



LSC TRANSPORTATION CONSULTANTS, INC.
2504 East Pikes Peak Avenue, Suite 304
Colorado Springs, CO 80909
(719) 633-2868
FAX (719) 633-5430
E-mail: lsc@lsctrans.com
Website: <http://www.lsctrans.com>

Monument Ridge East
Traffic Impact Study
EPC PCD File Nos. SP 241, P245, P246
(LSC #S234450)
August 7, 2024

Traffic Engineer's Statement

This traffic report and supporting information were prepared under my responsible charge and they comport with the standard of care. So far as is consistent with the standard of care, said report was prepared in general conformance with the criteria established by the County for traffic reports.



Developer's Statement

I, the Developer, have read and will comply with all commitments made on my behalf within this report.

Date

Monument Ridge East

Traffic Impact Study

Prepared for:
Monument Ridge East, LLC
5050 List Drive
Colorado Springs, CO 80919
<via email>

AUGUST 7, 2024

LSC Transportation Consultants, Inc.
Prepared by: Jeffrey C. Hodsdon, P.E.

LSC #S234450

PCD File No.: [P245](#)



CONTENTS

REPORT CONTENTS 1

LIST OF OTHER TRAFFIC REPORTS USED IN THE PREPARATION OF THIS REPORT 2

STUDY AREA 2

LAND USE AND ACCESS 2

 Proposed Land Uses 2

 Access and Circulation 3

SIGHT DISTANCE..... 3

 Entering Sight Distance 3

 Stopping Sight Distance Approaching an Intersection 4

ROAD AND TRAFFIC CONDITIONS AND MTCP CLASSIFICATION 4

 Existing Traffic Volumes 5

SHORT TERM (2024) BASELINE TRAFFIC VOLUMES 5

PEDESTRIAN AND BICYCLE FACILITIES 6

TRIP GENERATION 6

TRIP DISTRIBUTION AND ASSIGNMENT 7

 Trip Directional Distribution 7

 Site-Generated Traffic..... 7

 Short-Term (2024) Total Traffic Volumes 7

 2044 Background Traffic Volumes 7

 2044 Total Traffic Volumes 8

TRAFFIC SIGNAL WARRANT ANALYSIS 8

 2044 Background 8

 2044 Total 9

LEVEL OF SERVICE ANALYSIS 10

 I-25 Southbound Ramps/County Line Road..... 10

 Short Term 10

 Long Term 10

 I-25 Northbound Ramps/County Line Road 11

 Short Term 11

 Long Term 11

 County Line Road/Misty Acres Boulevard 11

 Short Term 11

Long Term	11
Misty Acres Boulevard/Plowman Drive	11
Misty Acres Boulevard/Nees Drive	11
Misty Acres Boulevard/Unbroken Drive	12
Misty Acres Boulevard/Monument Hill Road	12
Misty Acres Boulevard/Old Antlers Way	12
County Line Road/Doewood Drive	12
ROADWAY IMPROVEMENTS	12
Auxiliary Turn-Lane Thresholds and Design Parameters	12
Auxiliary Turn-Lane Needs Analysis	13
County Line Road/Misty Acres Boulevard	13
Misty Acres Boulevard/Unbroken Drive	14
Misty Acres Boulevard/Plowman Drive	14
Misty Acres Boulevard/Old Antlers Way/South Site Access.....	14
Monument Hill Road (Realigned)/Misty Acres Boulevard (New Proposed Intersection)	14
Monument Hill Road/Nees Drive.....	15
Monument Hill Road/Misty Acres Boulevard (South/Existing Intersection).....	15
Intersection Configuration and Traffic Control.....	15
County Line Road/Misty Acres Boulevard Proposed Intersection Location.....	15
County Line Road/Misty Acres Boulevard Alternate Intersection Location – Per CDOT Comments.....	17
Other Recommendations.....	17
ROADWAY CLASSIFICATIONS	18
COUNTY ROAD IMPROVEMENT FEE PROGRAM	18
Transportation Impact Fees.....	18
Reimbursable Improvements	19
CDOT ACCESS PERMITting.....	19
DEVIATIONS, DESIGN WAIVERS, AND LDC WAIVERS.....	19
Deviations to EPC ECM Criteria.....	19
CDOT Design Waivers	20
EPC Land Development Code (LDC) Waivers.....	20

POTENTIAL ESCROW FOR FUTURE INTERSECTION SIGNALIZATION..... 20
FINDINGS AND CONCLUSIONS..... 20
Enclosures: 21

Table 2

Figure 1 - Figure 13

Appendix Figure 1

Exhibits 1 - 3

Traffic Count Reports

Synchro LOS Reports

ECM Appendix B Percent Impact Calculations



LSC TRANSPORTATION CONSULTANTS, INC.
2504 E. Pikes Peak Ave., Suite 304
Colorado Springs, CO 80909
(719) 633-2868
FAX (719) 633-5430
E-mail: lsc@lsctrans.com
Website: <http://www.lsctrans.com>

August 7, 2024

Monument Ridge East, LLC
5050 List Drive
Colorado Springs, CO 80919
<via email>

RE: Monument Ridge East
El Paso County, CO
Traffic Impact Study
LSC #S234450
PCD File No.: [P245](#)

Dear Mr. Whitehead,

LSC Transportation Consultants, Inc. has prepared this Traffic Impact Study for the proposed Monument Ridge East residential development in El Paso County, Colorado. The site is located south of County Line Road and east of Monument Hill Road (Interstate 25 frontage road) Approximately 342 total dwelling units are planned for the site, including single-family and multi-family housing types.

This report has been prepared for submittal to El Paso County.

REPORT CONTENTS

The preparation of this report included the following:

- An inventory of existing roadway and traffic conditions on major thoroughfares adjacent to the site, including surface conditions, functional classification, widths, pavement markings, traffic-control signs, posted speed limits, intersection and access spacing, roadway and intersection alignments, roadway grades, and auxiliary turn lanes;
- Review of prior traffic reports and applicable data, estimates, and /or other report elements in the vicinity of the site;
- Analysis of intersection and stopping sight distance at the proposed site-access points;
- Weekday peak-hour turning-movement traffic counts at the following study-area intersections:
 - I-25 southbound ramps/County Line Road
 - I-25 northbound ramps/County Line Road
 - County Line Road/Monument Hill Road
 - Monument Hill Road/Misty Acres Boulevard (north)
 - Monument Hill Road/Misty Acres Boulevard (south)
 - Misty Acres Boulevard/Old Antlers Way

- Estimated average daily traffic (ADT) volumes adjacent to the proposed development on the following roadway segments: County Line Road, Monument Hill Road, Misty Acres Boulevard, and Old Antlers Way;
- Projections of 20-year background traffic volumes on the following roadways adjacent to the site: County Line Road, Monument Hill Road, Misty Acres Boulevard, Old Antlers Way;
- The proposed site land use and access plan;
- Estimates of average weekday and weekday peak-hour trip generation for the proposed development and the estimated directional distribution of site-generated vehicle trips on roadways and intersections adjacent to and in the vicinity of the site;
- Projected site-generated and resulting total peak-hour intersection traffic volumes at the following study-area intersections:
 - I-25 southbound ramps/County Line Road
 - I-25 northbound ramps/County Line Road
 - County Line Road/Monument Hill Road (future Misty Acres Boulevard)
 - Monument Hill Road/Misty Acres Boulevard (north)
 - Monument Hill Road/Misty Acres Boulevard (south)
 - Misty Acres Boulevard/Old Antlers Way
- Intersection level of service (LOS) analysis at the study-area intersections;
- Evaluation of short- and long-term projected intersection volumes to determine potential requirements for any auxiliary right-/left-turn lanes at the proposed site access points, based on the criteria in El Paso County's Engineering Criteria Manual (ECM). Also included are potential long-term lane requirements;
- Pedestrian facilities; and
- Findings and recommendations for submittal to El Paso County.

LIST OF OTHER TRAFFIC REPORTS USED IN THE PREPARATION OF THIS REPORT

The following traffic report was completed for this site within the past five years and has been used for reference and background information:

- Monument Ridge Development – by WSB, June 5, 2022 (PCD File No.: [ANX236](#))

STUDY AREA

Please refer to the attached study-area determination per Appendix B.

LAND USE AND ACCESS

Proposed Land Uses

Figure 1 shows the site location relative to the adjacent and nearby roadways. The proposed Monument Ridge East residential development site is located south of County Line Road and east of Monument Hill Road (Interstate 25 frontage road).

Approximately 342 total dwelling units are planned for the site, including 36 single-family lots on the east side of the planned extension of Misty Acres Boulevard and duplex, tri-plex, and four-plex dwelling units on the west side of the planned extension of Misty Acres Boulevard. Figure 2 shows the site plan.

Access and Circulation

Figure 2 also shows the proposed roadways, roadway realignments, and access points.

Figure 3 highlights the details of the proposed extension of Misty Acres Boulevard north to County Line Road, the realignment of the north portion of Monument Hill Road to the south to tie into the proposed extension of Misty Acres Boulevard, and the segments of existing roadway to be removed.

Access points are proposed at the following locations.

- Unbroken Drive – 395 feet south of the future County Line Road/Misty Acres Boulevard intersection (centerline spacing).
- Plowman Drive – 725 feet south of the future County Line Road/Misty Acres Boulevard intersection.
- Nees Drive – 280 feet west of the future Misty Acres Boulevard/Monument Hill Road intersection.
- New west leg at the existing Misty Acres Boulevard/Old Antlers Way T-intersection

SIGHT DISTANCE

Include sight distance exhibits for remaining intersections

Intersection sight distance at all proposed public road/site-access intersection locations on Misty Acres Boulevard and Monument Hill Road must meet intersection sight-distance requirements in *ECM* Table 2-21. Sight distance lines of sight for all public road intersections/access points will need to be kept clear of any sight-distance obstructions, including landscaping, signage, structures, fencing, parking areas, etc.

Only horizontal sight distance has been analyzed, as grading for the proposed roadways has not been completed. Thus, vertical sight distance cannot be measured yet and will need to be verified with the plan-and-profile drawings and construction drawings. Please refer to Exhibit 1 for more details.

Entering Sight Distance

With a proposed design speed of 40 mph (35-mph posted speed limit) on Misty Acres Boulevard, the sight distance to the south at the proposed Unbroken Drive site-access location would be 665 feet. This exceeds the required 445-foot requirement for entering sight distance per *ECM* Table 2-21. Sight distance looking to the north from Unbroken Drive would have a sight distance of 345 feet. Although the general *ECM* standard by classification for a 40-mph design speed is 445 feet, basically all approaching southbound vehicles on Misty Acres Boulevard would be

turning either left or right from County Line Road. Based on an approaching vehicle speed of about 25 mph, which is the estimated vehicle speed at the completion of a vehicle turn from County Line Road onto southbound Misty Acres Boulevard, the necessary/required (based on site-specific conditions) entering sight distance is 280 feet (also from Table 2-21, but for 25 mph). The plan-measured 345-foot distance would exceed this 280-foot distance.

Stopping Sight Distance Approaching an Intersection

The stopping sight distance to an access/intersection along Misty Acres Boulevard (to Unbroken Drive) from the north and south would meet the *ECM*-prescribed 305-foot stopping sight-distance requirement (grade adjustment may apply, depending on the roadway grades shown on the plan & profile drawings for Misty Acres Boulevard).

ROAD AND TRAFFIC CONDITIONS AND MTCP CLASSIFICATION

Figure 1 shows the roads adjacent to and in the vicinity of the site. Adjacent roads serving the site are identified below followed by a brief description of each:

Interstate Highway 25 (I-25) runs north-to-south throughout the entire state of Colorado and is classified as a four-lane F-W – Interstate System, Freeway. The nearest on/off ramps are located approximately 700 to 1,100 feet west of the site at mile marker 163. Adjacent to the site, the posted speed limit on I-25 is 75 miles per hour (mph). Auxiliary left-turn lanes exist on both the eastbound and westbound approaches at the I-25 on-ramps on County Line Road.

County Line Road is classified by El Paso County as a two-lane, Rural Minor Arterial and extends east and west from Interstate 25. The posted speed limit on County Line Road is generally 45 mph, but it decreases to 30 mph near the I-25 interchange between Beacon Lite Road and Doewood Drive. No auxiliary turn lanes currently exist at its intersection with Monument Hill Road.

Monument Hill Road (I-25 Frontage Road) is a two-lane paved Rural Major Collector that extends north from Woodmoor Drive to County Line Road. The posted speed limit on Monument Hill Road in the vicinity of the site is 45 mph. No auxiliary turn lanes currently exist at its intersection with County Line Road. The current alignment of the north portion of Monument Hill Road will be shifted to the south as part of this development (please refer to Figure 3).

Misty Acres Boulevard is a two-lane Major Collector that extends north from Monument Hill Road to about 800 feet north of Old Antlers Way. At this point, a temporary road extends west to Monument Hill Road. Misty Acres Boulevard is planned to be extended north to County Line Road and a new intersection would be created basically at the location of the existing Monument Hill Road/County Line Road intersection. The existing Misty Acres Boulevard is one through lane in each direction plus a raised center median. The proposed extension would be constructed as a two-lane, Urban Major Collector with a center left turn median (Non-Residential Collector cross section).

Existing Traffic Volumes

Vehicular turning-movement counts were conducted for the following dates and times at the following intersections, as shown in Figure 4. Raw count data is attached:

- I-25 southbound ramps/County Line Road
 - Thursday, January 18, 2024 from 6:30 – 8:30 a.m.
 - Wednesday, January 17, 2024 from 4:00 – 6:00 p.m.
- I-25 southbound ramps/County Line Road
 - Thursday, January 18, 2024 from 6:30 – 8:30 a.m.
 - Wednesday, January 17, 2024 from 4:00 – 6:00 p.m.
- County Line Road/Monument Hill Road
 - Wednesday, January 10, 2024 from 6:30 – 8:30 a.m.
 - Tuesday, January 9, 2024 from 4:00 – 6:00 p.m.
- Monument Hill Road/Misty Acres Boulevard (north)
 - Tuesday, December 12, 2023 from 6:30 – 8:30 a.m.
 - Tuesday, December 12, 2023 from 3:45 – 5:45 p.m.
- Monument Hill Road/Misty Acres Boulevard (south)
 - Wednesday, January 10, 2024 from 6:30 – 8:30 a.m.
 - Tuesday, January 9, 2024 from 4:00 – 6:00 p.m.
- County Line Road/Doewood Drive
 - Tuesday, June 18, 2024 from 6:30 – 8:30 a.m.
 - Tuesday, June 18, 2024 from 4:00 – 6:00 p.m.
- Misty Acres Boulevard/Old Antlers Way (from the WSB TIS report)
 - Wednesday, April 27, 2022 from 6:30 – 8:30 a.m.
 - Wednesday, April 27, 2022 from 4:00 – 6:00 p.m.

SHORT TERM (2024) BASELINE TRAFFIC VOLUMES

Unresolved: Counts are too old per B.3.1.A, please include updated values

Figure 5 shows the estimated short-term baseline volumes. These volumes account for projected shifts in **existing** traffic volumes following the extension of Misty Acres Boulevard to the north, realignment of Monument Hill Road, and associated closure of some segments of roadway (as depicted in Figure 3). The intent was to show shift/adjustment to existing and projected future background traffic volumes assuming the roadway changes.

Additional background traffic growth from currently-vacant parcels located southwest of I-25 and County Line Road has been estimated and included in the short and long-term background traffic volumes. The land uses assumed for the background traffic include 82,000 square feet of retail space, 12.5 acres of warehouse uses, and other area growth to the west -.

PEDESTRIAN AND BICYCLE FACILITIES

The proposed extension of Misty Acres through the site is proposed as an Urban Non-Residential Collector cross section. This standard cross section to be constructed will include sidewalks and paved outside shoulders, which will accommodate bicycles.

The existing west side of Misty Acres Boulevard on the south end near the high school is striped for an outside paved shoulder, but along most of the roadway, there is no shoulder striping. The roadway has sufficient width to accommodate bicycles. Monument Hill Road and County Line Road do not currently have paved outside shoulders.

TRIP GENERATION

Estimates of the vehicle trips projected to be generated by the proposed Monument Ridge East residential development have been made using the nationally published trip-generation rates from *Trip Generation, 11th Edition, 2021* by the Institute of Transportation Engineers (ITE). Corresponding trip-generation rates from the following ITE Land Use categories have been used to develop trip-generation estimates for the proposed 342 dwelling units:

- “210 – Single-Family (Detached) Housing”
- “215 – Single-Family (Attached) Housing”
- “220 – Multi-Family Housing (Low-Rise)”

Table 1 below presents a summary of the estimated site trip generation. A detailed trip-generation estimate for the site, including ITE rates land uses, is presented Table 2 (attached). The proposed preliminary site plan is attached for reference.

The site plan land uses are projected to generate about 2,580 total vehicle trips on the average weekday during a 24-hour period, with approximately half entering and half exiting the site. During the morning peak hour, approximately 52 entering vehicles and 123 exiting vehicles are estimated to be generated. Approximately 124 entering and 88 exiting vehicles are estimated to be generated by the site during the afternoon peak hour.

Table 1: Summary of Estimated Site Vehicle-Trip Generation

Analysis Period	Trips Generated		
	Entering	Exiting	Total
Morning Peak Hour (vehicles/hour)	52	123	175
Afternoon Peak Hour (vehicles/hour)	124	88	212
Daily/24-hour (vehicles/day)	1,290	1,290	2,580

TRIP DISTRIBUTION AND ASSIGNMENT

Trip Directional Distribution

The directional-distribution estimate of site-generated vehicle trips to the study-area roads and intersections is a necessary component in determining the site's traffic impacts. Figure 6 shows the percentages of the site-generated vehicle trips projected to be oriented to and from the site's major approaches. Estimates have been based on the following factors: LCS's previous traffic impact studies in the vicinity, the proposed new land uses, the area roadway system serving the site, and the site's geographic location relative to the overall greater El Paso County/Colorado Springs area and the Denver metro area. Figure 6 shows the estimated distribution splits.

Site-Generated Traffic

Site-generated volumes have been calculated by applying the directional-distribution percentages estimated by LSC (from Figure 6) to the trip-generation estimates (from Table 1). Figure 7 shows the projected site-generated traffic volumes for the weekday morning and afternoon peak hours.

Short-Term (2024) Total Traffic Volumes

Figure 8 shows the projected short-term total traffic, which is the sum of the short-term baseline (adjusted existing) traffic volumes (from Figure 5) and site-generated traffic volumes (from Figure 7). Laneage and traffic control at the study-area intersections are shown in Figure 8.

Note: as indicated in the "Short-Term Baseline Traffic Volumes" section and as shown in Figure 5, short-term baseline traffic volumes assume that existing traffic patterns would change following the realignment of Monument Hill Boulevard and extension of Misty Acres Boulevard (as depicted in Figure 3).

Please include a statement to verify that development west of I-25 was added to the short term traffic

2044 Background Traffic Volumes

Figure 9 shows estimated long-term background volumes. Projected 20-year background traffic volumes do **not** include projected traffic to be generated by the proposed site. Long-term background traffic volumes are estimates by LSC, which generally assume a two-percent annual growth rate on County Line Road. However, some additional specific growth was added for parcels southwest of Interstate 25 and County Line Road. With site-generated traffic, the total growth rate is about 3.3 percent west of Misty Acres Boulevard and about 2.3 percent east of Misty Acres Boulevard (growth over the short-term baseline/adjusted existing volume).

Additionally, long-term background traffic volumes assume that existing traffic patterns would change following the realignment of Monument Hill Boulevard and extension of Misty Acres Boulevard.

Please give your basis for this 2 percent growth rate

2044 Total Traffic Volumes

Figure 10 shows the sum of 2044 background traffic volumes (from Figure 9) plus site-generated traffic volumes (from Figure 7).

TRAFFIC SIGNAL WARRANT ANALYSIS

The intersection of County Line Road/Misty Acres Boulevard (future alignment) has been analyzed to evaluate the potential for meeting a warrant(s) for a traffic-control signal in the future. The combination of major-street approach volumes (includes the sum of eastbound and westbound approach volumes) and minor street left-turn volumes (greater of the northbound or southbound approach volume each hour) were analyzed to determine if the combination would exceed the threshold criteria for Four-Hour Vehicular-Volume Traffic-Signal Warrants and applicable other warrants in the 2009 Manual on Uniform Traffic Control Devices (MUTCD).

Four separate one-hour periods within the following morning and late-afternoon/periods have been analyzed:

- 6:30 a.m. – 7:30 a.m.
- 7:30 a.m. -- 8:30 a.m.
- 4:00 p.m. – 5:00 p.m.
- 5:00 p.m. - 6:30 p.m.

Note: For the signal-warrant evaluation, only left-turning-movement volumes have been included in the side-street volumes, as there is a separate northbound-right-turn lane.

2044 Background

Results from the four-hour traffic-signal warrant analysis for the 2044 Background scenario are shown in the Warrant 2, Four-Hour Vehicular-Volume (*MUTCD* Figure 4C-1) signal-warrant chart in Exhibit 2. Two major-/minor-street-volume data points exceeded the minimum threshold curve for an intersection with one lane for the major-street approaches and one lane for the minor-street approach (higher-volume minor street). As a result, the Four-Hour Vehicular-Volume Traffic-Signal Warrant threshold at the intersection of County Line Road/Misty Acres Boulevard (future alignment) is **not** projected to be exceeded, based on the 2044 Background scenario.

Major- and minor-street volumes shown in Exhibit 2 are summarized in Table 3 below.

Table 3: Major/Minor Volumes for 4-Hour Signal Warrants (2044 Background Only)

Start	End	Major Street Volume	Minor Street Volume	4-Hour Warrant Met?
6:30	7:30	1002	126	Yes
7:30	8:30	938	143	Yes
4:00	5:00	838	78	No
5:00	6:00	891	76	No
# of hours meeting respective warrant thresholds/hours required to satisfy the warrant (warrant satisfied?)				2/4 (No)

2044 Total

Results from the four-hour traffic-signal warrant analysis for the 2044 Total scenario are shown in the Warrant 2, Four-Hour Vehicular-Volume (*MUTCD* Figure 4C-1) signal-warrant chart in Exhibit 3. Four major-/minor-street-volume data points exceeded the minimum threshold curve for an intersection with one lane for the major-street approaches and one lane for the minor-street approach (higher-volume minor street). As a result, the Four-Hour Vehicular-Volume Traffic-Signal Warrant threshold at the intersection of County Line Road/Misty Acres Boulevard (future alignment) is projected to be exceeded, based on the 2044 Total scenario.

Major- and minor-street volumes shown in Exhibit 3 are summarized in Table 4 below.

Table 4: Major/Minor Volumes for 4-Hour Signal Warrants (2044 Background + Site)

Start	End	Major Street Volume	Minor Street Volume	4-Hour Warrant Met?
6:30	7:30	1043	213	Yes
7:30	8:30	953	230	Yes
4:00	5:00	901	156	Yes
5:00	6:00	994	140	Yes
# of hours meeting respective warrant thresholds/hours required to satisfy the warrant (warrant satisfied?)				4/4 (Yes)

LEVEL OF SERVICE ANALYSIS

Level of service (LOS) is a quantitative measure of the level of congestion or delay at an intersection and is indicated on a scale from “A” to “F.” LOS A is indicative of little congestion or delay. LOS F indicates a high level of congestion or delay. Table 5 shows the level of service delay ranges for signalized and unsignalized intersections.

Table 5: Intersection Levels of Service Delay Ranges

Level of Service	Signalized Intersections	Unsignalized Intersections
	Average Control Delay (seconds per vehicle)	Average Control Delay (seconds per vehicle) ¹
A	10.0 sec or less	10.0 sec or less
B	10.1-20.0 sec	10.1-15.0 sec
C	20.1-35.0 sec	15.1-25.0 sec
D	35.1-55.0 sec	25.1-35.0 sec
E	55.1-80.0 sec	35.1-50.0 sec
F	80.1 sec or more	50.1 sec or more

¹ For unsignalized intersections, if V/C ratio is greater than 1.0 the level of service is LOS F, regardless of the projected average control delay per vehicle.

Detailed Synchro reports are attached. A summary of LOS during the weekday morning and evening peak hours for the study-area intersections is shown in the following figures:

- Figure 4: 2024 Existing Traffic, Lane Geometry, Traffic Control, and LOS
- Figure 5: Short-Term Baseline Traffic, Lane Geometry, Traffic Control, and LOS
- Figure 8: Short-Term Total Traffic, Lane Geometry, Traffic Control, and LOS
- Figure 9: 2044 Background Traffic, Lane Geometry, Traffic Control, and LOS
- Figure 10: 2044 Background + Site Traffic, Lane Geometry, Traffic Control, and LOS

I-25 Southbound Ramps/County Line Road

Short Term

All individual turning movements and approaches are projected to operate at LOS D or better during the short term, with or without the addition of site-generated traffic.

Long Term

The single-lane southbound approach is projected to operate at LOS F during the 2044 PM peak hour with the addition of site-generated traffic. This single-lane approach is projected to have a volume-to-capacity (v/c) ratio of 0.933 during the PM peak hour with the addition of site-

generated traffic. All other individual turning movements and approaches are projected to operate at LOS D or better during all long-term scenarios.

I-25 Northbound Ramps/County Line Road

Short Term

All individual turning movements and approaches are projected to operate at LOS D or better through the short term, with or without the addition of site-generated traffic.

Long Term

The single-lane northbound approach is projected to operate at LOS F during the 2044 PM peak hour with the addition of site-generated traffic. This single-lane approach is projected to have a volume-to-capacity (v/c) ratio of 0.933 during the PM peak hour with the addition of site-generated traffic. All other individual turning movements and approaches are projected to operate at LOS D or better during all long-term scenarios.

County Line Road/Misty Acres Boulevard

Short Term

All individual turning movements and approaches are projected to operate at LOS D or better based on the short-term total traffic volumes.

Long Term

The northbound-left turning movement would operate at LOS F during the **long-term** morning peak hour if the intersection were to remain two-way, stop-sign controlled. This intersection will likely need to be signalized in the future based on the **long-term analysis**. Signalizing this intersection would result in all individual turning movements operating at LOS C or better during the long-term scenarios.

Misty Acres Boulevard/Plowman Drive

All individual turning movements and approaches are projected to operate at LOS B or better through the long term with the addition of site-generated traffic.

Misty Acres Boulevard/Nees Drive

All individual turning movements and approaches are projected to operate at LOS A through the long term with the addition of site-generated traffic.

Misty Acres Boulevard/Unbroken Drive

All individual turning movements and approaches are projected to operate at LOS B or better through the long term with the addition of site-generated traffic.

Misty Acres Boulevard/Monument Hill Road

LSC has accounted for changes to existing traffic patterns that would likely change following the realignment of Monument Hill Boulevard and extension of Misty Acres Boulevard. All individual turning movements and approaches are projected to operate at LOS B or better through the long term.

Misty Acres Boulevard/Old Antlers Way

All individual turning movements and approaches are projected to operate at LOS B or better through the long term, with or without the addition of site-generated traffic.

County Line Road/Doewood Drive

All individual turning movements and approaches are projected to operate at LOS C or better through the long term.

ROADWAY IMPROVEMENTS

Auxiliary Turn-Lane Thresholds and Design Parameters

Section 2.3.7.D of the *ECM* lists ingress/egress volume thresholds in which exclusive right- or left-turn lanes would be required, by classification. Prescribed auxiliary turn lanes would be required to meet design criteria outlined in Section 2.3.7.E of the *ECM*.

At the intersection of Misty Acres Boulevard/County Line Road, the **Colorado State Highway Access Code** criteria (Section 4.8) would apply.

Based on the classification, the **design speed** of Misty Acres Boulevard is 40 mph. LSC has based recommendations on an anticipated future **posted speed** of 40 mph on County Line Road generally between Doewood and the I-25 Interchange (i.e., through the Misty Acres Boulevard intersection). The existing posted speed is 30 mph, through County Line/Monument Hill Road, and 45 mph to the east. Given the proposed addition of turn lanes at the new Misty Acres/County Line intersection, we assumed an increase to 40 mph, but due to other site-specific conditions, such as grades, and the intersection spacing constraints, it is reasonable to assume an increase to 40 mph posted/45mph design speed through the Misty Acres/County Line intersection rather than an increase to 45 mph/50 design (which is the condition east of this location).

The design speed at the Monument Hill Road study-area intersections are noted for each one below.

Auxiliary Turn-Lane Needs Analysis

Please refer to Figure 11 and Figure 12 for preliminary recommendations for auxiliary turn lanes at the study-area intersections.

County Line Road/Misty Acres Boulevard

The following auxiliary turn lanes would be required at the future County Line Road/Misty Acres Boulevard intersection. The turn lanes on County Line Road are based on County Line Road grades of between 5-7 percent. Per *ECM* Table 2-5, a deceleration-lane grade-adjustment factor of 0.80 is applied on upgrades of 5-7 percent, while a factor of 1.35 is applied to the required turn-lane length on downgrades of 5-7 percent. Please refer to the site plan, which depicts the following laneage at this intersection. LSC provided the laneage recommendations for inclusion on the site plan.

- Northbound Right Turn Deceleration Lane
 - 175 feet of full-width lane (including storage) + 80-foot bay taper = 255 feet total
- Westbound-Left Turn Deceleration Lane
 - 176 feet of full-width lane + 50 feet of storage + 162-foot taper = 388 feet total
- Eastbound-Right-Turn Deceleration Lane
 - 140 feet of full-width lane + 75-foot taper = 215 feet total
 - Will require a design waiver from CDOT, as based on SHAC criteria, a 356-foot lane plus 144-foot taper is prescribed for a total of 500 feet. This waiver would be requested due to the challenging topography to the west of the intersection. The plans show a larger corner radius on the southwest corner as mitigation for the shorter lane which would allow for right turns at a higher speed, thus reducing the speed differential between eastbound through traffic and right-turning traffic.

Regarding the *ECM* threshold for a northbound left turn lane, the laneage plan shows a separate northbound right-turn lane and the No. 1 northbound (TH/LT) lane will be a “defacto left” with a very low straight through volume. The CDOT Access Code provision allowing a left-turn lane to be dropped when opposing through traffic is low would apply.

An eastbound-left-turn deceleration lane would not be required based on projected volumes and the threshold requirement for a turn lane. However, in the site plan, LSC recommends a short eastbound-left-turn bay for vehicle storage. The space will be striped this lane between the eastbound and westbound through lanes on the west leg of this intersection.

- Eastbound-left-Turn-Storage-Bay
 - 75 feet of full-width lane for vehicle storage + 120-foot taper = 195 feet total
 - Not required based on projected volumes but recommended by LSC

Please include the section of the Access Code here; Could the right turn lane include the through volume instead?

Unresolved: Please add a bullet point for explanation of why the turn lane is being recommended

Misty Acres Boulevard/Unbroken Drive

Based on projected total volumes, auxiliary turn lanes would **not** be required on any approach at the intersection of Monument Hill Road/Unbroken Drive.

Although the projected left-turn volume does not exceed the *ECM* threshold requiring a northbound-left-turn lane on Misty Acres Boulevard, the proposed major collector cross section of Misty Acres Boulevard includes a striped median for left-turning movements at intersections/access points.

Update to Maga Drive per Prelim plan drawings throughout the document

Misty Acres Boulevard/Plowman Drive

Based on projected total volumes, auxiliary turn lanes would **not** be **required** on any approach at the intersection of Misty Acres Boulevard/Plowman Drive.

Although the projected left-turn volume does not exceed the *ECM* threshold requiring a northbound-left-turn lane on Misty Acres Boulevard, the proposed major collector cross section of Misty Acres Boulevard includes a striped median for left-turning movements at intersections/access points.

Misty Acres Boulevard/Old Antlers Way/South Site Access

Based on projected total volumes, auxiliary turn lanes would **not** be required on any approach at the intersection of Misty Acres Boulevard/Old Antlers Way.

Unresolved: Please include discussion of southbound here as well

Although the projected left-turn volume does not exceed the *ECM* threshold requiring a northbound-left-turn lane on Misty Acres Boulevard, the proposed major collector cross section of Misty Acres Boulevard includes a striped median for left-turning movements at intersections/access points.

Monument Hill Road (Realigned)/Misty Acres Boulevard (New Proposed Intersection)

A 315-foot southbound-right-turn lane would be required on Misty Acres Boulevard approaching Monument Hill Road. This 315-foot turn lane would consist of 155 feet of deceleration length plus a 160-foot taper. Based on projected total volumes, other auxiliary turn lanes would **not** be required at the intersection of Misty Acres Boulevard/Monument Hill Road. The width that would otherwise be six-foot paved shoulder in the southbound direction (as part of the overall Misty Acres Boulevard cross section) could be utilized as part of the 12-foot right-turn lane width.

Although the projected left-turn volume does not exceed the *ECM* threshold requiring a northbound-left-turn lane on Misty Acres Boulevard, the proposed major collector cross section of Misty Acres Boulevard includes a striped median for left-turning movements at intersections/access points.

David Whitehead
Monument Ridge East

Unresolved: Address impacts to:
Monument Hill Rd / Deer Creek
Monument Hill Rd / Woodmoor Drive
Woodmoor Dr / Hwy 105
(or how project impacts (~600 trips?) are insignificant at these locations)

Page 15

August 7, 2024

Traffic Impact Study, Roundabout Report

Regarding the *ECM* threshold for an eastbound left-turn lane, the laneage plan shows a shared approach lane. Given the low straight through and right-turn volumes, the CDOT Access Code provision allowing a left-turn lane to be dropped when opposing through traffic is low, would apply.

Please include the section of the Access Code here

Monument Hill Road/Nees Drive

Based on projected total volumes, auxiliary turn lanes would **not** be required on any approach at the intersection of Monument Hill Road/Nees Drive. Based on the recommended classification of this new segment/new north terminus of Monument Hill Road (Urban Local), the design speed will be 25 mph.

Monument Hill Road/Misty Acres Boulevard (South/Existing Intersection)

No modifications would be required by the applicant at the intersection of Monument Hill Road/Misty Acres Boulevard despite additional site-generated traffic from this development.

Intersection Configuration and Traffic Control

County Line Road/Misty Acres Boulevard Proposed Intersection Location

All proposed site-access points would be two-way, stop-sign-controlled intersections.

Regarding the intersection of County Line Road and Misty Acres Boulevard, the project team has determined that a roundabout option for traffic control would not be feasible. The following are a list of pros and cons comparing a modern roundabout intersection to a conventional intersection with two-way, stop-sign control and the potential for future signalization once MUTCD warrant(s) are met.

Roundabout Intersection

Cons:

- Grades would not meet the established guidelines for grades. The following is criteria from the *Wisconsin DOT Roundabout Design Manual* (used by El Paso County, Colorado):
 - Entry grade profiles (approximately 2 car lengths from the ICD) are not to exceed 4%, with 2% being the typical maximum.
 - Roundabouts typically should be constructed on relatively flat or rolling terrain with an approach grade that is typically less than 3%, but not greater than 5%. Grades approaching 4% and steeper terrain may require greater transitions to provide an appropriate grade through the intersection. The profile grades along the central island should generally not exceed 4%, (typically 3% or less).

- A roundabout centered on the existing County Line Road would force realignment of the existing north leg [at the current County Line Road/Monument Hill Road intersection] into conservation easement on the north side of County Line Road, which is prohibited.
- If a roundabout circle were shifted south to avoid the conservation easement, then the grading for the roundabout footprint would encroach into the wetlands located southeast of the intersection, which would also not be feasible.
- Projected volumes are higher on County Line Road than Misty Acres approach. Balanced volumes are ideal for roundabouts.

Pros:

- Generally, roundabouts are self-regulating and offer safety advantages over conventional intersections.
- The LOS would potentially be better than the conventional intersection for the northbound approach before a signal warrant is met, and potentially after signalization as well.

Conventional Intersection

Pros:

- The intersection would be similar to the existing intersection, will little modification needed on the north leg.
- A signal would not likely need to be installed in the short term – could remain TWSC.
- The LOS is shown to be D or better, based on the short-term scenario.
- There are likely more precedent cases for signal installation at intersections with grades over 4 percent than with roundabout grades over 4 percent.

Cons:

- Installation of a signal at an intersection with approach grades over 4 percent is not ideal, and would require a deviation (county intersection maximum intersection grade is 4 percent)
- Generally, El Paso County staff has indicated that an intersection cannot be signalized until warrants are met. The LOS would potentially be worse with the conventional intersection for the northbound approach before a signal warrant is met. The short term shows LOS D for the northbound approach.
- The conventional intersection would require auxiliary turn lanes on the intersection legs as shown on Figure 11,

The intersection of Misty Acres Boulevard/County Line Road will likely need to be signalized in the future. Based on projected volumes the volumes for the AM and PM peak hours would meet the Warrant No. 2 (Four-Hour Volume) threshold. The volume threshold would need to be met for two other hours of the day, such as the afternoon “school” peak hour and two hours during the late afternoon/evening peak hour.

Please indicate whether
crash warrants would be met

County Line Road/Misty Acres Boulevard **Alternate** Intersection Location – Per CDOT Comments

The CDOT comments and follow-up meeting identified the need to consider shifting the intersection of Misty Acres Boulevard about 575 feet to the east and the Misty Acres Boulevard shown on the Preliminary Plan would be modified to an alignment more to the east to connect to this alternate intersection location. Lastly this alternate intersection would be constructed as a modern roundabout. Please refer to **Deviation No. 3** included with this submittal, which describes this alternative, includes the reasons this alternative is not viable - as summarized below, request for deviations to intersection spacing and intersection grade *ECM* criteria to allow the proposed intersection location as presented in this TIS report.

- The floodplain would present significant issues to this alignment.
- An alignment of Misty Acres more to the east to connect to this alternate intersection would be significantly closer to the existing homes west of Doewood. This alignment would have significant negative implications to the Preliminary Plan.
- A roundabout intersection would not likely fit without encroaching in the conservation easement and/or the Woodmoor Water & Sanitation property.
- The alternate alignment would need to have sharper reverse curves in order to connect to the alternate intersection location.
- The Doewood Drive/County Line Road intersection would likely need to be closed as this intersection would be only 250 feet from this alternate intersection location. The Doewood connection to County Line Road would need to be rerouted through an east-west connection to Misty Acres Boulevard.
- The Misty Acres/County Line intersection, as proposed, would meet the minimum CDOT 550-foot distance from end of the radius at the I-25 off-ramp intersection.

Other Recommendations

LSC recommends MUTCD horizontal curve warning signage be installed on Monument Hill Road for traffic on the northbound approach to the proposed curve to the east adjacent to the site. The specific signs and sign placement can be included for review as part of the construction plans.

please show
location on a plan

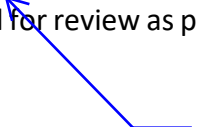

ROADWAY CLASSIFICATIONS

Based on the projected 2044 traffic volumes, roadway continuity, length, the *MTCP*, and other factors, LSC recommends roadway classifications for the study-area roadways. These are presented in Table 6 below and are shown on a roadway map in Figure 13.

Table 6: Roadway Classifications

Roadway	Direction from Intersecting Road	Intersecting Road	Projected ADT	Recommended Classification
County Line Rd	West	Misty Acres Blvd	10,972	Rural Minor Arterial (but under CDOT Access Control)
County Line Rd	East	Misty Acres Blvd	8,378	Rural Minor Arterial
Misty Acres Blvd	South	County Line Rd	4,000	Major Collector (Urban Non-Residential Collector)
Misty Acres Blvd	South	Old Antlers Way*	4,000	Major Collector (Hybrid Cross Section)
Plowman Drive	East	Misty Acres Blvd	298	Urban Local
Plowman Drive	West	Misty Acres Blvd	510	Urban Local (Private Street)
Monument Hill Rd	East (for 1,000 feet)	Misty Acres Blvd	119	Rural Major Collector**
Monument Hill Rd	South	725 feet west of Nees Drive	119	Rural Major Collector
Nees Drive	South	Monument Hill Rd	404	Urban Local (Private Street)
Old Antlers Way	West	Misty Acres Blvd	947	Urban Local (Private Street)

*More precisely, south of the south site boundary on the east side of Misty Acres, which is 175 feet north of Old Antlers Way
 ** PLEASE REFER TO THE DEVAITON REQUEST FOR PROPOSED MODIFIED DESIGN ELEMENTS OF THIS PARTICULAR SEGMENT OF ROADWAY.

COUNTY ROAD IMPROVEMENT FEE PROGRAM

Transportation Impact Fees

Per *ECM* Appendix B:

State what the current applicable Transportation Impact Fees are and what option the developer will be selecting for payment.

The applicant will be required to participate in this program.

The applicant will notify staff of the selected PID option prior to scheduling for public hearing this TIS will be updated accordingly once the option is confirmed.

Reimbursable Improvements

The following roadway improvement projects have been identified as being needed by the year 2045 per Figure 27 and Table 6 of El Paso County's 2024 *MTCP*:

- Project 495 – County Line Road

CDOT ACCESS PERMITTING

Prior access permits for County Line Road/Monument Hill Road are under Colorado State Highway Access Permit numbers 204054 and 204055. Newer permits may have been issued.

The previous access permits identified a requirement to construct a westbound-left-turn deceleration lane on County Line Road. This would also include widening for redirect tapers just west of the intersection that would tie into the recent road widening associated with the interchange improvements.

The previous permit terms and conditions identified that, "an eastbound right turn deceleration lane is required however, due to topography, the Permittee may elect to submit a design waiver." This design waiver would likely accompany the submittal of a new access permit application. CDOT will require a new access permit for the intersection of County Line Road/Misty Acres Boulevard. The permit application will likely be accompanied by the design waiver request. The final permit, once issued, will identify the resolution of the above design waivers and will identify the requirements of this development at this intersection. CDOT will not require an access permit for the current intersection adjacent to the site on Monument Hill Road, as jurisdictional control of Monument Hill Road has been transferred to El Paso County.

DEVIATIONS, DESIGN WAIVERS, AND LDC WAIVERS

Deviations to EPC ECM Criteria

- **Deviation No. 1: Major Collector Intersection Spacing along Misty Acres Boulevard:** A deviation has been prepared for the proposed location of the intersection of Misty Acres Boulevard/Unbroken Drive, which would result in intersection spacing less than 660' along an Urban Non-Residential Collector (from an arterial roadway – County Line Road).
- **Deviation No. 2: North End of Monument Hill Road - Rural Major Collector Standards:** A new east-to-west segment of Monument Hill Road is proposed to connect with Misty Acres Boulevard. South of the point of curvature on this segment, Monument Hill Road would be classified as a Rural Major Collector. However, this proposed 787-foot east-to-west segment would contain design elements typically found on Urban Residential Collector and Urban Local roadways.

- Deviation No. 3: County Line Road Intersection Spacing and Intersection:
 - Intersection Spacing – The proposed intersection of Misty Acres Boulevard/County Line Road would not meet Minor Arterial intersection spacing
 - **Grades** – The approach grades on County Line Road approaching the proposed Misty Acres Boulevard intersection would exceed *ECM* criteria. Although this is an existing condition, a deviation is be required.

CDOT Design Waivers

- Right Turn Deceleration Lane Length (CDOT Design Waiver – to be submitted as part of the access permit process)

EPC Land Development Code (LDC) Waivers

- Local (Private) Streets shown on the site plan areas west of Misty Acres Boulevard connecting to Access points C, A, B and the Misty Acres/Old Antlers Way intersection would likely need waivers to the LDC to allow for private streets.

POTENTIAL ESCROW FOR FUTURE INTERSECTION SIGNALIZATION

- Following the realignment of Monument Hill Road, County Line Road/Misty Acres Boulevard has the potential to warrant signalization in the future. El Paso County may require a fair-share escrow amount toward this future traffic signal, unless this intersection is determined to be an “eligible” intersection under the El Paso County Roadway Impact Fee program.

FINDINGS AND CONCLUSIONS

- The site is projected to generate about 3,580 new driveway vehicle-trips on the average weekday.
- During the weekday morning peak hour of adjacent street traffic, 52 vehicles would enter the site while 123 vehicles would exit.
- During the weekday afternoon peak hour of adjacent street traffic, 124 vehicles would enter the site while 88 vehicles would exit.
- Please refer to the “Level of Service” section above for detailed LOS results and discussion regarding all study-area intersections.
- Please refer to the “Auxiliary Turn-Lane Analysis” section for evaluation of turn-lane needs at the study-area intersections. Triggers/timing of these improvements at individual access points will depend on timing of individual parcel developments and will be based on the *ECM* turning-volume thresholds for right- and left-turn lanes. Turn lanes at Misty Acres/County Line Road will likely be needed with the extension of Misty Acres Boulevard.

- The timing of future signalization of Misty Acres Boulevard/County Line Road will be when warrants are met AND CDOT/El Paso County decide to signalize the intersection.
- A list of deviations submitted with this application is included above.

* * * * *

Please contact me if you have any questions regarding this report.

Respectfully Submitted,

LSC TRANSPORTATION CONSULTANTS, INC.

By: Jeffrey C. Hodsdon, P.E.
Principal

JCH/JAB:jas

Enclosures: Table 2
Figure 1 - Figure 13
Appendix Figure 1
Exhibits 1 - 3
Traffic Count Reports
Synchro LOS Reports
ECM Appendix B Percent Impact Calculations

Table 2



Table 2: Detailed Trip Generation Estimate

ITE		Value	Units ¹	Trip Generation Rates ²				Total Driveway Trips Generated					
Code	Description			Average Weekday	A.M.		P.M.		Average Weekday	A.M.		P.M.	
				In	Out	In	Out		In	Out	In	Out	
210	Single-Family (Detached) Housing	37	DU	9.15	0.17	0.49	0.58	0.34	338	7	19	22	13
215	Single-Family (Attached) Housing	261	DU	7.47	0.16	0.35	0.34	0.25	1950	41	91	88	67
220	Multi-Family Housing (Low-Rise)	44	DU	6.63	0.09	0.29	0.31	0.18	292	4	13	14	8
	Total	342	DU					Total	2580	52	123	124	88

¹ DU = dwelling units

² Source: *Trip Generation, 11th Edition (2021)* by the Institute of Transportation Engineers (ITE)

Updated: 07/01/2024

Figure 1-13





Figure 1

Vicinity

Monument Ridge East (LSC# S234450)





Approximate Scale
1" = 500'

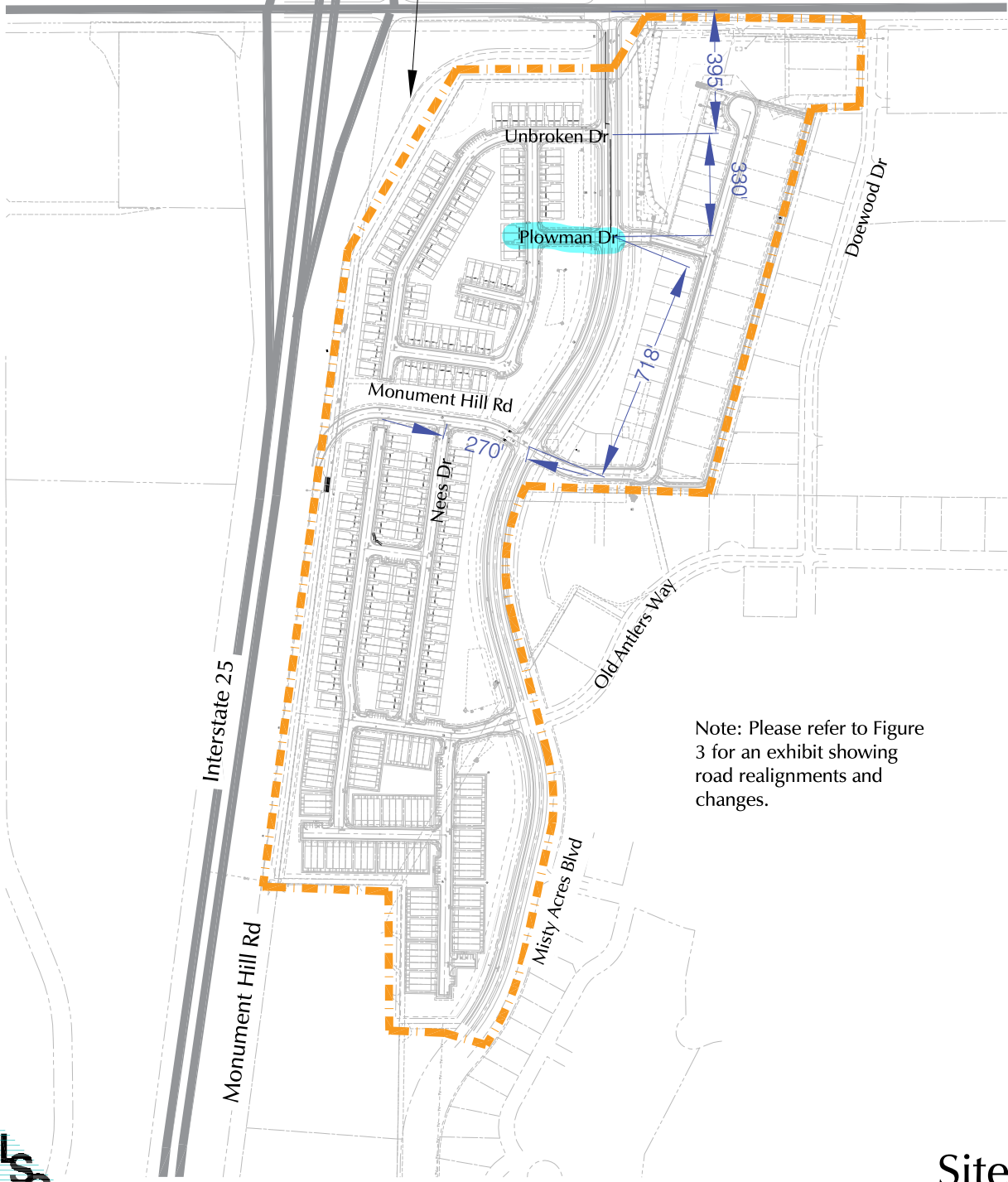
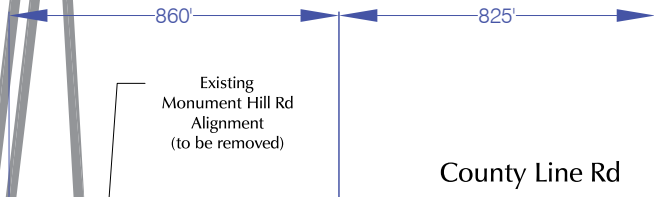

Note: Please refer to Figure 3 for an exhibit showing road realignments and changes.



Figure 2
Site Plan

Monument Ridge East (LSC# S234450)



Approximate Scale
1" = 500'

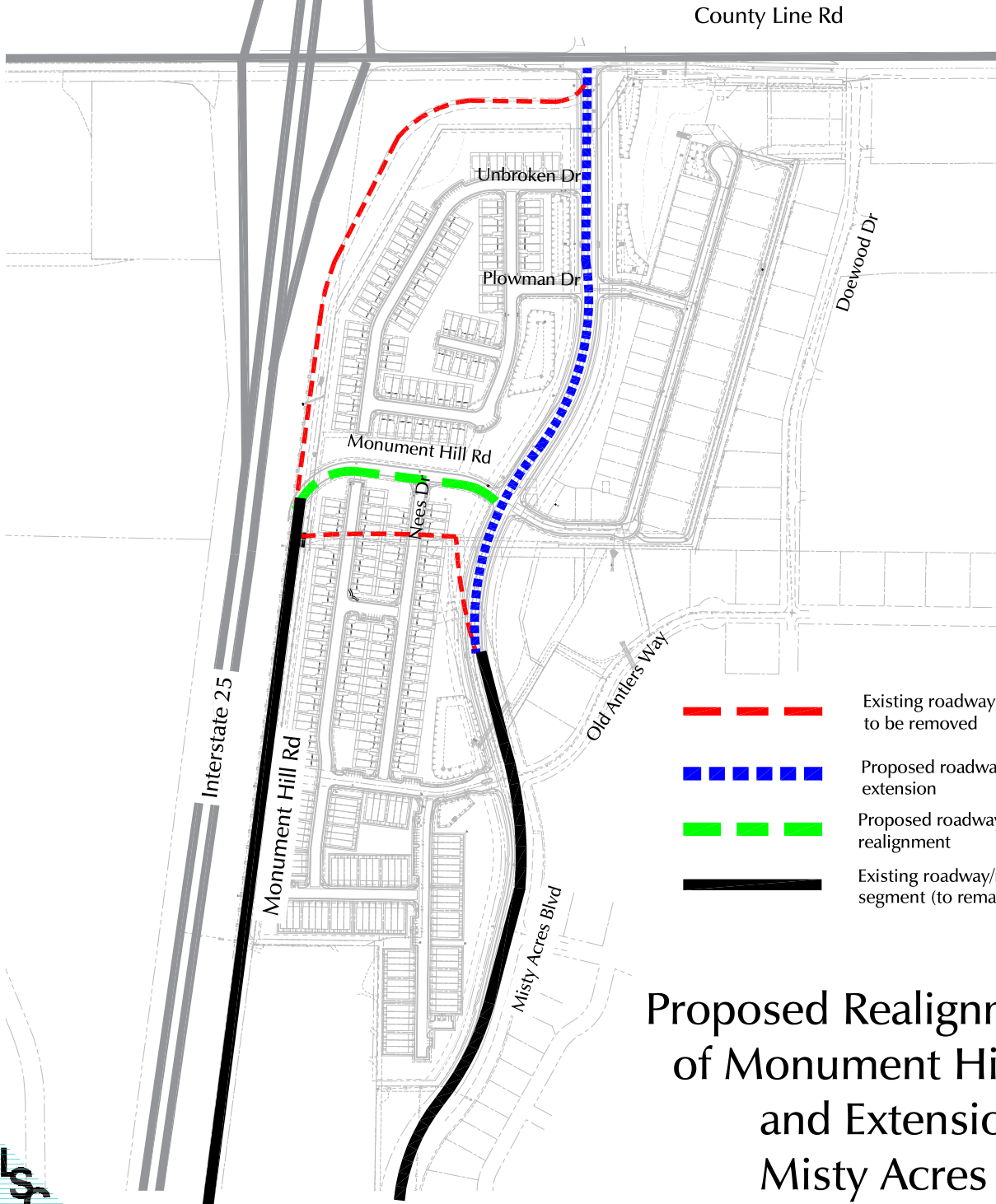
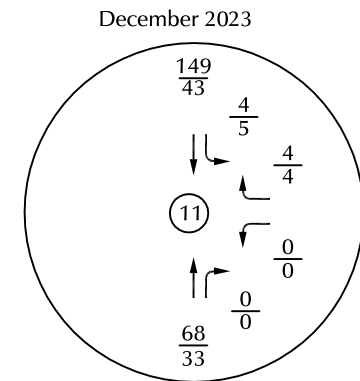
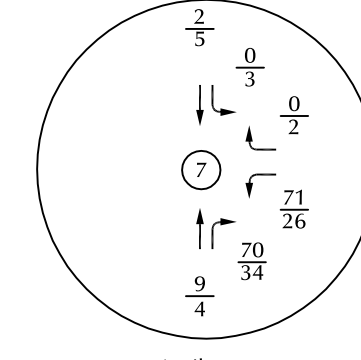
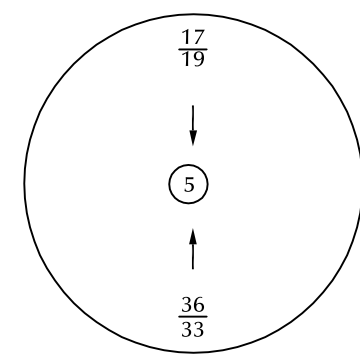
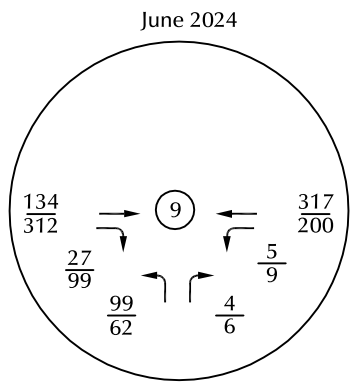
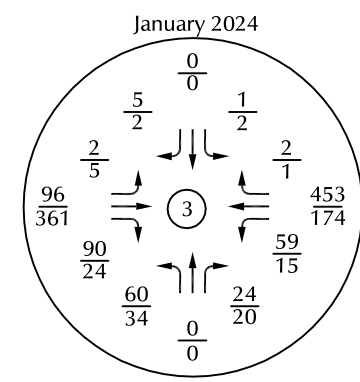
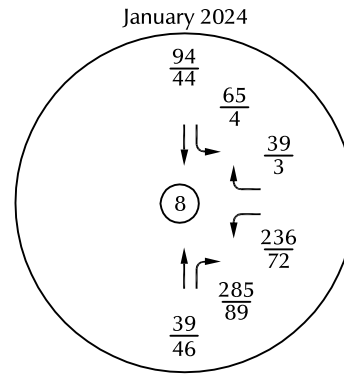
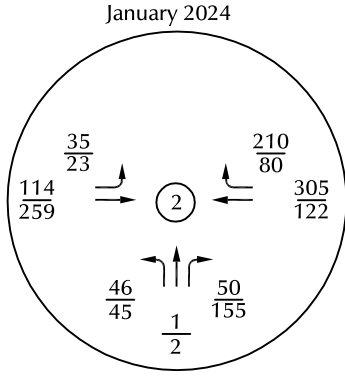
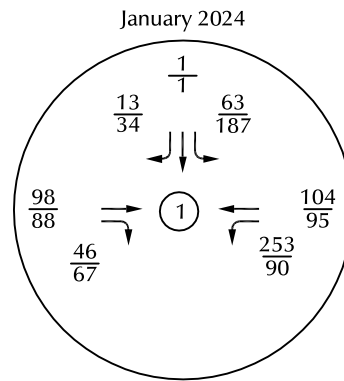

Figure 3

Proposed Realignment of Monument Hill Rd and Extension of Misty Acres Blvd

Monument Ridge East (LSC# S234450)



Approximate Scale
Scale: 1" = 3,000'

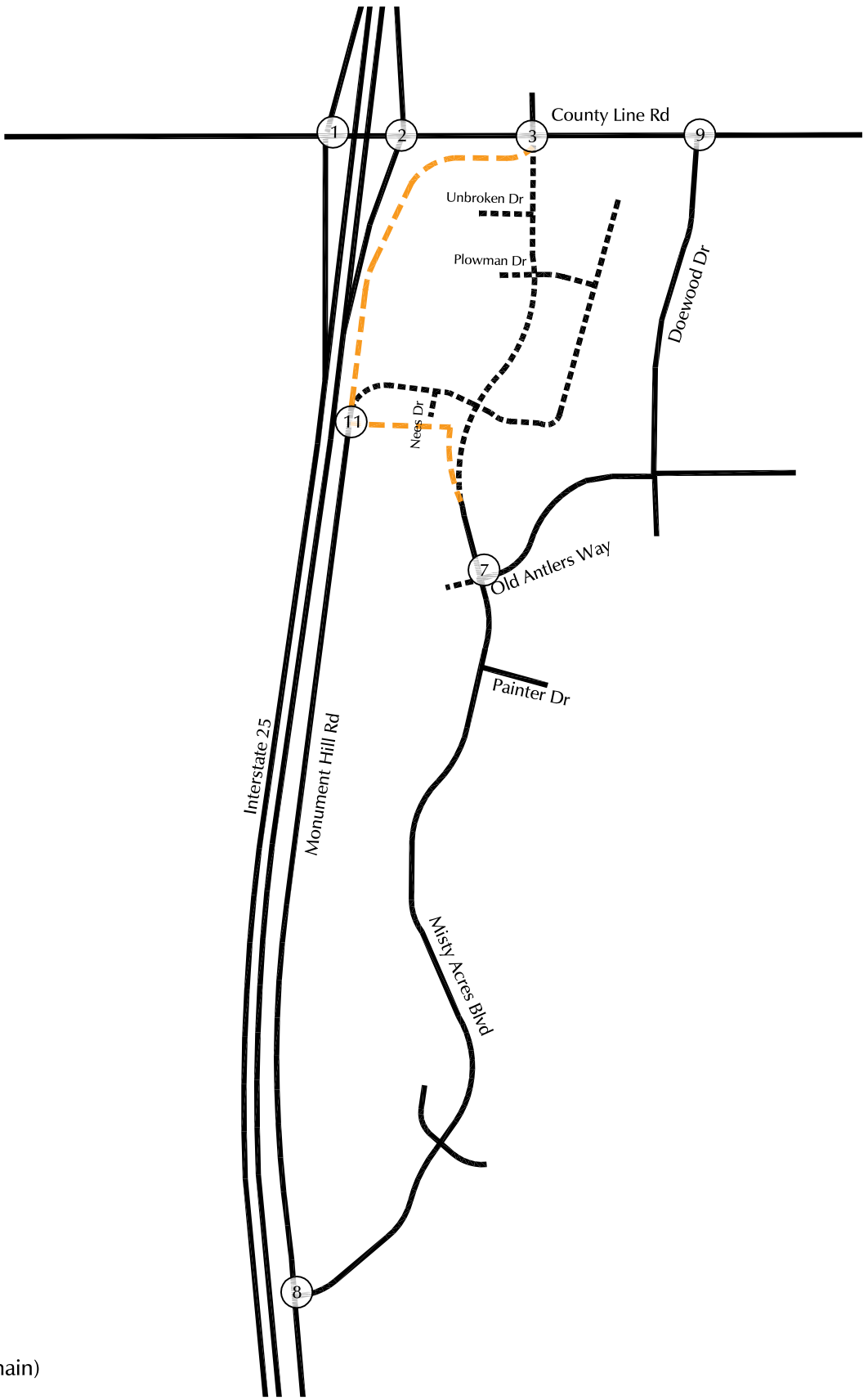

Existing Traffic Volumes

$$\frac{XX}{XX} = \frac{\text{AM Weekday Peak-Hour Traffic (vehicles per hour)}}{\text{PM Weekday Peak-Hour Traffic (vehicles per hour)}}$$

Roadways (as shown on Figure 3)

- Existing Roadway segments (to remain)
- Existing Roadway Segments (to be removed)
- Proposed New Roadway Segments



Figure 4
Existing Traffic Counts
Monument Ridge East (LSC# S234450)

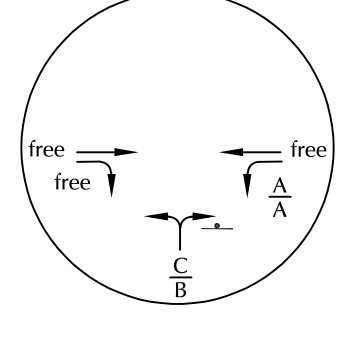
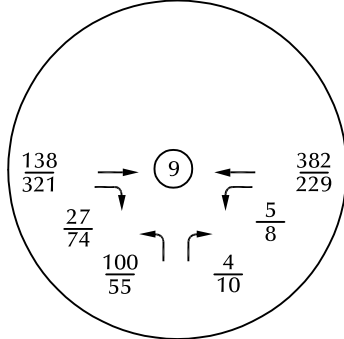
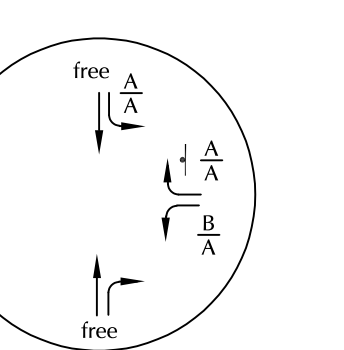
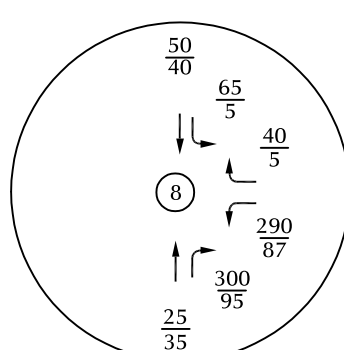
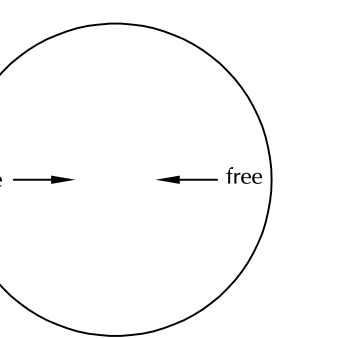
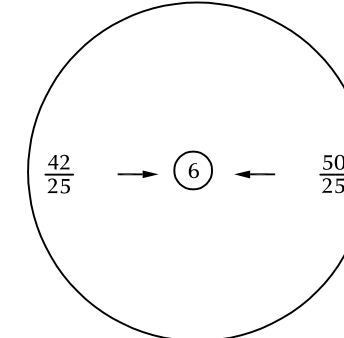
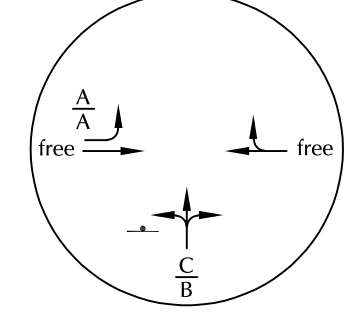
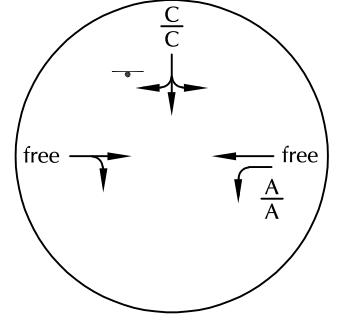
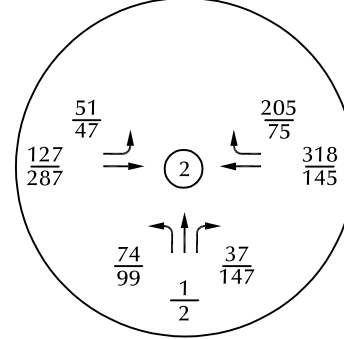
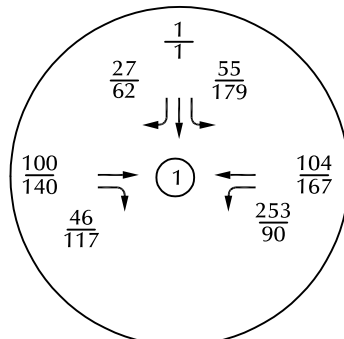
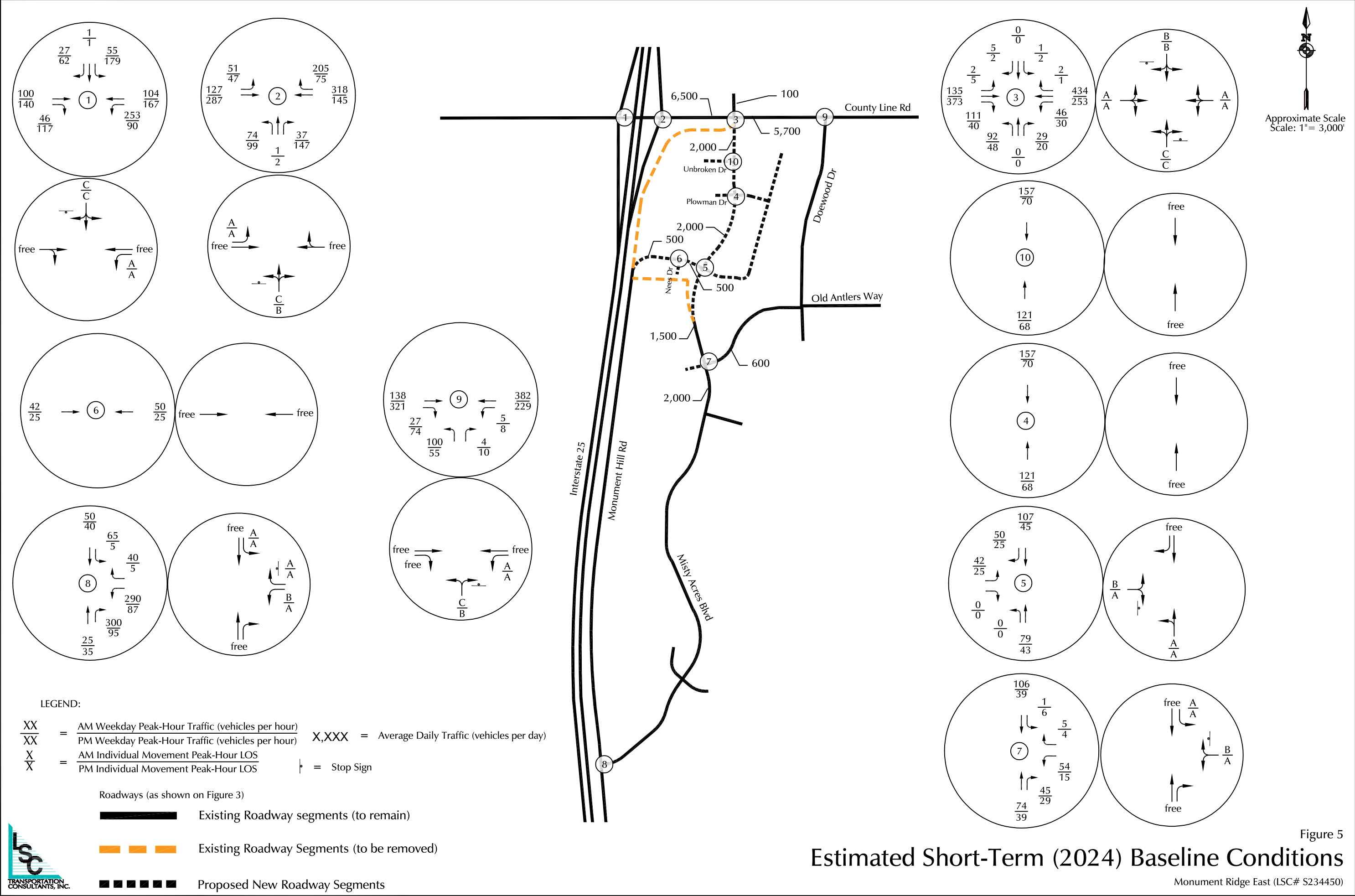

LEGEND:

XX/XX = AM Weekday Peak-Hour Traffic (vehicles per hour) / PM Weekday Peak-Hour Traffic (vehicles per hour) X,XXX = Average Daily Traffic (vehicles per day)

X/X = AM Individual Movement Peak-Hour LOS / PM Individual Movement Peak-Hour LOS

⊥ = Stop Sign

- Roadways (as shown on Figure 3)
- Existing Roadway segments (to remain)
 - Existing Roadway Segments (to be removed)
 - Proposed New Roadway Segments



Estimated Short-Term (2024) Baseline Conditions

Monument Ridge East (LSC# S234450)

Figure 5



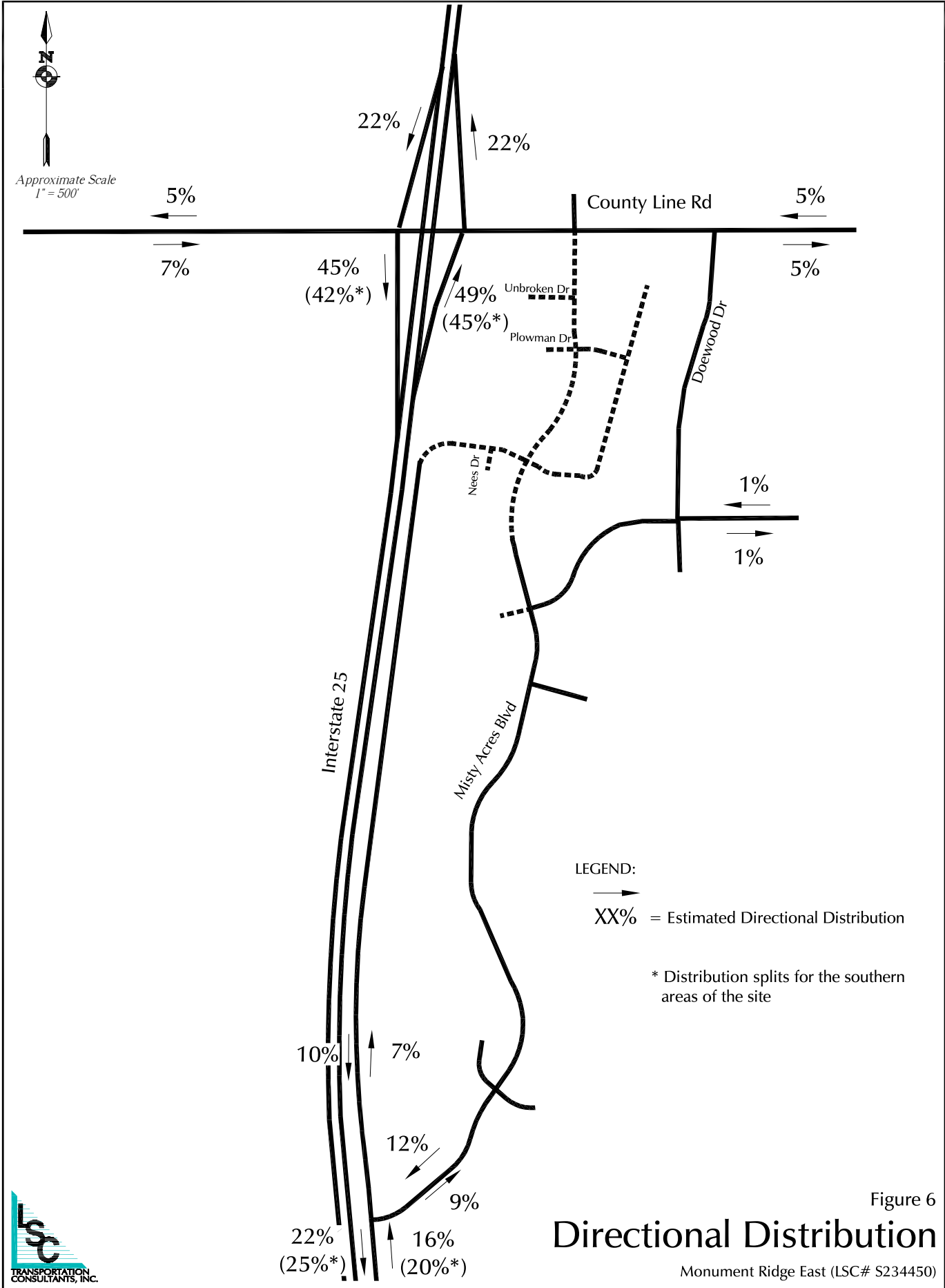
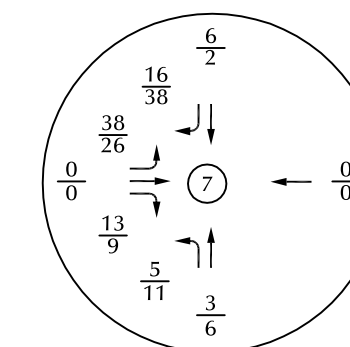
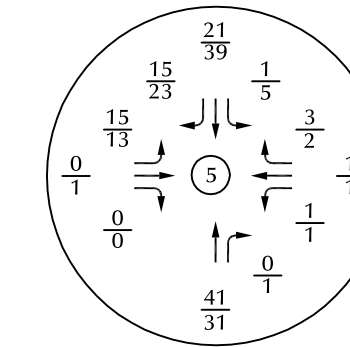
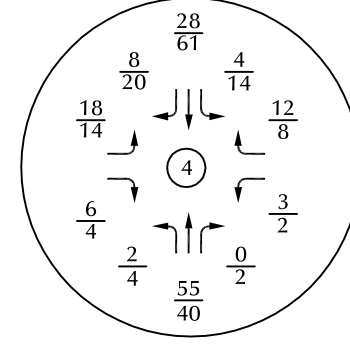
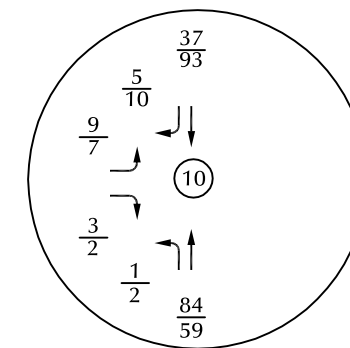
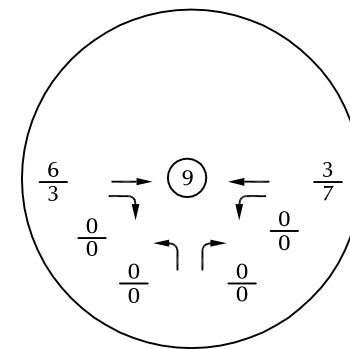
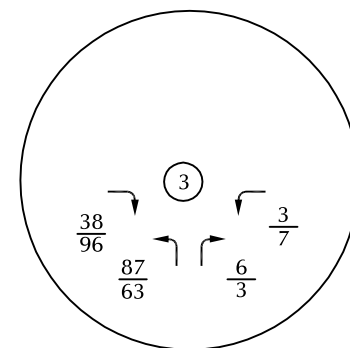
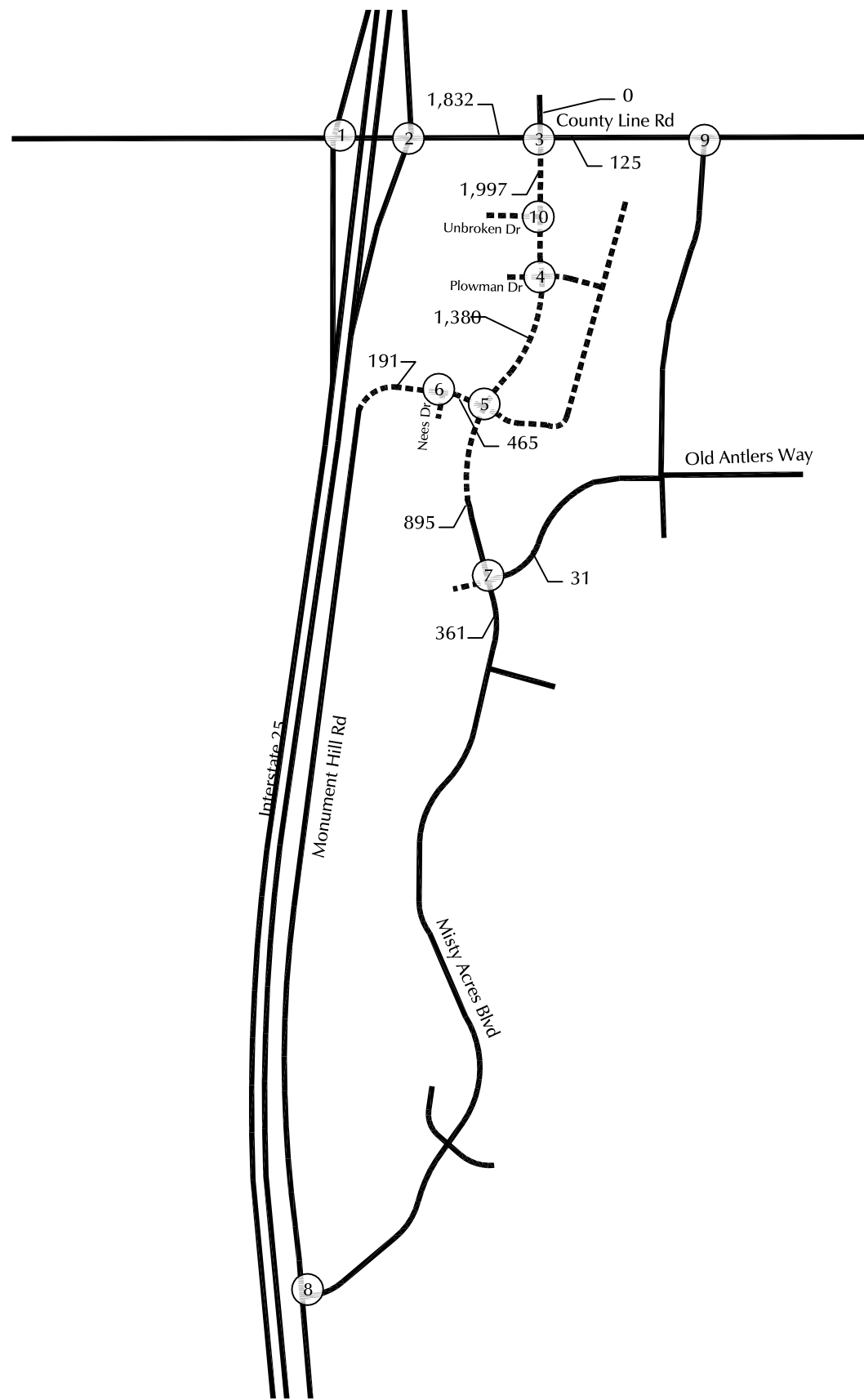
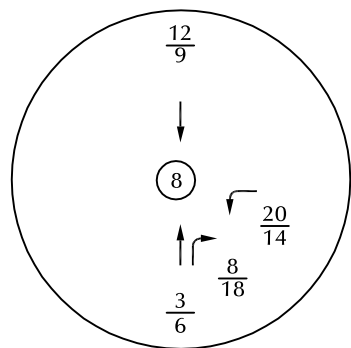
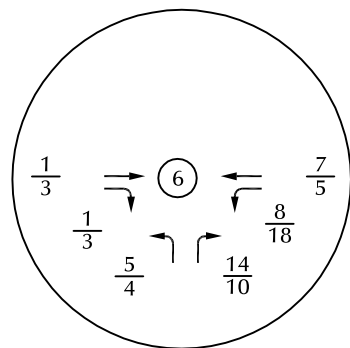
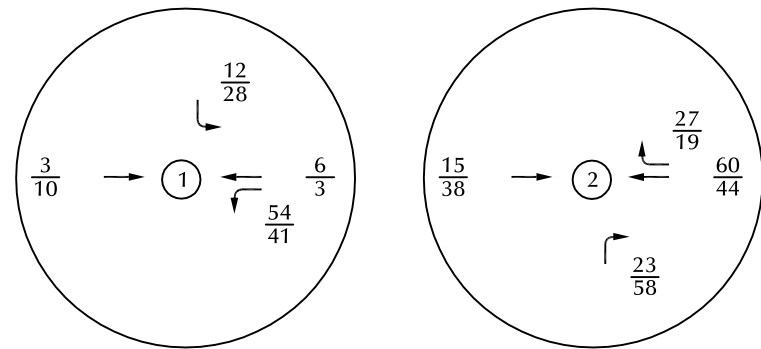

Figure 6
Directional Distribution

Monument Ridge East (LSC# S234450)



Approximate Scale
Scale: 1" = 3,000'

LEGEND:

$\frac{XX}{XX}$ = $\frac{\text{AM Weekday Peak-Hour Traffic (vehicles per hour)}}{\text{PM Weekday Peak-Hour Traffic (vehicles per hour)}}$

X,XXX = Average Daily Traffic (vehicles per day)

Roadways (as shown on Figure 3)

———— Existing Roadway segments (to remain)

■■■■■ Proposed New Roadway Segments



Figure 7
Site-Generated Traffic

Monument Ridge East (LSC# S234450)

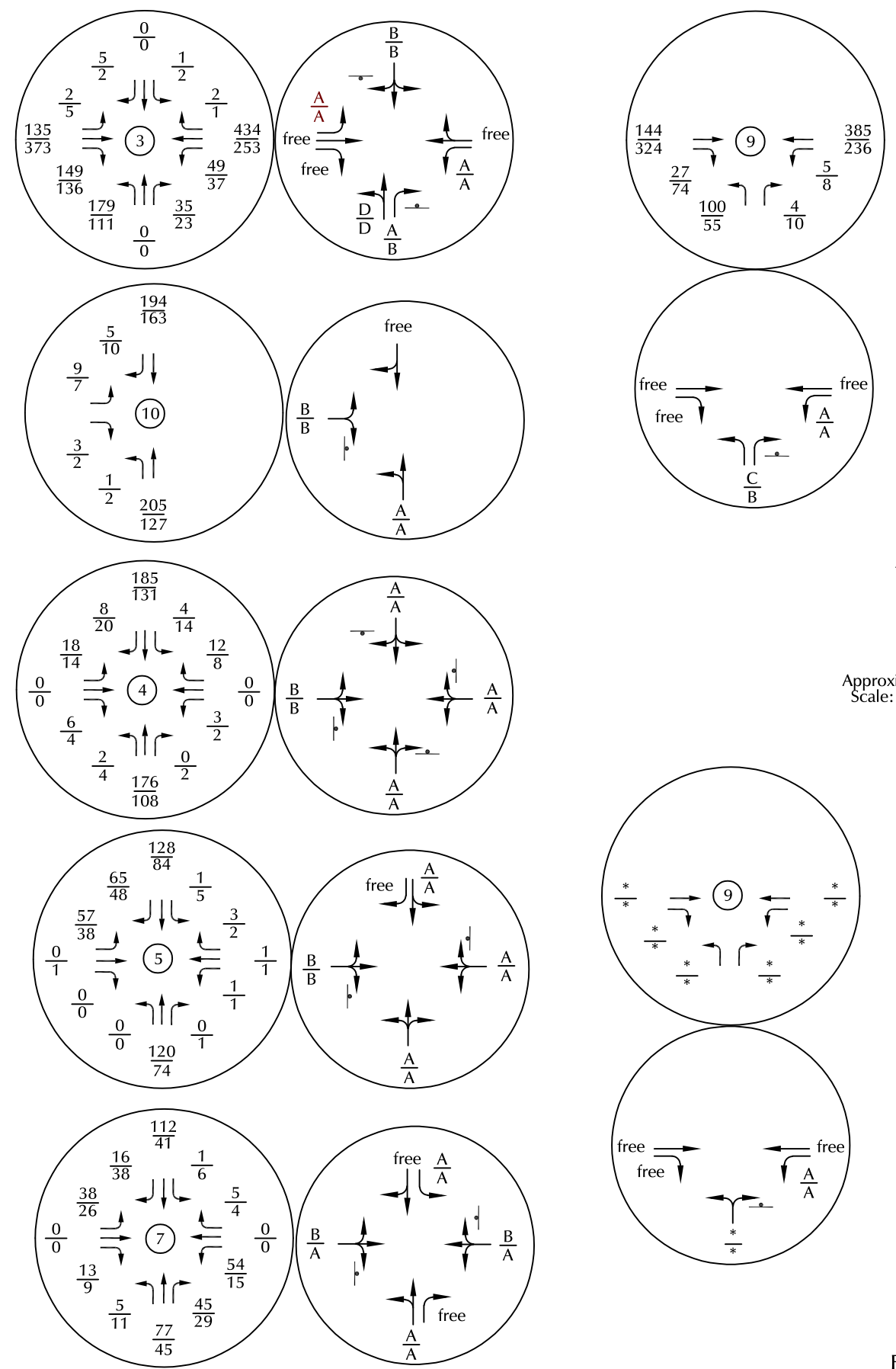
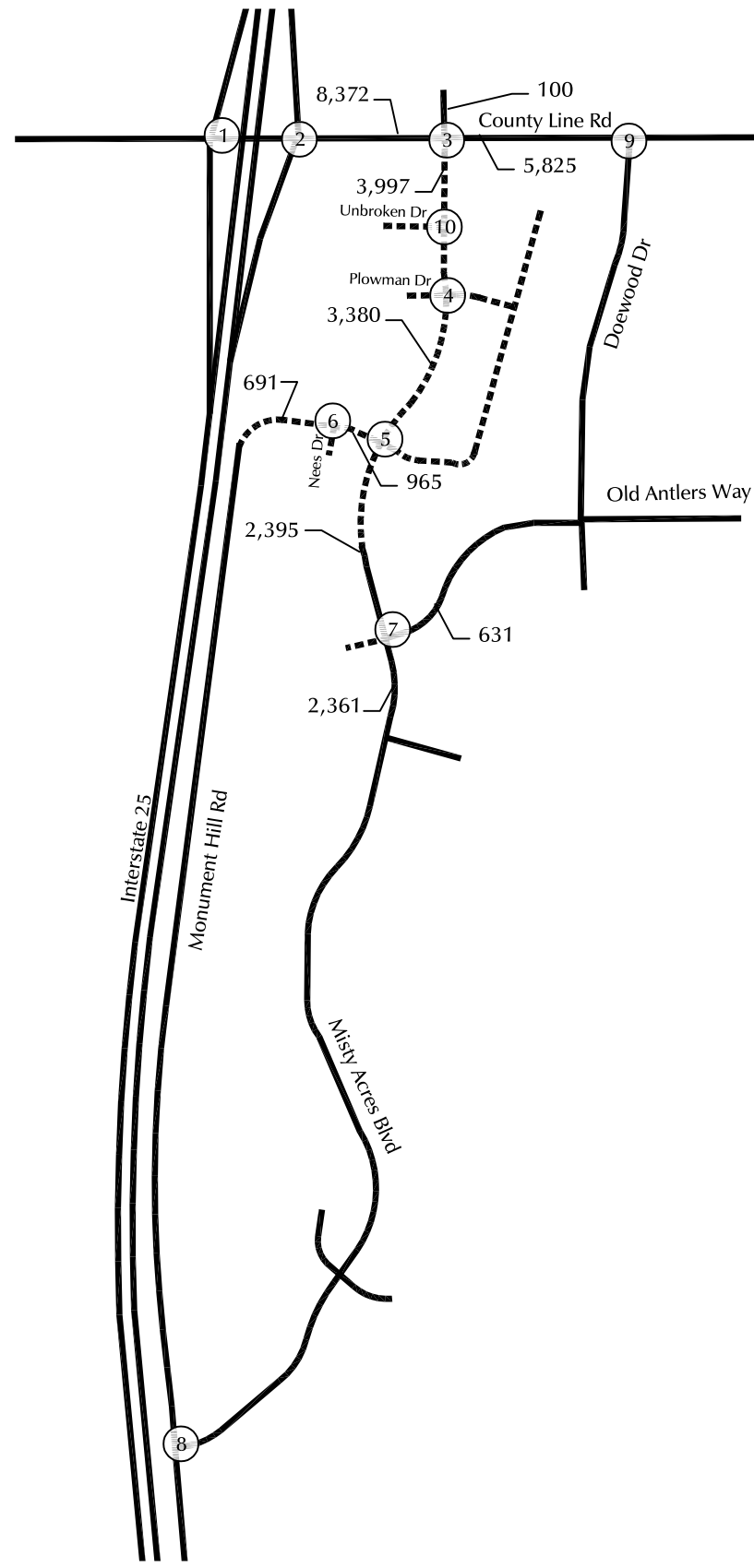
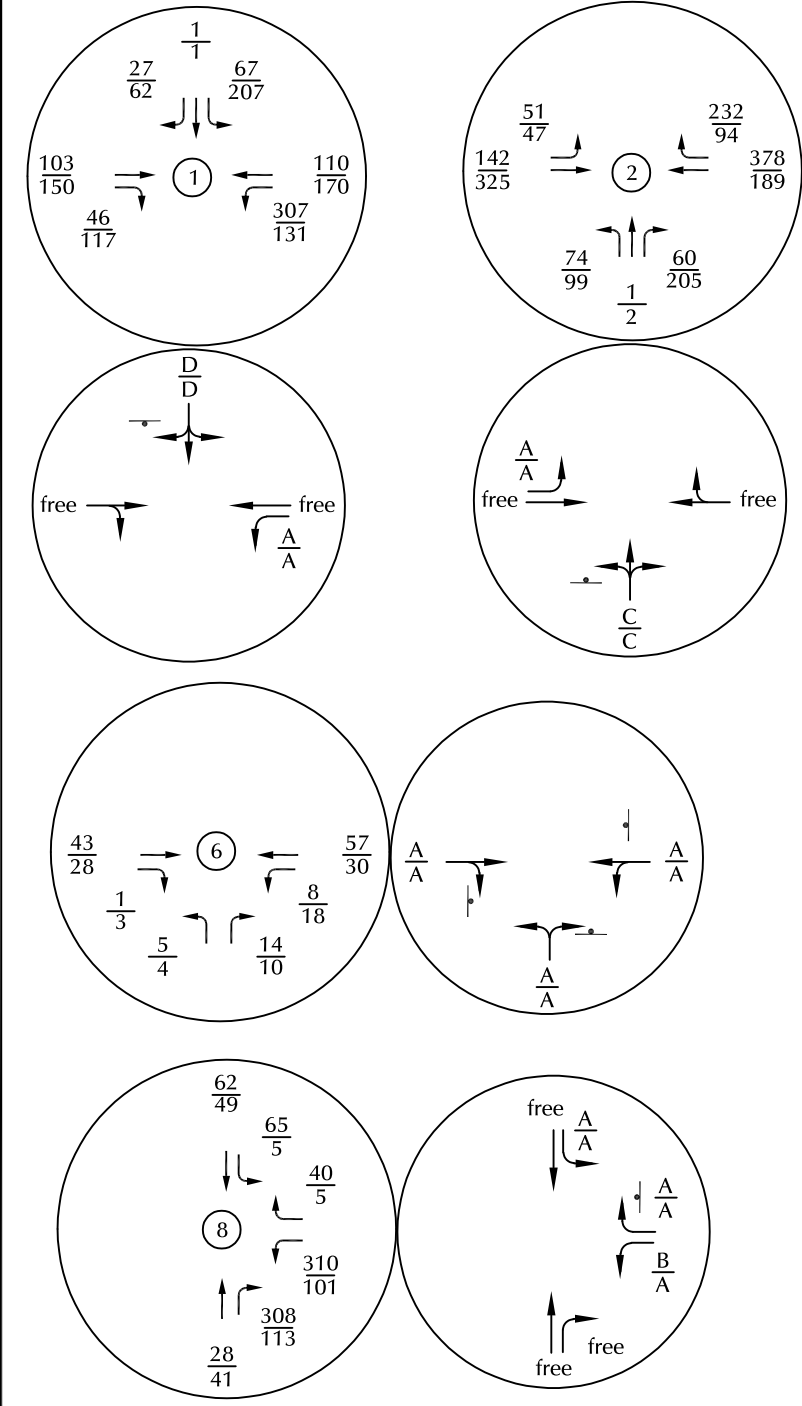

Approximate Scale
Scale: 1" = 3,000'

LEGEND:

X,XXX = Average Daily Traffic (vehicles per day)

$\frac{XX}{XX}$ = AM Weekday Peak-Hour Traffic (vehicles per hour)
PM Weekday Peak-Hour Traffic (vehicles per hour)

$\frac{X}{X}$ = AM Individual Movement Peak-Hour LOS
PM Individual Movement Peak-Hour LOS

$\frac{X}{X}$ = AM Entire Intersection Peak-Hour LOS
PM Entire Intersection Peak-Hour LOS

= Traffic Signal = Stop Sign

Roadways (as shown on Figure 3)

Existing Roadway segments (to remain)

Proposed New Roadway Segments

Short-Term (2024) Baseline + Site-Generated Traffic

Figure 8



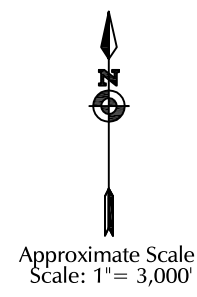
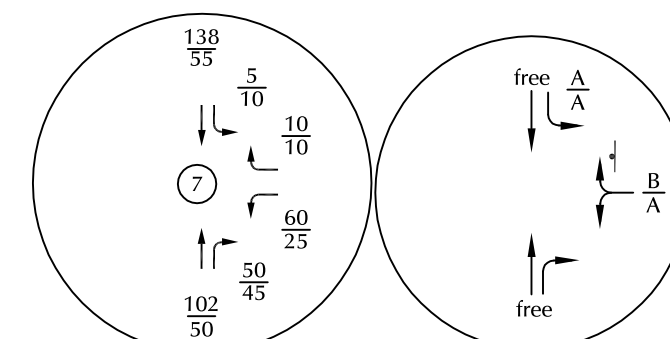
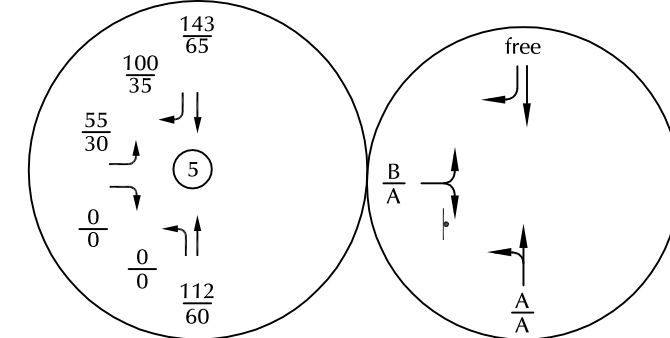
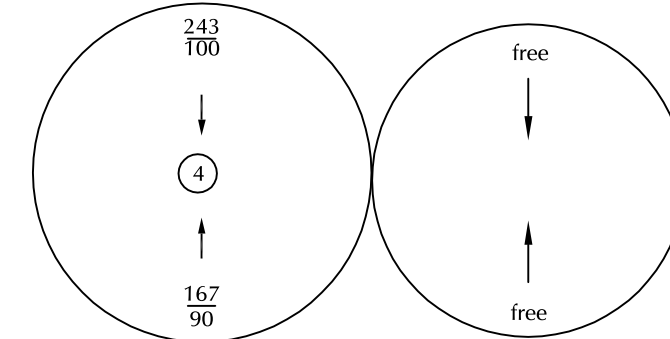
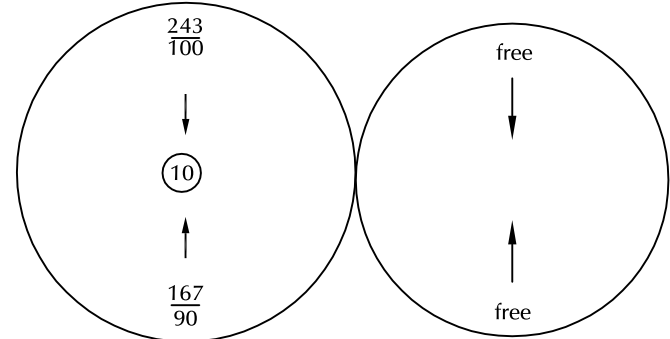
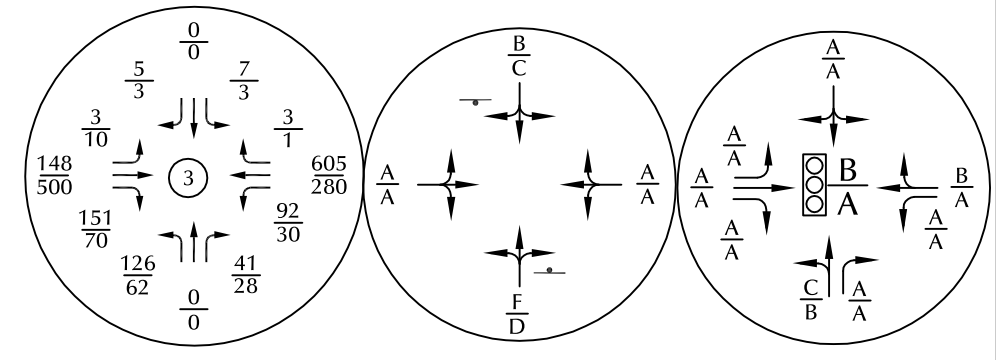
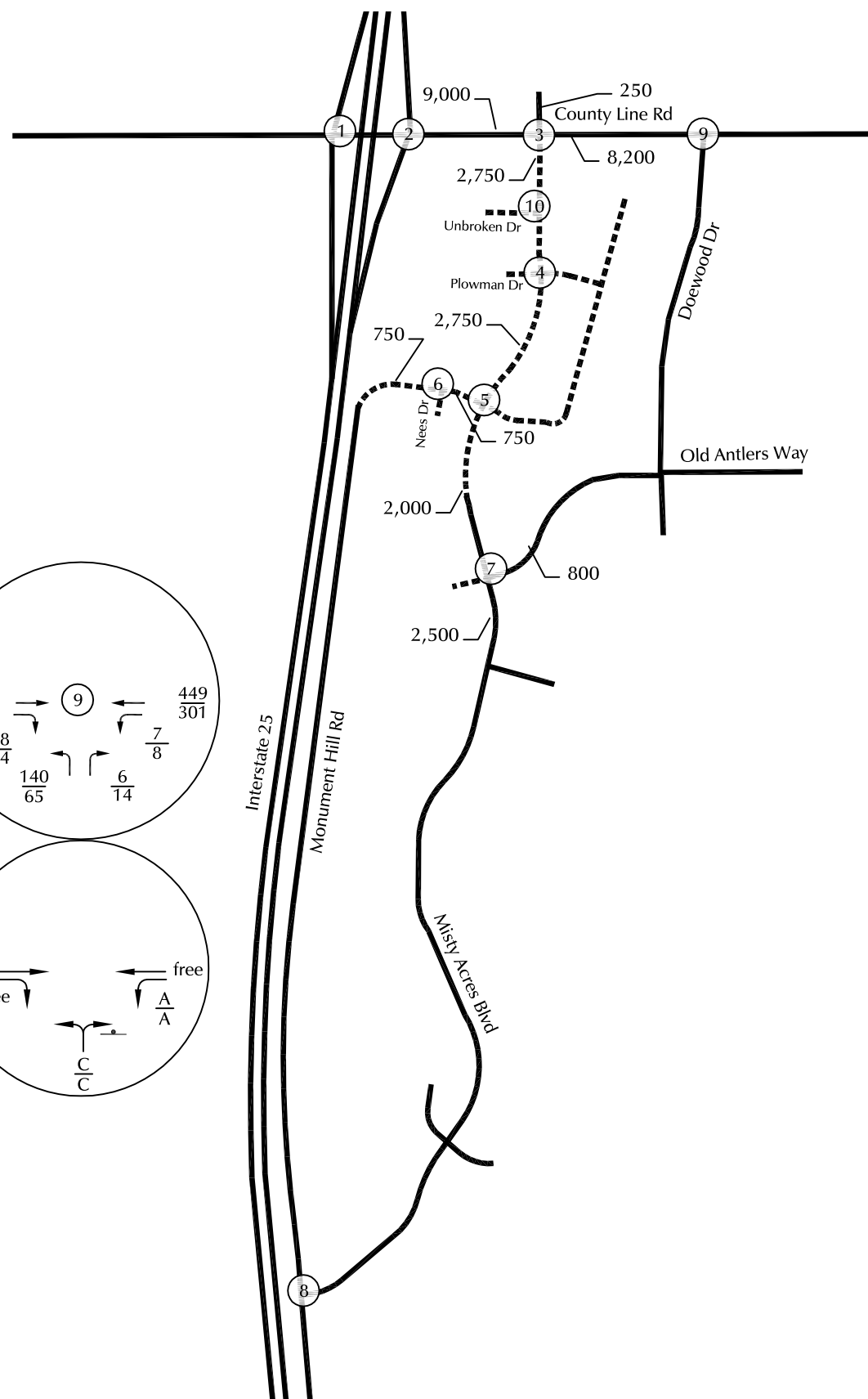
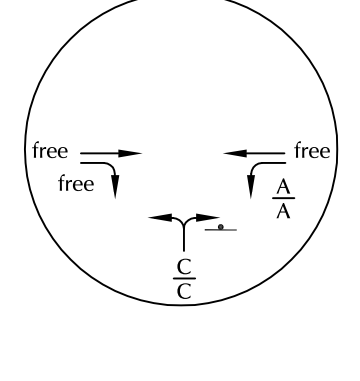
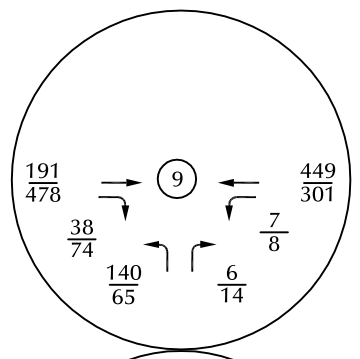
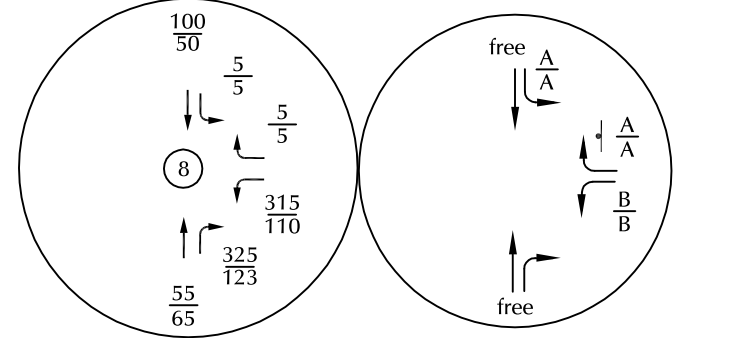
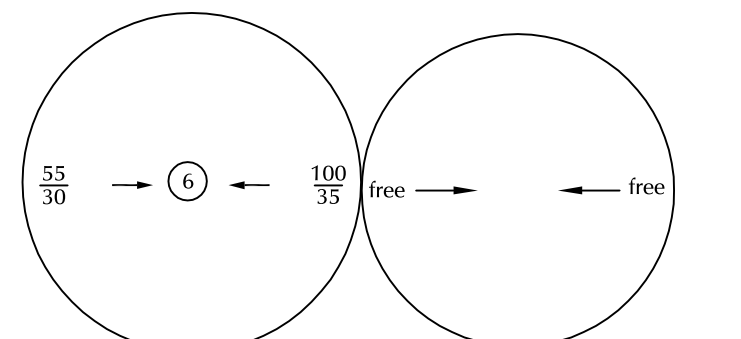
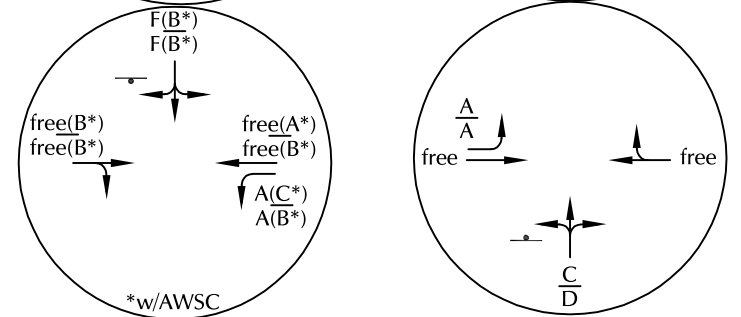
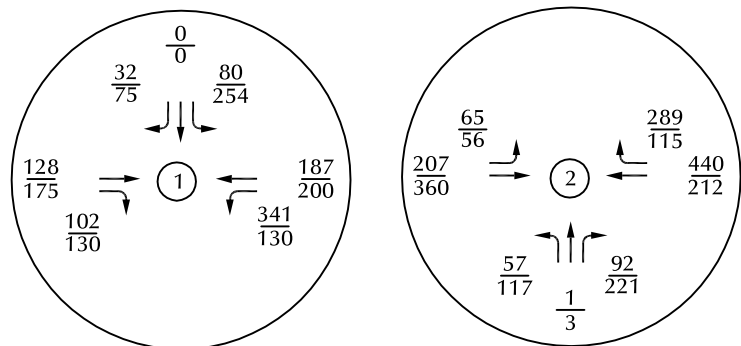

LEGEND:

- $\frac{XX}{XX}$ = AM Weekday Peak-Hour Traffic (vehicles per hour)
- $\frac{XX}{XX}$ = PM Weekday Peak-Hour Traffic (vehicles per hour)
- $\frac{X}{X}$ = AM Individual Movement Peak-Hour LOS
- $\frac{X}{X}$ = PM Individual Movement Peak-Hour LOS
- X,XXX = Average Daily Traffic (vehicles per day)
- ⊥ = Stop Sign

- Roadways (as shown on Figure 3)
- Existing Roadway segments (to remain)
 - Proposed New Roadway Segments



Figure 9
2044 Background Traffic

Monument Ridge East (LSC# S234450)

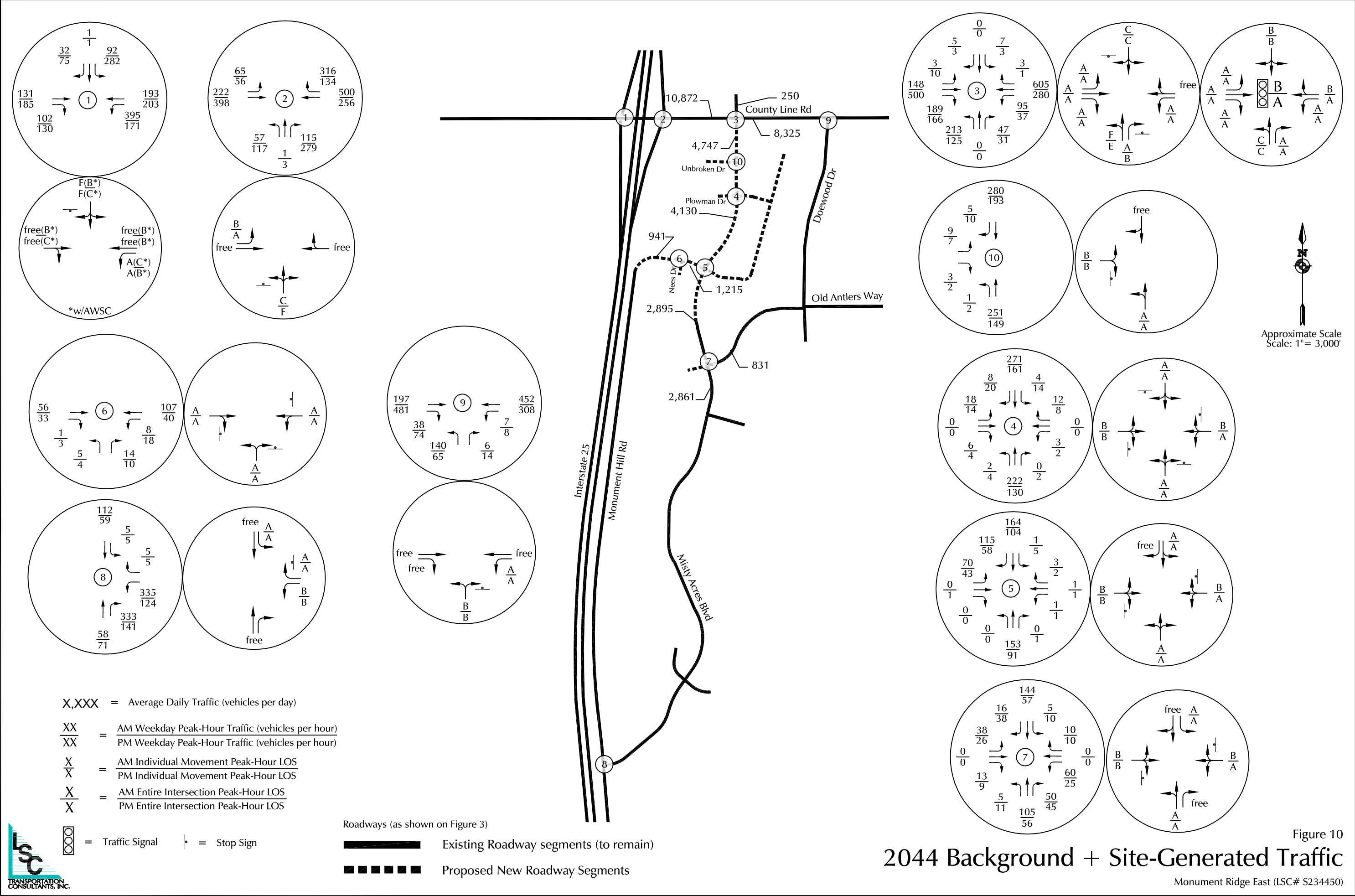

X,XXX = Average Daily Traffic (vehicles per day)

$\frac{XX}{XX}$ = $\frac{\text{AM Weekday Peak-Hour Traffic (vehicles per hour)}}{\text{PM Weekday Peak-Hour Traffic (vehicles per hour)}}$

$\frac{X}{X}$ = $\frac{\text{AM Individual Movement Peak-Hour LOS}}{\text{PM Individual Movement Peak-Hour LOS}}$

$\frac{X}{X}$ = $\frac{\text{AM Entire Intersection Peak-Hour LOS}}{\text{PM Entire Intersection Peak-Hour LOS}}$

= Traffic Signal = Stop Sign

Roadways (as shown on Figure 3)

Existing Roadway segments (to remain)

Proposed New Roadway Segments

2044 Background + Site-Generated Traffic

Figure 10

Monument Ridge East (LSC# S234450)



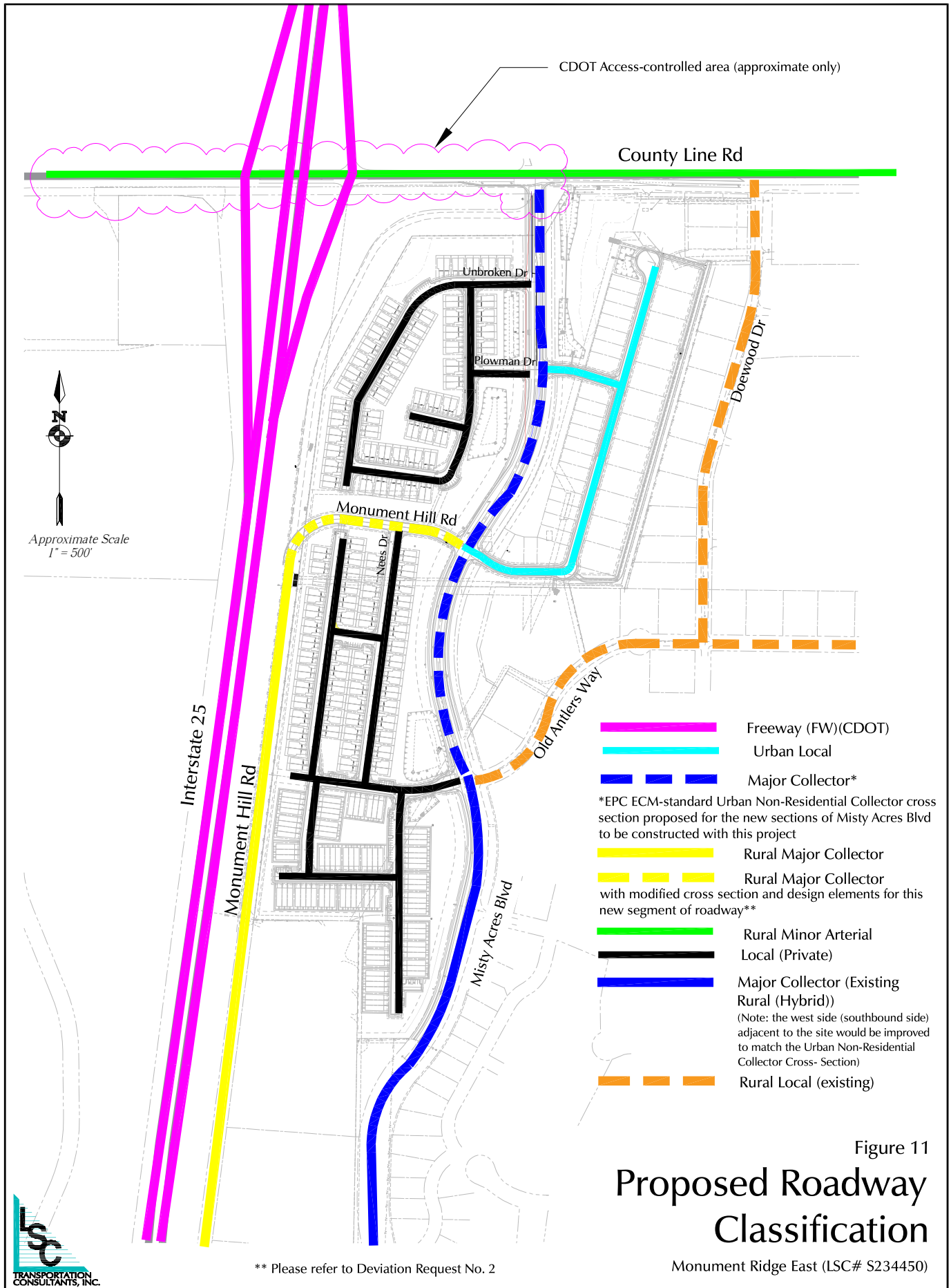
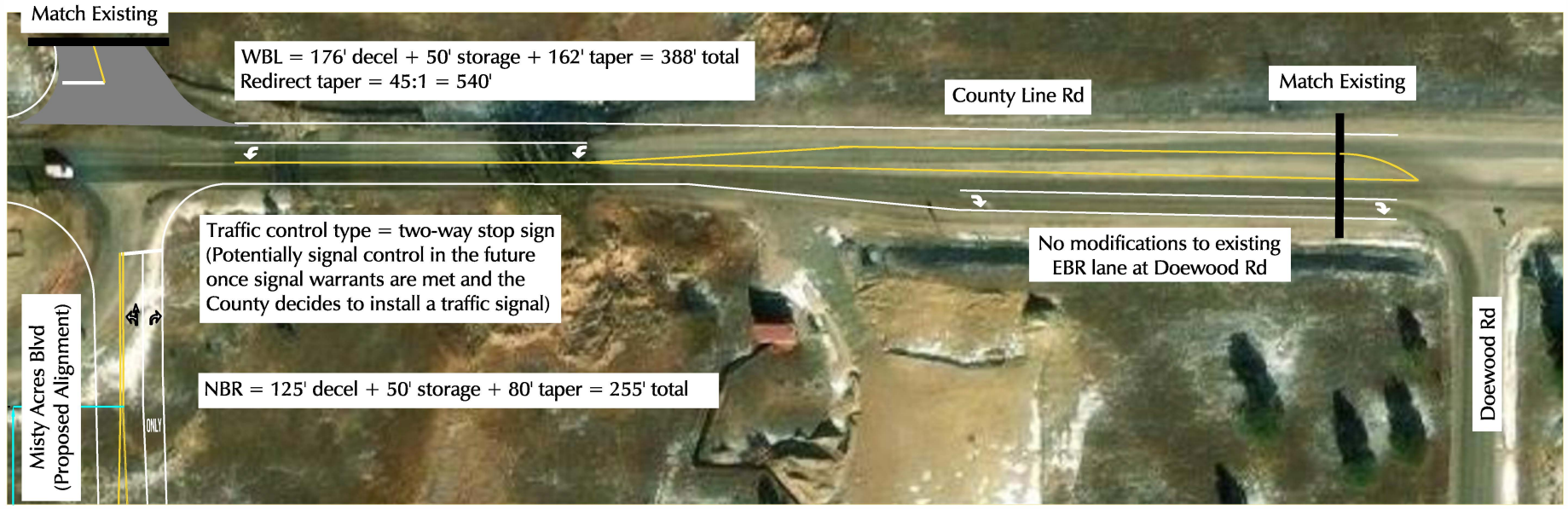
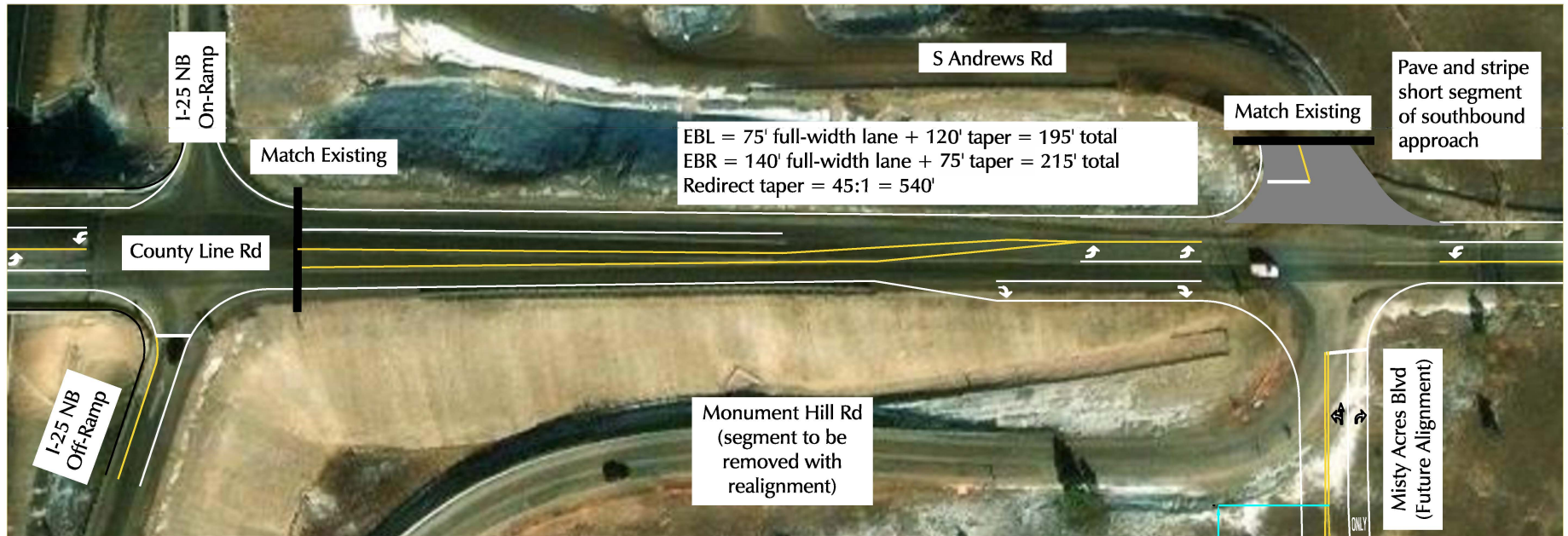

Figure 11
Proposed Roadway Classification

Monument Ridge East (LSC# S234450)



1" = 100'
scale

Figure 12
Proposed Laneage on County Line Rd

Monument Ridge East (LSC# S234450)



1" = 100'
scale

Figure 13

Proposed Laneage on Misty Acres Boulevard

Monument Ridge East (LSC# S234450)

Appendix Figure 1





Approximate Scale
Scale: 1" = 3,000'

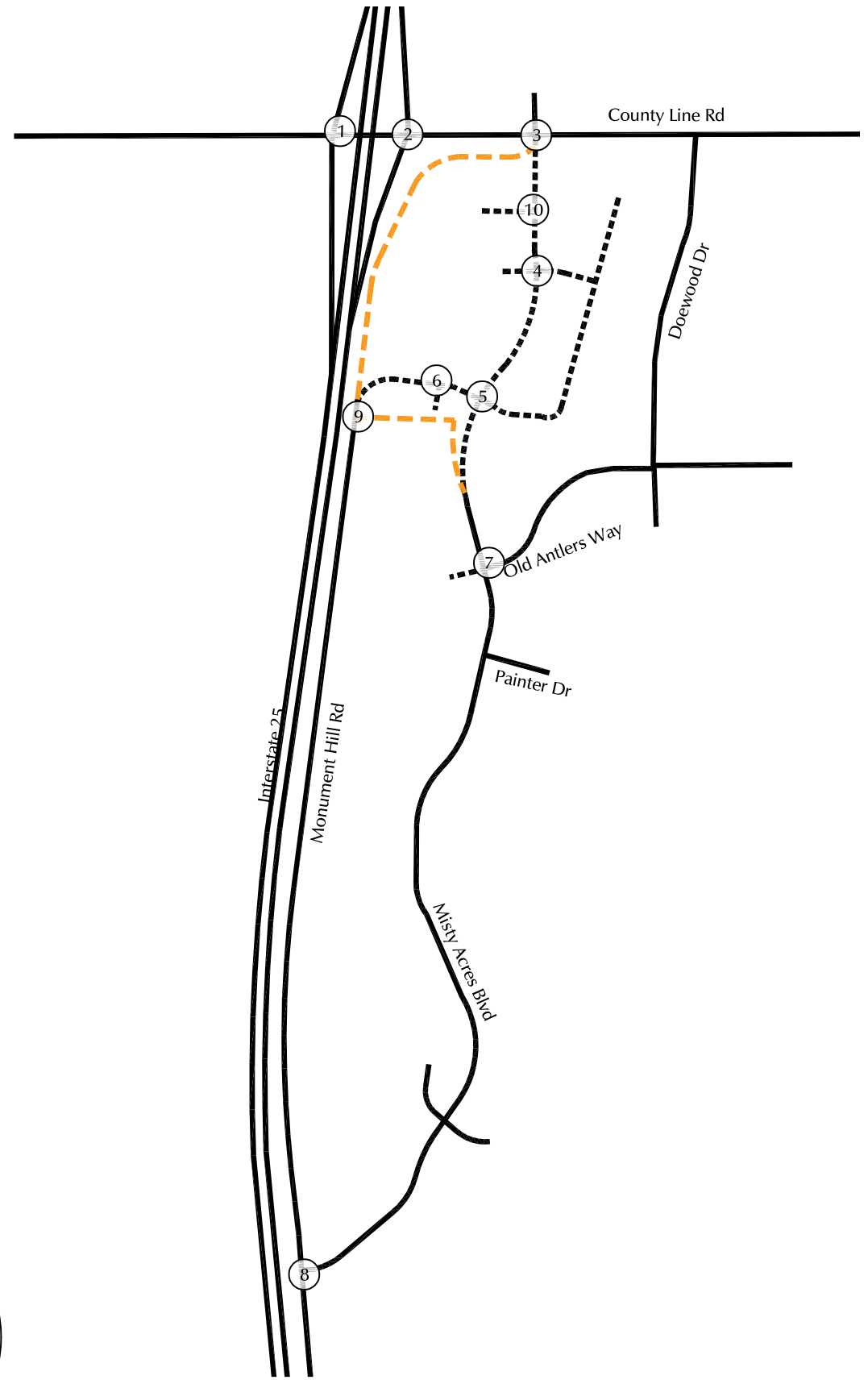
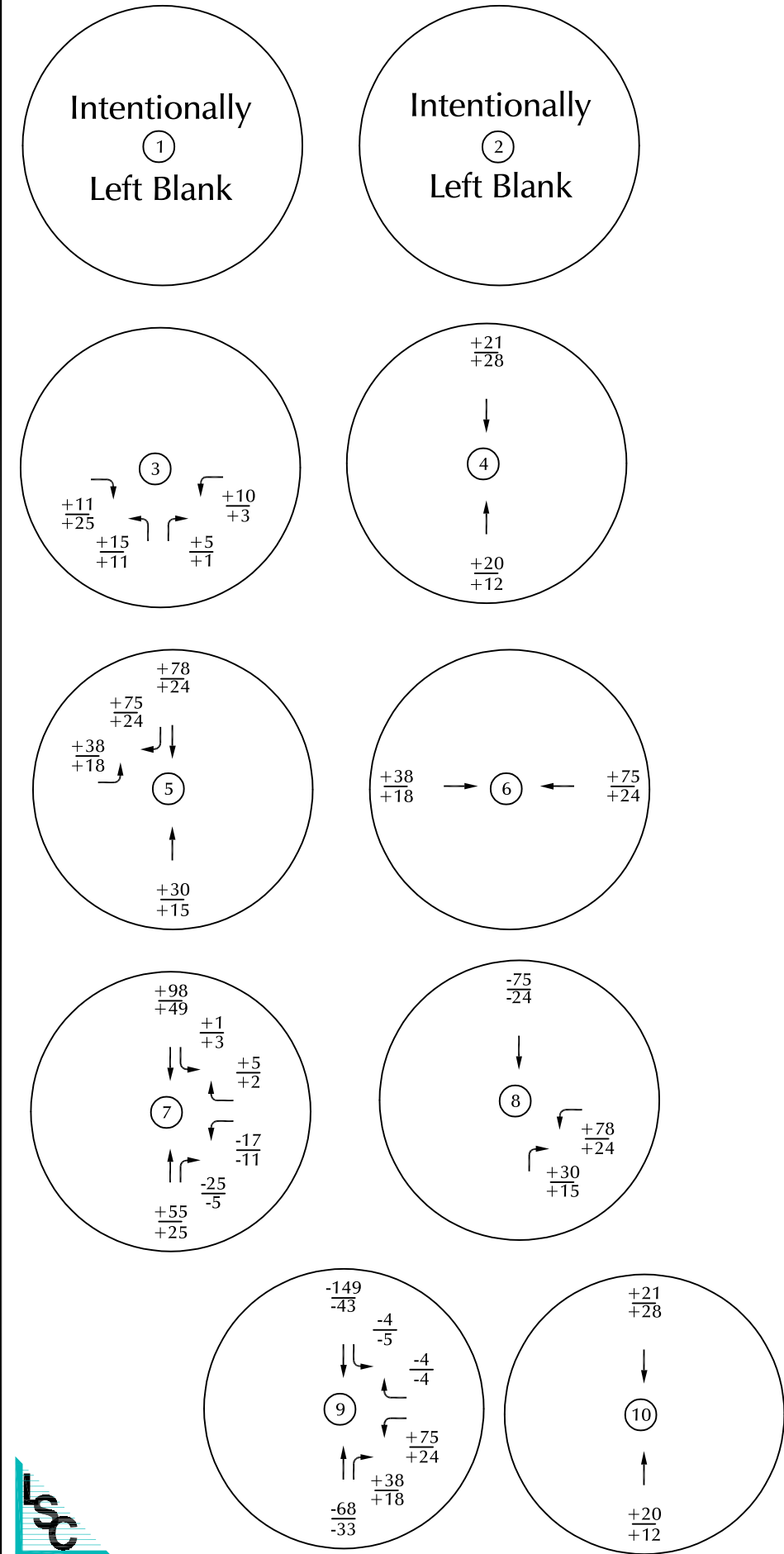

- Existing Roadway
- Existing Roadway - to be removed
- New Roadway

$\frac{XX}{XX}$ = $\frac{\text{AM Weekday Peak-Hour Traffic (vehicles per hour)}}{\text{PM Weekday Peak-Hour Traffic (vehicles per hour)}}$

Appendix Figure 1
**Shifted Traffic w/ Completion
of Misty Acres Blvd and
Realignment of Monument Hill**
Monument Ridge East (LSC# S234450)



Exhibits 1 - 3



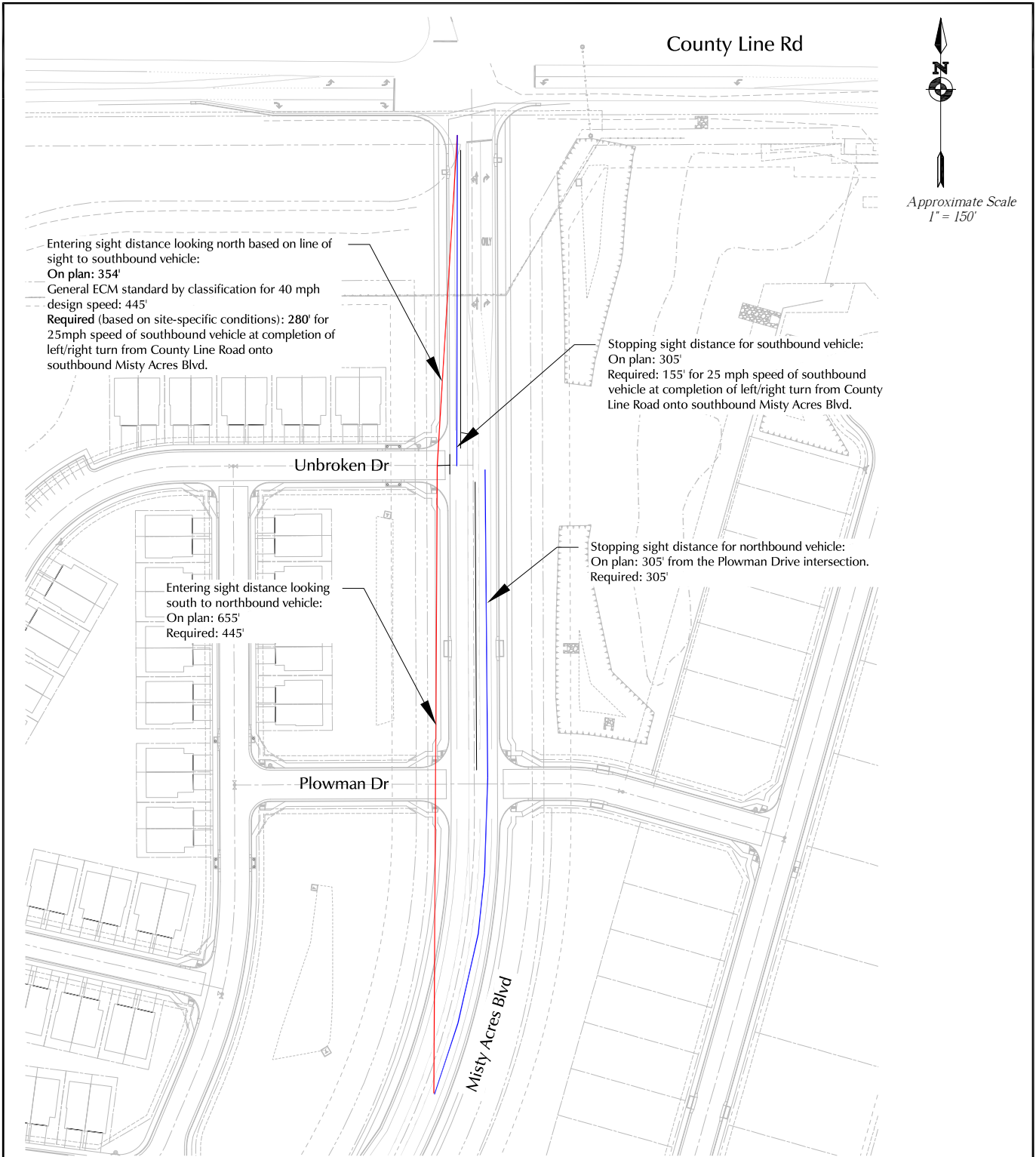
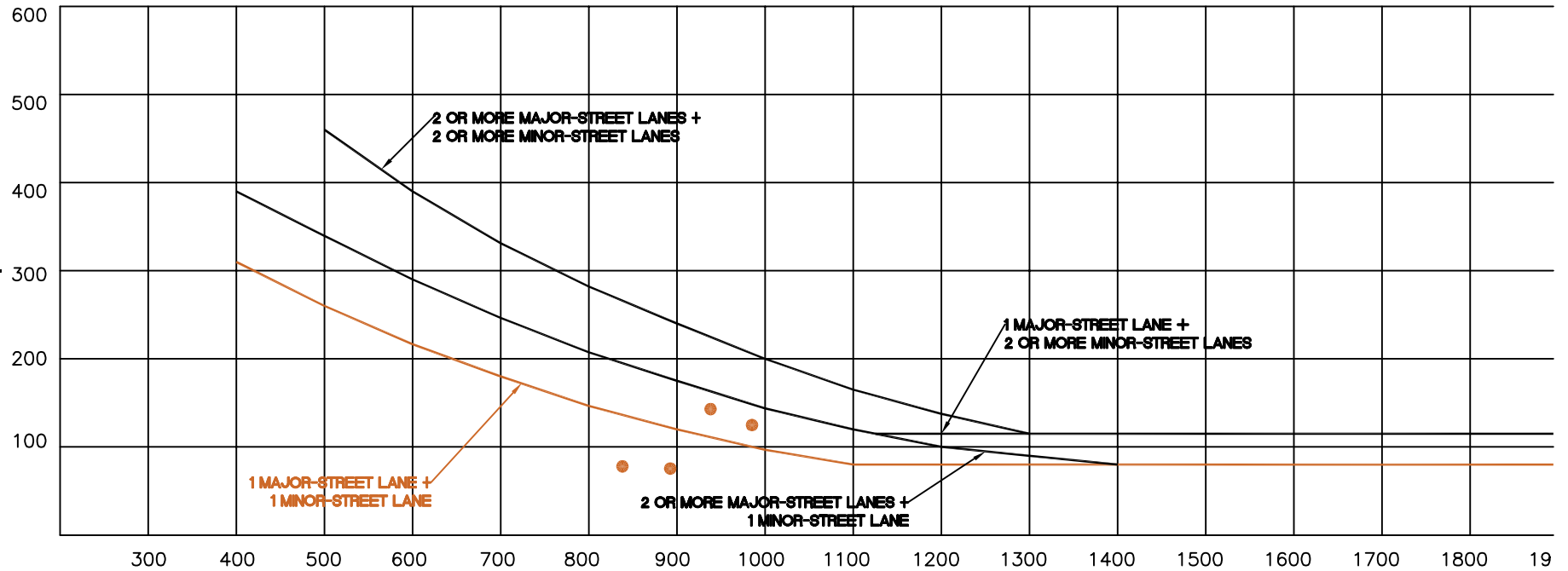

Exhibit 1

Sight Distance - Unbroken Drive (North Access Intersection)

Monument Ridge East (LSC# S234450)

Figure 4C-1. Warrant 2, Four-Hour Vehicular Volume



* Note: 115 vph applies as the lower threshold volume for a minor-street approach with two or more lanes and 80 vph applies as the lower threshold volume for a minor-street approach with one lane.

Exhibit 2

Traffic Signal Warrant Analysis

County Line Road + Misty Acres Boulevard

2044 Background (No Site-Generated Traffic)

Monument Ridge East (LSC# S234450)

Figure 4C-1. Warrant 2, Four-Hour Vehicular Volume

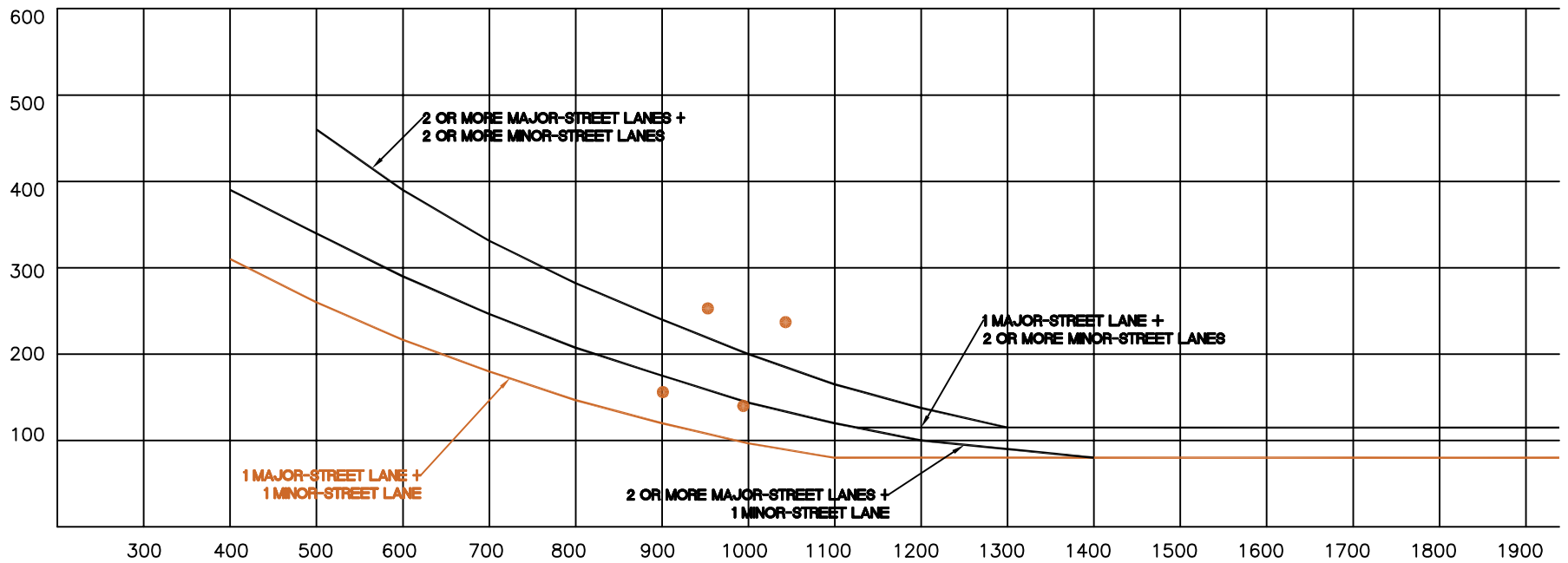

* Note: 115 vph applies as the lower threshold volume for a minor-street approach with two or more lanes and 80 vph applies as the lower threshold volume for a minor-street approach with one lane.

Exhibit 3

Traffic Signal Warrant Analysis

County Line Road + Misty Acres Boulevard

2044 Background + Site

Monument Ridge East (LSC# S234450)



Traffic Counts



LSC Transportation Consultants, Inc.

2504 E. Pikes Peak Ave, Suite 304
 Colorado Springs, CO 80909
 719-633-2868

File Name : Doewood Dr - County Line Rd AM

Site Code : S234450

Start Date : 6/18/2024

Page No : 1

Groups Printed- Unshifted

Start Time	Southbound					County Line Rd Westbound					Doewood Dr Northbound					County Line Rd Eastbound					Int. Total
	Right	Thru	Left	Peds	App. Total	Right	Thru	Left	Peds	App. Total	Right	Thru	Left	Peds	App. Total	Right	Thru	Left	Peds	App. Total	
16:00	0	0	0	0	0	0	21	3	0	24	0	0	5	0	5	5	24	0	0	29	58
16:05	0	0	0	0	0	0	24	4	0	28	1	0	6	0	7	7	27	0	0	34	69
16:10	0	0	0	0	0	0	16	1	0	17	1	0	5	0	6	4	18	0	0	22	45
16:15	0	0	0	0	0	0	19	0	0	19	1	0	3	0	4	10	20	0	0	30	53
16:20	0	0	0	0	0	0	24	0	0	24	0	0	9	0	9	7	28	0	0	35	68
16:25	0	0	0	0	0	0	26	1	0	27	0	0	6	0	6	5	20	0	0	25	58
16:30	0	0	0	0	0	0	14	0	0	14	0	0	7	0	7	12	26	0	0	38	59
16:35	0	0	0	0	0	0	9	0	0	9	0	0	4	0	4	8	14	0	0	22	35
16:40	0	0	0	0	0	0	19	1	0	20	0	0	6	0	6	6	21	0	0	27	53
16:45	0	0	0	0	0	0	14	1	0	15	1	0	8	0	9	9	29	0	0	38	62
16:50	0	0	0	0	0	0	16	0	0	16	1	0	3	0	4	10	26	0	0	36	56
16:55	0	0	0	0	0	0	17	2	0	19	0	0	6	0	6	8	24	0	0	32	57
Total	0	0	0	0	0	0	219	13	0	232	5	0	68	0	73	91	277	0	0	368	673
17:00	0	0	0	0	0	0	11	2	0	13	0	0	4	0	4	7	31	0	0	38	55
17:05	0	0	0	0	0	0	17	1	0	18	0	0	5	0	5	4	28	0	0	32	55
17:10	0	0	0	0	0	0	23	0	0	23	0	0	2	0	2	3	29	0	0	32	57
17:15	0	0	0	0	0	0	20	0	0	20	0	0	6	0	6	14	18	0	0	32	58
17:20	0	0	0	0	0	0	10	0	0	10	3	0	4	0	7	9	23	0	0	32	49
17:25	0	0	0	0	0	0	18	1	0	19	0	0	8	0	8	6	19	0	0	25	52
17:30	0	0	0	0	0	0	17	0	0	17	1	0	2	0	3	12	28	0	0	40	60
17:35	0	0	0	0	0	0	18	1	0	19	0	0	8	0	8	11	36	0	0	47	74
17:40	0	0	0	0	0	0	13	0	0	13	0	0	2	0	2	6	16	0	0	22	37
17:45	0	0	0	0	0	0	11	1	0	12	1	0	2	0	3	6	28	0	0	34	49
17:50	0	0	0	0	0	0	7	0	0	7	0	0	5	0	5	8	26	0	0	34	46
17:55	0	0	0	0	0	0	19	0	0	19	0	0	3	0	3	7	20	0	0	27	49
Total	0	0	0	0	0	0	184	6	0	190	5	0	51	0	56	93	302	0	0	395	641
Grand Total	0	0	0	0	0	0	403	19	0	422	10	0	119	0	129	184	579	0	0	763	1314
Apprch %	0	0	0	0	0	0	95.5	4.5	0	422	7.8	0	92.2	0	129	24.1	75.9	0	0	763	1314
Total %	0	0	0	0	0	0	30.7	1.4	0	422	0.8	0	9.1	0	129	14	44.1	0	0	763	1314

LSC Transportation Consultants, Inc.

2504 E. Pikes Peak Ave, Suite 304
 Colorado Springs, CO 80909
 719-633-2868

File Name : Doewood Dr - County Line Rd AM

Site Code : S234450

Start Date : 6/18/2024

Page No : 2

Start Time	Southbound					County Line Rd Westbound					Doewood Dr Northbound					County Line Rd Eastbound					Int. Total
	Right	Thru	Left	Peds	App. Total	Right	Thru	Left	Peds	App. Total	Right	Thru	Left	Peds	App. Total	Right	Thru	Left	Peds	App. Total	
Peak Hour Analysis From 16:00 to 17:55 - Peak 1 of 1																					
Peak Hour for Entire Intersection Begins at 16:40																					
16:40	0	0	0	0	0	0	19	1	0	20	0	0	6	0	6	6	21	0	0	27	53
16:45	0	0	0	0	0	0	14	1	0	15	1	0	8	0	9	9	29	0	0	38	62
16:50	0	0	0	0	0	0	16	0	0	16	1	0	3	0	4	10	26	0	0	36	56
16:55	0	0	0	0	0	0	17	2	0	19	0	0	6	0	6	8	24	0	0	32	57
17:00	0	0	0	0	0	0	11	2	0	13	0	0	4	0	4	7	31	0	0	38	55
17:05	0	0	0	0	0	0	17	1	0	18	0	0	5	0	5	4	28	0	0	32	55
17:10	0	0	0	0	0	0	23	0	0	23	0	0	2	0	2	3	29	0	0	32	57
17:15	0	0	0	0	0	0	20	0	0	20	0	0	6	0	6	14	18	0	0	32	58
17:20	0	0	0	0	0	0	10	0	0	10	3	0	4	0	7	9	23	0	0	32	49
17:25	0	0	0	0	0	0	18	1	0	19	0	0	8	0	8	6	19	0	0	25	52
17:30	0	0	0	0	0	0	17	0	0	17	1	0	2	0	3	12	28	0	0	40	60
17:35	0	0	0	0	0	0	18	1	0	19	0	0	8	0	8	11	36	0	0	47	74
Total Volume	0	0	0	0	0	0	200	9	0	209	6	0	62	0	68	99	312	0	0	411	688
% App. Total	0	0	0	0	0	0	95.7	4.3	0		8.8	0	91.2	0		24.1	75.9	0	0		
PHF	.000	.000	.000	.000	.000	.000	.725	.375	.000	.757	.167	.000	.646	.000	.630	.589	.722	.000	.000	.729	.775

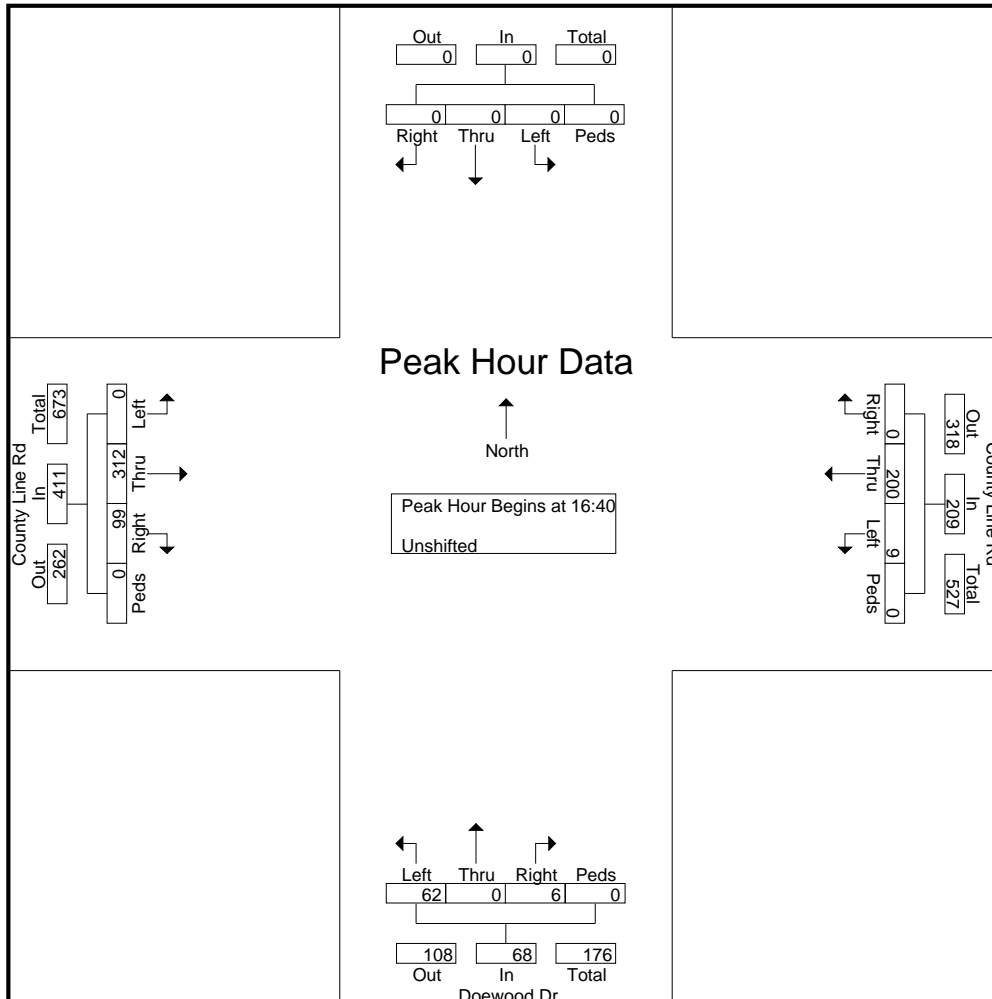

LSC Transportation Consultants, Inc.

2504 E. Pikes Peak Ave, Suite 304
 Colorado Springs, CO 80909
 719-633-2868

File Name : Doewood Dr - County Line Rd AM
 Site Code : S234450
 Start Date : 6/18/2024
 Page No : 3

Start Time	Southbound					County Line Rd Westbound					Doewood Dr Northbound					County Line Rd Eastbound					Int. Total
	Right	Thru	Left	Peds	App. Total	Right	Thru	Left	Peds	App. Total	Right	Thru	Left	Peds	App. Total	Right	Thru	Left	Peds	App. Total	
Peak Hour Analysis From 16:00 to 17:55 - Peak 1 of 1																					
Peak Hour for Each Approach Begins at:																					
	16:00					16:00					16:00					16:40					
+0 mins.	0	0	0	0	0	0	21	3	0	24	0	0	5	0	5	6	21	0	0	27	
+5 mins.	0	0	0	0	0	0	24	4	0	28	1	0	6	0	7	9	29	0	0	38	
+10 mins.	0	0	0	0	0	0	16	1	0	17	1	0	5	0	6	10	26	0	0	36	
+15 mins.	0	0	0	0	0	0	19	0	0	19	1	0	3	0	4	8	24	0	0	32	
+20 mins.	0	0	0	0	0	0	24	0	0	24	0	0	9	0	9	7	31	0	0	38	
+25 mins.	0	0	0	0	0	0	26	1	0	27	0	0	6	0	6	4	28	0	0	32	
+30 mins.	0	0	0	0	0	0	14	0	0	14	0	0	7	0	7	3	29	0	0	32	
+35 mins.	0	0	0	0	0	0	9	0	0	9	0	0	4	0	4	14	18	0	0	32	
+40 mins.	0	0	0	0	0	0	19	1	0	20	0	0	6	0	6	9	23	0	0	32	
+45 mins.	0	0	0	0	0	0	14	1	0	15	1	0	8	0	9	6	19	0	0	25	
+50 mins.	0	0	0	0	0	0	16	0	0	16	1	0	3	0	4	12	28	0	0	40	
+55 mins.	0	0	0	0	0	0	17	2	0	19	0	0	6	0	6	11	36	0	0	47	
Total Volume	0	0	0	0	0	0	219	13	0	232	5	0	68	0	73	99	312	0	0	411	
% App. Total	0	0	0	0	0	0	94.4	5.6	0		6.8	0	93.2	0		24.1	75.9	0	0		
PHF	.000	.000	.000	.000	.000	.000	.702	.271	.000	.690	.417	.000	.630	.000	.676	.589	.722	.000	.000	.729	

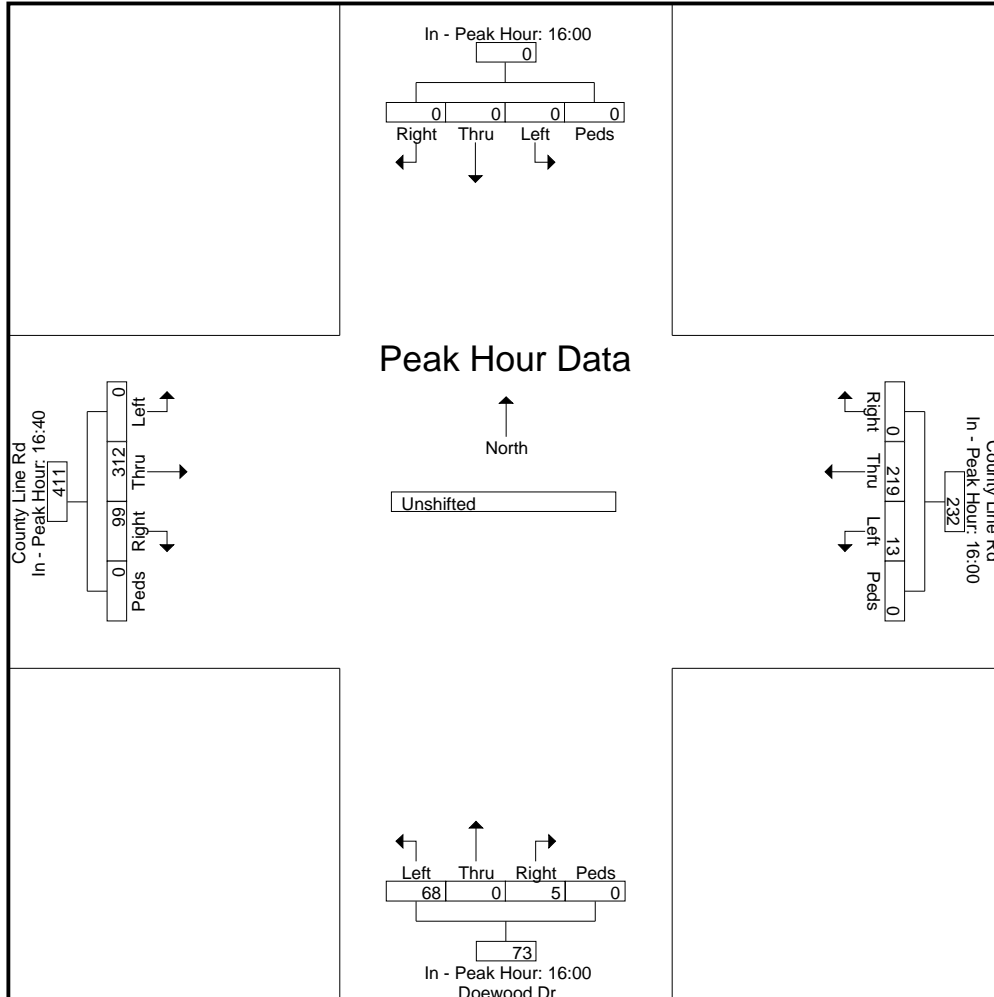

LSC Transportation Consultants, Inc.

2504 E. Pikes Peak Ave, Suite 304
 Colorado Springs, CO 80909
 719-633-2868

File Name : doewood dr - county line rd Pm
 Site Code : S234450
 Start Date : 6/18/2024
 Page No : 1

Groups Printed- Unshifted

Start Time	Southbound					County Line Rd Westbound					Doewood Dr Northbound					County Line Rd Eastbound					Int. Total
	Right	Thru	Left	Peds	App. Total	Right	Thru	Left	Peds	App. Total	Right	Thru	Left	Peds	App. Total	Right	Thru	Left	Peds	App. Total	
16:00	0	0	0	0	0	0	21	3	0	24	0	0	5	0	5	5	24	0	0	29	58
16:05	0	0	0	0	0	0	24	4	0	28	1	0	6	0	7	7	27	0	0	34	69
16:10	0	0	0	0	0	0	16	1	0	17	1	0	5	0	6	4	18	0	0	22	45
16:15	0	0	0	0	0	0	19	0	0	19	1	0	3	0	4	10	20	0	0	30	53
16:20	0	0	0	0	0	0	24	0	0	24	0	0	9	0	9	7	28	0	0	35	68
16:25	0	0	0	0	0	0	26	1	0	27	0	0	6	0	6	5	20	0	0	25	58
16:30	0	0	0	0	0	0	14	0	0	14	0	0	7	0	7	12	26	0	0	38	59
16:35	0	0	0	0	0	0	9	0	0	9	0	0	4	0	4	8	14	0	0	22	35
16:40	0	0	0	0	0	0	19	1	0	20	0	0	6	0	6	6	21	0	0	27	53
16:45	0	0	0	0	0	0	14	1	0	15	1	0	8	0	9	9	29	0	0	38	62
16:50	0	0	0	0	0	0	16	0	0	16	1	0	3	0	4	10	26	0	0	36	56
16:55	0	0	0	0	0	0	17	2	0	19	0	0	6	0	6	8	24	0	0	32	57
Total	0	0	0	0	0	0	219	13	0	232	5	0	68	0	73	91	277	0	0	368	673
17:00	0	0	0	0	0	0	11	2	0	13	0	0	4	0	4	7	31	0	0	38	55
17:05	0	0	0	0	0	0	17	1	0	18	0	0	5	0	5	4	28	0	0	32	55
17:10	0	0	0	0	0	0	23	0	0	23	0	0	2	0	2	3	29	0	0	32	57
17:15	0	0	0	0	0	0	20	0	0	20	0	0	6	0	6	14	18	0	0	32	58
17:20	0	0	0	0	0	0	10	0	0	10	3	0	4	0	7	9	23	0	0	32	49
17:25	0	0	0	0	0	0	18	1	0	19	0	0	8	0	8	6	19	0	0	25	52
17:30	0	0	0	0	0	0	17	0	0	17	1	0	2	0	3	12	28	0	0	40	60
17:35	0	0	0	0	0	0	18	1	0	19	0	0	8	0	8	11	36	0	0	47	74
17:40	0	0	0	0	0	0	13	0	0	13	0	0	2	0	2	6	16	0	0	22	37
17:45	0	0	0	0	0	0	11	1	0	12	1	0	2	0	3	6	28	0	0	34	49
17:50	0	0	0	0	0	0	7	0	0	7	0	0	5	0	5	8	26	0	0	34	46
17:55	0	0	0	0	0	0	19	0	0	19	0	0	3	0	3	7	20	0	0	27	49
Total	0	0	0	0	0	0	184	6	0	190	5	0	51	0	56	93	302	0	0	395	641
Grand Total	0	0	0	0	0	0	403	19	0	422	10	0	119	0	129	184	579	0	0	763	1314
Apprch %	0	0	0	0	0	0	95.5	4.5	0	422	7.8	0	92.2	0	129	24.1	75.9	0	0	763	1314
Total %	0	0	0	0	0	0	30.7	1.4	0	422	0.8	0	9.1	0	129	14	44.1	0	0	763	1314

LSC Transportation Consultants, Inc.

2504 E. Pikes Peak Ave, Suite 304
 Colorado Springs, CO 80909
 719-633-2868

File Name : doewood dr - county line rd Pm

Site Code : S234450

Start Date : 6/18/2024

Page No : 2

Start Time	Southbound					County Line Rd Westbound					Doewood Dr Northbound					County Line Rd Eastbound					Int. Total
	Right	Thru	Left	Peds	App. Total	Right	Thru	Left	Peds	App. Total	Right	Thru	Left	Peds	App. Total	Right	Thru	Left	Peds	App. Total	
Peak Hour Analysis From 16:00 to 17:55 - Peak 1 of 1																					
Peak Hour for Entire Intersection Begins at 16:40																					
16:40	0	0	0	0	0	0	19	1	0	20	0	0	6	0	6	6	21	0	0	27	53
16:45	0	0	0	0	0	0	14	1	0	15	1	0	8	0	9	9	29	0	0	38	62
16:50	0	0	0	0	0	0	16	0	0	16	1	0	3	0	4	10	26	0	0	36	56
16:55	0	0	0	0	0	0	17	2	0	19	0	0	6	0	6	8	24	0	0	32	57
17:00	0	0	0	0	0	0	11	2	0	13	0	0	4	0	4	7	31	0	0	38	55
17:05	0	0	0	0	0	0	17	1	0	18	0	0	5	0	5	4	28	0	0	32	55
17:10	0	0	0	0	0	0	23	0	0	23	0	0	2	0	2	3	29	0	0	32	57
17:15	0	0	0	0	0	0	20	0	0	20	0	0	6	0	6	14	18	0	0	32	58
17:20	0	0	0	0	0	0	10	0	0	10	3	0	4	0	7	9	23	0	0	32	49
17:25	0	0	0	0	0	0	18	1	0	19	0	0	8	0	8	6	19	0	0	25	52
17:30	0	0	0	0	0	0	17	0	0	17	1	0	2	0	3	12	28	0	0	40	60
17:35	0	0	0	0	0	0	18	1	0	19	0	0	8	0	8	11	36	0	0	47	74
Total Volume	0	0	0	0	0	0	200	9	0	209	6	0	62	0	68	99	312	0	0	411	688
% App. Total	0	0	0	0	0	0	95.7	4.3	0		8.8	0	91.2	0		24.1	75.9	0	0		
PHF	.000	.000	.000	.000	.000	.000	.725	.375	.000	.757	.167	.000	.646	.000	.630	.589	.722	.000	.000	.729	.775

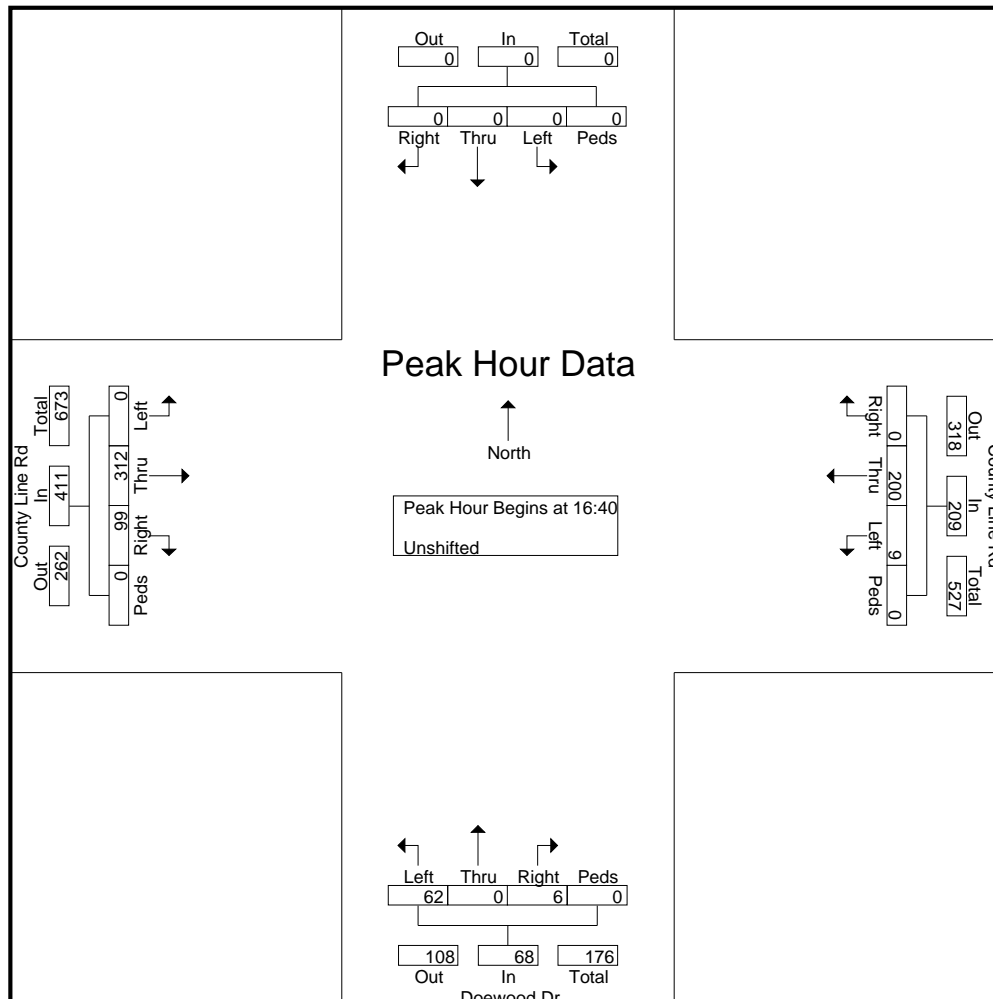

LSC Transportation Consultants, Inc.

2504 E. Pikes Peak Ave, Suite 304
 Colorado Springs, CO 80909
 719-633-2868

File Name : doewood dr - county line rd Pm
 Site Code : S234450
 Start Date : 6/18/2024
 Page No : 3

Start Time	Southbound					County Line Rd Westbound					Doewood Dr Northbound					County Line Rd Eastbound					Int. Total
	Right	Thru	Left	Peds	App. Total	Right	Thru	Left	Peds	App. Total	Right	Thru	Left	Peds	App. Total	Right	Thru	Left	Peds	App. Total	
Peak Hour Analysis From 16:00 to 17:55 - Peak 1 of 1																					
Peak Hour for Each Approach Begins at:																					
	16:00					16:00					16:00					16:40					
+0 mins.	0	0	0	0	0	0	21	3	0	24	0	0	5	0	5	6	21	0	0	27	
+5 mins.	0	0	0	0	0	0	24	4	0	28	1	0	6	0	7	9	29	0	0	38	
+10 mins.	0	0	0	0	0	0	16	1	0	17	1	0	5	0	6	10	26	0	0	36	
+15 mins.	0	0	0	0	0	0	19	0	0	19	1	0	3	0	4	8	24	0	0	32	
+20 mins.	0	0	0	0	0	0	24	0	0	24	0	0	9	0	9	7	31	0	0	38	
+25 mins.	0	0	0	0	0	0	26	1	0	27	0	0	6	0	6	4	28	0	0	32	
+30 mins.	0	0	0	0	0	0	14	0	0	14	0	0	7	0	7	3	29	0	0	32	
+35 mins.	0	0	0	0	0	0	9	0	0	9	0	0	4	0	4	14	18	0	0	32	
+40 mins.	0	0	0	0	0	0	19	1	0	20	0	0	6	0	6	9	23	0	0	32	
+45 mins.	0	0	0	0	0	0	14	1	0	15	1	0	8	0	9	6	19	0	0	25	
+50 mins.	0	0	0	0	0	0	16	0	0	16	1	0	3	0	4	12	28	0	0	40	
+55 mins.	0	0	0	0	0	0	17	2	0	19	0	0	6	0	6	11	36	0	0	47	
Total Volume	0	0	0	0	0	0	219	13	0	232	5	0	68	0	73	99	312	0	0	411	
% App. Total	0	0	0	0	0	0	94.4	5.6	0		6.8	0	93.2	0		24.1	75.9	0	0		
PHF	.000	.000	.000	.000	.000	.000	.702	.271	.000	.690	.417	.000	.630	.000	.676	.589	.722	.000	.000	.729	

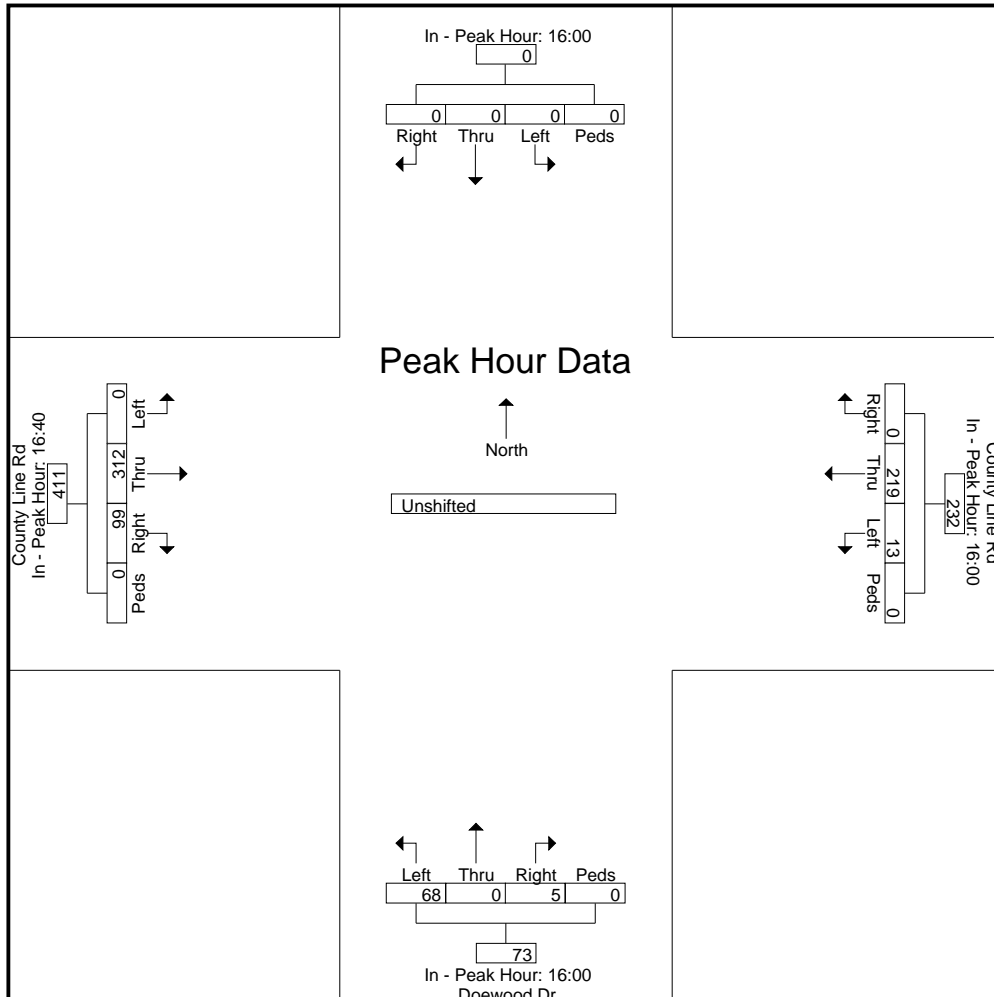

LSC Transportation Consultants, Inc.

2504 E. Pikes Peak Ave, Suite 304
 Colorado Springs, CO 80909
 719-633-2868

File Name : I-25 NB Ramps - County Line Rd AM

Site Code : S214862

Start Date : 1/18/2024

Page No : 1

Groups Printed- Unshifted

Start Time	I-25 NB On Ramp Southbound					County Line Rd Westbound					I-25 NB Off Ramp Northbound					County Line Rd Eastbound					Int. Total
	Right	Thru	Left	Peds	App. Total	Right	Thru	Left	Peds	App. Total	Right	Thru	Left	Peds	App. Total	Right	Thru	Left	Peds	App. Total	
06:30	0	0	0	0	0	14	21	0	0	35	0	1	0	0	1	0	3	5	0	8	44
06:35	0	0	0	0	0	21	13	0	0	34	1	0	2	0	3	0	4	9	0	13	50
06:40	0	0	0	0	0	21	13	0	0	34	4	0	0	0	4	0	4	4	0	8	46
06:45	0	0	0	0	0	19	14	0	0	33	0	0	3	0	3	0	6	3	0	9	45
06:50	0	0	0	0	0	15	5	0	0	20	2	0	2	0	4	0	5	3	0	8	32
06:55	0	0	0	0	0	22	10	0	0	32	3	0	3	0	6	0	13	2	0	15	53
Total	0	0	0	0	0	112	76	0	0	188	10	1	10	0	21	0	35	26	0	61	270
07:00	0	0	0	0	0	19	13	0	0	32	1	0	1	0	2	0	8	5	0	13	47
07:05	0	0	0	0	0	17	26	0	0	43	2	0	0	0	2	0	12	4	0	16	61
07:10	0	0	0	0	0	24	20	0	0	44	3	0	3	0	6	0	7	2	0	9	59
07:15	0	0	0	0	0	10	19	0	0	29	7	0	6	0	13	0	12	5	0	17	59
07:20	0	0	0	0	0	18	32	0	0	50	3	0	3	0	6	0	13	0	0	13	69
07:25	0	0	0	0	0	18	26	0	0	44	2	0	3	0	5	0	15	3	0	18	67
07:30	0	0	0	0	0	24	42	0	0	66	1	1	1	0	3	0	8	1	0	9	78
07:35	0	0	0	0	0	16	24	0	0	40	2	0	2	0	4	0	9	3	0	12	56
07:40	0	0	0	0	0	18	30	0	0	48	1	0	6	0	7	0	10	3	0	13	68
07:45	0	0	0	0	0	20	32	0	0	52	7	0	2	0	9	0	9	4	0	13	74
07:50	0	0	0	0	0	19	19	0	0	38	7	0	3	0	10	0	10	6	0	16	64
07:55	0	0	0	0	0	11	14	0	0	25	7	0	6	0	13	0	9	3	0	12	50
Total	0	0	0	0	0	214	297	0	0	511	43	1	36	0	80	0	122	39	0	161	752
08:00	0	0	0	0	0	18	18	0	0	36	5	0	4	0	9	0	7	2	0	9	54
08:05	0	0	0	0	0	14	29	0	0	43	5	0	7	0	12	0	5	3	0	8	63
08:10	0	0	0	0	0	21	19	0	0	40	5	0	3	0	8	0	10	1	0	11	59
08:15	0	0	0	0	0	10	11	0	0	21	5	0	4	0	9	0	5	8	0	13	43
08:20	0	0	0	0	0	14	14	0	0	28	9	1	5	0	15	0	8	4	0	12	55
08:25	0	0	0	0	0	21	20	0	0	41	10	0	4	0	14	0	4	3	0	7	62
Grand Total	0	0	0	0	0	424	484	0	0	908	92	3	73	0	168	0	196	86	0	282	1358
Apprch %	0	0	0	0	0	46.7	53.3	0	0		54.8	1.8	43.5	0		0	69.5	30.5	0		
Total %	0	0	0	0	0	31.2	35.6	0	0	66.9	6.8	0.2	5.4	0	12.4	0	14.4	6.3	0	20.8	

LSC Transportation Consultants, Inc.

2504 E. Pikes Peak Ave, Suite 304
 Colorado Springs, CO 80909
 719-633-2868

File Name : I-25 NB Ramps - County Line Rd AM

Site Code : S214862

Start Date : 1/18/2024

Page No : 2

Start Time	I-25 NB On Ramp Southbound					County Line Rd Westbound					I-25 NB Off Ramp Northbound					County Line Rd Eastbound					Int. Total
	Right	Thru	Left	Peds	App. Total	Right	Thru	Left	Peds	App. Total	Right	Thru	Left	Peds	App. Total	Right	Thru	Left	Peds	App. Total	
Peak Hour Analysis From 06:30 to 08:25 - Peak 1 of 1																					
Peak Hour for Entire Intersection Begins at 07:10																					
07:10	0	0	0	0	0	24	20	0	0	44	3	0	3	0	6	0	7	2	0	9	59
07:15	0	0	0	0	0	10	19	0	0	29	7	0	6	0	13	0	12	5	0	17	59
07:20	0	0	0	0	0	18	32	0	0	50	3	0	3	0	6	0	13	0	0	13	69
07:25	0	0	0	0	0	18	26	0	0	44	2	0	3	0	5	0	15	3	0	18	67
07:30	0	0	0	0	0	24	42	0	0	66	1	1	1	0	3	0	8	1	0	9	78
07:35	0	0	0	0	0	16	24	0	0	40	2	0	2	0	4	0	9	3	0	12	56
07:40	0	0	0	0	0	18	30	0	0	48	1	0	6	0	7	0	10	3	0	13	68
07:45	0	0	0	0	0	20	32	0	0	52	7	0	2	0	9	0	9	4	0	13	74
07:50	0	0	0	0	0	19	19	0	0	38	7	0	3	0	10	0	10	6	0	16	64
07:55	0	0	0	0	0	11	14	0	0	25	7	0	6	0	13	0	9	3	0	12	50
08:00	0	0	0	0	0	18	18	0	0	36	5	0	4	0	9	0	7	2	0	9	54
08:05	0	0	0	0	0	14	29	0	0	43	5	0	7	0	12	0	5	3	0	8	63
Total Volume	0	0	0	0	0	210	305	0	0	515	50	1	46	0	97	0	114	35	0	149	761
% App. Total	0	0	0	0	0	40.8	59.2	0	0		51.5	1	47.4	0		0	76.5	23.5	0		
PHF	.000	.000	.000	.000	.000	.729	.605	.000	.000	.650	.595	.083	.548	.000	.622	.000	.633	.486	.000	.690	.813

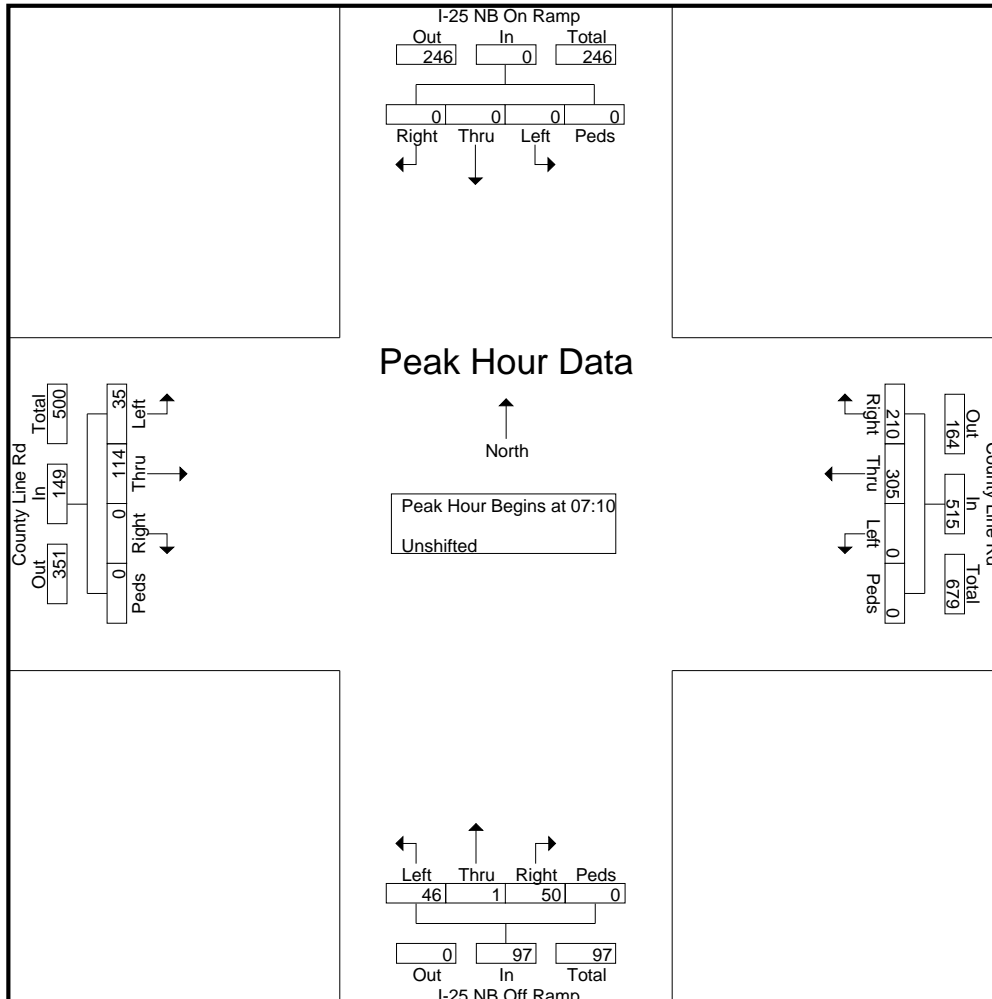

LSC Transportation Consultants, Inc.

2504 E. Pikes Peak Ave, Suite 304
 Colorado Springs, CO 80909
 719-633-2868

File Name : I-25 NB Ramps - County Line Rd AM

Site Code : S214862

Start Date : 1/18/2024

Page No : 3

Start Time	I-25 NB On Ramp Southbound					County Line Rd Westbound					I-25 NB Off Ramp Northbound					County Line Rd Eastbound					Int. Total
	Right	Thru	Left	Peds	App. Total	Right	Thru	Left	Peds	App. Total	Right	Thru	Left	Peds	App. Total	Right	Thru	Left	Peds	App. Total	

Peak Hour Analysis From 06:30 to 08:25 - Peak 1 of 1

Peak Hour for Each Approach Begins at:

	06:30					06:55					07:30					06:55				
+0 mins.	0	0	0	0	0	22	10	0	0	32	1	1	1	0	3	0	13	2	0	15
+5 mins.	0	0	0	0	0	19	13	0	0	32	2	0	2	0	4	0	8	5	0	13
+10 mins.	0	0	0	0	0	17	26	0	0	43	1	0	6	0	7	0	12	4	0	16
+15 mins.	0	0	0	0	0	24	20	0	0	44	7	0	2	0	9	0	7	2	0	9
+20 mins.	0	0	0	0	0	10	19	0	0	29	7	0	3	0	10	0	12	5	0	17
+25 mins.	0	0	0	0	0	18	32	0	0	50	7	0	6	0	13	0	13	0	0	13
+30 mins.	0	0	0	0	0	18	26	0	0	44	5	0	4	0	9	0	15	3	0	18
+35 mins.	0	0	0	0	0	24	42	0	0	66	5	0	7	0	12	0	8	1	0	9
+40 mins.	0	0	0	0	0	16	24	0	0	40	5	0	3	0	8	0	9	3	0	12
+45 mins.	0	0	0	0	0	18	30	0	0	48	5	0	4	0	9	0	10	3	0	13
+50 mins.	0	0	0	0	0	20	32	0	0	52	9	1	5	0	15	0	9	4	0	13
+55 mins.	0	0	0	0	0	19	19	0	0	38	10	0	4	0	14	0	10	6	0	16
Total Volume	0	0	0	0	0	225	293	0	0	518	64	2	47	0	113	0	126	38	0	164
% App. Total	0	0	0	0	0	43.4	56.6	0	0		56.6	1.8	41.6	0		0	76.8	23.2	0	
PHF	.000	.000	.000	.000	.000	.781	.581	.000	.000	.654	.533	.167	.560	.000	.628	.000	.700	.528	.000	.759

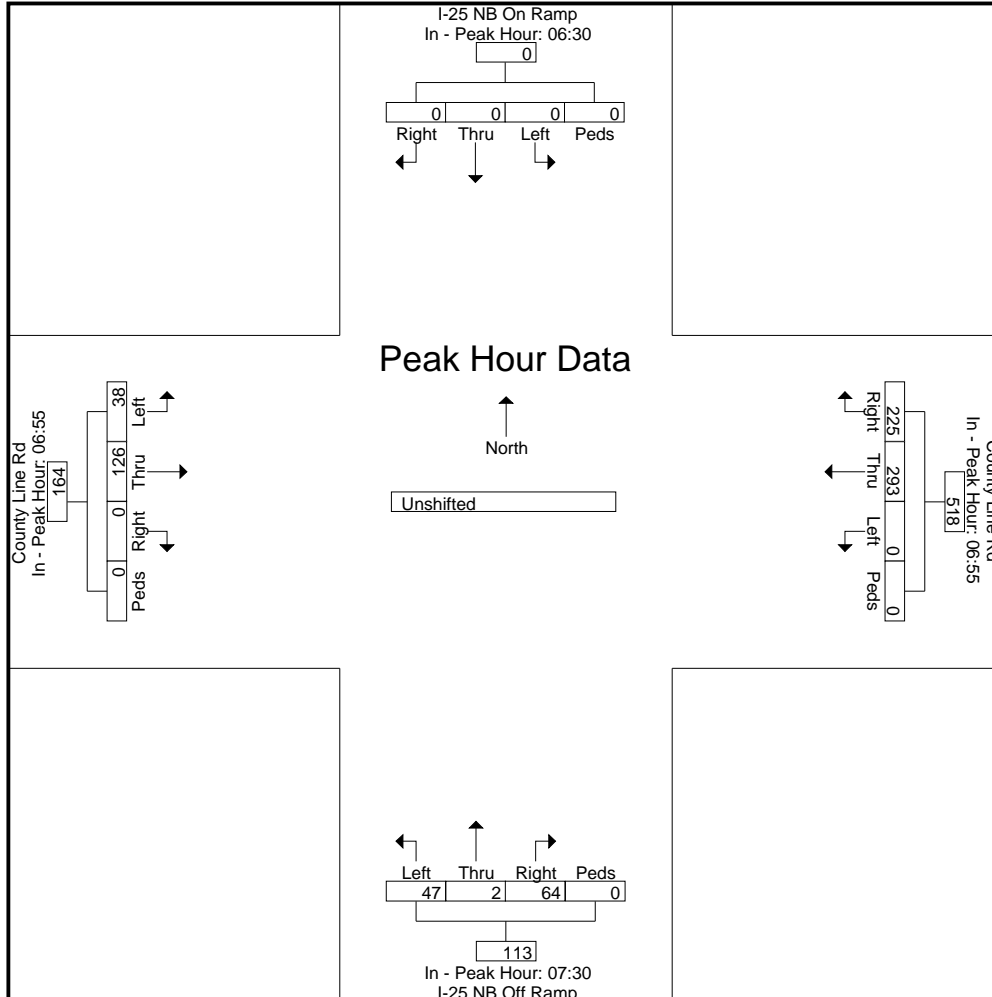

LSC Transportation Consultants, Inc.

2504 E. Pikes Peak Ave, Suite 304
 Colorado Springs, CO 80909
 719-633-2868

File Name : I-25 NB Ramps - County Line Rd PM

Site Code : S214862

Start Date : 1/17/2024

Page No : 1

Groups Printed- Unshifted

Start Time	I-25 NB On Ramp Southbound					County Line Rd Westbound					I-25 NB Off Ramp Northbound					County Line Rd Eastbound					Int. Total
	Right	Thru	Left	Peds	App. Total	Right	Thru	Left	Peds	App. Total	Right	Thru	Left	Peds	App. Total	Right	Thru	Left	Peds	App. Total	
16:00	0	0	0	0	0	5	14	0	0	19	14	0	4	0	18	0	12	0	0	12	49
16:05	0	0	0	0	0	6	16	0	0	22	11	0	4	0	15	0	21	2	0	23	60
16:10	0	0	0	0	0	2	10	0	0	12	11	0	4	0	15	0	16	2	0	18	45
16:15	0	0	0	0	0	8	15	0	0	23	15	0	5	0	20	0	15	3	0	18	61
16:20	0	0	0	0	0	3	18	0	0	21	9	0	8	0	17	0	18	1	0	19	57
16:25	0	0	0	0	0	5	8	0	0	13	8	0	1	0	9	0	35	2	0	37	59
16:30	0	0	0	0	0	5	5	0	0	10	7	0	3	0	10	0	16	1	0	17	37
16:35	0	0	0	0	0	3	14	0	0	17	13	0	5	0	18	0	19	3	0	22	57
16:40	0	0	0	0	0	6	15	0	0	21	15	0	5	0	20	0	18	2	0	20	61
16:45	0	0	0	0	0	8	8	0	0	16	17	1	3	0	21	0	24	5	0	29	66
16:50	0	0	0	0	0	7	7	0	0	14	19	0	5	0	24	0	23	1	0	24	62
16:55	0	0	0	0	0	2	9	0	0	11	9	0	0	0	9	0	21	1	0	22	42
Total	0	0	0	0	0	60	139	0	0	199	148	1	47	0	196	0	238	23	0	261	656
17:00	0	0	0	0	0	4	12	0	0	16	13	0	6	0	19	0	22	0	0	22	57
17:05	0	0	0	0	0	8	18	0	0	26	9	0	2	0	11	0	25	1	0	26	63
17:10	0	0	0	0	0	12	9	0	0	21	8	0	6	0	14	0	20	3	0	23	58
17:15	0	0	0	0	0	5	7	0	0	12	14	0	3	0	17	0	12	3	0	15	44
17:20	0	0	0	0	0	8	6	0	0	14	13	0	2	0	15	0	30	2	0	32	61
17:25	0	0	0	0	0	11	9	0	0	20	15	1	4	0	20	0	20	1	0	21	61
17:30	0	0	0	0	0	6	8	0	0	14	10	0	4	1	15	0	25	1	0	26	55
17:35	0	0	0	0	0	7	8	0	0	15	8	0	11	0	19	0	21	1	0	22	56
17:40	0	0	0	0	0	1	10	0	0	11	17	0	3	0	20	0	17	1	0	18	49
17:45	0	0	0	0	0	9	3	0	0	12	21	0	3	0	24	0	16	1	0	17	53
17:50	0	0	0	0	0	8	10	0	0	18	9	0	7	0	16	0	23	2	0	25	59
17:55	0	0	0	0	0	9	12	0	0	21	6	0	3	0	9	0	29	2	0	31	61
Total	0	0	0	0	0	88	112	0	0	200	143	1	54	1	199	0	260	18	0	278	677
Grand Total	0	0	0	0	0	148	251	0	0	399	291	2	101	1	395	0	498	41	0	539	1333
Apprch %	0	0	0	0	0	37.1	62.9	0	0	39.9	73.7	0.5	25.6	0.3	39.5	0	92.4	7.6	0	53.9	133.3
Total %	0	0	0	0	0	11.1	18.8	0	0	29.9	21.8	0.2	7.6	0.1	29.6	0	37.4	3.1	0	40.4	67.7

LSC Transportation Consultants, Inc.

2504 E. Pikes Peak Ave, Suite 304
 Colorado Springs, CO 80909
 719-633-2868

File Name : I-25 NB Ramps - County Line Rd PM

Site Code : S214862

Start Date : 1/17/2024

Page No : 2

Start Time	I-25 NB On Ramp Southbound					County Line Rd Westbound					I-25 NB Off Ramp Northbound					County Line Rd Eastbound					Int. Total
	Right	Thru	Left	Peds	App. Total	Right	Thru	Left	Peds	App. Total	Right	Thru	Left	Peds	App. Total	Right	Thru	Left	Peds	App. Total	
Peak Hour Analysis From 16:00 to 17:55 - Peak 1 of 1																					
Peak Hour for Entire Intersection Begins at 16:35																					
16:35	0	0	0	0	0	3	14	0	0	17	13	0	5	0	18	0	19	3	0	22	57
16:40	0	0	0	0	0	6	15	0	0	21	15	0	5	0	20	0	18	2	0	20	61
16:45	0	0	0	0	0	8	8	0	0	16	17	1	3	0	21	0	24	5	0	29	66
16:50	0	0	0	0	0	7	7	0	0	14	19	0	5	0	24	0	23	1	0	24	62
16:55	0	0	0	0	0	2	9	0	0	11	9	0	0	0	9	0	21	1	0	22	42
17:00	0	0	0	0	0	4	12	0	0	16	13	0	6	0	19	0	22	0	0	22	57
17:05	0	0	0	0	0	8	18	0	0	26	9	0	2	0	11	0	25	1	0	26	63
17:10	0	0	0	0	0	12	9	0	0	21	8	0	6	0	14	0	20	3	0	23	58
17:15	0	0	0	0	0	5	7	0	0	12	14	0	3	0	17	0	12	3	0	15	44
17:20	0	0	0	0	0	8	6	0	0	14	13	0	2	0	15	0	30	2	0	32	61
17:25	0	0	0	0	0	11	9	0	0	20	15	1	4	0	20	0	20	1	0	21	61
17:30	0	0	0	0	0	6	8	0	0	14	10	0	4	1	15	0	25	1	0	26	55
Total Volume	0	0	0	0	0	80	122	0	0	202	155	2	45	1	203	0	259	23	0	282	687
% App. Total	0	0	0	0	0	39.6	60.4	0	0		76.4	1	22.2	0.5		0	91.8	8.2	0		
PHF	.000	.000	.000	.000	.000	.556	.565	.000	.000	.647	.680	.167	.625	.083	.705	.000	.719	.383	.000	.734	.867

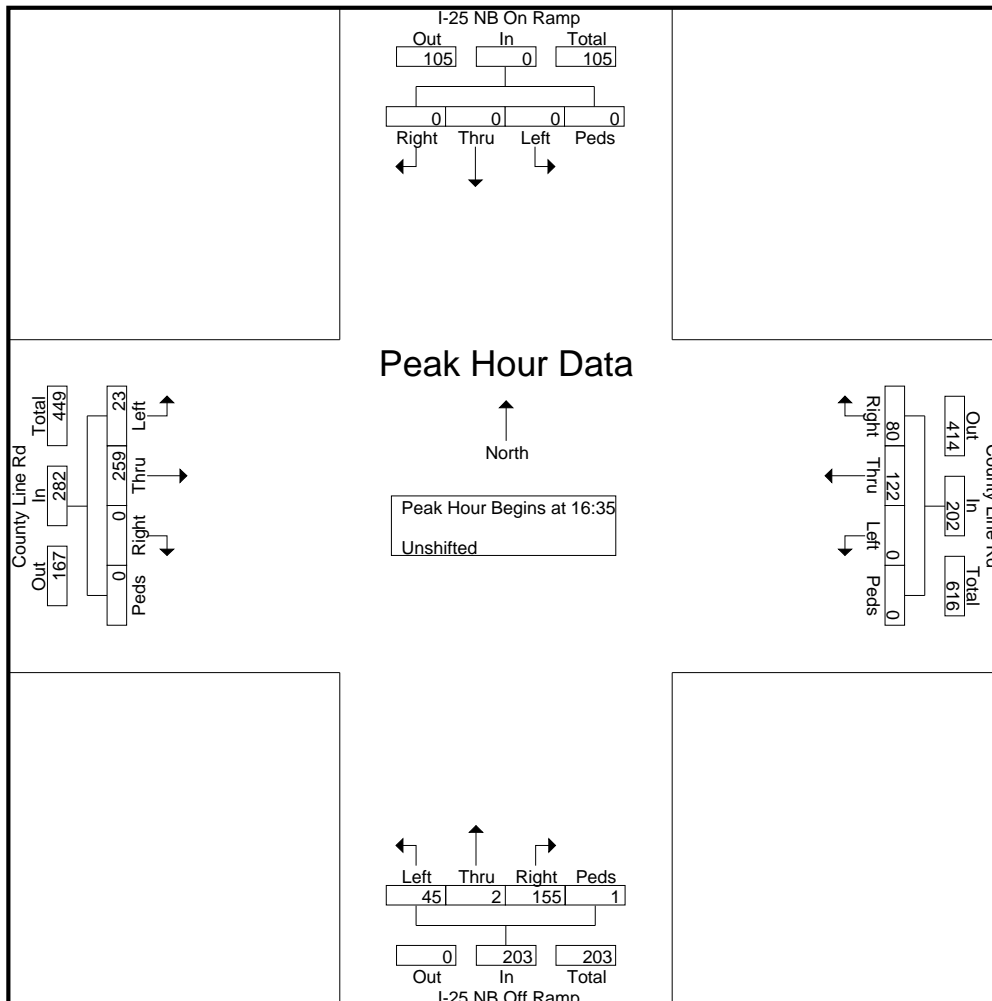

LSC Transportation Consultants, Inc.

2504 E. Pikes Peak Ave, Suite 304
 Colorado Springs, CO 80909
 719-633-2868

File Name : I-25 NB Ramps - County Line Rd PM
 Site Code : S214862
 Start Date : 1/17/2024
 Page No : 3

Start Time	I-25 NB On Ramp Southbound					County Line Rd Westbound					I-25 NB Off Ramp Northbound					County Line Rd Eastbound					Int. Total
	Right	Thru	Left	Peds	App. Total	Right	Thru	Left	Peds	App. Total	Right	Thru	Left	Peds	App. Total	Right	Thru	Left	Peds	App. Total	

Peak Hour Analysis From 16:00 to 17:55 - Peak 1 of 1
 Peak Hour for Each Approach Begins at:

	16:00					16:15					16:50					16:25				
+0 mins.	0	0	0	0	0	8	15	0	0	23	19	0	5	0	24	0	35	2	0	37
+5 mins.	0	0	0	0	0	3	18	0	0	21	9	0	0	0	9	0	16	1	0	17
+10 mins.	0	0	0	0	0	5	8	0	0	13	13	0	6	0	19	0	19	3	0	22
+15 mins.	0	0	0	0	0	5	5	0	0	10	9	0	2	0	11	0	18	2	0	20
+20 mins.	0	0	0	0	0	3	14	0	0	17	8	0	6	0	14	0	24	5	0	29
+25 mins.	0	0	0	0	0	6	15	0	0	21	14	0	3	0	17	0	23	1	0	24
+30 mins.	0	0	0	0	0	8	8	0	0	16	13	0	2	0	15	0	21	1	0	22
+35 mins.	0	0	0	0	0	7	7	0	0	14	15	1	4	0	20	0	22	0	0	22
+40 mins.	0	0	0	0	0	2	9	0	0	11	10	0	4	1	15	0	25	1	0	26
+45 mins.	0	0	0	0	0	4	12	0	0	16	8	0	11	0	19	0	20	3	0	23
+50 mins.	0	0	0	0	0	8	18	0	0	26	17	0	3	0	20	0	12	3	0	15
+55 mins.	0	0	0	0	0	12	9	0	0	21	21	0	3	0	24	0	30	2	0	32
Total Volume	0	0	0	0	0	71	138	0	0	209	156	1	49	1	207	0	265	24	0	289
% App. Total	0	0	0	0	0	34	66	0	0		75.4	0.5	23.7	0.5		0	91.7	8.3	0	
PHF	.000	.000	.000	.000	.000	.493	.639	.000	.000	.670	.619	.083	.371	.083	.719	.000	.631	.400	.000	.651

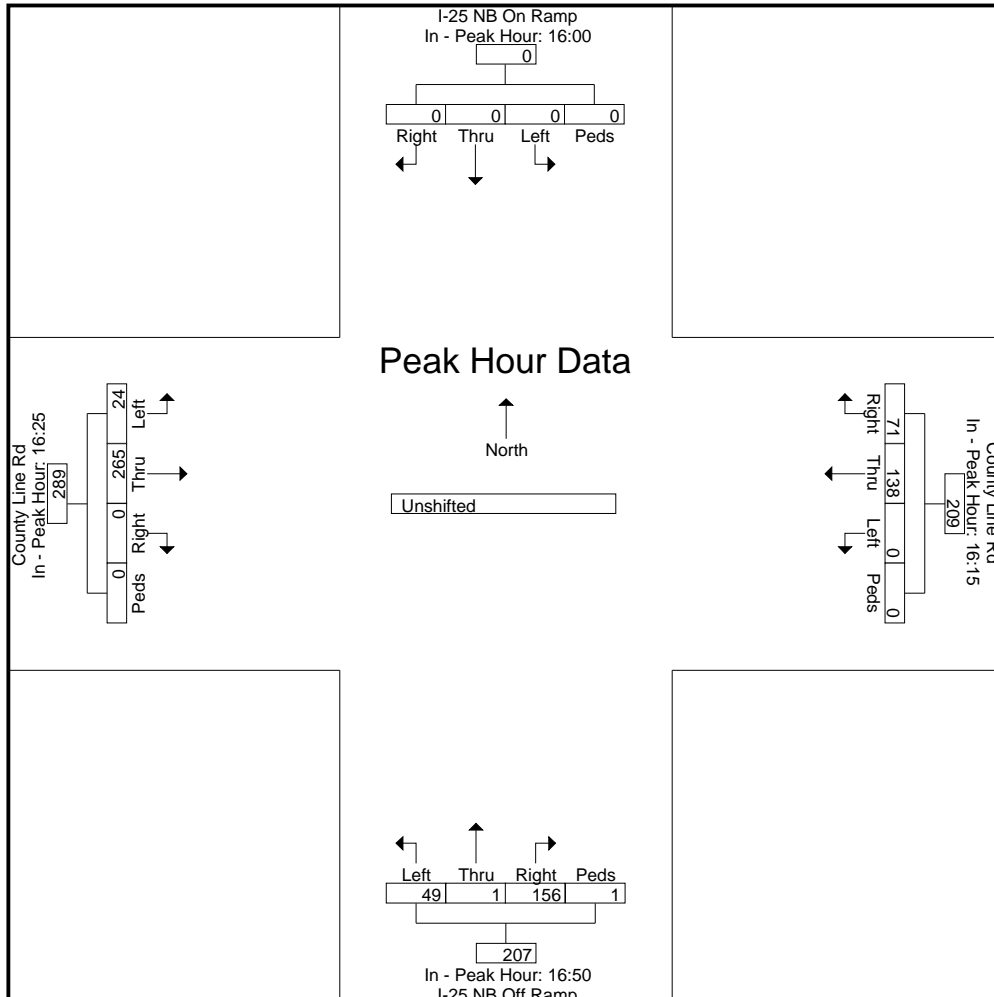

LSC Transportation Consultants, Inc.

2504 E. Pikes Peak Ave, Suite 304
 Colorado Springs, CO 80909
 719-633-2868

File Name : I-25 SB Ramps - County Line Rd AM

Site Code : S214862

Start Date : 1/18/2024

Page No : 1

Groups Printed- Bank 1

Start Time	I-25 SB Off Ramp Southbound					County Line Rd Westbound					I-25 SB On Ramp Northbound					County Line Rd Eastbound					Int. Total
	Right	Thru	Left	Peds	App. Total	Right	Thru	Left	Peds	App. Total	Right	Thru	Left	Peds	App. Total	Right	Thru	Left	Peds	App. Total	
06:30	0	0	3	0	3	0	4	14	0	18	0	0	0	0	0	2	6	0	0	8	29
06:35	0	0	3	0	3	0	3	13	0	16	0	0	0	0	0	2	9	0	0	11	30
06:40	0	0	3	0	3	0	2	11	0	13	0	0	0	0	0	3	5	0	0	8	24
06:45	1	0	6	0	7	0	3	13	0	16	0	0	0	0	0	5	2	0	0	7	30
06:50	0	0	1	0	1	0	2	5	0	7	0	0	0	0	0	2	6	0	0	8	16
06:55	0	0	7	0	7	0	3	9	0	12	0	0	0	0	0	2	9	0	0	11	30
Total	1	0	23	0	24	0	17	65	0	82	0	0	0	0	0	16	37	0	0	53	159
07:00	1	1	2	0	4	0	2	11	0	13	0	0	0	0	0	2	9	0	0	11	28
07:05	0	0	6	0	6	0	3	23	0	26	0	0	0	0	0	4	11	0	0	15	47
07:10	0	0	4	0	4	0	6	17	0	23	0	0	0	0	0	2	3	0	0	5	32
07:15	2	1	3	0	6	0	6	17	0	23	0	0	0	0	0	3	14	0	0	17	46
07:20	0	0	3	0	3	0	6	30	0	36	0	0	0	0	0	5	14	0	0	19	58
07:25	0	0	6	0	6	0	13	20	0	33	0	0	0	0	0	4	17	0	0	21	60
07:30	1	0	7	0	8	0	10	34	0	44	0	0	0	0	0	6	3	0	0	9	61
07:35	1	0	5	0	6	0	9	20	0	29	0	0	0	0	0	3	8	0	0	11	46
07:40	1	0	8	0	9	0	11	24	0	35	0	0	0	0	0	10	6	0	0	16	60
07:45	1	0	6	0	7	0	7	25	0	32	0	0	0	0	0	3	8	0	0	11	50
07:50	1	0	8	0	9	0	9	14	0	23	0	0	0	0	0	2	7	0	0	9	41
07:55	1	0	9	0	10	0	10	10	0	20	0	0	0	0	0	1	3	0	0	4	34
Total	9	2	67	0	78	0	92	245	0	337	0	0	0	0	0	45	103	0	0	148	563
08:00	1	0	2	0	3	0	7	15	0	22	0	0	0	0	0	4	8	0	0	12	37
08:05	3	0	2	0	5	0	11	26	0	37	0	0	0	0	0	4	4	0	0	8	50
08:10	1	0	4	0	5	0	5	18	0	23	0	0	0	0	0	1	6	0	0	7	35
08:15	1	0	3	0	4	0	7	7	0	14	0	0	0	0	0	4	6	0	0	10	28
08:20	1	1	4	0	6	0	8	10	0	18	0	0	0	0	0	4	7	0	0	11	35
08:25	0	0	2	0	2	0	7	17	0	24	0	0	0	0	0	3	6	0	0	9	35
Grand Total	17	3	107	0	127	0	154	403	0	557	0	0	0	0	0	81	177	0	0	258	942
Apprch %	13.4	2.4	84.3	0		0	27.6	72.4	0		0	0	0	0		31.4	68.6	0	0		
Total %	1.8	0.3	11.4	0	13.5	0	16.3	42.8	0	59.1	0	0	0	0	0	8.6	18.8	0	0	27.4	

LSC Transportation Consultants, Inc.

2504 E. Pikes Peak Ave, Suite 304
 Colorado Springs, CO 80909
 719-633-2868

File Name : I-25 SB Ramps - County Line Rd AM

Site Code : S214862

Start Date : 1/18/2024

Page No : 2

Start Time	I-25 SB Off Ramp Southbound					County Line Rd Westbound					I-25 SB On Ramp Northbound					County Line Rd Eastbound					Int. Total
	Right	Thru	Left	Peds	App. Total	Right	Thru	Left	Peds	App. Total	Right	Thru	Left	Peds	App. Total	Right	Thru	Left	Peds	App. Total	
Peak Hour Analysis From 06:30 to 08:25 - Peak 1 of 1																					
Peak Hour for Entire Intersection Begins at 07:15																					
07:15	2	1	3	0	6	0	6	17	0	23	0	0	0	0	0	3	14	0	0	17	46
07:20	0	0	3	0	3	0	6	30	0	36	0	0	0	0	0	5	14	0	0	19	58
07:25	0	0	6	0	6	0	13	20	0	33	0	0	0	0	0	4	17	0	0	21	60
07:30	1	0	7	0	8	0	10	34	0	44	0	0	0	0	0	6	3	0	0	9	61
07:35	1	0	5	0	6	0	9	20	0	29	0	0	0	0	0	3	8	0	0	11	46
07:40	1	0	8	0	9	0	11	24	0	35	0	0	0	0	0	10	6	0	0	16	60
07:45	1	0	6	0	7	0	7	25	0	32	0	0	0	0	0	3	8	0	0	11	50
07:50	1	0	8	0	9	0	9	14	0	23	0	0	0	0	0	2	7	0	0	9	41
07:55	1	0	9	0	10	0	10	10	0	20	0	0	0	0	0	1	3	0	0	4	34
08:00	1	0	2	0	3	0	7	15	0	22	0	0	0	0	0	4	8	0	0	12	37
08:05	3	0	2	0	5	0	11	26	0	37	0	0	0	0	0	4	4	0	0	8	50
08:10	1	0	4	0	5	0	5	18	0	23	0	0	0	0	0	1	6	0	0	7	35
Total Volume	13	1	63	0	77	0	104	253	0	357	0	0	0	0	0	46	98	0	0	144	578
% App. Total	16.9	1.3	81.8	0		0	29.1	70.9	0		0	0	0	0		31.9	68.1	0	0		
PHF	.361	.083	.583	.000	.642	.000	.667	.620	.000	.676	.000	.000	.000	.000	.000	.383	.480	.000	.000	.571	.790

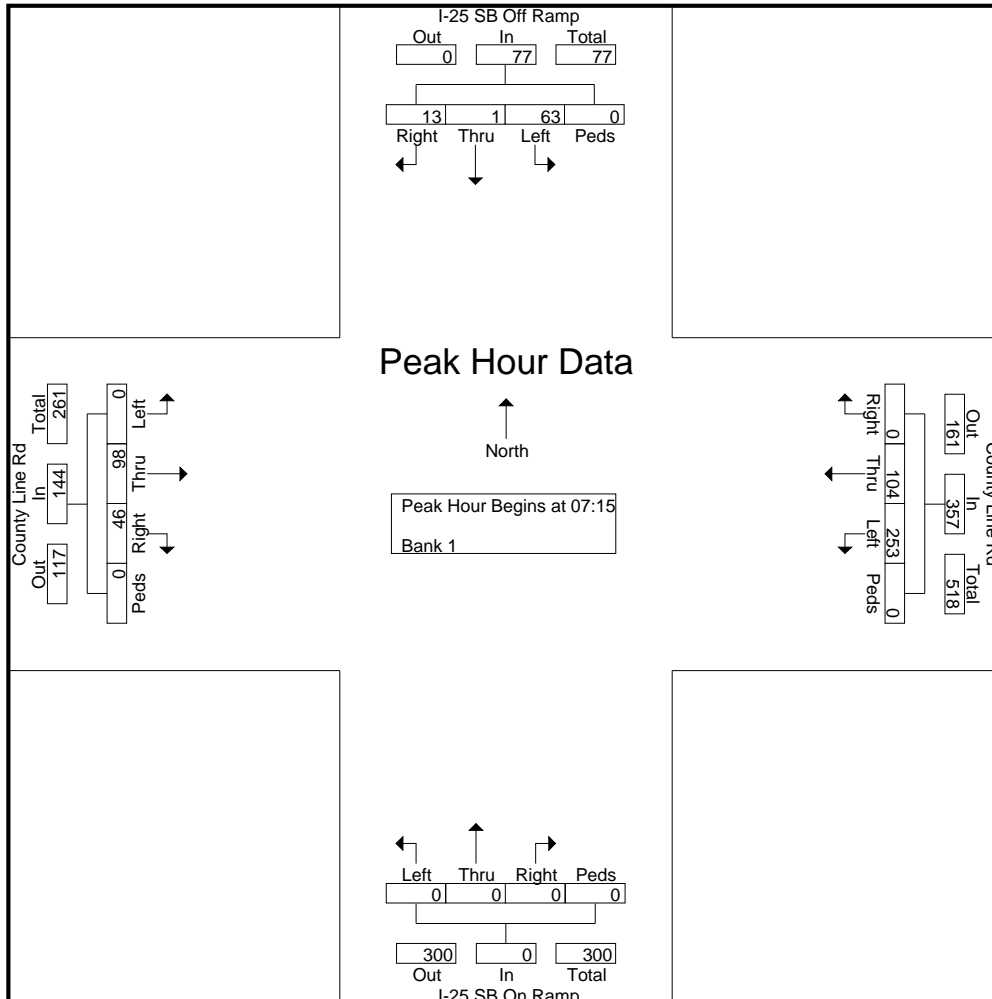

LSC Transportation Consultants, Inc.

2504 E. Pikes Peak Ave, Suite 304
 Colorado Springs, CO 80909
 719-633-2868

File Name : I-25 SB Ramps - County Line Rd AM
 Site Code : S214862
 Start Date : 1/18/2024
 Page No : 3

	I-25 SB Off Ramp Southbound					County Line Rd Westbound					I-25 SB On Ramp Northbound					County Line Rd Eastbound					Int. Total
	Right	Thru	Left	Peds	App. Total	Right	Thru	Left	Peds	App. Total	Right	Thru	Left	Peds	App. Total	Right	Thru	Left	Peds	App. Total	
Peak Hour Analysis From 06:30 to 08:25 - Peak 1 of 1																					
Peak Hour for Each Approach Begins at:																					
	07:00					07:10					06:30					06:55					
+0 mins.	1	1	2	0	4	0	6	17	0	23	0	0	0	0	0	2	9	0	0	11	
+5 mins.	0	0	6	0	6	0	6	17	0	23	0	0	0	0	0	2	9	0	0	11	
+10 mins.	0	0	4	0	4	0	6	30	0	36	0	0	0	0	0	4	11	0	0	15	
+15 mins.	2	1	3	0	6	0	13	20	0	33	0	0	0	0	0	2	3	0	0	5	
+20 mins.	0	0	3	0	3	0	10	34	0	44	0	0	0	0	0	3	14	0	0	17	
+25 mins.	0	0	6	0	6	0	9	20	0	29	0	0	0	0	0	5	14	0	0	19	
+30 mins.	1	0	7	0	8	0	11	24	0	35	0	0	0	0	0	4	17	0	0	21	
+35 mins.	1	0	5	0	6	0	7	25	0	32	0	0	0	0	0	6	3	0	0	9	
+40 mins.	1	0	8	0	9	0	9	14	0	23	0	0	0	0	0	3	8	0	0	11	
+45 mins.	1	0	6	0	7	0	10	10	0	20	0	0	0	0	0	10	6	0	0	16	
+50 mins.	1	0	8	0	9	0	7	15	0	22	0	0	0	0	0	3	8	0	0	11	
+55 mins.	1	0	9	0	10	0	11	26	0	37	0	0	0	0	0	2	7	0	0	9	
Total Volume	9	2	67	0	78	0	105	252	0	357	0	0	0	0	0	46	109	0	0	155	
% App. Total	11.5	2.6	85.9	0		0	29.4	70.6	0		0	0	0	0		29.7	70.3	0	0		
PHF	.375	.167	.620	.000	.650	.000	.673	.618	.000	.676	.000	.000	.000	.000	.000	.383	.534	.000	.000	.615	

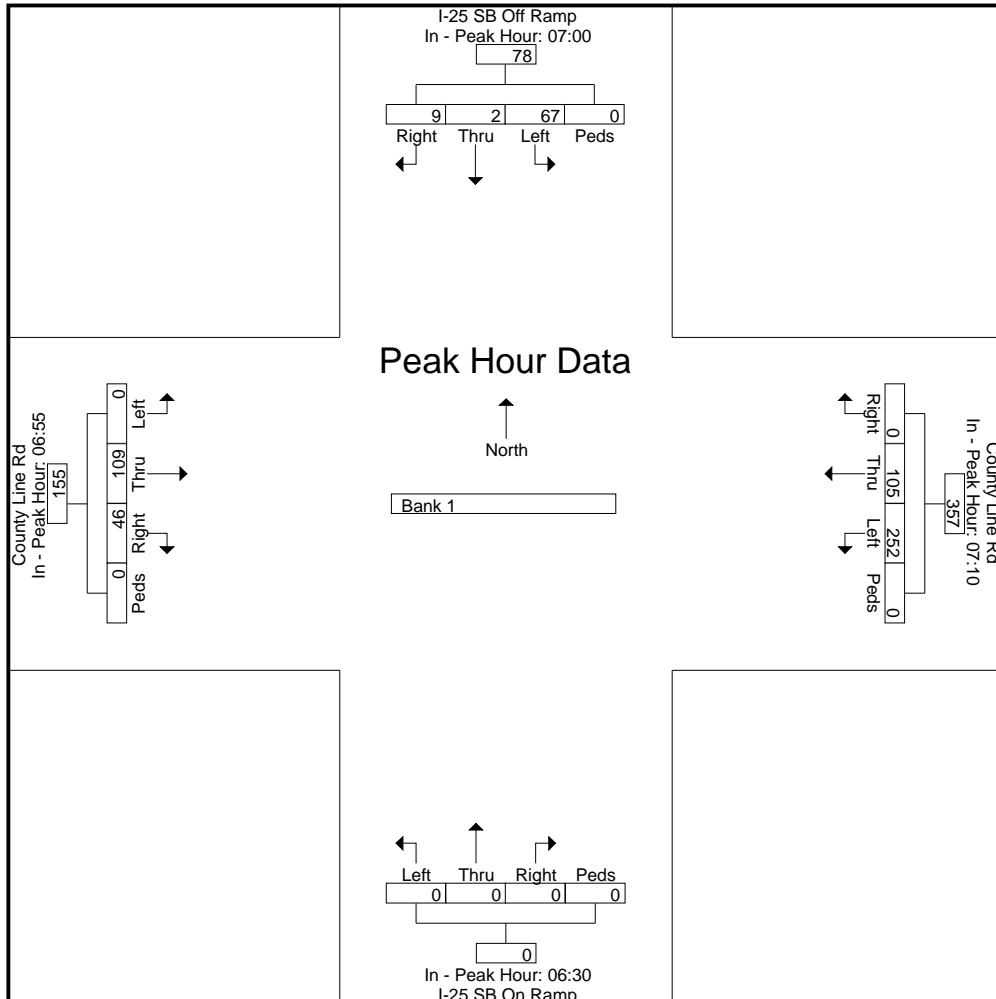

LSC Transportation Consultants, Inc.

2504 E. Pikes Peak Ave, Suite 304
 Colorado Springs, CO 80909
 719-633-2868

File Name : I-25 SB Ramps - County Line Rd PM

Site Code : S214862

Start Date : 1/17/2024

Page No : 1

Groups Printed- Bank 1

Start Time	I-25 SB Off Ramp Southbound					County Line Rd Westbound					I-25 SB On Ramp Northbound					County Line Rd Eastbound					Int. Total
	Right	Thru	Left	Peds	App. Total	Right	Thru	Left	Peds	App. Total	Right	Thru	Left	Peds	App. Total	Right	Thru	Left	Peds	App. Total	
16:00	1	0	10	0	11	0	9	7	0	16	0	0	0	0	0	3	5	0	0	8	35
16:05	5	0	15	0	20	0	6	12	0	18	0	0	0	0	0	6	12	1	0	19	57
16:10	1	0	15	0	16	0	6	10	0	16	0	0	0	0	0	3	4	1	0	8	40
16:15	2	0	12	0	14	0	8	12	0	20	0	0	0	0	0	3	5	0	0	8	42
16:20	4	0	18	0	22	0	14	10	0	24	0	0	0	0	0	8	5	0	0	13	59
16:25	3	0	25	0	28	0	7	6	0	13	0	0	0	0	0	10	6	0	0	16	57
16:30	3	0	12	0	15	0	6	6	0	12	0	0	0	0	0	8	8	0	0	16	43
16:35	3	0	13	0	16	0	9	10	0	19	0	0	0	0	0	4	8	0	0	12	47
16:40	1	0	16	0	17	0	10	8	0	18	0	0	0	0	0	5	4	0	0	9	44
16:45	3	0	13	0	16	0	7	4	0	11	0	0	0	0	0	6	14	0	0	20	47
16:50	4	0	19	0	23	0	5	5	0	10	0	0	0	0	0	5	3	0	0	8	41
16:55	2	0	15	0	17	0	5	6	0	11	0	0	0	0	0	4	6	0	0	10	38
Total	32	0	183	0	215	0	92	96	0	188	0	0	0	0	0	65	80	2	0	147	550
17:00	2	1	16	0	19	0	6	9	0	15	0	0	0	0	0	4	3	0	0	7	41
17:05	3	0	13	0	16	0	9	9	0	18	0	0	0	0	0	5	18	0	0	23	57
17:10	4	0	15	0	19	0	9	5	0	14	0	0	0	0	0	5	8	0	0	13	46
17:15	3	0	11	0	14	0	5	6	0	11	0	0	0	0	0	6	4	0	0	10	35
17:20	4	0	26	0	30	0	6	4	0	10	0	0	0	0	0	2	5	0	0	7	47
17:25	3	0	17	0	20	0	6	6	0	12	0	0	0	0	0	5	3	0	0	8	40
17:30	7	0	21	0	28	0	5	7	0	12	0	0	0	0	0	2	7	0	0	9	49
17:35	3	0	16	0	19	0	12	6	0	18	0	0	0	0	0	7	6	0	0	13	50
17:40	3	0	11	0	14	0	8	7	0	15	0	0	0	0	0	1	7	0	0	8	37
17:45	2	0	10	0	12	0	5	4	0	9	0	0	0	0	0	2	5	0	0	7	28
17:50	6	0	15	0	21	0	9	7	0	16	0	0	0	0	0	1	9	0	0	10	47
17:55	2	0	18	0	20	0	4	10	0	14	0	0	0	0	0	3	12	0	0	15	49
Total	42	1	189	0	232	0	84	80	0	164	0	0	0	0	0	43	87	0	0	130	526
Grand Total	74	1	372	0	447	0	176	176	0	352	0	0	0	0	0	108	167	2	0	277	1076
Apprch %	16.6	0.2	83.2	0		0	50	50	0		0	0	0	0		39	60.3	0.7	0		
Total %	6.9	0.1	34.6	0	41.5	0	16.4	16.4	0	32.7	0	0	0	0	0	10	15.5	0.2	0	25.7	

LSC Transportation Consultants, Inc.

2504 E. Pikes Peak Ave, Suite 304
 Colorado Springs, CO 80909
 719-633-2868

File Name : I-25 SB Ramps - County Line Rd PM

Site Code : S214862

Start Date : 1/17/2024

Page No : 2

Start Time	I-25 SB Off Ramp Southbound					County Line Rd Westbound					I-25 SB On Ramp Northbound					County Line Rd Eastbound					Int. Total
	Right	Thru	Left	Peds	App. Total	Right	Thru	Left	Peds	App. Total	Right	Thru	Left	Peds	App. Total	Right	Thru	Left	Peds	App. Total	
Peak Hour Analysis From 16:00 to 17:55 - Peak 1 of 1																					
Peak Hour for Entire Intersection Begins at 16:15																					
16:15	2	0	12	0	14	0	8	12	0	20	0	0	0	0	0	3	5	0	0	8	42
16:20	4	0	18	0	22	0	14	10	0	24	0	0	0	0	0	8	5	0	0	13	59
16:25	3	0	25	0	28	0	7	6	0	13	0	0	0	0	0	10	6	0	0	16	57
16:30	3	0	12	0	15	0	6	6	0	12	0	0	0	0	0	8	8	0	0	16	43
16:35	3	0	13	0	16	0	9	10	0	19	0	0	0	0	0	4	8	0	0	12	47
16:40	1	0	16	0	17	0	10	8	0	18	0	0	0	0	0	5	4	0	0	9	44
16:45	3	0	13	0	16	0	7	4	0	11	0	0	0	0	0	6	14	0	0	20	47
16:50	4	0	19	0	23	0	5	5	0	10	0	0	0	0	0	5	3	0	0	8	41
16:55	2	0	15	0	17	0	5	6	0	11	0	0	0	0	0	4	6	0	0	10	38
17:00	2	1	16	0	19	0	6	9	0	15	0	0	0	0	0	4	3	0	0	7	41
17:05	3	0	13	0	16	0	9	9	0	18	0	0	0	0	0	5	18	0	0	23	57
17:10	4	0	15	0	19	0	9	5	0	14	0	0	0	0	0	5	8	0	0	13	46
Total Volume	34	1	187	0	222	0	95	90	0	185	0	0	0	0	0	67	88	0	0	155	562
% App. Total	15.3	0.5	84.2	0		0	51.4	48.6	0		0	0	0	0		43.2	56.8	0	0		
PHF	.708	.083	.623	.000	.661	.000	.565	.625	.000	.642	.000	.000	.000	.000	.000	.558	.407	.000	.000	.562	.794

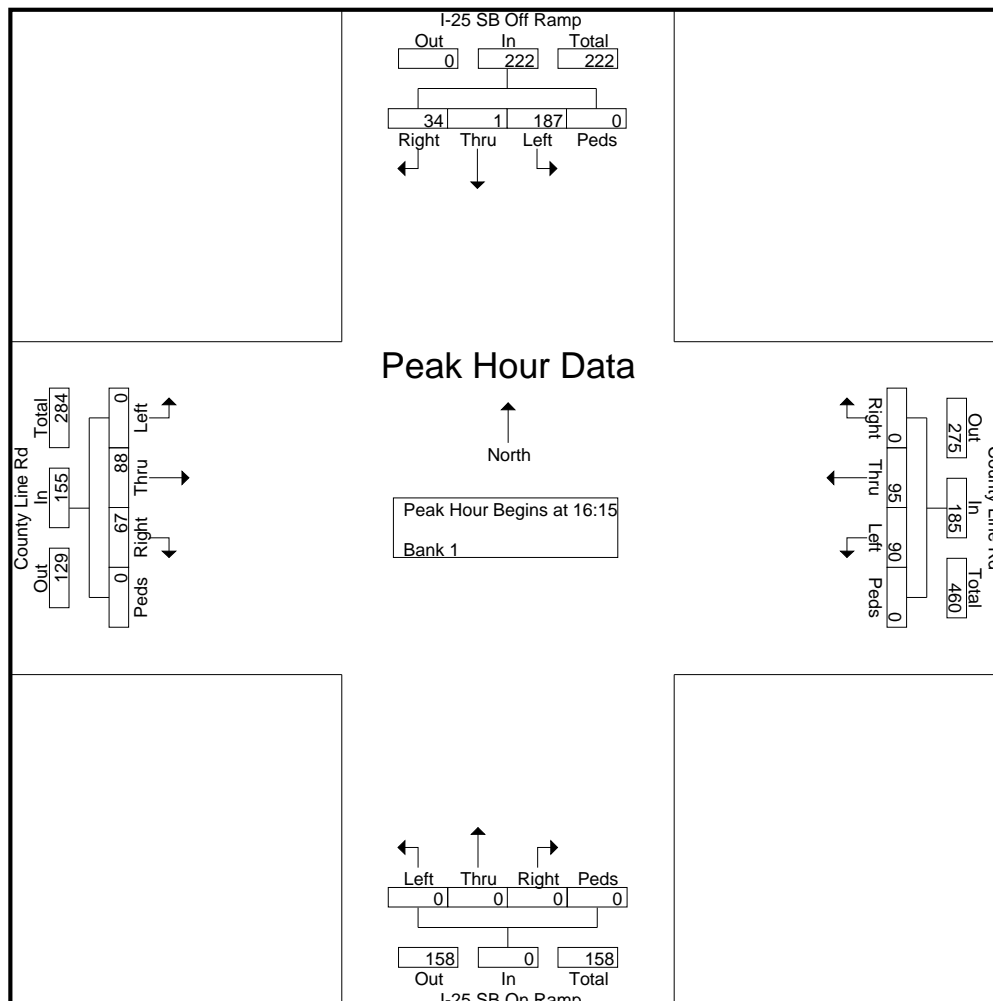

LSC Transportation Consultants, Inc.

2504 E. Pikes Peak Ave, Suite 304
 Colorado Springs, CO 80909
 719-633-2868

File Name : I-25 SB Ramps - County Line Rd PM

Site Code : S214862

Start Date : 1/17/2024

Page No : 3

Start Time	I-25 SB Off Ramp Southbound					County Line Rd Westbound					I-25 SB On Ramp Northbound					County Line Rd Eastbound					Int. Total
	Right	Thru	Left	Peds	App. Total	Right	Thru	Left	Peds	App. Total	Right	Thru	Left	Peds	App. Total	Right	Thru	Left	Peds	App. Total	

Peak Hour Analysis From 16:00 to 17:55 - Peak 1 of 1

Peak Hour for Each Approach Begins at:

	16:40					16:00					16:00					16:20				
+0 mins.	1	0	16	0	17	0	9	7	0	16	0	0	0	0	0	8	5	0	0	13
+5 mins.	3	0	13	0	16	0	6	12	0	18	0	0	0	0	0	10	6	0	0	16
+10 mins.	4	0	19	0	23	0	6	10	0	16	0	0	0	0	0	8	8	0	0	16
+15 mins.	2	0	15	0	17	0	8	12	0	20	0	0	0	0	0	4	8	0	0	12
+20 mins.	2	1	16	0	19	0	14	10	0	24	0	0	0	0	0	5	4	0	0	9
+25 mins.	3	0	13	0	16	0	7	6	0	13	0	0	0	0	0	6	14	0	0	20
+30 mins.	4	0	15	0	19	0	6	6	0	12	0	0	0	0	0	5	3	0	0	8
+35 mins.	3	0	11	0	14	0	9	10	0	19	0	0	0	0	0	4	6	0	0	10
+40 mins.	4	0	26	0	30	0	10	8	0	18	0	0	0	0	0	4	3	0	0	7
+45 mins.	3	0	17	0	20	0	7	4	0	11	0	0	0	0	0	5	18	0	0	23
+50 mins.	7	0	21	0	28	0	5	5	0	10	0	0	0	0	0	5	8	0	0	13
+55 mins.	3	0	16	0	19	0	5	6	0	11	0	0	0	0	0	6	4	0	0	10
Total Volume	39	1	198	0	238	0	92	96	0	188	0	0	0	0	0	70	87	0	0	157
% App. Total	16.4	0.4	83.2	0		0	48.9	51.1	0		0	0	0	0		44.6	55.4	0	0	
PHF	.464	.083	.635	.000	.661	.000	.548	.667	.000	.653	.000	.000	.000	.000	.000	.583	.403	.000	.000	.569

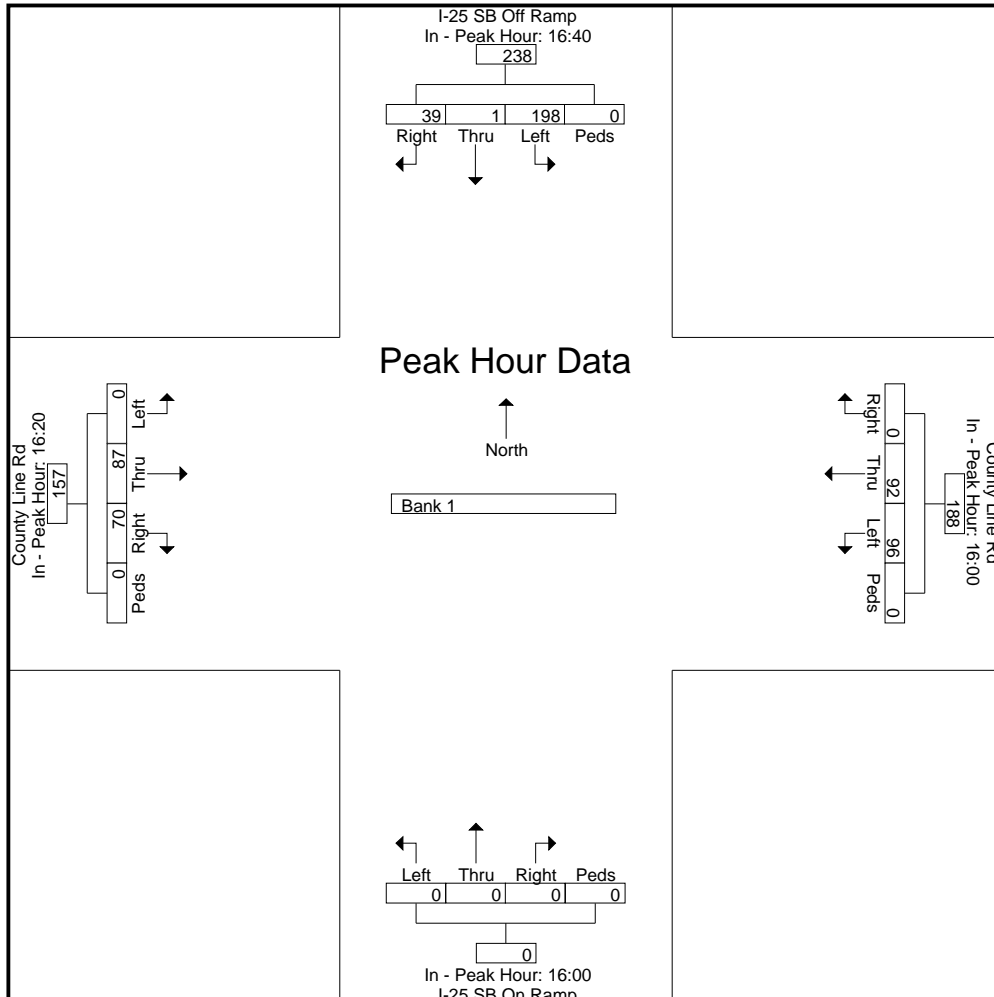

LSC Transportation Consultants, Inc.

2504 E. Pikes Peak Ave, Suite 304
 Colorado Springs, CO 80909
 719-633-2868

File Name : Monument Hill Rd - County Line Rd AM

Site Code : S214862

Start Date : 1/10/2024

Page No : 1

Groups Printed- Unshifted

Start Time	S Andrews Rd Southbound					County Line Rd Westbound					Monument Hill Rd Northbound					County Line Rd Eastbound					Int. Total
	Right	Thru	Left	Peds	App. Total	Right	Thru	Left	Peds	App. Total	Right	Thru	Left	Peds	App. Total	Right	Thru	Left	Peds	App. Total	
06:30	0	0	0	0	0	0	30	0	0	30	0	0	4	0	4	1	4	0	0	5	39
06:35	0	0	0	0	0	0	33	1	0	34	0	0	2	0	2	2	6	0	0	8	44
06:40	0	0	0	0	0	0	37	1	0	38	1	0	1	0	2	3	2	0	0	5	45
06:45	1	0	0	0	1	0	34	0	0	34	0	0	1	0	1	2	5	1	0	8	44
06:50	0	0	0	0	0	0	16	0	0	16	0	0	2	0	2	5	3	0	0	8	26
06:55	0	0	0	0	0	0	27	2	0	29	1	0	2	0	3	6	6	1	0	13	45
Total	1	0	0	0	1	0	177	4	0	181	2	0	12	0	14	19	26	2	0	47	243
07:00	2	0	0	0	2	1	35	1	0	37	0	0	2	0	2	9	1	0	0	10	51
07:05	0	0	0	0	0	0	30	3	0	33	2	0	4	0	6	8	5	0	0	13	52
07:10	0	0	0	0	0	0	34	5	0	39	1	0	4	0	5	11	7	1	0	19	63
07:15	0	0	0	0	0	0	33	6	0	39	3	0	10	0	13	9	7	0	0	16	68
07:20	0	0	0	0	0	0	43	14	0	57	2	0	3	0	5	19	17	0	0	36	98
07:25	1	0	0	0	1	0	45	13	0	58	4	0	6	0	10	12	10	0	0	22	91
07:30	0	0	0	0	0	0	46	9	0	55	3	0	10	0	13	11	7	0	0	18	86
07:35	0	0	0	0	0	0	43	2	0	45	3	0	11	0	14	3	9	0	0	12	71
07:40	0	0	0	0	0	1	35	3	0	39	4	0	7	0	11	3	9	0	0	12	62
07:45	0	0	1	0	1	0	42	0	0	42	0	0	1	0	1	4	11	0	0	15	59
07:50	0	0	0	0	0	0	35	1	0	36	1	0	1	0	2	0	6	1	0	7	45
07:55	2	0	0	0	2	0	32	2	0	34	1	0	1	0	2	1	7	0	0	8	46
Total	5	0	1	0	6	2	453	59	0	514	24	0	60	0	84	90	96	2	0	188	792
08:00	0	0	0	0	0	0	27	1	0	28	1	0	4	0	5	2	7	1	0	10	43
08:05	0	0	0	0	0	1	39	0	0	40	0	0	3	0	3	0	12	0	0	12	55
08:10	1	0	0	0	1	0	35	1	0	36	1	0	1	0	2	0	7	0	0	7	46
08:15	1	0	0	0	1	0	20	0	0	20	1	0	0	0	1	1	9	0	0	10	32
08:20	1	0	0	0	1	0	30	0	0	30	0	0	0	0	0	4	13	1	0	18	49
08:25	0	0	0	0	0	0	26	0	0	26	1	0	0	0	1	2	8	0	0	10	37
Grand Total	9	0	1	0	10	3	807	65	0	875	30	0	80	0	110	118	178	6	0	302	1297
Apprch %	90	0	10	0		0.3	92.2	7.4	0		27.3	0	72.7	0		39.1	58.9	2	0		
Total %	0.7	0	0.1	0	0.8	0.2	62.2	5	0	67.5	2.3	0	6.2	0	8.5	9.1	13.7	0.5	0	23.3	

LSC Transportation Consultants, Inc.

2504 E. Pikes Peak Ave, Suite 304
 Colorado Springs, CO 80909
 719-633-2868

File Name : Monument Hill Rd - County Line Rd AM

Site Code : S214862

Start Date : 1/10/2024

Page No : 2

Start Time	S Andrews Rd Southbound					County Line Rd Westbound					Monument Hill Rd Northbound					County Line Rd Eastbound					Int. Total
	Right	Thru	Left	Peds	App. Total	Right	Thru	Left	Peds	App. Total	Right	Thru	Left	Peds	App. Total	Right	Thru	Left	Peds	App. Total	
Peak Hour Analysis From 06:30 to 08:25 - Peak 1 of 1																					
Peak Hour for Entire Intersection Begins at 07:00																					
07:00	2	0	0	0	2	1	35	1	0	37	0	0	2	0	2	9	1	0	0	10	51
07:05	0	0	0	0	0	0	30	3	0	33	2	0	4	0	6	8	5	0	0	13	52
07:10	0	0	0	0	0	0	34	5	0	39	1	0	4	0	5	11	7	1	0	19	63
07:15	0	0	0	0	0	0	33	6	0	39	3	0	10	0	13	9	7	0	0	16	68
07:20	0	0	0	0	0	0	43	14	0	57	2	0	3	0	5	19	17	0	0	36	98
07:25	1	0	0	0	1	0	45	13	0	58	4	0	6	0	10	12	10	0	0	22	91
07:30	0	0	0	0	0	0	46	9	0	55	3	0	10	0	13	11	7	0	0	18	86
07:35	0	0	0	0	0	0	43	2	0	45	3	0	11	0	14	3	9	0	0	12	71
07:40	0	0	0	0	0	1	35	3	0	39	4	0	7	0	11	3	9	0	0	12	62
07:45	0	0	1	0	1	0	42	0	0	42	0	0	1	0	1	4	11	0	0	15	59
07:50	0	0	0	0	0	0	35	1	0	36	1	0	1	0	2	0	6	1	0	7	45
07:55	2	0	0	0	2	0	32	2	0	34	1	0	1	0	2	1	7	0	0	8	46
Total Volume	5	0	1	0	6	2	453	59	0	514	24	0	60	0	84	90	96	2	0	188	792
% App. Total	83.3	0	16.7	0		0.4	88.1	11.5	0		28.6	0	71.4	0		47.9	51.1	1.1	0		
PHF	.208	.000	.083	.000	.250	.167	.821	.351	.000	.739	.500	.000	.455	.000	.500	.395	.471	.167	.000	.435	.673

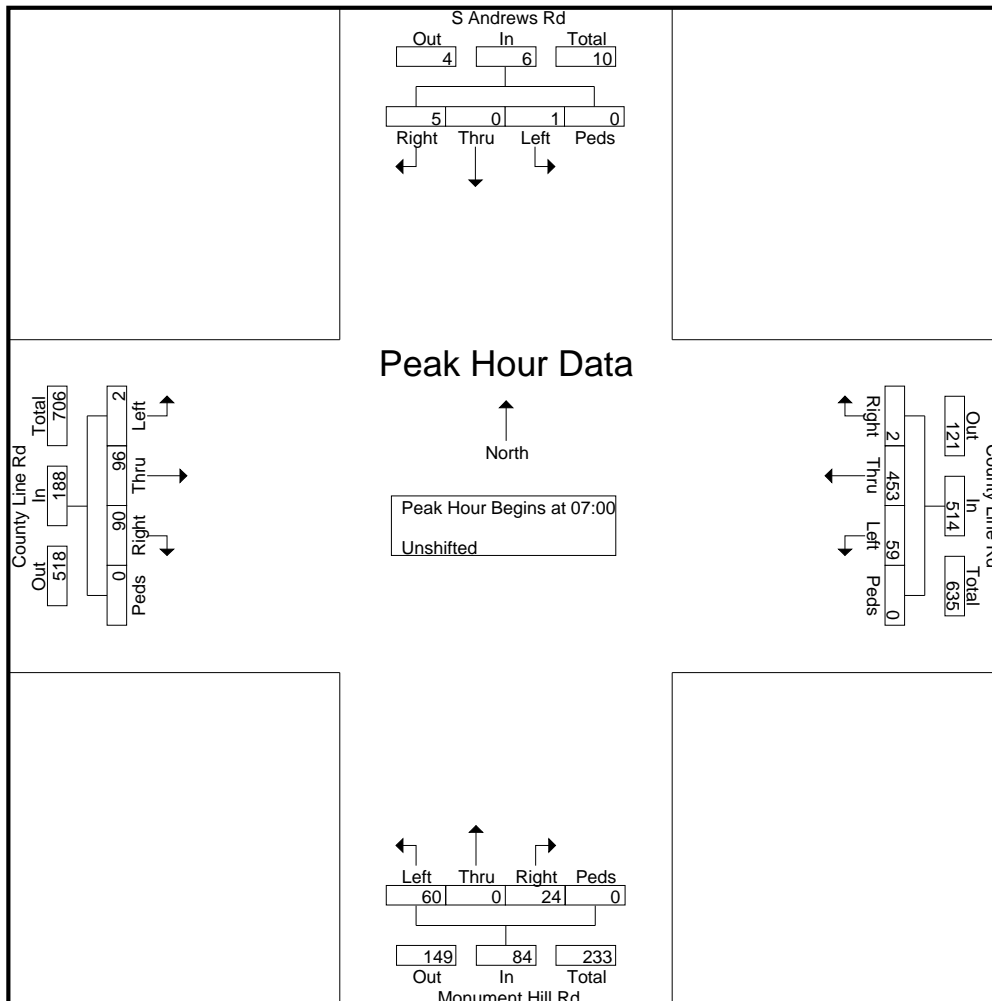

LSC Transportation Consultants, Inc.

2504 E. Pikes Peak Ave, Suite 304
 Colorado Springs, CO 80909
 719-633-2868

File Name : Monument Hill Rd - County Line Rd AM

Site Code : S214862

Start Date : 1/10/2024

Page No : 3

Start Time	S Andrews Rd Southbound					County Line Rd Westbound					Monument Hill Rd Northbound					County Line Rd Eastbound					Int. Total
	Right	Thru	Left	Peds	App. Total	Right	Thru	Left	Peds	App. Total	Right	Thru	Left	Peds	App. Total	Right	Thru	Left	Peds	App. Total	

Peak Hour Analysis From 06:30 to 08:25 - Peak 1 of 1

Peak Hour for Each Approach Begins at:

	07:25					07:00					07:05					06:50				
+0 mins.	1	0	0	0	1	1	35	1	0	37	2	0	4	0	6	5	3	0	0	8
+5 mins.	0	0	0	0	0	0	30	3	0	33	1	0	4	0	5	6	6	1	0	13
+10 mins.	0	0	0	0	0	0	34	5	0	39	3	0	10	0	13	9	1	0	0	10
+15 mins.	0	0	0	0	0	0	33	6	0	39	2	0	3	0	5	8	5	0	0	13
+20 mins.	0	0	1	0	1	0	43	14	0	57	4	0	6	0	10	11	7	1	0	19
+25 mins.	0	0	0	0	0	0	45	13	0	58	3	0	10	0	13	9	7	0	0	16
+30 mins.	2	0	0	0	2	0	46	9	0	55	3	0	11	0	14	19	17	0	0	36
+35 mins.	0	0	0	0	0	0	43	2	0	45	4	0	7	0	11	12	10	0	0	22
+40 mins.	0	0	0	0	0	1	35	3	0	39	0	0	1	0	1	11	7	0	0	18
+45 mins.	1	0	0	0	1	0	42	0	0	42	1	0	1	0	2	3	9	0	0	12
+50 mins.	1	0	0	0	1	0	35	1	0	36	1	0	1	0	2	3	9	0	0	12
+55 mins.	1	0	0	0	1	0	32	2	0	34	1	0	4	0	5	4	11	0	0	15
Total Volume	6	0	1	0	7	2	453	59	0	514	25	0	62	0	87	100	92	2	0	194
% App. Total	85.7	0	14.3	0		0.4	88.1	11.5	0		28.7	0	71.3	0		51.5	47.4	1	0	
PHF	.250	.000	.083	.000	.292	.167	.821	.351	.000	.739	.521	.000	.470	.000	.518	.439	.451	.167	.000	.449

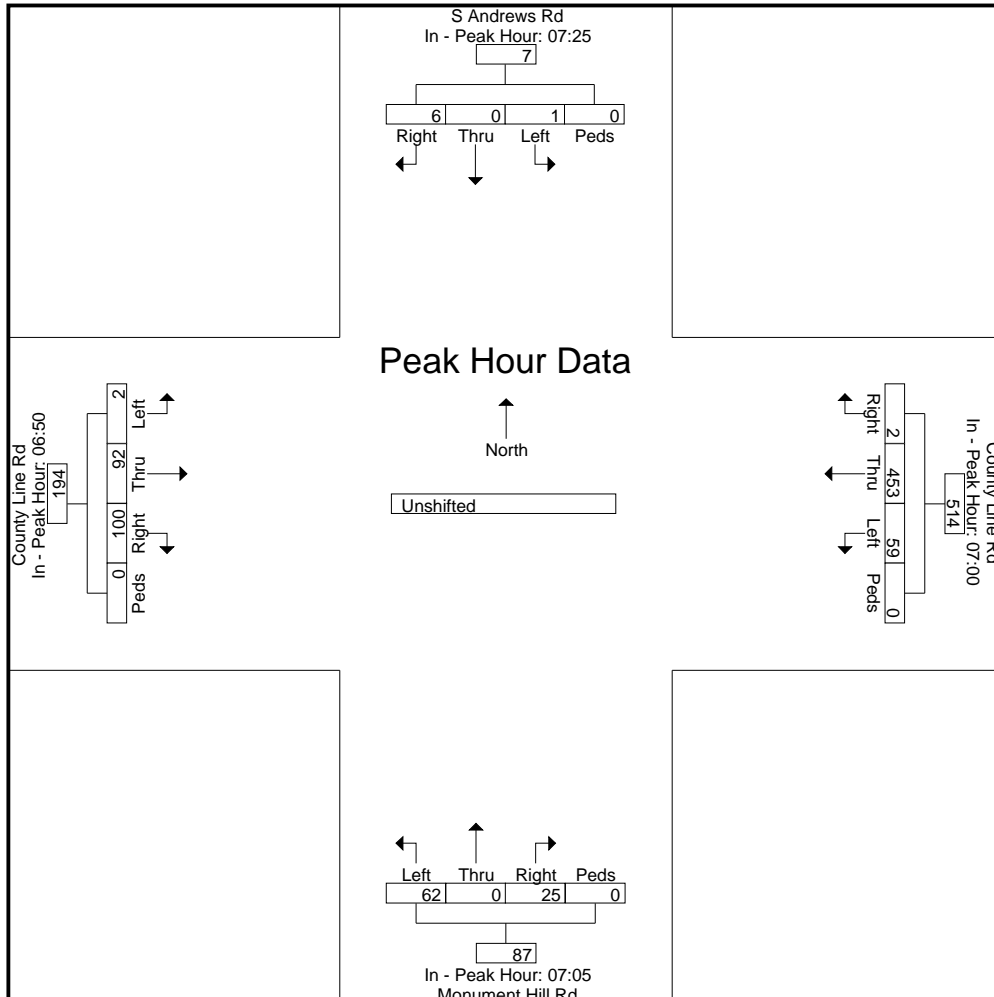

LSC Transportation Consultants, Inc.

2504 E. Pikes Peak Ave, Suite 304
 Colorado Springs, CO 80909
 719-633-2868

File Name : Monument Hill Rd - County Line Rd PM

Site Code : S214862

Start Date : 1/9/2024

Page No : 1

Groups Printed- Unshifted

Start Time	S Andrews Rd Southbound					County Line Rd Westbound					Monument Hill Rd Northbound					County Line Rd Eastbound					Int. Total
	Right	Thru	Left	Peds	App. Total	Right	Thru	Left	Peds	App. Total	Right	Thru	Left	Peds	App. Total	Right	Thru	Left	Peds	App. Total	
16:00	0	0	0	0	0	0	18	2	0	20	0	0	0	0	0	0	22	0	0	22	42
16:05	0	0	0	0	0	0	16	1	0	17	0	0	0	0	0	0	19	0	0	19	36
16:10	0	0	1	0	1	0	19	2	0	21	2	0	0	0	2	2	21	0	0	23	47
16:15	0	0	0	0	0	0	20	1	0	21	1	0	1	0	2	3	27	0	0	30	53
16:20	0	0	0	0	0	1	20	0	0	21	1	0	3	0	4	4	33	0	0	37	62
16:25	0	0	0	0	0	0	17	0	0	17	1	0	2	0	3	2	25	0	0	27	47
16:30	0	0	0	0	0	0	15	1	0	16	1	0	1	0	2	4	29	0	0	33	51
16:35	0	0	0	0	0	0	12	3	0	15	0	0	3	0	3	4	27	2	0	33	51
16:40	0	0	0	0	0	0	18	1	0	19	4	0	3	0	7	0	37	0	0	37	63
16:45	1	0	0	0	1	0	17	3	0	20	3	0	7	0	10	1	27	0	0	28	59
16:50	0	0	0	0	0	0	16	2	0	18	3	0	2	0	5	1	26	1	0	28	51
16:55	0	0	0	0	0	0	10	0	0	10	2	0	1	0	3	3	39	0	0	42	55
Total	1	0	1	0	2	1	198	16	0	215	18	0	23	0	41	24	332	3	0	359	617
17:00	0	0	0	0	0	0	15	1	0	16	0	0	4	0	4	0	25	1	0	26	46
17:05	0	0	1	0	1	1	13	0	0	14	4	0	1	0	5	5	22	0	0	27	47
17:10	0	0	0	0	0	0	17	0	0	17	0	0	0	0	0	1	32	0	0	33	50
17:15	1	0	0	0	1	0	12	0	0	12	2	0	3	0	5	0	32	0	0	32	50
17:20	0	0	0	0	0	0	14	3	0	17	2	0	1	0	3	5	31	0	0	36	56
17:25	0	0	1	0	1	0	9	2	0	11	0	0	4	0	4	2	36	0	0	38	54
17:30	0	0	0	0	0	0	21	0	0	21	0	0	5	0	5	2	27	1	0	30	56
17:35	1	0	0	0	1	1	12	0	0	13	1	0	6	0	7	3	27	0	0	30	51
17:40	0	0	0	0	0	0	10	0	0	10	6	0	1	0	7	0	39	0	0	39	56
17:45	0	0	0	0	0	0	9	0	0	9	4	0	3	0	7	2	25	2	0	29	45
17:50	0	0	0	0	0	0	5	0	0	5	0	0	3	0	3	2	21	0	0	23	31
17:55	2	0	0	0	2	0	18	1	0	19	1	0	1	0	2	3	19	0	0	22	45
Total	4	0	2	0	6	2	155	7	0	164	20	0	32	0	52	25	336	4	0	365	587
Grand Total	5	0	3	0	8	3	353	23	0	379	38	0	55	0	93	49	668	7	0	724	1204
Apprch %	62.5	0	37.5	0		0.8	93.1	6.1	0		40.9	0	59.1	0		6.8	92.3	1	0		
Total %	0.4	0	0.2	0	0.7	0.2	29.3	1.9	0	31.5	3.2	0	4.6	0	7.7	4.1	55.5	0.6	0	60.1	

LSC Transportation Consultants, Inc.

2504 E. Pikes Peak Ave, Suite 304
 Colorado Springs, CO 80909
 719-633-2868

File Name : Monument Hill Rd - County Line Rd PM

Site Code : S214862

Start Date : 1/9/2024

Page No : 2

Start Time	S Andrews Rd Southbound					County Line Rd Westbound					Monument Hill Rd Northbound					County Line Rd Eastbound					Int. Total
	Right	Thru	Left	Peds	App. Total	Right	Thru	Left	Peds	App. Total	Right	Thru	Left	Peds	App. Total	Right	Thru	Left	Peds	App. Total	
Peak Hour Analysis From 16:00 to 17:55 - Peak 1 of 1																					
Peak Hour for Entire Intersection Begins at 16:35																					
16:35	0	0	0	0	0	0	12	3	0	15	0	0	3	0	3	4	27	2	0	33	51
16:40	0	0	0	0	0	0	18	1	0	19	4	0	3	0	7	0	37	0	0	37	63
16:45	1	0	0	0	1	0	17	3	0	20	3	0	7	0	10	1	27	0	0	28	59
16:50	0	0	0	0	0	0	16	2	0	18	3	0	2	0	5	1	26	1	0	28	51
16:55	0	0	0	0	0	0	10	0	0	10	2	0	1	0	3	3	39	0	0	42	55
17:00	0	0	0	0	0	0	15	1	0	16	0	0	4	0	4	0	25	1	0	26	46
17:05	0	0	1	0	1	1	13	0	0	14	4	0	1	0	5	5	22	0	0	27	47
17:10	0	0	0	0	0	0	17	0	0	17	0	0	0	0	0	1	32	0	0	33	50
17:15	1	0	0	0	1	0	12	0	0	12	2	0	3	0	5	0	32	0	0	32	50
17:20	0	0	0	0	0	0	14	3	0	17	2	0	1	0	3	5	31	0	0	36	56
17:25	0	0	1	0	1	0	9	2	0	11	0	0	4	0	4	2	36	0	0	38	54
17:30	0	0	0	0	0	0	21	0	0	21	0	0	5	0	5	2	27	1	0	30	56
Total Volume	2	0	2	0	4	1	174	15	0	190	20	0	34	0	54	24	361	5	0	390	638
% App. Total	50	0	50	0		0.5	91.6	7.9	0		37	0	63	0		6.2	92.6	1.3	0		
PHF	.167	.000	.167	.000	.333	.083	.690	.417	.000	.754	.417	.000	.405	.000	.450	.400	.771	.208	.000	.774	.844

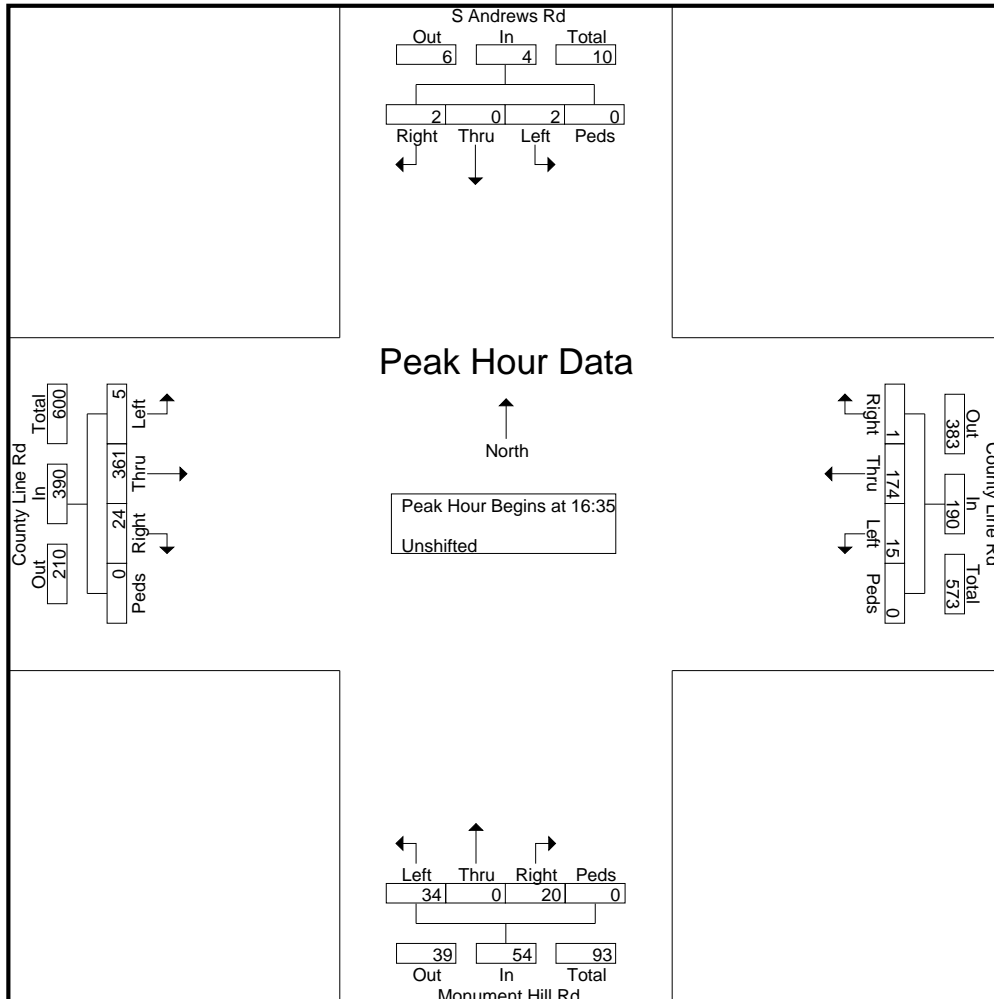

LSC Transportation Consultants, Inc.

2504 E. Pikes Peak Ave, Suite 304
 Colorado Springs, CO 80909
 719-633-2868

File Name : Monument Hill Rd - County Line Rd PM
 Site Code : S214862
 Start Date : 1/9/2024
 Page No : 3

Start Time	S Andrews Rd Southbound					County Line Rd Westbound					Monument Hill Rd Northbound					County Line Rd Eastbound					Int. Total
	Right	Thru	Left	Peds	App. Total	Right	Thru	Left	Peds	App. Total	Right	Thru	Left	Peds	App. Total	Right	Thru	Left	Peds	App. Total	

Peak Hour Analysis From 16:00 to 17:55 - Peak 1 of 1
 Peak Hour for Each Approach Begins at:

	17:00					16:00					16:40					16:30				
+0 mins.	0	0	0	0	0	0	18	2	0	20	4	0	3	0	7	4	29	0	0	33
+5 mins.	0	0	1	0	1	0	16	1	0	17	3	0	7	0	10	4	27	2	0	33
+10 mins.	0	0	0	0	0	0	19	2	0	21	3	0	2	0	5	0	37	0	0	37
+15 mins.	1	0	0	0	1	0	20	1	0	21	2	0	1	0	3	1	27	0	0	28
+20 mins.	0	0	0	0	0	1	20	0	0	21	0	0	4	0	4	1	26	1	0	28
+25 mins.	0	0	1	0	1	0	17	0	0	17	4	0	1	0	5	3	39	0	0	42
+30 mins.	0	0	0	0	0	0	15	1	0	16	0	0	0	0	0	0	25	1	0	26
+35 mins.	1	0	0	0	1	0	12	3	0	15	2	0	3	0	5	5	22	0	0	27
+40 mins.	0	0	0	0	0	0	18	1	0	19	2	0	1	0	3	1	32	0	0	33
+45 mins.	0	0	0	0	0	0	17	3	0	20	0	0	4	0	4	0	32	0	0	32
+50 mins.	0	0	0	0	0	0	16	2	0	18	0	0	5	0	5	5	31	0	0	36
+55 mins.	2	0	0	0	2	0	10	0	0	10	1	0	6	0	7	2	36	0	0	38
Total Volume	4	0	2	0	6	1	198	16	0	215	21	0	37	0	58	26	363	4	0	393
% App. Total	66.7	0	33.3	0		0.5	92.1	7.4	0		36.2	0	63.8	0		6.6	92.4	1	0	
PHF	.167	.000	.167	.000	.250	.083	.825	.444	.000	.853	.438	.000	.440	.000	.483	.433	.776	.167	.000	.780

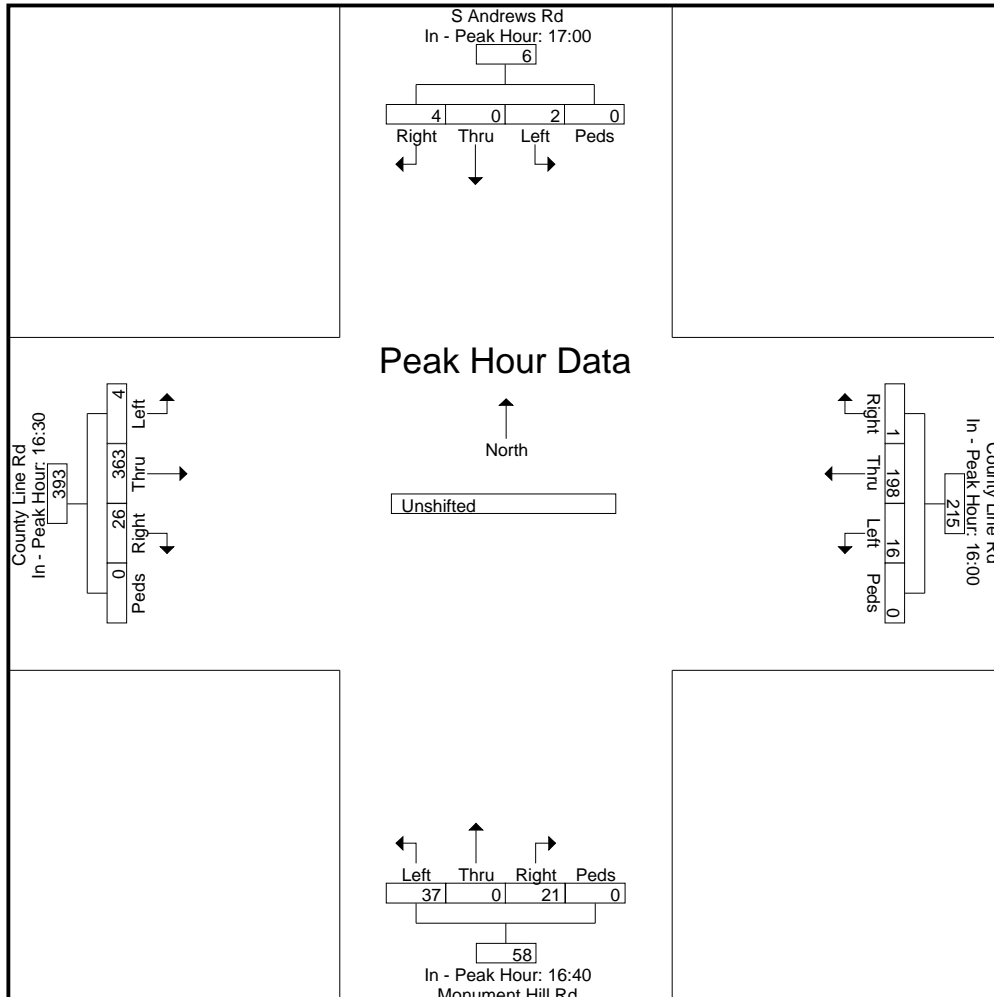

LSC Transportation Consultants, Inc.

2504 E. Pikes Peak Ave, Suite 304
 Colorado Springs, CO 80909
 719-633-2868

File Name : Monument Hill Rd - N Misty Acres Blvd AM 1-24-24

Site Code : S214862

Start Date : 1/24/2024

Page No : 1

Groups Printed- Unshifted

Start Time	Monument Hill Rd Southbound					N Misty Acres Blvd Westbound					Monument Hill Rd Northbound					Eastbound					Int. Total	
	Right	Thru	Left	Peds	App. Total	Right	Thru	Left	Peds	App. Total	Right	Thru	Left	Peds	App. Total	Right	Thru	Left	Peds	App. Total		
06:30	0	1	0	0	1	0	0	0	0	0	0	1	0	0	1	0	0	0	0	0	0	2
06:35	0	3	0	0	3	0	0	0	0	0	0	2	0	0	2	0	0	0	0	0	0	5
06:40	0	2	0	0	2	0	0	0	0	0	0	0	0	0	0	0	0	0	0	0	0	2
06:45	0	5	0	0	5	0	0	0	0	0	0	2	0	0	2	0	0	0	0	0	0	7
06:50	0	7	1	0	8	0	0	0	0	0	0	1	0	0	1	0	0	0	0	0	0	9
06:55	0	3	0	0	3	0	0	0	0	0	0	6	0	0	6	0	0	0	0	0	0	9
Total	0	21	1	0	22	0	0	0	0	0	0	12	0	0	12	0	0	0	0	0	0	34
07:00	0	6	0	0	6	0	0	0	0	0	0	1	0	0	1	0	0	0	0	0	0	7
07:05	0	9	0	0	9	0	0	0	0	0	0	5	0	0	5	0	0	0	0	0	0	14
07:10	0	26	1	0	27	2	0	0	0	2	0	8	0	0	8	0	0	0	0	0	0	37
07:15	0	18	0	0	18	0	0	0	0	0	0	12	0	0	12	0	0	0	0	0	0	30
07:20	0	17	0	0	17	0	0	0	0	0	0	5	0	0	5	0	0	0	0	0	0	22
07:25	0	26	2	0	28	1	0	0	0	1	0	6	0	0	6	0	0	0	0	0	0	35
07:30	0	22	0	0	22	0	0	0	0	0	0	6	0	0	6	0	0	0	0	0	0	28
07:35	0	6	0	0	6	1	0	0	0	1	0	11	0	0	11	0	0	0	0	0	0	18
07:40	0	4	0	0	4	0	0	0	0	0	0	5	0	0	5	0	0	0	0	0	0	9
07:45	0	2	0	0	2	0	0	0	0	0	0	4	0	0	4	0	0	0	0	0	0	6
07:50	0	2	0	0	2	0	0	0	0	0	0	1	0	0	1	0	0	0	0	0	0	3
07:55	0	5	0	0	5	1	0	0	0	1	0	1	0	0	1	0	0	0	0	0	0	7
Total	0	143	3	0	146	5	0	0	0	5	0	65	0	0	65	0	0	0	0	0	0	216
08:00	0	1	0	0	1	0	0	0	0	0	1	5	0	0	6	0	0	0	0	0	0	7
08:05	0	4	0	0	4	0	0	0	0	0	0	1	0	0	1	0	0	0	0	0	0	5
08:10	0	4	0	0	4	0	0	0	0	0	0	1	0	0	1	0	0	0	0	0	0	5
08:15	0	1	0	0	1	0	0	0	0	0	0	2	0	0	2	0	0	0	0	0	0	3
08:20	0	4	1	0	5	0	0	0	0	0	0	3	0	0	3	0	0	0	0	0	0	8
08:25	0	2	0	0	2	0	0	0	0	0	0	3	0	0	3	0	0	0	0	0	0	5
Grand Total	0	180	5	0	185	5	0	0	0	5	1	92	0	0	93	0	0	0	0	0	0	283
Apprch %	0	97.3	2.7	0		100	0	0	0		1.1	98.9	0	0		0	0	0	0	0	0	
Total %	0	63.6	1.8	0	65.4	1.8	0	0	0	1.8	0.4	32.5	0	0	32.9	0	0	0	0	0	0	

LSC Transportation Consultants, Inc.

2504 E. Pikes Peak Ave, Suite 304
 Colorado Springs, CO 80909
 719-633-2868

File Name : Monument Hill Rd - N Misty Acres Blvd AM 1-24-24

Site Code : S214862

Start Date : 1/24/2024

Page No : 2

Start Time	Monument Hill Rd Southbound					N Misty Acres Blvd Westbound					Monument Hill Rd Northbound					Eastbound					Int. Total
	Right	Thru	Left	Peds	App. Total	Right	Thru	Left	Peds	App. Total	Right	Thru	Left	Peds	App. Total	Right	Thru	Left	Peds	App. Total	
Peak Hour Analysis From 06:30 to 08:25 - Peak 1 of 1																					
Peak Hour for Entire Intersection Begins at 06:45																					
06:45	0	5	0	0	5	0	0	0	0	0	0	2	0	0	2	0	0	0	0	0	7
06:50	0	7	1	0	8	0	0	0	0	0	0	1	0	0	1	0	0	0	0	0	9
06:55	0	3	0	0	3	0	0	0	0	0	0	6	0	0	6	0	0	0	0	0	9
07:00	0	6	0	0	6	0	0	0	0	0	0	1	0	0	1	0	0	0	0	0	7
07:05	0	9	0	0	9	0	0	0	0	0	0	5	0	0	5	0	0	0	0	0	14
07:10	0	26	1	0	27	2	0	0	0	2	0	8	0	0	8	0	0	0	0	0	37
07:15	0	18	0	0	18	0	0	0	0	0	0	12	0	0	12	0	0	0	0	0	30
07:20	0	17	0	0	17	0	0	0	0	0	0	5	0	0	5	0	0	0	0	0	22
07:25	0	26	2	0	28	1	0	0	0	1	0	6	0	0	6	0	0	0	0	0	35
07:30	0	22	0	0	22	0	0	0	0	0	0	6	0	0	6	0	0	0	0	0	28
07:35	0	6	0	0	6	1	0	0	0	1	0	11	0	0	11	0	0	0	0	0	18
07:40	0	4	0	0	4	0	0	0	0	0	0	5	0	0	5	0	0	0	0	0	9
Total Volume	0	149	4	0	153	4	0	0	0	4	0	68	0	0	68	0	0	0	0	0	225
% App. Total	0	97.4	2.6	0		100	0	0	0		0	100	0	0		0	0	0	0		
PHF	.000	.478	.167	.000	.455	.167	.000	.000	.000	.167	.000	.472	.000	.000	.472	.000	.000	.000	.000	.000	.507

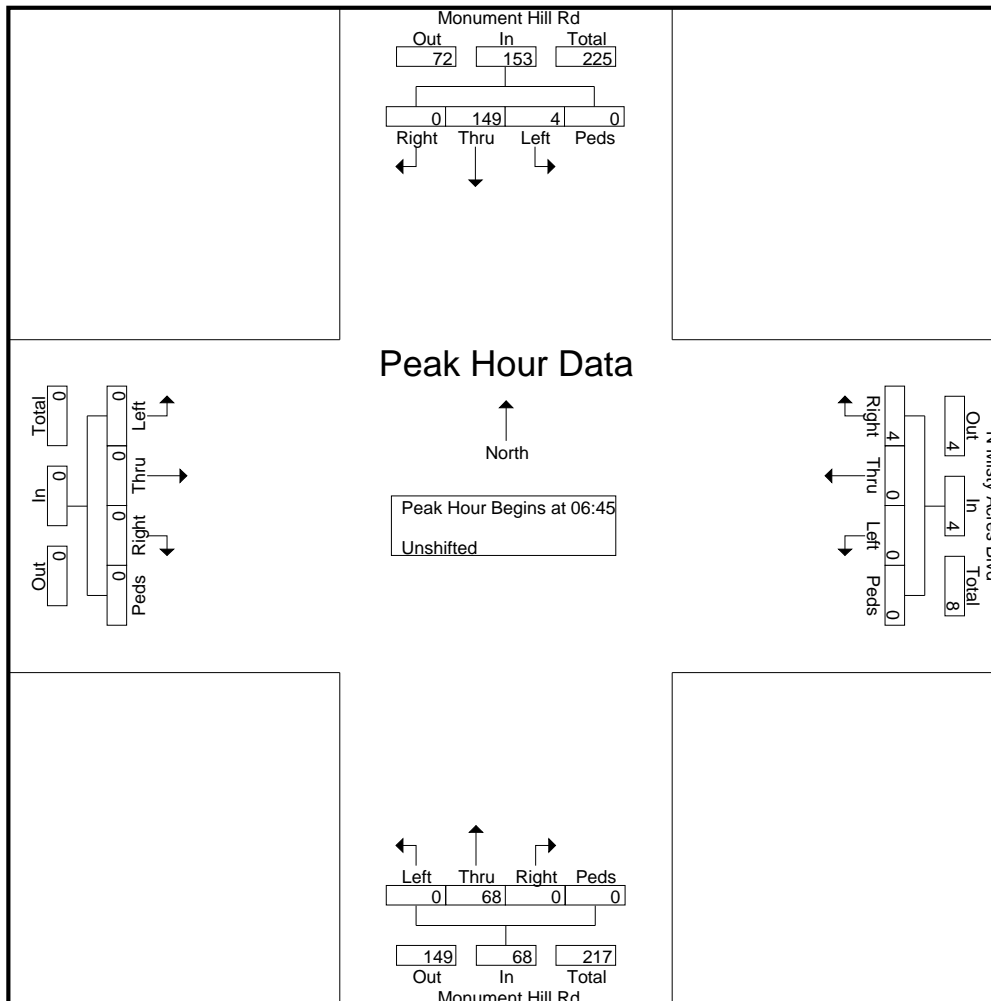

LSC Transportation Consultants, Inc.

2504 E. Pikes Peak Ave, Suite 304
 Colorado Springs, CO 80909
 719-633-2868

File Name : Monument Hill Rd - N Misty Acres Blvd AM 1-24-24

Site Code : S214862

Start Date : 1/24/2024

Page No : 3

Start Time	Monument Hill Rd Southbound					N Misty Acres Blvd Westbound					Monument Hill Rd Northbound					Eastbound					Int. Total
	Right	Thru	Left	Peds	App. Total	Right	Thru	Left	Peds	App. Total	Right	Thru	Left	Peds	App. Total	Right	Thru	Left	Peds	App. Total	

Peak Hour Analysis From 06:30 to 08:25 - Peak 1 of 1

Peak Hour for Each Approach Begins at:

	06:45					07:00					06:50					06:30				
+0 mins.	0	5	0	0	5	0	0	0	0	0	0	1	0	0	1	0	0	0	0	0
+5 mins.	0	7	1	0	8	0	0	0	0	0	0	6	0	0	6	0	0	0	0	0
+10 mins.	0	3	0	0	3	2	0	0	0	2	0	1	0	0	1	0	0	0	0	0
+15 mins.	0	6	0	0	6	0	0	0	0	0	0	5	0	0	5	0	0	0	0	0
+20 mins.	0	9	0	0	9	0	0	0	0	0	0	8	0	0	8	0	0	0	0	0
+25 mins.	0	26	1	0	27	1	0	0	0	1	0	12	0	0	12	0	0	0	0	0
+30 mins.	0	18	0	0	18	0	0	0	0	0	0	5	0	0	5	0	0	0	0	0
+35 mins.	0	17	0	0	17	1	0	0	0	1	0	6	0	0	6	0	0	0	0	0
+40 mins.	0	26	2	0	28	0	0	0	0	0	0	6	0	0	6	0	0	0	0	0
+45 mins.	0	22	0	0	22	0	0	0	0	0	0	11	0	0	11	0	0	0	0	0
+50 mins.	0	6	0	0	6	0	0	0	0	0	0	5	0	0	5	0	0	0	0	0
+55 mins.	0	4	0	0	4	1	0	0	0	1	0	4	0	0	4	0	0	0	0	0
Total Volume	0	149	4	0	153	5	0	0	0	5	0	70	0	0	70	0	0	0	0	0
% App. Total	0	97.4	2.6	0		100	0	0	0		0	100	0	0		0	0	0	0	
PHF	.000	.478	.167	.000	.455	.208	.000	.000	.000	.208	.000	.486	.000	.000	.486	.000	.000	.000	.000	.000

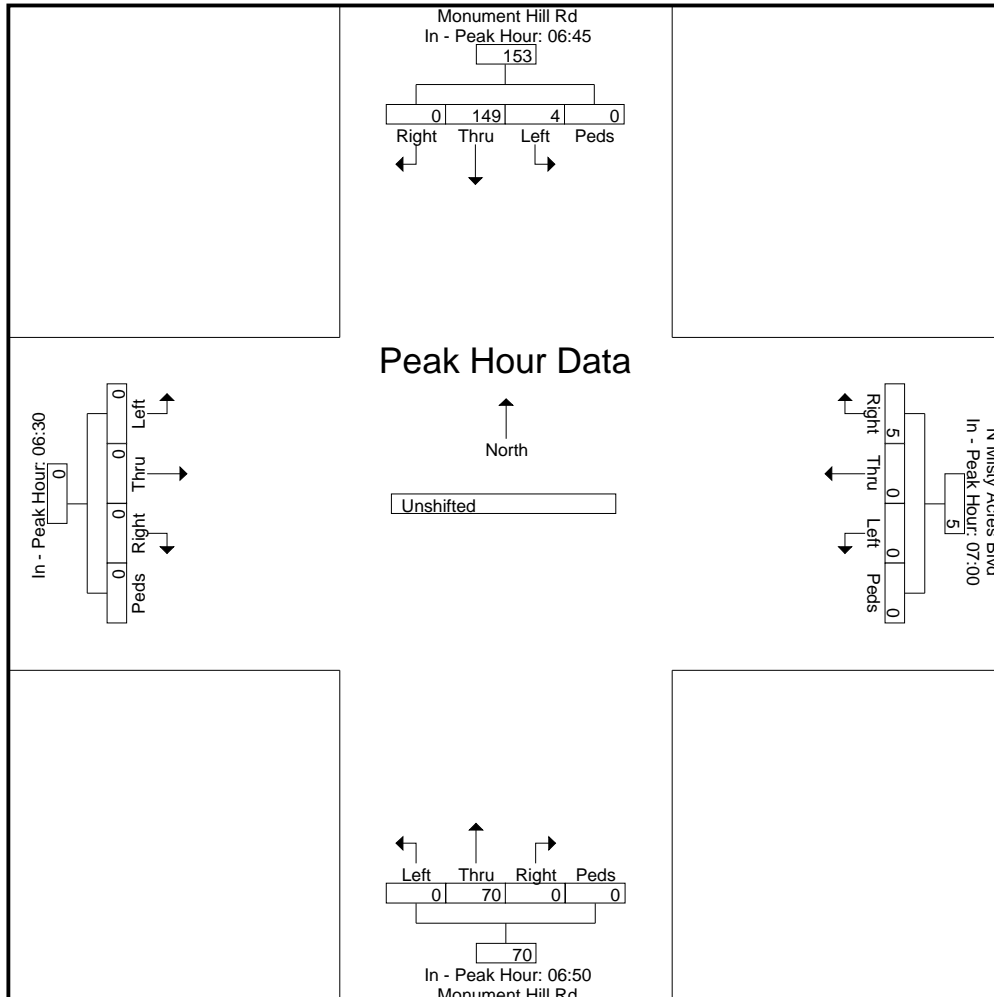

LSC Transportation Consultants, Inc.

2504 E. Pikes Peak Ave, Suite 304
 Colorado Springs, CO 80909
 719-633-2868

File Name : Monument Hill Rd - Misty Acres Blvd Mid 12-12-23

Site Code : S214862

Start Date : 12/12/2023

Page No : 1

Groups Printed- Unshifted

Start Time	Monument Hill Rd Southbound					Misty Acres Blvd Westbound					Monument Hill Rd Northbound					Eastbound					Int. Total
	Right	Thru	Left	Peds	App. Total	Right	Thru	Left	Peds	App. Total	Right	Thru	Left	Peds	App. Total	Right	Thru	Left	Peds	App. Total	
13:45	0	3	0	0	3	0	0	0	0	0	0	2	0	0	2	0	0	0	0	0	0
13:50	0	2	0	0	2	0	0	0	0	0	0	3	0	0	3	0	0	0	0	0	0
13:55	0	2	0	0	2	0	0	0	0	0	0	3	0	0	3	0	0	0	0	0	0
Total	0	7	0	0	7	0	0	0	0	0	0	8	0	0	8	0	0	0	0	0	0
14:00	0	2	0	0	2	1	0	0	0	1	1	1	0	0	2	0	0	0	0	0	0
14:05	0	2	0	0	2	0	0	0	0	0	0	0	0	0	0	0	0	0	0	0	0
14:10	0	6	0	0	6	0	0	0	0	0	0	4	0	0	4	0	0	0	0	0	0
14:15	0	4	0	0	4	0	0	0	0	0	0	2	0	0	2	0	0	0	0	0	0
14:20	0	5	0	0	5	0	0	0	0	0	0	2	0	0	2	0	0	0	0	0	0
14:25	0	5	0	0	5	0	0	0	0	0	0	3	0	0	3	0	0	0	0	0	0
14:30	0	9	1	0	10	0	0	0	0	0	0	3	0	0	3	0	0	0	0	0	0
14:35	0	6	0	0	6	0	0	1	0	1	0	6	0	0	6	0	0	0	0	0	0
14:40	0	3	0	0	3	0	0	0	0	0	0	9	0	0	9	0	0	0	0	0	0
14:45	0	3	0	0	3	0	0	0	0	0	0	11	0	0	11	0	0	0	0	0	0
14:50	0	2	0	0	2	0	0	0	0	0	0	10	0	0	10	0	0	0	0	0	0
14:55	0	7	2	0	9	0	0	0	0	0	0	6	0	0	6	0	0	0	0	0	0
Total	0	54	3	0	57	1	0	1	0	2	1	57	0	0	58	0	0	0	0	0	0
15:00	0	2	0	0	2	1	0	0	0	1	0	7	0	0	7	0	0	0	0	0	0
15:05	0	3	0	0	3	0	0	0	0	0	0	5	0	0	5	0	0	0	0	0	0
15:10	0	1	0	0	1	0	0	0	0	0	0	4	0	0	4	0	0	0	0	0	0
15:15	0	5	0	0	5	0	0	0	0	0	0	9	0	0	9	0	0	0	0	0	0
15:20	0	2	0	0	2	0	0	0	0	0	0	3	0	0	3	0	0	0	0	0	0
15:25	0	5	0	0	5	0	0	0	0	0	0	5	0	0	5	0	0	0	0	0	0
15:30	0	3	0	0	3	0	0	0	0	0	0	4	0	0	4	0	0	0	0	0	0
15:35	0	4	0	0	4	0	0	0	0	0	0	4	0	0	4	0	0	0	0	0	0
15:40	0	6	0	0	6	0	0	0	0	0	1	2	0	0	3	0	0	0	0	0	0
Grand Total	0	92	3	0	95	2	0	1	0	3	2	108	0	0	110	0	0	0	0	0	0
Apprch %	0	96.8	3.2	0		66.7	0	33.3	0		1.8	98.2	0	0		0	0	0	0		
Total %	0	44.2	1.4	0	45.7	1	0	0.5	0	1.4	1	51.9	0	0	52.9	0	0	0	0	0	

LSC Transportation Consultants, Inc.

2504 E. Pikes Peak Ave, Suite 304
 Colorado Springs, CO 80909
 719-633-2868

File Name : Monument Hill Rd - Misty Acres Blvd Mid 12-12-23

Site Code : S214862

Start Date : 12/12/2023

Page No : 2

Start Time	Monument Hill Rd Southbound					Misty Acres Blvd Westbound					Monument Hill Rd Northbound					Eastbound					Int. Total
	Right	Thru	Left	Peds	App. Total	Right	Thru	Left	Peds	App. Total	Right	Thru	Left	Peds	App. Total	Right	Thru	Left	Peds	App. Total	
Peak Hour Analysis From 13:45 to 15:40 - Peak 1 of 1																					
Peak Hour for Entire Intersection Begins at 14:20																					
14:20	0	5	0	0	5	0	0	0	0	0	0	2	0	0	2	0	0	0	0	0	7
14:25	0	5	0	0	5	0	0	0	0	0	0	3	0	0	3	0	0	0	0	0	8
14:30	0	9	1	0	10	0	0	0	0	0	0	3	0	0	3	0	0	0	0	0	13
14:35	0	6	0	0	6	0	0	1	0	1	0	6	0	0	6	0	0	0	0	0	13
14:40	0	3	0	0	3	0	0	0	0	0	0	9	0	0	9	0	0	0	0	0	12
14:45	0	3	0	0	3	0	0	0	0	0	0	11	0	0	11	0	0	0	0	0	14
14:50	0	2	0	0	2	0	0	0	0	0	0	10	0	0	10	0	0	0	0	0	12
14:55	0	7	2	0	9	0	0	0	0	0	0	6	0	0	6	0	0	0	0	0	15
15:00	0	2	0	0	2	1	0	0	0	1	0	7	0	0	7	0	0	0	0	0	10
15:05	0	3	0	0	3	0	0	0	0	0	0	5	0	0	5	0	0	0	0	0	8
15:10	0	1	0	0	1	0	0	0	0	0	0	4	0	0	4	0	0	0	0	0	5
15:15	0	5	0	0	5	0	0	0	0	0	0	9	0	0	9	0	0	0	0	0	14
Total Volume	0	51	3	0	54	1	0	1	0	2	0	75	0	0	75	0	0	0	0	0	131
% App. Total	0	94.4	5.6	0		50	0	50	0		0	100	0	0		0	0	0	0		
PHF	.000	.472	.125	.000	.450	.083	.000	.083	.000	.167	.000	.568	.000	.000	.568	.000	.000	.000	.000	.000	.728

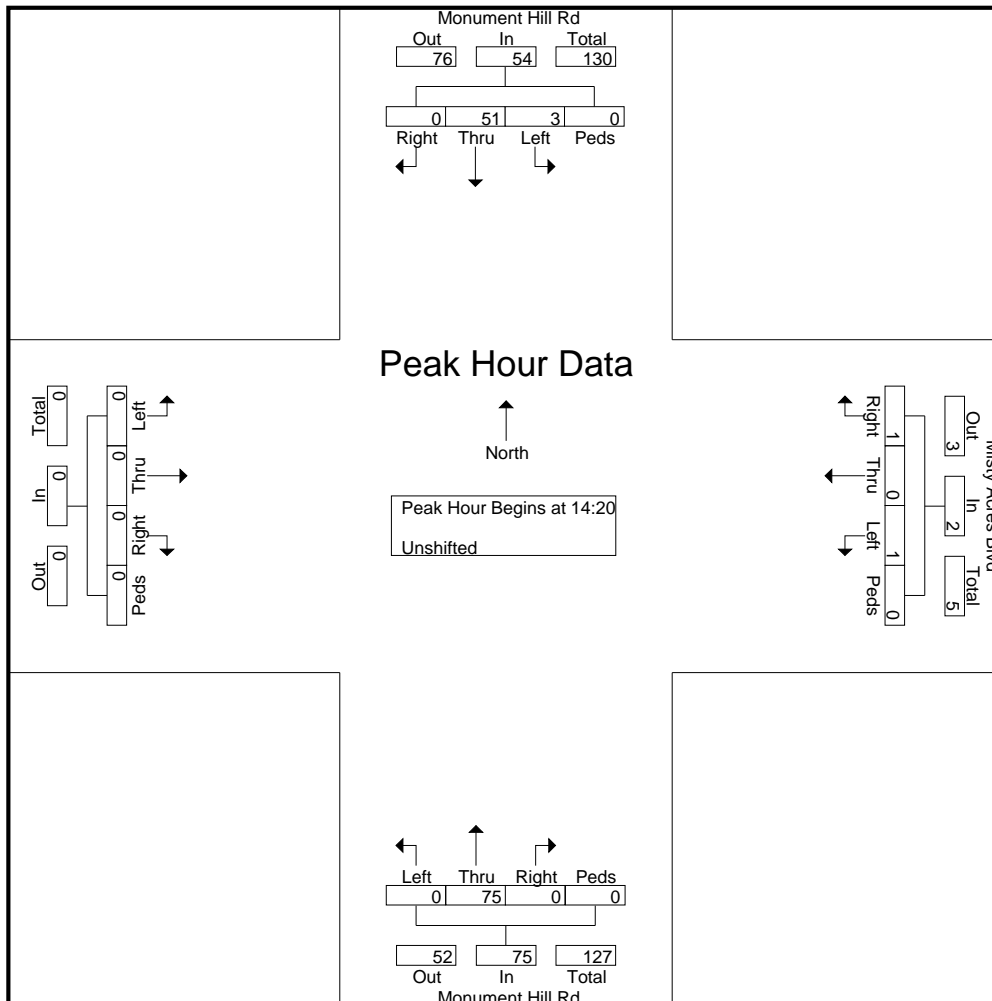

LSC Transportation Consultants, Inc.

2504 E. Pikes Peak Ave, Suite 304
 Colorado Springs, CO 80909
 719-633-2868

File Name : Monument Hill Rd - Misty Acres Blvd Mid 12-12-23

Site Code : S214862

Start Date : 12/12/2023

Page No : 3

Start Time	Monument Hill Rd Southbound					Misty Acres Blvd Westbound					Monument Hill Rd Northbound					Eastbound					Int. Total
	Right	Thru	Left	Peds	App. Total	Right	Thru	Left	Peds	App. Total	Right	Thru	Left	Peds	App. Total	Right	Thru	Left	Peds	App. Total	

Peak Hour Analysis From 13:45 to 15:40 - Peak 1 of 1

Peak Hour for Each Approach Begins at:

	14:10					13:45					14:35					13:45				
+0 mins.	0	6	0	0	6	0	0	0	0	0	0	6	0	0	6	0	0	0	0	0
+5 mins.	0	4	0	0	4	0	0	0	0	0	0	9	0	0	9	0	0	0	0	0
+10 mins.	0	5	0	0	5	0	0	0	0	0	0	11	0	0	11	0	0	0	0	0
+15 mins.	0	5	0	0	5	1	0	0	0	1	0	10	0	0	10	0	0	0	0	0
+20 mins.	0	9	1	0	10	0	0	0	0	0	0	6	0	0	6	0	0	0	0	0
+25 mins.	0	6	0	0	6	0	0	0	0	0	0	7	0	0	7	0	0	0	0	0
+30 mins.	0	3	0	0	3	0	0	0	0	0	0	5	0	0	5	0	0	0	0	0
+35 mins.	0	3	0	0	3	0	0	0	0	0	0	4	0	0	4	0	0	0	0	0
+40 mins.	0	2	0	0	2	0	0	0	0	0	0	9	0	0	9	0	0	0	0	0
+45 mins.	0	7	2	0	9	0	0	0	0	0	0	3	0	0	3	0	0	0	0	0
+50 mins.	0	2	0	0	2	0	0	1	0	1	0	5	0	0	5	0	0	0	0	0
+55 mins.	0	3	0	0	3	0	0	0	0	0	0	4	0	0	4	0	0	0	0	0
Total Volume	0	55	3	0	58	1	0	1	0	2	0	79	0	0	79	0	0	0	0	0
% App. Total	0	94.8	5.2	0		50	0	50	0		0	100	0	0		0	0	0	0	
PHF	.000	.509	.125	.000	.483	.083	.000	.083	.000	.167	.000	.598	.000	.000	.598	.000	.000	.000	.000	.000

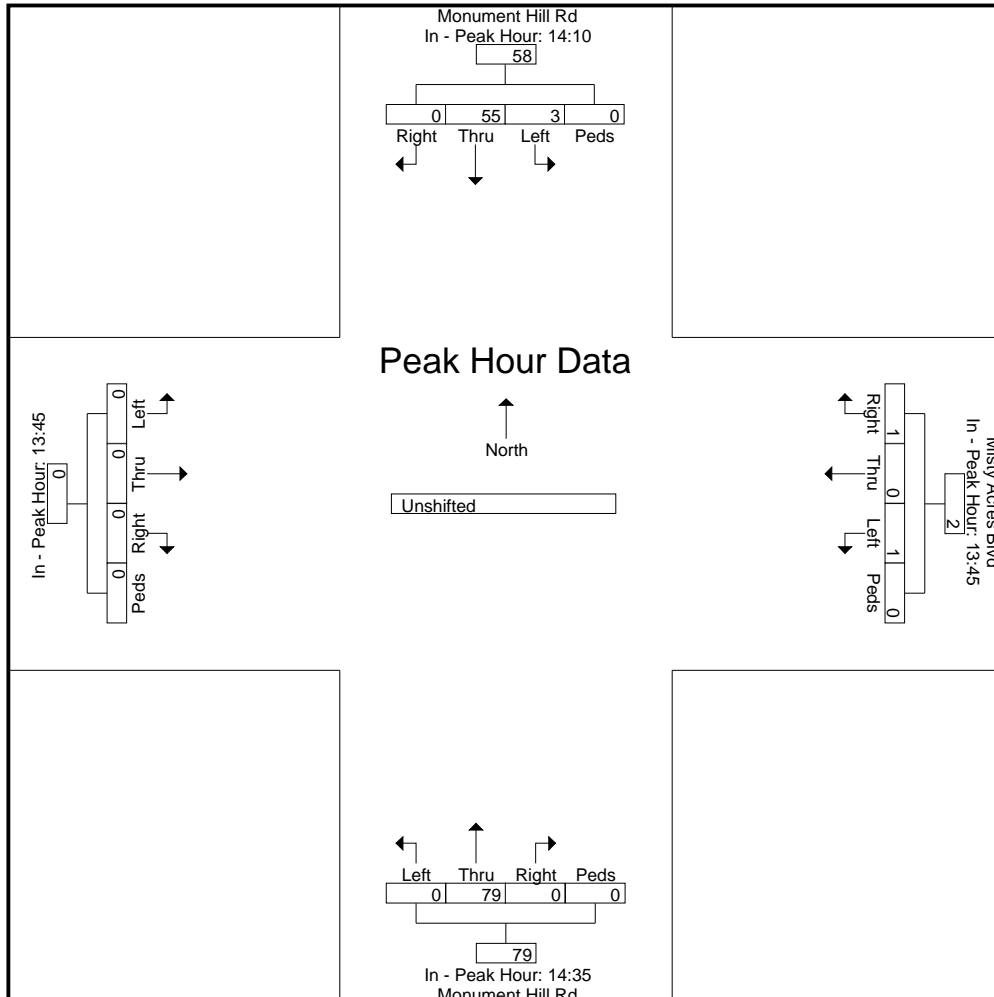

LSC Transportation Consultants, Inc.

2504 E. Pikes Peak Ave, Suite 304
 Colorado Springs, CO 80909
 719-633-2868

File Name : Monument Hill Rd - Misty Acres Blvd PM 12-12-23

Site Code : S214862

Start Date : 12/12/2023

Page No : 1

Groups Printed- Unshifted

Start Time	Monument Hill Rd Southbound					Misty Acres Blvd Westbound					Monument Hill Rd Northbound					Eastbound					Int. Total	
	Right	Thru	Left	Peds	App. Total	Right	Thru	Left	Peds	App. Total	Right	Thru	Left	Peds	App. Total	Right	Thru	Left	Peds	App. Total		
15:45	0	3	0	0	3	0	0	0	0	0	0	2	0	0	2	0	0	0	0	0	0	5
15:50	0	2	0	0	2	0	0	0	0	0	0	3	0	0	3	0	0	0	0	0	0	5
15:55	0	2	0	0	2	0	0	0	0	0	0	3	0	0	3	0	0	0	0	0	0	5
Total	0	7	0	0	7	0	0	0	0	0	0	8	0	0	8	0	0	0	0	0	0	15
16:00	0	4	0	0	4	0	0	0	0	0	0	1	0	0	1	0	0	0	0	0	0	5
16:05	0	2	0	0	2	0	0	0	0	0	0	2	0	0	2	0	0	0	0	0	0	4
16:10	0	2	0	0	2	1	0	0	0	1	1	3	0	0	4	0	0	0	0	0	0	7
16:15	0	5	0	0	5	0	0	0	0	0	0	1	0	0	1	0	0	0	0	0	0	6
16:20	0	3	0	0	3	0	0	0	0	0	1	1	0	0	2	0	0	0	0	0	0	5
16:25	0	5	1	0	6	1	0	0	0	1	0	5	0	0	5	0	0	0	0	0	0	12
16:30	0	4	1	0	5	0	0	0	0	0	0	3	0	0	3	0	0	0	0	0	0	8
16:35	0	3	1	0	4	0	0	0	0	0	0	3	0	0	3	0	0	0	0	0	0	7
16:40	0	6	1	0	7	1	0	0	0	1	0	3	0	0	3	0	0	0	0	0	0	11
16:45	0	2	1	0	3	0	0	0	0	0	0	0	0	0	0	0	0	0	0	0	0	3
16:50	0	2	0	0	2	0	0	0	0	0	0	6	0	0	6	0	0	0	0	0	0	8
16:55	0	1	0	0	1	1	0	0	0	1	0	1	0	0	1	0	0	0	0	0	0	3
Total	0	39	5	0	44	4	0	0	0	4	2	29	0	0	31	0	0	0	0	0	0	79
17:00	0	3	0	0	3	0	0	0	0	0	0	1	0	0	1	0	0	0	0	0	0	4
17:05	0	6	0	0	6	0	0	0	0	0	0	1	0	0	1	0	0	0	0	0	0	7
17:10	0	4	0	0	4	0	0	0	0	0	0	4	0	0	4	0	0	0	0	0	0	8
17:15	0	3	0	0	3	0	0	0	0	0	0	3	0	0	3	0	0	0	0	0	0	6
17:20	0	4	0	0	4	1	0	0	0	1	0	3	0	0	3	0	0	0	0	0	0	8
17:25	0	7	1	0	8	0	0	0	0	0	0	1	0	0	1	0	0	0	0	0	0	9
17:30	0	2	0	0	2	0	0	0	0	0	0	4	0	0	4	0	0	0	0	0	0	6
17:35	0	2	0	0	2	0	0	0	0	0	0	2	0	0	2	0	0	0	0	0	0	4
17:40	0	2	0	0	2	0	0	0	0	0	0	3	0	0	3	0	0	0	0	0	0	5
Grand Total	0	79	6	0	85	5	0	0	0	5	2	59	0	0	61	0	0	0	0	0	0	151
Apprch %	0	92.9	7.1	0		100	0	0	0		3.3	96.7	0	0		0	0	0	0	0		
Total %	0	52.3	4	0	56.3	3.3	0	0	0	3.3	1.3	39.1	0	0	40.4	0	0	0	0	0	0	

LSC Transportation Consultants, Inc.

2504 E. Pikes Peak Ave, Suite 304
 Colorado Springs, CO 80909
 719-633-2868

File Name : Monument Hill Rd - Misty Acres Blvd PM 12-12-23

Site Code : S214862

Start Date : 12/12/2023

Page No : 2

Start Time	Monument Hill Rd Southbound					Misty Acres Blvd Westbound					Monument Hill Rd Northbound					Eastbound					Int. Total
	Right	Thru	Left	Peds	App. Total	Right	Thru	Left	Peds	App. Total	Right	Thru	Left	Peds	App. Total	Right	Thru	Left	Peds	App. Total	
Peak Hour Analysis From 15:45 to 17:40 - Peak 1 of 1																					
Peak Hour for Entire Intersection Begins at 16:25																					
16:25	0	5	1	0	6	1	0	0	0	1	0	5	0	0	5	0	0	0	0	0	12
16:30	0	4	1	0	5	0	0	0	0	0	0	3	0	0	3	0	0	0	0	0	8
16:35	0	3	1	0	4	0	0	0	0	0	0	3	0	0	3	0	0	0	0	0	7
16:40	0	6	1	0	7	1	0	0	0	1	0	3	0	0	3	0	0	0	0	0	11
16:45	0	2	1	0	3	0	0	0	0	0	0	0	0	0	0	0	0	0	0	0	3
16:50	0	2	0	0	2	0	0	0	0	0	0	6	0	0	6	0	0	0	0	0	8
16:55	0	1	0	0	1	1	0	0	0	1	0	1	0	0	1	0	0	0	0	0	3
17:00	0	3	0	0	3	0	0	0	0	0	0	1	0	0	1	0	0	0	0	0	4
17:05	0	6	0	0	6	0	0	0	0	0	0	1	0	0	1	0	0	0	0	0	7
17:10	0	4	0	0	4	0	0	0	0	0	0	4	0	0	4	0	0	0	0	0	8
17:15	0	3	0	0	3	0	0	0	0	0	0	3	0	0	3	0	0	0	0	0	6
17:20	0	4	0	0	4	1	0	0	0	1	0	3	0	0	3	0	0	0	0	0	8
Total Volume	0	43	5	0	48	4	0	0	0	4	0	33	0	0	33	0	0	0	0	0	85
% App. Total	0	89.6	10.4	0		100	0	0	0		0	100	0	0		0	0	0	0		
PHF	.000	.597	.417	.000	.571	.333	.000	.000	.000	.333	.000	.458	.000	.000	.458	.000	.000	.000	.000	.000	.590

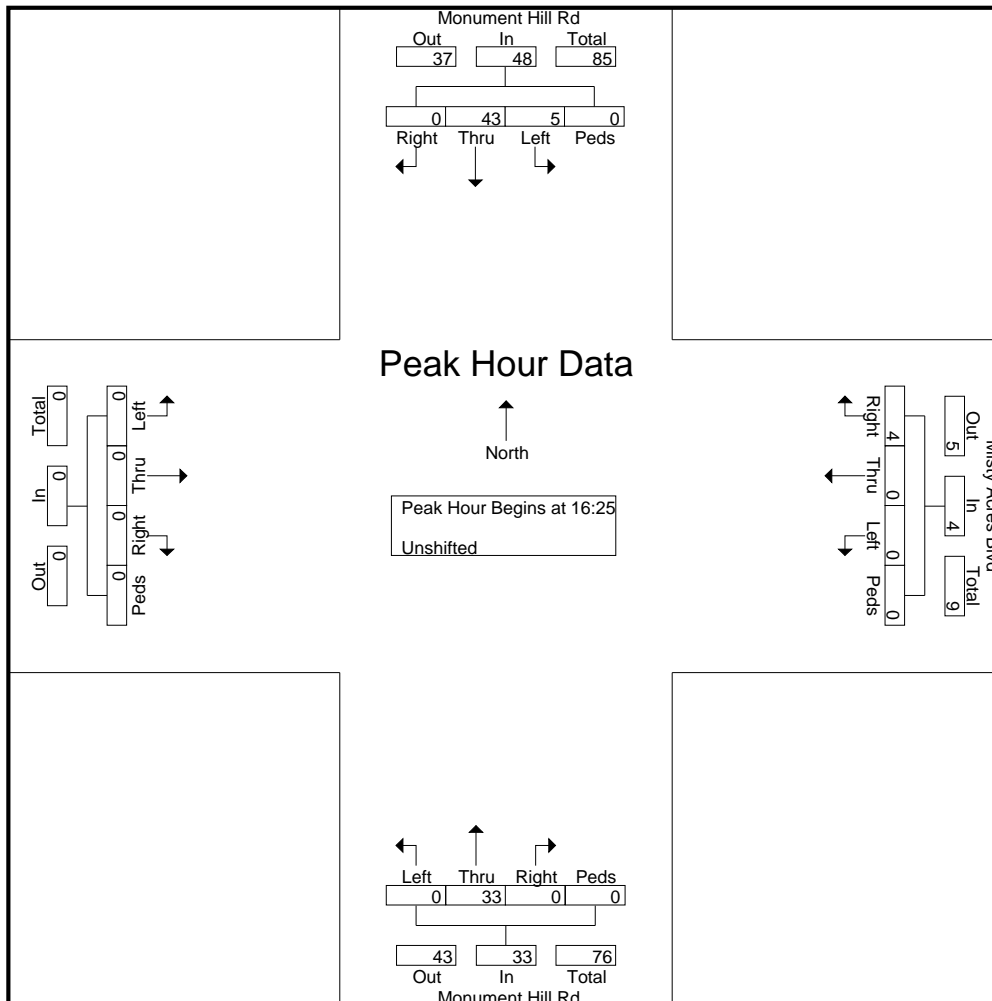

LSC Transportation Consultants, Inc.

2504 E. Pikes Peak Ave, Suite 304
 Colorado Springs, CO 80909
 719-633-2868

File Name : Monument Hill Rd - Misty Acres Blvd PM 12-12-23

Site Code : S214862

Start Date : 12/12/2023

Page No : 3

Start Time	Monument Hill Rd Southbound					Misty Acres Blvd Westbound					Monument Hill Rd Northbound					Eastbound					Int. Total
	Right	Thru	Left	Peds	App. Total	Right	Thru	Left	Peds	App. Total	Right	Thru	Left	Peds	App. Total	Right	Thru	Left	Peds	App. Total	

Peak Hour Analysis From 15:45 to 17:40 - Peak 1 of 1

Peak Hour for Each Approach Begins at:

	16:30					16:00					15:55					15:45				
+0 mins.	0	4	1	0	5	0	0	0	0	0	0	3	0	0	3	0	0	0	0	0
+5 mins.	0	3	1	0	4	0	0	0	0	0	0	1	0	0	1	0	0	0	0	0
+10 mins.	0	6	1	0	7	1	0	0	0	1	0	2	0	0	2	0	0	0	0	0
+15 mins.	0	2	1	0	3	0	0	0	0	0	1	3	0	0	4	0	0	0	0	0
+20 mins.	0	2	0	0	2	0	0	0	0	0	0	1	0	0	1	0	0	0	0	0
+25 mins.	0	1	0	0	1	1	0	0	0	1	1	1	0	0	2	0	0	0	0	0
+30 mins.	0	3	0	0	3	0	0	0	0	0	0	5	0	0	5	0	0	0	0	0
+35 mins.	0	6	0	0	6	0	0	0	0	0	0	3	0	0	3	0	0	0	0	0
+40 mins.	0	4	0	0	4	1	0	0	0	1	0	3	0	0	3	0	0	0	0	0
+45 mins.	0	3	0	0	3	0	0	0	0	0	0	3	0	0	3	0	0	0	0	0
+50 mins.	0	4	0	0	4	0	0	0	0	0	0	0	0	0	0	0	0	0	0	0
+55 mins.	0	7	1	0	8	1	0	0	0	1	0	6	0	0	6	0	0	0	0	0
Total Volume	0	45	5	0	50	4	0	0	0	4	2	31	0	0	33	0	0	0	0	0
% App. Total	0	90	10	0		100	0	0	0		6.1	93.9	0	0		0	0	0	0	
PHF	.000	.536	.417	.000	.521	.333	.000	.000	.000	.333	.167	.431	.000	.000	.458	.000	.000	.000	.000	.000

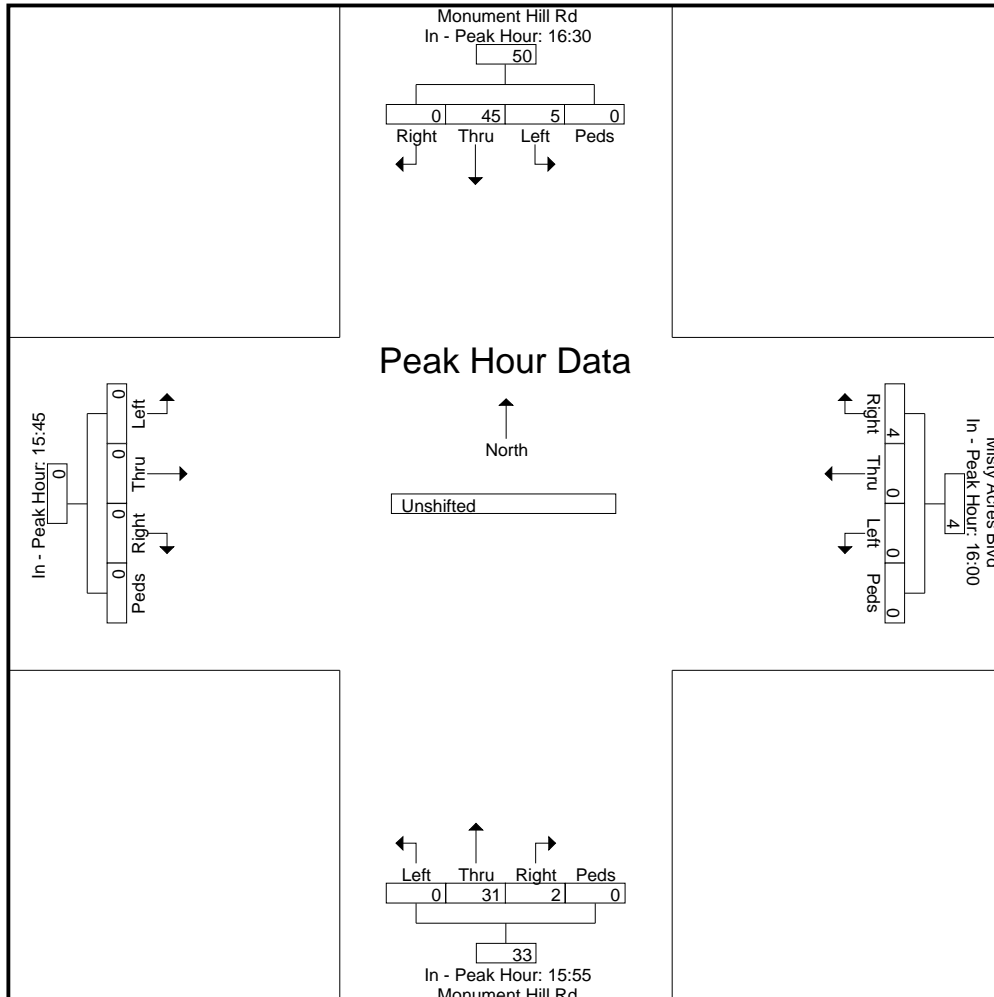

LSC Transportation Consultants, Inc.

2504 E. Pikes Peak Ave, Suite 304
 Colorado Springs, CO 80909
 719-633-2868

File Name : Monument Hill Rd - S Misty Acres Blvd AM 1-10-24

Site Code : S214862

Start Date : 1/10/2024

Page No : 1

Groups Printed- Unshifted

Start Time	Monument Hill Rd Southbound					S Misty Acres Blvd Westbound					Monument Hill Rd Northbound					Eastbound					Int. Total
	Right	Thru	Left	Peds	App. Total	Right	Thru	Left	Peds	App. Total	Right	Thru	Left	Peds	App. Total	Right	Thru	Left	Peds	App. Total	
06:30	0	0	1	0	1	0	0	0	0	0	2	1	0	0	3	0	0	0	0	0	0
06:35	0	4	0	0	4	0	0	1	0	1	1	1	0	0	2	0	0	0	0	0	0
06:40	0	3	0	0	3	0	0	2	0	2	6	3	0	0	9	0	0	0	0	0	0
06:45	0	2	0	0	2	0	0	2	0	2	4	0	0	0	4	0	0	0	0	0	0
06:50	0	4	0	0	4	0	0	3	0	3	5	3	0	0	8	0	0	0	0	0	0
06:55	0	5	0	0	5	0	0	8	0	8	10	2	0	0	12	0	0	0	0	0	0
Total	0	18	1	0	19	0	0	16	0	16	28	10	0	0	38	0	0	0	0	0	0
07:00	0	7	3	0	10	1	0	14	0	15	26	2	0	0	28	0	0	0	0	0	0
07:05	0	7	4	0	11	2	0	16	0	18	16	3	0	0	19	0	0	0	0	0	0
07:10	0	8	9	0	17	1	0	17	0	18	27	4	0	0	31	0	0	0	0	0	0
07:15	0	5	8	0	13	6	0	24	0	30	40	7	0	0	47	0	0	0	0	0	0
07:20	0	16	8	0	24	4	0	27	0	31	31	1	0	0	32	0	0	0	0	0	0
07:25	0	11	10	0	21	7	0	30	0	37	40	4	0	0	44	0	0	0	0	0	0
07:30	0	13	15	0	28	4	0	26	0	30	50	7	0	0	57	0	0	0	0	0	0
07:35	0	9	6	0	15	9	0	39	0	48	28	5	0	0	33	0	0	0	0	0	0
07:40	0	4	1	0	5	3	0	20	0	23	3	1	0	0	4	0	0	0	0	0	0
07:45	0	5	1	0	6	2	0	12	0	14	9	0	0	0	9	0	0	0	0	0	0
07:50	0	2	0	0	2	0	0	11	0	11	2	0	0	0	2	0	0	0	0	0	0
07:55	0	1	0	0	1	2	0	4	0	6	5	2	0	0	7	0	0	0	0	0	0
Total	0	88	65	0	153	41	0	240	0	281	277	36	0	0	313	0	0	0	0	0	0
08:00	0	2	1	0	3	0	0	9	0	9	3	3	0	0	6	0	0	0	0	0	0
08:05	0	2	0	0	2	0	0	5	0	5	4	2	0	0	6	0	0	0	0	0	0
08:10	0	1	0	0	1	0	0	6	0	6	4	3	0	0	7	0	0	0	0	0	0
08:15	0	0	0	0	0	0	0	2	0	2	1	0	0	0	1	0	0	0	0	0	0
08:20	0	3	0	0	3	0	0	5	0	5	1	1	0	0	2	0	0	0	0	0	0
08:25	0	2	0	0	2	0	0	2	0	2	1	0	0	0	1	0	0	0	0	0	0
Grand Total	0	116	67	0	183	41	0	285	0	326	319	55	0	0	374	0	0	0	0	0	0
Apprch %	0	63.4	36.6	0		12.6	0	87.4	0		85.3	14.7	0	0		0	0	0	0	0	
Total %	0	13.1	7.6	0	20.7	4.6	0	32.3	0	36.9	36.1	6.2	0	0	42.4	0	0	0	0	0	0

LSC Transportation Consultants, Inc.

2504 E. Pikes Peak Ave, Suite 304
 Colorado Springs, CO 80909
 719-633-2868

File Name : Monument Hill Rd - S Misty Acres Blvd AM 1-10-24

Site Code : S214862

Start Date : 1/10/2024

Page No : 2

Start Time	Monument Hill Rd Southbound					S Misty Acres Blvd Westbound					Monument Hill Rd Northbound					Eastbound					Int. Total
	Right	Thru	Left	Peds	App. Total	Right	Thru	Left	Peds	App. Total	Right	Thru	Left	Peds	App. Total	Right	Thru	Left	Peds	App. Total	
Peak Hour Analysis From 06:30 to 08:25 - Peak 1 of 1																					
Peak Hour for Entire Intersection Begins at 06:50																					
06:50	0	4	0	0	4	0	0	3	0	3	5	3	0	0	8	0	0	0	0	0	15
06:55	0	5	0	0	5	0	0	8	0	8	10	2	0	0	12	0	0	0	0	0	25
07:00	0	7	3	0	10	1	0	14	0	15	26	2	0	0	28	0	0	0	0	0	53
07:05	0	7	4	0	11	2	0	16	0	18	16	3	0	0	19	0	0	0	0	0	48
07:10	0	8	9	0	17	1	0	17	0	18	27	4	0	0	31	0	0	0	0	0	66
07:15	0	5	8	0	13	6	0	24	0	30	40	7	0	0	47	0	0	0	0	0	90
07:20	0	16	8	0	24	4	0	27	0	31	31	1	0	0	32	0	0	0	0	0	87
07:25	0	11	10	0	21	7	0	30	0	37	40	4	0	0	44	0	0	0	0	0	102
07:30	0	13	15	0	28	4	0	26	0	30	50	7	0	0	57	0	0	0	0	0	115
07:35	0	9	6	0	15	9	0	39	0	48	28	5	0	0	33	0	0	0	0	0	96
07:40	0	4	1	0	5	3	0	20	0	23	3	1	0	0	4	0	0	0	0	0	32
07:45	0	5	1	0	6	2	0	12	0	14	9	0	0	0	9	0	0	0	0	0	29
Total Volume	0	94	65	0	159	39	0	236	0	275	285	39	0	0	324	0	0	0	0	0	758
% App. Total	0	59.1	40.9	0		14.2	0	85.8	0		88	12	0	0		0	0	0	0		
PHF	.000	.490	.361	.000	.473	.361	.000	.504	.000	.477	.475	.464	.000	.000	.474	.000	.000	.000	.000	.000	.549

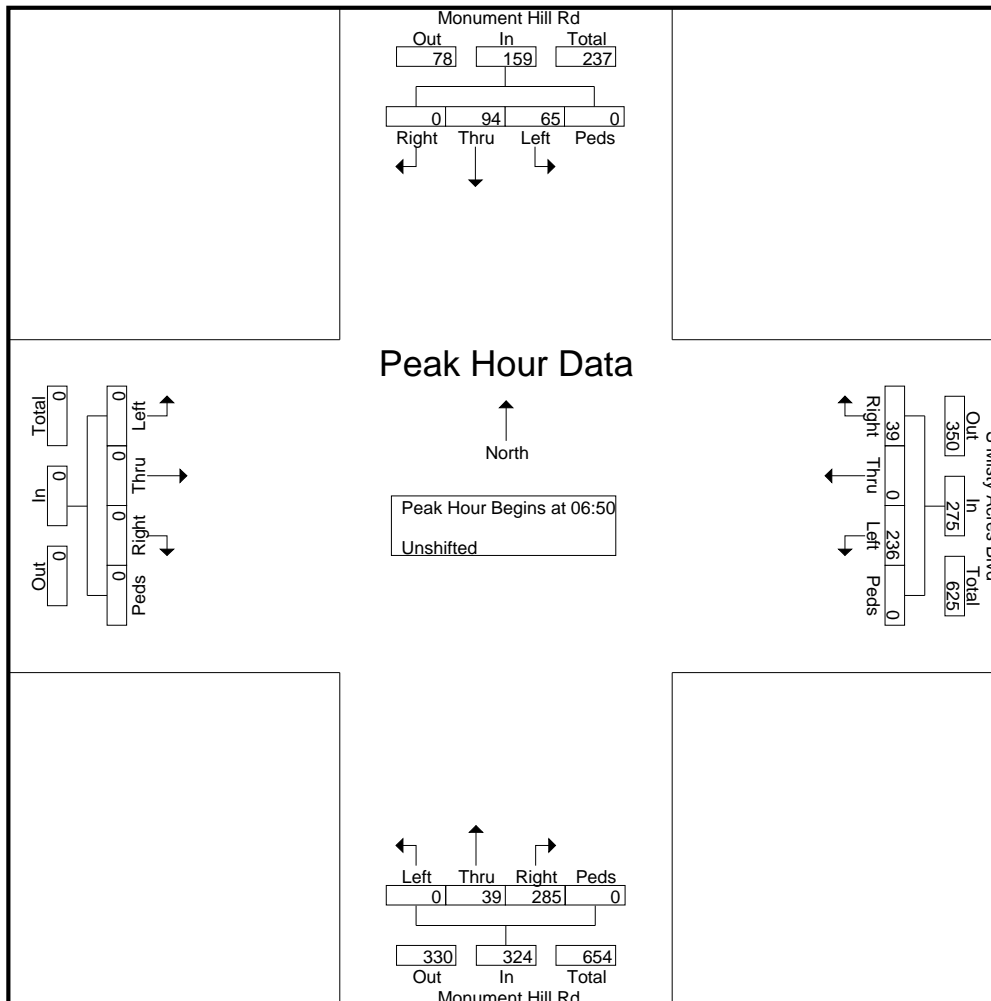

LSC Transportation Consultants, Inc.

2504 E. Pikes Peak Ave, Suite 304
 Colorado Springs, CO 80909
 719-633-2868

File Name : Monument Hill Rd - S Misty Acres Blvd AM 1-10-24

Site Code : S214862

Start Date : 1/10/2024

Page No : 3

Start Time	Monument Hill Rd Southbound					S Misty Acres Blvd Westbound					Monument Hill Rd Northbound					Eastbound					Int. Total
	Right	Thru	Left	Peds	App. Total	Right	Thru	Left	Peds	App. Total	Right	Thru	Left	Peds	App. Total	Right	Thru	Left	Peds	App. Total	

Peak Hour Analysis From 06:30 to 08:25 - Peak 1 of 1

Peak Hour for Each Approach Begins at:

	06:50					06:55					06:40					06:30				
+0 mins.	0	4	0	0	4	0	0	8	0	8	6	3	0	0	9	0	0	0	0	0
+5 mins.	0	5	0	0	5	1	0	14	0	15	4	0	0	0	4	0	0	0	0	0
+10 mins.	0	7	3	0	10	2	0	16	0	18	5	3	0	0	8	0	0	0	0	0
+15 mins.	0	7	4	0	11	1	0	17	0	18	10	2	0	0	12	0	0	0	0	0
+20 mins.	0	8	9	0	17	6	0	24	0	30	26	2	0	0	28	0	0	0	0	0
+25 mins.	0	5	8	0	13	4	0	27	0	31	16	3	0	0	19	0	0	0	0	0
+30 mins.	0	16	8	0	24	7	0	30	0	37	27	4	0	0	31	0	0	0	0	0
+35 mins.	0	11	10	0	21	4	0	26	0	30	40	7	0	0	47	0	0	0	0	0
+40 mins.	0	13	15	0	28	9	0	39	0	48	31	1	0	0	32	0	0	0	0	0
+45 mins.	0	9	6	0	15	3	0	20	0	23	40	4	0	0	44	0	0	0	0	0
+50 mins.	0	4	1	0	5	2	0	12	0	14	50	7	0	0	57	0	0	0	0	0
+55 mins.	0	5	1	0	6	0	0	11	0	11	28	5	0	0	33	0	0	0	0	0
Total Volume	0	94	65	0	159	39	0	244	0	283	283	41	0	0	324	0	0	0	0	0
% App. Total	0	59.1	40.9	0		13.8	0	86.2	0		87.3	12.7	0	0		0	0	0	0	
PHF	.000	.490	.361	.000	.473	.361	.000	.521	.000	.491	.472	.488	.000	.000	.474	.000	.000	.000	.000	.000

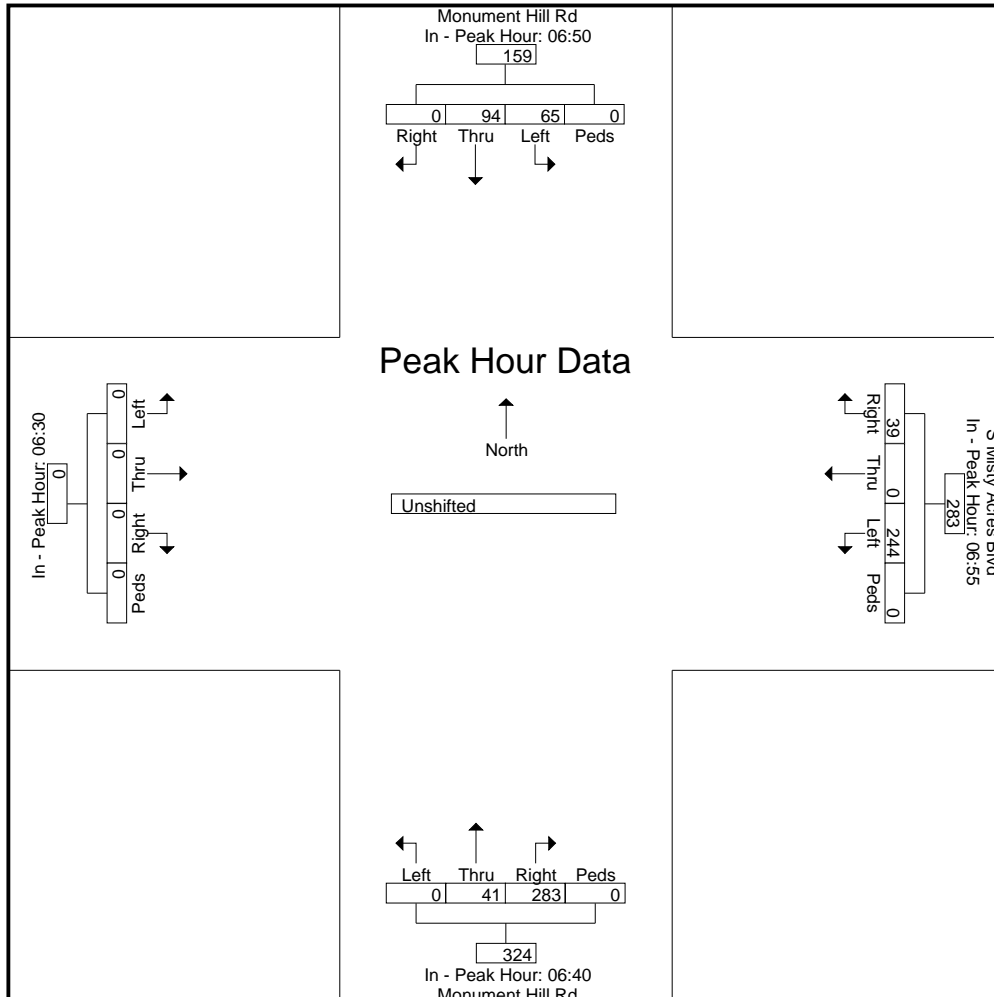

LSC Transportation Consultants, Inc.

2504 E. Pikes Peak Ave, Suite 304
 Colorado Springs, CO 80909
 719-633-2868

File Name : Monument Hill Rd - S Misty Acres Blvd PM 1-9-24

Site Code : S214862

Start Date : 1/9/2024

Page No : 2

Start Time	Monument Hill Rd Southbound					S Misty Acres Blvd Westbound					Monument Hill Rd Northbound					Eastbound					Int. Total
	Right	Thru	Left	Peds	App. Total	Right	Thru	Left	Peds	App. Total	Right	Thru	Left	Peds	App. Total	Right	Thru	Left	Peds	App. Total	
Peak Hour Analysis From 16:00 to 17:55 - Peak 1 of 1																					
Peak Hour for Entire Intersection Begins at 16:10																					
16:10	0	4	0	0	4	0	0	1	0	1	13	3	0	0	16	0	0	0	0	0	21
16:15	0	6	0	0	6	0	0	13	0	13	7	1	0	0	8	0	0	0	0	0	27
16:20	0	5	0	0	5	0	0	4	0	4	7	5	0	0	12	0	0	0	0	0	21
16:25	0	2	0	0	2	0	0	7	0	7	5	4	0	0	9	0	0	0	0	0	18
16:30	0	3	1	0	4	0	0	2	0	2	5	1	0	0	6	0	0	0	0	0	12
16:35	0	2	1	0	3	0	0	12	0	12	3	3	0	0	6	0	0	0	0	0	21
16:40	0	5	0	0	5	2	0	7	0	9	7	8	0	0	15	0	0	0	0	0	29
16:45	0	3	0	0	3	0	0	3	0	3	10	6	0	0	16	0	0	0	0	0	22
16:50	0	5	0	0	5	0	0	5	0	5	6	5	0	0	11	0	0	0	0	0	21
16:55	0	2	0	0	2	1	0	5	0	6	9	2	0	0	11	0	0	0	0	0	19
17:00	0	3	1	0	4	0	0	9	0	9	4	4	0	0	8	0	0	0	0	0	21
17:05	0	4	1	0	5	0	0	4	0	4	11	4	0	0	15	0	0	0	0	0	24
Total Volume	0	44	4	0	48	3	0	72	0	75	87	46	0	0	133	0	0	0	0	0	256
% App. Total	0	91.7	8.3	0		4	0	96	0		65.4	34.6	0	0		0	0	0	0		
PHF	.000	.611	.333	.000	.667	.125	.000	.462	.000	.481	.558	.479	.000	.000	.693	.000	.000	.000	.000	.000	.736

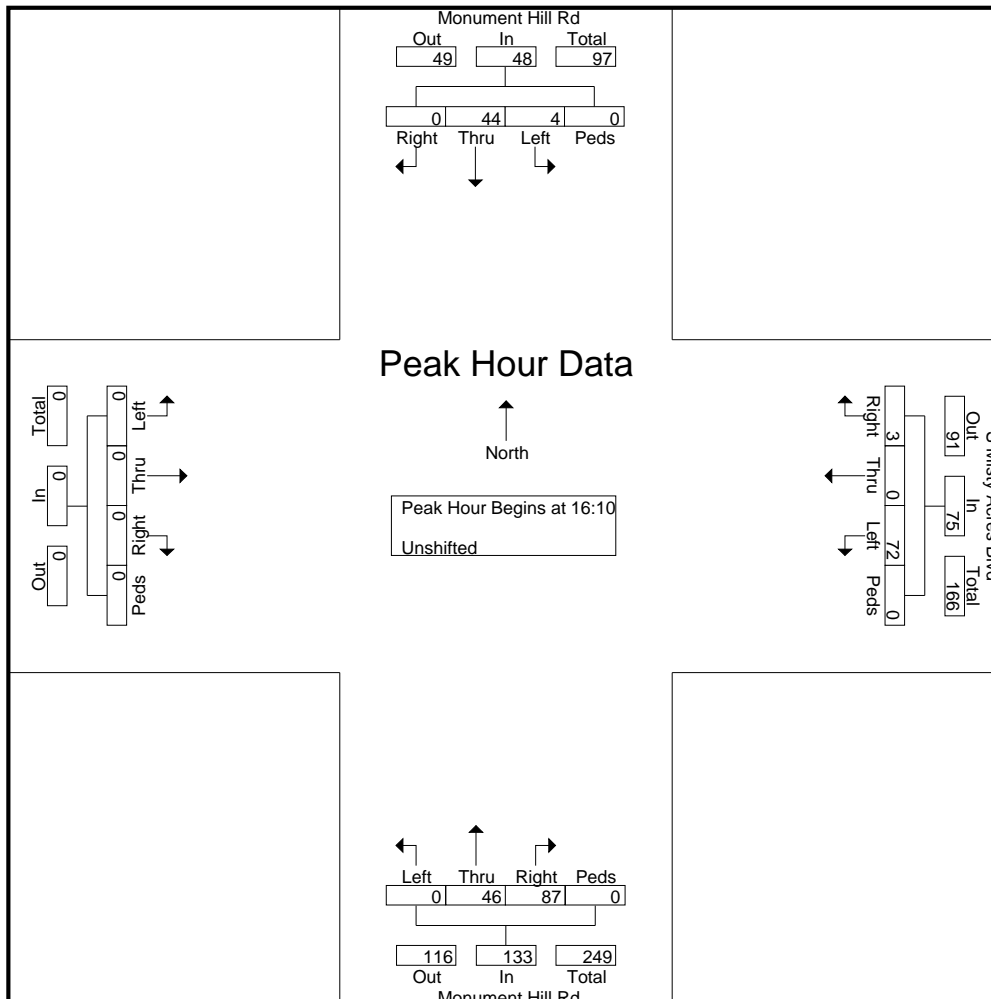

LSC Transportation Consultants, Inc.

2504 E. Pikes Peak Ave, Suite 304
 Colorado Springs, CO 80909
 719-633-2868

File Name : Monument Hill Rd - S Misty Acres Blvd PM 1-9-24

Site Code : S214862

Start Date : 1/9/2024

Page No : 3

Start Time	Monument Hill Rd Southbound					S Misty Acres Blvd Westbound					Monument Hill Rd Northbound					Eastbound					Int. Total
	Right	Thru	Left	Peds	App. Total	Right	Thru	Left	Peds	App. Total	Right	Thru	Left	Peds	App. Total	Right	Thru	Left	Peds	App. Total	

Peak Hour Analysis From 16:00 to 17:55 - Peak 1 of 1

Peak Hour for Each Approach Begins at:

	16:10					16:15					16:45					16:00				
+0 mins.	0	4	0	0	4	0	0	13	0	13	10	6	0	0	16	0	0	0	0	0
+5 mins.	0	6	0	0	6	0	0	4	0	4	6	5	0	0	11	0	0	0	0	0
+10 mins.	0	5	0	0	5	0	0	7	0	7	9	2	0	0	11	0	0	0	0	0
+15 mins.	0	2	0	0	2	0	0	2	0	2	4	4	0	0	8	0	0	0	0	0
+20 mins.	0	3	1	0	4	0	0	12	0	12	11	4	0	0	15	0	0	0	0	0
+25 mins.	0	2	1	0	3	2	0	7	0	9	6	1	0	0	7	0	0	0	0	0
+30 mins.	0	5	0	0	5	0	0	3	0	3	8	6	0	0	14	0	0	0	0	0
+35 mins.	0	3	0	0	3	0	0	5	0	5	5	3	0	0	8	0	0	0	0	0
+40 mins.	0	5	0	0	5	1	0	5	0	6	6	3	0	0	9	0	0	0	0	0
+45 mins.	0	2	0	0	2	0	0	9	0	9	9	9	0	0	18	0	0	0	0	0
+50 mins.	0	3	1	0	4	0	0	4	0	4	3	4	0	0	7	0	0	0	0	0
+55 mins.	0	4	1	0	5	0	0	3	0	3	9	9	0	0	18	0	0	0	0	0
Total Volume	0	44	4	0	48	3	0	74	0	77	86	56	0	0	142	0	0	0	0	0
% App. Total	0	91.7	8.3	0		3.9	0	96.1	0		60.6	39.4	0	0		0	0	0	0	
PHF	.000	.611	.333	.000	.667	.125	.000	.474	.000	.494	.652	.519	.000	.000	.657	.000	.000	.000	.000	.000

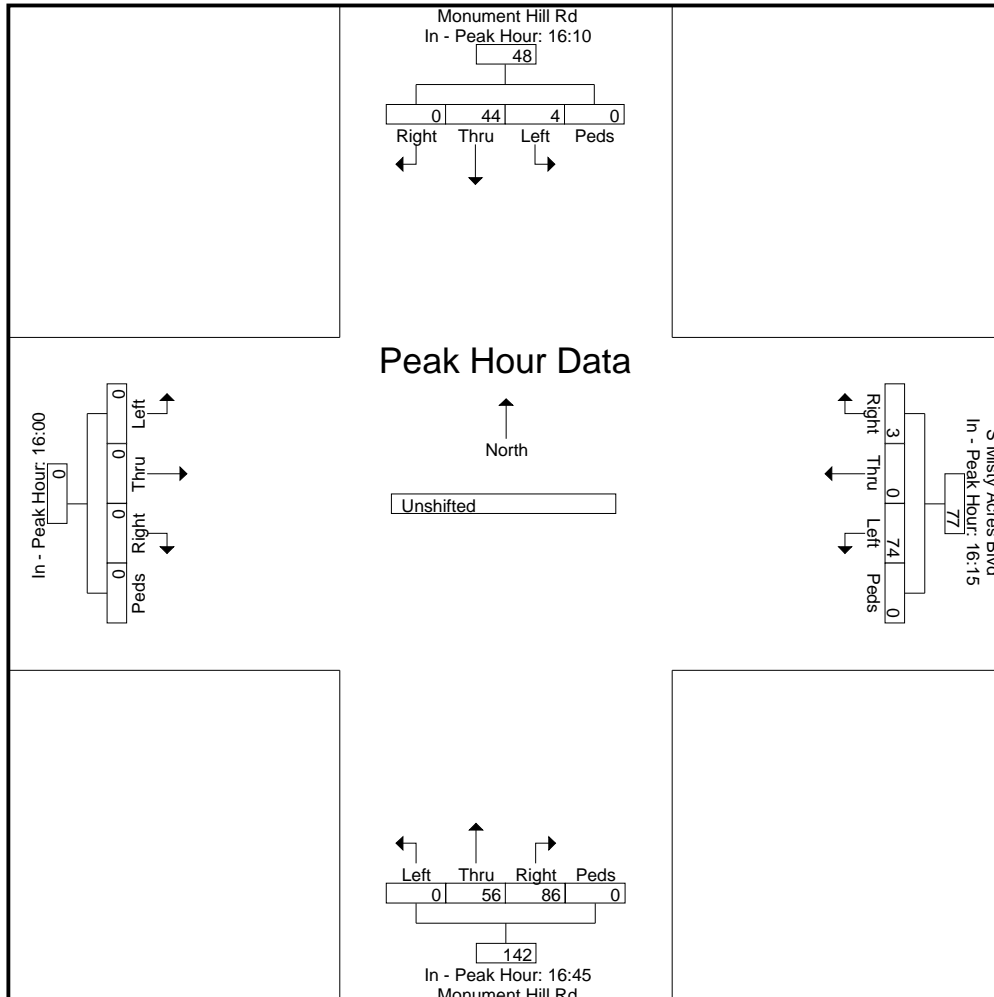

Level of Service Reports



HCM 6th TWSC
1: County Line Rd & I-25 SB Ramps

ST Baseline
AM

Intersection												
Int Delay, s/veh	6.2											
Movement	EBL	EBT	EBR	WBL	WBT	WBR	NBL	NBT	NBR	SBL	SBT	SBR
Lane Configurations		↕		↕	↑						↕	
Traffic Vol, veh/h	0	100	46	253	104	0	0	0	0	55	1	27
Future Vol, veh/h	0	100	46	253	104	0	0	0	0	55	1	27
Conflicting Peds, #/hr	0	0	0	0	0	0	0	0	0	0	0	0
Sign Control	Free	Free	Free	Free	Free	Free	Stop	Stop	Stop	Stop	Stop	Stop
RT Channelized	-	-	None	-	-	None	-	-	None	-	-	None
Storage Length	-	-	-	0	-	-	-	-	-	-	-	-
Veh in Median Storage, #	-	0	-	-	0	-	-	0	-	-	0	-
Grade, %	-	0	-	-	0	-	-	0	-	-	0	-
Peak Hour Factor	83	83	83	92	92	92	92	92	92	83	83	83
Heavy Vehicles, %	2	2	2	2	2	2	2	2	2	2	2	2
Mvmt Flow	0	120	55	275	113	0	0	0	0	66	1	33

Major/Minor	Major1			Major2			Minor2		
Conflicting Flow All	113	0	0	175	0	0	811	838	113
Stage 1	-	-	-	-	-	-	663	663	-
Stage 2	-	-	-	-	-	-	148	175	-
Critical Hdwy	4.12	-	-	4.12	-	-	6.42	6.52	6.22
Critical Hdwy Stg 1	-	-	-	-	-	-	5.42	5.52	-
Critical Hdwy Stg 2	-	-	-	-	-	-	5.42	5.52	-
Follow-up Hdwy	2.218	-	-	2.218	-	-	3.518	4.018	3.318
Pot Cap-1 Maneuver	1476	-	-	1401	-	0	349	302	940
Stage 1	-	-	-	-	-	0	512	459	-
Stage 2	-	-	-	-	-	0	880	754	-
Platoon blocked, %	-	-	-	-	-	-	-	-	-
Mov Cap-1 Maneuver	1476	-	-	1401	-	-	281	0	940
Mov Cap-2 Maneuver	-	-	-	-	-	-	281	0	-
Stage 1	-	-	-	-	-	-	512	0	-
Stage 2	-	-	-	-	-	-	708	0	-

Approach	EB	WB	SB
HCM Control Delay, s	0	5.8	18.5
HCM LOS			C

Minor Lane/Major Mvmt	EBL	EBT	EBR	WBL	WBT	SBLn1
Capacity (veh/h)	1476	-	-	1401	-	365
HCM Lane V/C Ratio	-	-	-	0.196	-	0.274
HCM Control Delay (s)	0	-	-	8.2	-	18.5
HCM Lane LOS	A	-	-	A	-	C
HCM 95th %tile Q(veh)	0	-	-	0.7	-	1.1

HCM 6th TWSC
2: I-25 NB Ramps & County Line Rd

ST Baseline
AM

Intersection												
Int Delay, s/veh	2.9											
Movement	EBL	EBT	EBR	WBL	WBT	WBR	NBL	NBT	NBR	SBL	SBT	SBR
Lane Configurations	↖	↑			↗			↕				
Traffic Vol, veh/h	51	127	0	0	318	205	74	1	37	0	0	0
Future Vol, veh/h	51	127	0	0	318	205	74	1	37	0	0	0
Conflicting Peds, #/hr	0	0	0	0	0	0	0	0	0	0	0	0
Sign Control	Free	Free	Free	Free	Free	Free	Stop	Stop	Stop	Stop	Stop	Stop
RT Channelized	-	-	None	-	-	None	-	-	None	-	-	None
Storage Length	0	-	-	-	-	-	-	-	-	-	-	-
Veh in Median Storage, #	-	0	-	-	0	-	-	0	-	-	0	-
Grade, %	-	0	-	-	0	-	-	0	-	-	0	-
Peak Hour Factor	87	87	87	92	92	92	83	83	83	92	92	92
Heavy Vehicles, %	2	2	2	2	2	2	2	2	2	2	2	2
Mvmt Flow	59	146	0	0	346	223	89	1	45	0	0	0

Major/Minor	Major1	Major2	Minor1
Conflicting Flow All	569	0	-
Stage 1	-	-	-
Stage 2	-	-	-
Critical Hdwy	4.12	-	-
Critical Hdwy Stg 1	-	-	-
Critical Hdwy Stg 2	-	-	-
Follow-up Hdwy	2.218	-	-
Pot Cap-1 Maneuver	1003	0	0
Stage 1	-	0	0
Stage 2	-	0	0
Platoon blocked, %	-	-	-
Mov Cap-1 Maneuver	1003	-	-
Mov Cap-2 Maneuver	-	-	-
Stage 1	-	-	-
Stage 2	-	-	-

Approach	EB	WB	NB
HCM Control Delay, s	2.5	0	16
HCM LOS			C

Minor Lane/Major Mvmt	NBLn1	EBL	EBT	WBT	WBR
Capacity (veh/h)	461	1003	-	-	-
HCM Lane V/C Ratio	0.293	0.058	-	-	-
HCM Control Delay (s)	16	8.8	-	-	-
HCM Lane LOS	C	A	-	-	-
HCM 95th %tile Q(veh)	1.2	0.2	-	-	-

HCM 6th TWSC
 3: Monument Hill Rd/Andrews Rd & County Line Rd

ST Baseline
 AM

Intersection												
Int Delay, s/veh	4.1											
Movement	EBL	EBT	EBR	WBL	WBT	WBR	NBL	NBT	NBR	SBL	SBT	SBR
Lane Configurations		↕			↕			↕			↕	
Traffic Vol, veh/h	2	135	111	46	434	2	92	0	29	1	0	5
Future Vol, veh/h	2	135	111	46	434	2	92	0	29	1	0	5
Conflicting Peds, #/hr	0	0	0	0	0	0	0	0	0	0	0	0
Sign Control	Free	Free	Free	Free	Free	Free	Stop	Stop	Stop	Stop	Stop	Stop
RT Channelized	-	-	None	-	-	None	-	-	None	-	-	None
Storage Length	-	-	-	-	-	-	-	-	-	-	-	-
Veh in Median Storage, #	-	0	-	-	0	-	-	0	-	-	0	-
Grade, %	-	-7	-	-	4	-	-	0	-	-	0	-
Peak Hour Factor	87	87	87	92	92	92	83	83	83	78	78	78
Heavy Vehicles, %	2	2	2	2	2	2	2	2	2	2	2	2
Mvmt Flow	2	155	128	50	472	2	111	0	35	1	0	6

Major/Minor	Major1			Major2			Minor1			Minor2		
Conflicting Flow All	474	0	0	283	0	0	799	797	219	814	860	473
Stage 1	-	-	-	-	-	-	223	223	-	573	573	-
Stage 2	-	-	-	-	-	-	576	574	-	241	287	-
Critical Hdwy	4.12	-	-	4.12	-	-	7.12	6.52	6.22	7.12	6.52	6.22
Critical Hdwy Stg 1	-	-	-	-	-	-	6.12	5.52	-	6.12	5.52	-
Critical Hdwy Stg 2	-	-	-	-	-	-	6.12	5.52	-	6.12	5.52	-
Follow-up Hdwy	2.218	-	-	2.218	-	-	3.518	4.018	3.318	3.518	4.018	3.318
Pot Cap-1 Maneuver	1088	-	-	1279	-	-	304	319	821	297	294	591
Stage 1	-	-	-	-	-	-	780	719	-	505	504	-
Stage 2	-	-	-	-	-	-	503	503	-	762	674	-
Platoon blocked, %	-	-	-	-	-	-	-	-	-	-	-	-
Mov Cap-1 Maneuver	1088	-	-	1279	-	-	288	301	821	272	278	591
Mov Cap-2 Maneuver	-	-	-	-	-	-	288	301	-	272	278	-
Stage 1	-	-	-	-	-	-	778	718	-	504	477	-
Stage 2	-	-	-	-	-	-	471	476	-	728	673	-

Approach	EB			WB			NB			SB		
HCM Control Delay, s	0.1			0.8			23.2			12.4		
HCM LOS							C			B		

Minor Lane/Major Mvmt	NBLn1	EBL	EBT	EBR	WBL	WBT	WBR	SBLn1
Capacity (veh/h)	341	1088	-	-	1279	-	-	494
HCM Lane V/C Ratio	0.428	0.002	-	-	0.039	-	-	0.016
HCM Control Delay (s)	23.2	8.3	0	-	7.9	0	-	12.4
HCM Lane LOS	C	A	A	-	A	A	-	B
HCM 95th %tile Q(veh)	2.1	0	-	-	0.1	-	-	0

Intersection						
Int Delay, s/veh	1.5					
Movement	EBL	EBR	NBL	NBT	SBT	SBR
Lane Configurations	WT			WT	WT	WT
Traffic Vol, veh/h	0	42	0	79	107	50
Future Vol, veh/h	0	42	0	79	107	50
Conflicting Peds, #/hr	0	0	0	0	0	0
Sign Control	Stop	Stop	Free	Free	Free	Free
RT Channelized	-	None	-	None	-	None
Storage Length	0	-	-	-	-	186
Veh in Median Storage, #	0	-	-	0	0	-
Grade, %	0	-	-	0	0	-
Peak Hour Factor	78	78	83	83	87	87
Heavy Vehicles, %	2	2	2	2	2	2
Mvmt Flow	0	54	0	95	123	57

Major/Minor	Minor2	Major1		Major2	
Conflicting Flow All	218	123	180	0	0
Stage 1	123	-	-	-	-
Stage 2	95	-	-	-	-
Critical Hdwy	6.42	6.22	4.12	-	-
Critical Hdwy Stg 1	5.42	-	-	-	-
Critical Hdwy Stg 2	5.42	-	-	-	-
Follow-up Hdwy	3.518	3.318	2.218	-	-
Pot Cap-1 Maneuver	770	928	1396	-	-
Stage 1	902	-	-	-	-
Stage 2	929	-	-	-	-
Platoon blocked, %				-	-
Mov Cap-1 Maneuver	770	928	1396	-	-
Mov Cap-2 Maneuver	770	-	-	-	-
Stage 1	902	-	-	-	-
Stage 2	929	-	-	-	-

Approach	EB	NB	SB
HCM Control Delay, s	9.1	0	0
HCM LOS	A		

Minor Lane/Major Mvmt	NBL	NBT	EBLn1	SBT	SBR
Capacity (veh/h)	1396	-	928	-	-
HCM Lane V/C Ratio	-	-	0.058	-	-
HCM Control Delay (s)	0	-	9.1	-	-
HCM Lane LOS	A	-	A	-	-
HCM 95th %tile Q(veh)	0	-	0.2	-	-

Intersection						
Int Delay, s/veh	2.1					
Movement	WBL	WBR	NBT	NBR	SBL	SBT
Lane Configurations	Y		↑	↑	↑	↑
Traffic Vol, veh/h	54	5	74	45	1	106
Future Vol, veh/h	54	5	74	45	1	106
Conflicting Peds, #/hr	0	0	0	0	0	0
Sign Control	Stop	Stop	Free	Free	Free	Free
RT Channelized	-	None	-	None	-	None
Storage Length	0	-	-	100	120	-
Veh in Median Storage, #	0	-	0	-	-	0
Grade, %	0	-	0	-	-	0
Peak Hour Factor	83	83	83	83	83	83
Heavy Vehicles, %	2	2	2	2	2	2
Mvmt Flow	65	6	89	54	1	128

Major/Minor	Minor1	Major1	Major2		
Conflicting Flow All	219	89	0	0	143
Stage 1	89	-	-	-	-
Stage 2	130	-	-	-	-
Critical Hdwy	6.42	6.22	-	-	4.12
Critical Hdwy Stg 1	5.42	-	-	-	-
Critical Hdwy Stg 2	5.42	-	-	-	-
Follow-up Hdwy	3.518	3.318	-	-	2.218
Pot Cap-1 Maneuver	769	969	-	-	1440
Stage 1	934	-	-	-	-
Stage 2	896	-	-	-	-
Platoon blocked, %			-	-	-
Mov Cap-1 Maneuver	768	969	-	-	1440
Mov Cap-2 Maneuver	768	-	-	-	-
Stage 1	934	-	-	-	-
Stage 2	895	-	-	-	-

Approach	WB	NB	SB
HCM Control Delay, s	10.1	0	0.1
HCM LOS	B		

Minor Lane/Major Mvmt	NBT	NBRWBLn1	SBL	SBT
Capacity (veh/h)	-	-	782	1440
HCM Lane V/C Ratio	-	-	0.091	0.001
HCM Control Delay (s)	-	-	10.1	7.5
HCM Lane LOS	-	-	B	A
HCM 95th %tile Q(veh)	-	-	0.3	0

Intersection						
Int Delay, s/veh	6.5					
Movement	WBL	WBR	NBT	NBR	SBL	SBT
Lane Configurations	↘	↗	↑	↗	↘	↑
Traffic Vol, veh/h	290	40	25	300	65	50
Future Vol, veh/h	290	40	25	300	65	50
Conflicting Peds, #/hr	0	0	0	0	0	0
Sign Control	Stop	Stop	Free	Free	Free	Free
RT Channelized	-	None	-	None	-	None
Storage Length	250	0	-	0	280	-
Veh in Median Storage, #	0	-	0	-	-	0
Grade, %	0	-	0	-	-	0
Peak Hour Factor	92	92	92	92	83	83
Heavy Vehicles, %	2	2	2	2	2	2
Mvmt Flow	315	43	27	326	78	60

Major/Minor	Minor1	Major1	Major2		
Conflicting Flow All	243	27	0	0	353
Stage 1	27	-	-	-	-
Stage 2	216	-	-	-	-
Critical Hdwy	6.42	6.22	-	-	4.12
Critical Hdwy Stg 1	5.42	-	-	-	-
Critical Hdwy Stg 2	5.42	-	-	-	-
Follow-up Hdwy	3.518	3.318	-	-	2.218
Pot Cap-1 Maneuver	745	1048	-	-	1206
Stage 1	996	-	-	-	-
Stage 2	820	-	-	-	-
Platoon blocked, %			-	-	-
Mov Cap-1 Maneuver	697	1048	-	-	1206
Mov Cap-2 Maneuver	697	-	-	-	-
Stage 1	996	-	-	-	-
Stage 2	767	-	-	-	-

Approach	WB	NB	SB
HCM Control Delay, s	13.7	0	4.6
HCM LOS	B		

Minor Lane/Major Mvmt	NBT	NBRWBLn1	WBLn2	SBL	SBT
Capacity (veh/h)	-	-	697	1048	1206
HCM Lane V/C Ratio	-	-	0.452	0.041	0.065
HCM Control Delay (s)	-	-	14.4	8.6	8.2
HCM Lane LOS	-	-	B	A	A
HCM 95th %tile Q(veh)	-	-	2.4	0.1	0.2

Intersection						
Int Delay, s/veh	2.6					
Movement	EBT	EBR	WBL	WBT	NBL	NBR
Lane Configurations	↑	↗	↖	↑	↘	↙
Traffic Vol, veh/h	138	27	5	382	100	4
Future Vol, veh/h	138	27	5	382	100	4
Conflicting Peds, #/hr	0	0	0	0	0	0
Sign Control	Free	Free	Free	Free	Stop	Stop
RT Channelized	-	None	-	None	-	None
Storage Length	-	285	450	-	0	-
Veh in Median Storage, #	0	-	-	0	0	-
Grade, %	0	-	-	0	0	-
Peak Hour Factor	87	87	92	92	83	83
Heavy Vehicles, %	2	2	2	2	2	2
Mvmt Flow	159	31	5	415	120	5

Major/Minor	Major1	Major2	Minor1		
Conflicting Flow All	0	0	190	0	584
Stage 1	-	-	-	-	159
Stage 2	-	-	-	-	425
Critical Hdwy	-	-	4.12	-	6.42
Critical Hdwy Stg 1	-	-	-	-	5.42
Critical Hdwy Stg 2	-	-	-	-	5.42
Follow-up Hdwy	-	-	2.218	-	3.518
Pot Cap-1 Maneuver	-	-	1384	-	474
Stage 1	-	-	-	-	870
Stage 2	-	-	-	-	659
Platoon blocked, %	-	-	-	-	-
Mov Cap-1 Maneuver	-	-	1384	-	472
Mov Cap-2 Maneuver	-	-	-	-	472
Stage 1	-	-	-	-	870
Stage 2	-	-	-	-	656

Approach	EB	WB	NB
HCM Control Delay, s	0	0.1	15.1
HCM LOS			C

Minor Lane/Major Mvmt	NBLn1	EBT	EBR	WBL	WBT
Capacity (veh/h)	481	-	-	1384	-
HCM Lane V/C Ratio	0.261	-	-	0.004	-
HCM Control Delay (s)	15.1	-	-	7.6	-
HCM Lane LOS	C	-	-	A	-
HCM 95th %tile Q(veh)	1	-	-	0	-

HCM 6th TWSC
1: County Line Rd & I-25 SB Ramps

ST Baseline
PM

Intersection												
Int Delay, s/veh	7.9											
Movement	EBL	EBT	EBR	WBL	WBT	WBR	NBL	NBT	NBR	SBL	SBT	SBR
Lane Configurations		↕		↕	↑						↕	
Traffic Vol, veh/h	0	140	117	90	167	0	0	0	0	179	1	62
Future Vol, veh/h	0	140	117	90	167	0	0	0	0	179	1	62
Conflicting Peds, #/hr	0	0	0	0	0	0	0	0	0	0	0	0
Sign Control	Free	Free	Free	Free	Free	Free	Stop	Stop	Stop	Stop	Stop	Stop
RT Channelized	-	-	None	-	-	None	-	-	None	-	-	None
Storage Length	-	-	-	0	-	-	-	-	-	-	-	-
Veh in Median Storage, #	-	0	-	-	0	-	-	0	-	-	0	-
Grade, %	-	0	-	-	0	-	-	0	-	-	0	-
Peak Hour Factor	92	92	92	92	92	92	92	92	92	87	87	87
Heavy Vehicles, %	2	2	2	2	2	2	2	2	2	2	2	2
Mvmt Flow	0	152	127	98	182	0	0	0	0	206	1	71

Major/Minor	Major1			Major2			Minor2		
Conflicting Flow All	182	0	0	279	0	0	594	657	182
Stage 1	-	-	-	-	-	-	378	378	-
Stage 2	-	-	-	-	-	-	216	279	-
Critical Hdwy	4.12	-	-	4.12	-	-	6.42	6.52	6.22
Critical Hdwy Stg 1	-	-	-	-	-	-	5.42	5.52	-
Critical Hdwy Stg 2	-	-	-	-	-	-	5.42	5.52	-
Follow-up Hdwy	2.218	-	-	2.218	-	-	3.518	4.018	3.318
Pot Cap-1 Maneuver	1393	-	-	1284	-	0	468	385	861
Stage 1	-	-	-	-	-	0	693	615	-
Stage 2	-	-	-	-	-	0	820	680	-
Platoon blocked, %	-	-	-	-	-	-	-	-	-
Mov Cap-1 Maneuver	1393	-	-	1284	-	-	432	0	861
Mov Cap-2 Maneuver	-	-	-	-	-	-	432	0	-
Stage 1	-	-	-	-	-	-	693	0	-
Stage 2	-	-	-	-	-	-	758	0	-

Approach	EB	WB	SB
HCM Control Delay, s	0	2.8	21.1
HCM LOS			C

Minor Lane/Major Mvmt	EBL	EBT	EBR	WBL	WBT	SBLn1
Capacity (veh/h)	1393	-	-	1284	-	496
HCM Lane V/C Ratio	-	-	-	0.076	-	0.561
HCM Control Delay (s)	0	-	-	8	-	21.1
HCM Lane LOS	A	-	-	A	-	C
HCM 95th %tile Q(veh)	0	-	-	0.2	-	3.4

Intersection												
Int Delay, s/veh	6											
Movement	EBL	EBT	EBR	WBL	WBT	WBR	NBL	NBT	NBR	SBL	SBT	SBR
Lane Configurations	↙	↑			↘			↕				
Traffic Vol, veh/h	47	287	0	0	145	75	99	2	147	0	0	0
Future Vol, veh/h	47	287	0	0	145	75	99	2	147	0	0	0
Conflicting Peds, #/hr	0	0	0	0	0	0	0	0	0	0	0	0
Sign Control	Free	Free	Free	Free	Free	Free	Stop	Stop	Stop	Stop	Stop	Stop
RT Channelized	-	-	None	-	-	None	-	-	None	-	-	None
Storage Length	0	-	-	-	-	-	-	-	-	-	-	-
Veh in Median Storage, #	-	0	-	-	0	-	-	0	-	-	0	-
Grade, %	-	0	-	-	0	-	-	0	-	-	0	-
Peak Hour Factor	92	92	92	87	87	87	87	87	87	92	92	92
Heavy Vehicles, %	2	2	2	2	2	2	2	2	2	2	2	2
Mvmt Flow	51	312	0	0	167	86	114	2	169	0	0	0

Major/Minor	Major1	Major2	Minor1
Conflicting Flow All	253	0	- - - 0 624 667 312
Stage 1	-	-	- - - 414 414 -
Stage 2	-	-	- - - 210 253 -
Critical Hdwy	4.12	-	- - - 6.42 6.52 6.22
Critical Hdwy Stg 1	-	-	- - - 5.42 5.52 -
Critical Hdwy Stg 2	-	-	- - - 5.42 5.52 -
Follow-up Hdwy	2.218	-	- - - 3.518 4.018 3.318
Pot Cap-1 Maneuver	1312	- 0 0	- - - 449 380 728
Stage 1	-	- 0 0	- - - 667 593 -
Stage 2	-	- 0 0	- - - 825 698 -
Platoon blocked, %	-	-	- -
Mov Cap-1 Maneuver	1312	- - -	- - - 431 0 728
Mov Cap-2 Maneuver	-	- - -	- - - 431 0 -
Stage 1	-	- - -	- - - 641 0 -
Stage 2	-	- - -	- - - 825 0 -

Approach	EB	WB	NB
HCM Control Delay, s	1.1	0	17.5
HCM LOS			C

Minor Lane/Major Mvmt	NBLn1	EBL	EBT	WBT	WBR
Capacity (veh/h)	570	1312	-	-	-
HCM Lane V/C Ratio	0.5	0.039	-	-	-
HCM Control Delay (s)	17.5	7.9	-	-	-
HCM Lane LOS	C	A	-	-	-
HCM 95th %tile Q(veh)	2.8	0.1	-	-	-

Intersection												
Int Delay, s/veh	2.2											
Movement	EBL	EBT	EBR	WBL	WBT	WBR	NBL	NBT	NBR	SBL	SBT	SBR
Lane Configurations		↕			↕			↕			↕	
Traffic Vol, veh/h	5	373	40	30	253	1	48	0	20	2	0	2
Future Vol, veh/h	5	373	40	30	253	1	48	0	20	2	0	2
Conflicting Peds, #/hr	0	0	0	0	0	0	0	0	0	0	0	0
Sign Control	Free	Free	Free	Free	Free	Free	Stop	Stop	Stop	Stop	Stop	Stop
RT Channelized	-	-	None	-	-	None	-	-	None	-	-	None
Storage Length	-	-	-	-	-	-	-	-	-	-	-	-
Veh in Median Storage, #	-	0	-	-	0	-	-	0	-	-	0	-
Grade, %	-	-7	-	-	4	-	-	0	-	-	0	-
Peak Hour Factor	92	92	92	92	92	92	83	83	83	78	78	78
Heavy Vehicles, %	2	2	2	2	2	2	2	2	2	2	2	2
Mvmt Flow	5	405	43	33	275	1	58	0	24	3	0	3

Major/Minor	Major1			Major2			Minor1			Minor2		
Conflicting Flow All	276	0	0	448	0	0	780	779	427	791	800	276
Stage 1	-	-	-	-	-	-	437	437	-	342	342	-
Stage 2	-	-	-	-	-	-	343	342	-	449	458	-
Critical Hdwy	4.12	-	-	4.12	-	-	7.12	6.52	6.22	7.12	6.52	6.22
Critical Hdwy Stg 1	-	-	-	-	-	-	6.12	5.52	-	6.12	5.52	-
Critical Hdwy Stg 2	-	-	-	-	-	-	6.12	5.52	-	6.12	5.52	-
Follow-up Hdwy	2.218	-	-	2.218	-	-	3.518	4.018	3.318	3.518	4.018	3.318
Pot Cap-1 Maneuver	1287	-	-	1112	-	-	313	327	628	307	318	763
Stage 1	-	-	-	-	-	-	598	579	-	673	638	-
Stage 2	-	-	-	-	-	-	672	638	-	589	567	-
Platoon blocked, %	-	-	-	-	-	-	-	-	-	-	-	-
Mov Cap-1 Maneuver	1287	-	-	1112	-	-	302	314	628	286	305	763
Mov Cap-2 Maneuver	-	-	-	-	-	-	302	314	-	286	305	-
Stage 1	-	-	-	-	-	-	595	576	-	670	616	-
Stage 2	-	-	-	-	-	-	646	616	-	564	564	-

Approach	EB			WB			NB			SB		
HCM Control Delay, s	0.1			0.9			18.1			13.8		
HCM LOS							C			B		

Minor Lane/Major Mvmt	NBLn1	EBL	EBT	EBR	WBL	WBT	WBR	SBLn1
Capacity (veh/h)	356	1287	-	-	1112	-	-	416
HCM Lane V/C Ratio	0.23	0.004	-	-	0.029	-	-	0.012
HCM Control Delay (s)	18.1	7.8	0	-	8.3	0	-	13.8
HCM Lane LOS	C	A	A	-	A	A	-	B
HCM 95th %tile Q(veh)	0.9	0	-	-	0.1	-	-	0

Intersection						
Int Delay, s/veh	1.7					
Movement	EBL	EBR	NBL	NBT	SBT	SBR
Lane Configurations						
Traffic Vol, veh/h	25	0	0	43	45	25
Future Vol, veh/h	25	0	0	43	45	25
Conflicting Peds, #/hr	0	0	0	0	0	0
Sign Control	Stop	Stop	Free	Free	Free	Free
RT Channelized	-	None	-	None	-	None
Storage Length	0	-	-	-	-	186
Veh in Median Storage, #	0	-	-	0	0	-
Grade, %	0	-	-	0	0	-
Peak Hour Factor	78	78	78	78	83	83
Heavy Vehicles, %	2	2	2	2	2	2
Mvmt Flow	32	0	0	55	54	30

Major/Minor	Minor2	Major1		Major2	
Conflicting Flow All	109	54	84	0	0
Stage 1	54	-	-	-	-
Stage 2	55	-	-	-	-
Critical Hdwy	6.42	6.22	4.12	-	-
Critical Hdwy Stg 1	5.42	-	-	-	-
Critical Hdwy Stg 2	5.42	-	-	-	-
Follow-up Hdwy	3.518	3.318	2.218	-	-
Pot Cap-1 Maneuver	888	1013	1513	-	-
Stage 1	969	-	-	-	-
Stage 2	968	-	-	-	-
Platoon blocked, %				-	-
Mov Cap-1 Maneuver	888	1013	1513	-	-
Mov Cap-2 Maneuver	888	-	-	-	-
Stage 1	969	-	-	-	-
Stage 2	968	-	-	-	-

Approach	EB	NB	SB
HCM Control Delay, s	9.2	0	0
HCM LOS	A		

Minor Lane/Major Mvmt	NBL	NBT	EBLn1	SBT	SBR
Capacity (veh/h)	1513	-	888	-	-
HCM Lane V/C Ratio	-	-	0.036	-	-
HCM Control Delay (s)	0	-	9.2	-	-
HCM Lane LOS	A	-	A	-	-
HCM 95th %tile Q(veh)	0	-	0.1	-	-

Intersection						
Int Delay, s/veh	1.7					
Movement	WBL	WBR	NBT	NBR	SBL	SBT
Lane Configurations	↔		↑	↗	↖	↑
Traffic Vol, veh/h	15	4	39	29	6	39
Future Vol, veh/h	15	4	39	29	6	39
Conflicting Peds, #/hr	0	0	0	0	0	0
Sign Control	Stop	Stop	Free	Free	Free	Free
RT Channelized	-	None	-	None	-	None
Storage Length	0	-	-	100	120	-
Veh in Median Storage, #	0	-	0	-	-	0
Grade, %	0	-	0	-	-	0
Peak Hour Factor	78	78	83	83	78	78
Heavy Vehicles, %	2	2	2	2	2	2
Mvmt Flow	19	5	47	35	8	50

Major/Minor	Minor1	Major1	Major2		
Conflicting Flow All	113	47	0	0	82
Stage 1	47	-	-	-	-
Stage 2	66	-	-	-	-
Critical Hdwy	6.42	6.22	-	-	4.12
Critical Hdwy Stg 1	5.42	-	-	-	-
Critical Hdwy Stg 2	5.42	-	-	-	-
Follow-up Hdwy	3.518	3.318	-	-	2.218
Pot Cap-1 Maneuver	884	1022	-	-	1515
Stage 1	975	-	-	-	-
Stage 2	957	-	-	-	-
Platoon blocked, %			-	-	-
Mov Cap-1 Maneuver	880	1022	-	-	1515
Mov Cap-2 Maneuver	880	-	-	-	-
Stage 1	975	-	-	-	-
Stage 2	952	-	-	-	-

Approach	WB	NB	SB
HCM Control Delay, s	9.1	0	1
HCM LOS	A		

Minor Lane/Major Mvmt	NBT	NBRWBLn1	SBL	SBT
Capacity (veh/h)	-	-	907	1515
HCM Lane V/C Ratio	-	-	0.027	0.005
HCM Control Delay (s)	-	-	9.1	7.4
HCM Lane LOS	-	-	A	A
HCM 95th %tile Q(veh)	-	-	0.1	0

Intersection						
Int Delay, s/veh	3.4					
Movement	WBL	WBR	NBT	NBR	SBL	SBT
Lane Configurations	↘	↗	↑	↗	↘	↑
Traffic Vol, veh/h	87	5	35	95	5	40
Future Vol, veh/h	87	5	35	95	5	40
Conflicting Peds, #/hr	0	0	0	0	0	0
Sign Control	Stop	Stop	Free	Free	Free	Free
RT Channelized	-	None	-	None	-	None
Storage Length	250	0	-	0	280	-
Veh in Median Storage, #	0	-	0	-	-	0
Grade, %	0	-	0	-	-	0
Peak Hour Factor	83	83	83	83	78	78
Heavy Vehicles, %	2	2	2	2	2	2
Mvmt Flow	105	6	42	114	6	51

Major/Minor	Minor1	Major1	Major2		
Conflicting Flow All	105	42	0	0	156
Stage 1	42	-	-	-	-
Stage 2	63	-	-	-	-
Critical Hdwy	6.42	6.22	-	-	4.12
Critical Hdwy Stg 1	5.42	-	-	-	-
Critical Hdwy Stg 2	5.42	-	-	-	-
Follow-up Hdwy	3.518	3.318	-	-	2.218
Pot Cap-1 Maneuver	893	1029	-	-	1424
Stage 1	980	-	-	-	-
Stage 2	960	-	-	-	-
Platoon blocked, %			-	-	-
Mov Cap-1 Maneuver	889	1029	-	-	1424
Mov Cap-2 Maneuver	889	-	-	-	-
Stage 1	980	-	-	-	-
Stage 2	956	-	-	-	-

Approach	WB	NB	SB
HCM Control Delay, s	9.5	0	0.8
HCM LOS	A		

Minor Lane/Major Mvmt	NBT	NBR	WBLn1	WBLn2	SBL	SBT
Capacity (veh/h)	-	-	889	1029	1424	-
HCM Lane V/C Ratio	-	-	0.118	0.006	0.005	-
HCM Control Delay (s)	-	-	9.6	8.5	7.5	-
HCM Lane LOS	-	-	A	A	A	-
HCM 95th %tile Q(veh)	-	-	0.4	0	0	-

Intersection						
Int Delay, s/veh	1.5					
Movement	EBT	EBR	WBL	WBT	NBL	NBR
Lane Configurations	↑	↑	↑	↑	↑	↑
Traffic Vol, veh/h	321	74	8	229	55	10
Future Vol, veh/h	321	74	8	229	55	10
Conflicting Peds, #/hr	0	0	0	0	0	0
Sign Control	Free	Free	Free	Free	Stop	Stop
RT Channelized	-	None	-	None	-	None
Storage Length	-	285	450	-	0	-
Veh in Median Storage, #	0	-	-	0	0	-
Grade, %	0	-	-	0	0	-
Peak Hour Factor	92	92	92	92	83	83
Heavy Vehicles, %	2	2	2	2	2	2
Mvmt Flow	349	80	9	249	66	12





















Major/Minor	Major1	Major2	Minor1	Minor2	Minor3
Conflicting Flow All	0	0	429	0	616
Stage 1	-	-	-	-	349
Stage 2	-	-	-	-	267
Critical Hdwy	-	-	4.12	-	6.42
Critical Hdwy Stg 1	-	-	-	-	5.42
Critical Hdwy Stg 2	-	-	-	-	5.42
Follow-up Hdwy	-	-	2.218	-	3.518
Pot Cap-1 Maneuver	-	-	1130	-	454
Stage 1	-	-	-	-	714
Stage 2	-	-	-	-	778
Platoon blocked, %	-	-	-	-	-
Mov Cap-1 Maneuver	-	-	1130	-	450
Mov Cap-2 Maneuver	-	-	-	-	450
Stage 1	-	-	-	-	714
Stage 2	-	-	-	-	772

Approach	EB	WB	NB
HCM Control Delay, s	0	0.3	14
HCM LOS			B

Minor Lane/Major Mvmt	NBLn1	EBT	EBR	WBL	WBT
Capacity (veh/h)	476	-	-	1130	-
HCM Lane V/C Ratio	0.165	-	-	0.008	-
HCM Control Delay (s)	14	-	-	8.2	-
HCM Lane LOS	B	-	-	A	-
HCM 95th %tile Q(veh)	0.6	-	-	0	-

Lanes, Volumes, Timings
 3: Misty Acres Blvd/Andrews Rd & County Line Rd

ST Baseline + Site
 AM

												
Lane Group	EBL	EBT	EBR	WBL	WBT	WBR	NBL	NBT	NBR	SBL	SBT	SBR
Lane Configurations												
Traffic Volume (vph)	2	135	149	49	434	2	179	0	35	1	0	5
Future Volume (vph)	2	135	149	49	434	2	179	0	35	1	0	5
Ideal Flow (vphpl)	1900	1900	1900	1900	1900	1900	1900	1900	1900	1900	1900	1900
Grade (%)		-7%			3%			0%			0%	
Storage Length (ft)	232		182	172		0	0		155	0		0
Storage Lanes	1		1	1		0	0		1	0		0
Taper Length (ft)	189			126			25			25		
Lane Util. Factor	1.00	1.00	1.00	1.00	1.00	1.00	1.00	1.00	1.00	1.00	1.00	1.00
Frt			0.850			0.999				0.850		0.884
Flt Protected	0.950			0.950				0.950				0.993
Satd. Flow (prot)	1832	1928	1639	1743	1833	0	0	1770	1583	0	1635	0
Flt Permitted	0.440			0.663				0.753				0.944
Satd. Flow (perm)	848	1928	1639	1216	1833	0	0	1403	1583	0	1554	0
Right Turn on Red			Yes			Yes			Yes			Yes
Satd. Flow (RTOR)			162			1			55			55
Link Speed (mph)		30			30			35			25	
Link Distance (ft)		705			807			335			248	
Travel Time (s)		16.0			18.3			6.5			6.8	
Peak Hour Factor	0.92	0.92	0.92	0.92	0.92	0.92	0.87	0.87	0.87	0.78	0.78	0.78
Adj. Flow (vph)	2	147	162	53	472	2	206	0	40	1	0	6
Shared Lane Traffic (%)												
Lane Group Flow (vph)	2	147	162	53	474	0	0	206	40	0	7	0
Enter Blocked Intersection	No	No	No	No	No	No	No	No	No	No	No	No
Lane Alignment	Left	Left	Right	Left	Left	Right	Left	Left	Right	Left	Left	Right
Median Width(ft)		12			12			0			0	
Link Offset(ft)		0			0			0			0	
Crosswalk Width(ft)		16			16			16			16	
Two way Left Turn Lane												
Headway Factor	0.96	0.96	0.96	1.02	1.02	1.02	1.00	1.00	1.00	1.00	1.00	1.00
Turning Speed (mph)	15		9	15		9	15		9	15		9
Number of Detectors	1	2	1	1	2		1	2	1	1	2	
Detector Template	Left	Thru	Right	Left	Thru		Left	Thru	Right	Left	Thru	
Leading Detector (ft)	20	100	20	20	100		20	100	20	20	100	
Trailing Detector (ft)	0	0	0	0	0		0	0	0	0	0	
Detector 1 Position(ft)	0	0	0	0	0		0	0	0	0	0	
Detector 1 Size(ft)	20	6	20	20	6		20	6	20	20	6	
Detector 1 Type	Cl+Ex	Cl+Ex	Cl+Ex	Cl+Ex	Cl+Ex		Cl+Ex	Cl+Ex	Cl+Ex	Cl+Ex	Cl+Ex	
Detector 1 Channel												
Detector 1 Extend (s)	0.0	0.0	0.0	0.0	0.0		0.0	0.0	0.0	0.0	0.0	
Detector 1 Queue (s)	0.0	0.0	0.0	0.0	0.0		0.0	0.0	0.0	0.0	0.0	
Detector 1 Delay (s)	0.0	0.0	0.0	0.0	0.0		0.0	0.0	0.0	0.0	0.0	
Detector 2 Position(ft)		94			94			94			94	
Detector 2 Size(ft)		6			6			6			6	
Detector 2 Type		Cl+Ex			Cl+Ex			Cl+Ex			Cl+Ex	
Detector 2 Channel												
Detector 2 Extend (s)		0.0			0.0			0.0			0.0	
Turn Type	Perm	NA	Perm	Perm	NA		Perm	NA	Perm	Perm	NA	
Protected Phases		8			4			6			2	

Lanes, Volumes, Timings
3: Misty Acres Blvd/Andrews Rd & County Line Rd

ST Baseline + Site
AM



Lane Group	EBL	EBT	EBR	WBL	WBT	WBR	NBL	NBT	NBR	SBL	SBT	SBR
Permitted Phases	8		8	4			6		6	2		
Detector Phase	8	8	8	4	4		6	6	6	2	2	
Switch Phase												
Minimum Initial (s)	5.0	5.0	5.0	5.0	5.0		5.0	5.0	5.0	5.0	5.0	
Minimum Split (s)	25.0	25.0	25.0	25.0	25.0		10.5	10.5	10.5	10.5	10.5	
Total Split (s)	45.0	45.0	45.0	45.0	45.0		15.0	15.0	15.0	15.0	15.0	
Total Split (%)	75.0%	75.0%	75.0%	75.0%	75.0%		25.0%	25.0%	25.0%	25.0%	25.0%	
Maximum Green (s)	39.0	39.0	39.0	39.0	39.0		9.5	9.5	9.5	9.5	9.5	
Yellow Time (s)	4.0	4.0	4.0	4.0	4.0		3.5	3.5	3.5	3.5	3.5	
All-Red Time (s)	2.0	2.0	2.0	2.0	2.0		2.0	2.0	2.0	2.0	2.0	
Lost Time Adjust (s)	0.0	0.0	0.0	0.0	0.0			0.0	0.0		0.0	
Total Lost Time (s)	6.0	6.0	6.0	6.0	6.0			5.5	5.5		5.5	
Lead/Lag												
Lead-Lag Optimize?												
Vehicle Extension (s)	3.0	3.0	3.0	3.0	3.0		3.0	3.0	3.0	3.0	3.0	
Recall Mode	None	None	None	None	None		Max	Max	Max	Max	Max	
Act Effct Green (s)	14.9	14.9	14.9	14.9	14.9			9.7	9.7		9.7	
Actuated g/C Ratio	0.41	0.41	0.41	0.41	0.41			0.27	0.27		0.27	
v/c Ratio	0.01	0.19	0.21	0.11	0.63			0.55	0.09		0.02	
Control Delay	5.5	6.9	2.1	6.4	12.3			22.2	4.6		0.0	
Queue Delay	0.0	0.0	0.0	0.0	0.0			0.0	0.0		0.0	
Total Delay	5.5	6.9	2.1	6.4	12.3			22.2	4.6		0.0	
LOS	A	A	A	A	B			C	A		A	
Approach Delay		4.4			11.7			19.4				
Approach LOS		A			B			B				
Queue Length 50th (ft)	0	17	0	6	67			34	0		0	
Queue Length 95th (ft)	2	36	18	17	124			#117	13		0	
Internal Link Dist (ft)		625			727			255			168	
Turn Bay Length (ft)	232		182	172					155			
Base Capacity (vph)	830	1887	1608	1190	1794			374	462		454	
Starvation Cap Reductn	0	0	0	0	0			0	0		0	
Spillback Cap Reductn	0	0	0	0	0			0	0		0	
Storage Cap Reductn	0	0	0	0	0			0	0		0	
Reduced v/c Ratio	0.00	0.08	0.10	0.04	0.26			0.55	0.09		0.02	

Intersection Summary

Area Type: Other
 Cycle Length: 60
 Actuated Cycle Length: 36.2
 Natural Cycle: 40
 Control Type: Semi Act-Uncoord
 Maximum v/c Ratio: 0.63
 Intersection Signal Delay: 11.3
 Intersection Capacity Utilization 58.3%
 Analysis Period (min) 15
 # 95th percentile volume exceeds capacity, queue may be longer.
 Queue shown is maximum after two cycles.

Lanes, Volumes, Timings
3: Misty Acres Blvd/Andrews Rd & County Line Rd

ST Baseline + Site
AM

Splits and Phases: 3: Misty Acres Blvd/Andrews Rd & County Line Rd

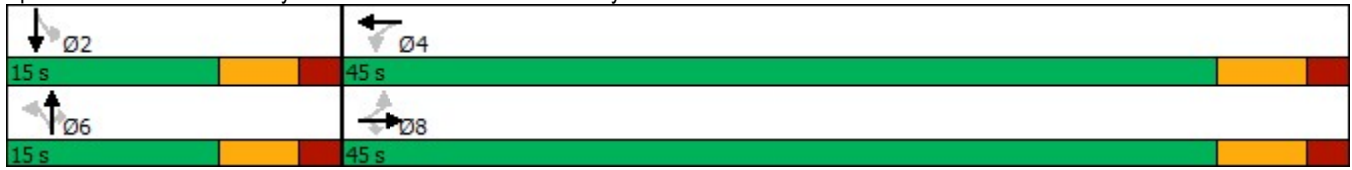

HCM 6th TWSC
1: County Line Rd & I-25 SB Ramps

ST Baseline + Site
AM

Intersection												
Int Delay, s/veh	7.7											
Movement	EBL	EBT	EBR	WBL	WBT	WBR	NBL	NBT	NBR	SBL	SBT	SBR
Lane Configurations		↕		↕	↕						↕	
Traffic Vol, veh/h	0	103	46	307	110	0	0	0	0	67	1	27
Future Vol, veh/h	0	103	46	307	110	0	0	0	0	67	1	27
Conflicting Peds, #/hr	0	0	0	0	0	0	0	0	0	0	0	0
Sign Control	Free	Free	Free	Free	Free	Free	Stop	Stop	Stop	Stop	Stop	Stop
RT Channelized	-	-	None	-	-	None	-	-	None	-	-	None
Storage Length	-	-	-	0	-	-	-	-	-	-	-	-
Veh in Median Storage, #	-	0	-	-	0	-	-	0	-	-	0	-
Grade, %	-	0	-	-	0	-	-	0	-	-	0	-
Peak Hour Factor	83	83	83	92	92	92	92	92	92	83	83	83
Heavy Vehicles, %	2	2	2	2	2	2	2	2	2	2	2	2
Mvmt Flow	0	124	55	334	120	0	0	0	0	81	1	33

Major/Minor	Major1			Major2			Minor2		
Conflicting Flow All	120	0	0	179	0	0	940	967	120
Stage 1	-	-	-	-	-	-	788	788	-
Stage 2	-	-	-	-	-	-	152	179	-
Critical Hdwy	4.12	-	-	4.12	-	-	6.42	6.52	6.22
Critical Hdwy Stg 1	-	-	-	-	-	-	5.42	5.52	-
Critical Hdwy Stg 2	-	-	-	-	-	-	5.42	5.52	-
Follow-up Hdwy	2.218	-	-	2.218	-	-	3.518	4.018	3.318
Pot Cap-1 Maneuver	1468	-	-	1397	-	0	293	254	931
Stage 1	-	-	-	-	-	0	448	402	-
Stage 2	-	-	-	-	-	0	876	751	-
Platoon blocked, %	-	-	-	-	-	-	-	-	-
Mov Cap-1 Maneuver	1468	-	-	1397	-	-	223	0	931
Mov Cap-2 Maneuver	-	-	-	-	-	-	223	0	-
Stage 1	-	-	-	-	-	-	448	0	-
Stage 2	-	-	-	-	-	-	667	0	-

Approach	EB	WB	SB
HCM Control Delay, s	0	6.2	25.9
HCM LOS			D

Minor Lane/Major Mvmt	EBL	EBT	EBR	WBL	WBT	SBLn1
Capacity (veh/h)	1468	-	-	1397	-	285
HCM Lane V/C Ratio	-	-	-	0.239	-	0.402
HCM Control Delay (s)	0	-	-	8.4	-	25.9
HCM Lane LOS	A	-	-	A	-	D
HCM 95th %tile Q(veh)	0	-	-	0.9	-	1.9

HCM 6th TWSC
2: I-25 NB Ramps & County Line Rd

ST Baseline + Site
AM

Intersection												
Int Delay, s/veh	3.2											
Movement	EBL	EBT	EBR	WBL	WBT	WBR	NBL	NBT	NBR	SBL	SBT	SBR
Lane Configurations	↙	↑			↘			↕				
Traffic Vol, veh/h	51	142	0	0	378	232	74	1	60	0	0	0
Future Vol, veh/h	51	142	0	0	378	232	74	1	60	0	0	0
Conflicting Peds, #/hr	0	0	0	0	0	0	0	0	0	0	0	0
Sign Control	Free	Free	Free	Free	Free	Free	Stop	Stop	Stop	Stop	Stop	Stop
RT Channelized	-	-	None	-	-	None	-	-	None	-	-	None
Storage Length	0	-	-	-	-	-	-	-	-	-	-	-
Veh in Median Storage, #	-	0	-	-	0	-	-	0	-	-	0	-
Grade, %	-	0	-	-	0	-	-	0	-	-	0	-
Peak Hour Factor	87	87	87	93	93	93	83	83	83	92	92	92
Heavy Vehicles, %	2	2	2	2	2	2	2	2	2	2	2	2
Mvmt Flow	59	163	0	0	406	249	89	1	72	0	0	0

Major/Minor	Major1	Major2	Minor1
Conflicting Flow All	655	0	-
Stage 1	-	-	-
Stage 2	-	-	-
Critical Hdwy	4.12	-	-
Critical Hdwy Stg 1	-	-	-
Critical Hdwy Stg 2	-	-	-
Follow-up Hdwy	2.218	-	-
Pot Cap-1 Maneuver	932	0	0
Stage 1	-	0	0
Stage 2	-	0	0
Platoon blocked, %	-	-	-
Mov Cap-1 Maneuver	932	-	-
Mov Cap-2 Maneuver	-	-	-
Stage 1	-	-	-
Stage 2	-	-	-

Approach	EB	WB	NB
HCM Control Delay, s	2.4	0	17.3
HCM LOS			C

Minor Lane/Major Mvmt	NBLn1	EBL	EBT	WBT	WBR
Capacity (veh/h)	454	932	-	-	-
HCM Lane V/C Ratio	0.358	0.063	-	-	-
HCM Control Delay (s)	17.3	9.1	-	-	-
HCM Lane LOS	C	A	-	-	-
HCM 95th %tile Q(veh)	1.6	0.2	-	-	-

Intersection						
Int Delay, s/veh	4.9					
Movement	WBL	WBR	NBT	NBR	SBL	SBT
Lane Configurations	↘	↗	↑	↗	↘	↑
Traffic Vol, veh/h	308	0	28	306	0	61
Future Vol, veh/h	308	0	28	306	0	61
Conflicting Peds, #/hr	0	0	0	0	0	0
Sign Control	Stop	Stop	Free	Free	Free	Free
RT Channelized	-	None	-	None	-	None
Storage Length	250	0	-	0	280	-
Veh in Median Storage, #	0	-	0	-	-	0
Grade, %	0	-	0	-	-	0
Peak Hour Factor	92	92	92	92	83	83
Heavy Vehicles, %	2	2	2	2	2	2
Mvmt Flow	335	0	30	333	0	73

Major/Minor	Minor1	Major1	Major2			
Conflicting Flow All	103	30	0	0	363	0
Stage 1	30	-	-	-	-	-
Stage 2	73	-	-	-	-	-
Critical Hdwy	6.42	6.22	-	-	4.12	-
Critical Hdwy Stg 1	5.42	-	-	-	-	-
Critical Hdwy Stg 2	5.42	-	-	-	-	-
Follow-up Hdwy	3.518	3.318	-	-	2.218	-
Pot Cap-1 Maneuver	895	1044	-	-	1196	-
Stage 1	993	-	-	-	-	-
Stage 2	950	-	-	-	-	-
Platoon blocked, %			-	-		
Mov Cap-1 Maneuver	895	1044	-	-	1196	-
Mov Cap-2 Maneuver	895	-	-	-	-	-
Stage 1	993	-	-	-	-	-
Stage 2	950	-	-	-	-	-

Approach	WB	NB	SB
HCM Control Delay, s	11.4	0	0
HCM LOS	B		

Minor Lane/Major Mvmt	NBT	NBRWBLn1	WBLn2	SBL	SBT
Capacity (veh/h)	-	-	895	-	1196
HCM Lane V/C Ratio	-	-	0.374	-	-
HCM Control Delay (s)	-	-	11.4	0	0
HCM Lane LOS	-	-	B	A	A
HCM 95th %tile Q(veh)	-	-	1.7	-	0

Intersection						
Int Delay, s/veh	2.6					
Movement	EBT	EBR	WBL	WBT	NBL	NBR
Lane Configurations	↑	↗	↖	↑	↘	↙
Traffic Vol, veh/h	144	27	5	385	100	4
Future Vol, veh/h	144	27	5	385	100	4
Conflicting Peds, #/hr	0	0	0	0	0	0
Sign Control	Free	Free	Free	Free	Stop	Stop
RT Channelized	-	None	-	None	-	None
Storage Length	-	285	450	-	0	-
Veh in Median Storage, #	0	-	-	0	0	-
Grade, %	0	-	-	0	0	-
Peak Hour Factor	87	87	92	92	83	83
Heavy Vehicles, %	2	2	2	2	2	2
Mvmt Flow	166	31	5	418	120	5

Major/Minor	Major1	Major2	Minor1		
Conflicting Flow All	0	0	197	0	594
Stage 1	-	-	-	-	166
Stage 2	-	-	-	-	428
Critical Hdwy	-	-	4.12	-	6.42
Critical Hdwy Stg 1	-	-	-	-	5.42
Critical Hdwy Stg 2	-	-	-	-	5.42
Follow-up Hdwy	-	-	2.218	-	3.518
Pot Cap-1 Maneuver	-	-	1376	-	468
Stage 1	-	-	-	-	863
Stage 2	-	-	-	-	657
Platoon blocked, %	-	-	-	-	-
Mov Cap-1 Maneuver	-	-	1376	-	466
Mov Cap-2 Maneuver	-	-	-	-	466
Stage 1	-	-	-	-	863
Stage 2	-	-	-	-	654

Approach	EB	WB	NB
HCM Control Delay, s	0	0.1	15.3
HCM LOS			C

Minor Lane/Major Mvmt	NBLn1	EBT	EBR	WBL	WBT
Capacity (veh/h)	475	-	-	1376	-
HCM Lane V/C Ratio	0.264	-	-	0.004	-
HCM Control Delay (s)	15.3	-	-	7.6	-
HCM Lane LOS	C	-	-	A	-
HCM 95th %tile Q(veh)	1.1	-	-	0	-

Intersection												
Int Delay, s/veh	7.3											
Movement	EBL	EBT	EBR	WBL	WBT	WBR	NBL	NBT	NBR	SBL	SBT	SBR
Lane Configurations												
Traffic Vol, veh/h	2	135	149	49	434	2	179	0	35	1	0	5
Future Vol, veh/h	2	135	149	49	434	2	179	0	35	1	0	5
Conflicting Peds, #/hr	0	0	0	0	0	0	0	0	0	0	0	0
Sign Control	Free	Free	Free	Free	Free	Free	Stop	Stop	Stop	Stop	Stop	Stop
RT Channelized	-	-	None	-	-	None	-	-	None	-	-	None
Storage Length	232	-	182	172	-	-	-	-	155	-	-	-
Veh in Median Storage, #	-	0	-	-	0	-	-	0	-	-	0	-
Grade, %	-	0	-	-	0	-	-	0	-	-	0	-
Peak Hour Factor	92	92	92	92	92	92	87	87	87	78	78	78
Heavy Vehicles, %	2	2	2	2	2	2	2	2	2	2	2	2
Mvmt Flow	2	147	162	53	472	2	206	0	40	1	0	6

Major/Minor	Major1			Major2			Minor1			Minor2		
Conflicting Flow All	474	0	0	309	0	0	733	731	147	831	892	473
Stage 1	-	-	-	-	-	-	151	151	-	579	579	-
Stage 2	-	-	-	-	-	-	582	580	-	252	313	-
Critical Hdwy	4.12	-	-	4.12	-	-	7.12	6.52	6.22	7.12	6.52	6.22
Critical Hdwy Stg 1	-	-	-	-	-	-	6.12	5.52	-	6.12	5.52	-
Critical Hdwy Stg 2	-	-	-	-	-	-	6.12	5.52	-	6.12	5.52	-
Follow-up Hdwy	2.218	-	-	2.218	-	-	3.518	4.018	3.318	3.518	4.018	3.318
Pot Cap-1 Maneuver	1088	-	-	1252	-	-	336	349	900	289	281	591
Stage 1	-	-	-	-	-	-	851	772	-	501	501	-
Stage 2	-	-	-	-	-	-	499	500	-	752	657	-
Platoon blocked, %	-	-	-	-	-	-	-	-	-	-	-	-
Mov Cap-1 Maneuver	1088	-	-	1252	-	-	321	334	900	267	269	591
Mov Cap-2 Maneuver	-	-	-	-	-	-	321	334	-	267	269	-
Stage 1	-	-	-	-	-	-	849	770	-	500	480	-
Stage 2	-	-	-	-	-	-	473	479	-	717	656	-

Approach	EB			WB			NB			SB		
HCM Control Delay, s	0.1			0.8			30.1			12.4		
HCM LOS							D			B		

Minor Lane/Major Mvmt	NBLn1	NBLn2	EBL	EBT	EBR	WBL	WBT	WBR	SBLn1
Capacity (veh/h)	321	900	1088	-	-	1252	-	-	492
HCM Lane V/C Ratio	0.641	0.045	0.002	-	-	0.043	-	-	0.016
HCM Control Delay (s)	34.2	9.2	8.3	-	-	8	-	-	12.4
HCM Lane LOS	D	A	A	-	-	A	-	-	B
HCM 95th %tile Q(veh)	4.2	0.1	0	-	-	0.1	-	-	0

Intersection												
Int Delay, s/veh	1.3											
Movement	EBL	EBT	EBR	WBL	WBT	WBR	NBL	NBT	NBR	SBL	SBT	SBR
Lane Configurations		↕			↕			↕			↕	
Traffic Vol, veh/h	18	0	6	3	0	12	2	176	0	4	185	8
Future Vol, veh/h	18	0	6	3	0	12	2	176	0	4	185	8
Conflicting Peds, #/hr	0	0	0	0	0	0	0	0	0	0	0	0
Sign Control	Stop	Stop	Stop	Stop	Stop	Stop	Free	Free	Free	Free	Free	Free
RT Channelized	-	-	None	-	-	None	-	-	None	-	-	None
Storage Length	-	-	-	-	-	-	-	-	-	-	-	-
Veh in Median Storage, #	-	0	-	-	0	-	-	0	-	-	0	-
Grade, %	-	0	-	-	0	-	-	0	-	-	0	-
Peak Hour Factor	78	78	78	78	78	78	87	87	87	87	87	87
Heavy Vehicles, %	2	2	2	2	2	2	2	2	2	2	2	2
Mvmt Flow	23	0	8	4	0	15	2	202	0	5	213	9

Major/Minor	Minor2		Minor1		Major1		Major2					
Conflicting Flow All	442	434	218	438	438	202	222	0	0	202	0	0
Stage 1	228	228	-	206	206	-	-	-	-	-	-	-
Stage 2	214	206	-	232	232	-	-	-	-	-	-	-
Critical Hdwy	7.12	6.52	6.22	7.12	6.52	6.22	4.12	-	-	4.12	-	-
Critical Hdwy Stg 1	6.12	5.52	-	6.12	5.52	-	-	-	-	-	-	-
Critical Hdwy Stg 2	6.12	5.52	-	6.12	5.52	-	-	-	-	-	-	-
Follow-up Hdwy	3.518	4.018	3.318	3.518	4.018	3.318	2.218	-	-	2.218	-	-
Pot Cap-1 Maneuver	526	515	822	529	512	839	1347	-	-	1370	-	-
Stage 1	775	715	-	796	731	-	-	-	-	-	-	-
Stage 2	788	731	-	771	713	-	-	-	-	-	-	-
Platoon blocked, %								-	-	-	-	-
Mov Cap-1 Maneuver	514	512	822	522	509	839	1347	-	-	1370	-	-
Mov Cap-2 Maneuver	514	512	-	522	509	-	-	-	-	-	-	-
Stage 1	773	712	-	794	730	-	-	-	-	-	-	-
Stage 2	772	730	-	761	710	-	-	-	-	-	-	-

Approach	EB	WB	NB	SB
HCM Control Delay, s	11.7	9.9	0.1	0.2
HCM LOS	B	A		

Minor Lane/Major Mvmt	NBL	NBT	NBR	EBLn1	WBLn1	SBL	SBT	SBR
Capacity (veh/h)	1347	-	-	567	748	1370	-	-
HCM Lane V/C Ratio	0.002	-	-	0.054	0.026	0.003	-	-
HCM Control Delay (s)	7.7	0	-	11.7	9.9	7.6	0	-
HCM Lane LOS	A	A	-	B	A	A	A	-
HCM 95th %tile Q(veh)	0	-	-	0.2	0.1	0	-	-

HCM 6th TWSC
5: Misty Acres Blvd & Monument Hill Rd

ST Baseline + Site
AM

Intersection												
Int Delay, s/veh	1.9											
Movement	NBL	NBT	NBR	SBL	SBT	SBR	SEL	SET	SER	NWL	NWT	NWR
Lane Configurations		↕			↕	↕		↕			↕	
Traffic Vol, veh/h	0	120	0	1	128	65	57	0	0	1	1	3
Future Vol, veh/h	0	120	0	1	128	65	57	0	0	1	1	3
Conflicting Peds, #/hr	0	0	0	0	0	0	0	0	0	0	0	0
Sign Control	Free	Free	Free	Free	Free	Free	Stop	Stop	Stop	Stop	Stop	Stop
RT Channelized	-	-	None	-	-	None	-	-	None	-	-	None
Storage Length	-	-	-	-	-	186	-	-	-	-	-	-
Veh in Median Storage, #	-	0	-	-	0	-	-	0	-	-	0	-
Grade, %	-	0	-	-	0	-	-	0	-	-	0	-
Peak Hour Factor	83	83	83	87	87	87	83	83	83	78	78	78
Heavy Vehicles, %	2	2	2	2	2	2	2	2	2	2	2	2
Mvmt Flow	0	145	0	1	147	75	69	0	0	1	1	4

Major/Minor	Major1		Major2		Minor2			Minor1				
Conflicting Flow All	222	0	0	145	0	0	297	294	147	332	369	145
Stage 1	-	-	-	-	-	-	149	149	-	145	145	-
Stage 2	-	-	-	-	-	-	148	145	-	187	224	-
Critical Hdwy	4.12	-	-	4.12	-	-	7.12	6.52	6.22	7.12	6.52	6.22
Critical Hdwy Stg 1	-	-	-	-	-	-	6.12	5.52	-	6.12	5.52	-
Critical Hdwy Stg 2	-	-	-	-	-	-	6.12	5.52	-	6.12	5.52	-
Follow-up Hdwy	2.218	-	-	2.218	-	-	3.518	4.018	3.318	3.518	4.018	3.318
Pot Cap-1 Maneuver	1347	-	-	1437	-	-	655	617	900	621	560	902
Stage 1	-	-	-	-	-	-	854	774	-	858	777	-
Stage 2	-	-	-	-	-	-	855	777	-	815	718	-
Platoon blocked, %		-	-	-	-	-						
Mov Cap-1 Maneuver	1347	-	-	1437	-	-	650	616	900	620	559	902
Mov Cap-2 Maneuver	-	-	-	-	-	-	650	616	-	620	559	-
Stage 1	-	-	-	-	-	-	854	773	-	858	777	-
Stage 2	-	-	-	-	-	-	850	777	-	814	717	-

Approach	NB	SB	SE	NW
HCM Control Delay, s	0	0	11.2	9.9
HCM LOS			B	A

Minor Lane/Major Mvmt	NBL	NBT	NBRNWLn1	SELn1	SBL	SBT	SBR
Capacity (veh/h)	1347	-	-	743	650	1437	-
HCM Lane V/C Ratio	-	-	-	0.009	0.106	0.001	-
HCM Control Delay (s)	0	-	-	9.9	11.2	7.5	0
HCM Lane LOS	A	-	-	A	B	A	A
HCM 95th %tile Q(veh)	0	-	-	0	0.4	0	-

Intersection						
Int Delay, s/veh	1.8					
Movement	EBT	EBR	WBL	WBT	NBL	NBR
Lane Configurations						
Traffic Vol, veh/h	43	1	8	57	5	14
Future Vol, veh/h	43	1	8	57	5	14
Conflicting Peds, #/hr	0	0	0	0	0	0
Sign Control	Free	Free	Free	Free	Stop	Stop
RT Channelized	-	None	-	None	-	None
Storage Length	-	-	-	-	0	-
Veh in Median Storage, #	0	-	-	0	0	-
Grade, %	0	-	-	0	0	-
Peak Hour Factor	78	78	83	83	78	78
Heavy Vehicles, %	2	2	2	2	2	2
Mvmt Flow	55	1	10	69	6	18

Major/Minor	Major1	Major2	Minor1	Minor2	Minor3
Conflicting Flow All	0	0	56	0	145
Stage 1	-	-	-	-	56
Stage 2	-	-	-	-	89
Critical Hdwy	-	-	4.12	-	6.42
Critical Hdwy Stg 1	-	-	-	-	5.42
Critical Hdwy Stg 2	-	-	-	-	5.42
Follow-up Hdwy	-	-	2.218	-	3.518
Pot Cap-1 Maneuver	-	-	1549	-	847
Stage 1	-	-	-	-	967
Stage 2	-	-	-	-	934
Platoon blocked, %	-	-	-	-	-
Mov Cap-1 Maneuver	-	-	1549	-	841
Mov Cap-2 Maneuver	-	-	-	-	841
Stage 1	-	-	-	-	967
Stage 2	-	-	-	-	927

Approach	EB	WB	NB
HCM Control Delay, s	0	0.9	8.8
HCM LOS			A

Minor Lane/Major Mvmt	NBLn1	EBT	EBR	WBL	WBT
Capacity (veh/h)	960	-	-	1549	-
HCM Lane V/C Ratio	0.025	-	-	0.006	-
HCM Control Delay (s)	8.8	-	-	7.3	0
HCM Lane LOS	A	-	-	A	A
HCM 95th %tile Q(veh)	0.1	-	-	0	-

HCM 6th TWSC
7: Misty Acres Blvd & Old Antlers Way

ST Baseline + Site
AM

Intersection												
Int Delay, s/veh	3.3											
Movement	EBL	EBT	EBR	WBL	WBT	WBR	NBL	NBT	NBR	SBL	SBT	SBR
Lane Configurations		↕			↕			↕	↕	↕	↕	
Traffic Vol, veh/h	38	0	13	54	0	5	5	77	45	1	112	16
Future Vol, veh/h	38	0	13	54	0	5	5	77	45	1	112	16
Conflicting Peds, #/hr	0	0	0	0	0	0	0	0	0	0	0	0
Sign Control	Stop	Stop	Stop	Stop	Stop	Stop	Free	Free	Free	Free	Free	Free
RT Channelized	-	-	None	-	-	None	-	-	None	-	-	None
Storage Length	-	-	-	-	-	-	-	-	100	120	-	-
Veh in Median Storage, #	-	0	-	-	0	-	-	0	-	-	0	-
Grade, %	-	0	-	-	0	-	-	0	-	-	0	-
Peak Hour Factor	83	83	83	83	83	83	83	83	83	83	83	83
Heavy Vehicles, %	2	2	2	2	2	2	2	2	2	2	2	2
Mvmt Flow	46	0	16	65	0	6	6	93	54	1	135	19

Major/Minor	Minor2		Minor1		Major1		Major2					
Conflicting Flow All	282	306	145	260	261	93	154	0	0	147	0	0
Stage 1	147	147	-	105	105	-	-	-	-	-	-	-
Stage 2	135	159	-	155	156	-	-	-	-	-	-	-
Critical Hdwy	7.12	6.52	6.22	7.12	6.52	6.22	4.12	-	-	4.12	-	-
Critical Hdwy Stg 1	6.12	5.52	-	6.12	5.52	-	-	-	-	-	-	-
Critical Hdwy Stg 2	6.12	5.52	-	6.12	5.52	-	-	-	-	-	-	-
Follow-up Hdwy	3.518	4.018	3.318	3.518	4.018	3.318	2.218	-	-	2.218	-	-
Pot Cap-1 Maneuver	670	608	902	693	644	964	1426	-	-	1435	-	-
Stage 1	856	775	-	901	808	-	-	-	-	-	-	-
Stage 2	868	766	-	847	769	-	-	-	-	-	-	-
Platoon blocked, %								-	-	-	-	-
Mov Cap-1 Maneuver	663	604	902	678	640	964	1426	-	-	1435	-	-
Mov Cap-2 Maneuver	663	604	-	678	640	-	-	-	-	-	-	-
Stage 1	852	774	-	896	804	-	-	-	-	-	-	-
Stage 2	858	762	-	832	768	-	-	-	-	-	-	-

Approach	EB		WB		NB		SB	
HCM Control Delay, s	10.5		10.8		0.3		0.1	
HCM LOS	B		B					

Minor Lane/Major Mvmt	NBL	NBT	NBR	EBLn1	WBLn1	SBL	SBT	SBR
Capacity (veh/h)	1426	-	-	711	695	1435	-	-
HCM Lane V/C Ratio	0.004	-	-	0.086	0.102	0.001	-	-
HCM Control Delay (s)	7.5	0	-	10.5	10.8	7.5	0	-
HCM Lane LOS	A	A	-	B	B	A	A	-
HCM 95th %tile Q(veh)	0	-	-	0.3	0.3	0	-	-

Intersection						
Int Delay, s/veh	0.4					
Movement	EBL	EBR	NBL	NBT	SBT	SBR
Lane Configurations	T			T		T
Traffic Vol, veh/h	9	3	1	205	194	5
Future Vol, veh/h	9	3	1	205	194	5
Conflicting Peds, #/hr	0	0	0	0	0	0
Sign Control	Stop	Stop	Free	Free	Free	Free
RT Channelized	-	None	-	None	-	None
Storage Length	0	-	-	-	-	-
Veh in Median Storage, #	0	-	-	0	0	-
Grade, %	0	-	-	0	0	-
Peak Hour Factor	78	78	87	87	87	87
Heavy Vehicles, %	2	2	2	2	2	2
Mvmt Flow	12	4	1	236	223	6





















Major/Minor	Minor2	Major1		Major2	
Conflicting Flow All	464	226	229	0	0
Stage 1	226	-	-	-	-
Stage 2	238	-	-	-	-
Critical Hdwy	6.42	6.22	4.12	-	-
Critical Hdwy Stg 1	5.42	-	-	-	-
Critical Hdwy Stg 2	5.42	-	-	-	-
Follow-up Hdwy	3.518	3.318	2.218	-	-
Pot Cap-1 Maneuver	556	813	1339	-	-
Stage 1	812	-	-	-	-
Stage 2	802	-	-	-	-
Platoon blocked, %				-	-
Mov Cap-1 Maneuver	555	813	1339	-	-
Mov Cap-2 Maneuver	555	-	-	-	-
Stage 1	811	-	-	-	-
Stage 2	802	-	-	-	-

Approach	EB	NB	SB
HCM Control Delay, s	11.1	0	0
HCM LOS	B		

Minor Lane/Major Mvmt	NBL	NBT	EBLn1	SBT	SBR
Capacity (veh/h)	1339	-	603	-	-
HCM Lane V/C Ratio	0.001	-	0.026	-	-
HCM Control Delay (s)	7.7	0	11.1	-	-
HCM Lane LOS	A	A	B	-	-
HCM 95th %tile Q(veh)	0	-	0.1	-	-

Lanes, Volumes, Timings
3: Misty Acres Blvd/Andrews Rd & County Line Rd

Adjusted Existing + Site
PM

												
Lane Group	EBL	EBT	EBR	WBL	WBT	WBR	NBL	NBT	NBR	SBL	SBT	SBR
Lane Configurations												
Traffic Volume (vph)	5	373	136	37	253	1	111	0	23	2	0	2
Future Volume (vph)	5	373	136	37	253	1	111	0	23	2	0	2
Ideal Flow (vphpl)	1900	1900	1900	1900	1900	1900	1900	1900	1900	1900	1900	1900
Grade (%)		-7%			3%			0%			0%	
Storage Length (ft)	232		182	172		0	0		155	0		0
Storage Lanes	1		1	1		0	0		1	0		0
Taper Length (ft)	189			126			25			25		
Lane Util. Factor	1.00	1.00	1.00	1.00	1.00	1.00	1.00	1.00	1.00	1.00	1.00	1.00
Frt			0.850		0.999				0.850		0.932	
Flt Protected	0.950			0.950				0.950			0.976	
Satd. Flow (prot)	1832	1928	1639	1743	1833	0	0	1770	1583	0	1694	0
Flt Permitted	0.590			0.505				0.754			0.856	
Satd. Flow (perm)	1137	1928	1639	927	1833	0	0	1405	1583	0	1486	0
Right Turn on Red			Yes			Yes			Yes			Yes
Satd. Flow (RTOR)			148		1				28			27
Link Speed (mph)		30			30			35				25
Link Distance (ft)		705			807			335				248
Travel Time (s)		16.0			18.3			6.5				6.8
Peak Hour Factor	0.92	0.92	0.92	0.92	0.92	0.92	0.83	0.83	0.83	0.78	0.78	0.78
Adj. Flow (vph)	5	405	148	40	275	1	134	0	28	3	0	3
Shared Lane Traffic (%)												
Lane Group Flow (vph)	5	405	148	40	276	0	0	134	28	0	6	0
Enter Blocked Intersection	No	No	No	No	No	No	No	No	No	No	No	No
Lane Alignment	Left	Left	Right	Left	Left	Right	Left	Left	Right	Left	Left	Right
Median Width(ft)		12			12			0			0	
Link Offset(ft)		0			0			0			0	
Crosswalk Width(ft)		16			16			16			16	
Two way Left Turn Lane												
Headway Factor	0.96	0.96	0.96	1.02	1.02	1.02	1.00	1.00	1.00	1.00	1.00	1.00
Turning Speed (mph)	15		9	15		9	15		9	15		9
Number of Detectors	1	2	1	1	2		1	2	1	1	2	
Detector Template	Left	Thru	Right	Left	Thru		Left	Thru	Right	Left	Thru	
Leading Detector (ft)	20	100	20	20	100		20	100	20	20	100	
Trailing Detector (ft)	0	0	0	0	0		0	0	0	0	0	
Detector 1 Position(ft)	0	0	0	0	0		0	0	0	0	0	
Detector 1 Size(ft)	20	6	20	20	6		20	6	20	20	6	
Detector 1 Type	Cl+Ex	Cl+Ex	Cl+Ex	Cl+Ex	Cl+Ex		Cl+Ex	Cl+Ex	Cl+Ex	Cl+Ex	Cl+Ex	
Detector 1 Channel												
Detector 1 Extend (s)	0.0	0.0	0.0	0.0	0.0		0.0	0.0	0.0	0.0	0.0	
Detector 1 Queue (s)	0.0	0.0	0.0	0.0	0.0		0.0	0.0	0.0	0.0	0.0	
Detector 1 Delay (s)	0.0	0.0	0.0	0.0	0.0		0.0	0.0	0.0	0.0	0.0	
Detector 2 Position(ft)		94			94			94			94	
Detector 2 Size(ft)		6			6			6			6	
Detector 2 Type		Cl+Ex			Cl+Ex			Cl+Ex			Cl+Ex	
Detector 2 Channel												
Detector 2 Extend (s)		0.0			0.0			0.0			0.0	
Turn Type	Perm	NA	Perm	Perm	NA		Perm	NA	Perm	Perm	NA	
Protected Phases		4			8			2			6	

Lanes, Volumes, Timings
3: Misty Acres Blvd/Andrews Rd & County Line Rd

Adjusted Existing + Site
PM



Lane Group	EBL	EBT	EBR	WBL	WBT	WBR	NBL	NBT	NBR	SBL	SBT	SBR
Permitted Phases	4		4	8			2		2	6		
Detector Phase	4	4	4	8	8		2	2	2	6	6	
Switch Phase												
Minimum Initial (s)	5.0	5.0	5.0	5.0	5.0		5.0	5.0	5.0	5.0	5.0	
Minimum Split (s)	22.5	22.5	22.5	22.5	22.5		22.5	22.5	22.5	22.5	22.5	
Total Split (s)	45.0	45.0	45.0	45.0	45.0		15.0	15.0	15.0	15.0	15.0	
Total Split (%)	75.0%	75.0%	75.0%	75.0%	75.0%		25.0%	25.0%	25.0%	25.0%	25.0%	
Maximum Green (s)	40.5	40.5	40.5	40.5	40.5		10.5	10.5	10.5	10.5	10.5	
Yellow Time (s)	3.5	3.5	3.5	3.5	3.5		3.5	3.5	3.5	3.5	3.5	
All-Red Time (s)	1.0	1.0	1.0	1.0	1.0		1.0	1.0	1.0	1.0	1.0	
Lost Time Adjust (s)	0.0	0.0	0.0	0.0	0.0			0.0	0.0		0.0	
Total Lost Time (s)	4.5	4.5	4.5	4.5	4.5			4.5	4.5		4.5	
Lead/Lag												
Lead-Lag Optimize?												
Vehicle Extension (s)	3.0	3.0	3.0	3.0	3.0		3.0	3.0	3.0	3.0	3.0	
Recall Mode	None	None	None	None	None		Min	Min	Min	Min	Min	
Walk Time (s)	7.0	7.0	7.0	7.0	7.0		7.0	7.0	7.0	7.0	7.0	
Flash Dont Walk (s)	11.0	11.0	11.0	11.0	11.0		11.0	11.0	11.0	11.0	11.0	
Pedestrian Calls (#/hr)	0	0	0	0	0		0	0	0	0	0	
Act Effct Green (s)	12.5	12.5	12.5	12.5	12.5			8.1	8.1		8.1	
Actuated g/C Ratio	0.42	0.42	0.42	0.42	0.42			0.27	0.27		0.27	
v/c Ratio	0.01	0.50	0.19	0.10	0.36			0.35	0.06		0.01	
Control Delay	5.0	8.9	2.1	6.0	7.4			13.1	5.5		1.6	
Queue Delay	0.0	0.0	0.0	0.0	0.0			0.0	0.0		0.0	
Total Delay	5.0	8.9	2.1	6.0	7.4			13.1	5.5		1.6	
LOS	A	A	A	A	A			B	A		A	
Approach Delay		7.0			7.2			11.8			1.6	
Approach LOS		A			A			B			A	
Queue Length 50th (ft)	1	39	0	3	25			16	0		0	
Queue Length 95th (ft)	3	91	16	14	61			50	10		1	
Internal Link Dist (ft)		625			727			255			168	
Turn Bay Length (ft)	232		182	172					155			
Base Capacity (vph)	1137	1928	1639	927	1833			512	595		558	
Starvation Cap Reductn	0	0	0	0	0			0	0		0	
Spillback Cap Reductn	0	0	0	0	0			0	0		0	
Storage Cap Reductn	0	0	0	0	0			0	0		0	
Reduced v/c Ratio	0.00	0.21	0.09	0.04	0.15			0.26	0.05		0.01	

Intersection Summary

Area Type:	Other
Cycle Length:	60
Actuated Cycle Length:	29.9
Natural Cycle:	45
Control Type:	Actuated-Uncoordinated
Maximum v/c Ratio:	0.50
Intersection Signal Delay:	7.8
Intersection LOS:	A
Intersection Capacity Utilization:	45.9%
ICU Level of Service:	A
Analysis Period (min):	15

Lanes, Volumes, Timings
3: Misty Acres Blvd/Andrews Rd & County Line Rd

Adjusted Existing + Site
PM

Splits and Phases: 3: Misty Acres Blvd/Andrews Rd & County Line Rd

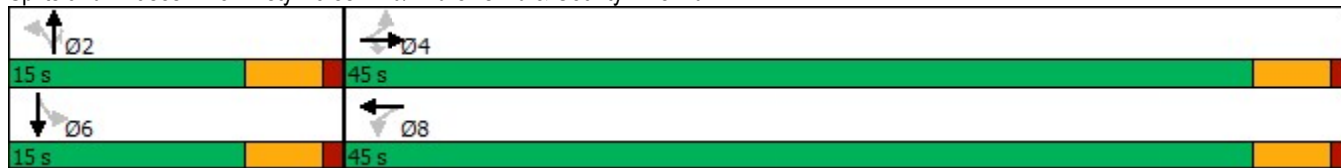

HCM 6th TWSC
1: County Line Rd & I-25 SB Ramps

Adjusted Existing + Site
PM

Intersection												
Int Delay, s/veh	11.4											
Movement	EBL	EBT	EBR	WBL	WBT	WBR	NBL	NBT	NBR	SBL	SBT	SBR
Lane Configurations		↕		↕	↑						↕	
Traffic Vol, veh/h	0	150	117	131	170	0	0	0	0	207	1	62
Future Vol, veh/h	0	150	117	131	170	0	0	0	0	207	1	62
Conflicting Peds, #/hr	0	0	0	0	0	0	0	0	0	0	0	0
Sign Control	Free	Free	Free	Free	Free	Free	Stop	Stop	Stop	Stop	Stop	Stop
RT Channelized	-	-	None	-	-	None	-	-	None	-	-	None
Storage Length	-	-	-	0	-	-	-	-	-	-	-	-
Veh in Median Storage, #	-	0	-	-	0	-	-	0	-	-	0	-
Grade, %	-	0	-	-	0	-	-	0	-	-	0	-
Peak Hour Factor	92	92	92	92	92	92	92	92	92	92	92	92
Heavy Vehicles, %	2	2	2	2	2	2	2	2	2	2	2	2
Mvmt Flow	0	163	127	142	185	0	0	0	0	225	1	67

Major/Minor	Major1			Major2			Minor2		
Conflicting Flow All	185	0	0	290	0	0	696	759	185
Stage 1	-	-	-	-	-	-	469	469	-
Stage 2	-	-	-	-	-	-	227	290	-
Critical Hdwy	4.12	-	-	4.12	-	-	6.42	6.52	6.22
Critical Hdwy Stg 1	-	-	-	-	-	-	5.42	5.52	-
Critical Hdwy Stg 2	-	-	-	-	-	-	5.42	5.52	-
Follow-up Hdwy	2.218	-	-	2.218	-	-	3.518	4.018	3.318
Pot Cap-1 Maneuver	1390	-	-	1272	-	0	408	336	857
Stage 1	-	-	-	-	-	0	630	561	-
Stage 2	-	-	-	-	-	0	811	672	-
Platoon blocked, %	-	-	-	-	-	-	-	-	-
Mov Cap-1 Maneuver	1390	-	-	1272	-	-	362	0	857
Mov Cap-2 Maneuver	-	-	-	-	-	-	362	0	-
Stage 1	-	-	-	-	-	-	630	0	-
Stage 2	-	-	-	-	-	-	720	0	-

Approach	EB	WB	SB
HCM Control Delay, s	0	3.6	31.5
HCM LOS			D

Minor Lane/Major Mvmt	EBL	EBT	EBR	WBL	WBT	SBLn1
Capacity (veh/h)	1390	-	-	1272	-	418
HCM Lane V/C Ratio	-	-	-	0.112	-	0.702
HCM Control Delay (s)	0	-	-	8.2	-	31.5
HCM Lane LOS	A	-	-	A	-	D
HCM 95th %tile Q(veh)	0	-	-	0.4	-	5.3

Intersection												
Int Delay, s/veh	7.1											
Movement	EBL	EBT	EBR	WBL	WBT	WBR	NBL	NBT	NBR	SBL	SBT	SBR
Lane Configurations	↙	↑			↘			↕				
Traffic Vol, veh/h	47	325	0	0	189	94	99	2	205	0	0	0
Future Vol, veh/h	47	325	0	0	189	94	99	2	205	0	0	0
Conflicting Peds, #/hr	0	0	0	0	0	0	0	0	0	0	0	0
Sign Control	Free	Free	Free	Free	Free	Free	Stop	Stop	Stop	Stop	Stop	Stop
RT Channelized	-	-	None	-	-	None	-	-	None	-	-	None
Storage Length	0	-	-	-	-	-	-	-	-	-	-	-
Veh in Median Storage, #	-	0	-	-	0	-	-	0	-	-	0	-
Grade, %	-	0	-	-	0	-	-	0	-	-	0	-
Peak Hour Factor	92	92	92	92	92	92	92	92	92	92	92	92
Heavy Vehicles, %	2	2	2	2	2	2	2	2	2	2	2	2
Mvmt Flow	51	353	0	0	205	102	108	2	223	0	0	0

Major/Minor	Major1	Major2	Minor1
Conflicting Flow All	307	0	- - - 0 711 762 353
Stage 1	-	-	- - - 455 455 -
Stage 2	-	-	- - - 256 307 -
Critical Hdwy	4.12	-	- - - 6.42 6.52 6.22
Critical Hdwy Stg 1	-	-	- - - 5.42 5.52 -
Critical Hdwy Stg 2	-	-	- - - 5.42 5.52 -
Follow-up Hdwy	2.218	-	- - - 3.518 4.018 3.318
Pot Cap-1 Maneuver	1254	- 0 0	- - 400 335 691
Stage 1	-	- 0 0	- - 639 569 -
Stage 2	-	- 0 0	- - 787 661 -
Platoon blocked, %	-	-	- -
Mov Cap-1 Maneuver	1254	- - -	- - 384 0 691
Mov Cap-2 Maneuver	-	- - -	- - 384 0 -
Stage 1	-	- - -	- - 613 0 -
Stage 2	-	- - -	- - 787 0 -

Approach	EB	WB	NB
HCM Control Delay, s	1	0	21.2
HCM LOS			C

Minor Lane/Major Mvmt	NBLn1	EBL	EBT	WBT	WBR
Capacity (veh/h)	548	1254	-	-	-
HCM Lane V/C Ratio	0.607	0.041	-	-	-
HCM Control Delay (s)	21.2	8	-	-	-
HCM Lane LOS	C	A	-	-	-
HCM 95th %tile Q(veh)	4	0.1	-	-	-

Intersection						
Int Delay, s/veh	3.4					
Movement	WBL	WBR	NBT	NBR	SBL	SBT
Lane Configurations	↘	↗	↑	↗	↘	↑
Traffic Vol, veh/h	101	5	41	113	5	49
Future Vol, veh/h	101	5	41	113	5	49
Conflicting Peds, #/hr	0	0	0	0	0	0
Sign Control	Stop	Stop	Free	Free	Free	Free
RT Channelized	-	None	-	None	-	None
Storage Length	250	0	-	0	280	-
Veh in Median Storage, #	0	-	0	-	-	0
Grade, %	0	-	0	-	-	0
Peak Hour Factor	83	83	87	87	78	78
Heavy Vehicles, %	2	2	2	2	2	2
Mvmt Flow	122	6	47	130	6	63

Major/Minor	Minor1	Major1	Major2			
Conflicting Flow All	122	47	0	0	177	0
Stage 1	47	-	-	-	-	-
Stage 2	75	-	-	-	-	-
Critical Hdwy	6.42	6.22	-	-	4.12	-
Critical Hdwy Stg 1	5.42	-	-	-	-	-
Critical Hdwy Stg 2	5.42	-	-	-	-	-
Follow-up Hdwy	3.518	3.318	-	-	2.218	-
Pot Cap-1 Maneuver	873	1022	-	-	1399	-
Stage 1	975	-	-	-	-	-
Stage 2	948	-	-	-	-	-
Platoon blocked, %			-	-		-
Mov Cap-1 Maneuver	870	1022	-	-	1399	-
Mov Cap-2 Maneuver	870	-	-	-	-	-
Stage 1	975	-	-	-	-	-
Stage 2	944	-	-	-	-	-

Approach	WB	NB	SB
HCM Control Delay, s	9.7	0	0.7
HCM LOS	A		

Minor Lane/Major Mvmt	NBT	NBR	WBLn1	WBLn2	SBL	SBT
Capacity (veh/h)	-	-	870	1022	1399	-
HCM Lane V/C Ratio	-	-	0.14	0.006	0.005	-
HCM Control Delay (s)	-	-	9.8	8.5	7.6	-
HCM Lane LOS	-	-	A	A	A	-
HCM 95th %tile Q(veh)	-	-	0.5	0	0	-

Intersection						
Int Delay, s/veh	1.5					
Movement	EBT	EBR	WBL	WBT	NBL	NBR
Lane Configurations	↑	↗	↖	↑	↘	↙
Traffic Vol, veh/h	324	74	8	236	55	10
Future Vol, veh/h	324	74	8	236	55	10
Conflicting Peds, #/hr	0	0	0	0	0	0
Sign Control	Free	Free	Free	Free	Stop	Stop
RT Channelized	-	None	-	None	-	None
Storage Length	-	285	450	-	0	-
Veh in Median Storage, #	0	-	-	0	0	-
Grade, %	0	-	-	0	0	-
Peak Hour Factor	92	92	87	87	83	83
Heavy Vehicles, %	2	2	2	2	2	2
Mvmt Flow	352	80	9	271	66	12

Major/Minor	Major1	Major2	Minor1		
Conflicting Flow All	0	0	432	0	641
Stage 1	-	-	-	-	352
Stage 2	-	-	-	-	289
Critical Hdwy	-	-	4.12	-	6.42
Critical Hdwy Stg 1	-	-	-	-	5.42
Critical Hdwy Stg 2	-	-	-	-	5.42
Follow-up Hdwy	-	-	2.218	-	3.518
Pot Cap-1 Maneuver	-	-	1128	-	439
Stage 1	-	-	-	-	712
Stage 2	-	-	-	-	760
Platoon blocked, %	-	-	-	-	-
Mov Cap-1 Maneuver	-	-	1128	-	435
Mov Cap-2 Maneuver	-	-	-	-	435
Stage 1	-	-	-	-	712
Stage 2	-	-	-	-	754

Approach	EB	WB	NB
HCM Control Delay, s	0	0.3	14.4
HCM LOS			B

Minor Lane/Major Mvmt	NBLn1	EBT	EBR	WBL	WBT
Capacity (veh/h)	461	-	-	1128	-
HCM Lane V/C Ratio	0.17	-	-	0.008	-
HCM Control Delay (s)	14.4	-	-	8.2	-
HCM Lane LOS	B	-	-	A	-
HCM 95th %tile Q(veh)	0.6	-	-	0	-

HCM 6th TWSC
 3: Misty Acres Blvd/S Andrews Rd & County Line Rd

Adjusted Existing + Site
 PM

Intersection												
Int Delay, s/veh	4											
Movement	EBL	EBT	EBR	WBL	WBT	WBR	NBL	NBT	NBR	SBL	SBT	SBR
Lane Configurations	↙	↑	↗	↙	↑	↗		↙	↗		↕	
Traffic Vol, veh/h	5	373	136	37	253	1	111	0	23	2	0	2
Future Vol, veh/h	5	373	136	37	253	1	111	0	23	2	0	2
Conflicting Peds, #/hr	0	0	0	0	0	0	0	0	0	0	0	0
Sign Control	Free	Free	Free	Free	Free	Free	Stop	Stop	Stop	Stop	Stop	Stop
RT Channelized	-	-	None	-	-	None	-	-	None	-	-	None
Storage Length	232	-	182	172	-	-	-	-	155	-	-	-
Veh in Median Storage, #	-	0	-	-	0	-	-	0	-	-	0	-
Grade, %	-	0	-	-	0	-	-	0	-	-	0	-
Peak Hour Factor	92	92	92	92	92	92	83	83	83	78	78	78
Heavy Vehicles, %	2	2	2	2	2	2	2	2	2	2	2	2
Mvmt Flow	5	405	148	40	275	1	134	0	28	3	0	3

Major/Minor	Major1			Major2			Minor1			Minor2		
Conflicting Flow All	276	0	0	553	0	0	772	771	405	859	919	276
Stage 1	-	-	-	-	-	-	415	415	-	356	356	-
Stage 2	-	-	-	-	-	-	357	356	-	503	563	-
Critical Hdwy	4.12	-	-	4.12	-	-	7.12	6.52	6.22	7.12	6.52	6.22
Critical Hdwy Stg 1	-	-	-	-	-	-	6.12	5.52	-	6.12	5.52	-
Critical Hdwy Stg 2	-	-	-	-	-	-	6.12	5.52	-	6.12	5.52	-
Follow-up Hdwy	2.218	-	-	2.218	-	-	3.518	4.018	3.318	3.518	4.018	3.318
Pot Cap-1 Maneuver	1287	-	-	1017	-	-	317	331	646	277	271	763
Stage 1	-	-	-	-	-	-	615	592	-	661	629	-
Stage 2	-	-	-	-	-	-	661	629	-	551	509	-
Platoon blocked, %	-	-	-	-	-	-	-	-	-	-	-	-
Mov Cap-1 Maneuver	1287	-	-	1017	-	-	306	317	646	257	259	763
Mov Cap-2 Maneuver	-	-	-	-	-	-	306	317	-	257	259	-
Stage 1	-	-	-	-	-	-	613	590	-	658	604	-
Stage 2	-	-	-	-	-	-	633	604	-	525	507	-

Approach	EB			WB			NB			SB		
HCM Control Delay, s	0.1			1.1			23.1			14.5		
HCM LOS							C			B		

Minor Lane/Major Mvmt	NBLn1	NBLn2	EBL	EBT	EBR	WBL	WBT	WBR	SBLn1
Capacity (veh/h)	306	646	1287	-	-	1017	-	-	384
HCM Lane V/C Ratio	0.437	0.043	0.004	-	-	0.04	-	-	0.013
HCM Control Delay (s)	25.6	10.8	7.8	-	-	8.7	-	-	14.5
HCM Lane LOS	D	B	A	-	-	A	-	-	B
HCM 95th %tile Q(veh)	2.1	0.1	0	-	-	0.1	-	-	0

Intersection												
Int Delay, s/veh	1.4											
Movement	EBL	EBT	EBR	WBL	WBT	WBR	NBL	NBT	NBR	SBL	SBT	SBR
Lane Configurations		↕			↕			↕			↕	
Traffic Vol, veh/h	14	0	4	2	0	8	4	108	2	14	131	20
Future Vol, veh/h	14	0	4	2	0	8	4	108	2	14	131	20
Conflicting Peds, #/hr	0	0	0	0	0	0	0	0	0	0	0	0
Sign Control	Stop	Stop	Stop	Stop	Stop	Stop	Free	Free	Free	Free	Free	Free
RT Channelized	-	-	None	-	-	None	-	-	None	-	-	None
Storage Length	-	-	-	-	-	-	-	-	-	-	-	-
Veh in Median Storage, #	-	0	-	-	0	-	-	0	-	-	0	-
Grade, %	-	0	-	-	0	-	-	0	-	-	0	-
Peak Hour Factor	78	78	78	78	78	78	83	83	83	87	87	87
Heavy Vehicles, %	2	2	2	2	2	2	2	2	2	2	2	2
Mvmt Flow	18	0	5	3	0	10	5	130	2	16	151	23

Major/Minor	Minor2		Minor1		Major1			Major2				
Conflicting Flow All	341	337	163	338	347	131	174	0	0	132	0	0
Stage 1	195	195	-	141	141	-	-	-	-	-	-	-
Stage 2	146	142	-	197	206	-	-	-	-	-	-	-
Critical Hdwy	7.12	6.52	6.22	7.12	6.52	6.22	4.12	-	-	4.12	-	-
Critical Hdwy Stg 1	6.12	5.52	-	6.12	5.52	-	-	-	-	-	-	-
Critical Hdwy Stg 2	6.12	5.52	-	6.12	5.52	-	-	-	-	-	-	-
Follow-up Hdwy	3.518	4.018	3.318	3.518	4.018	3.318	2.218	-	-	2.218	-	-
Pot Cap-1 Maneuver	613	584	882	616	576	919	1403	-	-	1453	-	-
Stage 1	807	739	-	862	780	-	-	-	-	-	-	-
Stage 2	857	779	-	805	731	-	-	-	-	-	-	-
Platoon blocked, %								-	-	-	-	-
Mov Cap-1 Maneuver	599	575	882	605	567	919	1403	-	-	1453	-	-
Mov Cap-2 Maneuver	599	575	-	605	567	-	-	-	-	-	-	-
Stage 1	804	730	-	859	777	-	-	-	-	-	-	-
Stage 2	844	776	-	791	722	-	-	-	-	-	-	-

Approach	EB		WB		NB		SB	
HCM Control Delay, s	10.8		9.4		0.3		0.6	
HCM LOS	B		A					

Minor Lane/Major Mvmt	NBL	NBT	NBR	EBLn1	WBLn1	SBL	SBT	SBR
Capacity (veh/h)	1403	-	-	645	833	1453	-	-
HCM Lane V/C Ratio	0.003	-	-	0.036	0.015	0.011	-	-
HCM Control Delay (s)	7.6	0	-	10.8	9.4	7.5	0	-
HCM Lane LOS	A	A	-	B	A	A	A	-
HCM 95th %tile Q(veh)	0	-	-	0.1	0	0	-	-

HCM 6th TWSC
5: Misty Acres Blvd & Monument Hill Rd

Adjusted Existing + Site
PM

Intersection												
Int Delay, s/veh	2											
Movement	NBL	NBT	NBR	SBL	SBT	SBR	SEL	SET	SER	NWL	NWT	NWR
Lane Configurations		↕			↕	↕		↕			↕	
Traffic Vol, veh/h	0	74	1	5	84	48	38	1	0	1	1	2
Future Vol, veh/h	0	74	1	5	84	48	38	1	0	1	1	2
Conflicting Peds, #/hr	0	0	0	0	0	0	0	0	0	0	0	0
Sign Control	Free	Free	Free	Free	Free	Free	Stop	Stop	Stop	Stop	Stop	Stop
RT Channelized	-	-	None	-	-	None	-	-	None	-	-	None
Storage Length	-	-	-	-	-	186	-	-	-	-	-	-
Veh in Median Storage, #	-	0	-	-	0	-	-	0	-	-	0	-
Grade, %	-	0	-	-	0	-	-	0	-	-	0	-
Peak Hour Factor	83	83	83	83	83	83	78	78	78	78	78	78
Heavy Vehicles, %	2	2	2	2	2	2	2	2	2	2	2	2
Mvmt Flow	0	89	1	6	101	58	49	1	0	1	1	3

Major/Minor	Major1	Major2	Minor2	Minor1
Conflicting Flow All	159	0	0	90
Stage 1	-	-	-	-
Stage 2	-	-	-	-
Critical Hdwy	4.12	-	-	4.12
Critical Hdwy Stg 1	-	-	-	-
Critical Hdwy Stg 2	-	-	-	-
Follow-up Hdwy	2.218	-	-	2.218
Pot Cap-1 Maneuver	1420	-	-	1505
Stage 1	-	-	-	-
Stage 2	-	-	-	-
Platoon blocked, %	-	-	-	-
Mov Cap-1 Maneuver	1420	-	-	1505
Mov Cap-2 Maneuver	-	-	-	-
Stage 1	-	-	-	-
Stage 2	-	-	-	-

Approach	NB	SB	SE	NW
HCM Control Delay, s	0	0.3	10.2	9.5
HCM LOS			B	A

Minor Lane/Major Mvmt	NBL	NBT	NBRNWLn1	SELn1	SBL	SBT	SBR
Capacity (veh/h)	1420	-	-	797	746	1505	-
HCM Lane V/C Ratio	-	-	-	0.006	0.067	0.004	-
HCM Control Delay (s)	0	-	-	9.5	10.2	7.4	0
HCM Lane LOS	A	-	-	A	B	A	A
HCM 95th %tile Q(veh)	0	-	-	0	0.2	0	-

Intersection						
Int Delay, s/veh	2.7					
Movement	EBT	EBR	WBL	WBT	NBL	NBR
Lane Configurations						
Traffic Vol, veh/h	28	3	18	30	4	10
Future Vol, veh/h	28	3	18	30	4	10
Conflicting Peds, #/hr	0	0	0	0	0	0
Sign Control	Free	Free	Free	Free	Stop	Stop
RT Channelized	-	None	-	None	-	None
Storage Length	-	-	-	-	0	-
Veh in Median Storage, #	0	-	-	0	0	-
Grade, %	0	-	-	0	0	-
Peak Hour Factor	78	78	78	78	78	78
Heavy Vehicles, %	2	2	2	2	2	2
Mvmt Flow	36	4	23	38	5	13

Major/Minor	Major1	Major2	Minor1	Minor2	Minor3
Conflicting Flow All	0	0	40	0	122 38
Stage 1	-	-	-	-	38 -
Stage 2	-	-	-	-	84 -
Critical Hdwy	-	-	4.12	-	6.42 6.22
Critical Hdwy Stg 1	-	-	-	-	5.42 -
Critical Hdwy Stg 2	-	-	-	-	5.42 -
Follow-up Hdwy	-	-	2.218	-	3.518 3.318
Pot Cap-1 Maneuver	-	-	1570	-	873 1034
Stage 1	-	-	-	-	984 -
Stage 2	-	-	-	-	939 -
Platoon blocked, %	-	-	-	-	-
Mov Cap-1 Maneuver	-	-	1570	-	860 1034
Mov Cap-2 Maneuver	-	-	-	-	860 -
Stage 1	-	-	-	-	984 -
Stage 2	-	-	-	-	925 -

Approach	EB	WB	NB
HCM Control Delay, s	0	2.7	8.8
HCM LOS			A

Minor Lane/Major Mvmt	NBLn1	EBT	EBR	WBL	WBT
Capacity (veh/h)	977	-	-	1570	-
HCM Lane V/C Ratio	0.018	-	-	0.015	-
HCM Control Delay (s)	8.8	-	-	7.3	0
HCM Lane LOS	A	-	-	A	A
HCM 95th %tile Q(veh)	0.1	-	-	0	-

HCM 6th TWSC
7: Misty Acres Blvd & Old Antlers Way

Adjusted Existing + Site
PM

Intersection												
Int Delay, s/veh	3											
Movement	EBL	EBT	EBR	WBL	WBT	WBR	NBL	NBT	NBR	SBL	SBT	SBR
Lane Configurations		↕			↕			↕	↕	↕	↕	
Traffic Vol, veh/h	26	0	9	15	0	4	11	45	29	6	41	38
Future Vol, veh/h	26	0	9	15	0	4	11	45	29	6	41	38
Conflicting Peds, #/hr	0	0	0	0	0	0	0	0	0	0	0	0
Sign Control	Stop	Stop	Stop	Stop	Stop	Stop	Free	Free	Free	Free	Free	Free
RT Channelized	-	-	None	-	-	None	-	-	None	-	-	None
Storage Length	-	-	-	-	-	-	-	-	100	120	-	-
Veh in Median Storage, #	-	0	-	-	0	-	-	0	-	-	0	-
Grade, %	-	0	-	-	0	-	-	0	-	-	0	-
Peak Hour Factor	78	78	78	78	78	78	83	83	83	83	83	83
Heavy Vehicles, %	2	2	2	2	2	2	2	2	2	2	2	2
Mvmt Flow	33	0	12	19	0	5	13	54	35	7	49	46

Major/Minor	Minor2		Minor1		Major1			Major2				
Conflicting Flow All	186	201	72	172	189	54	95	0	0	89	0	0
Stage 1	86	86	-	80	80	-	-	-	-	-	-	-
Stage 2	100	115	-	92	109	-	-	-	-	-	-	-
Critical Hdwy	7.12	6.52	6.22	7.12	6.52	6.22	4.12	-	-	4.12	-	-
Critical Hdwy Stg 1	6.12	5.52	-	6.12	5.52	-	-	-	-	-	-	-
Critical Hdwy Stg 2	6.12	5.52	-	6.12	5.52	-	-	-	-	-	-	-
Follow-up Hdwy	3.518	4.018	3.318	3.518	4.018	3.318	2.218	-	-	2.218	-	-
Pot Cap-1 Maneuver	775	695	990	791	706	1013	1499	-	-	1506	-	-
Stage 1	922	824	-	929	828	-	-	-	-	-	-	-
Stage 2	906	800	-	915	805	-	-	-	-	-	-	-
Platoon blocked, %								-	-	-	-	-
Mov Cap-1 Maneuver	763	685	990	774	696	1013	1499	-	-	1506	-	-
Mov Cap-2 Maneuver	763	685	-	774	696	-	-	-	-	-	-	-
Stage 1	914	820	-	921	821	-	-	-	-	-	-	-
Stage 2	893	793	-	900	801	-	-	-	-	-	-	-

Approach	EB		WB		NB		SB	
HCM Control Delay, s	9.7		9.6		1		0.5	
HCM LOS	A		A					

Minor Lane/Major Mvmt	NBL	NBT	NBR	EBLn1WBLn1	SBL	SBT	SBR
Capacity (veh/h)	1499	-	-	811	814	1506	-
HCM Lane V/C Ratio	0.009	-	-	0.055	0.03	0.005	-
HCM Control Delay (s)	7.4	0	-	9.7	9.6	7.4	0
HCM Lane LOS	A	A	-	A	A	A	A
HCM 95th %tile Q(veh)	0	-	-	0.2	0.1	0	-

Intersection						
Int Delay, s/veh	0.4					
Movement	EBL	EBR	NBL	NBT	SBT	SBR
Lane Configurations	T			T		T
Traffic Vol, veh/h	7	2	2	127	163	10
Future Vol, veh/h	7	2	2	127	163	10
Conflicting Peds, #/hr	0	0	0	0	0	0
Sign Control	Stop	Stop	Free	Free	Free	Free
RT Channelized	-	None	-	None	-	None
Storage Length	0	-	-	-	-	-
Veh in Median Storage, #	0	-	-	0	0	-
Grade, %	0	-	-	0	0	-
Peak Hour Factor	78	78	83	83	87	87
Heavy Vehicles, %	2	2	2	2	2	2
Mvmt Flow	9	3	2	153	187	11





















Major/Minor	Minor2	Major1		Major2	
Conflicting Flow All	350	193	198	0	0
Stage 1	193	-	-	-	-
Stage 2	157	-	-	-	-
Critical Hdwy	6.42	6.22	4.12	-	-
Critical Hdwy Stg 1	5.42	-	-	-	-
Critical Hdwy Stg 2	5.42	-	-	-	-
Follow-up Hdwy	3.518	3.318	2.218	-	-
Pot Cap-1 Maneuver	647	849	1375	-	-
Stage 1	840	-	-	-	-
Stage 2	871	-	-	-	-
Platoon blocked, %				-	-
Mov Cap-1 Maneuver	646	849	1375	-	-
Mov Cap-2 Maneuver	646	-	-	-	-
Stage 1	838	-	-	-	-
Stage 2	871	-	-	-	-

Approach	EB	NB	SB
HCM Control Delay, s	10.4	0.1	0
HCM LOS	B		

Minor Lane/Major Mvmt	NBL	NBT	EBLn1	SBT	SBR
Capacity (veh/h)	1375	-	682	-	-
HCM Lane V/C Ratio	0.002	-	0.017	-	-
HCM Control Delay (s)	7.6	0	10.4	-	-
HCM Lane LOS	A	A	B	-	-
HCM 95th %tile Q(veh)	0	-	0.1	-	-

Lanes, Volumes, Timings
3: Misty Acres Blvd/Andrews Rd & County Line Rd

2044 Background
AM

												
Lane Group	EBL	EBT	EBR	WBL	WBT	WBR	NBL	NBT	NBR	SBL	SBT	SBR
Lane Configurations												
Traffic Volume (vph)	3	148	151	92	605	3	126	0	41	7	0	5
Future Volume (vph)	3	148	151	92	605	3	126	0	41	7	0	5
Ideal Flow (vphpl)	1900	1900	1900	1900	1900	1900	1900	1900	1900	1900	1900	1900
Grade (%)		-7%			3%			0%			0%	
Storage Length (ft)	232		182	172		0	0		155	0		0
Storage Lanes	1		1	1		0	0		1	0		0
Taper Length (ft)	189			126			25			25		
Lane Util. Factor	1.00	1.00	1.00	1.00	1.00	1.00	1.00	1.00	1.00	1.00	1.00	1.00
Fr _t			0.850		0.999				0.850		0.946	
Fl _t Protected	0.950			0.950				0.950			0.971	
Satd. Flow (prot)	1832	1928	1639	1743	1833	0	0	1770	1583	0	1711	0
Fl _t Permitted	0.332			0.655				0.748			0.791	
Satd. Flow (perm)	640	1928	1639	1202	1833	0	0	1393	1583	0	1394	0
Right Turn on Red			Yes			Yes			Yes			Yes
Satd. Flow (RTOR)			164		1				47		45	
Link Speed (mph)		30			30			35			25	
Link Distance (ft)		705			807			335			248	
Travel Time (s)		16.0			18.3			6.5			6.8	
Peak Hour Factor	0.92	0.92	0.92	0.93	0.93	0.93	0.87	0.87	0.87	0.78	0.78	0.78
Adj. Flow (vph)	3	161	164	99	651	3	145	0	47	9	0	6
Shared Lane Traffic (%)												
Lane Group Flow (vph)	3	161	164	99	654	0	0	145	47	0	15	0
Enter Blocked Intersection	No	No	No	No	No	No	No	No	No	No	No	No
Lane Alignment	Left	Left	Right	Left	Left	Right	Left	Left	Right	Left	Left	Right
Median Width(ft)		12			12			0			0	
Link Offset(ft)		0			0			0			0	
Crosswalk Width(ft)		16			16			16			16	
Two way Left Turn Lane												
Headway Factor	0.96	0.96	0.96	1.02	1.02	1.02	1.00	1.00	1.00	1.00	1.00	1.00
Turning Speed (mph)	15		9	15		9	15		9	15		9
Number of Detectors	1	2	1	1	2		1	2	1	1	2	
Detector Template	Left	Thru	Right	Left	Thru		Left	Thru	Right	Left	Thru	
Leading Detector (ft)	20	100	20	20	100		20	100	20	20	100	
Trailing Detector (ft)	0	0	0	0	0		0	0	0	0	0	
Detector 1 Position(ft)	0	0	0	0	0		0	0	0	0	0	
Detector 1 Size(ft)	20	6	20	20	6		20	6	20	20	6	
Detector 1 Type	Cl+Ex	Cl+Ex	Cl+Ex	Cl+Ex	Cl+Ex		Cl+Ex	Cl+Ex	Cl+Ex	Cl+Ex	Cl+Ex	
Detector 1 Channel												
Detector 1 Extend (s)	0.0	0.0	0.0	0.0	0.0		0.0	0.0	0.0	0.0	0.0	
Detector 1 Queue (s)	0.0	0.0	0.0	0.0	0.0		0.0	0.0	0.0	0.0	0.0	
Detector 1 Delay (s)	0.0	0.0	0.0	0.0	0.0		0.0	0.0	0.0	0.0	0.0	
Detector 2 Position(ft)		94			94			94			94	
Detector 2 Size(ft)		6			6			6			6	
Detector 2 Type		Cl+Ex			Cl+Ex			Cl+Ex			Cl+Ex	
Detector 2 Channel												
Detector 2 Extend (s)		0.0			0.0			0.0			0.0	
Turn Type	Perm	NA	Perm	Perm	NA		Perm	NA	Perm	Perm	NA	
Protected Phases		4			8			2			6	

Lanes, Volumes, Timings
3: Misty Acres Blvd/Andrews Rd & County Line Rd

2044 Background
AM



Lane Group	EBL	EBT	EBR	WBL	WBT	WBR	NBL	NBT	NBR	SBL	SBT	SBR
Permitted Phases	4		4	8			2		2	6		
Detector Phase	4	4	4	8	8		2	2	2	6	6	
Switch Phase												
Minimum Initial (s)	5.0	5.0	5.0	5.0	5.0		5.0	5.0	5.0	5.0	5.0	
Minimum Split (s)	23.5	23.5	23.5	23.5	23.5		23.0	23.0	23.0	23.0	23.0	
Total Split (s)	37.0	37.0	37.0	37.0	37.0		23.0	23.0	23.0	23.0	23.0	
Total Split (%)	61.7%	61.7%	61.7%	61.7%	61.7%		38.3%	38.3%	38.3%	38.3%	38.3%	
Maximum Green (s)	31.5	31.5	31.5	31.5	31.5		18.0	18.0	18.0	18.0	18.0	
Yellow Time (s)	4.5	4.5	4.5	4.5	4.5		4.0	4.0	4.0	4.0	4.0	
All-Red Time (s)	1.0	1.0	1.0	1.0	1.0		1.0	1.0	1.0	1.0	1.0	
Lost Time Adjust (s)	0.0	0.0	0.0	0.0	0.0			0.0	0.0		0.0	
Total Lost Time (s)	5.5	5.5	5.5	5.5	5.5			5.0	5.0		5.0	
Lead/Lag												
Lead-Lag Optimize?												
Vehicle Extension (s)	3.0	3.0	3.0	3.0	3.0		3.0	3.0	3.0	3.0	3.0	
Recall Mode	Min	Min	Min	Min	Min		None	None	None	None	None	
Walk Time (s)	7.0	7.0	7.0	7.0	7.0		7.0	7.0	7.0	7.0	7.0	
Flash Dont Walk (s)	11.0	11.0	11.0	11.0	11.0		11.0	11.0	11.0	11.0	11.0	
Pedestrian Calls (#/hr)	0	0	0	0	0		0	0	0	0	0	
Act Effct Green (s)	28.2	28.2	28.2	28.2	28.2			10.4	10.4		10.3	
Actuated g/C Ratio	0.63	0.63	0.63	0.63	0.63			0.23	0.23		0.23	
v/c Ratio	0.01	0.13	0.15	0.13	0.56			0.45	0.12		0.04	
Control Delay	6.0	6.2	1.8	6.6	10.1			21.0	6.6		1.6	
Queue Delay	0.0	0.0	0.0	0.0	0.0			0.0	0.0		0.0	
Total Delay	6.0	6.2	1.8	6.6	10.1			21.0	6.6		1.6	
LOS	A	A	A	A	B			C	A		A	
Approach Delay		4.0			9.6			17.5			1.6	
Approach LOS		A			A			B			A	
Queue Length 50th (ft)	0	18	0	11	101			28	0		0	
Queue Length 95th (ft)	3	49	21	35	243			81	19		2	
Internal Link Dist (ft)		625			727			255			168	
Turn Bay Length (ft)	232		182	172					155			
Base Capacity (vph)	465	1402	1236	874	1333			595	703		621	
Starvation Cap Reductn	0	0	0	0	0			0	0		0	
Spillback Cap Reductn	0	0	0	0	0			0	0		0	
Storage Cap Reductn	0	0	0	0	0			0	0		0	
Reduced v/c Ratio	0.01	0.11	0.13	0.11	0.49			0.24	0.07		0.02	

Intersection Summary

Area Type:	Other
Cycle Length:	60
Actuated Cycle Length:	44.6
Natural Cycle:	60
Control Type:	Actuated-Uncoordinated
Maximum v/c Ratio:	0.56
Intersection Signal Delay:	9.3
Intersection LOS:	A
Intersection Capacity Utilization:	60.3%
ICU Level of Service:	B
Analysis Period (min):	15

Lanes, Volumes, Timings
3: Misty Acres Blvd/Andrews Rd & County Line Rd

2044 Background
AM

Splits and Phases: 3: Misty Acres Blvd/Andrews Rd & County Line Rd

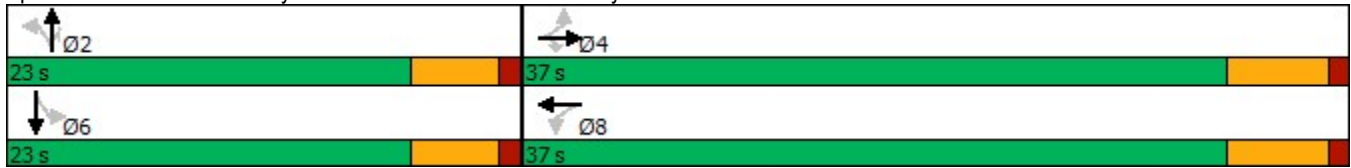

Intersection												
Int Delay, s/veh	10.7											
Movement	EBL	EBT	EBR	WBL	WBT	WBR	NBL	NBT	NBR	SBL	SBT	SBR
Lane Configurations		↕		↕	↑						↕	
Traffic Vol, veh/h	0	128	102	341	187	0	0	0	0	80	1	32
Future Vol, veh/h	0	128	102	341	187	0	0	0	0	80	1	32
Conflicting Peds, #/hr	0	0	0	0	0	0	0	0	0	0	0	0
Sign Control	Free	Free	Free	Free	Free	Free	Stop	Stop	Stop	Stop	Stop	Stop
RT Channelized	-	-	None	-	-	None	-	-	None	-	-	None
Storage Length	-	-	-	0	-	-	-	-	-	-	-	-
Veh in Median Storage, #	-	0	-	-	0	-	-	0	-	-	0	-
Grade, %	-	0	-	-	0	-	-	0	-	-	0	-
Peak Hour Factor	87	87	87	92	92	92	92	92	92	83	83	83
Heavy Vehicles, %	2	2	2	2	2	2	2	2	2	2	2	2
Mvmt Flow	0	147	117	371	203	0	0	0	0	96	1	39

Major/Minor	Major1			Major2			Minor2		
Conflicting Flow All	203	0	0	264	0	0	1151	1209	203
Stage 1	-	-	-	-	-	-	945	945	-
Stage 2	-	-	-	-	-	-	206	264	-
Critical Hdwy	4.12	-	-	4.12	-	-	6.42	6.52	6.22
Critical Hdwy Stg 1	-	-	-	-	-	-	5.42	5.52	-
Critical Hdwy Stg 2	-	-	-	-	-	-	5.42	5.52	-
Follow-up Hdwy	2.218	-	-	2.218	-	-	3.518	4.018	3.318
Pot Cap-1 Maneuver	1369	-	-	1300	-	0	219	183	838
Stage 1	-	-	-	-	-	0	378	340	-
Stage 2	-	-	-	-	-	0	829	690	-
Platoon blocked, %	-	-	-	-	-	-	-	-	-
Mov Cap-1 Maneuver	1369	-	-	1300	-	-	157	0	838
Mov Cap-2 Maneuver	-	-	-	-	-	-	157	0	-
Stage 1	-	-	-	-	-	-	378	0	-
Stage 2	-	-	-	-	-	-	593	0	-

Approach	EB	WB	SB
HCM Control Delay, s	0	5.7	52.2
HCM LOS			F

Minor Lane/Major Mvmt	EBL	EBT	EBR	WBL	WBT	SBLn1
Capacity (veh/h)	1369	-	-	1300	-	204
HCM Lane V/C Ratio	-	-	-	0.285	-	0.667
HCM Control Delay (s)	0	-	-	8.9	-	52.2
HCM Lane LOS	A	-	-	A	-	F
HCM 95th %tile Q(veh)	0	-	-	1.2	-	4.1

Intersection												
Int Delay, s/veh	3.1											
Movement	EBL	EBT	EBR	WBL	WBT	WBR	NBL	NBT	NBR	SBL	SBT	SBR
Lane Configurations	↙	↑			↘			↕				
Traffic Vol, veh/h	65	207	0	0	440	289	57	1	92	0	0	0
Future Vol, veh/h	65	207	0	0	440	289	57	1	92	0	0	0
Conflicting Peds, #/hr	0	0	0	0	0	0	0	0	0	0	0	0
Sign Control	Free	Free	Free	Free	Free	Free	Stop	Stop	Stop	Stop	Stop	Stop
RT Channelized	-	-	None	-	-	None	-	-	None	-	-	None
Storage Length	0	-	-	-	-	-	-	-	-	-	-	-
Veh in Median Storage, #	-	0	-	-	0	-	-	0	-	-	0	-
Grade, %	-	0	-	-	0	-	-	0	-	-	0	-
Peak Hour Factor	92	92	92	93	93	93	87	87	87	92	92	92
Heavy Vehicles, %	2	2	2	2	2	2	2	2	2	2	2	2
Mvmt Flow	71	225	0	0	473	311	66	1	106	0	0	0

Major/Minor	Major1	Major2	Minor1
Conflicting Flow All	784	0	-
Stage 1	-	-	-
Stage 2	-	-	-
Critical Hdwy	4.12	-	-
Critical Hdwy Stg 1	-	-	-
Critical Hdwy Stg 2	-	-	-
Follow-up Hdwy	2.218	-	-
Pot Cap-1 Maneuver	834	0	0
Stage 1	-	0	0
Stage 2	-	0	0
Platoon blocked, %	-	-	-
Mov Cap-1 Maneuver	834	-	-
Mov Cap-2 Maneuver	-	-	-
Stage 1	-	-	-
Stage 2	-	-	-

Approach	EB	WB	NB
HCM Control Delay, s	2.3	0	18.6
HCM LOS			C

Minor Lane/Major Mvmt	NBLn1	EBL	EBT	WBT	WBR
Capacity (veh/h)	435	834	-	-	-
HCM Lane V/C Ratio	0.396	0.085	-	-	-
HCM Control Delay (s)	18.6	9.7	-	-	-
HCM Lane LOS	C	A	-	-	-
HCM 95th %tile Q(veh)	1.9	0.3	-	-	-

Intersection												
Int Delay, s/veh	14.6											
Movement	EBL	EBT	EBR	WBL	WBT	WBR	NBL	NBT	NBR	SBL	SBT	SBR
Lane Configurations		↕			↕			↕			↕	
Traffic Vol, veh/h	3	148	151	92	605	3	126	0	41	7	0	5
Future Vol, veh/h	3	148	151	92	605	3	126	0	41	7	0	5
Conflicting Peds, #/hr	0	0	0	0	0	0	0	0	0	0	0	0
Sign Control	Free	Free	Free	Free	Free	Free	Stop	Stop	Stop	Stop	Stop	Stop
RT Channelized	-	-	None	-	-	None	-	-	None	-	-	None
Storage Length	-	-	-	-	-	-	-	-	-	-	-	-
Veh in Median Storage, #	-	0	-	-	0	-	-	0	-	-	0	-
Grade, %	-	-7	-	-	4	-	-	0	-	-	0	-
Peak Hour Factor	92	92	92	93	93	93	87	87	87	78	78	78
Heavy Vehicles, %	2	2	2	2	2	2	2	2	2	2	2	2
Mvmt Flow	3	161	164	99	651	3	145	0	47	9	0	6

Major/Minor	Major1			Major2			Minor1			Minor2		
Conflicting Flow All	654	0	0	325	0	0	1103	1101	243	1124	1182	653
Stage 1	-	-	-	-	-	-	249	249	-	851	851	-
Stage 2	-	-	-	-	-	-	854	852	-	273	331	-
Critical Hdwy	4.12	-	-	4.12	-	-	7.12	6.52	6.22	7.12	6.52	6.22
Critical Hdwy Stg 1	-	-	-	-	-	-	6.12	5.52	-	6.12	5.52	-
Critical Hdwy Stg 2	-	-	-	-	-	-	6.12	5.52	-	6.12	5.52	-
Follow-up Hdwy	2.218	-	-	2.218	-	-	3.518	4.018	3.318	3.518	4.018	3.318
Pot Cap-1 Maneuver	933	-	-	1235	-	-	189	212	796	183	190	467
Stage 1	-	-	-	-	-	-	755	701	-	355	376	-
Stage 2	-	-	-	-	-	-	353	376	-	733	645	-
Platoon blocked, %	-	-	-	-	-	-	-	-	-	-	-	-
Mov Cap-1 Maneuver	933	-	-	1235	-	-	168	185	796	155	165	467
Mov Cap-2 Maneuver	-	-	-	-	-	-	168	185	-	155	165	-
Stage 1	-	-	-	-	-	-	752	698	-	354	329	-
Stage 2	-	-	-	-	-	-	304	329	-	687	642	-

Approach	EB			WB			NB			SB		
HCM Control Delay, s	0.1			1.1			91.5			23		
HCM LOS							F			C		

Minor Lane/Major Mvmt	NBLn1	EBL	EBT	EBR	WBL	WBT	WBR	SBLn1
Capacity (veh/h)	208	933	-	-	1235	-	-	215
HCM Lane V/C Ratio	0.923	0.003	-	-	0.08	-	-	0.072
HCM Control Delay (s)	91.5	8.9	0	-	8.2	0	-	23
HCM Lane LOS	F	A	A	-	A	A	-	C
HCM 95th %tile Q(veh)	7.5	0	-	-	0.3	-	-	0.2

Intersection						
Int Delay, s/veh	1.5					
Movement	EBL	EBR	NBL	NBT	SBT	SBR
Lane Configurations						
Traffic Vol, veh/h	55	0	0	112	143	100
Future Vol, veh/h	55	0	0	112	143	100
Conflicting Peds, #/hr	0	0	0	0	0	0
Sign Control	Stop	Stop	Free	Free	Free	Free
RT Channelized	-	None	-	None	-	None
Storage Length	0	-	-	-	-	186
Veh in Median Storage, #	0	-	-	0	0	-
Grade, %	0	-	-	0	0	-
Peak Hour Factor	83	83	83	83	87	87
Heavy Vehicles, %	2	2	2	2	2	2
Mvmt Flow	66	0	0	135	164	115

Major/Minor	Minor2	Major1	Major2			
Conflicting Flow All	299	164	279	0	-	0
Stage 1	164	-	-	-	-	-
Stage 2	135	-	-	-	-	-
Critical Hdwy	6.42	6.22	4.12	-	-	-
Critical Hdwy Stg 1	5.42	-	-	-	-	-
Critical Hdwy Stg 2	5.42	-	-	-	-	-
Follow-up Hdwy	3.518	3.318	2.218	-	-	-
Pot Cap-1 Maneuver	692	881	1284	-	-	-
Stage 1	865	-	-	-	-	-
Stage 2	891	-	-	-	-	-
Platoon blocked, %				-	-	-
Mov Cap-1 Maneuver	692	881	1284	-	-	-
Mov Cap-2 Maneuver	692	-	-	-	-	-
Stage 1	865	-	-	-	-	-
Stage 2	891	-	-	-	-	-

Approach	EB	NB	SB
HCM Control Delay, s	10.8	0	0
HCM LOS	B		

Minor Lane/Major Mvmt	NBL	NBT	EBLn1	SBT	SBR
Capacity (veh/h)	1284	-	692	-	-
HCM Lane V/C Ratio	-	-	0.096	-	-
HCM Control Delay (s)	0	-	10.8	-	-
HCM Lane LOS	A	-	B	-	-
HCM 95th %tile Q(veh)	0	-	0.3	-	-

Intersection						
Int Delay, s/veh	2.2					
Movement	WBL	WBR	NBT	NBR	SBL	SBT
Lane Configurations	Y		↑	↑	↑	↑
Traffic Vol, veh/h	60	10	102	50	5	138
Future Vol, veh/h	60	10	102	50	5	138
Conflicting Peds, #/hr	0	0	0	0	0	0
Sign Control	Stop	Stop	Free	Free	Free	Free
RT Channelized	-	None	-	None	-	None
Storage Length	0	-	-	100	120	-
Veh in Median Storage, #	0	-	0	-	-	0
Grade, %	0	-	0	-	-	0
Peak Hour Factor	83	83	87	87	87	87
Heavy Vehicles, %	2	2	2	2	2	2
Mvmt Flow	72	12	117	57	6	159

Major/Minor	Minor1	Major1	Major2		
Conflicting Flow All	288	117	0	0	174
Stage 1	117	-	-	-	-
Stage 2	171	-	-	-	-
Critical Hdwy	6.42	6.22	-	-	4.12
Critical Hdwy Stg 1	5.42	-	-	-	-
Critical Hdwy Stg 2	5.42	-	-	-	-
Follow-up Hdwy	3.518	3.318	-	-	2.218
Pot Cap-1 Maneuver	702	935	-	-	1403
Stage 1	908	-	-	-	-
Stage 2	859	-	-	-	-
Platoon blocked, %			-	-	-
Mov Cap-1 Maneuver	699	935	-	-	1403
Mov Cap-2 Maneuver	699	-	-	-	-
Stage 1	908	-	-	-	-
Stage 2	856	-	-	-	-

Approach	WB	NB	SB
HCM Control Delay, s	10.6	0	0.3
HCM LOS	B		

Minor Lane/Major Mvmt	NBT	NBRWBLn1	SBL	SBT
Capacity (veh/h)	-	-	725	1403
HCM Lane V/C Ratio	-	-	0.116	0.004
HCM Control Delay (s)	-	-	10.6	7.6
HCM Lane LOS	-	-	B	A
HCM 95th %tile Q(veh)	-	-	0.4	0

Intersection						
Int Delay, s/veh	5.1					
Movement	WBL	WBR	NBT	NBR	SBL	SBT
Lane Configurations	↘	↗	↑	↗	↘	↑
Traffic Vol, veh/h	315	5	55	325	5	100
Future Vol, veh/h	315	5	55	325	5	100
Conflicting Peds, #/hr	0	0	0	0	0	0
Sign Control	Stop	Stop	Free	Free	Free	Free
RT Channelized	-	None	-	None	-	None
Storage Length	250	0	-	0	280	-
Veh in Median Storage, #	0	-	0	-	-	0
Grade, %	0	-	0	-	-	0
Peak Hour Factor	92	92	92	92	83	83
Heavy Vehicles, %	2	2	2	2	2	2
Mvmt Flow	342	5	60	353	6	120

Major/Minor	Minor1	Major1	Major2		
Conflicting Flow All	192	60	0	0	413
Stage 1	60	-	-	-	-
Stage 2	132	-	-	-	-
Critical Hdwy	6.42	6.22	-	-	4.12
Critical Hdwy Stg 1	5.42	-	-	-	-
Critical Hdwy Stg 2	5.42	-	-	-	-
Follow-up Hdwy	3.518	3.318	-	-	2.218
Pot Cap-1 Maneuver	797	1005	-	-	1146
Stage 1	963	-	-	-	-
Stage 2	894	-	-	-	-
Platoon blocked, %					
Mov Cap-1 Maneuver	793	1005	-	-	1146
Mov Cap-2 Maneuver	793	-	-	-	-
Stage 1	963	-	-	-	-
Stage 2	890	-	-	-	-

Approach	WB	NB	SB
HCM Control Delay, s	12.8	0	0.4
HCM LOS	B		

Minor Lane/Major Mvmt	NBT	NBRWBLn1	WBLn2	SBL	SBT
Capacity (veh/h)	-	-	793	1005	1146
HCM Lane V/C Ratio	-	-	0.432	0.005	0.005
HCM Control Delay (s)	-	-	12.9	8.6	8.2
HCM Lane LOS	-	-	B	A	A
HCM 95th %tile Q(veh)	-	-	2.2	0	0

Intersection						
Int Delay, s/veh	4					
Movement	EBT	EBR	WBL	WBT	NBL	NBR
Lane Configurations	↑	↗	↖	↑	↘	↙
Traffic Vol, veh/h	191	38	7	449	140	6
Future Vol, veh/h	191	38	7	449	140	6
Conflicting Peds, #/hr	0	0	0	0	0	0
Sign Control	Free	Free	Free	Free	Stop	Stop
RT Channelized	-	None	-	None	-	None
Storage Length	-	285	450	-	0	-
Veh in Median Storage, #	0	-	-	0	0	-
Grade, %	0	-	-	0	0	-
Peak Hour Factor	87	87	92	92	83	83
Heavy Vehicles, %	2	2	2	2	2	2
Mvmt Flow	220	44	8	488	169	7





















Major/Minor	Major1	Major2	Minor1	Minor2	Minor3
Conflicting Flow All	0	0	264	0	724
Stage 1	-	-	-	-	220
Stage 2	-	-	-	-	504
Critical Hdwy	-	-	4.12	-	6.42
Critical Hdwy Stg 1	-	-	-	-	5.42
Critical Hdwy Stg 2	-	-	-	-	5.42
Follow-up Hdwy	-	-	2.218	-	3.518
Pot Cap-1 Maneuver	-	-	1300	-	393
Stage 1	-	-	-	-	817
Stage 2	-	-	-	-	607
Platoon blocked, %	-	-	-	-	-
Mov Cap-1 Maneuver	-	-	1300	-	391
Mov Cap-2 Maneuver	-	-	-	-	391
Stage 1	-	-	-	-	817
Stage 2	-	-	-	-	603

Approach	EB	WB	NB
HCM Control Delay, s	0	0.1	20.9
HCM LOS			C

Minor Lane/Major Mvmt	NBLn1	EBT	EBR	WBL	WBT
Capacity (veh/h)	400	-	-	1300	-
HCM Lane V/C Ratio	0.44	-	-	0.006	-
HCM Control Delay (s)	20.9	-	-	7.8	-
HCM Lane LOS	C	-	-	A	-
HCM 95th %tile Q(veh)	2.2	-	-	0	-

Lanes, Volumes, Timings
 3: Misty Acres Blvd/Andrews Rd & County Line Rd

2044 Background
 PM

												
Lane Group	EBL	EBT	EBR	WBL	WBT	WBR	NBL	NBT	NBR	SBL	SBT	SBR
Lane Configurations												
Traffic Volume (vph)	10	500	70	30	280	1	62	0	28	3	0	3
Future Volume (vph)	10	500	70	30	280	1	62	0	28	3	0	3
Ideal Flow (vphpl)	1900	1900	1900	1900	1900	1900	1900	1900	1900	1900	1900	1900
Grade (%)		-7%			3%			0%			0%	
Storage Length (ft)	232		182	172		0	0		155	0		0
Storage Lanes	1		1	1		0	0		1	0		0
Taper Length (ft)	189			126			25			25		
Lane Util. Factor	1.00	1.00	1.00	1.00	1.00	1.00	1.00	1.00	1.00	1.00	1.00	1.00
Frt			0.850						0.850		0.932	
Flt Protected	0.950			0.950				0.950			0.976	
Satd. Flow (prot)	1832	1928	1639	1743	1835	0	0	1770	1583	0	1694	0
Flt Permitted	0.574			0.440				0.755			0.803	
Satd. Flow (perm)	1107	1928	1639	807	1835	0	0	1406	1583	0	1394	0
Right Turn on Red			Yes			Yes			Yes			Yes
Satd. Flow (RTOR)			75						45			45
Link Speed (mph)		30			30			35			25	
Link Distance (ft)		705			807			335			248	
Travel Time (s)		16.0			18.3			6.5			6.8	
Peak Hour Factor	0.93	0.93	0.93	0.92	0.92	0.92	0.83	0.83	0.83	0.78	0.78	0.78
Adj. Flow (vph)	11	538	75	33	304	1	75	0	34	4	0	4
Shared Lane Traffic (%)												
Lane Group Flow (vph)	11	538	75	33	305	0	0	75	34	0	8	0
Enter Blocked Intersection	No	No	No	No	No	No	No	No	No	No	No	No
Lane Alignment	Left	Left	Right	Left	Left	Right	Left	Left	Right	Left	Left	Right
Median Width(ft)		12			12			0			0	
Link Offset(ft)		0			0			0			0	
Crosswalk Width(ft)		16			16			16			16	
Two way Left Turn Lane												
Headway Factor	0.96	0.96	0.96	1.02	1.02	1.02	1.00	1.00	1.00	1.00	1.00	1.00
Turning Speed (mph)	15		9	15		9	15		9	15		9
Number of Detectors	1	2	1	1	2		1	2	1	1	2	
Detector Template	Left	Thru	Right	Left	Thru		Left	Thru	Right	Left	Thru	
Leading Detector (ft)	20	100	20	20	100		20	100	20	20	100	
Trailing Detector (ft)	0	0	0	0	0		0	0	0	0	0	
Detector 1 Position(ft)	0	0	0	0	0		0	0	0	0	0	
Detector 1 Size(ft)	20	6	20	20	6		20	6	20	20	6	
Detector 1 Type	Cl+Ex	Cl+Ex	Cl+Ex	Cl+Ex	Cl+Ex		Cl+Ex	Cl+Ex	Cl+Ex	Cl+Ex	Cl+Ex	
Detector 1 Channel												
Detector 1 Extend (s)	0.0	0.0	0.0	0.0	0.0		0.0	0.0	0.0	0.0	0.0	
Detector 1 Queue (s)	0.0	0.0	0.0	0.0	0.0		0.0	0.0	0.0	0.0	0.0	
Detector 1 Delay (s)	0.0	0.0	0.0	0.0	0.0		0.0	0.0	0.0	0.0	0.0	
Detector 2 Position(ft)		94			94			94			94	
Detector 2 Size(ft)		6			6			6			6	
Detector 2 Type		Cl+Ex			Cl+Ex			Cl+Ex			Cl+Ex	
Detector 2 Channel												
Detector 2 Extend (s)		0.0			0.0			0.0			0.0	
Turn Type	Perm	NA	Perm	Perm	NA		Perm	NA	Perm	Perm	NA	
Protected Phases		4			8			2			6	

Lanes, Volumes, Timings
3: Misty Acres Blvd/Andrews Rd & County Line Rd

2044 Background
PM



Lane Group	EBL	EBT	EBR	WBL	WBT	WBR	NBL	NBT	NBR	SBL	SBT	SBR
Permitted Phases	4		4	8			2		2	6		
Detector Phase	4	4	4	8	8		2	2	2	6	6	
Switch Phase												
Minimum Initial (s)	5.0	5.0	5.0	5.0	5.0		10.0	10.0	10.0	10.0	10.0	
Minimum Split (s)	25.0	25.0	25.0	23.5	23.5		23.0	23.0	23.0	23.0	23.0	
Total Split (s)	36.0	36.0	36.0	36.0	36.0		24.0	24.0	24.0	24.0	24.0	
Total Split (%)	60.0%	60.0%	60.0%	60.0%	60.0%		40.0%	40.0%	40.0%	40.0%	40.0%	
Maximum Green (s)	30.5	30.5	30.5	30.5	30.5		19.0	19.0	19.0	19.0	19.0	
Yellow Time (s)	4.5	4.5	4.5	4.5	4.5		4.0	4.0	4.0	4.0	4.0	
All-Red Time (s)	1.0	1.0	1.0	1.0	1.0		1.0	1.0	1.0	1.0	1.0	
Lost Time Adjust (s)	0.0	0.0	0.0	0.0	0.0			0.0	0.0		0.0	
Total Lost Time (s)	5.5	5.5	5.5	5.5	5.5			5.0	5.0		5.0	
Lead/Lag												
Lead-Lag Optimize?												
Vehicle Extension (s)	3.0	3.0	3.0	3.0	3.0		3.0	3.0	3.0	3.0	3.0	
Recall Mode	Min	Min	Min	Min	Min		None	None	None	None	None	
Walk Time (s)	7.0	7.0	7.0	7.0	7.0		7.0	7.0	7.0	7.0	7.0	
Flash Dont Walk (s)	11.0	11.0	11.0	11.0	11.0		11.0	11.0	11.0	11.0	11.0	
Pedestrian Calls (#/hr)	0	0	0	0	0		0	0	0	0	0	
Act Effct Green (s)	27.3	27.3	27.3	27.3	27.3			10.7	10.7		10.7	
Actuated g/C Ratio	0.72	0.72	0.72	0.72	0.72			0.28	0.28		0.28	
v/c Ratio	0.01	0.39	0.06	0.06	0.23			0.19	0.07		0.02	
Control Delay	5.2	6.5	2.0	5.5	5.5			14.9	5.1		0.0	
Queue Delay	0.0	0.0	0.0	0.0	0.0			0.0	0.0		0.0	
Total Delay	5.2	6.5	2.0	5.5	5.5			14.9	5.1		0.0	
LOS	A	A	A	A	A			B	A		A	
Approach Delay		6.0			5.5			11.9				
Approach LOS		A			A			B				
Queue Length 50th (ft)	1	75	0	3	37			16	0		0	
Queue Length 95th (ft)	6	144	12	13	75			39	11		0	
Internal Link Dist (ft)		625			727			255			168	
Turn Bay Length (ft)	232		182	172					155			
Base Capacity (vph)	900	1567	1346	656	1492			735	849		750	
Starvation Cap Reductn	0	0	0	0	0			0	0		0	
Spillback Cap Reductn	0	0	0	0	0			0	0		0	
Storage Cap Reductn	0	0	0	0	0			0	0		0	
Reduced v/c Ratio	0.01	0.34	0.06	0.05	0.20			0.10	0.04		0.01	

Intersection Summary

Area Type:	Other
Cycle Length:	60
Actuated Cycle Length:	38.1
Natural Cycle:	50
Control Type:	Actuated-Uncoordinated
Maximum v/c Ratio:	0.39
Intersection Signal Delay:	6.4
Intersection LOS:	A
Intersection Capacity Utilization:	55.9%
ICU Level of Service:	B
Analysis Period (min):	15

Splits and Phases: 3: Misty Acres Blvd/Andrews Rd & County Line Rd

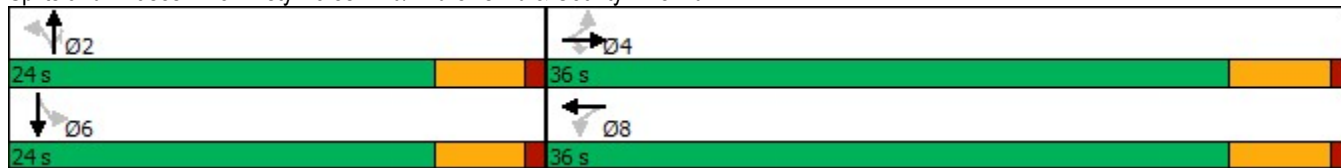

Intersection												
Int Delay, s/veh	23.3											
Movement	EBL	EBT	EBR	WBL	WBT	WBR	NBL	NBT	NBR	SBL	SBT	SBR
Lane Configurations		↕		↕	↕						↕	
Traffic Vol, veh/h	0	175	130	130	200	0	0	0	0	254	1	75
Future Vol, veh/h	0	175	130	130	200	0	0	0	0	254	1	75
Conflicting Peds, #/hr	0	0	0	0	0	0	0	0	0	0	0	0
Sign Control	Free	Free	Free	Free	Free	Free	Stop	Stop	Stop	Stop	Stop	Stop
RT Channelized	-	-	None	-	-	None	-	-	None	-	-	None
Storage Length	-	-	-	0	-	-	-	-	-	-	-	-
Veh in Median Storage, #	-	0	-	-	0	-	-	0	-	-	0	-
Grade, %	-	0	-	-	0	-	-	0	-	-	0	-
Peak Hour Factor	92	92	92	92	92	92	92	92	92	92	92	92
Heavy Vehicles, %	2	2	2	2	2	2	2	2	2	2	2	2
Mvmt Flow	0	190	141	141	217	0	0	0	0	276	1	82

Major/Minor	Major1			Major2			Minor2			
Conflicting Flow All	217	0	0	331	0	0		760	830	217
Stage 1	-	-	-	-	-	-		499	499	-
Stage 2	-	-	-	-	-	-		261	331	-
Critical Hdwy	4.12	-	-	4.12	-	-		6.42	6.52	6.22
Critical Hdwy Stg 1	-	-	-	-	-	-		5.42	5.52	-
Critical Hdwy Stg 2	-	-	-	-	-	-		5.42	5.52	-
Follow-up Hdwy	2.218	-	-	2.218	-	-		3.518	4.018	3.318
Pot Cap-1 Maneuver	1353	-	-	1228	-	0		374	306	823
Stage 1	-	-	-	-	-	0		610	544	-
Stage 2	-	-	-	-	-	0		783	645	-
Platoon blocked, %		-	-	-						
Mov Cap-1 Maneuver	1353	-	-	1228	-	-		331	0	823
Mov Cap-2 Maneuver	-	-	-	-	-	-		331	0	-
Stage 1	-	-	-	-	-	-		610	0	-
Stage 2	-	-	-	-	-	-		693	0	-

Approach	EB	WB	SB
HCM Control Delay, s	0	3.3	64.7
HCM LOS			F

Minor Lane/Major Mvmt	EBL	EBT	EBR	WBL	WBT	SBLn1
Capacity (veh/h)	1353	-	-	1228	-	383
HCM Lane V/C Ratio	-	-	-	0.115	-	0.937
HCM Control Delay (s)	0	-	-	8.3	-	64.7
HCM Lane LOS	A	-	-	A	-	F
HCM 95th %tile Q(veh)	0	-	-	0.4	-	10.2

Intersection												
Int Delay, s/veh	10.3											
Movement	EBL	EBT	EBR	WBL	WBT	WBR	NBL	NBT	NBR	SBL	SBT	SBR
Lane Configurations	↙	↑			↘			↕				
Traffic Vol, veh/h	56	360	0	0	212	115	117	3	221	0	0	0
Future Vol, veh/h	56	360	0	0	212	115	117	3	221	0	0	0
Conflicting Peds, #/hr	0	0	0	0	0	0	0	0	0	0	0	0
Sign Control	Free	Free	Free	Free	Free	Free	Stop	Stop	Stop	Stop	Stop	Stop
RT Channelized	-	-	None	-	-	None	-	-	None	-	-	None
Storage Length	0	-	-	-	-	-	-	-	-	-	-	-
Veh in Median Storage, #	-	0	-	-	0	-	-	0	-	-	0	-
Grade, %	-	0	-	-	0	-	-	0	-	-	0	-
Peak Hour Factor	92	92	92	92	92	92	92	92	92	92	92	92
Heavy Vehicles, %	2	2	2	2	2	2	2	2	2	2	2	2
Mvmt Flow	61	391	0	0	230	125	127	3	240	0	0	0

Major/Minor	Major1	Major2	Minor1
Conflicting Flow All	355	0	- - - 0 806 868 391
Stage 1	-	-	- - - 513 513 -
Stage 2	-	-	- - - 293 355 -
Critical Hdwy	4.12	-	- - - 6.42 6.52 6.22
Critical Hdwy Stg 1	-	-	- - - 5.42 5.52 -
Critical Hdwy Stg 2	-	-	- - - 5.42 5.52 -
Follow-up Hdwy	2.218	-	- - - 3.518 4.018 3.318
Pot Cap-1 Maneuver	1204	- 0 0	- - 351 290 658
Stage 1	-	- 0 0	- - 601 536 -
Stage 2	-	- 0 0	- - 757 630 -
Platoon blocked, %	-	-	- -
Mov Cap-1 Maneuver	1204	- - -	- - 333 0 658
Mov Cap-2 Maneuver	-	- - -	- - 333 0 -
Stage 1	-	- - -	- - 570 0 -
Stage 2	-	- - -	- - 757 0 -

Approach	EB	WB	NB
HCM Control Delay, s	1.1	0	31.4
HCM LOS			D

Minor Lane/Major Mvmt	NBLn1	EBL	EBT	WBT	WBR
Capacity (veh/h)	492	1204	-	-	-
HCM Lane V/C Ratio	0.753	0.051	-	-	-
HCM Control Delay (s)	31.4	8.1	-	-	-
HCM Lane LOS	D	A	-	-	-
HCM 95th %tile Q(veh)	6.4	0.2	-	-	-

Intersection												
Int Delay, s/veh	3.2											
Movement	EBL	EBT	EBR	WBL	WBT	WBR	NBL	NBT	NBR	SBL	SBT	SBR
Lane Configurations		↕			↕			↕			↕	
Traffic Vol, veh/h	10	500	70	30	280	1	62	0	28	3	0	3
Future Vol, veh/h	10	500	70	30	280	1	62	0	28	3	0	3
Conflicting Peds, #/hr	0	0	0	0	0	0	0	0	0	0	0	0
Sign Control	Free	Free	Free	Free	Free	Free	Stop	Stop	Stop	Stop	Stop	Stop
RT Channelized	-	-	None	-	-	None	-	-	None	-	-	None
Storage Length	-	-	-	-	-	-	-	-	-	-	-	-
Veh in Median Storage, #	-	0	-	-	0	-	-	0	-	-	0	-
Grade, %	-	-7	-	-	4	-	-	0	-	-	0	-
Peak Hour Factor	93	93	93	92	92	92	83	83	83	78	78	78
Heavy Vehicles, %	2	2	2	2	2	2	2	2	2	2	2	2
Mvmt Flow	11	538	75	33	304	1	75	0	34	4	0	4

Major/Minor	Major1			Major2			Minor1			Minor2		
Conflicting Flow All	305	0	0	613	0	0	971	969	576	986	1006	305
Stage 1	-	-	-	-	-	-	598	598	-	371	371	-
Stage 2	-	-	-	-	-	-	373	371	-	615	635	-
Critical Hdwy	4.12	-	-	4.12	-	-	7.12	6.52	6.22	7.12	6.52	6.22
Critical Hdwy Stg 1	-	-	-	-	-	-	6.12	5.52	-	6.12	5.52	-
Critical Hdwy Stg 2	-	-	-	-	-	-	6.12	5.52	-	6.12	5.52	-
Follow-up Hdwy	2.218	-	-	2.218	-	-	3.518	4.018	3.318	3.518	4.018	3.318
Pot Cap-1 Maneuver	1256	-	-	966	-	-	232	254	517	227	241	735
Stage 1	-	-	-	-	-	-	489	491	-	649	620	-
Stage 2	-	-	-	-	-	-	648	620	-	479	472	-
Platoon blocked, %	-	-	-	-	-	-	-	-	-	-	-	-
Mov Cap-1 Maneuver	1256	-	-	966	-	-	221	241	517	204	228	735
Mov Cap-2 Maneuver	-	-	-	-	-	-	221	241	-	204	228	-
Stage 1	-	-	-	-	-	-	483	485	-	641	595	-
Stage 2	-	-	-	-	-	-	618	595	-	442	466	-

Approach	EB			WB			NB			SB		
HCM Control Delay, s	0.1			0.9			27.1			16.6		
HCM LOS							D			C		

Minor Lane/Major Mvmt	NBLn1	EBL	EBT	EBR	WBL	WBT	WBR	SBLn1
Capacity (veh/h)	269	1256	-	-	966	-	-	319
HCM Lane V/C Ratio	0.403	0.009	-	-	0.034	-	-	0.024
HCM Control Delay (s)	27.1	7.9	0	-	8.9	0	-	16.6
HCM Lane LOS	D	A	A	-	A	A	-	C
HCM 95th %tile Q(veh)	1.9	0	-	-	0.1	-	-	0.1

Intersection						
Int Delay, s/veh	1.6					
Movement	EBL	EBR	NBL	NBT	SBT	SBR
Lane Configurations						
Traffic Vol, veh/h	30	0	0	60	65	35
Future Vol, veh/h	30	0	0	60	65	35
Conflicting Peds, #/hr	0	0	0	0	0	0
Sign Control	Stop	Stop	Free	Free	Free	Free
RT Channelized	-	None	-	None	-	None
Storage Length	0	-	-	-	-	186
Veh in Median Storage, #	0	-	-	0	0	-
Grade, %	0	-	-	0	0	-
Peak Hour Factor	78	78	83	83	83	83
Heavy Vehicles, %	2	2	2	2	2	2
Mvmt Flow	38	0	0	72	78	42

Major/Minor	Minor2	Major1		Major2	
Conflicting Flow All	150	78	120	0	-
Stage 1	78	-	-	-	-
Stage 2	72	-	-	-	-
Critical Hdwy	6.42	6.22	4.12	-	-
Critical Hdwy Stg 1	5.42	-	-	-	-
Critical Hdwy Stg 2	5.42	-	-	-	-
Follow-up Hdwy	3.518	3.318	2.218	-	-
Pot Cap-1 Maneuver	842	983	1468	-	-
Stage 1	945	-	-	-	-
Stage 2	951	-	-	-	-
Platoon blocked, %				-	-
Mov Cap-1 Maneuver	842	983	1468	-	-
Mov Cap-2 Maneuver	842	-	-	-	-
Stage 1	945	-	-	-	-
Stage 2	951	-	-	-	-

Approach	EB	NB	SB
HCM Control Delay, s	9.5	0	0
HCM LOS	A		

Minor Lane/Major Mvmt	NBL	NBT	EBLn1	SBT	SBR
Capacity (veh/h)	1468	-	842	-	-
HCM Lane V/C Ratio	-	-	0.046	-	-
HCM Control Delay (s)	0	-	9.5	-	-
HCM Lane LOS	A	-	A	-	-
HCM 95th %tile Q(veh)	0	-	0.1	-	-

Intersection						
Int Delay, s/veh	2.1					
Movement	WBL	WBR	NBT	NBR	SBL	SBT
Lane Configurations	Y		↑	↑	↑	↑
Traffic Vol, veh/h	25	10	50	45	10	55
Future Vol, veh/h	25	10	50	45	10	55
Conflicting Peds, #/hr	0	0	0	0	0	0
Sign Control	Stop	Stop	Free	Free	Free	Free
RT Channelized	-	None	-	None	-	None
Storage Length	0	-	-	100	120	-
Veh in Median Storage, #	0	-	0	-	-	0
Grade, %	0	-	0	-	-	0
Peak Hour Factor	78	78	83	83	83	83
Heavy Vehicles, %	2	2	2	2	2	2
Mvmt Flow	32	13	60	54	12	66

Major/Minor	Minor1	Major1	Major2		
Conflicting Flow All	150	60	0	0	114
Stage 1	60	-	-	-	-
Stage 2	90	-	-	-	-
Critical Hdwy	6.42	6.22	-	-	4.12
Critical Hdwy Stg 1	5.42	-	-	-	-
Critical Hdwy Stg 2	5.42	-	-	-	-
Follow-up Hdwy	3.518	3.318	-	-	2.218
Pot Cap-1 Maneuver	842	1005	-	-	1475
Stage 1	963	-	-	-	-
Stage 2	934	-	-	-	-
Platoon blocked, %			-	-	-
Mov Cap-1 Maneuver	835	1005	-	-	1475
Mov Cap-2 Maneuver	835	-	-	-	-
Stage 1	963	-	-	-	-
Stage 2	927	-	-	-	-

Approach	WB	NB	SB
HCM Control Delay, s	9.3	0	1.1
HCM LOS	A		

Minor Lane/Major Mvmt	NBT	NBRWBLn1	SBL	SBT
Capacity (veh/h)	-	-	877	1475
HCM Lane V/C Ratio	-	-	0.051	0.008
HCM Control Delay (s)	-	-	9.3	7.5
HCM Lane LOS	-	-	A	A
HCM 95th %tile Q(veh)	-	-	0.2	0

Intersection						
Int Delay, s/veh	3.4					
Movement	WBL	WBR	NBT	NBR	SBL	SBT
Lane Configurations	↘	↗	↑	↗	↘	↑
Traffic Vol, veh/h	110	5	65	123	5	50
Future Vol, veh/h	110	5	65	123	5	50
Conflicting Peds, #/hr	0	0	0	0	0	0
Sign Control	Stop	Stop	Free	Free	Free	Free
RT Channelized	-	None	-	None	-	None
Storage Length	250	0	-	0	280	-
Veh in Median Storage, #	0	-	0	-	-	0
Grade, %	0	-	0	-	-	0
Peak Hour Factor	83	83	87	87	78	78
Heavy Vehicles, %	2	2	2	2	2	2
Mvmt Flow	133	6	75	141	6	64

Major/Minor	Minor1	Major1	Major2		
Conflicting Flow All	151	75	0	0	216
Stage 1	75	-	-	-	-
Stage 2	76	-	-	-	-
Critical Hdwy	6.42	6.22	-	-	4.12
Critical Hdwy Stg 1	5.42	-	-	-	-
Critical Hdwy Stg 2	5.42	-	-	-	-
Follow-up Hdwy	3.518	3.318	-	-	2.218
Pot Cap-1 Maneuver	841	986	-	-	1354
Stage 1	948	-	-	-	-
Stage 2	947	-	-	-	-
Platoon blocked, %			-	-	-
Mov Cap-1 Maneuver	838	986	-	-	1354
Mov Cap-2 Maneuver	838	-	-	-	-
Stage 1	948	-	-	-	-
Stage 2	943	-	-	-	-

Approach	WB	NB	SB
HCM Control Delay, s	10	0	0.7
HCM LOS	B		

Minor Lane/Major Mvmt	NBT	NBRWBLn1	WBLn2	SBL	SBT
Capacity (veh/h)	-	-	838	986	1354
HCM Lane V/C Ratio	-	-	0.158	0.006	0.005
HCM Control Delay (s)	-	-	10.1	8.7	7.7
HCM Lane LOS	-	-	B	A	A
HCM 95th %tile Q(veh)	-	-	0.6	0	0

Intersection						
Int Delay, s/veh	1.8					
Movement	EBT	EBR	WBL	WBT	NBL	NBR
Lane Configurations	↑	↗	↖	↑	↘	↙
Traffic Vol, veh/h	478	74	8	301	65	14
Future Vol, veh/h	478	74	8	301	65	14
Conflicting Peds, #/hr	0	0	0	0	0	0
Sign Control	Free	Free	Free	Free	Stop	Stop
RT Channelized	-	None	-	None	-	None
Storage Length	-	285	450	-	0	-
Veh in Median Storage, #	0	-	-	0	0	-
Grade, %	0	-	-	0	0	-
Peak Hour Factor	93	93	92	92	83	83
Heavy Vehicles, %	2	2	2	2	2	2
Mvmt Flow	514	80	9	327	78	17





















Major/Minor	Major1	Major2	Minor1		
Conflicting Flow All	0	0	594	0	859
Stage 1	-	-	-	-	514
Stage 2	-	-	-	-	345
Critical Hdwy	-	-	4.12	-	6.42
Critical Hdwy Stg 1	-	-	-	-	5.42
Critical Hdwy Stg 2	-	-	-	-	5.42
Follow-up Hdwy	-	-	2.218	-	3.518
Pot Cap-1 Maneuver	-	-	982	-	327
Stage 1	-	-	-	-	600
Stage 2	-	-	-	-	717
Platoon blocked, %	-	-	-	-	-
Mov Cap-1 Maneuver	-	-	982	-	324
Mov Cap-2 Maneuver	-	-	-	-	324
Stage 1	-	-	-	-	600
Stage 2	-	-	-	-	711

Approach	EB	WB	NB
HCM Control Delay, s	0	0.2	19.1
HCM LOS			C

Minor Lane/Major Mvmt	NBLn1	EBT	EBR	WBL	WBT
Capacity (veh/h)	350	-	-	982	-
HCM Lane V/C Ratio	0.272	-	-	0.009	-
HCM Control Delay (s)	19.1	-	-	8.7	-
HCM Lane LOS	C	-	-	A	-
HCM 95th %tile Q(veh)	1.1	-	-	0	-

Lanes, Volumes, Timings
3: Misty Acres Blvd/Andrews Rd & County Line Rd

2044 Background + Site
AM

												
Lane Group	EBL	EBT	EBR	WBL	WBT	WBR	NBL	NBT	NBR	SBL	SBT	SBR
Lane Configurations												
Traffic Volume (vph)	5	148	189	95	605	3	213	0	47	7	0	5
Future Volume (vph)	5	148	189	95	605	3	213	0	47	7	0	5
Ideal Flow (vphpl)	1900	1900	1900	1900	1900	1900	1900	1900	1900	1900	1900	1900
Grade (%)		-7%			3%			0%			0%	
Storage Length (ft)	232		182	172		0	0		155	0		0
Storage Lanes	1		1	1		0	0		1	0		0
Taper Length (ft)	189			126			25			25		
Lane Util. Factor	1.00	1.00	1.00	1.00	1.00	1.00	1.00	1.00	1.00	1.00	1.00	1.00
Frt			0.850		0.999				0.850		0.946	
Flt Protected	0.950			0.950				0.950			0.971	
Satd. Flow (prot)	1832	1928	1639	1743	1833	0	0	1770	1583	0	1711	0
Flt Permitted	0.277			0.655				0.748			0.795	
Satd. Flow (perm)	534	1928	1639	1202	1833	0	0	1393	1583	0	1401	0
Right Turn on Red			Yes			Yes			Yes			Yes
Satd. Flow (RTOR)			205		1				55		55	
Link Speed (mph)		30			30			35			25	
Link Distance (ft)		705			807			335			248	
Travel Time (s)		16.0			18.3			6.5			6.8	
Peak Hour Factor	0.92	0.92	0.92	0.93	0.93	0.93	0.92	0.92	0.92	0.78	0.78	0.78
Adj. Flow (vph)	5	161	205	102	651	3	232	0	51	9	0	6
Shared Lane Traffic (%)												
Lane Group Flow (vph)	5	161	205	102	654	0	0	232	51	0	15	0
Enter Blocked Intersection	No	No	No	No	No	No	No	No	No	No	No	No
Lane Alignment	Left	Left	Right	Left	Left	Right	Left	Left	Right	Left	Left	Right
Median Width(ft)		12			12			0			0	
Link Offset(ft)		0			0			0			0	
Crosswalk Width(ft)		16			16			16			16	
Two way Left Turn Lane												
Headway Factor	0.96	0.96	0.96	1.02	1.02	1.02	1.00	1.00	1.00	1.00	1.00	1.00
Turning Speed (mph)	15		9	15		9	15		9	15		9
Number of Detectors	1	2	1	1	2		1	2	1	1	2	
Detector Template	Left	Thru	Right	Left	Thru		Left	Thru	Right	Left	Thru	
Leading Detector (ft)	20	100	20	20	100		20	100	20	20	100	
Trailing Detector (ft)	0	0	0	0	0		0	0	0	0	0	
Detector 1 Position(ft)	0	0	0	0	0		0	0	0	0	0	
Detector 1 Size(ft)	20	6	20	20	6		20	6	20	20	6	
Detector 1 Type	Cl+Ex	Cl+Ex	Cl+Ex	Cl+Ex	Cl+Ex		Cl+Ex	Cl+Ex	Cl+Ex	Cl+Ex	Cl+Ex	
Detector 1 Channel												
Detector 1 Extend (s)	0.0	0.0	0.0	0.0	0.0		0.0	0.0	0.0	0.0	0.0	
Detector 1 Queue (s)	0.0	0.0	0.0	0.0	0.0		0.0	0.0	0.0	0.0	0.0	
Detector 1 Delay (s)	0.0	0.0	0.0	0.0	0.0		0.0	0.0	0.0	0.0	0.0	
Detector 2 Position(ft)		94			94			94			94	
Detector 2 Size(ft)		6			6			6			6	
Detector 2 Type		Cl+Ex			Cl+Ex			Cl+Ex			Cl+Ex	
Detector 2 Channel												
Detector 2 Extend (s)		0.0			0.0			0.0			0.0	
Turn Type	Perm	NA	Perm	Perm	NA		Perm	NA	Perm	Perm	NA	
Protected Phases		8			4			6			2	

Lanes, Volumes, Timings
 3: Misty Acres Blvd/Andrews Rd & County Line Rd

2044 Background + Site
 AM



Lane Group	EBL	EBT	EBR	WBL	WBT	WBR	NBL	NBT	NBR	SBL	SBT	SBR
Permitted Phases	8		8	4			6		6	2		
Detector Phase	8	8	8	4	4		6	6	6	2	2	
Switch Phase												
Minimum Initial (s)	5.0	5.0	5.0	5.0	5.0		4.0	4.0	4.0	4.0	4.0	
Minimum Split (s)	25.0	25.0	25.0	25.0	25.0		10.0	10.0	10.0	10.0	10.0	
Total Split (s)	35.0	35.0	35.0	35.0	35.0		25.0	25.0	25.0	25.0	25.0	
Total Split (%)	58.3%	58.3%	58.3%	58.3%	58.3%		41.7%	41.7%	41.7%	41.7%	41.7%	
Maximum Green (s)	29.0	29.0	29.0	29.0	29.0		19.0	19.0	19.0	19.0	19.0	
Yellow Time (s)	4.0	4.0	4.0	4.0	4.0		4.0	4.0	4.0	4.0	4.0	
All-Red Time (s)	2.0	2.0	2.0	2.0	2.0		2.0	2.0	2.0	2.0	2.0	
Lost Time Adjust (s)	0.0	0.0	0.0	0.0	0.0			0.0	0.0		0.0	
Total Lost Time (s)	6.0	6.0	6.0	6.0	6.0			6.0	6.0		6.0	
Lead/Lag												
Lead-Lag Optimize?												
Vehicle Extension (s)	3.0	3.0	3.0	3.0	3.0		3.0	3.0	3.0	3.0	3.0	
Recall Mode	Min	Min	Min	Min	Min		None	None	None	None	None	
Act Effct Green (s)	25.3	25.3	25.3	25.3	25.3			13.4	13.4		13.4	
Actuated g/C Ratio	0.50	0.50	0.50	0.50	0.50			0.26	0.26		0.26	
v/c Ratio	0.02	0.17	0.22	0.17	0.72			0.63	0.11		0.04	
Control Delay	8.0	8.5	2.3	9.0	16.6			25.2	5.5		0.2	
Queue Delay	0.0	0.0	0.0	0.0	0.0			0.0	0.0		0.0	
Total Delay	8.0	8.5	2.3	9.0	16.6			25.2	5.5		0.2	
LOS	A	A	A	A	B			C	A		A	
Approach Delay		5.1			15.6			21.7			0.2	
Approach LOS		A			B			C			A	
Queue Length 50th (ft)	1	24	0	15	138			57	0		0	
Queue Length 95th (ft)	6	60	27	44	295			128	19		0	
Internal Link Dist (ft)		625			727			255			168	
Turn Bay Length (ft)	232		182	172					155			
Base Capacity (vph)	310	1119	1038	697	1065			530	636		567	
Starvation Cap Reductn	0	0	0	0	0			0	0		0	
Spillback Cap Reductn	0	0	0	0	0			0	0		0	
Storage Cap Reductn	0	0	0	0	0			0	0		0	
Reduced v/c Ratio	0.02	0.14	0.20	0.15	0.61			0.44	0.08		0.03	

Intersection Summary

Area Type: Other
 Cycle Length: 60
 Actuated Cycle Length: 51
 Natural Cycle: 60
 Control Type: Actuated-Uncoordinated
 Maximum v/c Ratio: 0.72
 Intersection Signal Delay: 13.9
 Intersection Capacity Utilization 69.3%
 Analysis Period (min) 15
 Intersection LOS: B
 ICU Level of Service C

Splits and Phases: 3: Misty Acres Blvd/Andrews Rd & County Line Rd

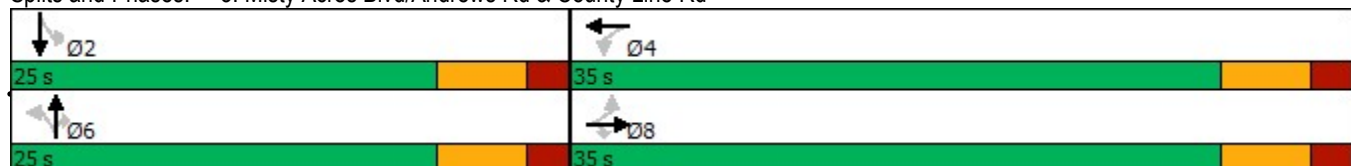

Intersection												
Int Delay, s/veh	29.5											
Movement	EBL	EBT	EBR	WBL	WBT	WBR	NBL	NBT	NBR	SBL	SBT	SBR
Lane Configurations		↕		↕	↕						↕	
Traffic Vol, veh/h	0	131	102	395	193	0	0	0	0	92	1	32
Future Vol, veh/h	0	131	102	395	193	0	0	0	0	92	1	32
Conflicting Peds, #/hr	0	0	0	0	0	0	0	0	0	0	0	0
Sign Control	Free	Free	Free	Free	Free	Free	Stop	Stop	Stop	Stop	Stop	Stop
RT Channelized	-	-	None	-	-	None	-	-	None	-	-	None
Storage Length	-	-	-	0	-	-	-	-	-	-	-	-
Veh in Median Storage, #	-	0	-	-	0	-	-	0	-	-	0	-
Grade, %	-	0	-	-	0	-	-	0	-	-	0	-
Peak Hour Factor	87	87	87	83	93	93	92	92	92	83	83	83
Heavy Vehicles, %	2	2	2	2	2	2	2	2	2	2	2	2
Mvmt Flow	0	151	117	476	208	0	0	0	0	111	1	39

Major/Minor	Major1			Major2			Minor2		
Conflicting Flow All	208	0	0	268	0	0	1370	1428	208
Stage 1	-	-	-	-	-	-	1160	1160	-
Stage 2	-	-	-	-	-	-	210	268	-
Critical Hdwy	4.12	-	-	4.12	-	-	6.42	6.52	6.22
Critical Hdwy Stg 1	-	-	-	-	-	-	5.42	5.52	-
Critical Hdwy Stg 2	-	-	-	-	-	-	5.42	5.52	-
Follow-up Hdwy	2.218	-	-	2.218	-	-	3.518	4.018	3.318
Pot Cap-1 Maneuver	1363	-	-	1296	-	0	161	135	832
Stage 1	-	-	-	-	-	0	298	270	-
Stage 2	-	-	-	-	-	0	825	687	-
Platoon blocked, %	-	-	-	-	-	-	-	-	-
Mov Cap-1 Maneuver	1363	-	-	1296	-	-	~ 102	0	832
Mov Cap-2 Maneuver	-	-	-	-	-	-	~ 102	0	-
Stage 1	-	-	-	-	-	-	298	0	-
Stage 2	-	-	-	-	-	-	522	0	-

Approach	EB	WB	SB
HCM Control Delay, s	0	6.5	186.5
HCM LOS			F

Minor Lane/Major Mvmt	EBL	EBT	EBR	WBL	WBT	SBLn1
Capacity (veh/h)	1363	-	-	1296	-	132
HCM Lane V/C Ratio	-	-	-	0.367	-	1.141
HCM Control Delay (s)	0	-	-	9.4	-	186.5
HCM Lane LOS	A	-	-	A	-	F
HCM 95th %tile Q(veh)	0	-	-	1.7	-	8.8

Notes
 ~: Volume exceeds capacity \$: Delay exceeds 300s +: Computation Not Defined *: All major volume in platoon

Intersection												
Int Delay, s/veh	3.6											
Movement	EBL	EBT	EBR	WBL	WBT	WBR	NBL	NBT	NBR	SBL	SBT	SBR
Lane Configurations	↙	↑			↘			↕				
Traffic Vol, veh/h	65	222	0	0	500	316	57	1	115	0	0	0
Future Vol, veh/h	65	222	0	0	500	316	57	1	115	0	0	0
Conflicting Peds, #/hr	0	0	0	0	0	0	0	0	0	0	0	0
Sign Control	Free	Free	Free	Free	Free	Free	Stop	Stop	Stop	Stop	Stop	Stop
RT Channelized	-	-	None	-	-	None	-	-	None	-	-	None
Storage Length	0	-	-	-	-	-	-	-	-	-	-	-
Veh in Median Storage, #	-	0	-	-	0	-	-	0	-	-	0	-
Grade, %	-	0	-	-	0	-	-	0	-	-	0	-
Peak Hour Factor	87	87	87	93	93	93	87	87	87	92	92	92
Heavy Vehicles, %	2	2	2	2	2	2	2	2	2	2	2	2
Mvmt Flow	75	255	0	0	538	340	66	1	132	0	0	0

Major/Minor	Major1	Major2	Minor1
Conflicting Flow All	878	0	- - - 0 1113 1283 255
Stage 1	-	-	- - - 405 405 -
Stage 2	-	-	- - - 708 878 -
Critical Hdwy	4.12	-	- - - 6.42 6.52 6.22
Critical Hdwy Stg 1	-	-	- - - 5.42 5.52 -
Critical Hdwy Stg 2	-	-	- - - 5.42 5.52 -
Follow-up Hdwy	2.218	-	- - - 3.518 4.018 3.318
Pot Cap-1 Maneuver	769	- 0 0	- - - 231 165 784
Stage 1	-	- 0 0	- - - 673 598 -
Stage 2	-	- 0 0	- - - 488 366 -
Platoon blocked, %	-	-	- -
Mov Cap-1 Maneuver	769	- - -	- - - 208 0 784
Mov Cap-2 Maneuver	-	- - -	- - - 208 0 -
Stage 1	-	- - -	- - - 607 0 -
Stage 2	-	- - -	- - - 488 0 -

Approach	EB	WB	NB
HCM Control Delay, s	2.3	0	21.9
HCM LOS			C

Minor Lane/Major Mvmt	NBLn1	EBL	EBT	WBT	WBR
Capacity (veh/h)	409	769	-	-	-
HCM Lane V/C Ratio	0.486	0.097	-	-	-
HCM Control Delay (s)	21.9	10.2	-	-	-
HCM Lane LOS	C	B	-	-	-
HCM 95th %tile Q(veh)	2.6	0.3	-	-	-

Intersection						
Int Delay, s/veh	5.4					
Movement	WBL	WBR	NBT	NBR	SBL	SBT
Lane Configurations	↘	↗	↑	↗	↘	↑
Traffic Vol, veh/h	335	5	58	333	5	112
Future Vol, veh/h	335	5	58	333	5	112
Conflicting Peds, #/hr	0	0	0	0	0	0
Sign Control	Stop	Stop	Free	Free	Free	Free
RT Channelized	-	None	-	None	-	None
Storage Length	250	0	-	0	280	-
Veh in Median Storage, #	0	-	0	-	-	0
Grade, %	0	-	0	-	-	0
Peak Hour Factor	92	92	92	92	83	83
Heavy Vehicles, %	2	2	2	2	2	2
Mvmt Flow	364	5	63	362	6	135

Major/Minor	Minor1	Major1	Major2		
Conflicting Flow All	210	63	0	0	425
Stage 1	63	-	-	-	-
Stage 2	147	-	-	-	-
Critical Hdwy	6.42	6.22	-	-	4.12
Critical Hdwy Stg 1	5.42	-	-	-	-
Critical Hdwy Stg 2	5.42	-	-	-	-
Follow-up Hdwy	3.518	3.318	-	-	2.218
Pot Cap-1 Maneuver	778	1002	-	-	1134
Stage 1	960	-	-	-	-
Stage 2	880	-	-	-	-
Platoon blocked, %			-	-	-
Mov Cap-1 Maneuver	774	1002	-	-	1134
Mov Cap-2 Maneuver	774	-	-	-	-
Stage 1	960	-	-	-	-
Stage 2	876	-	-	-	-

Approach	WB	NB	SB
HCM Control Delay, s	13.6	0	0.4
HCM LOS	B		

Minor Lane/Major Mvmt	NBT	NBRWBLn1	WBLn2	SBL	SBT
Capacity (veh/h)	-	-	774	1002	1134
HCM Lane V/C Ratio	-	-	0.47	0.005	0.005
HCM Control Delay (s)	-	-	13.7	8.6	8.2
HCM Lane LOS	-	-	B	A	A
HCM 95th %tile Q(veh)	-	-	2.5	0	0

Intersection						
Int Delay, s/veh	10.2					
Movement	EBT	EBR	WBL	WBT	NBL	NBR
Lane Configurations	↑	↗	↘	↑	↘	
Traffic Vol, veh/h	197	38	140	6	7	452
Future Vol, veh/h	197	38	140	6	7	452
Conflicting Peds, #/hr	0	0	0	0	0	0
Sign Control	Free	Free	Free	Free	Stop	Stop
RT Channelized	-	None	-	None	-	None
Storage Length	-	285	450	-	0	-
Veh in Median Storage, #	0	-	-	0	0	-
Grade, %	0	-	-	0	0	-
Peak Hour Factor	87	87	83	83	92	92
Heavy Vehicles, %	2	2	2	2	2	2
Mvmt Flow	226	44	169	7	8	491

Major/Minor	Major1	Major2	Minor1		
Conflicting Flow All	0	0	270	0	571
Stage 1	-	-	-	-	226
Stage 2	-	-	-	-	345
Critical Hdwy	-	-	4.12	-	6.42
Critical Hdwy Stg 1	-	-	-	-	5.42
Critical Hdwy Stg 2	-	-	-	-	5.42
Follow-up Hdwy	-	-	2.218	-	3.518
Pot Cap-1 Maneuver	-	-	1293	-	482
Stage 1	-	-	-	-	812
Stage 2	-	-	-	-	717
Platoon blocked, %	-	-	-	-	-
Mov Cap-1 Maneuver	-	-	1293	-	419
Mov Cap-2 Maneuver	-	-	-	-	419
Stage 1	-	-	-	-	812
Stage 2	-	-	-	-	623

Approach	EB	WB	NB
HCM Control Delay, s	0	7.9	16.6
HCM LOS			C

Minor Lane/Major Mvmt	NBLn1	EBT	EBR	WBL	WBT
Capacity (veh/h)	802	-	-	1293	-
HCM Lane V/C Ratio	0.622	-	-	0.13	-
HCM Control Delay (s)	16.6	-	-	8.2	-
HCM Lane LOS	C	-	-	A	-
HCM 95th %tile Q(veh)	4.4	-	-	0.4	-

Intersection												
Int Delay, s/veh	29											
Movement	EBL	EBT	EBR	WBL	WBT	WBR	NBL	NBT	NBR	SBL	SBT	SBR
Lane Configurations	↖	↑	↗	↖	↑	↗		↖	↗		↕	
Traffic Vol, veh/h	3	148	189	95	605	3	213	0	47	7	0	5
Future Vol, veh/h	3	148	189	95	605	3	213	0	47	7	0	5
Conflicting Peds, #/hr	0	0	0	0	0	0	0	0	0	0	0	0
Sign Control	Free	Free	Free	Free	Free	Free	Stop	Stop	Stop	Stop	Stop	Stop
RT Channelized	-	-	None	-	-	None	-	-	None	-	-	None
Storage Length	232	-	182	172	-	-	-	-	155	-	-	-
Veh in Median Storage, #	-	0	-	-	0	-	-	0	-	-	0	-
Grade, %	-	0	-	-	0	-	-	0	-	-	0	-
Peak Hour Factor	92	92	92	93	93	93	92	92	92	78	78	78
Heavy Vehicles, %	2	2	2	2	2	2	2	2	2	2	2	2
Mvmt Flow	3	161	205	102	651	3	232	0	51	9	0	6

Major/Minor	Major1			Major2			Minor1			Minor2		
Conflicting Flow All	654	0	0	366	0	0	1027	1025	161	1152	1229	653
Stage 1	-	-	-	-	-	-	167	167	-	857	857	-
Stage 2	-	-	-	-	-	-	860	858	-	295	372	-
Critical Hdwy	4.12	-	-	4.12	-	-	7.12	6.52	6.22	7.12	6.52	6.22
Critical Hdwy Stg 1	-	-	-	-	-	-	6.12	5.52	-	6.12	5.52	-
Critical Hdwy Stg 2	-	-	-	-	-	-	6.12	5.52	-	6.12	5.52	-
Follow-up Hdwy	2.218	-	-	2.218	-	-	3.518	4.018	3.318	3.518	4.018	3.318
Pot Cap-1 Maneuver	933	-	-	1193	-	-	~213	235	884	175	178	467
Stage 1	-	-	-	-	-	-	835	760	-	352	374	-
Stage 2	-	-	-	-	-	-	351	374	-	713	619	-
Platoon blocked, %	-	-	-	-	-	-	-	-	-	-	-	-
Mov Cap-1 Maneuver	933	-	-	1193	-	-	~196	214	884	154	162	467
Mov Cap-2 Maneuver	-	-	-	-	-	-	~196	214	-	154	162	-
Stage 1	-	-	-	-	-	-	832	758	-	351	342	-
Stage 2	-	-	-	-	-	-	317	342	-	670	617	-

Approach	EB	WB	NB	SB
HCM Control Delay, s	0.1	1.1	141.8	23.1
HCM LOS			F	C

Minor Lane/Major Mvmt	NBLn1	NBLn2	EBL	EBT	EBR	WBL	WBT	WBR	SBLn1
Capacity (veh/h)	196	884	933	-	-	1193	-	-	214
HCM Lane V/C Ratio	1.181	0.058	0.003	-	-	0.086	-	-	0.072
HCM Control Delay (s)	171	9.3	8.9	-	-	8.3	-	-	23.1
HCM Lane LOS	F	A	A	-	-	A	-	-	C
HCM 95th %tile Q(veh)	11.8	0.2	0	-	-	0.3	-	-	0.2

Notes
 ~: Volume exceeds capacity \$: Delay exceeds 300s +: Computation Not Defined *: All major volume in platoon

Intersection												
Int Delay, s/veh	1.1											
Movement	EBL	EBT	EBR	WBL	WBT	WBR	NBL	NBT	NBR	SBL	SBT	SBR
Lane Configurations		↕			↕			↕			↕	
Traffic Vol, veh/h	18	0	6	3	0	12	2	222	0	4	271	8
Future Vol, veh/h	18	0	6	3	0	12	2	222	0	4	271	8
Conflicting Peds, #/hr	0	0	0	0	0	0	0	0	0	0	0	0
Sign Control	Stop	Stop	Stop	Stop	Stop	Stop	Free	Free	Free	Free	Free	Free
RT Channelized	-	-	None	-	-	None	-	-	None	-	-	None
Storage Length	-	-	-	-	-	-	-	-	-	-	-	-
Veh in Median Storage, #	-	0	-	-	0	-	-	0	-	-	0	-
Grade, %	-	0	-	-	0	-	-	0	-	-	0	-
Peak Hour Factor	78	78	78	78	78	78	87	87	87	92	92	92
Heavy Vehicles, %	2	2	2	2	2	2	2	2	2	2	2	2
Mvmt Flow	23	0	8	4	0	15	2	255	0	4	295	9

Major/Minor	Minor2		Minor1		Major1		Major2					
Conflicting Flow All	575	567	300	571	571	255	304	0	0	255	0	0
Stage 1	308	308	-	259	259	-	-	-	-	-	-	-
Stage 2	267	259	-	312	312	-	-	-	-	-	-	-
Critical Hdwy	7.12	6.52	6.22	7.12	6.52	6.22	4.12	-	-	4.12	-	-
Critical Hdwy Stg 1	6.12	5.52	-	6.12	5.52	-	-	-	-	-	-	-
Critical Hdwy Stg 2	6.12	5.52	-	6.12	5.52	-	-	-	-	-	-	-
Follow-up Hdwy	3.518	4.018	3.318	3.518	4.018	3.318	2.218	-	-	2.218	-	-
Pot Cap-1 Maneuver	429	433	740	432	431	784	1257	-	-	1310	-	-
Stage 1	702	660	-	746	694	-	-	-	-	-	-	-
Stage 2	738	694	-	699	658	-	-	-	-	-	-	-
Platoon blocked, %								-	-	-	-	-
Mov Cap-1 Maneuver	419	430	740	426	428	784	1257	-	-	1310	-	-
Mov Cap-2 Maneuver	419	430	-	426	428	-	-	-	-	-	-	-
Stage 1	701	657	-	745	693	-	-	-	-	-	-	-
Stage 2	722	693	-	689	655	-	-	-	-	-	-	-

Approach	EB		WB		NB		SB	
HCM Control Delay, s	13.2		10.5		0.1		0.1	
HCM LOS	B		B					

Minor Lane/Major Mvmt	NBL	NBT	NBR	EBLn1	WBLn1	SBL	SBT	SBR
Capacity (veh/h)	1257	-	-	470	671	1310	-	-
HCM Lane V/C Ratio	0.002	-	-	0.065	0.029	0.003	-	-
HCM Control Delay (s)	7.9	0	-	13.2	10.5	7.8	0	-
HCM Lane LOS	A	A	-	B	B	A	A	-
HCM 95th %tile Q(veh)	0	-	-	0.2	0.1	0	-	-

Intersection												
Int Delay, s/veh	1.9											
Movement	NBL	NBT	NBR	SBL	SBT	SBR	SEL	SET	SER	NWL	NWT	NWR
Lane Configurations		↕			↕	↕		↕			↕	
Traffic Vol, veh/h	0	153	0	1	164	115	70	0	0	1	1	3
Future Vol, veh/h	0	153	0	1	164	115	70	0	0	1	1	3
Conflicting Peds, #/hr	0	0	0	0	0	0	0	0	0	0	0	0
Sign Control	Free	Free	Free	Free	Free	Free	Stop	Stop	Stop	Stop	Stop	Stop
RT Channelized	-	-	None	-	-	None	-	-	None	-	-	None
Storage Length	-	-	-	-	-	186	-	-	-	-	-	-
Veh in Median Storage, #	-	0	-	-	0	-	-	0	-	-	0	-
Grade, %	-	0	-	-	0	-	-	0	-	-	0	-
Peak Hour Factor	87	87	87	92	92	92	83	83	83	78	78	78
Heavy Vehicles, %	2	2	2	2	2	2	2	2	2	2	2	2
Mvmt Flow	0	176	0	1	178	125	84	0	0	1	1	4

Major/Minor	Major1		Major2		Minor2		Minor1					
Conflicting Flow All	303	0	0	176	0	0	359	356	178	419	481	176
Stage 1	-	-	-	-	-	-	180	180	-	176	176	-
Stage 2	-	-	-	-	-	-	179	176	-	243	305	-
Critical Hdwy	4.12	-	-	4.12	-	-	7.12	6.52	6.22	7.12	6.52	6.22
Critical Hdwy Stg 1	-	-	-	-	-	-	6.12	5.52	-	6.12	5.52	-
Critical Hdwy Stg 2	-	-	-	-	-	-	6.12	5.52	-	6.12	5.52	-
Follow-up Hdwy	2.218	-	-	2.218	-	-	3.518	4.018	3.318	3.518	4.018	3.318
Pot Cap-1 Maneuver	1258	-	-	1400	-	-	596	570	865	544	485	867
Stage 1	-	-	-	-	-	-	822	750	-	826	753	-
Stage 2	-	-	-	-	-	-	823	753	-	761	662	-
Platoon blocked, %	-	-	-	-	-	-	-	-	-	-	-	-
Mov Cap-1 Maneuver	1258	-	-	1400	-	-	592	569	865	543	485	867
Mov Cap-2 Maneuver	-	-	-	-	-	-	592	569	-	543	485	-
Stage 1	-	-	-	-	-	-	822	749	-	826	753	-
Stage 2	-	-	-	-	-	-	818	753	-	760	661	-

Approach	NB	SB	SE	NW
HCM Control Delay, s	0	0	12.1	10.4
HCM LOS			B	B

Minor Lane/Major Mvmt	NBL	NBT	NBRNWLn1	SELn1	SBL	SBT	SBR
Capacity (veh/h)	1258	-	-	679	592	1400	-
HCM Lane V/C Ratio	-	-	-	0.009	0.142	0.001	-
HCM Control Delay (s)	0	-	-	10.4	12.1	7.6	0
HCM Lane LOS	A	-	-	B	B	A	A
HCM 95th %tile Q(veh)	0	-	-	0	0.5	0	-

Intersection						
Int Delay, s/veh	1.2					
Movement	EBT	EBR	WBL	WBT	NBL	NBR
Lane Configurations						
Traffic Vol, veh/h	56	1	8	107	5	14
Future Vol, veh/h	56	1	8	107	5	14
Conflicting Peds, #/hr	0	0	0	0	0	0
Sign Control	Free	Free	Free	Free	Stop	Stop
RT Channelized	-	None	-	None	-	None
Storage Length	-	-	-	-	0	-
Veh in Median Storage, #	0	-	-	0	0	-
Grade, %	0	-	-	0	0	-
Peak Hour Factor	83	83	83	83	78	78
Heavy Vehicles, %	2	2	2	2	2	2
Mvmt Flow	67	1	10	129	6	18

Major/Minor	Major1	Major2	Minor1	Minor2	Minor3
Conflicting Flow All	0	0	68	0	217
Stage 1	-	-	-	-	68
Stage 2	-	-	-	-	149
Critical Hdwy	-	-	4.12	-	6.42
Critical Hdwy Stg 1	-	-	-	-	5.42
Critical Hdwy Stg 2	-	-	-	-	5.42
Follow-up Hdwy	-	-	2.218	-	3.518
Pot Cap-1 Maneuver	-	-	1533	-	771
Stage 1	-	-	-	-	955
Stage 2	-	-	-	-	879
Platoon blocked, %	-	-	-	-	-
Mov Cap-1 Maneuver	-	-	1533	-	766
Mov Cap-2 Maneuver	-	-	-	-	766
Stage 1	-	-	-	-	955
Stage 2	-	-	-	-	873

Approach	EB	WB	NB
HCM Control Delay, s	0	0.5	9
HCM LOS			A

Minor Lane/Major Mvmt	NBLn1	EBT	EBR	WBL	WBT
Capacity (veh/h)	922	-	-	1533	-
HCM Lane V/C Ratio	0.026	-	-	0.006	-
HCM Control Delay (s)	9	-	-	7.4	0
HCM Lane LOS	A	-	-	A	A
HCM 95th %tile Q(veh)	0.1	-	-	0	-

Intersection												
Int Delay, s/veh	3.3											
Movement	EBL	EBT	EBR	WBL	WBT	WBR	NBL	NBT	NBR	SBL	SBT	SBR
Lane Configurations		↕			↕			↕	↕	↕	↕	
Traffic Vol, veh/h	38	0	13	60	0	10	5	105	50	5	144	16
Future Vol, veh/h	38	0	13	60	0	10	5	105	50	5	144	16
Conflicting Peds, #/hr	0	0	0	0	0	0	0	0	0	0	0	0
Sign Control	Stop	Stop	Stop	Stop	Stop	Stop	Free	Free	Free	Free	Free	Free
RT Channelized	-	-	None	-	-	None	-	-	None	-	-	None
Storage Length	-	-	-	-	-	-	-	-	100	120	-	-
Veh in Median Storage, #	-	0	-	-	0	-	-	0	-	-	0	-
Grade, %	-	0	-	-	0	-	-	0	-	-	0	-
Peak Hour Factor	83	83	83	83	83	83	87	87	87	87	87	87
Heavy Vehicles, %	2	2	2	2	2	2	2	2	2	2	2	2
Mvmt Flow	46	0	16	72	0	12	6	121	57	6	166	18

Major/Minor	Minor2		Minor1		Major1		Major2					
Conflicting Flow All	355	377	175	328	329	121	184	0	0	178	0	0
Stage 1	187	187	-	133	133	-	-	-	-	-	-	-
Stage 2	168	190	-	195	196	-	-	-	-	-	-	-
Critical Hdwy	7.12	6.52	6.22	7.12	6.52	6.22	4.12	-	-	4.12	-	-
Critical Hdwy Stg 1	6.12	5.52	-	6.12	5.52	-	-	-	-	-	-	-
Critical Hdwy Stg 2	6.12	5.52	-	6.12	5.52	-	-	-	-	-	-	-
Follow-up Hdwy	3.518	4.018	3.318	3.518	4.018	3.318	2.218	-	-	2.218	-	-
Pot Cap-1 Maneuver	600	555	868	625	590	930	1391	-	-	1398	-	-
Stage 1	815	745	-	870	786	-	-	-	-	-	-	-
Stage 2	834	743	-	807	739	-	-	-	-	-	-	-
Platoon blocked, %								-	-	-	-	-
Mov Cap-1 Maneuver	588	550	868	609	585	930	1391	-	-	1398	-	-
Mov Cap-2 Maneuver	588	550	-	609	585	-	-	-	-	-	-	-
Stage 1	811	742	-	866	782	-	-	-	-	-	-	-
Stage 2	819	739	-	789	736	-	-	-	-	-	-	-

Approach	EB		WB		NB		SB	
HCM Control Delay, s	11.2		11.5		0.2		0.2	
HCM LOS	B		B					

Minor Lane/Major Mvmt	NBL	NBT	NBR	EBLn1	WBLn1	SBL	SBT	SBR
Capacity (veh/h)	1391	-	-	641	641	1398	-	-
HCM Lane V/C Ratio	0.004	-	-	0.096	0.132	0.004	-	-
HCM Control Delay (s)	7.6	0	-	11.2	11.5	7.6	0	-
HCM Lane LOS	A	A	-	B	B	A	A	-
HCM 95th %tile Q(veh)	0	-	-	0.3	0.5	0	-	-

Intersection						
Int Delay, s/veh	0.3					
Movement	EBL	EBR	NBL	NBT	SBT	SBR
Lane Configurations	T			T		T
Traffic Vol, veh/h	9	3	1	251	280	5
Future Vol, veh/h	9	3	1	251	280	5
Conflicting Peds, #/hr	0	0	0	0	0	0
Sign Control	Stop	Stop	Free	Free	Free	Free
RT Channelized	-	None	-	None	-	None
Storage Length	0	-	-	-	-	-
Veh in Median Storage, #	0	-	-	0	0	-
Grade, %	0	-	-	0	0	-
Peak Hour Factor	78	78	92	92	92	92
Heavy Vehicles, %	2	2	2	2	2	2
Mvmt Flow	12	4	1	273	304	5





















Major/Minor	Minor2	Major1	Major2			
Conflicting Flow All	582	307	309	0	-	0
Stage 1	307	-	-	-	-	-
Stage 2	275	-	-	-	-	-
Critical Hdwy	6.42	6.22	4.12	-	-	-
Critical Hdwy Stg 1	5.42	-	-	-	-	-
Critical Hdwy Stg 2	5.42	-	-	-	-	-
Follow-up Hdwy	3.518	3.318	2.218	-	-	-
Pot Cap-1 Maneuver	475	733	1252	-	-	-
Stage 1	746	-	-	-	-	-
Stage 2	771	-	-	-	-	-
Platoon blocked, %				-	-	-
Mov Cap-1 Maneuver	475	733	1252	-	-	-
Mov Cap-2 Maneuver	475	-	-	-	-	-
Stage 1	745	-	-	-	-	-
Stage 2	771	-	-	-	-	-

Approach	EB	NB	SB
HCM Control Delay, s	12.1	0	0
HCM LOS	B		

Minor Lane/Major Mvmt	NBL	NBT	EBLn1	SBT	SBR
Capacity (veh/h)	1252	-	521	-	-
HCM Lane V/C Ratio	0.001	-	0.03	-	-
HCM Control Delay (s)	7.9	0	12.1	-	-
HCM Lane LOS	A	A	B	-	-
HCM 95th %tile Q(veh)	0	-	0.1	-	-

Lanes, Volumes, Timings
 3: Misty Acres Blvd/Andrews Rd & County Line Rd

2044 Background + Site
 PM

												
Lane Group	EBL	EBT	EBR	WBL	WBT	WBR	NBL	NBT	NBR	SBL	SBT	SBR
Lane Configurations												
Traffic Volume (vph)	10	500	166	37	280	1	125	0	31	3	0	3
Future Volume (vph)	10	500	166	37	280	1	125	0	31	3	0	3
Ideal Flow (vphpl)	1900	1900	1900	1900	1900	1900	1900	1900	1900	1900	1900	1900
Grade (%)		-7%			3%			0%			0%	
Storage Length (ft)	232		182	172		0	0		155	0		0
Storage Lanes	1		1	1		0	0		1	0		0
Taper Length (ft)	189			126			25			25		
Lane Util. Factor	1.00	1.00	1.00	1.00	1.00	1.00	1.00	1.00	1.00	1.00	1.00	1.00
Frt			0.850						0.850		0.932	
Flt Protected	0.950			0.950				0.950			0.976	
Satd. Flow (prot)	1832	1928	1639	1743	1835	0	0	1770	1583	0	1694	0
Flt Permitted	0.574			0.420				0.752			0.840	
Satd. Flow (perm)	1107	1928	1639	771	1835	0	0	1401	1583	0	1458	0
Right Turn on Red			Yes			Yes			Yes			Yes
Satd. Flow (RTOR)			178						64			64
Link Speed (mph)		30			30			35			25	
Link Distance (ft)		705			807			335			248	
Travel Time (s)		16.0			18.3			6.5			6.8	
Peak Hour Factor	0.93	0.93	0.93	0.92	0.92	0.92	0.87	0.87	0.87	0.78	0.78	0.78
Adj. Flow (vph)	11	538	178	40	304	1	144	0	36	4	0	4
Shared Lane Traffic (%)												
Lane Group Flow (vph)	11	538	178	40	305	0	0	144	36	0	8	0
Enter Blocked Intersection	No	No	No	No	No	No	No	No	No	No	No	No
Lane Alignment	Left	Left	Right	Left	Left	Right	Left	Left	Right	Left	Left	Right
Median Width(ft)		12			12			0			0	
Link Offset(ft)		0			0			0			0	
Crosswalk Width(ft)		16			16			16			16	
Two way Left Turn Lane												
Headway Factor	0.96	0.96	0.96	1.02	1.02	1.02	1.00	1.00	1.00	1.00	1.00	1.00
Turning Speed (mph)	15		9	15		9	15		9	15		9
Number of Detectors	1	2	1	1	2		1	2	1	1	2	
Detector Template	Left	Thru	Right	Left	Thru		Left	Thru	Right	Left	Thru	
Leading Detector (ft)	20	100	20	20	100		20	100	20	20	100	
Trailing Detector (ft)	0	0	0	0	0		0	0	0	0	0	
Detector 1 Position(ft)	0	0	0	0	0		0	0	0	0	0	
Detector 1 Size(ft)	20	6	20	20	6		20	6	20	20	6	
Detector 1 Type	Cl+Ex	Cl+Ex	Cl+Ex	Cl+Ex	Cl+Ex		Cl+Ex	Cl+Ex	Cl+Ex	Cl+Ex	Cl+Ex	
Detector 1 Channel												
Detector 1 Extend (s)	0.0	0.0	0.0	0.0	0.0		0.0	0.0	0.0	0.0	0.0	
Detector 1 Queue (s)	0.0	0.0	0.0	0.0	0.0		0.0	0.0	0.0	0.0	0.0	
Detector 1 Delay (s)	0.0	0.0	0.0	0.0	0.0		0.0	0.0	0.0	0.0	0.0	
Detector 2 Position(ft)		94			94			94			94	
Detector 2 Size(ft)		6			6			6			6	
Detector 2 Type		Cl+Ex			Cl+Ex			Cl+Ex			Cl+Ex	
Detector 2 Channel												
Detector 2 Extend (s)		0.0			0.0			0.0			0.0	
Turn Type	Perm	NA	Perm	Perm	NA		Perm	NA	Perm	Perm	NA	
Protected Phases		8			4			6			2	

Lanes, Volumes, Timings
 3: Misty Acres Blvd/Andrews Rd & County Line Rd

2044 Background + Site
 PM



Lane Group	EBL	EBT	EBR	WBL	WBT	WBR	NBL	NBT	NBR	SBL	SBT	SBR
Permitted Phases	8		8	4			6		6	2		
Detector Phase	8	8	8	4	4		6	6	6	2	2	
Switch Phase												
Minimum Initial (s)	25.0	25.0	25.0	25.0	25.0		10.0	10.0	10.0	4.0	4.0	
Minimum Split (s)	31.5	31.5	31.5	31.5	31.5		16.0	16.0	16.0	9.5	9.5	
Total Split (s)	38.0	38.0	38.0	38.0	38.0		22.0	22.0	22.0	22.0	22.0	
Total Split (%)	63.3%	63.3%	63.3%	63.3%	63.3%		36.7%	36.7%	36.7%	36.7%	36.7%	
Maximum Green (s)	31.5	31.5	31.5	31.5	31.5		16.0	16.0	16.0	16.5	16.5	
Yellow Time (s)	4.5	4.5	4.5	4.5	4.5		4.0	4.0	4.0	3.5	3.5	
All-Red Time (s)	2.0	2.0	2.0	2.0	2.0		2.0	2.0	2.0	2.0	2.0	
Lost Time Adjust (s)	0.0	0.0	0.0	0.0	0.0			0.0	0.0		0.0	
Total Lost Time (s)	6.5	6.5	6.5	6.5	6.5			6.0	6.0		5.5	
Lead/Lag												
Lead-Lag Optimize?												
Vehicle Extension (s)	3.0	3.0	3.0	3.0	3.0		3.0	3.0	3.0	3.0	3.0	
Recall Mode	Min	Min	Min	Min	Min		None	None	None	None	None	
Act Effct Green (s)	31.0	31.0	31.0	31.0	31.0			11.5	11.5		10.9	
Actuated g/C Ratio	0.62	0.62	0.62	0.62	0.62			0.23	0.23		0.22	
v/c Ratio	0.02	0.45	0.16	0.08	0.27			0.45	0.09		0.02	
Control Delay	6.6	9.3	1.9	7.3	7.7			22.2	3.0		0.2	
Queue Delay	0.0	0.0	0.0	0.0	0.0			0.0	0.0		0.0	
Total Delay	6.6	9.3	1.9	7.3	7.7			22.2	3.0		0.2	
LOS	A	A	A	A	A			C	A		A	
Approach Delay		7.4			7.6			18.3			0.2	
Approach LOS		A			A			B			A	
Queue Length 50th (ft)	1	86	0	5	42			35	0		0	
Queue Length 95th (ft)	8	193	23	20	100			84	9		0	
Internal Link Dist (ft)		625			727			255			168	
Turn Bay Length (ft)	232		182	172					155			
Base Capacity (vph)	772	1345	1197	538	1280			450	552		526	
Starvation Cap Reductn	0	0	0	0	0			0	0		0	
Spillback Cap Reductn	0	0	0	0	0			0	0		0	
Storage Cap Reductn	0	0	0	0	0			0	0		0	
Reduced v/c Ratio	0.01	0.40	0.15	0.07	0.24			0.32	0.07		0.02	

Intersection Summary

Area Type: Other
 Cycle Length: 60
 Actuated Cycle Length: 50.2
 Natural Cycle: 50
 Control Type: Actuated-Uncoordinated
 Maximum v/c Ratio: 0.45
 Intersection Signal Delay: 9.0
 Intersection Capacity Utilization 60.4%
 Analysis Period (min) 15
 Intersection LOS: A
 ICU Level of Service B

Splits and Phases: 3: Misty Acres Blvd/Andrews Rd & County Line Rd

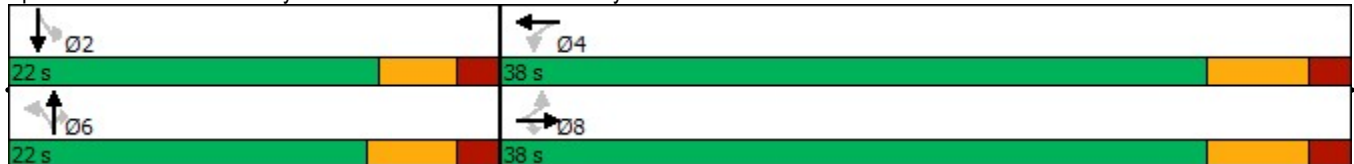

Intersection												
Int Delay, s/veh	188.8											
Movement	EBL	EBT	EBR	WBL	WBT	WBR	NBL	NBT	NBR	SBL	SBT	SBR
Lane Configurations		↕		↕	↕						↕	
Traffic Vol, veh/h	185	130	95	171	203	0	0	0	0	282	1	75
Future Vol, veh/h	185	130	95	171	203	0	0	0	0	282	1	75
Conflicting Peds, #/hr	0	0	0	0	0	0	0	0	0	0	0	0
Sign Control	Free	Free	Free	Free	Free	Free	Stop	Stop	Stop	Stop	Stop	Stop
RT Channelized	-	-	None	-	-	None	-	-	None	-	-	None
Storage Length	-	-	-	0	-	-	-	-	-	-	-	-
Veh in Median Storage, #	-	0	-	-	0	-	-	0	-	-	0	-
Grade, %	-	0	-	-	0	-	-	0	-	-	0	-
Peak Hour Factor	92	92	92	92	92	92	92	92	92	92	92	92
Heavy Vehicles, %	2	2	2	2	2	2	2	2	2	2	2	2
Mvmt Flow	201	141	103	186	221	0	0	0	0	307	1	82

Major/Minor	Major1			Major2			Minor2		
Conflicting Flow All	221	0	0	244	0	0	1188	1239	221
Stage 1	-	-	-	-	-	-	593	593	-
Stage 2	-	-	-	-	-	-	595	646	-
Critical Hdwy	4.12	-	-	4.12	-	-	6.42	6.52	6.22
Critical Hdwy Stg 1	-	-	-	-	-	-	5.42	5.52	-
Critical Hdwy Stg 2	-	-	-	-	-	-	5.42	5.52	-
Follow-up Hdwy	2.218	-	-	2.218	-	-	3.518	4.018	3.318
Pot Cap-1 Maneuver	1348	-	-	1322	-	0	~ 208	175	819
Stage 1	-	-	-	-	-	0	552	493	-
Stage 2	-	-	-	-	-	0	551	467	-
Platoon blocked, %	-	-	-	-	-	-	-	-	-
Mov Cap-1 Maneuver	1348	-	-	1322	-	-	~ 147	0	819
Mov Cap-2 Maneuver	-	-	-	-	-	-	~ 147	0	-
Stage 1	-	-	-	-	-	-	455	0	-
Stage 2	-	-	-	-	-	-	473	0	-

Approach	EB	WB	SB
HCM Control Delay, s	3.7	3.7	\$ 594
HCM LOS			F

Minor Lane/Major Mvmt	EBL	EBT	EBR	WBL	WBT	SBLn1
Capacity (veh/h)	1348	-	-	1322	-	178
HCM Lane V/C Ratio	0.149	-	-	0.141	-	2.186
HCM Control Delay (s)	8.1	0	-	8.2	-	\$ 594
HCM Lane LOS	A	A	-	A	-	F
HCM 95th %tile Q(veh)	0.5	-	-	0.5	-	31.1

Notes
 ~: Volume exceeds capacity \$: Delay exceeds 300s +: Computation Not Defined *: All major volume in platoon

Intersection												
Int Delay, s/veh	18.5											
Movement	EBL	EBT	EBR	WBL	WBT	WBR	NBL	NBT	NBR	SBL	SBT	SBR
Lane Configurations	↙	↑			↘			↕				
Traffic Vol, veh/h	56	398	0	0	256	134	117	3	279	0	0	0
Future Vol, veh/h	56	398	0	0	256	134	117	3	279	0	0	0
Conflicting Peds, #/hr	0	0	0	0	0	0	0	0	0	0	0	0
Sign Control	Free	Free	Free	Free	Free	Free	Stop	Stop	Stop	Stop	Stop	Stop
RT Channelized	-	-	None	-	-	None	-	-	None	-	-	None
Storage Length	0	-	-	-	-	-	-	-	-	-	-	-
Veh in Median Storage, #	-	0	-	-	0	-	-	0	-	-	0	-
Grade, %	-	0	-	-	0	-	-	0	-	-	0	-
Peak Hour Factor	92	92	92	92	92	92	92	92	92	92	92	92
Heavy Vehicles, %	2	2	2	2	2	2	2	2	2	2	2	2
Mvmt Flow	61	433	0	0	278	146	127	3	303	0	0	0

Major/Minor	Major1	Major2	Minor1
Conflicting Flow All	424	0	- - - 0 906 979 433
Stage 1	-	-	- - - 555 555 -
Stage 2	-	-	- - - 351 424 -
Critical Hdwy	4.12	-	- - - 6.42 6.52 6.22
Critical Hdwy Stg 1	-	-	- - - 5.42 5.52 -
Critical Hdwy Stg 2	-	-	- - - 5.42 5.52 -
Follow-up Hdwy	2.218	-	- - - 3.518 4.018 3.318
Pot Cap-1 Maneuver	1135	- 0 0	- - - 307 250 623
Stage 1	-	- 0 0	- - - 575 513 -
Stage 2	-	- 0 0	- - - 713 587 -
Platoon blocked, %	-	-	- -
Mov Cap-1 Maneuver	1135	- - -	- - - 290 0 623
Mov Cap-2 Maneuver	-	- - -	- - - 290 0 -
Stage 1	-	- - -	- - - 544 0 -
Stage 2	-	- - -	- - - 713 0 -

Approach	EB	WB	NB
HCM Control Delay, s	1	0	56.6
HCM LOS			F

Minor Lane/Major Mvmt	NBLn1	EBL	EBT	WBT	WBR
Capacity (veh/h)	465	1135	-	-	-
HCM Lane V/C Ratio	0.933	0.054	-	-	-
HCM Control Delay (s)	56.6	8.4	-	-	-
HCM Lane LOS	F	A	-	-	-
HCM 95th %tile Q(veh)	10.9	0.2	-	-	-

Intersection						
Int Delay, s/veh	3.3					
Movement	WBL	WBR	NBT	NBR	SBL	SBT
Lane Configurations	↘	↗	↑	↗	↘	↑
Traffic Vol, veh/h	124	5	71	141	5	59
Future Vol, veh/h	124	5	71	141	5	59
Conflicting Peds, #/hr	0	0	0	0	0	0
Sign Control	Stop	Stop	Free	Free	Free	Free
RT Channelized	-	None	-	None	-	None
Storage Length	250	0	-	0	280	-
Veh in Median Storage, #	0	-	0	-	-	0
Grade, %	0	-	0	-	-	0
Peak Hour Factor	87	87	87	87	83	83
Heavy Vehicles, %	2	2	2	2	2	2
Mvmt Flow	143	6	82	162	6	71

Major/Minor	Minor1	Major1	Major2		
Conflicting Flow All	165	82	0	0	244
Stage 1	82	-	-	-	-
Stage 2	83	-	-	-	-
Critical Hdwy	6.42	6.22	-	-	4.12
Critical Hdwy Stg 1	5.42	-	-	-	-
Critical Hdwy Stg 2	5.42	-	-	-	-
Follow-up Hdwy	3.518	3.318	-	-	2.218
Pot Cap-1 Maneuver	826	978	-	-	1322
Stage 1	941	-	-	-	-
Stage 2	940	-	-	-	-
Platoon blocked, %			-	-	-
Mov Cap-1 Maneuver	822	978	-	-	1322
Mov Cap-2 Maneuver	822	-	-	-	-
Stage 1	941	-	-	-	-
Stage 2	935	-	-	-	-

Approach	WB	NB	SB
HCM Control Delay, s	10.2	0	0.6
HCM LOS	B		

Minor Lane/Major Mvmt	NBT	NBR	WBLn1	WBLn2	SBL	SBT
Capacity (veh/h)	-	-	822	978	1322	-
HCM Lane V/C Ratio	-	-	0.173	0.006	0.005	-
HCM Control Delay (s)	-	-	10.3	8.7	7.7	-
HCM Lane LOS	-	-	B	A	A	-
HCM 95th %tile Q(veh)	-	-	0.6	0	0	-

Intersection						
Int Delay, s/veh	1.8					
Movement	EBT	EBR	WBL	WBT	NBL	NBR
Lane Configurations	↑	↗	↖	↑	↘	↙
Traffic Vol, veh/h	481	74	8	308	65	14
Future Vol, veh/h	481	74	8	308	65	14
Conflicting Peds, #/hr	0	0	0	0	0	0
Sign Control	Free	Free	Free	Free	Stop	Stop
RT Channelized	-	None	-	None	-	None
Storage Length	-	285	450	-	0	-
Veh in Median Storage, #	0	-	-	0	0	-
Grade, %	0	-	-	0	0	-
Peak Hour Factor	92	92	92	92	83	83
Heavy Vehicles, %	2	2	2	2	2	2
Mvmt Flow	523	80	9	335	78	17

Major/Minor	Major1	Major2	Minor1		
Conflicting Flow All	0	0	603	0	876 523
Stage 1	-	-	-	-	523 -
Stage 2	-	-	-	-	353 -
Critical Hdwy	-	-	4.12	-	6.42 6.22
Critical Hdwy Stg 1	-	-	-	-	5.42 -
Critical Hdwy Stg 2	-	-	-	-	5.42 -
Follow-up Hdwy	-	-	2.218	-	3.518 3.318
Pot Cap-1 Maneuver	-	-	975	-	319 554
Stage 1	-	-	-	-	595 -
Stage 2	-	-	-	-	711 -
Platoon blocked, %	-	-	-	-	-
Mov Cap-1 Maneuver	-	-	975	-	316 554
Mov Cap-2 Maneuver	-	-	-	-	316 -
Stage 1	-	-	-	-	595 -
Stage 2	-	-	-	-	705 -

Approach	EB	WB	NB
HCM Control Delay, s	0	0.2	19.5
HCM LOS			C

Minor Lane/Major Mvmt	NBLn1	EBT	EBR	WBL	WBT
Capacity (veh/h)	342	-	-	975	-
HCM Lane V/C Ratio	0.278	-	-	0.009	-
HCM Control Delay (s)	19.5	-	-	8.7	-
HCM Lane LOS	C	-	-	A	-
HCM 95th %tile Q(veh)	1.1	-	-	0	-

Intersection												
Int Delay, s/veh	5.8											
Movement	EBL	EBT	EBR	WBL	WBT	WBR	NBL	NBT	NBR	SBL	SBT	SBR
Lane Configurations	↙	↑	↗	↙	↑	↗		↙	↗		↕	
Traffic Vol, veh/h	10	500	166	37	280	1	125	0	31	3	0	3
Future Vol, veh/h	10	500	166	37	280	1	125	0	31	3	0	3
Conflicting Peds, #/hr	0	0	0	0	0	0	0	0	0	0	0	0
Sign Control	Free	Free	Free	Free	Free	Free	Stop	Stop	Stop	Stop	Stop	Stop
RT Channelized	-	-	None	-	-	None	-	-	None	-	-	None
Storage Length	232	-	182	172	-	-	-	-	155	-	-	-
Veh in Median Storage, #	-	0	-	-	0	-	-	0	-	-	0	-
Grade, %	-	0	-	-	0	-	-	0	-	-	0	-
Peak Hour Factor	93	93	93	92	92	92	87	87	87	78	78	78
Heavy Vehicles, %	2	2	2	2	2	2	2	2	2	2	2	2
Mvmt Flow	11	538	178	40	304	1	144	0	36	4	0	4

Major/Minor	Major1			Major2			Minor1			Minor2		
Conflicting Flow All	305	0	0	716	0	0	947	945	538	1052	1123	305
Stage 1	-	-	-	-	-	-	560	560	-	385	385	-
Stage 2	-	-	-	-	-	-	387	385	-	667	738	-
Critical Hdwy	4.12	-	-	4.12	-	-	7.12	6.52	6.22	7.12	6.52	6.22
Critical Hdwy Stg 1	-	-	-	-	-	-	6.12	5.52	-	6.12	5.52	-
Critical Hdwy Stg 2	-	-	-	-	-	-	6.12	5.52	-	6.12	5.52	-
Follow-up Hdwy	2.218	-	-	2.218	-	-	3.518	4.018	3.318	3.518	4.018	3.318
Pot Cap-1 Maneuver	1256	-	-	885	-	-	241	262	543	204	206	735
Stage 1	-	-	-	-	-	-	513	511	-	638	611	-
Stage 2	-	-	-	-	-	-	637	611	-	448	424	-
Platoon blocked, %	-	-	-	-	-	-	-	-	-	-	-	-
Mov Cap-1 Maneuver	1256	-	-	885	-	-	230	248	543	183	195	735
Mov Cap-2 Maneuver	-	-	-	-	-	-	230	248	-	183	195	-
Stage 1	-	-	-	-	-	-	508	506	-	632	584	-
Stage 2	-	-	-	-	-	-	605	584	-	415	420	-

Approach	EB			WB			NB			SB		
HCM Control Delay, s	0.1			1.1			37.3			17.6		
HCM LOS							E			C		

Minor Lane/Major Mvmt	NBLn1	NBLn2	EBL	EBT	EBR	WBL	WBT	WBR	SBLn1
Capacity (veh/h)	230	543	1256	-	-	885	-	-	293
HCM Lane V/C Ratio	0.625	0.066	0.009	-	-	0.045	-	-	0.026
HCM Control Delay (s)	43.6	12.1	7.9	-	-	9.3	-	-	17.6
HCM Lane LOS	E	B	A	-	-	A	-	-	C
HCM 95th %tile Q(veh)	3.7	0.2	0	-	-	0.1	-	-	0.1

Intersection												
Int Delay, s/veh	1.2											
Movement	EBL	EBT	EBR	WBL	WBT	WBR	NBL	NBT	NBR	SBL	SBT	SBR
Lane Configurations		↕			↕			↕			↕	
Traffic Vol, veh/h	14	0	4	2	0	8	4	130	2	14	161	20
Future Vol, veh/h	14	0	4	2	0	8	4	130	2	14	161	20
Conflicting Peds, #/hr	0	0	0	0	0	0	0	0	0	0	0	0
Sign Control	Stop	Stop	Stop	Stop	Stop	Stop	Free	Free	Free	Free	Free	Free
RT Channelized	-	-	None	-	-	None	-	-	None	-	-	None
Storage Length	-	-	-	-	-	-	-	-	-	-	-	-
Veh in Median Storage, #	-	0	-	-	0	-	-	0	-	-	0	-
Grade, %	-	0	-	-	0	-	-	0	-	-	0	-
Peak Hour Factor	78	78	78	78	78	78	83	83	83	87	87	87
Heavy Vehicles, %	2	2	2	2	2	2	2	2	2	2	2	2
Mvmt Flow	18	0	5	3	0	10	5	157	2	16	185	23

Major/Minor	Minor2		Minor1		Major1			Major2				
Conflicting Flow All	402	398	197	399	408	158	208	0	0	159	0	0
Stage 1	229	229	-	168	168	-	-	-	-	-	-	-
Stage 2	173	169	-	231	240	-	-	-	-	-	-	-
Critical Hdwy	7.12	6.52	6.22	7.12	6.52	6.22	4.12	-	-	4.12	-	-
Critical Hdwy Stg 1	6.12	5.52	-	6.12	5.52	-	-	-	-	-	-	-
Critical Hdwy Stg 2	6.12	5.52	-	6.12	5.52	-	-	-	-	-	-	-
Follow-up Hdwy	3.518	4.018	3.318	3.518	4.018	3.318	2.218	-	-	2.218	-	-
Pot Cap-1 Maneuver	559	540	844	561	533	887	1363	-	-	1420	-	-
Stage 1	774	715	-	834	759	-	-	-	-	-	-	-
Stage 2	829	759	-	772	707	-	-	-	-	-	-	-
Platoon blocked, %								-	-	-	-	-
Mov Cap-1 Maneuver	546	531	844	550	524	887	1363	-	-	1420	-	-
Mov Cap-2 Maneuver	546	531	-	550	524	-	-	-	-	-	-	-
Stage 1	771	706	-	831	756	-	-	-	-	-	-	-
Stage 2	816	756	-	757	698	-	-	-	-	-	-	-

Approach	EB		WB		NB			SB		
HCM Control Delay, s	11.3		9.6		0.2			0.5		
HCM LOS	B		A							

Minor Lane/Major Mvmt	NBL	NBT	NBR	EBLn1	WBLn1	SBL	SBT	SBR
Capacity (veh/h)	1363	-	-	592	790	1420	-	-
HCM Lane V/C Ratio	0.004	-	-	0.039	0.016	0.011	-	-
HCM Control Delay (s)	7.7	0	-	11.3	9.6	7.6	0	-
HCM Lane LOS	A	A	-	B	A	A	A	-
HCM 95th %tile Q(veh)	0	-	-	0.1	0	0	-	-

Intersection												
Int Delay, s/veh	1.9											
Movement	NBL	NBT	NBR	SBL	SBT	SBR	SEL	SET	SER	NWL	NWT	NWR
Lane Configurations		↕			↕	↕		↕			↕	
Traffic Vol, veh/h	0	91	1	5	104	58	43	1	0	1	1	2
Future Vol, veh/h	0	91	1	5	104	58	43	1	0	1	1	2
Conflicting Peds, #/hr	2	0	0	0	0	0	0	0	0	0	0	0
Sign Control	Free	Free	Free	Free	Free	Free	Stop	Stop	Stop	Stop	Stop	Stop
RT Channelized	-	-	None	-	-	None	-	-	None	-	-	None
Storage Length	-	-	-	-	-	186	-	-	-	-	-	-
Veh in Median Storage, #	-	0	-	-	0	-	-	0	-	-	0	-
Grade, %	-	0	-	-	0	-	-	0	-	-	0	-
Peak Hour Factor	83	83	83	87	87	87	78	78	78	78	78	78
Heavy Vehicles, %	2	2	2	2	2	2	2	2	2	2	2	2
Mvmt Flow	0	110	1	6	120	67	55	1	0	1	1	3

Major/Minor	Major1		Major2		Minor2			Minor1				
Conflicting Flow All	189	0	0	111	0	0	247	245	122	277	312	111
Stage 1	-	-	-	-	-	-	134	134	-	111	111	-
Stage 2	-	-	-	-	-	-	113	111	-	166	201	-
Critical Hdwy	4.12	-	-	4.12	-	-	7.12	6.52	6.22	7.12	6.52	6.22
Critical Hdwy Stg 1	-	-	-	-	-	-	6.12	5.52	-	6.12	5.52	-
Critical Hdwy Stg 2	-	-	-	-	-	-	6.12	5.52	-	6.12	5.52	-
Follow-up Hdwy	2.218	-	-	2.218	-	-	3.518	4.018	3.318	3.518	4.018	3.318
Pot Cap-1 Maneuver	1385	-	-	1479	-	-	707	657	929	675	603	942
Stage 1	-	-	-	-	-	-	869	785	-	894	804	-
Stage 2	-	-	-	-	-	-	892	804	-	836	735	-
Platoon blocked, %		-	-	-	-	-						
Mov Cap-1 Maneuver	1382	-	-	1479	-	-	700	652	927	672	599	942
Mov Cap-2 Maneuver	-	-	-	-	-	-	700	652	-	672	599	-
Stage 1	-	-	-	-	-	-	867	780	-	894	804	-
Stage 2	-	-	-	-	-	-	888	804	-	830	730	-

Approach	NB	SB	SE	NW
HCM Control Delay, s	0	0.2	10.6	9.8
HCM LOS			B	A

Minor Lane/Major Mvmt	NBL	NBT	NBRNWLn1	SELn1	SBL	SBT	SBR
Capacity (veh/h)	1382	-	-	757	699	1479	-
HCM Lane V/C Ratio	-	-	-	0.007	0.081	0.004	-
HCM Control Delay (s)	0	-	-	9.8	10.6	7.4	0
HCM Lane LOS	A	-	-	A	B	A	A
HCM 95th %tile Q(veh)	0	-	-	0	0.3	0	-

Intersection						
Int Delay, s/veh	2.4					
Movement	EBT	EBR	WBL	WBT	NBL	NBR
Lane Configurations						
Traffic Vol, veh/h	33	3	18	40	4	10
Future Vol, veh/h	33	3	18	40	4	10
Conflicting Peds, #/hr	0	0	0	0	0	0
Sign Control	Free	Free	Free	Free	Stop	Stop
RT Channelized	-	None	-	None	-	None
Storage Length	-	-	-	-	0	-
Veh in Median Storage, #	0	-	-	0	0	-
Grade, %	0	-	-	0	0	-
Peak Hour Factor	78	78	83	83	78	78
Heavy Vehicles, %	2	2	2	2	2	2
Mvmt Flow	42	4	22	48	5	13

Major/Minor	Major1	Major2	Minor1	Minor2	Minor3
Conflicting Flow All	0	0	46	0	136 44
Stage 1	-	-	-	-	44 -
Stage 2	-	-	-	-	92 -
Critical Hdwy	-	-	4.12	-	6.42 6.22
Critical Hdwy Stg 1	-	-	-	-	5.42 -
Critical Hdwy Stg 2	-	-	-	-	5.42 -
Follow-up Hdwy	-	-	2.218	-	3.518 3.318
Pot Cap-1 Maneuver	-	-	1562	-	857 1026
Stage 1	-	-	-	-	978 -
Stage 2	-	-	-	-	932 -
Platoon blocked, %	-	-	-	-	-
Mov Cap-1 Maneuver	-	-	1562	-	845 1026
Mov Cap-2 Maneuver	-	-	-	-	845 -
Stage 1	-	-	-	-	978 -
Stage 2	-	-	-	-	919 -

Approach	EB	WB	NB
HCM Control Delay, s	0	2.3	8.8
HCM LOS			A

Minor Lane/Major Mvmt	NBLn1	EBT	EBR	WBL	WBT
Capacity (veh/h)	967	-	-	1562	-
HCM Lane V/C Ratio	0.019	-	-	0.014	-
HCM Control Delay (s)	8.8	-	-	7.3	0
HCM Lane LOS	A	-	-	A	A
HCM 95th %tile Q(veh)	0.1	-	-	0	-

Intersection												
Int Delay, s/veh	3.1											
Movement	EBL	EBT	EBR	WBL	WBT	WBR	NBL	NBT	NBR	SBL	SBT	SBR
Lane Configurations		↔			↔			↔	↔	↔	↔	
Traffic Vol, veh/h	26	0	9	25	0	10	11	56	45	10	57	38
Future Vol, veh/h	26	0	9	25	0	10	11	56	45	10	57	38
Conflicting Peds, #/hr	0	0	0	0	0	0	0	0	0	0	0	0
Sign Control	Stop	Stop	Stop	Stop	Stop	Stop	Free	Free	Free	Free	Free	Free
RT Channelized	-	-	None	-	-	None	-	-	None	-	-	None
Storage Length	-	-	-	-	-	-	-	-	100	120	-	-
Veh in Median Storage, #	-	0	-	-	0	-	-	0	-	-	0	-
Grade, %	-	0	-	-	0	-	-	0	-	-	0	-
Peak Hour Factor	78	78	78	78	78	78	83	83	83	83	83	83
Heavy Vehicles, %	2	2	2	2	2	2	2	2	2	2	2	2
Mvmt Flow	33	0	12	32	0	13	13	67	54	12	69	46

Major/Minor	Minor2		Minor1		Major1		Major2					
Conflicting Flow All	243	263	92	215	232	67	115	0	0	121	0	0
Stage 1	116	116	-	93	93	-	-	-	-	-	-	-
Stage 2	127	147	-	122	139	-	-	-	-	-	-	-
Critical Hdwy	7.12	6.52	6.22	7.12	6.52	6.22	4.12	-	-	4.12	-	-
Critical Hdwy Stg 1	6.12	5.52	-	6.12	5.52	-	-	-	-	-	-	-
Critical Hdwy Stg 2	6.12	5.52	-	6.12	5.52	-	-	-	-	-	-	-
Follow-up Hdwy	3.518	4.018	3.318	3.518	4.018	3.318	2.218	-	-	2.218	-	-
Pot Cap-1 Maneuver	711	642	965	742	668	997	1474	-	-	1467	-	-
Stage 1	889	800	-	914	818	-	-	-	-	-	-	-
Stage 2	877	775	-	882	782	-	-	-	-	-	-	-
Platoon blocked, %								-	-	-	-	-
Mov Cap-1 Maneuver	693	630	965	723	656	997	1474	-	-	1467	-	-
Mov Cap-2 Maneuver	693	630	-	723	656	-	-	-	-	-	-	-
Stage 1	880	794	-	905	810	-	-	-	-	-	-	-
Stage 2	857	767	-	864	776	-	-	-	-	-	-	-

Approach	EB		WB		NB		SB	
HCM Control Delay, s	10.1		9.9		0.7		0.7	
HCM LOS	B		A					

Minor Lane/Major Mvmt	NBL	NBT	NBR	EBLn1	WBLn1	SBL	SBT	SBR
Capacity (veh/h)	1474	-	-	747	785	1467	-	-
HCM Lane V/C Ratio	0.009	-	-	0.06	0.057	0.008	-	-
HCM Control Delay (s)	7.5	0	-	10.1	9.9	7.5	0	-
HCM Lane LOS	A	A	-	B	A	A	A	-
HCM 95th %tile Q(veh)	0	-	-	0.2	0.2	0	-	-

Intersection						
Int Delay, s/veh	0.3					
Movement	EBL	EBR	NBL	NBT	SBT	SBR
Lane Configurations						
Traffic Vol, veh/h	7	2	2	149	193	10
Future Vol, veh/h	7	2	2	149	193	10
Conflicting Peds, #/hr	0	0	0	0	0	0
Sign Control	Stop	Stop	Free	Free	Free	Free
RT Channelized	-	None	-	None	-	None
Storage Length	0	-	-	-	-	-
Veh in Median Storage, #	0	-	-	0	0	-
Grade, %	0	-	-	0	0	-
Peak Hour Factor	78	78	87	87	87	87
Heavy Vehicles, %	2	2	2	2	2	2
Mvmt Flow	9	3	2	171	222	11

Major/Minor	Minor2	Major1		Major2	
Conflicting Flow All	403	228	233	0	0
Stage 1	228	-	-	-	-
Stage 2	175	-	-	-	-
Critical Hdwy	6.42	6.22	4.12	-	-
Critical Hdwy Stg 1	5.42	-	-	-	-
Critical Hdwy Stg 2	5.42	-	-	-	-
Follow-up Hdwy	3.518	3.318	2.218	-	-
Pot Cap-1 Maneuver	603	811	1335	-	-
Stage 1	810	-	-	-	-
Stage 2	855	-	-	-	-
Platoon blocked, %				-	-
Mov Cap-1 Maneuver	602	811	1335	-	-
Mov Cap-2 Maneuver	602	-	-	-	-
Stage 1	808	-	-	-	-
Stage 2	855	-	-	-	-

Approach	EB	NB	SB
HCM Control Delay, s	10.7	0.1	0
HCM LOS	B		

Minor Lane/Major Mvmt	NBL	NBT	EBLn1	SBT	SBR
Capacity (veh/h)	1335	-	639	-	-
HCM Lane V/C Ratio	0.002	-	0.018	-	-
HCM Control Delay (s)	7.7	0	10.7	-	-
HCM Lane LOS	A	A	B	-	-
HCM 95th %tile Q(veh)	0	-	0.1	-	-

ECM Appendix B Percent Impact Calculations



ECM Appendix B Percent Impact Calculations

Monument Hill Road south of Misty Acres Boulevard

PERCENT IMPACT SOUTH OF Misty/MHR intersection

	SB	NB
AM	9%	3%
Late PM	18%	16%

Percent Impact - N. Leg of Deer Creek - from AECOM Study

	SB	NB LEG	SB	NB LEG	
AM	29	9	9%	2%	AM Peak 7-8 am
School Peak	21	22	5%	8%	PM Peak 2:30-3:30
	327	497.333			
	417.667	268			

NB Approach

405
262

NB Approach

2%
8%

AM Peak 7-8 am
PM Peak 2:30-3:30

V2_Traffic Impact Study.pdf Markup Summary

9/16/2024 2:19:28 PM (1)

it taper = 195 feet total
needed by LSC
Unresolved: Please add a bullet point for explanation of why the turn lane is being recommended

Subject: Engineer
Page Label: 18
Author: Bret
Date: 9/16/2024 2:19:28 PM
Status:
Color: ■
Layer:
Space:

Unresolved: Please add a bullet point for explanation of why the turn lane is being recommended

9/16/2024 2:48:20 PM (1)

Unresolved: Address impacts to Monument Hill Rd / Deer Creek Monument Hill Rd / Woodmoor Drive Woodmoor Dr / Hwy 105 (or how project impacts (~600 trips?) are insignificant at these locations)

Subject: Text Box
Page Label: 20
Author: Bret
Date: 9/16/2024 2:48:20 PM
Status:
Color: ■
Layer:
Space:

Unresolved: Address impacts to:
Monument Hill Rd / Deer Creek
Monument Hill Rd / Woodmoor Drive
Woodmoor Dr / Hwy 105
(or how project impacts (~600 trips?) are insignificant at these locations)

9/19/2024 9:51:34 AM (1)

7/19, 2024 from 6:00 - 6:00 p.m.
annual 2746
8, 2024 from 6:30 - 8:30 p.m.
8, 2024 from 6:00 - 8:00 p.m.
102 Autos Way from the WSR TIS report
#127, 2022 from 6:00 - 8:00 p.m.
#127, 2024 from 6:00 - 8:00 p.m.
Unresolved: Counts are too old per B.3.1.A, please include updated values

Subject: Engineer
Page Label: 10
Author: Bret
Date: 9/19/2024 9:51:34 AM
Status:
Color: ■
Layer:
Space:

Unresolved: Counts are too old per B.3.1.A, please include updated values

9/19/2024 9:54:37 AM (1)

Unresolved: Please include discussion of southbound here as well

Subject: Engineer
Page Label: 19
Author: Bret
Date: 9/19/2024 9:54:37 AM
Status:
Color: ■
Layer:
Space:

Unresolved: Please include discussion of southbound here as well

9/19/2024 9:56:12 AM (1)

warning signage be installed on Monument Hill Road to be proposed curve to the east adjacent to the site. included to review as part of the construction plans.
Unresolved: please show location on a plan

Subject: Callout
Page Label: 22
Author: Bret
Date: 9/19/2024 9:56:12 AM
Status:
Color: ■
Layer:
Space:

please show location on a plan

9/19/2024 9:58:13 AM (1)

ss points.

ard/Plowman Drive

I total volumes, auxiliary
Misty Acres Boulevard ff

Subject: Engineer
Page Label: 19
Author: Bret
Date: 9/19/2024 9:58:13 AM
Status:
Color: ■
Layer:
Space:

Plowman Drive

9/19/2024 9:59:28 AM (1)

turn volume does not exceed the ECM thresho
Misty Acres Boulevard, the proposed major collect
includes a striped median for left-turning r
to Drive
Update to Maga Drive per
Prelim plan drawings
Throughout the document

els, auxiliary turn lanes would not be required on a
Boulevard/Plowman Drive.

turn volume does not exceed the ECM thresho

Subject: Engineer
Page Label: 19
Author: Bret
Date: 9/19/2024 9:59:28 AM
Status:
Color: ■
Layer:
Space:

Update to Maga Drive per Prelim plan drawings
throughout the document

9/19/2024 10:00:54 AM (1)

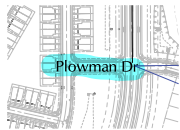

Subject: Engineer
Page Label: 31
Author: Bret
Date: 9/19/2024 10:00:54 AM
Status:
Color: ■
Layer:
Space:

9/19/2024 10:18:05 AM (1)

at a higher speed, thus reducing the
ph traffic and right turning traffic.
1. The drainage plan shows a separate
T) lane will be a "defacto left" with a
median separating a left-turn
by
Please include the section
of the Access Code here:
required based on
Could the right turn lane
include the through volume
space. The space w
request" - 1-14

* 120-foot taper = 235 feet total
* recommended by IJC

Subject: Engineer
Page Label: 18
Author: Bret
Date: 9/19/2024 10:18:05 AM
Status:
Color: ■
Layer:
Space:

Please include the section of the Access Code
here;
Could the right turn lane include the through
volume instead?

9/19/2024 1:45:19 PM (1)

and leg at the existing Misty Acres Boulevard/US Antlers Way T-
ICE
include sight distance exhibits
for remaining intersections
light distance of all proposed public road/air access intersection
and Monument Hill Road must meet intersection sight-distan
22. Sight distance line of sight for all public road intersection
keep clear of any sight distance obstructions, including lan
rough parking areas, etc.
if sight distance has been analyzed, as grading for the proposed roa
so, vertical sight distance cannot be measured yet and need to
be drawing and construction drawings. Please refer to exhibit 1 to

* Distances

Subject: Engineer
Page Label: 8
Author: Bret
Date: 9/19/2024 1:45:19 PM
Status:
Color: ■
Layer:
Space:

Include sight distance exhibits for remaining
intersections

9/19/2024 1:49:03 PM (1)

ontrol at the study-area intersections are shown in Fig
* "Short-Term Baseline Traffic Volumes" section and a
traffic volume assume that existing traffic pattern
of Monument Hill Boulevard and extension of Mist
Please include a statement to verify
that development west of I-25 was
* Volumes added to the short term traffic

d long term background volumes. Projected 20-year t
projected traffic to be generated by the propos
are estimates by IJC, which generally assume a 1e
Line Road. However, some additional specific grow

Subject: Engineer
Page Label: 12
Author: Bret
Date: 9/19/2024 1:49:03 PM
Status:
Color: ■
Layer:
Space:

Please include a statement to verify that
development west of I-25 was added to the short
term traffic

9/19/2024 1:57:40 PM (1)

estimated long-term background volume. Proposed 20-year background volume is projected to be generated by the proposed site. LU 20-year volume is estimated to be 100,000 vehicles per year. The proposed site is located on County Line Road. However, other additional traffic is expected to be generated by the proposed site. The proposed site is located on County Line Road. However, other additional traffic is expected to be generated by the proposed site. The proposed site is located on County Line Road. However, other additional traffic is expected to be generated by the proposed site.

Subject: Engineer
Page Label: 12
Author: Bret
Date: 9/19/2024 1:57:40 PM
Status:
Color: ■
Layer:
Space:

Please give your basis for this 2 percent growth rate

9/19/2024 2:34:54 PM (1)

stboard left turn lane, the laneage plan shows a sh through and right turn volumes, the CDOT Access i e dropped when opposing through traffic is low, w

Subject: Engineer
Page Label: 20
Author: Bret
Date: 9/19/2024 2:34:54 PM
Status:
Color: ■
Layer:
Space:

Please include the section of the Access Code here

9/19/2024 2:35:56 PM (1)

ases on projected volumes the volumes for No. 2 (Four-Hour Volume) threshold. The v r hours of the day, such as the afternoon's noon/evening peak hour.

Subject: Engineer
Page Label: 21
Author: Bret
Date: 9/19/2024 2:35:56 PM
Status:
Color: ■
Layer:
Space:

Please indicate whether crash warrants would be met