

# MONUMENT RIDGE EAST

LOCATED IN THE NORTH ONE-HALF OF SECTION 2, T 11 S, R 67 W OF THE 6th P.M.  
EL PASO COUNTY, COLORADO

LINE	BEARING	LENGTH
L120	N00°13'38"W	76.50
L121	S89°46'22"E	286.00
L122	S00°13'38"E	89.72
L123	N89°46'22"E	210.01
L124	N29°57'52"E	353.71
L125	N60°02'08"W	76.50
L126	S29°57'52"W	401.00
L127	S60°02'08"E	64.00
L128	S07°26'31"W	306.65
L129	S82°33'30"E	80.33
L130	N07°26'31"E	348.00
L131	N82°33'30"W	76.50
L132	N07°26'31"E	76.50
L133	N82°33'30"W	279.00
L134	S07°26'31"W	74.19
L135	S82°33'30"E	262.52
L136	N82°33'30"W	290.40
L137	S58°25'02"W	11.60
L138	S07°26'31"W	69.22
L139	S82°33'30"E	222.80
L140	S07°26'31"W	121.50
L141	S82°33'30"E	76.08
L142	N07°26'13"E	185.83
L143	N60°02'09"W	76.29
L144	S29°57'52"W	398.00
L145	S60°02'108"E	73.28
L146	N29°57'52"E	355.93
L147	S89°46'22"W	76.50
L148	S00°13'38"E	359.00
L149	N89°46'22"E	76.50
L150	N00°13'38"E	359.00
L151	N00°13'38"W	229.00
L152	S89°46'122"W	76.50
L153	S00°13'38"E	229.00
L154	N89°46'22"E	76.50
L155	N12°36'26"E	73.50
L156	N77°23'34"W	172.00
L157	S12°36'26"W	73.50
L158	S77°23'34"E	172.00
L159	S77°23'34"E	165.00
L160	N12°36'26"E	73.50
L161	N77°23'34"W	165.00
L162	S12°36'26"W	73.50
L163	S07°26'31"W	860.00
L164	S82°33'30"E	76.50
L165	N07°26'31"E	860.00

NOTE: L109-L119 NOT USED

LINE	BEARING	LENGTH
L166	N82°33'30"W	76.50
L167	S07°26'31"W	309.92
L168	S82°33'30"E	76.50
L169	N07°26'31"E	309.92
L170	N82°33'30"W	76.50
L171	S07°26'31"W	111.00
L172	S82°33'30"E	76.50
L173	N07°26'31"E	111.00
L174	N82°33'30"W	76.50
L175	S82°33'30"E	695.00
L176	N07°26'31"E	695.00
L177	N82°33'30"W	76.50
L178	S07°26'31"E	695.00
L179	N07°26'31"E	462.00
L180	N82°33'30"W	76.50
L181	S07°26'31"E	462.00
L182	S82°33'30"E	76.50
L183	N07°26'31"E	97.50
L184	N82°33'30"W	140.00
L185	S07°26'31"E	97.50
L186	S82°33'30"E	140.00
L187	N07°26'30"E	160.00
L188	N82°33'30"W	97.50
L189	S07°26'31"E	160.00
L190	S82°33'30"E	97.50
L191	S07°26'31"E	169.67
L192	S82°33'30"E	97.50
L193	N07°26'31"E	187.10
L194	N00°51'05"E	83.90
L195	N89°08'55"W	97.46
L196	S00°45'58"W	63.82
L197	S89°08'55"E	400.00
L198	N00°51'05"E	97.50
L199	N89°08'55"W	400.00
L200	S00°51'05"W	97.50
L201	S89°14'03"E	97.50
L202	N00°45'58"E	330.00
L203	N89°14'03"W	97.50
L204	S00°45'58"W	330.00
L205	N89°14'03"W	97.50
L206	S00°45'57"W	565.11
L207	S89°14'03"E	97.50
L208	N00°45'58"E	565.11
L209	S00°51'05"W	97.50
L210	S89°08'55"E	250.00
L211	N00°51'05"E	97.50
L212	N89°08'55"W	250.00

CURVE	LENGTH	RADIUS
C40	77.51	225.00
C41	46.86	225.00
C42	41.59	225.00
C43	16.70	60.00
C44	12.18	175.00
C45	33.65	175.00
C46	8.64	175.00
C47	26.22	225.00

NOTE: C29-C39 NOT USED

LOT	SQ FT	ACRES
1	6150.00	0.14
2	6150.00	0.14
3	6150.00	0.14
4	6150.00	0.14
5	6150.00	0.14
6	6150.00	0.14
7	7743.30	0.18
8	7743.30	0.18
9	6150.00	0.14
10	6150.00	0.14
11	6150.00	0.14
12	6150.00	0.14
13	6150.00	0.14
14	6150.00	0.14
15	6150.00	0.14
16	6150.00	0.14
17	6150.00	0.14
18	6150.00	0.14
19	6150.00	0.14
20	9643.75	0.22
21	5182.18	0.12
22	6933.15	0.16
23	5665.55	0.13
24	15019.14	0.35
25	15000.00	0.34
26	15000.00	0.34
27	15000.00	0.34
28	15000.00	0.34
29	15000.00	0.34
30	15000.00	0.34
31	15000.00	0.34
32	15000.00	0.34
33	15000.00	0.34
34	15000.00	0.34
35	15047.00	0.35

LOT	SQ FT	ACRES
36	29258.83	0.67
37	23686.04	0.54
38	22207.79	0.51
39	30748.61	0.71
40	26674.66	0.61
41	21330.92	0.49
42	32163.26	0.71
43	30410.57	0.74
44	27463.50	0.63
45	17514.39	0.40
46	12642.00	0.29
47	11217.50	0.28
48	65790.00	1.51
49	47417.74	1.09
50	8491.50	0.20
51	53167.50	1.22
52	70686.00	1.62
53	13650.03	0.31
54	15600.04	0.36
55	25865.81	0.59
56	39000.00	0.90
57	32175.00	0.74
58	55099.30	1.27
59	24374.91	0.56

TRACT	SQ FT	ACRES
A	318454.27	7.31
B	62913.61	1.44
C	239816.12	5.51
D	28181.77	0.65
E	67113.55	1.54
F	99703.55	2.29
G	230772.26	5.30
H	3901.50	0.09
I	3901.50	0.09
J	32000.09	0.74

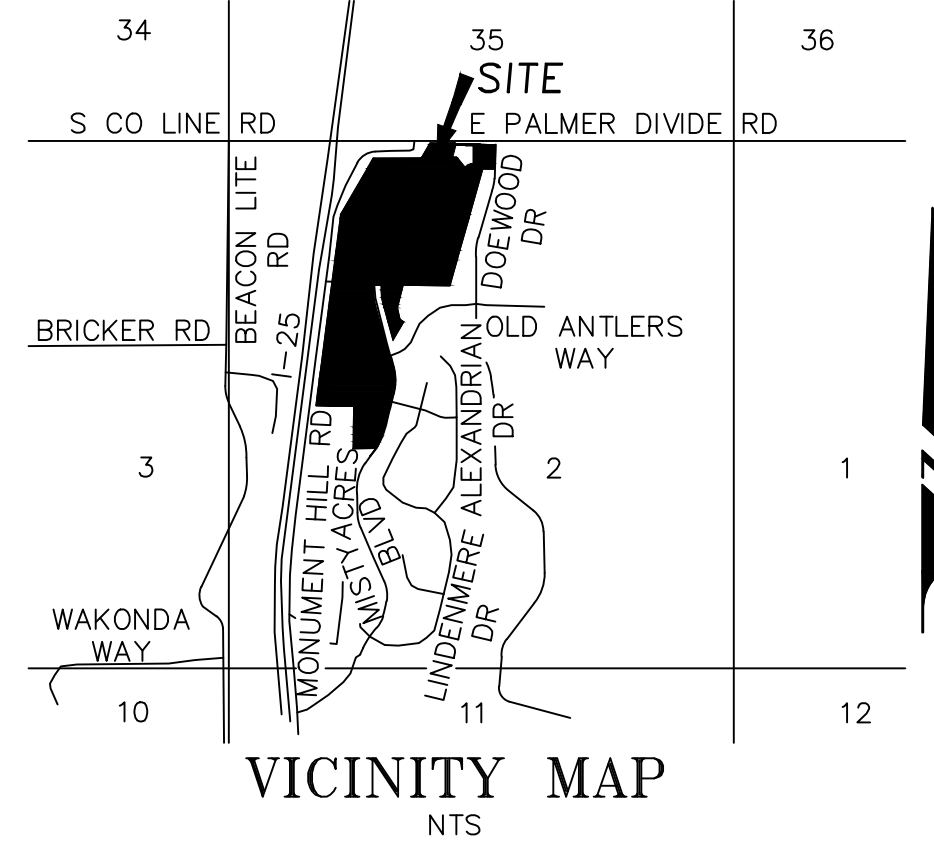

VICINITY MAP  
NTS

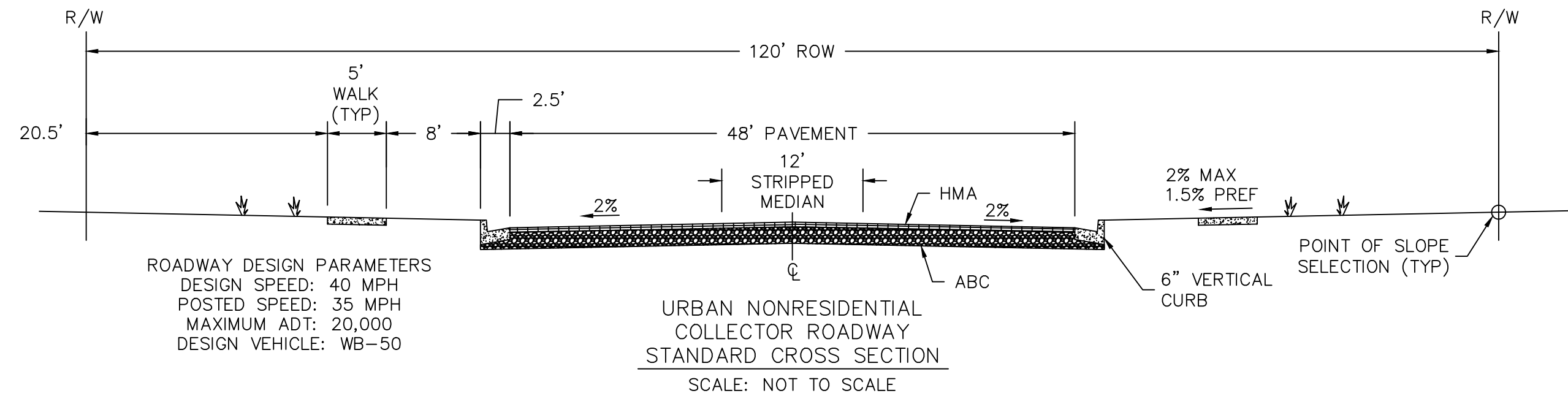
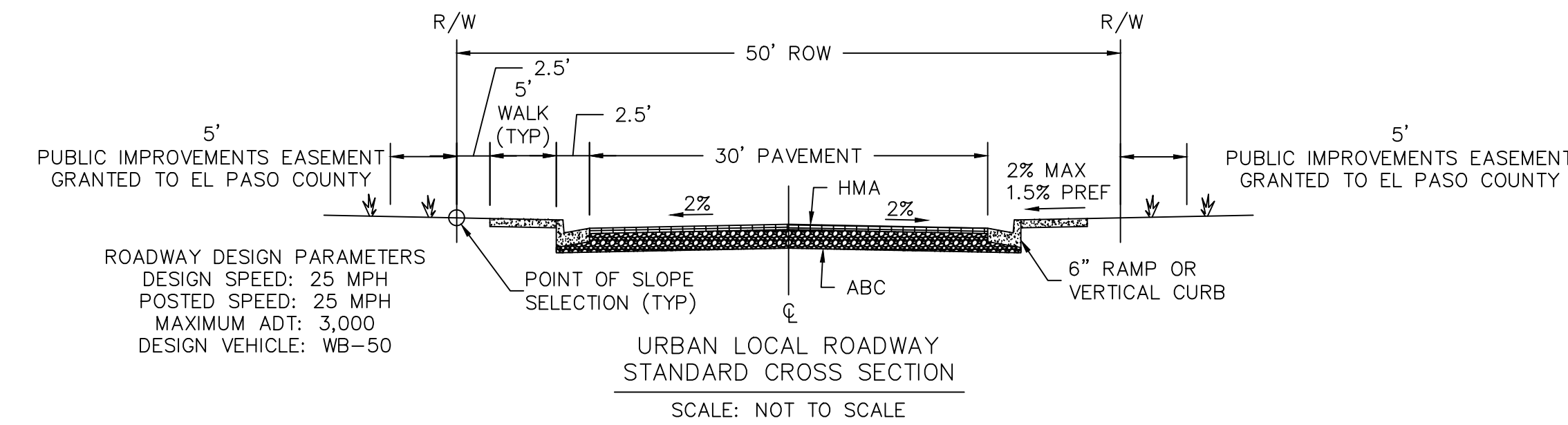
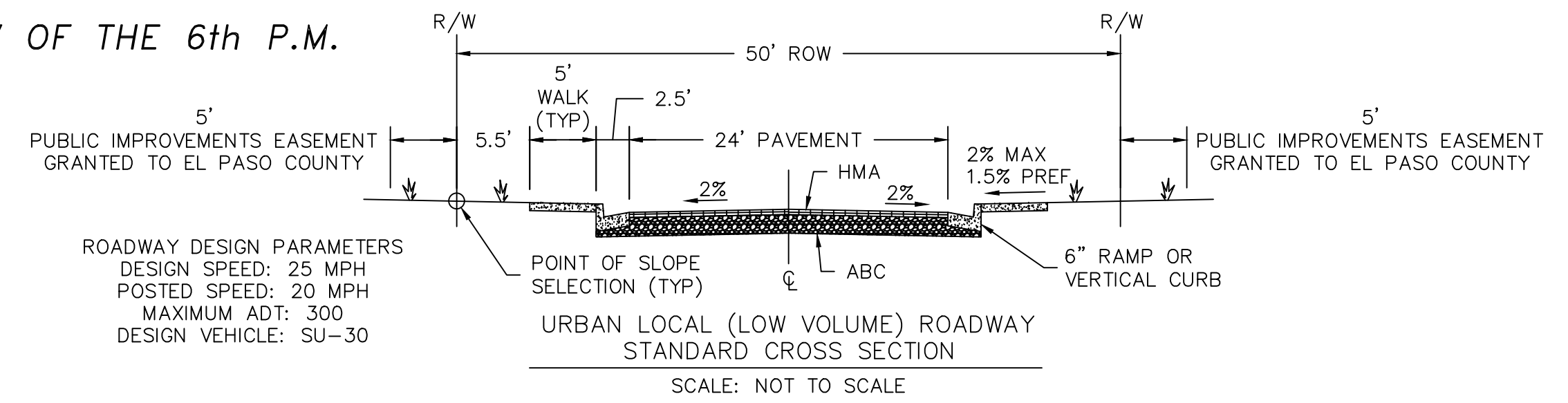

LEGAL DESCRIPTION

A TRACT OF LAND IN THE NORTH ONE-HALF OF SECTION 2, TOWNSHIP 11 SOUTH, RANGE 67 WEST OF THE 6TH P.M., EL PASO COUNTY, COLORADO, MORE PARTICULARLY DESCRIBED AS FOLLOWS: COMMENCING AT THE POINT OF INTERSECTION OF THE SOUTHERLY RIGHT OF WAY LINE OF 60 FOOT WIDE COUNTY LINE ROAD AND THE WESTERLY RIGHT OF WAY LINE OF 60 FOOT WIDE DOEWOOD DRIVE AS DEDICATED IN "HEIGHTS FILING TWO" AS RECORDED IN PLAT BOOK E-5 AT PAGE 228 UNDER RECEPTION NO. 2287623 OF THE RECORDS OF EL PASO COUNTY, COLORADO, SAID POINT BEING ALSO THE NORTHEAST CORNER OF THAT RIGHT OF WAY PARCEL FOR COUNTY LINE ROAD GRANTED IN SPECIAL WARRANTY DEED RECORDED UNDER RECEPTION NO. 214002145, OF THE RECORDS OF EL PASO COUNTY, COLORADO; THENCE S 00° 02' 24" W, ALONG THE EASTERLY LINE THEREOF, 20.00 FEET TO THE POINT OF BEGINNING; THENCE CONTINUE S 00° 02' 24" W, ALONG THE WESTERLY RIGHT OF WAY LINE OF SAID DOEWOOD DRIVE, 250.05 FEET TO THE NORTHEAST CORNER OF LOT 10 IN SAID "HEIGHTS FILING TWO"; THENCE S 89° 06' 54" W, ALONG SAID NORTHERLY LINE, 129.47 FEET TO THE NORTHWEST CORNER THEREOF; THENCE S 15° 04' 41" W, ALONG THE WESTERLY LINE OF SAID "HEIGHTS FILING TWO", 981.29 FEET TO THE NORTHEAST CORNER OF "HEIGHTS FILING ONE" AS RECORDED IN PLAT BOOK E-5 AT PAGE 167 UNDER RECEPTION NO. 2225904 OF THE RECORDS OF EL PASO COUNTY, COLORADO; THENCE S 88° 45' 14" W, ALONG THE NORTHERLY LINE THEREOF, 306.89 FEET TO A POINT ON THE EASTERLY LINE OF THAT TRACT OF LAND DESCRIBED IN BOOK 3951 AT PAGE 1433 OF THE RECORDS OF EL PASO COUNTY, COLORADO AND AN EASTERLY LINE OF THAT TRACT OF LAND DESCRIBED IN PUBLIC TRUSTEES DEED RECORDED IN BOOK 5852 AT PAGE 323 OF THE RECORDS OF EL PASO COUNTY, COLORADO; THENCE N 14° 12' 38" E, ALONG SAID EASTERLY LINES, 102.54 FEET TO THE NORTHEAST CORNER OF THAT TRACT OF LAND DESCRIBED IN BOOK 3951 AT PAGE 1433 OF THE RECORDS OF EL PASO COUNTY, COLORADO; THENCE N 89° 57' 36" W, ALONG THE NORTHERLY LINE THEREOF, 732.00 FEET TO A POINT ON THE EASTERLY LINE OF A TRACT OF LAND DESCRIBED IN BOOK 6488 AT PAGE 243 OF THE RECORDS OF EL PASO COUNTY, COLORADO; THE FOLLOWING TWO COURSES ARE ALONG THE BOUNDARY OF SAID TRACT; THENCE (1) N 06° 43' 00" E, 337.98 FEET; THENCE (2) N 89° 57' 36" W, 251.71 FEET TO A POINT ON THE EASTERLY LINE OF THAT TRACT OF LAND DESCRIBED IN DEED TO THE DEPARTMENT OF HIGHWAYS, STATE OF COLORADO RECORDED IN BOOK 1984 AT PAGE 836 OF THE RECORDS OF EL PASO COUNTY, COLORADO; THE FOLLOWING FOUR COURSES ARE ALONG SAID EASTERLY LINE; THENCE (1) N 06° 43' 00" E, 36.92 FEET; THENCE (2) N 29° 16' 30" E, 675.30 FEET; THENCE (3) N 89° 05' 00" E, 500.00 FEET; THENCE (4) N 29° 33' 00" E (BASIS OF BEARING), 180.19 FEET TO INTERSECT THE SOUTHERLY LINE OF AFORESAID 60 FOOT WIDE COUNTY LINE ROAD; THENCE N 89° 06' 54" E, ALONG SAID SOUTHERLY LINE 258.85 FEET TO THE NORTHWEST CORNER OF THE AFORESAID RIGHT OF WAY PARCEL GRANTED TO EL PASO COUNTY FOR COUNTY LINE ROAD UNDER RECEPTION NO. 214002145 OF THE RECORDS OF EL PASO COUNTY, COLORADO; THE FOLLOWING FOUR COURSES ARE ALONG THE SOUTHERLY LINE THEREOF; THENCE (1) S 00° 53' 11" E, 11.00 FEET; THENCE (2) S 89° 57' 43" E, 186.01 FEET; THENCE (3) N 89° 46' 13" E, 87.26 FEET; THENCE (4) S 89° 02' 16" E, 154.69 FEET TO THE POINT OF BEGINNING. EXCEPTING THEREFROM THAT PARCEL CONVEYED TO WOODMOOR WATER AND SANITATION DISTRICT FOR THE CRYSTAL CREEK LIFT STATION BY DEED RECORDED NOVEMBER 30, 1998 AT RECEPTION NO. 98175218 OF THE RECORDS OF EL PASO COUNTY, COLORADO; EXCEPTING DEED RECORDED NOVEMBER 29, 2010 AT RECEPTION NO. 210120918 AND JANUARY 9, 2014 AT RECEPTION NO. 214002145 AND FURTHER EXCEPTING ANY PORTION WITHIN THE RIGHT OF WAY OF COUNTY LINE ROAD OR INTERSTATE HIGHWAY 25, AND FURTHER EXCEPTING THAT PORTION DEDICATED AS DOEWOOD DRIVE IN "HEIGHTS FILING TWO" AS RECORDED IN PLAT BOOK E-5 AT PAGE 228 UNDER RECEPTION NO. 2287623 OF THE RECORDS OF EL PASO COUNTY, COLORADO CONTAINING 29.19 ACRES MORE OR LESS.

LEGAL DESCRIPTION CONTINUED

PARCEL E-1:  
LOT 1, HEIGHTS FILING ONE, COUNTY OF EL PASO, STATE OF COLORADO CONTAINING 3.62 ACRES MORE OR LESS.

PARCEL E-2:  
AN EASEMENT FOR INGRESS, EGRESS AND UTILITIES AS DESCRIBED IN DEED RECORDED DECEMBER 5, 1989 IN BOOK 5691 AT PAGE 1415 AND RE-RECORDED NOVEMBER 8, 1991 IN BOOK 5901 AT PAGE 177 AND RE-RECORDED JANUARY 14, 1992 IN BOOK 5924 AT PAGE 316 CONTAINING 0.00 ACRES (EASEMENT BENEFITING PARCEL E-1 ONLY).

PARCEL E-3:  
A TRACT OF LAND LOCATED IN THE NORTH ONE HALF OF SECTION 2, TOWNSHIP 11 SOUTH, RANGE 67 WEST OF THE 6TH P.M. IN EL PASO COUNTY, COLORADO, MORE PARTICULARLY DESCRIBED AS FOLLOWS: COMMENCING AT THE NORTHEAST CORNER OF SAID SECTION; TH S 89 DEGREES 06 MINUTES 54 SECONDS WA DISTANCE OF 1320.00 FEET; THENCE S 00 DEGREES 53 MINUTES 12 SECONDS WA DISTANCE OF 300.01 FEET; THENCE S 89 DEGREES 06 MINUTES 34 SECONDS WA DISTANCE OF 1599.97 FEET; THENCE S 14 DEGREES 12 MINUTES 38 SECONDS WA DISTANCE OF 887.45 FEET; FOR THE TRUE POINT OF BEGINNING OF THE PARCEL TO BE DESCRIBED HEREBY; THENCE CONTINUE S 14 DEGREES 12 MINUTES 38 SECONDS W, A DISTANCE OF 102.63 FEET; THENCE S 86 DEGREES 45 MINUTES 14 SECONDS WA DISTANCE OF 350.00 FEET; THENCE S 00 DEGREES 24 MINUTES 09 SECONDS WA DISTANCE OF 236.98 FEET; THENCE N 89 DEGREES 57 MINUTES 36 SECONDS WA DISTANCE OF 649.40 FEET TO A POINT ON THE EASTERLY RIGHT OF WAY LINE OF INTERSTATE HIGHWAY 25; THENCE N 06 DEGREES 43 MINUTES 00 SECONDS E, ALONG SAID RIGHT OF WAY LINE, 696.96 FEET; THENCE S 89 DEGREES 57 MINUTES 36 SECONDS EA DISTANCE OF 251.71 FEET; THENCE S 06 DEGREES 43 MINUTES 00 SECONDS WA DISTANCE OF 337.98 FEET; THENCE S 89 DEGREES 57 MINUTES 36 SECONDS EA DISTANCE OF 732.00 FEET TO THE POINT OF BEGINNING CONTAINING 8.00 ACRES MORE OR LESS.

LEGAL DESCRIPTION CONTINUED

PARCEL E-4:  
A TRACT OF LAND BEING A PORTION OF SECTION 2, TOWNSHIP 11 SOUTH, RANGE 67 WEST OF THE 6TH PRINCIPAL MERIDIAN, ALSO BEING A PORTION OF PARCEL A AND PARCEL BAS DESCRIBED BY DOCUMENT (RECEPTION NO. 99035205, EL PASO COUNTY, COLORADO RECORDS), SITUATE IN COUNTY OF EL PASO, STATE OF COLORADO, DESCRIBED AS FOLLOWS: BEGINNING AT THE SOUTHWEST CORNER OF PARCEL A (ALL BEARINGS IN THIS DESCRIPTION ARE RELATIVE TO A PORTION OF THE WESTERLY LINE OF SAID PARCEL A, MONUMENTED AS SHOWN AND ASSUMED TO BEAR NORTH 01 DEGREES 04 MINUTES 39 SECONDS EAST, A DISTANCE OF 1833.20 FEET) (THE FOLLOWING SIX (6) COURSES ARE ALONG THE LINES OF SAID PARCEL A AND PARCEL B); 1) NORTH 01 DEGREES 04 MINUTES 39 SECONDS EAST, 1833.20 FEET; 2) NORTH 00 DEGREES 50 MINUTES 54 SECONDS EAST, 370.05 FEET; 3) NORTH 00 DEGREES 47 MINUTES 39 SECONDS EAST, 443.01 FEET; 4) NORTH 89 DEGREES 06 MINUTES 35 SECONDS WEST, 395.12 FEET; 5) NORTH 07 DEGREES 27 MINUTES 26 SECONDS EAST, 1273.57 FEET TO THE NORTHWEST CORNER OF SAID PARCEL B; 6) SOUTH 89 DEGREES 15 MINUTES 42 SECONDS EAST, 437.24 FEET TO THE NORTHWEST CORNER OF MISTY ACRES SUBDIVISION FILING NO. 1 (RECEPTION NO. 205190028, SAID EL PASO COUNTY RECORDS) (THE FOLLOWING FOURTEEN (14) COURSES ARE ALONG THE WESTERLY LINES OF SAID FILING); 1) SOUTH 00 DEGREES 48 MINUTES 57 SECONDS WEST, 54.29 FEET; 2) ON A CURVE TO THE LEFT, SAID CURVE HAVING A CENTRAL ANGLE OF 16 DEGREES 23 MINUTES 27 SECONDS, A RADIUS OF 601.00 FEET, AN ARC LENGTH OF 171.93 FEET; 3) SOUTH 15 DEGREES 34 MINUTES 30 SECONDS EAST, 647.10 FEET; 4) ON A CURVE TO THE RIGHT, SAID CURVE HAVING A CENTRAL ANGLE OF 29 DEGREES 05 MINUTES 22 SECONDS, A RADIUS OF 521.00 FEET, AN ARC LENGTH OF 264.52 FEET; 5) SOUTH 13 DEGREES 30 MINUTES 52 SECONDS WEST, 382.56 FEET; 6) AN CURVE TO THE RIGHT, SAID CURVE HAVING A CENTRAL ANGLE OF 29 DEGREES 13 MINUTES 34 SECONDS, A RADIUS OF 650.71 FEET, AN ARC LENGTH OF 331.92 FEET TO A POINT OF REVERSE CURVE; 7) AN SAID REVERSE CURVE TO THE LEFT HAVING A CENTRAL ANGLE OF 41 DEGREES 42 MINUTES 48 SECONDS, A RADIUS OF 548.00 FEET, AN ARC LENGTH OF 398.96 FEET; 8) SOUTH 01 DEGREES 01 MINUTES 38 SECONDS WEST, 172.86 FEET; 9) ON A CURVE TO THE LEFT, SAID CURVE HAVING A CENTRAL ANGLE OF 25 DEGREES 14 MINUTES 35 SECONDS, A RADIUS OF 740.00 FEET, AN ARC LENGTH OF 326.03 FEET; 10) SOUTH 24 DEGREES 12 MINUTES 57 SECONDS EAST, 474.89 FEET; 11) ON A CURVE TO THE RIGHT, SAID CURVE HAVING A CENTRAL ANGLE OF 63 DEGREES 38 MINUTES 53 SECONDS, A RADIUS OF 521.00 FEET, AN ARC LENGTH OF 578.76 FEET; 12) SOUTH 39 DEGREES 25 MINUTES 56 SECONDS WEST, 87.74 FEET; 13) ON A CURVE TO THE LEFT, SAID CURVE HAVING A CENTRAL ANGLE OF 17 DEGREES 26 MINUTES 58 SECONDS, A RADIUS OF 601.00 FEET, AN ARC LENGTH OF 183.08 FEET; 14) SOUTH 21 DEGREES 58 MINUTES 58 SECONDS WEST, 91.58 FEET TO A POINT ON THE SOUTHERLY LINE OF SAID PARCEL A; THENCE NORTH 89 DEGREES 35 MINUTES 50 SECONDS WEST ALONG SAID PARCEL A'S SOUTHERLY LINE, 64.39 FEET TO THE POINT OF BEGINNING CONTAINING 21.74 ACRES MORE OR LESS.

NOTES:

- BEARINGS ARE BASED ON THE WEST LINE OF SECTION 2, TOWNSHIP 11 SOUTH, RANGE 67 WEST, OF THE 6TH PRINCIPLE MERIDIAN EL PASO COUNTY COLORADO WITH AN ASSUMED BEARING OF NORTH 00°15'53" EAST.
- LINEAR UNITS USED IN THIS DRAWING ARE US SURVEY FEET.
- THERE WILL BE NO VEHICLE ACCESS TO ANY LOT TO COUNTY LINE ROAD, MONUMENT HILL ROAD, INTERSTATE 25, OR MISTY ACRES BOULEVARD.
- TRACT A IS FOR THE USE AS OPEN SPACE, UTILITIES AND DRAINAGE.
- TRACT B IS FOR THE USE OF OPEN SPACE AND UTILITIES
- EXISTING STRUCTURED ARE TO BE REMOVED.
- THIS SITE IS SUBJECT TO WETLANDS AS SHOWN.

EASEMENTS:

- ALL RIGHTS OF WAYS SHALL HAVE A 5' UTILITY EASEMENT ALONG AND ADJACENT TO RIGHT OF WAY.
- INDICATES EXISTING EASMENT TO REMAIN.
- INDICATES PROPOSED EASEMENT AS SHOWN.
- INDICATES EXISTING EASEMENT TO BE VACATED.

CERTIFICATION:

THE UNDERSIGNED PROFESSIONAL LAND SURVEYOR LICENSED IN THE STATE OF COLORADO, HEREBY STATES AND DECLARES THAT THE ACCOMPANYING PLAT WAS SURVEYED AND DRAWN UNDER HIS RESPONSIBLE CHARGE AND ACCURATELY SHOWS THE DESCRIBED TRACT OF LAND AND SUBDIVISION THEREOF, AND THAT THE REQUIREMENTS OF TITLE 38 OF THE COLORADO REVISED STATUTES, 1973, AS AMENDED, HAVE BEEN MET TO THE BEST OF HIS KNOWLEDGE AND BELIEF. THIS STATEMENT IS NEITHER A WARRANTY NOR GUARANTEE, EITHER EXPRESSED OR IMPLIED.

DARRYL DEAN DECORA COLORADO PROFESSIONAL LAND SURVEYOR NO 38068

SHEET INDEX

- COVER/NOTES/DETAILS
- PRELIMINARY PLAN
- PRELIMINARY GRADING

<p><b>BEAR CREEK SURVEYING INC.</b> BRENT SMITH 95 South Bear Creek Road, Bayfield, CO 81122 P.O. Box 2015, Bayfield, CO 81122 ph(970)884-5069</p>	<p>CLIENT: <b>MONUMENT RIDGE EAST, LLC</b></p> <p>MUNICIPALITY: <b>COLORADO SPRINGS</b> COUNTY: <b>EL PASO</b></p>		<p>SUBMISSION DATE: 1/18/24</p> <p>REVISION DATES: 4/12/24</p>
	<p><b>PRELIMINARY PLAN</b></p>		<p>PROJECT #: <b>21-041</b></p>
<p>DRAFTED BY: <b>DBH</b></p> <p>CHECKED BY: <b>BUS</b></p>			



# MONUMENT RIDGE EAST

LOCATED IN THE NORTH ONE-HALF OF SECTION 2, T 11 S, R 67 W OF THE 6th P.M.  
EL PASO COUNTY, COLORADO

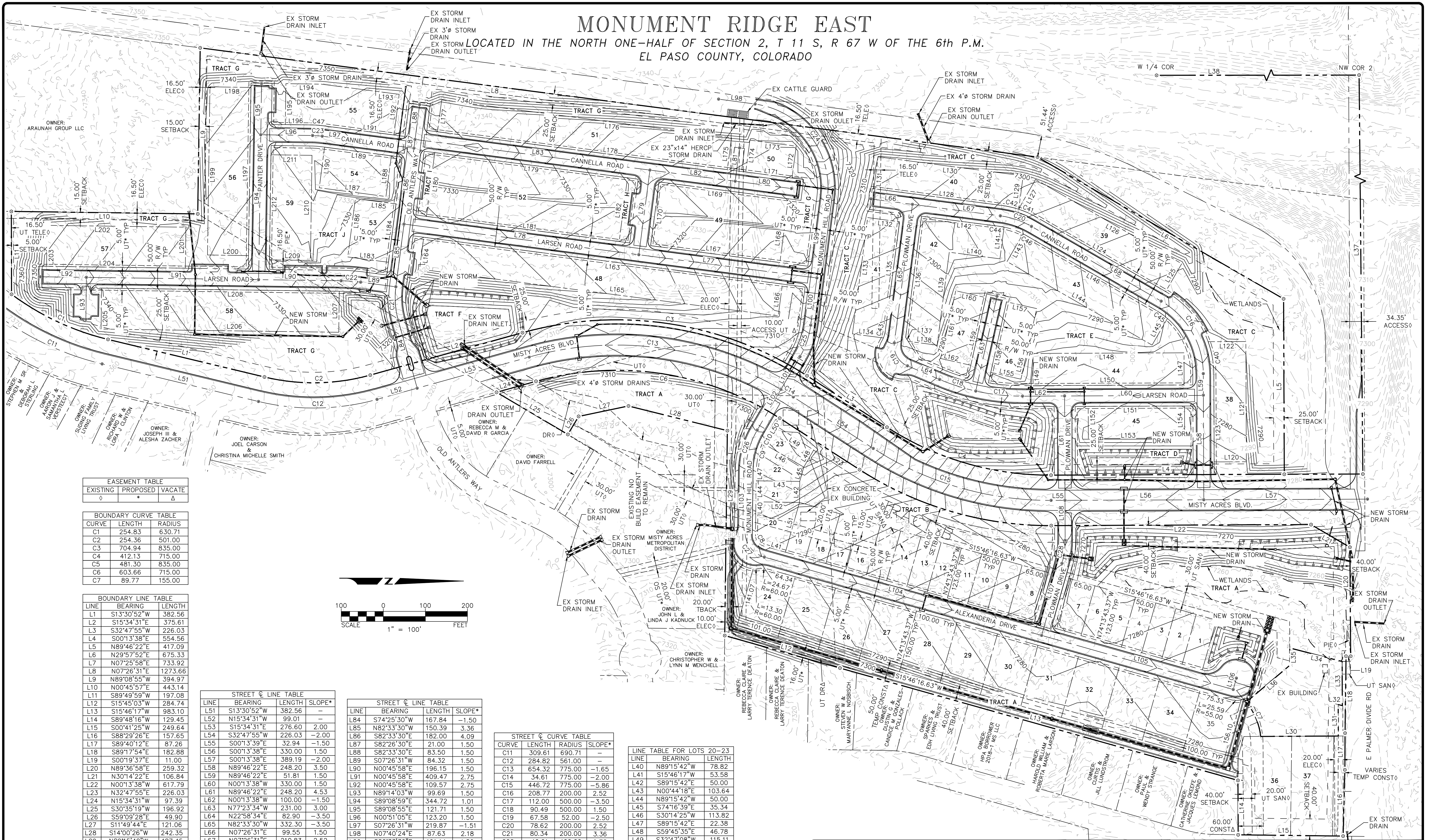

EASEMENT TABLE		
EXISTING	PROPOSED	VACATE
0	0	0

BOUNDARY CURVE TABLE		
CURVE	LENGTH	RADIUS
C1	254.83	630.71
C2	254.36	501.00
C3	704.94	835.00
C4	412.13	715.00
C5	481.30	835.00
C6	603.66	715.00
C7	89.77	155.00

BOUNDARY LINE TABLE		
LINE	BEARING	LENGTH
L1	S13°30'52"W	382.56
L2	S15°34'31"E	375.61
L3	S32°47'55"W	226.03
L4	S00°13'38"E	554.56
L5	N89°46'22"E	417.09
L6	N29°57'52"E	675.33
L7	N07°25'58"E	733.92
L8	N07°26'31"E	1273.66
L9	N89°08'55"W	394.97
L10	N00°45'57"E	443.14
L11	S89°49'59"W	197.08
L12	S15°45'03"W	284.74
L13	S15°46'17"W	983.10
L14	S89°48'16"W	129.45
L15	S00°41'25"W	249.64
L16	S88°29'26"E	157.65
L17	S89°40'12"E	87.26
L18	S89°17'54"E	182.88
L19	S00°19'37"E	11.00
L20	N89°36'58"E	259.32
L21	N30°14'22"E	106.84
L22	N00°13'38"W	617.79
L23	N32°47'55"E	226.03
L24	N15°34'31"W	97.39
L25	S30°35'19"W	196.92
L26	S59°09'28"E	49.90
L27	S11°49'44"E	121.06
L28	S14°00'26"W	242.35
L29	N89°15'42"W	487.45
L30	S00°17'38"E	184.62
L31	S89°42'21"W	74.90
L32	S14°23'28"W	10.26
L33	N89°42'21"E	104.86
L34	N14°32'38"E	128.71
L35	S89°35'16"W	41.27
L36	N40°11'32"W	135.79
L37	S89°35'16"W	41.27
L38	N40°11'32"W	135.79

STREET & LINE TABLE				
LINE	BEARING	LENGTH	SLOPE*	
L51	S13°30'52"W	382.56	-	
L52	N15°34'31"W	99.01	-	
L53	S15°34'31"E	276.60	2.00	
L54	S32°47'55"W	226.03	-2.00	
L55	S00°13'38"E	32.94	-1.50	
L56	S00°13'38"E	330.00	1.50	
L57	S00°13'38"E	389.19	-2.00	
L58	N89°46'22"E	248.20	3.50	
L59	N89°46'22"E	51.81	1.50	
L60	N00°13'38"W	330.00	1.50	
L61	N89°46'22"E	248.20	4.53	
L62	N00°13'38"W	100.00	-1.50	
L63	N77°23'34"W	231.00	3.00	
L64	N22°58'34"E	82.90	-3.50	
L65	N82°33'30"W	332.30	-3.50	
L66	N07°26'31"E	99.55	1.50	
L67	N07°26'31"E	210.83	2.52	
L68	N29°57'52"W	355.93	2.52	
L69	L69 - L76 NOT USED			
L77	N07°26'31"E	426.96	-3.02	
L78	N07°26'31"E	563.00	-1.50	
L79	N82°33'30"W	203.00	2.77	
L80	N07°26'31"E	134.87	-1.50	
L81	S82°33'30"E	80.00	-1.50	
L82	N07°26'31"E	204.50	-1.50	
L83	N07°26'31"E	563.00	-2.50	

STREET & LINE TABLE			
LINE	BEARING	LENGTH	SLOPE*
L84	S74°25'30"W	167.84	-1.50
L85	N82°33'30"W	150.39	3.36
L86	S82°33'30"E	182.00	4.09
L87	S82°26'30"E	21.00	1.50
L88	S82°33'30"E	83.50	1.50
L89	S07°26'31"W	84.32	1.50
L90	N00°45'58"E	196.15	1.50
L91	N00°45'58"E	409.47	2.75
L92	N00°45'58"E	109.57	2.75
L93	N89°14'03"W	99.69	1.50
L94	S89°08'59"E	344.72	1.01
L95	S89°08'55"E	121.71	1.50
L96	N00°51'05"E	123.20	1.50
L97	S07°26'31"W	219.87	-1.51
L98	N07°40'24"E	87.63	2.18
L99	S82°33'30"E	191.14	1.50
L100	S82°33'30"E	113.30	1.50
L101	S59°45'36"E	90.00	1.50
L102	N59°45'36"W	112.03	1.50
L103	S89°15'42"W	142.64	-4.25
L104	S15°46'17"W	685.14	-1.07
L105	S15°46'17"W	473.34	-1.50
L106	N74°13'43"E	28.00	1.50
L107	S74°13'43"E	178.07	4.08
L108	S89°46'22"W	94.77	1.50

STREET & CURVE TABLE			
CURVE	LENGTH	RADIUS	SLOPE*
C11	309.61	690.71	-
C12	284.82	561.00	-
C13	654.32	775.00	-1.65
C14	34.61	775.00	-2.00
C15	446.72	775.00	-5.86
C16	208.77	200.00	2.52
C17	112.00	500.00	-3.50
C18	90.49	500.00	1.50
C19	67.58	52.00	-2.50
C20	78.62	200.00	2.52
C21	80.34	200.00	3.36
C22	46.61	400.00	2.75
C23	23.01	200.00	1.50
C24	313.35	200.00	6.30
C25	79.58	200.00	6.00
C26	102.98	200.00	-4.25
C27	82.43	63.00	-4.25
C28	55.85	200.00	1.50

LINE TABLE FOR LOTS 20-23		
LINE	BEARING	LENGTH
L40	N89°15'42"W	78.82
L41	S15°46'17"W	53.58
L42	S89°15'42"E	50.00
L43	N00°44'18"E	103.64
L44	N89°15'42"W	50.00
L45	S74°16'39"E	35.34
L46	S30°14'25"W	113.82
L47	S89°15'42"E	22.38
L48	S59°45'36"E	46.78
L49	S32°47'08"W	115.11
L50	N59°45'36"W	31.59
L51	S74°13'43"E	123.00
L52	N00°44'18"E	103.64

CURVE TABLE FOR LOTS 20-23		
CURVE	LENGTH	RADIUS
C8	35.33	27.00
C9	69.64	175.00
C10	20.35	175.00

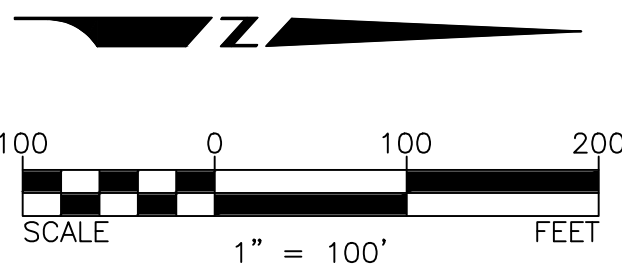

<p><b>BEAR CREEK SURVEYING INC.</b> BRENT SMITH 95 South Bear Creek Road, Bayfield, CO 8122 P.O. Box 2015, Bayfield, CO 8122 ph(970)884-5069</p>	<p>CLIENT: <b>MONUMENT RIDGE EAST, LLC</b></p> <p>MUNICIPALITY: COLORADO SPRINGS COUNTY: EL PASO</p>	<p>SUBMISSION DATE: 1/18/24</p> <p>REVISION DATES: 4/12/24</p>
	<p>DRAFTED BY: <b>DBH</b></p> <p>CHECKED BY: <b>BJS</b></p>	<p>DEVELOPER: MONUMENT RIDGE EAST LLC 5055 LIST DRIVE COLORADO SPRINGS, CO 80919</p>



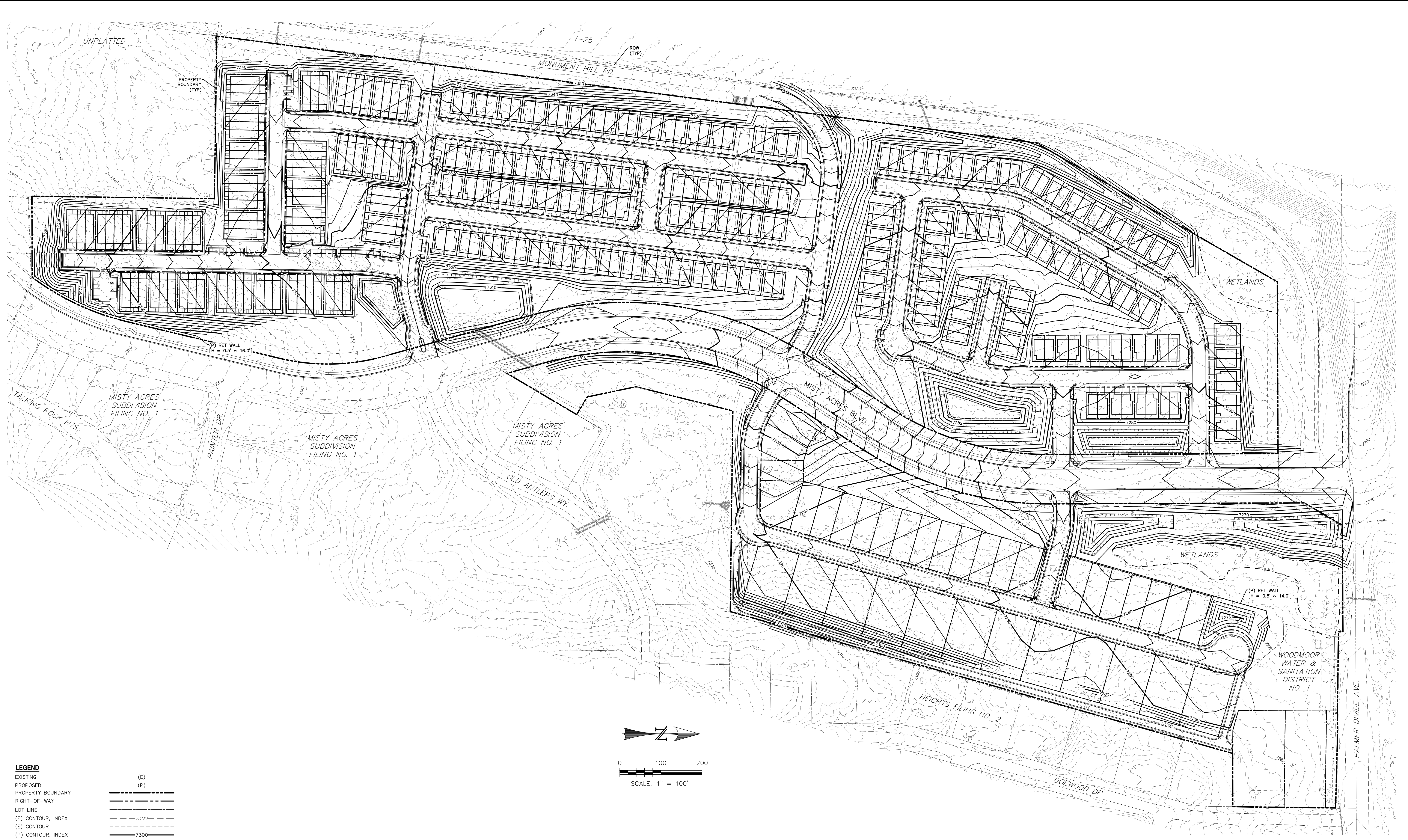

**LEGEND**

EXISTING	(E)
PROPOSED	(P)
PROPERTY BOUNDARY	---
RIGHT-OF-WAY	---
LOT LINE	---
(E) CONTOUR, INDEX	---7300---
(E) CONTOUR	---
(P) CONTOUR, INDEX	---7300---
(P) CONTOUR	---
(E) STORM SEWER	---

REV.	DESCRIPTION	DATE

**811** Know what's below.  
 Call 72 hours before you dig.  
 For more details visit:  
[www.call811.com](http://www.call811.com)

PREPARED FOR:  
**MONUMENT RIDGE EAST, LLC**  
 5055 LIST DRIVE  
 COLORADO SPRINGS, CO 80919

**NOT FOR CONSTRUCTION**

**PRC**  
 ENGINEERING  
 4465 NORTH PARK DRIVE, SUITE 400A  
 COLORADO SPRINGS, CO 80907  
 (719) 291-2744

**MONUMENT RIDGE EAST**  
**EAST & WEST PARCEL**  
**GRADING EXHIBIT**

DESIGNED BY: MGP	DRAWN BY: MGP
SCALE: 1" = 100'	DATE: 03/07/24
JOB NUMBER: 21-003	SHEET: 1 OF 1