

- NOTE:
1. AERIAL IMAGERY SHOULD BE UTILIZED FOR REFERENCE ONLY (SOURCE: GOOGLE MAPS & EPC ASSESSOR).
  2. THE PARTIES RESPONSIBLE FOR THIS PLAN HAVE FAMILIARIZED THEMSELVES WITH ALL CURRENT ACCESSIBILITY CRITERIA AND SPECIFICATIONS AND THE PROPOSED PLAN REFLECTS ALL SITE ELEMENTS REQUIRED BY THE APPLICABLE ADA DESIGN STANDARDS AND GUIDELINES AS PUBLISHED BY THE UNITED STATES DEPARTMENT OF JUSTICE. APPROVAL OF THIS PLAN BY EL PASO COUNTY DOES NOT ASSURE COMPLIANCE WITH THE ADA OR ANY REGULATIONS OR GUIDELINES ENACTED OR PROMULGATED UNDER OR WITH RESPECT TO SUCH LAWS.
  3. PROPOSED BUILDING SITE IS LOCATED OUTSIDE OF FLOODPLAIN (SEE FEMA FLOODPLAIN MAP).
  4. UTILITIES NOT SHOWN THIS SHEET FOR CLARITY, SEE UTILITY PLAN.
  5. SEE SHEET C1 FOR EX. EASEMENT AND SITE OUT-BUILDING DETAILS.
  6. SITE LANDSCAPE ITEMS TO GENERALLY COINCIDE W/FUTURE DEVELOPMENT, SEE THE ESTATES AT ROLLING HILLS RANCH FILING 2 LANDSCAPE CONSTRUCTION DRAWINGS BY N.E.S. INC. SEE FOLLOWING SHEETS FOR LANDSCAPE DETAILS/SCHEDULES/LEGEND.
  7. SEE SHEET C2 FOR FENCE LEGEND.
  8. SEE SHEET C2 FOR FENCE LEGEND.

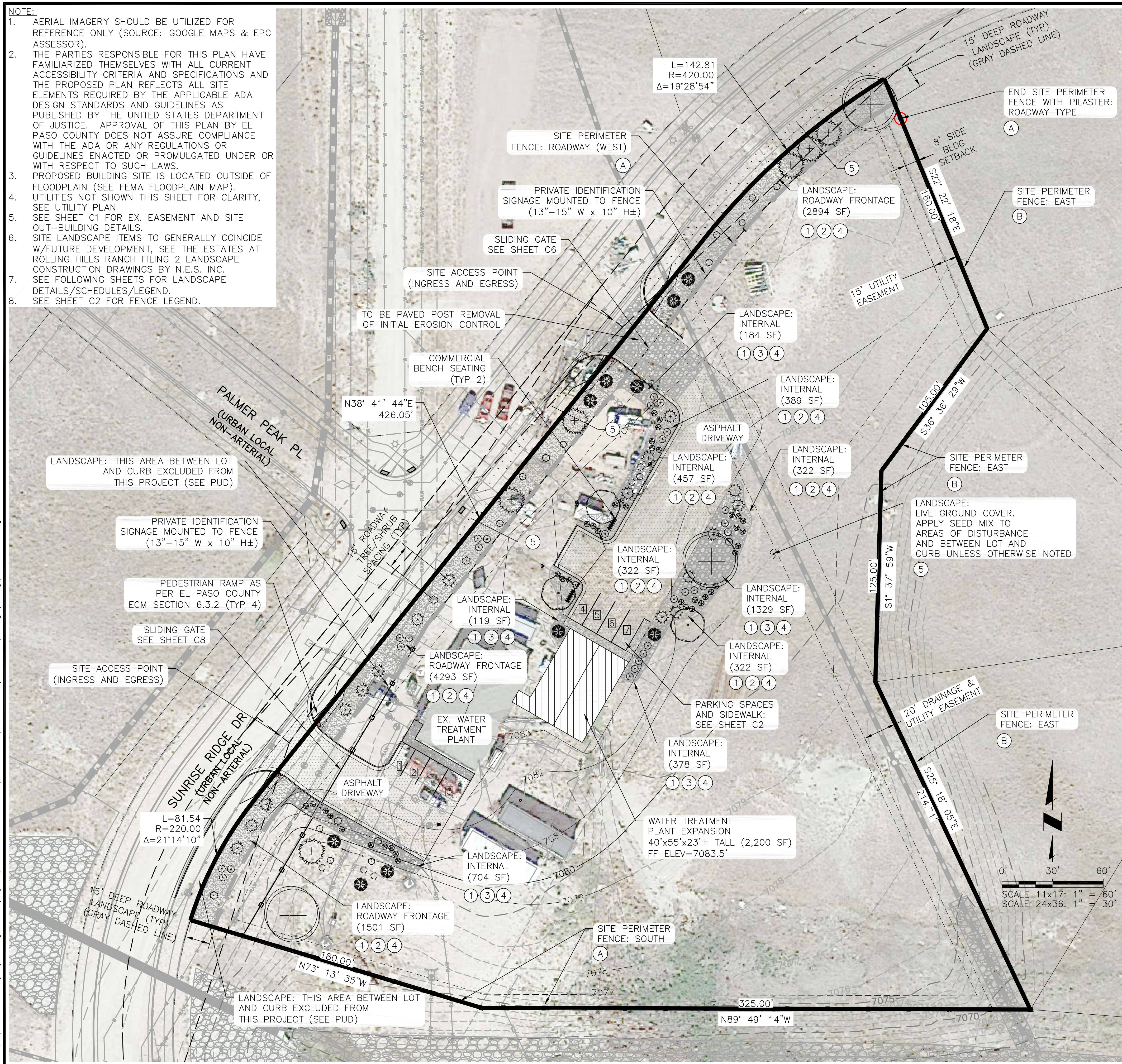

**LEGEND**

	FUT PROPERTY LINE
	EX RIGHT-OF-WAY
	EX WATER LINE
	EX WATER LINE (QUALITY B)
	EX WATER LINE (QUALITY D)
	EX SANITARY SEWER LINE
	EX RAW WATER LINE
	EX STORM SEWER LINE
	EX CONTOURS-MAJOR
	EX CONTOURS-MINOR
	EX U.G. ELECTRIC LINE
	EX U.G. FIBEROPTIC LINE (QUALITY B)
	EX U.G. TELEPHONE LINE (QUALITY B)
	EX U.G. GAS LINE (QUALITY B)
	EX FIRE HYDRANT
	EX WATER VALVE
	EX SANITARY SEWER MANHOLE
	EX LIGHT POLE
	SIGHT LINE
	PP CONTOURS-MAJOR
	PP CONTOURS-MINOR
	PP U.G. ELECTRIC LINE
	PP FENCE TYPE A
	PP FENCE TYPE B
	PP WATER LINE
	PP SANITARY SEWER LINE
	PP RAW WATER LINE
	PP FIRE HYDRANT
	PP VEHICLE CIRCULATION PATH
	PP EROSION CONTROL
	PP SILT FENCE (INITIAL)
	PP VEHICLE TRACKING PAD (INITIAL)
	DEVELOPED FLOW DIRECTION
	PP STAGING AREA (INITIAL)
	PP CONCRETE WASHOUT (INITIAL)
	PP GRAVEL/RIPRAP (FINAL)

NOTE: UTILITY DESIGNATIONS (B) AND (D) INDICATE SUE QUALITY LEVELS. REFER TO SUE DATED 11/19/21 CONDUCTED BY SAM, LLC.

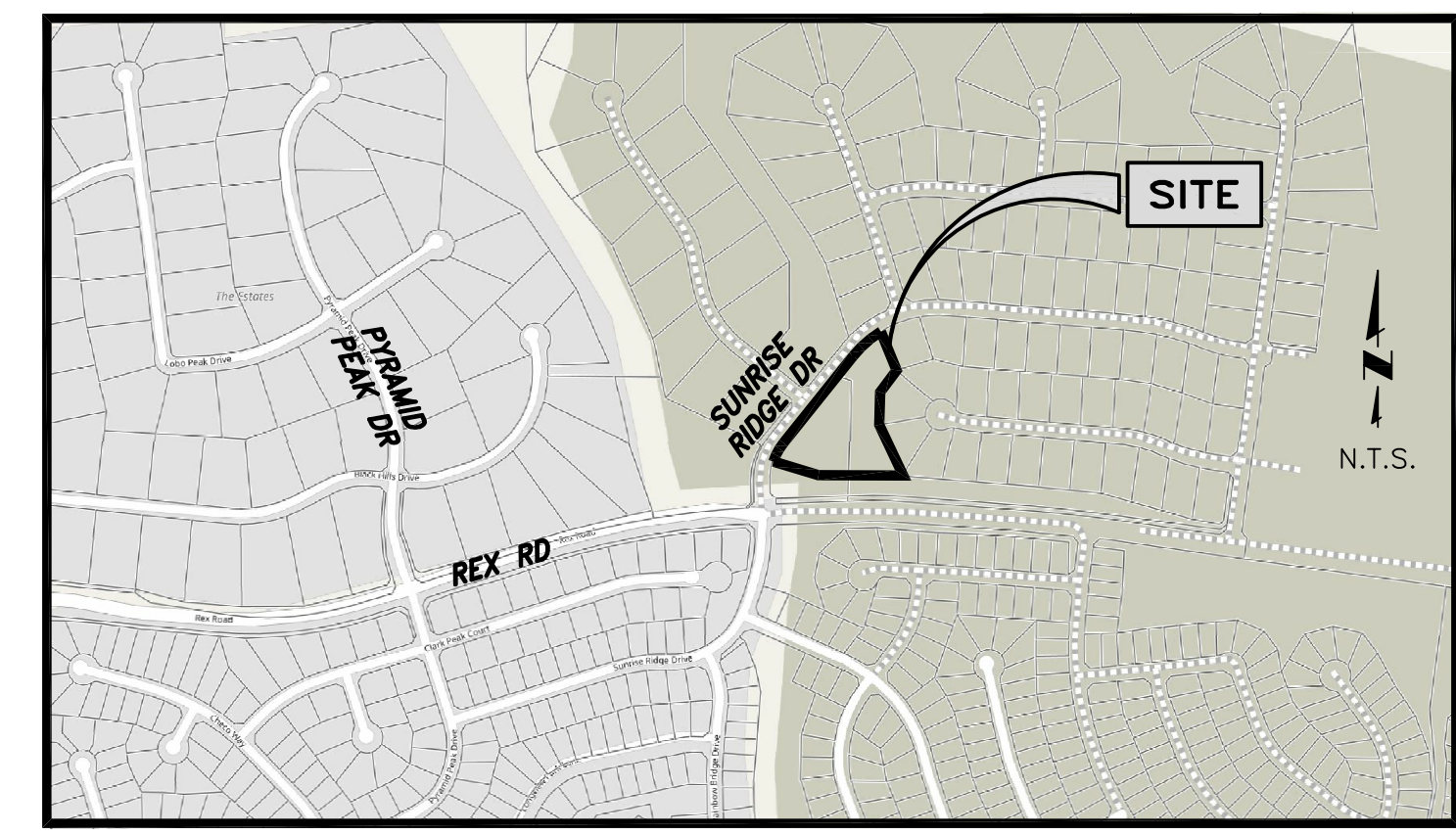

LEGAL DESCRIPTION  
TRACT B, THE ESTATES AT ROLLING HILLS RANCH NO. 2

SCALE 11x17: 1" = 60'  
SCALE 24x36: 1" = 30'

**JDSHYDRO** a Division of **RESPEC**  
5540 TECH CENTER DR., SUITE 100  
COLORADO SPRINGS, COLORADO 80919  
(719) 227-0072

DESIGNER: THE ENGINEER SHALL VERIFY ALL DIMENSIONS, ANY ERRORS, AND OMISSIONS SHALL BE REPORTED TO JDS-HYDRO, A DIVISION OF RESPEC. JDS-HYDRO ASSUMES NO LIABILITY FOR UNAUTHORIZED CHANGES AND/OR REVISIONS MADE TO PLANS.

MERIDIAN SERVICE METROPOLITAN DISTRICT  
WATER TREATMENT PLANT EXPANSION  
ALTERNATE LANDSCAPE PLAN

REVISIONS

NO.	DESCRIPTION	BY	APP.	DATE
1				
2				
3				
4				
5				
6				
7				

100% DESIGN

Project No.: 151.52  
Date: 09/06/22  
Design: RMM  
Drawn: GGM  
Check: JCS

PCD File No. PPR-22-012

C14

2022/10/12 12:54 PM By: Ryan Mangino N:\Project\151 Meridian Service Metropolitan District\151.52 WTP Expansion\_SDP\Drawings\Working\151.52\_1\_Civil.dwg



2022/10/12 12:54 PM By: Ryan Mangino N:\Project\151 Meridian Service Metropolitan District\151.52 WTP Expansion\_SDP\Drawings\Working\151.52\_1\_Civil.dwg

ALTERNATE LANDSCAPING COVERAGES:	
SITE AREA: TRACT B	144,837
<b>ROADWAY FRONTAGE</b>	
SUNRISE RIDGE DR, NON-ARTERIAL	580' (USABLE)
DEPTH REQUIRED/PROVIDED	15'/15'
TREES REQUIRED/PROVIDED	39/19 (UTILITY CONFLICT: SEE LOI FOR ALT. LANDSCAPE REQUEST/SHRUBS IN LIEU OF TREES)
<b>PARKING LOT</b>	
	N/A
<b>BUFFER &amp; SCREEN AREAS (PROPERTY LINES)</b>	
	N/A (SEE LOI FOR ALT. LANDSCAPE REQUEST)
<b>INTERNAL</b>	
% MINIMUM INTERNAL AREA REQUIRED	5
INTERNAL AREA REQUIRED/PROVIDED (PLANTINGS & HARDSCAPE)	7242/5123 (SEE LOI FOR ALT. LANDSCAPE REQUEST)
<b>LIVE MATERIAL GROUND COVER</b>	
% GROUND COVER REQUIRED/PROVIDED (SEED MIX)	75/100 (SEE LOI FOR SEED MIX EXTENT)
<b>OTHER</b>	
ZONING DISTRICT BOUNDARY TREES	N/A (SEE LOI FOR ALT. LANDSCAPE REQUEST)
LANDSCAPING BETWEEN LOT AND CURB	SEE ALT. LANDSCAPE PLAN FOR AREAS TO BE INCLUDED W/THIS PROJECT

LANDSCAPE SCHEDULE -- XERIC/LOW WATER VEGETATION							
SYMBOL		BOTANICAL NAME	COMMON NAME	QTY	MATURE SIZE (HEIGHT x WIDTH)	PLANTING SIZE (MIN)	COMMENTS
	JS	<i>EVERGREEN TREE</i> JUNIPERUS SCOPULORUM	ROCKY MOUNTAIN JUNIPER	10	15' x 8'	6" MIN. HEIGHT	MUST ARRIVE BALLED AND BURLAPPED. PRUNE OUT SPORE HORNS WHEN SEEN IN SPRING
	PE	PINUS EDULIS	PINON PINE	6	25'/30' x 15'	6" MIN. HEIGHT	MUST ARRIVE BALLED AND BURLAPPED. PRUNE TO SHAPE TREE AT EARLY GROWTH
		<i>UPRIGHT EVERGREEN TREE</i>					
	JSW	JUNIPERUS SCOPULORUM "WOODWARD"	WOODWARD	17	20' x 4'	6" MIN. HEIGHT	MUST ARRIVE BALLED AND BURLAPPED. NO MAINTENANCE - STAKE ONLY; DO NOT SHEAR
		<i>DECIDUOUS SHADE TREE</i>					
	AXF	ACER X FREEMANII 'JEFFSRED'	AUTUMN BLAZE MAPLE	3	20' x 30'	3" CAL	MUST ARRIVE BALLED AND BURLAPPED. PRUNE TWICE YEARLY IN FALL AND SPRING. REMOVE DEAD/WEAK LIMBS. R/D LOWER TRUNK OF ANY NEW GROWTH
		<i>DECIDUOUS ORNAMENTAL TREE</i>					
	MR	MALUS X 'RADIANT'	RADIANT CRAB APPLE	3	25'x20'	2" CAL	MUST ARRIVE BALLED AND BURLAPPED. ONLY PRUNE OFF ANY WEAK, DAMAGED OR BROKEN BRANCHES
		<i>SHRUBS</i>					
	JBC	JUNIPERUS HORIZONTALIS 'BLUE CHIP'	BLUE CHIP JUNIPER	17	1'x8'	5 GAL	TRIM IN EARLY SPRING. CORRECTIVE PRUNE MID-SUMMER AND IDEALLY SECOND HALF OF AUTUMN
	RAG	RHUS AROMATICA 'GRO-LOW'	GLOW-LOW FRAGRANT SUMAC	29	3'x4'	5 GAL	PRUNE EARLY SPRING. RENEWAL PRUNING IS REQUIRED BY REMOVING LARGEST CANES TO GROUND LEVEL
	SNI	SPIRAEA NIPPONICA 'SNOWMOUND'	SNOWMOUND SPIREA	6	5'x5'	5 GAL	PRUNE AFTER FLOWERS FADE THE THIRD GROWING SEASON AFTER PLANTING. REMOVE DEAD/DAMAGED STEMS AT GROUND LEVEL.
		<i>ORNAMENTAL GRASSES</i>					
	CBR	CALAMAGROSTIS BRACHYTRICHA	REED GRASS	40	4'x3'	1 GAL	TRIM AWAY OLD FOLIAGE AND INFLORESCENCES DEBRIS IN SPRING

LANDSCAPE KEY/DESCRIPTIONS	
①	TYP PLANTING REF: SHEET LS3
②	GRAVEL/MULCH @ 4" MIN.
③	ROCK/MULCH @ 4" MIN.
④	STEEL LANDSCAPE EDGER REF: DETAIL G/LS3 AND NOTES THIS SHEET. TO BE INSTALLED BETWEEN ALL SEED OR SOD AREAS AND PLANTING BEDS. INSTALL PER MANUFACTURER'S SPECS
⑤	TYP SEED MIX REF: SEE SHEET C11. SEED BLEND INSTALLED PER SUPPLIER'S SPECS. SUBMIT CUT SHEET FOR REVIEW AND APPROVAL PRIOR TO INSTALLATION. APPLY TO EXTENT OF SITE DISTURBED AREA AND AS PER ALT. LANDSCAPE PLAN
<b>LANDSCAPE SCHEDULE -- HARDSCAPE/MULCH AND SEED MIX</b>	
	3/8" GRAVEL MULCH: PIONEER WASHED RIVER ROCK OR APPROVED EQUAL (OVER WEED BARRIER FABRIC)
	1.5"-2" ROCK MULCH: PIONEER GLACIER WHITE GRANITE RIVER ROCK OR APPROVED EQUAL (OVER WEED BARRIER FABRIC)
	NATIVE SEED: SEE ABOVE KEY/DESCRIPTIONS FOR DETAILS

**LANDSCAPING NOTES:**

- PLANT QUANTITY AND SUBSTITUTION:** IN CASE OF DISCREPANCY IN PLANT QUANTITIES SHOWN ON THE PLANT TABLE AND THOSE SHOWN ON THE PLANTING PLAN, THE QUANTITIES SHOWN ON THE PLANTING PLAN SHALL GOVERN. THE MINIMUM ACCEPTABLE SIZES OF PLANTS MEASURED BEFORE PRUNING WITH BRANCHES IN NORMAL POSITION SHALL CONFORM TO THE PLANTING SIZES AS SPECIFIED IN THE SCHEDULE. ANY SUBSTITUTION OF PLANT SIZE OR SPECIES MUST BE SUBMITTED TO THE ENGINEER IN WRITING FOR APPROVAL PRIOR TO INSTALLATION.
  - ACCEPTABLE PLANT MATERIAL:** ALL PLANTS SHALL MEET OR EXCEED STANDARDS SET BY THE "COLORADO NURSERY ASSOCIATION," AND THE "AMERICAN STANDARD OF NURSERY STOCK." ALL PLANTS SHALL BE TYPICAL OF THEIR SPECIES, HEALTHY, FREE OF DISEASE, INSECT PESTS, MECHANICAL INJURIES, AND HAVE ADEQUATE ROOT SYSTEMS. ALL PLANTINGS SHALL BE INSTALLED PER PLANTING DETAILS. ALL PLANT MATERIAL SHALL BE INSPECTED BY THE ENGINEER OR OWNER PRIOR TO INSTALLATION. STAKING/CONTRACTOR INSPECTION NOTE: ALL PLANTING LOCATIONS TO BE STAKED AND INSPECTED BY CONTRACTOR PRIOR TO INSTALLATION. ALL PLANTS TO BE INSPECTED AT NURSERY LOCATION PRIOR TO TRANSPORTING TO THE SITE.
  - SITE DISTURBANCE:** ALL AREAS OF SITE DISTURBANCE DUE TO CONSTRUCTION SHALL BE RENOVATED OR PLANTED PER THIS PLAN UNLESS OTHERWISE NOTED. SITE-SPECIFIC LANDSCAPING SHALL AT A MINIMUM, INCLUDE REVEGETATION OF DISTURBED AREAS WITH MATERIALS INDIGENOUS TO THE SITE OR OTHERWISE ADAPTABLE (SEE LEFT KEY DESCRIPTIONS AND EROSION CONTROL NOTES SHEET FOR SEED MIX).
  - SOIL AMENDMENTS:** CONTRACTOR SHALL AMENDED PLANTING AREAS AS FOLLOWS:  
 -ADD MINIMUM OF 3 CUBIC YARDS OF WELL-COMPOSTED AGED MANURE OR PREMIUM COMPOST PER 1000 S.F.  
 -ALL AMENDED AREAS SHALL BE TILLED TO A DEPTH OF 6" PRIOR TO PLANTING.  
 -3 CUBIC YARDS PER 1000 S.F. OF WELL-COMPOSTED AGED MANURE OR PREMIUM COMPOST.  
 -ALL AMENDED AREAS SHALL BE TILLED TO A DEPTH OF 6" PRIOR TO PLANTING.
  - SEEDED TURF:** ALL SEEDED OR HYDROMULCHED AREAS SHALL DEMONSTRATE 95% GERMINATION PRIOR TO FINAL ACCEPTANCE.
  - IRRIGATION:** OWNER TO WATER FOR ONE TO TWO GROWING SEASONS UNTIL ESTABLISHED AND ON AN AS-NEEDED BASIS THEREAFTER. DISTURBED AREA SEED/GRASS MIXTURE MUST BE IRRIGATED BY OWNER UNTIL ESTABLISHED AND IN TIMES OF DROUGHT. THE ON-GOING MAINTENANCE OF THE NATIVE GRASS IS THE RESPONSIBILITY OF OWNER. AUTOMATED IRRIGATION SYSTEM SHALL DRIP IRRIGATE ALL TREE, SHRUB, AND GROUND COVER PLANTING AREAS AND SPRAY ANY TURF.
  - INORGANIC AND ORGANIC MULCH/FABRIC:** ALL PLANTINGS (INCLUDING THOSE IN ROCK MULCH AREAS) TO RECEIVE 3-INCH DEPTH OF SHREDDED CEDAR WOOD MULCH UNLESS OTHERWISE SPECIFIED. MULCH RINGS TO BE SIZED PER PLANTING DETAILS (15-INCH DIA. FOR (5) GALLON SHRUBS/GRASSES. WOOD MULCH TO BE "GORILLA HAIR CEDAR MULCH" AVAILABLE FROM C&C SAND CO. (719)471-7222 OR PIONEER SAND CO. (719)599-8100. SUBMIT PRODUCT INFOR. TO DESIGN ENGINEER FOR APPROVAL PRIOR TO INSTALLATION. HIGH QUALITY COMMERCIAL-GRADE (SPUN-BONDED POLYPROPYLENE OR EQUAL) LANDSCAPING FABRIC SHALL BE APPLIED UNDER ALL ROCK BASES.
  - STEEL EDGE:** ALL EDGER SHALL BE ACME 4" PERFORATED STEEL EDGER "SELF COLORING" 14 GAUGE OR APPROVED EQUAL.
  - APPROVAL:** ANY FIELD CHANGES OR DEVIATIONS TO THESE PLANS WITHOUT PRIOR APPROVAL OF AN AMENDED DEVELOPMENT PLAN MAY RESULT IN A DELAY OF FINAL APPROVAL AND THE ISSUANCE OF A CERTIFICATE OF OCCUPANCY.
  - FINAL TREE AND SHRUB LOCATIONS:** ALL TREE LOCATIONS SHALL BE STAKED FOR APPROVAL BY OWNER REPRESENTATIVE/ENGINEER PRIOR TO PLANTING. SHRUBS SHALL BE PLACED IN THEIR LOCATIONS PER THIS PLAN AND APPROVED BY OWNER REPRESENTATIVE/ENGINEER. THE FINAL LOCATION OF TREES TO BE PLANTED MAY REQUIRE ADJUSTMENT BASED ON APPROVAL OF THE FINAL UTILITIES PLANS AND ASSOCIATED FINAL PLAT AND EASEMENTS.
- \*\* BY APPROVING THIS PLAN, THE DIRECTOR IS APPROVING AN ALTERNATE LANDSCAPING DESIGN AS IT RELATES AND CONFORMS TO HOMELAND SECURITY STANDARDS AND PROMOTES WATER CONSERVATION WHILE MEETING THE PURPOSES DESCRIBED IN THE LAND DEVELOPMENT CODE.
- \*\* CONTRACTOR TO REFER TO MERIDIAN RANCH LANDSCAPE SPECIFICATIONS FOR SPECIFIC SOIL AMENDMENT AND PREPARATION FOR SOD, SEED AND PLANTING AREAS.

**JDSHYDRO** a Division of **RESPEC**  
 5540 TECH CENTER DR., SUITE 100  
 COLORADO SPRINGS, COLORADO 80919  
 (719) 227-0072  
THE CONTRACTOR SHALL VERIFY ALL DIMENSIONS. ANY ERRORS, OMISSIONS OR DISCREPANCIES SHALL BE REPORTED TO JDS-HYDRO, A DIVISION OF RESPEC. JDS-HYDRO ASSUMES NO LIABILITY FOR UNAUTHORIZED CHANGES AND/OR REVISIONS MADE TO PLANS.

**MERIDIAN SERVICE METROPOLITAN DISTRICT**  
**WATER TREATMENT PLANT EXPANSION**  
**LANDSCAPE DETAILS 1**

NO.	DESCRIPTION	BY	APP.	DATE
1				
2				
3				
4				
5				
6				
7				

**100% DESIGN**

Project No.: 151.52  
 Date: 09/06/22  
 Design: RMM  
 Drawn: GGM  
 Check: JCS

PCD File No. PPR-22-012

**C15**

2022/10/12 12:54 PM By: Ryan Mangino N:\Projects\151 Meridian Service Metropolitan District\151.52 WTP Expansion SGP\Drawings\Working\151.52\_1\_Civil.dwg

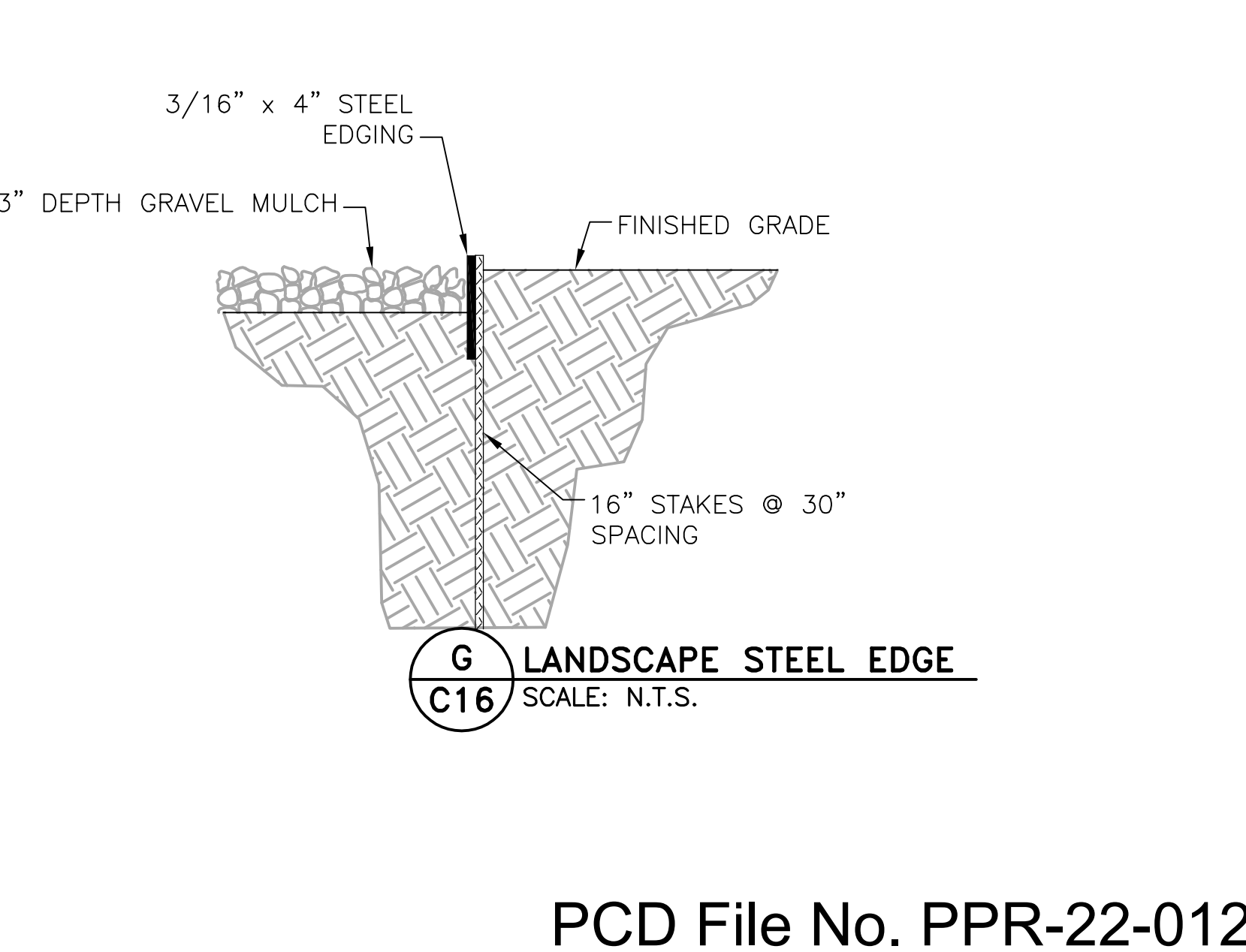
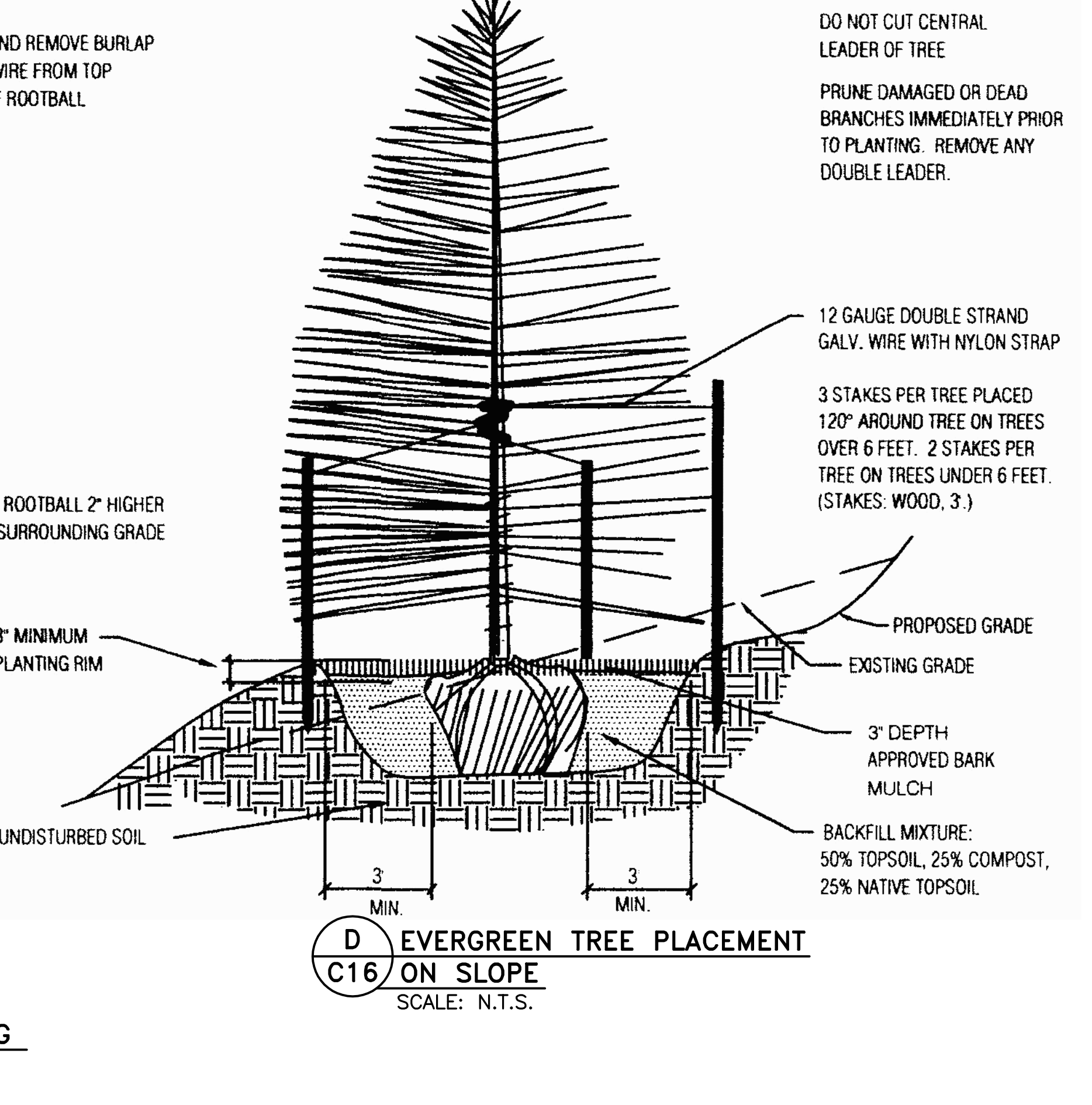
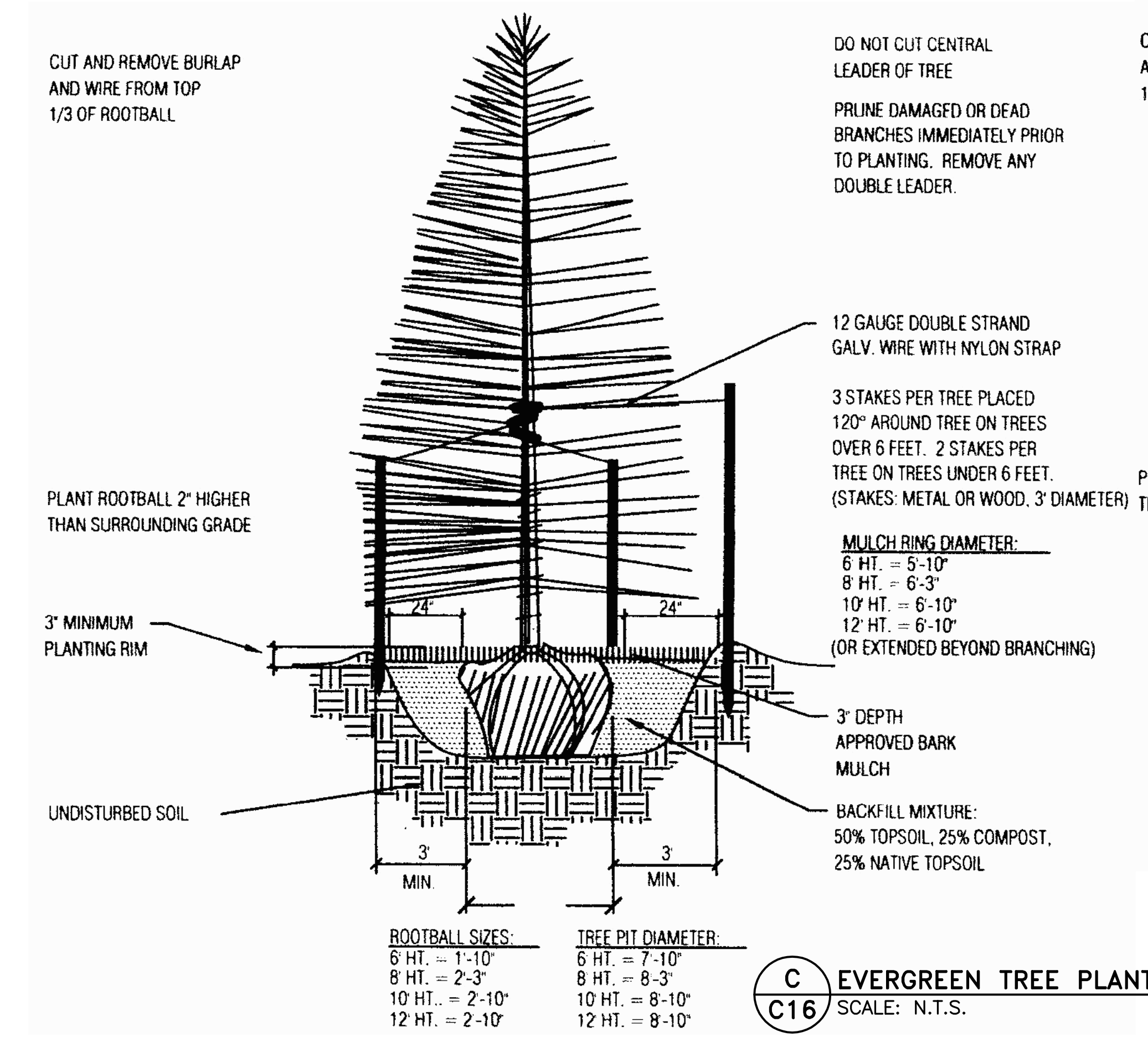
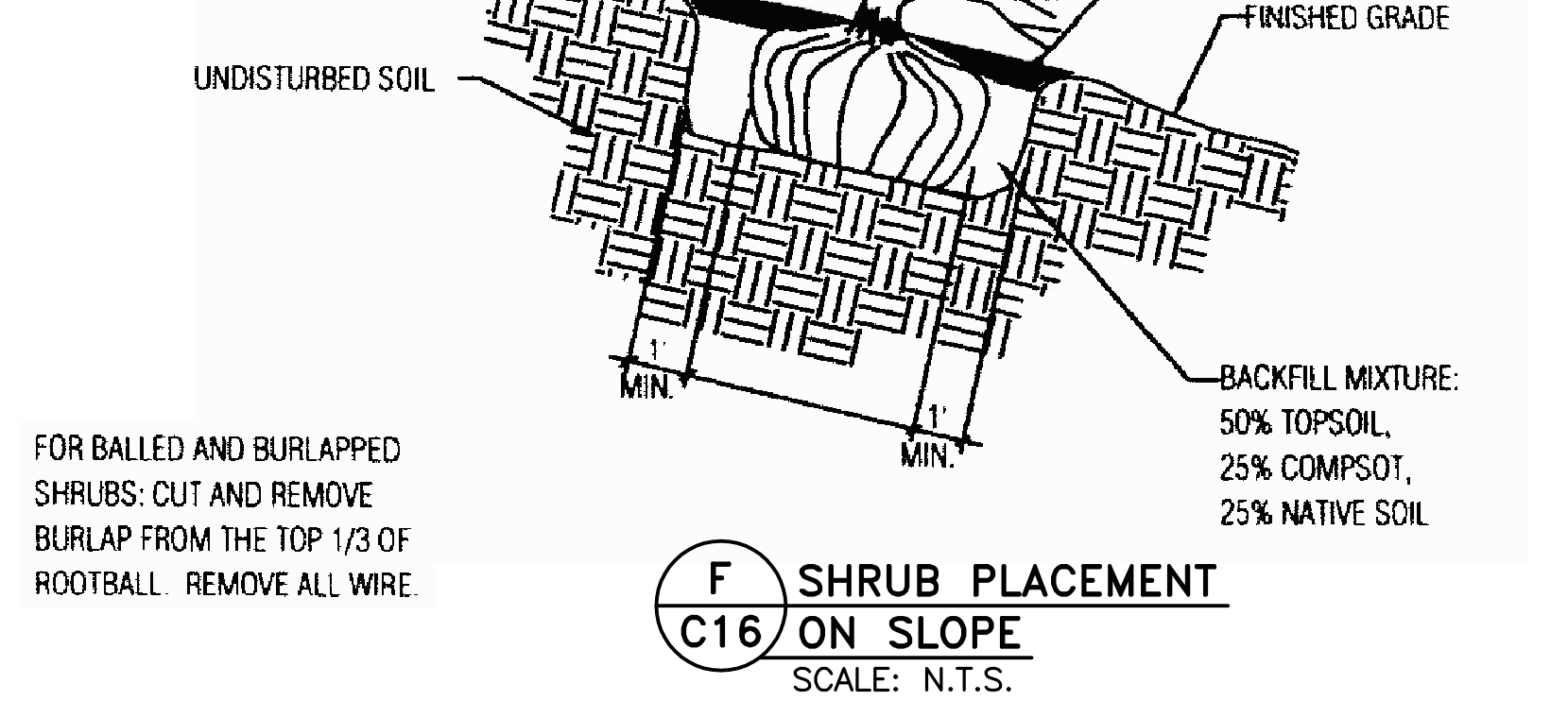
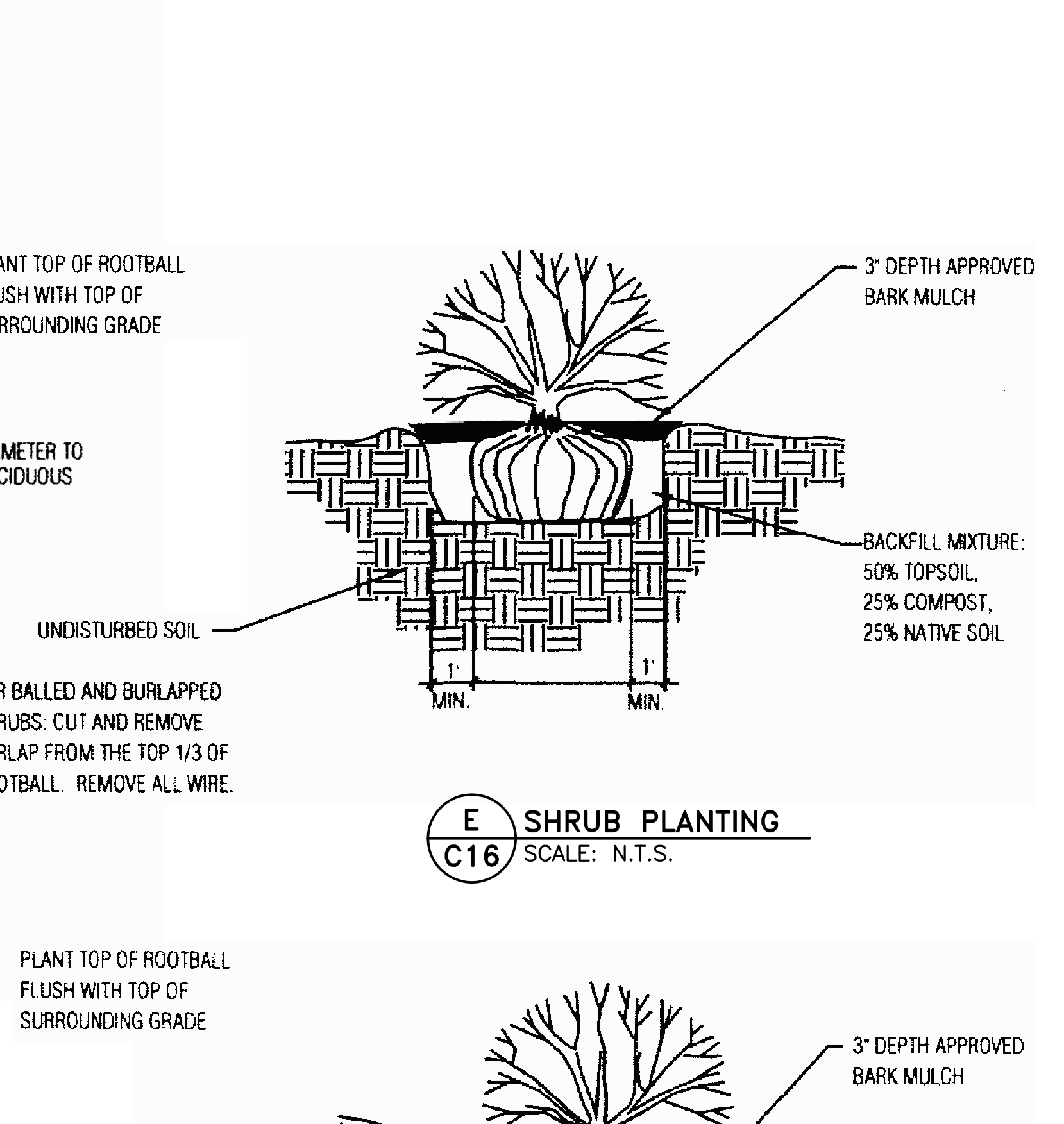
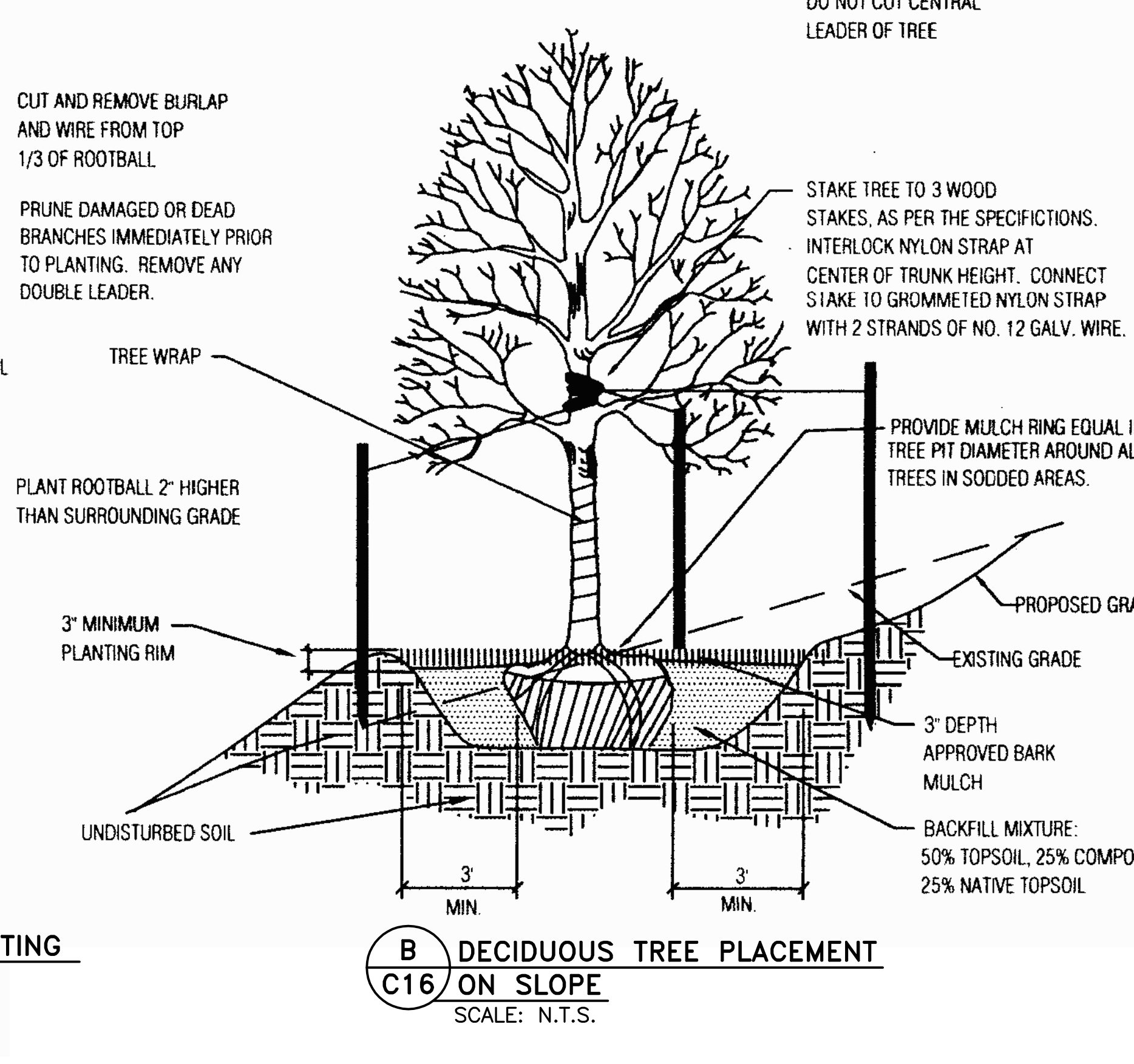
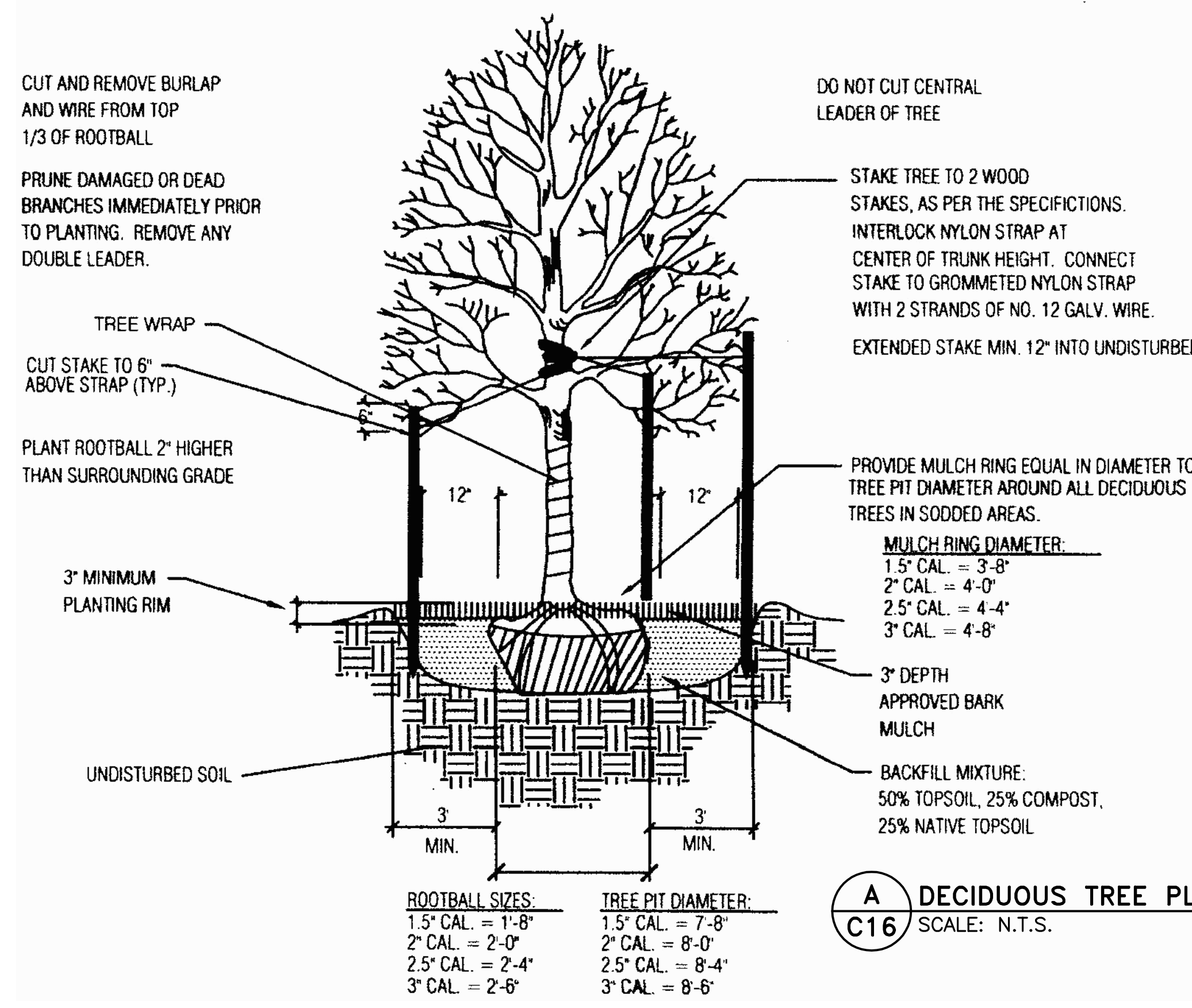

**JDSHYDRO** a Division of **RESPEC**  
5540 TECH CENTER DR., SUITE 100  
COLORADO SPRINGS, COLORADO 80919  
(719) 227-0072

DESIGNER: THE CONTRACTOR SHALL VERIFY ALL DIMENSIONS. ANY ERRORS, OMISSIONS OR CONFLICTS SHALL BE REPORTED TO JDS-HYDRO, A DIVISION OF RESPEC. JDS-HYDRO ASSUMES NO LIABILITY FOR UNAUTHORIZED CHANGES AND/OR REVISIONS MADE TO PLANS.

**MERIDIAN SERVICE METROPOLITAN DISTRICT**  
WATER TREATMENT PLANT EXPANSION  
LANDSCAPE DETAILS 2

NO.	DESCRIPTION	BY	APP.	DATE
1				
2				
3				
4				
5				
6				
7				

**100% DESIGN**

Project No.: 151.52  
Date: 09/06/22  
Design: RMM  
Drawn: GGM  
Check: JCS

PCD File No. PPR-22-012

**C16**



2022/10/12 12:54 PM By: Ryan Mangino I:\Projects\151 Meridian Service Metropolitan District\151.52 WTP Expansion\_SDP\Drawings\Working\151.52\_1\_Civil.dwg

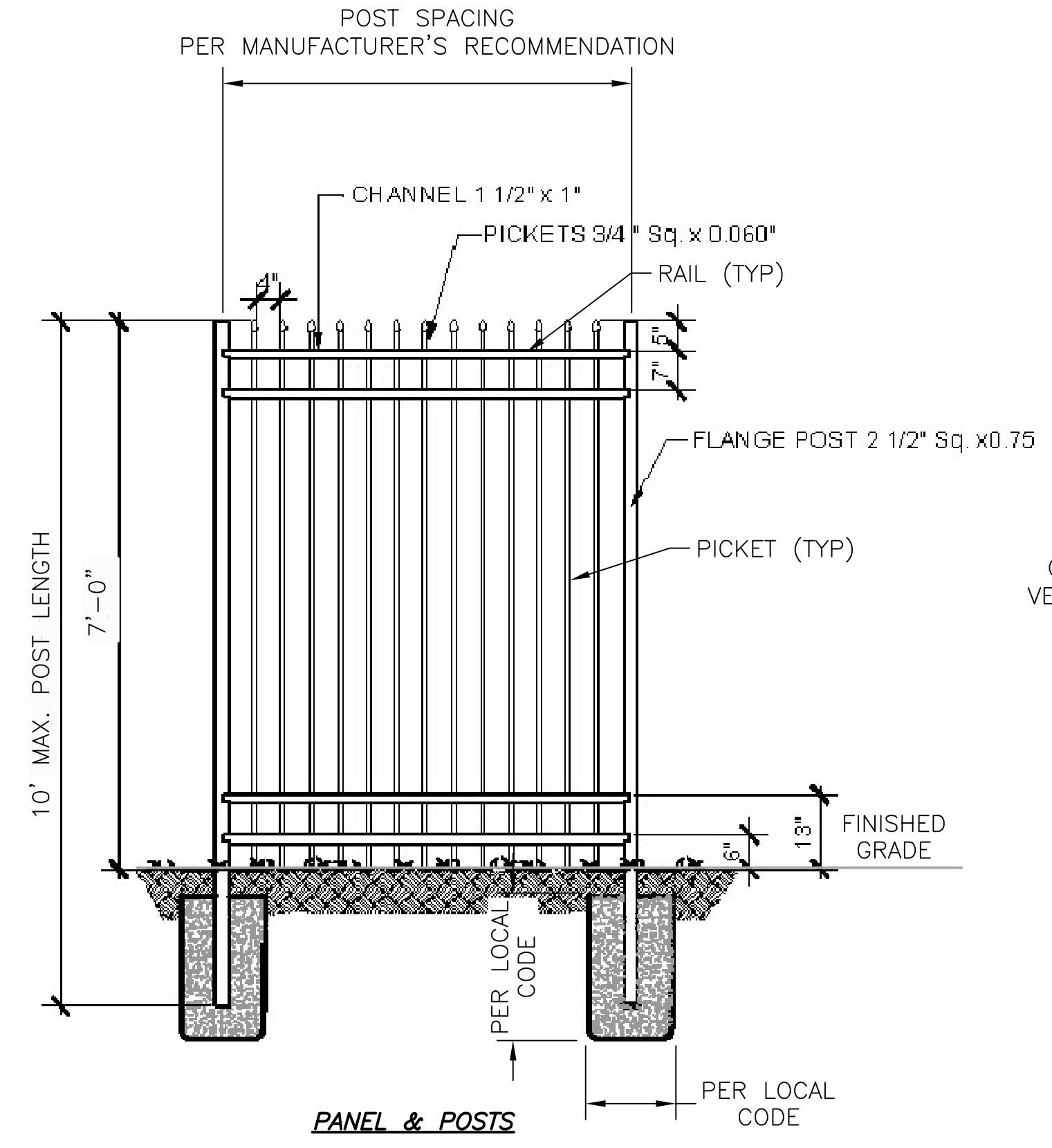
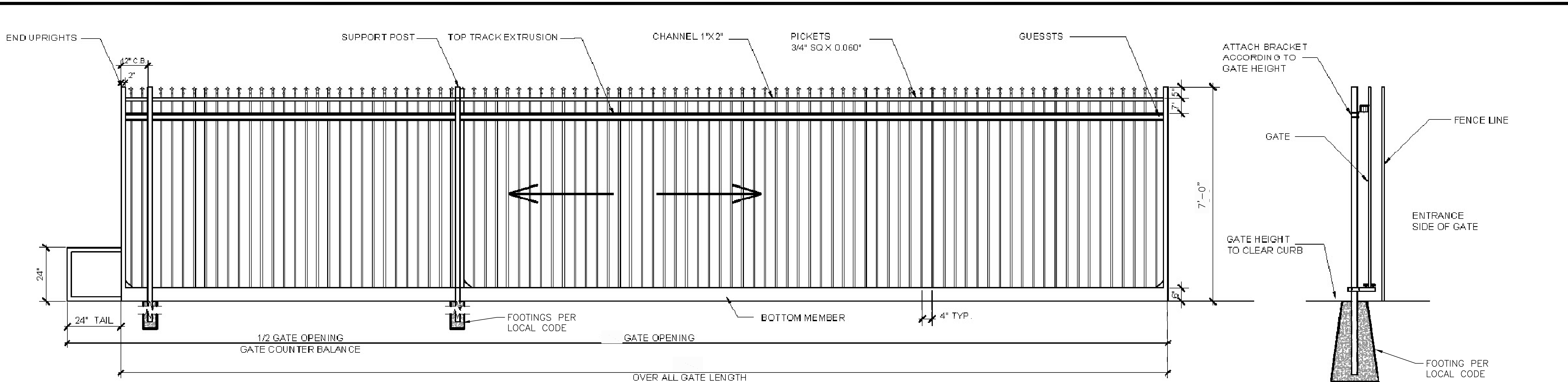

**A FENCE TYPE A: ALUMINUM SPEAR-TOP W/FREESTANDING PILASTERS**  
SCALE: N.T.S.

NOTE, FENCE TYPE A: PILASTERS SHALL MATCH ALL DEFINING CHARACTERISTICS OF THE DEVELOPMENT WHICH SHALL INCLUDE, BUT IS NOT LIMITED TO, DIMENSIONS, COLOR, FINISH STYLE, FINISH PATTERN, ETC. SEE THE ESTATES AT ROLLING HILLS RANCH FILING NO. 2 PUD/PRELIM. PLAN

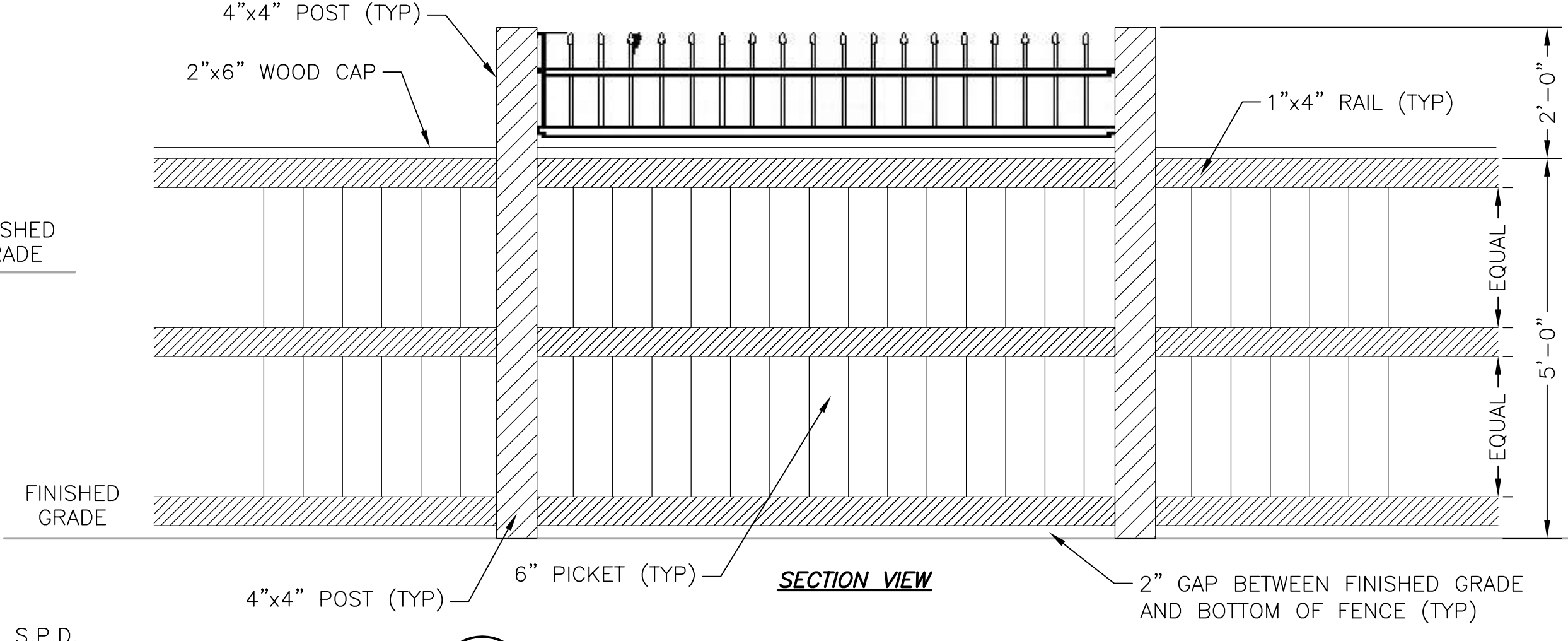
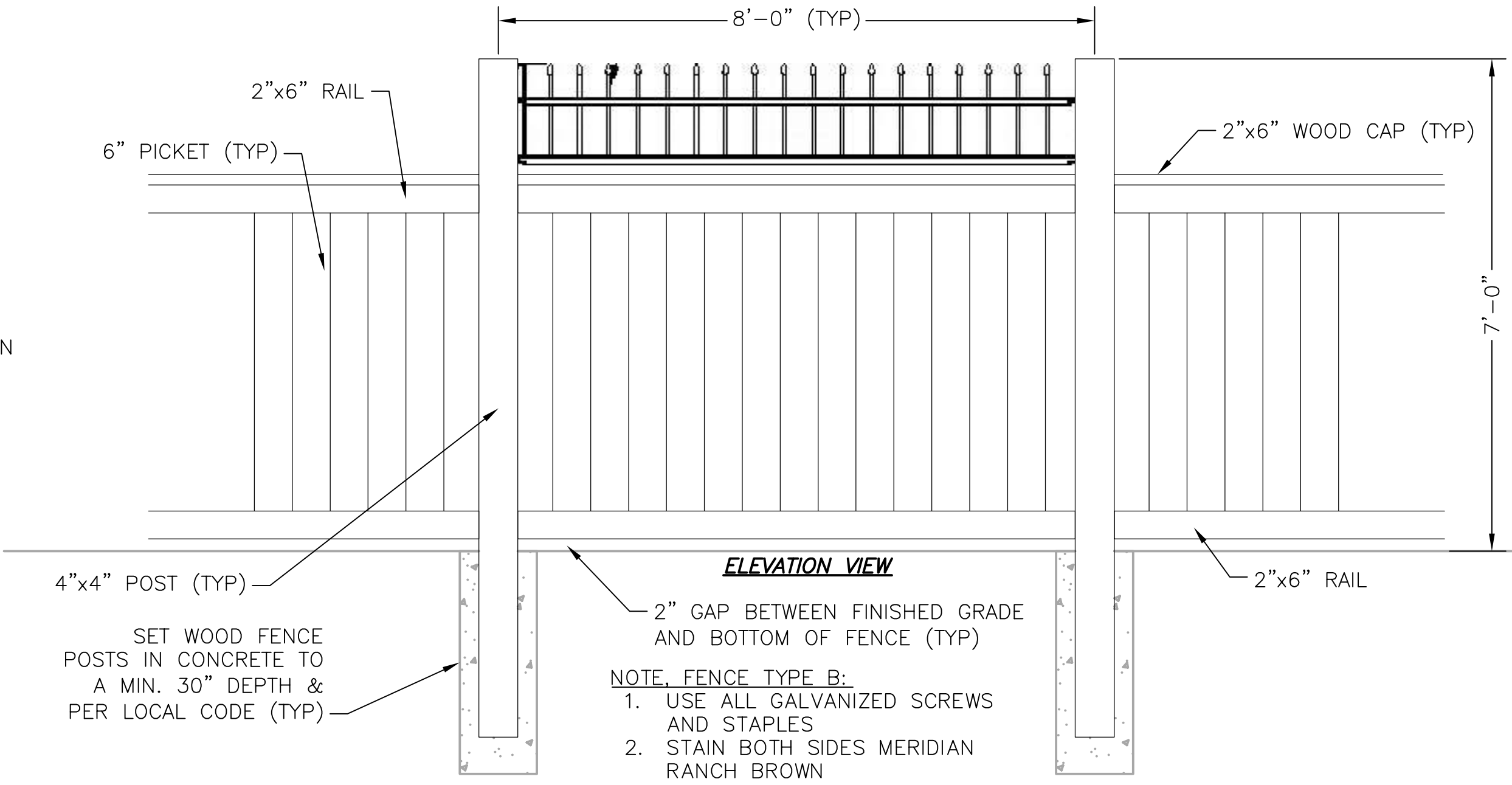
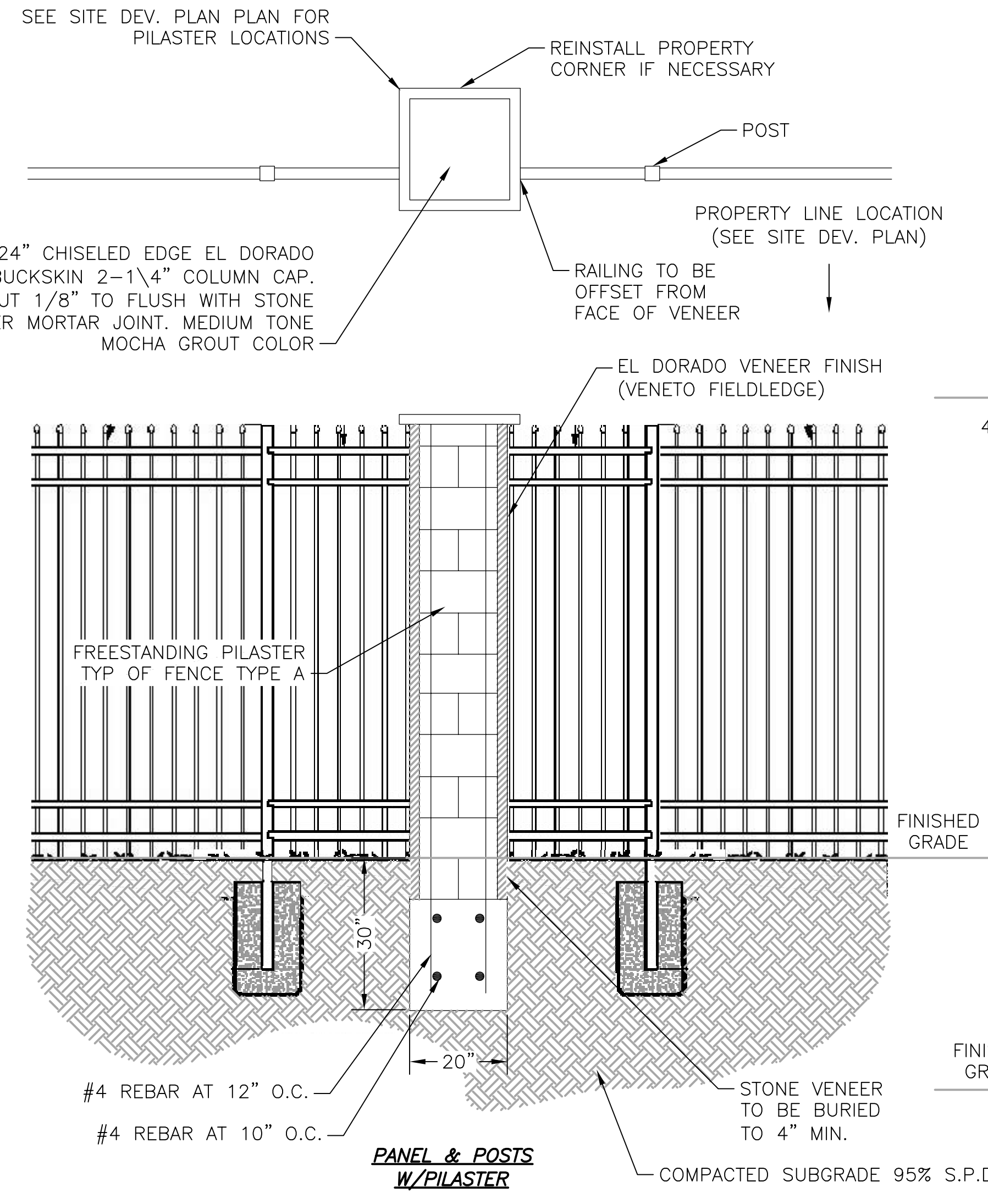

**B FENCE TYPE B: WOOD**  
**C17 W/SPEAR-TOP ALUMINUM**  
SCALE: N.T.S.

PCD File No. PPR-22-012

**JDSHYDRO** a Division of **RESPEC**  
5540 TECH CENTER DR., SUITE 100  
COLORADO SPRINGS, COLORADO 80919  
(719) 227-0072

UNLESS OTHERWISE SPECIFIED, ALL DIMENSIONS, FINISHES, AND MATERIALS SHALL BE REPORTED TO JDS-HYDRO, A DIVISION OF RESPEC. JDS-HYDRO ASSUMES NO LIABILITY FOR UNAUTHORIZED CHANGES AND/OR REVISIONS MADE TO PLANS.

MERIDIAN SERVICE METROPOLITAN DISTRICT  
WATER TREATMENT PLANT EXPANSION  
LANDSCAPE DETAILS 3

NO.	DESCRIPTION	BY	APP.	DATE
1				
2				
3				
4				
5				
6				
7				

100% DESIGN

Project No.: 151.52  
Date: 09/06/22  
Design: RMM  
Drawn: GGM  
Check: JCS

C17