



STORMWATER MANAGEMENT PLAN FOR STERLING RANCH FILING NO. 2

Prepared For (Applicant):

Prepared For:

SR Land, LLC
20 Boulder Crescent, Suite 200
Colorado Springs, CO 80903
720-491-3024

Contractor Information

: _____

Qualified Stormwater Manager

: _____

Prepared By:

JR Engineering, LLC
5475 Tech Center Drive, Suite 235
Colorado Springs, Colorado 80919
(303) 267-6240
Contact: Mike Bramlett

JR Project No. 25188.01

PCD Project No. SF-20-015

Add Project No. CDR-20-005

September, 2020

ENGINEER OF RECORD:

The Stormwater Management Plan was prepared under my direction and supervision and is correct to the best of my knowledge and belief. Said Plan has been prepared according to the criteria established by the County and State for Stormwater Management Plans.

Mike Bramlett, P.E.

Date

Registered Professional Engineer

State of Colorado No. 32314

For and on behalf of JR Engineering, LLC.

REVIEW ENGINEER:

The Stormwater Management Plan was reviewed and found to meet the checklist requirements except where otherwise noted or allowed by an approved deviation request.

Review Engineer

Date

TABLE OF CONTENTS

1.	Applicant / Contact Information	1
2.	Site Description and Location	1
3.	Proposed Sequence of Major Activities	2
4.	BMPs for Stormwater Pollution Prevention	3
5.	Final Stabilization and Long-Term Stormwater Management.....	5
6.	Inspection and Maintenance.....	6

Appendices

- A. Vicinity Map**
- B. Soils Map**
- C. GEC Plans and Details**
- D. SWMP Report and GEC Plan Checklists**
- E. Inspection Report Template**

1. Applicant / Contact Information

Owner/Developer: SR Land, LLC
Attn: Jim Morley
20 Boulder Crest, Suite 200
Colorado Springs, CO 80903
(720) 491-3024

Engineer: JR Engineering, LLC
5475 Tech Center Drive, Suite 235
Colorado Springs, CO 80919
Attn: Mike Bramlett (303) 267-6240
mbramlett@jrengineering.com

**Qualified Stormwater
Manager:** To Be Determined

Contractor: To Be Determined

2. Site Description and Location

Sterling Ranch Filing No. 2 is located in Section 32, Township 12 South, Range 65 West of the 6th Principal Meridian, Section 33, Township 12 South, Range 65 West of the 6th Principal Meridian and Section 4, Township 13 South, Range 65 West of the 6th Principal Meridian within unincorporated El Paso County, Colorado. The site is bound on the west by existing Vollmer Road. The site is bound on the north by the Barbarick Subdivision. The property is bound to the east by the Sterling Ranch Phase 2 and Vollmer Road to the west. The site is bound on the south by Sterling Ranch Road and Marksheffel Road. Sterling Ranch lies within the Sand Creek Drainage Basin. Flows from this site are tributary to Sand Creek.

Site details:

- a. Sterling Ranch Filing No. 2 consists of 49.643 acres and is presently undeveloped. The total disturbed site area is 56.314 acres.
- b. Estimated 100-year runoff coefficients:
 - i. Historic: $C = 0.37$
 - ii. Developed: $C = 0.64$
- c. Soils for this project are classified as Blakeland Loamy Sand (8), Flakeland-Fluvaquentic Haplaquolis (9) and Columbine Gravelly Sandy Loam (19). These soils are characterized as Hydrologic Soil Types "A". Group A soils exhibit high infiltration rates when thoroughly wet, and consist mainly of deep, well drained to excessively drained sands or gravelly sands. Pring Coarse Sandy Loam (71) is characterized as Hydrologic Soil Types "B". Group B soils exhibit moderate infiltration rate when thoroughly wet, and consist primarily of deep, moderately well drained or well drained soils that have moderately fine texture to moderately

coarse texture. Refer to Appendix B for a soils map. Eroded soil may adversely impact downstream drainageways. BMPs will be installed and maintained to mitigate adverse impacts due to soil erosion.

- d. Existing vegetation: Native meadow grasses (approximately 75% coverage), determined using a combination of visual field verification and aerial inspection.
- e. Location and description of potential pollution sources: Potential sources of pollution include: onsite vehicle fueling, portable toilets, temporary stock pile, offsite soil tracking, waste disposal, and concrete washout area. The locations of these sources are shown in the GEC plans in Appendix C or will be determined by the contractor.
- f. Spill prevention and pollution controls for dedicated batch plants: Not applicable for this site since there will be no dedicated batch plants.
- g. Location and description of anticipated non-stormwater components of discharge: There will be a concrete washout area (CWA) where the cleaning of concrete trucks could produce a non-stormwater discharge. Proper installation and maintenance of the CWA will not allow runoff from this area. Another potential source of non-stormwater discharge could be the irrigation of permanent seeding (PS). Irrigation will be kept at a rate so as to not create runoff.
- h. Ultimate receiving waters: Surface drainage from this site will follow historic drainage patterns. The main tributary of the site is Sand Creek. Sand Creek is located east of the site running north to south. Sand Creek is tributary to the Arkansas River.
- i. Streams located within project area: No stream, the main tributary of the site is Sank Creek.

3. Proposed Sequence of Major Activities

The project will follow standard construction sequences for construction, i.e., clearing and grubbing, over excavation, overlot grading, utility installation, street paving, and installation of the EDBs.

The contractor will be responsible for implementing and maintaining the erosion and sediment control measures described in this document and the accompanying design drawings. The contractor may designate these tasks to certain subcontractors as they see fit, but the ultimate responsibility for implementing these controls and their proposed function at each phase of the project remains with the contractor.

The phasing plan is shown on the GEC. The order of major activities (with estimated completion dates) will be as follows:

1. Install VTC and other perimeter soil erosion control measures (September 2020).
2. Clear and rough grade for improvements (September 2020).
3. Excavate and install improvements including underground piping and drainage structures (October 2020).
4. Fine grading (December 2020).
5. Install paving (February 2021).
6. Install landscaping (June 2021).
7. Clean up and final stabilization (September 2021).

4. BMPs for Stormwater Pollution Prevention

See GEC plans in Appendix C for BMP locations and detail sheets.

a. Erosion and Sediment Controls

i. Structural BMPs:

1. Sediment basins (SBs) to collect runoff before it enters receiving waters
2. Silt fence (SF) along downstream limits of disturbed areas to filter sediment from runoff
3. Stabilized staging area (SSA) near site entrance to consolidate construction equipment in a stabilized location
4. Construction marker (CM) to identify limits of construction (LOC)
5. Vehicle tracking control (VTC) at site entrance to prevent sediment from leaving the site via vehicle tires
6. Temporary stock pile (TSP) to consolidate materials such as topsoil in a controlled area bounded by silt fence
7. Erosion control blanket (ECB) placed on any slopes of 3:1 or greater, including the sides of sediment basins
8. Inlet protection (IP) around culvert entrances
9. Outlet protection (OP) at culvert outlets
10. Diversion ditch (DD) to convey runoff to sediment basins
11. Concrete washout area (CWA) to allow a controlled area for concrete trucks to be washed
12. Reinforced rock berm (RRB) in Tributary 6 to slow and filter sediment from runoff
13. Extended Detention Basins (EDBs) to collect and filter runoff before it enters receiving waters

ii. Non-structural BMPs:

1. Mulching (MU) to stabilize soils and promote seed growth
2. Permanent seeding (PS) to stabilize disturbed areas

b. Materials Handling and Spill Prevention

i. General Materials Handling Practices:

1. Potential pollutants shall be stored and used in a manner consistent with the manufacturer's instructions in a secure location. To the extent practical, material storage areas should not be located near storm drain inlets and should be equipped with covers, roofs, or secondary containment as required to prevent storm water from contacting stored materials. Chemicals that are not compatible shall be stored in segregated areas so that spilled materials cannot combine and react.
2. Disposal of materials shall be in accordance with the manufacturer's instructions and applicable local, state, and federal regulations.
3. Materials no longer required for construction shall be removed from the site as soon as possible.
4. Adequate garbage, construction waste, and sanitary waste handling

and disposal facilities shall be provided as necessary to keep the site clear of obstruction and BMPs clear and functional.

ii. Specific Materials Handling Practices

1. All pollutants, including waste materials and demolition debris, that occur onsite during construction shall be handled in a way that does not contaminate storm water.
2. All chemicals including liquid products, petroleum products, water treatment chemicals, and wastes stored onsite shall be covered and protected from vandalism.
3. Maintenance, fueling, and repair of all equipment and vehicles involving oil changes, hydraulic system drain down, degreasing operations, fuel tank drain down and removal, and other activities which may result in the accidental release of contaminants, shall be conducted under cover during wet weather and on an impervious surface to prevent release of contaminants onto the ground. Materials spilled during maintenance operations shall be cleaned up immediately and properly disposed of.
4. Wheel wash water shall be settled and discharged onsite by infiltration.
5. Application of agricultural chemicals, including fertilizers and pesticides, shall be conducted in a manner and at application rates that will not result in loss of chemical to storm water runoff. Follow manufacturer's recommendations for application rates and procedures.
6. pH-modifying sources shall be managed to prevent contamination of runoff and storm water collected onsite. The most common sources of pH-modifying materials are bulk cement, cement kiln dust (CKD), fly ash, new concrete washing and curing waters, waste streams generated from concrete grinding and sawing, exposed aggregate processes, and concrete pumping and mixer washout waters.

iii. Spill Prevention and Response Procedures

1. The primary objective in responding to a spill is to quickly contain the material(s) and prevent or minimize their migration into storm water runoff and conveyance systems. If the release has impacted onsite storm water, it is critical to contain the released materials onsite and prevent their release into receiving waters.
2. Spill Response Procedures:
 - a. Notify site superintendent immediately when a spill, or the threat of a spill, is observed. The superintendent shall assess the situation and determine the appropriate response.
 - b. If spills represent an imminent threat of escaping onsite facilities and entering the receiving waters, site personnel shall respond immediately to contain the release and notify the superintendent after the situation has stabilized.
 - c. The site superintendent, or his/her designee, shall be

- responsible for completing a spill reporting form and for reporting the spill to the appropriate agency.
- d. Spill response equipment shall be inspected and maintained as necessary to replace any materials used in spill response activities.
3. Spill kits shall be on-hand at all fueling sites. Spill kit location(s) shall be reported to the Qualified Stormwater Manager.
 4. Absorbent materials shall be on-hand at all fueling areas for use in containing inadvertent spills. Containers shall be on-hand at all fueling sites for disposal of used absorbents.
 5. Recommended components of spill kits include the following:
 - a. Oil absorbent pads (one bale)
 - b. Oil absorbent booms (40 feet)
 - c. 55-gallon drums (2)
 - d. 9-mil plastic bags (10)
 - e. Personal protective equipment including gloves and goggles
 6. Concrete wash water: unless confined in a pre-defined, bermed containment area, the cleaning of concrete truck delivery chutes is prohibited at the job site.
 7. Notification procedures:
 - a. In the event of an accident or spill, the Qualified Stormwater Manager shall be notified.
 - b. Depending on the nature of the spill material involved, the Colorado Department of Public Health and Environment (24-hour spill reporting line: 887-518-5608), downstream water users, or other agencies may also need to be notified.
 - c. Any spill of oil which 1) violates water quality standards, 2) produces a “sheen” on a surface water, or 3) causes a sludge or emulsion, or any hazardous substance release, or hazardous waste release which exceeds the reportable quantity, must be reported immediately by telephone to the National Response Center Hotline at (800) 424-8802.

5. Final Stabilization and Long-Term Stormwater Management

- a. Permanent seeding will be provided to achieve long-term stabilization of the site.
- b. Seed Mix: Pawnee Buttes Seed Inc. – “Low Grow native Mix” or approved equal.
- c. Seeding Application Rate: Drill seed 0.25” to 0.5” into the soil. In small areas not accessible to a drill, hand broadcast at double the rate and rake 0.25” to 0.5” into the soil. Apply seed at the following rates:
 - i. Dryland: 20-25 lbs/acre
 - ii. Irrigated: 40 lbs/acre
- d. Soil stabilization Practices:
 - i. Mulching Application: Apply 1-1/2 tons of certified weed free hay per acre mechanically crimped into the soil in combination with an organic mulch tackifier. On slopes and ditches requiring a blanket, the blanket

shall be placed in lieu of mulch and mulch tackifier.

- e. Soil Conditioning and Fertilization Requirements:
 - i. Soil conditioner, organic amendment shall be applied to all seeded areas at 3 CY / 1000 SF.
 - ii. Fertilizer shall consist of 90% fungal biomass (mycelium) and 10% potassium-magnesia with a grade of 6-1-3 or approved equal. Fertilizer shall be applied as recommended by seed supplier.
 - iii. Add SOPs for fertilizer application. (i.e., follow label directions when applying, storing, handling, mixing, recycling, and disposing of chemicals and empty containers.
 - iv. Use care to transfer, mix or dispose of chemicals. Never perform these activities near storm drains or drainage areas.
 - v. Have spill cleanup materials available in case of a spill and clean up chemical spills promptly.
 - vi. Always follow the manufacturer's recommendation on handling and applying the chemicals.
 - vii. Chemicals should not be applied right before or during rain storms or while the area is being irrigated.
 - viii. Chemicals should not be applied right before or during high-wind events.
 - ix. Apply only the recommended amounts of chemicals to avoid chemicals being picked up by irrigation or stormwater runoff.
 - x. Be careful not to overspray chemicals onto an impervious surface, such as a sidewalk or roadway. These chemicals will wash into the storm drain inlet during the next rainstorm.
 - xi. Clean up all over-sprayed chemicals.
 - xii. Do not apply landscape chemicals to frozen ground.
 - xiii. Avoid application of chemicals at the water's edge. Maintain a native buffer between treated turf and waterways.)
- f. Final stabilization is reached when all soil-disturbing activities at the site have been completed, and uniform vegetative cover has been established with an individual plan density of at least 70 percent of pre-disturbance levels, or equivalent permanent, physical erosion reduction methods have been employed. This project does not rely on control measures owned or operated by another entity.
- g. → Long term stormwater quality will be provided via the extended detention basin to collect and filter runoff before it enters receiving waters.

Item 26. Add a note stating that this project does not rely on control measures owned or operated by another entity.

6. Inspection and Maintenance

- a. Inspection Schedules:
 - i. The contractor shall inspect BMPs once every 14 days at a minimum, and immediately (within 24 hours) after any precipitation or snowmelt event that causes surface erosion (i.e. that results in storm water running across the ground), to ensure that BMPs are maintained in effective operating condition.
- b. Inspection Procedures:

- i. Site Inspection / Observation Items:
 1. Construction site perimeter and discharge points
 2. All disturbed areas
 3. Areas used for material / waste storage that are exposed to precipitation
 4. Other areas having a significant potential for storm water pollution, such as demolition areas or concrete washout areas, or locations where vehicles enter or leave the site
 5. Erosion and sediment control measures identified in the SWMP
 6. Any other structural BMPs that may require maintenance, such as secondary containment around fuel tanks, or the conditions of spill response kits.
- ii. Inspection Requirements:
 1. Determine if there is any evidence of, or potential for, pollutants entering the receiving waters.
 2. Review BMPs to determine if they still meet design and operational criteria in the SWMP, and if they continue to adequately control pollutants at the site.
 3. Upgrade and/or revise any BMPs not operating in accordance with the SWMP and update the SWMP to reflect any revisions.
- iii. BMP Maintenance / Replacement and Failed BMPs:
 1. The contractor shall remove sediment that has been collected by perimeter controls, such as silt fence and inlet protection, on a regular basis to prevent failure of BMPs, and remove potential of sediment from being discharged from the site in the event of BMP failure.
 2. Removed sediment must be moved to an appropriate location where it will not become an additional pollutant source, and should never be placed in ditches or streams.
 3. The contractor shall update the GEC as required with any new BMPs added during the construction period.
 4. The contractor shall address BMPs that have failed or have the potential to fail without maintenance or modifications, as soon as possible, immediately in most cases, to prevent discharge of pollutants.
- iv. Record Keeping and Documenting Inspections:
 1. The contractor shall maintain records of all inspection reports, including signed inspection logs, at the project site.
 2. The permittee shall document inspection results and maintain a record of the results for a period of 3 years following expiration or inactivation of permit coverage.
 3. Site inspection records shall include the following:
 - a. Inspection date
 - b. Name and title of personnel making the inspection
 - c. Location of discharges of sediment or other pollutants from the site

- d. Location(s) of BMPs in need of maintenance
- e. Location(s) of BMPs that failed to operate as designed or proved inadequate for a particular location
- f. Location(s) where additional BMPs are needed that were not in place at the time of inspection
- g. Deviations from the minimum inspection schedule

APPENDIX A – VICINITY MAP

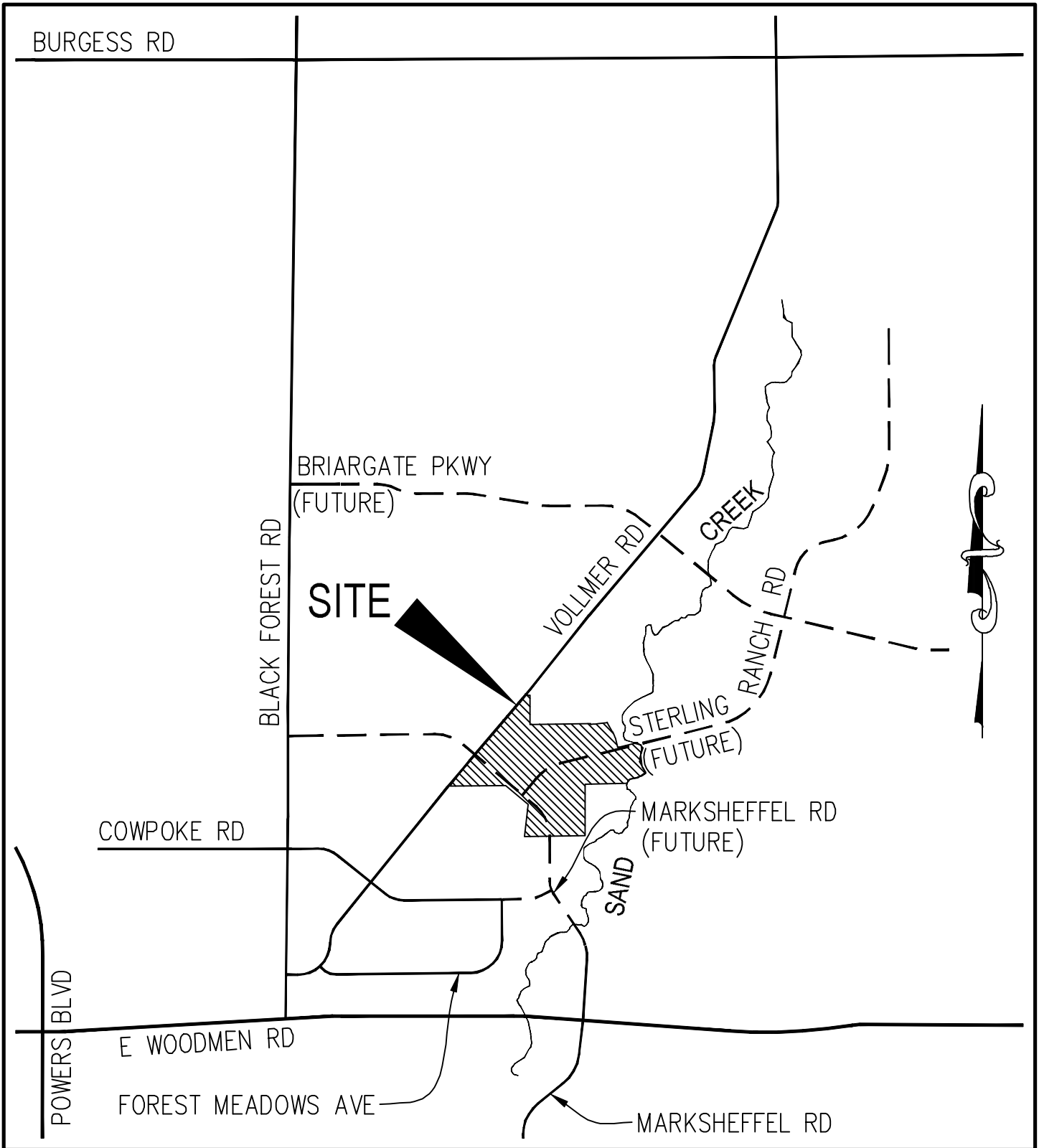

VICINITY MAP

N.T.S.

APPENDIX B – SOILS MAP

Hydrologic Soil Group—El Paso County Area, Colorado

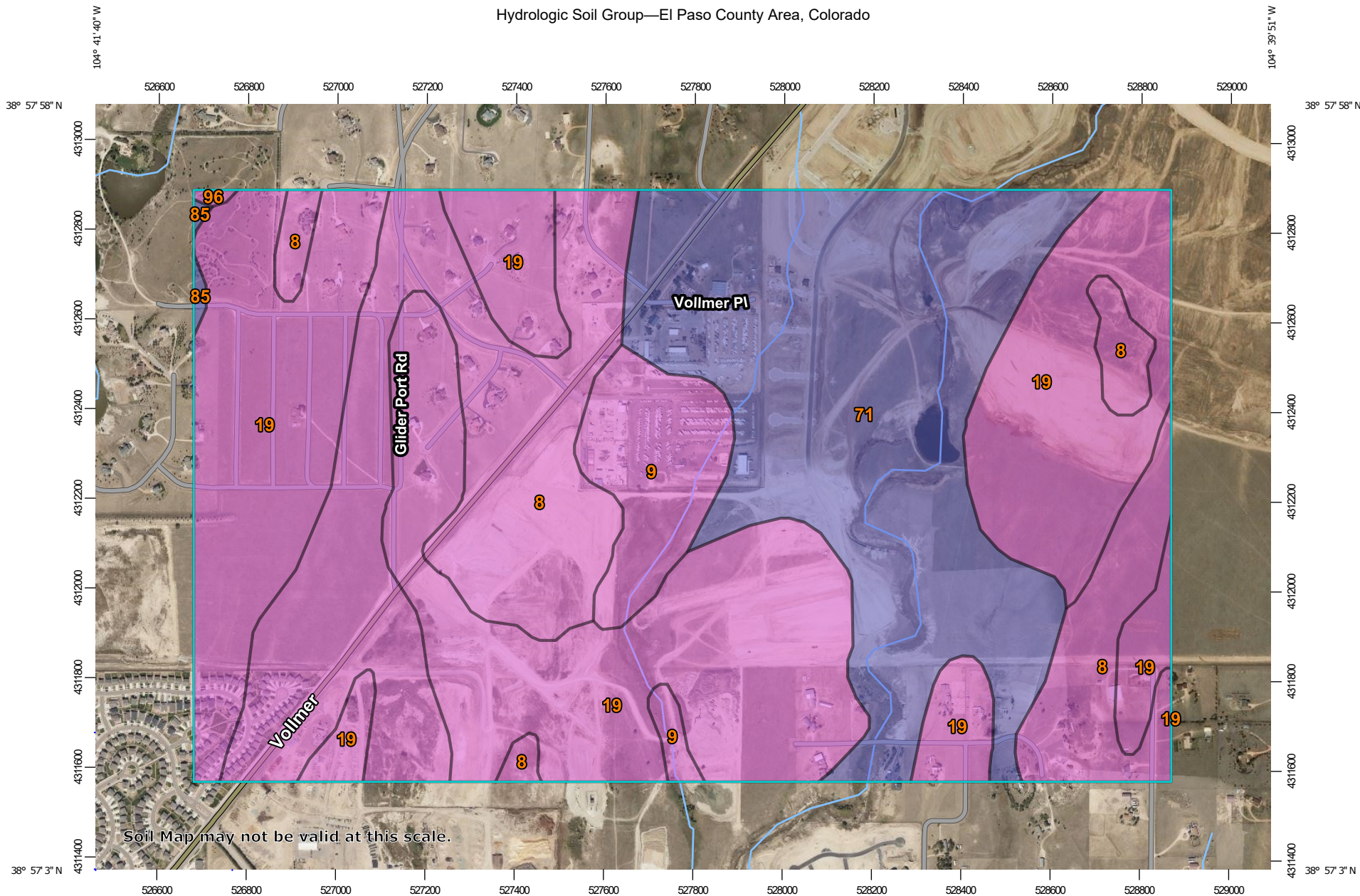

Soil Map may not be valid at this scale.

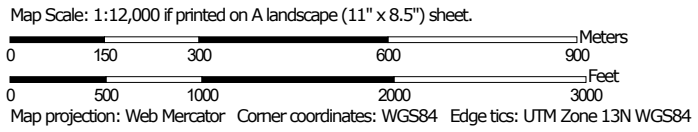

MAP LEGEND

Area of Interest (AOI)









 Area of Interest (AOI)

Soils

Soil Rating Polygons





-  A
-  A/D
-  B
-  B/D
-  C
-  C/D
-  D
-  Not rated or not available

Soil Rating Lines

-  A
-  A/D
-  B
-  B/D
-  C
-  C/D
-  D
-  Not rated or not available

Soil Rating Points





-  A
-  A/D
-  B
-  B/D

-  C
-  C/D
-  D
-  Not rated or not available

Water Features

 Streams and Canals

Transportation

-  Rails
-  Interstate Highways
-  US Routes
-  Major Roads
-  Local Roads

Background

 Aerial Photography

MAP INFORMATION

The soil surveys that comprise your AOI were mapped at 1:24,000.

Warning: Soil Map may not be valid at this scale.

Enlargement of maps beyond the scale of mapping can cause misunderstanding of the detail of mapping and accuracy of soil line placement. The maps do not show the small areas of contrasting soils that could have been shown at a more detailed scale.

Please rely on the bar scale on each map sheet for map measurements.

Source of Map: Natural Resources Conservation Service
 Web Soil Survey URL:
 Coordinate System: Web Mercator (EPSG:3857)

Maps from the Web Soil Survey are based on the Web Mercator projection, which preserves direction and shape but distorts distance and area. A projection that preserves area, such as the Albers equal-area conic projection, should be used if more accurate calculations of distance or area are required.

This product is generated from the USDA-NRCS certified data as of the version date(s) listed below.

Soil Survey Area: El Paso County Area, Colorado
 Survey Area Data: Version 17, Sep 13, 2019

Soil map units are labeled (as space allows) for map scales 1:50,000 or larger.

Date(s) aerial images were photographed: Aug 19, 2018—May 26, 2019

The orthophoto or other base map on which the soil lines were compiled and digitized probably differs from the background imagery displayed on these maps. As a result, some minor shifting of map unit boundaries may be evident.

Hydrologic Soil Group

Map unit symbol	Map unit name	Rating	Acres in AOI	Percent of AOI
8	Blakeland loamy sand, 1 to 9 percent slopes	A	182.3	25.4%
9	Blakeland-Fluvaquentic Haplaquolls	A	36.8	5.1%
19	Columbine gravelly sandy loam, 0 to 3 percent slopes	A	307.5	42.9%
71	Pring coarse sandy loam, 3 to 8 percent slopes	B	188.4	26.3%
85	Stapleton-Bernal sandy loams, 3 to 20 percent slopes	B	1.2	0.2%
96	Truckton sandy loam, 0 to 3 percent slopes	A	0.6	0.1%
Totals for Area of Interest			716.9	100.0%

Description

Hydrologic soil groups are based on estimates of runoff potential. Soils are assigned to one of four groups according to the rate of water infiltration when the soils are not protected by vegetation, are thoroughly wet, and receive precipitation from long-duration storms.

The soils in the United States are assigned to four groups (A, B, C, and D) and three dual classes (A/D, B/D, and C/D). The groups are defined as follows:

Group A. Soils having a high infiltration rate (low runoff potential) when thoroughly wet. These consist mainly of deep, well drained to excessively drained sands or gravelly sands. These soils have a high rate of water transmission.

Group B. Soils having a moderate infiltration rate when thoroughly wet. These consist chiefly of moderately deep or deep, moderately well drained or well drained soils that have moderately fine texture to moderately coarse texture. These soils have a moderate rate of water transmission.

Group C. Soils having a slow infiltration rate when thoroughly wet. These consist chiefly of soils having a layer that impedes the downward movement of water or soils of moderately fine texture or fine texture. These soils have a slow rate of water transmission.

Group D. Soils having a very slow infiltration rate (high runoff potential) when thoroughly wet. These consist chiefly of clays that have a high shrink-swell potential, soils that have a high water table, soils that have a claypan or clay layer at or near the surface, and soils that are shallow over nearly impervious material. These soils have a very slow rate of water transmission.

If a soil is assigned to a dual hydrologic group (A/D, B/D, or C/D), the first letter is for drained areas and the second is for undrained areas. Only the soils that in their natural condition are in group D are assigned to dual classes.

Rating Options

Aggregation Method: Dominant Condition

Component Percent Cutoff: None Specified

Tie-break Rule: Higher

APPENDIX C – GEC PLANS AND DETAILS

STERLING RANCH FILING NO.2

COUNTY OF EL PASO, STATE OF COLORADO

GRADING & EROSION CONTROL PLAN

SEPTEMBER 2020

GRADING AND EROSION CONTROL STANDARD NOTES

- STORMWATER DISCHARGES FROM CONSTRUCTION SITES SHALL NOT CAUSE OR THREATEN TO CAUSE POLLUTION, CONTAMINATION, OR DEGRADATION OF STATE WATERS. ALL WORK AND EARTH DISTURBANCE SHALL BE DONE IN A MANNER THAT MINIMIZES POLLUTION OF ANY ON-SITE OR OFF-SITE WATERS, INCLUDING WETLANDS.
- NOTWITHSTANDING ANYTHING DEPICTED IN THESE PLANS IN WORDS OR GRAPHIC REPRESENTATION, ALL DESIGN AND CONSTRUCTION RELATED TO ROADS, STORM DRAINAGE AND EROSION CONTROL SHALL CONFORM TO THE STANDARDS AND REQUIREMENTS OF THE MOST RECENT VERSION OF THE RELEVANT ADOPTED EL PASO COUNTY STANDARDS, INCLUDING THE LAND DEVELOPMENT CODE, THE ENGINEERING CRITERIA MANUAL, THE DRAINAGE CRITERIA MANUAL, AND THE DRAINAGE CRITERIA MANUAL VOLUME 2. ANY DEVIATIONS FROM REGULATIONS AND STANDARDS MUST BE REQUESTED, AND APPROVED, IN WRITING.
- A SEPARATE STORMWATER MANAGEMENT PLAN (SWMP) FOR THIS PROJECT SHALL BE COMPLETED AND AN EROSION AND STORMWATER QUALITY CONTROL PERMIT (ESQCP) ISSUED PRIOR TO COMMENCING CONSTRUCTION. MANAGEMENT OF THE SWMP DURING CONSTRUCTION IS THE RESPONSIBILITY OF THE DESIGNATED QUALIFIED STORMWATER MANAGER OR CERTIFIED EROSION CONTROL INSPECTOR. THE SWMP SHALL BE LOCATED ON SITE AT ALL TIMES DURING CONSTRUCTION AND SHALL BE KEPT UP TO DATE WITH WORK PROGRESS AND CHANGES IN THE FIELD.
- ONCE THE ESQCP IS APPROVED AND A "NOTICE TO PROCEED" HAS BEEN ISSUED, THE CONTRACTOR MAY INSTALL THE INITIAL STAGE EROSION AND SEDIMENT CONTROL MEASURES AS INDICATED ON THE APPROVED GEC. A PRE-CONSTRUCTION MEETING BETWEEN THE CONTRACTOR, ENGINEER, AND EL PASO COUNTY WILL BE HELD PRIOR TO ANY CONSTRUCTION. IT IS THE RESPONSIBILITY OF THE APPLICANT TO COORDINATE THE MEETING TIME AND PLACE WITH COUNTY STAFF.
- CONTROL MEASURES MUST BE INSTALLED PRIOR TO COMMENCEMENT OF ACTIVITIES THAT COULD CONTRIBUTE POLLUTANTS TO STORMWATER. CONTROL MEASURES FOR ALL SLOPES, CHANNELS, DITCHES, AND DISTURBED LAND AREAS SHALL BE INSTALLED IMMEDIATELY UPON COMPLETION OF THE DISTURBANCE.
- ALL TEMPORARY SEDIMENT AND EROSION CONTROL MEASURES SHALL BE MAINTAINED AND REMAIN IN EFFECTIVE OPERATING CONDITION UNTIL PERMANENT SOIL EROSION CONTROL MEASURES ARE IMPLEMENTED AND FINAL STABILIZATION IS ESTABLISHED. ALL PERSONS ENGAGED IN LAND DISTURBANCE ACTIVITIES SHALL ASSESS THE ADEQUACY OF CONTROL MEASURES AT THE SITE AND IDENTIFY IF CHANGES TO THOSE CONTROL MEASURES ARE NEEDED TO ENSURE THE CONTINUED EFFECTIVE PERFORMANCE OF THE CONTROL MEASURES. ALL CHANGES TO TEMPORARY SEDIMENT AND EROSION CONTROL MEASURES MUST BE INCORPORATED INTO THE STORMWATER MANAGEMENT PLAN.
- TEMPORARY STABILIZATION SHALL BE IMPLEMENTED ON DISTURBED AREAS AND STOCKPILES WHERE GROUND DISTURBING CONSTRUCTION ACTIVITY HAS PERMANENTLY CEASED OR TEMPORARILY CEASED FOR LONGER THAN 14 DAYS.
- FINAL STABILIZATION MUST BE IMPLEMENTED AT ALL APPLICABLE CONSTRUCTION SITES. FINAL STABILIZATION IS ACHIEVED WHEN ALL GROUND DISTURBING ACTIVITIES ARE COMPLETE AND ALL DISTURBED AREAS EITHER HAVE A UNIFORM VEGETATIVE COVER WITH INDIVIDUAL PLANT DENSITY OF 70 PERCENT OF PRE-DISTURBANCE LEVELS ESTABLISHED OR EQUIVALENT PERMANENT ALTERNATIVE STABILIZATION METHOD IS IMPLEMENTED. ALL TEMPORARY SEDIMENT AND EROSION CONTROL MEASURES SHALL BE REMOVED UPON FINAL STABILIZATION AND BEFORE PERMIT CLOSURE.
- ALL PERMANENT STORMWATER MANAGEMENT FACILITIES SHALL BE INSTALLED AS DESIGNED IN THE APPROVED PLANS. ANY PROPOSED CHANGES THAT AFFECT THE DESIGN OR FUNCTION OF PERMANENT STORMWATER MANAGEMENT STRUCTURES MUST BE APPROVED BY THE ECM ADMINISTRATOR PRIOR TO IMPLEMENTATION.
- EARTH DISTURBANCES SHALL BE CONDUCTED IN SUCH A MANNER SO AS TO EFFECTIVELY MINIMIZE ACCELERATED SOIL EROSION AND RESULTING SEDIMENTATION. ALL DISTURBANCES SHALL BE DESIGNED, CONSTRUCTED, AND COMPLETED SO THAT THE EXPOSED AREA OF ANY DISTURBED LAND SHALL BE LIMITED TO THE SHORTEST PRACTICAL PERIOD OF TIME. PRE-EXISTING VEGETATION SHALL BE PROTECTED AND MAINTAINED WITHIN 50 HORIZONTAL FEET OF A WATERS OF THE STATE UNLESS SHOWN TO BE INFEASIBLE AND SPECIFICALLY REQUESTED AND APPROVED.
- COMPACTION OF SOIL MUST BE PREVENTED IN AREAS DESIGNATED FOR INFILTRATION CONTROL MEASURES OR WHERE FINAL STABILIZATION WILL BE ACHIEVED BY VEGETATIVE COVER. AREAS DESIGNATED FOR INFILTRATION CONTROL MEASURES SHALL ALSO BE PROTECTED FROM SEDIMENTATION DURING CONSTRUCTION UNTIL FINAL STABILIZATION IS ACHIEVED. IF COMPACTION PREVENTION IS NOT FEASIBLE DUE TO SITE CONSTRAINTS, ALL AREAS DESIGNATED FOR INFILTRATION AND VEGETATION CONTROL MEASURES MUST BE LOOSENEED PRIOR TO INSTALLATION OF THE CONTROL MEASURE(S).
- ANY TEMPORARY OR PERMANENT FACILITY DESIGNED AND CONSTRUCTED FOR THE CONVEYANCE OF STORMWATER AROUND, THROUGH, OR FROM THE EARTH DISTURBANCE AREA SHALL BE A STABILIZED CONVEYANCE DESIGNED TO MINIMIZE EROSION AND THE DISCHARGE OF SEDIMENT OFF SITE.
- CONCRETE WASH WATER SHALL BE CONTAINED AND DISPOSED OF IN ACCORDANCE WITH THE SWMP. NO WASH WATER SHALL BE DISCHARGED TO OR ALLOWED TO ENTER STATE WATERS, INCLUDING ANY SURFACE OR SUBSURFACE STORM DRAINAGE SYSTEM OR FACILITIES. CONCRETE WASHOUTS SHALL NOT BE LOCATED IN AN AREA WHERE SHALLOW GROUNDWATER MAY BE PRESENT, OR WITHIN 50 FEET OF A SURFACE WATER BODY, CREEK OR STREAM.
- DURING DEWATERING OPERATIONS OF UNCONTAMINATED GROUND WATER MAY BE DISCHARGED ON SITE, BUT SHALL NOT LEAVE THE SITE IN THE FORM OF SURFACE RUNOFF UNLESS AN APPROVED STATE DEWATERING PERMIT IS IN PLACE.
- EROSION CONTROL BLANKETING OR OTHER PROTECTIVE COVERING SHALL BE USED ON SLOPES STEEPER THAN 3:1.
- CONTRACTOR SHALL BE RESPONSIBLE FOR THE REMOVAL OF ALL WASTES FROM THE CONSTRUCTION SITE FOR DISPOSAL IN ACCORDANCE WITH LOCAL AND STATE REGULATORY REQUIREMENTS. NO CONSTRUCTION DEBRIS, TREE SLASH, BUILDING MATERIAL WASTES OR UNUSED BUILDING MATERIALS SHALL BE BURIED, DUMPED, OR DISCHARGED AT THE SITE.
- WASTE MATERIALS SHALL NOT BE TEMPORARILY PLACED OR STORED IN THE STREET, ALLEY, OR OTHER PUBLIC WAY, UNLESS IN ACCORDANCE WITH AN APPROVED TRAFFIC CONTROL PLAN. CONTROL MEASURES MAY BE REQUIRED BY EL PASO COUNTY ENGINEERING IF DEEMED NECESSARY, BASED ON SPECIFIC CONDITIONS AND CIRCUMSTANCES.
- TRACKING OF SOILS AND CONSTRUCTION DEBRIS OFF-SITE SHALL BE MINIMIZED. MATERIALS TRACKED OFF-SITE SHALL BE CLEANED UP AND PROPERLY DISPOSED OF IMMEDIATELY.
- THE OWNER/DEVELOPER SHALL BE RESPONSIBLE FOR THE REMOVAL OF ALL CONSTRUCTION DEBRIS, DIRT, TRASH, ROCK, SEDIMENT, SOIL, AND SAND THAT MAY ACCUMULATE IN ROADS, STORM DRAINS AND OTHER DRAINAGE CONVEYANCE SYSTEMS AND STORMWATER APPURTENANCES AS A RESULT OF SITE DEVELOPMENT.
- THE QUANTITY OF MATERIALS STORED ON THE PROJECT SITE SHALL BE LIMITED, AS MUCH AS PRACTICAL, TO THAT QUANTITY REQUIRED TO PERFORM THE WORK IN AN ORDERLY SEQUENCE. ALL MATERIALS STORED ON-SITE SHALL BE STORED IN A NEAT, ORDERLY MANNER, IN THEIR ORIGINAL CONTAINERS, WITH ORIGINAL MANUFACTURER'S LABELS.
- NO CHEMICAL(S) HAVING THE POTENTIAL TO BE RELEASED IN STORMWATER ARE TO BE STORED OR USED ON-SITE UNLESS PERMISSION FOR THE USE OF SUCH CHEMICAL(S) IS GRANTED IN WRITING BY THE ECM ADMINISTRATOR. IN GRANTING APPROVAL FOR THE USE OF SUCH CHEMICAL(S), SPECIAL CONDITIONS AND MONITORING MAY BE REQUIRED.
- BULK STORAGE OF ALLOWED PETROLEUM PRODUCTS OR OTHER ALLOWED LIQUID CHEMICALS IN EXCESS OF 55 GALLONS SHALL REQUIRE ADEQUATE SECONDARY CONTAINMENT PROTECTION TO CONTAIN ALL SPILLS ON-SITE AND TO PREVENT ANY SPILLED MATERIALS FROM ENTERING STATE WATERS, ANY SURFACE OR SUBSURFACE STORM DRAINAGE SYSTEM OR OTHER FACILITIES.
- NO PERSON SHALL CAUSE THE IMPEDIMENT OF STORMWATER FLOW IN THE CURB AND GUTTER OR DITCH EXCEPT WITH APPROVED SEDIMENT CONTROL MEASURES.
- OWNER/DEVELOPER AND THEIR AGENTS SHALL COMPLY WITH THE "COLORADO WATER QUALITY CONTROL ACT" (TITLE 25, ARTICLE 8, CRS), AND THE "CLEAN WATER ACT" (33 USC 1344), IN ADDITION TO THE REQUIREMENTS OF THE LAND DEVELOPMENT CODE, DCM VOLUME II AND THE ECM APPENDIX I. ALL APPROPRIATE PERMITS MUST BE OBTAINED BY THE CONTRACTOR PRIOR TO CONSTRUCTION (1041, NPDES, FLOODPLAIN, 404, FUGITIVE DUST, ETC.). IN THE EVENT OF CONFLICTS BETWEEN THESE REQUIREMENTS AND OTHER LAWS, RULES, OR REGULATIONS OF OTHER FEDERAL, STATE, LOCAL, OR COUNTY AGENCIES, THE MOST RESTRICTIVE LAWS, RULES, OR REGULATIONS SHALL APPLY.
- ALL CONSTRUCTION TRAFFIC MUST ENTER/EXIT THE SITE ONLY AT APPROVED CONSTRUCTION ACCESS POINTS.
- PRIOR TO CONSTRUCTION THE PERMITEE SHALL VERIFY THE LOCATION OF EXISTING UTILITIES.
- A WATER SOURCE SHALL BE AVAILABLE ON SITE DURING EARTHWORK OPERATIONS AND SHALL BE UTILIZED AS REQUIRED TO MINIMIZE DUST FROM EARTHWORK EQUIPMENT AND WIND.
- THE SOILS REPORT FOR THIS SITE HAS BEEN PREPARED BY ENTECH ENGINEERING INC. ON FEBRUARY 10, 2020 AND SHALL BE CONSIDERED A PART OF THESE PLANS.
- AT LEAST TEN (10) DAYS PRIOR TO THE ANTICIPATED START OF CONSTRUCTION, FOR PROJECTS THAT WILL DISTURB ONE (1) ACRE OR MORE, THE OWNER OR OPERATOR OF CONSTRUCTION ACTIVITY SHALL SUBMIT A PERMIT APPLICATION FOR STORMWATER DISCHARGE TO THE COLORADO DEPARTMENT OF PUBLIC HEALTH AND ENVIRONMENT, WATER QUALITY DIVISION. THE APPLICATION CONTAINS CERTIFICATION OF COMPLETION OF A STORMWATER MANAGEMENT PLAN (SWMP), OF WHICH THIS GRADING AND EROSION CONTROL PLAN MAY BE A PART. FOR INFORMATION OR APPLICATION MATERIALS CONTACT:

COLORADO DEPARTMENT OF PUBLIC HEALTH AND ENVIRONMENT
WATER QUALITY CONTROL DIVISION
WOOD - PERMITS
4300 CHERRY CREEK DRIVE SOUTH
DENVER, CO 80246-1530
ATTN: PERMITS UNIT

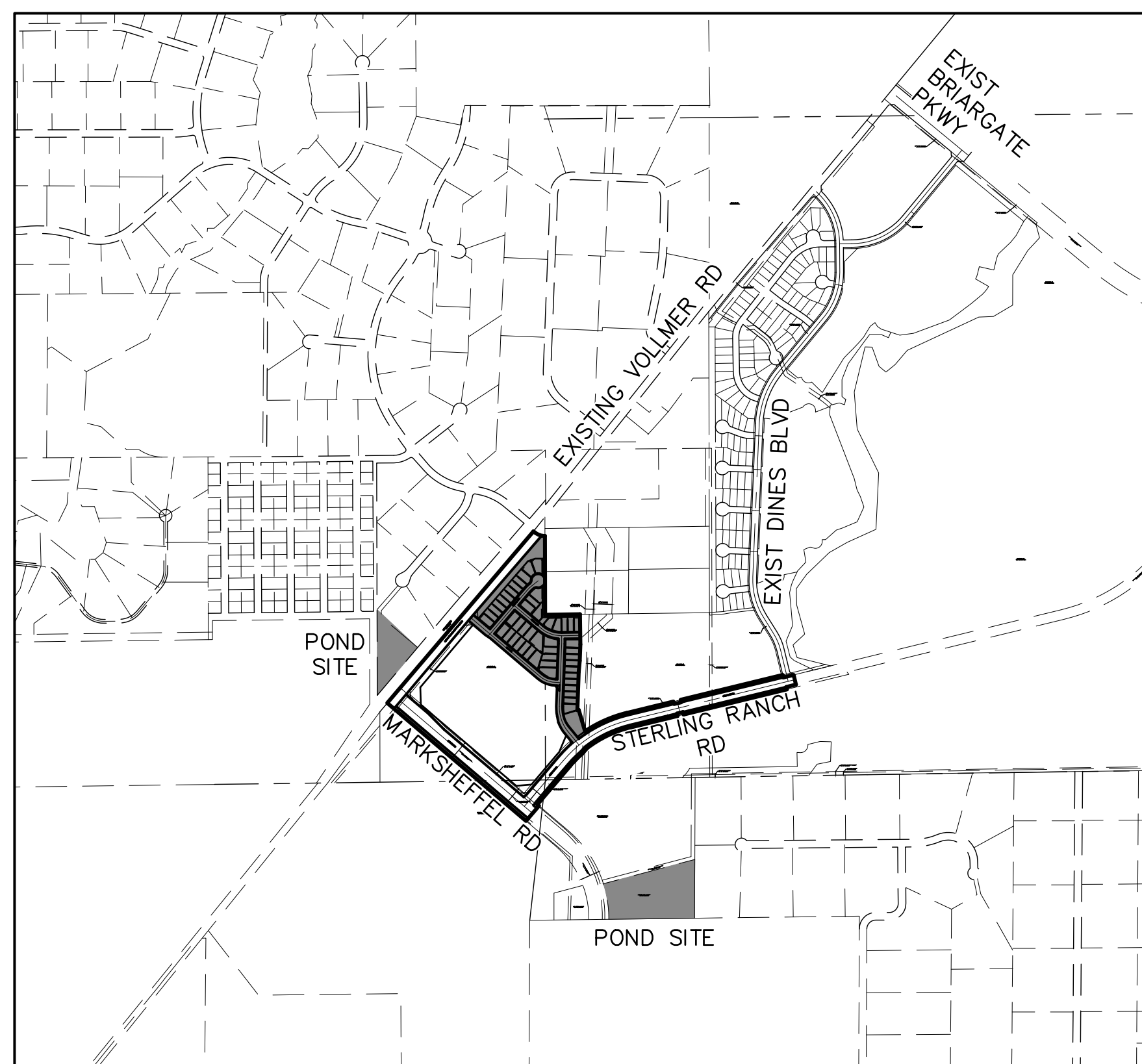

VICINITY MAP
SCALE: 1"=1,000'

SHEET INDEX

- 1 COVER
- 2-6 GRADING & EROSION CONTROL PLAN
- 7-8 DETAIL SHEET

STANDARD NOTES FOR EL PASO COUNTY CONSTRUCTION PLANS

- ALL DRAINAGE AND ROADWAY CONSTRUCTION SHALL MEET THE STANDARDS AND SPECIFICATIONS OF THE CITY OF COLORADO SPRINGS/EL PASO COUNTY DRAINAGE CRITERIA MANUAL, VOLUMES 1 AND 2, AND THE EL PASO COUNTY ENGINEERING CRITERIA MANUAL.
- CONTRACTOR SHALL BE RESPONSIBLE FOR THE NOTIFICATION AND FIELD NOTIFICATION OF ALL EXISTING UTILITIES, WHETHER SHOWN ON THE PLANS OR NOT, BEFORE BEGINNING CONSTRUCTION. LOCATION OF EXISTING UTILITIES SHALL BE VERIFIED BY THE CONTRACTOR PRIOR TO CONSTRUCTION. CALL 811 TO CONTACT THE UTILITY NOTIFICATION CENTER OF COLORADO (UNCC).
- CONTRACTOR SHALL KEEP A COPY OF THESE APPROVED PLANS, THE GRADING AND EROSION CONTROL PLAN, THE STORMWATER MANAGEMENT PLAN (SWMP), THE SOIL AND GEOTECHNICAL REPORT, AND THE APPROPRIATE DESIGN AND CONSTRUCTION STANDARDS AND SPECIFICATIONS AT THE JOB SITE AT ALL TIMES, INCLUDING THE FOLLOWING:
 - 3.1. EL PASO COUNTY ENGINEERING CRITERIA MANUAL (ECM)
 - 3.2. CITY OF COLORADO SPRINGS/ EL PASO COUNTY DRAINAGE CRITERIA MANUAL, VOLUMES 1 AND 2
 - 3.3. COLORADO DEPARTMENT OF TRANSPORTATION (CDOT) STANDARD SPECIFICATIONS AND BRIDGE CONSTRUCTION
 - 3.4. CDOT M&S STANDARDS
- NOTWITHSTANDING ANYTHING DEPICTED IN THESE PLANS IN WORDS OR GRAPHIC REPRESENTATION, ALL DESIGN AND CONSTRUCTION RELATED TO ROADS, STORM DRAINAGE AND EROSION CONTROL SHALL CONFORM TO THE STANDARDS AND REQUIREMENTS OF THE MOST RECENT VERSIONS OF THE RELEVANT ADOPTED EL PASO COUNTY STANDARDS, INCLUDING THE LAND DEVELOPMENT CODE, THE ENGINEERING CRITERIA MANUAL, THE DRAINAGE CRITERIA MANUAL, AND THE DRAINAGE CRITERIA MANUAL VOLUME 2. ANY DEVIATIONS FROM REGULATIONS AND STANDARDS MUST BE REQUESTED, AND APPROVED, IN WRITING. ANY MODIFICATIONS NECESSARY TO MEET CRITERIA AFTER-THE-FACT WILL BE ENTIRELY THE DEVELOPER'S RESPONSIBILITY TO RECTIFY.
- IT IS THE DESIGN ENGINEER'S RESPONSIBILITY TO ACCURATELY SHOW EXISTING CONDITIONS, BOTH ONSITE AND OFFSITE, ON THE CONSTRUCTION PLANS. ANY MODIFICATIONS NECESSARY DUE TO CONFLICTS, OMISSIONS, OR CHANGED CONDITIONS WILL BE ENTIRELY THE DEVELOPER'S RESPONSIBILITY TO RECTIFY.
- CONTRACTOR SHALL SCHEDULE A PRE-CONSTRUCTION MEETING WITH EL PASO COUNTY PLANNING AND COMMUNITY DEVELOPMENT INSPECTIONS, PRIOR TO STARTING CONSTRUCTION.
- IT IS THE CONTRACTOR'S RESPONSIBILITY TO UNDERSTAND THE REQUIREMENTS OF ALL JURISDICTIONAL AGENCIES TO OBTAIN ALL REQUIRED PERMITS, INCLUDING BUT NOT LIMITED TO EL PASO COUNTY EROSION AND STORMWATER QUALITY CONTROL PERMIT (ESQCP), REGIONAL BUILDING FLOODPLAIN DEVELOPMENT PERMIT, U.S. ARMY CORPS OF ENGINEERS-ISSUED 401 AND/OR 404 PERMITS, AND COUNTY AND STATE FUGITIVE DUST PERMITS.
- CONTRACTOR SHALL NOT DEVIATE FROM THE PLANS WITHOUT FIRST OBTAINING WRITTEN APPROVAL FROM THE DESIGN ENGINEER AND PCD. CONTRACTOR SHALL NOTIFY THE DESIGN ENGINEER IMMEDIATELY UPON DISCOVERY OF ANY ERRORS OR INCONSISTENCIES.
- CONTRACTOR SHALL COORDINATE GEOTECHNICAL TESTING PER ECM STANDARDS. PAVEMENT DESIGN SHALL BE APPROVED BY EL PASO COUNTY PCD PRIOR TO PLACEMENT OF CURB AND GUTTER AND PAVEMENT.
- ALL CONSTRUCTION TRAFFIC MUST ENTER/EXIT THE SITE AT APPROVED CONSTRUCTION ACCESS POINTS.
- SIGHT VISIBILITY TRIANGLES ARE IDENTIFIED IN THE PLANS SHALL BE PROVIDED AT ALL INTERSECTIONS. OBSTRUCTIONS GREATER THAN 18 INCHES ABOVE FLOWLINE ARE NOT ALLOWED IN SIGHT TRIANGLES.
- SIGNING AND STRIPING SHALL COMPLY WITH EL PASO COUNTY DEPARTMENT OF PUBLIC WORKS AND MUTCD CRITERIA.
- CONTRACTOR SHALL OBTAIN ANY PERMITS REQUIRED BY EL PASO COUNTY DEPARTMENT OF PUBLIC WORKS, INCLUDING WORK WITHIN THE RIGHT-OF-WAY AND SPECIAL TRANSPORT PERMITS.
- THE LIMITS OF CONSTRUCTION SHALL REMAIN WITHIN THE PROPERTY LINE UNLESS OTHERWISE NOTED. THE OWNER/DEVELOPER SHALL OBTAIN WRITTEN PERMISSION AND EASEMENTS, WHERE REQUIRED, FROM ADJOINING PROPERTY OWNER(S) PRIOR TO ANY OFF-SITE DISTURBANCE, GRADING, OR CONSTRUCTION.

AGENCIES

OWNER/DEVELOPER:	SR LAND, LLC 20 BOULDER CRESCENT, SUITE 201 COLORADO SPRINGS, CO 80903 JAMES F. MORLEY (719) 471-1742
CIVIL ENGINEER:	JR ENGINEERING, LLC 5475 TECH CENTER DRIVE COLORADO SPRINGS, CO 80919 MIKE BRAMLETT P.E. (303) 267-6240
COUNTY ENGINEERING:	EL PASO COUNTY PLANNING AND COMMUNITY DEVELOPMENT 2880 INTERNATIONAL CIRCLE, SUITE 110 COLORADO SPRINGS, CO 80910 JEFF RICE, P.E. (719) 520-6300
TRAFFIC ENGINEERING:	EL PASO COUNTY DEPARTMENT OF PUBLIC WORKS 3275 AKERS DRIVE COLORADO SPRINGS, CO 80922 JENNIFER IRVINE, P.E. (719) 520-6460
WATER RESOURCES:	STERLING RANCH METRO DISTRICT ENGINEERS JDS-HYDRO CONSULTANTS 545 E. PIKES PEAK AVE., SUITE 300 COLORADO SPRINGS, CO 80903 JOHN MCGINN (719) 668-8769
FIRE DISTRICT:	BLACK FOREST FIRE PROTECTION DISTRICT 11445 TEACHOUT ROAD COLORADO SPRINGS, CO 80908 CHIEF BRYAN JACK (719) 495-4300
GAS DEPARTMENT:	COLORADO SPRINGS UTILITIES 7710 DURANT DR. COLORADO SPRINGS, CO 80947 TIM WENDT (719) 668-3556
ELECTRIC DEPARTMENT:	MOUNTAIN VIEW ELECTRIC 11140 E. WOODMEN ROAD FALCON, CO 80831 (719) 495-2283
COMMUNICATIONS:	QWEST COMMUNICATIONS (U.N.C.C. LOCATORS) (800) 922-1987 AT&T (LOCATORS) (719) 635-3674
STORMWATER:	STORMWATER ENTERPRISE 30 S. NEVADA AVENUE, SUITE 401 COLORADO SPRINGS, CO 80903 (719)-385-5980
TRAFFIC:	TRAFFIC AND TRANSPORTATION ENGINEERING 30 S. NEVADA AVE. COLORADO SPRINGS, CO 80903 (719)-385-5908
GAS:	STEPHEN BACON ROW AGENT II COLORADO INTERSTATE GAS CO. (KINDER MORGAN) 2 N. NEVADA AVE. COLORADO SPRINGS, CO 80903 (719)-659-5936
GAS:	CRAIG KERSEY REAL ESTATE MAGELLAN MIDSTREAM PARTNERS, L.P. ONE WILLIAMS CENTER, OTC-8, TULSA, OK 74172 (918)-574-7986

EL PASO COUNTY STATEMENT

COUNTY PLAN REVIEW IS PROVIDED ONLY FOR GENERAL CONFORMANCE WITH COUNTY DESIGN CRITERIA. THE COUNTY IS NOT RESPONSIBLE FOR THE ACCURACY AND ADEQUACY OF THE DESIGN, DIMENSIONS, AND/OR ELEVATIONS WHICH SHALL BE CONFIRMED AT THE JOB SITE. THE COUNTY THROUGH THE APPROVAL OF THIS DOCUMENT ASSUMES NO RESPONSIBILITY FOR COMPLETENESS AND/OR ACCURACY OF THIS DOCUMENT.

FILED IN ACCORDANCE WITH THE REQUIREMENTS OF THE EL PASO COUNTY LAND DEVELOPMENT CODE, DRAINAGE CRITERIA MANUAL, VOLUMES 1 AND 2, AND ENGINEERING CRITERIA MANUAL AS AMENDED.

IN ACCORDANCE WITH ECM SECTION 1.12, THESE CONSTRUCTION DOCUMENTS WILL BE VALID FOR CONSTRUCTION FOR A PERIOD OF 2 YEARS FROM THE DATE SIGNED BY THE EL PASO COUNTY ENGINEER. IF CONSTRUCTION HAS NOT STARTED WITHIN THOSE 2 YEARS, THE PLANS WILL NEED TO BE RESUBMITTED FOR APPROVAL, INCLUDING PAYMENT OF REVIEW FEES AT THE PLANNING AND COMMUNITY DEVELOPMENT DIRECTORS DISCRETION.

JENNIFER IRVINE, P.E. _____ DATE _____
COUNTY ENGINEER/ECM ADMINISTRATOR

OWNER/DEVELOPER STATEMENT

I, THE OWNER/DEVELOPER HAVE READ AND WILL COMPLY WITH THE REQUIREMENTS OF THE GRADING AND EROSION CONTROL PLAN.

JAMES F. MORLEY _____ DATE _____
SR LAND, LLC
20 BOULDER CRESCENT, SUITE 201
COLORADO SPRINGS, CO 80903

ENGINEER'S STATEMENT

THIS GRADING AND EROSION CONTROL PLAN WAS PREPARED UNDER MY DIRECTION AND SUPERVISION AND IS CORRECT TO THE BEST OF MY KNOWLEDGE AND BELIEF. SAID PLAN HAS BEEN PREPARED ACCORDING TO THE CRITERIA ESTABLISHED BY THE COUNTY FOR GRADING AND EROSION CONTROL PLANS. I ACCEPT RESPONSIBILITY FOR ANY LIABILITY CAUSED BY ANY NEGLIGENT ACTS, ERRORS OR OMISSIONS ON MY PART IN PREPARING THIS PLANS.

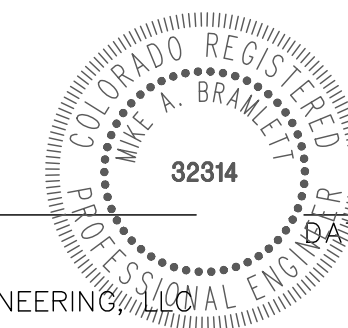

MIKE A. BRAMLETT, P.E.
COLORADO P.E. 32314
FOR AND ON BEHALF OF JR ENGINEERING, LLC



Know what's below.
Call before you dig.

UNTIL SUCH TIME AS THESE DRAWINGS ARE APPROVED BY THE APPROPRIATE REVIEWING AGENCIES, OR ENGINEERING APPROVES THEIR USE, THESE DRAWINGS ARE DESIGNATED BY WRITTEN AUTHORIZATION. PREPARED FOR SR LAND, LLC 20 BOULDER CRESCENT SUITE 201 COLORADO SPRINGS, CO 80903 JAMES F. MORLEY (719) 471-1742	J.R. ENGINEERING A Westman Company Centennial 303-740-9383 • Colorado Springs 719-588-2583 Fort Collins 970-491-9888 • www.jrengineering.com	BY	DATE	REVISION	No.	N/A	N/A	N/A	09/01/20	AUH	AUH
		H-SCALE	V-SCALE	DESIGNED BY	DRAWN BY	CHECKED BY					
STERLING RANCH FILING NO.2 GRADING & EROSION CONTROL PLAN											
SHEET 1 OF 8 JOB NO. 25188.01											

CONSTRUCTION NOTES

NO WETLANDS ARE TO BE PERMANENTLY DISTURBED PER THIS GRADING PLAN.
 NO EARLY GRADING IS TO OCCUR WITHIN THE 100 YEAR FLOODPLAIN.
 ALL TEMPORARY RIPRAP SHOWN ON THE PLANS SHALL BE TYPE "M". RIPRAP SHALL BE PLACED IN THE LOCATIONS INDICATED BY THE PLAN OR IN AREAS AS THE CONTRACTOR SEES FIT TO CONTROL EROSION. ALL RIPRAP SHALL BE PLACED AT A MINIMUM THICKNESS OF 1.5' DEEP.
 ALL TEMPORARY STORM SEWER SHOWN ON PLANS SHALL BE 24" DIA. HP POLYPROPYLENE BY ADS OR APPROVED EQUAL. ALL PIPE SHALL BE LAID TO ACHIEVE A MIN. SLOPE OF 0.5%.

ADDITIONAL NOTES

STAGING AREA TO BE DETERMINED BY CONTRACTOR IN THE FIELD. THE LOCATIONS SHALL BE DELINEATED ON THIS PLAN BY THE CONTRACTOR.
 THE EROSION CONTROL DELINEATED ON THIS PLAN SHALL BE REGULARLY UPDATED BY THE CONTRACTOR.
 EXISTING VEGETATION IS NATIVE MEADOW GRASS (APPROXIMATELY 75% COVERAGE).
 NO ASPHALT OR CONCRETE BATCH PLANTS WILL BE UTILIZED ONSITE.

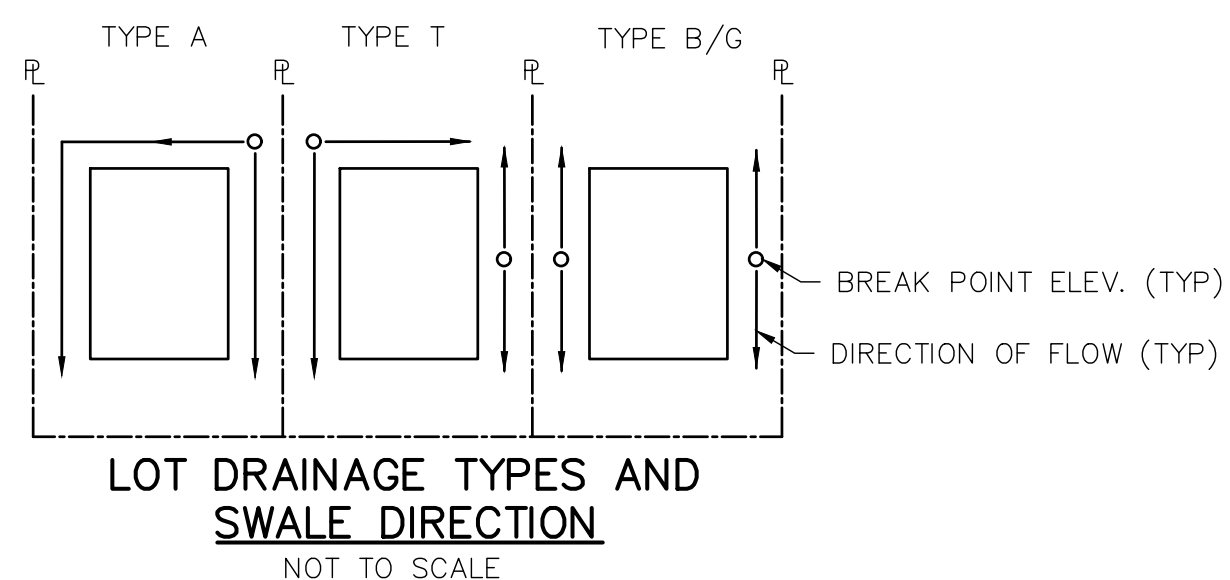

LEGEND

- | | | | |
|---|-----|------------------------------------|--|
| EXISTING STORM SEWER | | INLET | |
| STORM SEWER PROPOSED | | LOW POINT/HIGH POINT | |
| PROPOSED R.O.W | | FLOW DIRECTION & SLOPE | |
| PROPOSED PROPERTY LINES | | FLOW DIRECTION ARROW | |
| PROPOSED SIDEWALK | | EXISTING FLOW DIRECTION ARROW | |
| EXISTING PROPERTY LINE | | EMERGENCY OVERFLOW DIRECTION | |
| ROW EXISTING | | CONCRETE WASHOUT AREA (INITIAL) | |
| FL EXISTING | | INLET PROTECTION (INITIAL/INTERIM) | |
| SIDEWALK EXISTING | | TEMPORARY SEDIMENT BASIN (INITIAL) | |
| EASEMENT | | SILT FENCE (INITIAL) | |
| SILT FENCE | | VEHICLE TRACKING CONTROL (INITIAL) | |
| EXISTING MAJOR CONTOUR | | STAGE STABILIZED AREA (INITIAL) | |
| EXISTING MINOR CONTOUR | | LIMITS OF DISTURBANCE | |
| PROPOSED MAJOR CONTOUR | | CURB SOCK (INITIAL/INTERIM) | |
| PROPOSED MINOR CONTOUR | | CONSTRUCTION FENCE (INITIAL) | |
| FLING BOUNDARY LINE | | TEMPORARY SEEDING (FINAL) | |
| LIMITS OF DISTURBANCE/CONSTRUCTION BOUNDARY | | PERMANENT SEEDING (FINAL) | |
| CURB & GUTTER FLOW LINE | | CHECK DAM (INTERIM/FINAL) | |
| SWALE | | | |
| CUT/FILL LINE | | | |
| CONSTRUCTION FENCE | | | |
| WETLANDS | | | |
| TYPE A LOT | A | | |
| TYPE B LOT | B | | |
| TYPE G LOT | G | | |
| TYPE G LOT | W/O | | |
| TRANSITION LOT | T | | |

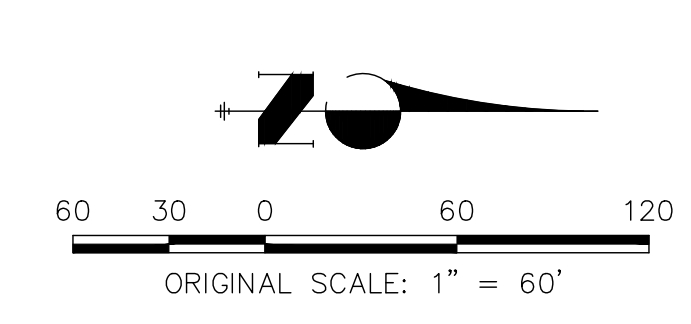
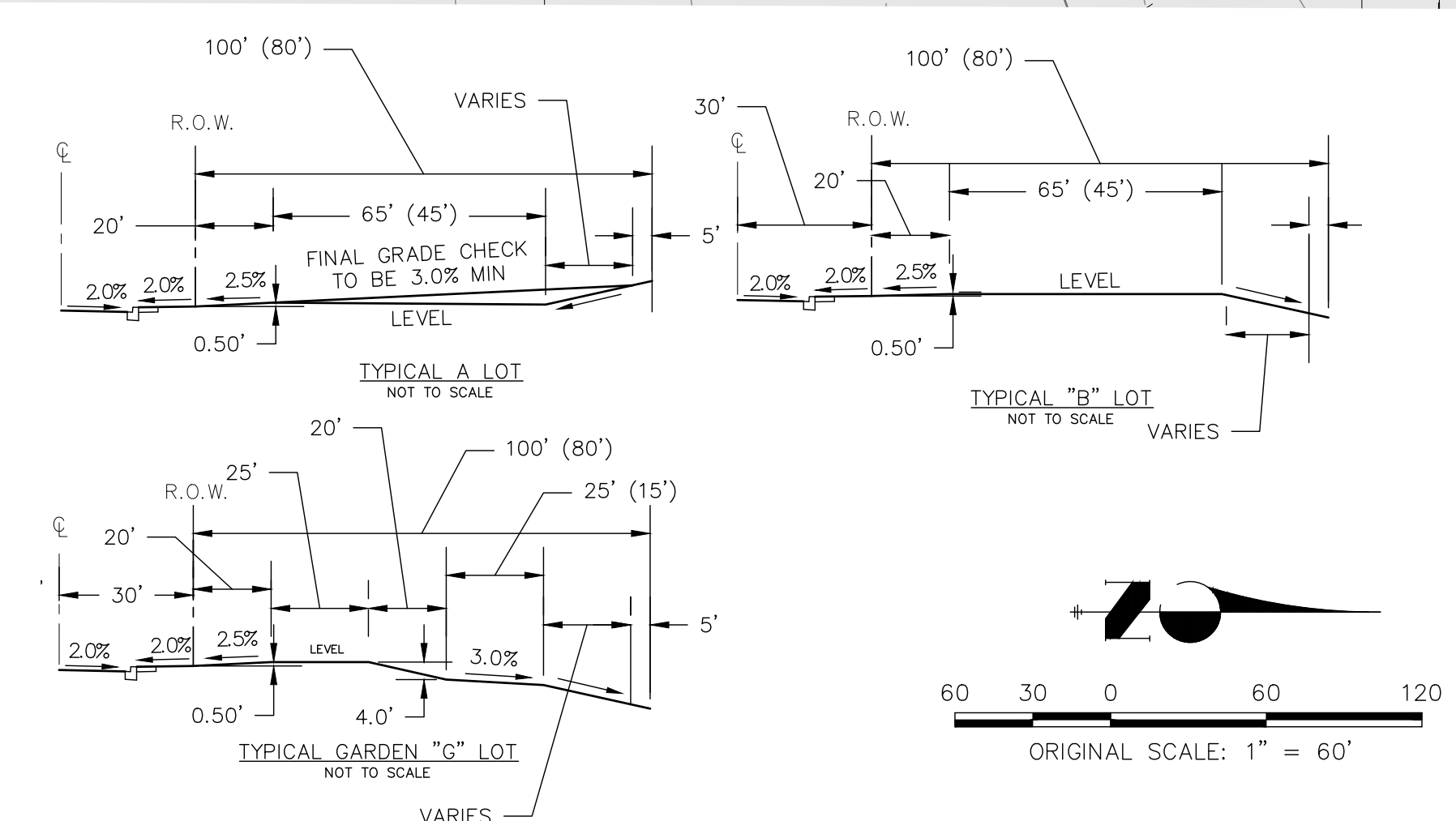
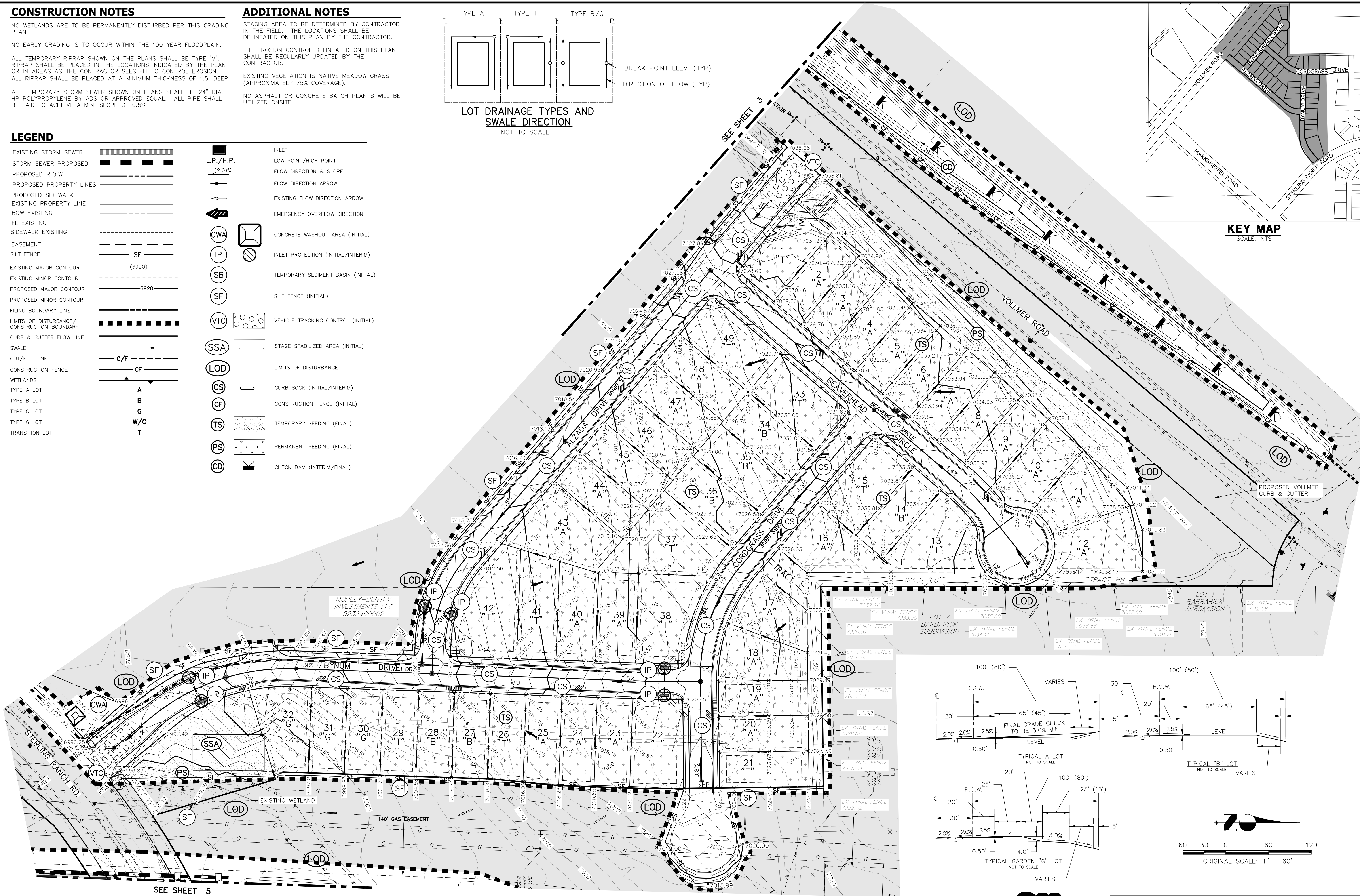
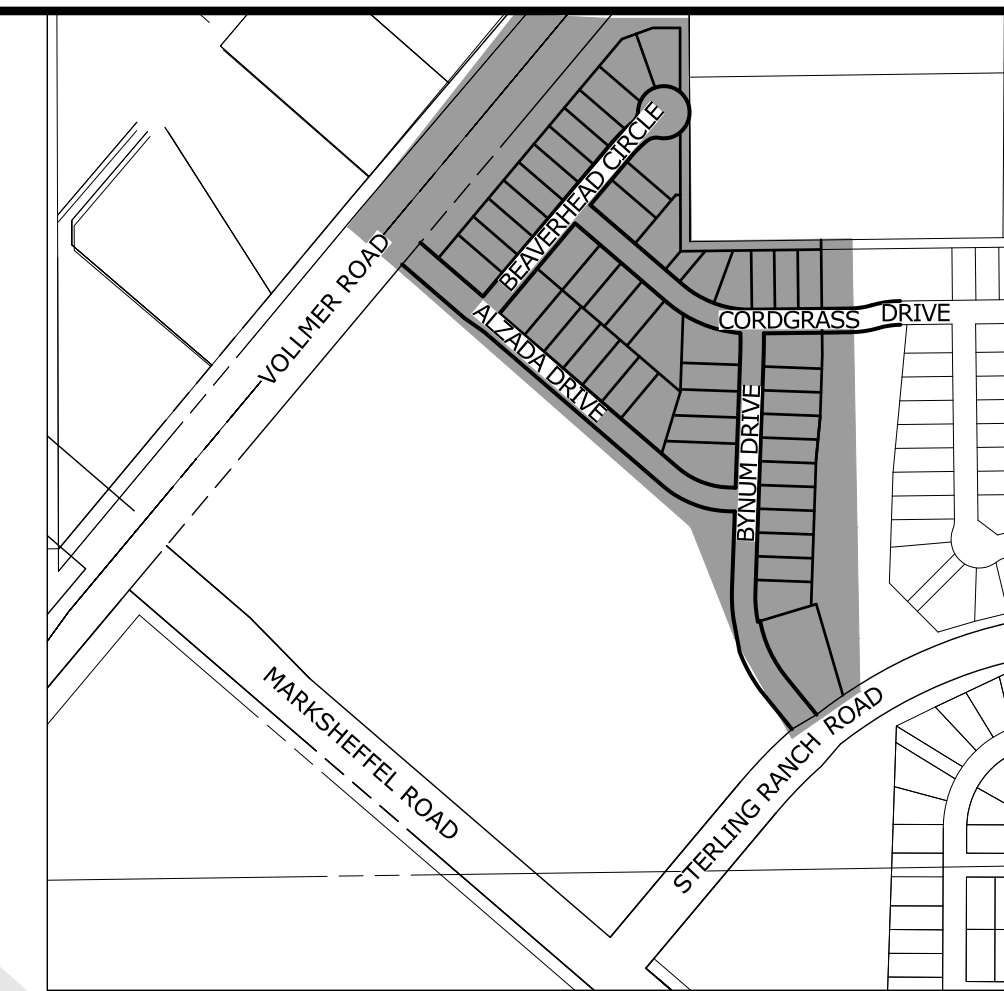

ENGINEER'S STATEMENT

PREPARED UNDER MY DIRECT SUPERVISION AND ON BEHALF OF JR ENGINEERING
 MIKE A. BRAMLETT, P.E.
 COLORADO P.E. 32314
 FOR AND ON BEHALF OF JR ENGINEERING

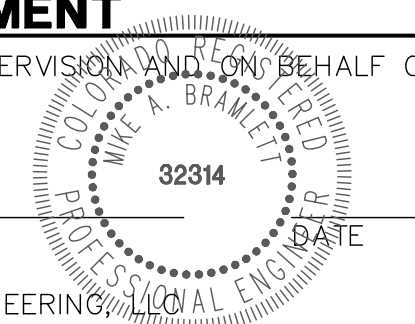

PREPARED FOR SR LAND, LLC 20 BOULDER CRESCENT SUITE 201 COLORADO SPRINGS, CO 80903 JAMES F. MORLEY (719) 471-1742	UNTIL SUCH TIME AS THESE DRAWINGS ARE APPROVED BY THE APPROPRIATE REVIEWING AGENCIES, JR ENGINEERING APPROVES THEIR USE. DESIGNATED BY WRITTEN AUTHORIZATION.
BY DATE	No. REVISION
H-SCALE 1"=60' V-SCALE N/A DATE 09/01/20 DESIGNED BY XXX DRAWN BY XXX CHECKED BY	STERLING RANCH FILING NO.2 GRADING & EROSION CONTROL PLAN SHEET 2 OF 8 JOB NO. 25188.01

CONSTRUCTION NOTES

NO WETLANDS ARE TO BE PERMANENTLY DISTURBED PER THIS GRADING PLAN.

NO EARLY GRADING IS TO OCCUR WITHIN THE 100 YEAR FLOODPLAIN.

ALL TEMPORARY RIPRAP SHOWN ON THE PLANS SHALL BE TYPE 'M'. RIPRAP SHALL BE PLACED IN THE LOCATIONS INDICATED BY THE PLAN OR IN AREAS AS THE CONTRACTOR SEES FIT TO CONTROL EROSION. ALL RIPRAP SHALL BE PLACED AT A MINIMUM THICKNESS OF 1.5' DEEP.

ALL TEMPORARY STORM SEWER SHOWN ON PLANS SHALL BE 24" DIA. HP POLYPROPYLENE BY ADS OR APPROVED EQUAL. ALL PIPE SHALL BE LAID TO ACHIEVE A MIN. SLOPE OF 0.5%.

ADDITIONAL NOTES

STAGING AREA TO BE DETERMINED BY CONTRACTOR IN THE FIELD. THE LOCATIONS SHALL BE DELINEATED ON THIS PLAN BY THE CONTRACTOR.

THE EROSION CONTROL DELINEATED ON THIS PLAN SHALL BE REGULARLY UPDATED BY THE CONTRACTOR.

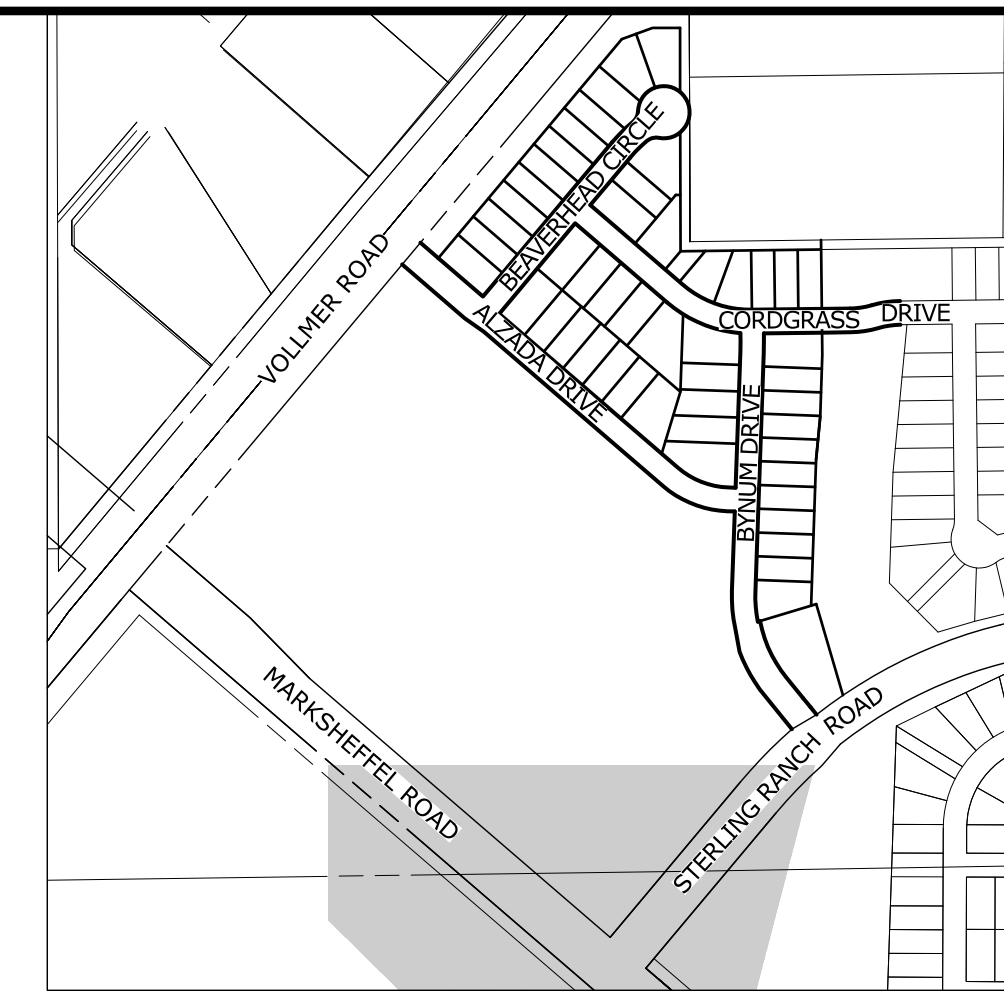
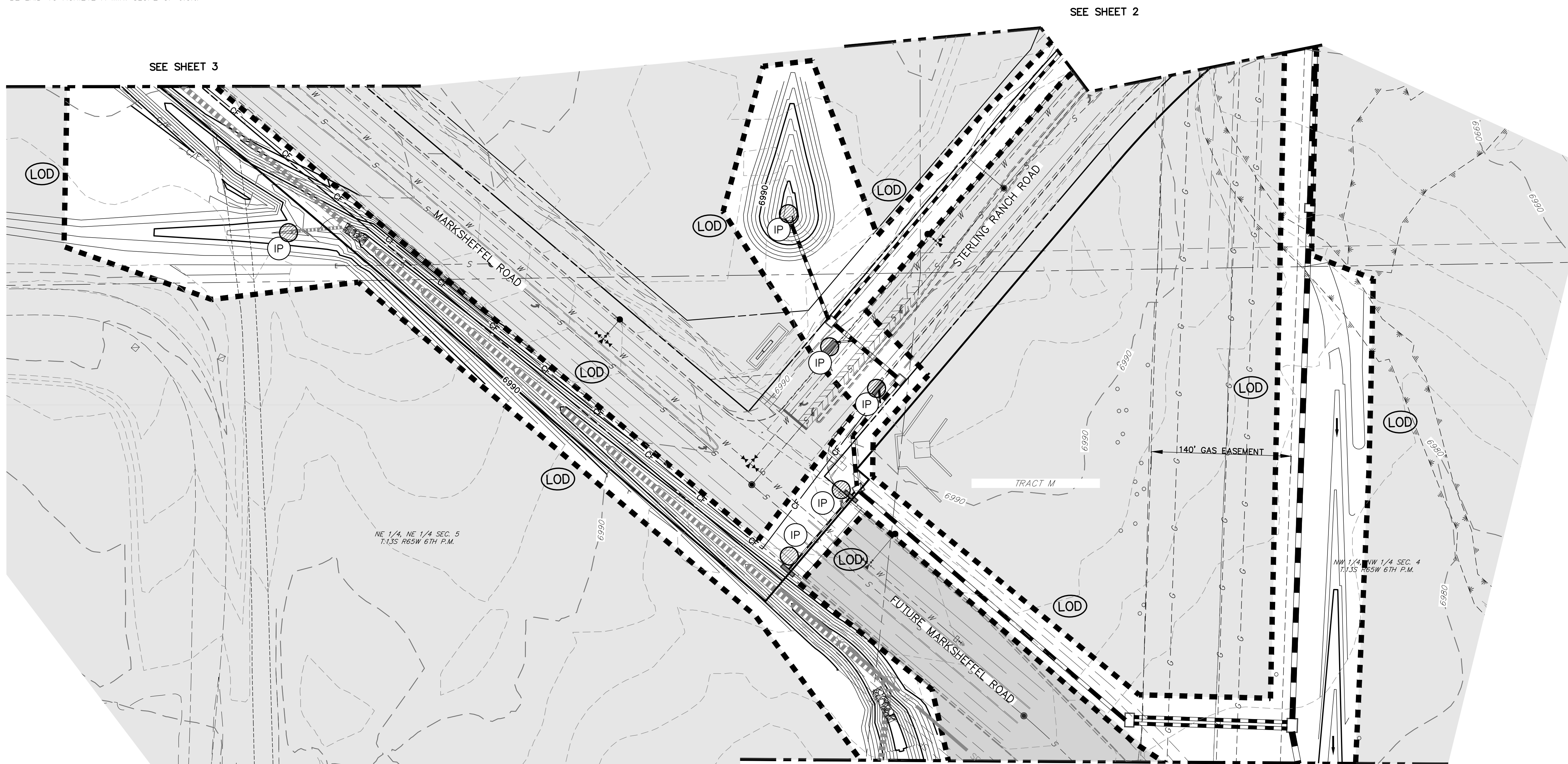

KEY MAP
SCALE: NTS

LEGEND

EXISTING STORM SEWER		INLET		PERMANENT SEEDING (FINAL)	
STORM SEWER PROPOSED		L.P./H.P.		CHECK DAM (INTERIM/FINAL)	
PROPOSED R.O.W		LOW POINT/HIGH POINT			
PROPOSED PROPERTY LINES		FLOW DIRECTION & SLOPE			
PROPOSED SIDEWALK		FLOW DIRECTION ARROW			
EXISTING PROPERTY LINE		EXISTING FLOW DIRECTION ARROW			
ROW EXISTING		EMERGENCY OVERFLOW DIRECTION			
FL EXISTING		CONCRETE WASHOUT AREA (INITIAL)			
SIDEWALK EXISTING		INLET PROTECTION (INITIAL/INTERIM)			
EASEMENT		TEMPORARY SEDIMENT BASIN (INITIAL)			
SILT FENCE		SILT FENCE (INITIAL)			
EXISTING MAJOR CONTOUR		VEHICLE TRACKING CONTROL (INITIAL)			
EXISTING MINOR CONTOUR		STAGE STABILIZED AREA (INITIAL)			
PROPOSED MAJOR CONTOUR		LIMITS OF DISTURBANCE			
PROPOSED MINOR CONTOUR		CURB SOCK (INITIAL/INTERIM)			
FILING BOUNDARY LINE		CONSTRUCTION FENCE (INITIAL)			
LIMITS OF DISTURBANCE/CONSTRUCTION BOUNDARY		TEMPORARY SEEDING (FINAL)			
CURB & GUTTER FLOW LINE					
SWALE					
CUT/FILL LINE					
CONSTRUCTION FENCE					
WETLANDS					
TYPE A LOT	A				
TYPE B LOT	B				
TYPE G LOT	G				
TYPE G LOT	G				
TYPE G LOT	W/O				
TRANSITION LOT	T				



ENGINEER'S STATEMENT
 PREPARED UNDER MY DIRECT SUPERVISION AND ON BEHALF OF JR ENGINEERING
 MIKE A. BRAMLETT, P.E.
 COLORADO P.E. 32314
 FOR AND ON BEHALF OF JR ENGINEERING, INC. LOCAL ENGINEER

PREPARED FOR
SR LAND, LLC
 20 BOULDER CRESCENT
 SUITE 201
 COLORADO SPRINGS, CO 80903
 JAMES F. MORLEY
 (719) 471-1742

J.R. ENGINEERING
 A Westman Company
 Centennial 303-740-9888 • Colorado Springs 719-583-2583
 Fort Collins 970-491-9888 • www.jrengineering.com

BY	DATE	No.	REVISION

H-SCALE	1"=60'
V-SCALE	N/A
DATE	09/01/20
DESIGNED BY	XXX
DRAWN BY	XXX
CHECKED BY	

STERLING RANCH FILING NO.2
GRADING & EROSION CONTROL PLAN
 SHEET 4 OF 8
 JOB NO. 25188.01

I:\info\02\proj\02\0000_00\2118801\Drawings\shelved\dwg\sterling_ranch_filing_2_cad\grading\plans\GR01.dwg, GR03, 09/20/20 1:46:56 PM, PC

CONSTRUCTION NOTES

NO WETLANDS ARE TO BE PERMANENTLY DISTURBED PER THIS GRADING PLAN.
 NO EARLY GRADING IS TO OCCUR WITHIN THE 100 YEAR FLOODPLAIN.
 ALL TEMPORARY RIPRAP SHOWN ON THE PLANS SHALL BE TYPE 'M'. RIPRAP SHALL BE PLACED IN THE LOCATIONS INDICATED BY THE PLAN OR IN AREAS AS THE CONTRACTOR SEES FIT TO CONTROL EROSION. ALL RIPRAP SHALL BE PLACED AT A MINIMUM THICKNESS OF 1.5' DEEP.
 ALL TEMPORARY STORM SEWER SHOWN ON PLANS SHALL BE 24" DIA. HP POLYPROPYLENE BY ADS OR APPROVED EQUAL. ALL PIPE SHALL BE LAID TO ACHIEVE A MIN. SLOPE OF 0.5%.

ADDITIONAL NOTES

STAGING AREA TO BE DETERMINED BY CONTRACTOR IN THE FIELD. THE LOCATIONS SHALL BE DELINEATED ON THIS PLAN BY THE CONTRACTOR.
 THE EROSION CONTROL DELINEATED ON THIS PLAN SHALL BE REGULARLY UPDATED BY THE CONTRACTOR.

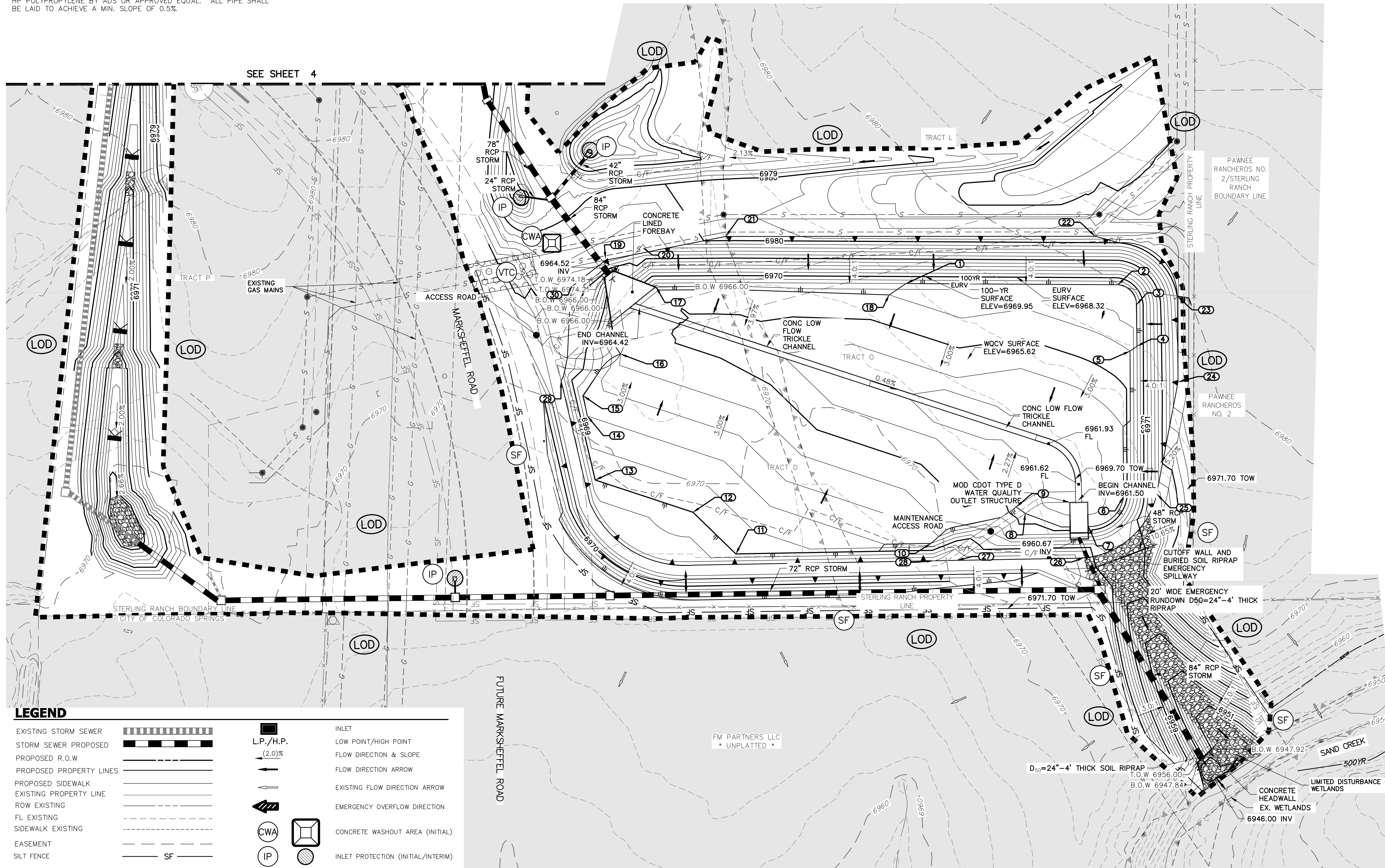

SEE SHEET 4

KEY MAP
SCALE: NTS

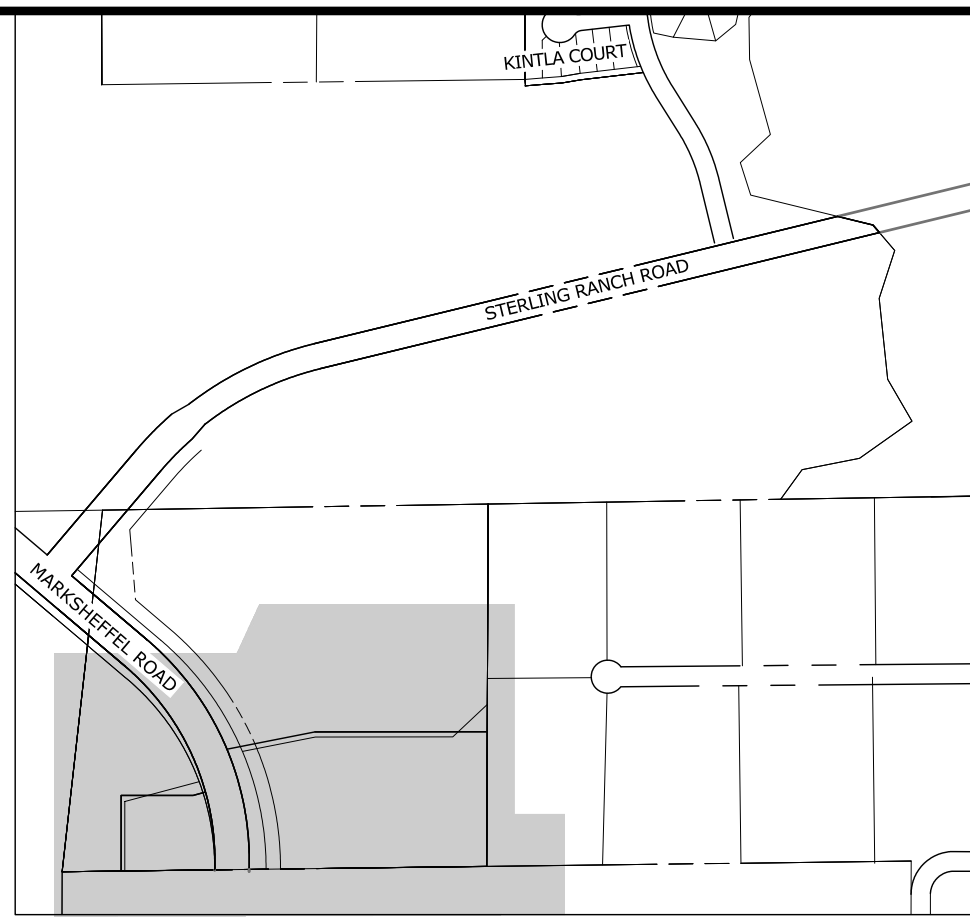

POINT TABULATION			
ID NO.	DESCRIPTION	NORTHING/EASTING	ELEVATION
1	GR - TOE	N: 409330.59 E: 234719.59	6968.00
2	GR - TOE	N: 409329.24 E: 234962.15	6968.01
3	GR - TOE	N: 409306.19 E: 234983.29	6967.98
4	GR - TOE	N: 409258.87 E: 234984.05	6968.01
5	GR - TOE	N: 409253.26 E: 234976.07	6966.00
6	GR - TOE	N: 409086.75 E: 234968.77	6964.00
7	GR - TOE	N: 409052.41 E: 234928.44	6964.00
8	GR - TOE	N: 409067.42 E: 234856.19	6964.00
9	GR - TOE	N: 409074.88 E: 234845.86	6964.00
10	GR - TOE	N: 409033.16 E: 234748.21	6968.00
11	GR - TOE	N: 409021.08 E: 234524.79	6970.00
12	GR - TOE	N: 409068.77 E: 234475.75	6970.00
13	GR - TOE	N: 409105.73 E: 234363.76	6970.00
14	GR - TOE	N: 409178.88 E: 234354.80	6968.00
15	GR - TOE	N: 409202.09 E: 234350.11	6967.97
16	GR - TOE	N: 409249.98 E: 234392.72	6966.00
17	GR - TOE	N: 409326.72 E: 234433.40	6966.32
18	GR - TOE	N: 409317.60 E: 234700.23	6966.00
19	GR - TOP	N: 409359.23 E: 234375.39	6977.61
20	GR - TOP	N: 409370.91 E: 234419.36	6976.90
21	GR - TOP	N: 409384.53 E: 234513.21	6980.23
22	GR - TOP	N: 409384.74 E: 234936.25	6981.82
23	GR - TOP	N: 409316.18 E: 235030.15	6980.00
24	GR - TOP	N: 409217.86 E: 235030.90	6978.46
25	GR - TOP	N: 409089.67 E: 235006.64	6972.60
26	GR - TOP	N: 409016.69 E: 234923.18	6971.08
27	GR - TOP	N: 409013.69 E: 234777.86	6972.00
28	GR - TOP	N: 409013.21 E: 234750.66	6972.00
29	GR - TOP	N: 409219.16 E: 234324.80	6972.25
30	GR - TOP	N: 409326.96 E: 234336.70	6976.41

LEGEND

EXISTING STORM SEWER	[Symbol]	INLET	[Symbol]
STORM SEWER PROPOSED	[Symbol]	LOW POINT/HIGH POINT	[Symbol]
PROPOSED R.O.W	[Symbol]	FLOW DIRECTION & SLOPE	[Symbol]
PROPOSED PROPERTY LINES	[Symbol]	FLOW DIRECTION & SLOPE	[Symbol]
PROPOSED SIDEWALK	[Symbol]	EXISTING FLOW DIRECTION ARROW	[Symbol]
EXISTING PROPERTY LINE	[Symbol]	EMERGENCY OVERFLOW DIRECTION	[Symbol]
ROW EXISTING	[Symbol]	CONCRETE WASHOUT AREA (INITIAL)	[Symbol]
FL EXISTING	[Symbol]	INLET PROTECTION (INITIAL/INTERIM)	[Symbol]
SIDEWALK EXISTING	[Symbol]	TEMPORARY SEDIMENT BASIN (INITIAL)	[Symbol]
EASEMENT	[Symbol]	SILT FENCE (INITIAL)	[Symbol]
SILT FENCE	[Symbol]	PERMANENT SEEDING (FINAL)	[Symbol]
EXISTING MAJOR CONTOUR	[Symbol]	CHECK DAM (INTERIM/FINAL)	[Symbol]
EXISTING MINOR CONTOUR	[Symbol]		
PROPOSED MAJOR CONTOUR	[Symbol]	VEHICLE TRACKING CONTROL (INITIAL)	[Symbol]
PROPOSED MINOR CONTOUR	[Symbol]	STAGE STABILIZED AREA (INITIAL)	[Symbol]
FILING BOUNDARY LINE	[Symbol]	LIMITS OF DISTURBANCE	[Symbol]
LIMITS OF DISTURBANCE/ CONSTRUCTION BOUNDARY	[Symbol]	CURB SOCK (INITIAL/INTERIM)	[Symbol]
CURB & GUTTER FLOW LINE	[Symbol]	CONSTRUCTION FENCE (INITIAL)	[Symbol]
SWALE	[Symbol]	TEMPORARY SEEDING (FINAL)	[Symbol]
CUT/FILL LINE	[Symbol]		
CONSTRUCTION FENCE	[Symbol]		
WETLANDS	[Symbol]		
TYPE A LOT	[Symbol]		
TYPE B LOT	[Symbol]		
TYPE G LOT	[Symbol]		
TYPE G LOT	[Symbol]		

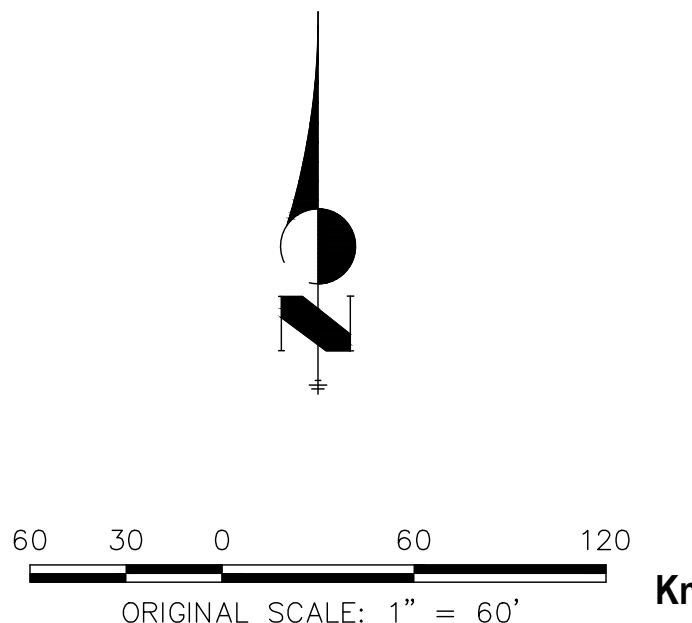

811
Know what's below.
Call before you dig.

ENGINEER'S STATEMENT

PREPARED UNDER MY DIRECT SUPERVISION AND ON BEHALF OF JR ENGINEERING
 MIKE A. BRAMLETT, P.E.
 COLORADO P.E. 32314
 FOR AND ON BEHALF OF JR ENGINEERING, P.C.
 DATE

PREPARED FOR
SR LAND, LLC
 20 BOULDER CRESCENT
 SUITE 201
 COLORADO SPRINGS, CO 80903
 JAMES F. MORLEY
 (719) 471-1742

J.R. ENGINEERING
 A Westman Company
 Central 303-740-0888 • Colorado Springs 719-588-2693
 Fort Collins 970-491-9888 • www.jrengineering.com

UNTIL SUCH TIME AS THESE DRAWINGS ARE APPROVED BY THE APPROPRIATE REVIEWING AGENCIES, JR ENGINEERING APPROVES THEIR USES DESIGNATED BY WRITTEN AUTHORIZATION.

STERLING RANCH FILING NO. 2
GRADING & EROSION CONTROL PLAN

H-SCALE	1" = 60'
V-SCALE	N/A
DATE	09/01/20
DESIGNED BY	XXX
DRAWN BY	XXX
CHECKED BY	

SHEET 6 OF 8
 JOB NO. 25188.01

Silt Fence (SF)

SC-1

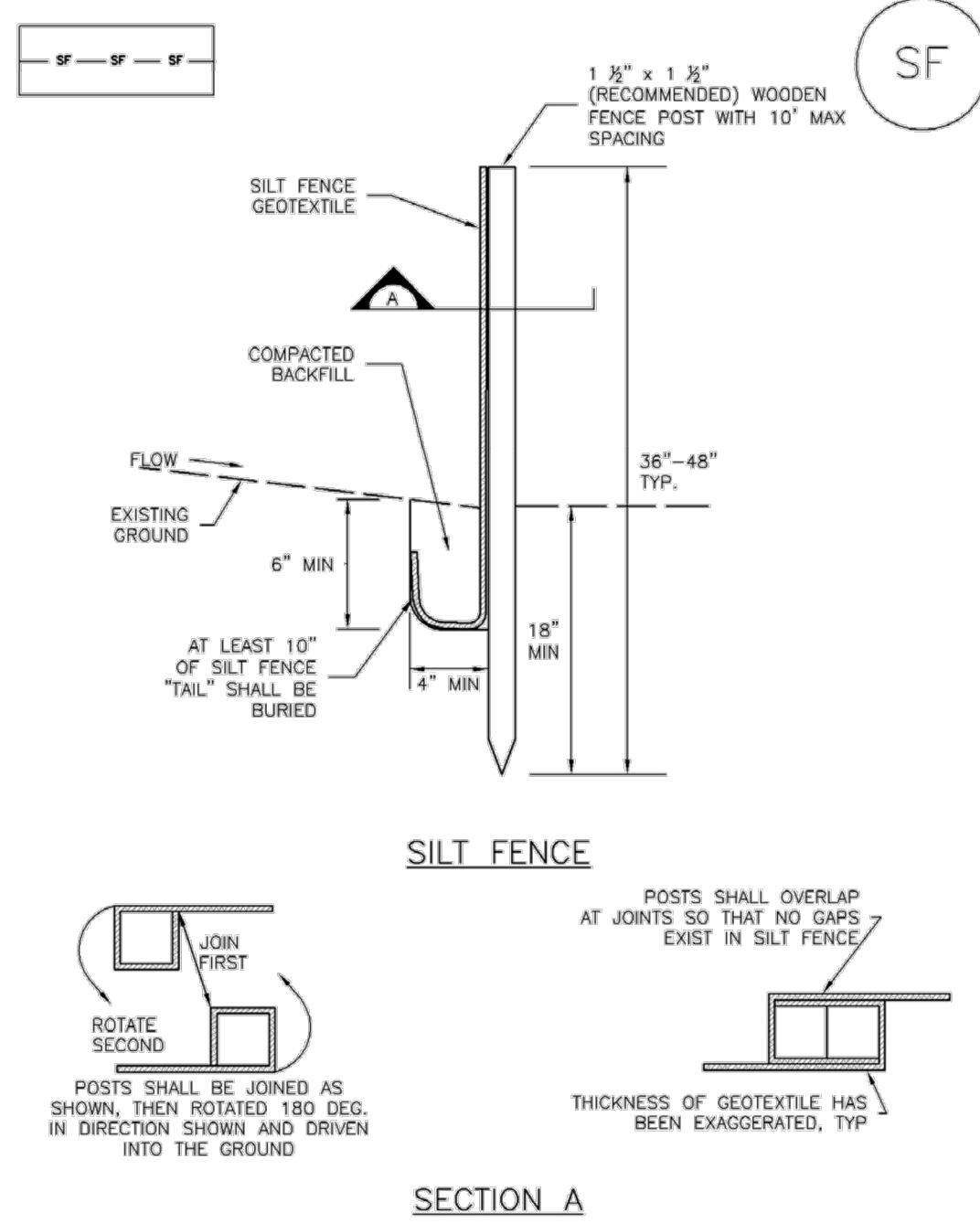

SILT FENCE

SECTION A

SF-1. SILT FENCE

November 2010 Urban Drainage and Flood Control District Urban Storm Drainage Criteria Manual Volume 3 SF-3

SC-1

Silt Fence (SF)

SILT FENCE INSTALLATION NOTES

- SILT FENCE MUST BE PLACED AWAY FROM THE TOE OF THE SLOPE TO ALLOW FOR WATER PONDING. SILT FENCE AT THE TOE OF A SLOPE SHOULD BE INSTALLED IN A FLAT LOCATION AT LEAST SEVERAL FEET (2-5 FT) FROM THE TOE OF THE SLOPE TO ALLOW ROOM FOR PONDING AND DEPOSITION.
- A UNIFORM 6" X 4" ANCHOR TRENCH SHALL BE EXCAVATED USING TRENCHER OR SILT FENCE INSTALLATION DEVICE. NO ROAD GRADERS, BACKHOES, OR SIMILAR EQUIPMENT SHALL BE USED.
- COMPACT ANCHOR TRENCH BY HAND WITH A "JUMPING JACK" OR BY WHEEL ROLLING. COMPACTATION SHALL BE SUCH THAT SILT FENCE RESISTS BEING PULLED OUT OF ANCHOR TRENCH BY HAND.
- SILT FENCE SHALL BE PULLED TIGHT AS IT IS ANCHORED TO THE STAKES. THERE SHOULD BE NO NOTICEABLE GAPS BETWEEN STAKES AFTER IT HAS BEEN ANCHORED TO THE STAKES.
- SILT FENCE FABRIC SHALL BE ANCHORED TO THE STAKES USING 1" HEAVY DUTY STAPLES OR NAILS WITH 1" HEADS. STAPLES AND NAILS SHOULD BE PLACED 3" ALONG THE FABRIC DOWN THE STAKE.
- AT THE END OF A RUN OF SILT FENCE ALONG A CONTOUR, THE SILT FENCE SHOULD BE TURNED PERPENDICULAR TO THE CONTOUR TO CREATE A "U-HOOK." THE "U-HOOK" EXTENDING PERPENDICULAR TO THE CONTOUR SHOULD BE OF SUFFICIENT LENGTH TO KEEP RUNOFF FROM FLOWING AROUND THE END OF THE SILT FENCE (TYPICALLY 10' - 20').
- SILT FENCE SHALL BE INSTALLED PRIOR TO ANY LAND DISTURBING ACTIVITIES.

SILT FENCE MAINTENANCE NOTES

- INSPECT BMPs EACH WORKDAY, AND MAINTAIN THEM IN EFFECTIVE OPERATING CONDITION. MAINTENANCE OF BMPs SHOULD BE PROACTIVE, NOT REACTIVE. INSPECT BMPs AS SOON AS POSSIBLE (AND ALWAYS WITHIN 24 HOURS) FOLLOWING A STORM THAT CAUSES SURFACE EROSION, AND PERFORM NECESSARY MAINTENANCE.
- FREQUENT OBSERVATIONS AND MAINTENANCE ARE NECESSARY TO MAINTAIN BMPs IN EFFECTIVE OPERATING CONDITION. INSPECTIONS AND CORRECTIVE MEASURES SHOULD BE DOCUMENTED THOROUGHLY.
- WHERE BMPs HAVE FAILED, REPAIR OR REPLACEMENT SHOULD BE INITIATED UPON DISCOVERY OF THE FAILURE.
- SEDIMENT ACCUMULATED UPSTREAM OF THE SILT FENCE SHOULD BE REMOVED AS NEEDED TO MAINTAIN THE FUNCTIONALITY OF THE BMP, TYPICALLY WHEN DEPTH OF ACCUMULATED SEDIMENTS IS APPROXIMATELY 6".
- REPAIR OR REPLACE SILT FENCE WHEN THERE ARE SIGNS OF WEAR, SUCH AS SAGGING, TEARING, OR COLLAPSE.
- SILT FENCE IS TO REMAIN IN PLACE UNTIL THE UPSTREAM DISTURBED AREA IS STABILIZED AND APPROVED BY THE LOCAL JURISDICTION, OR IS REPLACED BY AN EQUIVALENT PERIMETER SEDIMENT CONTROL BMP.
- WHEN SILT FENCE IS REMOVED, ALL DISTURBED AREAS SHALL BE COVERED WITH TOPSOIL, SEEDED AND MULCHED OR OTHERWISE STABILIZED AS APPROVED BY LOCAL JURISDICTION.

(DETAIL ADAPTED FROM TOWN OF PARKER, COLORADO AND CITY OF AURORA, NOT AVAILABLE IN AUTOCAD)

NOTE: MANY JURISDICTIONS HAVE BMP DETAILS THAT VARY FROM UDFCD STANDARD DETAILS. CONSULT WITH LOCAL JURISDICTIONS AS TO WHICH DETAIL SHOULD BE USED WHEN DIFFERENCES ARE NOTED.

November 2010 Urban Drainage and Flood Control District Urban Storm Drainage Criteria Manual Volume 3 SF-4

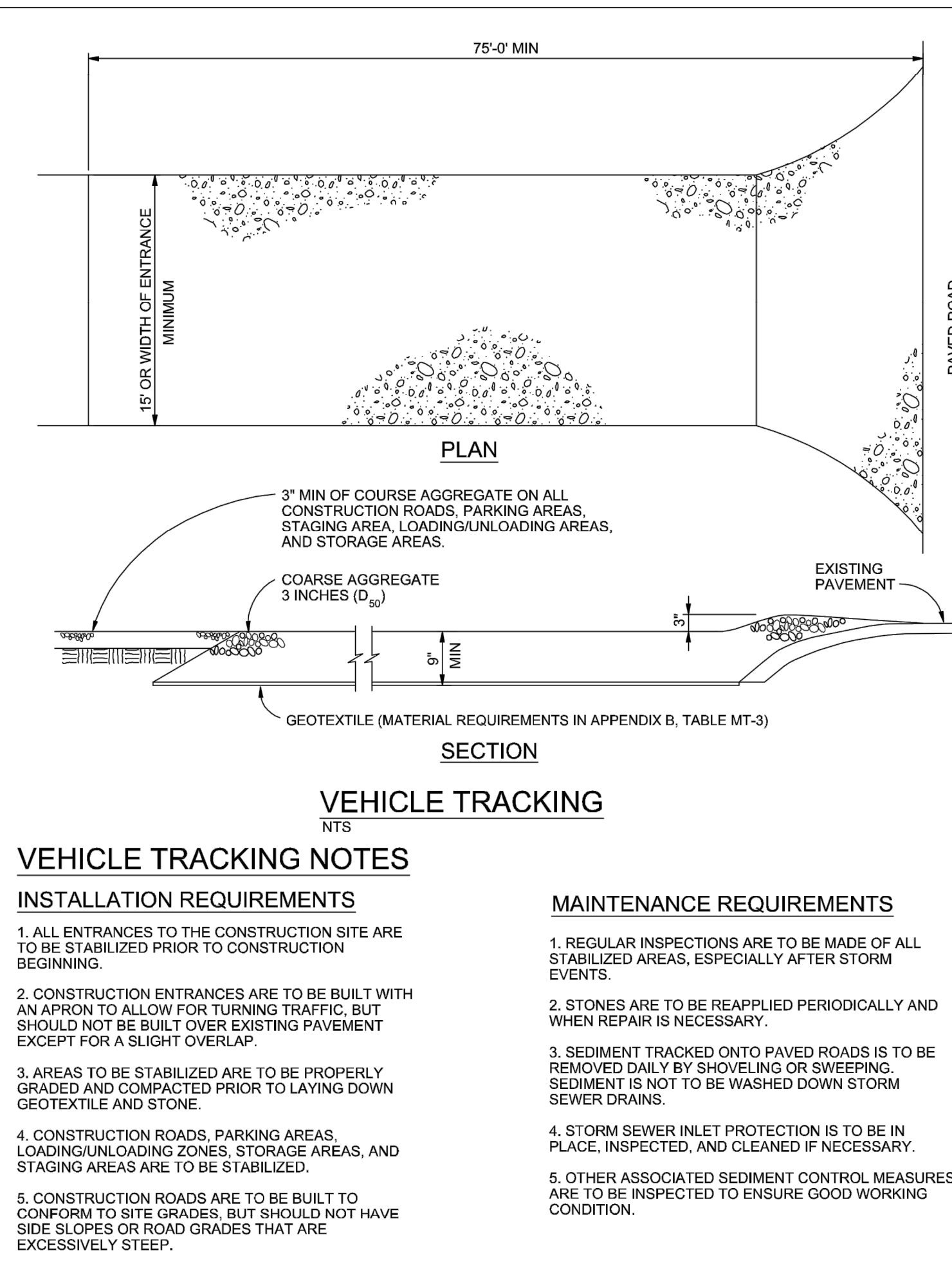

PLAN

SECTION

VEHICLE TRACKING

VEHICLE TRACKING NOTES

INSTALLATION REQUIREMENTS

- ALL ENTRANCES TO THE CONSTRUCTION SITE ARE TO BE STABILIZED PRIOR TO CONSTRUCTION BEGINNING.
- CONSTRUCTION ENTRANCES ARE TO BE BUILT WITH AN APRON TO ALLOW FOR TURNING TRAFFIC, BUT SHOULD NOT BE BUILT OVER EXISTING PAVEMENT EXCEPT FOR A SLIGHT OVERLAP.
- AREAS TO BE STABILIZED ARE TO BE PROPERLY GRADED AND COMPACTED PRIOR TO LAYING DOWN GEOTEXTILE AND STONE.
- CONSTRUCTION ROADS, PARKING AREAS, LOADING/UNLOADING ZONES, STORAGE AREAS, AND STAGING AREAS ARE TO BE STABILIZED.
- CONSTRUCTION ROADS ARE TO BE BUILT TO CONFORM TO SITE GRADES, BUT SHOULD NOT HAVE SIDE SLOPES OR ROAD GRADES THAT ARE EXCESSIVELY STEEP.

MAINTENANCE REQUIREMENTS

- REGULAR INSPECTIONS ARE TO BE MADE OF ALL STABILIZED AREAS, ESPECIALLY AFTER STORM EVENTS.
- STONES ARE TO BE REAPPLIED PERIODICALLY AND WHEN REPAIR IS NECESSARY.
- SEDIMENT TRACKED ONTO PAVED ROADS IS TO BE REMOVED DAILY BY SHOVELING OR SWEEPING. SEDIMENT IS NOT TO BE WASHED DOWN STORM SEWER DRAINS.
- STORM SEWER INLET PROTECTION IS TO BE IN PLACE, INSPECTED, AND CLEANED IF NECESSARY.
- OTHER ASSOCIATED SEDIMENT CONTROL MEASURES ARE TO BE INSPECTED TO ENSURE GOOD WORKING CONDITION.

STOCKPILE PROTECTION MAINTENANCE NOTES

- INSPECT BMPs EACH WORKDAY, AND MAINTAIN THEM IN EFFECTIVE OPERATING CONDITION. MAINTENANCE OF BMPs SHOULD BE PROACTIVE, NOT REACTIVE. INSPECT BMPs AS SOON AS POSSIBLE (AND ALWAYS WITHIN 24 HOURS) FOLLOWING A STORM THAT CAUSES SURFACE EROSION, AND PERFORM NECESSARY MAINTENANCE.
- FREQUENT OBSERVATIONS AND MAINTENANCE ARE NECESSARY TO MAINTAIN BMPs IN EFFECTIVE OPERATING CONDITION. INSPECTIONS AND CORRECTIVE MEASURES SHOULD BE DOCUMENTED THOROUGHLY.
- WHERE BMPs HAVE FAILED, REPAIR OR REPLACEMENT SHOULD BE INITIATED UPON DISCOVERY OF THE FAILURE.
- IF PERIMETER PROTECTION MUST BE MOVED TO ACCESS SOIL STOCKPILE, REPLACE PERIMETER CONTROLS BY THE END OF THE WORKDAY.
- STOCKPILE PERIMETER CONTROLS CAN BE REMOVED ONCE ALL THE MATERIAL FROM THE STOCKPILE HAS BEEN USED.

(DETAILS ADAPTED FROM PARKER, COLORADO, NOT AVAILABLE IN AUTOCAD)

NOTE: MANY JURISDICTIONS HAVE BMP DETAILS THAT VARY FROM UDFCD STANDARD DETAILS. CONSULT WITH LOCAL JURISDICTIONS AS TO WHICH DETAIL SHOULD BE USED WHEN DIFFERENCES ARE NOTED.

MM-2 Stockpile Management (SM)

November 2010 Urban Drainage and Flood Control District Urban Storm Drainage Criteria Manual Volume 3 SP-4

SM-4 Vehicle Tracking Control (VTC)

STABILIZED CONSTRUCTION ENTRANCE/EXIT INSTALLATION NOTES

- SEE PLAN VIEW FOR:
 - LOCATION OF CONSTRUCTION ENTRANCE(S)/EXIT(S).
 - TYPE OF CONSTRUCTION ENTRANCE(S)/EXIT(S) (WITH/WITHOUT WHEEL WASH, CONSTRUCTION MAT OR TRM).
- CONSTRUCTION MAT OR TRM STABILIZED CONSTRUCTION ENTRANCES ARE ONLY TO BE USED ON SHORT DURATION PROJECTS (TYPICALLY RANGING FROM A WEEK TO A MONTH) WHERE THERE WILL BE LIMITED VEHICULAR ACCESS.
- A STABILIZED CONSTRUCTION ENTRANCE/EXIT SHALL BE LOCATED AT ALL ACCESS POINTS WHERE VEHICLES ACCESS THE CONSTRUCTION SITE FROM PAVED RIGHT-OF-WAYS.
- STABILIZED CONSTRUCTION ENTRANCE/EXIT SHALL BE INSTALLED PRIOR TO ANY LAND DISTURBING ACTIVITIES.
- A NON-WOVEN GEOTEXTILE FABRIC SHALL BE PLACED UNDER THE STABILIZED CONSTRUCTION ENTRANCE/EXIT PRIOR TO THE PLACEMENT OF ROCK.
- UNLESS OTHERWISE SPECIFIED BY LOCAL JURISDICTION, ROCK SHALL CONSIST OF DOT SECT. #703, AASHTO #3 COARSE AGGREGATE OR 6" (MINUS) ROCK.

STABILIZED CONSTRUCTION ENTRANCE/EXIT MAINTENANCE NOTES

- INSPECT BMPs EACH WORKDAY, AND MAINTAIN THEM IN EFFECTIVE OPERATING CONDITION. MAINTENANCE OF BMPs SHOULD BE PROACTIVE, NOT REACTIVE. INSPECT BMPs AS SOON AS POSSIBLE (AND ALWAYS WITHIN 24 HOURS) FOLLOWING A STORM THAT CAUSES SURFACE EROSION, AND PERFORM NECESSARY MAINTENANCE.
- FREQUENT OBSERVATIONS AND MAINTENANCE ARE NECESSARY TO MAINTAIN BMPs IN EFFECTIVE OPERATING CONDITION. INSPECTIONS AND CORRECTIVE MEASURES SHOULD BE DOCUMENTED THOROUGHLY.
- WHERE BMPs HAVE FAILED, REPAIR OR REPLACEMENT SHOULD BE INITIATED UPON DISCOVERY OF THE FAILURE.
- ROCK SHALL BE REAPPLIED OR REGRADED AS NECESSARY TO THE STABILIZED ENTRANCE/EXIT TO MAINTAIN A CONSISTENT DEPTH.
- SEDIMENT TRACKED ONTO PAVED ROADS IS TO BE REMOVED THROUGHOUT THE DAY AND AT THE END OF THE DAY BY SHOVELING OR SWEEPING. SEDIMENT MAY NOT BE WASHED DOWN STORM SEWER DRAINS.

NOTE: MANY JURISDICTIONS HAVE BMP DETAILS THAT VARY FROM UDFCD STANDARD DETAILS. CONSULT WITH LOCAL JURISDICTIONS AS TO WHICH DETAIL SHOULD BE USED WHEN DIFFERENCES ARE NOTED.

(DETAILS ADAPTED FROM CITY OF BROOMFIELD, COLORADO, NOT AVAILABLE IN AUTOCAD)

November 2010 Urban Drainage and Flood Control District Urban Storm Drainage Criteria Manual Volume 3 VTC-6

MM-2 Stockpile Management (SP)

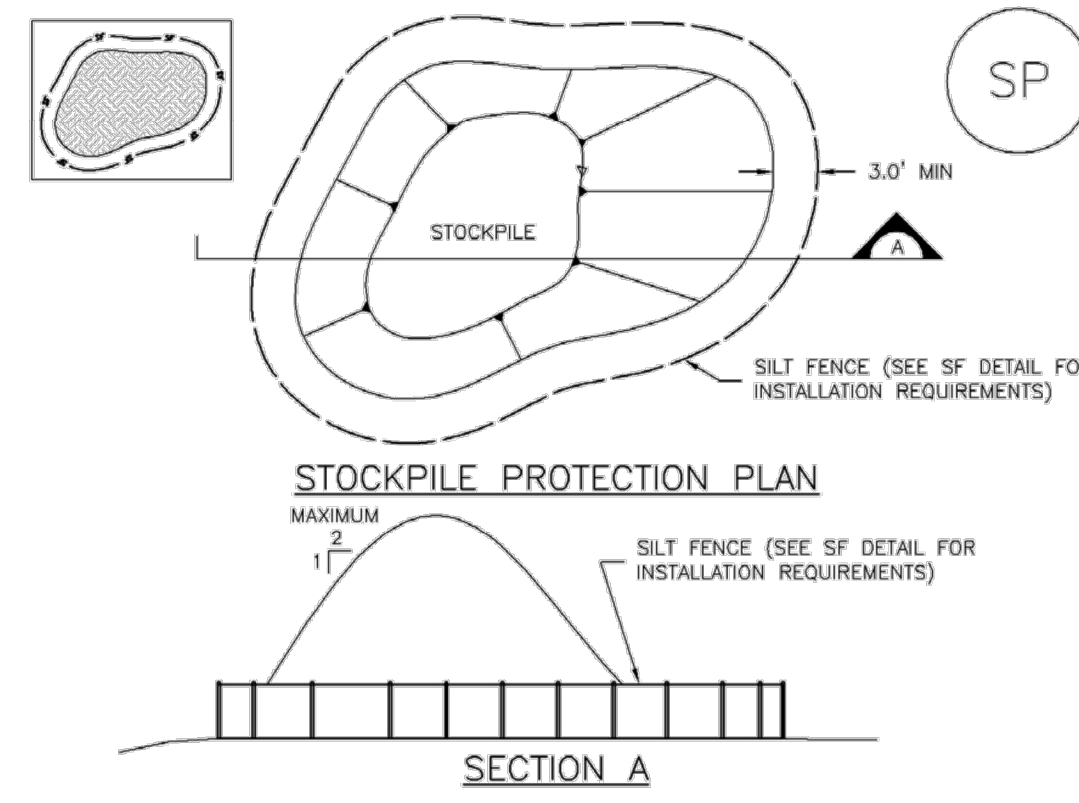

STOCKPILE PROTECTION PLAN

SECTION A

SP-1. STOCKPILE PROTECTION

STOCKPILE PROTECTION INSTALLATION NOTES

- SEE PLAN VIEW FOR:
 - LOCATION OF STOCKPILES.
 - TYPE OF STOCKPILE PROTECTION.
- INSTALL PERIMETER CONTROLS IN ACCORDANCE WITH THEIR RESPECTIVE DESIGN DETAILS. SILT FENCE IS SHOWN IN THE STOCKPILE PROTECTION DETAILS; HOWEVER, OTHER TYPES OF PERIMETER CONTROLS INCLUDING SEDIMENT CONTROL LOGS OR ROCK SOCKS MAY BE SUITABLE IN SOME CIRCUMSTANCES. CONSIDERATIONS FOR DETERMINING THE APPROPRIATE TYPE OF PERIMETER CONTROL FOR A STOCKPILE INCLUDE WHETHER THE STOCKPILE IS LOCATED ON A PERVIOUS OR IMPERVIOUS SURFACE, THE RELATIVE HEIGHTS OF THE PERIMETER CONTROL AND STOCKPILE, THE ABILITY OF THE PERIMETER CONTROL TO CONTAIN THE STOCKPILE WITHOUT FAILING IN THE EVENT THAT MATERIAL FROM THE STOCKPILE SHIFTS OR SLUMPS AGAINST THE PERIMETER, AND OTHER FACTORS.
- STABILIZE THE STOCKPILE SURFACE WITH SURFACE ROUGHENING, TEMPORARY SEEDING AND MULCHING, EROSION CONTROL BLANKETS, OR SOIL BINDERS. SOILS STOCKPILED FOR AN EXTENDED PERIOD (TYPICALLY FOR MORE THAN 60 DAYS) SHOULD BE SEEDED AND MULCHED WITH A TEMPORARY GRASS COVER ONCE THE STOCKPILE IS PLACED (TYPICALLY WITHIN 14 DAYS). USE OF MULCH ONLY OR A SOIL BINDER IS ACCEPTABLE IF THE STOCKPILE WILL BE IN PLACE FOR A MORE LIMITED TIME PERIOD (TYPICALLY 30-60 DAYS).
- FOR TEMPORARY STOCKPILES ON THE INTERIOR PORTION OF A CONSTRUCTION SITE, WHERE OTHER DOWNGRADIENT CONTROLS, INCLUDING PERIMETER CONTROL, ARE IN PLACE, STOCKPILE PERIMETER CONTROLS MAY NOT BE REQUIRED.

November 2010 Urban Drainage and Flood Control District Urban Storm Drainage Criteria Manual Volume 3 SP-3

Stabilized Staging Area (SSA)

SM-6

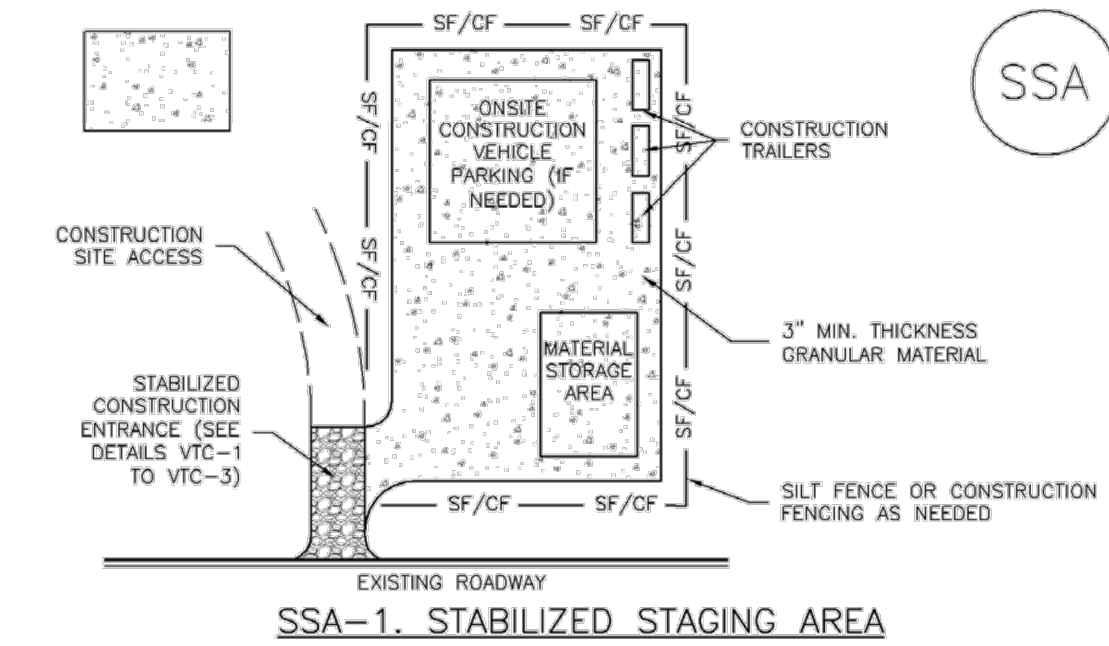

SSA-1. STABILIZED STAGING AREA

STABILIZED STAGING AREA INSTALLATION NOTES

- SEE PLAN VIEW FOR:
 - LOCATION OF STAGING AREA(S).
 - CONTRACTOR MAY ADJUST LOCATION AND SIZE OF STAGING AREA WITH APPROVAL FROM THE LOCAL JURISDICTION.
- STABILIZED STAGING AREA SHOULD BE APPROPRIATE FOR THE NEEDS OF THE SITE. OVERSIZING RESULTS IN A LARGER AREA TO STABILIZE FOLLOWING CONSTRUCTION.
- STAGING AREA SHALL BE STABILIZED PRIOR TO OTHER OPERATIONS ON THE SITE.
- THE STABILIZED STAGING AREA SHALL CONSIST OF A MINIMUM 3" THICK GRANULAR MATERIAL.
- UNLESS OTHERWISE SPECIFIED BY LOCAL JURISDICTION, ROCK SHALL CONSIST OF DOT SECT. #703, AASHTO #3 COARSE AGGREGATE OR 6" (MINUS) ROCK.

STABILIZED STAGING AREA MAINTENANCE NOTES

- INSPECT BMPs EACH WORKDAY, AND MAINTAIN THEM IN EFFECTIVE OPERATING CONDITION. MAINTENANCE OF BMPs SHOULD BE PROACTIVE, NOT REACTIVE. INSPECT BMPs AS SOON AS POSSIBLE (AND ALWAYS WITHIN 24 HOURS) FOLLOWING A STORM THAT CAUSES SURFACE EROSION, AND PERFORM NECESSARY MAINTENANCE.
- FREQUENT OBSERVATIONS AND MAINTENANCE ARE NECESSARY TO MAINTAIN BMPs IN EFFECTIVE OPERATING CONDITION. INSPECTIONS AND CORRECTIVE MEASURES SHOULD BE DOCUMENTED THOROUGHLY.
- WHERE BMPs HAVE FAILED, REPAIR OR REPLACEMENT SHOULD BE INITIATED UPON DISCOVERY OF THE FAILURE.
- ROCK SHALL BE REAPPLIED OR REGRADED AS NECESSARY IF RUTTING OCCURS OR UNDERLYING SUBGRADE BECOMES EXPOSED.

November 2010 Urban Drainage and Flood Control District Urban Storm Drainage Criteria Manual Volume 3 SSA-3

SM-6 Stabilized Staging Area (SSA)

STABILIZED STAGING AREA MAINTENANCE NOTES

- STABILIZED STAGING AREA SHALL BE ENLARGED IF NECESSARY TO CONTAIN PARKING, STORAGE, AND UNLOADING/LOADING OPERATIONS.
- THE STABILIZED STAGING AREA SHALL BE REMOVED AT THE END OF CONSTRUCTION. THE GRANULAR MATERIAL SHALL BE REMOVED OR, IF APPROVED BY THE LOCAL JURISDICTION, USED ON SITE, AND THE AREA COVERED WITH TOPSOIL, SEEDED AND MULCHED OR OTHERWISE STABILIZED IN A MANNER APPROVED BY LOCAL JURISDICTION.

NOTE: MANY MUNICIPALITIES PROHIBIT THE USE OF RECYCLED CONCRETE AS GRANULAR MATERIAL FOR STABILIZED STAGING AREAS DUE TO DIFFICULTIES WITH RE-ESTABLISHMENT OF VEGETATION IN AREAS WHERE RECYCLED CONCRETE WAS PLACED.

NOTE: MANY JURISDICTIONS HAVE BMP DETAILS THAT VARY FROM UDFCD STANDARD DETAILS. CONSULT WITH LOCAL JURISDICTIONS AS TO WHICH DETAIL SHOULD BE USED WHEN DIFFERENCES ARE NOTED.

(DETAILS ADAPTED FROM DOUGLAS COUNTY, COLORADO, NOT AVAILABLE IN AUTOCAD)

November 2010 Urban Drainage and Flood Control District Urban Storm Drainage Criteria Manual Volume 3 SSA-4

UNTIL SUCH TIME AS THESE DRAWINGS ARE APPROVED BY THE APPROPRIATE REVIEWING AGENCIES, OR ENGINEERING APPROVES THEIR USE, THESE DRAWINGS ARE DESIGNATED BY WRITTEN AUTHORIZATION.

PREPARED FOR
SR LAND, LLC
20 BOULDER CRESCENT
SUITE 201
COLORADO SPRINGS, CO 80903
JAMES F. MORLEY
(719) 471-1742

J.R. ENGINEERING
A Westman Company
Central 303-740-9383 • Colorado Springs 719-583-2593
Fort Collins 970-491-9888 • www.jrengineering.com

BY	DATE	REVISION

H-SCALE	V-SCALE	DATE	DESIGNED BY	DRAWN BY	CHECKED BY
1"=XX'	1"=X'	09/01/20	XXX	XXX	

STERLING RANCH FILING NO.2
GRADING & EROSION CONTROL PLAN

SC-6 Inlet Protection (IP)

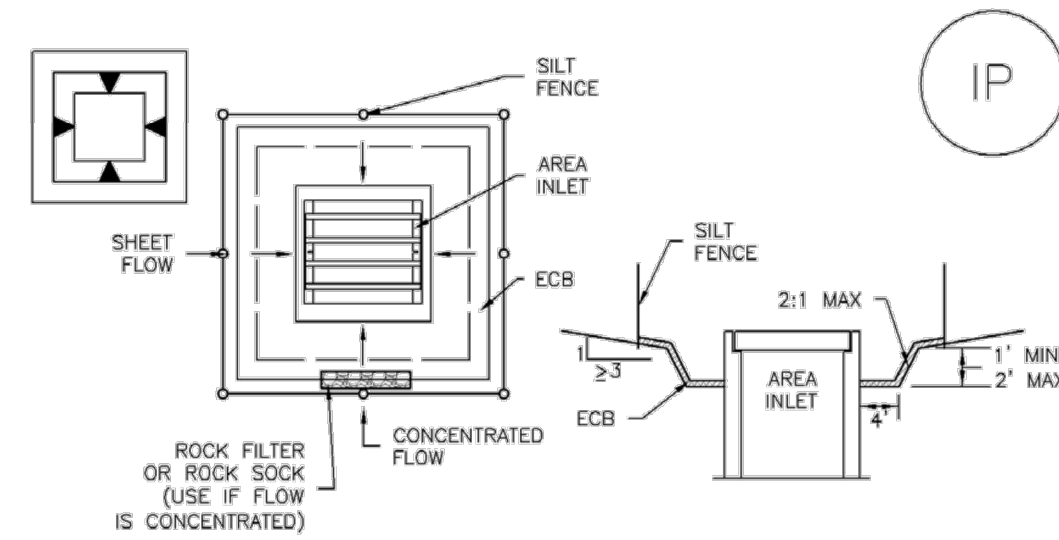

IP-5. OVEREXCAVATION INLET PROTECTION

OVEREXCAVATION INLET PROTECTION INSTALLATION NOTES

1. THIS FORM OF INLET PROTECTION IS PRIMARILY APPLICABLE FOR SITES THAT HAVE NOT YET REACHED FINAL GRADE AND SHOULD BE USED ONLY FOR INLETS WITH A RELATIVELY SMALL CONTRIBUTING DRAINAGE AREA.
2. WHEN USING FOR CONCENTRATED FLOWS, SHAPE BASIN IN 2:1 RATIO WITH LENGTH ORIENTED TOWARDS DIRECTION OF FLOW.
3. SEDIMENT MUST BE PERIODICALLY REMOVED FROM THE OVEREXCAVATED AREA.

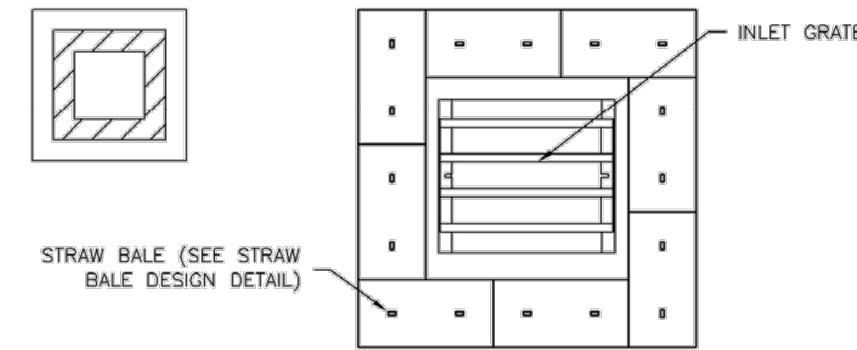

IP-6. STRAW BALE FOR SUMP INLET PROTECTION

STRAW BALE BARRIER INLET PROTECTION INSTALLATION NOTES

1. SEE STRAW BALE DESIGN DETAIL FOR INSTALLATION REQUIREMENTS.
2. BALES SHALL BE PLACED IN A SINGLE ROW AROUND THE INLET WITH ENDS OF BALES TIGHTLY ADJUTING ONE ANOTHER.

IP-6 Urban Drainage and Flood Control District August 2013
Urban Storm Drainage Criteria Manual Volume 3

Inlet Protection (IP) SC-6

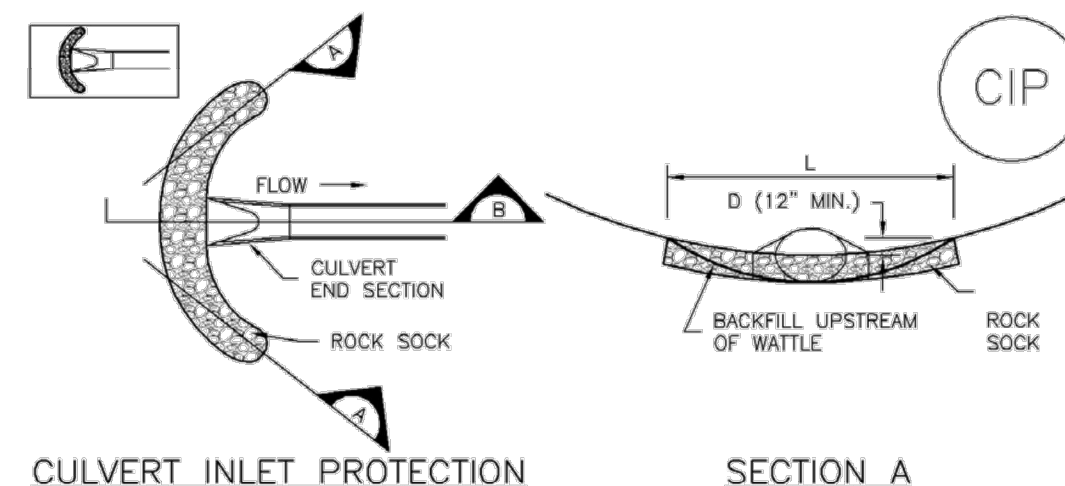

CIP-1. CULVERT INLET PROTECTION

CULVERT INLET PROTECTION INSTALLATION NOTES

1. SEE PLAN VIEW FOR LOCATION OF CULVERT INLET PROTECTION.
2. SEE ROCK SOCK DESIGN DETAIL FOR ROCK GRADATION REQUIREMENTS AND JOINTING DETAIL.

CULVERT INLET PROTECTION MAINTENANCE NOTES

1. INSPECT BMPs EACH WORKDAY, AND MAINTAIN THEM IN EFFECTIVE OPERATING CONDITION. MAINTENANCE OF BMPs SHOULD BE PROACTIVE, NOT REACTIVE. INSPECT BMPs AS SOON AS POSSIBLE (AND ALWAYS WITHIN 24 HOURS) FOLLOWING A STORM THAT CAUSES SURFACE EROSION, AND PERFORM NECESSARY MAINTENANCE.
2. FREQUENT OBSERVATIONS AND MAINTENANCE ARE NECESSARY TO MAINTAIN BMPs IN EFFECTIVE OPERATING CONDITION. INSPECTIONS AND CORRECTIVE MEASURES SHOULD BE DOCUMENTED THOROUGHLY.
3. WHERE BMPs HAVE FAILED, REPAIR OR REPLACEMENT SHOULD BE INITIATED UPON DISCOVERY OF THE FAILURE.
4. SEDIMENT ACCUMULATED UPSTREAM OF THE CULVERT SHALL BE REMOVED WHEN THE SEDIMENT DEPTH IS 1/2 THE HEIGHT OF THE ROCK SOCK.
5. CULVERT INLET PROTECTION SHALL REMAIN IN PLACE UNTIL THE UPSTREAM DISTURBED AREA IS PERMANENTLY STABILIZED AND APPROVED BY THE LOCAL JURISDICTION.

August 2013 Urban Drainage and Flood Control District IP-7
Urban Storm Drainage Criteria Manual Volume 3

EC-2 Temporary and Permanent Seeding (TS/PS)

Table TS/PS-2. Minimum Drill Seeding Rates for Perennial Grasses

Common Name	Botanical Name	Growth Season*	Growth Form	Seeds/ Pound	Pounds of PLS/Acre
Alkali Soil Seed Mix					
Alkali sacaton	<i>Sporobolus airoides</i>	Cool	Bunch	1,750,000	0.25
Basin wildrye	<i>Elymus cinereus</i>	Cool	Bunch	165,000	2.5
Sodar streambank wheatgrass	<i>Agropyron riparium 'Sodar'</i>	Cool	Sod	170,000	2.5
Jose tall wheatgrass	<i>Agropyron elongatum 'Jose'</i>	Cool	Bunch	79,000	7.0
Arriba western wheatgrass	<i>Agropyron smithii 'Arriba'</i>	Cool	Sod	110,000	5.5
Total					17.75
Fertile Loamy Soil Seed Mix					
Ephraim crested wheatgrass	<i>Agropyron cristatum 'Ephraim'</i>	Cool	Sod	175,000	2.0
Dural hard fescue	<i>Festuca ovina 'duriscula'</i>	Cool	Bunch	565,000	1.0
Lincoln smooth brome	<i>Bromus inermis leysii 'Lincoln'</i>	Cool	Sod	130,000	3.0
Sodar streambank wheatgrass	<i>Agropyron riparium 'Sodar'</i>	Cool	Sod	170,000	2.5
Arriba western wheatgrass	<i>Agropyron smithii 'Arriba'</i>	Cool	Sod	110,000	7.0
Total					15.5
High Water Table Soil Seed Mix					
Meadow foxtail	<i>Alopecurus pratensis</i>	Cool	Sod	900,000	0.5
Redtop	<i>Agrostis alba</i>	Warm	Open sod	5,000,000	0.25
Reed canarygrass	<i>Phalaris arundinacea</i>	Cool	Sod	68,000	0.5
Lincoln smooth brome	<i>Bromus inermis leysii 'Lincoln'</i>	Cool	Sod	130,000	3.0
Pathfinder switchgrass	<i>Panicum virgatum 'Pathfinder'</i>	Warm	Sod	389,000	1.0
Alkar tall wheatgrass	<i>Agropyron elongatum 'Alkar'</i>	Cool	Bunch	79,000	5.5
Total					10.75
Transition Turf Seed Mix*					
Ruebens Canadian bluegrass	<i>Poa compressa 'Ruebens'</i>	Cool	Sod	2,500,000	0.5
Dural hard fescue	<i>Festuca ovina 'duriscula'</i>	Cool	Bunch	565,000	1.0
Citation perennial ryegrass	<i>Lolium perenne 'Citation'</i>	Cool	Sod	247,000	3.0
Lincoln smooth brome	<i>Bromus inermis leysii 'Lincoln'</i>	Cool	Sod	130,000	3.0
Total					7.5

TS/PS-4 Urban Drainage and Flood Control District June 2012
Urban Storm Drainage Criteria Manual Volume 3

Temporary and Permanent Seeding (TS/PS) EC-2

Table TS/PS-2. Minimum Drill Seeding Rates for Perennial Grasses (cont.)

Common Name	Botanical Name	Growth Season*	Growth Form	Seeds/ Pound	Pounds of PLS/Acre
Sandy Soil Seed Mix					
Blue grama	<i>Bouteloua gracilis</i>	Warm	Sod-forming bunchgrass	825,000	0.5
Camper litle bluestem	<i>Schizachyrium scoparium 'Camper'</i>	Warm	Bunch	240,000	1.0
Prairie sandreed	<i>Calamovilfa longifolia</i>	Warm	Open sod	274,000	1.0
Sand dropseed	<i>Sporobolus cryptandrus 'Vaughn'</i>	Cool	Bunch	5,298,000	0.25
Vaughn sideoats grama	<i>Bouteloua curtipendula 'Vaughn'</i>	Warm	Sod	191,000	2.0
Arriba western wheatgrass	<i>Agropyron smithii 'Arriba'</i>	Cool	Sod	110,000	5.5
Total					10.25
Heavy Clay, Rocky Foothill Seed Mix					
Ephraim crested wheatgrass*	<i>Agropyron cristatum 'Ephraim'</i>	Cool	Sod	175,000	1.5
Oahu Intermediate wheatgrass	<i>Agropyron intermedium 'Oahu'</i>	Cool	Sod	115,000	5.5
Vaughn sideoats grama*	<i>Bouteloua curtipendula 'Vaughn'</i>	Warm	Sod	191,000	2.0
Lincoln smooth brome	<i>Bromus inermis leysii 'Lincoln'</i>	Cool	Sod	130,000	3.0
Arriba western wheatgrass	<i>Agropyron smithii 'Arriba'</i>	Cool	Sod	110,000	5.5
Total					17.5

- * All of the above seeding mixes and rates are based on drill seeding followed by crimped straw mulch. These rates should be doubled if seed is broadcast and should be increased by 50 percent if the seeding is done using a Britton Drill or is applied through hydraulic seeding. Hydraulic seeding may be substituted for drilling only where slopes are steeper than 3:1. If hydraulic seeding is used, hydraulic mulching should be done as a separate operation.
- † See Table TS/PS-3 for seeding dates.
- ‡ If site is to be irrigated, the transition turf seed rates should be doubled.
- § Crested wheatgrass should not be used on slopes steeper than 6H to 1V.
- ¶ Can substitute 0.5 lbs PLS of blue grama for the 2.0 lbs PLS of Vaughn sideoats grama.

June 2012 Urban Drainage and Flood Control District TS/PS-5
Urban Storm Drainage Criteria Manual Volume 3

EC-2 Temporary and Permanent Seeding (TS/PS)

Table TS/PS-3. Seeding Dates for Annual and Perennial Grasses

Seeding Dates	Annual Grasses (Numbers in table reference species in Table TS/PS-1)		Perennial Grasses	
	Warm	Cool	Warm	Cool
January 1-March 15			✓	✓
March 16-April 30	4	1,2,3	✓	✓
May 1-May 15	4		✓	
May 16-June 30	4,5,6,7			
July 1-July 15	5,6,7			
July 16-August 31				
September 1-September 30		8,9,10,11		
October 1-December 31			✓	✓

Mulch

Cover seeded areas with mulch or an appropriate rolled erosion control product to promote establishment of vegetation. Anchor mulch by crimping, netting or use of a non-toxic tackifier. See the Mulching BMP Fact Sheet for additional guidance.

Maintenance and Removal

Monitor and observe seeded areas to identify areas of poor growth or areas that fail to germinate. Reseed and mulch these areas, as needed.

An area that has been permanently seeded should have a good stand of vegetation within one growing season if irrigated and within three growing seasons without irrigation in Colorado. Reseed portions of the site that fail to germinate or remain bare after the first growing season.

Seeded areas may require irrigation, particularly during extended dry periods. Targeted weed control may also be necessary.

Protect seeded areas from construction equipment and vehicle access.

TS/PS-6 Urban Drainage and Flood Control District June 2012
Urban Storm Drainage Criteria Manual Volume 3

Check Dams (CD) EC-12

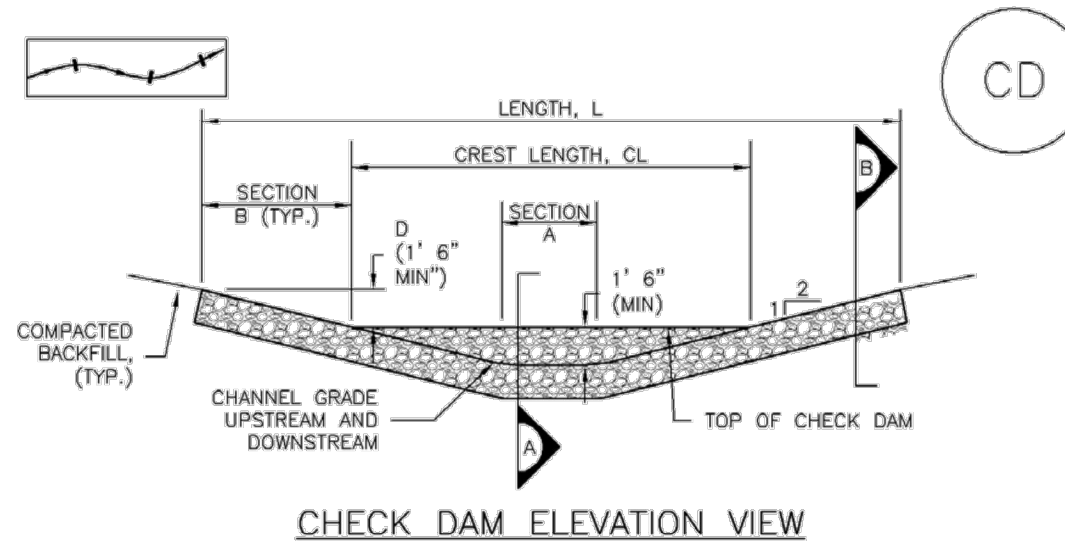

CD-1. CHECK DAM

1. SEE PLAN VIEW FOR LOCATION OF CHECK DAMS.
2. CHECK DAM TYPE (CHECK DAM OR REINFORCED CHECK DAM), LENGTH (L), CREST LENGTH (CL), AND DEPTH (D).
3. RIPRAP UTILIZED FOR CHECK DAMS SHOULD BE OF APPROPRIATE SIZE FOR THE APPLICATION. TYPICAL TYPES OF RIPRAP USED FOR CHECK DAMS ARE TYPE M (D50 12") OR TYPE L (D50 9").
4. RIPRAP PAD SHALL BE TRENCHED INTO THE GROUND A MINIMUM OF 1'.
5. THE ENDS OF THE CHECK DAM SHALL BE A MINIMUM OF 1' 6" HIGHER THAN THE CENTER OF THE CHECK DAM.

1. INSPECT BMPs EACH WORKDAY, AND MAINTAIN THEM IN EFFECTIVE OPERATING CONDITION. MAINTENANCE OF BMPs SHOULD BE PROACTIVE, NOT REACTIVE. INSPECT BMPs AS SOON AS POSSIBLE (AND ALWAYS WITHIN 24 HOURS) FOLLOWING A STORM THAT CAUSES SURFACE EROSION, AND PERFORM NECESSARY MAINTENANCE.
2. FREQUENT OBSERVATIONS AND MAINTENANCE ARE NECESSARY TO MAINTAIN BMPs IN EFFECTIVE OPERATING CONDITION. INSPECTIONS AND CORRECTIVE MEASURES SHOULD BE DOCUMENTED THOROUGHLY.
3. WHERE BMPs HAVE FAILED, REPAIR OR REPLACEMENT SHOULD BE INITIATED UPON DISCOVERY OF THE FAILURE.
4. SEDIMENT ACCUMULATED UPSTREAM OF THE CHECK DAMS SHALL BE REMOVED WHEN THE SEDIMENT DEPTH IS WITHIN 1/2 THE HEIGHT OF THE CREST.
5. CHECK DAMS ARE TO REMAIN IN PLACE UNTIL THE UPSTREAM DISTURBED AREA IS STABILIZED AND APPROVED BY THE LOCAL JURISDICTION.
6. WHEN CHECK DAMS ARE REMOVED, EXCAVATIONS SHALL BE FILLED WITH SUITABLE COMPACTED BACKFILL. DISTURBED AREA SHALL BE SEEDED AND MULCHED AND COVERED WITH GEOTEXTILE OR OTHERWISE STABILIZED IN A MANNER APPROVED BY THE LOCAL JURISDICTION.

1. SEE PLAN VIEW FOR LOCATION OF CHECK DAMS.
2. CHECK DAM TYPE (CHECK DAM OR REINFORCED CHECK DAM), LENGTH (L), CREST LENGTH (CL), AND DEPTH (D).
3. RIPRAP UTILIZED FOR CHECK DAMS SHOULD BE OF APPROPRIATE SIZE FOR THE APPLICATION. TYPICAL TYPES OF RIPRAP USED FOR CHECK DAMS ARE TYPE M (D50 12") OR TYPE L (D50 9").
4. RIPRAP PAD SHALL BE TRENCHED INTO THE GROUND A MINIMUM OF 1'.
5. THE ENDS OF THE CHECK DAM SHALL BE A MINIMUM OF 1' 6" HIGHER THAN THE CENTER OF THE CHECK DAM.

1. INSPECT BMPs EACH WORKDAY, AND MAINTAIN THEM IN EFFECTIVE OPERATING CONDITION. MAINTENANCE OF BMPs SHOULD BE PROACTIVE, NOT REACTIVE. INSPECT BMPs AS SOON AS POSSIBLE (AND ALWAYS WITHIN 24 HOURS) FOLLOWING A STORM THAT CAUSES SURFACE EROSION, AND PERFORM NECESSARY MAINTENANCE.
2. FREQUENT OBSERVATIONS AND MAINTENANCE ARE NECESSARY TO MAINTAIN BMPs IN EFFECTIVE OPERATING CONDITION. INSPECTIONS AND CORRECTIVE MEASURES SHOULD BE DOCUMENTED THOROUGHLY.
3. WHERE BMPs HAVE FAILED, REPAIR OR REPLACEMENT SHOULD BE INITIATED UPON DISCOVERY OF THE FAILURE.
4. SEDIMENT ACCUMULATED UPSTREAM OF THE CHECK DAMS SHALL BE REMOVED WHEN THE SEDIMENT DEPTH IS WITHIN 1/2 THE HEIGHT OF THE CREST.
5. CHECK DAMS ARE TO REMAIN IN PLACE UNTIL THE UPSTREAM DISTURBED AREA IS STABILIZED AND APPROVED BY THE LOCAL JURISDICTION.
6. WHEN CHECK DAMS ARE REMOVED, EXCAVATIONS SHALL BE FILLED WITH SUITABLE COMPACTED BACKFILL. DISTURBED AREA SHALL BE SEEDED AND MULCHED AND COVERED WITH GEOTEXTILE OR OTHERWISE STABILIZED IN A MANNER APPROVED BY THE LOCAL JURISDICTION.

1. SEE PLAN VIEW FOR LOCATION OF CHECK DAMS.
2. CHECK DAM TYPE (CHECK DAM OR REINFORCED CHECK DAM), LENGTH (L), CREST LENGTH (CL), AND DEPTH (D).
3. RIPRAP UTILIZED FOR CHECK DAMS SHOULD BE OF APPROPRIATE SIZE FOR THE APPLICATION. TYPICAL TYPES OF RIPRAP USED FOR CHECK DAMS ARE TYPE M (D50 12") OR TYPE L (D50 9").
4. RIPRAP PAD SHALL BE TRENCHED INTO THE GROUND A MINIMUM OF 1'.
5. THE ENDS OF THE CHECK DAM SHALL BE A MINIMUM OF 1' 6" HIGHER THAN THE CENTER OF THE CHECK DAM.

November 2010 Urban Drainage and Flood Control District CD-3
Urban Storm Drainage Criteria Manual Volume 3

EC-12 Check Dams (CD)

CHECK DAM INSTALLATION NOTES

1. SEE PLAN VIEW FOR LOCATION OF CHECK DAMS.
2. CHECK DAM TYPE (CHECK DAM OR REINFORCED CHECK DAM), LENGTH (L), CREST LENGTH (CL), AND DEPTH (D).
3. RIPRAP UTILIZED FOR CHECK DAMS SHOULD BE OF APPROPRIATE SIZE FOR THE APPLICATION. TYPICAL TYPES OF RIPRAP USED FOR CHECK DAMS ARE TYPE M (D50 12") OR TYPE L (D50 9").
4. RIPRAP PAD SHALL BE TRENCHED INTO THE GROUND A MINIMUM OF 1'.
5. THE ENDS OF THE CHECK DAM SHALL BE A MINIMUM OF 1' 6" HIGHER THAN THE CENTER OF THE CHECK DAM.

CHECK DAM MAINTENANCE NOTES

1. INSPECT BMPs EACH WORKDAY, AND MAINTAIN THEM IN EFFECTIVE OPERATING CONDITION. MAINTENANCE OF BMPs SHOULD BE PROACTIVE, NOT REACTIVE. INSPECT BMPs AS SOON AS POSSIBLE (AND ALWAYS WITHIN 24 HOURS) FOLLOWING A STORM THAT CAUSES SURFACE EROSION, AND PERFORM NECESSARY MAINTENANCE.
2. FREQUENT OBSERVATIONS AND MAINTENANCE ARE NECESSARY TO MAINTAIN BMPs IN EFFECTIVE OPERATING CONDITION. INSPECTIONS AND CORRECTIVE MEASURES SHOULD BE DOCUMENTED THOROUGHLY.
3. WHERE BMPs HAVE FAILED, REPAIR OR REPLACEMENT SHOULD BE INITIATED UPON DISCOVERY OF THE FAILURE.
4. SEDIMENT ACCUMULATED UPSTREAM OF THE CHECK DAMS SHALL BE REMOVED WHEN THE SEDIMENT DEPTH IS WITHIN 1/2 THE HEIGHT OF THE CREST.
5. CHECK DAMS ARE TO REMAIN IN PLACE UNTIL THE UPSTREAM DISTURBED AREA IS STABILIZED AND APPROVED BY THE LOCAL JURISDICTION.
6. WHEN CHECK DAMS ARE REMOVED, EXCAVATIONS SHALL BE FILLED WITH SUITABLE COMPACTED BACKFILL. DISTURBED AREA SHALL BE SEEDED AND MULCHED AND COVERED WITH GEOTEXTILE OR OTHERWISE STABILIZED IN A MANNER APPROVED BY THE LOCAL JURISDICTION.

CD-4 Urban Drainage and Flood Control District November 2010
Urban Storm Drainage Criteria Manual Volume 3

Streambank Stabilization (SS) EC-13

Description

Streambank stabilization involves a combination of erosion and sediment control practices to protect streams, banks, and in-stream habitat from accelerated erosion. BMPs associated with streambank stabilization may include protection of existing vegetation, check dams/grade control, temporary and permanent seeding, outlet protection, rolled erosion control products, temporary diversions, dewatering operations and bioengineering practices such as brush layering, live staking and fascines.



Photograph SS-1. Streambank stabilization using geotextiles following installation of a permanent in-stream grade control structure.

Appropriate Uses

Streambank stabilization may be a construction activity in and of itself, or it may be in conjunction with a broader construction project that discharges to a waterway that is susceptible to accelerated erosion due to increases in the rate and volume of stormwater runoff. Depending on the health of the stream, water quality sampling and testing may be advisable prior to and/or during construction to evaluate health and stability of the stream and potential effects from adjacent construction activities.

Design and Installation

Streambank stabilization consists of protecting the stream in a variety of ways to minimize negative effects to the stream environment. The following lists the minimum requirements necessary for construction streambank stabilization:

- Protect existing vegetation along the stream bank in accordance with the Vegetated Buffers and Protection of Existing Vegetation Fact Sheets. Preserving a riparian buffer along the streambank will help to remove sediment and decrease runoff rates from the disturbed area.
- Outside the riparian buffer, provide sediment control in the form of a silt fence or equivalent sediment control practice along the entire length of the stream that will receive runoff from the area of disturbance. In some cases, a double-layered perimeter control may be justified adjacent to sensitive receiving waters and wetlands to provide additional protection.
- Stabilize all areas that will be draining to the stream. Use rolled erosion control products, temporary or permanent seeding, or other appropriate measures.
- Ensure all point discharges entering the stream are adequately armored with a velocity dissipation device and appropriate outlet protection.

Streambank Stabilization	
Functions	
Erosion Control	Yes
Sediment Control	No
Site/Material Management	No

See individual design details and notes for the various BMPs referenced in this practice. Additional information on bioengineering techniques for stream stabilization can be

November 2010 Urban Drainage and Flood Control District SS-1
Urban Storm Drainage Criteria Manual Volume 3

UNTIL SUCH TIME AS THESE DRAWINGS ARE APPROVED BY THE APPROPRIATE REVIEWING AGENCIES, JR ENGINEERING APPROVES THEIR USE. DESIGNATED BY WRITTEN AUTHORIZATION.

PREPARED FOR
SR LAND, LLC
20 BOULDER CRESCENT
SUITE 201
COLORADO SPRINGS, CO 80903
JAMES F. MORLEY
(719) 471-1742

J.R. ENGINEERING
A Westman Company
Central 303-740-9383 • Colorado Springs 719-583-2593
Fort Collins 970-491-9888 • www.jrengineering.com

STERLING RANCH FILING NO.2
GRADING & EROSION CONTROL PLAN

H-SCALE	1"=XX'
V-SCALE	1"=X'
DATE	09/01/20
DESIGNED BY	XXX
DRAWN BY	XXX
CHECKED BY	

SHEET 8 OF 8
JOB NO. 25188.01

Description

Concrete waste management involves designating and properly managing a specific area of the construction site as a concrete washout area. A concrete washout area can be created using one of several approaches designed to receive wash water from washing of tools and concrete mixer chutes, liquid concrete waste from dump trucks, mobile batch mixers, or pump trucks. Three basic approaches are available: excavation of a pit in the ground, use of an above ground storage area, or use of prefabricated haul-away concrete washout containers. Surface discharges of concrete washout water from construction sites are prohibited.



Photograph CWA-1. Example of concrete washout area. Note gravel tracking pad for access and sign.

Appropriate Uses

Concrete washout areas must be designated on all sites that will generate concrete wash water or liquid concrete waste from onsite concrete mixing or concrete delivery.

Because pH is a pollutant of concern for washout activities, when unlined pits are used for concrete washout, the soil must have adequate buffering capacity to result in protection of state groundwater standards; otherwise, a liner/containment must be used. The following management practices are recommended to prevent an impact from unlined pits to groundwater:

- The use of the washout site should be temporary (less than 1 year), and
- The washout site should be not be located in an area where shallow groundwater may be present, such as near natural drainages, springs, or wetlands.

Design and Installation

Concrete washout activities must be conducted in a manner that does not contribute pollutants to surface waters or stormwater runoff. Concrete washout areas may be lined or unlined excavated pits in the ground, commercially manufactured prefabricated washout containers, or aboveground holding areas constructed of berms, sandbags or straw bales with a plastic liner.

Although unlined washout areas may be used, lined pits may be required to protect groundwater under certain conditions.

Do not locate an unlined washout area within 400 feet of any natural drainage pathway or waterbody or within 1,000 feet of any wells or drinking water sources. Even for lined concrete washouts, it is advisable to locate the facility away from waterbodies and drainage paths. If site constraints make these

Concrete Washout Area	
Functions	
Erosion Control	No
Sediment Control	No
Site/Material Management	Yes

setbacks infeasible or if highly permeable soils exist in the area, then the pit must be installed with an impermeable liner (16 mil minimum thickness) or surface storage alternatives using prefabricated concrete washout devices or a lined aboveground storage area should be used.

Design details with notes are provided in Detail CWA-1 for pits and CWA-2 for aboveground storage areas. Pre-fabricated concrete washout container information can be obtained from vendors.

Maintenance and Removal

A key consideration for concrete washout areas is to ensure that adequate signage is in place identifying the location of the washout area. Part of inspecting and maintaining washout areas is ensuring that adequate signage is provided and in good repair and that the washout area is being used, as opposed to washout in non-designated areas of the site.

Remove concrete waste in the washout area, as needed to maintain BMP function (typically when filled to about two-thirds of its capacity). Collect concrete waste and deliver offsite to a designated disposal location.

Upon termination of use of the washout site, accumulated solid waste, including concrete waste and any contaminated soils, must be removed from the site to prevent on-site disposal of solid waste. If the wash water is allowed to evaporate and the concrete hardens, it may be recycled.



Photograph CWA-2. Prefabricated concrete washout. Photo courtesy of CDOT.



Photograph CWA-3. Earthen concrete washout. Photo courtesy of CDOT.

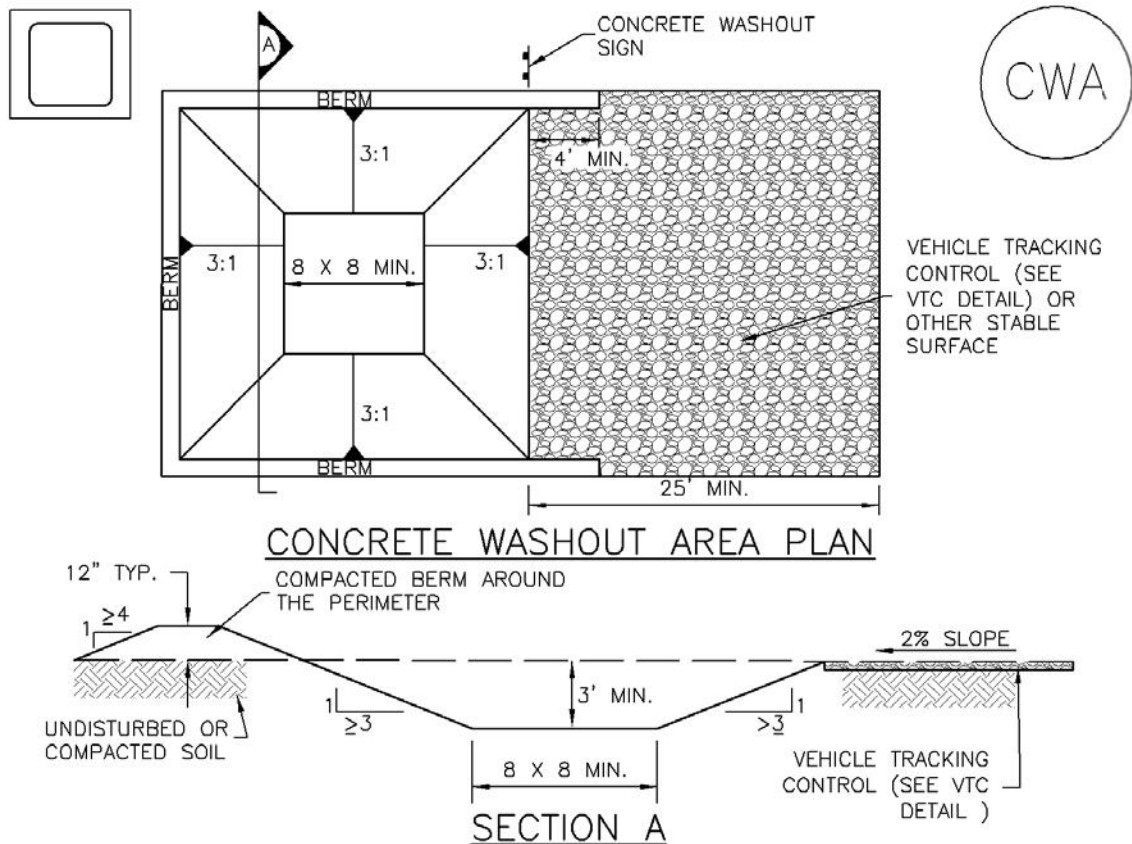

CWA-1. CONCRETE WASHOUT AREA

CWA INSTALLATION NOTES

1. SEE PLAN VIEW FOR:
-CWA INSTALLATION LOCATION.
2. DO NOT LOCATE AN UNLINED CWA WITHIN 400' OF ANY NATURAL DRAINAGE PATHWAY OR WATERBODY. DO NOT LOCATE WITHIN 1,000' OF ANY WELLS OR DRINKING WATER SOURCES. IF SITE CONSTRAINTS MAKE THIS INFEASIBLE, OR IF HIGHLY PERMEABLE SOILS EXIST ON SITE, THE CWA MUST BE INSTALLED WITH AN IMPERMEABLE LINER (16 MIL MIN. THICKNESS) OR SURFACE STORAGE ALTERNATIVES USING PREFABRICATED CONCRETE WASHOUT DEVICES OR A LINED ABOVE GROUND STORAGE ARE SHOULD BE USED.
3. THE CWA SHALL BE INSTALLED PRIOR TO CONCRETE PLACEMENT ON SITE.
4. CWA SHALL INCLUDE A FLAT SUBSURFACE PIT THAT IS AT LEAST 8' BY 8' SLOPES LEADING OUT OF THE SUBSURFACE PIT SHALL BE 3:1 OR FLATTER. THE PIT SHALL BE AT LEAST 3' DEEP.
5. BERM SURROUNDING SIDES AND BACK OF THE CWA SHALL HAVE MINIMUM HEIGHT OF 1'.
6. VEHICLE TRACKING PAD SHALL BE SLOPED 2% TOWARDS THE CWA.
7. SIGNS SHALL BE PLACED AT THE CONSTRUCTION ENTRANCE, AT THE CWA, AND ELSEWHERE AS NECESSARY TO CLEARLY INDICATE THE LOCATION OF THE CWA TO OPERATORS OF CONCRETE TRUCKS AND PUMP RIGS.
8. USE EXCAVATED MATERIAL FOR PERIMETER BERM CONSTRUCTION.

CWA MAINTENANCE NOTES

1. INSPECT BMPs EACH WORKDAY, AND MAINTAIN THEM IN EFFECTIVE OPERATING CONDITION. MAINTENANCE OF BMPs SHOULD BE PROACTIVE, NOT REACTIVE. INSPECT BMPs AS SOON AS POSSIBLE (AND ALWAYS WITHIN 24 HOURS) FOLLOWING A STORM THAT CAUSES SURFACE EROSION, AND PERFORM NECESSARY MAINTENANCE.

2. FREQUENT OBSERVATIONS AND MAINTENANCE ARE NECESSARY TO MAINTAIN BMPs IN EFFECTIVE OPERATING CONDITION. INSPECTIONS AND CORRECTIVE MEASURES SHOULD BE DOCUMENTED THOROUGHLY.

3. WHERE BMPs HAVE FAILED, REPAIR OR REPLACEMENT SHOULD BE INITIATED UPON DISCOVERY OF THE FAILURE.

4. THE CWA SHALL BE REPAIRED, CLEANED, OR ENLARGED AS NECESSARY TO MAINTAIN CAPACITY FOR CONCRETE WASTE. CONCRETE MATERIALS, ACCUMULATED IN PIT, SHALL BE REMOVED ONCE THE MATERIALS HAVE REACHED A DEPTH OF 2'.

5. CONCRETE WASHOUT WATER, WASTED PIECES OF CONCRETE AND ALL OTHER DEBRIS IN THE SUBSURFACE PIT SHALL BE TRANSPORTED FROM THE JOB SITE IN A WATER-TIGHT CONTAINER AND DISPOSED OF PROPERLY.

6. THE CWA SHALL REMAIN IN PLACE UNTIL ALL CONCRETE FOR THE PROJECT IS PLACED.

7. WHEN THE CWA IS REMOVED, COVER THE DISTURBED AREA WITH TOP SOIL, SEED AND MULCH OR OTHERWISE STABILIZED IN A MANNER APPROVED BY THE LOCAL JURISDICTION.

(DETAIL ADAPTED FROM DOUGLAS COUNTY, COLORADO AND THE CITY OF PARKER, COLORADO, NOT AVAILABLE IN AUTOCAD).

NOTE: MANY JURISDICTIONS HAVE BMP DETAILS THAT VARY FROM UDFCD STANDARD DETAILS. CONSULT WITH LOCAL JURISDICTIONS AS TO WHICH DETAIL SHOULD BE USED WHEN DIFFERENCES ARE NOTED.

Erosion Control Blankets

What it is

Erosion control blankets are geotextiles or filter fabrics that are used to stabilize soils, steep slopes and drainage channels.

TYPES OF EROSION CONTROL BLANKETS

- WOVEN OR BONDED SYNTHETIC MATERIALS SUCH AS POLYPROPYLENE, POLYESTER, POLYETHYLENE, NYLON, POLYVINYL CHLORIDE, GLASS AND VARIOUS MIXTURES OF THESE.
- MULCH MATTING MADE FROM JUTE OR OTHER WOOD FIBER THAT HAS BEEN FORMED INTO SHEETS.
- NETTING MADE FROM JUTE OR OTHER WOOD FIBER, PLASTIC, PAPER, OR COTTON USED TO HOLD MULCH AND MATTING TO THE GROUND.
- BLANKETS OF WOVEN STRAW MULCH WITH A SYNTHETIC LAYER OR NET.



When and Where to use it

- In temporary and permanent swales.
- To protect recently seeded slopes.
- In drainageway channels.

When and Where NOT to use it

- In swales with slopes greater than 5 percent or with stormwater velocities > 8 feet per second.

Installation and Maintenance Requirements

Installation requirements are provided in Figures ECB-1 and ECB-2.

Maintenance requirements include regular inspections to determine if fabric is damaged or has come loose, and appropriate repairs or replacement of damaged materials.

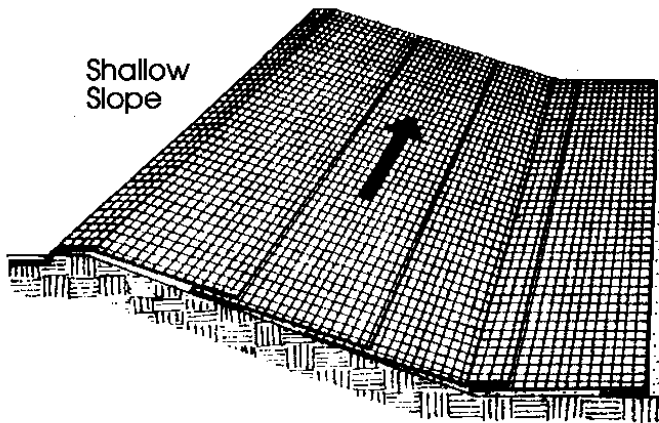

Shallow Slope

On shallow slopes, strips of netting may be applied across the slope.

Where there is a berm at the top of the slope, bring the netting over the berm and anchor it behind the berm.

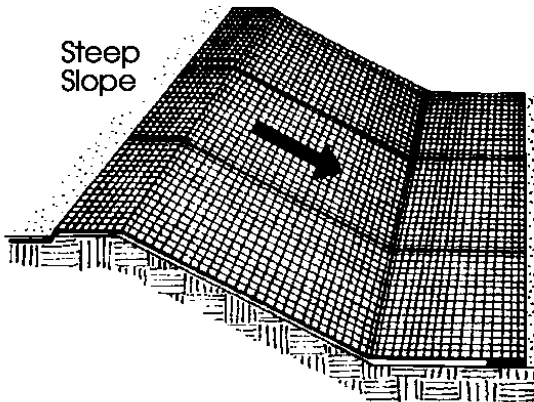

Steep Slope

On steep slopes, apply strips of netting parallel to the direction of flow and anchor securely.

Bring netting down to a level area before terminating the installation. Turn the end under 6" and staple at 12" intervals.

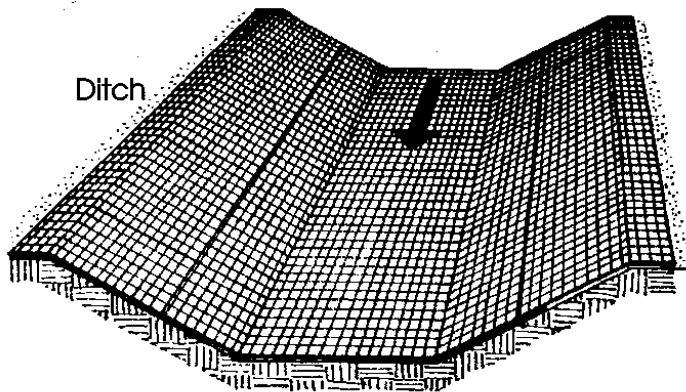
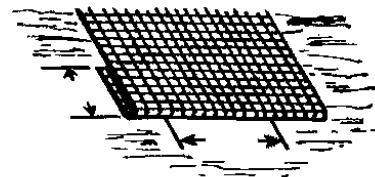

Ditch

In ditches, apply netting parallel to the direction of flow. Use check slots every 15 feet. Do not join strips in the center of the ditch.

From: Virginia Soil and Water Conservation Commission, 1985

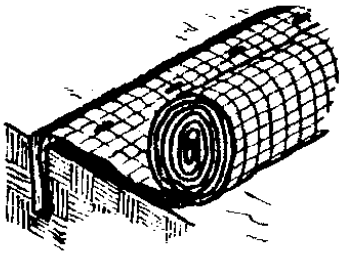

Anchor Slot: Bury the up-channel end of the net in a 6" deep trench. Tamp the soil firmly. Staple at 12" intervals across the net.

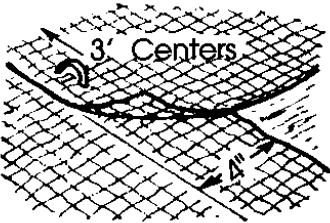

Overlap: Overlap edges of the strips at least 4". Staple every 3 feet down the center of the strip.

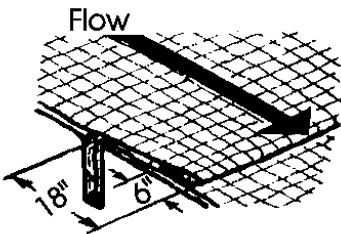
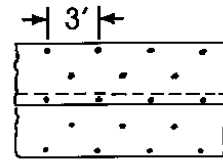

Joining Strips: Insert the new roll of net in a trench, as with the Anchor Slot. Overlap the up-channel end of the previous roll 18" and turn the end under 6". Staple the end of the previous roll just below the anchor slot and at the end at 12" intervals.

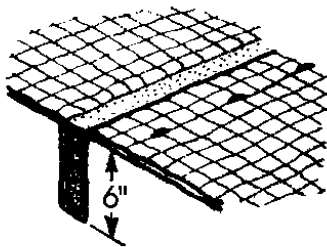

Check Slots: On erodible soils or steep slopes, check slots should be made every 15 feet. Insert a fold of the net into a 6" trench and tamp firmly. Staple at 12" intervals across the net. Lay the net smoothly on the surface of the soil - do not stretch the net, and do not allow wrinkles.

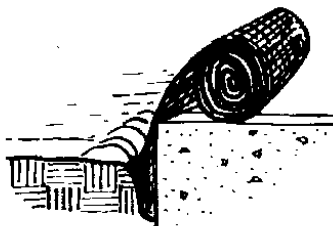

Anchoring Ends At Structures: Place the end of the net in a 6" slot on the up-channel side of the structure. Fill the trench and tamp firmly. Roll the net up the channel. Place staples at 12" intervals along the anchor end of the net.

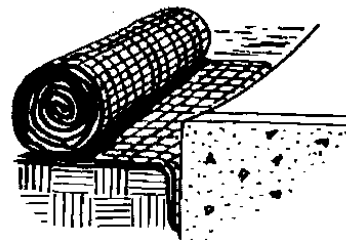

From: Virginia Soil and Water Conservation Commission, 1985

City of Colorado Springs
Storm Water Quality

Figure ECB-2
Erosion Control Blanket
Installation Requirements

Inlet Protection

What it is

Inlet protection is a sediment control barrier formed around a storm drain inlet. A number of alternative inlet protection designs are available, including:

- Silt Fence Inlet Protection.
- Straw Bale Barrier Inlet Protection.
- Block and Gravel Bag Inlet Protection.
- Curb Socks Inlet Protection.



When and Where to use it

Application of inlet protection differs by design.

- Filter fabric and straw bale inlet protection are used for area inlets (not located within streets).
- Block and gravel bag curb inlet protection is used for street inlets in sumps.
- Curb sock protection is used for street inlets in sumps or on continuous grade.



When and Where NOT to use it

- Filter fabric and straw bale inlet protection cannot be used for drain inlets that are paved because these designs require excavation and/or staking of materials.
- Block and gravel bag inlet protection is not recommended for continuous grade inlets due to concerns about damage from bypassed flow.

Construction Detail and Maintenance Requirements

Figures IP-1 through IP-4 provide a construction detail and maintenance requirements for each inlet protection design alternative.

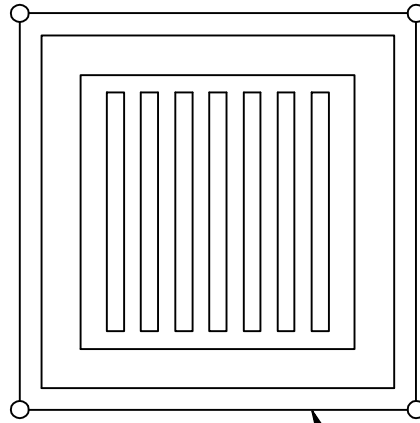

FILTER FABRIC
(SEE FIG. SF-2 FOR
INSTALLATION
REQUIREMENTS)

FILTER FABRIC INLET PROTECTION

NTS

FILTER FABRIC INLET PROTECTION NOTES

INSTALLATION REQUIREMENTS

1. INLET PROTECTION SHALL BE INSTALLED IMMEDIATELY AFTER CONSTRUCTION OF INLET.
2. SEE SILT FENCE FIGURE SF-2 FOR INSTALLATION REQUIREMENTS.
3. POSTS ARE TO BE PLACED AT EACH CORNER OF THE INLET AND AROUND THE EDGES AT A MAXIMUM SPACING OF 3 FEET.

MAINTENANCE REQUIREMENTS

1. CONTRACTOR SHALL INSPECT INLET PROTECTION IMMEDIATELY AFTER EACH RAINFALL, AT LEAST DAILY DURING PROLONGED RAINFALL, AND WEEKLY DURING PERIODS NO RAINFALL.
2. DAMAGED, COLLAPSED, UNENTRENCHED OR INEFFECTIVE INLET PROTECTION SHALL BE PROMPTLY REPAIRED OR REPLACED.
3. SEDIMENT SHALL BE REMOVED FROM BEHIND FILTER FABRIC WHEN IT ACCUMULATES TO HALF THE EXPOSED GEOTEXTILE HEIGHT.
4. FILTER FABRIC PROTECTION SHALL BE REMOVED WHEN ADEQUATE VEGETATIVE COVER IS ATTAINED IN THE DRAINAGE AREA AS APPROVED BY THE CITY.

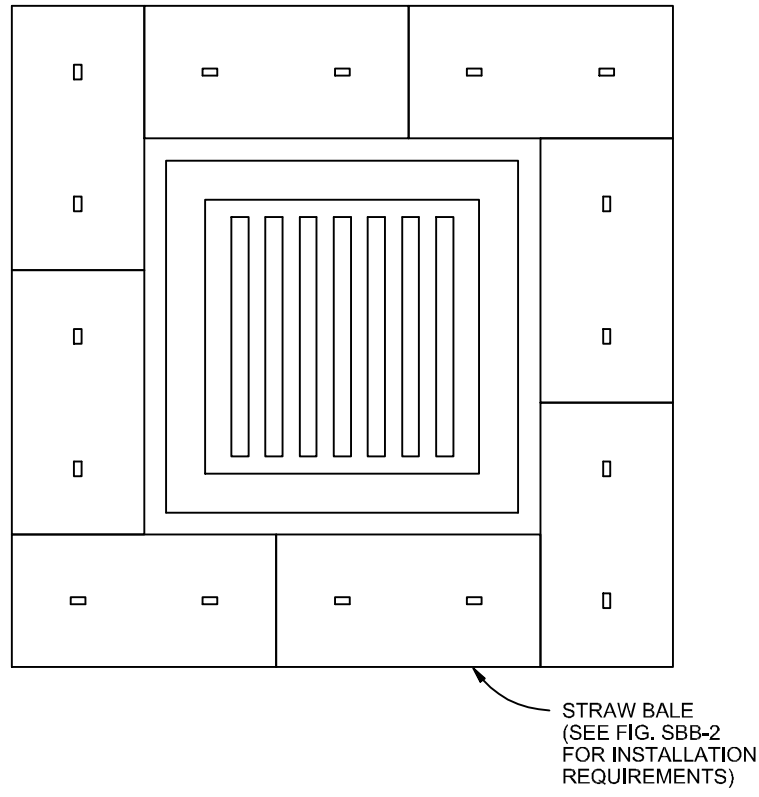

STRAW BALE INLET PROTECTION
NTS

STRAW BALE INLET PROTECTION NOTES

INSTALLATION REQUIREMENTS

1. INLET PROTECTION SHALL BE INSTALLED IMMEDIATELY AFTER CONSTRUCTION OF INLET.
2. BALES ARE TO BE PLACED IN A SINGLE ROW AROUND THE INLET WITH THE END OF THE BALES TIGHTLY ABUTTING ONE ANOTHER.
3. SEE STRAW BALE BARRIER FIGURE SBB-2 FOR INSTALLATION REQUIREMENTS.

MAINTENANCE REQUIREMENTS

1. CONTRACTOR SHALL INSPECT STRAW BALE INLET PROTECTION IMMEDIATELY AFTER EACH RAINFALL, AT LEAST DAILY DURING PROLONGED RAINFALL, AND WEEKLY DURING PERIODS NO RAINFALL.
2. DAMAGED OR INEFFECTIVE INLET PROTECTION SHALL PROMPTLY BE REPAIRED, REPLACING BALES IF NECESSARY, AND UNENTRENCHED BALES NEED TO BE REPAIRED WITH COMPACTED BACKFILL MATERIAL.
3. SEDIMENT SHALL BE REMOVED FROM BEHIND STRAW BALES WHEN IT ACCUMULATES TO APPROXIMATELY 1/3 THE HEIGHT OF THE BARRIER.
4. INLET PROTECTION SHALL BE REMOVED WHEN ADEQUATE VEGETATIVE COVER IS ATTAINED WITHIN THE DRAINAGE AREA AS APPROVED BY THE CITY.

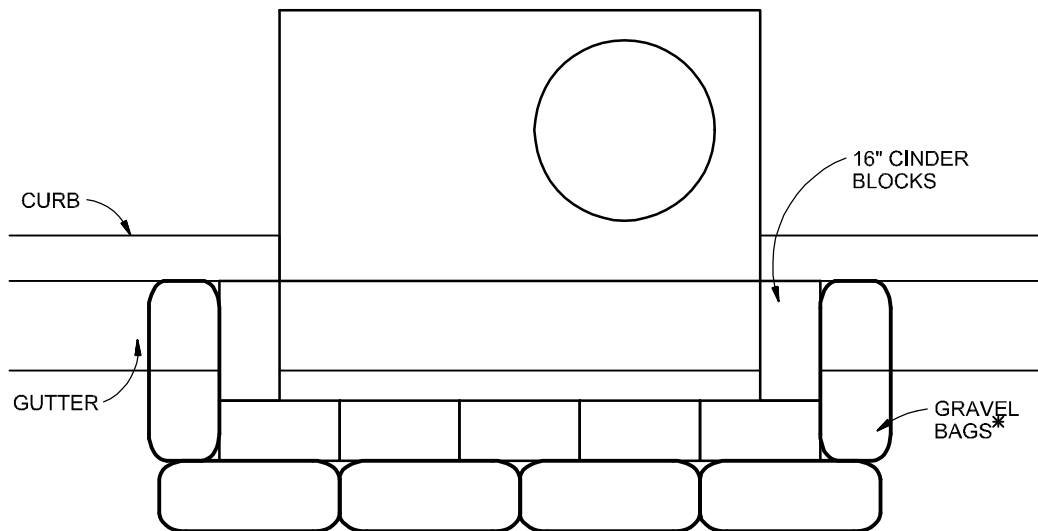

PLAN

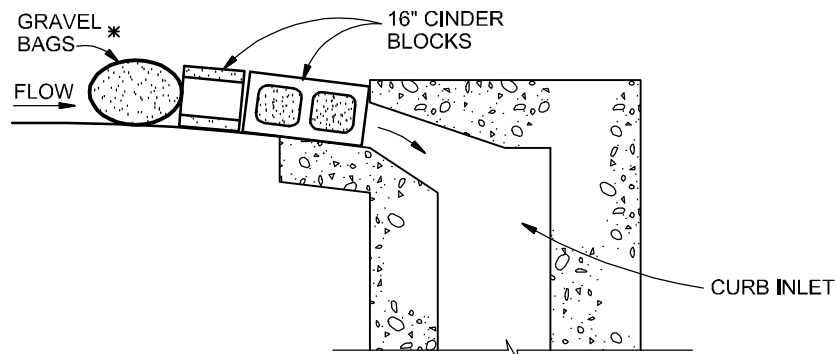

SECTION

BLOCK AND GRAVEL BAG*CURB INLET PROTECTION

NTS

BLOCK AND GRAVEL BAG*CURB INLET PROTECTION NOTES

INSTALLATION REQUIREMENTS

1. INLET PROTECTION SHALL BE INSTALLED IMMEDIATELY AFTER CONSTRUCTION OF INLET.
2. CONCRETE BLOCKS ARE TO BE LAID AROUND THE INLET IN A SINGLE ROW ON THEIR SIDES, ABUTTING ONE ANOTHER WITH THE OPEN ENDS OF THE BLOCK FACING OUTWARD.
3. GRAVEL BAGS ARE TO BE PLACED AROUND THE CONCRETE BLOCKS CLOSELY ABUTTING ONE ANOTHER SO THERE ARE NO GAPS.
4. GRAVEL BAGS ARE TO CONTAIN WASHED SAND OR GRAVEL APPROXIMATELY 3/4 INCH IN DIAMETER.
5. BAGS ARE TO BE MADE OF 1/4" INCH WIRE MESH (USED WITH GRAVEL ONLY) OR GEOTEXTILE.

* AN ALTERNATE 3/4" TO 1" GRAVEL FILTER OVER A WIRE SCREEN MAY BE USED IN PLACE OF GRAVEL BAGS. THE WIRE MESH SHALL EXTEND ABOVE THE TOP OF THE CONCRETE BLOCKS AND THE GRAVEL PLACED OVER THE WIRE SCREEN TO THE TOP OF THE CONCRETE BLOCKS.

MAINTENANCE REQUIREMENTS

1. CONTRACTOR SHALL INSPECT INLET PROTECTION IMMEDIATELY AFTER EACH RAINFALL, AT LEAST DAILY DURING PROLONGED RAINFALL, AND WEEKLY DURING PERIODS NO RAINFALL.
2. DAMAGED OR INEFFECTIVE INLET PROTECTION SHALL PROMPTLY BE REPAIRED OR REPLACED.
3. SEDIMENT SHALL BE REMOVED WHEN SEDIMENT HAS ACCUMULATED TO APPROXIMATELY 1/2 THE DESIGN DEPTH OF THE TRAP.
4. INLET PROTECTION SHALL BE REMOVED WHEN ADEQUATE VEGETATIVE COVER IS ATTAINED WITHIN THE DRAINAGE AREA AS APPROVED BY THE CITY.

City of Colorado Springs
Stormwater Quality

Figure IP-3
Block & Gravel Bag Curb Inlet Protection
Construction Detail and Maintenance
Requirements

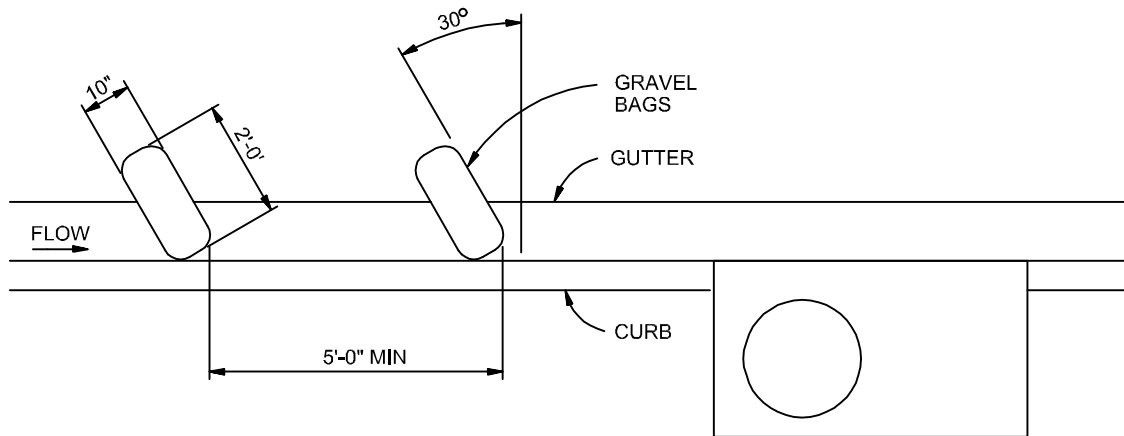

CURB SOCK INLET PROTECTION

NTS

CURB SOCK INLET PROTECTION NOTES

INSTALLATION REQUIREMENTS

1. INLET PROTECTION SHALL BE INSTALLED IMMEDIATELY AFTER CONSTRUCTION OF INLET.
2. SOCK IS TO BE MADE OF 1/4 INCH WIRE MESH (USED WITH GRAVEL ONLY) OR GEOTEXTILE.
3. WASHED SAND OR GRAVEL 3/4 INCH TO 4 INCHES IN DIAMETER IS PLACED INSIDE THE SOCK.
4. PLACEMENT OF THE SOCK IS TO BE 30 DEGREES FROM PERPENDICULAR IN THE OPPOSITE DIRECTION OF FLOW.
5. SOCKS ARE TO BE FLUSH WITH THE CURB AND SPACED AT A MINIMUM 5 FEET APART.
6. AT LEAST 2 CURB SOCKS IN SERIES IS REQUIRED.

MAINTENANCE REQUIREMENTS

1. CONTRACTOR SHALL INSPECT INLET PROTECTION IMMEDIATELY AFTER EACH RAINFALL, AT LEAST DAILY DURING PROLONGED RAINFALL AND WEEKLY DURING PERIODS NO RAINFALL.
2. DAMAGED OR INEFFECTIVE INLET PROTECTION SHALL PROMPTLY BE REPAIRED OR REPLACED.
3. SEDIMENT SHALL BE REMOVED FROM BEHIND THE SOCK WHEN GUTTER WIDTH IS FILLED.
4. INLET PROTECTION SHALL BE REMOVED WHEN ADEQUATE VEGETATIVE COVER IS ATTAINED WITHIN THE DRAINAGE AREA AS APPROVED BY THE CITY.

Mulching

What it is

Mulching is used to temporarily stabilize soils by securely applying materials such as grass, hay, woodchips or wood fibers to the soil's surface.

Mulching protects the soil from raindrop impact and reduces the velocity of overland runoff. Mulch also aids in the growth of temporary seeding by holding seeds and topsoil in place, retaining moisture, and insulating against extreme temperatures.



When and Where to use it

- All disturbed areas and stockpiles shall be mulched within 21 days after final grade is reached.
- Disturbed areas and stockpiles which are not at final grade but will remain dormant for longer than 30 days shall also be mulched within 21 days after interim grading.
- An area that is going to remain in an interim state for more than 60 days shall also be seeded.
- Mulching is always to be used when applying temporary or permanent seeding.
- Mulching is often used when temporary seeding cannot be used due to the season or climate.

When and Where NOT to use it

- In areas that will involve paving, building, or utility construction within 21 days after final grade is reached.

Application Techniques and Maintenance Requirements

Figure MU-1 provides application techniques and maintenance requirements for mulching.

MULCHING NOTES

INSTALLATION REQUIREMENTS

1. ALL DISTURBED AREAS MUST BE MULCHED WITHIN 21 DAYS AFTER FINAL GRADE AND SEEDED AREAS ARE TO BE MULCHED WITHIN 24 HOURS AFTER SEEDING.
2. MATERIAL USED FOR MULCH CAN BE CERTIFIED CLEAN, WEED- AND SEED-FREE LONG STEMMED FIELD OR MARSH HAY, OR STRAW OF OATS, BARLEY, WHEAT, RYE, OR TRITICALE CERTIFIED BY THE COLORADO DEPARTMENT OF AGRICULTURE WEED FREE FORAGE CERTIFICATION PROGRAM.
3. HYDRAULIC MULCHING MATERIAL SHALL CONSIST OF VIRGIN WOOD FIBER MANUFACTURED FROM CLEAN WHOLE WOOD CHIPS. WOOD CHIPS CANNOT CONTAIN ANY GROWTH OR GERMINATION INHIBITORS OR BE PRODUCED FROM RECYCLED MATERIAL. GRAVEL CAN ALSO BE USED.
4. MULCH IS TO BE APPLIED EVENLY AT A RATE OF 2 TONS PER ACRE.
5. MULCH IS TO BE ANCHORED EITHER BY CRIMPING (TUCKING MULCH FIBERS 4 INCHES INTO THE SOIL), USING NETTING (USED ON SMALL AREAS WITH STEEP SLOPES), OR WITH A TACKIFIER.
6. HYDRAULIC MULCHING AND TACKIFIERS ARE NOT TO BE USED IN THE PRESENCE OF FREE SURFACE WATER.

MAINTENANCE REQUIREMENTS

1. REGULAR INSPECTIONS ARE TO BE MADE OF ALL MULCHED AREAS.
2. MULCH IS TO BE REPLACED IMMEDIATELY IN THOSE AREAS IT HAS BEEN REMOVED, AND IF NECESSARY THE AREA SHOULD BE RESEDED.

Description

Outlet protection helps to reduce erosion immediately downstream of a pipe, culvert, slope drain, rundown or other conveyance with concentrated, high-velocity flows. Typical outlet protection consists of riprap or rock aprons at the conveyance outlet.



Photograph TOP-1. Riprap outlet protection.

Appropriate Uses

Outlet protection should be used when a conveyance discharges onto a disturbed area where there is potential for accelerated erosion due to concentrated flow. Outlet protection should be provided where the velocity at the culvert outlet exceeds the maximum permissible velocity of the material in the receiving channel.

Note: This Fact Sheet and detail are for temporary outlet protection, outlets that are intended to be used for less than 2 years. For permanent, long-term outlet protection, see the *Major Drainage* chapter of Volume 1.

Design and Installation

Design outlet protection to handle runoff from the largest drainage area that may be contributing runoff during construction (the drainage area may change as a result of grading). Key in rock, around the entire perimeter of the apron, to a minimum depth of 6 inches for stability. Extend riprap to the height of the culvert or the normal flow depth of the downstream channel, whichever is less. Additional erosion control measures such as vegetative lining, turf reinforcement mat and/or other channel lining methods may be required downstream of the outlet protection if the channel is susceptible to erosion. See Design Detail OP-1 for additional information.

Maintenance and Removal

Inspect apron for damage and displaced rocks. If rocks are missing or significantly displaced, repair or replace as necessary. If rocks are continuously missing or displaced, consider increasing the size of the riprap or deeper keying of the perimeter.

Remove sediment accumulated at the outlet before the outlet protection becomes buried and ineffective. When sediment accumulation is noted, check that upgradient BMPs, including inlet protection, are in effective operating condition.

Outlet protection may be removed once the pipe is no longer draining an upstream area, or once the downstream area has been sufficiently stabilized. If the drainage pipe is permanent, outlet protection can be left in place; however, permanent outlet protection should be designed and constructed in accordance with the requirements of the *Major Drainage* chapter of Volume 2.

Outlet Protection	
Functions	
Erosion Control	Yes
Sediment Control	Moderate
Site/Material Management	No

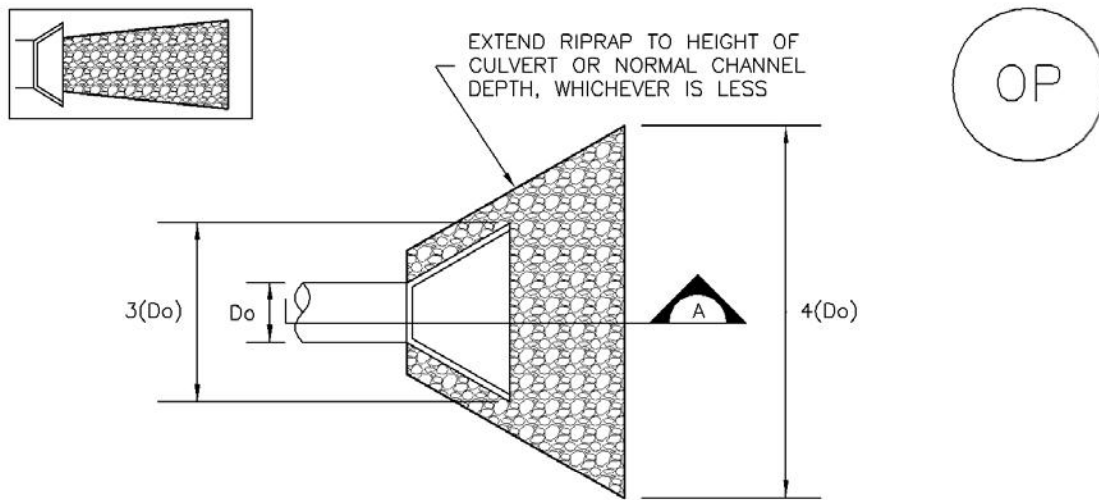

TEMPORARY OUTLET PROTECTION PLAN

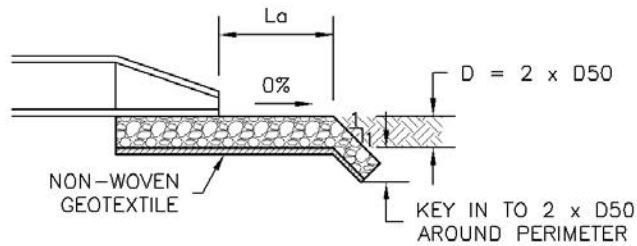

SECTION A

TABLE OP-1. TEMPORARY OUTLET PROTECTION SIZING TABLE			
PIPE DIAMETER, D_o (INCHES)	DISCHARGE, Q (CFS)	APRON LENGTH, L_a (FT)	RIPRAP D50 DIAMETER MIN (INCHES)
8	2.5	5	4
	5	10	6
12	5	10	4
	10	13	6
18	10	10	6
	20	16	9
	30	23	12
24	40	26	16
	30	16	9
	40	26	9
	50	26	12
	60	30	16

OP-1. TEMPORARY OUTLET PROTECTION

TEMPORARY OUTLET PROTECTION INSTALLATION NOTES

1. SEE PLAN VIEW FOR
 - LOCATION OF OUTLET PROTECTION.
 - DIMENSIONS OF OUTLET PROTECTION.
2. DETAIL IS INTENDED FOR PIPES WITH SLOPE $\leq 10\%$. ADDITIONAL EVALUATION OF RIPRAP SIZING AND OUTLET PROTECTION DIMENSIONS REQUIRED FOR STEEPER SLOPES.
3. TEMPORARY OUTLET PROTECTION INFORMATION IS FOR OUTLETS INTENDED TO BE UTILIZED LESS THAN 2 YEARS.

TEMPORARY OUTLET PROTECTION INSPECTION AND MAINTENANCE NOTES

1. INSPECT BMPs EACH WORKDAY, AND MAINTAIN THEM IN EFFECTIVE OPERATING CONDITION. MAINTENANCE OF BMPs SHOULD BE PROACTIVE, NOT REACTIVE. INSPECT BMPs AS SOON AS POSSIBLE (AND ALWAYS WITHIN 24 HOURS) FOLLOWING A STORM THAT CAUSES SURFACE EROSION, AND PERFORM NECESSARY MAINTENANCE.
2. FREQUENT OBSERVATIONS AND MAINTENANCE ARE NECESSARY TO MAINTAIN BMPs IN EFFECTIVE OPERATING CONDITION. INSPECTIONS AND CORRECTIVE MEASURES SHOULD BE DOCUMENTED THOROUGHLY.
3. WHERE BMPs HAVE FAILED, REPAIR OR REPLACEMENT SHOULD BE INITIATED UPON DISCOVERY OF THE FAILURE.

NOTE: MANY JURISDICTIONS HAVE BMP DETAILS THAT VARY FROM UDFCD STANDARD DETAILS. CONSULT WITH LOCAL JURISDICTIONS AS TO WHICH DETAIL SHOULD BE USED WHEN DIFFERENCES ARE NOTED.

(DETAILS ADAPTED FROM AURORA, COLORADO AND PREVIOUS VERSION OF VOLUME 3, NOT AVAILABLE IN AUTOCAD)

Description

Temporary seeding can be used to stabilize disturbed areas that will be inactive for an extended period. Permanent seeding should be used to stabilize areas at final grade that will not be otherwise stabilized. Effective seeding includes preparation of a seedbed, selection of an appropriate seed mixture, proper planting techniques, and protection of the seeded area with mulch, geotextiles, or other appropriate measures.



Photograph TS/PS -1. Equipment used to drill seed. Photo courtesy of Douglas County.

Appropriate Uses

When the soil surface is disturbed and will remain inactive for an extended period (typically 30 days or longer), proactive stabilization measures should be implemented. If the inactive period is short-lived (on the order of two weeks), techniques such as surface roughening may be appropriate. For longer periods of inactivity, temporary seeding and mulching can provide effective erosion control. Permanent seeding should be used on finished areas that have not been otherwise stabilized.

Typically, local governments have their own seed mixes and timelines for seeding. Check jurisdictional requirements for seeding and temporary stabilization.

Design and Installation

Effective seeding requires proper seedbed preparation, selection of an appropriate seed mixture, use of appropriate seeding equipment to ensure proper coverage and density, and protection with mulch or fabric until plants are established.

The USDCM Volume 2 *Revegetation* Chapter contains detailed seed mix, soil preparations, and seeding and mulching recommendations that may be referenced to supplement this Fact Sheet.

Drill seeding is the preferred seeding method. Hydroseeding is not recommended except in areas where steep slopes prevent use of drill seeding equipment, and even in these instances it is preferable to hand seed and mulch. Some jurisdictions do not allow hydroseeding or hydromulching.

Seedbed Preparation

Prior to seeding, ensure that areas to be revegetated have soil conditions capable of supporting vegetation. Overlot grading can result in loss of topsoil, resulting in poor quality subsoils at the ground surface that have low nutrient value, little organic matter content, few soil microorganisms, rooting restrictions, and conditions less conducive to infiltration of precipitation. As a result, it is typically necessary to provide stockpiled topsoil, compost, or other

Temporary and Permanent Seeding	
Functions	
Erosion Control	Yes
Sediment Control	No
Site/Material Management	No

EC-2 Temporary and Permanent Seeding (TS/PS)

soil amendments and rototill them into the soil to a depth of 6 inches or more.

Topsoil should be salvaged during grading operations for use and spread on areas to be revegetated later. Topsoil should be viewed as an important resource to be utilized for vegetation establishment, due to its water-holding capacity, structure, texture, organic matter content, biological activity, and nutrient content. The rooting depth of most native grasses in the semi-arid Denver metropolitan area is 6 to 18 inches. At a minimum, the upper 6 inches of topsoil should be stripped, stockpiled, and ultimately respread across areas that will be revegetated.

Where topsoil is not available, subsoils should be amended to provide an appropriate plant-growth medium. Organic matter, such as well digested compost, can be added to improve soil characteristics conducive to plant growth. Other treatments can be used to adjust soil pH conditions when needed. Soil testing, which is typically inexpensive, should be completed to determine and optimize the types and amounts of amendments that are required.

If the disturbed ground surface is compacted, rip or rototill the surface prior to placing topsoil. If adding compost to the existing soil surface, rototilling is necessary. Surface roughening will assist in placement of a stable topsoil layer on steeper slopes, and allow infiltration and root penetration to greater depth.

Prior to seeding, the soil surface should be rough and the seedbed should be firm, but neither too loose nor compacted. The upper layer of soil should be in a condition suitable for seeding at the proper depth and conducive to plant growth. Seed-to-soil contact is the key to good germination.

Seed Mix for Temporary Vegetation

To provide temporary vegetative cover on disturbed areas which will not be paved, built upon, or fully landscaped or worked for an extended period (typically 30 days or more), plant an annual grass appropriate for the time of planting and mulch the planted areas. Annual grasses suitable for the Denver metropolitan area are listed in Table TS/PS-1. These are to be considered only as general recommendations when specific design guidance for a particular site is not available. Local governments typically specify seed mixes appropriate for their jurisdiction.

Seed Mix for Permanent Revegetation

To provide vegetative cover on disturbed areas that have reached final grade, a perennial grass mix should be established. Permanent seeding should be performed promptly (typically within 14 days) after reaching final grade. Each site will have different characteristics and a landscape professional or the local jurisdiction should be contacted to determine the most suitable seed mix for a specific site. In lieu of a specific recommendation, one of the perennial grass mixes appropriate for site conditions and growth season listed in Table TS/PS-2 can be used. The pure live seed (PLS) rates of application recommended in these tables are considered to be absolute minimum rates for seed applied using proper drill-seeding equipment.

If desired for wildlife habitat or landscape diversity, shrubs such as rubber rabbitbrush (*Chrysothamnus nauseosus*), fourwing saltbush (*Atriplex canescens*) and skunkbrush sumac (*Rhus trilobata*) could be added to the upland seedmixes at 0.25, 0.5 and 1 pound PLS/acre, respectively. In riparian zones, planting root stock of such species as American plum (*Prunus americana*), woods rose (*Rosa woodsii*), plains cottonwood (*Populus sargentii*), and willow (*Populus spp.*) may be considered. On non-topsoiled upland sites, a legume such as Ladak alfalfa at 1 pound PLS/acre can be included as a source of nitrogen for perennial grasses.

Seeding dates for the highest success probability of perennial species along the Front Range are generally in the spring from April through early May and in the fall after the first of September until the ground freezes. If the area is irrigated, seeding may occur in summer months, as well. See Table TS/PS-3 for appropriate seeding dates.

Table TS/PS-1. Minimum Drill Seeding Rates for Various Temporary Annual Grasses

Species ^a (Common name)	Growth Season ^b	Pounds of Pure Live Seed (PLS)/acre ^c	Planting Depth (inches)
1. Oats	Cool	35 - 50	1 - 2
2. Spring wheat	Cool	25 - 35	1 - 2
3. Spring barley	Cool	25 - 35	1 - 2
4. Annual ryegrass	Cool	10 - 15	½
5. Millet	Warm	3 - 15	½ - ¾
6. Sudangrass	Warm	5-10	½ - ¾
7. Sorghum	Warm	5-10	½ - ¾
8. Winter wheat	Cool	20-35	1 - 2
9. Winter barley	Cool	20-35	1 - 2
10. Winter rye	Cool	20-35	1 - 2
11. Triticale	Cool	25-40	1 - 2

^a Successful seeding of annual grass resulting in adequate plant growth will usually produce enough dead-plant residue to provide protection from wind and water erosion for an additional year. This assumes that the cover is not disturbed or mowed closer than 8 inches.

Hydraulic seeding may be substituted for drilling only where slopes are steeper than 3:1 or where access limitations exist. When hydraulic seeding is used, hydraulic mulching should be applied as a separate operation, when practical, to prevent the seeds from being encapsulated in the mulch.

^b See Table TS/PS-3 for seeding dates. Irrigation, if consistently applied, may extend the use of cool season species during the summer months.

^c Seeding rates should be doubled if seed is broadcast, or increased by 50 percent if done using a Brillion Drill or by hydraulic seeding.

EC-2 Temporary and Permanent Seeding (TS/PS)

Table TS/PS-2. Minimum Drill Seeding Rates for Perennial Grasses

Common ^a Name	Botanical Name	Growth Season ^b	Growth Form	Seeds/ Pound	Pounds of PLS/acre
Alkali Soil Seed Mix					
Alkali sacaton	<i>Sporobolus airoides</i>	Cool	Bunch	1,750,000	0.25
Basin wildrye	<i>Elymus cinereus</i>	Cool	Bunch	165,000	2.5
Sodar streambank wheatgrass	<i>Agropyron riparium 'Sodar'</i>	Cool	Sod	170,000	2.5
Jose tall wheatgrass	<i>Agropyron elongatum 'Jose'</i>	Cool	Bunch	79,000	7.0
Arriba western wheatgrass	<i>Agropyron smithii 'Arriba'</i>	Cool	Sod	110,000	5.5
Total					17.75
Fertile Loamy Soil Seed Mix					
Ephriam crested wheatgrass	<i>Agropyron cristatum 'Ephriam'</i>	Cool	Sod	175,000	2.0
Dural hard fescue	<i>Festuca ovina 'duriuscula'</i>	Cool	Bunch	565,000	1.0
Lincoln smooth brome	<i>Bromus inermis leys 'Lincoln'</i>	Cool	Sod	130,000	3.0
Sodar streambank wheatgrass	<i>Agropyron riparium 'Sodar'</i>	Cool	Sod	170,000	2.5
Arriba western wheatgrass	<i>Agropyron smithii 'Arriba'</i>	Cool	Sod	110,000	7.0
Total					15.5
High Water Table Soil Seed Mix					
Meadow foxtail	<i>Alopecurus pratensis</i>	Cool	Sod	900,000	0.5
Redtop	<i>Agrostis alba</i>	Warm	Open sod	5,000,000	0.25
Reed canarygrass	<i>Phalaris arundinacea</i>	Cool	Sod	68,000	0.5
Lincoln smooth brome	<i>Bromus inermis leys 'Lincoln'</i>	Cool	Sod	130,000	3.0
Pathfinder switchgrass	<i>Panicum virgatum 'Pathfinder'</i>	Warm	Sod	389,000	1.0
Alkar tall wheatgrass	<i>Agropyron elongatum 'Alkar'</i>	Cool	Bunch	79,000	5.5
Total					10.75
Transition Turf Seed Mix^c					
Ruebens Canadian bluegrass	<i>Poa compressa 'Ruebens'</i>	Cool	Sod	2,500,000	0.5
Dural hard fescue	<i>Festuca ovina 'duriuscula'</i>	Cool	Bunch	565,000	1.0
Citation perennial ryegrass	<i>Lolium perenne 'Citation'</i>	Cool	Sod	247,000	3.0
Lincoln smooth brome	<i>Bromus inermis leys 'Lincoln'</i>	Cool	Sod	130,000	3.0
Total					7.5

Table TS/PS-2. Minimum Drill Seeding Rates for Perennial Grasses (cont.)

Common Name	Botanical Name	Growth Season ^b	Growth Form	Seeds/Pound	Pounds of PLS/acre
Sandy Soil Seed Mix					
Blue grama	<i>Bouteloua gracilis</i>	Warm	Sod-forming bunchgrass	825,000	0.5
Camper little bluestem	<i>Schizachyrium scoparium</i> 'Camper'	Warm	Bunch	240,000	1.0
Prairie sandreed	<i>Calamovilfa longifolia</i>	Warm	Open sod	274,000	1.0
Sand dropseed	<i>Sporobolus cryptandrus</i>	Cool	Bunch	5,298,000	0.25
Vaughn sideoats grama	<i>Bouteloua curtipendula</i> 'Vaughn'	Warm	Sod	191,000	2.0
Arriba western wheatgrass	<i>Agropyron smithii</i> 'Arriba'	Cool	Sod	110,000	5.5
Total					10.25
Heavy Clay, Rocky Foothill Seed Mix					
Ephriam crested wheatgrass ^d	<i>Agropyron cristatum</i> 'Ephriam'	Cool	Sod	175,000	1.5
Oahe Intermediate wheatgrass	<i>Agropyron intermedium</i> 'Oahe'	Cool	Sod	115,000	5.5
Vaughn sideoats grama ^e	<i>Bouteloua curtipendula</i> 'Vaughn'	Warm	Sod	191,000	2.0
Lincoln smooth brome	<i>Bromus inermis</i> leys 'Lincoln'	Cool	Sod	130,000	3.0
Arriba western wheatgrass	<i>Agropyron smithii</i> 'Arriba'	Cool	Sod	110,000	5.5
Total					17.5
<p>^a All of the above seeding mixes and rates are based on drill seeding followed by crimped straw mulch. These rates should be doubled if seed is broadcast and should be increased by 50 percent if the seeding is done using a Brillion Drill or is applied through hydraulic seeding. Hydraulic seeding may be substituted for drilling only where slopes are steeper than 3:1. If hydraulic seeding is used, hydraulic mulching should be done as a separate operation.</p> <p>^b See Table TS/PS-3 for seeding dates.</p> <p>^c If site is to be irrigated, the transition turf seed rates should be doubled.</p> <p>^d Crested wheatgrass should not be used on slopes steeper than 6H to 1V.</p> <p>^e Can substitute 0.5 lbs PLS of blue grama for the 2.0 lbs PLS of Vaughn sideoats grama.</p>					

EC-2 Temporary and Permanent Seeding (TS/PS)

Table TS/PS-3. Seeding Dates for Annual and Perennial Grasses

Seeding Dates	Annual Grasses (Numbers in table reference species in Table TS/PS-1)		Perennial Grasses	
	Warm	Cool	Warm	Cool
January 1–March 15			✓	✓
March 16–April 30	4	1,2,3	✓	✓
May 1–May 15	4		✓	
May 16–June 30	4,5,6,7			
July 1–July 15	5,6,7			
July 16–August 31				
September 1–September 30		8,9,10,11		
October 1–December 31			✓	✓

Mulch

Cover seeded areas with mulch or an appropriate rolled erosion control product to promote establishment of vegetation. Anchor mulch by crimping, netting or use of a non-toxic tackifier. See the Mulching BMP Fact Sheet for additional guidance.

Maintenance and Removal

Monitor and observe seeded areas to identify areas of poor growth or areas that fail to germinate. Reseed and mulch these areas, as needed.

An area that has been permanently seeded should have a good stand of vegetation within one growing season if irrigated and within three growing seasons without irrigation in Colorado. Reseed portions of the site that fail to germinate or remain bare after the first growing season.

Seeded areas may require irrigation, particularly during extended dry periods. Targeted weed control may also be necessary.

Protect seeded areas from construction equipment and vehicle access.

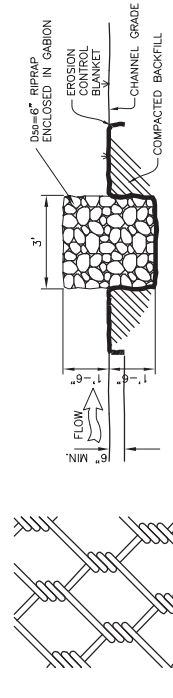
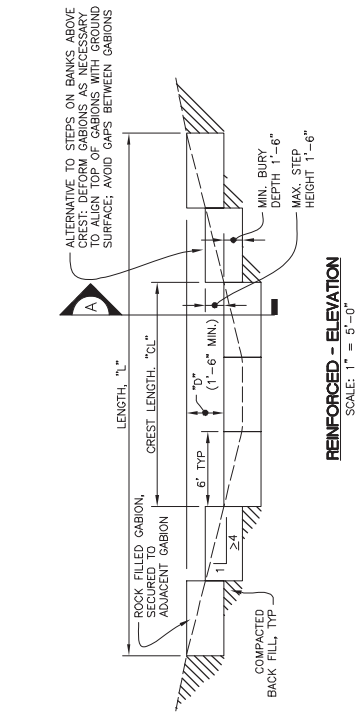

BLOW UP OF TWISTED WIRE GABION
SCALE: 1" = 1'-0"

REINFORCED CHECK DAM INSTALLATION NOTES

- SEE PLAN VIEW FOR:
 - LOCATIONS OF CHECK DAMS,
 - CHECK DAM TYPE (CHECK DAM OR REINFORCED CHECK DAM),
 - LENGTH, "L", CREST LENGTH, "CL", AND DEPTH, "D".
- CHECK DAMS INDICATED ON INITIAL GESC PLAN SHALL BE INSTALLED AFTER CONSTRUCTION FENCE, BUT PRIOR TO ANY UPSTREAM LAND-DISTURBING ACTIVITIES.
- REINFORCED CHECK DAMS, GABIONS SHALL HAVE GALVANIZED TWISTED WIRE NETTING WITH A "HOG RINGS" AT 4" SPACING OR OTHER APPROVED MEANS SHALL BE USED AT ALL GABION SEAMS AND TO SECURE THE GABION TO THE ADJACENT GABION.
- RIPRAP UTILIZED FOR CHECK DAMS SHALL HAVE A D_{50} MEDIAN STONE SIZE OF 6".
- THE CHECK DAM SHALL BE TRENCHED INTO THE GROUND A MINIMUM OF 1'-6".
- EROSION BLANKET SHALL BE PLACED IN THE REINFORCED CHECK DAM TRENCH EXTENDING A MINIMUM OF 1'-6" ON BOTH THE UPSTREAM AND DOWNSTREAM SIDES OF THE REINFORCED CHECK DAM.

REINFORCED CHECK DAM MAINTENANCE NOTES

- THE GESC MANAGER SHALL INSPECT CHECK DAMS WEEKLY, DURING AND AFTER ANY STORM EVENT AND MAKE REPAIRS OR CLEAN OUT AS NECESSARY.
- SEDIMENT ACCUMULATED UPSTREAM OF CHECK DAMS SHALL BE REMOVED WHEN THE SEDIMENT DEPTH UPSTREAM OF CHECK DAM IS WITHIN $\frac{1}{2}$ OF THE HEIGHT OF THE CREST.
- CHECK DAMS ARE TO REMAIN IN PLACE UNTIL THE UPSTREAM DISTURBED AREA IS STABILIZED AND GRASS COVER IS APPROVED BY THE TOWN.
- WHEN CHECK DAMS ARE REMOVED, EXCAVATIONS SHALL BE FILLED WITH SUITABLE COMPACTED BACK FILL, ANY DISTURBED AREA SHALL BE DRILL SEEDED AND CRIMP MULCHED AND COVERED WITH EROSION CONTROL BLANKET OR OTHERWISE STABILIZED IN A MANNER APPROVED BY THE TOWN.

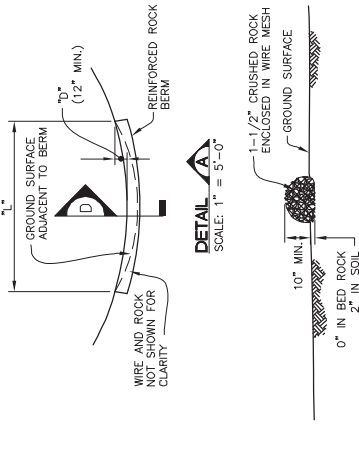

SECTION D-D
SCALE: 1" = 5'-0"

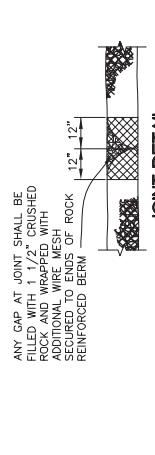

JOINT DETAIL
SCALE: 1/2" = 1'-0"

REINFORCED ROCK BERM INSTALLATION NOTES

- SEE PLAN VIEW FOR:
 - LOCATIONS OF REINFORCED ROCK BERMS,
 - LENGTH, "L", AND DEPTH, "D", DIMENSIONS.
- REINFORCED ROCK BERM SECTION APPLIES TO CULVERT INLET FILTER AND INLET PROTECTION.
- CRUSHED ROCK SHALL BE FRACTURED FACE (ALL SIDES) AND SHALL COMPLY WITH GRADATION SHOWN ON SHEET 14 (1-1/2" MINUS), RECYCLED CONCRETE MEETING THIS GRADATION MAY BE USED.
- WIRE MESH SHALL BE FABRICATED OF 10 GAUGE WIRE TWISTED INTO A MESH WITH A MAXIMUM OPENING OF 1.0 INCH (COMMONLY TERMED "CHICKEN WIRE"). ROLL WIDTH SHALL BE 48-INCHES.
- WIRE MESH SHALL BE SECURED USING "HOG RINGS" OR WIRE TIES AT 6-INCH CENTERS ALONG ALL JOINTS AND AT 2-INCH CENTERS ON ENDS OF BERM.
- FOR CONCENTRATED FLOW AREAS THE ENDS OF THE REINFORCED ROCK BERM SHALL BE 12" HIGHER THAN THE CENTER OF THE BERM.

REINFORCED ROCK BERM MAINTENANCE NOTES

- THE GESC MANAGER SHALL INSPECT REINFORCED ROCK BERM WEEKLY, DURING AND AFTER ANY STORM EVENT AND MAKE REPAIRS OR CLEAN OUT AS NECESSARY.
- SEDIMENT ACCUMULATED UPSTREAM OF REINFORCED ROCK BERM SHALL BE REMOVED WHEN THE SEDIMENT DEPTH UPSTREAM OF FILTER IS WITHIN 5 INCHES OF THE CREST.
- REINFORCED ROCK BERMS ARE TO REMAIN IN PLACE UNTIL THE UPSTREAM DISTURBED AREA IS STABILIZED AND GRASS COVER IS APPROVED.
- WHEN REINFORCED ROCK BERMS ARE REMOVED, ANY DISTURBED AREA SHALL BE DRILL SEEDED AND CRIMP MULCHED OR OTHERWISE STABILIZED IN A MANNER APPROVED BY THE TOWN.

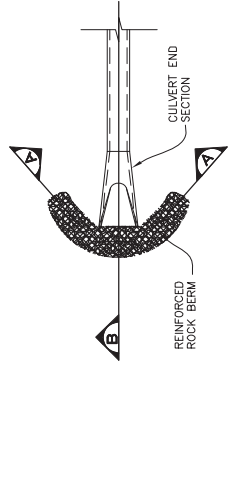

PLAN
SCALE: 1" = 5'-0"

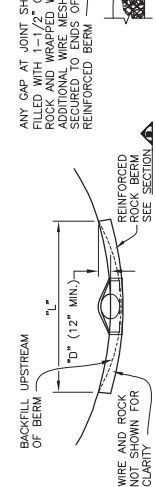

SECTION A-A
SCALE: 1" = 5'-0"

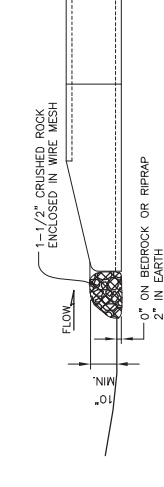

SECTION B-B
SCALE: 1/2" = 1'-0"

INSTALLATION NOTES

- SEE PLAN VIEW FOR:
 - LOCATIONS OF CULVERT INLET FILTERS,
 - LENGTH, "L", AND DEPTH, "D".
- CRUSHED ROCK SHALL BE FRACTURED FACE (ALL SIDES) AND SHALL COMPLY WITH GRADATION SHOWN ON SHEET 14 (1-1/2" MINUS). RECYCLED CONCRETE MEETING THIS GRADATION MAY BE USED.
- WIRE MESH SHALL BE FABRICATED OF 10 GAUGE WIRE TWISTED INTO A MESH WITH A MAXIMUM OPENING OF 1.0 INCH (COMMONLY TERMED "CHICKEN WIRE").
- WIRE MESH SHALL BE SECURED USING "HOG RINGS" OR WIRE TIES AT 6-INCH CENTERS ALONG ALL JOINTS AND AT 2-INCH CENTERS ON ENDS OF BERM.
- THE ENDS OF THE REINFORCED ROCK BERM SHALL BE 12" HIGHER THAN THE CENTER OF THE BERM.

MAINTENANCE NOTES

- THE GESC MANAGER SHALL INSPECT CULVERT INLET FILTER WEEKLY, DURING AND AFTER ANY STORM EVENT AND MAKE REPAIRS OR CLEAN OUT AS NECESSARY.
- SEDIMENT ACCUMULATED UPSTREAM OF CULVERT INLET FILTER SHALL BE REMOVED WHEN THE SEDIMENT DEPTH UPSTREAM OF FILTER IS $\frac{1}{2}$ THE HEIGHT OF THE REINFORCED ROCK BERM.
- RFB FOR CULVERT PROTECTION ARE TO REMAIN IN PLACE UNTIL THE UPSTREAM DISTURBED AREA IS STABILIZED AND GRASS COVER IS APPROVED BY THE TOWN.
- WHEN CULVERT INLET FILTERS ARE REMOVED, ANY DISTURBED AREA SHALL BE DRILL SEEDED AND CRIMP MULCHED OR OTHERWISE STABILIZED IN A MANNER APPROVED BY THE TOWN.

RCD

REINFORCED CHECK DAM

RRB

REINFORCED ROCK BERM

ARC

RRB FOR CULVERT PROTECTION

REV	DATE	DESCRIPTION
(R1)	3/11	GESC MANUAL UPDATES
(R2)	5/15	GESC MANUAL UPDATES



UTILITIES DEPARTMENT
Stormwater Engineering Division

GESC
GRADING, EROSION, AND SEDIMENT CONTROL

GESC PLAN
STANDARD NOTES AND DETAILS

SHEET
7 OF 14

Sediment Basin

What it is

A temporary sediment basin detains sediment-laden runoff long enough to allow much of the sediment to settle out. Sediment basins are constructed by excavation and/or by placing an earthen embankment across a low area or drainage swale. Basins can be designed to maintain a permanent pool or to drain completely dry through a controlled outlet structure.



When and Where to use it

- Required in disturbed areas draining more than one acre.
- Where there is sufficient space and appropriate topography.
- In areas that allow access for maintenance and sediment removal.
- Positioned so that it captures sediment from the entire upstream disturbed area.
- Where a permanent detention basin is planned for the site.

When and Where NOT to use it

- Sediment basins are not to be installed in active streams.



This low area will provide for some removal of sediment; however, it lacks a designed outlet structure.

Construction Detail and Maintenance Requirements

Figure SB-1 provides a construction detail and maintenance requirements for a sediment basin.

BASIN GEOMETRY:
 $\frac{\text{LENGTH (L)}}{\text{WIDTH (W)}} \geq 2$

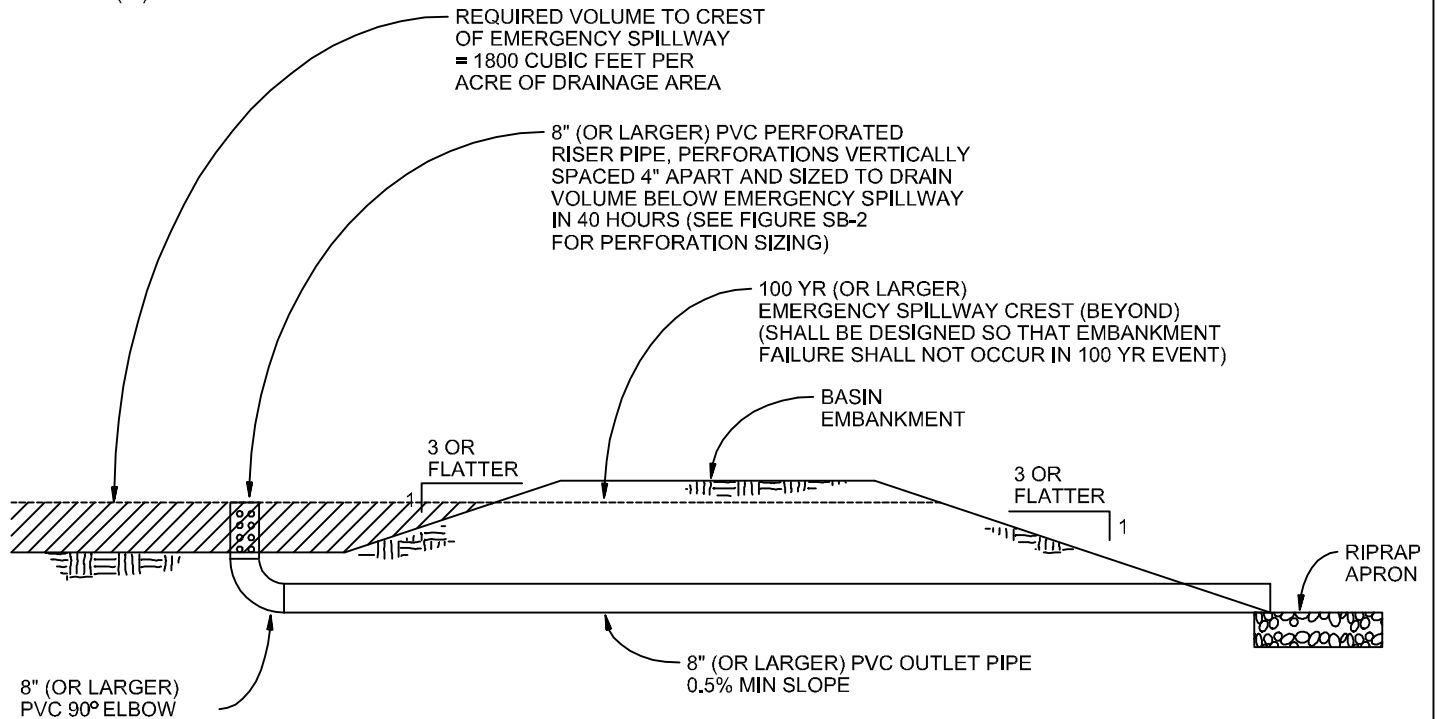

SEDIMENT BASIN

NTS

SEDIMENT BASIN NOTES

INSTALLATION REQUIREMENTS

1. SEDIMENT BASINS SHALL BE INSTALLED BEFORE ANY CLEARING AND/OR GRADING IS UNDERTAKEN.
2. THE AREA UNDER WHICH THE EMBANKMENT IS TO BE INSTALLED SHALL BE CLEARED, GRUBBED, AND STRIPPED OF ALL VEGETATION AND ROOT MAT.
3. THE OUTLET OF THE BASIN SHALL BE DESIGNED TO DRAIN ITS VOLUME IN 40 HOURS.
4. THE OUTLET IS TO BE LOCATED AT THE FURTHEST DISTANCE FROM THE INLET OF THE BASIN. BAFFLES MAY BE NEEDED TO INCREASE THE FLOW LENGTH AND SETTLING TIME.
5. EMBANKMENT MATERIAL SHALL CONSIST OF SOIL WITH A MINIMUM OF 15% PASSING A #200 SIEVE. EXCAVATED SOIL CAN BE USED IF IT MEETS THIS REQUIREMENT.
6. EMBANKMENT IS TO BE COMPACTED TO AT LEAST 90% OF MAXIMUM DENSITY AND WITHIN 2% OF OPTIMUM MOISTURE CONTENT ACCORDING TO ASTM D 698.
7. WHEN A BASIN IS INSTALLED NEAR A RESIDENTIAL AREA, FOR SAFETY REASONS, A SIGN SHALL BE POSTED AND THE AREA SECURED WITH A FENCE.

MAINTENANCE REQUIREMENTS

1. CONTRACTOR SHALL INSPECT SEDIMENT BASINS AFTER EACH RAINFALL, AT LEAST DAILY DURING PROLONGED RAINFALL, AND WEEKLY DURING PERIODS NO RAINFALL.
2. SEDIMENT BASINS SHALL BE CLEANED OUT BEFORE SEDIMENT HAS FILLED HALF THE VOLUME OF THE BASIN.
3. SEDIMENT BASINS SHALL REMAIN OPERATIONAL AND PROPERLY MAINTAINED UNTIL THE SITE AREA IS PERMANENTLY STABILIZED WITH ADEQUATE VEGETATIVE COVER AND/OR OTHER PERMANENT STRUCTURE AS APPROVED BY THE CITY.

City of Colorado Springs
 Stormwater Quality

Figure SB-1
 Sediment Basin
 Construction Detail and Maintenance
 Requirements

Required Area per Row (in²)

		Depth at Outlet (ft)							
		1.0	1.5	2.0	2.5	3.0	3.5	4.0	4.5
Design Volume (acre-ft)	2	15.04	7.71	5.10	3.76	2.95	2.41	2.02	1.73
	1	7.52	3.86	2.55	1.88	1.48	1.21	1.01	0.87
	0.6	4.51	2.31	1.53	1.13	0.89	0.72	0.61	0.52
	0.4	3.01	1.54	1.02	0.75	0.59	0.48	0.40	0.35
	0.2	1.50	0.77	0.51	0.38	0.30	0.24	0.20	0.17
	0.1	0.75	0.39	0.26	0.19	0.15	0.12	0.10	0.09
	0.06	0.45	0.23	0.15	0.11	0.09	0.07	0.06	0.05
	0.04	0.30	0.15	0.10	0.08	0.06	0.05	0.04	0.03
	0.02	0.15	0.08	0.05	0.04	0.03	0.02	0.02	0.02
	0.01	0.08	0.04	0.03	0.02	0.01	0.01	0.01	0.01

TABLE SB-1

Circular Perforation Sizing

Hole Diameter (in)	Hole Diameter (in)	Area per Row (in ²)		
		n = 1	n = 2	n = 3
1/4	0.250	0.05	0.10	0.15
5/16	0.313	0.08	0.15	0.23
3/8	0.375	0.11	0.22	0.33
7/16	0.438	0.15	0.30	0.45
1/2	0.500	0.20	0.39	0.59
9/16	0.563	0.25	0.50	0.75
5/8	0.625	0.31	0.61	0.92
11/16	0.688	0.37	0.74	1.11
3/4	0.750	0.44	0.88	1.33
7/8	0.875	0.60	1.20	1.80
1	1.000	0.79	1.57	2.36
1 1/8	1.125	0.99	1.99	2.98
1 1/4	1.250	1.23	2.45	3.68
1 3/8	1.375	1.48	2.97	4.45
1 1/2	1.500	1.77	3.53	5.30
1 5/8	1.625	2.07	4.15	6.22
1 3/4	1.750	2.41	4.81	7.22
1 7/8	1.875	2.76	5.52	8.28
2	2.000	3.14	6.28	9.42
n = Number of columns of perforations				
Minimum steel plate thickness		1/4"	5/16"	3/8"

TABLE SB-2

Silt Fence

What it is

A silt fence is a temporary sediment barrier constructed of filter fabric stretched across supporting posts. The bottom edge of the fabric is entrenched and covered with backfill.



When and Where to use it

- On the down gradient perimeters of a construction site.
- On a contour to control overland sheet flow.
- At the top or toe of a steep slope.
- As a form of inlet protection (see inlet protection factsheet).

Figure SF-1 depicts five cases where the use of silt fence is appropriate.

When and Where NOT to use it

- In areas of concentrated flows such as in ditches, swales or channels that drain areas greater than 1.0 acre.
- At the top of a slope or at high points which do not receive any drainage flows.



This photo reveals a silt fence that has become unentrenched because it was not securely installed.



This photo illustrates what will happen to a silt fence if it is installed in an area of concentrated flow.

Construction Detail and Maintenance Requirements

Figure SF-2 provides a construction detail and maintenance requirements for a silt fence.

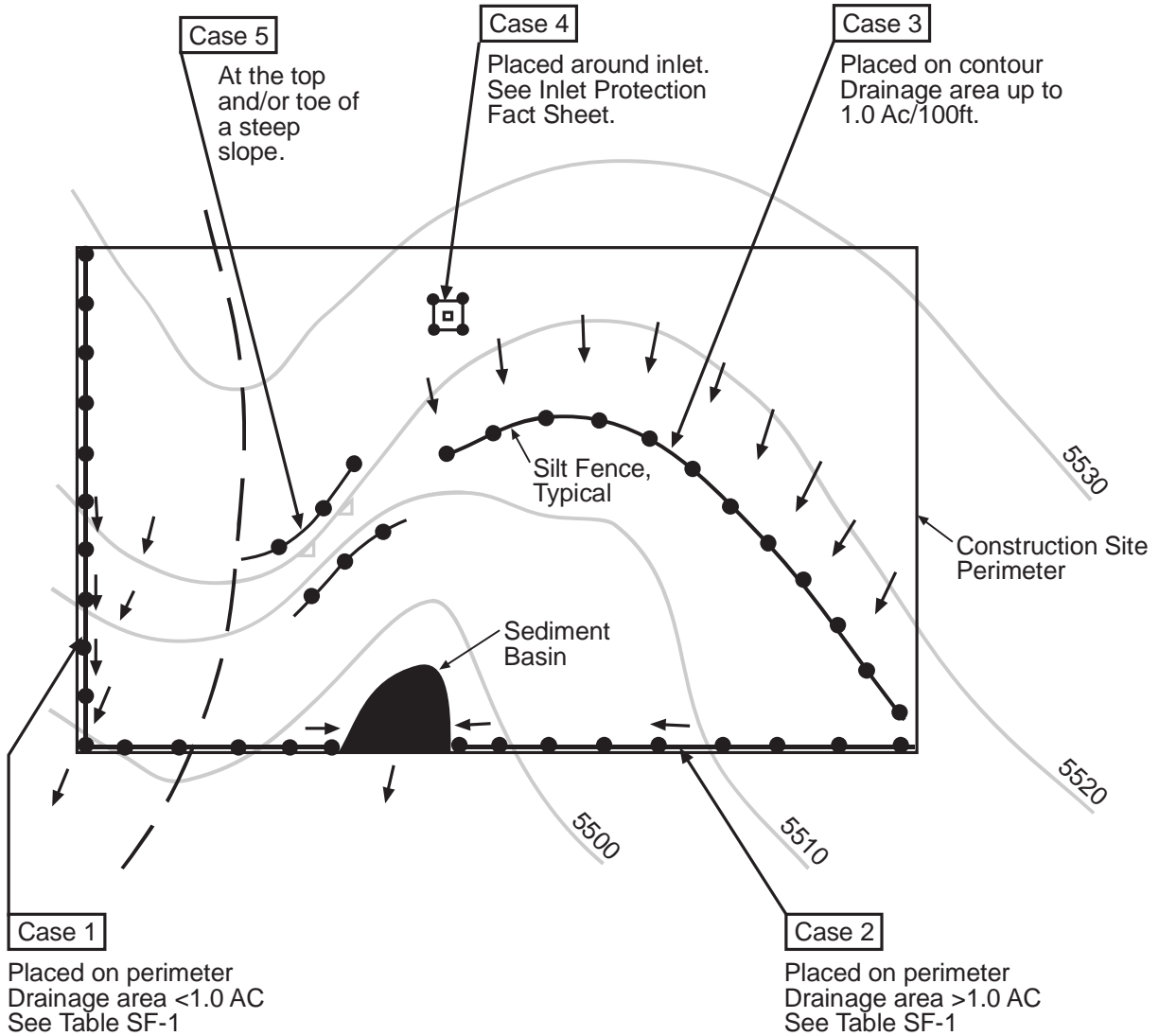

Table SF-1

Silt Fence Used as Perimeter Control	Case 1		Case 2 DA > 1.0 AC
	DA < 0.25 AC	0.25 < DA < 1 AC	
Continuous Grade	OK ⁽¹⁾	OK ⁽¹⁾	OK ⁽¹⁾
Area of Concentrated Flow	OK	NO ⁽²⁾	NO ⁽³⁾

(1) Temporary Swale or Straw Bale Barrier may be used as alternative to a Silt Fence.

(2) Check Dam may also be used as alternative to Silt Fence at low point.

(3) Sediment Basin is required for concentrated flow from drainage areas > 1.0 AC.

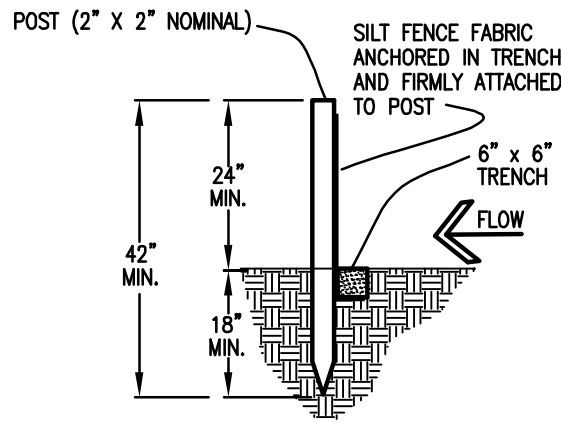
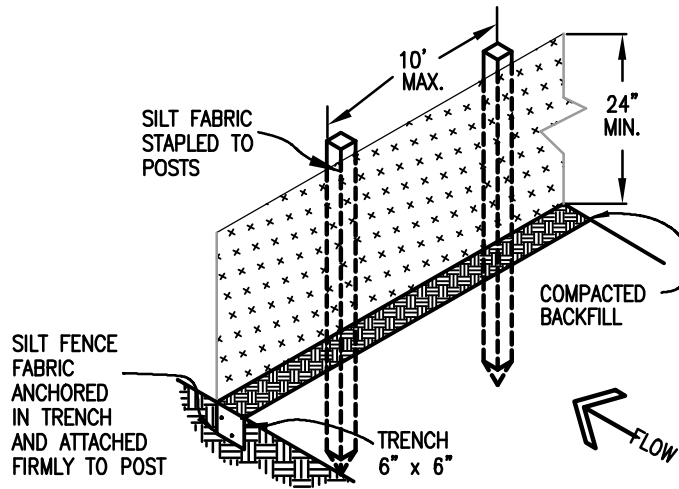

SILT FENCE

SILT FENCE NOTES

INSTALLATION REQUIREMENTS

1. SILT FENCES SHALL BE INSTALLED PRIOR TO ANY LAND DISTURBING ACTIVITIES.
2. WHEN JOINTS ARE NECESSARY, SILT FENCE GEOTEXTILE SHALL BE SPLICED TOGETHER ONLY AT SUPPORT POST AND SECURELY SEALED.
3. METAL POSTS SHALL BE "STUDDED TEE" OR "U" TYPE WITH MINIMUM WEIGHT OF 1.33 POUNDS PER LINEAR FOOT. WOOD POSTS SHALL HAVE A MINIMUM DIAMETER OR CROSS SECTION DIMENSION OF 2 INCHES.
4. THE FILTER MATERIAL SHALL BE FASTENED SECURELY TO METAL OR WOOD POSTS USING WIRE TIES, OR TO WOOD POSTS WITH 3/4" LONG #9 HEAVY-DUTY STAPLES. THE SILT FENCE GEOTEXTILE SHALL NOT BE STAPLED TO EXISTING TREES.
5. WHILE NOT REQUIRED, WIRE MESH FENCE MAY BE USED TO SUPPORT THE GEOTEXTILE. WIRE FENCE SHALL BE FASTENED SECURELY TO THE UPSLOPE SIDE OF THE POSTS USING HEAVY-DUTY WIRE STAPLES AT LEAST 3/4" LONG, TIE WIRES OR HOG RINGS. THE WIRE SHALL EXTEND INTO THE TRENCH A MINIMUM OF 6" AND SHALL NOT EXTEND MORE THAN 3' ABOVE THE ORIGINAL GROUND SURFACE.

6. ALONG THE TOE OF FILLS, INSTALL THE SILT FENCE ALONG A LEVEL CONTOUR AND PROVIDE AN AREA BEHIND THE FENCE FOR RUNOFF TO POND AND SEDIMENT TO SETTLE. A MINIMUM DISTANCE OF 5 FEET FROM THE TOE OF THE FILL IS RECOMMENDED.

7. THE HEIGHT OF THE SILT FENCE FROM THE GROUND SURFACE SHALL BE MINIMUM OF 24 INCHES AND SHALL NOT EXCEED 36 INCHES; HIGHER FENCES MAY INPOUND VOLUMES OF WATER SUFFICIENT TO CAUSE FAILURE OF THE STRUCTURE.

MAINTENANCE REQUIREMENTS

1. CONTRACTOR SHALL INSPECT SILT FENCES IMMEDIATELY AFTER EACH RAINFALL, AT LEAST DAILY DURING PROLONGED RAINFALL, AND WEEKLY DURING PERIODS OF NO RAINFALL. DAMAGED, COLLAPSED, UNENTRENCHED OR INEFFECTIVE SILT FENCES SHALL BE PROMPTLY REPAIRED OR REPLACED.
2. SEDIMENT SHALL BE REMOVED FROM BEHIND SILT FENCE WHEN IT ACCUMULATES TO HALF THE EXPOSED GEOTEXTILE HEIGHT.
3. SILT FENCES SHALL BE REMOVED WHEN ADEQUATE VEGETATIVE COVER IS ATTAINED AS APPROVED BY THE CITY.

Top View of Silt Fence Posts Detail

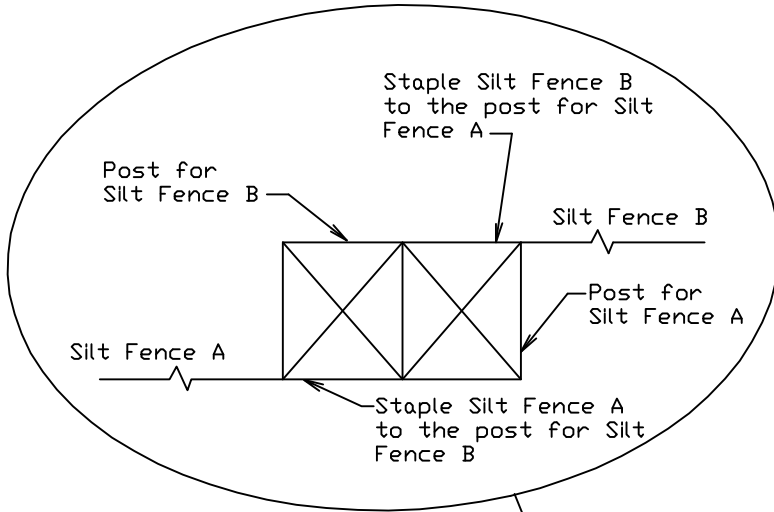

Refer to "Top View of Silt Fence Posts Detail"

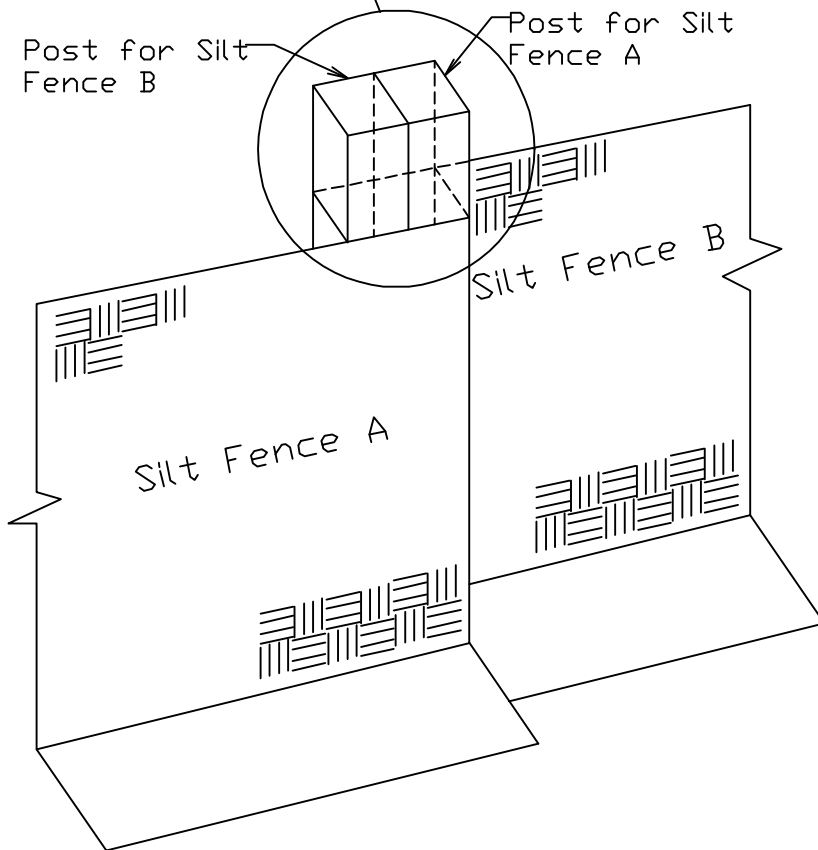

Description

A stabilized staging area is a clearly designated area where construction equipment and vehicles, stockpiles, waste bins, and other construction-related materials are stored. The contractor office trailer may also be located in this area. Depending on the size of the construction site, more than one staging area may be necessary.



Photograph SSA-1. Example of a staging area with a gravel surface to prevent mud tracking and reduce runoff. Photo courtesy of Douglas County.

Appropriate Uses

Most construction sites will require a staging area, which should be clearly designated in SWMP drawings. The layout of the staging area may vary depending on the type of construction activity. Staging areas located in roadways due to space constraints require special measures to avoid materials being washed into storm inlets.

Design and Installation

Stabilized staging areas should be completed prior to other construction activities beginning on the site. Major components of a stabilized staging area include:

- Appropriate space to contain storage and provide for loading/unloading operations, as well as parking if necessary.
- A stabilized surface, either paved or covered, with 3-inch diameter aggregate or larger.
- Perimeter controls such as silt fence, sediment control logs, or other measures.
- Construction fencing to prevent unauthorized access to construction materials.
- Provisions for Good Housekeeping practices related to materials storage and disposal, as described in the Good Housekeeping BMP Fact Sheet.
- A stabilized construction entrance/exit, as described in the Vehicle Tracking Control BMP Fact Sheet, to accommodate traffic associated with material delivery and waste disposal vehicles.

Over-sizing the stabilized staging area may result in disturbance of existing vegetation in excess of that required for the project. This increases costs, as well as requirements for long-term stabilization following the construction period. When designing the stabilized staging area, minimize the area of disturbance to the extent practical.

Stabilized Staging Area	
Functions	
Erosion Control	Yes
Sediment Control	Moderate
Site/Material	Yes

Minimizing Long-Term Stabilization Requirements

- Utilize off-site parking and restrict vehicle access to the site.
- Use construction mats in lieu of rock when staging is provided in an area that will not be disturbed otherwise.
- Consider use of a bermed contained area for materials and equipment that do not require a stabilized surface.
- Consider phasing of staging areas to avoid disturbance in an area that will not be otherwise disturbed.

See Detail SSA-1 for a typical stabilized staging area and SSA-2 for a stabilized staging area when materials staging in roadways is required.

Maintenance and Removal

Maintenance of stabilized staging areas includes maintaining a stable surface cover of gravel, repairing perimeter controls, and following good housekeeping practices.

When construction is complete, debris, unused stockpiles and materials should be recycled or properly disposed. In some cases, this will require disposal of contaminated soil from equipment leaks in an appropriate landfill. Staging areas should then be permanently stabilized with vegetation or other surface cover planned for the development.

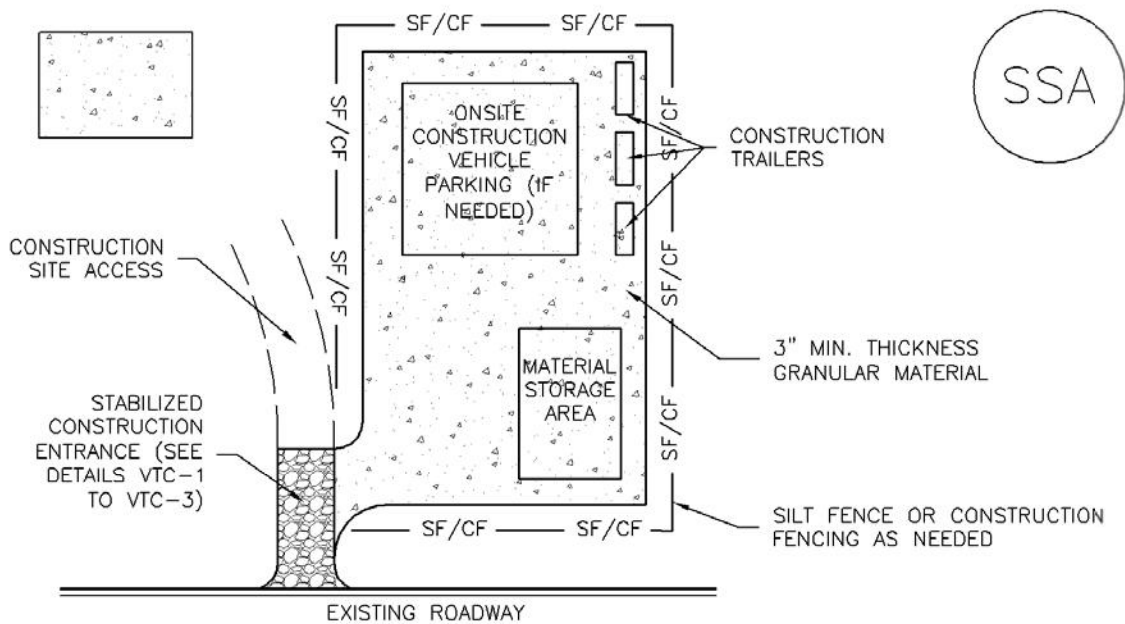

SSA-1. STABILIZED STAGING AREA

STABILIZED STAGING AREA INSTALLATION NOTES

1. SEE PLAN VIEW FOR
 - LOCATION OF STAGING AREA(S).
 - CONTRACTOR MAY ADJUST LOCATION AND SIZE OF STAGING AREA WITH APPROVAL FROM THE LOCAL JURISDICTION.
2. STABILIZED STAGING AREA SHOULD BE APPROPRIATE FOR THE NEEDS OF THE SITE. OVERSIZING RESULTS IN A LARGER AREA TO STABILIZE FOLLOWING CONSTRUCTION.
3. STAGING AREA SHALL BE STABILIZED PRIOR TO OTHER OPERATIONS ON THE SITE.
4. THE STABILIZED STAGING AREA SHALL CONSIST OF A MINIMUM 3" THICK GRANULAR MATERIAL.
5. UNLESS OTHERWISE SPECIFIED BY LOCAL JURISDICTION, ROCK SHALL CONSIST OF DOT SECT. #703, AASHTO #3 COARSE AGGREGATE OR 6" (MINUS) ROCK.
6. ADDITIONAL PERIMETER BMPs MAY BE REQUIRED INCLUDING BUT NOT LIMITED TO SILT FENCE AND CONSTRUCTION FENCING.

STABILIZED STAGING AREA MAINTENANCE NOTES

1. INSPECT BMPs EACH WORKDAY, AND MAINTAIN THEM IN EFFECTIVE OPERATING CONDITION. MAINTENANCE OF BMPs SHOULD BE PROACTIVE, NOT REACTIVE. INSPECT BMPs AS SOON AS POSSIBLE (AND ALWAYS WITHIN 24 HOURS) FOLLOWING A STORM THAT CAUSES SURFACE EROSION, AND PERFORM NECESSARY MAINTENANCE.
2. FREQUENT OBSERVATIONS AND MAINTENANCE ARE NECESSARY TO MAINTAIN BMPs IN EFFECTIVE OPERATING CONDITION. INSPECTIONS AND CORRECTIVE MEASURES SHOULD BE DOCUMENTED THOROUGHLY.
3. WHERE BMPs HAVE FAILED, REPAIR OR REPLACEMENT SHOULD BE INITIATED UPON DISCOVERY OF THE FAILURE.
4. ROCK SHALL BE REAPPLIED OR REGRADED AS NECESSARY IF RUTTING OCCURS OR UNDERLYING SUBGRADE BECOMES EXPOSED.

STABILIZED STAGING AREA MAINTENANCE NOTES

5. STABILIZED STAGING AREA SHALL BE ENLARGED IF NECESSARY TO CONTAIN PARKING, STORAGE, AND UNLOADING/LOADING OPERATIONS.

6. THE STABILIZED STAGING AREA SHALL BE REMOVED AT THE END OF CONSTRUCTION. THE GRANULAR MATERIAL SHALL BE REMOVED OR, IF APPROVED BY THE LOCAL JURISDICTION, USED ON SITE, AND THE AREA COVERED WITH TOPSOIL, SEEDED AND MULCHED OR OTHERWISE STABILIZED IN A MANNER APPROVED BY LOCAL JURISDICTION.

NOTE: MANY MUNICIPALITIES PROHIBIT THE USE OF RECYCLED CONCRETE AS GRANULAR MATERIAL FOR STABILIZED STAGING AREAS DUE TO DIFFICULTIES WITH RE-ESTABLISHMENT OF VEGETATION IN AREAS WHERE RECYCLED CONCRETE WAS PLACED.

NOTE: MANY JURISDICTIONS HAVE BMP DETAILS THAT VARY FROM UDFCD STANDARD DETAILS. CONSULT WITH LOCAL JURISDICTIONS AS TO WHICH DETAIL SHOULD BE USED WHEN DIFFERENCES ARE NOTED.

(DETAILS ADAPTED FROM DOUGLAS COUNTY, COLORADO, NOT AVAILABLE IN AUTOCAD)

Slope Drain

What it is

Slope drains are either flexible or rigid pipes that convey concentrated runoff from the top of a slope to a stable discharge point at the bottom of the slope. Slope drains can be either temporary or permanent depending on the method of installation and material used.

When and Where to use it

- At the top of cut-and-fill slopes to convey stormwater down the slope.
- Before a slope has been stabilized or before permanent drainage structures are ready for use.
- In combination with other BMPs that have been used to concentrate flows, including temporary swales.

When and Where NOT to use it

Slope drains should not be used for drainage areas larger than 5 acres.

Construction Detail and Maintenance Requirements

Figure SD-1 provides a construction detail and maintenance requirements for a slope drain.

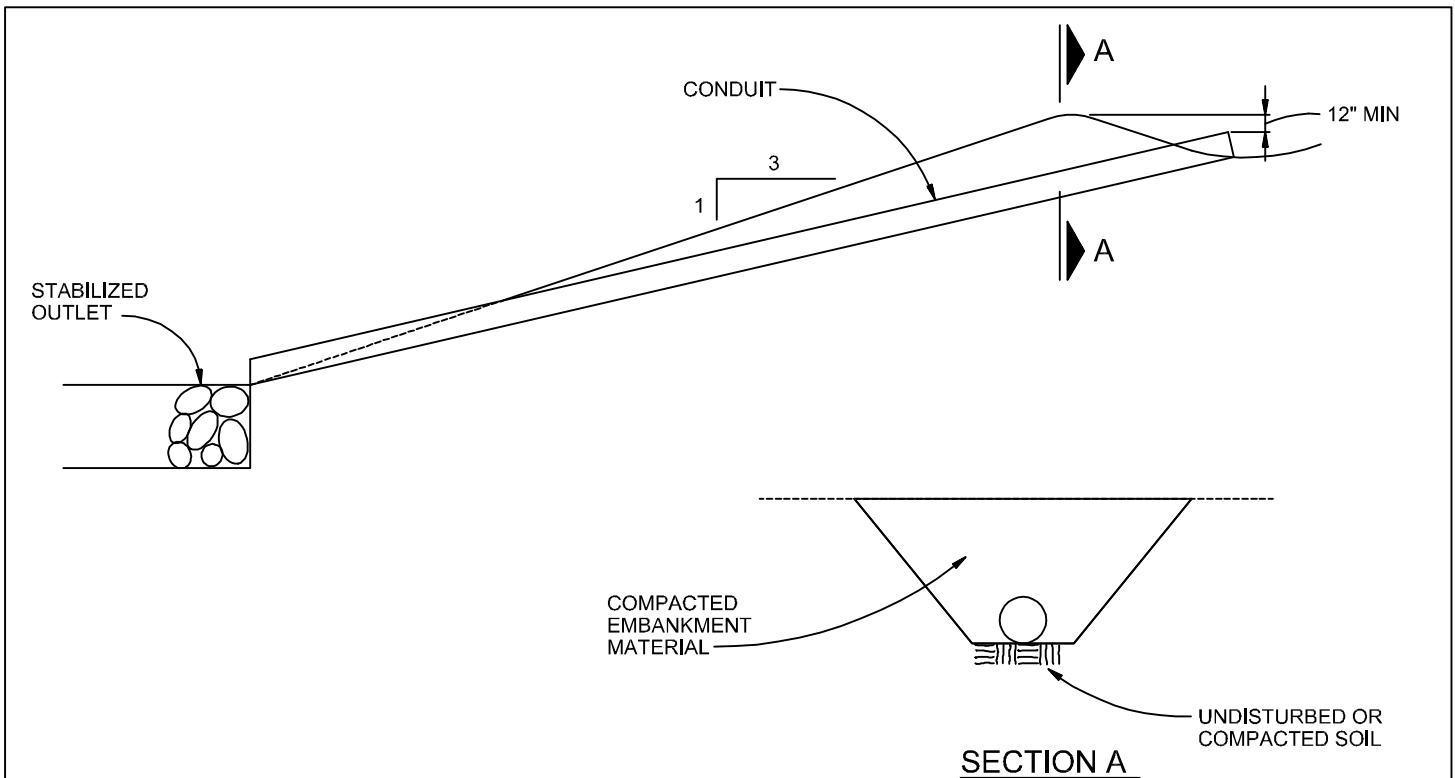

SLOPE DRAIN

NTS

SLOPE DRAIN NOTES

INSTALLATION REQUIREMENTS

1. THE SLOPE DRAIN IS TO BE DESIGNED TO CONVEY THE PEAK RUNOFF FOR THE 2-YEAR STORM.
2. PIPE MATERIAL MAY INCLUDE CORRUGATED METAL, OR RIGID OR FLEXIBLE PLASTIC.
3. EMBANKMENT MATERIAL SHALL CONSIST OF SOIL WITH A MINIMUM OF 15% PASSING A #200 SIEVE. EXCAVATED SOIL CAN BE USED IF IT MEETS THIS REQUIREMENT.
4. EMBANKMENT IS TO BE COMPACTED TO AT LEAST 90% OF MAXIMUM DENSITY AND WITHIN 2% OF OPTIMUM MOISTURE CONTENT ACCORDING TO ASTM D 698.
5. SLOPE DRAIN SECTIONS ARE TO BE SECURELY FASTENED TOGETHER AND HAVE WATERTIGHT FITTINGS.
6. THE OUTLET IS TO BE STABILIZED AND, UNLESS THE DRAIN DISCHARGES DIRECTLY TO A SEDIMENT BASIN, A TEMPORARY SURFACE IS TO BE PROVIDED TO CONVEY FLOWS DOWN STREAM.
7. IMMEDIATELY STABILIZE ALL AREAS DISTURBED BY INSTALLATION OR REMOVAL OF THE PIPE SLOPE DRAIN.

MAINTENANCE REQUIREMENTS

1. INLET AND OUTLET POINTS ARE TO BE CHECKED REGULARLY, AND AFTER HEAVY STORMS FOR CLOGGING AND OVERCHARGING. ANY BREAKS IN THE PIPE ARE TO BE PROMPTLY REPAIRED, AND CLOGS REMOVED AS NEEDED.
2. WATER IS NOT TO BYPASS OR UNDERCUT THE INLET OR PIPE. IF THESE PROBLEMS DO EXIST, THE HEADWALL NEEDS TO BE REINFORCED WITH COMPACT EARTH OR SANDBAGS.
3. THE OUTLET POINT IS TO BE FREE OF EROSION, AND, IF NECESSARY, ADDITIONAL OUTLET PROTECTION SHOULD BE INSTALLED.
4. CONSTRUCTION TRAFFIC IS NOT TO CROSS THE SLOPE DRAIN AND MATERIALS ARE NOT TO BE PLACED ON IT.
5. THE SLOPE DRAIN IS TO REMAIN IN PLACE UNTIL THE SLOPE HAS BEEN COMPLETELY STABILIZED OR UP TO 30 DAYS AFTER PERMANENT SLOPE STABILIZATION.

Description

Stockpile management includes measures to minimize erosion and sediment transport from soil stockpiles.

Appropriate Uses

Stockpile management should be used when soils or other erodible materials are stored at the construction site. Special attention should be given to stockpiles in close proximity to natural or manmade storm systems.



Photograph SP-1. A topsoil stockpile that has been partially revegetated and is protected by silt fence perimeter control.

Design and Installation

Locate stockpiles away from all drainage system components including storm sewer inlets. Where practical, choose stockpile locations that that will remain undisturbed for the longest period of time as the phases of construction progress. Place sediment control BMPs around the perimeter of the stockpile, such as sediment control logs, rock socks, silt fence, straw bales and sand bags. See Detail SP-1 for guidance on proper establishment of perimeter controls around a stockpile. For stockpiles in active use, provide a stabilized designated access point on the upgradient side of the stockpile.

Stabilize the stockpile surface with surface roughening, temporary seeding and mulching, erosion control blankets, or soil binders. Soils stockpiled for an extended period (typically for more than 60 days) should be seeded and mulched with a temporary grass cover once the stockpile is placed (typically within 14 days). Use of mulch only or a soil binder is acceptable if the stockpile will be in place for a more limited time period (typically 30-60 days). Timeframes for stabilization of stockpiles noted in this fact sheet are "typical" guidelines. Check permit requirements for specific federal, state, and/or local requirements that may be more prescriptive.

Stockpiles should not be placed in streets or paved areas unless no other practical alternative exists. See the Stabilized Staging Area Fact Sheet for guidance when staging in roadways is unavoidable due to space or right-of-way constraints. For paved areas, rock socks must be used for perimeter control and all inlets with the potential to receive sediment from the stockpile (even from vehicle tracking) must be protected.

Maintenance and Removal

Inspect perimeter controls and inlet protection in accordance with their respective BMP Fact Sheets. Where seeding, mulch and/or soil binders are used, reseeding or reapplication of soil binder may be necessary.

When temporary removal of a perimeter BMP is necessary to access a stockpile, ensure BMPs are reinstalled in accordance with their respective design detail section.

Stockpile Management	
Functions	
Erosion Control	Yes
Sediment Control	Yes
Site/Material Management	Yes

When the stockpile is no longer needed, properly dispose of excess materials and revegetate or otherwise stabilize the ground surface where the stockpile was located.

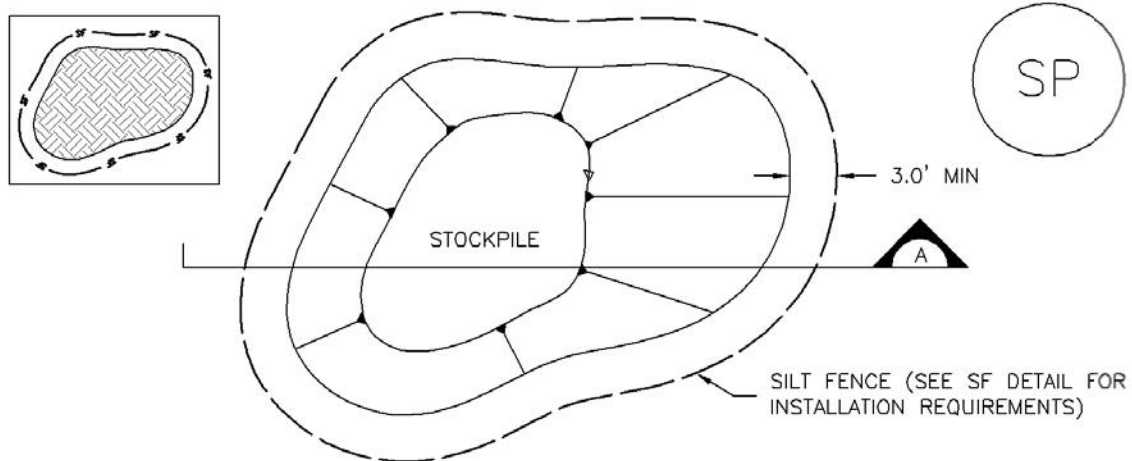

STOCKPILE PROTECTION PLAN

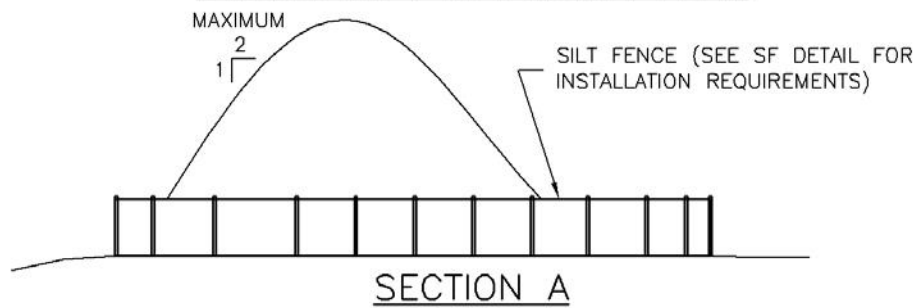

SP-1. STOCKPILE PROTECTION

STOCKPILE PROTECTION INSTALLATION NOTES

1. SEE PLAN VIEW FOR:
 - LOCATION OF STOCKPILES.
 - TYPE OF STOCKPILE PROTECTION.
2. INSTALL PERIMETER CONTROLS IN ACCORDANCE WITH THEIR RESPECTIVE DESIGN DETAILS. SILT FENCE IS SHOWN IN THE STOCKPILE PROTECTION DETAILS; HOWEVER, OTHER TYPES OF PERIMETER CONTROLS INCLUDING SEDIMENT CONTROL LOGS OR ROCK SOCKS MAY BE SUITABLE IN SOME CIRCUMSTANCES. CONSIDERATIONS FOR DETERMINING THE APPROPRIATE TYPE OF PERIMETER CONTROL FOR A STOCKPILE INCLUDE WHETHER THE STOCKPILE IS LOCATED ON A PERVIOUS OR IMPERVIOUS SURFACE, THE RELATIVE HEIGHTS OF THE PERIMETER CONTROL AND STOCKPILE, THE ABILITY OF THE PERIMETER CONTROL TO CONTAIN THE STOCKPILE WITHOUT FAILING IN THE EVENT THAT MATERIAL FROM THE STOCKPILE SHIFTS OR SLUMPS AGAINST THE PERIMETER, AND OTHER FACTORS.
3. STABILIZE THE STOCKPILE SURFACE WITH SURFACE ROUGHENING, TEMPORARY SEEDING AND MULCHING, EROSION CONTROL BLANKETS, OR SOIL BINDERS. SOILS STOCKPILED FOR AN EXTENDED PERIOD (TYPICALLY FOR MORE THAN 60 DAYS) SHOULD BE SEEDING AND MULCHED WITH A TEMPORARY GRASS COVER ONCE THE STOCKPILE IS PLACED (TYPICALLY WITHIN 14 DAYS). USE OF MULCH ONLY OR A SOIL BINDER IS ACCEPTABLE IF THE STOCKPILE WILL BE IN PLACE FOR A MORE LIMITED TIME PERIOD (TYPICALLY 30-60 DAYS).
4. FOR TEMPORARY STOCKPILES ON THE INTERIOR PORTION OF A CONSTRUCTION SITE, WHERE OTHER DOWNGRADIENT CONTROLS, INCLUDING PERIMETER CONTROL, ARE IN PLACE, STOCKPILE PERIMETER CONTROLS MAY NOT BE REQUIRED.

STOCKPILE PROTECTION MAINTENANCE NOTES

1. INSPECT BMPs EACH WORKDAY, AND MAINTAIN THEM IN EFFECTIVE OPERATING CONDITION. MAINTENANCE OF BMPs SHOULD BE PROACTIVE, NOT REACTIVE. INSPECT BMPs AS SOON AS POSSIBLE (AND ALWAYS WITHIN 24 HOURS) FOLLOWING A STORM THAT CAUSES SURFACE EROSION, AND PERFORM NECESSARY MAINTENANCE.

2. FREQUENT OBSERVATIONS AND MAINTENANCE ARE NECESSARY TO MAINTAIN BMPs IN EFFECTIVE OPERATING CONDITION. INSPECTIONS AND CORRECTIVE MEASURES SHOULD BE DOCUMENTED THOROUGHLY.

3. WHERE BMPs HAVE FAILED, REPAIR OR REPLACEMENT SHOULD BE INITIATED UPON DISCOVERY OF THE FAILURE.

STOCKPILE PROTECTION MAINTENANCE NOTES

4. IF PERIMETER PROTECTION MUST BE MOVED TO ACCESS SOIL STOCKPILE, REPLACE PERIMETER CONTROLS BY THE END OF THE WORKDAY.

5. STOCKPILE PERIMETER CONTROLS CAN BE REMOVED ONCE ALL THE MATERIAL FROM THE STOCKPILE HAS BEEN USED.

(DETAILS ADAPTED FROM PARKER, COLORADO, NOT AVAILABLE IN AUTOCAD)

NOTE: MANY JURISDICTIONS HAVE BMP DETAILS THAT VARY FROM UDFCD STANDARD DETAILS. CONSULT WITH LOCAL JURISDICTIONS AS TO WHICH DETAIL SHOULD BE USED WHEN DIFFERENCES ARE NOTED.

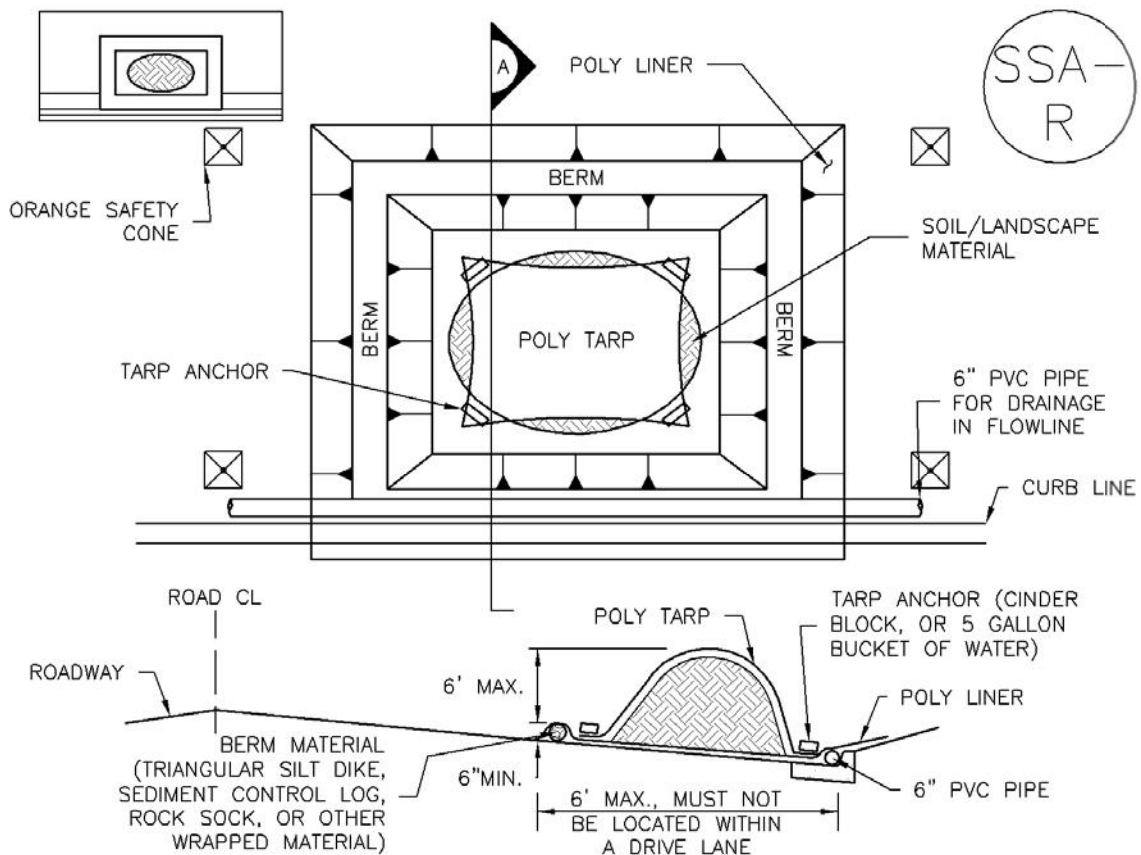

SP-2. MATERIALS STAGING IN ROADWAY

MATERIALS STAGING IN ROADWAYS INSTALLATION NOTES

1. SEE PLAN VIEW FOR
 - LOCATION OF MATERIAL STAGING AREA(S).
 - CONTRACTOR MAY ADJUST LOCATION AND SIZE OF STAGING AREA WITH APPROVAL FROM THE LOCAL JURISDICTION.
2. FEATURE MUST BE INSTALLED PRIOR TO EXCAVATION, EARTHWORK OR DELIVERY OF MATERIALS.
3. MATERIALS MUST BE STATIONED ON THE POLY LINER. ANY INCIDENTAL MATERIALS DEPOSITED ON PAVED SECTION OR ALONG CURB LINE MUST BE CLEANED UP PROMPTLY.
4. POLY LINER AND TARP COVER SHOULD BE OF SIGNIFICANT THICKNESS TO PREVENT DAMAGE OR LOSS OF INTEGRITY.
5. SAND BAGS MAY BE SUBSTITUTED TO ANCHOR THE COVER TARP OR PROVIDE BERMING UNDER THE BASE LINER.
6. FEATURE IS NOT INTENDED FOR USE WITH WET MATERIAL THAT WILL BE DRAINING AND/OR SPREADING OUT ON THE POLY LINER OR FOR DEMOLITION MATERIALS.
7. THIS FEATURE CAN BE USED FOR:
 - UTILITY REPAIRS.
 - WHEN OTHER STAGING LOCATIONS AND OPTIONS ARE LIMITED.
 - OTHER LIMITED APPLICATION AND SHORT DURATION STAGING.

MATERIALS STAGING IN ROADWAY MAINTENANCE NOTES

1. INSPECT BMPs EACH WORKDAY, AND MAINTAIN THEM IN EFFECTIVE OPERATING CONDITION. MAINTENANCE OF BMPs SHOULD BE PROACTIVE, NOT REACTIVE. INSPECT BMPs AS SOON AS POSSIBLE (AND ALWAYS WITHIN 24 HOURS) FOLLOWING A STORM THAT CAUSES SURFACE EROSION, AND PERFORM NECESSARY MAINTENANCE.

2. FREQUENT OBSERVATIONS AND MAINTENANCE ARE NECESSARY TO MAINTAIN BMPs IN EFFECTIVE OPERATING CONDITION. INSPECTIONS AND CORRECTIVE MEASURES SHOULD BE DOCUMENTED THOROUGHLY.

3. WHERE BMPs HAVE FAILED, REPAIR OR REPLACEMENT SHOULD BE INITIATED UPON DISCOVERY OF THE FAILURE.

4. INSPECT PVC PIPE ALONG CURB LINE FOR CLOGGING AND DEBRIS. REMOVE OBSTRUCTIONS PROMPTLY.

5. CLEAN MATERIAL FROM PAVED SURFACES BY SWEEPING OR VACUUMING.

NOTE: MANY JURISDICTIONS HAVE BMP DETAILS THAT VARY FROM UDFCD STANDARD DETAILS. CONSULT WITH LOCAL JURISDICTIONS AS TO WHICH DETAIL SHOULD BE USED WHEN DIFFERENCES ARE NOTED.

(DETAILS ADAPTED FROM AURORA, COLORADO)

Temporary Swale

What it is

A temporary swale is an earth channel used to convey runoff. A temporary swale can be excavated or formed upslope from an earthen berm, and may be lined or unlined.



When and Where to use it

- At the top of a slope to divert upland runoff away from the slope face.
- At the bottom of a slope to convey sediment-laden runoff to a sediment-trapping device such as a sediment basin.
- Along the perimeter of the construction site to keep runoff from leaving the site.

Figure TSW-1 illustrates cases where temporary swales are most effective.

When and Where NOT to use it

- Where longitudinal slope exceeds 10 percent (lining is required where longitudinal slope exceeds 2 percent).
- In areas where concentrated flow will overtop the swale transversely.

Construction Detail and Maintenance Requirements

Figure TSW-2 provides a construction detail and maintenance requirements for a temporary swale. Figure TSW-3 provides a construction detail and maintenance requirements for swale linings.

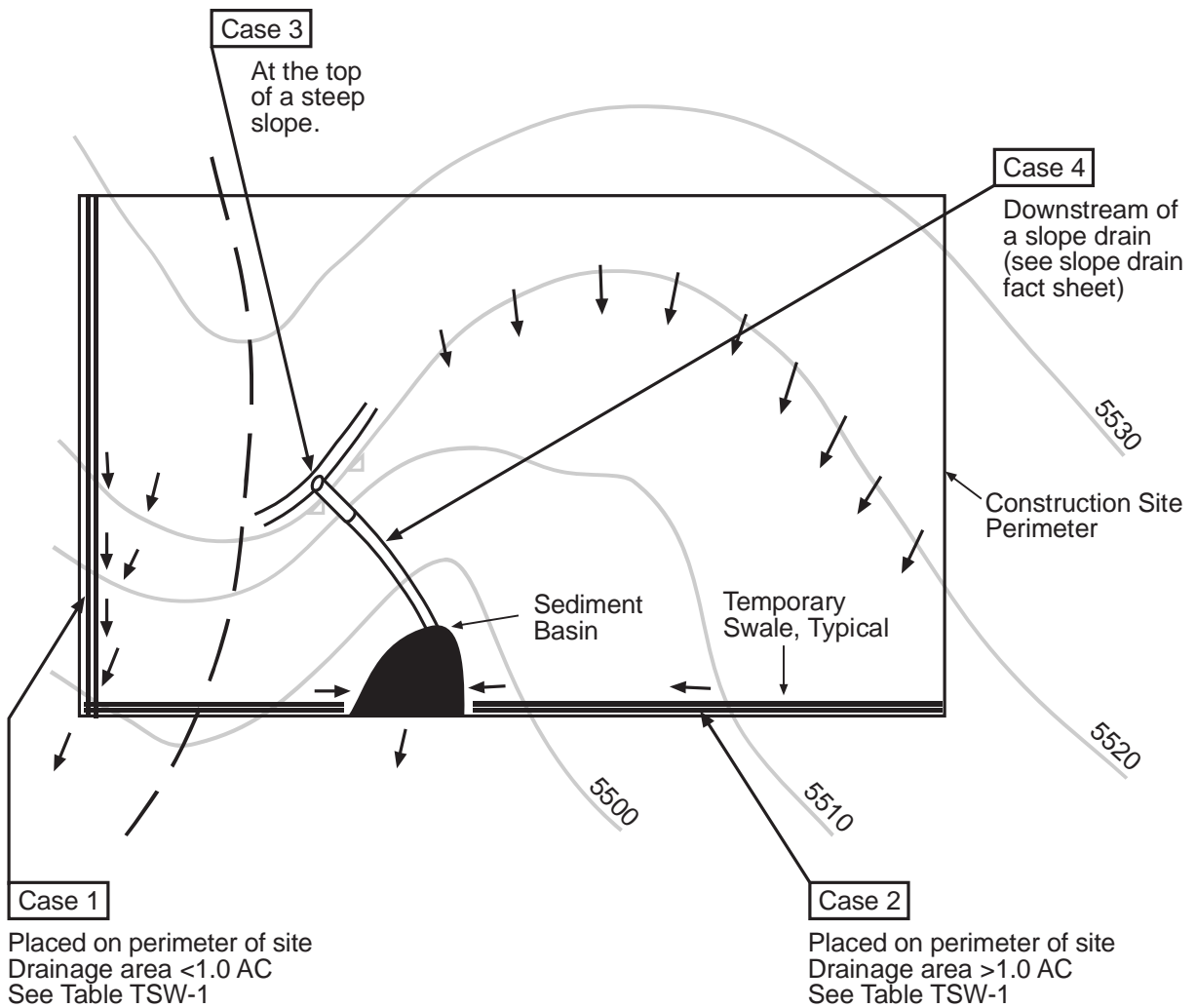

Table TSW-1

Temporary Swale Used as Perimeter Control	Case 1 DA < 1.0 AC	Case 2 DA > 1.0 AC
Continuous Grade	OK ⁽¹⁾	OK ⁽¹⁾
Area of Concentrated Flow	NO ⁽³⁾	NO ⁽²⁾

(1) Silt Fence or Straw Bale Barrier may be used as alternative to a Temporary Swale.

(2) With Temporary Swales Sediment Basin is required for concentrated flow from drainage areas > 1.0 AC.

(3) Check Dam is required at concentrated flow for drainage areas > 1.0 acres.

CONVEYANCE
SIZED FOR 2 YEAR
FLOW OR GREATER

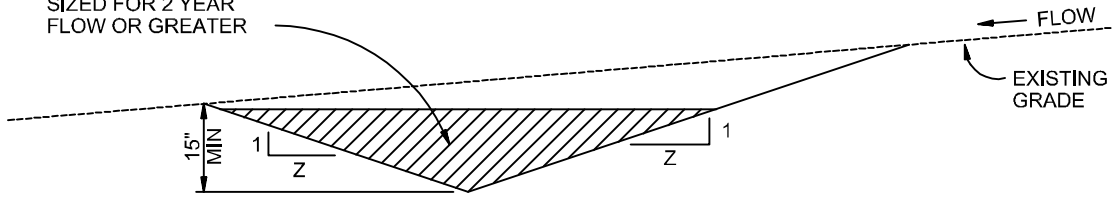

A. EXCAVATED SWALE

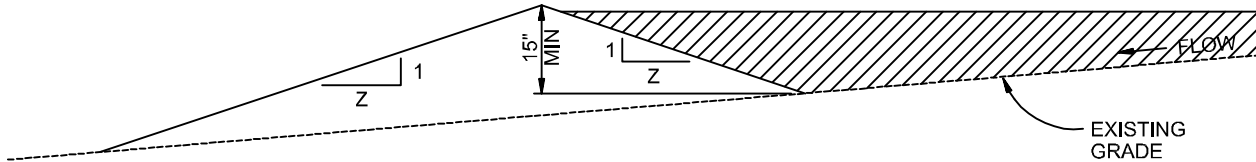

B. SWALE FORMED BY BERM

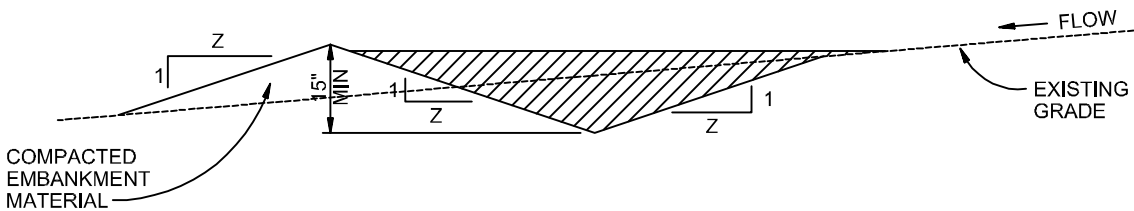

C. SWALE FORMED BY CUT AND FILL

COMPACTED
EMBANKMENT
MATERIAL

TEMPORARY SWALE

NTS

TEMPORARY SWALE NOTES

INSTALLATION REQUIREMENTS

1. TEMPORARY SWALES SHALL BE INSTALLED PRIOR TO ANY LAND DISTURBING ACTIVITIES.
2. THE AREA UNDER WHICH THE EMBANKMENT IS TO BE INSTALLED SHALL BE CLEARED, GRUBBED, AND STRIPPED OF ALL VEGETATION AND ROOT MAT.
3. EMBANKMENT MATERIAL SHALL CONSIST OF SOIL WITH A MINIMUM OF 15% PASSING A #200 SIEVE. EXCAVATED SOIL CAN BE USED IF IT MEETS THIS REQUIREMENT.
4. EMBANKMENT IS TO BE COMPACTED TO AT LEAST 90% OF MAXIMUM DENSITY AND WITHIN 2% OF OPTIMUM MOISTURE CONTENT ACCORDING TO ASTM D 698.
5. SWALES WITH SLOPE > 2% SHALL BE LINED, SEE FIGURE TSW-3.
6. SWALES ARE TO DRAIN INTO A SEDIMENT BASIN OR OTHER STABILIZED OUTLET.
7. Z SHALL BE 3 OR GREATER.

MAINTENANCE REQUIREMENTS

1. CONTRACTOR SHALL INSPECT SWALES AFTER EACH RAINFALL, AT LEAST DAILY DURING PROLONGED RAINFALL, AND WEEKLY DURING PERIODS OF NO RAINFALL.
2. SWALES SHALL BE ROUTINELY CLEARED OF ANY DEBRIS OR ACCUMULATION OF SEDIMENT.
3. ERODED SLOPES OR DAMAGED LININGS SHALL IMMEDIATELY BE REPAIRED.
4. TEMPORARY SWALES SHALL REMAIN OPERATIONAL AND PROPERLY MAINTAINED UNTIL THE SITE AREA IS PERMANENTLY STABILIZED WITH ADEQUATE VEGETATIVE COVER AND/OR OTHER PERMANENT STRUCTURE AS APPROVED BY THE CITY.

City of Colorado Springs
Stormwater Quality

Figure TSW-2
Temporary Swale
Construction Detail and Maintenance
Requirements

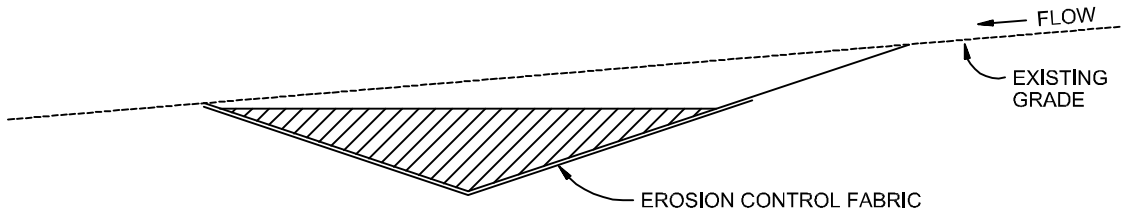

A. EROSION CONTROL FABRIC
 $2\% \leq \text{SLOPE} \leq 5\%$ AND VELOCITY ≤ 8 FPS

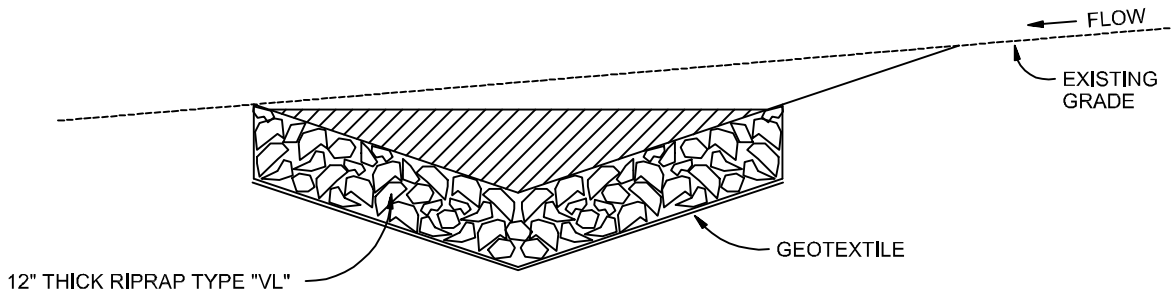

B. RIPRAP
 SLOPE $> 5\%$ OR VELOCITY > 8 FPS

SWALE LINING
 NTS

SWALE LINING NOTES

INSTALLATION REQUIREMENTS

1. REFER TO THE EROSION CONTROL BLANKETS FACTSHEET FOR PROPER INSTALLATION OF EROSION CONTROL FABRIC LINING.
2. SWALES WITH EASILY EROSIVE SOILS AND SLOPES LESS THAN 2%, SHALL BE LINED WITH EROSION CONTROL FABRIC.
3. VELOCITIES FOR EROSION CONTROL FABRICS SHALL NOT EXCEED 8 FPS. SWALES WITH VELOCITIES GREATER THAN 8 FPS SHALL BE LINED WITH RIP RAP.

MAINTENANCE REQUIREMENTS

1. CONTRACTOR SHALL INSPECT SWALE LININGS AFTER EACH RAINFALL, AT LEAST DAILY DURING PROLONGED RAINFALL AND WEEKLY DURING PERIODS OF NO RAINFALL.
2. DAMAGED LININGS SHALL IMMEDIATELY BE REPAIRED.
3. REFER TO THE EROSION CONTROL BLANKETS FACTSHEET FOR PROPER MAINTENANCE.
4. DISPLACED RIPRAP OR COARSE AGGREGATE IS TO BE REPLACED AS SOON AS POSSIBLE.
5. SWALE LININGS ARE TO REMAIN IN PLACE AND BE PROPERLY MAINTAINED UNTIL THE TEMPORARY SWALE IS REMOVED.

Vehicle Tracking

What it is

Vehicle tracking refers to the stabilization of construction entrances, roads, parking areas, and staging areas to prevent the tracking of sediment from the construction site.



When and Where to use it

- All points where vehicles exit the construction site onto a public road.
- Construction entrance/exit should be located at permanent access locations if at all possible.
- Construction roads and parking areas.
- Loading and unloading areas.
- Storage and staging areas.
- Where trailers are parked.
- Any construction area that receives high vehicular traffic.

When and Where NOT to use it

- The vehicle tracking area should not be located in areas that are wet or where soils erode easily.



This picture shows an unstabilized entrance where dirt is being tracked onto a public road.

Construction Details and Maintenance Requirements

Figure VT-1 and VT-2 provide construction details and maintenance requirements for vehicle tracking.

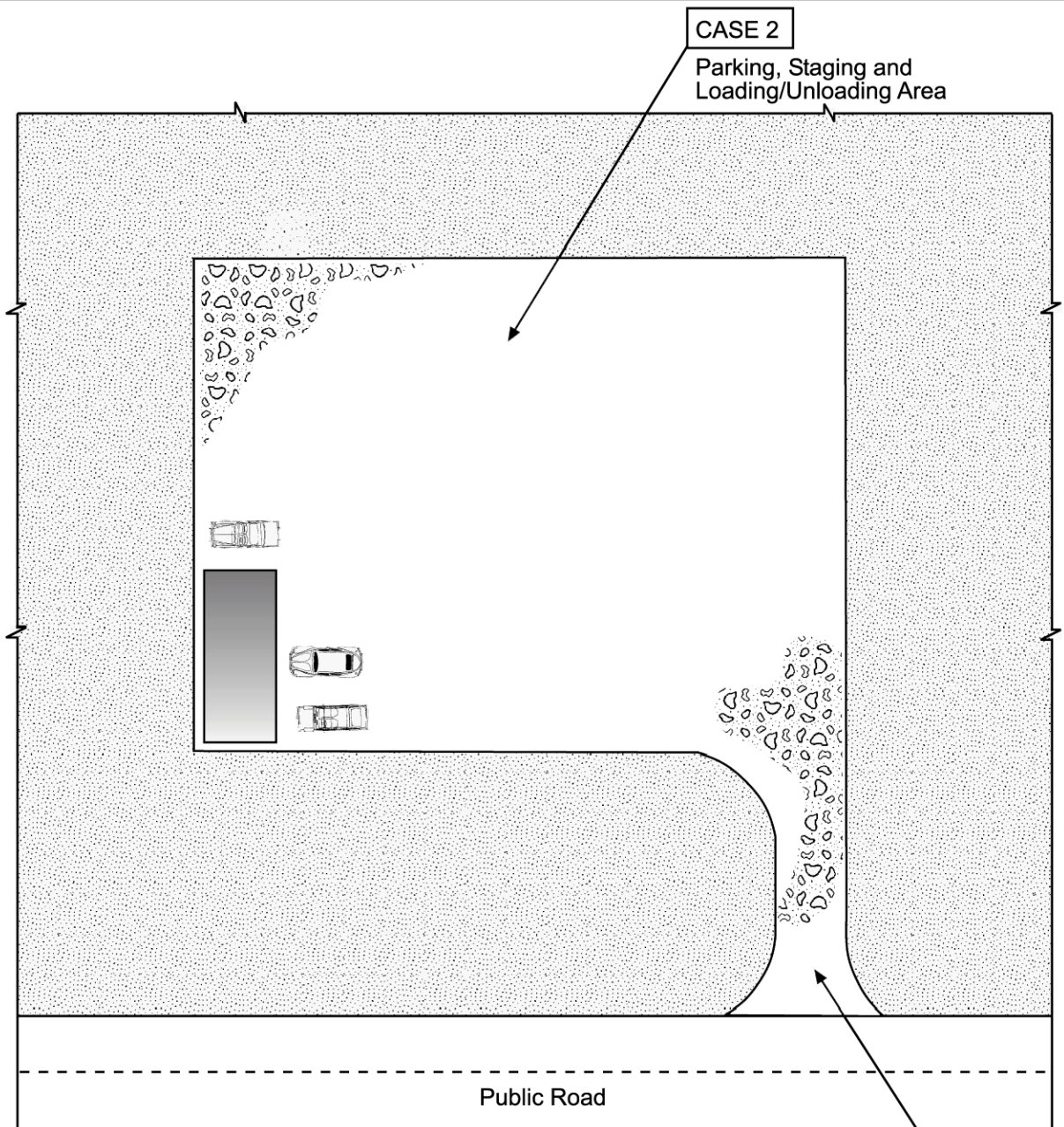

CASE 1
Construction Entrance

Table VT-1

	Case 1	Case 2
Gravel Thickness	9"	3"
Filter Fabric	YES	NO

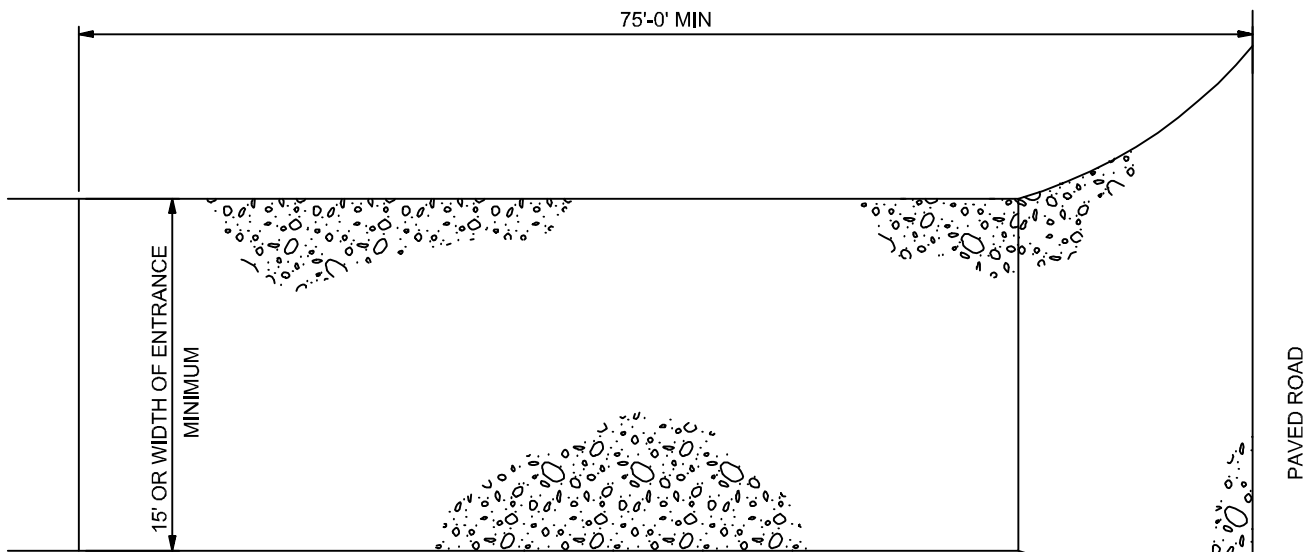

PLAN

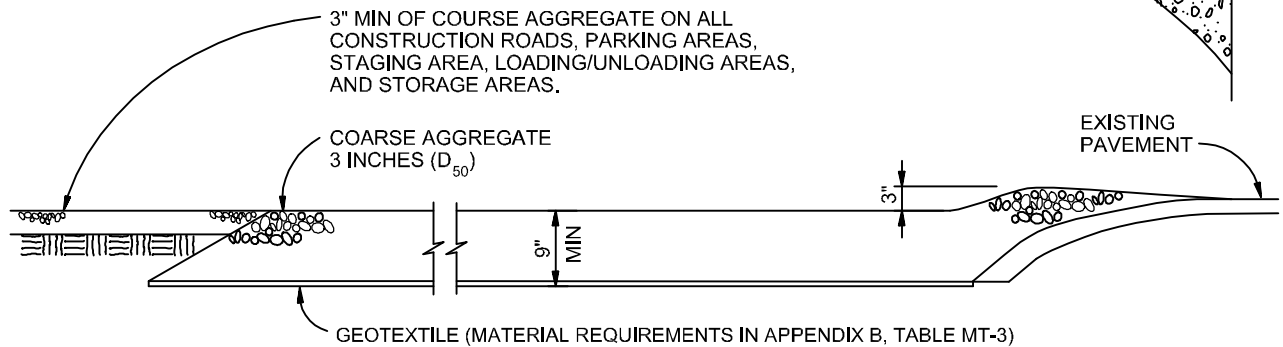

SECTION

VEHICLE TRACKING

NTS

VEHICLE TRACKING NOTES

INSTALLATION REQUIREMENTS

1. ALL ENTRANCES TO THE CONSTRUCTION SITE ARE TO BE STABILIZED PRIOR TO CONSTRUCTION BEGINNING.
2. CONSTRUCTION ENTRANCES ARE TO BE BUILT WITH AN APRON TO ALLOW FOR TURNING TRAFFIC, BUT SHOULD NOT BE BUILT OVER EXISTING PAVEMENT EXCEPT FOR A SLIGHT OVERLAP.
3. AREAS TO BE STABILIZED ARE TO BE PROPERLY GRADED AND COMPACTED PRIOR TO LAYING DOWN GEOTEXTILE AND STONE.
4. CONSTRUCTION ROADS, PARKING AREAS, LOADING/UNLOADING ZONES, STORAGE AREAS, AND STAGING AREAS ARE TO BE STABILIZED.
5. CONSTRUCTION ROADS ARE TO BE BUILT TO CONFORM TO SITE GRADES, BUT SHOULD NOT HAVE SIDE SLOPES OR ROAD GRADES THAT ARE EXCESSIVELY STEEP.

MAINTENANCE REQUIREMENTS

1. REGULAR INSPECTIONS ARE TO BE MADE OF ALL STABILIZED AREAS, ESPECIALLY AFTER STORM EVENTS.
2. STONES ARE TO BE REAPPLIED PERIODICALLY AND WHEN REPAIR IS NECESSARY.
3. SEDIMENT TRACKED ONTO PAVED ROADS IS TO BE REMOVED DAILY BY SHOVELING OR SWEEPING. SEDIMENT IS NOT TO BE WASHED DOWN STORM SEWER DRAINS.
4. STORM SEWER INLET PROTECTION IS TO BE IN PLACE, INSPECTED, AND CLEANED IF NECESSARY.
5. OTHER ASSOCIATED SEDIMENT CONTROL MEASURES ARE TO BE INSPECTED TO ENSURE GOOD WORKING CONDITION.

City of Colorado Springs
Stormwater Quality

Figure VT-2
Vehicle Tracking
Application Examples

APPENDIX D – SWMP Report and GEC Plan Checklists



2880 International Circle, Suite 110
 Colorado Springs, CO 80910
 Phone 719-520-6300
 Fax 719-520-6695
 www.elpasoco.com

**EL PASO COUNTY PLANNING AND
 COMMUNITY DEVELOPMENT
 DEPARTMENT**

STORMWATER MANAGEMENT PLAN CHECKLIST

Revised: July 2019

		Applicant	PCD
1. STORMWATER MANAGEMENT PLAN (SWMP)			
1	Applicant (owner/designated operator), SWMP Preparer, Qualified Stormwater Manager, and Contractor Information. (On cover/title sheet)	✓	
2	Table of Contents	✓	
3	Site description and location to include: vicinity map with nearest street/crossroads description.	✓	
4	Narrative description of construction activities proposed (e.g., may include clearing and grubbing, temporary stabilization, road grading, utility / storm installation, final grading, final stabilization, and removal of temporary control measures)	✓	
5	Phasing plan – may require separate drawings indicating initial, interim, and final site phases for larger projects. Provide “living maps” that can be revised in the field as conditions dictate.	✓	
6	Proposed sequence for major activities: Provide a construction schedule of anticipated starting and completion dates for each stage of land-disturbing activity depicting conservation measures anticipated, including the expected date on which the final stabilization will be completed.	✓	
7	Estimates of the total site area and area to undergo disturbance; current area of disturbance must be updated on the SWMP as changes occur.	✓	
8	Soil erosion potential and impacts on discharge that includes a summary of the data used to determine soil erosion potential	✓	
9	A description of existing vegetation at the site and percent ground cover and method used to determine ground cover	✓	
10	Location and description of all potential pollution sources including but not limited to: disturbed and stored soils; vehicle tracking; management of contaminated soils; loading and unloading operations; outdoor storage of materials; vehicle and equipment maintenance and fueling; significant dust generating process; routine maintenance activities involving fertilizers, pesticides, herbicides, detergents, fuels, solvents, oils, etc.; on-site waste management; concrete truck/equipment washing; dedicated asphalt, concrete batch plants and masonry mixing stations; non-industrial waste such as trash and portable toilets	✓	
11	Material handling to include spill prevention and response plan and procedures.	✓	
12	Spill prevention and pollution controls for dedicated batch plants	✓	
13	Other SW pollutant control measures to include waste disposal and off site soil tracking	✓	
14	Location and description of any anticipated allowable non-stormwater discharge (ground water, springs, irrigation, discharge covered by CDPHE Low Risk Guidance, etc.)	✓	
15	Name(s) of ultimate receiving waters; size, type and location of stormwater outfall or storm sewer system discharge	✓	
16	Description of all stream crossings located within the project area or statement that no streams cross the project area	✓	



2880 International Circle, Suite 110
 Colorado Springs, CO 80910
 Phone 719-520-6300
 Fax 719-520-6695
 www.elpasoco.com

**EL PASO COUNTY PLANNING AND
 COMMUNITY DEVELOPMENT
 DEPARTMENT**

STORMWATER MANAGEMENT PLAN CHECKLIST

Revised: July 2019		Applicant	PCD
17	SWMP Map to include:	✓	
17a	construction site boundaries	✓	
17b	flow arrows to depict stormwater flow directions	✓	
17c	all areas of disturbance	✓	
17d	areas of cut and fill	✓	
17e	areas used for storage of building materials, soils (stockpiles) or wastes	✓	
17f	location of any dedicated asphalt / concrete batch plants	✓	
17g	location of all structural control measures	✓	
17h	location of all non-structural control measures	✓	
17i	springs, streams, wetlands and other surface waters, including areas that require maintenance of pre-existing vegetation within 50 feet of a receiving water	✓	
18	Narrative description of all structural control measures to be used. Modifications to EPC standard control measures must meet or exceed County-approved details.	✓	
19	Description of all non-structural control measures to be used including seeding, mulching, protection of existing vegetation, site watering, sod placement, etc.	✓	
20	Technical drawing details for all control measure installation and maintenance; custom or other jurisdiction's details used must meet or exceed EPC standards	✓	
21	Procedure describing how the SWMP is to be revised	✓	
22	Description of Final Stabilization and Long-term Stormwater Quality (describe nonstructural and structural measures to control SW pollutants after construction operations have been completed, including detention, water quality control measure etc.)	✓	
23	Specification that final vegetative cover density is to be 70% of pre-disturbed levels	✓	
24	Outline of permit holder inspection procedures to install, maintain, and effectively operate control measures to manage erosion and sediment	✓	
25	Record keeping procedures identified to include signature on inspection logs and location of SWMP records on-site	✓	
26	If this project relies on control measures owned or operated by another entity, a documented agreement must be included in the SWMP that identifies location, installation and design specifications, and maintenance requirements and responsibility of the control measure(s).	✓	
Please note: all items above must be addressed. If not applicable, explain why, simply identifying "not applicable" will not satisfy CDPHE requirement of explanation.			
2. ADDITIONAL REPORTS/PERMITS/DOCUMENTS			
a	Grading and Erosion Control Plan (signed)		
b	Erosion and Stormwater Quality Control Permit (ESQCP) (signed)		
3. Applicant Comments:			

SWMP Content Checklist - Stormwater Discharges Associated with Construction Activity (COR400000)

PART I.C.2.a...	Yes	No	
i) Qualified Stormwater Manager - Does the SWMP list individual(s) by title and name who are designated as the site's qualified stormwater manager(s) responsible for implementing the SWMP in its entirety?	✓		
ii) Spill Prevention and Response Plan - Does the SWMP have a spill prevention and response plan?	✓		
iii) Materials Handling - Does the SWMP describe and locate all control measures implemented at the site to minimize impacts from handling significant materials that could contribute pollutants to runoff	✓		
iv) Potential Sources of Pollution - Does the SWMP list all potential sources of pollution which may reasonably be expected to affect the quality of stormwater discharges associated with construction activity from the site. This shall include, but is not limited to, the following pollutant sources:	✓		
a) disturbed and stored soils		✓	
b) vehicle tracking of sediments		✓	
c) management of contaminated soils		✓	
d) loading and unloading operations		✓	
e) outdoor storage activities (erodible building materials, fertilizers, chemicals, etc.)		✓	
f) vehicle and equipment maintenance and fueling		✓	
g) significant dust or particulate generating processes (e.g., saw cutting material, including dust)		✓	
h) routine maintenance activities involving fertilizers, pesticides, herbicides, detergents, fuels, solvents, oils, etc.		✓	
i) on-site waste management practices (waste piles, liquid wastes, dumpsters)		✓	
j) concrete truck/equipment washing, including washing of the concrete truck chute and associated fixtures and equipment		✓	
k) dedicated asphalt, concrete batch plants and masonry mixing stations		✓	
l) non-industrial waste sources such as worker trash and portable toilets		✓	
vi) Implementation of Control Measures - Does the SWMP include design specifications that contain information on the implementation of the control measure in accordance with good engineering hydrologic and pollution control practices; including as applicable drawings, dimensions, installation information, materials, implementation processes, control measure-specific inspection expectations, and maintenance requirements.	✓		
Notes:			

SWMP Content Checklist - Stormwater Discharges Associated with Construction Activity (COR400000)

	Yes	No
vi) Site Description - Does the SWMP include a site description which includes, at a minimum, the following:		
a) the nature of the construction activity at the site		
b) the proposed schedule for the sequence for major construction activities and the planned implementation of control measures for each phase. (e.g.: clearing, grading, utilities, vertical, etc.)		
c) estimates of the total acreage of the site, and the acreage expected to be disturbed by clearing, excavation, grading, or any other construction activities		
d) a summary of any existing data used in the development of the construction site plans or SWMP that describe the soil or existing potential for soil erosion		
e) a description of the percent of existing vegetative ground cover relative to the entire site and the method for determining the percentage		
f) a description of any allowable non-stormwater discharges at the site, including those being discharged under a division low risk discharge guidance policy		
g) a description of areas receiving discharge from the site. Including a description of the immediate source receiving the discharge. If the stormwater discharge is to a municipal separate storm sewer system, the name of the entity owning that system, the location of the storm sewer discharge, and the ultimate receiving water(s)		
h) a description of all stream crossings located within the construction site boundary		
Notes:		

SWMP Content Checklist - Stormwater Discharges Associated with Construction Activity (COR400000)

	Yes	No
vii) Site Map - Does the SWMP include a site map which includes, at a minimum, the following:		
a) construction site boundaries		
b) flow arrows that depict stormwater flow directions on-site and runoff direction		
c) all areas of ground disturbance including areas of borrow and fill		
d) areas used for storage of soil		
e) locations of all waste accumulation areas, including areas for liquid, concrete, masonry, and asphalt		
f) locations of dedicated asphalt, concrete batch plants and masonry mixing stations		
g) locations of all structural control measures		
h) locations of all non-structural control measures		
i) locations of springs, streams, wetlands and other state waters, including areas that require pre-existing vegetation be maintained within 50 feet of a receiving water, where determined feasible in accordance with Part I.B.1.a.i.(d)		
j) locations of all stream crossings located within the construction site boundary		
viii) Final Stabilization and Long Term Stormwater Management - Does the SWMP describe the practices used to achieve final stabilization of all disturbed areas at the site and any planned practices to control pollutants in stormwater discharges that will occur after construction operations are completed. Including but not limited to, detention/retention ponds, rain gardens, stormwater vaults, etc		

Notes:

SWMP Content Checklist - Stormwater Discharges Associated with Construction Activity (COR400000)

	Yes	No
ix) Inspection Reports - Does the SWMP include documented inspection reports in accordance with Part I.D. of the permit?		✓
a) Is the inspector a qualified stormwater manager?	✓	
b) Do the inspection records meet the minimum required inspection frequency identified on the inspection reports? <ul style="list-style-type: none"> • What minimum inspection frequency is being implemented at the site? • Is a reduced inspection frequency being implemented? 	✓	
c) Were the following areas inspected for evidence of, or the potential for, pollutants leaving the construction site boundaries, entering the stormwater drainage system, or discharging to state waters:	✓	
1) Construction site perimeter	✓	
2) All disturbed areas	✓	
3) Designated haul routes	✓	
4) Material and waste storage areas exposed to precipitation	✓	
5) Locations where stormwater has the potential to discharge offsite	✓	
6) Locations where vehicles exit the site	✓	
d) Do the inspection records include the following requirements:	✓	
1) Visually verify whether all implemented control measures are in effective operational condition and are working as designed in their specifications to minimize pollutant discharges	✓	
2) Determine if there are new potential sources of pollutants	✓	
3) Assess the adequacy of control measures at the site to identify areas requiring new or modified control measures to minimize pollutant discharges	✓	
4) Identify all areas of non-compliance with the permit requirements and, if necessary, implement corrective action as described below	✓	
e) Do the inspection reports include, at a minimum, the following items:	✓	
1) The inspection date	✓	
2) Name(s) and title(s) of personnel conducting the inspection	✓	
3) Weather conditions at the time of inspection	✓	
4) Phase of construction at the time of inspection	✓	
5) Estimated acreage of disturbance at the time of inspection	✓	
6) Location(s) of discharges of sediment or other pollutants from the site	✓	
7) Location(s) of control measures requiring routine maintenance (see Section VI)	✓	
8) Location(s) and identification of inadequate control measures and requiring corrective actions (see Section VII)	✓	
9) Location(s) and identification of additional control measures are needed that were not in place at the time of inspection	✓	
10) Description of the minimum inspection frequency and any deviations from the minimum inspection schedule	✓	
11) After adequate corrective action(s) and maintenance have been taken, or where a report does not identify any incidents requiring corrective action or maintenance, the report shall contain the following statement: "I verify that, to the best of my knowledge and belief, all corrective action and maintenance items identified during the inspection are complete, and the site is currently in compliance with the permit."	✓	

Notes:



2880 International Circle, Suite 110
 Colorado Springs, CO 80910
 Phone 719-520-6300
 Fax 719-520-6695
 www.elpasoco.com

**EL PASO COUNTY PLANNING AND
 COMMUNITY DEVELOPMENT
 DEPARTMENT**

GRADING AND EROSION CONTROL PLAN CHECKLIST

Revised: July 2019

		Applicant	PCD
1. GRADING AND EROSION CONTROL PLAN			
a	Vicinity map.	✓	
b	Adjacent city/town/jurisdictional boundaries, subdivision names, and property parcel numbers labeled.	✓	
c	North arrow and acceptable scale (1"=20' to 1"=100').	✓	
d	Legend for all symbols used in the plan.	✓	
e	Existing and proposed property lines. Proposed subdivision boundary for subdivision projects.	✓	
f	All existing structures.	✓	
g	All existing utilities.	✓	
h	Construction site boundaries.	✓	
i	Existing vegetation (notes are acceptable in cases where there is no notable vegetation, only grasses/weeds, or site has already been stripped).	✓	
j	FEMA 100-yr floodplain.	✓	
k	Existing and proposed water courses including springs, streams, wetlands, detention ponds, stormwater quality structures, roadside ditches, irrigation ditches and other water surfaces. Show maintenance of pre-existing vegetation within 50 feet of a receiving water.	✓	
l	Existing and proposed contours 2 feet or less (except for hillside).	✓	
m	Limits of disturbance delineating all anticipated areas of soil disturbance.	✓	
n	Identify and protect areas outside of the construction site boundary with existing fencing, construction fencing or other methods as appropriate.	✓	
o	Offsite grading clearly shown and called out.	N/A	
p	Areas of cut and fill identified.	✓	
q	Conclusions from soils/geotechnical report and geologic hazards report incorporated in grading design (slopes, embankments, materials, mitigation, etc.)	✓	
r	Proposed slopes steeper than 3:1 with top and toe of slope delineated. Erosion control blanketing or other protective covering required.	✓	
s	Stormwater flow direction arrows.	✓	
t	Location of any dedicated asphalt / concrete batch plants.	N/A	
u	Areas used for staging, storage of building materials, soils (stockpiles) or wastes. The use of construction office trailers requires PCD permitting.	✓	
v	All proposed temporary construction control measures, structural and non-structural. Temporary construction control measures shall be identified by phase of implementation to include "initial," "interim," and "final" or shown on separate phased maps identifying each phase.	✓	
w	Vehicle tracking provided at all construction entrances/exits. Construction fencing, barricades, and/or signage provided at access points not to be used for construction.	✓	
x	Temporary sediment ponds provided for disturbed drainage areas greater than 1 acre.	✓	



2880 International Circle, Suite 110
 Colorado Springs, CO 80910
 Phone 719-520-6300
 Fax 719-520-6695
 www.elpasoco.com

**EL PASO COUNTY PLANNING AND
 COMMUNITY DEVELOPMENT
 DEPARTMENT**

GRADING AND EROSION CONTROL PLAN CHECKLIST

Revised: July 2019

		Applicant	PCD
ii	<p>Owner's Statement (for GEC Plan within Construction Drawing set): I, the owner/developer have read and will comply with the requirements of the grading and erosion control plan and all of the requirements specified in these detailed plans and specifications.</p> <p>_____ Date _____ Owner Signature</p>	N/A	
jj	<p>El Paso County (standalone GEC Plan): County plan review is provided only for general conformance with County Design Criteria. The County is not responsible for the accuracy and adequacy of the design, dimensions, and/ or elevations which shall be confirmed at the job site. The County through the approval of this document assumes no responsibility for completeness and/ or accuracy of this document. Filed in accordance with the requirements of the El Paso County Land Development Code, Drainage Criteria Manual Volumes 1 and 2, and Engineering Criteria Manual, as amended.</p> <p>In accordance with ECM Section 1.12, these construction documents will be valid for construction for a period of 2 years from the date signed by the El Paso County Engineer. If construction has not started within those 2 years, the plans will need to be resubmitted for approval, including payment of review fees at the Planning and Community Development Director's discretion.</p> <p>_____ Date _____ County Engineer/ECM Administrator</p>	✓	
2. ADDITIONAL REPORTS/PERMITS/DOCUMENTS			
a	Soils report / geotechnical investigation as appropriate for grading/utilities/drainage/road construction.	✓	
b	Use Agreement/easement between the Owner or Operator and other third party for use of all offsite grading or stormwater control measures, used by the owner or operator but not under their direct control or ownership.	N/A	
c	Floodplain Development Permit	X	
d	USACE 404/wetlands permit/mitigation plan	X	
e	FEMA CLOMR	N/A	
f	State Engineer's permit/Notice Of Intent to Construct		
g	Stormwater Management Plan (SWMP)	X	
h	Financial Assurance Estimate (FAE) (signed)	X	
i	Erosion and Stormwater Quality Control Permit (ESQCP) (signed)	X	
j	Pre-Development Site Grading Acknowledgement and Right of Access Form (signed)	X	
k	Conditions of Approval met?	X	



2880 International Circle, Suite 110
 Colorado Springs, CO 80910
 Phone 719-520-6300
 Fax 719-520-6695
 www.elpasoco.com

**EL PASO COUNTY PLANNING AND
 COMMUNITY DEVELOPMENT
 DEPARTMENT**

GRADING AND EROSION CONTROL PLAN CHECKLIST

Revised: July 2019

		Applicant	PCD
3. STANDARD NOTES FOR EL PASO COUNTY GRADING AND EROSION CONTROL PLANS			
1	Stormwater discharges from construction sites shall not cause or threaten to cause pollution, contamination, or degradation of State Waters. All work and earth disturbance shall be done in a manner that minimizes pollution of any on-site or off-site waters, including wetlands.	✓	
2	Notwithstanding anything depicted in these plans in words or graphic representation, all design and construction related to roads, storm drainage and erosion control shall conform to the standards and requirements of the most recent version of the relevant adopted El Paso County standards, including the Land Development Code, the Engineering Criteria Manual, the Drainage Criteria Manual, and the Drainage Criteria Manual Volume 2. Any deviations from regulations and standards must be requested, and approved, in writing.	✓	
3	A separate Stormwater Management Plan (SMWP) for this project shall be completed and an Erosion and Stormwater Quality Control Permit (ESQCP) issued prior to commencing construction. Management of the SWMP during construction is the responsibility of the designated Qualified Stormwater Manager or Certified Erosion Control Inspector. The SWMP shall be located on site at all times during construction and shall be kept up to date with work progress and changes in the field.	✓	
4	Once the ESQCP is approved and a "Notice to Proceed" has been issued, the contractor may install the initial stage erosion and sediment control measures as indicated on the approved GEC. A Preconstruction Meeting between the contractor, engineer, and El Paso County will be held prior to any construction. It is the responsibility of the applicant to coordinate the meeting time and place with County staff.	✓	
5	Control measures must be installed prior to commencement of activities that could contribute pollutants to stormwater. control measures for all slopes, channels, ditches, and disturbed land areas shall be installed immediately upon completion of the disturbance.	✓	
6	All temporary sediment and erosion control measures shall be maintained and remain in effective operating condition until permanent soil erosion control measures are implemented and final stabilization is established. All persons engaged in land disturbance activities shall assess the adequacy of control measures at the site and identify if changes to those control measures are needed to ensure the continued effective performance of the control measures. All changes to temporary sediment and erosion control measures must be incorporated into the Stormwater Management Plan.	✓	
7	Temporary stabilization shall be implemented on disturbed areas and stockpiles where ground disturbing construction activity has permanently ceased or temporarily ceased for longer than 14 days.	✓	
8	Final stabilization must be implemented at all applicable construction sites. Final stabilization is achieved when all ground disturbing activities are complete and all disturbed areas either have a uniform vegetative cover with individual plant density of 70 percent of pre-disturbance levels established or equivalent permanent alternative stabilization method is implemented. All temporary sediment and erosion control measures shall be removed upon final stabilization and before permit closure.	✓	
9	All permanent stormwater management facilities shall be installed as designed in the approved plans. Any proposed changes that effect the design or function of permanent stormwater management structures must be approved by the ECM Administrator prior to implementation.	✓	



2880 International Circle, Suite 110
 Colorado Springs, CO 80910
 Phone 719-520-6300
 Fax 719-520-6695
 www.elpasoco.com

**EL PASO COUNTY PLANNING AND
 COMMUNITY DEVELOPMENT
 DEPARTMENT**

GRADING AND EROSION CONTROL PLAN CHECKLIST

Revised: July 2019

		Applicant	PCD
10	Earth disturbances shall be conducted in such a manner so as to effectively minimize accelerated soil erosion and resulting sedimentation. All disturbances shall be designed, constructed, and completed so that the exposed area of any disturbed land shall be limited to the shortest practical period of time. Pre-existing vegetation shall be protected and maintained within 50 horizontal feet of a waters of the state unless shown to be infeasible and specifically requested and approved.	✓	
11	Compaction of soil must be prevented in areas designated for infiltration control measures or where final stabilization will be achieved by vegetative cover. Areas designated for infiltration control measures shall also be protected from sedimentation during construction until final stabilization is achieved. If compaction prevention is not feasible due to site constraints, all areas designated for infiltration and vegetation control measures must be loosened prior to installation of the control measure(s).	✓	
12	Any temporary or permanent facility designed and constructed for the conveyance of stormwater around, through, or from the earth disturbance area shall be a stabilized conveyance designed to minimize erosion and the discharge of sediment off site.	✓	
13	Concrete wash water shall be contained and disposed of in accordance with the SWMP. No wash water shall be discharged to or allowed to enter State Waters, including any surface or subsurface storm drainage system or facilities. Concrete washouts shall not be located in an area where shallow groundwater may be present, or within 50 feet of a surface water body, creek or stream.	✓	
14	During dewatering operations of uncontaminated ground water may be discharged on site, but shall not leave the site in the form of surface runoff unless an approved State dewatering permit is in place.	✓	
15	Erosion control blanketing or other protective covering shall be used on slopes steeper than 3:1.	✓	
16	Contractor shall be responsible for the removal of all wastes from the construction site for disposal in accordance with local and State regulatory requirements. No construction debris, tree slash, building material wastes or unused building materials shall be buried, dumped, or discharged at the site.	✓	
17	Waste materials shall not be temporarily placed or stored in the street, alley, or other public way, unless in accordance with an approved Traffic Control Plan. control measures may be required by El Paso County Engineering if deemed necessary, based on specific conditions and circumstances.	✓	
18	Tracking of soils and construction debris off-site shall be minimized. Materials tracked off-site shall be cleaned up and properly disposed of immediately.	✓	
19	The owner/developer shall be responsible for the removal of all construction debris, dirt, trash, rock, sediment, soil, and sand that may accumulate in roads, storm drains and other drainage conveyance systems and stormwater appurtenances as a result of site development.	✓	
20	The quantity of materials stored on the project site shall be limited, as much as practical, to that quantity required to perform the work in an orderly sequence. All materials stored on-site shall be stored in a neat, orderly manner, in their original containers, with original manufacturer's labels.	✓	
21	No chemical(s) having the potential to be released in stormwater are to be stored or used onsite unless permission for the use of such chemical(s) is granted in writing by the ECM Administrator. In granting approval for the use of such chemical(s), special conditions and monitoring may be required.	✓	



2880 International Circle, Suite 110
 Colorado Springs, CO 80910
 Phone 719-520-6300
 Fax 719-520-6695
 www.elpasoco.com

**EL PASO COUNTY PLANNING AND
 COMMUNITY DEVELOPMENT
 DEPARTMENT**

GRADING AND EROSION CONTROL PLAN CHECKLIST

Revised: July 2019

		Applicant	PCD
22	Bulk storage of allowed petroleum products or other allowed liquid chemicals in excess of 55 gallons shall require adequate secondary containment protection to contain all spills onsite and to prevent any spilled materials from entering State Waters, any surface or subsurface storm drainage system or other facilities.	✓	
23	No person shall cause the impediment of stormwater flow in the curb and gutter or ditch except with approved sediment control measures.	✓	
24	Owner/developer and their agents shall comply with the "Colorado Water Quality Control Act" (Title 25, Article 8, CRS), and the "Clean Water Act" (33 USC 1344), in addition to the requirements of the Land Development Code, DCM Volume II and the ECM Appendix I. All appropriate permits must be obtained by the contractor prior to construction (1041, NPDES, Floodplain, 404, fugitive dust, etc.). In the event of conflicts between these requirements and other laws, rules, or regulations of other Federal, State, local, or County agencies, the most restrictive laws, rules, or regulations shall apply.	✓	
25	All construction traffic must enter/exit the site only at approved construction access points.	✓	
26	Prior to construction the permittee shall verify the location of existing utilities.	✓	
27	A water source shall be available on site during earthwork operations and shall be utilized as required to minimize dust from earthwork equipment and wind.	✓	
28	The soils report for this site has been prepared by _____ and shall be considered a part of these plans.	X	
29	At least ten (10) days prior to the anticipated start of construction, for projects that will disturb one (1) acre or more, the owner or operator of construction activity shall submit a permit application for stormwater discharge to the Colorado Department of Public Health and Environment, Water Quality Division. The application contains certification of completion of a stormwater management plan (SWMP), of which this Grading and Erosion Control Plan may be a part. For information or application materials contact: Colorado Department of Public Health and Environment Water Quality Control Division WQCD – Permits 4300 Cherry Creek Drive South Denver, CO 80246-1530 Attn: Permits Unit	✓	

APPENDIX E – Inspection Report Template

CONSTRUCTION STORMWATER SITE INSPECTION REPORT

Facility Name		Permittee					
Date of Inspection		Weather Conditions					
Permit Certification #		Disturbed Acreage					
Phase of Construction		Inspector Title					
Inspector Name							
Is the above inspector a qualified stormwater manager? (permittee is responsible for ensuring that the inspector is a qualified stormwater manager)			<table border="1" style="width: 100%; border-collapse: collapse;"> <tr> <td style="width: 50%; text-align: center;">YES</td> <td style="width: 50%; text-align: center;">NO</td> </tr> <tr> <td style="text-align: center;"><input type="checkbox"/></td> <td style="text-align: center;"><input type="checkbox"/></td> </tr> </table>	YES	NO	<input type="checkbox"/>	<input type="checkbox"/>
YES	NO						
<input type="checkbox"/>	<input type="checkbox"/>						

INSPECTION FREQUENCY					
Check the box that describes the minimum inspection frequency utilized when conducting each inspection					
At least one inspection every 7 calendar days	<input type="checkbox"/>				
At least one inspection every 14 calendar days, with post-storm event inspections conducted within 24 hours after the end of any precipitation or snowmelt event that causes surface erosions	<input type="checkbox"/>				
<ul style="list-style-type: none"> • This is this a post-storm event inspection. Event Date: _____ 	<input type="checkbox"/>				
Reduced inspection frequency - Include site conditions that warrant reduced inspection frequency	<input type="checkbox"/>				
<ul style="list-style-type: none"> • Post-storm inspections at temporarily idle sites 	<input type="checkbox"/>				
<ul style="list-style-type: none"> • Inspections at completed sites/area 	<input type="checkbox"/>				
<ul style="list-style-type: none"> • Winter conditions exclusion 	<input type="checkbox"/>				
Have there been any deviations from the minimum inspection schedule? If yes, describe below.	<table border="1" style="width: 100%; border-collapse: collapse;"> <tr> <td style="width: 50%; text-align: center;">YES</td> <td style="width: 50%; text-align: center;">NO</td> </tr> <tr> <td style="text-align: center;"><input type="checkbox"/></td> <td style="text-align: center;"><input type="checkbox"/></td> </tr> </table>	YES	NO	<input type="checkbox"/>	<input type="checkbox"/>
YES	NO				
<input type="checkbox"/>	<input type="checkbox"/>				

INSPECTION REQUIREMENTS*
i. Visually verify all implemented control measures are in effective operational condition and are working as designed in the specifications
ii. Determine if there are new potential sources of pollutants
iii. Assess the adequacy of control measures at the site to identify areas requiring new or modified control measures to minimize pollutant discharges
iv. Identify all areas of non-compliance with the permit requirements, and if necessary, implement corrective action
*Use the attached Control Measures Requiring Routine Maintenance and Inadequate Control Measures Requiring Corrective Action forms to document results of this assessment that trigger either maintenance or corrective actions

AREAS TO BE INSPECTED			
Is there evidence of, or the potential for, pollutants leaving the construction site boundaries, entering the stormwater drainage system or discharging to state waters at the following locations?			
	NO	YES	If "YES" describe discharge or potential for discharge below. Document related maintenance, inadequate control measures and corrective actions Inadequate Control Measures Requiring Corrective Action form
Construction site perimeter	<input type="checkbox"/>	<input type="checkbox"/>	
All disturbed areas	<input type="checkbox"/>	<input type="checkbox"/>	
Designated haul routes	<input type="checkbox"/>	<input type="checkbox"/>	
Material and waste storage areas exposed to precipitation	<input type="checkbox"/>	<input type="checkbox"/>	
Locations where stormwater has the potential to discharge offsite	<input type="checkbox"/>	<input type="checkbox"/>	
Locations where vehicles exit the site	<input type="checkbox"/>	<input type="checkbox"/>	
Other: _____	<input type="checkbox"/>	<input type="checkbox"/>	

REPORTING REQUIREMENTS

The permittee shall report the following circumstances orally within twenty-four (24) hours from the time the permittee becomes aware of the circumstances, and shall mail to the division a written report containing the information requested within five (5) working days after becoming aware of the following circumstances. The division may waive the written report required if the oral report has been received within 24 hours.

All Noncompliance Requiring 24-Hour Notification per Part II.L.6 of the Permit		
a. Endangerment to Health or the Environment Circumstances leading to any noncompliance which may endanger health or the environment regardless of the cause of the incident (See Part II.L.6.a of the Permit) <i>This category would primarily result from the discharge of pollutants in violation of the permit</i>		
b. Numeric Effluent Limit Violations <ul style="list-style-type: none"> o Circumstances leading to any unanticipated bypass which exceeds any effluent limitations (See Part II.L.6.b of the Permit) o Circumstances leading to any upset which causes an exceedance of any effluent limitation (See Part II.L.6.c of the Permit) o Daily maximum violations (See Part II.L.6.d of the Permit) <i>Numeric effluent limits are very uncommon in certifications under the COR400000 general permit. This category of noncompliance only applies if numeric effluent limits are included in a permit certification.</i>		

Has there been an incident of noncompliance requiring 24-hour notification?	NO	YES	
	<input type="checkbox"/>	<input type="checkbox"/>	If "YES" document below

Date and Time of Incident	Location	Description of Noncompliance	Description of Corrective Action	Date and Time of 24 Hour Oral Notification	Date of 5 Day Written Notification *

*Attach copy of 5 day written notification to report. Indicate if written notification was waived, including the name of the division personnel who granted waiver.

After adequate corrective action(s) and maintenance have been taken, or where a report does not identify any incidents requiring corrective action or maintenance, the individual(s) designated as the Qualified Stormwater Manager, shall sign and certify the below statement:

"I verify that, to the best of my knowledge and belief, all corrective action and maintenance items identified during the inspection are complete, and the site is currently in compliance with the permit."

Name of Qualified Stormwater Manager

Title of Qualified Stormwater Manager

Signature of Qualified Stormwater Manager

Date

Notes/Comments