



MDDP & DBPS Amendment

Eagleview El Paso County, Colorado

Prepared for:

Joe DesJardin
PT Eagleview LLC
1864 Woodmoor Drive, Suite 100
Monument, CO 80132

Prepared by:

Kimley-Horn and Associates, Inc.
2 North Nevada Avenue, Suite 900
Colorado Springs, Colorado 80903
(719) 453-0180
Contact: Kevin Kofford, P.E.

Project #: 196288000

PCD Filing No.: MDP232

Prepared: February 6, 2024

Kimley»Horn



CERTIFICATION

DESIGN ENGINEER'S STATEMENT

The attached MDDP & DBPS Amendment was prepared under my direction and supervision and are correct to the best of my knowledge and belief. Said hydraulic report has been prepared according to the criteria established by the County for drainage reports and said report is in conformity with the master plan of the drainage basin. I accept responsibility for any liability caused by any negligent acts, errors or omissions on my part in preparation of this report.

SIGNATURE (Affix Seal): _____
Kevin Kofford, P.E.
Colorado P.E. No. 57234
Date

OWNER/DEVELOPER'S STATEMENT

I, the developer, have read and will comply with all of the requirements specified in this Drainage Report and Plan.

PT Eagleview LLC
Name of Developer

Authorized Signature Date

Joe DesJardin
Printed Name

Director of Entitlements
Title

1864 Woodmoor Drive Suite 100, Monument, CO 80132
Address

EL PASO COUNTY

Filed in accordance with the requirements of the Drainage Criteria Manual, Volumes 1 and 2, El Paso County Engineering Criteria Manual and Land Development Code as amended.

Joshua Palmer, P.E. Date
County Engineer/ ECM Administrator

Conditions:

TABLE OF CONTENTS

CERTIFICATION2

TABLE OF CONTENTS3

INTRODUCTION4

DRAINAGE DESIGN CRITERIA.....5

DBPS DRAINAGE RECOMMENDATIONS7

HYDRAULIC ANALYSIS8

PROPOSED AMENDMENTS TO RECOMMENDATIONS.....10

THE FOUR STEP PROCESS13

MAINTENANCE14

FLOODPLAIN STATEMENT14

WETLAND MITIGATION14

GRADING AND EROSION CONTROL.....14

DRAINAGE FEES AND REIMBURSABLE COSTS15

CONCLUSION.....17

REFERENCES18

APPENDIX

- APPENDIX A: FIGURES
- APPENDIX B: HYDROLOGY
- APPENDIX C: HYDRAULICS
- APPENDIX D: DBPS EXCERPTS
- APPENDIX E: OPCC

INTRODUCTION

PURPOSE AND SCOPE

The purpose of this report is to serve as an MDDP and DBPS Amendment (“Amendment”) to the previously approved Falcon Drainage Basin Planning Study completed by Matrix Design Group, September 2015 (DBPS). Changes to the DBPS include the removal of the small drop structures for the entire length of reaches RWT054, RWT080, and RWT092, to be replaced with natural channel design measures in appropriate locations. Additionally, this DBPS Amendment allows the construction of Sub-Regional Pond 1 (SR1) by the County at a later date. Lastly, this Amendment changes some of the costs for drainage improvements from County costs to developer costs in support of the proposed Eagleview development (“Project”) and thus amending the Falcon Drainage Basin, drainage fee.

GENERAL LOCATION AND DESCRIPTION

The Site is located approximately 4 miles northwest of Falcon, Colorado within Section 26, Township 12 South, Range 65 West of the 6th Principal Meridian, County of El Paso, State of Colorado (“the Site”). There are four identified reaches and one sub regional pond associated with this Amendment. All features are located on the Eagleview Project, a Site that comprises two parcels of land which are bound by Stapleton Estates Filing No. 1 on the west and south, Paint Brush Hills Filing No. 14 (PCD File No. SF2024) to the east, and the Rodgwick Subdivision and MFY Farm Subdivision to the north. Reaches RWT080 and RWT054 extend beyond the northern property of the Eagleview Site, RWT080 to the northwest and RWT054 to the northeast. This report intends to amend the full extent of these reaches beyond the Eagleview site. Table 1 below describes the general description and location of each feature as identified in the DBPS.

Table 1: General Description and Location of Affected Reaches

Reach/Feature	Description	Location
RWT094	South of SR1	Eagleview Site
SR1	Sub-Regional Pond	Eagleview Site
RWT080	Northwest of SR1	Extends ~1,815’ beyond Eagleview Site
RWT092	Northeast of SR1	Eagleview Site
RWT054	Northeast of SR1	Extends ~1,650’ beyond Eagleview Site

A vicinity map has been provided in the **Appendix** of this report. The project is within the Falcon Drainage Basin (CHWS1400), a part of the El Paso County Drainage Basin Fee Program, which is based on the total amount of impervious acres for the Site. The identified features are located within the West Tributary of the Falcon Drainage Basin. The watershed contains three natural streams and has an overall area of approximately 10.6 square miles at the confluence of Black Squirrel Creek. The headwaters of the watershed are made up of ponderosa pine forest, grassland on undeveloped land, and 2-to-5-acre rural residential lots.

The Eagleview Site is approximately 121 acres consisting of undeveloped land with native vegetation. Vegetation within the site is characterized primarily by prairie grasses along with some area of scrub brush and a limited occurrence of small oaks. The Site does not currently provide water quality or detention for the Project area. The existing land use is undeveloped vacant land.

There are no existing irrigation ditches on the Site. The Site is currently owned by PT Eagleview LLC and will be developed by PT Eagleview LLC.

According to NRCS soil mapping data, USCS Type B soils are the primary soil type within the site, indicating high levels of permeability. Soils present at the Site consist mainly of “Pring coarse sandy loam” which represent a moderate hazard for erosion. The Appendix contains detailed NRCS soil data. The existing topography consists of slopes ranging from 1% to 20%. The west tributary of the Falcon drainage basin runs from the northwest corner of the site to the southeast corner of the Site.

PREVIOUS REPORTS

The following is a complete list of the existing reports pertaining to the Eagleview site and corresponding area:

1. Falcon Drainage Basin Planning Study Selected Plan Report (DBPS), prepared by Matrix Design Group, September 2015. PCD File No. MP132.
2. Eagleview Preliminary Drainage Report (PDR), prepared by Kimley-Horn, October 28, 2022. PCD File No. SP216.
3. Eagleview Final Drainage Report (FDR), prepared by Kimley-Horn, under review.

DRAINAGE DESIGN CRITERIA

DEVELOPMENT CRITERIA REFERENCE

The proposed storm facilities are designed to be in compliance with the El Paso County “Engineering Criteria Manual”, as revised in October 2023 (“the ECM”), the El Paso County “Drainage Criteria Manual”, as revised in November 1991 with County adopted Chapter 6 and Section 3.2.1 of Chapter 13 of the City of Colorado Springs May 2014 Drainage Criteria Manual, Volume 1, (“the DCM”).

HYDROLOGIC CRITERIA

The existing conditions hydrology used for this report is unchanged from the approved Eagleview Preliminary Drainage Report (PDR), prepared by Kimley-Horn, October 28, 2022. PCD File No. SP216. A brief summary of the differences between the approved PDR and the Falcon DBPS is provided below:

The PDR hydrology model utilizes the NRCS Type II rainfall distribution, the cumulative depth for the 5-year storm is 2.7 inches and the cumulative depth for the 100-year storm is 4.6 inches. Per the DCM both Frontal and Thunderstorms were evaluated to determine the higher design flow. The comparative analysis between the two storms shows that the Frontal Storm produces a significantly higher flow rates therefore, this storm was used for the drainage design. The rainfall distribution for the Frontal Storm was selected as the dominant storm-type for this project. See **Table 2** below for the rainfall values.

Table 2: Colorado Springs Rainfall Depths

Storm Event	Duration (HRS)	
	1 HR	24 HR
5 Year	1.5	2.7
100 Year	2.52	4.6

It should be noted that the DBPS used a slightly lower cumulative depth for the 5-yr (2.6 inches) and used the same cumulative depth for the 100-year of (4.6 inches) because the DBPS used an areal reduction of 2% to the rainfall depths as the Falcon Watershed is slightly larger than 10 square miles. This areal reduction was not applied to the rainfall depths for this Site as the drainage area analyzed was smaller and didn't require an areal reduction. Refer to Tables 6-2 and 6-4 in Chapter 6 of the DCM for the frontal rainfall distribution curve and Colorado Springs rainfall depths data for the 5-year and 100-year design storm events utilized for the project.

The project model was compared to the DBPS model, and it generally reflects lower flows for the project site area. This is mainly due to using the Type II rainfall distribution curve versus the Type IIa rainfall distribution curve that the DBPS model used. Design point JWT080 in the DBPS model and design points J4 and P7 in the project models were used as critical points to compare the existing and proposed condition models. Routing of channelized flow was based on the Muskingum-Cunge method for all reaches for the existing and proposed model. This aligned with the methodology utilized in the DBPS models. Reference the approved Eagleview PDR hydrologic calculations included in the Appendix. Here is a brief summary of the difference in the flow between the DBPS, the hydrology approved in the Eagleview Preliminary Drainage Report, and Final Drainage Report at the same junction point (the confluence of the RWT092 and RWT080 into RWT092). This junction point is in the middle of the Site and provides a suitable location for comparison between the results of the hydrology:

Table 3: DBPS vs. Eagleview Preliminary Drainage

Scenario	5 YR	100 YR
JWT080 (DBPS Junction)	140 cfs	610 cfs
J4 (PDR Existing Conditions)	169 cfs	478 cfs
(P8?) P7 (FDR Future Conditions)	174 cfs	490 cfs

(see DBPS...)

(see Pre-development Drainage Plan)

(see Post-development Drainage Plan)

HYDRAULIC CRITERIA

Applicable design methods were used to analyze the project using HEC-HMS and HEC-RAS models. Proposals have been analyzed using the following hydrologic methods: the Mile High Flood Districts, Urban Drainage Criteria Manual (UDFCDCM), (Volumes 1, 2 and 3) (ASCE, 2001, with latest revisions).

Review C2: Provide the values and headers for comparison.

Review C3: Unresolved. The comparison is unclear. Please provide excerpt of J4, and JWT080 including but not limited to calculations, text discussion, drainage map. Please highlight the relevant information in the excerpt.

include the use of drainage features in Section 4, consistent with Drainage Criteria Manual, ASCE, June

Basin P7 does not appear to match the label on the proposed drainage map.

Table 4: Hydraulic Design Parameters for Natural Channels

Design Parameter	Design Value
Maximum 100-year depth outside of bankfull channel	5 ft
Roughness values	Per Table 8-5
Maximum 5-year velocity, main channel (within bankfull channel width) (ft/s)	5 ft/s
Maximum 100-year velocity, main channel (within bankfull channel width) (ft/s)	7 ft/s
Froude No., 5-year, main channel (within bankfull channel width)	0.7
Froude No., 100-year, main channel (within bankfull channel width)	0.8
Maximum shear stress, 100-year, main channel (within bankfull channel width)	1.2 lb/sf
Minimum bankfull capacity of bankfull channel (based on future development conditions)	70% of 2-year discharge or 10% of 100-yr discharge, whichever is greater ¹
Minimum bankfull channel geometry	Per Table 8-2
Minimum bankfull channel width/depth ratio (Equation 8-3)	9
Minimum entrenchment ratio (Equation 8-4)	3
Maximum longitudinal slope of low flow channel (assuming unlined, unvegetated low flow channel)	0.2 percent →
Bankfull channel sinuosity (Equation 8-5)	1.1 to 1.3
Maximum overbank side slope	4(H):1(V)
Maximum bankfull side slope	2.5(H):1(V)
Minimum radius of curvature	2.5 times top width

Revised to 0.4% based on Falcon DBPS recommendations.

¹Roughly equivalent to a 1.5-year event based on extrapolation of regional data.

DBPS DRAINAGE RECOMMENDATIONS

The DBPS made recommendations for reaches (RWT054), (RWT092), (RWT080), and (RWT094). The DBPS also identified a sub-regional detention pond (SR1) at the confluence of RWT094, RWT092 and RWT 080 to provide water quality and flood attenuation.

The following is a description of the improvements identified within the DBPS for each reach or feature:

RWT094:

- Natural Channel Design - Five (5) riffle drops identified between SR1 and Property Line

SR1 (Sub Regional Pond 1):

- 11.03 AC-FT (100 YR) Sub Regional Pond
- Assumed as Non-Jurisdictional Dam
- Sized for the WQCV + 100 YR Detention Volume

RWT080:

- Small Drop Structures – Twenty-six (26) drops identified, eleven (11) within the Eagleview project limits

RWT092:

- Small Drop Structures - Two (2) drops identified between SR1 and Reach RWT054

RWT054:

- Small Drop Structures - Sixteen (16) drops identified, five (5) within the Eagleview project limits

HYDRAULIC ANALYSIS

The hydraulic analysis performed was based on the HEC-RAS model created for the Falcon DBPS. The model was updated to more accurately represent the existing condition of the channel. A summary of the changes to the model are included below.

UPDATES TO THE DBPS MODEL

Due to a cross section at the confluence of RWT080 and RWT092, DBPS cross section 39+618.78 was removed and replaced with two new cross sections that straddle the new junction (39+666 and 39+542). The original DBPS model did not include any analysis for Reach RWT080, therefore nine (9) cross sections were added on Reach RWT080 to provide analysis for the reach. Manning's n values for parts of the channel were modified based on qualitative data; a more detailed discussion of Manning's n changes are provided below.

Manning's n Adjustments

Based on visual inspection, the velocity and Froude from the HEC-RAS modeling, of the Falcon DBPS, did not appear to match the channel stability of Falcon Creek as seen in the field. The reaches appear to function with more stability than the results of the DBPS imply in the initial DBPS HEC-RAS models. Additional field investigation was completed in an effort to evaluate Manning's n based on existing channel and vegetation conditions. Pictures were taken at each HEC-RAS cross section identified in the DBPS to assess vegetation type, height, and flow resistance. Pictures of each corresponding cross section have been included in **Appendix C**. Engineering judgement was used to revise the Manning's n by considering flow depth relative to vegetation type. As a result of this evaluation, Manning's n values in the RWT092 and RWT054 reach were increased to be closer to 0.1 for the channel bottom and 0.045 for the channel slopes based on the following factors:

- Vegetation is comprised mostly of willows and cattails about 4 to 6 feet in height.
- Flow depths are 4-feet or less.
- Willows and cattails are known to be highly resistant to flow until they are submerged.

Where flow depths are unable to submerge the vegetation, a Manning's n roughness of 0.08 to 0.1 is an acceptable range hydraulic modeling in areas with this type of vegetation.

A HEC-RAS model was completed for the existing conditions, using flow rates determined based on hydrologic analyses completed as a part of the Eagleview Subdivision PDR and the results of that study are presented therein. A full overview of the updated flows and Manning's n updates are included in the **Appendix C**. A abbreviated overview of the existing results from revised HEC-RAS modeling is provided in Table 5.

Table 5: HEC-RAS Results Comparison Between Existing and Proposed Conditions

	Cross Section	Revised Falcon DBPS HEC-RAS Cross Sections (Existing Condition)				HEC-RAS Cross Sections (Proposed Condition)	
		DBPS		Eagleview		Eagleview	
		Input	Output	Input	Output	Input	Output
		100-yr Flow (cfs)	Froude No.	100-yr Flow (cfs)	Froude No.	100-yr Flow (cfs)	Froude No.
Offsite	41218.78	480	0.74	285	0.57	285	0.57
Eagleview Onsite	40884.05	480	0.97	285	0.40	285	0.40
	40418.78	480	0.91	285	0.49	285	0.49
	40018.78	740	1.01	375	0.38	375	0.38
	39618.78 ¹	740	1.04	375	0.56	375	0.57
				478	0.29	478	0.28
	39218.78	740	1.15	478	0.51	478	0.52
	38818.78	740	1.03	478	0.55	480	0.39
	38418.78 ²	740	1.07	478	0.75	480	0.56
	38018.78 ³	740	1.06	502	0.82	502	0.57
37618.78 ⁴	740	1.04	502	0.87	502	0.77	
Offsite	37218.78	740	0.93	502	0.82	502	0.82

¹ DBPS cross section 39618.78 corresponds to existing and proposed Eagleview cross sections 39666 and 39542

² DBPS and existing Eagleview cross section 38418.78 corresponds to proposed Eagleview cross section 38437

³ DBPS and existing Eagleview cross section 38018.78 corresponds to proposed Eagleview cross section 38001

⁴ DBPS and existing Eagleview cross section 37618.78 corresponds to proposed Eagleview cross section 37609

As shown in Table 5, there are sections of the reaches that are not in compliance with the hydraulic criteria in existing condition which will be improved, and comply with criteria, in the proposed condition. The proposed improvements that were modeled are described in detail in the following section of the report. Note that cross section 37218.78, the downstream offsite cross section, is not meeting criteria in the existing condition and the hydraulic results remain identical in the proposed condition. Full hydraulic results, including results for proposed design cross sections not present in the DBPS, are provided in **Appendix C**. An overview map of the DBPS cross sections are provided in **Appendix A**.

PROPOSED AMENDMENTS TO RECOMMENDATIONS

To mitigate the velocities and Froude numbers within the existing reaches, proposed improvements, alternative to those proposed in the Falcon DBPS are proposed to provide a stable, natural channel through the Site. Through a combination of riffle drops, concrete check structures, and improved vegetation, the proposed improvements meet the design criteria for velocity and Froude. See **Appendix C** for proposed HEC-RAS results. The proposed improvements are based on the principle found in the El Paso County's Drainage Criteria Manual (DCM). Per Section 2.2.1 of the DCM "A stable channel reaches "equilibrium" over many years. Therefore, channel modifications should be minimal." A summary of the proposed changes in comparison to the DBPS improvements are included below and represented in the exhibit shown in **Appendix A**:

RWT094

Proposed Amendments to the DBPS

- This channel will remain unchanged from the DBPS designation of a natural reach.
- A combination of natural riprap riffle drops, coir matting and channel grading will be shown south of the proposed road (South Arroya Lane) due to the width of the channel in this section, approximately DBPS stations 37+600 to 38+800.
- Concrete check structures north of South Arroya Lane to the confluence of RWT094 with RWT080 and RWT092, approximately DBPS stations 38+800 to 39+600. Check structures are proposed to be installed at grade in the existing channel to minimize disturbance and protect the channel by maintaining a three-foot maximum drop and a 0% longitudinal slope between structures. Refer to Appendix A for concrete check structure typical detail.

RWT094 is located south the confluence with RWT080 and RWT092 and flows south to the southern property line and beyond. The portion of RWT094 within the Eagleview property is approximately bounded by DBPS stations 37+600 to 39+600. It is divided into two sections, split by the proposed South Arroya Lane. The section north of the proposed roadway (approximately DBPS stations 37+600 to 38+800) has a narrower cross section and more closely resembles the cross section of reach RWT092 to the north. A total of five check structures are proposed in the northern section of this reach.

South of the proposed South Arroya Lane, the channel becomes much wider with shallower slopes (approximately DBPS stations 38+800 to 39+600). A total of four constructed riffles are proposed within this section of the reach. The drop heights of the constructed riffles range from 2.3 feet to 3 feet with 3% to 4% slopes. The channel sections outside of the riffles within this reach use the DBPS recommended stable channel slope of 0.40% to reduce the potential of erosion. For the riffle portion of the RWT094 reach, the 2-year flow of 77.5 cfs at design point P3 was used as the basis to size the low flow portion of the channel in this reach that will be regraded. This results in a 22 foot wide low flow channel. The Falcon DBPS states, "The crest width for a natural channel drop structure is the channel width associated with the low flow (bankfull) event as defined in the DCM update Section 3.1.1.1". Thus riprap protection is provided for only the low flow portion of the riffle. A full analysis of the riffle drop structures is included in **Appendix C**.

RWT092

Proposed Amendments to the DBPS

- Remove two small grouted boulder drop structures and replace with concrete check structures. Check structures are proposed to be installed at grade in the existing channel to minimize disturbance and protect the channel by maintaining a three-foot maximum

drop and a 0% longitudinal slope between structures. Refer to Appendix A for concrete check structure typical detail.

RWT092 is located between RWT054 and the sub regional detention pond SR1, approximately DBPS stations 39+600 to 40+150. A total of four check structures are proposed within this reach. The reach ends at the confluence with another smaller channel from the west. A proposed rock chute at this confluence will reduce the potential of erosion entering the reach.

RWT054

Proposed Amendments to the DBPS

- Remove five small grouted boulder drop structures and replace with a concrete check structures at approximately DBPS station 40+300. Check structures are proposed to be installed at grade in the existing channel to minimize disturbance and protect the channel by maintaining a three-foot maximum drop and a 0% longitudinal slope between structures. Refer to Appendix A for concrete check structure typical detail.

RWT054 is located north of reach RWT092, approximately DBPS stations 40+150 to 41+000. A total of one check structure is proposed within this reach at approximately 40+300. Due to the denser vegetation, including fully grown willows, cattails, and ponderosa trees within the low flow channel, no improvements are proposed north of structure at 40+300. A discussion and justification of the Manning's n was previously provided.

While this DBPS Amendment does not include full analysis upstream of the Site on Reach RWT054, based on the on-site conditions observed and included in Appendix C, a similar approach to raising manning's n values, due to the thick vegetation and planting is recommended north of the Site.

RWT080

Proposed Amendments to the DBPS

- No previous analysis for this reach was completed in the Falcon DBPS.
- A full spectrum detention facility is proposed along this reach. Design details will be provided in the Final Drainage Report for the Site.
- Remove the eleven (11) small grouted boulder drop structures and replace with vegetation or willow plantings.

RWT080 is located west of RWT092. Based on the extent of existing vegetation on this reach, willow plantings are proposed as a channel improvement. During the 100 YR event, RWT080 experiences relatively low flow depths of approximately 1 foot, making willow plantings an ideal natural and less invasive solution for channel stability. A maintenance agreement with the County would be required to maintain the vegetation along the channel to maintain the channel

The construction of the 11.03 AC-FT (100 YR) Sub Regional Pond (SR-1) will be completed by the County at a later date. A 2.4 AC-FT full spectrum detention basin is proposed on the RWT080 reach in the northwest corner of the Eagleview site. The proposed pond will have two riprap rock chutes with stilling basins to address head cutting and to provide entrance into the proposed pond.

SR1 (SUB REGIONAL POND 1)

Proposed Amendments to the DBPS

- The construction of the 11.03 AC-FT (100 YR) sub regional pond SR1 will be completed by the County at a later date, as it is considered a County cost. A proposed drainage

easement will be provided as part of the Eagleview project to cover the needed area for a future regional pond, to be built by the County.

- The Site will be required to adhere to standard County drainage criteria and provide a separate full spectrum detention facility to release less than historic rates downstream of the property. This separate facility will treat approximately 250 acres of tributary area.

This DBPS proposed a 11.03 AC-FT (100 YR) Sub Regional Pond (SR-1) at junction JWT080 reach in the northwest corner of the Eagleview site. There are approximately 720 acres of tributary area to pond SR-1. Although the construction of the sub regional pond will be completed by the County at a later date, a proposed drainage easement will be provided to allow for adequate area to build the facility.

verify

The Sub Regional Pond proposed in the DBPS accounts for approximately 720 acres of tributary area while the proposed, separate full spectrum detention facility will account for approximately 150 acres of tributary area.

A preliminary design of the full spectrum detention pond design was completed as part of the approved Eagleview Preliminary Drainage Report. The design used Mile High Flood District's UD-Detention spreadsheet to preliminary design the pond outlet structure. Due to limitations present in the UD-Detention spreadsheet when large tributary areas are analyzed, the flows and volume entering the pond tend to be greater than those reported in the HEC-HMS model when analyzing similar storm events. To compensate for this, the UD-Detention spreadsheet was calibrated, based on area, to show a similar 100-year flow entering the pond which resulted in a lower inflow volume being shown in UD-detention. This is fully documented in the approved Eagleview Preliminary Drainage Report.

After calibration, the sub regional pond is estimated to have a volume of 17.2 ac-ft which is larger than the 11.03 ac-ft pond shown in the DBPS, for two reasons. First, the DBPS assumed a 0% on directly connected impervious surfaces, while the Eagleview Preliminary Drainage Report assumed 8.2%. Secondly, the reason for this discrepancy is the difference of water quality capture volume (WQCV) between the DBPS and the Eagleview model differed by approximately two ac-ft of storage. The percent imperviousness and the area tributary to the pond were the two factors main factors contributing to this discrepancy.

Preliminary grading was completed to provide sufficient room for the 17.2 ac-ft pond. The proposed drainage easement provided is based on this analysis and should provide sufficient room for construction of the sub regional pond by the County in the future. The easement and value will be finalized with the FDR. Restrictions on the easement will be finalized with the FDR.

Note that although the Sub Regional Pond will be constructed by the County in the future, the proposed drainage easement is reimbursable. A value of \$50,000 per acre for land cost was taken from the Falcon DBPS and multiplied by 1.6 to a cost of \$80,000 per acre (accounting for escalation since 2013). The cost is shown in the Drainage Fees section of this proposal.

CHECK STRUCTURES

Check Structures are a less invasive alternative to the traditional grouted riprap drops proposed by the DBPS. This Amendment proposes to use concrete check structures in place of these traditional drops to provide a less invasive and natural approach to channel stabilization. Check structures are described in Urban Storm Drainage Criteria Manual, Volume 2, Chapter 9, Section 2.9 as a useful solution for channels that have "not yet experienced significant erosion or degradation." Based on the visual inspection described above and acceptable Froude values from the revised HEC-RAS modeling, check structures can accomplish the goals of the DBPS for these

reaches to provide protection and reinforcement and prevent future degradation. The check structures allow for construction and protection of the channel in more sensitive areas with established vegetation by not requiring regrading of the channel bottom between drops and allows for the channel to reach a natural equilibrium longitudinal slope over time. It additionally holds the invert low flow of the channel in place during larger storm events and provides the benefits of reducing velocity and scour.

Check structure construction typically consists of filling an excavated narrow trench (12" minimum width) with reinforced concrete to a depth of six feet, in place. The structures are then backfilled to existing grade. The check structures are placed with a 3 foot vertical drop from the crest of the check to the projected downstream invert based on the estimated long-term equilibrium slope of 0%. Over time the channel finds the equilibrium between the check structures. Additional soil riprap protection downstream of the check structure will be provided to mitigate scour potential. A geotechnical analysis and recommendations will need to be provided at final design of the check structures to confirm structure depth is suitable and stable. A detail is provided in **Appendix A**.

The following assumptions were made for the purposes of this Amendment:

- An assumed 10 feet of riprap upstream of the check structure was provided, with 20 feet of riprap provided downstream to mitigate scour.
- Widths of the check structures were based on criteria set forth in in Urban Storm Drainage Criteria Manual, Volume 2, Chapter 9, Section 2.9:
 - For the RWT094 reach this results in a 22 foot wide low flow channel. Based on the guidance given, the structure is extended laterally to contain the 10-yr flow and shall be no less than 2 feet above the top of the low-flow channel bank, resulting in a 42 foot wide check structure.
 - For the RWT092 and RWT052 reaches a 18 foot wide low flow channel. Based on the guidance given, the structure is extended laterally to contain the 10-yr flow and shall be no less than 2 feet above the top of the low-flow channel bank, resulting in a 38 foot wide check structure.

THE FOUR STEP PROCESS

The Project was designed in accordance with the four-step process to minimize adverse impacts of urbanization, as outlined in the El Paso County Engineering Manual for BMP selection as noted below:

Step 1. Employ Runoff Reduction Practices – The project is proposing a low-density residential development that will be designed to minimize the impact to the current existing terrain. The Site's proposed paved roadways will increase the Site's impervious area, however, roadside ditches and channels will be constructed to slow down the runoff velocity and reduce runoff peaks.

This value may need to be updated again per my comment on the "Overview Map - PBMP Trib Areas."

Step 2. Implement BMPs That Provide a Water Quality Capture Volume with Slow Release –The sub regional detention pond and two water quality features will be used to capture stormwater, provide water quality treatment, and maintain flows discharging off site at or below historic levels. Water quality measures are being used for all stormwater that contacts roadways, excluding 0.39 acres which cannot practicably be treated. Per ECM Appendix I Section 1.7.C.A., 20% of the development site or less than 1 acre can be excluded from providing water quality. As mentioned, 0.774 acres of impervious area will not be able to be treated which is less than 1 acre of the overall site. Per ECM Appendix I Section 1.7.1.B, in development areas of low-density housing, water quality is

required for all roads, but is not required for the entirety of the large-lots. Due to the Project consisting of single family large-lots, lot imperviousness shall be limited to 10 percent or less. Refer to **Appendix A** for PBMP Tributary Areas map.

Step 3 Stabilize Drainageways– The existing natural channels will be stabilized using the methods described in this Amendment. The design of the natural channels will meet the criteria set forth by the DCM.

Step 4. Implement Site Specific and Other Source Control BMPs – The erosion control construction BMPs of the Project were designed to reduce contamination. Source control BMPs include the use of vehicle tracking control, culvert protection, stockpile management, and stabilized staging areas.

MAINTENANCE

Maintenance access for the proposed channel improvements is provided by proposed maintenance roads adjacent to channels. Access for the RWT094 south of South Arroya Lane is provided by a maintenance road starting at the proposed Chemita Trail and ending at South Arroya Lane, near the 72 inch culvert crossing. Access for the northern portion of site to reaches RWT094, RWT092, and RWT054 will be accessed by a maintenance road starting on the north end of South Arroya Lane and ending at the cul-de-sac at the end of South Arroya Lane. Access to RWT080 will be accessed from a maintenance road starting at the cul-de-sac of Arroya Lane in the northwest corner of the site.

Once construction of the proposed channel improvements are completed, maintenance of the channel will be the responsibility of El Paso County, if applicable criteria are met. Ownership of all drainage facilities within public rights-of-way shall fall to El Paso County, pending Board of County Commissioners approval.

FLOODPLAIN STATEMENT

There is no FEMA mapped floodplain on the project site. Refer to **Appendix A** for the Flood Insurance Rate Map (FIRM) number 08041C05350G effective date, December 7, 2018.

WETLAND MITIGATION

The U.S. Army Corps of Engineers (USACE) provided an approved jurisdictional determination (AJD) for the wetlands present within the Eagleview site. The USACE AJD found that the wetlands within the site were isolated and not Waters of the U.S. (WOTUS); therefore impacts to these wetlands will not require permitting under Section 404 of the Clean Water Act. Furthermore, the wetlands onsite are unregulated and shall not incur any additional permitting requirements beyond the scope of El Paso County.

GRADING AND EROSION CONTROL

The Site will disturb more than 1 acre and will require a Colorado Discharge Permit System (CDPS) General Permit for Stormwater Discharge Associated with Construction Activities from the Colorado Department of Public Health and Environment (CDPHE). The proposed sub-regional detention pond will be non-jurisdictional and will therefore require the submission of a Non-

Jurisdictional Water Impoundment Structure application form as a part of the platting process.

DRAINAGE FEES AND REIMBURSABLE COSTS

REIMBURSABLE COSTS

The Falcon Drainage Basin Study identifies two types improvements for the identified reaches and features, County Costs or Developer Costs. Items identified as Developer Costs (those incurred by the Developer) are eligible for reimbursement. County Costs are not eligible for reimbursement. Each reach and feature was classified in the DBPS as follows:

Table 6: Summary of Identified Costs per DBPS

Reach/Feature	Description	Type of Cost	Reimbursable
RWT094	South of SR1	Developer Cost	Yes
SR1	Sub-Regional Pond	County Cost	No
RWT080	Northwest of SR1	County Cost	No
RWT092	Northeast of SR1	County Cost	No

The developer intends to amend the DBPS to allow for the costs on reaches RWT080, RWT092, RWT054, and Sub-Regional Pond SR1 drainage easement to become reimbursable by following the process outlined below:

1. Drainage reimbursement request application with PCD.
2. Amendment to the DBPS Memorandum requesting RWT080, RWT092 and Pond SR1 changed from a County Cost to Developer Cost
 - o Amendment request hearing to the Drainage Board and Board of County Commissioners
3. The subsequent Final Drainage Report associated with the Final Plat application will include the following:
 - o Channel analysis to determine the number of drop structures and locations needed to stabilize the channel/meet criteria.
 - o Provide cost estimates for the reimbursable improvements.
 - o Drainage fee section would reference the BoCC resolution (if approved).
4. Once construction of the reimbursable facilities is completed, procedures for Drainage Improvement Credits and Reimbursements outlined in Chapter 3 of the Drainage Criteria Manual will be in effect.

DRAINAGE FEES

The costs per reach/ feature provided in DBPS were scaled by length of reach within the Project site to determine an estimate of improvement costs as shown below. Costs are shown are taken from the values in the DBPS on tables 6-4 and 6-10. Costs are based on 2013 costs shown in the DBPS.

Table 7: Scaled DBPS Costs within Eagleview Project Limits

DBPS Reach	UNIT	QUANTITY	UNIT COST	COST (2013)
RWT-094	LF	2,010	\$ 114.78	\$ 230,707.80
Engineering/Administration/Contingency	%	35%		\$ 80,747.73
TOTAL (DEVELOPER RESPONSIBLE REACHES/FEATURES)				\$311,455.53
RWT-080	LF	1680	\$ 671.19	\$ 1,127,599.00
RWT-092	LF	626	\$ 662.04	\$ 414,437.00
RWT-054	LF	784	\$ 566.49	\$ 444,128.00
Sub Regional Detention Pond SR1	LS	1	\$ 405,769	\$ 405,769.00
Engineering/Administration/Contingency	%	35%		\$ 837,176.55
TOTAL (COUNTY RESPONSIBLE REACHES/FEATURES)				\$ 3,229,109.55
TOTAL:				\$ 3,540,565.08

The identified reaches RWT080, RWT092, RWT054, and Sub Regional Pond SR1 are proposed to be amended within the Falcon DBPS to change from County Costs to Developer Costs and become reimbursable. A summary of the DBPS costs, proposed costs and total differences are provided in a table below. 2013 costs were brought to present value by a factor of 1.605 which was provided from the County and based on the percentage increases for the Drainage Basin Fees over the years.

Table 8: Summary DBPS Costs vs. Proposed Costs

DBPS Reach	DBPS COST (2013) W/ 35%	INFLATED DBPS COST(2023) (1.605 Factor)	PROPOSED COST(2023) W/ 35%	DIFFERENCE
RWT-094	\$311,456.00	\$499,887.00	\$469,342.00	(\$30,545.00)
Total Developer Cost:	\$311,456.00	\$499,887.00	\$469,342.00	(\$30,545.00)
RWT-080	\$1,522,259.00	\$2,443,226.00	\$46,778.00	(\$2,396,448.00)
RWT-092	\$559,490.00	\$897,981.00	\$200,367.00	(\$697,614.00)
RWT-054	\$599,573.00	\$962,315.00	\$61,700.00	(\$900,615.00)
Sub Regional Detention Pond (SR1)	\$547,788.00	\$879,200.00	\$773,776.00	(\$105,424.00)
Total County Cost:	\$3,229,110.00	\$5,182,722.00	\$1,353,443.00	(\$3,829,279.00)
Total:	\$3,540,566.00	\$5,682,609.00	\$1,822,785.00	(\$3,859,824.00)

The costs estimated by the DBPS for the reaches and features identified is **\$3,540,566.00** in 2013 dollars and **\$5,682,609.00** in 2023 dollars. The proposed County Costs of \$1,082,621.00 compared to the estimated \$5,182,722.00 estimated by the DBPS saved the County **\$4,100,101.00** in improvements. Costs are outlined in the Opinion of Probable Construction Cost as part of **Appendix E**.

Note that although the Sub Regional Pond is being constructed by the County at a later time, the proposed drainage easement for the facility is reimbursable. A value of \$50,000 per acre for land

cost was taken from the Falcon DBPS and multiplied by 1.6 to a cost of \$80,000 per acre. The cost shown in this Amendment is the cost of the land reimbursement only and does not include any construction items.

The current 2024 Falcon Drainage Basin Fee is **\$37,256** per Impervious Acre. The remaining unplatted developable area within the Falcon Drainage Basin as determined by El Paso County as 1,433 total developable acres at an assumed average 29.2% imperviousness for a total of **418** acres.

The difference in actual proposed cost for RWT-094 (Developer Cost) and the inflated DBPS cost is less than the proposed amount, thus resulting in no additional drainage fee increase.

Should RWT080, RWT092, RWT054, and Sub Regional Pond SR1 be amended as Developer Costs, the estimated improvements of **\$1,082,621.00** would cause an increase of at least **\$2,590.00** per impervious acre. The final drainage basin fee will be determined by County Staff using the estimates provided.

Fees are deferred at plat recordation due to reimbursement expenses being greater than the required drainage fees. The final drainage basin fee will be determined by County Staff using the estimates provided.

CONCLUSION

This MDDP and DBPS Amendment to the previously approved Falcon Drainage Basin Planning Study completed by Matrix Design Group, September 2015 (DBPS) removes the small drop structures for the entire length of reaches RWT054, RWT080, and RWT092, to be replaced with natural channel design measures in appropriate locations. Additionally, this DBPS Amendment allows the construction of Sub-Regional Pond 1 (SR1) by the County at a later date.

The proposed modifications and improvements would cause a change in the Drainage Basin Fee. The difference in actual proposed cost for RWT-094 (Developer Cost) and the inflated DBPS do not result in an increase of Drainage Basin Fees. Should RWT080, RWT092, RWT054, and Sub Regional Pond SR1 be amended as Developer Costs, the estimated improvements of **\$1,082,621.00** would cause an increase of at least **\$2,590.00** per impervious acre.

REFERENCES

1. El Paso County Drainage Criteria Manual, as revised in November 1991 and October 2023 with County adopted Chapter 6 and Section 3.2.1 of Chapter 13 of the City of Colorado Springs May 2014 Drainage Criteria Manual, Volume 1
2. El Paso County “Engineering Criteria Manual” Volumes 1 & 2, dated October 31, 2018
3. Urban Drainage and Flood Control District Drainage Criteria Manuals (UDFCDCM), (Volumes 1, 2 and 3), prepared by Wright-McLaughlin Engineers, June 2001, with latest revisions.
4. Flood Insurance Rate Map, El Paso County, Colorado and Incorporated Areas, Map Number 08041C0507F and 08041C0530F, Effective Date March 17, 1997, prepared by the Federal Emergency Management Agency (FEMA).
5. Falcon Drainage Basin Planning Study Selected Plan Report (DBPS), prepared by Matrix Design Group, September 2015. PCD File No. MP132.
6. Eagleview Subdivision Preliminary Drainage Report (PDR), prepared by Kimley-Horn, October 28, 2022. PCD File No. SP216
7. Eagleview Subdivision Final Drainage Report (FDR), prepared by Kimley-Horn, under review.

APPENDIX

APPENDIX A: FIGURES

- Existing Conditions Drainage Map (Excerpt from PDR)
- Proposed Conditions Drainage Map (Excerpt from PDR)
- Proposed Conditions Drainage Map (Revised)
- Overall Drainage Improvements Exhibit (Revised)
- Stream Improvement Details

K:\COS_Civil\196288000_Eagleview\CADD\Exhibits\Drainage Analysis\196288000_EX_DRN.dwg Morey, Doug 8/1/2022 10:49 AM



LEGEND

- DRAINAGE BASIN AREAS
- A - HEC-HMS BASINS
 - B - BASIN ACREAGE
 - C - 5-YR RUNOFF
 - D - 100-YR RUNOFF
- DESIGN POINT
- EXISTING CONTOURS
- PROPERTY BOUNDARY
- FLOW ARROW
- FLOW PATH
- PARCEL LINE

HEC-HMS - EXISTING RUNOFF TABLE						
DESIGN POINT	BASIN DESIGNATION	BASIN AREA (ACRES)	DIRECT 5-YR RUNOFF (CFS)	DIRECT 100-YR RUNOFF (CFS)	CUMULATIVE DIRECT 5-YR RUNOFF (CFS)	CUMULATIVE DIRECT 100-YR RUNOFF (CFS)
	B1	5.55	3.0	8.5	-	-
J1	OB1	10.37	7.1	18.8	10.1	27.3
	B2	41.43	15.4	48.5	-	-
	OB2	28.06	20.6	52.7	-	-
	OB3	43.44	25.3	67.1	-	-
J2	OB4	10.50	7.5	18.9	67.5	183.8
	OB5	143.82	36.8	106.9	-	-
	OB6	118.40	40.8	113.2	-	-
J4	OB7	421.43	101.4	284.2	169.2	478.0
	B3	59.54	36.4	110.0	-	-
	B4	14.68	5.4	18.2	-	-
J3	OB8	33.07	19.5	51.6	183.1	515.5

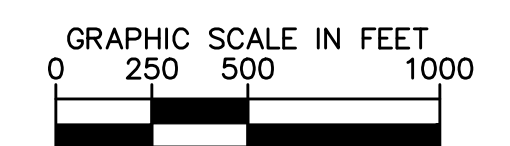
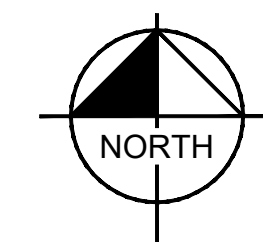

Kimley»Horn
 2022 KIMLEY-HORN AND ASSOCIATES, INC.
 2 North Nevada Avenue Suite 300
 Colorado Springs, Colorado 80903 (719) 453-0180

DESIGNED BY: MK
 DRAWN BY: RS
 CHECKED BY: KK
 DATE: 04/08/2022

EAGLEVIEW
 EL PASO COUNTY, COLORADO
 PRE DEVELOPMENT DRAINAGE MAP

PRELIMINARY
 FOR REVIEW ONLY
 NOT FOR
 CONSTRUCTION
Kimley»Horn
 Kimley-Horn and Associates, Inc.

PROJECT NO.
 196288000

SHEET

1

NO.	REVISION	BY	DATE	APPR.

K:\COS_Civil\196288000_Eagleview\CADD\Exhibits\Drainage Analysis\196288000_EX_DRN.dwg Morey, Doug 8/1/2022 10:46 AM

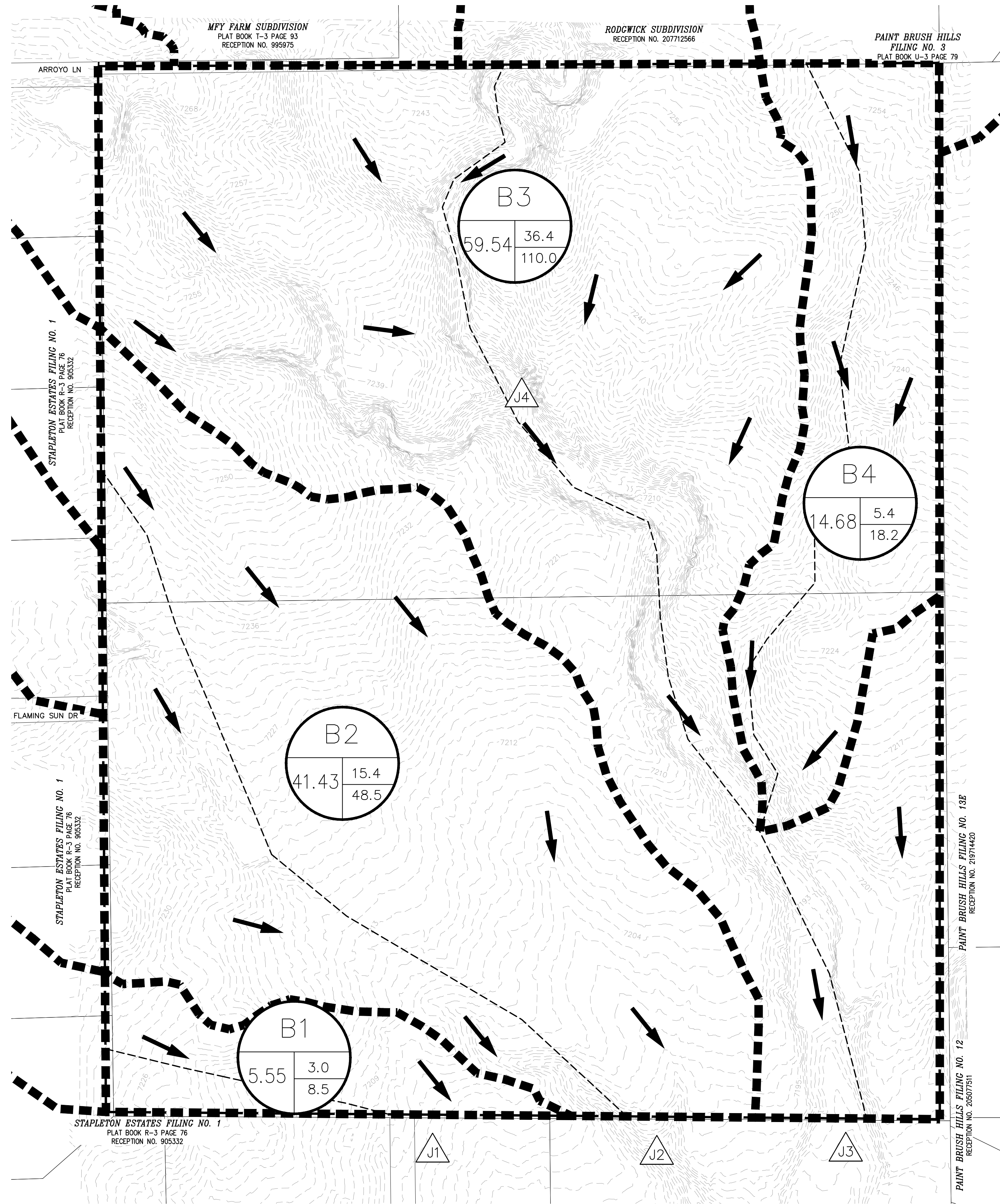

LEGEND

- DRAINAGE BASIN AREAS
- A - HEC-HMS BASINS
B - BASIN ACREAGE
C - 5-YR RUNOFF
D - 100-YR RUNOFF
- DESIGN POINT
- EXISTING CONTOURS
- PROPERTY BOUNDARY
- FLOW ARROW
- FLOW PATH

HEC-HMS - EXISTING RUNOFF TABLE

DESIGN POINT	BASIN DESIGNATION	BASIN AREA (ACRES)	DIRECT 5-YR RUNOFF (CFS)	DIRECT 100-YR RUNOFF (CFS)	CUMULATIVE DIRECT 5-YR RUNOFF (CFS)	CUMULATIVE DIRECT 100-YR RUNOFF (CFS)
	B1	5.55	3.0	8.5	-	-
J1	OB1	10.37	7.1	18.8	10.1	27.3
	B2	41.43	15.4	48.5	-	-
	OB2	28.06	20.6	52.7	-	-
	OB3	43.44	25.3	67.1	-	-
J2	OB4	10.50	7.5	18.9	67.5	183.8
	OB5	143.82	36.8	106.9	-	-
	OB6	118.40	40.8	113.2	-	-
J4	OB7	421.43	101.4	284.2	169.2	478.0
	B3	59.54	36.4	110.0	-	-
	B4	14.68	5.4	18.2	-	-
J3	OB8	33.07	19.5	51.6	183.1	515.5

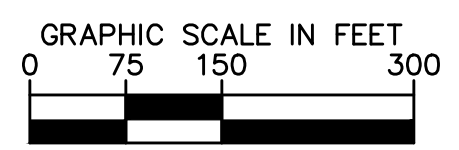
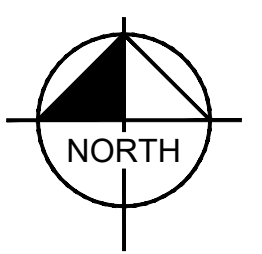

Kimley»Horn
 2022 KIMLEY-HORN AND ASSOCIATES, INC.
 2 North Nevada Avenue Suite 300
 Colorado Springs, Colorado 80903 (719) 453-0180

DESIGNED BY: MK
 DRAWN BY: RS
 CHECKED BY: KK
 DATE: 04/08/2022

EAGLEVIEW
 EL PASO COUNTY, COLORADO
 PRE DEVELOPMENT DRAINAGE MAP

PRELIMINARY
 FOR REVIEW ONLY
 NOT FOR
 CONSTRUCTION
Kimley»Horn
 Kimley-Horn and Associates, Inc.

PROJECT NO.
 196288000

SHEET
2

NO.	REVISION	BY	DATE	APPR.

K:\COS_Civil\196288000_Eagleview\CADD\Exhibits\Drainage_Analysis\196288000_PR_DRN.dwg Morey, Doug 8/1/2022 10:44 AM

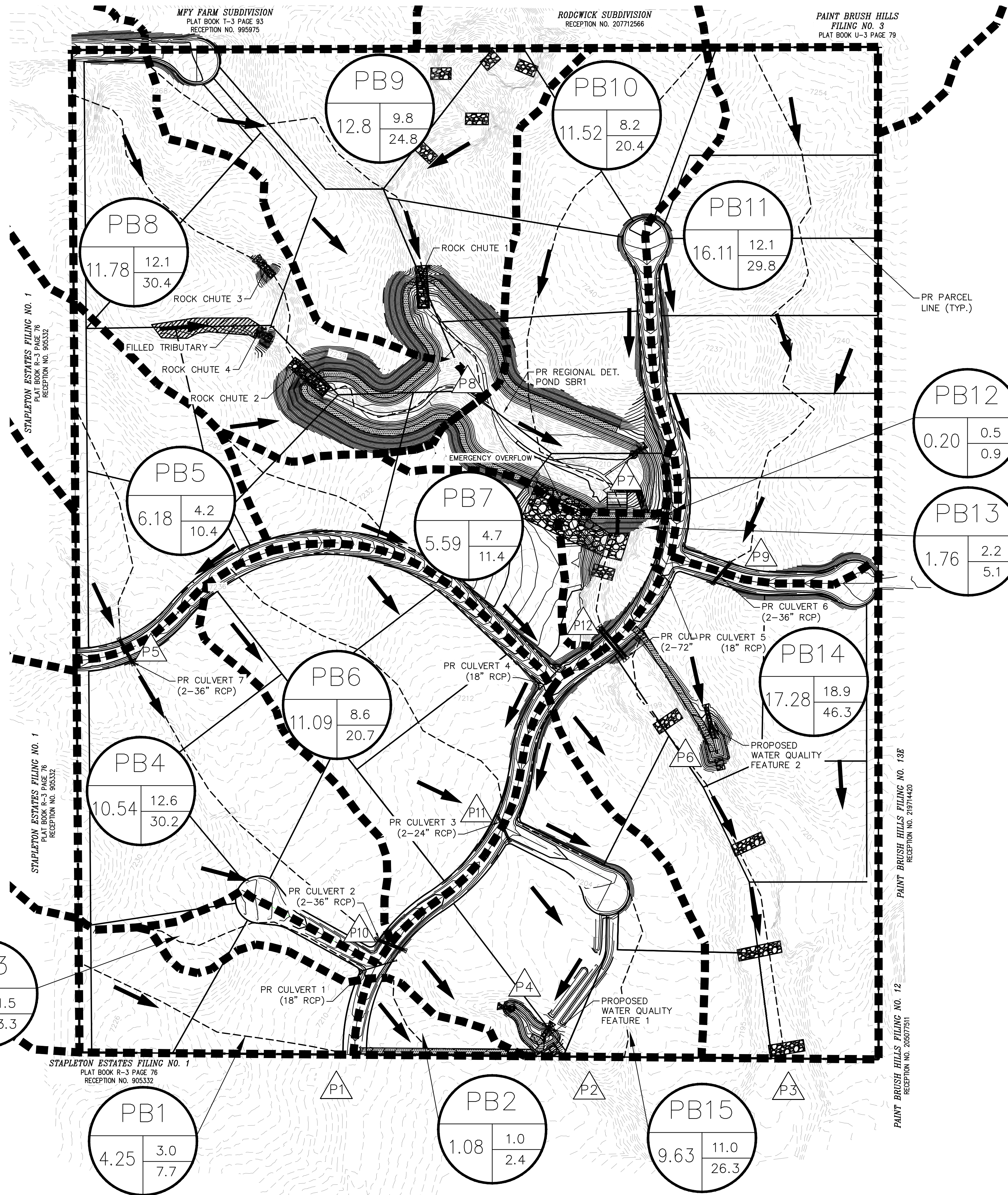

LEGEND

- DRAINAGE BASIN AREAS
- A - HEC-HMS BASINS
B - BASIN ACREAGE
C - 5-YR RUNOFF
D - 100-YR RUNOFF
- DESIGN POINT
- EXISTING CONTOURS
- PROPOSED CONTOURS
- PROPERTY BOUNDARY
- FLOW ARROW
- FLOW PATH
- DROP STRUCTURE

HEC-HMS - DEVELOPED RUNOFF BASIN TABLE

BASIN DESIGNATION	BASIN AREA (ACRES)	DIRECT 5-YR RUNOFF (CFS)	DIRECT 100-YR RUNOFF (CFS)
OB1	10.37	7.1	18.8
OB2	28.06	20.6	52.7
OB3	43.44	25.3	67.1
OB4	10.50	7.5	18.9
OB5	143.82	36.8	106.9
OB6	118.40	42.1	114.9
OB7	421.43	101.4	284.3
OB8	33.07	19.0	51.0
PB1	4.25	3.0	7.7
PB2	1.08	1.0	2.4
PB3	1.38	1.5	3.3
PB4	10.54	12.6	30.2
PB5	6.18	4.2	10.4
PB6	11.09	8.6	20.7
PB7	5.59	4.7	11.4
PB8	11.78	12.1	29.8
PB9	12.8	9.8	24.8
PB10	11.52	8.2	20.4
PB11	16.11	12.1	29.8
PB12	0.20	0.5	0.9
PB13	1.76	2.2	5.1
PB14	17.28	18.9	46.3
PB15	9.63	11.0	26.3

HEC-HMS - DEVELOPED RUNOFF DESIGN POINT TABLE

DESIGN POINT	TRIBUTARY BASINS	TRIBUTARY AREA (ACRES)	CUMULATIVE 5-YR FLOW (CFS)	CUMULATIVE 100-YR FLOW (CFS)
P1	OB1, PB1	14.62	10.1	26.4
P2	OB2, OB3, OB4, PB3, PB4, PB5, PB6, PB7, PB15	126.42	74.1	189.1
P3	OB5, OB6, OB7, OB8, OB8, PB9, PB10, PB11, PB12, PB13, PB14	787.97	131.8	437.7
P4	OB2, OB3, OB4, PB3, PB4, PB5, PB6, PB7	116.79	72.2	184.6
P5 (CULVERT 7)	OB3, OB4, PB5	60.12	36.8	95.9
P6	OB8, PB11, PB12	49.38	29.9	78.5
P7 (POND SR1)	OB5, OB6, OB7, PB8, PB9, PB10	719.49	131.7	420.1
P8	OB5, OB6, OB7, PB8, PB9, PB10	707.97	173.4	486.7
P9 (CULVERT 6)	OB8, PB11	49.18	29.8	78.4
P10 (CULVERT 2)	OB2, OB3, OB4, PB4, PB5	98.72	57.9	150.1
P11 (CULVERT 3)	PB6, PB7	16.68	13.2	31.9
P12 (CULVERT 8)	OB5, OB6, OB7, PB8, PB9, PB10, PB13	721.28	137.9	420.3

NOTES:
1. LOCATION OF DROP STRUCTURES IS APPROXIMATE AND WILL BE FINALIZED IN THE FINAL DRAINAGE REPORT.

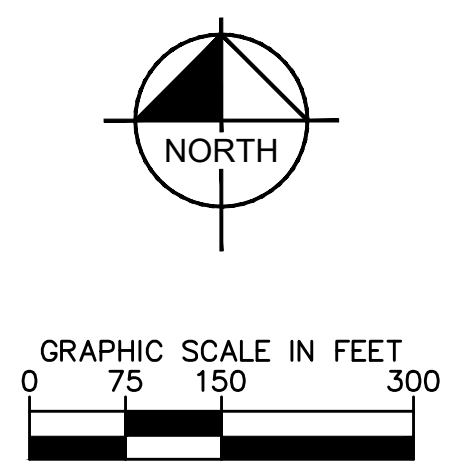

DESIGNED BY: MK
DRAWN BY: RS
CHECKED BY: KK
DATE: 04/08/2022

REVISION NO. BY DATE APPR.

2022 KIMLEY-HORN AND ASSOCIATES, INC.
2 North Nevada Avenue Suite 300
Colorado Springs, Colorado 80903 (719) 453-0180

EAGLEVIEW
EL PASO COUNTY, COLORADO
POST DEVELOPMENT DRAINAGE MAP

PRELIMINARY
FOR REVIEW ONLY
NOT FOR
CONSTRUCTION

PROJECT NO.
196288000

SHEET
3

K:\DOS_Civil\196288000_Eagleview\CADD\Exhibits\Drainage_Analysis\196288000_PROPDRMAP.dwg Koffard, Kevin 1/29/2024 4:53 PM

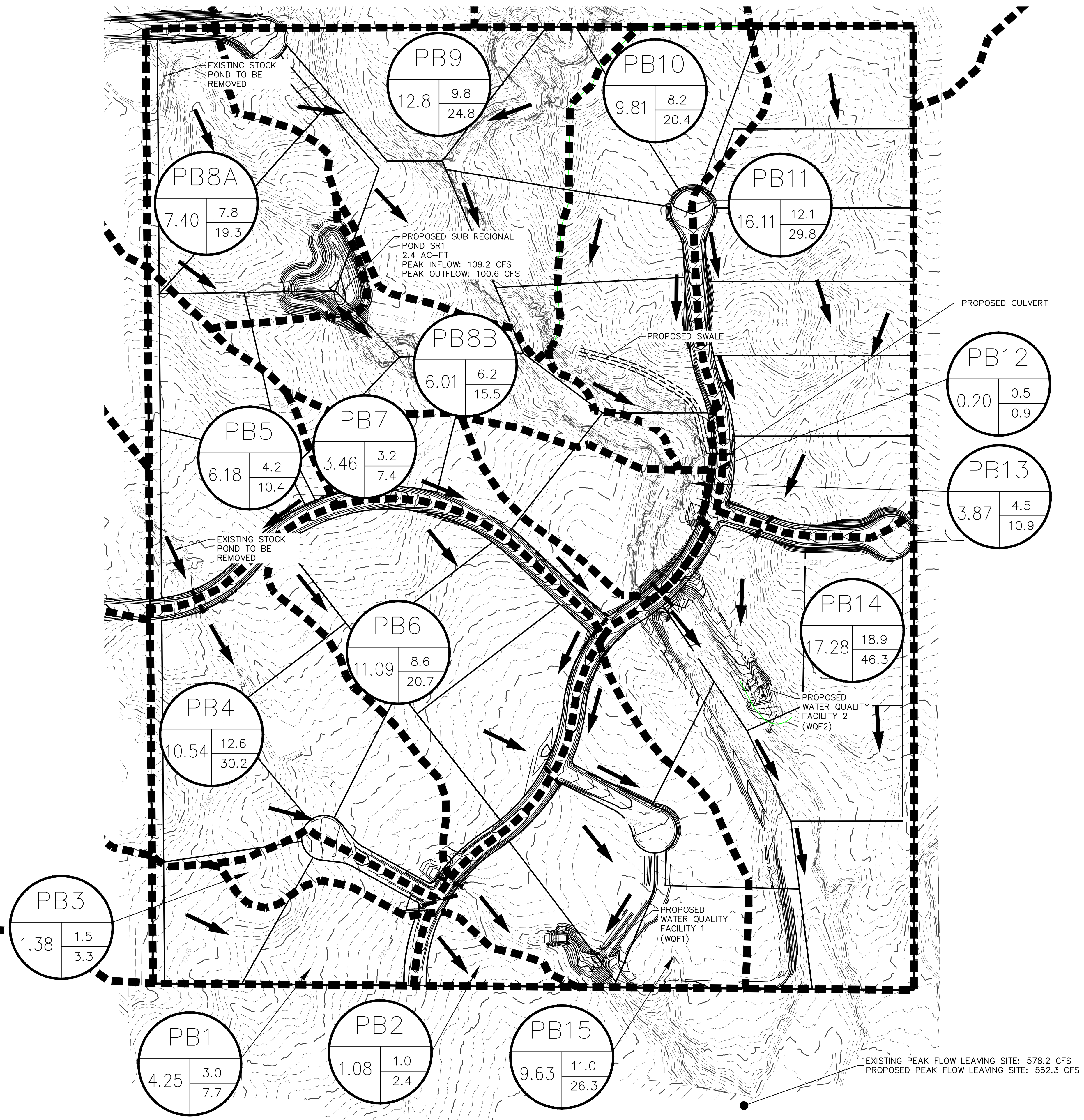

LEGEND

- DRAINAGE BASIN AREAS
- A - HEC-HMS BASINS
 - B - BASIN ACREAGE
 - C - 5-YR RUNOFF
 - D - 100-YR RUNOFF
- EXISTING CONTOURS
- PROPOSED CONTOURS
- PROPERTY BOUNDARY
- FLOW ARROW
- FLOW PATH

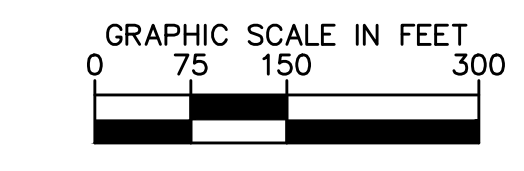
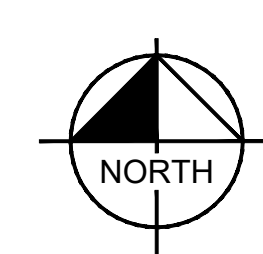

NO.	REVISION	BY	DATE	APPR.

Kimley»Horn
 2023 KIMLEY-HORN AND ASSOCIATES, INC.
 2 North Nevada Avenue Suite 300
 Colorado Springs, Colorado 80903 (719) 453-0180

DESIGNED BY: MK
 DRAWN BY: RS
 CHECKED BY: BH
 DATE: 10/12/2023

EAGLEVIEW
 EL PASO COUNTY, COLORADO
 PROPOSED CONDITIONS DRAINAGE MAP

PRELIMINARY
 FOR REVIEW ONLY
 NOT FOR
 CONSTRUCTION

Kimley»Horn
 Kimley-Horn and Associates, Inc.

PROJECT NO.
196288000

SHEET
1

k:\COS_Civil\196288000_Eagleview\CADD\Exhibits\DBPS Amendment\OverallDrainageImprovements_Amend.dwg Schelboch, Ryan 12/22/2023 7:46 AM

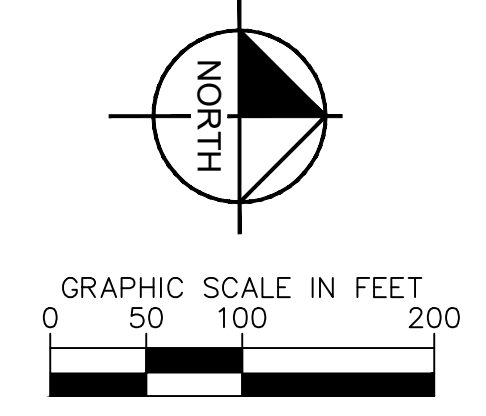
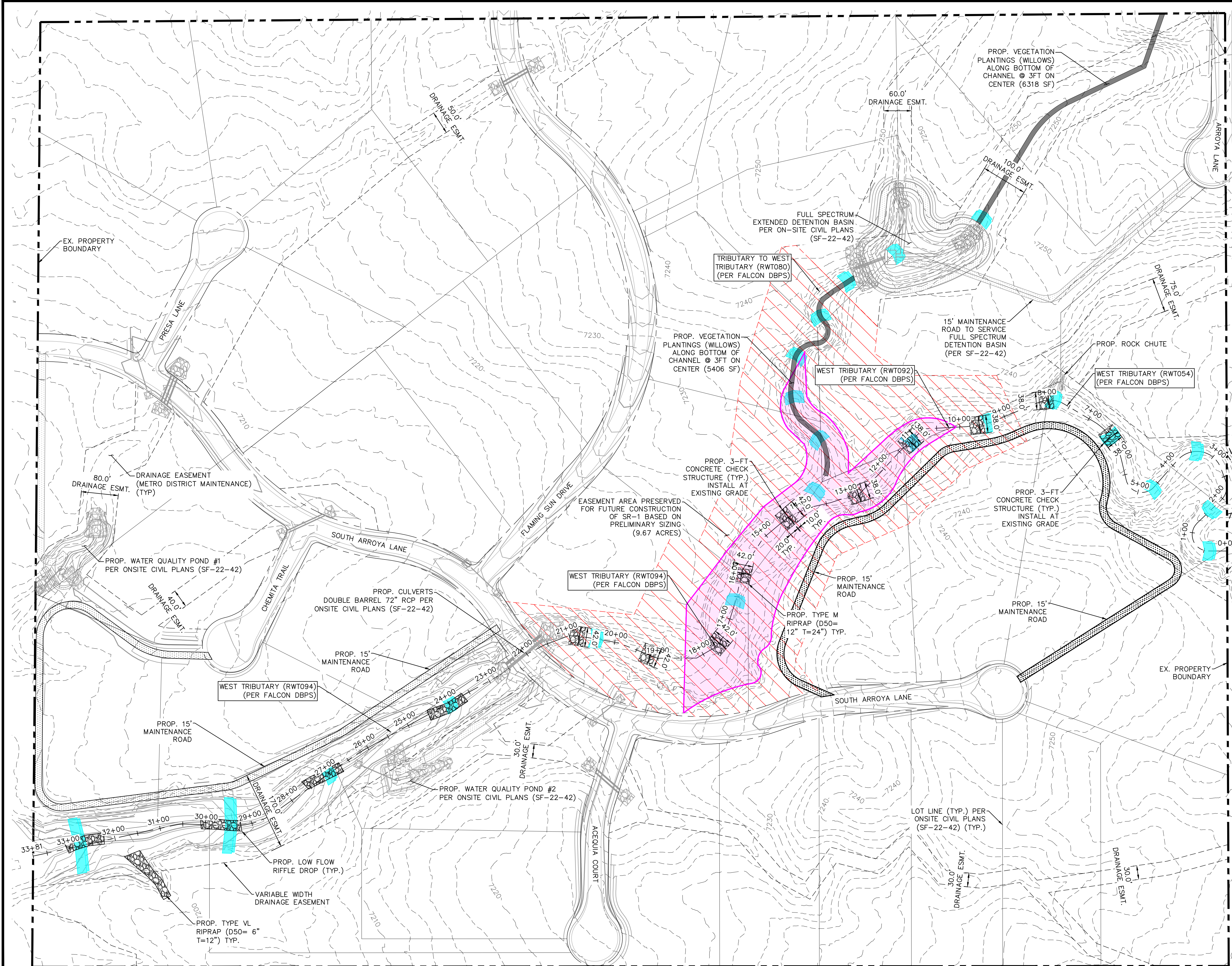

LEGEND

- EXISTING PROPERTY BOUNDARY
- EXISTING MAJOR CONTOUR
- EXISTING MINOR CONTOUR
- PROPOSED MAJOR CONTOUR
- PROPOSED MINOR CONTOUR
- PROPOSED RIPRAP
- PROPOSED STORM PIPE
- STORM PIPE PER ONSITE CIVIL PLANS
- DBPS SUB REGIONAL POND
- DBPS DROP STRUCTURES
- PROP. DBPS AMENDMENT CONCRETE CHECK STRUCTURES
- PRESERVED AREA FOR FUTURE CONSTRUCTION OF SUB REGIONAL POND (SR1)
- PROP. DBPS AMENDMENT VEGETATION PLANTINGS (WILLOWS) ALONG BOTTOM OF CHANNEL

NOTES:

1. PROPOSED CONCRETE CHECK STRUCTURES SHALL SPAN THE WIDTH OF THE LOW FLOW CHANNEL AND EXTEND 10-FT INTO EACH BANK.
2. ADDITIONAL EROSION CONTROL MEASURES TO BE IMPLEMENTED AS NECESSARY BASED ON THE RESULTS OF DETAILED CHANNEL ANALYSIS WHICH WILL BE COMPLETED AS A PART OF FINAL DESIGN.

NO.	REVISION	BY	DATE	APPR.

Kimley»Horn
 2023 KIMLEY-HORN AND ASSOCIATES, INC.
 2 North Nevada Avenue Suite 900
 Colorado Springs, Colorado 80903 (719) 453-0180

DESIGNED BY: DCM
 DRAWN BY: DCM
 CHECKED BY: BAH
 DATE: 12/20/2023

EAGLEVIEW
 EL PASO COUNTY, COLORADO
 CONSTRUCTION DOCUMENTS
OVERALL DRAINAGE IMPROVEMENTS

PRELIMINARY
 FOR REVIEW ONLY
 NOT FOR CONSTRUCTION

PROJECT NO.
 196288000
 SHEET

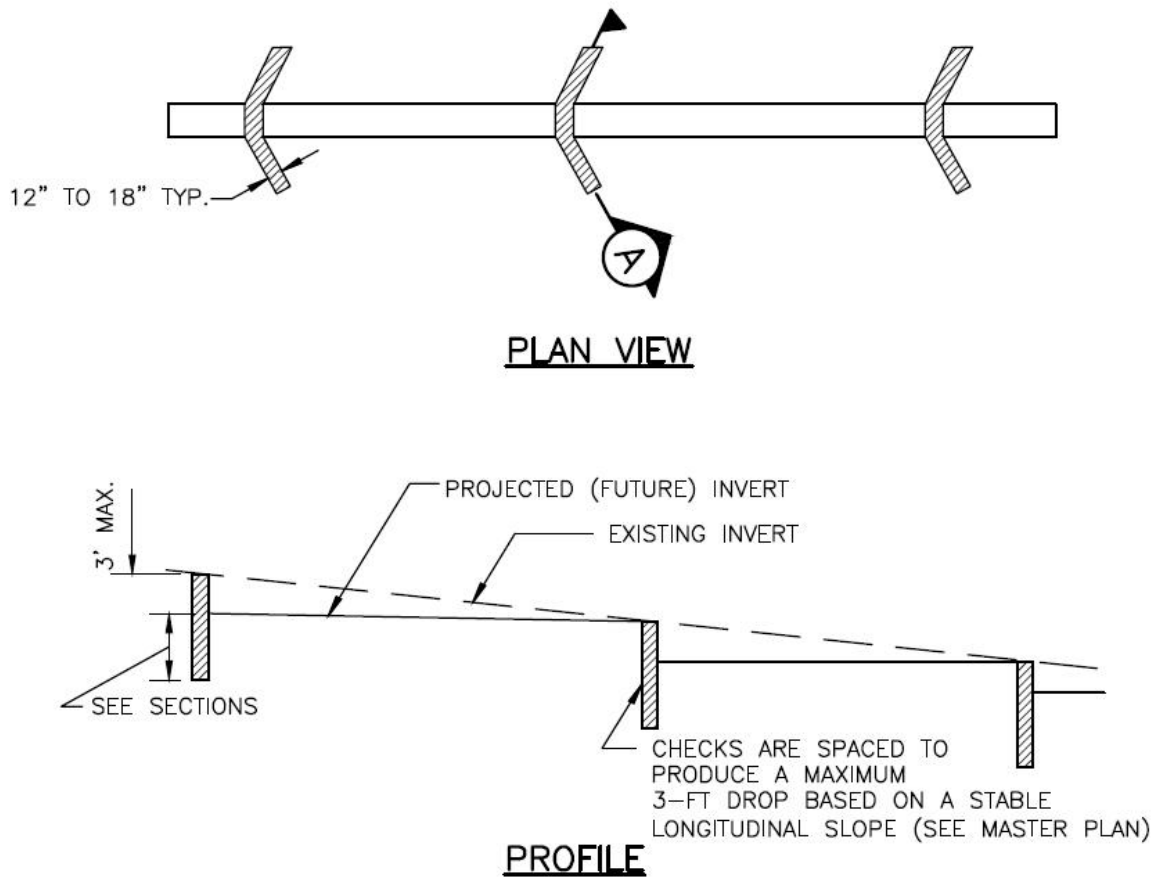

- NOTES:**
1. SHEET PILE IS PREFERRED AND MUST BE USED WHERE SOIL CANNOT HOLD A VERTICAL WALL.

Figure 9-26. Check structure details (Part 1 of 3)

CONCRETE
(ANTICIPATED)

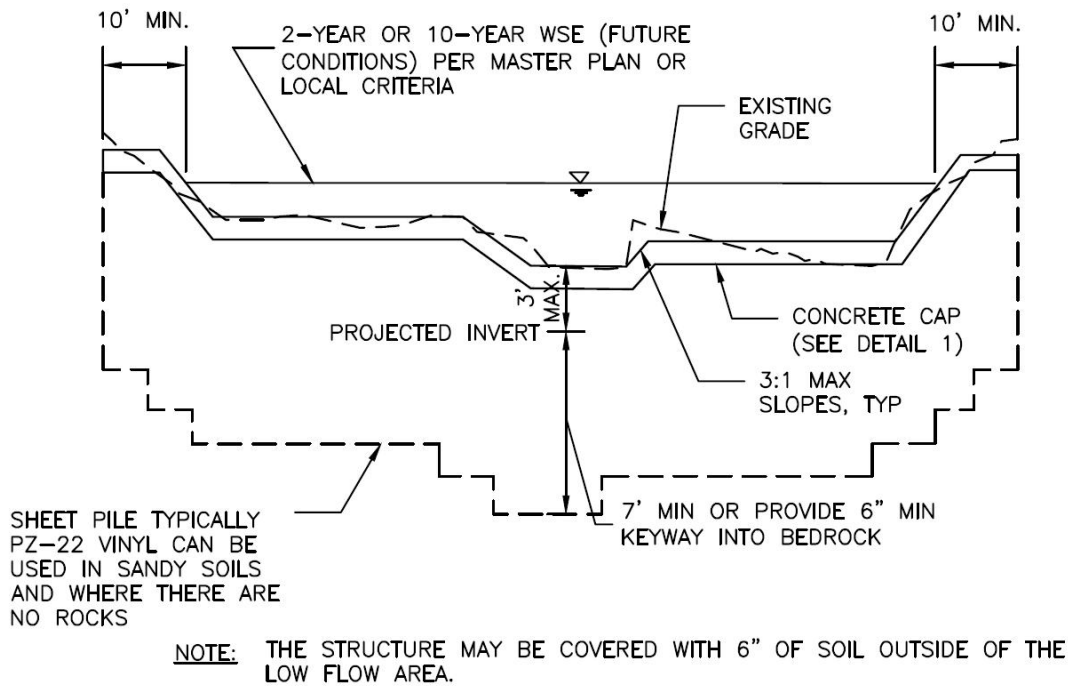

SECTION A1
SHEET PILE CHECK

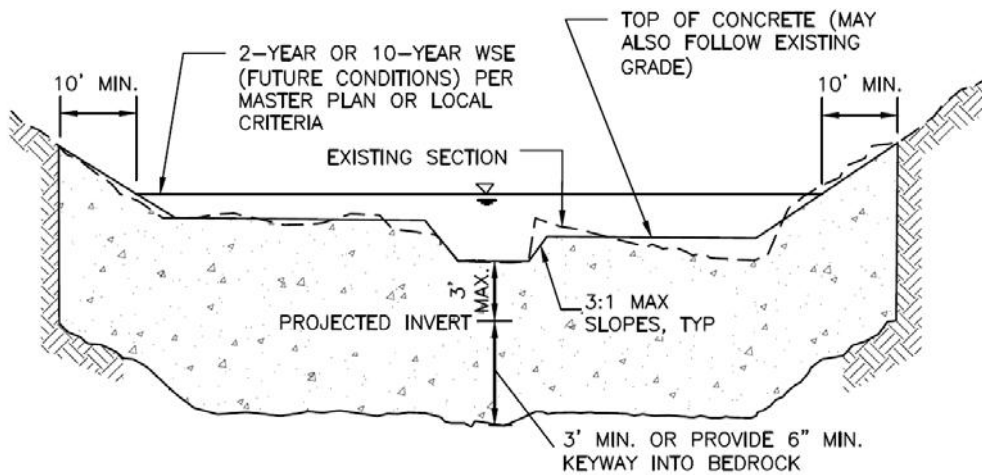

- NOTES:**
1. TRENCH IN UNDISTURBED SOIL. FORM TOP 6" OF CHECK. DO NOT OVER EXCAVATE TO FORM WALLS OR CONSTRUCT A FOOTING.
 2. THE STRUCTURE MAY BE COVERED WITH 6" OF SOIL OUTSIDE OF THE LOW FLOW AREA.
 3. VIBRATE CONCRETE INTO TRENCH.

SECTION A2
CONCRETE CHECK

Figure 9-27. Check structure details (Part 2 of 3)

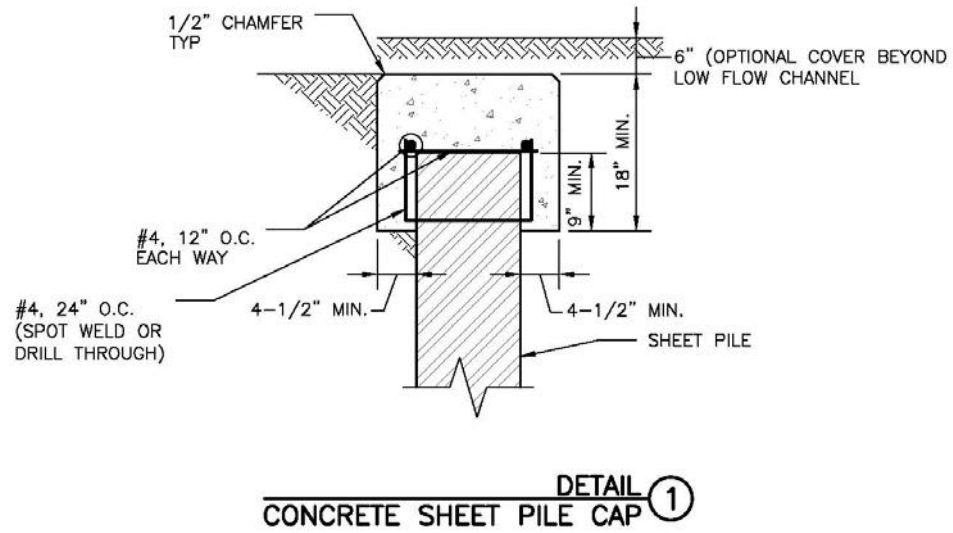
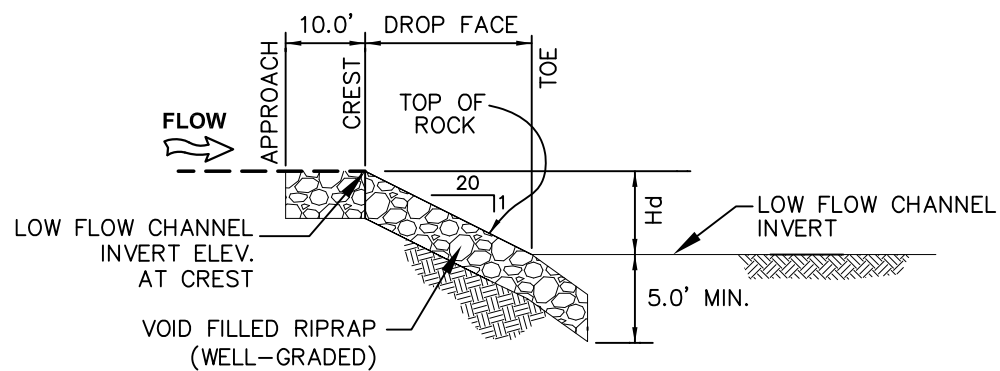

Figure 9-28. Check structure details (Part 3 of 3)

NOTE:
REFER TO EROSION CONTROL BLANKET DETAIL FOR BLANKET INSTALLATION NEAR STRUCTURES.



NOTE:
REFER TO EROSION CONTROL BLANKET DETAIL FOR BLANKET INSTALLATION.

RIFFLE DROP STRUCTURE PROFILE

NTS

A



CONSTRUCTED RIFFLE DROP STRUCTURE

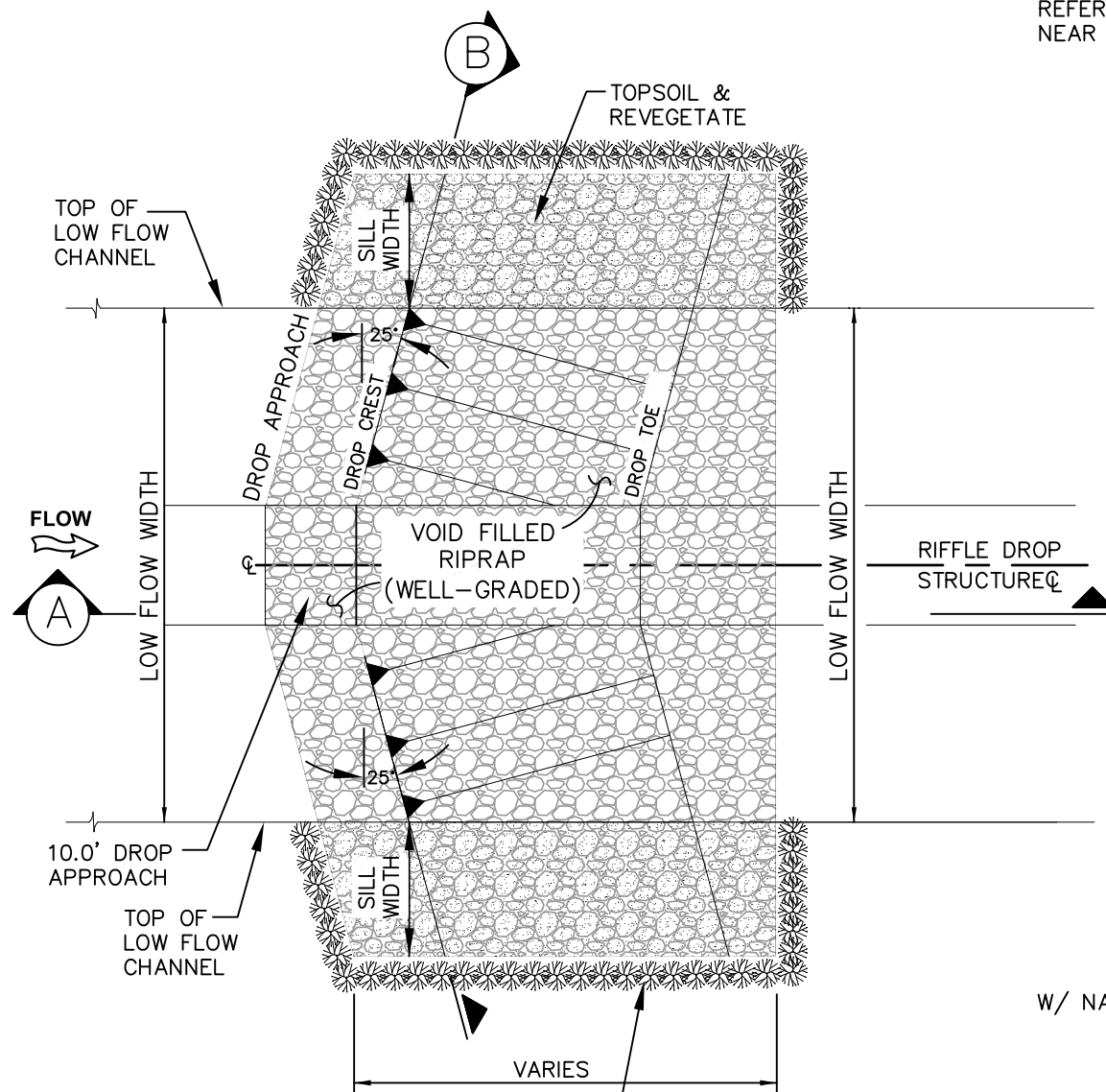

IF ACCESS OR AVAILABILITY PRECLUDES *
LIVE WILLOW TRANSPLANTS, PLACE
CONTINUOUS LAYER OF WILLOW STAKES
VERTICALLY IN SILL TRENCH
PRIOR TO BACKFILL

RIFFLE DROP STRUCTURE PLAN

NTS

REACH	LOW FLOW CHANNEL WIDTH (FT)
RET120	29
RET154	22
RWT150	18
RWT210	30

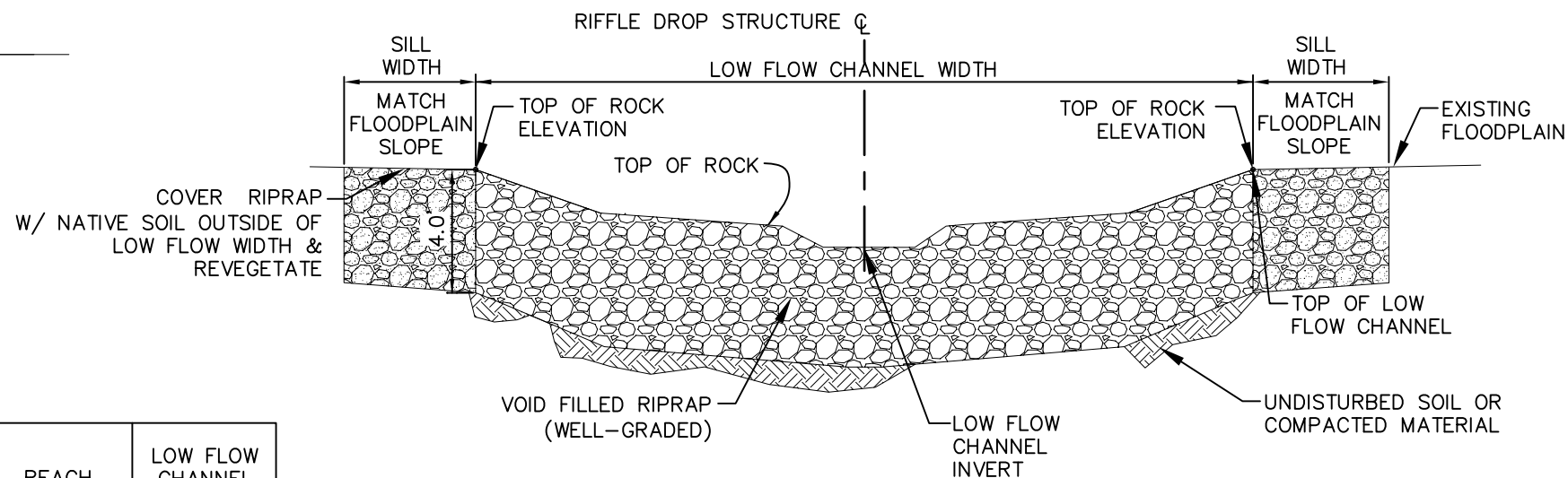

RIFFLE DROP STRUCTURE SECTION

NTS

B

**TYPICAL RIFFLE DROP STRUCTURE
FOR USE IN NATURAL CHANNEL DESIGN REACHES**

NOT FOR CONSTRUCTION



NAME: S:\10.122.003 (Falcon DBPS)\DWG\XSEC-RCVANE-RDSehibit.dwg
PCP: Matrix.ctb
PLOT DATE: Tue Jun 18, 2013 1:49pm

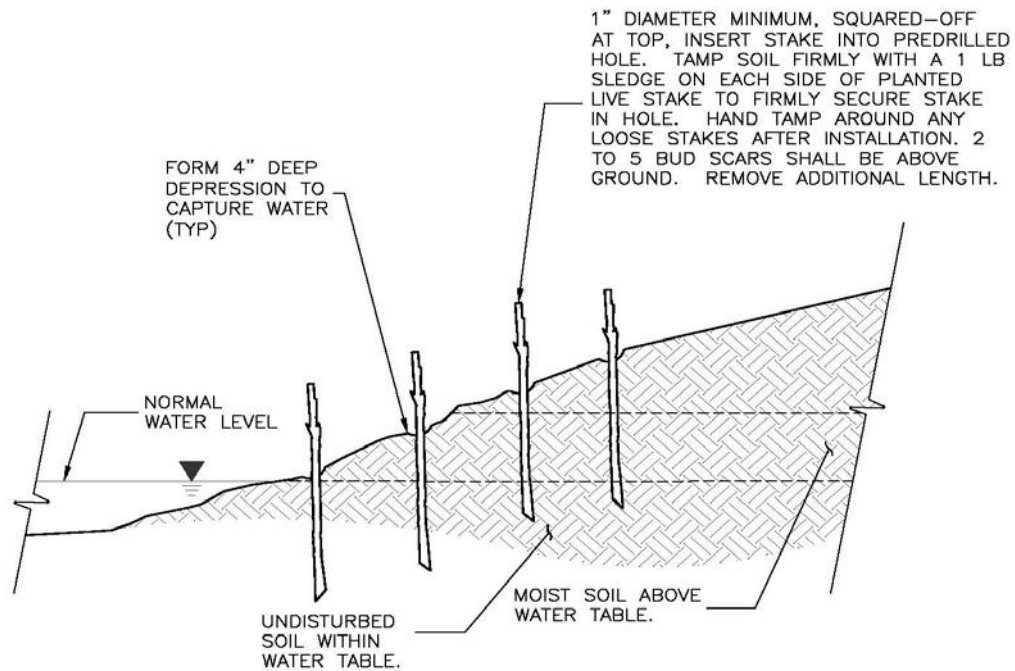

2435 Research Parkway, Suite 300
Colorado Springs, CO 80920
Phone 719-575-0100
Fax 719-575-0208

**NOTES**

1. HARVEST AND PLANT WILLOW LIVE STAKES DURING DORMANT SEASON
2. WILLOW STAKE SHALL HAVE CUT END ON AN ANGLE TO SIGNIFY PLANTING END.
3. USE HEALTHY, STRAIGHT, AND LIVE WOOD AT 2 TO 3 YEARS OLD.
4. MAKE CLEAN CUTS AND DO NOT DAMAGE STAKES OR SPLIT ENDS.
5. PLACE CUTTINGS IN WATER IMMEDIATELY AFTER HARVESTING.
6. SOAK CUTTINGS FOR 24 HOURS (MIN.) PRIOR TO INSTALLATION.
7. STORE CUT WILLOWS WITH LOWER ENDS IN WATER FOR NO LONGER THAN 7 DAYS BEFORE PLANTING.
8. LENGTH OF STAKES SHALL BE 2' (MIN.). PRE-DRILL HOLES WITH STEEL REBAR.
9. PLANT AT LEAST 3/4 LENGTH OF STAKE INTO MOIST SOIL.

Figure 13-14. Willow live stakes planting

APPENDIX B: HYDROLOGY

- Existing and Proposed Conditions Hydrology (Excerpts from PDR)
- Proposed Conditions Hydrology (Revised)

Appendix B Hydrology Excerpts from PDR (Existing Conditions and
Proposed Conditions)



A product of the National Cooperative Soil Survey, a joint effort of the United States Department of Agriculture and other Federal agencies, State agencies including the Agricultural Experiment Stations, and local participants

Custom Soil Resource Report for El Paso County Area, Colorado

Eagleview

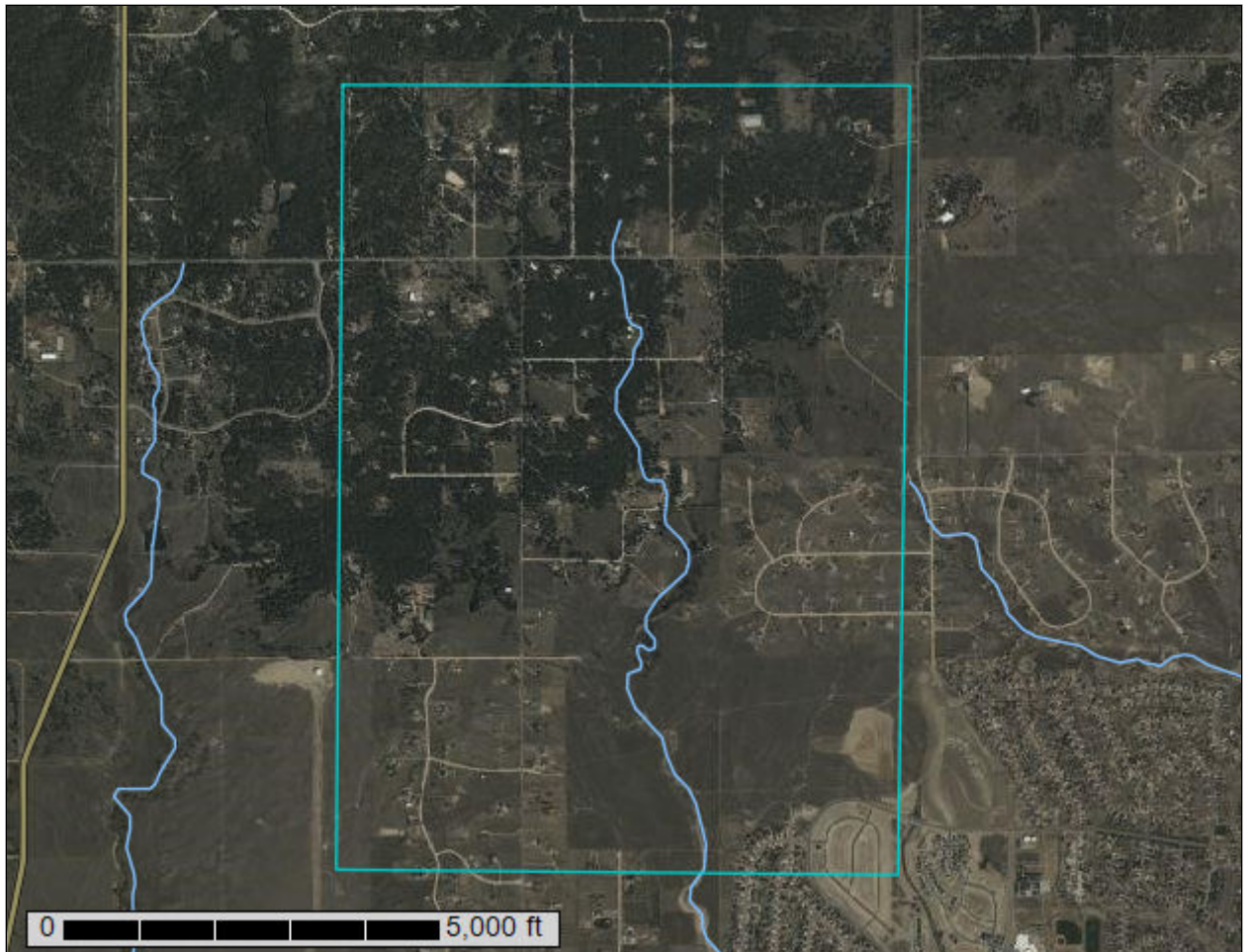

Preface

Soil surveys contain information that affects land use planning in survey areas. They highlight soil limitations that affect various land uses and provide information about the properties of the soils in the survey areas. Soil surveys are designed for many different users, including farmers, ranchers, foresters, agronomists, urban planners, community officials, engineers, developers, builders, and home buyers. Also, conservationists, teachers, students, and specialists in recreation, waste disposal, and pollution control can use the surveys to help them understand, protect, or enhance the environment.

Various land use regulations of Federal, State, and local governments may impose special restrictions on land use or land treatment. Soil surveys identify soil properties that are used in making various land use or land treatment decisions. The information is intended to help the land users identify and reduce the effects of soil limitations on various land uses. The landowner or user is responsible for identifying and complying with existing laws and regulations.

Although soil survey information can be used for general farm, local, and wider area planning, onsite investigation is needed to supplement this information in some cases. Examples include soil quality assessments (<http://www.nrcs.usda.gov/wps/portal/nrcs/main/soils/health/>) and certain conservation and engineering applications. For more detailed information, contact your local USDA Service Center (<https://offices.sc.egov.usda.gov/locator/app?agency=nrcs>) or your NRCS State Soil Scientist (http://www.nrcs.usda.gov/wps/portal/nrcs/detail/soils/contactus/?cid=nrcs142p2_053951).

Great differences in soil properties can occur within short distances. Some soils are seasonally wet or subject to flooding. Some are too unstable to be used as a foundation for buildings or roads. Clayey or wet soils are poorly suited to use as septic tank absorption fields. A high water table makes a soil poorly suited to basements or underground installations.

The National Cooperative Soil Survey is a joint effort of the United States Department of Agriculture and other Federal agencies, State agencies including the Agricultural Experiment Stations, and local agencies. The Natural Resources Conservation Service (NRCS) has leadership for the Federal part of the National Cooperative Soil Survey.

Information about soils is updated periodically. Updated information is available through the NRCS Web Soil Survey, the site for official soil survey information.

The U.S. Department of Agriculture (USDA) prohibits discrimination in all its programs and activities on the basis of race, color, national origin, age, disability, and where applicable, sex, marital status, familial status, parental status, religion, sexual orientation, genetic information, political beliefs, reprisal, or because all or a part of an individual's income is derived from any public assistance program. (Not all prohibited bases apply to all programs.) Persons with disabilities who require

alternative means for communication of program information (Braille, large print, audiotape, etc.) should contact USDA's TARGET Center at (202) 720-2600 (voice and TDD). To file a complaint of discrimination, write to USDA, Director, Office of Civil Rights, 1400 Independence Avenue, S.W., Washington, D.C. 20250-9410 or call (800) 795-3272 (voice) or (202) 720-6382 (TDD). USDA is an equal opportunity provider and employer.

Contents

Preface	2
How Soil Surveys Are Made	5
Soil Map	8
Soil Map.....	9
Legend.....	10
Map Unit Legend.....	11
Map Unit Descriptions.....	11
El Paso County Area, Colorado.....	13
19—Columbine gravelly sandy loam, 0 to 3 percent slopes.....	13
40—Kettle gravelly loamy sand, 3 to 8 percent slopes.....	14
41—Kettle gravelly loamy sand, 8 to 40 percent slopes.....	15
71—Pring coarse sandy loam, 3 to 8 percent slopes.....	16
References	18

How Soil Surveys Are Made

Soil surveys are made to provide information about the soils and miscellaneous areas in a specific area. They include a description of the soils and miscellaneous areas and their location on the landscape and tables that show soil properties and limitations affecting various uses. Soil scientists observed the steepness, length, and shape of the slopes; the general pattern of drainage; the kinds of crops and native plants; and the kinds of bedrock. They observed and described many soil profiles. A soil profile is the sequence of natural layers, or horizons, in a soil. The profile extends from the surface down into the unconsolidated material in which the soil formed or from the surface down to bedrock. The unconsolidated material is devoid of roots and other living organisms and has not been changed by other biological activity.

Currently, soils are mapped according to the boundaries of major land resource areas (MLRAs). MLRAs are geographically associated land resource units that share common characteristics related to physiography, geology, climate, water resources, soils, biological resources, and land uses (USDA, 2006). Soil survey areas typically consist of parts of one or more MLRA.

The soils and miscellaneous areas in a survey area occur in an orderly pattern that is related to the geology, landforms, relief, climate, and natural vegetation of the area. Each kind of soil and miscellaneous area is associated with a particular kind of landform or with a segment of the landform. By observing the soils and miscellaneous areas in the survey area and relating their position to specific segments of the landform, a soil scientist develops a concept, or model, of how they were formed. Thus, during mapping, this model enables the soil scientist to predict with a considerable degree of accuracy the kind of soil or miscellaneous area at a specific location on the landscape.

Commonly, individual soils on the landscape merge into one another as their characteristics gradually change. To construct an accurate soil map, however, soil scientists must determine the boundaries between the soils. They can observe only a limited number of soil profiles. Nevertheless, these observations, supplemented by an understanding of the soil-vegetation-landscape relationship, are sufficient to verify predictions of the kinds of soil in an area and to determine the boundaries.

Soil scientists recorded the characteristics of the soil profiles that they studied. They noted soil color, texture, size and shape of soil aggregates, kind and amount of rock fragments, distribution of plant roots, reaction, and other features that enable them to identify soils. After describing the soils in the survey area and determining their properties, the soil scientists assigned the soils to taxonomic classes (units). Taxonomic classes are concepts. Each taxonomic class has a set of soil characteristics with precisely defined limits. The classes are used as a basis for comparison to classify soils systematically. Soil taxonomy, the system of taxonomic classification used in the United States, is based mainly on the kind and character of soil properties and the arrangement of horizons within the profile. After the soil

Custom Soil Resource Report

scientists classified and named the soils in the survey area, they compared the individual soils with similar soils in the same taxonomic class in other areas so that they could confirm data and assemble additional data based on experience and research.

The objective of soil mapping is not to delineate pure map unit components; the objective is to separate the landscape into landforms or landform segments that have similar use and management requirements. Each map unit is defined by a unique combination of soil components and/or miscellaneous areas in predictable proportions. Some components may be highly contrasting to the other components of the map unit. The presence of minor components in a map unit in no way diminishes the usefulness or accuracy of the data. The delineation of such landforms and landform segments on the map provides sufficient information for the development of resource plans. If intensive use of small areas is planned, onsite investigation is needed to define and locate the soils and miscellaneous areas.

Soil scientists make many field observations in the process of producing a soil map. The frequency of observation is dependent upon several factors, including scale of mapping, intensity of mapping, design of map units, complexity of the landscape, and experience of the soil scientist. Observations are made to test and refine the soil-landscape model and predictions and to verify the classification of the soils at specific locations. Once the soil-landscape model is refined, a significantly smaller number of measurements of individual soil properties are made and recorded. These measurements may include field measurements, such as those for color, depth to bedrock, and texture, and laboratory measurements, such as those for content of sand, silt, clay, salt, and other components. Properties of each soil typically vary from one point to another across the landscape.

Observations for map unit components are aggregated to develop ranges of characteristics for the components. The aggregated values are presented. Direct measurements do not exist for every property presented for every map unit component. Values for some properties are estimated from combinations of other properties.

While a soil survey is in progress, samples of some of the soils in the area generally are collected for laboratory analyses and for engineering tests. Soil scientists interpret the data from these analyses and tests as well as the field-observed characteristics and the soil properties to determine the expected behavior of the soils under different uses. Interpretations for all of the soils are field tested through observation of the soils in different uses and under different levels of management. Some interpretations are modified to fit local conditions, and some new interpretations are developed to meet local needs. Data are assembled from other sources, such as research information, production records, and field experience of specialists. For example, data on crop yields under defined levels of management are assembled from farm records and from field or plot experiments on the same kinds of soil.

Predictions about soil behavior are based not only on soil properties but also on such variables as climate and biological activity. Soil conditions are predictable over long periods of time, but they are not predictable from year to year. For example, soil scientists can predict with a fairly high degree of accuracy that a given soil will have a high water table within certain depths in most years, but they cannot predict that a high water table will always be at a specific level in the soil on a specific date.

After soil scientists located and identified the significant natural bodies of soil in the survey area, they drew the boundaries of these bodies on aerial photographs and

Custom Soil Resource Report

identified each as a specific map unit. Aerial photographs show trees, buildings, fields, roads, and rivers, all of which help in locating boundaries accurately.

Soil Map

The soil map section includes the soil map for the defined area of interest, a list of soil map units on the map and extent of each map unit, and cartographic symbols displayed on the map. Also presented are various metadata about data used to produce the map, and a description of each soil map unit.

Custom Soil Resource Report Soil Map

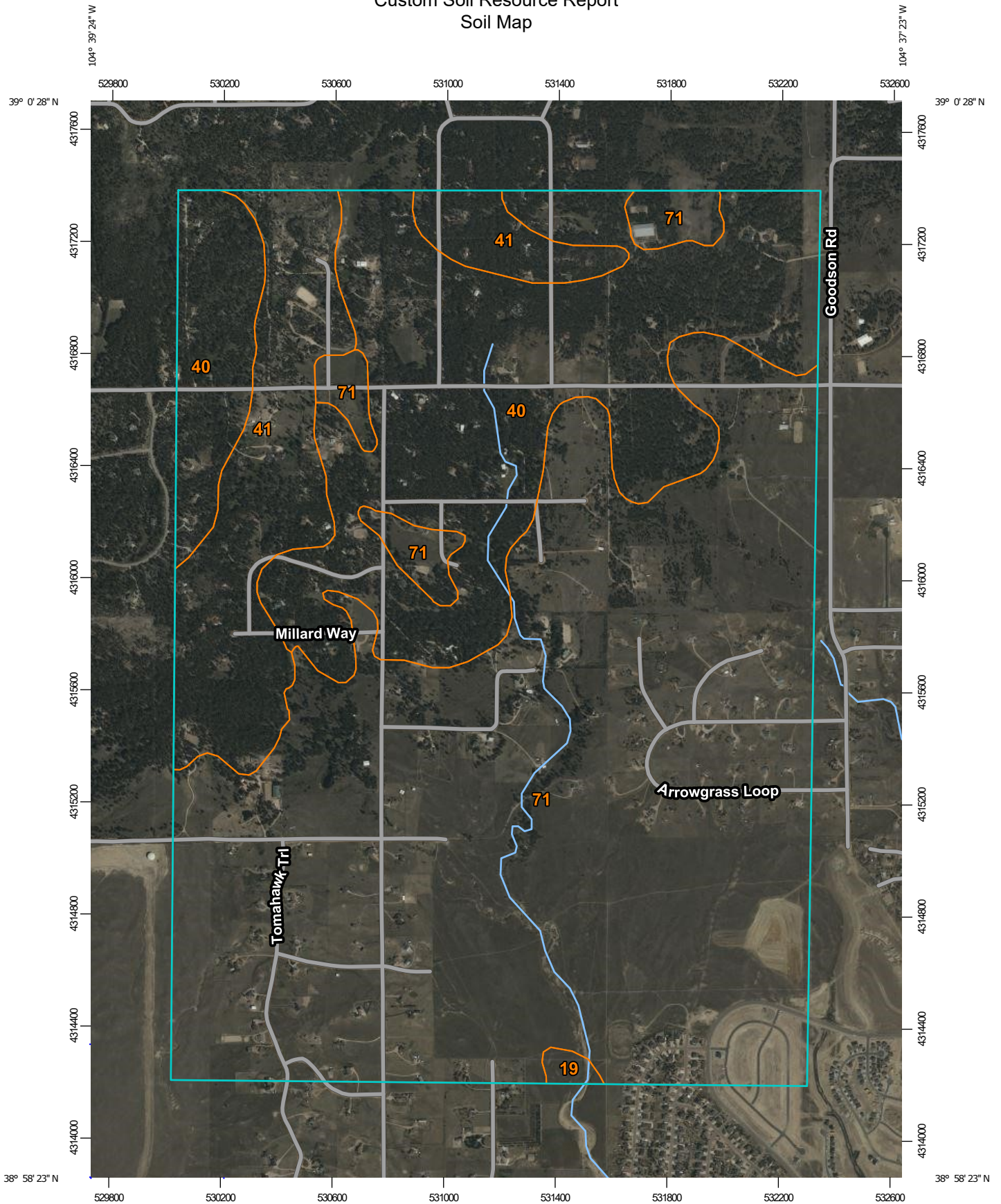

Map Scale: 1:18,700 if printed on A portrait (8.5" x 11") sheet.

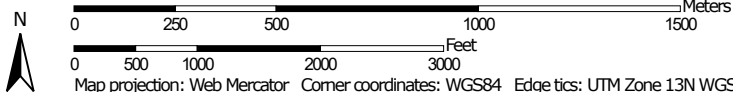

Map projection: Web Mercator Corner coordinates: WGS84 Edge tics: UTM Zone 13N WGS84

MAP LEGEND

Area of Interest (AOI)

 Area of Interest (AOI)

Soils







 Soil Map Unit Polygons

 Soil Map Unit Lines

 Soil Map Unit Points

Special Point Features





-  Blowout
-  Borrow Pit
-  Clay Spot
-  Closed Depression
-  Gravel Pit
-  Gravelly Spot
-  Landfill
-  Lava Flow
-  Marsh or swamp
-  Mine or Quarry
-  Miscellaneous Water
-  Perennial Water
-  Rock Outcrop
-  Saline Spot
-  Sandy Spot
-  Severely Eroded Spot
-  Sinkhole
-  Slide or Slip
-  Sodic Spot

-  Spoil Area
-  Stony Spot
-  Very Stony Spot
-  Wet Spot
-  Other
-  Special Line Features

Water Features

 Streams and Canals

Transportation

-  Rails
-  Interstate Highways
-  US Routes
-  Major Roads
-  Local Roads

Background

 Aerial Photography

MAP INFORMATION

The soil surveys that comprise your AOI were mapped at 1:24,000.

Please rely on the bar scale on each map sheet for map measurements.

Source of Map: Natural Resources Conservation Service
 Web Soil Survey URL:
 Coordinate System: Web Mercator (EPSG:3857)

Maps from the Web Soil Survey are based on the Web Mercator projection, which preserves direction and shape but distorts distance and area. A projection that preserves area, such as the Albers equal-area conic projection, should be used if more accurate calculations of distance or area are required.

This product is generated from the USDA-NRCS certified data as of the version date(s) listed below.

Soil Survey Area: El Paso County Area, Colorado
 Survey Area Data: Version 19, Aug 31, 2021

Soil map units are labeled (as space allows) for map scales 1:50,000 or larger.

Date(s) aerial images were photographed: Sep 11, 2018—Oct 20, 2018

The orthophoto or other base map on which the soil lines were compiled and digitized probably differs from the background imagery displayed on these maps. As a result, some minor shifting of map unit boundaries may be evident.

Map Unit Legend

Map Unit Symbol	Map Unit Name	Acres in AOI	Percent of AOI
19	Columbine gravelly sandy loam, 0 to 3 percent slopes	5.2	0.3%
40	Kettle gravelly loamy sand, 3 to 8 percent slopes	506.7	28.0%
41	Kettle gravelly loamy sand, 8 to 40 percent slopes	205.0	11.3%
71	Pring coarse sandy loam, 3 to 8 percent slopes	1,092.9	60.4%
Totals for Area of Interest		1,809.9	100.0%

Map Unit Descriptions

The map units delineated on the detailed soil maps in a soil survey represent the soils or miscellaneous areas in the survey area. The map unit descriptions, along with the maps, can be used to determine the composition and properties of a unit.

A map unit delineation on a soil map represents an area dominated by one or more major kinds of soil or miscellaneous areas. A map unit is identified and named according to the taxonomic classification of the dominant soils. Within a taxonomic class there are precisely defined limits for the properties of the soils. On the landscape, however, the soils are natural phenomena, and they have the characteristic variability of all natural phenomena. Thus, the range of some observed properties may extend beyond the limits defined for a taxonomic class. Areas of soils of a single taxonomic class rarely, if ever, can be mapped without including areas of other taxonomic classes. Consequently, every map unit is made up of the soils or miscellaneous areas for which it is named and some minor components that belong to taxonomic classes other than those of the major soils.

Most minor soils have properties similar to those of the dominant soil or soils in the map unit, and thus they do not affect use and management. These are called noncontrasting, or similar, components. They may or may not be mentioned in a particular map unit description. Other minor components, however, have properties and behavioral characteristics divergent enough to affect use or to require different management. These are called contrasting, or dissimilar, components. They generally are in small areas and could not be mapped separately because of the scale used. Some small areas of strongly contrasting soils or miscellaneous areas are identified by a special symbol on the maps. If included in the database for a given area, the contrasting minor components are identified in the map unit descriptions along with some characteristics of each. A few areas of minor components may not have been observed, and consequently they are not mentioned in the descriptions, especially where the pattern was so complex that it was impractical to make enough observations to identify all the soils and miscellaneous areas on the landscape.

Custom Soil Resource Report

The presence of minor components in a map unit in no way diminishes the usefulness or accuracy of the data. The objective of mapping is not to delineate pure taxonomic classes but rather to separate the landscape into landforms or landform segments that have similar use and management requirements. The delineation of such segments on the map provides sufficient information for the development of resource plans. If intensive use of small areas is planned, however, onsite investigation is needed to define and locate the soils and miscellaneous areas.

An identifying symbol precedes the map unit name in the map unit descriptions. Each description includes general facts about the unit and gives important soil properties and qualities.

Soils that have profiles that are almost alike make up a *soil series*. Except for differences in texture of the surface layer, all the soils of a series have major horizons that are similar in composition, thickness, and arrangement.

Soils of one series can differ in texture of the surface layer, slope, stoniness, salinity, degree of erosion, and other characteristics that affect their use. On the basis of such differences, a soil series is divided into *soil phases*. Most of the areas shown on the detailed soil maps are phases of soil series. The name of a soil phase commonly indicates a feature that affects use or management. For example, Alpha silt loam, 0 to 2 percent slopes, is a phase of the Alpha series.

Some map units are made up of two or more major soils or miscellaneous areas. These map units are complexes, associations, or undifferentiated groups.

A *complex* consists of two or more soils or miscellaneous areas in such an intricate pattern or in such small areas that they cannot be shown separately on the maps. The pattern and proportion of the soils or miscellaneous areas are somewhat similar in all areas. Alpha-Beta complex, 0 to 6 percent slopes, is an example.

An *association* is made up of two or more geographically associated soils or miscellaneous areas that are shown as one unit on the maps. Because of present or anticipated uses of the map units in the survey area, it was not considered practical or necessary to map the soils or miscellaneous areas separately. The pattern and relative proportion of the soils or miscellaneous areas are somewhat similar. Alpha-Beta association, 0 to 2 percent slopes, is an example.

An *undifferentiated group* is made up of two or more soils or miscellaneous areas that could be mapped individually but are mapped as one unit because similar interpretations can be made for use and management. The pattern and proportion of the soils or miscellaneous areas in a mapped area are not uniform. An area can be made up of only one of the major soils or miscellaneous areas, or it can be made up of all of them. Alpha and Beta soils, 0 to 2 percent slopes, is an example.

Some surveys include *miscellaneous areas*. Such areas have little or no soil material and support little or no vegetation. Rock outcrop is an example.

El Paso County Area, Colorado

19—Columbine gravelly sandy loam, 0 to 3 percent slopes

Map Unit Setting

National map unit symbol: 367p
Elevation: 6,500 to 7,300 feet
Mean annual precipitation: 14 to 16 inches
Mean annual air temperature: 46 to 50 degrees F
Frost-free period: 125 to 145 days
Farmland classification: Not prime farmland

Map Unit Composition

Columbine and similar soils: 97 percent
Minor components: 3 percent
Estimates are based on observations, descriptions, and transects of the mapunit.

Description of Columbine

Setting

Landform: Flood plains, fan terraces, fans
Down-slope shape: Linear
Across-slope shape: Linear
Parent material: Alluvium

Typical profile

A - 0 to 14 inches: gravelly sandy loam
C - 14 to 60 inches: very gravelly loamy sand

Properties and qualities

Slope: 0 to 3 percent
Depth to restrictive feature: More than 80 inches
Drainage class: Well drained
Runoff class: Very low
Capacity of the most limiting layer to transmit water (Ksat): High to very high (5.95 to 19.98 in/hr)
Depth to water table: More than 80 inches
Frequency of flooding: None
Frequency of ponding: None
Available water supply, 0 to 60 inches: Very low (about 2.5 inches)

Interpretive groups

Land capability classification (irrigated): 4e
Land capability classification (nonirrigated): 6e
Hydrologic Soil Group: A
Ecological site: R049XY214CO - Gravelly Foothill
Hydric soil rating: No

Minor Components

Fluvaquentic haplaquolls

Percent of map unit: 1 percent
Landform: Swales
Hydric soil rating: Yes

Other soils

Percent of map unit: 1 percent
Hydric soil rating: No

Pleasant

Percent of map unit: 1 percent
Landform: Depressions
Hydric soil rating: Yes

40—Kettle gravelly loamy sand, 3 to 8 percent slopes

Map Unit Setting

National map unit symbol: 368g
Elevation: 7,000 to 7,700 feet
Farmland classification: Not prime farmland

Map Unit Composition

Kettle and similar soils: 85 percent
Estimates are based on observations, descriptions, and transects of the mapunit.

Description of Kettle

Setting

Landform: Hills
Landform position (three-dimensional): Side slope
Down-slope shape: Linear
Across-slope shape: Linear
Parent material: Sandy alluvium derived from arkose

Typical profile

E - 0 to 16 inches: gravelly loamy sand
Bt - 16 to 40 inches: gravelly sandy loam
C - 40 to 60 inches: extremely gravelly loamy sand

Properties and qualities

Slope: 3 to 8 percent
Depth to restrictive feature: More than 80 inches
Drainage class: Somewhat excessively drained
Runoff class: Low
Capacity of the most limiting layer to transmit water (Ksat): High (2.00 to 6.00 in/hr)
Depth to water table: More than 80 inches
Frequency of flooding: None
Frequency of ponding: None
Available water supply, 0 to 60 inches: Low (about 3.4 inches)

Interpretive groups

Land capability classification (irrigated): None specified
Land capability classification (nonirrigated): 4e
Hydrologic Soil Group: B
Ecological site: F048AY908CO - Mixed Conifer

Custom Soil Resource Report

Hydric soil rating: No

Minor Components

Other soils

Percent of map unit:

Hydric soil rating: No

Pleasant

Percent of map unit:

Landform: Depressions

Hydric soil rating: Yes

41—Kettle gravelly loamy sand, 8 to 40 percent slopes

Map Unit Setting

National map unit symbol: 368h

Elevation: 7,000 to 7,700 feet

Farmland classification: Not prime farmland

Map Unit Composition

Kettle and similar soils: 85 percent

Estimates are based on observations, descriptions, and transects of the mapunit.

Description of Kettle

Setting

Landform: Hills

Landform position (three-dimensional): Side slope

Down-slope shape: Linear

Across-slope shape: Linear

Parent material: Sandy alluvium derived from arkose

Typical profile

E - 0 to 16 inches: gravelly loamy sand

Bt - 16 to 40 inches: gravelly sandy loam

C - 40 to 60 inches: extremely gravelly loamy sand

Properties and qualities

Slope: 8 to 40 percent

Depth to restrictive feature: More than 80 inches

Drainage class: Somewhat excessively drained

Runoff class: Medium

Capacity of the most limiting layer to transmit water (Ksat): High (2.00 to 6.00 in/hr)

Depth to water table: More than 80 inches

Frequency of flooding: None

Frequency of ponding: None

Available water supply, 0 to 60 inches: Low (about 3.4 inches)

Interpretive groups

Land capability classification (irrigated): None specified

Custom Soil Resource Report

Land capability classification (nonirrigated): 7e
Hydrologic Soil Group: B
Ecological site: F048AY908CO - Mixed Conifer
Hydric soil rating: No

Minor Components

Pleasant

Percent of map unit:
Landform: Depressions
Hydric soil rating: Yes

Other soils

Percent of map unit:
Hydric soil rating: No

71—Pring coarse sandy loam, 3 to 8 percent slopes

Map Unit Setting

National map unit symbol: 369k
Elevation: 6,800 to 7,600 feet
Farmland classification: Not prime farmland

Map Unit Composition

Pring and similar soils: 85 percent
Estimates are based on observations, descriptions, and transects of the mapunit.

Description of Pring

Setting

Landform: Hills
Landform position (three-dimensional): Side slope
Down-slope shape: Linear
Across-slope shape: Linear
Parent material: Arkosic alluvium derived from sedimentary rock

Typical profile

A - 0 to 14 inches: coarse sandy loam
C - 14 to 60 inches: gravelly sandy loam

Properties and qualities

Slope: 3 to 8 percent
Depth to restrictive feature: More than 80 inches
Drainage class: Well drained
Runoff class: Low
Capacity of the most limiting layer to transmit water (Ksat): High (2.00 to 6.00 in/hr)
Depth to water table: More than 80 inches
Frequency of flooding: None
Frequency of ponding: None
Available water supply, 0 to 60 inches: Low (about 6.0 inches)

Custom Soil Resource Report

Interpretive groups

Land capability classification (irrigated): None specified

Land capability classification (nonirrigated): 3e

Hydrologic Soil Group: B

Ecological site: R048AY222CO - Loamy Park

Hydric soil rating: No

Minor Components

Pleasant

Percent of map unit:

Landform: Depressions

Hydric soil rating: Yes

Other soils

Percent of map unit:

Hydric soil rating: No

References

- American Association of State Highway and Transportation Officials (AASHTO). 2004. Standard specifications for transportation materials and methods of sampling and testing. 24th edition.
- American Society for Testing and Materials (ASTM). 2005. Standard classification of soils for engineering purposes. ASTM Standard D2487-00.
- Cowardin, L.M., V. Carter, F.C. Golet, and E.T. LaRoe. 1979. Classification of wetlands and deep-water habitats of the United States. U.S. Fish and Wildlife Service FWS/OBS-79/31.
- Federal Register. July 13, 1994. Changes in hydric soils of the United States.
- Federal Register. September 18, 2002. Hydric soils of the United States.
- Hurt, G.W., and L.M. Vasilas, editors. Version 6.0, 2006. Field indicators of hydric soils in the United States.
- National Research Council. 1995. Wetlands: Characteristics and boundaries.
- Soil Survey Division Staff. 1993. Soil survey manual. Soil Conservation Service. U.S. Department of Agriculture Handbook 18. http://www.nrcs.usda.gov/wps/portal/nrcs/detail/national/soils/?cid=nrcs142p2_054262
- Soil Survey Staff. 1999. Soil taxonomy: A basic system of soil classification for making and interpreting soil surveys. 2nd edition. Natural Resources Conservation Service, U.S. Department of Agriculture Handbook 436. http://www.nrcs.usda.gov/wps/portal/nrcs/detail/national/soils/?cid=nrcs142p2_053577
- Soil Survey Staff. 2010. Keys to soil taxonomy. 11th edition. U.S. Department of Agriculture, Natural Resources Conservation Service. http://www.nrcs.usda.gov/wps/portal/nrcs/detail/national/soils/?cid=nrcs142p2_053580
- Tiner, R.W., Jr. 1985. Wetlands of Delaware. U.S. Fish and Wildlife Service and Delaware Department of Natural Resources and Environmental Control, Wetlands Section.
- United States Army Corps of Engineers, Environmental Laboratory. 1987. Corps of Engineers wetlands delineation manual. Waterways Experiment Station Technical Report Y-87-1.
- United States Department of Agriculture, Natural Resources Conservation Service. National forestry manual. http://www.nrcs.usda.gov/wps/portal/nrcs/detail/soils/home/?cid=nrcs142p2_053374
- United States Department of Agriculture, Natural Resources Conservation Service. National range and pasture handbook. <http://www.nrcs.usda.gov/wps/portal/nrcs/detail/national/landuse/rangepasture/?cid=stelprdb1043084>

Custom Soil Resource Report

United States Department of Agriculture, Natural Resources Conservation Service. National soil survey handbook, title 430-VI. http://www.nrcs.usda.gov/wps/portal/nrcs/detail/soils/scientists/?cid=nrcs142p2_054242

United States Department of Agriculture, Natural Resources Conservation Service. 2006. Land resource regions and major land resource areas of the United States, the Caribbean, and the Pacific Basin. U.S. Department of Agriculture Handbook 296. http://www.nrcs.usda.gov/wps/portal/nrcs/detail/national/soils/?cid=nrcs142p2_053624

United States Department of Agriculture, Soil Conservation Service. 1961. Land capability classification. U.S. Department of Agriculture Handbook 210. http://www.nrcs.usda.gov/Internet/FSE_DOCUMENTS/nrcs142p2_052290.pdf



HEC-HMS

Project : Eagleview_Subdivision

Basin Model : Eagleview_Existing

Mar 11 13:21:39 MST 2022

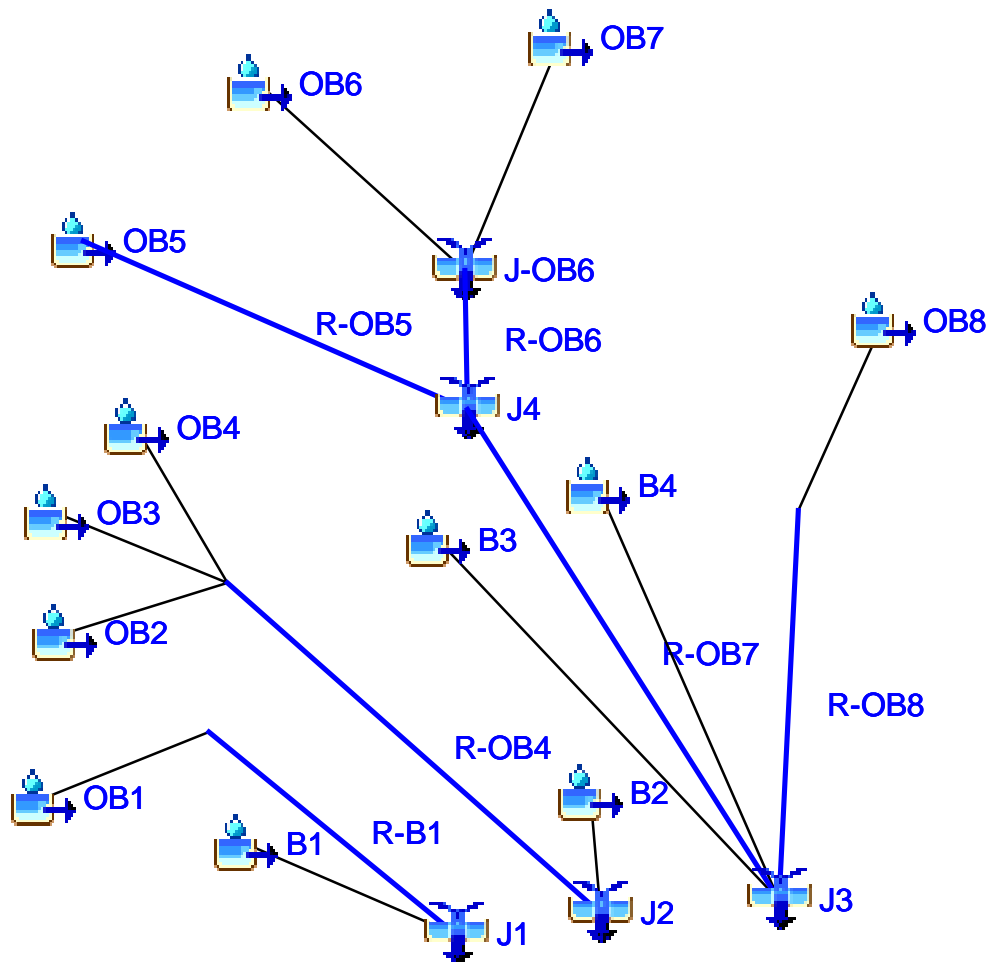

El Paso County Chapter 5: Table 5-2 SCS 24-hr Type II Distribution for TR-20 Input

Hour	Minutes			
	15	30	45	60
1	0.002	0.005	0.008	0.01
2	0.014	0.017	0.020	0.02
3	0.026	0.029	0.032	0.04
4	0.038	0.041	0.044	0.05
5	0.052	0.056	0.060	0.06
6	0.068	0.072	0.076	0.08
7	0.085	0.090	0.095	0.1
8	0.105	0.110	0.115	0.12
9	0.126	0.133	0.140	0.15
10	0.155	0.163	0.172	0.18
11	0.191	0.203	0.218	0.24
12	0.257	0.283	0.387	0.66
13	0.707	0.735	0.758	0.78
14	0.791	0.804	0.815	0.83
15	0.834	0.842	0.849	0.86
16	0.863	0.869	0.875	0.88
17	0.887	0.893	0.898	0.9
18	0.908	0.913	0.918	0.92
19	0.926	0.930	0.934	0.94
20	0.942	0.946	0.950	0.95
21	0.956	0.959	0.962	0.97
22	0.968	0.971	0.974	0.98
23	0.980	0.983	0.986	0.99
24	0.992	0.995	0.998	1

Table 6-2. 24hr Rainfall Depths for Colorado Springs

Return Period	Depths
2-yr	2.1
5-yr	2.7
10-yr	3.2
25-yr	3.6
50-yr	4.2
100-yr	4.6

Design Storm Hyetograph Table

	Time (mins)	Fraction of 1-hr	2-yr	5-yr	10-yr	25-yr	50-yr	100-yr
		Rainfall Depth						
	0	0	0	0	0	0	0	0
	15	0.002	0.0042	0.0054	0.0064	0.0072	0.0084	0.0092
	30	0.005	0.0105	0.0135	0.016	0.018	0.021	0.023
	45	0.008	0.0168	0.0216	0.0256	0.0288	0.0336	0.0368
1	60	0.011	0.0231	0.0297	0.0352	0.0396	0.0462	0.0506
	75	0.014	0.0294	0.0378	0.0448	0.0504	0.0588	0.0644
	90	0.017	0.0357	0.0459	0.0544	0.0612	0.0714	0.0782
	105	0.02	0.042	0.054	0.064	0.072	0.084	0.092
2	120	0.023	0.0483	0.0621	0.0736	0.0828	0.0966	0.1058
	135	0.026	0.0546	0.0702	0.0832	0.0936	0.1092	0.1196
	150	0.029	0.0609	0.0783	0.0928	0.1044	0.1218	0.1334
	165	0.032	0.0672	0.0864	0.1024	0.1152	0.1344	0.1472
3	180	0.035	0.0735	0.0945	0.112	0.126	0.147	0.161
	195	0.038	0.0798	0.1026	0.1216	0.1368	0.1596	0.1748
	210	0.041	0.0861	0.1107	0.1312	0.1476	0.1722	0.1886
	225	0.044	0.0924	0.1188	0.1408	0.1584	0.1848	0.2024
4	240	0.048	0.1008	0.1296	0.1536	0.1728	0.2016	0.2208
	255	0.052	0.1092	0.1404	0.1664	0.1872	0.2184	0.2392
	270	0.056	0.1176	0.1512	0.1792	0.2016	0.2352	0.2576
	285	0.06	0.126	0.162	0.192	0.216	0.252	0.276
5	300	0.0604	0.12684	0.16308	0.19328	0.21744	0.25368	0.27784
	315	0.068	0.1428	0.1836	0.2176	0.2448	0.2856	0.3128
	330	0.072	0.1512	0.1944	0.2304	0.2592	0.3024	0.3312
	345	0.076	0.1596	0.2052	0.2432	0.2736	0.3192	0.3496
6	360	0.08	0.168	0.216	0.256	0.288	0.336	0.368
	375	0.085	0.1785	0.2295	0.272	0.306	0.357	0.391
	390	0.09	0.189	0.243	0.288	0.324	0.378	0.414
	405	0.095	0.1995	0.2565	0.304	0.342	0.399	0.437
7	420	0.1	0.21	0.27	0.32	0.36	0.42	0.46
	435	0.105	0.2205	0.2835	0.336	0.378	0.441	0.483
	450	0.11	0.231	0.297	0.352	0.396	0.462	0.506
	465	0.115	0.2415	0.3105	0.368	0.414	0.483	0.529
8	480	0.12	0.252	0.324	0.384	0.432	0.504	0.552
	495	0.126	0.2646	0.3402	0.4032	0.4536	0.5292	0.5796
	510	0.133	0.2793	0.3591	0.4256	0.4788	0.5586	0.6118
	525	0.14	0.294	0.378	0.448	0.504	0.588	0.644
9	540	0.147	0.3087	0.3969	0.4704	0.5292	0.6174	0.6762
	555	0.155	0.3255	0.4185	0.496	0.558	0.651	0.713
	570	0.163	0.3423	0.4401	0.5216	0.5868	0.6846	0.7498
	585	0.172	0.3612	0.4644	0.5504	0.6192	0.7224	0.7912
10	600	0.181	0.3801	0.4887	0.5792	0.6516	0.7602	0.8326
	615	0.191	0.4011	0.5157	0.6112	0.6876	0.8022	0.8786
	630	0.203	0.4263	0.5481	0.6496	0.7308	0.8526	0.9338
	645	0.218	0.4578	0.5886	0.6976	0.7848	0.9156	1.0028
11	660	0.236	0.4956	0.6372	0.7552	0.8496	0.9912	1.0856
	675	0.257	0.5397	0.6939	0.8224	0.9252	1.0794	1.1822
	690	0.283	0.5943	0.7641	0.9056	1.0188	1.1886	1.3018
	705	0.387	0.8127	1.0449	1.2384	1.3932	1.6254	1.7802
12	720	0.663	1.3923	1.7901	2.1216	2.3868	2.7846	3.0498
	735	0.707	1.4847	1.9089	2.2624	2.5452	2.9694	3.2522
	750	0.735	1.5435	1.9845	2.352	2.646	3.087	3.381
	765	0.758	1.5918	2.0466	2.4256	2.7288	3.1836	3.4868
13	780	0.776	1.6296	2.0952	2.4832	2.7936	3.2592	3.5696
	795	0.791	1.6611	2.1357	2.5312	2.8476	3.3222	3.6386
	810	0.804	1.6884	2.1708	2.5728	2.8944	3.3768	3.6984
	825	0.815	1.7115	2.2005	2.608	2.934	3.423	3.749

14	840	0.825	1.7325	2.2275	2.64	2.97	3.465	3.795
	855	0.834	1.7514	2.2518	2.6688	3.0024	3.5028	3.8364
	870	0.842	1.7682	2.2734	2.6944	3.0312	3.5364	3.8732
	885	0.849	1.7829	2.2923	2.7168	3.0564	3.5658	3.9054
15	900	0.856	1.7976	2.3112	2.7392	3.0816	3.5952	3.9376
	915	0.863	1.8123	2.3301	2.7616	3.1068	3.6246	3.9698
	930	0.869	1.8249	2.3463	2.7808	3.1284	3.6498	3.9974
	945	0.875	1.8375	2.3625	2.8	3.15	3.675	4.025
16	960	0.881	1.8501	2.3787	2.8192	3.1716	3.7002	4.0526
	975	0.887	1.8627	2.3949	2.8384	3.1932	3.7254	4.0802
	990	0.893	1.8753	2.4111	2.8576	3.2148	3.7506	4.1078
	1005	0.898	1.8858	2.4246	2.8736	3.2328	3.7716	4.1308
17	1020	0.903	1.8963	2.4381	2.8896	3.2508	3.7926	4.1538
	1035	0.908	1.9068	2.4516	2.9056	3.2688	3.8136	4.1768
	1050	0.913	1.9173	2.4651	2.9216	3.2868	3.8346	4.1998
	1065	0.918	1.9278	2.4786	2.9376	3.3048	3.8556	4.2228
18	1080	0.922	1.9362	2.4894	2.9504	3.3192	3.8724	4.2412
	1095	0.926	1.9446	2.5002	2.9632	3.3336	3.8892	4.2596
	1110	0.93	1.953	2.511	2.976	3.348	3.906	4.278
	1125	0.934	1.9614	2.5218	2.9888	3.3624	3.9228	4.2964
19	1140	0.938	1.9698	2.5326	3.0016	3.3768	3.9396	4.3148
	1155	0.942	1.9782	2.5434	3.0144	3.3912	3.9564	4.3332
	1170	0.946	1.9866	2.5542	3.0272	3.4056	3.9732	4.3516
	1185	0.95	1.995	2.565	3.04	3.42	3.99	4.37
20	1200	0.953	2.0013	2.5731	3.0496	3.4308	4.0026	4.3838
	1215	0.956	2.0076	2.5812	3.0592	3.4416	4.0152	4.3976
	1230	0.959	2.0139	2.5893	3.0688	3.4524	4.0278	4.4114
	1245	0.962	2.0202	2.5974	3.0784	3.4632	4.0404	4.4252
21	1260	0.965	2.0265	2.6055	3.088	3.474	4.053	4.439
	1275	0.968	2.0328	2.6136	3.0976	3.4848	4.0656	4.4528
	1290	0.971	2.0391	2.6217	3.1072	3.4956	4.0782	4.4666
	1305	0.974	2.0454	2.6298	3.1168	3.5064	4.0908	4.4804
22	1320	0.977	2.0517	2.6379	3.1264	3.5172	4.1034	4.4942
	1335	0.98	2.058	2.646	3.136	3.528	4.116	4.508
	1350	0.983	2.0643	2.6541	3.1456	3.5388	4.1286	4.5218
	1365	0.986	2.0706	2.6622	3.1552	3.5496	4.1412	4.5356
23	1380	0.989	2.0769	2.6703	3.1648	3.5604	4.1538	4.5494
	1395	0.992	2.0832	2.6784	3.1744	3.5712	4.1664	4.5632
	1410	0.995	2.0895	2.6865	3.184	3.582	4.179	4.577
	1425	0.998	2.0958	2.6946	3.1936	3.5928	4.1916	4.5908
24	1440	1	2.1	2.7	3.2	3.6	4.2	4.6

IMPERVIOUS FACTOR CALCULATION TABLE - EXISTING CONDITIONS

	Basin	Area (Acre)	Open Space (2%)	Buildings (100%)	Paved Roadway (100%)	Gravel Roadway (80%)	Total % Check	Weighted Impervious
Onsite	B1	5.55	93%	0%	0%	6%	99%	7%
	B2	41.43	100%	0%	0%	0%	100%	2%
	B3	59.54	100%	0%	0%	0%	100%	2%
	B4	14.68	100%	0%	0%	0%	100%	2%
Offsite	OB1	10.37	93%	2%	4%	2%	100%	9%
	OB2	28.06	90%	3%	3%	5%	100%	11%
	OB3	43.44	92%	2%	2%	4%	100%	9%
	OB4	10.50	87%	4%	5%	4%	100%	13%
	OB5	143.82	94%	2%	1%	3%	100%	7%
	OB6	118.40	93%	1%	2%	4%	100%	8%
	OB7	421.43	93%	2%	1%	4%	100%	8%
	OB8	33.08	93%	2%	1%	5%	100%	8%
Total		930.30						10.6%

Pre Runoff Analysis
Time of Concentration

Project Information

Project Name: Eagleview
 KHA Project #: 106288000
 Designed by: DCM Date: 3/17/2022
 Revised by: _____ Date: _____
 Checked by: BAH Date: 3/17/2022

Minimum Time of Concentration 5.0 minutes
 2YR-24HR Rainfall, P2 2.10

Pre-Development												
Drainage Area: OB1												
		Flow Length, L (ft)	Slope, s (ft/ft)	Manning's Roughness Coefficient, n	Two-year, 24-hr rainfall, P2 (in)	Paved or Unpaved	Cross Sectional Area of Flow, A (ft ²)	Wetted Perimeter, pw (ft)	Hydraulic radius, r (ft)	Average Velocity, V (ft/s)**	Travel Time, Tt (min)	Lag Time (min)
SHEET	T1 SHEET FLOW	300.00	0.073	0.15	2.10						17.35	
SHALLOW CONCENTRATED	T2 SHALLOW CONCENTRATED FLOW	1118.00	0.038			U				3.14	5.93	
Pre-Development Time of Concentration, OB1											23.28	13.97

Pre-Development												
Drainage Area: OB2												
		Flow Length, L (ft)	Slope, s (ft/ft)	Manning's Roughness Coefficient, n	Two-year, 24-hr rainfall, P2 (in)	Paved or Unpaved	Cross Sectional Area of Flow, A (ft ²)	Wetted Perimeter, pw (ft)	Hydraulic radius, r (ft)	Average Velocity, V (ft/s)**	Travel Time, Tt (min)	Lag Time (min)
SHEET	T1 SHEET FLOW	300.00	0.063	0.15	2.10						16.41	
SHALLOW CONCENTRATED	T2 SHALLOW CONCENTRATED FLOW	554.00	0.046			U				3.45	2.67	
CHANNEL	T2 CHANNEL FLOW	841.00	0.029	0.05		U	9.50	6.60	1.44	6.45	2.17	
Pre-Development Time of Concentration, OB2											23.26	13.95

Pre-Development												
Drainage Area: OB3												
		Flow Length, L (ft)	Slope, s (ft/ft)	Manning's Roughness Coefficient, n	Two-year, 24-hr rainfall, P2 (in)	Paved or Unpaved	Cross Sectional Area of Flow, A (ft ²)	Wetted Perimeter, pw (ft)	Hydraulic radius, r (ft)	Average Velocity, V (ft/s)**	Travel Time, Tt (min)	Lag Time (min)
SHEET	T1 SHEET FLOW	300.00	0.074	0.15	2.10						17.26	
SHALLOW CONCENTRATED	T2 SHALLOW CONCENTRATED FLOW	2436.00	0.034			U				2.97	13.65	
Pre-Development Time of Concentration, OB3											30.91	18.55

Pre-Development												
Drainage Area: OB4												
		Flow Length, L (ft)	Slope, s (ft/ft)	Manning's Roughness Coefficient, n	Two-year, 24-hr rainfall, P2 (in)	Paved or Unpaved	Cross Sectional Area of Flow, A (ft ²)	Wetted Perimeter, pw (ft)	Hydraulic radius, r (ft)	Average Velocity, V (ft/s)**	Travel Time, Tt (min)	Lag Time (min)
SHEET	T1 SHEET FLOW	300.00	0.043	0.15	2.10						21.65	
SHALLOW CONCENTRATED	T2 SHALLOW CONCENTRATED FLOW	783.00	0.038			U				3.16	4.13	
CHANNEL	T2 CHANNEL FLOW	577.00	0.028	0.05		U	9.50	6.60	1.44	6.36	1.51	
Pre-Development Time of Concentration, OB4											27.29	16.38

Pre-Development												
Drainage Area: OB5												
		Flow Length, L (ft)	Slope, s (ft/ft)	Manning's Roughness Coefficient, n	Two-year, 24-hr rainfall, P2 (in)	Paved or Unpaved	Cross Sectional Area of Flow, A (ft ²)	Wetted Perimeter, pw (ft)	Hydraulic radius, r (ft)	Average Velocity, V (ft/s)**	Travel Time, Tt (min)	Lag Time (min)
SHEET	T1 SHEET FLOW	300.00	0.037	0.40	2.10						49.91	
SHALLOW CONCENTRATED	T2 SHALLOW CONCENTRATED FLOW	3838.00	0.033			U				2.93	21.83	
CHANNEL	T2 CHANNEL FLOW	1407.00	0.024	0.04		U	9.50	6.60	1.44	7.36	3.19	
Pre-Development Time of Concentration, OB5											74.93	44.96

Pre-Development												
Drainage Area: OB6												
		Flow Length, L (ft)	Slope, s (ft/ft)	Manning's Roughness Coefficient, n	Two-year, 24-hr rainfall, P2 (in)	Paved or Unpaved	Cross Sectional Area of Flow, A (ft ²)	Wetted Perimeter, pw (ft)	Hydraulic radius, r (ft)	Average Velocity, V (ft/s)**	Travel Time, Tt (min)	Lag Time (min)
SHEET	T1 SHEET FLOW	300.00	0.064	0.40	2.10						40.09	
SHALLOW CONCENTRATED	T2 SHALLOW CONCENTRATED FLOW	2569.00	0.038			U				3.14	13.62	
CHANNEL	T2 CHANNEL FLOW	2110.00	0.027	0.04		U	9.50	6.60	1.44	7.78	4.55	
Pre-Development Time of Concentration, OB6											58.25	34.95

Pre-Development												
Drainage Area: OB7												
		Flow Length, L (ft)	Slope, s (ft/ft)	Manning's Roughness Coefficient, n	Two-year, 24-hr rainfall, P2 (in)	Paved or Unpaved	Cross Sectional Area of Flow, A (ft ²)	Wetted Perimeter, pw (ft)	Hydraulic radius, r (ft)	Average Velocity, V (ft/s)**	Travel Time, Tt (min)	Lag Time (min)
SHEET	T1 SHEET FLOW	300.00	0.028	0.40	2.10						55.80	
SHALLOW CONCENTRATED	T2 SHALLOW CONCENTRATED FLOW	2068.00	0.036			U				3.06	11.26	
CHANNEL	T2 CHANNEL FLOW	6198.00	0.03	0.04		U	12.00	22.00	0.55	4.09	25.29	
Pre-Development Time of Concentration, OB7											92.35	55.41

Pre-Development												
Drainage Area: OB8												
		Flow Length, L (ft)	Slope, s (ft/ft)	Manning's Roughness Coefficient, n	Two-year, 24-hr rainfall, P2 (in)	Paved or Unpaved	Cross Sectional Area of Flow, A (ft ²)	Wetted Perimeter, pw (ft)	Hydraulic radius, r (ft)	Average Velocity, V (ft/s)**	Travel Time, Tt (min)	Lag Time (min)
SHEET	T1 SHEET FLOW	300.00	0.029	0.15	2.10						25.10	
SHALLOW CONCENTRATED	T2 SHALLOW CONCENTRATED FLOW	1117.00	0.043			U				3.34	5.57	
CHANNEL	T2 CHANNEL FLOW	762.00	0.033	0.03		U	9.50	6.60	1.44	13.43	1.11	
Pre-Development Time of Concentration, OB8											31.78	19.07

Pre-Development												
Drainage Area: B1												
		Flow Length, L (ft)	Slope, s (ft/ft)	Manning's Roughness Coefficient, n	Two-year, 24-hr rainfall, P2 (in)	Paved or Unpaved	Cross Sectional Area of Flow, A (ft ²)	Wetted Perimeter, pw (ft)	Hydraulic radius, r (ft)	Average Velocity, V (ft/s)**	Travel Time, Tt (min)	Lag Time (min)
SHEET	T1 SHEET FLOW	300.00	0.027	0.15	2.10						25.83	
SHALLOW CONCENTRATED	T2 SHALLOW CONCENTRATED FLOW	368.00	0.033			U				2.91	2.11	
CHANNEL	T2 CHANNEL FLOW	210.00	0.034	0.03		U	9.50	6.60	1.44	11.68	0.30	
Pre-Development Time of Concentration, B1											28.24	16.94

Pre-Development												
Drainage Area: B2												
		Flow Length, L (ft)	Slope, s (ft/ft)	Manning's Roughness Coefficient, n	Two-year, 24-hr rainfall, P2 (in)	Paved or Unpaved	Cross Sectional Area of Flow, A (ft ²)	Wetted Perimeter, pw (ft)	Hydraulic radius, r (ft)	Average Velocity, V (ft/s)**	Travel Time, Tt (min)	Lag Time (min)
SHEET	T1 SHEET FLOW	300.00	0.022	0.15	2.10						28.04	
SHALLOW CONCENTRATED	T2 SHALLOW CONCENTRATED FLOW	737.00	0.025			U				2.55	4.82	
CHANNEL	T2 CHANNEL FLOW	1086.00	0.02	0.03		U	9.50	6.60	1.44	9.18	1.07	
Pre-Development Time of Concentration, B2											34.83	20.90

Pre-Development												
Drainage Area: B3												
		Flow Length, L (ft)	Slope, s (ft/ft)	Manning's Roughness Coefficient, n	Two-year, 24-hr rainfall, P2 (in)	Paved or Unpaved	Cross Sectional Area of Flow, A (ft ²)	Wetted Perimeter, pw (ft)	Hydraulic radius, r (ft)	Average Velocity, V (ft/s)**	Travel Time, Tt (min)	Lag Time (min)
CHANNEL	T1 CHANNEL FLOW	2965.00	0.02	0.03		U	14.00	34.50	0.41	3.58	13.60	
Pre-Development Time of Concentration, B3											13.88	8.33

Pre Runoff Analysis
Time of Concentration

Project Information

Project Name: Eagleview
 KHA Project #: 106288000
 Designed by: DCM Date: 3/17/2022
 Revised by: _____ Date: _____
 Checked by: BAH Date: 3/17/2022

Minimum Time of Concentration 5.0 minutes
 2YR-24HR Rainfall, P2 2.10

Pre-Development												
Drainage Area: B4												
		Row Length, L (ft)	Slope, s (ft/ft)	Manning's Roughness Coefficient, n	Two-year, 24-hr rainfall, P2 (in)	Faced or Unpaved	Cross Sectional Area of Flow, A (ft ²)	Wetted Perimeter, pw (ft)	Hydraulic radius, r (ft)	Average Velocity, V (ft/s)**	Travel Time, Tt (min)	Lag Time (min)
SHEET	T1 SHEET FLOW	300.00	0.020	0.15	2.10						29.13	
SHALLOW CONCENTRATED	T2 SHALLOW CONCENTRATED FLOW	181.00	0.044			U				3.37	0.90	
CHANNEL	T3 CHANNEL FLOW	1548.00	0.033	0.03		U	9.50	6.60	1.44	11.50	2.24	
Pre-Development Time of Concentration, B4											32.27	19.36

Pre Runoff Analysis
Composite CN

Project Name: Eagleview
 KHA Project #: 196288000
 Designed by: DCM Date: 3/17/2022
 Revised by: _____ Date: _____
 Revised by: _____ Date: _____
 Checked by: BAH Date: 3/17/2022

Pre-Development					
Drainage Area: OB1					
COVER DESCRIPTION	HYDROLOGIC CONDITION OR COVER TYPE	HYDROLOGIC SOIL GROUP	SCS CURVE NUMBER (CN)	AREA, A (ac.)	INITIAL ABSTRACTION, IA
RESIDENTIAL	RR-5 (Rangeland Landuse)	B	62.00	9.79	--
IMPERVIOUS	Paved; curbs and storm sewers (excluding right-of-way)	B	98.00	0.38	--
IMPERVIOUS	Gravel (including right of way)	B	85.00	0.20	--
CUTSOM					
COMPOSITE SCS CURVE NUMBER - OB1			63.76	10.37	0.569

Pre-Development					
Drainage Area: OB2					
COVER DESCRIPTION	HYDROLOGIC CONDITION OR COVER TYPE	HYDROLOGIC SOIL GROUP	SCS CURVE NUMBER (CN)	AREA, A (ac.)	INITIAL ABSTRACTION, IA
RESIDENTIAL	RR-5 (Rangeland Landuse)	B	62.00	25.92	--
IMPERVIOUS	Paved; curbs and storm sewers (excluding right-of-way)	B	98.00	0.86	--
IMPERVIOUS	Gravel (including right of way)	B	85.00	1.28	--
CUTSOM					
COMPOSITE SCS CURVE NUMBER - OB2			64.16	28.06	0.559

Pre-Development					
Drainage Area: OB3					
COVER DESCRIPTION	HYDROLOGIC CONDITION OR COVER TYPE	HYDROLOGIC SOIL GROUP	SCS CURVE NUMBER (CN)	AREA, A (ac.)	INITIAL ABSTRACTION, IA
RESIDENTIAL	RR-5 (Rangeland Landuse)	B	62.00	40.88	--
IMPERVIOUS	Paved; curbs and storm sewers (excluding right-of-way)	B	98.00	0.89	--
IMPERVIOUS	Gravel (including right of way)	B	85.00	1.67	--
CUTSOM					
COMPOSITE SCS CURVE NUMBER - OB3			63.62	43.44	0.572

Pre-Development					
Drainage Area: OB4					
COVER DESCRIPTION	HYDROLOGIC CONDITION OR COVER TYPE	HYDROLOGIC SOIL GROUP	SCS CURVE NUMBER (CN)	AREA, A (ac.)	INITIAL ABSTRACTION, IA
RESIDENTIAL	RR-5 (Rangeland Landuse)	B	62.00	9.55	0.00
IMPERVIOUS	Paved; curbs and storm sewers (excluding right-of-way)	B	98.00	0.52	0.55
IMPERVIOUS	Gravel (including right of way)	B	85.00	0.43	9.95
CUTSOM					
COMPOSITE SCS CURVE NUMBER - OB4			64.71	10.50	0.545

Pre-Development					
Drainage Area: OB5					
COVER DESCRIPTION	HYDROLOGIC CONDITION OR COVER TYPE	HYDROLOGIC SOIL GROUP	SCS CURVE NUMBER (CN)	AREA, A (ac.)	INITIAL ABSTRACTION, IA
RESIDENTIAL	RR-5 (Rangeland Landuse)	B	62.00	28.58	--
RESIDENTIAL	RR-5 (Woods Landuse)	B	58.00	109.48	--
IMPERVIOUS	Paved; curbs and storm sewers (excluding right-of-way)	B	98.00	1.12	--
IMPERVIOUS	Gravel (including right of way)	B	85.00	4.64	--
CUTSOM					
COMPOSITE SCS CURVE NUMBER - OB5			59.98	143.82	0.667

Pre-Development					
Drainage Area: OB6					
COVER DESCRIPTION	HYDROLOGIC CONDITION OR COVER TYPE	HYDROLOGIC SOIL GROUP	SCS CURVE NUMBER (CN)	AREA, A (ac.)	INITIAL ABSTRACTION, IA
RESIDENTIAL	RR-5 (Rangeland Landuse)	B	62.00	60.64	--
RESIDENTIAL	RR-5 (Woods Landuse)	B	58.00	51.19	--
IMPERVIOUS	Paved; curbs and storm sewers (excluding right-of-way)	B	98.00	2.04	--
IMPERVIOUS	Gravel (including right of way)	B	85.00	4.53	--
CUTSOM					
COMPOSITE SCS CURVE NUMBER - OB6			61.77	118.40	0.619

Pre Runoff Analysis
Composite CN

Project Name: Eagleview
 KHA Project #: 196288000
 Designed by: DCM Date: 3/17/2022
 Revised by: _____ Date: _____
 Revised by: _____ Date: _____
 Checked by: BAH Date: 3/17/2022

Pre-Development					
Drainage Area: OB7					
COVER DESCRIPTION	HYDROLOGIC CONDITION OR COVER TYPE	HYDROLOGIC SOIL GROUP	SCS CURVE NUMBER (CN)	AREA, A (ac.)	INITIAL ABSTRACTION, IA
RESIDENTIAL	RR-5 (Rangeland Landuse)	B	62.00	122.08	--
RESIDENTIAL	RR-5 (Woods Landuse)	B	58.00	259.48	--
RESIDENTIAL	2.5 acre	B	64.00	16.02	--
IMPERVIOUS	Paved; curbs and storm sewers (excluding right-of-way)	B	98.00	5.46	--
IMPERVIOUS	Gravel (including right of way)	B	85.00	18.17	--
CUTSOM					
COMPOSITE SCS CURVE NUMBER - OB7			61.07	421.20	0.637

Pre-Development					
Drainage Area: OB8					
COVER DESCRIPTION	HYDROLOGIC CONDITION OR COVER TYPE	HYDROLOGIC SOIL GROUP	SCS CURVE NUMBER (CN)	AREA, A (ac.)	INITIAL ABSTRACTION, IA
RESIDENTIAL	RR-5 (Rangeland Landuse)	B	62.00	8.71	--
RESIDENTIAL	2.5 acre	B	64.00	21.76	--
RESIDENTIAL	1/2 acre (25% Imp.)	B	71.00	0.79	--
IMPERVIOUS	Paved; curbs and storm sewers (excluding right-of-way)	B	98.00	0.24	--
IMPERVIOUS	Gravel (including right of way)	B	85.00	1.57	--
CUTSOM					
COMPOSITE SCS CURVE NUMBER - OB8			64.89	33.07	0.541

Pre-Development					
Drainage Area: B1					
COVER DESCRIPTION	HYDROLOGIC CONDITION OR COVER TYPE	HYDROLOGIC SOIL GROUP	SCS CURVE NUMBER (CN)	AREA, A (ac.)	INITIAL ABSTRACTION, IA
OPEN_SPACE	Good condition (grass cover >75%)	B	61.00	5.55	--
CUTSOM					
COMPOSITE SCS CURVE NUMBER - B1			61.00	5.55	0.639

Pre-Development					
Drainage Area: B2					
COVER DESCRIPTION	HYDROLOGIC CONDITION OR COVER TYPE	HYDROLOGIC SOIL GROUP	SCS CURVE NUMBER (CN)	AREA, A (ac.)	INITIAL ABSTRACTION, IA
OPEN_SPACE	Good condition (grass cover >75%)	A	39.00	0.61	--
OPEN_SPACE	Good condition (grass cover >75%)	B	61.00	40.82	--
CUTSOM					
COMPOSITE SCS CURVE NUMBER - B2			60.68	41.43	0.648

Pre-Development					
Drainage Area: B3					
COVER DESCRIPTION	HYDROLOGIC CONDITION OR COVER TYPE	HYDROLOGIC SOIL GROUP	SCS CURVE NUMBER (CN)	AREA, A (ac.)	INITIAL ABSTRACTION, IA
OPEN_SPACE	Good condition (grass cover >75%)	A	39.00	0.28	--
OPEN_SPACE	Good condition (grass cover >75%)	B	61.00	59.27	--
CUTSOM					
COMPOSITE SCS CURVE NUMBER - B3			60.90	59.54	0.642

Pre-Development					
Drainage Area: B4					
COVER DESCRIPTION	HYDROLOGIC CONDITION OR COVER TYPE	HYDROLOGIC SOIL GROUP	SCS CURVE NUMBER (CN)	AREA, A (ac.)	INITIAL ABSTRACTION, IA
OPEN_SPACE	Good condition (grass cover >75%)	B	61.00	14.68	--
CUTSOM					
COMPOSITE SCS CURVE NUMBER - B4			61.00	14.68	0.639

Project: Eagleview_Subdivision Simulation Run: EV 5-yr Ex. Type II

Start of Run: 01Oct2021, 00:00 Basin Model: Eagleview_Existing
 End of Run: 02Oct2021, 00:00 Meteorologic Model: 5-yr Type II
 Compute Time: 11Mar2022, 14:50:40 Control Specifications: 24-hr Storm

Hydrologic Element	Drainage Area (MI ²)	Peak Discharge (CFS)	Time of Peak	Volume (AC-FT)
B1	0.0091800	3.0	01Oct2021, 12:11	0.3
B2	0.0647266	15.4	01Oct2021, 12:16	1.8
B3	0.0930359	36.4	01Oct2021, 12:04	2.7
B4	0.0229422	5.8	01Oct2021, 12:14	0.7
J1	0.0253831	10.1	01Oct2021, 12:11	1.0
J2	0.1928516	67.5	01Oct2021, 12:15	7.3
J3	1.2354980	183.1	01Oct2021, 12:47	42.8
J4	1.0678500	169.2	01Oct2021, 12:46	37.4
J-OB6	0.8431300	132.4	01Oct2021, 12:45	30.1
OB1	0.0162031	7.1	01Oct2021, 12:08	0.7
OB2	0.0438438	20.6	01Oct2021, 12:08	1.9
OB3	0.0678750	25.3	01Oct2021, 12:13	2.8
OB4	0.0164062	7.5	01Oct2021, 12:10	0.8
OB5	0.2247200	36.8	01Oct2021, 12:42	7.4
OB6	0.1850100	40.8	01Oct2021, 12:30	6.8
OB7	0.6581200	101.4	01Oct2021, 12:53	23.3
OB8	0.0516699	19.5	01Oct2021, 12:13	2.1
R-B1	0.0162031	7.1	01Oct2021, 12:11	0.7
R-OB4	0.1281250	52.2	01Oct2021, 12:14	5.4
R-OB5	0.2247200	36.8	01Oct2021, 12:45	7.4
R-OB6	0.8431300	132.4	01Oct2021, 12:46	30.0
R-OB7	1.0678500	169.2	01Oct2021, 12:49	37.3
R-OB8	0.0516699	19.4	01Oct2021, 12:17	2.1

Subbasin "B1" Results for Run "EV 5-yr Ex. Type II"

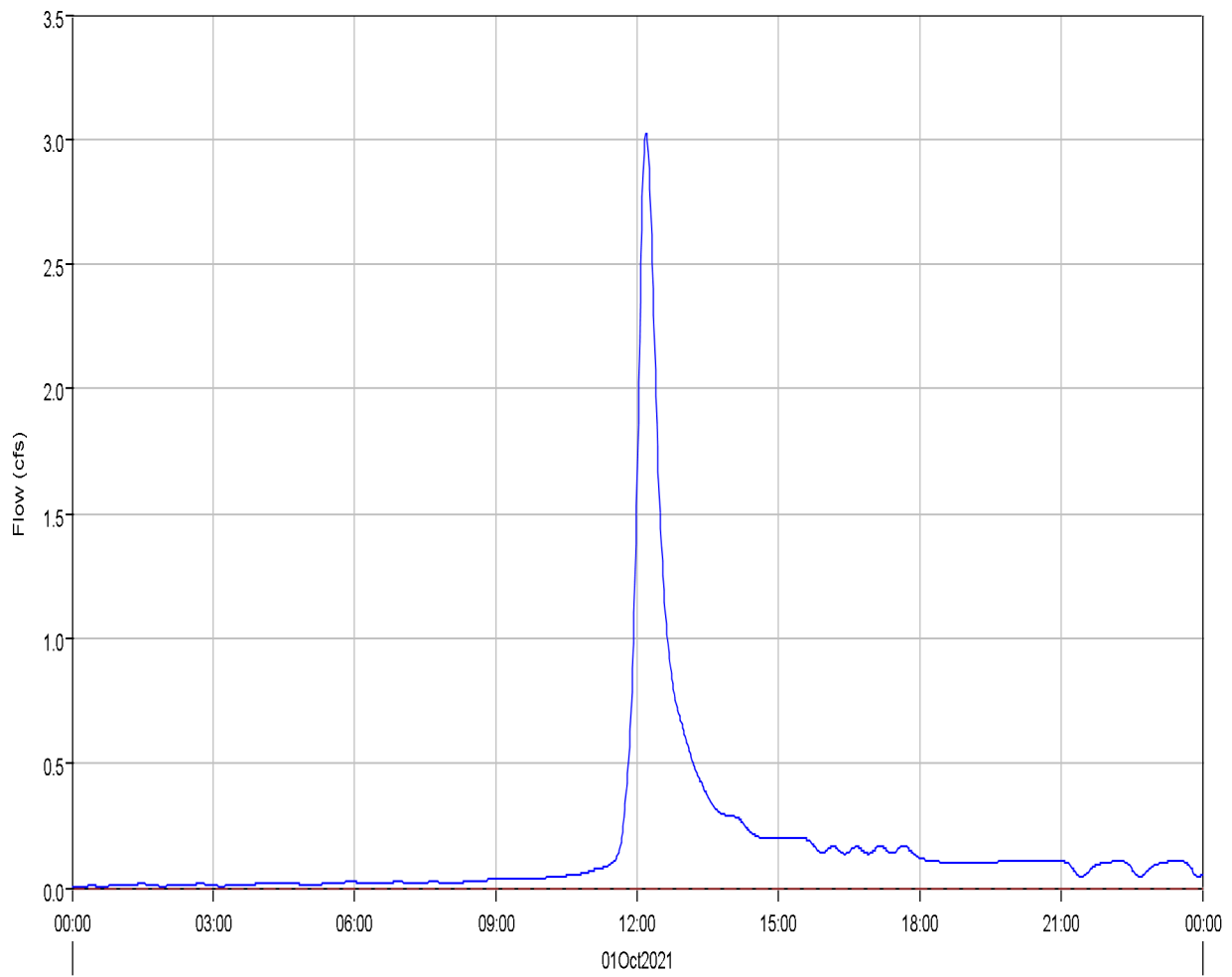
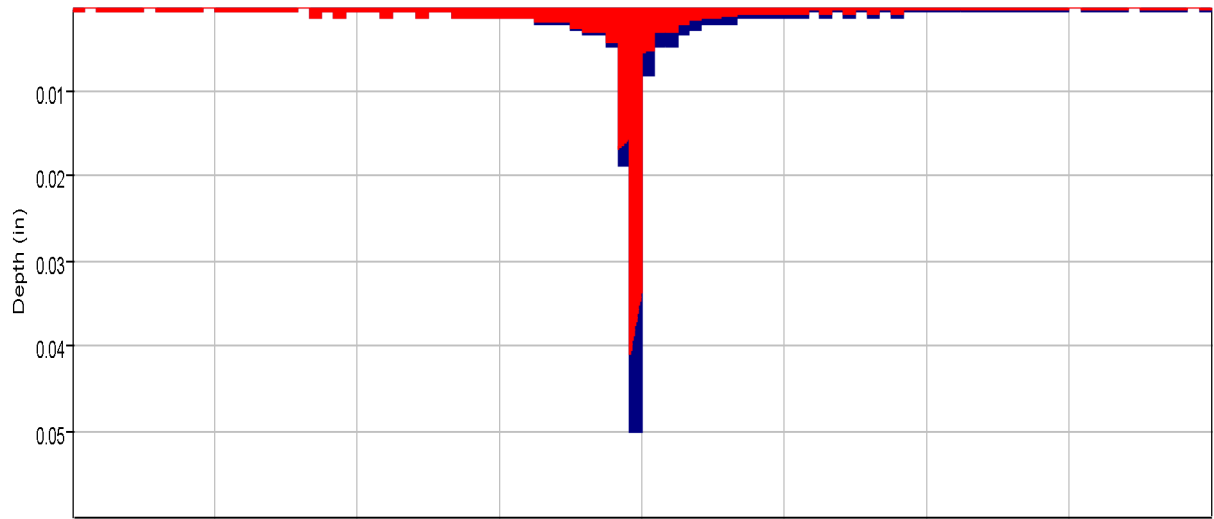

Run:EV 5-yr Ex. Type II Element:B1 Result:Precipitation Run:EV 5-yr Ex. Type II Element:B1 Result:Precipitation Loss Run:EV 5-yr Ex. Type II Element:B1 Result:Outflow
Run:EV 5-yr Ex. Type II Element:B1 Result:Baseflow

Project: Eagleview_Subdivision
Simulation Run: EV 5-yr Ex. Type II Subbasin: B1

Start of Run: 01Oct2021, 00:00 Basin Model: Eagleview_Existing
End of Run: 02Oct2021, 00:00 Meteorologic Model: 5-yr Type II
Compute Time: 11Mar2022, 14:50:40 Control Specifications: 24-hr Storm

Volume Units: AC-FT

Computed Results

Peak Discharge :	3.0 (CFS)	Date/Time of Peak Discharge :	01Oct2021, 12:11
Total Precipitation :	1.3 (AC-FT)	Total Direct Runoff :	0.3 (AC-FT)
Total Loss :	1.0 (AC-FT)	Total Baseflow :	0.0 (AC-FT)
Total Excess :	0.3 (AC-FT)	Discharge :	0.3 (AC-FT)

Subbasin "B2" Results for Run "EV 5-yr Ex. Type II"

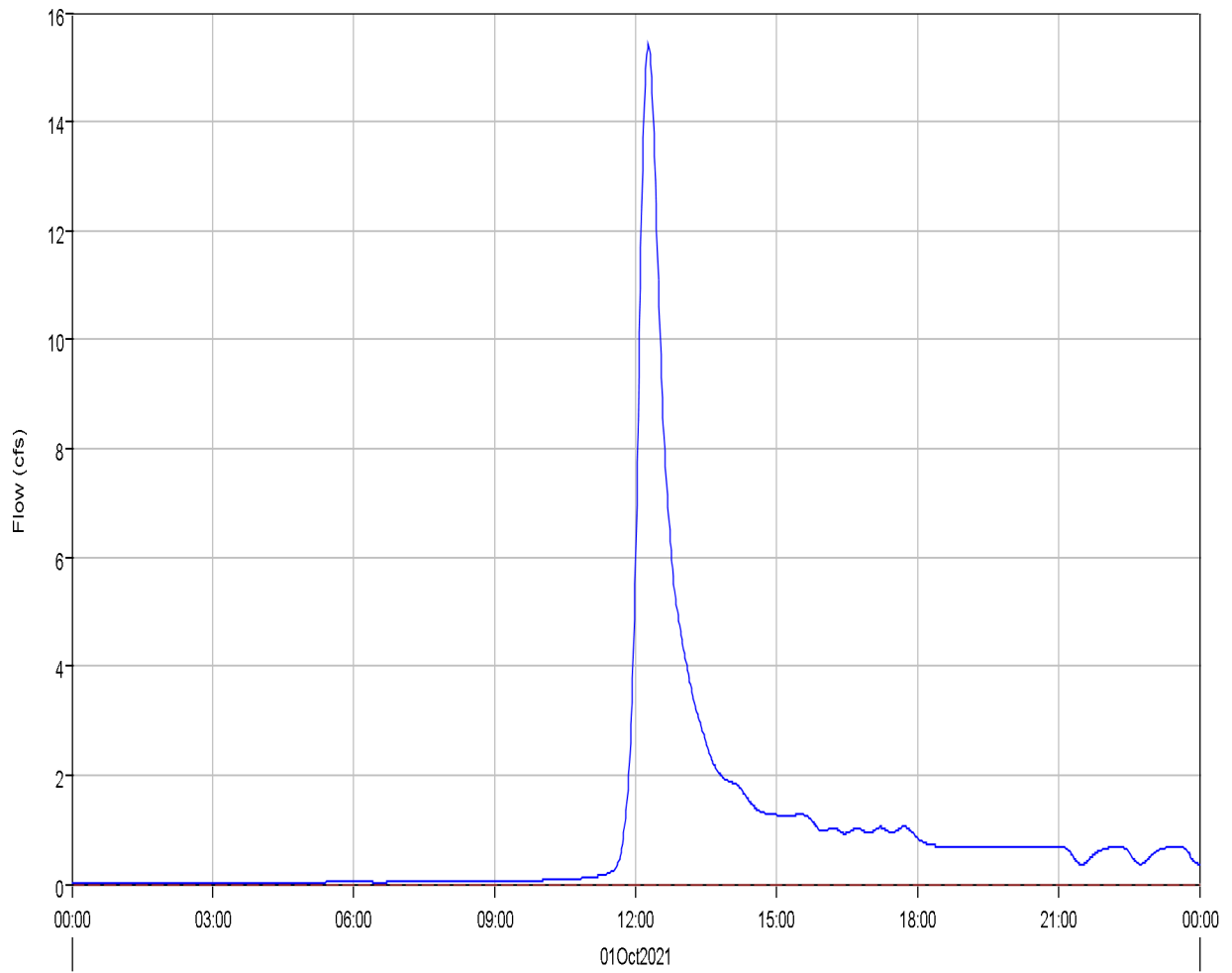
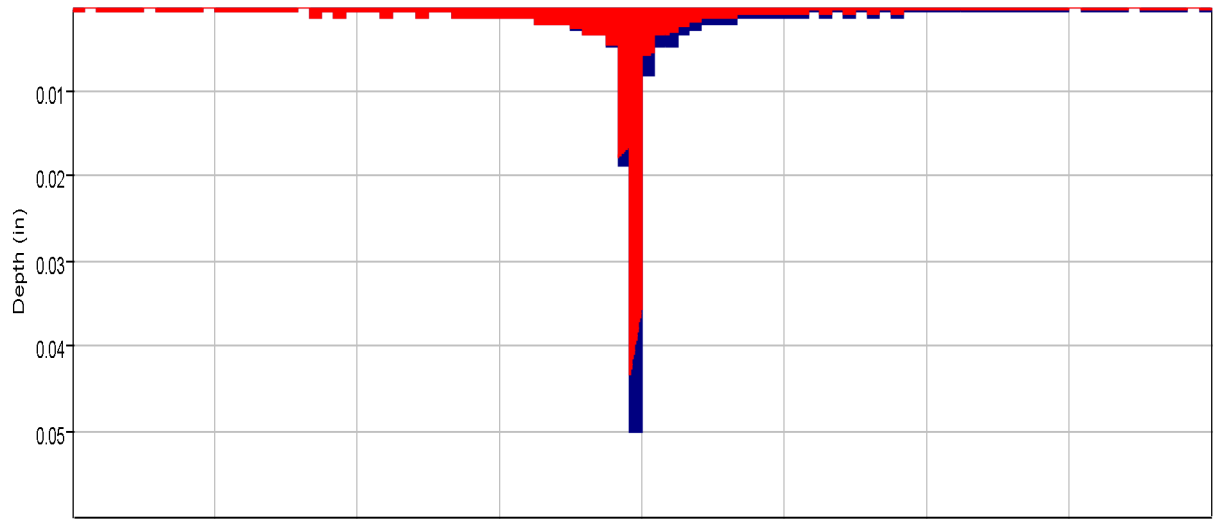

Run:EV 5-yr Ex. Type II Element:B2 Result:Precipitation Run:EV 5-yr Ex. Type II Element:B2 Result:Precipitation Loss Run:EV 5-yr Ex. Type II Element:B2 Result:Outflow
Run:EV 5-yr Ex. Type II Element:B2 Result:Baseflow

Project: Eagleview_Subdivision
Simulation Run: EV 5-yr Ex. Type II Subbasin: B2
Start of Run: 01Oct2021, 00:00 Basin Model: Eagleview_Existing
End of Run: 02Oct2021, 00:00 Meteorologic Model: 5-yr Type II
Compute Time: 11Mar2022, 14:50:40 Control Specifications: 24-hr Storm
Volume Units: AC-FT

Computed Results

Peak Discharge :	15.4 (CFS)	Date/Time of Peak Discharge :	01Oct2021, 12:16
Total Precipitation :	9.3 (AC-FT)	Total Direct Runoff :	1.8 (AC-FT)
Total Loss :	7.5 (AC-FT)	Total Baseflow :	0.0 (AC-FT)
Total Excess :	1.9 (AC-FT)	Discharge :	1.8 (AC-FT)

Subbasin "B3" Results for Run "EV 5-yr Ex. Type II"

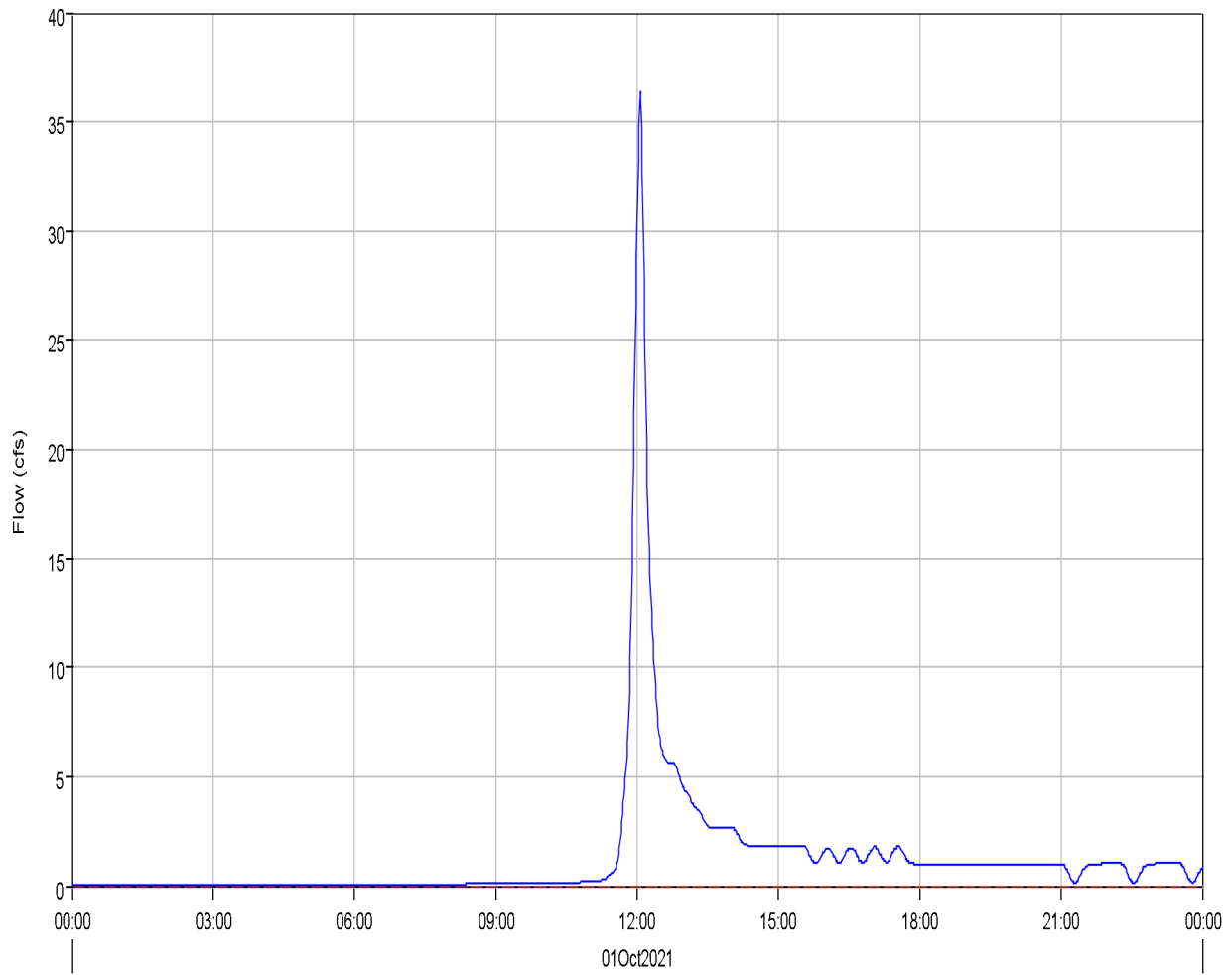
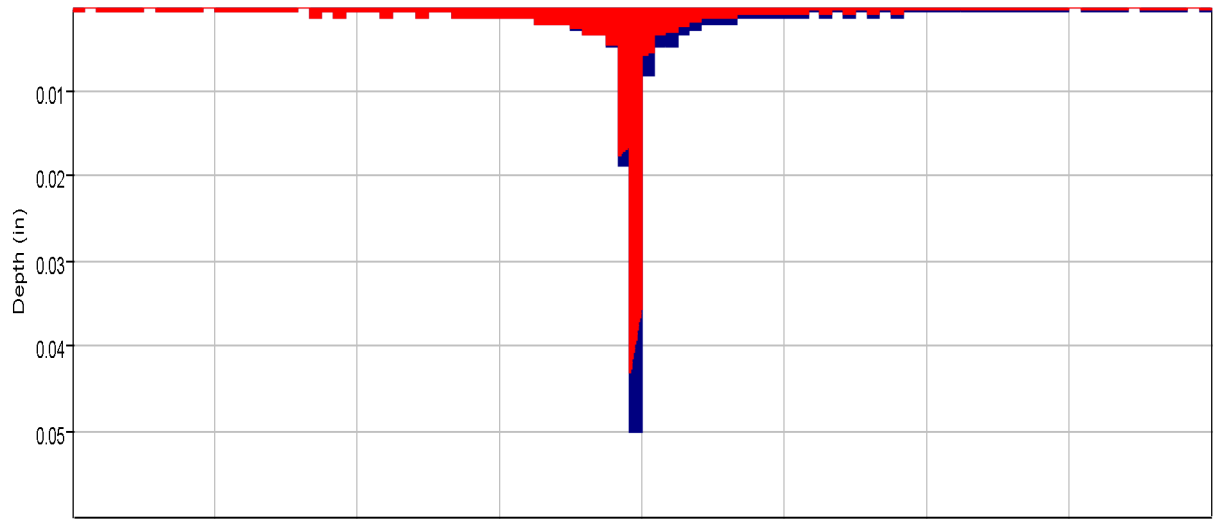

Run:EV 5-yr Ex. Type II Element:B3 Result:Precipitation Run:EV 5-yr Ex. Type II Element:B3 Result:Precipitation Loss Run:EV 5-yr Ex. Type II Element:B3 Result:Outflow
Run:EV 5-yr Ex. Type II Element:B3 Result:Baseflow

Project: Eagleview_Subdivision
Simulation Run: EV 5-yr Ex. Type II Subbasin: B3
Start of Run: 01Oct2021, 00:00 Basin Model: Eagleview_Existing
End of Run: 02Oct2021, 00:00 Meteorologic Model: 5-yr Type II
Compute Time: 11Mar2022, 14:50:40 Control Specifications: 24-hr Storm
Volume Units: AC-FT

Computed Results

Peak Discharge :	36.4 (CFS)	Date/Time of Peak Discharge :	01Oct2021, 12:04
Total Precipitation :	13.4 (AC-FT)	Total Direct Runoff :	2.7 (AC-FT)
Total Loss :	10.7 (AC-FT)	Total Baseflow :	0.0 (AC-FT)
Total Excess :	2.7 (AC-FT)	Discharge :	2.7 (AC-FT)

Subbasin "B4" Results for Run "EV 5-yr Ex. Type II"

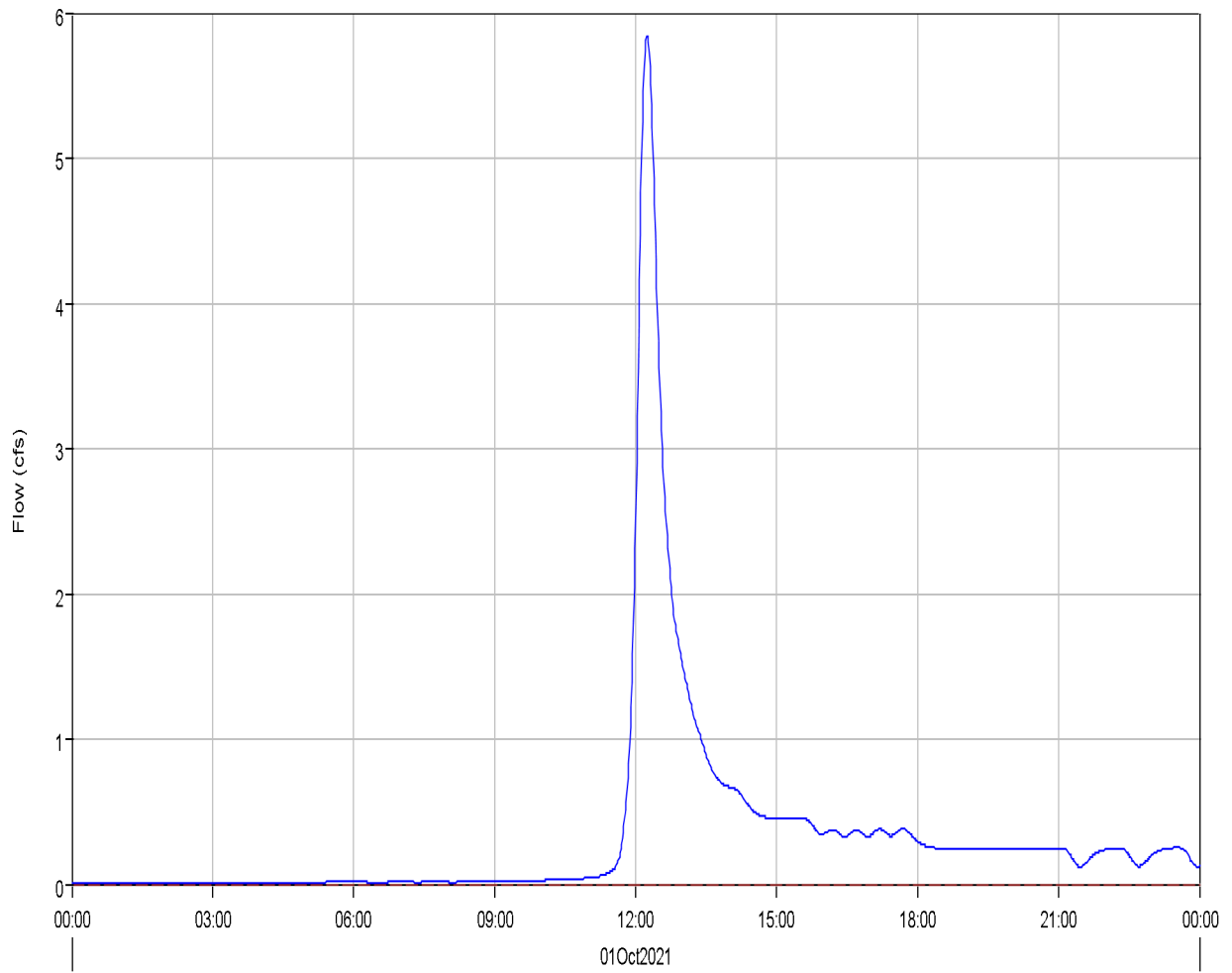
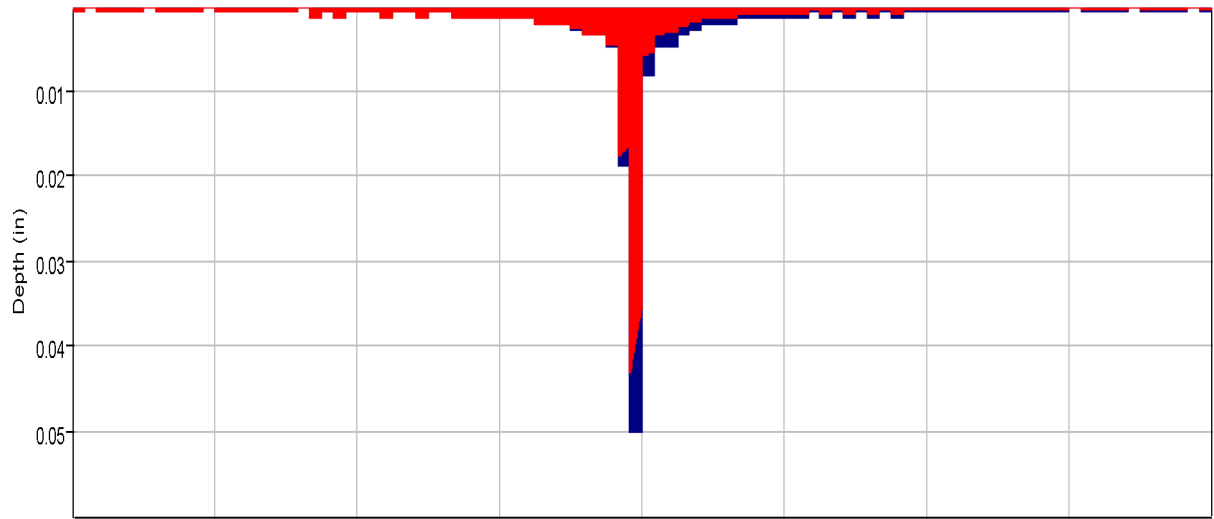

Run:EV 5-yr Ex. Type II Element:B4 Result:Precipitation Run:EV 5-yr Ex. Type II Element:B4 Result:Precipitation Loss Run:EV 5-yr Ex. Type II Element:B4 Result:Outflow
Run:EV 5-yr Ex. Type II Element:B4 Result:Baseflow

Project: Eagleview_Subdivision
Simulation Run: EV 5-yr Ex. Type II Subbasin: B4

Start of Run: 01Oct2021, 00:00 Basin Model: Eagleview_Existing
End of Run: 02Oct2021, 00:00 Meteorologic Model: 5-yr Type II
Compute Time: 11Mar2022, 14:50:40 Control Specifications: 24-hr Storm

Volume Units: AC-FT

Computed Results

Peak Discharge :	5.8 (CFS)	Date/Time of Peak Discharge :	01Oct2021, 12:14
Total Precipitation :	3.3 (AC-FT)	Total Direct Runoff :	0.7 (AC-FT)
Total Loss :	2.6 (AC-FT)	Total Baseflow :	0.0 (AC-FT)
Total Excess :	0.7 (AC-FT)	Discharge :	0.7 (AC-FT)

Junction 'J1' Results for Run 'EV 5-yr Ex. Type II'

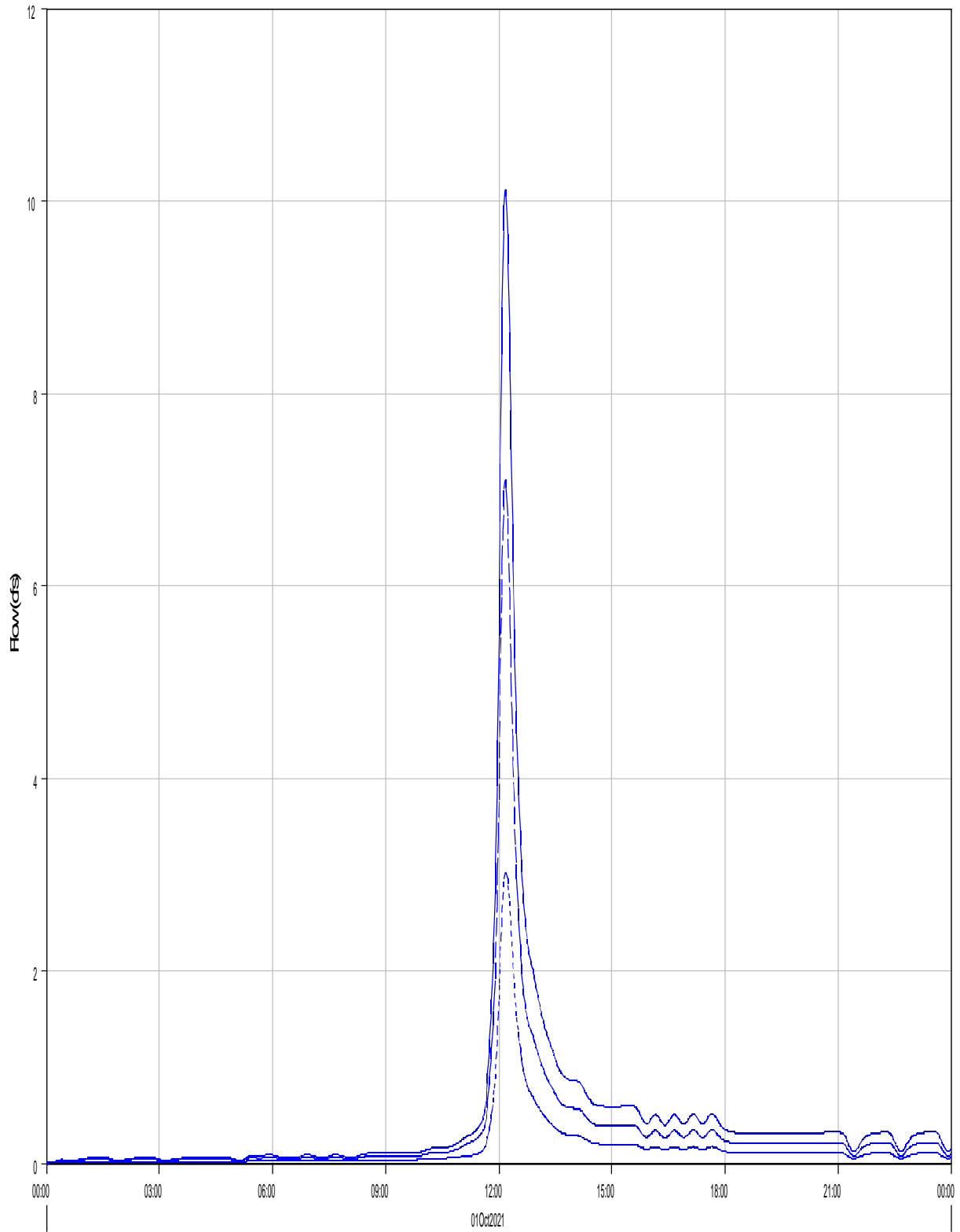

Run:EV 5-yr Ex. Type II Element:J1 Result:Outflow

Run:EV 5-yr Ex. Type II Element:R-B1 Result:Outflow

Run:EV 5-yr Ex. Type II Element:B1 Result:Outflow

Project: Eagleview_Subdivision
Simulation Run: EV 5-yr Ex. Type II Junction: J1
Start of Run: 01Oct2021, 00:00 Basin Model: Eagleview_Existing
End of Run: 02Oct2021, 00:00 Meteorologic Model: 5-yr Type II
Compute Time: 11Mar2022, 14:50:40 Control Specifications: 24-hr Storm

Volume Units: AC-FT

Computed Results

Peak Outflow : 10.1 (CFS) Date/Time of Peak Outflow : 01Oct2021, 12:11
Total Outflow : 1.0 (AC-FT)

Junction 'J2' Results for Run 'EV 5-yr Ex. Type II'

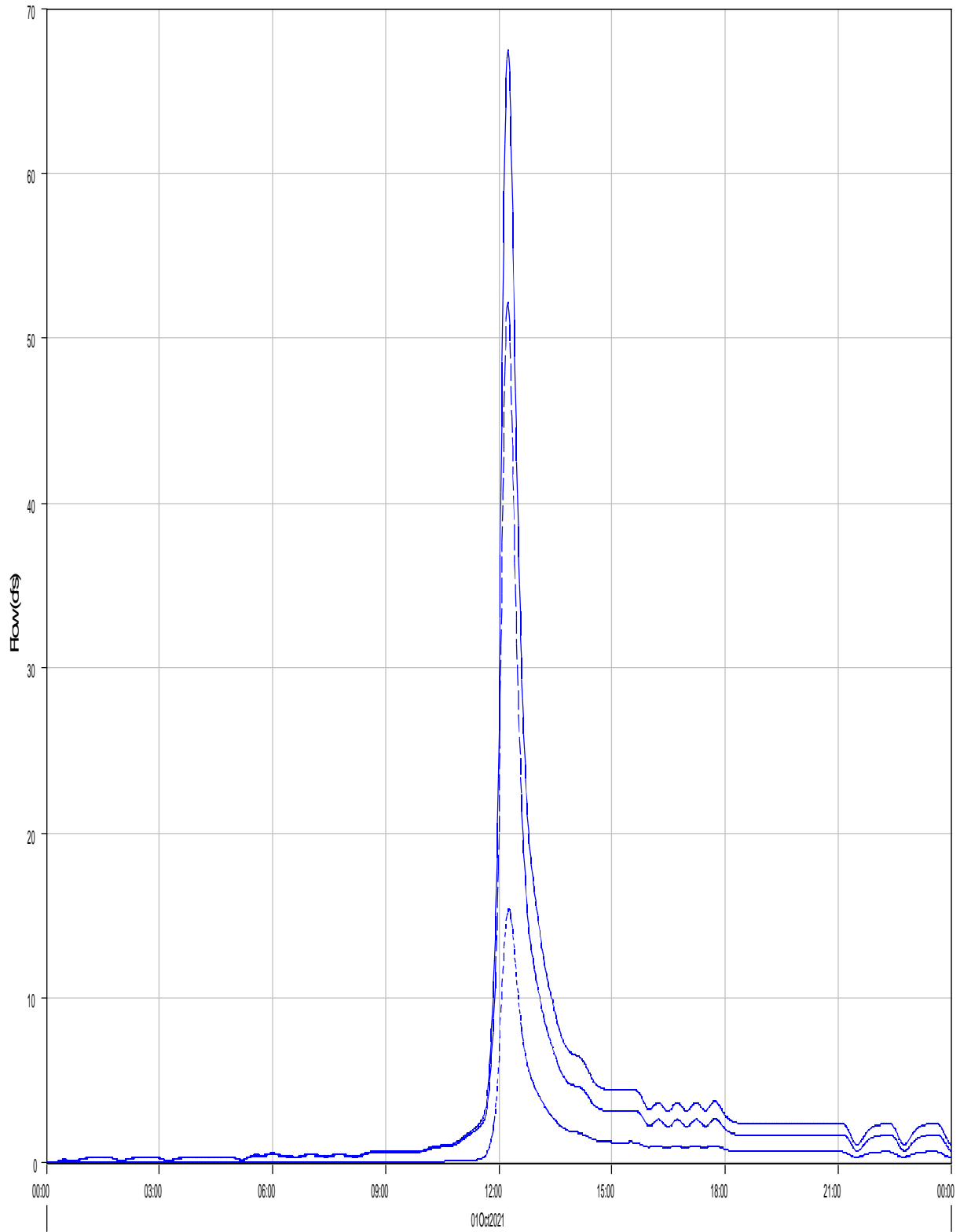

Run:EV 5-yr Ex. Type II Element J2 Result:Outflow

Run:EV 5-yr Ex. Type II Element R:OB4 Result:Outflow

Run:EV 5-yr Ex. Type II Element B2 Result:Outflow

Project: Eagleview_Subdivision
Simulation Run: EV 5-yr Ex. Type II Junction: J2
Start of Run: 01Oct2021, 00:00 Basin Model: Eagleview_Existing
End of Run: 02Oct2021, 00:00 Meteorologic Model: 5-yr Type II
Compute Time: 11Mar2022, 14:50:40 Control Specifications: 24-hr Storm

Volume Units: AC-FT

Computed Results

Peak Outflow : 67.5 (CFS) Date/Time of Peak Outflow : 01Oct2021, 12:15
Total Outflow : 7.3 (AC-FT)

Junction 'J3' Results for Run 'EV 5-yr Ex. Type II'

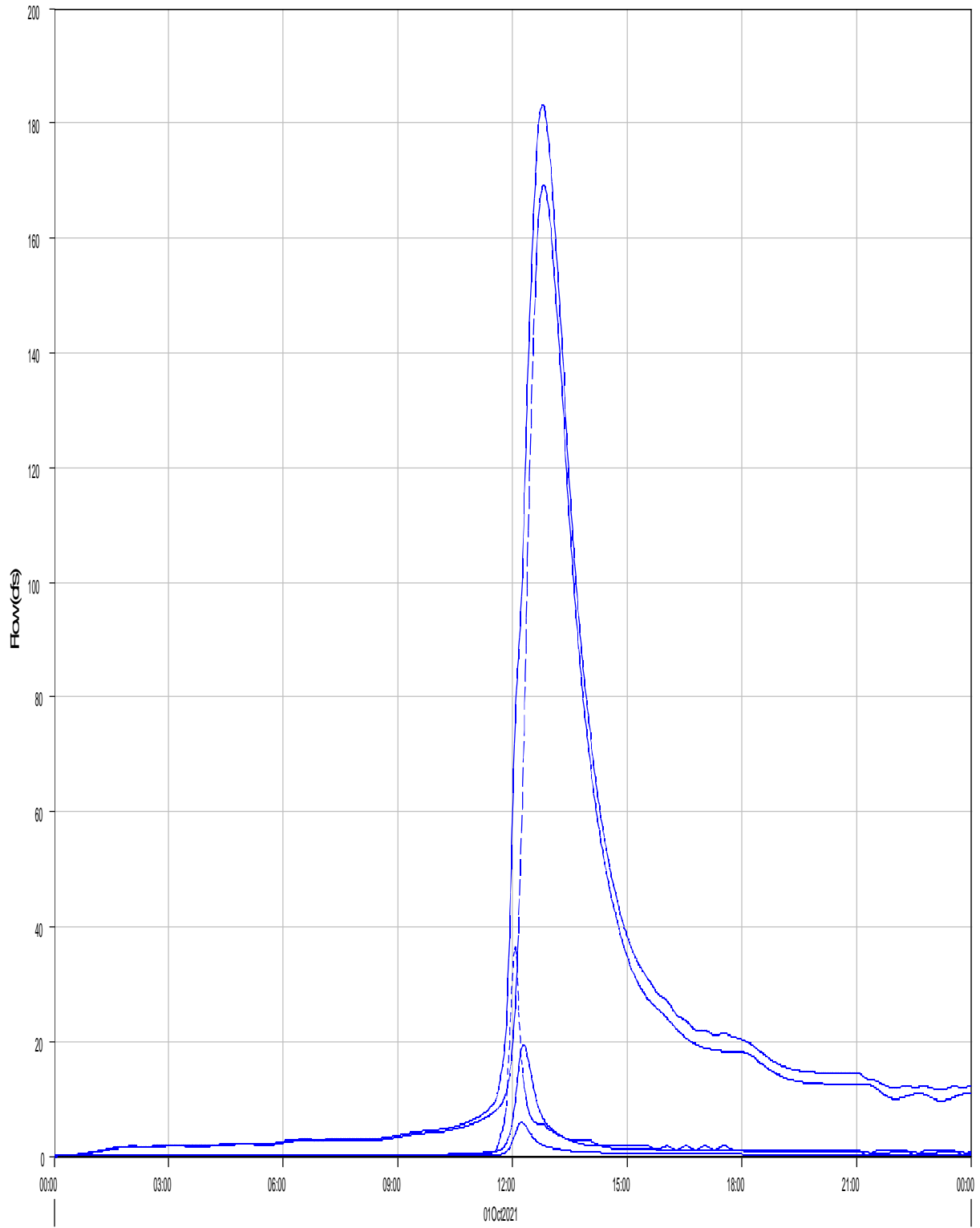

Run.EV 5-yr Ex. Type II Element.J3 Result.Outflow

Run.EV 5-yr Ex. Type II Element.R-OB7 Result.Outflow

Run.EV 5-yr Ex. Type II Element.B3 Result.Outflow

Run.EV 5-yr Ex. Type II Element.R-OB8 Result.Outflow

Run.EV 5-yr Ex. Type II Element.B4 Result.Outflow

Project: Eagleview_Subdivision
Simulation Run: EV 5-yr Ex. Type II Junction: J3
Start of Run: 01Oct2021, 00:00 Basin Model: Eagleview_Existing
End of Run: 02Oct2021, 00:00 Meteorologic Model: 5-yr Type II
Compute Time: 11Mar2022, 14:50:40 Control Specifications: 24-hr Storm

Volume Units: AC-FT

Computed Results

Peak Outflow : 183.1 (CFS) Date/Time of Peak Outflow : 01Oct2021, 12:47
Total Outflow : 42.8 (AC-FT)

Junction 'J4' Results for Run 'EV 5-yr Ex. Type II'

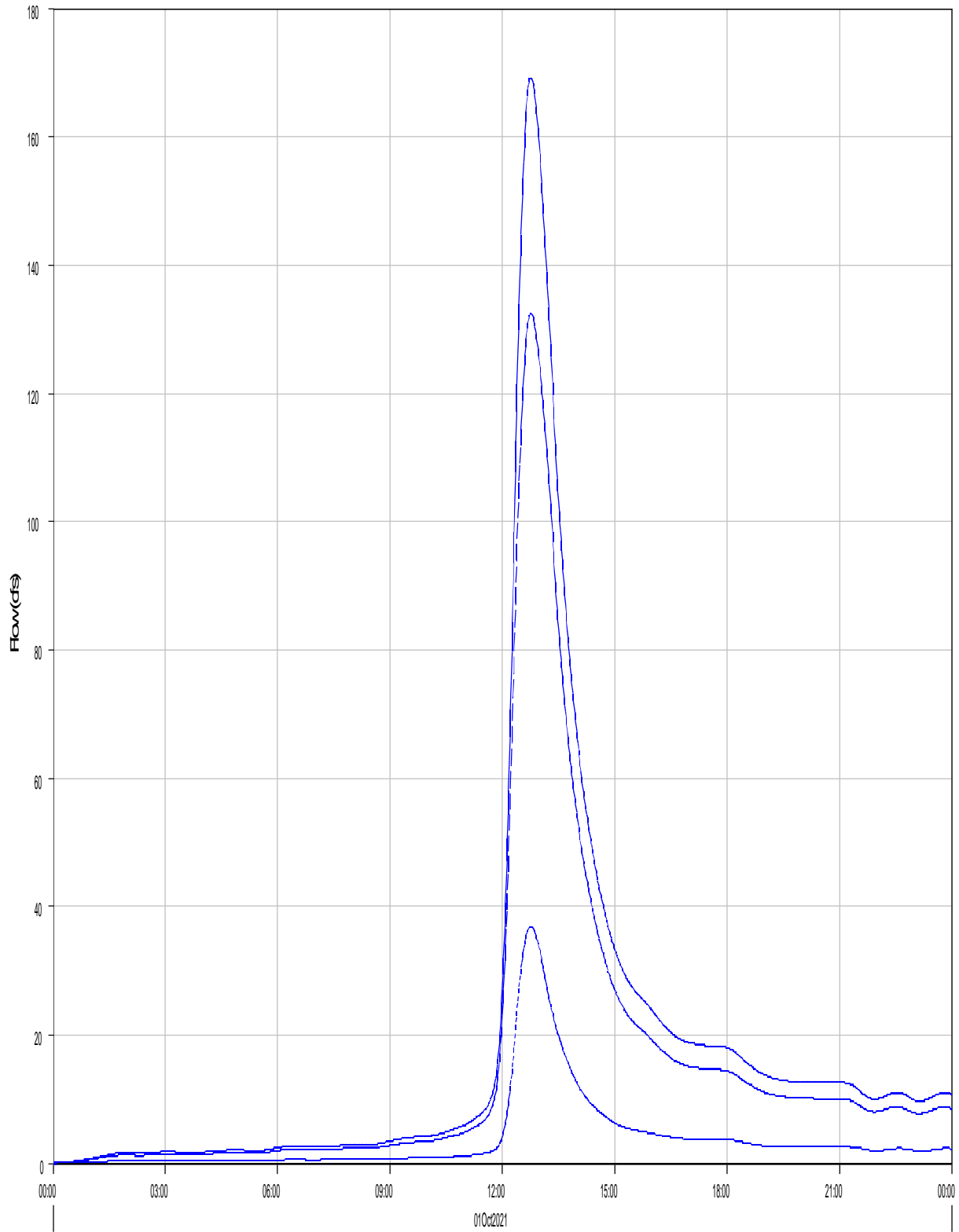

Run:EV 5-yr Ex. Type II Element:J4 Result:Outflow

Run:EV 5-yr Ex. Type II Element:R-OB6 Result:Outflow

Run:EV 5-yr Ex. Type II Element:R-OB5 Result:Outflow

Project: Eagleview_Subdivision
Simulation Run: EV 5-yr Ex. Type II Junction: J4
Start of Run: 01Oct2021, 00:00 Basin Model: Eagleview_Existing
End of Run: 02Oct2021, 00:00 Meteorologic Model: 5-yr Type II
Compute Time: 11Mar2022, 14:50:40 Control Specifications: 24-hr Storm

Volume Units: AC-FT

Computed Results

Peak Outflow : 169.2 (CFS) Date/Time of Peak Outflow : 01Oct2021, 12:46
Total Outflow : 37.4 (AC-FT)

Junction 'J-OB6' Results for Run 'EV 5-yr Ex. Type II'

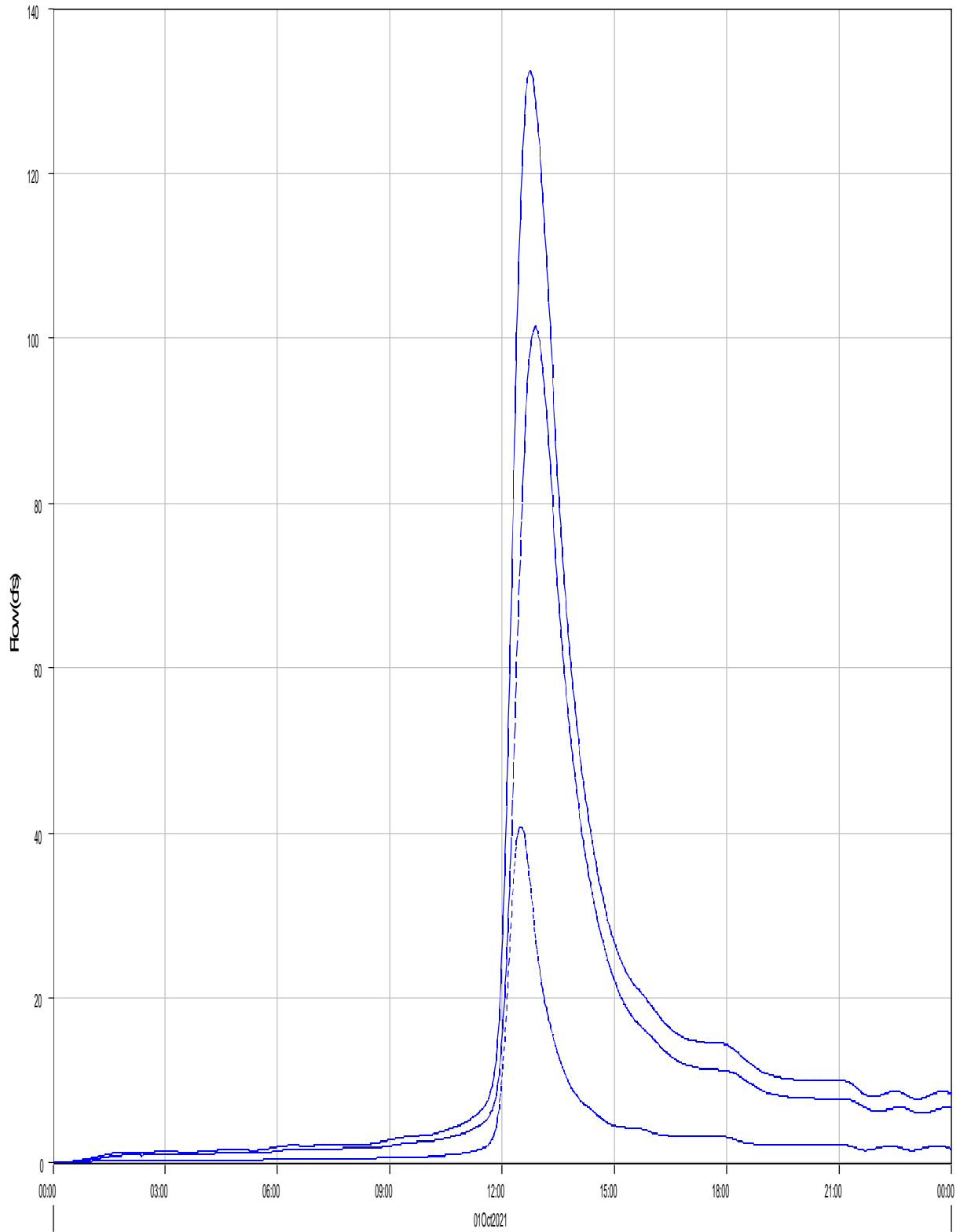

Run:EV 5-yr Ex. Type II Element:OB6 Result:Outflow

Run:EV 5-yr Ex. Type II Element:OB7 Result:Outflow

Run:EV 5-yr Ex. Type II Element:OB6 Result:Outflow

Project: Eagleview_Subdivision
Simulation Run: EV 5-yr Ex. Type II Junction: J-OB6

Start of Run: 01Oct2021, 00:00 Basin Model: Eagleview_Existing
End of Run: 02Oct2021, 00:00 Meteorologic Model: 5-yr Type II
Compute Time: 11Mar2022, 14:50:40 Control Specifications: 24-hr Storm

Volume Units: AC-FT

Computed Results

Peak Outflow : 132.4 (CFS) Date/Time of Peak Outflow : 01Oct2021, 12:45
Total Outflow : 30.1 (AC-FT)

Subbasin "OB1" Results for Run "EV 5-yr Ex. Type II"

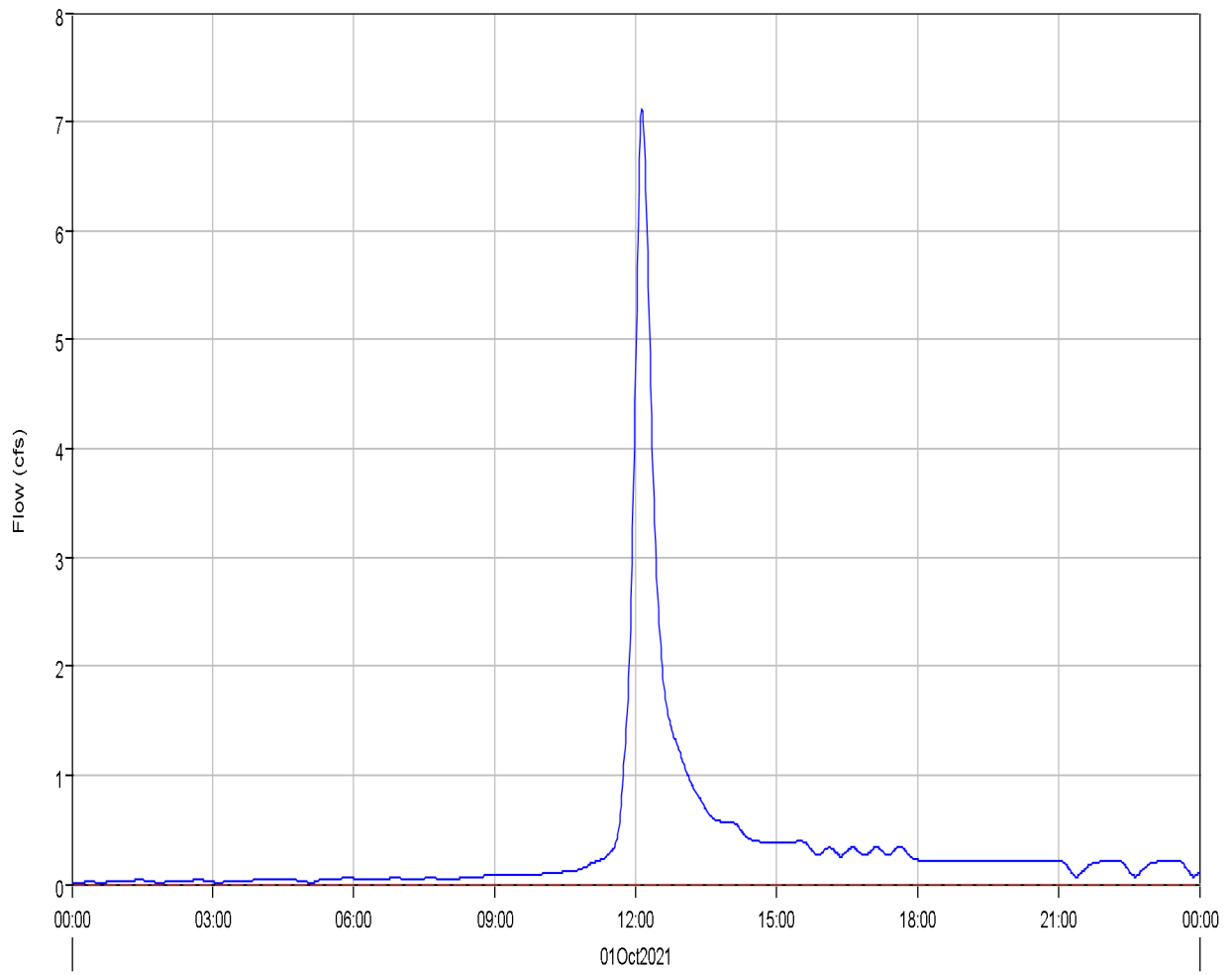
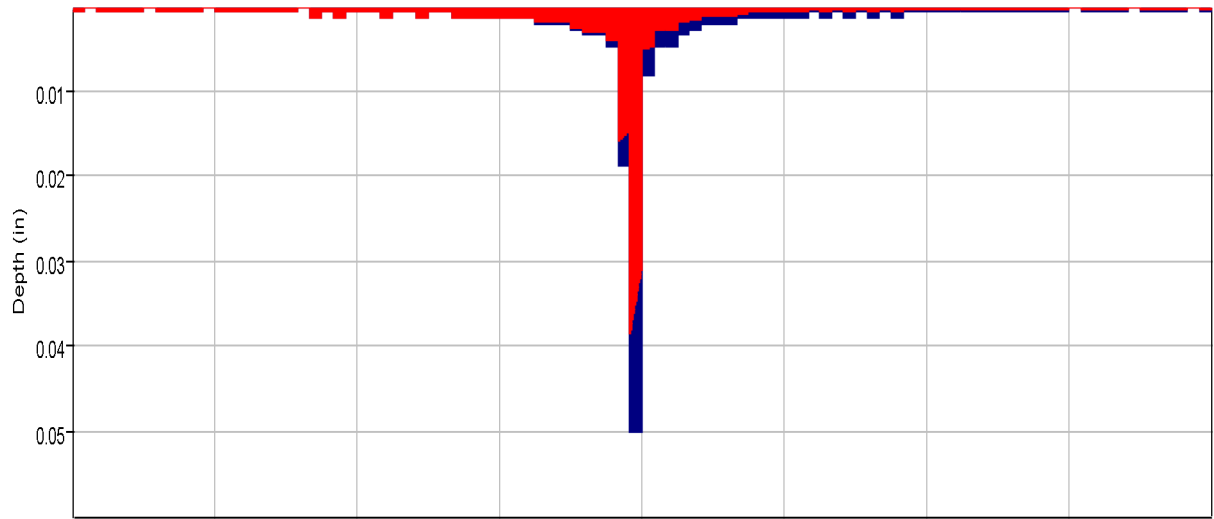

Run:EV 5-yr Ex. Type II Element:OB1 Result:Precipitation
Run:EV 5-yr Ex. Type II Element:OB1 Result:Outflow

Run:EV 5-yr Ex. Type II Element:OB1 Result:Precipitation Loss
Run:EV 5-yr Ex. Type II Element:OB1 Result:Baseflow

Project: Eagleview_Subdivision
Simulation Run: EV 5-yr Ex. Type II Subbasin: OB1

Start of Run: 01Oct2021, 00:00 Basin Model: Eagleview_Existing
End of Run: 02Oct2021, 00:00 Meteorologic Model: 5-yr Type II
Compute Time: 11Mar2022, 14:50:40 Control Specifications: 24-hr Storm

Volume Units: AC-FT

Computed Results

Peak Discharge :	7.1 (CFS)	Date/Time of Peak Discharge :	01Oct2021, 12:08
Total Precipitation :	2.3 (AC-FT)	Total Direct Runoff :	0.7 (AC-FT)
Total Loss :	1.7 (AC-FT)	Total Baseflow :	0.0 (AC-FT)
Total Excess :	0.7 (AC-FT)	Discharge :	0.7 (AC-FT)

Subbasin "OB2" Results for Run "EV 5-yr Ex. Type II"

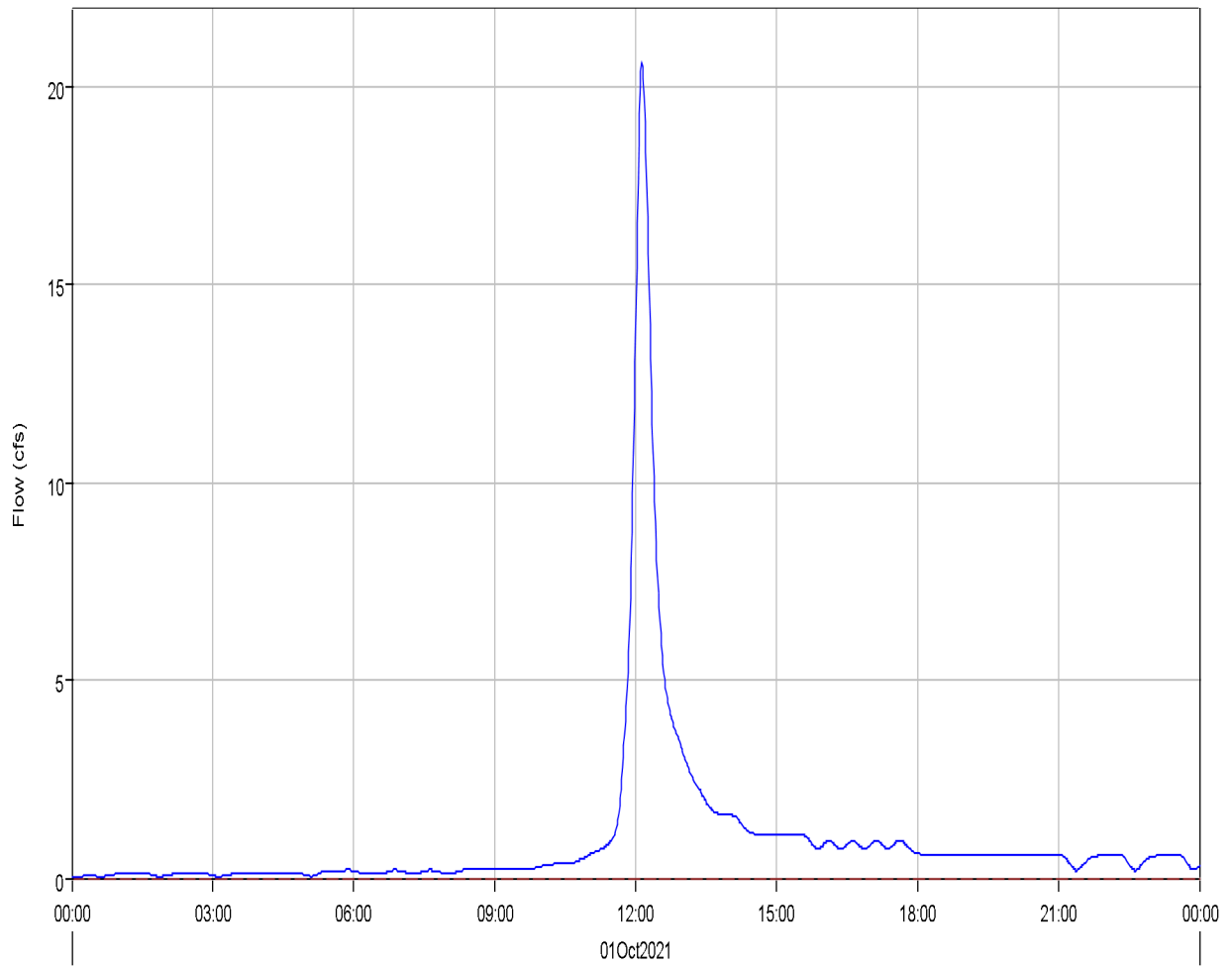
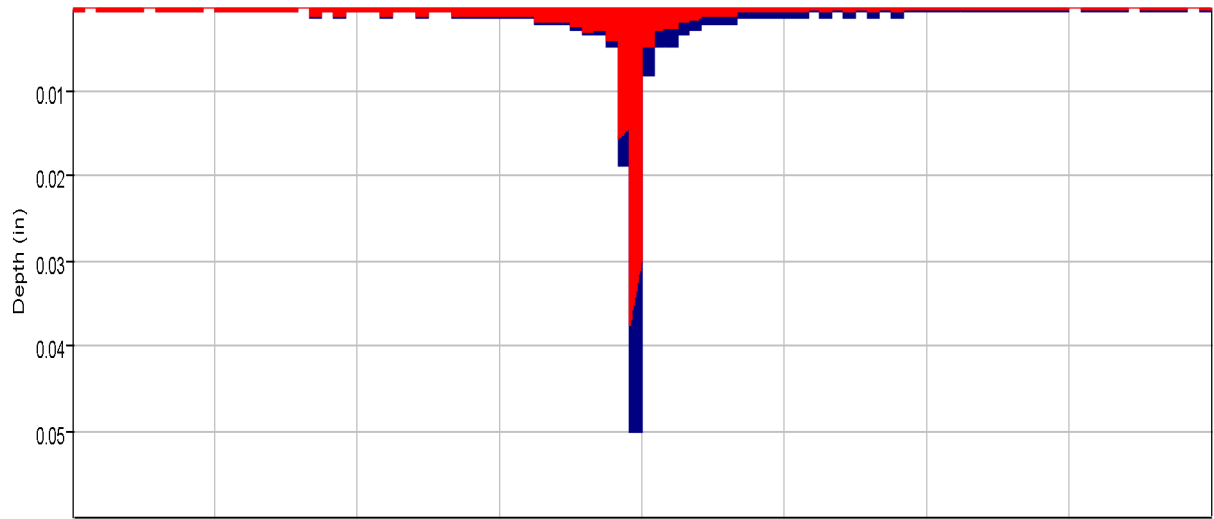

Run:EV 5-yr Ex. Type II Element:OB2 Result:Precipitation

Run:EV 5-yr Ex. Type II Element:OB2 Result:Outflow

Run:EV 5-yr Ex. Type II Element:OB2 Result:Precipitation Loss

Run:EV 5-yr Ex. Type II Element:OB2 Result:Baseflow

Project: Eagleview_Subdivision
Simulation Run: EV 5-yr Ex. Type II Subbasin: OB2

Start of Run: 01Oct2021, 00:00 Basin Model: Eagleview_Existing
End of Run: 02Oct2021, 00:00 Meteorologic Model: 5-yr Type II
Compute Time: 11Mar2022, 14:50:40 Control Specifications: 24-hr Storm

Volume Units: AC-FT

Computed Results

Peak Discharge :	20.6 (CFS)	Date/Time of Peak Discharge :	01Oct2021, 12:08
Total Precipitation :	6.3 (AC-FT)	Total Direct Runoff :	1.9 (AC-FT)
Total Loss :	4.4 (AC-FT)	Total Baseflow :	0.0 (AC-FT)
Total Excess :	1.9 (AC-FT)	Discharge :	1.9 (AC-FT)

Subbasin "OB3" Results for Run "EV 5-yr Ex. Type II"

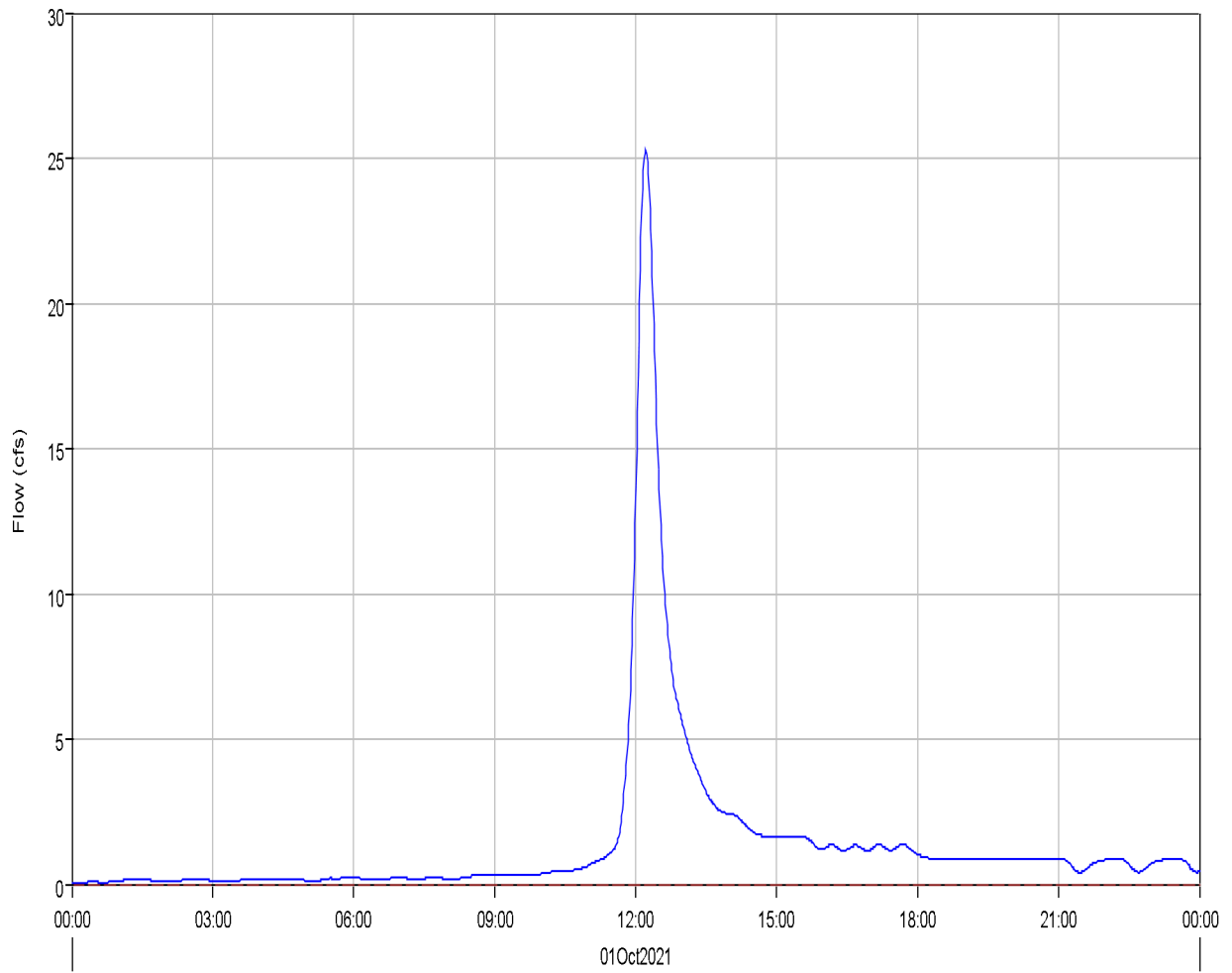
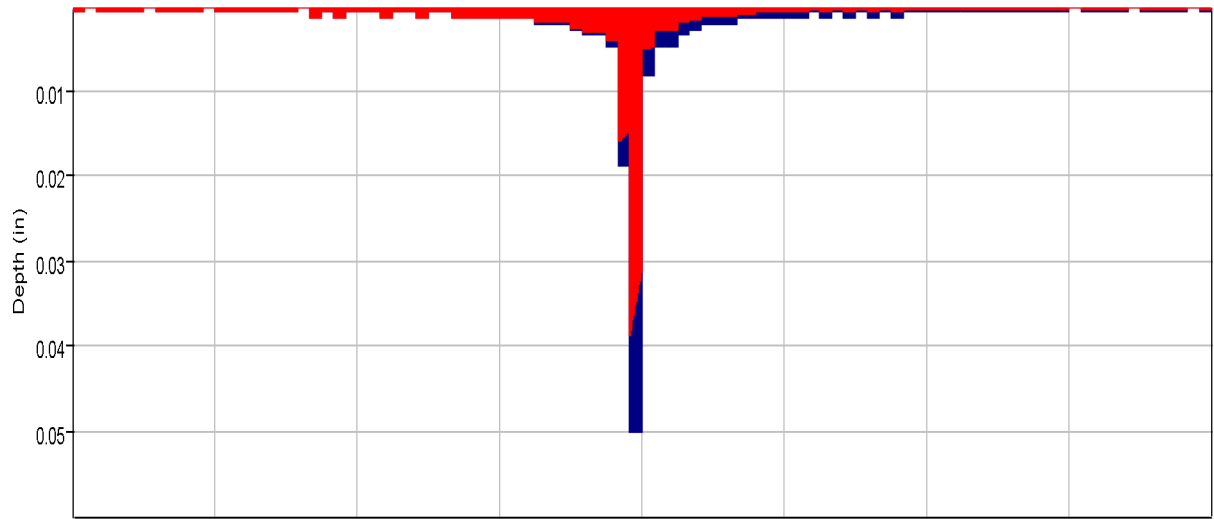

Run:EV 5-yr Ex. Type II Element:OB3 Result:Precipitation

Run:EV 5-yr Ex. Type II Element:OB3 Result:Precipitation Loss

Run:EV 5-yr Ex. Type II Element:OB3 Result:Outflow

Run:EV 5-yr Ex. Type II Element:OB3 Result:Baseflow

Project: Eagleview_Subdivision
Simulation Run: EV 5-yr Ex. Type II Subbasin: OB3

Start of Run: 01Oct2021, 00:00 Basin Model: Eagleview_Existing
End of Run: 02Oct2021, 00:00 Meteorologic Model: 5-yr Type II
Compute Time: 11Mar2022, 14:50:40 Control Specifications: 24-hr Storm

Volume Units: AC-FT

Computed Results

Peak Discharge :	25.3 (CFS)	Date/Time of Peak Discharge :	01Oct2021, 12:13
Total Precipitation :	9.8 (AC-FT)	Total Direct Runoff :	2.8 (AC-FT)
Total Loss :	7.0 (AC-FT)	Total Baseflow :	0.0 (AC-FT)
Total Excess :	2.8 (AC-FT)	Discharge :	2.8 (AC-FT)

Subbasin "OB4" Results for Run "EV 5-yr Ex. Type II"

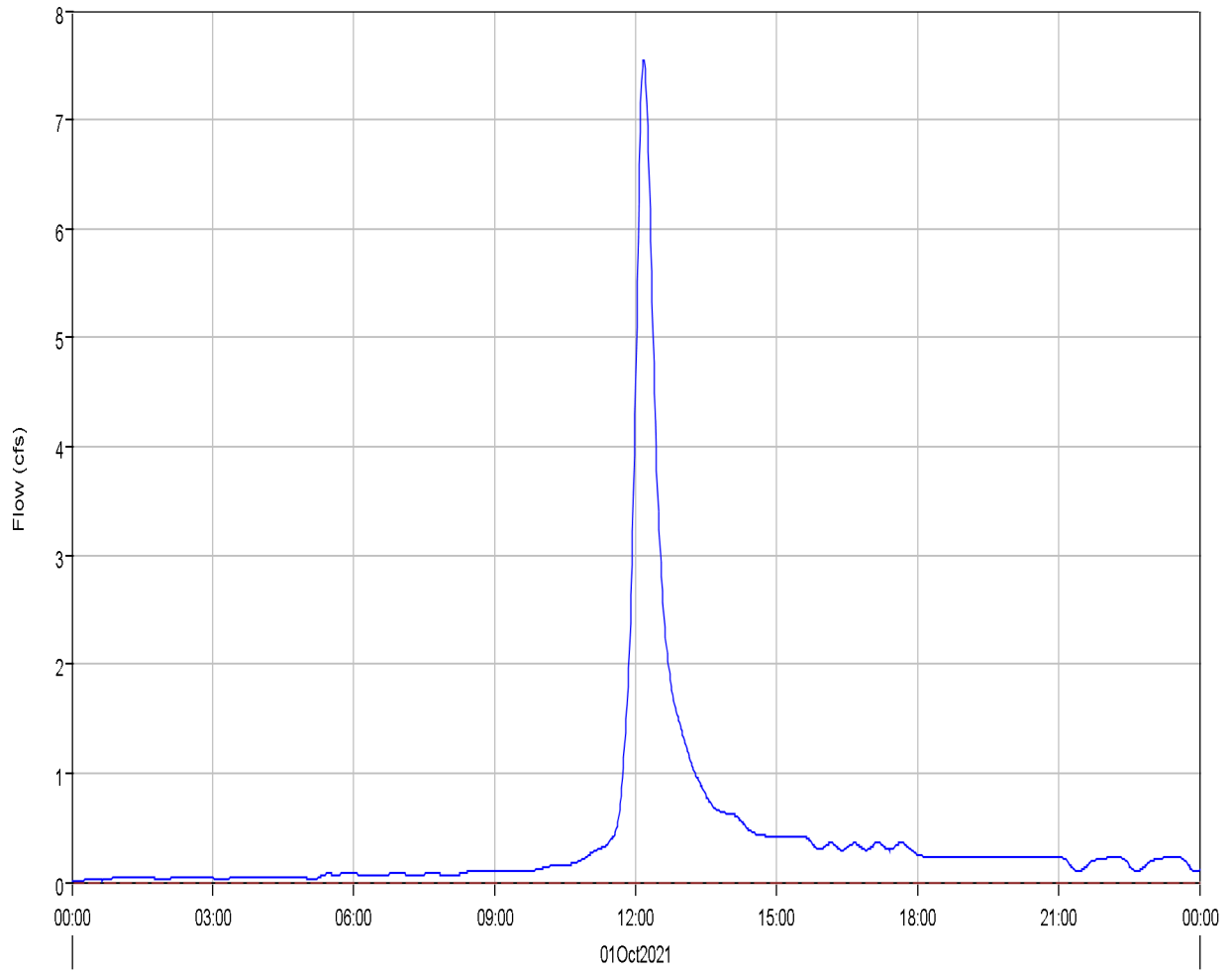
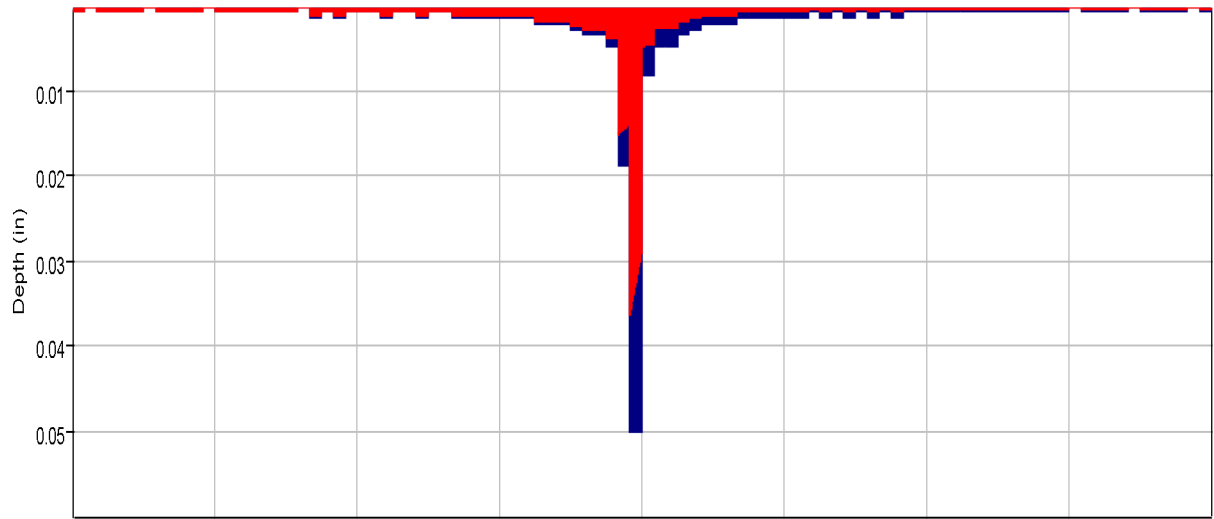

Run:EV 5-yr Ex. Type II Element:OB4 Result:Precipitation

Run:EV 5-yr Ex. Type II Element:OB4 Result:Precipitation Loss

Run:EV 5-yr Ex. Type II Element:OB4 Result:Outflow

Run:EV 5-yr Ex. Type II Element:OB4 Result:Baseflow

Project: Eagleview_Subdivision
Simulation Run: EV 5-yr Ex. Type II Subbasin: OB4

Start of Run: 01Oct2021, 00:00 Basin Model: Eagleview_Existing
End of Run: 02Oct2021, 00:00 Meteorologic Model: 5-yr Type II
Compute Time: 11Mar2022, 14:50:40 Control Specifications: 24-hr Storm

Volume Units: AC-FT

Computed Results

Peak Discharge :	7.5 (CFS)	Date/Time of Peak Discharge :	01Oct2021, 12:10
Total Precipitation :	2.4 (AC-FT)	Total Direct Runoff :	0.8 (AC-FT)
Total Loss :	1.6 (AC-FT)	Total Baseflow :	0.0 (AC-FT)
Total Excess :	0.8 (AC-FT)	Discharge :	0.8 (AC-FT)

Subbasin "OB5" Results for Run "EV 5-yr Ex. Type II"

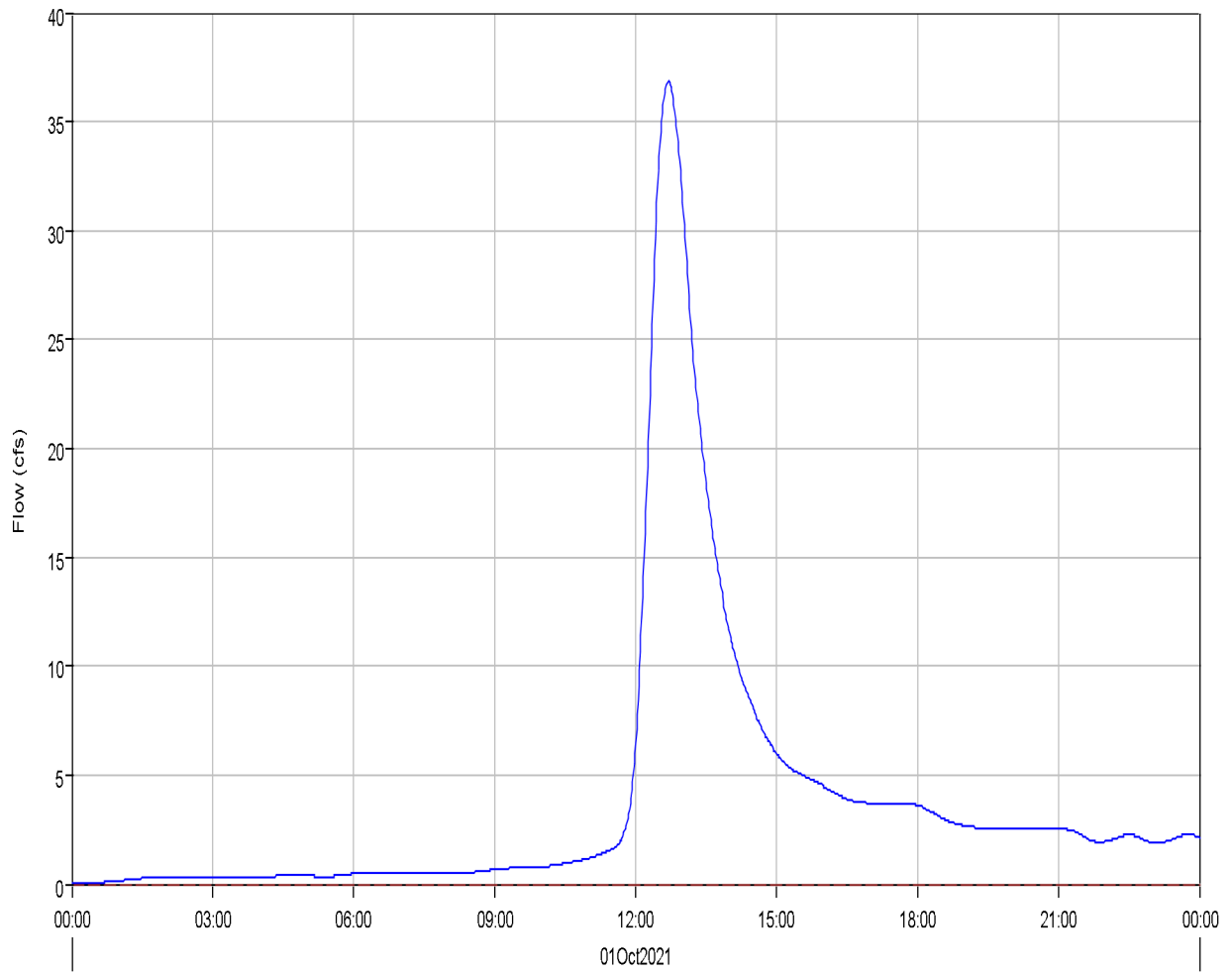
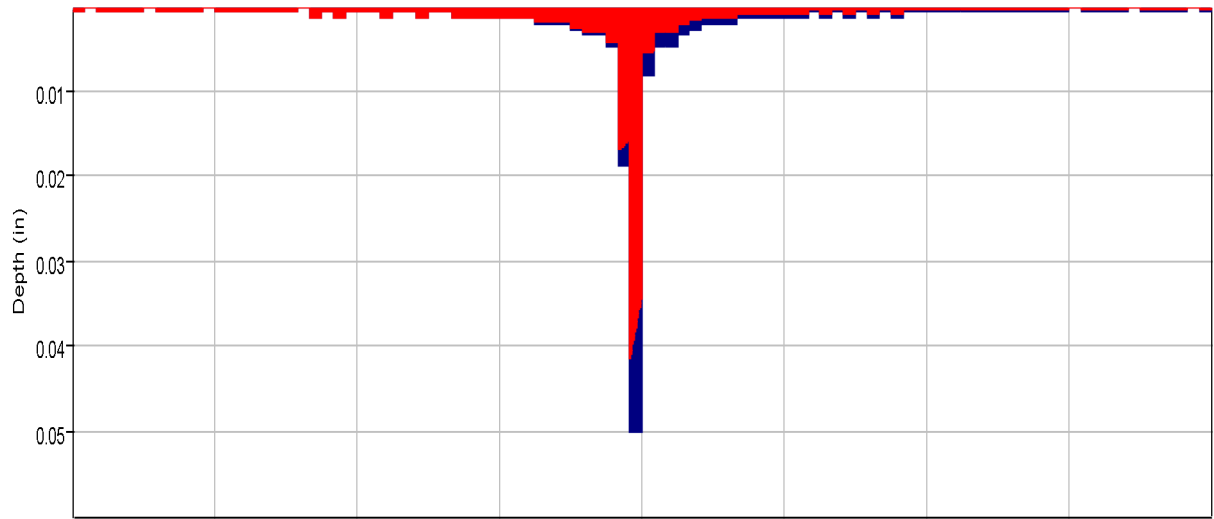

Run:EV 5-yr Ex. Type II Element:OB5 Result:Precipitation

Run:EV 5-yr Ex. Type II Element:OB5 Result:Outflow

Run:EV 5-yr Ex. Type II Element:OB5 Result:Precipitation Loss

Run:EV 5-yr Ex. Type II Element:OB5 Result:Baseflow

Project: Eagleview_Subdivision
Simulation Run: EV 5-yr Ex. Type II Subbasin: OB5

Start of Run: 01Oct2021, 00:00 Basin Model: Eagleview_Existing
End of Run: 02Oct2021, 00:00 Meteorologic Model: 5-yr Type II
Compute Time: 11Mar2022, 14:50:40 Control Specifications: 24-hr Storm

Volume Units: AC-FT

Computed Results

Peak Discharge :	36.8 (CFS)	Date/Time of Peak Discharge :	01Oct2021, 12:42
Total Precipitation :	32.4 (AC-FT)	Total Direct Runoff :	7.4 (AC-FT)
Total Loss :	24.8 (AC-FT)	Total Baseflow :	0.0 (AC-FT)
Total Excess :	7.6 (AC-FT)	Discharge :	7.4 (AC-FT)

Subbasin "OB6" Results for Run "EV 5-yr Ex. Type II"

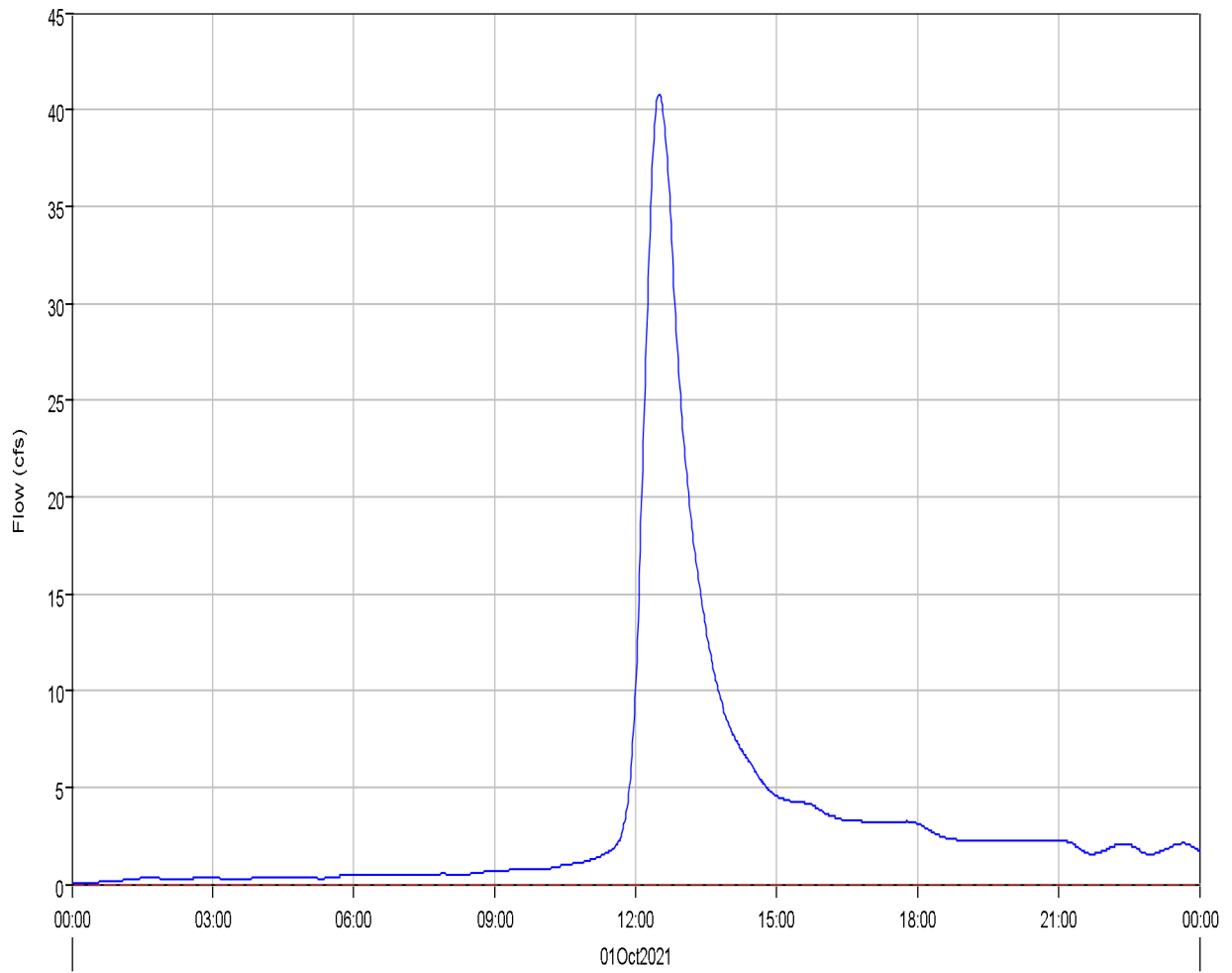
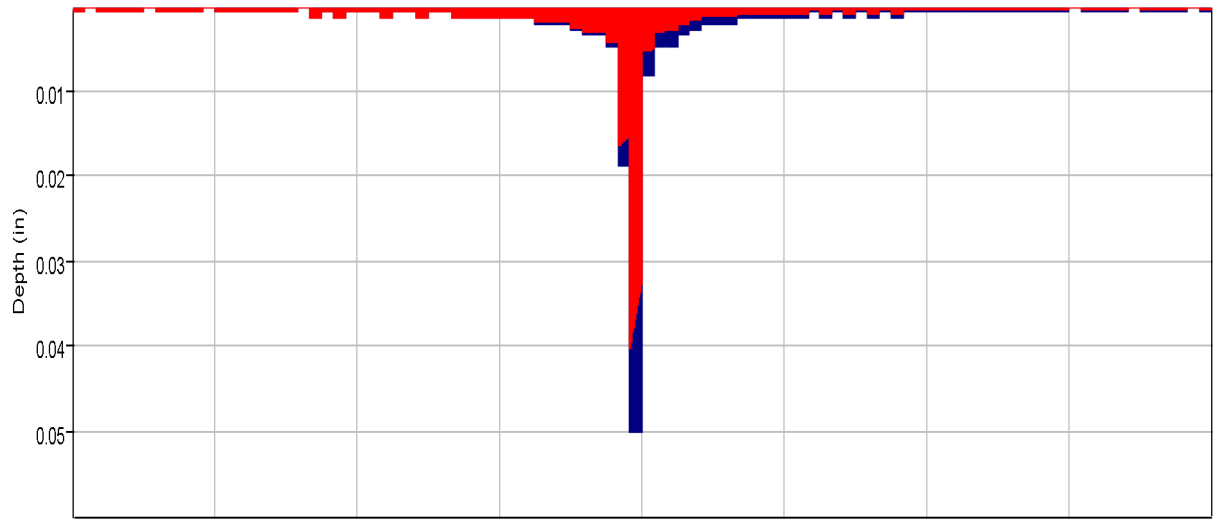

Run:EV 5-yr Ex. Type II Element:OB6 Result:Precipitation

Run:EV 5-yr Ex. Type II Element:OB6 Result:Outflow

Run:EV 5-yr Ex. Type II Element:OB6 Result:Precipitation Loss

Run:EV 5-yr Ex. Type II Element:OB6 Result:Baseflow

Project: Eagleview_Subdivision
Simulation Run: EV 5-yr Ex. Type II Subbasin: OB6

Start of Run: 01Oct2021, 00:00 Basin Model: Eagleview_Existing
End of Run: 02Oct2021, 00:00 Meteorologic Model: 5-yr Type II
Compute Time: 11Mar2022, 14:50:40 Control Specifications: 24-hr Storm

Volume Units: AC-FT

Computed Results

Peak Discharge :	40.8 (CFS)	Date/Time of Peak Discharge :	01Oct2021, 12:30
Total Precipitation :	26.6 (AC-FT)	Total Direct Runoff :	6.8 (AC-FT)
Total Loss :	19.8 (AC-FT)	Total Baseflow :	0.0 (AC-FT)
Total Excess :	6.9 (AC-FT)	Discharge :	6.8 (AC-FT)

Subbasin "OB7" Results for Run "EV 5-yr Ex. Type II"

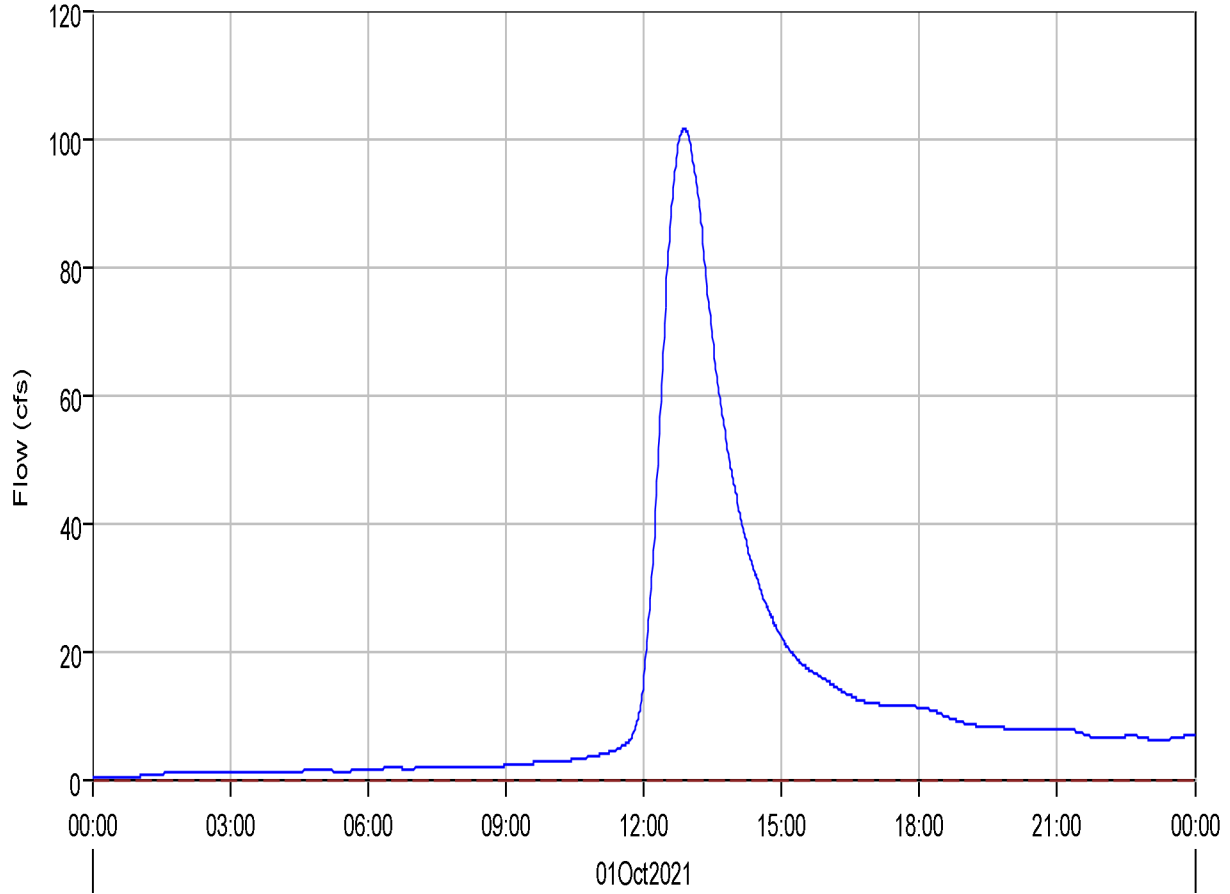
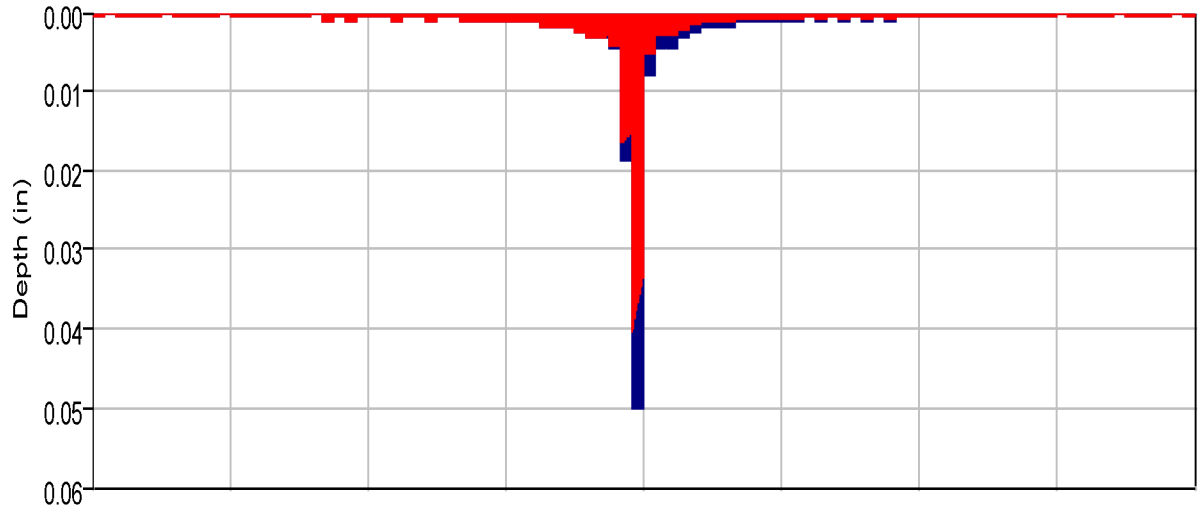

- Run:EV 5-yr Ex. Type II Element:OB7 Result:Precipitation
- Run:EV 5-yr Ex. Type II Element:OB7 Result:Precipitation Loss
- Run:EV 5-yr Ex. Type II Element:OB7 Result:Outflow
- Run:EV 5-yr Ex. Type II Element:OB7 Result:Baseflow

Project: Eagleview_Subdivision
Simulation Run: EV 5-yr Ex. Type II Subbasin: OB7

Start of Run: 01Oct2021, 00:00 Basin Model: Eagleview_Existing
End of Run: 02Oct2021, 00:00 Meteorologic Model: 5-yr Type II
Compute Time: 11Mar2022, 14:50:40 Control Specifications: 24-hr Storm

Volume Units: AC-FT

Computed Results

Peak Discharge :	101.4 (CFS)	Date/Time of Peak Discharge :	01Oct2021, 12:53
Total Precipitation :	94.8 (AC-FT)	Total Direct Runoff :	23.3 (AC-FT)
Total Loss :	70.9 (AC-FT)	Total Baseflow :	0.0 (AC-FT)
Total Excess :	23.9 (AC-FT)	Discharge :	23.3 (AC-FT)

Subbasin "OB8" Results for Run "EV 5-yr Ex. Type II"

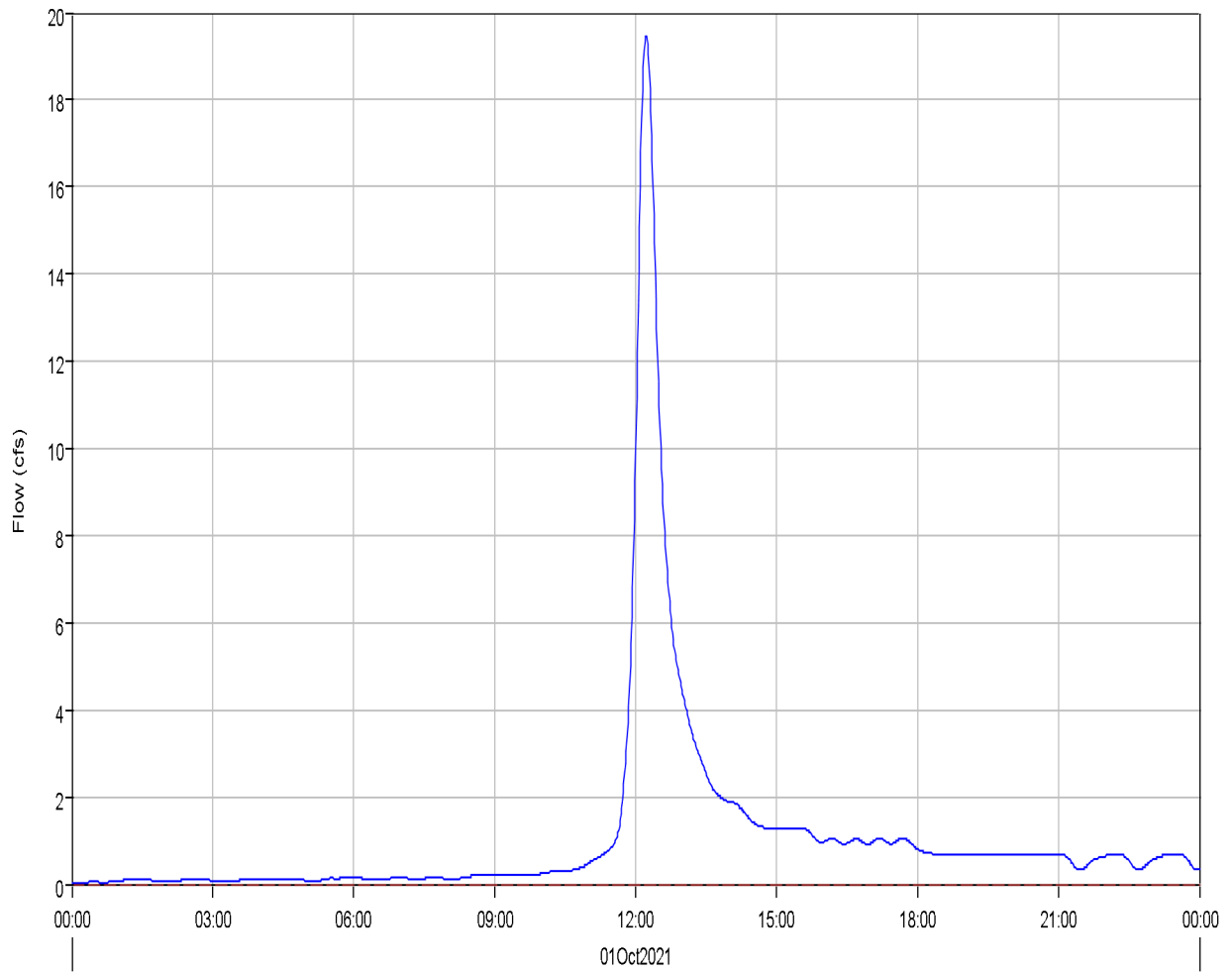
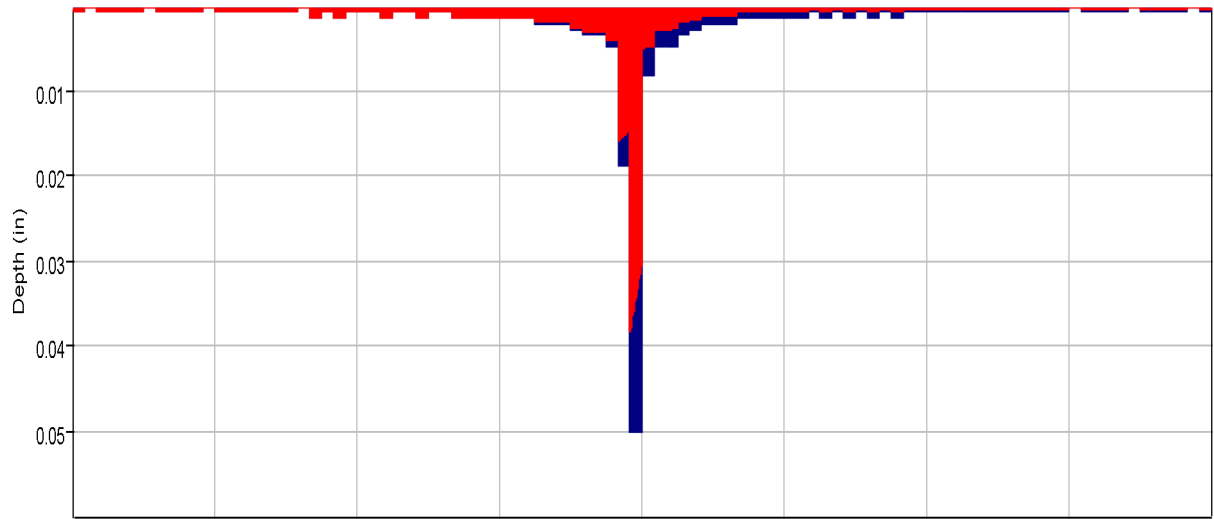

Run:EV 5-yr Ex. Type II Element:OB8 Result:Precipitation

Run:EV 5-yr Ex. Type II Element:OB8 Result:Precipitation Loss

Run:EV 5-yr Ex. Type II Element:OB8 Result:Outflow

Run:EV 5-yr Ex. Type II Element:OB8 Result:Baseflow

Project: Eagleview_Subdivision
Simulation Run: EV 5-yr Ex. Type II Subbasin: OB8

Start of Run: 01Oct2021, 00:00 Basin Model: Eagleview_Existing
End of Run: 02Oct2021, 00:00 Meteorologic Model: 5-yr Type II
Compute Time: 11Mar2022, 14:50:40 Control Specifications: 24-hr Storm

Volume Units: AC-FT

Computed Results

Peak Discharge :	19.5 (CFS)	Date/Time of Peak Discharge :	01Oct2021, 12:13
Total Precipitation :	7.4 (AC-FT)	Total Direct Runoff :	2.1 (AC-FT)
Total Loss :	5.3 (AC-FT)	Total Baseflow :	0.0 (AC-FT)
Total Excess :	2.2 (AC-FT)	Discharge :	2.1 (AC-FT)

Reach 'R-B1' Results for Run 'EV 5-yr Ex. Type II'

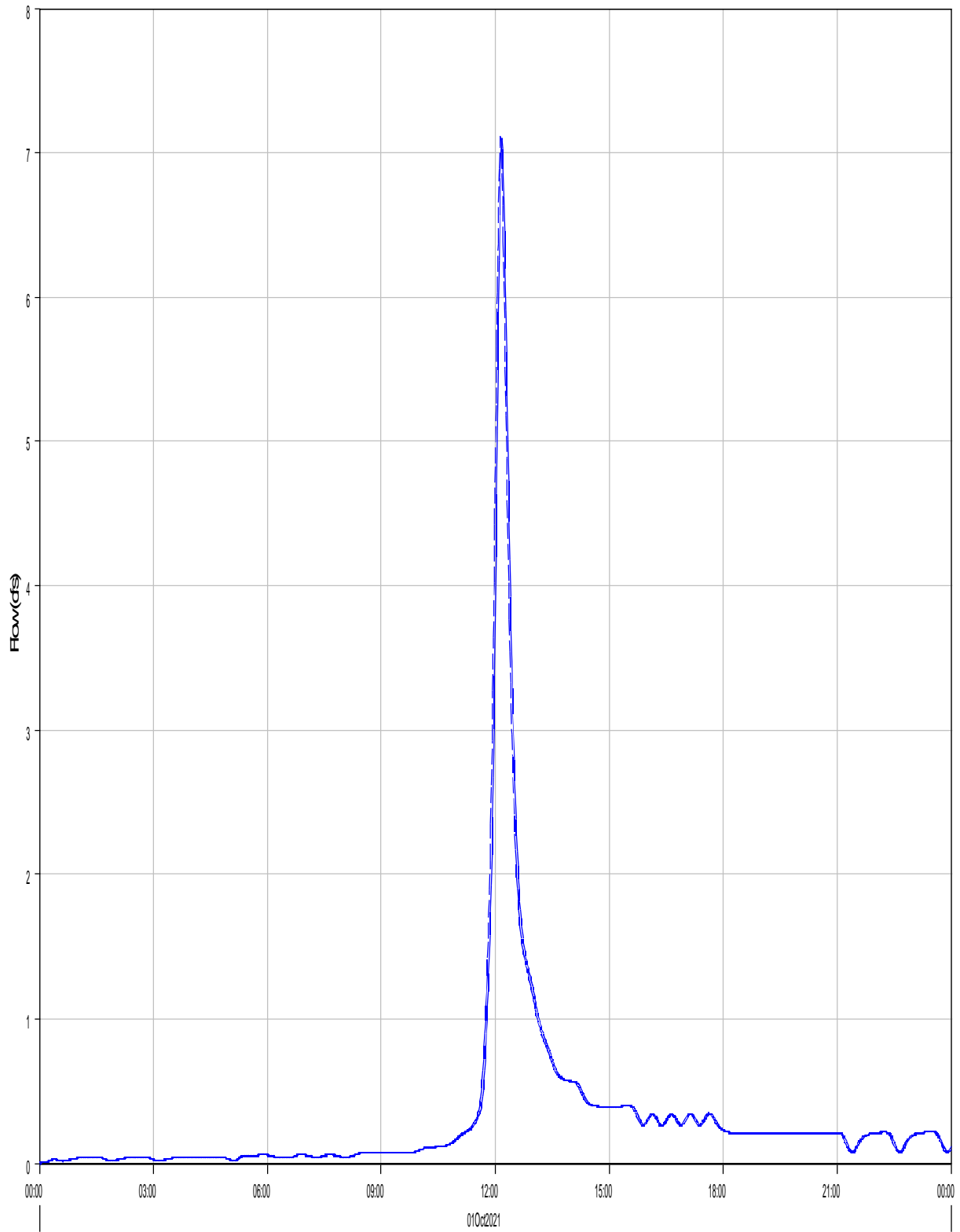

— Run:EV 5-yr Ex. Type II Element:R-B1 Result:Outflow

- - - Run:EV 5-yr Ex. Type II Element:R-B1 Result:Combined Inflow

Project: Eagleview_Subdivision
Simulation Run: EV 5-yr Ex. Type II Reach: R-B1

Start of Run: 01Oct2021, 00:00 Basin Model: Eagleview_Existing
End of Run: 02Oct2021, 00:00 Meteorologic Model: 5-yr Type II
Compute Time: 11Mar2022, 14:50:40 Control Specifications: 24-hr Storm

Volume Units: AC-FT

Computed Results

Peak Inflow :	7.1 (CFS)	Date/Time of Peak Inflow :	01Oct2021, 12:08
Peak Outflow :	7.1 (CFS)	Date/Time of Peak Outflow :	01Oct2021, 12:11
Total Inflow :	0.7 (AC-FT)	Total Outflow :	0.7 (AC-FT)

Reach 'R-OB4' Results for Run 'EV 5-yr Ex. Type II'

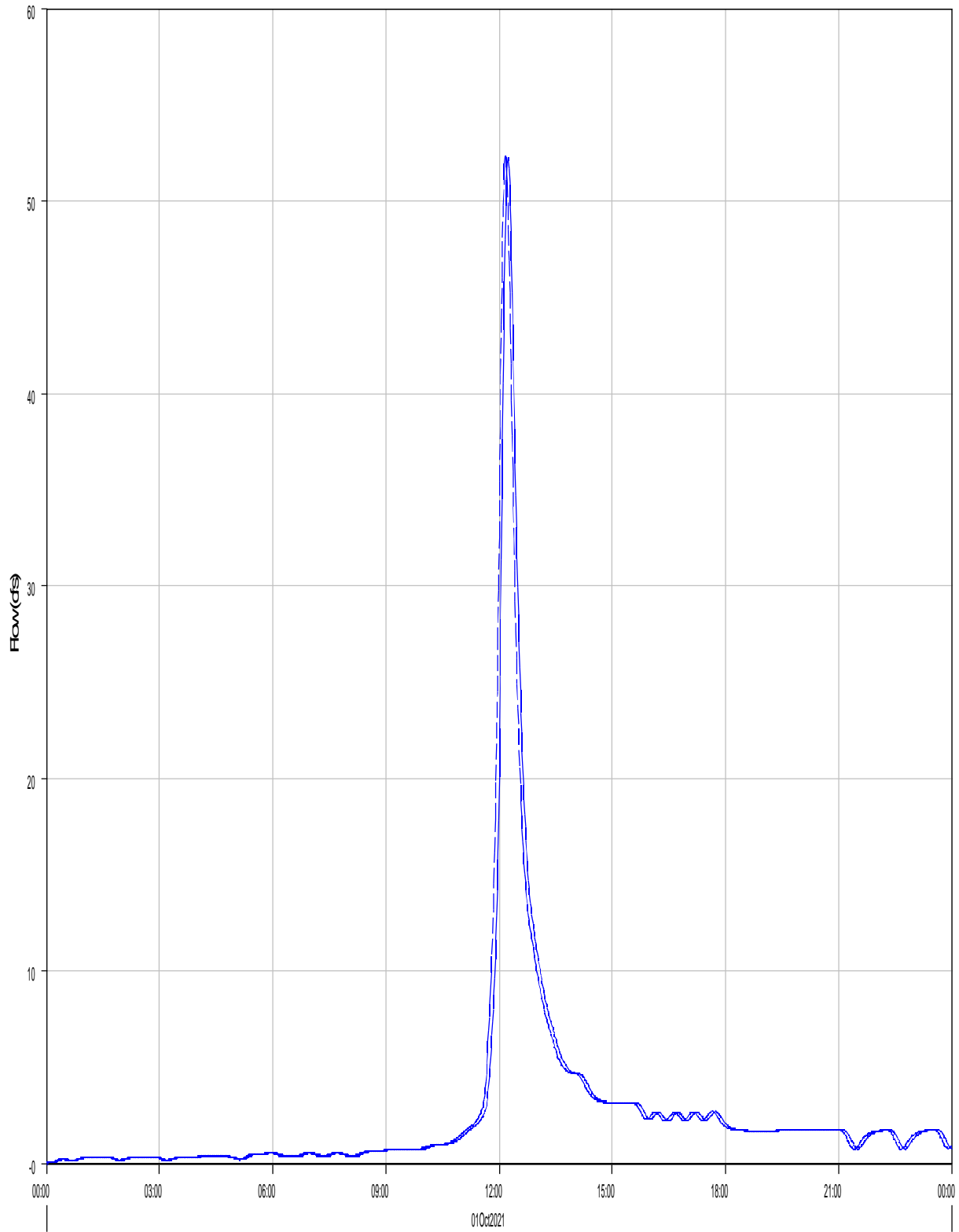

Run: EV 5-yr Ex. Type II Element: R-OB4 Result: Outflow

Run: EV 5-yr Ex. Type II Element: R-OB4 Result: Combined Inflow

Project: Eagleview_Subdivision
Simulation Run: EV 5-yr Ex. Type II Reach: R-OB4

Start of Run:	01Oct2021, 00:00	Basin Model:	Eagleview_Existing
End of Run:	02Oct2021, 00:00	Meteorologic Model:	5-yr Type II
Compute Time:	11Mar2022, 14:50:40	Control Specifications:	24-hr Storm

Volume Units: AC-FT

Computed Results

Peak Inflow :	52.3 (CFS)	Date/Time of Peak Inflow :	01Oct2021, 12:10
Peak Outflow :	52.2 (CFS)	Date/Time of Peak Outflow :	01Oct2021, 12:14
Total Inflow :	5.4 (AC-FT)	Total Outflow :	5.4 (AC-FT)

Reach 'R-OBS' Results for Run 'EV 5-yr Ex. Type II'

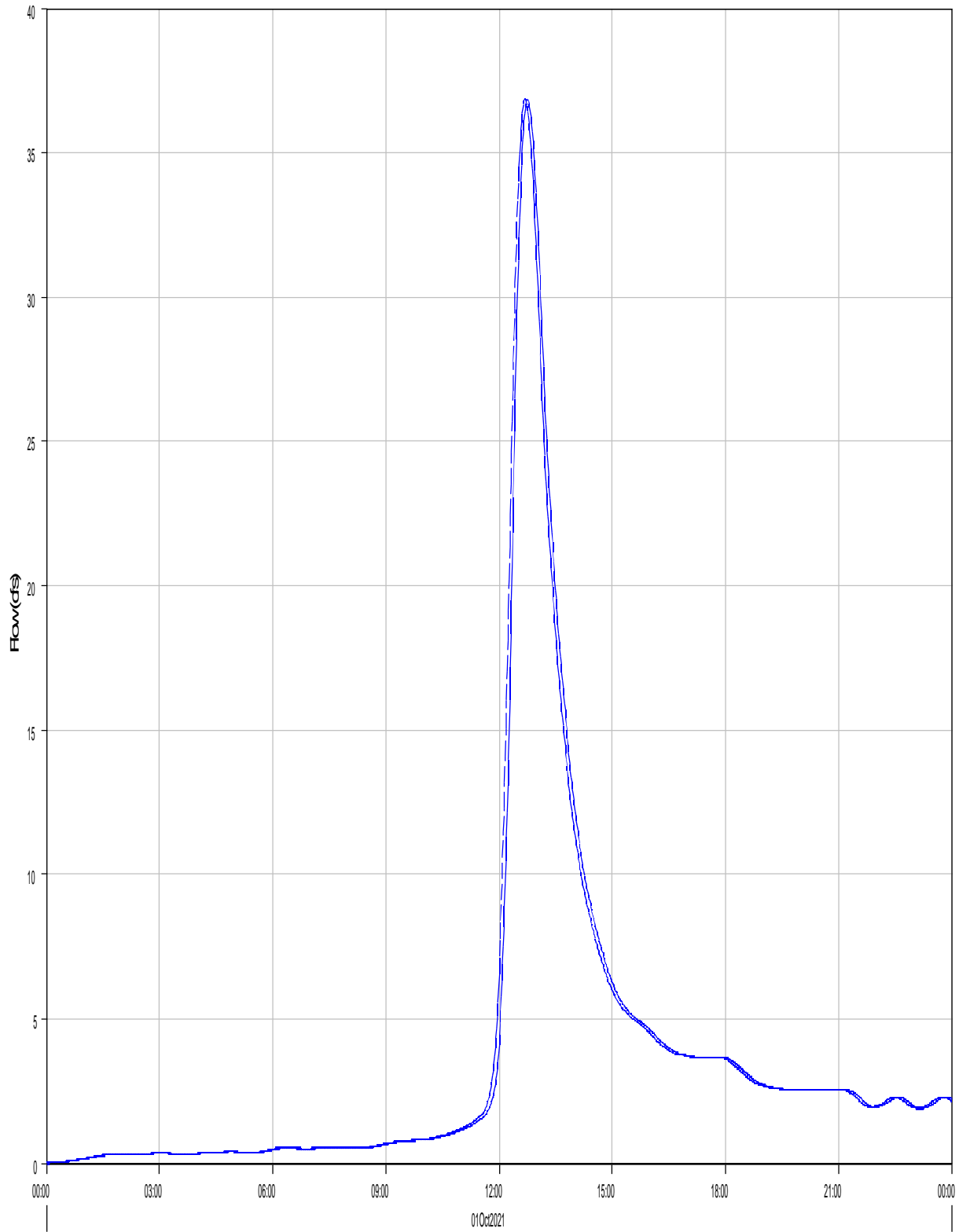

Run:EV 5-yr Ex. Type II Element:R-OBS Result:Outflow

Run:EV 5-yr Ex. Type II Element:R-OBS Result:Combined Inflow

Project: Eagleview_Subdivision
Simulation Run: EV 5-yr Ex. Type II Reach: R-OB5

Start of Run: 01Oct2021, 00:00 Basin Model: Eagleview_Existing
End of Run: 02Oct2021, 00:00 Meteorologic Model: 5-yr Type II
Compute Time: 11Mar2022, 14:50:40 Control Specifications: 24-hr Storm

Volume Units: AC-FT

Computed Results

Peak Inflow :	36.8 (CFS)	Date/Time of Peak Inflow :	01Oct2021, 12:42
Peak Outflow :	36.8 (CFS)	Date/Time of Peak Outflow :	01Oct2021, 12:45
Total Inflow :	7.4 (AC-FT)	Total Outflow :	7.4 (AC-FT)

Reach 'R-OB6' Results for Run 'EV 5-yr Ex. Type II'

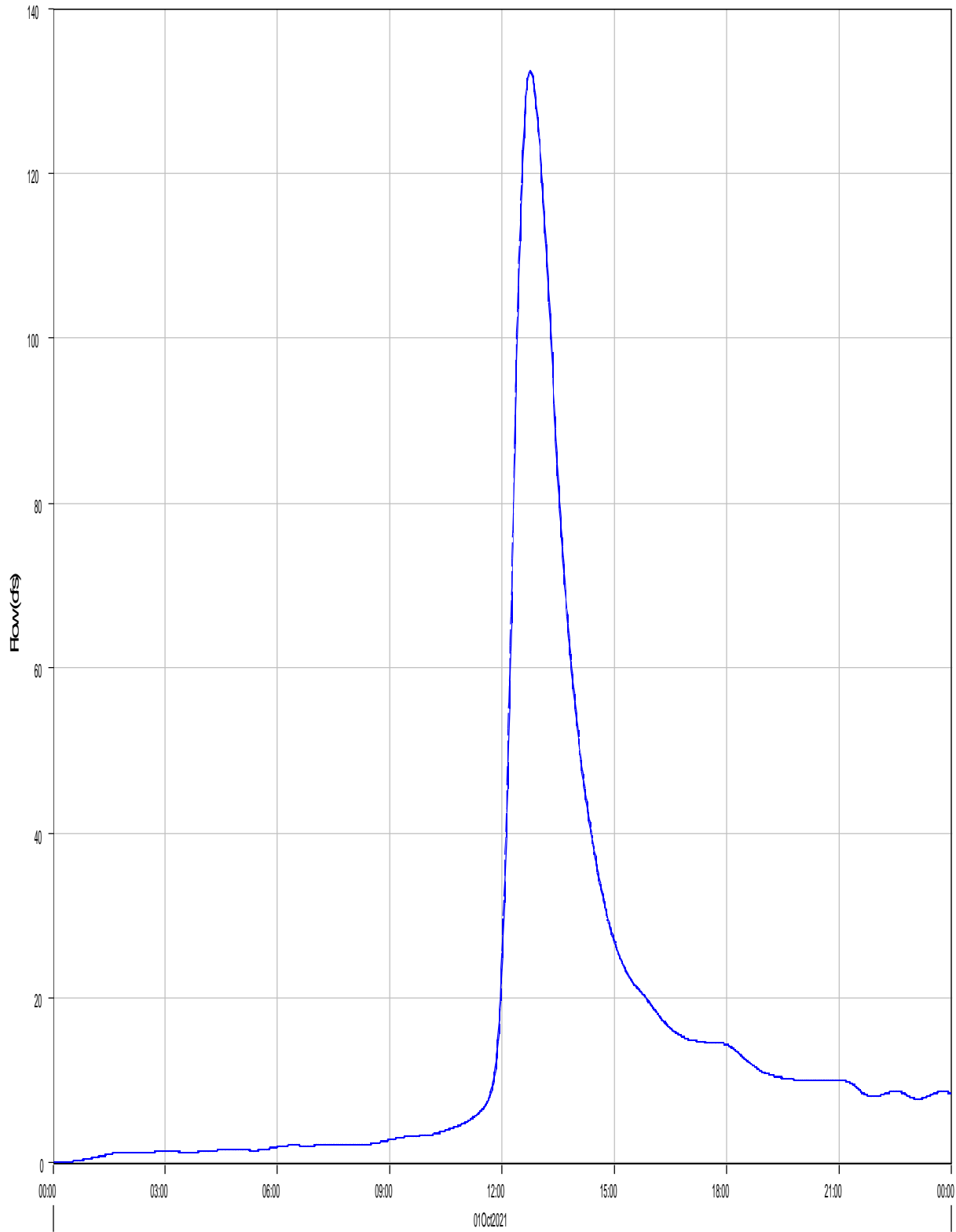

Run:EV 5-yr Ex. Type II Element:R-OB6 Result:Outflow

Run:EV 5-yr Ex. Type II Element:R-OB6 Result:Combined Inflow

Project: Eagleview_Subdivision
Simulation Run: EV 5-yr Ex. Type II Reach: R-OB6

Start of Run: 01Oct2021, 00:00 Basin Model: Eagleview_Existing
End of Run: 02Oct2021, 00:00 Meteorologic Model: 5-yr Type II
Compute Time: 11Mar2022, 14:50:40 Control Specifications: 24-hr Storm

Volume Units: AC-FT

Computed Results

Peak Inflow :	132.4 (CFS)	Date/Time of Peak Inflow :	01Oct2021, 12:45
Peak Outflow :	132.4 (CFS)	Date/Time of Peak Outflow :	01Oct2021, 12:46
Total Inflow :	30.1 (AC-FT)	Total Outflow :	30.0 (AC-FT)

Reach 'R-OB7' Results for Run 'EV 5-yr Ex. Type II'

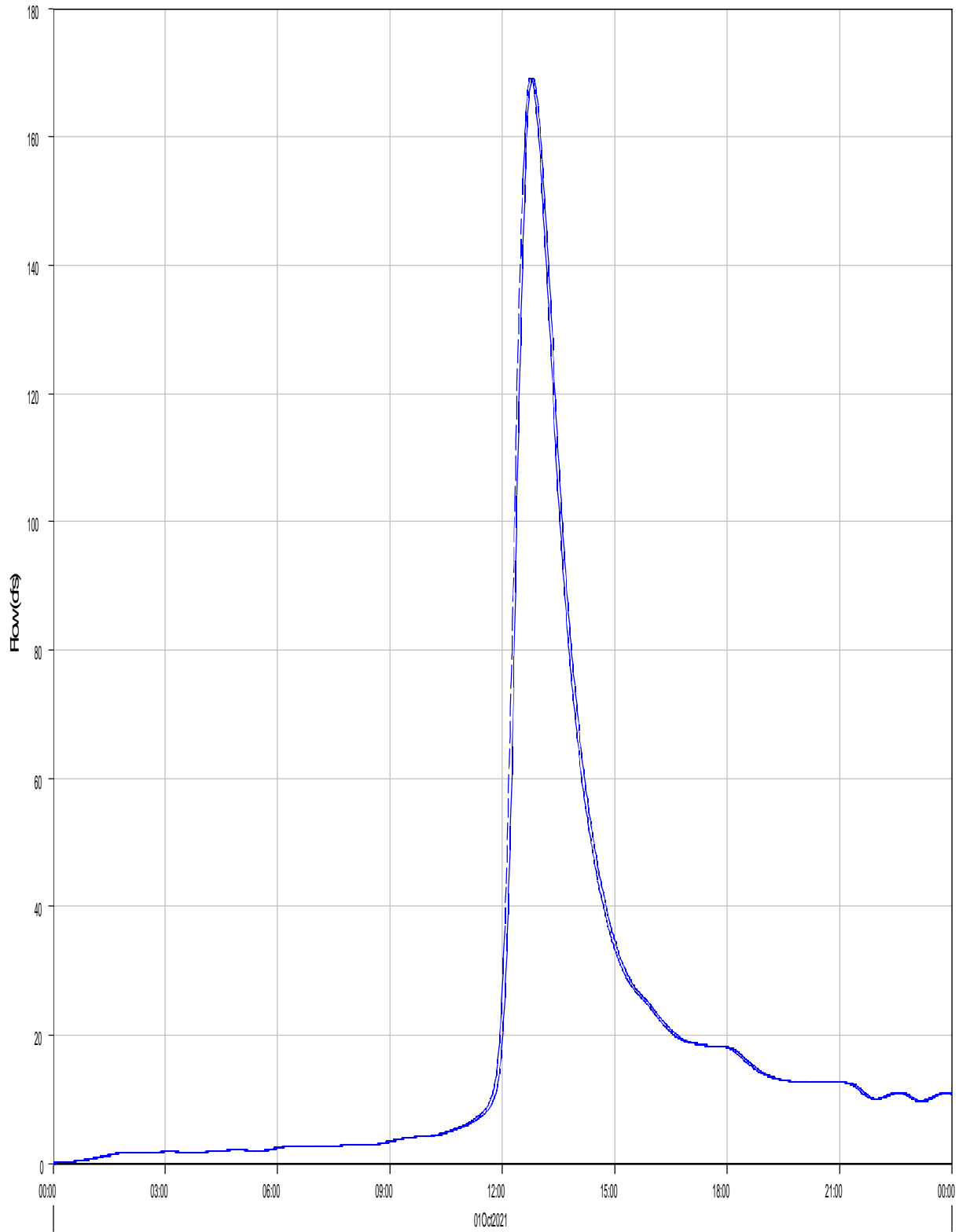

Run:EV 5-yr Ex. Type II Element:R-OB7 Result:Outflow

Run:EV 5-yr Ex. Type II Element:R-OB7 Result:Combined Inflow

Project: Eagleview_Subdivision
Simulation Run: EV 5-yr Ex. Type II Reach: R-OB7

Start of Run: 01Oct2021, 00:00 Basin Model: Eagleview_Existing
End of Run: 02Oct2021, 00:00 Meteorologic Model: 5-yr Type II
Compute Time: 11Mar2022, 14:50:40 Control Specifications: 24-hr Storm

Volume Units: AC-FT

Computed Results

Peak Inflow :	169.2 (CFS)	Date/Time of Peak Inflow :	01Oct2021, 12:46
Peak Outflow :	169.2 (CFS)	Date/Time of Peak Outflow :	01Oct2021, 12:49
Total Inflow :	37.4 (AC-FT)	Total Outflow :	37.3 (AC-FT)

Reach 'R-OB8' Results for Run 'EV 5-yr Ex. Type II'

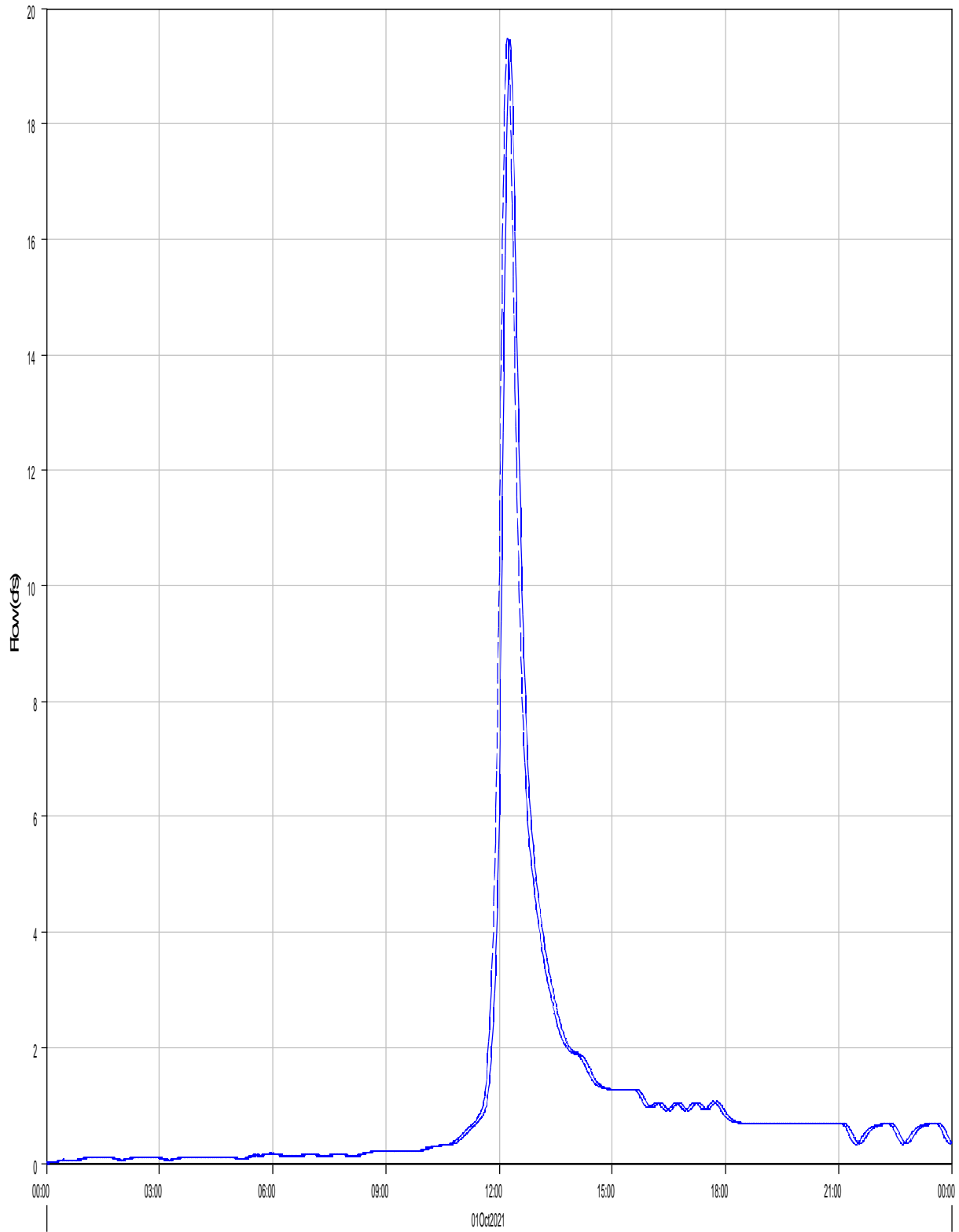

— Run:EV 5-yr Ex. Type II Element:R-OB8 Result:Outflow

- - - Run:EV 5-yr Ex. Type II Element:R-OB8 Result:Combined Inflow

Project: Eagleview_Subdivision
Simulation Run: EV 5-yr Ex. Type II Reach: R-OB8

Start of Run: 01Oct2021, 00:00 Basin Model: Eagleview_Existing
End of Run: 02Oct2021, 00:00 Meteorologic Model: 5-yr Type II
Compute Time: 11Mar2022, 14:50:40 Control Specifications: 24-hr Storm

Volume Units: AC-FT

Computed Results

Peak Inflow :	19.5 (CFS)	Date/Time of Peak Inflow :	01Oct2021, 12:13
Peak Outflow :	19.4 (CFS)	Date/Time of Peak Outflow :	01Oct2021, 12:17
Total Inflow :	2.1 (AC-FT)	Total Outflow :	2.1 (AC-FT)

Project: Eagleview_Subdivision Simulation Run: EV 100-yr Ex. Type II

Start of Run: 01Oct2021, 00:00 Basin Model: Eagleview_Existing
 End of Run: 02Oct2021, 00:00 Meteorologic Model: 100-yr Type II
 Compute Time: 11Mar2022, 10:12:01 Control Specifications: 24-hr Storm

Hydrologic Element	Drainage Area (MI ²)	Peak Discharge (CFS)	Time of Peak	Volume (AC-FT)
B1	0.0091800	8.5	01Oct2021, 12:11	0.8
B2	0.0647266	48.5	01Oct2021, 12:15	5.3
B3	0.0930359	110.0	01Oct2021, 12:04	7.8
B4	0.0229422	18.2	01Oct2021, 12:13	1.9
J1	0.0253831	27.3	01Oct2021, 12:10	2.5
J2	0.1928516	183.8	01Oct2021, 12:13	18.8
J3	1.2354980	515.5	01Oct2021, 12:44	112.7
J4	1.0678500	478.0	01Oct2021, 12:44	97.8
J-OB6	0.8431300	371.3	01Oct2021, 12:43	78.1
OB1	0.0162031	18.8	01Oct2021, 12:08	1.7
OB2	0.0438438	52.7	01Oct2021, 12:08	4.7
OB3	0.0678750	67.1	01Oct2021, 12:12	6.9
OB4	0.0164062	18.9	01Oct2021, 12:10	1.8
OB5	0.2247200	106.9	01Oct2021, 12:40	19.7
OB6	0.1850100	113.2	01Oct2021, 12:29	17.5
OB7	0.6581200	284.2	01Oct2021, 12:52	60.6
OB8	0.0516699	51.6	01Oct2021, 12:13	5.4
R-B1	0.0162031	18.7	01Oct2021, 12:10	1.7
R-OB4	0.1281250	135.8	01Oct2021, 12:13	13.4
R-OB5	0.2247200	106.8	01Oct2021, 12:43	19.7
R-OB6	0.8431300	371.3	01Oct2021, 12:44	78.1
R-OB7	1.0678500	477.9	01Oct2021, 12:46	97.7
R-OB8	0.0516699	51.5	01Oct2021, 12:16	5.4

Subbasin "B1" Results for Run "EV 100-yr Ex. Type II"

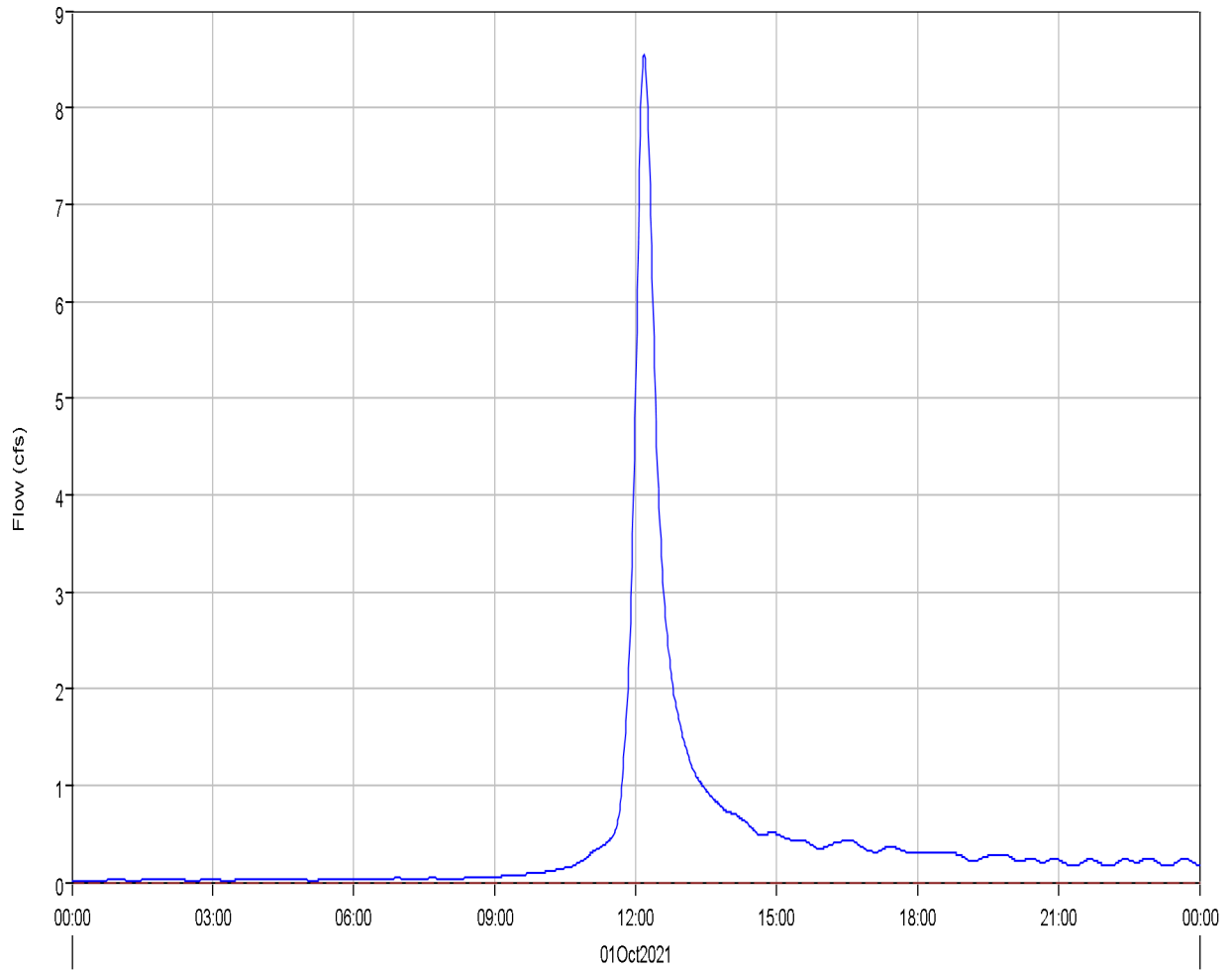
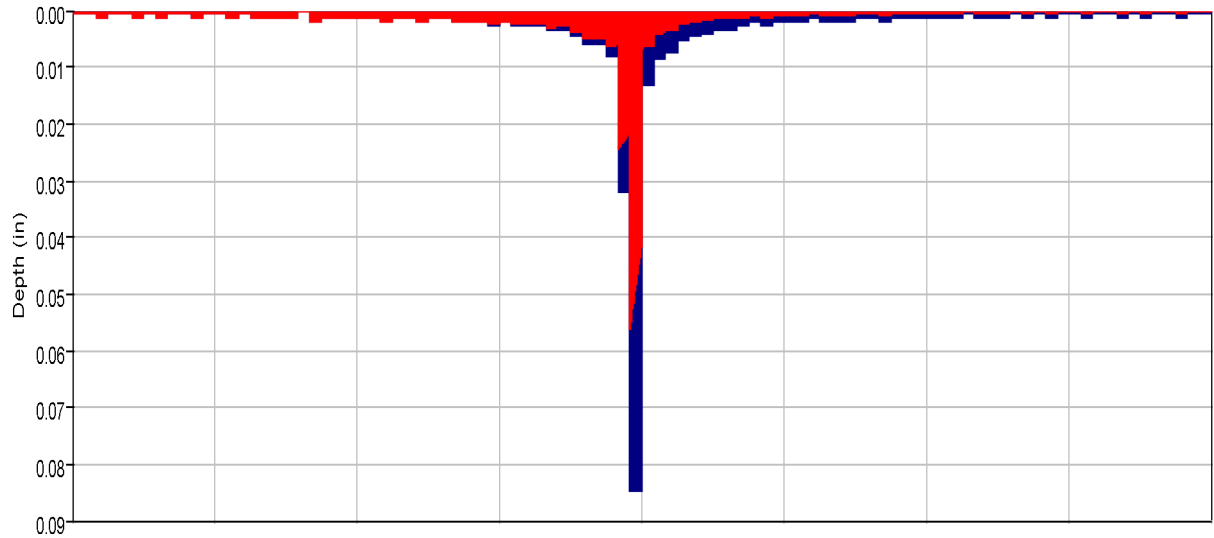

Run:EV 100-yr Ex. Type II Element:B1 Result:Precipitation
Run:EV 100-yr Ex. Type II Element:B1 Result:Outflow

Run:EV 100-yr Ex. Type II Element:B1 Result:Precipitation Loss
Run:EV 100-yr Ex. Type II Element:B1 Result:Baseflow

Project: Eagleview_Subdivision
Simulation Run: EV 100-yr Ex. Type II Subbasin: B1

Start of Run: 01Oct2021, 00:00 Basin Model: Eagleview_Existing
End of Run: 02Oct2021, 00:00 Meteorologic Model: 100-yr Type II
Compute Time: 11Mar2022, 10:12:01 Control Specifications: 24-hr Storm

Volume Units: AC-FT

Computed Results

Peak Discharge :	8.5 (CFS)	Date/Time of Peak Discharge :	01Oct2021, 12:11
Total Precipitation :	2.3 (AC-FT)	Total Direct Runoff :	0.8 (AC-FT)
Total Loss :	1.4 (AC-FT)	Total Baseflow :	0.0 (AC-FT)
Total Excess :	0.8 (AC-FT)	Discharge :	0.8 (AC-FT)

Subbasin "B2" Results for Run "EV 100-yr Ex. Type II"

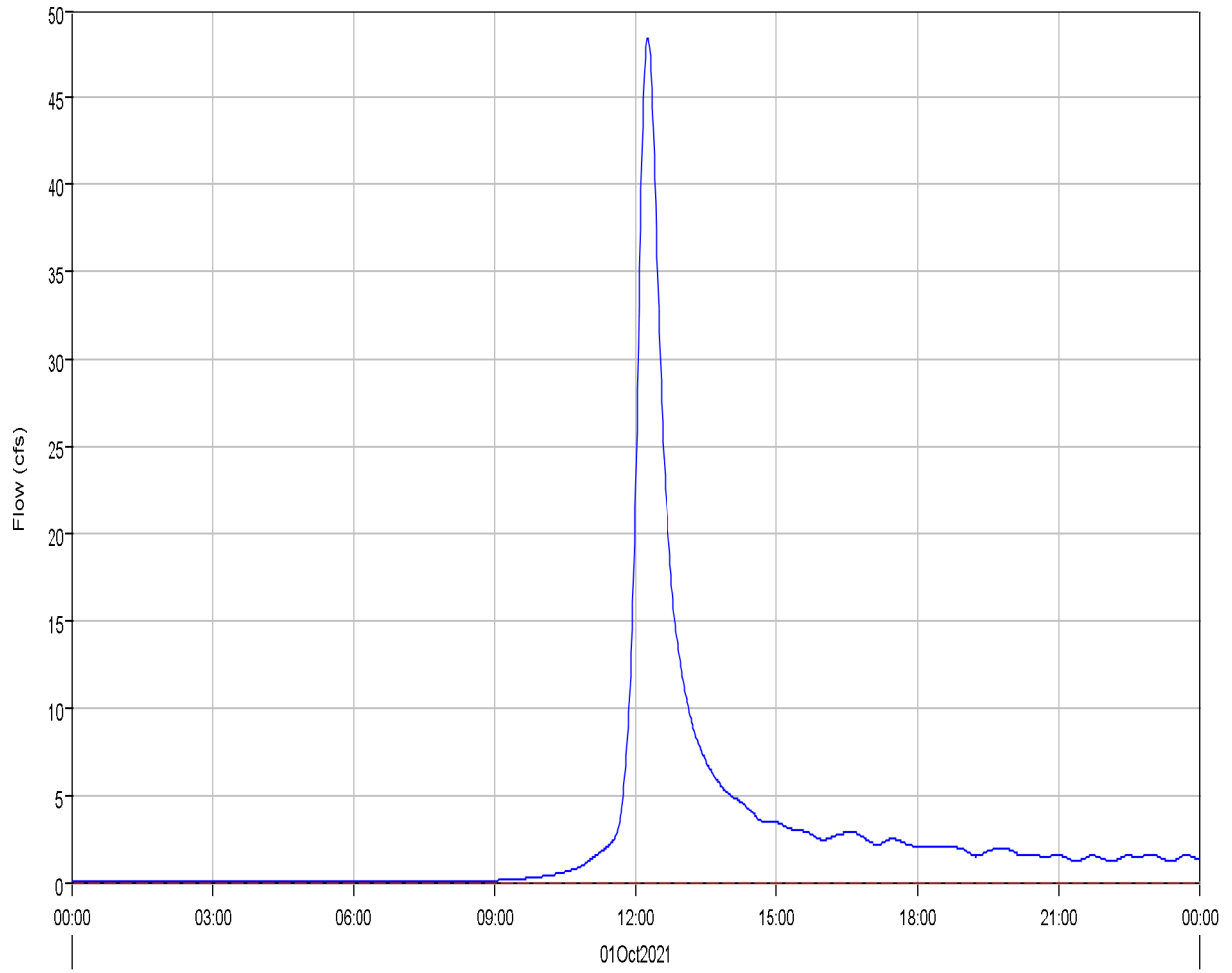
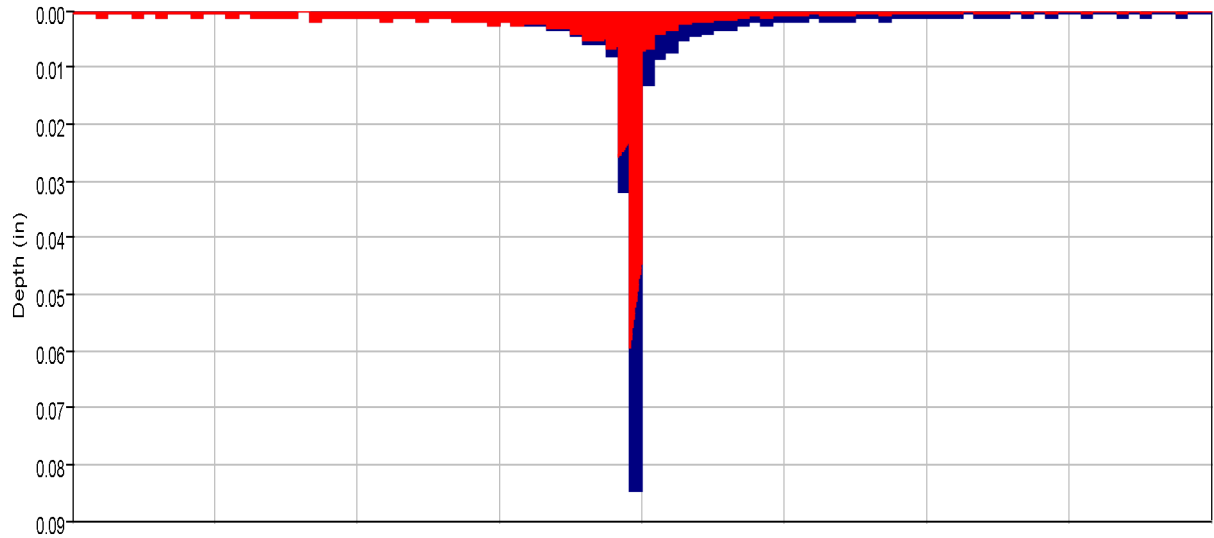

Run:EV 100-yr Ex. Type II Element:B2 Result:Precipitation
Run:EV 100-yr Ex. Type II Element:B2 Result:Outflow

Run:EV 100-yr Ex. Type II Element:B2 Result:Precipitation Loss
Run:EV 100-yr Ex. Type II Element:B2 Result:Baseflow

Project: Eagleview_Subdivision
Simulation Run: EV 100-yr Ex. Type II Subbasin: B2
Start of Run: 01Oct2021, 00:00 Basin Model: Eagleview_Existing
End of Run: 02Oct2021, 00:00 Meteorologic Model: 100-yr Type II
Compute Time: 11Mar2022, 10:12:01 Control Specifications: 24-hr Storm
Volume Units: AC-FT

Computed Results

Peak Discharge :	48.5 (CFS)	Date/Time of Peak Discharge :	01Oct2021, 12:15
Total Precipitation :	15.9 (AC-FT)	Total Direct Runoff :	5.3 (AC-FT)
Total Loss :	10.5 (AC-FT)	Total Baseflow :	0.0 (AC-FT)
Total Excess :	5.4 (AC-FT)	Discharge :	5.3 (AC-FT)

Subbasin "B3" Results for Run "EV 100-yr Ex. Type II"

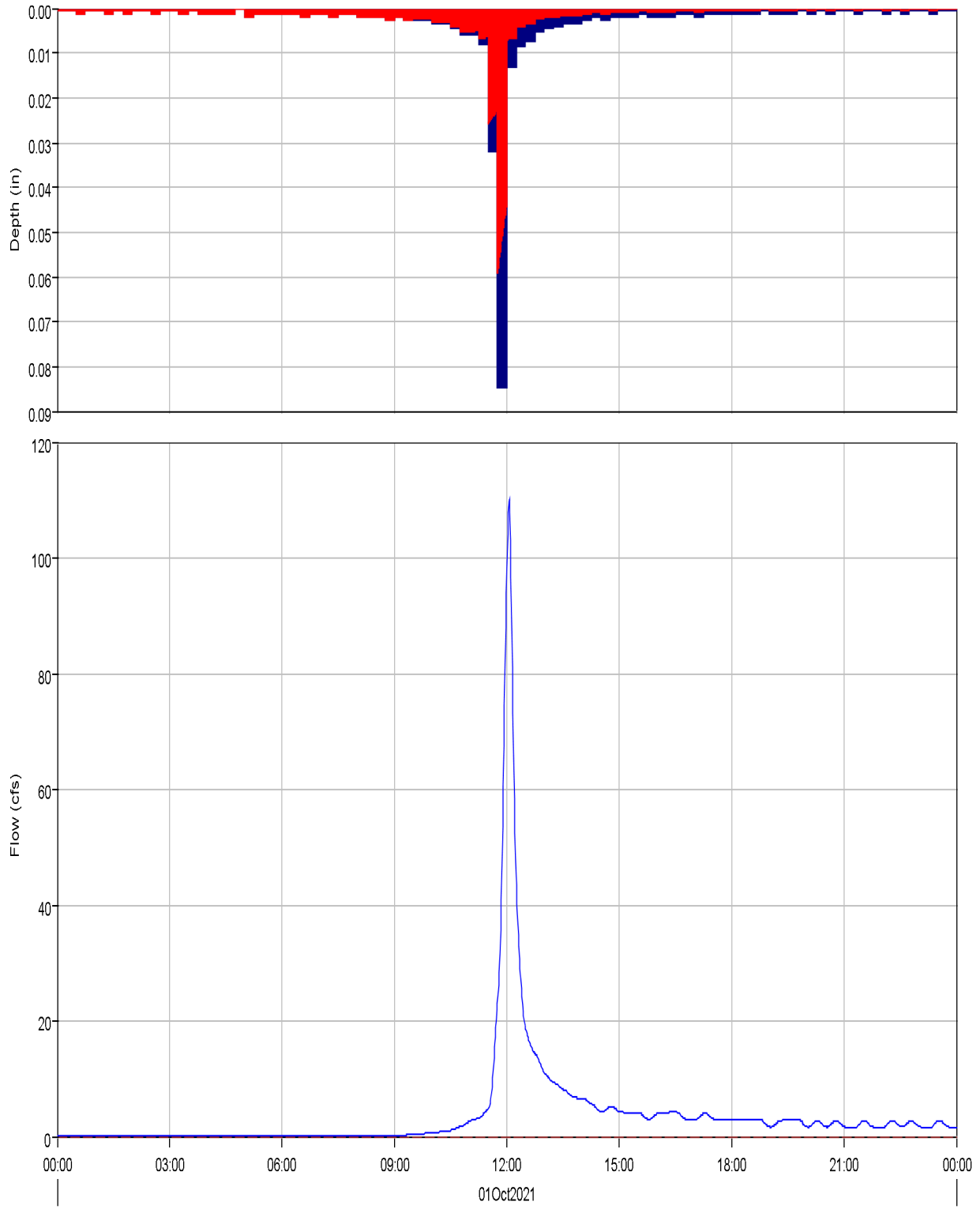

Run:EV 100-yr Ex. Type II Element:B3 Result:Precipitation
Run:EV 100-yr Ex. Type II Element:B3 Result:Outflow

Run:EV 100-yr Ex. Type II Element:B3 Result:Precipitation Loss
Run:EV 100-yr Ex. Type II Element:B3 Result:Baseflow

Project: Eagleview_Subdivision
Simulation Run: EV 100-yr Ex. Type II Subbasin: B3

Start of Run: 01Oct2021, 00:00 Basin Model: Eagleview_Existing
End of Run: 02Oct2021, 00:00 Meteorologic Model: 100-yr Type II
Compute Time: 11Mar2022, 10:12:01 Control Specifications: 24-hr Storm

Volume Units: AC-FT

Computed Results

Peak Discharge :	110.0 (CFS)	Date/Time of Peak Discharge :	01Oct2021, 12:04
Total Precipitation :	22.8 (AC-FT)	Total Direct Runoff :	7.8 (AC-FT)
Total Loss :	15.0 (AC-FT)	Total Baseflow :	0.0 (AC-FT)
Total Excess :	7.8 (AC-FT)	Discharge :	7.8 (AC-FT)

Subbasin "B4" Results for Run "EV 100-yr Ex. Type II"

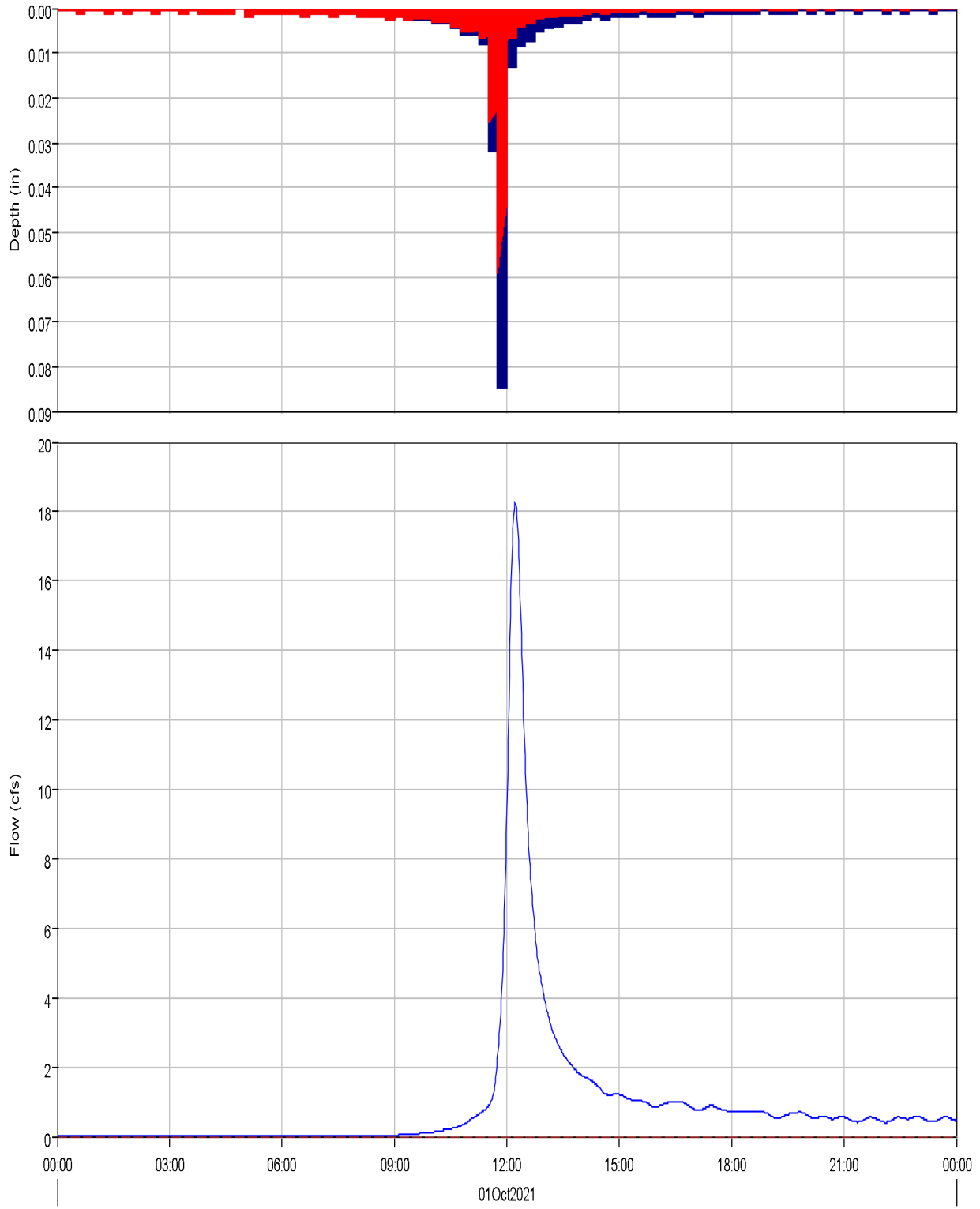

Run:EV 100-yr Ex. Type II Element:B4 Result:Precipitation
Run:EV 100-yr Ex. Type II Element:B4 Result:Outflow

Run:EV 100-yr Ex. Type II Element:B4 Result:Precipitation Loss
Run:EV 100-yr Ex. Type II Element:B4 Result:Baseflow

Project: Eagleview_Subdivision
Simulation Run: EV 100-yr Ex. Type II Subbasin: B4
Start of Run: 01Oct2021, 00:00 Basin Model: Eagleview_Existing
End of Run: 02Oct2021, 00:00 Meteorologic Model: 100-yr Type II
Compute Time: 11Mar2022, 10:12:01 Control Specifications: 24-hr Storm

Volume Units: AC-FT

Computed Results

Peak Discharge :	18.2 (CFS)	Date/Time of Peak Discharge :	01Oct2021, 12:13
Total Precipitation :	5.6 (AC-FT)	Total Direct Runoff :	1.9 (AC-FT)
Total Loss :	3.7 (AC-FT)	Total Baseflow :	0.0 (AC-FT)
Total Excess :	1.9 (AC-FT)	Discharge :	1.9 (AC-FT)

Junction 'J1' Results for Run 'EV 100-yr Ex. Type II'

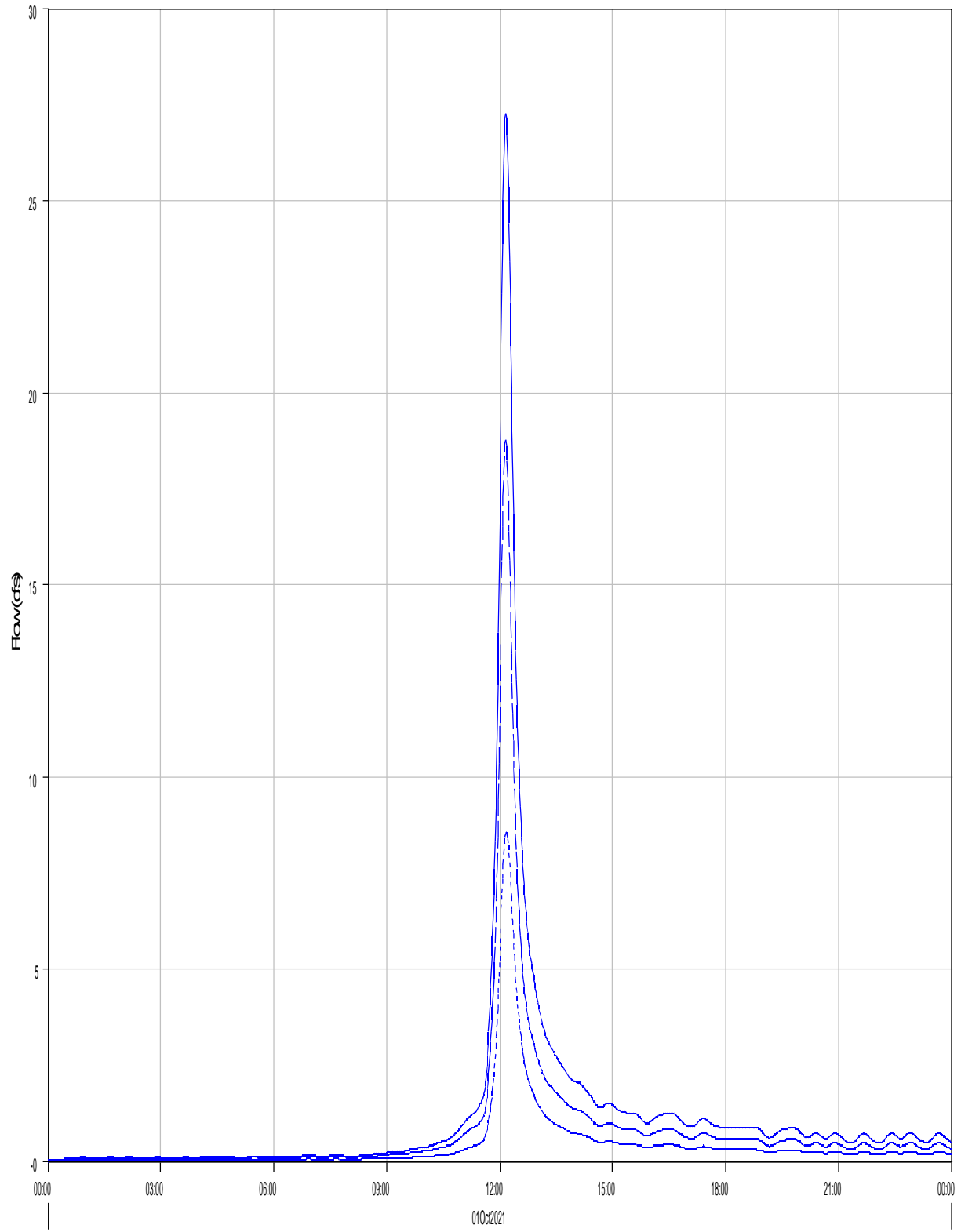

— Run:EV 100-yr Ex. Type II Element:J1 Result:Outflow

- - - Run:EV 100-yr Ex. Type II Element:R-B1 Result:Outflow

... Run:EV 100-yr Ex. Type II Element:B1 Result:Outflow

Project: Eagleview_Subdivision
Simulation Run: EV 100-yr Ex. Type II Junction: J1
Start of Run: 01Oct2021, 00:00 Basin Model: Eagleview_Existing
End of Run: 02Oct2021, 00:00 Meteorologic Model: 100-yr Type II
Compute Time: 11Mar2022, 10:12:01 Control Specifications: 24-hr Storm

Volume Units: AC-FT

Computed Results

Peak Outflow : 27.3 (CFS) Date/Time of Peak Outflow : 01Oct2021, 12:10
Total Outflow : 2.5 (AC-FT)

Junction "J2" Results for Run "EV 100-yr Ex. Type II"

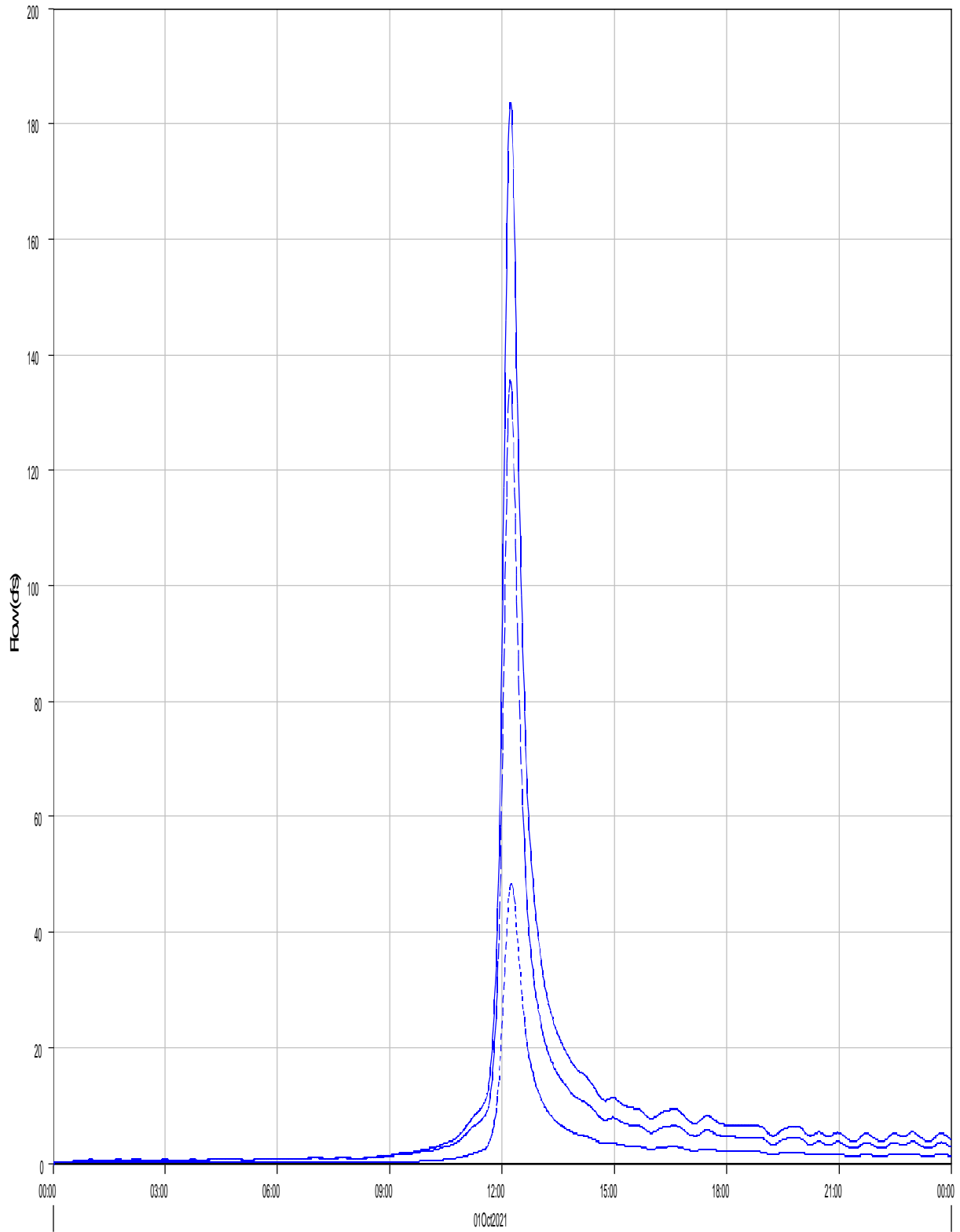

— Run: EV 100-yr Ex. Type II Element: J2 Result: Outflow

- - - Run: EV 100-yr Ex. Type II Element: R-OB4 Result: Outflow

... Run: EV 100-yr Ex. Type II Element: B2 Result: Outflow

Project: Eagleview_Subdivision
Simulation Run: EV 100-yr Ex. Type II Junction: J2
Start of Run: 01Oct2021, 00:00 Basin Model: Eagleview_Existing
End of Run: 02Oct2021, 00:00 Meteorologic Model: 100-yr Type II
Compute Time: 11Mar2022, 10:12:01 Control Specifications: 24-hr Storm

Volume Units: AC-FT

Computed Results

Peak Outflow : 183.8 (CFS) Date/Time of Peak Outflow : 01Oct2021, 12:13
Total Outflow : 18.8 (AC-FT)

Junction 'J3' Results for Run 'EV 100-yr Ex. Type II'

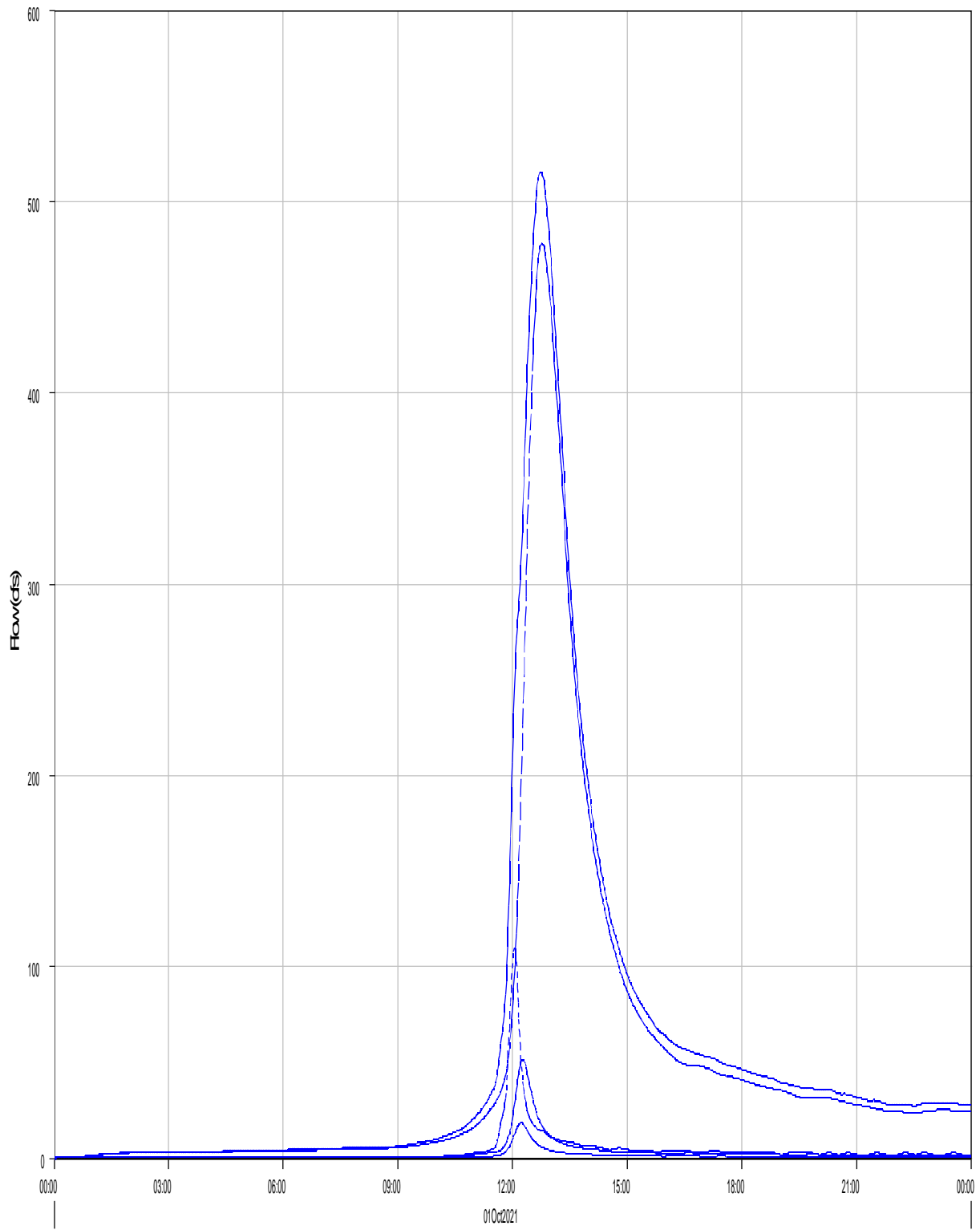

— Run EV 100-yr Ex. Type II Element J3 Result Outflow
- - - Run EV 100-yr Ex. Type II Element R-OB8 Result Outflow

- - - Run EV 100-yr Ex. Type II Element R-OB7 Result Outflow
- - - Run EV 100-yr Ex. Type II Element B4 Result Outflow

- - - Run EV 100-yr Ex. Type II Element B3 Result Outflow

Project: Eagleview_Subdivision
Simulation Run: EV 100-yr Ex. Type II Junction: J3
Start of Run: 01Oct2021, 00:00 Basin Model: Eagleview_Existing
End of Run: 02Oct2021, 00:00 Meteorologic Model: 100-yr Type II
Compute Time: 11Mar2022, 10:12:01 Control Specifications: 24-hr Storm

Volume Units: AC-FT

Computed Results

Peak Outflow : 515.5 (CFS) Date/Time of Peak Outflow : 01Oct2021, 12:44
Total Outflow : 112.7 (AC-FT)

Junction 'J4' Results for Run 'EV 100-yr Ex. Type II'

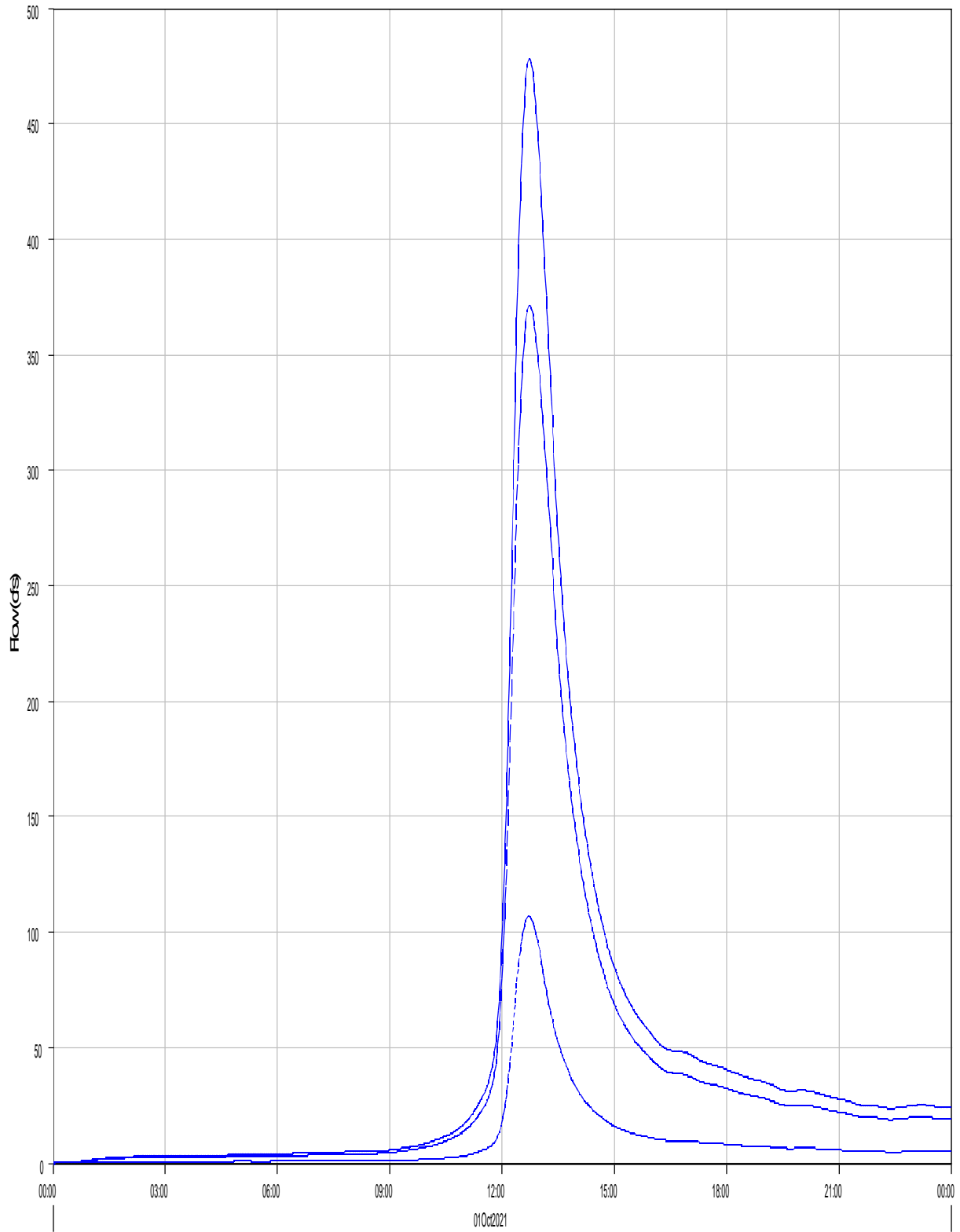

— Run:EV 100-yr Ex. Type II Element:J4 Result:Outflow

- - - Run:EV 100-yr Ex. Type II Element:R-OB6 Result:Outflow

... Run:EV 100-yr Ex. Type II Element:R-OB5 Result:Outflow

Project: Eagleview_Subdivision
Simulation Run: EV 100-yr Ex. Type II Junction: J4
Start of Run: 01Oct2021, 00:00 Basin Model: Eagleview_Existing
End of Run: 02Oct2021, 00:00 Meteorologic Model: 100-yr Type II
Compute Time: 11Mar2022, 10:12:01 Control Specifications: 24-hr Storm

Volume Units: IN

Computed Results

Peak Outflow : 478.0 (CFS) Date/Time of Peak Outflow : 01Oct2021, 12:44
Total Outflow : 1.72 (IN)

Junction 'J-OB6' Results for Run 'EV 100-yr Ex. Type II'

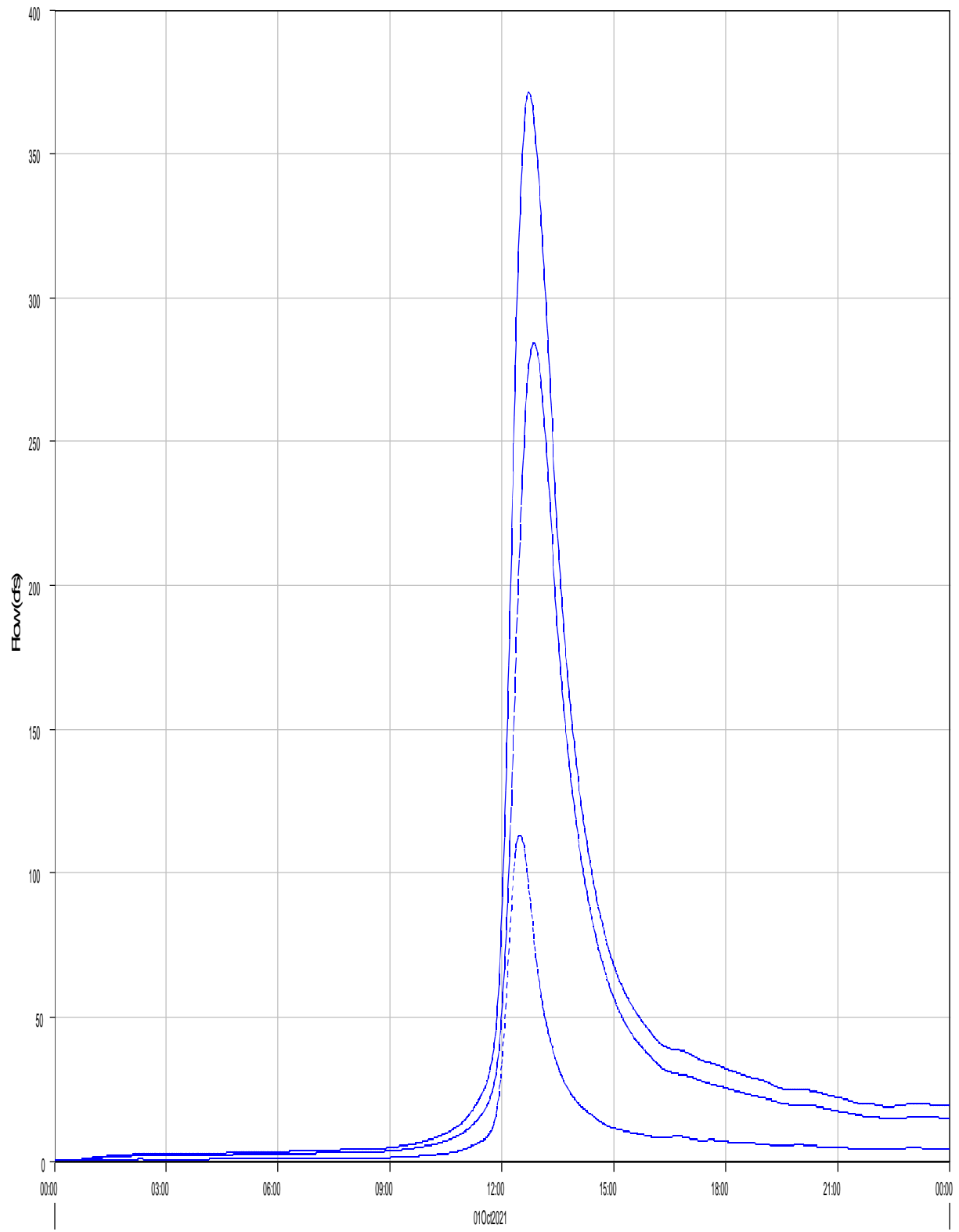

Run:EV 100-yr Ex. Type II Element:OB6 Result:Outflow

Run:EV 100-yr Ex. Type II Element:OB7 Result:Outflow

Run:EV 100-yr Ex. Type II Element:OB8 Result:Outflow

Project: Eagleview_Subdivision
Simulation Run: EV 100-yr Ex. Type II Junction: J-OB6
Start of Run: 01Oct2021, 00:00 Basin Model: Eagleview_Existing
End of Run: 02Oct2021, 00:00 Meteorologic Model: 100-yr Type II
Compute Time: 11Mar2022, 10:12:01 Control Specifications: 24-hr Storm
Volume Units: AC-FT

Computed Results

Peak Outflow : 371.3 (CFS) Date/Time of Peak Outflow : 01Oct2021, 12:43
Total Outflow : 78.1 (AC-FT)

Subbasin "OB1" Results for Run "EV 100-yr Ex. Type II"

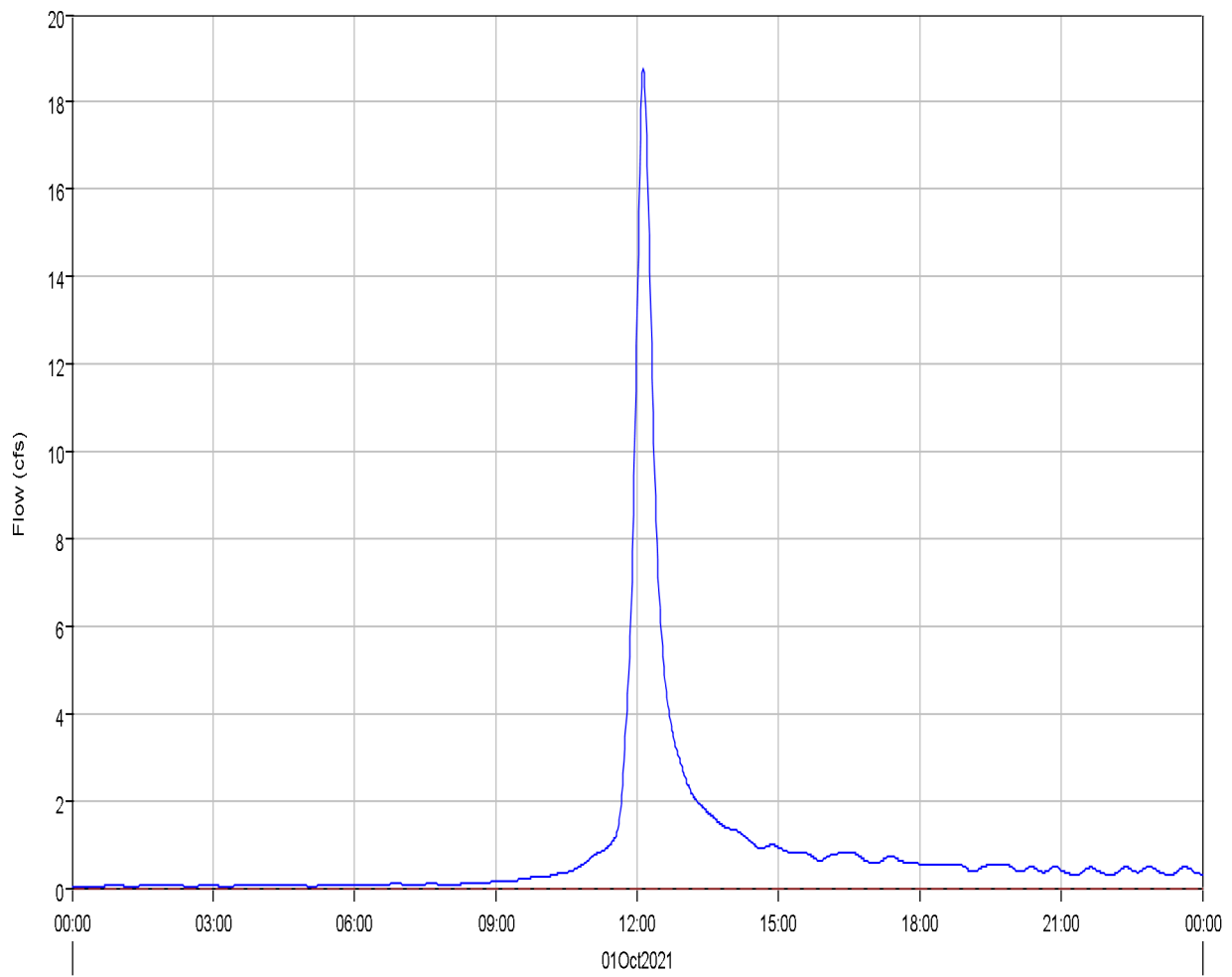
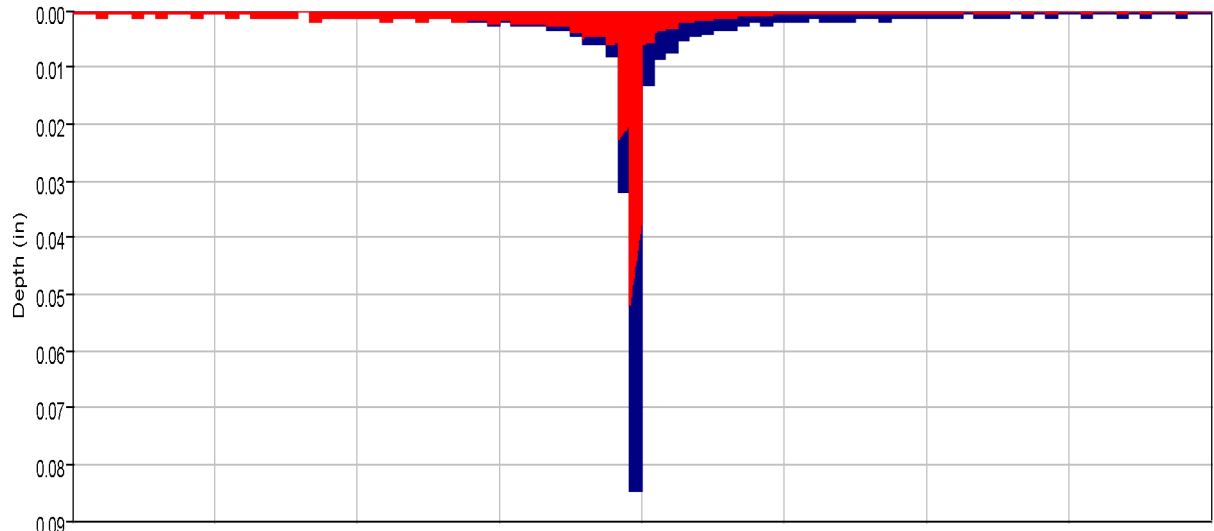

Run:EV 100-yr Ex. Type II Element:OB1 Result:Precipitation

Run:EV 100-yr Ex. Type II Element:OB1 Result:Precipitation Loss

Run:EV 100-yr Ex. Type II Element:OB1 Result:Outflow

Run:EV 100-yr Ex. Type II Element:OB1 Result:Baseflow

Project: Eagleview_Subdivision
Simulation Run: EV 100-yr Ex. Type II Subbasin: OB1
Start of Run: 01Oct2021, 00:00 Basin Model: Eagleview_Existing
End of Run: 02Oct2021, 00:00 Meteorologic Model: 100-yr Type II
Compute Time: 11Mar2022, 10:12:01 Control Specifications: 24-hr Storm
Volume Units: AC-FT

Computed Results

Peak Discharge :	18.8 (CFS)	Date/Time of Peak Discharge :	01Oct2021, 12:08
Total Precipitation :	4.0 (AC-FT)	Total Direct Runoff :	1.7 (AC-FT)
Total Loss :	2.3 (AC-FT)	Total Baseflow :	0.0 (AC-FT)
Total Excess :	1.7 (AC-FT)	Discharge :	1.7 (AC-FT)

Subbasin "OB2" Results for Run "EV 100-yr Ex. Type II"

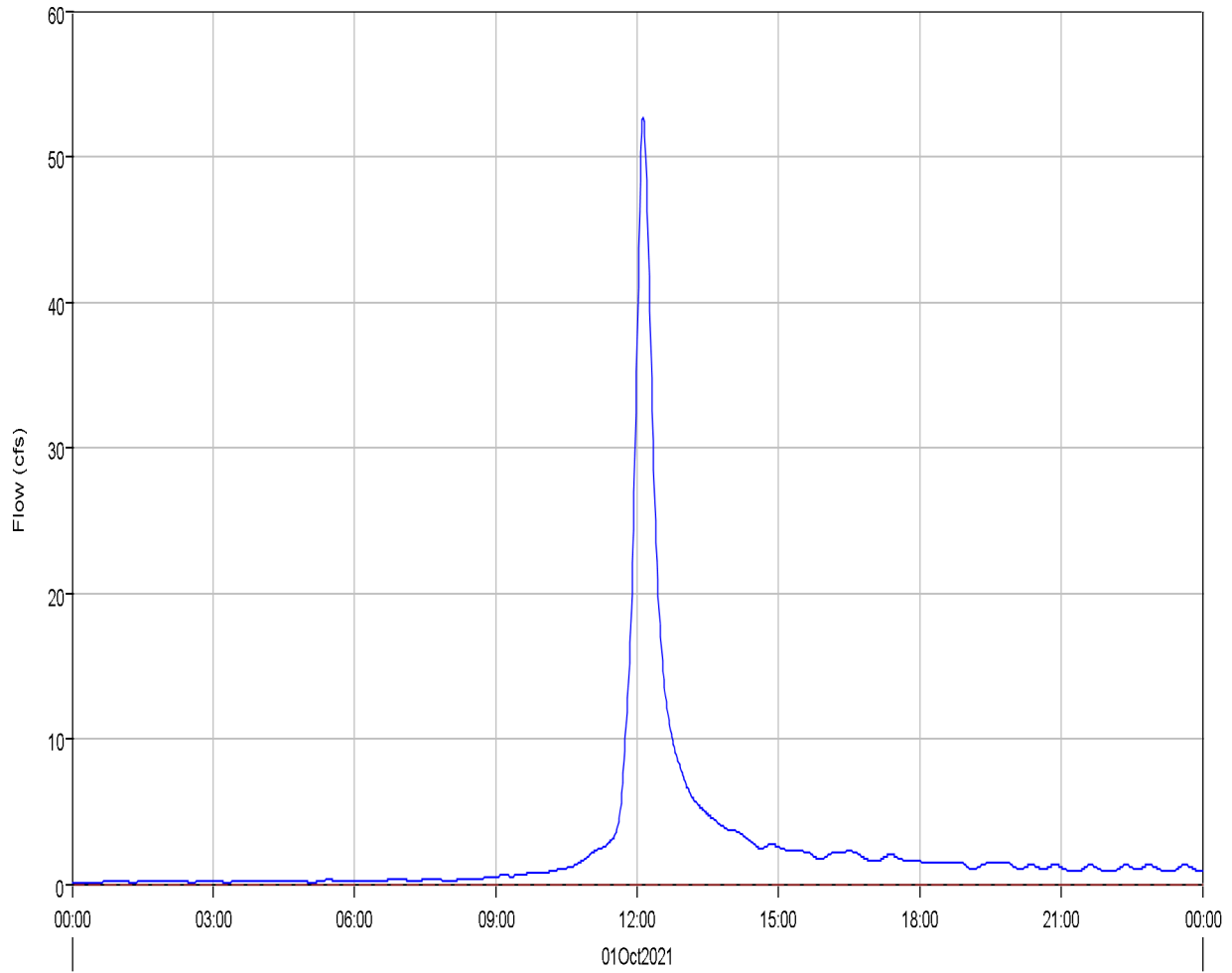
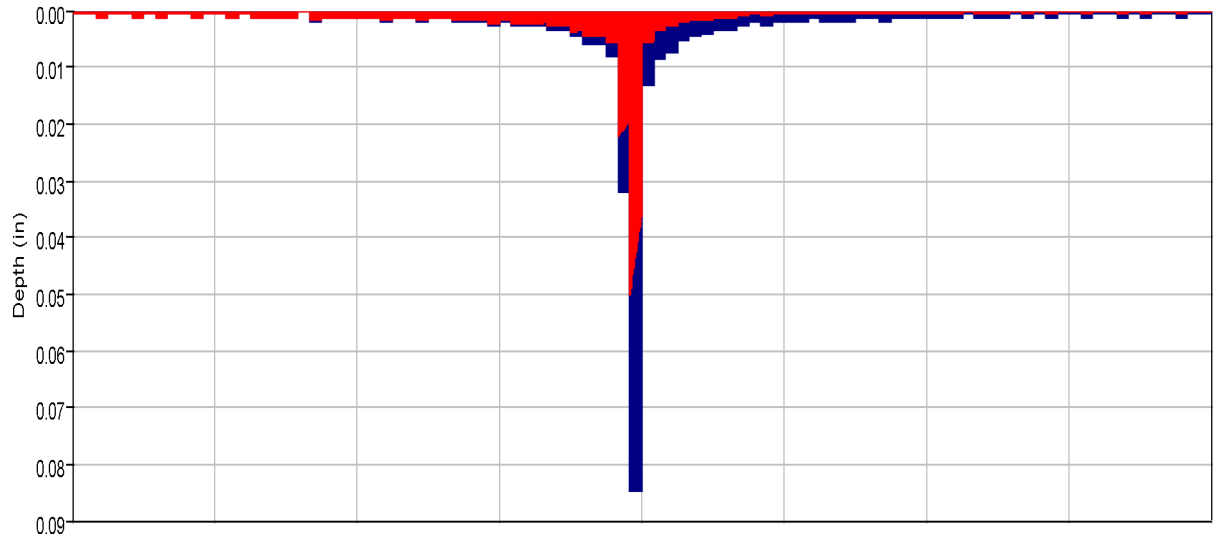

Run:EV 100-yr Ex. Type II Element:OB2 Result:Precipitation
Run:EV 100-yr Ex. Type II Element:OB2 Result:Outflow

Run:EV 100-yr Ex. Type II Element:OB2 Result:Precipitation Loss
Run:EV 100-yr Ex. Type II Element:OB2 Result:Baseflow

Project: Eagleview_Subdivision
Simulation Run: EV 100-yr Ex. Type II Subbasin: OB2
Start of Run: 01Oct2021, 00:00 Basin Model: Eagleview_Existing
End of Run: 02Oct2021, 00:00 Meteorologic Model: 100-yr Type II
Compute Time: 11Mar2022, 10:12:01 Control Specifications: 24-hr Storm
Volume Units: AC-FT

Computed Results

Peak Discharge :	52.7 (CFS)	Date/Time of Peak Discharge :	01Oct2021, 12:08
Total Precipitation :	10.8 (AC-FT)	Total Direct Runoff :	4.7 (AC-FT)
Total Loss :	6.0 (AC-FT)	Total Baseflow :	0.0 (AC-FT)
Total Excess :	4.7 (AC-FT)	Discharge :	4.7 (AC-FT)

Subbasin "OB3" Results for Run "EV 100-yr Ex. Type II"

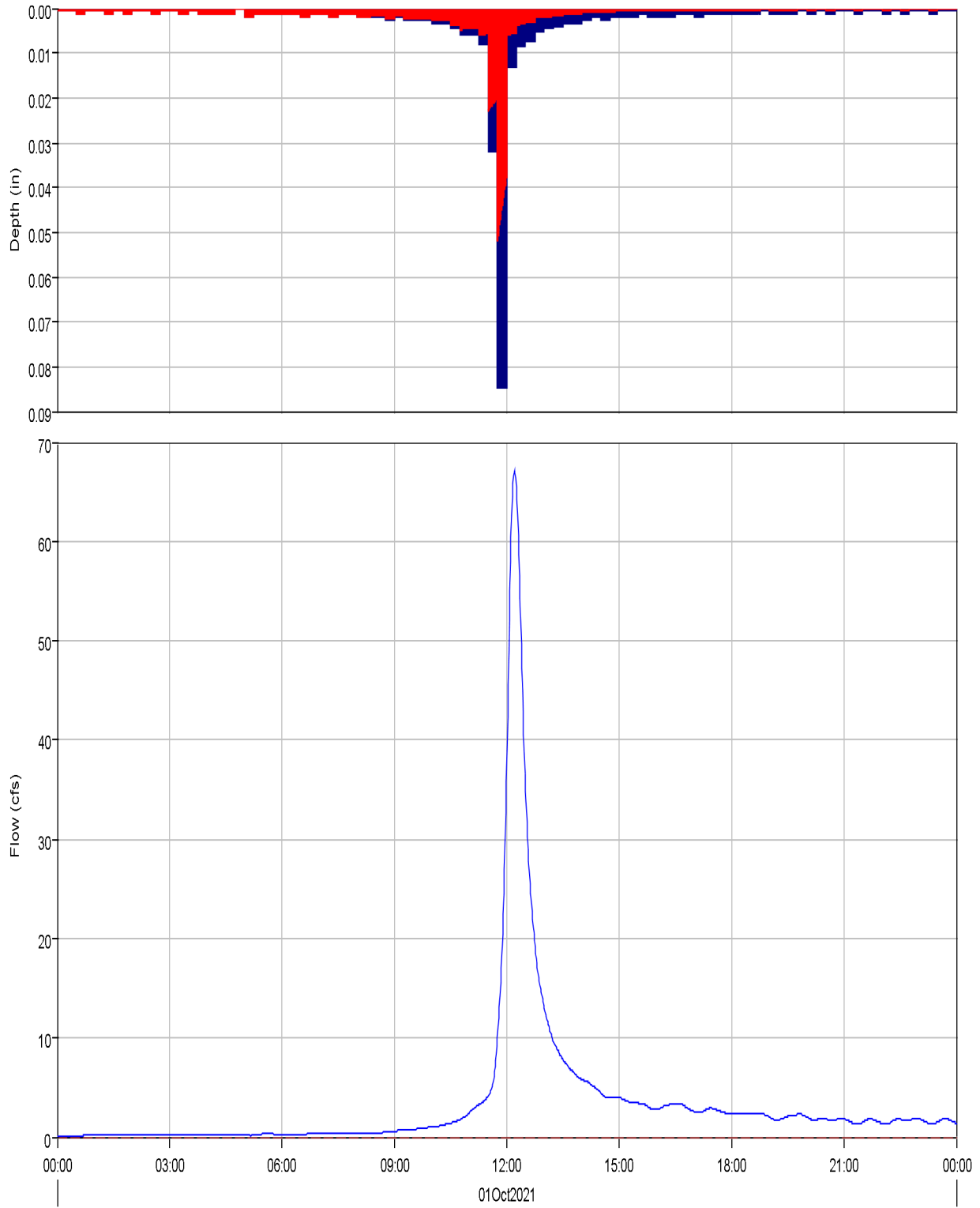

Run:EV 100-yr Ex. Type II Element:OB3 Result:Precipitation
Run:EV 100-yr Ex. Type II Element:OB3 Result:Outflow

Run:EV 100-yr Ex. Type II Element:OB3 Result:Precipitation Loss
Run:EV 100-yr Ex. Type II Element:OB3 Result:Baseflow

Project: Eagleview_Subdivision
Simulation Run: EV 100-yr Ex. Type II Subbasin: OB3
Start of Run: 01Oct2021, 00:00 Basin Model: Eagleview_Existing
End of Run: 02Oct2021, 00:00 Meteorologic Model: 100-yr Type II
Compute Time: 11Mar2022, 10:12:01 Control Specifications: 24-hr Storm

Volume Units: AC-FT

Computed Results

Peak Discharge :	67.1 (CFS)	Date/Time of Peak Discharge :	01Oct2021, 12:12
Total Precipitation :	16.7 (AC-FT)	Total Direct Runoff :	6.9 (AC-FT)
Total Loss :	9.7 (AC-FT)	Total Baseflow :	0.0 (AC-FT)
Total Excess :	7.0 (AC-FT)	Discharge :	6.9 (AC-FT)

Subbasin "OB4" Results for Run "EV 100-yr Ex. Type II"

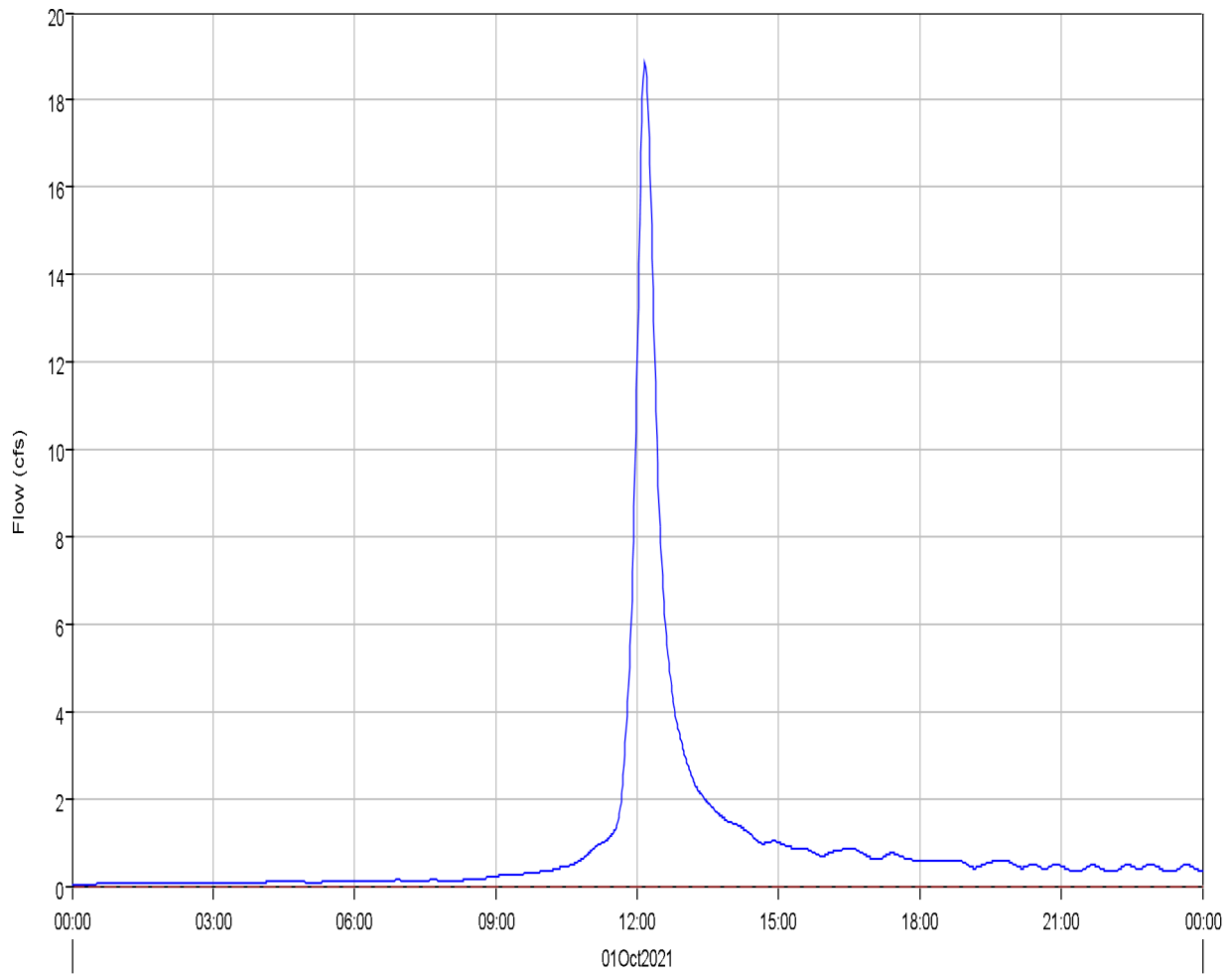
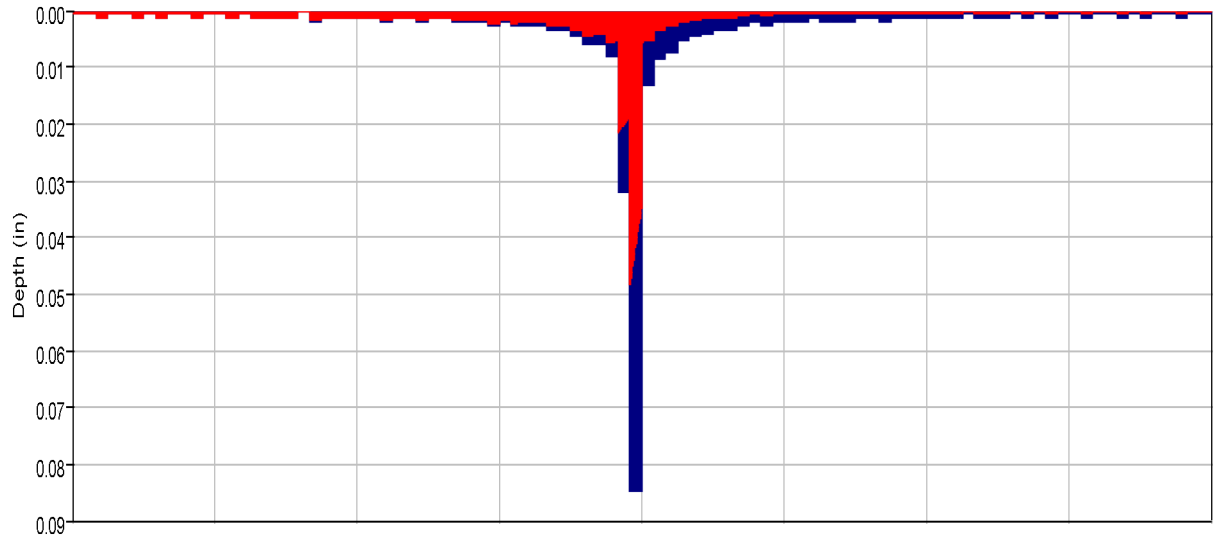

Run:EV 100-yr Ex. Type II Element:OB4 Result:Precipitation
Run:EV 100-yr Ex. Type II Element:OB4 Result:Outflow

Run:EV 100-yr Ex. Type II Element:OB4 Result:Precipitation Loss
Run:EV 100-yr Ex. Type II Element:OB4 Result:Baseflow

Project: Eagleview_Subdivision
Simulation Run: EV 100-yr Ex. Type II Subbasin: OB4
Start of Run: 01Oct2021, 00:00 Basin Model: Eagleview_Existing
End of Run: 02Oct2021, 00:00 Meteorologic Model: 100-yr Type II
Compute Time: 11Mar2022, 10:12:01 Control Specifications: 24-hr Storm
Volume Units: AC-FT

Computed Results

Peak Discharge :	18.9 (CFS)	Date/Time of Peak Discharge :	01Oct2021, 12:10
Total Precipitation :	4.0 (AC-FT)	Total Direct Runoff :	1.8 (AC-FT)
Total Loss :	2.2 (AC-FT)	Total Baseflow :	0.0 (AC-FT)
Total Excess :	1.8 (AC-FT)	Discharge :	1.8 (AC-FT)

Subbasin "OB5" Results for Run "EV 100-yr Ex. Type II"

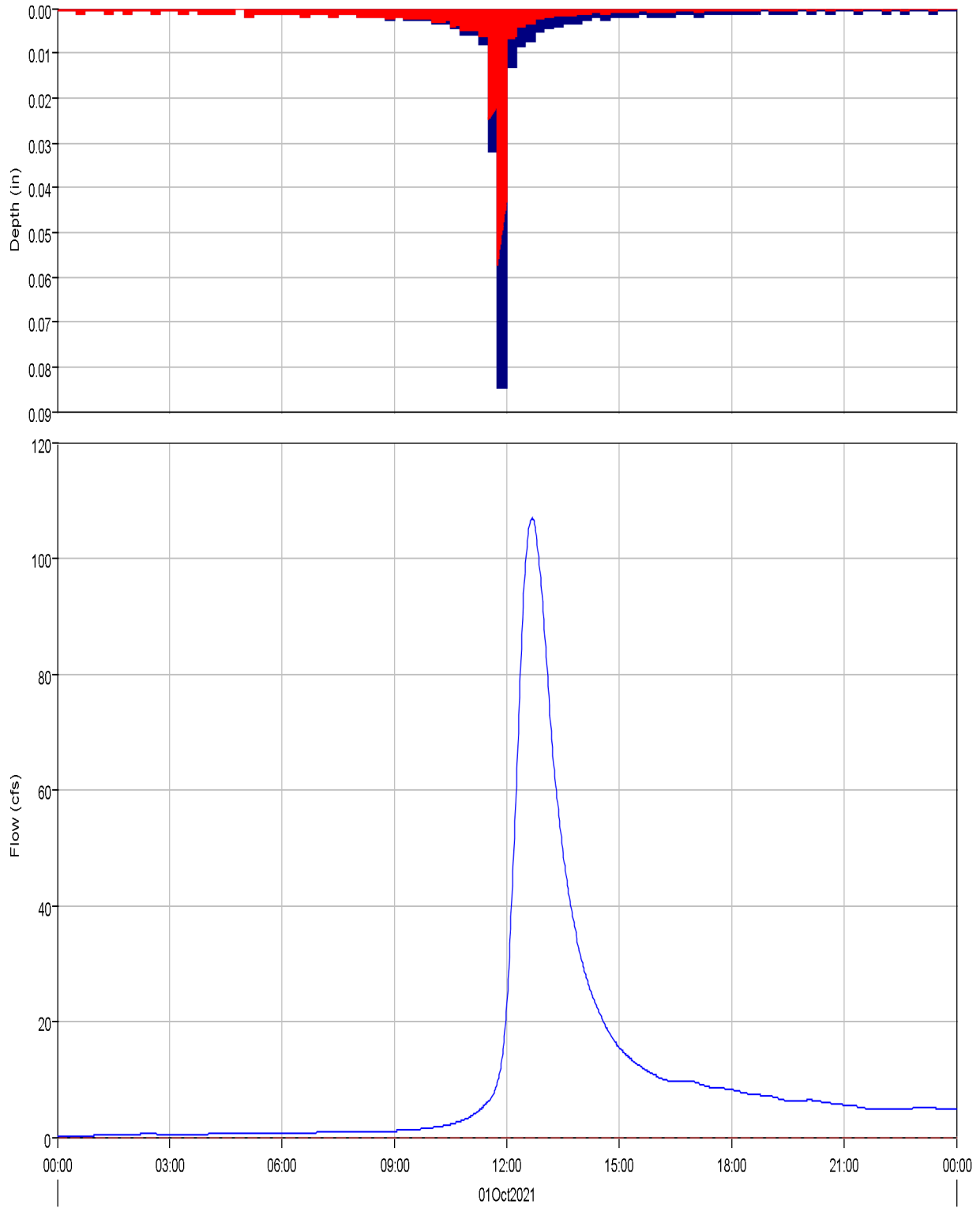

Run:EV 100-yr Ex. Type II Element:OB5 Result:Precipitation
Run:EV 100-yr Ex. Type II Element:OB5 Result:Outflow

Run:EV 100-yr Ex. Type II Element:OB5 Result:Precipitation Loss
Run:EV 100-yr Ex. Type II Element:OB5 Result:Baseflow

Project: Eagleview_Subdivision
Simulation Run: EV 100-yr Ex. Type II Subbasin: OB5

Start of Run: 01Oct2021, 00:00 Basin Model: Eagleview_Existing
End of Run: 02Oct2021, 00:00 Meteorologic Model: 100-yr Type II
Compute Time: 11Mar2022, 10:12:01 Control Specifications: 24-hr Storm

Volume Units: AC-FT

Computed Results

Peak Discharge :	106.9 (CFS)	Date/Time of Peak Discharge :	01Oct2021, 12:40
Total Precipitation :	55.1 (AC-FT)	Total Direct Runoff :	19.7 (AC-FT)
Total Loss :	35.0 (AC-FT)	Total Baseflow :	0.0 (AC-FT)
Total Excess :	20.1 (AC-FT)	Discharge :	19.7 (AC-FT)

Subbasin "OB6" Results for Run "EV 100-yr Ex. Type II"

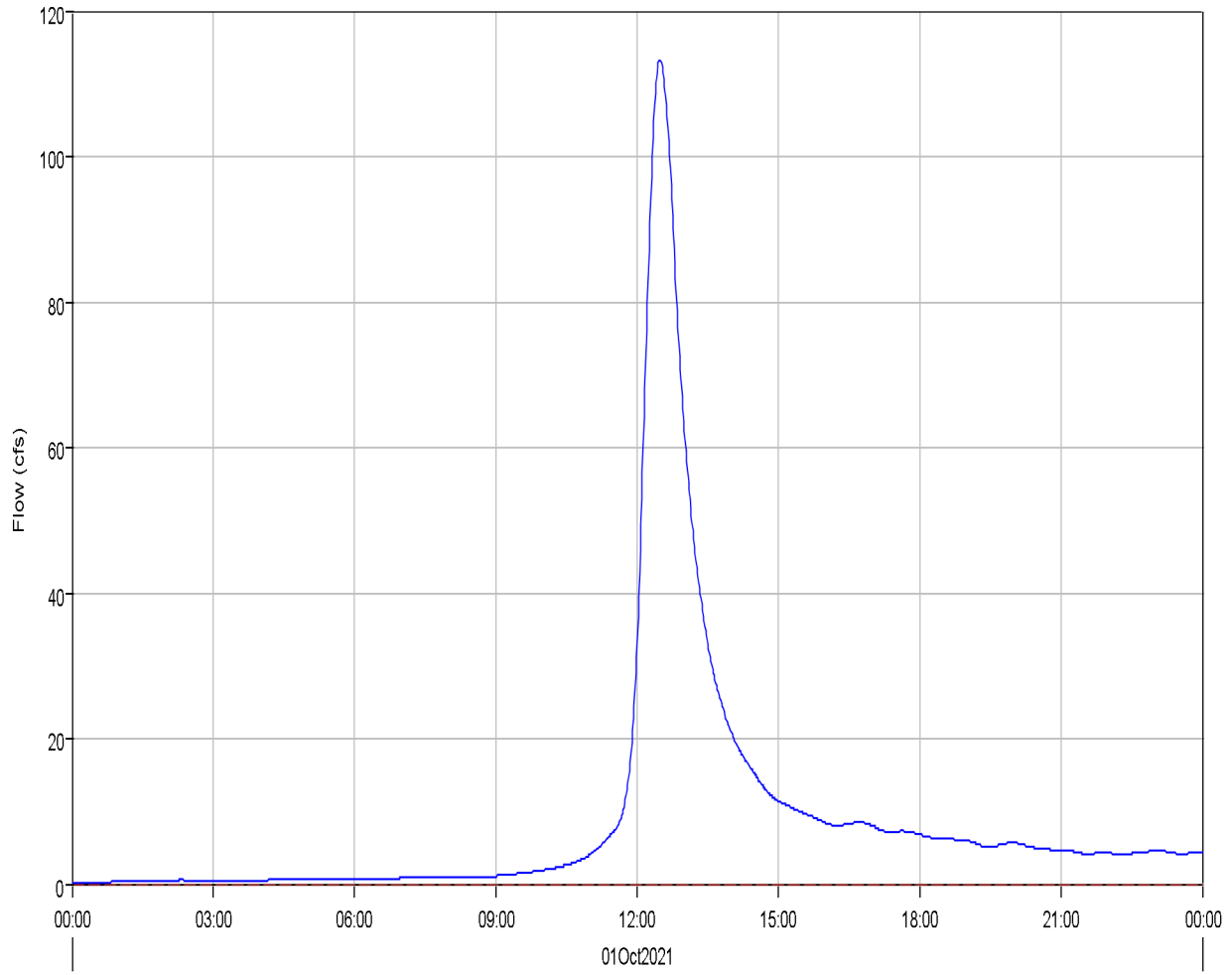
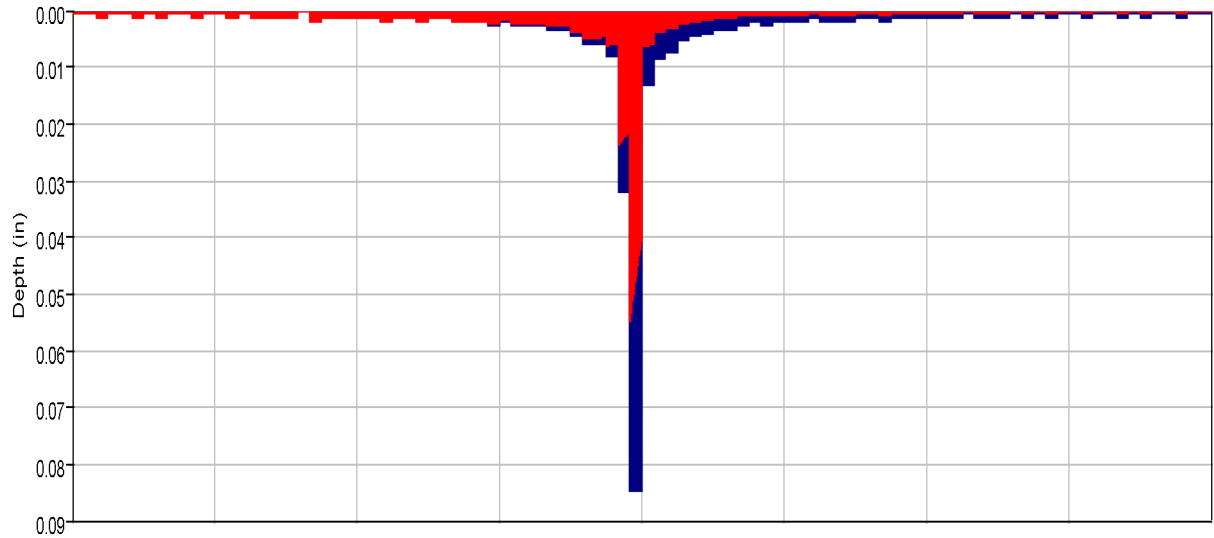

Run:EV 100-yr Ex. Type II Element:OB6 Result:Precipitation
Run:EV 100-yr Ex. Type II Element:OB6 Result:Outflow

Run:EV 100-yr Ex. Type II Element:OB6 Result:Precipitation Loss
Run:EV 100-yr Ex. Type II Element:OB6 Result:Baseflow

Project: Eagleview_Subdivision
Simulation Run: EV 100-yr Ex. Type II Subbasin: OB6

Start of Run: 01Oct2021, 00:00 Basin Model: Eagleview_Existing
End of Run: 02Oct2021, 00:00 Meteorologic Model: 100-yr Type II
Compute Time: 11Mar2022, 10:12:01 Control Specifications: 24-hr Storm

Volume Units: AC-FT

Computed Results

Peak Discharge :	113.2 (CFS)	Date/Time of Peak Discharge :	01Oct2021, 12:29
Total Precipitation :	45.4 (AC-FT)	Total Direct Runoff :	17.5 (AC-FT)
Total Loss :	27.6 (AC-FT)	Total Baseflow :	0.0 (AC-FT)
Total Excess :	17.8 (AC-FT)	Discharge :	17.5 (AC-FT)

Subbasin "OB7" Results for Run "EV 100-yr Ex. Type II"

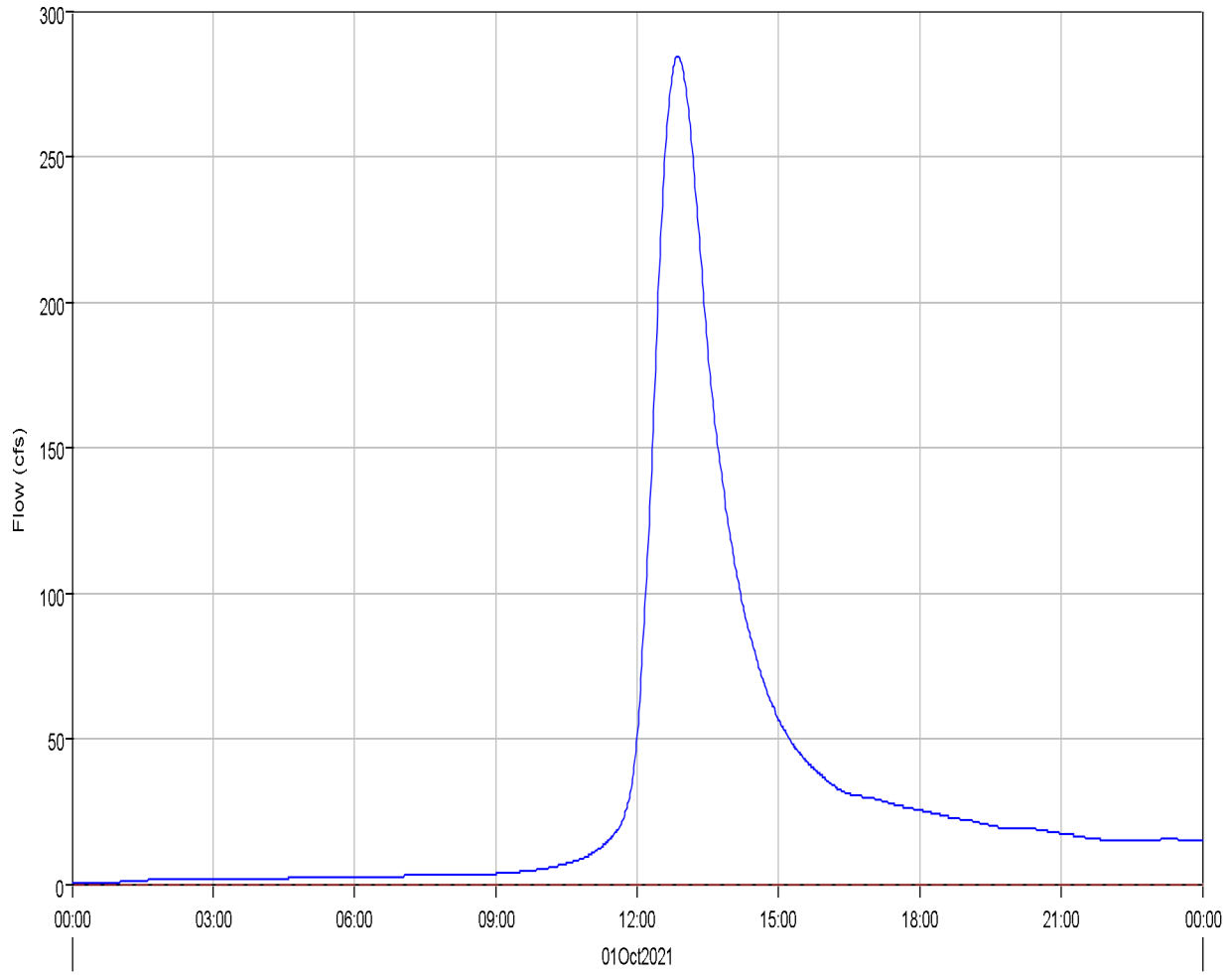
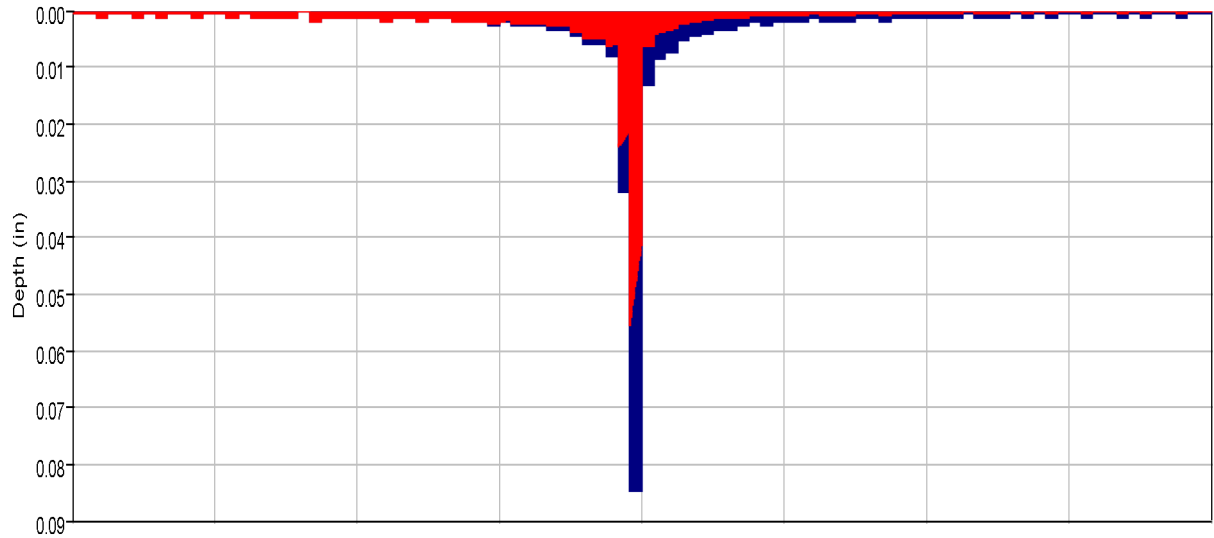

Run:EV 100-yr Ex. Type II Element:OB7 Result:Precipitation
Run:EV 100-yr Ex. Type II Element:OB7 Result:Outflow

Run:EV 100-yr Ex. Type II Element:OB7 Result:Precipitation Loss
Run:EV 100-yr Ex. Type II Element:OB7 Result:Baseflow

Project: Eagleview_Subdivision
Simulation Run: EV 100-yr Ex. Type II Subbasin: OB7

Start of Run: 01Oct2021, 00:00 Basin Model: Eagleview_Existing
End of Run: 02Oct2021, 00:00 Meteorologic Model: 100-yr Type II
Compute Time: 11Mar2022, 10:12:01 Control Specifications: 24-hr Storm

Volume Units: AC-FT

Computed Results

Peak Discharge :	284.2 (CFS)	Date/Time of Peak Discharge :	01Oct2021, 12:52
Total Precipitation :	161.5 (AC-FT)	Total Direct Runoff :	60.6 (AC-FT)
Total Loss :	99.5 (AC-FT)	Total Baseflow :	0.0 (AC-FT)
Total Excess :	62.0 (AC-FT)	Discharge :	60.6 (AC-FT)

Subbasin "OB8" Results for Run "EV 100-yr Ex. Type II"

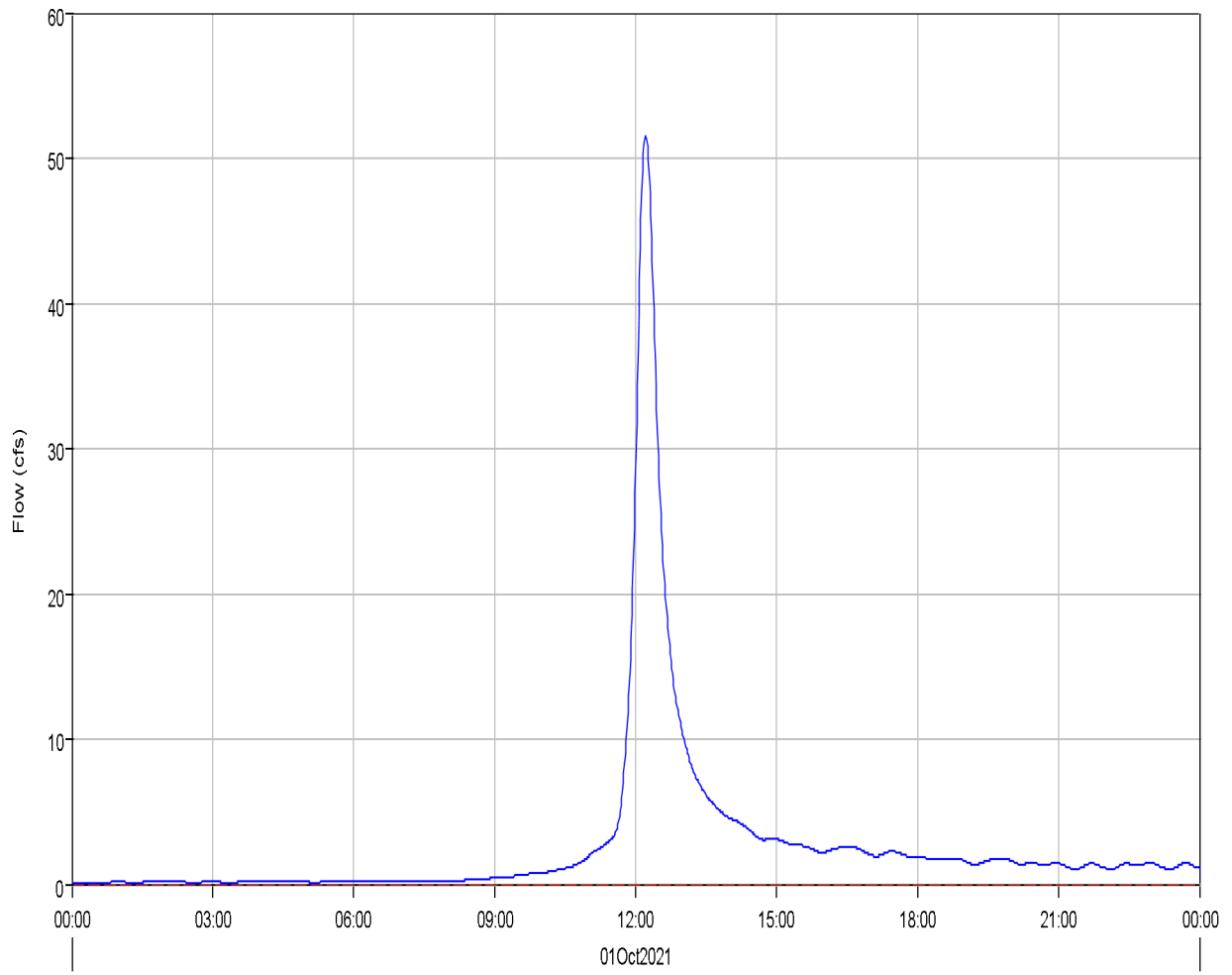
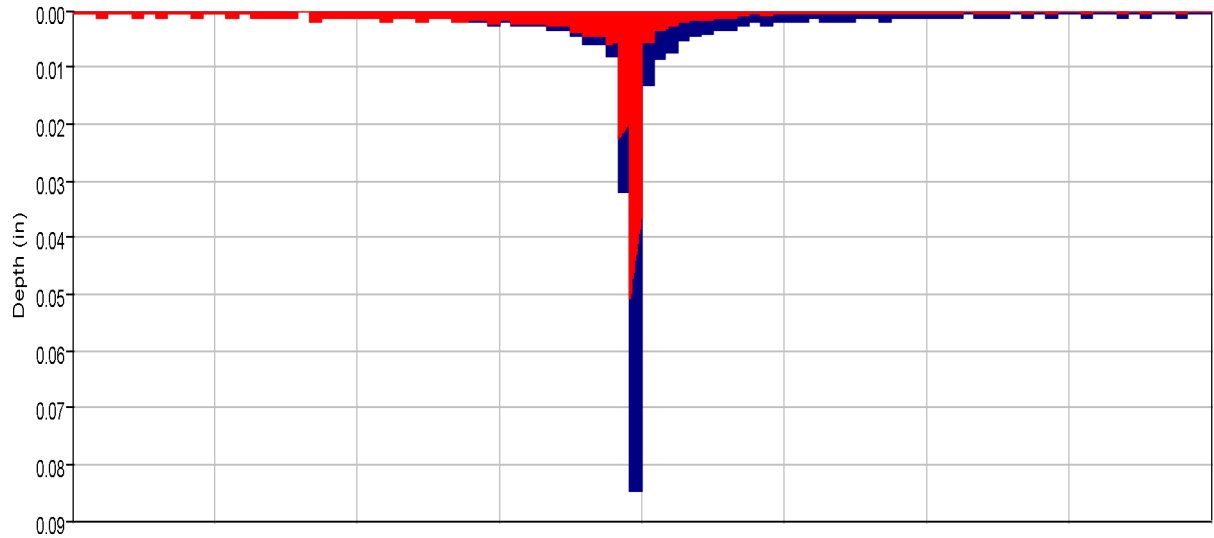

Run:EV 100-yr Ex. Type II Element:OB8 Result:Precipitation
Run:EV 100-yr Ex. Type II Element:OB8 Result:Outflow

Run:EV 100-yr Ex. Type II Element:OB8 Result:Precipitation Loss
Run:EV 100-yr Ex. Type II Element:OB8 Result:Baseflow

Project: Eagleview_Subdivision
Simulation Run: EV 100-yr Ex. Type II Subbasin: OB8
Start of Run: 01Oct2021, 00:00 Basin Model: Eagleview_Existing
End of Run: 02Oct2021, 00:00 Meteorologic Model: 100-yr Type II
Compute Time: 11Mar2022, 10:12:01 Control Specifications: 24-hr Storm
Volume Units: AC-FT

Computed Results

Peak Discharge :	51.6 (CFS)	Date/Time of Peak Discharge :	01Oct2021, 12:13
Total Precipitation :	12.7 (AC-FT)	Total Direct Runoff :	5.4 (AC-FT)
Total Loss :	7.3 (AC-FT)	Total Baseflow :	0.0 (AC-FT)
Total Excess :	5.4 (AC-FT)	Discharge :	5.4 (AC-FT)

Reach 'R-B1' Results for Run 'EV 100-yr Ex. Type II'

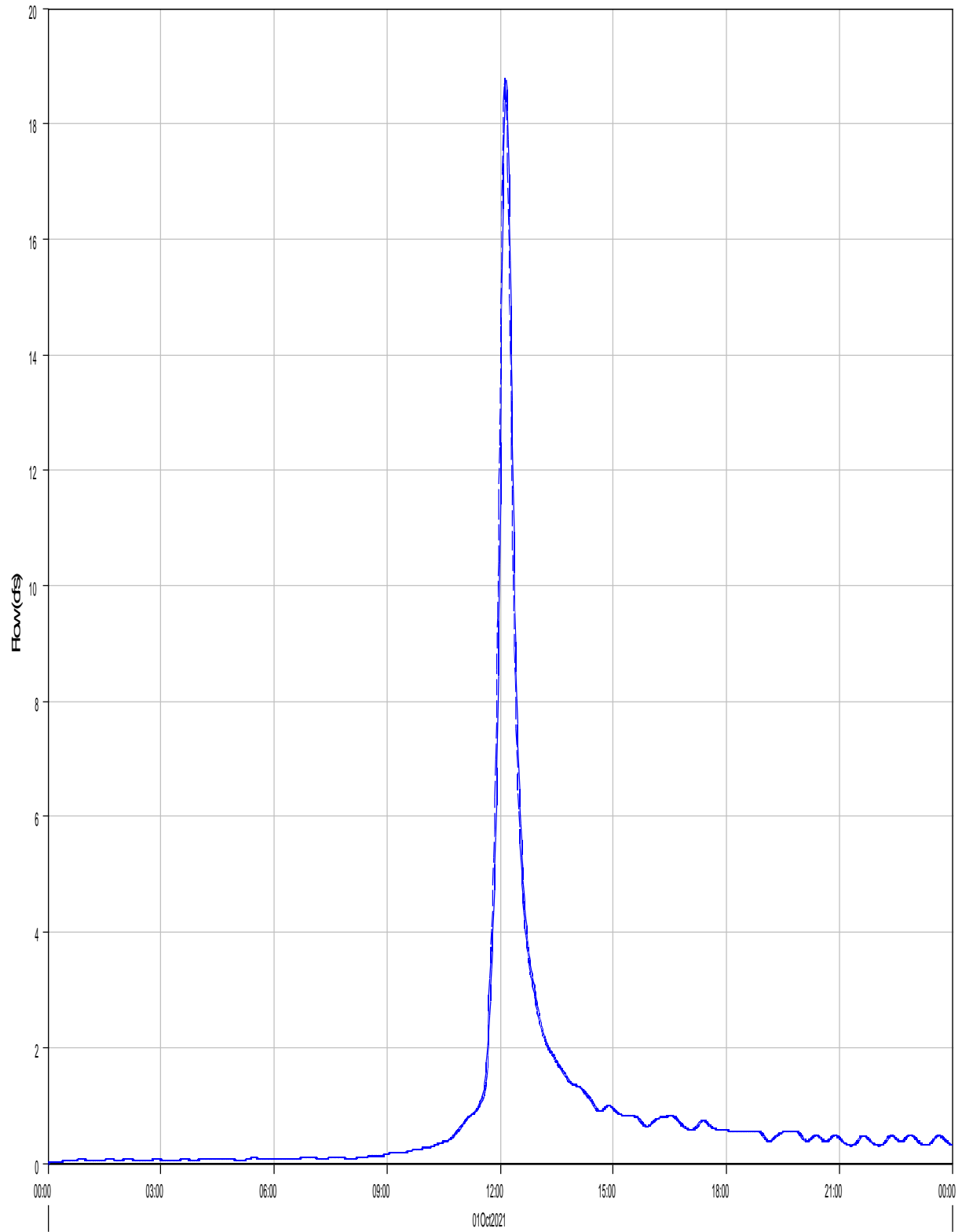

Run:EV 100-yr Ex. Type II Element:R-B1 Result:Outflow

Run:EV 100-yr Ex. Type II Element:R-B1 Result:Combined Inflow

Project: Eagleview_Subdivision
Simulation Run: EV 100-yr Ex. Type II Reach: R-B1
Start of Run: 01Oct2021, 00:00 Basin Model: Eagleview_Existing
End of Run: 02Oct2021, 00:00 Meteorologic Model: 100-yr Type II
Compute Time: 11Mar2022, 10:12:01 Control Specifications: 24-hr Storm

Volume Units: AC-FT

Computed Results

Peak Inflow :	18.8 (CFS)	Date/Time of Peak Inflow :	01Oct2021, 12:08
Peak Outflow :	18.7 (CFS)	Date/Time of Peak Outflow :	01Oct2021, 12:10
Total Inflow :	1.7 (AC-FT)	Total Outflow :	1.7 (AC-FT)

Reach 'R-OB4' Results for Run 'EV 100-yr Ex. Type II'

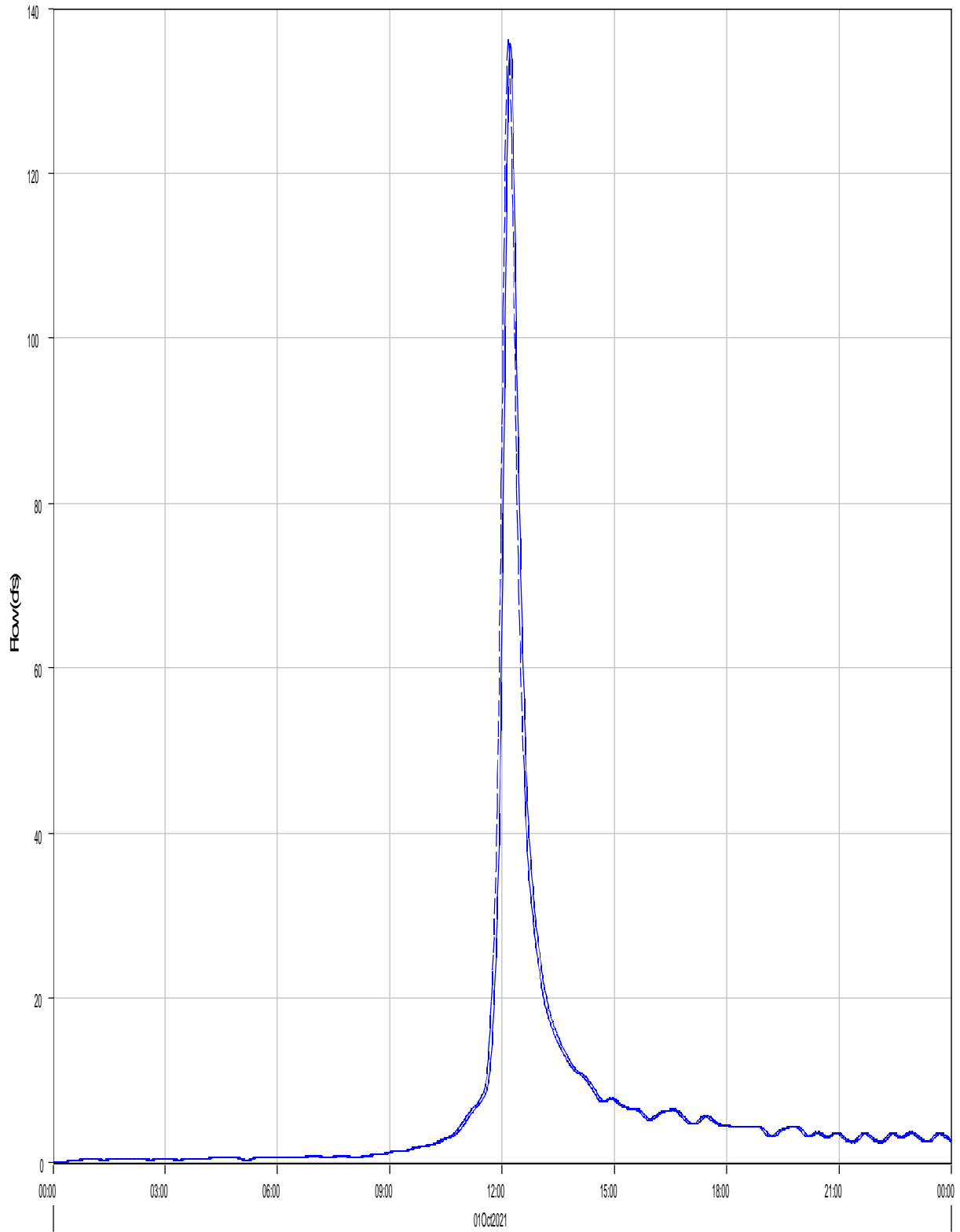

Run:EV 100-yr Ex. Type II Element:R-OB4 Result:Outflow

Run:EV 100-yr Ex. Type II Element:R-OB4 Result:Combined Inflow

Project: Eagleview_Subdivision
Simulation Run: EV 100-yr Ex. Type II Reach: R-OB4

Start of Run: 01Oct2021, 00:00 Basin Model: Eagleview_Existing
End of Run: 02Oct2021, 00:00 Meteorologic Model: 100-yr Type II
Compute Time: 11Mar2022, 10:12:01 Control Specifications: 24-hr Storm

Volume Units: AC-FT

Computed Results

Peak Inflow :	136.1 (CFS)	Date/Time of Peak Inflow :	01Oct2021, 12:10
Peak Outflow :	135.8 (CFS)	Date/Time of Peak Outflow :	01Oct2021, 12:13
Total Inflow :	13.5 (AC-FT)	Total Outflow :	13.4 (AC-FT)

Reach 'R-CBS' Results for Run 'EV 100-yr Ex. Type II'

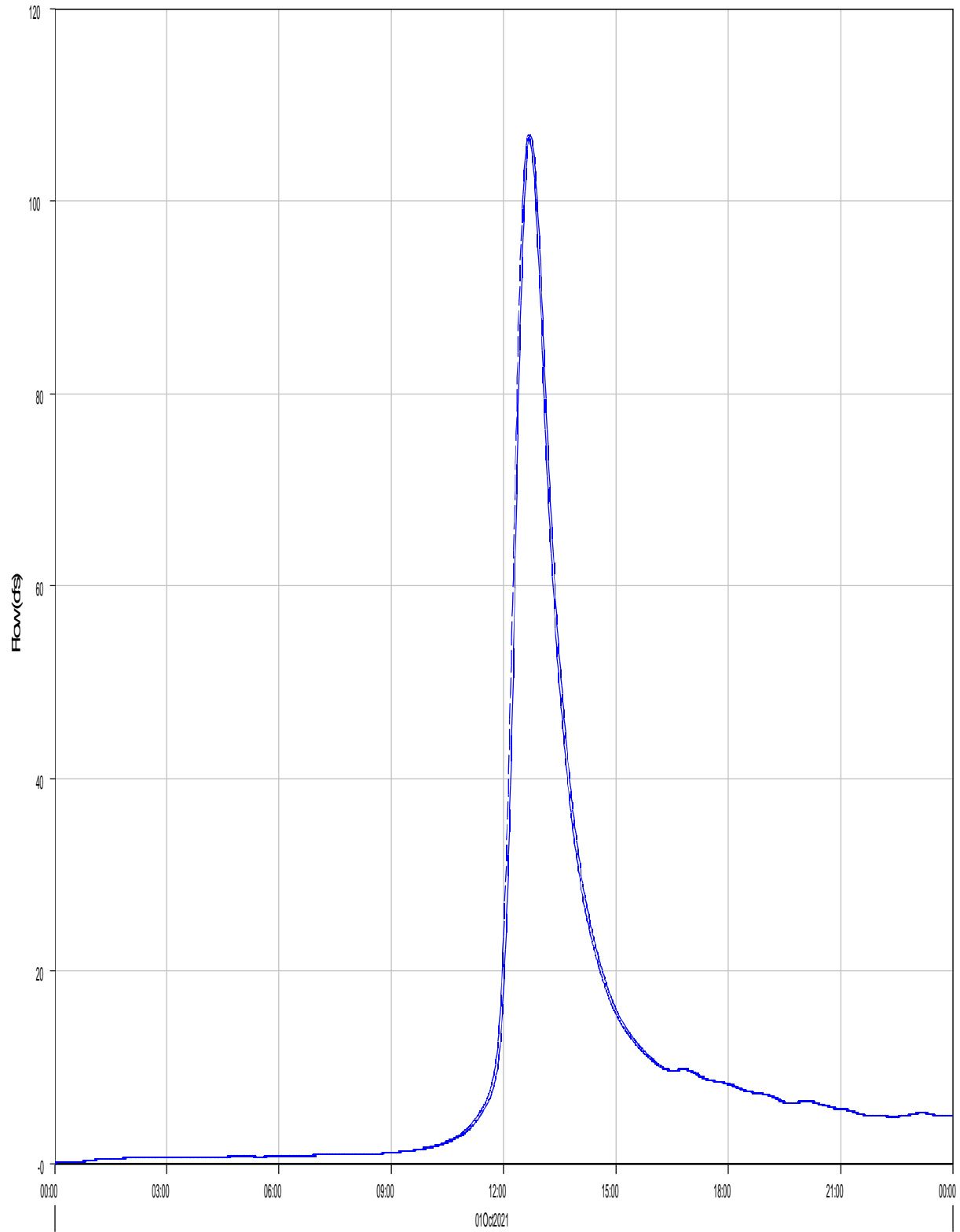

Run:EV 100-yr Ex. Type II Element:R-CBS Result:Outflow

Run:EV 100-yr Ex. Type II Element:R-CBS Result:Combined Inflow

Project: Eagleview_Subdivision
Simulation Run: EV 100-yr Ex. Type II Reach: R-OB5

Start of Run: 01Oct2021, 00:00 Basin Model: Eagleview_Existing
End of Run: 02Oct2021, 00:00 Meteorologic Model: 100-yr Type II
Compute Time: 11Mar2022, 10:12:01 Control Specifications: 24-hr Storm

Volume Units: AC-FT

Computed Results

Peak Inflow :	106.9 (CFS)	Date/Time of Peak Inflow :	01Oct2021, 12:40
Peak Outflow :	106.8 (CFS)	Date/Time of Peak Outflow :	01Oct2021, 12:43
Total Inflow :	19.7 (AC-FT)	Total Outflow :	19.7 (AC-FT)

Reach 'R-OB6' Results for Run 'EV 100-yr Ex. Type II'

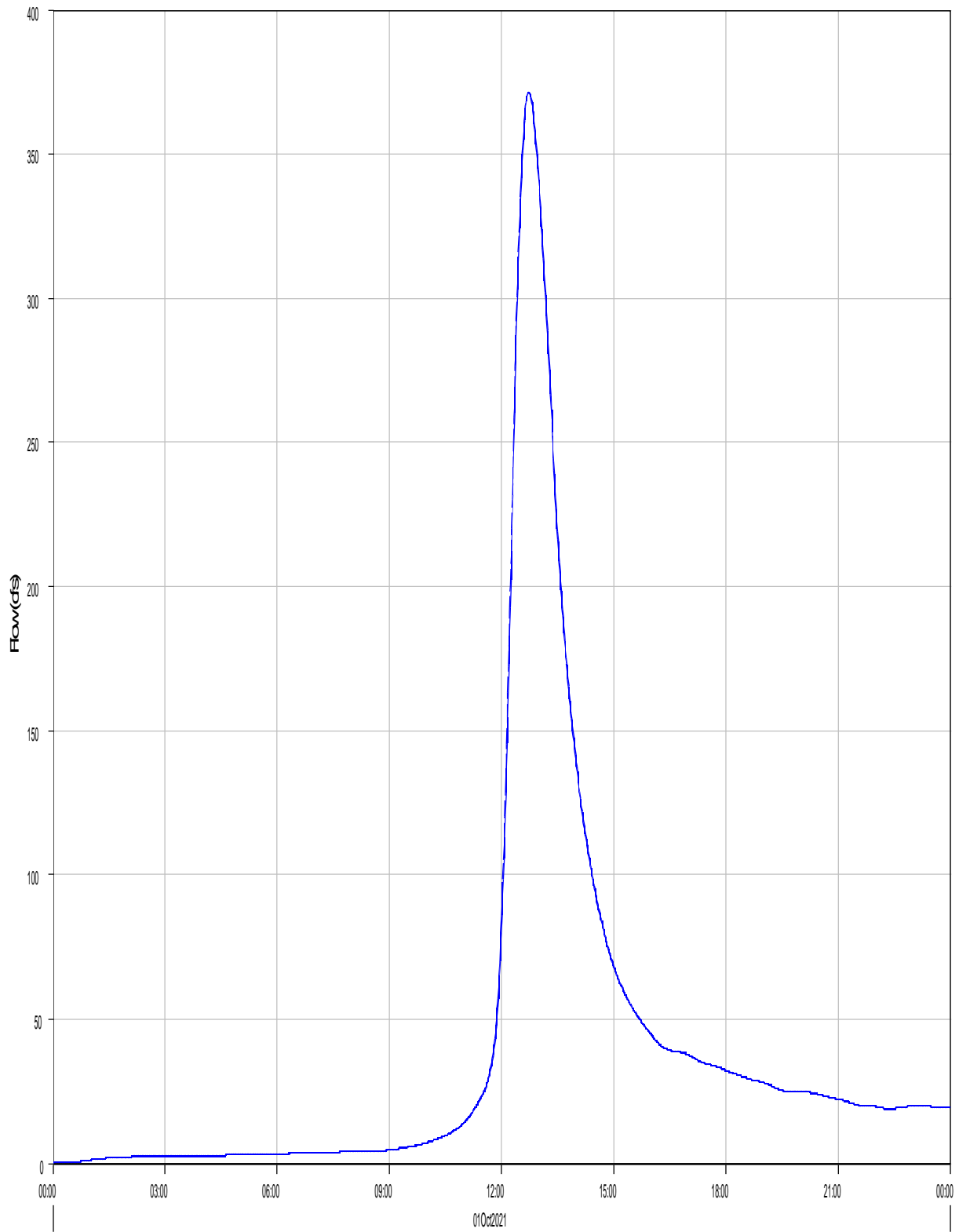

— Run:EV 100-yr Ex. Type II Element:R-OB6 Result:Outflow

- - - Run:EV 100-yr Ex. Type II Element:R-OB6 Result:Combined Inflow

Project: Eagleview_Subdivision
Simulation Run: EV 100-yr Ex. Type II Reach: R-OB6

Start of Run: 01Oct2021, 00:00 Basin Model: Eagleview_Existing
End of Run: 02Oct2021, 00:00 Meteorologic Model: 100-yr Type II
Compute Time: 11Mar2022, 10:12:01 Control Specifications: 24-hr Storm

Volume Units: AC-FT

Computed Results

Peak Inflow :	371.3 (CFS)	Date/Time of Peak Inflow :	01Oct2021, 12:43
Peak Outflow :	371.3 (CFS)	Date/Time of Peak Outflow :	01Oct2021, 12:44
Total Inflow :	78.1 (AC-FT)	Total Outflow :	78.1 (AC-FT)

Reach 'R-OB7' Results for Run 'EV 100-yr Ex. Type II'

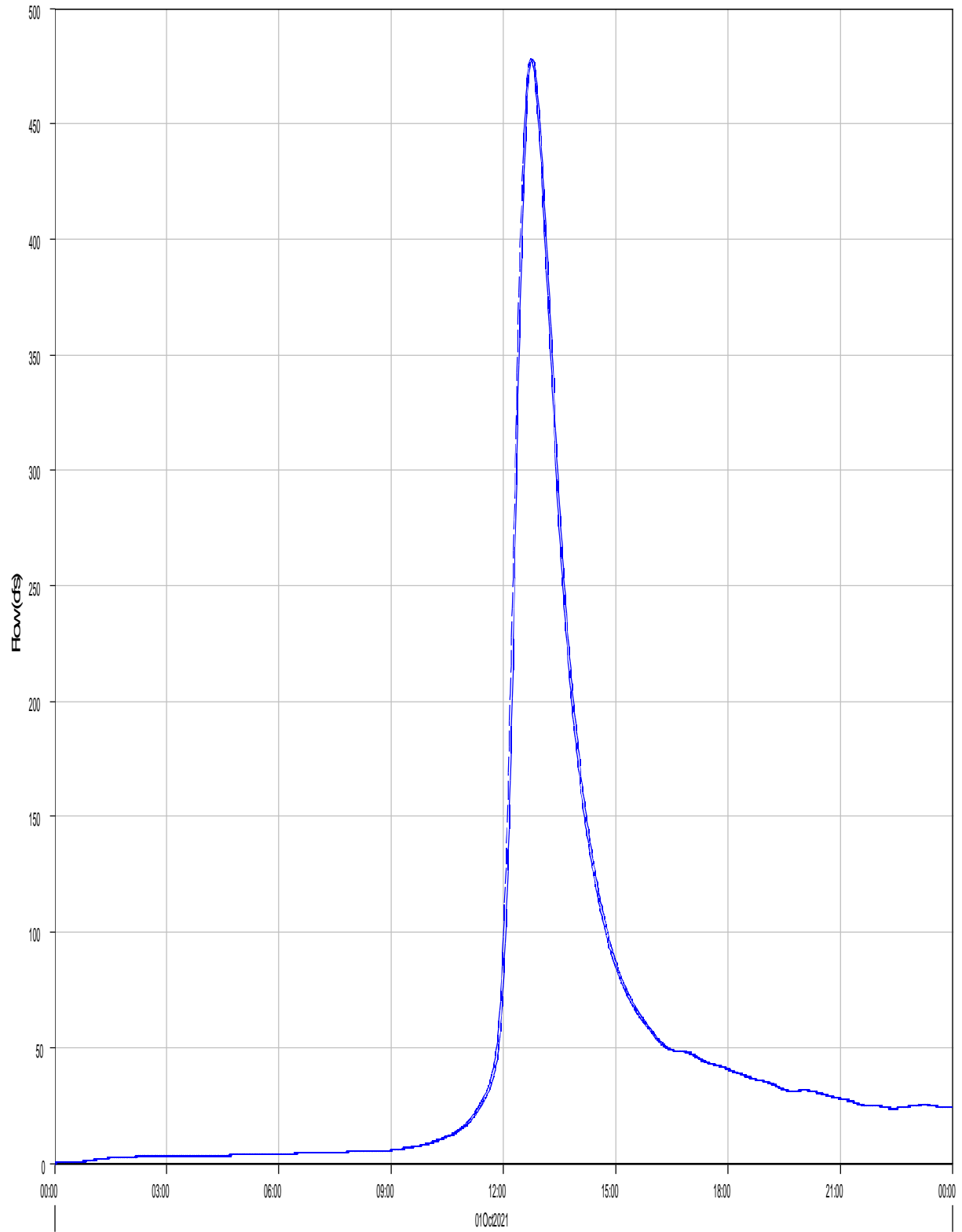

Run:EV 100-yr Ex. Type II Element:R-OB7 Result:Outflow

Run:EV 100-yr Ex. Type II Element:R-OB7 Result:Combined Inflow

Project: Eagleview_Subdivision
Simulation Run: EV 100-yr Ex. Type II Reach: R-OB7

Start of Run: 01Oct2021, 00:00 Basin Model: Eagleview_Existing
End of Run: 02Oct2021, 00:00 Meteorologic Model: 100-yr Type II
Compute Time: 11Mar2022, 10:12:01 Control Specifications: 24-hr Storm

Volume Units: AC-FT

Computed Results

Peak Inflow :	478.0 (CFS)	Date/Time of Peak Inflow :	01Oct2021, 12:44
Peak Outflow :	477.9 (CFS)	Date/Time of Peak Outflow :	01Oct2021, 12:46
Total Inflow :	97.8 (AC-FT)	Total Outflow :	97.7 (AC-FT)

Reach 'R-CB8' Results for Run 'EV 100-yr Ex. Type II'

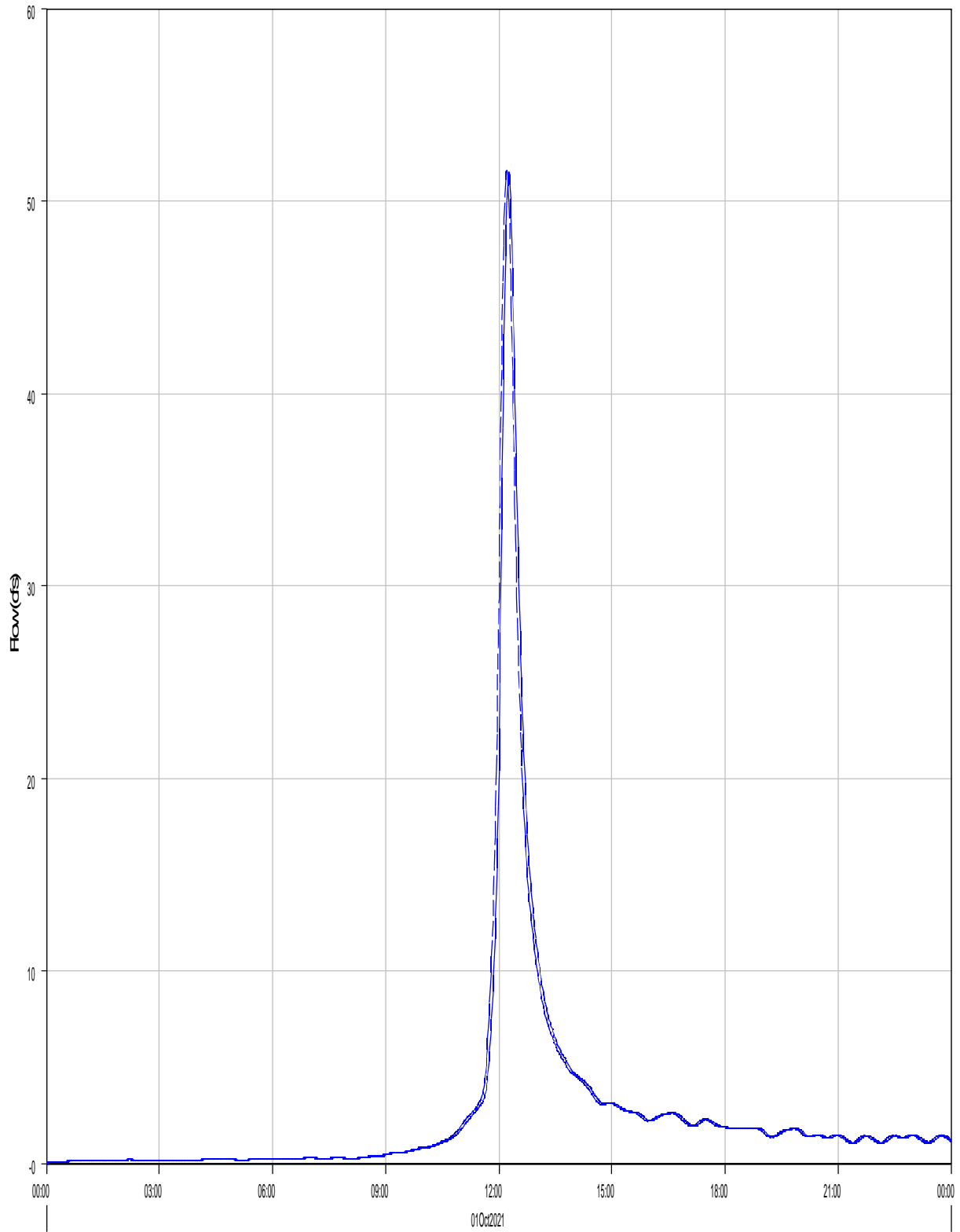

Run:EV 100-yr Ex. Type II Element:R-CB8 Result:Outflow

Run:EV 100-yr Ex. Type II Element:R-CB8 Result:Combined Inflow

Project: Eagleview_Subdivision
Simulation Run: EV 100-yr Ex. Type II Reach: R-OB8
Start of Run: 01Oct2021, 00:00 Basin Model: Eagleview_Existing
End of Run: 02Oct2021, 00:00 Meteorologic Model: 100-yr Type II
Compute Time: 11Mar2022, 10:12:01 Control Specifications: 24-hr Storm

Volume Units: AC-FT

Computed Results

Peak Inflow :	51.6 (CFS)	Date/Time of Peak Inflow :	01Oct2021, 12:13
Peak Outflow :	51.5 (CFS)	Date/Time of Peak Outflow :	01Oct2021, 12:16
Total Inflow :	5.4 (AC-FT)	Total Outflow :	5.4 (AC-FT)

Post Runoff Analysis
Time of Concentration

Project Information

Project Name: Eagleview
 KHA Project #: 19628800
 Designed by: DCM Date: 3/17/2022
 Revised by: _____ Date: _____
 Checked by: BAH Date: 3/17/2022

Minimum Time of Concentration 5.0 minutes
 2YR-24HR Rainfall, P2 2.10

Post-Development												
Drainage Area: OB1												
		Flow Length, L (ft)	Slope, s (ft/ft)	Manning's Roughness Coefficient, n	Two-year, 24-hr rainfall, P2 (in)	Paved or Unpaved	Cross Sectional Area of Flow, A (ft ²)	Wetted Perimeter, pw (ft)	Hydraulic radius, r (ft)	Average Velocity, V (ft/s)**	Travel Time, Tt (min)	Lag Time (min)
SHEET	T1 SHEET FLOW	300.00	0.073	0.15	2.10						17.35	
SHALLOW CONCENTRATED	T3 SHALLOW CONCENTRATED FLOW	1118.00	0.038			U				3.14	5.93	
Post-Development Time of Concentration, OB1											23.28	13.97

Post-Development												
Drainage Area: OB2												
		Flow Length, L (ft)	Slope, s (ft/ft)	Manning's Roughness Coefficient, n	Two-year, 24-hr rainfall, P2 (in)	Paved or Unpaved	Cross Sectional Area of Flow, A (ft ²)	Wetted Perimeter, pw (ft)	Hydraulic radius, r (ft)	Average Velocity, V (ft/s)**	Travel Time, Tt (min)	Lag Time (min)
SHEET	T1 SHEET FLOW	300.00	0.063	0.15	2.10						19.41	
SHALLOW CONCENTRATED	T3 SHALLOW CONCENTRATED FLOW	554.00	0.046			U				3.45	2.67	
CHANNEL	T2 CHANNEL FLOW	841.00	0.029	0.05		U	9.50	6.60	1.44	6.45	2.17	
Post-Development Time of Concentration, OB2											23.26	13.95

Post-Development												
Drainage Area: OB3												
		Flow Length, L (ft)	Slope, s (ft/ft)	Manning's Roughness Coefficient, n	Two-year, 24-hr rainfall, P2 (in)	Paved or Unpaved	Cross Sectional Area of Flow, A (ft ²)	Wetted Perimeter, pw (ft)	Hydraulic radius, r (ft)	Average Velocity, V (ft/s)**	Travel Time, Tt (min)	Lag Time (min)
SHEET	T1 SHEET FLOW	300.00	0.074	0.15	2.10						17.26	
SHALLOW CONCENTRATED	T3 SHALLOW CONCENTRATED FLOW	2436.00	0.034			U				2.97	13.65	
Post-Development Time of Concentration, OB3											30.91	18.55

Post-Development												
Drainage Area: OB4												
		Flow Length, L (ft)	Slope, s (ft/ft)	Manning's Roughness Coefficient, n	Two-year, 24-hr rainfall, P2 (in)	Paved or Unpaved	Cross Sectional Area of Flow, A (ft ²)	Wetted Perimeter, pw (ft)	Hydraulic radius, r (ft)	Average Velocity, V (ft/s)**	Travel Time, Tt (min)	Lag Time (min)
SHEET	T1 SHEET FLOW	300.00	0.043	0.15	2.10						21.65	
SHALLOW CONCENTRATED	T3 SHALLOW CONCENTRATED FLOW	793.00	0.038			U				3.16	4.13	
CHANNEL	T2 CHANNEL FLOW	577.00	0.028	0.05		U	9.50	6.60	1.44	6.36	1.51	
Post-Development Time of Concentration, OB4											27.29	16.38

Post-Development												
Drainage Area: OB5												
		Flow Length, L (ft)	Slope, s (ft/ft)	Manning's Roughness Coefficient, n	Two-year, 24-hr rainfall, P2 (in)	Paved or Unpaved	Cross Sectional Area of Flow, A (ft ²)	Wetted Perimeter, pw (ft)	Hydraulic radius, r (ft)	Average Velocity, V (ft/s)**	Travel Time, Tt (min)	Lag Time (min)
SHEET	T1 SHEET FLOW	300.00	0.037	0.40	2.10						49.91	
SHALLOW CONCENTRATED	T3 SHALLOW CONCENTRATED FLOW	838.00	0.033			U				2.93	21.83	
CHANNEL	T2 CHANNEL FLOW	1407.00	0.024	0.04		U	9.50	6.60	1.44	7.36	3.19	
Post-Development Time of Concentration, OB5											74.93	44.96

Post-Development												
Drainage Area: OB6												
		Flow Length, L (ft)	Slope, s (ft/ft)	Manning's Roughness Coefficient, n	Two-year, 24-hr rainfall, P2 (in)	Paved or Unpaved	Cross Sectional Area of Flow, A (ft ²)	Wetted Perimeter, pw (ft)	Hydraulic radius, r (ft)	Average Velocity, V (ft/s)**	Travel Time, Tt (min)	Lag Time (min)
SHEET	T1 SHEET FLOW	300.00	0.064	0.40	2.10						40.09	
SHALLOW CONCENTRATED	T3 SHALLOW CONCENTRATED FLOW	2569.00	0.038			U				3.14	13.62	
CHANNEL	T2 CHANNEL FLOW	2110.00	0.027	0.04		U	9.50	6.60	1.44	7.73	4.56	
Post-Development Time of Concentration, OB6											58.25	34.95

Post-Development												
Drainage Area: OB7												
		Flow Length, L (ft)	Slope, s (ft/ft)	Manning's Roughness Coefficient, n	Two-year, 24-hr rainfall, P2 (in)	Paved or Unpaved	Cross Sectional Area of Flow, A (ft ²)	Wetted Perimeter, pw (ft)	Hydraulic radius, r (ft)	Average Velocity, V (ft/s)**	Travel Time, Tt (min)	Lag Time (min)
SHEET	T1 SHEET FLOW	300.00	0.028	0.40	2.10						55.80	
SHALLOW CONCENTRATED	T3 SHALLOW CONCENTRATED FLOW	2068.00	0.036			U				3.06	11.28	
CHANNEL	T2 CHANNEL FLOW	6198.00	0.03	0.04		U	12.00	22.00	0.55	4.09	25.29	
Post-Development Time of Concentration, OB7											92.35	55.41

Post-Development												
Drainage Area: OB8												
		Flow Length, L (ft)	Slope, s (ft/ft)	Manning's Roughness Coefficient, n	Two-year, 24-hr rainfall, P2 (in)	Paved or Unpaved	Cross Sectional Area of Flow, A (ft ²)	Wetted Perimeter, pw (ft)	Hydraulic radius, r (ft)	Average Velocity, V (ft/s)**	Travel Time, Tt (min)	Lag Time (min)
SHEET	T1 SHEET FLOW	300.00	0.029	0.15	2.10						25.10	
SHALLOW CONCENTRATED	T3 SHALLOW CONCENTRATED FLOW	1117.00	0.043			U				3.34	5.57	
CHANNEL	T2 CHANNEL FLOW	762.00	0.033	0.03		U	9.50	6.60	1.44	11.43	1.11	
Post-Development Time of Concentration, OB8											31.78	19.07

Post-Development												
Drainage Area: PB1												
		Flow Length, L (ft)	Slope, s (ft/ft)	Manning's Roughness Coefficient, n	Two-year, 24-hr rainfall, P2 (in)	Paved or Unpaved	Cross Sectional Area of Flow, A (ft ²)	Wetted Perimeter, pw (ft)	Hydraulic radius, r (ft)	Average Velocity, V (ft/s)**	Travel Time, Tt (min)	Lag Time (min)
SHEET	T1 SHEET FLOW	300.00	0.033	0.15	2.10						23.84	
SHALLOW CONCENTRATED	T3 SHALLOW CONCENTRATED FLOW	400.00	0.041			U				3.27	2.04	
Post-Development Time of Concentration, PB1											25.88	15.53

Post-Development												
Drainage Area: PB2												
		Flow Length, L (ft)	Slope, s (ft/ft)	Manning's Roughness Coefficient, n	Two-year, 24-hr rainfall, P2 (in)	Paved or Unpaved	Cross Sectional Area of Flow, A (ft ²)	Wetted Perimeter, pw (ft)	Hydraulic radius, r (ft)	Average Velocity, V (ft/s)**	Travel Time, Tt (min)	Lag Time (min)
SHEET	T1 SHEET FLOW	227.00	0.033	0.15	2.10						19.07	
Post-Development Time of Concentration, PB2											19.07	11.44

Post-Development												
Drainage Area: PB3												
		Flow Length, L (ft)	Slope, s (ft/ft)	Manning's Roughness Coefficient, n	Two-year, 24-hr rainfall, P2 (in)	Paved or Unpaved	Cross Sectional Area of Flow, A (ft ²)	Wetted Perimeter, pw (ft)	Hydraulic radius, r (ft)	Average Velocity, V (ft/s)**	Travel Time, Tt (min)	Lag Time (min)
SHEET	T1 SHEET FLOW	313.00	0.05	0.15	2.10						21.99	
CHANNEL	T3 CHANNEL FLOW	315.00	0.02	0.03		U	9.00	12.40	0.73	6.08	0.86	
Post-Development Time of Concentration, PB3											22.46	13.47

Post-Development												
Drainage Area: PB4												
		Flow Length, L (ft)	Slope, s (ft/ft)	Manning's Roughness Coefficient, n	Two-year, 24-hr rainfall, P2 (in)	Paved or Unpaved	Cross Sectional Area of Flow, A (ft ²)	Wetted Perimeter, pw (ft)	Hydraulic radius, r (ft)	Average Velocity, V (ft/s)**	Travel Time, Tt (min)	Lag Time (min)
MINIMUM TC	T2 MINIMUM TC FLOW										5.00	
Post-Development Time of Concentration, PB4											5.00	3.00

Post Runoff Analysis
Time of Concentration

Project Information

Project Name: Eagleview
 KHA Project #: 19628800
 Designed by: DCM Date: 3/17/2022
 Revised by: _____ Date: _____
 Checked by: BAH Date: 3/17/2022

Minimum Time of Concentration 5.0 minutes
 2YR-24HR Rainfall, P2 2.10

Post-Development												
Drainage Area: PB5												
		Flow Length, L (ft)	Slope, s (ft/ft)	Manning's Roughness Coefficient, n	Two-year, 24-hr rainfall, P2 (in)	Paved or Unpaved	Cross Sectional Area of Flow, A (ft ²)	Wetted Perimeter, pw (ft)	Hydraulic radius, r (ft)	Average Velocity, V (ft/s)**	Travel Time, Tt (min)	Lag Time (min)
SHEET	T1 SHEET FLOW	300.00	0.021	0.15	2.10						23.56	
SHALLOW CONCENTRATED	T2 SHALLOW CONCENTRATED FLOW	292.00	0.024			U				2.50	1.95	
CHANNEL	T2 CHANNEL FLOW	44.00	0.032	0.03		U	9.50	6.60	1.44	11.33	0.06	
Post-Development Time of Concentration, PB5											30.58	18.35

Post-Development												
Drainage Area: PB6												
		Flow Length, L (ft)	Slope, s (ft/ft)	Manning's Roughness Coefficient, n	Two-year, 24-hr rainfall, P2 (in)	Paved or Unpaved	Cross Sectional Area of Flow, A (ft ²)	Wetted Perimeter, pw (ft)	Hydraulic radius, r (ft)	Average Velocity, V (ft/s)**	Travel Time, Tt (min)	Lag Time (min)
SHEET	T1 SHEET FLOW	300.00	0.034	0.15	2.10						23.56	
SHALLOW CONCENTRATED	T2 SHALLOW CONCENTRATED FLOW	650.00	0.036			U				3.06	3.54	
CHANNEL	T2 CHANNEL FLOW	66.00	0.001	0.03		U	9.00	12.40	0.73	1.27	0.87	
Post-Development Time of Concentration, PB6											27.96	16.78

Post-Development												
Drainage Area: PB7												
		Flow Length, L (ft)	Slope, s (ft/ft)	Manning's Roughness Coefficient, n	Two-year, 24-hr rainfall, P2 (in)	Paved or Unpaved	Cross Sectional Area of Flow, A (ft ²)	Wetted Perimeter, pw (ft)	Hydraulic radius, r (ft)	Average Velocity, V (ft/s)**	Travel Time, Tt (min)	Lag Time (min)
SHEET	T1 SHEET FLOW	300.00	0.043	0.15	2.10						23.64	
SHALLOW CONCENTRATED	T2 SHALLOW CONCENTRATED FLOW	235.00	0.051			U				3.64	1.98	
CHANNEL	T2 CHANNEL FLOW	539.00	0.035	0.03		U	9.00	12.40	0.73	7.50	1.20	
Post-Development Time of Concentration, PB7											23.72	14.23

Post-Development												
Drainage Area: PB8												
		Flow Length, L (ft)	Slope, s (ft/ft)	Manning's Roughness Coefficient, n	Two-year, 24-hr rainfall, P2 (in)	Paved or Unpaved	Cross Sectional Area of Flow, A (ft ²)	Wetted Perimeter, pw (ft)	Hydraulic radius, r (ft)	Average Velocity, V (ft/s)**	Travel Time, Tt (min)	Lag Time (min)
SHEET	T1 SHEET FLOW	17.00	0.018	0.15	2.10						3.06	
SHALLOW CONCENTRATED	T2 SHALLOW CONCENTRATED FLOW	136.00	0.110			U				5.35	0.42	
CHANNEL	T2 CHANNEL FLOW	1445.00	0.031	0.03		U	14.00	34.00	0.41	4.84	4.98	
Post-Development Time of Concentration, PB8											8.46	5.07

Post-Development												
Drainage Area: PB9												
		Flow Length, L (ft)	Slope, s (ft/ft)	Manning's Roughness Coefficient, n	Two-year, 24-hr rainfall, P2 (in)	Paved or Unpaved	Cross Sectional Area of Flow, A (ft ²)	Wetted Perimeter, pw (ft)	Hydraulic radius, r (ft)	Average Velocity, V (ft/s)**	Travel Time, Tt (min)	Lag Time (min)
SHEET	T1 SHEET FLOW	300.00	0.060	0.15	2.10						18.77	
SHALLOW CONCENTRATED	T2 SHALLOW CONCENTRATED FLOW	171.00	0.072			U				4.33	0.66	
CHANNEL	T2 CHANNEL FLOW	873.00	0.028	0.03		U	14.00	34.00	0.41	4.60	3.16	
Post-Development Time of Concentration, PB9											22.59	13.56

Post-Development												
Drainage Area: PB10												
		Flow Length, L (ft)	Slope, s (ft/ft)	Manning's Roughness Coefficient, n	Two-year, 24-hr rainfall, P2 (in)	Paved or Unpaved	Cross Sectional Area of Flow, A (ft ²)	Wetted Perimeter, pw (ft)	Hydraulic radius, r (ft)	Average Velocity, V (ft/s)**	Travel Time, Tt (min)	Lag Time (min)
SHEET	T1 SHEET FLOW	300.00	0.035	0.15	2.10						23.29	
SHALLOW CONCENTRATED	T2 SHALLOW CONCENTRATED FLOW	395.00	0.034			U				2.97	2.21	
CHANNEL	T2 CHANNEL FLOW	771.00	0.042	0.03		U	14.00	34.00	0.41	5.63	2.28	
Post-Development Time of Concentration, PB10											27.78	16.67

Post-Development												
Drainage Area: PB11												
		Flow Length, L (ft)	Slope, s (ft/ft)	Manning's Roughness Coefficient, n	Two-year, 24-hr rainfall, P2 (in)	Paved or Unpaved	Cross Sectional Area of Flow, A (ft ²)	Wetted Perimeter, pw (ft)	Hydraulic radius, r (ft)	Average Velocity, V (ft/s)**	Travel Time, Tt (min)	Lag Time (min)
SHEET	T1 SHEET FLOW	300.00	0.031	0.15	2.10						24.44	
CHANNEL	T2 CHANNEL FLOW	1252.00	0.025	0.03		U	9.50	6.60	1.44	10.01	2.08	
Post-Development Time of Concentration, PB11											26.53	15.92

Post-Development												
Drainage Area: PB12												
		Flow Length, L (ft)	Slope, s (ft/ft)	Manning's Roughness Coefficient, n	Two-year, 24-hr rainfall, P2 (in)	Paved or Unpaved	Cross Sectional Area of Flow, A (ft ²)	Wetted Perimeter, pw (ft)	Hydraulic radius, r (ft)	Average Velocity, V (ft/s)**	Travel Time, Tt (min)	Lag Time (min)
MINIMUM TC	T2 MINIMUM TC FLOW										5.00	
Post-Development Time of Concentration, PB12											5.00	3.00

Post-Development												
Drainage Area: PB13												
		Flow Length, L (ft)	Slope, s (ft/ft)	Manning's Roughness Coefficient, n	Two-year, 24-hr rainfall, P2 (in)	Paved or Unpaved	Cross Sectional Area of Flow, A (ft ²)	Wetted Perimeter, pw (ft)	Hydraulic radius, r (ft)	Average Velocity, V (ft/s)**	Travel Time, Tt (min)	Lag Time (min)
MINIMUM TC	T2 MINIMUM TC FLOW										5.00	
Post-Development Time of Concentration, PB13											5.00	3.00

Post-Development												
Drainage Area: PB14												
		Flow Length, L (ft)	Slope, s (ft/ft)	Manning's Roughness Coefficient, n	Two-year, 24-hr rainfall, P2 (in)	Paved or Unpaved	Cross Sectional Area of Flow, A (ft ²)	Wetted Perimeter, pw (ft)	Hydraulic radius, r (ft)	Average Velocity, V (ft/s)**	Travel Time, Tt (min)	Lag Time (min)
SHEET	T1 SHEET FLOW	40.00	0.085	0.013	2.10						0.46	
CHANNEL	T2 CHANNEL FLOW	244.00	0.060	0.03		U	9.00	12.40	0.73	9.82	0.41	
CHANNEL	T2 CHANNEL FLOW	1123.00	0.014	0.03		U	14.00	34.00	0.41	3.25	5.76	
Post-Development Time of Concentration, PB14											6.63	3.98

Post-Development												
Drainage Area: PB15												
		Flow Length, L (ft)	Slope, s (ft/ft)	Manning's Roughness Coefficient, n	Two-year, 24-hr rainfall, P2 (in)	Paved or Unpaved	Cross Sectional Area of Flow, A (ft ²)	Wetted Perimeter, pw (ft)	Hydraulic radius, r (ft)	Average Velocity, V (ft/s)**	Travel Time, Tt (min)	Lag Time (min)
MINIMUM TC	T2 MINIMUM TC FLOW										5.00	
Post-Development Time of Concentration, PB15											5.00	3.00

Post Runoff Analysis
Composite CN

Project Name: Eagleview
 KHA Project #: 196288000
 Designed by: DCM Date: 3/17/2022
 Revised by: _____ Date: _____
 Revised by: _____ Date: _____
 Checked by: BAH Date: 3/17/2022

Post-Development					
Drainage Area: OB1					
COVER DESCRIPTION	HYDROLOGIC CONDITION OR COVER TYPE	HYDROLOGIC SOIL GROUP	SCS CURVE NUMBER (CN)	AREA, A (ac.)	INITIAL ABSTRACTION, IA
RESIDENTIAL	RR-5 (Rangeland Landuse)	B	62.00	9.79	--
IMPERVIOUS	Paved; curbs and storm sewers (excluding right-of-way)	B	98.00	0.38	--
IMPERVIOUS	Gravel (including right of way)	B	85.00	0.20	--
CUTSOM					
COMPOSITE SCS CURVE NUMBER - OB1			63.76	10.37	0.569

Post-Development					
Drainage Area: OB2					
COVER DESCRIPTION	HYDROLOGIC CONDITION OR COVER TYPE	HYDROLOGIC SOIL GROUP	SCS CURVE NUMBER (CN)	AREA, A (ac.)	INITIAL ABSTRACTION, IA
RESIDENTIAL	RR-5 (Rangeland Landuse)	B	62.00	25.92	--
IMPERVIOUS	Paved; curbs and storm sewers (excluding right-of-way)	B	98.00	0.86	--
IMPERVIOUS	Gravel (including right of way)	B	85.00	1.28	--
CUTSOM					
COMPOSITE SCS CURVE NUMBER - OB2			64.16	28.06	0.559

Post-Development					
Drainage Area: OB3					
COVER DESCRIPTION	HYDROLOGIC CONDITION OR COVER TYPE	HYDROLOGIC SOIL GROUP	SCS CURVE NUMBER (CN)	AREA, A (ac.)	INITIAL ABSTRACTION, IA
RESIDENTIAL	RR-5 (Rangeland Landuse)	B	62.00	40.88	--
IMPERVIOUS	Paved; curbs and storm sewers (excluding right-of-way)	B	98.00	0.89	--
IMPERVIOUS	Gravel (including right of way)	B	85.00	1.67	--
CUTSOM					
COMPOSITE SCS CURVE NUMBER - OB3			63.62	43.44	0.572

Post-Development					
Drainage Area: OB4					
COVER DESCRIPTION	HYDROLOGIC CONDITION OR COVER TYPE	HYDROLOGIC SOIL GROUP	SCS CURVE NUMBER (CN)	AREA, A (ac.)	INITIAL ABSTRACTION, IA
RESIDENTIAL	RR-5 (Rangeland Landuse)	B	62.00	9.55	--
IMPERVIOUS	Paved; curbs and storm sewers (excluding right-of-way)	B	98.00	0.52	--
IMPERVIOUS	Gravel (including right of way)	B	85.00	0.43	--
CUTSOM					
COMPOSITE SCS CURVE NUMBER - OB4			64.71	10.50	0.545

Post-Development					
Drainage Area: OB5					
COVER DESCRIPTION	HYDROLOGIC CONDITION OR COVER TYPE	HYDROLOGIC SOIL GROUP	SCS CURVE NUMBER (CN)	AREA, A (ac.)	INITIAL ABSTRACTION, IA
RESIDENTIAL	RR-5 (Rangeland Landuse)	B	62.00	28.58	--
RESIDENTIAL	RR-5 (Woods Landuse)	B	58.00	109.48	--
IMPERVIOUS	Paved; curbs and storm sewers (excluding right-of-way)	B	98.00	1.12	--
IMPERVIOUS	Gravel (including right of way)	B	85.00	4.64	--
CUTSOM					
COMPOSITE SCS CURVE NUMBER - OB5			59.98	143.82	0.667

Post-Development					
Drainage Area: OB6					
COVER DESCRIPTION	HYDROLOGIC CONDITION OR COVER TYPE	HYDROLOGIC SOIL GROUP	SCS CURVE NUMBER (CN)	AREA, A (ac.)	INITIAL ABSTRACTION, IA
RESIDENTIAL	RR-5 (Rangeland Landuse)	B	62.00	60.64	--
RESIDENTIAL	RR-5 (Woods Landuse)	B	58.00	51.19	--
IMPERVIOUS	Paved; curbs and storm sewers (excluding right-of-way)	B	98.00	2.04	--
IMPERVIOUS	Gravel (including right of way)	B	85.00	4.53	--
CUTSOM					
COMPOSITE SCS CURVE NUMBER - OB6			61.77	118.40	0.619

Post Runoff Analysis
Composite CN

Project Name: Eagleview
 KHA Project #: 196288000
 Designed by: DCM Date: 3/17/2022
 Revised by: _____ Date: _____
 Revised by: _____ Date: _____
 Checked by: BAH Date: 3/17/2022

Post-Development					
Drainage Area: OB7					
COVER DESCRIPTION	HYDROLOGIC CONDITION OR COVER TYPE	HYDROLOGIC SOIL GROUP	SCS CURVE NUMBER (CN)	AREA, A (ac.)	INITIAL ABSTRACTION, IA
RESIDENTIAL	RR-5 (Rangeland Landuse)	B	62.00	122.08	--
RESIDENTIAL	RR-5 (Woods Landuse)	B	58.00	259.48	--
RESIDENTIAL	2.5 acre	B	64.00	16.02	--
IMPERVIOUS	Paved; curbs and storm sewers (excluding right-of-way)	B	98.00	5.46	--
IMPERVIOUS	Gravel (including right of way)	B	85.00	18.17	--
CUTSOM					
COMPOSITE SCS CURVE NUMBER - OB7			61.07	421.20	0.637

Post-Development					
Drainage Area: OB8					
COVER DESCRIPTION	HYDROLOGIC CONDITION OR COVER TYPE	HYDROLOGIC SOIL GROUP	SCS CURVE NUMBER (CN)	AREA, A (ac.)	INITIAL ABSTRACTION, IA
RESIDENTIAL	RR-5 (Rangeland Landuse)	B	62.00	8.71	--
RESIDENTIAL	2.5 acre	B	64.00	21.76	--
RESIDENTIAL	1/2 acre (25% imp.)	B	71.00	0.79	--
IMPERVIOUS	Paved; curbs and storm sewers (excluding right-of-way)	B	98.00	0.24	--
IMPERVIOUS	Gravel (including right of way)	B	85.00	1.57	--
CUTSOM					
COMPOSITE SCS CURVE NUMBER - OB8			64.89	33.07	0.541

Post-Development					
Drainage Area: PB1					
COVER DESCRIPTION	HYDROLOGIC CONDITION OR COVER TYPE	HYDROLOGIC SOIL GROUP	SCS CURVE NUMBER (CN)	AREA, A (ac.)	INITIAL ABSTRACTION, IA
RESIDENTIAL	2.5 acre	B	64.00	4.19	--
IMPERVIOUS	Paved; open ditches (including right-of-way)	B	89.00	0.06	--
CUTSOM					
COMPOSITE SCS CURVE NUMBER - PB1			64.35	4.25	0.554

Post-Development					
Drainage Area: PB2					
COVER DESCRIPTION	HYDROLOGIC CONDITION OR COVER TYPE	HYDROLOGIC SOIL GROUP	SCS CURVE NUMBER (CN)	AREA, A (ac.)	INITIAL ABSTRACTION, IA
RESIDENTIAL	2.5 acre	B	64.00	1.02	--
IMPERVIOUS	Paved; open ditches (including right-of-way)	B	89.00	0.06	--
CUTSOM					
COMPOSITE SCS CURVE NUMBER - PB2			65.38	1.08	0.530

Post-Development					
Drainage Area: PB3					
COVER DESCRIPTION	HYDROLOGIC CONDITION OR COVER TYPE	HYDROLOGIC SOIL GROUP	SCS CURVE NUMBER (CN)	AREA, A (ac.)	INITIAL ABSTRACTION, IA
RESIDENTIAL	2.5 acre	B	64.00	1.18	--
IMPERVIOUS	Paved; open ditches (including right-of-way)	B	89.00	0.20	--
CUTSOM					
COMPOSITE SCS CURVE NUMBER - PB3			67.68	1.38	0.478

Post-Development					
Drainage Area: PB4					
COVER DESCRIPTION	HYDROLOGIC CONDITION OR COVER TYPE	HYDROLOGIC SOIL GROUP	SCS CURVE NUMBER (CN)	AREA, A (ac.)	INITIAL ABSTRACTION, IA
RESIDENTIAL	2.5 acre	B	64.00	10.18	--
IMPERVIOUS	Paved; open ditches (including right-of-way)	B	89.00	0.35	--
CUTSOM					
COMPOSITE SCS CURVE NUMBER - PB4			64.84	10.54	0.542

Post-Development					
Drainage Area: PB5					
COVER DESCRIPTION	HYDROLOGIC CONDITION OR COVER TYPE	HYDROLOGIC SOIL GROUP	SCS CURVE NUMBER (CN)	AREA, A (ac.)	INITIAL ABSTRACTION, IA
RESIDENTIAL	2.5 acre	B	64.00	6.01	--
IMPERVIOUS	Paved; open ditches (including right-of-way)	B	89.00	0.17	--
CUTSOM					
COMPOSITE SCS CURVE NUMBER - PB5			64.70	6.18	0.546



**Post Runoff Analysis
Composite CN**

Project Name: Eagleview
 KHA Project #: 196288000
 Designed by: DCM Date: 3/17/2022
 Revised by: _____ Date: _____
 Revised by: _____ Date: _____
 Checked by: BAH Date: 3/17/2022

Post-Development					
Drainage Area: PB6					
COVER DESCRIPTION	HYDROLOGIC CONDITION OR COVER TYPE	HYDROLOGIC SOIL GROUP	SCS CURVE NUMBER (CN)	AREA, A (ac.)	INITIAL ABSTRACTION, IA
RESIDENTIAL	2.5 acre	B	64.00	10.50	--
IMPERVIOUS	Paved; open ditches (including right-of-way)	B	89.00	0.59	--
CUTSOM					
COMPOSITE SCS CURVE NUMBER - PB6			65.33	11.09	0.531

Post-Development					
Drainage Area: PB7					
COVER DESCRIPTION	HYDROLOGIC CONDITION OR COVER TYPE	HYDROLOGIC SOIL GROUP	SCS CURVE NUMBER (CN)	AREA, A (ac.)	INITIAL ABSTRACTION, IA
RESIDENTIAL	2.5 acre	B	64.00	5.28	--
IMPERVIOUS	Paved; open ditches (including right-of-way)	B	89.00	0.31	--
CUTSOM					
COMPOSITE SCS CURVE NUMBER - PB7			65.38	5.59	0.530

Post-Development					
Drainage Area: PB8					
COVER DESCRIPTION	HYDROLOGIC CONDITION OR COVER TYPE	HYDROLOGIC SOIL GROUP	SCS CURVE NUMBER (CN)	AREA, A (ac.)	INITIAL ABSTRACTION, IA
RESIDENTIAL	2.5 acre	B	64.00	11.72	--
IMPERVIOUS	Paved; open ditches (including right-of-way)	B	89.00	0.06	--
CUTSOM					
COMPOSITE SCS CURVE NUMBER - PB8			64.13	11.78	0.559

Post-Development					
Drainage Area: PB9					
COVER DESCRIPTION	HYDROLOGIC CONDITION OR COVER TYPE	HYDROLOGIC SOIL GROUP	SCS CURVE NUMBER (CN)	AREA, A (ac.)	INITIAL ABSTRACTION, IA
RESIDENTIAL	2.5 acre	B	64.00	12.60	--
IMPERVIOUS	Paved; open ditches (including right-of-way)	B	89.00	0.20	--
CUTSOM					
COMPOSITE SCS CURVE NUMBER - PB9			64.39	12.80	0.553

Post-Development					
Drainage Area: PB10					
COVER DESCRIPTION	HYDROLOGIC CONDITION OR COVER TYPE	HYDROLOGIC SOIL GROUP	SCS CURVE NUMBER (CN)	AREA, A (ac.)	INITIAL ABSTRACTION, IA
RESIDENTIAL	2.5 acre	B	64.00	11.25	--
IMPERVIOUS	Paved; open ditches (including right-of-way)	B	89.00	0.26	--
CUTSOM					
COMPOSITE SCS CURVE NUMBER - PB10			64.57	11.52	0.549

Post-Development					
Drainage Area: PB11					
COVER DESCRIPTION	HYDROLOGIC CONDITION OR COVER TYPE	HYDROLOGIC SOIL GROUP	SCS CURVE NUMBER (CN)	AREA, A (ac.)	INITIAL ABSTRACTION, IA
RESIDENTIAL	2.5 acre	B	64.00	15.60	--
IMPERVIOUS	Paved; open ditches (including right-of-way)	B	89.00	0.51	--
CUTSOM					
COMPOSITE SCS CURVE NUMBER - PB11			64.80	16.11	0.543

Post-Development					
Drainage Area: PB12					
COVER DESCRIPTION	HYDROLOGIC CONDITION OR COVER TYPE	HYDROLOGIC SOIL GROUP	SCS CURVE NUMBER (CN)	AREA, A (ac.)	INITIAL ABSTRACTION, IA
RESIDENTIAL	2.5 acre	B	64.00	0.10	--
IMPERVIOUS	Paved; open ditches (including right-of-way)	B	89.00	0.10	--
CUTSOM					
COMPOSITE SCS CURVE NUMBER - PB12			76.50	0.20	0.307



**Post Runoff Analysis
Composite CN**

Project Name: Eagleview
 KHA Project #: 196288000
 Designed by: DCM Date: 3/17/2022
 Revised by: _____ Date: _____
 Revised by: _____ Date: _____
 Checked by: BAH Date: 3/17/2022

Post-Development					
Drainage Area: PB13					
COVER DESCRIPTION	HYDROLOGIC CONDITION OR COVER TYPE	HYDROLOGIC SOIL GROUP	SCS CURVE NUMBER (CN)	AREA, A (ac.)	INITIAL ABSTRACTION, IA
RESIDENTIAL	2.5 acre	B	64.00	1.68	--
IMPERVIOUS	Paved; open ditches (including right-of-way)	B	89.00	0.08	--
CUTSOM					
COMPOSITE SCS CURVE NUMBER - PB13			65.12	1.76	0.536

Post-Development					
Drainage Area: PB14					
COVER DESCRIPTION	HYDROLOGIC CONDITION OR COVER TYPE	HYDROLOGIC SOIL GROUP	SCS CURVE NUMBER (CN)	AREA, A (ac.)	INITIAL ABSTRACTION, IA
RESIDENTIAL	2.5 acre	A	45.00	0.28	--
RESIDENTIAL	2.5 acre	B	64.00	16.54	--
IMPERVIOUS	Paved; open ditches (including right-of-way)	B	89.00	0.46	--
CUTSOM					
COMPOSITE SCS CURVE NUMBER - PB14			63.64	17.28	0.571

Post-Development					
Drainage Area: PB15					
COVER DESCRIPTION	HYDROLOGIC CONDITION OR COVER TYPE	HYDROLOGIC SOIL GROUP	SCS CURVE NUMBER (CN)	AREA, A (ac.)	INITIAL ABSTRACTION, IA
RESIDENTIAL	2.5 acre	A	45.00	0.61	--
RESIDENTIAL	2.5 acre	B	64.00	8.38	--
IMPERVIOUS	Paved; open ditches (including right-of-way)	B	89.00	0.65	--
CUTSOM					
COMPOSITE SCS CURVE NUMBER - PB15			61.65	9.63	0.622

Project: Eagleview_Subdivision Simulation Run: EV 5-yr Pr. Type II

Start of Run: 01Oct2021, 00:00 Basin Model: Eagleview_Proposed
 End of Run: 02Oct2021, 00:00 Meteorologic Model: 5-yr Type II
 Compute Time: 14Mar2022, 16:43:16 Control Specifications: 24-hr Storm

Hydrologic Element	Drainage Area (MI ²)	Peak Discharge (CFS)	Time of Peak	Volume (AC-FT)
CULV1	0.0021625	1.5	01Oct2021, 12:08	0.1
CULV4	0.0087281	4.7	01Oct2021, 12:08	0.4
CULV5	.000315625	0.5	01Oct2021, 12:00	0.0
OB1	0.0162031	7.1	01Oct2021, 12:08	0.7
OB2	0.0438438	20.6	01Oct2021, 12:08	1.9
OB3	0.0678750	25.3	01Oct2021, 12:13	2.8
OB4	0.0164062	7.5	01Oct2021, 12:10	0.8
OB5	0.22472	36.8	01Oct2021, 12:42	7.4
OB6	0.18501	42.1	01Oct2021, 12:30	7.0
OB7	0.65812	101.4	01Oct2021, 12:53	23.3
OB8	0.0516699	19.0	01Oct2021, 12:13	2.1
P1	0.0228484	10.1	01Oct2021, 12:10	1.0
P10 (CULV2)	0.15425	57.9	01Oct2021, 12:13	6.7
P11 (CULV3)	0.0260593	13.2	01Oct2021, 12:10	1.3
P12 (CULV8)	1.1270	131.8	01Oct2021, 13:19	33.3
P2	0.19753	74.1	01Oct2021, 12:14	8.9
P3	1.2312	137.9	01Oct2021, 13:19	37.8
P4	0.18248	72.2	01Oct2021, 12:13	8.1
P5 (CULV7)	0.0939437	36.8	01Oct2021, 12:13	4.0
P6	0.0771621	29.9	01Oct2021, 12:15	3.3
P7	1.1242	131.7	01Oct2021, 13:18	33.2
P8	1.1062	173.4	01Oct2021, 12:46	39.3
P9 (CULV6)	0.0768465	29.8	01Oct2021, 12:14	3.3
PB1	0.0066453	3.0	01Oct2021, 12:10	0.3
PB10	0.0179938	8.2	01Oct2021, 12:11	0.8
PB11	0.0251766	12.1	01Oct2021, 12:10	1.2

Hydrologic Element	Drainage Area (MI ²)	Peak Discharge (CFS)	Time of Peak	Volume (AC-FT)
PB12	.000315625	0.5	01Oct2021, 12:00	0.0
PB13	0.0027469	2.2	01Oct2021, 12:00	0.1
PB14	0.0270031	18.9	01Oct2021, 12:01	1.2
PB15	0.0150500	11.0	01Oct2021, 12:00	0.7
PB2	0.0016938	1.0	01Oct2021, 12:06	0.1
PB3	0.0021625	1.5	01Oct2021, 12:07	0.1
PB4	0.0164672	12.6	01Oct2021, 12:00	0.8
PB5	0.0096625	4.2	01Oct2021, 12:12	0.5
PB6	0.0173312	8.6	01Oct2021, 12:11	0.9
PB7	0.0087281	4.7	01Oct2021, 12:08	0.4
PB8	0.0184000	12.1	01Oct2021, 12:01	0.8
PB9	0.0199984	9.8	01Oct2021, 12:08	0.9
R-OB1	0.0162031	7.1	01Oct2021, 12:10	0.7
R-OB2	0.0438438	20.5	01Oct2021, 12:10	1.9
R-OB4-A	0.0842812	32.6	01Oct2021, 12:13	3.5
R-OB4-B	0.0939437	36.7	01Oct2021, 12:15	4.0
R-OB7	1.0678	170.1	01Oct2021, 12:46	37.6
R-OB8	0.0516699	19.0	01Oct2021, 12:16	2.1
R-PB10	1.1242	131.6	01Oct2021, 13:19	33.2
R-PB11	0.0768465	29.8	01Oct2021, 12:15	3.3
R-PB12-A	.000315625	0.5	01Oct2021, 12:02	0.0
R-PB12-B	0.0771621	29.9	01Oct2021, 12:17	3.3
R-PB13	1.1270	131.7	01Oct2021, 13:21	33.2
R-PB3	0.0021625	1.5	01Oct2021, 12:09	0.1
R-PB5	0.15425	57.9	01Oct2021, 12:14	6.7
R-PB7-A	0.0087281	4.7	01Oct2021, 12:10	0.4
R-PB7-B	0.0260593	13.2	01Oct2021, 12:12	1.3
R-PB7-C	0.18248	72.1	01Oct2021, 12:14	8.1
R-PB9	1.1062	173.3	01Oct2021, 12:47	39.3

Reach "CULV1" Results for Run "EV 5-yr Pr. Type II"

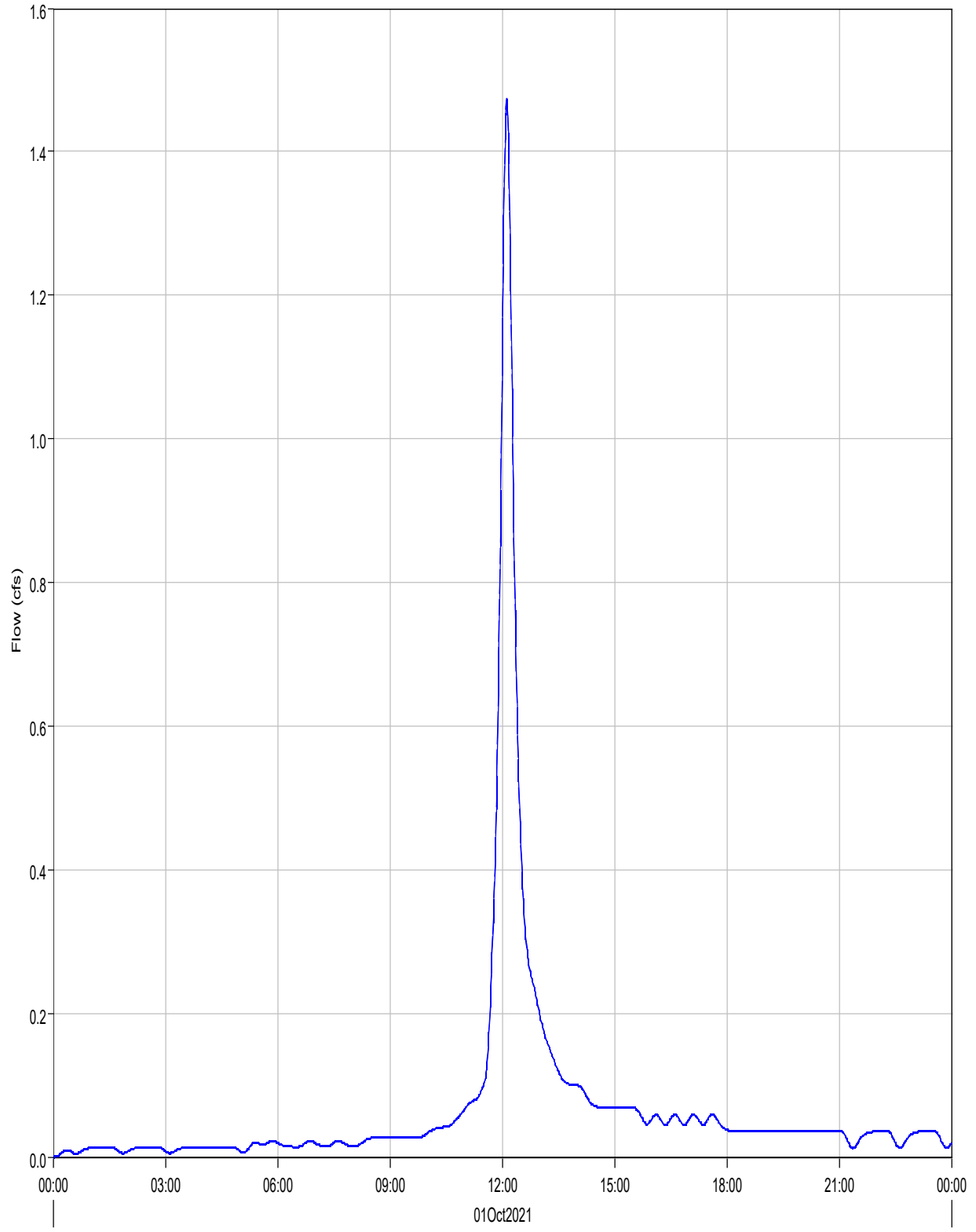

— Run:EV 5-yr Pr. Type II Element:CULV1 Result:Outflow

- - - Run:EV 5-YR PR. TYPE II Element:CULV1 Result:Combined Inflow

Project: Eagleview_Subdivision
Simulation Run: EV 5-yr Pr. Type II Reach: CULV1

Start of Run: 01Oct2021, 00:00 Basin Model: Eagleview_Proposed
End of Run: 02Oct2021, 00:00 Meteorologic Model: 5-yr Type II
Compute Time: 14Mar2022, 16:43:16 Control Specifications: 24-hr Storm

Volume Units: AC-FT

Computed Results

Peak Inflow :	1.5 (CFS)	Date/Time of Peak Inflow :	01Oct2021, 12:07
Peak Outflow :	1.5 (CFS)	Date/Time of Peak Outflow :	01Oct2021, 12:08
Total Inflow :	0.1 (AC-FT)	Total Outflow :	0.1 (AC-FT)

Reach "CULV4" Results for Run "EV 5-yr Pr. Type II"

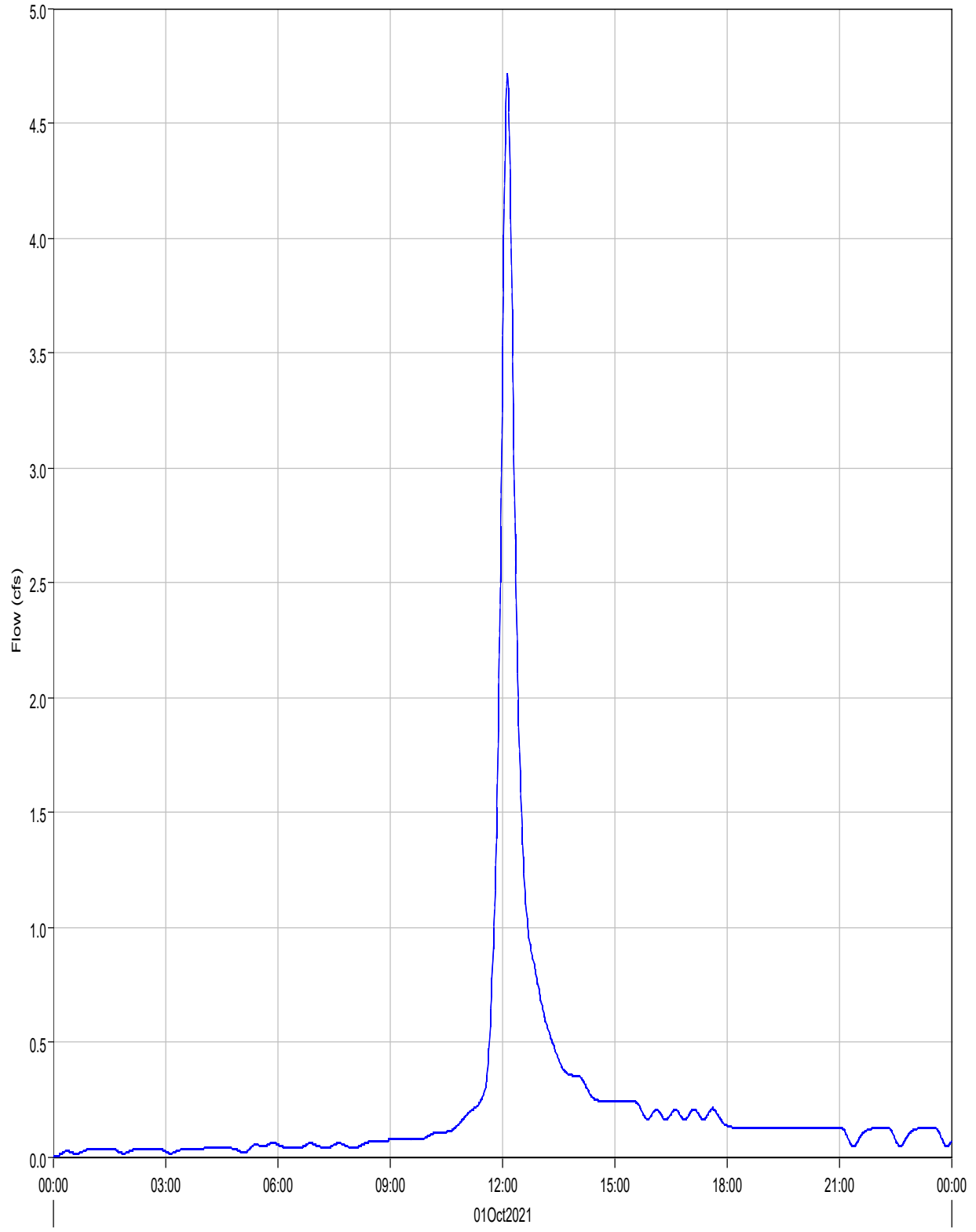

— Run:EV 5-yr Pr. Type II Element:CULV4 Result:Outflow

- - - Run:EV 5-YR PR. TYPE II Element:CULV4 Result:Combined Inflow

Project: Eagleview_Subdivision
Simulation Run: EV 5-yr Pr. Type II Reach: CULV4

Start of Run: 01Oct2021, 00:00 Basin Model: Eagleview_Proposed
End of Run: 02Oct2021, 00:00 Meteorologic Model: 5-yr Type II
Compute Time: 14Mar2022, 16:43:16 Control Specifications: 24-hr Storm

Volume Units: AC-FT

Computed Results

Peak Inflow :	4.7 (CFS)	Date/Time of Peak Inflow :	01Oct2021, 12:08
Peak Outflow :	4.7 (CFS)	Date/Time of Peak Outflow :	01Oct2021, 12:08
Total Inflow :	0.4 (AC-FT)	Total Outflow :	0.4 (AC-FT)

Reach "CULV5" Results for Run "EV 5-yr Pr. Type II"

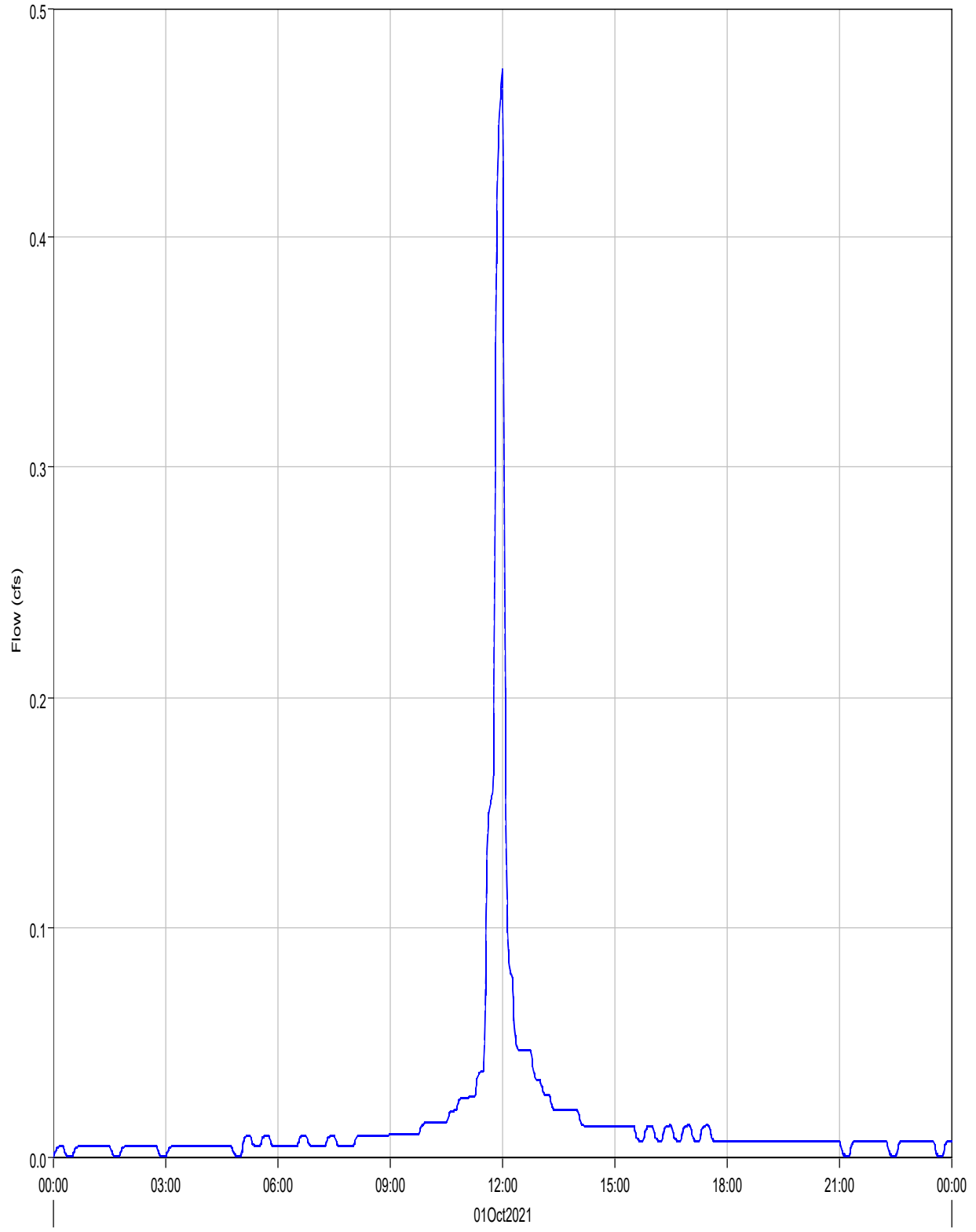

Run:EV 5-yr Pr. Type II Element:CULV5 Result:Outflow

Run:EV 5-YR PR. TYPE II Element:CULV5 Result:Combined Inflow

Project: Eagleview_Subdivision
Simulation Run: EV 5-yr Pr. Type II Reach: CULV5

Start of Run: 01Oct2021, 00:00 Basin Model: Eagleview_Proposed
End of Run: 02Oct2021, 00:00 Meteorologic Model: 5-yr Type II
Compute Time: 14Mar2022, 16:43:16 Control Specifications: 24-hr Storm

Volume Units: IN

Computed Results

Peak Inflow :	0.5 (CFS)	Date/Time of Peak Inflow :	01Oct2021, 12:00
Peak Outflow :	0.5 (CFS)	Date/Time of Peak Outflow :	01Oct2021, 12:00
Total Inflow :	1.95 (IN)	Total Outflow :	1.95 (IN)

Subbasin "OB1" Results for Run "EV 5-yr Pr. Type II"

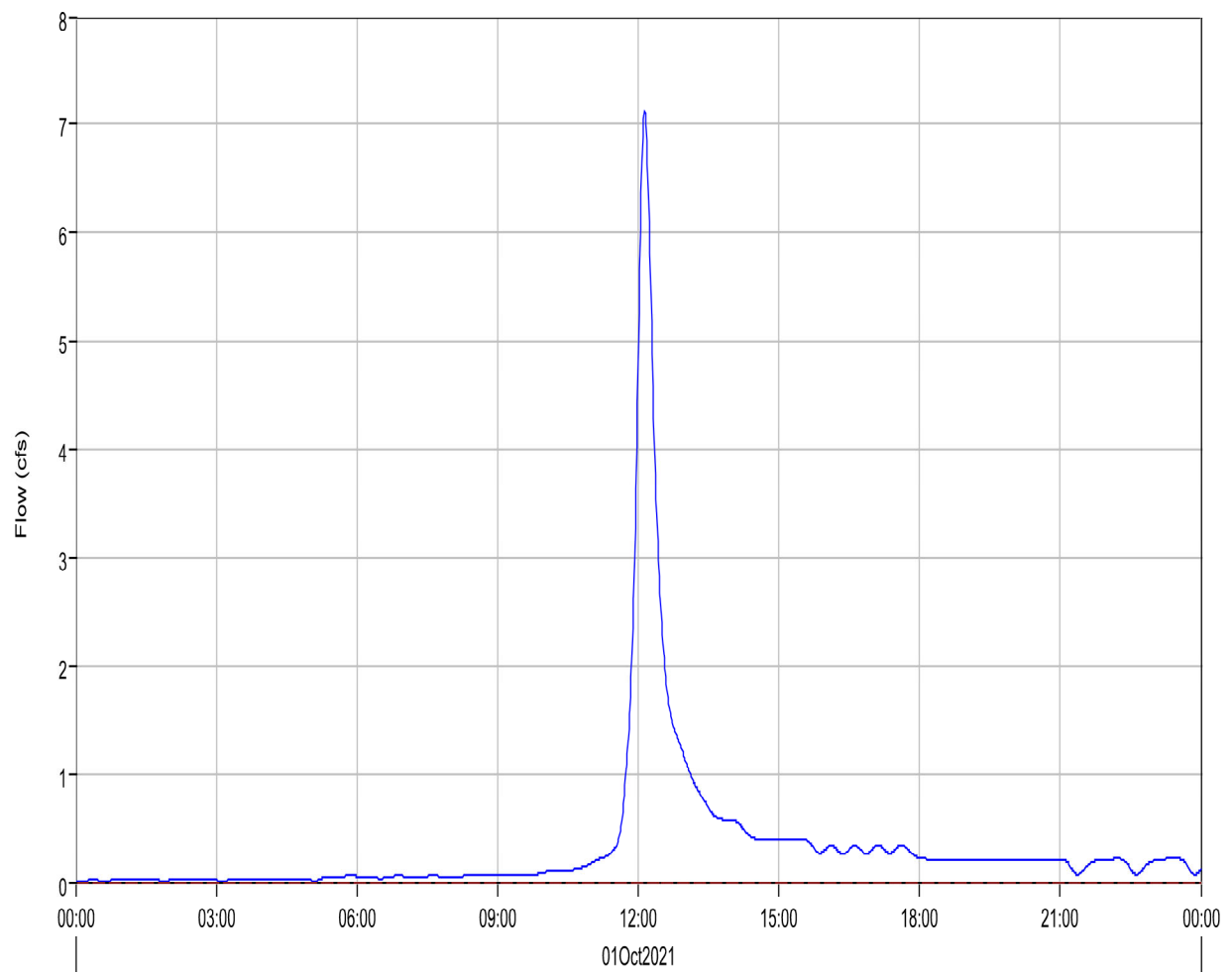
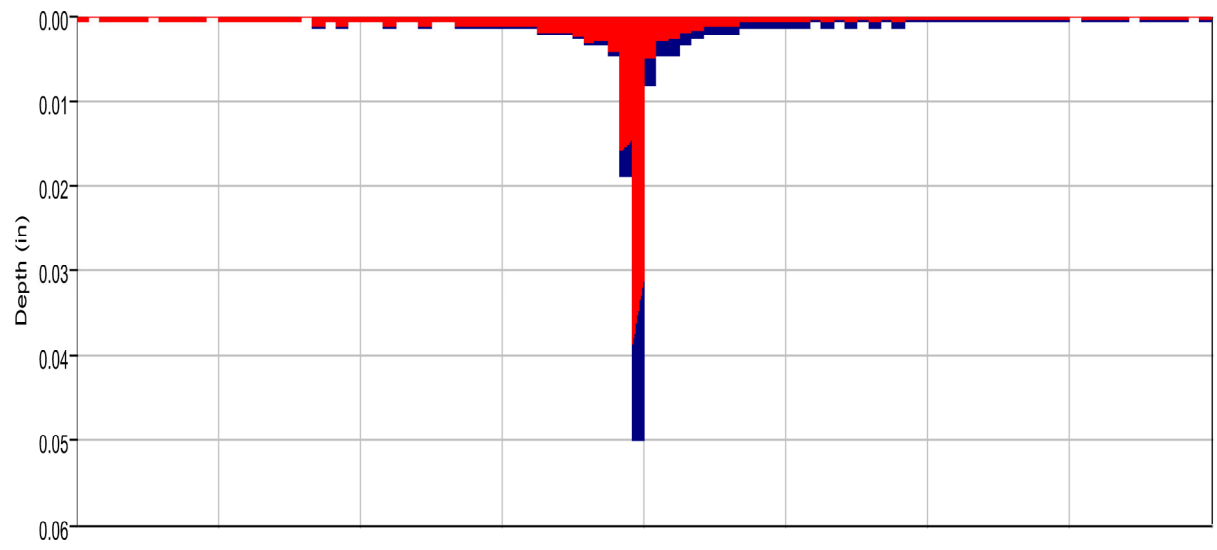

- Run:EV 5-yr Pr. Type II Element:OB1 Result:Precipitation
- Run:EV 5-YR PR. TYPE II Element:OB1 Result:Precipitation Loss
- Run:EV 5-yr Pr. Type II Element:OB1 Result:Outflow
- - - Run:EV 5-YR PR. TYPE II Element:OB1 Result:Baseflow

Project: Eagleview_Subdivision
Simulation Run: EV 5-yr Pr. Type II Subbasin: OB1

Start of Run: 01Oct2021, 00:00 Basin Model: Eagleview_Proposed
End of Run: 02Oct2021, 00:00 Meteorologic Model: 5-yr Type II
Compute Time: 14Mar2022, 16:43:16 Control Specifications: 24-hr Storm

Volume Units: AC-FT

Computed Results

Peak Discharge :	7.1 (CFS)	Date/Time of Peak Discharge :	01Oct2021, 12:08
Total Precipitation :	2.3 (AC-FT)	Total Direct Runoff :	0.7 (AC-FT)
Total Loss :	1.7 (AC-FT)	Total Baseflow :	0.0 (AC-FT)
Total Excess :	0.7 (AC-FT)	Discharge :	0.7 (AC-FT)

Subbasin "OB2" Results for Run "EV 5-yr Pr. Type II"

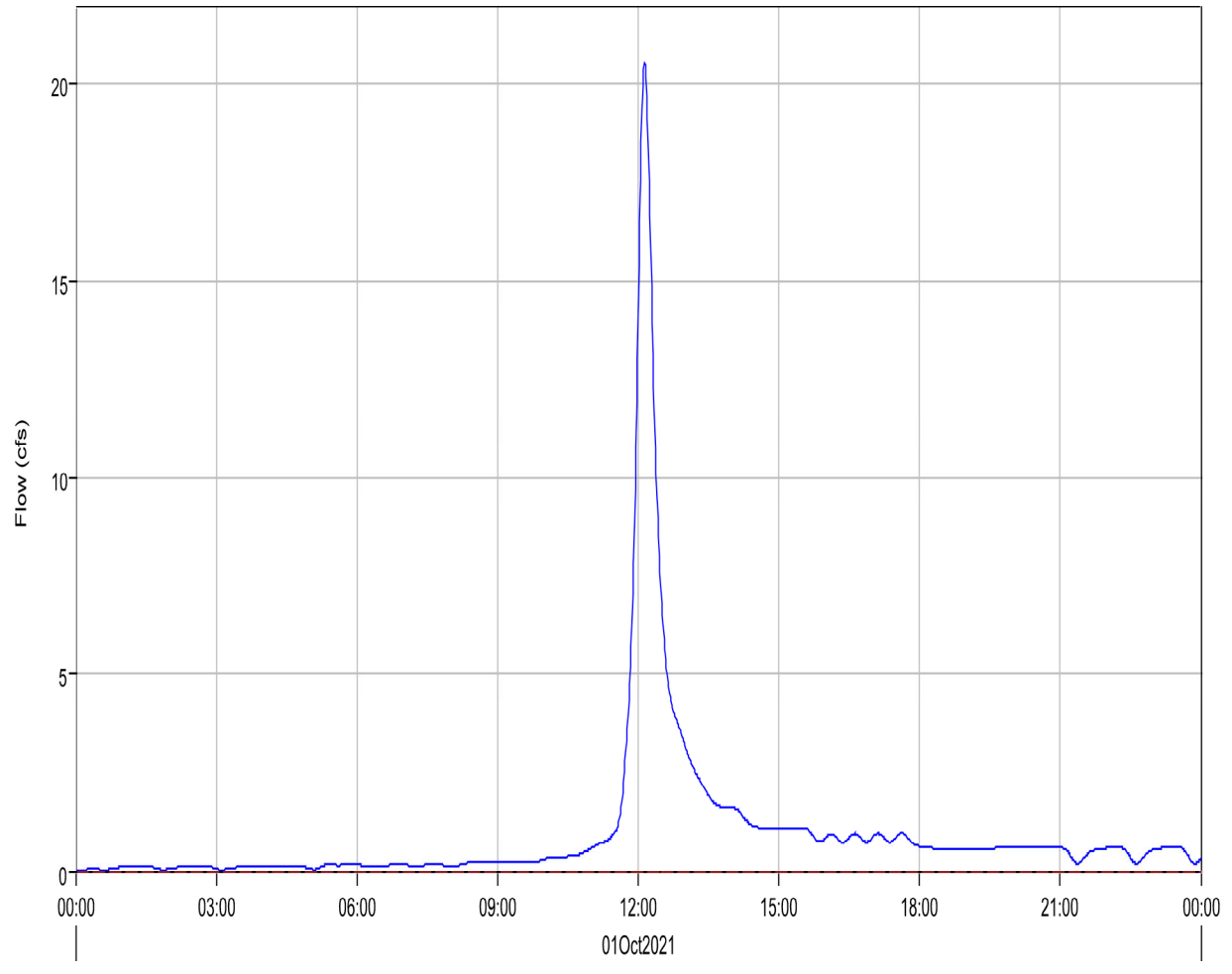
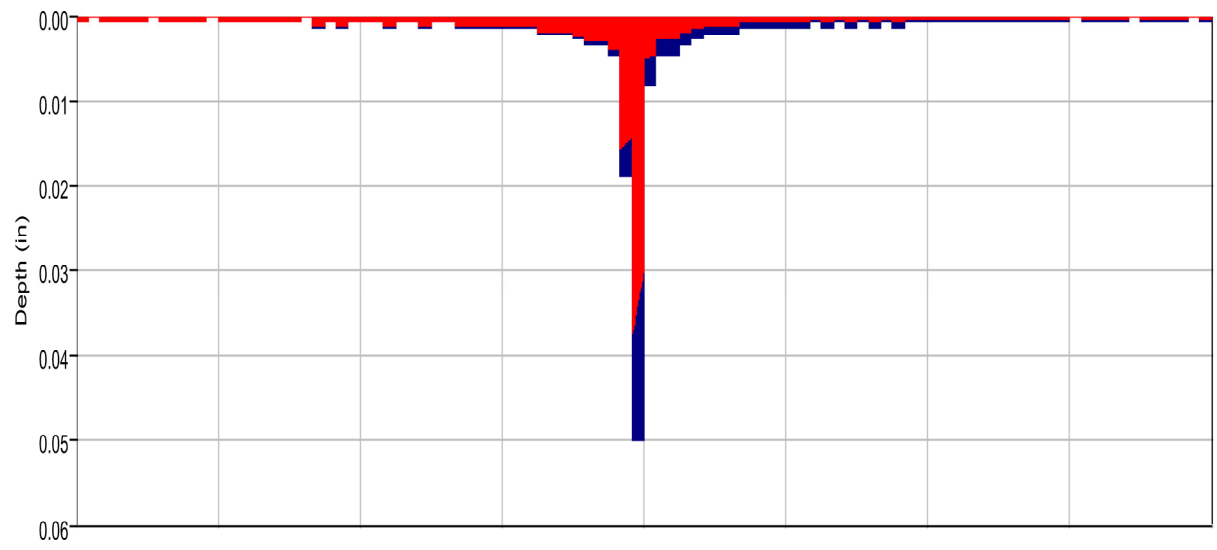

- Run:EV 5-yr Pr. Type II Element:OB2 Result:Precipitation
- Run:EV 5-yr Pr. Type II Element:OB2 Result:Outflow
- Run:EV 5-YR PR. TYPE II Element:OB2 Result:Precipitation Loss
- Run:EV 5-YR PR. TYPE II Element:OB2 Result:Baseflow

Project: Eagleview_Subdivision
Simulation Run: EV 5-yr Pr. Type II Subbasin: OB2
Start of Run: 01Oct2021, 00:00 Basin Model: Eagleview_Proposed
End of Run: 02Oct2021, 00:00 Meteorologic Model: 5-yr Type II
Compute Time: 14Mar2022, 16:43:16 Control Specifications: 24-hr Storm

Volume Units: AC-FT

Computed Results

Peak Discharge :	20.6 (CFS)	Date/Time of Peak Discharge :	01Oct2021, 12:08
Total Precipitation :	6.3 (AC-FT)	Total Direct Runoff :	1.9 (AC-FT)
Total Loss :	4.4 (AC-FT)	Total Baseflow :	0.0 (AC-FT)
Total Excess :	1.9 (AC-FT)	Discharge :	1.9 (AC-FT)

Subbasin "OB3" Results for Run "EV 5-yr Pr. Type II"

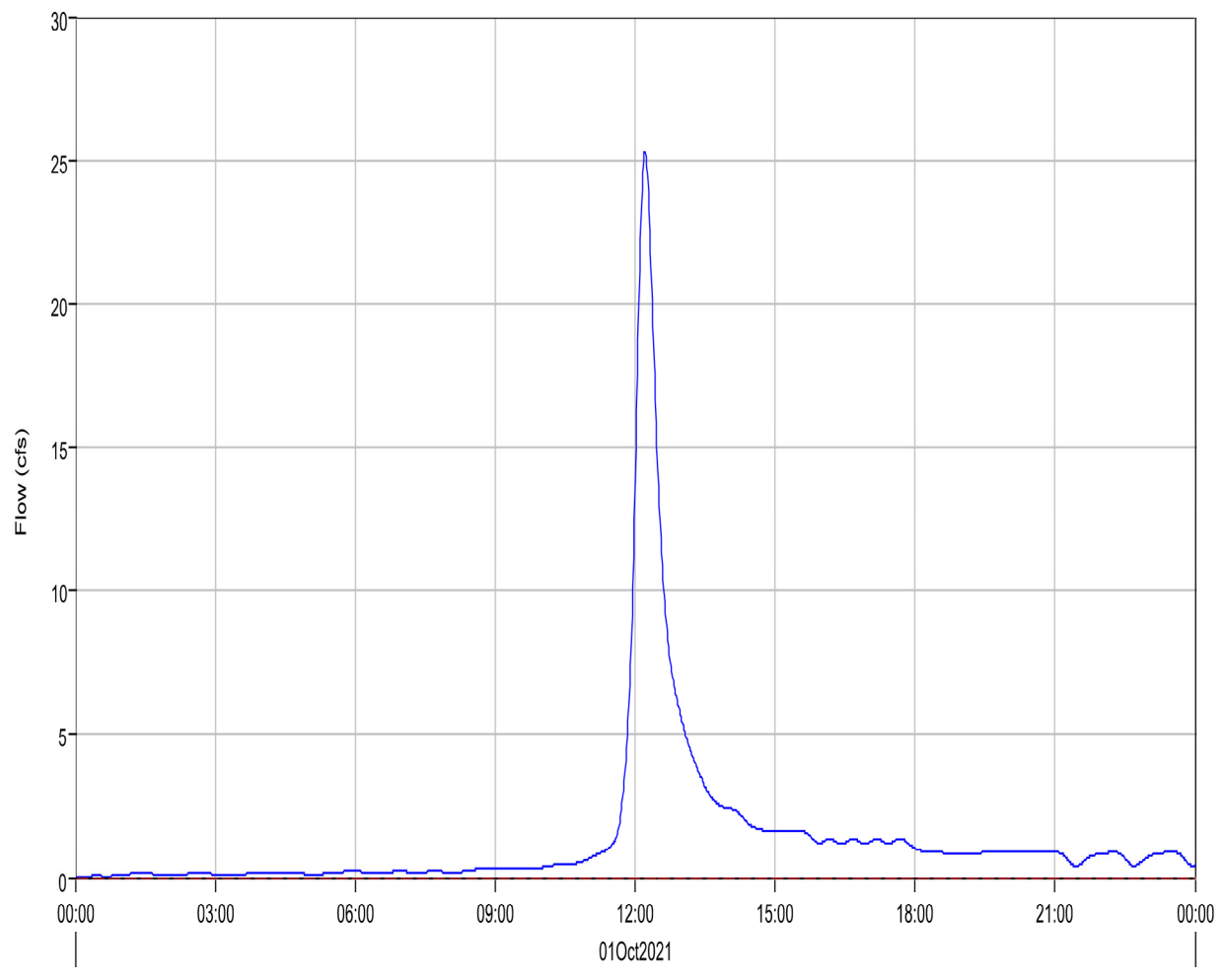
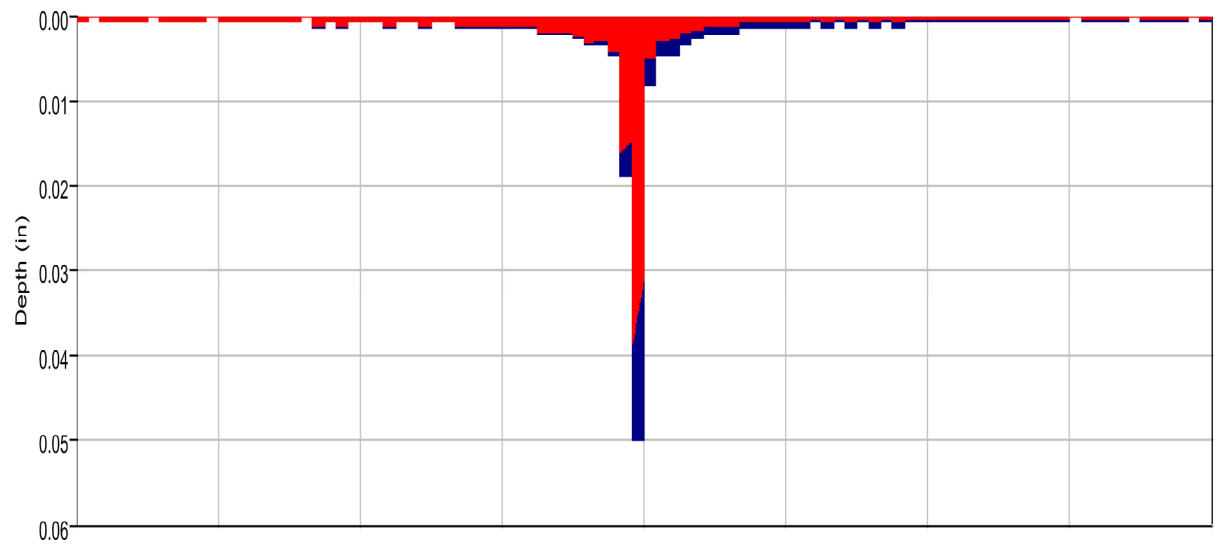

- Run:EV 5-yr Pr. Type II Element:OB3 Result:Precipitation
- Run:EV 5-yr Pr. Type II Element:OB3 Result:Outflow
- Run:EV 5-YR PR. TYPE II Element:OB3 Result:Precipitation Loss
- Run:EV 5-YR PR. TYPE II Element:OB3 Result:Baseflow

Project: Eagleview_Subdivision
Simulation Run: EV 5-yr Pr. Type II Subbasin: OB3
Start of Run: 01Oct2021, 00:00 Basin Model: Eagleview_Proposed
End of Run: 02Oct2021, 00:00 Meteorologic Model: 5-yr Type II
Compute Time: 14Mar2022, 16:43:16 Control Specifications: 24-hr Storm

Volume Units: AC-FT

Computed Results

Peak Discharge :	25.3 (CFS)	Date/Time of Peak Discharge :	01Oct2021, 12:13
Total Precipitation :	9.8 (AC-FT)	Total Direct Runoff :	2.8 (AC-FT)
Total Loss :	7.0 (AC-FT)	Total Baseflow :	0.0 (AC-FT)
Total Excess :	2.8 (AC-FT)	Discharge :	2.8 (AC-FT)

Subbasin "OB4" Results for Run "EV 5-yr Pr. Type II"

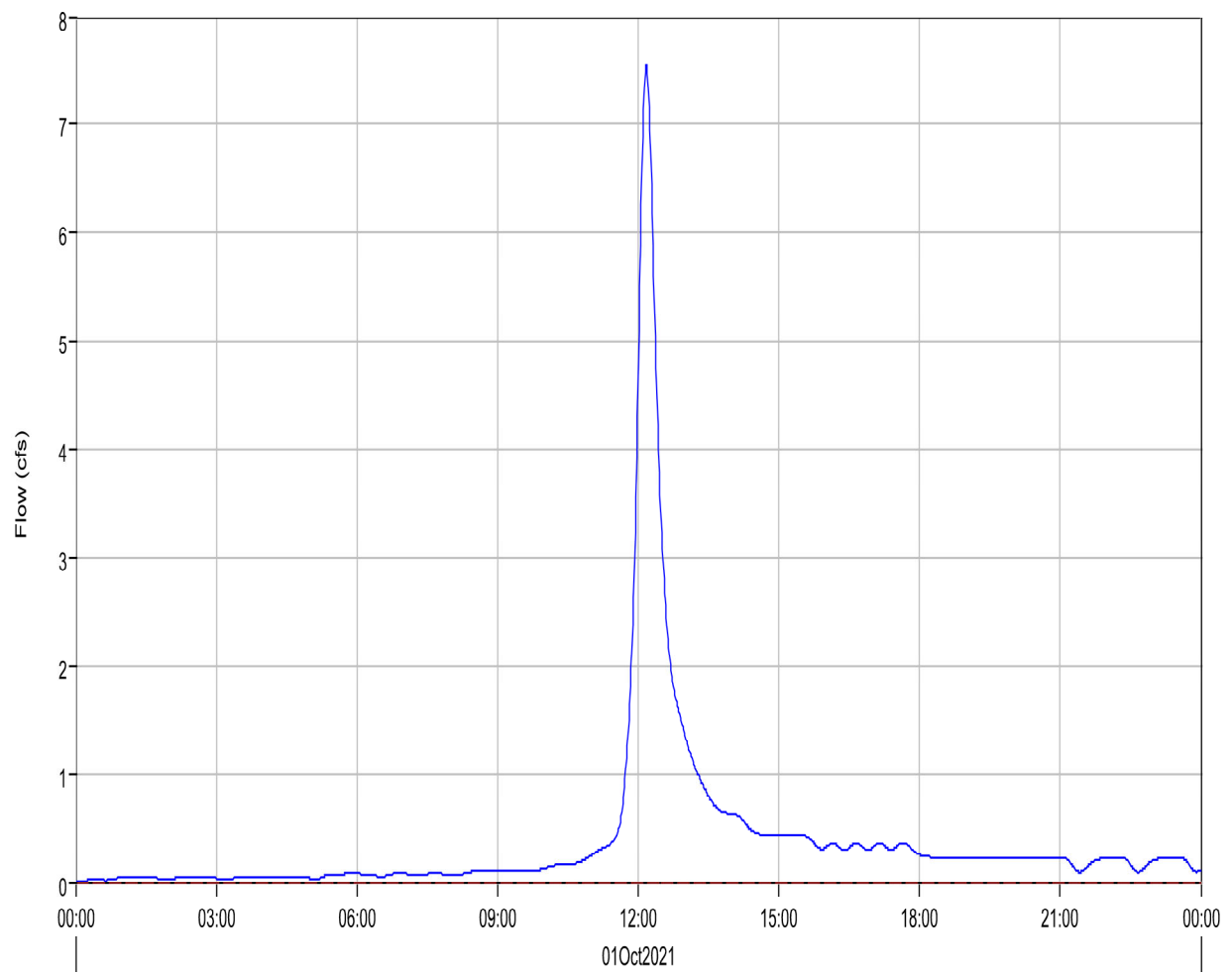
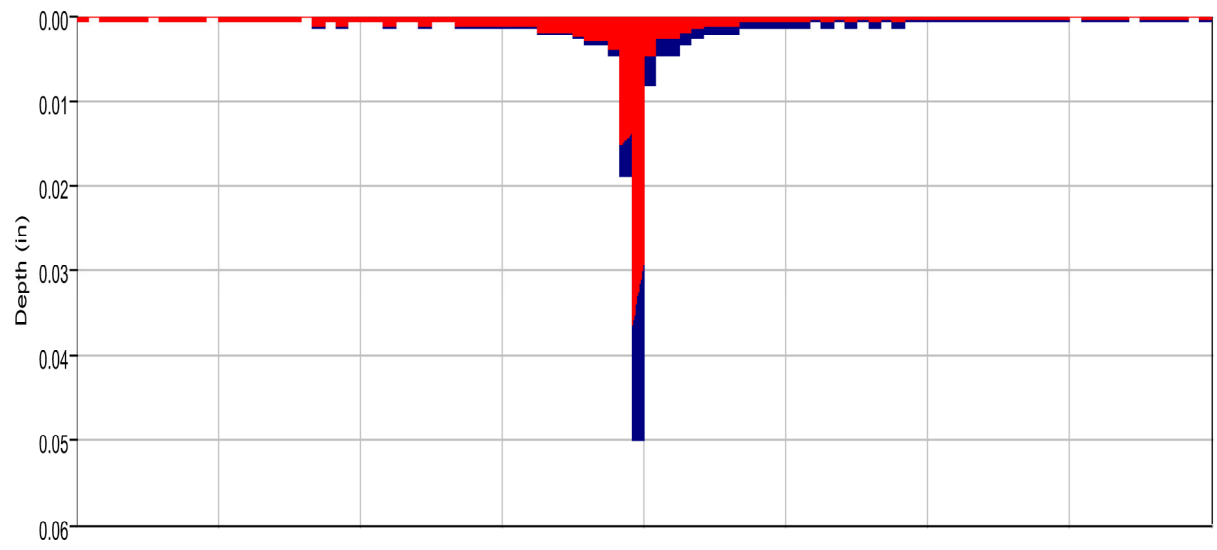

- Run:EV 5-yr Pr. Type II Element:OB4 Result:Precipitation
- Run:EV 5-yr Pr. Type II Element:OB4 Result:Outflow
- Run:EV 5-YR PR. TYPE II Element:OB4 Result:Precipitation Loss
- Run:EV 5-YR PR. TYPE II Element:OB4 Result:Baseflow

Project: Eagleview_Subdivision
Simulation Run: EV 5-yr Pr. Type II Subbasin: OB4

Start of Run: 01Oct2021, 00:00 Basin Model: Eagleview_Proposed
End of Run: 02Oct2021, 00:00 Meteorologic Model: 5-yr Type II
Compute Time: 14Mar2022, 16:43:16 Control Specifications: 24-hr Storm

Volume Units: AC-FT

Computed Results

Peak Discharge :	7.5 (CFS)	Date/Time of Peak Discharge :	01Oct2021, 12:10
Total Precipitation :	2.4 (AC-FT)	Total Direct Runoff :	0.8 (AC-FT)
Total Loss :	1.6 (AC-FT)	Total Baseflow :	0.0 (AC-FT)
Total Excess :	0.8 (AC-FT)	Discharge :	0.8 (AC-FT)

Subbasin "OB5" Results for Run "EV 5-yr Pr. Type II"

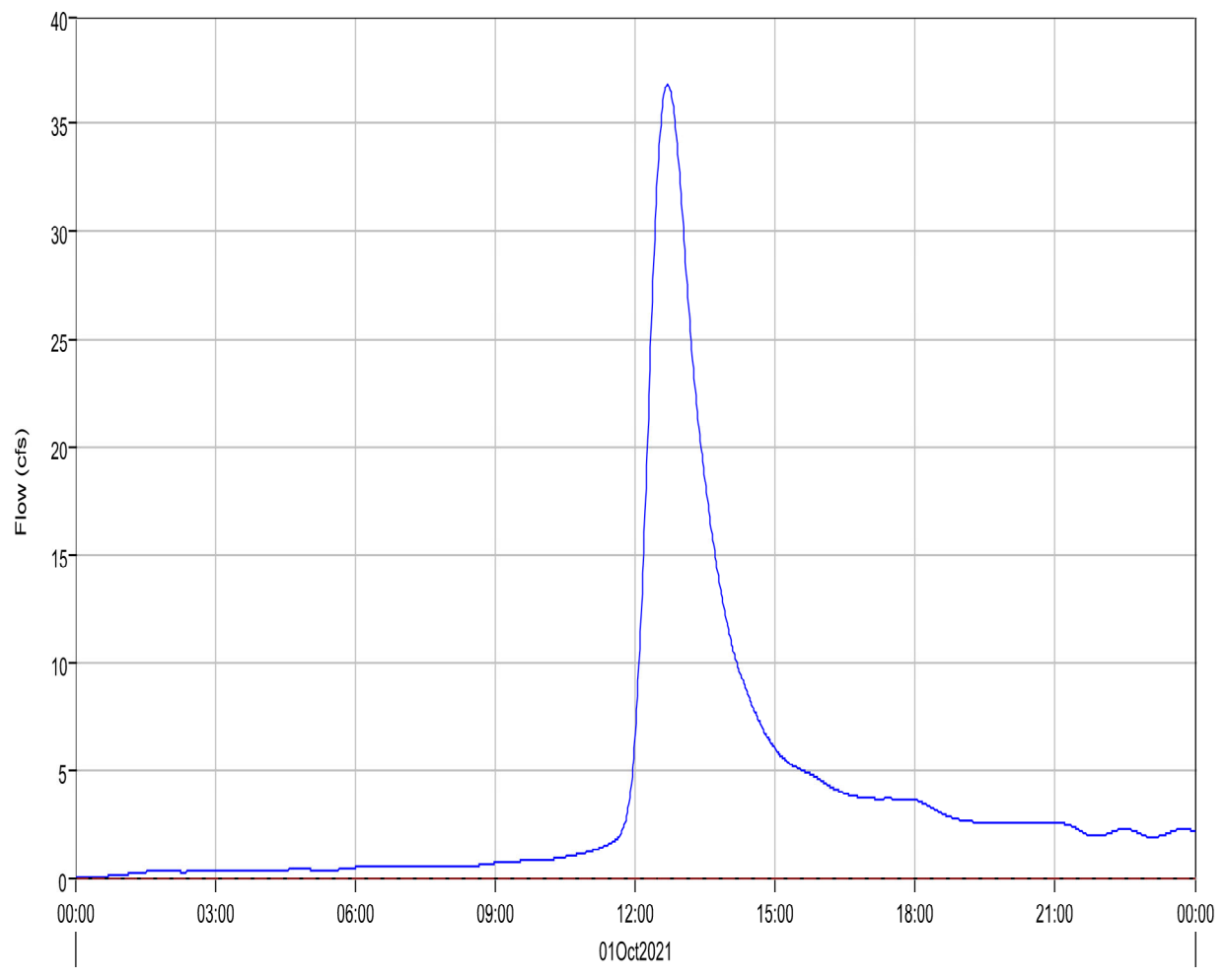
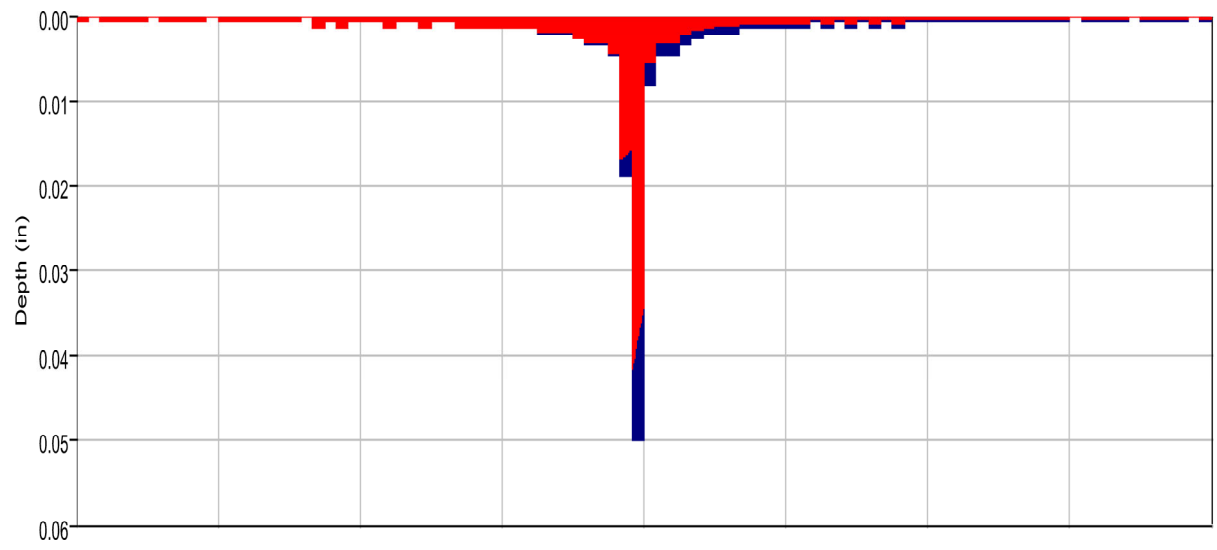

- Run:EV 5-yr Pr. Type II Element:OB5 Result:Precipitation
- Run:EV 5-yr Pr. Type II Element:OB5 Result:Outflow
- Run:EV 5-YR PR. TYPE II Element:OB5 Result:Precipitation Loss
- Run:EV 5-YR PR. TYPE II Element:OB5 Result:Baseflow

Project: Eagleview_Subdivision
Simulation Run: EV 5-yr Pr. Type II Subbasin: OB5
Start of Run: 01Oct2021, 00:00 Basin Model: Eagleview_Proposed
End of Run: 02Oct2021, 00:00 Meteorologic Model: 5-yr Type II
Compute Time: 14Mar2022, 16:43:16 Control Specifications: 24-hr Storm

Volume Units: IN

Computed Results

Peak Discharge :	36.8 (CFS)	Date/Time of Peak Discharge :	01Oct2021, 12:42
Total Precipitation :	2.70 (IN)	Total Direct Runoff :	0.62 (IN)
Total Loss :	2.07 (IN)	Total Baseflow :	0.00 (IN)
Total Excess :	0.63 (IN)	Discharge :	0.62 (IN)

Subbasin "OB6" Results for Run "EV 5-yr Pr. Type II"

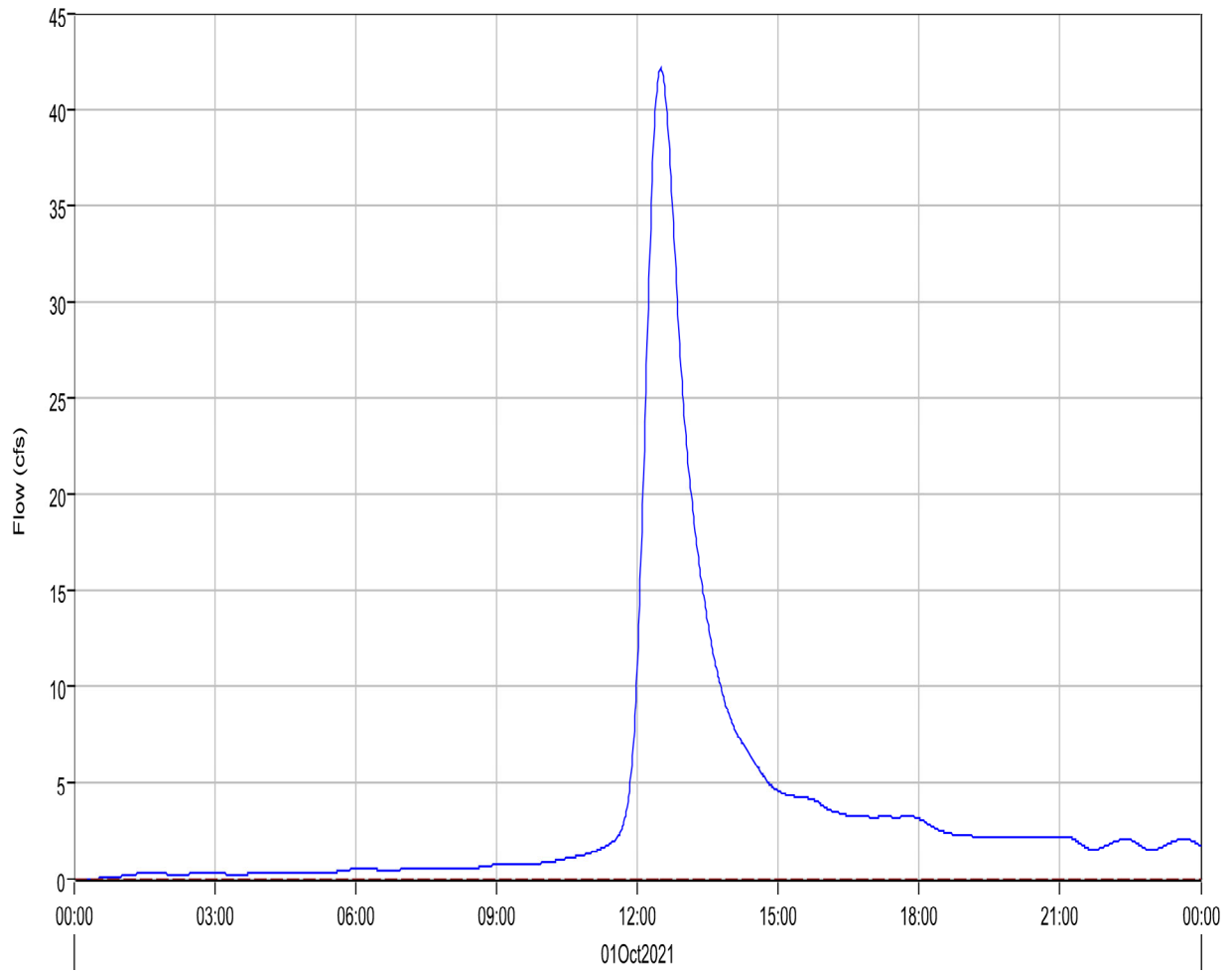
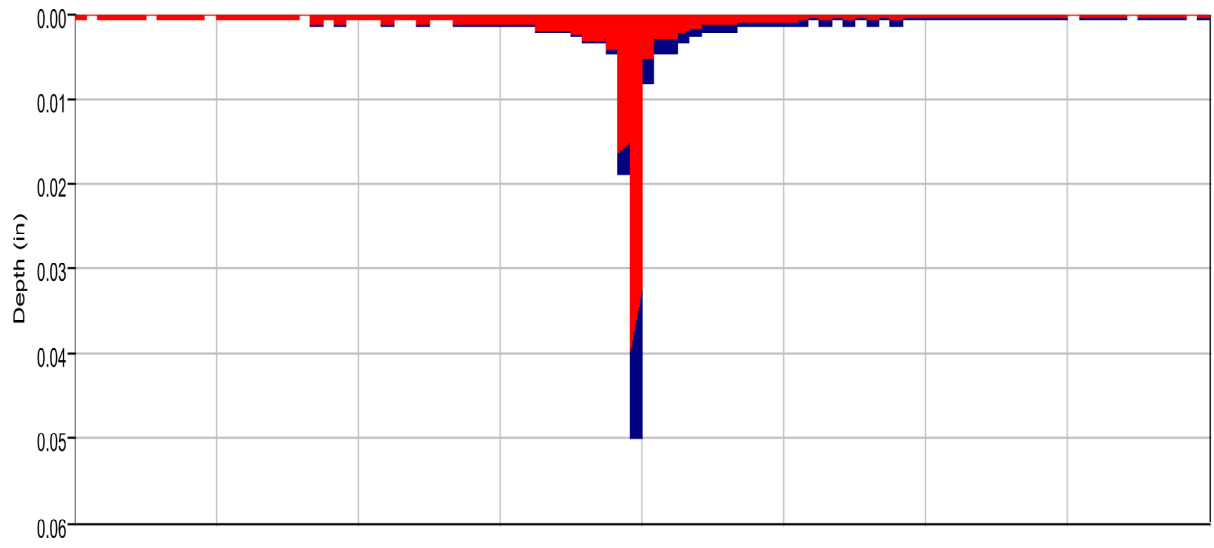

Run:EV 5-yr Pr. Type II Element:OB6 Result:Precipitation

Run:EV 5-YR PR. TYPE II Element:OB6 Result:Precipitation Loss

Run:EV 5-yr Pr. Type II Element:OB6 Result:Outflow

Run:EV 5-YR PR. TYPE II Element:OB6 Result:Baseflow

Project: Eagleview_Subdivision
Simulation Run: EV 5-yr Pr. Type II Subbasin: OB6
Start of Run: 01Oct2021, 00:00 Basin Model: Eagleview_Proposed
End of Run: 02Oct2021, 00:00 Meteorologic Model: 5-yr Type II
Compute Time: 14Mar2022, 16:43:16 Control Specifications: 24-hr Storm

Volume Units: IN

Computed Results

Peak Discharge :	42.1 (CFS)	Date/Time of Peak Discharge :	01Oct2021, 12:30
Total Precipitation :	2.70 (IN)	Total Direct Runoff :	0.71 (IN)
Total Loss :	1.98 (IN)	Total Baseflow :	0.00 (IN)
Total Excess :	0.72 (IN)	Discharge :	0.71 (IN)

Subbasin "OB7" Results for Run "EV 5-yr Pr. Type II"

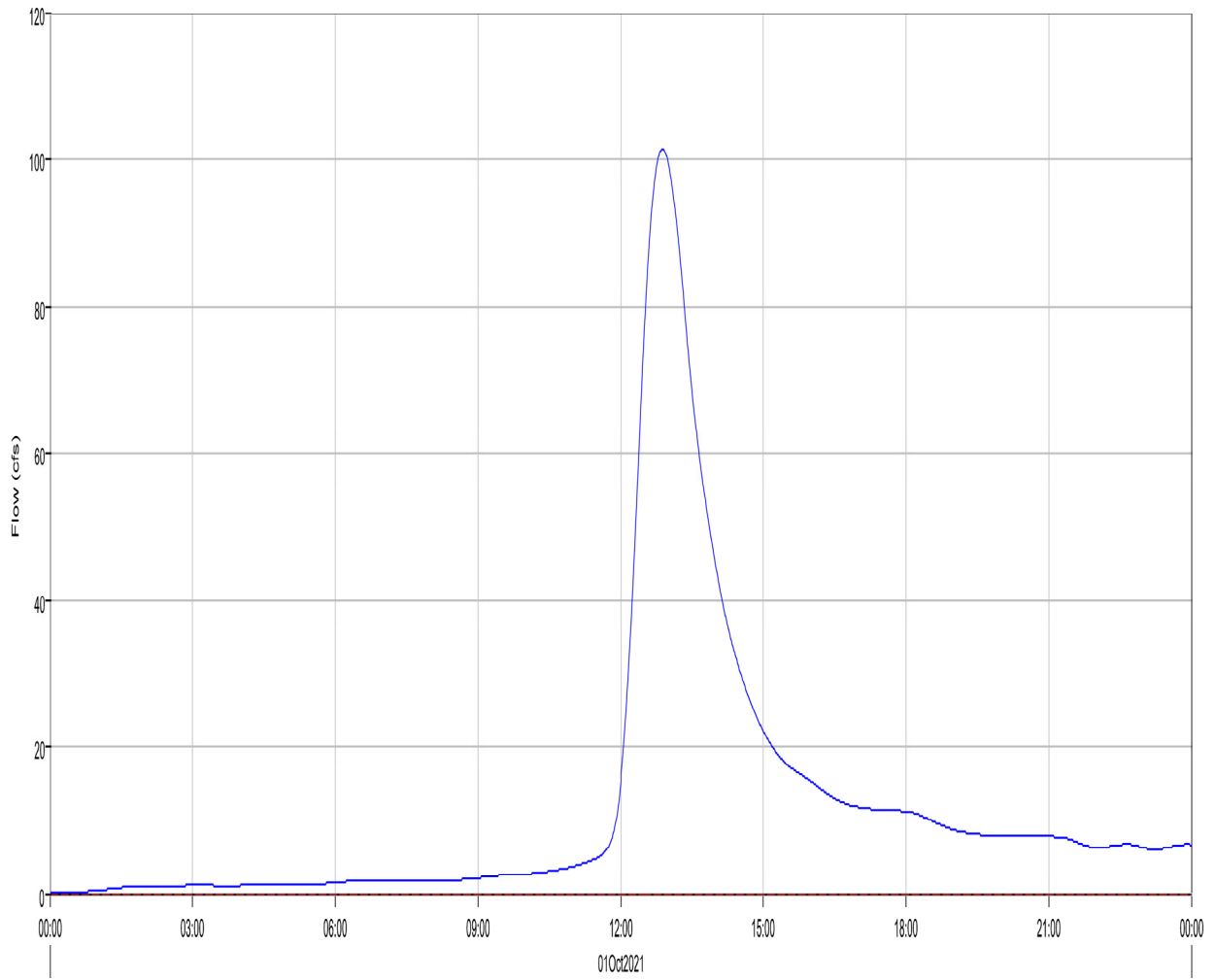
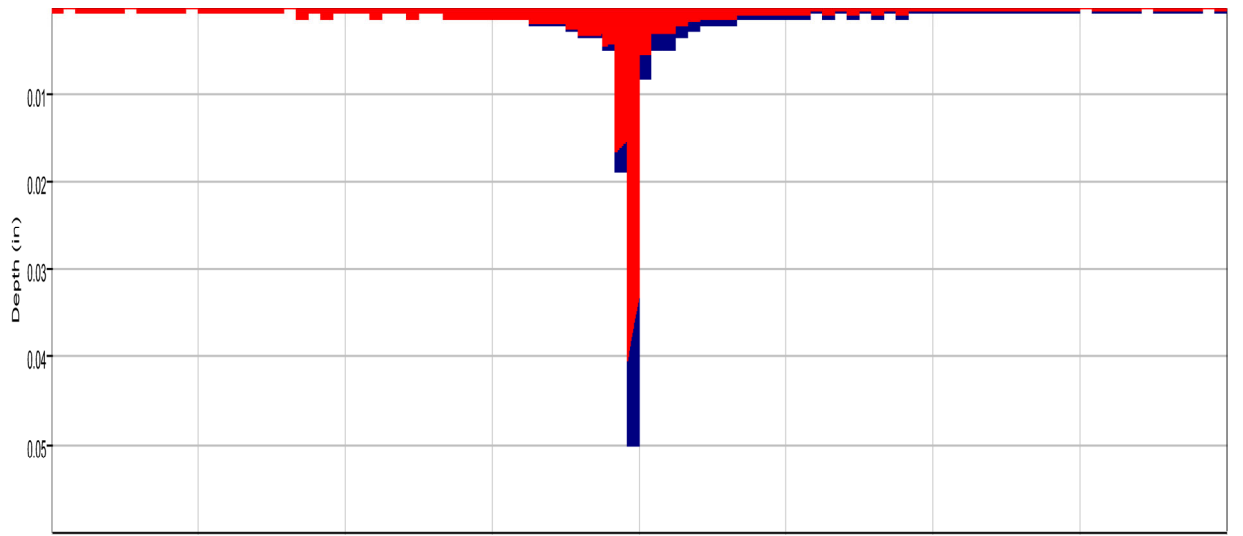

Run:EV 5-yr Pr. Type II Element:OB7 Result:Precipitation Run:EV 5-YR PR. TYPE II Element:OB7 Result:Precipitation Loss Run:EV 5-yr Pr. Type II Element:OB7 Result:Outflow Run:EV 5-YR PR. TYPE II Element:OB7 Result:Baseflow

Project: Eagleview_Subdivision
Simulation Run: EV 5-yr Pr. Type II Subbasin: OB7
Start of Run: 01Oct2021, 00:00 Basin Model: Eagleview_Proposed
End of Run: 02Oct2021, 00:00 Meteorologic Model: 5-yr Type II
Compute Time: 14Mar2022, 16:43:16 Control Specifications: 24-hr Storm

Volume Units: IN

Computed Results

Peak Discharge :	101.4 (CFS)	Date/Time of Peak Discharge :	01Oct2021, 12:53
Total Precipitation :	2.70 (IN)	Total Direct Runoff :	0.66 (IN)
Total Loss :	2.02 (IN)	Total Baseflow :	0.00 (IN)
Total Excess :	0.68 (IN)	Discharge :	0.66 (IN)

Subbasin "OB8" Results for Run "EV 5-yr Pr. Type II"

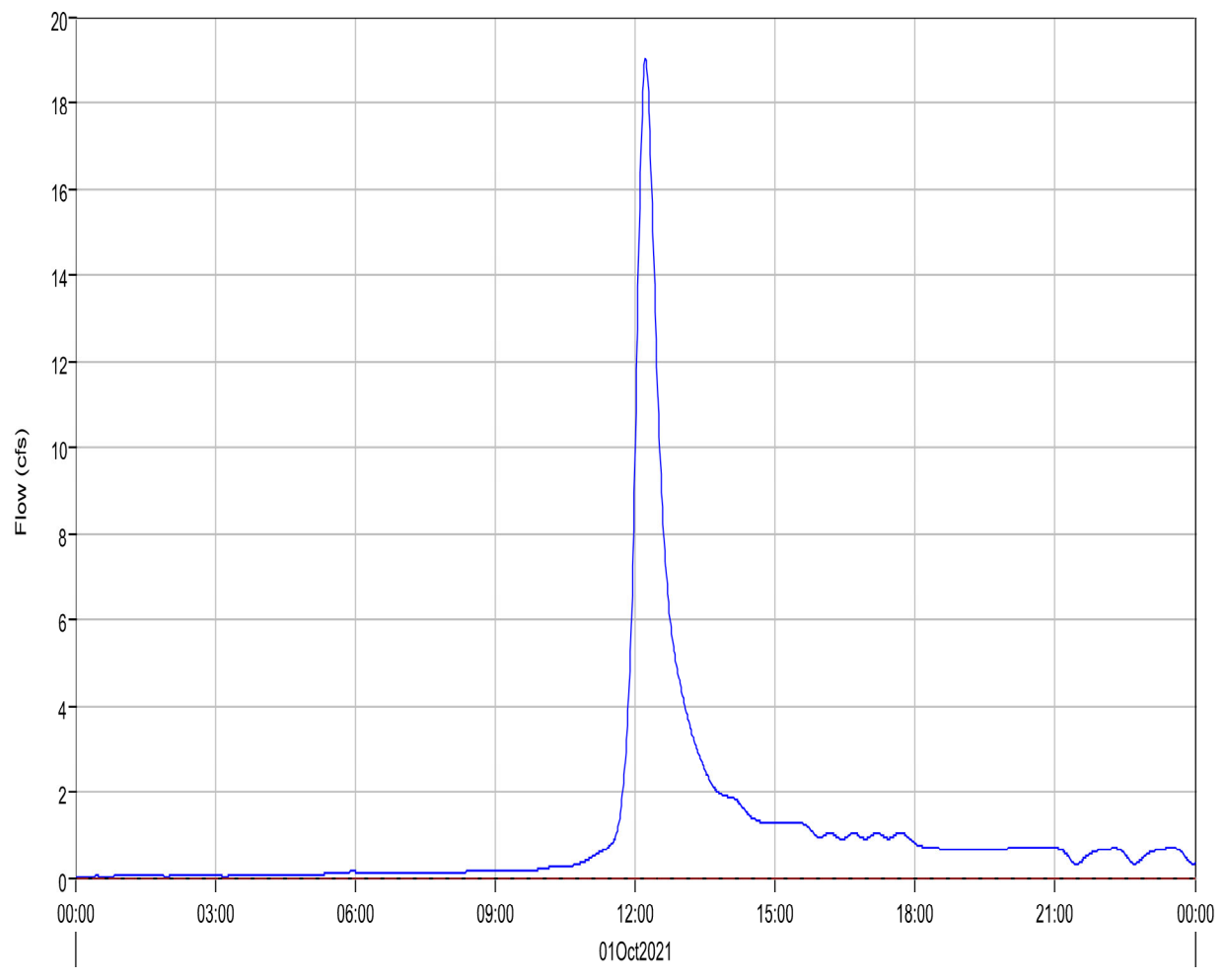
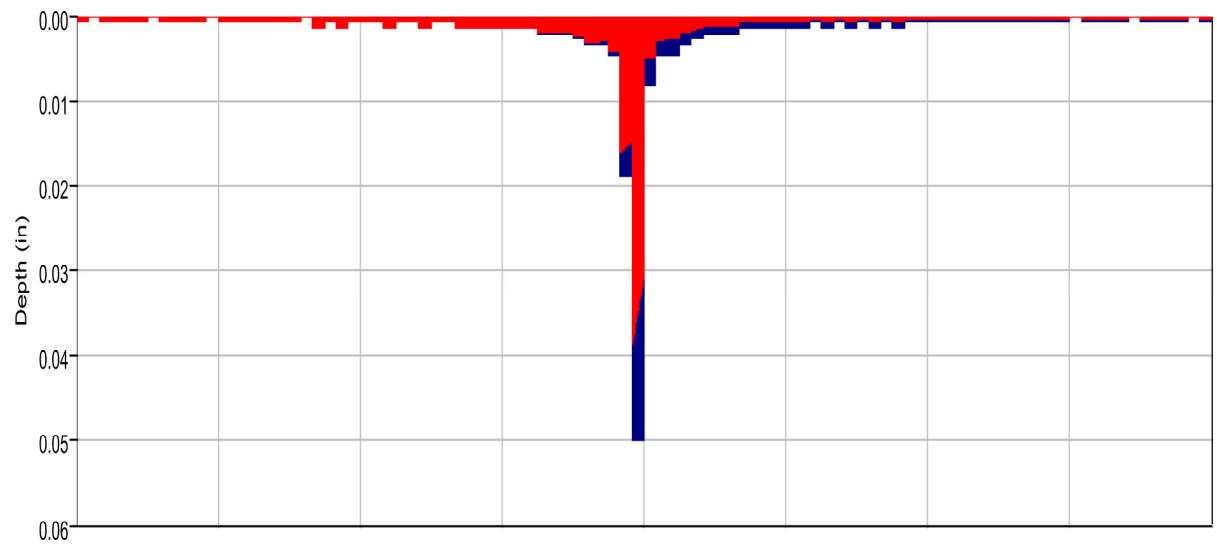

- Run:EV 5-yr Pr. Type II Element:OB8 Result:Precipitation
- Run:EV 5-yr Pr. Type II Element:OB8 Result:Outflow
- Run:EV 5-YR PR. TYPE II Element:OB8 Result:Precipitation Loss
- Run:EV 5-YR PR. TYPE II Element:OB8 Result:Baseflow

Project: Eagleview_Subdivision
Simulation Run: EV 5-yr Pr. Type II Subbasin: OB8
Start of Run: 01Oct2021, 00:00 Basin Model: Eagleview_Proposed
End of Run: 02Oct2021, 00:00 Meteorologic Model: 5-yr Type II
Compute Time: 14Mar2022, 16:43:16 Control Specifications: 24-hr Storm

Volume Units: IN

Computed Results

Peak Discharge :	19.0 (CFS)	Date/Time of Peak Discharge :	01Oct2021, 12:13
Total Precipitation :	2.70 (IN)	Total Direct Runoff :	0.76 (IN)
Total Loss :	1.94 (IN)	Total Baseflow :	0.00 (IN)
Total Excess :	0.76 (IN)	Discharge :	0.76 (IN)

Junction "P1" Results for Run "EV 5-yr Pr. Type II"

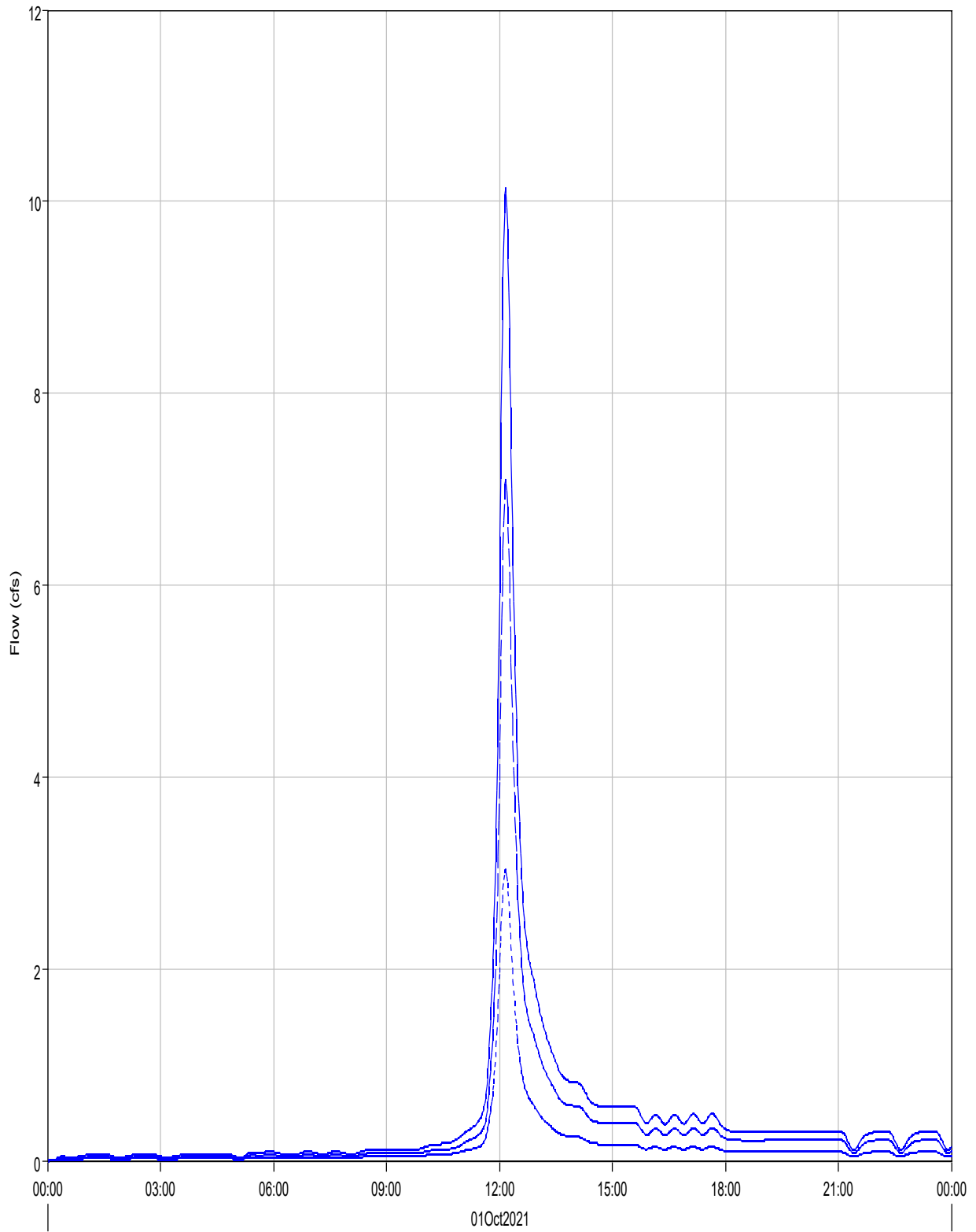

— Run:EV 5-yr Pr. Type II Element:P1 Result:Outflow - - - Run:EV 5-yr Pr. Type II Element:R-OB1 Result:Outflow . . . Run:EV 5-yr Pr. Type II Element:PB1 Result:Outflow

Project: Eagleview_Subdivision
Simulation Run: EV 5-yr Pr. Type II Junction: P1
Start of Run: 01Oct2021, 00:00 Basin Model: Eagleview_Proposed
End of Run: 02Oct2021, 00:00 Meteorologic Model: 5-yr Type II
Compute Time: 14Mar2022, 16:43:16 Control Specifications: 24-hr Storm

Volume Units: AC-FT

Computed Results

Peak Outflow : 10.1 (CFS) Date/Time of Peak Outflow : 01Oct2021, 12:10
Total Outflow : 1.0 (AC-FT)

Junction "P2" Results for Run "EV 5-yr Pr. Type II"

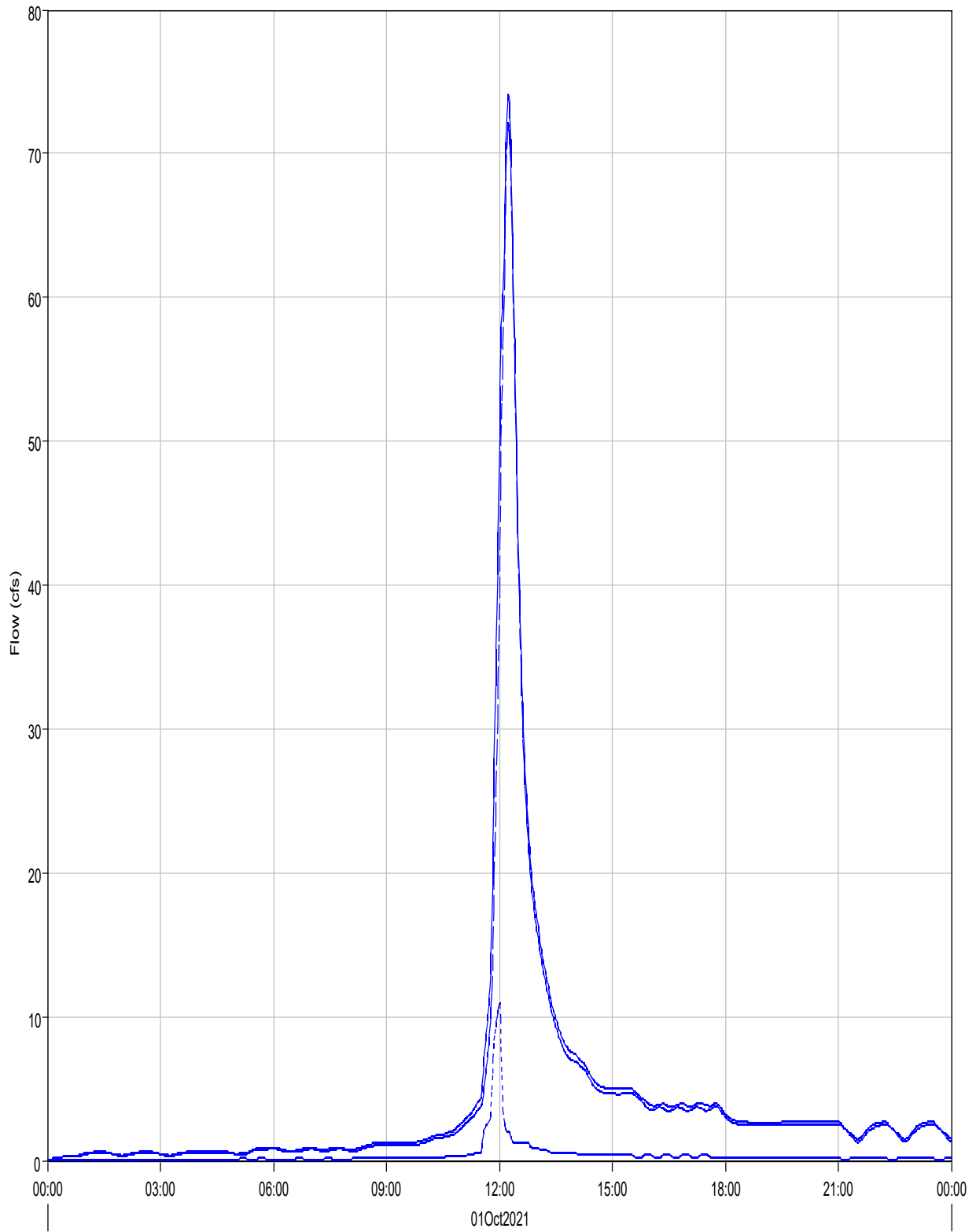

— Run:EV 5-yr Pr. Type II Element:P2 Result:Outflow - - - Run:EV 5-yr Pr. Type II Element:R-PB7-C Result:Outflow ····· Run:EV 5-yr Pr. Type II Element:PB15 Result:Outflow

Project: Eagleview_Subdivision
Simulation Run: EV 5-yr Pr. Type II Junction: P2
Start of Run: 01Oct2021, 00:00 Basin Model: Eagleview_Proposed
End of Run: 02Oct2021, 00:00 Meteorologic Model: 5-yr Type II
Compute Time: 14Mar2022, 16:43:16 Control Specifications: 24-hr Storm

Volume Units: AC-FT

Computed Results

Peak Outflow :	74.1 (CFS)	Date/Time of Peak Outflow :	01Oct2021, 12:14
Total Outflow :	8.9 (AC-FT)		

Junction "P3" Results for Run "EV 5-yr Pr. Type II"

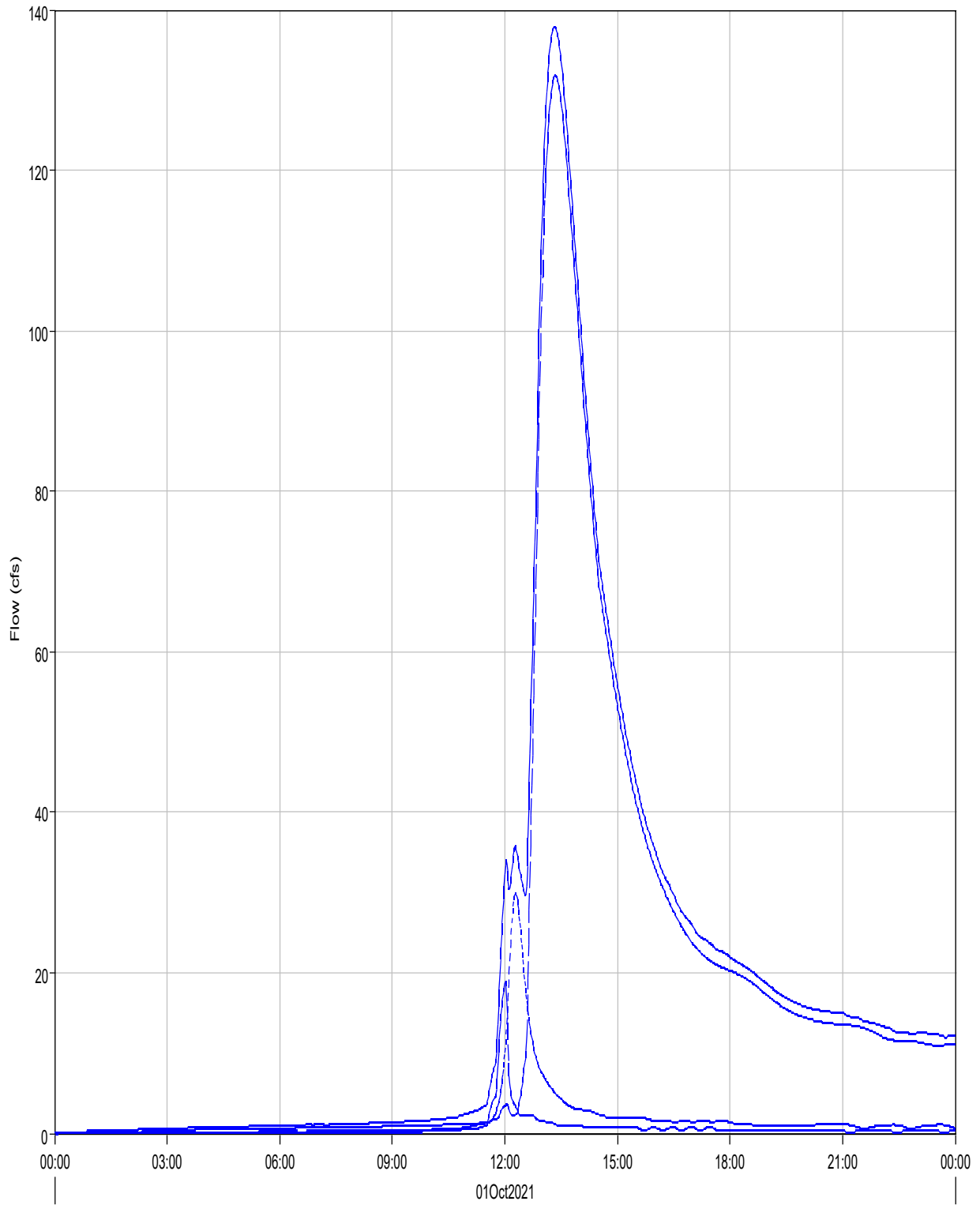

— Run:EV 5-yr Pr. Type II Element:P3 Result:Outflow - - - Run:EV 5-yr Pr. Type II Element:R-PB13 Result:Outflow ····· Run:EV 5-yr Pr. Type II Element:R-PB12-B Result:Outflow
- · - · Run:EV 5-yr Pr. Type II Element:PB14 Result:Outflow

Project: Eagleview_Subdivision
Simulation Run: EV 5-yr Pr. Type II Junction: P3
Start of Run: 01Oct2021, 00:00 Basin Model: Eagleview_Proposed
End of Run: 02Oct2021, 00:00 Meteorologic Model: 5-yr Type II
Compute Time: 14Mar2022, 16:43:16 Control Specifications: 24-hr Storm

Volume Units: AC-FT

Computed Results

Peak Outflow : 137.9 (CFS) Date/Time of Peak Outflow : 01Oct2021, 13:19
Total Outflow : 37.8 (AC-FT)

Junction "P4" Results for Run "EV 5-yr Pr. Type II"

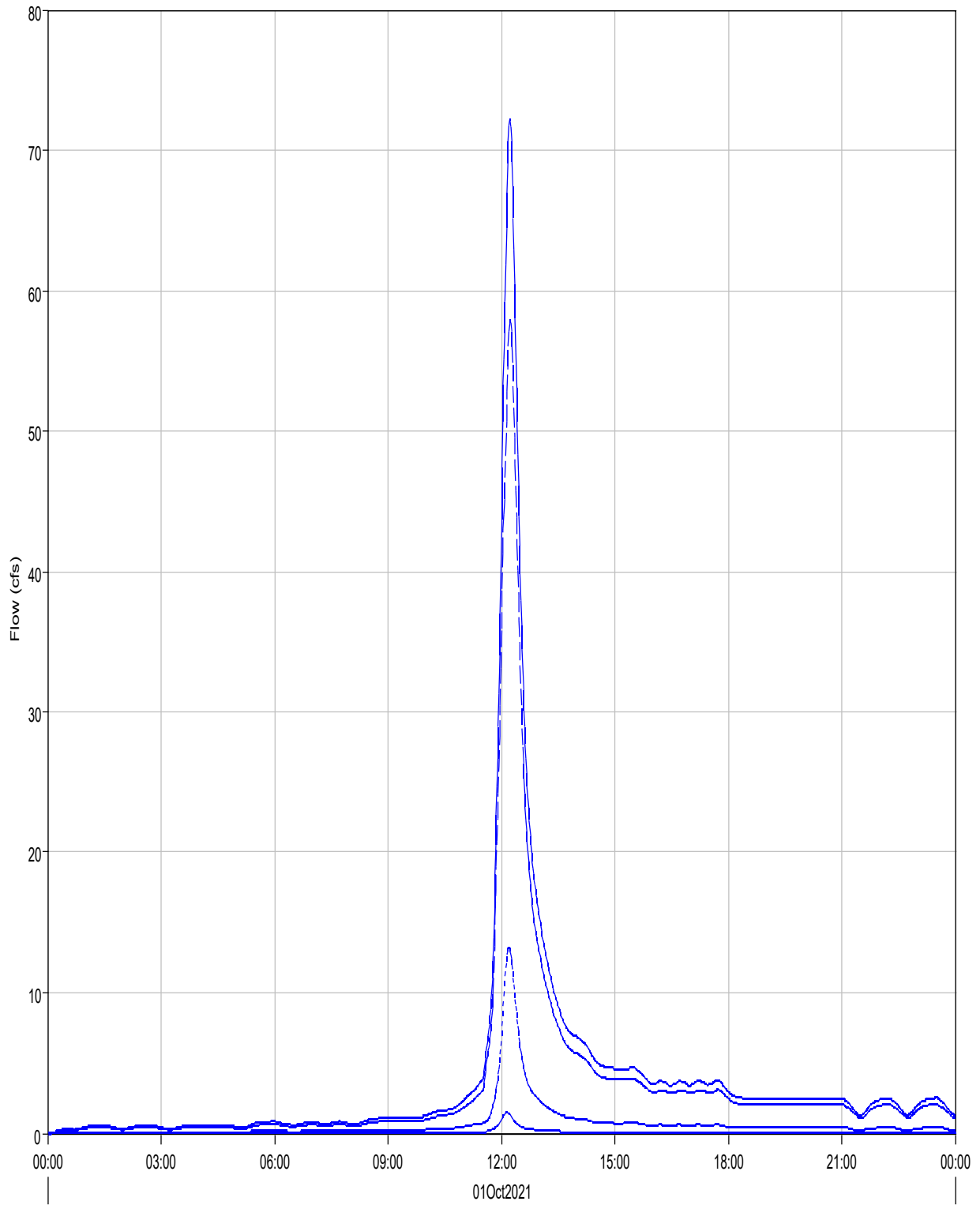

Run:EV 5-yr Pr. Type II Element:P4 Result:Outflow Run:EV 5-yr Pr. Type II Element:R-PB5 Result:Outflow Run:EV 5-yr Pr. Type II Element:R-PB7-B Result:Outflow
Run:EV 5-yr Pr. Type II Element:R-PB3 Result:Outflow

Project: Eagleview_Subdivision
Simulation Run: EV 5-yr Pr. Type II Junction: P4
Start of Run: 01Oct2021, 00:00 Basin Model: Eagleview_Proposed
End of Run: 02Oct2021, 00:00 Meteorologic Model: 5-yr Type II
Compute Time: 14Mar2022, 16:43:16 Control Specifications: 24-hr Storm

Volume Units: AC-FT

Computed Results

Peak Outflow :	72.2 (CFS)	Date/Time of Peak Outflow :	01Oct2021, 12:13
Total Outflow :	8.1 (AC-FT)		

Reach "P5 (CULV7)" Results for Run "EV 5-yr Pr. Type II"

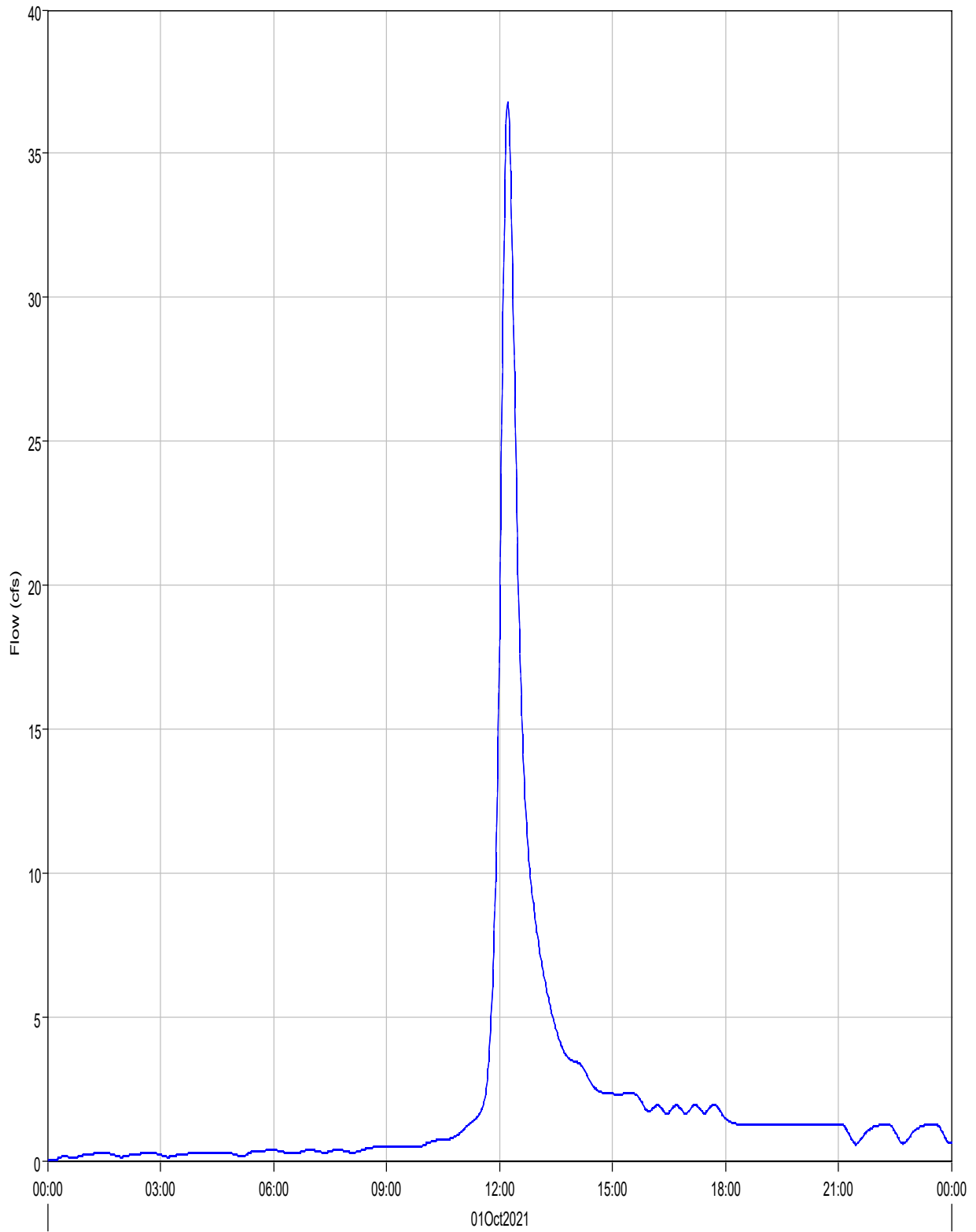

— Run:EV 5-yr Pr. Type II Element:P5 (CULV7) Result:Outflow

- - - Run:EV 5-YR PR. TYPE II Element:P5 (CULV7) Result:Combined Inflow

Project: Eagleview_Subdivision
Simulation Run: EV 5-yr Pr. Type II Reach: P5 (CULV7)

Start of Run: 01Oct2021, 00:00 Basin Model: Eagleview_Proposed
End of Run: 02Oct2021, 00:00 Meteorologic Model: 5-yr Type II
Compute Time: 14Mar2022, 16:43:16 Control Specifications: 24-hr Storm

Volume Units: AC-FT

Computed Results

Peak Inflow :	36.8 (CFS)	Date/Time of Peak Inflow :	01Oct2021, 12:13
Peak Outflow :	36.8 (CFS)	Date/Time of Peak Outflow :	01Oct2021, 12:13
Total Inflow :	4.0 (AC-FT)	Total Outflow :	4.0 (AC-FT)

Junction "P6" Results for Run "EV 5-yr Pr. Type II"

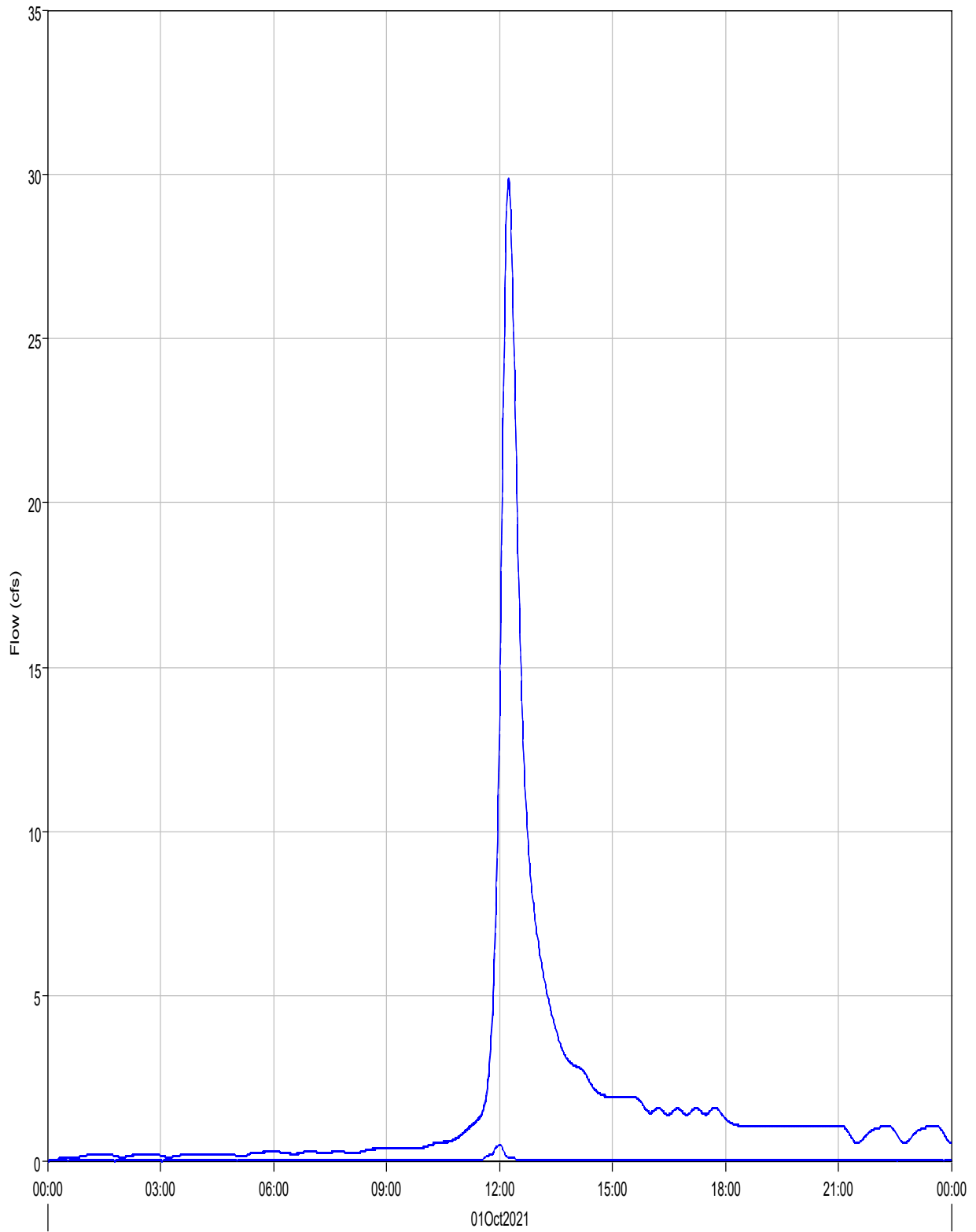

— Run:EV 5-yr Pr. Type II Element:P6 Result:Outflow - - - Run:EV 5-yr Pr. Type II Element:R-PB11 Result:Outflow ····· Run:EV 5-yr Pr. Type II Element:R-PB12-A Result:Outflow

Project: Eagleview_Subdivision
Simulation Run: EV 5-yr Pr. Type II Junction: P6
Start of Run: 01Oct2021, 00:00 Basin Model: Eagleview_Proposed
End of Run: 02Oct2021, 00:00 Meteorologic Model: 5-yr Type II
Compute Time: 14Mar2022, 16:43:16 Control Specifications: 24-hr Storm

Volume Units: AC-FT

Computed Results

Peak Outflow : 29.9 (CFS) Date/Time of Peak Outflow : 01Oct2021, 12:15
Total Outflow : 3.3 (AC-FT)

Reservoir "P7" Results for Run "EV 5-yr Pr. Type II"

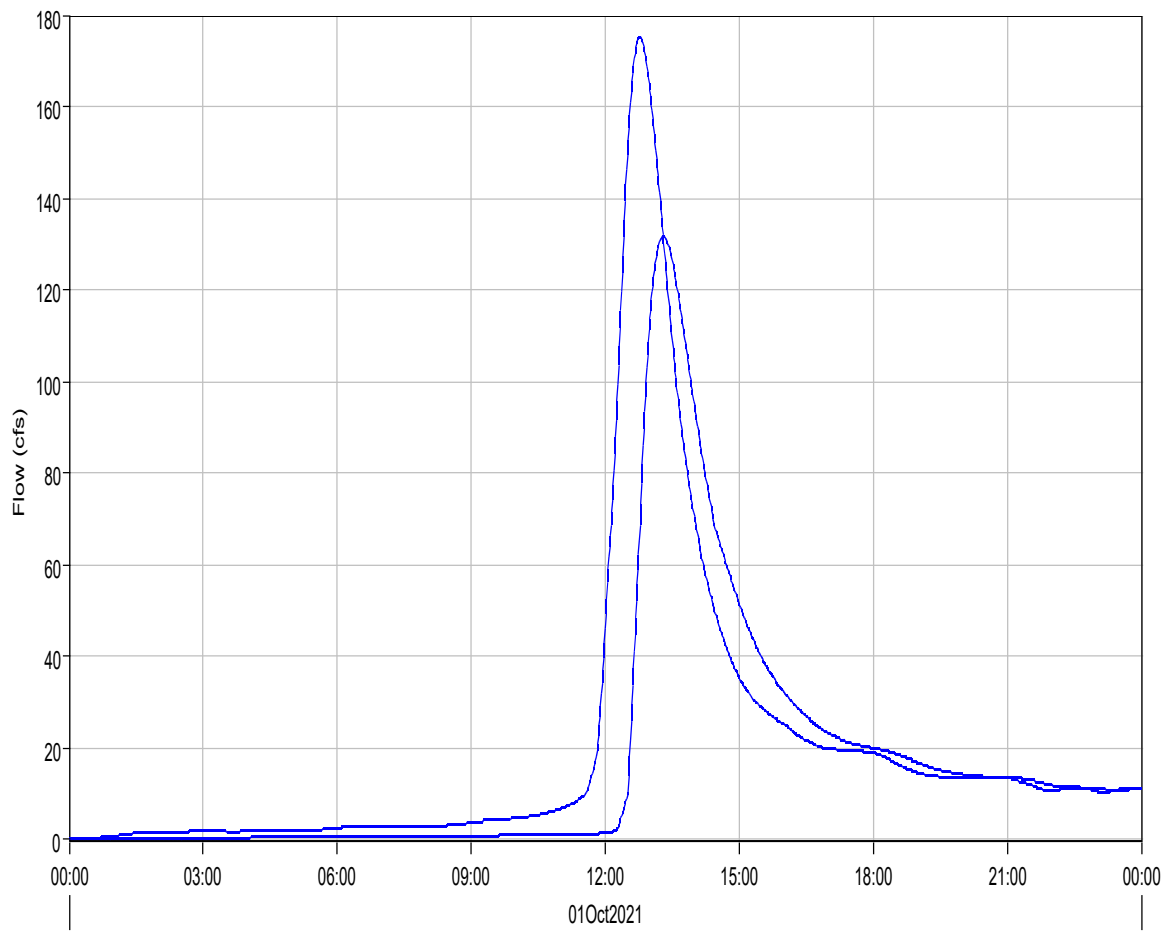
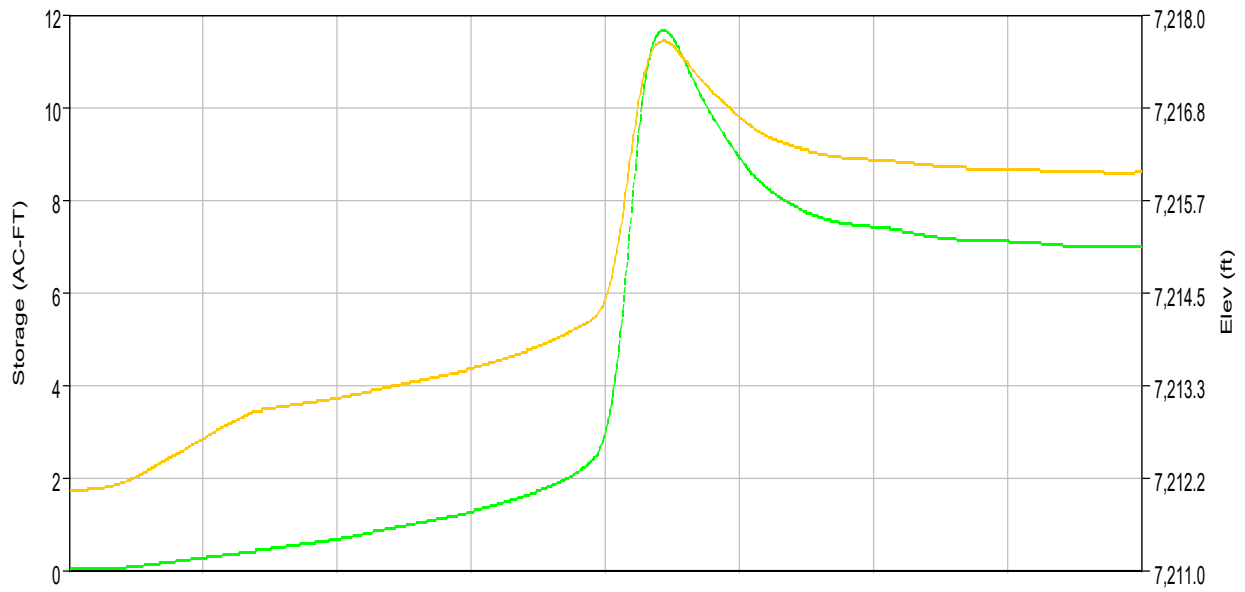

--- Run:EV 5-YR PR. TYPE II Element:P7 Result:Storage

--- Run:EV 5-YR PR. TYPE II Element:P7 Result:Pool Elevation

--- Run:EV 5-yr Pr. Type II Element:P7 Result:Outflow

--- Run:EV 5-YR PR. TYPE II Element:P7 Result:Combined Flow

Project: Eagleview_Subdivision
Simulation Run: EV 5-yr Pr. Type II Reservoir: P7
Start of Run: 01Oct2021, 00:00 Basin Model: Eagleview_Proposed
End of Run: 02Oct2021, 00:00 Meteorologic Model: 5-yr Type II
Compute Time: 14Mar2022, 16:43:16 Control Specifications: 24-hr Storm

Volume Units: AC-FT

Computed Results

Peak Inflow :	175.3 (CFS)	Date/Time of Peak Inflow :	01Oct2021, 12:46
Peak Outflow :	131.7 (CFS)	Date/Time of Peak Outflow :	01Oct2021, 13:18
Total Inflow :	40.1 (AC-FT)	Peak Storage :	11.7 (AC-FT)
Total Outflow :	33.2 (AC-FT)	Peak Elevation :	7217.7 (FT)

Junction "P8" Results for Run "EV 5-yr Pr. Type II"

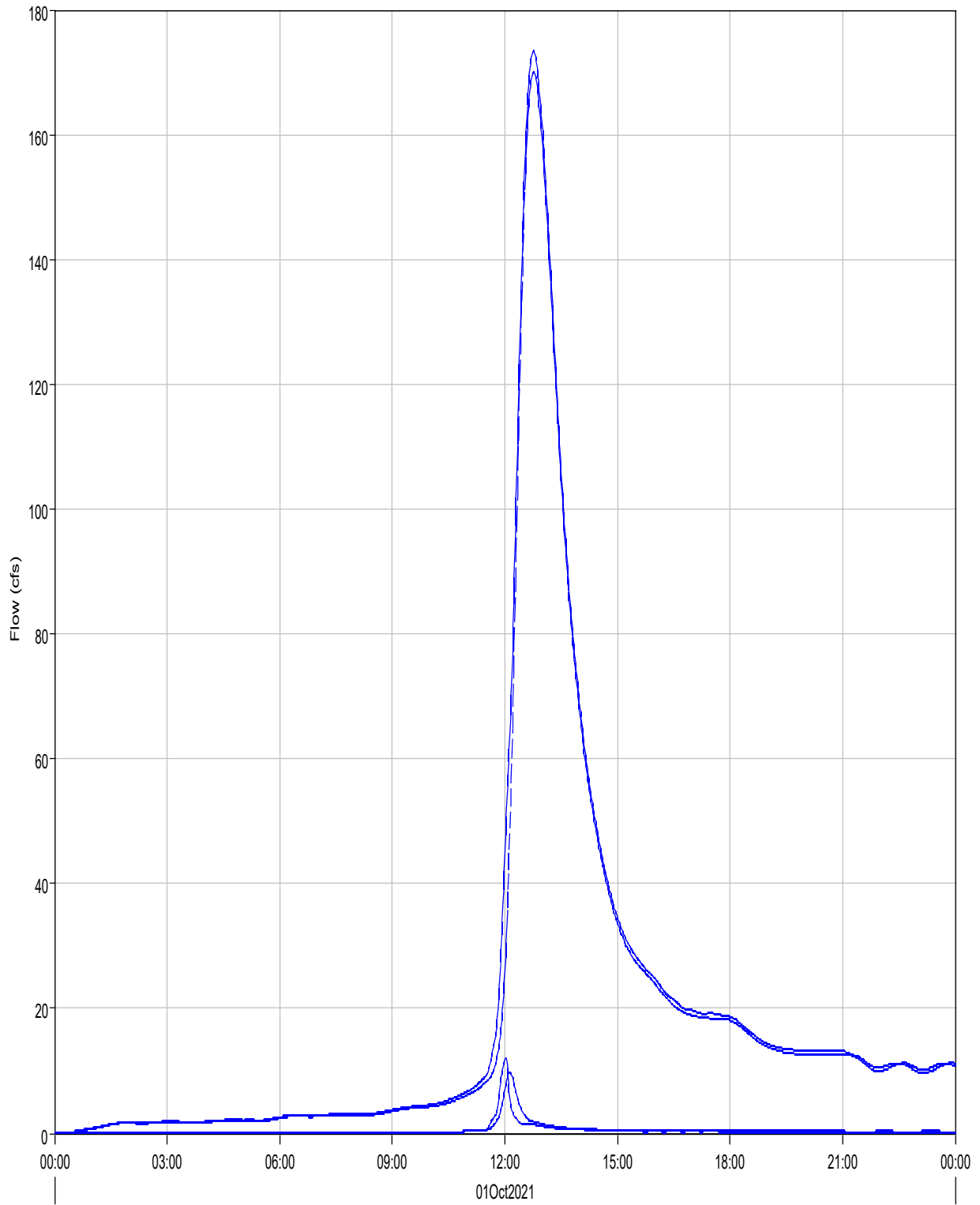

— Run:EV 5-yr Pr. Type II Element:P8 Result:Outflow - - - Run:EV 5-yr Pr. Type II Element:R-OB7 Result:Outflow ····· Run:EV 5-yr Pr. Type II Element:PB9 Result:Outflow
- · - · Run:EV 5-yr Pr. Type II Element:PB8 Result:Outflow

Project: Eagleview_Subdivision
Simulation Run: EV 5-yr Pr. Type II Junction: P8
Start of Run: 01Oct2021, 00:00 Basin Model: Eagleview_Proposed
End of Run: 02Oct2021, 00:00 Meteorologic Model: 5-yr Type II
Compute Time: 14Mar2022, 16:43:16 Control Specifications: 24-hr Storm

Volume Units: IN

Computed Results

Peak Outflow : 173.4 (CFS) Date/Time of Peak Outflow : 01Oct2021, 12:46
Total Outflow : 0.67 (IN)

Reach "P9 (CULV6)" Results for Run "EV 5-yr Pr. Type II"

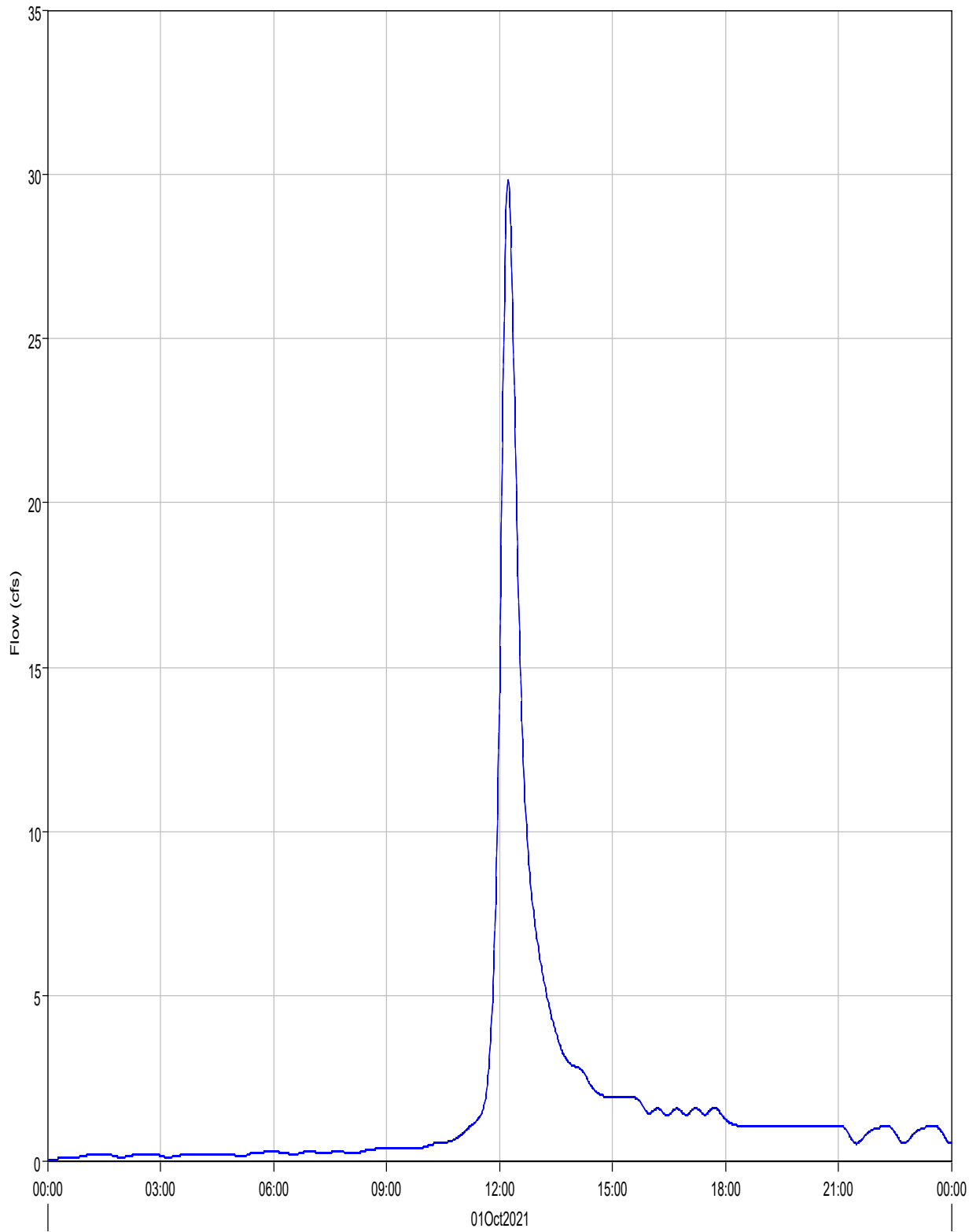

— Run:EV 5-yr Pr. Type II Element:P9 (CULV6) Result:Outflow

- - - Run:EV 5-YR PR. TYPE II Element:P9 (CULV6) Result:Combined Inflow

Project: Eagleview_Subdivision
Simulation Run: EV 5-yr Pr. Type II Reach: P9 (CULV6)

Start of Run: 01Oct2021, 00:00 Basin Model: Eagleview_Proposed
End of Run: 02Oct2021, 00:00 Meteorologic Model: 5-yr Type II
Compute Time: 14Mar2022, 16:43:16 Control Specifications: 24-hr Storm

Volume Units: IN

Computed Results

Peak Inflow :	29.9 (CFS)	Date/Time of Peak Inflow :	01Oct2021, 12:14
Peak Outflow :	29.8 (CFS)	Date/Time of Peak Outflow :	01Oct2021, 12:14
Total Inflow :	0.80 (IN)	Total Outflow :	0.80 (IN)

Reach "P10 (CULV2)" Results for Run "EV 5-yr Pr. Type II"

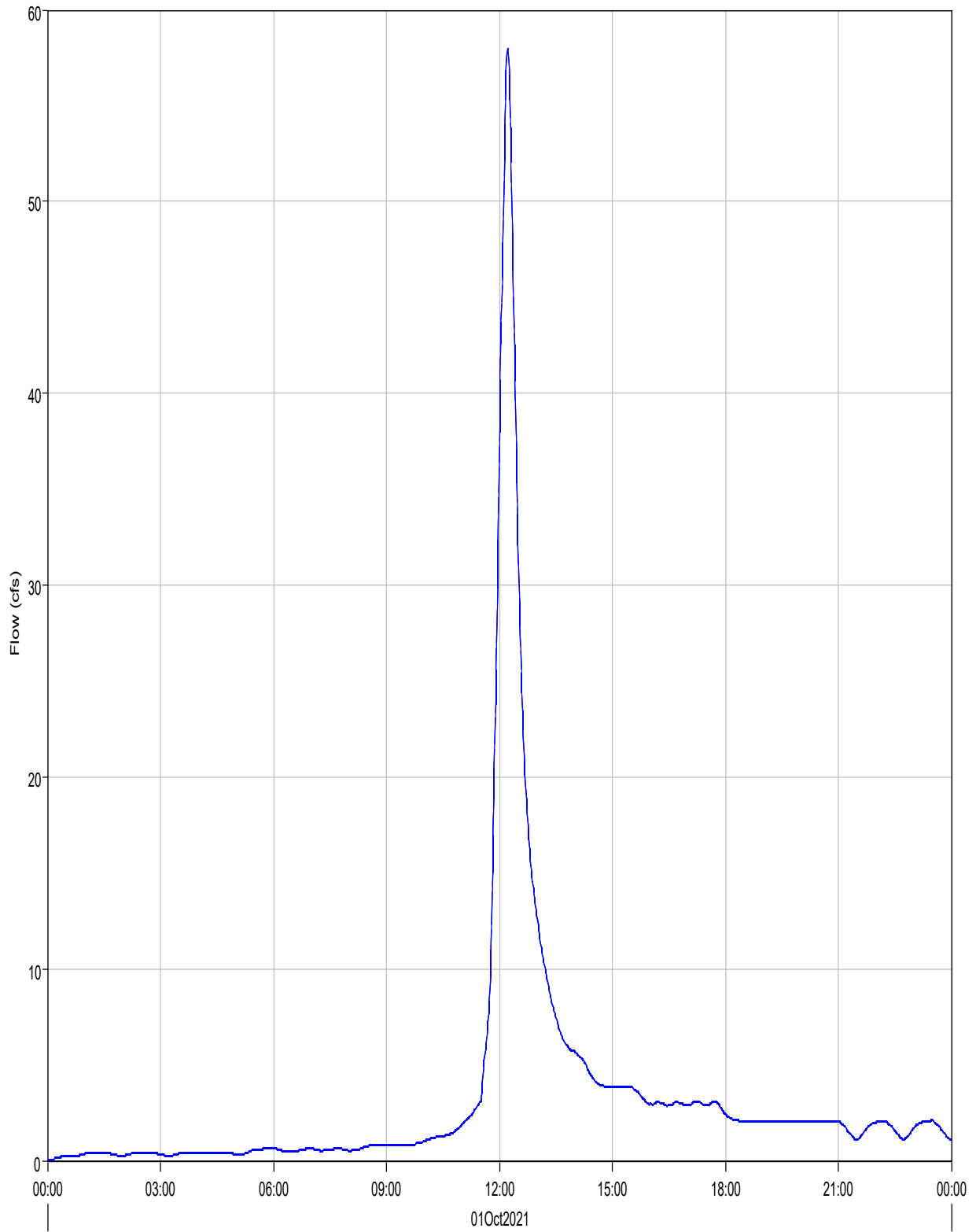

Run:EV 5-yr Pr. Type II Element:P10 (CULV2) Result:Outflow

Run:EV 5-YR PR. TYPE II Element:P10 (CULV2) Result:Combined Inflow

Project: Eagleview_Subdivision
Simulation Run: EV 5-yr Pr. Type II Reach: P10 (CULV2)

Start of Run: 01Oct2021, 00:00 Basin Model: Eagleview_Proposed
End of Run: 02Oct2021, 00:00 Meteorologic Model: 5-yr Type II
Compute Time: 14Mar2022, 16:43:16 Control Specifications: 24-hr Storm

Volume Units: AC-FT

Computed Results

Peak Inflow :	58.0 (CFS)	Date/Time of Peak Inflow :	01Oct2021, 12:13
Peak Outflow :	57.9 (CFS)	Date/Time of Peak Outflow :	01Oct2021, 12:13
Total Inflow :	6.7 (AC-FT)	Total Outflow :	6.7 (AC-FT)

Reach "P11 (CULV3)" Results for Run "EV 5-yr Pr. Type II"

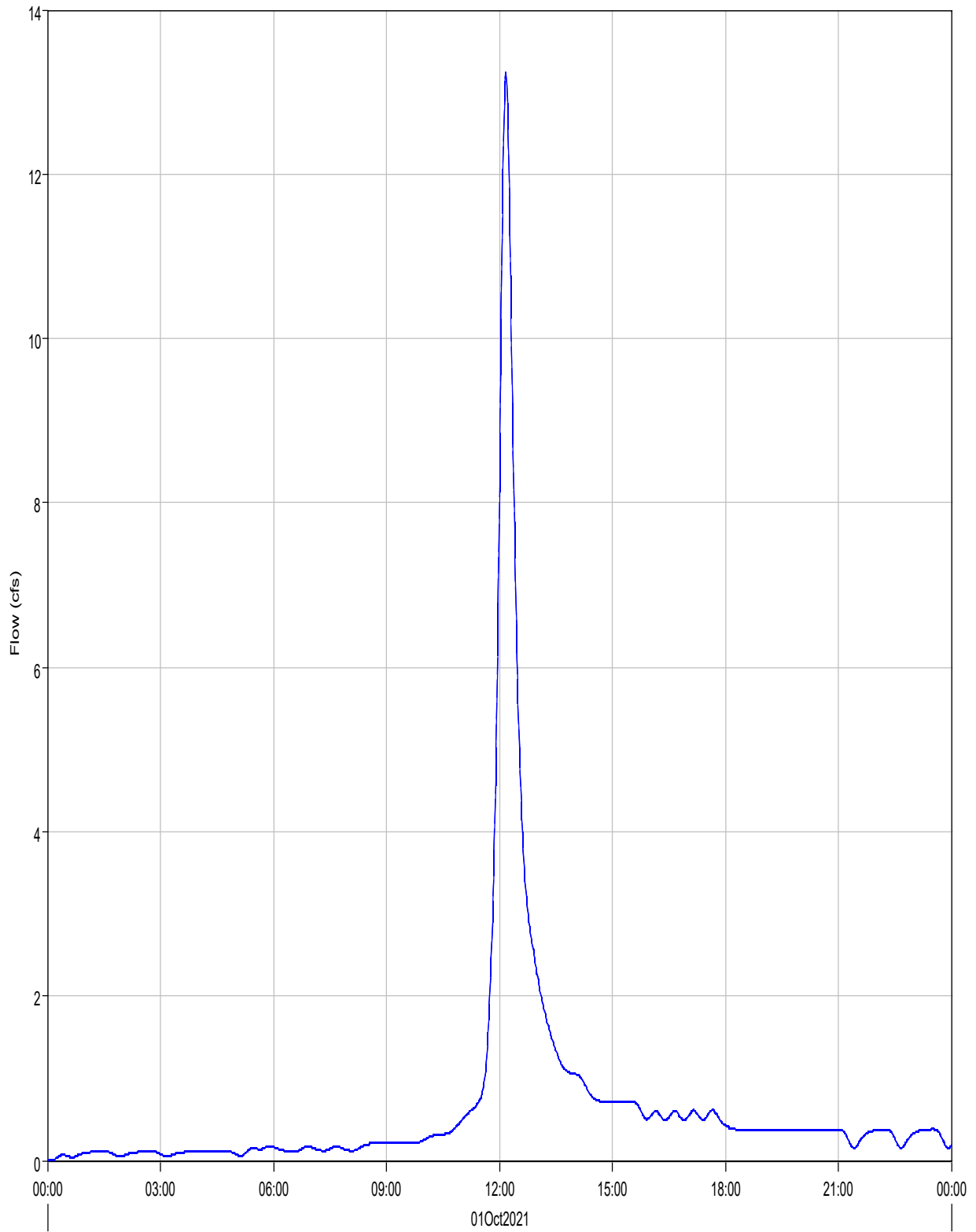

— Run:EV 5-yr Pr. Type II Element:P11 (CULV3) Result:Outflow

- - - Run:EV 5-YR PR. TYPE II Element:P11 (CULV3) Result:Combined Inflow

Project: Eagleview_Subdivision
Simulation Run: EV 5-yr Pr. Type II Reach: P11 (CULV3)

Start of Run: 01Oct2021, 00:00 Basin Model: Eagleview_Proposed
End of Run: 02Oct2021, 00:00 Meteorologic Model: 5-yr Type II
Compute Time: 14Mar2022, 16:43:16 Control Specifications: 24-hr Storm

Volume Units: AC-FT

Computed Results

Peak Inflow :	13.3 (CFS)	Date/Time of Peak Inflow :	01Oct2021, 12:10
Peak Outflow :	13.2 (CFS)	Date/Time of Peak Outflow :	01Oct2021, 12:10
Total Inflow :	1.3 (AC-FT)	Total Outflow :	1.3 (AC-FT)

Reach "P12 (CULV8)" Results for Run "EV 5-yr Pr. Type II"

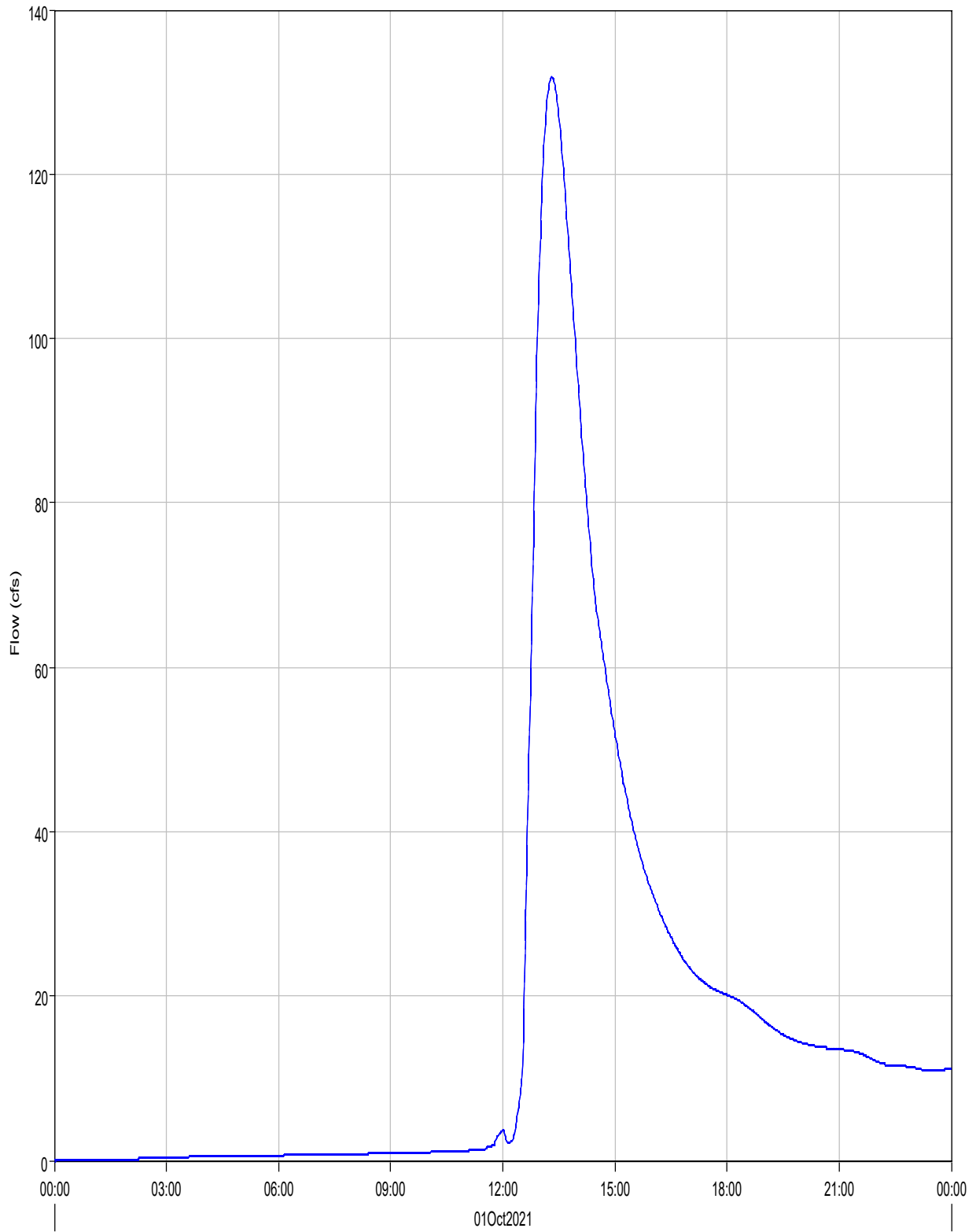

— Run:EV 5-yr Pr. Type II Element:P12 (CULV8) Result:Outflow

--- Run:EV 5-YR PR. TYPE II Element:P12 (CULV8) Result:Combined Inflow

Project: Eagleview_Subdivision
Simulation Run: EV 5-yr Pr. Type II Reach: P12 (CULV8)

Start of Run: 01Oct2021, 00:00 Basin Model: Eagleview_Proposed
End of Run: 02Oct2021, 00:00 Meteorologic Model: 5-yr Type II
Compute Time: 14Mar2022, 16:43:16 Control Specifications: 24-hr Storm

Volume Units: IN

Computed Results

Peak Inflow :	131.8 (CFS)	Date/Time of Peak Inflow :	01Oct2021, 13:19
Peak Outflow :	131.8 (CFS)	Date/Time of Peak Outflow :	01Oct2021, 13:19
Total Inflow :	0.55 (IN)	Total Outflow :	0.55 (IN)

Subbasin "PB1" Results for Run "EV 5-yr Pr. Type II"

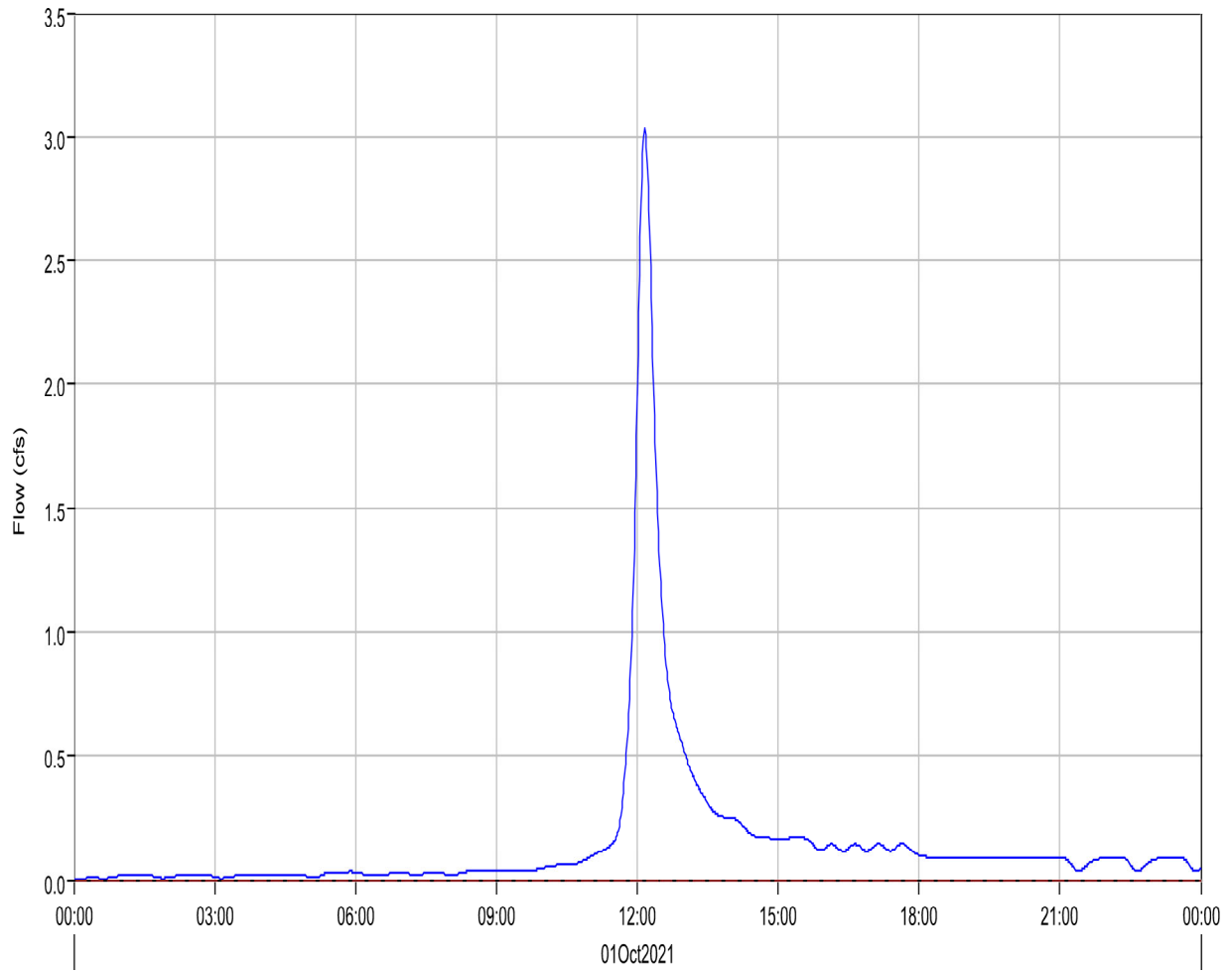
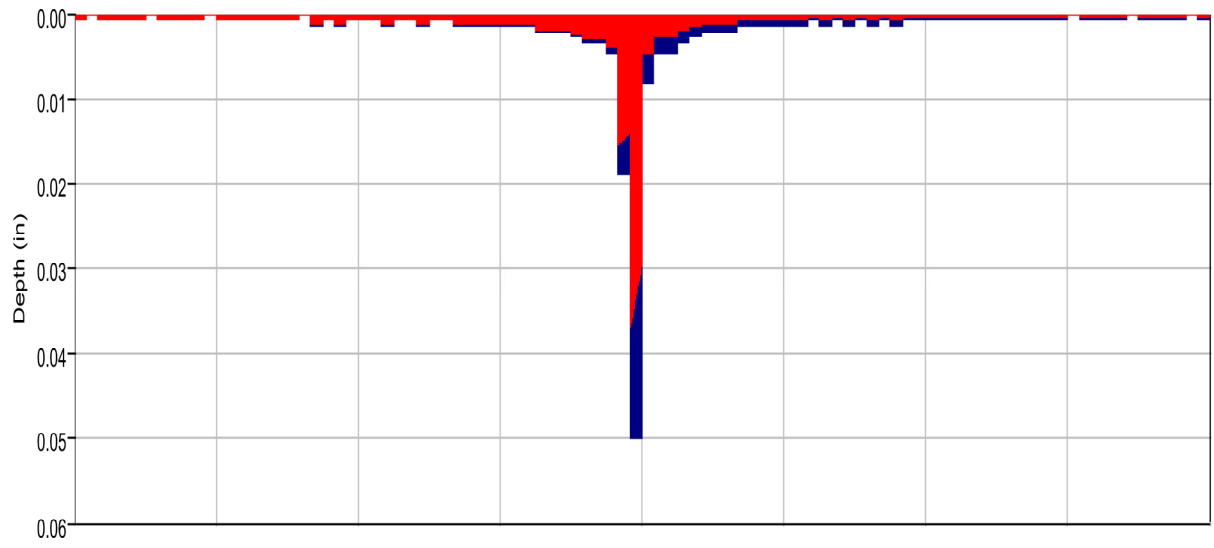

Run:EV 5-yr Pr. Type II Element:PB1 Result:Precipitation
Run:EV 5-yr Pr. Type II Element:PB1 Result:Outflow

Run:EV 5-YR PR. TYPE II Element:PB1 Result:Precipitation Loss
Run:EV 5-YR PR. TYPE II Element:PB1 Result:Baseflow

Project: Eagleview_Subdivision
Simulation Run: EV 5-yr Pr. Type II Subbasin: PB1
Start of Run: 01Oct2021, 00:00 Basin Model: Eagleview_Proposed
End of Run: 02Oct2021, 00:00 Meteorologic Model: 5-yr Type II
Compute Time: 14Mar2022, 16:43:16 Control Specifications: 24-hr Storm

Volume Units: AC-FT

Computed Results

Peak Discharge :	3.0 (CFS)	Date/Time of Peak Discharge :	01Oct2021, 12:10
Total Precipitation :	1.0 (AC-FT)	Total Direct Runoff :	0.3 (AC-FT)
Total Loss :	0.7 (AC-FT)	Total Baseflow :	0.0 (AC-FT)
Total Excess :	0.3 (AC-FT)	Discharge :	0.3 (AC-FT)

Subbasin "PB2" Results for Run "EV 5-yr Pr. Type II"

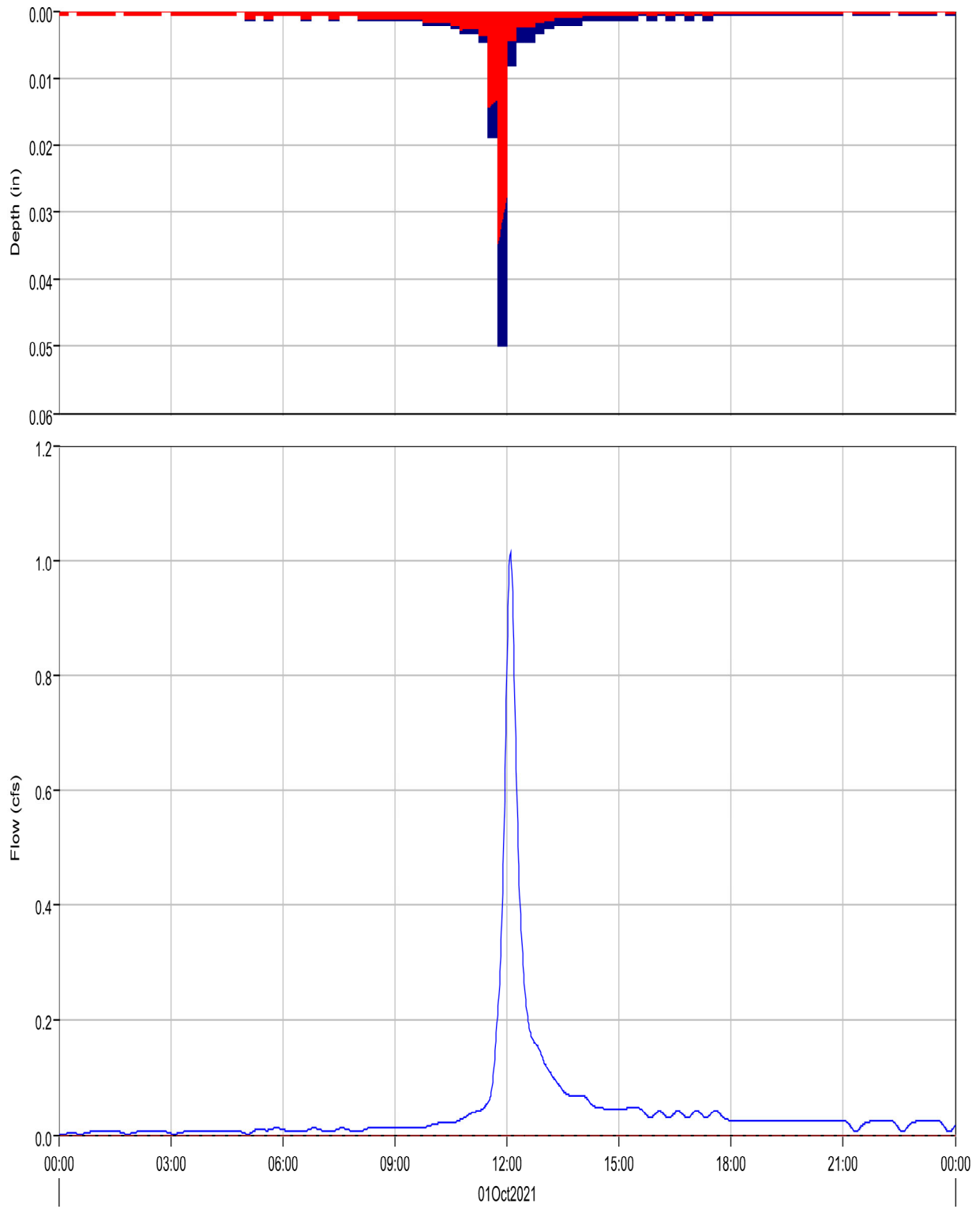

Run:EV 5-yr Pr. Type II Element:PB2 Result:Precipitation
Run:EV 5-yr Pr. Type II Element:PB2 Result:Outflow

Run:EV 5-YR PR. TYPE II Element:PB2 Result:Precipitation Loss
Run:EV 5-YR PR. TYPE II Element:PB2 Result:Baseflow

Project: Eagleview_Subdivision
Simulation Run: EV 5-yr Pr. Type II Subbasin: PB2
Start of Run: 01Oct2021, 00:00 Basin Model: Eagleview_Proposed
End of Run: 02Oct2021, 00:00 Meteorologic Model: 5-yr Type II
Compute Time: 14Mar2022, 16:43:16 Control Specifications: 24-hr Storm

Volume Units: AC-FT

Computed Results

Peak Discharge :	1.0 (CFS)	Date/Time of Peak Discharge :	01Oct2021, 12:06
Total Precipitation :	0.2 (AC-FT)	Total Direct Runoff :	0.1 (AC-FT)
Total Loss :	0.2 (AC-FT)	Total Baseflow :	0.0 (AC-FT)
Total Excess :	0.1 (AC-FT)	Discharge :	0.1 (AC-FT)

Subbasin "PB3" Results for Run "EV 5-yr Pr. Type II"

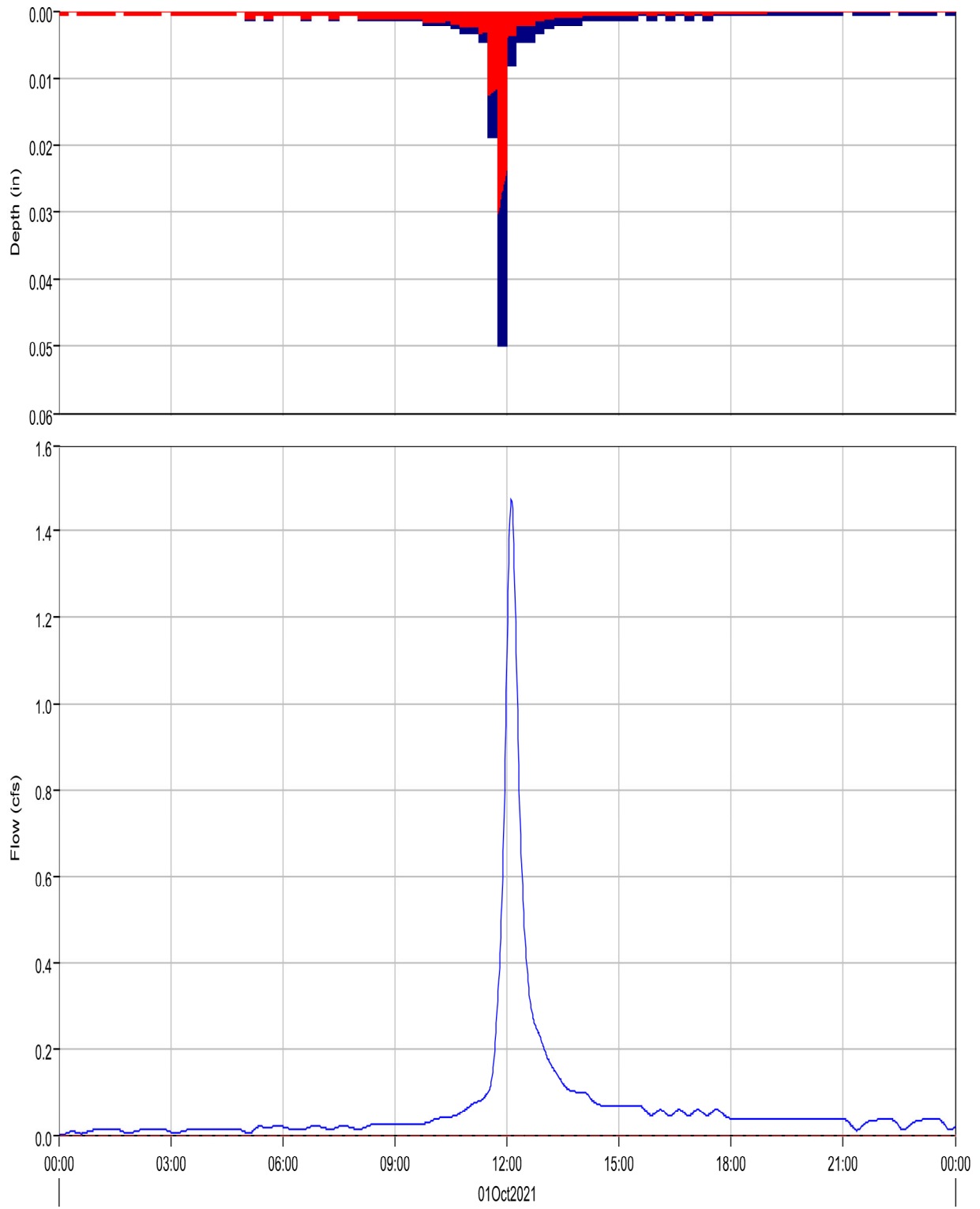

■ Run:EV 5-yr Pr. Type II Element:PB3 Result:Precipitation
— Run:EV 5-yr Pr. Type II Element:PB3 Result:Outflow

■ Run:EV 5-YR PR. TYPE II Element:PB3 Result:Precipitation Loss
- - - Run:EV 5-YR PR. TYPE II Element:PB3 Result:Baseflow

Project: Eagleview_Subdivision
Simulation Run: EV 5-yr Pr. Type II Subbasin: PB3
Start of Run: 01Oct2021, 00:00 Basin Model: Eagleview_Proposed
End of Run: 02Oct2021, 00:00 Meteorologic Model: 5-yr Type II
Compute Time: 14Mar2022, 16:43:16 Control Specifications: 24-hr Storm

Volume Units: AC-FT

Computed Results

Peak Discharge :	1.5 (CFS)	Date/Time of Peak Discharge :	01Oct2021, 12:07
Total Precipitation :	0.3 (AC-FT)	Total Direct Runoff :	0.1 (AC-FT)
Total Loss :	0.2 (AC-FT)	Total Baseflow :	0.0 (AC-FT)
Total Excess :	0.1 (AC-FT)	Discharge :	0.1 (AC-FT)

Subbasin "PB4" Results for Run "EV 5-yr Pr. Type II"

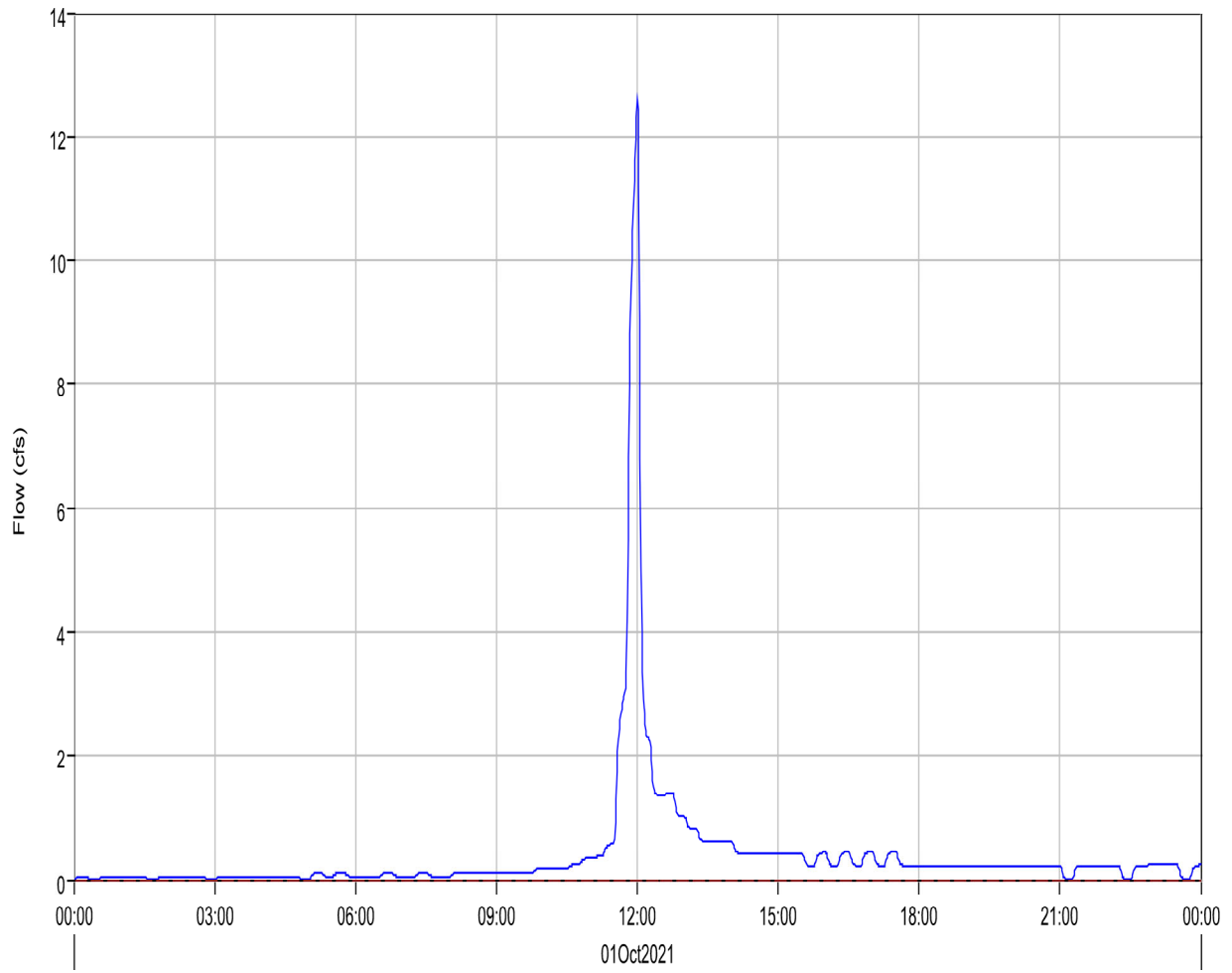
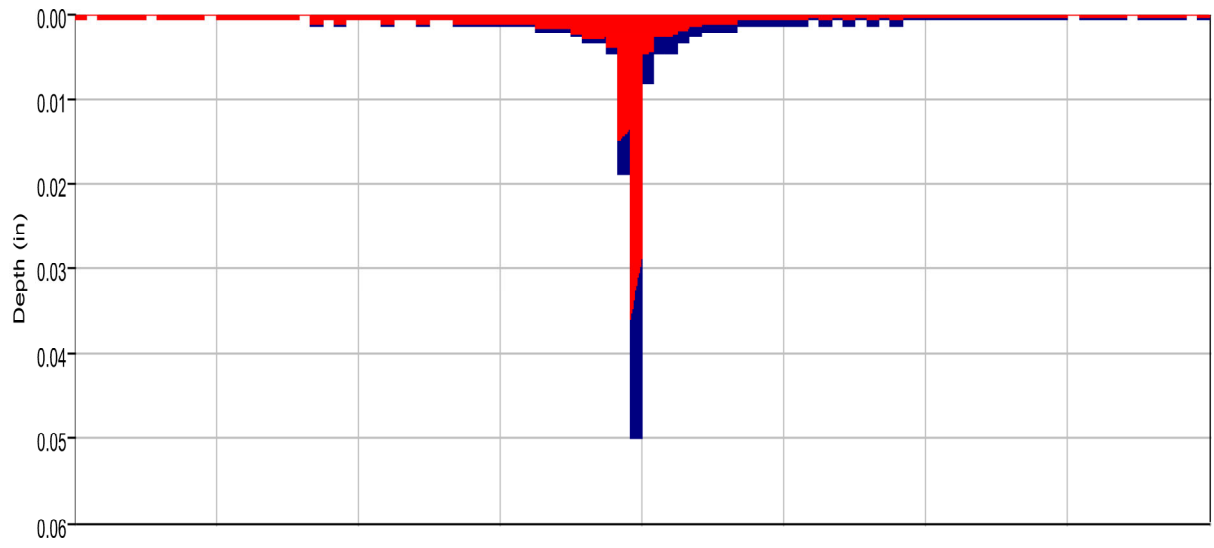

- Run:EV 5-yr Pr. Type II Element:PB4 Result:Precipitation
- Run:EV 5-yr Pr. Type II Element:PB4 Result:Outflow
- Run:EV 5-YR PR. TYPE II Element:PB4 Result:Precipitation Loss
- Run:EV 5-YR PR. TYPE II Element:PB4 Result:Baseflow

Project: Eagleview_Subdivision
Simulation Run: EV 5-yr Pr. Type II Subbasin: PB4
Start of Run: 01Oct2021, 00:00 Basin Model: Eagleview_Proposed
End of Run: 02Oct2021, 00:00 Meteorologic Model: 5-yr Type II
Compute Time: 14Mar2022, 16:43:16 Control Specifications: 24-hr Storm

Volume Units: AC-FT

Computed Results

Peak Discharge :	12.6 (CFS)	Date/Time of Peak Discharge :	01Oct2021, 12:00
Total Precipitation :	2.4 (AC-FT)	Total Direct Runoff :	0.8 (AC-FT)
Total Loss :	1.6 (AC-FT)	Total Baseflow :	0.0 (AC-FT)
Total Excess :	0.8 (AC-FT)	Discharge :	0.8 (AC-FT)

Subbasin "PB5" Results for Run "EV 5-yr Pr. Type II"

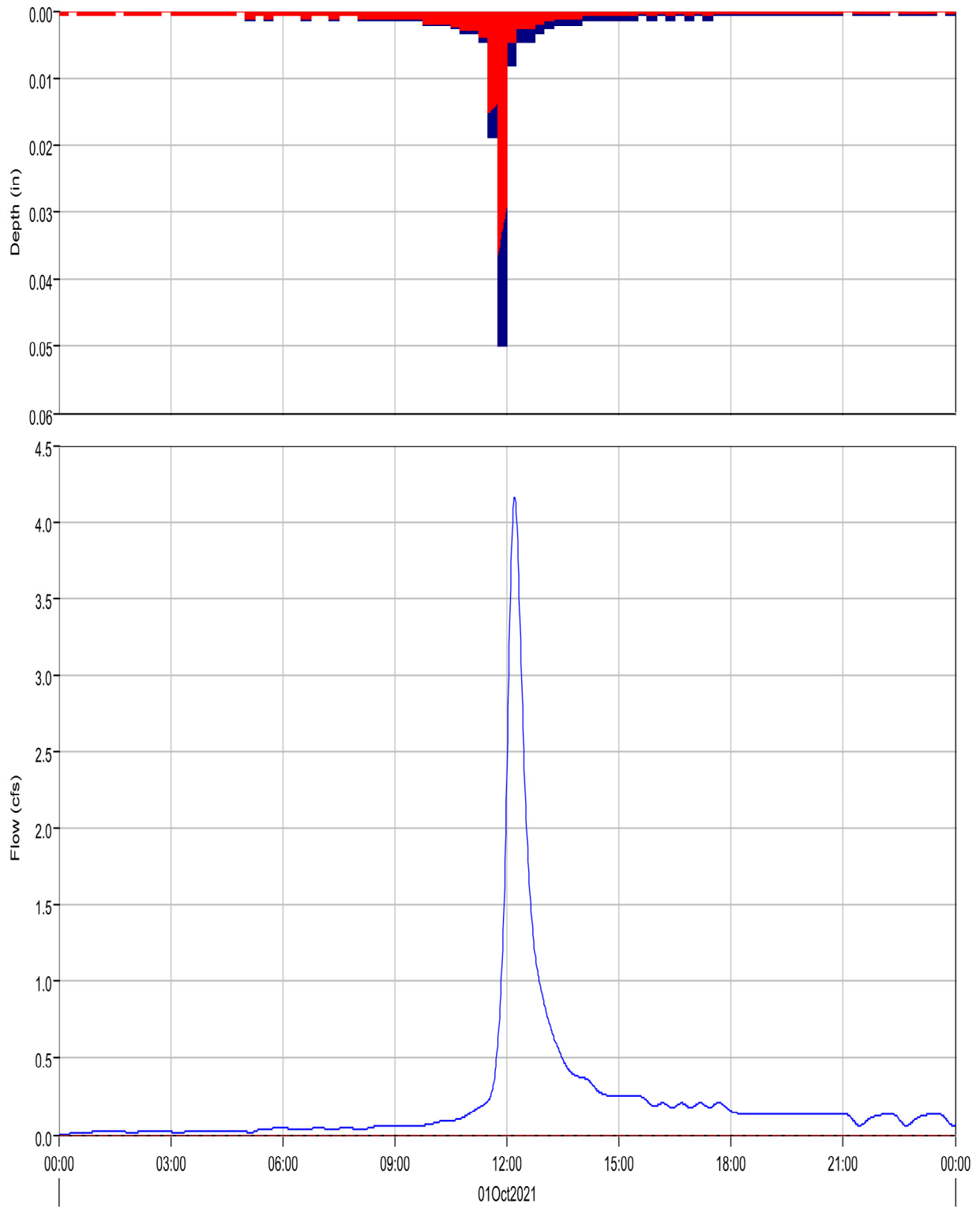

Run:EV 5-yr Pr. Type II Element:PB5 Result:Precipitation
Run:EV 5-yr Pr. Type II Element:PB5 Result:Outflow

Run:EV 5-YR PR. TYPE II Element:PB5 Result:Precipitation Loss
Run:EV 5-YR PR. TYPE II Element:PB5 Result:Baseflow

Project: Eagleview_Subdivision
Simulation Run: EV 5-yr Pr. Type II Subbasin: PB5
Start of Run: 01Oct2021, 00:00 Basin Model: Eagleview_Proposed
End of Run: 02Oct2021, 00:00 Meteorologic Model: 5-yr Type II
Compute Time: 14Mar2022, 16:43:16 Control Specifications: 24-hr Storm

Volume Units: AC-FT

Computed Results

Peak Discharge :	4.2 (CFS)	Date/Time of Peak Discharge :	01Oct2021, 12:12
Total Precipitation :	1.4 (AC-FT)	Total Direct Runoff :	0.5 (AC-FT)
Total Loss :	0.9 (AC-FT)	Total Baseflow :	0.0 (AC-FT)
Total Excess :	0.5 (AC-FT)	Discharge :	0.5 (AC-FT)

Subbasin "PB6" Results for Run "EV 5-yr Pr. Type II"

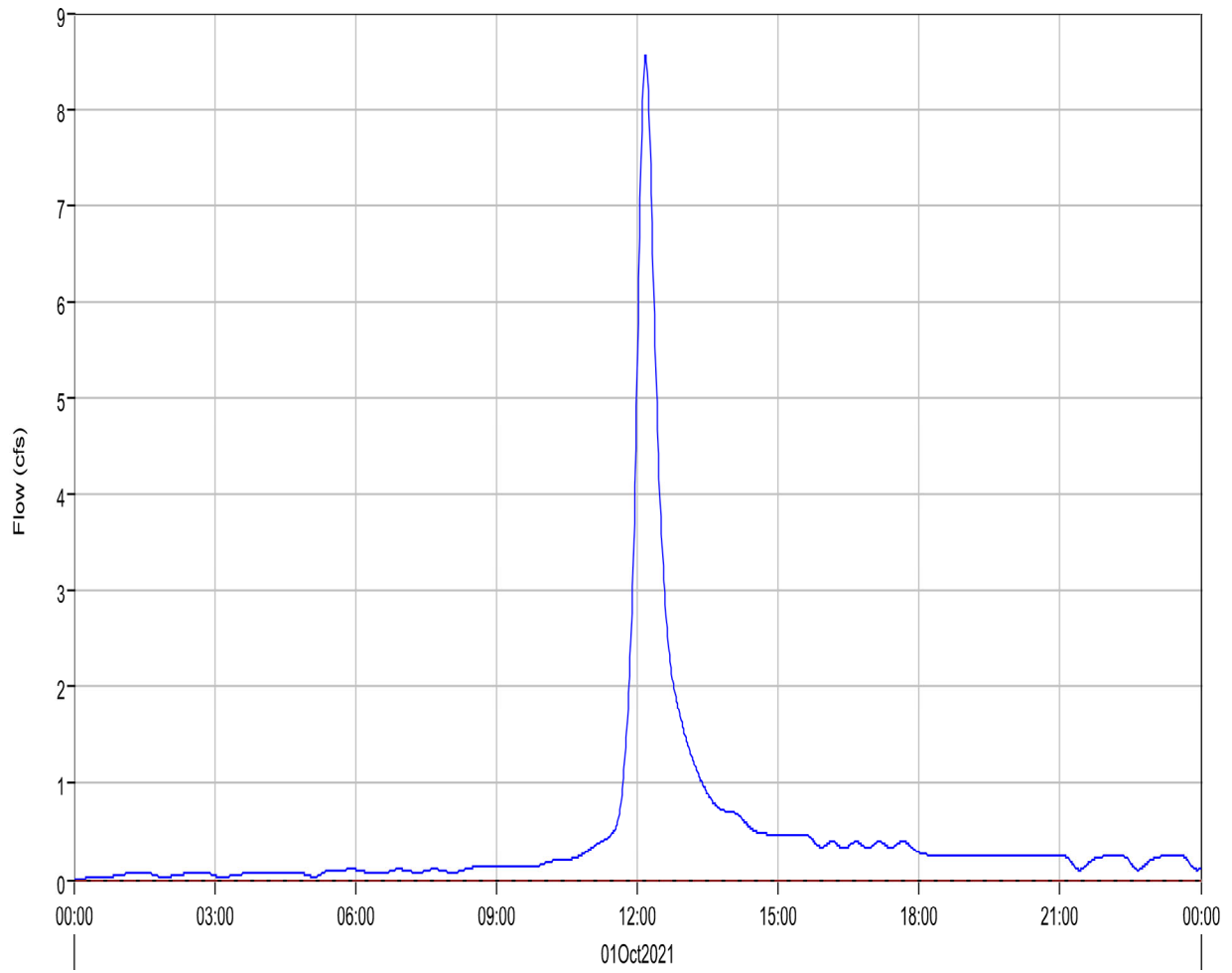
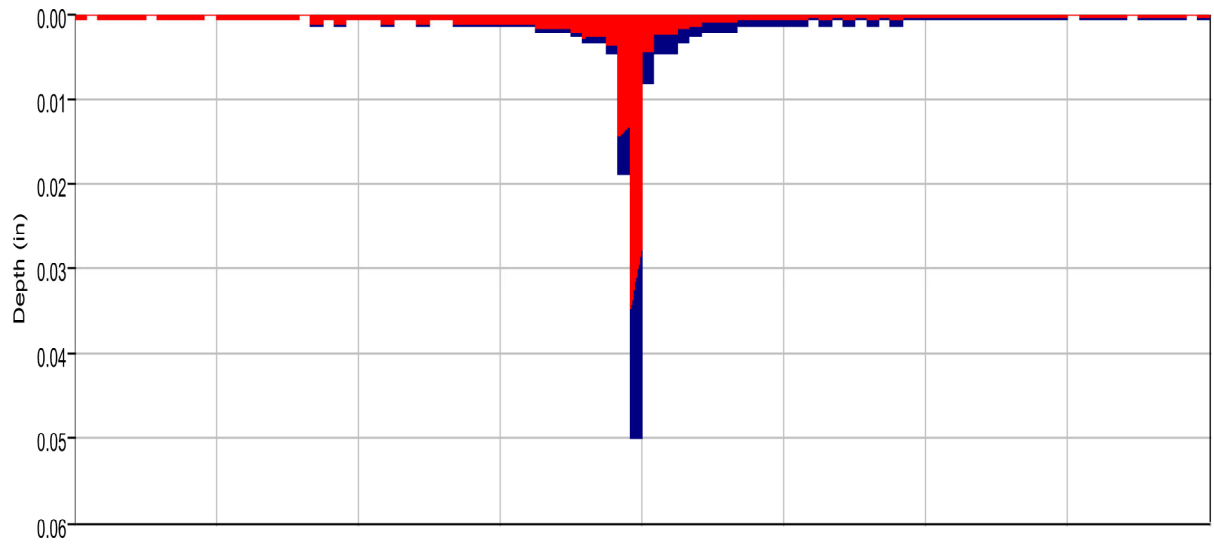

Run:EV 5-yr Pr. Type II Element:PB6 Result:Precipitation
Run:EV 5-yr Pr. Type II Element:PB6 Result:Outflow

Run:EV 5-yr Pr. Type II Element:PB6 Result:Precipitation Loss
Run:EV 5-yr Pr. Type II Element:PB6 Result:Baseflow

Project: Eagleview_Subdivision
Simulation Run: EV 5-yr Pr. Type II Subbasin: PB6
Start of Run: 01Oct2021, 00:00 Basin Model: Eagleview_Proposed
End of Run: 02Oct2021, 00:00 Meteorologic Model: 5-yr Type II
Compute Time: 14Mar2022, 16:43:16 Control Specifications: 24-hr Storm

Volume Units: AC-FT

Computed Results

Peak Discharge :	8.6 (CFS)	Date/Time of Peak Discharge :	01Oct2021, 12:11
Total Precipitation :	2.5 (AC-FT)	Total Direct Runoff :	0.9 (AC-FT)
Total Loss :	1.6 (AC-FT)	Total Baseflow :	0.0 (AC-FT)
Total Excess :	0.9 (AC-FT)	Discharge :	0.9 (AC-FT)

Subbasin "PB7" Results for Run "EV 5-yr Pr. Type II"

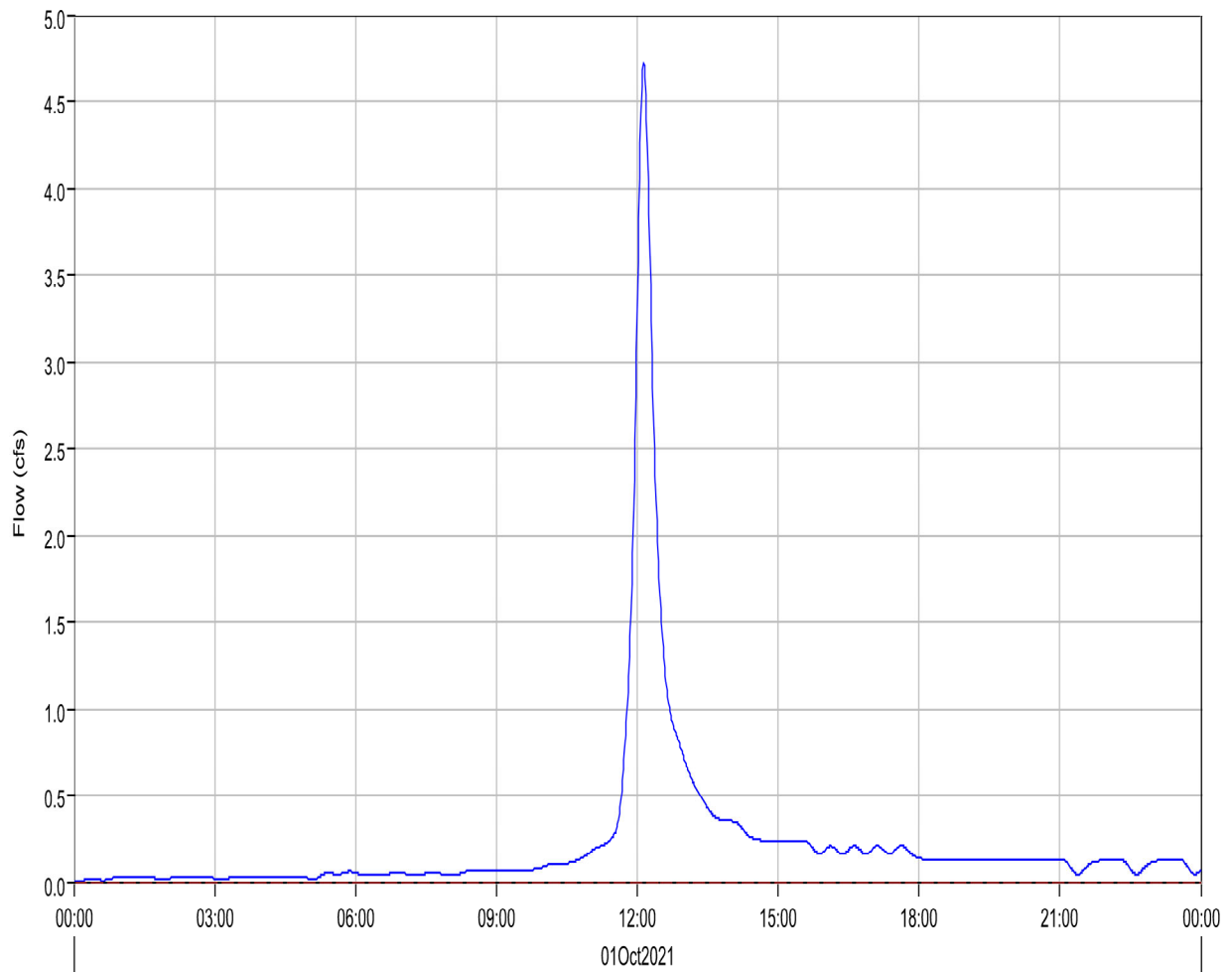
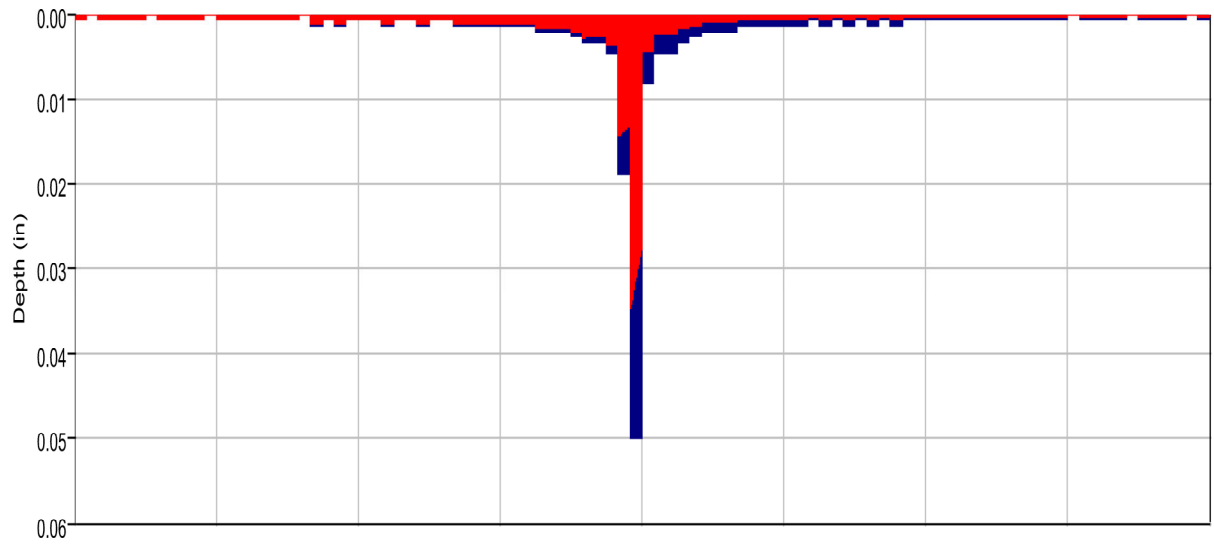

Run:EV 5-yr Pr. Type II Element:PB7 Result:Precipitation
Run:EV 5-yr Pr. Type II Element:PB7 Result:Outflow

Run:EV 5-YR PR. TYPE II Element:PB7 Result:Precipitation Loss
Run:EV 5-YR PR. TYPE II Element:PB7 Result:Baseflow

Project: Eagleview_Subdivision
Simulation Run: EV 5-yr Pr. Type II Subbasin: PB7
Start of Run: 01Oct2021, 00:00 Basin Model: Eagleview_Proposed
End of Run: 02Oct2021, 00:00 Meteorologic Model: 5-yr Type II
Compute Time: 14Mar2022, 16:43:16 Control Specifications: 24-hr Storm

Volume Units: AC-FT

Computed Results

Peak Discharge :	4.7 (CFS)	Date/Time of Peak Discharge :	01Oct2021, 12:08
Total Precipitation :	1.3 (AC-FT)	Total Direct Runoff :	0.4 (AC-FT)
Total Loss :	0.8 (AC-FT)	Total Baseflow :	0.0 (AC-FT)
Total Excess :	0.4 (AC-FT)	Discharge :	0.4 (AC-FT)

Subbasin "PB8" Results for Run "EV 5-yr Pr. Type II"

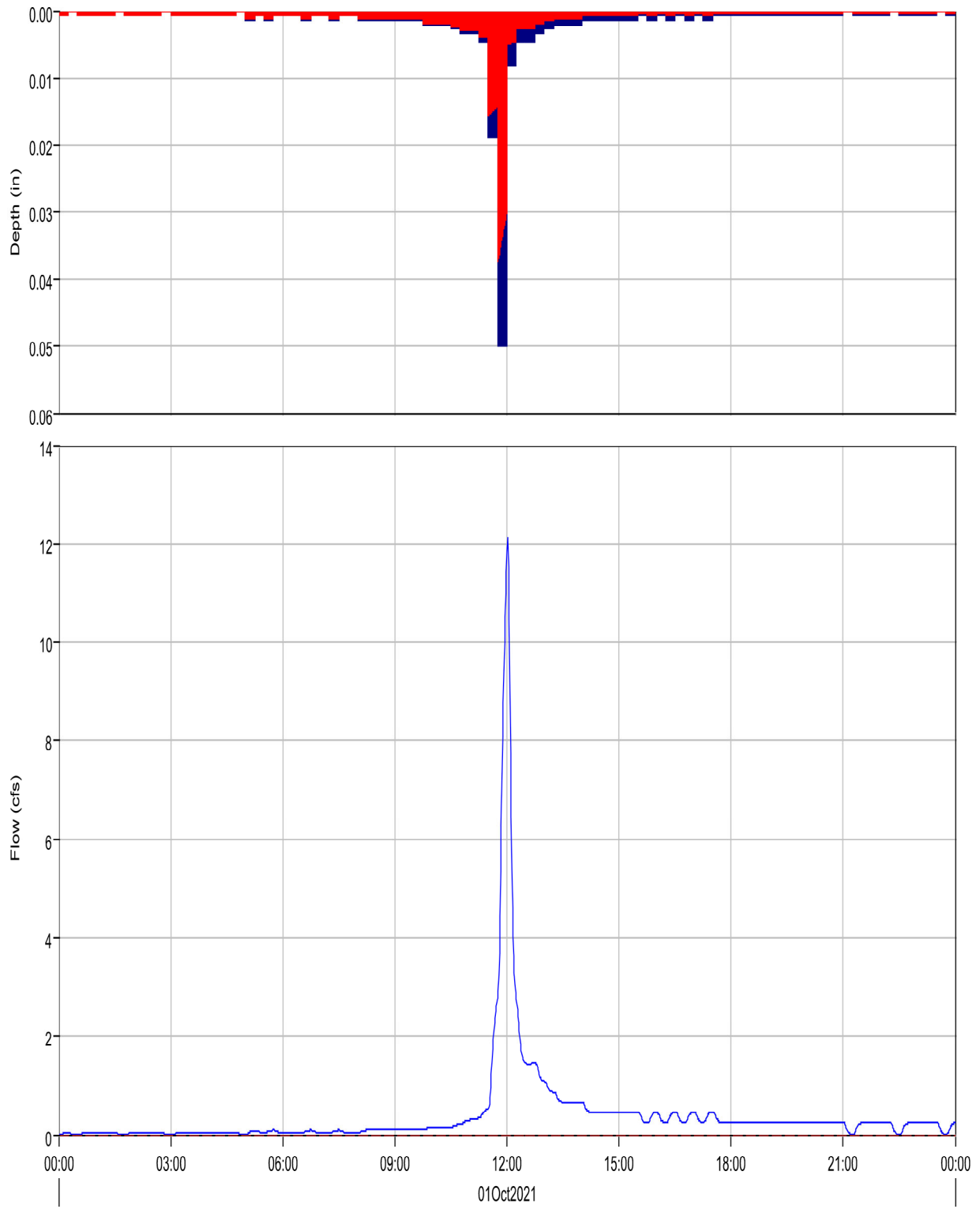

Run:EV 5-yr Pr. Type II Element:PB8 Result:Precipitation
Run:EV 5-yr Pr. Type II Element:PB8 Result:Outflow

Run:EV 5-YR PR. TYPE II Element:PB8 Result:Precipitation Loss
Run:EV 5-YR PR. TYPE II Element:PB8 Result:Baseflow

Project: Eagleview_Subdivision
Simulation Run: EV 5-yr Pr. Type II Subbasin: PB8
Start of Run: 01Oct2021, 00:00 Basin Model: Eagleview_Proposed
End of Run: 02Oct2021, 00:00 Meteorologic Model: 5-yr Type II
Compute Time: 14Mar2022, 16:43:16 Control Specifications: 24-hr Storm

Volume Units: IN

Computed Results

Peak Discharge :	12.1 (CFS)	Date/Time of Peak Discharge :	01Oct2021, 12:01
Total Precipitation :	2.70 (IN)	Total Direct Runoff :	0.82 (IN)
Total Loss :	1.88 (IN)	Total Baseflow :	0.00 (IN)
Total Excess :	0.82 (IN)	Discharge :	0.82 (IN)

Subbasin "PB9" Results for Run "EV 5-yr Pr. Type II"

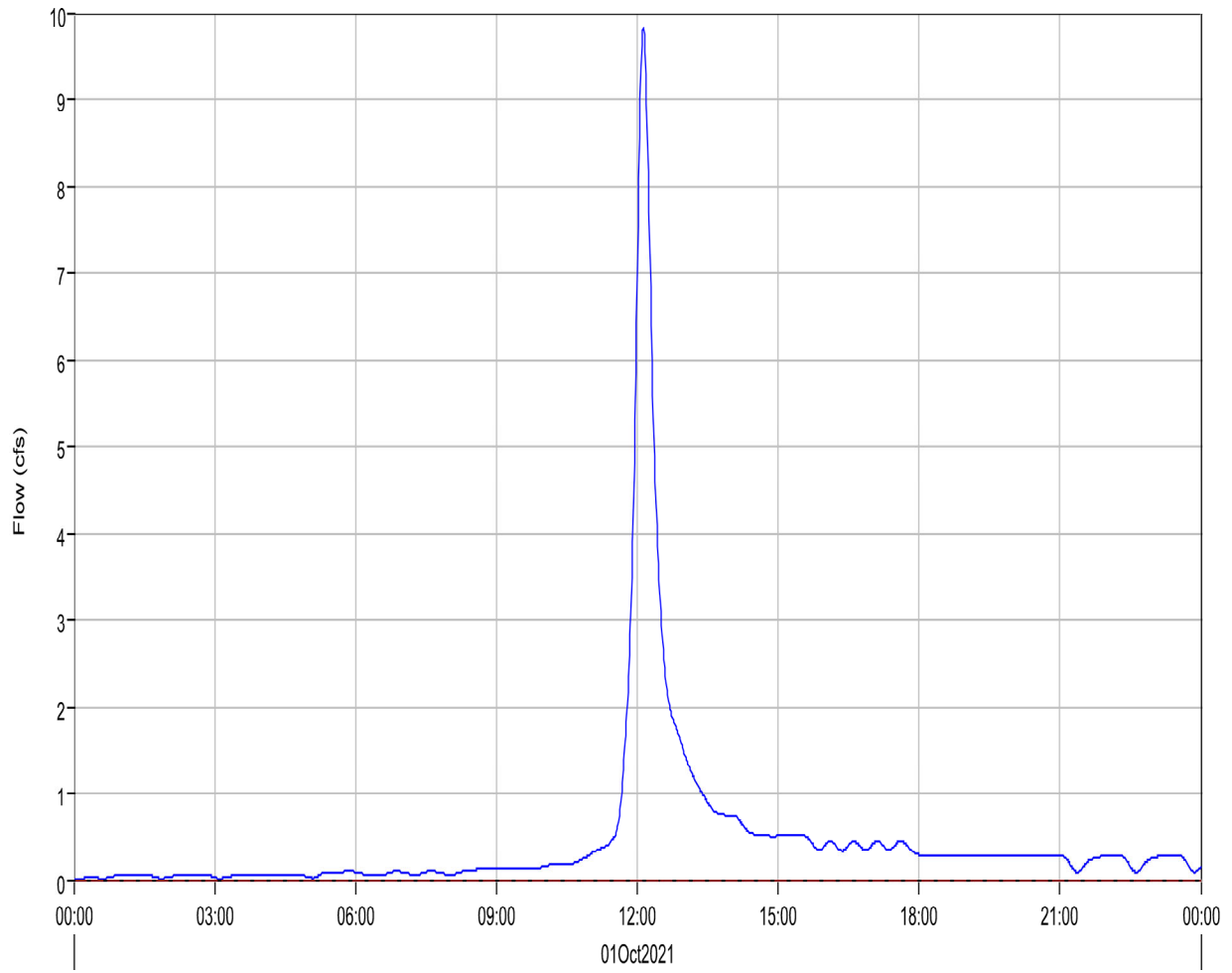
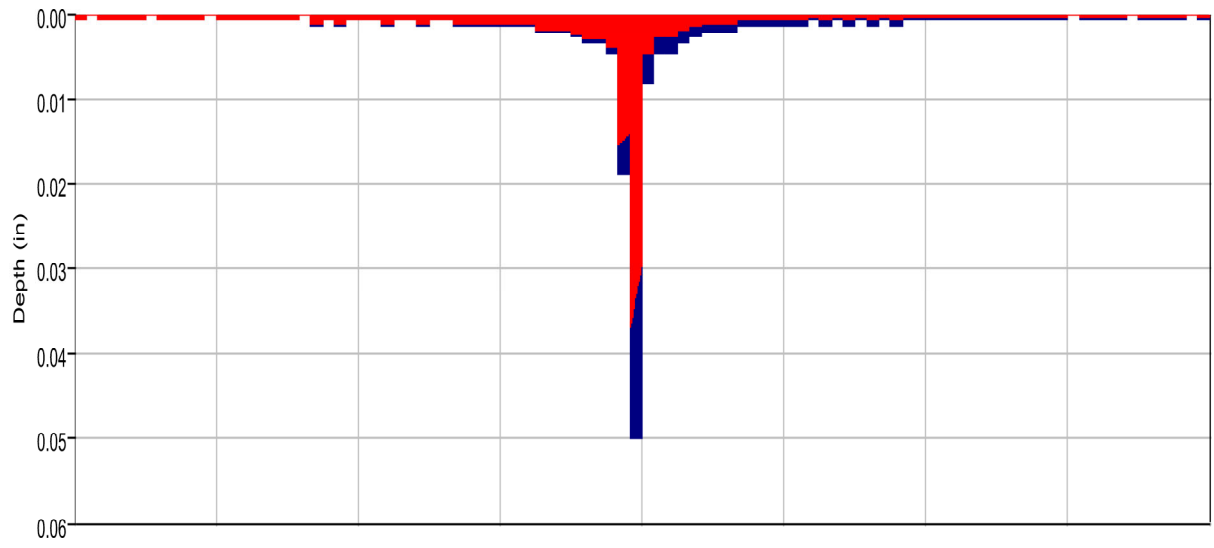

Run:EV 5-yr Pr. Type II Element:PB9 Result:Precipitation
Run:EV 5-yr Pr. Type II Element:PB9 Result:Outflow

Run:EV 5-YR PR. TYPE II Element:PB9 Result:Precipitation Loss
Run:EV 5-YR PR. TYPE II Element:PB9 Result:Baseflow

Project: Eagleview_Subdivision
Simulation Run: EV 5-yr Pr. Type II Subbasin: PB9
Start of Run: 01Oct2021, 00:00 Basin Model: Eagleview_Proposed
End of Run: 02Oct2021, 00:00 Meteorologic Model: 5-yr Type II
Compute Time: 14Mar2022, 16:43:16 Control Specifications: 24-hr Storm

Volume Units: IN

Computed Results

Peak Discharge :	9.8 (CFS)	Date/Time of Peak Discharge :	01Oct2021, 12:08
Total Precipitation :	2.70 (IN)	Total Direct Runoff :	0.85 (IN)
Total Loss :	1.85 (IN)	Total Baseflow :	0.00 (IN)
Total Excess :	0.85 (IN)	Discharge :	0.85 (IN)

Subbasin "PB10" Results for Run "EV 5-yr Pr. Type II"

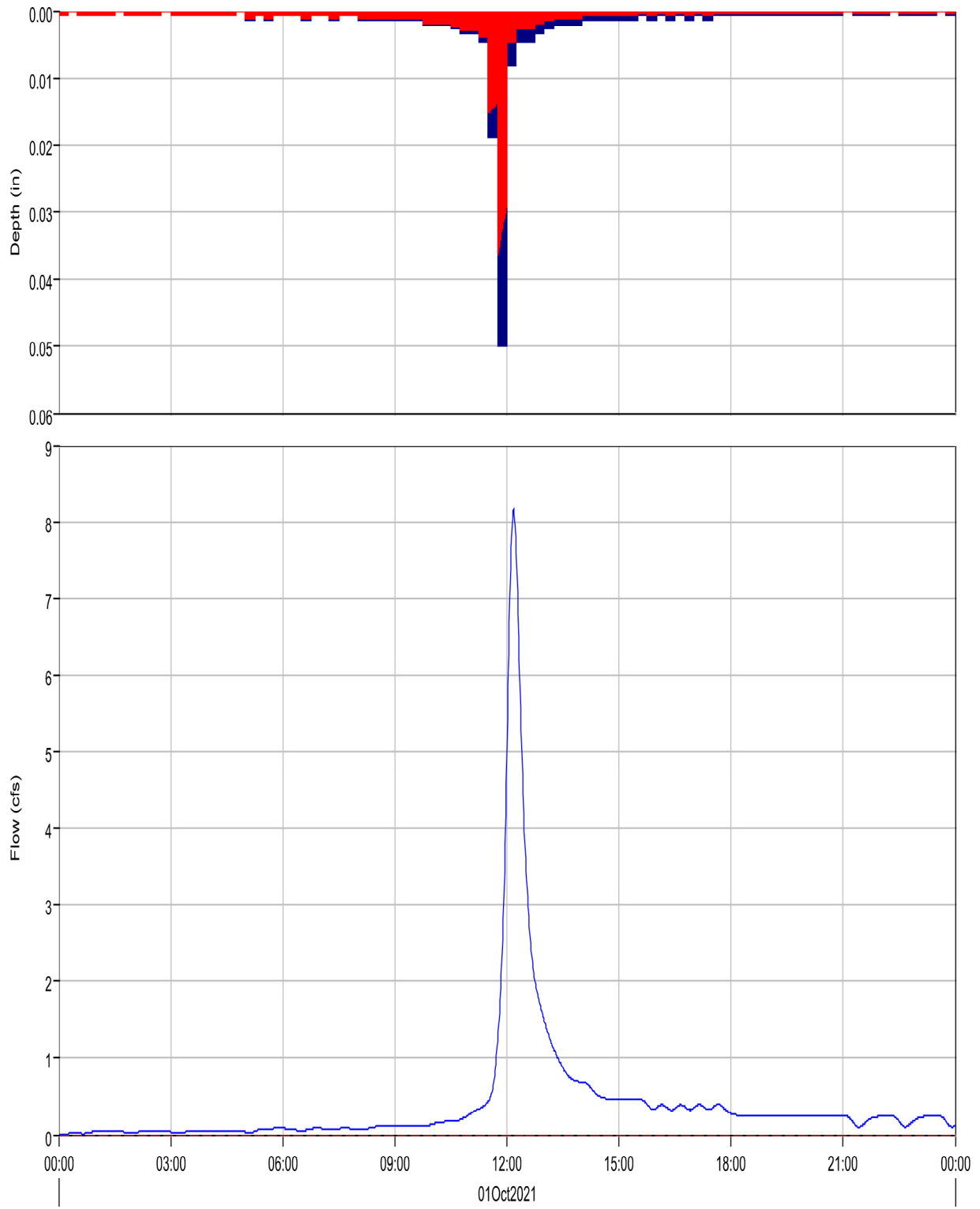

Run:EV 5-yr Pr. Type II Element:PB10 Result:Precipitation

Run:EV 5-YR PR. TYPE II Element:PB10 Result:Precipitation Loss

Run:EV 5-yr Pr. Type II Element:PB10 Result:Outflow

Run:EV 5-YR PR. TYPE II Element:PB10 Result:Baseflow

Project: Eagleview_Subdivision
Simulation Run: EV 5-yr Pr. Type II Subbasin: PB10

Start of Run: 01Oct2021, 00:00 Basin Model: Eagleview_Proposed
End of Run: 02Oct2021, 00:00 Meteorologic Model: 5-yr Type II
Compute Time: 14Mar2022, 16:43:16 Control Specifications: 24-hr Storm

Volume Units: IN

Computed Results

Peak Discharge :	8.2 (CFS)	Date/Time of Peak Discharge :	01Oct2021, 12:11
Total Precipitation :	2.70 (IN)	Total Direct Runoff :	0.87 (IN)
Total Loss :	1.82 (IN)	Total Baseflow :	0.00 (IN)
Total Excess :	0.88 (IN)	Discharge :	0.87 (IN)

Subbasin "PB11" Results for Run "EV 5-yr Pr. Type II"

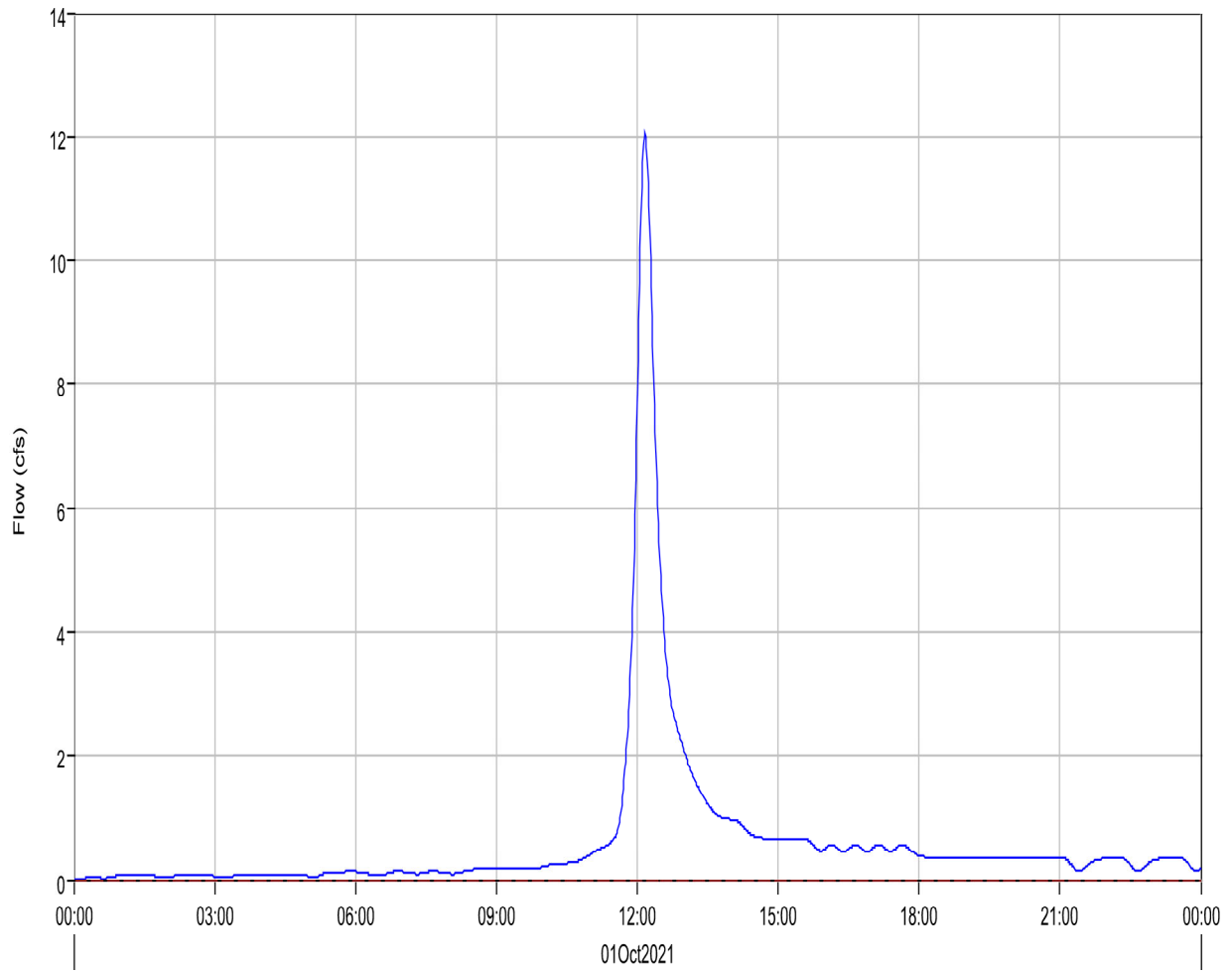
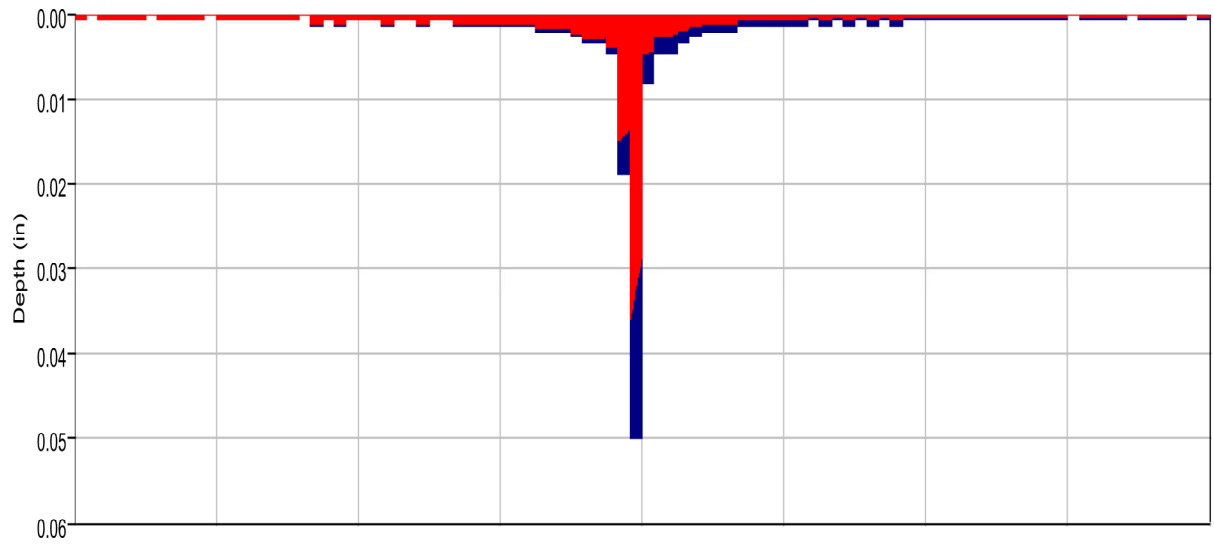

Run:EV 5-yr Pr. Type II Element:PB11 Result:Precipitation
Run:EV 5-yr Pr. Type II Element:PB11 Result:Outflow

Run:EV 5-YR PR. TYPE II Element:PB11 Result:Precipitation Loss
Run:EV 5-YR PR. TYPE II Element:PB11 Result:Baseflow

Project: Eagleview_Subdivision
Simulation Run: EV 5-yr Pr. Type II Subbasin: PB11

Start of Run: 01Oct2021, 00:00 Basin Model: Eagleview_Proposed
End of Run: 02Oct2021, 00:00 Meteorologic Model: 5-yr Type II
Compute Time: 14Mar2022, 16:43:16 Control Specifications: 24-hr Storm

Volume Units: IN

Computed Results

Peak Discharge :	12.1 (CFS)	Date/Time of Peak Discharge :	01Oct2021, 12:10
Total Precipitation :	2.70 (IN)	Total Direct Runoff :	0.90 (IN)
Total Loss :	1.79 (IN)	Total Baseflow :	0.00 (IN)
Total Excess :	0.91 (IN)	Discharge :	0.90 (IN)

Subbasin "PB12" Results for Run "EV 5-yr Pr. Type II"

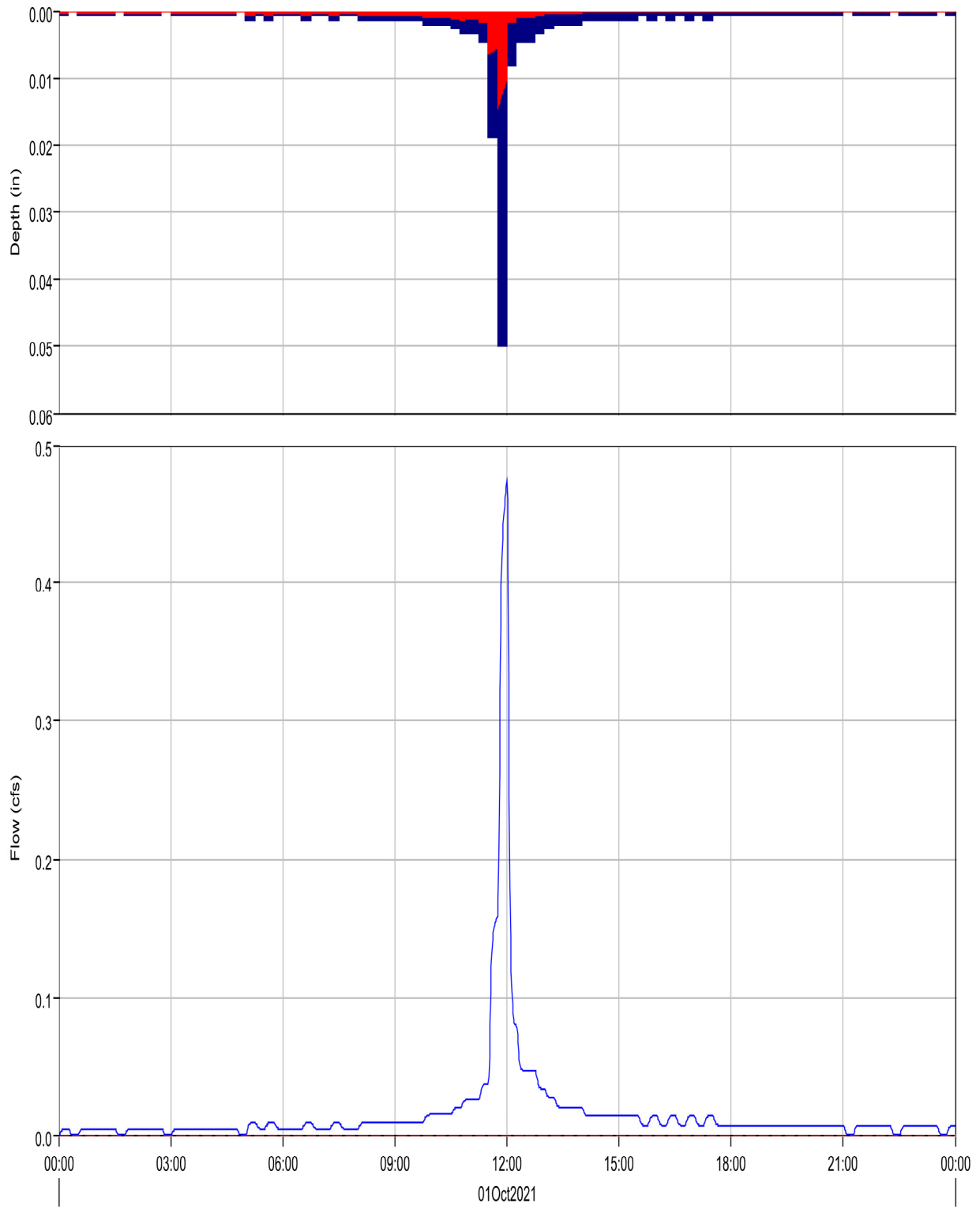

Run:EV 5-yr Pr. Type II Element:PB12 Result:Precipitation
Run:EV 5-yr Pr. Type II Element:PB12 Result:Outflow

Run:EV 5-YR PR. TYPE II Element:PB12 Result:Precipitation Loss
Run:EV 5-YR PR. TYPE II Element:PB12 Result:Baseflow

Project: Eagleview_Subdivision
Simulation Run: EV 5-yr Pr. Type II Subbasin: PB12

Start of Run: 01Oct2021, 00:00 Basin Model: Eagleview_Proposed
End of Run: 02Oct2021, 00:00 Meteorologic Model: 5-yr Type II
Compute Time: 14Mar2022, 16:43:16 Control Specifications: 24-hr Storm

Volume Units: IN

Computed Results

Peak Discharge :	0.5 (CFS)	Date/Time of Peak Discharge :	01Oct2021, 12:00
Total Precipitation :	2.70 (IN)	Total Direct Runoff :	1.95 (IN)
Total Loss :	0.74 (IN)	Total Baseflow :	0.00 (IN)
Total Excess :	1.96 (IN)	Discharge :	1.95 (IN)

Subbasin "PB13" Results for Run "EV 5-yr Pr. Type II"

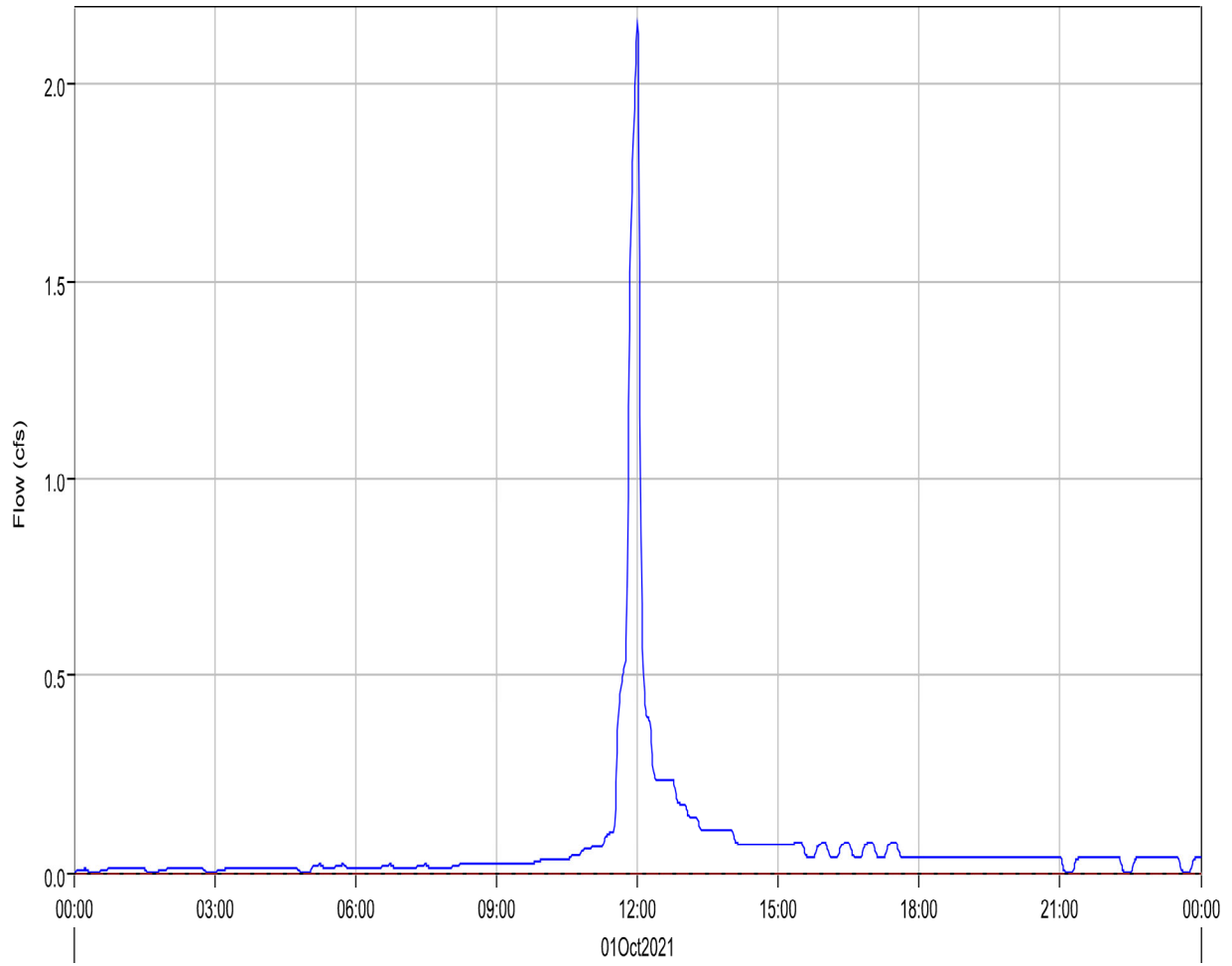
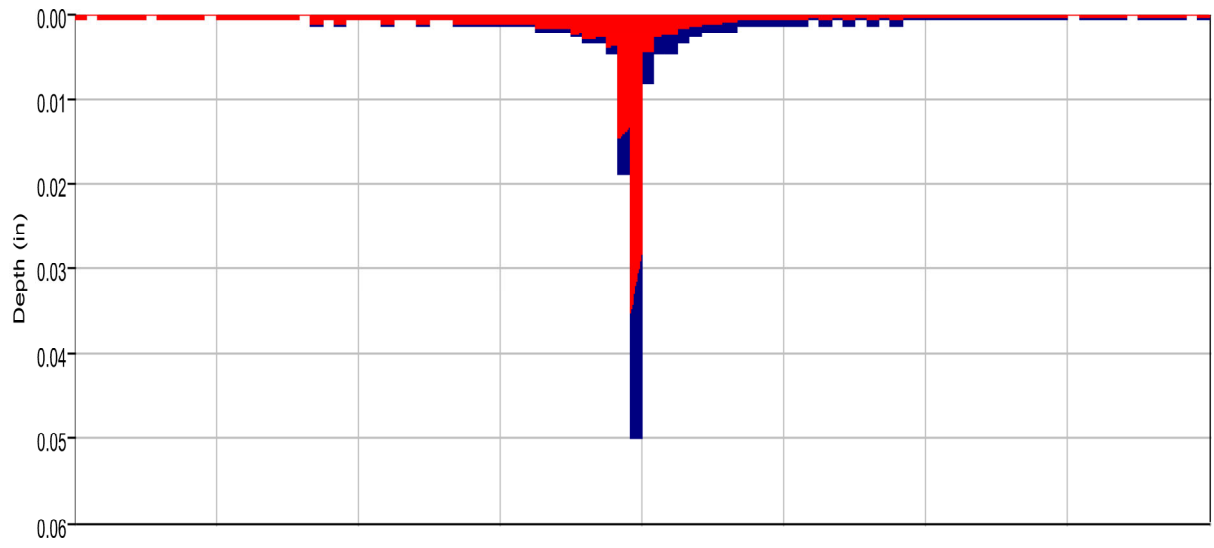

- Run:EV 5-yr Pr. Type II Element:PB13 Result:Precipitation
- Run:EV 5-yr Pr. Type II Element:PB13 Result:Outflow
- Run:EV 5-YR PR. TYPE II Element:PB13 Result:Precipitation Loss
- Run:EV 5-YR PR. TYPE II Element:PB13 Result:Baseflow

Project: Eagleview_Subdivision
Simulation Run: EV 5-yr Pr. Type II Subbasin: PB13

Start of Run: 01Oct2021, 00:00 Basin Model: Eagleview_Proposed
End of Run: 02Oct2021, 00:00 Meteorologic Model: 5-yr Type II
Compute Time: 14Mar2022, 16:43:16 Control Specifications: 24-hr Storm

Volume Units: IN

Computed Results

Peak Discharge :	2.2 (CFS)	Date/Time of Peak Discharge :	01Oct2021, 12:00
Total Precipitation :	2.70 (IN)	Total Direct Runoff :	0.93 (IN)
Total Loss :	1.77 (IN)	Total Baseflow :	0.00 (IN)
Total Excess :	0.93 (IN)	Discharge :	0.93 (IN)

Subbasin "PB14" Results for Run "EV 5-yr Pr. Type II"

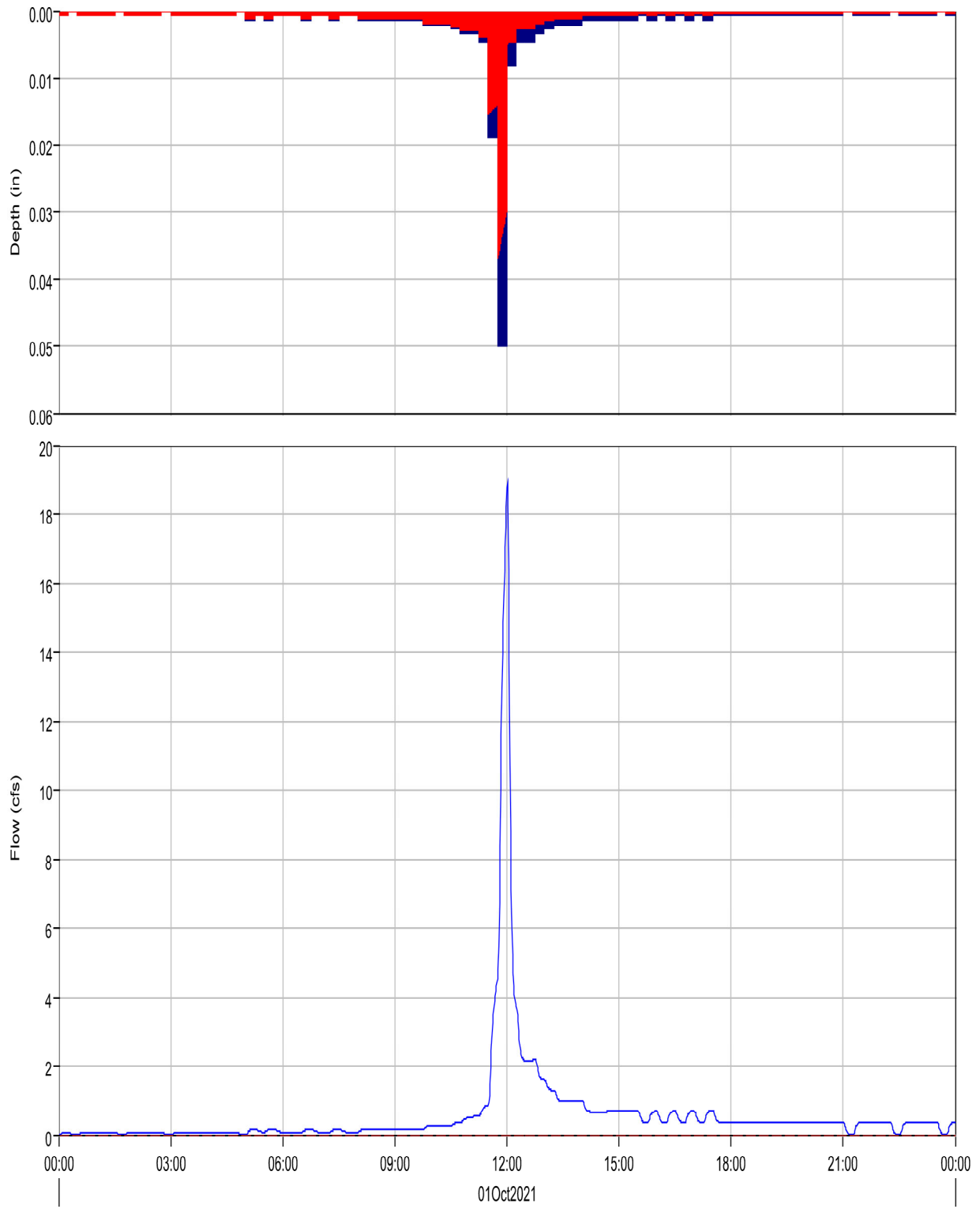

Run:EV 5-yr Pr. Type II Element:PB14 Result:Precipitation
Run:EV 5-yr Pr. Type II Element:PB14 Result:Outflow

Run:EV 5-YR PR. TYPE II Element:PB14 Result:Precipitation Loss
Run:EV 5-YR PR. TYPE II Element:PB14 Result:Baseflow

Project: Eagleview_Subdivision
Simulation Run: EV 5-yr Pr. Type II Subbasin: PB14

Start of Run: 01Oct2021, 00:00 Basin Model: Eagleview_Proposed
End of Run: 02Oct2021, 00:00 Meteorologic Model: 5-yr Type II
Compute Time: 14Mar2022, 16:43:16 Control Specifications: 24-hr Storm

Volume Units: AC-FT

Computed Results

Peak Discharge :	18.9 (CFS)	Date/Time of Peak Discharge :	01Oct2021, 12:01
Total Precipitation :	3.9 (AC-FT)	Total Direct Runoff :	1.2 (AC-FT)
Total Loss :	2.7 (AC-FT)	Total Baseflow :	0.0 (AC-FT)
Total Excess :	1.2 (AC-FT)	Discharge :	1.2 (AC-FT)

Subbasin "PB15" Results for Run "EV 5-yr Pr. Type II"

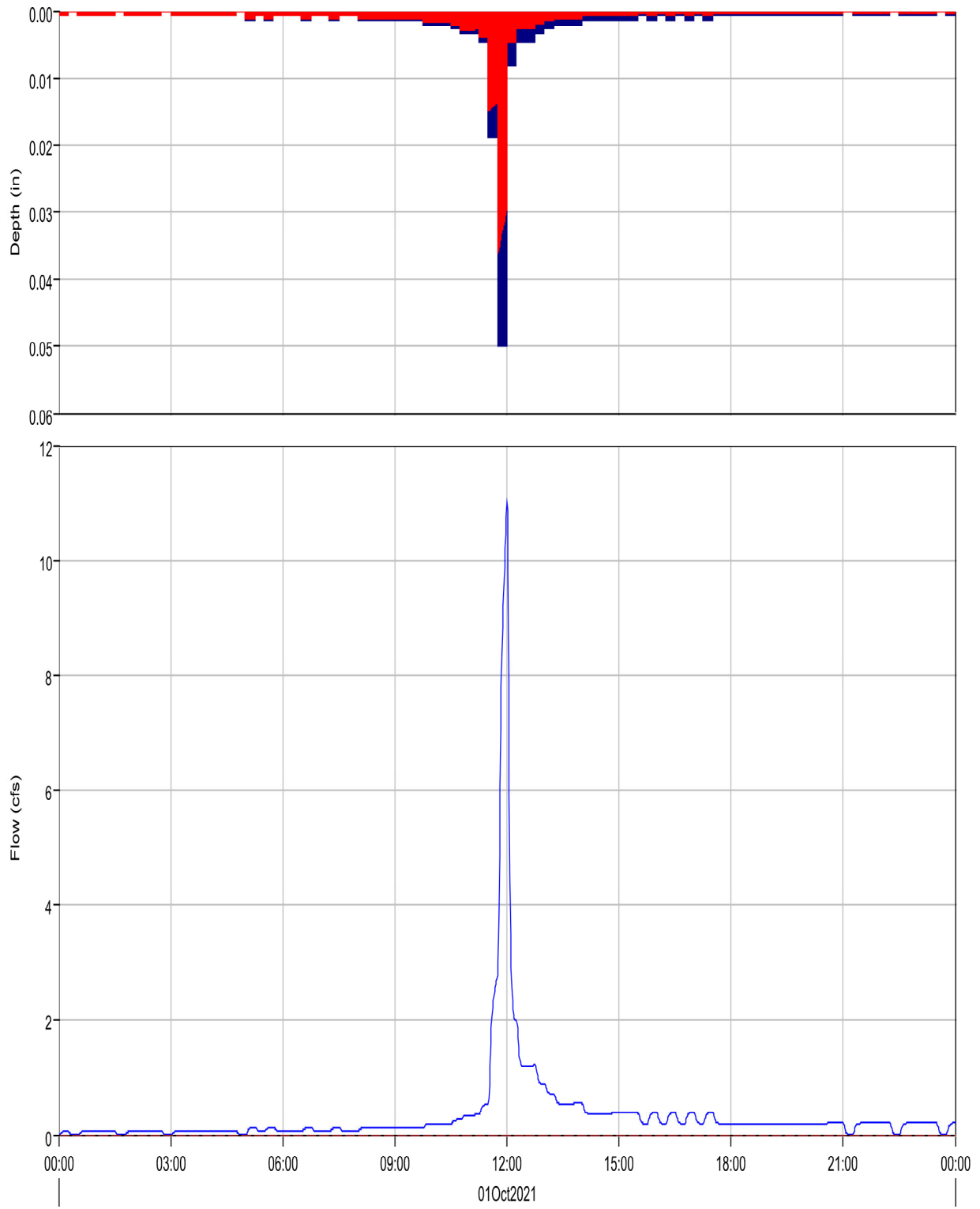

Run:EV 5-yr Pr. Type II Element:PB15 Result:Precipitation
Run:EV 5-yr Pr. Type II Element:PB15 Result:Outflow

Run:EV 5-YR PR. TYPE II Element:PB15 Result:Precipitation Loss
Run:EV 5-YR PR. TYPE II Element:PB15 Result:Baseflow

Project: Eagleview_Subdivision
Simulation Run: EV 5-yr Pr. Type II Subbasin: PB15

Start of Run: 01Oct2021, 00:00 Basin Model: Eagleview_Proposed
End of Run: 02Oct2021, 00:00 Meteorologic Model: 5-yr Type II
Compute Time: 14Mar2022, 16:43:16 Control Specifications: 24-hr Storm

Volume Units: AC-FT

Computed Results

Peak Discharge :	11.0 (CFS)	Date/Time of Peak Discharge :	01Oct2021, 12:00
Total Precipitation :	2.2 (AC-FT)	Total Direct Runoff :	0.7 (AC-FT)
Total Loss :	1.5 (AC-FT)	Total Baseflow :	0.0 (AC-FT)
Total Excess :	0.7 (AC-FT)	Discharge :	0.7 (AC-FT)

Reach "R-OB1" Results for Run "EV 5-yr Pr. Type II"

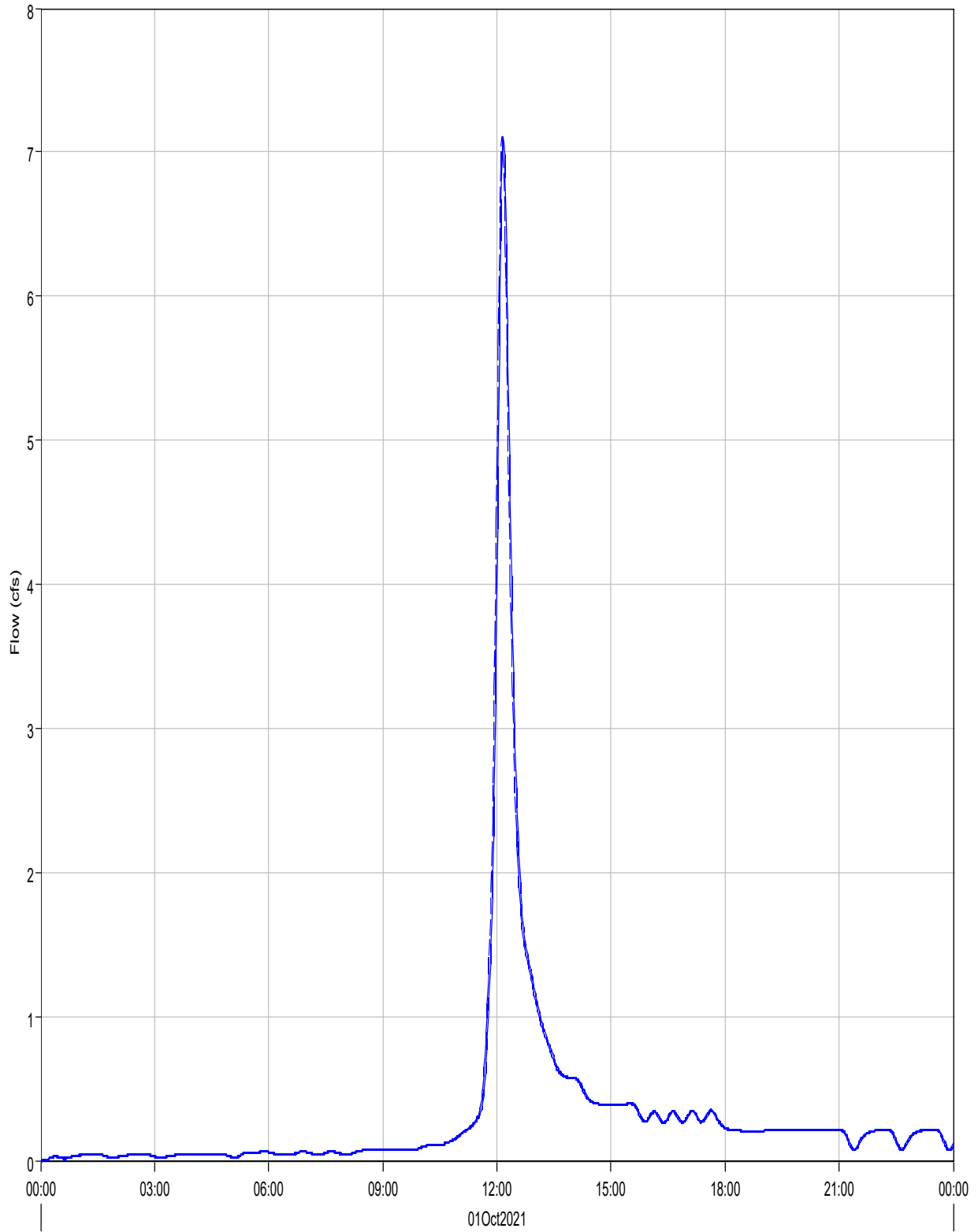

— Run:EV 5-yr Pr. Type II Element:R-OB1 Result:Outflow

- - - Run:EV 5-YR PR. TYPE II Element:R-OB1 Result:Combined Inflow

Project: Eagleview_Subdivision
Simulation Run: EV 5-yr Pr. Type II Reach: R-OB1

Start of Run: 01Oct2021, 00:00 Basin Model: Eagleview_Proposed
End of Run: 02Oct2021, 00:00 Meteorologic Model: 5-yr Type II
Compute Time: 14Mar2022, 16:43:16 Control Specifications: 24-hr Storm

Volume Units: AC-FT

Computed Results

Peak Inflow :	7.1 (CFS)	Date/Time of Peak Inflow :	01Oct2021, 12:08
Peak Outflow :	7.1 (CFS)	Date/Time of Peak Outflow :	01Oct2021, 12:10
Total Inflow :	0.7 (AC-FT)	Total Outflow :	0.7 (AC-FT)

Reach "R-OB2" Results for Run "EV 5-yr Pr. Type II"

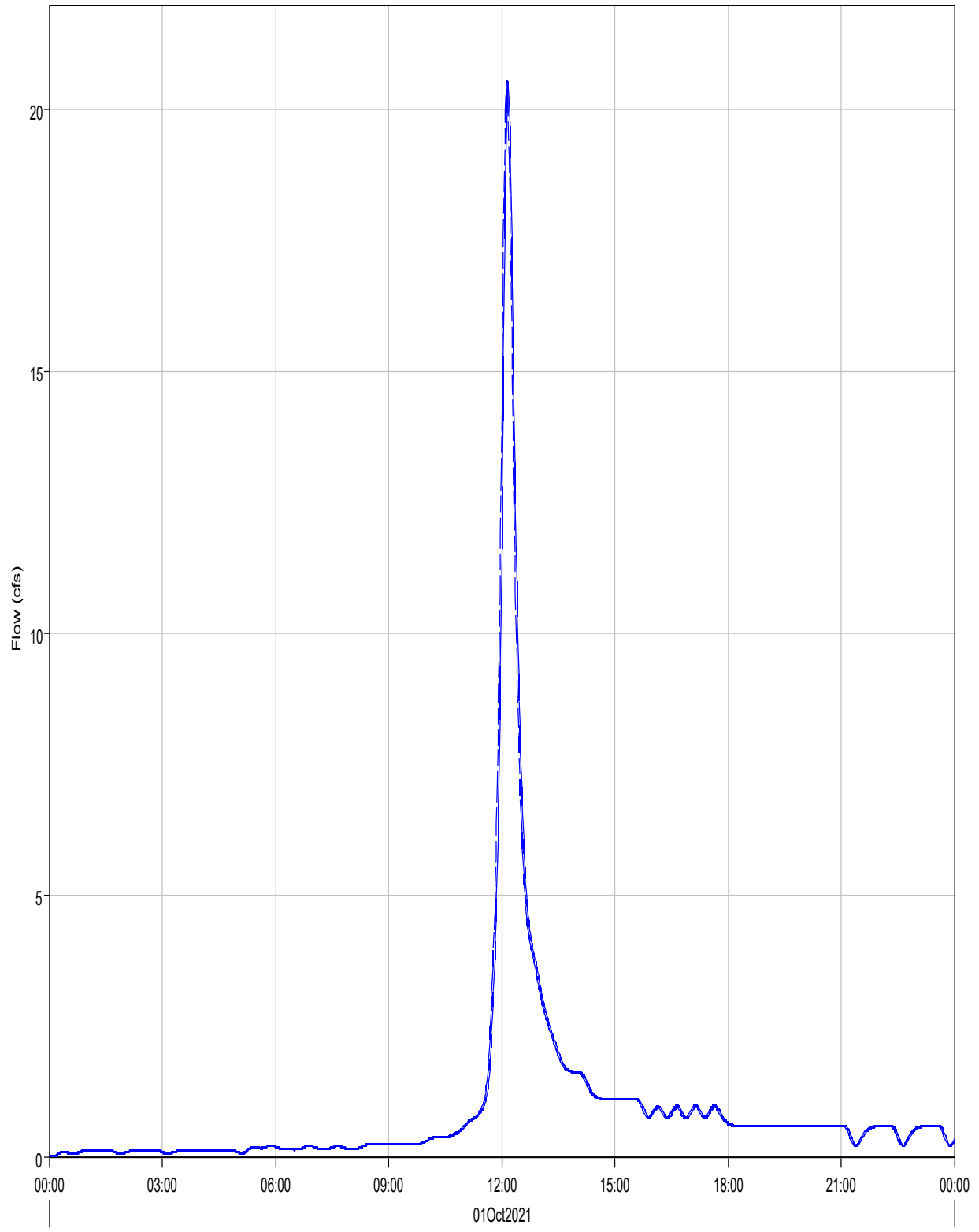

— Run:EV 5-yr Pr. Type II Element:R-OB2 Result:Outflow

- - - Run:EV 5-YR PR. TYPE II Element:R-OB2 Result:Combined Inflow

Project: Eagleview_Subdivision
Simulation Run: EV 5-yr Pr. Type II Reach: R-OB2

Start of Run: 01Oct2021, 00:00 Basin Model: Eagleview_Proposed
End of Run: 02Oct2021, 00:00 Meteorologic Model: 5-yr Type II
Compute Time: 14Mar2022, 16:43:16 Control Specifications: 24-hr Storm

Volume Units: AC-FT

Computed Results

Peak Inflow :	20.6 (CFS)	Date/Time of Peak Inflow :	01Oct2021, 12:08
Peak Outflow :	20.5 (CFS)	Date/Time of Peak Outflow :	01Oct2021, 12:10
Total Inflow :	1.9 (AC-FT)	Total Outflow :	1.9 (AC-FT)

Reach "R-OB4-A" Results for Run "EV 5-yr Pr. Type II"

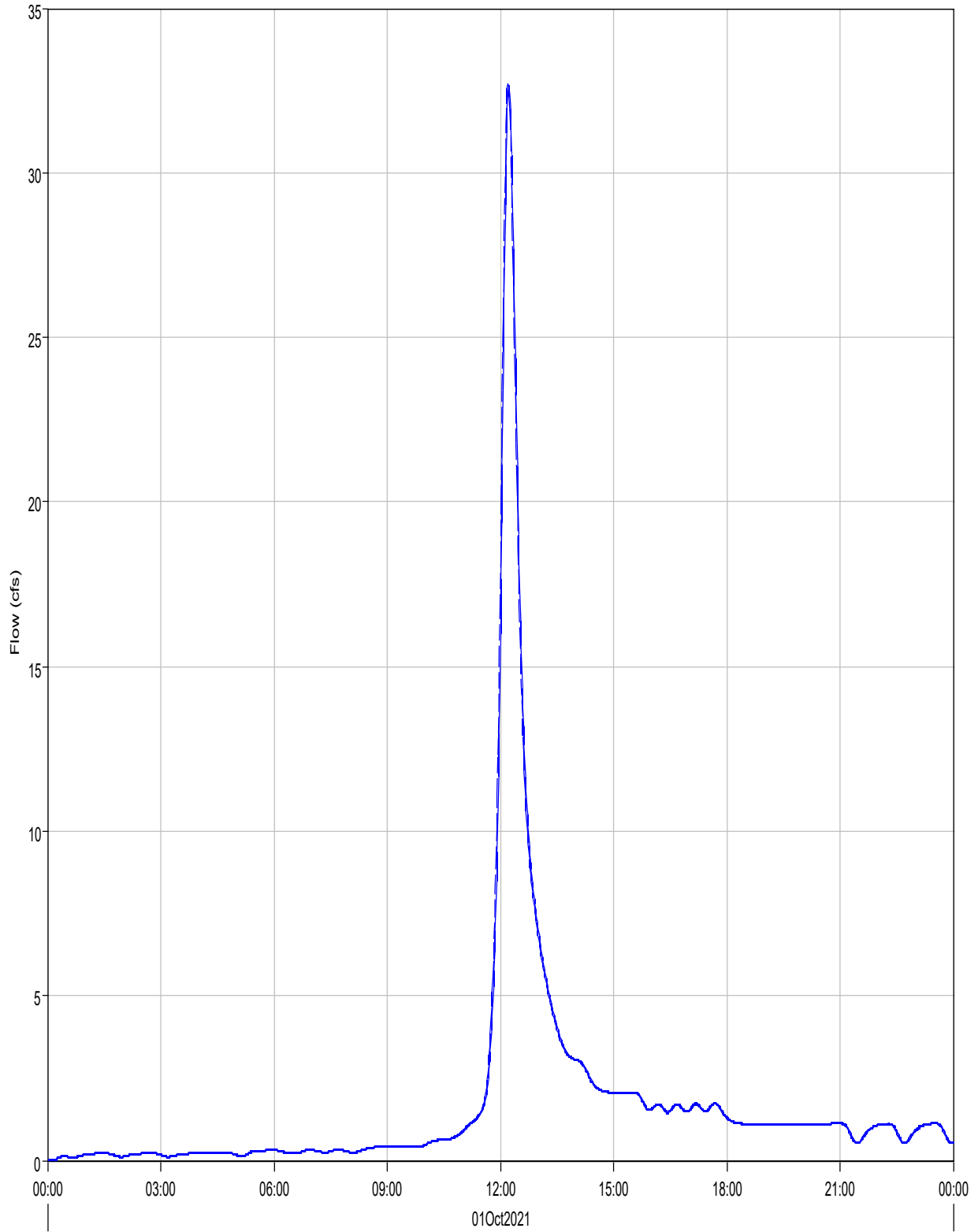

Run:EV 5-yr Pr. Type II Element:R-OB4-A Result:Outflow

Run:EV 5-YR PR. TYPE II Element:R-OB4-A Result:Combined Inflow

Project: Eagleview_Subdivision
Simulation Run: EV 5-yr Pr. Type II Reach: R-OB4-A

Start of Run: 01Oct2021, 00:00 Basin Model: Eagleview_Proposed
End of Run: 02Oct2021, 00:00 Meteorologic Model: 5-yr Type II
Compute Time: 14Mar2022, 16:43:16 Control Specifications: 24-hr Storm

Volume Units: AC-FT

Computed Results

Peak Inflow :	32.7 (CFS)	Date/Time of Peak Inflow :	01Oct2021, 12:12
Peak Outflow :	32.6 (CFS)	Date/Time of Peak Outflow :	01Oct2021, 12:13
Total Inflow :	3.5 (AC-FT)	Total Outflow :	3.5 (AC-FT)

Reach "R-OB4-B" Results for Run "EV 5-yr Pr. Type II"

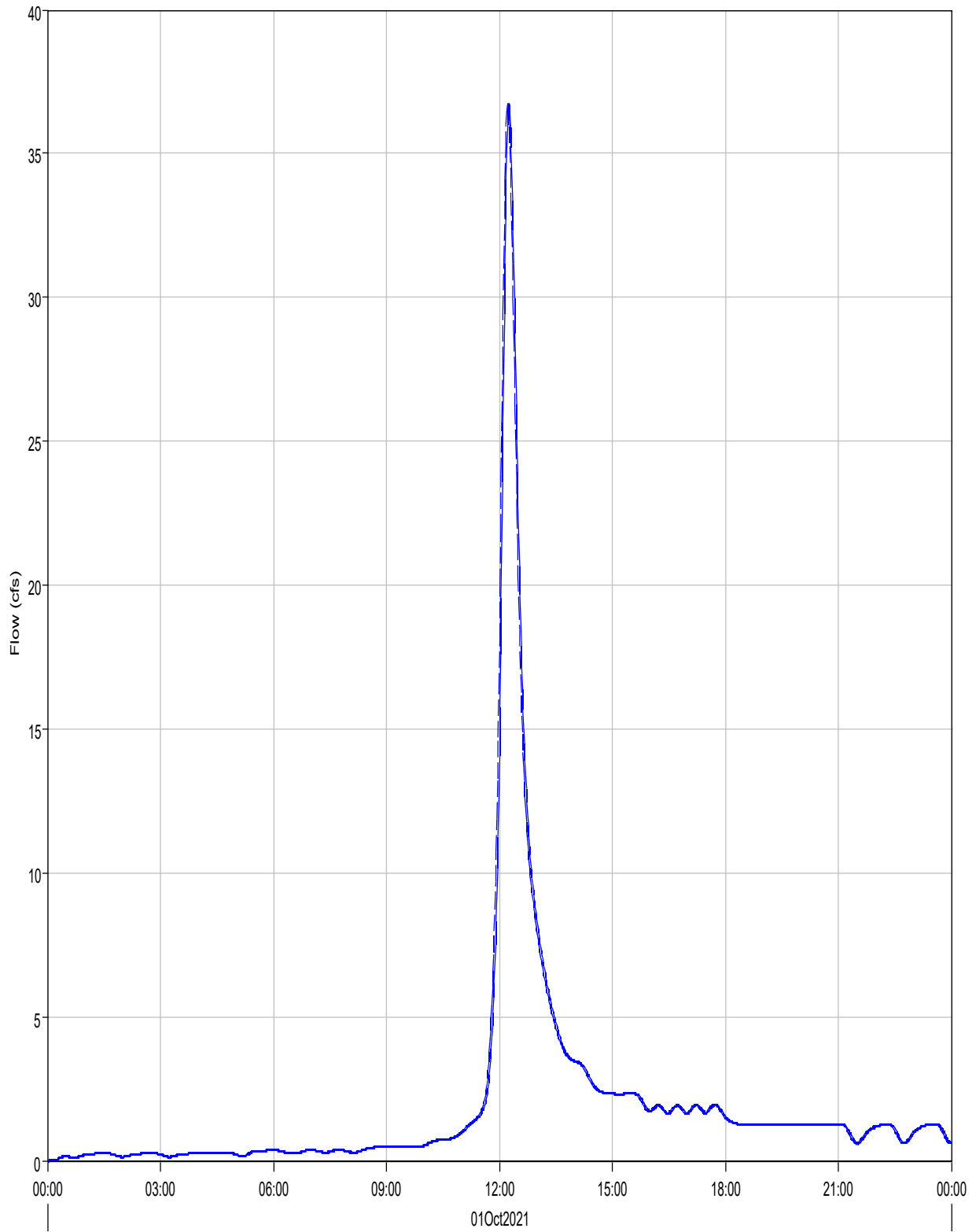

— Run:EV 5-yr Pr. Type II Element:R-OB4-B Result:Outflow

- - - Run:EV 5-YR PR. TYPE II Element:R-OB4-B Result:Combined Inflow

Project: Eagleview_Subdivision
Simulation Run: EV 5-yr Pr. Type II Reach: R-OB4-B

Start of Run: 01Oct2021, 00:00 Basin Model: Eagleview_Proposed
End of Run: 02Oct2021, 00:00 Meteorologic Model: 5-yr Type II
Compute Time: 14Mar2022, 16:43:16 Control Specifications: 24-hr Storm

Volume Units: IN

Computed Results

Peak Inflow :	36.8 (CFS)	Date/Time of Peak Inflow :	01Oct2021, 12:13
Peak Outflow :	36.7 (CFS)	Date/Time of Peak Outflow :	01Oct2021, 12:15
Total Inflow :	0.79 (IN)	Total Outflow :	0.79 (IN)

Reach "R-OB7" Results for Run "EV 5-yr Pr. Type II"

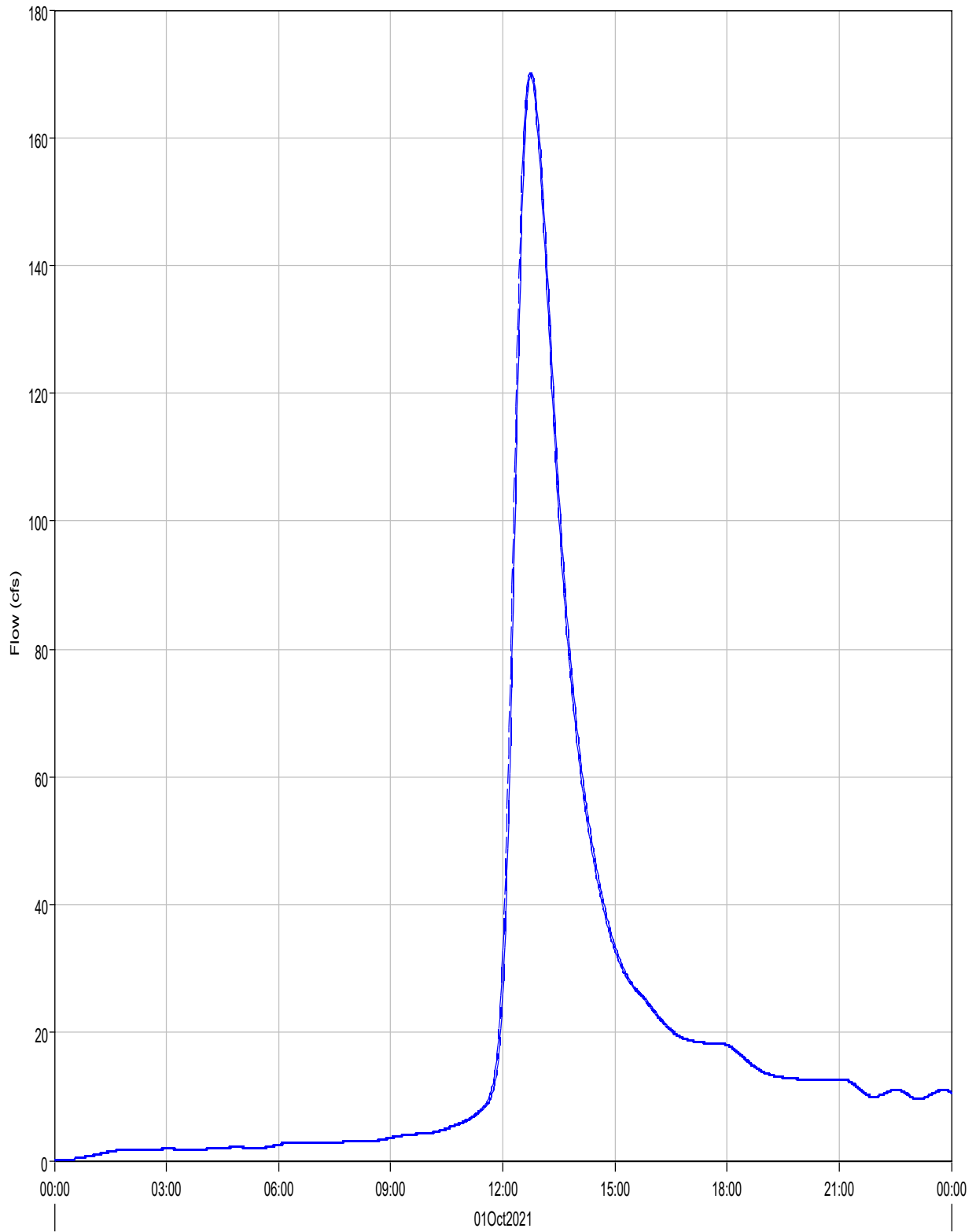

— Run:EV 5-yr Pr. Type II Element:R-OB7 Result:Outflow

- - - Run:EV 5-YR PR. TYPE II Element:R-OB7 Result:Combined Inflow

Project: Eagleview_Subdivision
Simulation Run: EV 5-yr Pr. Type II Reach: R-OB7

Start of Run: 01Oct2021, 00:00 Basin Model: Eagleview_Proposed
End of Run: 02Oct2021, 00:00 Meteorologic Model: 5-yr Type II
Compute Time: 14Mar2022, 16:43:16 Control Specifications: 24-hr Storm

Volume Units: IN

Computed Results

Peak Inflow :	170.1 (CFS)	Date/Time of Peak Inflow :	01Oct2021, 12:44
Peak Outflow :	170.1 (CFS)	Date/Time of Peak Outflow :	01Oct2021, 12:46
Total Inflow :	0.66 (IN)	Total Outflow :	0.66 (IN)

Reach "R-OB8" Results for Run "EV 5-yr Pr. Type II"

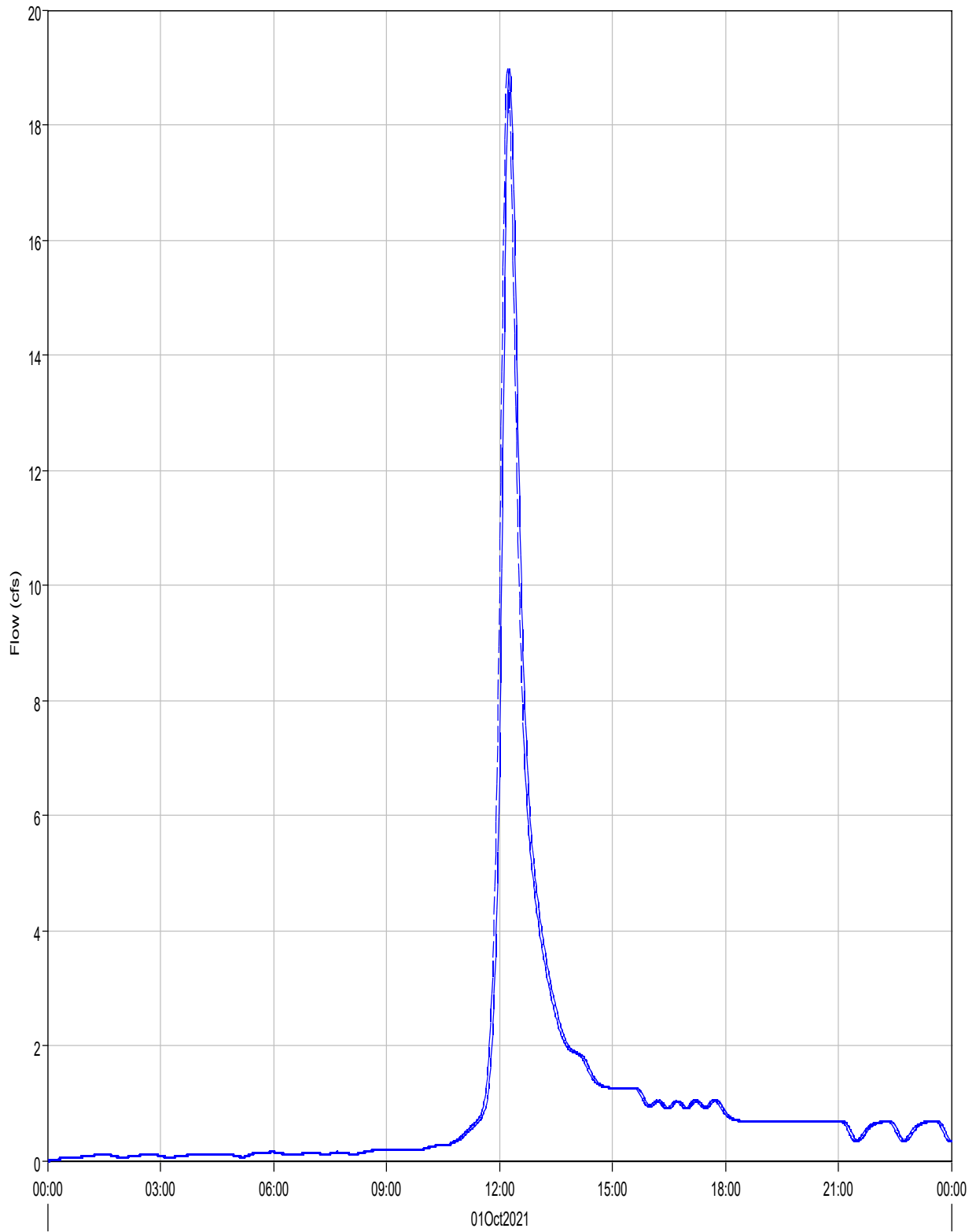

— Run:EV 5-yr Pr. Type II Element:R-OB8 Result:Outflow

- - - Run:EV 5-YR PR. TYPE II Element:R-OB8 Result:Combined Inflow

Project: Eagleview_Subdivision
Simulation Run: EV 5-yr Pr. Type II Reach: R-OB8

Start of Run: 01Oct2021, 00:00 Basin Model: Eagleview_Proposed
End of Run: 02Oct2021, 00:00 Meteorologic Model: 5-yr Type II
Compute Time: 14Mar2022, 16:43:16 Control Specifications: 24-hr Storm

Volume Units: IN

Computed Results

Peak Inflow :	19.0 (CFS)	Date/Time of Peak Inflow :	01Oct2021, 12:13
Peak Outflow :	19.0 (CFS)	Date/Time of Peak Outflow :	01Oct2021, 12:16
Total Inflow :	0.76 (IN)	Total Outflow :	0.76 (IN)

Reach "R-PB3" Results for Run "EV 5-yr Pr. Type II"

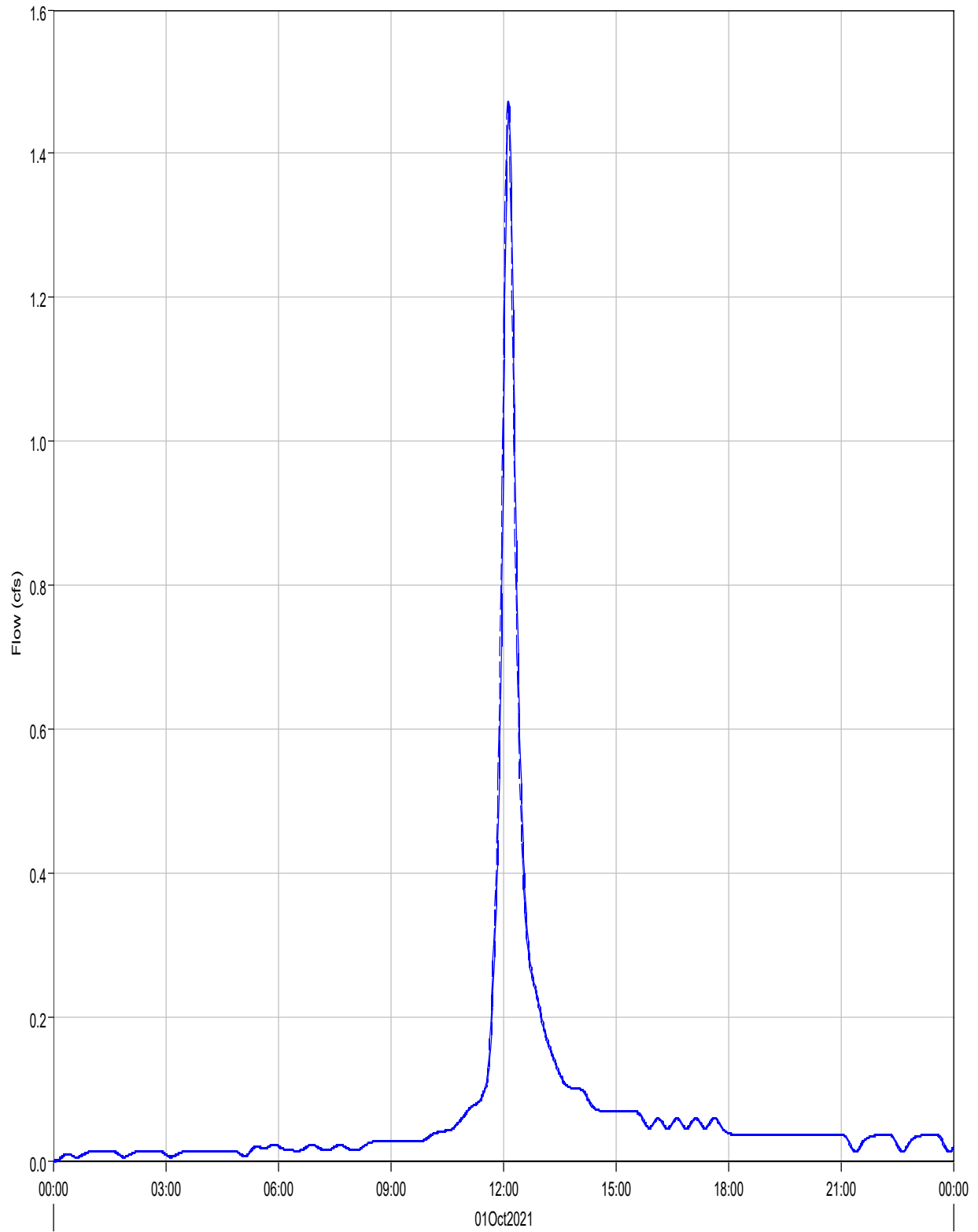

Run:EV 5-yr Pr. Type II Element:R-PB3 Result:Outflow

Run:EV 5-YR PR. TYPE II Element:R-PB3 Result:Combined Inflow

Project: Eagleview_Subdivision
Simulation Run: EV 5-yr Pr. Type II Reach: R-PB3
Start of Run: 01Oct2021, 00:00 Basin Model: Eagleview_Proposed
End of Run: 02Oct2021, 00:00 Meteorologic Model: 5-yr Type II
Compute Time: 14Mar2022, 16:43:16 Control Specifications: 24-hr Storm

Volume Units: AC-FT

Computed Results

Peak Inflow :	1.5 (CFS)	Date/Time of Peak Inflow :	01Oct2021, 12:08
Peak Outflow :	1.5 (CFS)	Date/Time of Peak Outflow :	01Oct2021, 12:09
Total Inflow :	0.1 (AC-FT)	Total Outflow :	0.1 (AC-FT)

Reach "R-PB5" Results for Run "EV 5-yr Pr. Type II"

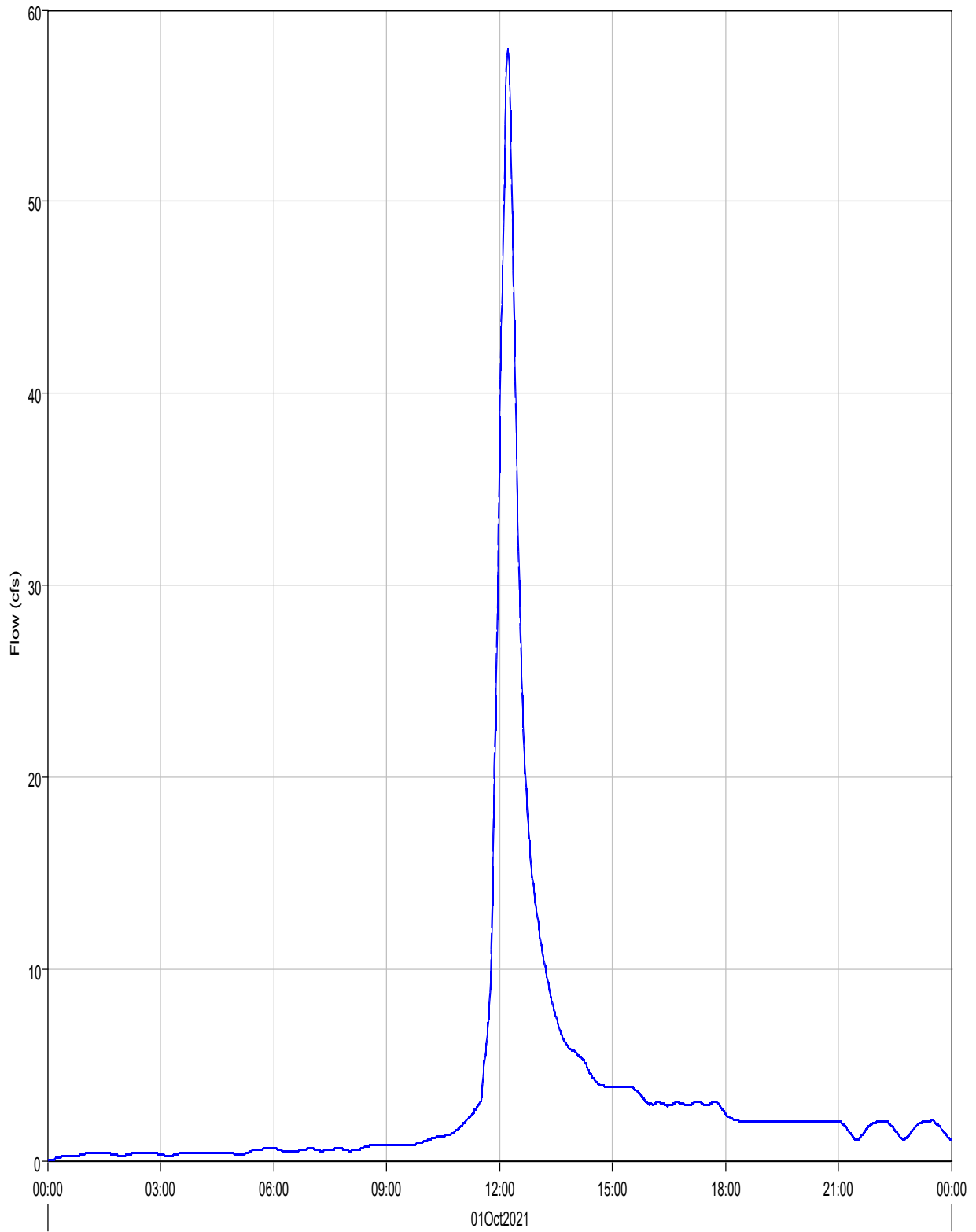

— Run:EV 5-yr Pr. Type II Element:R-PB5 Result:Outflow

- - - Run:EV 5-YR PR. TYPE II Element:R-PB5 Result:Combined Inflow

Project: Eagleview_Subdivision
Simulation Run: EV 5-yr Pr. Type II Reach: R-PB5
Start of Run: 01Oct2021, 00:00 Basin Model: Eagleview_Proposed
End of Run: 02Oct2021, 00:00 Meteorologic Model: 5-yr Type II
Compute Time: 14Mar2022, 16:43:16 Control Specifications: 24-hr Storm

Volume Units: AC-FT

Computed Results

Peak Inflow :	57.9 (CFS)	Date/Time of Peak Inflow :	01Oct2021, 12:13
Peak Outflow :	57.9 (CFS)	Date/Time of Peak Outflow :	01Oct2021, 12:14
Total Inflow :	6.7 (AC-FT)	Total Outflow :	6.7 (AC-FT)

Reach "R-PB7-A" Results for Run "EV 5-yr Pr. Type II"

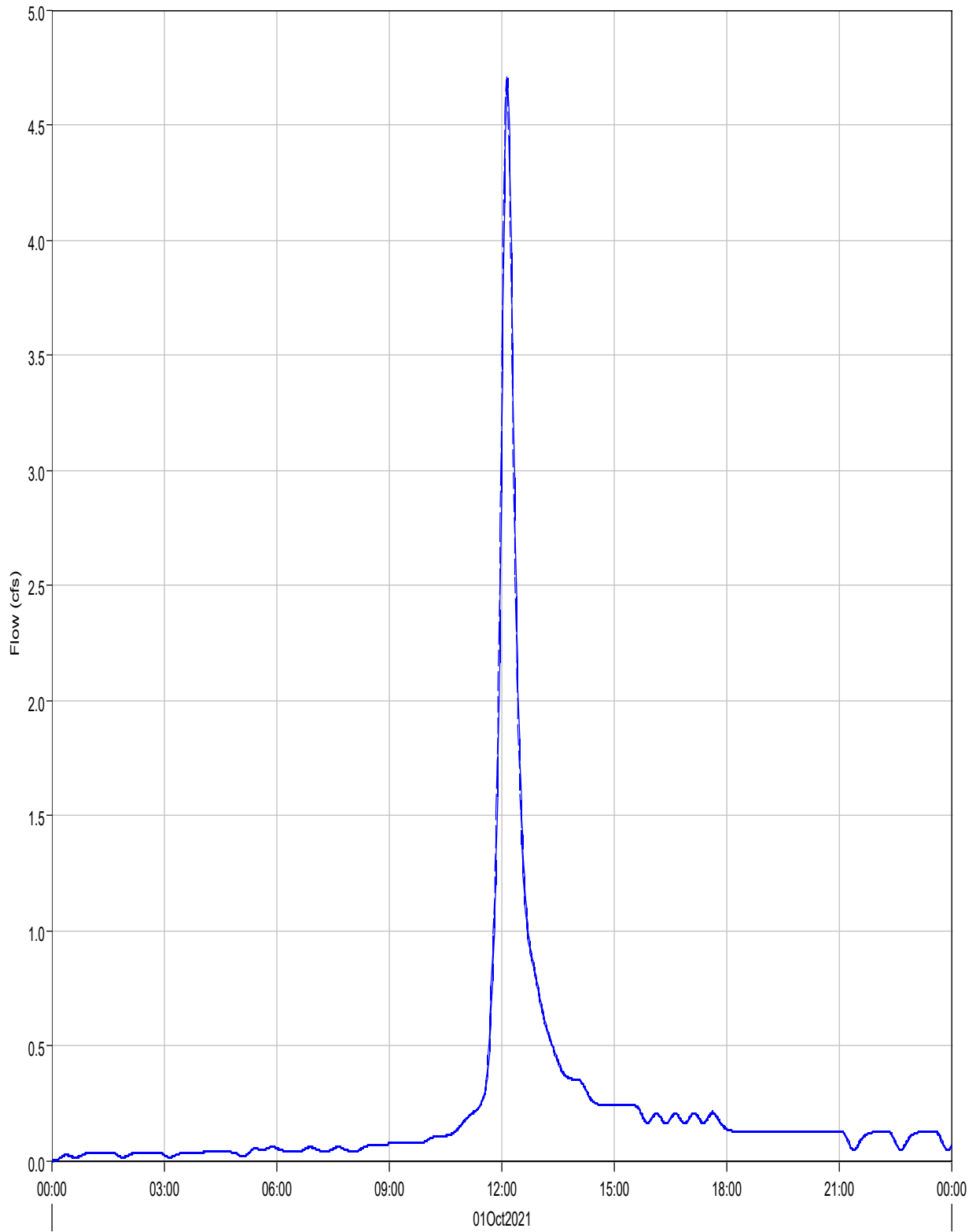

— Run:EV 5-yr Pr. Type II Element:R-PB7-A Result:Outflow

- - - Run:EV 5-YR PR. TYPE II Element:R-PB7-A Result:Combined Inflow

Project: Eagleview_Subdivision
Simulation Run: EV 5-yr Pr. Type II Reach: R-PB7-A

Start of Run: 01Oct2021, 00:00 Basin Model: Eagleview_Proposed
End of Run: 02Oct2021, 00:00 Meteorologic Model: 5-yr Type II
Compute Time: 14Mar2022, 16:43:16 Control Specifications: 24-hr Storm

Volume Units: AC-FT

Computed Results

Peak Inflow :	4.7 (CFS)	Date/Time of Peak Inflow :	01Oct2021, 12:08
Peak Outflow :	4.7 (CFS)	Date/Time of Peak Outflow :	01Oct2021, 12:10
Total Inflow :	0.4 (AC-FT)	Total Outflow :	0.4 (AC-FT)

Reach "R-PB7-B" Results for Run "EV 5-yr Pr. Type II"

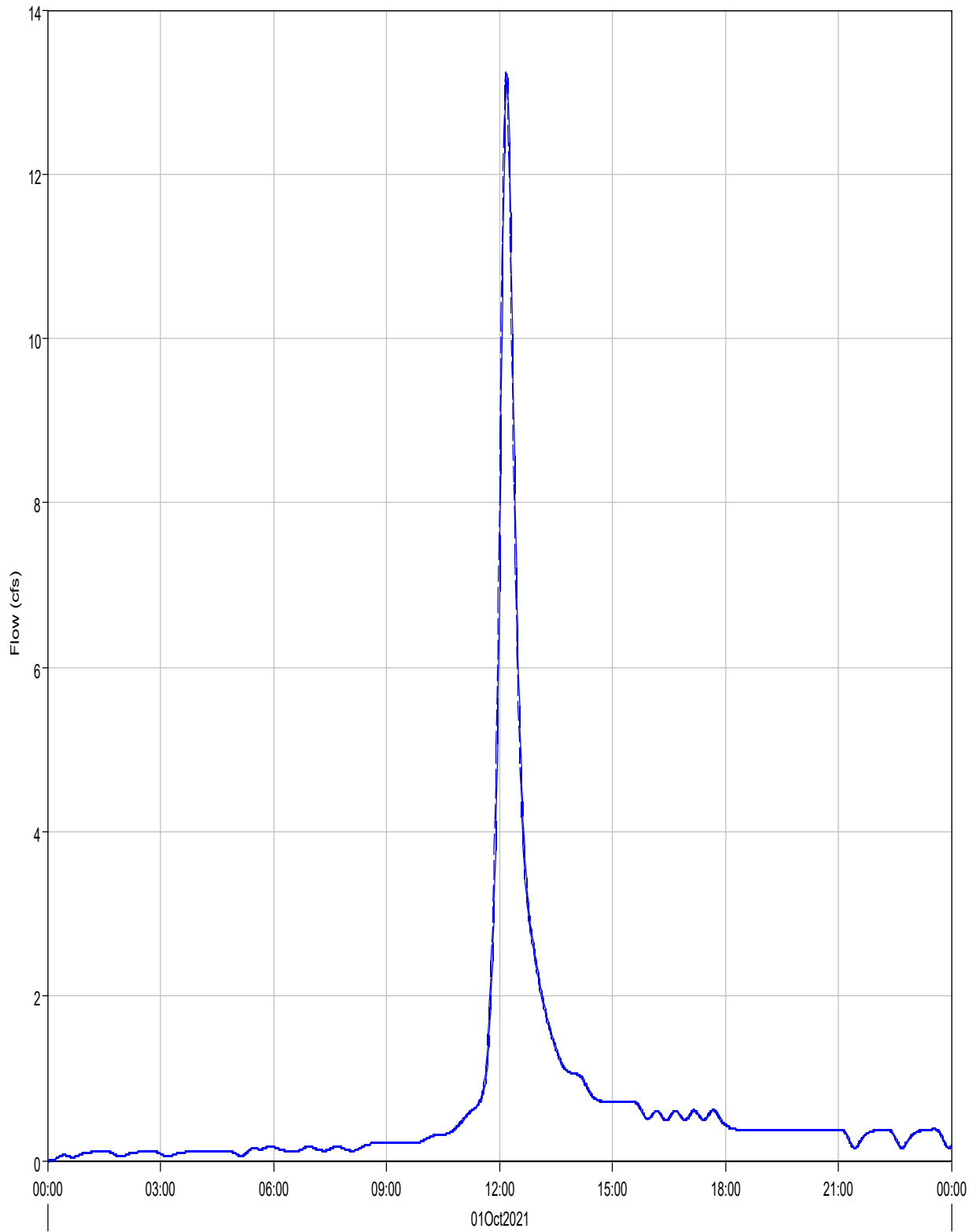

— Run:EV 5-yr Pr. Type II Element:R-PB7-B Result:Outflow

- - - Run:EV 5-YR PR. TYPE II Element:R-PB7-B Result:Combined Inflow

Project: Eagleview_Subdivision
Simulation Run: EV 5-yr Pr. Type II Reach: R-PB7-B

Start of Run: 01Oct2021, 00:00 Basin Model: Eagleview_Proposed
End of Run: 02Oct2021, 00:00 Meteorologic Model: 5-yr Type II
Compute Time: 14Mar2022, 16:43:16 Control Specifications: 24-hr Storm

Volume Units: AC-FT

Computed Results

Peak Inflow :	13.2 (CFS)	Date/Time of Peak Inflow :	01Oct2021, 12:10
Peak Outflow :	13.2 (CFS)	Date/Time of Peak Outflow :	01Oct2021, 12:12
Total Inflow :	1.3 (AC-FT)	Total Outflow :	1.3 (AC-FT)

Reach "R-PB7-C" Results for Run "EV 5-yr Pr. Type II"

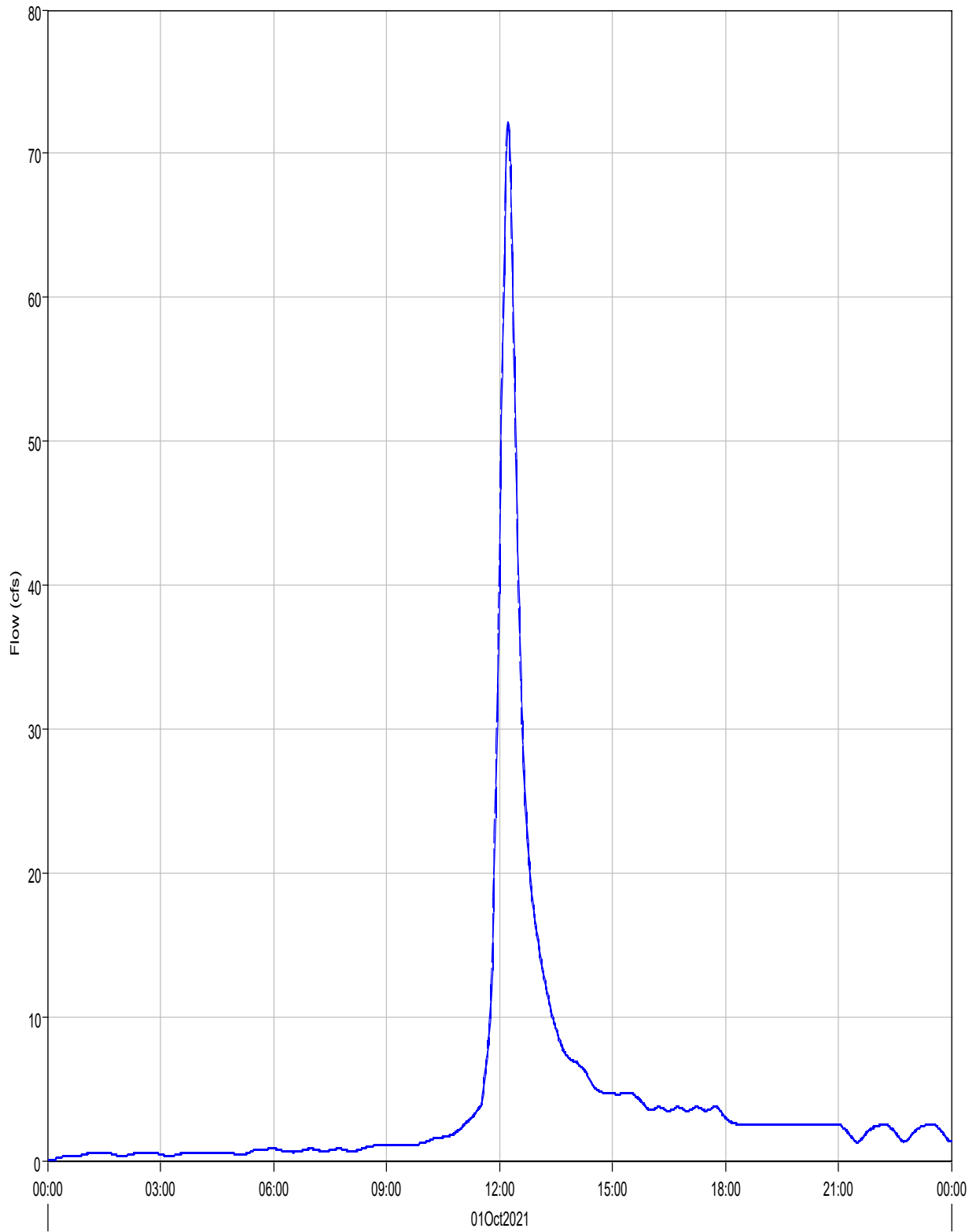

— Run:EV 5-yr Pr. Type II Element:R-PB7-C Result:Outflow

- - - Run:EV 5-YR PR. TYPE II Element:R-PB7-C Result:Combined Inflow

Project: Eagleview_Subdivision
Simulation Run: EV 5-yr Pr. Type II Reach: R-PB7-C

Start of Run: 01Oct2021, 00:00 Basin Model: Eagleview_Proposed
End of Run: 02Oct2021, 00:00 Meteorologic Model: 5-yr Type II
Compute Time: 14Mar2022, 16:43:16 Control Specifications: 24-hr Storm

Volume Units: AC-FT

Computed Results

Peak Inflow :	72.2 (CFS)	Date/Time of Peak Inflow :	01Oct2021, 12:13
Peak Outflow :	72.1 (CFS)	Date/Time of Peak Outflow :	01Oct2021, 12:14
Total Inflow :	8.1 (AC-FT)	Total Outflow :	8.1 (AC-FT)

Reach "R-PB9" Results for Run "EV 5-yr Pr. Type II"

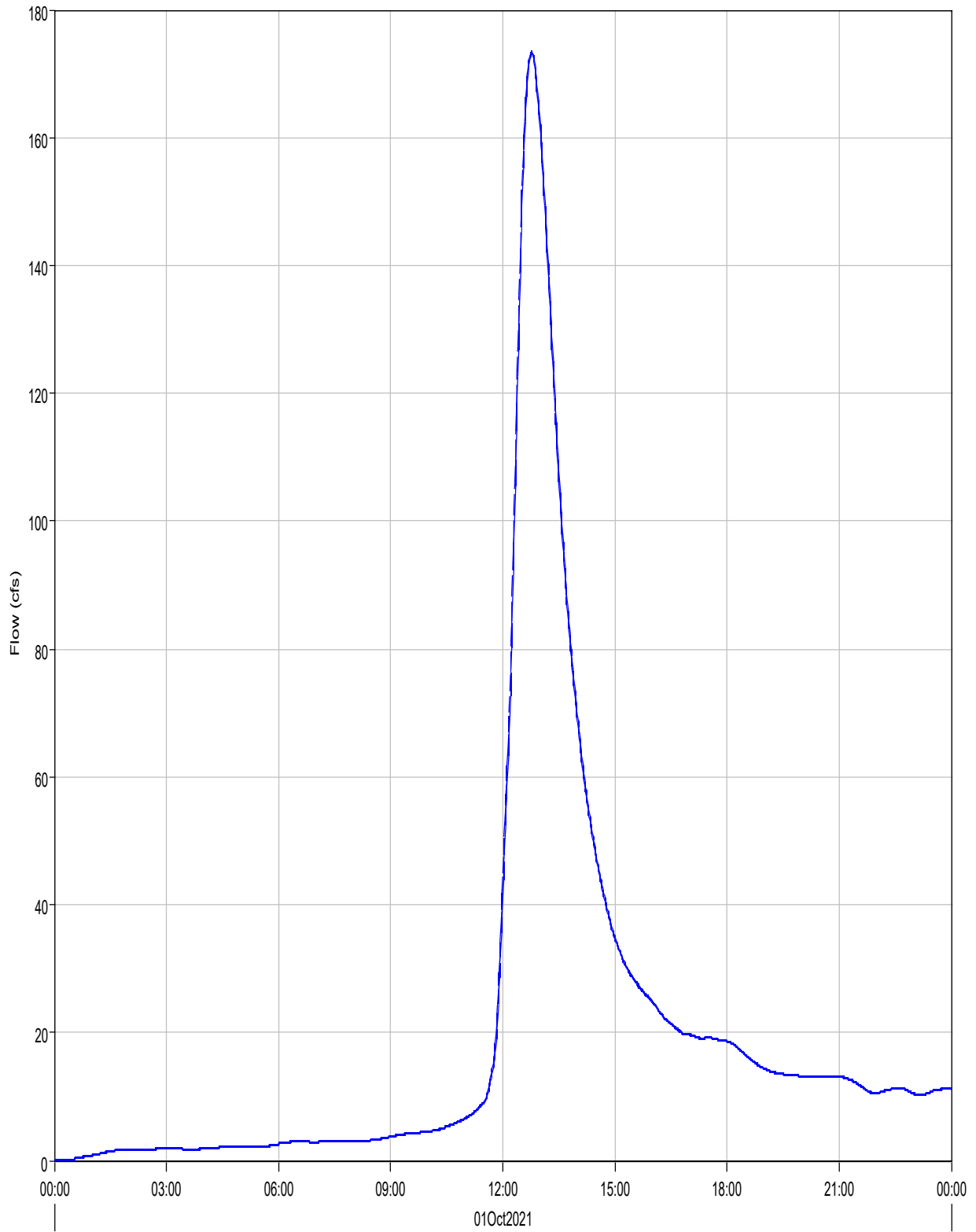

— Run:EV 5-yr Pr. Type II Element:R-PB9 Result:Outflow

- - - Run:EV 5-YR PR. TYPE II Element:R-PB9 Result:Combined Inflow

Project: Eagleview_Subdivision
Simulation Run: EV 5-yr Pr. Type II Reach: R-PB9
Start of Run: 01Oct2021, 00:00 Basin Model: Eagleview_Proposed
End of Run: 02Oct2021, 00:00 Meteorologic Model: 5-yr Type II
Compute Time: 14Mar2022, 16:43:16 Control Specifications: 24-hr Storm

Volume Units: IN

Computed Results

Peak Inflow :	173.4 (CFS)	Date/Time of Peak Inflow :	01Oct2021, 12:46
Peak Outflow :	173.3 (CFS)	Date/Time of Peak Outflow :	01Oct2021, 12:47
Total Inflow :	0.67 (IN)	Total Outflow :	0.67 (IN)

Reach "R-PB10" Results for Run "EV 5-yr Pr. Type II"

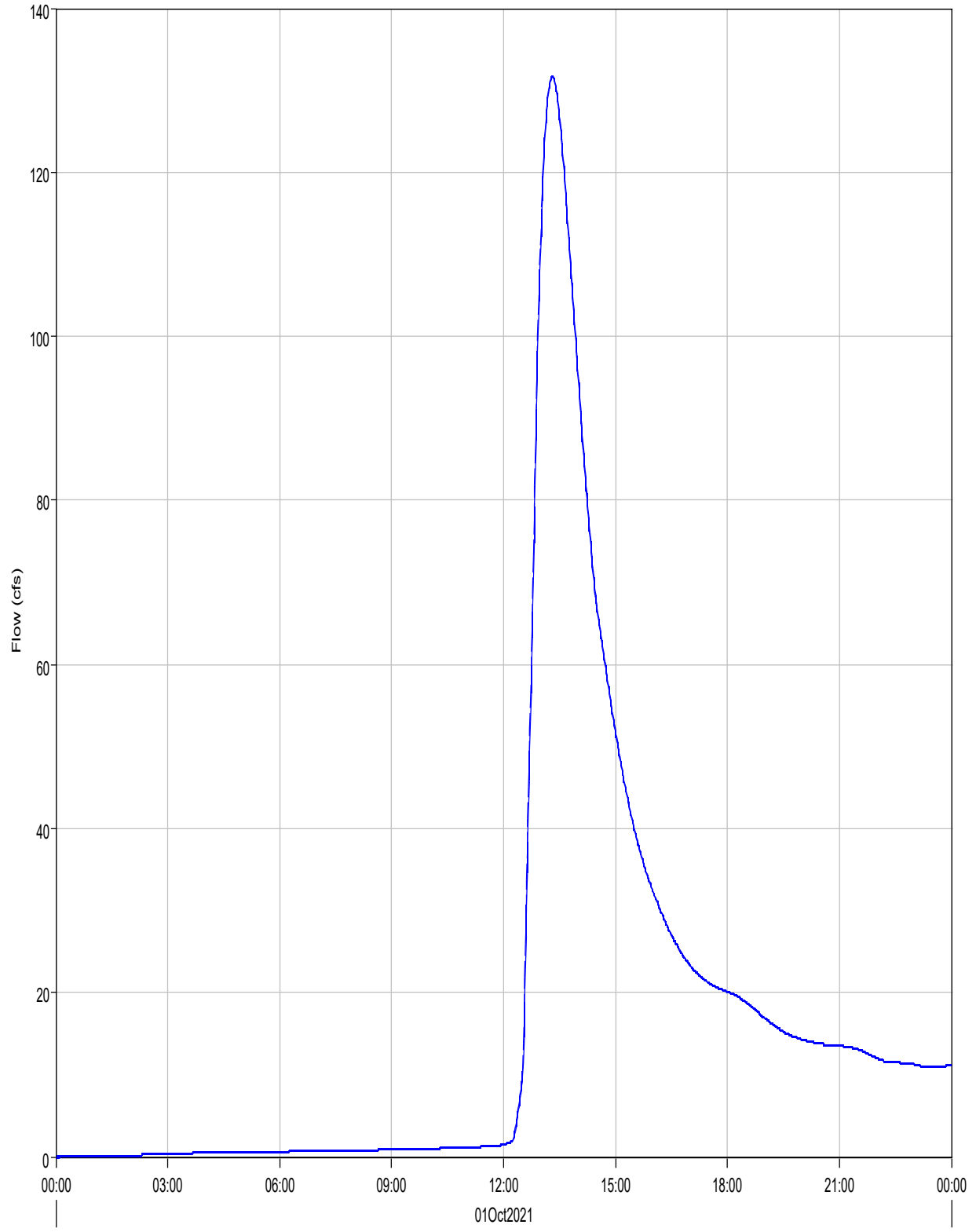

— Run:EV 5-yr Pr. Type II Element:R-PB10 Result:Outflow

- - - Run:EV 5-YR PR. TYPE II Element:R-PB10 Result:Combined Inflow

Project: Eagleview_Subdivision
Simulation Run: EV 5-yr Pr. Type II Reach: R-PB10

Start of Run: 01Oct2021, 00:00 Basin Model: Eagleview_Proposed
End of Run: 02Oct2021, 00:00 Meteorologic Model: 5-yr Type II
Compute Time: 14Mar2022, 16:43:16 Control Specifications: 24-hr Storm

Volume Units: IN

Computed Results

Peak Inflow :	131.7 (CFS)	Date/Time of Peak Inflow :	01Oct2021, 13:18
Peak Outflow :	131.6 (CFS)	Date/Time of Peak Outflow :	01Oct2021, 13:19
Total Inflow :	0.55 (IN)	Total Outflow :	0.55 (IN)

Project: Eagleview_Subdivision
Simulation Run: EV 5-yr Pr. Type II Reach: R-PB11

Start of Run:	01Oct2021, 00:00	Basin Model:	Eagleview_Proposed
End of Run:	02Oct2021, 00:00	Meteorologic Model:	5-yr Type II
Compute Time:	14Mar2022, 16:43:16	Control Specifications:	24-hr Storm

Volume Units: IN

Computed Results

Peak Inflow :	29.8 (CFS)	Date/Time of Peak Inflow :	01Oct2021, 12:14
Peak Outflow :	29.8 (CFS)	Date/Time of Peak Outflow :	01Oct2021, 12:15
Total Inflow :	0.80 (IN)	Total Outflow :	0.80 (IN)

Reach "R-PB11" Results for Run "EV 5-yr Pr. Type II"

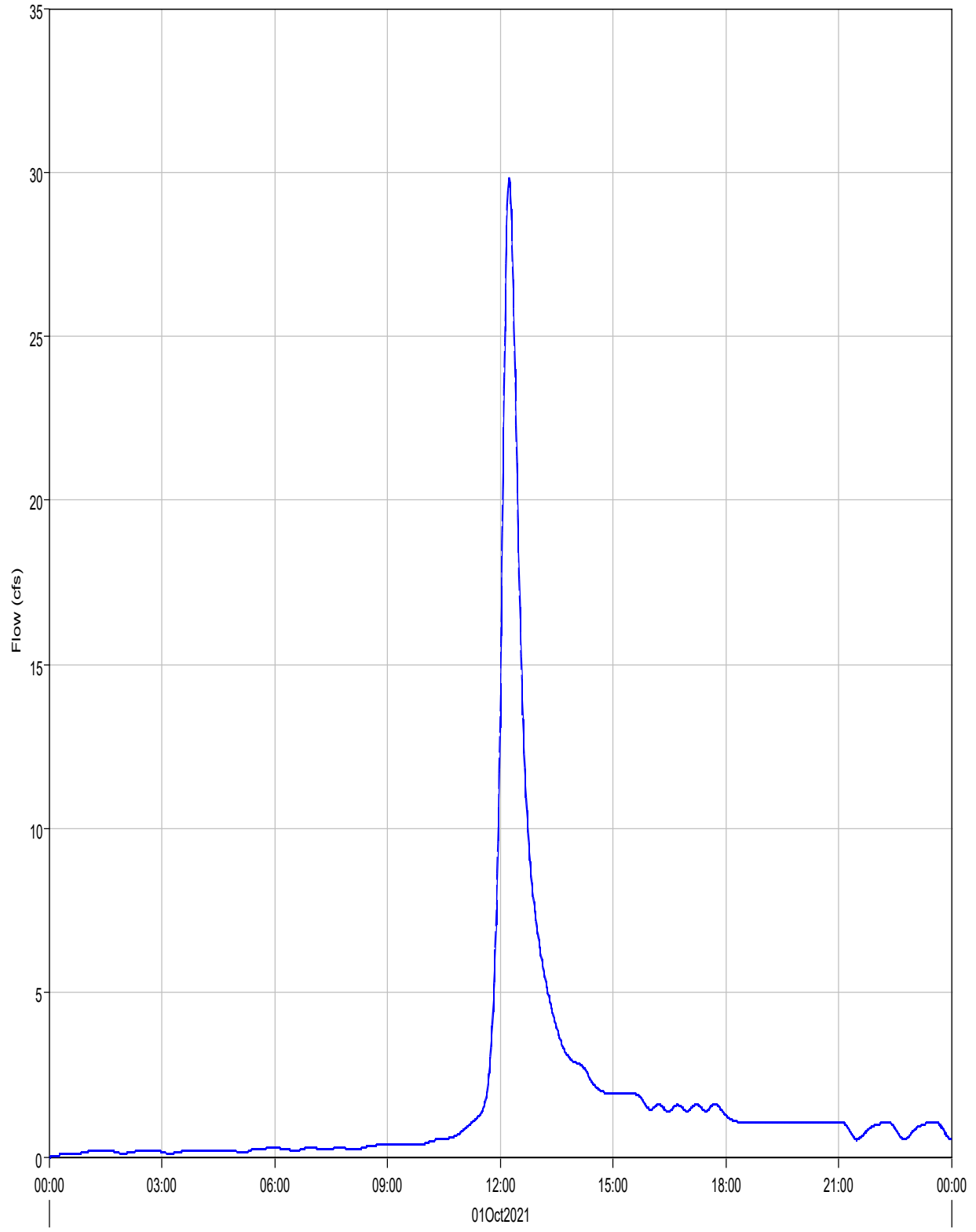

— Run:EV 5-yr Pr. Type II Element:R-PB11 Result:Outflow

- - - Run:EV 5-YR PR. TYPE II Element:R-PB11 Result:Combined Inflow

Reach "R-PB12-A" Results for Run "EV 5-yr Pr. Type II"

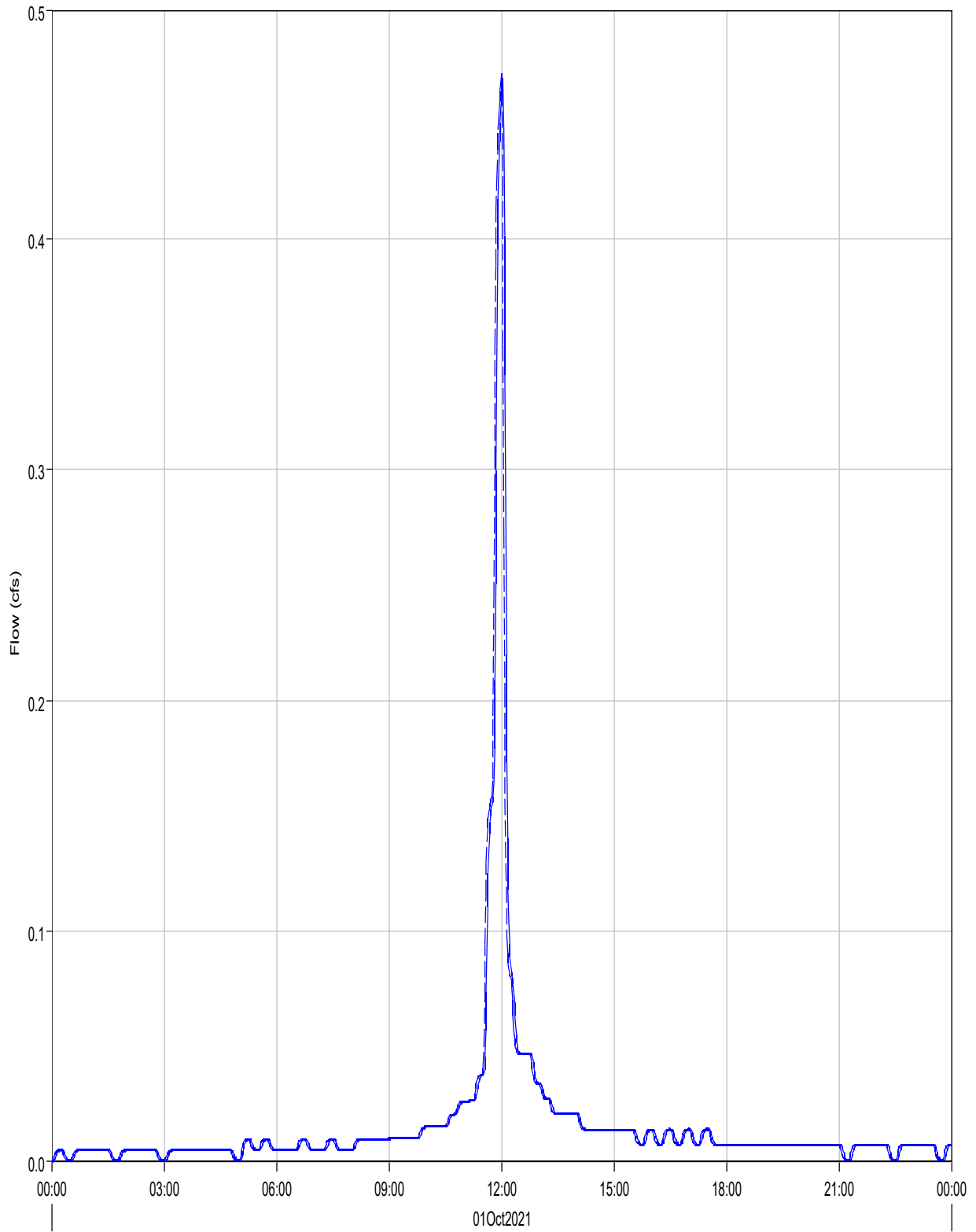

— Run:EV 5-yr Pr. Type II Element:R-PB12-A Result:Outflow

- - - Run:EV 5-YR PR. TYPE II Element:R-PB12-A Result:Combined Inflow

Project: Eagleview_Subdivision
Simulation Run: EV 5-yr Pr. Type II Reach: R-PB12-A

Start of Run: 01Oct2021, 00:00 Basin Model: Eagleview_Proposed
End of Run: 02Oct2021, 00:00 Meteorologic Model: 5-yr Type II
Compute Time: 14Mar2022, 16:43:16 Control Specifications: 24-hr Storm

Volume Units: AC-FT

Computed Results

Peak Inflow :	0.5 (CFS)	Date/Time of Peak Inflow :	01Oct2021, 12:00
Peak Outflow :	0.5 (CFS)	Date/Time of Peak Outflow :	01Oct2021, 12:02
Total Inflow :	0.0 (AC-FT)	Total Outflow :	0.0 (AC-FT)

Reach "R-PB12-B" Results for Run "EV 5-yr Pr. Type II"

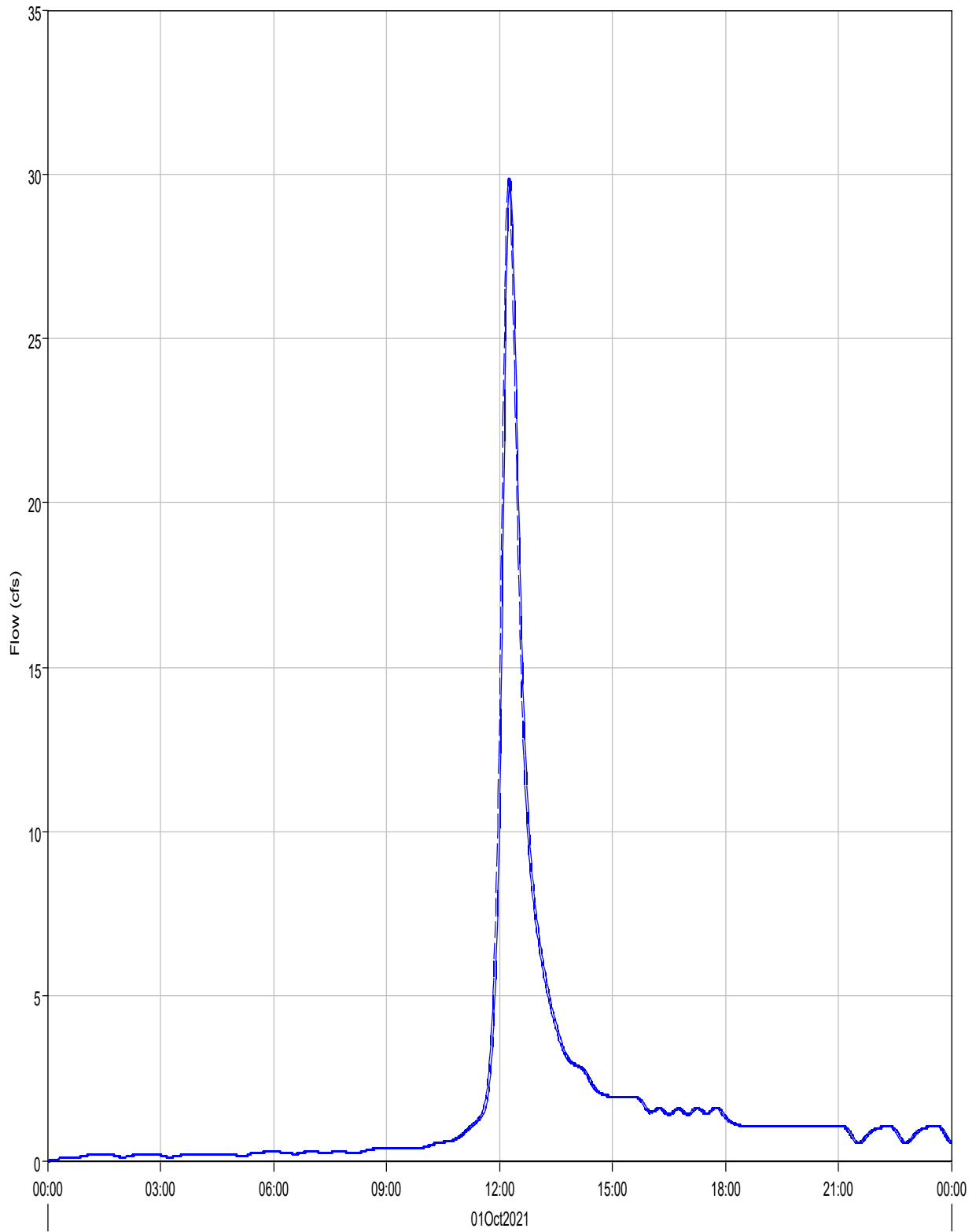

— Run:EV 5-yr Pr. Type II Element:R-PB12-B Result:Outflow

- - - Run:EV 5-YR PR. TYPE II Element:R-PB12-B Result:Combined Inflow

Project: Eagleview_Subdivision
Simulation Run: EV 5-yr Pr. Type II Reach: R-PB12-B

Start of Run: 01Oct2021, 00:00 Basin Model: Eagleview_Proposed
End of Run: 02Oct2021, 00:00 Meteorologic Model: 5-yr Type II
Compute Time: 14Mar2022, 16:43:16 Control Specifications: 24-hr Storm

Volume Units: AC-FT

Computed Results

Peak Inflow :	29.9 (CFS)	Date/Time of Peak Inflow :	01Oct2021, 12:15
Peak Outflow :	29.9 (CFS)	Date/Time of Peak Outflow :	01Oct2021, 12:17
Total Inflow :	3.3 (AC-FT)	Total Outflow :	3.3 (AC-FT)

Reach "R-PB13" Results for Run "EV 5-yr Pr. Type II"

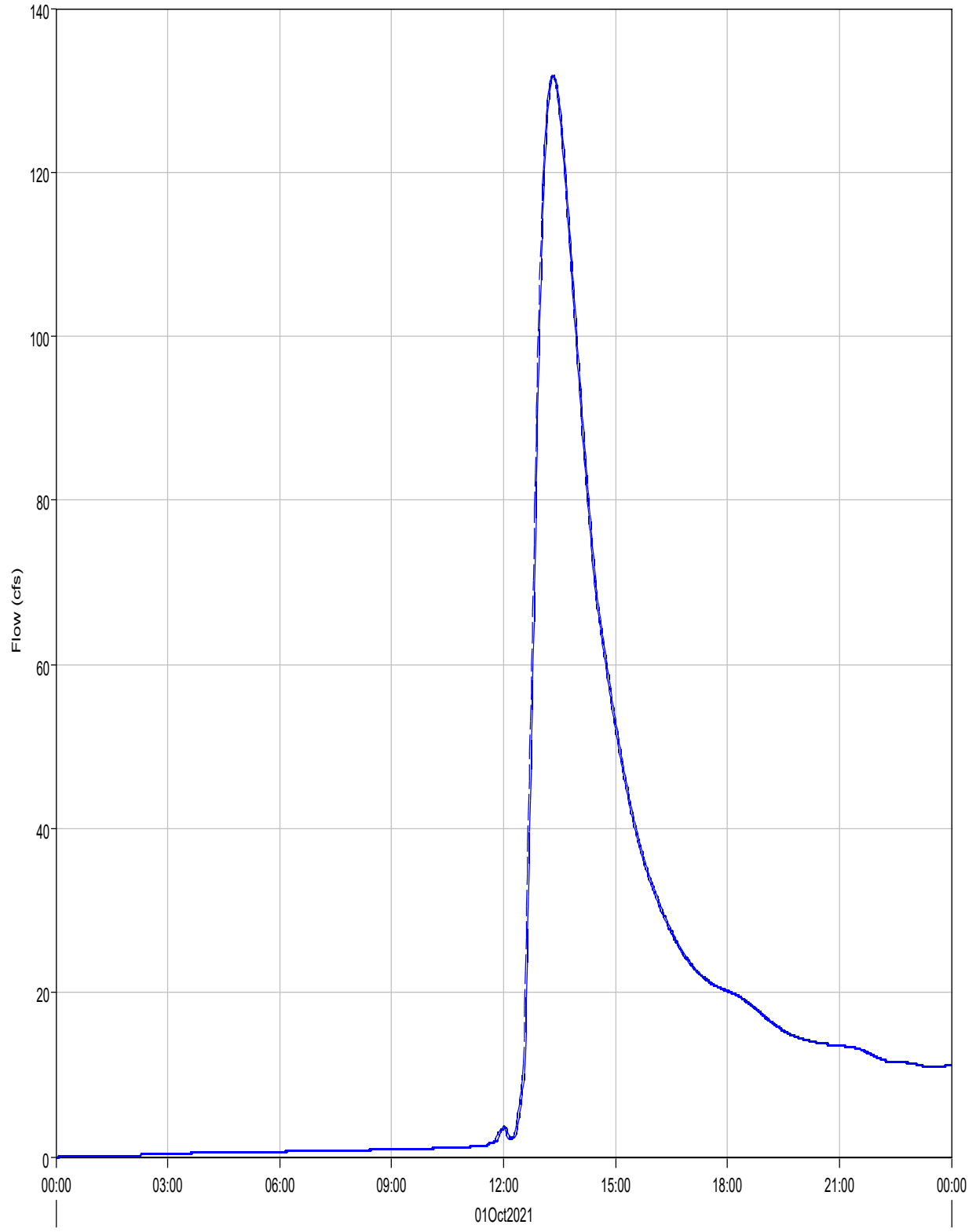

Run:EV 5-yr Pr. Type II Element:R-PB13 Result:Outflow

Run:EV 5-YR PR. TYPE II Element:R-PB13 Result:Combined Inflow

Project: Eagleview_Subdivision
Simulation Run: EV 5-yr Pr. Type II Reach: R-PB13

Start of Run: 01Oct2021, 00:00 Basin Model: Eagleview_Proposed
End of Run: 02Oct2021, 00:00 Meteorologic Model: 5-yr Type II
Compute Time: 14Mar2022, 16:43:16 Control Specifications: 24-hr Storm

Volume Units: IN

Computed Results

Peak Inflow :	131.8 (CFS)	Date/Time of Peak Inflow :	01Oct2021, 13:19
Peak Outflow :	131.7 (CFS)	Date/Time of Peak Outflow :	01Oct2021, 13:21
Total Inflow :	0.55 (IN)	Total Outflow :	0.55 (IN)

Project: Eagleview_Subdivision Simulation Run: EV 100-yr Pr. Type II

Start of Run: 01Oct2021, 00:00 Basin Model: Eagleview_Proposed
 End of Run: 02Oct2021, 00:00 Meteorologic Model: 100-yr Type II
 Compute Time: 15Mar2022, 09:38:27 Control Specifications: 24-hr Storm

Hydrologic Element	Drainage Area (MI ²)	Peak Discharge (CFS)	Time of Peak	Volume (AC-FT)
CULV1	0.0021625	3.3	01Oct2021, 12:07	0.3
CULV4	0.0087281	11.3	01Oct2021, 12:08	1.0
CULV5	.000315625	0.9	01Oct2021, 12:00	0.1
OB1	0.0162031	18.8	01Oct2021, 12:08	1.7
OB2	0.0438438	52.7	01Oct2021, 12:08	4.7
OB3	0.0678750	67.1	01Oct2021, 12:12	6.9
OB4	0.0164062	18.9	01Oct2021, 12:10	1.8
OB5	0.22472	106.9	01Oct2021, 12:40	19.7
OB6	0.18501	114.9	01Oct2021, 12:29	17.8
OB7	0.65812	284.3	01Oct2021, 12:52	60.6
OB8	0.0516699	51.0	01Oct2021, 12:13	5.3
P1	0.0228484	26.4	01Oct2021, 12:09	2.4
P10 (CULV2)	0.15425	150.1	01Oct2021, 12:12	16.4
P11 (CULV3)	0.0260593	31.9	01Oct2021, 12:10	3.1
P12 (CULV8)	1.1270	420.3	01Oct2021, 13:06	96.8
P2	0.19753	189.1	01Oct2021, 12:13	21.4
P3	1.2312	437.7	01Oct2021, 13:07	107.9
P4	0.18248	184.6	01Oct2021, 12:12	19.8
P5 (CULV7)	0.0939437	95.9	01Oct2021, 12:13	9.8
P6	0.0771621	78.5	01Oct2021, 12:14	8.2
P7	1.1242	420.1	01Oct2021, 13:05	96.5
P8	1.1062	486.7	01Oct2021, 12:44	102.2
P9 (CULV6)	0.0768465	78.4	01Oct2021, 12:13	8.2
PB1	0.0066453	7.7	01Oct2021, 12:09	0.7
PB10	0.0179938	20.4	01Oct2021, 12:10	2.0
PB11	0.0251766	29.8	01Oct2021, 12:10	2.9

Hydrologic Element	Drainage Area (MI ²)	Peak Discharge (CFS)	Time of Peak	Volume (AC-FT)
PB12	.000315625	0.9	01Oct2021, 12:00	0.1
PB13	0.0027469	5.1	01Oct2021, 12:00	0.3
PB14	0.0270031	46.3	01Oct2021, 12:01	2.9
PB15	0.0150500	26.3	01Oct2021, 12:00	1.7
PB2	0.0016938	2.4	01Oct2021, 12:06	0.2
PB3	0.0021625	3.3	01Oct2021, 12:07	0.3
PB4	0.0164672	30.2	01Oct2021, 12:00	1.9
PB5	0.0096625	10.4	01Oct2021, 12:12	1.1
PB6	0.0173312	20.7	01Oct2021, 12:10	2.0
PB7	0.0087281	11.4	01Oct2021, 12:08	1.0
PB8	0.0184000	30.4	01Oct2021, 12:01	2.0
PB9	0.0199984	24.8	01Oct2021, 12:07	2.2
R-OB1	0.0162031	18.7	01Oct2021, 12:09	1.7
R-OB2	0.0438438	52.5	01Oct2021, 12:09	4.7
R-OB4-A	0.0842812	85.5	01Oct2021, 12:13	8.8
R-OB4-B	0.0939437	95.8	01Oct2021, 12:14	9.8
R-OB7	1.0678	479.0	01Oct2021, 12:44	98.1
R-OB8	0.0516699	50.9	01Oct2021, 12:15	5.3
R-PB10	1.1242	420.0	01Oct2021, 13:06	96.5
R-PB11	0.0768465	78.3	01Oct2021, 12:14	8.2
R-PB12-A	.000315625	0.9	01Oct2021, 12:02	0.1
R-PB12-B	0.0771621	78.4	01Oct2021, 12:15	8.2
R-PB13	1.1270	420.1	01Oct2021, 13:07	96.7
R-PB3	0.0021625	3.3	01Oct2021, 12:09	0.3
R-PB5	0.15425	150.0	01Oct2021, 12:13	16.4
R-PB7-A	0.0087281	11.3	01Oct2021, 12:09	1.0
R-PB7-B	0.0260593	31.9	01Oct2021, 12:11	3.1
R-PB7-C	0.18248	184.4	01Oct2021, 12:13	19.8
R-PB9	1.1062	486.6	01Oct2021, 12:44	102.2

Reach "CULV1" Results for Run "EV 100-yr Pr. Type II"

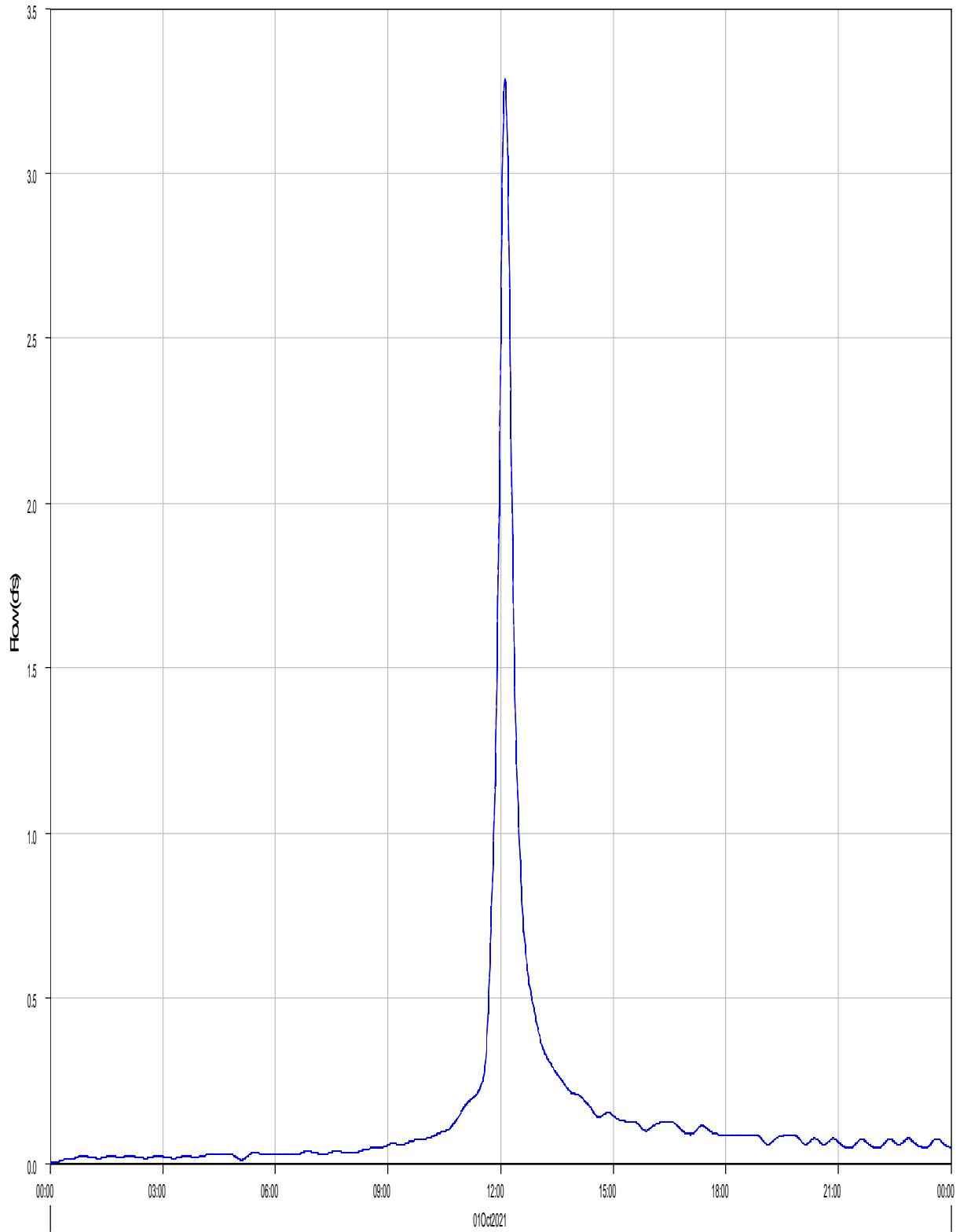

Run:EV 100-yr Pr. Type II Element:CULV1 Result:Outflow

Run:EV 100-yr Pr. Type II Element:CULV1 Result:Combined Inflow

Project: Eagleview_Subdivision
Simulation Run: EV 100-yr Pr. Type II Reach: CULV1
Start of Run: 01Oct2021, 00:00 Basin Model: Eagleview_Proposed
End of Run: 02Oct2021, 00:00 Meteorologic Model: 100-yr Type II
Compute Time: 15Mar2022, 09:38:27 Control Specifications: 24-hr Storm

Volume Units: AC-FT

Computed Results

Peak Inflow :	3.3 (CFS)	Date/Time of Peak Inflow :	01Oct2021, 12:07
Peak Outflow :	3.3 (CFS)	Date/Time of Peak Outflow :	01Oct2021, 12:07
Total Inflow :	0.3 (AC-FT)	Total Outflow :	0.3 (AC-FT)

Reach 'CULV4' Results for Run 'EV 100-yr Pr. Type II'

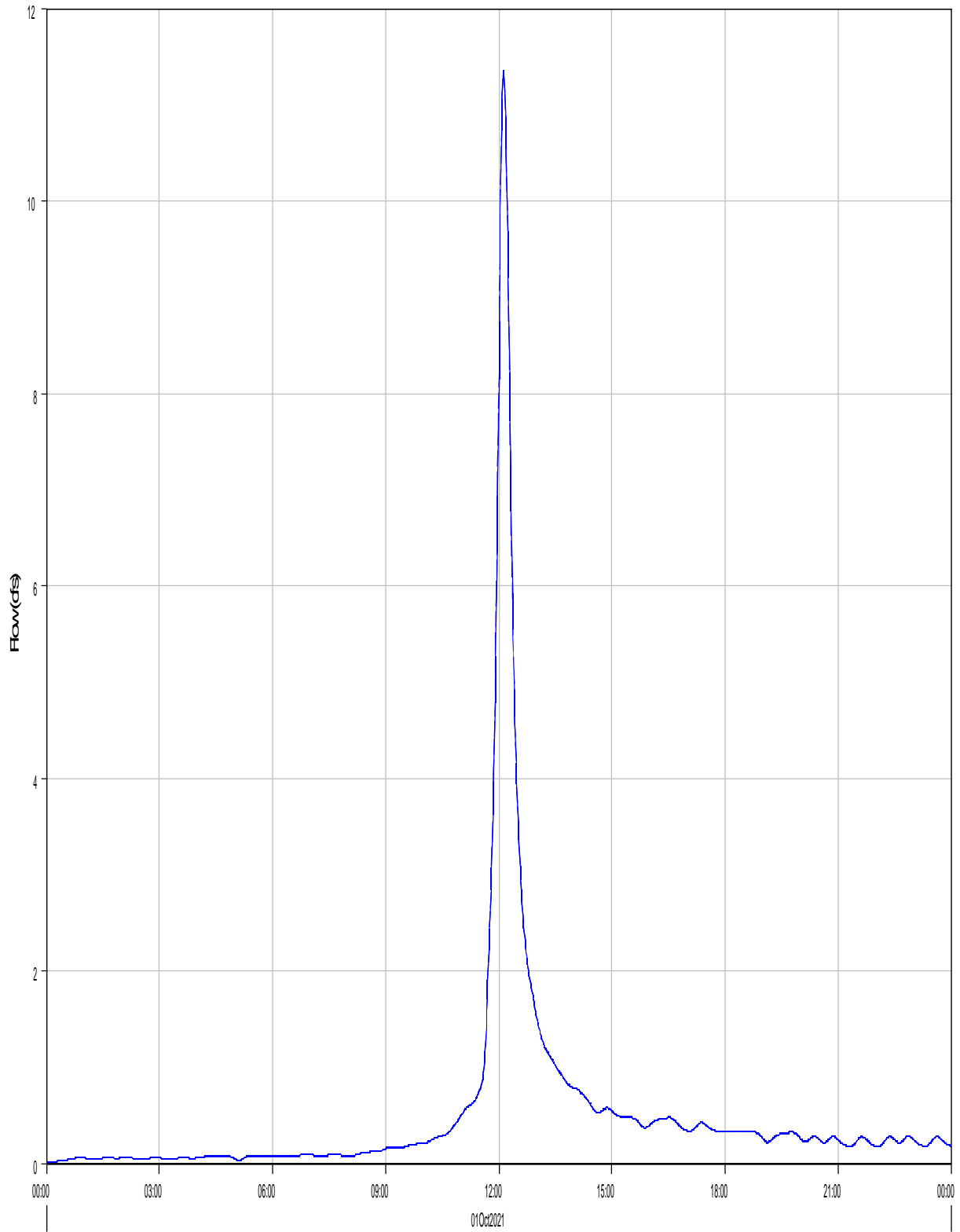

Run:EV 100-yr Pr. Type II Element:CULV4 Result:Outflow

Run:EV 100-yr Pr. Type II Element:CULV4 Result:Combined Inflow

Project: Eagleview_Subdivision
Simulation Run: EV 100-yr Pr. Type II Reach: CULV4
Start of Run: 01Oct2021, 00:00 Basin Model: Eagleview_Proposed
End of Run: 02Oct2021, 00:00 Meteorologic Model: 100-yr Type II
Compute Time: 15Mar2022, 09:38:27 Control Specifications: 24-hr Storm

Volume Units: AC-FT

Computed Results

Peak Inflow :	11.4 (CFS)	Date/Time of Peak Inflow :	01Oct2021, 12:08
Peak Outflow :	11.3 (CFS)	Date/Time of Peak Outflow :	01Oct2021, 12:08
Total Inflow :	1.0 (AC-FT)	Total Outflow :	1.0 (AC-FT)

Reach "CULV5" Results for Run "EV 100-yr Pr. Type II"

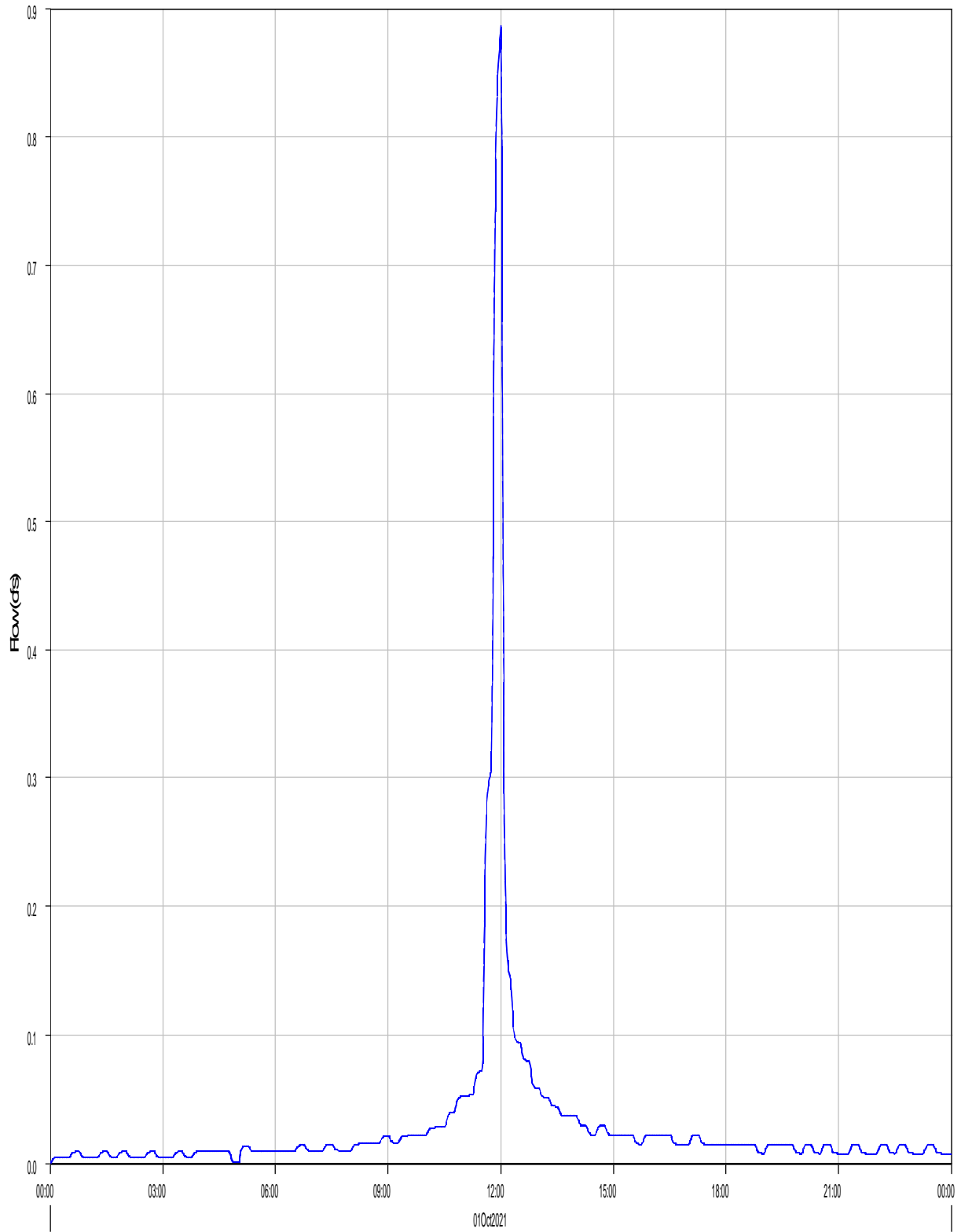

— Run:EV 100-yr Pr. Type II Element:CULV5 Result:Outflow

- - - Run:EV 100-yr Pr. Type II Element:CULV5 Result:Combined Inflow

Project: Eagleview_Subdivision
Simulation Run: EV 100-yr Pr. Type II Reach: CULV5
Start of Run: 01Oct2021, 00:00 Basin Model: Eagleview_Proposed
End of Run: 02Oct2021, 00:00 Meteorologic Model: 100-yr Type II
Compute Time: 15Mar2022, 09:38:27 Control Specifications: 24-hr Storm

Volume Units: AC-FT

Computed Results

Peak Inflow :	0.9 (CFS)	Date/Time of Peak Inflow :	01Oct2021, 12:00
Peak Outflow :	0.9 (CFS)	Date/Time of Peak Outflow :	01Oct2021, 12:00
Total Inflow :	0.1 (AC-FT)	Total Outflow :	0.1 (AC-FT)

Subbasin "OB1" Results for Run "EV 100-yr Pr. Type II"

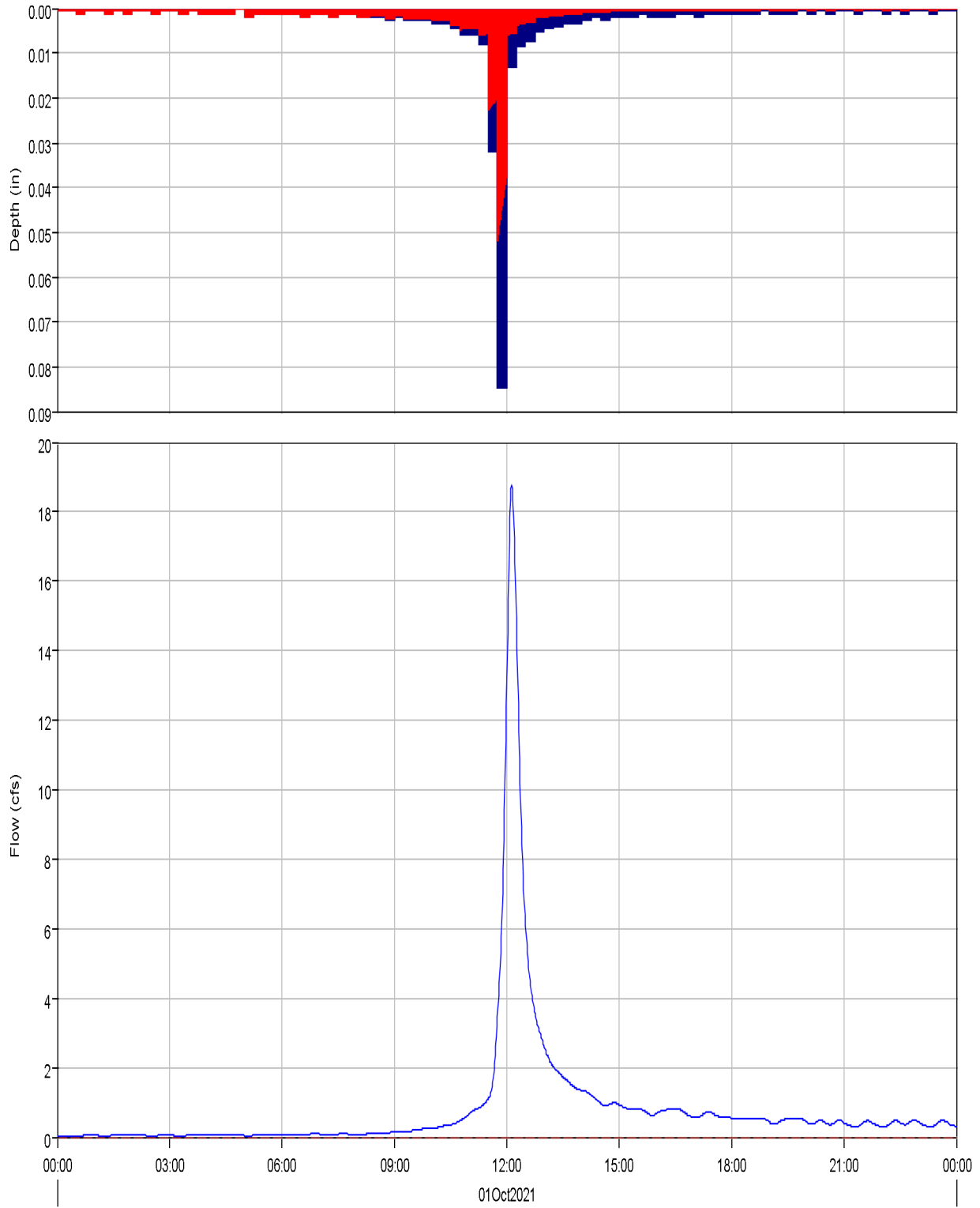

Run:EV 100-yr Pr. Type II Element:OB1 Result:Precipitation
Run:EV 100-yr Pr. Type II Element:OB1 Result:Outflow

Run:EV 100-yr Pr. Type II Element:OB1 Result:Precipitation Loss
Run:EV 100-yr Pr. Type II Element:OB1 Result:Baseflow

Project: Eagleview_Subdivision
Simulation Run: EV 100-yr Pr. Type II Subbasin: OB1

Start of Run: 01Oct2021, 00:00 Basin Model: Eagleview_Proposed
End of Run: 02Oct2021, 00:00 Meteorologic Model: 100-yr Type II
Compute Time: 15Mar2022, 09:38:27 Control Specifications: 24-hr Storm

Volume Units: AC-FT

Computed Results

Peak Discharge :	18.8 (CFS)	Date/Time of Peak Discharge :	01Oct2021, 12:08
Total Precipitation :	4.0 (AC-FT)	Total Direct Runoff :	1.7 (AC-FT)
Total Loss :	2.3 (AC-FT)	Total Baseflow :	0.0 (AC-FT)
Total Excess :	1.7 (AC-FT)	Discharge :	1.7 (AC-FT)

Subbasin "OB2" Results for Run "EV 100-yr Pr. Type II"

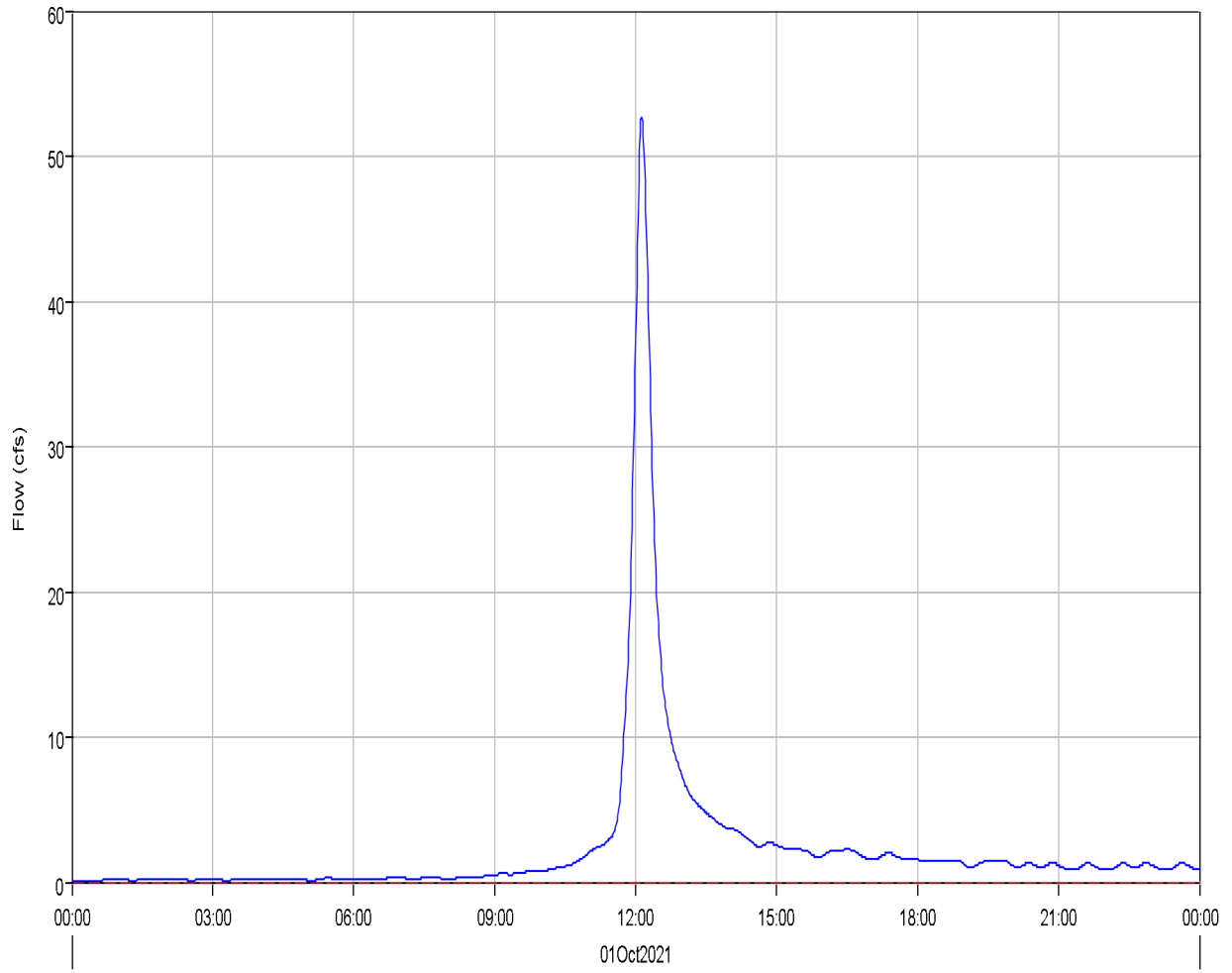
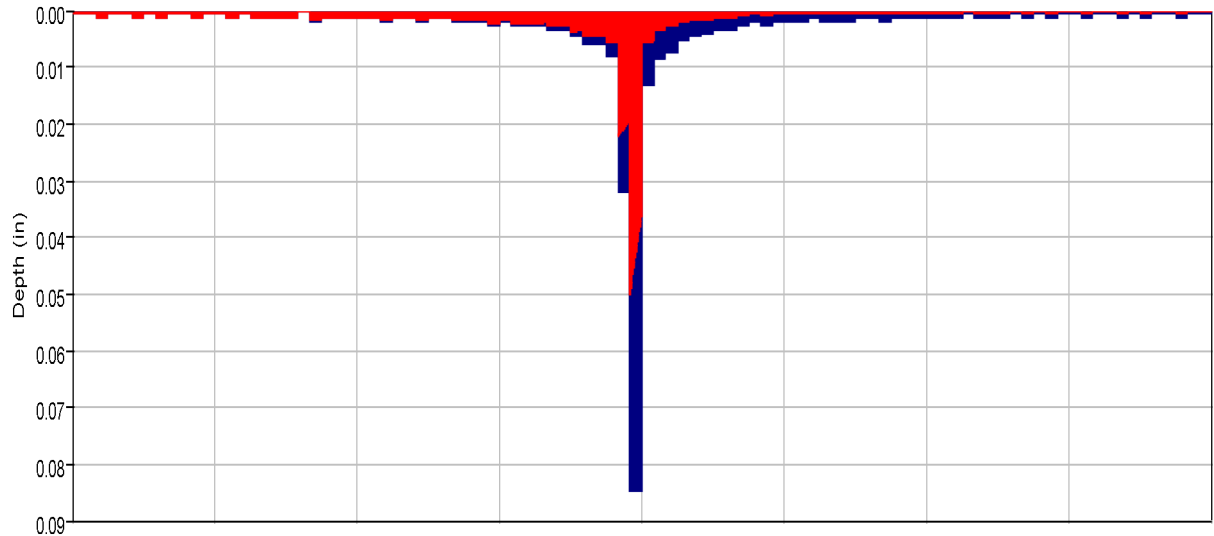

Run:EV 100-yr Pr. Type II Element:OB2 Result:Precipitation
Run:EV 100-yr Pr. Type II Element:OB2 Result:Outflow

Run:EV 100-yr Pr. Type II Element:OB2 Result:Precipitation Loss
Run:EV 100-yr Pr. Type II Element:OB2 Result:Baseflow

Project: Eagleview_Subdivision
Simulation Run: EV 100-yr Pr. Type II Subbasin: OB2

Start of Run: 01Oct2021, 00:00 Basin Model: Eagleview_Proposed
End of Run: 02Oct2021, 00:00 Meteorologic Model: 100-yr Type II
Compute Time: 15Mar2022, 09:38:27 Control Specifications: 24-hr Storm

Volume Units: AC-FT

Computed Results

Peak Discharge :	52.7 (CFS)	Date/Time of Peak Discharge :	01Oct2021, 12:08
Total Precipitation :	10.8 (AC-FT)	Total Direct Runoff :	4.7 (AC-FT)
Total Loss :	6.0 (AC-FT)	Total Baseflow :	0.0 (AC-FT)
Total Excess :	4.7 (AC-FT)	Discharge :	4.7 (AC-FT)

Subbasin "OB3" Results for Run "EV 100-yr Pr. Type II"

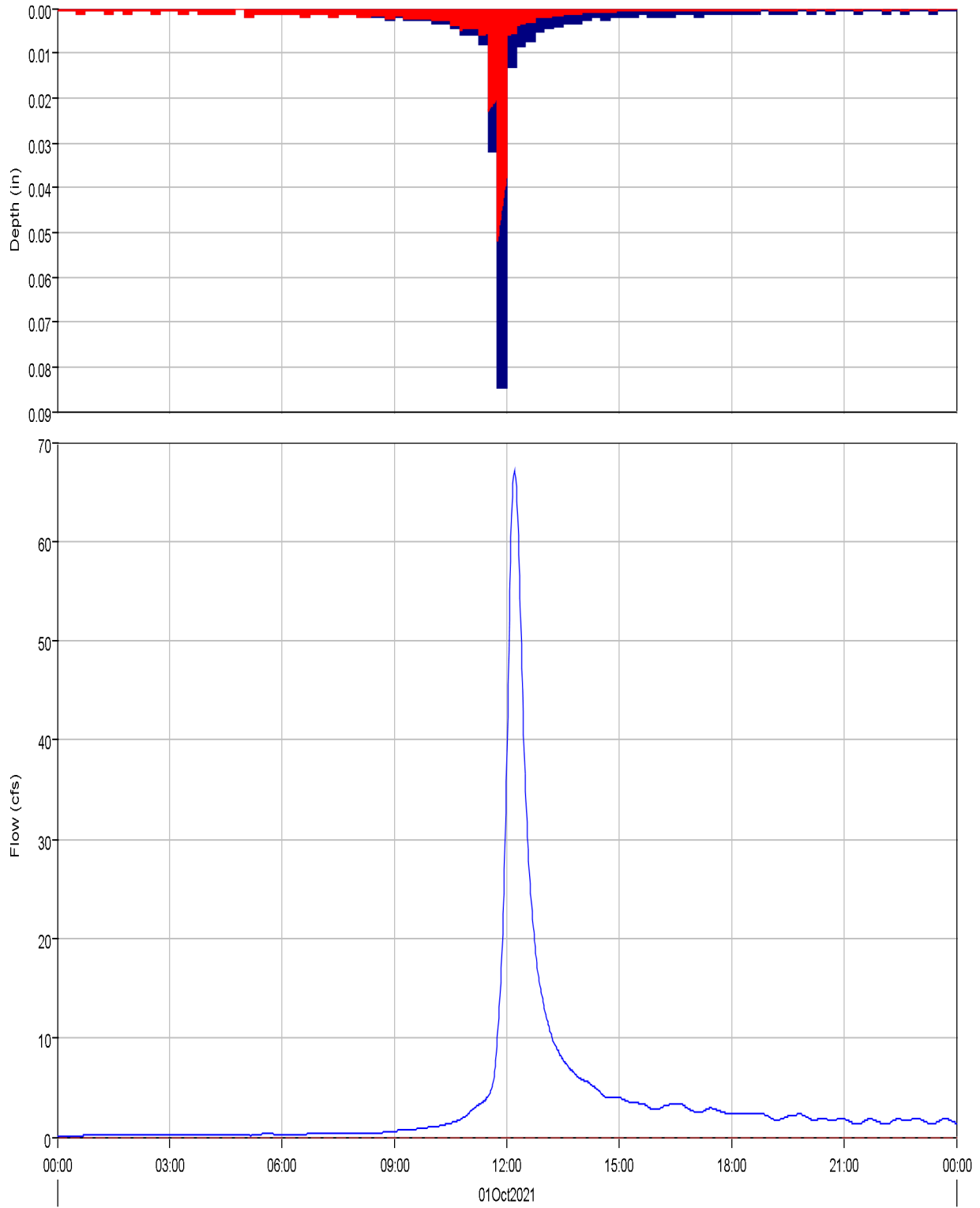

Run:EV 100-yr Pr. Type II Element:OB3 Result:Precipitation
Run:EV 100-yr Pr. Type II Element:OB3 Result:Outflow

Run:EV 100-yr Pr. Type II Element:OB3 Result:Precipitation Loss
Run:EV 100-yr Pr. Type II Element:OB3 Result:Baseflow

Project: Eagleview_Subdivision
Simulation Run: EV 100-yr Pr. Type II Subbasin: OB3

Start of Run: 01Oct2021, 00:00 Basin Model: Eagleview_Proposed
End of Run: 02Oct2021, 00:00 Meteorologic Model: 100-yr Type II
Compute Time: 15Mar2022, 09:38:27 Control Specifications: 24-hr Storm

Volume Units: AC-FT

Computed Results

Peak Discharge :	67.1 (CFS)	Date/Time of Peak Discharge :	01Oct2021, 12:12
Total Precipitation :	16.7 (AC-FT)	Total Direct Runoff :	6.9 (AC-FT)
Total Loss :	9.7 (AC-FT)	Total Baseflow :	0.0 (AC-FT)
Total Excess :	7.0 (AC-FT)	Discharge :	6.9 (AC-FT)

Subbasin "OB4" Results for Run "EV 100-yr Pr. Type II"

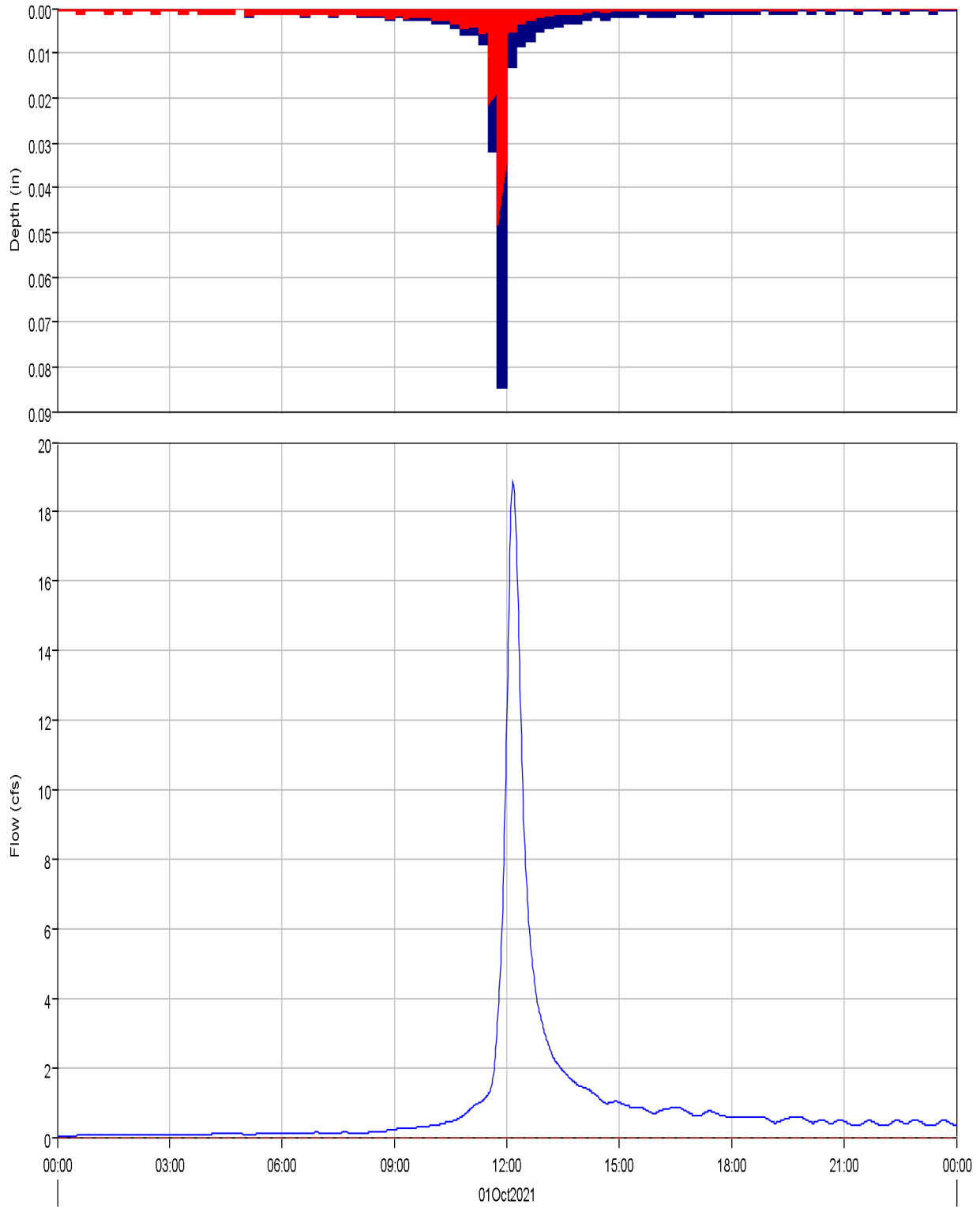

Run:EV 100-yr Pr. Type II Element:OB4 Result:Precipitation
Run:EV 100-yr Pr. Type II Element:OB4 Result:Outflow

Run:EV 100-yr Pr. Type II Element:OB4 Result:Precipitation Loss
Run:EV 100-yr Pr. Type II Element:OB4 Result:Baseflow

Project: Eagleview_Subdivision
Simulation Run: EV 100-yr Pr. Type II Subbasin: OB4

Start of Run: 01Oct2021, 00:00 Basin Model: Eagleview_Proposed
End of Run: 02Oct2021, 00:00 Meteorologic Model: 100-yr Type II
Compute Time: 15Mar2022, 09:38:27 Control Specifications: 24-hr Storm

Volume Units: AC-FT

Computed Results

Peak Discharge :	18.9 (CFS)	Date/Time of Peak Discharge :	01Oct2021, 12:10
Total Precipitation :	4.0 (AC-FT)	Total Direct Runoff :	1.8 (AC-FT)
Total Loss :	2.2 (AC-FT)	Total Baseflow :	0.0 (AC-FT)
Total Excess :	1.8 (AC-FT)	Discharge :	1.8 (AC-FT)

Subbasin "OB5" Results for Run "EV 100-yr Pr. Type II"

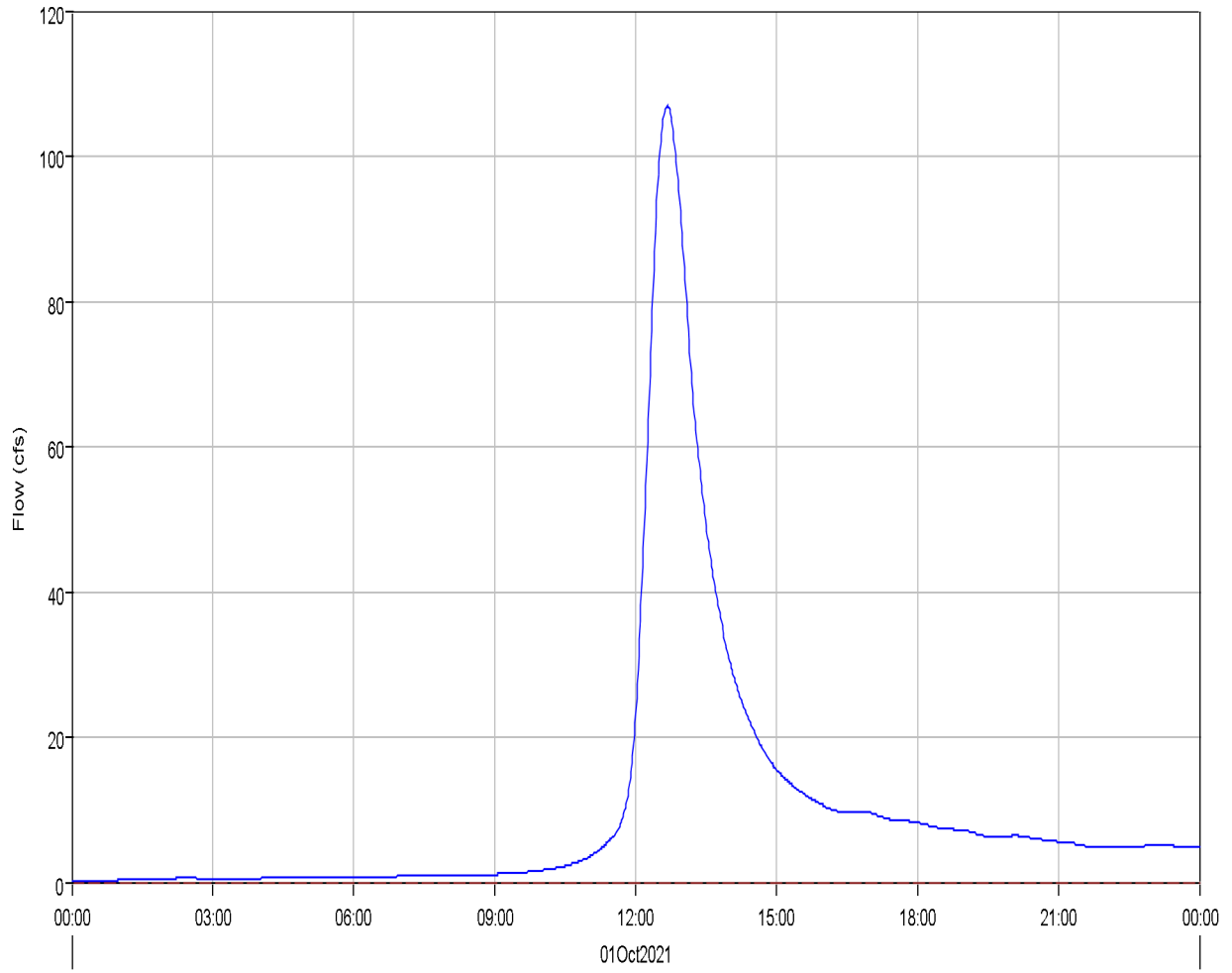
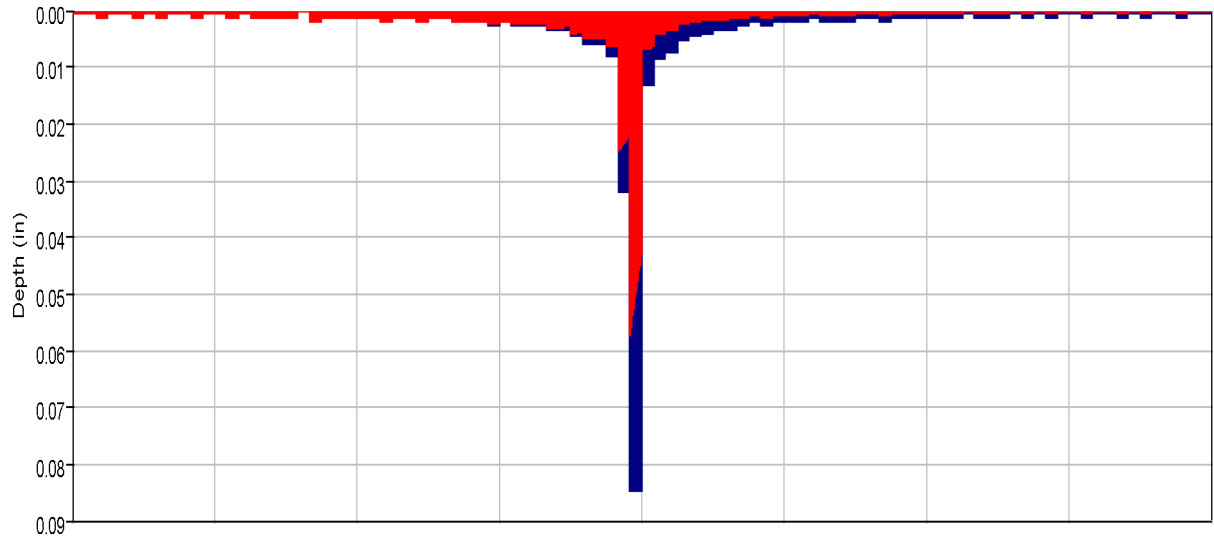

Run:EV 100-yr Pr. Type II Element:OB5 Result:Precipitation
Run:EV 100-yr Pr. Type II Element:OB5 Result:Outflow

Run:EV 100-yr Pr. Type II Element:OB5 Result:Precipitation Loss
Run:EV 100-yr Pr. Type II Element:OB5 Result:Baseflow

Project: Eagleview_Subdivision
Simulation Run: EV 100-yr Pr. Type II Subbasin: OB5

Start of Run: 01Oct2021, 00:00 Basin Model: Eagleview_Proposed
End of Run: 02Oct2021, 00:00 Meteorologic Model: 100-yr Type II
Compute Time: 15Mar2022, 09:38:27 Control Specifications: 24-hr Storm

Volume Units: AC-FT

Computed Results

Peak Discharge :	106.9 (CFS)	Date/Time of Peak Discharge :	01Oct2021, 12:40
Total Precipitation :	55.1 (AC-FT)	Total Direct Runoff :	19.7 (AC-FT)
Total Loss :	35.0 (AC-FT)	Total Baseflow :	0.0 (AC-FT)
Total Excess :	20.1 (AC-FT)	Discharge :	19.7 (AC-FT)

Subbasin "OB6" Results for Run "EV 100-yr Pr. Type II"

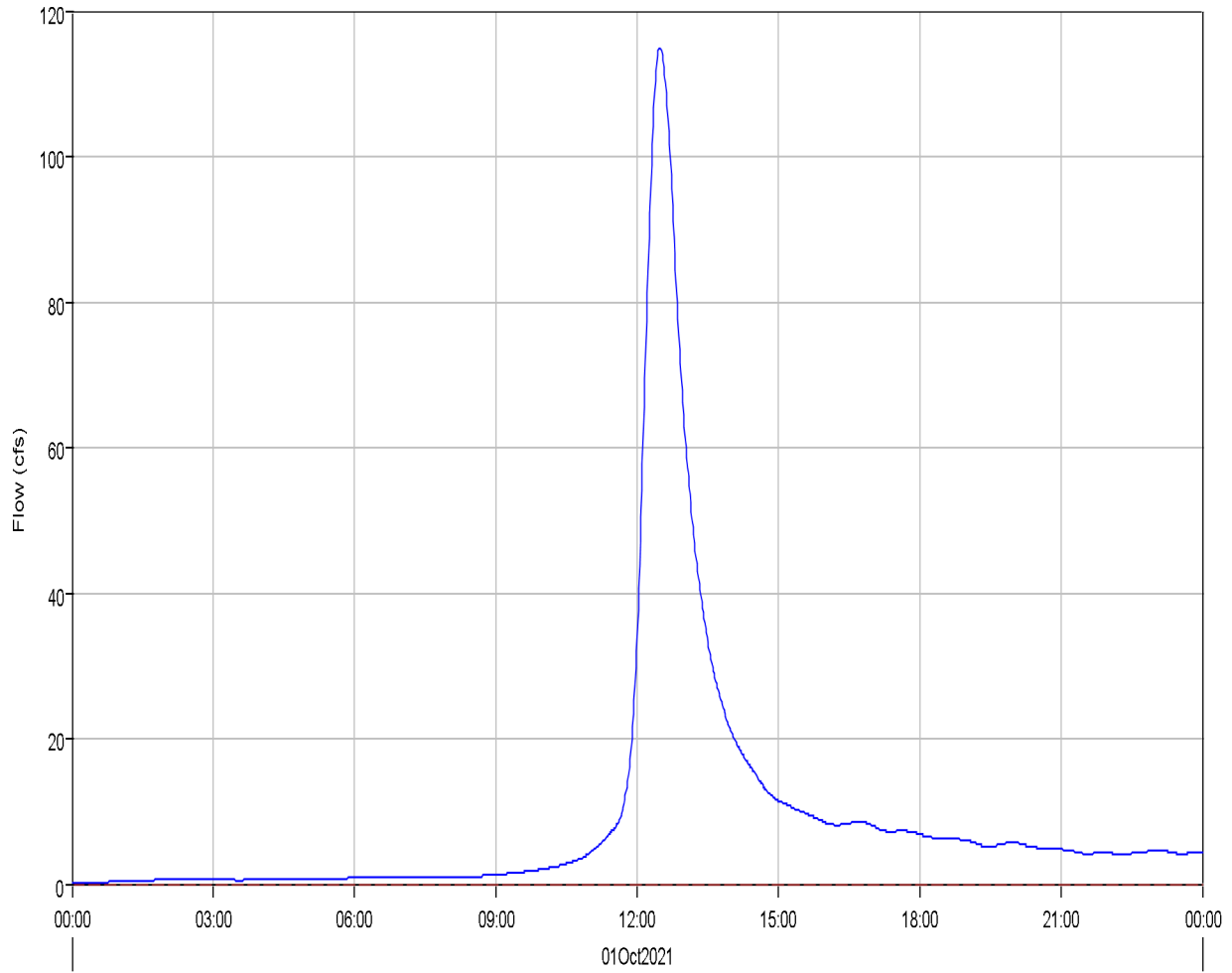
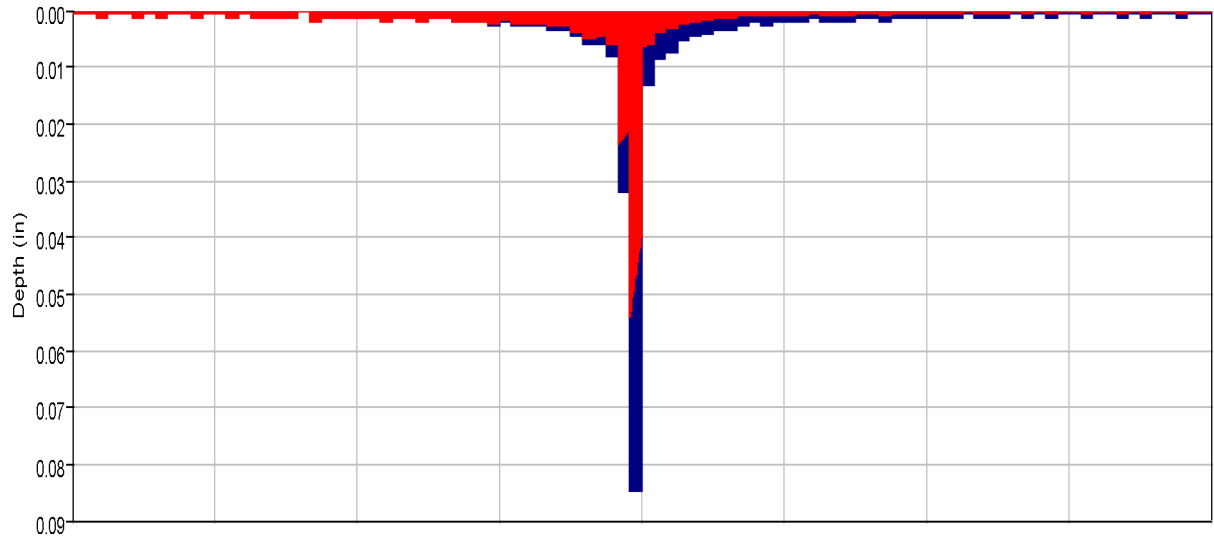

Run:EV 100-yr Pr. Type II Element:OB6 Result:Precipitation
Run:EV 100-yr Pr. Type II Element:OB6 Result:Outflow

Run:EV 100-yr Pr. Type II Element:OB6 Result:Precipitation Loss
Run:EV 100-yr Pr. Type II Element:OB6 Result:Baseflow

Project: Eagleview_Subdivision
Simulation Run: EV 100-yr Pr. Type II Subbasin: OB6

Start of Run: 01Oct2021, 00:00 Basin Model: Eagleview_Proposed
End of Run: 02Oct2021, 00:00 Meteorologic Model: 100-yr Type II
Compute Time: 15Mar2022, 09:38:27 Control Specifications: 24-hr Storm

Volume Units: AC-FT

Computed Results

Peak Discharge :	114.9 (CFS)	Date/Time of Peak Discharge :	01Oct2021, 12:29
Total Precipitation :	45.4 (AC-FT)	Total Direct Runoff :	17.8 (AC-FT)
Total Loss :	27.3 (AC-FT)	Total Baseflow :	0.0 (AC-FT)
Total Excess :	18.1 (AC-FT)	Discharge :	17.8 (AC-FT)

Subbasin "OB7" Results for Run "EV 100-yr Pr. Type II"

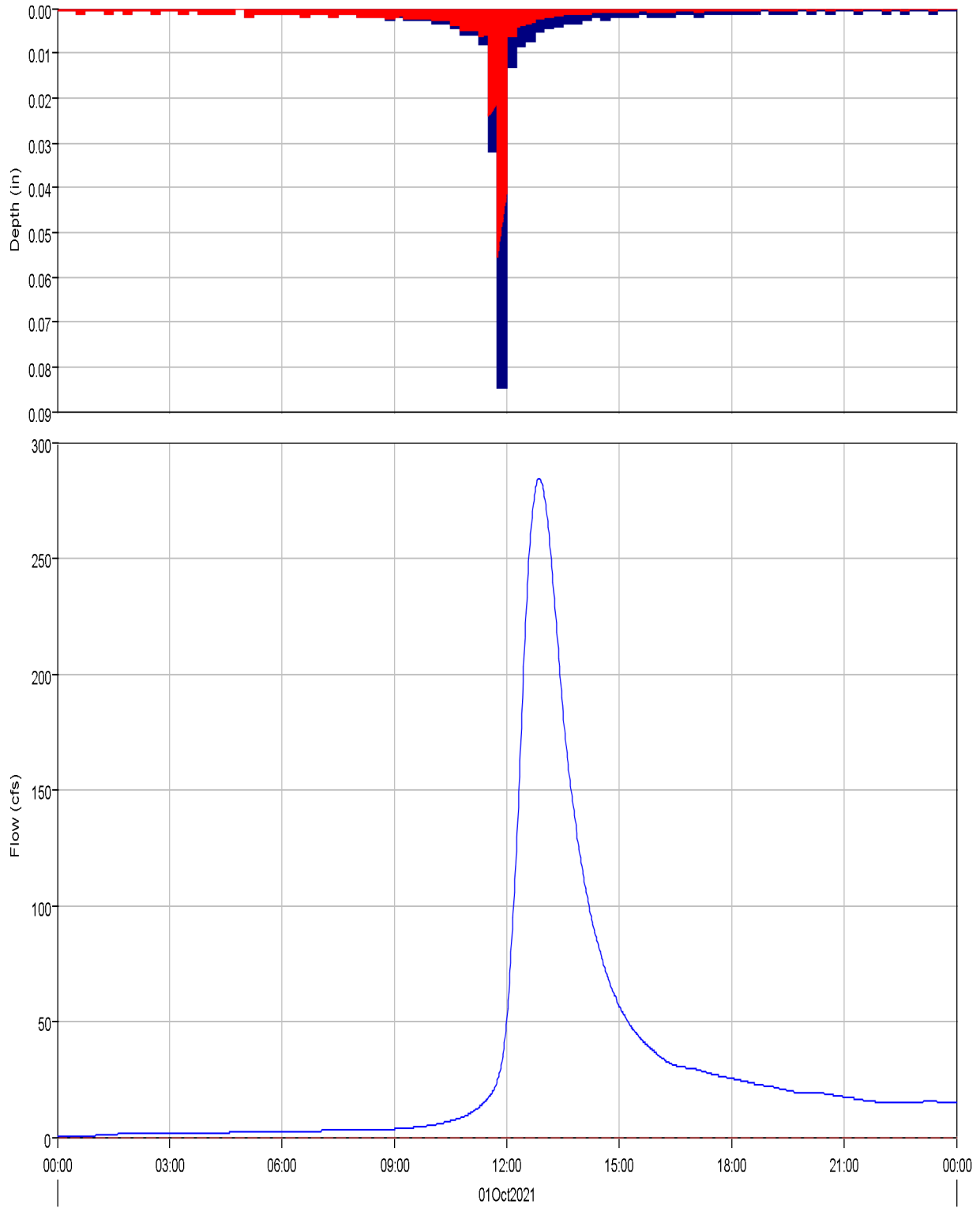

Run:EV 100-yr Pr. Type II Element:OB7 Result:Precipitation
Run:EV 100-yr Pr. Type II Element:OB7 Result:Outflow

Run:EV 100-yr Pr. Type II Element:OB7 Result:Precipitation Loss
Run:EV 100-yr Pr. Type II Element:OB7 Result:Baseflow

Project: Eagleview_Subdivision
Simulation Run: EV 100-yr Pr. Type II Subbasin: OB7

Start of Run: 01Oct2021, 00:00 Basin Model: Eagleview_Proposed
End of Run: 02Oct2021, 00:00 Meteorologic Model: 100-yr Type II
Compute Time: 15Mar2022, 09:38:27 Control Specifications: 24-hr Storm

Volume Units: AC-FT

Computed Results

Peak Discharge :	284.3 (CFS)	Date/Time of Peak Discharge :	01Oct2021, 12:52
Total Precipitation :	161.5 (AC-FT)	Total Direct Runoff :	60.6 (AC-FT)
Total Loss :	99.5 (AC-FT)	Total Baseflow :	0.0 (AC-FT)
Total Excess :	62.0 (AC-FT)	Discharge :	60.6 (AC-FT)

Subbasin "OB8" Results for Run "EV 100-yr Pr. Type II"

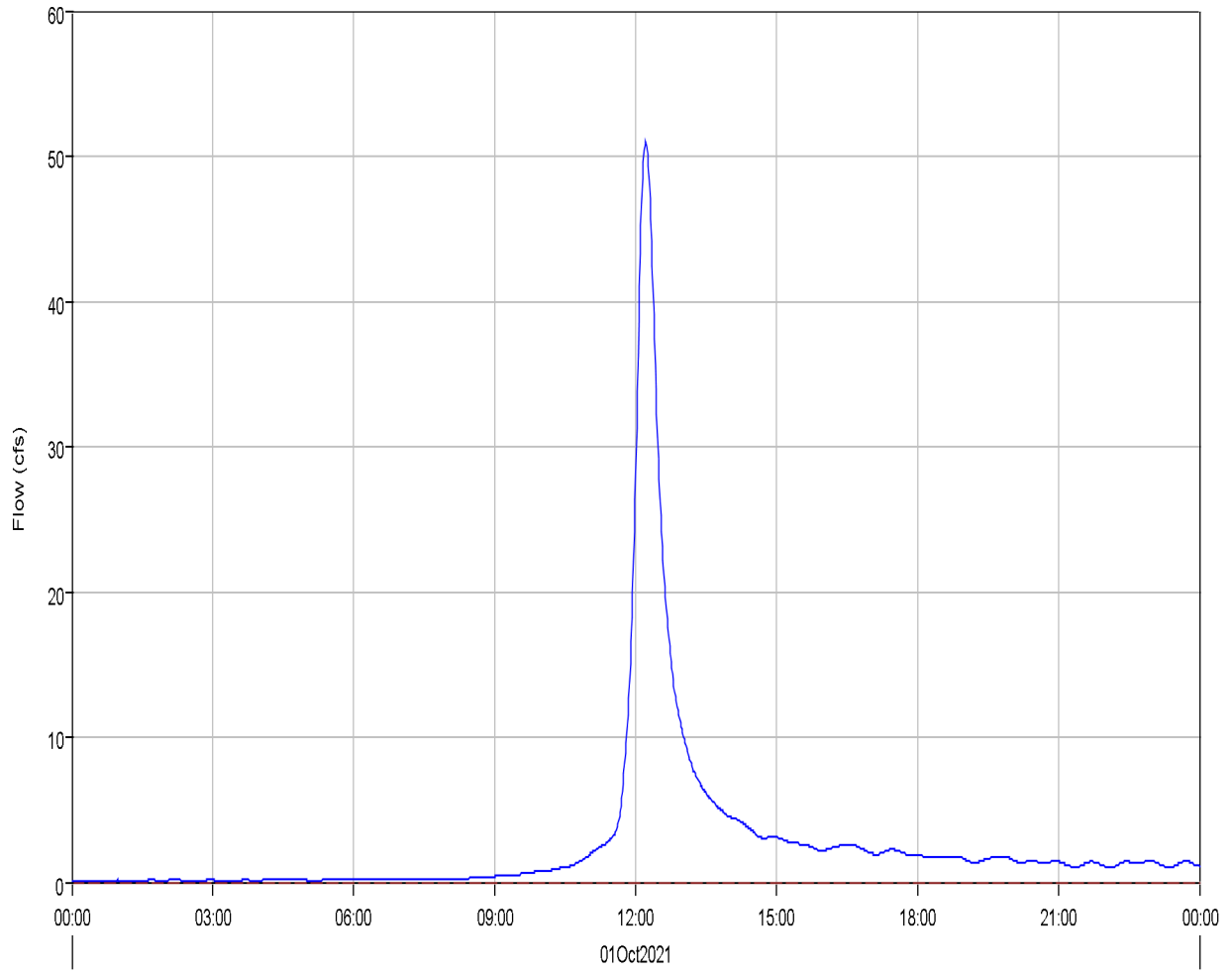
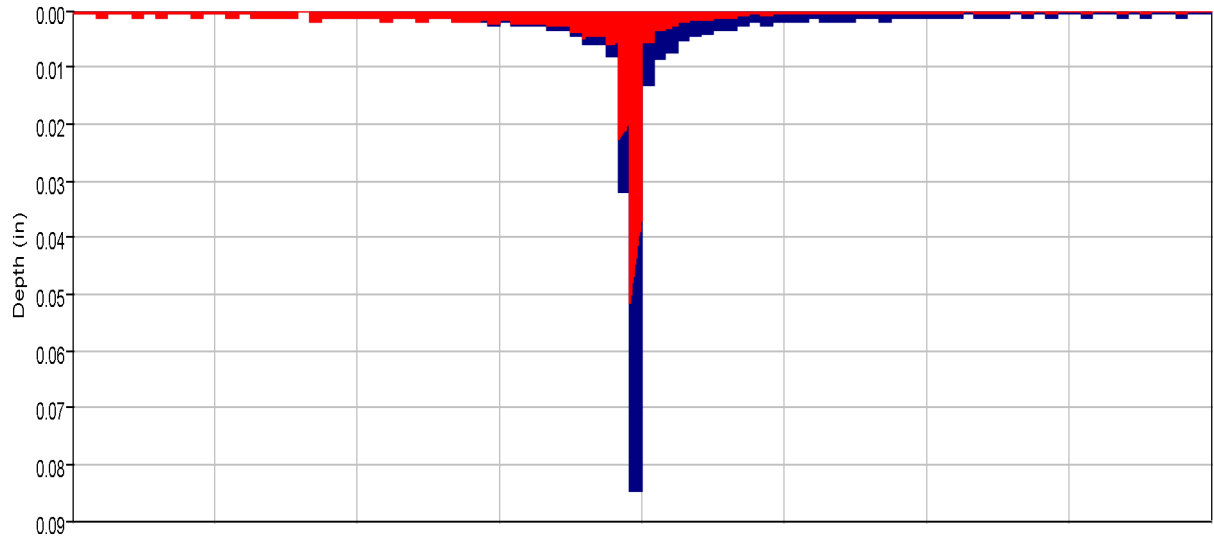

Run:EV 100-yr Pr. Type II Element:OB8 Result:Precipitation
Run:EV 100-yr Pr. Type II Element:OB8 Result:Outflow

Run:EV 100-yr Pr. Type II Element:OB8 Result:Precipitation Loss
Run:EV 100-yr Pr. Type II Element:OB8 Result:Baseflow

Project: Eagleview_Subdivision
Simulation Run: EV 100-yr Pr. Type II Subbasin: OB8

Start of Run: 01Oct2021, 00:00 Basin Model: Eagleview_Proposed
End of Run: 02Oct2021, 00:00 Meteorologic Model: 100-yr Type II
Compute Time: 15Mar2022, 09:38:27 Control Specifications: 24-hr Storm

Volume Units: AC-FT

Computed Results

Peak Discharge :	51.0 (CFS)	Date/Time of Peak Discharge :	01Oct2021, 12:13
Total Precipitation :	12.7 (AC-FT)	Total Direct Runoff :	5.3 (AC-FT)
Total Loss :	7.3 (AC-FT)	Total Baseflow :	0.0 (AC-FT)
Total Excess :	5.3 (AC-FT)	Discharge :	5.3 (AC-FT)

Junction 'P1' Results for Run 'EV 100-yr Pr. Type II'

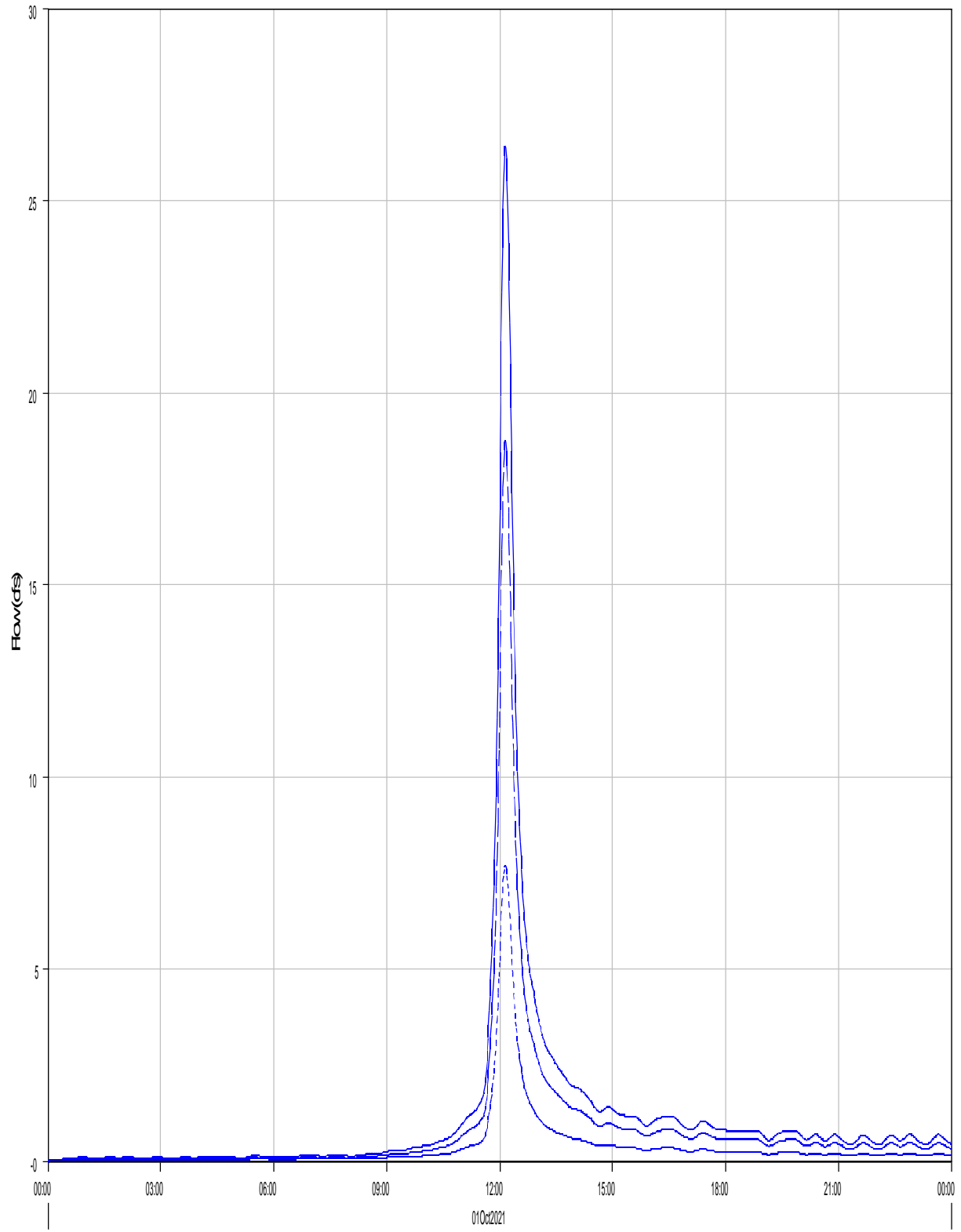

— Run:EV 100-yr Pr. Type II Element:P1 Result:Outflow

- - - Run:EV 100-yr Pr. Type II Element:R-CB1 Result:Outflow

... Run:EV 100-yr Pr. Type II Element:PB1 Result:Outflow

Project: Eagleview_Subdivision
Simulation Run: EV 100-yr Pr. Type II Junction: P1
Start of Run: 01Oct2021, 00:00 Basin Model: Eagleview_Proposed
End of Run: 02Oct2021, 00:00 Meteorologic Model: 100-yr Type II
Compute Time: 15Mar2022, 09:38:27 Control Specifications: 24-hr Storm

Volume Units: AC-FT

Computed Results

Peak Outflow : 26.4 (CFS) Date/Time of Peak Outflow : 01Oct2021, 12:09
Total Outflow : 2.4 (AC-FT)

Junction 'P2' Results for Run 'EV 100-yr Pr. Type II'

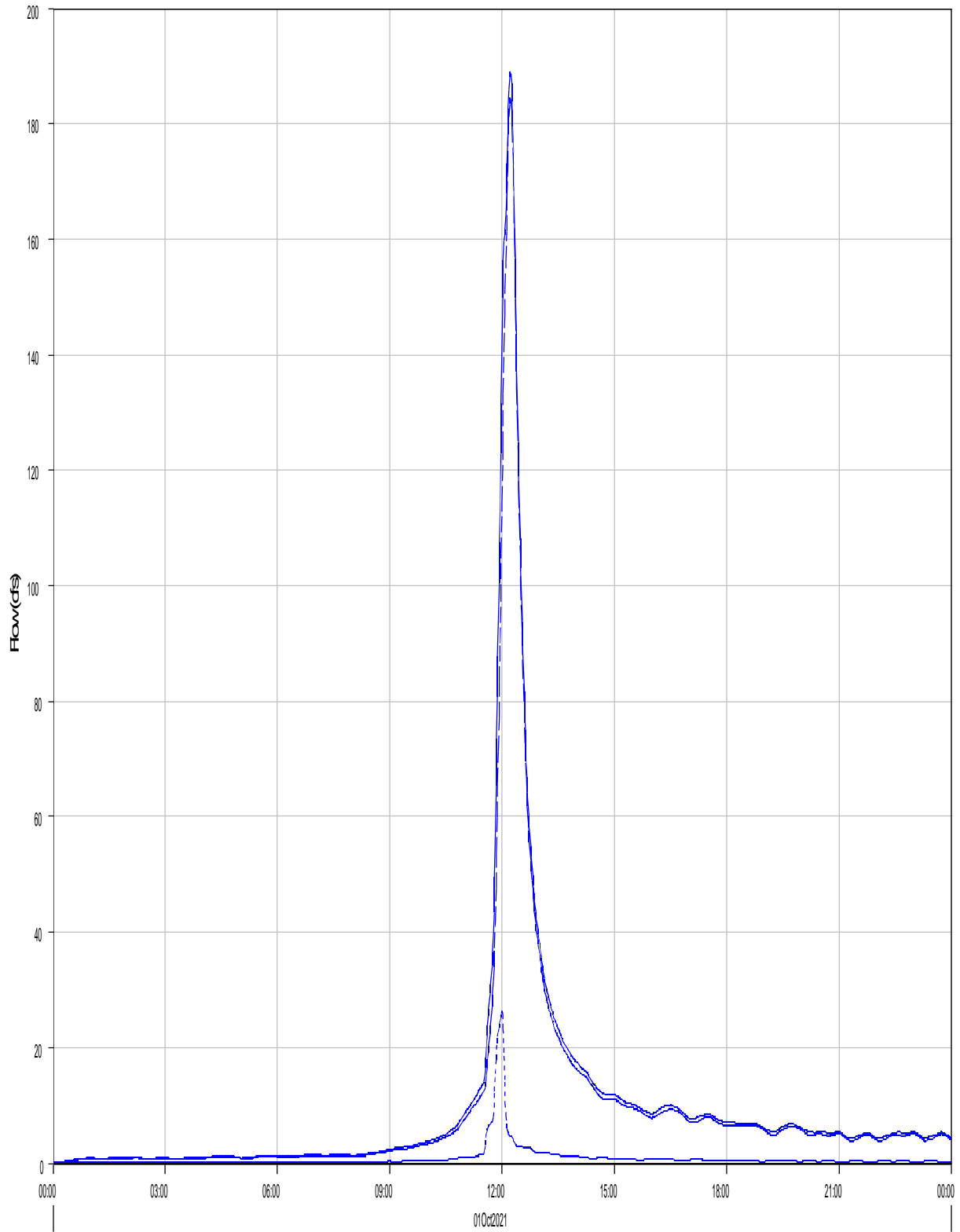

— Run:EV 100-yr Pr. Type II Element:P2 Result:Outflow

- - - Run:EV 100-yr Pr. Type II Element:R-PB7C Result:Outflow

... Run:EV 100-yr Pr. Type II Element:PB15 Result:Outflow

Project: Eagleview_Subdivision
Simulation Run: EV 100-yr Pr. Type II Junction: P2
Start of Run: 01Oct2021, 00:00 Basin Model: Eagleview_Proposed
End of Run: 02Oct2021, 00:00 Meteorologic Model: 100-yr Type II
Compute Time: 15Mar2022, 09:38:27 Control Specifications: 24-hr Storm

Volume Units: AC-FT

Computed Results

Peak Outflow : 189.1 (CFS) Date/Time of Peak Outflow : 01Oct2021, 12:13
Total Outflow : 21.4 (AC-FT)

Junction 'P3' Results for Run 'EV 100-yr Pr. Type II'

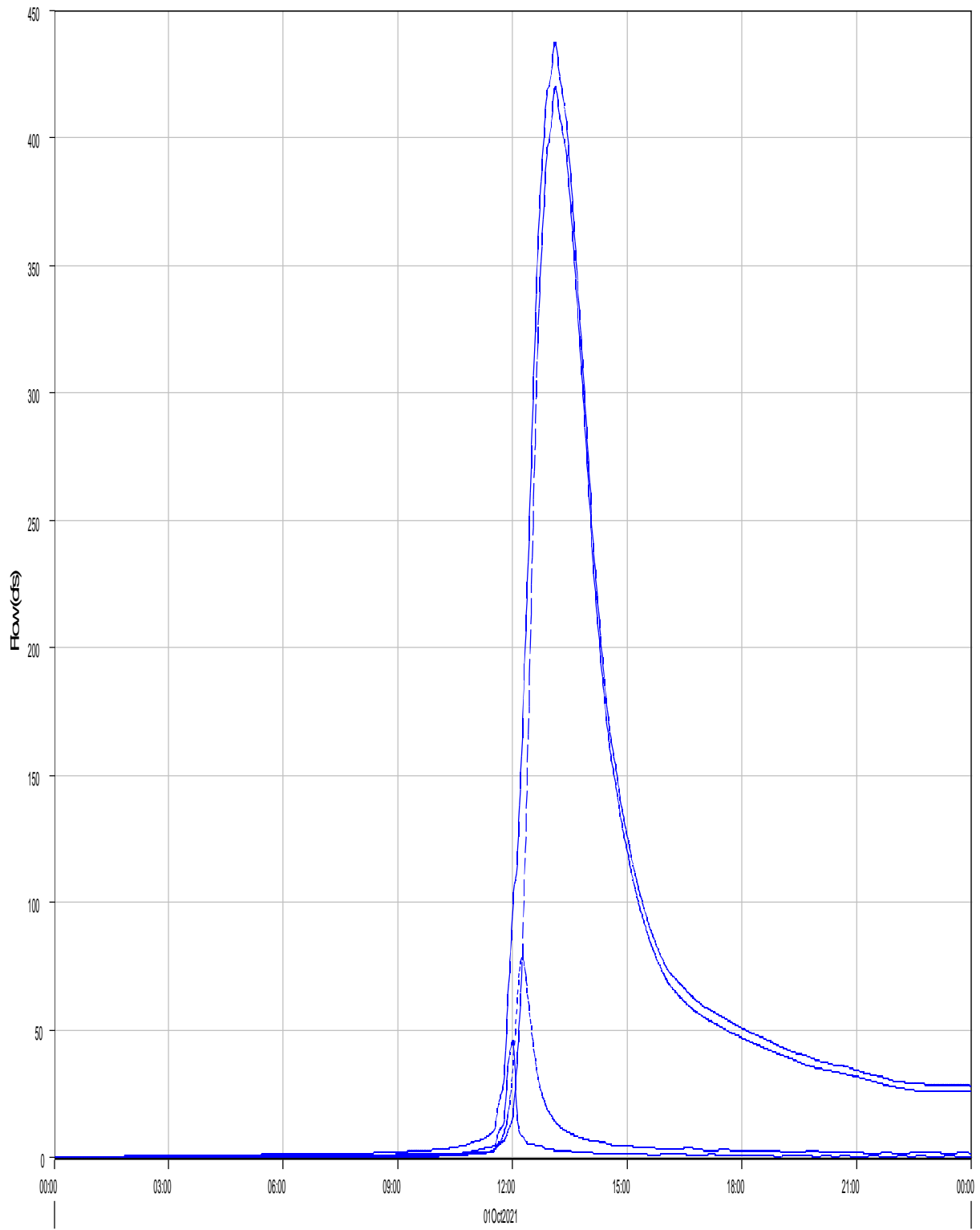

Run:EV 100-yr Pr. Type II Element:P3 Result:Outflow

Run:EV 100-yr Pr. Type II Element:R-PB13 Result:Outflow

Run:EV 100-yr Pr. Type II Element:R-PB12-B Result:Outflow

Run:EV 100-yr Pr. Type II Element:PB14 Result:Outflow

Project: Eagleview_Subdivision
Simulation Run: EV 100-yr Pr. Type II Junction: P3
Start of Run: 01Oct2021, 00:00 Basin Model: Eagleview_Proposed
End of Run: 02Oct2021, 00:00 Meteorologic Model: 100-yr Type II
Compute Time: 15Mar2022, 09:38:27 Control Specifications: 24-hr Storm

Volume Units: AC-FT

Computed Results

Peak Outflow : 437.7 (CFS) Date/Time of Peak Outflow : 01Oct2021, 13:07
Total Outflow : 107.9 (AC-FT)

Junction 'P4' Results for Run 'EV 100-yr Pr. Type II'

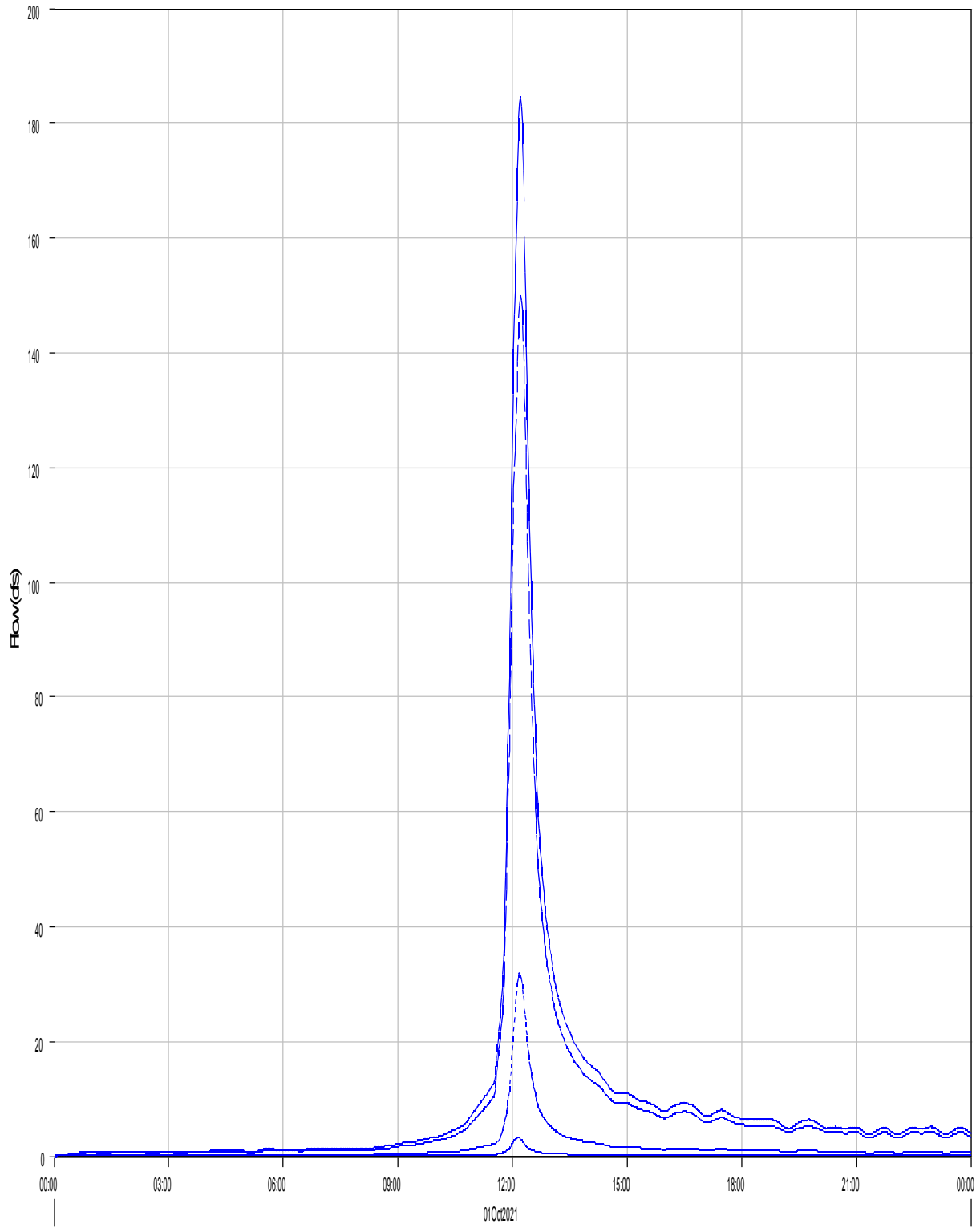

Run:EV 100-yr Pr. Type II Element:P4 Result:Outflow
Run:EV 100-yr Pr. Type II Element:R-PB3 Result:Outflow

Run:EV 100-yr Pr. Type II Element:R-PB5 Result:Outflow

Run:EV 100-yr Pr. Type II Element:R-PB7-B Result:Outflow

Project: Eagleview_Subdivision
Simulation Run: EV 100-yr Pr. Type II Junction: P4
Start of Run: 01Oct2021, 00:00 Basin Model: Eagleview_Proposed
End of Run: 02Oct2021, 00:00 Meteorologic Model: 100-yr Type II
Compute Time: 15Mar2022, 09:38:27 Control Specifications: 24-hr Storm

Volume Units: AC-FT

Computed Results

Peak Outflow : 184.6 (CFS) Date/Time of Peak Outflow : 01Oct2021, 12:12
Total Outflow : 19.8 (AC-FT)

Reach 'P5 (CULV7)' Results for Run 'EV 100-yr Pr. Type II'

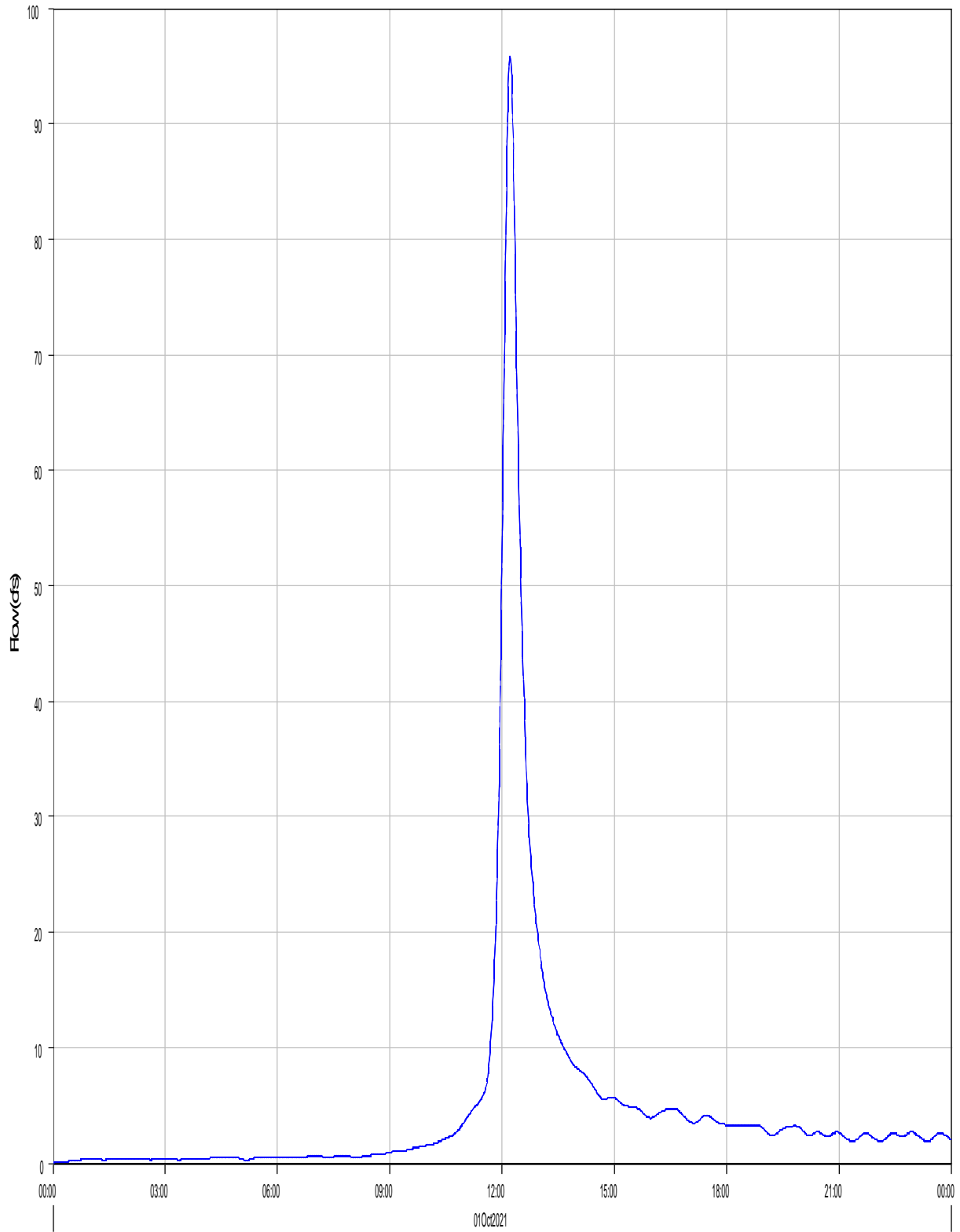

— Run:EV 100-yr Pr. Type II Element:P5 (CULV7) Result:Outflow

- - - Run:EV 100-yr Pr. Type II Element:P5 (CULV7) Result:Combined Inflow

Project: Eagleview_Subdivision

Simulation Run: EV 100-yr Pr. Type II Reach: P5 (CULV7)

Start of Run: 01Oct2021, 00:00 Basin Model: Eagleview_Proposed

End of Run: 02Oct2021, 00:00 Meteorologic Model: 100-yr Type II

Compute Time: 15Mar2022, 09:38:27 Control Specifications: 24-hr Storm

Volume Units: AC-FT

Computed Results

Peak Inflow :	95.9 (CFS)	Date/Time of Peak Inflow :	01Oct2021, 12:13
Peak Outflow :	95.9 (CFS)	Date/Time of Peak Outflow :	01Oct2021, 12:13
Total Inflow :	9.8 (AC-FT)	Total Outflow :	9.8 (AC-FT)

Junction 'P6' Results for Run 'EV 100-yr Pr. Type II'

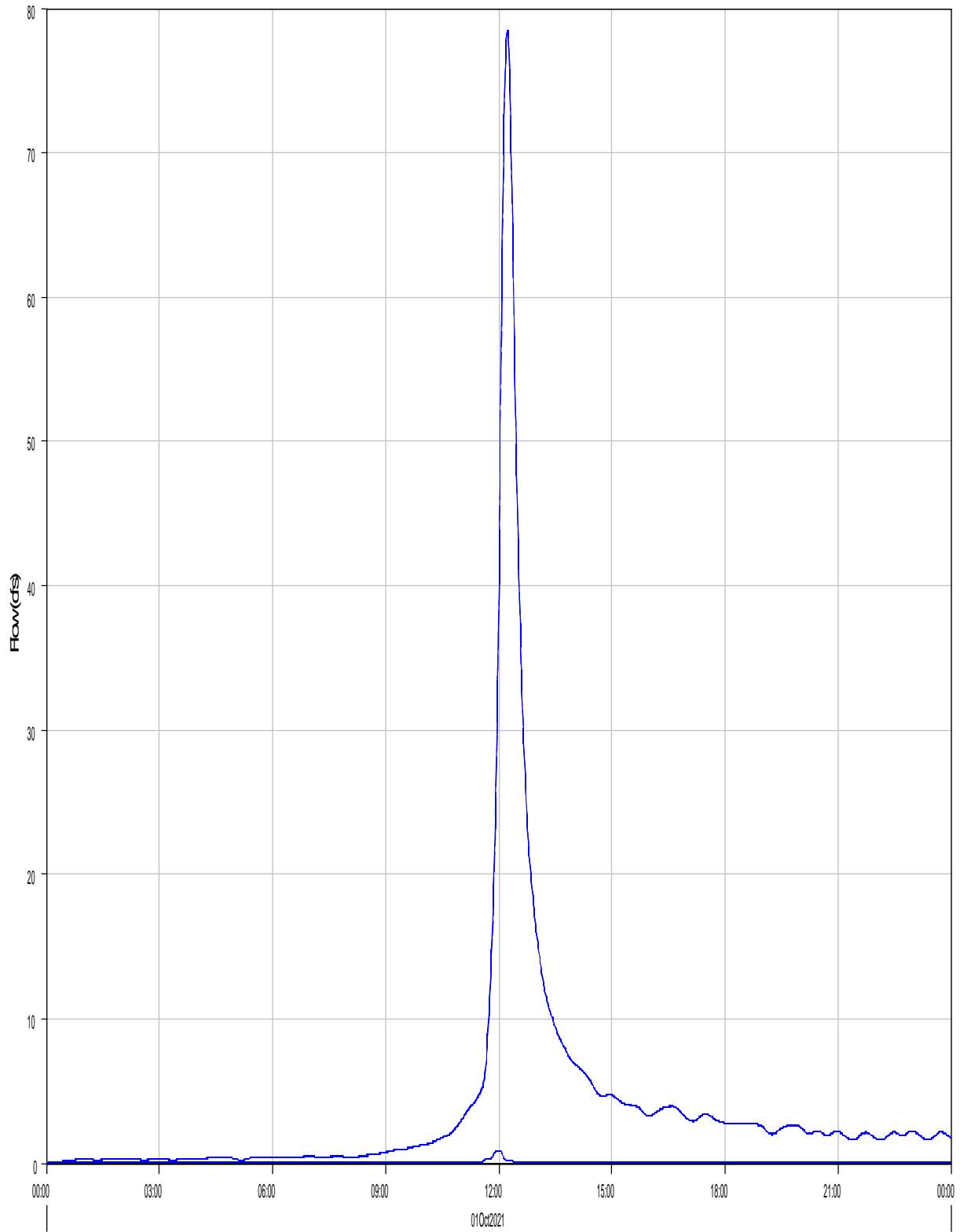

Run:EV 100-yr Pr. Type II Element:P6 Result:Outflow

Run:EV 100-yr Pr. Type II Element:R-PB11 Result:Outflow

Run:EV 100-yr Pr. Type II Element:R-PB12-A Result:Outflow

Project: Eagleview_Subdivision
Simulation Run: EV 100-yr Pr. Type II Junction: P6
Start of Run: 01Oct2021, 00:00 Basin Model: Eagleview_Proposed
End of Run: 02Oct2021, 00:00 Meteorologic Model: 100-yr Type II
Compute Time: 15Mar2022, 09:38:27 Control Specifications: 24-hr Storm

Volume Units: AC-FT

Computed Results

Peak Outflow : 78.5 (CFS) Date/Time of Peak Outflow : 01Oct2021, 12:14
Total Outflow : 8.2 (AC-FT)

Reservoir 'P7' Results for Run 'EV 100-yr Pr. Type II'

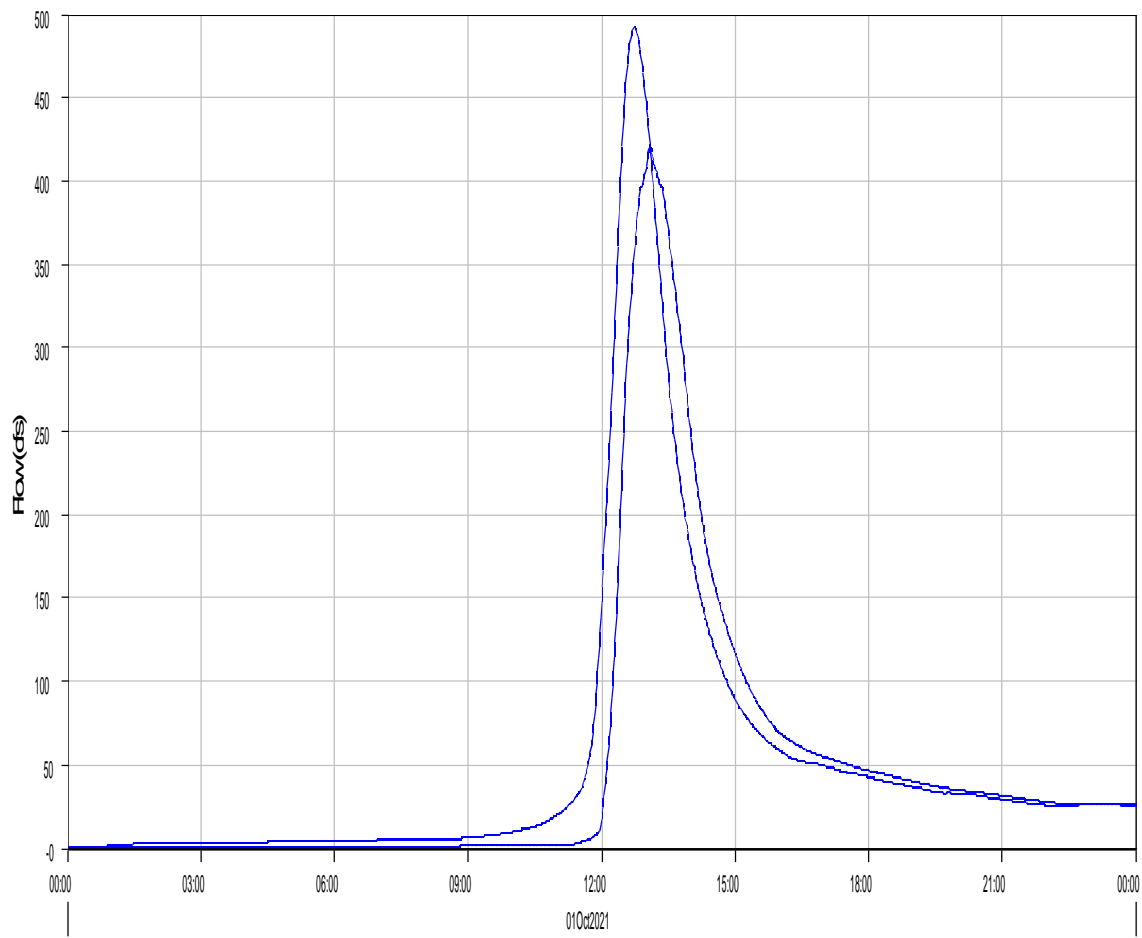
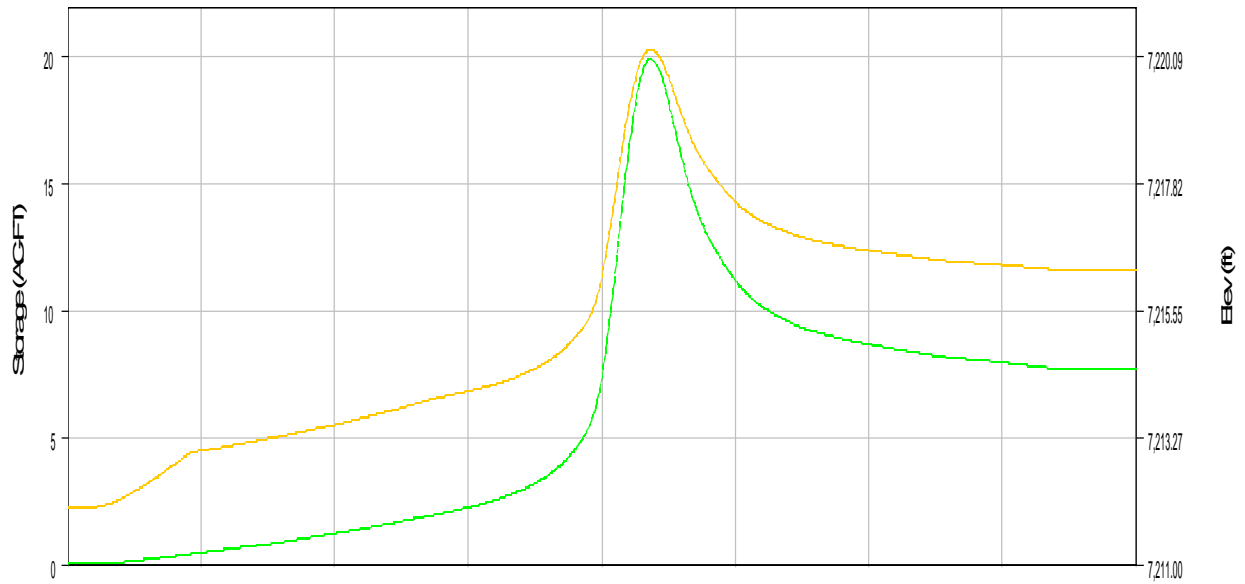

- - - Run:EV 100-yr Pr. Type II Element:P7 Result:Storage
- - - Run:EV 100-yr Pr. Type II Element:P7 Result:Pool Elevation
- Run:EV 100-yr Pr. Type II Element:P7 Result:Outflow
- - - Run:EV 100-yr Pr. Type II Element:P7 Result:Combined Flow

Project: Eagleview_Subdivision
Simulation Run: EV 100-yr Pr. Type II Reservoir: P7
Start of Run: 01Oct2021, 00:00 Basin Model: Eagleview_Proposed
End of Run: 02Oct2021, 00:00 Meteorologic Model: 100-yr Type II
Compute Time: 15Mar2022, 09:38:27 Control Specifications: 24-hr Storm

Volume Units: AC-FT

Computed Results

Peak Inflow :	491.6 (CFS)	Date/Time of Peak Inflow :	01Oct2021, 12:44
Peak Outflow :	420.1 (CFS)	Date/Time of Peak Outflow :	01Oct2021, 13:05
Total Inflow :	104.2 (AC-FT)	Peak Storage :	19.9 (AC-FT)
Total Outflow :	96.5 (AC-FT)	Peak Elevation :	7220.2 (FT)

Junction 'P8' Results for Run 'EV 100-yr Pr. Type II'

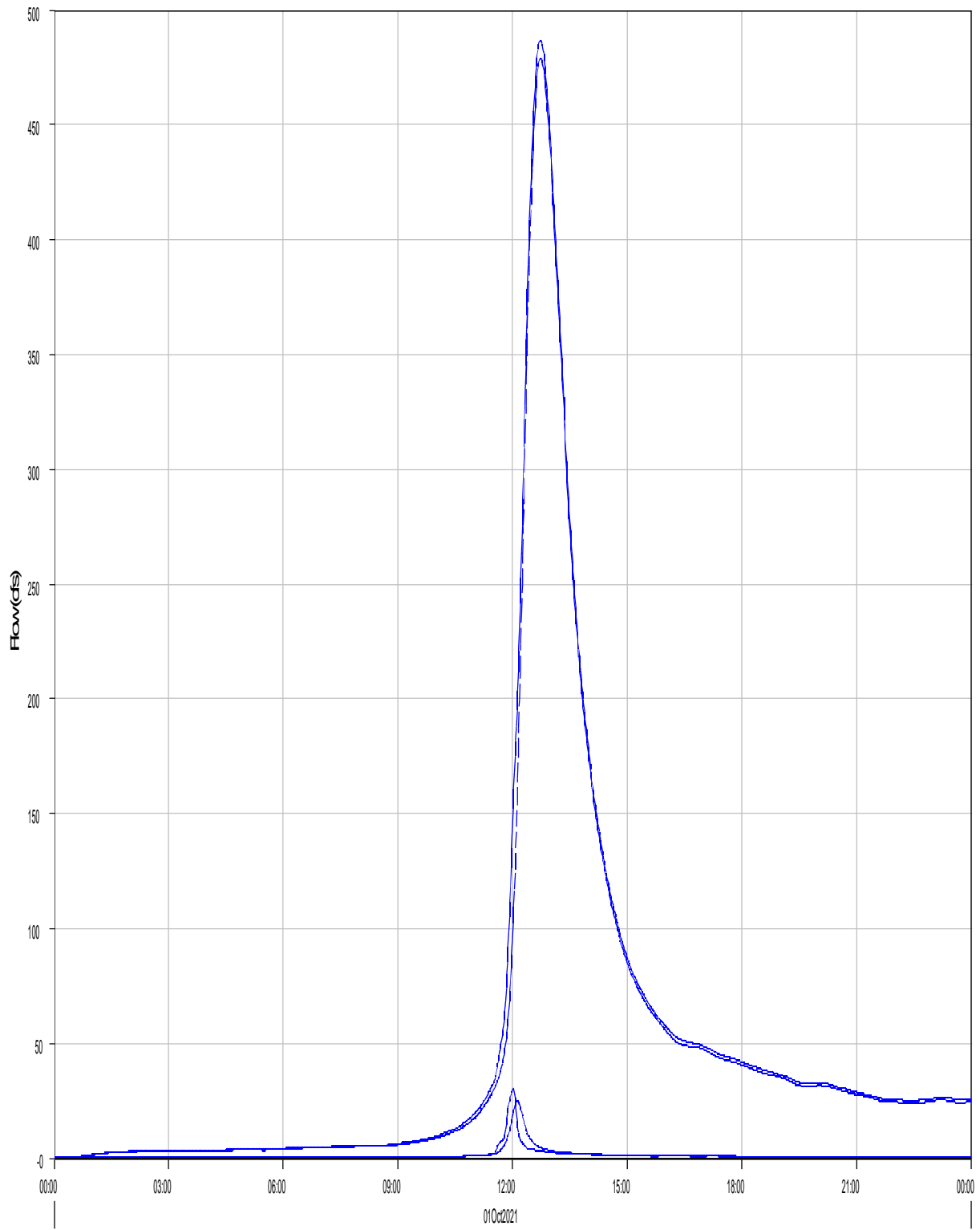

Run:EV 100-yr Pr. Type II Element:P8 Result:Outflow
Run:EV 100-yr Pr. Type II Element:P88 Result:Outflow

Run:EV 100-yr Pr. Type II Element:R-0B7 Result:Outflow

Run:EV 100-yr Pr. Type II Element:P88 Result:Outflow

Project: Eagleview_Subdivision
Simulation Run: EV 100-yr Pr. Type II Junction: P8
Start of Run: 01Oct2021, 00:00 Basin Model: Eagleview_Proposed
End of Run: 02Oct2021, 00:00 Meteorologic Model: 100-yr Type II
Compute Time: 15Mar2022, 09:38:27 Control Specifications: 24-hr Storm

Volume Units: AC-FT

Computed Results

Peak Outflow : 486.7 (CFS) Date/Time of Peak Outflow : 01Oct2021, 12:44
Total Outflow : 102.2 (AC-FT)

Reach 'P9 (CULV6)' Results for Run 'EV 100-yr Pr. Type II'

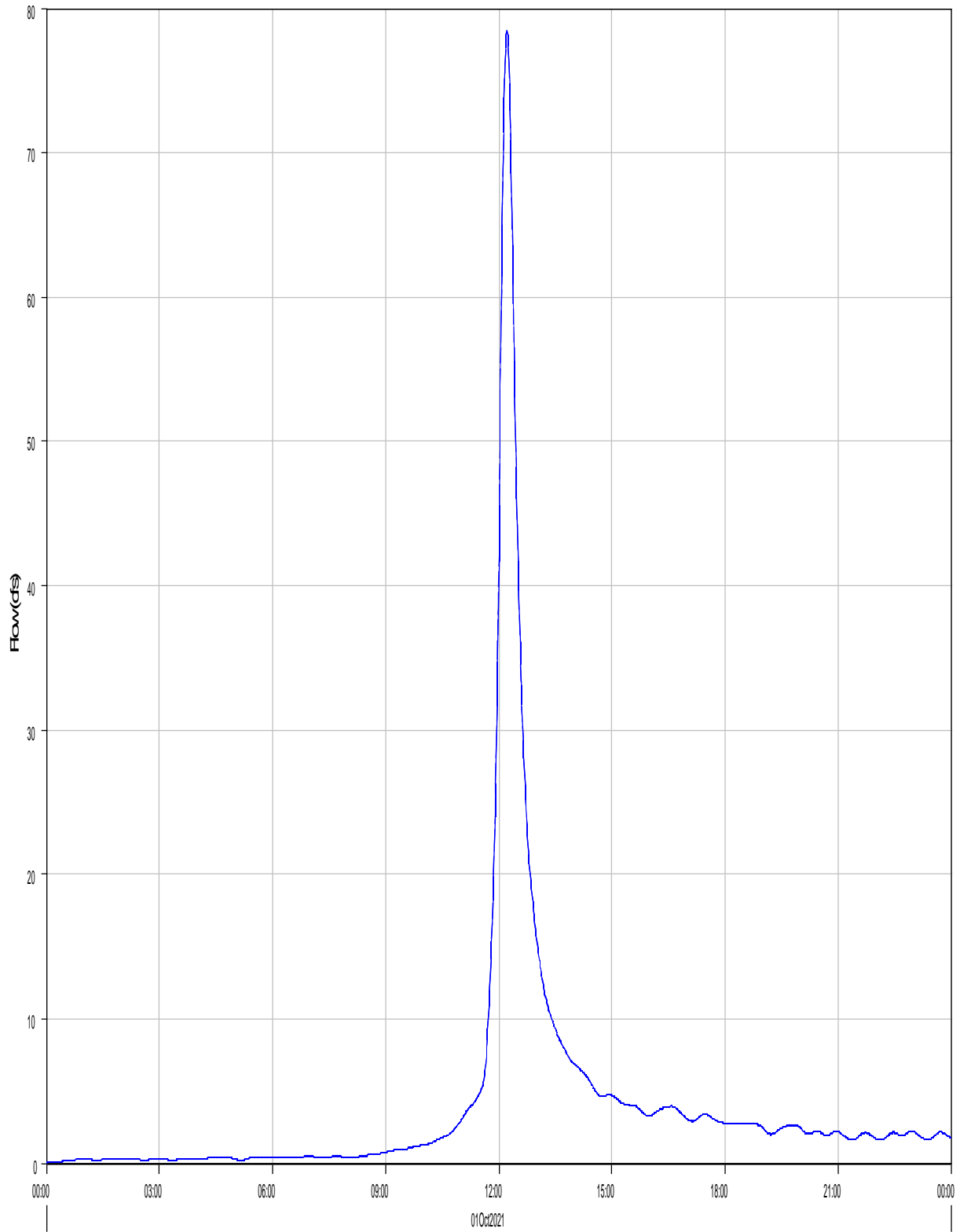

Run:EV 100-yr Pr. Type II Element:P9 (CULV6) Result:Outflow

Run:EV 100-yr Pr. Type II Element:P9 (CULV6) Result:Combined Inflow

Project: Eagleview_Subdivision

Simulation Run: EV 100-yr Pr. Type II Reach: P9 (CULV6)

Start of Run: 01Oct2021, 00:00 Basin Model: Eagleview_Proposed

End of Run: 02Oct2021, 00:00 Meteorologic Model: 100-yr Type II

Compute Time: 15Mar2022, 09:38:27 Control Specifications: 24-hr Storm

Volume Units: AC-FT

Computed Results

Peak Inflow :	78.4 (CFS)	Date/Time of Peak Inflow :	01Oct2021, 12:13
Peak Outflow :	78.4 (CFS)	Date/Time of Peak Outflow :	01Oct2021, 12:13
Total Inflow :	8.2 (AC-FT)	Total Outflow :	8.2 (AC-FT)

Reach 'P10 (CULV2)' Results for Run 'EV 100-yr Pr. Type II'

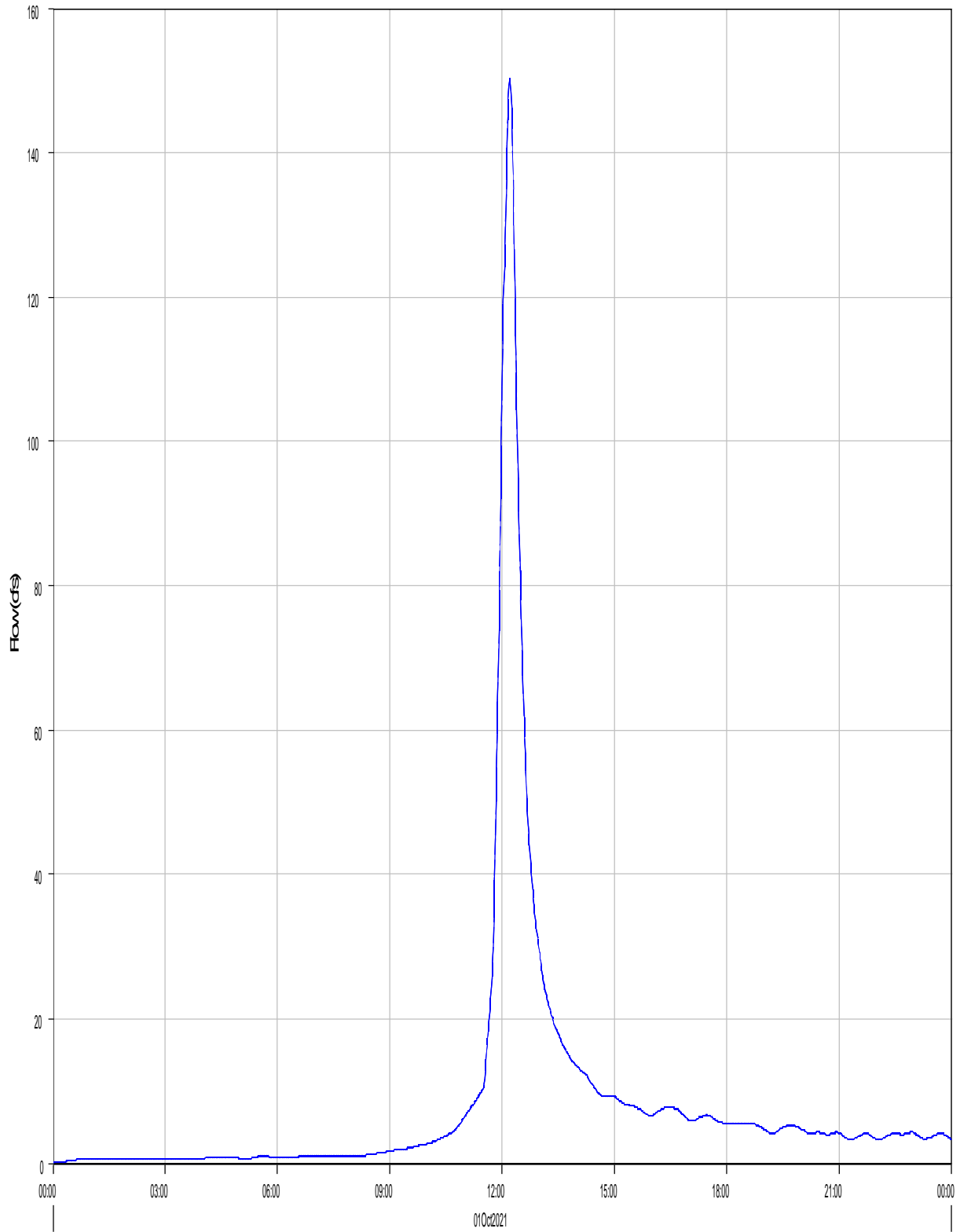

Run:EV 100-yr Pr. Type II Element:P10 (CULV2) Result:Outflow

Run:EV 100-yr Pr. Type II Element:P10 (CULV2) Result:Combined Inflow

Project: Eagleview_Subdivision

Simulation Run: EV 100-yr Pr. Type II Reach: P10 (CULV2)

Start of Run: 01Oct2021, 00:00 Basin Model: Eagleview_Proposed

End of Run: 02Oct2021, 00:00 Meteorologic Model: 100-yr Type II

Compute Time: 15Mar2022, 09:38:27 Control Specifications: 24-hr Storm

Volume Units: AC-FT

Computed Results

Peak Inflow :	150.2 (CFS)	Date/Time of Peak Inflow :	01Oct2021, 12:12
Peak Outflow :	150.1 (CFS)	Date/Time of Peak Outflow :	01Oct2021, 12:12
Total Inflow :	16.4 (AC-FT)	Total Outflow :	16.4 (AC-FT)

Reach 'P11 (CULV3)' Results for Run 'EV 100-yr Pr. Type II'

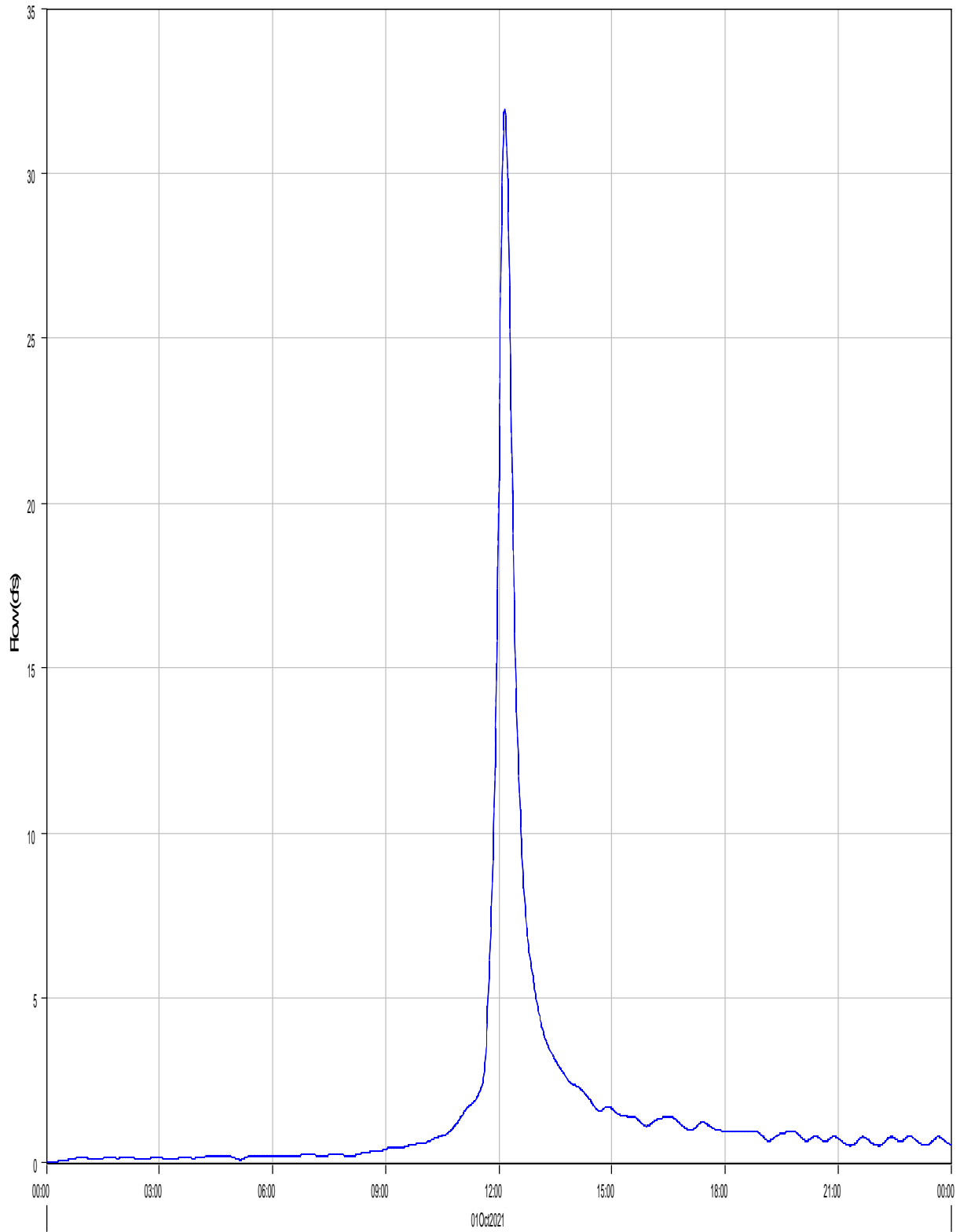

Run:EV 100-yr Pr. Type II Element:P11 (CULV3) Result:Outflow

Run:EV 100-yr Pr. Type II Element:P11 (CULV3) Result:Combined Inflow

Project: Eagleview_Subdivision

Simulation Run: EV 100-yr Pr. Type II Reach: P11 (CULV3)

Start of Run: 01Oct2021, 00:00 Basin Model: Eagleview_Proposed

End of Run: 02Oct2021, 00:00 Meteorologic Model: 100-yr Type II

Compute Time: 15Mar2022, 09:38:27 Control Specifications: 24-hr Storm

Volume Units: AC-FT

Computed Results

Peak Inflow :	31.9 (CFS)	Date/Time of Peak Inflow :	01Oct2021, 12:10
Peak Outflow :	31.9 (CFS)	Date/Time of Peak Outflow :	01Oct2021, 12:10
Total Inflow :	3.1 (AC-FT)	Total Outflow :	3.1 (AC-FT)

Reach 'P12 (CULV8)' Results for Run 'EV 100-yr Pr. Type II'

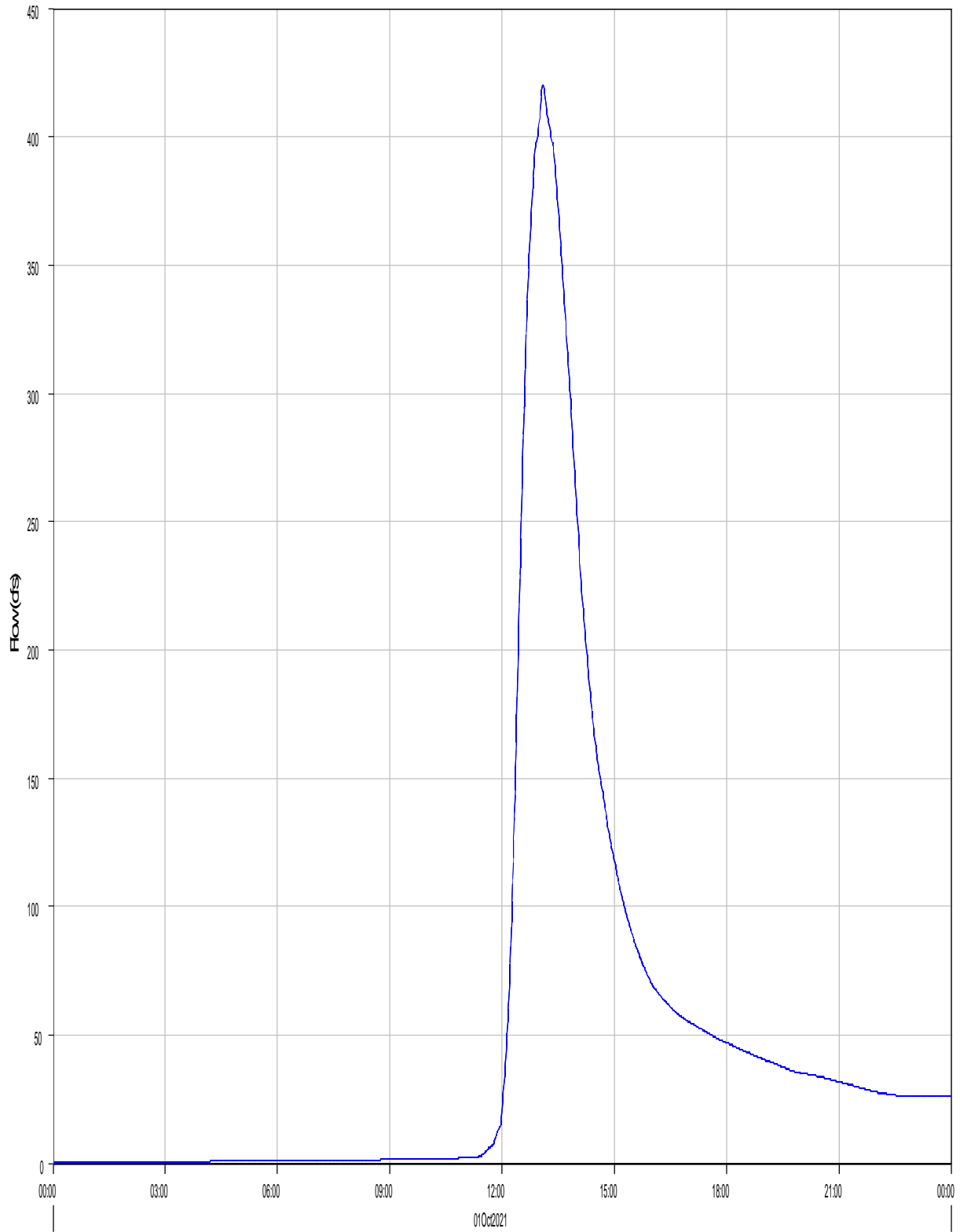

Run:EV 100-yr Pr. Type II Element:P12 (CULV8) Result:Outflow

Run:EV 100-yr Pr. Type II Element:P12 (CULV8) Result:Combined Inflow

Project: Eagleview_Subdivision
Simulation Run: EV 100-yr Pr. Type II Reach: P12 (CULV8)

Start of Run: 01Oct2021, 00:00 Basin Model: Eagleview_Proposed
End of Run: 02Oct2021, 00:00 Meteorologic Model: 100-yr Type II
Compute Time: 15Mar2022, 09:38:27 Control Specifications: 24-hr Storm

Volume Units: AC-FT

Computed Results

Peak Inflow :	420.4 (CFS)	Date/Time of Peak Inflow :	01Oct2021, 13:06
Peak Outflow :	420.3 (CFS)	Date/Time of Peak Outflow :	01Oct2021, 13:06
Total Inflow :	96.8 (AC-FT)	Total Outflow :	96.8 (AC-FT)

Subbasin "PB1" Results for Run "EV 100-yr Pr. Type II"

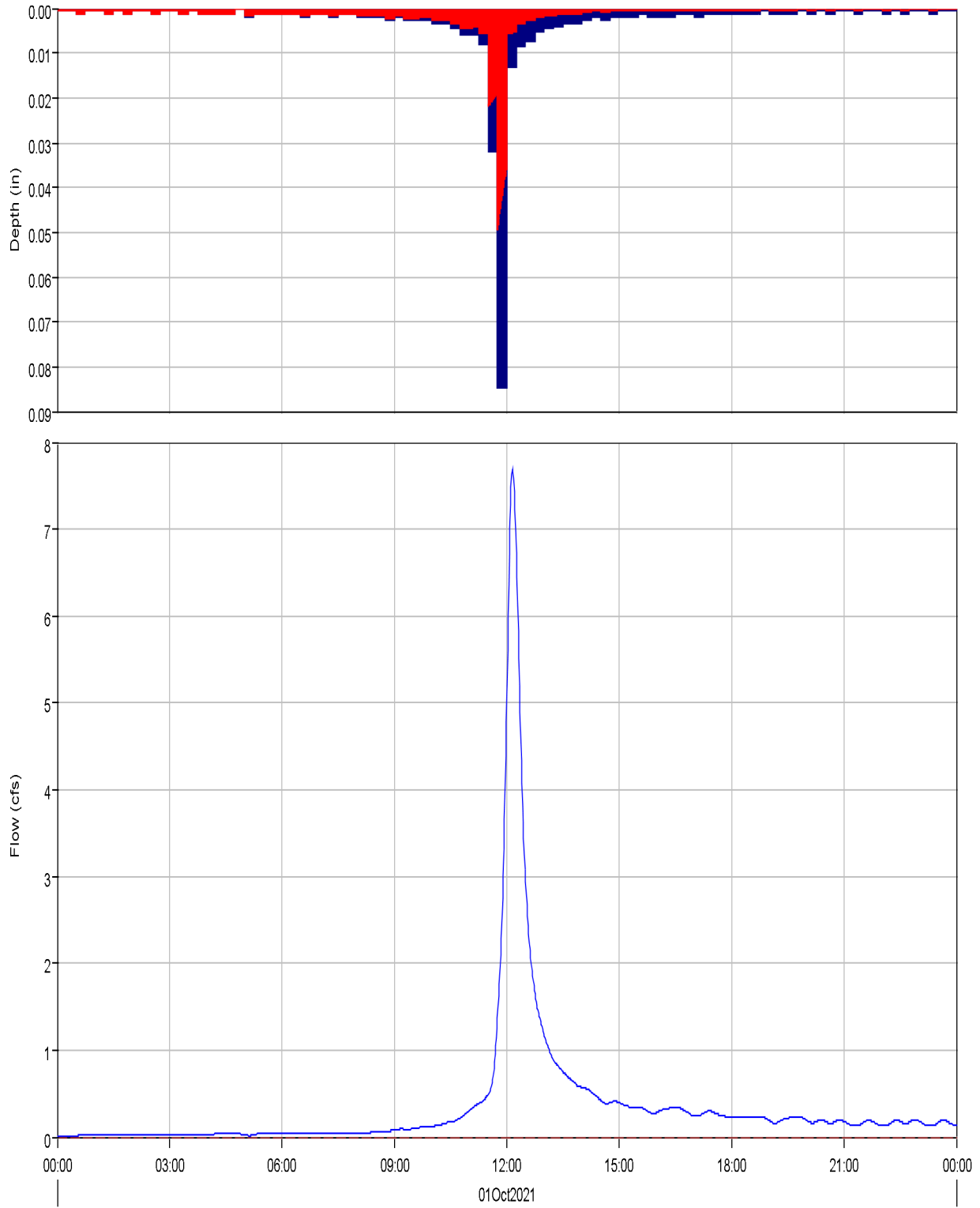

Run:EV 100-yr Pr. Type II Element:PB1 Result:Precipitation
Run:EV 100-yr Pr. Type II Element:PB1 Result:Outflow

Run:EV 100-yr Pr. Type II Element:PB1 Result:Precipitation Loss
Run:EV 100-yr Pr. Type II Element:PB1 Result:Baseflow

Project: Eagleview_Subdivision
Simulation Run: EV 100-yr Pr. Type II Subbasin: PB1
Start of Run: 01Oct2021, 00:00 Basin Model: Eagleview_Proposed
End of Run: 02Oct2021, 00:00 Meteorologic Model: 100-yr Type II
Compute Time: 15Mar2022, 09:38:27 Control Specifications: 24-hr Storm

Volume Units: AC-FT

Computed Results

Peak Discharge :	7.7 (CFS)	Date/Time of Peak Discharge :	01Oct2021, 12:09
Total Precipitation :	1.6 (AC-FT)	Total Direct Runoff :	0.7 (AC-FT)
Total Loss :	0.9 (AC-FT)	Total Baseflow :	0.0 (AC-FT)
Total Excess :	0.7 (AC-FT)	Discharge :	0.7 (AC-FT)

Subbasin "PB2" Results for Run "EV 100-yr Pr. Type II"

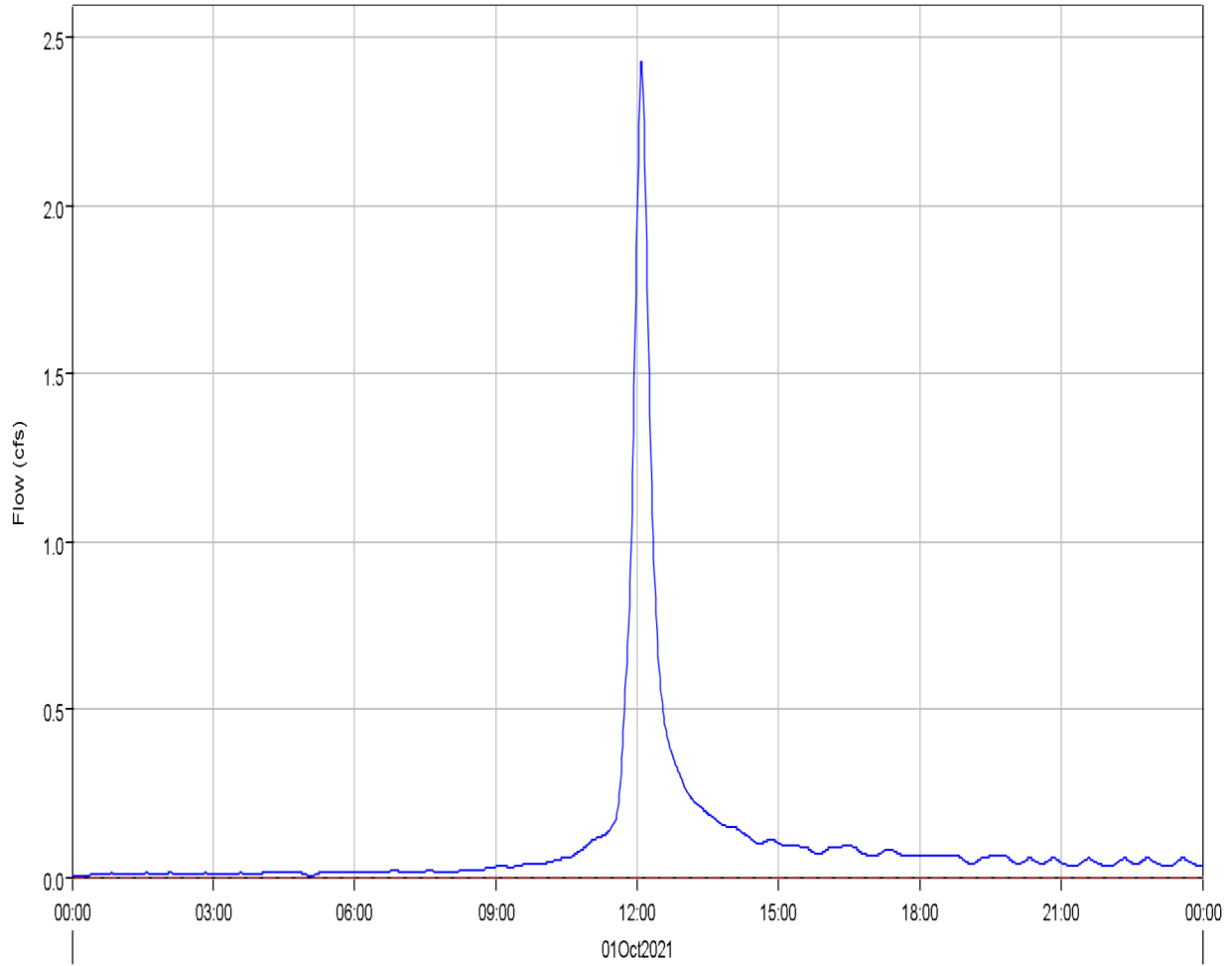
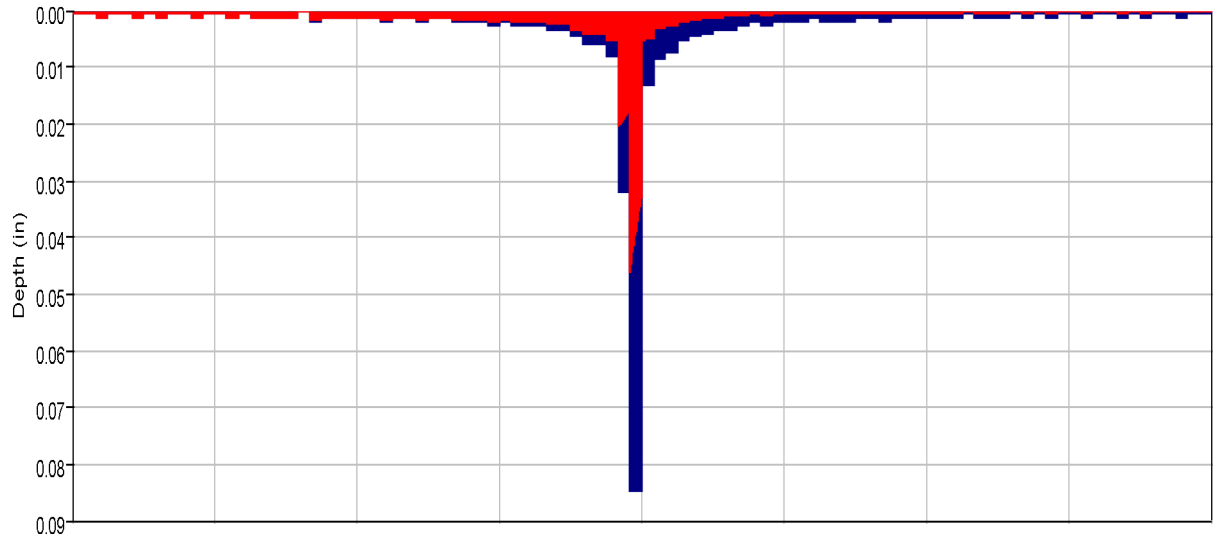

Run:EV 100-yr Pr. Type II Element:PB2 Result:Precipitation
Run:EV 100-yr Pr. Type II Element:PB2 Result:Outflow

Run:EV 100-yr Pr. Type II Element:PB2 Result:Precipitation Loss
Run:EV 100-yr Pr. Type II Element:PB2 Result:Baseflow

Project: Eagleview_Subdivision
Simulation Run: EV 100-yr Pr. Type II Subbasin: PB2
Start of Run: 01Oct2021, 00:00 Basin Model: Eagleview_Proposed
End of Run: 02Oct2021, 00:00 Meteorologic Model: 100-yr Type II
Compute Time: 15Mar2022, 09:38:27 Control Specifications: 24-hr Storm

Volume Units: AC-FT

Computed Results

Peak Discharge :	2.4 (CFS)	Date/Time of Peak Discharge :	01Oct2021, 12:06
Total Precipitation :	0.4 (AC-FT)	Total Direct Runoff :	0.2 (AC-FT)
Total Loss :	0.2 (AC-FT)	Total Baseflow :	0.0 (AC-FT)
Total Excess :	0.2 (AC-FT)	Discharge :	0.2 (AC-FT)

Subbasin "PB3" Results for Run "EV 100-yr Pr. Type II"

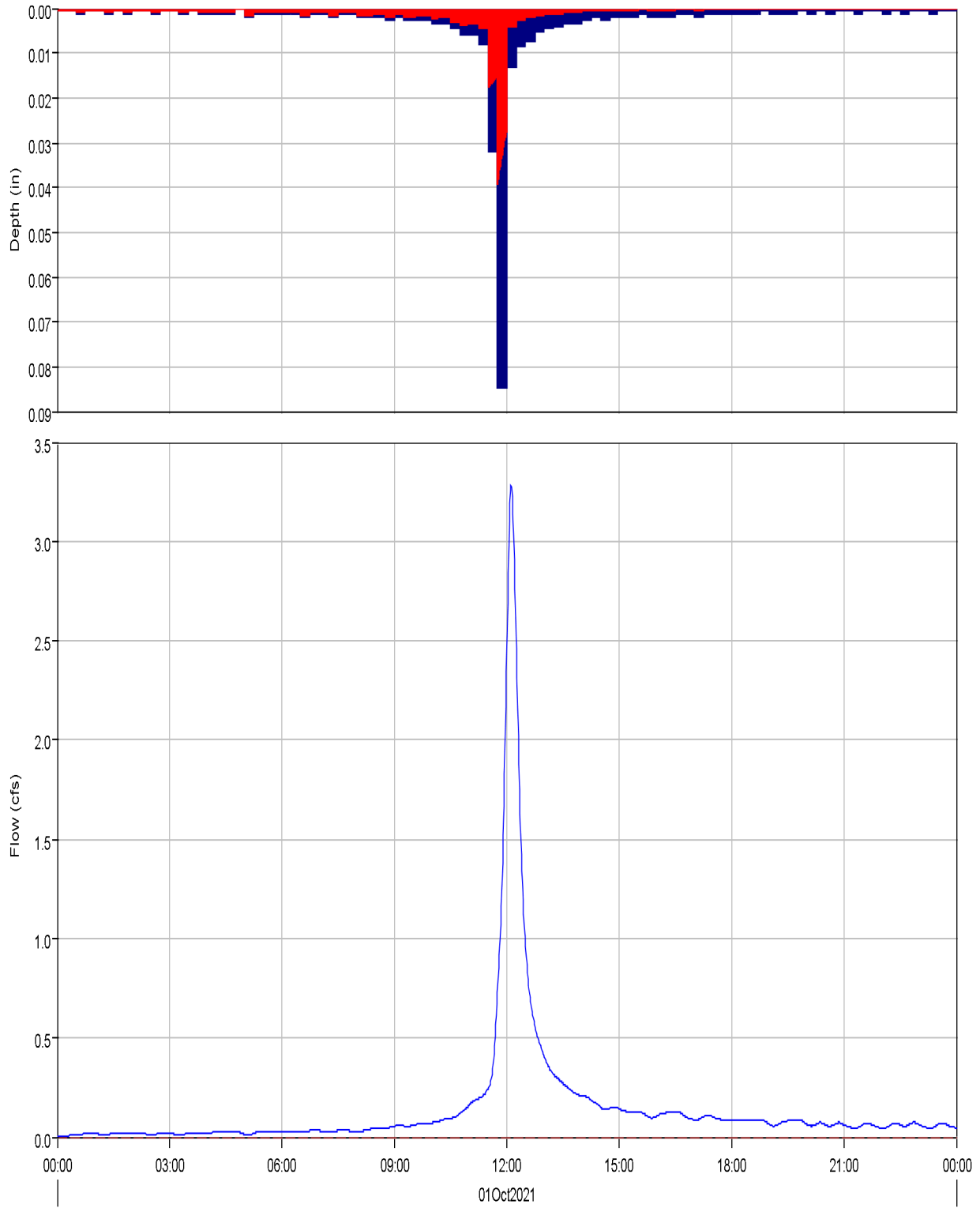

Run:EV 100-yr Pr. Type II Element:PB3 Result:Precipitation
Run:EV 100-yr Pr. Type II Element:PB3 Result:Outflow

Run:EV 100-yr Pr. Type II Element:PB3 Result:Precipitation Loss
Run:EV 100-yr Pr. Type II Element:PB3 Result:Baseflow

Project: Eagleview_Subdivision
Simulation Run: EV 100-yr Pr. Type II Subbasin: PB3

Start of Run: 01Oct2021, 00:00 Basin Model: Eagleview_Proposed
End of Run: 02Oct2021, 00:00 Meteorologic Model: 100-yr Type II
Compute Time: 15Mar2022, 09:38:27 Control Specifications: 24-hr Storm

Volume Units: AC-FT

Computed Results

Peak Discharge :	3.3 (CFS)	Date/Time of Peak Discharge :	01Oct2021, 12:07
Total Precipitation :	0.5 (AC-FT)	Total Direct Runoff :	0.3 (AC-FT)
Total Loss :	0.2 (AC-FT)	Total Baseflow :	0.0 (AC-FT)
Total Excess :	0.3 (AC-FT)	Discharge :	0.3 (AC-FT)

Subbasin "PB4" Results for Run "EV 100-yr Pr. Type II"

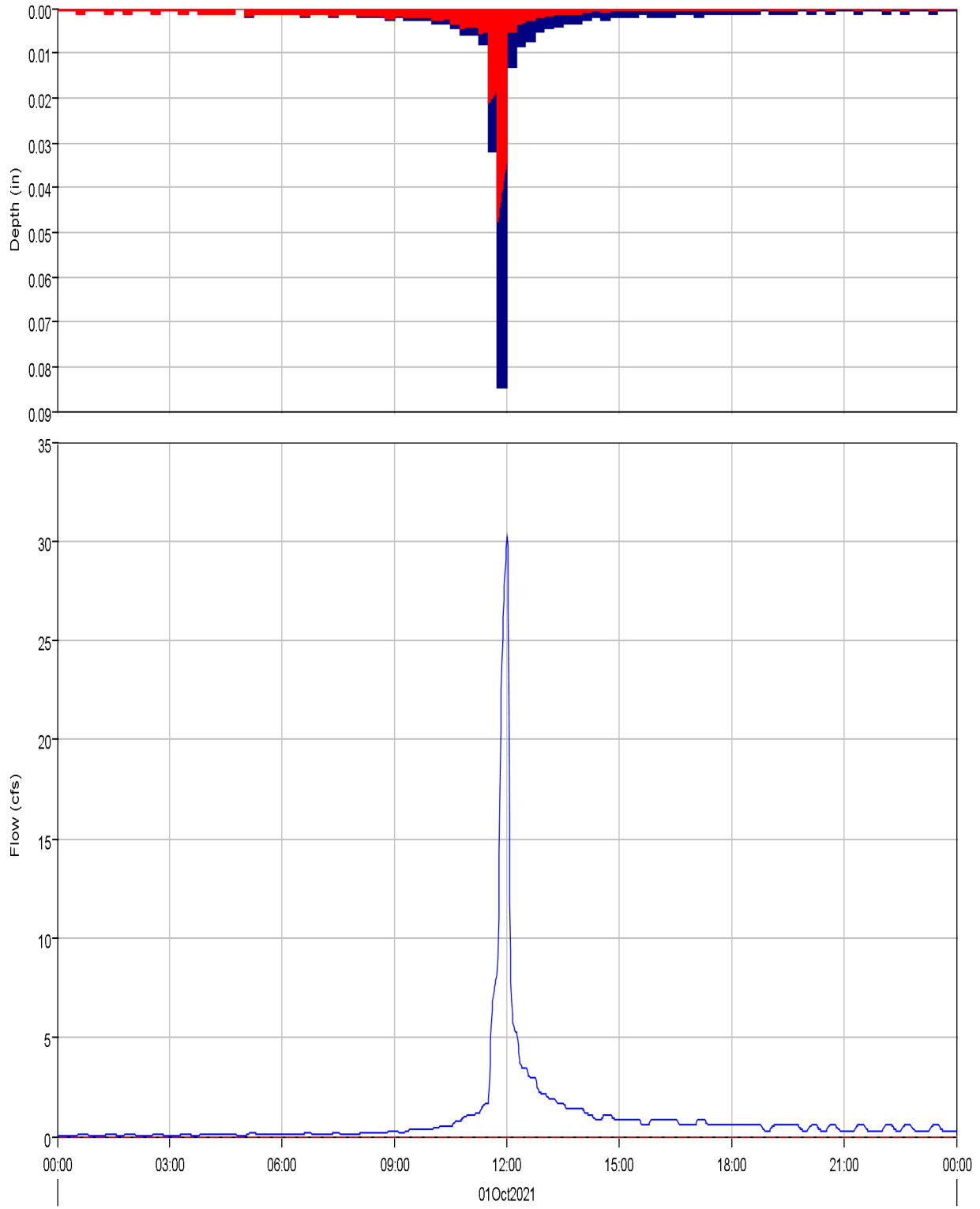

Run:EV 100-yr Pr. Type II Element:PB4 Result:Precipitation
Run:EV 100-yr Pr. Type II Element:PB4 Result:Outflow

Run:EV 100-yr Pr. Type II Element:PB4 Result:Precipitation Loss
Run:EV 100-yr Pr. Type II Element:PB4 Result:Baseflow

Project: Eagleview_Subdivision
Simulation Run: EV 100-yr Pr. Type II Subbasin: PB4

Start of Run: 01Oct2021, 00:00 Basin Model: Eagleview_Proposed
End of Run: 02Oct2021, 00:00 Meteorologic Model: 100-yr Type II
Compute Time: 15Mar2022, 09:38:27 Control Specifications: 24-hr Storm

Volume Units: AC-FT

Computed Results

Peak Discharge :	30.2 (CFS)	Date/Time of Peak Discharge :	01Oct2021, 12:00
Total Precipitation :	4.0 (AC-FT)	Total Direct Runoff :	1.9 (AC-FT)
Total Loss :	2.2 (AC-FT)	Total Baseflow :	0.0 (AC-FT)
Total Excess :	1.9 (AC-FT)	Discharge :	1.9 (AC-FT)

Subbasin "PB5" Results for Run "EV 100-yr Pr. Type II"

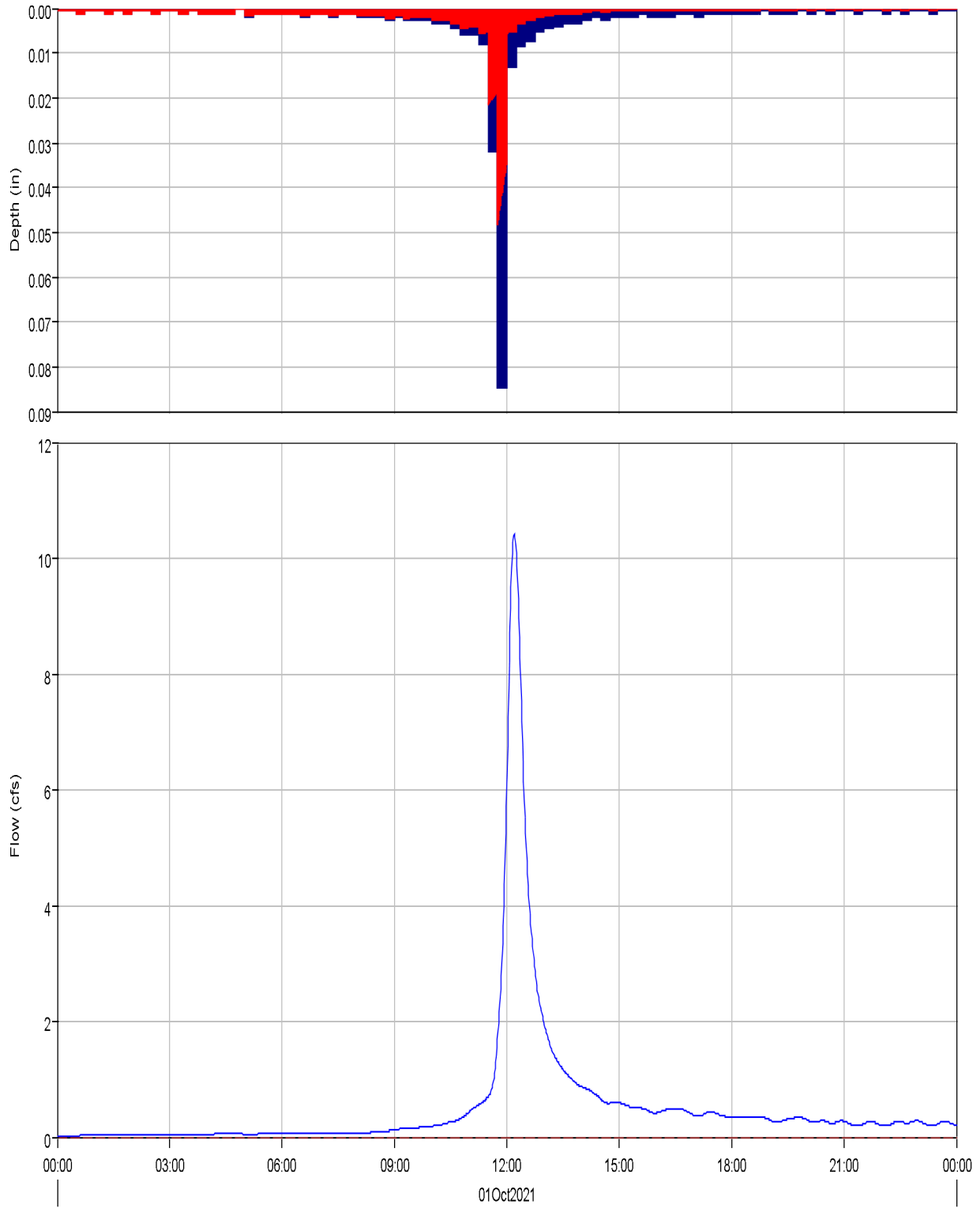

Run:EV 100-yr Pr. Type II Element:PB5 Result:Precipitation
Run:EV 100-yr Pr. Type II Element:PB5 Result:Outflow

Run:EV 100-yr Pr. Type II Element:PB5 Result:Precipitation Loss
Run:EV 100-yr Pr. Type II Element:PB5 Result:Baseflow

Project: Eagleview_Subdivision
Simulation Run: EV 100-yr Pr. Type II Subbasin: PB5

Start of Run: 01Oct2021, 00:00 Basin Model: Eagleview_Proposed
End of Run: 02Oct2021, 00:00 Meteorologic Model: 100-yr Type II
Compute Time: 15Mar2022, 09:38:27 Control Specifications: 24-hr Storm

Volume Units: AC-FT

Computed Results

Peak Discharge :	10.4 (CFS)	Date/Time of Peak Discharge :	01Oct2021, 12:12
Total Precipitation :	2.4 (AC-FT)	Total Direct Runoff :	1.1 (AC-FT)
Total Loss :	1.3 (AC-FT)	Total Baseflow :	0.0 (AC-FT)
Total Excess :	1.1 (AC-FT)	Discharge :	1.1 (AC-FT)

Subbasin "PB6" Results for Run "EV 100-yr Pr. Type II"

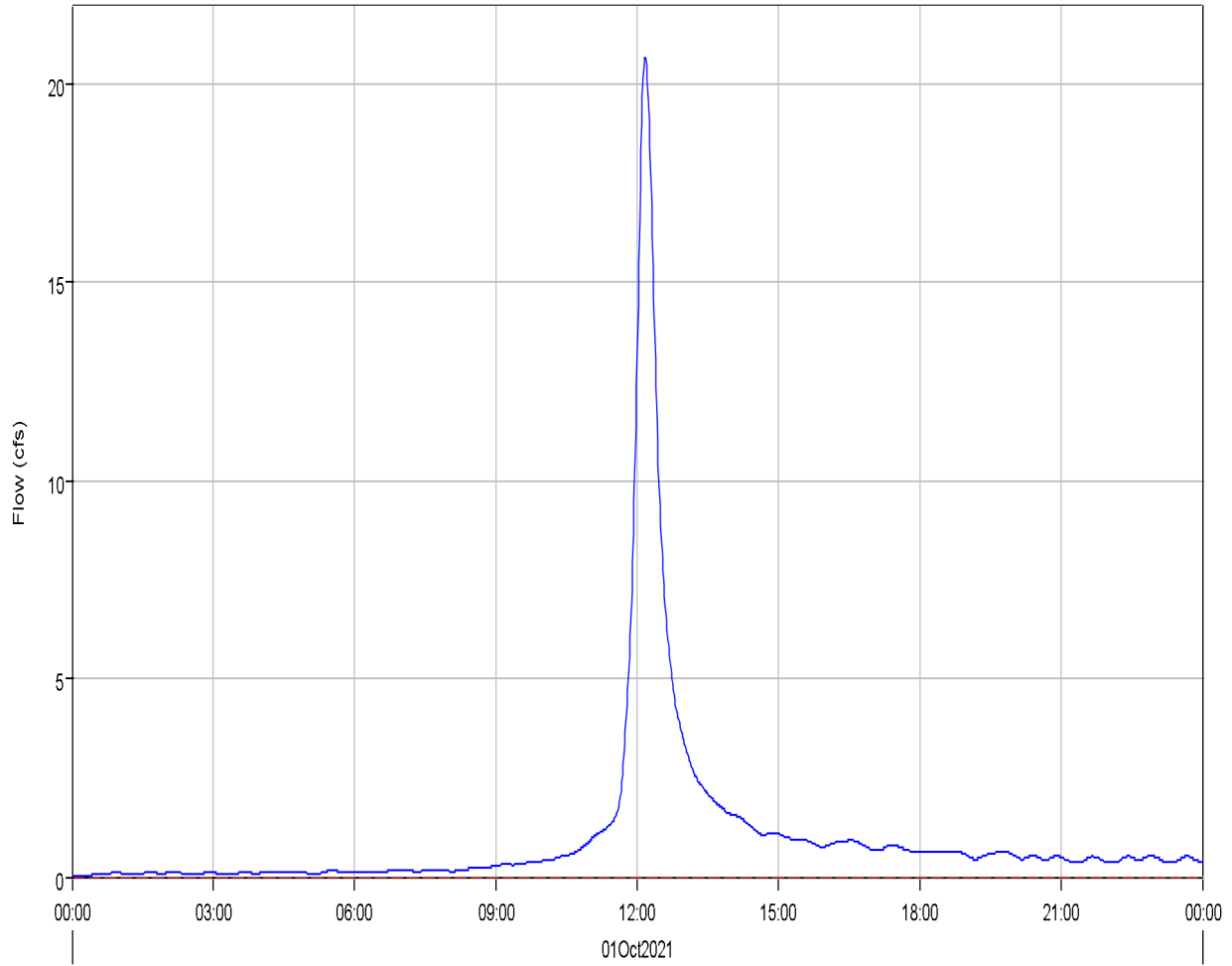
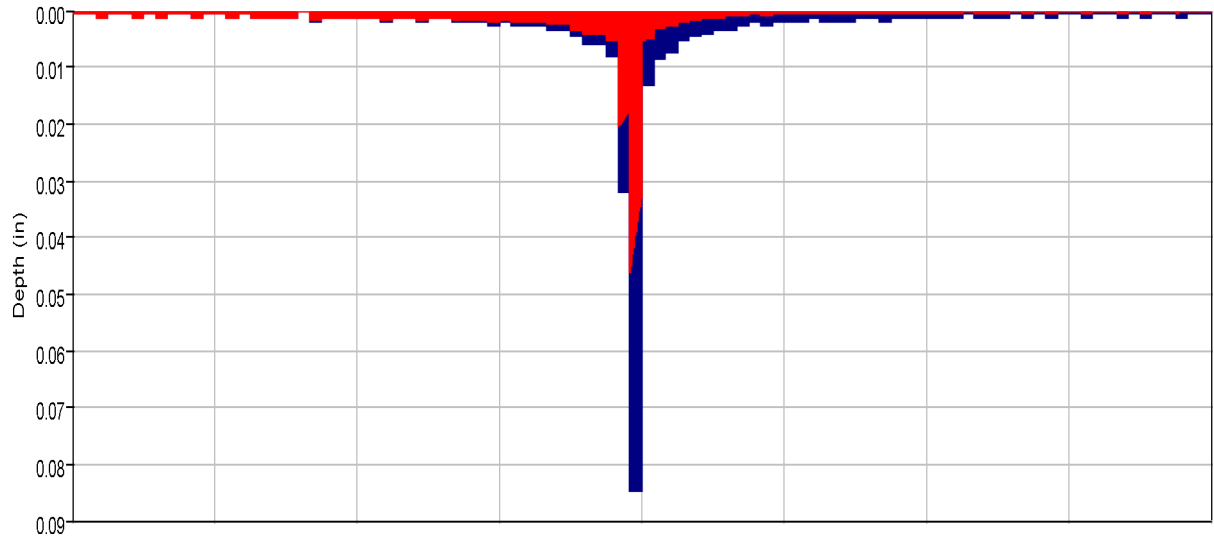

Run:EV 100-yr Pr. Type II Element:PB6 Result:Precipitation
Run:EV 100-yr Pr. Type II Element:PB6 Result:Outflow

Run:EV 100-yr Pr. Type II Element:PB6 Result:Precipitation Loss
Run:EV 100-yr Pr. Type II Element:PB6 Result:Baseflow

Project: Eagleview_Subdivision
Simulation Run: EV 100-yr Pr. Type II Subbasin: PB6

Start of Run: 01Oct2021, 00:00 Basin Model: Eagleview_Proposed
End of Run: 02Oct2021, 00:00 Meteorologic Model: 100-yr Type II
Compute Time: 15Mar2022, 09:38:27 Control Specifications: 24-hr Storm

Volume Units: AC-FT

Computed Results

Peak Discharge :	20.7 (CFS)	Date/Time of Peak Discharge :	01Oct2021, 12:10
Total Precipitation :	4.3 (AC-FT)	Total Direct Runoff :	2.0 (AC-FT)
Total Loss :	2.2 (AC-FT)	Total Baseflow :	0.0 (AC-FT)
Total Excess :	2.1 (AC-FT)	Discharge :	2.0 (AC-FT)

Subbasin "PB7" Results for Run "EV 100-yr Pr. Type II"

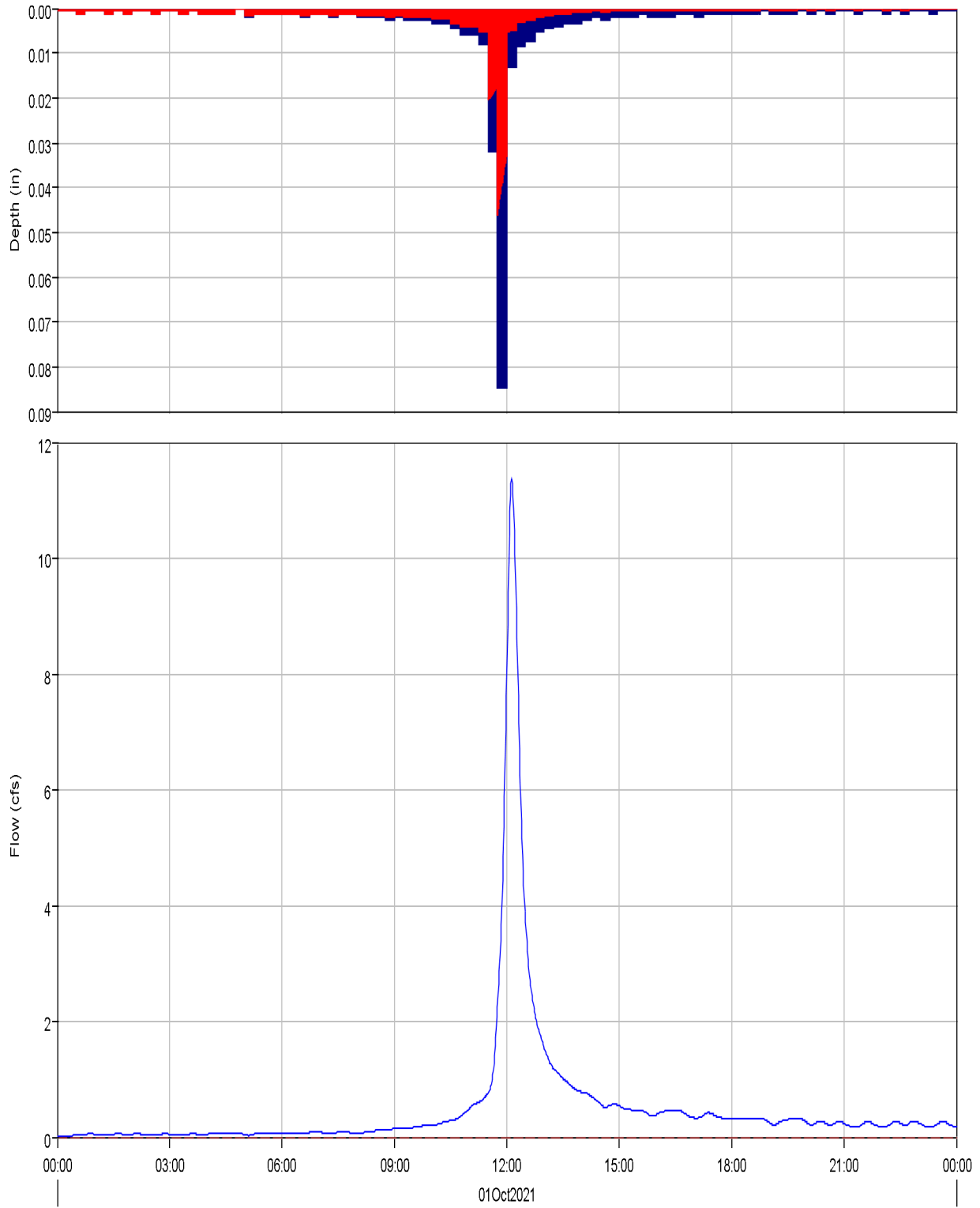

Run:EV 100-yr Pr. Type II Element:PB7 Result:Precipitation
Run:EV 100-yr Pr. Type II Element:PB7 Result:Outflow

Run:EV 100-yr Pr. Type II Element:PB7 Result:Precipitation Loss
Run:EV 100-yr Pr. Type II Element:PB7 Result:Baseflow

Project: Eagleview_Subdivision
Simulation Run: EV 100-yr Pr. Type II Subbasin: PB7

Start of Run: 01Oct2021, 00:00 Basin Model: Eagleview_Proposed
End of Run: 02Oct2021, 00:00 Meteorologic Model: 100-yr Type II
Compute Time: 15Mar2022, 09:38:27 Control Specifications: 24-hr Storm

Volume Units: AC-FT

Computed Results

Peak Discharge :	11.4 (CFS)	Date/Time of Peak Discharge :	01Oct2021, 12:08
Total Precipitation :	2.1 (AC-FT)	Total Direct Runoff :	1.0 (AC-FT)
Total Loss :	1.1 (AC-FT)	Total Baseflow :	0.0 (AC-FT)
Total Excess :	1.0 (AC-FT)	Discharge :	1.0 (AC-FT)

Subbasin "PB8" Results for Run "EV 100-yr Pr. Type II"

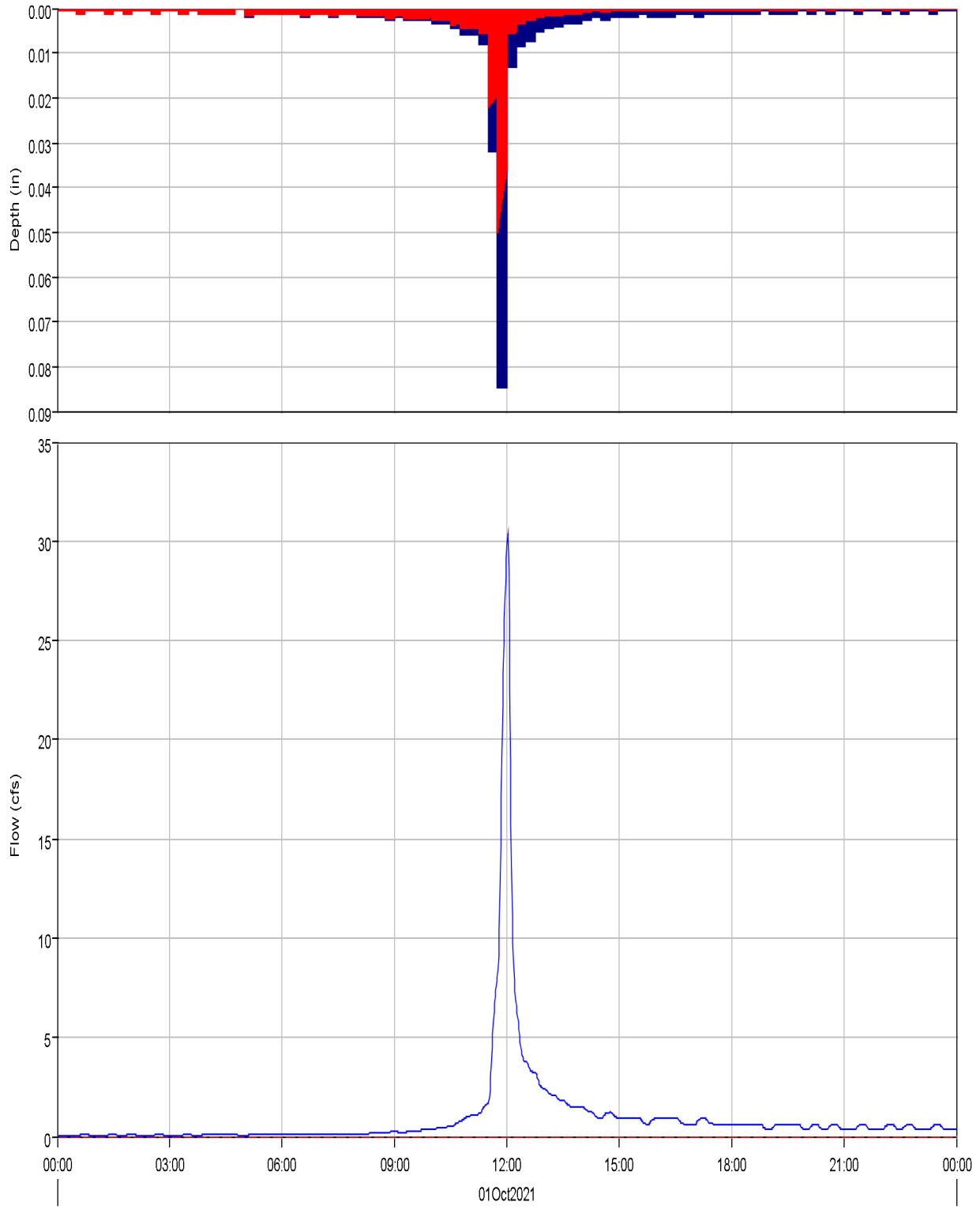

Run:EV 100-yr Pr. Type II Element:PB8 Result:Precipitation
Run:EV 100-yr Pr. Type II Element:PB8 Result:Outflow

Run:EV 100-yr Pr. Type II Element:PB8 Result:Precipitation Loss
Run:EV 100-yr Pr. Type II Element:PB8 Result:Baseflow

Project: Eagleview_Subdivision
Simulation Run: EV 100-yr Pr. Type II Subbasin: PB8

Start of Run: 01Oct2021, 00:00 Basin Model: Eagleview_Proposed
End of Run: 02Oct2021, 00:00 Meteorologic Model: 100-yr Type II
Compute Time: 15Mar2022, 09:38:27 Control Specifications: 24-hr Storm

Volume Units: AC-FT

Computed Results

Peak Discharge :	30.4 (CFS)	Date/Time of Peak Discharge :	01Oct2021, 12:01
Total Precipitation :	4.5 (AC-FT)	Total Direct Runoff :	2.0 (AC-FT)
Total Loss :	2.5 (AC-FT)	Total Baseflow :	0.0 (AC-FT)
Total Excess :	2.0 (AC-FT)	Discharge :	2.0 (AC-FT)

Subbasin "PB9" Results for Run "EV 100-yr Pr. Type II"

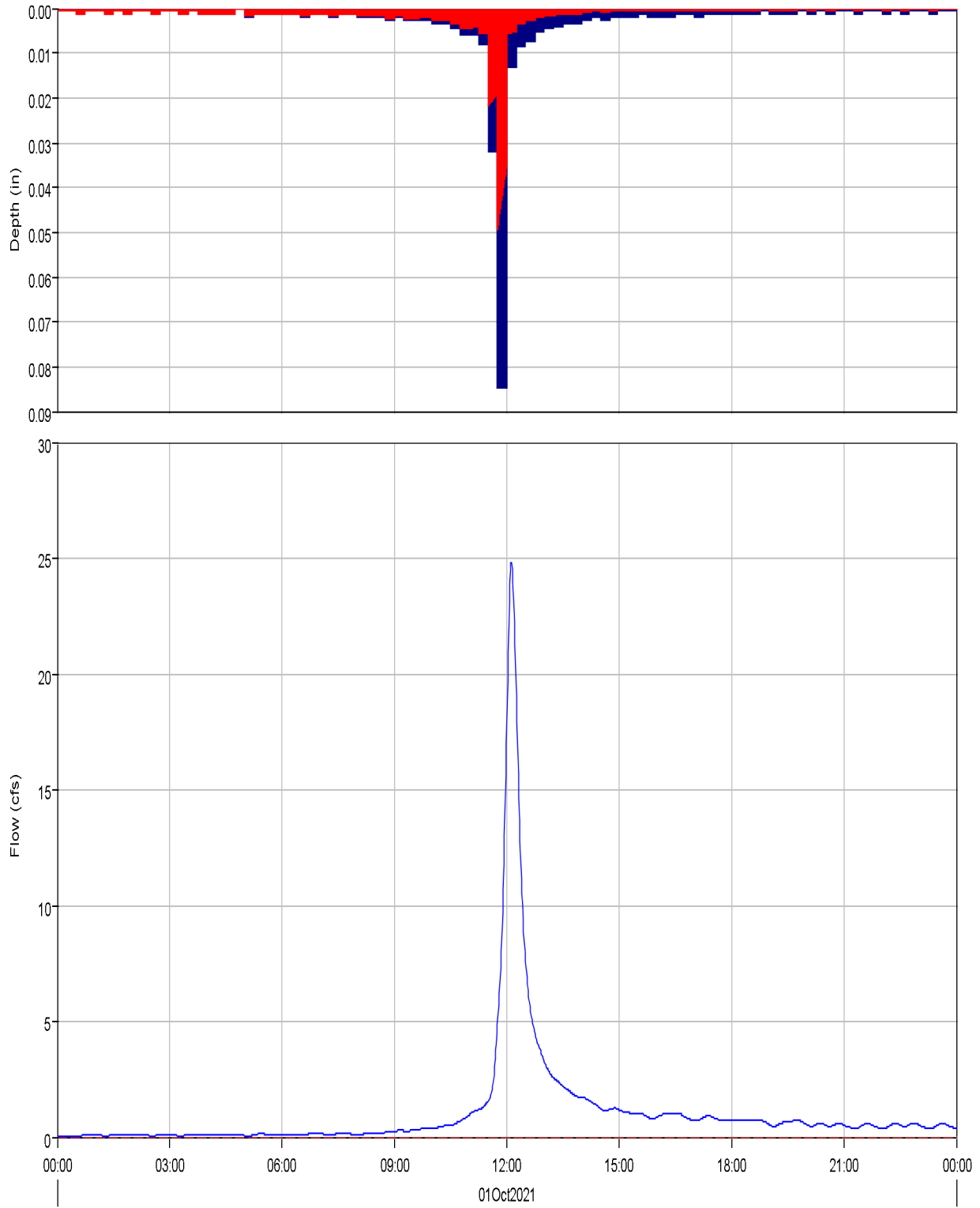

Run:EV 100-yr Pr. Type II Element:PB9 Result:Precipitation
Run:EV 100-yr Pr. Type II Element:PB9 Result:Outflow

Run:EV 100-yr Pr. Type II Element:PB9 Result:Precipitation Loss
Run:EV 100-yr Pr. Type II Element:PB9 Result:Baseflow

Project: Eagleview_Subdivision
Simulation Run: EV 100-yr Pr. Type II Subbasin: PB9

Start of Run: 01Oct2021, 00:00 Basin Model: Eagleview_Proposed
End of Run: 02Oct2021, 00:00 Meteorologic Model: 100-yr Type II
Compute Time: 15Mar2022, 09:38:27 Control Specifications: 24-hr Storm

Volume Units: AC-FT

Computed Results

Peak Discharge :	24.8 (CFS)	Date/Time of Peak Discharge :	01Oct2021, 12:07
Total Precipitation :	4.9 (AC-FT)	Total Direct Runoff :	2.2 (AC-FT)
Total Loss :	2.7 (AC-FT)	Total Baseflow :	0.0 (AC-FT)
Total Excess :	2.2 (AC-FT)	Discharge :	2.2 (AC-FT)

Subbasin "PB10" Results for Run "EV 100-yr Pr. Type II"

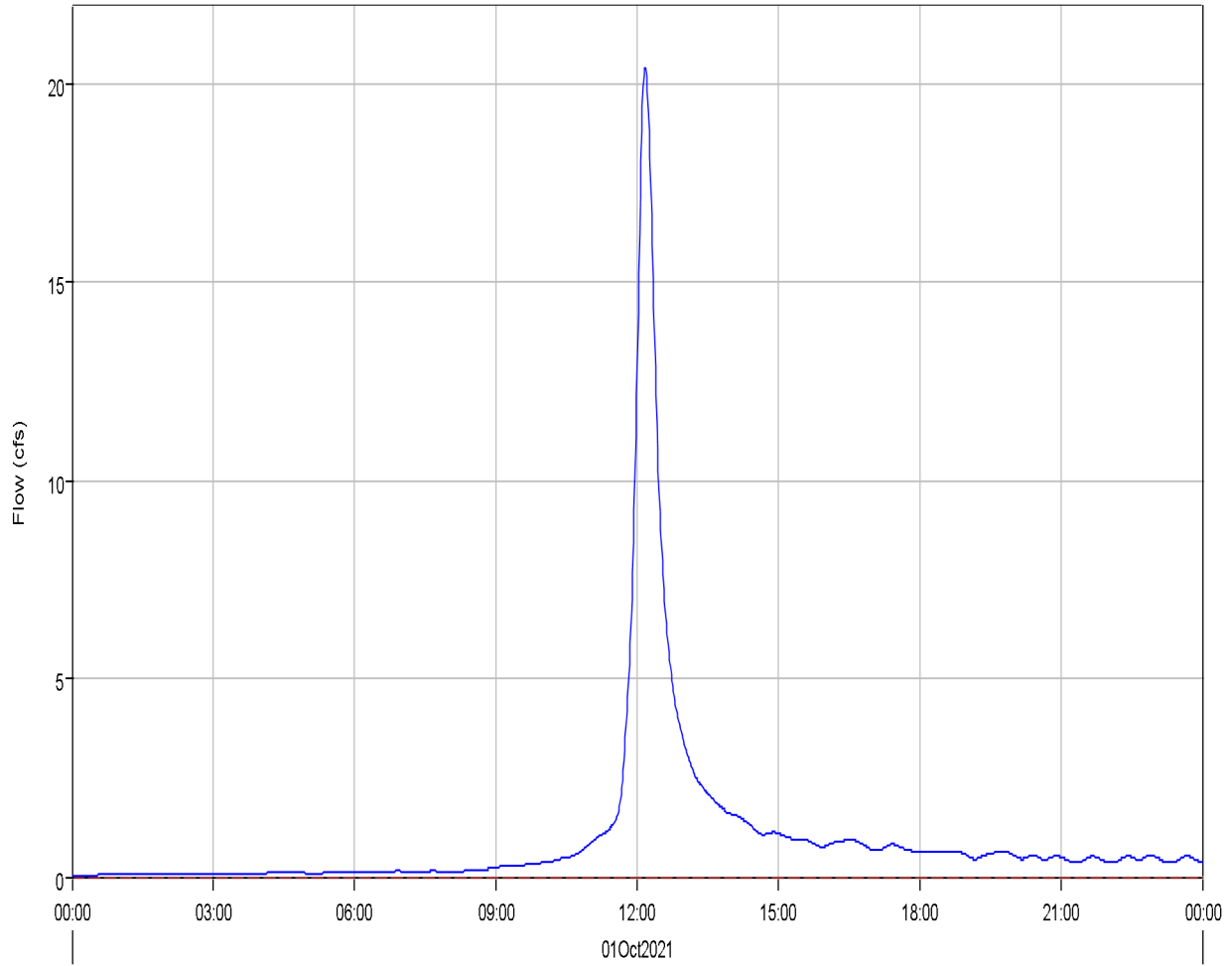
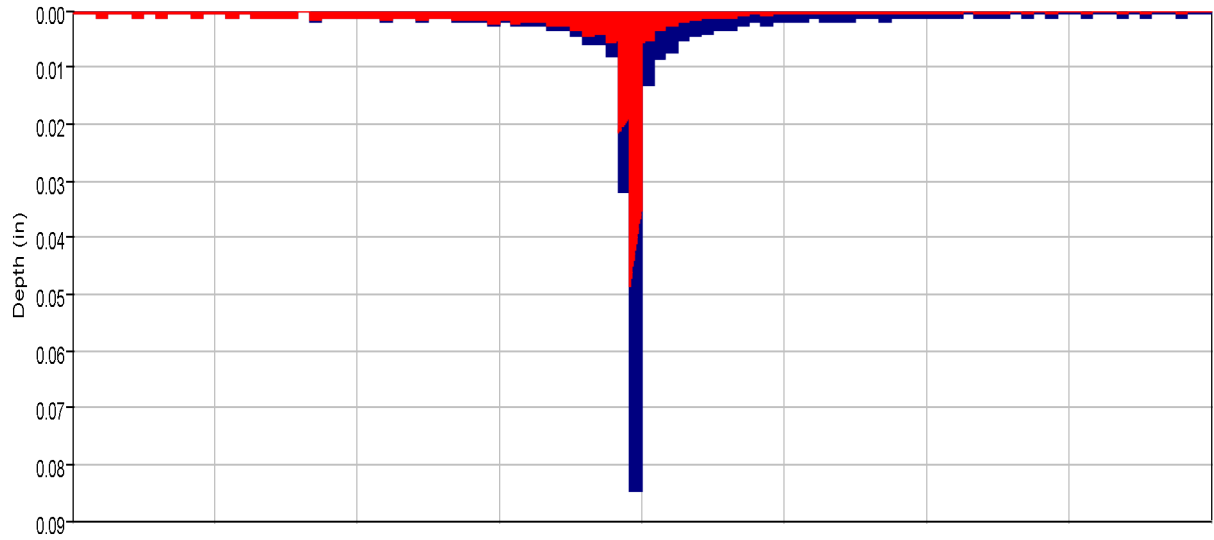

Run:EV 100-yr Pr. Type II Element:PB10 Result:Precipitation
Run:EV 100-yr Pr. Type II Element:PB10 Result:Outflow

Run:EV 100-yr Pr. Type II Element:PB10 Result:Precipitation Loss
Run:EV 100-yr Pr. Type II Element:PB10 Result:Baseflow

Project: Eagleview_Subdivision
Simulation Run: EV 100-yr Pr. Type II Subbasin: PB10
Start of Run: 01Oct2021, 00:00 Basin Model: Eagleview_Proposed
End of Run: 02Oct2021, 00:00 Meteorologic Model: 100-yr Type II
Compute Time: 15Mar2022, 09:38:27 Control Specifications: 24-hr Storm

Volume Units: AC-FT

Computed Results

Peak Discharge :	20.4 (CFS)	Date/Time of Peak Discharge :	01Oct2021, 12:10
Total Precipitation :	4.4 (AC-FT)	Total Direct Runoff :	2.0 (AC-FT)
Total Loss :	2.4 (AC-FT)	Total Baseflow :	0.0 (AC-FT)
Total Excess :	2.0 (AC-FT)	Discharge :	2.0 (AC-FT)

Subbasin "PB11" Results for Run "EV 100-yr Pr. Type II"

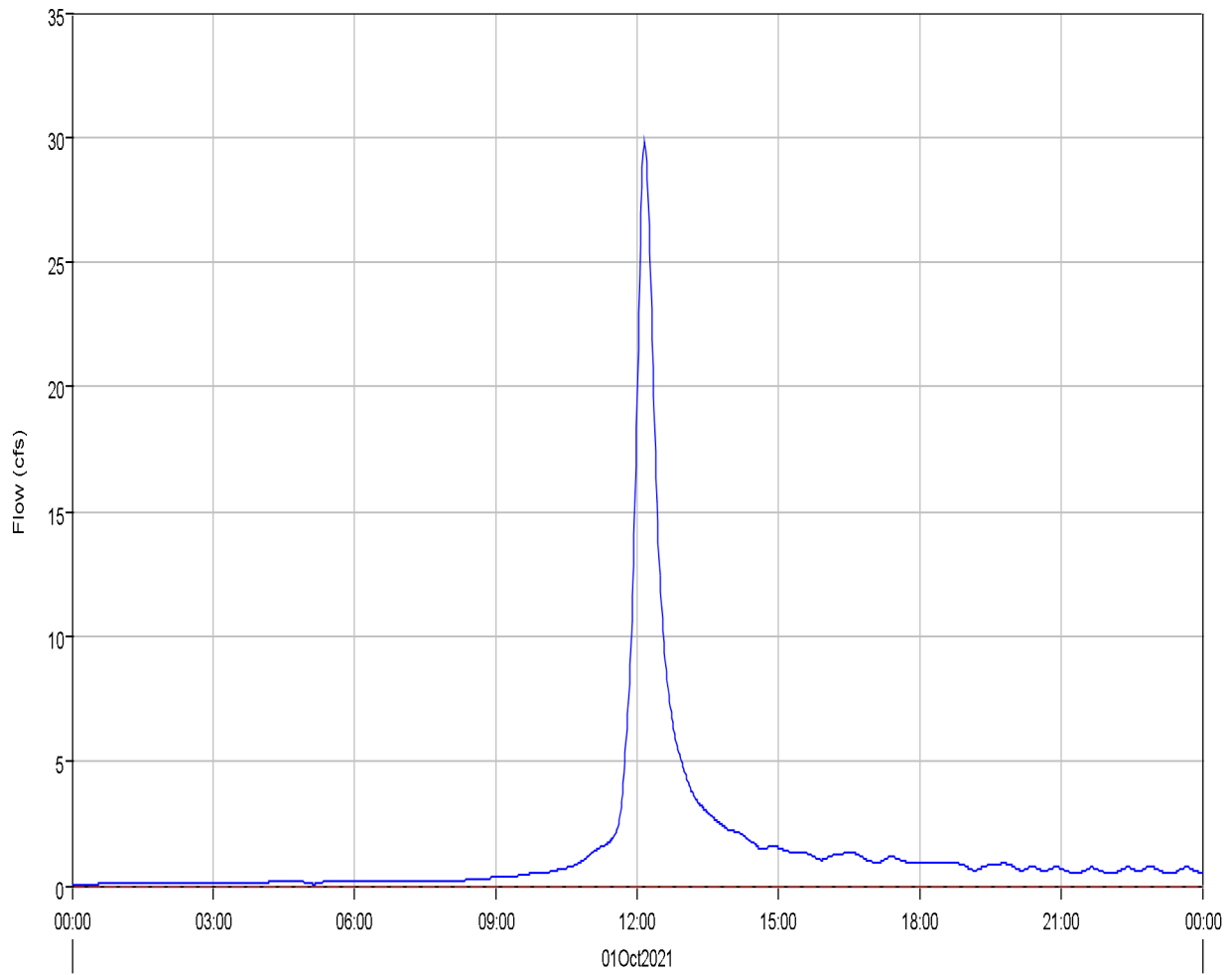
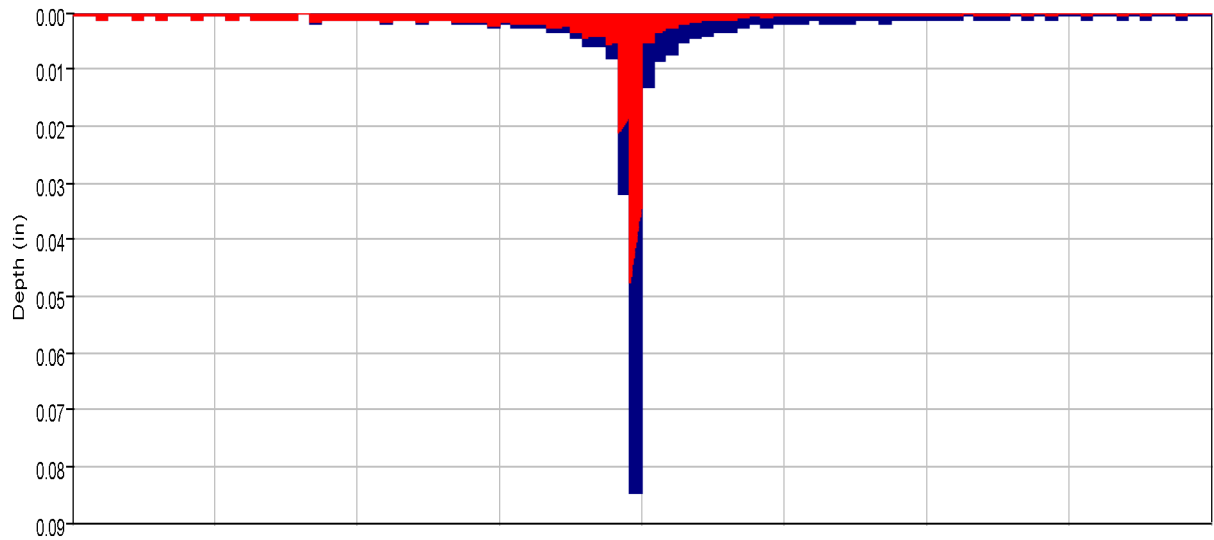

Run:EV 100-yr Pr. Type II Element:PB11 Result:Precipitation
Run:EV 100-yr Pr. Type II Element:PB11 Result:Outflow

Run:EV 100-yr Pr. Type II Element:PB11 Result:Precipitation Loss
Run:EV 100-yr Pr. Type II Element:PB11 Result:Baseflow

Project: Eagleview_Subdivision
Simulation Run: EV 100-yr Pr. Type II Subbasin: PB11

Start of Run: 01Oct2021, 00:00 Basin Model: Eagleview_Proposed
End of Run: 02Oct2021, 00:00 Meteorologic Model: 100-yr Type II
Compute Time: 15Mar2022, 09:38:27 Control Specifications: 24-hr Storm

Volume Units: AC-FT

Computed Results

Peak Discharge :	29.8 (CFS)	Date/Time of Peak Discharge :	01Oct2021, 12:10
Total Precipitation :	6.2 (AC-FT)	Total Direct Runoff :	2.9 (AC-FT)
Total Loss :	3.3 (AC-FT)	Total Baseflow :	0.0 (AC-FT)
Total Excess :	2.9 (AC-FT)	Discharge :	2.9 (AC-FT)

Subbasin "PB12" Results for Run "EV 100-yr Pr. Type II"

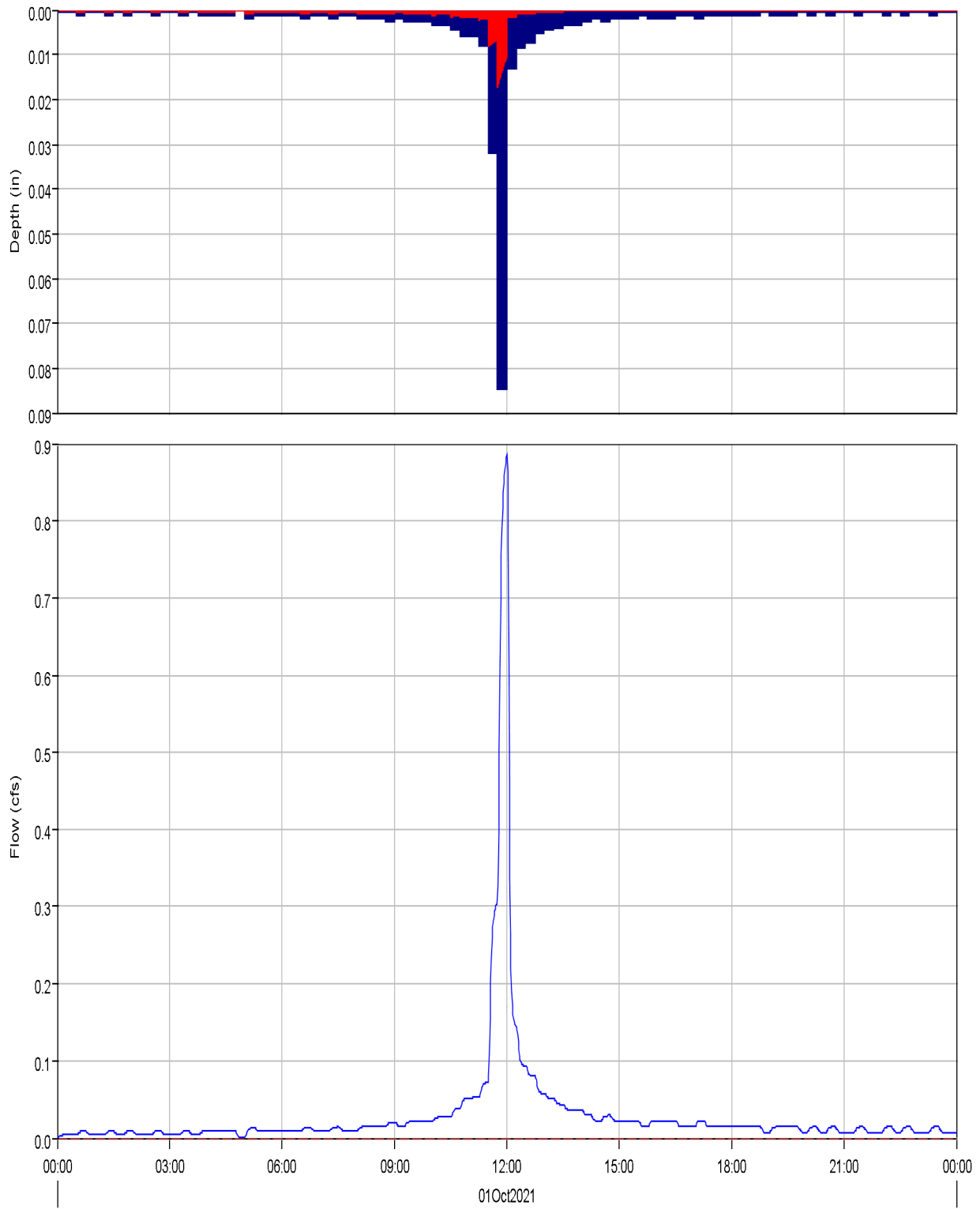

Run:EV 100-yr Pr. Type II Element:PB12 Result:Precipitation
Run:EV 100-yr Pr. Type II Element:PB12 Result:Outflow

Run:EV 100-yr Pr. Type II Element:PB12 Result:Precipitation Loss
Run:EV 100-yr Pr. Type II Element:PB12 Result:Baseflow

Project: Eagleview_Subdivision
Simulation Run: EV 100-yr Pr. Type II Subbasin: PB12

Start of Run: 01Oct2021, 00:00 Basin Model: Eagleview_Proposed
End of Run: 02Oct2021, 00:00 Meteorologic Model: 100-yr Type II
Compute Time: 15Mar2022, 09:38:27 Control Specifications: 24-hr Storm

Volume Units: AC-FT

Computed Results

Peak Discharge :	0.9 (CFS)	Date/Time of Peak Discharge :	01Oct2021, 12:00
Total Precipitation :	0.1 (AC-FT)	Total Direct Runoff :	0.1 (AC-FT)
Total Loss :	0.0 (AC-FT)	Total Baseflow :	0.0 (AC-FT)
Total Excess :	0.1 (AC-FT)	Discharge :	0.1 (AC-FT)

Subbasin "PB13" Results for Run "EV 100-yr Pr. Type II"

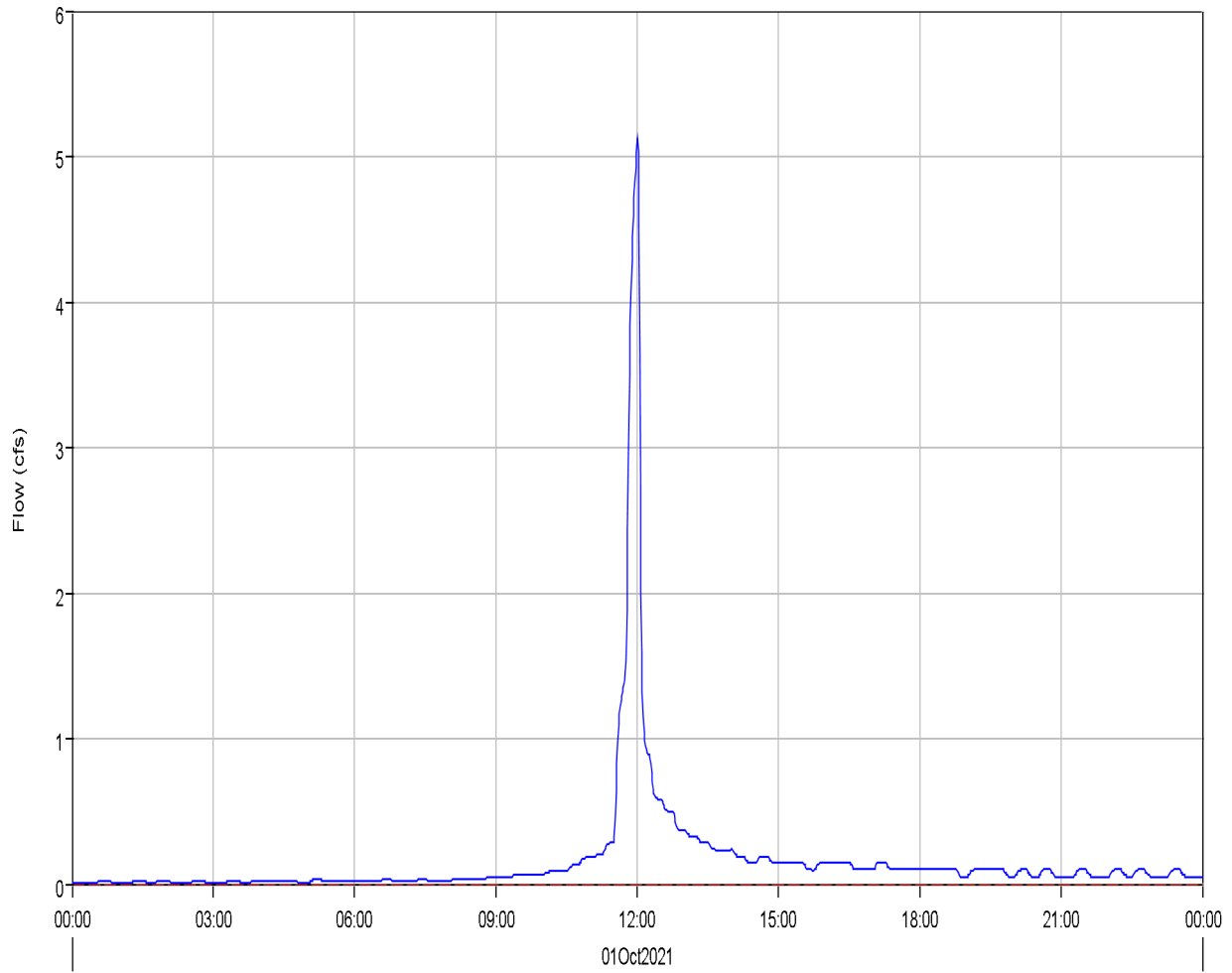
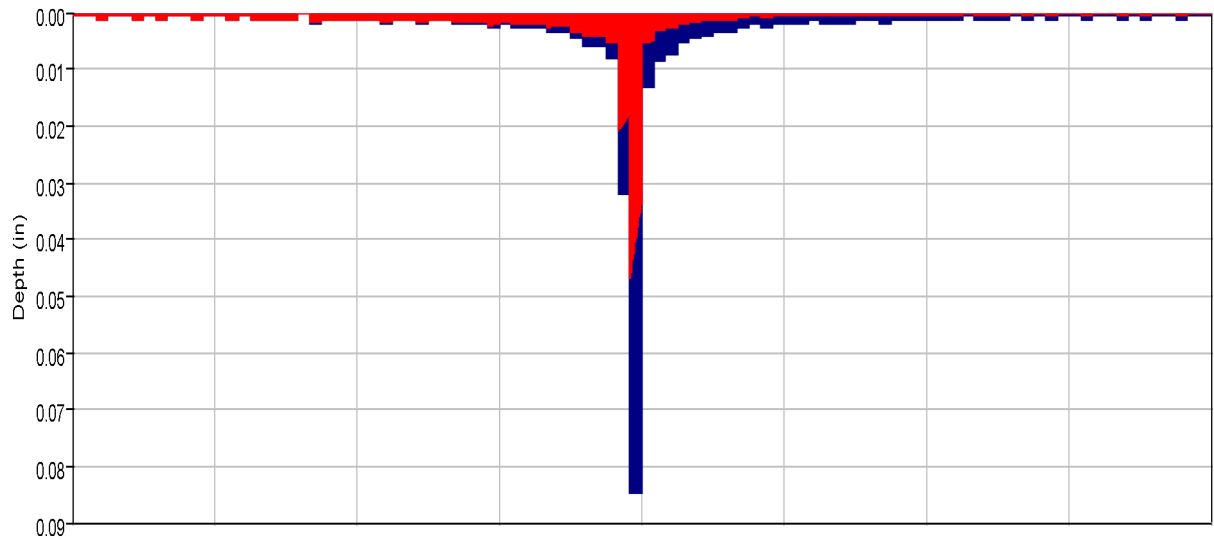

Run:EV 100-yr Pr. Type II Element:PB13 Result:Precipitation
Run:EV 100-yr Pr. Type II Element:PB13 Result:Outflow

Run:EV 100-yr Pr. Type II Element:PB13 Result:Precipitation Loss
Run:EV 100-yr Pr. Type II Element:PB13 Result:Baseflow

Project: Eagleview_Subdivision
Simulation Run: EV 100-yr Pr. Type II Subbasin: PB13

Start of Run: 01Oct2021, 00:00 Basin Model: Eagleview_Proposed
End of Run: 02Oct2021, 00:00 Meteorologic Model: 100-yr Type II
Compute Time: 15Mar2022, 09:38:27 Control Specifications: 24-hr Storm

Volume Units: AC-FT

Computed Results

Peak Discharge :	5.1 (CFS)	Date/Time of Peak Discharge :	01Oct2021, 12:00
Total Precipitation :	0.7 (AC-FT)	Total Direct Runoff :	0.3 (AC-FT)
Total Loss :	0.4 (AC-FT)	Total Baseflow :	0.0 (AC-FT)
Total Excess :	0.3 (AC-FT)	Discharge :	0.3 (AC-FT)

Subbasin "PB14" Results for Run "EV 100-yr Pr. Type II"

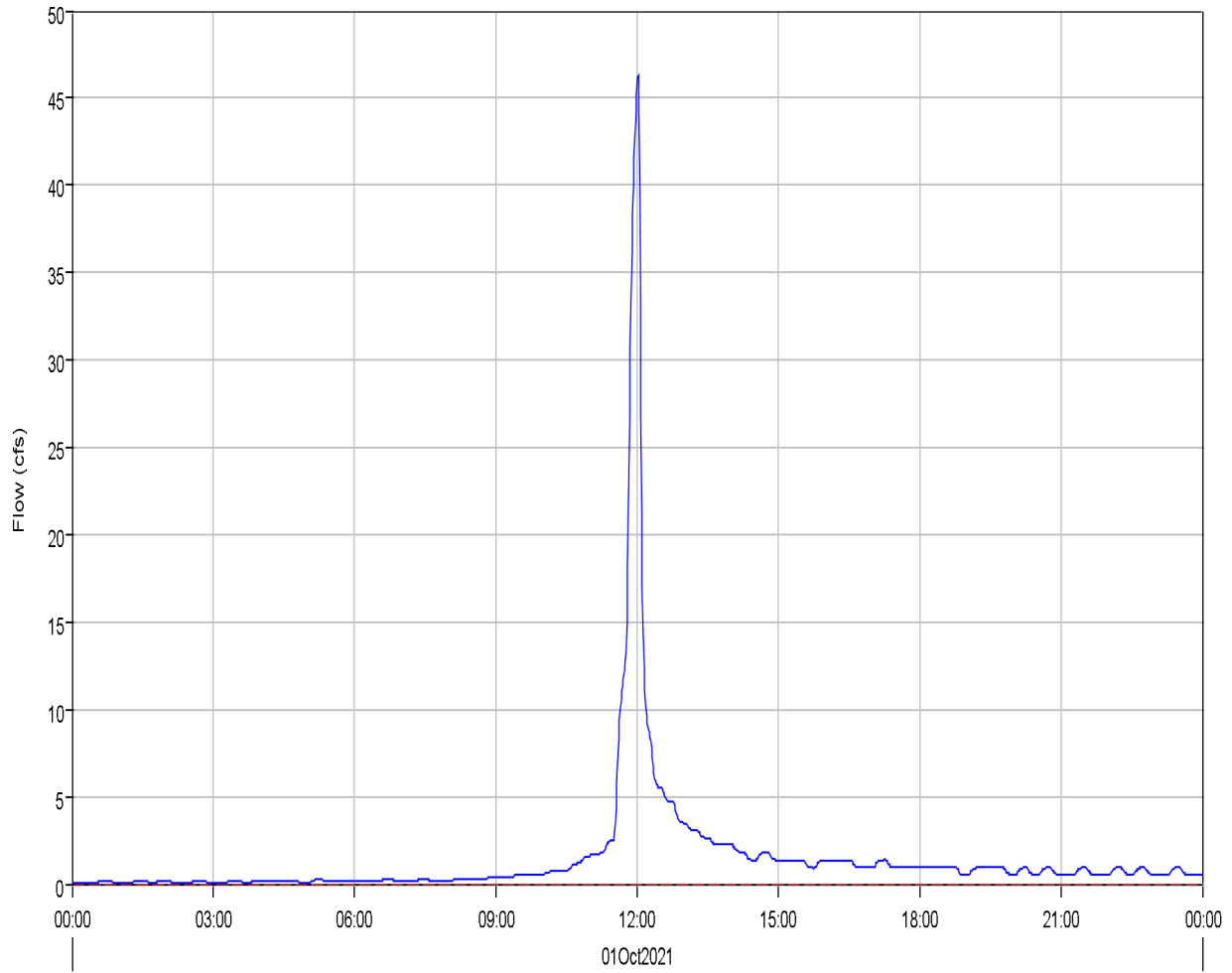
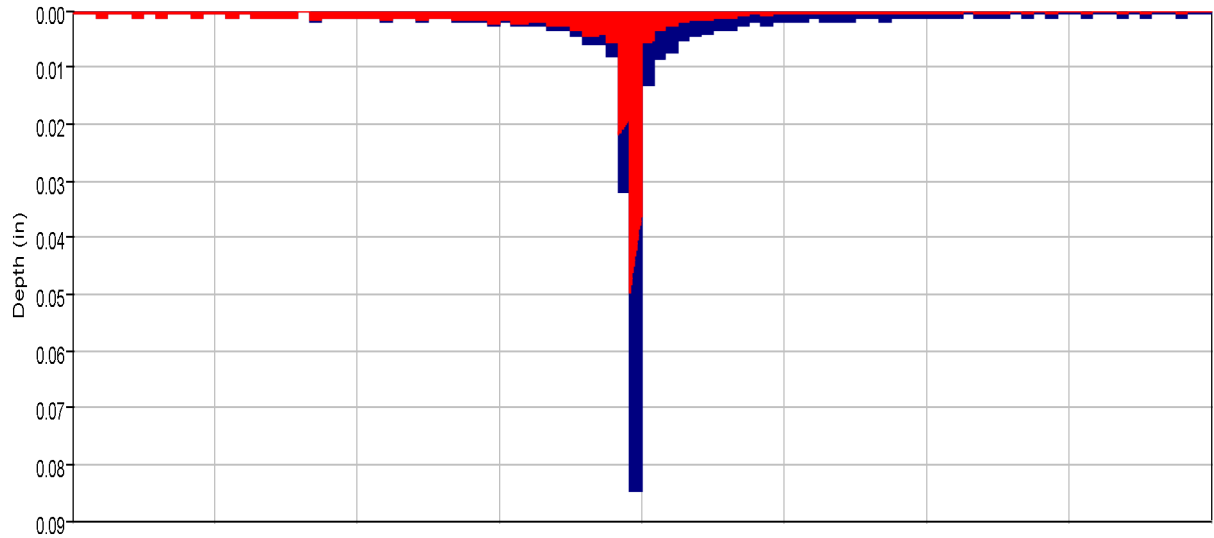

Run:EV 100-yr Pr. Type II Element:PB14 Result:Precipitation
Run:EV 100-yr Pr. Type II Element:PB14 Result:Outflow

Run:EV 100-yr Pr. Type II Element:PB14 Result:Precipitation Loss
Run:EV 100-yr Pr. Type II Element:PB14 Result:Baseflow

Project: Eagleview_Subdivision
Simulation Run: EV 100-yr Pr. Type II Subbasin: PB14

Start of Run: 01Oct2021, 00:00 Basin Model: Eagleview_Proposed
End of Run: 02Oct2021, 00:00 Meteorologic Model: 100-yr Type II
Compute Time: 15Mar2022, 09:38:27 Control Specifications: 24-hr Storm

Volume Units: AC-FT

Computed Results

Peak Discharge :	46.3 (CFS)	Date/Time of Peak Discharge :	01Oct2021, 12:01
Total Precipitation :	6.6 (AC-FT)	Total Direct Runoff :	2.9 (AC-FT)
Total Loss :	3.7 (AC-FT)	Total Baseflow :	0.0 (AC-FT)
Total Excess :	2.9 (AC-FT)	Discharge :	2.9 (AC-FT)

Subbasin "PB15" Results for Run "EV 100-yr Pr. Type II"

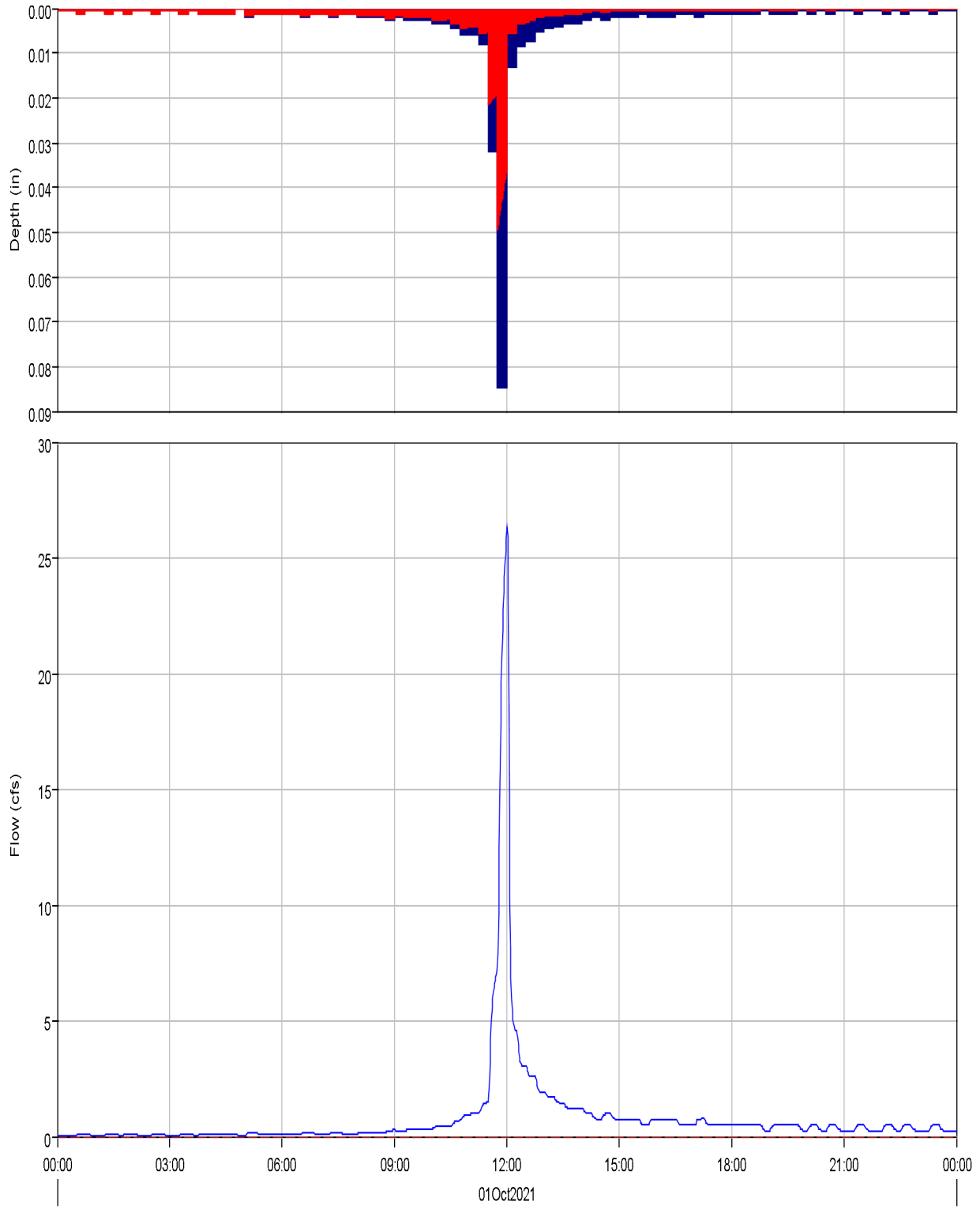

Run:EV 100-yr Pr. Type II Element:PB15 Result:Precipitation
Run:EV 100-yr Pr. Type II Element:PB15 Result:Outflow

Run:EV 100-yr Pr. Type II Element:PB15 Result:Precipitation Loss
Run:EV 100-yr Pr. Type II Element:PB15 Result:Baseflow

Project: Eagleview_Subdivision
Simulation Run: EV 100-yr Pr. Type II Subbasin: PB15

Start of Run: 01Oct2021, 00:00 Basin Model: Eagleview_Proposed
End of Run: 02Oct2021, 00:00 Meteorologic Model: 100-yr Type II
Compute Time: 15Mar2022, 09:38:27 Control Specifications: 24-hr Storm

Volume Units: AC-FT

Computed Results

Peak Discharge :	26.3 (CFS)	Date/Time of Peak Discharge :	01Oct2021, 12:00
Total Precipitation :	3.7 (AC-FT)	Total Direct Runoff :	1.7 (AC-FT)
Total Loss :	2.0 (AC-FT)	Total Baseflow :	0.0 (AC-FT)
Total Excess :	1.7 (AC-FT)	Discharge :	1.7 (AC-FT)

Reach 'R-OB1' Results for Run 'EV 100-yr Pr. Type II'

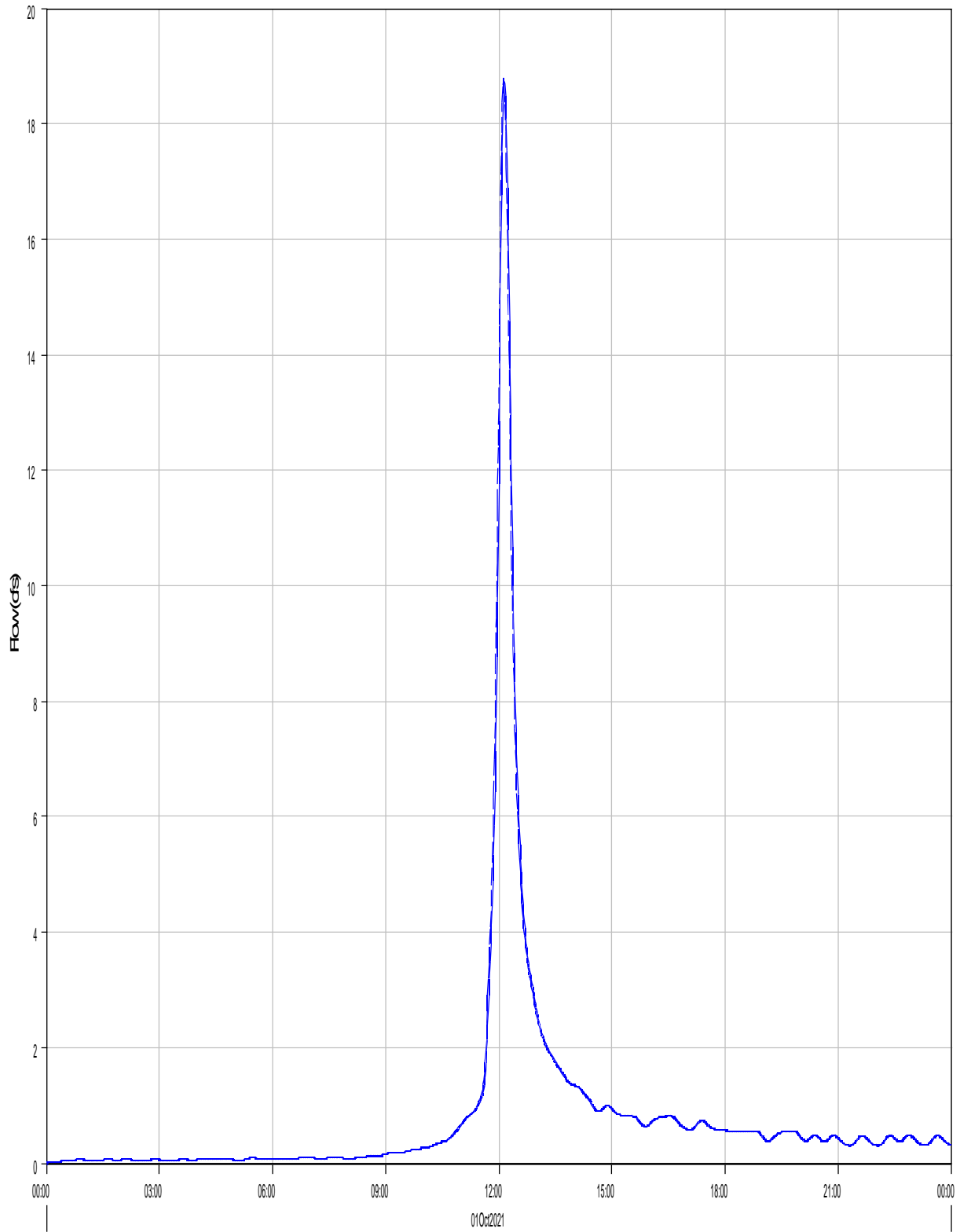

— Run:EV 100-yr Pr. Type II Element:R-OB1 Result:Outflow

- - - Run:EV 100-yr Pr. Type II Element:R-OB1 Result:Combined Inflow

Project: Eagleview_Subdivision
Simulation Run: EV 100-yr Pr. Type II Reach: R-OB1
Start of Run: 01Oct2021, 00:00 Basin Model: Eagleview_Proposed
End of Run: 02Oct2021, 00:00 Meteorologic Model: 100-yr Type II
Compute Time: 15Mar2022, 09:38:27 Control Specifications: 24-hr Storm

Volume Units: AC-FT

Computed Results

Peak Inflow :	18.8 (CFS)	Date/Time of Peak Inflow :	01Oct2021, 12:08
Peak Outflow :	18.7 (CFS)	Date/Time of Peak Outflow :	01Oct2021, 12:09
Total Inflow :	1.7 (AC-FT)	Total Outflow :	1.7 (AC-FT)

Reach 'R-OB2' Results for Run 'EV 100-yr Pr. Type II'

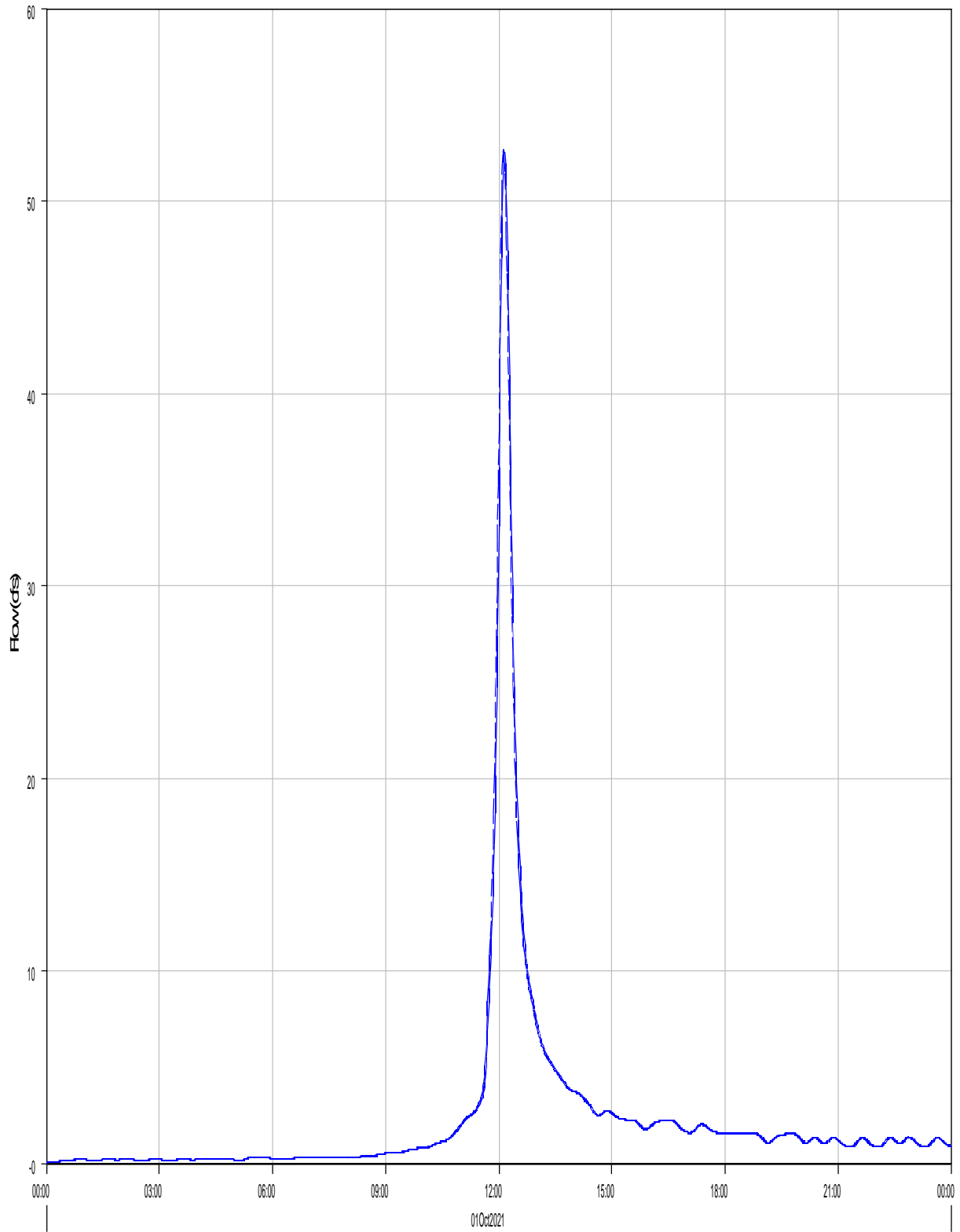

Run:EV 100-yr Pr. Type II Element:R-OB2 Result:Outflow

Run:EV 100-yr Pr. Type II Element:R-OB2 Result:Combined Inflow

Project: Eagleview_Subdivision
Simulation Run: EV 100-yr Pr. Type II Reach: R-OB2
Start of Run: 01Oct2021, 00:00 Basin Model: Eagleview_Proposed
End of Run: 02Oct2021, 00:00 Meteorologic Model: 100-yr Type II
Compute Time: 15Mar2022, 09:38:27 Control Specifications: 24-hr Storm

Volume Units: AC-FT

Computed Results

Peak Inflow :	52.7 (CFS)	Date/Time of Peak Inflow :	01Oct2021, 12:08
Peak Outflow :	52.5 (CFS)	Date/Time of Peak Outflow :	01Oct2021, 12:09
Total Inflow :	4.7 (AC-FT)	Total Outflow :	4.7 (AC-FT)

Reach 'R-0B4-A' Results for Run 'EV 100-yr Pr. Type II'

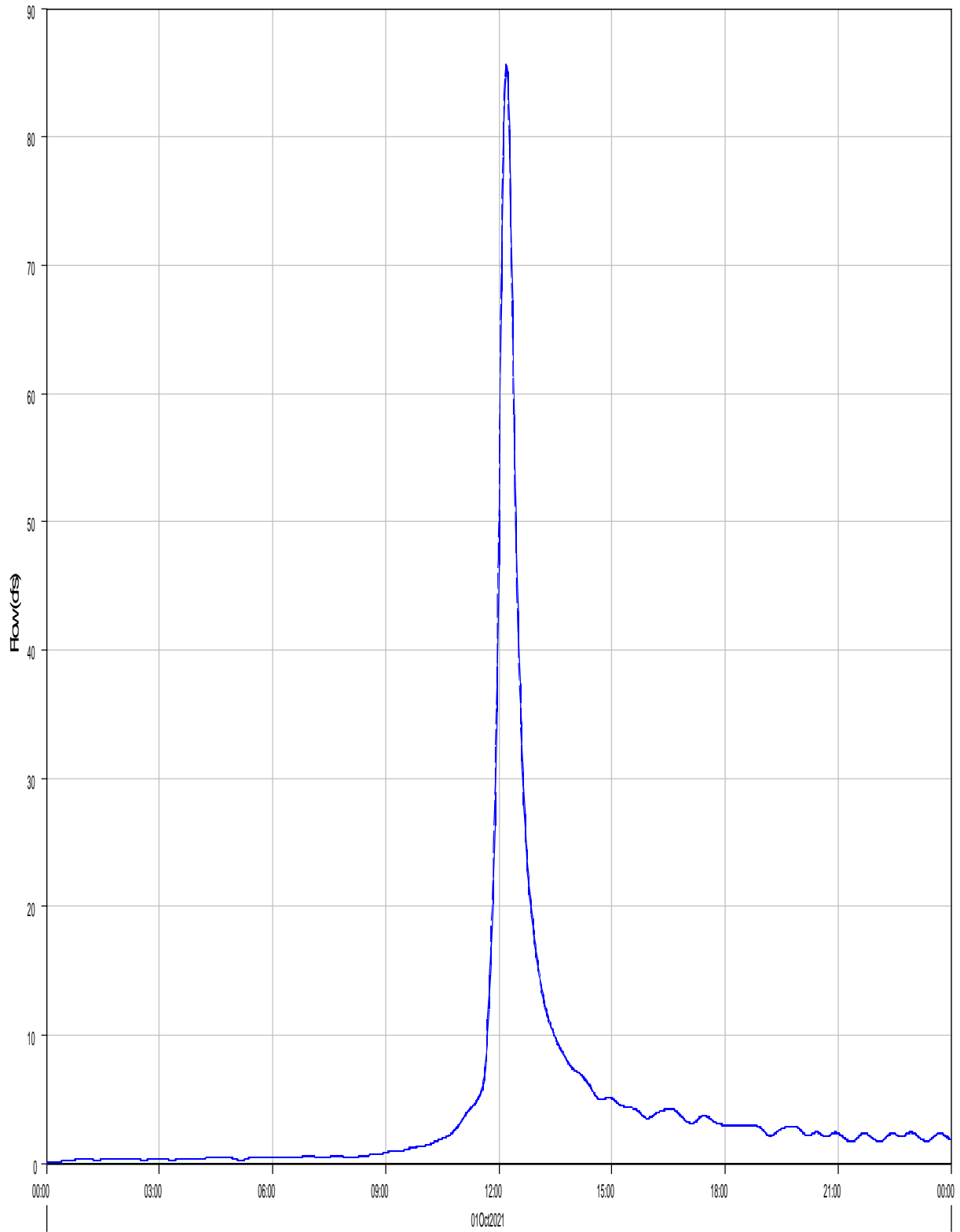

Run:EV 100-yr Pr. Type II Element:R-0B4-A Result:Outflow

Run:EV 100-yr Pr. Type II Element:R-0B4-A Result:Combined Inflow

Project: Eagleview_Subdivision
Simulation Run: EV 100-yr Pr. Type II Reach: R-OB4-A

Start of Run: 01Oct2021, 00:00 Basin Model: Eagleview_Proposed
End of Run: 02Oct2021, 00:00 Meteorologic Model: 100-yr Type II
Compute Time: 15Mar2022, 09:38:27 Control Specifications: 24-hr Storm

Volume Units: AC-FT

Computed Results

Peak Inflow :	85.6 (CFS)	Date/Time of Peak Inflow :	01Oct2021, 12:12
Peak Outflow :	85.5 (CFS)	Date/Time of Peak Outflow :	01Oct2021, 12:13
Total Inflow :	8.8 (AC-FT)	Total Outflow :	8.8 (AC-FT)

Reach 'R-0B4-B' Results for Run 'EV 100-yr Pr. Type II'

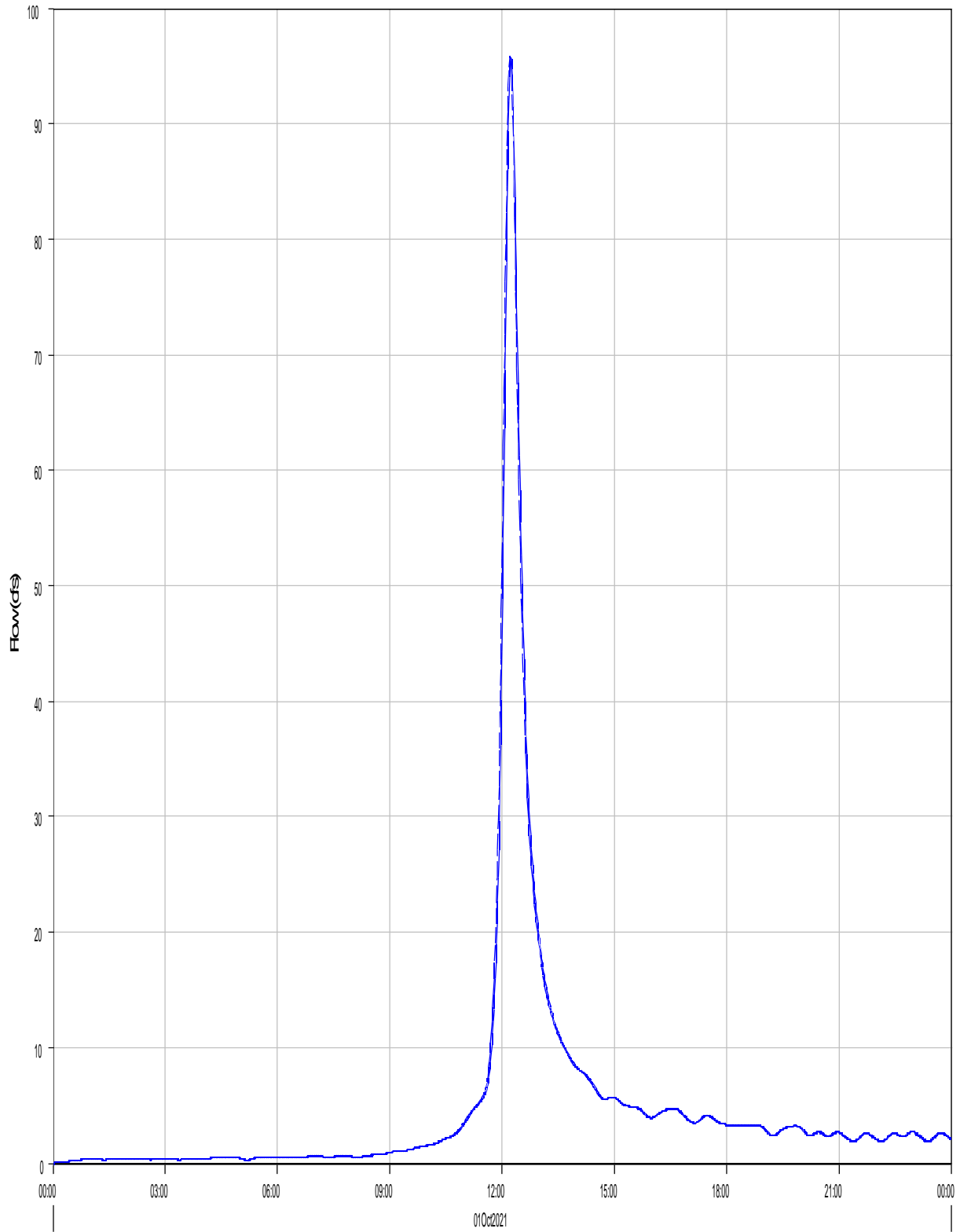

Run:EV 100-yr Pr. Type II Element:R-0B4-B Result:Outflow

Run:EV 100-yr Pr. Type II Element:R-0B4-B Result:Combined Inflow

Project: Eagleview_Subdivision
Simulation Run: EV 100-yr Pr. Type II Reach: R-OB4-B

Start of Run: 01Oct2021, 00:00 Basin Model: Eagleview_Proposed
End of Run: 02Oct2021, 00:00 Meteorologic Model: 100-yr Type II
Compute Time: 15Mar2022, 09:38:27 Control Specifications: 24-hr Storm

Volume Units: AC-FT

Computed Results

Peak Inflow :	95.9 (CFS)	Date/Time of Peak Inflow :	01Oct2021, 12:13
Peak Outflow :	95.8 (CFS)	Date/Time of Peak Outflow :	01Oct2021, 12:14
Total Inflow :	9.8 (AC-FT)	Total Outflow :	9.8 (AC-FT)

Reach 'R-OB7' Results for Run 'EV 100-yr Pr. Type II'

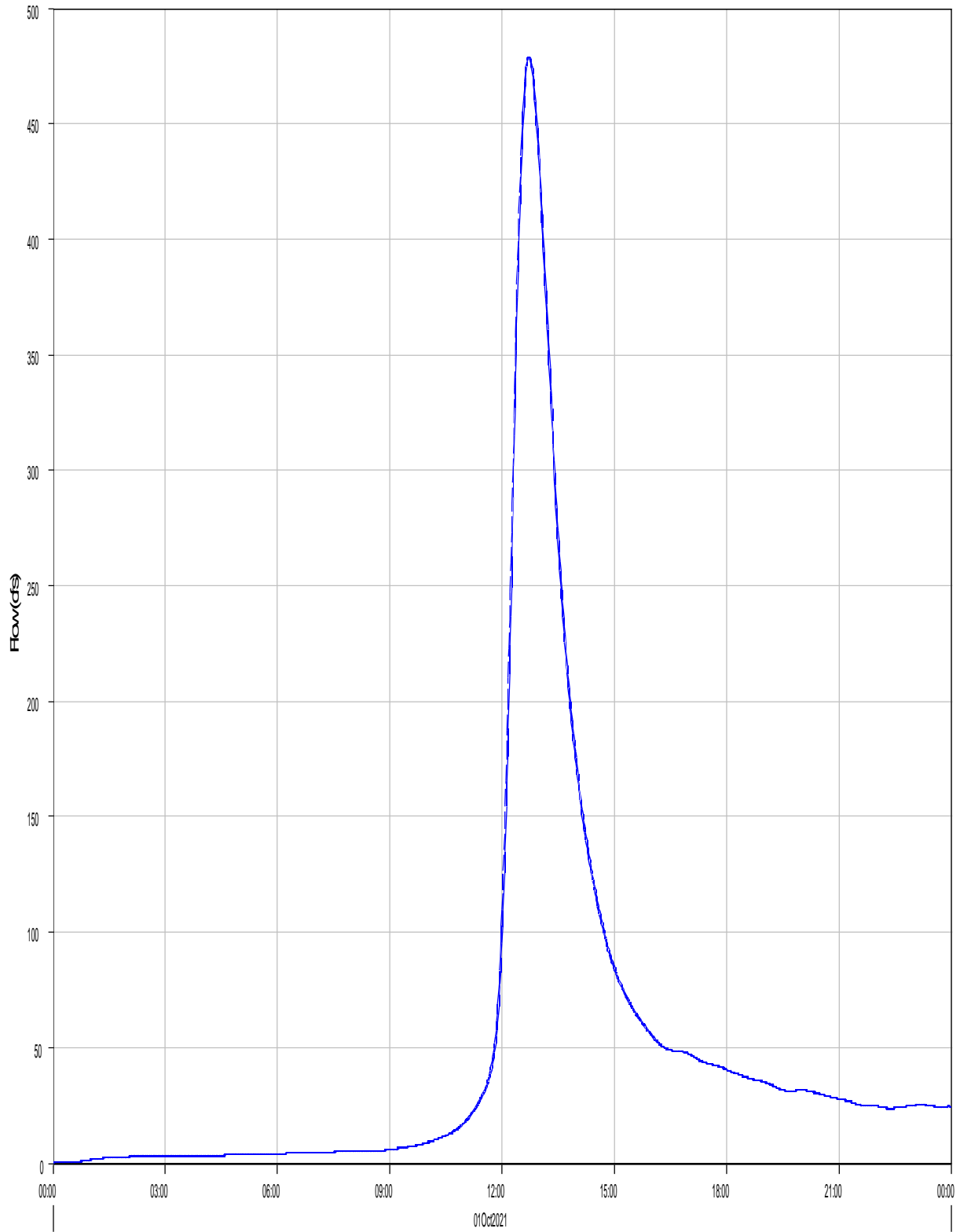

Run:EV 100-yr Pr. Type II Element:R-OB7 Result:Outflow

Run:EV 100-yr Pr. Type II Element:R-OB7 Result:Combined Inflow

Project: Eagleview_Subdivision
Simulation Run: EV 100-yr Pr. Type II Reach: R-OB7
Start of Run: 01Oct2021, 00:00 Basin Model: Eagleview_Proposed
End of Run: 02Oct2021, 00:00 Meteorologic Model: 100-yr Type II
Compute Time: 15Mar2022, 09:38:27 Control Specifications: 24-hr Storm

Volume Units: AC-FT

Computed Results

Peak Inflow :	479.0 (CFS)	Date/Time of Peak Inflow :	01Oct2021, 12:42
Peak Outflow :	479.0 (CFS)	Date/Time of Peak Outflow :	01Oct2021, 12:44
Total Inflow :	98.2 (AC-FT)	Total Outflow :	98.1 (AC-FT)

Reach 'R-OB8' Results for Run 'EV 100-yr Pr. Type II'

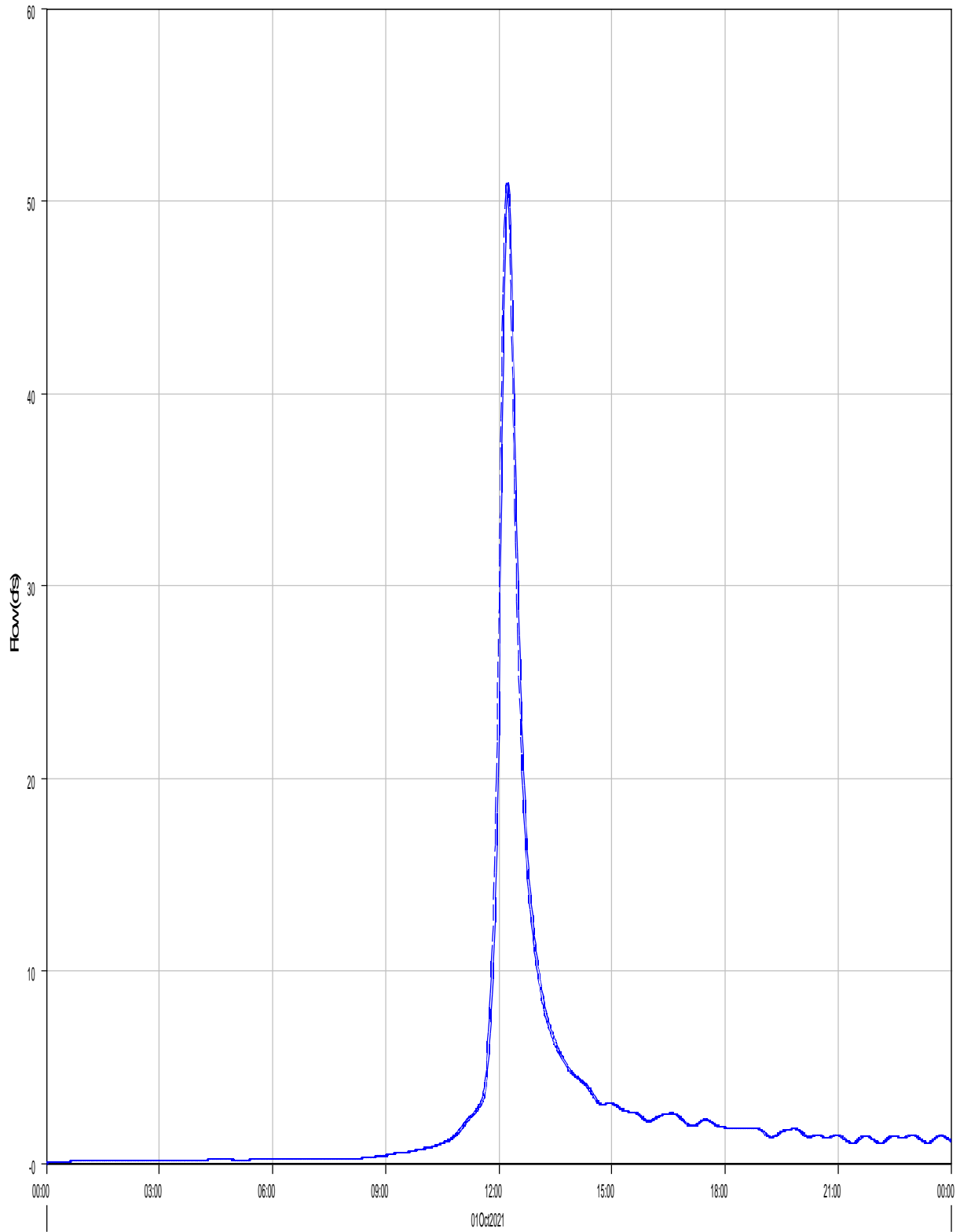

— Run:EV 100-yr Pr. Type II Element:R-OB8 Result:Outflow

- - - Run:EV 100-yr Pr. Type II Element:R-OB8 Result:Combined Inflow

Project: Eagleview_Subdivision
Simulation Run: EV 100-yr Pr. Type II Reach: R-OB8
Start of Run: 01Oct2021, 00:00 Basin Model: Eagleview_Proposed
End of Run: 02Oct2021, 00:00 Meteorologic Model: 100-yr Type II
Compute Time: 15Mar2022, 09:38:27 Control Specifications: 24-hr Storm

Volume Units: AC-FT

Computed Results

Peak Inflow :	51.0 (CFS)	Date/Time of Peak Inflow :	01Oct2021, 12:13
Peak Outflow :	50.9 (CFS)	Date/Time of Peak Outflow :	01Oct2021, 12:15
Total Inflow :	5.3 (AC-FT)	Total Outflow :	5.3 (AC-FT)

Reach 'R-PB3' Results for Run 'EV 100-yr Pr. Type II'

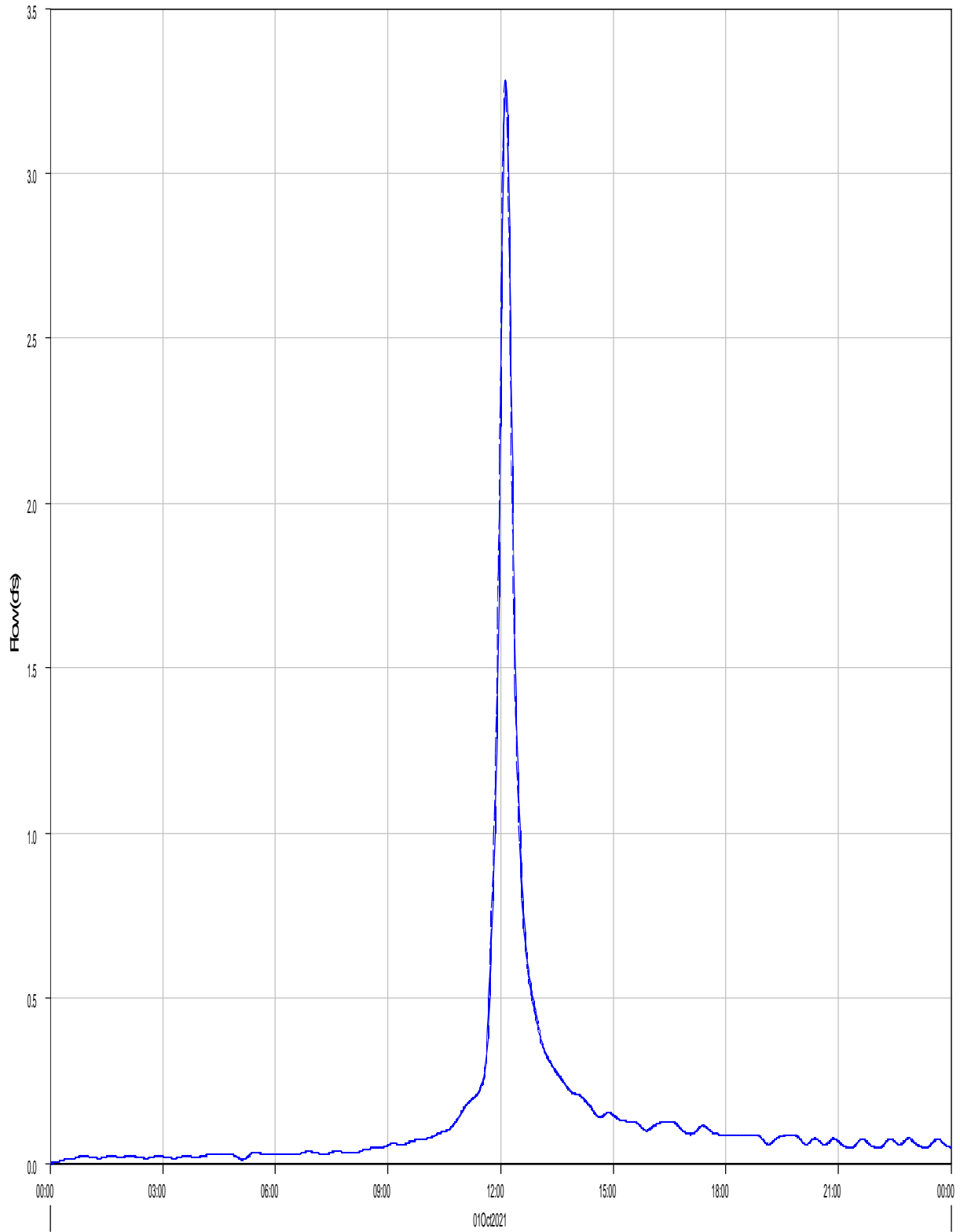

Run:EV 100-yr Pr. Type II Element:R-PB3 Result:Outflow

Run:EV 100-yr Pr. Type II Element:R-PB3 Result:Combined Inflow

Project: Eagleview_Subdivision
Simulation Run: EV 100-yr Pr. Type II Reach: R-PB3
Start of Run: 01Oct2021, 00:00 Basin Model: Eagleview_Proposed
End of Run: 02Oct2021, 00:00 Meteorologic Model: 100-yr Type II
Compute Time: 15Mar2022, 09:38:27 Control Specifications: 24-hr Storm

Volume Units: AC-FT

Computed Results

Peak Inflow :	3.3 (CFS)	Date/Time of Peak Inflow :	01Oct2021, 12:07
Peak Outflow :	3.3 (CFS)	Date/Time of Peak Outflow :	01Oct2021, 12:09
Total Inflow :	0.3 (AC-FT)	Total Outflow :	0.3 (AC-FT)

Reach 'R-PB5' Results for Run 'EV 100-yr Pr. Type II'

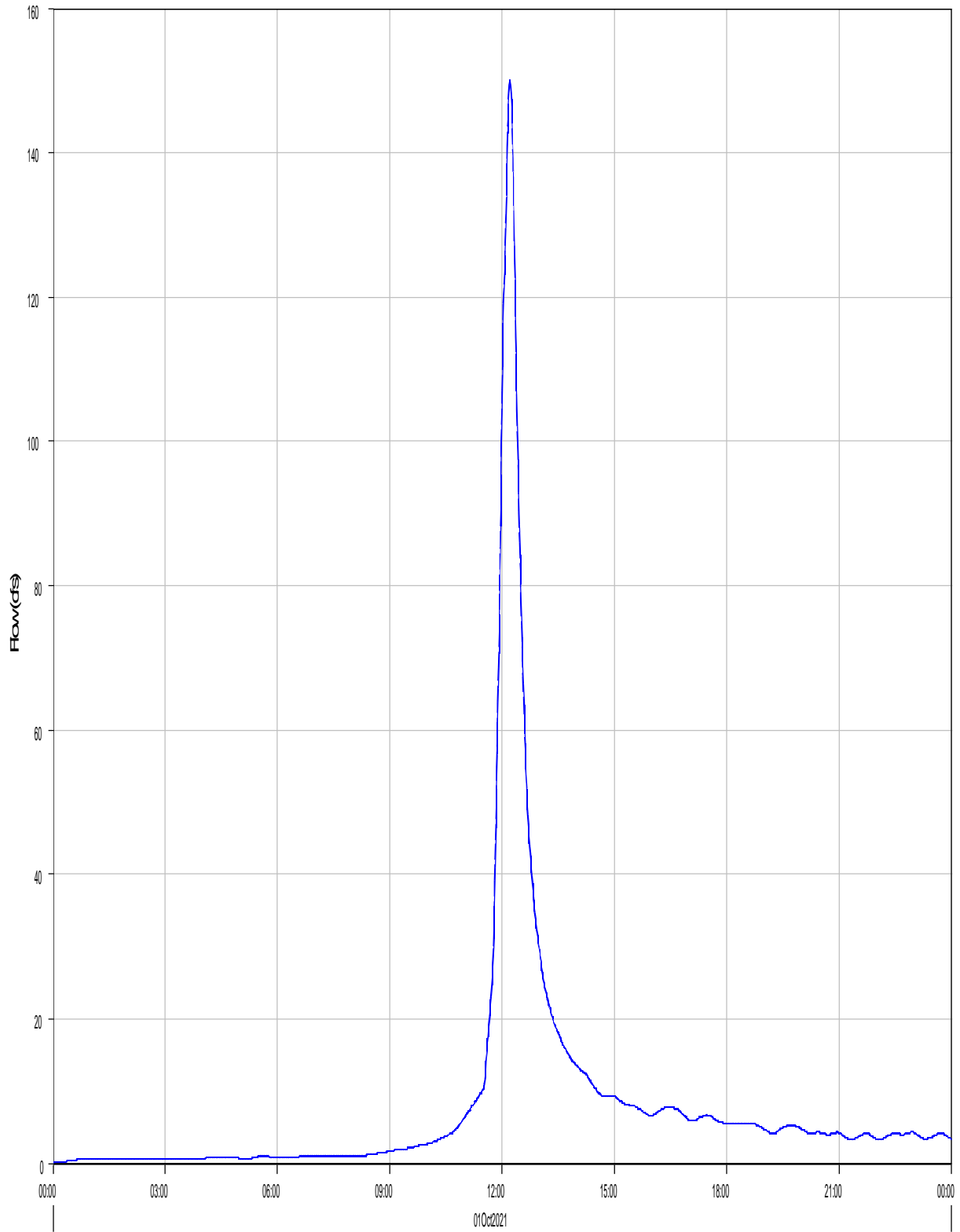

— Run:EV 100-yr Pr. Type II Element:R-PB5 Result:Outflow

- - - Run:EV 100-yr Pr. Type II Element:R-PB5 Result:Combined Inflow

Project: Eagleview_Subdivision
Simulation Run: EV 100-yr Pr. Type II Reach: R-PB5
Start of Run: 01Oct2021, 00:00 Basin Model: Eagleview_Proposed
End of Run: 02Oct2021, 00:00 Meteorologic Model: 100-yr Type II
Compute Time: 15Mar2022, 09:38:27 Control Specifications: 24-hr Storm

Volume Units: AC-FT

Computed Results

Peak Inflow :	150.1 (CFS)	Date/Time of Peak Inflow :	01Oct2021, 12:12
Peak Outflow :	150.0 (CFS)	Date/Time of Peak Outflow :	01Oct2021, 12:13
Total Inflow :	16.4 (AC-FT)	Total Outflow :	16.4 (AC-FT)

Project: Eagleview_Subdivision
Simulation Run: EV 100-yr Pr. Type II Reach: R-PB7-A

Start of Run: 01Oct2021, 00:00 Basin Model: Eagleview_Proposed
End of Run: 02Oct2021, 00:00 Meteorologic Model: 100-yr Type II
Compute Time: 15Mar2022, 09:38:27 Control Specifications: 24-hr Storm

Volume Units: AC-FT

Computed Results

Peak Inflow :	11.3 (CFS)	Date/Time of Peak Inflow :	01Oct2021, 12:08
Peak Outflow :	11.3 (CFS)	Date/Time of Peak Outflow :	01Oct2021, 12:09
Total Inflow :	1.0 (AC-FT)	Total Outflow :	1.0 (AC-FT)

Reach 'R-PB7-B' Results for Run 'EV 100-yr Pr. Type II'

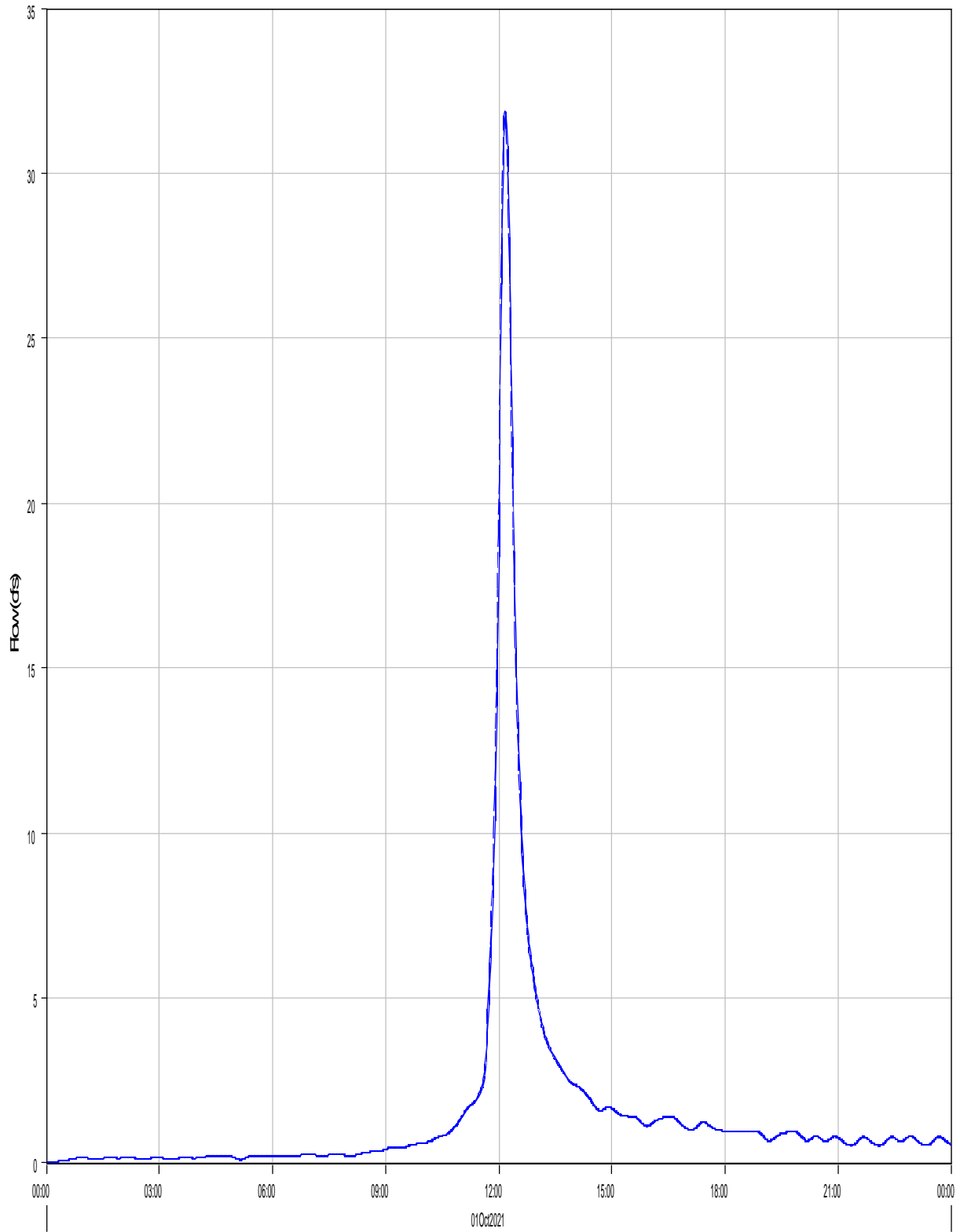

Run:EV 100-yr Pr. Type II Element:R-PB7-B Result:Outflow

Run:EV 100-yr Pr. Type II Element:R-PB7-B Result:Combined Inflow

Project: Eagleview_Subdivision

Simulation Run: EV 100-yr Pr. Type II Reach: R-PB7-B

Start of Run: 01Oct2021, 00:00 Basin Model: Eagleview_Proposed

End of Run: 02Oct2021, 00:00 Meteorologic Model: 100-yr Type II

Compute Time: 15Mar2022, 09:38:27 Control Specifications: 24-hr Storm

Volume Units: AC-FT

Computed Results

Peak Inflow :	31.9 (CFS)	Date/Time of Peak Inflow :	01Oct2021, 12:10
Peak Outflow :	31.9 (CFS)	Date/Time of Peak Outflow :	01Oct2021, 12:11
Total Inflow :	3.1 (AC-FT)	Total Outflow :	3.1 (AC-FT)

Reach 'R-PB7-C' Results for Run 'EV 100-yr Pr. Type II'

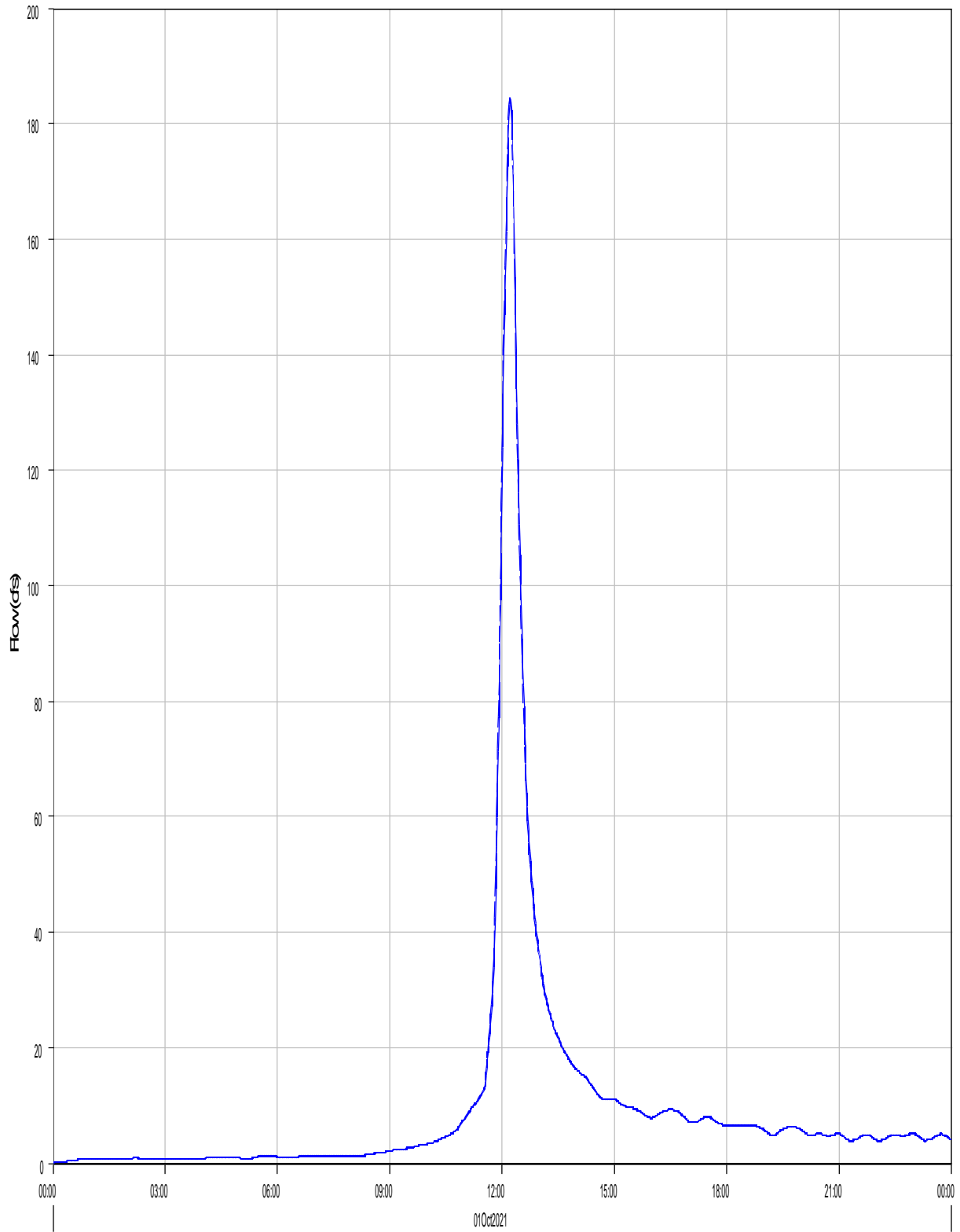

Run:EV 100-yr Pr. Type II Element:R-PB7-C Result:Outflow

Run:EV 100-yr Pr. Type II Element:R-PB7-C Result:Combined Inflow

Project: Eagleview_Subdivision
Simulation Run: EV 100-yr Pr. Type II Reach: R-PB7-C

Start of Run: 01Oct2021, 00:00 Basin Model: Eagleview_Proposed
End of Run: 02Oct2021, 00:00 Meteorologic Model: 100-yr Type II
Compute Time: 15Mar2022, 09:38:27 Control Specifications: 24-hr Storm

Volume Units: AC-FT

Computed Results

Peak Inflow :	184.6 (CFS)	Date/Time of Peak Inflow :	01Oct2021, 12:12
Peak Outflow :	184.4 (CFS)	Date/Time of Peak Outflow :	01Oct2021, 12:13
Total Inflow :	19.8 (AC-FT)	Total Outflow :	19.8 (AC-FT)

Reach 'R-PB7-A' Results for Run 'EV 100-yr Pr. Type II'

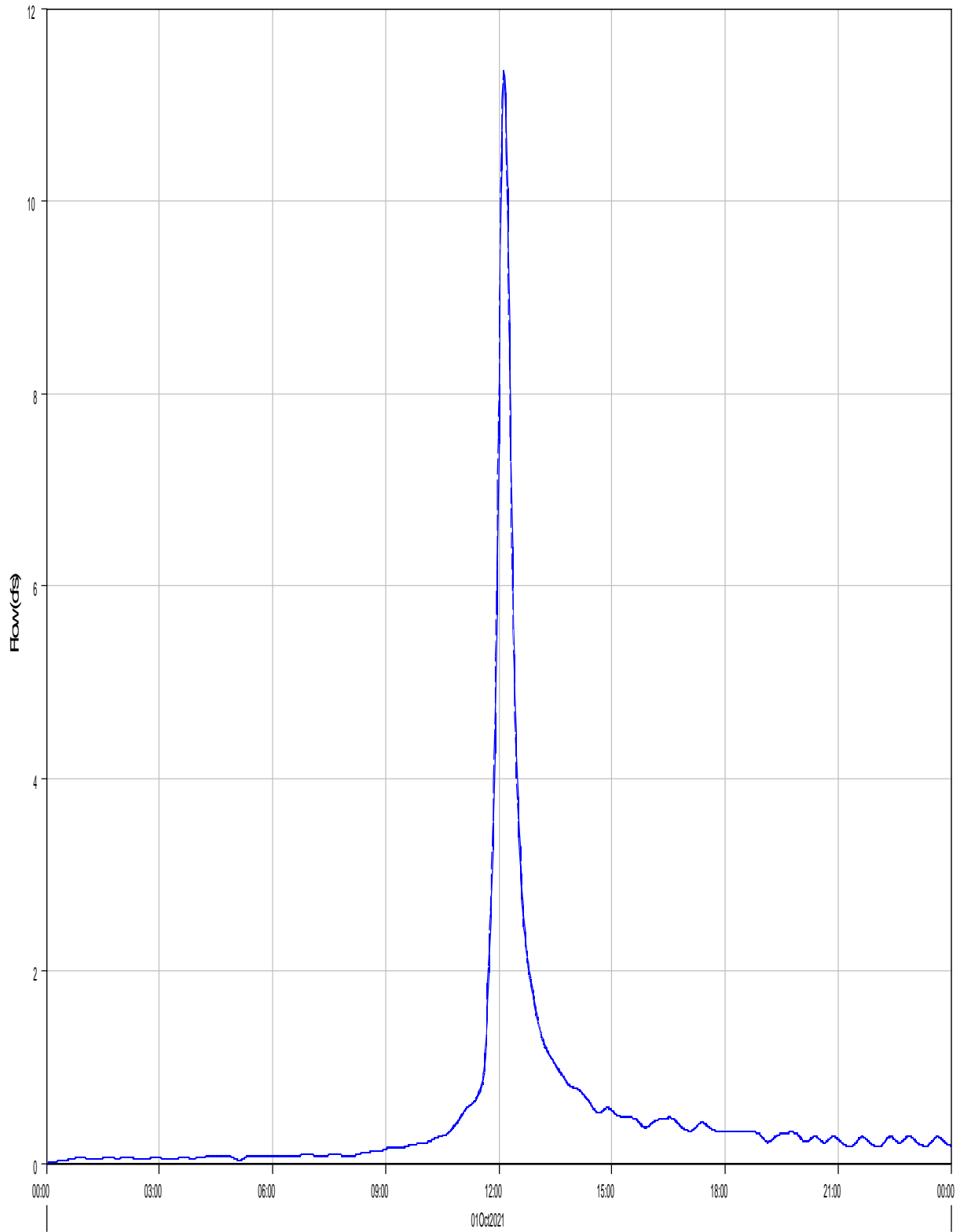

Run:EV 100-yr Pr. Type II Element:R-PB7-A Result:Outflow

Run:EV 100-yr Pr. Type II Element:R-PB7-A Result:Combined Inflow

Reach 'R-PB9' Results for Run 'EV 100-yr Pr. Type II'

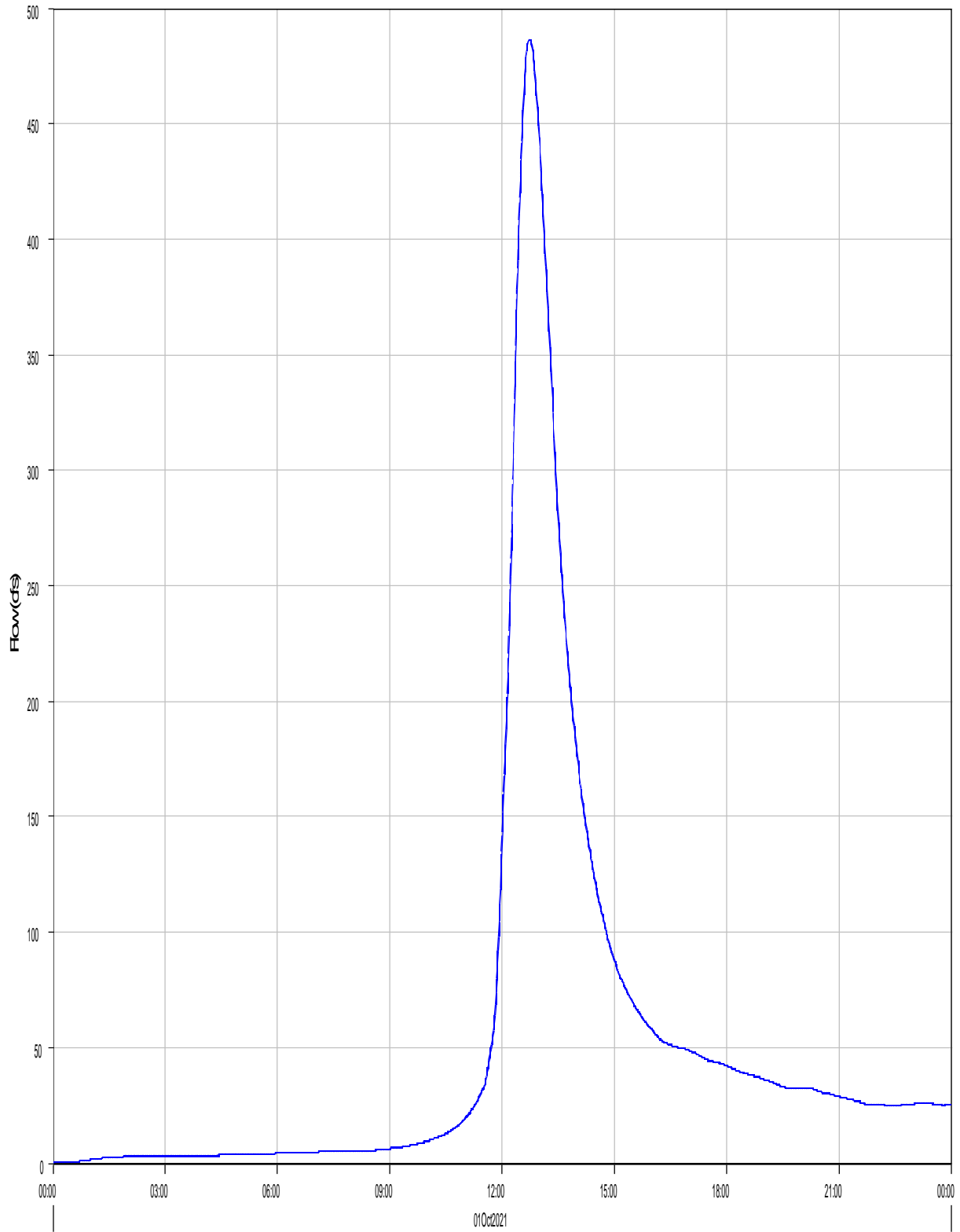

Run:EV 100-yr Pr. Type II Element:R-PB9 Result:Outflow

Run:EV 100-yr Pr. Type II Element:R-PB9 Result:Combined Inflow

Project: Eagleview_Subdivision
Simulation Run: EV 100-yr Pr. Type II Reach: R-PB9
Start of Run: 01Oct2021, 00:00 Basin Model: Eagleview_Proposed
End of Run: 02Oct2021, 00:00 Meteorologic Model: 100-yr Type II
Compute Time: 15Mar2022, 09:38:27 Control Specifications: 24-hr Storm

Volume Units: AC-FT

Computed Results

Peak Inflow :	486.7 (CFS)	Date/Time of Peak Inflow :	01Oct2021, 12:44
Peak Outflow :	486.6 (CFS)	Date/Time of Peak Outflow :	01Oct2021, 12:44
Total Inflow :	102.2 (AC-FT)	Total Outflow :	102.2 (AC-FT)

Reach 'R-PB10' Results for Run 'EV 100-yr Pr. Type II'

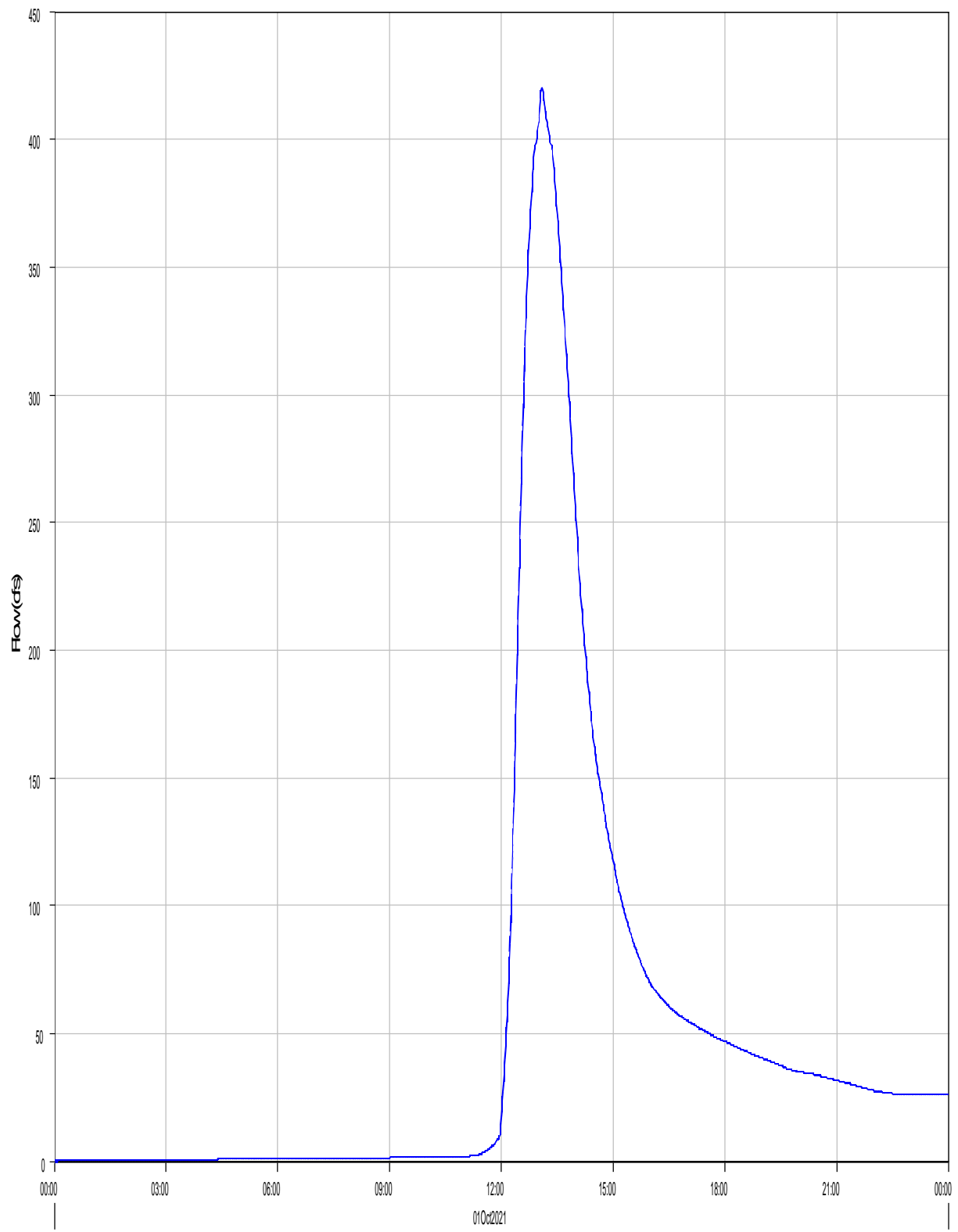

Run:EV 100-yr Pr. Type II Element:R-PB10 Result:Outflow

Run:EV 100-yr Pr. Type II Element:R-PB10 Result:Combined Inflow

Project: Eagleview_Subdivision
Simulation Run: EV 100-yr Pr. Type II Reach: R-PB10

Start of Run: 01Oct2021, 00:00 Basin Model: Eagleview_Proposed
End of Run: 02Oct2021, 00:00 Meteorologic Model: 100-yr Type II
Compute Time: 15Mar2022, 09:38:27 Control Specifications: 24-hr Storm

Volume Units: AC-FT

Computed Results

Peak Inflow :	420.1 (CFS)	Date/Time of Peak Inflow :	01Oct2021, 13:05
Peak Outflow :	420.0 (CFS)	Date/Time of Peak Outflow :	01Oct2021, 13:06
Total Inflow :	96.5 (AC-FT)	Total Outflow :	96.5 (AC-FT)

Reach 'R-PB11' Results for Run 'EV 100-yr Pr. Type II'

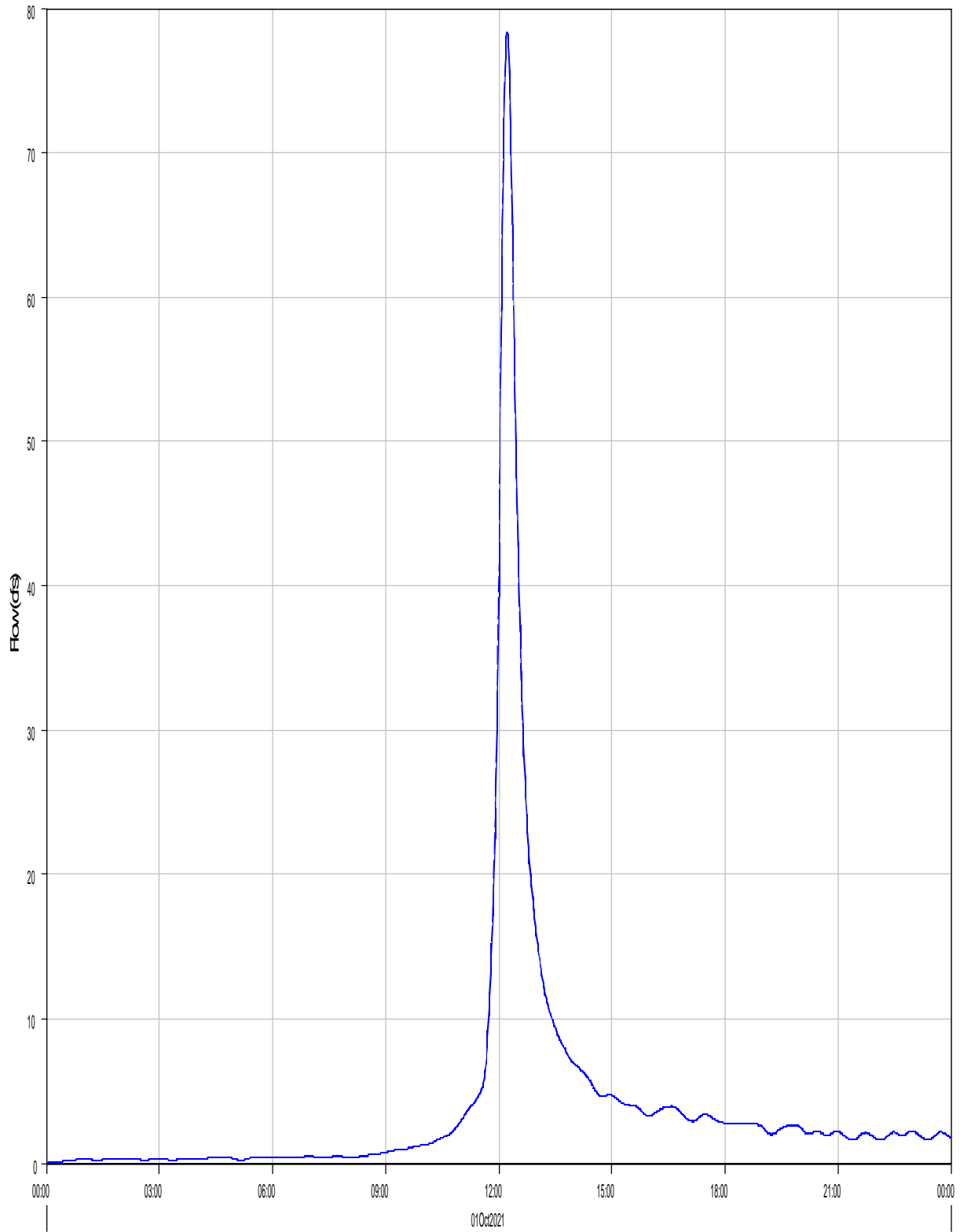

Run:EV 100-yr Pr. Type II Element:R-PB11 Result:Outflow

Run:EV 100-yr Pr. Type II Element:R-PB11 Result:Combined Inflow

Project: Eagleview_Subdivision
Simulation Run: EV 100-yr Pr. Type II Reach: R-PB11

Start of Run: 01Oct2021, 00:00 Basin Model: Eagleview_Proposed
End of Run: 02Oct2021, 00:00 Meteorologic Model: 100-yr Type II
Compute Time: 15Mar2022, 09:38:27 Control Specifications: 24-hr Storm

Volume Units: AC-FT

Computed Results

Peak Inflow :	78.4 (CFS)	Date/Time of Peak Inflow :	01Oct2021, 12:13
Peak Outflow :	78.3 (CFS)	Date/Time of Peak Outflow :	01Oct2021, 12:14
Total Inflow :	8.2 (AC-FT)	Total Outflow :	8.2 (AC-FT)

Reach 'R-PB12-A' Results for Run 'EV 100-yr Pr. Type II'

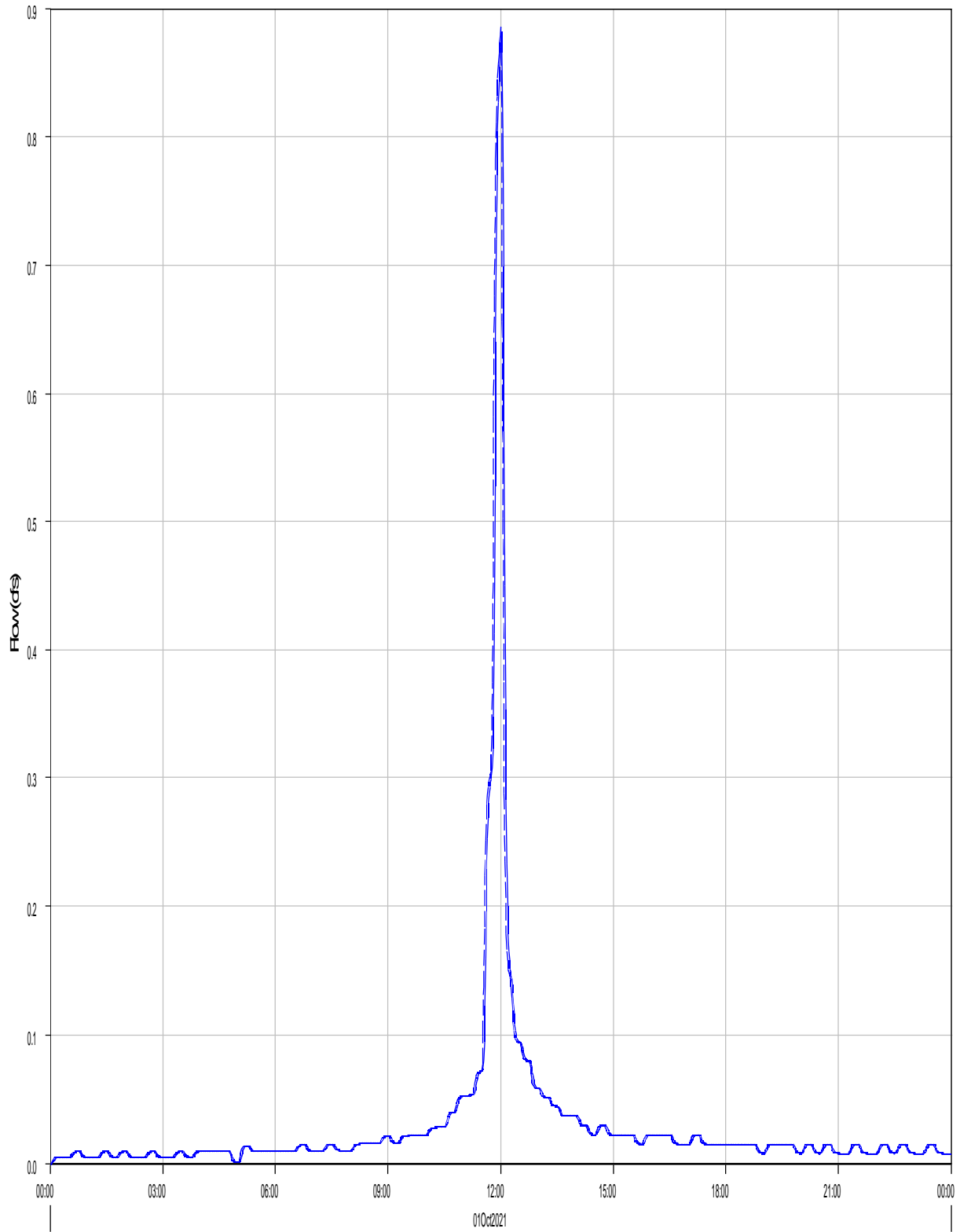

— Run:EV 100-yr Pr. Type II Element:R-PB12-A Result:Outflow

- - - Run:EV 100-yr Pr. Type II Element:R-PB12-A Result:Combined Inflow

Project: Eagleview_Subdivision
Simulation Run: EV 100-yr Pr. Type II Reach: R-PB12-A

Start of Run: 01Oct2021, 00:00 Basin Model: Eagleview_Proposed
End of Run: 02Oct2021, 00:00 Meteorologic Model: 100-yr Type II
Compute Time: 15Mar2022, 09:38:27 Control Specifications: 24-hr Storm

Volume Units: AC-FT

Computed Results

Peak Inflow :	0.9 (CFS)	Date/Time of Peak Inflow :	01Oct2021, 12:00
Peak Outflow :	0.9 (CFS)	Date/Time of Peak Outflow :	01Oct2021, 12:02
Total Inflow :	0.1 (AC-FT)	Total Outflow :	0.1 (AC-FT)

Reach 'R-PB12-B' Results for Run 'EV 100-yr Pr. Type II'

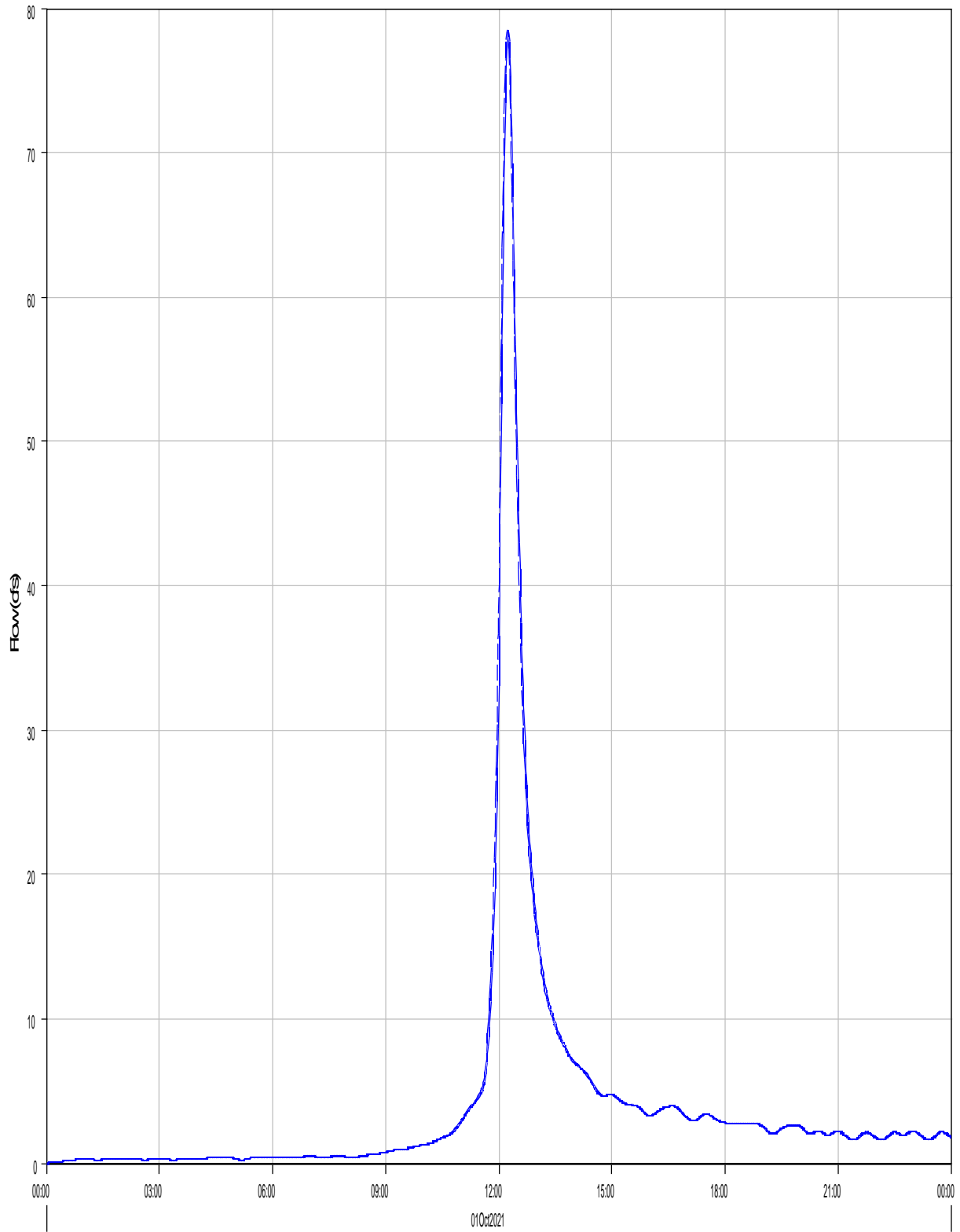

Run:EV 100-yr Pr. Type II Element:R-PB12-B Result:Outflow

Run:EV 100-yr Pr. Type II Element:R-PB12-B Result:Combined Inflow

Project: Eagleview_Subdivision
Simulation Run: EV 100-yr Pr. Type II Reach: R-PB12-B

Start of Run: 01Oct2021, 00:00 Basin Model: Eagleview_Proposed
End of Run: 02Oct2021, 00:00 Meteorologic Model: 100-yr Type II
Compute Time: 15Mar2022, 09:38:27 Control Specifications: 24-hr Storm

Volume Units: AC-FT

Computed Results

Peak Inflow :	78.5 (CFS)	Date/Time of Peak Inflow :	01Oct2021, 12:14
Peak Outflow :	78.4 (CFS)	Date/Time of Peak Outflow :	01Oct2021, 12:15
Total Inflow :	8.2 (AC-FT)	Total Outflow :	8.2 (AC-FT)

Reach 'R-PB13' Results for Run 'EV 100-yr Pr. Type II'

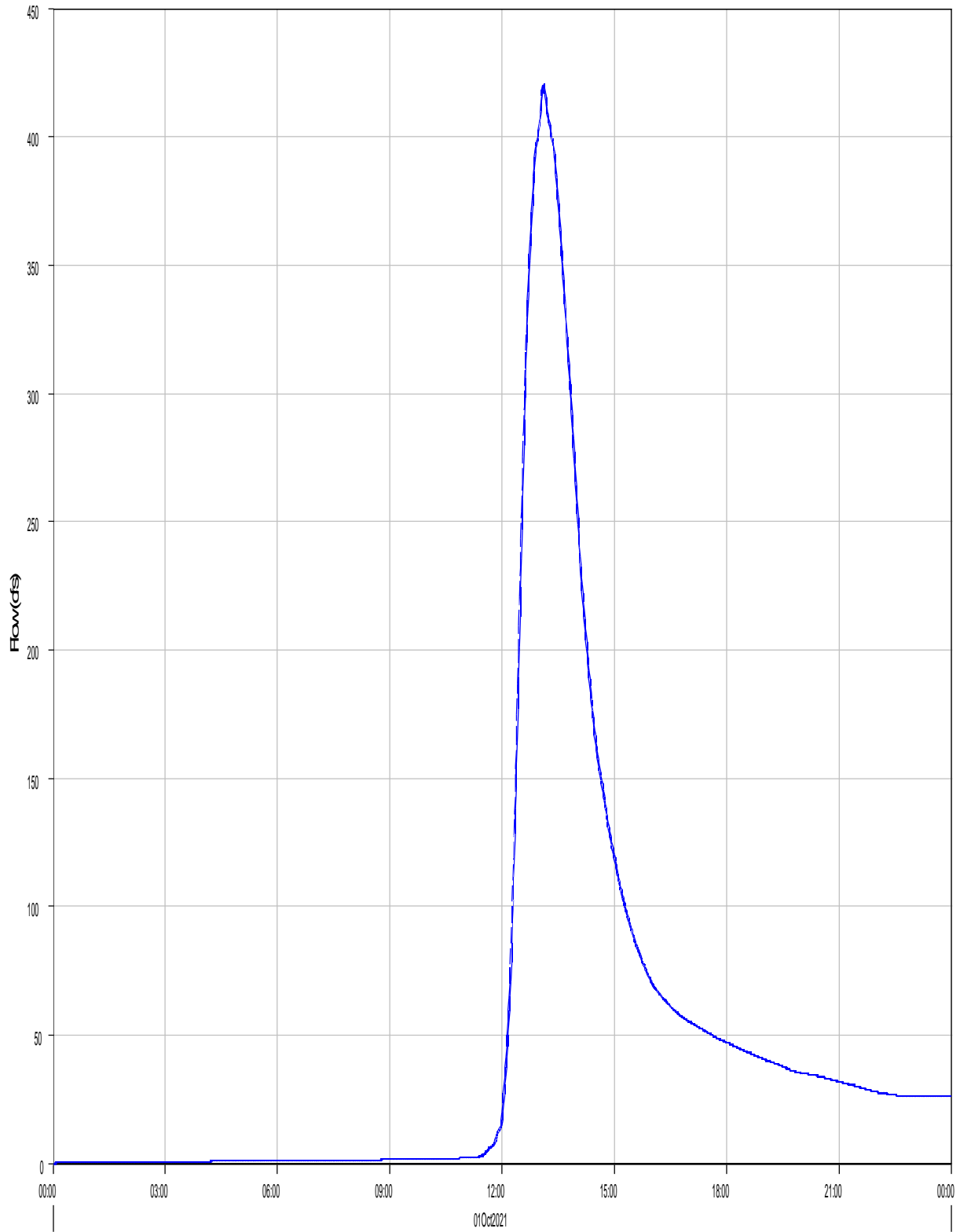

Run:EV 100-yr Pr. Type II Element:R-PB13 Result:Outflow

Run:EV 100-yr Pr. Type II Element:R-PB13 Result:Combined Inflow

Project: Eagleview_Subdivision
Simulation Run: EV 100-yr Pr. Type II Reach: R-PB13

Start of Run: 01Oct2021, 00:00 Basin Model: Eagleview_Proposed
End of Run: 02Oct2021, 00:00 Meteorologic Model: 100-yr Type II
Compute Time: 15Mar2022, 09:38:27 Control Specifications: 24-hr Storm

Volume Units: AC-FT

Computed Results

Peak Inflow :	420.3 (CFS)	Date/Time of Peak Inflow :	01Oct2021, 13:06
Peak Outflow :	420.1 (CFS)	Date/Time of Peak Outflow :	01Oct2021, 13:07
Total Inflow :	96.8 (AC-FT)	Total Outflow :	96.7 (AC-FT)

TypicalChannel

Project Description	
Friction Method	Manning
	Formula
Solve For	Discharge
Input Data	
Roughness Coefficient	0.030
Channel Slope	0.025 ft/ft
Normal Depth	24.0 in
Left Side Slope	1.300 H:V
Right Side Slope	1.300 H:V
Results	
Discharge	34.88 cfs
Flow Area	5.2 ft ²
Wetted Perimeter	6.6 ft
Hydraulic Radius	9.5 in
Top Width	5.20 ft
Critical Depth	25.7 in
Critical Slope	0.017 ft/ft
Velocity	6.71 ft/s
Velocity Head	0.70 ft
Specific Energy	2.70 ft
Froude Number	1.183
Flow Type	Supercritical
GVF Input Data	
Downstream Depth	0.0 in
Length	0.0 ft
Number Of Steps	0
GVF Output Data	
Upstream Depth	0.0 in
Profile Description	N/A
Profile Headloss	0.00 ft
Downstream Velocity	Infinity ft/s
Upstream Velocity	Infinity ft/s
Normal Depth	24.0 in
Critical Depth	25.7 in
Channel Slope	0.025 ft/ft
Critical Slope	0.017 ft/ft

Note: This worksheet was used for HEC-HMS input and is for hydrologic routing purposes only

Worksheet for Typical Ditch

Project Description	
Friction Method	Manning Formula
Solve For	Discharge
Input Data	
Roughness Coefficient	0.030
Channel Slope	0.025 ft/ft
Normal Depth	18.0 in
Left Side Slope	4.000 H:V
Right Side Slope	4.000 H:V
Results	
Discharge	57.02 cfs
Flow Area	9.0 ft ²
Wetted Perimeter	12.4 ft
Hydraulic Radius	8.7 in
Top Width	12.00 ft
Critical Depth	19.9 in
Critical Slope	0.015 ft/ft
Velocity	6.34 ft/s
Velocity Head	0.62 ft
Specific Energy	2.12 ft
Froude Number	1.290
Flow Type	Supercritical
GVF Input Data	
Downstream Depth	0.0 in
Length	0.0 ft
Number Of Steps	0
GVF Output Data	
Upstream Depth	0.0 in
Profile Description	N/A
Profile Headloss	0.00 ft
Downstream Velocity	Infinity ft/s
Upstream Velocity	Infinity ft/s
Normal Depth	18.0 in
Critical Depth	19.9 in
Channel Slope	0.025 ft/ft
Critical Slope	0.015 ft/ft

Note: This worksheet was used for HEC-HMS input and is for hydrologic routing purposes only

Proposed Conditions Hydrology (Revised)

Proposed Conditions HEC-HMS (Includes sub regional detention Pond_OB5)

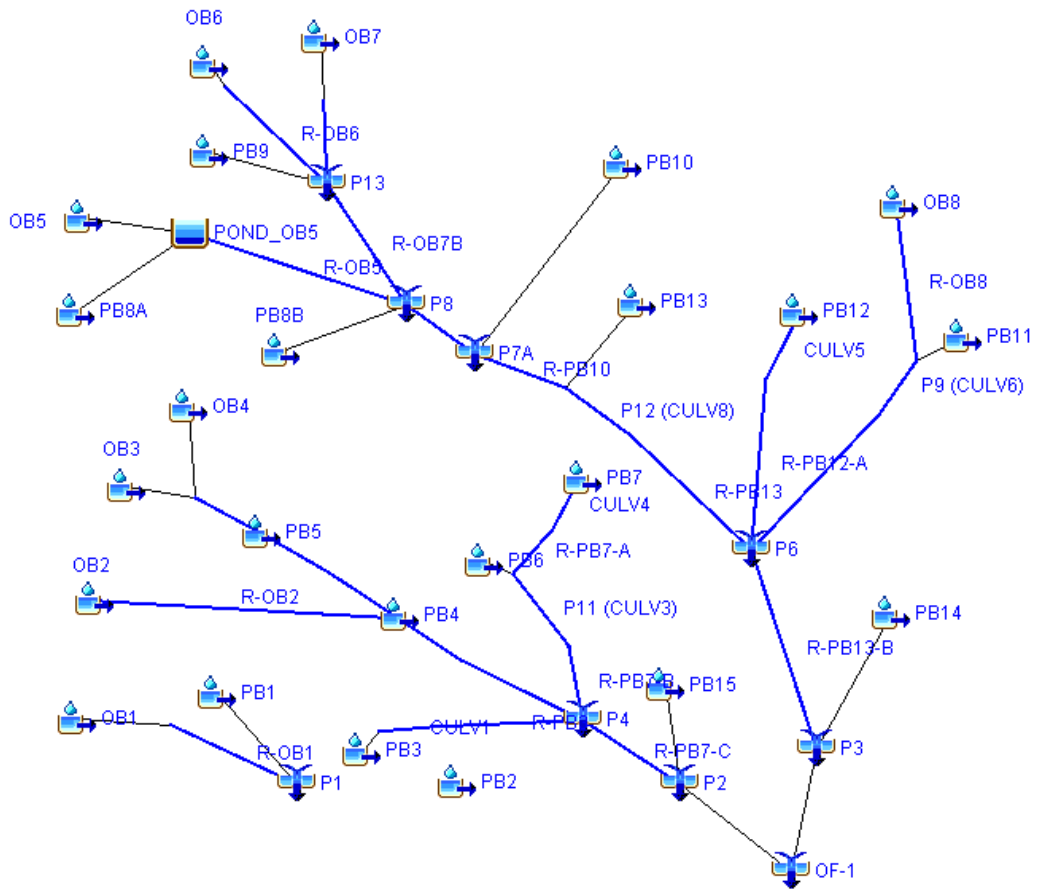

Project: Eagleview_Subdivision_Update

Simulation Run: Pr

Start of Run: 01Oct2021, 00:00

Basin Model:

End of Run: 02Oct2021, 00:00

Meteorologic Model:

Compute Time: 12Oct2023, 09:44:12

Control Specifications:

Hydrologic Element	Drainage Area (MI2)	Peak Discharge (CFS)	Time of Peak	Volume (AC-FT)
OB7	0.65812	284.3	01Oct2021, 12:52	60.6
R-OB7A	0.65812	284.3	01Oct2021, 12:53	60.5
OB6	0.18501	113.3	01Oct2021, 12:29	17.5
R-OB6	0.18501	113.3	01Oct2021, 12:30	17.5
PB9	0.0199984	24.8	01Oct2021, 12:07	2.2
P13	0.86313	375.0	01Oct2021, 12:44	80.3
R-OB7B	0.86313	374.9	01Oct2021, 12:45	80.2
OB5	0.22472	107.1	01Oct2021, 12:40	19.8
PB8A	0.0115600	19.3	01Oct2021, 12:01	1.3
POND_OB5	0.23628	100.6	01Oct2021, 12:52	20.0
R-OB5	0.23628	100.6	01Oct2021, 12:55	20.0
PB8B	0.0093900	15.5	01Oct2021, 12:01	1.0
P8	1.1088	473.9	01Oct2021, 12:47	101.2
R-PB9	1.1088	473.9	01Oct2021, 12:48	101.2
PB10	0.0180156	20.4	01Oct2021, 12:10	2.0
P7A	1.1268	478.3	01Oct2021, 12:48	103.2
R-PB10	1.1268	478.3	01Oct2021, 12:48	103.2
PB13	0.0060438	10.9	01Oct2021, 12:00	0.7
P12 (CULV8)	1.1329	479.2	01Oct2021, 12:48	103.9
R-PB13	1.1329	479.2	01Oct2021, 12:48	103.8
OB8	0.0516742	51.6	01Oct2021, 12:13	5.4
R-OB8	0.0516742	51.6	01Oct2021, 12:15	5.4
PB11	0.0251766	29.8	01Oct2021, 12:10	2.9
P9 (CULV6)	0.0768508	79.1	01Oct2021, 12:13	8.2
R-PB11	0.0768508	79.0	01Oct2021, 12:14	8.2

Hydrologic Element	Drainage Area (MI ²)	Peak Discharge (CFS)	Time of Peak	Volume (AC-FT)
PB12	.000315625	0.9	01Oct2021, 12:00	0.1
CULV5	.000315625	0.9	01Oct2021, 12:00	0.1
R-PB12-A	.000315625	0.9	01Oct2021, 12:02	0.1
P6	1.2100	501.7	01Oct2021, 12:46	112.1
R-PB13-B	1.2100	501.6	01Oct2021, 12:47	112.1
PB14	0.0270031	46.3	01Oct2021, 12:01	2.9
P3	1.2370	506.2	01Oct2021, 12:47	115.0
OB3	0.0678750	67.2	01Oct2021, 12:12	7.0
OB4	0.0164062	18.9	01Oct2021, 12:10	1.8
R-OB4-A	0.0842812	85.7	01Oct2021, 12:13	8.8
PB5	0.0096625	10.4	01Oct2021, 12:12	1.1
P5 (CULV7)	0.0939437	96.1	01Oct2021, 12:13	9.9
R-OB4-B	0.0939437	95.9	01Oct2021, 12:14	9.8
OB2	0.0438438	52.7	01Oct2021, 12:08	4.7
R-OB2	0.0438438	52.5	01Oct2021, 12:09	4.7
PB4	0.0164672	30.2	01Oct2021, 12:00	1.9
P10 (CULV2)	0.15425	150.2	01Oct2021, 12:12	16.4
R-PB5	0.15425	150.1	01Oct2021, 12:13	16.4
PB6	0.0173312	20.7	01Oct2021, 12:10	2.0
PB7	0.0054094	7.4	01Oct2021, 12:08	0.7
CULV4	0.0054094	7.4	01Oct2021, 12:08	0.7
R-PB7-A	0.0054094	7.4	01Oct2021, 12:09	0.7
P11 (CULV3)	0.0227406	28.0	01Oct2021, 12:10	2.7
R-PB7-B	0.0227406	27.9	01Oct2021, 12:11	2.7
PB3	0.0021625	3.3	01Oct2021, 12:07	0.3
CULV1	0.0021625	3.3	01Oct2021, 12:07	0.3
R-PB3	0.0021625	3.3	01Oct2021, 12:09	0.3
P4	0.17916	180.8	01Oct2021, 12:12	19.4
R-PB7-C	0.17916	180.8	01Oct2021, 12:13	19.4
PB15	0.0150500	26.3	01Oct2021, 12:00	1.7
P2	0.19421	185.4	01Oct2021, 12:13	21.1

Hydrologic Element	Drainage Area (MI ²)	Peak Discharge (CFS)	Time of Peak	Volume (AC-FT)
OF-1	1.4312	562.3	01Oct2021, 12:42	136.1
OB1	0.0162031	18.8	01Oct2021, 12:08	1.7
R-OB1	0.0162031	18.7	01Oct2021, 12:09	1.7
PB1	0.0066453	7.7	01Oct2021, 12:09	0.7
P1	0.0228484	26.4	01Oct2021, 12:09	2.4
PB2	0.0016935	2.4	01Oct2021, 12:06	0.2

Project: Eagleview_Subdivision_Update

Simulation Run: Proposed_PondOB5 Reservoir: POND_OB5

Start of Run: 01Oct2021, 00:00 Basin Model: Eagleview_Proposed_OB5_Pond

End of Run: 02Oct2021, 00:00 Meteorologic Model: 100-yr Type II

Compute Time: 12Oct2023, 09:44:12 Control Specifications: 24-hr Storm

Volume Units: AC-FT

Computed Results

Peak Inflow :	109.2 (CFS)	Date/Time of Peak Inflow :	01Oct2021, 12:40
Peak Outflow :	100.6 (CFS)	Date/Time of Peak Outflow :	01Oct2021, 12:52
Total Inflow :	21.0 (AC-FT)	Peak Storage :	2.4 (AC-FT)
Total Outflow :	20.0 (AC-FT)	Peak Elevation :	7241.3 (FT)

APPENDIX C: HYDRAULICS

- HEC-RAS Model Overview Map and Photos
- HEC-RAS Comparison Table

Overview Map

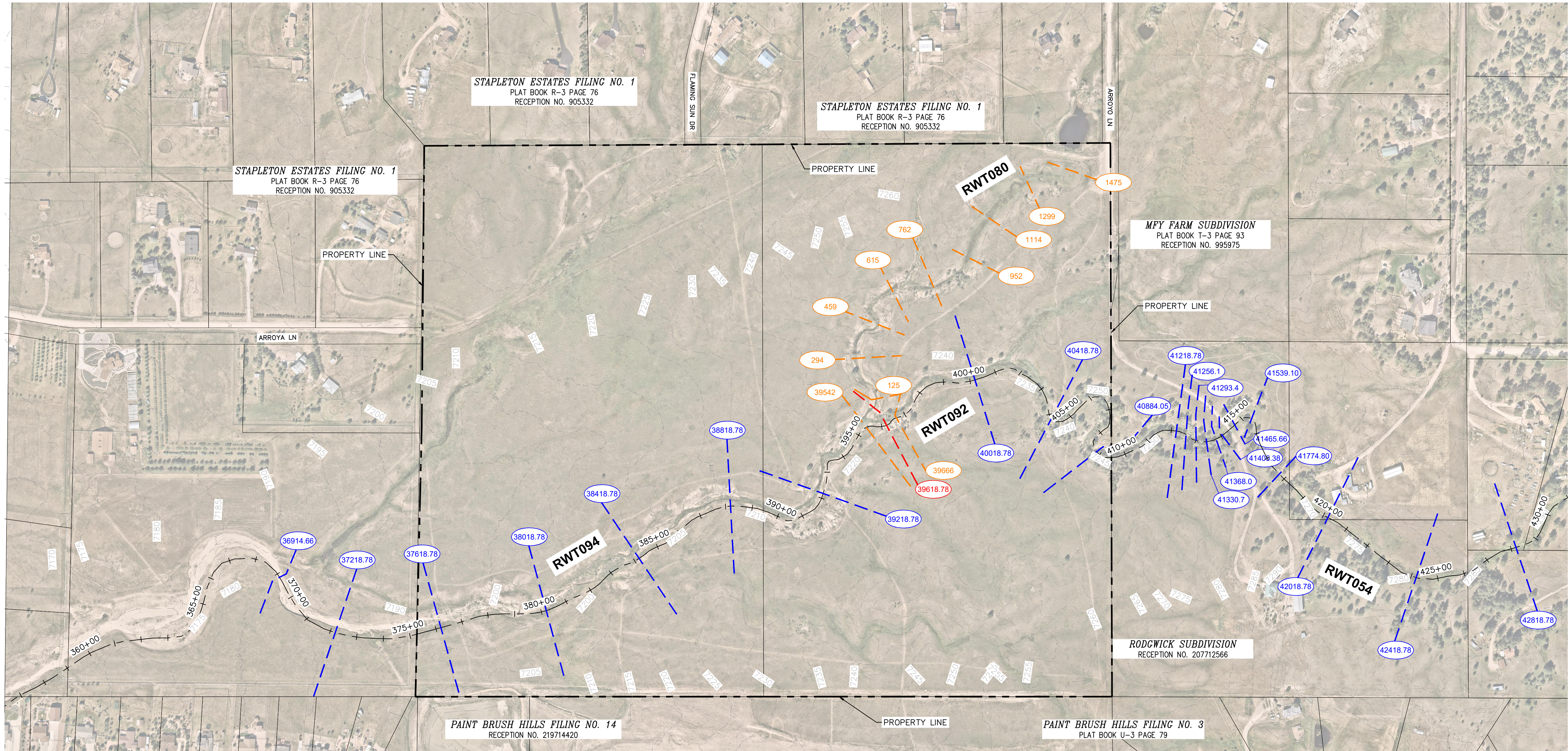

LEGEND

- PROPERTY LINE
- LOT LINE
- - - - - DBPS HEC-RAS CROSS SECTION
- - - - - DBPS HEC-RAS CROSS SECTION (REMOVED)
- - - - - NEW HEC-RAS CROSS SECTION
- XXXX ----- EXISTING MAJOR CONTOUR
- XXXX ----- EXISTING MINOR CONTOUR
- (XXXX.XX) HEC-RAS CROSS SECTION ID

NOTE:
 PHOTOS NOT PROVIDED FOR CROSS SECTIONS 36914.66,
 37218.78, 42018.78, 42418.78, AND 42818.78.

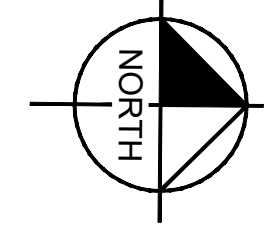
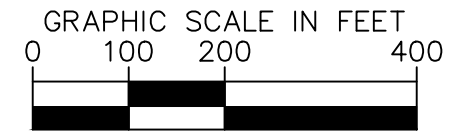

EAGLEVIEW HEC-RAS CROSS SECTIONS EXHIBIT
 10/12/2023

Kimley»Horn
 © 2023 KIMLEY-HORN AND ASSOCIATES, INC.
 2 N NEVADA AVE, SUITE 900, COLORADO SPRINGS, CO 80903
 PHONE: 719-453-0160

Cross Section Photos

HEC-RAS Results Comparison (Falcon DBPS HEC-RAS Cross Sections vs Eagleview)															
Cross Section	DBPS							Cross Section	Eagleview						
	100-yr Flow (cfs)	Input			Output				100-yr Flow (cfs)	Input			Output		
		Manning's n			Velocity (fps)	Shear (lb/sf)	Froude No.			Manning's n			Velocity (fps)	Shear (lb/sf)	Froude No.
Left Overbank	Channel	Right Overbank	Left Overbank	Channel	Right Overbank	Left Overbank	Channel	Right Overbank	Left Overbank	Channel	Right Overbank	Left Overbank	Channel	Right Overbank	
42818.78	260	0.08	0.05	0.08	3.39	0.67	0.45	42818.78	284.2	0.04	0.06	0.04	4.90	1.15	0.55
42418.78	480	0.08	0.05	0.08	6.47	2.42	1.04	42418.78	284.2	0.04	0.06	0.04	5.11	1.71	0.77
42018.78	480	0.08	0.05	0.08	5.46	1.77	0.74	42018.78	284.2	0.04	0.06	0.04	5.19	1.38	0.59
41774.8	480	0.08	0.05	0.08	7.32	3.12	1.02	41774.8	284.2	0.05	0.06	0.04	6.59	2.64	0.89
41539.1	480	0.08	0.05	0.08	3.34	0.63	0.42	41539.1	284.2	0.05	0.06	0.08	2.42	0.28	0.24
41465.66	480	0.08	0.05	0.08	3.28	0.28	0.32	41465.66	284.2	0.08	0.06	0.1	1.53	0.07	0.10
41441.59 (Culvert)	480	-	-	-	-	-	-	41441.59 (Culvert)	284.2	-	-	-	-	-	-
41405.38	480	0.08	0.05	0.08	5.99	2.17	0.87	41405.38	284.2	0.05	0.06	0.08	7.55	1.97	0.77
41368	480	0.08	0.05	0.08	6.06	2.22	0.86	41368	284.2	0.08	0.06	0.08	7.93	3.78	0.90
41330.7	480	0.08	0.05	0.08	6.32	2.43	0.88	41330.7	284.2	0.08	0.06	0.08	6.78	3.21	0.80
41293.4	480	0.08	0.05	0.08	6.36	2.41	0.86	41293.4	284.2	0.1	0.06	0.1	5.72	2.51	0.69
41256.1	480	0.08	0.05	0.08	6.79	2.73	0.91	41256.1	284.2	0.1	0.07	0.1	5.28	3.06	0.64
41218.78	480	0.08	0.05	0.08	5.93	1.99	0.74	41218.78	284.2	0.1	0.07	0.1	4.22	1.89	0.49
40884.05	480	0.08	0.05	0.08	7.00	2.48	0.97	40884.05	284.2	0.025	0.06	0.1	7.45	3.67	0.93
40418.78	480	0.08	0.05	0.08	5.99	2.30	0.91	40418.78	284.2	0.1	0.06	0.1	4.09	1.02	0.52
40018.78	740	0.08	0.03	0.08	9.05	1.56	1.01	40018.78	371.3	0.04	0.06	0.04	7.65	3.87	0.94
39618.78	740	0.08	0.03	0.08	7.56	1.09	1.04	39618.78	478	0.04	0.06	0.04	4.31	0.81	0.48
39218.78	740	0.08	0.03	0.08	9.28	0.78	1.15	39218.78	478	0.04	0.06	0.04	6.90	1.99	0.75
38818.78	740	0.08	0.03	0.08	8.62	1.35	1.03	38818.78	478	0.04	0.05	0.04	6.06	1.49	0.66
38418.78	740	0.08	0.03	0.08	7.39	0.91	1.07	38418.78	478	0.04	0.05	0.04	6.11	1.19	0.73
38018.78	740	0.08	0.03	0.08	8.77	0.91	1.06	38018.78	478	0.045	0.04	0.045	7.31	1.02	0.85
37618.78	740	0.08	0.03	0.08	7.16	0.95	1.04	37618.78	515.5	0.045	0.04	0.045	7.22	0.96	0.88

add downstream section

Potential issues identified. Provide complete modeling and profiles showing effects of grade control/drops

Identify deviations from ECM 3.3.3 and DCM. Revise the design to eliminate deviations or provide deviation request. DBPS revisions and County maintenance depend on meeting criteria and installation of adequate stabilization features.

Replace table from previous report

Cross Section 41774.8

North:



South:



East:



West:



Cross Section 41539.1

North:



South:



East:



West:



Cross Section 41465.66

North:



South:



East:



West:



Cross Section 41441.59

North:



South:



East:



West:



Cross Section 41405.38

North:



South:



East:



West:



Cross Section 41368

North:



South:



East:



West:



Cross Section 41330.7

North:



South:



East:



West:



Cross Section 41293.4

North:



South:



East:



West:



Cross Section 41256.1

North:



South:



Cross Section 41218.78

North:



South:



East:



West:



Cross Section 40884.05

North:



South:



East:



West:



Cross Section 40418.78

North:



South:



East:



West:



Cross Section 40018.78

North:



South:



East:



West:



Cross Section 39618.78

North:



South:



East:



West:



Cross Section 39218.78

North:



South:



East:



West:



Cross Section 38818.78

North:



South:



East:



West:



Cross Section 38418.78

North:



South:



East:



West:



Cross Section 38018.78

North:



South:



East:



West:



Cross Section 37618.78

North:



South:



East:



West:



EXISTING CONDITIONS HEC-RAS RESULTS

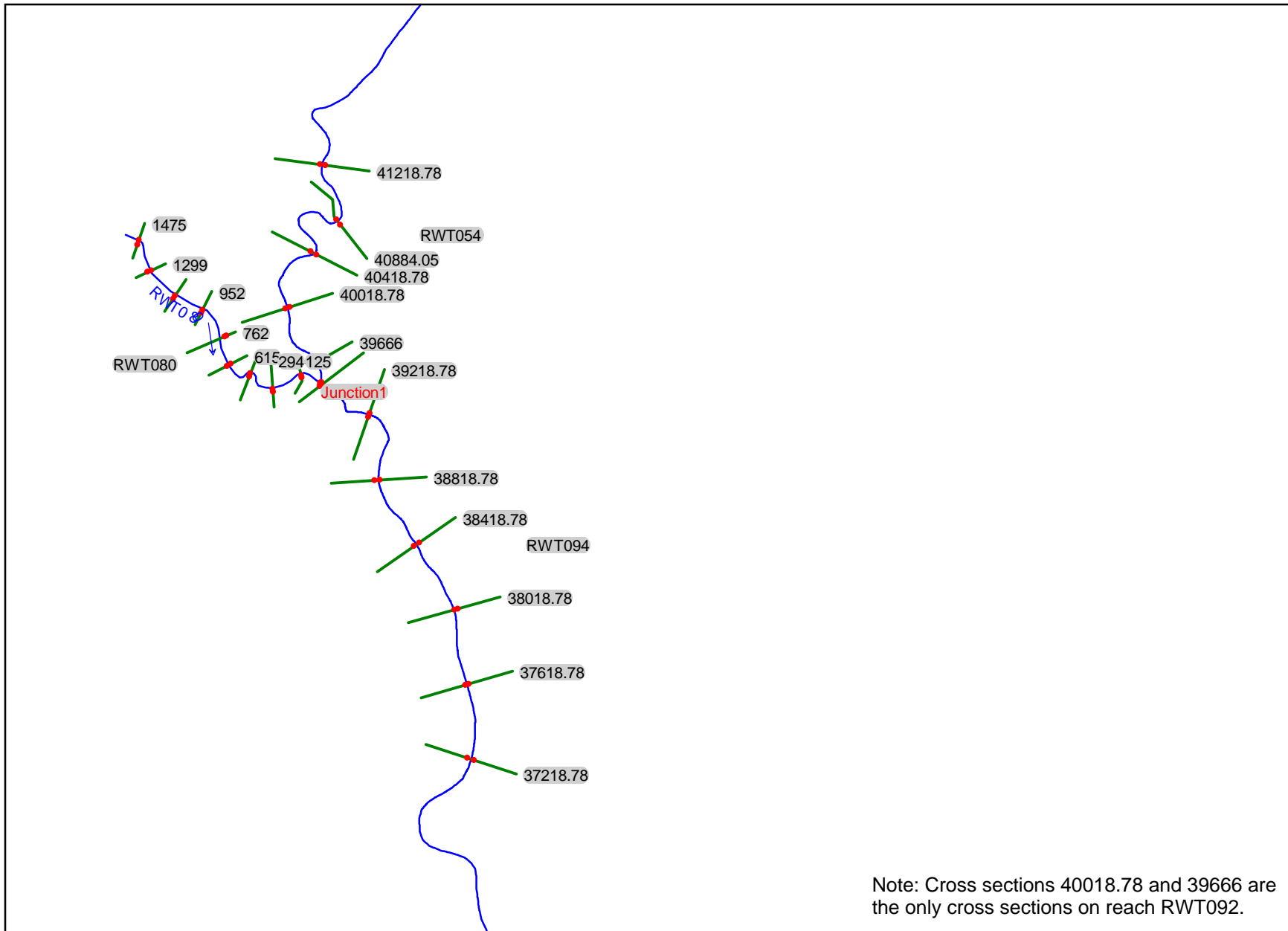

RWT080 RWT080

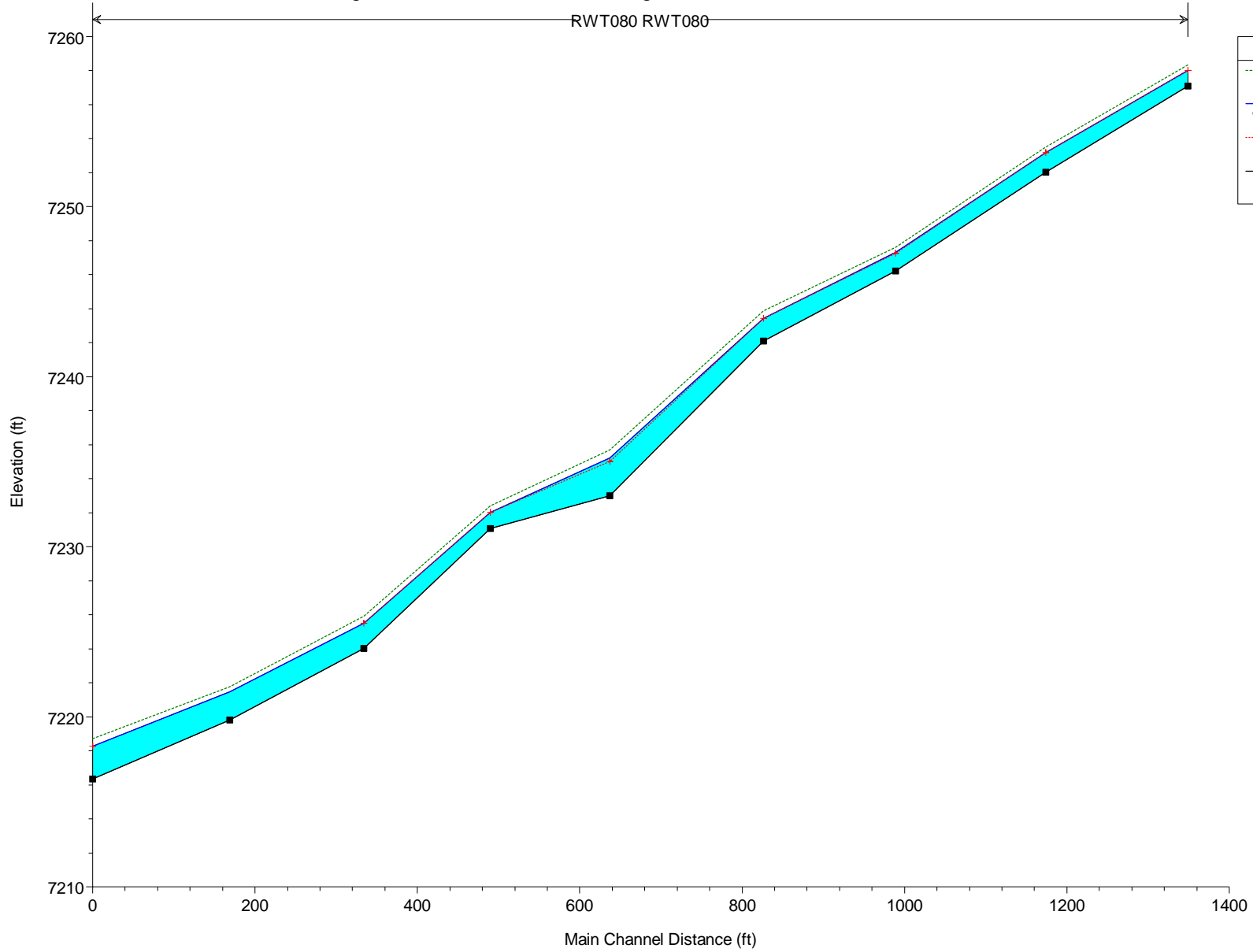

Legend	
EG 100-yr	(dashed green line)
WS 100-yr	(solid blue line)
Crit 100-yr	(dotted red line)
Ground	(solid black line with square markers)

WestTrib RWT054

Legend	
EG 100-yr	
WS 100-yr	
Crit 100-yr	
Ground	

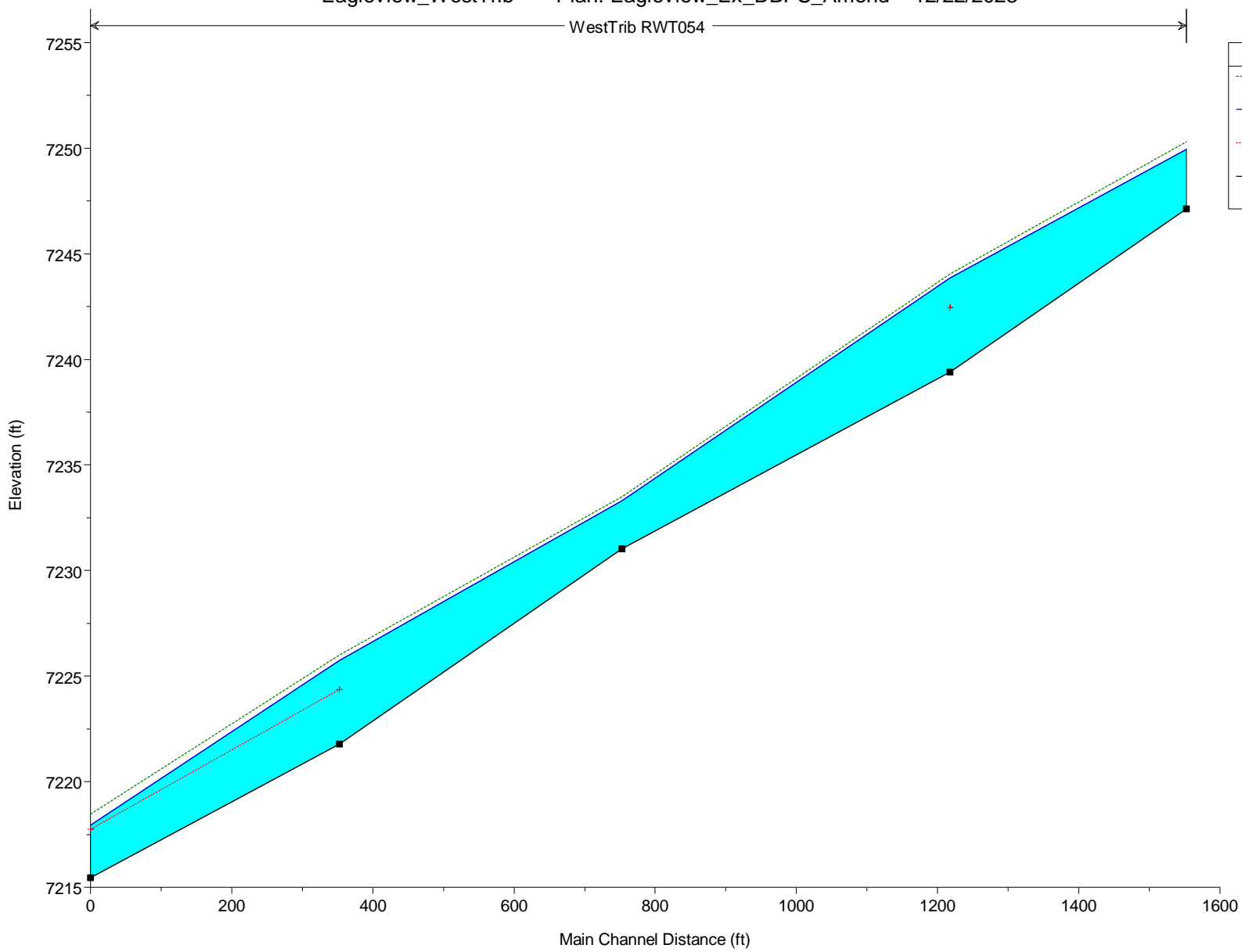

WestTrib RWT094

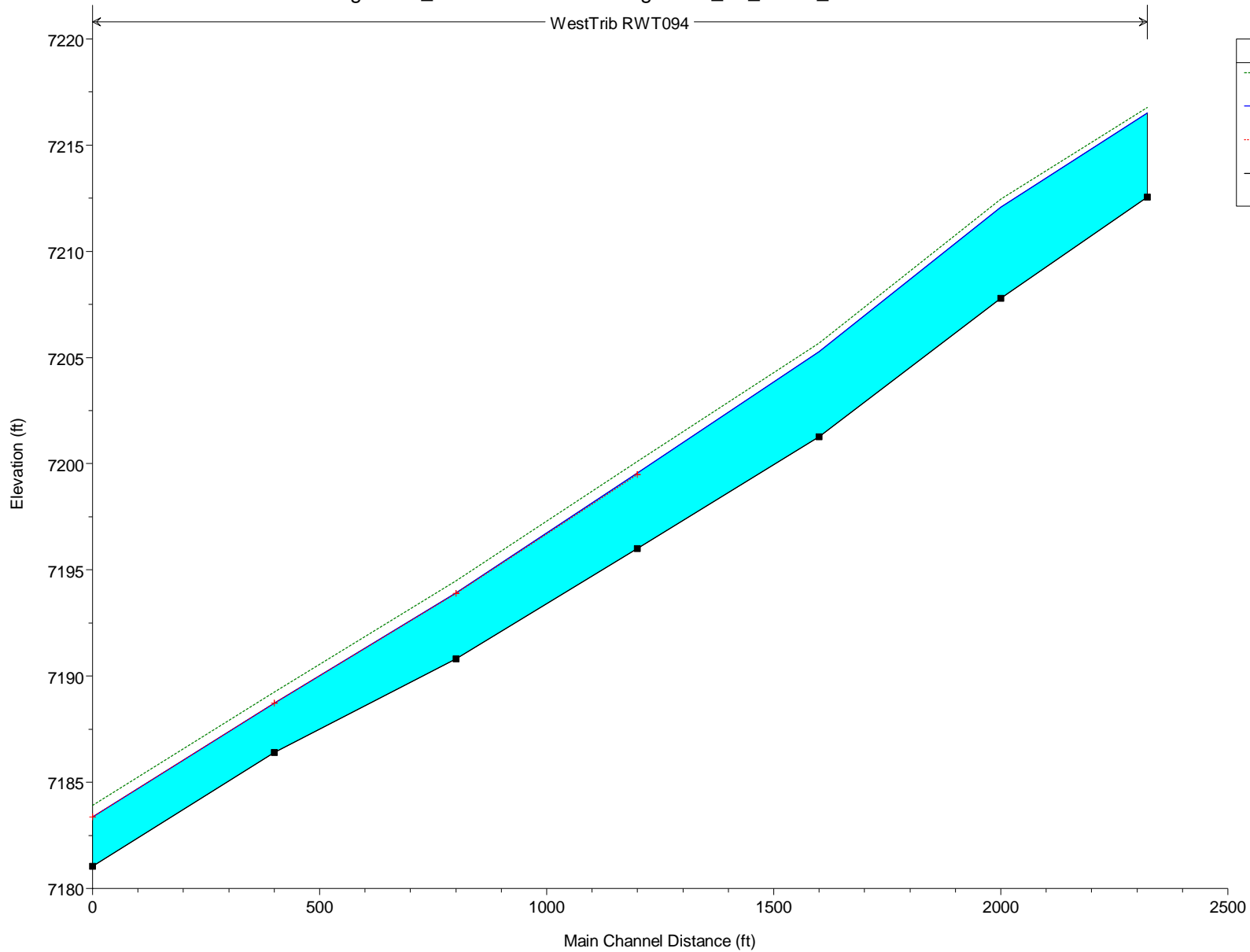

Cross section
outside project area

HEC-RAS Plan: Ex_DBPS_Amend Profile: 100-yr

River	Reach	River Sta	Profile	Q Total (cfs)	Min Ch El (ft)	W. S. Elev (ft)	Crit W. S. (ft)	E.G. Elev (ft)	E.G. Slope (ft/ft)	Vel Chnl (ft/s)	Flow Area (sq ft)	Top Width (ft)	Froude # Chl	Shear Total (lb/sq ft)
WestTrib	RWT054	41218.78	100-yr	285.00	7247.13	7249.95		7250.31	0.018854	4.76	59.87	28.01	0.57	2.42
WestTrib	RWT054	40884.05	100-yr	285.00	7239.41	7243.85	7242.45	7244.04	0.018267	3.53	80.86	34.51	0.40	2.58
WestTrib	RWT054	40418.78	100-yr	285.00	7231.04	7233.30		7233.50	0.028680	3.77	83.64	59.72	0.49	2.49
WestTrib	RWT092	40018.78	100-yr	375.00	7221.79	7225.74	7224.36	7225.99	0.014303	3.94	93.70	33.92	0.38	2.36
WestTrib	RWT092	39666	100-yr	375.00	7215.46	7217.95	7217.76	7218.46	0.035530	4.70	69.87	52.16	0.56	2.94
WestTrib	RWT094	39542	100-yr	478.00	7212.56	7216.52		7216.77	0.008165	3.03	125.66	58.70	0.29	1.07
WestTrib	RWT094	39218.78	100-yr	478.00	7207.80	7212.07		7212.47	0.027829	4.90	95.16	57.21	0.51	2.82
WestTrib	RWT094	38818.78	100-yr	478.00	7201.28	7205.27		7205.69	0.011630	5.31	93.31	40.73	0.55	1.60
WestTrib	RWT094	38418.78	100-yr	478.00	7196.01	7199.55	7199.49	7200.10	0.016669	6.25	86.43	71.63	0.75	1.24
WestTrib	RWT094	38018.78	100-yr	502.00	7190.82	7193.92	7193.89	7194.49	0.012139	7.22	97.33	73.20	0.82	1.00
WestTrib	RWT094	37618.78	100-yr	502.00	7186.41	7188.73	7188.73	7189.24	0.014100	7.17	103.73	96.78	0.87	0.94
WestTrib	RWT094	37218.78	100-yr	502.00	7181.04	7183.38	7183.38	7183.92	0.009919	6.32	97.73	108.66	0.82	0.55
RWT080	RWT080	1475	100-yr	107.00	7257.10	7258.03	7258.03	7258.33	0.026387	4.53	25.34	42.71	0.91	0.98
RWT080	RWT080	1299	100-yr	107.00	7252.03	7253.19	7253.19	7253.50	0.029085	4.77	24.27	39.39	0.95	1.12
RWT080	RWT080	1114	100-yr	107.00	7246.23	7247.32	7247.26	7247.62	0.021513	4.67	24.82	33.00	0.85	1.01
RWT080	RWT080	952	100-yr	107.00	7242.11	7243.43	7243.43	7243.88	0.024629	5.56	20.70	24.06	0.93	1.31
RWT080	RWT080	762	100-yr	107.00	7233.00	7235.23	7235.02	7235.71	0.017553	5.57	19.47	14.63	0.80	1.38
RWT080	RWT080	615	100-yr	107.00	7231.06	7232.01	7232.01	7232.40	0.029365	5.04	21.79	28.83	0.97	1.38
RWT080	RWT080	459	100-yr	107.00	7224.03	7225.49	7225.49	7225.93	0.025019	5.34	20.86	26.59	0.92	1.21
RWT080	RWT080	294	100-yr	107.00	7219.80	7221.48		7221.76	0.010406	4.31	25.99	21.05	0.63	0.78
RWT080	RWT080	125	100-yr	107.00	7216.33	7218.26	7218.26	7218.72	0.037599	5.67	20.02	21.68	0.87	2.12

Cross section
outside project area

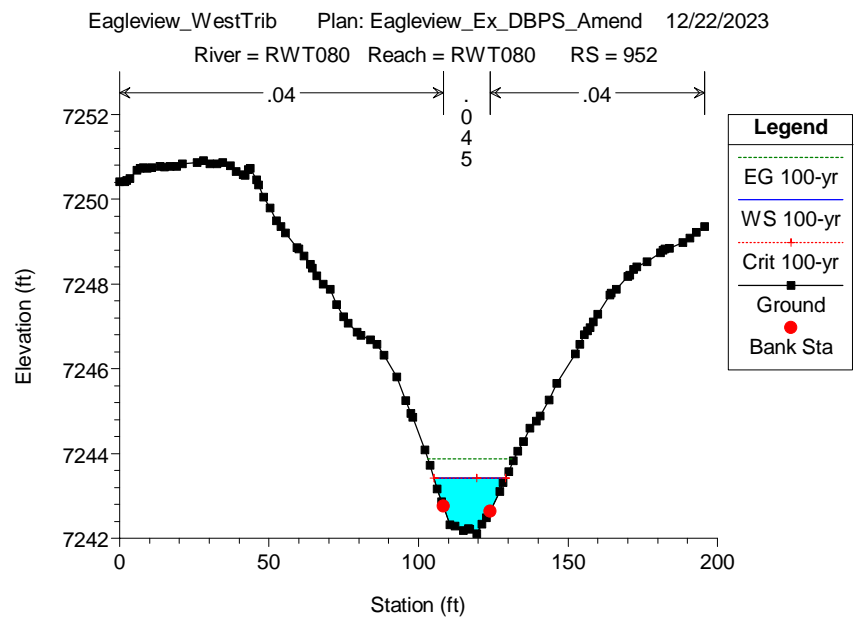
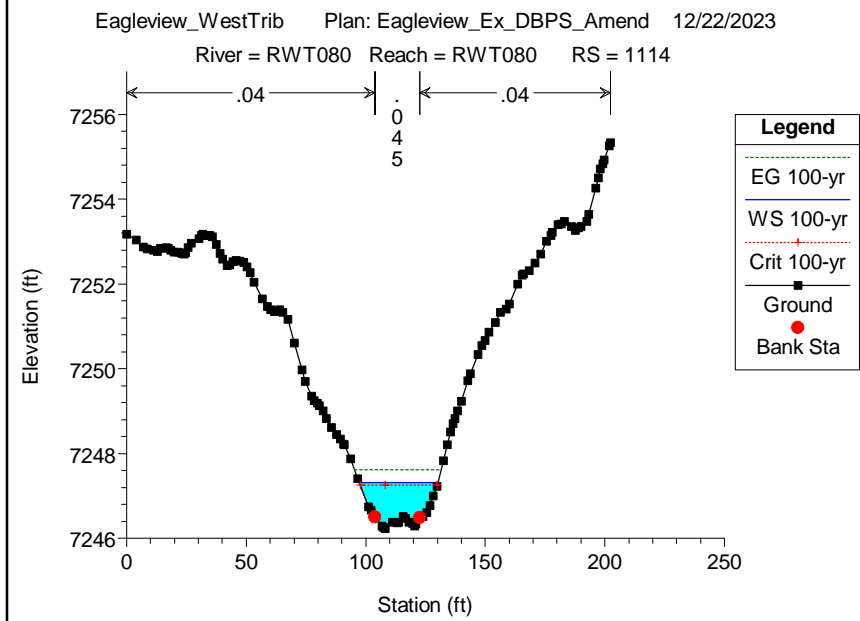
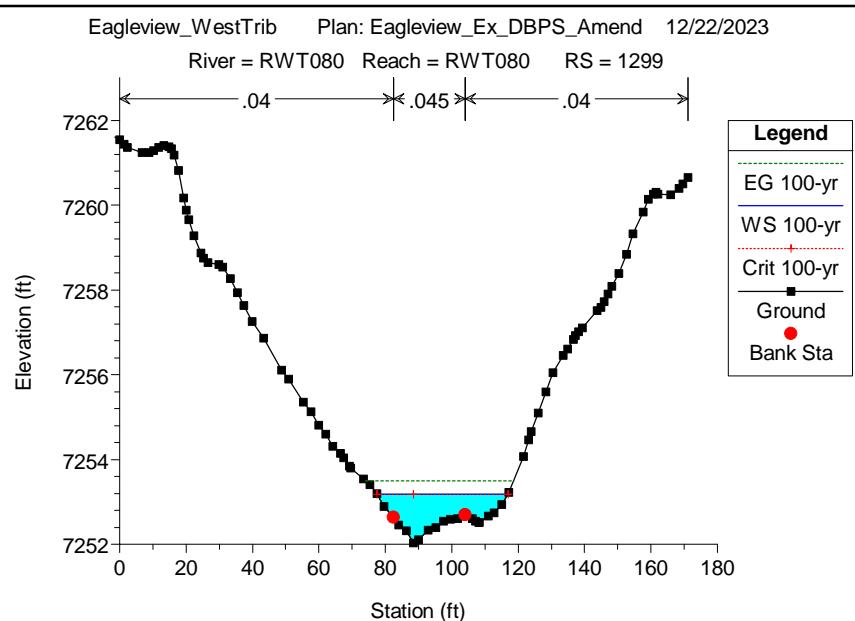
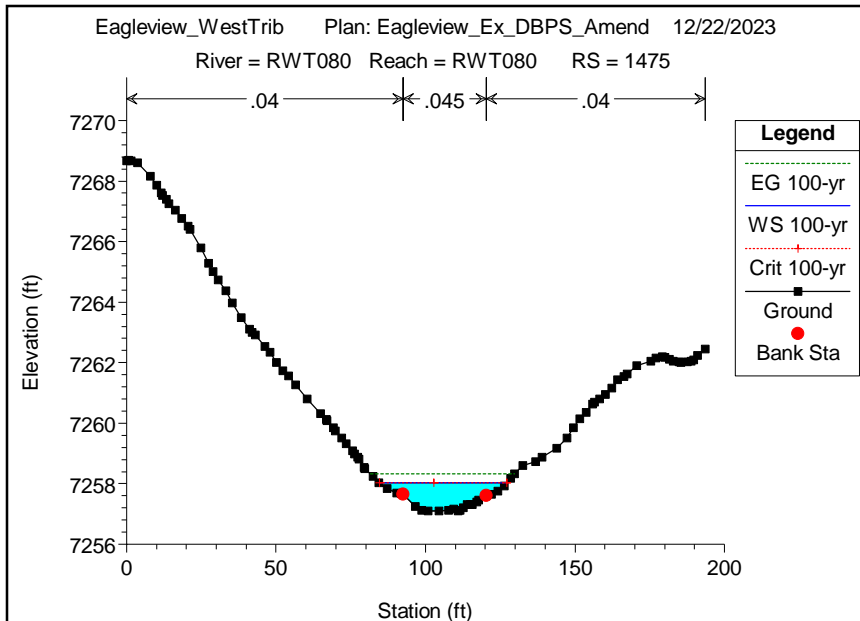

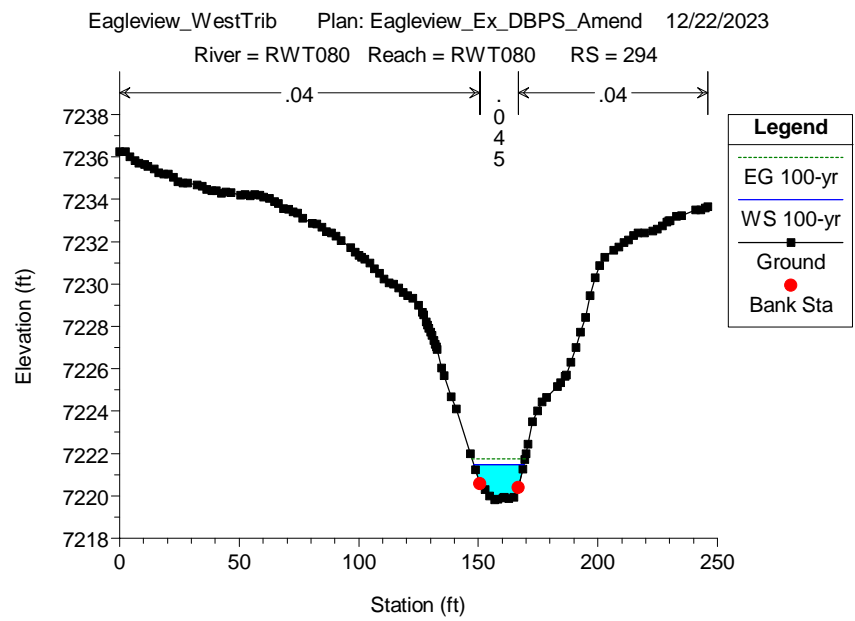
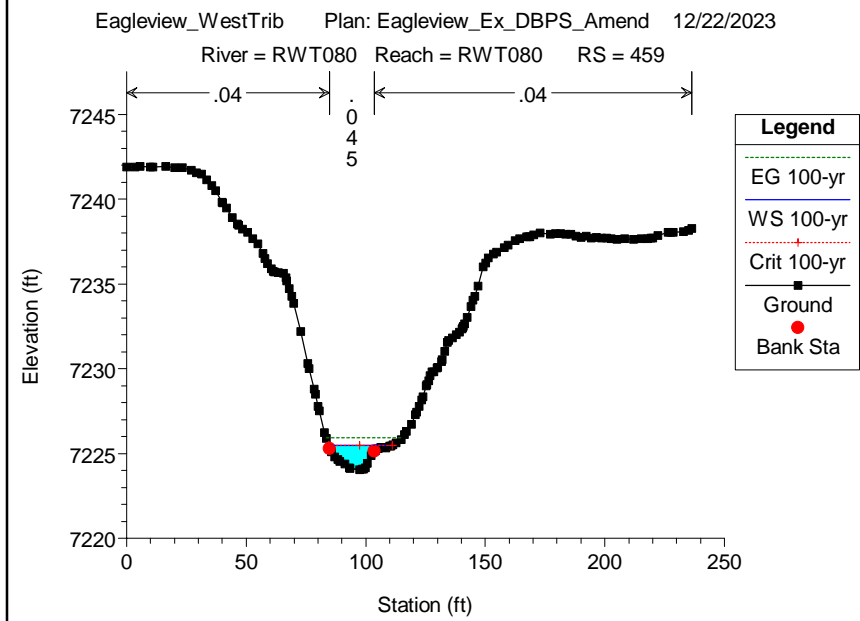
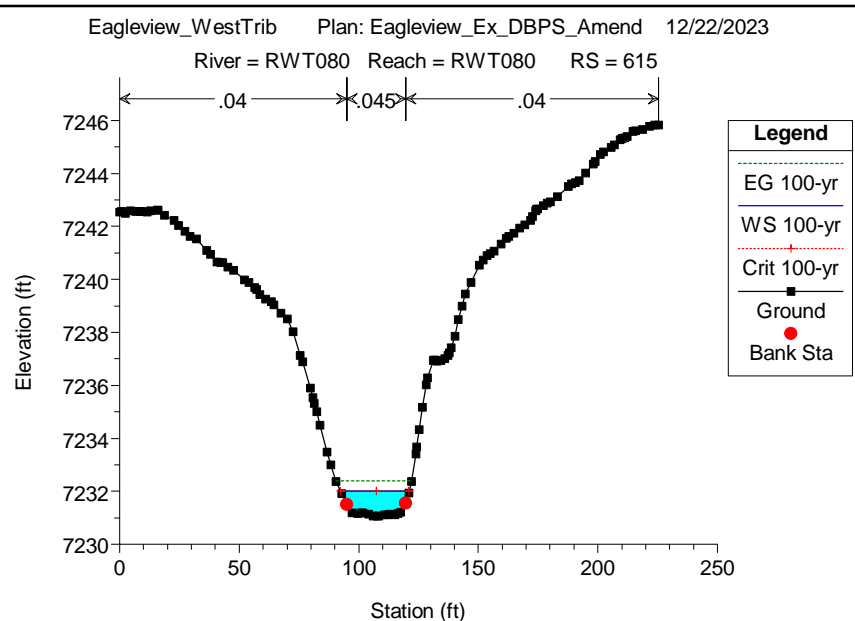
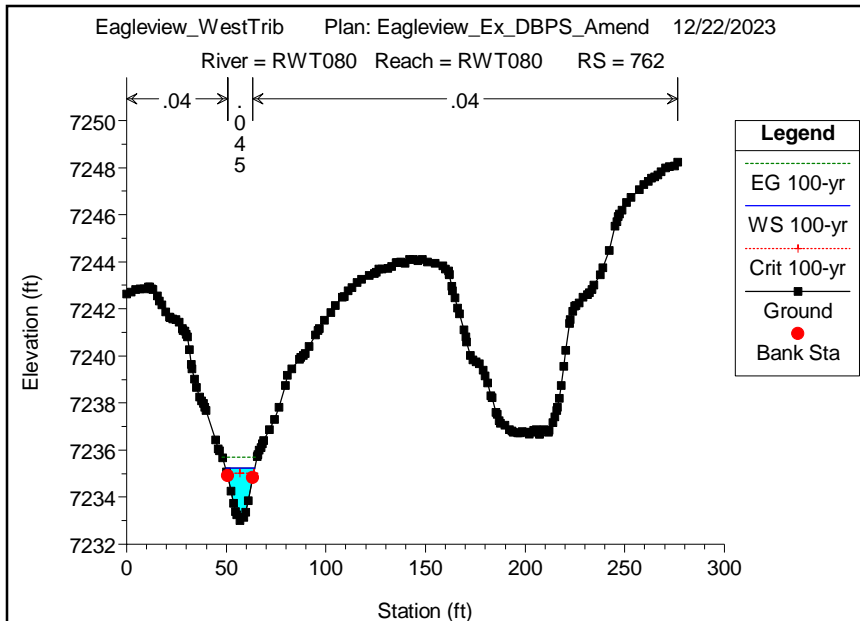

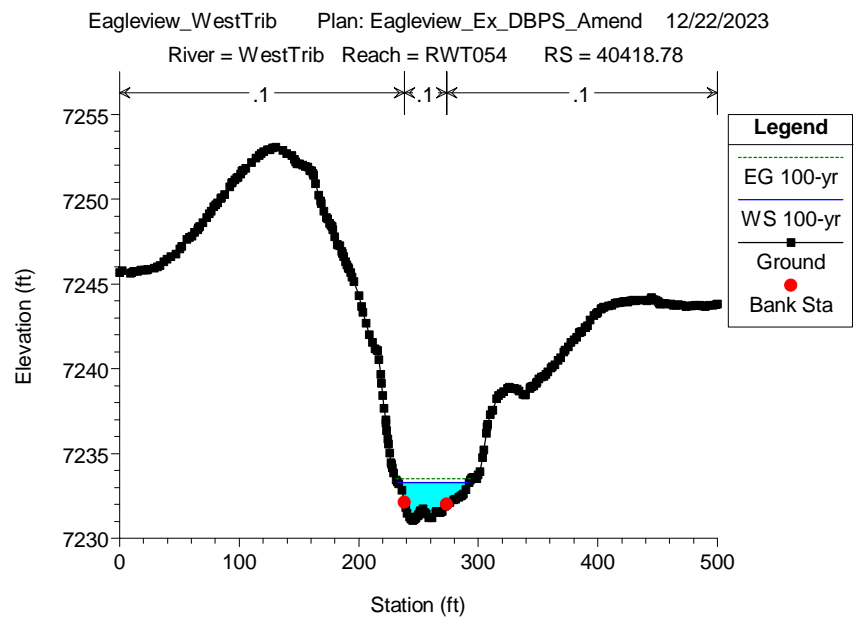
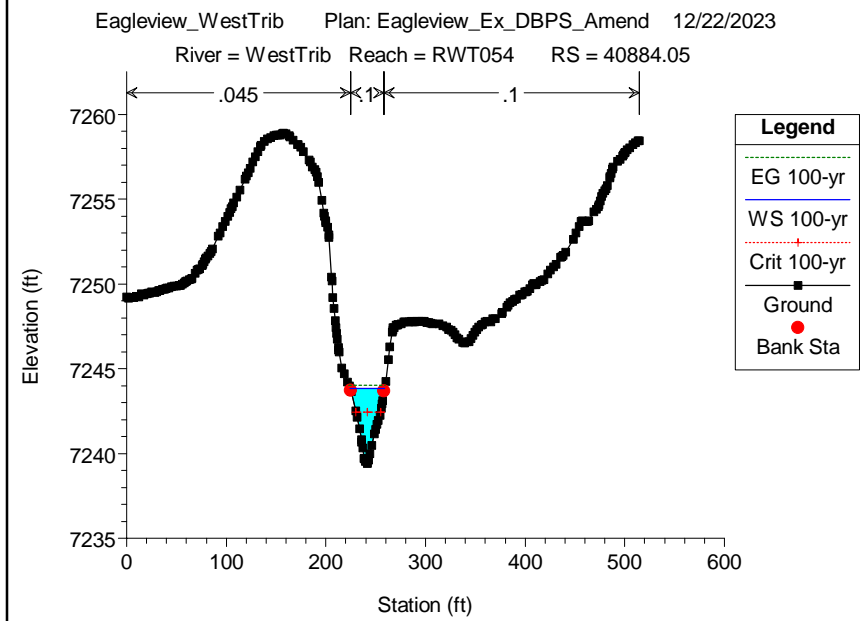
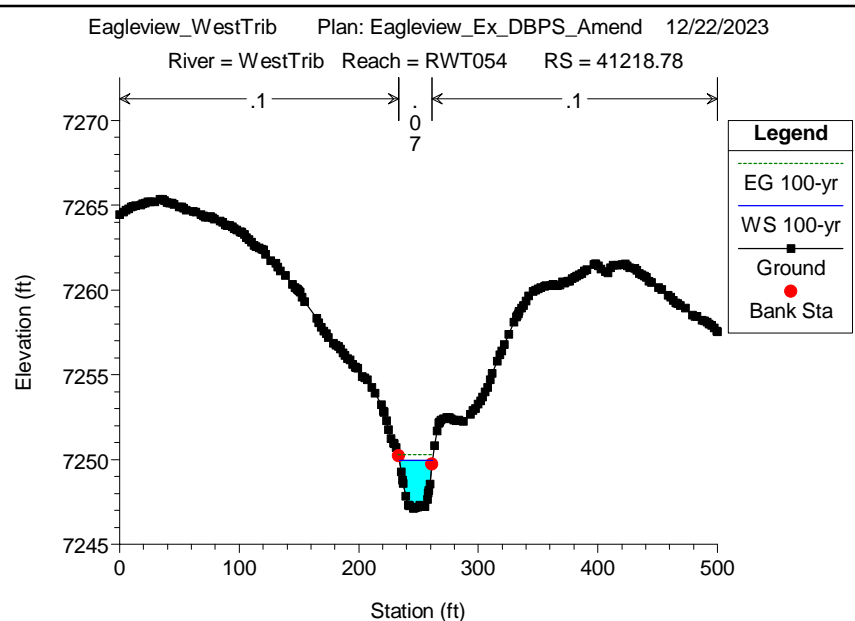
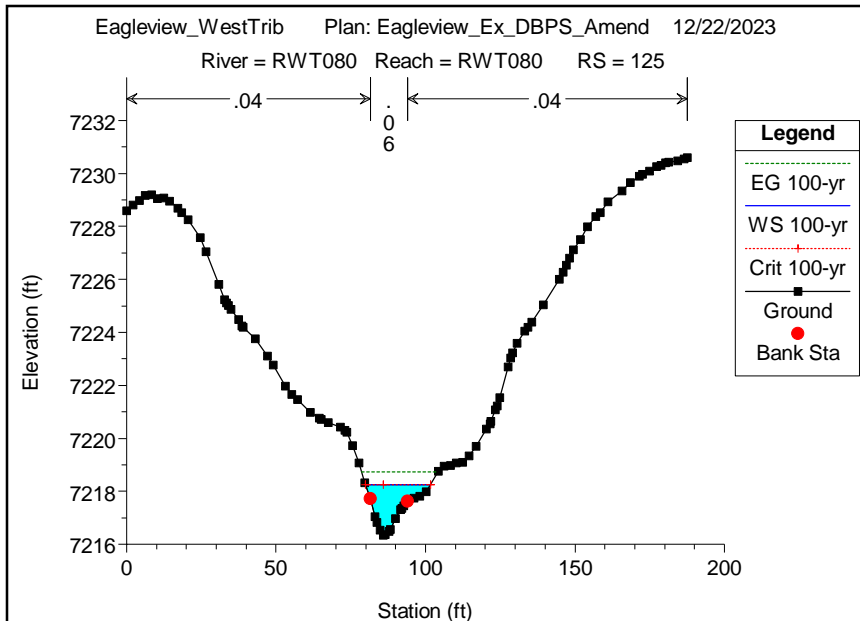

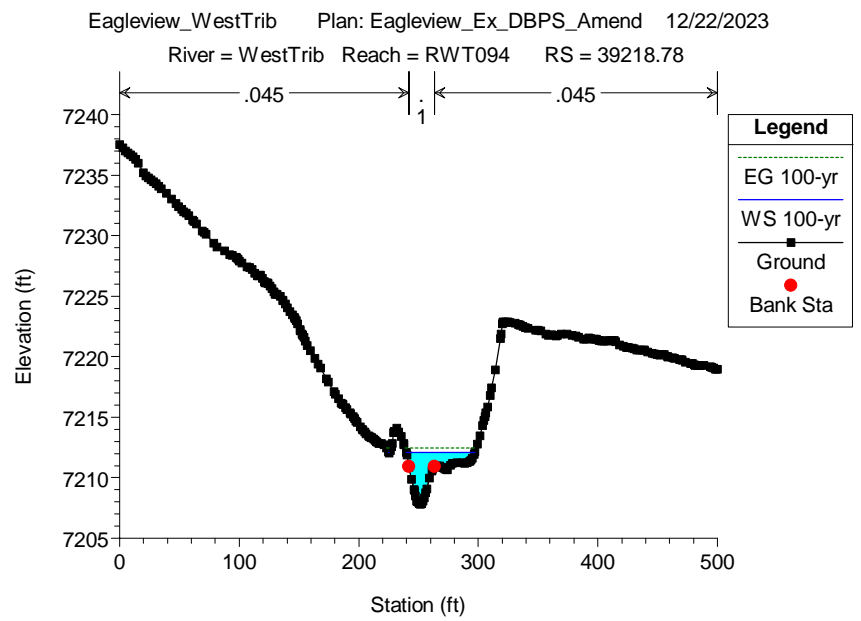
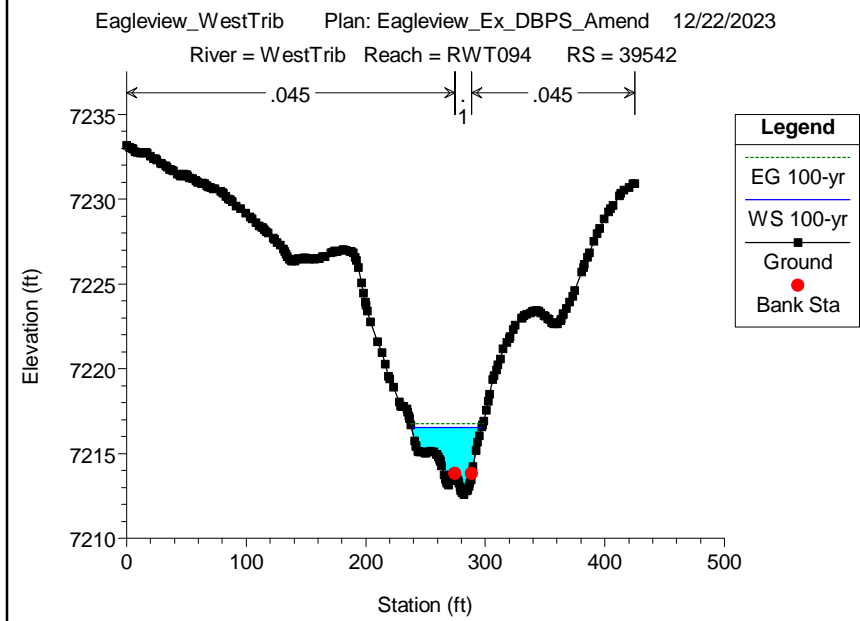
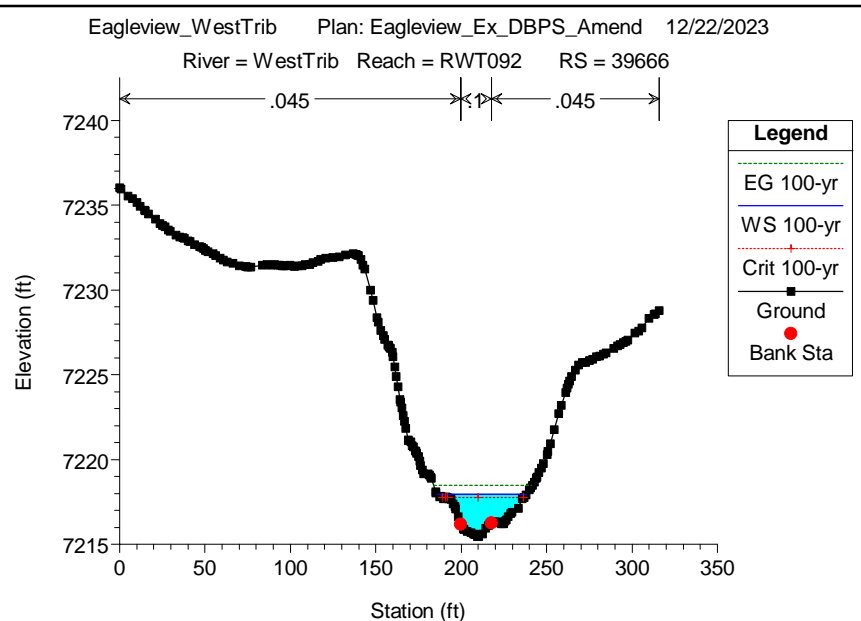
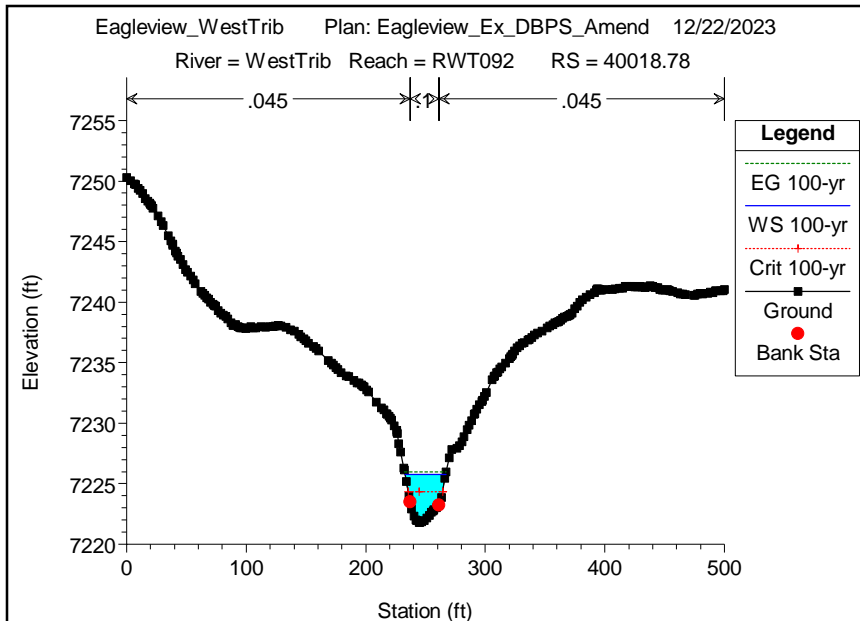

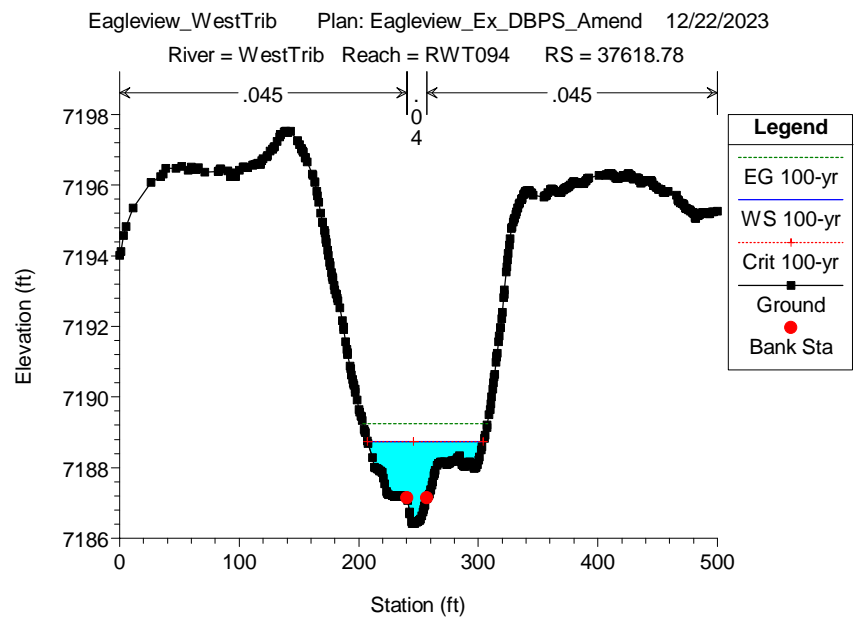
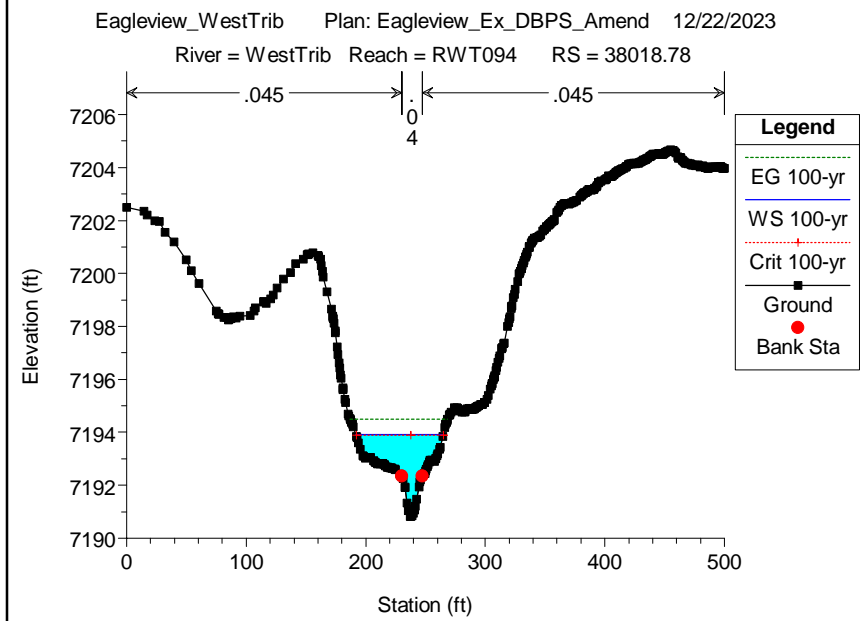
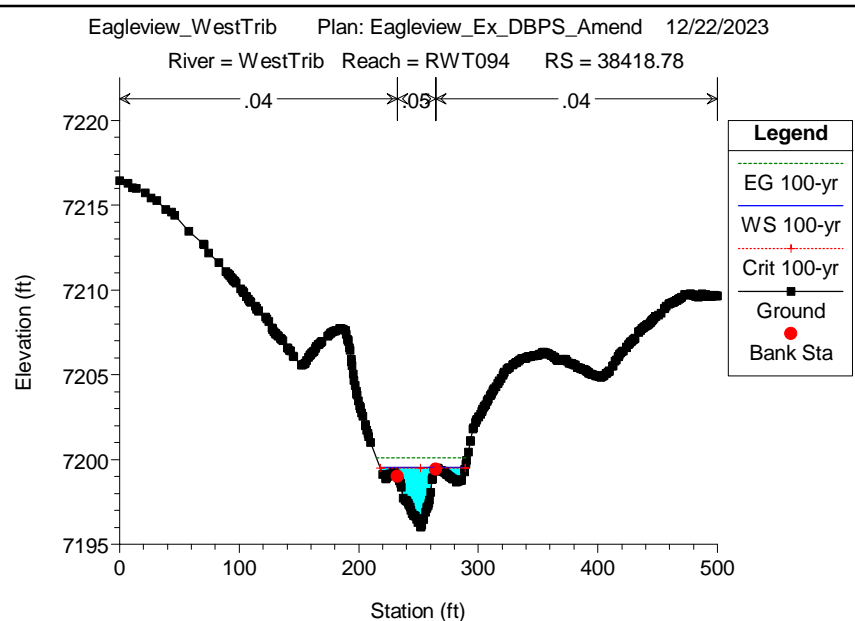
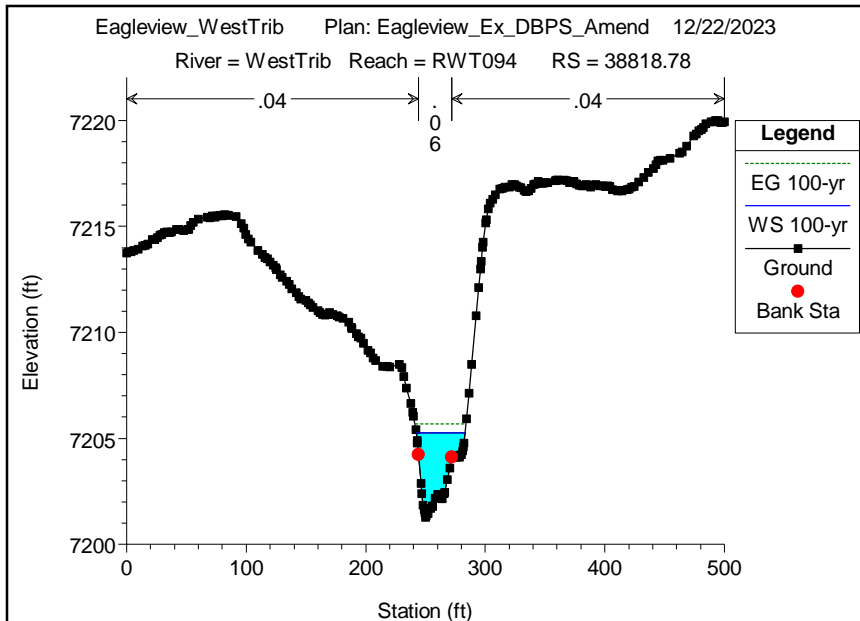

Eagleview_WestTrib Plan: Eagleview_Ex_DBPS_Amend 12/22/2023

River = WestTrib Reach = RWT094 RS = 37218.78

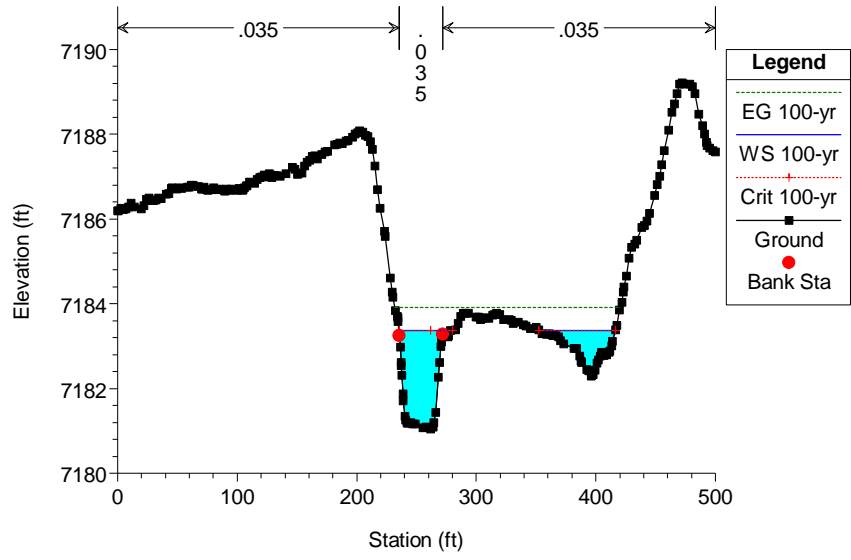

PROPOSED CONDITIONS HEC-RAS RESULTS

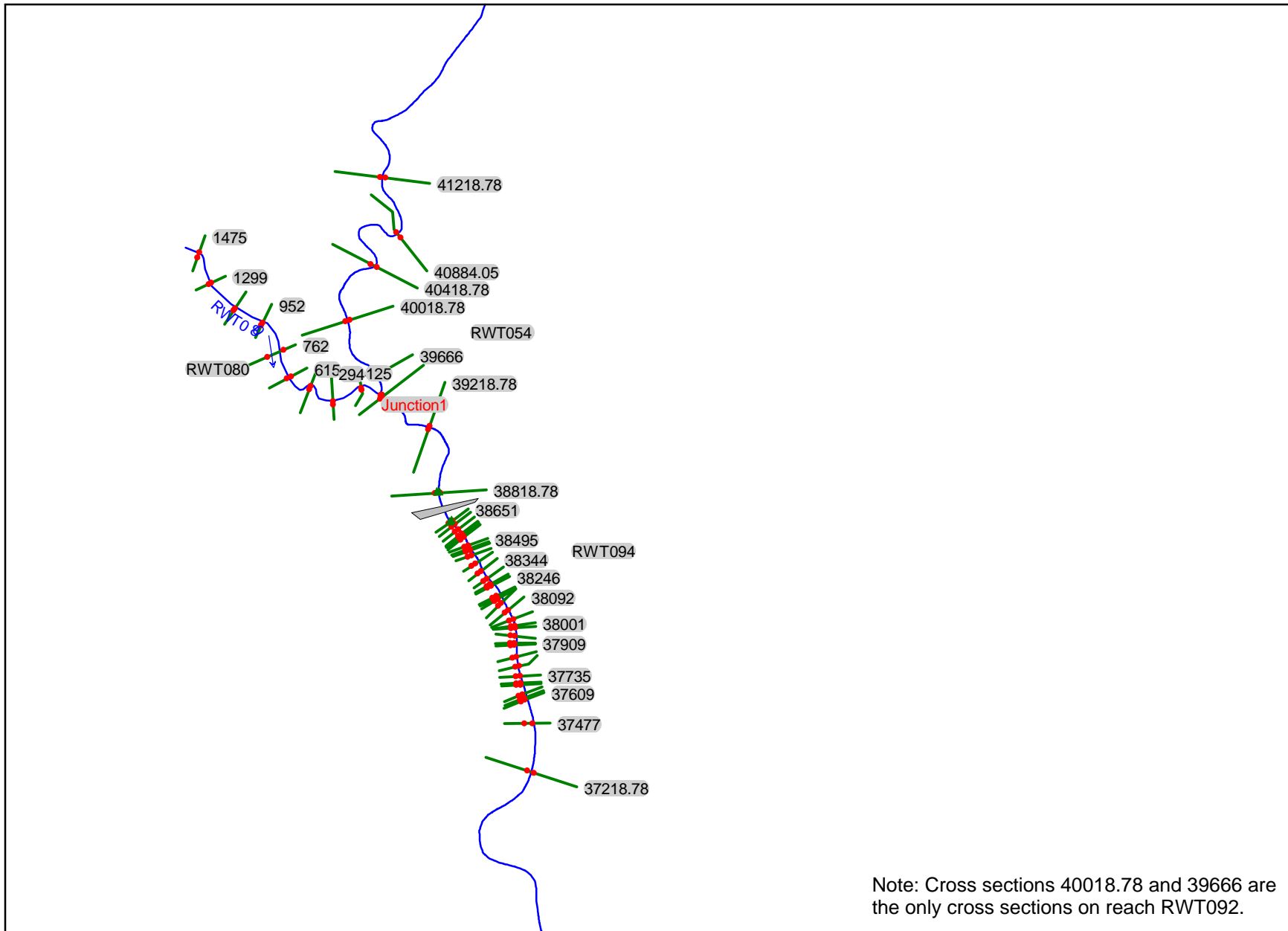

Note: Cross sections 40018.78 and 39666 are the only cross sections on reach RWT092.

RWT080 RWT080

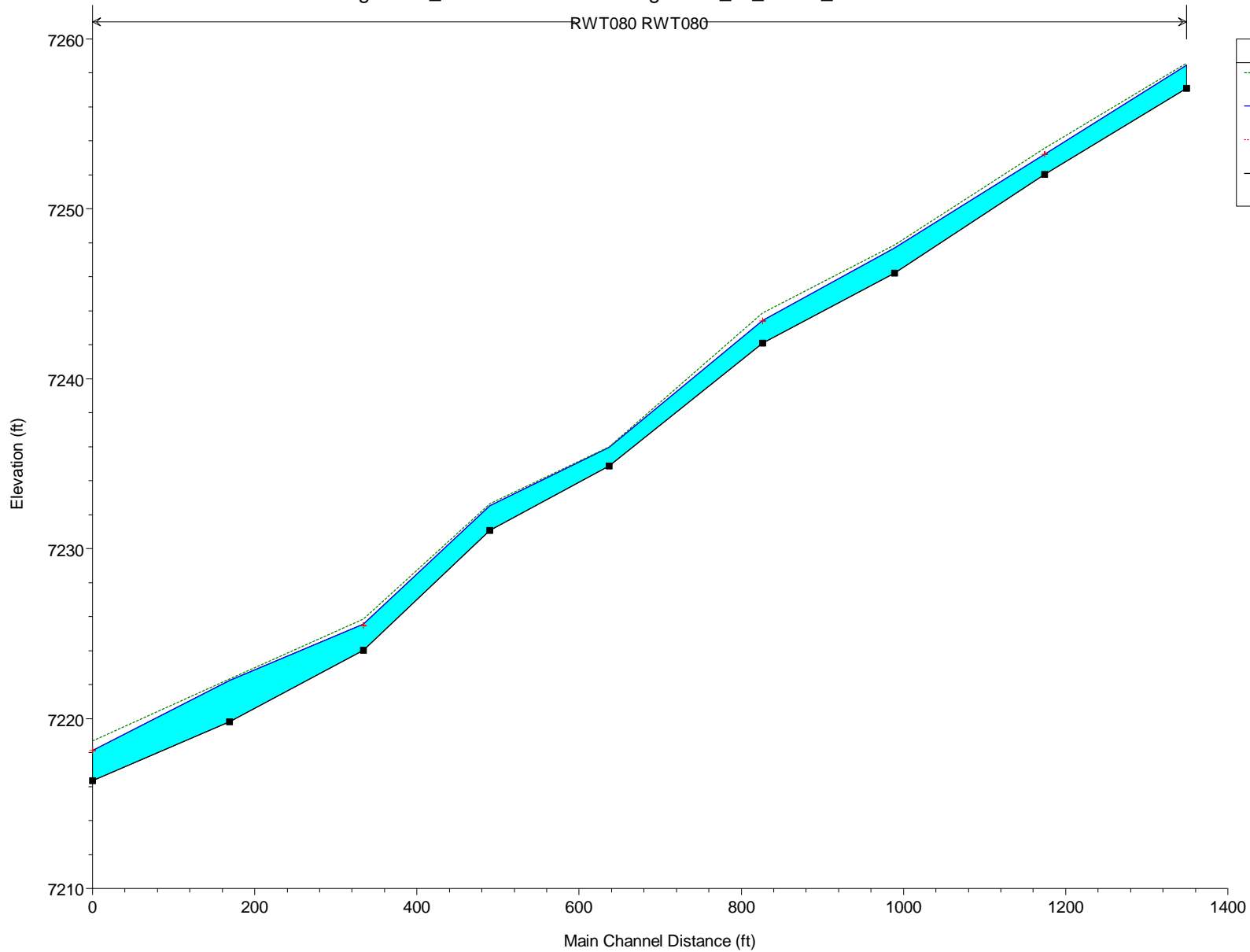

Legend	
EG 100-yr	(Dashed green line)
WS 100-yr	(Solid blue line)
Crit 100-yr	(Dotted red line)
Ground	(Black square)

WestTrib RWT054

Legend	
EG 100-yr	
WS 100-yr	
Crit 100-yr	
Ground	

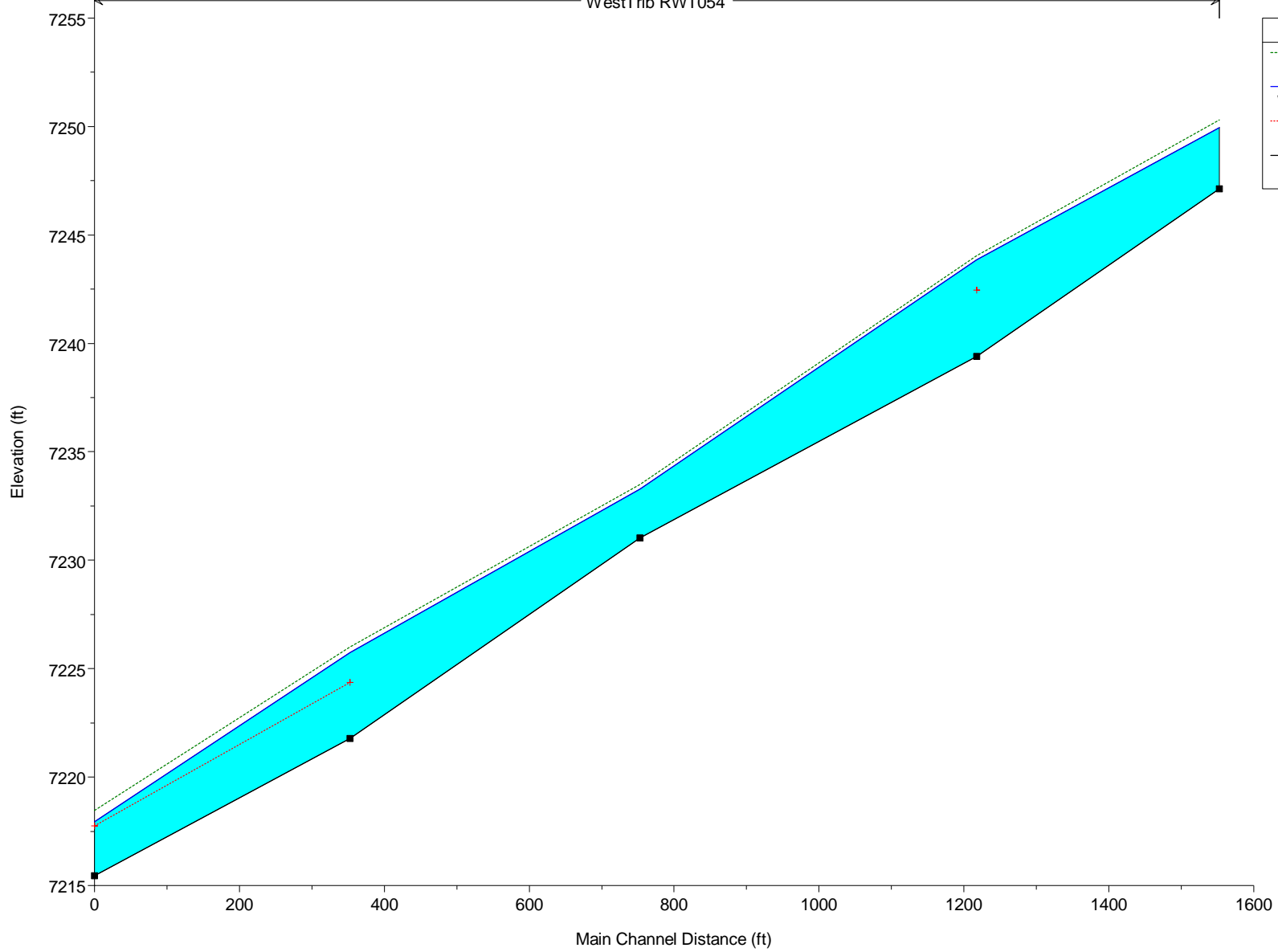

WestTrib RWT094

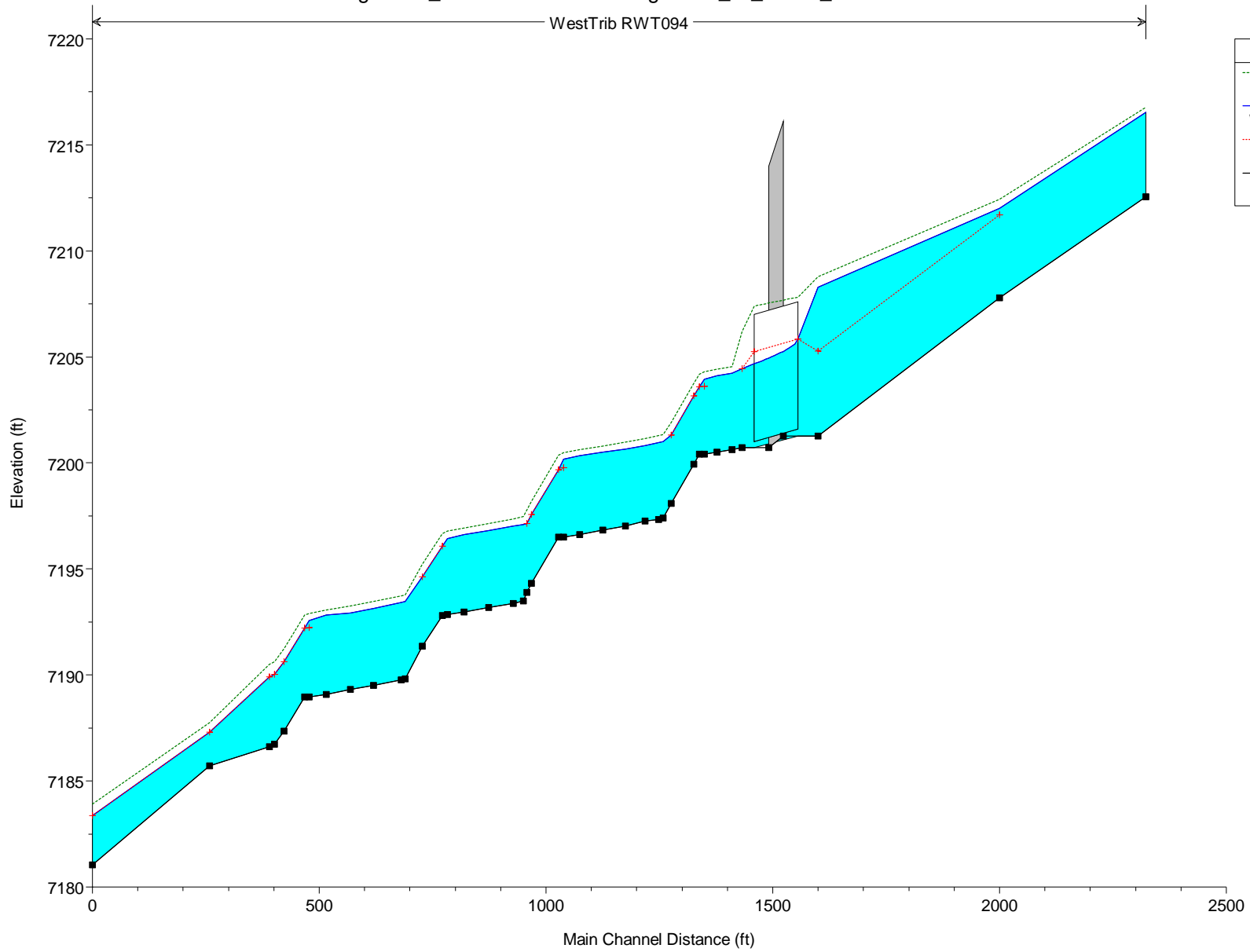

Legend	
EG 100-yr	(dotted green line)
WS 100-yr	(solid blue line)
Crit 100-yr	(dotted red line with '+' markers)
Ground	(solid black line with square markers)

Cross section
outside project area

HEC-RAS Plan: Pr_DBPS_Amend Profile: 100-yr

River	Reach	River Sta	Profile	Q Total (cfs)	Min Ch El (ft)	W. S. Elev (ft)	Crit W. S. (ft)	E.G. Elev (ft)	E.G. Slope (ft/ft)	Vel Chnl (ft/s)	Flow Area (sq ft)	Top Width (ft)	Froude # Chl	Shear Total (lb/sq ft)
WestTrib	RWT054	41218.78	100-yr	285.00	7247.13	7249.95		7250.30	0.018985	4.77	59.73	27.99	0.57	2.43
WestTrib	RWT054	40884.05	100-yr	285.00	7239.41	7243.85	7242.45	7244.05	0.018095	3.52	81.09	34.57	0.40	2.56
WestTrib	RWT054	40418.78	100-yr	285.00	7231.04	7233.29		7233.49	0.029142	3.79	83.18	59.58	0.49	2.52
WestTrib	RWT092	40018.78	100-yr	375.00	7221.79	7225.75	7224.36	7226.00	0.014143	3.92	94.03	33.96	0.38	2.34
WestTrib	RWT092	39666	100-yr	375.00	7215.46	7217.94	7217.76	7218.46	0.036273	4.73	69.39	52.02	0.57	2.99
WestTrib	RWT094	39542	100-yr	478.00	7212.56	7216.54		7216.78	0.007978	3.00	126.58	58.82	0.28	1.05
WestTrib	RWT094	39218.78	100-yr	478.00	7207.80	7212.02	7211.70	7212.44	0.029777	5.13	92.09	56.58	0.52	2.95
WestTrib	RWT094	38818.78	100-yr	480.00	7201.28	7208.28	7205.27	7208.78	0.004427	5.69	84.40	57.62	0.39	1.77
WestTrib	RWT094	38726		Culvert										
WestTrib	RWT094	38651	100-yr	480.00	7200.72	7204.46	7204.46	7206.19	0.012010	10.58	45.36	82.88	1.00	2.57
WestTrib	RWT094	38628	100-yr	480.00	7200.62	7204.23		7204.54	0.003752	5.14	125.43	89.65	0.54	0.33
WestTrib	RWT094	38596	100-yr	480.00	7200.50	7204.11		7204.42	0.003748	5.19	126.68	93.03	0.54	0.32
WestTrib	RWT094	38567	100-yr	480.00	7200.41	7203.95	7203.61	7204.29	0.005231	5.35	121.13	89.62	0.56	0.44
WestTrib	RWT094	38557	100-yr	480.00	7200.41	7203.59	7203.59	7204.20	0.010483	6.87	90.84	78.96	0.78	0.75
WestTrib	RWT094	38545	100-yr	480.00	7199.94	7203.17	7203.17	7203.75	0.009839	6.76	92.87	78.99	0.76	0.72
WestTrib	RWT094	38495	100-yr	480.00	7198.10	7201.31	7201.31	7201.91	0.010311	6.92	89.32	71.16	0.77	0.80
WestTrib	RWT094	38477	100-yr	480.00	7197.41	7201.01		7201.33	0.004722	5.19	119.77	74.49	0.54	0.47
WestTrib	RWT094	38467	100-yr	480.00	7197.34	7200.96		7201.28	0.004782	5.20	119.36	74.88	0.54	0.47
WestTrib	RWT094	38437	100-yr	480.00	7197.25	7200.82		7201.16	0.004035	5.33	116.60	75.41	0.56	0.39
WestTrib	RWT094	38394	100-yr	480.00	7197.03	7200.66		7200.98	0.003736	5.21	120.89	78.68	0.54	0.36
WestTrib	RWT094	38344	100-yr	480.00	7196.84	7200.51		7200.79	0.003332	4.95	127.51	81.24	0.51	0.32
WestTrib	RWT094	38293	100-yr	480.00	7196.62	7200.34		7200.63	0.003218	4.92	129.53	83.97	0.50	0.31
WestTrib	RWT094	38257	100-yr	502.00	7196.50	7200.18	7199.77	7200.49	0.004615	5.18	131.76	92.22	0.53	0.41
WestTrib	RWT094	38246	100-yr	502.00	7196.50	7199.68	7199.68	7200.37	0.011966	7.39	89.74	81.66	0.83	0.81
WestTrib	RWT094	38186	100-yr	502.00	7194.32	7197.58	7197.58	7198.18	0.010192	6.95	95.31	80.68	0.77	0.75
WestTrib	RWT094	38176	100-yr	502.00	7193.90	7197.15	7197.15	7197.78	0.010546	7.00	93.46	78.16	0.78	0.78
WestTrib	RWT094	38169	100-yr	502.00	7193.50	7197.11		7197.47	0.005551	5.54	120.58	86.18	0.58	0.48
WestTrib	RWT094	38146	100-yr	502.00	7193.38	7197.02		7197.35	0.003922	5.35	126.30	88.52	0.55	0.35
WestTrib	RWT094	38092	100-yr	502.00	7193.18	7196.82		7197.14	0.003729	5.23	128.16	85.21	0.54	0.35
WestTrib	RWT094	38038	100-yr	502.00	7192.97	7196.63		7196.94	0.003694	5.21	130.14	89.33	0.54	0.33
WestTrib	RWT094	38001	100-yr	502.00	7192.84	7196.43		7196.78	0.005331	5.49	125.19	92.62	0.57	0.45
WestTrib	RWT094	37990	100-yr	502.00	7192.81	7196.06	7196.06	7196.67	0.010335	6.93	95.15	81.54	0.77	0.75
WestTrib	RWT094	37946	100-yr	502.00	7191.35	7194.63	7194.63	7195.22	0.009868	6.88	97.36	84.27	0.76	0.71
WestTrib	RWT094	37909	100-yr	502.00	7189.81	7193.46		7193.77	0.004712	5.17	131.16	91.54	0.54	0.42
WestTrib	RWT094	37900	100-yr	502.00	7189.78	7193.42		7193.73	0.004722	5.20	130.51	90.17	0.54	0.42
WestTrib	RWT094	37838	100-yr	502.00	7189.50	7193.14		7193.46	0.003848	5.30	130.81	96.05	0.55	0.32
WestTrib	RWT094	37787	100-yr	502.00	7189.31	7192.93		7193.27	0.003980	5.37	130.55	100.92	0.56	0.32
WestTrib	RWT094	37735	100-yr	502.00	7189.09	7192.83		7193.06	0.002753	4.58	153.86	106.97	0.46	0.25
WestTrib	RWT094	37696	100-yr	502.00	7188.97	7192.57	7192.23	7192.91	0.005231	5.43	127.19	95.14	0.56	0.43
WestTrib	RWT094	37687	100-yr	502.00	7188.97	7192.22	7192.22	7192.82	0.010177	6.88	96.67	85.74	0.77	0.71
WestTrib	RWT094	37641	100-yr	502.00	7187.36	7190.62	7190.62	7191.24	0.010587	7.00	94.92	84.61	0.78	0.74
WestTrib	RWT094	37620	100-yr	502.00	7186.74	7190.03	7190.02	7190.62	0.009805	6.88	98.21	87.54	0.76	0.68
WestTrib	RWT094	37609	100-yr	502.00	7186.62	7189.90	7189.90	7190.50	0.010047	6.93	97.03	86.07	0.77	0.70
WestTrib	RWT094	37477	100-yr	502.00	7185.72	7187.30	7187.30	7187.75	0.012728	6.05	102.10	114.12	0.90	0.71
WestTrib	RWT094	37218.78	100-yr	502.00	7181.04	7183.38	7183.38	7183.92	0.009919	6.32	97.73	108.66	0.82	0.55
RWT080	RWT080	1475	100-yr	107.00	7257.10	7258.47		7258.56	0.017587	2.04	45.85	51.04	0.33	0.98

Cross sections
outside project area

HEC-RAS Plan: Pr_DBPS_Amend Profile: 100-yr (Continued)

River	Reach	River Sta	Profile	Q Total (cfs)	Min Ch El (ft)	W.S. Elev (ft)	Crit W.S. (ft)	E.G. Elev (ft)	E.G. Slope (ft/ft)	Vel Chnl (ft/s)	Flow Area (sq ft)	Top Width (ft)	Froude # Chl	Shear Total (lb/sq ft)
RWT080	RWT080	1299	100-yr	107.00	7252.03	7253.22	7253.22	7253.58	0.054712	2.95	25.83	40.07	0.55	2.19
RWT080	RWT080	1114	100-yr	107.00	7246.23	7247.71		7247.87	0.010471	1.69	38.50	37.23	0.26	0.67
RWT080	RWT080	952	100-yr	107.00	7242.11	7243.44	7243.41	7243.86	0.109855	4.83	20.95	24.18	0.80	5.89
RWT080	RWT080	762	100-yr	107.00	7234.88	7235.95		7235.99	0.021254	1.61	66.34	89.57	0.33	0.98
RWT080	RWT080	615	100-yr	101.00	7231.06	7232.52		7232.64	0.024496	2.58	37.32	32.37	0.39	1.75
RWT080	RWT080	459	100-yr	101.00	7224.03	7225.56	7225.47	7225.87	0.096854	4.48	22.72	27.53	0.75	4.93
RWT080	RWT080	294	100-yr	101.00	7219.80	7222.24		7222.33	0.009024	2.17	43.13	24.39	0.26	0.96
RWT080	RWT080	125	100-yr	101.00	7216.33	7218.11	7218.11	7218.67	0.101209	5.36	17.41	17.26	0.79	6.20

Eagleview_WestTrib Plan: Eagleview_Pr_DBPS_Amend 1/30/2024
 River = RWT080 Reach = RWT080 RS = 1475

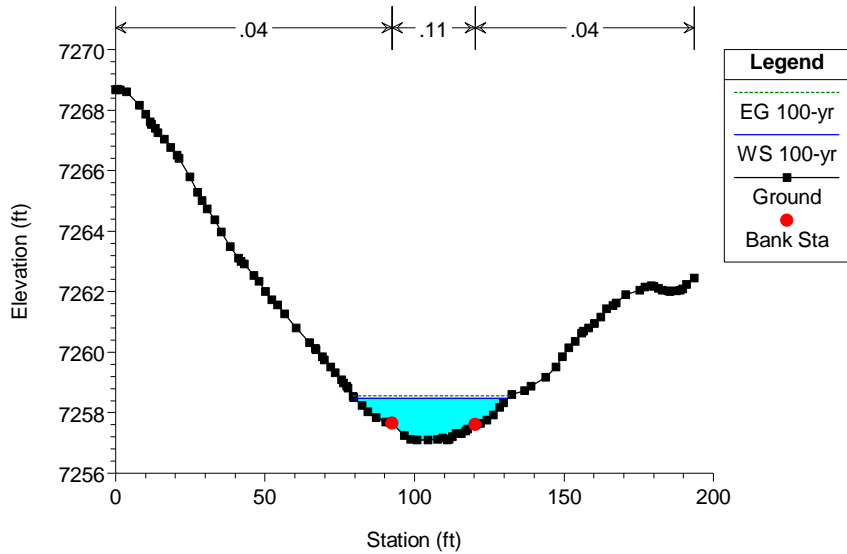

Eagleview_WestTrib Plan: Eagleview_Pr_DBPS_Amend 1/30/2024
 River = RWT080 Reach = RWT080 RS = 1299

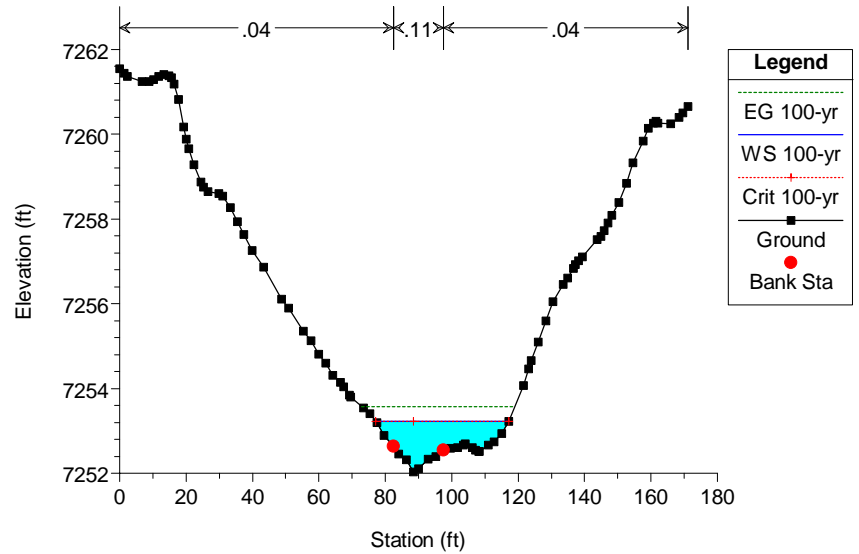

Eagleview_WestTrib Plan: Eagleview_Pr_DBPS_Amend 1/30/2024
 River = RWT080 Reach = RWT080 RS = 1114

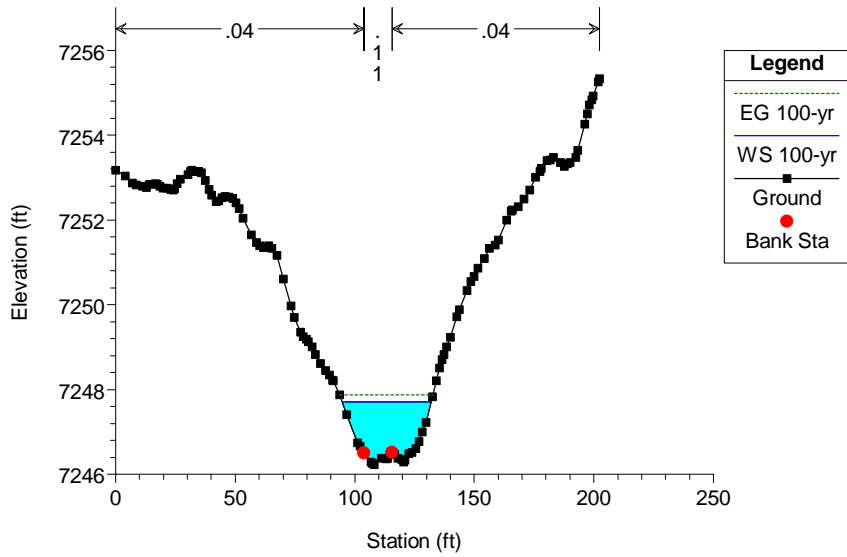

Eagleview_WestTrib Plan: Eagleview_Pr_DBPS_Amend 1/30/2024
 River = RWT080 Reach = RWT080 RS = 952

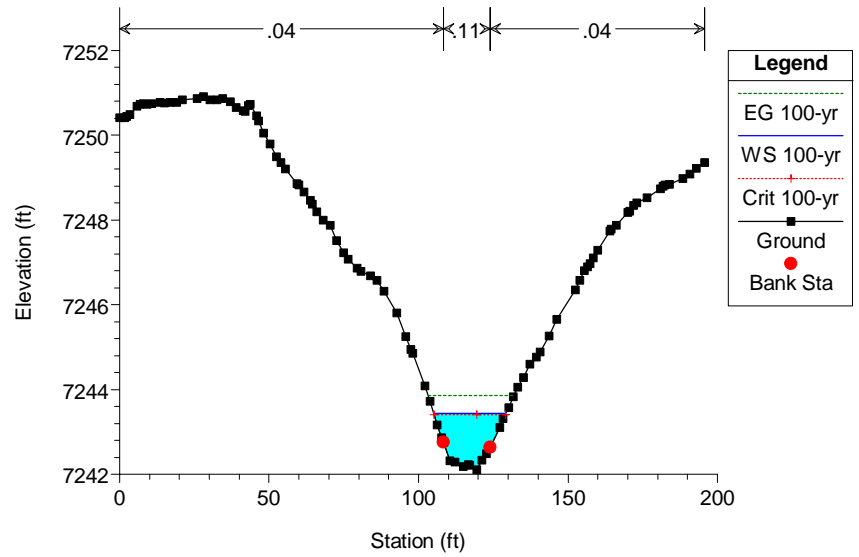

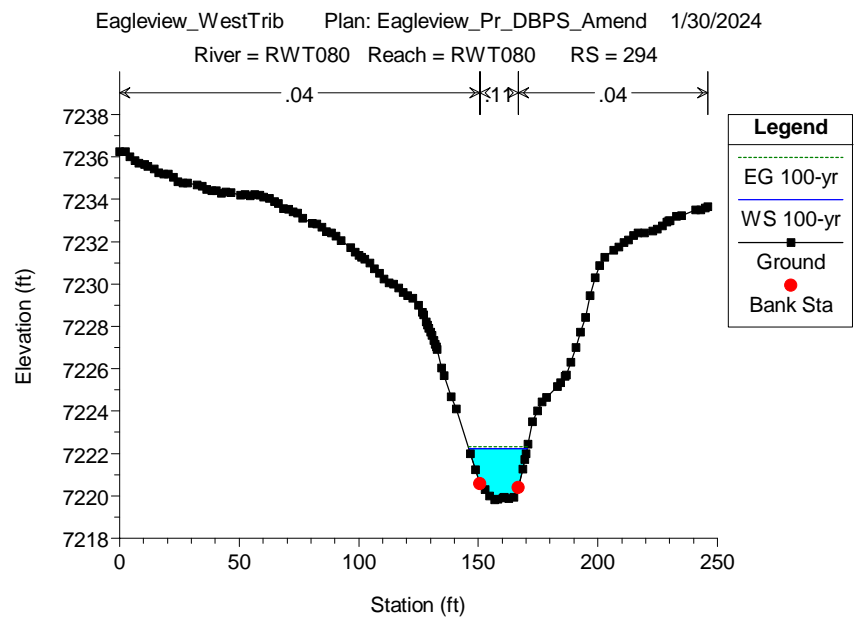
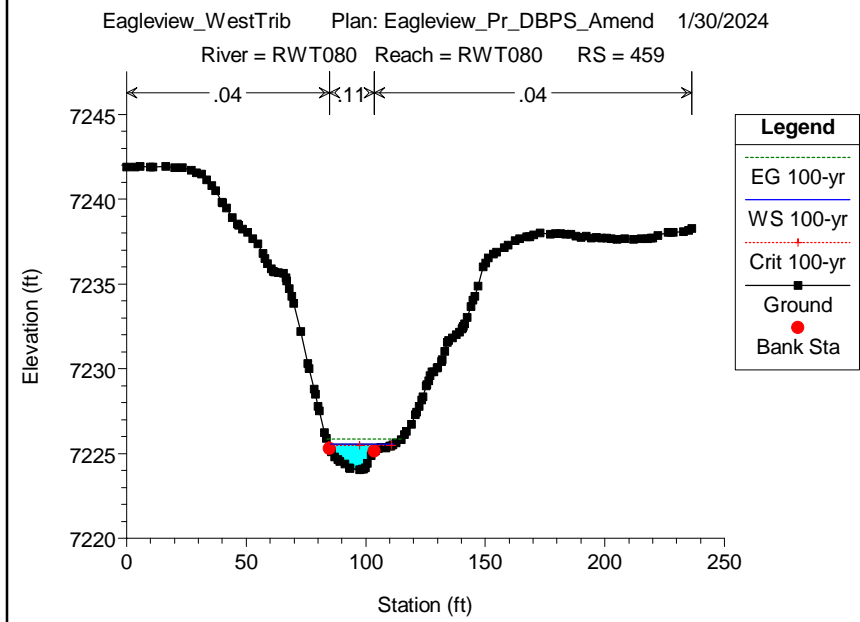
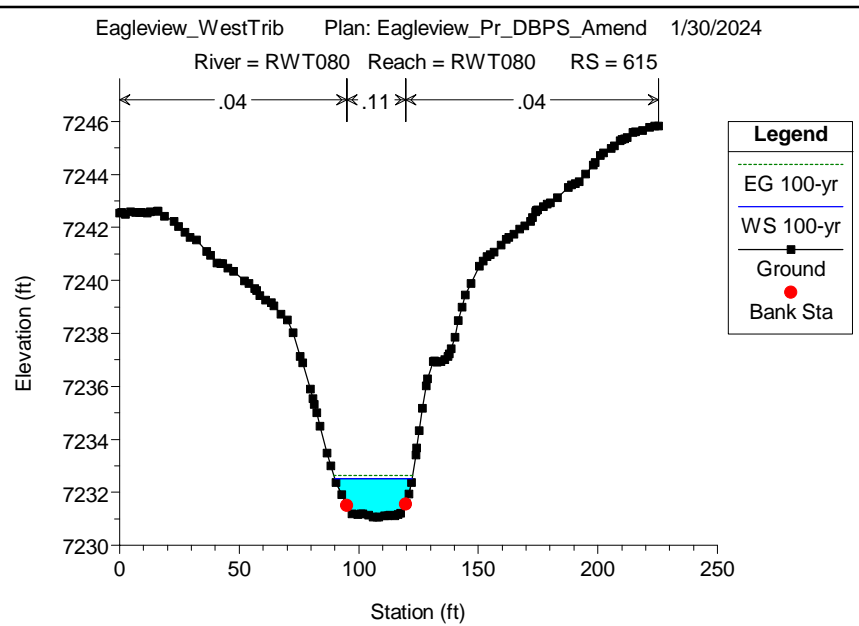
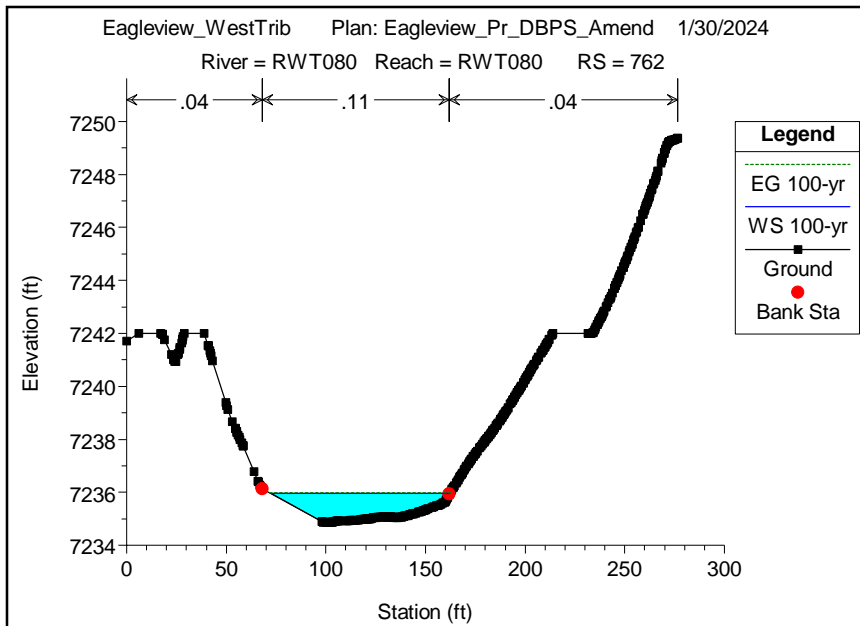

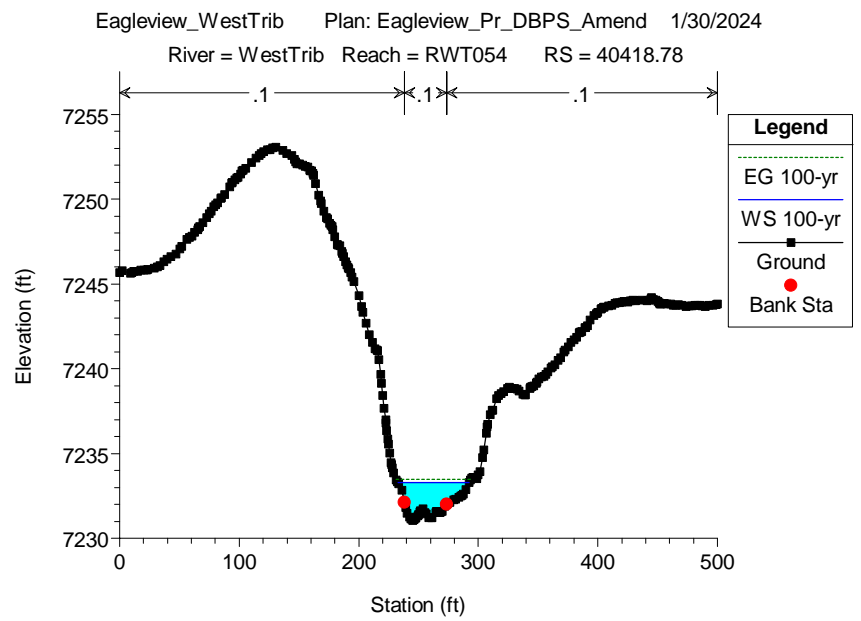
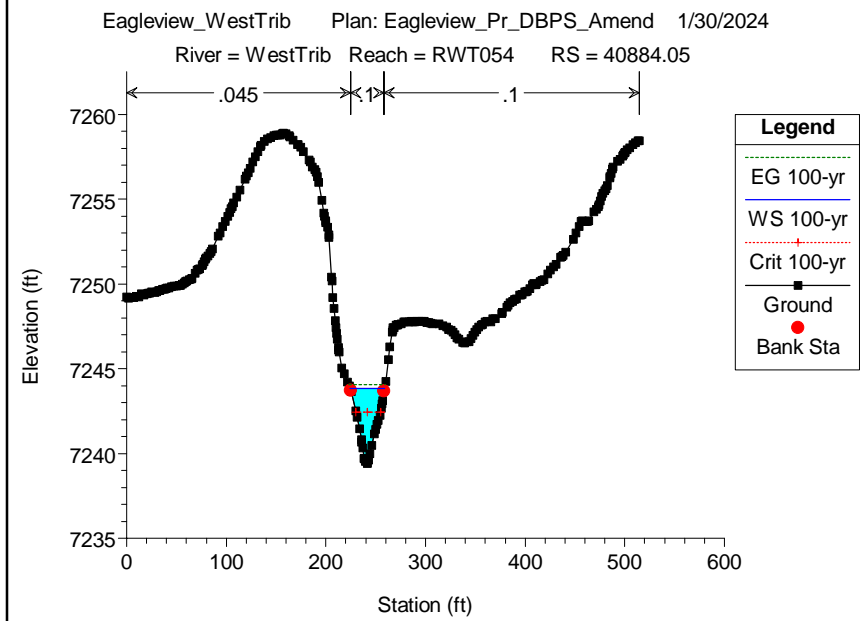
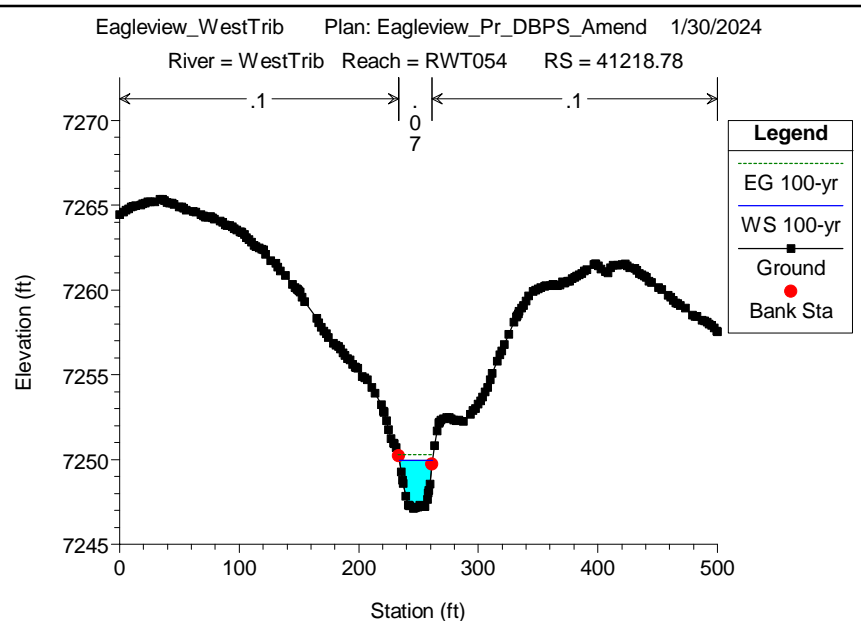
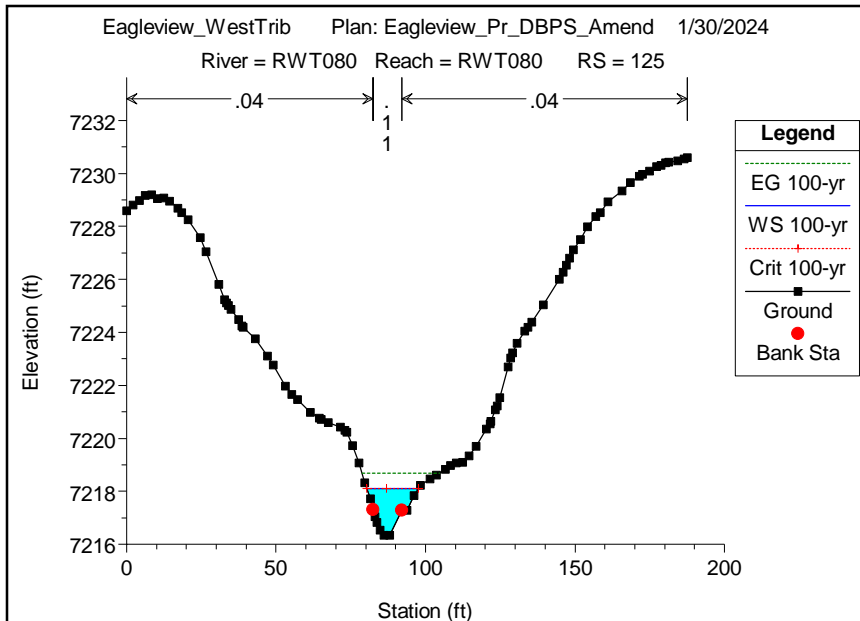

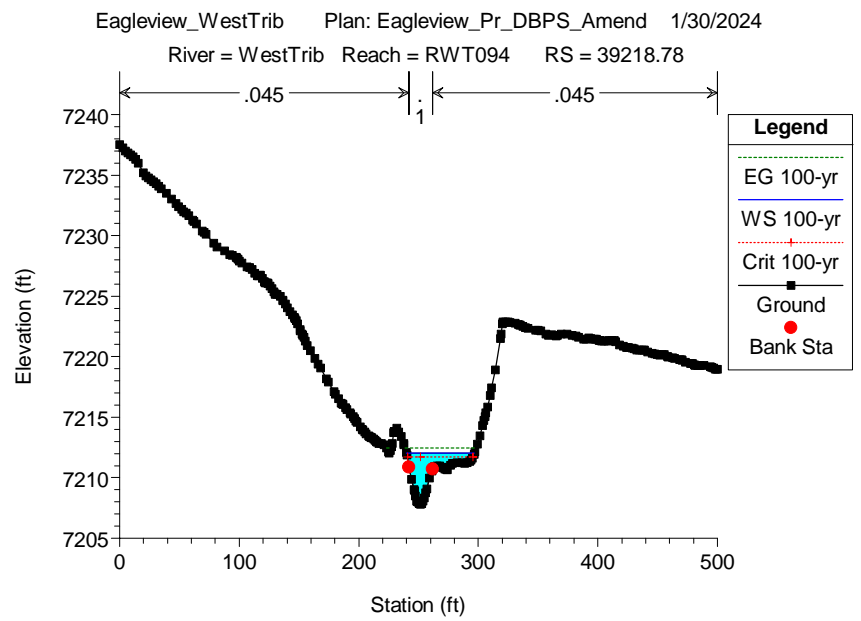
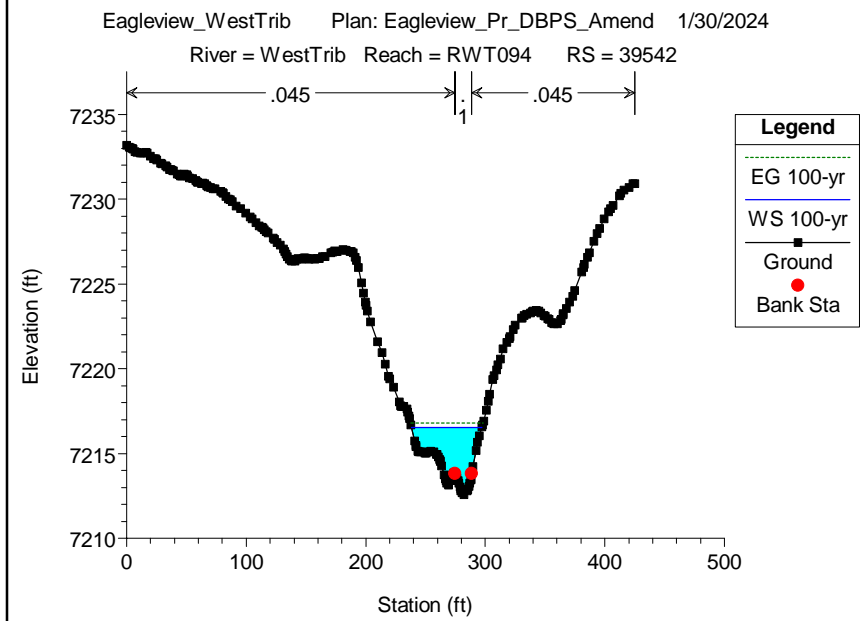
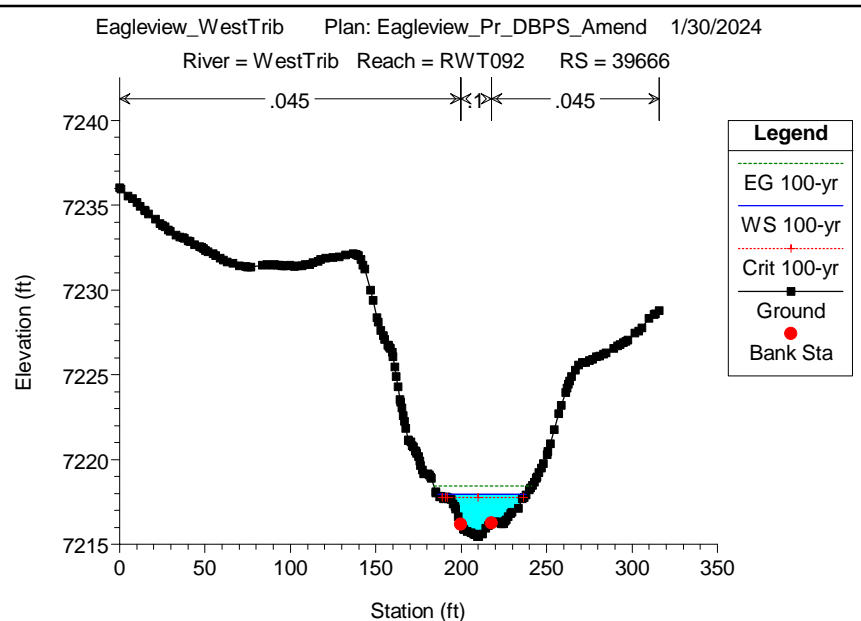
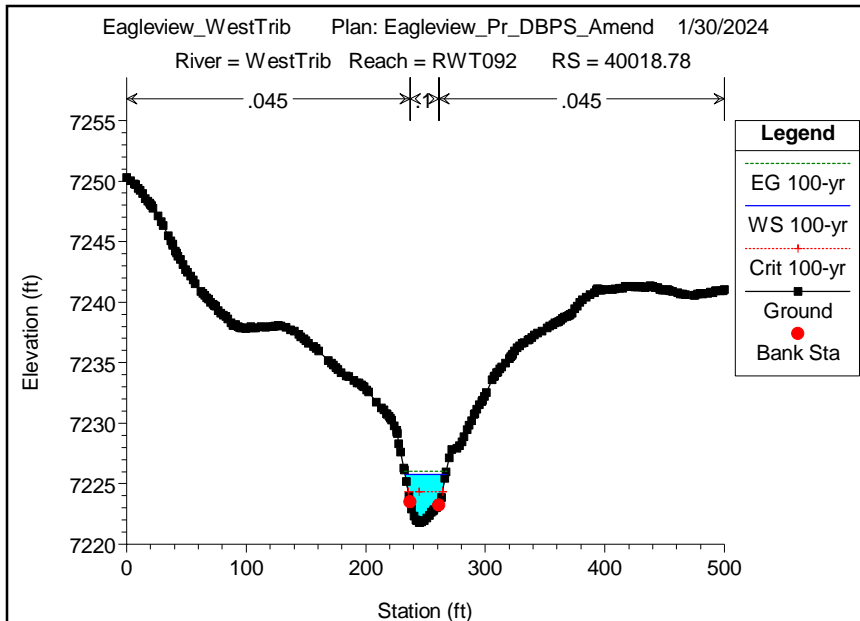

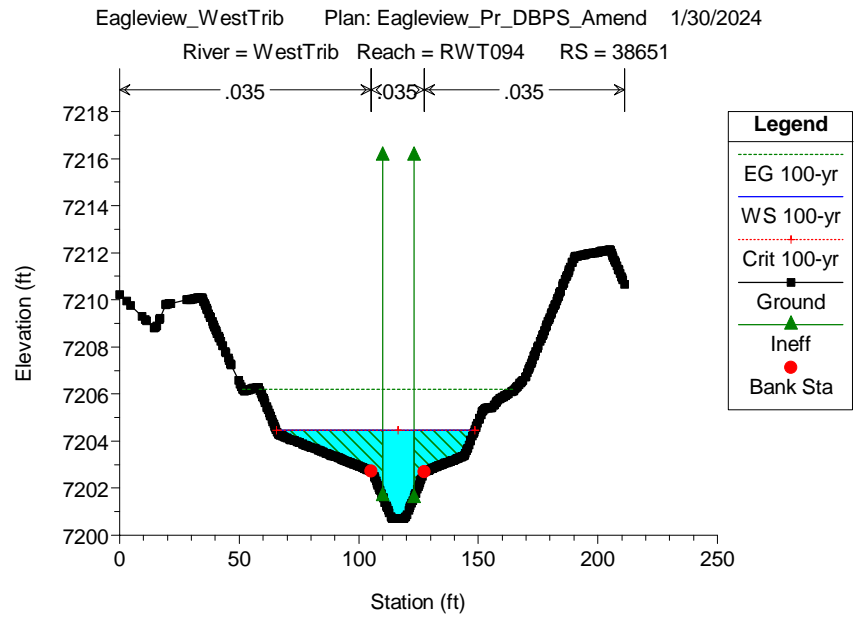
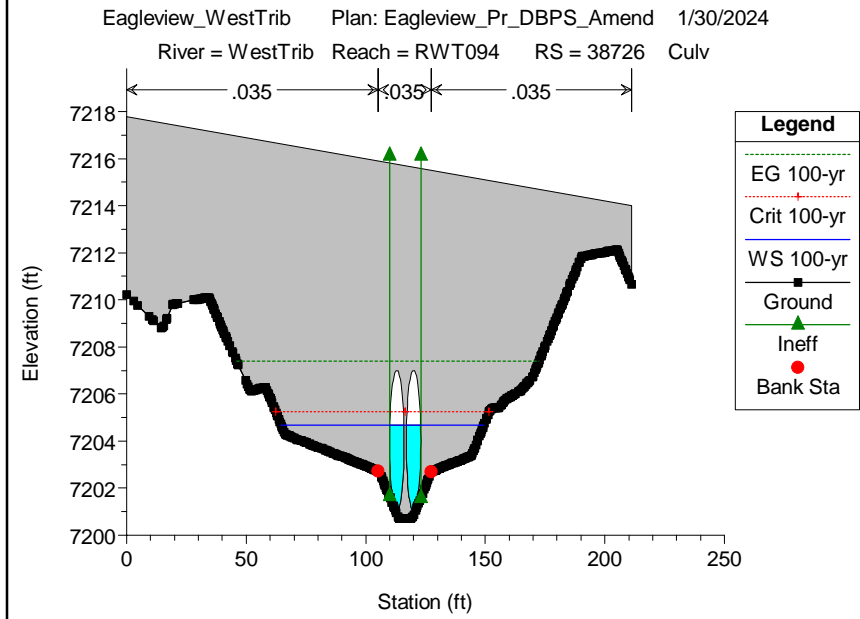
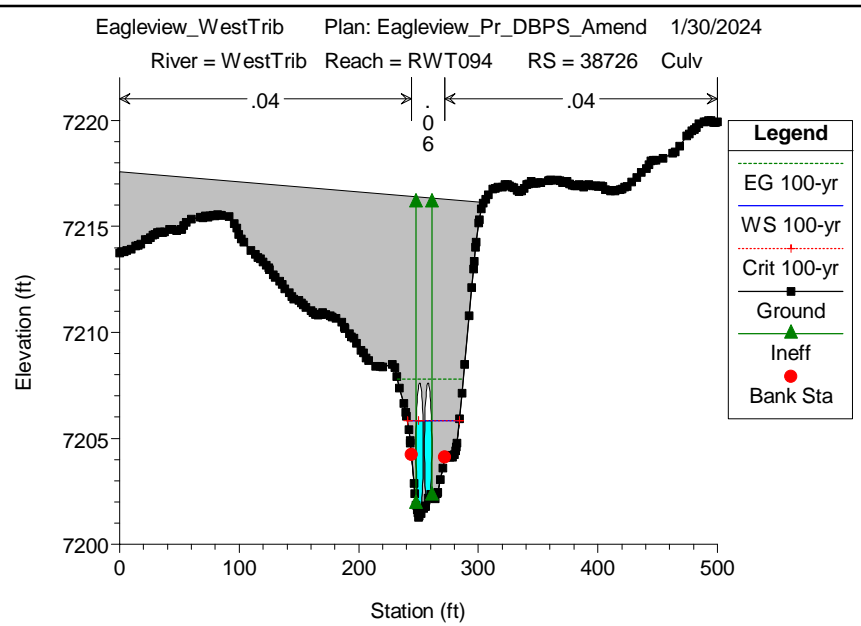
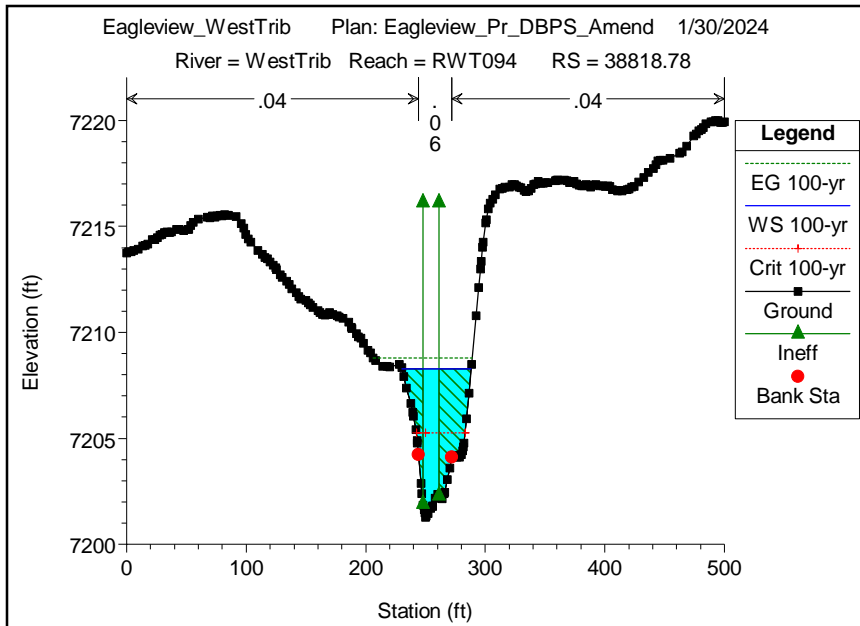

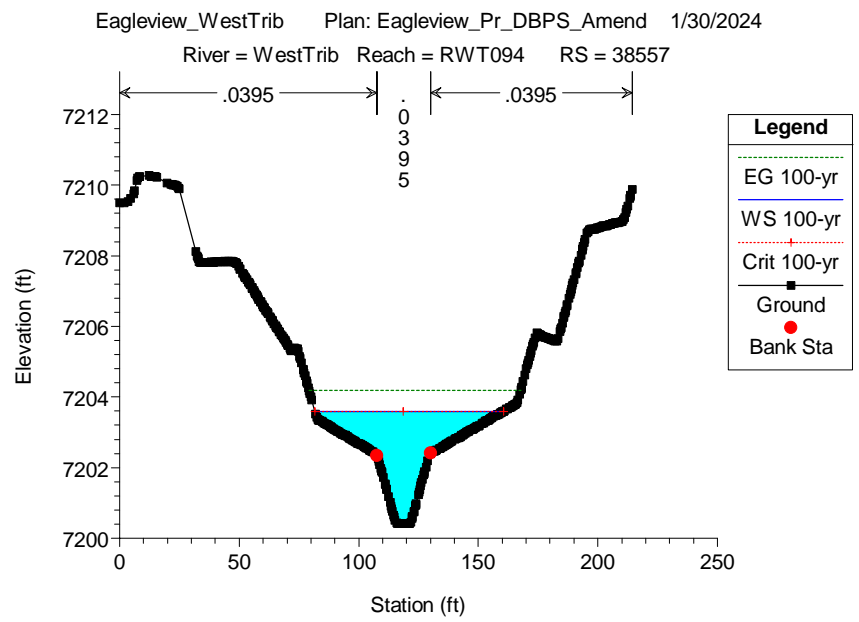
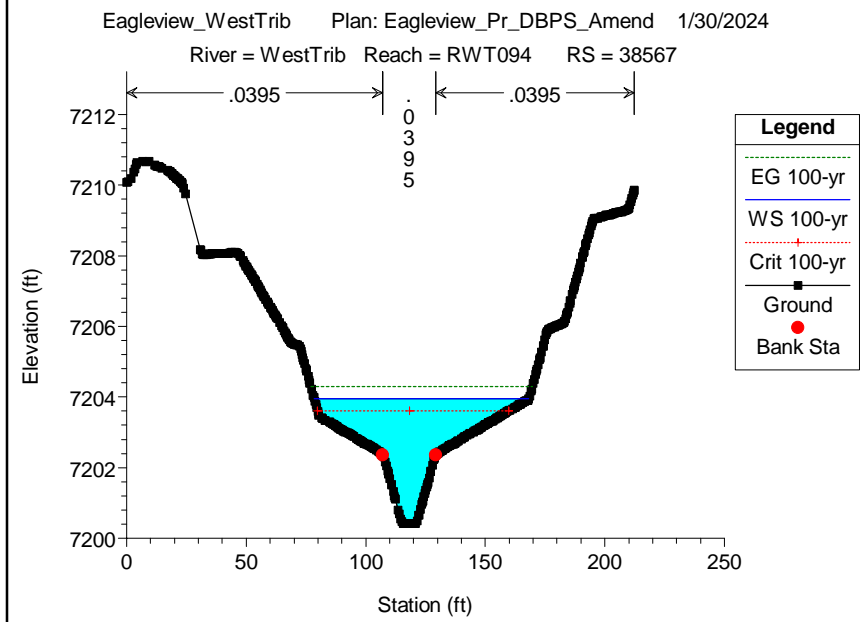
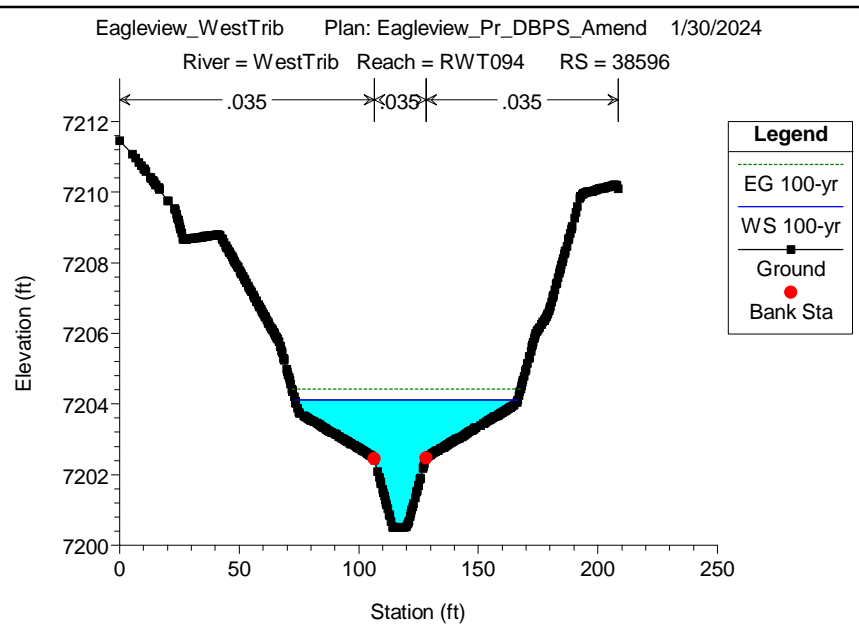
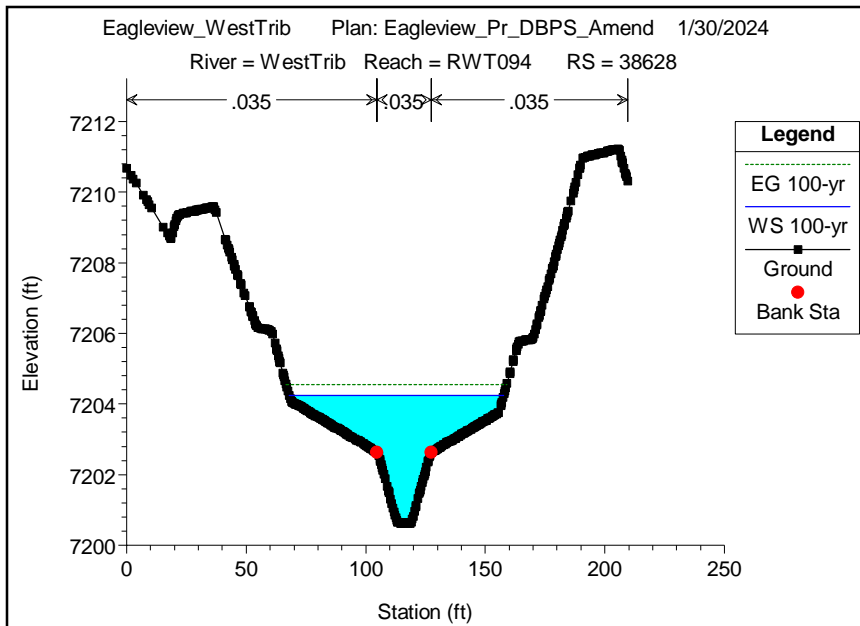

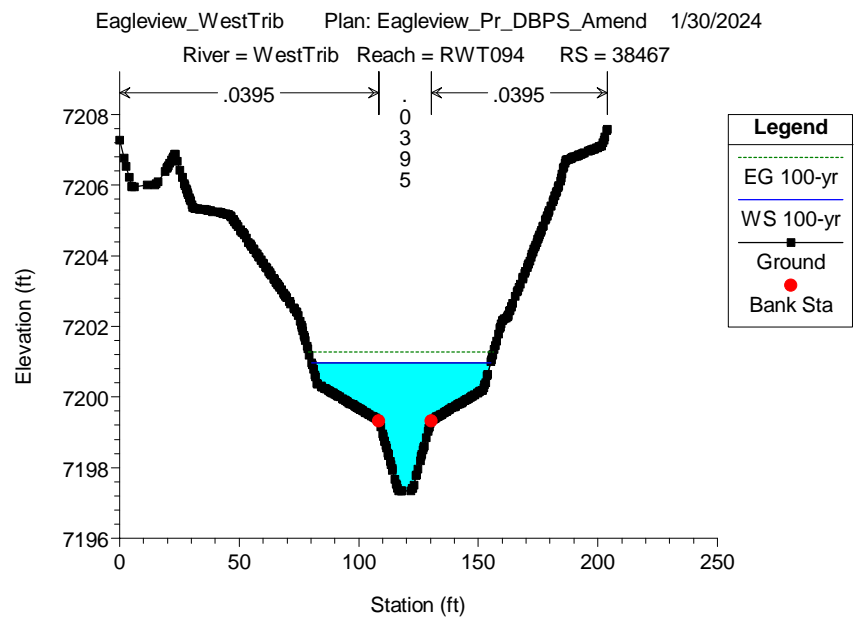
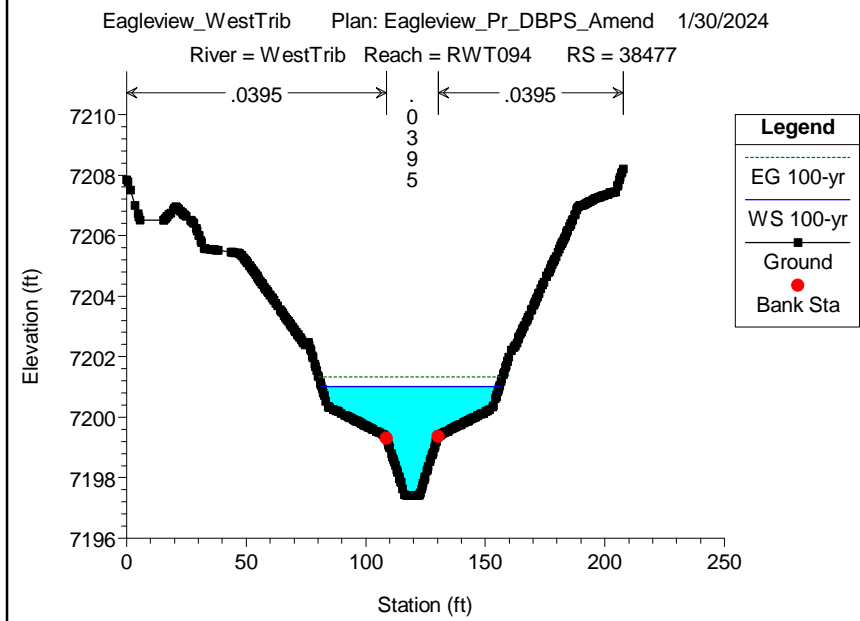
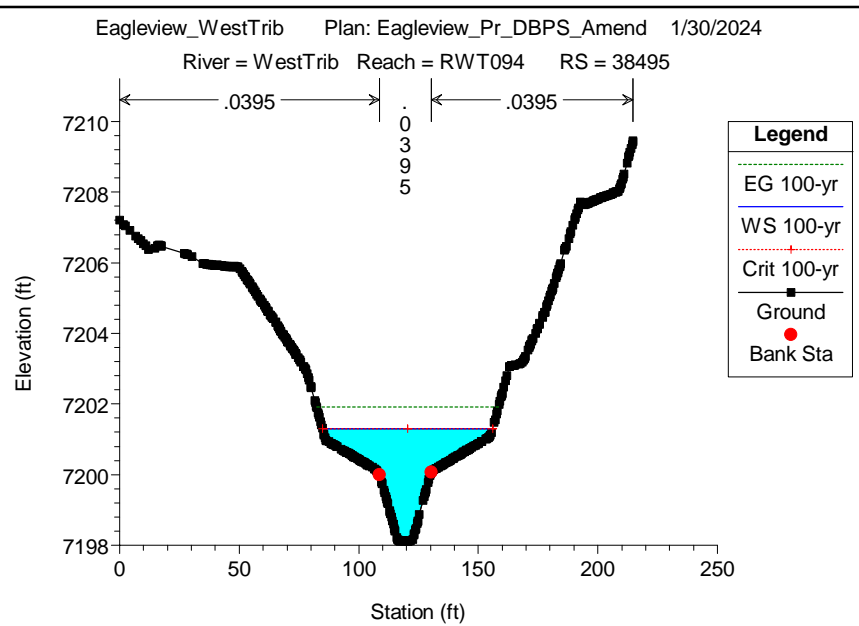
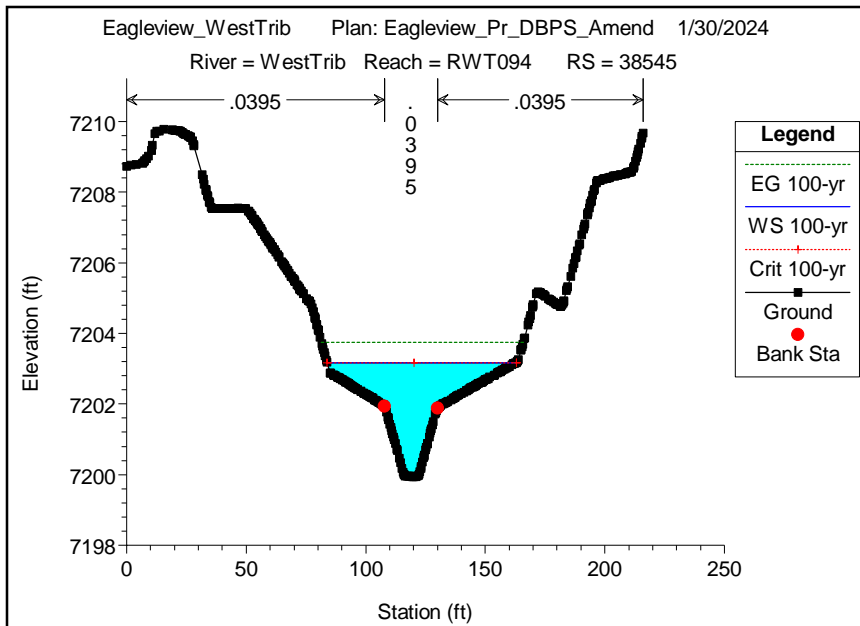

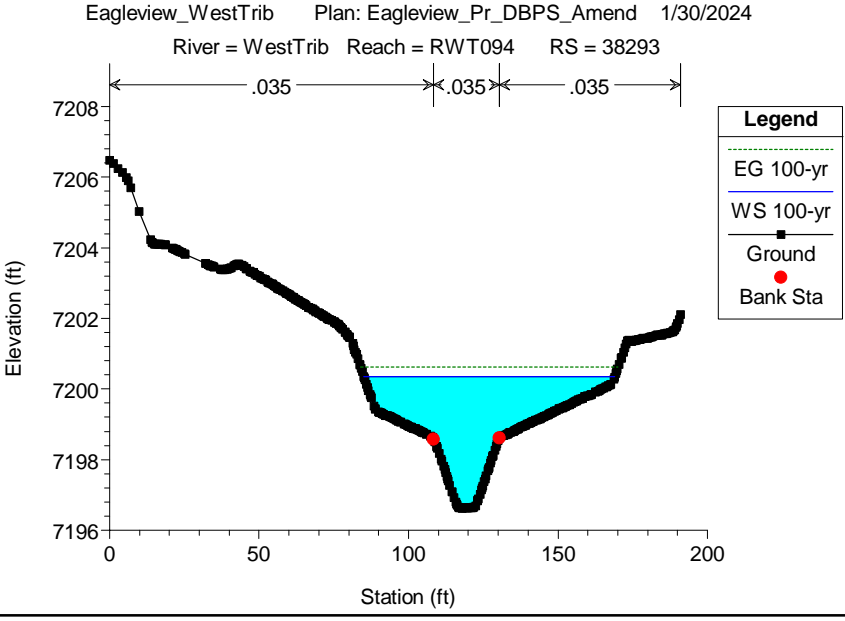
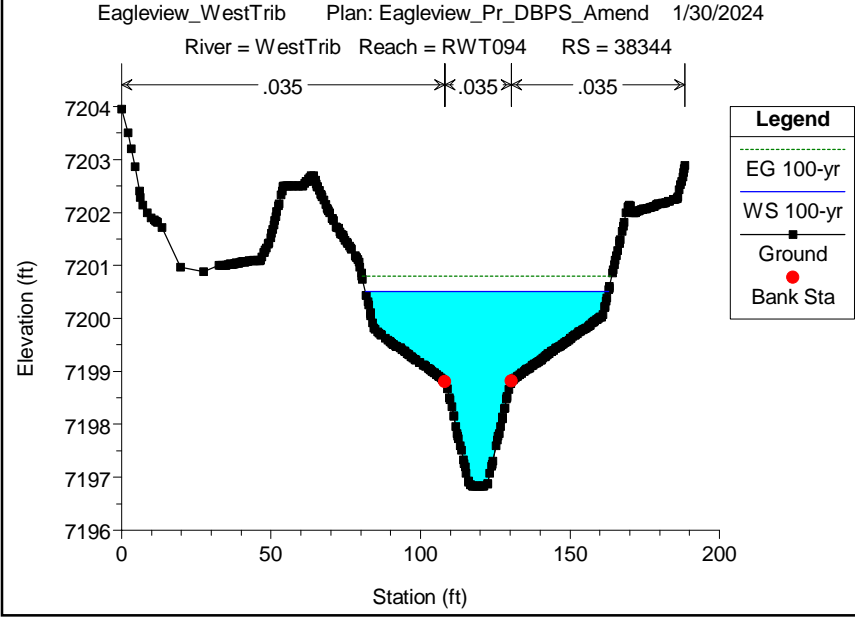
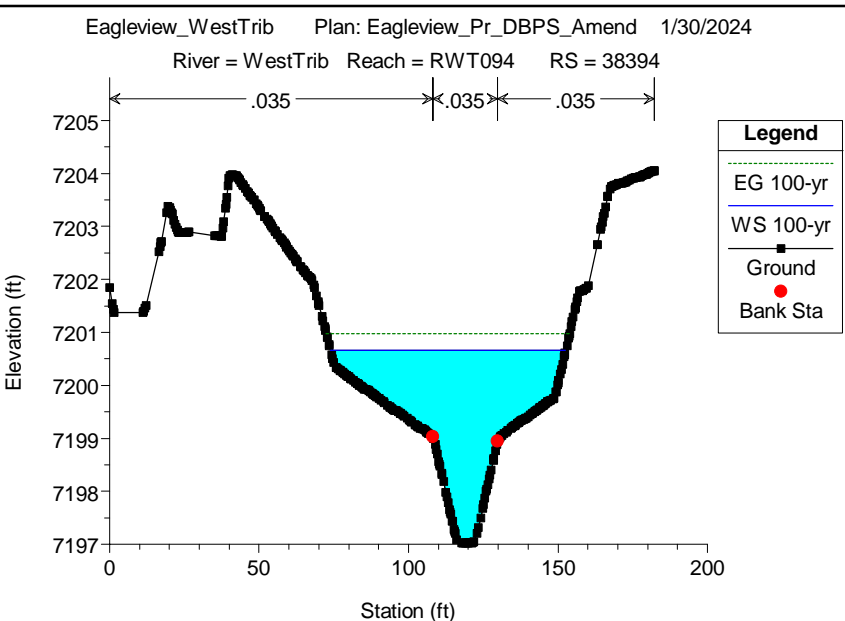
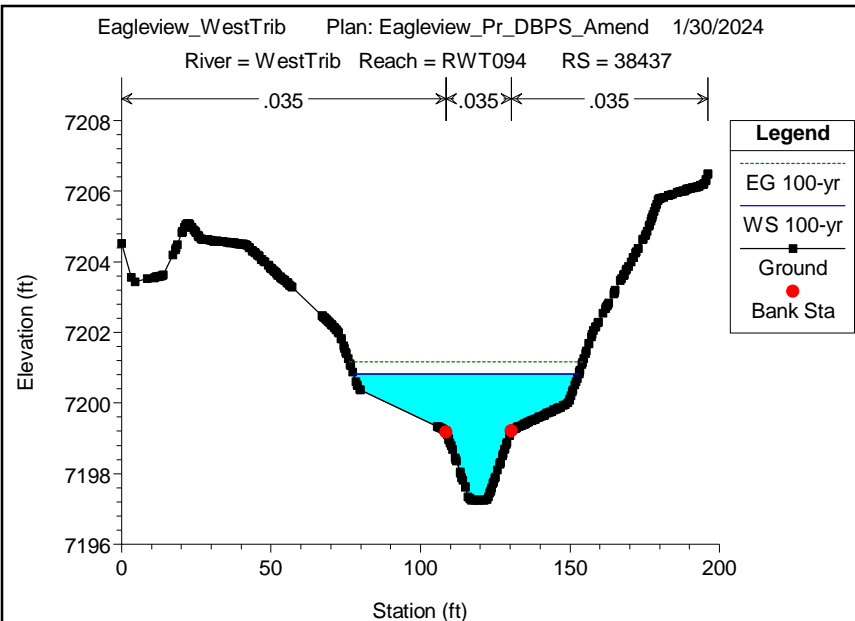

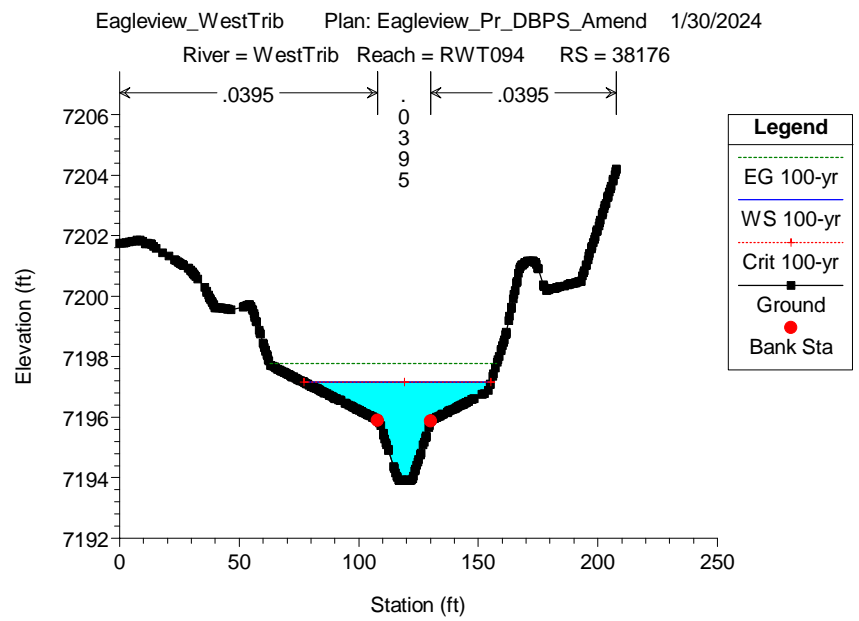
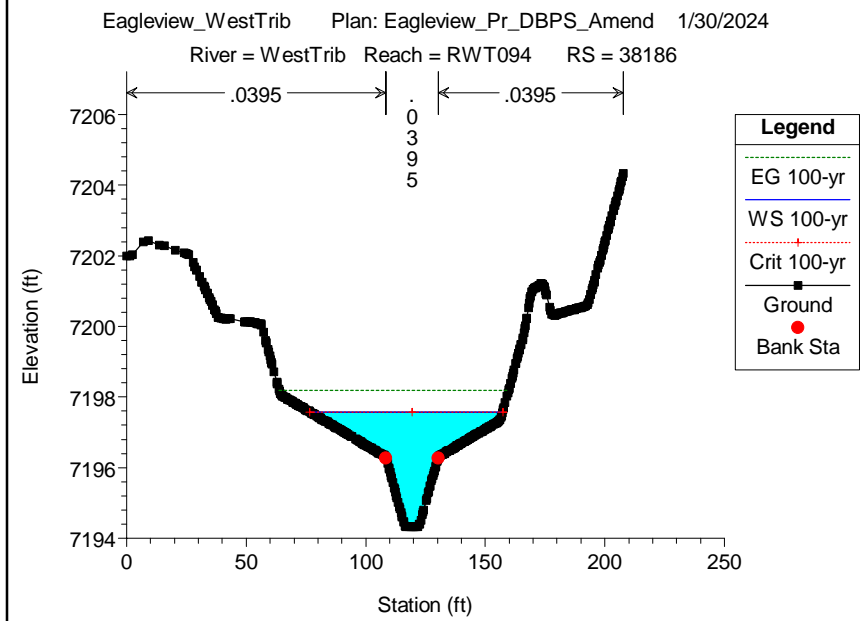
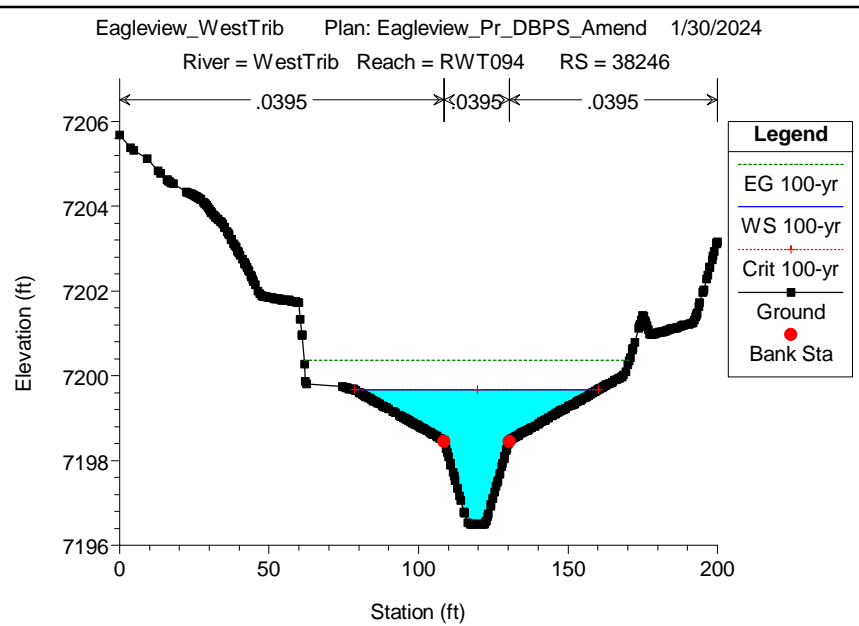
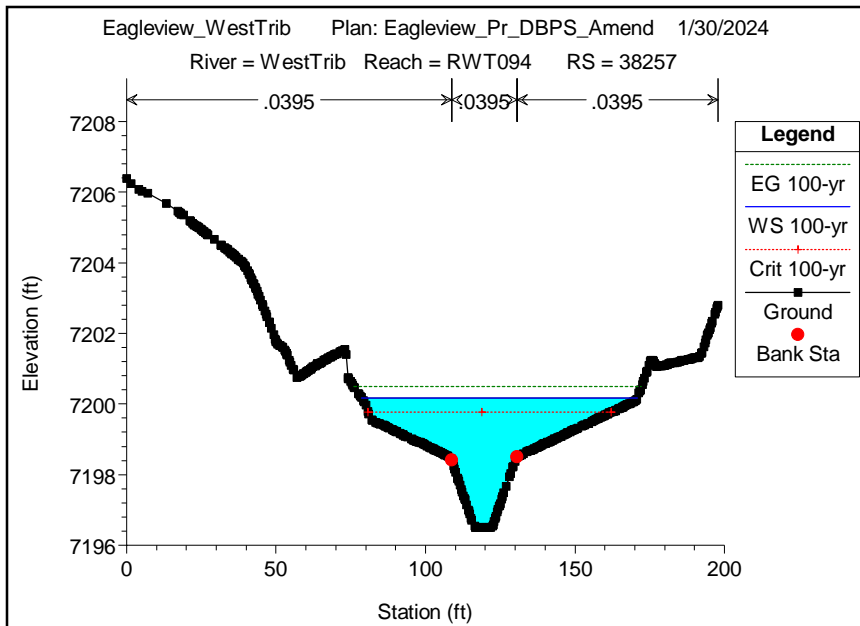

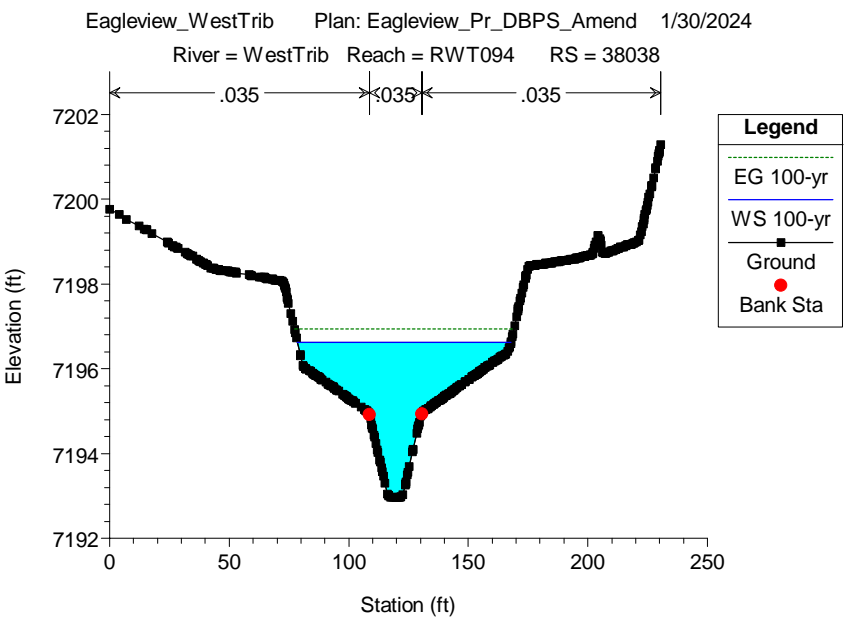
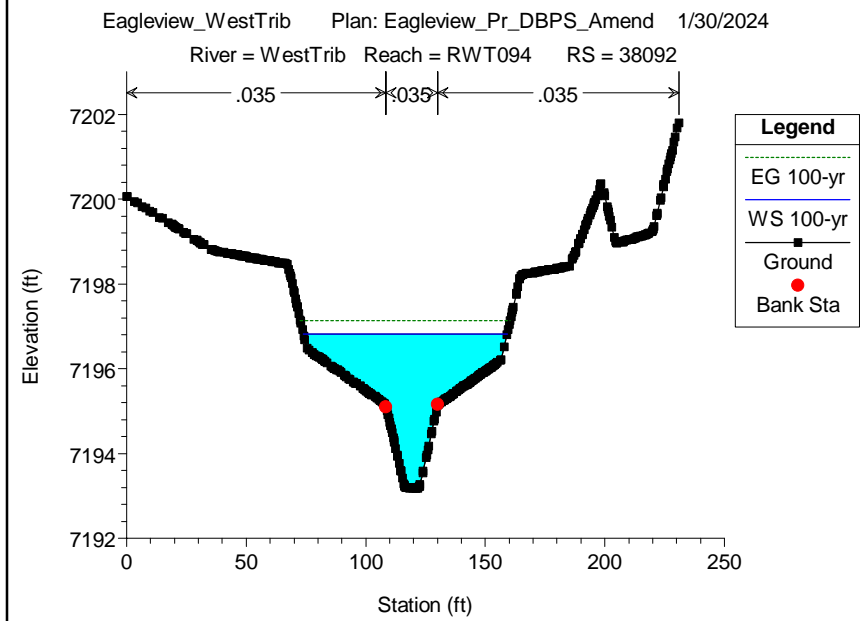
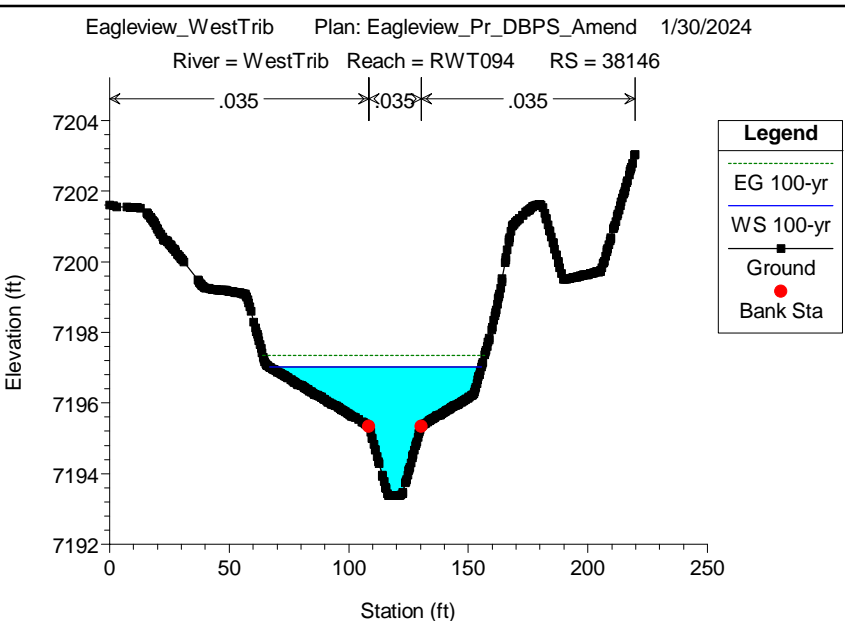
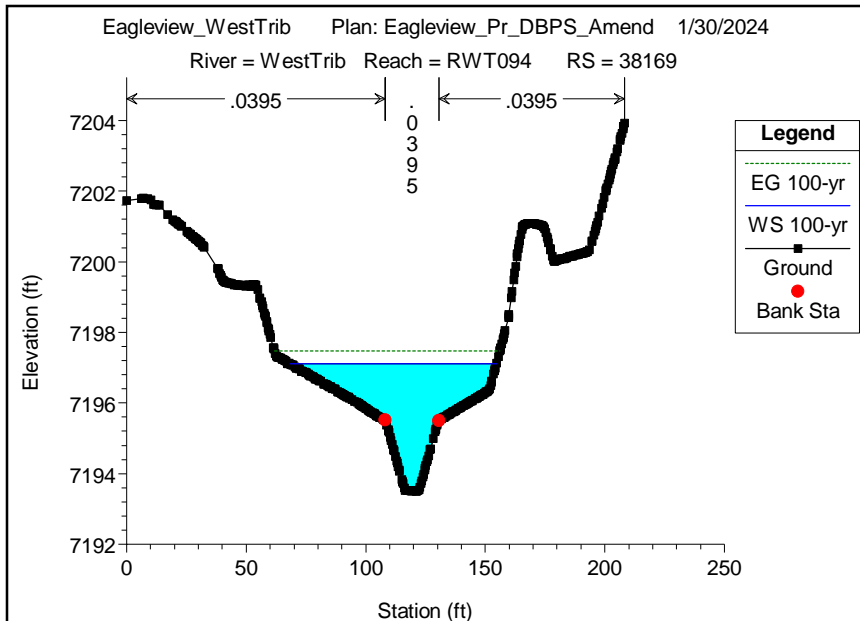

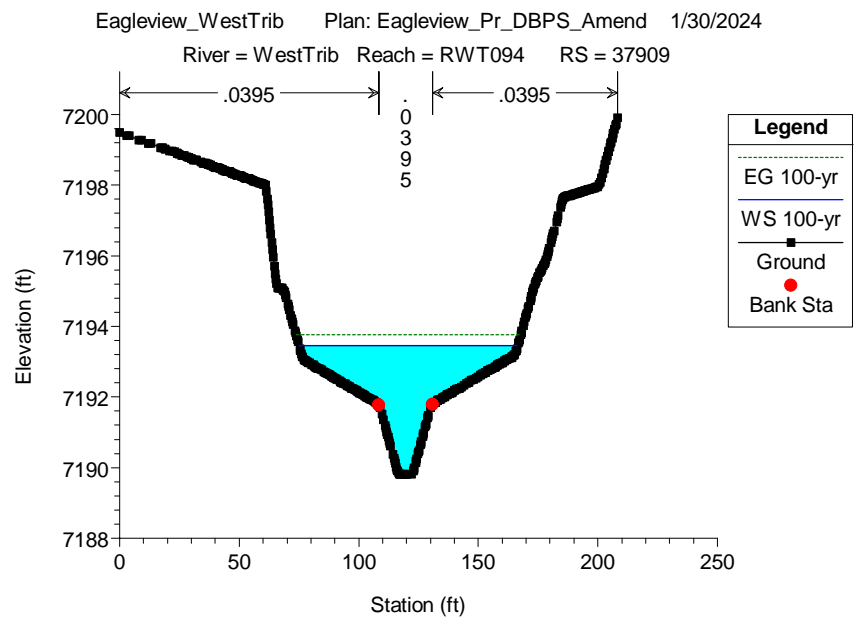
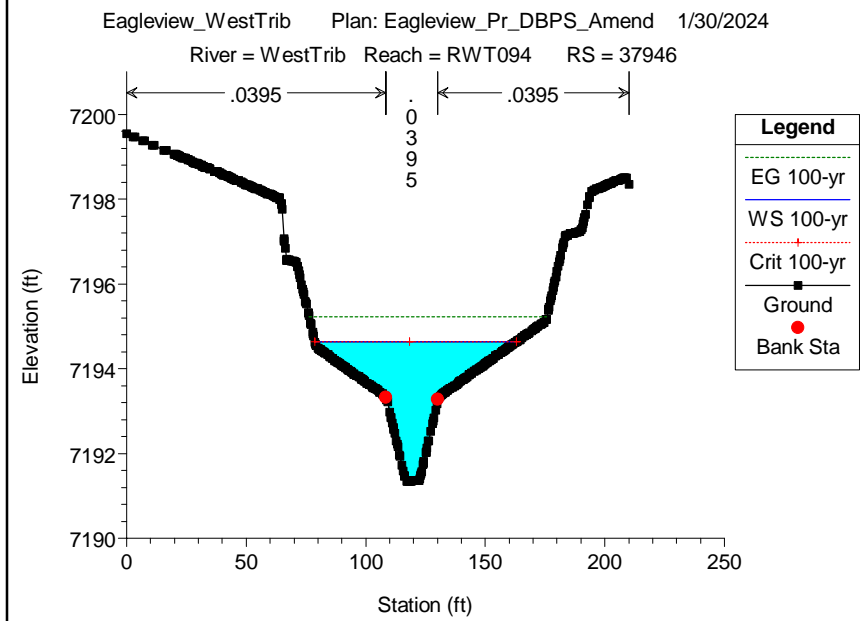
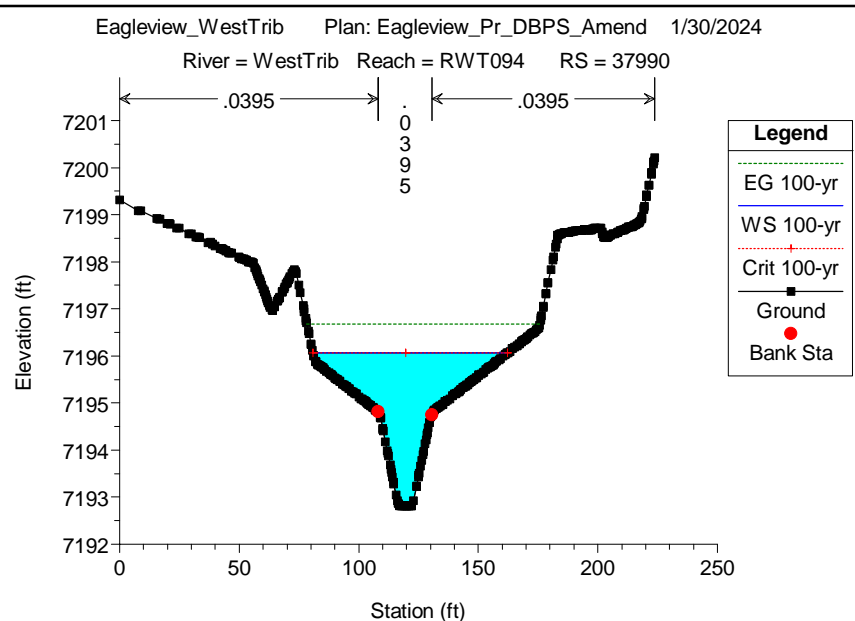
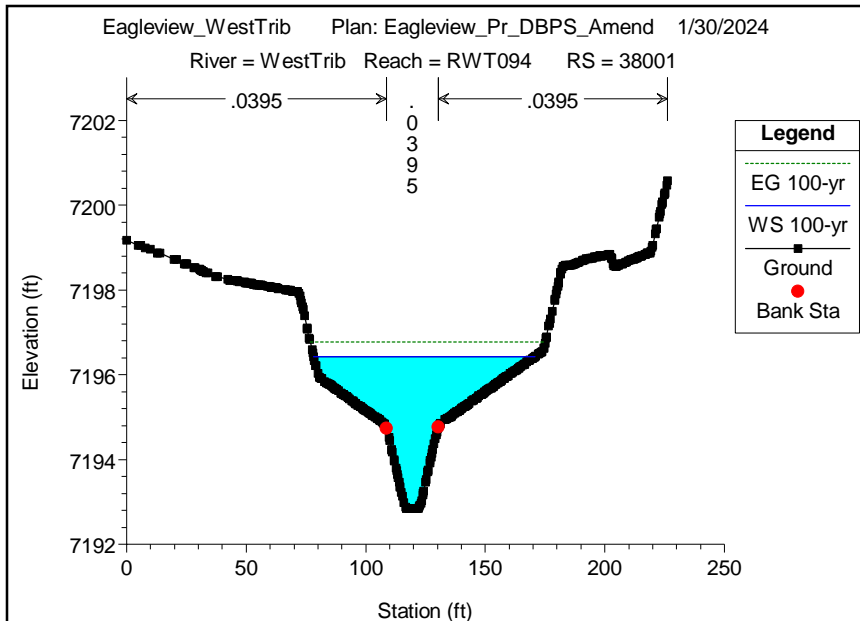

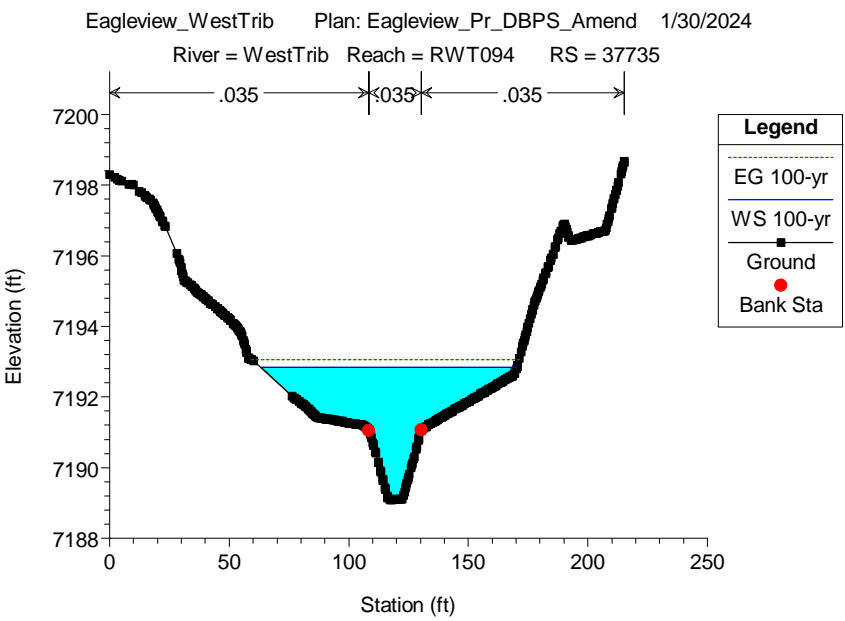
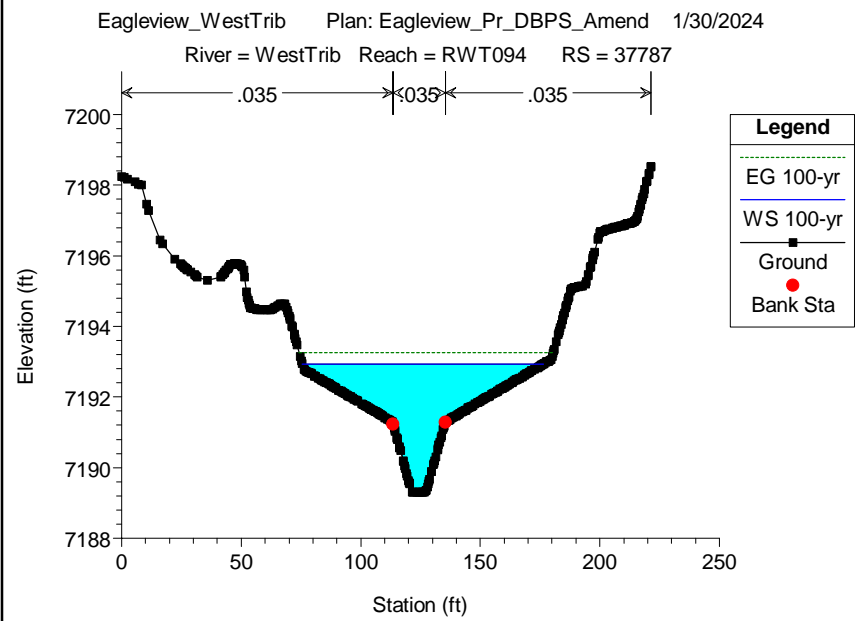
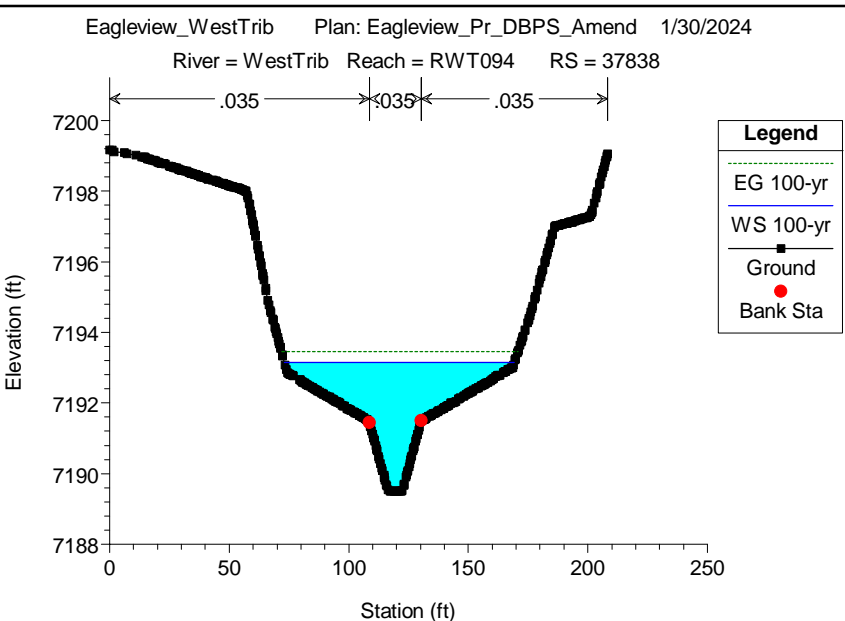
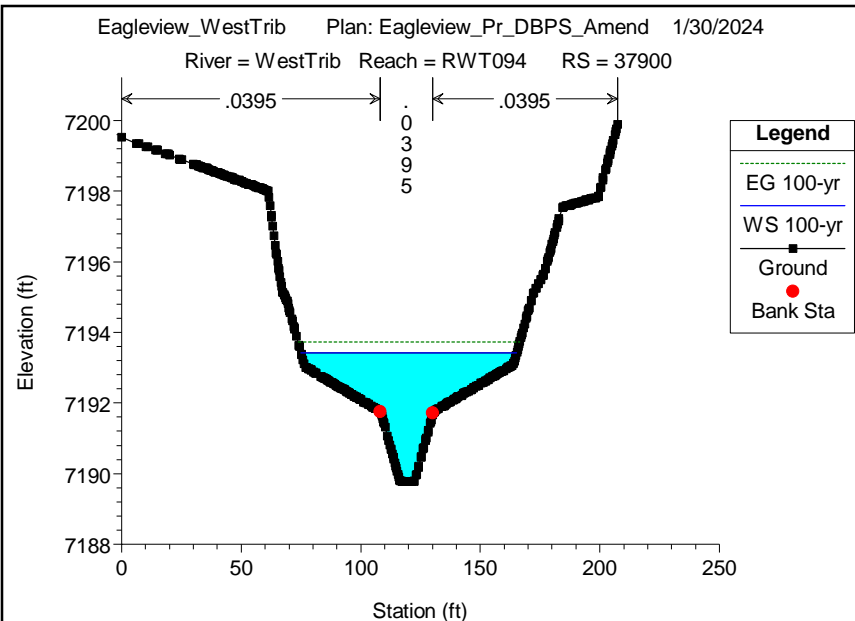

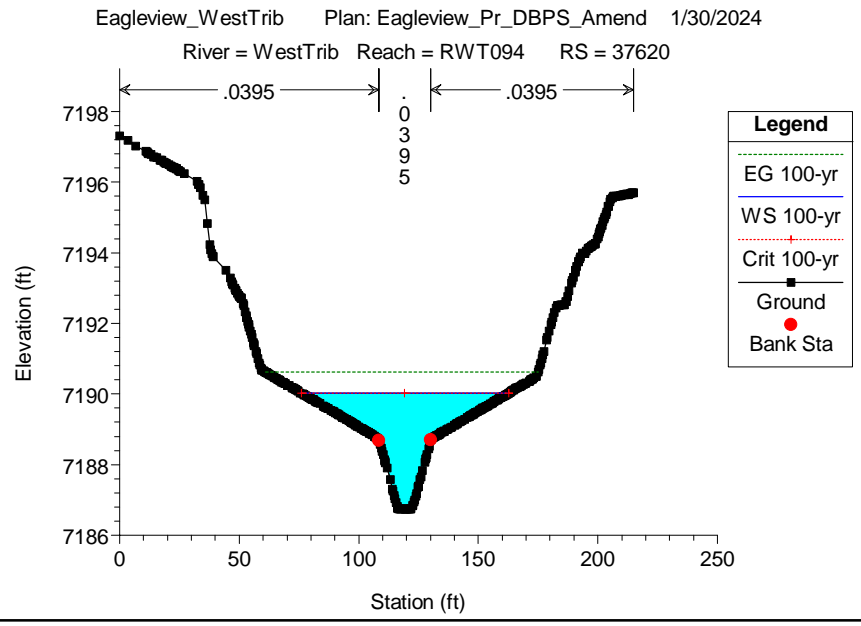
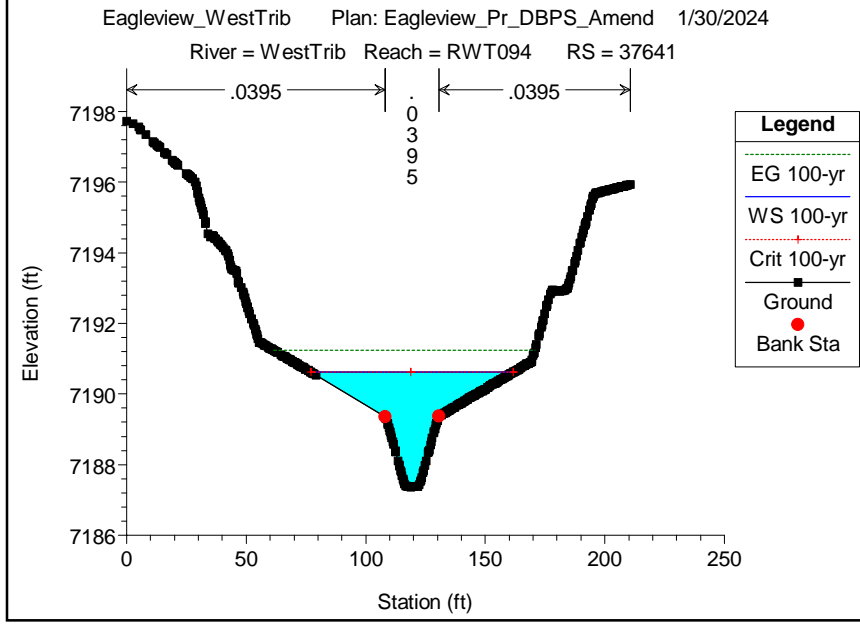
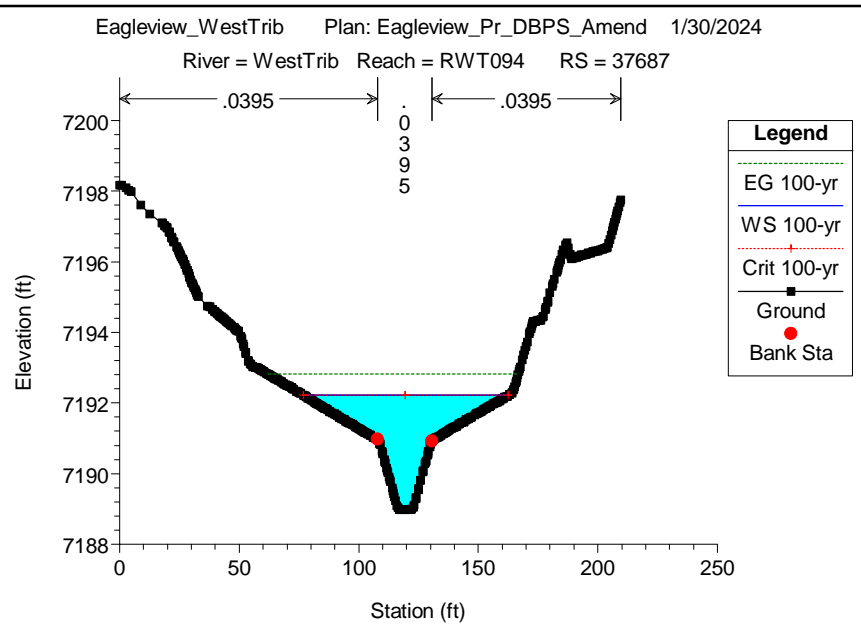
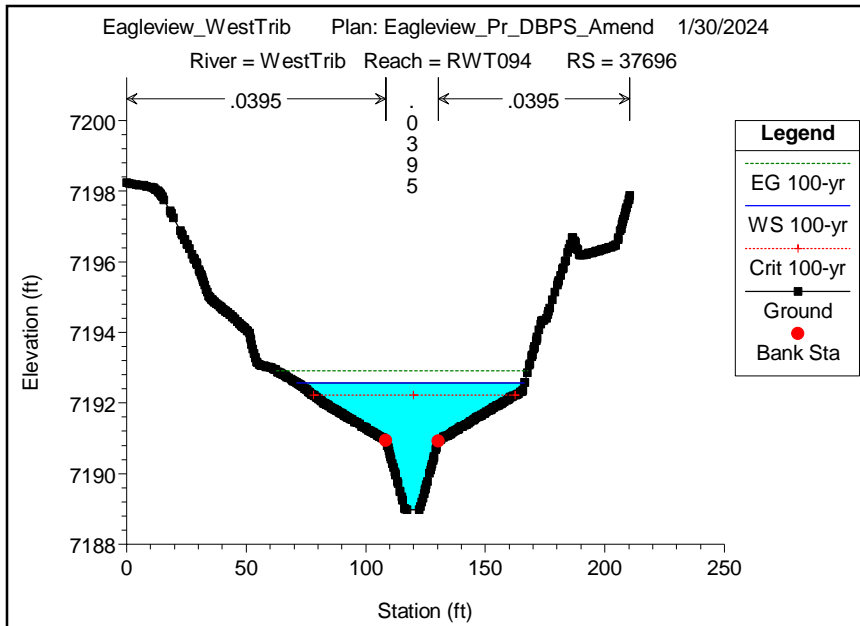

Eagleview_WestTrib Plan: Eagleview_Pr_DBPS_Amend 1/30/2024

River = WestTrib Reach = RWT094 RS = 37609

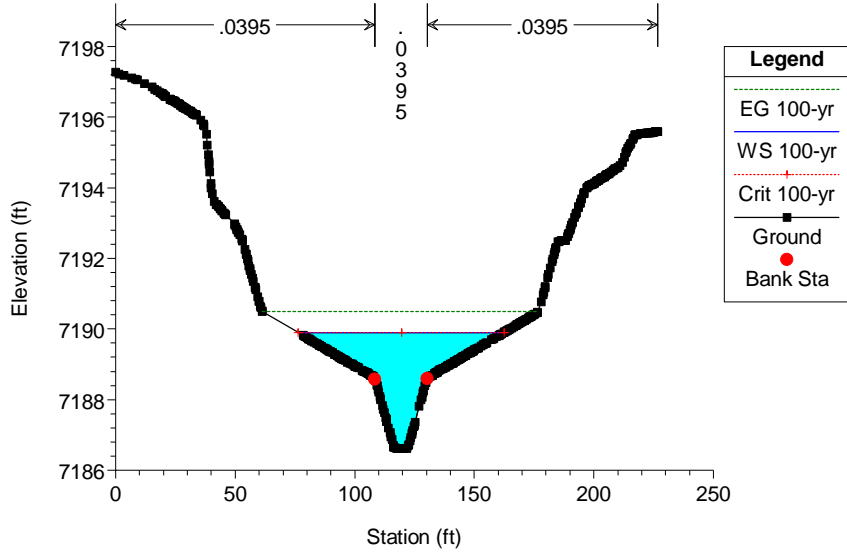

Eagleview_WestTrib Plan: Eagleview_Pr_DBPS_Amend 1/30/2024

River = WestTrib Reach = RWT094 RS = 37477

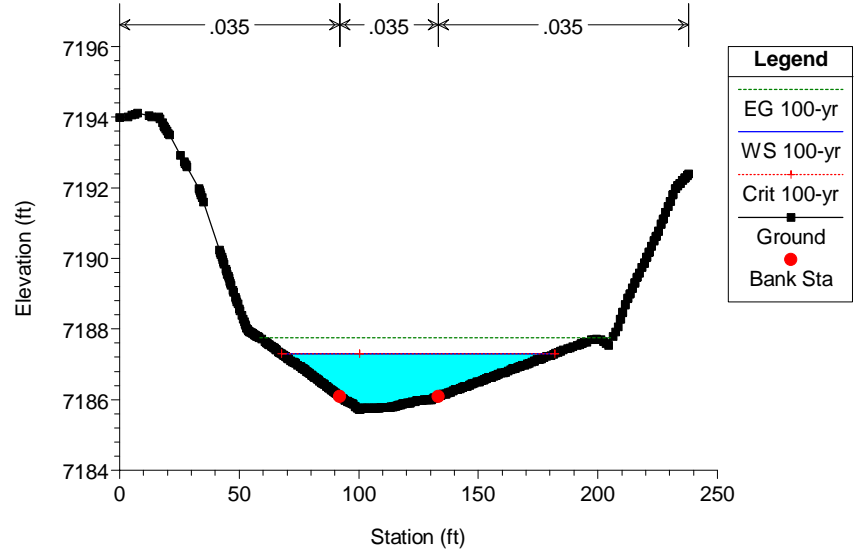

Eagleview_WestTrib Plan: Eagleview_Pr_DBPS_Amend 1/30/2024

River = WestTrib Reach = RWT094 RS = 37218.78

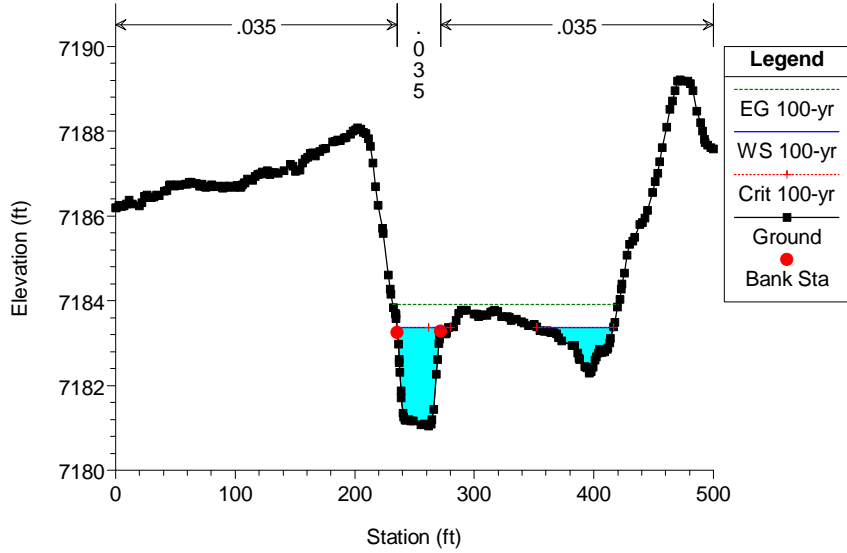

APPENDIX D: DBPS EXCERPTS

FalconDBPS WestTrib

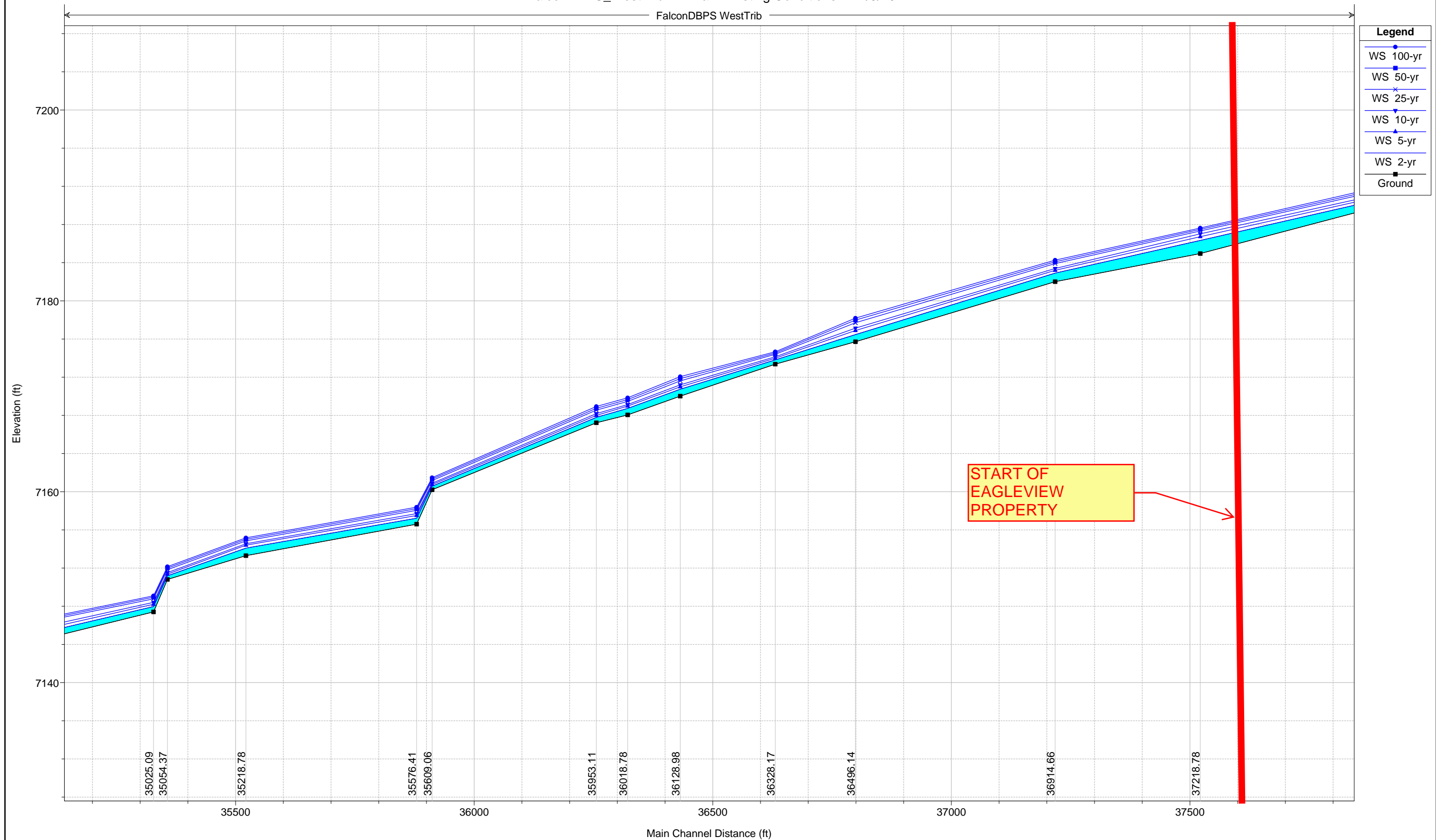

1 in Horiz. = 200 ft 1 in Vert. = 10 ft

FalconDBPS WestTrib

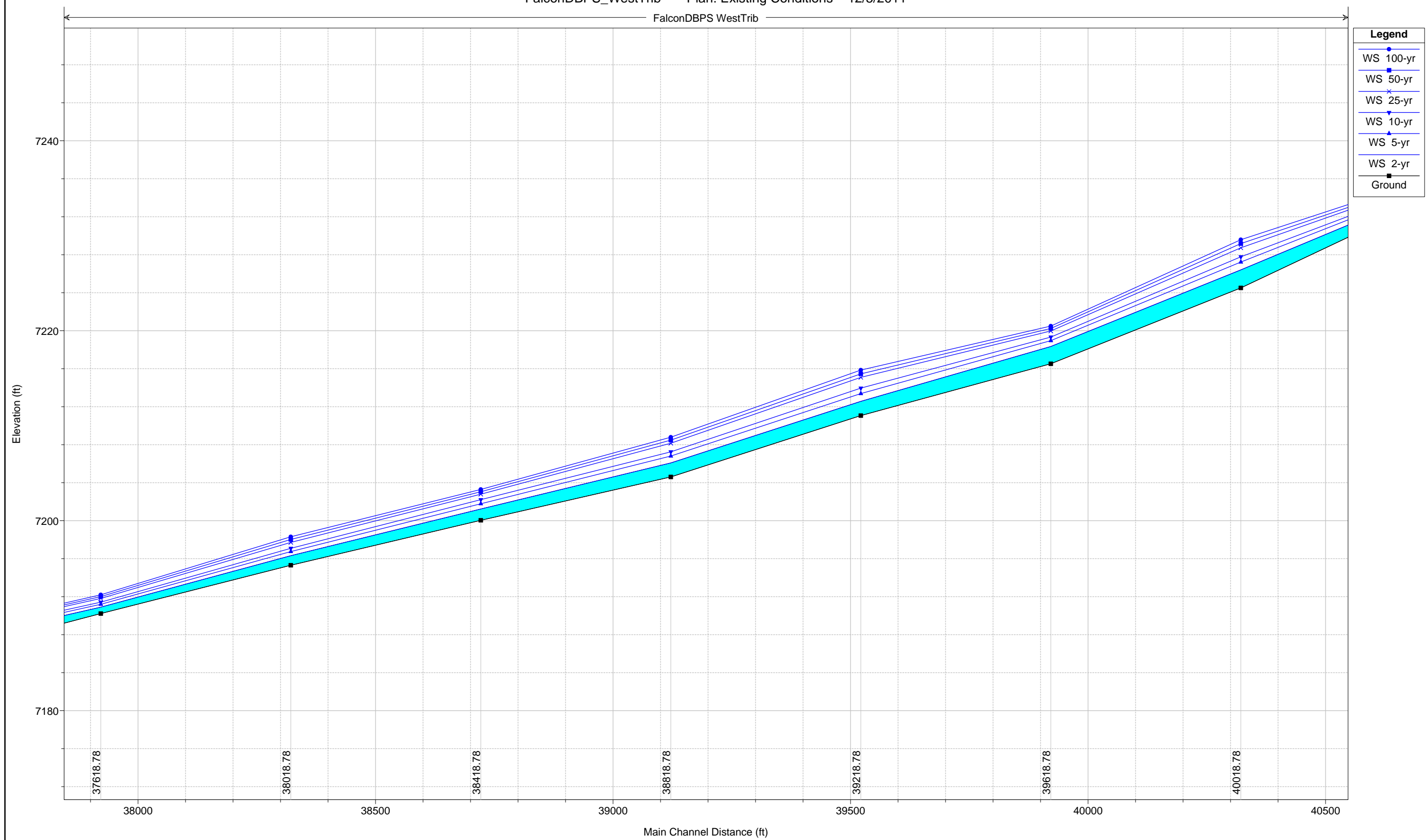

1 in Horiz. = 200 ft 1 in Vert. = 10 ft

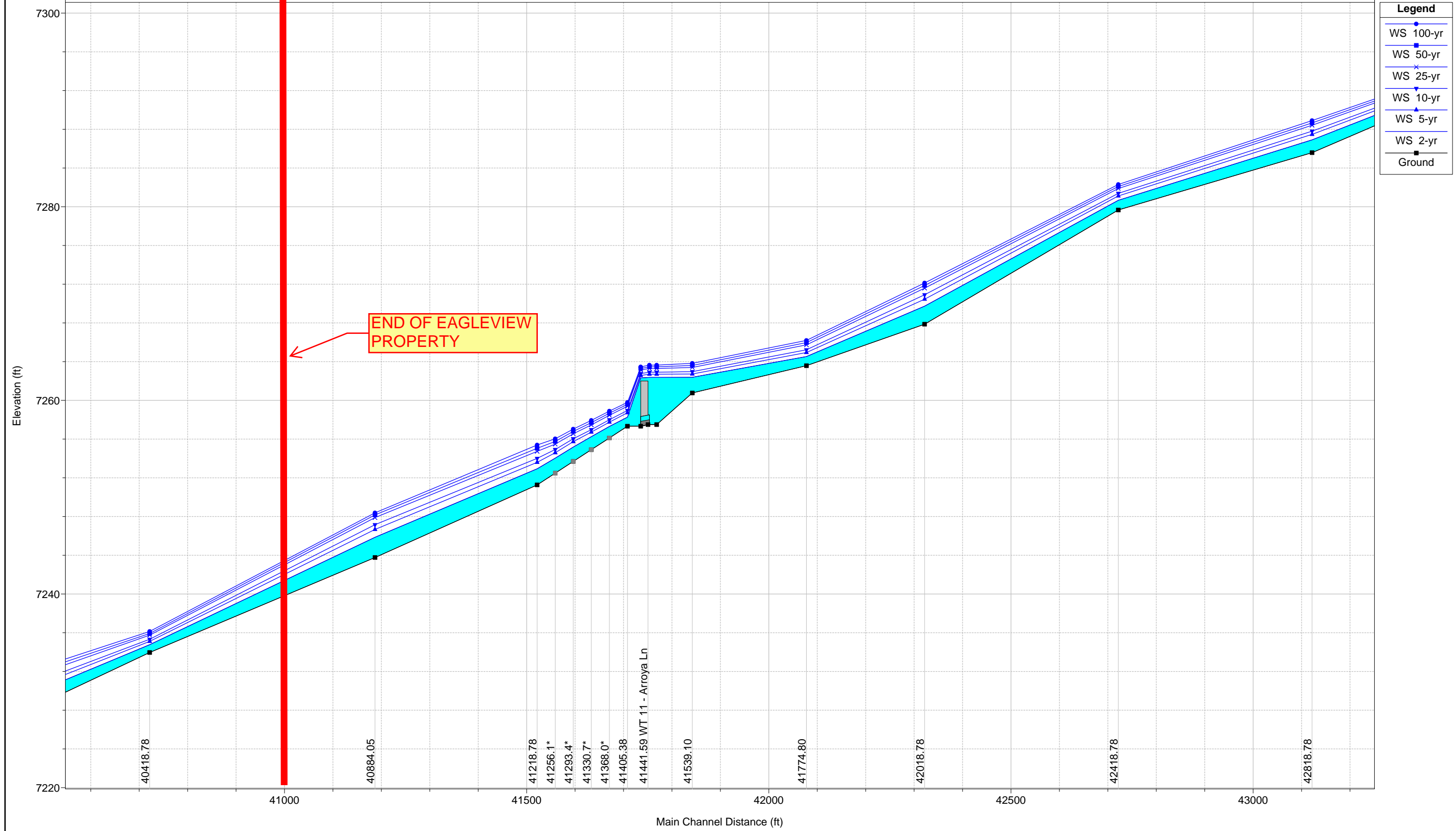

1 in Horiz. = 200 ft 1 in Vert. = 10 ft

FalconDBPS WestTrib

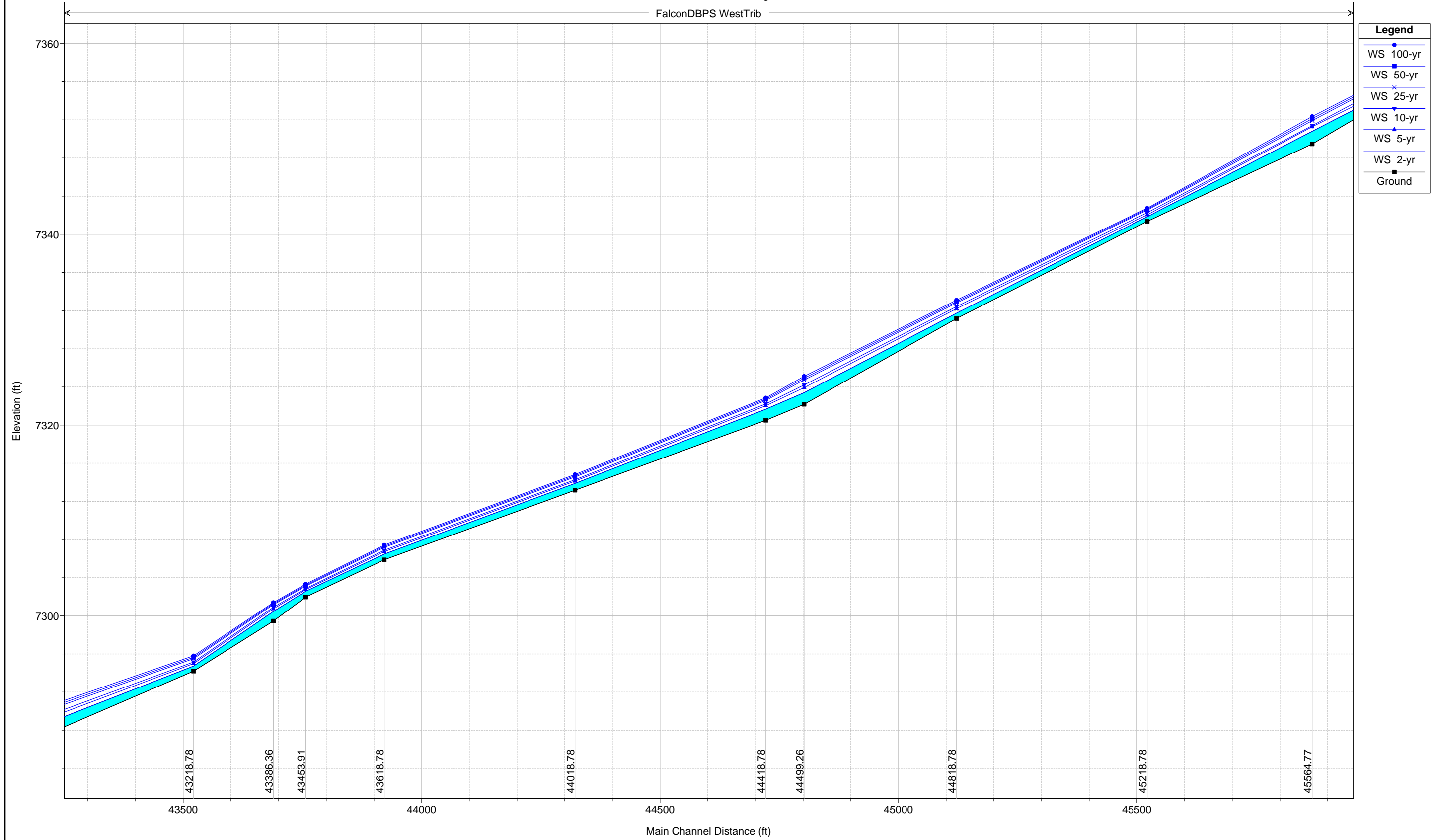

1 in Horiz. = 200 ft 1 in Vert. = 10 ft

FalconDBPS WestTrib

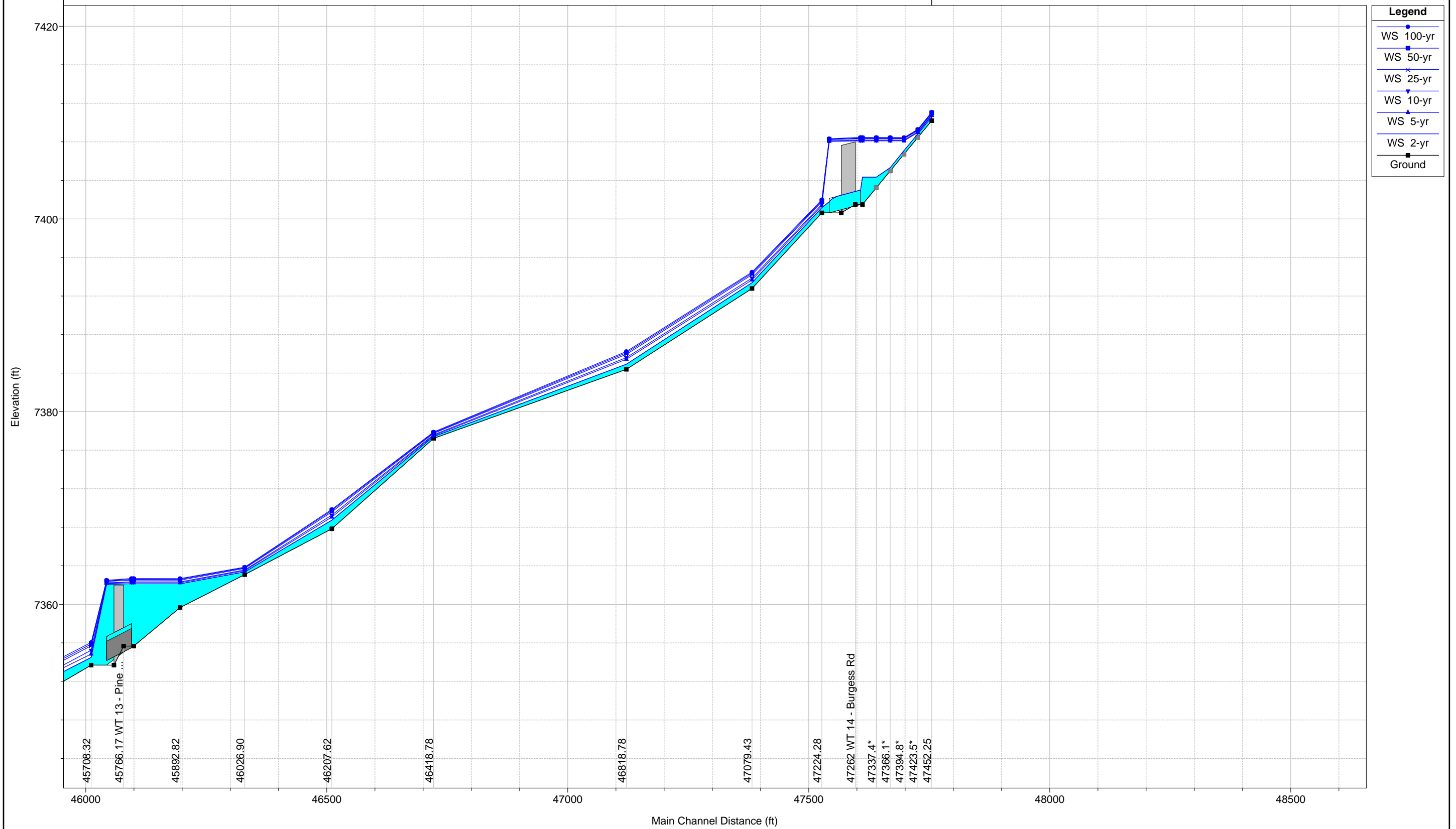

1 in Horiz. = 200 ft 1 in Vert. = 10 ft

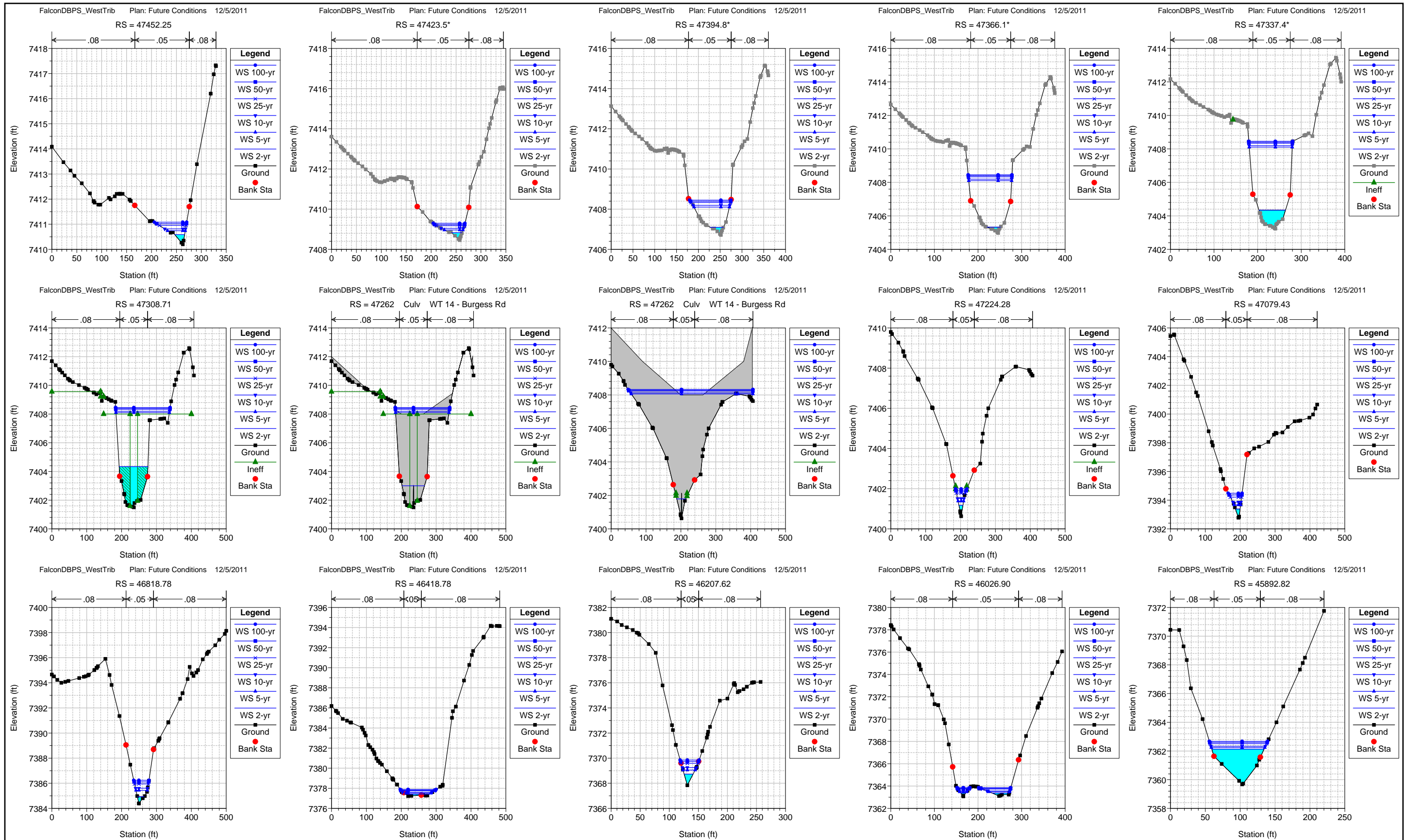

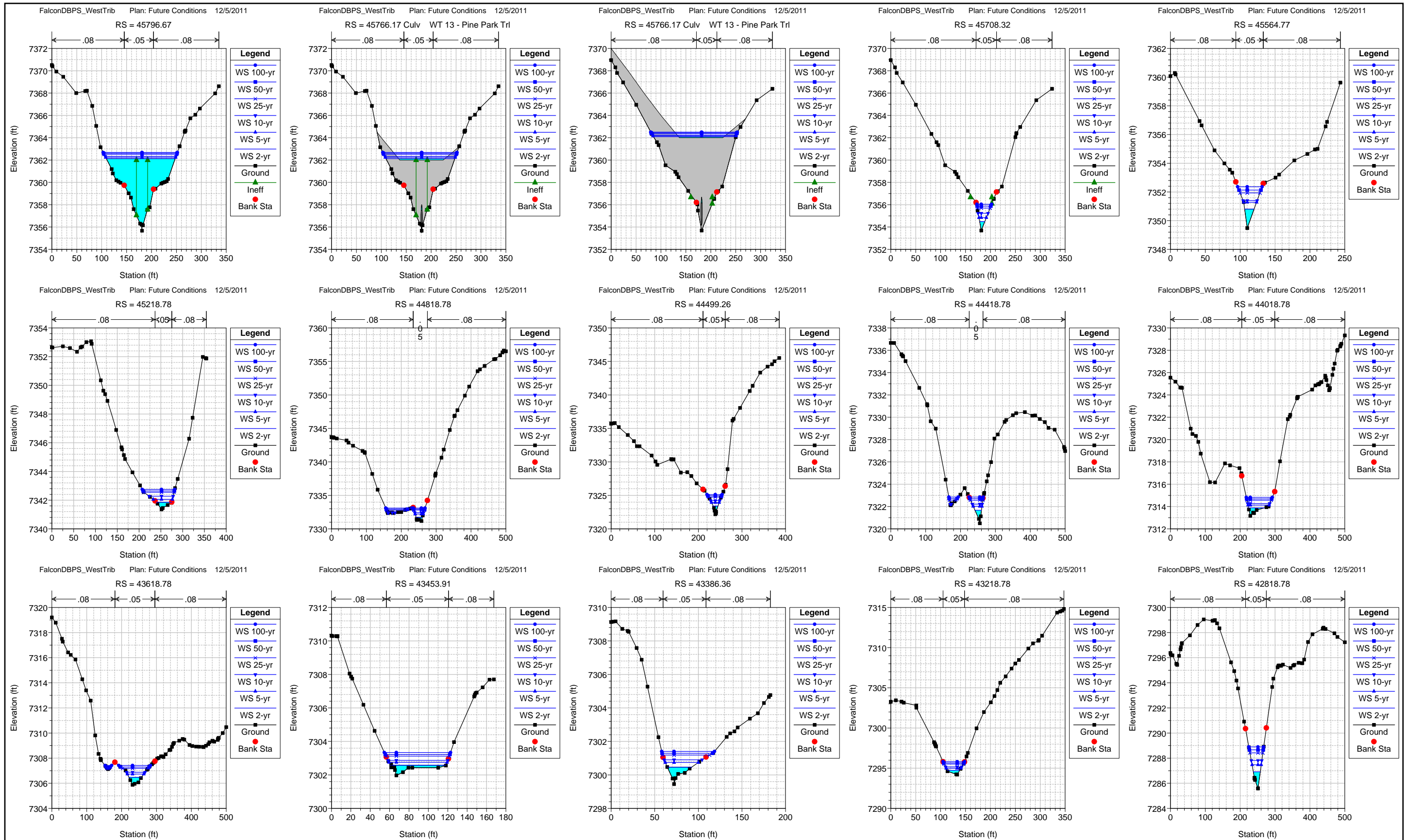

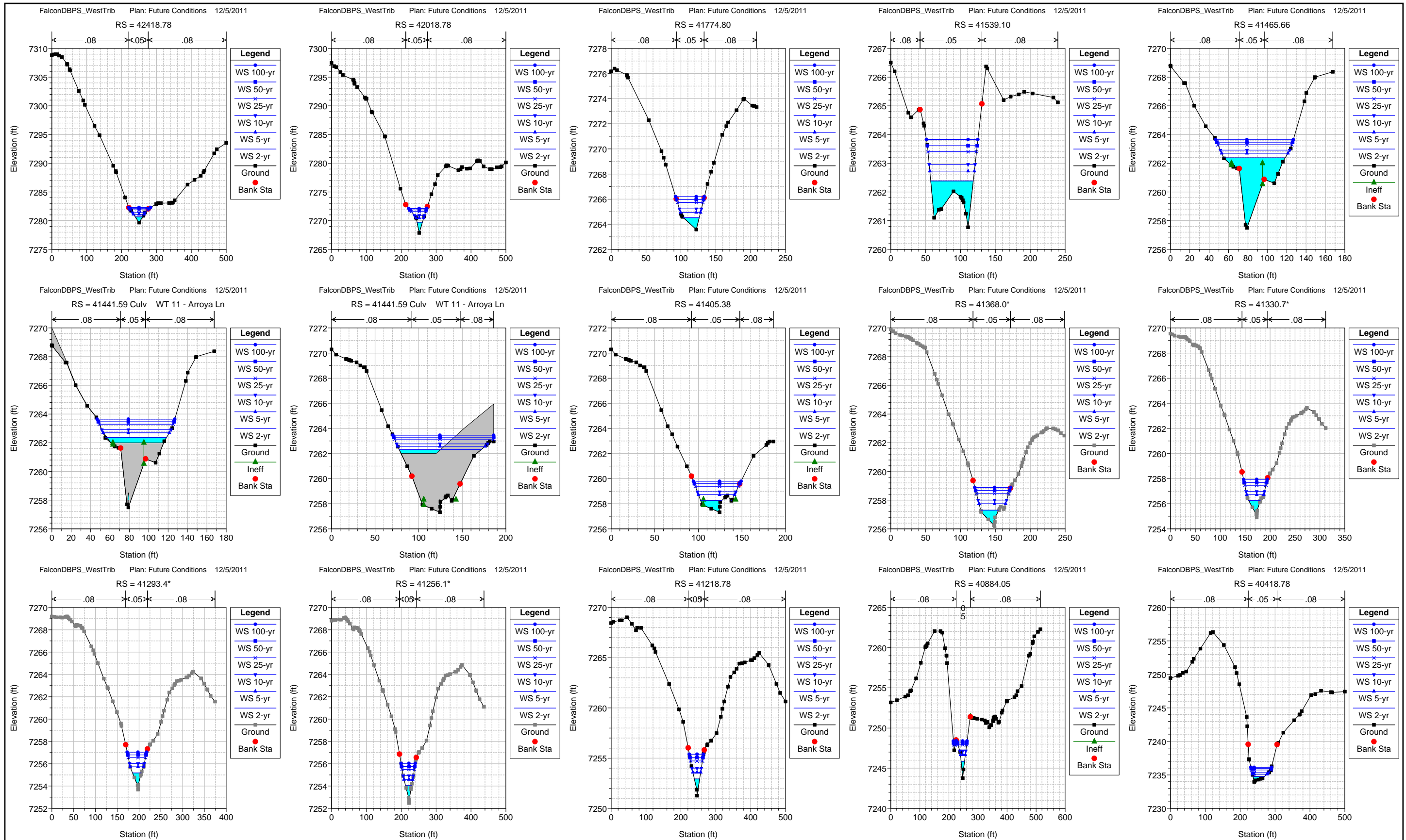

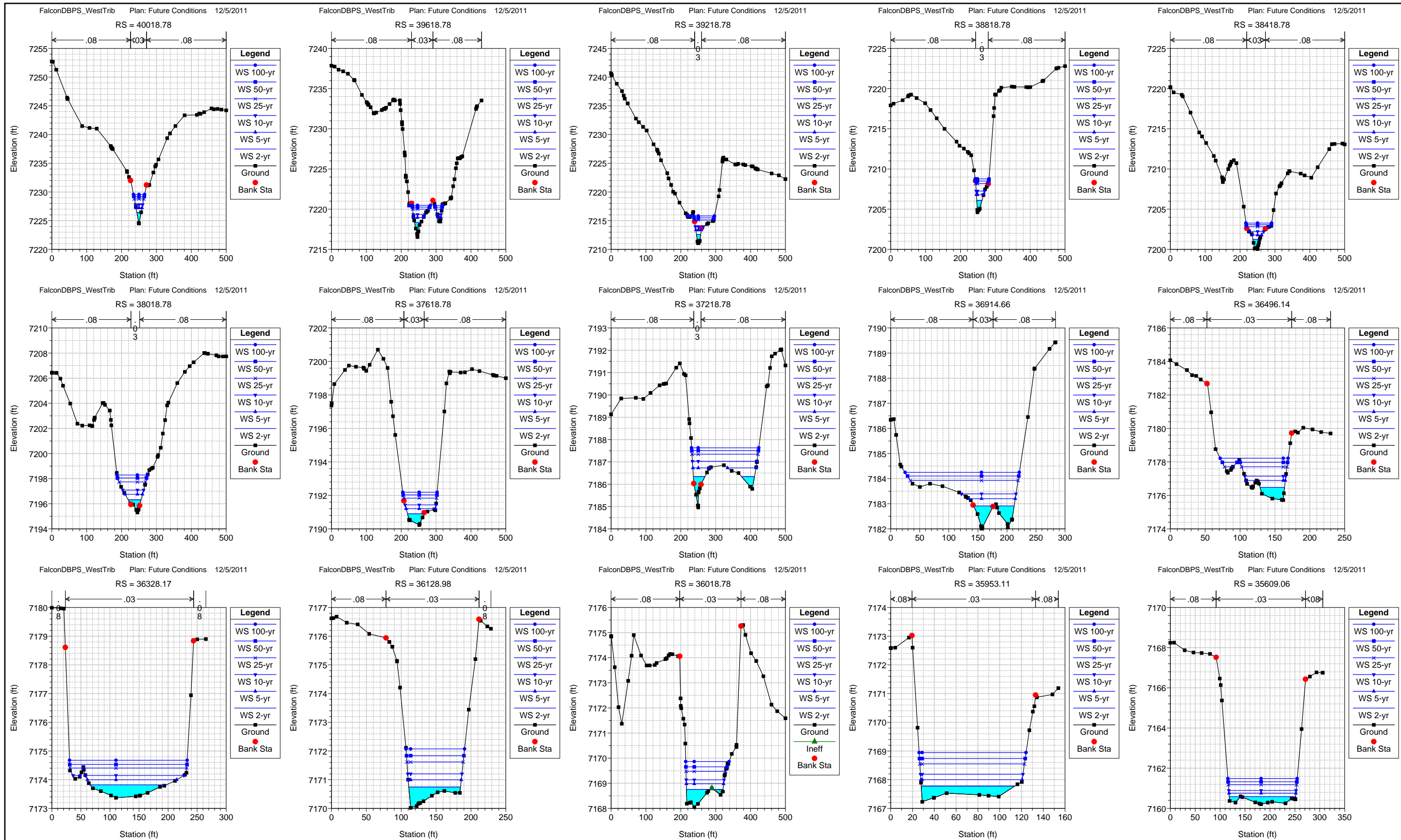

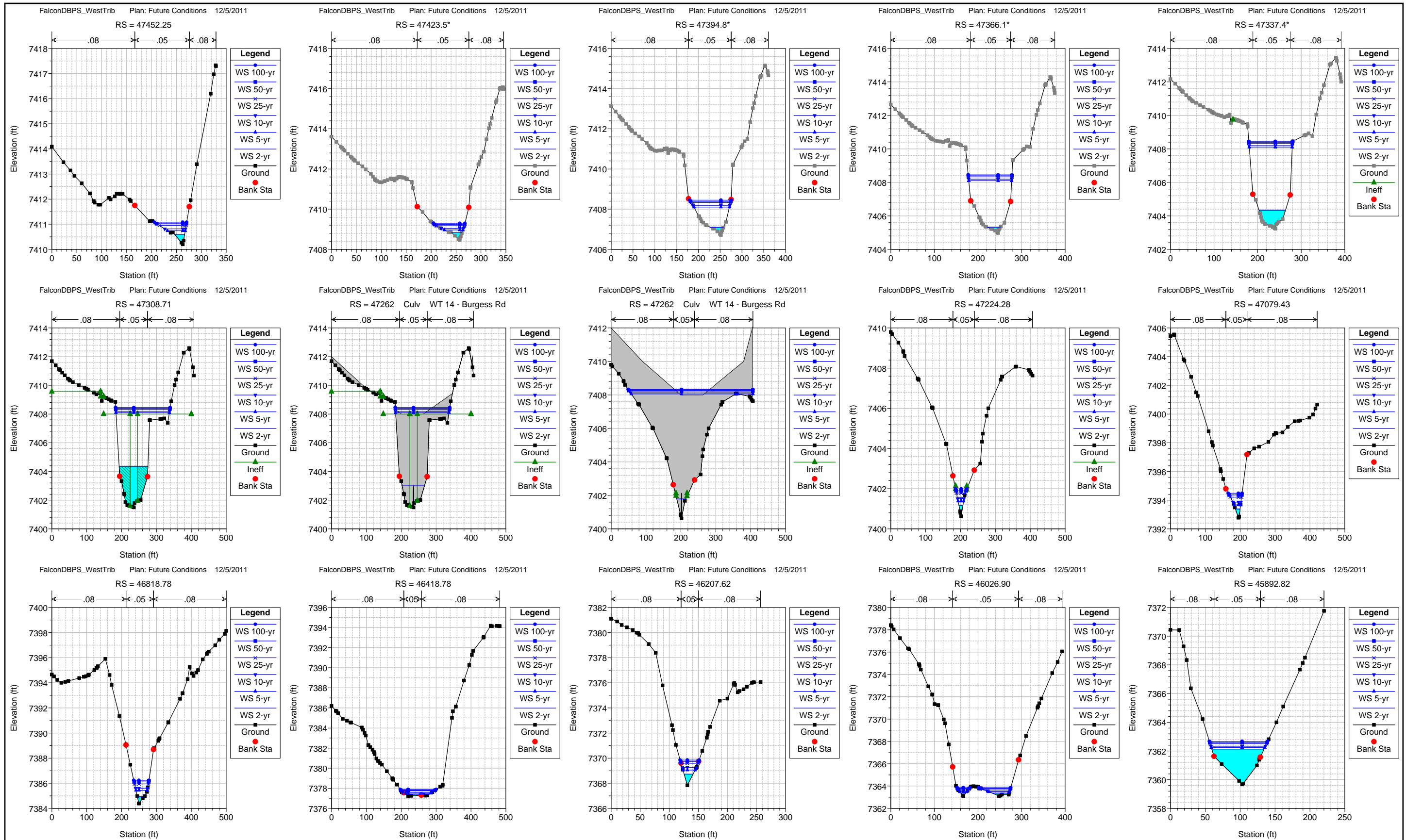

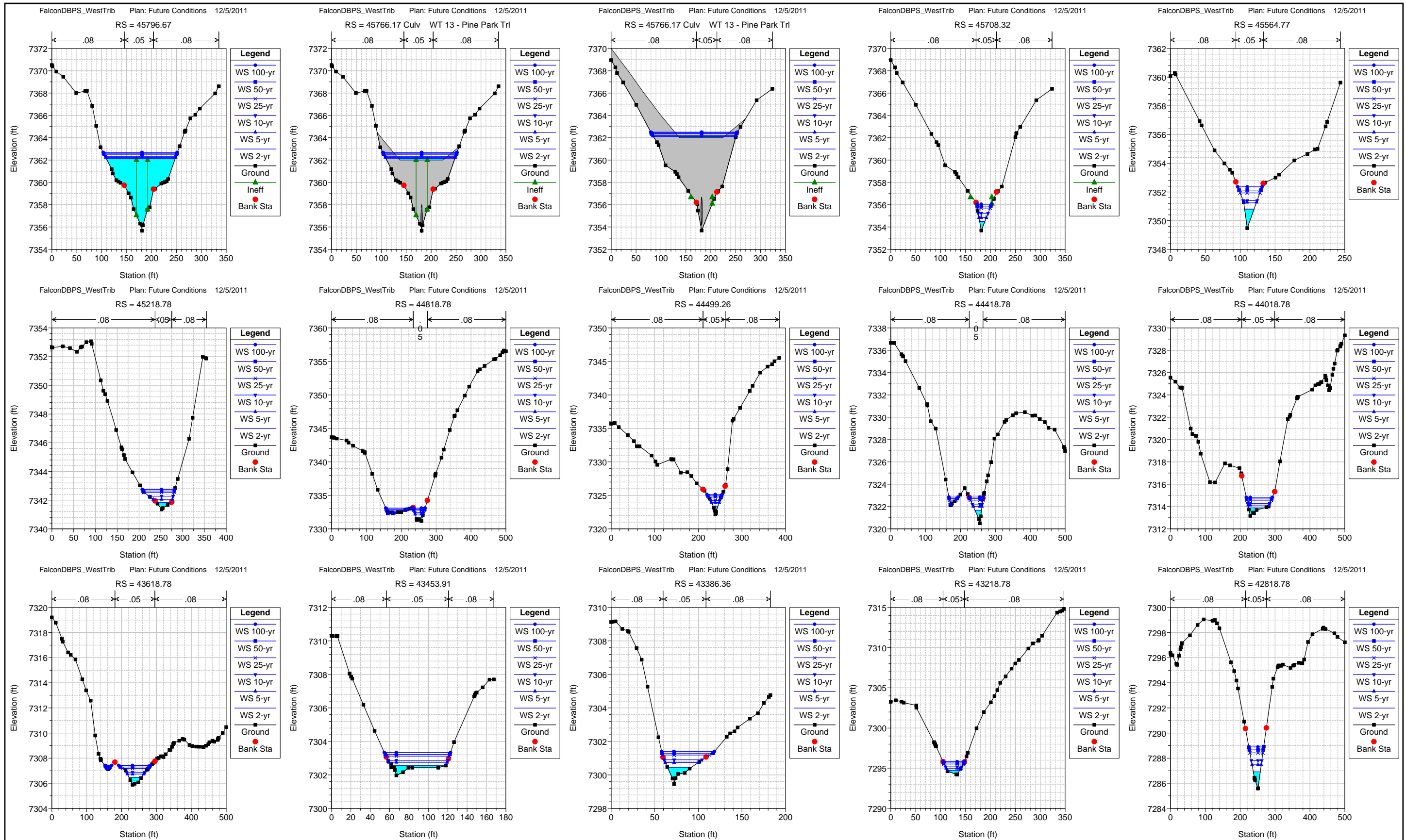

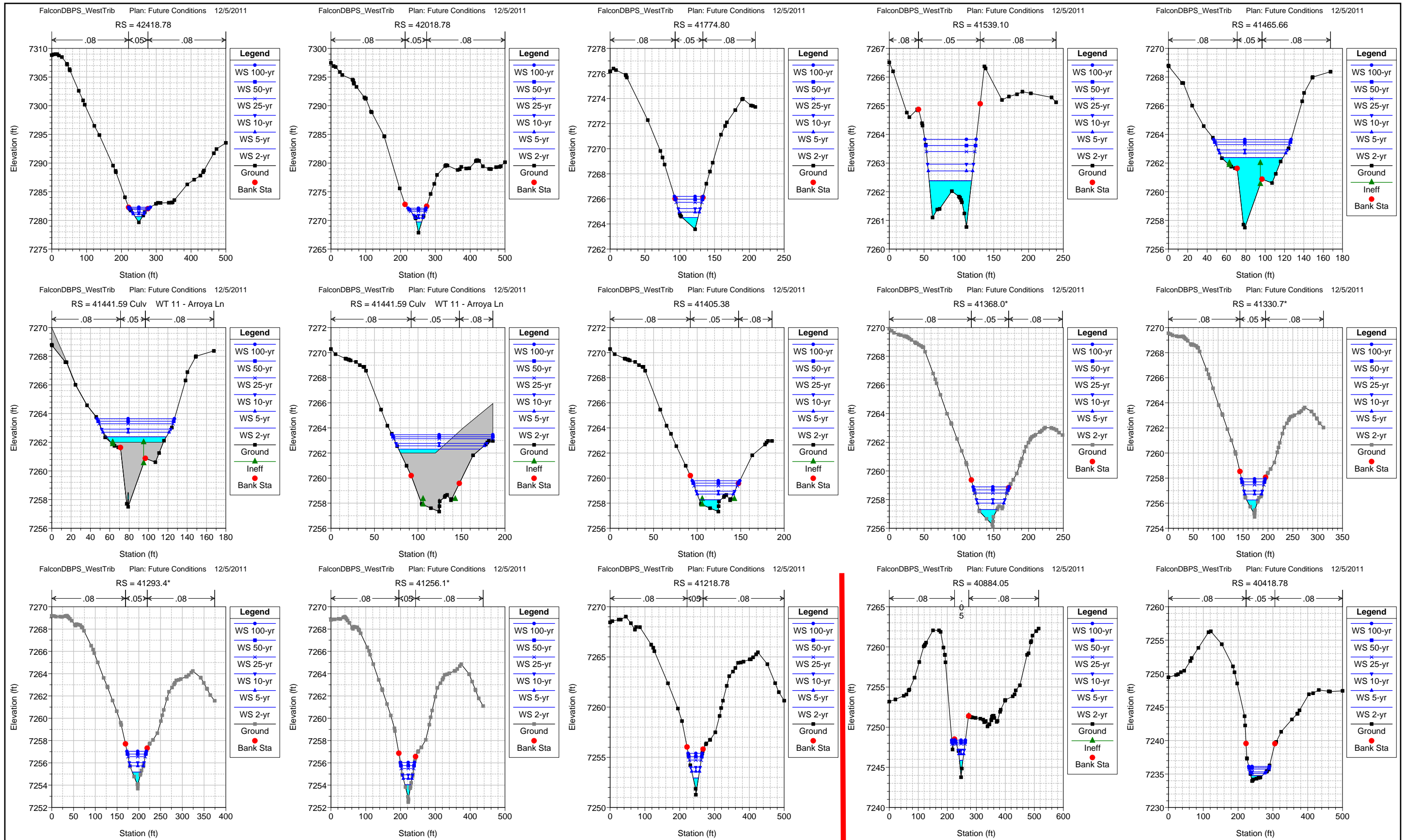

START EAGLEVIEW PROPERTY

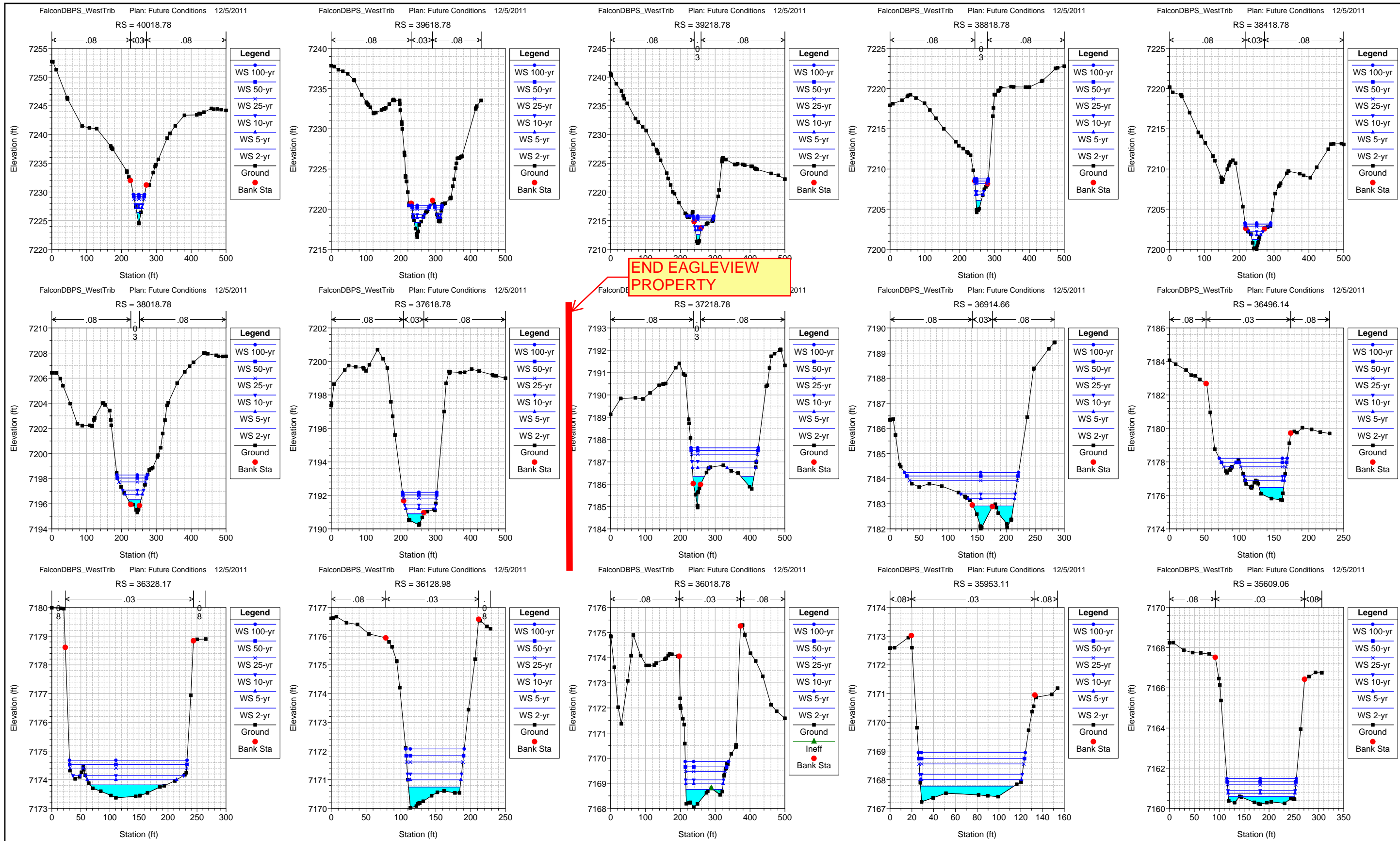

**Falcon DBPS
Manning's n Values**

West Tributary				
River Station	Frctn (n/K)	n #1	n #2	n #3
47452.25	n	0.08	0.05	0.08
47423.5*	n	0.08	0.05	0.08
47394.8*	n	0.08	0.05	0.08
47366.1*	n	0.08	0.05	0.08
47337.4*	n	0.08	0.05	0.08
47308.71	n	0.08	0.05	0.08
47262	Culvert			
47224.28	n	0.08	0.05	0.08
47079.43	n	0.08	0.05	0.08
46818.78	n	0.08	0.05	0.08
46418.78	n	0.08	0.05	0.08
46207.62	n	0.08	0.05	0.08
46026.9	n	0.08	0.05	0.08
45892.82	n	0.08	0.05	0.08
45796.67	n	0.08	0.05	0.08
45766.17	Culvert			
45708.32	n	0.08	0.05	0.08
45564.77	n	0.08	0.05	0.08
45218.78	n	0.08	0.05	0.08
44818.78	n	0.08	0.05	0.08
44499.26	n	0.08	0.05	0.08
44418.78	n	0.08	0.05	0.08
44018.78	n	0.08	0.05	0.08
43618.78	n	0.08	0.05	0.08
43453.91	n	0.08	0.05	0.08
43386.36	n	0.08	0.05	0.08
43218.78	n	0.08	0.05	0.08
42818.78	n	0.08	0.05	0.08
42418.78	n	0.08	0.05	0.08
42018.78	n	0.08	0.05	0.08
41774.8	n	0.08	0.05	0.08
41539.1	n	0.08	0.05	0.08
41465.66	n	0.08	0.05	0.08
41441.59	Culvert			
41405.38	n	0.08	0.05	0.08
41368.0*	n	0.08	0.05	0.08
41330.7*	n	0.08	0.05	0.08
41293.4*	n	0.08	0.05	0.08
41256.1*	n	0.08	0.05	0.08
41218.78	n	0.08	0.05	0.08
40884.05	n	0.08	0.05	0.08
40418.78	n	0.08	0.05	0.08

Middle Tributary				
River Station	Frctn (n/K)	n #1	n #2	n #3
15477.33	n	0.08	0.05	0.08
15411.72	n	0.08	0.05	0.08
15205.81	n	0.08	0.05	0.08
15182.0*	n	0.08	0.05	0.08
15158.2*	n	0.08	0.05	0.08
15134.4*	n	0.08	0.05	0.08
15110.6*	n	0.08	0.05	0.08
15086.8*	n	0.08	0.05	0.08
15063.05	n	0.08	0.05	0.08
14907.55	n	0.08	0.05	0.08
14773.98	n	0.08	0.05	0.08
14507.55	n	0.08	0.05	0.08
14107.55	n	0.08	0.05	0.08
13707.55	n	0.08	0.05	0.08
13306.32	n	0.08	0.05	0.08
13111.17	n	0.08	0.05	0.08
12893	n	0.08	0.05	0.08
12511.32	n	0.08	0.05	0.08
12037.33	n	0.08	0.05	0.08
11628.61	n	0.08	0.05	0.08
11228.61	n	0.08	0.05	0.08
10828.61	n	0.08	0.05	0.08
10741.93	n	0.08	0.05	0.08
10706	Culvert			
10665.96	n	0.08	0.05	0.08
10428.61	n	0.08	0.05	0.08
10028.61	n	0.08	0.05	0.08
9628.612	n	0.08	0.05	0.08
9228.612	n	0.08	0.05	0.08
8741.269	n	0.08	0.05	0.08
8483.946	n	0.08	0.05	0.08
7238	Culvert			
6738.77	n	0.15	0.07	0.15
6420.92	n	0.15	0.07	0.15
6411.64*	n	0.15	0.07	0.15
6402.37*	n	0.15	0.07	0.15
6393.09*	n	0.15	0.07	0.15
6383.82*	n	0.15	0.07	0.15
6374.54*	n	0.15	0.07	0.15
6365.27*	n	0.15	0.07	0.15
6356.00*	n	0.15	0.07	0.15
6346.727	n	0.15	0.07	0.15

East Tributary				
River Station	Frctn (n/K)	n #1	n #2	n #3
32631.79	n	0.08	0.05	0.08
32576.48	n	0.08	0.05	0.08
32537.9*	n	0.08	0.05	0.08
32499.3*	n	0.08	0.05	0.08
32460.7*	n	0.08	0.05	0.08
32422.2	n	0.08	0.05	0.08
32376.64	Culvert			
32335.71	n	0.08	0.05	0.08
32288.3*	n	0.08	0.05	0.08
32241.*	n	0.08	0.05	0.08
32193.6*	n	0.08	0.05	0.08
32146.2*	n	0.08	0.05	0.08
32098.94	n	0.08	0.05	0.08
31698.94	n	0.08	0.05	0.08
31657.1*	n	0.08	0.05	0.08
31615.3*	n	0.08	0.05	0.08
31573.5*	n	0.08	0.05	0.08
31531.79	n	0.08	0.05	0.08
31486	Culvert			
31411.01	n	0.08	0.05	0.08
31375.5*	n	0.08	0.05	0.08
31340.1*	n	0.08	0.05	0.08
31304.66	n	0.08	0.05	0.08
30904.66	n	0.08	0.05	0.08
30742.51	n	0.08	0.05	0.08
28941.08	n	0.08	0.05	0.08
28754.33	n	0.08	0.05	0.08
28478.62	n	0.08	0.05	0.08
28298.89	Culvert			
28137.71	n	0.08	0.07	0.08
28081.78	n	0.08	0.07	0.08
27748.51	n	0.08	0.07	0.08
27350.22	n	0.08	0.07	0.08
26950.22	n	0.08	0.07	0.08
26646.28	n	0.08	0.07	0.08
26550.03	n	0.08	0.07	0.08
26454.7	Culvert			
26366.53	n	0.08	0.07	0.08
26300.77	n	0.08	0.07	0.08
26150.22	n	0.08	0.07	0.08
25750.22	n	0.08	0.07	0.08
25599.02	n	0.08	0.07	0.08

**Falcon DBPS
Manning's n Values**

West Tributary				
River Station	Frctn (n/K)	n #1	n #2	n #3
40018.78	n	0.08	0.03	0.08
39618.78	n	0.08	0.03	0.08
39218.78	n	0.08	0.03	0.08
38818.78	n	0.08	0.03	0.08
38418.78	n	0.08	0.03	0.08
38018.78	n	0.08	0.03	0.08
37618.78	n	0.08	0.03	0.08
37218.78	n	0.08	0.03	0.08
36914.66	n	0.08	0.03	0.08
36496.14	n	0.08	0.03	0.08
36328.17	n	0.08	0.03	0.08
36128.98	n	0.08	0.03	0.08
36018.78	n	0.08	0.03	0.08
35953.11	n	0.08	0.03	0.08
35609.06	n	0.08	0.03	0.08
35576.41	n	0.08	0.03	0.08
35218.78	n	0.08	0.03	0.08
35054.37	n	0.08	0.03	0.08
35025.09	n	0.08	0.03	0.08
34818.78	n	0.08	0.03	0.08
34639.33	n	0.08	0.03	0.08
34399.04	n	0.08	0.03	0.08
34320.25	n	0.08	0.05	0.08
34018.33	n	0.08	0.05	0.08
33792.91	n	0.08	0.05	0.08
33635.33	n	0.08	0.05	0.08
33235.67	n	0.08	0.05	0.08
32862.6	n	0.08	0.05	0.08
32439.34	n	0.08	0.05	0.08
32034.26	n	0.08	0.05	0.08
31765.2	n	0.08	0.05	0.08
31571.99	n	0.08	0.05	0.08
31384.44	n	0.08	0.03	0.08
31149.9	n	0.08	0.03	0.08
30906.88	n	0.08	0.03	0.08
30466.36	n	0.08	0.03	0.08
30109.14	n	0.08	0.03	0.08
29876.27	n	0.08	0.03	0.08
29632.62	n	0.08	0.03	0.08
29330.53	n	0.08	0.03	0.08
29004.24	n	0.08	0.03	0.08
28833.58	n	0.08	0.03	0.08

Middle Tributary				
River Station	Frctn (n/K)	n #1	n #2	n #3
6320.979	n	0.15	0.07	0.15
6276.979	Bridge			
6210.5	n	0.15	0.07	0.15
6158.16*	n	0.15	0.07	0.15
6105.82*	n	0.15	0.07	0.15
6053.48*	n	0.15	0.07	0.15
6001.15*	n	0.15	0.07	0.15
5948.81*	n	0.15	0.07	0.15
5896.477	n	0.15	0.07	0.15
5551.916	n	0.15	0.07	0.15
5362.949	n	0.15	0.07	0.15
5337.60*	n	0.15	0.07	0.15
5312.26*	n	0.15	0.07	0.15
5286.91*	n	0.15	0.07	0.15
5261.57*	n	0.15	0.07	0.15
5236.23*	n	0.15	0.07	0.15
5210.887	n	0.15	0.07	0.15
5184.12	Bridge			
5159.05	n	0.15	0.07	0.15
5120.029	n	0.15	0.07	0.15
5091.662	n	0.15	0.07	0.15
5035.56	Culvert			
4988.302	n	0.15	0.07	0.15
4971.81*	n	0.15	0.07	0.15
4955.33*	n	0.15	0.07	0.15
4938.84*	n	0.15	0.07	0.15
4922.36*	n	0.15	0.07	0.15
4905.881	n	0.15	0.07	0.15
4751.912	n	0.15	0.07	0.15
4351.913	n	0.15	0.07	0.15
3951.913	n	0.15	0.07	0.15
3849.362	n	0.15	0.07	0.15
3822.34*	n	0.15	0.07	0.15
3795.32*	n	0.15	0.07	0.15
3768.30*	n	0.15	0.07	0.15
3741.28*	n	0.15	0.07	0.15
3714.26	n	0.15	0.07	0.15
3667.171	Culvert			
3619.655	n	0.15	0.07	0.15
3385.78*	n	0.15	0.07	0.15
3151.913	n	0.15	0.07	0.15
2744.492	n	0.15	0.07	0.15

East Tributary				
River Station	Frctn (n/K)	n #1	n #2	n #3
25501.42	n	0.08	0.07	0.08
25447.05	n	0.08	0.07	0.08
25383.89	n	0.08	0.07	0.08
25320.79	n	0.08	0.07	0.08
25265.56	n	0.08	0.07	0.08
25173.45	n	0.08	0.07	0.08
24950.22	n	0.08	0.07	0.08
24550.22	n	0.08	0.07	0.08
24161.18	n	0.08	0.07	0.08
24122.58	n	0.08	0.07	0.08
24087.33	n	0.08	0.07	0.08
24032.8	n	0.08	0.07	0.08
23750.22	n	0.08	0.07	0.08
23617.72	n	0.08	0.07	0.08
23513.91	n	0.08	0.07	0.08
23413.07	Culvert			
23316.27	n	0.15	0.07	0.15
23184.63	n	0.15	0.07	0.15
22950.22	n	0.15	0.07	0.15
22550.22	n	0.15	0.07	0.15
22150.22	n	0.15	0.07	0.15
21750.22	n	0.15	0.07	0.15
21732.7*	n	0.15	0.07	0.15
21715.3*	n	0.15	0.07	0.15
21697.9*	n	0.15	0.07	0.15
21680.48	n	0.15	0.07	0.15
21604.86	Culvert			
21520.49	n	0.08	0.07	0.08
21350.22	n	0.08	0.07	0.08
21169.19	n	0.08	0.07	0.08
21150.6*	n	0.08	0.07	0.08
21132.0*	n	0.08	0.07	0.08
21113.4*	n	0.08	0.07	0.08
21094.9*	n	0.08	0.07	0.08
21076.3*	n	0.08	0.07	0.08
21057.78	n	0.08	0.07	0.08
20950.22	n	0.08	0.07	0.08
20786.19	n	0.08	0.07	0.08
20763.13	n	0.08	0.07	0.08
20550.22	n	0.08	0.07	0.08
20452.99	n	0.08	0.07	0.08
20393.38	n	0.08	0.07	0.08

Falcon DBPS
West Tributary Existing Conditions HEC-RAS Outputs

Reach	River Sta	Profile	Q Left (cfs)	Q Channel (cfs)	Q Right (cfs)	Min Ch El (ft)	W.S. Elev (ft)	Crit W.S. (ft)	E.G. Elev (ft)	E.G. Slope (ft/ft)	Vel Chnl (ft/s)	Flow Area (sq ft)	Top Width (ft)	Froude # XS	Headloss (ft)	Shear Total (lb/sq ft)
WestTrib	47452.25	2-yr		9		7410.2	7410.59	7410.57	7410.67	0.057877	2.38	3.78	19.64	0.96	1.76	0.69
WestTrib	47452.25	5-yr		21		7410.2	7410.74	7410.74	7410.85	0.059512	2.66	7.9	35.51	0.99	1.78	0.83
WestTrib	47452.25	10-yr		32		7410.2	7410.82	7410.82	7410.95	0.060295	2.96	10.83	41.98	1.03	1.72	0.97
WestTrib	47452.25	25-yr		58		7410.2	7410.96	7410.96	7411.13	0.056237	3.32	17.45	53.8	1.03	1.59	1.14
WestTrib	47452.25	50-yr		73		7410.2	7411.02	7411.02	7411.21	0.052171	3.42	21.35	59.69	1.01	1.52	1.16
WestTrib	47452.25	100-yr		89		7410.2	7411.08	7411.08	7411.28	0.051479	3.56	24.97	64.94	1.01	1.45	1.23
WestTrib	47423.5*	2-yr		9		7408.46	7408.83	7408.83	7408.92	0.06487	2.4	3.75	20.92	1	1.71	0.72
WestTrib	47423.5*	5-yr		21		7408.46	7408.97	7408.97	7409.08	0.064271	2.66	7.88	37.45	1.02	0.05	0.84
WestTrib	47423.5*	10-yr		32		7408.46	7409.05	7409.05	7409.17	0.059416	2.86	11.18	45.01	1.01	0.06	0.92
WestTrib	47423.5*	25-yr		58		7408.46	7409.18	7409.18	7409.34	0.054376	3.24	17.92	56.12	1.01	0.1	1.08
WestTrib	47423.5*	50-yr		73		7408.46	7409.24	7409.24	7409.42	0.05383	3.44	21.25	60.38	1.02	0.12	1.18
WestTrib	47423.5*	100-yr		89		7408.46	7409.3	7409.3	7409.49	0.049503	3.55	25.04	63.48	1	0.14	1.22
WestTrib	47394.8*	2-yr		9		7406.72	7407.1	7407.09	7407.16	0.05461	1.97	4.56	30.12	0.89	1.77	0.52
WestTrib	47394.8*	5-yr		21		7406.72	7408.11		7408.11	0.000148	0.32	66.51	81.27	0.06	0	0.01
WestTrib	47394.8*	10-yr		32		7406.72	7408.19		7408.2	0.000255	0.43	73.74	84.24	0.08	0	0.01
WestTrib	47394.8*	25-yr		58		7406.72	7408.33		7408.34	0.000553	0.68	85.71	89.84	0.12	0	0.03
WestTrib	47394.8*	50-yr		73		7406.72	7408.39		7408.4	0.000735	0.8	91.41	92.54	0.14	0.01	0.05
WestTrib	47394.8*	100-yr		89		7406.72	7408.45		7408.46	0.000934	0.92	96.86	95.05	0.16	0.01	0.06
WestTrib	47366.1*	2-yr		9		7404.98	7405.33	7405.33	7405.39	0.069848	2.11	4.27	30.72	1	0.04	0.61
WestTrib	47366.1*	5-yr	0.06	20.91	0.03	7404.98	7408.11		7408.11	0.000003	0.1	223.24	98.43	0.01	0	0
WestTrib	47366.1*	10-yr	0.11	31.84	0.05	7404.98	7408.19		7408.19	0.000007	0.14	231.86	98.92	0.02	0	0
WestTrib	47366.1*	25-yr	0.24	57.65	0.12	7404.98	7408.33		7408.33	0.000018	0.24	245.68	99.69	0.03	0	0
WestTrib	47366.1*	50-yr	0.32	72.52	0.16	7404.98	7408.4		7408.4	0.000027	0.3	251.92	100.04	0.03	0	0
WestTrib	47366.1*	100-yr	0.42	88.38	0.2	7404.98	7408.45		7408.46	0.000037	0.35	257.84	100.36	0.04	0	0.01
WestTrib	47337.4*	2-yr		9		7403.24	7404.34	7403.55	7404.34	0.000077	0.21	43.26	60.77	0.04	0	0
WestTrib	47337.4*	5-yr	0.2	20.69	0.11	7403.24	7408.11	7403.66	7408.11	0.000001	0.06	371.79	98.63	0.01	0	0
WestTrib	47337.4*	10-yr	0.32	31.51	0.17	7403.24	7408.19	7403.74	7408.19	0.000001	0.09	380.48	99.03	0.01	0	0
WestTrib	47337.4*	25-yr	0.63	57.04	0.33	7403.24	7408.33	7403.87	7408.33	0.000004	0.15	394.25	99.67	0.01	0	0
WestTrib	47337.4*	50-yr	0.81	71.76	0.43	7403.24	7408.4	7403.92	7408.4	0.000006	0.19	400.54	99.95	0.02	0	0
WestTrib	47337.4*	100-yr	1.02	87.48	0.5	7403.24	7408.45	7403.99	7408.46	0.000008	0.23	406.41	100.93	0.02	0	0
WestTrib	47308.71	2-yr		9		7401.5	7404.34	7401.82	7404.34	0.000008	0.16	56.79	82.41	0.02		0
WestTrib	47308.71	5-yr	0.33	20.4	0.27	7401.5	7408.11	7402.02	7408.11	0	0.04	532.04	153.26	0		0
WestTrib	47308.71	10-yr	0.52	31	0.48	7401.5	7408.19	7402.12	7408.19	0	0.07	545.54	154.06	0.01		0
WestTrib	47308.71	25-yr	0.97	55.93	1.1	7401.5	7408.33	7402.31	7408.33	0.000001	0.12	567.07	155.33	0.01		0
WestTrib	47308.71	50-yr	1.24	70.24	1.52	7401.5	7408.4	7402.41	7408.4	0.000002	0.14	576.79	155.9	0.01		0
WestTrib	47308.71	100-yr	1.54	85.46	2.01	7401.5	7408.45	7402.5	7408.45	0.000003	0.17	585.94	156.43	0.02		0

Falcon DBPS
West Tributary Existing Conditions HEC-RAS Outputs

Reach	River Sta	Profile	Q Left (cfs)	Q Channel (cfs)	Q Right (cfs)	Min Ch El (ft)	W.S. Elev (ft)	Crit W.S. (ft)	E.G. Elev (ft)	E.G. Slope (ft/ft)	Vel Chnl (ft/s)	Flow Area (sq ft)	Top Width (ft)	Froude # XS	Headloss (ft)	Shear Total (lb/sq ft)
WestTrib	47262		Culvert													
WestTrib	47224.28	2-yr		9		7400.63	7401.17	7401.17	7401.3	0.051606	2.85	3.16	11.44	0.96	7.75	0.88
WestTrib	47224.28	5-yr		21		7400.63	7401.39	7401.39	7401.57	0.049322	3.46	6.06	15.88	0.99	6.9	1.17
WestTrib	47224.28	10-yr		32		7400.63	7401.51	7401.51	7401.75	0.050153	3.87	8.27	18.55	1.02	6.76	1.39
WestTrib	47224.28	25-yr		58		7400.63	7401.78	7401.78	7402.05	0.042725	4.12	14.07	25.48	0.98	6.21	1.47
WestTrib	47224.28	50-yr		73		7400.63	7401.89	7401.89	7402.18	0.042069	4.25	17.16	29.32	0.98	6.01	1.53
WestTrib	47224.28	100-yr		89		7400.63	7401.99	7401.99	7402.29	0.040745	4.43	20.11	32.57	0.98	5.93	1.61
WestTrib	47079.43	2-yr		15		7392.78	7393.38	7393.38	7393.56	0.054487	3.34	4.5	13.41	1.02		1.13
WestTrib	47079.43	5-yr		37		7392.78	7393.68	7393.68	7393.93	0.046548	3.99	9.27	18.78	1	4.58	1.43
WestTrib	47079.43	10-yr		57		7392.78	7393.87	7393.87	7394.16	0.044693	4.32	13.2	23.02	1.01	4.82	1.59
WestTrib	47079.43	25-yr		110		7392.78	7394.21	7394.21	7394.58	0.042686	4.84	22.75	32.36	1.02	5.03	1.86
WestTrib	47079.43	50-yr		140		7392.78	7394.36	7394.36	7394.75	0.040828	5.01	27.94	36.45	1.01	5.01	1.94
WestTrib	47079.43	100-yr		170		7392.78	7394.48	7394.48	7394.91	0.040699	5.23	32.51	39.7	1.02	5.18	2.07
WestTrib	46818.78	2-yr		15		7384.39	7384.93	7384.93	7385.06	0.059518	2.95	5.09	19.56	1.02		0.96
WestTrib	46818.78	5-yr		37		7384.39	7385.44	7385.16	7385.5	0.008998	1.96	18.89	32.54	0.45	7.88	0.33
WestTrib	46818.78	10-yr		57		7384.39	7385.6	7385.3	7385.69	0.009871	2.33	24.49	34.87	0.49	7.98	0.43
WestTrib	46818.78	25-yr		110		7384.39	7385.95		7386.08	0.010714	2.94	37.37	39.75	0.54	8.14	0.63
WestTrib	46818.78	50-yr		140		7384.39	7386.11		7386.27	0.010899	3.19	43.94	42.03	0.55	8.22	0.71
WestTrib	46818.78	100-yr		170		7384.39	7386.24		7386.42	0.011475	3.44	49.43	43.81	0.57	8.3	0.8
WestTrib	46418.78	2-yr		12.46	2.54	7377.22	7377.41	7377.41	7377.48	0.076519	2.18	8.01	64.73	1.02	6.46	0.59
WestTrib	46418.78	5-yr		29.54	7.46	7377.22	7377.51	7377.51	7377.63	0.072436	2.97	14.7	71.06	1.06	6.96	0.94
WestTrib	46418.78	10-yr	0.02	44.23	12.75	7377.22	7377.6	7377.6	7377.73	0.062682	3.17	21.23	84.91	1.03	6.89	0.98
WestTrib	46418.78	25-yr	1.15	83.51	25.34	7377.22	7377.75	7377.75	7377.94	0.052411	3.88	34.98	95.15	1.02	7	1.2
WestTrib	46418.78	50-yr	2.11	105.15	32.74	7377.22	7377.81	7377.81	7378.04	0.052187	4.25	41.24	99	1.05	7.12	1.36
WestTrib	46418.78	100-yr	3.38	126.17	40.46	7377.22	7377.88	7377.88	7378.13	0.04812	4.46	48.4	103.23	1.03	7.01	1.41
WestTrib	46207.62	2-yr		15		7367.84	7368.73	7368.56	7368.8	0.016352	2.2	6.81	15.33	0.58	5.36	0.45
WestTrib	46207.62	5-yr		37		7367.84	7369.06	7368.86	7369.19	0.018737	2.9	12.74	20.96	0.66	5.59	0.71
WestTrib	46207.62	10-yr		57		7367.84	7369.25	7369.06	7369.42	0.019939	3.3	17.25	24.51	0.69	5.73	0.87
WestTrib	46207.62	25-yr		110		7367.84	7369.59	7369.41	7369.86	0.022804	4.17	26.35	29.15	0.77	5.96	1.28
WestTrib	46207.62	50-yr	0.02	139.98		7367.84	7369.74	7369.57	7370.06	0.023527	4.57	30.69	31.09	0.81	6.06	1.44
WestTrib	46207.62	100-yr	0.13	169.85	0.02	7367.84	7369.85	7369.71	7370.24	0.024196	4.98	34.36	32.66	0.85	6.14	1.58
WestTrib	46026.9	2-yr		15		7363.08	7363.37	7363.37	7363.44	0.069538	2.12	7.06	50.05	1	0.03	0.61
WestTrib	46026.9	5-yr		37		7363.08	7363.49	7363.49	7363.6	0.06019	2.66	13.92	63.22	1	0.07	0.83
WestTrib	46026.9	10-yr		57		7363.08	7363.57	7363.57	7363.7	0.057661	2.96	19.23	71.76	1.01	0.1	0.96
WestTrib	46026.9	25-yr		110		7363.08	7363.73	7363.73	7363.91	0.051226	3.42	32.18	88.76	1	0.21	1.16
WestTrib	46026.9	50-yr		140		7363.08	7363.8	7363.8	7364	0.050828	3.6	38.89	98.66	1.01	0.27	1.25

Falcon DBPS
West Tributary Existing Conditions HEC-RAS Outputs

Reach	River Sta	Profile	Q Left (cfs)	Q Channel (cfs)	Q Right (cfs)	Min Ch El (ft)	W.S. Elev (ft)	Crit W.S. (ft)	E.G. Elev (ft)	E.G. Slope (ft/ft)	Vel Chnl (ft/s)	Flow Area (sq ft)	Top Width (ft)	Froude # XS	Headloss (ft)	Shear Total (lb/sq ft)
WestTrib	46026.9	100-yr		170		7363.08	7363.86	7363.86	7364.08	0.05026	3.8	44.7	103.55	1.02	0.33	1.35
WestTrib	45892.82	2-yr	0.02	14.93	0.04	7359.67	7362.13		7362.13	0.000014	0.15	104.12	74.98	0.02	0	0
WestTrib	45892.82	5-yr	0.08	36.76	0.16	7359.67	7362.24		7362.25	0.000066	0.34	112.57	76.74	0.05	0	0.01
WestTrib	45892.82	10-yr	0.16	56.53	0.3	7359.67	7362.33		7362.33	0.000132	0.49	119.18	78.09	0.07	0	0.01
WestTrib	45892.82	25-yr	0.49	108.63	0.88	7359.67	7362.51		7362.52	0.00035	0.86	133.67	80.97	0.12	0.01	0.04
WestTrib	45892.82	50-yr	0.74	137.95	1.31	7359.67	7362.6		7362.61	0.000488	1.04	140.69	82.33	0.14	0.01	0.05
WestTrib	45892.82	100-yr	1.04	167.16	1.81	7359.67	7362.67		7362.7	0.000631	1.21	147.08	83.55	0.16	0.01	0.07
WestTrib	45796.67	2-yr	0.82	12.75	1.43	7355.67	7362.13	7356.68	7362.13	0	0.05	392.02	138.28	0		0
WestTrib	45796.67	5-yr	2.13	31.22	3.65	7355.67	7362.25	7357	7362.25	0.000002	0.12	407.6	140.42	0.01		0
WestTrib	45796.67	10-yr	3.4	47.83	5.77	7355.67	7362.33	7357.17	7362.33	0.000005	0.18	419.67	142.06	0.02		0
WestTrib	45796.67	25-yr	7.06	91.22	11.72	7355.67	7362.51	7357.56	7362.52	0.000015	0.33	446.15	145.59	0.03		0
WestTrib	45796.67	50-yr	9.29	115.46	15.25	7355.67	7362.6	7357.7	7362.6	0.000023	0.4	458.94	147.26	0.04		0
WestTrib	45796.67	100-yr	11.6	139.52	18.88	7355.67	7362.68	7357.88	7362.68	0.000032	0.48	470.51	148.76	0.04		0.01
WestTrib	45766.17		Culvert													
WestTrib	45708.32	2-yr		15		7353.69	7354.49	7354.49	7354.7	0.051554	3.63	4.13	10.32	1.01	3.11	1.27
WestTrib	45708.32	5-yr		37		7353.69	7354.84	7354.84	7355.13	0.044878	4.32	8.57	14.87	1	3.38	1.59
WestTrib	45708.32	10-yr		57		7353.69	7355.24	7355.07	7355.45	0.022188	3.7	15.42	19.95	0.74	3.71	1.06
WestTrib	45708.32	25-yr		110		7353.69	7355.7	7355.47	7355.98	0.020141	4.23	26.01	25.53	0.74	3.61	1.26
WestTrib	45708.32	50-yr		140		7353.69	7355.88	7355.66	7356.2	0.020748	4.56	30.69	27.48	0.76	3.59	1.42
WestTrib	45708.32	100-yr		170		7353.69	7356.04	7355.82	7356.4	0.020983	4.82	35.3	29.36	0.77	3.53	1.55
WestTrib	45564.77	2-yr		24		7349.48	7350.81	7350.54	7350.92	0.014295	2.66	9.01	13.56	0.58	8.94	0.58
WestTrib	45564.77	5-yr		59		7349.48	7351.29	7351	7351.48	0.016797	3.54	16.65	18.44	0.66	9.21	0.93
WestTrib	45564.77	10-yr		89		7349.48	7351.41	7351.27	7351.75	0.028106	4.7	18.95	20.24	0.86	9.29	1.61
WestTrib	45564.77	25-yr		170		7349.48	7351.93	7351.82	7352.38	0.028695	5.36	31.7	28.32	0.89	9.54	1.97
WestTrib	45564.77	50-yr		210		7349.48	7352.14	7352.02	7352.61	0.027924	5.55	37.83	31.47	0.89	9.63	2.06
WestTrib	45564.77	100-yr		260		7349.48	7352.36	7352.22	7352.87	0.026889	5.73	45.34	34.94	0.89	9.71	2.14
WestTrib	45218.78	2-yr		24		7341.36	7341.85	7341.85	7341.98	0.060057	2.82	8.51	35.3	1.01		0.9
WestTrib	45218.78	5-yr	0.13	58.74	0.13	7341.36	7342.06	7342.06	7342.26	0.048485	3.67	16.39	44.11	1.06		1.12
WestTrib	45218.78	10-yr	2.01	86.29	0.7	7341.36	7342.28	7342.2	7342.46	0.025402	3.52	27.43	55.24	0.87	9.78	0.79
WestTrib	45218.78	25-yr	10.12	157.2	2.68	7341.36	7342.55	7342.48	7342.84	0.026255	4.52	44.1	68.69	0.96	9.75	1.05
WestTrib	45218.78	50-yr	15.91	190.21	3.89	7341.36	7342.64	7342.61	7342.99	0.027507	4.95	50.88	71.76	0.99	9.75	1.22
WestTrib	45218.78	100-yr	24.03	230.41	5.56	7341.36	7342.75	7342.74	7343.16	0.029133	5.44	58.45	74.43	1.03	9.76	1.43
WestTrib	44818.78	2-yr		24		7331.17	7331.74	7331.74	7331.93	0.051582	3.52	6.82	18.02	1.01		1.21
WestTrib	44818.78	5-yr		59		7331.17	7332.21	7332.06	7332.41	0.022494	3.55	16.61	23.15	0.74	8.2	1
WestTrib	44818.78	10-yr	0.05	88.95		7331.17	7332.43	7332.27	7332.69	0.023538	4.07	22.06	35.99	0.92	8.15	0.89

Falcon DBPS
West Tributary Existing Conditions HEC-RAS Outputs

Reach	River Sta	Profile	Q Left (cfs)	Q Channel (cfs)	Q Right (cfs)	Min Ch El (ft)	W.S. Elev (ft)	Crit W.S. (ft)	E.G. Elev (ft)	E.G. Slope (ft/ft)	Vel Chnl (ft/s)	Flow Area (sq ft)	Top Width (ft)	Froude # XS	Headloss (ft)	Shear Total (lb/sq ft)
WestTrib	44818.78	25-yr	19.65	150.35		7331.17	7332.8	7332.78	7333.1	0.02267	4.67	47.94	82.6	1.02	7.94	0.82
WestTrib	44818.78	50-yr	34.56	175.44		7331.17	7332.94	7332.9	7333.25	0.021695	4.8	60.33	92.72	0.97	7.84	0.88
WestTrib	44818.78	100-yr	55.01	204.99		7331.17	7333.1	7333.02	7333.41	0.020603	4.91	76.22	107.91	0.93	7.75	0.91
WestTrib	44499.26	2-yr		24		7322.18	7323.41	7323.34	7323.63	0.035359	3.78	6.34	11.04	0.88	1.87	1.23
WestTrib	44499.26	5-yr		59		7322.18	7323.93	7323.81	7324.21	0.029476	4.28	13.8	17.55	0.85	2.01	1.41
WestTrib	44499.26	10-yr		89		7322.18	7324.22	7324.08	7324.54	0.02768	4.59	19.38	21.15	0.85	2.08	1.55
WestTrib	44499.26	25-yr		170		7322.18	7324.74	7324.61	7325.17	0.027265	5.27	32.24	28.38	0.87	2.24	1.9
WestTrib	44499.26	50-yr		210		7322.18	7324.93	7324.8	7325.41	0.027826	5.54	37.92	31.52	0.89	2.3	2.05
WestTrib	44499.26	100-yr		260		7322.18	7325.12	7325.03	7325.66	0.028804	5.87	44.32	34.72	0.92	2.37	2.26
WestTrib	44418.78	2-yr		24		7320.5	7321.67	7321.46	7321.76	0.015852	2.43	9.86	18.6	0.59	7.81	0.52
WestTrib	44418.78	5-yr		59		7320.5	7322.02	7321.84	7322.2	0.020796	3.36	17.54	24.97	0.71	7.99	0.9
WestTrib	44418.78	10-yr	0.11	88.89		7320.5	7322.22	7322.05	7322.46	0.02362	3.91	22.99	31.97	0.81	8.09	1.05
WestTrib	44418.78	25-yr	4.9	165.1		7320.5	7322.58	7322.51	7322.93	0.027835	4.84	38.3	53.24	0.99	8.22	1.24
WestTrib	44418.78	50-yr	10.02	199.98		7320.5	7322.71	7322.67	7323.1	0.028729	5.13	45.96	60.23	1.01	8.23	1.36
WestTrib	44418.78	100-yr	17.49	242.5	0.01	7320.5	7322.85	7322.83	7323.29	0.029387	5.47	54.77	67.62	1.04	8.27	1.48
WestTrib	44018.78	2-yr		24		7313.17	7313.89		7313.95	0.024605	1.96	12.27	45.06	0.66	7.43	0.42
WestTrib	44018.78	5-yr		59		7313.17	7314.13	7314	7314.21	0.019092	2.31	25.57	60.6	0.63	7.38	0.5
WestTrib	44018.78	10-yr		89		7313.17	7314.27	7314.1	7314.37	0.017359	2.6	34.29	63.42	0.62	7.37	0.58
WestTrib	44018.78	25-yr		170		7313.17	7314.57	7314.33	7314.72	0.015595	3.14	54.13	69.41	0.63	7.36	0.76
WestTrib	44018.78	50-yr		210		7313.17	7314.69		7314.86	0.015256	3.35	62.72	71.85	0.63	7.36	0.83
WestTrib	44018.78	100-yr		260		7313.17	7314.82		7315.02	0.015121	3.58	72.55	74.54	0.64	7.39	0.92
WestTrib	43618.78	2-yr		24		7305.88	7306.48	7306.33	7306.53	0.014607	1.83	13.09	35.83	0.53	3.88	0.33
WestTrib	43618.78	5-yr		59		7305.88	7306.73		7306.83	0.017836	2.51	23.55	46.93	0.62	3.96	0.56
WestTrib	43618.78	10-yr		89		7305.88	7306.88	7306.7	7307.01	0.019575	2.89	30.85	53.32	0.67	3.99	0.71
WestTrib	43618.78	25-yr	0.02	169.98		7305.88	7307.18		7307.36	0.022017	3.42	49.79	76.36	0.75	4.02	0.9
WestTrib	43618.78	50-yr	0.52	209.48		7305.88	7307.3		7307.5	0.022583	3.58	59.46	92.57	0.79	4.02	0.9
WestTrib	43618.78	100-yr	2.16	257.84		7305.88	7307.42		7307.63	0.023056	3.74	71.65	109.86	0.81	3.98	0.94
WestTrib	43453.91	2-yr		24		7301.97	7302.58	7302.55	7302.65	0.044163	2.13	11.27	56.45	0.84	2.1	0.55
WestTrib	43453.91	5-yr		59		7301.97	7302.75	7302.72	7302.87	0.03413	2.75	21.43	60.07	0.81	1.98	0.76
WestTrib	43453.91	10-yr		89		7301.97	7302.87	7302.8	7303.02	0.030636	3.11	28.66	61.86	0.8	1.93	0.88
WestTrib	43453.91	25-yr	0	169.96	0.04	7301.97	7303.12	7303.02	7303.35	0.027117	3.82	44.55	65.43	0.82	1.87	1.15
WestTrib	43453.91	50-yr	0.05	209.81	0.15	7301.97	7303.22	7303.12	7303.48	0.026254	4.12	51.24	66.78	0.83	1.85	1.25
WestTrib	43453.91	100-yr	0.22	259.39	0.39	7301.97	7303.34	7303.22	7303.64	0.025233	4.43	59.25	68.38	0.84	1.84	1.36
WestTrib	43386.36	2-yr		24		7299.45	7300.46	7300.35	7300.55	0.023122	2.31	10.38	27.95	0.67	5.66	0.53
WestTrib	43386.36	5-yr		59		7299.45	7300.74	7300.62	7300.88	0.025357	3.02	19.56	37.97	0.74	5.63	0.81
WestTrib	43386.36	10-yr		89		7299.45	7300.9	7300.78	7301.08	0.026691	3.42	26.03	43.58	0.78	5.61	0.98

Falcon DBPS
West Tributary Existing Conditions HEC-RAS Outputs

Reach	River Sta	Profile	Q Left (cfs)	Q Channel (cfs)	Q Right (cfs)	Min Ch El (ft)	W.S. Elev (ft)	Crit W.S. (ft)	E.G. Elev (ft)	E.G. Slope (ft/ft)	Vel Chnl (ft/s)	Flow Area (sq ft)	Top Width (ft)	Froude # XS	Headloss (ft)	Shear Total (lb/sq ft)
WestTrib	43386.36	25-yr	0.02	169.87	0.11	7299.45	7301.19	7301.09	7301.47	0.028076	4.28	39.97	53.96	0.88	5.54	1.29
WestTrib	43386.36	50-yr	0.1	209.31	0.6	7299.45	7301.29	7301.21	7301.63	0.028471	4.67	45.77	57.94	0.92	5.5	1.39
WestTrib	43386.36	100-yr	0.27	257.83	1.89	7299.45	7301.4	7301.34	7301.81	0.029194	5.12	52.5	60.62	0.96	5.47	1.56
WestTrib	43218.78	2-yr		24		7294.2	7294.74	7294.74	7294.89	0.053834	3.12	7.69	25.18	1	4.54	1.02
WestTrib	43218.78	5-yr		59		7294.2	7294.99	7294.99	7295.24	0.046436	4.01	14.7	29.58	1	4.57	1.44
WestTrib	43218.78	10-yr		89		7294.2	7295.17	7295.17	7295.47	0.042954	4.45	20.01	32.51	1	4.53	1.65
WestTrib	43218.78	25-yr		170		7294.2	7295.52	7295.52	7295.94	0.039207	5.24	32.46	38.54	1.01	4.8	2.05
WestTrib	43218.78	50-yr		210		7294.2	7295.66	7295.66	7296.13	0.038086	5.52	38.05	40.83	1.01	4.83	2.21
WestTrib	43218.78	100-yr	0	260	0	7294.2	7295.81	7295.81	7296.34	0.036629	5.82	44.66	43.31	1.01	5	2.35
WestTrib	42818.78	2-yr		24		7285.58	7286.91		7286.95	0.004739	1.65	14.57	19.95	0.34	6.03	0.21
WestTrib	42818.78	5-yr		59		7285.58	7287.47		7287.54	0.004972	2.14	27.54	26.33	0.37	6.06	0.32
WestTrib	42818.78	10-yr		89		7285.58	7287.81		7287.9	0.005019	2.4	37.13	30.19	0.38	6.05	0.38
WestTrib	42818.78	25-yr		170		7285.58	7288.42		7288.56	0.005593	2.95	57.56	37.1	0.42	6.12	0.53
WestTrib	42818.78	50-yr		210		7285.58	7288.66		7288.82	0.005687	3.14	66.92	39.87	0.43	6.12	0.59
WestTrib	42818.78	100-yr		260		7285.58	7288.9		7289.08	0.006047	3.39	76.66	42.56	0.45	6.12	0.67
WestTrib	42418.78	2-yr		43		7279.67	7280.66	7280.66	7280.92	0.04723	4.04	10.64	21.42	1.01	8.26	1.46
WestTrib	42418.78	5-yr		110		7279.67	7281.11	7281.11	7281.49	0.041499	4.92	22.37	30.42	1.01	8.8	1.9
WestTrib	42418.78	10-yr		170		7279.67	7281.39	7281.39	7281.84	0.039464	5.42	31.39	35.56	1.02	9.15	2.16
WestTrib	42418.78	25-yr		310		7279.67	7281.88	7281.88	7282.43	0.03659	5.95	52.13	48.51	1.01	9.38	2.44
WestTrib	42418.78	50-yr		389.99	0.01	7279.67	7282.1	7282.1	7282.69	0.035103	6.19	63.01	54.93	1.02	9.35	2.5
WestTrib	42418.78	100-yr	0	479.25	0.75	7279.67	7282.3	7282.3	7282.95	0.032552	6.47	74.91	62.59	1.04	9.2	2.42
WestTrib	42018.78	2-yr		43		7267.87	7269.74	7269.32	7269.87	0.011442	2.98	14.45	15.49	0.54	5.1	0.65
WestTrib	42018.78	5-yr		110		7267.87	7270.45	7269.98	7270.69	0.013499	3.99	27.55	21.53	0.62	5.36	1.05
WestTrib	42018.78	10-yr		170		7267.87	7270.91	7270.39	7271.21	0.014782	4.35	39.05	28.82	0.66	5.49	1.22
WestTrib	42018.78	25-yr		310		7267.87	7271.59	7271.13	7271.97	0.016158	4.92	62.95	41.5	0.7	5.58	1.5
WestTrib	42018.78	50-yr		390		7267.87	7271.87	7271.43	7272.29	0.016522	5.19	75.17	46.67	0.72	5.57	1.63
WestTrib	42018.78	100-yr		480		7267.87	7272.13	7271.7	7272.59	0.016944	5.46	87.88	51.52	0.74	5.56	1.77
WestTrib	41774.8	2-yr		43		7263.58	7264.52	7264.52	7264.77	0.049342	3.99	10.79	22.86	1.02	1.03	1.45
WestTrib	41774.8	5-yr		110		7263.58	7264.94	7264.94	7265.34	0.041569	5.03	21.88	28.73	1.02	1.74	1.96
WestTrib	41774.8	10-yr		170		7263.58	7265.23	7265.23	7265.71	0.037917	5.61	30.32	31.53	1.01	2.05	2.26
WestTrib	41774.8	25-yr		310		7263.58	7265.73	7265.73	7266.39	0.034384	6.52	47.55	36.58	1.01	2.44	2.76
WestTrib	41774.8	50-yr		390		7263.58	7265.97	7265.97	7266.71	0.033144	6.89	56.61	38.98	1.01	2.58	2.97
WestTrib	41774.8	100-yr	0.06	479.94	0.01	7263.58	7266.2	7266.2	7267.03	0.031712	7.32	65.65	41.24	1.02	2.7	3.12
WestTrib	41539.1	2-yr		43		7260.77	7262.38		7262.4	0.001382	0.92	46.7	60.95	0.19	0.01	0.07
WestTrib	41539.1	5-yr		110		7260.77	7262.73		7262.77	0.002736	1.61	68.12	63.84	0.28	0.05	0.18
WestTrib	41539.1	10-yr		170		7260.77	7262.96		7263.03	0.003453	2.03	83.54	65.85	0.32	0.09	0.27

Falcon DBPS
West Tributary Existing Conditions HEC-RAS Outputs

Reach	River Sta	Profile	Q Left (cfs)	Q Channel (cfs)	Q Right (cfs)	Min Ch El (ft)	W.S. Elev (ft)	Crit W.S. (ft)	E.G. Elev (ft)	E.G. Slope (ft/ft)	Vel Chnl (ft/s)	Flow Area (sq ft)	Top Width (ft)	Froude # XS	Headloss (ft)	Shear Total (lb/sq ft)
WestTrib	41539.1	25-yr		310		7260.77	7263.4		7263.52	0.004484	2.74	113.25	69.54	0.38	0.15	0.45
WestTrib	41539.1	50-yr		390		7260.77	7263.61		7263.76	0.004878	3.05	128.04	71.31	0.4	0.19	0.54
WestTrib	41539.1	100-yr		480		7260.77	7263.83		7264	0.005266	3.34	143.65	73.73	0.42	0.22	0.63
WestTrib	41465.66	2-yr	0.64	38.16	4.2	7257.5	7262.38	7258.93	7262.38	0.000058	0.47	115.09	63.38	0.06		0.01
WestTrib	41465.66	5-yr	3.11	94.57	12.33	7257.5	7262.7	7259.66	7262.71	0.000257	1.06	136.22	68.35	0.12		0.03
WestTrib	41465.66	10-yr	6.34	143.06	20.6	7257.5	7262.91	7260.08	7262.94	0.000483	1.51	151.12	71.64	0.17		0.06
WestTrib	41465.66	25-yr	16.38	250.42	43.2	7257.5	7263.29	7260.8	7263.36	0.001069	2.39	179.21	76.25	0.25		0.15
WestTrib	41465.66	50-yr	23.32	309.2	57.48	7257.5	7263.47	7261.09	7263.57	0.001415	2.83	192.82	78.15	0.29		0.21
WestTrib	41465.66	100-yr	31.95	373.73	74.32	7257.5	7263.64	7261.43	7263.78	0.001804	3.28	206.8	80.07	0.32		0.28
WestTrib	41441.59		Culvert													
WestTrib	41405.38	2-yr		43		7257.33	7258.27	7258.14	7258.44	0.026369	3.35	12.83	25	0.77	0.99	0.95
WestTrib	41405.38	5-yr		110		7257.33	7258.73	7258.6	7258.95	0.026345	3.78	29.09	41.35	0.79	0.96	1.14
WestTrib	41405.38	10-yr		170		7257.33	7258.96	7258.8	7259.25	0.025956	4.36	38.97	44.22	0.82	0.94	1.41
WestTrib	41405.38	25-yr		310		7257.33	7259.39	7259.26	7259.81	0.024835	5.23	59.29	49.6	0.84	0.92	1.83
WestTrib	41405.38	50-yr		390	0	7257.33	7259.6	7259.44	7260.08	0.024336	5.59	69.8	52.17	0.85	0.9	2.01
WestTrib	41405.38	100-yr		479.9	0.1	7257.33	7259.79	7259.64	7260.35	0.023897	5.99	80.27	54.6	0.87	0.89	2.17
WestTrib	41368.0*	2-yr		43		7256.12	7257.31		7257.46	0.025882	3.1	13.85	26.11	0.75	1.02	0.85
WestTrib	41368.0*	5-yr		110		7256.12	7257.75		7257.98	0.024963	3.86	28.53	37.9	0.78	0.99	1.16
WestTrib	41368.0*	10-yr		170		7256.12	7258		7258.31	0.024299	4.42	38.49	40.86	0.8	0.98	1.41
WestTrib	41368.0*	25-yr		310		7256.12	7258.46		7258.9	0.023914	5.32	58.25	46.18	0.84	0.94	1.86
WestTrib	41368.0*	50-yr		390		7256.12	7258.68		7259.18	0.023643	5.69	68.57	48.77	0.85	0.92	2.05
WestTrib	41368.0*	100-yr		479.99	0.01	7256.12	7258.89	7258.7	7259.46	0.023453	6.06	79.22	51.56	0.86	0.9	2.22
WestTrib	41330.7*	2-yr		43		7254.91	7256.25	7256.15	7256.43	0.029059	3.38	12.73	23.05	0.8	1.07	0.99
WestTrib	41330.7*	5-yr		110		7254.91	7256.72		7256.99	0.028202	4.17	26.36	34.11	0.84	0.99	1.35
WestTrib	41330.7*	10-yr		170		7254.91	7256.98	7256.86	7257.33	0.027958	4.8	35.43	36.92	0.86	0.97	1.66
WestTrib	41330.7*	25-yr		310		7254.91	7257.47		7257.96	0.026031	5.65	54.83	42.31	0.88	0.92	2.08
WestTrib	41330.7*	50-yr		390		7254.91	7257.7	7257.55	7258.26	0.025458	6.01	64.85	44.85	0.88	0.91	2.27
WestTrib	41330.7*	100-yr		480		7254.91	7257.94	7257.78	7258.56	0.024713	6.32	75.91	47.61	0.88	0.89	2.43
WestTrib	41293.4*	2-yr		43		7253.69	7255.18		7255.37	0.027983	3.53	12.18	20.02	0.8	1.11	1.05
WestTrib	41293.4*	5-yr		110		7253.69	7255.73		7256	0.025079	4.19	26.25	30.83	0.8	1.05	1.32
WestTrib	41293.4*	10-yr		170		7253.69	7256.03		7256.38	0.02389	4.73	35.97	34	0.81	1.01	1.56
WestTrib	41293.4*	25-yr		310		7253.69	7256.55		7257.04	0.023281	5.62	55.21	39.51	0.84	0.96	2
WestTrib	41293.4*	50-yr		390		7253.69	7256.79		7257.35	0.023186	6	65.04	42.04	0.85	0.94	2.21
WestTrib	41293.4*	100-yr		480		7253.69	7257.04	7256.84	7257.66	0.023193	6.36	75.45	44.63	0.86	0.92	2.41
WestTrib	41256.1*	2-yr		43		7252.48	7254.04	7253.94	7254.27	0.031276	3.89	11.06	17.02	0.85	1.1	1.24

Falcon DBPS
West Tributary Existing Conditions HEC-RAS Outputs

Reach	River Sta	Profile	Q Left (cfs)	Q Channel (cfs)	Q Right (cfs)	Min Ch El (ft)	W.S. Elev (ft)	Crit W.S. (ft)	E.G. Elev (ft)	E.G. Slope (ft/ft)	Vel Chnl (ft/s)	Flow Area (sq ft)	Top Width (ft)	Froude # XS	Headloss (ft)	Shear Total (lb/sq ft)
WestTrib	41256.1*	5-yr		110		7252.48	7254.59	7254.51	7254.96	0.031078	4.85	22.66	24.95	0.9	1.03	1.73
WestTrib	41256.1*	10-yr		170		7252.48	7254.93	7254.84	7255.37	0.030111	5.34	31.81	29.66	0.91	0.97	1.98
WestTrib	41256.1*	25-yr		310		7252.48	7255.49	7255.38	7256.08	0.027933	6.2	50.03	35.28	0.92	0.88	2.43
WestTrib	41256.1*	50-yr		390		7252.48	7255.76	7255.64	7256.42	0.026777	6.51	59.88	37.97	0.91	0.85	2.59
WestTrib	41256.1*	100-yr		480		7252.48	7256.03	7255.9	7256.75	0.02558	6.79	70.71	40.71	0.91	0.81	2.73
WestTrib	41218.78	2-yr		43		7251.27	7252.93	7252.81	7253.17	0.028003	3.92	10.98	15.23	0.81	7.11	1.22
WestTrib	41218.78	5-yr		110		7251.27	7253.6	7253.41	7253.94	0.024178	4.67	23.55	22.58	0.81	6.92	1.53
WestTrib	41218.78	10-yr		170		7251.27	7254.01	7253.79	7254.4	0.022229	5.04	33.71	27.1	0.8	6.81	1.68
WestTrib	41218.78	25-yr		310		7251.27	7254.73	7254.39	7255.21	0.018488	5.52	56.14	34.33	0.76	6.75	1.84
WestTrib	41218.78	50-yr		390		7251.27	7255.05	7254.68	7255.57	0.017662	5.77	67.57	37.36	0.76	6.77	1.95
WestTrib	41218.78	100-yr		480		7251.27	7255.4	7254.95	7255.94	0.016388	5.93	80.96	40.66	0.74	6.81	1.99
WestTrib	40884.05	2-yr		43		7243.77	7245.86	7245.55	7246.07	0.016636	3.68	11.69	11.71	0.65	11.15	0.98
WestTrib	40884.05	5-yr		110		7243.77	7246.66	7246.32	7247.02	0.017885	4.76	23.1	16.63	0.71	11.63	1.46
WestTrib	40884.05	10-yr		170		7243.77	7247.16	7246.78	7247.59	0.018671	5.28	32.19	20.57	0.74	11.91	1.73
WestTrib	40884.05	25-yr	2.11	307.89		7243.77	7247.89	7247.64	7248.46	0.022044	6.08	52.3	35.04	0.87	12.26	1.97
WestTrib	40884.05	50-yr	5.55	384.45		7243.77	7248.17	7247.99	7248.81	0.023272	6.46	62.85	40.77	0.91	12.37	2.15
WestTrib	40884.05	100-yr	10.22	469.78		7243.77	7248.39	7248.31	7249.13	0.02576	6.99	72.29	45.29	0.97	12.44	2.47
WestTrib	40418.78	2-yr		43		7233.96	7234.77	7234.73	7234.93	0.037324	3.17	13.57	32.96	0.87	8.02	0.96
WestTrib	40418.78	5-yr		110		7233.96	7235.11	7235.07	7235.38	0.03719	4.21	26.14	41.38	0.93	7.45	1.46
WestTrib	40418.78	10-yr		170		7233.96	7235.33	7235.29	7235.68	0.037068	4.76	35.7	46.83	0.96	7.06	1.76
WestTrib	40418.78	25-yr		310		7233.96	7235.75	7235.69	7236.2	0.03185	5.38	57.57	56.03	0.94	6.39	2.03
WestTrib	40418.78	50-yr		390		7233.96	7235.93	7235.86	7236.44	0.030457	5.76	67.69	57.51	0.94	6.09	2.23
WestTrib	40418.78	100-yr		480		7233.96	7236.14	7236.04	7236.7	0.027534	6	80.01	59.27	0.91	5.83	2.31
WestTrib	40018.78	2-yr		67		7224.51	7226.41	7226.41	7226.92	0.014516	5.71	11.74	11.96	1.01	5.72	0.85
WestTrib	40018.78	5-yr		160		7224.51	7227.23	7227.23	7227.94	0.012809	6.75	23.7	17.07	1.01	5.2	1.06
WestTrib	40018.78	10-yr		250		7224.51	7227.79	7227.79	7228.62	0.011921	7.33	34.13	20.62	1	4.91	1.17
WestTrib	40018.78	25-yr		470		7224.51	7228.73	7228.73	7229.81	0.011084	8.32	56.51	26.74	1.01	4.69	1.39
WestTrib	40018.78	50-yr		600		7224.51	7229.18	7229.18	7230.35	0.010591	8.68	69.1	29.63	1	4.57	1.47
WestTrib	40018.78	100-yr		740		7224.51	7229.58	7229.58	7230.86	0.01035	9.07	81.63	32.25	1	4.5	1.56
WestTrib	39618.78	2-yr		67		7216.53	7218.34	7218.31	7218.7	0.013852	4.81	13.94	18.21	0.97	5.64	0.65
WestTrib	39618.78	5-yr		157.41	2.59	7216.53	7218.96	7218.96	7219.43	0.012816	5.55	30.88	35.53	1.04	5.13	0.68
WestTrib	39618.78	10-yr		242.04	7.96	7216.53	7219.33	7219.33	7219.89	0.012185	6.05	45.85	44.33	1.03	4.74	0.77
WestTrib	39618.78	25-yr		443.43	26.57	7216.53	7219.98	7219.98	7220.65	0.011802	6.78	80.13	62.5	1.03	3.79	0.93
WestTrib	39618.78	50-yr		561.35	38.65	7216.53	7220.24	7220.24	7221	0.011696	7.2	97.54	68.85	1.03	3.75	1.02
WestTrib	39618.78	100-yr	0	687.1	52.9	7216.53	7220.5	7220.5	7221.33	0.011505	7.56	115.79	74.96	1.04	3.59	1.09
WestTrib	39218.78	2-yr		67		7211.07	7212.57	7212.57	7213.07	0.014258	5.71	11.74	11.86	1.01	5.68	0.84

Falcon DBPS
West Tributary Existing Conditions HEC-RAS Outputs

Reach	River Sta	Profile	Q Left (cfs)	Q Channel (cfs)	Q Right (cfs)	Min Ch El (ft)	W.S. Elev (ft)	Crit W.S. (ft)	E.G. Elev (ft)	E.G. Slope (ft/ft)	Vel Chnl (ft/s)	Flow Area (sq ft)	Top Width (ft)	Froude # XS	Headloss (ft)	Shear Total (lb/sq ft)
WestTrib	39218.78	5-yr		160		7211.07	7213.38	7213.38	7214.14	0.01269	6.96	22.99	15.65	1.01	5.01	1.1
WestTrib	39218.78	10-yr		249.73	0.27	7211.07	7213.96	7213.96	7214.86	0.011376	7.64	33.28	22.95	1.12	4.8	0.98
WestTrib	39218.78	25-yr	0.03	441.83	28.15	7211.07	7215.09	7215.09	7216.06	0.007656	8.15	77.05	54.63	1.17	3.76	0.66
WestTrib	39218.78	50-yr	0.31	542.09	57.6	7211.07	7215.46	7215.46	7216.55	0.007552	8.81	97.71	56.92	1.13	3.62	0.79
WestTrib	39218.78	100-yr	1.75	642.33	95.92	7211.07	7215.86	7215.86	7217.02	0.007089	9.25	122.29	68.57	1.14	3.4	0.77
WestTrib	38818.78	2-yr		67		7204.61	7206.09	7206.07	7206.5	0.014015	5.17	12.97	15.09	0.98	4.98	0.72
WestTrib	38818.78	5-yr		160		7204.61	7206.81	7206.78	7207.4	0.012134	6.19	25.86	20.54	0.97	5.12	0.91
WestTrib	38818.78	10-yr		250		7204.61	7207.25	7207.25	7208.01	0.012439	7	35.69	23.94	1.01	5.26	1.11
WestTrib	38818.78	25-yr		470		7204.61	7208.16	7208.16	7209.04	0.011646	7.53	62.43	35.95	1.01	4.81	1.22
WestTrib	38818.78	50-yr		599.89	0.11	7204.61	7208.48	7208.48	7209.5	0.010925	8.09	74.31	37.64	1.02	4.42	1.29
WestTrib	38818.78	100-yr	0.07	739.26	0.67	7204.61	7208.79	7208.79	7209.96	0.010392	8.66	86.21	39.63	1.03	4.2	1.35
WestTrib	38418.78	2-yr		67		7200.04	7201.23	7201.15	7201.53	0.010975	4.39	15.27	19.33	0.87	4.93	0.53
WestTrib	38418.78	5-yr		160		7200.04	7201.78	7201.78	7202.29	0.013386	5.71	28.01	27.76	1	5.08	0.83
WestTrib	38418.78	10-yr		250		7200.04	7202.22	7202.22	7202.75	0.013561	5.81	42.99	42.06	1.01	4.81	0.86
WestTrib	38418.78	25-yr	0.02	469.46	0.52	7200.04	7202.79	7202.79	7203.46	0.01211	6.57	72.55	63.69	1.08	4.3	0.85
WestTrib	38418.78	50-yr	0.21	595.49	4.3	7200.04	7203.05	7203.05	7203.8	0.010797	6.99	90.61	72.18	1.09	3.96	0.84
WestTrib	38418.78	100-yr	0.66	728.2	11.14	7200.04	7203.29	7203.29	7204.14	0.010114	7.42	108.14	73.77	1.07	3.78	0.92
WestTrib	38018.78	2-yr	1.05	65.16	0.8	7195.31	7196.32	7196.31	7196.59	0.013916	4.24	17.8	36.85	1.06	5.51	0.42
WestTrib	38018.78	5-yr	7.68	147.86	4.46	7195.31	7196.76	7196.76	7197.21	0.011998	5.63	36.9	50.08	1.11	5.11	0.55
WestTrib	38018.78	10-yr	18.44	221.67	9.89	7195.31	7197.09	7197.09	7197.66	0.010713	6.4	55.48	59.76	1.11	4.67	0.62
WestTrib	38018.78	25-yr	55.05	386.96	28	7195.31	7197.72	7197.72	7198.49	0.009571	7.73	97.77	75.55	1.09	4.39	0.77
WestTrib	38018.78	50-yr	81.23	477.53	41.23	7195.31	7198.02	7198.02	7198.88	0.009065	8.27	122.21	82.56	1.08	4.18	0.84
WestTrib	38018.78	100-yr	114.71	570.67	54.63	7195.31	7198.31	7198.31	7199.25	0.008801	8.81	146.56	87.82	1.06	4.06	0.91
WestTrib	37618.78	2-yr		67		7190.23	7190.9	7190.86	7191.07	0.013496	3.3	20.28	46.56	0.88	4.54	0.37
WestTrib	37618.78	5-yr		157.66	2.34	7190.23	7191.21	7191.21	7191.51	0.013404	4.46	39.63	84.38	1.14		0.39
WestTrib	37618.78	10-yr		237.96	12.04	7190.23	7191.43	7191.43	7191.81	0.012448	5.03	59.15	88.67	1.06	3.84	0.52
WestTrib	37618.78	25-yr	0.02	428.64	41.34	7190.23	7191.82	7191.82	7192.36	0.012266	6.19	94.72	94.59	1.04	4.41	0.77
WestTrib	37618.78	50-yr	0.21	539.7	60.09	7190.23	7192.01	7192.01	7192.65	0.011787	6.7	113.3	96.65	1.04	4.44	0.86
WestTrib	37618.78	100-yr	0.71	658.19	81.11	7190.23	7192.2	7192.2	7192.92	0.011392	7.18	132.09	98.7	1.04	4.52	0.95
WestTrib	37218.78	2-yr	0.1	57.94	8.97	7184.96	7186.34	7186.28	7186.54	0.009658	3.88	27.2	69.67	1.02	3.49	0.23
WestTrib	37218.78	5-yr	0.87	118.97	40.17	7184.96	7186.73	7186.7	7187.04	0.009492	5.15	65.65	130.11	1.11	3.56	0.3
WestTrib	37218.78	10-yr	1.99	157.16	90.85	7184.96	7187.03	7187.03	7187.32	0.007525	5.37	117.02	185.32	0.95	3.21	0.3
WestTrib	37218.78	25-yr	4.59	247.57	217.84	7184.96	7187.33	7187.33	7187.75	0.009804	6.97	173.59	189.03	0.95	3.14	0.56
WestTrib	37218.78	50-yr	6.42	294.29	299.29	7184.96	7187.5	7187.5	7187.96	0.010252	7.57	204.49	191.02	0.93	3.19	0.68
WestTrib	37218.78	100-yr	8.53	343.9	387.57	7184.96	7187.64	7187.64	7188.16	0.010914	8.21	232.51	192.82	0.93	3.28	0.82
WestTrib	36914.66	2-yr		48.14	18.86	7182.01	7182.91	7182.83	7183.04	0.01365	3.31	28.87	64.94	0.76	6.29	0.38

Falcon DBPS
West Tributary Future Conditions HEC-RAS Outputs

Reach	River Sta	Profile	Q Left (cfs)	Q Channel (cfs)	Q Right (cfs)	Min Ch El (ft)	W.S. Elev (ft)	Crit W.S. (ft)	E.G. Elev (ft)	E.G. Slope (ft/ft)	Vel Chnl (ft/s)	Flow Area (sq ft)	Top Width (ft)	Froude # XS	Headloss (ft)	Shear Total (lb/sq ft)
WestTrib	47452.25	2-yr		9		7410.2	7410.59	7410.57	7410.67	0.057877	2.38	3.78	19.64	0.96	1.76	0.69
WestTrib	47452.25	5-yr		21		7410.2	7410.74	7410.74	7410.85	0.059512	2.66	7.9	35.51	0.99	1.78	0.83
WestTrib	47452.25	10-yr		32		7410.2	7410.82	7410.82	7410.95	0.060295	2.96	10.83	41.98	1.03	1.72	0.97
WestTrib	47452.25	25-yr		58		7410.2	7410.96	7410.96	7411.13	0.056237	3.32	17.45	53.8	1.03	1.59	1.14
WestTrib	47452.25	50-yr		73		7410.2	7411.02	7411.02	7411.21	0.052171	3.42	21.35	59.69	1.01	1.52	1.16
WestTrib	47452.25	100-yr		89		7410.2	7411.08	7411.08	7411.28	0.051479	3.56	24.97	64.94	1.01	1.45	1.23
WestTrib	47423.5*	2-yr		9		7408.46	7408.83	7408.83	7408.92	0.06487	2.4	3.75	20.92	1	1.71	0.72
WestTrib	47423.5*	5-yr		21		7408.46	7408.97	7408.97	7409.08	0.064271	2.66	7.88	37.45	1.02	0.05	0.84
WestTrib	47423.5*	10-yr		32		7408.46	7409.05	7409.05	7409.17	0.059416	2.86	11.18	45.01	1.01	0.06	0.92
WestTrib	47423.5*	25-yr		58		7408.46	7409.18	7409.18	7409.34	0.054376	3.24	17.92	56.12	1.01	0.1	1.08
WestTrib	47423.5*	50-yr		73		7408.46	7409.24	7409.24	7409.42	0.05383	3.44	21.25	60.38	1.02	0.12	1.18
WestTrib	47423.5*	100-yr		89		7408.46	7409.3	7409.3	7409.49	0.049503	3.55	25.04	63.48	1	0.14	1.22
WestTrib	47394.8*	2-yr		9		7406.72	7407.1	7407.09	7407.16	0.05461	1.97	4.56	30.12	0.89	1.77	0.52
WestTrib	47394.8*	5-yr		21		7406.72	7408.11		7408.11	0.000148	0.32	66.51	81.27	0.06	0	0.01
WestTrib	47394.8*	10-yr		32		7406.72	7408.19		7408.2	0.000255	0.43	73.74	84.24	0.08	0	0.01
WestTrib	47394.8*	25-yr		58		7406.72	7408.33		7408.34	0.000553	0.68	85.71	89.84	0.12	0	0.03
WestTrib	47394.8*	50-yr		73		7406.72	7408.39		7408.4	0.000735	0.8	91.41	92.54	0.14	0.01	0.05
WestTrib	47394.8*	100-yr		89		7406.72	7408.45		7408.46	0.000934	0.92	96.86	95.05	0.16	0.01	0.06
WestTrib	47366.1*	2-yr		9		7404.98	7405.33	7405.33	7405.39	0.069848	2.11	4.27	30.72	1	0.04	0.61
WestTrib	47366.1*	5-yr	0.06	20.91	0.03	7404.98	7408.11		7408.11	0.000003	0.1	223.24	98.43	0.01	0	0
WestTrib	47366.1*	10-yr	0.11	31.84	0.05	7404.98	7408.19		7408.19	0.000007	0.14	231.86	98.92	0.02	0	0
WestTrib	47366.1*	25-yr	0.24	57.65	0.12	7404.98	7408.33		7408.33	0.000018	0.24	245.68	99.69	0.03	0	0
WestTrib	47366.1*	50-yr	0.32	72.52	0.16	7404.98	7408.4		7408.4	0.000027	0.3	251.92	100.04	0.03	0	0
WestTrib	47366.1*	100-yr	0.42	88.38	0.2	7404.98	7408.45		7408.46	0.000037	0.35	257.84	100.36	0.04	0	0.01
WestTrib	47337.4*	2-yr		9		7403.24	7404.34	7403.55	7404.34	0.000077	0.21	43.26	60.77	0.04	0	0
WestTrib	47337.4*	5-yr	0.2	20.69	0.11	7403.24	7408.11	7403.66	7408.11	0.000001	0.06	371.79	98.63	0.01	0	0
WestTrib	47337.4*	10-yr	0.32	31.51	0.17	7403.24	7408.19	7403.74	7408.19	0.000001	0.09	380.48	99.03	0.01	0	0
WestTrib	47337.4*	25-yr	0.63	57.04	0.33	7403.24	7408.33	7403.87	7408.33	0.000004	0.15	394.25	99.67	0.01	0	0
WestTrib	47337.4*	50-yr	0.81	71.76	0.43	7403.24	7408.4	7403.92	7408.4	0.000006	0.19	400.54	99.95	0.02	0	0
WestTrib	47337.4*	100-yr	1.02	87.48	0.5	7403.24	7408.45	7403.99	7408.46	0.000008	0.23	406.41	100.93	0.02	0	0
WestTrib	47308.71	2-yr		9		7401.5	7404.34	7401.82	7404.34	0.000008	0.16	56.79	82.41	0.02		0
WestTrib	47308.71	5-yr	0.33	20.4	0.27	7401.5	7408.11	7402.02	7408.11	0	0.04	532.04	153.26	0		0
WestTrib	47308.71	10-yr	0.52	31	0.48	7401.5	7408.19	7402.12	7408.19	0	0.07	545.54	154.06	0.01		0
WestTrib	47308.71	25-yr	0.97	55.93	1.1	7401.5	7408.33	7402.31	7408.33	0.000001	0.12	567.07	155.33	0.01		0
WestTrib	47308.71	50-yr	1.24	70.24	1.52	7401.5	7408.4	7402.41	7408.4	0.000002	0.14	576.79	155.9	0.01		0
WestTrib	47308.71	100-yr	1.54	85.46	2.01	7401.5	7408.45	7402.5	7408.45	0.000003	0.17	585.94	156.43	0.02		0

Falcon DBPS
West Tributary Future Conditions HEC-RAS Outputs

Reach	River Sta	Profile	Q Left (cfs)	Q Channel (cfs)	Q Right (cfs)	Min Ch El (ft)	W.S. Elev (ft)	Crit W.S. (ft)	E.G. Elev (ft)	E.G. Slope (ft/ft)	Vel Chnl (ft/s)	Flow Area (sq ft)	Top Width (ft)	Froude # XS	Headloss (ft)	Shear Total (lb/sq ft)
WestTrib	47262		Culvert													
WestTrib	47224.28	2-yr		9		7400.63	7401.17	7401.17	7401.3	0.051606	2.85	3.16	11.44	0.96	7.75	0.88
WestTrib	47224.28	5-yr		21		7400.63	7401.39	7401.39	7401.57	0.049322	3.46	6.06	15.88	0.99	6.9	1.17
WestTrib	47224.28	10-yr		32		7400.63	7401.51	7401.51	7401.75	0.050153	3.87	8.27	18.55	1.02	6.76	1.39
WestTrib	47224.28	25-yr		58		7400.63	7401.78	7401.78	7402.05	0.042725	4.12	14.07	25.48	0.98	6.21	1.47
WestTrib	47224.28	50-yr		73		7400.63	7401.89	7401.89	7402.18	0.042069	4.25	17.16	29.32	0.98	6.01	1.53
WestTrib	47224.28	100-yr		89		7400.63	7401.99	7401.99	7402.29	0.040745	4.43	20.11	32.57	0.98	5.93	1.61
WestTrib	47079.43	2-yr		15		7392.78	7393.38	7393.38	7393.56	0.054487	3.34	4.5	13.41	1.02		1.13
WestTrib	47079.43	5-yr		37		7392.78	7393.68	7393.68	7393.93	0.046548	3.99	9.27	18.78	1	4.58	1.43
WestTrib	47079.43	10-yr		57		7392.78	7393.87	7393.87	7394.16	0.044693	4.32	13.2	23.02	1.01	4.82	1.59
WestTrib	47079.43	25-yr		110		7392.78	7394.21	7394.21	7394.58	0.042686	4.84	22.75	32.36	1.02	5.03	1.86
WestTrib	47079.43	50-yr		140		7392.78	7394.36	7394.36	7394.75	0.040828	5.01	27.94	36.45	1.01	5.01	1.94
WestTrib	47079.43	100-yr		170		7392.78	7394.48	7394.48	7394.91	0.040699	5.23	32.51	39.7	1.02	5.18	2.07
WestTrib	46818.78	2-yr		15		7384.39	7384.93	7384.93	7385.06	0.059518	2.95	5.09	19.56	1.02		0.96
WestTrib	46818.78	5-yr		37		7384.39	7385.44	7385.16	7385.5	0.008998	1.96	18.89	32.54	0.45	7.88	0.33
WestTrib	46818.78	10-yr		57		7384.39	7385.6	7385.3	7385.69	0.009871	2.33	24.49	34.87	0.49	7.98	0.43
WestTrib	46818.78	25-yr		110		7384.39	7385.95		7386.08	0.010714	2.94	37.37	39.75	0.54	8.14	0.63
WestTrib	46818.78	50-yr		140		7384.39	7386.11		7386.27	0.010899	3.19	43.94	42.03	0.55	8.22	0.71
WestTrib	46818.78	100-yr		170		7384.39	7386.24		7386.42	0.011475	3.44	49.43	43.81	0.57	8.3	0.8
WestTrib	46418.78	2-yr		12.46	2.54	7377.22	7377.41	7377.41	7377.48	0.076519	2.18	8.01	64.73	1.02	6.46	0.59
WestTrib	46418.78	5-yr		29.54	7.46	7377.22	7377.51	7377.51	7377.63	0.072436	2.97	14.7	71.06	1.06	6.96	0.94
WestTrib	46418.78	10-yr	0.02	44.23	12.75	7377.22	7377.6	7377.6	7377.73	0.062682	3.17	21.23	84.91	1.03	6.89	0.98
WestTrib	46418.78	25-yr	1.15	83.51	25.34	7377.22	7377.75	7377.75	7377.94	0.052411	3.88	34.98	95.15	1.02	7	1.2
WestTrib	46418.78	50-yr	2.11	105.15	32.74	7377.22	7377.81	7377.81	7378.04	0.052187	4.25	41.24	99	1.05	7.12	1.36
WestTrib	46418.78	100-yr	3.38	126.17	40.46	7377.22	7377.88	7377.88	7378.13	0.04812	4.46	48.4	103.23	1.03	7.01	1.41
WestTrib	46207.62	2-yr		15		7367.84	7368.73	7368.56	7368.8	0.016352	2.2	6.81	15.33	0.58	5.36	0.45
WestTrib	46207.62	5-yr		37		7367.84	7369.06	7368.86	7369.19	0.018737	2.9	12.74	20.96	0.66	5.59	0.71
WestTrib	46207.62	10-yr		57		7367.84	7369.25	7369.06	7369.42	0.019939	3.3	17.25	24.51	0.69	5.73	0.87
WestTrib	46207.62	25-yr		110		7367.84	7369.59	7369.41	7369.86	0.022804	4.17	26.35	29.15	0.77	5.96	1.28
WestTrib	46207.62	50-yr	0.02	139.98		7367.84	7369.74	7369.57	7370.06	0.023527	4.57	30.69	31.09	0.81	6.06	1.44
WestTrib	46207.62	100-yr	0.13	169.85	0.02	7367.84	7369.85	7369.71	7370.24	0.024196	4.98	34.36	32.66	0.85	6.14	1.58
WestTrib	46026.9	2-yr		15		7363.08	7363.37	7363.37	7363.44	0.069538	2.12	7.06	50.05	1	0.03	0.61
WestTrib	46026.9	5-yr		37		7363.08	7363.49	7363.49	7363.6	0.06019	2.66	13.92	63.22	1	0.07	0.83
WestTrib	46026.9	10-yr		57		7363.08	7363.57	7363.57	7363.7	0.057661	2.96	19.23	71.76	1.01	0.1	0.96
WestTrib	46026.9	25-yr		110		7363.08	7363.73	7363.73	7363.91	0.051226	3.42	32.18	88.76	1	0.21	1.16
WestTrib	46026.9	50-yr		140		7363.08	7363.8	7363.8	7364	0.050828	3.6	38.89	98.66	1.01	0.27	1.25

Falcon DBPS
West Tributary Future Conditions HEC-RAS Outputs

Reach	River Sta	Profile	Q Left (cfs)	Q Channel (cfs)	Q Right (cfs)	Min Ch El (ft)	W.S. Elev (ft)	Crit W.S. (ft)	E.G. Elev (ft)	E.G. Slope (ft/ft)	Vel Chnl (ft/s)	Flow Area (sq ft)	Top Width (ft)	Froude # XS	Headloss (ft)	Shear Total (lb/sq ft)
WestTrib	46026.9	100-yr		170		7363.08	7363.86	7363.86	7364.08	0.05026	3.8	44.7	103.55	1.02	0.33	1.35
WestTrib	45892.82	2-yr	0.02	14.93	0.04	7359.67	7362.13		7362.13	0.000014	0.15	104.12	74.98	0.02	0	0
WestTrib	45892.82	5-yr	0.08	36.76	0.16	7359.67	7362.24		7362.25	0.000066	0.34	112.57	76.74	0.05	0	0.01
WestTrib	45892.82	10-yr	0.16	56.53	0.3	7359.67	7362.33		7362.33	0.000132	0.49	119.18	78.09	0.07	0	0.01
WestTrib	45892.82	25-yr	0.49	108.63	0.88	7359.67	7362.51		7362.52	0.00035	0.86	133.67	80.97	0.12	0.01	0.04
WestTrib	45892.82	50-yr	0.74	137.95	1.31	7359.67	7362.6		7362.61	0.000488	1.04	140.69	82.33	0.14	0.01	0.05
WestTrib	45892.82	100-yr	1.04	167.16	1.81	7359.67	7362.67		7362.7	0.000631	1.21	147.08	83.55	0.16	0.01	0.07
WestTrib	45796.67	2-yr	0.82	12.75	1.43	7355.67	7362.13	7356.68	7362.13	0	0.05	392.02	138.28	0		0
WestTrib	45796.67	5-yr	2.13	31.22	3.65	7355.67	7362.25	7357	7362.25	0.000002	0.12	407.6	140.42	0.01		0
WestTrib	45796.67	10-yr	3.4	47.83	5.77	7355.67	7362.33	7357.17	7362.33	0.000005	0.18	419.67	142.06	0.02		0
WestTrib	45796.67	25-yr	7.06	91.22	11.72	7355.67	7362.51	7357.56	7362.52	0.000015	0.33	446.15	145.59	0.03		0
WestTrib	45796.67	50-yr	9.29	115.46	15.25	7355.67	7362.6	7357.7	7362.6	0.000023	0.4	458.94	147.26	0.04		0
WestTrib	45796.67	100-yr	11.6	139.52	18.88	7355.67	7362.68	7357.88	7362.68	0.000032	0.48	470.51	148.76	0.04		0.01
WestTrib	45766.17		Culvert													
WestTrib	45708.32	2-yr		15		7353.69	7354.49	7354.49	7354.7	0.051554	3.63	4.13	10.32	1.01	3.11	1.27
WestTrib	45708.32	5-yr		37		7353.69	7354.84	7354.84	7355.13	0.044878	4.32	8.57	14.87	1	3.38	1.59
WestTrib	45708.32	10-yr		57		7353.69	7355.24	7355.07	7355.45	0.022188	3.7	15.42	19.95	0.74	3.71	1.06
WestTrib	45708.32	25-yr		110		7353.69	7355.7	7355.47	7355.98	0.020141	4.23	26.01	25.53	0.74	3.61	1.26
WestTrib	45708.32	50-yr		140		7353.69	7355.88	7355.66	7356.2	0.020748	4.56	30.69	27.48	0.76	3.59	1.42
WestTrib	45708.32	100-yr		170		7353.69	7356.04	7355.82	7356.4	0.020983	4.82	35.3	29.36	0.77	3.53	1.55
WestTrib	45564.77	2-yr		24		7349.48	7350.81	7350.54	7350.92	0.014295	2.66	9.01	13.56	0.58	8.94	0.58
WestTrib	45564.77	5-yr		59		7349.48	7351.29	7351	7351.48	0.016797	3.54	16.65	18.44	0.66	9.21	0.93
WestTrib	45564.77	10-yr		89		7349.48	7351.41	7351.27	7351.75	0.028106	4.7	18.95	20.24	0.86	9.29	1.61
WestTrib	45564.77	25-yr		170		7349.48	7351.93	7351.82	7352.38	0.028695	5.36	31.7	28.32	0.89	9.54	1.97
WestTrib	45564.77	50-yr		210		7349.48	7352.14	7352.02	7352.61	0.027924	5.55	37.83	31.47	0.89	9.63	2.06
WestTrib	45564.77	100-yr		260		7349.48	7352.36	7352.22	7352.87	0.026889	5.73	45.34	34.94	0.89	9.71	2.14
WestTrib	45218.78	2-yr		24		7341.36	7341.85	7341.85	7341.98	0.060057	2.82	8.51	35.3	1.01		0.9
WestTrib	45218.78	5-yr	0.13	58.74	0.13	7341.36	7342.06	7342.06	7342.26	0.048485	3.67	16.39	44.11	1.06		1.12
WestTrib	45218.78	10-yr	2.01	86.29	0.7	7341.36	7342.28	7342.2	7342.46	0.025402	3.52	27.43	55.24	0.87	9.78	0.79
WestTrib	45218.78	25-yr	10.12	157.2	2.68	7341.36	7342.55	7342.48	7342.84	0.026255	4.52	44.1	68.69	0.96	9.75	1.05
WestTrib	45218.78	50-yr	15.91	190.21	3.89	7341.36	7342.64	7342.61	7342.99	0.027507	4.95	50.88	71.76	0.99	9.75	1.22
WestTrib	45218.78	100-yr	24.03	230.41	5.56	7341.36	7342.75	7342.74	7343.16	0.029133	5.44	58.45	74.43	1.03	9.76	1.43
WestTrib	44818.78	2-yr		24		7331.17	7331.74	7331.74	7331.93	0.051582	3.52	6.82	18.02	1.01		1.21
WestTrib	44818.78	5-yr		59		7331.17	7332.21	7332.06	7332.41	0.022494	3.55	16.61	23.15	0.74	8.2	1
WestTrib	44818.78	10-yr	0.05	88.95		7331.17	7332.43	7332.27	7332.69	0.023538	4.07	22.06	35.99	0.92	8.15	0.89

Falcon DBPS
West Tributary Future Conditions HEC-RAS Outputs

Reach	River Sta	Profile	Q Left (cfs)	Q Channel (cfs)	Q Right (cfs)	Min Ch El (ft)	W.S. Elev (ft)	Crit W.S. (ft)	E.G. Elev (ft)	E.G. Slope (ft/ft)	Vel Chnl (ft/s)	Flow Area (sq ft)	Top Width (ft)	Froude # XS	Headloss (ft)	Shear Total (lb/sq ft)
WestTrib	44818.78	25-yr	19.65	150.35		7331.17	7332.8	7332.78	7333.1	0.02267	4.67	47.94	82.6	1.02	7.94	0.82
WestTrib	44818.78	50-yr	34.56	175.44		7331.17	7332.94	7332.9	7333.25	0.021695	4.8	60.33	92.72	0.97	7.84	0.88
WestTrib	44818.78	100-yr	55.01	204.99		7331.17	7333.1	7333.02	7333.41	0.020603	4.91	76.22	107.91	0.93	7.75	0.91
WestTrib	44499.26	2-yr		24		7322.18	7323.41	7323.34	7323.63	0.035359	3.78	6.34	11.04	0.88	1.87	1.23
WestTrib	44499.26	5-yr		59		7322.18	7323.93	7323.81	7324.21	0.029476	4.28	13.8	17.55	0.85	2.01	1.41
WestTrib	44499.26	10-yr		89		7322.18	7324.22	7324.08	7324.54	0.02768	4.59	19.38	21.15	0.85	2.08	1.55
WestTrib	44499.26	25-yr		170		7322.18	7324.74	7324.61	7325.17	0.027265	5.27	32.24	28.38	0.87	2.24	1.9
WestTrib	44499.26	50-yr		210		7322.18	7324.93	7324.8	7325.41	0.027826	5.54	37.92	31.52	0.89	2.3	2.05
WestTrib	44499.26	100-yr		260		7322.18	7325.12	7325.03	7325.66	0.028804	5.87	44.32	34.72	0.92	2.37	2.26
WestTrib	44418.78	2-yr		24		7320.5	7321.67	7321.46	7321.76	0.015852	2.43	9.86	18.6	0.59	7.81	0.52
WestTrib	44418.78	5-yr		59		7320.5	7322.02	7321.84	7322.2	0.020796	3.36	17.54	24.97	0.71	7.99	0.9
WestTrib	44418.78	10-yr	0.11	88.89		7320.5	7322.22	7322.05	7322.46	0.02362	3.91	22.99	31.97	0.81	8.09	1.05
WestTrib	44418.78	25-yr	4.9	165.1		7320.5	7322.58	7322.51	7322.93	0.027835	4.84	38.3	53.24	0.99	8.22	1.24
WestTrib	44418.78	50-yr	10.02	199.98		7320.5	7322.71	7322.67	7323.1	0.028729	5.13	45.96	60.23	1.01	8.23	1.36
WestTrib	44418.78	100-yr	17.49	242.5	0.01	7320.5	7322.85	7322.83	7323.29	0.029387	5.47	54.77	67.62	1.04	8.27	1.48
WestTrib	44018.78	2-yr		24		7313.17	7313.89		7313.95	0.024605	1.96	12.27	45.06	0.66	7.43	0.42
WestTrib	44018.78	5-yr		59		7313.17	7314.13	7314	7314.21	0.019092	2.31	25.57	60.6	0.63	7.38	0.5
WestTrib	44018.78	10-yr		89		7313.17	7314.27	7314.1	7314.37	0.017359	2.6	34.29	63.42	0.62	7.37	0.58
WestTrib	44018.78	25-yr		170		7313.17	7314.57	7314.33	7314.72	0.015595	3.14	54.13	69.41	0.63	7.36	0.76
WestTrib	44018.78	50-yr		210		7313.17	7314.69		7314.86	0.015256	3.35	62.72	71.85	0.63	7.36	0.83
WestTrib	44018.78	100-yr		260		7313.17	7314.82		7315.02	0.015121	3.58	72.55	74.54	0.64	7.39	0.92
WestTrib	43618.78	2-yr		24		7305.88	7306.48	7306.33	7306.53	0.014607	1.83	13.09	35.83	0.53	3.88	0.33
WestTrib	43618.78	5-yr		59		7305.88	7306.73		7306.83	0.017836	2.51	23.55	46.93	0.62	3.96	0.56
WestTrib	43618.78	10-yr		89		7305.88	7306.88	7306.7	7307.01	0.019575	2.89	30.85	53.32	0.67	3.99	0.71
WestTrib	43618.78	25-yr	0.02	169.98		7305.88	7307.18		7307.36	0.022017	3.42	49.79	76.36	0.75	4.02	0.9
WestTrib	43618.78	50-yr	0.52	209.48		7305.88	7307.3		7307.5	0.022583	3.58	59.46	92.57	0.79	4.02	0.9
WestTrib	43618.78	100-yr	2.16	257.84		7305.88	7307.42		7307.63	0.023056	3.74	71.65	109.86	0.81	3.98	0.94
WestTrib	43453.91	2-yr		24		7301.97	7302.58	7302.55	7302.65	0.044163	2.13	11.27	56.45	0.84	2.1	0.55
WestTrib	43453.91	5-yr		59		7301.97	7302.75	7302.72	7302.87	0.03413	2.75	21.43	60.07	0.81	1.98	0.76
WestTrib	43453.91	10-yr		89		7301.97	7302.87	7302.8	7303.02	0.030636	3.11	28.66	61.86	0.8	1.93	0.88
WestTrib	43453.91	25-yr	0	169.96	0.04	7301.97	7303.12	7303.02	7303.35	0.027117	3.82	44.55	65.43	0.82	1.87	1.15
WestTrib	43453.91	50-yr	0.05	209.81	0.15	7301.97	7303.22	7303.12	7303.48	0.026254	4.12	51.24	66.78	0.83	1.85	1.25
WestTrib	43453.91	100-yr	0.22	259.39	0.39	7301.97	7303.34	7303.22	7303.64	0.025233	4.43	59.25	68.38	0.84	1.84	1.36
WestTrib	43386.36	2-yr		24		7299.45	7300.46	7300.35	7300.55	0.023122	2.31	10.38	27.95	0.67	5.66	0.53
WestTrib	43386.36	5-yr		59		7299.45	7300.74	7300.62	7300.88	0.025357	3.02	19.56	37.97	0.74	5.63	0.81
WestTrib	43386.36	10-yr		89		7299.45	7300.9	7300.78	7301.08	0.026691	3.42	26.03	43.58	0.78	5.61	0.98

Falcon DBPS
West Tributary Future Conditions HEC-RAS Outputs

Reach	River Sta	Profile	Q Left (cfs)	Q Channel (cfs)	Q Right (cfs)	Min Ch El (ft)	W.S. Elev (ft)	Crit W.S. (ft)	E.G. Elev (ft)	E.G. Slope (ft/ft)	Vel Chnl (ft/s)	Flow Area (sq ft)	Top Width (ft)	Froude # XS	Headloss (ft)	Shear Total (lb/sq ft)
WestTrib	43386.36	25-yr	0.02	169.87	0.11	7299.45	7301.19	7301.09	7301.47	0.028076	4.28	39.97	53.96	0.88	5.54	1.29
WestTrib	43386.36	50-yr	0.1	209.31	0.6	7299.45	7301.29	7301.21	7301.63	0.028471	4.67	45.77	57.94	0.92	5.5	1.39
WestTrib	43386.36	100-yr	0.27	257.83	1.89	7299.45	7301.4	7301.34	7301.81	0.029194	5.12	52.5	60.62	0.96	5.47	1.56
WestTrib	43218.78	2-yr		24		7294.2	7294.74	7294.74	7294.89	0.053834	3.12	7.69	25.18	1	4.54	1.02
WestTrib	43218.78	5-yr		59		7294.2	7294.99	7294.99	7295.24	0.046436	4.01	14.7	29.58	1	4.57	1.44
WestTrib	43218.78	10-yr		89		7294.2	7295.17	7295.17	7295.47	0.042954	4.45	20.01	32.51	1	4.53	1.65
WestTrib	43218.78	25-yr		170		7294.2	7295.52	7295.52	7295.94	0.039207	5.24	32.46	38.54	1.01	4.8	2.05
WestTrib	43218.78	50-yr		210		7294.2	7295.66	7295.66	7296.13	0.038086	5.52	38.05	40.83	1.01	4.83	2.21
WestTrib	43218.78	100-yr	0	260	0	7294.2	7295.81	7295.81	7296.34	0.036629	5.82	44.66	43.31	1.01	5	2.35
WestTrib	42818.78	2-yr		24		7285.58	7286.91		7286.95	0.004739	1.65	14.57	19.95	0.34	6.03	0.21
WestTrib	42818.78	5-yr		59		7285.58	7287.47		7287.54	0.004972	2.14	27.54	26.33	0.37	6.06	0.32
WestTrib	42818.78	10-yr		89		7285.58	7287.81		7287.9	0.005019	2.4	37.13	30.19	0.38	6.05	0.38
WestTrib	42818.78	25-yr		170		7285.58	7288.42		7288.56	0.005593	2.95	57.56	37.1	0.42	6.12	0.53
WestTrib	42818.78	50-yr		210		7285.58	7288.66		7288.82	0.005687	3.14	66.92	39.87	0.43	6.12	0.59
WestTrib	42818.78	100-yr		260		7285.58	7288.9		7289.08	0.006047	3.39	76.66	42.56	0.45	6.12	0.67
WestTrib	42418.78	2-yr		43		7279.67	7280.66	7280.66	7280.92	0.04723	4.04	10.64	21.42	1.01	8.26	1.46
WestTrib	42418.78	5-yr		110		7279.67	7281.11	7281.11	7281.49	0.041499	4.92	22.37	30.42	1.01	8.8	1.9
WestTrib	42418.78	10-yr		170		7279.67	7281.39	7281.39	7281.84	0.039464	5.42	31.39	35.56	1.02	9.15	2.16
WestTrib	42418.78	25-yr		310		7279.67	7281.88	7281.88	7282.43	0.03659	5.95	52.13	48.51	1.01	9.38	2.44
WestTrib	42418.78	50-yr		389.99	0.01	7279.67	7282.1	7282.1	7282.69	0.035103	6.19	63.01	54.93	1.02	9.35	2.5
WestTrib	42418.78	100-yr	0	479.25	0.75	7279.67	7282.3	7282.3	7282.95	0.032552	6.47	74.91	62.59	1.04	9.2	2.42
WestTrib	42018.78	2-yr		43		7267.87	7269.74	7269.32	7269.87	0.011442	2.98	14.45	15.49	0.54	5.1	0.65
WestTrib	42018.78	5-yr		110		7267.87	7270.45	7269.98	7270.69	0.013499	3.99	27.55	21.53	0.62	5.36	1.05
WestTrib	42018.78	10-yr		170		7267.87	7270.91	7270.39	7271.21	0.014782	4.35	39.05	28.82	0.66	5.49	1.22
WestTrib	42018.78	25-yr		310		7267.87	7271.59	7271.13	7271.97	0.016158	4.92	62.95	41.5	0.7	5.58	1.5
WestTrib	42018.78	50-yr		390		7267.87	7271.87	7271.43	7272.29	0.016522	5.19	75.17	46.67	0.72	5.57	1.63
WestTrib	42018.78	100-yr		480		7267.87	7272.13	7271.7	7272.59	0.016944	5.46	87.88	51.52	0.74	5.56	1.77
WestTrib	41774.8	2-yr		43		7263.58	7264.52	7264.52	7264.77	0.049342	3.99	10.79	22.86	1.02	1.03	1.45
WestTrib	41774.8	5-yr		110		7263.58	7264.94	7264.94	7265.34	0.041569	5.03	21.88	28.73	1.02	1.74	1.96
WestTrib	41774.8	10-yr		170		7263.58	7265.23	7265.23	7265.71	0.037917	5.61	30.32	31.53	1.01	2.05	2.26
WestTrib	41774.8	25-yr		310		7263.58	7265.73	7265.73	7266.39	0.034384	6.52	47.55	36.58	1.01	2.44	2.76
WestTrib	41774.8	50-yr		390		7263.58	7265.97	7265.97	7266.71	0.033144	6.89	56.61	38.98	1.01	2.58	2.97
WestTrib	41774.8	100-yr	0.06	479.94	0.01	7263.58	7266.2	7266.2	7267.03	0.031712	7.32	65.65	41.24	1.02	2.7	3.12
WestTrib	41539.1	2-yr		43		7260.77	7262.38		7262.4	0.001382	0.92	46.7	60.95	0.19	0.01	0.07
WestTrib	41539.1	5-yr		110		7260.77	7262.73		7262.77	0.002736	1.61	68.12	63.84	0.28	0.05	0.18
WestTrib	41539.1	10-yr		170		7260.77	7262.96		7263.03	0.003453	2.03	83.54	65.85	0.32	0.09	0.27

Falcon DBPS

West Tributary Future Conditions HEC-RAS Outputs

Reach	River Sta	Profile	Q Left (cfs)	Q Channel (cfs)	Q Right (cfs)	Min Ch El (ft)	W.S. Elev (ft)	Crit W.S. (ft)	E.G. Elev (ft)	E.G. Slope (ft/ft)	Vel Chnl (ft/s)	Flow Area (sq ft)	Top Width (ft)	Froude # XS	Headloss (ft)	Shear Total (lb/sq ft)
WestTrib	41539.1	25-yr		310		7260.77	7263.4		7263.52	0.004484	2.74	113.25	69.54	0.38	0.15	0.45
WestTrib	41539.1	50-yr		390		7260.77	7263.61		7263.76	0.004878	3.05	128.04	71.31	0.4	0.19	0.54
WestTrib	41539.1	100-yr		480		7260.77	7263.83		7264	0.005266	3.34	143.65	73.73	0.42	0.22	0.63
WestTrib	41465.66	2-yr	0.64	38.16	4.2	7257.5	7262.38	7258.93	7262.38	0.000058	0.47	115.09	63.38	0.06		0.01
WestTrib	41465.66	5-yr	3.11	94.57	12.33	7257.5	7262.7	7259.66	7262.71	0.000257	1.06	136.22	68.35	0.12		0.03
WestTrib	41465.66	10-yr	6.34	143.06	20.6	7257.5	7262.91	7260.08	7262.94	0.000483	1.51	151.12	71.64	0.17		0.06
WestTrib	41465.66	25-yr	16.38	250.42	43.2	7257.5	7263.29	7260.8	7263.36	0.001069	2.39	179.21	76.25	0.25		0.15
WestTrib	41465.66	50-yr	23.32	309.2	57.48	7257.5	7263.47	7261.09	7263.57	0.001415	2.83	192.82	78.15	0.29		0.21
WestTrib	41465.66	100-yr	31.95	373.73	74.32	7257.5	7263.64	7261.43	7263.78	0.001804	3.28	206.8	80.07	0.32		0.28
WestTrib	41441.59		Culvert													
WestTrib	41405.38	2-yr		43		7257.33	7258.27	7258.14	7258.44	0.026281	3.35	12.85	25.05	0.77	0.99	0.95
WestTrib	41405.38	5-yr		110		7257.33	7258.73	7258.6	7258.95	0.026345	3.78	29.09	41.35	0.79	0.96	1.14
WestTrib	41405.38	10-yr		170		7257.33	7258.96	7258.8	7259.25	0.025956	4.36	38.97	44.22	0.82	0.94	1.41
WestTrib	41405.38	25-yr		310		7257.33	7259.39	7259.26	7259.81	0.024835	5.23	59.29	49.6	0.84	0.92	1.83
WestTrib	41405.38	50-yr		390	0	7257.33	7259.6	7259.44	7260.08	0.024336	5.59	69.8	52.17	0.85	0.9	2.01
WestTrib	41405.38	100-yr		479.9	0.1	7257.33	7259.79	7259.64	7260.35	0.023897	5.99	80.27	54.6	0.87	0.89	2.17
WestTrib	41368.0*	2-yr		43		7256.12	7257.31		7257.46	0.025954	3.11	13.84	26.1	0.75	1.02	0.85
WestTrib	41368.0*	5-yr		110		7256.12	7257.75		7257.98	0.024963	3.86	28.53	37.9	0.78	0.99	1.16
WestTrib	41368.0*	10-yr		170		7256.12	7258		7258.31	0.024299	4.42	38.49	40.86	0.8	0.98	1.41
WestTrib	41368.0*	25-yr		310		7256.12	7258.46		7258.9	0.023914	5.32	58.25	46.18	0.84	0.94	1.86
WestTrib	41368.0*	50-yr		390		7256.12	7258.68		7259.18	0.023643	5.69	68.57	48.77	0.85	0.92	2.05
WestTrib	41368.0*	100-yr		479.99	0.01	7256.12	7258.89	7258.7	7259.46	0.023453	6.06	79.22	51.56	0.86	0.9	2.22
WestTrib	41330.7*	2-yr		43		7254.91	7256.26	7256.15	7256.43	0.028858	3.37	12.76	23.08	0.8	1.07	0.98
WestTrib	41330.7*	5-yr		110		7254.91	7256.72		7256.99	0.028202	4.17	26.36	34.11	0.84	0.99	1.35
WestTrib	41330.7*	10-yr		170		7254.91	7256.98	7256.86	7257.33	0.027958	4.8	35.43	36.92	0.86	0.97	1.66
WestTrib	41330.7*	25-yr		310		7254.91	7257.47		7257.96	0.026003	5.65	54.85	42.31	0.87	0.92	2.08
WestTrib	41330.7*	50-yr		390		7254.91	7257.7	7257.55	7258.26	0.025458	6.01	64.85	44.85	0.88	0.91	2.27
WestTrib	41330.7*	100-yr		480		7254.91	7257.94	7257.78	7258.56	0.024713	6.32	75.91	47.61	0.88	0.89	2.43
WestTrib	41293.4*	2-yr		43		7253.69	7255.18		7255.37	0.028162	3.54	12.15	20	0.8	1.11	1.05
WestTrib	41293.4*	5-yr		110		7253.69	7255.73		7256	0.025079	4.19	26.25	30.83	0.8	1.05	1.32
WestTrib	41293.4*	10-yr		170		7253.69	7256.03		7256.38	0.02389	4.73	35.97	34	0.81	1.01	1.56
WestTrib	41293.4*	25-yr		310		7253.69	7256.55		7257.04	0.023327	5.62	55.17	39.5	0.84	0.96	2.01
WestTrib	41293.4*	50-yr		390		7253.69	7256.8		7257.35	0.023165	5.99	65.06	42.05	0.85	0.94	2.21
WestTrib	41293.4*	100-yr		480		7253.69	7257.04	7256.84	7257.66	0.023193	6.36	75.45	44.63	0.86	0.92	2.41
WestTrib	41256.1*	2-yr		43		7252.48	7254.04	7253.94	7254.27	0.03109	3.88	11.09	17.04	0.85	1.11	1.24

Falcon DBPS
West Tributary Future Conditions HEC-RAS Outputs

Reach	River Sta	Profile	Q Left (cfs)	Q Channel (cfs)	Q Right (cfs)	Min Ch El (ft)	W.S. Elev (ft)	Crit W.S. (ft)	E.G. Elev (ft)	E.G. Slope (ft/ft)	Vel Chnl (ft/s)	Flow Area (sq ft)	Top Width (ft)	Froude # XS	Headloss (ft)	Shear Total (lb/sq ft)
WestTrib	41256.1*	5-yr		110		7252.48	7254.59	7254.51	7254.96	0.031078	4.85	22.66	24.95	0.9	1.03	1.73
WestTrib	41256.1*	10-yr		170		7252.48	7254.93	7254.84	7255.37	0.030111	5.34	31.81	29.66	0.91	0.97	1.98
WestTrib	41256.1*	25-yr		310		7252.48	7255.49	7255.38	7256.08	0.027826	6.19	50.1	35.3	0.92	0.88	2.42
WestTrib	41256.1*	50-yr		390		7252.48	7255.76	7255.64	7256.42	0.0268	6.51	59.86	37.96	0.91	0.84	2.59
WestTrib	41256.1*	100-yr		480		7252.48	7256.03	7255.9	7256.75	0.02556	6.79	70.73	40.72	0.91	0.8	2.72
WestTrib	41218.78	2-yr		43		7251.27	7252.93	7252.81	7253.17	0.028204	3.93	10.95	15.21	0.82	7.11	1.23
WestTrib	41218.78	5-yr		110		7251.27	7253.6	7253.41	7253.94	0.024178	4.67	23.55	22.58	0.81	6.92	1.53
WestTrib	41218.78	10-yr		170		7251.27	7254.01	7253.79	7254.4	0.022229	5.04	33.71	27.1	0.8	6.81	1.68
WestTrib	41218.78	25-yr		310		7251.27	7254.72	7254.39	7255.2	0.018931	5.57	55.65	34.19	0.77	6.74	1.88
WestTrib	41218.78	50-yr		390		7251.27	7255.07	7254.68	7255.58	0.017152	5.71	68.3	37.55	0.75	6.77	1.9
WestTrib	41218.78	100-yr		480		7251.27	7255.4	7254.95	7255.94	0.016345	5.92	81.03	40.68	0.74	6.81	1.99
WestTrib	40884.05	2-yr		43		7243.77	7245.86	7245.55	7246.07	0.016529	3.67	11.72	11.72	0.65	11.14	0.97
WestTrib	40884.05	5-yr		110		7243.77	7246.66	7246.32	7247.02	0.017885	4.76	23.1	16.63	0.71	11.63	1.46
WestTrib	40884.05	10-yr		170		7243.77	7247.16	7246.78	7247.59	0.018671	5.28	32.19	20.57	0.74	11.91	1.73
WestTrib	40884.05	25-yr	2.26	307.74		7243.77	7247.91	7247.64	7248.47	0.021378	6	53.04	35.48	0.86	12.27	1.91
WestTrib	40884.05	50-yr	5.27	384.73		7243.77	7248.14	7247.99	7248.8	0.024108	6.55	61.86	40.27	0.93	12.36	2.22
WestTrib	40884.05	100-yr	10.2	469.8		7243.77	7248.39	7248.31	7249.13	0.025814	7	72.22	45.26	0.97	12.44	2.48
WestTrib	40418.78	2-yr		43		7233.96	7234.77	7234.73	7234.93	0.037584	3.18	13.53	32.93	0.87	8	0.96
WestTrib	40418.78	5-yr		110		7233.96	7235.11	7235.07	7235.38	0.03719	4.21	26.14	41.38	0.93	7.45	1.46
WestTrib	40418.78	10-yr		170		7233.96	7235.33	7235.29	7235.68	0.037068	4.76	35.7	46.83	0.96	7.06	1.76
WestTrib	40418.78	25-yr		310		7233.96	7235.73	7235.69	7236.2	0.033161	5.45	56.84	55.92	0.95	6.35	2.09
WestTrib	40418.78	50-yr		390		7233.96	7235.94	7235.86	7236.44	0.029161	5.68	68.65	57.65	0.92	6.06	2.16
WestTrib	40418.78	100-yr		480		7233.96	7236.14	7236.04	7236.7	0.027473	5.99	80.07	59.28	0.91	5.86	2.3
WestTrib	40018.78	2-yr		68		7224.51	7226.42	7226.42	7226.93	0.014505	5.73	11.88	12.02	1.02	5.73	0.85
WestTrib	40018.78	5-yr		160		7224.51	7227.23	7227.23	7227.94	0.012809	6.75	23.7	17.07	1.01	5.2	1.06
WestTrib	40018.78	10-yr		250		7224.51	7227.79	7227.79	7228.62	0.011921	7.33	34.13	20.62	1	4.91	1.17
WestTrib	40018.78	25-yr		480		7224.51	7228.78	7228.78	7229.85	0.01089	8.3	57.8	27.05	1	4.64	1.38
WestTrib	40018.78	50-yr		610		7224.51	7229.2	7229.2	7230.39	0.01073	8.76	69.63	29.75	1.01	4.6	1.49
WestTrib	40018.78	100-yr		730		7224.51	7229.56	7229.56	7230.83	0.010388	9.05	80.69	32.06	1.01	4.53	1.56
WestTrib	39618.78	2-yr		68		7216.53	7218.35	7218.32	7218.71	0.013929	4.83	14.09	18.35	0.97	5.62	0.65
WestTrib	39618.78	5-yr		157.41	2.59	7216.53	7218.96	7218.96	7219.43	0.012816	5.55	30.88	35.53	1.04	5.13	0.68
WestTrib	39618.78	10-yr		242.04	7.96	7216.53	7219.33	7219.33	7219.89	0.012185	6.05	45.85	44.33	1.03	4.74	0.77
WestTrib	39618.78	25-yr		452.51	27.49	7216.53	7220	7220	7220.68	0.011744	6.8	81.63	63.07	1.03	3.76	0.93
WestTrib	39618.78	50-yr		570.37	39.63	7216.53	7220.26	7220.26	7221.03	0.011665	7.22	98.92	69.33	1.03	3.74	1.02
WestTrib	39618.78	100-yr	0	678.31	51.69	7216.53	7220.47	7220.47	7221.3	0.011639	7.56	114.04	74.31	1.04	3.66	1.09
WestTrib	39218.78	2-yr		68		7211.07	7212.58	7212.58	7213.09	0.014094	5.71	11.91	11.93	1.01	5.64	0.84

Falcon DBPS
West Tributary Future Conditions HEC-RAS Outputs

Reach	River Sta	Profile	Q Left (cfs)	Q Channel (cfs)	Q Right (cfs)	Min Ch El (ft)	W.S. Elev (ft)	Crit W.S. (ft)	E.G. Elev (ft)	E.G. Slope (ft/ft)	Vel Chnl (ft/s)	Flow Area (sq ft)	Top Width (ft)	Froude # XS	Headloss (ft)	Shear Total (lb/sq ft)
WestTrib	39218.78	5-yr		160		7211.07	7213.38	7213.38	7214.14	0.01269	6.96	22.99	15.65	1.01	5.01	1.1
WestTrib	39218.78	10-yr		249.73	0.27	7211.07	7213.96	7213.96	7214.86	0.011376	7.64	33.28	22.95	1.12	4.8	0.98
WestTrib	39218.78	25-yr	0.04	449.42	30.54	7211.07	7215.13	7215.13	7216.1	0.007574	8.18	79.08	54.9	1.16	3.72	0.67
WestTrib	39218.78	50-yr	0.35	549.63	60.03	7211.07	7215.49	7215.49	7216.59	0.007548	8.85	99.22	57.07	1.13	3.62	0.8
WestTrib	39218.78	100-yr	1.41	636.39	92.2	7211.07	7215.82	7215.82	7216.99	0.00725	9.28	119.37	67.49	1.15	3.45	0.78
WestTrib	38818.78	2-yr		68		7204.61	7206.1	7206.08	7206.51	0.013993	5.19	13.11	15.16	0.98	4.98	0.73
WestTrib	38818.78	5-yr		160		7204.61	7206.81	7206.78	7207.4	0.012134	6.19	25.86	20.54	0.97	5.12	0.91
WestTrib	38818.78	10-yr		250		7204.61	7207.25	7207.25	7208.01	0.012439	7	35.69	23.94	1.01	5.26	1.11
WestTrib	38818.78	25-yr		480	0	7204.61	7208.19	7208.19	7209.08	0.011531	7.56	63.45	36.1	1.01	4.75	1.22
WestTrib	38818.78	50-yr		609.87	0.13	7204.61	7208.51	7208.51	7209.53	0.0109	8.14	75.15	37.75	1.02	4.42	1.3
WestTrib	38818.78	100-yr	0.06	729.33	0.62	7204.61	7208.77	7208.77	7209.92	0.010415	8.62	85.4	39.52	1.03	4.2	1.35
WestTrib	38418.78	2-yr		68		7200.04	7201.24	7201.15	7201.54	0.010999	4.41	15.42	19.41	0.87	4.95	0.54
WestTrib	38418.78	5-yr		160		7200.04	7201.78	7201.78	7202.29	0.013386	5.71	28.01	27.76	1	5.08	0.83
WestTrib	38418.78	10-yr		250		7200.04	7202.22	7202.22	7202.75	0.013561	5.81	42.99	42.06	1.01	4.81	0.86
WestTrib	38418.78	25-yr	0.03	479.31	0.66	7200.04	7202.82	7202.82	7203.49	0.011913	6.6	74.06	65.2	1.09	4.26	0.84
WestTrib	38418.78	50-yr	0.23	605.11	4.66	7200.04	7203.07	7203.07	7203.83	0.010814	7.03	91.67	72.27	1.1	3.93	0.85
WestTrib	38418.78	100-yr	0.62	718.74	10.64	7200.04	7203.28	7203.28	7204.11	0.010119	7.39	107.06	73.67	1.07	3.78	0.91
WestTrib	38018.78	2-yr	1.08	66.1	0.82	7195.31	7196.32	7196.31	7196.6	0.013949	4.27	17.98	37	1.06	5.53	0.42
WestTrib	38018.78	5-yr	7.68	147.86	4.46	7195.31	7196.76	7196.76	7197.21	0.011998	5.63	36.9	50.08	1.11	5.11	0.55
WestTrib	38018.78	10-yr	18.44	221.67	9.89	7195.31	7197.09	7197.09	7197.66	0.010713	6.4	55.48	59.76	1.11	4.67	0.62
WestTrib	38018.78	25-yr	56.92	394.13	28.95	7195.31	7197.74	7197.74	7198.52	0.009554	7.78	99.55	76.08	1.09	4.36	0.78
WestTrib	38018.78	50-yr	83.58	484.01	42.42	7195.31	7198.05	7198.05	7198.91	0.008932	8.28	124.63	83.23	1.07	4.12	0.83
WestTrib	38018.78	100-yr	112.2	564.14	53.62	7195.31	7198.29	7198.29	7199.23	0.008819	8.77	144.85	87.48	1.06	4.07	0.91
WestTrib	37618.78	2-yr		68		7190.23	7190.9	7190.86	7191.08	0.013536	3.32	20.46	46.67	0.88	4.53	0.37
WestTrib	37618.78	5-yr		157.66	2.34	7190.23	7191.21	7191.21	7191.51	0.013404	4.46	39.63	84.38	1.14		0.39
WestTrib	37618.78	10-yr		237.96	12.04	7190.23	7191.43	7191.43	7191.81	0.012448	5.03	59.15	88.67	1.06	3.84	0.52
WestTrib	37618.78	25-yr	0.03	437.11	42.87	7190.23	7191.84	7191.84	7192.39	0.012103	6.21	96.52	94.79	1.04	4.39	0.77
WestTrib	37618.78	50-yr	0.25	548	61.75	7190.23	7192.03	7192.03	7192.67	0.011588	6.71	115.24	96.86	1.03	4.42	0.86
WestTrib	37618.78	100-yr	0.65	649.82	79.52	7190.23	7192.19	7192.19	7192.91	0.011465	7.16	130.6	98.54	1.04	4.52	0.95
WestTrib	37218.78	2-yr	0.1	58.65	9.25	7184.96	7186.34	7186.28	7186.55	0.009589	3.89	27.68	70.37	1.02	3.49	0.23
WestTrib	37218.78	5-yr	0.87	118.97	40.17	7184.96	7186.73	7186.7	7187.04	0.009492	5.15	65.65	130.11	1.11	3.56	0.3
WestTrib	37218.78	10-yr	1.99	157.16	90.85	7184.96	7187.03	7187.03	7187.32	0.007525	5.37	117.02	185.32	0.95	3.21	0.3
WestTrib	37218.78	25-yr	4.72	251.14	224.14	7184.96	7187.35	7187.35	7187.77	0.009817	7.01	176.27	189.2	0.95	3.13	0.57
WestTrib	37218.78	50-yr	6.56	297.87	305.57	7184.96	7187.51	7187.51	7187.97	0.010296	7.61	206.63	191.16	0.93	3.21	0.69
WestTrib	37218.78	100-yr	8.38	340.39	381.23	7184.96	7187.63	7187.63	7188.15	0.010866	8.16	230.62	192.7	0.93	3.3	0.81
WestTrib	36914.66	2-yr		48.87	19.13	7182.01	7182.91	7182.83	7183.05	0.013791	3.34	29.06	65.23	0.77	6.3	0.38

FILE: G:\gis_projects\Falcon_Creek_DBPS\active\apps\20130617\mapbooks\Sel_Alt_West_Trib_20151230.mxd, 1/11/2016, Jeff Clontis

Sheet 6-2 Falcon DBPS Conceptual Plan West Tributary El Paso County, CO

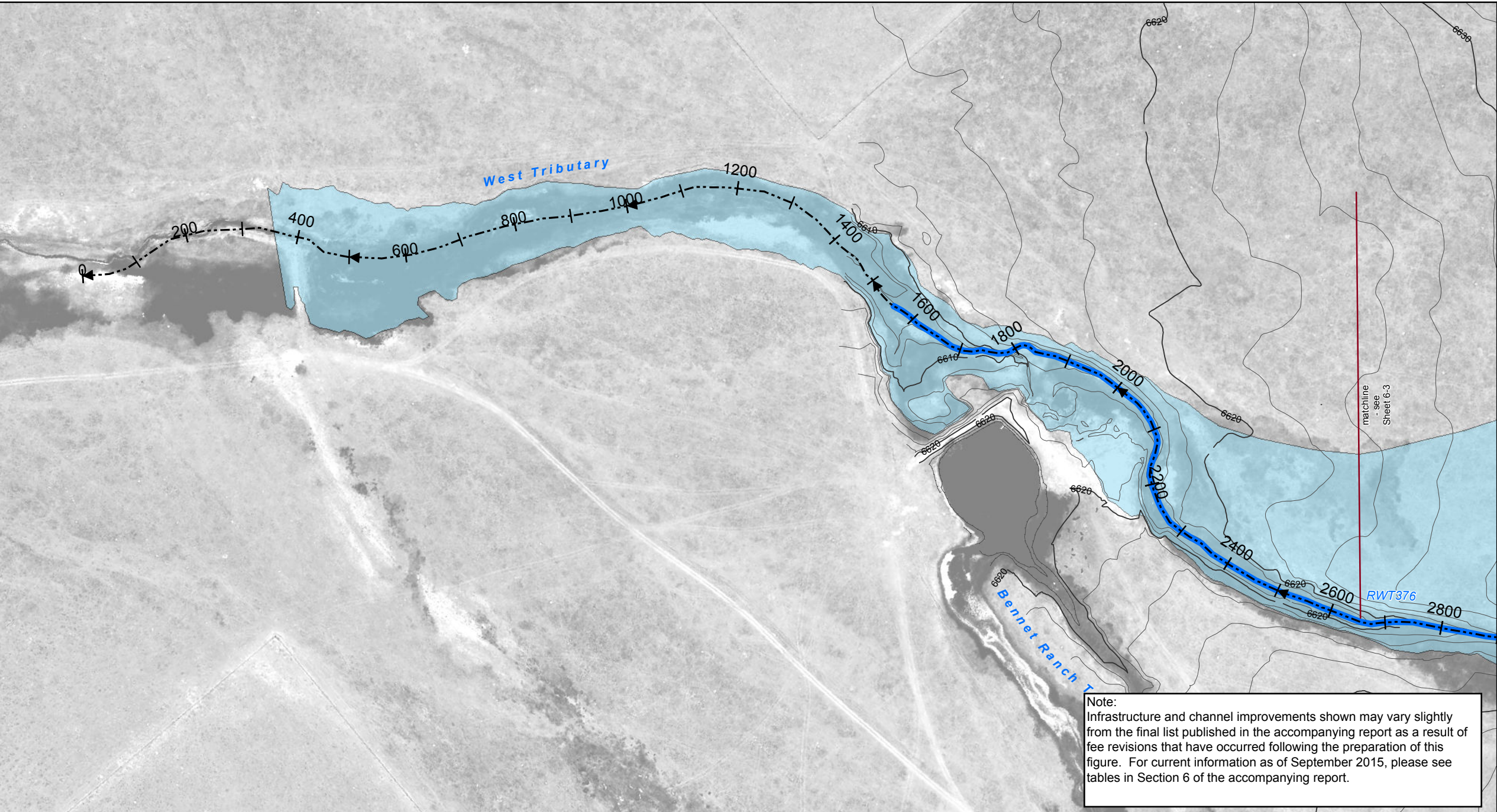

- | | |
|---|--|
| Drainageway Crossing | Reach Improvements
Natural Channel Design |
| Stream Centerline | Protect In Place |
| Existing Approximate 100-yr Floodplain* | Roadside Ditch Improvement |
| Floodplain Study Limit | Small Drop Structures w/ Toe Protection |
| Storm Sewer | Existing Detention |
| Inlet | Proposed Detention |
| Manhole | Proposed Detention Grading |
| Pipe | Small Drop Structure |
| | Cross Vane |
| | Immediate Action Required to Preserve Existing Condition |

* These approximate 100-yr floodplain boundaries are for planning purposes only. This information is not intended to replace the information provided on the FEMA Flood Insurance Rate Maps for this area.
** These are conceptual design drawings and are subject to change. These drawings are not intended for construction purposes.



Note:
Infrastructure and channel improvements shown may vary slightly from the final list published in the accompanying report as a result of fee revisions that have occurred following the preparation of this figure. For current information as of September 2015, please see tables in Section 6 of the accompanying report.

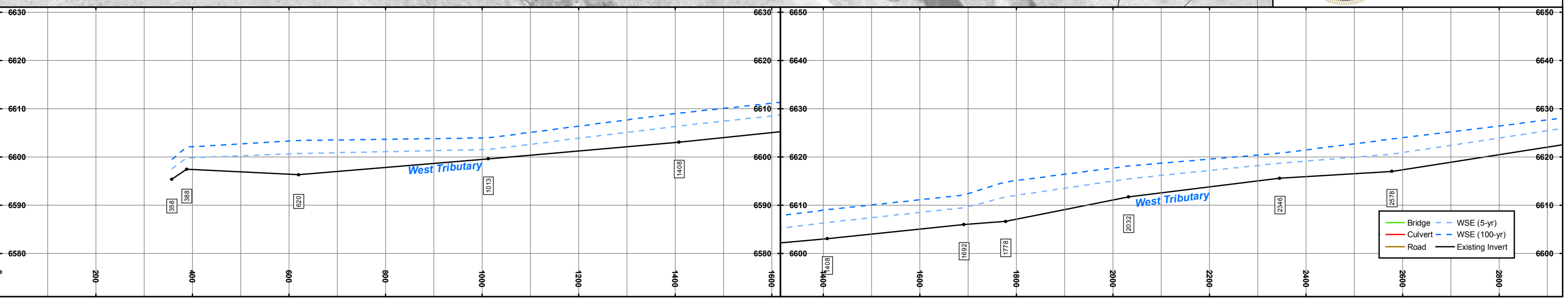

Sheet 6-3 Falcon DBPS Conceptual Plan West Tributary El Paso County, CO

- Drainageway Crossing
- Stream Centerline
- Existing Approximate 100-yr Floodplain*
- Floodplain Study Limit
- Storm Sewer**
 - Inlet
 - Manhole
 - Pipe
- Reach Improvements**
 - Natural Channel Design
 - Protect In Place
 - Roadside Ditch Improvement
 - Small Drop Structures w/ Toe Protection
 - Existing Detention
 - Proposed Detention
 - Proposed Detention Grading
 - Small Drop Structure
 - Cross Vane
 - Immediate Action Required to Preserve Existing Condition

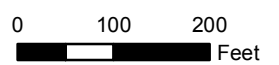

* These approximate 100-yr floodplain boundaries are for planning purposes only. This information is not intended to replace the information provided on the FEMA Flood Insurance Rate Maps for this area.
 ** These are conceptual design drawings and are subject to change. These drawings are not intended for construction purposes.

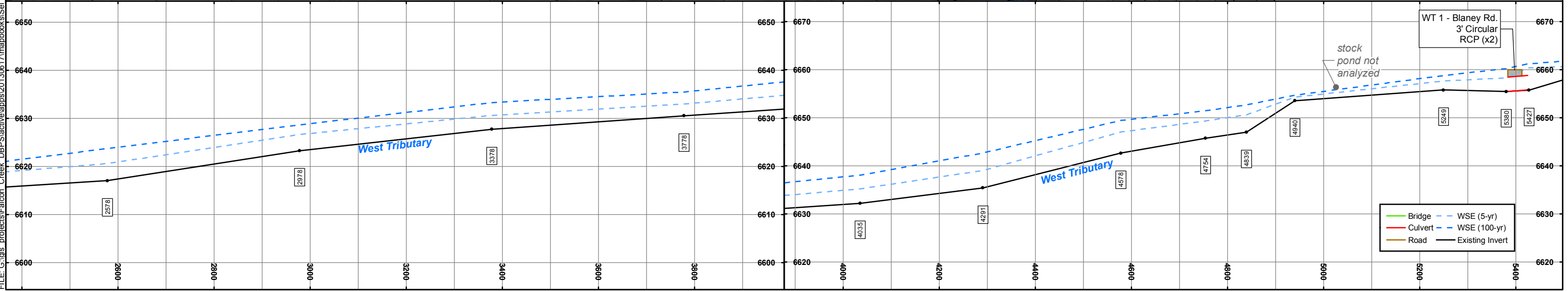
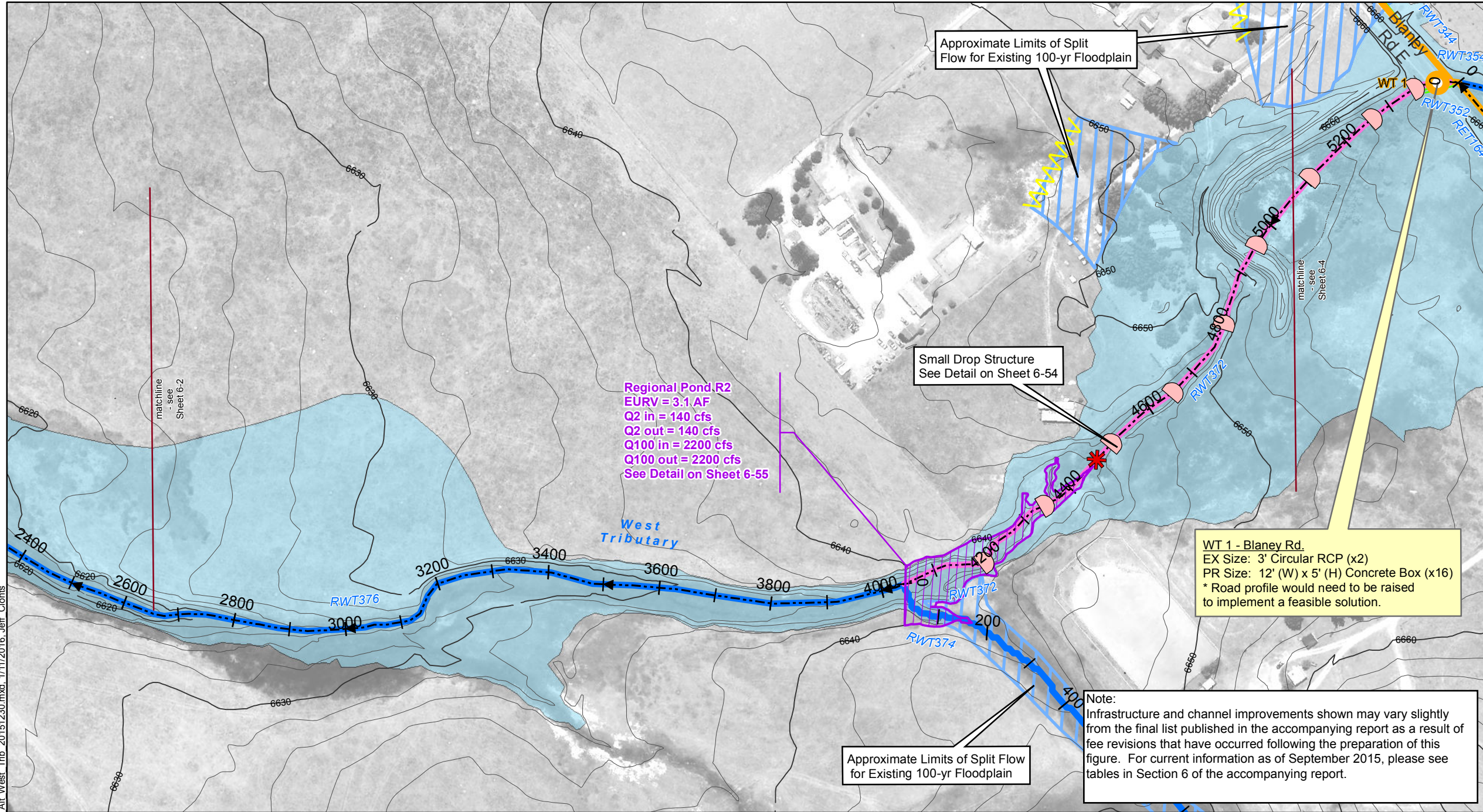

FILE: G:\gis_projects\Falcon_Creek_DBPS\active\apps\20130817\mapbook\sel_Alt_West_Trib_20151230.mxd, 1/11/2016, Jeff Clonis

Sheet 6-4 Falcon DBPS Conceptual Plan West Tributary El Paso County, CO

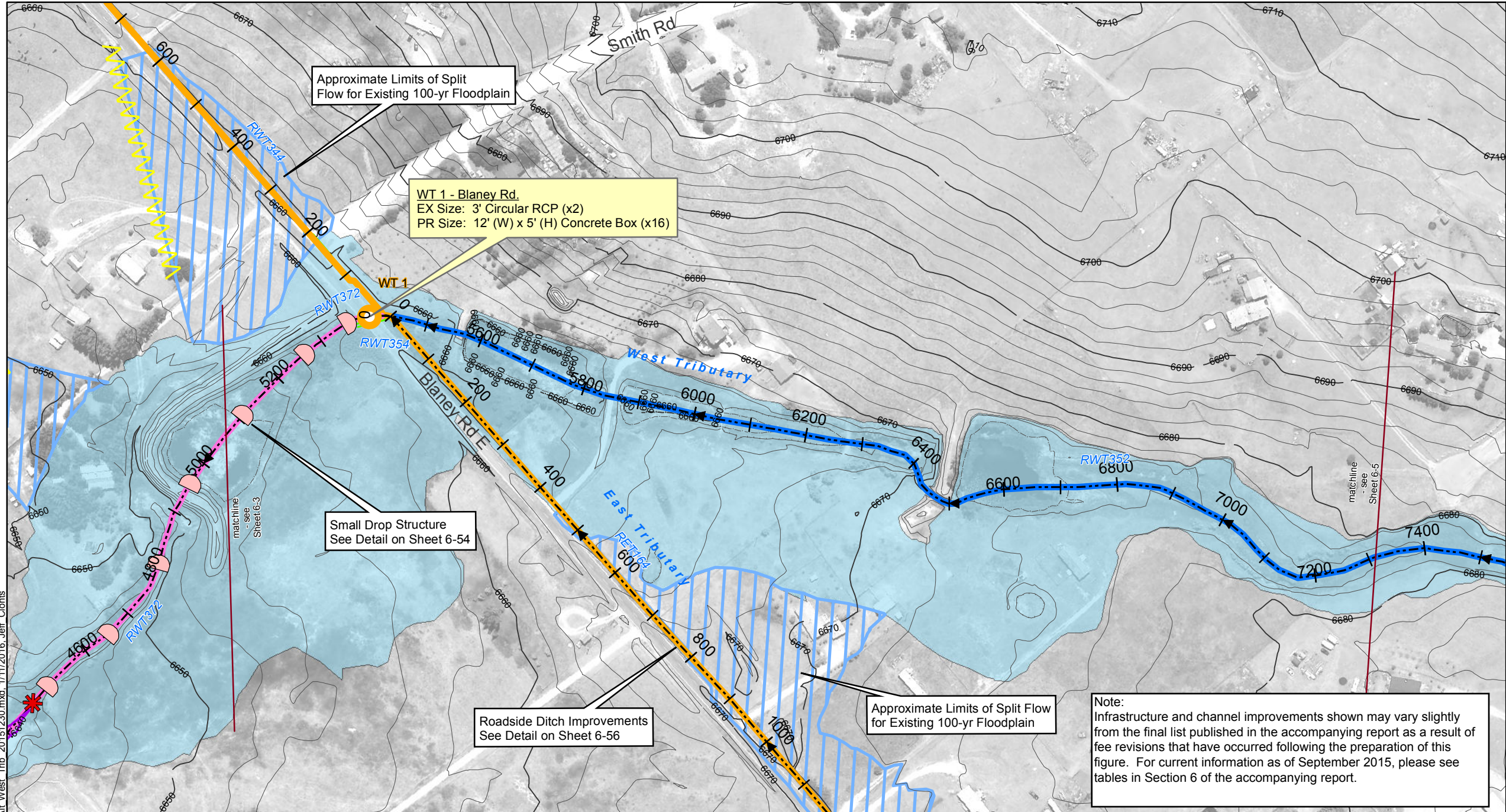

Drainageway Crossing	Reach Improvements
Stream Centerline	Natural Channel Design
Existing Approximate 100-yr Floodplain*	Protect In Place
Floodplain Study Limit	Roadside Ditch Improvement
Storm Sewer	Small Drop Structures w/ Toe Protection
Inlet	Existing Detention
Manhole	Proposed Detention
Pipe	Proposed Detention Grading
	Small Drop Structure
	Cross Vane
	Immediate Action Required to Preserve Existing Condition

0 100 200 Feet

* These approximate 100-yr floodplain boundaries are for planning purposes only. This information is not intended to replace the information provided on the FEMA Flood Insurance Rate Maps for this area.
 ** These are conceptual design drawings and are subject to change. These drawings are not intended for construction purposes.

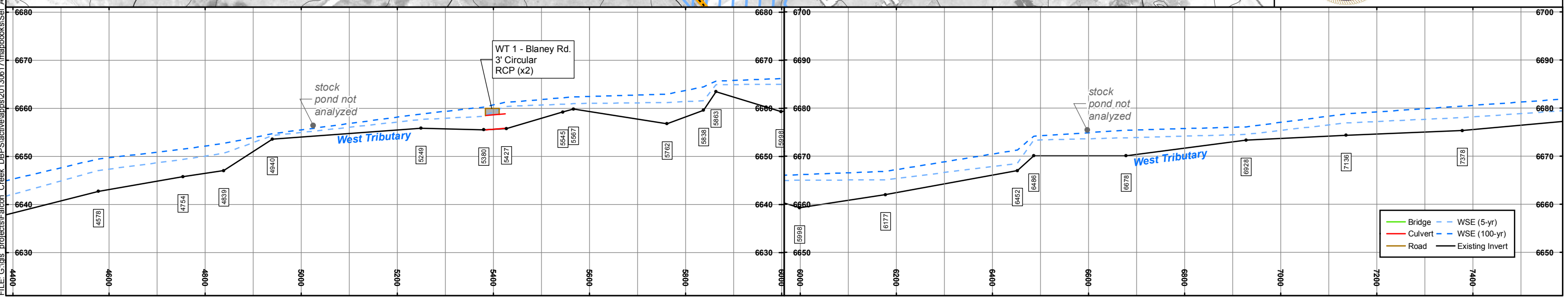
FILE: G:\gis_projects\Falcon_Creek_DBPS\active\apps\20130617\mapbooks\Set_Alt_West_Trib_20151230.mxd, 1/11/2016, Jeff Clonis

Sheet 6-5 Falcon DBPS Conceptual Plan West Tributary El Paso County, CO

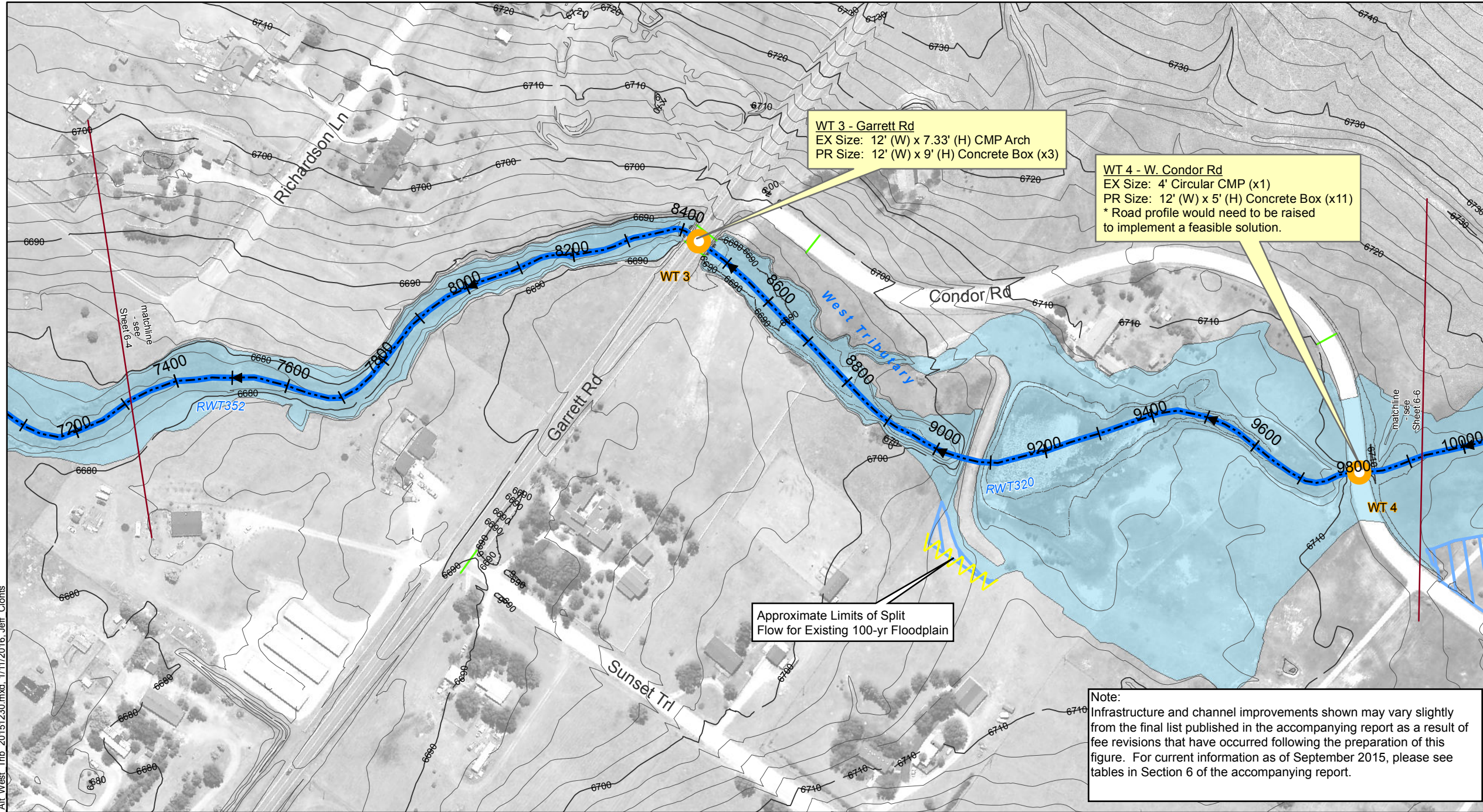

WT 3 - Garrett Rd
EX Size: 12' (W) x 7.33' (H) CMP Arch
PR Size: 12' (W) x 9' (H) Concrete Box (x3)

WT 4 - W. Condor Rd
EX Size: 4' Circular CMP (x1)
PR Size: 12' (W) x 5' (H) Concrete Box (x11)
* Road profile would need to be raised to implement a feasible solution.

Approximate Limits of Split Flow for Existing 100-yr Floodplain

Note:
Infrastructure and channel improvements shown may vary slightly from the final list published in the accompanying report as a result of fee revisions that have occurred following the preparation of this figure. For current information as of September 2015, please see tables in Section 6 of the accompanying report.

Drainageway Crossing	Reach Improvements
Stream Centerline	Natural Channel Design
Existing Approximate 100-yr Floodplain*	Protect In Place
Floodplain Study Limit	Roadside Ditch Improvement
Storm Sewer Inlet	Small Drop Structures w/ Toe Protection
Storm Sewer Manhole	Existing Detention
Storm Sewer Pipe	Proposed Detention
	Proposed Detention Grading
	Small Drop Structure
	Cross Vane
	Immediate Action Required to Preserve Existing Condition

0 100 200 Feet

* These approximate 100-yr floodplain boundaries are for planning purposes only. This information is not intended to replace the information provided on the FEMA Flood Insurance Rate Maps for this area.
** These are conceptual design drawings and are subject to change. These drawings are not intended for construction purposes.

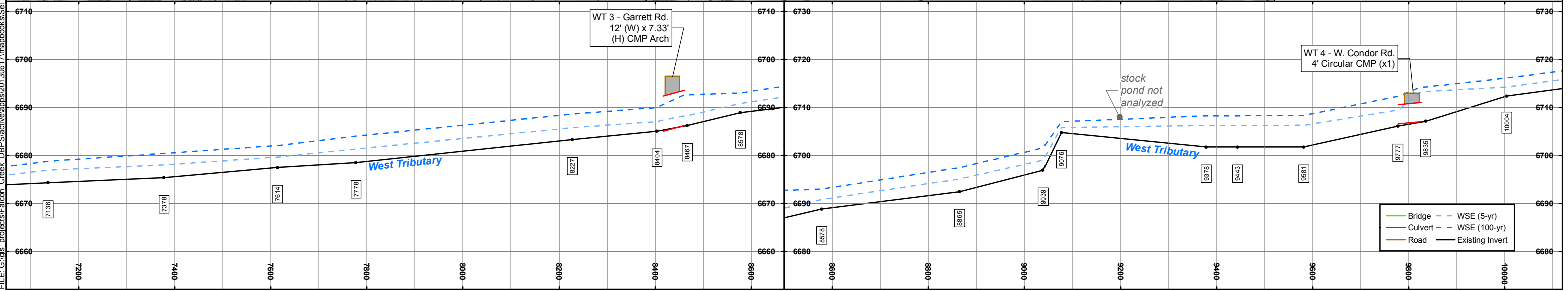

FILE: G:\gis\projects\Falcon_Creek_DBPS\active\apps\20130617\mapbooks\sel\Alt West Trib 20151230.mxd, 1/11/2016, Jeff Clonis

Sheet 6-6 Falcon DBPS Conceptual Plan West Tributary El Paso County, CO

- Drainageway Crossing
 - Stream Centerline
 - Existing Approximate 100-yr Floodplain*
 - Floodplain Study Limit
 - Storm Sewer**
 - Inlet
 - Manhole
 - Pipe
 - Reach Improvements**
 - Natural Channel Design
 - Protect In Place
 - Roadside Ditch Improvement
 - Small Drop Structures w/ Toe Protection
 - Existing Detention
 - Proposed Detention
 - Proposed Detention Grading
 - Small Drop Structure
 - Cross Vane
 - Immediate Action Required to Preserve Existing Condition
- 0 100 200 Feet

WT 4 - W. Condor Rd
EX Size: 4' Circular CMP (x1)
PR Size: 12' (W) x 5' (H) Concrete Box (x11)

Approximate Limits of Undefined Flow for Existing 100-yr Floodplain

Note:
Infrastructure and channel improvements shown may vary slightly from the final list published in the accompanying report as a result of fee revisions that have occurred following the preparation of this figure. For current information as of September 2015, please see tables in Section 6 of the accompanying report.

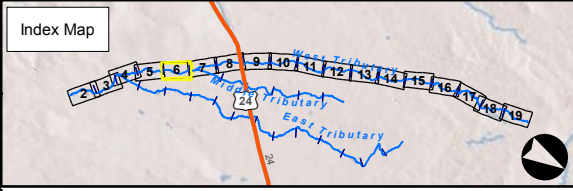

FILE: G:\gis_projects\Falcon_Creek_DBPS\active\apps\20130617\mapbooks\sel Alt West Trib 20151230.mxd, 1/11/2016, Jeff Clonis

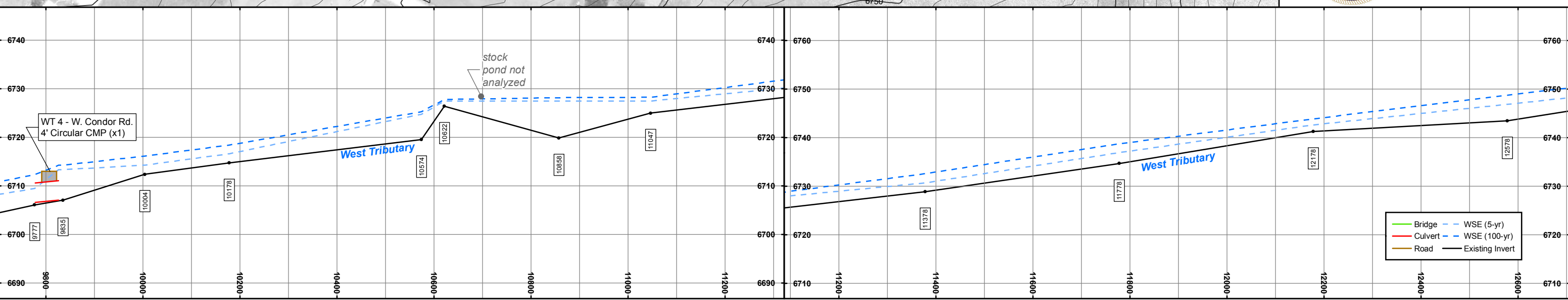

Sheet 6-7 Falcon DBPS Conceptual Plan West Tributary El Paso County, CO

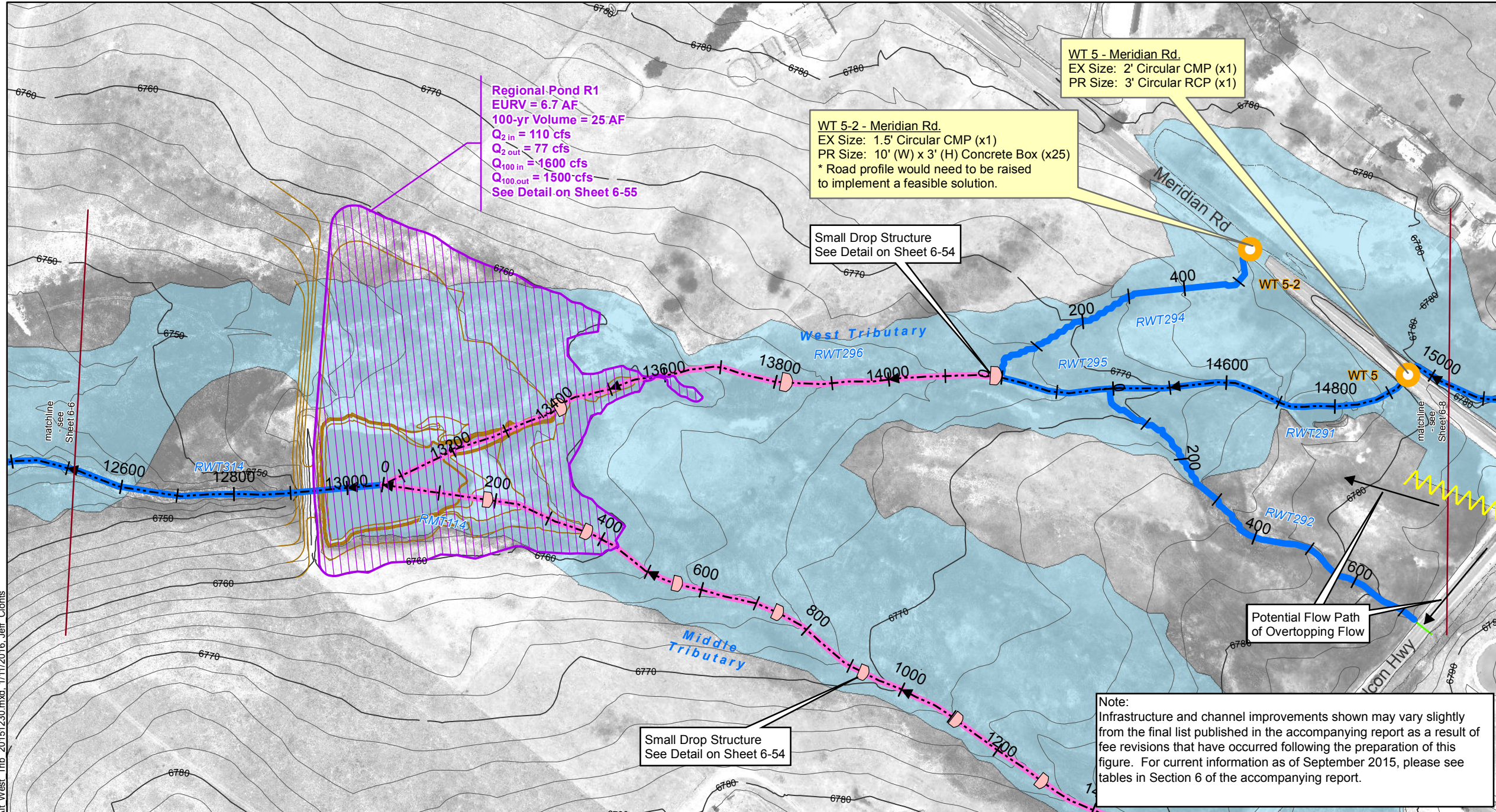

Regional Pond R1
EURV = 6.7 AF
100-yr Volume = 25 AF
Q_{2 in} = 110 cfs
Q_{2 out} = 77 cfs
Q_{100 in} = 1600 cfs
Q_{100 out} = 1500 cfs
See Detail on Sheet 6-55

WT 5-2 - Meridian Rd.
EX Size: 1.5' Circular CMP (x1)
PR Size: 10' (W) x 3' (H) Concrete Box (x25)
* Road profile would need to be raised to implement a feasible solution.

WT 5 - Meridian Rd.
EX Size: 2' Circular CMP (x1)
PR Size: 3' Circular RCP (x1)

Small Drop Structure
See Detail on Sheet 6-54

Small Drop Structure
See Detail on Sheet 6-54

Potential Flow Path of Overtopping Flow

Note:
Infrastructure and channel improvements shown may vary slightly from the final list published in the accompanying report as a result of fee revisions that have occurred following the preparation of this figure. For current information as of September 2015, please see tables in Section 6 of the accompanying report.

- | | |
|---|--|
| Drainageway Crossing | Reach Improvements |
| Stream Centerline | Natural Channel Design |
| Existing Approximate 100-yr Floodplain* | Protect In Place |
| Floodplain Study Limit | Roadside Ditch Improvement |
| Storm Sewer | Small Drop Structures w/ Toe Protection |
| Inlet | Existing Detention |
| Manhole | Proposed Detention |
| Pipe | Proposed Detention Grading |
| | Small Drop Structure |
| | Cross Vane |
| | Immediate Action Required to Preserve Existing Condition |

* These approximate 100-yr floodplain boundaries are for planning purposes only. This information is not intended to replace the information provided on the FEMA Flood Insurance Rate Maps for this area.
** These are conceptual design drawings and are subject to change. These drawings are not intended for construction purposes.

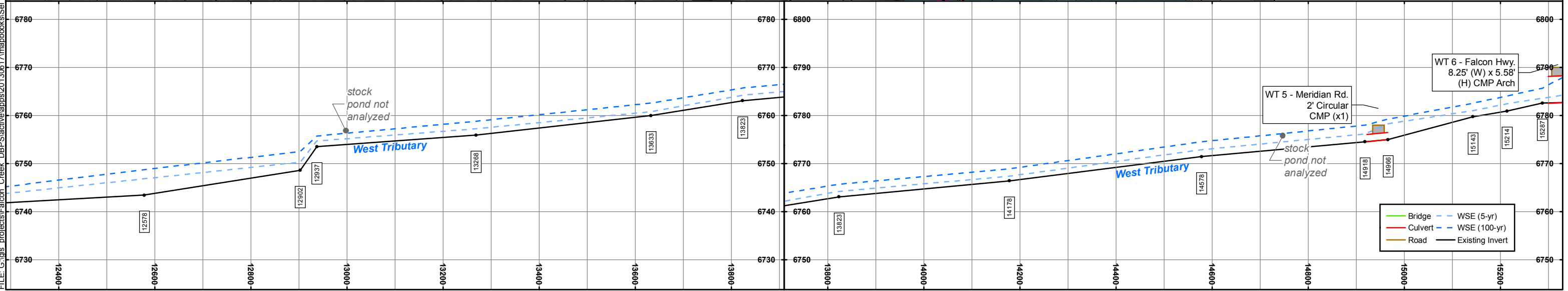
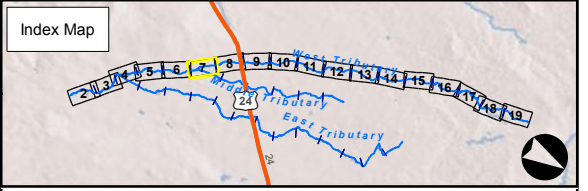

FILE: G:\dis_projects\Falcon_Creek_DBPS\active\apps\20130617\mapbook\sel_Alt_West_Trib_20151230.mxd, 1/11/2016, Jeff Clonis

Sheet 6-8 Falcon DBPS Conceptual Plan West Tributary El Paso County, CO

- Drainageway Crossing
- Stream Centerline
- Existing Approximate 100-yr Floodplain*
- Floodplain Study Limit
- Storm Sewer Inlet
- Storm Sewer Manhole
- Storm Sewer Pipe
- Reach Improvements Natural Channel Design
- Reach Improvements Protect In Place
- Reach Improvements Roadside Ditch Improvement
- Reach Improvements Small Drop Structures w/ Toe Protection Existing Detention
- Reach Improvements Proposed Detention
- Reach Improvements Proposed Detention Grading
- Reach Improvements Small Drop Structure
- Reach Improvements Cross Vane
- Immediate Action Required to Preserve Existing Condition

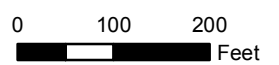

* These approximate 100-yr floodplain boundaries are for planning purposes only. This information is not intended to replace the information provided on the FEMA Flood Insurance Rate Maps for this area.
 ** These are conceptual design drawings and are subject to change. These drawings are not intended for construction purposes.

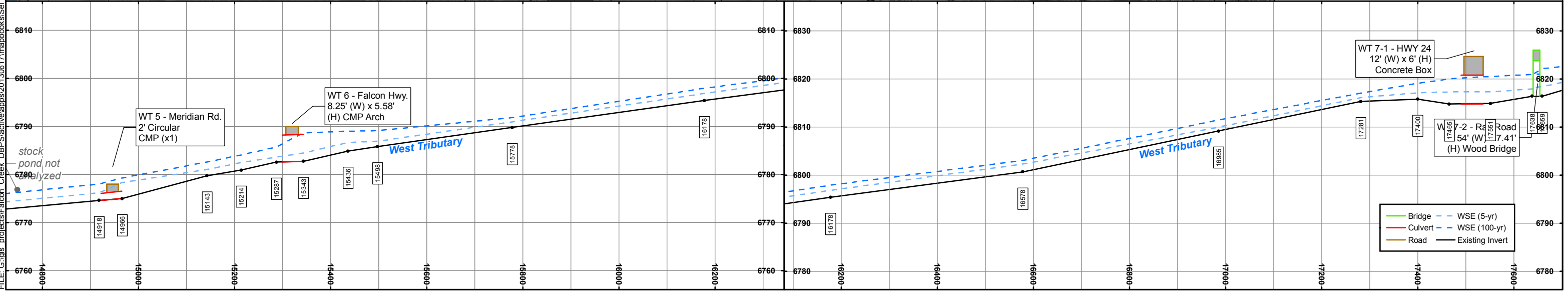
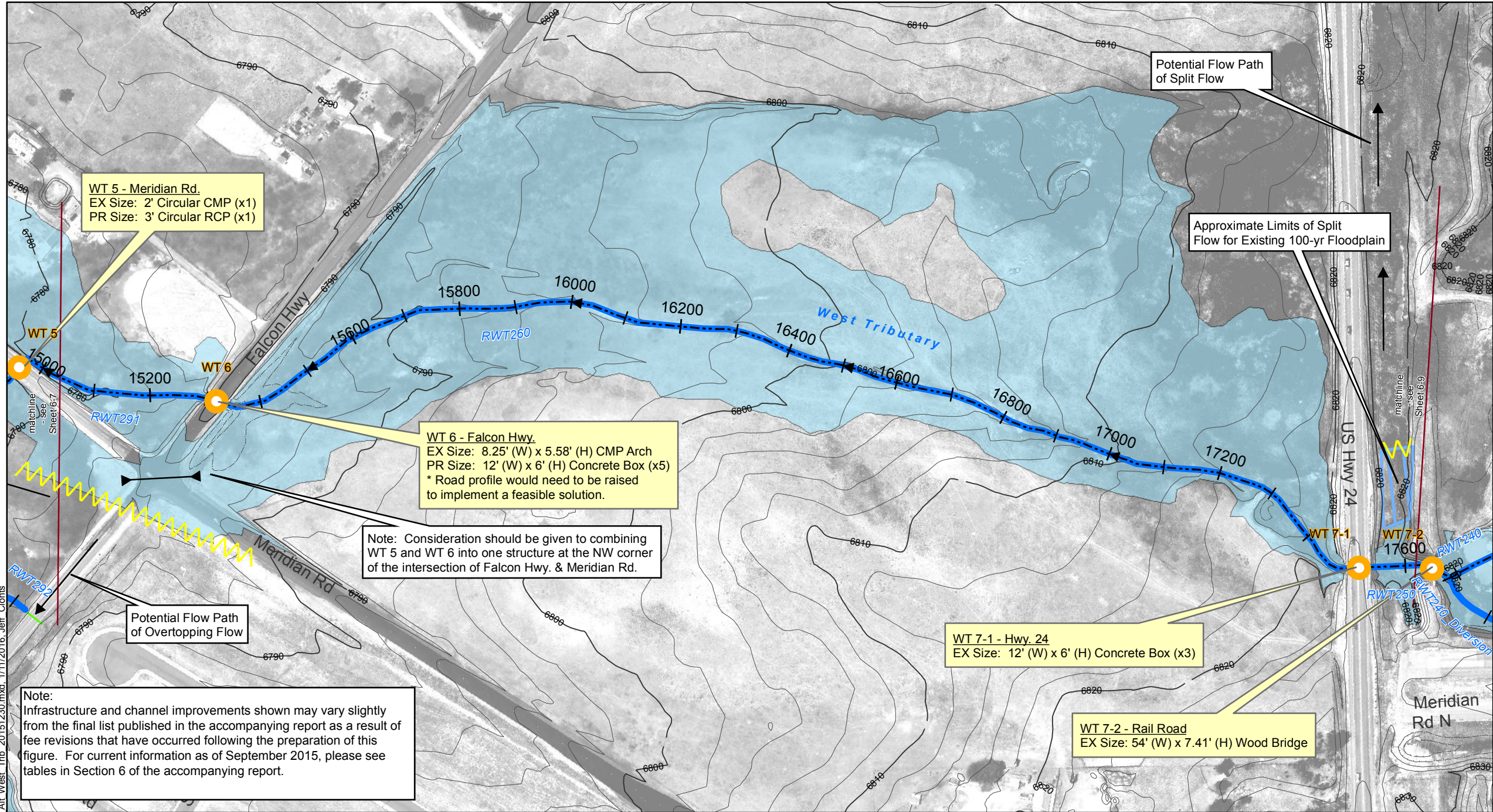

FILE: G:\gis\projects\Falcon_Creek_DBPS\active\apps\20130617\mapbooks\sel\Alt West Trib. 20151230.mxd, 1/11/2016, Jeff Clonis

Sheet 6-9 Falcon DBPS Conceptual Plan West Tributary El Paso County, CO

- Drainageway Crossing
 - Stream Centerline
 - Existing Approximate 100-yr Floodplain*
 - Floodplain Study Limit
 - Storm Sewer**
 - Inlet
 - Manhole
 - Pipe
 - Reach Improvements**
 - Natural Channel Design
 - Protect In Place
 - Roadside Ditch Improvement
 - Small Drop Structures w/ Toe Protection
 - Existing Detention
 - Proposed Detention
 - Proposed Detention Grading
 - Small Drop Structure
 - Cross Vane
 - Immediate Action Required to Preserve Existing Condition
- 0 100 200 Feet

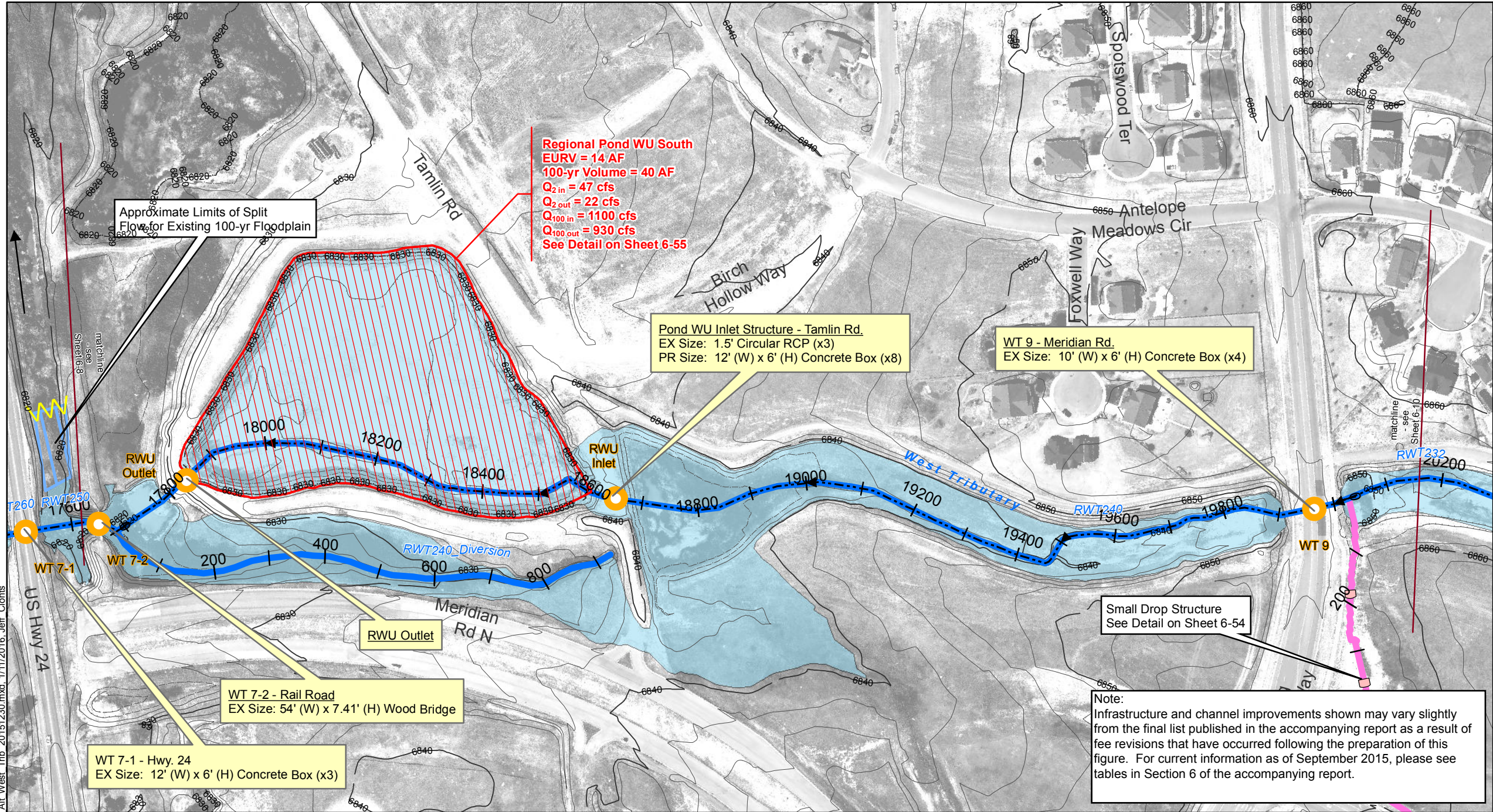

* These approximate 100-yr floodplain boundaries are for planning purposes only. This information is not intended to replace the information provided on the FEMA Flood Insurance Rate Maps for this area.
** These are conceptual design drawings and are subject to change. These drawings are not intended for construction purposes.

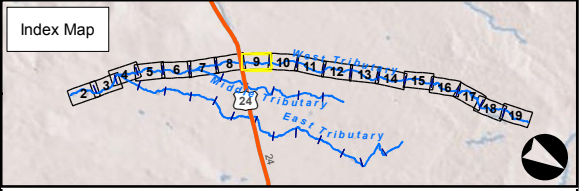

Note:
Infrastructure and channel improvements shown may vary slightly from the final list published in the accompanying report as a result of fee revisions that have occurred following the preparation of this figure. For current information as of September 2015, please see tables in Section 6 of the accompanying report.

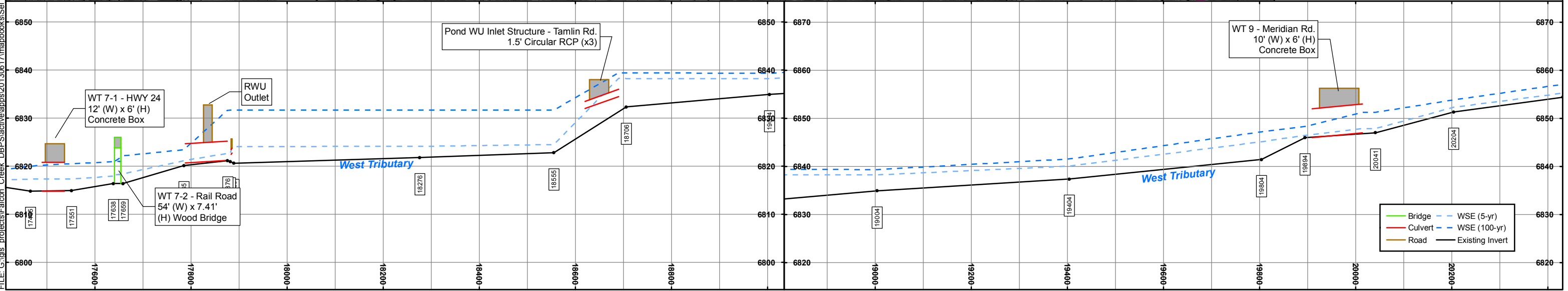

FILE: G:\gis\projects\Falcon_Creek_DBPS\active\apps\20130817\mapbook\sel\Alt West Trib. 20151230.mxd, 1/11/2016, Jeff Clonits

Sheet 6-10

Falcon DBPS

Conceptual Plan

West Tributary

El Paso County, CO

- Drainageway Crossing
 - Stream Centerline
 - Existing Approximate 100-yr Floodplain*
 - Floodplain Study Limit
 - Storm Sewer**
 - Inlet
 - Manhole
 - Pipe
 - Reach Improvements**
 - Natural Channel Design
 - Protect In Place
 - Roadside Ditch Improvement
 - Small Drop Structures w/ Toe Protection
 - Existing Detention
 - Proposed Detention
 - Proposed Detention Grading
 - Small Drop Structure
 - Cross Vane
 - Immediate Action Required to Preserve Existing Condition
- 0 100 200 Feet

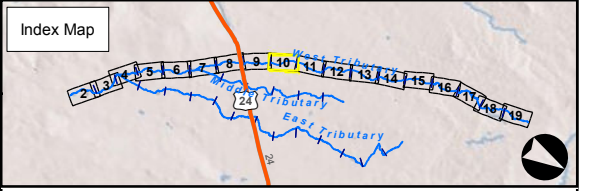
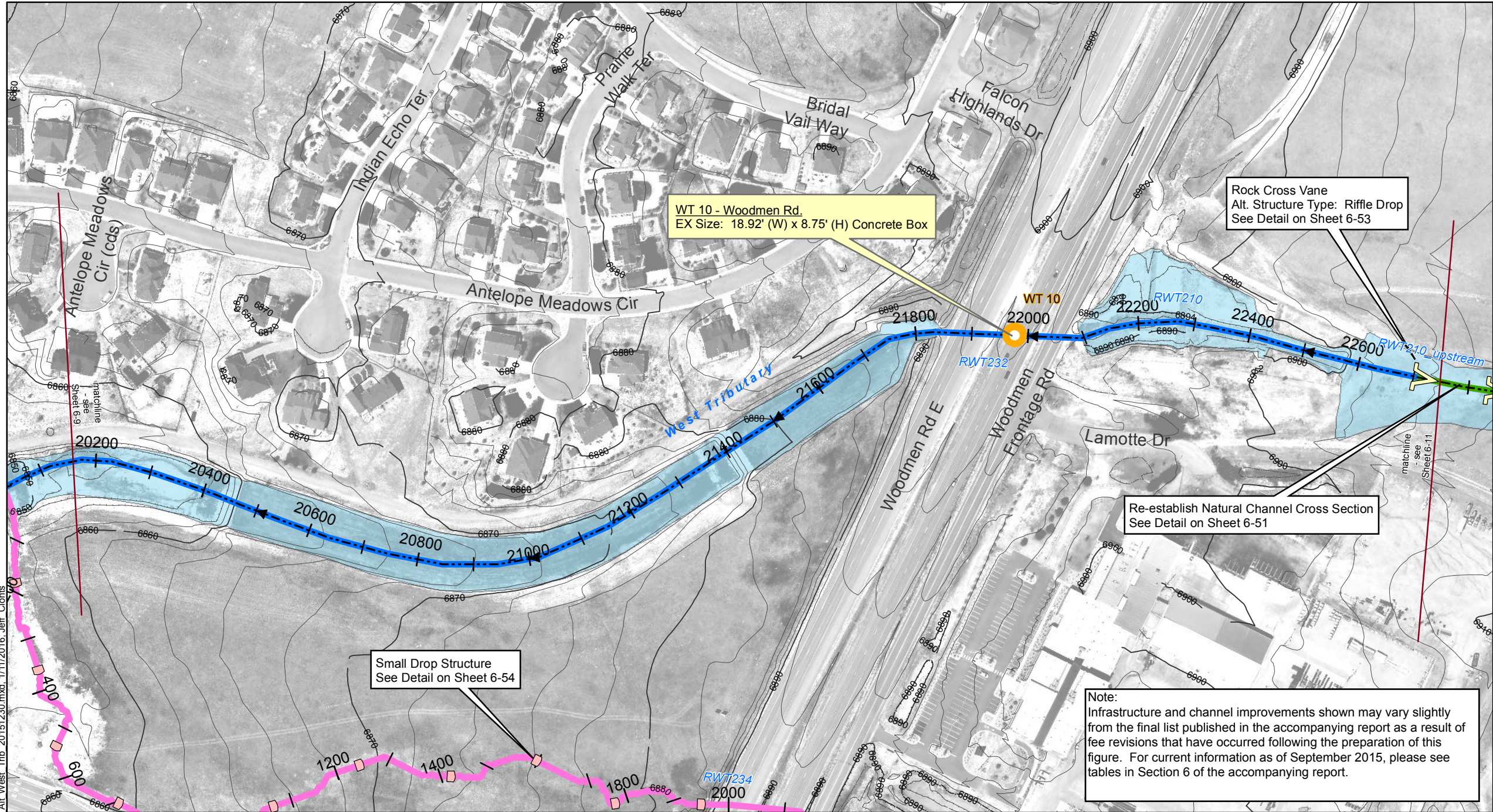

Note:
 Infrastructure and channel improvements shown may vary slightly from the final list published in the accompanying report as a result of fee revisions that have occurred following the preparation of this figure. For current information as of September 2015, please see tables in Section 6 of the accompanying report.

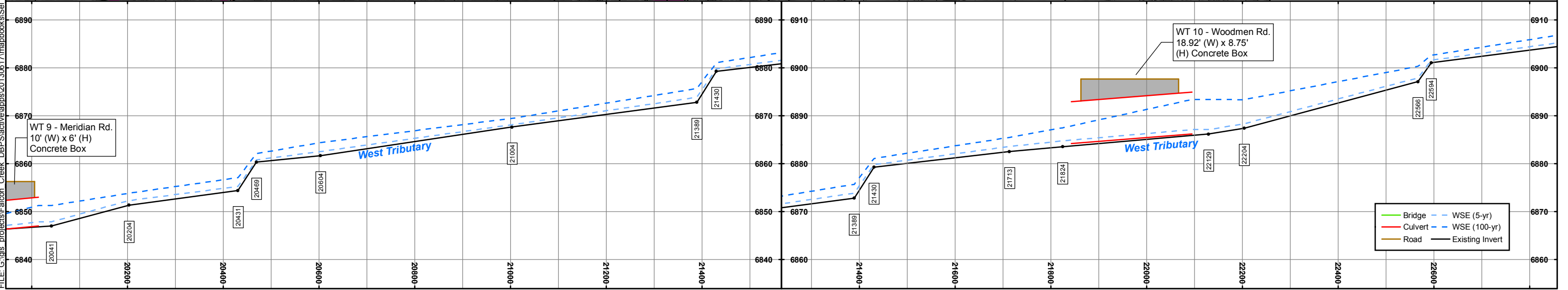

Sheet 6-11
Falcon DBPS
Conceptual Plan
West Tributary
El Paso County, CO

- | | |
|---|--|
| Drainageway Crossing | Reach Improvements
Natural Channel Design |
| Stream Centerline | Protect In Place |
| Existing Approximate 100-yr Floodplain* | Roadside Ditch Improvement |
| Floodplain Study Limit | Small Drop Structures w/ Toe Protection |
| Storm Sewer | Existing Detention |
| Inlet | Proposed Detention |
| Manhole | Proposed Detention Grading |
| Pipe | Small Drop Structure |
| | Cross Vane |
| | Immediate Action Required to Preserve Existing Condition |

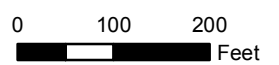

* These approximate 100-yr floodplain boundaries are for planning purposes only. This information is not intended to replace the information provided on the FEMA Flood Insurance Rate Maps for this area.
 ** These are conceptual design drawings and are subject to change. These drawings are not intended for construction purposes.

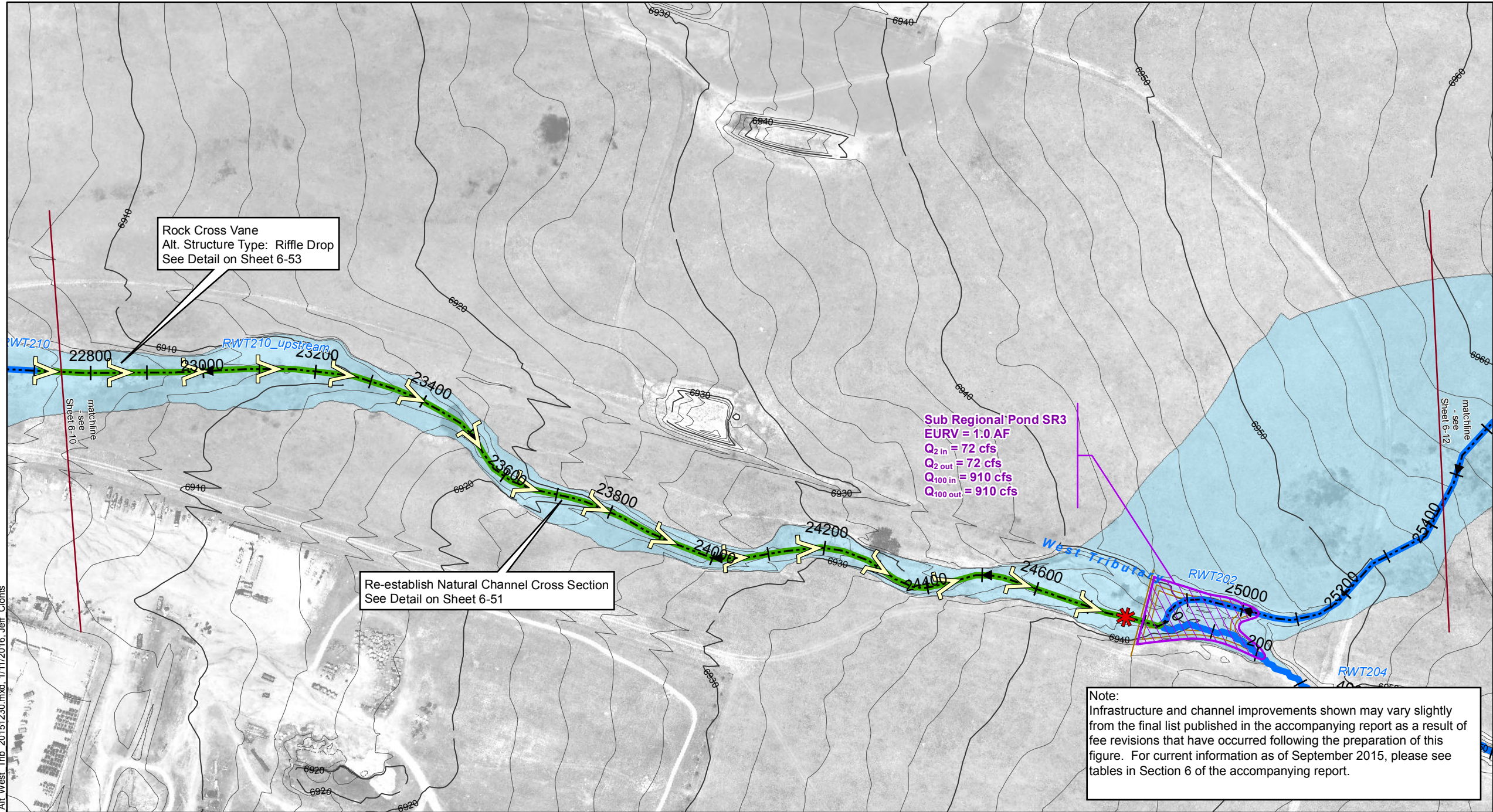
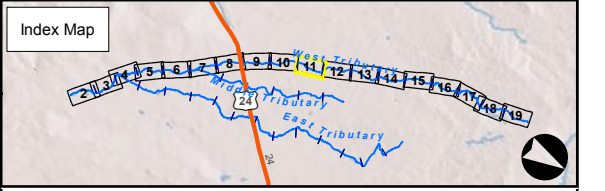

Rock Cross Vane
 Alt. Structure Type: Riffle Drop
 See Detail on Sheet 6-53

Sub Regional Pond SR3
 EURV = 1:0 AF
 Q_{2 in} = 72 cfs
 Q_{2 out} = 72 cfs
 Q_{100 in} = 910 cfs
 Q_{100 out} = 910 cfs

Re-establish Natural Channel Cross Section
 See Detail on Sheet 6-51

Note:
 Infrastructure and channel improvements shown may vary slightly from the final list published in the accompanying report as a result of fee revisions that have occurred following the preparation of this figure. For current information as of September 2015, please see tables in Section 6 of the accompanying report.

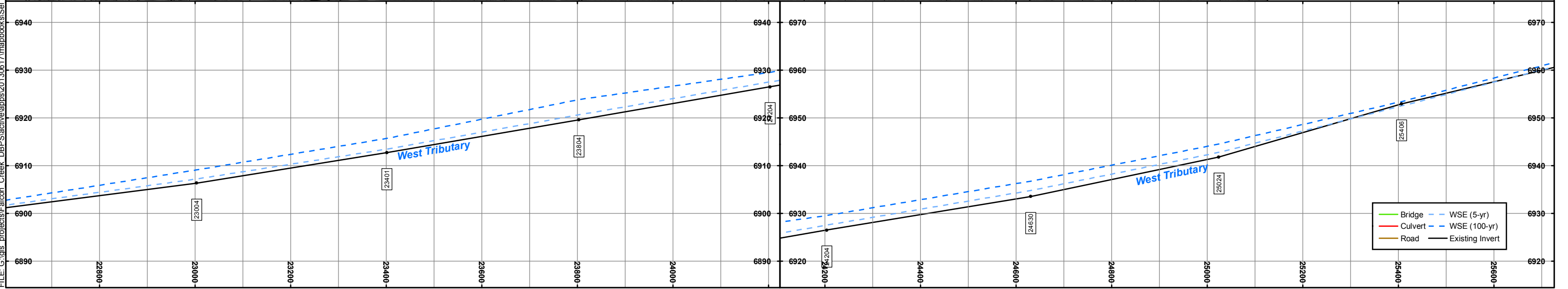

FILE: G:\gis_projects\Falcon_Creek_DBPS\active\apps\20130817\mapbooks\sel_Alt_West_Trib_20151230.mxd, 1/11/2016, Jeff Clonis

Sheet 6-12 Falcon DBPS Conceptual Plan West Tributary El Paso County, CO

- Drainageway Crossing
 - Stream Centerline
 - Existing Approximate 100-yr Floodplain*
 - Floodplain Study Limit
 - Storm Sewer**
 - Inlet
 - Manhole
 - Pipe
 - Reach Improvements**
 - Natural Channel Design
 - Protect In Place
 - Roadside Ditch Improvement
 - Small Drop Structures w/ Toe Protection
 - Existing Detention
 - Proposed Detention
 - Proposed Detention Grading
 - Small Drop Structure
 - Cross Vane
 - Immediate Action Required to Preserve Existing Condition
- 0 100 200 Feet

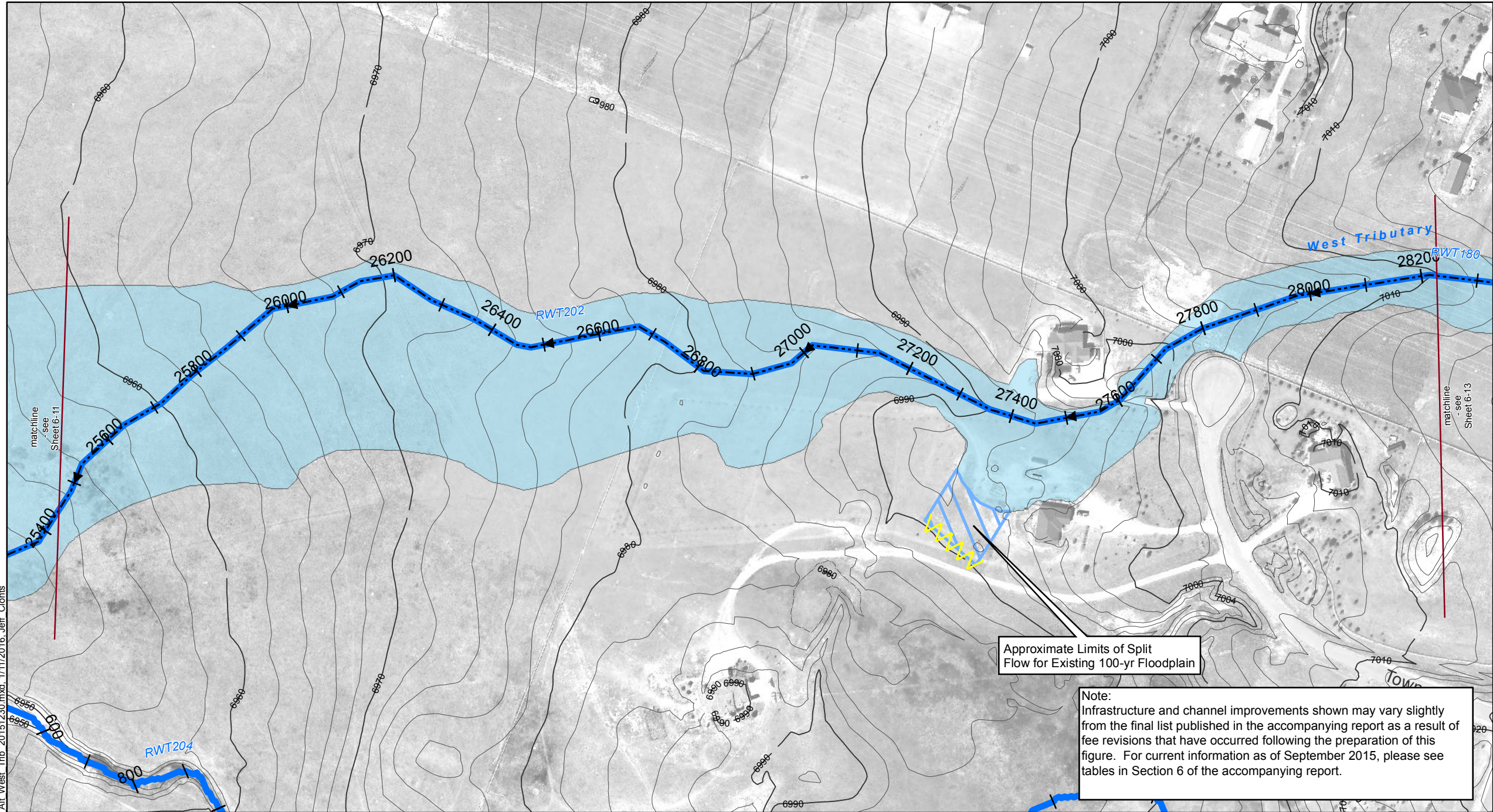

Approximate Limits of Split Flow for Existing 100-yr Floodplain

Note:
Infrastructure and channel improvements shown may vary slightly from the final list published in the accompanying report as a result of fee revisions that have occurred following the preparation of this figure. For current information as of September 2015, please see tables in Section 6 of the accompanying report.

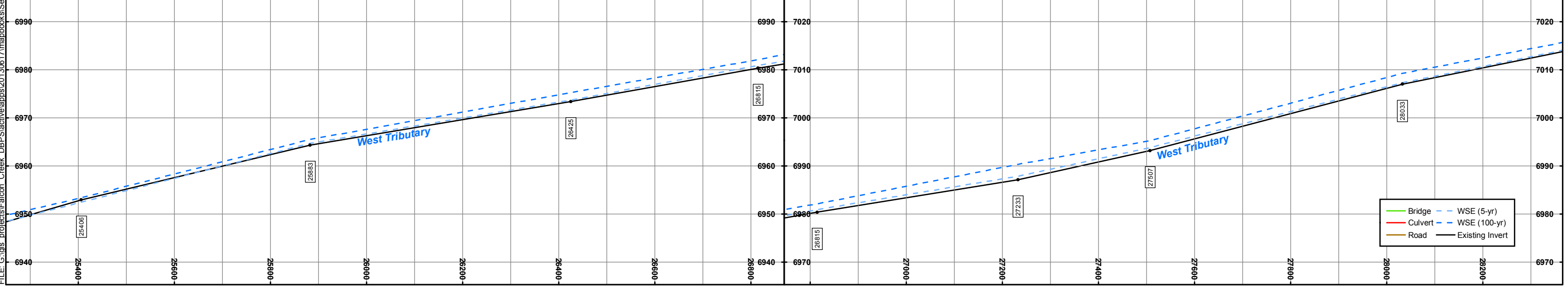

FILE: G:\gis_projects\Falcon_Creek_DBPS\active\apps\20130617\mapbooks\sel_Alt_West_Trib_20151230.mxd, 1/11/2016, Jeff Clontis

Sheet 6-13 Falcon DBPS Conceptual Plan West Tributary El Paso County, CO

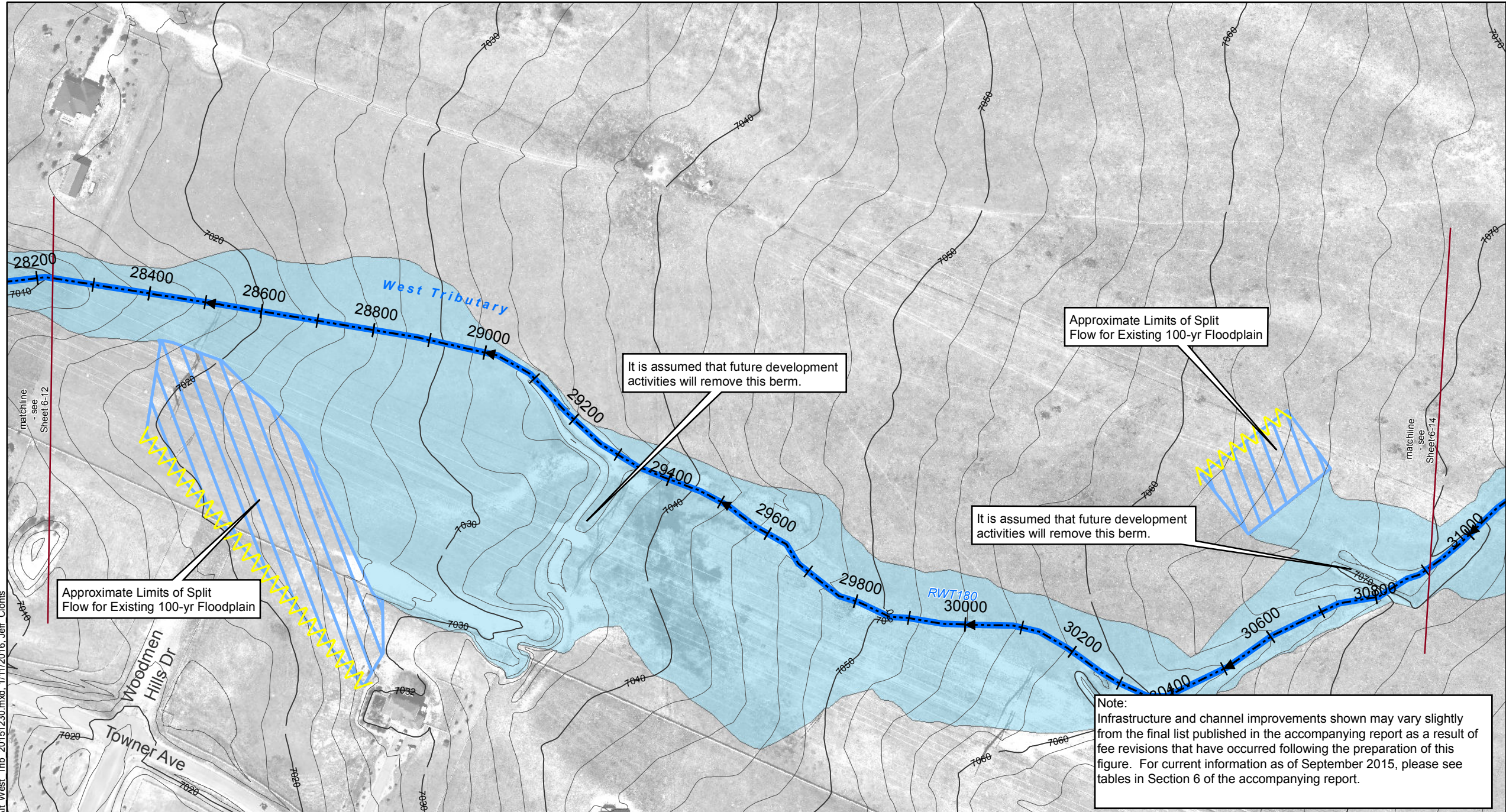

- Drainageway Crossing
- Stream Centerline
- Existing Approximate 100-yr Floodplain*
- Floodplain Study Limit
- Storm Sewer**
 - Inlet
 - Manhole
 - Pipe
- Reach Improvements**
 - Natural Channel Design
 - Protect In Place
 - Roadside Ditch Improvement
 - Small Drop Structures w/ Toe Protection
 - Existing Detention
 - Proposed Detention
 - Proposed Detention Grading
 - Small Drop Structure
 - Cross Vane
 - Immediate Action Required to Preserve Existing Condition



* These approximate 100-yr floodplain boundaries are for planning purposes only. This information is not intended to replace the information provided on the FEMA Flood Insurance Rate Maps for this area.
** These are conceptual design drawings and are subject to change. These drawings are not intended for construction purposes.



Approximate Limits of Split Flow for Existing 100-yr Floodplain

It is assumed that future development activities will remove this berm.

Approximate Limits of Split Flow for Existing 100-yr Floodplain

It is assumed that future development activities will remove this berm.

Note:
Infrastructure and channel improvements shown may vary slightly from the final list published in the accompanying report as a result of fee revisions that have occurred following the preparation of this figure. For current information as of September 2015, please see tables in Section 6 of the accompanying report.

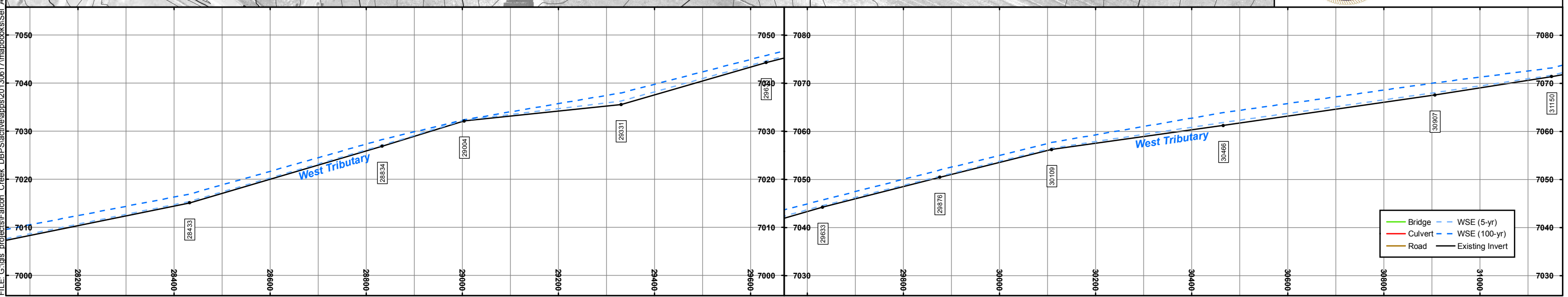

FILE: G:\gis_projects\Falcon_Creek_DBPS\active\apps\20130617\mapbooks\sel Alt West Trib 20151230.mxd, 1/11/2016, Jeff Clonis

Sheet 6-14 Falcon DBPS Conceptual Plan West Tributary El Paso County, CO

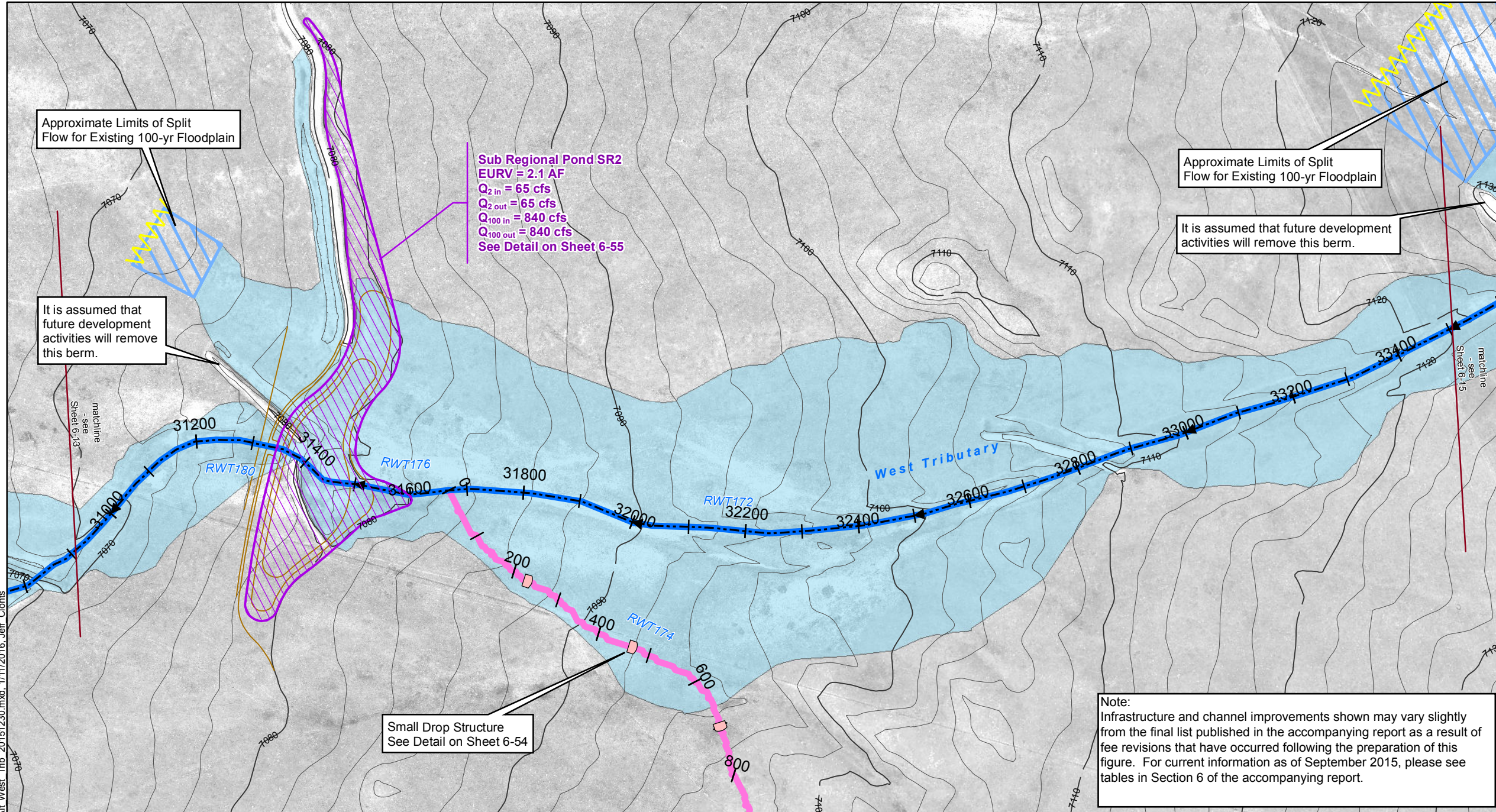

- Drainageway Crossing**
- Orange circle: Drainageway Crossing
- Stream Centerline**
- Black dashed line: Stream Centerline
- Existing Approximate 100-yr Floodplain***
- Light blue shaded area: Existing Approximate 100-yr Floodplain*
- Floodplain Study Limit**
- Yellow wavy line: Floodplain Study Limit
- Storm Sewer**
- Green square: Inlet
 - Green circle: Manhole
 - Green line: Pipe
- Reach Improvements**
- Green line: Natural Channel Design
 - Blue line: Protect In Place
 - Orange line: Roadside Ditch Improvement
 - Pink line: Small Drop Structures w/ Toe Protection
 - Red hatched box: Existing Detention
 - Purple hatched box: Proposed Detention
 - Orange line: Proposed Detention Grading
 - Pink box: Small Drop Structure
 - Yellow box: Cross Vane
 - Red star: Immediate Action Required to Preserve Existing Condition
- 0 100 200 Feet

* These approximate 100-yr floodplain boundaries are for planning purposes only. This information is not intended to replace the information provided on the FEMA Flood Insurance Rate Maps for this area.
** These are conceptual design drawings and are subject to change. These drawings are not intended for construction purposes.

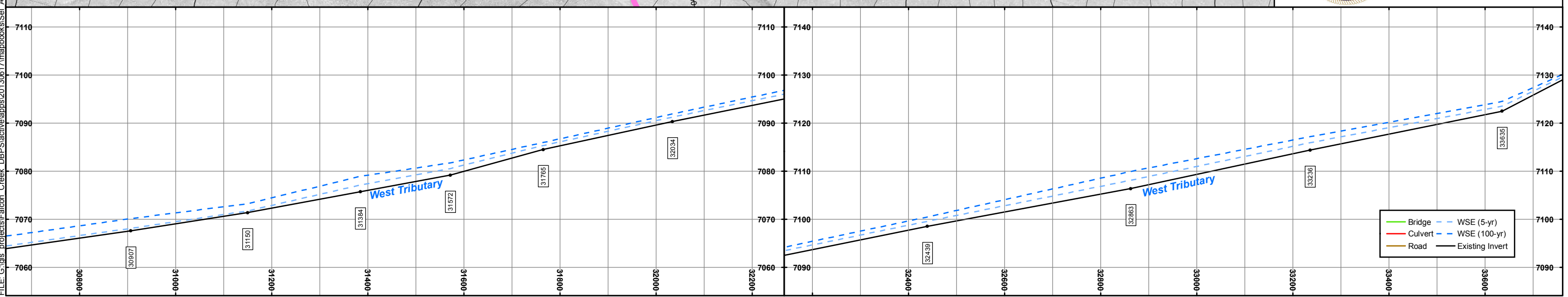

FILE: G:\gis\projects\Falcon_Creek_DBPS\active\apps\20130617\mapbook\sel_Alt_West_Trib_20151230.mxd, 1/11/2016, Jeff Clontis

Sheet 6-15 Falcon DBPS Conceptual Plan West Tributary El Paso County, CO

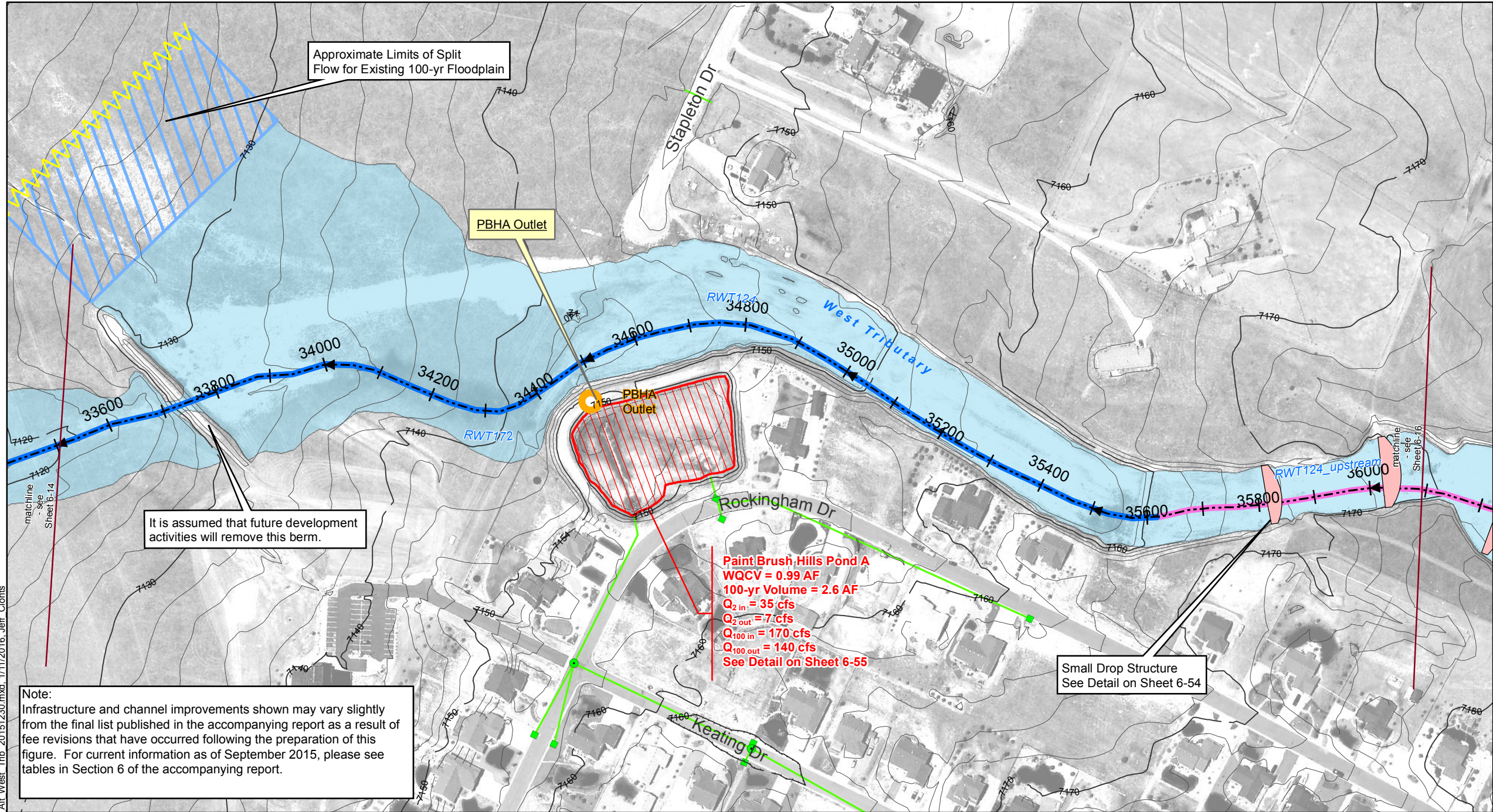

Drainageway Crossing	Reach Improvements Natural Channel Design
Stream Centerline	Protect In Place
Existing Approximate 100-yr Floodplain*	Roadside Ditch Improvement
Floodplain Study Limit	Small Drop Structures w/ Toe Protection
Storm Sewer	Existing Detention
Inlet	Proposed Detention
Manhole	Proposed Detention Grading
Pipe	Small Drop Structure
	Cross Vane
	Immediate Action Required to Preserve Existing Condition

0 100 200 Feet

* These approximate 100-yr floodplain boundaries are for planning purposes only. This information is not intended to replace the information provided on the FEMA Flood Insurance Rate Maps for this area.
** These are conceptual design drawings and are subject to change. These drawings are not intended for construction purposes.



Approximate Limits of Split Flow for Existing 100-yr Floodplain

PBHA Outlet

PBHA Outlet

Rockingham Dr

Paint Brush Hills Pond A
 WQCV = 0.99 AF
 100-yr Volume = 2.6 AF
 Q_{2 in} = 35 cfs
 Q_{2 out} = 7 cfs
 Q_{100 in} = 170 cfs
 Q_{100 out} = 140 cfs
 See Detail on Sheet 6-55

Small Drop Structure
See Detail on Sheet 6-54

It is assumed that future development activities will remove this berm.

Note:
Infrastructure and channel improvements shown may vary slightly from the final list published in the accompanying report as a result of fee revisions that have occurred following the preparation of this figure. For current information as of September 2015, please see tables in Section 6 of the accompanying report.

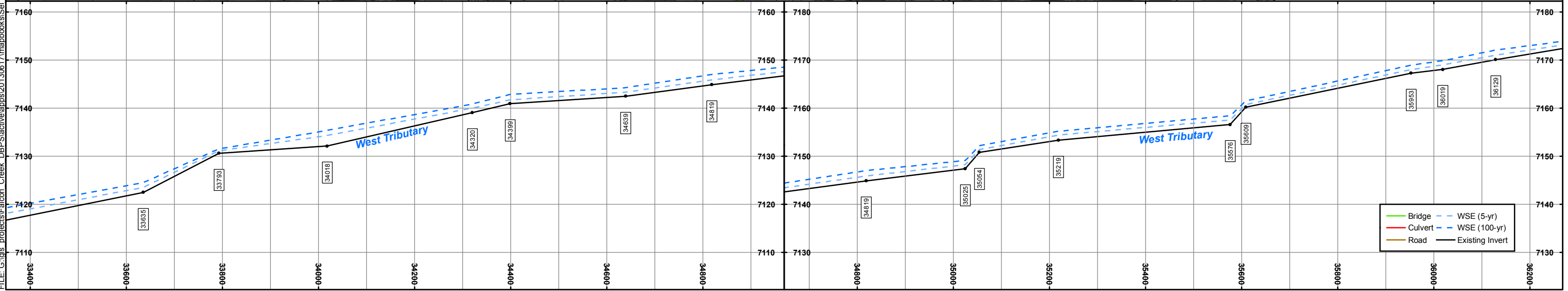

FILE: G:\gis_projects\Falcon_Creek_DBPS\active\apps\20130617\mapbooks\sel_Alt_West_Trib_20151230.mxd, 1/11/2016, Jeff Clonis

Sheet 6-16 Falcon DBPS Conceptual Plan West Tributary El Paso County, CO

- Drainageway Crossing
 - Stream Centerline
 - Existing Approximate 100-yr Floodplain*
 - Floodplain Study Limit
 - Storm Sewer**
 - Inlet
 - Manhole
 - Pipe
 - Reach Improvements**
 - Natural Channel Design
 - Protect In Place
 - Roadside Ditch Improvement
 - Small Drop Structures w/ Toe Protection
 - Existing Detention
 - Proposed Detention
 - Proposed Detention Grading
 - Small Drop Structure
 - Cross Vane
 - Immediate Action Required to Preserve Existing Condition
- 0 100 200 Feet

Show and label property boundary, limits of proposed changes...

Small Drop Structure
See Detail on Sheet 6-54

Paint Brush Hills Pond C
EURV = 2.2 AF
100-yr Volume = 6.8 AF
Q_{2 in} = 56 cfs
Q_{2 out} = 3 cfs
Q_{100 in} = 300 cfs
Q_{100 out} = 140 cfs
See Detail on Sheet 6-55

PBHC Outlet

Note:
Infrastructure and channel improvements shown may vary slightly from the final list published in the accompanying report as a result of fee revisions that have occurred following the preparation of this figure. For current information as of September 2015, please see tables in Section 6 of the accompanying report.

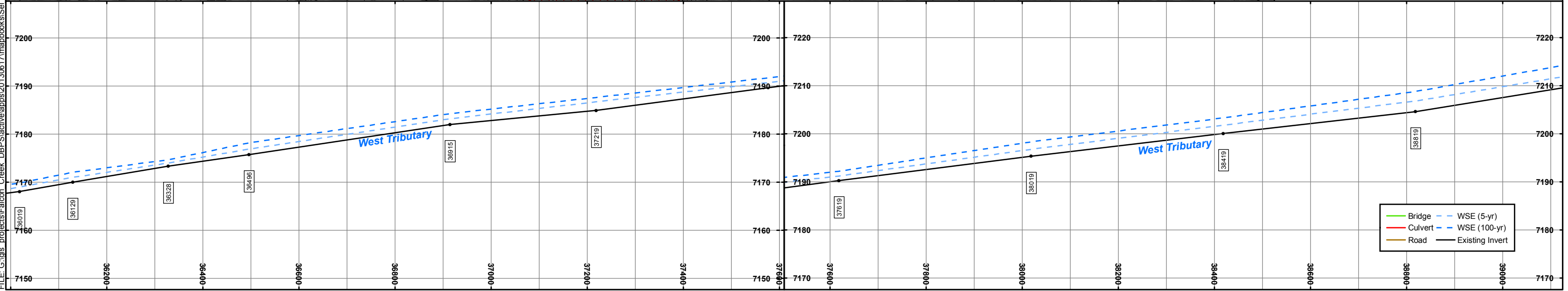
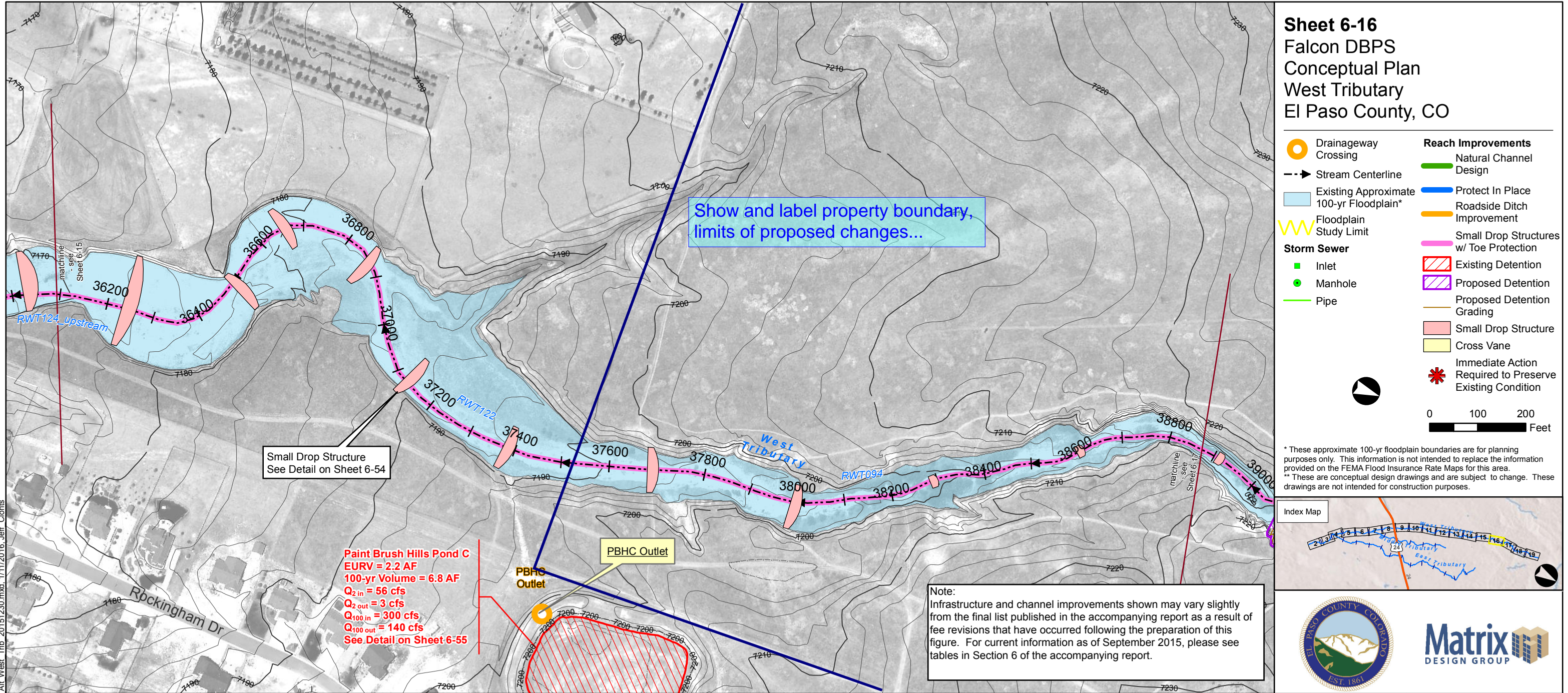
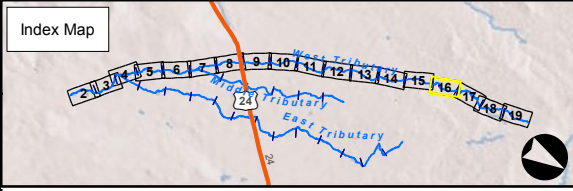

FILE: G:\gis_projects\Falcon_Creek_DBPS\active\apps\20130617\mapbooks\sel_Alt_West_Trib_20151230.mxd, 1/11/2016, Jeff Clonis

Sheet 6-17 Falcon DBPS Conceptual Plan West Tributary El Paso County, CO

- | | |
|---|--|
| Drainageway Crossing | Reach Improvements |
| Stream Centerline | Natural Channel Design |
| Existing Approximate 100-yr Floodplain* | Protect In Place |
| Floodplain Study Limit | Roadside Ditch Improvement |
| Storm Sewer | Small Drop Structures w/ Toe Protection |
| Inlet | Existing Detention |
| Manhole | Proposed Detention |
| Pipe | Proposed Detention Grading |
| | Small Drop Structure |
| | Cross Vane |
| | Immediate Action Required to Preserve Existing Condition |
- 0 100 200 Feet

* These approximate 100-yr floodplain boundaries are for planning purposes only. This information is not intended to replace the information provided on the FEMA Flood Insurance Rate Maps for this area.
** These are conceptual design drawings and are subject to change. These drawings are not intended for construction purposes.

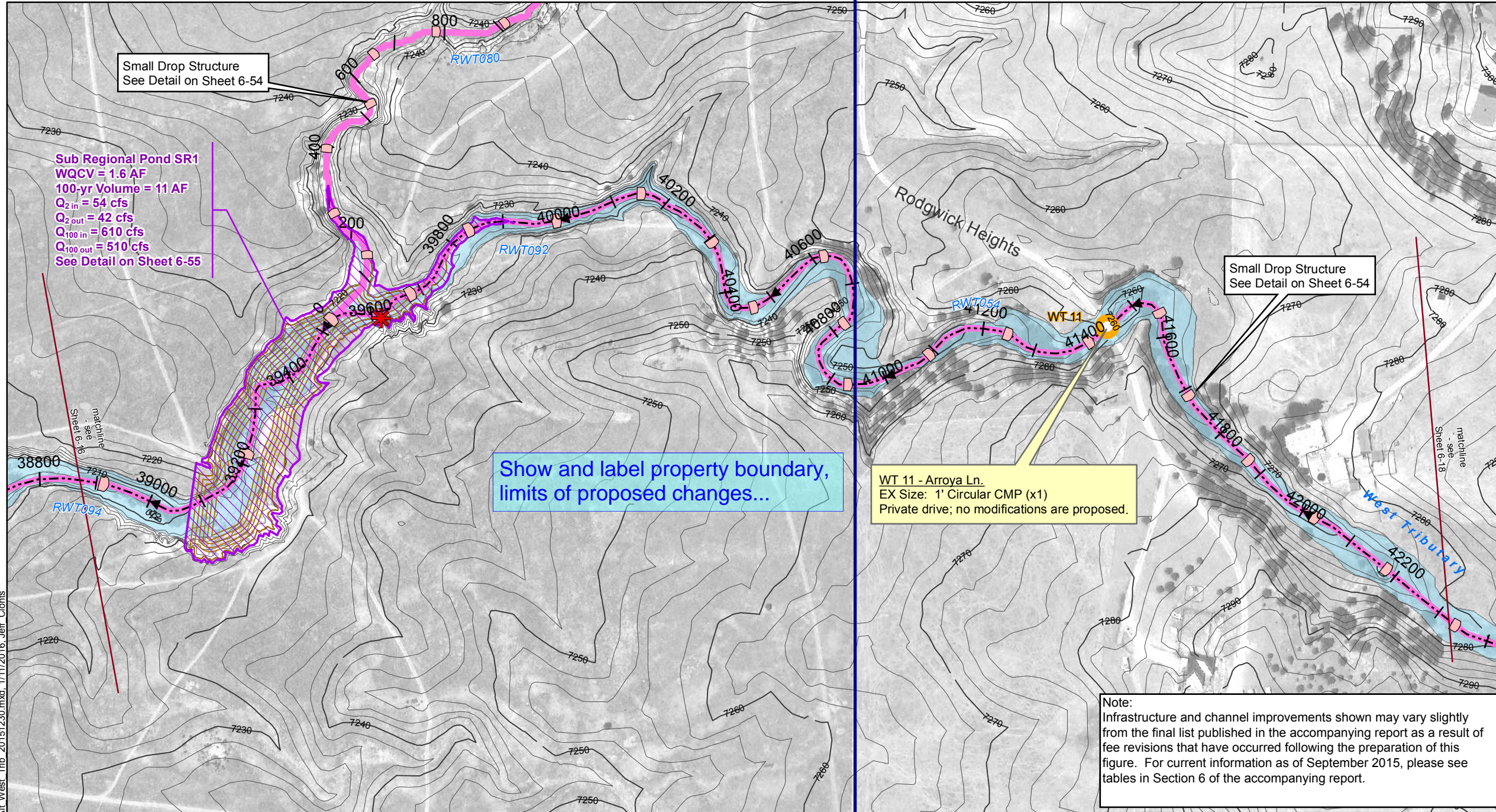
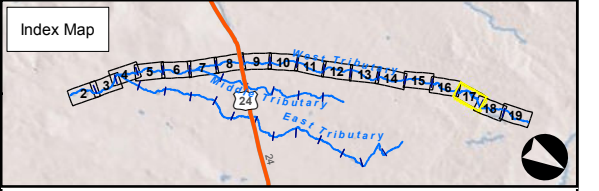

Show and label property boundary, limits of proposed changes...

WT 11 - Arroya Ln.
EX Size: 1' Circular CMP (x1)
Private drive; no modifications are proposed.

Note:
Infrastructure and channel improvements shown may vary slightly from the final list published in the accompanying report as a result of fee revisions that have occurred following the preparation of this figure. For current information as of September 2015, please see tables in Section 6 of the accompanying report.

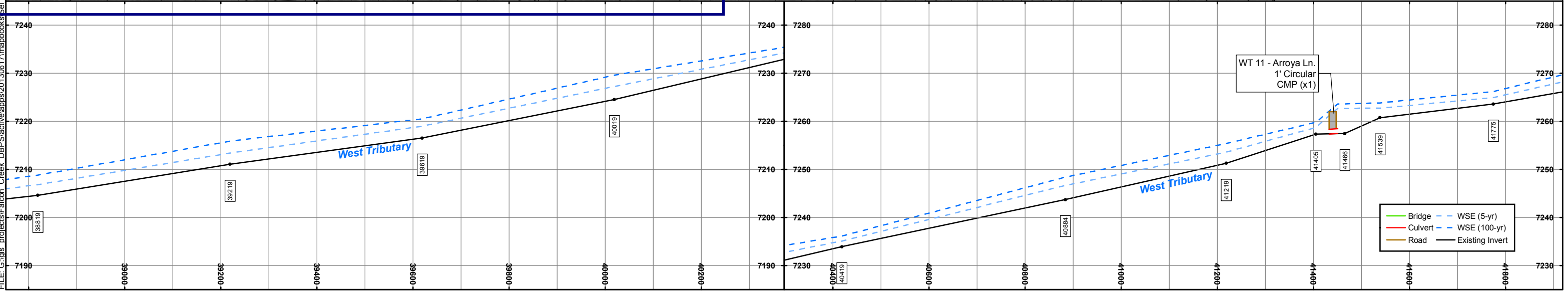

FILE: G:\gis\projects\Falcon_Creek_DBPS\active\apps\20130617\mapbooks\el Alt West Trib 20151230.mxd, 1/11/2016, Jeff Clonits

Sheet 6-18 Falcon DBPS Conceptual Plan West Tributary El Paso County, CO

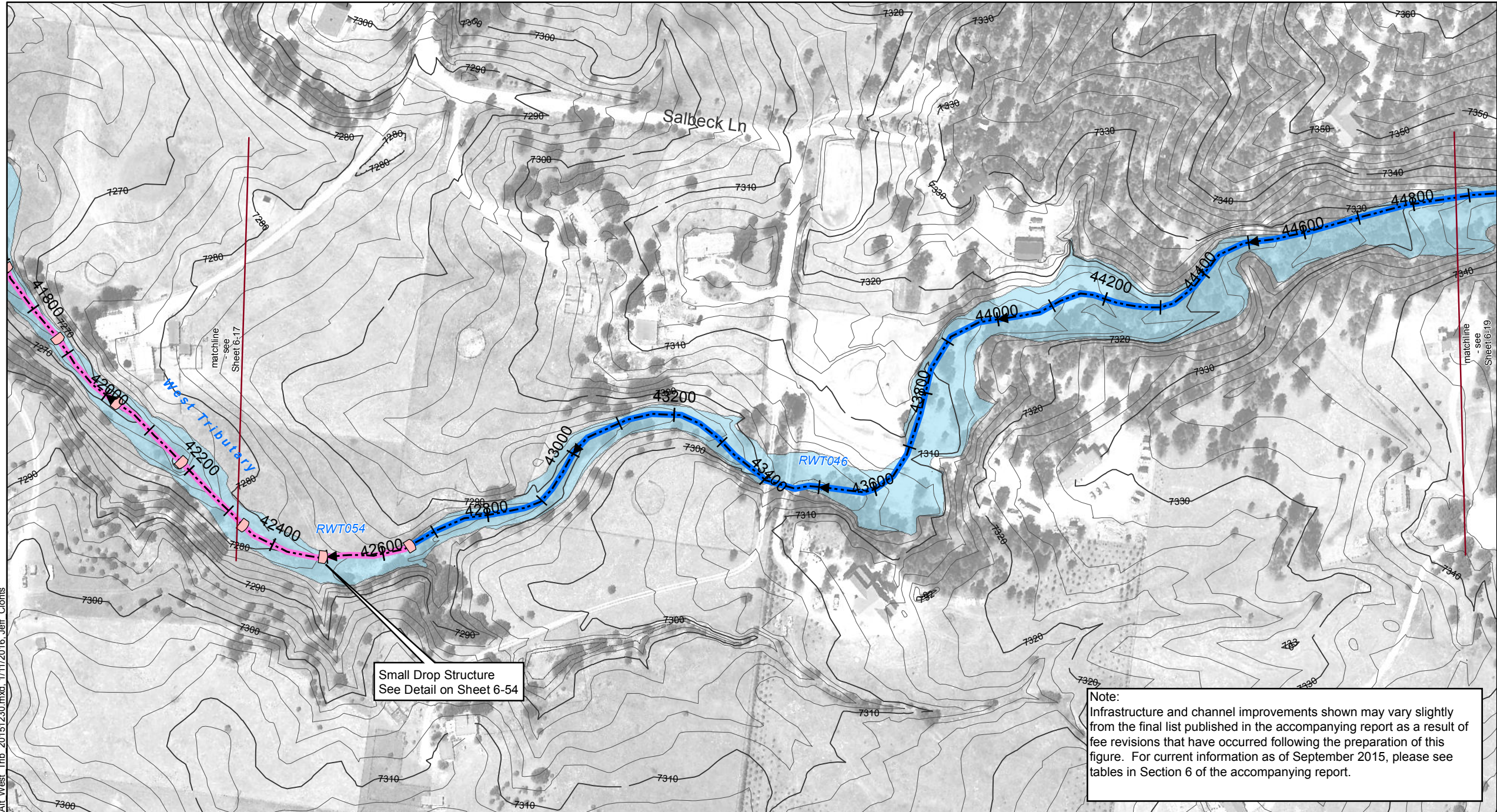

Drainageway Crossing	Reach Improvements
Stream Centerline	Natural Channel Design
Existing Approximate 100-yr Floodplain*	Protect In Place
Floodplain Study Limit	Roadside Ditch Improvement
Storm Sewer	Small Drop Structures w/ Toe Protection
Inlet	Existing Detention
Manhole	Proposed Detention
Pipe	Proposed Detention Grading
	Small Drop Structure
	Cross Vane
	Immediate Action Required to Preserve Existing Condition

0 100 200 Feet

* These approximate 100-yr floodplain boundaries are for planning purposes only. This information is not intended to replace the information provided on the FEMA Flood Insurance Rate Maps for this area.
 ** These are conceptual design drawings and are subject to change. These drawings are not intended for construction purposes.



Small Drop Structure
See Detail on Sheet 6-54

Note:
Infrastructure and channel improvements shown may vary slightly from the final list published in the accompanying report as a result of fee revisions that have occurred following the preparation of this figure. For current information as of September 2015, please see tables in Section 6 of the accompanying report.

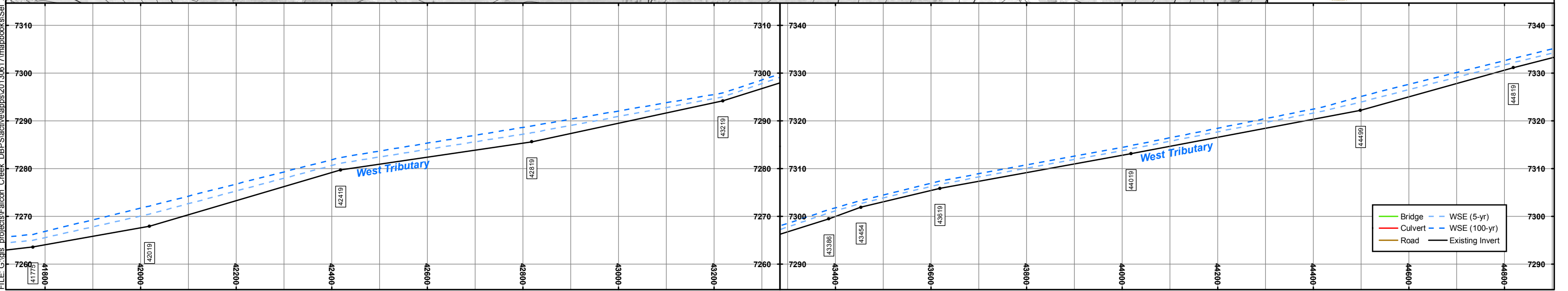

FILE: G:\gis\projects\Falcon_Creek_DBPS\active\apps\20130617\mapbooks\sel Alt West Trib_20151230.mxd, 1/11/2016, Jeff Clonis

Sheet 6-19

Falcon DBPS

Conceptual Plan

West Tributary

El Paso County, CO

- Drainageway Crossing
 - Stream Centerline
 - Existing Approximate 100-yr Floodplain*
 - Floodplain Study Limit
 - Storm Sewer**
 - Inlet
 - Manhole
 - Pipe
 - Reach Improvements**
 - Natural Channel Design
 - Protect In Place
 - Roadside Ditch Improvement
 - Small Drop Structures w/ Toe Protection
 - Existing Detention
 - Proposed Detention
 - Proposed Detention Grading
 - Small Drop Structure
 - Cross Vane
 - Immediate Action Required to Preserve Existing Condition
- 0 100 200 Feet

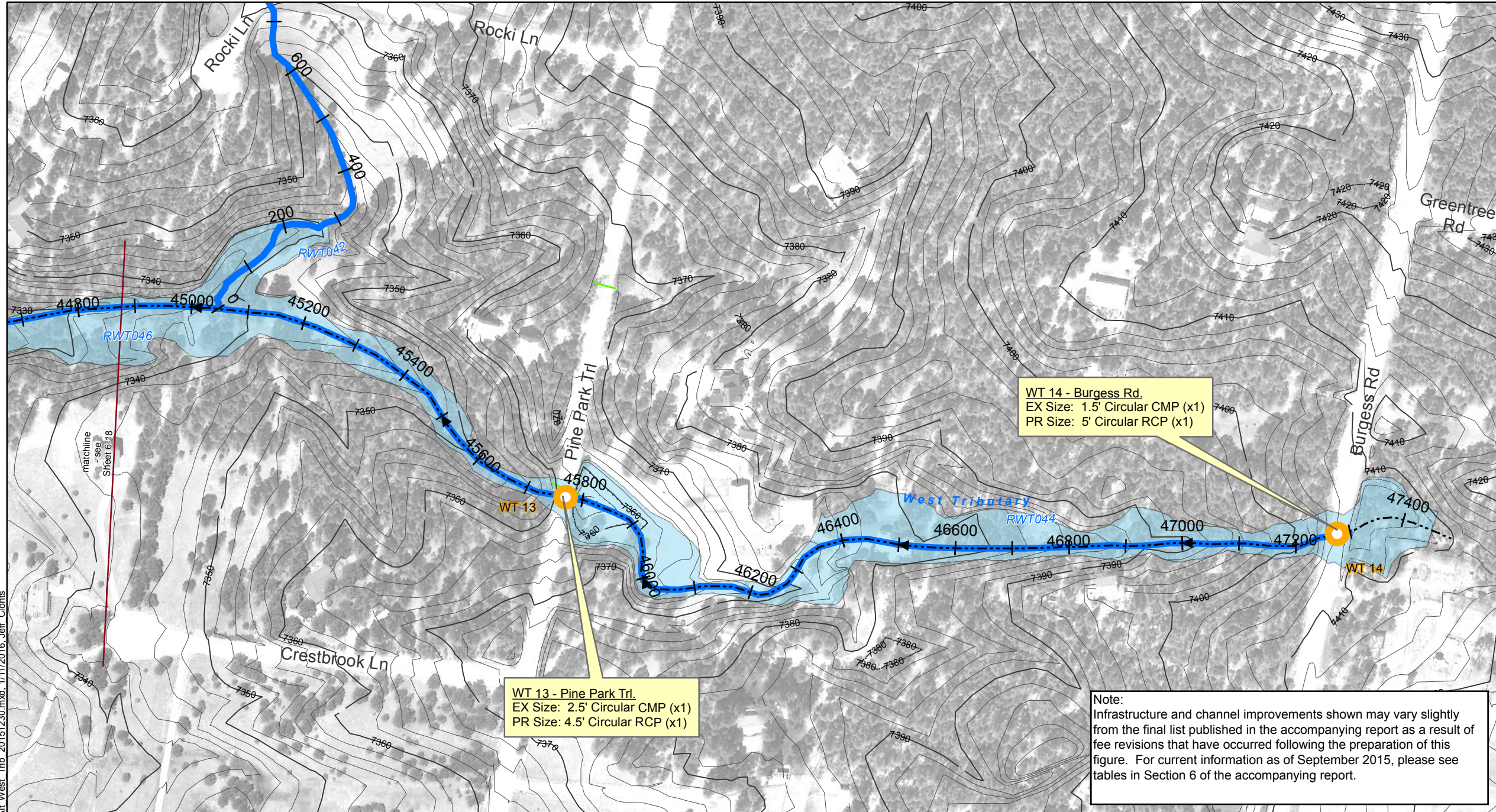

WT 14 - Burgess Rd.
 EX Size: 1.5' Circular CMP (x1)
 PR Size: 5' Circular RCP (x1)

WT 13 - Pine Park Trl.
 EX Size: 2.5' Circular CMP (x1)
 PR Size: 4.5' Circular RCP (x1)

Note:
 Infrastructure and channel improvements shown may vary slightly from the final list published in the accompanying report as a result of fee revisions that have occurred following the preparation of this figure. For current information as of September 2015, please see tables in Section 6 of the accompanying report.

* These approximate 100-yr floodplain boundaries are for planning purposes only. This information is not intended to replace the information provided on the FEMA Flood Insurance Rate Maps for this area.
 ** These are conceptual design drawings and are subject to change. These drawings are not intended for construction purposes.

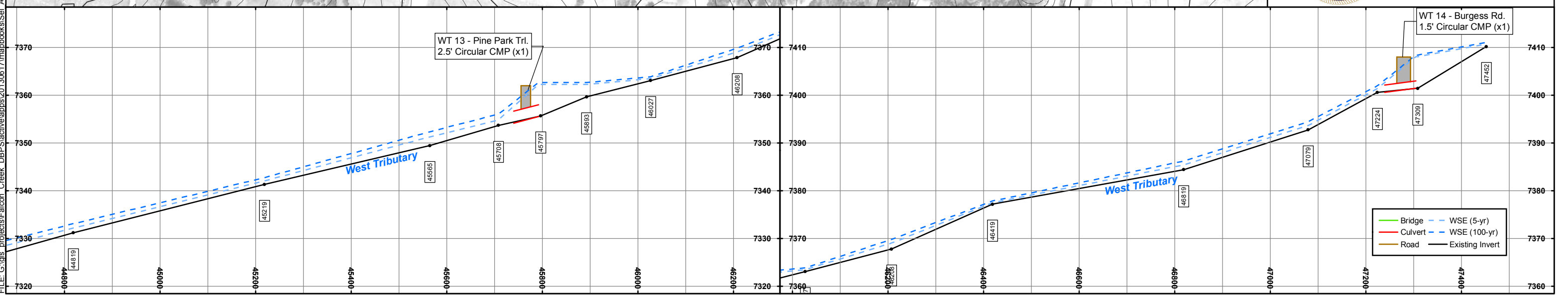

FILE: G:\gis\projects\Falcon_Creek_DBPS\active\apps\20130617\mapbooks\sel_Alt_West_Trib_20151230.mxd, 1/11/2016, Jeff Clontis

APPENDIX E: OPCC

Kimley»Horn

2 North Nevada, Suite 900
Colorado Springs, Colorado 80903

Project: Eagleview Regional Drainage Improvements

Prepared By: DM

Project Number:

Checked By: KRK

Date:

February 2, 2024

Regional Drainage Pond- SR1 (County Cost)					
	Proposed Drainage Easement (for future construction)	AC	9.67	\$ 80,000	\$ 773,776
	Subtotal				\$ 773,776
Reach RWT080 (County Cost)					
	Vegetation Plantings (Willows)	EA	1500	\$ 17.50	\$ 26,250
	Vegetation Monitoring and Replacement	EA	300	\$ 17.50	\$ 5,250
	Erosion Control (~10%)	LS	1	\$ 3,150	\$ 3,150
	Subtotal				\$ 34,650
Reach RWT092 (County Cost)					
	Concrete Check Wall (38' wide x 6' deep x 1' thick) (4)	CY	34	\$ 1,800	\$ 61,200
	Riprap Protection (Type M - 12")	CY	340	\$ 116	\$ 39,440
	Rip Rap Chute (18" Riprap) (Junction)	CY	170	\$ 116	\$ 19,720
	Maintenance Road (6" Thick)	CY	260	\$ 56	\$ 14,560
	Erosion Control (~10%)	LS	1	\$ 13,500	\$ 13,500
	Subtotal				\$ 148,420
Reach RWT054 (County Cost)					
	Concrete Check Wall (38' wide x 6' deep x 1' thick) (1)	CY	8	\$ 1,800	\$ 14,400
	Riprap Protection (Type M - 12")	CY	84	\$ 116	\$ 9,744
	Maintenance Road (6" Thick)	CY	310	\$ 56	\$ 17,360
	Erosion Control (~10%)	LS	1	\$ 4,200	\$ 4,200
	Subtotal				\$ 45,704
	Subtotal County Costs (w/o Easement)				\$ 228,774
	Contingency (35%)				\$ 80,071
	TOTAL COUNTY COST (w/o Easement)				\$ 308,845
	TOTAL COUNTY COST				\$ 1,082,621
Reach RWT094 (Developer Cost)					
	<u>South of Proposed Road/ 72" Culverts</u>				
	Earthwork	CY	6610	\$ 5	\$ 33,050
	Riprap Protection (Type M - 12") (Riffle) (4)	CY	580	\$ 116	\$ 67,280
	Riprap Protection (Type VL - 6")	CY	98	\$ 116	\$ 11,394
	Coir Mat 40	SY	6952	\$ 8	\$ 55,616
	<u>North of Proposed Road/ 72" Culverts</u>				
	Concrete Check Wall (42' wide x 6' deep x 1' thick) (5)	LF	47	\$ 1,800	\$ 84,600
	Riprap Protection (Type M - 12")	CY	470	\$ 116	\$ 54,520
	Maintenance Road (6" Thick)	CY	443	\$ 56	\$ 24,801
	Erosion Control (~10%)	LS	1	\$ 16,400	\$ 16,400
	Subtotal				\$ 347,661
	Subtotal Developer Costs				\$ 347,661
	Contingency (35%)				\$ 121,681
	TOTAL DEVELOPER COST				\$ 469,342
	TOTAL REGIONAL DRAINAGE COST				\$ 1,551,963

Conceptual Opinion of Probable Construction Cost

The Engineer has no control over the cost of labor, materials, equipment, or over the Contractor's methods of determining prices or over competitive bidding or market conditions. Opinions of probable costs provided herein are based on the information known to Engineer at this time and represent only the Engineer's judgment as a design professional familiar with the construction industry. The Engineer cannot and does not guarantee that proposals, bids, or actual construction costs will not vary from its opinions of probable costs.