



LSC TRANSPORTATION CONSULTANTS, INC.
2504 East Pikes Peak Avenue, Suite 304
Colorado Springs, CO 80909
(719) 633-2868
FAX (719) 633-5430
E-mail: lsc@lsctrans.com
Website: <http://www.lsctrans.com>

Esteban Rodriguez Subdivision Sketch Plan
Master Traffic Impact Study
PCD File No.: SKP237
(LSC #S224630)
July 31, 2024 (w/Minor revision 9-13-2024)

Traffic Engineer's Statement

This traffic report and supporting information were prepared under my responsible charge and they comport with the standard of care. So far as is consistent with the standard of care, said report was prepared in general conformance with the criteria established by the County for traffic reports.



Accepted for File
By: Gilbert LaForce, P.E.
Engineering Manager
Date: 09/25/2024 12:52:13 PM
El Paso County Department of Public Works

Developer's Statement

I, the Developer, have read and will comply with all commitments made on my behalf within this report.



7-31-24
Date

Esteban Rodriguez Subdivision Sketch Plan Master Traffic Impact Study

Prepared for:

Bill Guman, PLA, ASLA, APA
William Guman & Associates, Ltd.
731 North Weber Street, Suite 10
Colorado Springs, CO 80903

JULY 31, 2024 (W/ MINOR REVISION 9/13/24)

LSC Transportation Consultants, Inc.
Prepared by: Jeffrey C. Hodsdon, P.E.

LSC #S224630



CONTENTS

REPORT CONTENTS 1

LIST OF OTHER TRAFFIC REPORTS USED IN THE PREPARATION OF THIS REPORT 2

LAND USE AND ACCESS 3

 Proposed Land Uses 3

 Project Phasing 4

 Access and Circulation 4

SIGHT DISTANCE 4

ROAD AND TRAFFIC CONDITIONS AND MTCP CLASSIFICATION 4

 Existing Traffic Volumes 6

 Safety and Accident Analysis – Crash History 6

PEDESTRIAN AND BICYCLE FACILITIES 7

TRIP GENERATION 7

 Short Term 7

 Long Term 8

 Total Driveway Trips 8

 Pass-By and Diverted Trips 8

TRIP DISTRIBUTION AND ASSIGNMENT 9

 Trip Directional Distribution 9

 Site-Generated Traffic 10

 2030 Baseline Traffic Volume Estimates 10

 2030 Total (2030 Baseline Plus Site-Generated) Traffic Volumes 10

 2044 Background Traffic Volumes 10

 2044 Total Traffic Volumes 11

LEVEL OF SERVICE ANALYSIS 11

 Intersection Level of Service 11

 Judge Orr Road/Proposed East Site Access 12

 Judge Orr Road/Curtis Road 12

 US Highway 24/Stapleton Road 12

 US Highway 24/Judge Orr Road 13

 US Highway 24/Elbert Road 14

 Judge Orr Road/Elbert Road 15

 Generalized Daily Traffic Volume Level of Service 15

ROADWAY IMPROVEMENTS.....	15
MTCP-Identified Roadway Improvements.....	15
ROW Requirements and Roadway Segment Improvements.....	15
Intersection Improvements – Auxiliary Turn Lanes (El Paso County Intersections).....	15
Auxiliary Turn-Lane Thresholds	16
Evaluation Finding & Recommendations.....	16
Intersection Improvements – Auxiliary Turn Lane Needs Evaluation (CDOT Intersections)....	17
CDOT Auxiliary Turn-Lane Criteria	17
Evaluation Finding & Recommendations.....	17
Intersection Configuration and Traffic Control.....	18
US Highway 24/Stapleton	18
US Highway 24/Elbert Road	18
Judge Orr Road/Elbert Road/Site Access Intersections.....	18
Judge Orr Road/East Site Access Intersection	18
ROADWAY CLASSIFICATIONS	18
COUNTY ROAD IMPROVEMENT FEE PROGRAM	19
Transportation Impact Fees.....	19
Potentially Reimbursable Improvements	19
MULTI-MODAL TRANSPORTATION AND TDM OPPORTUNITIES.....	19
Pedestrian and Bicycle Accommodations.....	20
DEVIATIONS	20
Potentially-Required Deviations	20
Approved Deviations (for Reference)	21
Judge Orr Road.....	21
CDOT PROCESS AND REQUIREMENTS	21
FINDINGS AND CONCLUSIONS.....	22
Enclosures:	23
Table 1, Table 3, and Table 7	
Figure 1 - Figure 11	
Traffic Count Reports	
Synchro LOS Reports	
Appendix Table 1	
Appendix A	



LSC TRANSPORTATION CONSULTANTS, INC.
2504 E. Pikes Peak Ave., Suite 304
Colorado Springs, CO 80909
(719) 633-2868
FAX (719) 633-5430
E-mail: lsc@lsctrans.com
Website: <http://www.lsctrans.com>

July 31, 2024 (w/ minor revision 9/13/24)

Bill Guman, PLA, ASLA, APA
William Guman & Associates, Ltd.
731 North Weber Street, Suite 10
Colorado Springs, CO 80903

RE: Esteban Rodriguez Subdivision
Sketch Plan
El Paso County, CO
Master Traffic Impact Study
LSC #S224630
[SKP237](#)

Dear Mr. Guman,

LSC Transportation Consultants, Inc. has prepared this Master Traffic Impact Study for the proposed 493-acre Esteban Rodriguez Ranch Subdivision Sketch Plan in El Paso County, Colorado. The site is located southeast of the intersection of Judge Orr Road and Elbert Road. Approximately 142 single-family dwelling units and 19 acres of non-residential/designated commercial uses are shown on the sketch plan. Access to the site is proposed to Judge Orr Road.

This report has been prepared for submittal to El Paso County.

REPORT CONTENTS

The preparation of this report included the following:

- An inventory of existing roadway and traffic conditions on the adjacent and nearby roadway system, including surface conditions, functional classification, widths, pavement markings, traffic control signs, posted speed limits, intersection and access spacing, roadway and intersection alignments, roadway grades, and auxiliary turn lanes;
- Weekday peak-hour turning-movement traffic counts at the following study-area intersections:
 - US Hwy 24/Stapleton Road
 - US Hwy 24/Judge Orr Road
 - US Hwy 24/Elbert Road
 - Judge Orr Road/Curtis Road/Stapleton Road
 - Judge Orr Road/Elbert Road

- Estimated average daily traffic (ADT) volumes on the following study area roadway segments: US Highway 24, Judge Orr Road, Stapleton Road, Curtis Road, Elbert Road;
- Projections of 20-year background traffic volumes on the following study area roadways: US Highway 24, Judge Orr Road, Stapleton Road, Curtis Road, Elbert Road;
- The proposed sketch plan land uses and access plan;
- Estimates of average weekday and weekday peak-hour trip generation for the proposed development and the estimated directional distribution of site-generated vehicle trips on roadways and intersections adjacent to and in the vicinity of the site;
- Projected site-generated and resulting total peak-hour intersection traffic volumes at the following study-area intersections:
 - US Hwy 24/Stapleton Road
 - US Hwy 24/Judge Orr Road
 - US Hwy 24/Elbert Road
 - Judge Orr Road/Curtis Road/Stapleton Road
 - Judge Orr Road/Elbert Road/proposed west access (full-movement)
 - Judge Orr/proposed east access (full-movement)
- Projected total daily and peak-hour traffic volumes at the study-area intersections;
- Intersection level of service (LOS) analysis at the study-area intersections;
- Evaluation of short- and long-term projected intersection volumes to determine potential requirements for any auxiliary right-/left-turn lanes at the proposed site access points, based on the criteria in El Paso County's *Engineering Criteria Manual (ECM)*. Also included are potential long-term lane requirements; and
- Findings and recommendations for submittal to El Paso County.

LIST OF OTHER TRAFFIC REPORTS USED IN THE PREPARATION OF THIS REPORT

The following previously-completed traffic reports are located adjacent to the proposed Esteban Rodriguez Ranch subdivision and were used to provide reference and background information:

- Jane Davis Sketch Plan ([SKP 232](#))
- Saddlehorn Ranch – Filing No. 2 ([SF2133](#))
- Saddlehorn Ranch – Filing No. 3 ([SF234](#))
- Saddlehorn Ranch – Filing No. 4 ([SF236](#))
- Meadowlake Industrial Park Filing No. 1 Preliminary Plan ([SP236](#))

Excerpts of the LSC traffic reports from some of the above projects are attached for reference, as required by the review comments. Notes: The Saddlehorn Ranch Filing No. 3 excerpt accounts for Filing Nos. 2 and 4 and the Filing No. 3 TIS is the most recent; the excerpts for Jane Davis Sketch Plan include the current LSC model output for Jane Davis site-generated traffic volumes as the TIS revision/update is in-process (will be submitted soon).

LAND USE AND ACCESS

Proposed Land Uses

Figure 1 shows the site location relative to the adjacent and nearby roadways. The proposed 493-acre Esteban Rodriguez Ranch Subdivision Sketch Plan in El Paso County, Colorado is located southeast of the intersection of Judge Orr Road and Elbert Road. Approximately 142 single-family residential dwelling units and approximately 15.070 acres of commercial land uses are shown on the proposed sketch plan.

Please refer to the attached Table 1, which shows the assumed land uses for purposes of estimating vehicle trip generation and traffic impacts. The table shows the land uses by “Sketch Plan Land Use Designation.” For purposes of estimating trip generation, ITE Land Use “150 – Warehousing” has been used to estimate potential trip generation for 13.5 of the 15 acres with the “commercial” designation. This report assumes an estimated building square footage of 148,000 square feet. LSC has assumed 10,000 square feet of “strip retail plaza” space for the remaining 1.5 commercial acres. The strip retail use is assumed to be located on the southeast corner of the Judge Orr/Elbert Road intersection. Please refer to Appendix Table 1, which shows the details of the land use calculations and “conversion” to ITE Land Use categories.

Note: Given the relatively remote location and limited number of residential dwelling units in the vicinity, assumption of ITE shopping plaza or shopping center land use as a “highest and best use” for all 15 acres would result in an unrealistically high trip “attractor” from the nearby area. There nearby commercial sites shown on other plans for future development at far busier intersections on Highway 24 which have still not yet developed with retail/shopping center uses. If 15 acres of shopping plaza/center uses were assumed, unrealistically high traffic impacts on roadways to the west and potentially north would be the result, along with unrealistically high level of potential roadway improvements.

More trip-intensive land uses may end up being proposed by the owner/applicant, the LSC-assumed, specific commercial land-use mix by ITE land use and acreage identified above (for purposes of this report), will be noted on the Sketch Plan. If this changes in the future, a larger retail site could be addressed with an updated TIS at the zoning or preliminary plan stage (i.e., if a more trip-generation-intensive mix of commercial uses (such as a larger strip shopping plaza and/or business or industrial park uses with higher trip-generation rates than for ITE Land Use 150 are intended at zoning, preliminary plan(s) or site-development plan(s), the applicant shall be required to provide a revised traffic impact study to be submitted and approved prior to initiation of any uses beyond those included in this traffic impact study. The rezone and/or Preliminary Plan will contain conditions limiting the commercial land-use mix to a trip-generation intensity to comparable or lower than the assumptions in this report.

Existing zoning for the site is A-35. The property will be rezoned. Anticipated zone districts will be CC-Commercial Community, RR-2.5 Residential Rural, and RR-5 Residential Rural. These will be detailed at the rezone stage of the process. Please refer to Appendix Table 1 for more details.

Project Phasing

Please refer to the Sketch Plan sheet SKP1.3 submitted with this application for phasing information. The specific timing of phase completion is difficult to estimate. However, for purposes of a 2030 “short-term” analysis, this Master TIS includes estimated partial buildout of site land uses for 2030. These are called out in the Land Use Table and the Trip Generation Table. Buildout has been assumed for the 2044 horizon year. Note that this phasing is an estimate only and no requirements for transportation improvements are solidified at the sketch plan stage. Subsequent traffic reports for the preliminary plan(s) will address any updates to this phasing and corresponding traffic impacts as applicable.

Access and Circulation

The Sketch Plan shows the following proposed public roadway intersection spacings:

- Full-movement access as a new southern leg to Judge Orr/Elbert (currently a T-intersection)
- Full-movement access on Judge Orr Road 2,230 feet east of Elbert Road

Figure 2 contains the proposed Sketch Plan showing the proposed general sketch plan land uses, on-site roadway network, and proposed access points to Judge Orr Road.

SIGHT DISTANCE

Intersection sight distance at all proposed public road/site-access intersection locations on Judge Orr Road and Elbert Road shown in the site plan must meet intersection sight-distance requirements in *ECM* Table 2-21. Intersections not meeting sight distance may need to be shifted or otherwise mitigated for sight distance. Lines of sight for all public road intersections/access points will need to be kept clear of any sight-distance obstructions, including landscaping, signage, etc. **A detailed sight-distance analysis will be provided when access layout is finalized at the subdivision stage of the development.**

ROAD AND TRAFFIC CONDITIONS AND MTCP CLASSIFICATION

Figure 1 shows the roads adjacent to and in the vicinity of the site. Study area roads serving the site are identified below followed by a brief description of each:

US Highway 24 (US Hwy 24) is a state highway extending locally from the City of Colorado Springs to Peyton in a northeasterly direction and then continuing east. US Hwy 24 is planned to be widened to four lanes through the Falcon area and is classified as an E-X – Expressway by the Colorado Department of Transportation (CDOT) and a 4-lane Principal Arterial on the *El Paso*

County Major Transportation Corridors Plan (MTCP). The posted speed limit on US Hwy 24 at Stapleton Road is 65 miles per hour (mph). Auxiliary left-turn lanes currently exist on the northbound and southbound approaches at the intersections of Stapleton/US Hwy 24 and US Hwy 24/Judge Orr. The intersection of US Hwy 24/Stapleton is currently TWSC-controlled. CDOT has indicated that this intersection is on the list of intersections programmed for signalization. Per the *US 24 Planning and Environmental Linkages (PEL) Study*, US Hwy 24 will be expanded to four lanes in the vicinity of the site within the next 20 years. However, since the preparation of the PEL study, more detailed planning for US Highway 24 has been completed, and a design project is currently underway for expansion to four lanes between Garrett Road and Woodmen Road. This current project may have altered the timing of highway widening east of Woodmen Road. The following is posted on the US Highway 24 improvements website *“Funding was recently allocated for next steps in project development. This includes furthering design of US 24, widening to four lanes from Garrett Road to Stapleton Road [the current CDOT project is Garrett Road to Woodmen Road] and creating a new Access Control Plan from Elbert Road to the El Paso/Elbert County line. CDOT will continue to look for funding sources to design and construct study recommendations.”*

Judge Orr Road is a two-lane roadway that extends east from Eastonville Road across most of El Paso County. It is shown on the 2016 *El Paso County 2040 Major Transportation Corridors Plan* and the *Preserved Corridor Network Plan* as a four-lane Minor Arterial adjacent to the site (and west of Curtis Road). The 2045 Roadway Plan in the 2024 Draft MTCP currently shows Judge Orr as a 2-lane, Rural Minor Arterial. Posted speed limits within the study area range from 45 to 55 mph. West of Curtis Road, the speed limit is 45 mph, while it generally increases to 55 mph east of Curtis Road. The intersection of US Hwy 24/Judge Orr is currently signalized. Due to the oblique angle of this intersection, the eastbound and westbound approaches are split-phased. The *US 24 Access Control Plan/PEL Study* shows future plans for realignment of Judge Orr at US Hwy 24 to improve the intersection and provide an intersection angle closer to 90 degrees.

Curtis Road is a two-lane roadway that extends south from the intersection of US Hwy 24/Stapleton Road intersection to Drennan Road. It is shown as a two-lane, rural Principal Arterial on El Paso County’s *2040 Major Transportation Corridors Plan* and a four-lane Principal Arterial on the *Preserved Corridor Network Plan*. In the vicinity of Judge Orr Road, the posted speed limit is 45 mph. Both intersections of Curtis Road/Judge Orr Road and Curtis Road/Falcon Highway are two-way, stop-sign controlled. The newer section north of Judge Orr was constructed to current *ECM* standards with paved shoulders, etc. Generally, Curtis Road is an “unimproved,” two-lane paved road between Judge Orr and Falcon Highway. However, upgrades are planned as part of the Saddlehorn Development.

Stapleton Road

is shown as an Urban four-lane Principal Arterial on the 2016 El Paso County *Major Transportation Corridors Plan (MTCP)* and El Paso County *Corridor Preservation Plan (CPP)*. The 2045 Draft MTCP shows the segment Stapleton as a 2-lane, Rural Principal Arterial between Judge Orr Road and US Highway 24. The 2065 Corridor Preservation Plan shows this segment as a four-lane facility.

Stapleton Road extends east from Towner Drive to US Hwy 24. Stapleton continues southeast then south to Curtis Road at which point the roadway continues south as Curtis Road. It is planned to be ultimately extended west to connect with the Briargate Parkway extension. Stapleton Road currently is a half-section of a four-lane Principal Arterial (one through lane in each direction) between Meridian Road and US Hwy 24.

Elbert Road is a two-lane roadway that extends north from Judge Orr Road in El Paso County to State Highway 86 in Elbert Road. Shown on the 2016 *El Paso County 2040 Major Transportation Corridors Plan* as a two-lane Minor Arterial. The 2045 Draft MTCP shows the segment of Elbert Road between Judge Orr Road and US Highway 24 as a two-lane, Rural Minor Collector. The posted speed on Elbert Road is 55 mph. Elbert Road is paved without shoulders in the vicinity of the site (paved, unimproved roadway).

Existing Traffic Volumes

Vehicular turning-movement counts were conducted for the following dates and times at the following intersections. Please refer to Figure 3 for more details. Raw count data is attached.

- Judge Orr Road/Elbert Road
 - Wednesday, January 11, 2023 from 6:30 – 8:30 a.m.
 - Wednesday, January 11, 2023 from 4:00 – 6:00 p.m.
- Judge Orr Road/Curtis Road
 - Thursday, April 21, 2022 from 6:30 – 8:30 a.m.
 - Thursday, April 21, 2022 from 4:00 – 6:00 p.m.
- US Hwy 24/Elbert Road
 - Tuesday, January 17, 2023 from 6:30 – 8:30 a.m.
 - Tuesday, January 17, 2023 from 4:00 – 6:00 p.m.
- US Hwy 24/Judge Orr Road
 - Tuesday, May 10, 2022 from 6:30 – 8:30 a.m.
 - Tuesday, May 10, 2022 from 4:00 – 6:00 p.m.
- US Hwy 24/Stapleton Road
 - Tuesday, January 10, 2023 from 6:30 – 8:30 a.m.
 - Tuesday, January 10, 2023 from 4:00 – 6:00 p.m.

Safety and Accident Analysis – Crash History

Three years of crash data were collected at the following intersections:

- Judge Orr Road/Curtis Road – 4 crashes (1 injury, 0 fatalities)
- Judge Orr Road/Elbert Road – 3 crashes (2 injuries, 0 fatalities)
- US Hwy 24/Elbert Road – 10 crashes (5 injuries, 0 fatalities)
- US Hwy 24/Judge Orr Road – 19 crashes (2 injuries, 0 fatalities)
- US Hwy 24/Stapleton Road – 3 crashes (1 injury, 0 fatalities)

There were 11 crashes involving injuries at the 5 study-area intersections during the study period, none of which resulted in a fatality. The majority of crashes were property damage only. No correctable crash patterns were identified in the crashes reported.

Note: CDOT has indicated that the intersection of US Hwy 24/Stapleton is on the list of intersections programmed for signalization.

PEDESTRIAN AND BICYCLE FACILITIES

Judge Orr Road, Stapleton Road, and Elbert Road do not currently have sidewalks as these are rural facilities. Stapleton Road between Judge Orr and US Highway 24 has paved outside shoulders, which accommodate bicycles. Judge Orr Road and Elbert Road are currently paved, unimproved county roads, and as such, generally include 24-feet of pavement surface. Volumes are currently low, which allows for shared use with cyclists. Proposed internal subdivision roads are likely to be primarily Rural Local and potentially Rural Minor Collector roadways and, per *ECM* criteria, would not require sidewalks. The 2016 *MTCP* Table 5 identifies a bicycle improvement along Judge Orr. The section of this report entitled “Multi-Modal Transportation and TDM Opportunities” provides additional information and detail regarding *MTCP* plans and future facilities.

TRIP GENERATION

Estimates of the vehicle trips projected to be generated by the proposed Esteban Rodriguez Subdivision residential development have been made using the nationally published trip-generation rates from *Trip Generation, 11th Edition, 2021* by the Institute of Transportation Engineers (ITE). Corresponding trip-generation rates from ITE Land Use category “210 – Single-Family Detached Housing” have been used to develop trip-generation estimates for the proposed 142-dwelling units. ITE Land Use categories “822 – Strip Retail Plaza (<40 KSF)” and “150 – Warehousing” were used to estimate potential trip generation for the approximately 19 acres of commercial on the property (on two separate parcels). LSC has assumed that a 15-percent floor-area-ratio for the assumed 10,000 square feet of “strip retail” space, with the remainder of the 19 acres associated with warehousing land uses. A detailed trip-generation estimate for the site, including ITE rates land uses, is presented in Table 3 (attached). Also, please refer to Appendix Table 1, which shows the details of the land use calculations and “conversion” to ITE Land Use categories.

Short Term

Table 2 below presents a summary of the estimated short-term site trip generation, assuming no commercial land uses. A detailed short-term trip-generation estimate for the site, including ITE rates land uses, is presented in Table 3 (attached). Please refer to Figure 6a for more details.

The short-term sketch plan land uses are projected to generate about 1,663 total vehicle trips on the average weekday during a 24-hour period, with approximately half entering and half exiting the site. During the morning peak hour, approximately 58 entering vehicles and 85 exiting vehicles are estimated to be generated. Approximately 99 entering and 83 exiting vehicles are estimated to be generated by the site during the afternoon peak hour.

Table 2: Short-Term Estimated Site Vehicle-Trip Generation (Total Driveway Trips)

Analysis Period	Total Driveway Trips		
	In	Out	Total
Morning Peak Hour	58	85	143
Afternoon Peak Hour	99	83	182
Daily/24-hour	842	842	1,663

Long Term

Table 4 below presents a summary of the estimated buildout site trip generation, which includes commercial land uses. The proposed sketch plan is attached for reference. Please refer to Figure 6b for more details.

Total Driveway Trips

The buildout sketch plan land uses are projected to generate about 2,188 total vehicle trips on the average weekday during a 24-hour period, with approximately half entering and half exiting the site. During the morning peak hour, approximately 72 entering vehicles and 94 exiting vehicles are estimated to be generated. Approximately 131 entering and 114 exiting vehicles are estimated to be generated by the site during the afternoon peak hour.

Table 4: Long-Term Estimated Site Vehicle-Trip Generation (Total Driveway Trips)

Analysis Period	Total Driveway Trips		
	In	Out	Total
Morning Peak Hour	72	94	166
Afternoon Peak Hour	131	114	244
Daily/24-hour	1094	1094	2188

Pass-By and Diverted Trips

The ITE total trip-generation estimate for assumed 10,000 square feet of “strip retail” use on about 1.5 acres southeast of Judge Orr and Elbert Road site has also been aggregated by trip type to account for pass-by and diverted trips.

A pass-by trip is one made by a motorist who would already be on an adjacent street regardless of the proposed development, but who stops in at the site while passing by. That pass-by motorist would then continue on his or her way to a destination in the original direction.

Table 3 (attached) shows the percent of the trips generated by trip type.

Analysis also accounts for diverted trips from nearby US Hwy 24, Curtis Road, and Falcon Highway. Recommended ITE-average percent diverted trips for retail-related land uses were used for this study, as summarized in Table 3 (attached). Resulting primary and non-primary trips are shown in Table 5 below.

Average pass-by trip percentages from the *Trip Generation Handbook – An ITE Proposed Recommended Practice, 3rd Edition, 2014* by ITE have been assumed.

Table 5: Estimated Buildout Site Vehicle-Trip Generation (by Trip Type)

Analysis Period	Primary Trips		
	In	Out	Total
Morning Peak Hour	64	89	153
Afternoon Peak Hour	112	96	208
Daily/24-hour	942	942	1884
Analysis Period	Pass-By Trips		
	In	Out	Total
Morning Peak Hour	5	3	8
Afternoon Peak Hour	11	11	21
Daily/24-hour	89	89	179
Analysis Period	Diverted Trips		
	In	Out	Total
Morning Peak Hour	3	2	6
Afternoon Peak Hour	8	8	15
Daily/24-hour	63	63	126

TRIP DISTRIBUTION AND ASSIGNMENT

Trip Directional Distribution

The directional-distribution estimate of site-generated vehicle trips to the study-area roads and intersections is a necessary component in determining the site’s traffic impacts. Figure 5 shows the percentages of the site-generated vehicle trips projected to be oriented to and from the site’s major approaches. Estimates have been based on the following factors: the proposed new land uses, the area roadway system serving the site, and the site’s geographic location relative to the overall greater El Paso County/Colorado Springs area. The attached reports show estimated distribution splits.

Site-Generated Traffic

Site-generated traffic volumes have been estimated at the following intersections:

- US Hwy 24/Stapleton Road
- US Hwy 24/Judge Orr Road
- US Hwy 24/Elbert Road
- Judge Orr Road/Curtis Road/Stapleton Road
- Judge Orr Road/Elbert Road/proposed west access (full-movement)
- Judge Orr/proposed east access (full-movement)

Site-generated volumes have been calculated by applying the directional-distribution percentages estimated by LSC (from Figure 5) to the trip-generation estimates (from Table 3). Figure 6a includes the projected short-term site-generated traffic volumes (“net new site trips”) for the weekday morning and afternoon peak hours. Long-term site-generated traffic volumes for the weekday morning and afternoon peak hours are shown on Figure 6b.

2030 Baseline Traffic Volume Estimates

Figure 4 shows the estimates of baseline/background traffic volumes for the year 2030. These volumes assume the following:

- Buildout of the entire Saddlehorn residential development to the south
- Buildout of Filing 1 only for Meadowlake Industrial Park to the south
- Buildout of only the residential lots within Jane Davis Ranch to the north
- Annual background growth rate of 3 percent for 6 years applied to existing traffic volumes.

2030 Total (2030 Baseline Plus Site-Generated) Traffic Volumes

Figure 7 shows the sum of the 2030 baseline traffic volumes and site-generated peak-hour traffic volumes (from Figure 6a). These volumes represent the projected 2030 total traffic following site buildout. Laneage and traffic control at the study-area intersections following site buildout are shown in Figure 7 as well.

2044 Background Traffic Volumes

Please refer to Figure 8 for estimated long-term background volumes and assumed laneage at the study-area intersections.

Projected long-term background traffic volume projections have been based on LSC’s recent Saddlehorn and Meadowlake Industrial Park traffic studies. The resulting annual growth rates for the projected total volumes are identified in the next section.

Note: long-term background traffic volumes assume the following:

- Buildout of the entire Saddlehorn residential development to the west.
- Buildout of the entire Meadowlake Industrial Park to the southwest.
- Buildout the entire Jane Davis Ranch to the north/northwest.

2044 Total Traffic Volumes

Figure 9 shows the sum of 2044 background traffic volumes (from Figure 8) plus site-generated traffic volumes (from Figure 6b). Based on the projected 2044 total ADT volumes (**including the projected site-generated traffic**), the resulting calculated **average** annual growth rates are:

- Judge Orr Road west of the site: 9.1 percent per year for 20 years.
- Elbert Road north of the site: 17.7 percent per year for 20 years.

LEVEL OF SERVICE ANALYSIS

Intersection Level of Service

Level of service (LOS) is a quantitative measure of the level of congestion or delay at an intersection and is indicated on a scale from “A” to “F.” LOS A is indicative of little congestion or delay. LOS F indicates a high level of congestion or delay. Table 6 shows the level of service delay ranges for signalized and unsignalized intersections.

Table 6: Intersection Levels of Service Delay Range

Level of Service	Signalized Intersections	Unsignalized Intersections
	Average Control Delay (seconds per vehicle)	Average Control Delay (seconds per vehicle) ¹
A	10.0 sec or less	10.0 sec or less
B	10.1-20.0 sec	10.1-15.0 sec
C	20.1-35.0 sec	15.1-25.0 sec
D	35.1-55.0 sec	25.1-35.0 sec
E	55.1-80.0 sec	35.1-50.0 sec
F	80.1 sec or more	50.1 sec or more

¹ For unsignalized intersections, if v/c ratio is greater than 1.0 the level of service is LOS F, regardless of the projected average control delay per vehicle.

LOS values have been included in each figure for each turning movement/approach during the weekday morning and afternoon peak hours for the proposed site-access intersections and off-site intersections in the study area:

- Figure 3: Existing Traffic, Lane Geometry, Traffic Control, and LOS
- Figure 4: 2030 Baseline Traffic, Lane Geometry, Traffic Control, and LOS
- Figure 7: 2030 Baseline + Site Traffic, Lane Geometry, Traffic Control, and LOS

- Figure 8: 2044 Background Traffic, Lane Geometry, Traffic Control, and LOS
- Figure 9: 2044 Background + Site Traffic, Lane Geometry, Traffic Control, and LOS

LOS calculations for long-term scenarios were based upon the recommended lane geometries and traffic controls outlined in the figures above. Regarding peak-hour factors used in the analysis, please refer to Appendix A. For specific delay values, please refer to the attached Synchro reports.

Judge Orr Road/Proposed East Site Access

All individual turning movements and approaches are projected to operate at LOS B or better through the long term with the addition of site-generated traffic.

Judge Orr Road/Curtis Road

Short Term

Short-term analysis assumes two-way stop-sign control (TWSC) at Judge Orr/Curtis. The northbound-left turning movement is projected to operate at LOS E during the 2030 Baseline + Site AM peak hour with the addition of site-generated traffic. However, its volume-to-capacity (v/c) ratio would be well below 1.0 despite operating at LOS E. All other individual turning movements are projected to operate at LOS D or better during both 2030 peak hours, with or without the addition of site-generated traffic.

Long Term

Assuming the intersection of Judge Orr/Curtis is converted from TWSC to a two-lane roundabout in the future, all individual turning movements would operate at LOS C or better during both peak hours of the long-term buildout scenario. This intersection improvement was previously recommended in the *Saddlehorn Ranch* traffic study. Additionally, eastbound and westbound approaches on Judge Orr Road and the southbound approach on Curtis Road are assumed to be two through lanes in each direction (per the 2040 *MTCP*).

US Highway 24/Stapleton Road

Short-Term

Currently, the intersection of US Hwy 24/Stapleton is two-way stop-sign-controlled (TWSC). The following turning movements currently operate at LOS E or worse, with or without the addition of site-generated traffic: northwest-bound left, northwest-bound through, southeast-bound left, and southeast-bound through.

Once signalized, the intersection overall is projected to operate at and are projected to operate at LOS D or better during both short-term peak hours, with or without the addition of site-generated traffic. The southwest-left and northwest-left turning movements are projected to operate at LOS E during both peak hours in 2030, with or without the addition of site-generated traffic. CDOT has indicated that this intersection is on the list of intersections programmed for signalization.

The mitigation for side-street level of service at this intersection will be signalization. The signal is already warranted and CDOT has indicated that this intersection is on the list of intersections programmed for signalization. Area development projects are being required to escrow funds as contribution toward signalization. The more projects contributing, the more matching funds will become available, and the signalization will likely move up on the priority list. It would **not** be practical to implement an interim solution such as restricting turning movements or installing AWSC traffic control. This development will be required to contribute to the signal as development moves forward. This is only the sketch plan stage, so the escrow would not be required at this point, rather at a later stage of the County process and with the CDOT access permit process.

Long-Term

Based on the long-term scenario analyzed in this report, dual left-turn lanes are projected to be constructed to the northeast-left approach at the intersection of US Hwy 24/Stapleton Road. Additionally, all approaches on US Hwy 24 and Stapleton Road would be improved to two through lanes in each direction. Assuming the planned future traffic-signal control, the northeast-left and southwest-left turn lanes are projected to operate at LOS E during at least one long-term peak hour. All other individual turning movements and the intersection overall are projected to operate at LOS D or better during both long-term peak hours, with or without the addition of site-generated traffic. Please refer to Figure 8, Figure 9, and the attached Synchro sheets for anticipated/assumed future lane geometry and LOS at this intersection.

US Highway 24/Judge Orr Road

Existing Conditions

The intersection of US Hwy 24/Judge Orr is currently signalized. The *US 24 Access Control Plan* shows this intersection realigned to one of two alternate alignments that would provide an intersection angle closer to 90 degrees. All movements at this intersection except for the westbound-and eastbound single-lane turning movements are currently operating at LOS D or better during both peak hours.

2030

Analysis in 2030 assumes the proposed realignment has not yet been constructed, nor does it assume that the future southbound right-turn deceleration, a southbound right-turn acceleration, and an eastbound right-turn lane would be constructed in the short term. These turn lanes are shown at the intersection of US Hwy 24/Judge Orr in CDOT's *US 24 Planning & Environmental Linkages (PEL) Study*.

Due to additional background growth in the vicinity of this intersection, several shared turn lanes and single-lane approaches are projected to operate at LOS E or worse during both 2030 peak hours, with or without the addition of site-generated traffic. Overall, the intersection of US Hwy 24/Judge Orr Road is projected to operate at LOS E or worse in 2030 during the PM peak hour, with or without the addition of site-generated traffic. Please refer to Figure 4 and Figure 7 for details.

Long-Term

By 2044, it was assumed that this intersection would be realigned and both Judge Orr Road and US Hwy 24 would be widened to provide two through lanes in each direction. Based on the projected 2044 background and total traffic volumes and lane geometry shown in the Synchro reports, this intersection is projected to operate at an overall LOS D or better during the long-term peak hours. Some minor movements are projected to operate at LOS E during the peak hours simply because of the likelihood of arrival at the traffic signal at the beginning of the red phase at an intersection with many phases and a long cycle length. These movements would not be considered "failing," though, since the volume-to-capacity ratios would be less than 1.0. The justification is that to progress through traffic along an arterial corridor, the traffic signal offsets and left-turn and side street phase times have been adjusted to favor the through traffic band, which can often result in higher delay for the left-turn movements even though there is sufficient capacity for them.

US Highway 24/Elbert Road

Short Term

Short-term analysis assumes two-way stop-sign control (TWSC) at US Hwy 24/Elbert Road. All individual turning movements are projected to operate at LOS D or better during the short-term with the addition of site-generated traffic.

Long Term

Assuming the intersection of US Hwy 24/Elbert Road were to remain stop sign-controlled in the long term, the following individual turning movements are projected to operate at LOS F during both 2044 peak hours, with or without the addition of site-generated traffic: northwest-through, northwest-

left, southeast-through, and southeast-left. Traffic-signal warrants should be re-evaluated as more development occurs on a lot-by-lot basis during the proposed buildout period.

Judge Orr Road/Elbert Road

All single-lane approaches are projected to operate at LOS C or better through the long term with the addition of site-generated traffic.

Generalized Daily Traffic Volume Level of Service

Based on the projected traffic volumes, Figure 11 shows the **generalized daily traffic volume “level of service”** (or comparison of the projected ADT to the *ECM* design ADT by classification) on the study-area roadways.

ROADWAY IMPROVEMENTS

MTCP-Identified Roadway Improvements

State whether the MTCP or other approved corridor study calls for the construction of improvements in the immediate area.

The following roadway improvement projects have been identified as being needed by the year 2040 per Map 13 and Table 4 of El Paso County’s 2016 *MTCP*:

- C12 – Stapleton Road from Towner to Judge Orr Road (\$41,076,000)
 - Existing conditions – 2-lane Urban Principal Arterial
 - Future conditions – 4-lane Urban Principal Arterial
- C14 – Judge Orr Road from Eastonville Road to Peyton Highway (\$38,248,000)
 - Existing conditions – 2-lane Rural Minor Arterial
 - Future conditions – 4-lane Rural Minor Arterial

See the attached *MTCP* maps for reference.

ROW Requirements and Roadway Segment Improvements

Table 7 (attached) identifies the ROW requirements and roadway segment improvements.

Intersection Improvements – Auxiliary Turn Lanes (El Paso County Intersections)

Auxiliary turn lane needs evaluation for El Paso County intersections in the study area is presented below. Also, please refer to Table 7 (attached).

Auxiliary Turn-Lane Thresholds

Section 2.3.7.D of the *ECM* lists ingress/egress volume thresholds in which exclusive right- or left-turn lanes would be required, by classification:

- Principal Arterial
 - Left-turn deceleration lane – 10 vehicles per hour (vph) or greater
 - Right-turn deceleration lane – 25 vph or greater
 - Right-turn acceleration lane – 50 vph or greater (if speed limit exceeds 40 mph)
- Minor Arterial
 - Left-turn deceleration lane – 25 vph or greater
 - Right-turn deceleration lane – 50 vph or greater
 - Right-turn acceleration lane – not generally required

Major roadways in the study area have the following 2040 *MTCP* roadway classifications:

- **Stapleton Road** – Principal Arterial (Note: Stapleton south of US Highway 24 is shown as a two-lane, Rural, Principal Arterial on the Draft 2045 Roadway Functional Classifications map in the *Draft 2024 MTCP* update).
- **Judge Orr Road** – Minor Arterial (Note: Judge Orr between Highway 24 and Calhan Highway is shown as a **two-lane**, Rural, Minor Arterial on the Draft 2045 Roadway Functional Classifications map in the *Draft 2024 MTCP* update).
- **Elbert Road** – Minor Arterial (Note: Elbert Road south of Highway 24 is shown as a two-lane, Rural, Minor Collector on the Draft 2045 Roadway Functional Classifications map in the *Draft 2024 MTCP* update. The draft plan shows Elbert Road **north** of US Highway 24 as a two-lane, Rural, Minor Arterial).

All proposed auxiliary turn lanes would be required to meet design criteria outlined in Section 2.3.7.E of the *ECM*. Details can be addressed at the Preliminary Plan stage.

Evaluation Finding & Recommendations

This assessment and findings are based on the preliminary estimates of trip generation and traffic volumes in this report. Additional turn lanes may be needed if trip generation is higher than projected herein. The evaluation of auxiliary turn lane needs should be revisited with the Preliminary Plan(s).

Judge Orr Road/Elbert Road/Northwest Site Access (Proposed)

Based on projected left-turn and right-turn peak-hour turning volumes, the following auxiliary turn lane would be required at the proposed site access at Judge Orr Road/Elbert Road:

- Eastbound-right-turn deceleration lane

The following auxiliary turn lanes would **not** be required at the proposed northwest site access on Judge Orr Road or Elbert Road:

- Westbound-left-turn deceleration lane
- Westbound-right-turn deceleration lane
- Northbound-to-eastbound-right-turn acceleration lane

Judge Orr Road/Proposed East Site Access

Based on projected westbound-left and eastbound-right peak-hour turning volumes, **no** auxiliary turn lanes would be required at the proposed east site access on Judge Orr Road.

Intersection Improvements – Auxiliary Turn Lane Needs Evaluation (CDOT Intersections)

CDOT Auxiliary Turn-Lane Criteria

Please refer to section 3.5 of the *Colorado State Highway Access Code* for turn lane criteria at intersections under CDOT jurisdiction.

Evaluation Finding & Recommendations

US Highway 24/Judge Orr Road

The US Highway 24 PEL study presents recommendations for this intersection. Please refer to US Highway 24 subsection above and Table 7 Improvements Table. Auxiliary turn lanes would be added at this intersection as part of a future CDOT El Paso County intersection improvement project C14. This intersection is within the limits of the Judge Orr roadway segment improvement “project” C14, which has been identified as being needed by the year 2040 per Map 13 and Table 4 of El Paso County’s 2016 *MTCP*:

- C14 – Judge Orr Road from Eastonville Road to Peyton Highway (\$38,248,000)
 - Existing conditions – 2-lane Rural Minor Arterial
 - Future conditions – 4-lane Rural Minor Arterial*

*Note: Judge Orr between US Highway 24 and Calhan Highway is shown as a **two-lane**, Rural, Minor Arterial on the Draft 2045 Roadway Functional Classifications map in the *Draft 2024 MTCP* update).

US Hwy 24/Stapleton

CDOT has indicated that this intersection is on the list of intersections programmed for signalization. Area development projects are being required to escrow funds as contribution toward signalization.

US Highway 24/Elbert Road

Auxiliary left-turn and right-turn deceleration lanes currently exist on all four approaches at the intersection of US Hwy 24/Elbert Road. Please refer to Improvements Table 7 for details regarding the westbound left-turn deceleration lane.

Intersection Configuration and Traffic Control

US Highway 24/Stapleton

CDOT has indicated that this intersection is on the list of intersections programmed for signalization. Area development projects are being required to escrow funds as contribution toward signalization.

US Highway 24/Elbert Road

Several individual turning movements are projected to operate at LOS F during both 2044 peak hours, with or without the addition of site-generated traffic: northwest-through, northwest-left, southeast-through, and southeast-left. Traffic-signal warrants and this project's relative traffic impact should be evaluated at the Preliminary plan stage and/or as development proceeds. The addition of Rex Road between Eastonville and Elbert Road to the *Draft 2045 MTCP* may affect the future volume projections at the Elbert Road/US Highway 24 intersection.

Judge Orr Road/Elbert Road/Site Access Intersections

LSC recommends two-way, stop-sign control for this intersection (northbound and southbound approaches). This traffic control recommendation should be verified with the Preliminary Plan.

Judge Orr Road/East Site Access Intersection

LSC recommends stop-sign-control for this intersection (northbound approach). This traffic control recommendation should be verified with the Preliminary Plan.

ROADWAY CLASSIFICATIONS

Generally, roadways within the sketch plan should be classified as Rural Local or Rural Minor Collector as shown in Figure 10. The entry street segments are projected to carry about 1,686 and 394 vehicles per day (ADT) for the west and east access street connections to Judge Orr, respectively. Most of the streets south of these entry streets are projected to carry ADT volumes below 750 vehicles per day. These recommended classifications should be revisited at the preliminary plan stage when commercial land uses are more defined relative to trip generation. The classifications shown in Figure 10 are preliminary recommendations by LSC based on

estimated daily traffic volumes and other factors such as land uses served, design vehicles, and roadway continuity.

Figure 11 shows the study-area roadways and classifications shown on the Draft 2045 Roadway Functional Classifications map in the *Draft 2024 El Paso County Major Transportation Corridors Plan*.

COUNTY ROAD IMPROVEMENT FEE PROGRAM

Transportation Impact Fees

Per *ECM* Appendix B:

State what the current applicable Transportation Impact Fees are and what option the developer will be selecting for payment.

The applicant will be required to participate in this program. The PID option will be identified with a future Preliminary Plan/Plat submittal(s).

Potentially Reimbursable Improvements

Figure 27 of the *Draft 2024 El Paso County Major Transportation Corridors Plan* shows the following *MTCP* Projects:

- Project ID No. 159 Judge Orr Road Eastonville Road to Peyton Highway (rural county road upgrade)
- Project ID No. 401 Rex Road – Current Terminus in Meridian Ranch to Elbert Road (new road construction)

Also, participation in intersection improvements at the study-area intersections on US Hwy 24 (as may be required by CDOT) such as traffic signals and/or turn-lane improvements also have the potential for reimbursement.

MULTI-MODAL TRANSPORTATION AND TDM OPPORTUNITIES

The following roadway improvement projects have been identified as being needed by the year 2040 per Map 15 and Table 5 of El Paso County's 2016 *MTCP*:

- M7 – Elbert Road from Judge Orr Road to US 24
 - Bicycle improvements (7.00 miles)
- M8 – Judge Orr Road from Eastonville Road to South Peyton Highway
 - Bicycle improvements (2.98 miles)

These multimodal improvements would essentially extend to the Rock Island Trail along the north side of US Hwy 24. The Rock Island Trail provides connectivity to the park-and-ride facility near Meridian Road/US Hwy 24 and numerous commercial centers in the central Falcon area.

The project roads are anticipated to be Rural Local or Rural Minor Collector type roads, and as such, would not be required to provide sidewalks. Bicycles are accommodated on-street by the standard road cross sections of these two roadway classifications. Any anticipated changes to this would be addressed with the preliminary plan(s).

The **DRAFT 2045 MTCP** includes a Multimodal Plan.

While, currently, the proposed development is not projected to generate a significant percentage of multimodal trips, the *DRAFT 2045 MTCP* document includes an “Unincorporated El Paso County Targeted Sidewalk Gap Analysis.” This project is located on the fringe of one of these target areas. Any potential future sidewalks extending west along Judge Orr or north along Elbert Road could be addressed at the preliminary plan stage – by which point the 2045 *MTCP* may be adopted.

The *DRAFT 2045 MTCP* shows the potential for “enhanced transit service” to/from and through the central area of Falcon.

Pedestrian and Bicycle Accommodations

There are no existing public schools located within two miles of the site.

The following is a list of known and planned multi-modal and pedestrian accommodations in the general area:

- A park-and-ride facility has been constructed near Meridian Road and US Highway 24.
- The Rock Island Regional Trail runs along the north side of US Highway 24, generally between Falcon and Peyton.
- Many of the area County roads have been or will be upgraded to provide paved shoulders for cyclists. Stapleton is shown as a future “bike route.”
- The *Highway 24 PEL Study* also includes multi-modal elements.

DEVIATIONS

Potentially-Required Deviations

None with this Sketch Plan submittal. However, the locations of future commercial access points south of Judge Orr along the entry roads will need to be evaluated against criteria in *ECM* section 2.4. Also, internal public roads/streets not depicted on the sketch plan but shown on the preliminary plan(s) will need to meet intersection criteria, including spacing criteria shown in *ECM* Table 2-5 for Rural Minor Collector roadways (or Rural Local roadways, as applicable).

Deviation(s) will likely be required for any internal commercial access or internal public street intersection spacing not meeting criteria.

Approved Deviations (for Reference)

Judge Orr Road

As part of the Saddlehorn Ranch development, a deviation (by JR Engineering, dated September 4, 2020) was approved for modification to the standard *ECM* cross section of Judge Orr Road, which has a 2040 classification of Rural Four-Lane*, Minor Arterial roadway (*ECM* Section 2.2.4 criteria) [***Note: Judge Orr between US Highway 24 and Calhan Highway is shown as a two-lane, Rural, Minor Arterial on the Draft 2045 Roadway Functional Classifications map in the Draft 2024 MTCP update**]. Although Judge Orr Road is shown as a four-lane Rural Minor Arterial in the 2040 *MTCP**, the *ECM* does not have a standard cross-section for this type of roadway functional classification. The deviation shows an interim four-lane Rural Minor Arterial cross-section with an additional eastbound 12-foot travel lane on the south side (Saddlehorn side).

Additional ROW would be required for completion of the full 4-lane section*, but additional ROW is not available (not controlled by this development) on the north side of Judge Orr. Currently, Saddlehorn Ranch is dedicating an additional 40 feet of ROW to facilitate this in the future.

***Note: Judge Orr between US Highway 24 and Calhan Highway is shown as a two-lane, Rural, Minor Arterial on the Draft 2045 Roadway Functional Classifications map in the Draft 2024 MTCP update.**

CDOT PROCESS AND REQUIREMENTS

CDOT comments have indicated *“Escrow break down will need to be provide for the Fair Share Escrow Amount of the development in an updated Traffic Impact Study for each permit required.”*

The following is for information only, as this is a sketch plan application. The detailed escrow analysis will be provided will be at a later stage of the development process.

- US Hwy 24/Stapleton is planned to be signalized. The CDOT has indicated for other area projects a requirement to escrow a fair share amount toward this future traffic signal.
- The “formula” for calculating the development responsibility has been based on the average AM & PM site-generated passenger cars directly impacting the 4-hour warrant, the development would be responsible an amount based on the number of site-generated new vehicles / 60 vehicles-to-warrant x ~\$700K/signal cost.
- LSC Note: There are a number of developments – in progress and future/planned – in the area which will also add traffic to this intersection and impact the 4-hour warrant. As CDOT collects escrow for other developments, LSC recommends that as the collective impact trips (directly impacting the 4-hour warrant volumes) by area developments begins to exceed

the 60-vehicle-per-hour denominator, fair-share recalculation of pro-rata share escrow amounts and credit be provided to developments according to the updated fair-share calculations. Also, once the signal is installed, credit should be provided from the Countywide Fee Program based on a ratio of fee program unit signal cost divided by the \$700K signal cost.

FINDINGS AND CONCLUSIONS

- The site is projected to generate about 2,188 new driveway vehicle-trips on the average weekday.
- During the weekday morning peak hour of adjacent street traffic, 72 vehicles would enter the site while 94 vehicles would exit.
- During the weekday afternoon peak hour of adjacent street traffic, 131 vehicles would enter the site while 114 vehicles would exit.
- The above-referenced trip-generation estimates are for sketch plan buildout.
- Projected levels of service would be LOS C or better at all proposed site-access locations. Please refer to the “Level of Service” section above for detailed LOS results and discussion regarding all study-area intersections.
- Please refer to the “Auxiliary Turn-Lane Analysis” section and Table 7, the Roadway Improvements table for evaluation of potential turn-lane needs at the study-area intersections.
- Table 7 also includes other roadway improvements related to right-of-way, roadway segments, intersection traffic control, etc.
- All internal site access roadways are proposed to be public streets with LSC-recommended classifications (preliminary) of Rural Minor Collector and Rural Local. Please refer to Figure 10 for additional details.
- Deviations are not included with this submittal.

* * * * *

Please contact me if you have any questions regarding this report.

Respectfully Submitted,

LSC TRANSPORTATION CONSULTANTS, INC. ne

By: Jeffrey C. Hodsdon, P.E.
Principal

JCH/JAB:jas

Enclosures: Table 1, Table 3, and Table 7
Figure 1 - Figure 11
Traffic Count Reports
Synchro LOS Reports
Appendix Table 1
Appendix A

Table 1, Table 3, and Table 7



Table 1: Land Use Summary

Parcel	ITE Land Use		Value	Units
	Code	Description		
A	822	Strip Retail Plaza (< 40 KSF)	10.000	KSF
A	150	Warehouse	62.454	KSF
B	150	Warehouse	63.117	KSF
C	210	Single-Family (Detached) Housing	14.000	DU
D	210	Single-Family (Detached) Housing	12.000	DU
E	-	Detention Pond	-	-
F	210	Single-Family (Detached) Housing	3.000	DU
G	150	Warehouse	24.429	KSF
H	210	Single-Family (Detached) Housing	2.000	DU
I	210	Single-Family (Detached) Housing	18.000	DU
J	-	Park	-	-
K	210	Single-Family (Detached) Housing	7.000	DU
L	210	Single-Family (Detached) Housing	5.000	DU
M	210	Single-Family (Detached) Housing	13.000	DU
N	210	Single-Family (Detached) Housing	18.000	DU
O	210	Single-Family (Detached) Housing	18.000	DU
P	210	Single-Family (Detached) Housing	17.000	DU
Q	210	Single-Family (Detached) Housing	6.000	DU
R	210	Single-Family (Detached) Housing	9.000	DU
S	-	Detention Pond	-	-
T	-	Detention Pond	-	-

Table 3: Detailed Trip Generation Estimate

ITE		Value ³	Units ¹	Trip Generation Rates ²				% Internal		Driveway Trips Generated				% Primary	% Pass-By	% Diverted	External Trips Generated							
Code	Description			Average Weekday	A.M.		P.M.		A.M.	P.M.	Average Weekday	A.M.					P.M.		Average Weekday	A.M.		P.M.		
					In	Out	In	Out				In	Out				In	Out		In	Out			
Short Term																								
210	Single-Family (Detached) Housing	142	DU	9.81	0.19	0.53	0.61	0.36	0%	0%	1393	27	76	87	51	100%	0%	0%	1393	27	76	87	51	
150	Warehouse	150	KSF	1.84	0.21	0.06	0.08	0.21	2%	2%	270	31	9	12	31	100%	0%	0%	270	31	9	12	31	
Total											1663	58	85	99	83				Total	1663	58	85	99	83
Buildout																								
210	Single-Family (Detached) Housing	142	DU	9.81	0.19	0.53	0.61	0.36	0%	0%	1393	27	76	87	51	100%	0%	0%	1393	27	76	87	51	
150	Warehouse	150	KSF	1.84	0.21	0.06	0.08	0.21	2%	2%	270	31	9	12	31	100%	0%	0%	270	31	9	12	31	
822	Strip Retail Plaza (< 40 KSF)	10	KSF	54.45	1.42	0.94	3.30	3.30	2%	5%	525	14	9	31	31	42%	34%	24%	221	6	4	13	13	
Total											2188	72	94	131	114				Total	1884	64	89	112	96

¹ DU = dwelling units, KSF = 1,000 square feet

² Source: *Trip Generation, 11th Edition (2021)* by the Institute of Transportation Engineers (ITE)

³ Assumes 15% floor-area ratio for retail land uses and 25% for warehouse land uses

Table 7*: Roadway Improvements

Esteban Rodriguez Sketch Plan

CDOT Intersections				
Item #	Location/Roadway Segment	Improvement	Timing	Responsibility
US Highway 24/Judge Orr Intersection				
1.1	Judge Orr Road at US Highway 24	Realignment of Judge Orr Road at US Highway 24 per CDOT Hwy 24 PEL Study	Future (the PEL study identified this as a high priority project with a time frame of less than 5 years)	CDOT
1.2	US Highway 24 at Judge Orr Road	Southwest-bound right-turn deceleration lane on US Hwy 24 approaching Judge Orr Road	As required by other development(s) or with realignment of US Hwy 24/Judge Orr	CDOT or by others
1.3	US Highway 24 at Judge Orr Road	Construct southwest-bound right-turn acceleration lane on US Hwy 24 at Judge Orr Road	As required by other development(s) or with realignment of US Hwy 24/Judge Orr	CDOT or by others
1.4	Judge Orr Road at US Highway 24	Eastbound left-turn lane on Judge Orr Road approaching US Hwy 24	With realignment of US Hwy 24/Judge Orr	CDOT
1.5	Judge Orr Road at US Highway 24	Westbound dual left-turn lanes on Judge Orr Road approaching US Hwy 24	With realignment of US Hwy 24/Judge Orr	CDOT
1.6	US Highway 24 at Judge Orr Road	Northeast-bound right-turn deceleration lane on US Hwy 24 approaching Judge Orr Road	With realignment of US Hwy 24/Judge Orr	CDOT
1.7	Judge Orr Road at US Highway 24	Eastbound right-turn deceleration lane on Judge Orr Road approaching US Hwy 24	As required by other development(s) or with realignment of US Hwy 24/Judge Orr	CDOT or by others
US Highway 24/Stapleton Intersection				
2.1a	US Highway 24/Stapleton Intersection	Escrow Contribution toward traffic control upgrade - CDOT Escrow for Participation in the cost of future signalization	To be addressed with the Preliminary Plan/Plats and Future Access Permit(s)	Applicant
2.1b	US Highway 24/Stapleton Intersection	Traffic Control Upgrade - Signalization of the intersection	CDOT - Once warrants are met	CDOT is collecting escrow from area developments impacting this intersection.
US Highway 24/Elbert Road Intersections				
3.1	US Highway 24/Elbert Road Intersection (Westbound left-turn)	Lengthening of the westbound left-turn deceleration lane to CDOT standards (800-foot plus storage plus taper) - Existing deficiency.	Depending on the level of site-generated traffic added to this turning movement as development progresses, determination will be made if the project significantly impacts this intersection and this turning movement. If determined with the preliminary plan that site traffic impact is to a level that warrants the need for this project to submit an access permit and participate in some form toward this improvement, there will likely be either identification of an escrow contribution toward a future improvement or a requirement to complete this improvement (to be determined with the preliminary plan). (fee program credit per fee program provisions)	Applicant and/or other developments that may add westbound left-turning movements to this intersection
3.1a	US Highway 24/Elbert Road Intersection	Potential Escrow Contribution toward traffic control upgrade - CDOT Escrow for Participation in the cost of future signalization	To be addressed with the Preliminary Plan/Plats and Future Access Permit(s)	Applicant
3.1b	US Highway 24/Elbert Road Intersection	Traffic Control Upgrade - Signalization of the intersection	CDOT - Once warrants are met	CDOT is collecting escrow from area developments impacting this intersection.
US Highway 24/Rex Road (Future) Intersection				
4.1	US Highway 24/Rex Road Intersection (Future)	New Intersection Construction and Future Signalization	As Per CDOT AP No. 221088	Permittee (Grandview Reserve Development)
Adjacent County Arterial Roadway ROW Requirements				
5.1	Judge Orr Road Site Frontage	Right-of-Way Dedication Half of 2-Lane Rural Minor Arterial ROW (which is 100' total) Shown in 2024 DRAFT 2045 MTCP	Dedicate adjacent half ROW with plats but to be verified/detailed with the Preliminary Plan.	Applicant
5.2	Judge Orr Road Site Frontage	Corridor Preservation for 4-Lane Minor Arterial or updated 2065 Classification to be determined in the 2045 MTCP.	ROW preservation to be indicated with plats but to be verified/detailed with the Preliminary Plan.	Applicant
El Paso County Roadway Segment Improvements				
6.1	Judge Orr Road (Short Term) Site Frontage	Widening of the south half to the Rural Minor Arterial cross section as parcels develop (or provide funds toward future widening)	As development occurs - details to be determined at the Preliminary Plan stage	Applicant Note: potential for negotiated fee program credit based on construction of the ultimate Rural Minor Arterial half section. This will be subject to submission and review and potential acceptance of a proposed fee program credit agreement by EPC and the Fee Program Committee.
6.2	Judge Orr Road (Long Term) Adjacent to the site frontage, but on the north side of the roadway	Future widening on the north side, to complete the full Rural Minor Arterial cross section.	Two-lane Rural Minor Arterial Shown in DRAFT 2045 MTCP (note: not yet adopted)	Most likely the property owner on the north side of Judge Orr, if/when that property develops.
6.3	Judge Orr Road (Long Term) US Highway 24 to Peyton Highway	Rural county road upgrade to Rural Minor Arterial cross section, DRAFT 2045 MTCP Project No. 159	Two-lane Rural Minor Arterial Shown in DRAFT 2045 MTCP (note: not yet adopted)	Adjacent developments as they occur; any "gaps" may be projects completed by the county with fee program funds; applicant will pay fee program traffic impact fees.
6.4	Curtis Road (Long Term) Judge Orr Road to Highway 94	Rural county road upgrade to Rural Minor Arterial cross section, DRAFT 2045 MTCP Project No. 512	Two-lane Rural Minor Arterial Shown in DRAFT 2045 MTCP (note: not yet adopted)	Adjacent developments as they occur; any "gaps" may be projects completed by the county with fee program funds; applicant will pay fee program traffic impact fees.
6.5	Rex Road (Long Term) Elbert Road to US Highway 24	New county road connection - Rural Minor Arterial DRAFT 2045 MTCP Project No. 401	New two-lane Rural Minor Arterial Shown in DRAFT 2045 MTCP (note: not yet adopted)	Likely with development of the property through which the roadway segment is shown to connect through; any "gaps" may be projects completed by the county with fee program funds; applicant will pay fee program traffic impact fees.
Internal Development Roadways				
7.1	Internal Development Roadways (shown in Figure 10)	Construct to County Standards IAW the classification map (shown in Figure 10); details to be addressed with the preliminary plan.	As development occurs; phasing/timing details to be addressed with the Preliminary Plan.	Applicant
El Paso County Intersections and Site Access Intersections				
Item #		Improvement	Timing	Responsibility
Judge Orr/Curtis Road Intersection				
8.1	Judge Orr/Curtis Road Intersection (westbound approach)	Westbound right-turn deceleration lane	Once peak-hour westbound right-turn volume exceeds 50 vehicles per hour. Projections indicate this threshold would be exceeded, based on the 2030 analysis.	Install lane if threshold exceeded due to this development's traffic (to be determined with the preliminary plan) or if already exceeded at the time of Preliminary Plan or escrow a pro-rata share for future construction (fee program credit per fee program provisions)
8.2	Judge Orr/Curtis Road Intersection (eastbound approach)	Eastbound right-turn deceleration lane	Currently warranted by ECM. The Saddlehorn Filing No. 2 TIS report and MeadowLake Industrial Park Filing NO. 1 TIS reports include narrative for the provision in the "State Highway Access Code" Section 3.5 (5) for low through volumes. Please refer to those reports for details.	This project is not projected to add eastbound right turning traffic to this intersection, so the responsibility is "by others." Note: This project will add eastbound through traffic, which has the potential to affect the timing of need for the right-turn lane (by others) because the eastbound through volume is the key factor in the determination of the timing of this turn lane as described in the "timing" column.
8.3	Judge Orr/Curtis Road Intersection (northbound approach)	Northbound Left Turn Lane - potential future lengthening (restriping)	Proposed triggers 1) If ECM thresholds for additional stacking length are exceeded AND once (and if) the intersection is signalized or if stop signs are switched to EB and WB. OR 2) while NB stop control remains, if queue reaches lengths which result in operational or safety issues.	This project is not projected to add northbound left turning traffic to this intersection, so the responsibility is "by others."
8.4	Judge Orr/Curtis Road Intersection (Southbound approach)	Southbound Left Turn Lane = potential future lengthening for additional vehicle storage	Proposed triggers 1) If ECM thresholds for additional stacking length are exceeded AND once (and if) the intersection is signalized or if stop signs are switched to EB and WB. OR 2) while SB stop control remains, if the southbound queues reach lengths which result in operational or safety issues due to queuing - such as queues spilling into the adjacent through lane (this can be evaluated at Preliminary Plan);	Identify potentially Escrow for improvement depending on anticipated need at Preliminary Plan (or possibly construction if determined to be needed based on this development's traffic AND if conditions called out in the "Timing" column warrant the need for this lane extension. (fee program credit per fee program provisions)
8.5	Judge Orr/Curtis Road Intersection (Intersection Control)	Potentially sign for all-way stop-sign control (AWSC)	Once warrants for AWSC are met (Note: The 2030 Total traffic LOS indicates an E LOS for one of the peak hours (the AM peak); however the PM peak hour shows LOS C; while the AM peak LOS may be an indicator of a possible need for traffic control change, traffic control is not typically changed based on volumes during one hour of the day. Other considerations may include the future safety record, however. This can be reevaluated with the Preliminary Plan and/or Final Plats.	El Paso County and/or other developments as there are multiple projects in the area that may trigger the change in traffic control due to development traffic
8.6	Judge Orr/Curtis Road Intersection (Intersection Control)	Long Term: Reconstruct intersection as a modern roundabout (or signalize the intersection)	Once LOS of AWSC drops below acceptable levels (roundabout); or once signal warrants are met (for conversion to a signal or roundabout)	El Paso County and/or other developments as there are multiple projects in the area that may trigger the change in traffic control due to development traffic. This intersection will be fee-program eligible for a signal/roundabout and applicant will pay fee program traffic impact fees.
Judge Orr/Elbert Road/West Site Access				
9.1	Judge Orr/Elbert Road Intersection w/ addition of south leg (west Site Access) with this development.	The northbound left-turn and the eastbound right-turn volumes are projected to meet the thresholds requiring auxiliary lanes. These will be required (to be verified with the preliminary plan); a deviation may be submitted with the preliminary plan for the northbound left-turn lane if the northbound approach is likely to be stop-sign controlled through the long term, and if no projected queuing or LOS issues absent this lane; construct this intersection to County Standards; south leg to be added IAW the classification map (shown in Figure 10); details to be addressed with the preliminary plan; construct south leg of the intersection to County Standards IAW the classification map (shown in Figure 10); details to be addressed with the preliminary plan.	As development occurs this can be confirmed with the Preliminary Plan (if this changes with the preliminary plan, requirements and associated phasing/timing details to be addressed at that time)	Applicant and/or other developments that may add turning movements to this intersection
Judge Orr/East Site Access				
10.1	Judge Orr/East Site Access	No Auxiliary Turn Lanes Required (to be verified with the preliminary plan); construct this intersection to County Standards; south leg to be added IAW the classification map (shown in Figure 10); details to be addressed with the preliminary plan.	As development occurs this can be confirmed with the Preliminary Plan (if this changes with the preliminary plan, requirements and associated phasing/timing details to be addressed at that time)	Applicant

** Note: CDOT Formula taken from recent nearby projects: [sample] The development is required to participate in the cost of the future traffic signal at Stapleton and Hwy 24. Based on the average AM&PM site-generated passenger cars directly impacting the 4-hour warrant, the development would be responsible for ~\$_____, (____ new vehicles / 60 vehicles-to-warrant x ~\$700K/signal cost).

Figures 1-11



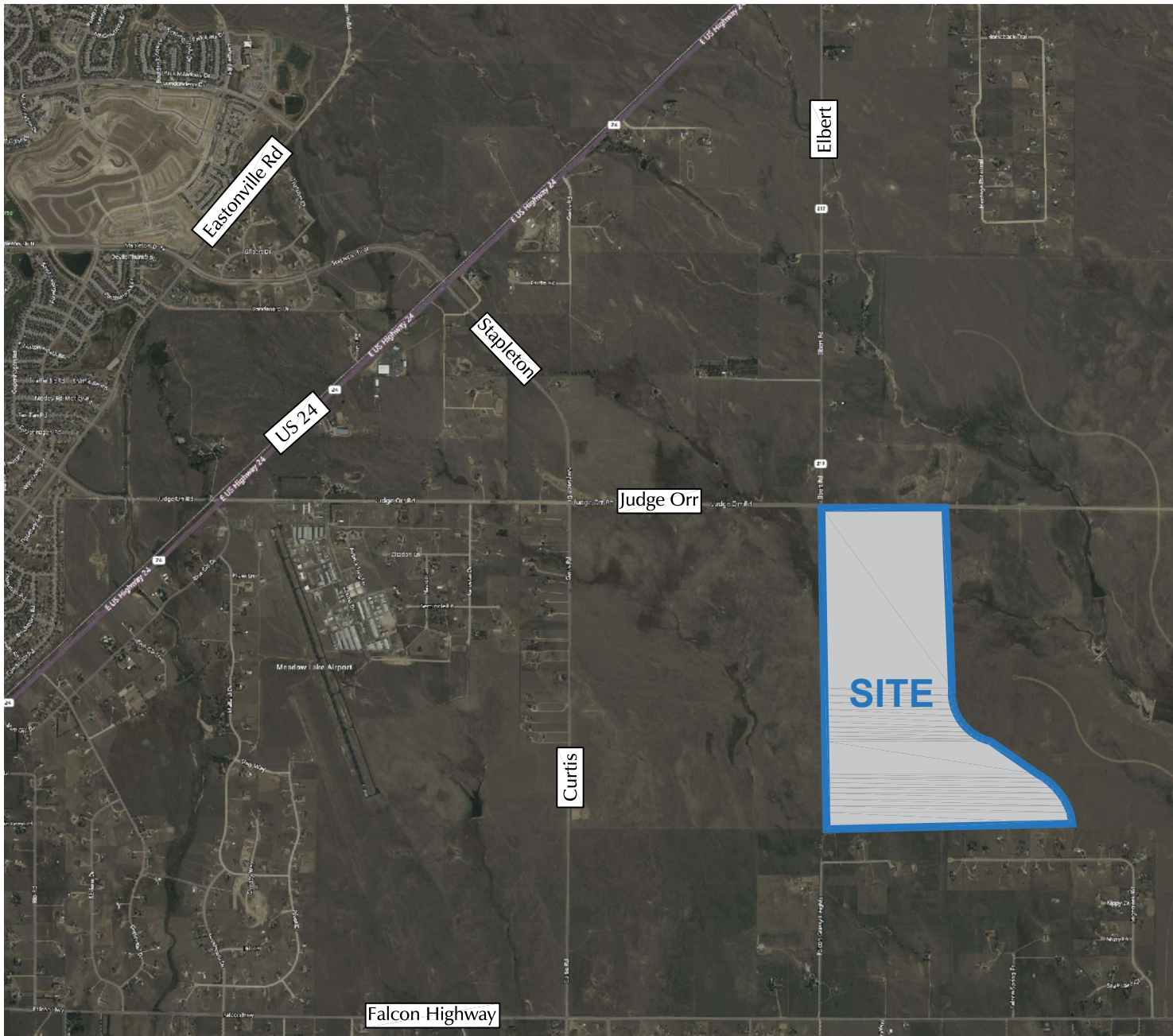

Figure 1
Vicinity Map

Esteban Rodriguez Sketch Plan (LSC# S224630)

Approximate
Scale
1" = 1,000'

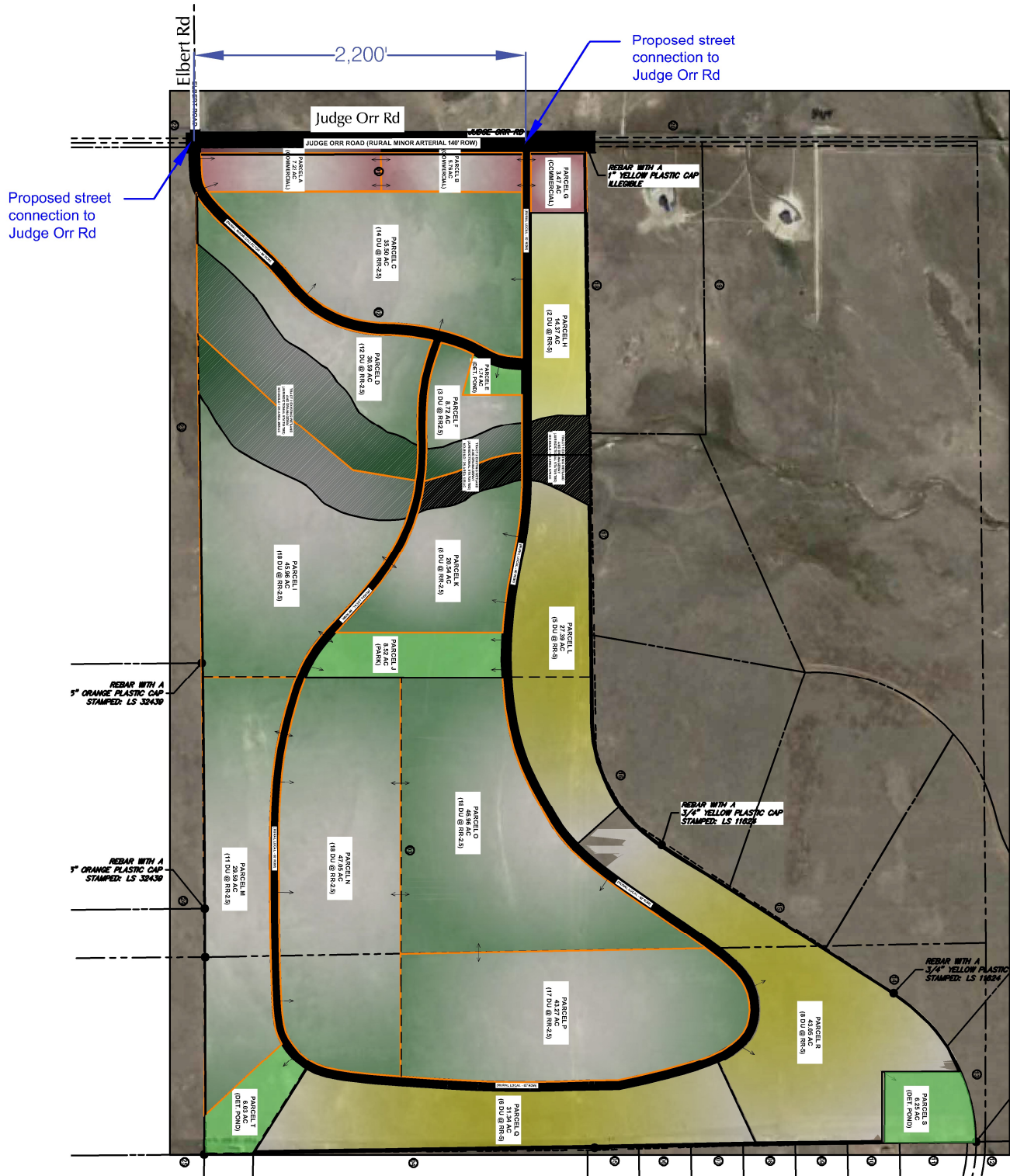
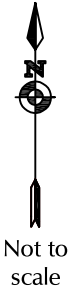
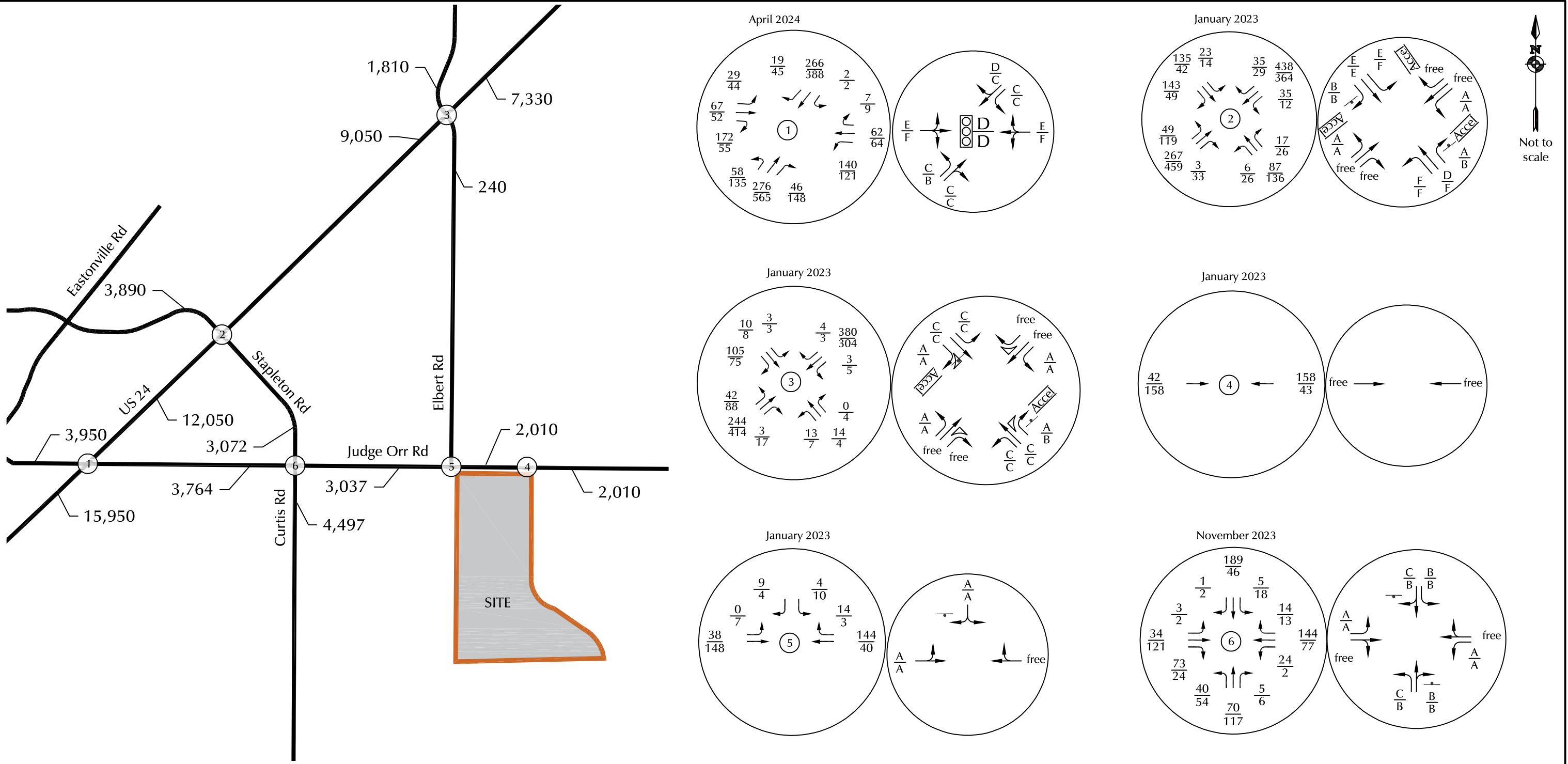

Figure 2
Sketch Plan

Esteban Rodriguez Sketch Plan (LSC# S224630)





$\frac{X}{X}$ = AM Individual Movement Peak-Hour LOS
 $\frac{X}{X}$ = PM Individual Movement Peak-Hour LOS
 $\frac{XX}{XX}$ = AM Weekday Peak-Hour Traffic (Veh/Hour)
 $\frac{XX}{XX}$ = PM Weekday Peak-Hour Traffic (Veh/Hour)
 X,XXX = Average Daily Traffic (Vehicles/Day)

T = Stop Sign
 = Traffic Signal
 Counts by LSC

Figure 3
 Existing Traffic, Lane
 Geometry, Traffic
 Control, and LOS

Esteban Rodriguez Sketch Plan (LSC# S224630)

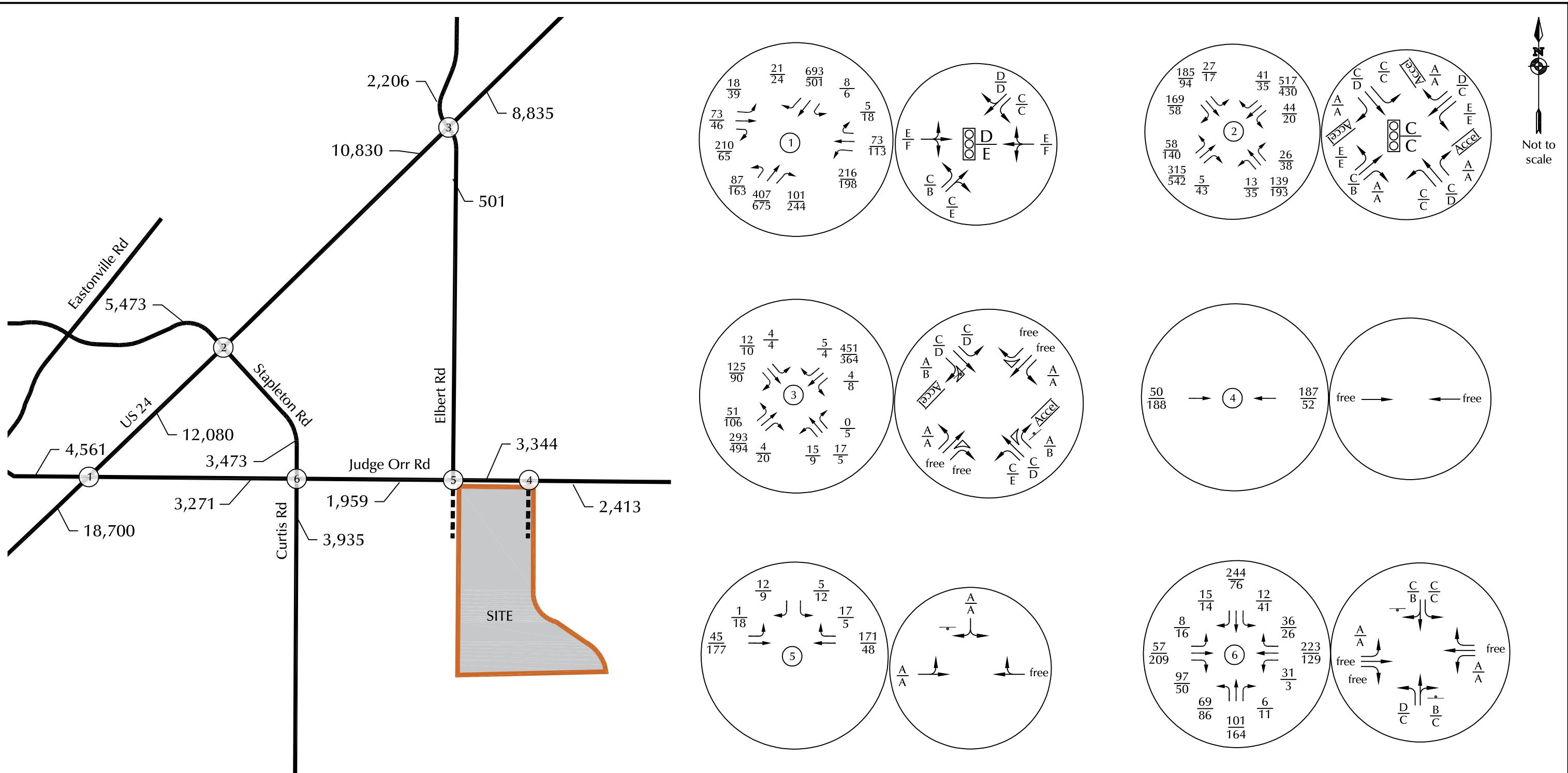

Not to scale

$\frac{X}{X}$ = AM Individual Movement Peak-Hour LOS
 $\frac{X}{X}$ = PM Individual Movement Peak-Hour LOS
 $\frac{XX}{XX}$ = AM Weekday Peak-Hour Traffic (Veh/Hour)
 $\frac{XX}{XX}$ = PM Weekday Peak-Hour Traffic (Veh/Hour)
 X,XXX = Average Daily Traffic (Vehicles/Day)

= Stop Sign
 = Traffic Signal

Figure 4
 2030 Baseline Traffic, Lane Geometry,
 Traffic Control, and LOS

Esteban Rodriguez Sketch Plan (LSC# S224630)

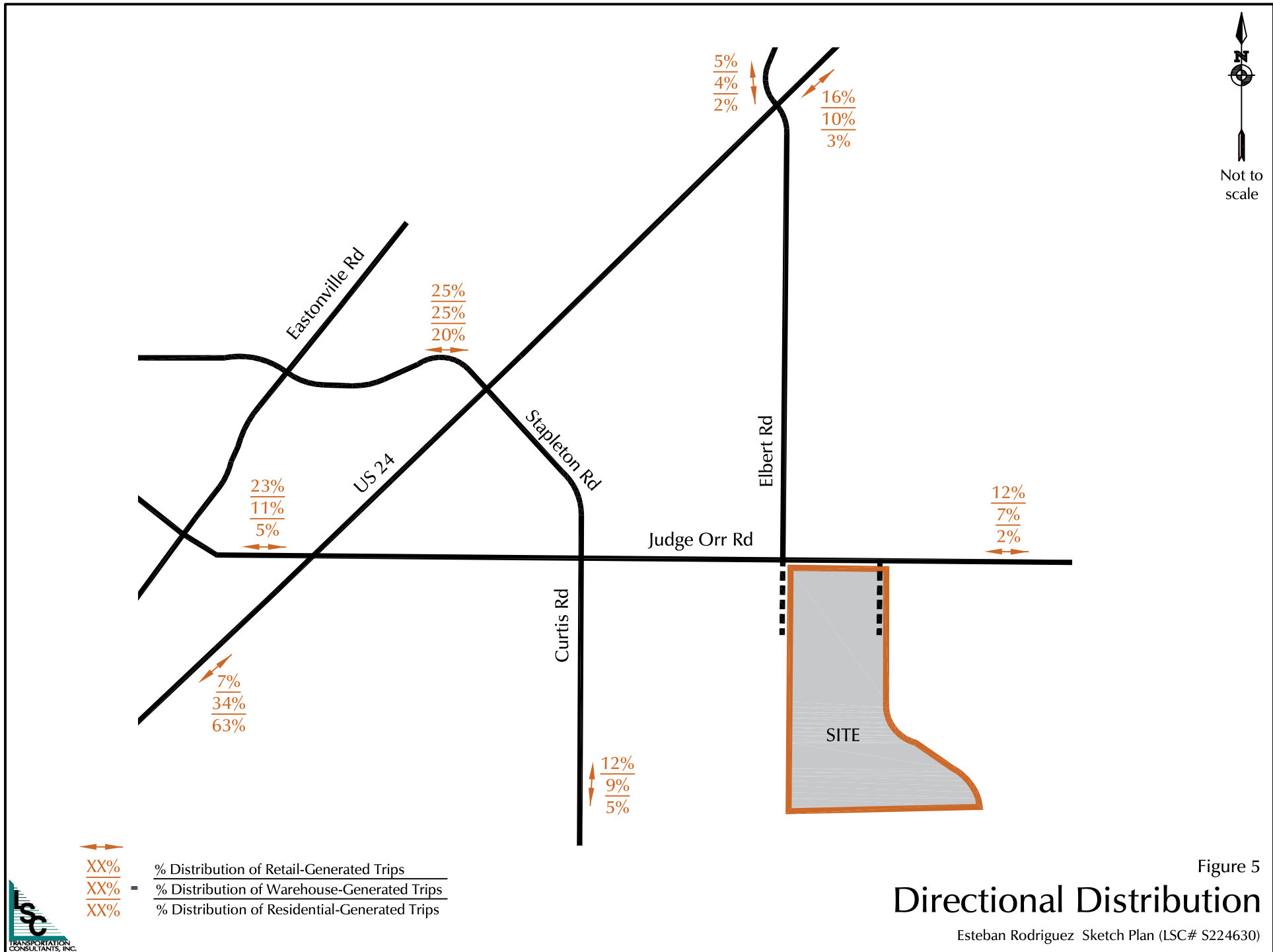
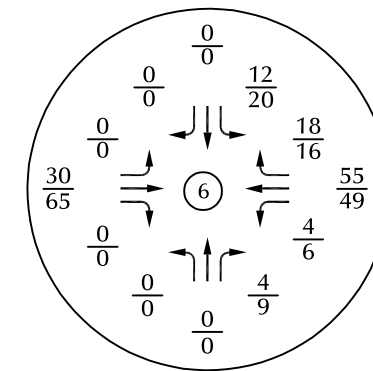
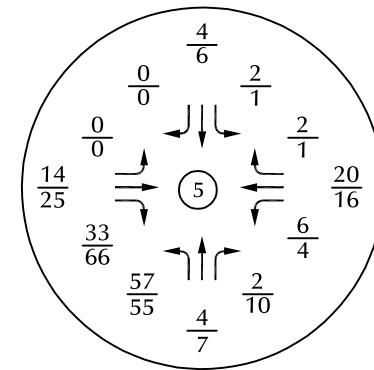
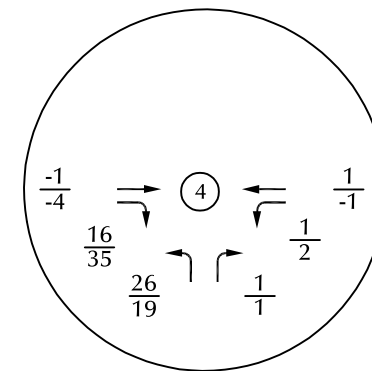
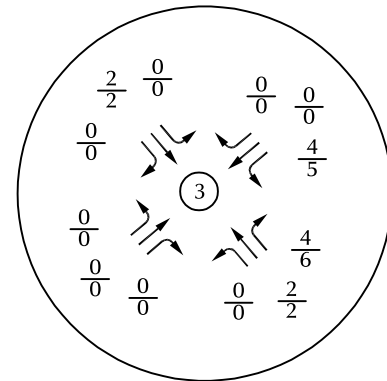
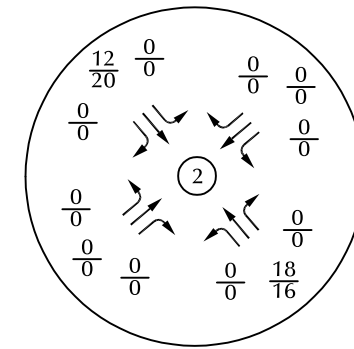
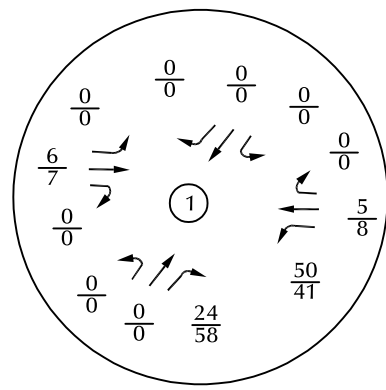
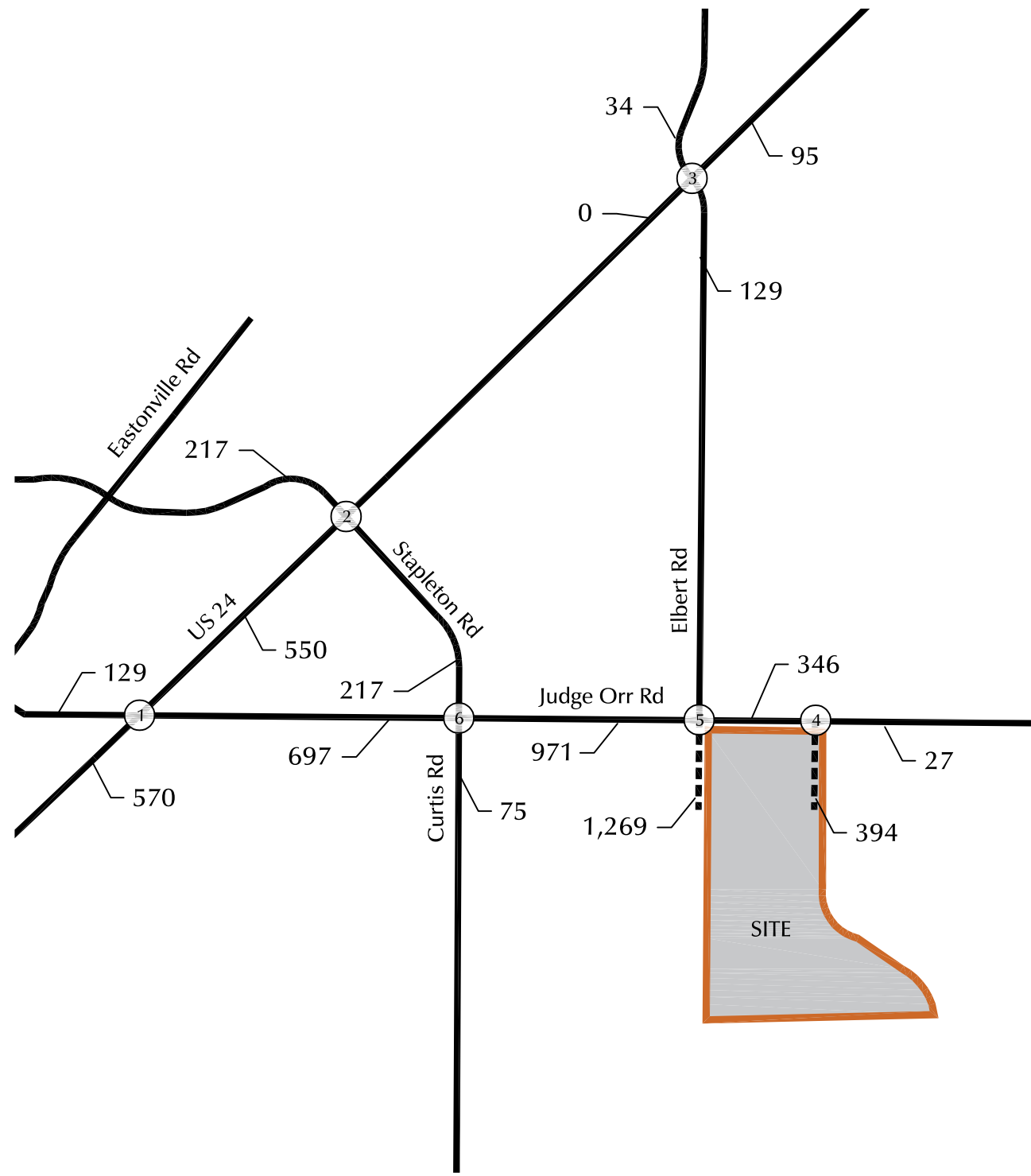

Figure 5

Directional Distribution

Esteban Rodriguez Sketch Plan (LSC# S224630)





$\frac{XX}{XX}$ = AM Weekday Peak-Hour Traffic (Veh/Hour)
 $\frac{XX}{XX}$ = PM Weekday Peak-Hour Traffic (Veh/Hour)
 X,XXX = Average Daily Traffic (Vehicles/Day)

Figure 6a
Short-Term
Site-Generated Traffic

Esteban Rodriguez Sketch Plan (LSC# S224630)

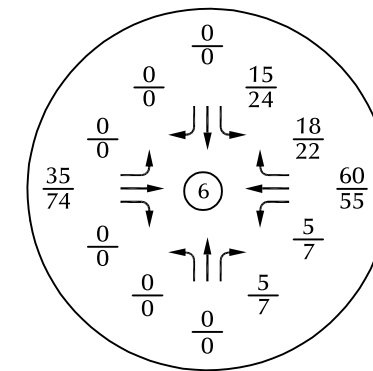
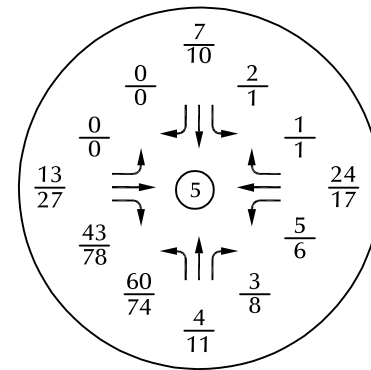
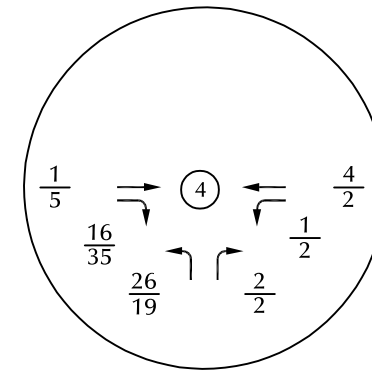
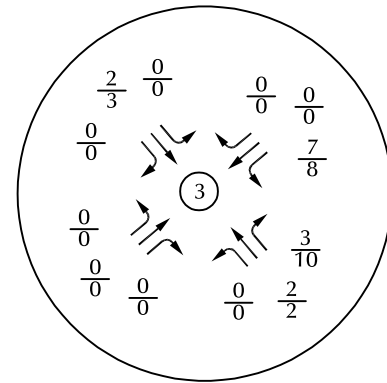
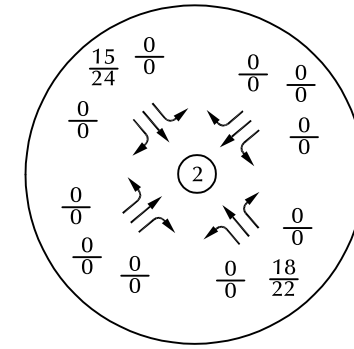
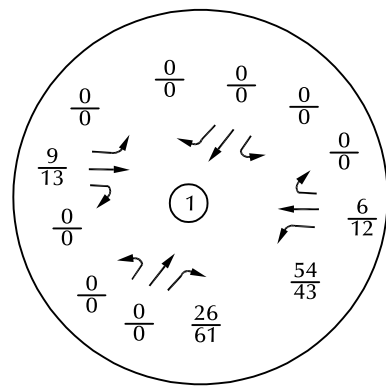
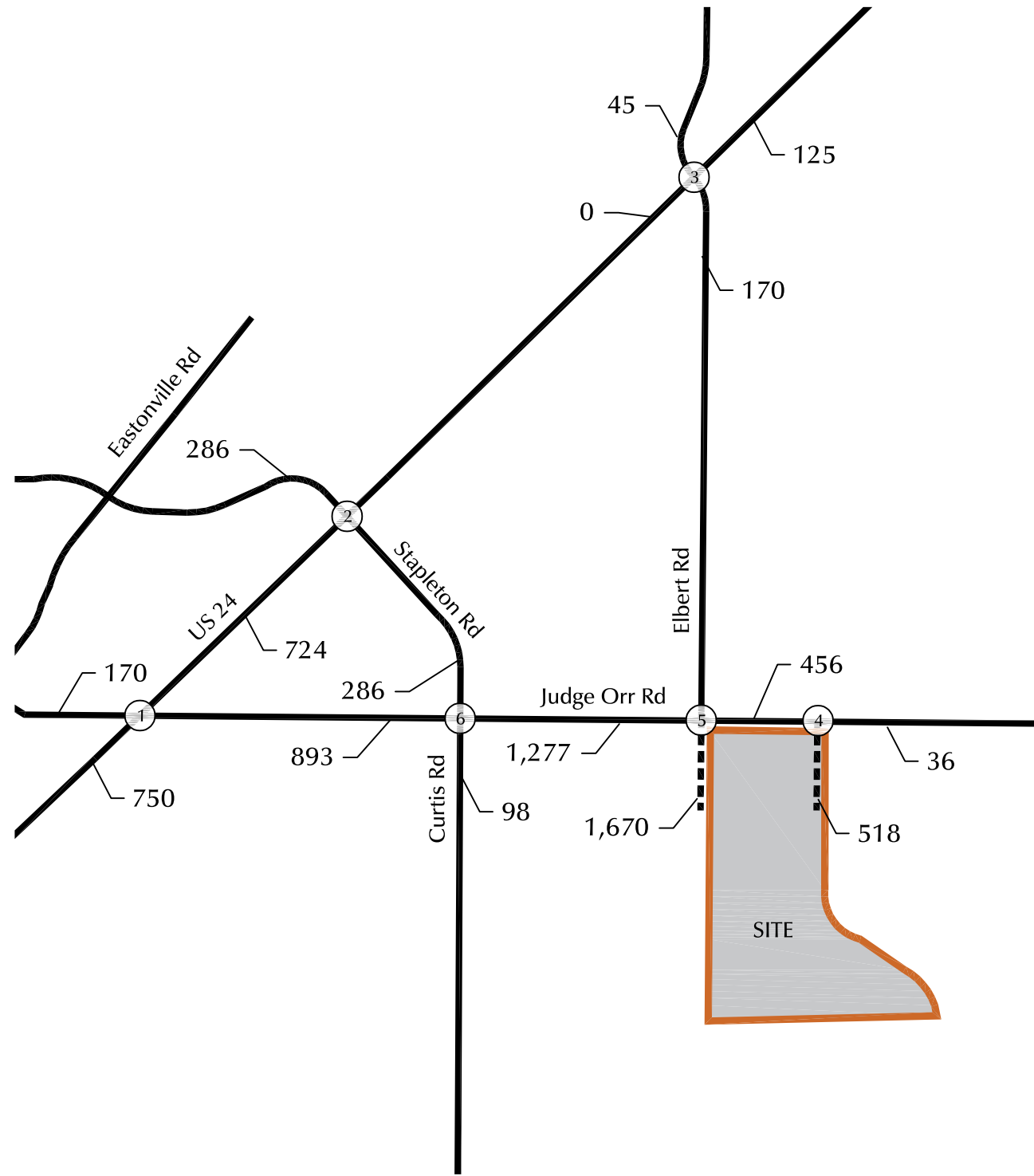

$\frac{XX}{XX}$ = AM Weekday Peak-Hour Traffic (Veh/Hour)
 $\frac{XX}{XX}$ = PM Weekday Peak-Hour Traffic (Veh/Hour)
 X,XXX = Average Daily Traffic (Vehicles/Day)

Figure 6b
Long-Term
Site-Generated Traffic

Esteban Rodriguez Sketch Plan (LSC# S224630)

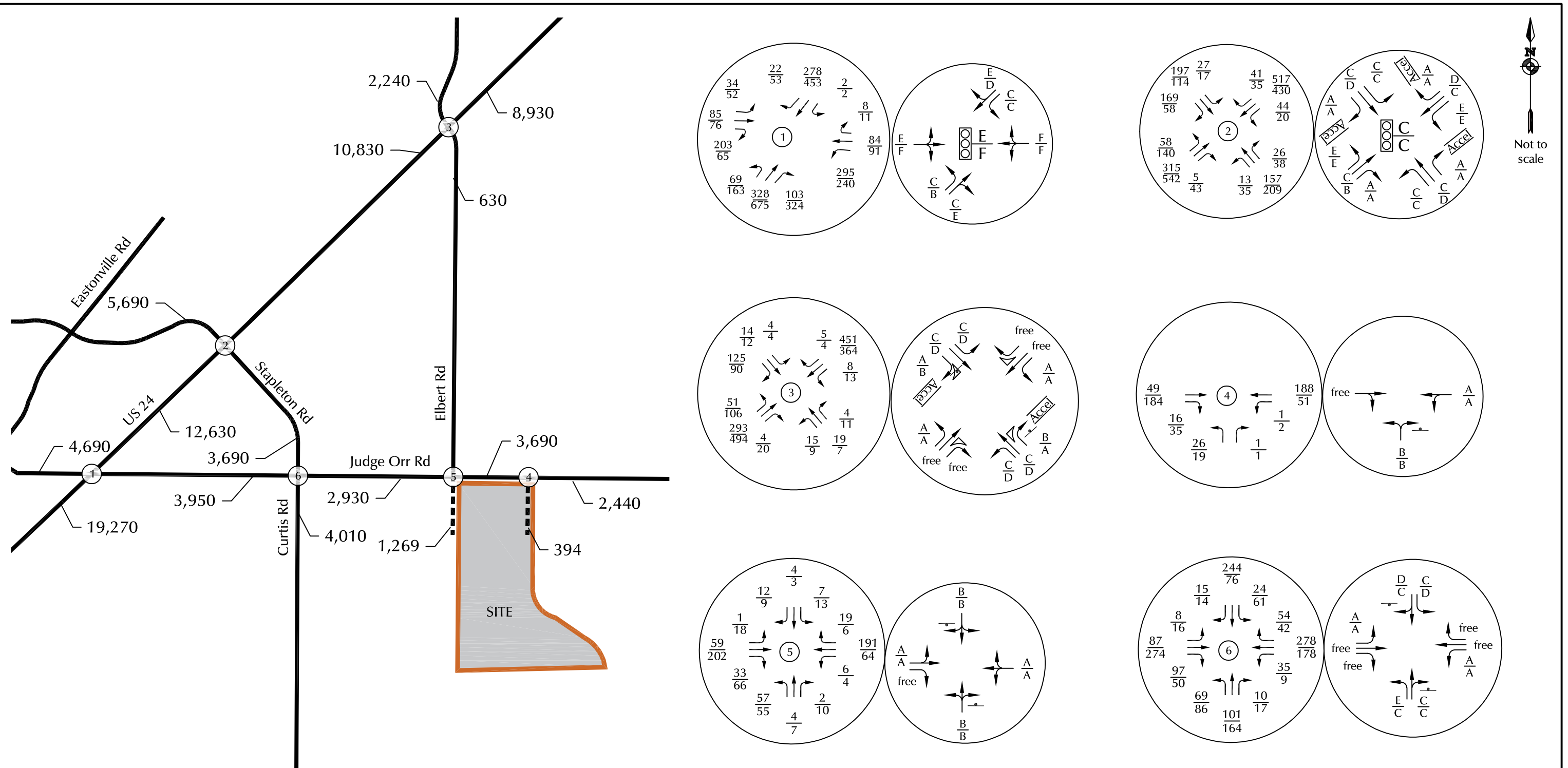

$\frac{X}{X}$ = AM Individual Movement Peak-Hour LOS
 $\frac{X}{X}$ = PM Individual Movement Peak-Hour LOS
 $\frac{XX}{XX}$ = AM Weekday Peak-Hour Traffic (Veh/Hour)
 $\frac{XX}{XX}$ = PM Weekday Peak-Hour Traffic (Veh/Hour)
 X,XXX = Average Daily Traffic (Vehicles/Day)

T = Stop Sign
 [Traffic Signal Symbol] = Traffic Signal



Figure 7
**2030 Baseline + Site Traffic, Lane
 Geometry, Traffic Control, and LOS**

Esteban Rodriguez Sketch Plan (LSC# S224630)

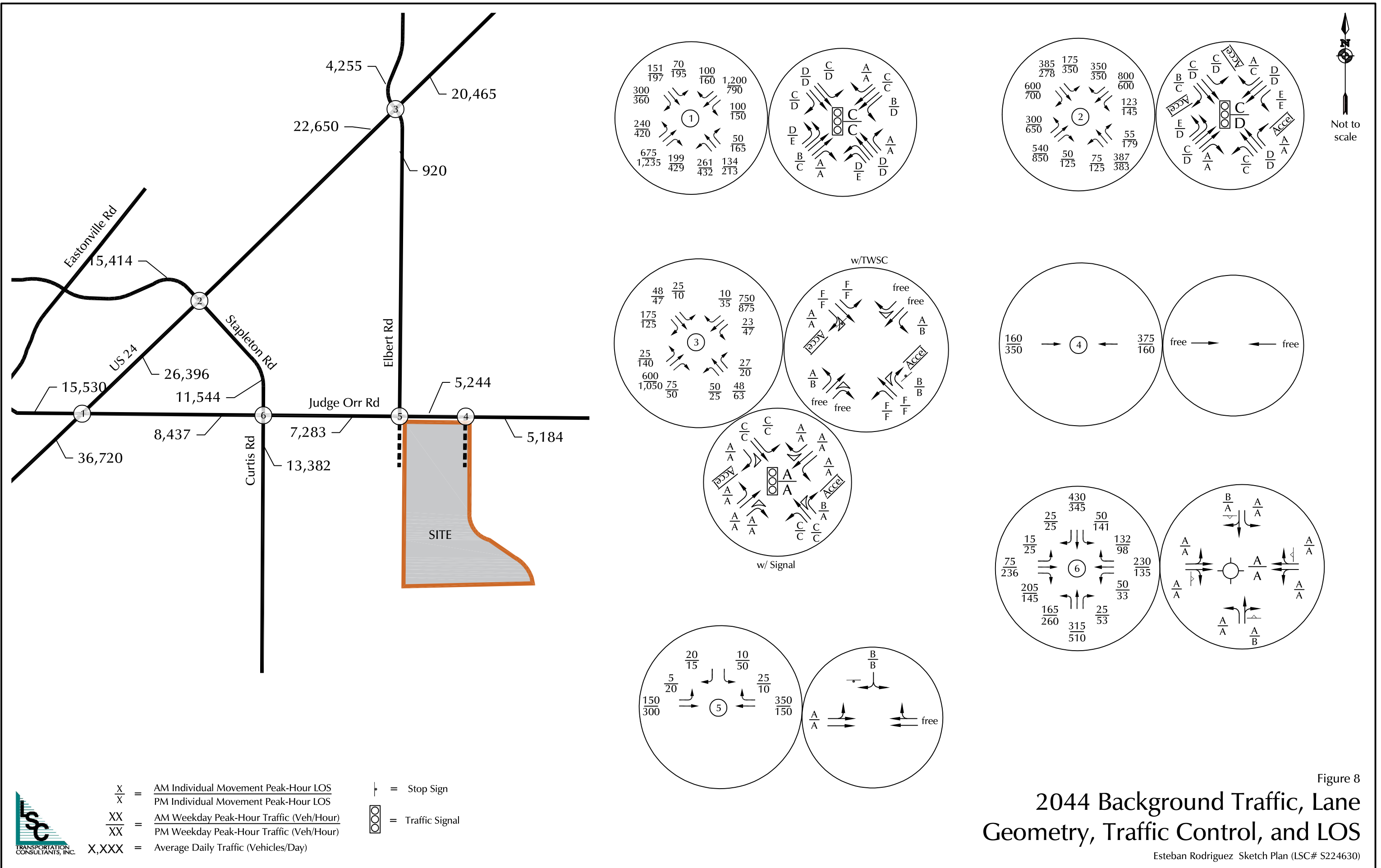
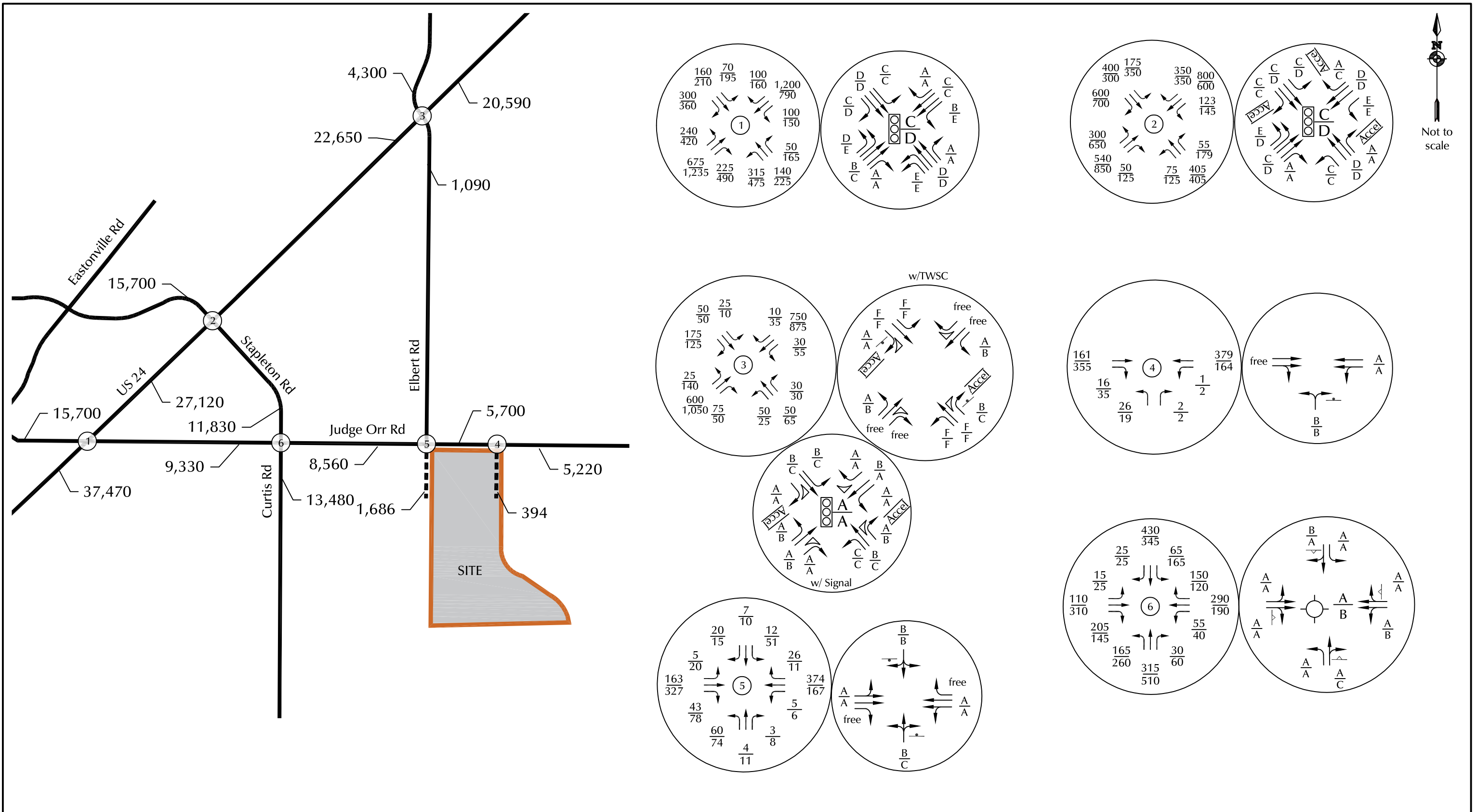

Figure 8
**2044 Background Traffic, Lane
 Geometry, Traffic Control, and LOS**

Esteban Rodriguez Sketch Plan (LSC# S224630)



X = AM Individual Movement Peak-Hour LOS

 X = PM Individual Movement Peak-Hour LOS

 XX = AM Weekday Peak-Hour Traffic (Veh/Hour)

 XX = PM Weekday Peak-Hour Traffic (Veh/Hour)

 X,XXX = Average Daily Traffic (Vehicles/Day)

 T = Stop Sign

 [Traffic Signal Symbol] = Traffic Signal

Figure 9
 2044 Total Traffic, Lane Geometry,
 Traffic Control, and LOS

Esteban Rodriguez Sketch Plan (LSC# S224630)

Approximate
Scale
1" = 1,000'



*LSC recommends rural minor collector, although the projected ADT along the commercial frontage exceeds 1,500 bpd. A deviation and/or potentially some level of enhanced cross sectional elements could be considered, if needed. This could be addressed with the Preliminary Plan

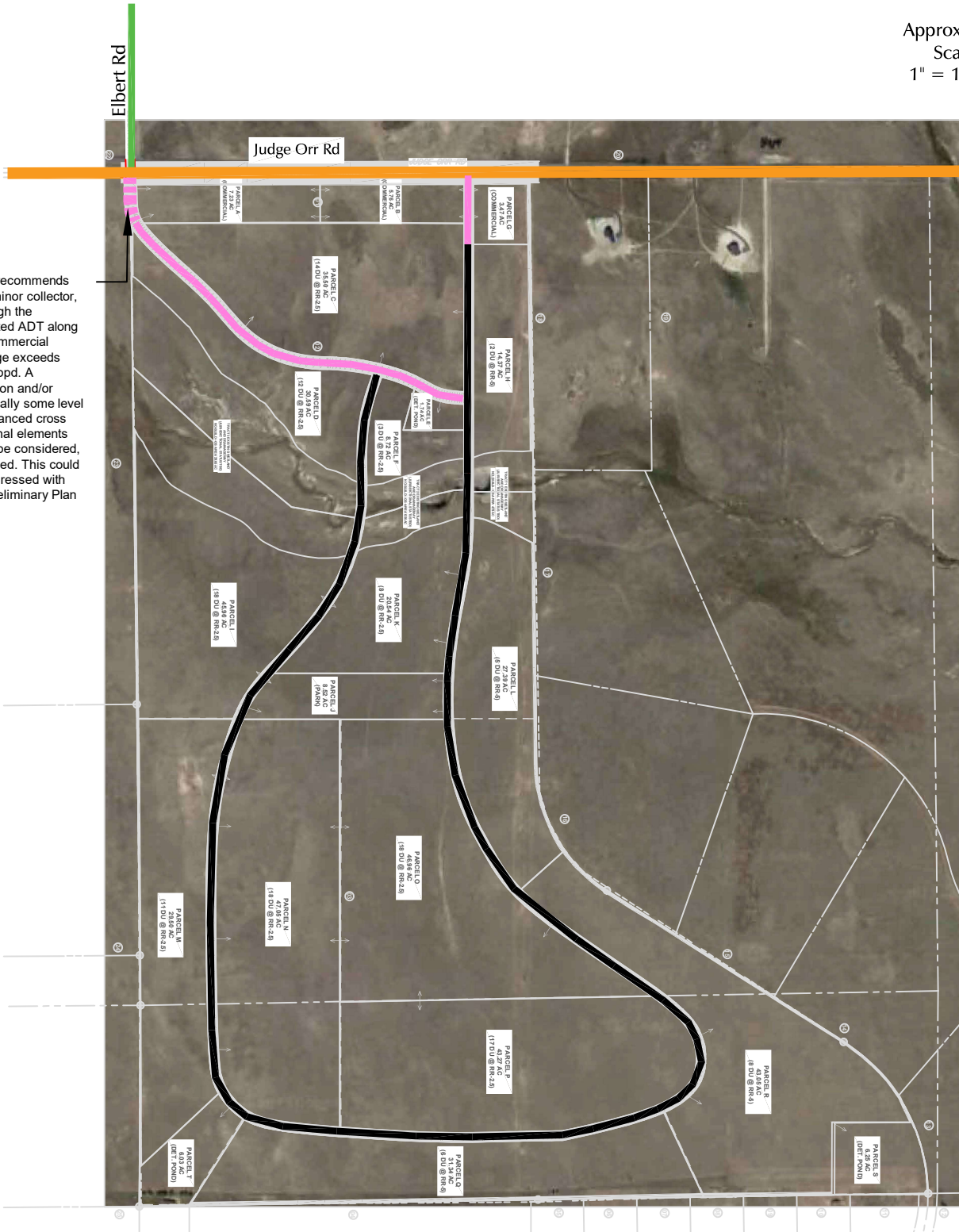

Note: The 2045 Draft MTCP shows Judge Orr as a 2-lane, Rural Minor Arterial. The 2045 Draft MTCP also shows this segment of Elbert Road as a 2-lane, Rural Minor Collector.

- Rural Minor Arterial (2 Lanes)
- Rural Minor Arterial (4 Lanes)
- Rural Minor Collector (2 Lanes)
- Rural Local (2 Lanes)

Figure 10 Roadway Classifications

Esteban Rodriguez Sketch Plan (LSC# S224630)

- Urban Principal Arterial
- Rural Principal Arterial
- Rural Minor Arterial (2 Lanes)
- Urban Major Collector (2 Lanes)
- Rural Minor Collector (2 Lanes)
- Rural Local (2 Lanes)

Based on the DRAFT 2045
MTCP Roadway Classifications

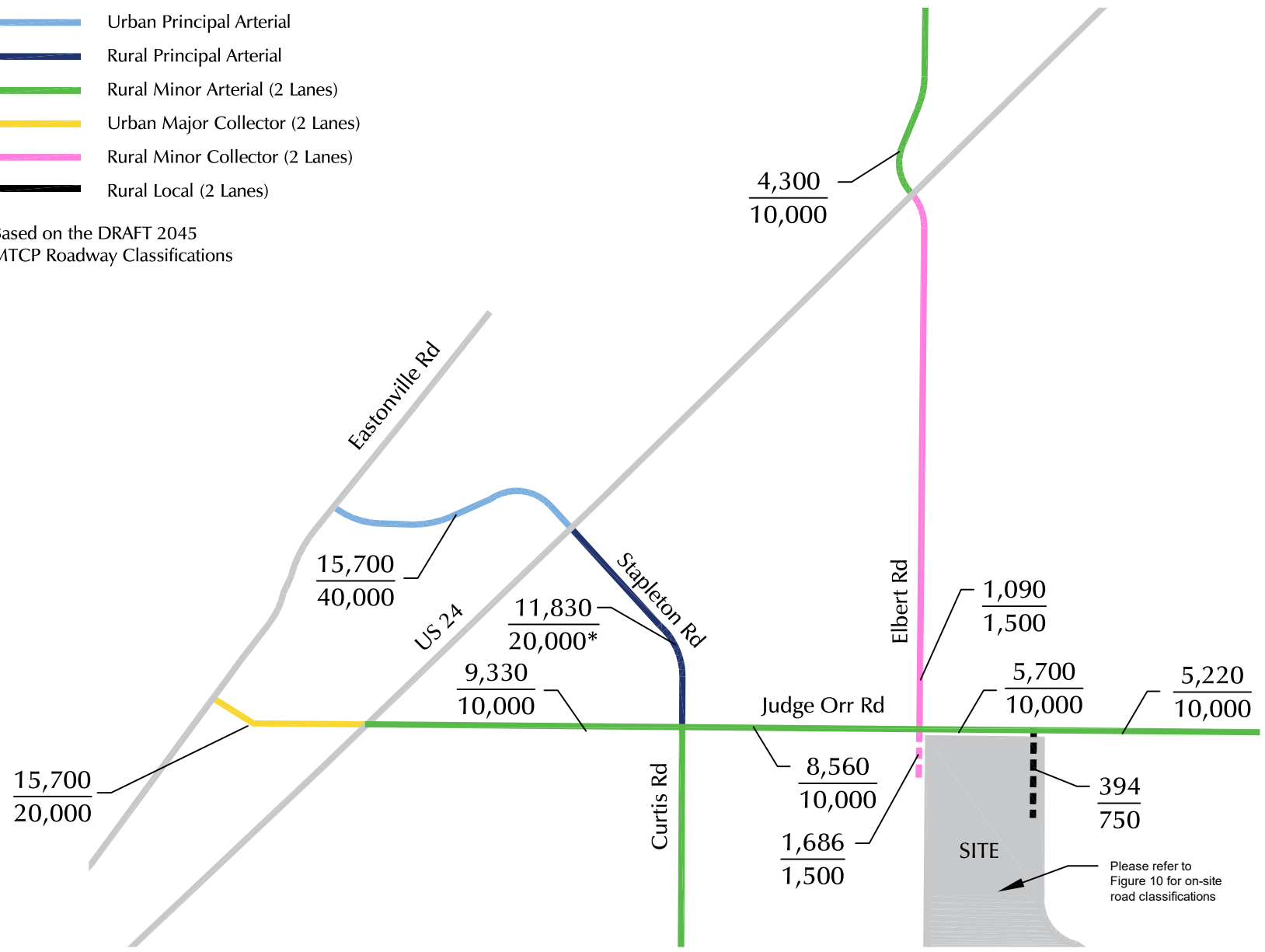

* Estimated ADT, as ECM doesn't provide design ADT for 2-lane Rural Principal Arterial

$$\frac{X,XXX}{X,XXX} = \frac{2044 \text{ Total ADT}}{\text{ECM's Design ADT by Roadway Classification Type}}$$

Figure 11
**ADT vs. Design ADT Comparison
by Roadway Classification**

Esteban Rodriguez Sketch Plan (LSC# S224630)



Traffic Counts



LSC Transportation Consultants, Inc.

2504 E. Pikes Peak Ave, Suite 304
 Colorado Springs, CO 80909
 719-633-2868

File Name : Curtis Rd - Judge Orr Rd AM 11-23

Site Code : S234040

Start Date : 11/7/2023

Page No : 1

Groups Printed- Unshifted

Start Time	Stapleton Rd Southbound					Judge Orr Rd Westbound					Curtis Rd Northbound					Judge Orr Rd Eastbound					Int. Total
	Right	Thru	Left	Peds	App. Total	Right	Thru	Left	Peds	App. Total	Right	Thru	Left	Peds	App. Total	Right	Thru	Left	Peds	App. Total	
06:30	0	11	0	0	11	1	6	1	0	8	0	3	2	0	5	5	1	1	0	7	31
06:35	0	16	1	0	17	1	7	0	0	8	0	1	2	0	3	4	1	0	0	5	33
06:40	0	8	0	0	8	2	8	0	0	10	0	6	2	0	8	9	1	1	0	11	37
06:45	0	12	0	0	12	1	13	2	0	16	1	3	2	0	6	10	2	1	0	13	47
06:50	0	14	0	0	14	0	6	1	0	7	0	9	2	0	11	7	2	1	0	10	42
06:55	0	20	0	0	20	1	11	2	0	14	0	5	1	0	6	7	6	0	0	13	53
Total	0	81	1	0	82	6	51	6	0	63	1	27	11	0	39	42	13	4	0	59	243
07:00	0	10	0	0	10	1	7	1	0	9	0	7	3	0	10	5	1	1	0	7	36
07:05	0	25	0	0	25	1	18	2	0	21	0	9	4	0	13	7	4	0	0	11	70
07:10	0	19	1	0	20	2	11	4	0	17	0	7	4	0	11	7	3	0	0	10	58
07:15	0	15	2	0	17	2	10	5	0	17	1	8	3	0	12	5	4	0	0	9	55
07:20	0	14	0	0	14	0	18	2	0	20	1	3	8	0	12	3	4	0	0	7	53
07:25	1	15	0	0	16	4	11	1	0	16	0	3	2	0	5	2	3	0	0	5	42
07:30	0	15	1	0	16	0	20	2	0	22	1	3	2	0	6	10	1	0	0	11	55
07:35	0	17	1	0	18	1	5	2	0	8	0	7	5	0	12	5	1	0	0	6	44
07:40	0	13	0	0	13	1	14	0	0	15	0	6	4	0	10	5	3	0	0	8	46
07:45	2	11	0	0	13	1	6	0	0	7	0	4	1	0	5	3	4	0	0	7	32
07:50	0	10	1	0	11	2	10	0	0	12	1	2	2	0	5	4	5	0	0	9	37
07:55	2	5	0	0	7	0	11	0	0	11	1	3	3	0	7	2	1	1	0	4	29
Total	5	169	6	0	180	15	141	19	0	175	5	62	41	0	108	58	34	2	0	94	557
08:00	1	12	0	0	13	0	6	0	0	6	0	1	2	0	3	0	3	1	0	4	26
08:05	0	11	1	0	12	0	7	1	0	8	0	2	2	0	4	2	4	0	0	6	30
08:10	0	8	0	0	8	1	7	0	0	8	0	3	3	0	6	4	4	0	0	8	30
08:15	1	7	0	0	8	1	7	0	0	8	0	3	1	0	4	4	7	0	0	11	31
08:20	0	7	2	0	9	0	7	0	0	7	0	2	1	0	3	1	4	0	0	5	24
08:25	0	11	1	0	12	1	7	1	0	9	0	3	0	0	3	3	9	0	0	12	36
Grand Total	7	306	11	0	324	24	233	27	0	284	6	103	61	0	170	114	78	7	0	199	977
Apprch %	2.2	94.4	3.4	0		8.5	82	9.5	0		3.5	60.6	35.9	0		57.3	39.2	3.5	0		
Total %	0.7	31.3	1.1	0	33.2	2.5	23.8	2.8	0	29.1	0.6	10.5	6.2	0	17.4	11.7	8	0.7	0	20.4	

LSC Transportation Consultants, Inc.

2504 E. Pikes Peak Ave, Suite 304
 Colorado Springs, CO 80909
 719-633-2868

File Name : Curtis Rd - Judge Orr Rd AM 11-23

Site Code : S234040

Start Date : 11/7/2023

Page No : 2

Start Time	Stapleton Rd Southbound					Judge Orr Rd Westbound					Curtis Rd Northbound					Judge Orr Rd Eastbound					Int. Total
	Right	Thru	Left	Peds	App. Total	Right	Thru	Left	Peds	App. Total	Right	Thru	Left	Peds	App. Total	Right	Thru	Left	Peds	App. Total	
Peak Hour Analysis From 06:30 to 08:25 - Peak 1 of 1																					
Peak Hour for Entire Intersection Begins at 06:45																					
06:45	0	12	0	0	12	1	13	2	0	16	1	3	2	0	6	10	2	1	0	13	47
06:50	0	14	0	0	14	0	6	1	0	7	0	9	2	0	11	7	2	1	0	10	42
06:55	0	20	0	0	20	1	11	2	0	14	0	5	1	0	6	7	6	0	0	13	53
07:00	0	10	0	0	10	1	7	1	0	9	0	7	3	0	10	5	1	1	0	7	36
07:05	0	25	0	0	25	1	18	2	0	21	0	9	4	0	13	7	4	0	0	11	70
07:10	0	19	1	0	20	2	11	4	0	17	0	7	4	0	11	7	3	0	0	10	58
07:15	0	15	2	0	17	2	10	5	0	17	1	8	3	0	12	5	4	0	0	9	55
07:20	0	14	0	0	14	0	18	2	0	20	1	3	8	0	12	3	4	0	0	7	53
07:25	1	15	0	0	16	4	11	1	0	16	0	3	2	0	5	2	3	0	0	5	42
07:30	0	15	1	0	16	0	20	2	0	22	1	3	2	0	6	10	1	0	0	11	55
07:35	0	17	1	0	18	1	5	2	0	8	0	7	5	0	12	5	1	0	0	6	44
07:40	0	13	0	0	13	1	14	0	0	15	0	6	4	0	10	5	3	0	0	8	46
Total Volume	1	189	5	0	195	14	144	24	0	182	4	70	40	0	114	73	34	3	0	110	601
% App. Total	0.5	96.9	2.6	0		7.7	79.1	13.2	0		3.5	61.4	35.1	0		66.4	30.9	2.7	0		
PHF	.083	.630	.208	.000	.650	.292	.600	.400	.000	.689	.333	.648	.417	.000	.731	.608	.472	.250	.000	.705	.715

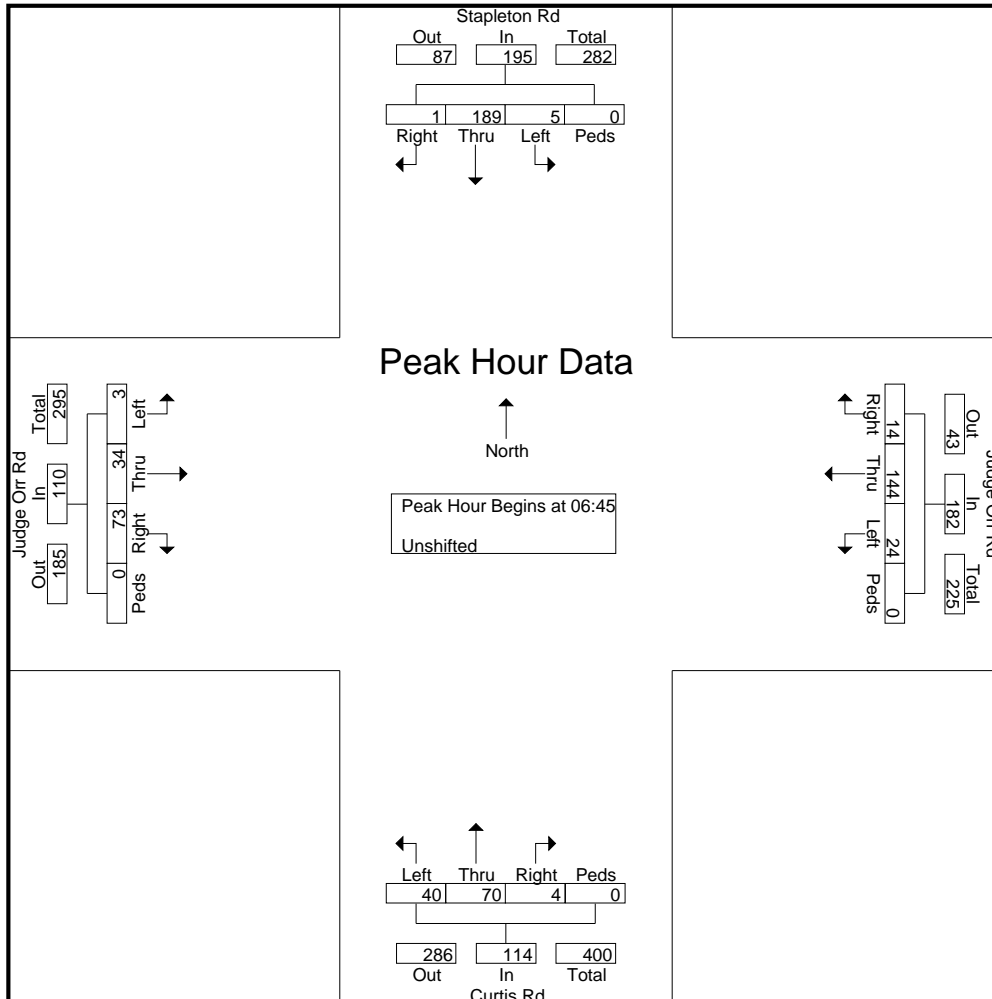

LSC Transportation Consultants, Inc.

2504 E. Pikes Peak Ave, Suite 304
 Colorado Springs, CO 80909
 719-633-2868

File Name : Curtis Rd - Judge Orr Rd AM 11-23

Site Code : S234040

Start Date : 11/7/2023

Page No : 3

Start Time	Stapleton Rd Southbound					Judge Orr Rd Westbound					Curtis Rd Northbound					Judge Orr Rd Eastbound					Int. Total
	Right	Thru	Left	Peds	App. Total	Right	Thru	Left	Peds	App. Total	Right	Thru	Left	Peds	App. Total	Right	Thru	Left	Peds	App. Total	

Peak Hour Analysis From 06:30 to 08:25 - Peak 1 of 1

Peak Hour for Each Approach Begins at:

	06:50					06:45					06:45					06:40				
+0 mins.	0	14	0	0	14	1	13	2	0	16	1	3	2	0	6	9	1	1	0	11
+5 mins.	0	20	0	0	20	0	6	1	0	7	0	9	2	0	11	10	2	1	0	13
+10 mins.	0	10	0	0	10	1	11	2	0	14	0	5	1	0	6	7	2	1	0	10
+15 mins.	0	25	0	0	25	1	7	1	0	9	0	7	3	0	10	7	6	0	0	13
+20 mins.	0	19	1	0	20	1	18	2	0	21	0	9	4	0	13	5	1	1	0	7
+25 mins.	0	15	2	0	17	2	11	4	0	17	0	7	4	0	11	7	4	0	0	11
+30 mins.	0	14	0	0	14	2	10	5	0	17	1	8	3	0	12	7	3	0	0	10
+35 mins.	1	15	0	0	16	0	18	2	0	20	1	3	8	0	12	5	4	0	0	9
+40 mins.	0	15	1	0	16	4	11	1	0	16	0	3	2	0	5	3	4	0	0	7
+45 mins.	0	17	1	0	18	0	20	2	0	22	1	3	2	0	6	2	3	0	0	5
+50 mins.	0	13	0	0	13	1	5	2	0	8	0	7	5	0	12	10	1	0	0	11
+55 mins.	2	11	0	0	13	1	14	0	0	15	0	6	4	0	10	5	1	0	0	6
Total Volume	3	188	5	0	196	14	144	24	0	182	4	70	40	0	114	77	32	4	0	113
% App. Total	1.5	95.9	2.6	0		7.7	79.1	13.2	0		3.5	61.4	35.1	0		68.1	28.3	3.5	0	
PHF	.125	.627	.208	.000	.653	.292	.600	.400	.000	.689	.333	.648	.417	.000	.731	.642	.444	.333	.000	.724

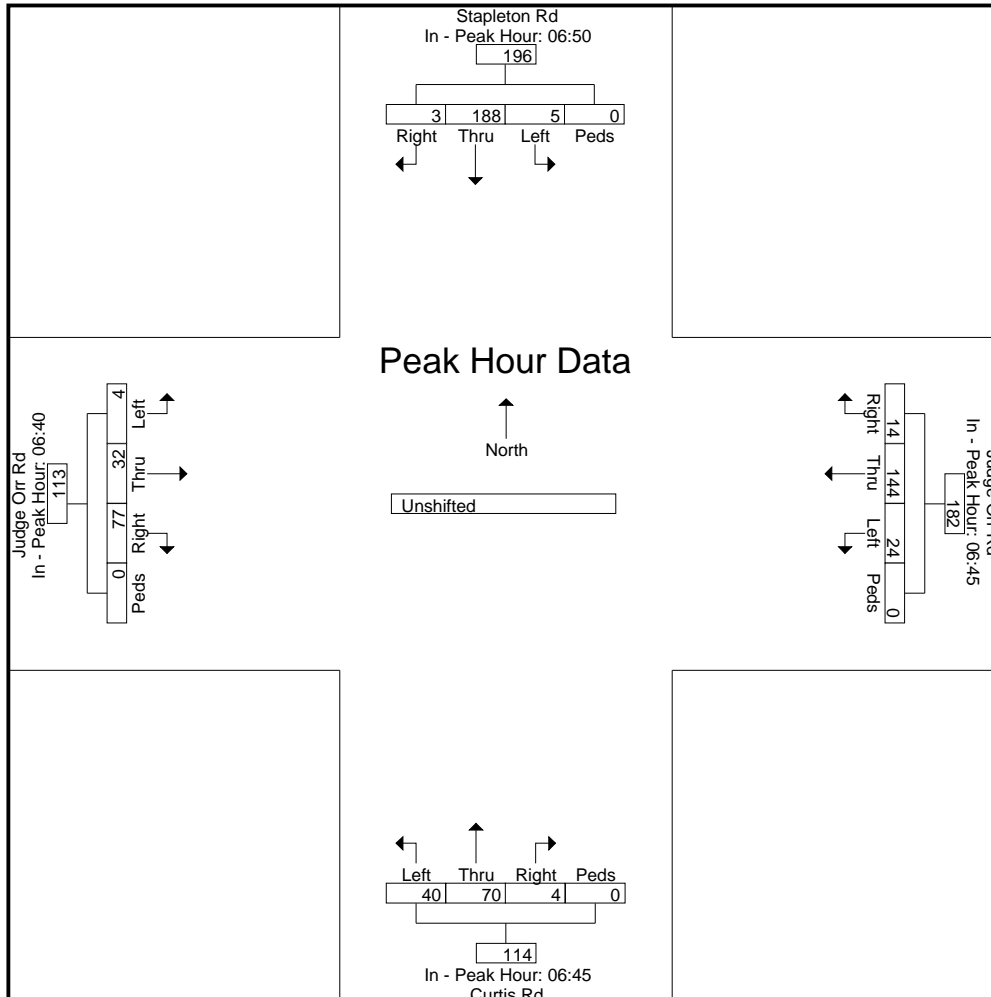

LSC Transportation Consultants, Inc.

2504 E. Pikes Peak Ave, Suite 304
 Colorado Springs, CO 80909
 719-633-2868

File Name : Curtis Rd - Judge Orr Rd PM 11-23

Site Code : S234040

Start Date : 11/2/2023

Page No : 1

Groups Printed- Unshifted

Start Time	Stapleton Rd Southbound					Judge Orr Rd Westbound					Curtis Rd Northbound					Judge Orr Rd Eastbound					Int. Total
	Right	Thru	Left	Peds	App. Total	Right	Thru	Left	Peds	App. Total	Right	Thru	Left	Peds	App. Total	Right	Thru	Left	Peds	App. Total	
16:00	0	4	2	0	6	1	2	1	0	4	0	8	4	0	12	2	8	0	0	10	32
16:05	0	5	3	0	8	0	2	0	0	2	0	9	5	0	14	2	9	0	0	11	35
16:10	0	6	3	0	9	3	5	1	0	9	0	12	6	0	18	1	15	0	0	16	52
16:15	1	3	1	0	5	0	11	0	0	11	0	6	5	0	11	3	9	0	0	12	39
16:20	0	3	0	0	3	0	7	0	0	7	1	9	4	0	14	1	10	0	0	11	35
16:25	1	6	2	0	9	2	11	0	0	13	1	22	11	0	34	0	12	1	0	13	69
16:30	0	8	2	0	10	2	6	0	0	8	0	10	4	0	14	2	6	0	0	8	40
16:35	0	3	0	0	3	3	1	1	0	5	1	11	5	0	17	3	10	0	0	13	38
16:40	0	2	1	0	3	0	10	0	0	10	0	4	3	0	7	1	10	0	0	11	31
16:45	0	3	1	0	4	2	6	0	0	8	1	8	4	0	13	2	9	0	0	11	36
16:50	0	2	2	0	4	0	5	0	0	5	0	7	5	0	12	4	8	0	0	12	33
16:55	0	2	2	0	4	1	5	0	0	6	2	6	2	0	10	2	14	0	0	16	36
Total	2	47	19	0	68	14	71	3	0	88	6	112	58	0	176	23	120	1	0	144	476
17:00	0	2	1	0	3	0	5	0	0	5	0	10	4	0	14	3	5	1	0	9	31
17:05	0	6	3	0	9	0	5	0	0	5	0	12	1	0	13	2	13	0	0	15	42
17:10	1	2	3	0	6	0	2	0	0	2	0	11	3	0	14	1	9	0	0	10	32
17:15	0	5	4	0	9	0	7	0	0	7	2	6	6	0	14	6	15	0	0	21	51
17:20	0	5	4	0	9	1	5	0	0	6	0	10	2	0	12	1	9	0	0	10	37
17:25	0	1	1	0	2	0	5	0	0	5	0	14	8	0	22	2	13	1	0	16	45
17:30	0	2	2	0	4	1	5	1	0	7	0	7	5	0	12	2	12	0	0	14	37
17:35	0	2	1	0	3	0	3	0	0	3	1	11	3	0	15	1	9	0	0	10	31
17:40	0	4	2	0	6	0	3	0	0	3	0	3	1	0	4	1	10	0	0	11	24
17:45	1	6	4	0	11	0	12	0	0	12	0	9	0	0	9	2	11	0	0	13	45
17:50	0	3	0	0	3	2	5	0	0	7	1	12	2	0	15	1	10	0	0	11	36
17:55	1	4	2	0	7	2	6	0	0	8	0	6	5	0	11	1	7	0	0	8	34
Total	3	42	27	0	72	6	63	1	0	70	4	111	40	0	155	23	123	2	0	148	445
Grand Total	5	89	46	0	140	20	134	4	0	158	10	223	98	0	331	46	243	3	0	292	921
Apprch %	3.6	63.6	32.9	0		12.7	84.8	2.5	0		3	67.4	29.6	0		15.8	83.2	1	0		
Total %	0.5	9.7	5	0	15.2	2.2	14.5	0.4	0	17.2	1.1	24.2	10.6	0	35.9	5	26.4	0.3	0	31.7	

LSC Transportation Consultants, Inc.

2504 E. Pikes Peak Ave, Suite 304
 Colorado Springs, CO 80909
 719-633-2868

File Name : Curtis Rd - Judge Orr Rd PM 11-23

Site Code : S234040

Start Date : 11/2/2023

Page No : 2

Start Time	Stapleton Rd Southbound					Judge Orr Rd Westbound					Curtis Rd Northbound					Judge Orr Rd Eastbound					Int. Total
	Right	Thru	Left	Peds	App. Total	Right	Thru	Left	Peds	App. Total	Right	Thru	Left	Peds	App. Total	Right	Thru	Left	Peds	App. Total	
Peak Hour Analysis From 16:00 to 17:55 - Peak 1 of 1																					
Peak Hour for Entire Intersection Begins at 16:10																					
16:10	0	6	3	0	9	3	5	1	0	9	0	12	6	0	18	1	15	0	0	16	52
16:15	1	3	1	0	5	0	11	0	0	11	0	6	5	0	11	3	9	0	0	12	39
16:20	0	3	0	0	3	0	7	0	0	7	1	9	4	0	14	1	10	0	0	11	35
16:25	1	6	2	0	9	2	11	0	0	13	1	22	11	0	34	0	12	1	0	13	69
16:30	0	8	2	0	10	2	6	0	0	8	0	10	4	0	14	2	6	0	0	8	40
16:35	0	3	0	0	3	3	1	1	0	5	1	11	5	0	17	3	10	0	0	13	38
16:40	0	2	1	0	3	0	10	0	0	10	0	4	3	0	7	1	10	0	0	11	31
16:45	0	3	1	0	4	2	6	0	0	8	1	8	4	0	13	2	9	0	0	11	36
16:50	0	2	2	0	4	0	5	0	0	5	0	7	5	0	12	4	8	0	0	12	33
16:55	0	2	2	0	4	1	5	0	0	6	2	6	2	0	10	2	14	0	0	16	36
17:00	0	2	1	0	3	0	5	0	0	5	0	10	4	0	14	3	5	1	0	9	31
17:05	0	6	3	0	9	0	5	0	0	5	0	12	1	0	13	2	13	0	0	15	42
Total Volume	2	46	18	0	66	13	77	2	0	92	6	117	54	0	177	24	121	2	0	147	482
% App. Total	3	69.7	27.3	0		14.1	83.7	2.2	0		3.4	66.1	30.5	0		16.3	82.3	1.4	0		
PHF	.167	.479	.500	.000	.550	.361	.583	.167	.000	.590	.250	.443	.409	.000	.434	.500	.672	.167	.000	.766	.582

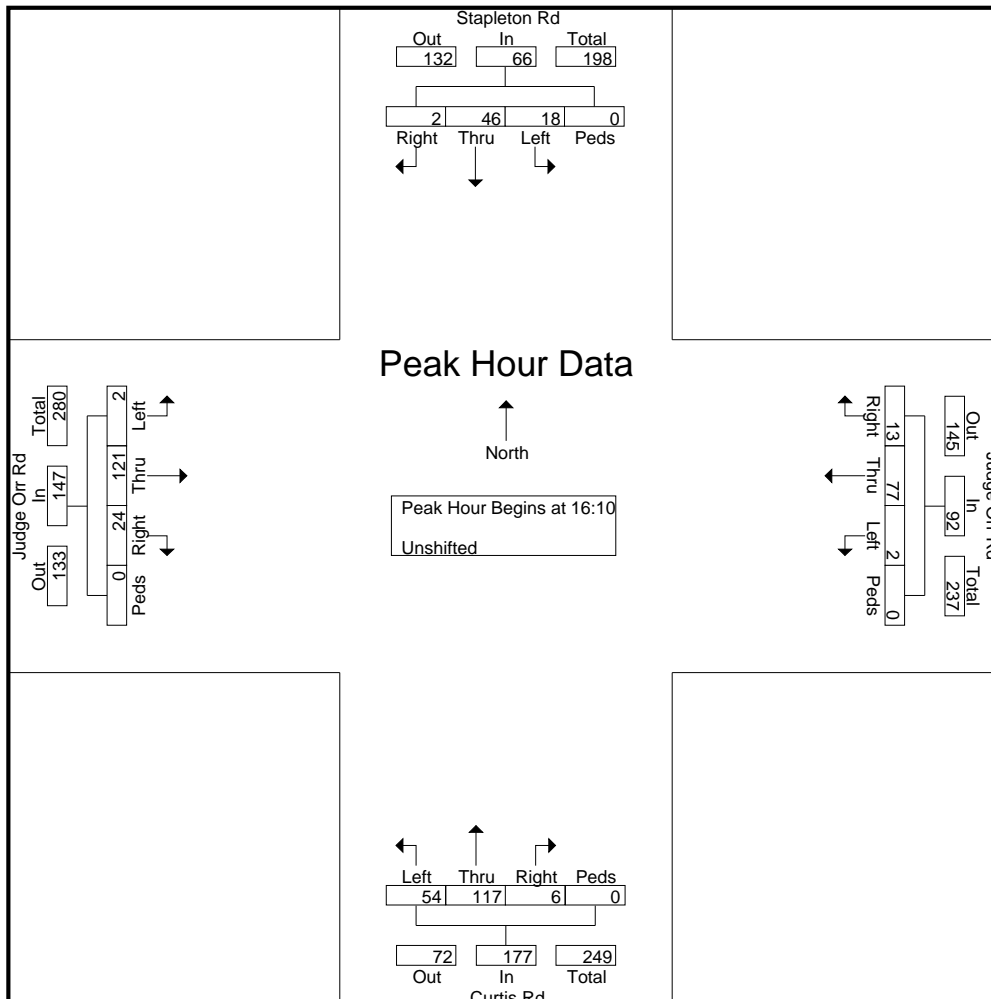

LSC Transportation Consultants, Inc.

2504 E. Pikes Peak Ave, Suite 304
 Colorado Springs, CO 80909
 719-633-2868

File Name : Curtis Rd - Judge Orr Rd PM 11-23

Site Code : S234040

Start Date : 11/2/2023

Page No : 3

Start Time	Stapleton Rd Southbound					Judge Orr Rd Westbound					Curtis Rd Northbound					Judge Orr Rd Eastbound					Int. Total
	Right	Thru	Left	Peds	App. Total	Right	Thru	Left	Peds	App. Total	Right	Thru	Left	Peds	App. Total	Right	Thru	Left	Peds	App. Total	

Peak Hour Analysis From 16:00 to 17:55 - Peak 1 of 1

Peak Hour for Each Approach Begins at:

	16:25					16:10					16:05					16:35				
+0 mins.	1	6	2	0	9	3	5	1	0	9	0	9	5	0	14	3	10	0	0	13
+5 mins.	0	8	2	0	10	0	11	0	0	11	0	12	6	0	18	1	10	0	0	11
+10 mins.	0	3	0	0	3	0	7	0	0	7	0	6	5	0	11	2	9	0	0	11
+15 mins.	0	2	1	0	3	2	11	0	0	13	1	9	4	0	14	4	8	0	0	12
+20 mins.	0	3	1	0	4	2	6	0	0	8	1	22	11	0	34	2	14	0	0	16
+25 mins.	0	2	2	0	4	3	1	1	0	5	0	10	4	0	14	3	5	1	0	9
+30 mins.	0	2	2	0	4	0	10	0	0	10	1	11	5	0	17	2	13	0	0	15
+35 mins.	0	2	1	0	3	2	6	0	0	8	0	4	3	0	7	1	9	0	0	10
+40 mins.	0	6	3	0	9	0	5	0	0	5	1	8	4	0	13	6	15	0	0	21
+45 mins.	1	2	3	0	6	1	5	0	0	6	0	7	5	0	12	1	9	0	0	10
+50 mins.	0	5	4	0	9	0	5	0	0	5	2	6	2	0	10	2	13	1	0	16
+55 mins.	0	5	4	0	9	0	5	0	0	5	0	10	4	0	14	2	12	0	0	14
Total Volume	2	46	25	0	73	13	77	2	0	92	6	114	58	0	178	29	127	2	0	158
% App. Total	2.7	63	34.2	0		14.1	83.7	2.2	0		3.4	64	32.6	0		18.4	80.4	1.3	0	
PHF	.167	.479	.521	.000	.608	.361	.583	.167	.000	.590	.250	.432	.439	.000	.436	.403	.706	.167	.000	.627

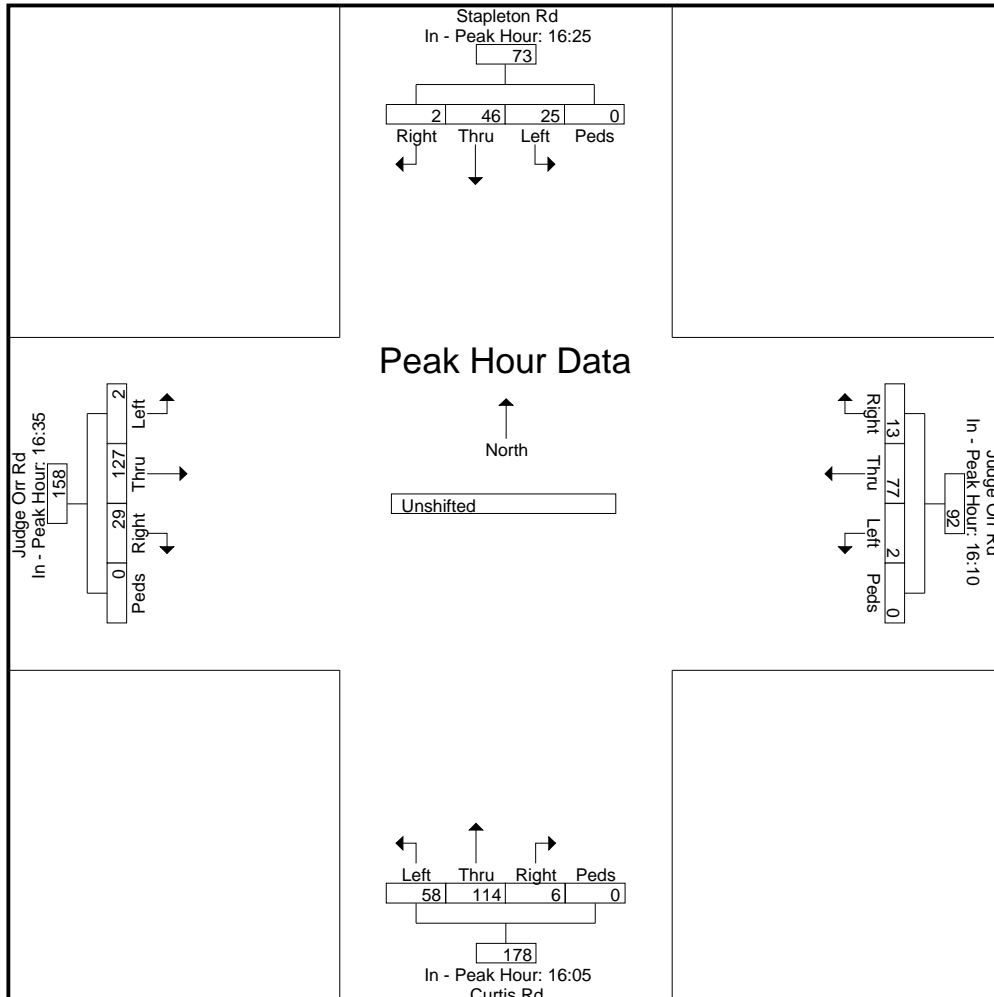

LSC Transportation Consultants, Inc.

2504 E. Pikes Peak Ave, Suite 304
 Colorado Springs, CO 80909
 719-633-2868

File Name : Elbert Rd - Hwy 24 AM
 Site Code : S224640
 Start Date : 1/17/2023
 Page No : 1

Groups Printed- Unshifted

Start Time	Elbert Rd Southbound					Hwy 24 Westbound					Elbert Rd Northbound					Hwy 24 Eastbound					Int. Total
	Right	Thru	Left	Peds	App. Total	Right	Thru	Left	Peds	App. Total	Right	Thru	Left	Peds	App. Total	Right	Thru	Left	Peds	App. Total	
06:30	0	29	0	0	29	0	0	1	0	1	0	6	2	0	8	5	0	0	0	5	43
06:35	0	27	0	0	27	0	0	0	0	0	0	6	0	0	6	7	0	0	0	7	40
06:40	0	27	0	0	27	0	0	1	0	1	0	14	1	0	15	10	0	0	0	10	53
06:45	0	25	0	0	25	0	2	1	0	3	1	11	4	0	16	6	2	0	0	8	52
06:50	0	21	0	0	21	0	0	3	0	3	1	23	1	0	25	12	2	0	0	14	63
06:55	2	26	0	0	28	0	0	0	0	0	0	19	0	0	19	7	1	1	0	9	56
Total	2	155	0	0	157	0	2	6	0	8	2	79	8	0	89	47	5	1	0	53	307
07:00	1	31	0	0	32	0	0	4	0	4	1	23	6	0	30	12	1	1	0	14	80
07:05	0	31	1	0	32	0	1	1	0	2	0	25	4	0	29	6	1	0	0	7	70
07:10	0	40	0	0	40	0	3	0	0	3	0	25	2	0	27	5	0	0	0	5	75
07:15	0	32	0	0	32	0	2	1	0	3	0	28	4	0	32	16	0	1	0	17	84
07:20	1	28	0	0	29	0	2	0	0	2	0	26	6	0	32	8	0	0	0	8	71
07:25	0	40	0	0	40	0	2	0	0	2	0	19	9	0	28	7	0	0	0	7	77
07:30	0	35	1	0	36	0	1	1	0	2	0	19	5	0	24	4	2	0	0	6	68
07:35	0	36	1	0	37	0	0	0	0	0	0	15	1	0	16	3	1	0	0	4	57
07:40	0	35	0	0	35	0	1	2	0	3	0	11	0	0	11	19	0	0	0	19	68
07:45	0	26	0	0	26	0	1	1	0	2	0	12	2	0	14	4	0	0	0	4	46
07:50	0	20	0	0	20	0	2	2	0	4	1	16	3	0	20	8	2	0	0	10	54
07:55	1	21	0	0	22	0	1	4	0	5	0	18	2	0	20	6	1	1	0	8	55
Total	3	375	3	0	381	0	16	16	0	32	2	237	44	0	283	98	8	3	0	109	805
08:00	0	29	0	0	29	0	2	1	0	3	0	20	6	0	26	7	0	0	0	7	65
08:05	0	28	0	0	28	0	2	3	0	5	0	8	4	0	12	4	0	0	0	4	49
08:10	1	27	0	0	28	0	0	3	0	3	2	9	2	0	13	5	1	0	0	6	50
08:15	0	30	0	0	30	0	0	0	0	0	0	11	5	0	16	11	1	0	0	12	58
08:20	0	31	0	0	31	0	0	3	0	3	1	8	2	0	11	4	0	1	0	5	50
08:25	1	22	0	0	23	0	2	0	0	2	0	19	3	0	22	5	0	0	0	5	52
Grand Total	7	697	3	0	707	0	24	32	0	56	7	391	74	0	472	181	15	5	0	201	1436
Apprch %	1	98.6	0.4	0		0	42.9	57.1	0		1.5	82.8	15.7	0		90	7.5	2.5	0		
Total %	0.5	48.5	0.2	0	49.2	0	1.7	2.2	0	3.9	0.5	27.2	5.2	0	32.9	12.6	1	0.3	0	14	

LSC Transportation Consultants, Inc.

2504 E. Pikes Peak Ave, Suite 304
 Colorado Springs, CO 80909
 719-633-2868

File Name : Elbert Rd - Hwy 24 AM

Site Code : S224640

Start Date : 1/17/2023

Page No : 2

Start Time	Elbert Rd Southbound					Hwy 24 Westbound					Elbert Rd Northbound					Hwy 24 Eastbound					Int. Total
	Right	Thru	Left	Peds	App. Total	Right	Thru	Left	Peds	App. Total	Right	Thru	Left	Peds	App. Total	Right	Thru	Left	Peds	App. Total	
Peak Hour Analysis From 06:30 to 08:25 - Peak 1 of 1																					
Peak Hour for Entire Intersection Begins at 06:45																					
06:45	0	25	0	0	25	0	2	1	0	3	1	11	4	0	16	6	2	0	0	8	52
06:50	0	21	0	0	21	0	0	3	0	3	1	23	1	0	25	12	2	0	0	14	63
06:55	2	26	0	0	28	0	0	0	0	0	0	19	0	0	19	7	1	1	0	9	56
07:00	1	31	0	0	32	0	0	4	0	4	1	23	6	0	30	12	1	1	0	14	80
07:05	0	31	1	0	32	0	1	1	0	2	0	25	4	0	29	6	1	0	0	7	70
07:10	0	40	0	0	40	0	3	0	0	3	0	25	2	0	27	5	0	0	0	5	75
07:15	0	32	0	0	32	0	2	1	0	3	0	28	4	0	32	16	0	1	0	17	84
07:20	1	28	0	0	29	0	2	0	0	2	0	26	6	0	32	8	0	0	0	8	71
07:25	0	40	0	0	40	0	2	0	0	2	0	19	9	0	28	7	0	0	0	7	77
07:30	0	35	1	0	36	0	1	1	0	2	0	19	5	0	24	4	2	0	0	6	68
07:35	0	36	1	0	37	0	0	0	0	0	0	15	1	0	16	3	1	0	0	4	57
07:40	0	35	0	0	35	0	1	2	0	3	0	11	0	0	11	19	0	0	0	19	68
Total Volume	4	380	3	0	387	0	14	13	0	27	3	244	42	0	289	105	10	3	0	118	821
% App. Total	1	98.2	0.8	0		0	51.9	48.1	0		1	84.4	14.5	0		89	8.5	2.5	0		
PHF	.167	.792	.250	.000	.806	.000	.389	.271	.000	.563	.250	.726	.389	.000	.753	.461	.417	.250	.000	.518	.814

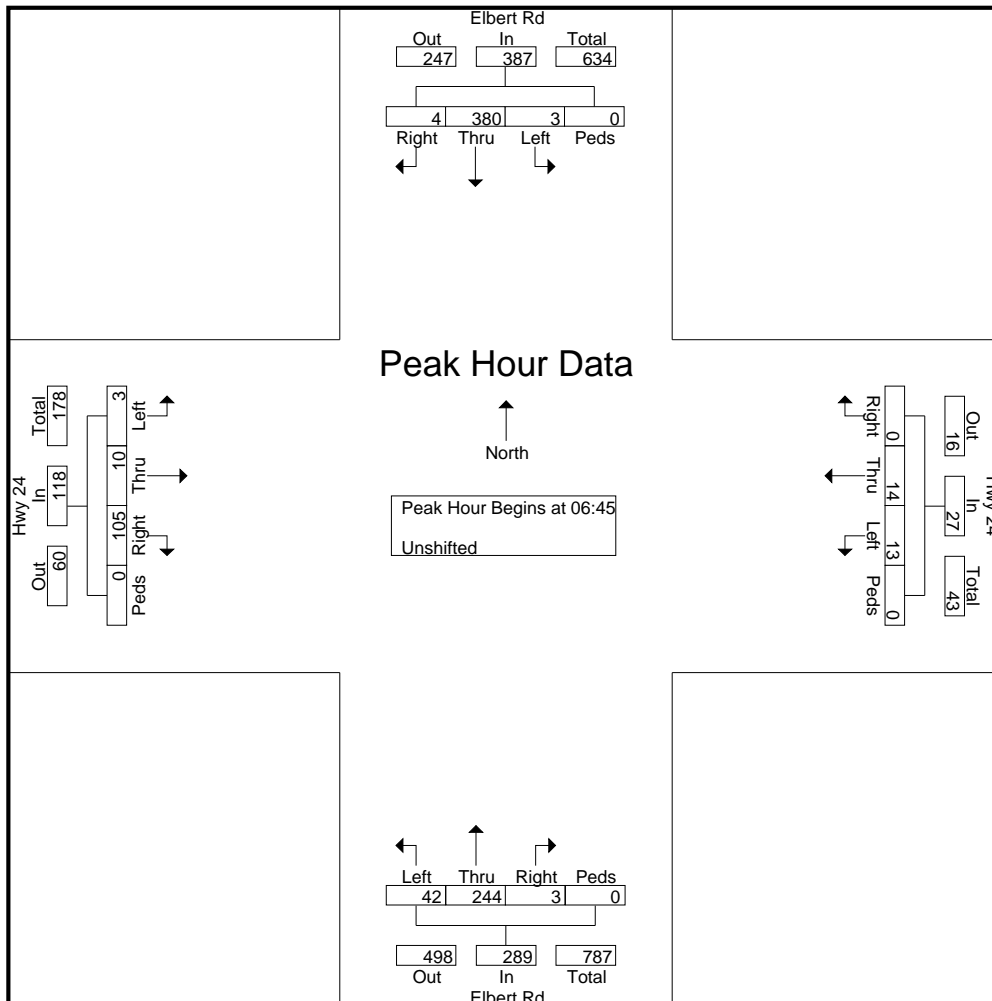

LSC Transportation Consultants, Inc.

2504 E. Pikes Peak Ave, Suite 304
Colorado Springs, CO 80909
719-633-2868

File Name : Elbert Rd - Hwy 24 AM

Site Code : S224640

Start Date : 1/17/2023

Page No : 3

Start Time	Elbert Rd Southbound					Hwy 24 Westbound					Elbert Rd Northbound					Hwy 24 Eastbound					Int. Total
	Right	Thru	Left	Peds	App. Total	Right	Thru	Left	Peds	App. Total	Right	Thru	Left	Peds	App. Total	Right	Thru	Left	Peds	App. Total	

Peak Hour Analysis From 06:30 to 08:25 - Peak 1 of 1

Peak Hour for Each Approach Begins at:

	06:50					07:10					06:40					06:45				
+0 mins.	0	21	0	0	21	0	3	0	0	3	0	14	1	0	15	6	2	0	0	8
+5 mins.	2	26	0	0	28	0	2	1	0	3	1	11	4	0	16	12	2	0	0	14
+10 mins.	1	31	0	0	32	0	2	0	0	2	1	23	1	0	25	7	1	1	0	9
+15 mins.	0	31	1	0	32	0	2	0	0	2	0	19	0	0	19	12	1	1	0	14
+20 mins.	0	40	0	0	40	0	1	1	0	2	1	23	6	0	30	6	1	0	0	7
+25 mins.	0	32	0	0	32	0	0	0	0	0	0	25	4	0	29	5	0	0	0	5
+30 mins.	1	28	0	0	29	0	1	2	0	3	0	25	2	0	27	16	0	1	0	17
+35 mins.	0	40	0	0	40	0	1	1	0	2	0	28	4	0	32	8	0	0	0	8
+40 mins.	0	35	1	0	36	0	2	2	0	4	0	26	6	0	32	7	0	0	0	7
+45 mins.	0	36	1	0	37	0	1	4	0	5	0	19	9	0	28	4	2	0	0	6
+50 mins.	0	35	0	0	35	0	2	1	0	3	0	19	5	0	24	3	1	0	0	4
+55 mins.	0	26	0	0	26	0	2	3	0	5	0	15	1	0	16	19	0	0	0	19
Total Volume	4	381	3	0	388	0	19	15	0	34	3	247	43	0	293	105	10	3	0	118
% App. Total	1	98.2	0.8	0		0	55.9	44.1	0		1	84.3	14.7	0		89	8.5	2.5	0	
PHF	.167	.794	.250	.000	.808	.000	.528	.313	.000	.567	.250	.735	.398	.000	.763	.461	.417	.250	.000	.518

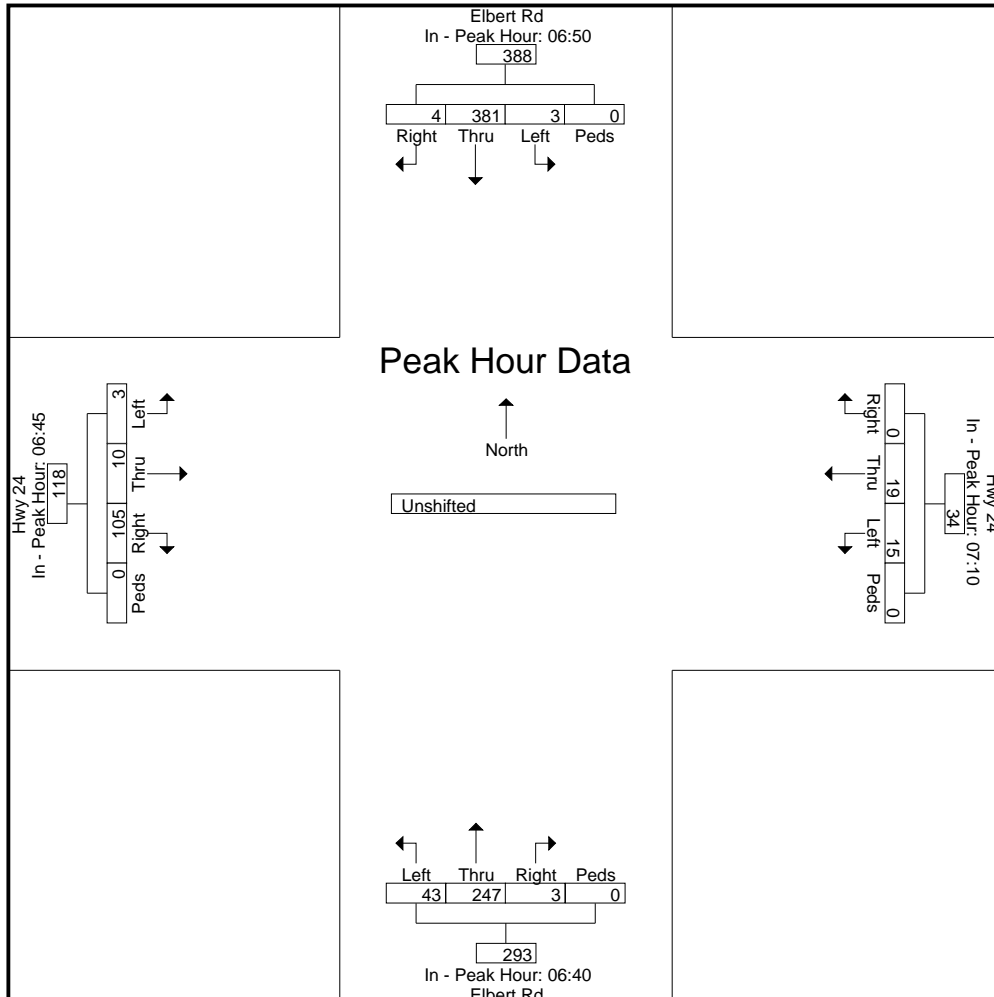

LSC Transportation Consultants, Inc.

2504 E. Pikes Peak Ave, Suite 304
 Colorado Springs, CO 80909
 719-633-2868

File Name : elbert rd - hwy 24 PM
 Site Code : S224640
 Start Date : 1/17/2023
 Page No : 1

Groups Printed- Unshifted

Start Time	Hwy 24 Southbound					Elbert Rd Westbound					Hwy 24 Northbound					Elbert Rd Eastbound					Int. Total
	Right	Thru	Left	Peds	App. Total	Right	Thru	Left	Peds	App. Total	Right	Thru	Left	Peds	App. Total	Right	Thru	Left	Peds	App. Total	
16:00	0	21	0	0	21	0	0	2	0	2	2	33	7	0	42	3	3	1	0	7	72
16:05	0	21	0	0	21	0	0	0	0	0	0	33	8	0	41	1	1	1	0	3	65
16:10	0	42	0	0	42	1	0	0	0	1	2	33	4	0	39	3	0	0	0	3	85
16:15	1	20	0	0	21	0	0	0	0	0	2	32	9	0	43	4	0	0	0	4	68
16:20	1	17	0	0	18	1	0	0	0	1	0	44	10	0	54	5	0	1	0	6	79
16:25	0	29	0	0	29	0	1	1	0	2	2	20	7	0	29	6	1	0	0	7	67
16:30	0	18	1	0	19	0	1	0	0	1	2	47	9	0	58	7	2	0	0	9	87
16:35	1	43	0	0	44	0	0	2	0	2	1	36	9	0	46	5	0	0	0	5	97
16:40	0	30	1	0	31	0	0	1	0	1	1	29	8	0	38	11	1	0	0	12	82
16:45	0	22	1	0	23	0	0	1	0	1	0	42	4	0	46	10	1	0	0	11	81
16:50	0	24	1	0	25	1	1	1	0	3	2	25	10	0	37	5	2	1	0	8	73
16:55	0	19	1	0	20	0	1	0	0	1	3	29	9	0	41	5	1	0	0	6	68
Total	3	306	5	0	314	3	4	8	0	15	17	403	94	0	514	65	12	4	0	81	924
17:00	0	16	0	0	16	1	0	1	0	2	0	38	2	0	40	9	0	0	0	9	67
17:05	0	24	0	0	24	0	0	0	0	0	2	39	7	0	48	5	0	1	0	6	78
17:10	0	20	0	0	20	1	0	0	0	1	0	34	12	0	46	6	1	1	0	8	75
17:15	0	24	1	0	25	1	0	0	0	1	3	36	3	0	42	5	0	1	0	6	74
17:20	0	16	0	0	16	0	1	0	0	1	3	32	5	0	40	3	1	0	0	4	61
17:25	0	14	0	0	14	0	1	0	0	1	1	39	7	0	47	3	4	0	0	7	69
17:30	0	11	0	0	11	0	1	0	0	1	0	39	12	0	51	4	2	0	0	6	69
17:35	0	21	0	0	21	0	0	2	0	2	1	50	11	0	62	3	1	1	0	5	90
17:40	1	14	0	0	15	1	0	2	0	3	2	28	9	0	39	5	1	0	0	6	63
17:45	0	17	0	0	17	0	1	0	0	1	2	45	9	0	56	4	2	0	0	6	80
17:50	0	15	0	0	15	1	0	1	0	2	1	36	8	0	45	4	1	1	0	6	68
17:55	0	16	0	0	16	0	1	1	0	2	2	38	7	0	47	5	2	1	0	8	73
Total	1	208	1	0	210	5	5	7	0	17	17	454	92	0	563	56	15	6	0	77	867
Grand Total	4	514	6	0	524	8	9	15	0	32	34	857	186	0	1077	121	27	10	0	158	1791
Apprch %	0.8	98.1	1.1	0		25	28.1	46.9	0		3.2	79.6	17.3	0		76.6	17.1	6.3	0		
Total %	0.2	28.7	0.3	0	29.3	0.4	0.5	0.8	0	1.8	1.9	47.9	10.4	0	60.1	6.8	1.5	0.6	0	8.8	

LSC Transportation Consultants, Inc.

2504 E. Pikes Peak Ave, Suite 304
 Colorado Springs, CO 80909
 719-633-2868

File Name : elbert rd - hwy 24 PM

Site Code : S224640

Start Date : 1/17/2023

Page No : 2

Start Time	Hwy 24 Southbound					Elbert Rd Westbound					Hwy 24 Northbound					Elbert Rd Eastbound					Int. Total
	Right	Thru	Left	Peds	App. Total	Right	Thru	Left	Peds	App. Total	Right	Thru	Left	Peds	App. Total	Right	Thru	Left	Peds	App. Total	
Peak Hour Analysis From 16:00 to 17:55 - Peak 1 of 1																					
Peak Hour for Entire Intersection Begins at 16:10																					
16:10	0	42	0	0	42	1	0	0	0	1	2	33	4	0	39	3	0	0	0	3	85
16:15	1	20	0	0	21	0	0	0	0	0	2	32	9	0	43	4	0	0	0	4	68
16:20	1	17	0	0	18	1	0	0	0	1	0	44	10	0	54	5	0	1	0	6	79
16:25	0	29	0	0	29	0	1	1	0	2	2	20	7	0	29	6	1	0	0	7	67
16:30	0	18	1	0	19	0	1	0	0	1	2	47	9	0	58	7	2	0	0	9	87
16:35	1	43	0	0	44	0	0	2	0	2	1	36	9	0	46	5	0	0	0	5	97
16:40	0	30	1	0	31	0	0	1	0	1	1	29	8	0	38	11	1	0	0	12	82
16:45	0	22	1	0	23	0	0	1	0	1	0	42	4	0	46	10	1	0	0	11	81
16:50	0	24	1	0	25	1	1	1	0	3	2	25	10	0	37	5	2	1	0	8	73
16:55	0	19	1	0	20	0	1	0	0	1	3	29	9	0	41	5	1	0	0	6	68
17:00	0	16	0	0	16	1	0	1	0	2	0	38	2	0	40	9	0	0	0	9	67
17:05	0	24	0	0	24	0	0	0	0	0	2	39	7	0	48	5	0	1	0	6	78
Total Volume	3	304	5	0	312	4	4	7	0	15	17	414	88	0	519	75	8	3	0	86	932
% App. Total	1	97.4	1.6	0		26.7	26.7	46.7	0		3.3	79.8	17	0		87.2	9.3	3.5	0		
PHF	.250	.589	.417	.000	.591	.333	.333	.292	.000	.417	.472	.734	.733	.000	.746	.568	.333	.250	.000	.597	.801

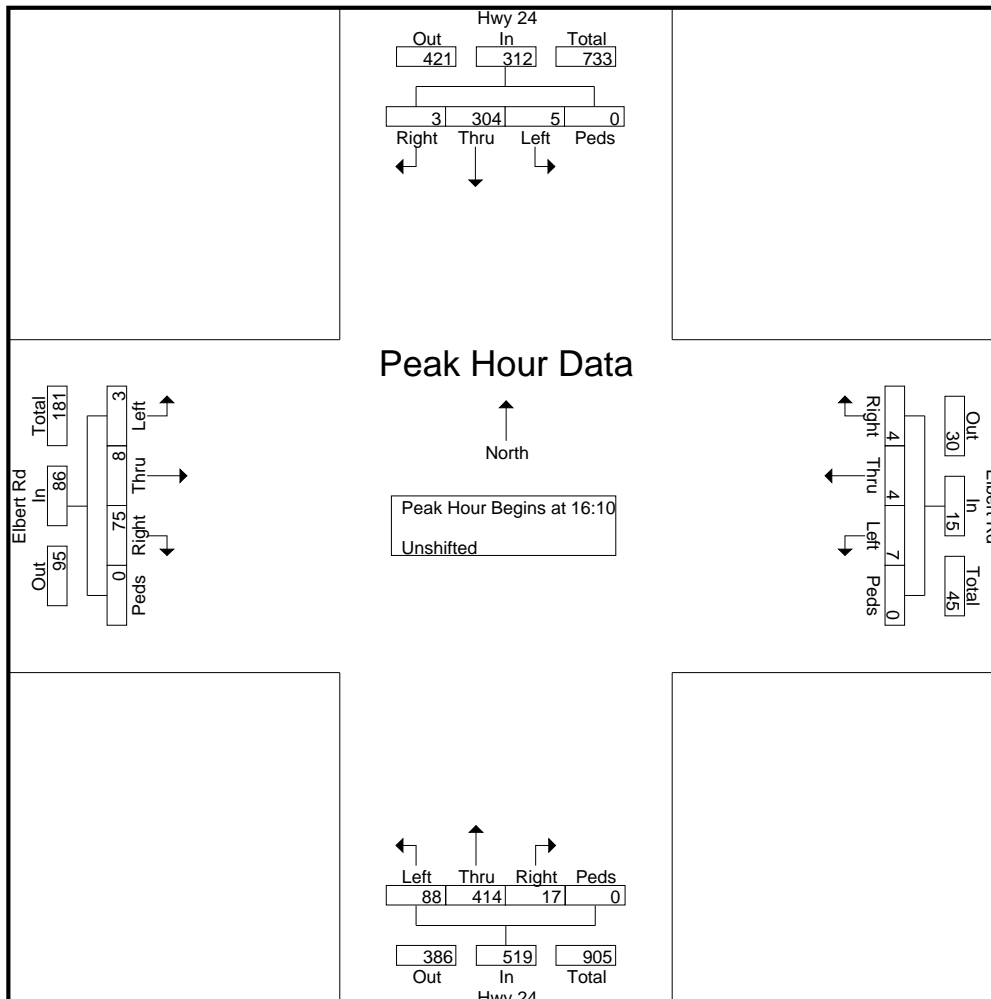

LSC Transportation Consultants, Inc.

2504 E. Pikes Peak Ave, Suite 304
 Colorado Springs, CO 80909
 719-633-2868

File Name : elbert rd - hwy 24 PM

Site Code : S224640

Start Date : 1/17/2023

Page No : 3

Start Time	Hwy 24 Southbound					Elbert Rd Westbound					Hwy 24 Northbound					Elbert Rd Eastbound					Int. Total
	Right	Thru	Left	Peds	App. Total	Right	Thru	Left	Peds	App. Total	Right	Thru	Left	Peds	App. Total	Right	Thru	Left	Peds	App. Total	

Peak Hour Analysis From 16:00 to 17:55 - Peak 1 of 1

Peak Hour for Each Approach Begins at:

	16:00					16:45					17:00					16:20				
+0 mins.	0	21	0	0	21	0	0	1	0	1	0	38	2	0	40	5	0	1	0	6
+5 mins.	0	21	0	0	21	1	1	1	0	3	2	39	7	0	48	6	1	0	0	7
+10 mins.	0	42	0	0	42	0	1	0	0	1	0	34	12	0	46	7	2	0	0	9
+15 mins.	1	20	0	0	21	1	0	1	0	2	3	36	3	0	42	5	0	0	0	5
+20 mins.	1	17	0	0	18	0	0	0	0	0	3	32	5	0	40	11	1	0	0	12
+25 mins.	0	29	0	0	29	1	0	0	0	1	1	39	7	0	47	10	1	0	0	11
+30 mins.	0	18	1	0	19	1	0	0	0	1	0	39	12	0	51	5	2	1	0	8
+35 mins.	1	43	0	0	44	0	1	0	0	1	1	50	11	0	62	5	1	0	0	6
+40 mins.	0	30	1	0	31	0	1	0	0	1	2	28	9	0	39	9	0	0	0	9
+45 mins.	0	22	1	0	23	0	1	0	0	1	2	45	9	0	56	5	0	1	0	6
+50 mins.	0	24	1	0	25	0	0	2	0	2	1	36	8	0	45	6	1	1	0	8
+55 mins.	0	19	1	0	20	1	0	2	0	3	2	38	7	0	47	5	0	1	0	6
Total Volume	3	306	5	0	314	5	5	7	0	17	17	454	92	0	563	79	9	5	0	93
% App. Total	1	97.5	1.6	0		29.4	29.4	41.2	0		3	80.6	16.3	0		84.9	9.7	5.4	0	
PHF	.250	.593	.417	.000	.595	.417	.417	.292	.000	.472	.472	.757	.639	.000	.757	.598	.375	.417	.000	.646

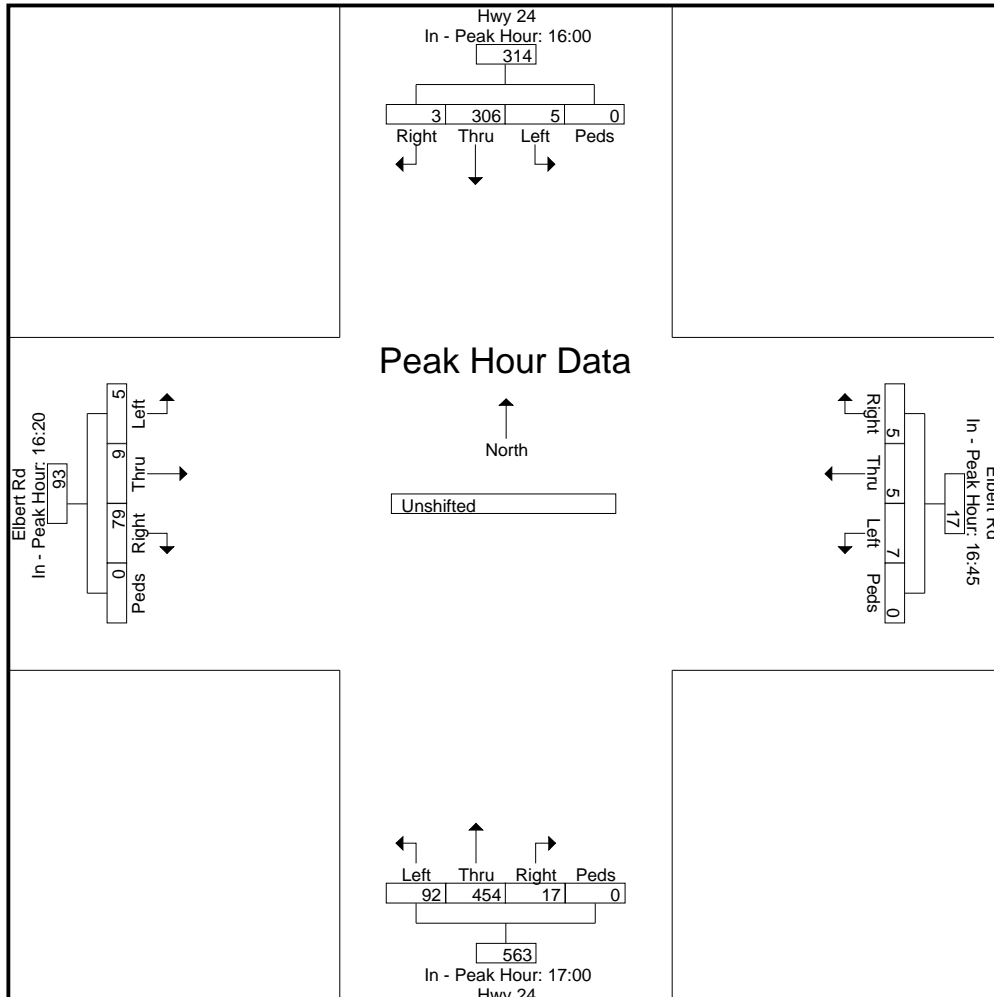

LSC Transportation Consultants, Inc.

2504 E. Pikes Peak Ave, Suite 304
 Colorado Springs, CO 80909
 719-633-2868

File Name : Elbert Rd - Judge Orr Rd AM 1-23

Site Code : S224640

Start Date : 1/11/2023

Page No : 1

Groups Printed- Unshifted

Start Time	Elbert Rd Southbound					Judge Orr Rd Westbound					Northbound					Judge Orr Rd Eastbound					Int. Total
	Right	Thru	Left	Peds	App. Total	Right	Thru	Left	Peds	App. Total	Right	Thru	Left	Peds	App. Total	Right	Thru	Left	Peds	App. Total	
06:30	1	0	1	0	2	0	15	0	0	15	0	0	0	0	0	0	3	0	0	3	20
06:35	0	0	1	0	1	1	6	0	0	7	0	0	0	0	0	0	1	0	0	1	9
06:40	0	0	0	0	0	1	14	0	0	15	0	0	0	0	0	0	1	1	0	2	17
06:45	0	0	2	0	2	0	11	0	0	11	0	0	0	0	0	0	1	0	0	1	14
06:50	0	0	0	0	0	3	8	0	0	11	0	0	0	0	0	0	1	0	0	1	12
06:55	1	0	0	0	1	2	8	0	0	10	0	0	0	0	0	0	3	0	0	3	14
Total	2	0	4	0	6	7	62	0	0	69	0	0	0	0	0	0	10	1	0	11	86
07:00	1	0	0	0	1	1	10	0	0	11	0	0	0	0	0	0	6	0	0	6	18
07:05	0	0	0	0	0	2	13	0	0	15	0	0	0	0	0	0	2	0	0	2	17
07:10	0	0	1	0	1	2	20	0	0	22	0	0	0	0	0	0	1	0	0	1	24
07:15	2	0	0	0	2	1	14	0	0	15	0	0	0	0	0	0	4	0	0	4	21
07:20	0	0	0	0	0	2	11	0	0	13	0	0	0	0	0	0	3	0	0	3	16
07:25	0	0	1	0	1	0	14	0	0	14	0	0	0	0	0	0	4	0	0	4	19
07:30	1	0	1	0	2	1	15	0	0	16	0	0	0	0	0	0	1	0	0	1	19
07:35	2	0	1	0	3	0	6	0	0	6	0	0	0	0	0	0	2	0	0	2	11
07:40	0	0	0	0	0	0	14	0	0	14	0	0	0	0	0	0	6	0	0	6	20
07:45	2	0	0	0	2	0	11	0	0	11	0	0	0	0	0	0	2	0	0	2	15
07:50	0	0	0	0	0	3	8	0	0	11	0	0	0	0	0	0	4	0	0	4	15
07:55	1	0	0	0	1	0	6	0	0	6	0	0	0	0	0	0	3	0	0	3	10
Total	9	0	4	0	13	12	142	0	0	154	0	0	0	0	0	0	38	0	0	38	205
08:00	1	0	0	0	1	3	5	0	0	8	0	0	0	0	0	0	3	0	0	3	12
08:05	0	0	0	0	0	0	7	0	0	7	0	0	0	0	0	0	2	0	0	2	9
08:10	1	0	0	0	1	1	12	0	0	13	0	0	0	0	0	0	4	0	0	4	18
08:15	0	0	0	0	0	0	9	0	0	9	0	0	0	0	0	0	1	1	0	2	11
08:20	0	0	1	0	1	0	9	0	0	9	0	0	0	0	0	0	4	1	0	5	15
08:25	1	0	0	0	1	2	5	0	0	7	0	0	0	0	0	0	3	0	0	3	11
Grand Total	14	0	9	0	23	25	251	0	0	276	0	0	0	0	0	0	65	3	0	68	367
Apprch %	60.9	0	39.1	0		9.1	90.9	0	0		0	0	0	0		0	95.6	4.4	0		
Total %	3.8	0	2.5	0	6.3	6.8	68.4	0	0	75.2	0	0	0	0	0	0	17.7	0.8	0	18.5	

LSC Transportation Consultants, Inc.

2504 E. Pikes Peak Ave, Suite 304
 Colorado Springs, CO 80909
 719-633-2868

File Name : Elbert Rd - Judge Orr Rd AM 1-23

Site Code : S224640

Start Date : 1/11/2023

Page No : 2

Start Time	Elbert Rd Southbound					Judge Orr Rd Westbound					Northbound					Judge Orr Rd Eastbound					Int. Total
	Right	Thru	Left	Peds	App. Total	Right	Thru	Left	Peds	App. Total	Right	Thru	Left	Peds	App. Total	Right	Thru	Left	Peds	App. Total	
Peak Hour Analysis From 06:30 to 08:25 - Peak 1 of 1																					
Peak Hour for Entire Intersection Begins at 06:55																					
06:55	1	0	0	0	1	2	8	0	0	10	0	0	0	0	0	0	3	0	0	3	14
07:00	1	0	0	0	1	1	10	0	0	11	0	0	0	0	0	0	6	0	0	6	18
07:05	0	0	0	0	0	2	13	0	0	15	0	0	0	0	0	0	2	0	0	2	17
07:10	0	0	1	0	1	2	20	0	0	22	0	0	0	0	0	0	1	0	0	1	24
07:15	2	0	0	0	2	1	14	0	0	15	0	0	0	0	0	0	4	0	0	4	21
07:20	0	0	0	0	0	2	11	0	0	13	0	0	0	0	0	0	3	0	0	3	16
07:25	0	0	1	0	1	0	14	0	0	14	0	0	0	0	0	0	4	0	0	4	19
07:30	1	0	1	0	2	1	15	0	0	16	0	0	0	0	0	0	1	0	0	1	19
07:35	2	0	1	0	3	0	6	0	0	6	0	0	0	0	0	0	2	0	0	2	11
07:40	0	0	0	0	0	0	14	0	0	14	0	0	0	0	0	0	6	0	0	6	20
07:45	2	0	0	0	2	0	11	0	0	11	0	0	0	0	0	0	2	0	0	2	15
07:50	0	0	0	0	0	3	8	0	0	11	0	0	0	0	0	0	4	0	0	4	15
Total Volume	9	0	4	0	13	14	144	0	0	158	0	0	0	0	0	0	38	0	0	38	209
% App. Total	69.2	0	30.8	0		8.9	91.1	0	0		0	0	0	0		0	100	0	0		
PHF	.375	.000	.333	.000	.361	.389	.600	.000	.000	.598	.000	.000	.000	.000	.000	.000	.528	.000	.000	.528	.726

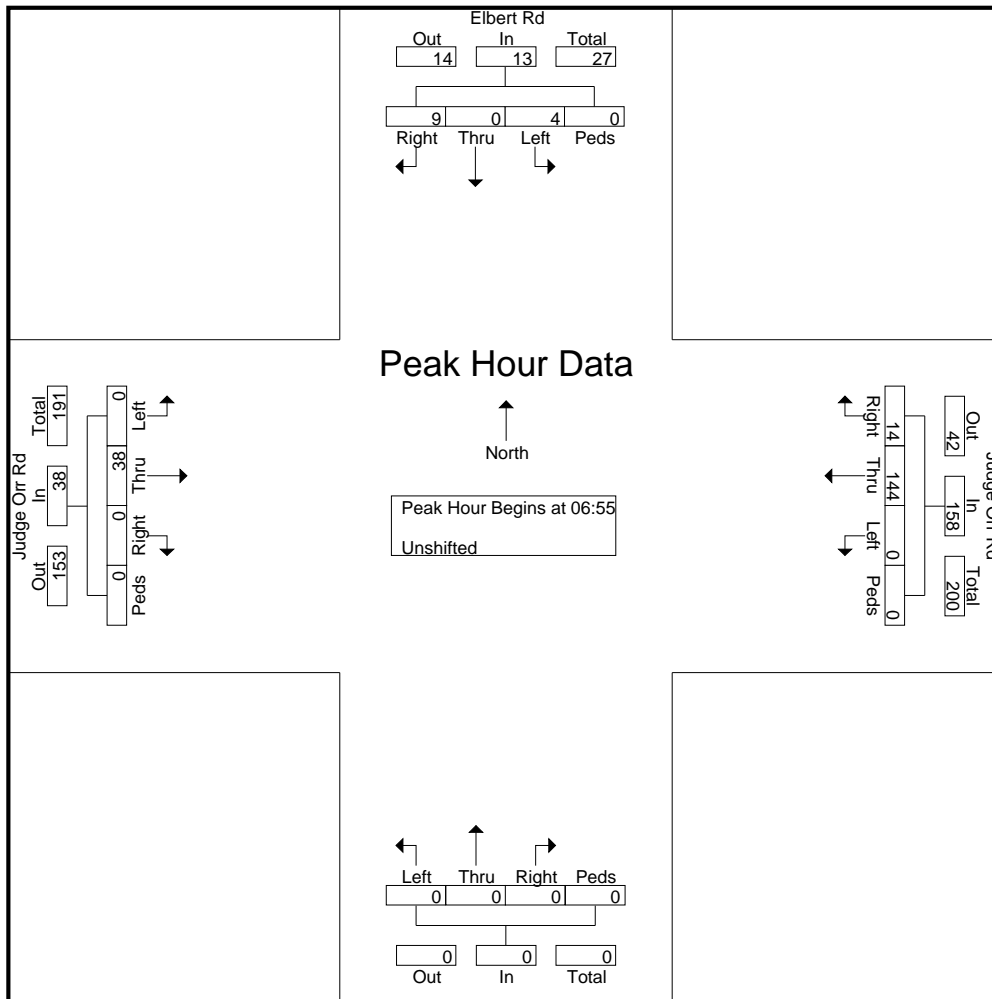

LSC Transportation Consultants, Inc.

2504 E. Pikes Peak Ave, Suite 304
 Colorado Springs, CO 80909
 719-633-2868

File Name : Elbert Rd - Judge Orr Rd AM 1-23

Site Code : S224640

Start Date : 1/11/2023

Page No : 3

Start Time	Elbert Rd Southbound					Judge Orr Rd Westbound					Northbound					Judge Orr Rd Eastbound					Int. Total
	Right	Thru	Left	Peds	App. Total	Right	Thru	Left	Peds	App. Total	Right	Thru	Left	Peds	App. Total	Right	Thru	Left	Peds	App. Total	
Peak Hour Analysis From 06:30 to 08:25 - Peak 1 of 1																					
Peak Hour for Each Approach Begins at:																					
	06:40					06:35					06:30					06:55					
+0 mins.	0	0	0	0	0	1	6	0	0	7	0	0	0	0	0	0	3	0	0	3	
+5 mins.	0	0	2	0	2	1	14	0	0	15	0	0	0	0	0	0	6	0	0	6	
+10 mins.	0	0	0	0	0	0	11	0	0	11	0	0	0	0	0	0	2	0	0	2	
+15 mins.	1	0	0	0	1	3	8	0	0	11	0	0	0	0	0	0	1	0	0	1	
+20 mins.	1	0	0	0	1	2	8	0	0	10	0	0	0	0	0	0	4	0	0	4	
+25 mins.	0	0	0	0	0	1	10	0	0	11	0	0	0	0	0	0	3	0	0	3	
+30 mins.	0	0	1	0	1	2	13	0	0	15	0	0	0	0	0	0	4	0	0	4	
+35 mins.	2	0	0	0	2	2	20	0	0	22	0	0	0	0	0	0	1	0	0	1	
+40 mins.	0	0	0	0	0	1	14	0	0	15	0	0	0	0	0	0	2	0	0	2	
+45 mins.	0	0	1	0	1	2	11	0	0	13	0	0	0	0	0	0	6	0	0	6	
+50 mins.	1	0	1	0	2	0	14	0	0	14	0	0	0	0	0	0	2	0	0	2	
+55 mins.	2	0	1	0	3	1	15	0	0	16	0	0	0	0	0	0	4	0	0	4	
Total Volume	7	0	6	0	13	16	144	0	0	160	0	0	0	0	0	0	38	0	0	38	
% App. Total	53.8	0	46.2	0		10	90	0	0		0	0	0	0		0	100	0	0		
PHF	.292	.000	.250	.000	.361	.444	.600	.000	.000	.606	.000	.000	.000	.000	.000	.000	.528	.000	.000	.528	

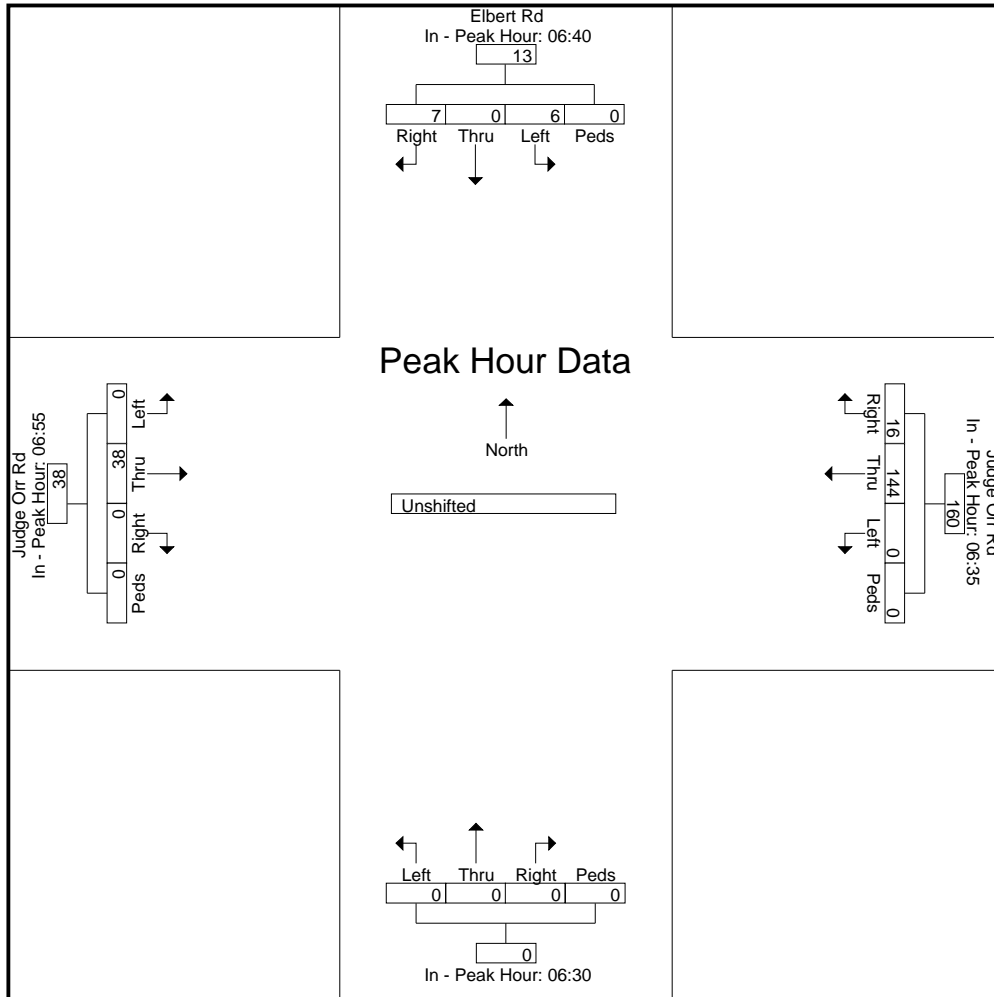

LSC Transportation Consultants, Inc.

2504 E. Pikes Peak Ave, Suite 304
 Colorado Springs, CO 80909
 719-633-2868

File Name : Elbert Rd - Judge Orr Rd AM PM

Site Code : S224640

Start Date : 1/11/2023

Page No : 1

Groups Printed- Unshifted

Start Time	Elbert Rd Southbound					Judge Orr Rd Westbound					Northbound					Judge Orr Rd Eastbound					Int. Total
	Right	Thru	Left	Peds	App. Total	Right	Thru	Left	Peds	App. Total	Right	Thru	Left	Peds	App. Total	Right	Thru	Left	Peds	App. Total	
06:30	1	0	1	0	2	0	15	0	0	15	0	0	0	0	0	0	3	0	0	3	20
06:35	0	0	1	0	1	1	6	0	0	7	0	0	0	0	0	0	1	0	0	1	9
06:40	0	0	0	0	0	1	14	0	0	15	0	0	0	0	0	0	1	1	0	2	17
06:45	0	0	2	0	2	0	11	0	0	11	0	0	0	0	0	0	1	0	0	1	14
06:50	0	0	0	0	0	3	8	0	0	11	0	0	0	0	0	0	1	0	0	1	12
06:55	1	0	0	0	1	2	8	0	0	10	0	0	0	0	0	0	3	0	0	3	14
Total	2	0	4	0	6	7	62	0	0	69	0	0	0	0	0	0	10	1	0	11	86
07:00	1	0	0	0	1	1	10	0	0	11	0	0	0	0	0	0	6	0	0	6	18
07:05	0	0	0	0	0	2	13	0	0	15	0	0	0	0	0	0	2	0	0	2	17
07:10	0	0	1	0	1	2	20	0	0	22	0	0	0	0	0	0	1	0	0	1	24
07:15	2	0	0	0	2	1	14	0	0	15	0	0	0	0	0	0	4	0	0	4	21
07:20	0	0	0	0	0	2	11	0	0	13	0	0	0	0	0	0	3	0	0	3	16
07:25	0	0	1	0	1	0	14	0	0	14	0	0	0	0	0	0	4	0	0	4	19
07:30	1	0	1	0	2	1	15	0	0	16	0	0	0	0	0	0	1	0	0	1	19
07:35	2	0	1	0	3	0	6	0	0	6	0	0	0	0	0	0	2	0	0	2	11
07:40	0	0	0	0	0	0	14	0	0	14	0	0	0	0	0	0	6	0	0	6	20
07:45	2	0	0	0	2	0	11	0	0	11	0	0	0	0	0	0	2	0	0	2	15
07:50	0	0	0	0	0	3	8	0	0	11	0	0	0	0	0	0	4	0	0	4	15
07:55	1	0	0	0	1	0	6	0	0	6	0	0	0	0	0	0	3	0	0	3	10
Total	9	0	4	0	13	12	142	0	0	154	0	0	0	0	0	0	38	0	0	38	205
08:00	1	0	0	0	1	3	5	0	0	8	0	0	0	0	0	0	3	0	0	3	12
08:05	0	0	0	0	0	0	7	0	0	7	0	0	0	0	0	0	2	0	0	2	9
08:10	1	0	0	0	1	1	12	0	0	13	0	0	0	0	0	0	4	0	0	4	18
08:15	0	0	0	0	0	0	9	0	0	9	0	0	0	0	0	0	1	1	0	2	11
08:20	0	0	1	0	1	0	9	0	0	9	0	0	0	0	0	0	4	1	0	5	15
08:25	1	0	0	0	1	2	5	0	0	7	0	0	0	0	0	0	3	0	0	3	11
*** BREAK ***																					
Total	3	0	1	0	4	6	47	0	0	53	0	0	0	0	0	0	17	2	0	19	76
16:00	0	0	1	0	1	1	6	0	0	7	0	0	0	0	0	0	9	1	0	10	18
16:05	0	0	1	0	1	1	4	0	0	5	0	0	0	0	0	0	7	0	0	7	13
16:10	0	0	1	0	1	1	4	0	0	5	0	0	0	0	0	0	8	0	0	8	14
16:15	0	0	1	0	1	0	2	0	0	2	0	0	0	0	0	0	16	0	0	16	19
16:20	1	0	1	0	2	1	5	0	0	6	0	0	0	0	0	0	9	0	0	9	17
16:25	1	0	1	0	2	0	4	0	0	4	0	0	0	0	0	0	13	0	0	13	19
16:30	0	0	0	0	0	0	6	0	0	6	0	0	0	0	0	0	16	1	0	17	23
16:35	0	0	0	0	0	0	3	0	0	3	0	0	0	0	0	0	14	1	0	15	18
16:40	0	0	0	0	0	0	4	0	0	4	0	0	0	0	0	0	14	1	0	15	19
16:45	1	0	0	0	1	0	3	0	0	3	0	0	0	0	0	0	16	1	0	17	21
16:50	0	0	1	0	1	0	4	0	0	4	0	0	0	0	0	0	7	1	0	8	13

LSC Transportation Consultants, Inc.

2504 E. Pikes Peak Ave, Suite 304
 Colorado Springs, CO 80909
 719-633-2868

File Name : Elbert Rd - Judge Orr Rd AM PM

Site Code : S224640

Start Date : 1/11/2023

Page No : 2

Groups Printed- Unshifted

Start Time	Elbert Rd Southbound					Judge Orr Rd Westbound					Northbound					Judge Orr Rd Eastbound					Int. Total
	Right	Thru	Left	Peds	App. Total	Right	Thru	Left	Peds	App. Total	Right	Thru	Left	Peds	App. Total	Right	Thru	Left	Peds	App. Total	
16:55	0	0	1	0	1	1	1	0	0	2	0	0	0	0	0	0	8	1	0	9	12
Total	3	0	8	0	11	5	46	0	0	51	0	0	0	0	0	0	137	7	0	144	206
17:00	1	0	0	0	1	0	1	0	0	1	0	0	0	0	0	0	13	1	0	14	16
17:05	0	0	4	0	4	0	3	0	0	3	0	0	0	0	0	0	14	0	0	14	21
17:10	0	0	1	0	1	0	6	0	0	6	0	0	0	0	0	0	5	0	0	5	12
17:15	0	0	0	0	0	1	1	0	0	2	0	0	0	0	0	0	9	1	0	10	12
17:20	1	0	0	0	1	2	5	0	0	7	0	0	0	0	0	0	12	0	0	12	20
17:25	0	0	0	0	0	0	2	0	0	2	0	0	0	0	0	0	5	0	0	5	7
17:30	0	0	2	0	2	1	6	0	0	7	0	0	0	0	0	0	12	0	0	12	21
17:35	0	0	0	0	0	1	6	0	0	7	0	0	0	0	0	0	6	0	0	6	13
17:40	0	0	1	0	1	0	1	0	0	1	0	0	0	0	0	0	19	0	0	19	21
17:45	0	0	1	0	1	0	1	0	0	1	0	0	0	0	0	0	2	0	0	2	4
17:50	0	0	1	0	1	0	1	0	0	1	0	0	0	0	0	0	5	0	0	5	7
17:55	0	0	2	0	2	0	3	0	0	3	0	0	0	0	0	0	3	0	0	3	8
Total	2	0	12	0	14	5	36	0	0	41	0	0	0	0	0	0	105	2	0	107	162
Grand Total	19	0	29	0	48	35	333	0	0	368	0	0	0	0	0	0	307	12	0	319	735
Apprch %	39.6	0	60.4	0		9.5	90.5	0	0		0	0	0	0		0	96.2	3.8	0		
Total %	2.6	0	3.9	0	6.5	4.8	45.3	0	0	50.1	0	0	0	0		0	41.8	1.6	0	43.4	

LSC Transportation Consultants, Inc.

2504 E. Pikes Peak Ave, Suite 304
 Colorado Springs, CO 80909
 719-633-2868

File Name : Elbert Rd - Judge Orr Rd AM PM

Site Code : S224640

Start Date : 1/11/2023

Page No : 3

Start Time	Elbert Rd Southbound					Judge Orr Rd Westbound					Northbound					Judge Orr Rd Eastbound					Int. Total
	Right	Thru	Left	Peds	App. Total	Right	Thru	Left	Peds	App. Total	Right	Thru	Left	Peds	App. Total	Right	Thru	Left	Peds	App. Total	
Peak Hour Analysis From 06:30 to 17:55 - Peak 1 of 1																					
Peak Hour for Entire Intersection Begins at 16:10																					
16:10	0	0	1	0	1	1	4	0	0	5	0	0	0	0	0	0	8	0	0	8	14
16:15	0	0	1	0	1	0	2	0	0	2	0	0	0	0	0	0	16	0	0	16	19
16:20	1	0	1	0	2	1	5	0	0	6	0	0	0	0	0	0	9	0	0	9	17
16:25	1	0	1	0	2	0	4	0	0	4	0	0	0	0	0	0	13	0	0	13	19
16:30	0	0	0	0	0	0	6	0	0	6	0	0	0	0	0	0	16	1	0	17	23
16:35	0	0	0	0	0	0	3	0	0	3	0	0	0	0	0	0	14	1	0	15	18
16:40	0	0	0	0	0	0	4	0	0	4	0	0	0	0	0	0	14	1	0	15	19
16:45	1	0	0	0	1	0	3	0	0	3	0	0	0	0	0	0	16	1	0	17	21
16:50	0	0	1	0	1	0	4	0	0	4	0	0	0	0	0	0	7	1	0	8	13
16:55	0	0	1	0	1	1	1	0	0	2	0	0	0	0	0	0	8	1	0	9	12
17:00	1	0	0	0	1	0	1	0	0	1	0	0	0	0	0	0	13	1	0	14	16
17:05	0	0	4	0	4	0	3	0	0	3	0	0	0	0	0	0	14	0	0	14	21
Total Volume	4	0	10	0	14	3	40	0	0	43	0	0	0	0	0	0	148	7	0	155	212
% App. Total	28.6	0	71.4	0		7	93	0	0		0	0	0	0		0	95.5	4.5	0		
PHF	.333	.000	.208	.000	.292	.250	.556	.000	.000	.597	.000	.000	.000	.000	.000	.000	.771	.583	.000	.760	.768

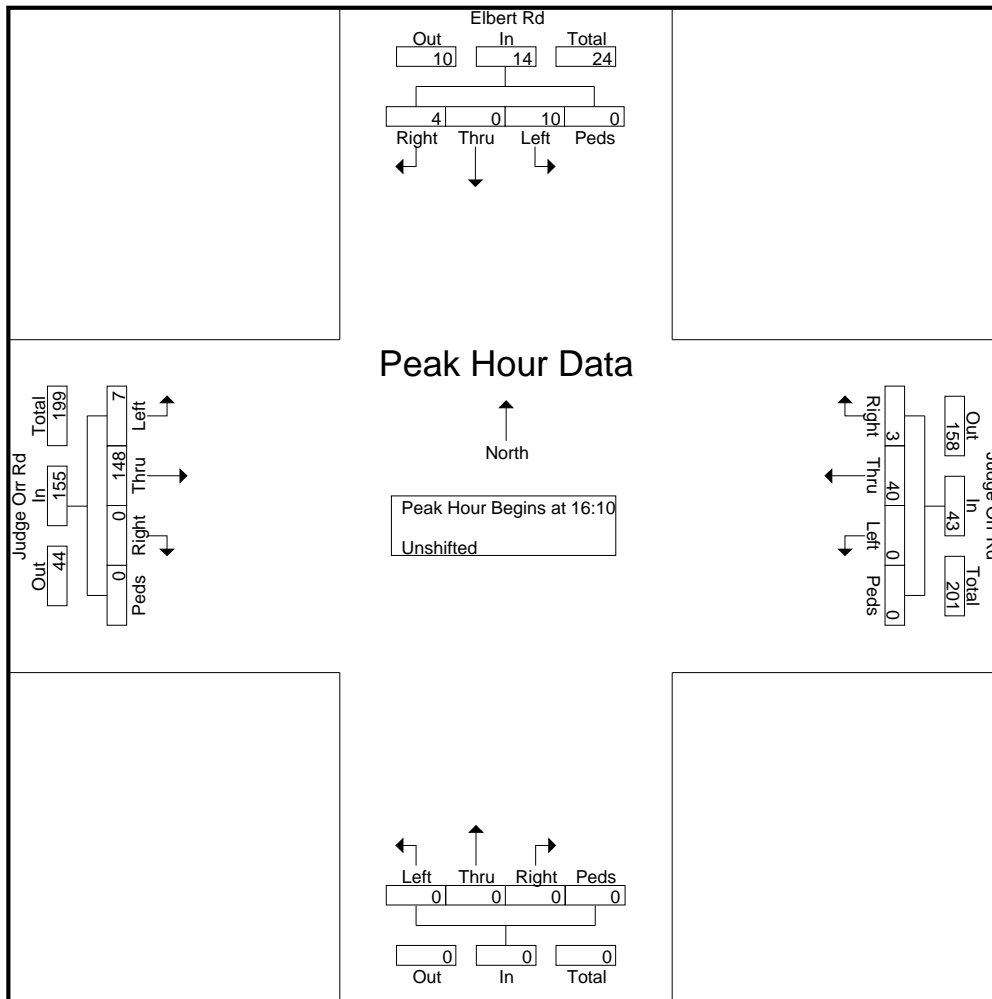

LSC Transportation Consultants, Inc.

2504 E. Pikes Peak Ave, Suite 304
 Colorado Springs, CO 80909
 719-633-2868

File Name : Elbert Rd - Judge Orr Rd AM PM

Site Code : S224640

Start Date : 1/11/2023

Page No : 4

Start Time	Elbert Rd Southbound					Judge Orr Rd Westbound					Northbound					Judge Orr Rd Eastbound					Int. Total
	Right	Thru	Left	Peds	App. Total	Right	Thru	Left	Peds	App. Total	Right	Thru	Left	Peds	App. Total	Right	Thru	Left	Peds	App. Total	

Peak Hour Analysis From 06:30 to 17:55 - Peak 1 of 1

Peak Hour for Each Approach Begins at:

	16:10					06:35					06:30					16:10				
+0 mins.	0	0	1	0	1	1	6	0	0	7	0	0	0	0	0	0	8	0	0	8
+5 mins.	0	0	1	0	1	1	14	0	0	15	0	0	0	0	0	0	16	0	0	16
+10 mins.	1	0	1	0	2	0	11	0	0	11	0	0	0	0	0	0	9	0	0	9
+15 mins.	1	0	1	0	2	3	8	0	0	11	0	0	0	0	0	0	13	0	0	13
+20 mins.	0	0	0	0	0	2	8	0	0	10	0	0	0	0	0	0	16	1	0	17
+25 mins.	0	0	0	0	0	1	10	0	0	11	0	0	0	0	0	0	14	1	0	15
+30 mins.	0	0	0	0	0	2	13	0	0	15	0	0	0	0	0	0	14	1	0	15
+35 mins.	1	0	0	0	1	2	20	0	0	22	0	0	0	0	0	0	16	1	0	17
+40 mins.	0	0	1	0	1	1	14	0	0	15	0	0	0	0	0	0	7	1	0	8
+45 mins.	0	0	1	0	1	2	11	0	0	13	0	0	0	0	0	0	8	1	0	9
+50 mins.	1	0	0	0	1	0	14	0	0	14	0	0	0	0	0	0	13	1	0	14
+55 mins.	0	0	4	0	4	1	15	0	0	16	0	0	0	0	0	0	14	0	0	14
Total Volume	4	0	10	0	14	16	144	0	0	160	0	0	0	0	0	0	148	7	0	155
% App. Total	28.6	0	71.4	0		10	90	0	0		0	0	0	0		0	95.5	4.5	0	
PHF	.333	.000	.208	.000	.292	.444	.600	.000	.000	.606	.000	.000	.000	.000	.000	.000	.771	.583	.000	.760

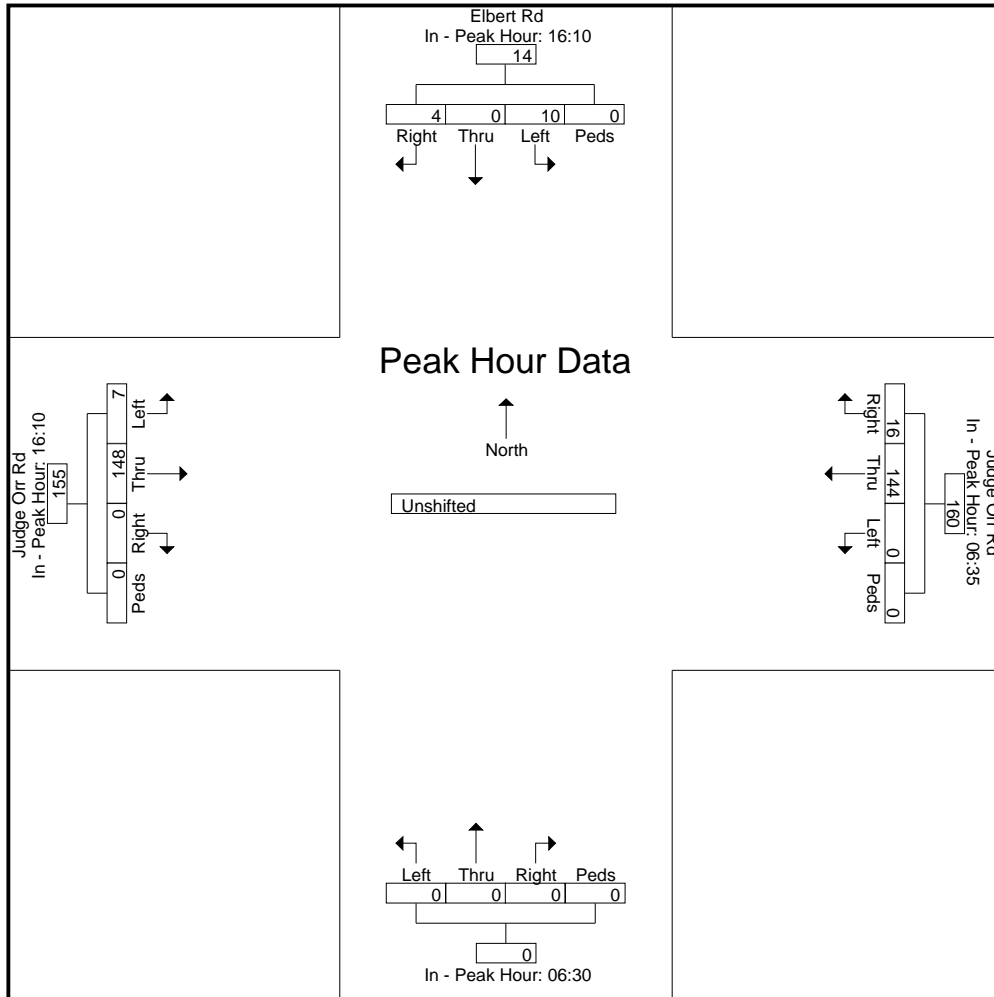

LSC Transportation Consultants, Inc.

2504 E. Pikes Peak Ave, Suite 304
 Colorado Springs, CO 80909
 719-633-2868

File Name : hwy 24 - judge orr rd am
 Site Code : S214950
 Start Date : 5/10/2022
 Page No : 1

Groups Printed- Unshifted

Start Time	Hwy 24 Southbound					Judge Orr Rd Westbound					Hwy 24 Northbound					Judge Orr Rd Eastbound					Int. Total
	Right	Thru	Left	Peds	App. Total	Right	Thru	Left	Peds	App. Total	Right	Thru	Left	Peds	App. Total	Right	Thru	Left	Peds	App. Total	
06:30	1	130	0	0	131	1	7	36	0	44	4	66	8	0	78	43	14	2	0	59	312
06:45	4	173	3	0	180	0	10	20	0	30	18	92	8	0	118	34	10	4	0	48	376
Total	5	303	3	0	311	1	17	56	0	74	22	158	16	0	196	77	24	6	0	107	688
07:00	2	132	0	0	134	3	7	39	0	49	18	98	23	0	139	50	16	9	0	75	397
07:15	3	137	2	0	142	1	23	26	0	50	19	82	18	0	119	43	16	2	0	61	372
07:30	9	137	2	0	148	0	17	30	0	47	9	71	24	0	104	51	20	0	0	71	370
07:45	1	102	1	0	104	1	15	15	0	31	21	67	17	0	105	21	15	3	0	39	279
Total	15	508	5	0	528	5	62	110	0	177	67	318	82	0	467	165	67	14	0	246	1418
08:00	2	108	1	0	111	1	8	22	0	31	23	68	12	1	104	28	20	5	0	53	299
08:15	5	96	1	0	102	2	3	29	0	34	15	70	14	0	99	15	13	4	0	32	267
Grand Total	27	1015	10	0	1052	9	90	217	0	316	127	614	124	1	866	285	124	29	0	438	2672
Apprch %	2.6	96.5	1	0		2.8	28.5	68.7	0		14.7	70.9	14.3	0.1		65.1	28.3	6.6	0		
Total %	1	38	0.4	0	39.4	0.3	3.4	8.1	0	11.8	4.8	23	4.6	0	32.4	10.7	4.6	1.1	0	16.4	

LSC Transportation Consultants, Inc.

2504 E. Pikes Peak Ave, Suite 304
 Colorado Springs, CO 80909
 719-633-2868

File Name : hwy 24 - judge orr rd am
 Site Code : S214950
 Start Date : 5/10/2022
 Page No : 2

Start Time	Hwy 24 Southbound					Judge Orr Rd Westbound					Hwy 24 Northbound					Judge Orr Rd Eastbound					Int. Total
	Right	Thru	Left	Peds	App. Total	Right	Thru	Left	Peds	App. Total	Right	Thru	Left	Peds	App. Total	Right	Thru	Left	Peds	App. Total	
Peak Hour Analysis From 6:30:00 AM to 8:15:00 AM - Peak 1 of 1																					
Peak Hour for Entire Intersection Begins at 6:45:00 AM																					
6:45:00 AM	4	173	3	0	180	0	10	20	0	30	18	92	8	0	118	34	10	4	0	48	376
7:00:00 AM	2	132	0	0	134	3	7	39	0	49	18	98	23	0	139	50	16	9	0	75	397
7:15:00 AM	3	137	2	0	142	1	23	26	0	50	19	82	18	0	119	43	16	2	0	61	372
7:30:00 AM	9	137	2	0	148	0	17	30	0	47	9	71	24	0	104	51	20	0	0	71	370
Total Volume	18	579	7	0	604	4	57	115	0	176	64	343	73	0	480	178	62	15	0	255	1515
% App. Total	3	95.9	1.2	0		2.3	32.4	65.3	0		13.3	71.5	15.2	0		69.8	24.3	5.9	0		
PHF	.500	.837	.583	.000	.839	.333	.620	.737	.000	.880	.842	.875	.760	.000	.863	.873	.775	.417	.000	.850	.954

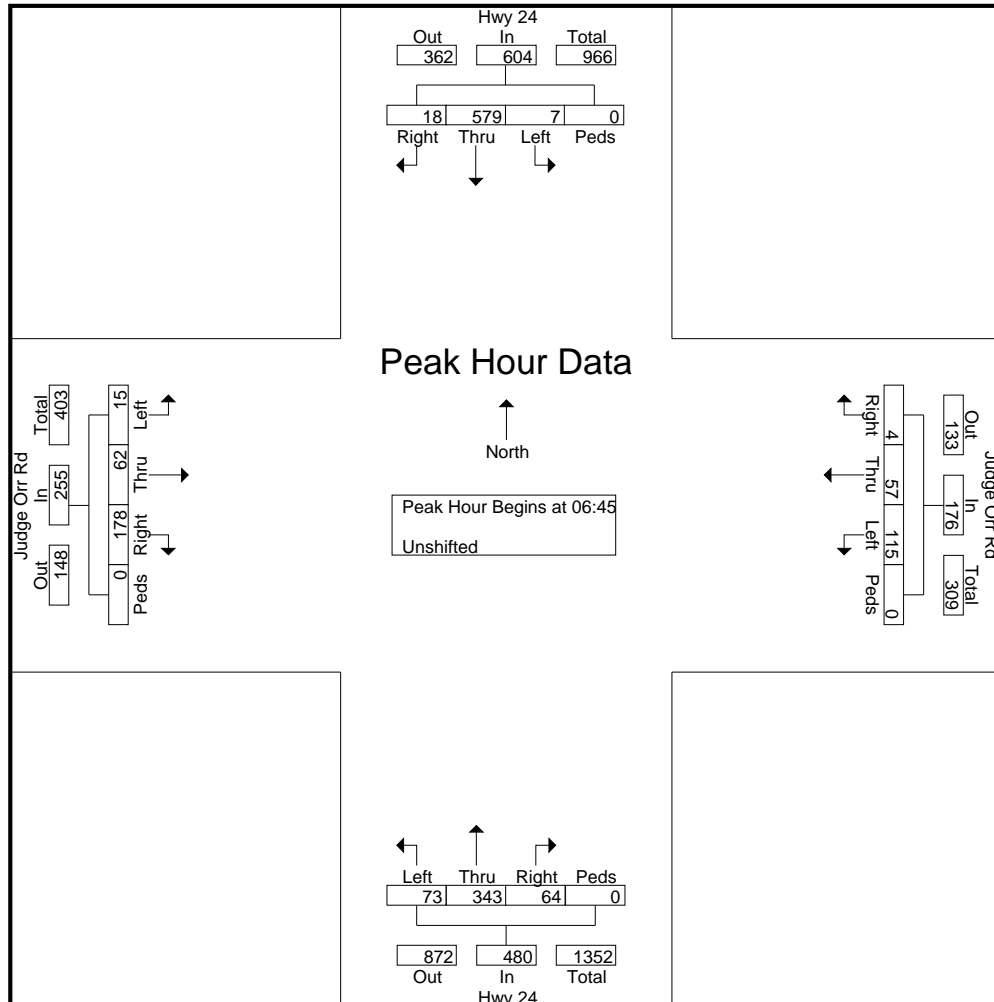

LSC Transportation Consultants, Inc.

2504 E. Pikes Peak Ave, Suite 304
 Colorado Springs, CO 80909
 719-633-2868

File Name : hwy 24 - judge orr rd am
 Site Code : S214950
 Start Date : 5/10/2022
 Page No : 3

Start Time	Hwy 24 Southbound					Judge Orr Rd Westbound					Hwy 24 Northbound					Judge Orr Rd Eastbound					Int. Total
	Right	Thru	Left	Peds	App. Total	Right	Thru	Left	Peds	App. Total	Right	Thru	Left	Peds	App. Total	Right	Thru	Left	Peds	App. Total	
Peak Hour Analysis From 6:30:00 AM to 8:15:00 AM - Peak 1 of 1																					
Peak Hour for Each Approach Begins at:																					
	6:45:00 AM					7:00:00 AM					6:45:00 AM					6:45:00 AM					
+0 mins.	4	173	3	0	180	3	7	39	0	49	18	92	8	0	118	34	10	4	0	48	
+5 mins.	2	132	0	0	134	1	23	26	0	50	18	98	23	0	139	50	16	9	0	75	
+10 mins.	3	137	2	0	142	0	17	30	0	47	19	82	18	0	119	43	16	2	0	61	
+15 mins.	9	137	2	0	148	1	15	15	0	31	9	71	24	0	104	51	20	0	0	71	
Total Volume	18	579	7	0	604	5	62	110	0	177	64	343	73	0	480	178	62	15	0	255	
% App. Total	3	95.9	1.2	0		2.8	35	62.1	0		13.3	71.5	15.2	0		69.8	24.3	5.9	0		
PHF	.500	.837	.583	.000	.839	.417	.674	.705	.000	.885	.842	.875	.760	.000	.863	.873	.775	.417	.000	.850	

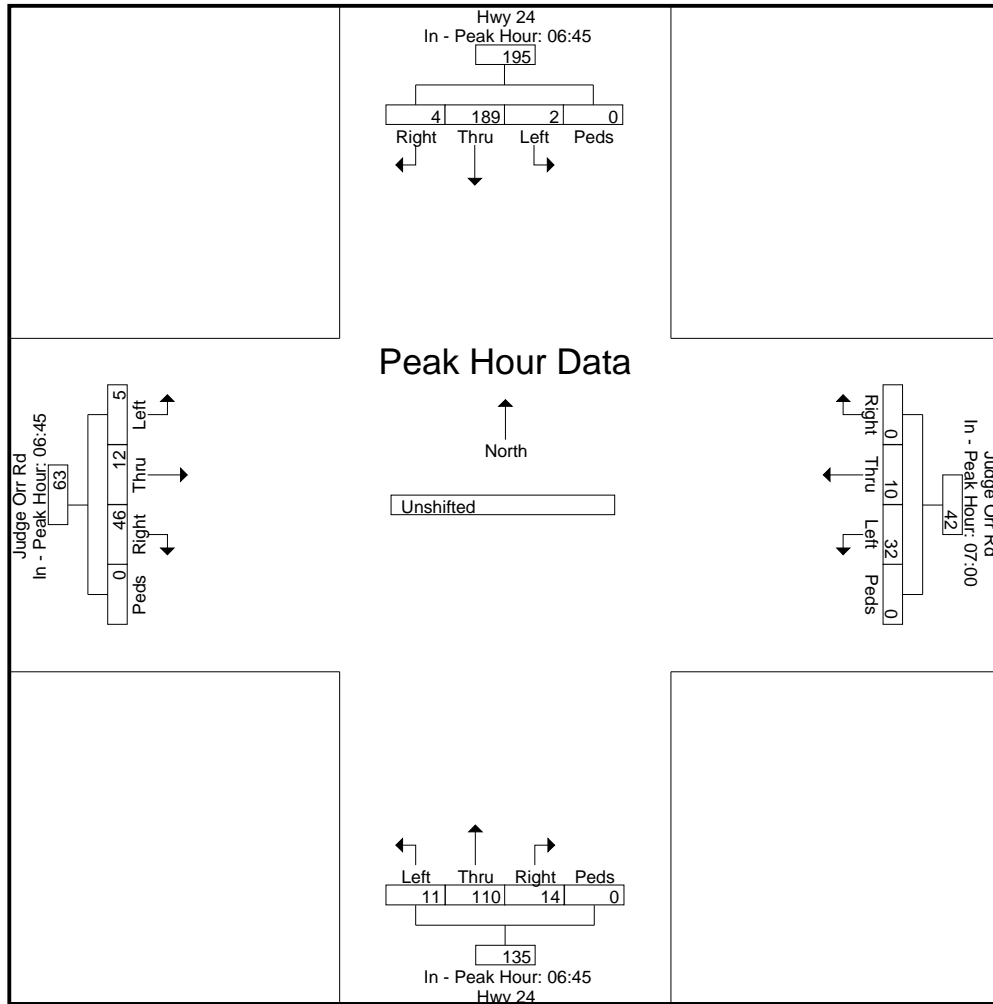

LSC Transportation Consultants, Inc.

2504 E. Pikes Peak Ave, Suite 304
 Colorado Springs, CO 80909
 719-633-2868

File Name : Hwy 24 - Judge Orr Rd PM

Site Code : S214950

Start Date : 5/10/2022

Page No : 1

Groups Printed- Unshifted

Start Time	Hwy 24 Southbound					Judge Orr Rd Westbound					Hwy 24 Northbound					Judge Orr Rd Eastbound					Int. Total
	Right	Thru	Left	Peds	App. Total	Right	Thru	Left	Peds	App. Total	Right	Thru	Left	Peds	App. Total	Right	Thru	Left	Peds	App. Total	
16:00	5	77	2	0	84	1	7	22	0	30	33	143	24	0	200	10	7	5	0	22	336
16:15	3	105	1	0	109	5	17	25	0	47	27	152	30	0	209	21	11	11	0	43	408
16:30	7	105	1	0	113	1	14	29	0	44	34	144	34	1	213	18	11	11	0	40	410
16:45	1	101	0	0	102	2	9	24	0	35	31	135	41	0	207	15	13	12	0	40	384
Total	16	388	4	0	408	9	47	100	0	156	125	574	129	1	829	64	42	39	0	145	1538
17:00	2	99	0	0	101	4	13	38	0	55	29	147	40	0	216	16	16	10	0	42	414
17:15	7	127	0	0	134	2	16	26	0	44	34	133	24	1	192	13	11	7	0	31	401
17:30	6	91	1	0	98	2	6	16	0	24	39	149	32	0	220	10	15	10	0	35	377
17:45	6	98	0	0	104	0	5	22	0	27	29	158	30	0	217	11	17	8	0	36	384
Total	21	415	1	0	437	8	40	102	0	150	131	587	126	1	845	50	59	35	0	144	1576
Grand Total	37	803	5	0	845	17	87	202	0	306	256	1161	255	2	1674	114	101	74	0	289	3114
Apprch %	4.4	95	0.6	0		5.6	28.4	66	0		15.3	69.4	15.2	0.1		39.4	34.9	25.6	0		
Total %	1.2	25.8	0.2	0	27.1	0.5	2.8	6.5	0	9.8	8.2	37.3	8.2	0.1	53.8	3.7	3.2	2.4	0	9.3	

LSC Transportation Consultants, Inc.

2504 E. Pikes Peak Ave, Suite 304
 Colorado Springs, CO 80909
 719-633-2868

File Name : Hwy 24 - Judge Orr Rd PM

Site Code : S214950

Start Date : 5/10/2022

Page No : 2

Start Time	Hwy 24 Southbound					Judge Orr Rd Westbound					Hwy 24 Northbound					Judge Orr Rd Eastbound					Int. Total
	Right	Thru	Left	Peds	App. Total	Right	Thru	Left	Peds	App. Total	Right	Thru	Left	Peds	App. Total	Right	Thru	Left	Peds	App. Total	
Peak Hour Analysis From 4:00:00 PM to 5:45:00 PM - Peak 1 of 1																					
Peak Hour for Entire Intersection Begins at 4:15:00 PM																					
4:15:00 PM	3	105	1	0	109	5	17	25	0	47	27	152	30	0	209	21	11	11	0	43	408
4:30:00 PM	7	105	1	0	113	1	14	29	0	44	34	144	34	1	213	18	11	11	0	40	410
4:45:00 PM	1	101	0	0	102	2	9	24	0	35	31	135	41	0	207	15	13	12	0	40	384
5:00:00 PM	2	99	0	0	101	4	13	38	0	55	29	147	40	0	216	16	16	10	0	42	414
Total Volume	13	410	2	0	425	12	53	116	0	181	121	578	145	1	845	70	51	44	0	165	1616
% App. Total	3.1	96.5	0.5	0		6.6	29.3	64.1	0		14.3	68.4	17.2	0.1		42.4	30.9	26.7	0		
PHF	.464	.976	.500	.000	.940	.600	.779	.763	.000	.823	.890	.951	.884	.250	.978	.833	.797	.917	.000	.959	.976

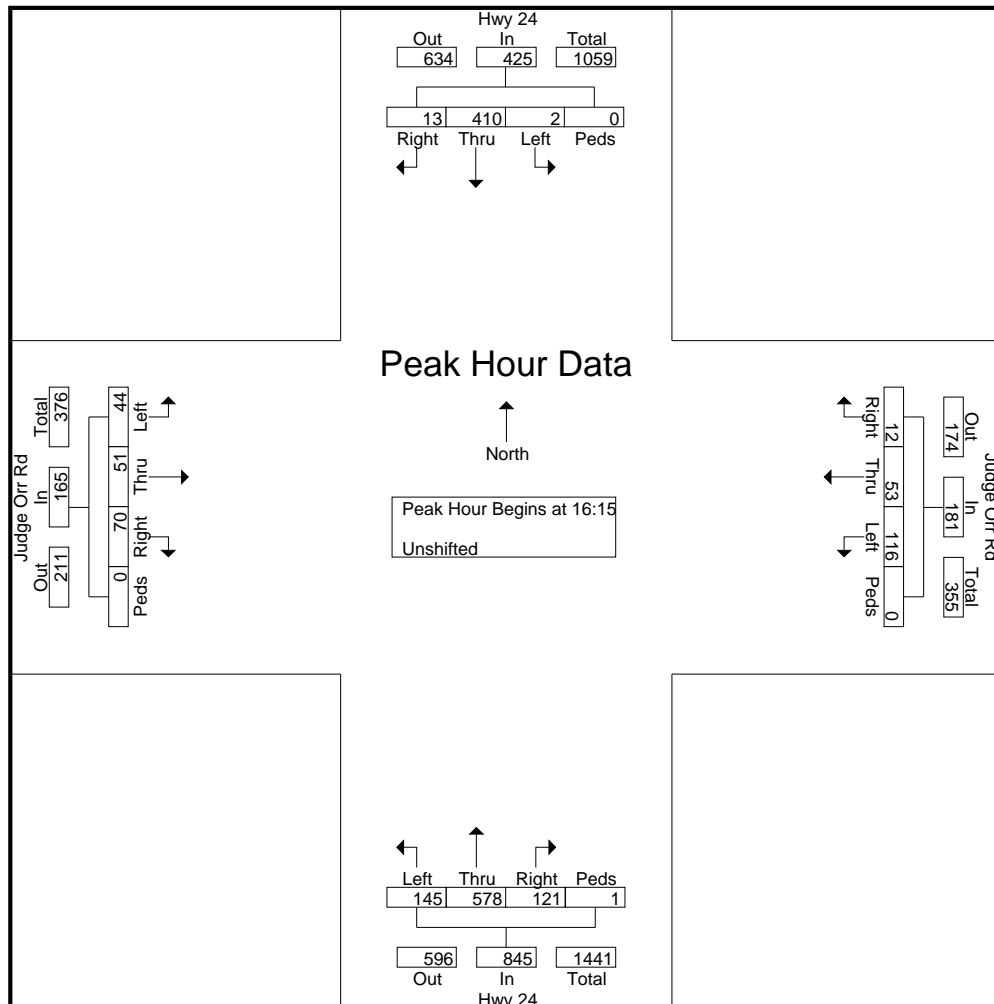

LSC Transportation Consultants, Inc.

2504 E. Pikes Peak Ave, Suite 304
 Colorado Springs, CO 80909
 719-633-2868

File Name : Hwy 24 - Judge Orr Rd PM
 Site Code : S214950
 Start Date : 5/10/2022
 Page No : 3

Start Time	Hwy 24 Southbound					Judge Orr Rd Westbound					Hwy 24 Northbound					Judge Orr Rd Eastbound					Int. Total
	Right	Thru	Left	Peds	App. Total	Right	Thru	Left	Peds	App. Total	Right	Thru	Left	Peds	App. Total	Right	Thru	Left	Peds	App. Total	

Peak Hour Analysis From 4:00:00 PM to 5:45:00 PM - Peak 1 of 1

Peak Hour for Each Approach Begins at:

	4:30:00 PM					4:15:00 PM					4:15:00 PM					4:15:00 PM				
+0 mins.	7	105	1	0	113	5	17	25	0	47	27	152	30	0	209	21	11	11	0	43
+5 mins.	1	101	0	0	102	1	14	29	0	44	34	144	34	1	213	18	11	11	0	40
+10 mins.	2	99	0	0	101	2	9	24	0	35	31	135	41	0	207	15	13	12	0	40
+15 mins.	7	127	0	0	134	4	13	38	0	55	29	147	40	0	216	16	16	10	0	42
Total Volume	17	432	1	0	450	12	53	116	0	181	121	578	145	1	845	70	51	44	0	165
% App. Total	3.8	96	0.2	0		6.6	29.3	64.1	0		14.3	68.4	17.2	0.1		42.4	30.9	26.7	0	
PHF	.607	.850	.250	.000	.840	.600	.779	.763	.000	.823	.890	.951	.884	.250	.978	.833	.797	.917	.000	.959

LSC Transportation Consultants, Inc.

2504 E. Pikes Peak Ave, Suite 304
 Colorado Springs, CO 80909
 719-633-2868

File Name : Hwy 24 - Stapleton Rd AM PM
 Site Code : S224640
 Start Date : 1/10/2023
 Page No : 1

Groups Printed- Unshifted

Start Time	Hwy 24 Southbound					Stapleton Dr Westbound					Hwy 24 Northbound					Stapleton Dr Eastbound					Int. Total
	Right	Thru	Left	Peds	App. Total	Right	Thru	Left	Peds	App. Total	Right	Thru	Left	Peds	App. Total	Right	Thru	Left	Peds	App. Total	
06:30	1	29	1	0	31	0	1	1	0	2	1	7	1	0	9	20	11	1	0	32	74
06:35	0	33	0	0	33	1	4	0	0	5	0	12	0	0	12	11	11	2	0	24	74
06:40	0	35	2	0	37	1	0	0	0	1	0	13	2	0	15	16	8	2	0	26	79
06:45	3	41	3	0	47	1	6	3	0	10	1	22	4	0	27	13	9	2	0	24	108
06:50	3	32	1	0	36	1	3	0	0	4	1	15	7	0	23	14	7	1	0	22	85
06:55	2	22	1	0	25	2	8	0	0	10	0	24	6	0	30	16	13	0	0	29	94
Total	9	192	8	0	209	6	22	4	0	32	3	93	20	0	116	90	59	8	0	157	514
07:00	4	35	3	0	42	2	6	0	0	8	0	29	2	0	31	7	13	1	0	21	102
07:05	4	33	4	0	41	1	10	0	0	11	0	22	4	0	26	7	11	6	0	24	102
07:10	0	33	3	0	36	4	11	1	0	16	0	30	5	0	35	15	12	2	0	29	116
07:15	2	36	2	0	40	4	14	1	0	19	0	29	7	0	36	13	15	3	0	31	126
07:20	4	46	1	0	51	1	6	0	0	7	0	30	4	0	34	11	13	1	0	25	117
07:25	5	51	8	0	64	0	7	0	0	7	0	28	0	0	28	10	7	1	0	18	117
07:30	2	34	2	0	38	0	7	0	0	7	1	16	6	0	23	9	20	2	0	31	99
07:35	6	40	5	0	51	0	9	1	0	10	0	9	2	0	11	12	7	2	0	21	93
07:40	4	31	1	0	36	0	7	2	0	9	0	9	3	0	12	5	9	0	0	14	71
07:45	1	31	1	0	33	2	5	1	0	8	0	13	6	0	19	6	17	2	0	25	85
07:50	3	21	4	0	28	0	5	0	0	5	1	18	1	0	20	10	15	2	0	27	80
07:55	2	15	3	0	20	1	1	0	0	2	0	16	4	0	20	8	5	1	0	14	56
Total	37	406	37	0	480	15	88	6	0	109	2	249	44	0	295	113	144	23	0	280	1164
08:00	3	39	2	0	44	0	6	0	0	6	0	10	5	0	15	4	10	2	0	16	81
08:05	1	30	0	0	31	1	2	1	0	4	2	19	5	0	26	4	6	4	0	14	75
08:10	2	27	2	0	31	2	2	1	0	5	0	13	4	0	17	5	6	0	0	11	64
08:15	4	31	0	0	35	5	1	2	0	8	0	7	5	0	12	8	5	2	0	15	70
08:20	5	22	3	0	30	1	7	0	0	8	0	3	3	0	6	7	4	1	0	12	56
08:25	4	34	1	0	39	0	2	0	0	2	1	14	0	0	15	4	7	5	0	16	72
*** BREAK ***																					
Total	19	183	8	0	210	9	20	4	0	33	3	66	22	0	91	32	38	14	0	84	418
*** BREAK ***																					
16:00	2	26	0	0	28	3	7	1	0	11	0	41	13	0	54	3	3	4	0	10	103
16:05	3	25	0	0	28	4	6	0	0	10	0	46	15	0	61	1	2	5	0	8	107
16:10	3	32	0	0	35	2	8	0	0	10	3	35	15	0	53	6	4	2	0	12	110
16:15	3	36	1	0	40	3	9	1	0	13	4	45	7	0	56	4	1	2	0	7	116
16:20	0	31	3	0	34	1	7	1	0	9	2	46	15	0	63	4	2	1	0	7	113
16:25	1	24	1	0	26	2	11	0	0	13	3	47	8	0	58	5	10	3	0	18	115
16:30	1	23	0	0	24	0	10	2	0	12	1	42	7	0	50	5	3	2	0	10	96
16:35	2	32	1	0	35	1	5	1	0	7	4	34	4	0	42	2	1	1	0	4	88
16:40	5	29	1	0	35	2	13	0	0	15	1	29	7	0	37	4	9	1	0	14	101
16:45	3	31	2	0	36	5	10	3	0	18	2	31	13	0	46	3	2	2	0	7	107
16:50	1	32	1	0	34	2	11	0	0	13	4	39	7	0	50	6	4	2	0	12	109

LSC Transportation Consultants, Inc.

2504 E. Pikes Peak Ave, Suite 304
 Colorado Springs, CO 80909
 719-633-2868

File Name : Hwy 24 - Stapleton Rd AM PM

Site Code : S224640

Start Date : 1/10/2023

Page No : 2

Groups Printed- Unshifted

Start Time	Hwy 24 Southbound					Stapleton Dr Westbound					Hwy 24 Northbound					Stapleton Dr Eastbound					Int. Total
	Right	Thru	Left	Peds	App. Total	Right	Thru	Left	Peds	App. Total	Right	Thru	Left	Peds	App. Total	Right	Thru	Left	Peds	App. Total	
16:55	5	29	1	0	35	3	15	2	0	20	3	31	15	0	49	2	4	2	0	8	112
Total	29	350	11	0	390	28	112	11	0	151	27	466	126	0	619	45	45	27	0	117	1277
17:00	3	22	0	0	25	0	20	0	0	20	1	37	13	0	51	8	1	0	0	9	105
17:05	2	30	0	0	32	4	6	1	0	11	7	47	14	0	68	2	4	0	0	6	117
17:10	3	45	1	0	49	3	19	1	0	23	1	31	9	0	41	4	1	1	0	6	119
17:15	3	29	1	0	33	1	4	1	0	6	0	46	7	0	53	3	1	1	0	5	97
17:20	3	27	1	0	31	4	11	1	0	16	3	34	8	0	45	3	5	2	0	10	102
17:25	3	21	0	0	24	3	2	0	0	5	0	30	11	0	41	2	4	2	0	8	78
17:30	3	18	0	0	21	5	8	0	0	13	2	43	8	0	53	1	3	0	0	4	91
17:35	3	17	0	0	20	2	6	0	0	8	0	33	14	0	47	2	1	3	0	6	81
17:40	1	18	0	0	19	2	6	2	0	10	1	32	6	0	39	0	1	3	0	4	72
17:45	4	24	1	0	29	2	4	1	0	7	1	51	7	0	59	3	2	1	0	6	101
17:50	1	13	0	0	14	1	6	1	0	8	0	48	13	0	61	2	5	3	0	10	93
17:55	3	18	0	0	21	3	7	0	0	10	1	23	9	0	33	4	7	2	0	13	77
Total	32	282	4	0	318	30	99	8	0	137	17	455	119	0	591	34	35	18	0	87	1133
Grand Total	126	1413	68	0	1607	88	341	33	0	462	52	1329	331	0	1712	314	321	90	0	725	4506
Apprch %	7.8	87.9	4.2	0		19	73.8	7.1	0		3	77.6	19.3	0		43.3	44.3	12.4	0		
Total %	2.8	31.4	1.5	0	35.7	2	7.6	0.7	0	10.3	1.2	29.5	7.3	0	38	7	7.1	2	0	16.1	

LSC Transportation Consultants, Inc.

2504 E. Pikes Peak Ave, Suite 304
 Colorado Springs, CO 80909
 719-633-2868

File Name : Hwy 24 - Stapleton Rd AM PM

Site Code : S224640

Start Date : 1/10/2023

Page No : 3

Start Time	Hwy 24 Southbound					Stapleton Dr Westbound					Hwy 24 Northbound					Stapleton Dr Eastbound					Int. Total
	Right	Thru	Left	Peds	App. Total	Right	Thru	Left	Peds	App. Total	Right	Thru	Left	Peds	App. Total	Right	Thru	Left	Peds	App. Total	
Peak Hour Analysis From 06:30 to 17:55 - Peak 1 of 1																					
Peak Hour for Entire Intersection Begins at 16:15																					
16:15	3	36	1	0	40	3	9	1	0	13	4	45	7	0	56	4	1	2	0	7	116
16:20	0	31	3	0	34	1	7	1	0	9	2	46	15	0	63	4	2	1	0	7	113
16:25	1	24	1	0	26	2	11	0	0	13	3	47	8	0	58	5	10	3	0	18	115
16:30	1	23	0	0	24	0	10	2	0	12	1	42	7	0	50	5	3	2	0	10	96
16:35	2	32	1	0	35	1	5	1	0	7	4	34	4	0	42	2	1	1	0	4	88
16:40	5	29	1	0	35	2	13	0	0	15	1	29	7	0	37	4	9	1	0	14	101
16:45	3	31	2	0	36	5	10	3	0	18	2	31	13	0	46	3	2	2	0	7	107
16:50	1	32	1	0	34	2	11	0	0	13	4	39	7	0	50	6	4	2	0	12	109
16:55	5	29	1	0	35	3	15	2	0	20	3	31	15	0	49	2	4	2	0	8	112
17:00	3	22	0	0	25	0	20	0	0	20	1	37	13	0	51	8	1	0	0	9	105
17:05	2	30	0	0	32	4	6	1	0	11	7	47	14	0	68	2	4	0	0	6	117
17:10	3	45	1	0	49	3	19	1	0	23	1	31	9	0	41	4	1	1	0	6	119
Total Volume	29	364	12	0	405	26	136	12	0	174	33	459	119	0	611	49	42	17	0	108	1298
% App. Total	7.2	89.9	3	0		14.9	78.2	6.9	0		5.4	75.1	19.5	0		45.4	38.9	15.7	0		
PHF	.483	.674	.333	.000	.689	.433	.567	.333	.000	.630	.393	.814	.661	.000	.749	.510	.350	.472	.000	.500	.909

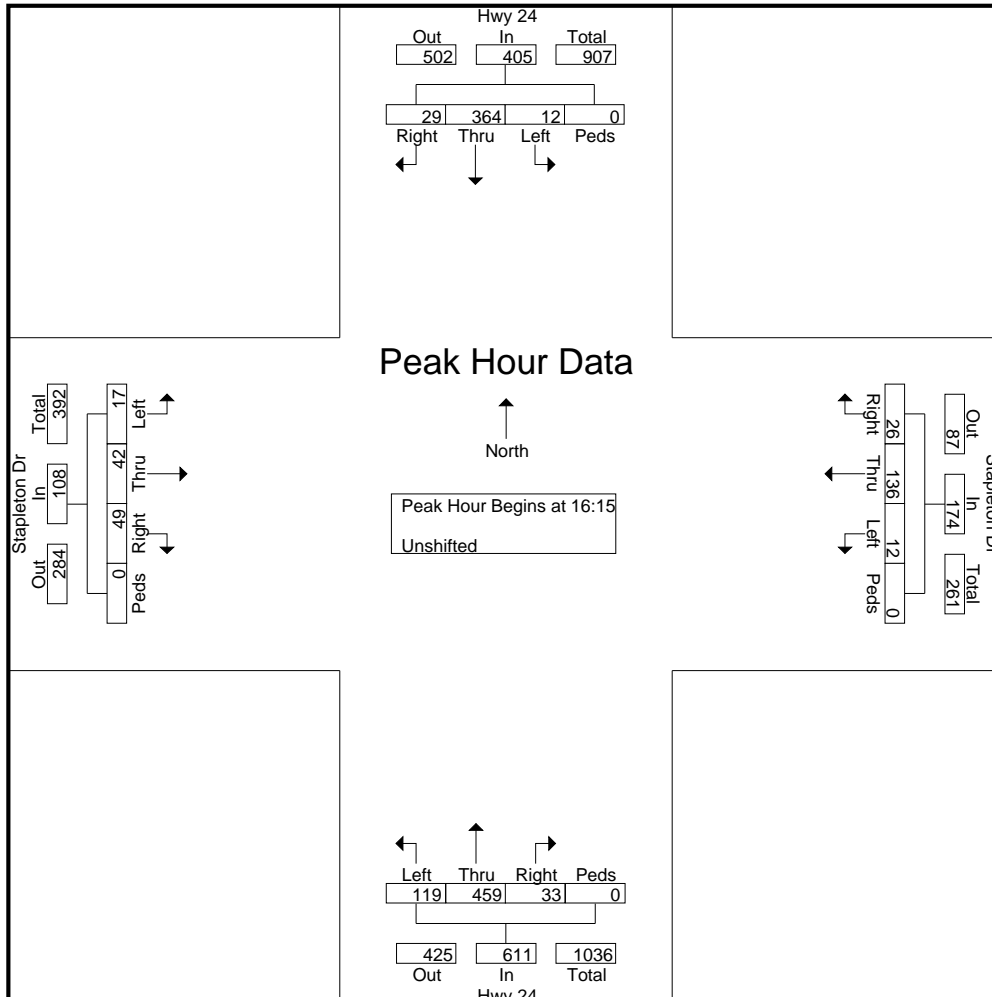

LSC Transportation Consultants, Inc.

2504 E. Pikes Peak Ave, Suite 304
 Colorado Springs, CO 80909
 719-633-2868

File Name : Hwy 24 - Stapleton Rd AM PM
 Site Code : S224640
 Start Date : 1/10/2023
 Page No : 4

Start Time	Hwy 24 Southbound					Stapleton Dr Westbound					Hwy 24 Northbound					Stapleton Dr Eastbound					Int. Total
	Right	Thru	Left	Peds	App. Total	Right	Thru	Left	Peds	App. Total	Right	Thru	Left	Peds	App. Total	Right	Thru	Left	Peds	App. Total	

Peak Hour Analysis From 06:30 to 17:55 - Peak 1 of 1
 Peak Hour for Each Approach Begins at:

	06:40					16:15					16:10					06:30				
+0 mins.	0	35	2	0	37	3	9	1	0	13	3	35	15	0	53	20	11	1	0	32
+5 mins.	3	41	3	0	47	1	7	1	0	9	4	45	7	0	56	11	11	2	0	24
+10 mins.	3	32	1	0	36	2	11	0	0	13	2	46	15	0	63	16	8	2	0	26
+15 mins.	2	22	1	0	25	0	10	2	0	12	3	47	8	0	58	13	9	2	0	24
+20 mins.	4	35	3	0	42	1	5	1	0	7	1	42	7	0	50	14	7	1	0	22
+25 mins.	4	33	4	0	41	2	13	0	0	15	4	34	4	0	42	16	13	0	0	29
+30 mins.	0	33	3	0	36	5	10	3	0	18	1	29	7	0	37	7	13	1	0	21
+35 mins.	2	36	2	0	40	2	11	0	0	13	2	31	13	0	46	7	11	6	0	24
+40 mins.	4	46	1	0	51	3	15	2	0	20	4	39	7	0	50	15	12	2	0	29
+45 mins.	5	51	8	0	64	0	20	0	0	20	3	31	15	0	49	13	15	3	0	31
+50 mins.	2	34	2	0	38	4	6	1	0	11	1	37	13	0	51	11	13	1	0	25
+55 mins.	6	40	5	0	51	3	19	1	0	23	7	47	14	0	68	10	7	1	0	18
Total Volume	35	438	35	0	508	26	136	12	0	174	35	463	125	0	623	153	130	22	0	305
% App. Total	6.9	86.2	6.9	0		14.9	78.2	6.9	0		5.6	74.3	20.1	0		50.2	42.6	7.2	0	
PHF	.486	.716	.365	.000	.661	.433	.567	.333	.000	.630	.417	.821	.694	.000	.763	.638	.722	.306	.000	.794

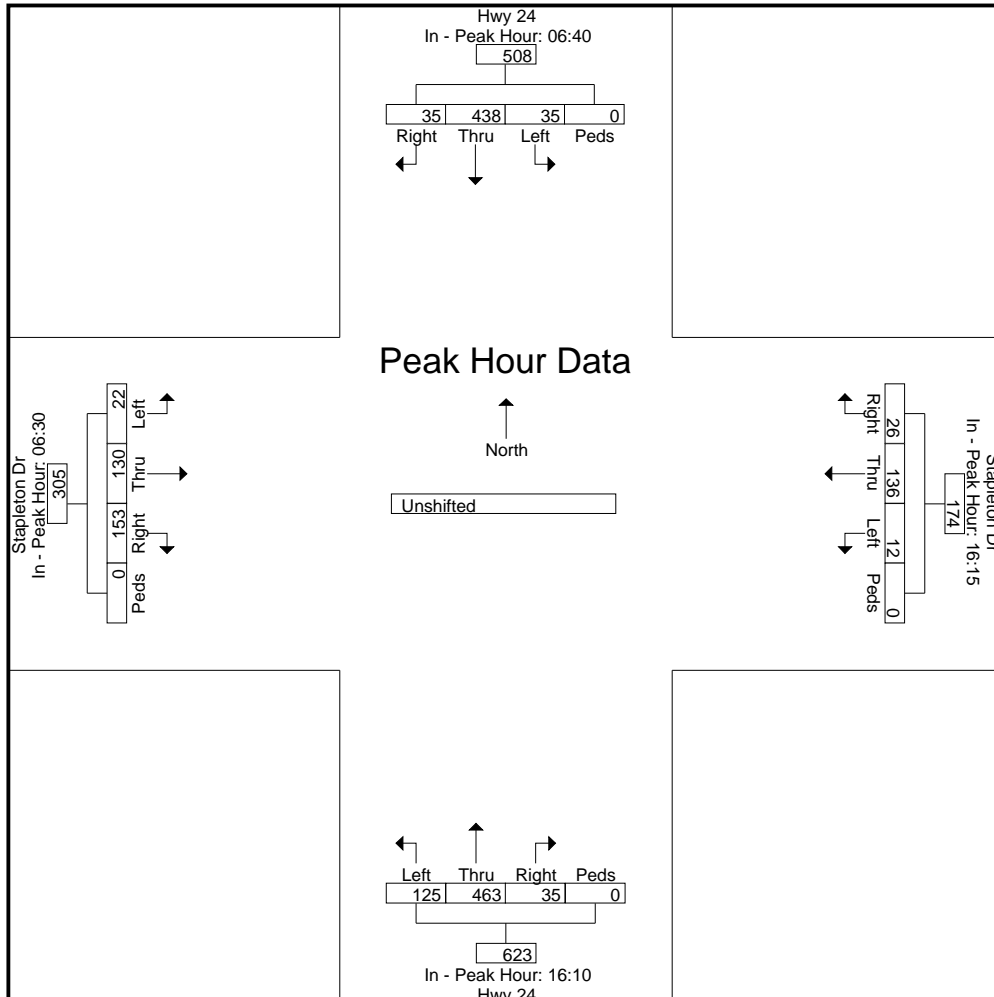

Level of Service Reports



Lanes, Volumes, Timings
1: US 24 & Judge Orr

2023 Existing
AM



Lane Group	EBL	EBT	EBR	WBL	WBT	WBR	NEL	NET	NER	SWL	SWT	SWR
Lane Configurations		↕			↕		↗	↘		↗	↘	
Traffic Volume (vph)	29	67	172	140	62	7	58	276	46	2	566	19
Future Volume (vph)	29	67	172	140	62	7	58	276	46	2	566	19
Ideal Flow (vphpl)	1900	1900	1900	1900	1900	1900	1900	1900	1900	1900	1900	1900
Storage Length (ft)	0		0	0		0	870		0	695		0
Storage Lanes	0		0	0		0	1		0	1		0
Taper Length (ft)	25			25			300			280		
Lane Util. Factor	1.00	1.00	1.00	1.00	1.00	1.00	1.00	1.00	1.00	1.00	1.00	1.00
Frt		0.914			0.995			0.979			0.995	
Flt Protected		0.995			0.968		0.950			0.950		
Satd. Flow (prot)	0	1694	0	0	1794	0	1770	1824	0	1770	1853	0
Flt Permitted		0.995			0.968		0.167			0.551		
Satd. Flow (perm)	0	1694	0	0	1794	0	311	1824	0	1026	1853	0
Right Turn on Red			Yes			Yes			Yes			Yes
Satd. Flow (RTOR)		57			1			8			1	
Link Speed (mph)		45			45			55			55	
Link Distance (ft)		927			7314			1546			3606	
Travel Time (s)		14.0			110.8			19.2			44.7	
Peak Hour Factor	0.92	0.92	0.92	0.87	0.87	0.87	0.92	0.92	0.92	0.93	0.93	0.93
Adj. Flow (vph)	32	73	187	161	71	8	63	300	50	2	609	20
Shared Lane Traffic (%)												
Lane Group Flow (vph)	0	292	0	0	240	0	63	350	0	2	629	0
Enter Blocked Intersection	No	No	No	No	No	No	No	No	No	No	No	No
Lane Alignment	Left	Left	Right	Left	Left	Right	Left	Left	Right	Left	Left	Right
Median Width(ft)		12			12			12			12	
Link Offset(ft)		0			0			0			0	
Crosswalk Width(ft)		16			16			16			16	
Two way Left Turn Lane												
Headway Factor	1.00	1.00	1.00	1.00	1.00	1.00	1.00	1.00	1.00	1.00	1.00	1.00
Turning Speed (mph)	60		60	60		60	60		60	60		60
Number of Detectors	1	2		1	2		1	2		1	2	
Detector Template	Left	Thru		Left	Thru		Left	Thru		Left	Thru	
Leading Detector (ft)	20	100		20	100		20	100		20	100	
Trailing Detector (ft)	0	0		0	0		0	0		0	0	
Detector 1 Position(ft)	0	0		0	0		0	0		0	0	
Detector 1 Size(ft)	20	6		20	6		20	6		20	6	
Detector 1 Type	Cl+Ex	Cl+Ex		Cl+Ex	Cl+Ex		Cl+Ex	Cl+Ex		Cl+Ex	Cl+Ex	
Detector 1 Channel												
Detector 1 Extend (s)	0.0	0.0		0.0	0.0		0.0	0.0		0.0	0.0	
Detector 1 Queue (s)	0.0	0.0		0.0	0.0		0.0	0.0		0.0	0.0	
Detector 1 Delay (s)	0.0	0.0		0.0	0.0		0.0	0.0		0.0	0.0	
Detector 2 Position(ft)		94			94			94			94	
Detector 2 Size(ft)		6			6			6			6	
Detector 2 Type		Cl+Ex			Cl+Ex			Cl+Ex			Cl+Ex	
Detector 2 Channel												
Detector 2 Extend (s)		0.0			0.0			0.0			0.0	
Turn Type	Split	NA		Split	NA		pm+pt	NA		Perm	NA	
Protected Phases	4	4		8	8		5	2			6	
Permitted Phases							2			6		

Lanes, Volumes, Timings
1: US 24 & Judge Orr

2023 Existing
AM



Lane Group	EBL	EBT	EBR	WBL	WBT	WBR	NEL	NET	NER	SWL	SWT	SWR
Detector Phase	4	4		8	8		5	2		6	6	
Switch Phase												
Minimum Initial (s)	6.0	6.0		6.0	6.0		6.0	37.0		22.0	22.0	
Minimum Split (s)	13.0	13.0		13.0	13.0		11.0	44.0		29.0	29.0	
Total Split (s)	35.0	35.0		35.0	35.0		12.0	70.0		58.0	58.0	
Total Split (%)	25.0%	25.0%		25.0%	25.0%		8.6%	50.0%		41.4%	41.4%	
Maximum Green (s)	28.0	28.0		28.0	28.0		7.0	63.0		51.0	51.0	
Yellow Time (s)	5.0	5.0		5.0	5.0		3.0	5.0		5.0	5.0	
All-Red Time (s)	2.0	2.0		2.0	2.0		2.0	2.0		2.0	2.0	
Lost Time Adjust (s)		0.0			0.0		0.0	0.0		0.0	0.0	
Total Lost Time (s)		7.0			7.0		5.0	7.0		7.0	7.0	
Lead/Lag							Lead			Lag	Lag	
Lead-Lag Optimize?							Yes			Yes	Yes	
Vehicle Extension (s)	3.0	3.0		3.0	3.0		3.0	3.0		3.0	3.0	
Recall Mode	None	None		None	None		None	C-Min		C-Min	C-Min	
Walk Time (s)								7.0		7.0	7.0	
Flash Dont Walk (s)								11.0		11.0	11.0	
Pedestrian Calls (#/hr)								0		0	0	
Act Effct Green (s)		24.0			23.1		73.9	71.9		62.4	62.4	
Actuated g/C Ratio		0.17			0.16		0.53	0.51		0.45	0.45	
v/c Ratio		0.87			0.81		0.27	0.37		0.00	0.76	
Control Delay		69.5			76.4		21.7	23.1		28.0	42.6	
Queue Delay		0.0			0.0		0.0	0.0		0.0	0.0	
Total Delay		69.5			76.4		21.7	23.1		28.0	42.6	
LOS		E			E		C	C		C	D	
Approach Delay		69.5			76.4			22.9			42.6	
Approach LOS		E			E			C			D	
Queue Length 50th (ft)		211			211		28	189		1	505	
Queue Length 95th (ft)		#333			287		60	293		8	#788	
Internal Link Dist (ft)		847			7234			1466			3526	
Turn Bay Length (ft)							870			695		
Base Capacity (vph)		384			359		237	941		456	825	
Starvation Cap Reductn		0			0		0	0		0	0	
Spillback Cap Reductn		0			0		0	0		0	0	
Storage Cap Reductn		0			0		0	0		0	0	
Reduced v/c Ratio		0.76			0.67		0.27	0.37		0.00	0.76	

Intersection Summary

Area Type: Other
 Cycle Length: 140
 Actuated Cycle Length: 140
 Offset: 34 (24%), Referenced to phase 2:NETL and 6:SWTL, Start of Green
 Natural Cycle: 90
 Control Type: Actuated-Coordinated
 Maximum v/c Ratio: 0.87
 Intersection Signal Delay: 47.6 Intersection LOS: D
 Intersection Capacity Utilization 92.8% ICU Level of Service F
 Analysis Period (min) 15
 # 95th percentile volume exceeds capacity, queue may be longer.

Queue shown is maximum after two cycles.

Splits and Phases: 1: US 24 & Judge Orr

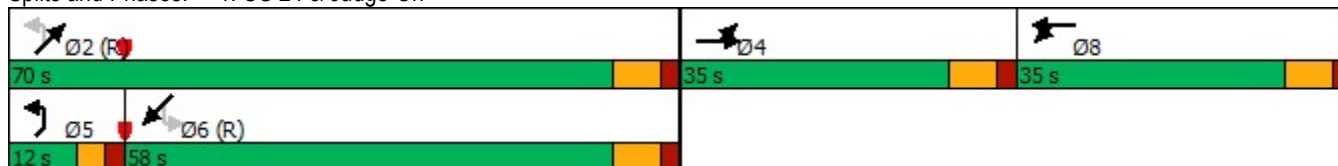

Intersection												
Int Delay, s/veh	10.1											
Movement	SEL	SET	SER	NWL	NWT	NWR	NEL	NET	NER	SWL	SWT	SWR
Lane Configurations	↖	↗	↖	↖	↗	↖	↖	↗	↖	↖	↗	↖
Traffic Vol, veh/h	23	135	143	6	87	17	49	267	3	35	438	35
Future Vol, veh/h	23	135	143	6	87	17	49	267	3	35	438	35
Conflicting Peds, #/hr	0	0	0	0	0	0	0	0	0	0	0	0
Sign Control	Stop	Stop	Stop	Stop	Stop	Stop	Free	Free	Free	Free	Free	Free
RT Channelized	-	-	None	-	-	None	-	-	None	-	-	None
Storage Length	190	-	325	215	-	215	890	-	1000	790	-	790
Veh in Median Storage, #	-	0	-	-	0	-	-	0	-	-	0	-
Grade, %	-	0	-	-	0	-	-	0	-	-	0	-
Peak Hour Factor	92	92	92	87	87	87	92	92	92	92	92	92
Heavy Vehicles, %	2	2	2	2	2	2	2	2	2	2	2	2
Mvmt Flow	25	147	155	7	100	20	53	290	3	38	476	38

Major/Minor	Minor2		Minor1		Major1			Major2				
Conflicting Flow All	1010	951	476	1118	986	290	514	0	0	293	0	0
Stage 1	552	552	-	396	396	-	-	-	-	-	-	-
Stage 2	458	399	-	722	590	-	-	-	-	-	-	-
Critical Hdwy	7.12	6.52	6.22	7.12	6.52	6.22	4.12	-	-	4.12	-	-
Critical Hdwy Stg 1	6.12	5.52	-	6.12	5.52	-	-	-	-	-	-	-
Critical Hdwy Stg 2	6.12	5.52	-	6.12	5.52	-	-	-	-	-	-	-
Follow-up Hdwy	3.518	4.018	3.318	3.518	4.018	3.318	2.218	-	-	2.218	-	-
Pot Cap-1 Maneuver	218	260	589	184	248	749	1052	-	-	1269	-	-
Stage 1	518	515	-	629	604	-	-	-	-	-	-	-
Stage 2	583	602	-	418	495	-	-	-	-	-	-	-
Platoon blocked, %	-	-	-	-	-	-	-	-	-	-	-	-
Mov Cap-1 Maneuver	132	240	589	66	229	749	1052	-	-	1269	-	-
Mov Cap-2 Maneuver	132	240	-	66	229	-	-	-	-	-	-	-
Stage 1	492	500	-	598	574	-	-	-	-	-	-	-
Stage 2	445	572	-	211	480	-	-	-	-	-	-	-

Approach	SE		NW		NE		SW	
HCM Control Delay, s	27.7		30.7		1.3		0.5	
HCM LOS	D		D					

Minor Lane/Major Mvmt	NEL	NET	NERN	NWLn1	NWLn2	NWLn3	SELn1	SELn2	SELn3	SWL	SWT	SWR
Capacity (veh/h)	1052	-	-	66	229	749	132	240	589	1269	-	-
HCM Lane V/C Ratio	0.051	-	-	0.104	0.437	0.026	0.189	0.611	0.264	0.03	-	-
HCM Control Delay (s)	8.6	-	-	65.8	32.4	9.9	38.5	41.1	13.3	7.9	-	-
HCM Lane LOS	A	-	-	F	D	A	E	E	B	A	-	-
HCM 95th %tile Q(veh)	0.2	-	-	0.3	2.1	0.1	0.7	3.6	1.1	0.1	-	-

Intersection												
Int Delay, s/veh	1.7											
Movement	SEL	SET	SER	NWL	NWT	NWR	NEL	NET	NER	SWL	SWT	SWR
Lane Configurations	↖	↗	↖	↖	↗	↖	↖	↗	↖	↖	↗	↖
Traffic Vol, veh/h	3	10	105	13	14	0	42	244	3	3	380	4
Future Vol, veh/h	3	10	105	13	14	0	42	244	3	3	380	4
Conflicting Peds, #/hr	0	0	0	0	0	0	0	0	0	0	0	0
Sign Control	Stop	Stop	Stop	Stop	Stop	Stop	Free	Free	Free	Free	Free	Free
RT Channelized	-	-	Free	-	-	Stop	-	-	Yield	-	-	Yield
Storage Length	170	-	250	125	-	25	620	-	550	540	-	480
Veh in Median Storage, #	-	0	-	-	0	-	-	0	-	-	0	-
Grade, %	-	0	-	-	0	-	-	0	-	-	0	-
Peak Hour Factor	83	83	83	78	78	78	92	92	92	92	92	92
Heavy Vehicles, %	2	2	2	2	2	2	2	2	2	2	2	2
Mvmt Flow	4	12	127	17	18	0	46	265	3	3	413	4

Major/Minor	Minor2		Minor1		Major1		Major2					
Conflicting Flow All	785	776	-	782	776	265	413	0	0	265	0	0
Stage 1	419	419	-	357	357	-	-	-	-	-	-	-
Stage 2	366	357	-	425	419	-	-	-	-	-	-	-
Critical Hdwy	7.12	6.52	-	7.12	6.52	6.22	4.12	-	-	4.12	-	-
Critical Hdwy Stg 1	6.12	5.52	-	6.12	5.52	-	-	-	-	-	-	-
Critical Hdwy Stg 2	6.12	5.52	-	6.12	5.52	-	-	-	-	-	-	-
Follow-up Hdwy	3.518	4.018	-	3.518	4.018	3.318	2.218	-	-	2.218	-	-
Pot Cap-1 Maneuver	310	328	0	312	328	774	1146	-	-	1299	-	-
Stage 1	612	590	0	661	628	-	-	-	-	-	-	-
Stage 2	653	628	0	607	590	-	-	-	-	-	-	-
Platoon blocked, %	-	-	-	-	-	-	-	-	-	-	-	-
Mov Cap-1 Maneuver	287	314	-	293	314	774	1146	-	-	1299	-	-
Mov Cap-2 Maneuver	287	314	-	293	314	-	-	-	-	-	-	-
Stage 1	588	589	-	635	603	-	-	-	-	-	-	-
Stage 2	608	603	-	593	589	-	-	-	-	-	-	-

Approach	SE		NW		NE		SW	
HCM Control Delay, s	17.1		17.6		1.2		0.1	
HCM LOS	C		C					

Minor Lane/Major Mvmt	NEL	NET	NERN	NWLn1	NWLn2	NWLn3	SELn1	SELn2	SELn3	SWL	SWT	SWR
Capacity (veh/h)	1146	-	-	293	314	-	287	314	-	1299	-	-
HCM Lane V/C Ratio	0.04	-	-	0.057	0.057	-	0.013	0.038	-	0.003	-	-
HCM Control Delay (s)	8.3	-	-	18	17.2	0	17.7	16.9	0	7.8	-	-
HCM Lane LOS	A	-	-	C	C	A	C	C	A	A	-	-
HCM 95th %tile Q(veh)	0.1	-	-	0.2	0.2	-	0	0.1	-	0	-	-

Intersection						
Int Delay, s/veh	0.6					
Movement	EBL	EBT	WBT	WBR	SBL	SBR
Lane Configurations		↶	↷		↶	↷
Traffic Vol, veh/h	0	38	144	14	4	9
Future Vol, veh/h	0	38	144	14	4	9
Conflicting Peds, #/hr	0	0	0	0	0	0
Sign Control	Free	Free	Free	Free	Stop	Stop
RT Channelized	-	None	-	None	-	None
Storage Length	-	-	-	-	0	-
Veh in Median Storage, #	-	0	0	-	0	-
Grade, %	-	0	0	-	0	-
Peak Hour Factor	78	78	87	87	78	78
Heavy Vehicles, %	2	2	2	2	2	2
Mvmt Flow	0	49	166	16	5	12

Major/Minor	Major1	Major2	Minor2		
Conflicting Flow All	182	0	-	0	223 174
Stage 1	-	-	-	-	174 -
Stage 2	-	-	-	-	49 -
Critical Hdwy	4.12	-	-	-	6.42 6.22
Critical Hdwy Stg 1	-	-	-	-	5.42 -
Critical Hdwy Stg 2	-	-	-	-	5.42 -
Follow-up Hdwy	2.218	-	-	-	3.518 3.318
Pot Cap-1 Maneuver	1393	-	-	-	765 869
Stage 1	-	-	-	-	856 -
Stage 2	-	-	-	-	973 -
Platoon blocked, %		-	-	-	
Mov Cap-1 Maneuver	1393	-	-	-	765 869
Mov Cap-2 Maneuver	-	-	-	-	765 -
Stage 1	-	-	-	-	856 -
Stage 2	-	-	-	-	973 -

Approach	EB	WB	SB
HCM Control Delay, s	0	0	9.4
HCM LOS			A

Minor Lane/Major Mvmt	EBL	EBT	WBT	WBR	SBLn1
Capacity (veh/h)	1393	-	-	-	834
HCM Lane V/C Ratio	-	-	-	-	0.02
HCM Control Delay (s)	0	-	-	-	9.4
HCM Lane LOS	A	-	-	-	A
HCM 95th %tile Q(veh)	0	-	-	-	0.1

Intersection												
Int Delay, s/veh	8											
Movement	EBL	EBT	EBR	WBL	WBT	WBR	NBL	NBT	NBR	SBL	SBT	SBR
Lane Configurations	↶	↷		↶	↷		↶	↷		↶	↷	
Traffic Vol, veh/h	3	34	73	24	144	14	40	70	5	5	189	1
Future Vol, veh/h	3	34	73	24	144	14	40	70	5	5	189	1
Conflicting Peds, #/hr	0	0	0	0	0	0	0	0	0	0	0	0
Sign Control	Free	Free	Free	Free	Free	Free	Stop	Stop	Stop	Stop	Stop	Stop
RT Channelized	-	-	None	-	-	None	-	-	None	-	-	None
Storage Length	245	-	-	235	-	-	265	-	-	265	-	-
Veh in Median Storage, #	-	0	-	-	0	-	-	0	-	-	0	-
Grade, %	-	0	-	-	0	-	-	0	-	-	0	-
Peak Hour Factor	83	83	83	87	87	87	83	83	83	87	87	87
Heavy Vehicles, %	2	2	2	2	2	2	2	2	2	2	2	2
Mvmt Flow	4	41	88	28	166	16	48	84	6	6	217	1

Major/Minor	Major1			Major2			Minor1			Minor2		
Conflicting Flow All	182	0	0	129	0	0	432	331	85	368	367	174
Stage 1	-	-	-	-	-	-	93	93	-	230	230	-
Stage 2	-	-	-	-	-	-	339	238	-	138	137	-
Critical Hdwy	4.12	-	-	4.12	-	-	7.12	6.52	6.22	7.12	6.52	6.22
Critical Hdwy Stg 1	-	-	-	-	-	-	6.12	5.52	-	6.12	5.52	-
Critical Hdwy Stg 2	-	-	-	-	-	-	6.12	5.52	-	6.12	5.52	-
Follow-up Hdwy	2.218	-	-	2.218	-	-	3.518	4.018	3.318	3.518	4.018	3.318
Pot Cap-1 Maneuver	1393	-	-	1457	-	-	534	588	974	588	562	869
Stage 1	-	-	-	-	-	-	914	818	-	773	714	-
Stage 2	-	-	-	-	-	-	676	708	-	865	783	-
Platoon blocked, %	-	-	-	-	-	-	-	-	-	-	-	-
Mov Cap-1 Maneuver	1393	-	-	1457	-	-	363	575	974	510	550	869
Mov Cap-2 Maneuver	-	-	-	-	-	-	363	575	-	510	550	-
Stage 1	-	-	-	-	-	-	911	816	-	771	700	-
Stage 2	-	-	-	-	-	-	457	695	-	769	781	-

Approach	EB	WB	NB	SB
HCM Control Delay, s	0.2	1	13.7	15.7
HCM LOS			B	C

Minor Lane/Major Mvmt	NBLn1	NBLn2	EBL	EBT	EBR	WBL	WBT	WBR	SBLn1	SBLn2
Capacity (veh/h)	363	591	1393	-	-	1457	-	-	510	551
HCM Lane V/C Ratio	0.133	0.153	0.003	-	-	0.019	-	-	0.011	0.396
HCM Control Delay (s)	16.4	12.2	7.6	-	-	7.5	-	-	12.1	15.8
HCM Lane LOS	C	B	A	-	-	A	-	-	B	C
HCM 95th %tile Q(veh)	0.5	0.5	0	-	-	0.1	-	-	0	1.9

Lanes, Volumes, Timings
1: US 24 & Judge Orr

2023 Existing
PM



Lane Group	EBL	EBT	EBR	WBL	WBT	WBR	NEL	NET	NER	SWL	SWT	SWR
Lane Configurations		↕			↕		↗	↘		↗	↘	
Traffic Volume (vph)	44	52	55	121	64	9	135	565	148	2	388	45
Future Volume (vph)	44	52	55	121	64	9	135	565	148	2	388	45
Ideal Flow (vphpl)	1900	1900	1900	1900	1900	1900	1900	1900	1900	1900	1900	1900
Storage Length (ft)	0		0	0		0	870		0	695		0
Storage Lanes	0		0	0		0	1		0	1		0
Taper Length (ft)	25			25			300			280		
Lane Util. Factor	1.00	1.00	1.00	1.00	1.00	1.00	1.00	1.00	1.00	1.00	1.00	1.00
Frt		0.951			0.994			0.969			0.984	
Flt Protected		0.986			0.970		0.950			0.950		
Satd. Flow (prot)	0	1747	0	0	1796	0	1770	1805	0	1770	1833	0
Flt Permitted		0.986			0.970		0.326			0.259		
Satd. Flow (perm)	0	1747	0	0	1796	0	607	1805	0	482	1833	0
Right Turn on Red			Yes			Yes			Yes			Yes
Satd. Flow (RTOR)		17			1			15			5	
Link Speed (mph)		45			45			55			55	
Link Distance (ft)		927			7314			1546			3606	
Travel Time (s)		14.0			110.8			19.2			44.7	
Peak Hour Factor	0.87	0.87	0.87	0.87	0.87	0.87	0.93	0.93	0.93	0.92	0.92	0.92
Adj. Flow (vph)	51	60	63	139	74	10	145	608	159	2	422	49
Shared Lane Traffic (%)												
Lane Group Flow (vph)	0	174	0	0	223	0	145	767	0	2	471	0
Enter Blocked Intersection	No	No	No	No	No	No	No	No	No	No	No	No
Lane Alignment	Left	Left	Right	Left	Left	Right	Left	Left	Right	Left	Left	Right
Median Width(ft)		12			12			12			12	
Link Offset(ft)		0			0			0			0	
Crosswalk Width(ft)		16			16			16			16	
Two way Left Turn Lane												
Headway Factor	1.00	1.00	1.00	1.00	1.00	1.00	1.00	1.00	1.00	1.00	1.00	1.00
Number of Detectors	1	2		1	2		1	2		1	2	
Detector Template	Left	Thru		Left	Thru		Left	Thru		Left	Thru	
Leading Detector (ft)	20	100		20	100		20	100		20	100	
Trailing Detector (ft)	0	0		0	0		0	0		0	0	
Detector 1 Position(ft)	0	0		0	0		0	0		0	0	
Detector 1 Size(ft)	20	6		20	6		20	6		20	6	
Detector 1 Type	Cl+Ex	Cl+Ex		Cl+Ex	Cl+Ex		Cl+Ex	Cl+Ex		Cl+Ex	Cl+Ex	
Detector 1 Channel												
Detector 1 Extend (s)	0.0	0.0		0.0	0.0		0.0	0.0		0.0	0.0	
Detector 1 Queue (s)	0.0	0.0		0.0	0.0		0.0	0.0		0.0	0.0	
Detector 1 Delay (s)	0.0	0.0		0.0	0.0		0.0	0.0		0.0	0.0	
Detector 2 Position(ft)		94			94			94			94	
Detector 2 Size(ft)		6			6			6			6	
Detector 2 Type		Cl+Ex			Cl+Ex			Cl+Ex			Cl+Ex	
Detector 2 Channel												
Detector 2 Extend (s)		0.0			0.0			0.0			0.0	
Turn Type	Split	NA		Split	NA		pm+pt	NA		Perm	NA	
Protected Phases	4	4		8	8		5	2			6	
Permitted Phases							2			6		
Detector Phase	4	4		8	8		5	2		6	6	

Lanes, Volumes, Timings
1: US 24 & Judge Orr

2023 Existing
PM



Lane Group	EBL	EBT	EBR	WBL	WBT	WBR	NEL	NET	NER	SWL	SWT	SWR
Switch Phase												
Minimum Initial (s)	6.0	6.0		6.0	6.0		6.0	37.0		22.0	22.0	
Minimum Split (s)	13.0	13.0		13.0	13.0		11.0	44.0		29.0	29.0	
Total Split (s)	25.0	25.0		30.0	30.0		20.0	85.0		65.0	65.0	
Total Split (%)	17.9%	17.9%		21.4%	21.4%		14.3%	60.7%		46.4%	46.4%	
Maximum Green (s)	18.0	18.0		23.0	23.0		15.0	78.0		58.0	58.0	
Yellow Time (s)	5.0	5.0		5.0	5.0		3.0	5.0		5.0	5.0	
All-Red Time (s)	2.0	2.0		2.0	2.0		2.0	2.0		2.0	2.0	
Lost Time Adjust (s)		0.0			0.0		0.0	0.0		0.0	0.0	
Total Lost Time (s)		7.0			7.0		5.0	7.0		7.0	7.0	
Lead/Lag							Lead			Lag	Lag	
Lead-Lag Optimize?							Yes			Yes	Yes	
Vehicle Extension (s)	3.0	3.0		3.0	3.0		3.0	3.0		3.0	3.0	
Recall Mode	None	None		None	None		None	C-Min		C-Min	C-Min	
Walk Time (s)								7.0		7.0	7.0	
Flash Dont Walk (s)								11.0		11.0	11.0	
Pedestrian Calls (#/hr)								0		0	0	
Act Effct Green (s)		16.2			20.9		83.9	81.9		66.2	66.2	
Actuated g/C Ratio		0.12			0.15		0.60	0.58		0.47	0.47	
v/c Ratio		0.80			0.83		0.32	0.72		0.01	0.54	
Control Delay		80.1			82.4		15.1	26.4		23.5	30.3	
Queue Delay		0.0			0.0		0.0	0.0		0.0	0.0	
Total Delay		80.1			82.4		15.1	26.4		23.5	30.3	
LOS		F			F		B	C		C	C	
Approach Delay		80.1			82.4			24.6			30.3	
Approach LOS		F			F			C			C	
Queue Length 50th (ft)		140			196		59	507		1	312	
Queue Length 95th (ft)		#226			#292		95	682		7	446	
Internal Link Dist (ft)		847			7234			1466			3526	
Turn Bay Length (ft)							870			695		
Base Capacity (vph)		239			295		488	1062		227	869	
Starvation Cap Reductn		0			0		0	0		0	0	
Spillback Cap Reductn		0			0		0	0		0	0	
Storage Cap Reductn		0			0		0	0		0	0	
Reduced v/c Ratio		0.73			0.76		0.30	0.72		0.01	0.54	

Intersection Summary

Area Type: Other
 Cycle Length: 140
 Actuated Cycle Length: 140
 Offset: 124 (89%), Referenced to phase 2:NETL and 6:SWTL, Start of Green
 Natural Cycle: 80
 Control Type: Actuated-Coordinated
 Maximum v/c Ratio: 0.83
 Intersection Signal Delay: 38.8
 Intersection Capacity Utilization 91.8%
 Analysis Period (min) 15
 # 95th percentile volume exceeds capacity, queue may be longer.
 Queue shown is maximum after two cycles.

Splits and Phases: 1: US 24 & Judge Orr

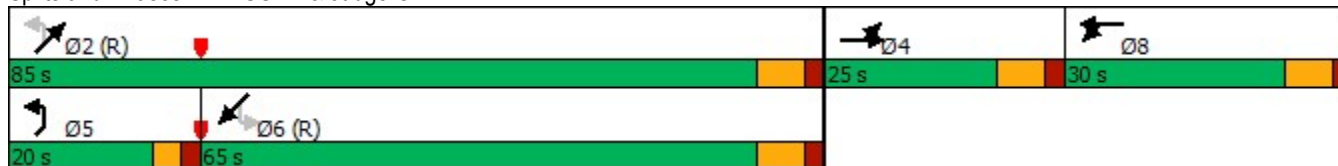

Intersection												
Int Delay, s/veh	25.2											
Movement	SEL	SET	SER	NWL	NWT	NWR	NEL	NET	NER	SWL	SWT	SWR
Lane Configurations	↖	↗	↖	↖	↗	↖	↖	↗	↖	↖	↗	↖
Traffic Vol, veh/h	14	42	49	26	136	26	119	459	33	12	364	29
Future Vol, veh/h	14	42	49	26	136	26	119	459	33	12	364	29
Conflicting Peds, #/hr	0	0	0	0	0	0	0	0	0	0	0	0
Sign Control	Stop	Stop	Stop	Stop	Stop	Stop	Free	Free	Free	Free	Free	Free
RT Channelized	-	-	None	-	-	None	-	-	None	-	-	None
Storage Length	190	-	325	215	-	215	890	-	1000	790	-	790
Veh in Median Storage, #	-	0	-	-	0	-	-	0	-	-	0	-
Grade, %	-	0	-	-	0	-	-	0	-	-	0	-
Peak Hour Factor	83	83	83	87	87	87	93	93	93	92	92	92
Heavy Vehicles, %	2	2	2	2	2	2	2	2	2	2	2	2
Mvmt Flow	17	51	59	30	156	30	128	494	35	13	396	32

Major/Minor	Minor2		Minor1		Major1			Major2				
Conflicting Flow All	1283	1207	396	1243	1204	494	428	0	0	529	0	0
Stage 1	422	422	-	750	750	-	-	-	-	-	-	-
Stage 2	861	785	-	493	454	-	-	-	-	-	-	-
Critical Hdwy	7.12	6.52	6.22	7.12	6.52	6.22	4.12	-	-	4.12	-	-
Critical Hdwy Stg 1	6.12	5.52	-	6.12	5.52	-	-	-	-	-	-	-
Critical Hdwy Stg 2	6.12	5.52	-	6.12	5.52	-	-	-	-	-	-	-
Follow-up Hdwy	3.518	4.018	3.318	3.518	4.018	3.318	2.218	-	-	2.218	-	-
Pot Cap-1 Maneuver	142	183	653	151	184	575	1131	-	-	1038	-	-
Stage 1	609	588	-	403	419	-	-	-	-	-	-	-
Stage 2	350	404	-	558	569	-	-	-	-	-	-	-
Platoon blocked, %								-	-	-	-	-
Mov Cap-1 Maneuver	~ 14	160	653	94	161	575	1131	-	-	1038	-	-
Mov Cap-2 Maneuver	~ 14	160	-	94	161	-	-	-	-	-	-	-
Stage 1	540	580	-	357	372	-	-	-	-	-	-	-
Stage 2	171	358	-	457	562	-	-	-	-	-	-	-

Approach	SE		NW		NE		SW	
HCM Control Delay, s	111.5		96.7		1.7		0.3	
HCM LOS	F		F					

Minor Lane/Major Mvmt	NEL	NET	NERN	NWLn1	NWLn2	NWLn3	SELn1	SELn2	SELn3	SWL	SWT	SWR
Capacity (veh/h)	1131	-	-	94	161	575	14	160	653	1038	-	-
HCM Lane V/C Ratio	0.113	-	-	0.318	0.971	0.052	1.205	0.316	0.09	0.013	-	-
HCM Control Delay (s)	8.6	-	-	60.2	119.9	11.6	684.4	37.6	11.1	8.5	-	-
HCM Lane LOS	A	-	-	F	F	B	F	E	B	A	-	-
HCM 95th %tile Q(veh)	0.4	-	-	1.2	7.4	0.2	2.7	1.3	0.3	0	-	-

Notes
 ~: Volume exceeds capacity \$: Delay exceeds 300s +: Computation Not Defined *: All major volume in platoon

Intersection												
Int Delay, s/veh	1.6											
Movement	SEL	SET	SER	NWL	NWT	NWR	NEL	NET	NER	SWL	SWT	SWR
Lane Configurations	↘	↑	↗	↘	↑	↗	↘	↑	↗	↘	↑	↗
Traffic Vol, veh/h	3	8	75	7	4	4	88	414	17	5	304	3
Future Vol, veh/h	3	8	75	7	4	4	88	414	17	5	304	3
Conflicting Peds, #/hr	0	0	0	0	0	0	0	0	0	0	0	0
Sign Control	Stop	Stop	Stop	Stop	Stop	Stop	Free	Free	Free	Free	Free	Free
RT Channelized	-	-	Free	-	-	Stop	-	-	Yield	-	-	Yield
Storage Length	170	-	250	125	-	25	620	-	550	540	-	480
Veh in Median Storage, #	-	0	-	-	0	-	-	0	-	-	0	-
Grade, %	-	0	-	-	0	-	-	0	-	-	0	-
Peak Hour Factor	83	83	83	78	78	78	92	92	92	92	92	92
Heavy Vehicles, %	2	2	2	2	2	2	2	2	2	2	2	2
Mvmt Flow	4	10	90	9	5	5	96	450	18	5	330	3

Major/Minor	Minor2		Minor1		Major1		Major2					
Conflicting Flow All	985	982	-	987	982	450	330	0	0	450	0	0
Stage 1	340	340	-	642	642	-	-	-	-	-	-	-
Stage 2	645	642	-	345	340	-	-	-	-	-	-	-
Critical Hdwy	7.12	6.52	-	7.12	6.52	6.22	4.12	-	-	4.12	-	-
Critical Hdwy Stg 1	6.12	5.52	-	6.12	5.52	-	-	-	-	-	-	-
Critical Hdwy Stg 2	6.12	5.52	-	6.12	5.52	-	-	-	-	-	-	-
Follow-up Hdwy	3.518	4.018	-	3.518	4.018	3.318	2.218	-	-	2.218	-	-
Pot Cap-1 Maneuver	227	249	0	226	249	609	1229	-	-	1110	-	-
Stage 1	675	639	0	463	469	-	-	-	-	-	-	-
Stage 2	461	469	0	671	639	-	-	-	-	-	-	-
Platoon blocked, %								-	-	-	-	-
Mov Cap-1 Maneuver	207	228	-	205	228	609	1229	-	-	1110	-	-
Mov Cap-2 Maneuver	207	228	-	205	228	-	-	-	-	-	-	-
Stage 1	622	636	-	427	432	-	-	-	-	-	-	-
Stage 2	416	432	-	658	636	-	-	-	-	-	-	-

Approach	SE		NW		NE		SW			
HCM Control Delay, s	21.8		19.5		1.4		0.1			
HCM LOS	C		C							

Minor Lane/Major Mvmt	NEL	NET	NERN	NWLn1	NWLn2	NWLn3	SELn1	SELn2	SELn3	SWL	SWT	SWR
Capacity (veh/h)	1229	-	-	205	228	609	207	228	-	1110	-	-
HCM Lane V/C Ratio	0.078	-	-	0.044	0.022	0.008	0.017	0.042	-	0.005	-	-
HCM Control Delay (s)	8.2	-	-	23.4	21.2	11	22.7	21.5	0	8.3	-	-
HCM Lane LOS	A	-	-	C	C	B	C	C	A	A	-	-
HCM 95th %tile Q(veh)	0.3	-	-	0.1	0.1	0	0.1	0.1	-	0	-	-

Intersection						
Int Delay, s/veh	0.9					
Movement	EBL	EBT	WBT	WBR	SBL	SBR
Lane Configurations		↶	↷		↶	
Traffic Vol, veh/h	7	148	40	3	10	4
Future Vol, veh/h	7	148	40	3	10	4
Conflicting Peds, #/hr	0	0	0	0	0	0
Sign Control	Free	Free	Free	Free	Stop	Stop
RT Channelized	-	None	-	None	-	None
Storage Length	-	-	-	-	0	-
Veh in Median Storage, #	-	0	0	-	0	-
Grade, %	-	0	0	-	0	-
Peak Hour Factor	87	87	78	78	78	78
Heavy Vehicles, %	2	2	2	2	2	2
Mvmt Flow	8	170	51	4	13	5

Major/Minor	Major1	Major2	Minor2		
Conflicting Flow All	55	0	-	0	239 53
Stage 1	-	-	-	-	53 -
Stage 2	-	-	-	-	186 -
Critical Hdwy	4.12	-	-	-	6.42 6.22
Critical Hdwy Stg 1	-	-	-	-	5.42 -
Critical Hdwy Stg 2	-	-	-	-	5.42 -
Follow-up Hdwy	2.218	-	-	-	3.518 3.318
Pot Cap-1 Maneuver	1550	-	-	-	749 1014
Stage 1	-	-	-	-	970 -
Stage 2	-	-	-	-	846 -
Platoon blocked, %		-	-	-	
Mov Cap-1 Maneuver	1550	-	-	-	745 1014
Mov Cap-2 Maneuver	-	-	-	-	745 -
Stage 1	-	-	-	-	964 -
Stage 2	-	-	-	-	846 -

Approach	EB	WB	SB
HCM Control Delay, s	0.3	0	9.6
HCM LOS			A

Minor Lane/Major Mvmt	EBL	EBT	WBT	WBR	SBLn1
Capacity (veh/h)	1550	-	-	-	806
HCM Lane V/C Ratio	0.005	-	-	-	0.022
HCM Control Delay (s)	7.3	0	-	-	9.6
HCM Lane LOS	A	A	-	-	A
HCM 95th %tile Q(veh)	0	-	-	-	0.1

Intersection												
Int Delay, s/veh	6											
Movement	EBL	EBT	EBR	WBL	WBT	WBR	NBL	NBT	NBR	SBL	SBT	SBR
Lane Configurations	↶	↷		↶	↷		↶	↷		↶	↷	
Traffic Vol, veh/h	2	121	24	2	77	13	54	117	6	18	46	2
Future Vol, veh/h	2	121	24	2	77	13	54	117	6	18	46	2
Conflicting Peds, #/hr	0	0	0	0	0	0	0	0	0	0	0	0
Sign Control	Free	Free	Free	Free	Free	Free	Stop	Stop	Stop	Stop	Stop	Stop
RT Channelized	-	-	None	-	-	None	-	-	None	-	-	None
Storage Length	245	-	-	235	-	-	265	-	-	265	-	-
Veh in Median Storage, #	-	0	-	-	0	-	-	0	-	-	0	-
Grade, %	-	0	-	-	0	-	-	0	-	-	0	-
Peak Hour Factor	83	83	83	83	83	83	87	87	87	83	83	83
Heavy Vehicles, %	2	2	2	2	2	2	2	2	2	2	2	2
Mvmt Flow	2	146	29	2	93	16	62	134	7	22	55	2

Major/Minor	Major1			Major2			Minor1			Minor2		
Conflicting Flow All	109	0	0	175	0	0	299	278	161	340	284	101
Stage 1	-	-	-	-	-	-	165	165	-	105	105	-
Stage 2	-	-	-	-	-	-	134	113	-	235	179	-
Critical Hdwy	4.12	-	-	4.12	-	-	7.12	6.52	6.22	7.12	6.52	6.22
Critical Hdwy Stg 1	-	-	-	-	-	-	6.12	5.52	-	6.12	5.52	-
Critical Hdwy Stg 2	-	-	-	-	-	-	6.12	5.52	-	6.12	5.52	-
Follow-up Hdwy	2.218	-	-	2.218	-	-	3.518	4.018	3.318	3.518	4.018	3.318
Pot Cap-1 Maneuver	1481	-	-	1401	-	-	653	630	884	614	625	954
Stage 1	-	-	-	-	-	-	837	762	-	901	808	-
Stage 2	-	-	-	-	-	-	869	802	-	768	751	-
Platoon blocked, %	-	-	-	-	-	-	-	-	-	-	-	-
Mov Cap-1 Maneuver	1481	-	-	1401	-	-	606	629	884	508	624	954
Mov Cap-2 Maneuver	-	-	-	-	-	-	606	629	-	508	624	-
Stage 1	-	-	-	-	-	-	836	761	-	900	807	-
Stage 2	-	-	-	-	-	-	806	801	-	627	750	-

Approach	EB			WB			NB			SB		
HCM Control Delay, s	0.1			0.2			12			11.6		
HCM LOS							B			B		

Minor Lane/Major Mvmt	NBLn1	NBLn2	EBL	EBT	EBR	WBL	WBT	WBR	SBLn1	SBLn2
Capacity (veh/h)	606	638	1481	-	-	1401	-	-	508	633
HCM Lane V/C Ratio	0.102	0.222	0.002	-	-	0.002	-	-	0.043	0.091
HCM Control Delay (s)	11.6	12.2	7.4	-	-	7.6	-	-	12.4	11.3
HCM Lane LOS	B	B	A	-	-	A	-	-	B	B
HCM 95th %tile Q(veh)	0.3	0.8	0	-	-	0	-	-	0.1	0.3

Lanes, Volumes, Timings
1: US 24 & Judge Orr

2030 Background
AM



Lane Group	EBL	EBT	EBR	WBL	WBT	WBR	NEL	NET	NER	SWL	SWT	SWR
Lane Configurations		↕			↕		↗	↘		↗	↘	
Traffic Volume (vph)	34	79	203	247	79	8	69	328	79	2	678	22
Future Volume (vph)	34	79	203	247	79	8	69	328	79	2	678	22
Ideal Flow (vphpl)	1900	1900	1900	1900	1900	1900	1900	1900	1900	1900	1900	1900
Storage Length (ft)	0		0	0		0	860		0	695		0
Storage Lanes	0		0	0		0	1		0	1		0
Taper Length (ft)	200			200			300			300		
Lane Util. Factor	1.00	1.00	1.00	1.00	1.00	1.00	1.00	1.00	1.00	1.00	1.00	1.00
Frt		0.913			0.997			0.971			0.995	
Flt Protected		0.995			0.964		0.950			0.950		
Satd. Flow (prot)	0	1692	0	0	1790	0	1770	1809	0	1770	1853	0
Flt Permitted		0.995			0.964		0.061			0.434		
Satd. Flow (perm)	0	1692	0	0	1790	0	114	1809	0	808	1853	0
Right Turn on Red			Yes			Yes			Yes			Yes
Satd. Flow (RTOR)		60			1			12			1	
Link Speed (mph)		45			45			55			55	
Link Distance (ft)		1112			1085			1307			1572	
Travel Time (s)		16.8			16.4			16.2			19.5	
Peak Hour Factor	0.92	0.92	0.92	0.92	0.92	0.92	0.93	0.93	0.93	0.93	0.93	0.93
Adj. Flow (vph)	37	86	221	268	86	9	74	353	85	2	729	24
Shared Lane Traffic (%)												
Lane Group Flow (vph)	0	344	0	0	363	0	74	438	0	2	753	0
Enter Blocked Intersection	No	No	No	No	No	No	No	No	No	No	No	No
Lane Alignment	Left	Left	Right	Left	Left	Right	Left	Left	Right	Left	Left	Right
Median Width(ft)		0			0			12			12	
Link Offset(ft)		0			0			0			0	
Crosswalk Width(ft)		16			16			16			16	
Two way Left Turn Lane												
Headway Factor	1.00	1.00	1.00	1.00	1.00	1.00	1.00	1.00	1.00	1.00	1.00	1.00
Number of Detectors	1	2		1	2		1	2		1	2	
Detector Template	Left	Thru		Left	Thru		Left	Thru		Left	Thru	
Leading Detector (ft)	20	100		20	100		20	100		20	100	
Trailing Detector (ft)	0	0		0	0		0	0		0	0	
Detector 1 Position(ft)	0	0		0	0		0	0		0	0	
Detector 1 Size(ft)	20	6		20	6		20	6		20	6	
Detector 1 Type	Cl+Ex	Cl+Ex		Cl+Ex	Cl+Ex		Cl+Ex	Cl+Ex		Cl+Ex	Cl+Ex	
Detector 1 Channel												
Detector 1 Extend (s)	0.0	0.0		0.0	0.0		0.0	0.0		0.0	0.0	
Detector 1 Queue (s)	0.0	0.0		0.0	0.0		0.0	0.0		0.0	0.0	
Detector 1 Delay (s)	0.0	0.0		0.0	0.0		0.0	0.0		0.0	0.0	
Detector 2 Position(ft)		94			94			94			94	
Detector 2 Size(ft)		6			6			6			6	
Detector 2 Type		Cl+Ex			Cl+Ex			Cl+Ex			Cl+Ex	
Detector 2 Channel												
Detector 2 Extend (s)		0.0			0.0			0.0			0.0	
Turn Type	Split	NA		Split	NA		pm+pt	NA		Perm	NA	
Protected Phases	4	4		8	8		5	2			6	
Permitted Phases							2			6		
Detector Phase	4	4		8	8		5	2		6	6	

Lanes, Volumes, Timings
1: US 24 & Judge Orr

2030 Background
AM







Lane Group	EBL	EBT	EBR	WBL	WBT	WBR	NEL	NET	NER	SWL	SWT	SWR
Switch Phase												
Minimum Initial (s)	6.0	6.0		6.0	6.0		6.0	37.0		22.0	22.0	
Minimum Split (s)	13.0	13.0		13.0	13.0		11.0	44.0		29.0	29.0	
Total Split (s)	35.0	35.0		35.0	35.0		12.0	70.0		58.0	58.0	
Total Split (%)	25.0%	25.0%		25.0%	25.0%		8.6%	50.0%		41.4%	41.4%	
Maximum Green (s)	32.0	32.0		32.0	32.0		9.0	67.0		55.0	55.0	
Yellow Time (s)	2.0	2.0		2.0	2.0		2.0	2.0		2.0	2.0	
All-Red Time (s)	1.0	1.0		1.0	1.0		1.0	1.0		1.0	1.0	
Lost Time Adjust (s)		0.0			0.0		0.0	0.0		0.0	0.0	
Total Lost Time (s)		3.0			3.0		3.0	3.0		3.0	3.0	
Lead/Lag							Lead			Lag	Lag	
Lead-Lag Optimize?							Yes			Yes	Yes	
Vehicle Extension (s)	3.0	3.0		3.0	3.0		3.0	3.0		3.0	3.0	
Recall Mode	None	None		None	None		None	C-Min		C-Min	C-Min	
Walk Time (s)								7.0		7.0	7.0	
Flash Dont Walk (s)								11.0		11.0	11.0	
Pedestrian Calls (#/hr)								0		0	0	
Act Effct Green (s)		28.0			31.1		71.9	71.9		62.7	62.7	
Actuated g/C Ratio		0.20			0.22		0.51	0.51		0.45	0.45	
v/c Ratio		0.89			0.91		0.48	0.47		0.01	0.91	
Control Delay		69.4			80.6		31.7	24.4		26.0	53.7	
Queue Delay		0.0			0.0		0.0	0.0		0.0	0.0	
Total Delay		69.4			80.6		31.7	24.4		26.0	53.7	
LOS		E			F		C	C		C	D	
Approach Delay		69.4			80.6			25.5			53.6	
Approach LOS		E			F			C			D	
Queue Length 50th (ft)		254			316		36	261		1	~729	
Queue Length 95th (ft)		#395			#502		73	361		7	#986	
Internal Link Dist (ft)		1032			1005			1227			1492	
Turn Bay Length (ft)							860			695		
Base Capacity (vph)		433			414		165	934		361	830	
Starvation Cap Reductn		0			0		0	0		0	0	
Spillback Cap Reductn		0			0		0	0		0	0	
Storage Cap Reductn		0			0		0	0		0	0	
Reduced v/c Ratio		0.79			0.88		0.45	0.47		0.01	0.91	

Intersection Summary

Area Type: Other
 Cycle Length: 140
 Actuated Cycle Length: 140
 Offset: 12 (9%), Referenced to phase 2:NETL and 6:SWTL, Start of Green
 Natural Cycle: 90
 Control Type: Actuated-Coordinated
 Maximum v/c Ratio: 0.91
 Intersection Signal Delay: 54.0
 Intersection LOS: D
 Intersection Capacity Utilization 99.3%
 ICU Level of Service F
 Analysis Period (min) 15
 ~ Volume exceeds capacity, queue is theoretically infinite.
 Queue shown is maximum after two cycles.

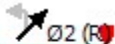



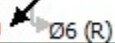



















95th percentile volume exceeds capacity, queue may be longer.
 Queue shown is maximum after two cycles.

Splits and Phases: 1: US 24 & Judge Orr

 Ø2 (R)	 Ø4	 Ø8
70 s	35 s	35 s
 Ø5 12 s	 Ø6 (R) 58 s	

Lanes, Volumes, Timings
2: US 24 & Stapleton

2030 Background
AM

												
Lane Group	SEL	SET	SER	NWL	NWT	NWR	NEL	NET	NER	SWL	SWT	SWR
Lane Configurations												
Traffic Volume (vph)	27	185	169	13	139	26	58	315	5	44	517	41
Future Volume (vph)	27	185	169	13	139	26	58	315	5	44	517	41
Ideal Flow (vphpl)	1900	1900	1900	1900	1900	1900	1900	1900	1900	1900	1900	1900
Storage Length (ft)	190		325	215		215	890		1000	790		790
Storage Lanes	1		1	1		1	1		1	1		1
Taper Length (ft)	240			200			190			190		
Lane Util. Factor	1.00	1.00	1.00	1.00	1.00	1.00	1.00	1.00	1.00	1.00	1.00	1.00
Frt			0.850			0.850			0.850			0.850
Flt Protected	0.950			0.950			0.950			0.950		
Satd. Flow (prot)	1770	1863	1583	1770	1863	1583	1770	1863	1583	1770	1863	1583
Flt Permitted	0.600			0.594			0.950			0.950		
Satd. Flow (perm)	1118	1863	1583	1106	1863	1583	1770	1863	1583	1770	1863	1583
Right Turn on Red			Yes			Yes			Yes			Yes
Satd. Flow (RTOR)			184			136			95			136
Link Speed (mph)		45			45			55			55	
Link Distance (ft)		836			3074			1254			1435	
Travel Time (s)		12.7			46.6			15.5			17.8	
Peak Hour Factor	0.92	0.92	0.92	0.87	0.87	0.87	0.92	0.92	0.92	0.93	0.93	0.93
Adj. Flow (vph)	29	201	184	15	160	30	63	342	5	47	556	44
Shared Lane Traffic (%)												
Lane Group Flow (vph)	29	201	184	15	160	30	63	342	5	47	556	44
Enter Blocked Intersection	No	No	No	No	No	No	No	No	No	No	No	No
Lane Alignment	Left	Left	Right	Left	L NA	Right	L NA	Left	Right	Left	Left	R NA
Median Width(ft)		12			12			12			12	
Link Offset(ft)		0			0			0			0	
Crosswalk Width(ft)		16			16			16			16	
Two way Left Turn Lane												
Headway Factor	1.00	1.00	1.00	1.00	1.00	1.00	1.00	1.00	1.00	1.00	1.00	1.00
Number of Detectors	1	2	1	1	2	1	1	2	1	1	2	1
Detector Template	Left	Thru	Right	Left	Thru	Right	Left	Thru	Right	Left	Thru	Right
Leading Detector (ft)	20	100	20	20	100	20	20	100	20	20	100	20
Trailing Detector (ft)	0	0	0	0	0	0	0	0	0	0	0	0
Detector 1 Position(ft)	0	0	0	0	0	0	0	0	0	0	0	0
Detector 1 Size(ft)	20	6	20	20	6	20	20	6	20	20	6	20
Detector 1 Type	Cl+Ex	Cl+Ex	Cl+Ex	Cl+Ex	Cl+Ex	Cl+Ex	Cl+Ex	Cl+Ex	Cl+Ex	Cl+Ex	Cl+Ex	Cl+Ex
Detector 1 Channel												
Detector 1 Extend (s)	0.0	0.0	0.0	0.0	0.0	0.0	0.0	0.0	0.0	0.0	0.0	0.0
Detector 1 Queue (s)	0.0	0.0	0.0	0.0	0.0	0.0	0.0	0.0	0.0	0.0	0.0	0.0
Detector 1 Delay (s)	0.0	0.0	0.0	0.0	0.0	0.0	0.0	0.0	0.0	0.0	0.0	0.0
Detector 2 Position(ft)		94			94			94			94	
Detector 2 Size(ft)		6			6			6			6	
Detector 2 Type		Cl+Ex			Cl+Ex			Cl+Ex			Cl+Ex	
Detector 2 Channel												
Detector 2 Extend (s)		0.0			0.0			0.0			0.0	
Turn Type	pm+pt	NA	Perm	pm+pt	NA	Perm	Prot	NA	Perm	Prot	NA	Perm
Protected Phases	1	6		5	2		7	4		3	8	
Permitted Phases	6		6	2		2			4			8
Detector Phase	1	6	6	5	2	2	7	4	4	3	8	8

Lanes, Volumes, Timings
2: US 24 & Stapleton

2030 Background
AM

Lane Group	SEL	SET	SER	NWL	NWT	NWR	NEL	NET	NER	SWL	SWT	SWR
Switch Phase												
Minimum Initial (s)	5.0	5.0	5.0	5.0	5.0	5.0	5.0	5.0	5.0	5.0	5.0	5.0
Minimum Split (s)	9.5	22.5	22.5	9.5	22.5	22.5	9.5	22.5	22.5	9.5	22.5	22.5
Total Split (s)	15.0	25.0	25.0	15.0	25.0	25.0	36.0	60.0	60.0	20.0	44.0	44.0
Total Split (%)	12.5%	20.8%	20.8%	12.5%	20.8%	20.8%	30.0%	50.0%	50.0%	16.7%	36.7%	36.7%
Maximum Green (s)	10.5	20.5	20.5	10.5	20.5	20.5	31.5	55.5	55.5	15.5	39.5	39.5
Yellow Time (s)	3.5	3.5	3.5	3.5	3.5	3.5	3.5	3.5	3.5	3.5	3.5	3.5
All-Red Time (s)	1.0	1.0	1.0	1.0	1.0	1.0	1.0	1.0	1.0	1.0	1.0	1.0
Lost Time Adjust (s)	0.0	0.0	0.0	0.0	0.0	0.0	0.0	0.0	0.0	0.0	0.0	0.0
Total Lost Time (s)	4.5	4.5	4.5	4.5	4.5	4.5	4.5	4.5	4.5	4.5	4.5	4.5
Lead/Lag	Lead	Lag	Lag	Lead	Lag	Lag	Lead	Lag	Lag	Lead	Lag	Lag
Lead-Lag Optimize?	Yes	Yes	Yes	Yes	Yes	Yes	Yes	Yes	Yes	Yes	Yes	Yes
Vehicle Extension (s)	3.0	3.0	3.0	3.0	3.0	3.0	3.0	3.0	3.0	3.0	3.0	3.0
Recall Mode	None	C-Min	C-Min	None	C-Min	C-Min	None	None	None	None	None	None
Act Effct Green (s)	56.0	52.9	52.9	54.3	50.3	50.3	9.6	42.5	42.5	8.6	41.5	41.5
Actuated g/C Ratio	0.47	0.44	0.44	0.45	0.42	0.42	0.08	0.35	0.35	0.07	0.35	0.35
v/c Ratio	0.05	0.24	0.23	0.03	0.20	0.04	0.44	0.52	0.01	0.37	0.86	0.07
Control Delay	21.5	26.8	5.3	21.6	28.2	0.1	61.6	32.9	0.0	60.6	50.7	0.2
Queue Delay	0.0	0.0	0.0	0.0	0.0	0.0	0.0	0.0	0.0	0.0	0.0	0.0
Total Delay	21.5	26.8	5.3	21.6	28.2	0.1	61.6	32.9	0.0	60.6	50.7	0.2
LOS	C	C	A	C	C	A	E	C	A	E	D	A
Approach Delay		16.9			23.6			36.9			48.0	
Approach LOS		B			C			D			D	
Queue Length 50th (ft)	12	94	0	6	86	0	47	204	0	35	391	0
Queue Length 95th (ft)	35	196	54	22	154	0	92	273	0	74	507	0
Internal Link Dist (ft)		756			2994			1174			1355	
Turn Bay Length (ft)	190		325	215		215	890		1000	790		790
Base Capacity (vph)	589	821	800	580	781	743	464	861	783	228	666	653
Starvation Cap Reductn	0	0	0	0	0	0	0	0	0	0	0	0
Spillback Cap Reductn	0	0	0	0	0	0	0	0	0	0	0	0
Storage Cap Reductn	0	0	0	0	0	0	0	0	0	0	0	0
Reduced v/c Ratio	0.05	0.24	0.23	0.03	0.20	0.04	0.14	0.40	0.01	0.21	0.83	0.07

Intersection Summary

Area Type: Other
 Cycle Length: 120
 Actuated Cycle Length: 120
 Offset: 0 (0%), Referenced to phase 2:NWTL and 6:SETL, Start of Green
 Natural Cycle: 70
 Control Type: Actuated-Coordinated
 Maximum v/c Ratio: 0.86
 Intersection Signal Delay: 34.6
 Intersection Capacity Utilization 60.3%
 Analysis Period (min) 15
 Intersection LOS: C
 ICU Level of Service B

Splits and Phases: 2: US 24 & Stapleton

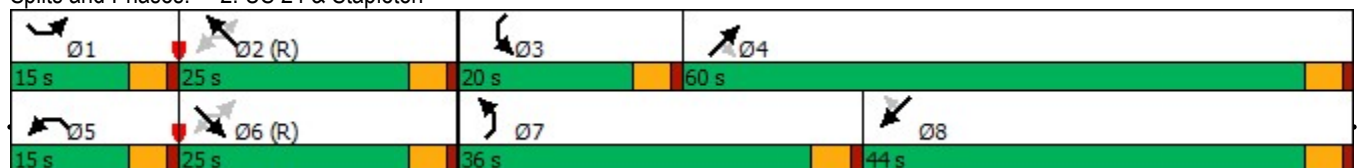

Lanes, Volumes, Timings

Lanes, Volumes, Timings

Intersection												
Int Delay, s/veh	1.9											
Movement	SEL	SET	SER	NWL	NWT	NWR	NEL	NET	NER	SWL	SWT	SWR
Lane Configurations	↘	↗	↗	↘	↗	↘	↘	↗	↗	↘	↗	↘
Traffic Vol, veh/h	4	12	125	15	17	0	51	293	4	4	451	5
Future Vol, veh/h	4	12	125	15	17	0	51	293	4	4	451	5
Conflicting Peds, #/hr	0	0	0	0	0	0	0	0	0	0	0	0
Sign Control	Stop	Stop	Stop	Stop	Stop	Stop	Free	Free	Free	Free	Free	Free
RT Channelized	-	-	Free	-	-	Stop	-	-	Yield	-	-	Yield
Storage Length	170	-	250	125	-	25	620	-	550	540	-	480
Veh in Median Storage, #	-	0	-	-	0	-	-	0	-	-	0	-
Grade, %	-	0	-	-	0	-	-	0	-	-	0	-
Peak Hour Factor	87	87	87	78	78	78	92	92	92	92	92	92
Heavy Vehicles, %	2	2	2	2	2	2	2	2	2	2	2	2
Mvmt Flow	5	14	144	19	22	0	55	318	4	4	490	5

Major/Minor	Minor2		Minor1		Major1		Major2					
Conflicting Flow All	937	926	-	933	926	318	490	0	0	318	0	0
Stage 1	498	498	-	428	428	-	-	-	-	-	-	-
Stage 2	439	428	-	505	498	-	-	-	-	-	-	-
Critical Hdwy	7.12	6.52	-	7.12	6.52	6.22	4.12	-	-	4.12	-	-
Critical Hdwy Stg 1	6.12	5.52	-	6.12	5.52	-	-	-	-	-	-	-
Critical Hdwy Stg 2	6.12	5.52	-	6.12	5.52	-	-	-	-	-	-	-
Follow-up Hdwy	3.518	4.018	-	3.518	4.018	3.318	2.218	-	-	2.218	-	-
Pot Cap-1 Maneuver	245	269	0	246	269	723	1073	-	-	1242	-	-
Stage 1	554	544	0	605	585	-	-	-	-	-	-	-
Stage 2	597	585	0	549	544	-	-	-	-	-	-	-
Platoon blocked, %								-	-	-	-	-
Mov Cap-1 Maneuver	220	254	-	226	254	723	1073	-	-	1242	-	-
Mov Cap-2 Maneuver	220	254	-	226	254	-	-	-	-	-	-	-
Stage 1	526	542	-	574	555	-	-	-	-	-	-	-
Stage 2	544	555	-	533	542	-	-	-	-	-	-	-

Approach	SE		NW		NE		SW				
HCM Control Delay, s	20.4		21.4		1.3		0.1				
HCM LOS	C		C								

Minor Lane/Major Mvmt	NEL	NET	NERN	NWLn1	NWLn2	NWLn3	SELn1	SELn2	SELn3	SWL	SWT	SWR
Capacity (veh/h)	1073	-	-	226	254	-	220	254	-	1242	-	-
HCM Lane V/C Ratio	0.052	-	-	0.085	0.086	-	0.021	0.054	-	0.004	-	-
HCM Control Delay (s)	8.5	-	-	22.4	20.5	0	21.7	20	0	7.9	-	-
HCM Lane LOS	A	-	-	C	C	A	C	C	A	A	-	-
HCM 95th %tile Q(veh)	0.2	-	-	0.3	0.3	-	0.1	0.2	-	0	-	-

Intersection						
Int Delay, s/veh	0.7					
Movement	EBL	EBT	WBT	WBR	SBL	SBR
Lane Configurations		↶	↷		↶	
Traffic Vol, veh/h	1	45	171	17	5	12
Future Vol, veh/h	1	45	171	17	5	12
Conflicting Peds, #/hr	0	0	0	0	0	0
Sign Control	Free	Free	Free	Free	Stop	Stop
RT Channelized	-	None	-	None	-	None
Storage Length	-	-	-	-	0	-
Veh in Median Storage, #	-	0	0	-	0	-
Grade, %	-	0	0	-	0	-
Peak Hour Factor	78	78	87	87	78	78
Heavy Vehicles, %	2	2	2	2	2	2
Mvmt Flow	1	58	197	20	6	15

Major/Minor	Major1	Major2	Minor2		
Conflicting Flow All	217	0	-	0	267
Stage 1	-	-	-	-	207
Stage 2	-	-	-	-	60
Critical Hdwy	4.12	-	-	-	6.42
Critical Hdwy Stg 1	-	-	-	-	5.42
Critical Hdwy Stg 2	-	-	-	-	5.42
Follow-up Hdwy	2.218	-	-	-	3.518
Pot Cap-1 Maneuver	1353	-	-	-	722
Stage 1	-	-	-	-	828
Stage 2	-	-	-	-	963
Platoon blocked, %		-	-	-	
Mov Cap-1 Maneuver	1353	-	-	-	721
Mov Cap-2 Maneuver	-	-	-	-	721
Stage 1	-	-	-	-	827
Stage 2	-	-	-	-	963

Approach	EB	WB	SB
HCM Control Delay, s	0.2	0	9.6
HCM LOS			A

Minor Lane/Major Mvmt	EBL	EBT	WBT	WBR	SBLn1
Capacity (veh/h)	1353	-	-	-	797
HCM Lane V/C Ratio	0.001	-	-	-	0.027
HCM Control Delay (s)	7.7	0	-	-	9.6
HCM Lane LOS	A	A	-	-	A
HCM 95th %tile Q(veh)	0	-	-	-	0.1

Intersection												
Int Delay, s/veh	11.7											
Movement	EBL	EBT	EBR	WBL	WBT	WBR	NBL	NBT	NBR	SBL	SBT	SBR
Lane Configurations	↖	↑	↗	↖	↑	↗	↖	↑	↗	↖	↑	↗
Traffic Vol, veh/h	8	57	97	31	223	36	69	101	6	12	244	15
Future Vol, veh/h	8	57	97	31	223	36	69	101	6	12	244	15
Conflicting Peds, #/hr	0	0	0	0	0	0	0	0	0	0	0	0
Sign Control	Free	Free	Free	Free	Free	Free	Stop	Stop	Stop	Stop	Stop	Stop
RT Channelized	-	-	None	-	-	None	-	-	None	-	-	None
Storage Length	245	-	195	235	-	-	265	-	-	265	-	-
Veh in Median Storage, #	-	0	-	-	0	-	-	0	-	-	0	-
Grade, %	-	0	-	-	0	-	-	0	-	-	0	-
Peak Hour Factor	87	87	87	92	92	92	87	87	87	92	92	92
Heavy Vehicles, %	2	2	2	2	2	2	2	2	2	2	2	2
Mvmt Flow	9	66	111	34	242	39	79	116	7	13	265	16

Major/Minor	Major1			Major2			Minor1			Minor2		
Conflicting Flow All	281	0	0	177	0	0	554	433	66	531	525	262
Stage 1	-	-	-	-	-	-	84	84	-	330	330	-
Stage 2	-	-	-	-	-	-	470	349	-	201	195	-
Critical Hdwy	4.12	-	-	4.12	-	-	7.12	6.52	6.22	7.12	6.52	6.22
Critical Hdwy Stg 1	-	-	-	-	-	-	6.12	5.52	-	6.12	5.52	-
Critical Hdwy Stg 2	-	-	-	-	-	-	6.12	5.52	-	6.12	5.52	-
Follow-up Hdwy	2.218	-	-	2.218	-	-	3.518	4.018	3.318	3.518	4.018	3.318
Pot Cap-1 Maneuver	1282	-	-	1399	-	-	443	516	998	459	458	777
Stage 1	-	-	-	-	-	-	924	825	-	683	646	-
Stage 2	-	-	-	-	-	-	574	633	-	801	739	-
Platoon blocked, %	-	-	-	-	-	-	-	-	-	-	-	-
Mov Cap-1 Maneuver	1282	-	-	1399	-	-	222	500	998	366	444	777
Mov Cap-2 Maneuver	-	-	-	-	-	-	222	500	-	366	444	-
Stage 1	-	-	-	-	-	-	918	819	-	678	630	-
Stage 2	-	-	-	-	-	-	317	618	-	678	734	-

Approach	EB			WB			NB			SB		
HCM Control Delay, s	0.4			0.8			20.4			24.5		
HCM LOS							C			C		

Minor Lane/Major Mvmt	NBLn1	NBLn2	EBL	EBT	EBR	WBL	WBT	WBR	SBLn1	SBLn2
Capacity (veh/h)	222	514	1282	-	-	1399	-	-	366	455
HCM Lane V/C Ratio	0.357	0.239	0.007	-	-	0.024	-	-	0.036	0.619
HCM Control Delay (s)	30	14.2	7.8	-	-	7.6	-	-	15.2	24.9
HCM Lane LOS	D	B	A	-	-	A	-	-	C	C
HCM 95th %tile Q(veh)	1.5	0.9	0	-	-	0.1	-	-	0.1	4.1

Lanes, Volumes, Timings
1: US 24 & Judge Orr

2030 Background
PM



Lane Group	EBL	EBT	EBR	WBL	WBT	WBR	NEL	NET	NER	SWL	SWT	SWR
Lane Configurations												
Traffic Volume (vph)	52	69	65	199	83	11	163	675	266	2	453	53
Future Volume (vph)	52	69	65	199	83	11	163	675	266	2	453	53
Ideal Flow (vphpl)	1900	1900	1900	1900	1900	1900	1900	1900	1900	1900	1900	1900
Storage Length (ft)	0		0	0		0	860		0	695		0
Storage Lanes	0		0	0		0	1		0	1		0
Taper Length (ft)	200			200			300			300		
Lane Util. Factor	1.00	1.00	1.00	1.00	1.00	1.00	1.00	1.00	1.00	1.00	1.00	1.00
Frt		0.953			0.995			0.958			0.984	
Flt Protected		0.986			0.967		0.950			0.950		
Satd. Flow (prot)	0	1750	0	0	1792	0	1770	1785	0	1770	1833	0
Flt Permitted		0.986			0.967		0.232			0.065		
Satd. Flow (perm)	0	1750	0	0	1792	0	432	1785	0	121	1833	0
Right Turn on Red			Yes			Yes			Yes			Yes
Satd. Flow (RTOR)		16			1			23			5	
Link Speed (mph)		45			45			55			55	
Link Distance (ft)		1112			1085			1307			1572	
Travel Time (s)		16.8			16.4			16.2			19.5	
Peak Hour Factor	0.87	0.87	0.87	0.92	0.92	0.92	0.95	0.95	0.95	0.92	0.92	0.92
Adj. Flow (vph)	60	79	75	216	90	12	172	711	280	2	492	58
Shared Lane Traffic (%)												
Lane Group Flow (vph)	0	214	0	0	318	0	172	991	0	2	550	0
Enter Blocked Intersection	No	No	No	No	No	No	No	No	No	No	No	No
Lane Alignment	Left	Left	Right	Left	Left	Right	Left	Left	Right	Left	Left	Right
Median Width(ft)		0			0			12			12	
Link Offset(ft)		0			0			0			0	
Crosswalk Width(ft)		16			16			16			16	
Two way Left Turn Lane												
Headway Factor	1.00	1.00	1.00	1.00	1.00	1.00	1.00	1.00	1.00	1.00	1.00	1.00
Turning Speed (mph)	60		60	60		60	60		60	60		60
Number of Detectors	1	2		1	2		1	2		1	2	
Detector Template	Left	Thru		Left	Thru		Left	Thru		Left	Thru	
Leading Detector (ft)	20	100		20	100		20	100		20	100	
Trailing Detector (ft)	0	0		0	0		0	0		0	0	
Detector 1 Position(ft)	0	0		0	0		0	0		0	0	
Detector 1 Size(ft)	20	6		20	6		20	6		20	6	
Detector 1 Type	Cl+Ex	Cl+Ex		Cl+Ex	Cl+Ex		Cl+Ex	Cl+Ex		Cl+Ex	Cl+Ex	
Detector 1 Channel												
Detector 1 Extend (s)	0.0	0.0		0.0	0.0		0.0	0.0		0.0	0.0	
Detector 1 Queue (s)	0.0	0.0		0.0	0.0		0.0	0.0		0.0	0.0	
Detector 1 Delay (s)	0.0	0.0		0.0	0.0		0.0	0.0		0.0	0.0	
Detector 2 Position(ft)		94			94			94			94	
Detector 2 Size(ft)		6			6			6			6	
Detector 2 Type		Cl+Ex			Cl+Ex			Cl+Ex			Cl+Ex	
Detector 2 Channel												
Detector 2 Extend (s)		0.0			0.0			0.0			0.0	
Turn Type	Split	NA		Split	NA		pm+pt	NA		Perm	NA	
Protected Phases	4	4		8	8		5	2			6	
Permitted Phases							2			6		

Lanes, Volumes, Timings
1: US 24 & Judge Orr

2030 Background
PM



Lane Group	EBL	EBT	EBR	WBL	WBT	WBR	NEL	NET	NER	SWL	SWT	SWR
Detector Phase	4	4		8	8		5	2		6	6	
Switch Phase												
Minimum Initial (s)	6.0	6.0		6.0	6.0		6.0	37.0		22.0	22.0	
Minimum Split (s)	13.0	13.0		13.0	13.0		11.0	44.0		29.0	29.0	
Total Split (s)	25.0	25.0		30.0	30.0		20.0	85.0		65.0	65.0	
Total Split (%)	17.9%	17.9%		21.4%	21.4%		14.3%	60.7%		46.4%	46.4%	
Maximum Green (s)	18.0	18.0		23.0	23.0		15.0	78.0		58.0	58.0	
Yellow Time (s)	5.0	5.0		5.0	5.0		3.0	5.0		5.0	5.0	
All-Red Time (s)	2.0	2.0		2.0	2.0		2.0	2.0		2.0	2.0	
Lost Time Adjust (s)		0.0			0.0		0.0	0.0		0.0	0.0	
Total Lost Time (s)		7.0			7.0		5.0	7.0		7.0	7.0	
Lead/Lag							Lead			Lag	Lag	
Lead-Lag Optimize?							Yes			Yes	Yes	
Vehicle Extension (s)	3.0	3.0		3.0	3.0		3.0	3.0		3.0	3.0	
Recall Mode	None	None		None	None		None	C-Min		C-Min	C-Min	
Walk Time (s)								7.0		7.0	7.0	
Flash Dont Walk (s)								11.0		11.0	11.0	
Pedestrian Calls (#/hr)								0		0	0	
Act Effct Green (s)		17.6			23.4		80.0	78.0		61.1	61.1	
Actuated g/C Ratio		0.13			0.17		0.57	0.56		0.44	0.44	
v/c Ratio		0.92			1.06		0.48	0.99		0.04	0.69	
Control Delay		96.3			122.7		18.9	55.6		26.5	37.3	
Queue Delay		0.0			0.0		0.0	0.0		0.0	0.0	
Total Delay		96.3			122.7		18.9	55.6		26.5	37.3	
LOS		F			F		B	E		C	D	
Approach Delay		96.3			122.7			50.2			37.3	
Approach LOS		F			F			D			D	
Queue Length 50th (ft)		181			~322		72	845		1	394	
Queue Length 95th (ft)		#314			#517		111	#1178		8	554	
Internal Link Dist (ft)		1032			1005			1227			1492	
Turn Bay Length (ft)							860			695		
Base Capacity (vph)		238			300		390	1004		52	802	
Starvation Cap Reductn		0			0		0	0		0	0	
Spillback Cap Reductn		0			0		0	0		0	0	
Storage Cap Reductn		0			0		0	0		0	0	
Reduced v/c Ratio		0.90			1.06		0.44	0.99		0.04	0.69	

Intersection Summary

Area Type: Other
 Cycle Length: 140
 Actuated Cycle Length: 140
 Offset: 20 (14%), Referenced to phase 2:NETL and 6:SWTL, Start of Green
 Natural Cycle: 130
 Control Type: Actuated-Coordinated
 Maximum v/c Ratio: 1.06
 Intersection Signal Delay: 61.7
 Intersection LOS: E
 Intersection Capacity Utilization 119.9%
 ICU Level of Service H
 Analysis Period (min) 15
 ~ Volume exceeds capacity, queue is theoretically infinite.





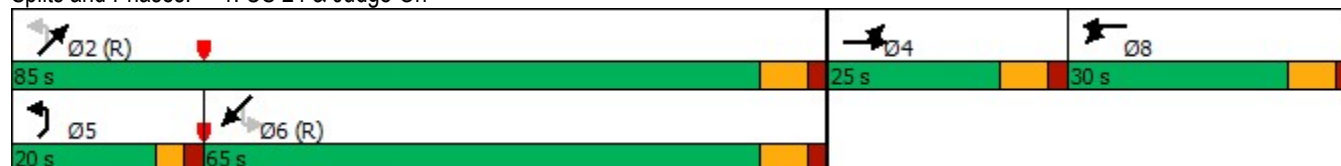



















Queue shown is maximum after two cycles.
 # 95th percentile volume exceeds capacity, queue may be longer.
 Queue shown is maximum after two cycles.

Splits and Phases: 1: US 24 & Judge Orr



Lanes, Volumes, Timings
2: US 24 & Stapleton

2030 Background
PM

												
Lane Group	SEL	SET	SER	NWL	NWT	NWR	NEL	NET	NER	SWL	SWT	SWR
Lane Configurations												
Traffic Volume (vph)	17	94	58	35	193	38	140	542	43	20	430	35
Future Volume (vph)	17	94	58	35	193	38	140	542	43	20	430	35
Ideal Flow (vphpl)	1900	1900	1900	1900	1900	1900	1900	1900	1900	1900	1900	1900
Storage Length (ft)	190		325	215		215	890		1000	790		790
Storage Lanes	1		1	1		1	1		1	1		1
Taper Length (ft)	240			200			190			190		
Lane Util. Factor	1.00	1.00	1.00	1.00	1.00	1.00	1.00	1.00	1.00	1.00	1.00	1.00
Frt			0.850			0.850			0.850			0.850
Flt Protected	0.950			0.950			0.950			0.950		
Satd. Flow (prot)	1770	1863	1583	1770	1863	1583	1770	1863	1583	1770	1863	1583
Flt Permitted	0.430			0.569			0.950			0.950		
Satd. Flow (perm)	801	1863	1583	1060	1863	1583	1770	1863	1583	1770	1863	1583
Right Turn on Red			Yes			Yes			Yes			Yes
Satd. Flow (RTOR)			136			136			95			136
Link Speed (mph)		45			45			55			55	
Link Distance (ft)		836			3074			1254			1435	
Travel Time (s)		12.7			46.6			15.5			17.8	
Peak Hour Factor	0.87	0.87	0.87	0.92	0.92	0.92	0.93	0.93	0.93	0.92	0.92	0.92
Adj. Flow (vph)	20	108	67	38	210	41	151	583	46	22	467	38
Shared Lane Traffic (%)												
Lane Group Flow (vph)	20	108	67	38	210	41	151	583	46	22	467	38
Enter Blocked Intersection	No	No	No	No	No	No	No	No	No	No	No	No
Lane Alignment	Left	Left	Right	Left	L NA	Right	L NA	Left	Right	Left	Left	R NA
Median Width(ft)		12			12			12			12	
Link Offset(ft)		0			0			0			0	
Crosswalk Width(ft)		16			16			16			16	
Two way Left Turn Lane												
Headway Factor	1.00	1.00	1.00	1.00	1.00	1.00	1.00	1.00	1.00	1.00	1.00	1.00
Turning Speed (mph)	15		9	15		9	15		9	15		9
Number of Detectors	1	2	1	1	2	1	1	2	1	1	2	1
Detector Template	Left	Thru	Right	Left	Thru	Right	Left	Thru	Right	Left	Thru	Right
Leading Detector (ft)	20	100	20	20	100	20	20	100	20	20	100	20
Trailing Detector (ft)	0	0	0	0	0	0	0	0	0	0	0	0
Detector 1 Position(ft)	0	0	0	0	0	0	0	0	0	0	0	0
Detector 1 Size(ft)	20	6	20	20	6	20	20	6	20	20	6	20
Detector 1 Type	Cl+Ex	Cl+Ex	Cl+Ex	Cl+Ex	Cl+Ex	Cl+Ex	Cl+Ex	Cl+Ex	Cl+Ex	Cl+Ex	Cl+Ex	Cl+Ex
Detector 1 Channel												
Detector 1 Extend (s)	0.0	0.0	0.0	0.0	0.0	0.0	0.0	0.0	0.0	0.0	0.0	0.0
Detector 1 Queue (s)	0.0	0.0	0.0	0.0	0.0	0.0	0.0	0.0	0.0	0.0	0.0	0.0
Detector 1 Delay (s)	0.0	0.0	0.0	0.0	0.0	0.0	0.0	0.0	0.0	0.0	0.0	0.0
Detector 2 Position(ft)		94			94			94			94	
Detector 2 Size(ft)		6			6			6			6	
Detector 2 Type		Cl+Ex			Cl+Ex			Cl+Ex			Cl+Ex	
Detector 2 Channel												
Detector 2 Extend (s)		0.0			0.0			0.0			0.0	
Turn Type	pm+pt	NA	Perm	pm+pt	NA	Perm	Prot	NA	Perm	Prot	NA	Perm
Protected Phases	1	6		5	2		7	4		3	8	
Permitted Phases	6		6	2		2			4			8

Lanes, Volumes, Timings
2: US 24 & Stapleton

2030 Background
PM



Lane Group	SEL	SET	SER	NWL	NWT	NWR	NEL	NET	NER	SWL	SWT	SWR
Detector Phase	1	6	6	5	2	2	7	4	4	3	8	8
Switch Phase												
Minimum Initial (s)	5.0	5.0	5.0	5.0	5.0	5.0	5.0	5.0	5.0	5.0	5.0	5.0
Minimum Split (s)	9.5	22.5	22.5	9.5	22.5	22.5	9.5	22.5	22.5	9.5	22.5	22.5
Total Split (s)	15.0	25.0	25.0	15.0	25.0	25.0	36.0	60.0	60.0	20.0	44.0	44.0
Total Split (%)	12.5%	20.8%	20.8%	12.5%	20.8%	20.8%	30.0%	50.0%	50.0%	16.7%	36.7%	36.7%
Maximum Green (s)	10.5	20.5	20.5	10.5	20.5	20.5	31.5	55.5	55.5	15.5	39.5	39.5
Yellow Time (s)	3.5	3.5	3.5	3.5	3.5	3.5	3.5	3.5	3.5	3.5	3.5	3.5
All-Red Time (s)	1.0	1.0	1.0	1.0	1.0	1.0	1.0	1.0	1.0	1.0	1.0	1.0
Lost Time Adjust (s)	0.0	0.0	0.0	0.0	0.0	0.0	0.0	0.0	0.0	0.0	0.0	0.0
Total Lost Time (s)	4.5	4.5	4.5	4.5	4.5	4.5	4.5	4.5	4.5	4.5	4.5	4.5
Lead/Lag	Lead	Lag	Lag	Lead	Lag	Lag	Lead	Lag	Lag	Lead	Lag	Lag
Lead-Lag Optimize?	Yes	Yes	Yes	Yes	Yes	Yes	Yes	Yes	Yes	Yes	Yes	Yes
Vehicle Extension (s)	3.0	3.0	3.0	3.0	3.0	3.0	3.0	3.0	3.0	3.0	3.0	3.0
Recall Mode	None	C-Min	C-Min	None	C-Min	C-Min	None	None	None	None	Max	Max
Act Effect Green (s)	28.3	24.0	24.0	30.5	26.9	26.9	15.6	71.8	71.8	7.1	59.2	59.2
Actuated g/C Ratio	0.24	0.20	0.20	0.25	0.22	0.22	0.13	0.60	0.60	0.06	0.49	0.49
v/c Ratio	0.08	0.29	0.16	0.12	0.50	0.09	0.66	0.52	0.05	0.21	0.51	0.04
Control Delay	31.9	44.2	0.8	32.6	46.2	0.4	62.7	18.2	0.1	58.0	24.8	0.1
Queue Delay	0.0	0.0	0.0	0.0	0.0	0.0	0.0	0.0	0.0	0.0	0.0	0.0
Total Delay	31.9	44.2	0.8	32.6	46.2	0.4	62.7	18.2	0.1	58.0	24.8	0.1
LOS	C	D	A	C	D	A	E	B	A	E	C	A
Approach Delay		28.0			37.9			25.8			24.4	
Approach LOS		C			D			C			C	
Queue Length 50th (ft)	12	75	0	22	135	0	113	272	0	17	238	0
Queue Length 95th (ft)	29	125	0	49	232	0	175	425	0	44	392	0
Internal Link Dist (ft)		756			2994			1174			1355	
Turn Bay Length (ft)	190		325	215		215	890		1000	790		790
Base Capacity (vph)	287	374	427	337	418	460	464	1114	985	228	918	849
Starvation Cap Reductn	0	0	0	0	0	0	0	0	0	0	0	0
Spillback Cap Reductn	0	0	0	0	0	0	0	0	0	0	0	0
Storage Cap Reductn	0	0	0	0	0	0	0	0	0	0	0	0
Reduced v/c Ratio	0.07	0.29	0.16	0.11	0.50	0.09	0.33	0.52	0.05	0.10	0.51	0.04

Intersection Summary

Area Type: Other
 Cycle Length: 120
 Actuated Cycle Length: 120
 Offset: 0 (0%), Referenced to phase 2:NWTL and 6:SETL, Start of Green
 Natural Cycle: 70
 Control Type: Actuated-Coordinated
 Maximum v/c Ratio: 0.66
 Intersection Signal Delay: 27.6
 Intersection LOS: C
 Intersection Capacity Utilization 58.1%
 ICU Level of Service B
 Analysis Period (min) 15

Splits and Phases: 2: US 24 & Stapleton

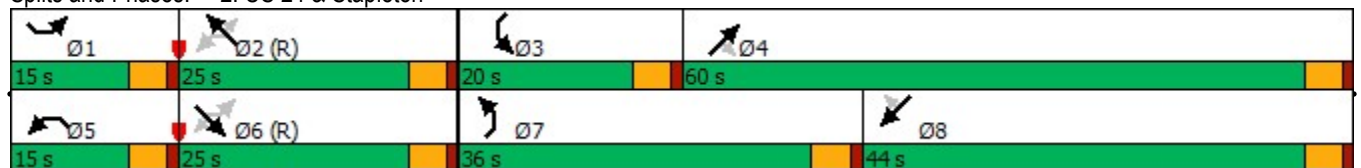

Intersection												
Int Delay, s/veh	1.9											
Movement	SEL	SET	SER	NWL	NWT	NWR	NEL	NET	NER	SWL	SWT	SWR
Lane Configurations	↘	↑	↗	↘	↑	↗	↘	↑	↗	↘	↑	↗
Traffic Vol, veh/h	4	10	90	9	5	5	106	494	20	8	364	4
Future Vol, veh/h	4	10	90	9	5	5	106	494	20	8	364	4
Conflicting Peds, #/hr	0	0	0	0	0	0	0	0	0	0	0	0
Sign Control	Stop	Stop	Stop	Stop	Stop	Stop	Free	Free	Free	Free	Free	Free
RT Channelized	-	-	Free	-	-	Stop	-	-	Yield	-	-	Yield
Storage Length	170	-	250	125	-	25	620	-	550	540	-	480
Veh in Median Storage, #	-	0	-	-	0	-	-	0	-	-	0	-
Grade, %	-	0	-	-	0	-	-	0	-	-	0	-
Peak Hour Factor	83	83	83	78	78	78	93	93	93	92	92	92
Heavy Vehicles, %	2	2	2	2	2	2	2	2	2	2	2	2
Mvmt Flow	5	12	108	12	6	6	114	531	22	9	396	4

Major/Minor	Minor2		Minor1		Major1		Major2					
Conflicting Flow All	1176	1173	-	1179	1173	531	396	0	0	531	0	0
Stage 1	414	414	-	759	759	-	-	-	-	-	-	-
Stage 2	762	759	-	420	414	-	-	-	-	-	-	-
Critical Hdwy	7.12	6.52	-	7.12	6.52	6.22	4.12	-	-	4.12	-	-
Critical Hdwy Stg 1	6.12	5.52	-	6.12	5.52	-	-	-	-	-	-	-
Critical Hdwy Stg 2	6.12	5.52	-	6.12	5.52	-	-	-	-	-	-	-
Follow-up Hdwy	3.518	4.018	-	3.518	4.018	3.318	2.218	-	-	2.218	-	-
Pot Cap-1 Maneuver	168	192	0	167	192	548	1163	-	-	1036	-	-
Stage 1	616	593	0	399	415	-	-	-	-	-	-	-
Stage 2	397	415	0	611	593	-	-	-	-	-	-	-
Platoon blocked, %	-	-	-	-	-	-	-	-	-	-	-	-
Mov Cap-1 Maneuver	148	172	-	145	172	548	1163	-	-	1036	-	-
Mov Cap-2 Maneuver	148	172	-	145	172	-	-	-	-	-	-	-
Stage 1	556	588	-	360	374	-	-	-	-	-	-	-
Stage 2	348	374	-	593	588	-	-	-	-	-	-	-

Approach	SE		NW		NE		SW	
HCM Control Delay, s	28.2		25.2		1.4		0.2	
HCM LOS	D		D					

Minor Lane/Major Mvmt	NEL	NET	NERN	NWLn1	NWLn2	NWLn3	SELn1	SELn2	SELn3	SWL	SWT	SWR
Capacity (veh/h)	1163	-	-	145	172	548	148	172	-	1036	-	-
HCM Lane V/C Ratio	0.098	-	-	0.08	0.037	0.012	0.033	0.07	-	0.008	-	-
HCM Control Delay (s)	8.4	-	-	32	26.7	11.6	30.1	27.5	0	8.5	-	-
HCM Lane LOS	A	-	-	D	D	B	D	D	A	A	-	-
HCM 95th %tile Q(veh)	0.3	-	-	0.3	0.1	0	0.1	0.2	-	0	-	-

Intersection						
Int Delay, s/veh	1.3					
Movement	EBL	EBT	WBT	WBR	SBL	SBR
Lane Configurations		↶	↷		↶	↷
Traffic Vol, veh/h	18	177	48	5	12	9
Future Vol, veh/h	18	177	48	5	12	9
Conflicting Peds, #/hr	0	0	0	0	0	0
Sign Control	Free	Free	Free	Free	Stop	Stop
RT Channelized	-	None	-	None	-	None
Storage Length	-	-	-	-	0	-
Veh in Median Storage, #	-	0	0	-	0	-
Grade, %	-	0	0	-	0	-
Peak Hour Factor	87	87	83	83	78	78
Heavy Vehicles, %	2	2	2	2	2	2
Mvmt Flow	21	203	58	6	15	12

Major/Minor	Major1	Major2	Minor2		
Conflicting Flow All	64	0	-	0	306 61
Stage 1	-	-	-	-	61 -
Stage 2	-	-	-	-	245 -
Critical Hdwy	4.12	-	-	-	6.42 6.22
Critical Hdwy Stg 1	-	-	-	-	5.42 -
Critical Hdwy Stg 2	-	-	-	-	5.42 -
Follow-up Hdwy	2.218	-	-	-	3.518 3.318
Pot Cap-1 Maneuver	1538	-	-	-	686 1004
Stage 1	-	-	-	-	962 -
Stage 2	-	-	-	-	796 -
Platoon blocked, %		-	-	-	
Mov Cap-1 Maneuver	1538	-	-	-	676 1004
Mov Cap-2 Maneuver	-	-	-	-	676 -
Stage 1	-	-	-	-	948 -
Stage 2	-	-	-	-	796 -

Approach	EB	WB	SB
HCM Control Delay, s	0.7	0	9.7
HCM LOS			A

Minor Lane/Major Mvmt	EBL	EBT	WBT	WBR	SBLn1
Capacity (veh/h)	1538	-	-	-	786
HCM Lane V/C Ratio	0.013	-	-	-	0.034
HCM Control Delay (s)	7.4	0	-	-	9.7
HCM Lane LOS	A	A	-	-	A
HCM 95th %tile Q(veh)	0	-	-	-	0.1

Intersection												
Int Delay, s/veh	7.7											
Movement	EBL	EBT	EBR	WBL	WBT	WBR	NBL	NBT	NBR	SBL	SBT	SBR
Lane Configurations	↖	↑	↗	↖	↑	↗	↖	↑	↗	↖	↑	↗
Traffic Vol, veh/h	16	209	50	3	129	26	86	164	11	41	76	14
Future Vol, veh/h	16	209	50	3	129	26	86	164	11	41	76	14
Conflicting Peds, #/hr	0	0	0	0	0	0	0	0	0	0	0	0
Sign Control	Free	Free	Free	Free	Free	Free	Stop	Stop	Stop	Stop	Stop	Stop
RT Channelized	-	-	None	-	-	None	-	-	None	-	-	None
Storage Length	245	-	195	235	-	-	265	-	-	265	-	-
Veh in Median Storage, #	-	0	-	-	0	-	-	0	-	-	0	-
Grade, %	-	0	-	-	0	-	-	0	-	-	0	-
Peak Hour Factor	92	92	92	87	87	87	92	92	92	87	87	87
Heavy Vehicles, %	2	2	2	2	2	2	2	2	2	2	2	2
Mvmt Flow	17	227	54	3	148	30	93	178	12	47	87	16

Major/Minor	Major1			Major2			Minor1			Minor2		
Conflicting Flow All	178	0	0	281	0	0	482	445	227	552	484	163
Stage 1	-	-	-	-	-	-	261	261	-	169	169	-
Stage 2	-	-	-	-	-	-	221	184	-	383	315	-
Critical Hdwy	4.12	-	-	4.12	-	-	7.12	6.52	6.22	7.12	6.52	6.22
Critical Hdwy Stg 1	-	-	-	-	-	-	6.12	5.52	-	6.12	5.52	-
Critical Hdwy Stg 2	-	-	-	-	-	-	6.12	5.52	-	6.12	5.52	-
Follow-up Hdwy	2.218	-	-	2.218	-	-	3.518	4.018	3.318	3.518	4.018	3.318
Pot Cap-1 Maneuver	1398	-	-	1282	-	-	495	508	812	444	483	882
Stage 1	-	-	-	-	-	-	744	692	-	833	759	-
Stage 2	-	-	-	-	-	-	781	747	-	640	656	-
Platoon blocked, %	-	-	-	-	-	-	-	-	-	-	-	-
Mov Cap-1 Maneuver	1398	-	-	1282	-	-	413	501	812	313	476	882
Mov Cap-2 Maneuver	-	-	-	-	-	-	413	501	-	313	476	-
Stage 1	-	-	-	-	-	-	735	684	-	823	757	-
Stage 2	-	-	-	-	-	-	677	746	-	461	648	-

Approach	EB			WB			NB			SB		
HCM Control Delay, s	0.4			0.1			16.1			15.3		
HCM LOS							C			C		

Minor Lane/Major Mvmt	NBLn1	NBLn2	EBL	EBT	EBR	WBL	WBT	WBR	SBLn1	SBLn2
Capacity (veh/h)	413	513	1398	-	-	1282	-	-	313	513
HCM Lane V/C Ratio	0.226	0.371	0.012	-	-	0.003	-	-	0.151	0.202
HCM Control Delay (s)	16.2	16.1	7.6	-	-	7.8	-	-	18.5	13.8
HCM Lane LOS	C	C	A	-	-	A	-	-	C	B
HCM 95th %tile Q(veh)	0.9	1.7	0	-	-	0	-	-	0.5	0.7

Lanes, Volumes, Timings
1: US 24 & Judge Orr

2030 Background + Site
AM



Lane Group	EBL	EBT	EBR	WBL	WBT	WBR	NEL	NET	NER	SWL	SWT	SWR
Lane Configurations		↕			↕		↗	↘		↗	↘	
Traffic Volume (vph)	34	85	203	295	84	8	69	328	103	2	678	22
Future Volume (vph)	34	85	203	295	84	8	69	328	103	2	678	22
Ideal Flow (vphpl)	1900	1900	1900	1900	1900	1900	1900	1900	1900	1900	1900	1900
Storage Length (ft)	0		0	0		0	860		0	695		0
Storage Lanes	0		0	0		0	1		0	1		0
Taper Length (ft)	200			200			300			300		
Lane Util. Factor	1.00	1.00	1.00	1.00	1.00	1.00	1.00	1.00	1.00	1.00	1.00	1.00
Frt		0.915			0.997			0.964			0.995	
Flt Protected		0.995			0.963		0.950			0.950		
Satd. Flow (prot)	0	1696	0	0	1788	0	1770	1796	0	1770	1853	0
Flt Permitted		0.995			0.963		0.066			0.389		
Satd. Flow (perm)	0	1696	0	0	1788	0	123	1796	0	725	1853	0
Right Turn on Red			Yes			Yes			Yes			Yes
Satd. Flow (RTOR)		57			1			16			1	
Link Speed (mph)		45			45			55			55	
Link Distance (ft)		1112			1085			1307			1572	
Travel Time (s)		16.8			16.4			16.2			19.5	
Peak Hour Factor	0.92	0.92	0.92	0.92	0.92	0.92	0.93	0.93	0.93	0.93	0.93	0.93
Adj. Flow (vph)	37	92	221	321	91	9	74	353	111	2	729	24
Shared Lane Traffic (%)												
Lane Group Flow (vph)	0	350	0	0	421	0	74	464	0	2	753	0
Enter Blocked Intersection	No	No	No	No	No	No	No	No	No	No	No	No
Lane Alignment	Left	Left	Right	Left	Left	Right	Left	Left	Right	Left	Left	Right
Median Width(ft)		0			0			12			12	
Link Offset(ft)		0			0			0			0	
Crosswalk Width(ft)		16			16			16			16	
Two way Left Turn Lane												
Headway Factor	1.00	1.00	1.00	1.00	1.00	1.00	1.00	1.00	1.00	1.00	1.00	1.00
Number of Detectors	1	2		1	2		1	2		1	2	
Detector Template	Left	Thru		Left	Thru		Left	Thru		Left	Thru	
Leading Detector (ft)	20	100		20	100		20	100		20	100	
Trailing Detector (ft)	0	0		0	0		0	0		0	0	
Detector 1 Position(ft)	0	0		0	0		0	0		0	0	
Detector 1 Size(ft)	20	6		20	6		20	6		20	6	
Detector 1 Type	Cl+Ex	Cl+Ex		Cl+Ex	Cl+Ex		Cl+Ex	Cl+Ex		Cl+Ex	Cl+Ex	
Detector 1 Channel												
Detector 1 Extend (s)	0.0	0.0		0.0	0.0		0.0	0.0		0.0	0.0	
Detector 1 Queue (s)	0.0	0.0		0.0	0.0		0.0	0.0		0.0	0.0	
Detector 1 Delay (s)	0.0	0.0		0.0	0.0		0.0	0.0		0.0	0.0	
Detector 2 Position(ft)		94			94			94			94	
Detector 2 Size(ft)		6			6			6			6	
Detector 2 Type		Cl+Ex			Cl+Ex			Cl+Ex			Cl+Ex	
Detector 2 Channel												
Detector 2 Extend (s)		0.0			0.0			0.0			0.0	
Turn Type	Split	NA		Split	NA		pm+pt	NA		Perm	NA	
Protected Phases	4	4		8	8		5	2			6	
Permitted Phases							2			6		
Detector Phase	4	4		8	8		5	2		6	6	

Lanes, Volumes, Timings
1: US 24 & Judge Orr

2030 Background + Site
AM







Lane Group	EBL	EBT	EBR	WBL	WBT	WBR	NEL	NET	NER	SWL	SWT	SWR
Switch Phase												
Minimum Initial (s)	6.0	6.0		6.0	6.0		6.0	37.0		22.0	22.0	
Minimum Split (s)	13.0	13.0		13.0	13.0		11.0	44.0		29.0	29.0	
Total Split (s)	35.0	35.0		35.0	35.0		12.0	70.0		58.0	58.0	
Total Split (%)	25.0%	25.0%		25.0%	25.0%		8.6%	50.0%		41.4%	41.4%	
Maximum Green (s)	32.0	32.0		32.0	32.0		9.0	67.0		55.0	55.0	
Yellow Time (s)	2.0	2.0		2.0	2.0		2.0	2.0		2.0	2.0	
All-Red Time (s)	1.0	1.0		1.0	1.0		1.0	1.0		1.0	1.0	
Lost Time Adjust (s)		0.0			0.0		0.0	0.0		0.0	0.0	
Total Lost Time (s)		3.0			3.0		3.0	3.0		3.0	3.0	
Lead/Lag							Lead			Lag	Lag	
Lead-Lag Optimize?							Yes			Yes	Yes	
Vehicle Extension (s)	3.0	3.0		3.0	3.0		3.0	3.0		3.0	3.0	
Recall Mode	None	None		None	None		None	C-Min		C-Min	C-Min	
Walk Time (s)								7.0		7.0	7.0	
Flash Dont Walk (s)								11.0		11.0	11.0	
Pedestrian Calls (#/hr)								0		0	0	
Act Effct Green (s)		28.5			35.1		67.4	67.4		58.1	58.1	
Actuated g/C Ratio		0.20			0.25		0.48	0.48		0.42	0.42	
v/c Ratio		0.90			0.94		0.48	0.53		0.01	0.98	
Control Delay		70.8			81.0		31.3	27.2		26.0	68.4	
Queue Delay		0.0			0.0		0.0	0.0		0.0	0.0	
Total Delay		70.8			81.0		31.3	27.2		26.0	68.4	
LOS		E			F		C	C		C	E	
Approach Delay		70.8			81.0			27.8			68.3	
Approach LOS		E			F			C			E	
Queue Length 50th (ft)		262			385		36	280		1	~729	
Queue Length 95th (ft)		#410			#623		69	387		7	#986	
Internal Link Dist (ft)		1032			1005			1227			1492	
Turn Bay Length (ft)							860			695		
Base Capacity (vph)		431			449		164	872		300	770	
Starvation Cap Reductn		0			0		0	0		0	0	
Spillback Cap Reductn		0			0		0	0		0	0	
Storage Cap Reductn		0			0		0	0		0	0	
Reduced v/c Ratio		0.81			0.94		0.45	0.53		0.01	0.98	

Intersection Summary

Area Type:	Other
Cycle Length:	140
Actuated Cycle Length:	140
Offset:	12 (9%), Referenced to phase 2:NETL and 6:SWTL, Start of Green
Natural Cycle:	100
Control Type:	Actuated-Coordinated
Maximum v/c Ratio:	0.98
Intersection Signal Delay:	60.7
Intersection LOS:	E
Intersection Capacity Utilization:	102.6%
ICU Level of Service:	G
Analysis Period (min):	15
~ Volume exceeds capacity, queue is theoretically infinite. Queue shown is maximum after two cycles.	

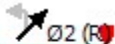



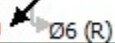



















95th percentile volume exceeds capacity, queue may be longer.
 Queue shown is maximum after two cycles.

Splits and Phases: 1: US 24 & Judge Orr

 Ø2 (R)	 Ø4	 Ø8
70 s	35 s	35 s
 Ø5	 Ø6 (R)	
12 s	58 s	

Lanes, Volumes, Timings
2: US 24 & Stapleton

2030 Background + Site
AM

												
Lane Group	SEL	SET	SER	NWL	NWT	NWR	NEL	NET	NER	SWL	SWT	SWR
Lane Configurations												
Traffic Volume (vph)	27	197	169	13	157	26	58	315	5	44	517	41
Future Volume (vph)	27	197	169	13	157	26	58	315	5	44	517	41
Ideal Flow (vphpl)	1900	1900	1900	1900	1900	1900	1900	1900	1900	1900	1900	1900
Storage Length (ft)	190		325	215		215	890		1000	790		790
Storage Lanes	1		1	1		1	1		1	1		1
Taper Length (ft)	240			200			190			190		
Lane Util. Factor	1.00	1.00	1.00	1.00	1.00	1.00	1.00	1.00	1.00	1.00	1.00	1.00
Frt			0.850			0.850			0.850			0.850
Flt Protected	0.950			0.950			0.950			0.950		
Satd. Flow (prot)	1770	1863	1583	1770	1863	1583	1770	1863	1583	1770	1863	1583
Flt Permitted	0.576			0.579			0.950			0.950		
Satd. Flow (perm)	1073	1863	1583	1079	1863	1583	1770	1863	1583	1770	1863	1583
Right Turn on Red			Yes			Yes			Yes			Yes
Satd. Flow (RTOR)			184			136			95			136
Link Speed (mph)		45			45			55			55	
Link Distance (ft)		767			3046			1493			1435	
Travel Time (s)		11.6			46.2			18.5			17.8	
Peak Hour Factor	0.92	0.92	0.92	0.87	0.87	0.87	0.92	0.92	0.92	0.93	0.93	0.93
Adj. Flow (vph)	29	214	184	15	180	30	63	342	5	47	556	44
Shared Lane Traffic (%)												
Lane Group Flow (vph)	29	214	184	15	180	30	63	342	5	47	556	44
Enter Blocked Intersection	No	No	No	No	No	No	No	No	No	No	No	No
Lane Alignment	Left	Left	Right	Left	L NA	Right	L NA	Left	Right	Left	Left	R NA
Median Width(ft)		12			12			12			12	
Link Offset(ft)		0			0			0			0	
Crosswalk Width(ft)		16			16			16			16	
Two way Left Turn Lane												
Headway Factor	1.00	1.00	1.00	1.00	1.00	1.00	1.00	1.00	1.00	1.00	1.00	1.00
Number of Detectors	1	2	1	1	2	1	1	2	1	1	2	1
Detector Template	Left	Thru	Right	Left	Thru	Right	Left	Thru	Right	Left	Thru	Right
Leading Detector (ft)	20	100	20	20	100	20	20	100	20	20	100	20
Trailing Detector (ft)	0	0	0	0	0	0	0	0	0	0	0	0
Detector 1 Position(ft)	0	0	0	0	0	0	0	0	0	0	0	0
Detector 1 Size(ft)	20	6	20	20	6	20	20	6	20	20	6	20
Detector 1 Type	Cl+Ex	Cl+Ex	Cl+Ex	Cl+Ex	Cl+Ex	Cl+Ex	Cl+Ex	Cl+Ex	Cl+Ex	Cl+Ex	Cl+Ex	Cl+Ex
Detector 1 Channel												
Detector 1 Extend (s)	0.0	0.0	0.0	0.0	0.0	0.0	0.0	0.0	0.0	0.0	0.0	0.0
Detector 1 Queue (s)	0.0	0.0	0.0	0.0	0.0	0.0	0.0	0.0	0.0	0.0	0.0	0.0
Detector 1 Delay (s)	0.0	0.0	0.0	0.0	0.0	0.0	0.0	0.0	0.0	0.0	0.0	0.0
Detector 2 Position(ft)		94			94			94			94	
Detector 2 Size(ft)		6			6			6			6	
Detector 2 Type		Cl+Ex			Cl+Ex			Cl+Ex			Cl+Ex	
Detector 2 Channel												
Detector 2 Extend (s)		0.0			0.0			0.0			0.0	
Turn Type	pm+pt	NA	Perm	pm+pt	NA	Perm	Prot	NA	Perm	Prot	NA	Perm
Protected Phases	1	6		5	2		7	4		3	8	
Permitted Phases	6		6	2		2			4			8
Detector Phase	1	6	6	5	2	2	7	4	4	3	8	8

Lanes, Volumes, Timings
2: US 24 & Stapleton

2030 Background + Site
AM

Lane Group	SEL	SET	SER	NWL	NWT	NWR	NEL	NET	NER	SWL	SWT	SWR
Switch Phase												
Minimum Initial (s)	5.0	5.0	5.0	5.0	5.0	5.0	5.0	5.0	5.0	5.0	5.0	5.0
Minimum Split (s)	9.5	22.5	22.5	9.5	22.5	22.5	9.5	22.5	22.5	9.5	22.5	22.5
Total Split (s)	15.0	25.0	25.0	15.0	25.0	25.0	36.0	60.0	60.0	20.0	44.0	44.0
Total Split (%)	12.5%	20.8%	20.8%	12.5%	20.8%	20.8%	30.0%	50.0%	50.0%	16.7%	36.7%	36.7%
Maximum Green (s)	10.5	20.5	20.5	10.5	20.5	20.5	31.5	55.5	55.5	15.5	39.5	39.5
Yellow Time (s)	3.5	3.5	3.5	3.5	3.5	3.5	3.5	3.5	3.5	3.5	3.5	3.5
All-Red Time (s)	1.0	1.0	1.0	1.0	1.0	1.0	1.0	1.0	1.0	1.0	1.0	1.0
Lost Time Adjust (s)	0.0	0.0	0.0	0.0	0.0	0.0	0.0	0.0	0.0	0.0	0.0	0.0
Total Lost Time (s)	4.5	4.5	4.5	4.5	4.5	4.5	4.5	4.5	4.5	4.5	4.5	4.5
Lead/Lag	Lead	Lag	Lag	Lead	Lag	Lag	Lead	Lag	Lag	Lead	Lag	Lag
Lead-Lag Optimize?	Yes	Yes	Yes	Yes	Yes	Yes	Yes	Yes	Yes	Yes	Yes	Yes
Vehicle Extension (s)	3.0	3.0	3.0	3.0	3.0	3.0	3.0	3.0	3.0	3.0	3.0	3.0
Recall Mode	None	C-Min	C-Min	None	C-Min	C-Min	None	None	None	None	None	None
Act Effct Green (s)	56.0	52.9	52.9	54.3	50.3	50.3	9.6	42.5	42.5	8.6	41.5	41.5
Actuated g/C Ratio	0.47	0.44	0.44	0.45	0.42	0.42	0.08	0.35	0.35	0.07	0.35	0.35
v/c Ratio	0.05	0.26	0.23	0.03	0.23	0.04	0.44	0.52	0.01	0.37	0.86	0.07
Control Delay	21.5	27.0	5.3	21.6	28.4	0.1	61.6	32.9	0.0	60.6	50.7	0.2
Queue Delay	0.0	0.0	0.0	0.0	0.0	0.0	0.0	0.0	0.0	0.0	0.0	0.0
Total Delay	21.5	27.0	5.3	21.6	28.4	0.1	61.6	32.9	0.0	60.6	50.7	0.2
LOS	C	C	A	C	C	A	E	C	A	E	D	A
Approach Delay		17.3			24.2			36.9			48.0	
Approach LOS		B			C			D			D	
Queue Length 50th (ft)	12	101	0	6	98	0	47	204	0	35	391	0
Queue Length 95th (ft)	35	208	54	22	172	0	92	273	0	74	507	0
Internal Link Dist (ft)		687			2966			1413			1355	
Turn Bay Length (ft)	190		325	215		215	890		1000	790		790
Base Capacity (vph)	571	821	800	569	781	743	464	861	783	228	666	653
Starvation Cap Reductn	0	0	0	0	0	0	0	0	0	0	0	0
Spillback Cap Reductn	0	0	0	0	0	0	0	0	0	0	0	0
Storage Cap Reductn	0	0	0	0	0	0	0	0	0	0	0	0
Reduced v/c Ratio	0.05	0.26	0.23	0.03	0.23	0.04	0.14	0.40	0.01	0.21	0.83	0.07

Intersection Summary

Area Type: Other
 Cycle Length: 120
 Actuated Cycle Length: 120
 Offset: 0 (0%), Referenced to phase 2:NWTL and 6:SETL, Start of Green
 Natural Cycle: 70
 Control Type: Actuated-Coordinated
 Maximum v/c Ratio: 0.86
 Intersection Signal Delay: 34.5
 Intersection Capacity Utilization 60.9%
 Analysis Period (min) 15
 Intersection LOS: C
 ICU Level of Service B

Splits and Phases: 2: US 24 & Stapleton

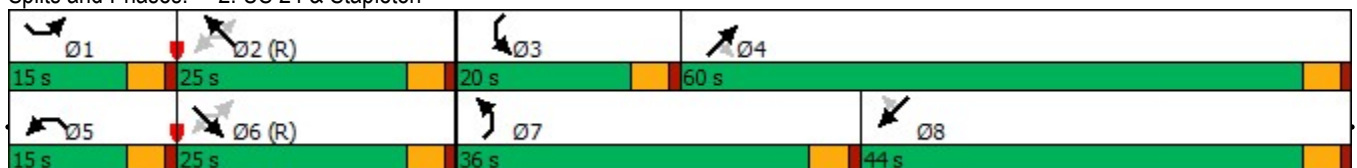

Lanes, Volumes, Timings

Lanes, Volumes, Timings

Intersection						
Int Delay, s/veh	1.1					
Movement	EBT	EBR	WBL	WBT	NBL	NBR
Lane Configurations						
Traffic Vol, veh/h	49	16	1	188	26	1
Future Vol, veh/h	49	16	1	188	26	1
Conflicting Peds, #/hr	0	0	0	0	0	0
Sign Control	Free	Free	Free	Free	Stop	Stop
RT Channelized	-	None	-	None	-	None
Storage Length	-	-	-	-	0	-
Veh in Median Storage, #	0	-	-	0	0	-
Grade, %	0	-	-	0	0	-
Peak Hour Factor	83	83	87	87	78	78
Heavy Vehicles, %	2	2	2	2	2	2
Mvmt Flow	59	19	1	216	33	1

Major/Minor	Major1	Major2	Minor1		
Conflicting Flow All	0	0	78	0	287 69
Stage 1	-	-	-	-	69 -
Stage 2	-	-	-	-	218 -
Critical Hdwy	-	-	4.12	-	6.42 6.22
Critical Hdwy Stg 1	-	-	-	-	5.42 -
Critical Hdwy Stg 2	-	-	-	-	5.42 -
Follow-up Hdwy	-	-	2.218	-	3.518 3.318
Pot Cap-1 Maneuver	-	-	1520	-	703 994
Stage 1	-	-	-	-	954 -
Stage 2	-	-	-	-	818 -
Platoon blocked, %	-	-	-	-	-
Mov Cap-1 Maneuver	-	-	1520	-	702 994
Mov Cap-2 Maneuver	-	-	-	-	702 -
Stage 1	-	-	-	-	954 -
Stage 2	-	-	-	-	817 -

Approach	EB	WB	NB
HCM Control Delay, s	0	0	10.3
HCM LOS			B

Minor Lane/Major Mvmt	NBLn1	EBT	EBR	WBL	WBT
Capacity (veh/h)	710	-	-	1520	-
HCM Lane V/C Ratio	0.049	-	-	0.001	-
HCM Control Delay (s)	10.3	-	-	7.4	0
HCM Lane LOS	B	-	-	A	A
HCM 95th %tile Q(veh)	0.2	-	-	0	-

Intersection												
Int Delay, s/veh	2.8											
Movement	EBL	EBT	EBR	WBL	WBT	WBR	NBL	NBT	NBR	SBL	SBT	SBR
Lane Configurations		↕	↗		↕			↕			↕	
Traffic Vol, veh/h	1	59	33	6	191	19	57	4	2	7	4	12
Future Vol, veh/h	1	59	33	6	191	19	57	4	2	7	4	12
Conflicting Peds, #/hr	0	0	0	0	0	0	0	0	0	0	0	0
Sign Control	Free	Free	Free	Free	Free	Free	Stop	Stop	Stop	Stop	Stop	Stop
RT Channelized	-	-	None	-	-	None	-	-	None	-	-	None
Storage Length	-	-	235	-	-	-	-	-	-	-	-	-
Veh in Median Storage, #	-	0	-	-	0	-	-	0	-	-	0	-
Grade, %	-	0	-	-	0	-	-	0	-	-	0	-
Peak Hour Factor	78	78	78	87	87	87	78	78	78	78	78	78
Heavy Vehicles, %	2	2	2	2	2	2	2	2	2	2	2	2
Mvmt Flow	1	76	42	7	220	22	73	5	3	9	5	15

Major/Minor	Major1			Major2			Minor1			Minor2		
Conflicting Flow All	242	0	0	118	0	0	333	334	76	348	365	231
Stage 1	-	-	-	-	-	-	78	78	-	245	245	-
Stage 2	-	-	-	-	-	-	255	256	-	103	120	-
Critical Hdwy	4.12	-	-	4.12	-	-	7.12	6.52	6.22	7.12	6.52	6.22
Critical Hdwy Stg 1	-	-	-	-	-	-	6.12	5.52	-	6.12	5.52	-
Critical Hdwy Stg 2	-	-	-	-	-	-	6.12	5.52	-	6.12	5.52	-
Follow-up Hdwy	2.218	-	-	2.218	-	-	3.518	4.018	3.318	3.518	4.018	3.318
Pot Cap-1 Maneuver	1324	-	-	1470	-	-	620	586	985	607	563	808
Stage 1	-	-	-	-	-	-	931	830	-	759	703	-
Stage 2	-	-	-	-	-	-	749	696	-	903	796	-
Platoon blocked, %		-	-		-	-						
Mov Cap-1 Maneuver	1324	-	-	1470	-	-	601	582	985	598	559	808
Mov Cap-2 Maneuver	-	-	-	-	-	-	601	582	-	598	559	-
Stage 1	-	-	-	-	-	-	930	829	-	758	699	-
Stage 2	-	-	-	-	-	-	725	692	-	894	795	-

Approach	EB			WB			NB			SB		
HCM Control Delay, s	0.1			0.2			11.8			10.5		
HCM LOS							B			B		

Minor Lane/Major Mvmt	NBLn1	EBL	EBT	EBR	WBL	WBT	WBR	SBLn1
Capacity (veh/h)	607	1324	-	-	1470	-	-	682
HCM Lane V/C Ratio	0.133	0.001	-	-	0.005	-	-	0.043
HCM Control Delay (s)	11.8	7.7	0	-	7.5	0	-	10.5
HCM Lane LOS	B	A	A	-	A	A	-	B
HCM 95th %tile Q(veh)	0.5	0	-	-	0	-	-	0.1

Intersection												
Int Delay, s/veh	2.1											
Movement	SEL	SET	SER	NWL	NWT	NWR	NEL	NET	NER	SWL	SWT	SWR
Lane Configurations	↘	↑	↗	↘	↑	↗	↘	↑	↗	↘	↑	↗
Traffic Vol, veh/h	4	14	125	15	19	4	51	293	4	8	451	5
Future Vol, veh/h	4	14	125	15	19	4	51	293	4	8	451	5
Conflicting Peds, #/hr	0	0	0	0	0	0	0	0	0	0	0	0
Sign Control	Stop	Stop	Stop	Stop	Stop	Stop	Free	Free	Free	Free	Free	Free
RT Channelized	-	-	Free	-	-	Stop	-	-	Yield	-	-	Yield
Storage Length	170	-	250	125	-	25	620	-	550	540	-	480
Veh in Median Storage, #	-	0	-	-	0	-	-	0	-	-	0	-
Grade, %	-	0	-	-	0	-	-	0	-	-	0	-
Peak Hour Factor	87	87	87	78	78	78	92	92	92	92	92	92
Heavy Vehicles, %	2	2	2	2	2	2	2	2	2	2	2	2
Mvmt Flow	5	16	144	19	24	5	55	318	4	9	490	5

Major/Minor	Minor2		Minor1		Major1		Major2					
Conflicting Flow All	948	936	-	944	936	318	490	0	0	318	0	0
Stage 1	508	508	-	428	428	-	-	-	-	-	-	-
Stage 2	440	428	-	516	508	-	-	-	-	-	-	-
Critical Hdwy	7.12	6.52	-	7.12	6.52	6.22	4.12	-	-	4.12	-	-
Critical Hdwy Stg 1	6.12	5.52	-	6.12	5.52	-	-	-	-	-	-	-
Critical Hdwy Stg 2	6.12	5.52	-	6.12	5.52	-	-	-	-	-	-	-
Follow-up Hdwy	3.518	4.018	-	3.518	4.018	3.318	2.218	-	-	2.218	-	-
Pot Cap-1 Maneuver	241	265	0	242	265	723	1073	-	-	1242	-	-
Stage 1	547	539	0	605	585	-	-	-	-	-	-	-
Stage 2	596	585	0	542	539	-	-	-	-	-	-	-
Platoon blocked, %								-	-	-	-	-
Mov Cap-1 Maneuver	212	250	-	220	250	723	1073	-	-	1242	-	-
Mov Cap-2 Maneuver	212	250	-	220	250	-	-	-	-	-	-	-
Stage 1	519	535	-	574	555	-	-	-	-	-	-	-
Stage 2	537	555	-	522	535	-	-	-	-	-	-	-

Approach	SE		NW		NE		SW	
HCM Control Delay, s	20.8		20.5		1.3		0.1	
HCM LOS	C		C					

Minor Lane/Major Mvmt	NEL	NET	NERN	NWLn1	NWLn2	NWLn3	SELn1	SELn2	SELn3	SWL	SWT	SWR
Capacity (veh/h)	1073	-	-	220	250	723	212	250	-	1242	-	-
HCM Lane V/C Ratio	0.052	-	-	0.087	0.097	0.007	0.022	0.064	-	0.007	-	-
HCM Control Delay (s)	8.5	-	-	22.9	20.9	10	22.4	20.4	0	7.9	-	-
HCM Lane LOS	A	-	-	C	C	B	C	C	A	A	-	-
HCM 95th %tile Q(veh)	0.2	-	-	0.3	0.3	0	0.1	0.2	-	0	-	-

Intersection												
Int Delay, s/veh	13.6											
Movement	EBL	EBT	EBR	WBL	WBT	WBR	NBL	NBT	NBR	SBL	SBT	SBR
Lane Configurations												
Traffic Vol, veh/h	8	87	97	35	278	54	69	101	10	24	244	15
Future Vol, veh/h	8	87	97	35	278	54	69	101	10	24	244	15
Conflicting Peds, #/hr	0	0	0	0	0	0	0	0	0	0	0	0
Sign Control	Free	Free	Free	Free	Free	Free	Stop	Stop	Stop	Stop	Stop	Stop
RT Channelized	-	-	None	-	-	None	-	-	None	-	-	None
Storage Length	245	-	195	235	-	195	265	-	-	265	-	-
Veh in Median Storage, #	-	0	-	-	0	-	-	0	-	-	0	-
Grade, %	-	0	-	-	0	-	-	0	-	-	0	-
Peak Hour Factor	87	87	87	92	92	92	87	87	87	92	92	92
Heavy Vehicles, %	2	2	2	2	2	2	2	2	2	2	2	2
Mvmt Flow	9	100	111	38	302	59	79	116	11	26	265	16

Major/Minor	Major1			Major2			Minor1			Minor2		
Conflicting Flow All	361	0	0	211	0	0	666	555	100	615	607	302
Stage 1	-	-	-	-	-	-	118	118	-	378	378	-
Stage 2	-	-	-	-	-	-	548	437	-	237	229	-
Critical Hdwy	4.12	-	-	4.12	-	-	7.12	6.52	6.22	7.12	6.52	6.22
Critical Hdwy Stg 1	-	-	-	-	-	-	6.12	5.52	-	6.12	5.52	-
Critical Hdwy Stg 2	-	-	-	-	-	-	6.12	5.52	-	6.12	5.52	-
Follow-up Hdwy	2.218	-	-	2.218	-	-	3.518	4.018	3.318	3.518	4.018	3.318
Pot Cap-1 Maneuver	1198	-	-	1360	-	-	373	440	956	403	411	738
Stage 1	-	-	-	-	-	-	887	798	-	644	615	-
Stage 2	-	-	-	-	-	-	521	579	-	766	715	-
Platoon blocked, %	-	-	-	-	-	-	-	-	-	-	-	-
Mov Cap-1 Maneuver	1198	-	-	1360	-	-	164	424	956	306	396	738
Mov Cap-2 Maneuver	-	-	-	-	-	-	164	424	-	306	396	-
Stage 1	-	-	-	-	-	-	880	792	-	639	598	-
Stage 2	-	-	-	-	-	-	276	563	-	641	709	-

Approach	EB			WB			NB			SB		
HCM Control Delay, s	0.3			0.7			27.7			30.3		
HCM LOS							D			D		

Minor Lane/Major Mvmt	NBLn1	NBLn2	EBL	EBT	EBR	WBL	WBT	WBR	SBLn1	SBLn2
Capacity (veh/h)	164	446	1198	-	-	1360	-	-	306	407
HCM Lane V/C Ratio	0.484	0.286	0.008	-	-	0.028	-	-	0.085	0.692
HCM Control Delay (s)	46	16.3	8	-	-	7.7	-	-	17.9	31.5
HCM Lane LOS	E	C	A	-	-	A	-	-	C	D
HCM 95th %tile Q(veh)	2.3	1.2	0	-	-	0.1	-	-	0.3	5.1

Lanes, Volumes, Timings
1: US 24 & Judge Orr

2030 Background + Site
PM



Lane Group	EBL	EBT	EBR	WBL	WBT	WBR	NEL	NET	NER	SWL	SWT	SWR
Lane Configurations		↕			↕		↗	↘		↗	↘	
Traffic Volume (vph)	52	76	65	240	91	11	163	675	324	2	453	53
Future Volume (vph)	52	76	65	240	91	11	163	675	324	2	453	53
Ideal Flow (vphpl)	1900	1900	1900	1900	1900	1900	1900	1900	1900	1900	1900	1900
Storage Length (ft)	0		0	0		0	860		0	695		0
Storage Lanes	0		0	0		0	1		0	1		0
Taper Length (ft)	200			200			300			300		
Lane Util. Factor	1.00	1.00	1.00	1.00	1.00	1.00	1.00	1.00	1.00	1.00	1.00	1.00
Frt		0.954			0.996			0.951			0.984	
Flt Protected		0.987			0.966		0.950			0.950		
Satd. Flow (prot)	0	1754	0	0	1792	0	1770	1771	0	1770	1833	0
Flt Permitted		0.987			0.966		0.232			0.065		
Satd. Flow (perm)	0	1754	0	0	1792	0	432	1771	0	121	1833	0
Right Turn on Red			Yes			Yes			Yes			Yes
Satd. Flow (RTOR)		15			1			28			5	
Link Speed (mph)		45			45			55			55	
Link Distance (ft)		1112			1085			1307			1572	
Travel Time (s)		16.8			16.4			16.2			19.5	
Peak Hour Factor	0.87	0.87	0.87	0.92	0.92	0.92	0.95	0.95	0.95	0.92	0.92	0.92
Adj. Flow (vph)	60	87	75	261	99	12	172	711	341	2	492	58
Shared Lane Traffic (%)												
Lane Group Flow (vph)	0	222	0	0	372	0	172	1052	0	2	550	0
Enter Blocked Intersection	No	No	No	No	No	No	No	No	No	No	No	No
Lane Alignment	Left	Left	Right	Left	Left	Right	Left	Left	Right	Left	Left	Right
Median Width(ft)		0			0			12			12	
Link Offset(ft)		0			0			0			0	
Crosswalk Width(ft)		16			16			16			16	
Two way Left Turn Lane												
Headway Factor	1.00	1.00	1.00	1.00	1.00	1.00	1.00	1.00	1.00	1.00	1.00	1.00
Turning Speed (mph)	60		60	60		60	60		60	60		60
Number of Detectors	1	2		1	2		1	2		1	2	
Detector Template	Left	Thru		Left	Thru		Left	Thru		Left	Thru	
Leading Detector (ft)	20	100		20	100		20	100		20	100	
Trailing Detector (ft)	0	0		0	0		0	0		0	0	
Detector 1 Position(ft)	0	0		0	0		0	0		0	0	
Detector 1 Size(ft)	20	6		20	6		20	6		20	6	
Detector 1 Type	Cl+Ex	Cl+Ex		Cl+Ex	Cl+Ex		Cl+Ex	Cl+Ex		Cl+Ex	Cl+Ex	
Detector 1 Channel												
Detector 1 Extend (s)	0.0	0.0		0.0	0.0		0.0	0.0		0.0	0.0	
Detector 1 Queue (s)	0.0	0.0		0.0	0.0		0.0	0.0		0.0	0.0	
Detector 1 Delay (s)	0.0	0.0		0.0	0.0		0.0	0.0		0.0	0.0	
Detector 2 Position(ft)		94			94			94			94	
Detector 2 Size(ft)		6			6			6			6	
Detector 2 Type		Cl+Ex			Cl+Ex			Cl+Ex			Cl+Ex	
Detector 2 Channel												
Detector 2 Extend (s)		0.0			0.0			0.0			0.0	
Turn Type	Split	NA		Split	NA		pm+pt	NA		Perm	NA	
Protected Phases	4	4		8	8		5	2			6	
Permitted Phases							2			6		

Lanes, Volumes, Timings
1: US 24 & Judge Orr

2030 Background + Site
PM



Lane Group	EBL	EBT	EBR	WBL	WBT	WBR	NEL	NET	NER	SWL	SWT	SWR
Detector Phase	4	4		8	8		5	2		6	6	
Switch Phase												
Minimum Initial (s)	6.0	6.0		6.0	6.0		6.0	37.0		22.0	22.0	
Minimum Split (s)	13.0	13.0		13.0	13.0		11.0	44.0		29.0	29.0	
Total Split (s)	25.0	25.0		30.0	30.0		20.0	85.0		65.0	65.0	
Total Split (%)	17.9%	17.9%		21.4%	21.4%		14.3%	60.7%		46.4%	46.4%	
Maximum Green (s)	18.0	18.0		23.0	23.0		15.0	78.0		58.0	58.0	
Yellow Time (s)	5.0	5.0		5.0	5.0		3.0	5.0		5.0	5.0	
All-Red Time (s)	2.0	2.0		2.0	2.0		2.0	2.0		2.0	2.0	
Lost Time Adjust (s)		0.0			0.0		0.0	0.0		0.0	0.0	
Total Lost Time (s)		7.0			7.0		5.0	7.0		7.0	7.0	
Lead/Lag							Lead			Lag	Lag	
Lead-Lag Optimize?							Yes			Yes	Yes	
Vehicle Extension (s)	3.0	3.0		3.0	3.0		3.0	3.0		3.0	3.0	
Recall Mode	None	None		None	None		None	C-Min		C-Min	C-Min	
Walk Time (s)								7.0		7.0	7.0	
Flash Dont Walk (s)								11.0		11.0	11.0	
Pedestrian Calls (#/hr)								0		0	0	
Act Effct Green (s)		17.9			23.1		80.0	78.0		61.1	61.1	
Actuated g/C Ratio		0.13			0.16		0.57	0.56		0.44	0.44	
v/c Ratio		0.94			1.26		0.48	1.05		0.04	0.68	
Control Delay		99.8			186.9		18.9	73.5		26.5	37.3	
Queue Delay		0.0			0.0		0.0	0.0		0.0	0.0	
Total Delay		99.8			186.9		18.9	73.5		26.5	37.3	
LOS		F			F		B	E		C	D	
Approach Delay		99.8			186.9			65.9			37.3	
Approach LOS		F			F			E			D	
Queue Length 50th (ft)		190			~425		72	~1033		1	394	
Queue Length 95th (ft)		#332			#632		111	#1300		8	554	
Internal Link Dist (ft)		1032			1005			1227			1492	
Turn Bay Length (ft)							860			695		
Base Capacity (vph)		238			296		390	999		52	803	
Starvation Cap Reductn		0			0		0	0		0	0	
Spillback Cap Reductn		0			0		0	0		0	0	
Storage Cap Reductn		0			0		0	0		0	0	
Reduced v/c Ratio		0.93			1.26		0.44	1.05		0.04	0.68	

Intersection Summary

Area Type: Other
 Cycle Length: 140
 Actuated Cycle Length: 140
 Offset: 20 (14%), Referenced to phase 2:NETL and 6:SWTL, Start of Green
 Natural Cycle: 150
 Control Type: Actuated-Coordinated
 Maximum v/c Ratio: 1.26
 Intersection Signal Delay: 81.4
 Intersection Capacity Utilization 126.5%
 Analysis Period (min) 15
 Intersection LOS: F
 ICU Level of Service H

~ Volume exceeds capacity, queue is theoretically infinite.





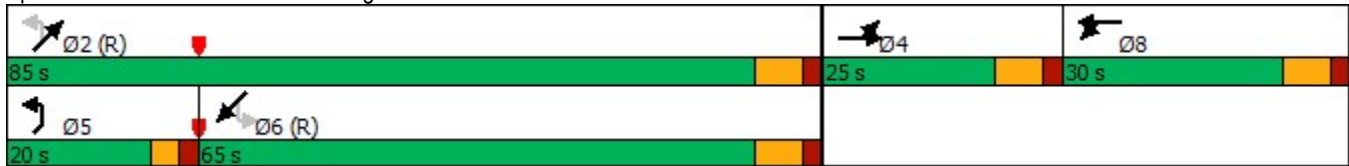





















Queue shown is maximum after two cycles.
 # 95th percentile volume exceeds capacity, queue may be longer.
 Queue shown is maximum after two cycles.

Splits and Phases: 1: US 24 & Judge Orr



Lanes, Volumes, Timings
2: US 24 & Stapleton

2030 Background + Site
PM

													
Lane Group	SEL	SET	SER	NWL	NWT	NWR	NEL	NET	NER	SWL	SWT	SWR	
Lane Configurations													
Traffic Volume (vph)	17	114	58	35	209	38	140	542	43	20	430	35	
Future Volume (vph)	17	114	58	35	209	38	140	542	43	20	430	35	
Ideal Flow (vphpl)	1900	1900	1900	1900	1900	1900	1900	1900	1900	1900	1900	1900	
Storage Length (ft)	190		325	215		215	890		1000	790		790	
Storage Lanes	1		1	1		1	1		1	1		1	
Taper Length (ft)	240			200			190			190			
Lane Util. Factor	1.00	1.00	1.00	1.00	1.00	1.00	1.00	1.00	1.00	1.00	1.00	1.00	
Frt			0.850			0.850			0.850			0.850	
Flt Protected	0.950			0.950			0.950			0.950			
Satd. Flow (prot)	1770	1863	1583	1770	1863	1583	1770	1863	1583	1770	1863	1583	
Flt Permitted	0.397			0.519			0.950			0.950			
Satd. Flow (perm)	740	1863	1583	967	1863	1583	1770	1863	1583	1770	1863	1583	
Right Turn on Red			Yes			Yes			Yes			Yes	
Satd. Flow (RTOR)			136			136			95			136	
Link Speed (mph)		45			45			55			55		
Link Distance (ft)		767			3046			1493			1435		
Travel Time (s)		11.6			46.2			18.5			17.8		
Peak Hour Factor	0.87	0.87	0.87	0.92	0.92	0.92	0.93	0.93	0.93	0.92	0.92	0.92	
Adj. Flow (vph)	20	131	67	38	227	41	151	583	46	22	467	38	
Shared Lane Traffic (%)													
Lane Group Flow (vph)	20	131	67	38	227	41	151	583	46	22	467	38	
Enter Blocked Intersection	No	No	No	No	No	No	No	No	No	No	No	No	
Lane Alignment	Left	Left	Right	Left	L NA	Right	L NA	Left	Right	Left	Left	R NA	
Median Width(ft)		12			12			12			12		
Link Offset(ft)		0			0			0			0		
Crosswalk Width(ft)		16			16			16			16		
Two way Left Turn Lane													
Headway Factor	1.00	1.00	1.00	1.00	1.00	1.00	1.00	1.00	1.00	1.00	1.00	1.00	
Turning Speed (mph)	15		9	15		9	15		9	15		9	
Number of Detectors	1	2	1	1	2	1	1	2	1	1	2	1	
Detector Template	Left	Thru	Right	Left	Thru	Right	Left	Thru	Right	Left	Thru	Right	
Leading Detector (ft)	20	100	20	20	100	20	20	100	20	20	100	20	
Trailing Detector (ft)	0	0	0	0	0	0	0	0	0	0	0	0	
Detector 1 Position(ft)	0	0	0	0	0	0	0	0	0	0	0	0	
Detector 1 Size(ft)	20	6	20	20	6	20	20	6	20	20	6	20	
Detector 1 Type	Cl+Ex	Cl+Ex	Cl+Ex	Cl+Ex	Cl+Ex	Cl+Ex	Cl+Ex	Cl+Ex	Cl+Ex	Cl+Ex	Cl+Ex	Cl+Ex	
Detector 1 Channel													
Detector 1 Extend (s)	0.0	0.0	0.0	0.0	0.0	0.0	0.0	0.0	0.0	0.0	0.0	0.0	
Detector 1 Queue (s)	0.0	0.0	0.0	0.0	0.0	0.0	0.0	0.0	0.0	0.0	0.0	0.0	
Detector 1 Delay (s)	0.0	0.0	0.0	0.0	0.0	0.0	0.0	0.0	0.0	0.0	0.0	0.0	
Detector 2 Position(ft)		94			94			94			94		
Detector 2 Size(ft)		6			6			6			6		
Detector 2 Type		Cl+Ex			Cl+Ex			Cl+Ex			Cl+Ex		
Detector 2 Channel													
Detector 2 Extend (s)		0.0			0.0			0.0			0.0		
Turn Type	pm+pt	NA	Perm	pm+pt	NA	Perm	Prot	NA	Perm	Prot	NA	Perm	
Protected Phases	1	6		5	2		7	4		3	8		
Permitted Phases	6		6	2		2			4			8	

Lanes, Volumes, Timings
2: US 24 & Stapleton

2030 Background + Site
PM

Lane Group	SEL	SET	SER	NWL	NWT	NWR	NEL	NET	NER	SWL	SWT	SWR
Detector Phase	1	6	6	5	2	2	7	4	4	3	8	8
Switch Phase												
Minimum Initial (s)	5.0	5.0	5.0	5.0	5.0	5.0	5.0	5.0	5.0	5.0	5.0	5.0
Minimum Split (s)	9.5	22.5	22.5	9.5	22.5	22.5	9.5	22.5	22.5	9.5	22.5	22.5
Total Split (s)	15.0	25.0	25.0	15.0	25.0	25.0	36.0	60.0	60.0	20.0	44.0	44.0
Total Split (%)	12.5%	20.8%	20.8%	12.5%	20.8%	20.8%	30.0%	50.0%	50.0%	16.7%	36.7%	36.7%
Maximum Green (s)	10.5	20.5	20.5	10.5	20.5	20.5	31.5	55.5	55.5	15.5	39.5	39.5
Yellow Time (s)	3.5	3.5	3.5	3.5	3.5	3.5	3.5	3.5	3.5	3.5	3.5	3.5
All-Red Time (s)	1.0	1.0	1.0	1.0	1.0	1.0	1.0	1.0	1.0	1.0	1.0	1.0
Lost Time Adjust (s)	0.0	0.0	0.0	0.0	0.0	0.0	0.0	0.0	0.0	0.0	0.0	0.0
Total Lost Time (s)	4.5	4.5	4.5	4.5	4.5	4.5	4.5	4.5	4.5	4.5	4.5	4.5
Lead/Lag	Lead	Lag	Lag	Lead	Lag	Lag	Lead	Lag	Lag	Lead	Lag	Lag
Lead-Lag Optimize?	Yes	Yes	Yes	Yes	Yes	Yes	Yes	Yes	Yes	Yes	Yes	Yes
Vehicle Extension (s)	3.0	3.0	3.0	3.0	3.0	3.0	3.0	3.0	3.0	3.0	3.0	3.0
Recall Mode	None	C-Min	C-Min	None	C-Min	C-Min	None	None	None	None	Max	Max
Act Effct Green (s)	28.9	24.6	24.6	31.1	27.5	27.5	15.6	71.2	71.2	7.1	58.6	58.6
Actuated g/C Ratio	0.24	0.20	0.20	0.26	0.23	0.23	0.13	0.59	0.59	0.06	0.49	0.49
v/c Ratio	0.09	0.34	0.15	0.13	0.53	0.09	0.66	0.53	0.05	0.21	0.51	0.05
Control Delay	31.8	44.8	0.8	32.4	46.6	0.4	62.7	18.6	0.1	58.0	25.2	0.1
Queue Delay	0.0	0.0	0.0	0.0	0.0	0.0	0.0	0.0	0.0	0.0	0.0	0.0
Total Delay	31.8	44.8	0.8	32.4	46.6	0.4	62.7	18.6	0.1	58.0	25.2	0.1
LOS	C	D	A	C	D	A	E	B	A	E	C	A
Approach Delay		30.1			38.7			26.0			24.8	
Approach LOS		C			D			C			C	
Queue Length 50th (ft)	11	91	0	22	146	0	113	279	0	17	242	0
Queue Length 95th (ft)	29	147	0	49	251	0	175	425	0	44	392	0
Internal Link Dist (ft)		687			2966			1413			1355	
Turn Bay Length (ft)	190		325	215		215	890		1000	790		790
Base Capacity (vph)	280	382	433	326	427	468	464	1105	977	228	909	842
Starvation Cap Reductn	0	0	0	0	0	0	0	0	0	0	0	0
Spillback Cap Reductn	0	0	0	0	0	0	0	0	0	0	0	0
Storage Cap Reductn	0	0	0	0	0	0	0	0	0	0	0	0
Reduced v/c Ratio	0.07	0.34	0.15	0.12	0.53	0.09	0.33	0.53	0.05	0.10	0.51	0.05

Intersection Summary

Area Type: Other
 Cycle Length: 120
 Actuated Cycle Length: 120
 Offset: 0 (0%), Referenced to phase 2:NWTL and 6:SETL, Start of Green
 Natural Cycle: 70
 Control Type: Actuated-Coordinated
 Maximum v/c Ratio: 0.66
 Intersection Signal Delay: 28.3
 Intersection LOS: C
 Intersection Capacity Utilization 58.1%
 ICU Level of Service B
 Analysis Period (min) 15

Splits and Phases: 2: US 24 & Stapleton

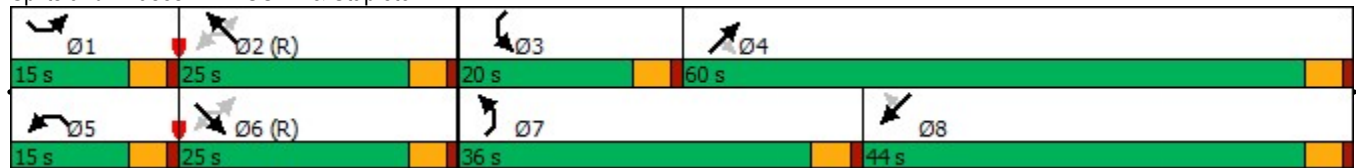

Intersection						
Int Delay, s/veh	0.8					
Movement	EBT	EBR	WBL	WBT	NBL	NBR
Lane Configurations						
Traffic Vol, veh/h	184	35	2	51	19	1
Future Vol, veh/h	184	35	2	51	19	1
Conflicting Peds, #/hr	0	0	0	0	0	0
Sign Control	Free	Free	Free	Free	Stop	Stop
RT Channelized	-	None	-	None	-	None
Storage Length	-	-	-	-	0	-
Veh in Median Storage, #	0	-	-	0	0	-
Grade, %	0	-	-	0	0	-
Peak Hour Factor	87	87	83	83	78	78
Heavy Vehicles, %	2	2	2	2	2	2
Mvmt Flow	211	40	2	61	24	1

Major/Minor	Major1	Major2	Minor1		
Conflicting Flow All	0	0	251	0	296
Stage 1	-	-	-	-	231
Stage 2	-	-	-	-	65
Critical Hdwy	-	-	4.12	-	6.42
Critical Hdwy Stg 1	-	-	-	-	5.42
Critical Hdwy Stg 2	-	-	-	-	5.42
Follow-up Hdwy	-	-	2.218	-	3.518
Pot Cap-1 Maneuver	-	-	1314	-	695
Stage 1	-	-	-	-	807
Stage 2	-	-	-	-	958
Platoon blocked, %	-	-	-	-	-
Mov Cap-1 Maneuver	-	-	1314	-	694
Mov Cap-2 Maneuver	-	-	-	-	694
Stage 1	-	-	-	-	807
Stage 2	-	-	-	-	956

Approach	EB	WB	NB
HCM Control Delay, s	0	0.3	10.3
HCM LOS			B

Minor Lane/Major Mvmt	NBLn1	EBT	EBR	WBL	WBT
Capacity (veh/h)	699	-	-	1314	-
HCM Lane V/C Ratio	0.037	-	-	0.002	-
HCM Control Delay (s)	10.3	-	-	7.7	0
HCM Lane LOS	B	-	-	A	A
HCM 95th %tile Q(veh)	0.1	-	-	0	-

Intersection												
Int Delay, s/veh	3.1											
Movement	EBL	EBT	EBR	WBL	WBT	WBR	NBL	NBT	NBR	SBL	SBT	SBR
Lane Configurations		↕	↗		↕			↕			↕	
Traffic Vol, veh/h	18	202	66	4	64	6	55	7	10	13	6	9
Future Vol, veh/h	18	202	66	4	64	6	55	7	10	13	6	9
Conflicting Peds, #/hr	0	0	0	0	0	0	0	0	0	0	0	0
Sign Control	Free	Free	Free	Free	Free	Free	Stop	Stop	Stop	Stop	Stop	Stop
RT Channelized	-	-	None	-	-	None	-	-	None	-	-	None
Storage Length	-	-	235	-	-	-	-	-	-	-	-	-
Veh in Median Storage, #	-	0	-	-	0	-	-	0	-	-	0	-
Grade, %	-	0	-	-	0	-	-	0	-	-	0	-
Peak Hour Factor	87	87	87	83	83	83	83	83	83	78	78	78
Heavy Vehicles, %	2	2	2	2	2	2	2	2	2	2	2	2
Mvmt Flow	21	232	76	5	77	7	66	8	12	17	8	12

Major/Minor	Major1			Major2			Minor1			Minor2		
Conflicting Flow All	84	0	0	308	0	0	375	368	232	413	441	81
Stage 1	-	-	-	-	-	-	274	274	-	91	91	-
Stage 2	-	-	-	-	-	-	101	94	-	322	350	-
Critical Hdwy	4.12	-	-	4.12	-	-	7.12	6.52	6.22	7.12	6.52	6.22
Critical Hdwy Stg 1	-	-	-	-	-	-	6.12	5.52	-	6.12	5.52	-
Critical Hdwy Stg 2	-	-	-	-	-	-	6.12	5.52	-	6.12	5.52	-
Follow-up Hdwy	2.218	-	-	2.218	-	-	3.518	4.018	3.318	3.518	4.018	3.318
Pot Cap-1 Maneuver	1513	-	-	1253	-	-	582	561	807	549	510	979
Stage 1	-	-	-	-	-	-	732	683	-	916	820	-
Stage 2	-	-	-	-	-	-	905	817	-	690	633	-
Platoon blocked, %	-	-	-	-	-	-	-	-	-	-	-	-
Mov Cap-1 Maneuver	1513	-	-	1253	-	-	559	549	807	526	499	979
Mov Cap-2 Maneuver	-	-	-	-	-	-	559	549	-	526	499	-
Stage 1	-	-	-	-	-	-	720	671	-	900	817	-
Stage 2	-	-	-	-	-	-	882	814	-	660	622	-

Approach	EB			WB			NB			SB		
HCM Control Delay, s	0.5			0.4			12.3			11.3		
HCM LOS							B			B		

Minor Lane/Major Mvmt	NBLn1	EBL	EBT	EBR	WBL	WBT	WBR	SBLn1
Capacity (veh/h)	583	1513	-	-	1253	-	-	610
HCM Lane V/C Ratio	0.149	0.014	-	-	0.004	-	-	0.059
HCM Control Delay (s)	12.3	7.4	0	-	7.9	0	-	11.3
HCM Lane LOS	B	A	A	-	A	A	-	B
HCM 95th %tile Q(veh)	0.5	0	-	-	0	-	-	0.2

Intersection												
Int Delay, s/veh	2.1											
Movement	SEL	SET	SER	NWL	NWT	NWR	NEL	NET	NER	SWL	SWT	SWR
Lane Configurations	↘	↑	↗	↘	↑	↗	↘	↑	↗	↘	↑	↗
Traffic Vol, veh/h	4	12	90	9	7	11	106	494	20	13	364	4
Future Vol, veh/h	4	12	90	9	7	11	106	494	20	13	364	4
Conflicting Peds, #/hr	0	0	0	0	0	0	0	0	0	0	0	0
Sign Control	Stop	Stop	Stop	Stop	Stop	Stop	Free	Free	Free	Free	Free	Free
RT Channelized	-	-	Free	-	-	Stop	-	-	Yield	-	-	Yield
Storage Length	170	-	250	125	-	25	620	-	550	540	-	480
Veh in Median Storage, #	-	0	-	-	0	-	-	0	-	-	0	-
Grade, %	-	0	-	-	0	-	-	0	-	-	0	-
Peak Hour Factor	83	83	83	78	78	78	93	93	93	92	92	92
Heavy Vehicles, %	2	2	2	2	2	2	2	2	2	2	2	2
Mvmt Flow	5	14	108	12	9	14	114	531	22	14	396	4

Major/Minor	Minor2		Minor1		Major1		Major2					
Conflicting Flow All	1188	1183	-	1190	1183	531	396	0	0	531	0	0
Stage 1	424	424	-	759	759	-	-	-	-	-	-	-
Stage 2	764	759	-	431	424	-	-	-	-	-	-	-
Critical Hdwy	7.12	6.52	-	7.12	6.52	6.22	4.12	-	-	4.12	-	-
Critical Hdwy Stg 1	6.12	5.52	-	6.12	5.52	-	-	-	-	-	-	-
Critical Hdwy Stg 2	6.12	5.52	-	6.12	5.52	-	-	-	-	-	-	-
Follow-up Hdwy	3.518	4.018	-	3.518	4.018	3.318	2.218	-	-	2.218	-	-
Pot Cap-1 Maneuver	165	189	0	165	189	548	1163	-	-	1036	-	-
Stage 1	608	587	0	399	415	-	-	-	-	-	-	-
Stage 2	396	415	0	603	587	-	-	-	-	-	-	-
Platoon blocked, %	-	-	-	-	-	-	-	-	-	-	-	-
Mov Cap-1 Maneuver	141	168	-	141	168	548	1163	-	-	1036	-	-
Mov Cap-2 Maneuver	141	168	-	141	168	-	-	-	-	-	-	-
Stage 1	548	579	-	360	374	-	-	-	-	-	-	-
Stage 2	340	374	-	580	579	-	-	-	-	-	-	-

Approach	SE		NW		NE		SW	
HCM Control Delay, s	29.1		22.9		1.4		0.3	
HCM LOS	D		C					

Minor Lane/Major Mvmt	NEL	NET	NERN	NWLn1	NWLn2	NWLn3	SELn1	SELn2	SELn3	SWL	SWT	SWR
Capacity (veh/h)	1163	-	-	141	168	548	141	168	-	1036	-	-
HCM Lane V/C Ratio	0.098	-	-	0.082	0.053	0.026	0.034	0.086	-	0.014	-	-
HCM Control Delay (s)	8.4	-	-	32.8	27.6	11.7	31.4	28.4	0	8.5	-	-
HCM Lane LOS	A	-	-	D	D	B	D	D	A	A	-	-
HCM 95th %tile Q(veh)	0.3	-	-	0.3	0.2	0.1	0.1	0.3	-	0	-	-

Intersection												
Int Delay, s/veh	9											
Movement	EBL	EBT	EBR	WBL	WBT	WBR	NBL	NBT	NBR	SBL	SBT	SBR
Lane Configurations	↙	↑	↗	↙	↑	↗	↙	↗		↙	↗	
Traffic Vol, veh/h	16	274	50	9	178	42	86	164	17	61	76	14
Future Vol, veh/h	16	274	50	9	178	42	86	164	17	61	76	14
Conflicting Peds, #/hr	0	0	0	0	0	0	0	0	0	0	0	0
Sign Control	Free	Free	Free	Free	Free	Free	Stop	Stop	Stop	Stop	Stop	Stop
RT Channelized	-	-	None	-	-	None	-	-	None	-	-	None
Storage Length	245	-	195	235	-	195	265	-	-	265	-	-
Veh in Median Storage, #	-	0	-	-	0	-	-	0	-	-	0	-
Grade, %	-	0	-	-	0	-	-	0	-	-	0	-
Peak Hour Factor	92	92	92	87	87	87	92	92	92	87	87	87
Heavy Vehicles, %	2	2	2	2	2	2	2	2	2	2	2	2
Mvmt Flow	17	298	54	10	205	48	93	178	18	70	87	16

























Major/Minor	Major1			Major2			Minor1			Minor2		
Conflicting Flow All	253	0	0	352	0	0	633	605	298	682	611	205
Stage 1	-	-	-	-	-	-	332	332	-	225	225	-
Stage 2	-	-	-	-	-	-	301	273	-	457	386	-
Critical Hdwy	4.12	-	-	4.12	-	-	7.12	6.52	6.22	7.12	6.52	6.22
Critical Hdwy Stg 1	-	-	-	-	-	-	6.12	5.52	-	6.12	5.52	-
Critical Hdwy Stg 2	-	-	-	-	-	-	6.12	5.52	-	6.12	5.52	-
Follow-up Hdwy	2.218	-	-	2.218	-	-	3.518	4.018	3.318	3.518	4.018	3.318
Pot Cap-1 Maneuver	1312	-	-	1207	-	-	392	412	741	364	409	836
Stage 1	-	-	-	-	-	-	681	644	-	778	718	-
Stage 2	-	-	-	-	-	-	708	684	-	583	610	-
Platoon blocked, %	-	-	-	-	-	-	-	-	-	-	-	-
Mov Cap-1 Maneuver	1312	-	-	1207	-	-	315	403	741	229	400	836
Mov Cap-2 Maneuver	-	-	-	-	-	-	315	403	-	229	400	-
Stage 1	-	-	-	-	-	-	672	636	-	768	712	-
Stage 2	-	-	-	-	-	-	604	679	-	404	602	-

Approach	EB			WB			NB			SB		
HCM Control Delay, s	0.4			0.3			20.9			20.5		
HCM LOS							C			C		

Minor Lane/Major Mvmt	NBLn1	NBLn2	EBL	EBT	EBR	WBL	WBT	WBR	SBLn1	SBLn2
Capacity (veh/h)	315	421	1312	-	-	1207	-	-	229	435
HCM Lane V/C Ratio	0.297	0.467	0.013	-	-	0.009	-	-	0.306	0.238
HCM Control Delay (s)	21.2	20.8	7.8	-	-	8	-	-	27.5	15.8
HCM Lane LOS	C	C	A	-	-	A	-	-	D	C
HCM 95th %tile Q(veh)	1.2	2.4	0	-	-	0	-	-	1.2	0.9













Lanes, Volumes, Timings
1: US 24 & Judge Orr

2044 Background
AM

												
Lane Group	SEL	SET	SER	NWL	NWT	NWR	NEL	NET	NER	SWL	SWT	SWR
Lane Configurations												
Traffic Volume (vph)	70	151	300	261	134	50	240	675	199	100	1200	100
Future Volume (vph)	70	151	300	261	134	50	240	675	199	100	1200	100
Ideal Flow (vphpl)	1900	1900	1900	1900	1900	1900	1900	1900	1900	1900	1900	1900
Storage Length (ft)	235		235	235		235	860		290	695		290
Storage Lanes	1		1	2		1	2		1	1		1
Taper Length (ft)	200			200			300			300		
Lane Util. Factor	1.00	0.95	1.00	0.97	0.95	1.00	0.97	0.95	1.00	1.00	0.95	1.00
Frt			0.850			0.850			0.850			0.850
Flt Protected	0.950			0.950			0.950			0.950		
Satd. Flow (prot)	1770	3539	1583	3433	3539	1583	3433	3539	1583	1770	3539	1583
Flt Permitted	0.659			0.950			0.950			0.354		
Satd. Flow (perm)	1228	3539	1583	3433	3539	1583	3433	3539	1583	659	3539	1583
Right Turn on Red			Yes			Yes			Yes			Yes
Satd. Flow (RTOR)			248			149			209			149
Link Speed (mph)		45			45			55			55	
Link Distance (ft)		1254			1178			1307			1572	
Travel Time (s)		19.0			17.8			16.2			19.5	
Peak Hour Factor	0.92	0.92	0.92	0.92	0.92	0.92	0.95	0.95	0.95	0.95	0.95	0.95
Adj. Flow (vph)	76	164	326	284	146	54	253	711	209	105	1263	105
Shared Lane Traffic (%)												
Lane Group Flow (vph)	76	164	326	284	146	54	253	711	209	105	1263	105
Enter Blocked Intersection	No	No	No	No	No	No	No	No	No	No	No	No
Lane Alignment	Left	Left	Right	Left	Left	Right	Left	Left	Right	Left	Left	Right
Median Width(ft)		24			24			24			24	
Link Offset(ft)		0			0			0			0	
Crosswalk Width(ft)		16			16			16			16	
Two way Left Turn Lane												
Headway Factor	1.00	1.00	1.00	1.00	1.00	1.00	1.00	1.00	1.00	1.00	1.00	1.00
Turning Speed (mph)	60		60	60		60	60		60	60		60
Number of Detectors	1	2	1	1	2	1	1	2	1	1	2	1
Detector Template	Left	Thru	Right	Left	Thru	Right	Left	Thru	Right	Left	Thru	Right
Leading Detector (ft)	20	100	20	20	100	20	20	100	20	20	100	20
Trailing Detector (ft)	0	0	0	0	0	0	0	0	0	0	0	0
Detector 1 Position(ft)	0	0	0	0	0	0	0	0	0	0	0	0
Detector 1 Size(ft)	20	6	20	20	6	20	20	6	20	20	6	20
Detector 1 Type	Cl+Ex	Cl+Ex	Cl+Ex	Cl+Ex	Cl+Ex	Cl+Ex	Cl+Ex	Cl+Ex	Cl+Ex	Cl+Ex	Cl+Ex	Cl+Ex
Detector 1 Channel												
Detector 1 Extend (s)	0.0	0.0	0.0	0.0	0.0	0.0	0.0	0.0	0.0	0.0	0.0	0.0
Detector 1 Queue (s)	0.0	0.0	0.0	0.0	0.0	0.0	0.0	0.0	0.0	0.0	0.0	0.0
Detector 1 Delay (s)	0.0	0.0	0.0	0.0	0.0	0.0	0.0	0.0	0.0	0.0	0.0	0.0
Detector 2 Position(ft)		94			94			94			94	
Detector 2 Size(ft)		6			6			6			6	
Detector 2 Type		Cl+Ex			Cl+Ex			Cl+Ex			Cl+Ex	
Detector 2 Channel												
Detector 2 Extend (s)		0.0			0.0			0.0			0.0	
Turn Type	pm+pt	NA	Perm	Prot	NA	Perm	Prot	NA	Perm	pm+pt	NA	Perm
Protected Phases	7	4		3	8		5	2		1	6	
Permitted Phases	4		4			8			2	6		6

Lanes, Volumes, Timings
1: US 24 & Judge Orr

2044 Background
AM

												
Lane Group	SEL	SET	SER	NWL	NWT	NWR	NEL	NET	NER	SWL	SWT	SWR
Detector Phase	7	4	4	3	8	8	5	2	2	1	6	6
Switch Phase												
Minimum Initial (s)	5.0	5.0	5.0	5.0	5.0	5.0	5.0	5.0	5.0	5.0	5.0	5.0
Minimum Split (s)	9.5	22.5	22.5	9.5	22.5	22.5	9.5	22.5	22.5	9.5	22.5	22.5
Total Split (s)	17.0	24.0	24.0	19.0	26.0	26.0	23.0	55.0	55.0	12.0	44.0	44.0
Total Split (%)	15.5%	21.8%	21.8%	17.3%	23.6%	23.6%	20.9%	50.0%	50.0%	10.9%	40.0%	40.0%
Maximum Green (s)	12.5	19.5	19.5	14.5	21.5	21.5	18.5	50.5	50.5	7.5	39.5	39.5
Yellow Time (s)	3.5	3.5	3.5	3.5	3.5	3.5	3.5	3.5	3.5	3.5	3.5	3.5
All-Red Time (s)	1.0	1.0	1.0	1.0	1.0	1.0	1.0	1.0	1.0	1.0	1.0	1.0
Lost Time Adjust (s)	0.0	0.0	0.0	0.0	0.0	0.0	0.0	0.0	0.0	0.0	0.0	0.0
Total Lost Time (s)	4.5	4.5	4.5	4.5	4.5	4.5	4.5	4.5	4.5	4.5	4.5	4.5
Lead/Lag	Lead	Lag	Lag	Lead	Lag	Lag	Lead	Lag	Lag	Lead	Lag	Lag
Lead-Lag Optimize?	Yes	Yes	Yes	Yes	Yes	Yes	Yes	Yes	Yes	Yes	Yes	Yes
Vehicle Extension (s)	3.0	3.0	3.0	3.0	3.0	3.0	3.0	3.0	3.0	3.0	3.0	3.0
Recall Mode	None	None	None	None	None	None	None	Max	Max	None	Max	Max
Walk Time (s)		7.0	7.0		7.0	7.0		7.0	7.0		7.0	7.0
Flash Dont Walk (s)		11.0	11.0		11.0	11.0		11.0	11.0		11.0	11.0
Pedestrian Calls (#/hr)		0	0		0	0		0	0		0	0
Act Effct Green (s)	21.1	12.4	12.4	12.7	18.8	18.8	12.8	50.8	50.8	52.2	45.1	45.1
Actuated g/C Ratio	0.21	0.12	0.12	0.13	0.19	0.19	0.13	0.50	0.50	0.52	0.45	0.45
v/c Ratio	0.25	0.38	0.79	0.66	0.22	0.13	0.58	0.40	0.23	0.25	0.80	0.13
Control Delay	28.1	43.1	26.2	50.7	37.0	0.6	47.9	17.5	3.1	11.6	30.8	1.7
Queue Delay	0.0	0.0	0.0	0.0	0.0	0.0	0.0	0.0	0.0	0.0	0.0	0.0
Total Delay	28.1	43.1	26.2	50.7	37.0	0.6	47.9	17.5	3.1	11.6	30.8	1.7
LOS	C	D	C	D	D	A	D	B	A	B	C	A
Approach Delay		31.4			41.0			21.5			27.4	
Approach LOS		C			D			C			C	
Queue Length 50th (ft)	36	52	48	90	43	0	80	143	0	25	354	0
Queue Length 95th (ft)	70	85	148	144	74	0	126	224	40	58	#602	14
Internal Link Dist (ft)		1174			1098			1227			1492	
Turn Bay Length (ft)	235		235	235		235	860		290	695		290
Base Capacity (vph)	370	686	506	494	762	457	631	1776	898	426	1578	788
Starvation Cap Reductn	0	0	0	0	0	0	0	0	0	0	0	0
Spillback Cap Reductn	0	0	0	0	0	0	0	0	0	0	0	0
Storage Cap Reductn	0	0	0	0	0	0	0	0	0	0	0	0
Reduced v/c Ratio	0.21	0.24	0.64	0.57	0.19	0.12	0.40	0.40	0.23	0.25	0.80	0.13

Intersection Summary





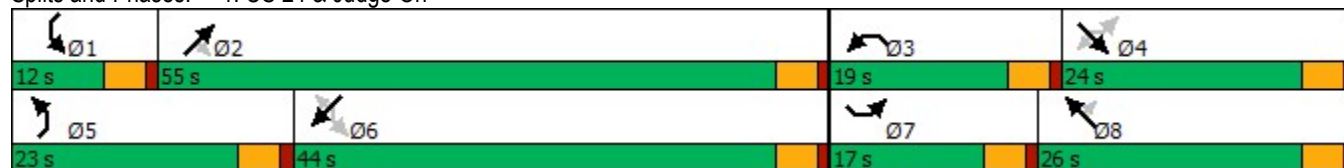



















Area Type: Other
 Cycle Length: 110
 Actuated Cycle Length: 101.1
 Natural Cycle: 90
 Control Type: Actuated-Uncoordinated
 Maximum v/c Ratio: 0.80
 Intersection Signal Delay: 27.9 Intersection LOS: C
 Intersection Capacity Utilization 70.4% ICU Level of Service C
 Analysis Period (min) 15
 # 95th percentile volume exceeds capacity, queue may be longer.
 Queue shown is maximum after two cycles.

Splits and Phases: 1: US 24 & Judge Orr



Lanes, Volumes, Timings
2: US 24 & Stapleton

2044 Background
AM

												
Lane Group	SEL	SET	SER	NWL	NWT	NWR	NEL	NET	NER	SWL	SWT	SWR
Lane Configurations												
Traffic Volume (vph)	175	385	600	75	387	55	300	540	50	123	800	350
Future Volume (vph)	175	385	600	75	387	55	300	540	50	123	800	350
Ideal Flow (vphpl)	1900	1900	1900	1900	1900	1900	1900	1900	1900	1900	1900	1900
Storage Length (ft)	190		325	215		215	890		1000	790		790
Storage Lanes	1		2	1		0	2		1	1		1
Taper Length (ft)	240			200			190			190		
Lane Util. Factor	1.00	0.95	1.00	1.00	0.95	1.00	0.97	0.95	1.00	1.00	0.95	1.00
Frt			0.850			0.850			0.850			0.850
Flt Protected	0.950			0.950			0.950			0.950		
Satd. Flow (prot)	1770	3539	1583	1770	3539	1583	3433	3539	1583	1770	3539	1583
Flt Permitted	0.359			0.506			0.950			0.950		
Satd. Flow (perm)	669	3539	1583	943	3539	1583	3433	3539	1583	1770	3539	1583
Right Turn on Red			Yes			Yes			Yes			Yes
Satd. Flow (RTOR)			483			136			95			317
Link Speed (mph)		45			45			55				55
Link Distance (ft)		1349			5480			1382				1435
Travel Time (s)		20.4			83.0			17.1				17.8
Peak Hour Factor	0.93	0.93	0.93	0.93	0.93	0.93	0.95	0.95	0.95	0.95	0.95	0.95
Adj. Flow (vph)	188	414	645	81	416	59	316	568	53	129	842	368
Shared Lane Traffic (%)												
Lane Group Flow (vph)	188	414	645	81	416	59	316	568	53	129	842	368
Enter Blocked Intersection	No	No	No	No	No	No	No	No	No	No	No	No
Lane Alignment	Left	Left	Right	Left	Left	Right	Left	Left	R NA	L NA	Left	Right
Median Width(ft)		12			12			24				24
Link Offset(ft)		0			0			0				0
Crosswalk Width(ft)		16			16			16				16
Two way Left Turn Lane												
Headway Factor	1.00	1.00	1.00	1.00	1.00	1.00	1.00	1.00	1.00	1.00	1.00	1.00
Turning Speed (mph)	15		9	15		9	15		9	15		9
Number of Detectors	1	2	1	1	2	1	1	2	1	1	2	1
Detector Template	Left	Thru	Right	Left	Thru	Right	Left	Thru	Right	Left	Thru	Right
Leading Detector (ft)	20	100	20	20	100	20	20	100	20	20	100	20
Trailing Detector (ft)	0	0	0	0	0	0	0	0	0	0	0	0
Detector 1 Position(ft)	0	0	0	0	0	0	0	0	0	0	0	0
Detector 1 Size(ft)	20	6	20	20	6	20	20	6	20	20	6	20
Detector 1 Type	Cl+Ex	Cl+Ex	Cl+Ex	Cl+Ex	Cl+Ex	Cl+Ex	Cl+Ex	Cl+Ex	Cl+Ex	Cl+Ex	Cl+Ex	Cl+Ex
Detector 1 Channel												
Detector 1 Extend (s)	0.0	0.0	0.0	0.0	0.0	0.0	0.0	0.0	0.0	0.0	0.0	0.0
Detector 1 Queue (s)	0.0	0.0	0.0	0.0	0.0	0.0	0.0	0.0	0.0	0.0	0.0	0.0
Detector 1 Delay (s)	0.0	0.0	0.0	0.0	0.0	0.0	0.0	0.0	0.0	0.0	0.0	0.0
Detector 2 Position(ft)		94			94			94				94
Detector 2 Size(ft)		6			6			6				6
Detector 2 Type		Cl+Ex			Cl+Ex			Cl+Ex				Cl+Ex
Detector 2 Channel												
Detector 2 Extend (s)		0.0			0.0			0.0				0.0
Turn Type	pm+pt	NA	Perm	pm+pt	NA	Perm	Prot	NA	Perm	Prot	NA	Perm
Protected Phases	1	6		5	2		7	4		3	8	
Permitted Phases	6		6	2		2			4			8

Lanes, Volumes, Timings
2: US 24 & Stapleton

2044 Background
AM

Lane Group	SEL	SET	SER	NWL	NWT	NWR	NEL	NET	NER	SWL	SWT	SWR
Detector Phase	1	6	6	5	2	2	7	4	4	3	8	8
Switch Phase												
Minimum Initial (s)	5.0	5.0	5.0	5.0	5.0	5.0	5.0	5.0	5.0	5.0	5.0	5.0
Minimum Split (s)	9.5	22.5	22.5	9.5	22.5	22.5	9.5	22.5	22.5	9.5	22.5	22.5
Total Split (s)	15.0	25.0	25.0	15.0	25.0	25.0	36.0	60.0	60.0	20.0	44.0	44.0
Total Split (%)	12.5%	20.8%	20.8%	12.5%	20.8%	20.8%	30.0%	50.0%	50.0%	16.7%	36.7%	36.7%
Maximum Green (s)	10.5	20.5	20.5	10.5	20.5	20.5	31.5	55.5	55.5	15.5	39.5	39.5
Yellow Time (s)	3.5	3.5	3.5	3.5	3.5	3.5	3.5	3.5	3.5	3.5	3.5	3.5
All-Red Time (s)	1.0	1.0	1.0	1.0	1.0	1.0	1.0	1.0	1.0	1.0	1.0	1.0
Lost Time Adjust (s)	0.0	0.0	0.0	0.0	0.0	0.0	0.0	0.0	0.0	0.0	0.0	0.0
Total Lost Time (s)	4.5	4.5	4.5	4.5	4.5	4.5	4.5	4.5	4.5	4.5	4.5	4.5
Lead/Lag	Lead	Lag	Lag	Lead	Lag	Lag	Lead	Lag	Lag	Lead	Lag	Lag
Lead-Lag Optimize?	Yes	Yes	Yes	Yes	Yes	Yes	Yes	Yes	Yes	Yes	Yes	Yes
Vehicle Extension (s)	3.0	3.0	3.0	3.0	3.0	3.0	3.0	3.0	3.0	3.0	3.0	3.0
Recall Mode	None	C-Min	C-Min	None	C-Min	C-Min	None	None	None	None	None	None
Act Effect Green (s)	53.6	42.4	42.4	44.3	35.4	35.4	16.4	39.8	39.8	13.1	36.5	36.5
Actuated g/C Ratio	0.45	0.35	0.35	0.37	0.30	0.30	0.14	0.33	0.33	0.11	0.30	0.30
v/c Ratio	0.44	0.33	0.74	0.20	0.40	0.10	0.68	0.48	0.09	0.67	0.78	0.52
Control Delay	26.5	32.8	16.1	24.0	38.1	0.4	56.4	32.7	1.0	68.0	43.4	8.2
Queue Delay	0.0	0.0	0.0	0.0	0.0	0.0	0.0	0.0	0.0	0.0	0.0	0.0
Total Delay	26.5	32.8	16.1	24.0	38.1	0.4	56.4	32.7	1.0	68.0	43.4	8.2
LOS	C	C	B	C	D	A	E	C	A	E	D	A
Approach Delay		23.2			32.1			38.9			36.1	
Approach LOS		C			C			D			D	
Queue Length 50th (ft)	88	126	106	36	136	0	121	185	0	97	312	28
Queue Length 95th (ft)	168	206	#378	80	217	0	163	208	6	161	353	100
Internal Link Dist (ft)		1269			5400			1302			1355	
Turn Bay Length (ft)	190		325	215		215	890		1000	790		790
Base Capacity (vph)	427	1249	871	438	1043	562	901	1636	783	228	1192	743
Starvation Cap Reductn	0	0	0	0	0	0	0	0	0	0	0	0
Spillback Cap Reductn	0	0	0	0	0	0	0	0	0	0	0	0
Storage Cap Reductn	0	0	0	0	0	0	0	0	0	0	0	0
Reduced v/c Ratio	0.44	0.33	0.74	0.18	0.40	0.10	0.35	0.35	0.07	0.57	0.71	0.50

Intersection Summary

Area Type: Other

Cycle Length: 120

Actuated Cycle Length: 120

Offset: 0 (0%), Referenced to phase 2:NWTL and 6:SETL, Start of Green

Natural Cycle: 70

Control Type: Actuated-Coordinated

Maximum v/c Ratio: 0.78

Intersection Signal Delay: 32.3 Intersection LOS: C

Intersection Capacity Utilization 74.7% ICU Level of Service D

Analysis Period (min) 15

























95th percentile volume exceeds capacity, queue may be longer.
Queue shown is maximum after two cycles.

Splits and Phases: 2: US 24 & Stapleton



Lanes, Volumes, Timings
30: US 24 & Elbert

2044 Background
AM

												
Lane Group	SEL	SET	SER	NWL	NWT	NWR	NEL	NET	NER	SWL	SWT	SWR
Lane Configurations												
Traffic Volume (vph)	25	48	175	50	48	27	25	600	75	23	750	10
Future Volume (vph)	25	48	175	50	48	27	25	600	75	23	750	10
Ideal Flow (vphpl)	1900	1900	1900	1900	1900	1900	1900	1900	1900	1900	1900	1900
Storage Length (ft)	170		250	125		25	620		550	540		480
Storage Lanes	1		1	1		1	1		1	1		1
Taper Length (ft)	120			85			300			255		
Lane Util. Factor	1.00	1.00	1.00	1.00	1.00	1.00	1.00	0.95	1.00	1.00	0.95	1.00
Frt			0.850			0.850			0.850			0.850
Flt Protected	0.950			0.950			0.950			0.950		
Satd. Flow (prot)	1770	1863	1583	1770	1863	1583	1770	3539	1583	1770	3539	1583
Flt Permitted	0.719			0.723			0.341			0.407		
Satd. Flow (perm)	1339	1863	1583	1347	1863	1583	635	3539	1583	758	3539	1583
Right Turn on Red			Yes			Yes			Yes			Yes
Satd. Flow (RTOR)			190			33			81			27
Link Speed (mph)		45			45			55			55	
Link Distance (ft)		604			654			977			945	
Travel Time (s)		9.2			9.9			12.1			11.7	
Peak Hour Factor	0.92	0.92	0.92	0.83	0.83	0.83	0.93	0.93	0.93	0.93	0.93	0.93
Adj. Flow (vph)	27	52	190	60	58	33	27	645	81	25	806	11
Shared Lane Traffic (%)												
Lane Group Flow (vph)	27	52	190	60	58	33	27	645	81	25	806	11
Enter Blocked Intersection	No	No	No	No	No	No	No	No	No	No	No	No
Lane Alignment	Left	Left	Right	Left	Left	Right	Left	Left	Right	Left	Left	Right
Median Width(ft)		12			12			12			12	
Link Offset(ft)		0			0			0			0	
Crosswalk Width(ft)		16			16			16			16	
Two way Left Turn Lane												
Headway Factor	1.00	1.00	1.00	1.00	1.00	1.00	1.00	1.00	1.00	1.00	1.00	1.00
Turning Speed (mph)	60		60	60		60	60		60	60		60
Number of Detectors	1	2	1	1	2	1	1	2	1	1	2	1
Detector Template	Left	Thru	Right	Left	Thru	Right	Left	Thru	Right	Left	Thru	Right
Leading Detector (ft)	20	100	20	20	100	20	20	100	20	20	100	20
Trailing Detector (ft)	0	0	0	0	0	0	0	0	0	0	0	0
Detector 1 Position(ft)	0	0	0	0	0	0	0	0	0	0	0	0
Detector 1 Size(ft)	20	6	20	20	6	20	20	6	20	20	6	20
Detector 1 Type	Cl+Ex	Cl+Ex	Cl+Ex	Cl+Ex	Cl+Ex	Cl+Ex	Cl+Ex	Cl+Ex	Cl+Ex	Cl+Ex	Cl+Ex	Cl+Ex
Detector 1 Channel												
Detector 1 Extend (s)	0.0	0.0	0.0	0.0	0.0	0.0	0.0	0.0	0.0	0.0	0.0	0.0
Detector 1 Queue (s)	0.0	0.0	0.0	0.0	0.0	0.0	0.0	0.0	0.0	0.0	0.0	0.0
Detector 1 Delay (s)	0.0	0.0	0.0	0.0	0.0	0.0	0.0	0.0	0.0	0.0	0.0	0.0
Detector 2 Position(ft)		94			94			94			94	
Detector 2 Size(ft)		6			6			6			6	
Detector 2 Type		Cl+Ex			Cl+Ex			Cl+Ex			Cl+Ex	
Detector 2 Channel												
Detector 2 Extend (s)		0.0			0.0			0.0			0.0	
Turn Type	Perm	NA	Perm	Perm	NA	Perm	Perm	NA	Perm	Perm	NA	Perm
Protected Phases		6			2			4			8	
Permitted Phases	6		6	2		2	4		4	8		8

Lanes, Volumes, Timings
30: US 24 & Elbert

2044 Background
AM

Lane Group	SEL	SET	SER	NWL	NWT	NWR	NEL	NET	NER	SWL	SWT	SWR
Detector Phase	6	6	6	2	2	2	4	4	4	8	8	8
Switch Phase												
Minimum Initial (s)	5.0	5.0	5.0	5.0	5.0	5.0	5.0	5.0	5.0	5.0	5.0	5.0
Minimum Split (s)	22.5	22.5	22.5	22.5	22.5	22.5	22.5	22.5	22.5	22.5	22.5	22.5
Total Split (s)	15.0	15.0	15.0	15.0	15.0	15.0	45.0	45.0	45.0	45.0	45.0	45.0
Total Split (%)	25.0%	25.0%	25.0%	25.0%	25.0%	25.0%	75.0%	75.0%	75.0%	75.0%	75.0%	75.0%
Maximum Green (s)	10.5	10.5	10.5	10.5	10.5	10.5	40.5	40.5	40.5	40.5	40.5	40.5
Yellow Time (s)	3.5	3.5	3.5	3.5	3.5	3.5	3.5	3.5	3.5	3.5	3.5	3.5
All-Red Time (s)	1.0	1.0	1.0	1.0	1.0	1.0	1.0	1.0	1.0	1.0	1.0	1.0
Lost Time Adjust (s)	0.0	0.0	0.0	0.0	0.0	0.0	0.0	0.0	0.0	0.0	0.0	0.0
Total Lost Time (s)	4.5	4.5	4.5	4.5	4.5	4.5	4.5	4.5	4.5	4.5	4.5	4.5
Lead/Lag												
Lead-Lag Optimize?												
Vehicle Extension (s)	3.0	3.0	3.0	3.0	3.0	3.0	3.0	3.0	3.0	3.0	3.0	3.0
Recall Mode	None	None	None	None	None	None	Max	Max	Max	Max	Max	Max
Act Effect Green (s)	7.9	7.9	7.9	7.9	7.9	7.9	40.8	40.8	40.8	40.8	40.8	40.8
Actuated g/C Ratio	0.14	0.14	0.14	0.14	0.14	0.14	0.71	0.71	0.71	0.71	0.71	0.71
v/c Ratio	0.15	0.20	0.50	0.33	0.23	0.13	0.06	0.26	0.07	0.05	0.32	0.01
Control Delay	23.4	23.7	9.2	27.2	24.0	10.2	3.5	3.5	1.1	3.3	3.8	0.7
Queue Delay	0.0	0.0	0.0	0.0	0.0	0.0	0.0	0.0	0.0	0.0	0.0	0.0
Total Delay	23.4	23.7	9.2	27.2	24.0	10.2	3.5	3.5	1.1	3.3	3.8	0.7
LOS	C	C	A	C	C	B	A	A	A	A	A	A
Approach Delay		13.4			22.3			3.3			3.8	
Approach LOS		B			C			A			A	
Queue Length 50th (ft)	8	16	0	19	18	0	2	31	0	2	41	0
Queue Length 95th (ft)	27	42	46	44	42	17	9	57	10	8	73	2
Internal Link Dist (ft)		524			574			897			865	
Turn Bay Length (ft)	170		250	125		25	620		550	540		480
Base Capacity (vph)	243	339	443	245	339	315	449	2502	1143	535	2502	1127
Starvation Cap Reductn	0	0	0	0	0	0	0	0	0	0	0	0
Spillback Cap Reductn	0	0	0	0	0	0	0	0	0	0	0	0
Storage Cap Reductn	0	0	0	0	0	0	0	0	0	0	0	0
Reduced v/c Ratio	0.11	0.15	0.43	0.24	0.17	0.10	0.06	0.26	0.07	0.05	0.32	0.01

Intersection Summary

Area Type: Other

Cycle Length: 60

Actuated Cycle Length: 57.7

Natural Cycle: 45

Control Type: Semi Act-Uncoord

Maximum v/c Ratio: 0.50

Intersection Signal Delay: 6.3

Intersection LOS: A

Intersection Capacity Utilization 47.0%

ICU Level of Service A

Analysis Period (min) 15

Splits and Phases: 30: US 24 & Elbert

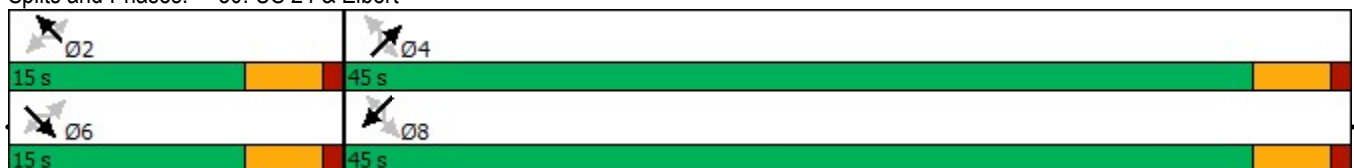

Lanes, Volumes, Timings

Lanes, Volumes, Timings

Intersection									
Intersection Delay, s/veh	7.7								
Intersection LOS	A								
Approach	EB		WB		NB		SB		
Entry Lanes	2		2		2		2		
Conflicting Circle Lanes	2		2		2		2		
Adj Approach Flow, veh/h	321		473		543		548		
Demand Flow Rate, veh/h	327		482		555		559		
Vehicles Circulating, veh/h	589		543		155		508		
Vehicles Exiting, veh/h	478		167		761		517		
Ped Vol Crossing Leg, #/h	0		0		0		0		
Ped Cap Adj	1.000		1.000		1.000		1.000		
Approach Delay, s/veh	6.8		7.4		5.3		10.8		
Approach LOS	A		A		A		B		
Lane	Left	Right	Left	Right	Left	Right	Left	Right	
Designated Moves	LT	TR	LT	TR	L	TR	L	TR	
Assumed Moves	LT	R	LT	TR	L	TR	L	TR	
RT Channelized									
Lane Util	0.306	0.694	0.471	0.529	0.326	0.674	0.098	0.902	
Follow-Up Headway, s	2.667	2.535	2.667	2.535	2.667	2.535	2.667	2.535	
Critical Headway, s	4.645	4.328	4.645	4.328	4.645	4.328	4.645	4.328	
Entry Flow, veh/h	100	227	227	255	181	374	55	504	
Cap Entry Lane, veh/h	785	861	819	895	1170	1245	846	922	
Entry HV Adj Factor	0.984	0.982	0.979	0.983	0.978	0.979	0.982	0.979	
Flow Entry, veh/h	98	223	222	251	177	366	54	494	
Cap Entry, veh/h	772	846	802	879	1145	1219	831	903	
V/C Ratio	0.127	0.264	0.277	0.285	0.155	0.300	0.065	0.547	
Control Delay, s/veh	6.0	7.1	7.6	7.1	4.5	5.7	5.0	11.4	
LOS	A	A	A	A	A	A	A	B	
95th %tile Queue, veh	0	1	1	1	1	1	0	3	

Intersection												
Int Delay, s/veh	10											
Movement	SEL	SET	SER	NWL	NWT	NWR	NEL	NET	NER	SWL	SWT	SWR
Lane Configurations	↘	↑	↗	↘	↑	↗	↘	↑↑	↗	↘	↑↑	↗
Traffic Vol, veh/h	25	48	175	50	48	27	25	600	75	23	750	10
Future Vol, veh/h	25	48	175	50	48	27	25	600	75	23	750	10
Conflicting Peds, #/hr	0	0	0	0	0	0	0	0	0	0	0	0
Sign Control	Stop	Stop	Stop	Stop	Stop	Stop	Free	Free	Free	Free	Free	Free
RT Channelized	-	-	Free	-	-	Stop	-	-	Yield	-	-	Yield
Storage Length	170	-	250	125	-	25	620	-	550	540	-	480
Veh in Median Storage, #	-	0	-	-	0	-	-	0	-	-	0	-
Grade, %	-	0	-	-	0	-	-	0	-	-	0	-
Peak Hour Factor	92	92	92	83	83	83	93	93	93	93	93	93
Heavy Vehicles, %	2	2	2	2	2	2	2	2	2	2	2	2
Mvmt Flow	27	52	190	60	58	33	27	645	81	25	806	11

Major/Minor	Minor2		Minor1		Major1		Major2					
Conflicting Flow All	1262	1555	-	1178	1555	323	806	0	0	645	0	0
Stage 1	856	856	-	699	699	-	-	-	-	-	-	-
Stage 2	406	699	-	479	856	-	-	-	-	-	-	-
Critical Hdwy	7.54	6.54	-	7.54	6.54	6.94	4.14	-	-	4.14	-	-
Critical Hdwy Stg 1	6.54	5.54	-	6.54	5.54	-	-	-	-	-	-	-
Critical Hdwy Stg 2	6.54	5.54	-	6.54	5.54	-	-	-	-	-	-	-
Follow-up Hdwy	3.52	4.02	-	3.52	4.02	3.32	2.22	-	-	2.22	-	-
Pot Cap-1 Maneuver	127	112	0	146	112	673	814	-	-	936	-	-
Stage 1	319	373	0	397	440	-	-	-	-	-	-	-
Stage 2	593	440	0	537	373	-	-	-	-	-	-	-
Platoon blocked, %	-	-	-	-	-	-	-	-	-	-	-	-
Mov Cap-1 Maneuver	65	105	-	85	105	673	814	-	-	936	-	-
Mov Cap-2 Maneuver	65	105	-	85	105	-	-	-	-	-	-	-
Stage 1	308	363	-	384	425	-	-	-	-	-	-	-
Stage 2	471	425	-	448	363	-	-	-	-	-	-	-

Approach	SE		NW		NE		SW	
HCM Control Delay, s	78.2		77.2		0.3		0.3	
HCM LOS	F		F					

Minor Lane/Major Mvmt	NEL	NET	NERNWLn1	NWLn2	NWLn3	SELn1	SELn2	SELn3	SWL	SWT	SWR	
Capacity (veh/h)	814	-	-	85	105	673	65	105	-	936	-	-
HCM Lane V/C Ratio	0.033	-	-	0.709	0.551	0.048	0.418	0.497	-	0.026	-	-
HCM Control Delay (s)	9.6	-	-	115.2	75	10.6	95.5	69.2	0	9	-	-
HCM Lane LOS	A	-	-	F	F	B	F	F	A	A	-	-
HCM 95th %tile Q(veh)	0.1	-	-	3.5	2.6	0.2	1.6	2.2	-	0.1	-	-

Intersection						
Int Delay, s/veh	0.7					
Movement	EBL	EBT	WBT	WBR	SBL	SBR
Lane Configurations		↑↑	↑↑		↑↑	
Traffic Vol, veh/h	5	150	350	25	10	20
Future Vol, veh/h	5	150	350	25	10	20
Conflicting Peds, #/hr	0	0	0	0	0	0
Sign Control	Free	Free	Free	Free	Stop	Stop
RT Channelized	-	None	-	None	-	None
Storage Length	-	-	-	-	0	-
Veh in Median Storage, #	-	0	0	-	0	-
Grade, %	-	0	0	-	0	-
Peak Hour Factor	87	87	92	92	83	83
Heavy Vehicles, %	2	2	2	2	2	2
Mvmt Flow	6	172	380	27	12	24

























Major/Minor	Major1	Major2	Minor2		
Conflicting Flow All	407	0	-	0	492
Stage 1	-	-	-	-	394
Stage 2	-	-	-	-	98
Critical Hdwy	4.14	-	-	-	6.84
Critical Hdwy Stg 1	-	-	-	-	5.84
Critical Hdwy Stg 2	-	-	-	-	5.84
Follow-up Hdwy	2.22	-	-	-	3.52
Pot Cap-1 Maneuver	1148	-	-	-	506
Stage 1	-	-	-	-	650
Stage 2	-	-	-	-	915
Platoon blocked, %		-	-	-	
Mov Cap-1 Maneuver	1148	-	-	-	503
Mov Cap-2 Maneuver	-	-	-	-	503
Stage 1	-	-	-	-	646
Stage 2	-	-	-	-	915

Approach	EB	WB	SB
HCM Control Delay, s	0.3	0	10.7
HCM LOS			B

Minor Lane/Major Mvmt	EBL	EBT	WBT	WBR	SBLn1
Capacity (veh/h)	1148	-	-	-	670
HCM Lane V/C Ratio	0.005	-	-	-	0.054
HCM Control Delay (s)	8.2	0	-	-	10.7
HCM Lane LOS	A	A	-	-	B
HCM 95th %tile Q(veh)	0	-	-	-	0.2

Lanes, Volumes, Timings
1: US 24 & Judge Orr

2044 Background
PM

												
Lane Group	SEL	SET	SER	NWL	NWT	NWR	NEL	NET	NER	SWL	SWT	SWR
Lane Configurations												
Traffic Volume (vph)	195	197	360	432	213	50	420	1235	429	150	790	160
Future Volume (vph)	195	197	360	432	213	50	420	1235	429	150	790	160
Ideal Flow (vphpl)	1900	1900	1900	1900	1900	1900	1900	1900	1900	1900	1900	1900
Storage Length (ft)	235		235	235		235	860		290	695		290
Storage Lanes	1		1	2		1	2		1	1		1
Taper Length (ft)	200			200			300			300		
Lane Util. Factor	1.00	0.95	1.00	0.97	0.95	1.00	0.97	0.95	1.00	1.00	0.95	1.00
Ped Bike Factor	0.79											
Fr _t			0.850			0.850			0.850			0.850
Fl _t Protected	0.950			0.950			0.950			0.950		
Satd. Flow (prot)	1770	3539	1583	3433	3539	1583	3433	3539	1583	1770	3539	1583
Fl _t Permitted	0.609			0.950			0.950			0.125		
Satd. Flow (perm)	892	3539	1583	3433	3539	1583	3433	3539	1583	233	3539	1583
Right Turn on Red			Yes			Yes			Yes			Yes
Satd. Flow (RTOR)			236			149			452			168
Link Speed (mph)		45			45			55				55
Link Distance (ft)		1254			1178			1307				1572
Travel Time (s)		19.0			17.8			16.2				19.5
Confl. Peds. (#/hr)	160											
Peak Hour Factor	0.93	0.93	0.93	0.93	0.93	0.93	0.95	0.99	0.95	0.95	0.95	0.95
Adj. Flow (vph)	210	212	387	465	229	54	442	1247	452	158	832	168
Shared Lane Traffic (%)												
Lane Group Flow (vph)	210	212	387	465	229	54	442	1247	452	158	832	168
Enter Blocked Intersection	No	No	No	No	No	No	No	No	No	No	No	No
Lane Alignment	Left	Left	Right	Left	Left	Right	Left	Left	Right	Left	Left	Right
Median Width(ft)		24			24			24				24
Link Offset(ft)		0			0			0				0
Crosswalk Width(ft)		16			16			16				16
Two way Left Turn Lane												
Headway Factor	1.00	1.00	1.00	1.00	1.00	1.00	1.00	1.00	1.00	1.00	1.00	1.00
Number of Detectors	1	2	1	1	2	1	1	2	1	1	2	1
Detector Template	Left	Thru	Right	Left	Thru	Right	Left	Thru	Right	Left	Thru	Right
Leading Detector (ft)	20	100	20	20	100	20	20	100	20	20	100	20
Trailing Detector (ft)	0	0	0	0	0	0	0	0	0	0	0	0
Detector 1 Position(ft)	0	0	0	0	0	0	0	0	0	0	0	0
Detector 1 Size(ft)	20	6	20	20	6	20	20	6	20	20	6	20
Detector 1 Type	Cl+Ex	Cl+Ex	Cl+Ex	Cl+Ex	Cl+Ex	Cl+Ex	Cl+Ex	Cl+Ex	Cl+Ex	Cl+Ex	Cl+Ex	Cl+Ex
Detector 1 Channel												
Detector 1 Extend (s)	0.0	0.0	0.0	0.0	0.0	0.0	0.0	0.0	0.0	0.0	0.0	0.0
Detector 1 Queue (s)	0.0	0.0	0.0	0.0	0.0	0.0	0.0	0.0	0.0	0.0	0.0	0.0
Detector 1 Delay (s)	0.0	0.0	0.0	0.0	0.0	0.0	0.0	0.0	0.0	0.0	0.0	0.0
Detector 2 Position(ft)		94			94			94				94
Detector 2 Size(ft)		6			6			6				6
Detector 2 Type		Cl+Ex			Cl+Ex			Cl+Ex				Cl+Ex
Detector 2 Channel												
Detector 2 Extend (s)		0.0			0.0			0.0				0.0
Turn Type	pm+pt	NA	Perm	Prot	NA	Perm	Prot	NA	Perm	pm+pt	NA	Perm
Protected Phases	7	4		3	8		5	2		1		6

Lanes, Volumes, Timings
1: US 24 & Judge Orr

2044 Background
PM

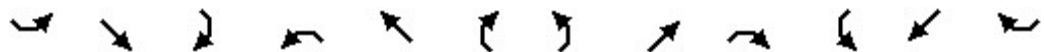

Lane Group	SEL	SET	SER	NWL	NWT	NWR	NEL	NET	NER	SWL	SWT	SWR
Permitted Phases	4		4				8		2	6		6
Detector Phase	7	4	4	3	8	8	5	2	2	1	6	6
Switch Phase												
Minimum Initial (s)	5.0	5.0	5.0	5.0	5.0	5.0	5.0	5.0	5.0	5.0	5.0	5.0
Minimum Split (s)	9.5	22.5	22.5	9.5	22.5	22.5	9.5	22.5	22.5	9.5	22.5	22.5
Total Split (s)	17.0	24.0	24.0	20.0	27.0	27.0	21.0	55.0	55.0	11.0	45.0	45.0
Total Split (%)	15.5%	21.8%	21.8%	18.2%	24.5%	24.5%	19.1%	50.0%	50.0%	10.0%	40.9%	40.9%
Maximum Green (s)	12.5	19.5	19.5	15.5	22.5	22.5	16.5	50.5	50.5	6.5	40.5	40.5
Yellow Time (s)	3.5	3.5	3.5	3.5	3.5	3.5	3.5	3.5	3.5	3.5	3.5	3.5
All-Red Time (s)	1.0	1.0	1.0	1.0	1.0	1.0	1.0	1.0	1.0	1.0	1.0	1.0
Lost Time Adjust (s)	0.0	0.0	0.0	0.0	0.0	0.0	0.0	0.0	0.0	0.0	0.0	0.0
Total Lost Time (s)	4.5	4.5	4.5	4.5	4.5	4.5	4.5	4.5	4.5	4.5	4.5	4.5
Lead/Lag	Lead	Lag	Lag	Lead	Lag	Lag	Lead	Lag	Lag	Lead	Lag	Lag
Lead-Lag Optimize?	Yes	Yes	Yes	Yes	Yes	Yes	Yes	Yes	Yes	Yes	Yes	Yes
Vehicle Extension (s)	3.0	3.0	3.0	3.0	3.0	3.0	3.0	3.0	3.0	3.0	3.0	3.0
Recall Mode	None	None	None	None	None	None	None	Max	Max	None	Max	Max
Walk Time (s)		7.0	7.0		7.0	7.0		7.0	7.0		7.0	7.0
Flash Dont Walk (s)		11.0	11.0		11.0	11.0		11.0	11.0		11.0	11.0
Pedestrian Calls (#/hr)		0	0		0	0		0	0		0	0
Act Effct Green (s)	27.9	15.9	15.9	15.5	19.5	19.5	16.0	50.6	50.6	47.6	41.1	41.1
Actuated g/C Ratio	0.26	0.15	0.15	0.15	0.18	0.18	0.15	0.47	0.47	0.45	0.39	0.39
v/c Ratio	0.63	0.40	0.89	0.93	0.36	0.13	0.86	0.74	0.46	0.80	0.61	0.24
Control Delay	36.4	42.9	39.9	72.5	39.5	0.7	61.7	26.7	3.3	47.5	29.4	4.5
Queue Delay	0.0	0.0	0.0	0.0	0.0	0.0	0.0	0.0	0.0	0.0	0.0	0.0
Total Delay	36.4	42.9	39.9	72.5	39.5	0.7	61.7	26.7	3.3	47.5	29.4	4.5
LOS	D	D	D	E	D	A	E	C	A	D	C	A
Approach Delay		39.8			57.2			29.0			28.3	
Approach LOS		D			E			C			C	
Queue Length 50th (ft)	107	69	104	170	73	0	158	376	0	51	252	0
Queue Length 95th (ft)	169	106	#262	#272	110	0	#241	464	55	#161	320	44
Internal Link Dist (ft)		1174			1098			1227			1492	
Turn Bay Length (ft)	235		235	235		235	860		290	695		290
Base Capacity (vph)	341	648	482	500	748	452	532	1680	989	198	1363	713
Starvation Cap Reductn	0	0	0	0	0	0	0	0	0	0	0	0
Spillback Cap Reductn	0	0	0	0	0	0	0	0	0	0	0	0
Storage Cap Reductn	0	0	0	0	0	0	0	0	0	0	0	0
Reduced v/c Ratio	0.62	0.33	0.80	0.93	0.31	0.12	0.83	0.74	0.46	0.80	0.61	0.24

Intersection Summary

Area Type: Other
 Cycle Length: 110
 Actuated Cycle Length: 106.6
 Natural Cycle: 90
 Control Type: Actuated-Uncoordinated
 Maximum v/c Ratio: 0.93
 Intersection Signal Delay: 35.0 Intersection LOS: C
 Intersection Capacity Utilization 75.2% ICU Level of Service D
 Analysis Period (min) 15
 # 95th percentile volume exceeds capacity, queue may be longer.





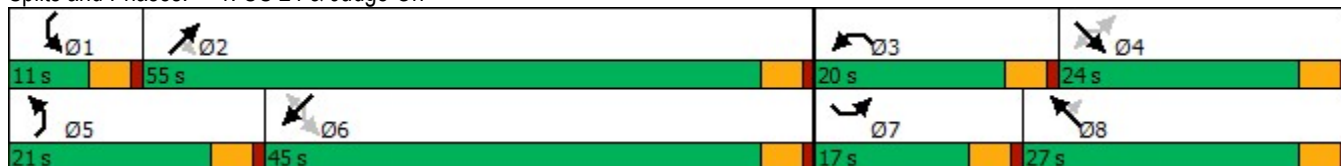





















Queue shown is maximum after two cycles.

Splits and Phases: 1: US 24 & Judge Orr



























Lanes, Volumes, Timings
2: US 24 & Stapleton

2044 Background
PM

													
Lane Group	SEL	SET	SER	NWL	NWT	NWR	NEL	NET	NER	SWL	SWT	SWR	
Lane Configurations													
Traffic Volume (vph)	350	276	700	125	383	179	650	850	125	145	600	350	
Future Volume (vph)	350	276	700	125	383	179	650	850	125	145	600	350	
Ideal Flow (vphpl)	1900	1900	1900	1900	1900	1900	1900	1900	1900	1900	1900	1900	
Storage Length (ft)	190		325	215		215	890		1000	790		790	
Storage Lanes	1		2	1		0	2		1	1		1	
Taper Length (ft)	240			200			190			190			
Lane Util. Factor	1.00	0.95	1.00	1.00	0.95	1.00	0.97	0.95	1.00	1.00	0.95	1.00	
Frt			0.850			0.850			0.850			0.850	
Flt Protected	0.950			0.950			0.950			0.950			
Satd. Flow (prot)	1770	3539	1583	1770	3539	1583	3433	3539	1583	1770	3539	1583	
Flt Permitted	0.231			0.574			0.950			0.950			
Satd. Flow (perm)	430	3539	1583	1069	3539	1583	3433	3539	1583	1770	3539	1583	
Right Turn on Red			Yes			Yes			Yes			Yes	
Satd. Flow (RTOR)			486			192			132			227	
Link Speed (mph)		45			45			55			55		
Link Distance (ft)		1349			5480			1382			1435		
Travel Time (s)		20.4			83.0			17.1			17.8		
Peak Hour Factor	0.95	0.95	0.95	0.93	0.93	0.93	0.95	0.95	0.95	0.95	0.95	0.95	
Adj. Flow (vph)	368	291	737	134	412	192	684	895	132	153	632	368	
Shared Lane Traffic (%)													
Lane Group Flow (vph)	368	291	737	134	412	192	684	895	132	153	632	368	
Enter Blocked Intersection	No	No	No	No	No	No	No	No	No	No	No	No	
Lane Alignment	Left	Left	Right	Left	Left	Right	Left	Left	R NA	L NA	Left	Right	
Median Width(ft)		12			12			24			24		
Link Offset(ft)		0			0			0			0		
Crosswalk Width(ft)		16			16			16			16		
Two way Left Turn Lane													
Headway Factor	1.00	1.00	1.00	1.00	1.00	1.00	1.00	1.00	1.00	1.00	1.00	1.00	
Number of Detectors	1	2	1	1	2	1	1	2	1	1	2	1	
Detector Template	Left	Thru	Right	Left	Thru	Right	Left	Thru	Right	Left	Thru	Right	
Leading Detector (ft)	20	100	20	20	100	20	20	100	20	20	100	20	
Trailing Detector (ft)	0	0	0	0	0	0	0	0	0	0	0	0	
Detector 1 Position(ft)	0	0	0	0	0	0	0	0	0	0	0	0	
Detector 1 Size(ft)	20	6	20	20	6	20	20	6	20	20	6	20	
Detector 1 Type	Cl+Ex	Cl+Ex	Cl+Ex	Cl+Ex	Cl+Ex	Cl+Ex	Cl+Ex	Cl+Ex	Cl+Ex	Cl+Ex	Cl+Ex	Cl+Ex	
Detector 1 Channel													
Detector 1 Extend (s)	0.0	0.0	0.0	0.0	0.0	0.0	0.0	0.0	0.0	0.0	0.0	0.0	
Detector 1 Queue (s)	0.0	0.0	0.0	0.0	0.0	0.0	0.0	0.0	0.0	0.0	0.0	0.0	
Detector 1 Delay (s)	0.0	0.0	0.0	0.0	0.0	0.0	0.0	0.0	0.0	0.0	0.0	0.0	
Detector 2 Position(ft)		94			94			94			94		
Detector 2 Size(ft)		6			6			6			6		
Detector 2 Type		Cl+Ex			Cl+Ex			Cl+Ex			Cl+Ex		
Detector 2 Channel													
Detector 2 Extend (s)		0.0			0.0			0.0			0.0		
Turn Type	pm+pt	NA	Perm	pm+pt	NA	Perm	Prot	NA	Perm	Prot	NA	Perm	
Protected Phases	1	6		5	2		7	4		3	8		
Permitted Phases	6		6	2		2			4			8	
Detector Phase	1	6	6	5	2	2	7	4	4	3	8	8	

Lanes, Volumes, Timings
30: US 24 & Elbert

2044 Background
PM

												
Lane Group	SEL	SET	SER	NWL	NWT	NWR	NEL	NET	NER	SWL	SWT	SWR
Lane Configurations												
Traffic Volume (vph)	10	47	125	25	63	20	140	1050	50	47	875	35
Future Volume (vph)	10	47	125	25	63	20	140	1050	50	47	875	35
Ideal Flow (vphpl)	1900	1900	1900	1900	1900	1900	1900	1900	1900	1900	1900	1900
Storage Length (ft)	170		250	125		25	620		550	540		480
Storage Lanes	1		1	1		1	1		1	1		1
Taper Length (ft)	120			85			300			255		
Lane Util. Factor	1.00	1.00	1.00	1.00	1.00	1.00	1.00	0.95	1.00	1.00	0.95	1.00
Frt			0.850			0.850			0.850			0.850
Flt Protected	0.950			0.950			0.950			0.950		
Satd. Flow (prot)	1770	1863	1583	1770	1863	1583	1770	3539	1583	1770	3539	1583
Flt Permitted	0.708			0.722			0.282			0.227		
Satd. Flow (perm)	1319	1863	1583	1345	1863	1583	525	3539	1583	423	3539	1583
Right Turn on Red			Yes			Yes			Yes			Yes
Satd. Flow (RTOR)			144			27			53			38
Link Speed (mph)		45			45			55			55	
Link Distance (ft)		604			654			977			945	
Travel Time (s)		9.2			9.9			12.1			11.7	
Peak Hour Factor	0.87	0.87	0.87	0.83	0.83	0.83	0.95	0.95	0.95	0.93	0.93	0.93
Adj. Flow (vph)	11	54	144	30	76	24	147	1105	53	51	941	38
Shared Lane Traffic (%)												
Lane Group Flow (vph)	11	54	144	30	76	24	147	1105	53	51	941	38
Enter Blocked Intersection	No	No	No	No	No	No	No	No	No	No	No	No
Lane Alignment	Left	Left	Right	Left	Left	Right	Left	Left	Right	Left	Left	Right
Median Width(ft)		12			12			12			12	
Link Offset(ft)		0			0			0			0	
Crosswalk Width(ft)		16			16			16			16	
Two way Left Turn Lane												
Headway Factor	1.00	1.00	1.00	1.00	1.00	1.00	1.00	1.00	1.00	1.00	1.00	1.00
Number of Detectors	1	2	1	1	2	1	1	2	1	1	2	1
Detector Template	Left	Thru	Right	Left	Thru	Right	Left	Thru	Right	Left	Thru	Right
Leading Detector (ft)	20	100	20	20	100	20	20	100	20	20	100	20
Trailing Detector (ft)	0	0	0	0	0	0	0	0	0	0	0	0
Detector 1 Position(ft)	0	0	0	0	0	0	0	0	0	0	0	0
Detector 1 Size(ft)	20	6	20	20	6	20	20	6	20	20	6	20
Detector 1 Type	Cl+Ex	Cl+Ex	Cl+Ex	Cl+Ex	Cl+Ex	Cl+Ex	Cl+Ex	Cl+Ex	Cl+Ex	Cl+Ex	Cl+Ex	Cl+Ex
Detector 1 Channel												
Detector 1 Extend (s)	0.0	0.0	0.0	0.0	0.0	0.0	0.0	0.0	0.0	0.0	0.0	0.0
Detector 1 Queue (s)	0.0	0.0	0.0	0.0	0.0	0.0	0.0	0.0	0.0	0.0	0.0	0.0
Detector 1 Delay (s)	0.0	0.0	0.0	0.0	0.0	0.0	0.0	0.0	0.0	0.0	0.0	0.0
Detector 2 Position(ft)		94			94			94			94	
Detector 2 Size(ft)		6			6			6			6	
Detector 2 Type		Cl+Ex			Cl+Ex			Cl+Ex			Cl+Ex	
Detector 2 Channel												
Detector 2 Extend (s)		0.0			0.0			0.0			0.0	
Turn Type	Perm	NA	Perm	Perm	NA	Perm	Perm	NA	Perm	Perm	NA	Perm
Protected Phases		6			2			4			8	
Permitted Phases	6		6	2		2	4		4	8		8
Detector Phase	6	6	6	2	2	2	4	4	4	8	8	8

Intersection									
Intersection Delay, s/veh	9.4								
Intersection LOS	A								
Approach	EB		WB		NB		SB		
Entry Lanes	2		2		2		2		
Conflicting Circle Lanes	2		2		2		2		
Adj Approach Flow, veh/h	442		290		885		550		
Demand Flow Rate, veh/h	451		296		903		561		
Vehicles Circulating, veh/h	570		873		445		473		
Vehicles Exiting, veh/h	464		475		576		696		
Ped Vol Crossing Leg, #/h	0		0		0		0		
Ped Cap Adj	1.000		1.000		1.000		1.000		
Approach Delay, s/veh	7.3		8.6		11.5		8.1		
Approach LOS	A		A		B		A		
Lane	Left	Right	Left	Right	Left	Right	Left	Right	
Designated Moves	LT	TR	LT	TR	L	TR	L	TR	
Assumed Moves	LT	TR	LT	TR	L	TR	L	TR	
RT Channelized									
Lane Util	0.470	0.530	0.470	0.530	0.317	0.683	0.276	0.724	
Follow-Up Headway, s	2.667	2.535	2.667	2.535	2.667	2.535	2.667	2.535	
Critical Headway, s	4.645	4.328	4.645	4.328	4.645	4.328	4.645	4.328	
Entry Flow, veh/h	212	239	139	157	286	617	155	406	
Cap Entry Lane, veh/h	799	875	605	676	896	973	874	950	
Entry HV Adj Factor	0.980	0.980	0.981	0.979	0.979	0.981	0.981	0.979	
Flow Entry, veh/h	208	234	136	154	280	605	152	398	
Cap Entry, veh/h	783	857	593	662	878	954	857	930	
V/C Ratio	0.265	0.273	0.230	0.232	0.319	0.634	0.177	0.427	
Control Delay, s/veh	7.6	7.1	9.0	8.2	7.6	13.2	6.0	8.9	
LOS	A	A	A	A	A	B	A	A	
95th %tile Queue, veh	1	1	1	1	1	5	1	2	

Intersection												
Int Delay, s/veh	0.9											
Movement	SEL	SET	SER	NWL	NWT	NWR	NEL	NET	NER	SWL	SWT	SWR
Lane Configurations	↘	↑	↗	↘	↑	↗	↘	↑↑	↗	↘	↑↑	↗
Traffic Vol, veh/h	10	47	125	25	63	20	140	1050	50	47	875	35
Future Vol, veh/h	10	47	125	25	63	20	140	1050	50	47	875	35
Conflicting Peds, #/hr	0	0	0	0	0	0	0	0	0	0	0	0
Sign Control	Stop	Stop	Stop	Stop	Stop	Stop	Free	Free	Free	Free	Free	Free
RT Channelized	-	-	Free	-	-	Stop	-	-	Yield	-	-	Yield
Storage Length	170	-	250	125	-	25	620	-	550	540	-	480
Veh in Median Storage, #	-	0	-	-	0	-	-	0	-	-	0	-
Grade, %	-	0	-	-	0	-	-	0	-	-	0	-
Peak Hour Factor	87	87	87	83	83	83	95	95	95	93	93	93
Heavy Vehicles, %	2	2	2	2	2	2	2	2	2	2	2	2
Mvmt Flow	11	54	144	30	76	24	147	1105	53	51	941	38

Major/Minor	Minor2		Minor1		Major1		Major2					
Conflicting Flow All	1928	2442	-	1999	2442	553	941	0	0	1105	0	0
Stage 1	1043	1043	-	1399	1399	-	-	-	-	-	-	-
Stage 2	885	1399	-	600	1043	-	-	-	-	-	-	-
Critical Hdwy	7.54	6.54	-	7.54	6.54	6.94	4.14	-	-	4.14	-	-
Critical Hdwy Stg 1	6.54	5.54	-	6.54	5.54	-	-	-	-	-	-	-
Critical Hdwy Stg 2	6.54	5.54	-	6.54	5.54	-	-	-	-	-	-	-
Follow-up Hdwy	3.52	4.02	-	3.52	4.02	3.32	2.22	-	-	2.22	-	-
Pot Cap-1 Maneuver	40	~ 31	0	35	~ 31	477	724	-	-	628	-	-
Stage 1	245	305	0	148	206	-	-	-	-	-	-	-
Stage 2	306	206	0	455	305	-	-	-	-	-	-	-
Platoon blocked, %	-	-	-	-	-	-	-	-	-	-	-	-
Mov Cap-1 Maneuver	-	~ 23	-	-	~ 23	477	724	-	-	628	-	-
Mov Cap-2 Maneuver	-	~ 23	-	-	~ 23	-	-	-	-	-	-	-
Stage 1	195	280	-	118	164	-	-	-	-	-	-	-
Stage 2	124	164	-	337	280	-	-	-	-	-	-	-

Approach	SE		NW		NE		SW	
HCM Control Delay, s					1.3		0.6	
HCM LOS	-		-					

Minor Lane/Major Mvmt	NEL	NET	NERNWLn1	NWLn2	NWLn3	SELn1	SELn2	SELn3	SWL	SWT	SWR	
Capacity (veh/h)	724	-	-	-	23	477	-	23	-	628	-	-
HCM Lane V/C Ratio	0.204	-	-	-	3.3	0.051	-	2.349	-	0.08	-	-
HCM Control Delay (s)	11.2	-	-	-	\$ 1386.4	12.9	-	\$ 972.5	0	11.2	-	-
HCM Lane LOS	B	-	-	-	F	B	-	F	A	B	-	-
HCM 95th %tile Q(veh)	0.8	-	-	-	9.6	0.2	-	6.8	-	0.3	-	-

Notes
 ~: Volume exceeds capacity \$: Delay exceeds 300s +: Computation Not Defined *: All major volume in platoon

Intersection						
Int Delay, s/veh	1.8					
Movement	EBL	EBT	WBT	WBR	SBL	SBR
Lane Configurations		↑↑	↑↑		↑↑	
Traffic Vol, veh/h	20	300	150	10	50	15
Future Vol, veh/h	20	300	150	10	50	15
Conflicting Peds, #/hr	0	0	0	0	0	0
Sign Control	Free	Free	Free	Free	Stop	Stop
RT Channelized	-	None	-	None	-	None
Storage Length	-	-	-	-	0	-
Veh in Median Storage, #	-	0	0	-	0	-
Grade, %	-	0	0	-	0	-
Peak Hour Factor	92	92	87	87	83	83
Heavy Vehicles, %	2	2	2	2	2	2
Mvmt Flow	22	326	172	11	60	18



























Major/Minor	Major1	Major2	Minor2		
Conflicting Flow All	183	0	-	0	385 92
Stage 1	-	-	-	-	178 -
Stage 2	-	-	-	-	207 -
Critical Hdwy	4.14	-	-	-	6.84 6.94
Critical Hdwy Stg 1	-	-	-	-	5.84 -
Critical Hdwy Stg 2	-	-	-	-	5.84 -
Follow-up Hdwy	2.22	-	-	-	3.52 3.32
Pot Cap-1 Maneuver	1389	-	-	-	591 947
Stage 1	-	-	-	-	835 -
Stage 2	-	-	-	-	807 -
Platoon blocked, %		-	-	-	
Mov Cap-1 Maneuver	1389	-	-	-	580 947
Mov Cap-2 Maneuver	-	-	-	-	580 -
Stage 1	-	-	-	-	819 -
Stage 2	-	-	-	-	807 -

Approach	EB	WB	SB
HCM Control Delay, s	0.6	0	11.4
HCM LOS			B

Minor Lane/Major Mvmt	EBL	EBT	WBT	WBR	SBLn1
Capacity (veh/h)	1389	-	-	-	637
HCM Lane V/C Ratio	0.016	-	-	-	0.123
HCM Control Delay (s)	7.6	0.1	-	-	11.4
HCM Lane LOS	A	A	-	-	B
HCM 95th %tile Q(veh)	0	-	-	-	0.4













Lanes, Volumes, Timings
1: US 24 & Judge Orr

2044 Background + Site
AM

													
Lane Group	SEL	SET	SER	NWL	NWT	NWR	NEL	NET	NER	SWL	SWT	SWR	
Lane Configurations													
Traffic Volume (vph)	70	160	300	315	140	50	240	675	225	100	1200	100	
Future Volume (vph)	70	160	300	315	140	50	240	675	225	100	1200	100	
Ideal Flow (vphpl)	1900	1900	1900	1900	1900	1900	1900	1900	1900	1900	1900	1900	
Storage Length (ft)	235		235	235		235	860		290	695		290	
Storage Lanes	1		1	2		1	2		1	1		1	
Taper Length (ft)	200			200			300			300			
Lane Util. Factor	1.00	0.95	1.00	0.97	0.95	1.00	0.97	0.95	1.00	1.00	0.95	1.00	
Frt			0.850			0.850			0.850			0.850	
Flt Protected	0.950			0.950			0.950			0.950			
Satd. Flow (prot)	1770	3539	1583	3433	3539	1583	3433	3539	1583	1770	3539	1583	
Flt Permitted	0.656			0.950			0.950			0.356			
Satd. Flow (perm)	1222	3539	1583	3433	3539	1583	3433	3539	1583	663	3539	1583	
Right Turn on Red			Yes			Yes			Yes			Yes	
Satd. Flow (RTOR)			272			149			237			149	
Link Speed (mph)		45			45			55				55	
Link Distance (ft)		1254			1178			1307				1572	
Travel Time (s)		19.0			17.8			16.2				19.5	
Peak Hour Factor	0.92	0.92	0.92	0.92	0.92	0.92	0.95	0.95	0.95	0.95	0.95	0.95	
Adj. Flow (vph)	76	174	326	342	152	54	253	711	237	105	1263	105	
Shared Lane Traffic (%)													
Lane Group Flow (vph)	76	174	326	342	152	54	253	711	237	105	1263	105	
Enter Blocked Intersection	No	No	No	No	No	No	No	No	No	No	No	No	
Lane Alignment	Left	Left	Right	Left	Left	Right	Left	Left	Right	Left	Left	Right	
Median Width(ft)		24			24			24				24	
Link Offset(ft)		0			0			0				0	
Crosswalk Width(ft)		16			16			16				16	
Two way Left Turn Lane													
Headway Factor	1.00	1.00	1.00	1.00	1.00	1.00	1.00	1.00	1.00	1.00	1.00	1.00	
Turning Speed (mph)	60		60	60		60	60		60	60		60	
Number of Detectors	1	2	1	1	2	1	1	2	1	1	2	1	
Detector Template	Left	Thru	Right	Left	Thru	Right	Left	Thru	Right	Left	Thru	Right	
Leading Detector (ft)	20	100	20	20	100	20	20	100	20	20	100	20	
Trailing Detector (ft)	0	0	0	0	0	0	0	0	0	0	0	0	
Detector 1 Position(ft)	0	0	0	0	0	0	0	0	0	0	0	0	
Detector 1 Size(ft)	20	6	20	20	6	20	20	6	20	20	6	20	
Detector 1 Type	Cl+Ex	Cl+Ex	Cl+Ex	Cl+Ex	Cl+Ex	Cl+Ex	Cl+Ex	Cl+Ex	Cl+Ex	Cl+Ex	Cl+Ex	Cl+Ex	
Detector 1 Channel													
Detector 1 Extend (s)	0.0	0.0	0.0	0.0	0.0	0.0	0.0	0.0	0.0	0.0	0.0	0.0	
Detector 1 Queue (s)	0.0	0.0	0.0	0.0	0.0	0.0	0.0	0.0	0.0	0.0	0.0	0.0	
Detector 1 Delay (s)	0.0	0.0	0.0	0.0	0.0	0.0	0.0	0.0	0.0	0.0	0.0	0.0	
Detector 2 Position(ft)		94			94			94				94	
Detector 2 Size(ft)		6			6			6				6	
Detector 2 Type		Cl+Ex			Cl+Ex			Cl+Ex				Cl+Ex	
Detector 2 Channel													
Detector 2 Extend (s)		0.0			0.0			0.0				0.0	
Turn Type	pm+pt	NA	Perm	Prot	NA	Perm	Prot	NA	Perm	pm+pt	NA	Perm	
Protected Phases	7	4		3	8		5	2		1	6		
Permitted Phases	4		4			8			2	6		6	

Lanes, Volumes, Timings
1: US 24 & Judge Orr

2044 Background + Site
AM

												
Lane Group	SEL	SET	SER	NWL	NWT	NWR	NEL	NET	NER	SWL	SWT	SWR
Detector Phase	7	4	4	3	8	8	5	2	2	1	6	6
Switch Phase												
Minimum Initial (s)	5.0	5.0	5.0	5.0	5.0	5.0	5.0	5.0	5.0	5.0	5.0	5.0
Minimum Split (s)	9.5	22.5	22.5	9.5	22.5	22.5	9.5	22.5	22.5	9.5	22.5	22.5
Total Split (s)	15.0	24.0	24.0	17.0	26.0	26.0	25.0	57.0	57.0	12.0	44.0	44.0
Total Split (%)	13.6%	21.8%	21.8%	15.5%	23.6%	23.6%	22.7%	51.8%	51.8%	10.9%	40.0%	40.0%
Maximum Green (s)	10.5	19.5	19.5	12.5	21.5	21.5	20.5	52.5	52.5	7.5	39.5	39.5
Yellow Time (s)	3.5	3.5	3.5	3.5	3.5	3.5	3.5	3.5	3.5	3.5	3.5	3.5
All-Red Time (s)	1.0	1.0	1.0	1.0	1.0	1.0	1.0	1.0	1.0	1.0	1.0	1.0
Lost Time Adjust (s)	0.0	0.0	0.0	0.0	0.0	0.0	0.0	0.0	0.0	0.0	0.0	0.0
Total Lost Time (s)	4.5	4.5	4.5	4.5	4.5	4.5	4.5	4.5	4.5	4.5	4.5	4.5
Lead/Lag	Lead	Lag	Lag	Lead	Lag	Lag	Lead	Lag	Lag	Lead	Lag	Lag
Lead-Lag Optimize?	Yes	Yes	Yes	Yes	Yes	Yes	Yes	Yes	Yes	Yes	Yes	Yes
Vehicle Extension (s)	3.0	3.0	3.0	3.0	3.0	3.0	3.0	3.0	3.0	3.0	3.0	3.0
Recall Mode	None	None	None	None	None	None	None	Max	Max	None	Max	Max
Walk Time (s)		7.0	7.0		7.0	7.0		7.0	7.0		7.0	7.0
Flash Dont Walk (s)		11.0	11.0		11.0	11.0		11.0	11.0		11.0	11.0
Pedestrian Calls (#/hr)		0	0		0	0		0	0		0	0
Act Effct Green (s)	20.5	12.1	12.1	12.4	18.3	18.3	12.8	52.6	52.6	54.0	46.9	46.9
Actuated g/C Ratio	0.20	0.12	0.12	0.12	0.18	0.18	0.13	0.51	0.51	0.53	0.46	0.46
v/c Ratio	0.26	0.42	0.77	0.82	0.24	0.13	0.59	0.39	0.26	0.25	0.78	0.13
Control Delay	29.7	44.5	21.6	61.5	38.5	0.7	48.4	16.5	2.8	10.7	28.9	1.6
Queue Delay	0.0	0.0	0.0	0.0	0.0	0.0	0.0	0.0	0.0	0.0	0.0	0.0
Total Delay	29.7	44.5	21.6	61.5	38.5	0.7	48.4	16.5	2.8	10.7	28.9	1.6
LOS	C	D	C	E	D	A	D	B	A	B	C	A
Approach Delay		29.6			49.1			20.5			25.6	
Approach LOS		C			D			C			C	
Queue Length 50th (ft)	37	56	33	111	46	0	80	137	0	23	341	0
Queue Length 95th (ft)	72	89	127	#204	77	0	126	215	41	55	#577	14
Internal Link Dist (ft)		1174			1098			1227			1492	
Turn Bay Length (ft)	235		235	235		235	860		290	695		290
Base Capacity (vph)	326	676	522	420	764	458	689	1821	929	434	1623	806
Starvation Cap Reductn	0	0	0	0	0	0	0	0	0	0	0	0
Spillback Cap Reductn	0	0	0	0	0	0	0	0	0	0	0	0
Storage Cap Reductn	0	0	0	0	0	0	0	0	0	0	0	0
Reduced v/c Ratio	0.23	0.26	0.62	0.81	0.20	0.12	0.37	0.39	0.26	0.24	0.78	0.13

Intersection Summary

Area Type: Other
 Cycle Length: 110
 Actuated Cycle Length: 102.3
 Natural Cycle: 90
 Control Type: Actuated-Uncoordinated
 Maximum v/c Ratio: 0.82
 Intersection Signal Delay: 28.0 Intersection LOS: C
 Intersection Capacity Utilization 72.0% ICU Level of Service C
 Analysis Period (min) 15
 # 95th percentile volume exceeds capacity, queue may be longer.
 Queue shown is maximum after two cycles.

Splits and Phases: 1: US 24 & Judge Orr

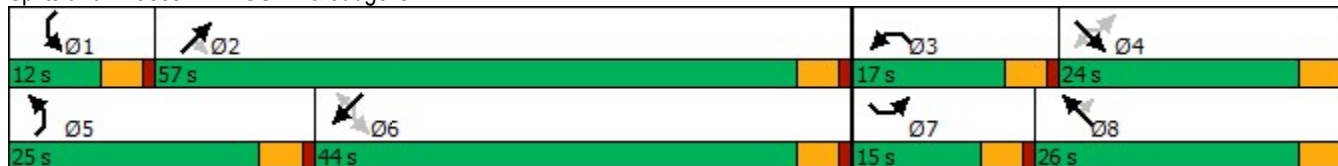

Lanes, Volumes, Timings
2: US 24 & Stapleton

2044 Background + Site
AM

Lane Group	SEL	SET	SER	NWL	NWT	NWR	NEL	NET	NER	SWL	SWT	SWR
Lane Configurations												
Traffic Volume (vph)	175	400	600	75	405	55	300	540	50	123	800	350
Future Volume (vph)	175	400	600	75	405	55	300	540	50	123	800	350
Ideal Flow (vphpl)	1900	1900	1900	1900	1900	1900	1900	1900	1900	1900	1900	1900
Storage Length (ft)	190		325	215		215	890		1000	790		790
Storage Lanes	1		2	1		0	2		1	1		1
Taper Length (ft)	240			200			190			190		
Lane Util. Factor	1.00	0.95	1.00	1.00	0.95	1.00	0.97	0.95	1.00	1.00	0.95	1.00
Frt			0.850			0.850			0.850			0.850
Flt Protected	0.950			0.950			0.950			0.950		
Satd. Flow (prot)	1770	3539	1583	1770	3539	1583	3433	3539	1583	1770	3539	1583
Flt Permitted	0.337			0.490			0.950			0.950		
Satd. Flow (perm)	628	3539	1583	913	3539	1583	3433	3539	1583	1770	3539	1583
Right Turn on Red			Yes			Yes			Yes			Yes
Satd. Flow (RTOR)			379			136			95			289
Link Speed (mph)		45			45			55			55	
Link Distance (ft)		1349			5480			1382			1435	
Travel Time (s)		20.4			83.0			17.1			17.8	
Peak Hour Factor	0.95	0.95	0.95	0.92	0.92	0.92	0.93	0.93	0.93	0.95	0.95	0.95
Adj. Flow (vph)	184	421	632	82	440	60	323	581	54	129	842	368
Shared Lane Traffic (%)												
Lane Group Flow (vph)	184	421	632	82	440	60	323	581	54	129	842	368
Enter Blocked Intersection	No	No	No	No	No	No	No	No	No	No	No	No
Lane Alignment	Left	Left	Right	Left	Left	Right	Left	Left	R NA	L NA	Left	Right
Median Width(ft)		12			12			24			24	
Link Offset(ft)		0			0			0			0	
Crosswalk Width(ft)		16			16			16			16	
Two way Left Turn Lane												
Headway Factor	1.00	1.00	1.00	1.00	1.00	1.00	1.00	1.00	1.00	1.00	1.00	1.00
Turning Speed (mph)	15		9	15		9	15		9	15		9
Number of Detectors	1	2	1	1	2	1	1	2	1	1	2	1
Detector Template	Left	Thru	Right	Left	Thru	Right	Left	Thru	Right	Left	Thru	Right
Leading Detector (ft)	20	100	20	20	100	20	20	100	20	20	100	20
Trailing Detector (ft)	0	0	0	0	0	0	0	0	0	0	0	0
Detector 1 Position(ft)	0	0	0	0	0	0	0	0	0	0	0	0
Detector 1 Size(ft)	20	6	20	20	6	20	20	6	20	20	6	20
Detector 1 Type	Cl+Ex	Cl+Ex	Cl+Ex	Cl+Ex	Cl+Ex	Cl+Ex	Cl+Ex	Cl+Ex	Cl+Ex	Cl+Ex	Cl+Ex	Cl+Ex
Detector 1 Channel												
Detector 1 Extend (s)	0.0	0.0	0.0	0.0	0.0	0.0	0.0	0.0	0.0	0.0	0.0	0.0
Detector 1 Queue (s)	0.0	0.0	0.0	0.0	0.0	0.0	0.0	0.0	0.0	0.0	0.0	0.0
Detector 1 Delay (s)	0.0	0.0	0.0	0.0	0.0	0.0	0.0	0.0	0.0	0.0	0.0	0.0
Detector 2 Position(ft)		94			94			94			94	
Detector 2 Size(ft)		6			6			6			6	
Detector 2 Type		Cl+Ex			Cl+Ex			Cl+Ex			Cl+Ex	
Detector 2 Channel												
Detector 2 Extend (s)		0.0			0.0			0.0			0.0	
Turn Type	pm+pt	NA	Perm	pm+pt	NA	Perm	Prot	NA	Perm	Prot	NA	Perm
Protected Phases	1	6		5	2		7	4		3	8	
Permitted Phases	6		6	2		2			4			8

Lanes, Volumes, Timings
2: US 24 & Stapleton

2044 Background + Site
AM



Lane Group	SEL	SET	SER	NWL	NWT	NWR	NEL	NET	NER	SWL	SWT	SWR
Detector Phase	1	6	6	5	2	2	7	4	4	3	8	8
Switch Phase												
Minimum Initial (s)	5.0	5.0	5.0	5.0	5.0	5.0	5.0	5.0	5.0	5.0	5.0	5.0
Minimum Split (s)	9.5	22.5	22.5	9.5	22.5	22.5	9.5	22.5	22.5	9.5	22.5	22.5
Total Split (s)	15.0	25.0	25.0	15.0	25.0	25.0	27.0	60.0	60.0	20.0	53.0	53.0
Total Split (%)	12.5%	20.8%	20.8%	12.5%	20.8%	20.8%	22.5%	50.0%	50.0%	16.7%	44.2%	44.2%
Maximum Green (s)	10.5	20.5	20.5	10.5	20.5	20.5	22.5	55.5	55.5	15.5	48.5	48.5
Yellow Time (s)	3.5	3.5	3.5	3.5	3.5	3.5	3.5	3.5	3.5	3.5	3.5	3.5
All-Red Time (s)	1.0	1.0	1.0	1.0	1.0	1.0	1.0	1.0	1.0	1.0	1.0	1.0
Lost Time Adjust (s)	0.0	0.0	0.0	0.0	0.0	0.0	0.0	0.0	0.0	0.0	0.0	0.0
Total Lost Time (s)	4.5	4.5	4.5	4.5	4.5	4.5	4.5	4.5	4.5	4.5	4.5	4.5
Lead/Lag	Lead	Lag	Lag	Lead	Lag	Lag	Lead	Lag	Lag	Lead	Lag	Lag
Lead-Lag Optimize?	Yes	Yes	Yes	Yes	Yes	Yes	Yes	Yes	Yes	Yes	Yes	Yes
Vehicle Extension (s)	3.0	3.0	3.0	3.0	3.0	3.0	3.0	3.0	3.0	3.0	3.0	3.0
Recall Mode	None	C-Min	C-Min	None	C-Min	C-Min	None	None	None	None	None	None
Walk Time (s)		7.0	7.0		7.0	7.0		7.0	7.0		7.0	7.0
Flash Dont Walk (s)		11.0	11.0		11.0	11.0		11.0	11.0		11.0	11.0
Pedestrian Calls (#/hr)		0	0		0	0		0	0		0	0
Act Effct Green (s)	52.1	41.2	41.2	43.7	34.7	34.7	16.5	40.8	40.8	13.1	37.4	37.4
Actuated g/C Ratio	0.43	0.34	0.34	0.36	0.29	0.29	0.14	0.34	0.34	0.11	0.31	0.31
v/c Ratio	0.46	0.35	0.80	0.21	0.43	0.11	0.68	0.48	0.09	0.67	0.76	0.53
Control Delay	27.7	34.0	24.7	24.9	39.1	0.4	56.7	31.9	1.1	68.0	41.8	10.0
Queue Delay	0.0	0.0	0.0	0.0	0.0	0.0	0.0	0.0	0.0	0.0	0.0	0.0
Total Delay	27.7	34.0	24.7	24.9	39.1	0.4	56.7	31.9	1.1	68.0	41.8	10.0
LOS	C	C	C	C	D	A	E	C	A	E	D	A
Approach Delay		28.3			33.1			38.6			35.5	
Approach LOS		C			C			D			D	
Queue Length 50th (ft)	88	130	193	37	147	0	124	187	0	97	308	44
Queue Length 95th (ft)	167	214	#504	83	230	0	167	207	6	161	345	119
Internal Link Dist (ft)		1269			5400			1302			1355	
Turn Bay Length (ft)	190		325	215		215	890		1000	790		790
Base Capacity (vph)	402	1213	792	424	1021	553	643	1636	783	228	1430	811
Starvation Cap Reductn	0	0	0	0	0	0	0	0	0	0	0	0
Spillback Cap Reductn	0	0	0	0	0	0	0	0	0	0	0	0
Storage Cap Reductn	0	0	0	0	0	0	0	0	0	0	0	0
Reduced v/c Ratio	0.46	0.35	0.80	0.19	0.43	0.11	0.50	0.36	0.07	0.57	0.59	0.45

Intersection Summary

Area Type:	Other
Cycle Length:	120
Actuated Cycle Length:	120
Offset:	0 (0%), Referenced to phase 2:NWTL and 6:SETL, Start of Green
Natural Cycle:	70
Control Type:	Actuated-Coordinated
Maximum v/c Ratio:	0.80
Intersection Signal Delay:	33.7
Intersection LOS:	C
Intersection Capacity Utilization:	74.7%
ICU Level of Service:	D
Analysis Period (min):	15

95th percentile volume exceeds capacity, queue may be longer.





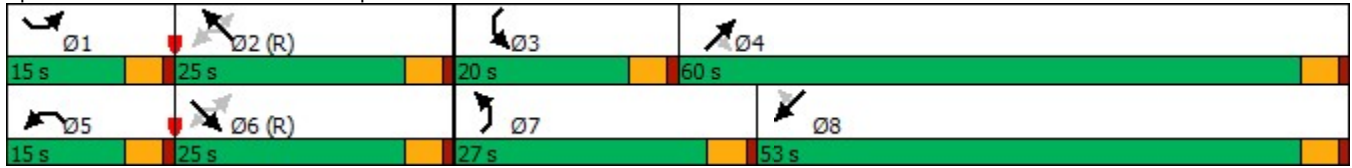



















Queue shown is maximum after two cycles.

Splits and Phases: 2: US 24 & Stapleton















Lanes, Volumes, Timings
30: US 24 & Elbert

2044 Background + Site
AM

												
Lane Group	SEL	SET	SER	NWL	NWT	NWR	NEL	NET	NER	SWL	SWT	SWR
Lane Configurations												
Traffic Volume (vph)	25	50	175	50	50	30	25	600	25	29	750	10
Future Volume (vph)	25	50	175	50	50	30	25	600	25	29	750	10
Ideal Flow (vphpl)	1900	1900	1900	1900	1900	1900	1900	1900	1900	1900	1900	1900
Storage Length (ft)	170		250	125		25	620		550	540		480
Storage Lanes	1		1	1		1	1		1	1		1
Taper Length (ft)	120			85			300			255		
Lane Util. Factor	1.00	1.00	1.00	1.00	1.00	1.00	1.00	1.00	1.00	1.00	1.00	1.00
Frt			0.850			0.850			0.850			0.850
Flt Protected	0.950			0.950			0.950			0.950		
Satd. Flow (prot)	1770	1863	1583	1770	1863	1583	1770	1863	1583	1770	1863	1583
Flt Permitted	0.720			0.722			0.222			0.334		
Satd. Flow (perm)	1341	1863	1583	1345	1863	1583	414	1863	1583	622	1863	1583
Right Turn on Red			Yes			Yes			Yes			Yes
Satd. Flow (RTOR)			190			34			27			27
Link Speed (mph)		45			45			55			55	
Link Distance (ft)		604			654			977			945	
Travel Time (s)		9.2			9.9			12.1			11.7	
Peak Hour Factor	0.92	0.92	0.92	0.87	0.87	0.87	0.93	0.93	0.93	0.93	0.93	0.93
Adj. Flow (vph)	27	54	190	57	57	34	27	645	27	31	806	11
Shared Lane Traffic (%)												
Lane Group Flow (vph)	27	54	190	57	57	34	27	645	27	31	806	11
Enter Blocked Intersection	No	No	No	No	No	No	No	No	No	No	No	No
Lane Alignment	Left	Left	Right	Left	Left	Right	Left	Left	Right	Left	Left	Right
Median Width(ft)		12			12			12			12	
Link Offset(ft)		0			0			0			0	
Crosswalk Width(ft)		16			16			16			16	
Two way Left Turn Lane												
Headway Factor	1.00	1.00	1.00	1.00	1.00	1.00	1.00	1.00	1.00	1.00	1.00	1.00
Turning Speed (mph)	15		9	15		9	15		9	15		9
Number of Detectors	1	2	1	1	2	1	1	2	1	1	2	1
Detector Template	Left	Thru	Right	Left	Thru	Right	Left	Thru	Right	Left	Thru	Right
Leading Detector (ft)	20	100	20	20	100	20	20	100	20	20	100	20
Trailing Detector (ft)	0	0	0	0	0	0	0	0	0	0	0	0
Detector 1 Position(ft)	0	0	0	0	0	0	0	0	0	0	0	0
Detector 1 Size(ft)	20	6	20	20	6	20	20	6	20	20	6	20
Detector 1 Type	Cl+Ex	Cl+Ex	Cl+Ex	Cl+Ex	Cl+Ex	Cl+Ex	Cl+Ex	Cl+Ex	Cl+Ex	Cl+Ex	Cl+Ex	Cl+Ex
Detector 1 Channel												
Detector 1 Extend (s)	0.0	0.0	0.0	0.0	0.0	0.0	0.0	0.0	0.0	0.0	0.0	0.0
Detector 1 Queue (s)	0.0	0.0	0.0	0.0	0.0	0.0	0.0	0.0	0.0	0.0	0.0	0.0
Detector 1 Delay (s)	0.0	0.0	0.0	0.0	0.0	0.0	0.0	0.0	0.0	0.0	0.0	0.0
Detector 2 Position(ft)		94			94			94			94	
Detector 2 Size(ft)		6			6			6			6	
Detector 2 Type		Cl+Ex			Cl+Ex			Cl+Ex			Cl+Ex	
Detector 2 Channel												
Detector 2 Extend (s)		0.0			0.0			0.0			0.0	
Turn Type	Perm	NA	Perm	Perm	NA	Perm	Perm	NA	Perm	Perm	NA	Perm
Protected Phases		6			2			4			8	
Permitted Phases	6		6	2		2	4		4	8		8

Lanes, Volumes, Timings
30: US 24 & Elbert

2044 Background + Site
AM

												
Lane Group	SEL	SET	SER	NWL	NWT	NWR	NEL	NET	NER	SWL	SWT	SWR
Detector Phase	6	6	6	2	2	2	4	4	4	8	8	8
Switch Phase												
Minimum Initial (s)	5.0	5.0	5.0	5.0	5.0	5.0	5.0	5.0	5.0	5.0	5.0	5.0
Minimum Split (s)	22.5	22.5	22.5	22.5	22.5	22.5	22.5	22.5	22.5	22.5	22.5	22.5
Total Split (s)	15.0	15.0	15.0	15.0	15.0	15.0	45.0	45.0	45.0	45.0	45.0	45.0
Total Split (%)	25.0%	25.0%	25.0%	25.0%	25.0%	25.0%	75.0%	75.0%	75.0%	75.0%	75.0%	75.0%
Maximum Green (s)	10.5	10.5	10.5	10.5	10.5	10.5	40.5	40.5	40.5	40.5	40.5	40.5
Yellow Time (s)	3.5	3.5	3.5	3.5	3.5	3.5	3.5	3.5	3.5	3.5	3.5	3.5
All-Red Time (s)	1.0	1.0	1.0	1.0	1.0	1.0	1.0	1.0	1.0	1.0	1.0	1.0
Lost Time Adjust (s)	0.0	0.0	0.0	0.0	0.0	0.0	0.0	0.0	0.0	0.0	0.0	0.0
Total Lost Time (s)	4.5	4.5	4.5	4.5	4.5	4.5	4.5	4.5	4.5	4.5	4.5	4.5
Lead/Lag												
Lead-Lag Optimize?												
Vehicle Extension (s)	3.0	3.0	3.0	3.0	3.0	3.0	3.0	3.0	3.0	3.0	3.0	3.0
Recall Mode	Min	Min	Min	Min	Min	Min	None	None	None	None	None	None
Walk Time (s)	7.0	7.0	7.0	7.0	7.0	7.0	7.0	7.0	7.0	7.0	7.0	7.0
Flash Dont Walk (s)	11.0	11.0	11.0	11.0	11.0	11.0	11.0	11.0	11.0	11.0	11.0	11.0
Pedestrian Calls (#/hr)	0	0	0	0	0	0	0	0	0	0	0	0
Act Effct Green (s)	7.6	7.6	7.6	7.6	7.6	7.6	23.2	23.2	23.2	23.2	23.2	23.2
Actuated g/C Ratio	0.19	0.19	0.19	0.19	0.19	0.19	0.57	0.57	0.57	0.57	0.57	0.57
v/c Ratio	0.11	0.15	0.42	0.23	0.16	0.10	0.11	0.61	0.03	0.09	0.76	0.01
Control Delay	19.1	18.7	7.4	20.2	18.7	9.2	4.8	8.0	1.6	4.1	11.4	0.7
Queue Delay	0.0	0.0	0.0	0.0	0.0	0.0	0.0	0.0	0.0	0.0	0.0	0.0
Total Delay	19.1	18.7	7.4	20.2	18.7	9.2	4.8	8.0	1.6	4.1	11.4	0.7
LOS	B	B	A	C	B	A	A	A	A	A	B	A
Approach Delay		10.8			17.1			7.6			11.0	
Approach LOS		B			B			A			B	
Queue Length 50th (ft)	5	10	0	10	10	0	2	69	0	2	99	0
Queue Length 95th (ft)	27	43	46	44	43	19	10	154	6	10	227	2
Internal Link Dist (ft)		524			574			897			865	
Turn Bay Length (ft)	170		250	125		25	620		550	540		480
Base Capacity (vph)	375	521	579	376	521	467	377	1698	1445	567	1698	1445
Starvation Cap Reductn	0	0	0	0	0	0	0	0	0	0	0	0
Spillback Cap Reductn	0	0	0	0	0	0	0	0	0	0	0	0
Storage Cap Reductn	0	0	0	0	0	0	0	0	0	0	0	0
Reduced v/c Ratio	0.07	0.10	0.33	0.15	0.11	0.07	0.07	0.38	0.02	0.05	0.47	0.01

Intersection Summary

Area Type:	Other
Cycle Length:	60
Actuated Cycle Length:	40.6
Natural Cycle:	60
Control Type:	Actuated-Uncoordinated
Maximum v/c Ratio:	0.76
Intersection Signal Delay:	10.2
Intersection LOS:	B
Intersection Capacity Utilization:	65.7%
ICU Level of Service:	C
Analysis Period (min):	15

Splits and Phases: 30: US 24 & Elbert



Intersection									
Intersection Delay, s/veh	8.2								
Intersection LOS	A								
Approach	EB		WB		NB		SB		
Entry Lanes	2		2		2		2		
Conflicting Circle Lanes	2		2		2		2		
Adj Approach Flow, veh/h	359		538		554		565		
Demand Flow Rate, veh/h	365		548		566		576		
Vehicles Circulating, veh/h	609		548		210		565		
Vehicles Exiting, veh/h	532		228		764		531		
Ped Vol Crossing Leg, #/h	0		0		0		0		
Ped Cap Adj	1.000		1.000		1.000		1.000		
Approach Delay, s/veh	7.0		7.9		5.7		11.6		
Approach LOS	A		A		A		B		
Lane	Left	Right	Left	Right	Left	Right	Left	Right	
Designated Moves	LT	TR	LT	TR	L	TR	L	TR	
Assumed Moves	LT	R	LT	TR	L	TR	L	TR	
RT Channelized									
Lane Util	0.378	0.622	0.471	0.529	0.323	0.677	0.125	0.875	
Follow-Up Headway, s	2.667	2.535	2.667	2.535	2.667	2.535	2.667	2.535	
Critical Headway, s	4.645	4.328	4.645	4.328	4.645	4.328	4.645	4.328	
Entry Flow, veh/h	138	227	258	290	183	383	72	504	
Cap Entry Lane, veh/h	771	846	815	891	1113	1188	803	878	
Entry HV Adj Factor	0.983	0.982	0.980	0.983	0.978	0.980	0.986	0.979	
Flow Entry, veh/h	136	223	253	285	179	375	71	494	
Cap Entry, veh/h	758	831	799	876	1088	1164	792	860	
V/C Ratio	0.179	0.268	0.316	0.325	0.164	0.322	0.090	0.574	
Control Delay, s/veh	6.7	7.3	8.2	7.7	4.8	6.2	5.4	12.5	
LOS	A	A	A	A	A	A	A	B	
95th %tile Queue, veh	1	1	1	1	1	1	0	4	

Intersection						
Int Delay, s/veh	0.6					
Movement	EBT	EBR	WBL	WBT	NBL	NBR
Lane Configurations	↑↑			↑↑	↑↑	
Traffic Vol, veh/h	161	16	1	379	26	2
Future Vol, veh/h	161	16	1	379	26	2
Conflicting Peds, #/hr	0	0	0	0	0	0
Sign Control	Free	Free	Free	Free	Stop	Stop
RT Channelized	-	None	-	None	-	None
Storage Length	-	-	-	-	0	-
Veh in Median Storage, #	0	-	-	0	0	-
Grade, %	0	-	-	0	0	-
Peak Hour Factor	87	87	92	92	78	78
Heavy Vehicles, %	2	2	2	2	2	2
Mvmt Flow	185	18	1	412	33	3

Major/Minor	Major1	Major2	Minor1		
Conflicting Flow All	0	0	203	0	402
Stage 1	-	-	-	-	194
Stage 2	-	-	-	-	208
Critical Hdwy	-	-	4.14	-	6.84
Critical Hdwy Stg 1	-	-	-	-	5.84
Critical Hdwy Stg 2	-	-	-	-	5.84
Follow-up Hdwy	-	-	2.22	-	3.52
Pot Cap-1 Maneuver	-	-	1366	-	576
Stage 1	-	-	-	-	820
Stage 2	-	-	-	-	807
Platoon blocked, %	-	-	-	-	-
Mov Cap-1 Maneuver	-	-	1366	-	575
Mov Cap-2 Maneuver	-	-	-	-	575
Stage 1	-	-	-	-	820
Stage 2	-	-	-	-	806

Approach	EB	WB	NB
HCM Control Delay, s	0	0	11.5
HCM LOS			B

Minor Lane/Major Mvmt	NBLn1	EBT	EBR	WBL	WBT
Capacity (veh/h)	591	-	-	1366	-
HCM Lane V/C Ratio	0.061	-	-	0.001	-
HCM Control Delay (s)	11.5	-	-	7.6	0
HCM Lane LOS	B	-	-	A	A
HCM 95th %tile Q(veh)	0.2	-	-	0	-

Intersection												
Int Delay, s/veh	2.2											
Movement	EBL	EBT	EBR	WBL	WBT	WBR	NBL	NBT	NBR	SBL	SBT	SBR
Lane Configurations		↕↕	↕		↕↕			↕↕			↕↕	
Traffic Vol, veh/h	5	163	43	5	374	26	60	4	3	12	7	20
Future Vol, veh/h	5	163	43	5	374	26	60	4	3	12	7	20
Conflicting Peds, #/hr	0	0	0	0	0	0	0	0	0	0	0	0
Sign Control	Free	Free	Free	Free	Free	Free	Stop	Stop	Stop	Stop	Stop	Stop
RT Channelized	-	-	None	-	-	None	-	-	None	-	-	None
Storage Length	-	-	235	-	-	-	-	-	-	-	-	-
Veh in Median Storage, #	-	0	-	-	0	-	-	0	-	-	0	-
Grade, %	-	0	-	-	0	-	-	0	-	-	0	-
Peak Hour Factor	87	87	87	92	92	92	83	83	83	78	78	78
Heavy Vehicles, %	2	2	2	2	2	2	2	2	2	2	2	2
Mvmt Flow	6	187	49	5	407	28	72	5	4	15	9	26

Major/Minor	Major1			Major2			Minor1			Minor2		
Conflicting Flow All	435	0	0	236	0	0	417	644	94	539	679	218
Stage 1	-	-	-	-	-	-	199	199	-	431	431	-
Stage 2	-	-	-	-	-	-	218	445	-	108	248	-
Critical Hdwy	4.14	-	-	4.14	-	-	7.54	6.54	6.94	7.54	6.54	6.94
Critical Hdwy Stg 1	-	-	-	-	-	-	6.54	5.54	-	6.54	5.54	-
Critical Hdwy Stg 2	-	-	-	-	-	-	6.54	5.54	-	6.54	5.54	-
Follow-up Hdwy	2.22	-	-	2.22	-	-	3.52	4.02	3.32	3.52	4.02	3.32
Pot Cap-1 Maneuver	1121	-	-	1328	-	-	520	390	944	426	372	786
Stage 1	-	-	-	-	-	-	784	735	-	573	581	-
Stage 2	-	-	-	-	-	-	764	573	-	886	700	-
Platoon blocked, %		-	-		-	-						
Mov Cap-1 Maneuver	1121	-	-	1328	-	-	489	386	944	417	368	786
Mov Cap-2 Maneuver	-	-	-	-	-	-	489	386	-	417	368	-
Stage 1	-	-	-	-	-	-	779	731	-	570	578	-
Stage 2	-	-	-	-	-	-	724	570	-	872	696	-

Approach	EB			WB			NB			SB		
HCM Control Delay, s	0.2			0.1			13.7			12.5		
HCM LOS							B			B		

Minor Lane/Major Mvmt	NBLn1	EBL	EBT	EBR	WBL	WBT	WBR	SBLn1
Capacity (veh/h)	492	1121	-	-	1328	-	-	532
HCM Lane V/C Ratio	0.164	0.005	-	-	0.004	-	-	0.094
HCM Control Delay (s)	13.7	8.2	0	-	7.7	0	-	12.5
HCM Lane LOS	B	A	A	-	A	A	-	B
HCM 95th %tile Q(veh)	0.6	0	-	-	0	-	-	0.3

Intersection												
Int Delay, s/veh	19.6											
Movement	SEL	SET	SER	NWL	NWT	NWR	NEL	NET	NER	SWL	SWT	SWR
Lane Configurations	↘	↗	↗	↘	↗	↗	↘	↗	↗	↘	↗	↗
Traffic Vol, veh/h	25	50	175	50	50	30	25	600	75	30	750	10
Future Vol, veh/h	25	50	175	50	50	30	25	600	75	30	750	10
Conflicting Peds, #/hr	0	0	0	0	0	0	0	0	0	0	0	0
Sign Control	Stop	Stop	Stop	Stop	Stop	Stop	Free	Free	Free	Free	Free	Free
RT Channelized	-	-	Free	-	-	Stop	-	-	Yield	-	-	Yield
Storage Length	170	-	250	125	-	25	620	-	550	540	-	480
Veh in Median Storage, #	-	0	-	-	0	-	-	0	-	-	0	-
Grade, %	-	0	-	-	0	-	-	0	-	-	0	-
Peak Hour Factor	92	92	92	83	83	83	93	93	93	93	93	93
Heavy Vehicles, %	2	2	2	2	2	2	2	2	2	2	2	2
Mvmt Flow	27	54	190	60	60	36	27	645	81	32	806	11

Major/Minor	Minor2		Minor1		Major1		Major2					
Conflicting Flow All	1599	1569	-	1596	1569	645	806	0	0	645	0	0
Stage 1	870	870	-	699	699	-	-	-	-	-	-	-
Stage 2	729	699	-	897	870	-	-	-	-	-	-	-
Critical Hdwy	7.12	6.52	-	7.12	6.52	6.22	4.12	-	-	4.12	-	-
Critical Hdwy Stg 1	6.12	5.52	-	6.12	5.52	-	-	-	-	-	-	-
Critical Hdwy Stg 2	6.12	5.52	-	6.12	5.52	-	-	-	-	-	-	-
Follow-up Hdwy	3.518	4.018	-	3.518	4.018	3.318	2.218	-	-	2.218	-	-
Pot Cap-1 Maneuver	86	111	0	86	111	472	819	-	-	940	-	-
Stage 1	346	369	0	430	442	-	-	-	-	-	-	-
Stage 2	414	442	0	334	369	-	-	-	-	-	-	-
Platoon blocked, %								-	-	-	-	-
Mov Cap-1 Maneuver	41	104	-	~ 48	104	472	819	-	-	940	-	-
Mov Cap-2 Maneuver	41	104	-	~ 48	104	-	-	-	-	-	-	-
Stage 1	335	356	-	416	427	-	-	-	-	-	-	-
Stage 2	318	427	-	273	356	-	-	-	-	-	-	-

























Approach	SE		NW		NE		SW	
HCM Control Delay, s	113.6		168.5		0.3		0.3	
HCM LOS	F		F					

Minor Lane/Major Mvmt	NEL	NET	NERN	NWLn1	NWLn2	NWLn3	SELn1	SELn2	SELn3	SWL	SWT	SWR
Capacity (veh/h)	819	-	-	48	104	472	41	104	-	940	-	-
HCM Lane V/C Ratio	0.033	-	-	1.255	0.579	0.077	0.663	0.523	-	0.034	-	-
HCM Control Delay (s)	9.5	-	-	\$ 351	79.1	13.3	195.7	72.5	0	9	-	-
HCM Lane LOS	A	-	-	F	F	B	F	F	A	A	-	-
HCM 95th %tile Q(veh)	0.1	-	-	5.6	2.7	0.2	2.4	2.4	-	0.1	-	-

Notes
 ~: Volume exceeds capacity \$: Delay exceeds 300s +: Computation Not Defined *: All major volume in platoon













Lanes, Volumes, Timings
1: US 24 & Judge Orr

2044 Background + Site
PM

												
Lane Group	SEL	SET	SER	NWL	NWT	NWR	NEL	NET	NER	SWL	SWT	SWR
Lane Configurations												
Traffic Volume (vph)	195	210	360	475	225	165	420	1235	490	150	790	160
Future Volume (vph)	195	210	360	475	225	165	420	1235	490	150	790	160
Ideal Flow (vphpl)	1900	1900	1900	1900	1900	1900	1900	1900	1900	1900	1900	1900
Storage Length (ft)	235		235	235		235	860		290	695		290
Storage Lanes	1		1	2		1	2		1	1		1
Taper Length (ft)	200			200			300			300		
Lane Util. Factor	1.00	0.95	1.00	0.97	0.95	1.00	0.97	0.95	1.00	1.00	0.95	1.00
Frt			0.850			0.850			0.850			0.850
Flt Protected	0.950			0.950			0.950			0.950		
Satd. Flow (prot)	1770	3539	1583	3433	3539	1583	3433	3539	1583	1770	3539	1583
Flt Permitted	0.601			0.950			0.950			0.117		
Satd. Flow (perm)	1120	3539	1583	3433	3539	1583	3433	3539	1583	218	3539	1583
Right Turn on Red			Yes			Yes			Yes			Yes
Satd. Flow (RTOR)			250			171			486			168
Link Speed (mph)		45			45			55			55	
Link Distance (ft)		1254			1178			1307			1572	
Travel Time (s)		19.0			17.8			16.2			19.5	
Peak Hour Factor	0.93	0.93	0.93	0.93	0.93	0.93	0.95	0.95	0.95	0.95	0.95	0.95
Adj. Flow (vph)	210	226	387	511	242	177	442	1300	516	158	832	168
Shared Lane Traffic (%)												
Lane Group Flow (vph)	210	226	387	511	242	177	442	1300	516	158	832	168
Enter Blocked Intersection	No	No	No	No	No	No	No	No	No	No	No	No
Lane Alignment	Left	Left	Right	Left	Left	Right	Left	Left	Right	Left	Left	Right
Median Width(ft)		24			24			24			24	
Link Offset(ft)		0			0			0			0	
Crosswalk Width(ft)		16			16			16			16	
Two way Left Turn Lane												
Headway Factor	1.00	1.00	1.00	1.00	1.00	1.00	1.00	1.00	1.00	1.00	1.00	1.00
Turning Speed (mph)	15		9	15		9	15		9	15		9
Number of Detectors	1	2	1	1	2	1	1	2	1	1	2	1
Detector Template	Left	Thru	Right	Left	Thru	Right	Left	Thru	Right	Left	Thru	Right
Leading Detector (ft)	20	100	20	20	100	20	20	100	20	20	100	20
Trailing Detector (ft)	0	0	0	0	0	0	0	0	0	0	0	0
Detector 1 Position(ft)	0	0	0	0	0	0	0	0	0	0	0	0
Detector 1 Size(ft)	20	6	20	20	6	20	20	6	20	20	6	20
Detector 1 Type	Cl+Ex	Cl+Ex	Cl+Ex	Cl+Ex	Cl+Ex	Cl+Ex	Cl+Ex	Cl+Ex	Cl+Ex	Cl+Ex	Cl+Ex	Cl+Ex
Detector 1 Channel												
Detector 1 Extend (s)	0.0	0.0	0.0	0.0	0.0	0.0	0.0	0.0	0.0	0.0	0.0	0.0
Detector 1 Queue (s)	0.0	0.0	0.0	0.0	0.0	0.0	0.0	0.0	0.0	0.0	0.0	0.0
Detector 1 Delay (s)	0.0	0.0	0.0	0.0	0.0	0.0	0.0	0.0	0.0	0.0	0.0	0.0
Detector 2 Position(ft)		94			94			94			94	
Detector 2 Size(ft)		6			6			6			6	
Detector 2 Type		Cl+Ex			Cl+Ex			Cl+Ex			Cl+Ex	
Detector 2 Channel												
Detector 2 Extend (s)		0.0			0.0			0.0			0.0	
Turn Type	pm+pt	NA	Perm	Prot	NA	Perm	Prot	NA	Perm	pm+pt	NA	Perm
Protected Phases	7	4		3	8		5	2		1	6	
Permitted Phases	4		4			8			2	6		6

Lanes, Volumes, Timings
1: US 24 & Judge Orr









2044 Background + Site
PM

												
Lane Group	SEL	SET	SER	NWL	NWT	NWR	NEL	NET	NER	SWL	SWT	SWR
Detector Phase	7	4	4	3	8	8	5	2	2	1	6	6
Switch Phase												
Minimum Initial (s)	5.0	5.0	5.0	5.0	5.0	5.0	5.0	5.0	5.0	5.0	5.0	5.0
Minimum Split (s)	9.5	22.5	22.5	9.5	22.5	22.5	9.5	22.5	22.5	9.5	22.5	22.5
Total Split (s)	17.0	23.0	23.0	21.0	27.0	27.0	22.0	56.0	56.0	10.0	44.0	44.0
Total Split (%)	15.5%	20.9%	20.9%	19.1%	24.5%	24.5%	20.0%	50.9%	50.9%	9.1%	40.0%	40.0%
Maximum Green (s)	12.5	18.5	18.5	16.5	22.5	22.5	17.5	51.5	51.5	5.5	39.5	39.5
Yellow Time (s)	3.5	3.5	3.5	3.5	3.5	3.5	3.5	3.5	3.5	3.5	3.5	3.5
All-Red Time (s)	1.0	1.0	1.0	1.0	1.0	1.0	1.0	1.0	1.0	1.0	1.0	1.0
Lost Time Adjust (s)	0.0	0.0	0.0	0.0	0.0	0.0	0.0	0.0	0.0	0.0	0.0	0.0
Total Lost Time (s)	4.5	4.5	4.5	4.5	4.5	4.5	4.5	4.5	4.5	4.5	4.5	4.5
Lead/Lag	Lead	Lag	Lag	Lead	Lag	Lag	Lead	Lag	Lag	Lead	Lag	Lag
Lead-Lag Optimize?	Yes	Yes	Yes	Yes	Yes	Yes	Yes	Yes	Yes	Yes	Yes	Yes
Vehicle Extension (s)	3.0	3.0	3.0	3.0	3.0	3.0	3.0	3.0	3.0	3.0	3.0	3.0
Recall Mode	None	None	None	None	None	None	None	Max	Max	None	Max	Max
Walk Time (s)		7.0	7.0		7.0	7.0		7.0	7.0		7.0	7.0
Flash Dont Walk (s)		11.0	11.0		11.0	11.0		11.0	11.0		11.0	11.0
Pedestrian Calls (#/hr)		0	0		0	0		0	0		0	0
Act Effct Green (s)	27.1	15.2	15.2	16.5	19.7	19.7	16.6	51.6	51.6	46.0	40.4	40.4
Actuated g/C Ratio	0.25	0.14	0.14	0.15	0.18	0.18	0.16	0.48	0.48	0.43	0.38	0.38
v/c Ratio	0.59	0.45	0.88	0.96	0.37	0.41	0.83	0.76	0.51	0.91	0.62	0.24
Control Delay	34.4	44.6	38.0	77.1	39.7	9.4	58.1	26.8	4.1	71.1	30.2	4.6
Queue Delay	0.0	0.0	0.0	0.0	0.0	0.0	0.0	0.0	0.0	0.0	0.0	0.0
Total Delay	34.4	44.6	38.0	77.1	39.7	9.4	58.1	26.8	4.1	71.1	30.2	4.6
LOS	C	D	D	E	D	A	E	C	A	E	C	A
Approach Delay		38.9			54.5			27.7			32.1	
Approach LOS		D			D			C			C	
Queue Length 50th (ft)	107	75	94	188	77	3	157	394	11	53	256	0
Queue Length 95th (ft)	169	113	#252	#299	115	61	#229	485	72	#185	325	44
Internal Link Dist (ft)		1174			1098			1227			1492	
Turn Bay Length (ft)	235		235	235		235	860		290	695		290
Base Capacity (vph)	366	614	481	530	746	468	563	1708	1015	173	1339	704
Starvation Cap Reductn	0	0	0	0	0	0	0	0	0	0	0	0
Spillback Cap Reductn	0	0	0	0	0	0	0	0	0	0	0	0
Storage Cap Reductn	0	0	0	0	0	0	0	0	0	0	0	0
Reduced v/c Ratio	0.57	0.37	0.80	0.96	0.32	0.38	0.79	0.76	0.51	0.91	0.62	0.24

Intersection Summary

























Area Type:	Other
Cycle Length:	110
Actuated Cycle Length:	106.8
Natural Cycle:	90
Control Type:	Actuated-Uncoordinated
Maximum v/c Ratio:	0.96
Intersection Signal Delay:	35.3
Intersection LOS:	D
Intersection Capacity Utilization:	76.8%
ICU Level of Service:	D
Analysis Period (min):	15
# 95th percentile volume exceeds capacity, queue may be longer. Queue shown is maximum after two cycles.	

Splits and Phases: 1: US 24 & Judge Orr

 Ø1	 Ø2	 Ø3	 Ø4
10 s	56 s	21 s	23 s
 Ø5	 Ø6	 Ø7	 Ø8
22 s	44 s	17 s	27 s

Lanes, Volumes, Timings
2: US 24 & Stapleton

2044 Background + Site
PM

													
Lane Group	SEL	SET	SER	NWL	NWT	NWR	NEL	NET	NER	SWL	SWT	SWR	
Lane Configurations													
Traffic Volume (vph)	350	300	700	125	405	179	650	850	125	145	600	350	
Future Volume (vph)	350	300	700	125	405	179	650	850	125	145	600	350	
Ideal Flow (vphpl)	1900	1900	1900	1900	1900	1900	1900	1900	1900	1900	1900	1900	
Storage Length (ft)	190		325	215		215	890		1000	790		790	
Storage Lanes	1		2	1		0	2		1	1		1	
Taper Length (ft)	240			200			190			190			
Lane Util. Factor	1.00	0.95	1.00	1.00	0.95	1.00	0.97	0.95	1.00	1.00	0.95	1.00	
Frt			0.850			0.850			0.850			0.850	
Flt Protected	0.950			0.950			0.950			0.950			
Satd. Flow (prot)	1770	3539	1583	1770	3539	1583	3433	3539	1583	1770	3539	1583	
Flt Permitted	0.208			0.560			0.950			0.950			
Satd. Flow (perm)	387	3539	1583	1043	3539	1583	3433	3539	1583	1770	3539	1583	
Right Turn on Red			Yes			Yes			Yes			Yes	
Satd. Flow (RTOR)			485			192			132			225	
Link Speed (mph)		45			45			55			55		
Link Distance (ft)		1349			5480			1382			1435		
Travel Time (s)		20.4			83.0			17.1			17.8		
Peak Hour Factor	0.95	0.95	0.95	0.93	0.93	0.93	0.95	0.95	0.95	0.95	0.95	0.95	
Adj. Flow (vph)	368	316	737	134	435	192	684	895	132	153	632	368	
Shared Lane Traffic (%)													
Lane Group Flow (vph)	368	316	737	134	435	192	684	895	132	153	632	368	
Enter Blocked Intersection	No	No	No	No	No	No	No	No	No	No	No	No	
Lane Alignment	Left	Left	Right	Left	Left	Right	Left	Left	R NA	L NA	Left	Right	
Median Width(ft)		12			12			24			24		
Link Offset(ft)		0			0			0			0		
Crosswalk Width(ft)		16			16			16			16		
Two way Left Turn Lane													
Headway Factor	1.00	1.00	1.00	1.00	1.00	1.00	1.00	1.00	1.00	1.00	1.00	1.00	
Turning Speed (mph)	15		9	15		9	15		9	15		9	
Number of Detectors	1	2	1	1	2	1	1	2	1	1	2	1	
Detector Template	Left	Thru	Right	Left	Thru	Right	Left	Thru	Right	Left	Thru	Right	
Leading Detector (ft)	20	100	20	20	100	20	20	100	20	20	100	20	
Trailing Detector (ft)	0	0	0	0	0	0	0	0	0	0	0	0	
Detector 1 Position(ft)	0	0	0	0	0	0	0	0	0	0	0	0	
Detector 1 Size(ft)	20	6	20	20	6	20	20	6	20	20	6	20	
Detector 1 Type	Cl+Ex	Cl+Ex	Cl+Ex	Cl+Ex	Cl+Ex	Cl+Ex	Cl+Ex	Cl+Ex	Cl+Ex	Cl+Ex	Cl+Ex	Cl+Ex	
Detector 1 Channel													
Detector 1 Extend (s)	0.0	0.0	0.0	0.0	0.0	0.0	0.0	0.0	0.0	0.0	0.0	0.0	
Detector 1 Queue (s)	0.0	0.0	0.0	0.0	0.0	0.0	0.0	0.0	0.0	0.0	0.0	0.0	
Detector 1 Delay (s)	0.0	0.0	0.0	0.0	0.0	0.0	0.0	0.0	0.0	0.0	0.0	0.0	
Detector 2 Position(ft)		94			94			94			94		
Detector 2 Size(ft)		6			6			6			6		
Detector 2 Type		Cl+Ex			Cl+Ex			Cl+Ex			Cl+Ex		
Detector 2 Channel													
Detector 2 Extend (s)		0.0			0.0			0.0			0.0		
Turn Type	pm+pt	NA	Perm	pm+pt	NA	Perm	Prot	NA	Perm	Prot	NA	Perm	
Protected Phases	1	6		5	2		7	4		3	8		
Permitted Phases	6		6	2		2			4			8	

Lanes, Volumes, Timings
2: US 24 & Stapleton

2044 Background + Site
PM



Lane Group	SEL	SET	SER	NWL	NWT	NWR	NEL	NET	NER	SWL	SWT	SWR
Detector Phase	1	6	6	5	2	2	7	4	4	3	8	8
Switch Phase												
Minimum Initial (s)	5.0	5.0	5.0	5.0	5.0	5.0	5.0	5.0	5.0	5.0	5.0	5.0
Minimum Split (s)	9.5	22.5	22.5	9.5	22.5	22.5	9.5	22.5	22.5	9.5	22.5	22.5
Total Split (s)	15.0	25.0	25.0	15.0	25.0	25.0	36.0	60.0	60.0	20.0	44.0	44.0
Total Split (%)	12.5%	20.8%	20.8%	12.5%	20.8%	20.8%	30.0%	50.0%	50.0%	16.7%	36.7%	36.7%
Maximum Green (s)	10.5	20.5	20.5	10.5	20.5	20.5	31.5	55.5	55.5	15.5	39.5	39.5
Yellow Time (s)	3.5	3.5	3.5	3.5	3.5	3.5	3.5	3.5	3.5	3.5	3.5	3.5
All-Red Time (s)	1.0	1.0	1.0	1.0	1.0	1.0	1.0	1.0	1.0	1.0	1.0	1.0
Lost Time Adjust (s)	0.0	0.0	0.0	0.0	0.0	0.0	0.0	0.0	0.0	0.0	0.0	0.0
Total Lost Time (s)	4.5	4.5	4.5	4.5	4.5	4.5	4.5	4.5	4.5	4.5	4.5	4.5
Lead/Lag	Lead	Lag	Lag	Lead	Lag	Lag	Lead	Lag	Lag	Lead	Lag	Lag
Lead-Lag Optimize?	Yes	Yes	Yes	Yes	Yes	Yes	Yes	Yes	Yes	Yes	Yes	Yes
Vehicle Extension (s)	3.0	3.0	3.0	3.0	3.0	3.0	3.0	3.0	3.0	3.0	3.0	3.0
Recall Mode	None	C-Min	C-Min	None	C-Min	C-Min	None	None	None	None	None	None
Walk Time (s)		7.0	7.0		7.0	7.0		7.0	7.0		7.0	7.0
Flash Dont Walk (s)		11.0	11.0		11.0	11.0		11.0	11.0		11.0	11.0
Pedestrian Calls (#/hr)		0	0		0	0		0	0		0	0
Act Effct Green (s)	48.4	33.8	33.8	31.5	20.5	20.5	28.2	43.3	43.3	14.0	29.0	29.0
Actuated g/C Ratio	0.40	0.28	0.28	0.26	0.17	0.17	0.24	0.36	0.36	0.12	0.24	0.24
v/c Ratio	0.85	0.32	0.93	0.39	0.72	0.45	0.85	0.70	0.20	0.74	0.74	0.67
Control Delay	50.0	38.0	34.6	30.1	54.7	9.6	54.4	35.5	4.3	72.8	47.1	20.9
Queue Delay	0.0	0.0	0.0	0.0	0.0	0.0	0.0	0.0	0.0	0.0	0.0	0.0
Total Delay	50.0	38.0	34.6	30.1	54.7	9.6	54.4	35.5	4.3	72.8	47.1	20.9
LOS	D	D	C	C	D	A	D	D	A	E	D	C
Approach Delay		39.3			39.0			40.7			42.1	
Approach LOS		D			D			D			D	
Queue Length 50th (ft)	212	103	229	66	169	0	260	312	0	114	238	97
Queue Length 95th (ft)	#521	166	#553	127	227	64	322	335	36	#199	280	191
Internal Link Dist (ft)		1269			5400			1302			1355	
Turn Bay Length (ft)	190		325	215		215	890		1000	790		790
Base Capacity (vph)	435	995	794	353	604	429	901	1636	803	228	1164	672
Starvation Cap Reductn	0	0	0	0	0	0	0	0	0	0	0	0
Spillback Cap Reductn	0	0	0	0	0	0	0	0	0	0	0	0
Storage Cap Reductn	0	0	0	0	0	0	0	0	0	0	0	0
Reduced v/c Ratio	0.85	0.32	0.93	0.38	0.72	0.45	0.76	0.55	0.16	0.67	0.54	0.55

Intersection Summary

Area Type:	Other
Cycle Length:	120
Actuated Cycle Length:	120
Offset:	0 (0%), Referenced to phase 2:NWTL and 6:SETL, Start of Green
Natural Cycle:	90
Control Type:	Actuated-Coordinated
Maximum v/c Ratio:	0.93
Intersection Signal Delay:	40.4
Intersection LOS:	D
Intersection Capacity Utilization:	80.7%
ICU Level of Service:	D
Analysis Period (min):	15
# 95th percentile volume exceeds capacity, queue may be longer.	

























Queue shown is maximum after two cycles.

Splits and Phases: 2: US 24 & Stapleton



Lanes, Volumes, Timings
30: US 24 & Elbert

2044 Background + Site
PM

												
Lane Group	SEL	SET	SER	NWL	NWT	NWR	NEL	NET	NER	SWL	SWT	SWR
Lane Configurations												
Traffic Volume (vph)	10	50	125	25	65	30	140	1050	50	55	875	35
Future Volume (vph)	10	50	125	25	65	30	140	1050	50	55	875	35
Ideal Flow (vphpl)	1900	1900	1900	1900	1900	1900	1900	1900	1900	1900	1900	1900
Storage Length (ft)	170		250	125		25	620		550	540		480
Storage Lanes	1		1	1		1	1		1	1		1
Taper Length (ft)	120			85			300			255		
Lane Util. Factor	1.00	1.00	1.00	1.00	1.00	1.00	1.00	1.00	1.00	1.00	1.00	1.00
Frt			0.850			0.850			0.850			0.850
Flt Protected	0.950			0.950			0.950			0.950		
Satd. Flow (prot)	1770	1863	1583	1770	1863	1583	1770	1863	1583	1770	1863	1583
Flt Permitted	0.706			0.720			0.225			0.144		
Satd. Flow (perm)	1315	1863	1583	1341	1863	1583	419	1863	1583	268	1863	1583
Right Turn on Red			Yes			Yes			Yes			Yes
Satd. Flow (RTOR)			144			36			53			38
Link Speed (mph)		45			45			55			55	
Link Distance (ft)		604			654			977			945	
Travel Time (s)		9.2			9.9			12.1			11.7	
Peak Hour Factor	0.87	0.87	0.87	0.83	0.83	0.83	0.95	0.95	0.95	0.93	0.93	0.93
Adj. Flow (vph)	11	57	144	30	78	36	147	1105	53	59	941	38
Shared Lane Traffic (%)												
Lane Group Flow (vph)	11	57	144	30	78	36	147	1105	53	59	941	38
Enter Blocked Intersection	No	No	No	No	No	No	No	No	No	No	No	No
Lane Alignment	Left	Left	Right	Left	Left	Right	Left	Left	Right	Left	Left	Right
Median Width(ft)		12			12			12			12	
Link Offset(ft)		0			0			0			0	
Crosswalk Width(ft)		16			16			16			16	
Two way Left Turn Lane												
Headway Factor	1.00	1.00	1.00	1.00	1.00	1.00	1.00	1.00	1.00	1.00	1.00	1.00
Turning Speed (mph)	60		60	60		60	60		60	60		60
Number of Detectors	1	2	1	1	2	1	1	2	1	1	2	1
Detector Template	Left	Thru	Right	Left	Thru	Right	Left	Thru	Right	Left	Thru	Right
Leading Detector (ft)	20	100	20	20	100	20	20	100	20	20	100	20
Trailing Detector (ft)	0	0	0	0	0	0	0	0	0	0	0	0
Detector 1 Position(ft)	0	0	0	0	0	0	0	0	0	0	0	0
Detector 1 Size(ft)	20	6	20	20	6	20	20	6	20	20	6	20
Detector 1 Type	Cl+Ex	Cl+Ex	Cl+Ex	Cl+Ex	Cl+Ex	Cl+Ex	Cl+Ex	Cl+Ex	Cl+Ex	Cl+Ex	Cl+Ex	Cl+Ex
Detector 1 Channel												
Detector 1 Extend (s)	0.0	0.0	0.0	0.0	0.0	0.0	0.0	0.0	0.0	0.0	0.0	0.0
Detector 1 Queue (s)	0.0	0.0	0.0	0.0	0.0	0.0	0.0	0.0	0.0	0.0	0.0	0.0
Detector 1 Delay (s)	0.0	0.0	0.0	0.0	0.0	0.0	0.0	0.0	0.0	0.0	0.0	0.0
Detector 2 Position(ft)		94			94			94			94	
Detector 2 Size(ft)		6			6			6			6	
Detector 2 Type		Cl+Ex			Cl+Ex			Cl+Ex			Cl+Ex	
Detector 2 Channel												
Detector 2 Extend (s)		0.0			0.0			0.0			0.0	
Turn Type	Perm	NA	Perm	Perm	NA	Perm	Perm	NA	Perm	Perm	NA	Perm
Protected Phases		6			2			4			8	
Permitted Phases	6		6	2		2	4		4	8		8

Lanes, Volumes, Timings
30: US 24 & Elbert

2044 Background + Site
PM



Lane Group	SEL	SET	SER	NWL	NWT	NWR	NEL	NET	NER	SWL	SWT	SWR
Detector Phase	6	6	6	2	2	2	4	4	4	8	8	8
Switch Phase												
Minimum Initial (s)	5.0	5.0	5.0	5.0	5.0	5.0	5.0	5.0	5.0	5.0	5.0	5.0
Minimum Split (s)	22.5	22.5	22.5	22.5	22.5	22.5	22.5	22.5	22.5	22.5	22.5	22.5
Total Split (s)	15.0	15.0	15.0	15.0	15.0	15.0	45.0	45.0	45.0	45.0	45.0	45.0
Total Split (%)	25.0%	25.0%	25.0%	25.0%	25.0%	25.0%	75.0%	75.0%	75.0%	75.0%	75.0%	75.0%
Maximum Green (s)	10.5	10.5	10.5	10.5	10.5	10.5	40.5	40.5	40.5	40.5	40.5	40.5
Yellow Time (s)	3.5	3.5	3.5	3.5	3.5	3.5	3.5	3.5	3.5	3.5	3.5	3.5
All-Red Time (s)	1.0	1.0	1.0	1.0	1.0	1.0	1.0	1.0	1.0	1.0	1.0	1.0
Lost Time Adjust (s)	0.0	0.0	0.0	0.0	0.0	0.0	0.0	0.0	0.0	0.0	0.0	0.0
Total Lost Time (s)	4.5	4.5	4.5	4.5	4.5	4.5	4.5	4.5	4.5	4.5	4.5	4.5
Lead/Lag												
Lead-Lag Optimize?												
Vehicle Extension (s)	3.0	3.0	3.0	3.0	3.0	3.0	3.0	3.0	3.0	3.0	3.0	3.0
Recall Mode	None	None	None	None	None	None	Max	Max	Max	Max	Max	Max
Act Effct Green (s)	7.8	7.8	7.8	7.8	7.8	7.8	44.3	44.3	44.3	44.3	44.3	44.3
Actuated g/C Ratio	0.13	0.13	0.13	0.13	0.13	0.13	0.76	0.76	0.76	0.76	0.76	0.76
v/c Ratio	0.06	0.23	0.43	0.17	0.31	0.15	0.46	0.78	0.04	0.29	0.67	0.03
Control Delay	22.0	24.1	9.1	23.8	25.6	10.1	10.4	12.3	1.2	8.3	8.1	1.3
Queue Delay	0.0	0.0	0.0	0.0	0.0	0.0	0.0	0.0	0.0	0.0	0.0	0.0
Total Delay	22.0	24.1	9.1	23.8	25.6	10.1	10.4	12.3	1.2	8.3	8.1	1.3
LOS	C	C	A	C	C	B	B	B	A	A	A	A
Approach Delay		13.8			21.4			11.6				7.9
Approach LOS		B			C			B				A
Queue Length 50th (ft)	3	18	0	9	25	0	17	203	0	6	142	0
Queue Length 95th (ft)	14	43	37	27	53	18	72	#582	8	28	317	7
Internal Link Dist (ft)		524			574			897				865
Turn Bay Length (ft)	170		250	125		25	620		550	540		480
Base Capacity (vph)	237	335	403	241	335	314	318	1415	1215	203	1415	1212
Starvation Cap Reductn	0	0	0	0	0	0	0	0	0	0	0	0
Spillback Cap Reductn	0	0	0	0	0	0	0	0	0	0	0	0
Storage Cap Reductn	0	0	0	0	0	0	0	0	0	0	0	0
Reduced v/c Ratio	0.05	0.17	0.36	0.12	0.23	0.11	0.46	0.78	0.04	0.29	0.67	0.03

Intersection Summary

Area Type: Other
 Cycle Length: 60
 Actuated Cycle Length: 58.3
 Natural Cycle: 80
 Control Type: Semi Act-Uncoord
 Maximum v/c Ratio: 0.78
 Intersection Signal Delay: 10.9
 Intersection LOS: B
 Intersection Capacity Utilization 78.7%
 ICU Level of Service D
 Analysis Period (min) 15
 # 95th percentile volume exceeds capacity, queue may be longer.
 Queue shown is maximum after two cycles.

Splits and Phases: 30: US 24 & Elbert

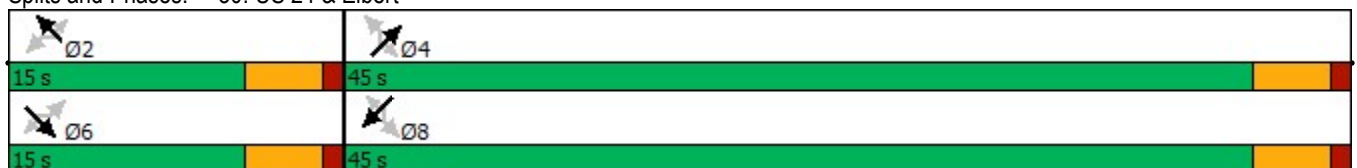

Intersection									
Intersection Delay, s/veh	11.0								
Intersection LOS	B								
Approach	EB		WB		NB		SB		
Entry Lanes	2		2		2		2		
Conflicting Circle Lanes	2		2		2		2		
Adj Approach Flow, veh/h	522		380		893		581		
Demand Flow Rate, veh/h	533		388		911		593		
Vehicles Circulating, veh/h	609		873		555		541		
Vehicles Exiting, veh/h	525		593		587		720		
Ped Vol Crossing Leg, #/h	0		0		0		0		
Ped Cap Adj	1.000		1.000		1.000		1.000		
Approach Delay, s/veh	8.4		9.7		14.4		8.9		
Approach LOS	A		A		B		A		
Lane	Left	Right	Left	Right	Left	Right	Left	Right	
Designated Moves	LT	TR	LT	TR	L	TR	L	TR	
Assumed Moves	LT	TR	LT	TR	L	TR	L	TR	
RT Channelized									
Lane Util	0.471	0.529	0.469	0.531	0.314	0.686	0.309	0.691	
Follow-Up Headway, s	2.667	2.535	2.667	2.535	2.667	2.535	2.667	2.535	
Critical Headway, s	4.645	4.328	4.645	4.328	4.645	4.328	4.645	4.328	
Entry Flow, veh/h	251	282	182	206	286	625	183	410	
Cap Entry Lane, veh/h	771	846	605	676	810	886	821	897	
Entry HV Adj Factor	0.978	0.982	0.981	0.977	0.979	0.981	0.978	0.979	
Flow Entry, veh/h	245	277	179	201	280	613	179	402	
Cap Entry, veh/h	754	831	593	661	793	869	803	878	
V/C Ratio	0.326	0.333	0.301	0.305	0.353	0.705	0.223	0.457	
Control Delay, s/veh	8.7	8.2	10.2	9.3	8.8	16.9	6.9	9.8	
LOS	A	A	B	A	A	C	A	A	
95th %tile Queue, veh	1	1	1	1	2	6	1	2	

Intersection						
Int Delay, s/veh	0.6					
Movement	EBT	EBR	WBL	WBT	NBL	NBR
Lane Configurations	↑↑			↑↑	↑↑	
Traffic Vol, veh/h	355	35	2	164	19	2
Future Vol, veh/h	355	35	2	164	19	2
Conflicting Peds, #/hr	0	0	0	0	0	0
Sign Control	Free	Free	Free	Free	Stop	Stop
RT Channelized	-	None	-	None	-	None
Storage Length	-	-	-	-	0	-
Veh in Median Storage, #	0	-	-	0	0	-
Grade, %	0	-	-	0	0	-
Peak Hour Factor	92	92	87	87	78	78
Heavy Vehicles, %	2	2	2	2	2	2
Mvmt Flow	386	38	2	189	24	3

Major/Minor	Major1	Major2	Minor1	Minor2	Minor3
Conflicting Flow All	0	0	424	0	504
Stage 1	-	-	-	-	405
Stage 2	-	-	-	-	99
Critical Hdwy	-	-	4.14	-	6.84
Critical Hdwy Stg 1	-	-	-	-	5.84
Critical Hdwy Stg 2	-	-	-	-	5.84
Follow-up Hdwy	-	-	2.22	-	3.52
Pot Cap-1 Maneuver	-	-	1132	-	497
Stage 1	-	-	-	-	642
Stage 2	-	-	-	-	914
Platoon blocked, %	-	-	-	-	-
Mov Cap-1 Maneuver	-	-	1132	-	496
Mov Cap-2 Maneuver	-	-	-	-	496
Stage 1	-	-	-	-	642
Stage 2	-	-	-	-	912

Approach	EB	WB	NB
HCM Control Delay, s	0	0.1	12.4
HCM LOS			B

Minor Lane/Major Mvmt	NBLn1	EBT	EBR	WBL	WBT
Capacity (veh/h)	514	-	-	1132	-
HCM Lane V/C Ratio	0.052	-	-	0.002	-
HCM Control Delay (s)	12.4	-	-	8.2	0
HCM Lane LOS	B	-	-	A	A
HCM 95th %tile Q(veh)	0.2	-	-	0	-

Intersection												
Int Delay, s/veh	3.8											
Movement	EBL	EBT	EBR	WBL	WBT	WBR	NBL	NBT	NBR	SBL	SBT	SBR
Lane Configurations		↕↕	↗		↕↕			↕↕			↕↕	
Traffic Vol, veh/h	20	327	78	6	167	11	74	11	8	51	10	15
Future Vol, veh/h	20	327	78	6	167	11	74	11	8	51	10	15
Conflicting Peds, #/hr	0	0	0	0	0	0	0	0	0	0	0	0
Sign Control	Free	Free	Free	Free	Free	Free	Stop	Stop	Stop	Stop	Stop	Stop
RT Channelized	-	-	None	-	-	None	-	-	None	-	-	None
Storage Length	-	-	235	-	-	-	-	-	-	-	-	-
Veh in Median Storage, #	-	0	-	-	0	-	-	0	-	-	0	-
Grade, %	-	0	-	-	0	-	-	0	-	-	0	-
Peak Hour Factor	92	92	92	87	87	87	83	83	83	83	83	83
Heavy Vehicles, %	2	2	2	2	2	2	2	2	2	2	2	2
Mvmt Flow	22	355	85	7	192	13	89	13	10	61	12	18

Major/Minor	Major1			Major2			Minor1			Minor2		
Conflicting Flow All	205	0	0	440	0	0	515	618	178	441	697	103
Stage 1	-	-	-	-	-	-	399	399	-	213	213	-
Stage 2	-	-	-	-	-	-	116	219	-	228	484	-
Critical Hdwy	4.14	-	-	4.14	-	-	7.54	6.54	6.94	7.54	6.54	6.94
Critical Hdwy Stg 1	-	-	-	-	-	-	6.54	5.54	-	6.54	5.54	-
Critical Hdwy Stg 2	-	-	-	-	-	-	6.54	5.54	-	6.54	5.54	-
Follow-up Hdwy	2.22	-	-	2.22	-	-	3.52	4.02	3.32	3.52	4.02	3.32
Pot Cap-1 Maneuver	1364	-	-	1116	-	-	443	403	834	500	363	932
Stage 1	-	-	-	-	-	-	598	601	-	769	725	-
Stage 2	-	-	-	-	-	-	876	721	-	754	550	-
Platoon blocked, %	-	-	-	-	-	-	-	-	-	-	-	-
Mov Cap-1 Maneuver	1364	-	-	1116	-	-	414	391	834	471	352	932
Mov Cap-2 Maneuver	-	-	-	-	-	-	414	391	-	471	352	-
Stage 1	-	-	-	-	-	-	585	588	-	752	720	-
Stage 2	-	-	-	-	-	-	839	716	-	712	538	-

Approach	EB			WB			NB			SB		
HCM Control Delay, s	0.4			0.3			16.3			13.9		
HCM LOS							C			B		

Minor Lane/Major Mvmt	NBLn1	EBL	EBT	EBR	WBL	WBT	WBR	SBLn1
Capacity (veh/h)	430	1364	-	-	1116	-	-	497
HCM Lane V/C Ratio	0.261	0.016	-	-	0.006	-	-	0.184
HCM Control Delay (s)	16.3	7.7	0.1	-	8.2	0	-	13.9
HCM Lane LOS	C	A	A	-	A	A	-	B
HCM 95th %tile Q(veh)	1	0	-	-	0	-	-	0.7

Intersection												
Int Delay, s/veh	0.9											
Movement	SEL	SET	SER	NWL	NWT	NWR	NEL	NET	NER	SWL	SWT	SWR
Lane Configurations	↖	↗	↖	↖	↗	↖	↖	↗	↖	↖	↗	↖
Traffic Vol, veh/h	10	50	125	25	65	30	140	1050	50	55	875	35
Future Vol, veh/h	10	50	125	25	65	30	140	1050	50	55	875	35
Conflicting Peds, #/hr	0	0	0	0	0	0	0	0	0	0	0	0
Sign Control	Stop	Stop	Stop	Stop	Stop	Stop	Free	Free	Free	Free	Free	Free
RT Channelized	-	-	Free	-	-	Stop	-	-	Yield	-	-	Yield
Storage Length	170	-	250	125	-	25	620	-	550	540	-	480
Veh in Median Storage, #	-	0	-	-	0	-	-	0	-	-	0	-
Grade, %	-	0	-	-	0	-	-	0	-	-	0	-
Peak Hour Factor	87	87	87	83	83	83	95	95	95	93	93	93
Heavy Vehicles, %	2	2	2	2	2	2	2	2	2	2	2	2
Mvmt Flow	11	57	144	30	78	36	147	1105	53	59	941	38

Major/Minor	Minor2		Minor1		Major1		Major2					
Conflicting Flow All	2497	2458	-	2487	2458	1105	941	0	0	1105	0	0
Stage 1	1059	1059	-	1399	1399	-	-	-	-	-	-	-
Stage 2	1438	1399	-	1088	1059	-	-	-	-	-	-	-
Critical Hdwy	7.12	6.52	-	7.12	6.52	6.22	4.12	-	-	4.12	-	-
Critical Hdwy Stg 1	6.12	5.52	-	6.12	5.52	-	-	-	-	-	-	-
Critical Hdwy Stg 2	6.12	5.52	-	6.12	5.52	-	-	-	-	-	-	-
Follow-up Hdwy	3.518	4.018	-	3.518	4.018	3.318	2.218	-	-	2.218	-	-
Pot Cap-1 Maneuver	20	~ 31	0	~ 20	~ 31	256	729	-	-	632	-	-
Stage 1	271	301	0	174	207	-	-	-	-	-	-	-
Stage 2	165	207	0	261	301	-	-	-	-	-	-	-
Platoon blocked, %	-	-	-	-	-	-	-	-	-	-	-	-
Mov Cap-1 Maneuver	-	~ 22	-	-	~ 22	256	729	-	-	632	-	-
Mov Cap-2 Maneuver	-	~ 22	-	-	~ 22	-	-	-	-	-	-	-
Stage 1	216	273	-	139	165	-	-	-	-	-	-	-
Stage 2	59	165	-	187	273	-	-	-	-	-	-	-

Approach	SE		NW		NE		SW	
HCM Control Delay, s					1.3		0.6	
HCM LOS	-		-					

Minor Lane/Major Mvmt	NEL	NET	NERNWLn1	NWLn2	NWLn3	SELn1	SELn2	SELn3	SWL	SWT	SWR	
Capacity (veh/h)	729	-	-	-	22	256	-	22	-	632	-	-
HCM Lane V/C Ratio	0.202	-	-	-	3.56	0.141	-	2.612	-	0.094	-	-
HCM Control Delay (s)	11.2	-	-	-	\$ 1515.2	21.4	-	\$ 1100.6	0	11.3	-	-
HCM Lane LOS	B	-	-	-	F	C	-	F	A	B	-	-
HCM 95th %tile Q(veh)	0.8	-	-	-	10	0.5	-	7.4	-	0.3	-	-

Notes
 ~: Volume exceeds capacity \$: Delay exceeds 300s +: Computation Not Defined *: All major volume in platoon

Appendix Table 1



Appendix Table 1: Land Use

Esteban Rodriguez Sketch Plan

Land Use Information		Corresponding ITE Land Uses and Quantities (for use in the Trip Generation Estimate)						
Sketch Plan Land Use Designation	Parcel	Acreage	ITE Land Use	Acreage	ITE Land Use Category	F.A.R.	Land Use Quantities (KSF)	
Commercial	Parcel A	7.15	Strip Retail Plaza (<40k)	1.50	822	0.15	10	KSF (Thousand square feet of building floor area)
			Warehousing	5.65	150	0.25	62	KSF
	Parcel B	5.71	Warehousing	5.71	150	0.25	62	KSF
	Parcel G	2.21	Warehousing	2.21	150	0.25	24	KSF
	Commercial Total	15.07	Warehousing Total	13.57			148	KSF
Residential			SF Detached		210		142	DU
Source: LSC Transportation Consultants, Inc								4/21/2024

Appendix A



Appendix A –Peak Hour Values

The peak-hour factors used for each approach are based on the traffic volumes for the peak 15 minutes of the entire intersection. If the peak 15 minutes for an approach occurs during an interval other than the peak 15 minutes of the entire intersection, the suggested peak-hour value based on the total approach volume from Table 10-1 of the *Synchro Studio User Guide* was used instead. Please refer to the *Synchro Studio User Guide's* "Suggested Peak Hour Values" documentation below for more details:

The HCM 6th Edition Chapter 19 provides suggested default values, that may be used in the absence of field measurements of peak-hour factor (PHF). For intersections with a total entering volume $\geq 1,000$ veh/h, 0.92 is a reasonable approximation for PHF. For conditions with a total entering volume $< 1,000$ veh/h, 0.90 is a reasonable estimate for PHF.

If the Analysis Period is set to a value of greater than 15 minutes, the PHF will be set to 1.0 and cannot be changed. The Analysis Period can be modified using the **Network-Settings** command, located in the Options tab.

The default PHF is 0.92 following the guidelines of the HCM 6th Edition. The user may change the default or reset existing Peak Hour Factors in the current data set in the **Network-Settings**. The range of PHF in Synchro is 0.25 to 1.00.

Note that 15-minute traffic volumes read from a UTDF Volume file automatically recalculate PHF for each volume period.

If traffic arrivals fit a Poisson distribution, probability suggests using the values in **Table 10-1** for the PHF. This assumes the highest 15-minute period is the 87.5 percentile based on average 15-minute periods of the hour.

Table 10-1 Suggested Peak Hour Values

Total Approach Volume (vph)	PHF
2000	0.95
1000	0.93
500	0.92
200	0.87
100	0.83
50	0.78

If the upstream intersection is at capacity for the entire peak hour, use a PHF of 1.0.

It is important to understand that the variance of traffic increases as the volume decreases. Therefore, lower traffic volumes create greater fluctuations in 15-minute volume levels which tends to increase PHF.

Additional Attachments

Signal Timing Judge Orr & 24G



Ped Service Limit	0	0	0	0	0	0	0	0	0	0	0	0	0	0	0	0	0	0	0	0
Pre Green	0.0	0.0	0.0	0.0	0.0	0.0	0.0	0.0	0.0	0.0	0.0	0.0	0.0	0.0	0.0	0.0	0.0	0.0	0.0	0.0
Pre Clearance	0.0	6.0	0.0	0.0	0.0	6.0	0.0	0.0	0.0	0.0	0.0	0.0	0.0	0.0	0.0	0.0	0.0	0.0	0.0	0.0

Phases	1	2	3	4	5	6	7	8	9	10	11	12	13	14	15	16	17	18	19	20
Pre Clearance 2	0.0	0.0	0.0	0.0	0.0	0.0	0.0	0.0	0.0	0.0	0.0	0.0	0.0	0.0	0.0	0.0	0.0	0.0	0.0	0.0
Red Clear Ext Max	0.0	0.0	0.0	0.0	0.0	0.0	0.0	0.0	0.0	0.0	0.0	0.0	0.0	0.0	0.0	0.0	0.0	0.0	0.0	0.0
Red Clear Ext Pass	0.0	0.0	0.0	0.0	0.0	0.0	0.0	0.0	0.0	0.0	0.0	0.0	0.0	0.0	0.0	0.0	0.0	0.0	0.0	0.0
Queue Jump	0.0	0.0	0.0	0.0	0.0	0.0	0.0	0.0	0.0	0.0	0.0	0.0	0.0	0.0	0.0	0.0	0.0	0.0	0.0	0.0
Adv Warning Ext	0.0	0.0	0.0	0.0	0.0	0.0	0.0	0.0	0.0	0.0	0.0	0.0	0.0	0.0	0.0	0.0	0.0	0.0	0.0	0.0

Phase Options

Phases	1	2	3	4	5	6	7	8	9	10	11	12	13	14	15	16	17	18	19	20
Enable		X		X	X	X		X												
Auto Flash Ent.		X				X														
Auto Flash Exit		X				X														
Non Actuated I																				
Non Actuated II																				
Non Lock Mem		X		X	X	X		X												
Min Veh Recall																				
Max Veh Recall																				
Ped Recall																				
Soft Veh Recall																				
Dual Entry																				
Sim Gap Dis																				
Guaranteed Pass																				
Act Rest Walk																				
Cond Service																				
Add Initial																				
Ped Clr During Yel																				
Ped Clr During Red																				
Cond Reservice																				
Yel Min Override																				
No Startup Call																				
Adv. Warn Flasher		X				X														
No Ped Str Up Call																				
Ped Clr OVTG																				
Flash Exit Call																				
Flash Exit Ped Call																				
MinGreen2																				
MaxGreen2																				
MaxGreen3																				
Ped2																				
Ped Clear Pre Clear																				
Ped NA+ Mode																				
Red Rest																				
Serve Evy Oth Even																				
Serve Evy Oth Odd																				
Coord Ped Yield																				
Ped Recycle																				
Coutdown																				

No Serve Phases

Sequence 1		Sequence 2		Sequence 3		Sequence 4	
Ph.	No Serve Phases	Ph.	No Serve Phases	Ph.	No Serve Phases	Ph.	No Serve Phases
1		1		1		1	
2		2		2		2	

3		3		3		3	
4		4		4		4	
5		5		5		5	
6		6		6		6	
7		7		7		7	
8		8		8		8	

Sequence 1		Sequence 2		Sequence 3		Sequence 4	
9		9		9		9	
10		10		10		10	
11		11		11		11	
12		12		12		12	
13		13		13		13	
14		14		14		14	
15		15		15		15	
16		16		16		16	

Phase Configuration

Ph.	Startup	Ring	Concurrent	Startup Min	Description
1	Phase Not On	0		0	
2	Green No Walk	1	5,6	0	
3	Phase Not On	0		0	
4	Phase Not On	1		0	
5	Phase Not On	2	2	0	
6	Green No Walk	2	2	0	
7	Phase Not On	0		0	
8	Phase Not On	1		0	
9	None	0		0	
10	None	0		0	
11	None	0		0	
12	None	0		0	
13	None	0		0	
14	None	0		0	
15	None	0		0	
16	None	0		0	
17	None	0		0	
18	None	0		0	
19	None	0		0	
20	None	0		0	

Sequence Configuration

Sequence 1		Sequence 2		Sequence 3		Sequence 4	
Ring	Phases	Ring	Phases	Ring	Phases	Ring	Phases
1	2,a,4,8,b	1	2,1,a,3,4,b	1	1,2,a,4,3,b	1	2,1,a,4,3,b
2	5,6,a,b	2	5,6,a,7,8,b	2	5,6,a,7,8,b	2	5,6,a,7,8,b
3		3		3		3	
4		4		4		4	
5		5		5		5	
6		6		6		6	
7		7		7		7	
8		8		8		8	
9		9		9		9	
10		10		10		10	
11		11		11		11	
12		12		12		12	
13		13		13		13	
14		14		14		14	

15	
16	

15	
16	

15	
16	

15	
16	

Sequence 5

Ring	Phases
1	1,2,a,3,4,b
2	6,5,a,7,8,b
3	
4	
5	
6	

Sequence 6

Ring	Phases
1	2,1,a,3,4,b
2	6,5,a,7,8,b
3	
4	
5	
6	

Sequence 7

Ring	Phases
1	1,2,a,4,3,b
2	6,5,a,7,8,b
3	
4	
5	
6	

Sequence 8

Ring	Phases
1	2,1,a,4,3,b
2	6,5,a,7,8,b
3	
4	
5	
6	

Sequence 5

7	
8	
9	
10	
11	
12	
13	
14	
15	
16	

Sequence 6

7	
8	
9	
10	
11	
12	
13	
14	
15	
16	

Sequence 7

7	
8	
9	
10	
11	
12	
13	
14	
15	
16	

Sequence 8

7	
8	
9	
10	
11	
12	
13	
14	
15	
16	

Sequence 9

Ring	Phases
1	1,2,a,3,4,b
2	5,6,a,8,7,b
3	
4	
5	
6	
7	
8	
9	
10	
11	
12	
13	
14	
15	
16	

Sequence 10

Ring	Phases
1	2,1,a,3,4,b
2	5,6,a,8,7,b
3	
4	
5	
6	
7	
8	
9	
10	
11	
12	
13	
14	
15	
16	

Sequence 11

Ring	Phases
1	1,2,a,4,3,b
2	5,6,a,8,7,b
3	
4	
5	
6	
7	
8	
9	
10	
11	
12	
13	
14	
15	
16	

Sequence 12

Ring	Phases
1	2,1,a,4,3,b
2	5,6,a,8,7,b
3	
4	
5	
6	
7	
8	
9	
10	
11	
12	
13	
14	
15	
16	

Sequence 13

Ring	Phases
1	1,2,a,3,4,b
2	6,5,a,8,7,b
3	
4	
5	
6	
7	
8	
9	
10	
11	
12	

Sequence 14

Ring	Phases
1	2,1,a,3,4,b
2	6,5,a,8,7,b
3	
4	
5	
6	
7	
8	
9	
10	
11	
12	

Sequence 15

Ring	Phases
1	1,2,a,4,3,b
2	6,5,a,8,7,b
3	
4	
5	
6	
7	
8	
9	
10	
11	
12	

Sequence 16

Ring	Phases
1	2,1,a,4,3,b
2	6,5,a,8,7,b
3	
4	
5	
6	
7	
8	
9	
10	
11	
12	

13	
14	
15	
16	

13	
14	
15	
16	

13	
14	
15	
16	

13	
14	
15	
16	

Sequence 17

Ring	Phases
1	
2	
3	
4	
5	
6	
7	
8	

Sequence 18

Ring	Phases
1	
2	
3	
4	
5	
6	
7	
8	

Sequence 19

Ring	Phases
1	
2	
3	
4	
5	
6	
7	
8	

Sequence 20

Ring	Phases
1	
2	
3	
4	
5	
6	
7	
8	

Sequence 17

9	
10	
11	
12	
13	
14	
15	
16	

Sequence 18

9	
10	
11	
12	
13	
14	
15	
16	

Sequence 19

9	
10	
11	
12	
13	
14	
15	
16	

Sequence 20

9	
10	
11	
12	
13	
14	
15	
16	

Global Phase Recalls

Phase	1	2	3	4	5	6	7	8	9	10	11	12	13	14	15	16	17	18	19	20
Min	X					X														
Max																				
Ped																				
Act Walk Rest																				

Global Veh Det Diagnostics

Global No Activity	0
Global Max Presence	0
Global Erractic Count	0
Global Failed Recall	None
Detector Reset Enable	Enabled

Global Ped Det Diagnostics

Global No Activity	0
Global Max Presence	0
Global Erractic Count	0

Global Pri/Pre Det Diag

Global No Activity	0
Global Max Presence	0
Global Erractic Count	0

Vehicle Detection Parameters

Det.	Call Phs	Call Ped	Call Ovl	Add Call Phases	Sw Phs	Delay	Extend	Queue Limit	Ext Hold	No Activity	Max Pres	Erratic Counts	Failed Time	Failed Recall	Fail Link	Description
1	1	0	0		0	0.0	0.0	0	0.0	0	0	0	0	None	0	
2	2	0	0		0	0.0	0.0	0	0.0	0	0	0	0	None	0	
3	2	0	0		0	0.0	0.0	0	0.0	0	0	0	0	None	0	
4	2	0	0		0	0.0	0.0	0	0.0	0	0	0	0	None	0	
5	2	0	0		0	0.0	0.0	0	0.0	0	0	0	0	None	0	
6	2	0	0		0	0.0	0.0	0	0.0	0	0	0	0	None	0	
7	3	0	0		0	0.0	0.0	0	0.0	0	0	0	0	None	0	
8	4	0	0		0	0.0	0.0	0	0.0	0	0	0	0	None	0	
9	4	0	0		0	0.0	0.0	0	0.0	0	0	0	0	None	0	
10	4	0	0		0	0.0	0.0	0	0.0	0	0	0	0	None	0	
11	4	0	0		0	0.0	0.0	0	0.0	0	0	0	0	None	0	
12	4	0	0		0	0.0	0.0	0	0.0	0	0	0	0	None	0	
13	1	0	0		0	0.0	0.0	0	0.0	0	0	0	0	None	0	
14	3	0	0		0	0.0	0.0	0	0.0	0	0	0	0	None	0	
15	5	0	0		0	0.0	0.0	0	0.0	0	0	0	0	None	0	

16	6	0	0		0	0.0	0.0	0	0.0	0	0	0	0	None	0	
17	6	0	0		0	0.0	0.0	0	0.0	0	0	0	0	None	0	
18	6	0	0		0	0.0	0.0	0	0.0	0	0	0	0	None	0	
19	6	0	0		0	0.0	0.0	0	0.0	0	0	0	0	None	0	
20	6	0	0		0	0.0	0.0	0	0.0	0	0	0	0	None	0	
21	7	0	0		0	0.0	0.0	0	0.0	0	0	0	0	None	0	
22	8	0	0		0	0.0	0.0	0	0.0	0	0	0	0	None	0	
23	8	0	0		0	0.0	0.0	0	0.0	0	0	0	0	None	0	
24	8	0	0		0	0.0	0.0	0	0.0	0	0	0	0	None	0	
25	8	0	0		0	0.0	0.0	0	0.0	0	0	0	0	None	0	
26	8	0	0		0	0.0	0.0	0	0.0	0	0	0	0	None	0	
27	5	0	0		0	0.0	0.0	0	0.0	0	0	0	0	None	0	
28	7	0	0		0	0.0	0.0	0	0.0	0	0	0	0	None	0	
29	0	0	0		0	0.0	0.0	0	0.0	0	0	0	0	None	0	
30	0	0	0		0	0.0	0.0	0	0.0	0	0	0	0	None	0	
31	0	0	0		0	0.0	0.0	0	0.0	0	0	0	0	None	0	
32	0	0	0		0	0.0	0.0	0	0.0	0	0	0	0	None	0	

Det.	Call	Call	Call	Add Call	Sw			Queue	Ext	No	Max	Erratic	Failed	Failed	Fail	Description
	Phs	Ped	Ovl			Phases	Phs									
33	0	0	0		0	0.0	0.0	0	0.0	0	0	0	0	None	0	
34	0	0	0		0	0.0	0.0	0	0.0	0	0	0	0	None	0	
35	0	0	0		0	0.0	0.0	0	0.0	0	0	0	0	None	0	
36	0	0	0		0	0.0	0.0	0	0.0	0	0	0	0	None	0	
37	0	0	0		0	0.0	0.0	0	0.0	0	0	0	0	None	0	
38	0	0	0		0	0.0	0.0	0	0.0	0	0	0	0	None	0	
39	0	0	0		0	0.0	0.0	0	0.0	0	0	0	0	None	0	
40	0	0	0		0	0.0	0.0	0	0.0	0	0	0	0	None	0	
41	0	0	0		0	0.0	0.0	0	0.0	0	0	0	0	None	0	
42	0	0	0		0	0.0	0.0	0	0.0	0	0	0	0	None	0	
43	0	0	0		0	0.0	0.0	0	0.0	0	0	0	0	None	0	
44	0	0	0		0	0.0	0.0	0	0.0	0	0	0	0	None	0	
45	0	0	0		0	0.0	0.0	0	0.0	0	0	0	0	None	0	
46	0	0	0		0	0.0	0.0	0	0.0	0	0	0	0	None	0	
47	0	0	0		0	0.0	0.0	0	0.0	0	0	0	0	None	0	
48	0	0	0		0	0.0	0.0	0	0.0	0	0	0	0	None	0	
49	0	0	0		0	0.0	0.0	0	0.0	0	0	0	0	None	0	
50	0	0	0		0	0.0	0.0	0	0.0	0	0	0	0	None	0	
51	0	0	0		0	0.0	0.0	0	0.0	0	0	0	0	None	0	
52	0	0	0		0	0.0	0.0	0	0.0	0	0	0	0	None	0	
53	0	0	0		0	0.0	0.0	0	0.0	0	0	0	0	None	0	
54	0	0	0		0	0.0	0.0	0	0.0	0	0	0	0	None	0	
55	0	0	0		0	0.0	0.0	0	0.0	0	0	0	0	None	0	
56	0	0	0		0	0.0	0.0	0	0.0	0	0	0	0	None	0	
57	0	0	0		0	0.0	0.0	0	0.0	0	0	0	0	None	0	
58	0	0	0		0	0.0	0.0	0	0.0	0	0	0	0	None	0	
59	0	0	0		0	0.0	0.0	0	0.0	0	0	0	0	None	0	
60	0	0	0		0	0.0	0.0	0	0.0	0	0	0	0	None	0	
61	0	0	0		0	0.0	0.0	0	0.0	0	0	0	0	None	0	
62	0	0	0		0	0.0	0.0	0	0.0	0	0	0	0	None	0	
63	0	0	0		0	0.0	0.0	0	0.0	0	0	0	0	None	0	
64	0	0	0		0	0.0	0.0	0	0.0	0	0	0	0	None	0	
65	0	0	0		0	0.0	0.0	0	0.0	0	0	0	0	None	0	
66	0	0	0		0	0.0	0.0	0	0.0	0	0	0	0	None	0	
67	0	0	0		0	0.0	0.0	0	0.0	0	0	0	0	None	0	
68	0	0	0		0	0.0	0.0	0	0.0	0	0	0	0	None	0	
69	0	0	0		0	0.0	0.0	0	0.0	0	0	0	0	None	0	

70	0	0	0	0	0	0.0	0.0	0	0.0	0	0	0	0	0	0	None	0
71	0	0	0	0	0	0.0	0.0	0	0.0	0	0	0	0	0	0	None	0
72	0	0	0	0	0	0.0	0.0	0	0.0	0	0	0	0	0	0	None	0

Vehicle Detection Options

Detector	1	2	3	4	5	6	7	8	9	10	11	12	13	14	15	16	17	18	19	20
Volume Detector																				
Occupancy																				
Yellow Lock Call																				
Red Lock call																				
Extend	X	X	X	X	X		X	X	X	X	X		X	X	X	X	X	X	X	
Added Initial																				
Queue																				
Call	X	X	X	X		X	X	X	X	X		X	X	X	X	X	X	X		X
Terminate																				
Min Green 2																				
Protected Perm																				
Disable Dly Lead																				
Disable TS2 Diag																				

Detector	21	22	23	24	25	26	27	28	29	30	31	32	33	34	35	36	37	38	39	40
Volume Detector																				
Occupancy																				
Yellow Lock Call																				
Red Lock call																				
Extend	X	X	X	X	X		X	X												
Added Initial																				
Queue																				
Call	X	X	X	X		X	X	X												
Terminate																				
Min Green 2																				
Protected Perm																				
Disable Dly Lead																				
Disable TS2 Diag																				

Detector	41	42	43	44	45	46	47	48	49	50	51	52	53	54	55	56	57	58	59	60
Volume Detector																				
Occupancy																				
Yellow Lock Call																				
Red Lock call																				
Extend																				
Added Initial																				
Queue																				
Call																				
Terminate																				
Min Green 2																				
Protected Perm																				
Disable Dly Lead																				
Disable TS2 Diag																				

Detector	61	62	63	64	65	66	67	68	69	70	71	72
Volume Detector												
Occupancy												
Yellow Lock Call												
Red Lock call												
Extend												
Added Initial												
Queue												

Data Collection Period	0
Number of Periods	1

Call																
Terminate																
Min Green 2																
Protected Perm																
Disable Dly Lead																
Disable TS2 Diag																

Speed Detectors

Det	Enable	Type	Units	Min	Max	Car	Det	Trail	Trap
				Log	Log				
1		Single	Inches	5	80	0	0	0	0
2		Single	Inches	5	80	0	0	0	0
3		Single	Inches	5	80	0	0	0	0
4		Single	Inches	5	80	0	0	0	0
5		Single	Inches	5	80	0	0	0	0
6		Single	Inches	5	80	0	0	0	0
7		Single	Inches	5	80	0	0	0	0
8		Single	Inches	5	80	0	0	0	0

Pedestrian Detectors

Det	Call Phs	Call Ovp	Add Call Phs	Walk 2	Clear 2	No Act	Max Pres	Erratic Count
1	0	0		0	0	0	0	0
2	2	0		0	0	0	0	0
3	0	0		0	0	0	0	0
4	4	0		0	0	0	0	0
5	0	0		0	0	0	0	0
6	6	0		0	0	0	0	0
7	0	0		0	0	0	0	0
8	8	0		0	0	0	0	0
9	0	0		0	0	0	0	0
10	0	0		0	0	0	0	0
11	0	0		0	0	0	0	0
12	0	0		0	0	0	0	0
13	0	0		0	0	0	0	0
14	0	0		0	0	0	0	0
15	0	0		0	0	0	0	0
16	0	0		0	0	0	0	0
17	0	0		0	0	0	0	0
18	0	0		0	0	0	0	0
19	0	0		0	0	0	0	0
20	0	0		0	0	0	0	0

Det	Call Phs	Call Ovp	Add Call Phs	Walk 2	Clear 2	No Act	Max Pres	Erratic Count
21	0	0		0	0	0	0	0
22	0	0		0	0	0	0	0
23	0	0		0	0	0	0	0
24	0	0		0	0	0	0	0
25	0	0		0	0	0	0	0
26	0	0		0	0	0	0	0
27	0	0		0	0	0	0	0
28	0	0		0	0	0	0	0
29	0	0		0	0	0	0	0
30	0	0		0	0	0	0	0
31	0	0		0	0	0	0	0
32	0	0		0	0	0	0	0
33	0	0		0	0	0	0	0
34	0	0		0	0	0	0	0
35	0	0		0	0	0	0	0
36	0	0		0	0	0	0	0
37	0	0		0	0	0	0	0
38	0	0		0	0	0	0	0
39	0	0		0	0	0	0	0
40	0	0		0	0	0	0	0

Pri/Pre Detectors

Det	Description	Low Call	High Call	Low	high	Lead/Trail	Arrival Time	Pri	Min On	Pri	No Act	Max Pres	Erratic Count
				Num	Num			Delay		Delay			
1		None	None	0	0	None	0	0	0	0	0	0	0
2		None	None	0	0	None	0	0	0	0	0	0	0
3		None	None	0	0	None	0	0	0	0	0	0	0
4		None	None	0	0	None	0	0	0	0	0	0	0
5		None	None	0	0	None	0	0	0	0	0	0	0
6		None	None	0	0	None	0	0	0	0	0	0	0
7		None	None	0	0	None	0	0	0	0	0	0	0
8		None	None	0	0	None	0	0	0	0	0	0	0

Overlaps

OLP	Enabled	Type	Included Phs	Modifier Phs	Modifier Ovlp	Neg Phases	Inhibit Neg Phs	Neg Ovlp
1	Enabled	Off	2	1				
2	Enabled	Off						

3	Enabled	Off	4	3				
4	Enabled	Off						
5	Enabled	Off	6	5				
6	Enabled	Off						
7	Enabled	Off	8	7				
8	Enabled	Off						
9	Enabled	Off						
10	Enabled	Off						
11	Enabled	Off						
12	Enabled	Off						
13	Enabled	Off						
14	Enabled	Off						
15	Enabled	Off						
16	Enabled	Off						

OLP	TrG Omit Phs	Negative Peds	Neg Ped Ovlp	Grn Sup Phs	N Ped Phs Calls	Description
1						
2						
3						
4						
5						
6						

OLP	TrG Omit Phs	Negative Peds	Neg Ped Ovlp	Grn Sup Phs	N Ped Phs Calls	Description
7						
8						
9						
10						
11						
12						
13						
14						
15						
16						

OLP	Trail	Trail	Trail	Walk	Ped	Walk	Ped	Delay	Flash	Min	Mx Grn	Red	Flash	Flash	Walk
	GRN	YEL	RED	1	Clr 1	2	Clr 2			Green	Ext	Revert	Inactive	Alt	Rest
1	0	0.0	0.0	0	0	0	0	0.0	Off	0	0	0.0	Off	Off	Off
2	0	0.0	0.0	0	0	0	0	0.0	Off	0	0	0.0	Off	Off	Off
3	0	0.0	0.0	0	0	0	0	0.0	Off	0	0	0.0	Off	Off	Off
4	0	0.0	0.0	0	0	0	0	0.0	Off	0	0	0.0	Off	Off	Off
5	0	0.0	0.0	0	0	0	0	0.0	Off	0	0	0.0	Off	Off	Off
6	0	0.0	0.0	0	0	0	0	0.0	Off	0	0	0.0	Off	Off	Off
7	0	0.0	0.0	0	0	0	0	0.0	Off	0	0	0.0	Off	Off	Off
8	0	0.0	0.0	0	0	0	0	0.0	Off	0	0	0.0	Off	Off	Off
9	0	0.0	0.0	0	0	0	0	0.0	Off	0	0	0.0	Off	Off	Off
10	0	0.0	0.0	0	0	0	0	0.0	Off	0	0	0.0	Off	Off	Off
11	0	0.0	0.0	0	0	0	0	0.0	Off	0	0	0.0	Off	Off	Off
12	0	0.0	0.0	0	0	0	0	0.0	Off	0	0	0.0	Off	Off	Off
13	0	0.0	0.0	0	0	0	0	0.0	Off	0	0	0.0	Off	Off	Off
14	0	0.0	0.0	0	0	0	0	0.0	Off	0	0	0.0	Off	Off	Off
15	0	0.0	0.0	0	0	0	0	0.0	Off	0	0	0.0	Off	Off	Off
16	0	0.0	0.0	0	0	0	0	0.0	Off	0	0	0.0	Off	Off	Off

Overlap Options																
Overlap	1	2	3	4	5	6	7	8	9	1	1	1	1	1	1	1
Startup Call																
Recall																

Overlap	1	2	3	4	5	6	7	8	9	1	1	1	1	1	1	1
Call for Service																
Trail Grn Bridge																

No Veh Reserv														
No Hold Trail Exit														
Ped Recycle														
No Yellow Protect														
No Bridging														
LRT Prepare Go														

FYA Prot. Red Cl																	
Phs Intvl Override																	
Queue Jump																	
No FYA Ped Wlk																	
Term After Call																	

Custom Overlap Rules

Rule	Custom Ovlp	Incl. State	Mod. State	Neg. State	Output	Flash
1	Disable	Any	Any	Any	Not Set	Not Set
2	Disable	Any	Any	Any	Not Set	Not Set
3	Disable	Any	Any	Any	Not Set	Not Set
4	Disable	Any	Any	Any	Not Set	Not Set
5	Disable	Any	Any	Any	Not Set	Not Set
6	Disable	Any	Any	Any	Not Set	Not Set
7	Disable	Any	Any	Any	Not Set	Not Set
8	Disable	Any	Any	Any	Not Set	Not Set
9	Disable	Any	Any	Any	Not Set	Not Set
10	Disable	Any	Any	Any	Not Set	Not Set

Coordination Parameters

Operational Mode	Automatic
Coordination Mode	Pattern
Correction Mode	Shortway (Auto)

Maximum Mode	Per Pattern
Force Mode	Per Pattern
Transition Cover Ped	Pattern

Max Cyc Limit %	15
Min Cyc Limit %	15
Max Dwell	0

Patterns

Pattern	Cycle	Offset					Split	Seq	Ref	Coord	Force	Max	Trans	Min	Phs	Det	Ped	Ovlp	Pri	Description
		1	2	3	Split	Seq														
1	140	124	0	0	1	1	Yel	Auto	Phase	Inh	Phase	Phs Only	1	1	1	1	1			
2	0	0	0	0	0	0	Yel	Auto	Fixed	Inh	Phase	Phs Only	1	1	1	1	1			
3	140	38	0	0	3	1	Yel	Auto	Phase	Inh	Phase	Phs Only	1	1	1	1	1			
4	0	0	0	0	0	0	Yel	Auto	Fixed	Inh	Phase	Phs Only	1	1	1	1	1			
5	0	0	0	0	0	0	Yel	Auto	Fixed	Inh	Phase	Phs Only	1	1	1	1	1			
6	0	0	0	0	0	0	Yel	Auto	Fixed	Inh	Phase	Phs Only	1	1	1	1	1			
7	0	0	0	0	0	0	Yel	Auto	Fixed	Inh	Phase	Phs Only	1	1	1	1	1			
8	0	0	0	0	0	0	Yel	Auto	Fixed	Inh	Phase	Phs Only	1	1	1	1	1			
9	0	0	0	0	0	0	Yel	Auto	Fixed	Inh	Phase	Phs Only	1	1	1	1	1			
10	0	0	0	0	0	0	Yel	Auto	Fixed	Inh	Phase	Phs Only	1	1	1	1	1			
11	0	0	0	0	0	0	Yel	Auto	Fixed	Inh	Phase	Phs Only	1	1	1	1	1			
12	0	0	0	0	0	0	Yel	Auto	Fixed	Inh	Phase	Phs Only	1	1	1	1	1			
13	0	0	0	0	0	0	Yel	Auto	Fixed	Inh	Phase	Phs Only	1	1	1	1	1			
14	0	0	0	0	0	0	Yel	Auto	Fixed	Inh	Phase	Phs Only	1	1	1	1	1			
15	0	0	0	0	0	0	Yel	Auto	Fixed	Inh	Phase	Phs Only	1	1	1	1	1			
16	0	0	0	0	0	0	Yel	Auto	Fixed	Inh	Phase	Phs Only	1	1	1	1	1			
17	0	0	0	0	0	0	Yel	Auto	Fixed	Inh	Phase	Phs Only	1	1	1	1	1			
18	0	0	0	0	0	0	Yel	Auto	Fixed	Inh	Phase	Phs Only	1	1	1	1	1			
19	0	0	0	0	0	0	Yel	Auto	Fixed	Inh	Phase	Phs Only	1	1	1	1	1			
20	0	0	0	0	0	0	Yel	Auto	Fixed	Inh	Phase	Phs Only	1	1	1	1	1			

Split Parameters

Split 1				Coord	Ref	Cover	Force Off	Mode	Mode	Pri	Pri	Pri
PH.	Time	Min	Max							PH	PH	Ped
1	0	0	0				Fix	None	0	0	Float	
2	70	0	0	X	X		Fix	Max Rcl	0	0	Float	
3	0	0	0				Fix	None	0	0	Float	
4	35	0	0				Fix	None	0	0	Float	
5	12	0	0				Flt	None	0	0	Float	
6	58	0	0	X	X		Fix	Max Rcl	0	0	Float	

7	0	0	0				Fix	None	0	0	Float
8	35	0	0				Fix	None	0	0	Float
9	0	0	0				Fix	None	0	0	Float
10	0	0	0				Fix	None	0	0	Float
11	0	0	0				Fix	None	0	0	Float
12	0	0	0				Fix	None	0	0	Float
13	0	0	0				Fix	None	0	0	Float
14	0	0	0				Fix	None	0	0	Float
15	0	0	0				Fix	None	0	0	Float
16	0	0	0				Fix	None	0	0	Float

Split 2

				Coord	Ref	Cover	Force Off		Pri	Pri	Pri
PH.	Time	Min	Max	PH	PH	Ped	Mode	Mode	Min	Max	F. Off
1	0	0	0				Fix	None	0	0	Float
2	0	0	0				Fix	None	0	0	Float
3	0	0	0				Fix	None	0	0	Float
4	0	0	0				Fix	None	0	0	Float
5	0	0	0				Fix	None	0	0	Float
6	0	0	0				Fix	None	0	0	Float
7	0	0	0				Fix	None	0	0	Float
8	0	0	0				Fix	None	0	0	Float
9	0	0	0				Fix	None	0	0	Float
10	0	0	0				Fix	None	0	0	Float
11	0	0	0				Fix	None	0	0	Float
12	0	0	0				Fix	None	0	0	Float
13	0	0	0				Fix	None	0	0	Float
14	0	0	0				Fix	None	0	0	Float
15	0	0	0				Fix	None	0	0	Float
16	0	0	0				Fix	None	0	0	Float

Split 3

				Coord	Ref	Cover	Force Off		Pri	Pri	Pri
PH.	Time	Min	Max	PH	PH	Ped	Mode	Mode	Min	Max	F. Off
1	0	0	0				Fix	None	0	0	Float
2	85	0	0	X	X		Fix	Max Rcl	0	0	Float
3	0	0	0				Fix	None	0	0	Float
4	25	0	0				Fix	None	0	0	Float
5	20	0	0				Flt	None	0	0	Float
6	65	0	0	X	X		Fix	Max Rcl	0	0	Float
7	0	0	0				Fix	None	0	0	Float
8	30	0	0				Fix	None	0	0	Float
9	0	0	0				Fix	None	0	0	Float
10	0	0	0				Fix	None	0	0	Float
11	0	0	0				Fix	None	0	0	Float
12	0	0	0				Fix	None	0	0	Float
13	0	0	0				Fix	None	0	0	Float
14	0	0	0				Fix	None	0	0	Float
15	0	0	0				Fix	None	0	0	Float
16	0	0	0				Fix	None	0	0	Float

Split 4

				Coord	Ref	Cover	Force Off		Pri	Pri	Pri
PH.	Time	Min	Max	PH	PH	Ped	Mode	Mode	Min	Max	F. Off
1	0	0	0				Fix	None	0	0	Float
2	0	0	0				Fix	None	0	0	Float
3	0	0	0				Fix	None	0	0	Float
4	0	0	0				Fix	None	0	0	Float
5	0	0	0				Fix	None	0	0	Float
6	0	0	0				Fix	None	0	0	Float
7	0	0	0				Fix	None	0	0	Float

8	0	0	0				Fix	None	0	0	Float
9	0	0	0				Fix	None	0	0	Float
10	0	0	0				Fix	None	0	0	Float
11	0	0	0				Fix	None	0	0	Float
12	0	0	0				Fix	None	0	0	Float
13	0	0	0				Fix	None	0	0	Float
14	0	0	0				Fix	None	0	0	Float
15	0	0	0				Fix	None	0	0	Float
16	0	0	0				Fix	None	0	0	Float

Split 5

PH.	Time	Min	Max	Coord PH	Ref PH	Cover Ped	Force Off		Pri Min	Pri Max	Pri F. Off
							Mode	Mode			
1	0	0	0				Fix	None	0	0	Float
2	0	0	0				Fix	None	0	0	Float
3	0	0	0				Fix	None	0	0	Float
4	0	0	0				Fix	None	0	0	Float
5	0	0	0				Fix	None	0	0	Float
6	0	0	0				Fix	None	0	0	Float
7	0	0	0				Fix	None	0	0	Float
8	0	0	0				Fix	None	0	0	Float
9	0	0	0				Fix	None	0	0	Float
10	0	0	0				Fix	None	0	0	Float
11	0	0	0				Fix	None	0	0	Float
12	0	0	0				Fix	None	0	0	Float
13	0	0	0				Fix	None	0	0	Float
14	0	0	0				Fix	None	0	0	Float
15	0	0	0				Fix	None	0	0	Float
16	0	0	0				Fix	None	0	0	Float

Split 6

PH.	Time	Min	Max	Coord PH	Ref PH	Cover Ped	Force Off		Pri Min	Pri Max	Pri F. Off
							Mode	Mode			
1	0	0	0				Fix	None	0	0	Float
2	0	0	0				Fix	None	0	0	Float

Split 6

PH.	Time	Min	Max	Coord PH	Ref PH	Cover Ped	Force Off		Pri Min	Pri Max	Pri F. Off
							Mode	Mode			
3	0	0	0				Fix	None	0	0	Float
4	0	0	0				Fix	None	0	0	Float
5	0	0	0				Fix	None	0	0	Float
6	0	0	0				Fix	None	0	0	Float
7	0	0	0				Fix	None	0	0	Float
8	0	0	0				Fix	None	0	0	Float
9	0	0	0				Fix	None	0	0	Float
10	0	0	0				Fix	None	0	0	Float
11	0	0	0				Fix	None	0	0	Float
12	0	0	0				Fix	None	0	0	Float
13	0	0	0				Fix	None	0	0	Float
14	0	0	0				Fix	None	0	0	Float
15	0	0	0				Fix	None	0	0	Float
16	0	0	0				Fix	None	0	0	Float

Split 7

PH.	Time	Min	Max	Coord PH	Ref PH	Cover Ped	Force Off		Pri Min	Pri Max	Pri F. Off
							Mode	Mode			
1	0	0	0				Fix	None	0	0	Float
2	0	0	0				Fix	None	0	0	Float
3	0	0	0				Fix	None	0	0	Float
4	0	0	0				Fix	None	0	0	Float

5	0	0	0				Fix	None	0	0	Float
6	0	0	0				Fix	None	0	0	Float
7	0	0	0				Fix	None	0	0	Float
8	0	0	0				Fix	None	0	0	Float
9	0	0	0				Fix	None	0	0	Float
10	0	0	0				Fix	None	0	0	Float
11	0	0	0				Fix	None	0	0	Float
12	0	0	0				Fix	None	0	0	Float
13	0	0	0				Fix	None	0	0	Float
14	0	0	0				Fix	None	0	0	Float
15	0	0	0				Fix	None	0	0	Float
16	0	0	0				Fix	None	0	0	Float

Split 8

				Coord	Ref	Cover	Force Off				
PH.	Time	Min	Max	PH	PH	Ped	Mode	Mode	Pri Min	Pri Max	Pri F. Off
1	0	0	0				Fix	None	0	0	Float
2	0	0	0				Fix	None	0	0	Float
3	0	0	0				Fix	None	0	0	Float
4	0	0	0				Fix	None	0	0	Float
5	0	0	0				Fix	None	0	0	Float
6	0	0	0				Fix	None	0	0	Float
7	0	0	0				Fix	None	0	0	Float
8	0	0	0				Fix	None	0	0	Float
9	0	0	0				Fix	None	0	0	Float
10	0	0	0				Fix	None	0	0	Float
11	0	0	0				Fix	None	0	0	Float
12	0	0	0				Fix	None	0	0	Float
13	0	0	0				Fix	None	0	0	Float
14	0	0	0				Fix	None	0	0	Float
15	0	0	0				Fix	None	0	0	Float
16	0	0	0				Fix	None	0	0	Float

Split 9

				Coord	Ref	Cover	Force Off				
PH.	Time	Min	Max	PH	PH	Ped	Mode	Mode	Pri Min	Pri Max	Pri F. Off
1	0	0	0				Fix	None	0	0	Float
2	0	0	0				Fix	None	0	0	Float
3	0	0	0				Fix	None	0	0	Float
4	0	0	0				Fix	None	0	0	Float

Split 9

				Coord	Ref	Cover	Force Off				
PH.	Time	Min	Max	PH	PH	Ped	Mode	Mode	Pri Min	Pri Max	Pri F. Off
5	0	0	0				Fix	None	0	0	Float
6	0	0	0				Fix	None	0	0	Float
7	0	0	0				Fix	None	0	0	Float
8	0	0	0				Fix	None	0	0	Float
9	0	0	0				Fix	None	0	0	Float
10	0	0	0				Fix	None	0	0	Float
11	0	0	0				Fix	None	0	0	Float
12	0	0	0				Fix	None	0	0	Float
13	0	0	0				Fix	None	0	0	Float
14	0	0	0				Fix	None	0	0	Float
15	0	0	0				Fix	None	0	0	Float
16	0	0	0				Fix	None	0	0	Float

Split 10

				Coord	Ref	Cover	Force Off				
PH.	Time	Min	Max	PH	PH	Ped	Mode	Mode	Pri Min	Pri Max	Pri F. Off
1	0	0	0				Fix	None	0	0	Float
2	0	0	0				Fix	None	0	0	Float

J	A	S	O	N	D	17	18	19	20	21	22	23	24	25	26	27	28	29	30	31

Day Plan On

Month of Year					Days of Week							Days of Month																	
J	F	M	A	M	J	S	M	T	W	T	F	S	1	2	3	4	5	6	7	8	9	10	11	12	13	14	15	16	
J	A	S	O	N	D	17	18	19	20	21	22	23	24	25	26	27	28	29	30	31									

Day Plan

Event	Hour	Min.	Act
1	5	30	1
2	9	0	10
3	14	0	3
4	18	0	10
5	0	0	
6	0	0	
7	0	0	
8	0	0	
9	0	0	
10	0	0	

Day Plan

Event	Hour	Min.	Act
1	0	1	10
2	0	0	
3	0	0	
4	0	0	
5	0	0	
6	0	0	
7	0	0	
8	0	0	
9	0	0	
10	0	0	

Day Plan

Event	Hour	Min.	Act
1	0	0	
2	0	0	
3	0	0	
4	0	0	
5	0	0	
6	0	0	
7	0	0	
8	0	0	
9	0	0	
10	0	0	

Day Plan

Event	Hour	Min.	Act
1	0	0	
2	0	0	
3	0	0	
4	0	0	
5	0	0	
6	0	0	
7	0	0	
8	0	0	
9	0	0	
10	0	0	

Day Plan

Event	Hour	Min.	Act
1	0	0	
2	0	0	
3	0	0	
4	0	0	
5	0	0	
6	0	0	
7	0	0	
8	0	0	
9	0	0	
10	0	0	

Day Plan

Event	Hour	Min.	Act
1	0	0	
2	0	0	
3	0	0	
4	0	0	
5	0	0	
6	0	0	
7	0	0	
8	0	0	
9	0	0	
10	0	0	

Day Plan

Event	Hour	Min.	Act
1	0	0	
2	0	0	
3	0	0	
4	0	0	
5	0	0	
6	0	0	
7	0	0	
8	0	0	
9	0	0	
10	0	0	

Day Plan

Event	Hour	Min.	Act
1	0	0	
2	0	0	
3	0	0	
4	0	0	
5	0	0	
6	0	0	
7	0	0	
8	0	0	
9	0	0	
10	0	0	

Day Plan

Event	Hour	Min.	Act
1	0	0	
2	0	0	
3	0	0	
4	0	0	
5	0	0	
6	0	0	
7	0	0	
8	0	0	
9	0	0	
10	0	0	

Day Plan

Event	Hour	Min.	Act
1	0	0	
2	0	0	
3	0	0	
4	0	0	
5	0	0	
6	0	0	
7	0	0	
8	0	0	
9	0	0	
10	0	0	

Day Plan

Event	Hour	Min.	Act
1	0	0	
2	0	0	
3	0	0	
4	0	0	
5	0	0	
6	0	0	
7	0	0	
8	0	0	
9	0	0	
10	0	0	

Day Plan

Event	Hour	Min.	Act
1	0	0	
2	0	0	
3	0	0	
4	0	0	
5	0	0	
6	0	0	
7	0	0	
8	0	0	
9	0	0	
10	0	0	

Day Plan

Event	Hour	Min.	Act
1	0	0	
2	0	0	
3	0	0	
4	0	0	
5	0	0	
6	0	0	

Day Plan

Event	Hour	Min.	Act
1	0	0	
2	0	0	
3	0	0	
4	0	0	
5	0	0	
6	0	0	

Day Plan

Event	Hour	Min.	Act
1	0	0	
2	0	0	
3	0	0	
4	0	0	
5	0	0	
6	0	0	

Day Plan

Event	Hour	Min.	Act
1	0	0	
2	0	0	
3	0	0	
4	0	0	
5	0	0	
6	0	0	

7	0	0	
8	0	0	
9	0	0	
10	0	0	

7	0	0	
8	0	0	
9	0	0	
10	0	0	

7	0	0	
8	0	0	
9	0	0	
10	0	0	

7	0	0	
8	0	0	
9	0	0	
10	0	0	

Day Plan				17
Event	Hour	Min.	Act	
1	0	0		
2	0	0		
3	0	0		
4	0	0		
5	0	0		
6	0	0		
7	0	0		
8	0	0		
9	0	0		
10	0	0		

Day Plan				18
Event	Hour	Min.	Act	
1	0	0		
2	0	0		
3	0	0		
4	0	0		
5	0	0		
6	0	0		
7	0	0		
8	0	0		
9	0	0		
10	0	0		

Day Plan				19
Event	Hour	Min.	Act	
1	0	0		
2	0	0		
3	0	0		
4	0	0		
5	0	0		
6	0	0		
7	0	0		
8	0	0		
9	0	0		
10	0	0		

Day Plan				20
Event	Hour	Min.	Act	
1	0	0		
2	0	0		
3	0	0		
4	0	0		
5	0	0		
6	0	0		
7	0	0		
8	0	0		
9	0	0		
10	0	0		

Actions		Aux.			Special Functions							
Act	Pattern	1	2	3	1	2	3	4	5	6	7	8
1	Pattern 1											
2	Pattern 2											
3	Pattern 3											
4	Pattern 4											
5	Pattern 5											
6	Pattern 6											
7	Pattern 7											
8	Pattern 8											
9	Pattern 9											
10	Free											
11	None											
12	None											
13	None											
14	None											
15	None											
16	None											
17	None											
18	None											
19	None											
20	None											
21	None											
22	None											
23	None											
24	None											
25	None											
26	None											
27	None											
28	None											
29	None											
30	None											
31	None											
32	None											

Actions		Aux.			Special Functions							
Act	Pattern	1	2	3	1	2	3	4	5	6	7	8
33	None											
34	None											
35	None											
36	None											
37	None											
38	None											
39	None											
40	None											
41	None											
42	None											
43	None											
44	None											
45	None											
46	None											
47	None											
48	None											
49	None											
50	None											
51	None											
52	None											
53	None											
54	None											
55	None											
56	None											
57	None											
58	None											
59	None											
60	None											
61	None											
62	None											
63	None											
64	None											

Action Commands

Action 1

Cmd	Command	Indexes
1	None	
2	None	

Action 2

Cmd	Command	Indexes
1	None	
2	None	

3	None	
4	None	
5	None	
6	None	
7	None	
8	None	
9	None	
10	None	

3	None	
4	None	
5	None	
6	None	
7	None	
8	None	
9	None	
10	None	

Master Sections By TOD

Action	1	2	3	4	5	6	7	8	9	0	1
Master Section 1											
Master Section 2											
Master Section 3											
Master Section 4											
Master Section 5											
Master Section 6											
Master Section 7											
Master Section 8											
Master Section 9											
Master Section 10											
Master Section 11											
Master Section 12											
Master Section 13											
Master Section 14											
Master Section 15											
Master Section 16											

Queue Responsive By TOD

Action	1	2	3	4	5	6	7	8	9	0	1
Queue Resp Plan 1											
Queue Resp Plan 2											
Queue Resp Plan 3											
Queue Resp Plan 4											
Queue Resp Plan 5											
Queue Resp Plan 6											
Queue Resp Plan 7											
Queue Resp Plan 8											
Queue Resp Plan 9											
Queue Resp Plan 10											
Queue Resp Plan 11											
Queue Resp Plan 12											
Queue Resp Plan 13											
Queue Resp Plan 14											
Queue Resp Plan 15											
Queue Resp Plan 16											

Preemption Parameters

Preempt	1	2	3	4	5	6	7	8
Link	0	0	0	0	0	0	0	0
Delay	0	0	0	0	0	0	0	0
Min Duration	0	0	0	0	0	0	0	0
Min Presence	0.0	0.0	0.0	0.0	0.0	0.0	0.0	0.0
Max Presence	0	0	0	0	0	0	0	0
Enter Min Green	0	0	0	0	0	0	0	0
Enter Yellow	25.5	25.5	25.5	25.5	25.5	25.5	25.5	25.5
Ent. Red Clear	25.5	25.5	25.5	25.5	25.5	25.5	25.5	25.5
Min Walk	0	0	0	0	0	0	0	0
Ent. Ped Clear	255	255	255	255	255	255	255	255
Track Green	0	0	0	0	0	0	0	0
Max Track Grn	0	0	0	0	0	0	0	0
Track Yellow	25.5	25.5	25.5	25.5	25.5	25.5	25.5	25.5
Track Red Clear	25.5	25.5	25.5	25.5	25.5	25.5	25.5	25.5
Track 2 Green	0	0	0	0	0	0	0	0
Track 2 Yellow	25.5	25.5	25.5	25.5	25.5	25.5	25.5	25.5
Track 2 Red	25.5	25.5	25.5	25.5	25.5	25.5	25.5	25.5
Track Ext Gate Dn	0	0	0	0	0	0	0	0
Dwell Green	0	0	0	0	0	0	0	0
Exit Ped Clear	255	255	255	255	255	255	255	255
Exit Yellow	25.5	25.5	25.5	25.5	25.5	25.5	25.5	25.5
Exit Red	25.5	25.5	25.5	25.5	25.5	25.5	25.5	25.5
Dwell Ext Time	0.0	0.0	0.0	0.0	0.0	0.0	0.0	0.0
Max Exit Green	0	0	0	0	0	0	0	0
Exit Max Time	0	0	0	0	0	0	0	0

Preempt	1	2	3	4	5	6	7	8
Non Lock Mem								
Not Override Flash								
NotOverrideNextPre								
Flash Dwell								
Ped Recycle								
Imm Ped Clear								
Dwell Only Status								
All Red Flash Dwell								
Allow All Overlaps								
Req All Red Entry								
Req Gate Dwn Trck Exit								
Req Gate Up Dwl Exit								
Normal On/Off Input								
Track Clear Override								
Aux Function 1								
Aux Function 2								
Aux Function 3								
Special Function 1								
Special Function 2								
Special Function 3								
Special Function 4								
Special Function 5								
Special Function 6								
Special Function 7								
Special Function 8								

Require CRC
Disabled

Pre	1	2	3	4	5	6	7	8
-----	---	---	---	---	---	---	---	---

Pre	1	2	3	4	5	6	7	8
-----	---	---	---	---	---	---	---	---

Pre	1	2	3	4	5	6	7	8
-----	---	---	---	---	---	---	---	---

Pre	1	2	3	4	5	6	7	8
-----	---	---	---	---	---	---	---	---

Peer Configuration

Ctrl	Peer ID	Device Type	IP address	IP Port	Http Port	Serial Port	Serial Addr.	Master Sect.	P2P TO	Description
1	0	Peer MaxTime		161	80	0	0	0	15	
2	0	Peer MaxTime		161	80	0	0	0	15	
3	0	Peer MaxTime		161	80	0	0	0	15	
4	0	Peer MaxTime		161	80	0	0	0	15	
5	0	Peer MaxTime		161	80	0	0	0	15	
6	0	Peer MaxTime		161	80	0	0	0	15	
7	0	Peer MaxTime		161	80	0	0	0	15	
8	0	Peer MaxTime		161	80	0	0	0	15	
9	0	Peer MaxTime		161	80	0	0	0	15	
10	0	Peer MaxTime		161	80	0	0	0	15	

Master Section Configuration

Section	Control	Poll	Req #	Fail Time	Algorithm Period	Description
1	None	60	1	300	240	
2	None	60	1	300	240	
3	None	60	1	300	240	
4	None	60	1	300	240	
5	None	60	1	300	240	
6	None	60	1	300	240	
7	None	60	1	300	240	
8	None	60	1	300	240	
9	None	60	1	300	240	
10	None	60	1	300	240	
11	None	60	1	300	240	
12	None	60	1	300	240	
13	None	60	1	300	240	
14	None	60	1	300	240	
15	None	60	1	300	240	
16	None	60	1	300	240	

User Program Info

Pgrm	Description	Pgrm	Description
1		17	
2		18	
3		19	
4		20	
5		21	
6		22	
7		23	
8		24	
9		25	
10		26	
11		27	
12		28	
13		29	
14		30	
15		31	
16		32	

Additional Attachments

VISTRO JANE DAVIS AM ST - SITE



Traffic Volume - Net New Site Trips

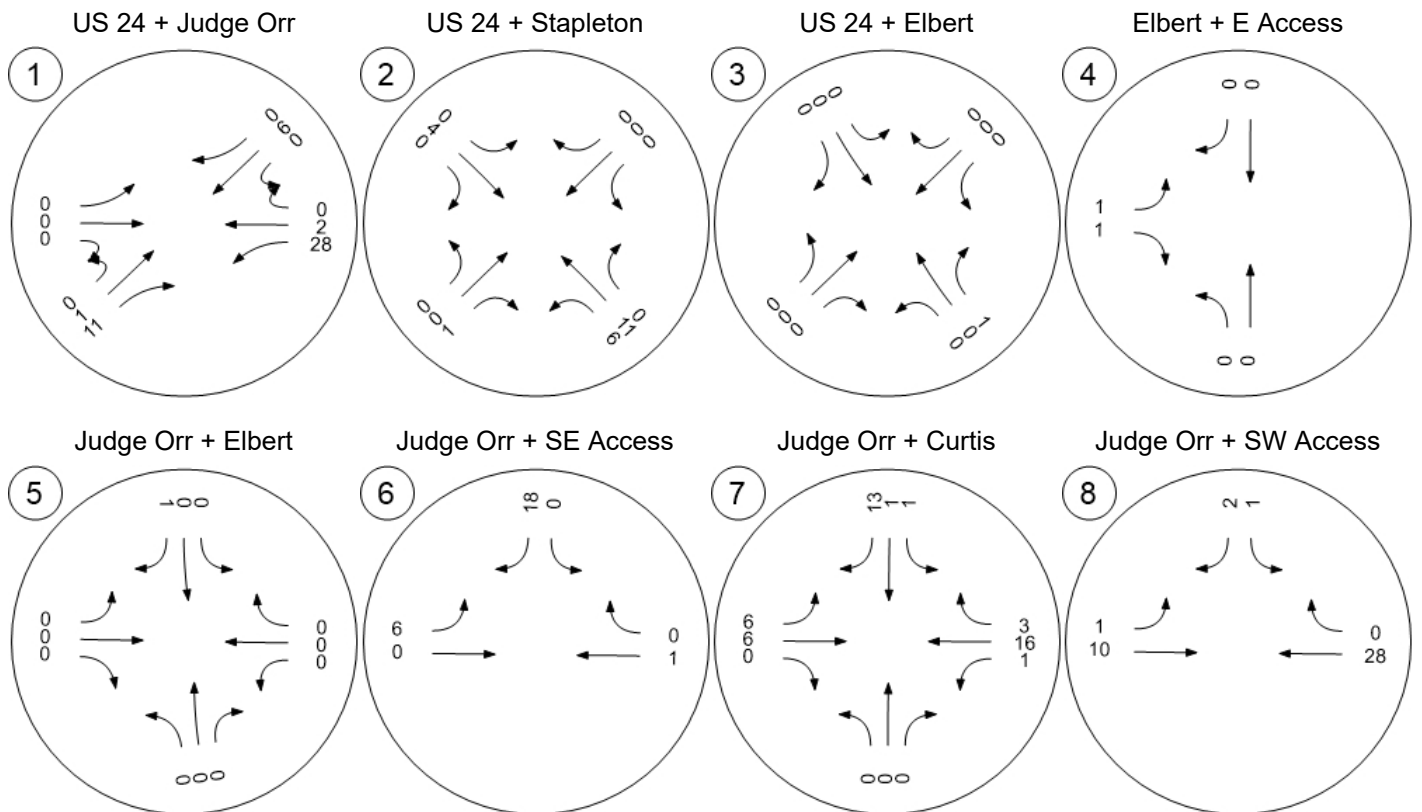

Traffic Volume - Net New Site Trips



Stapleton + W Access

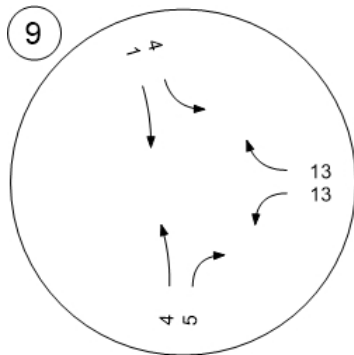

Additional Attachments

VISTRO JANE DAVIS PM ST - SITE



Traffic Volume - Net New Site Trips

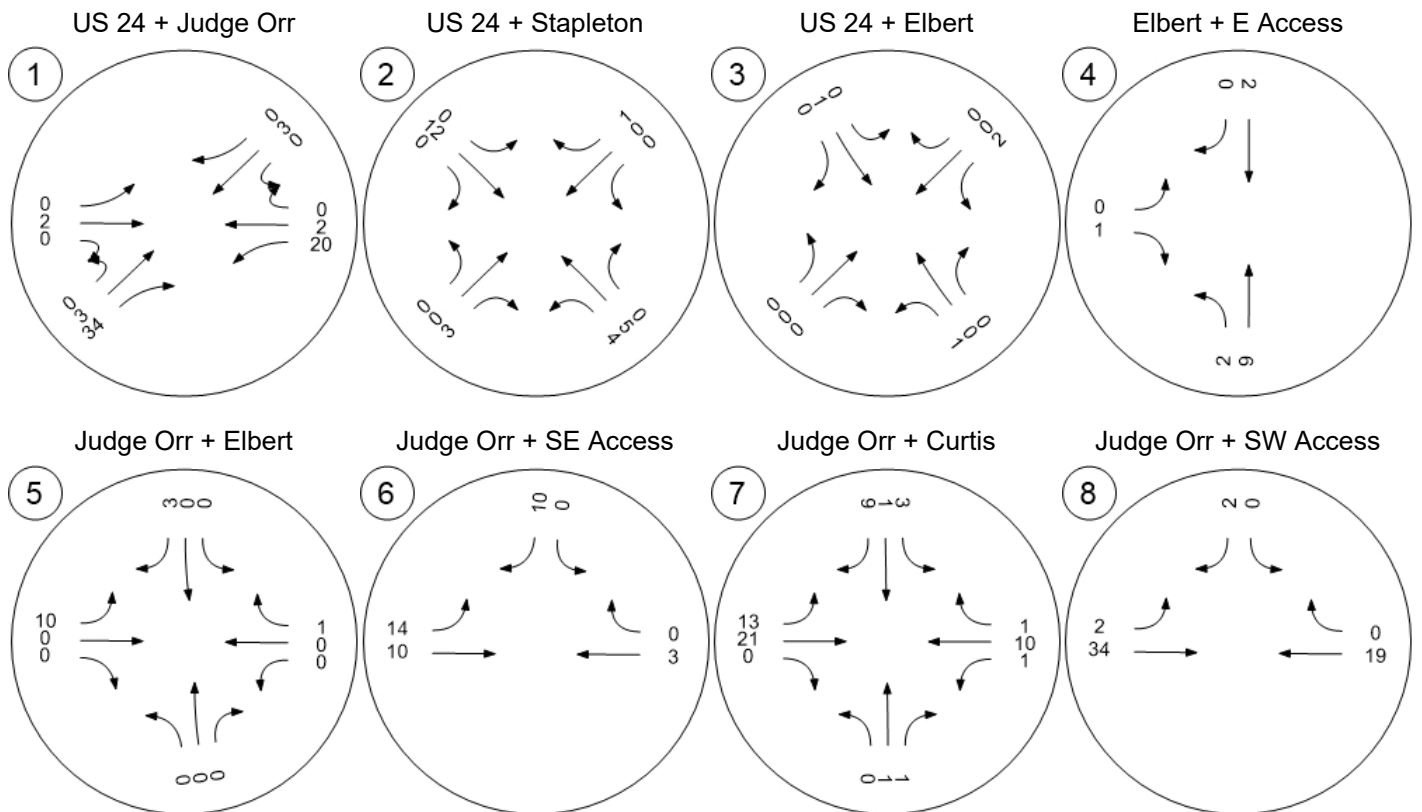

Traffic Volume - Net New Site Trips



Stapleton + W Access

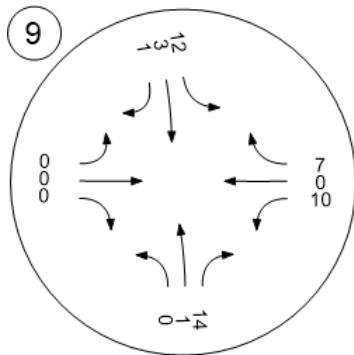

Additional Attachments

Excerpt of Pages from *Meadowlake Industrial Park Fil 1 Prelim Plan*





LSC TRANSPORTATION CONSULTANTS, INC.
2504 East Pikes Peak Avenue, Suite 304
Colorado Springs, CO 80909
(719) 633-2868
FAX (719) 633-5430
E-mail: lsc@lsctrans.com
Website: <http://www.lsctrans.com>

Meadowlake Industrial Park
Filing No. 1 Preliminary Plan
Traffic Impact Study
EPC PCD File No. SP236
(LSC #S234040)
February 2, 2024

Traffic Engineer's Statement

This traffic report and supporting information were prepared under my responsible charge and they comport with the standard of care. So far as is consistent with the standard of care, said report was prepared in general conformance with the criteria established by the County for traffic reports.

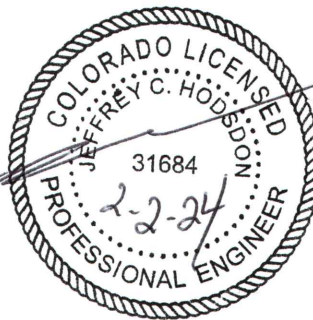

Developer's Statement

I, the Developer, have read and will comply with all commitments made on my behalf within this report.

Date

Table 2: Trip-Generation Estimate

TAZ	ITE Land Use		Land Use Details				Trip Generation Rates ²						Trips Generated				
	Code	Description	Value	Units	% Floor Area	Value	Units ¹	Average Weekday	A.M. Peak		P.M. Peak		Average Weekday	A.M. Peak		P.M. Peak	
									In	Out	In	Out		In	Out	In	Out
1	150	Warehousing	36.560	Acres	29%	462	KSF	1.71	0.13	0.04	0.05	0.13	790	60	18	23	60
¹ KSF = 1,000 square feet of building floor area ² Source: <i>Trip Generation, 11th Edition (2021)</i> by the Institute of Transportation Engineers (ITE)																	
9/22/2023																	

Table 3

(page 1 of 3)

**Auxiliary Turn Lane Analysis
Meadowlake Industrial Park
Filing No. 1 Preliminary Plan**

Judge Orr Rd + Curtis Rd/Stapleton Rd						
Criteria	SBL	WBL	NBL	EBL	EBR	WBR
Existing Traffic Control	Stop		Stop			
Assumed Short-Term Traffic Control	Stop		Stop			
Existing Volume (vph)	5 / 18	24 / 2	40 / 54	3 / 2	73 / 24	14 / 13
2025 Total Volume (vph)	5 / 34	28 / 3	61 / 77	7 / 7	87 / 45	25 / 13
Turn Lane Threshold Warrant (vph)	-	-	-	-	50	50
Volume Exceeds Threshold?	Existing	Existing	Existing	Existing	No**	No
Design Speed (mph)	50	60	50	50	50	60
Existing Turn Lane Lengths						
Total Length (ft)	535	495	520	522	-	-
Deceleration Length (ft)	265	240	265	250	-	-
Storage Length (ft)						
Taper Length (ft)	270	255	255	272	-	-
ECM-Prescribed Turn Lane Lengths						
Total Length (ft)	485	580	535	435	435	530
Deceleration Length (ft)	235	290	235	235	235	290
Storage Length (ft)	50	50	100	0	0	0
Taper Length (ft)	200	240	200	200	200	240
Recommended Turn Lane Lengths						
Total Length (ft)	-	-	Escrow for	-	Escrow for	-
Deceleration Length (ft)	-	-	Future	-	Future	-
Storage Length (ft)	-	-	Improvement	-	Improvement	-
Taper Length (ft)	-	-	-	-	-	-
Notes about ECM Criteria						
Improvements Table Reference #	-	-	7.4	-	7.1	-
Meets ECM Criteria?	No*	No	No	Yes		-
Additional Notes	However, total length exceeds ECM; Currently a stop-controlled approach	Saddlehorn Filing 3 CD plans call for upgrade	Currently a stop-controlled approach	Storage length not required, as EBL lane not required	** Assuming CDOT Access Code provision as outlined in the report page 13.	
Date: 2/1/2024						

Table 4

(page 1 of 3)

Meadowlake Industrial Park

Filing No. 1 Preliminary Plan

Roadway Improvements

Roadway Segment Improvements

Item #	Improvement	Timing	Responsibility
1.1	Curtis Road (Short-Term) -- South property line of Filing No. 1 to south end of planned Saddlehorn improvements Upgrade to 2-lane Principal Arterial.	Filing No. 1 Preliminary Plan: Upgrade Curtis Road from the south property boundary north to the south end of the Saddlehorn Ranch improvements. Incorporate paved and gravel shoulders comparable to the Saddlehorn Ranch Filing No. 1 approved CDs. The left-turn lane may need to be positioned off-center to the west given ROW constraints on the east side. Standard redirect taper ratios should be used to shift through lanes. If the southbound right-turn lane is not constructed with this first preliminary plan, install the paved and gravel shoulders. For the first 100+/- feet north and south of the access, install the radii in the anticipated ultimate location (to accommodate the width for a future SB RT decel and accel lanes plus shoulders) and pave a short temporary tapered pavement area to tie in with the the interim improvements. Also see turn lane improvements section of this table.	Applicant

Adjacent County Arterial Roadway ROW Requirements

Item #	Improvement	Timing	Responsibility
2.1	Curtis Road 2-Lane Rural Principal Arterial 144' total future ROW (Note: 4-lane Rural Principal is 180')	With the Filing No. 1 Plat: Show dedication of 72' of 1/2 ROW on the west side along the site frontage (including the existing 30').	Applicant (west side - half ROW)
2.2	Curtis Road 4-Lane Rural Principal Arterial 180' right-of-way preservation	Filing No. 1 Preliminary Plan: Show 90' of 1/2 ROW preservation on the west side along the site frontage.	Applicant (west side - half ROW)

Internal Subdivision Roadways

Item #	Improvement	Timing	Responsibility
3.1	Construct major internal streets to County Urban Non-Residential Collector Standards.	With Filing No. 1	Applicant
3.2	Construct minor internal streets as private local streets build to Urban, Local (private) standards with 30' of asphalt plus Typc C curb (optional) as shown on the Preliminary Plan.	With Filing No. 1, as development occurs	Applicant

CDOT Off-Site Intersections

US Highway 24/Stapleton Intersection (CDOT)

Item #	Improvement	Timing	Responsibility
4.1	Submit Access Permit Application to CDOT	Submit access permit application with the /plat stage of the development process.	Applicant
4.2	Escrow towards cost of signalization. CDOT Escrow for Participation in the cost of future signalization - \$92,000** (Note: Opportunity for County fee Program credit/reimbursement for a portion; also opportunity for cost recovery as other area project are required to escrow funds and if/when this development's overall fair share percentage is reduced accordingly in the future.	Escrow required w/the access permit process at the site development plan/Plat.	Applicant to escrow funds (as part of the CDOT access permit process) toward the future signal per the CDOT comment letter.

US Highway 24/Falcon Highway and US Highway 24/Judge Orr Intersections (CDOT)

Item #	Improvement	Timing	Responsibility
5.1	Falcon Highway with connection to SH 24G: Submittal Access Permit Applications to CDOT will be required for the: - Falcon Highway with connection to SH24G A State Highway Access Permit(s) are required by El Paso County or the Development for escrows for the equal fair share amount of the intersection signal at these intersections. (Per CDOT review letter dated October 31, 2023).	Submit access permit application(s) at the platting/site development plan stage. A requirement for escrow as part of the required CDOT access permit process has been identified; however, no amount was specified in the comment letter and these intersections are already signalized.	Applicant (El Paso County will likely be the Permittee)
5.2	Judge Orr Road connection to SH 24G Submittal Access Permit Applications to CDOT will be required for the: - - Judge Orr Road with connection to SH24G A State Highway Access Permit(s) are required by El Paso County or the Development for escrows for the equal fair share amount of the intersection signal at these intersections. (Per CDOT review letter dated October 31, 2023).	Submit access permit application(s) at the Preliminary Plan or platting/site development plan stage. A requirement for escrow as part of the required CDOT access permit process has been identified, however no amount was specified in the comment letter and these intersections are already signalized.	Applicant (El Paso County will likely be the Permittee)

Table 4 (page 2 of 3)			
Meadowlake Industrial Park Filing No. 1 Preliminary Plan Roadway Improvements El Paso County Off-Site Intersections Falcon Highway/Meridian Road Intersection			
6.1	<u>Short Term</u> Westbound right-turn deceleration lane	Currently warranted by ECM	Escrow portion toward improvement with Filing No. 1 final plat (fee program credit per fee)
Judge Orr/Curtis Road Intersection			
Item #	Improvement	Timing	Responsibility
7.1	<u>Short Term</u> Eastbound right-turn deceleration lane - Escrow funds toward this future improvement.	Financial assurances to be provided as part of the final plat.	Applicant
7.2	<u>Short Term - Traffic Control</u> This TIS indicates the intersection would continue to operate at an acceptable LOS with the current TWSC in the 2025/Short Term based on the Background + Filing No. 1 Site Traffic Scenario.	This TIS indicates the intersection would continue to operate at an acceptable LOS with the current TWSC in the 2025/Short Term based on the Background + Filing No. 1 Site Traffic Scenario.	N/A
7.3	<u>Long Term (or Prior to 2040) - Traffic Control</u> This intersection is likely an eligible intersection for future signalization within the fee program. This TIS indicates the intersection would continue to operate at an acceptable LOS with the current TWSC in the 2025/Short Term. Master Study: Participate on a pro-rata basis with a fair share contribution or upgrade the intersection, potentially including new traffic control, to mitigate anticipated substandard level of service, as necessary.	Once LOS of AWSC drops below acceptable levels; and/or once signal warrants are met. Depends on the pace and intensity of development of this site and the rate of other area development and associated background traffic growth. This TIS indicates the intersection would continue to operate at an acceptable LOS with the current TWSC in the 2025/Short Term based on the Background + Filing No. 1 Site Traffic Scenario.	The applicant will pay fee program traffic impact fees. This intersection is likely an eligible intersection for future signalization within the fee program.
7.4	<u>Long Term (if signalized in the future)</u> Lengthen northbound left-turn deceleration lane.	As needed based on future speed limit and turning volume/stacking length criteria.	Escrow for improvement or construction if warranted at the time of development (fee program credit per fee program provisions).
Adjacent & Access Intersections Curtis Road/Falcon Highway			
Item #	Improvement	Timing	Responsibility
8.1	<u>From Master Study (for Reference)</u> <u>Short Term/Long Term</u> Change to AWSC traffic control as necessary. Participate on a pro-rata basis with a fair share contribution toward upgrade the intersection, potentially including new traffic control, to mitigate substandard level of service, as necessary. Significant improvements may be needed in the short term if rapid site buildout and area growth occurs. Otherwise, intermediate term.	<u>From Master Study (for Reference)</u> Once LOS of AWSC drops below acceptable levels; and/or once signal warrants are met. Depends on the pace and intensity of development of this site and the rate of other area development and associated background traffic growth.	<u>From Master Study (for Reference)</u> The applicant will pay fee program traffic impact fees and any required intersection improvements (or participation) may be fee-program eligible for credit based on the program guidelines.
8.1a	<u>Short Term:</u> This TIS indicates the intersection would operate at LOS F/E (AM/PM) on the northbound approach with the current TWSC based on the in the 2025/Short Term based on the Background + Filing No. 1 Site Traffic Scenario. Consideration for interim conversion to AWSC.	Consider traffic-control change to interim AWSC once warrants for AWSC control are met.	
8.1b	<u>Long Term (or Prior to 2040)</u> This intersection is likely an eligible intersection for future signalization within the fee program. See above item 8.1a relative to the Short Term. A roundabout may also be considered. Master Study (for reference:) Participate on a pro-rata basis with a fair share contribution or upgrade the intersection, potentially including new traffic control, to mitigate anticipated substandard level of service, as necessary.	Once LOS of AWSC control (interim change to AWSC in the short term) drops below acceptable levels and/or once signal warrants are met. Depends on the pace and intensity of development of this site and the rate of other area development and associated background traffic growth.	
8.2	<u>Short Term (if planned to be signalized in the future)</u> Construct SB right-turn deceleration lane on Curtis Road approaching Falcon Highway. ONLY In the case of a future signalized intersection or reverse of the TWSC stop-sign traffic control orientation, or as needed in the future for acceptable operations. See footnote below.	Only required upon Signalization or reversal of the stop-sign traffic control orientation, or as needed in the future for acceptable operations. See footnote below. Escrow funds toward this future improvement with the site development plan /plat.	Applicant - Escrow for pro-rata share of improvement. Responsibility will likely be shared between this project and Saddlehorn Ranch, with the cost shared.
8.3	<u>Short Term</u> Escrow toward the cost of future lengthening of the existing EB left-turn deceleration lane on Falcon Highway approaching Curtis Road.	Note: EPC comments on Saddlehorn Filing No. 4 indicate "construct with Filing 4 if warranted based on 50' queuing length, per conditions of approval." A similar condition likely applies to this development. Previously recommended "trigger" from Saddlehorn Ranch: once projected queue (95th percentile) exceeds 50 feet. LSC suggests the same trigger for this project. When warrants require improvements, a deviation would be submitted. A deviation request, if approved, would allow interim use of the existing lane and taper (based on short term total turning volumes /associated queue length). Deviation not required at this time.	Escrow for pro-rata share of future improvement. Responsibility will likely be shared between this project and Saddlehorn Ranch, with the cost shared.
8.4	<u>Short Term</u> WB right-turn deceleration lane on Falcon Highway approaching Curtis Road. <u>From Master Study (for Reference)</u> Construct WB right-turn deceleration lane on Falcon Highway approaching Curtis Road. This turn lane is not projected to be warranted based on Filing No. 1 Preliminary Plan projected volume. Escrow toward the cost of future WB right-turn deceleration lane on Falcon Highway approaching Curtis Road.	This turn lane is not projected to be warranted based on Filing No. 1 Preliminary Plan projected volume.	Escrow for pro-rata share of improvement
8.5	<u>From Master TIS:</u> <u>Long Term (if planned to be signalized in the future)</u> Lengthen northbound left-turn deceleration lane This Preliminary Plan is not projected to add to this northbound left turn lane in the short term as no access is planned for Falcon Highway with the Filing No. 1 Preliminary Plan.	<u>N/A with this Preliminary Plan</u> As needed based on future speed limit and turning volume/stacking length criteria	<u>N/A with this Preliminary Plan</u> Escrow for improvement or construction if warranted at the time of development (fee program credit per fee program provisions)

Table 4

(page 3 of 3)

Meadowlake Industrial Park

Filing No. 1 Preliminary Plan

Roadway Improvements

Curtis Road/Sagebrush Street (Full-Movement Access)

Item #	Improvement	Timing	Responsibility
Short Term			
10a.1	<u>Short Term & Long Term</u> Master Study: w/ Roundabout Option - Construct one-lane modern roundabout, expandable to a two-lane roundabout. Roundabout not proposed with the Preliminary Plan.	Roundabout not proposed with the Preliminary Plan.	N/A
OR			
10b.1	<u>Short Term</u> Southbound right-turn deceleration lane on Curtis Rd approaching the site access.	This turn lane is not projected to be warranted based on Filing No. 1 Preliminary Plan projected right turn volume. The applicant may elect (volunteer) to install this turn lane as part of the access construction and required left turn lane improvement. See design notes under item 1.	Applicant
10b.2	<u>Short Term</u> Northbound left-turn deceleration lane on Curtis Rd approaching the site access. See Design notes under item 1.1.	With site development plan/plat. This turn lane is projected to be warranted based on Filing No. 1 Preliminary Plan projected volumes.	Applicant
10b.3	<u>Short Term</u> Southbound right-turn acceleration lane on Curtis Rd for right-turning traffic exiting the site access.	This auxiliary lane is not projected to be warranted based on Filing No. 1 Preliminary Plan projected volume.	Applicant
10b.4a	<u>Short Term</u> Construct intersection w/Stop-sign control for the eastbound approach. See design notes under item 1.1.	With site development plan/plat.	Applicant
10b.4b	<u>Long Term</u> From Master TIS: Install traffic signal A signal warrant would not be met based on Filing No. 1 Preliminary Plan projected volume.	Once warranted - with future MLIP development, as necessary to maintain acceptable intersection operations.	Applicant
Item 4.2 Note: CDOT Formula taken from CDOT review letter:US24 & Stapleton: Based on the average AM & PM site-generated passenger cars directly impacting the 4-hour signal warrant, the Meadowlake Industrial Park Filing No. 1 development is required to escrow \$92,000 (8.5 new vehicles / 60 vehicles-to-warrant x \$650K/signal cost) to CDOT for the construction of the traffic signal.			
Item 8.2 Note: The default ECM trigger for this potential right turn lane is 25 vph, and the threshold would be met with 2025 background or site-generated (and total) traffic. However, since the southbound approach is currently Stop-sign controlled, the turn lane is not currently needed due to mitigate speed differential between through traffic and right turning traffic. LSC recommends the following triggers: <ul style="list-style-type: none"> o Once the intersection is signalized (if as signal is the selected future traffic control instead of a modern roundabout) or o If El Paso County switches the orientation of the stop signs such that Curtis is changed to the "major street" and Falcon Highway is changed to the "minor street" (the intersection remains two-way, stop-sign control). o If or needed for operations – i.e., to maintain an acceptable level of service as an intersection with TWSC or AWSC As none of these triggers are met based on short term total traffic volumes, escrow for pro-rata share of this potential improvement with the plat submittal. LSC suggests escrow in lieu of lane construction as the above triggers are not met and the lane could potentially be "throw away" if a roundabout is selected as the future traffic control. The escrow for the southbound right turn lane could potentially be returned to the applicant, as it would not be necessary with a roundabout.			
LSC Transportation Consultants, Inc. (2/1/2024)			

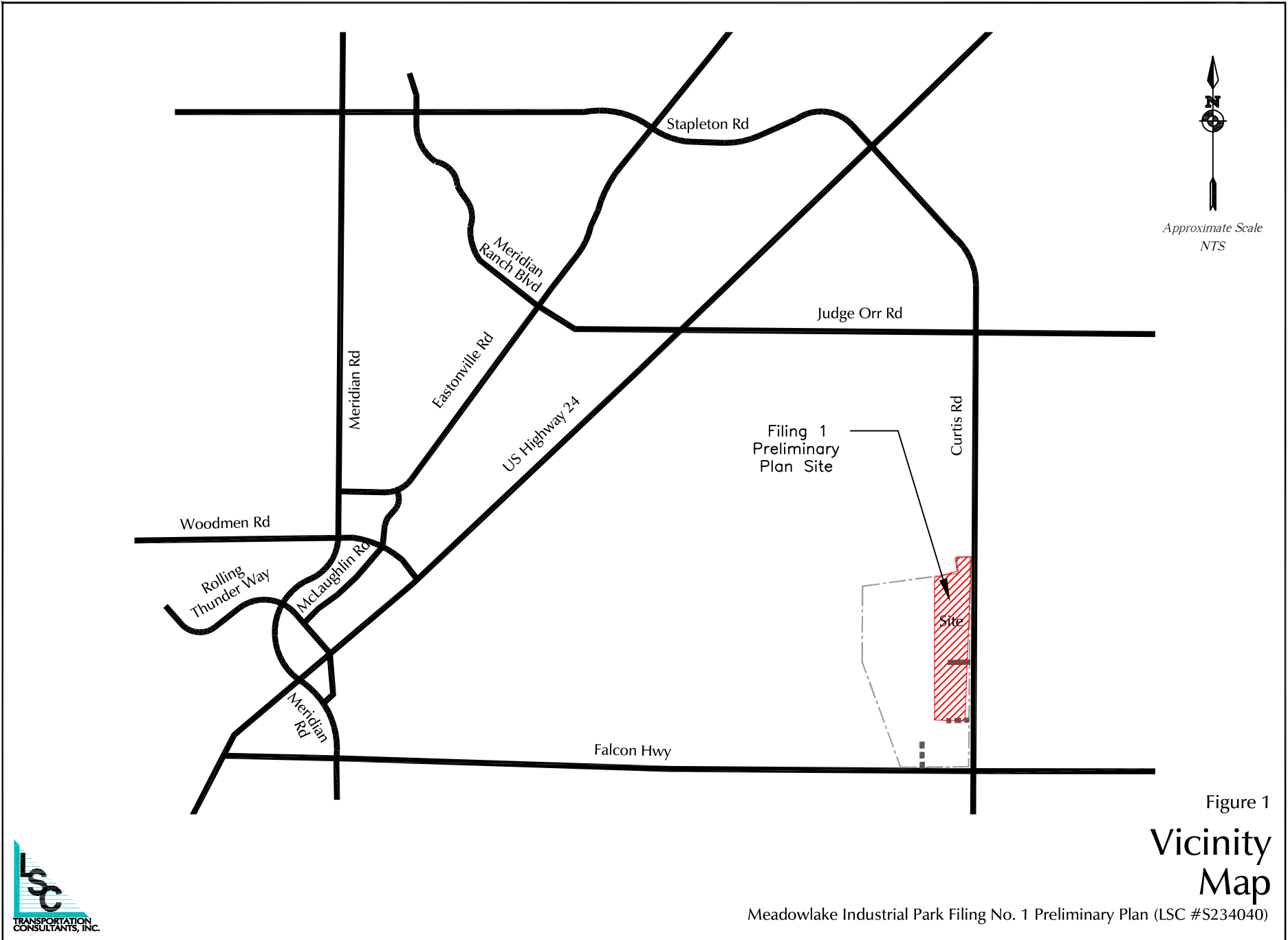

Figure 1
Vicinity
Map

Meadowlake Industrial Park Filing No. 1 Preliminary Plan (LSC #S234040)





Approximate Scale
1" = 600'

MEADOW LAKE AIRPORT
SCH. NO. 4300000963

SADDLEHORN RANCH
HOMES, LLC
SCH. NO. 4310001001

SADDLEHORN RANCH
SCH. NO. 4310001002

SADDLEHORN RANCH
HOMES, LLC
SCH. NO. 4310001003

GORILLA CAPITAL CO
SADDLEHORN RANCH, LLC
SCH. NO. 4310001019

Filing 1
Preliminary
Plan Site

Proposed Full-
Movement Access

FAYE REYNOLDS
SCH. NO. 4300000550

2,400'

Curtis Road

1,200'

340'

322'

600'

346'

UNNAMED TRIBUTARY

Center of future
planned access
road (not a part of
this application)

MEADOW LAKE AIRPORT, LLC/SOC.
SCH. NO. 4300000963

Falcon Hwy

JEANNE WINGS (MRS) WYNNER
SCH. NO. 4310001004

DAVE L. HANCOCK
MIGUEL R. HANCOCK P.
SCH. NO. 4310001005

BORGAT, WENDY
SCH. NO. 4310001006

Figure 2
Site
Plan

Meadowlake Industrial Park Filing No. 1 Preliminary Plan (LSC #S234040)





Approximate Scale
Scale: 1" = 3,000'

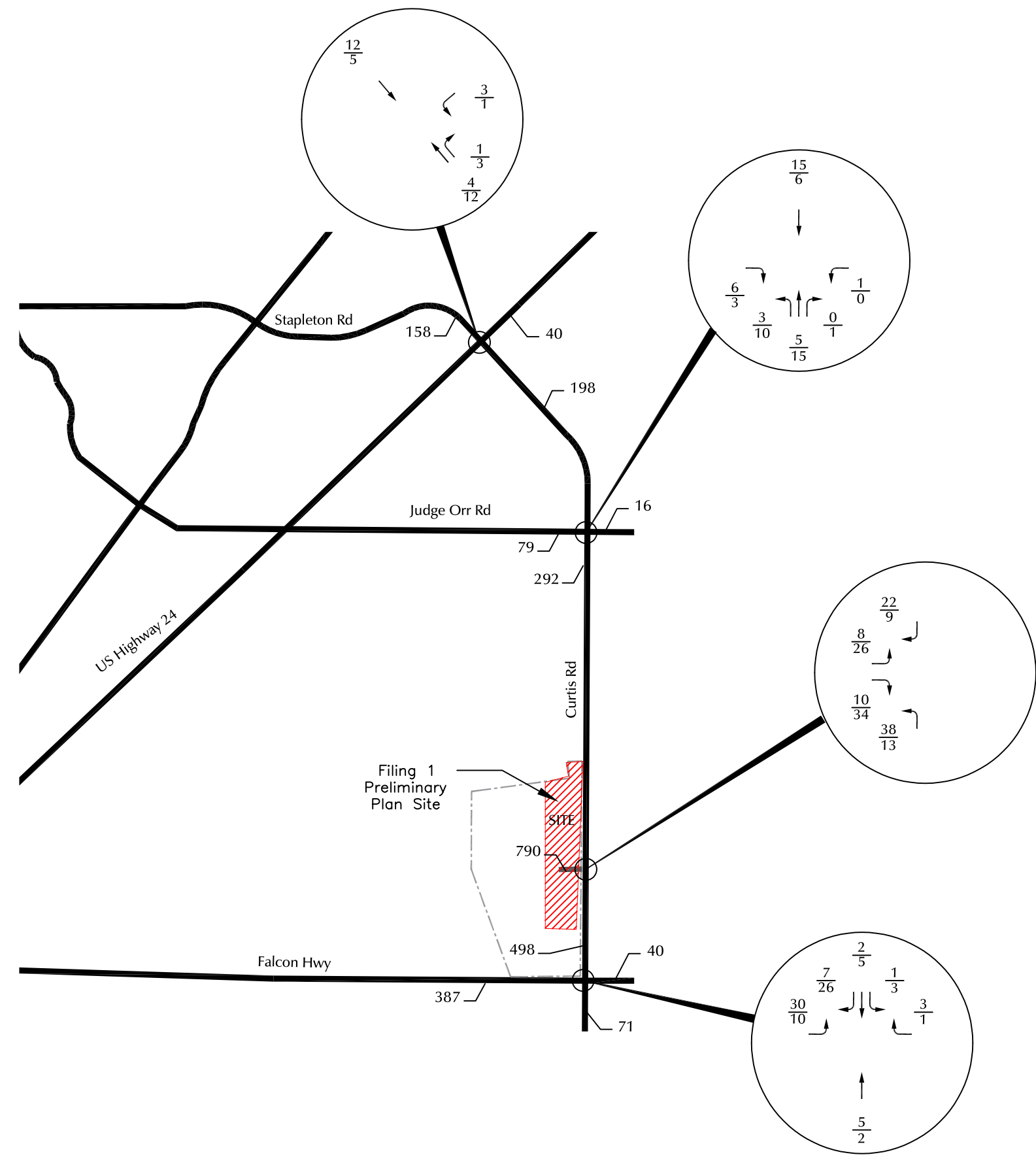

$\frac{XX}{XX}$ = AM Weekday Peak-Hour Traffic (vehicles per hour)
 $\frac{XX}{XX}$ = PM Weekday Peak-Hour Traffic (vehicles per hour)
 X,XXX = Average Daily Traffic (vehicles per day)

Figure 5
Short-Term Site-Generated Traffic
 Meadowlake Industrial Park Filing No. 1 Preliminary Plan (LSC #S234040)

Additional Attachments

Excerpt of Pages from *Saddlehorn Ranch (Filing 3) TIS* -- 2-01-2024





LSC TRANSPORTATION CONSULTANTS, INC.
2504 East Pikes Peak Avenue, Suite 304
Colorado Springs, CO 80909
(719) 633-2868
FAX (719) 633-5430
E-mail: lsc@lsctrans.com
Website: <http://www.lsctrans.com>

Saddlehorn Ranch Filing No. 3
Traffic Impact Study
EPC PCD File No. SF-23-004
(LSC #S224541)
February 1, 2024

Traffic Engineer's Statement

This traffic report and supporting information were prepared under my responsible charge and they comport with the standard of care. So far as is consistent with the standard of care, said report was prepared in general conformance with the criteria established by the County for traffic reports.



Developer's Statement

I, the Developer, have read and will comply with all commitments made on my behalf within this report.

Table 4*: Roadway Improvements			
Saddlehorn Ranch Filing No. 3			
Offsite Intersections			
Item #	Improvement	Timing	Responsibility
US Highway 24/Judge Orr Intersection			
1.1	Realignment of Judge Orr Road at US Highway 24 per CDOT Hwy 24 PEL Study	Future (the PEL study identified this as a high priority project with a time frame of less than 5 years)	CDOT
1.2	Southwest-bound right-turn deceleration lane on US Hwy 24 approaching Judge Orr Road	As required by other development(s) or with realignment of US Hwy 24/Judge Orr	CDOT or by others
1.3	Construct southwest-bound right-turn acceleration lane on US Hwy 24 at Judge Orr Road	As required by other development(s) or with realignment of US Hwy 24/Judge Orr	CDOT or by others
1.4	Eastbound left-turn lane on Judge Orr Road approaching US Hwy 24	With realignment of US Hwy 24/Judge Orr	CDOT
1.5	Westbound dual left-turn lanes on Judge Orr Road approaching US Hwy 24	With realignment of US Hwy 24/Judge Orr	CDOT
1.6	Northeast-bound right-turn deceleration lane on US 24 approaching Judge Orr Road	With realignment of US Hwy 24/Judge Orr	CDOT
1.7	Eastbound right-turn deceleration lane on Judge Orr Road approaching US Hwy 24	As required by other development(s) or with realignment of US Hwy 24/Judge Orr	CDOT or by others
US Highway 24/Stapleton Intersection			
2.1a	CDOT Escrow for Participation in the cost of future signalization - \$79,500** (Note: Opportunity for County fee Program credit/reimbursement for a portion; also opportunity for cost recovery as other area project are required to escrow funds and if/when this development's overall fair share percentage is reduced accordingly in the future.	With the Filing No. 3 Plat	Applicant
2.1b	Signalize the intersection	Once warrants are met	CDOT is collecting escrow from area developments impacting this intersection.
Curtis Road/Falcon Highway			
3.1	Filing No. 3 Escrow toward the cost of future lengthening of the eastbound left-turn lane to ECM standards on Falcon Highway approaching Curtis Road	When warrants require improvements, a deviation will be submitted. Deviation not required at this time. For Existing plus Fil. 1-5, recommended "trigger": once projected queue (95th percentile) exceeds 50'	Escrow for pro-rata share of improvement or construction at the time of Filing No. 3 development (fee program credit per fee program provisions)
3.2	Long Term: ONLY In the case of a future signalized intersection or reverse of the TWSC Stop-sign traffic control orientation- Construct southbound right-turn deceleration lane on Curtis Road approaching Falcon Highway	Upon Signalization or reversal of the Stop-sign traffic control orientation. See footnote below.	Check for either trigger with future subdivision filings and a determination could be made at that time if this project should install the turn lane (with fee program credit per fee program provisions). Otherwise, with each filing, escrow for pro-rata share of improvement or construction if warranted at the time of development (fee program credit per fee program provisions)
3.2	Long Term: Reconstruct intersection as a modern roundabout (or signalize the intersection)	Once LOS of AWSC drops below acceptable levels (roundabout); or once signal warrants are met (for conversion to a signal or roundabout)	El Paso County – This intersection will be fee-program eligible for a signal/roundabout and applicant will pay fee program traffic impact fees.
Adjacent County Arterial Roadway ROW Requirements			
4.1	Judge Orr Right-of-Way Dedication - 4 Lane Minor Arterial, Rural 130' to 150 estimated right-of-way dedication' (Note: 4-lane Rural Principal is 180')	Shown in 2040 MTCP; Dedicate adjacent ROW with the Filing No. 3 Plat	Applicant
4.2	Judge Orr - 4 Lane Minor Arterial - Beyond above dedication, no additional right-of-way preservation needed.	Shown in 2060 Corridor Pres Plan	Applicant
4.3	Curtis Road - 2 Lane Rural Principal Arterial 72' from existing centerline/section line to proposed ROW lind. This translates to 42 feet of ROW dedication. (Note: 4-lane Rural Principal is 180')	Dedicate adjacent ROW with the Filing No. 3 Plat	Applicant
4.4	Curtis Road - 4 Lane Rural Principal Arterial 180' right-of-way preservation (90 feet east of the existing centerline/section line).	Shown in 2060 Corridor Pres Plan; Reserve up to 90 feet as required with the Filing No. 3 plat.	Applicant
Roadway Segment Improvements			
5.1	Falcon Highway - Upgrade to Two-Lane Rural Minor Arterial	Shown in 2040 MTCP	MTCP Project No. U5; Details TBD; applicant will pay fee program traffic impact fees.
5.2a	Judge Orr Road (Short Term) - Filing No. 3 construction plans show widening of the south side along the site frontage to include an additional 24' of asphalt pavement, plus a two-foot gravel shoulder. Please see Filing No. 3 CDs.	With development of Filing No. 3	Applicant with potential for negotiated fee program credit based on construction of the ultimate four-lane, Rural Minor Arterial half section. This will be subject to submission and review and potential acceptance of a proposed fee program credit agreement by EPC and the Fee Program Committee.
5.2b	Judge Orr Road (Long Term) - Future widening on the north side to completed the ultimate Four Lane Rural Minor Arterial	Four-lane Rural Minor Arterial Shown in 2040 MTCP	MTCP Project No. C15; Details TBD; - applicant will pay fee program traffic impact fees.
5.3a	Short Term: Curtis Road Adjacent to Filing No. 1 - Interim upgrades to Curtis Road - to be constructed with Filing No. 1 - Please refer approved Filing No. 1 CDs.	To be constructed with Filing No. 2	Applicant with potential for negotiated fee program credit based on constructed half-section. This will be subject to submission and review and potential acceptance of a proposed fee program credit agreement by EPC and the Fee Program Committee.
5.3b	Short Term: Curtis Road Adjacent to Filing No. 2 - Interim upgrades to Curtis Road - to be constructed with Filing No. 2 - Please refer to Filing No. 2 CDs.	To be constructed with Filing No. 2	Applicant with potential for negotiated fee program credit based on constructed half-section. This will be subject to submission and review and potential acceptance of a proposed fee program credit agreement by EPC and the Fee Program Committee.
5.3c	Short Term: Curtis Road Adjacent to Filing No. 3 - Interim upgrades to Curtis Road - to be constructed with Filing No. 3 - Please refer to Filing No. 3 CDs.	To be constructed with Filing No. 3	Applicant with potential for negotiated fee program credit based on constructed half-section. This will be subject to submission and review and potential acceptance of a proposed fee program credit agreement by EPC and the Fee Program Committee.
5.3d	Long Term: Curtis Road - Upgrade to Two-Lane Rural Principal Arterial	Shown in 2040 MTCP; (Future - TBD - Limited ROW available on the west side. Please refer to approved Curtis Road Deviation). The segment from the south border of Saddlehorn and Falcon Highway is adjacent to the Meadowlake Industrial Park development. Please refer to the most recent TIS for that project for additional information.	MTCP Project No. U1; Applicant per rezone condition of approval, potentially subject to fee program credit.
Internal Subdivision Roadways			
6.1	Construct internal Filing No. 3 streets to County Rural Local Standards	Per the Filing 3 Construction Plans	Applicant
Adjacent Intersection and Access Intersections			
Judge Orr/Curtis Road Intersection			
7.1	Westbound right-turn deceleration lane	Once peak-hour westbound right-turn volume exceeds 50 vehicles per hour.	Escrow a pro-rata share for future construction with Filing No. 3 (fee program credit per fee program provisions)
7.2	Eastbound right-turn deceleration lane	Currently warranted by ECM. However, please refer to the Filing No. 2 TIS report narrative for the provision in the "State Highway Access Code" Section 3.5 (S) for low through volumes). Evaluate with future Final Plans. By Filing 5 (the last filing) a determination would be made if Saddlehorn Ranch should construct the turn lane or provide escrow toward future construction by others.	Check for eastbound through and right turning thresholds (as described in the report narrative) with future subdivision filings and a determination could be made at that time if this project should install the turn lane (with fee program credit per fee program provisions). Otherwise escrow a pro-rata share for future construction with Filing No. 3 (fee program credit per fee program provisions).
7.3	Potentially sign for all-way stop-sign control (AWSC)	Once warrants for AWSC are met	El Paso County
7.4	Long Term: Reconstruct intersection as a modern roundabout (or signalize the intersection)	Once LOS of AWSC drops below acceptable levels (roundabout); or once signal warrants are met (for conversion to a signal or roundabout)	El Paso County. This intersection will be fee-program eligible for a signal/roundabout and applicant will pay fee program traffic impact fees.
7.5	Long Term: In the case of a future signalized intersection - lengthening of northbound and southbound left-turn deceleration lanes.	As needed based on future speed limit and turning volume/stacking length criteria.	Escrow for improvement or construction if warranted at the time of development (fee program credit per fee program provisions)
7.6	Northbound Left Turn Lane - potential future lengthening (restriping)	Proposed trigger - once intersection is signalized Or if Stop signs are switched to EB and WB or while NB stop control remains, if queue reaches lengths	Escrow for improvement or construction if warranted at the time of development (fee program credit per fee program provisions)
Judge Orr/Barrosito Trail			
8.1	No Auxiliary Turn Lanes Required Construction Plans show an eastbound right-turn deceleration lane to be constructed with Filing 3	To be constructed with Filing No. 3	Applicant
Judge Orr/Del Cambre Trail			
9.1	No Auxiliary Turn Lanes Required Construction Plans show an eastbound right-turn deceleration lane to be constructed with Filing 3	To be constructed with Filing No. 3	Applicant
Curtis Road/Oscuro Trail			
10.1	Short Term Please Refer to Filing No. 2 TIS. Filing 3 is not projected to generate any left- or right-turning movements at this intersection. NOTE: The northbound right turn deceleration lane (Filing No. 1 improvement) has not yet been constructed.		
10.2	Long Term Please Refer to Filing No. 2 TIS. Filing 3 is not projected to generate any left- or right-turning movements at this intersection		
Curtis Road/Benito Wells Trail			
11.1	Short Term Construction Plans show Auxiliary Turn Lanes to be constructed with Filing 2	Construction Plans show Auxiliary Turn Lanes to be constructed with Filing 2	Applicant
11.2	Long Term Construct southbound left-turn deceleration lane on Curtis Rd approaching the site access	To be constructed with Filing No. 2	Applicant
11.3	Long Term Construct northbound right-turn deceleration lane on Curtis Rd approaching the site access	To be constructed with Filing No. 2	Applicant
* Modified version of Table 10 From the Saddlehorn Ranch Preliminary Plan TIS dated March 11, 2020.			
Note: Items with red borders - Filing No. 3 related; items in blue border - modifications associated with Filings 1 or 2.			
** Note: CDOT Formula taken from Filing No. 2 review letter: [for Filing 2] The development is required to participate in the cost of the future traffic signal at Stapleton and Hwy 24. Based on the average AM&PM site-generated passenger cars directly impacting the 4-hour warrant, the development would be responsible for ~\$75,000 [Filing 2 amount], (6.5 new vehicles / 60 vehicles-to-warrant x ~\$700K/signal cost). Filing 3 amount calculated using 44 lots/42 lots x Filing 2 amount			
Item 3.2 Note: The default ECM trigger for this potential right turn lane is 25 vph. However, since the southbound approach is currently Stop-sign controlled, the turn lane is not currently needed due to speed differential between through traffic and right turning traffic. LSC recommends the following triggers: a. Once the intersection is signalized (if as signal is the selected future traffic control instead of a modern roundabout) or b. If El Paso County switches the orientation of the stop signs such that Curtis is changed to the "major street" and Falcon Highway is changed to the "minor street" (the intersection remains two-way, stop-sign control). The check for either trigger could occur with future subdivision filings and a determination could be made at that time if this project should install the turn lane (with fee-program credit per fee program provisions). If neither trigger is met, escrow for pro-rata share of this potential improvement with each Filing. Per EPC, Saddlehorn values alone would exceed 25 vph, which could trigger the improvement LSC would suggest escrow in lieu of lane construction if the above two triggers are not met as the lane could potentially be "thrown away" if a roundabout is selected as the future traffic control. The escrow for the southbound right turn lane could potentially be returned to the applicant, as it would not be necessary with a roundabout.			
Source: LSC Transportation Consultants, Inc. REVISIONS: 1/31/2024 -see note below. Prior revisions: 2/8/2022, 11/18/2022 for Filing No. 2, 1/20/2023 and 4/30/2023 & 12/22/23 for Filing No. 3			
Note: The minor change on 1/31/2024 was to 3.1 (Timing column)			

Table 5: Detailed Trip Generation Estimate

Filing Number	Status	ITE		Inputs		Trip Generation Rates ²					Driveway Trips Generated					
		Code	Description	Values	Units ¹	Average Weekday	A.M.		P.M.		Average Weekday	A.M.		P.M.		
							In	Out	In	Out		In	Out	In	Out	
By Filing Number																
Filing 1	Approved	210	Single-Family (Detached) Housing	49	DU	10.09	0.19	0.55	0.63	0.37	494	9	27	31	18	
Filing 2	Under Review	210	Single-Family (Detached) Housing	42	DU	10.09	0.19	0.55	0.63	0.37	424	8	23	26	15	
Filing 3	This Report	210	Single-Family (Detached) Housing	44	DU	10.09	0.19	0.55	0.63	0.37	444	9	24	28	16	
Filing 4	Future	210	Single-Family (Detached) Housing	42	DU	10.09	0.19	0.55	0.63	0.37	424	8	23	26	15	
Filing 5	Future	210	Single-Family (Detached) Housing	41	DU	10.09	0.19	0.55	0.63	0.37	414	8	23	26	15	
			Total	218	DU						Total	2200	42	120	136	80
Cumulative by Filing Number																
Filing 1		210	Single-Family (Detached) Housing	49	DU	-	-	-	-	-	494	9	27	31	18	
Filings 1-2		210	Single-Family (Detached) Housing	91	DU	-	-	-	-	-	918	18	50	57	33	
Filings 1-3		210	Single-Family (Detached) Housing	135	DU	-	-	-	-	-	1362	26	74	85	50	
Filings 1-4		210	Single-Family (Detached) Housing	177	DU	-	-	-	-	-	1786	34	98	111	65	
Filings 1-5		210	Single-Family (Detached) Housing	218	DU	-	-	-	-	-	2200	42	120	136	80	
¹ DU = Dwelling Units ² Source: <i>Trip Generation, 11th Edition (2021)</i> by the Institute of Transportation Engineers (ITE)																

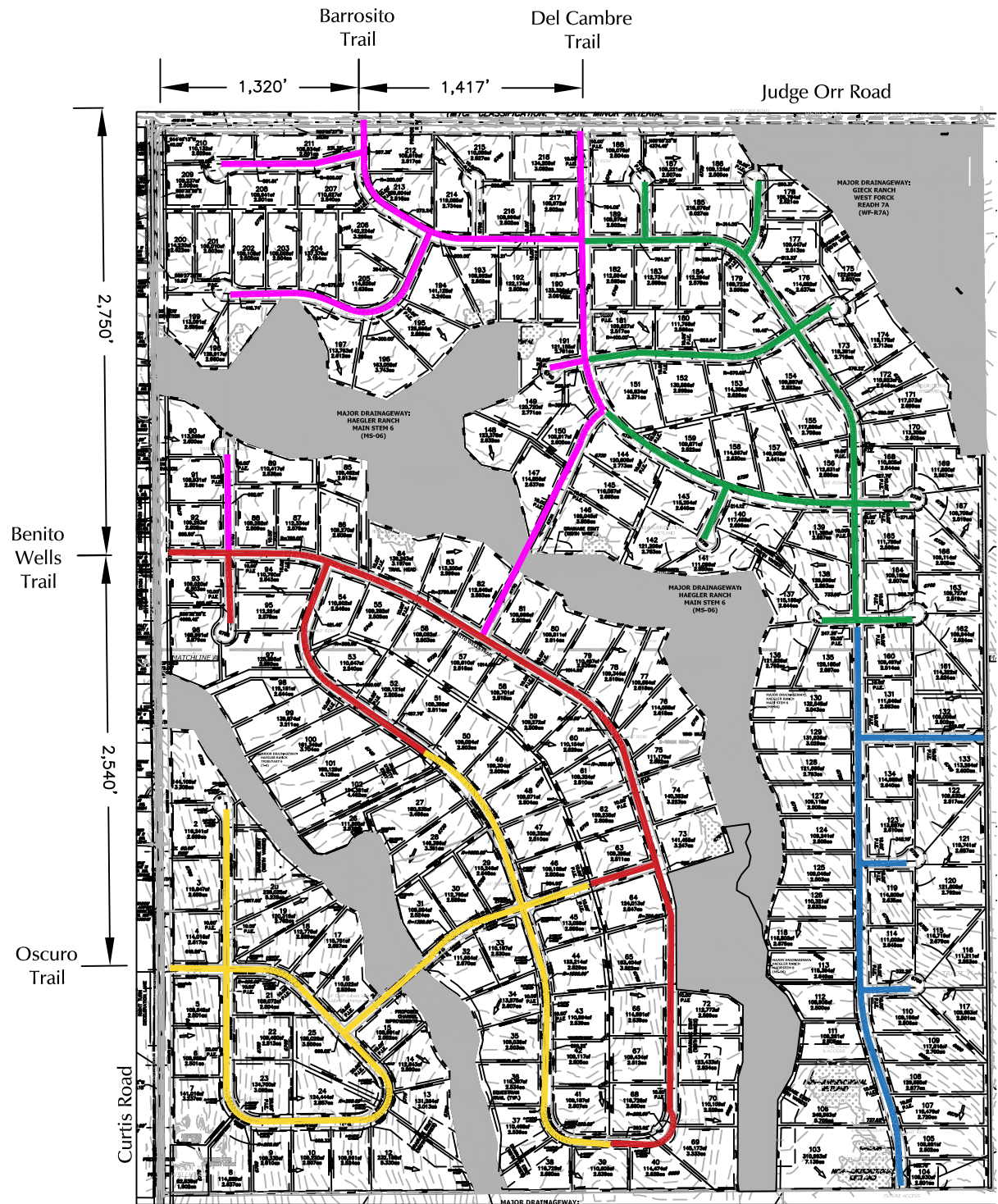

-  Filing 1
-  Filing 2
-  Filing 3
-  Filing 4
-  Filing 5

Figure 3

Roadways to be Constructed by Subdivision Filing

Saddlehorn Ranch Filing 3 (LSC # S224540)



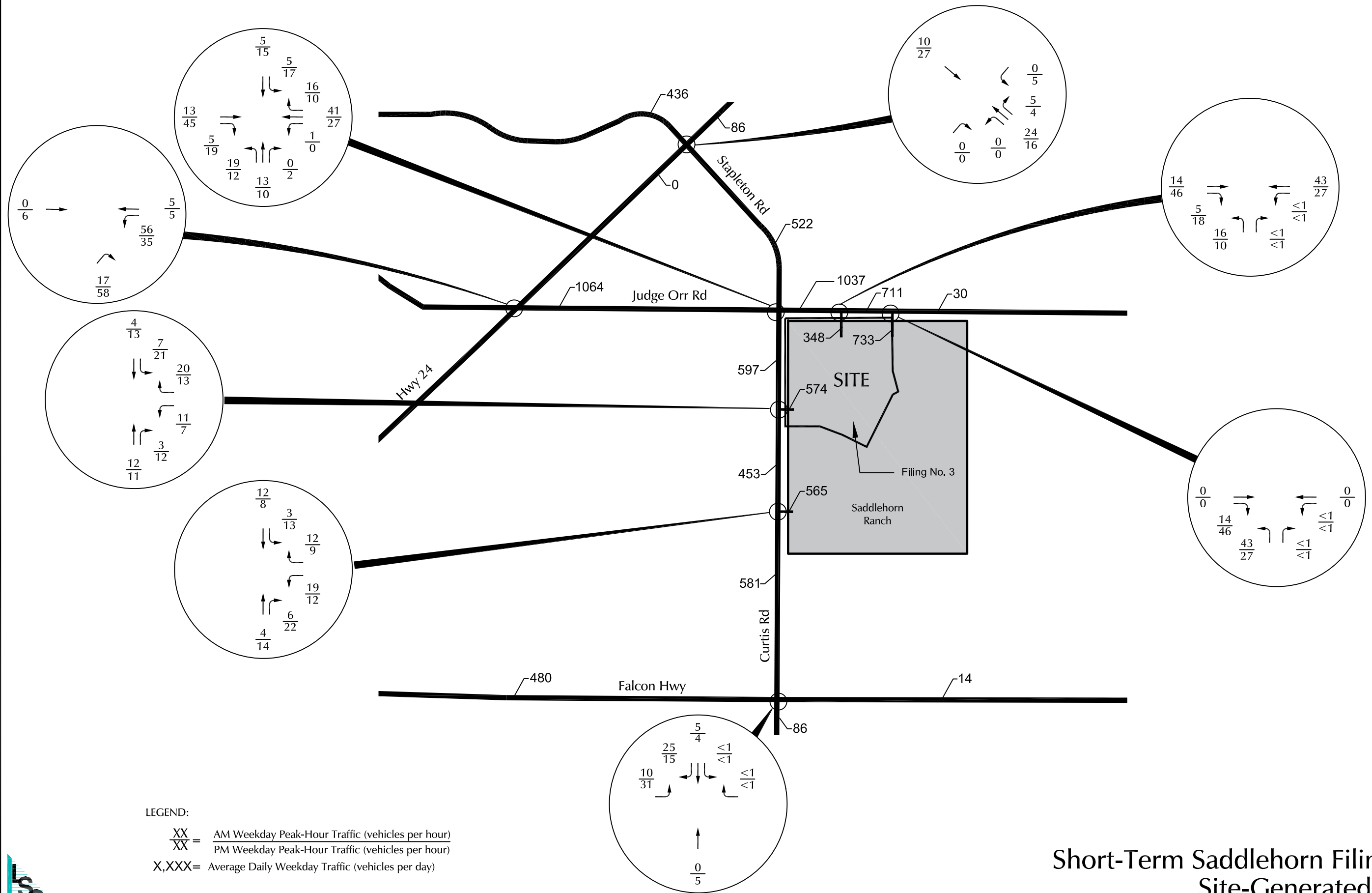

LEGEND:
 $\frac{XX}{XX}$ = AM Weekday Peak-Hour Traffic (vehicles per hour)
 $\frac{XX}{XX}$ = PM Weekday Peak-Hour Traffic (vehicles per hour)
 X,XXX = Average Daily Weekday Traffic (vehicles per day)



Figure 8
Short-Term Saddlehorn Filings 1-5
Site-Generated Traffic
 Saddlehorn Ranch Filing 3 (LSC # S224540)

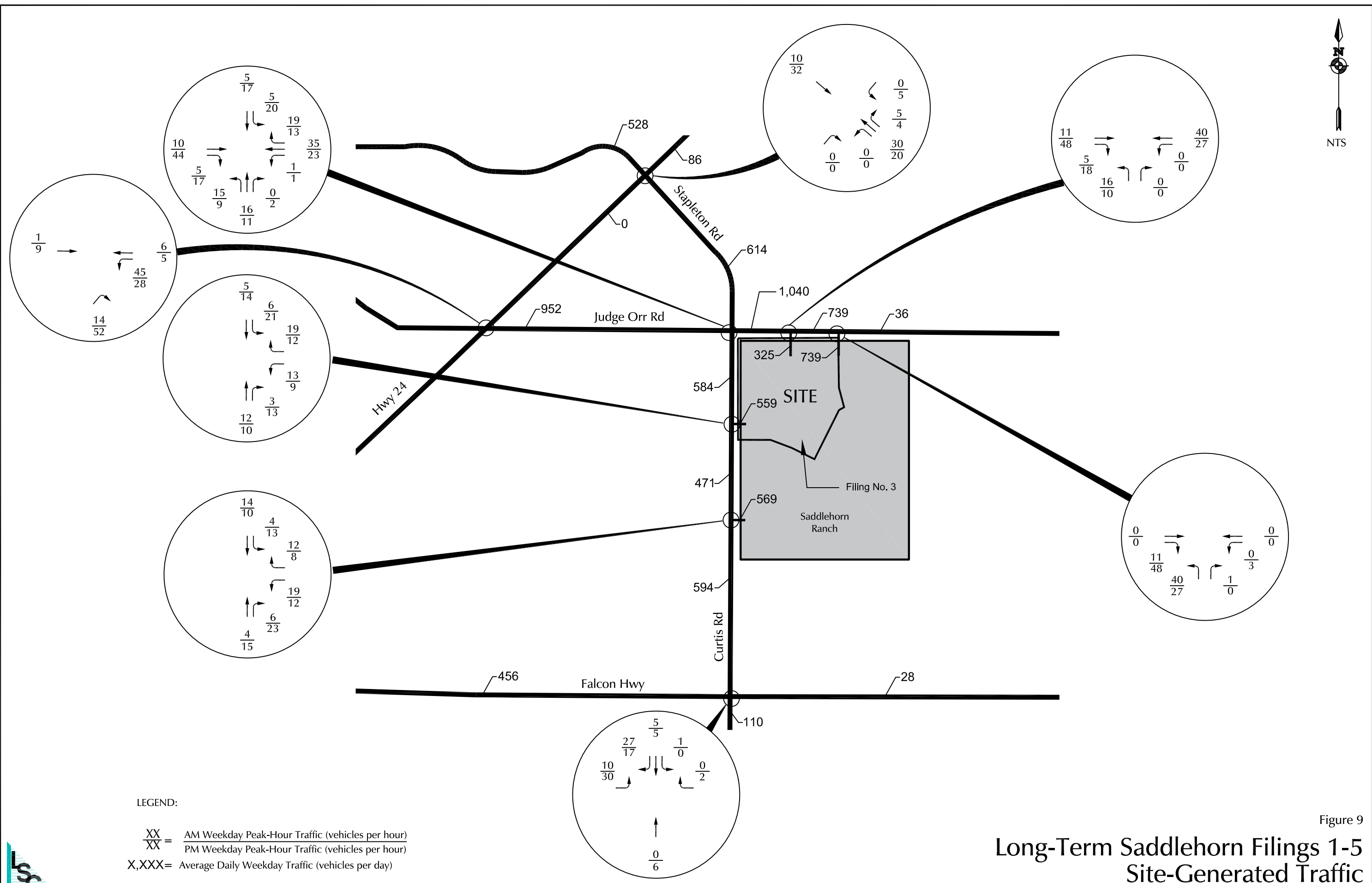

LEGEND:
 $\frac{XX}{XX}$ = AM Weekday Peak-Hour Traffic (vehicles per hour)
 $\frac{XX}{XX}$ = PM Weekday Peak-Hour Traffic (vehicles per hour)
 X,XXX= Average Daily Weekday Traffic (vehicles per day)



Figure 9
Long-Term Saddlehorn Filings 1-5
Site-Generated Traffic
 Saddlehorn Ranch Filing 3 (LSC # S224540)