

Since this drainage report is the same as that submitted for Filing No. 1, my comments are the same.

FINAL DRAINAGE PLAN

THE RIDGE AT LORSON RANCH

FILING NO. 1: SF 22-XX ← SF224

FILING NO. 2 : SF22-XX ← SF225

FILING NO. 3: SF22-XX ← SF227

JANUARY, 2022

Prepared for:

Lorson, LLC
212 N. Wahsatch Ave, Suite 301
Colorado Springs, Colorado 80903
(719) 635-3200

Prepared by:

Core Engineering Group, LLC
15004 1ST Avenue South
Burnsville, MN 55306
(719) 570-1100

Project No. 100.066



CORE
ENGINEERING GROUP

TABLE OF CONTENTS

<i>ENGINEER'S STATEMENT</i>	1
<i>OWNER'S STATEMENT</i>	1
<i>FLOODPLAIN STATEMENT</i>	1
<i>1.0 LOCATION and DESCRIPTION</i>	2
<i>2.0 DRAINAGE CRITERIA</i>	2
<i>3.0 EXISTING HYDROLOGICAL CONDITIONS</i>	3
<i>4.0 DEVELOPED HYDROLOGICAL CONDITIONS</i>	5
<i>5.0 HYDRAULIC SUMMARY</i>	10
<i>6.0 DETENTION and WATER QUALITY PONDS</i>	37
<i>7.0 DRAINAGE and BRIDGE FEES</i>	41
<i>8.0 FOUR STEP PROCESS</i>	42
<i>9.0 CONCLUSIONS</i>	42
<i>10.0 REFERENCES</i>	43

APPENDIX A

VICINITY MAP, SCS SOILS INFORMATION, FEMA FIRM MAP, SAMPLE LETTER OF UNDERSTANDING WITH OFFSITE LANDOWNER

APPENDIX B

HYDROLOGY CALCULATIONS

APPENDIX C

HYDRAULIC CALCULATIONS

APPENDIX D

POND CALCULATIONS and RUNOFF REDUCTION METHOD

APPENDIX E

STORM SEWER SCHEMATIC and HYDRAFLOW STORM SEWER CALCS

BACK POCKET

EXISTING CONDITIONS DRAINAGE MAP

DEVELOPED CONDITIONS DRAINAGE MAPS

FULL SPECTRUM OUTLET STRUCTURES

ENGINEER'S STATEMENT

The attached drainage plan and report were prepared under my direction and supervision and are correct to the best of my knowledge and belief. Said drainage report has been prepared according to the criteria established by El Paso County for drainage reports and said report is in conformity with the master plan of the drainage basin. I accept responsibility for any liability caused by any negligent acts, errors, or omissions on my part in preparing this report.

Richard L. Schindler, P.E. #33997 Date
For and on Behalf of Core Engineering Group, LLC

OWNER'S STATEMENT

I, the Owner, have read and will comply with all the requirements specified in the drainage report and plan.

Lorson, LLC Date

By
Jeff Mark

Title
Manager

Address
212 N. Wahsatch Avenue, Suite 301, Colorado Springs, CO 80903

FLOODPLAIN STATEMENT

To the best of my knowledge and belief, this development is not located within a designated floodplain as shown on Flood Insurance Rate Map Panel No. and 08041C0976 G, dated December 7, 2018. (See Appendix A, FEMA FIRM Exhibit)

Richard L. Schindler, #33997 Date

EL PASO COUNTY

Filed in accordance with the requirements of the El Paso County Land Development Code, Drainage Criteria Manual, Volume 1 and 2, and Engineering Criteria Manual, As Amended.

Jennifer Irvine Date
County Engineer/ECM Administrator

Conditions: _____

1.0 LOCATION and DESCRIPTION

The Ridge at Lorson Ranch Filing No's. 1-3 is located east of the East Tributary of Jimmy Camp Creek. The entire three filings are located on approximately 206.473 acres of vacant land. This project will develop this site into a single-family residential development. The land for the residential lots is currently owned by Love In Action

The site is located in the NE 1/4 of Sections 24 and the SE 1/4 of Section 13, Township 15 South and Range 65 West of the 6th Principal Meridian. The site is bounded on the north by unplatted land owned by Bull Hill, LLC, on the west by The Hills at Lorson Ranch, on the east by unplatted land, and the south by unplatted land in Lorson Ranch. For reference, a vicinity map is included in Appendix A of this report.

Conformance with applicable Drainage Basin Planning Studies (DBPS)

There is an existing (unapproved) DBPS for Jimmy Camp Creek prepared by Wilson & Company in 1987, and is referenced in this report. The only major drainage improvements for this study area according to the 1987 Wilson study was the reconstruction of the East Tributary of Jimmy Camp Creek (East Tributary). In 2014 and in 2018 the East Tributary was reconstructed from downstream of Lorson Boulevard north to the northern property line of Lorson Ranch in accordance with the 1987 study. The last section of the East Tributary (to the south property line of Lorson Ranch) has been designed by Kiowa Engineering and will be completed in 2020. There are no further improvements to be made on the East Tributary. On March 9, 2015 a new DBPS for Jimmy Camp Creek and the East Tributary was completed by Kiowa Engineering. The Kiowa Engineering DBPS for Jimmy Camp Creek has not been adopted by El Paso County but is allowed for concept design. The concept design includes the East Tributary armoring concept and the full spectrum detention pond requirements. The Kiowa DBPS did not calculate drainage fees so current El Paso County drainage/bridge fees apply to this development.

Conformance with Lorson East MDDP by Core Engineering Group

Core Engineering Group has an approved MDDP for Lorson East which covers this study area. This PDR conforms to the MDDP for Lorson East and is referenced in this report. The major infrastructure to be constructed in this site includes outlet structures in Detention/WQ Ponds C2.1 and C4 and WQ Pond F. Both detention ponds were graded, low flow channels, and forebays were constructed as part of The Hills at Lorson Ranch under PUDSP-20-003 and the WQ Pond F will be constructed with this project. There are also two bridges over the East Tributary that were built in 2018 to provide access to this development across the East Tributary. The bridges are located at Fontaine Boulevard and Lorson Boulevard.

The Ridge at Lorson Ranch is located within the ***“Jimmy Camp Creek Drainage Basin”***, which is a fee basin in El Paso County and a small portion (SE corner) within the “Upper Williams Creek Drainage Basin which does not have a DBPS.

2.0 DRAINAGE CRITERIA

The supporting drainage design and calculations were performed in accordance with the City of Colorado Springs and El Paso County “Drainage Criteria Manual (DCM)”, dated November, 1991, the El Paso County “Engineering Criteria Manual”, Chapter 6 and Section 3.2.1 Chapter 13 of the City of Colorado Springs Drainage Criteria Manual dated May 2014, and the UDFCD “Urban Storm Drainage Criteria Manual” Volumes 1, 2 and 3 for inlet sizing and full spectrum ponds. No deviations from these published criteria are requested for this site.

The Rational Method as outlined in Section 6.3.0 of the May 2014 “Drainage Criteria Manual” and in Section 3.2.8.F of the El Paso County “Engineering Criteria Manual” was used for basins less than 130

acres to determine the rainfall and runoff conditions for the proposed development of the site. The runoff rates for the 5-year initial storm and 100-year major design storm were calculated.

Current updates to the Drainage Criteria manual for El Paso County states the if detention is necessary, Full Spectrum Detention will be included in the design, based on this criteria, Full Spectrum Detention will be required for this development.

3.0 EXISTING HYDROLOGICAL CONDITIONS

This site is currently undeveloped with native vegetation (grass with no shrubs) and moderate to steep slopes in a westerly direction the East Tributary of Jimmy Camp Creek.

The Soil Conservation Service (SCS) classifies the soils within the site as Manzanola clay loam; Midway Clay Loam, Nelson-Tassel fine Sandy loam; Razor clay loam; and Wiley silt loam [3]. The sandy and silty loams are considered hydrologic soil group B soils with moderate to moderately rapid permeability. The Midway and Razor clay loams are considered hydrologic soil group C/D soils with slow permeability. All of these soils are susceptible to erosion by wind and water, have low bearing strength, moderate shrink-swell potential, and high frost heave potential (see table 3.1 below). The clay loams are difficult to vegetate and comprise of a small portion of the study area. These soils can be mitigated easily by limiting their use as topsoil since they comprise of a small portion of the study area. Weathered bedrock may be encountered beneath some of the site but it can be excavated using conventional techniques.

Table 3.1: SCS Soils Survey

Soil	Hydro. Group	Shrink/Swell Potential	Permeability	Surface Runoff Potential	Erosion Hazard
52-Manzanola Clay Loam	C	High	Slow	Medium	Moderate
54-Midway Clay Loam	D	High	Slow	Medium	Moderate
56-Nelson – Tassel Fine Sandy Loam	B	Moderate	Moderately Rapid	Slow	Moderate
75-Razor Clay Loam	C	High	Slow	Medium	Moderate
108-Wiley Silt Loam	B	Moderate	Moderate	Medium	Moderate

Excerpts from the SCS “Soil Survey of El Paso County Area, Colorado” are provided in **Appendix A** for further reference.

For the purpose of preparing hydrologic calculations for this report, the soil of each basin are assumed to be wholly comprised of the majority soil hydrologic group.

An existing electrical easement, with existing transmission towers, is located west side of this site and will be set aside as open space. It is the intent to utilize some of the open space under the towers for detention of storm flow.

This site is not located within the delineated 100-year floodplain of the East Tributary of Jimmy Camp Creek per the Federal Emergency Management Agency (FEMA) Flood Rate Insurance Map (FIRM) number 08041C10976 G, effective December 7, 2018.

Basin OS-B1.1

This existing offsite basin consists of existing flow from undeveloped areas east of Lorson Ranch. Runoff flows overland to the northwest and drains offsite at Design Point 1x. The existing runoff is 5.2cfs and 29.0cfs for the 5-year and 100-year events.

Basin EX-B1

This existing basin consists of existing flow from undeveloped areas within Lorson Ranch near the north property line. Runoff flows overland to the north and drains offsite at Design Point 1x. The existing runoff is 5.6cfs and 31.2cfs for the 5-year and 100-year events.

Design Point 1x

Design Point 1x is the total existing runoff flowing offsite to the north. The developed runoff flowing north will need to be lower than the existing runoff at this design point. The existing runoff is 9.7cfs and 54.2cfs for the 5-year and 100-year events.

Basin C1.1-ex

This existing basin consists of existing flow from undeveloped areas east of the Lorson Boulevard/Walleye Drive intersection. Runoff flows overland to the west and drains into an existing storm sewer system in Lorson/Walleye. The existing runoff is 3.2cfs and 21cfs for the 5-year and 100-year events.

Basin C2.1-ex

This existing basin consists of existing flow from undeveloped areas east of the Fontaine Boulevard/Walleye Drive intersection. Runoff flows overland to the west and drains into an existing storm sewer system in Fontaine/Walleye. The existing runoff is 6.1cfs and 40.2cfs for the 5-year and 100-year events.

Basin C2.2-ex

This existing basin consists of existing flow from undeveloped areas on west side of the site. Runoff flows overland to the west and drains to an existing 42" storm sewer that discharges west into Existing Pond C2.1. The existing runoff is 12.2cfs and 81.8cfs for the 5-year and 100-year events.

Basin C3.1-ex

This existing basin consists of existing flow from undeveloped areas on the central portion of the PUD. Runoff flows overland to the west and drains into an existing storm sewer system at the intersection of Walleye Drive/Grayling Drive. The existing runoff is 2.6cfs and 15.0cfs for the 5-year and 100-year events.

Basin C4.1-ex

This existing basin consists of existing flow from offsite undeveloped areas east of Lorson Ranch. Runoff flows overland to the west into Basin C4.2-ex. The existing runoff is 1.2cfs and 7.8cfs for the 5-year and 100-year events.

Basin C4.2-ex

This existing basin consists of existing flow from undeveloped areas in the northern portion of the PUD. Runoff flows overland to the west to Existing Pond C4 excavated as part of The Hills at Lorson Ranch. The existing runoff is 15.0cfs and 85.1cfs for the 5-year and 100-year events.

Design Point 4x

Design Point 4x is the existing flow entering Existing Pond C4 from Basin C4.1-ex and C4.2-ex. The existing runoff is 15.3cfs and 87.7cfs for the 5-year and 100-year events from these two basins. This flow is then routed south into Existing Pond C3.

Basin EX-F1

This existing basin consists of existing flow from undeveloped areas in the east portions of the PUD. Runoff flows overland eastward and offsite to the adjacent landowner located in the Upper Williams Creek Drainage Basin. The existing runoff is 6.3cfs and 38.5cfs for the 5-year and 100-year events.

Basin EX-F2

This existing basin consists of existing flow from undeveloped areas in the east portions of the PUD. Runoff flows overland southeast and offsite to the adjacent landowner located in the Upper Williams Creek Drainage Basin. The existing runoff is 9.1cfs and 51.1cfs for the 5-year and 100-year events.

Design Point 2x

Design Point 2x is the total existing flow at the east property line from Basins EX-F1 and EX-F2. The existing runoff is 12.4cfs and 72.7cfs for the 5-year and 100-year events from these two basins. This flows east overland and offsite in the Upper Williams Creek Drainage Basin. Per Colorado Water regulations Lorson Ranch will need to maintain existing runoff amounts into the Upper Williams Creek Drainage Basin.

4.0 DEVELOPED HYDROLOGICAL CONDITIONS

Hydrology for the **The Ridge at Lorson Ranch** drainage report was based on the City of Colorado Springs/El Paso County Drainage Criteria. Sub-basins that lie within this project were determined and the 5-year and 100-year peak discharges for the developed conditions have been presented in this report. Based on these flows, storm inlets will be added when the street capacity is exceeded.

Soil type B/C/D has been assumed for the developed hydrologic conditions. See Appendix A for SCS Soils Map.

The time of concentration for each basin and sub-basin was developed using an overland, ditch, street and pipe flow components. The maximum overland flow length for developed conditions was limited to 100 feet. Travel time velocities ranged from 2 to 6 feet per second. The travel time calculations are included in the back of this report.

Runoff coefficients for the various land uses were obtained from Table 6-6 dated May, 2014 from the updated City of Colorado Springs/El Paso County Drainage Criteria Manual. See Appendix B.

All detention ponds for this project have been constructed per The Hills at Lorson Ranch (SF21-010 & EGP 20-005) and WQ Pond F will be constructed with this project. See Section 6.0 for Detention Pond Discussions. The list below shows the ponds and the tributary drainage basins:

1. C1 Basins drain to Pond C1
2. C3 & C4 Basins drain to Pond C2.1
3. C5 Basins drain to Pond C2.2
4. C8 Basins drain to Pond C4
5. F Basins drain to WQ Pond F

Drainage concepts for each of the basins are briefly discussed as follow:

Basin C1.1

This basin consists of runoff from residential development and the east side of Nystrom Terrace and the north side of Aspen Butte Terrace. Runoff will be directed west to Design Point 1 in curb/gutter where it will be collected by a Type R inlet. The developed flow from this basin is 5.6cfs and 12.2cfs for the 5/100-year storm event. See the appendix for detailed calculations.

Basin C1.2

This basin consists of runoff from residential development and the west side of Nystrom Terrace and the south side of Aspen Butte Terrace. Runoff will be directed west to Design Point 2 in curb/gutter where it will be collected by a Type R inlet. The developed flow from this basin is 2.7cfs and 5.9cfs for the 5/100-year storm event. See the appendix for detailed calculations.

Basin C1.3

This basin consists of runoff from residential development and the north side of Lorson Blvd. Runoff will be directed south and west in Lorson Boulevard to Design Point 4 in curb/gutter where it will be collected by a Type R inlet. The developed flow from this basin is 14.1cfs and 30.9cfs for the 5/100-year storm event. See the appendix for detailed calculations.

Basin C1.4

This basin consists of runoff from residential development, Nystrom Terrace, and Walleye Drive. Runoff will be directed west to Walleye Drive, then south to Design Point 1b in curb/gutter where it will be collected by an existing 15' Type R inlet. The developed flow from this basin is 4.2cfs and 9.2cfs for the 5/100-year storm event. See the appendix for detailed calculations.

Basin C1.5

This basin consists of runoff from future residential development and the south side of Lorson Blvd. Runoff will be directed north and west in Lorson Boulevard to Design Point 6 in curb/gutter where it will be collected by a Type R inlet. The developed flow from this basin is 3.0cfs and 6.6cfs for the 5/100-year storm event. See the appendix for detailed calculations.

Basin C1.6

This basin consists of runoff from future residential development southeast of Walleye Dr./Lorson Blvd at Design Point 1a. Runoff will be directed north to Design Point 1a by future streets and a future storm sewer sized to handle a portion of the 100-year storm event from this basin. The remaining runoff will continue west in a future street to a future street intersection at Lorson Boulevard west of Brook Trout Trail. The future developed flow from this basin is 12.8cfs and 28.3cfs for the 5/100-year storm event. See the appendix for detailed calculations. This flow is only to be used to size a storm sewer stub from Design Point 6

Basin C3.1

This basin consists of runoff from residential development, Aspen Butte Terrace, Copper Butte Way, and the east half of Split Mountain Drive. Runoff will be directed west and north to Design Point 12 in curb/gutter of Split Mountain Drive where it will be collected by a Type R inlet. The developed flow from this basin is 9.9cfs and 21.8cfs for the 5/100-year storm event. See the appendix for detailed calculations.

Basin C3.2

This basin consists of runoff from residential development, Mission Peak Place, and the east half of Split Mountain Drive. Runoff will be directed west and north to Design Point 13 in curb/gutter of Split Mountain Drive where it will be collected by a Type R inlet. The developed flow from this basin is 7.9cfs and 17.3cfs for the 5/100-year storm event. See the appendix for detailed calculations.

Basin C3.3

This basin consists of runoff from residential development, Pearsoll Street, and the east half of Split Mountain Drive. Runoff will be directed west and north to Design Point 15 in curb/gutter of Split Mountain Drive where it will be collected by a Type R inlet. The developed flow from this basin is 8.5cfs and 18.6cfs for the 5/100-year storm event. See the appendix for detailed calculations.

Basin C3.4

This basin consists of runoff from residential development, Lost Peak Lane, and the east half of Split Mountain Drive. Runoff will be directed west and north to Design Point 17 in curb/gutter of Split Mountain Drive where it will be collected by a Type R inlet. The developed flow from this basin is 7.2cfs and 15.8cfs for the 5/100-year storm event. See the appendix for detailed calculations.

Basin C3.5

This basin consists of runoff from residential development, Split Mountain Drive, and the south side of Lake Trout Dr. Runoff will be directed north and west to Design Point 19 in curb/gutter of Lake Trout Dr where it will be collected by a Type R inlet. The developed flow from this basin is 10.3cfs and 22.6cfs for the 5/100-year storm event. See the appendix for detailed calculations.

Basin C3.6a

This basin consists of runoff from residential development and the north side of Lake Trout Dr. Runoff will be directed west to Design Point 20a in curb/gutter of Lake Trout Dr where it will be collected by a Type R inlet. The developed flow from this basin is 5.6cfs and 12.3cfs for the 5/100-year storm event. See the appendix for detailed calculations.

Basin C3.6b

This basin consists of runoff from residential development and Lookout Peak Lane. Runoff will be directed west and south to Design Point 21 in curb/gutter of Lake Trout Dr where it will be collected by a Type R inlet. The developed flow from this basin is 7.2cfs and 15.9cfs for the 5/100-year storm event. See the appendix for detailed calculations.

Basin C3.7

This basin consists of runoff from residential development, Dragontail Terrace, and the south side of Lake Trout Dr. Runoff will be directed north and west to Design Point 23 in curb/gutter of Lake Trout Dr where it will be collected by a Type R inlet. The developed flow from this basin is 8.7cfs and 19.1cfs for the 5/100-year storm event. See the appendix for detailed calculations.

Basin C3.8

This basin consists of runoff from residential development, Foraker Lane, Raven Ridge Terrace, and the north side of Lake Trout Dr. Runoff will be directed west and south to Design Point 25 in curb/gutter of Lake Trout Dr where it will be collected by a Type R inlet. The developed flow from this basin is 10.0cfs and 22.0cfs for the 5/100-year storm event. See the appendix for detailed calculations.

Basin C3.9

This basin consists of runoff from residential development, Raven Ridge Terrace, and the south side of Lake Trout Dr. Runoff will be directed north and west to Design Point 27 in curb/gutter of Lake Trout Dr where it will be collected by a Type R inlet. The developed flow from this basin is 8.1cfs and 17.9cfs for the 5/100-year storm event. See the appendix for detailed calculations.

Basin C3.10

This basin consists of runoff from residential development, Nystrom Terrace, and the south side of Lake Trout Dr. Runoff will be directed north and west to Design Point 29 in curb/gutter of Lake Trout Dr where it will be collected by a Type R inlet. The developed flow from this basin is 9.2cfs and 20.2cfs for the 5/100-year storm event. See the appendix for detailed calculations.

Basin C4.1

This basin consists of runoff from residential development, Pearsoll Street, Buckner Way, and the south side of Fontaine Boulevard. Runoff will be directed north and west to Fontaine Boulevard where it will flow west to Design Point 31. The developed flow from this basin is 6.4cfs and 14.0cfs for the 5/100-year storm event. See the appendix for detailed calculations.

Basin C4.2

This basin consists of runoff from residential development and the south side of Fontaine Boulevard. Runoff will be directed north and west to Fontaine Boulevard to Design Point 31. The developed flow from this basin is 4.8cfs and 10.5cfs for the 5/100-year storm event. See the appendix for detailed calculations.

Basin C4.3

This basin consists of runoff from residential development, Lake Trout Dr, and Nystrom Terrace. Runoff will be directed north and west to Design Point 32 in curb/gutter of Nystrom Terrace where it will be collected by a Type R inlet. The developed flow from this basin is 5.7cfs and 12.4cfs for the 5/100-year storm event. See the appendix for detailed calculations.

Basin C4.4

This basin consists of runoff from residential development, Lake Trout Dr, and the west side of Walleye Drive. Runoff will be directed west and north to an existing 25' Type R inlet at Design Point 33 in curb/gutter of Walleye Drive. The developed flow from this basin is 6.2cfs and 13.5cfs for the 5/100-year storm event. See the appendix for detailed calculations.

Basin C5.1a

This basin consists of runoff from residential development and the south side of Sanderling Street. Runoff will be directed west and south to Design Point 39 in curb/gutter where it will be collected by a Type R inlet. The developed flow from this basin is 4.2cfs and 9.2cfs for the 5/100-year storm event. See the appendix for detailed calculations.

Basin C5.1b

This basin consists of runoff from residential development and the north side of Gray Wolf Court. Runoff will be directed west to Design Point 36 in curb/gutter where it will be collected by a Type R inlet. The developed flow from this basin is 11.4cfs and 25.2cfs for the 5/100-year storm event. See the appendix for detailed calculations.

Basin C5.1c

This basin consists of runoff from residential development and the south side of Gray Wolf Court. Runoff will be directed west to Design Point 37 in curb/gutter where it will be collected by a Type R inlet. The developed flow from this basin is 7.4cfs and 16.3cfs for the 5/100-year storm event. See the appendix for detailed calculations.

Basin C5.1d

This basin consists of runoff from residential development and the north side of Snowfield Court. Runoff will be directed west and north to Design Point 41 in curb/gutter where it will be collected by a Type R inlet. The developed flow from this basin is 9.3cfs and 20.7cfs for the 5/100-year storm event. See the appendix for detailed calculations.

Basin C5.1e

This basin consists of runoff from residential development and the south side of Snowfield Court. Runoff will be directed west to Design Point 43 in curb/gutter where it will be collected by a Type R inlet. The developed flow from this basin is 10.0cfs and 21.9cfs for the 5/100-year storm event. See the appendix for detailed calculations.

Basin C5.2

This basin consists of runoff from residential development and the west side of Walleye Drive. Runoff will be directed south to Design Point 45 in curb/gutter where it will be collected by an existing 15' Type R inlet. The developed flow from this basin is 3.7cfs and 8.2cfs for the 5/100-year storm event. See the appendix for detailed calculations.

Basin C5.3

This basin consists of runoff from residential development and the north side of Fontaine Boulevard. Runoff will be directed west to Design Point 45 in curb/gutter where it will be collected by an existing 15' Type R inlet. The developed flow from this basin is 4.3cfs and 9.5cfs for the 5/100-year storm event. See the appendix for detailed calculations.

Basin C8.1a

This basin consists of runoff from residential development and the south side of Meridith Ridge Way. Runoff will be directed west to Design Point 47 in curb/gutter where it will be collected by a Type R inlet. The developed flow from this basin is 7.5cfs and 16.4cfs for the 5/100-year storm event. See the appendix for detailed calculations.

Basin C8.1b

This basin consists of runoff from residential development and the north side of Meridith Ridge Way and Donnas Drive. Runoff will be directed west and south to Design Point 49 in curb/gutter where it will be collected by a Type R inlet. The developed flow from this basin is 6.3cfs and 13.9cfs for the 5/100-year storm event. See the appendix for detailed calculations.

Basin C8.1c

This basin consists of runoff from residential development and the north side of Sanderling Street. Runoff will be directed west to Design Point 48 in curb/gutter where it will be collected by a Type R inlet. The developed flow from this basin is 3.4cfs and 7.6cfs for the 5/100-year storm event. See the appendix for detailed calculations.

Basin C8.2

This basin consists of runoff from residential development and the east side of Walleye Drive. Runoff will be directed west and north to Design Point 51 in curb/gutter where it will be collected by an existing 25' Type R inlet in Walleye Drive. The developed flow from this basin is 4.5cfs and 10.0cfs for the 5/100-year storm event. See the appendix for detailed calculations.

Basin OS-C4a

This basin consists of runoff from undeveloped offsite land east of Lorson Ranch. Runoff will be directed northwest to a swale where the flow is conveyed north to Design Point 63a. The existing flow from this basin is 1.2cfs and 7.7cfs for the 5/100-year storm event. See the appendix for detailed calculations.

Basin C8.3a

This basin consists of runoff from residential development and the east side of Danis Drive. Runoff will be directed north to Design Point 53 in curb/gutter where it will be collected by a Type R inlet. The developed flow from this basin is 10.5cfs and 23.0cfs for the 5/100-year storm event. See the appendix for detailed calculations.

Basin C8.3b

This basin consists of runoff from residential development and the west side of Rikers Ridge Lane and the south side of Walley Drive. Runoff will be directed west to Design Point 54 in curb/gutter where it will be collected by a Type R inlet. The developed flow from this basin is 6.0cfs and 13.2cfs for the 5/100-year storm event. See the appendix for detailed calculations.

Basin OS-C4b

This basin consists of runoff from undeveloped offsite land east of Lorson Ranch. Runoff will be directed northwest to a swale where the flow is conveyed north to Design Point 63a. At Design Point 63a the concentrated flow will be dissipated by two rip rap pads to change the flow to be closer to overland sheet flow. Lorson Ranch owns the downstream offsite land (to the north) and a letter of understanding will be secured at the final plat stage to address maintenance of any erosion issues should they occur on the offsite area and to acknowledge the manner of which drainage enters the

offsite property has changed. The existing flow from this basin is 0.9cfs and 5.5cfs for the 5/100-year storm event. See the appendix for detailed calculations.

Basin C8.3c

These basins consist of runoff from residential development and the south side of Rikers Ridge Lane and Danis Drive. Runoff will be directed west to Design Point 54 in curb/gutter where it will be collected by a Type R inlet. The developed flow from this basin is 4.5cfs and 9.9cfs for the 5/100-year storm event. See the appendix for detailed calculations.

Basin C8.3d

This basin consists of runoff from residential development and the north side of Jasons Ridge Way, and Donnas Drive. Runoff will be directed northwest to Design Point 56 in curb/gutter where it will be collected by a Type R inlet. The developed flow from this basin is 8.9cfs and 19.2cfs for the 5/100-year storm event. See the appendix for detailed calculations.

Basin C8.4

This basin consists of runoff from residential development and the south side of Jasons Ridge Way and Donnas Drive. Runoff will be directed southwest to Design Point 57 in curb/gutter where it will be collected by a Type R inlet. The developed flow from this basin is 11.0cfs and 24.1cfs for the 5/100-year storm event. See the appendix for detailed calculations.

Basin C8.5

This basin consists of runoff from residential development and the west side of Rikers Ridge Way and north side of Walleye Drive. Runoff will be directed southwest to Design Point 59 in curb/gutter where it will be collected by a Type R inlet. The developed flow from this basin is 7.0cfs and 15.5cfs for the 5/100-year storm event. See the appendix for detailed calculations.

Basin C8.6

This basin consists of runoff from residential development, west side of Walleye Drive, and the north side of Grayling Drive. Runoff will be directed west to Design Point 62 in curb/gutter where it will be collected by a Type R inlet. The developed flow from this basin is 4.0cfs and 6.4cfs for the 5/100-year storm event. See the appendix for detailed calculations.

Basin C8.7a

This basin consists of runoff from residential development and the north side of Logans Ridge Lane and the south side of Reagan Ridge Drive. Runoff will be directed west to Design Point 63 in curb/gutter where it will be collected by a Type R inlet. The developed flow from this basin is 8.1cfs and 18.0cfs for the 5/100-year storm event. See the appendix for detailed calculations.

Basin C8.7b

This basin consists of runoff from residential development and the south side of Logans Ridge Lane. Runoff will be directed west to Design Point 63 in curb/gutter where it will be collected by a Type R inlet. The developed flow from this basin is 3.4cfs and 7.6cfs for the 5/100-year storm event. See the appendix for detailed calculations.

Basin C8.7c

This basin consists of runoff from residential development and Cody Ridge Way. Runoff will be directed west to Design Point 64 in curb/gutter where it will be collected by a Type R inlet. The developed flow from this basin is 9.4cfs and 21.0cfs for the 5/100-year storm event. See the appendix for detailed calculations.

Basin C8.7d

This basin consists of runoff from residential development and the east side of Reagan Ridge Drive. Runoff will be directed west to Design Point 66 in curb/gutter where it will be collected by a Type R inlet. The developed flow from this basin is 0.6cfs and 1.4cfs for the 5/100-year storm event. See the appendix for detailed calculations.

Basin C8.7e

This basin consists of runoff from residential development, the east side of Reagan Ridge Drive, and Alpine Ridge Lane. Runoff will be directed southwest to Design Point 62 in curb/gutter where it will be collected by a Type R inlet. The developed flow from this basin is 11.1cfs and 24.5cfs for the 5/100-year storm event. See the appendix for detailed calculations.

Basin OS-B1

This basin consists of runoff from undeveloped offsite land east of Lorson Ranch. Runoff will be directed north to Design Point 63a in a swale. The existing flow from this basin is 5.2cfs and 29.0cfs for the 5/100-year storm event. See the appendix for detailed calculations.

Basin C8.8a

This basin consists of runoff from residential development, the west/north side of Reagan Ridge Drive. Runoff will be directed southwest to Design Point 69 in curb/gutter where it will be collected by an existing 25' Type R inlet. The developed flow from this basin is 7.9cfs and 17.3cfs for the 5/100-year storm event. See the appendix for detailed calculations.

Basin C8.8

This basin consists of runoff from residential development. Runoff will be directed south directly to existing Pond C4. The developed flow from this basin is 5.9cfs and 21.8cfs for the 5/100-year storm event. See the appendix for detailed calculations.

Basin F1.1

This basin consists of runoff from residential development. Runoff will be directed east into Basin F1.2 as sheet flow. The developed flow from this basin is 7.5cfs and 16.5cfs for the 5/100-year storm event. See the appendix for detailed calculations. Water quality for this basin flowing offsite will be addressed by the Runoff Reduction method for sheet flows crossing open space in Basin F1.2. See water quality section.

Basin F1.2

This basin consists of runoff from open space and will be directed east offsite generally as sheet flow which will not significantly be changed from existing conditions and grading. The flow from this basin is 6.1cfs and 44.6cfs for the 5/100-year storm event. See the appendix for detailed calculations.

Basin F1.3

This basin consists of runoff from residential development, the east/north side of Kingston Peak Place. Runoff will be directed south to Design Point 35b in curb/gutter where it will be collected by a Type R inlet. The developed flow from this basin is 1.9cfs and 4.6cfs for the 5/100-year storm event. See the appendix for detailed calculations.

Basin F1.4

This basin consists of runoff from residential development, the west/south side of Kingston Peak Place. Runoff will be directed south to Design Point 35a in curb/gutter where it will be collected by a Type R inlet. The developed flow from this basin is 5.9cfs and 13.2cfs for the 5/100-year storm event. See the appendix for detailed calculations.

Combined Flow From the "F" developed basins

Developed runoff flowing east into the Upper Williams Creek Drainage Basin is required to match existing conditions. See Design Point 35 for analysis of offsite flows to the east.

Interim Basin G1

This basin consists of existing runoff from undeveloped land. Runoff flows south to Design Point 35e located on the south property line of Lorson Ranch. This basin was added to analyze existing runoff rates before and after development flowing south in the Upper Williams Creek Drainage Basin at the Lorson Ranch south property line. See Design Point 35e for this analysis. The existing flow from this basin is 2.5cfs and 18.2cfs for the 5/100-year storm event. See the appendix for detailed calculations.

See the Developed Conditions Hydrology Calculations in the back of this report and the Developed Conditions Drainage Map (Map Pocket) for the 5-year and 100-year storm event amounts.

5.0 HYDRAULIC SUMMARY

The sizing of the hydraulic structures and detentions ponds were prepared by using the *Storm Sewer* and *Hydrographs* computer software programs developed by Intellisolve, which conforms to the methods outlined in the "City of Colorado Springs/EI Paso County Drainage Criteria Manual". Street capacities and Inlets were sized by Denver Urban Drainage's xcel spreadsheet UD-Inlet.

It is the intent of this drainage report to use the proposed curb/gutter and storm sewer in the streets to convey runoff to detention and water quality ponds then to the East Tributary of Jimmy Camp Creek. Inlet size and location are preliminary only as shown on the storm sewer layout in the appendix. See Appendix C for detailed hydraulic calculations and the storm sewer model.

Table 1: Street Capacities (100-year capacity is only ½ of street)

Street Slope	Residential Local		Residential Collector		Principal Arterial	
	5-year	100-year	5-year	100-year	5-year	100-year
0.5%	6.3	26.4	9.7	29.3	9.5	28.5
0.6%	6.9	28.9	10.6	32.1	10.4	31.2
0.7%	7.5	31.2	11.5	34.6	11.2	33.7
0.8%	8.0	33.4	12.3	37.0	12.0	36.0
0.9%	8.5	35.4	13.0	39.3	12.7	38.2
1.0%	9.0	37.3	13.7	41.4	13.4	40.2
1.4%	10.5	44.1	16.2	49.0	15.9	47.6
1.8%	12.0	45.4	18.4	50.4	18.0	50.4
2.2%	13.3	42.8	19.4	47.5	19.5	47.5
2.6%	14.4	40.7	18.5	45.1	18.5	45.1
3.0%	15.5	39.0	17.7	43.2	17.8	43.2
3.5%	16.7	37.2	16.9	41.3	17.0	41.3
4.0%	17.9	35.7	16.2	39.7	16.3	29.7
4.5%	19.0	34.5	15.7	38.3	15.7	38.3
5.0%	19.9	33.4	15.2	37.1	15.2	37.1

Note: all flows are in cfs (cubic feet per second)

Design Point 1a

Design Point 1a is located south of Lorson Boulevard and Walleye Drive and flow is from future development from Basin C1.6. A 24" storm sewer will be stubbed out from Design Pt. 6 at Lorson Boulevard north towards this design point. The total future flow is 12.8cfs/28.3cfs in the 5/100-year storm events for this basin. In the 5-year storm event 12cfs will be routed north to Design Point 6 (in pipe) and 0.8cfs will be routed to west in the future street (surface flow in street). In the 100-year storm event 20cfs will be routed north to Design Point 6 (in pipe) and 8.3cfs will be routed west in the future street (surface flow in street).

Design Point 1

Design Point 1 is located at the NE corner of Nystrom Terrace and Aspen Butte Terrace at a knuckle and accepts flows from Basin C1.1. The developed conditions are as follows:

<u>(5-year storm)</u>	
Tributary Basins: C1.1	Inlet/MH Number: Inlet DP1
Upstream flowby:	Total Street Flow: 5.6cfs
Flow Intercepted: 5.6cfs	Flow Bypassed: 0
Inlet Size: 10' type R, sump	
Street Capacity: Street slope = 1.0%, capacity = 9cfs, okay	
<u>(100-year storm)</u>	
Tributary Basins: C1.1	Inlet/MH Number: Inlet DP1
Upstream flowby:	Total Street Flow: 12.2cfs
Flow Intercepted: 12.2cfs	Flow Bypassed:
Inlet Size: 10' type R, sump	
Street Capacity: Street slope = 1.0%, capacity = 37cfs (half street) is okay	

Design Point 2

Design Point 2 is located at the SW corner of Nystrom Terrace at a knuckle and accepts flows from Basin C1.2. The developed conditions are as follows:

<u>(5-year storm)</u>	
Tributary Basins: C1.2	Inlet/MH Number: Inlet DP2
Upstream flowby:	Total Street Flow: 2.7cfs
Flow Intercepted: 2.7cfs	Flow Bypassed: 0
Inlet Size: 10' type R, sump	
Street Capacity: Street slope = 1.0%, capacity = 9cfs, okay	
<u>(100-year storm)</u>	
Tributary Basins: C1.2	Inlet/MH Number: Inlet DP2
Upstream flowby:	Total Street Flow: 5.9cfs
Flow Intercepted: 5.9cfs	Flow Bypassed:
Inlet Size: 10' type R, sump	
Street Capacity: Street slope = 1.0%, capacity = 37cfs (half street) is okay	

Design Point 3

Design Point 3 is the storm sewer pipe flow from Nystrom Terrace to Lorson Boulevard from Design Pt's 1 and 2. The total pipe flow is 8.3cfs/18.1cfs in the 5/100-year storm events in the storm sewer.

Design Point 4

Design Point 4 is located at the NE of Lorson Boulevard and Walleye Drive and accepts flows from Lorson Boulevard (Basin C1.3).

(5-year storm)

Tributary Basins: C1.3
Upstream flowby:

Inlet/MH Number: Inlet DP4
Total Street Flow: 8.9cfs

Flow Intercepted: 13.5cfs
Inlet Size: 20' type R, on-grade

Flow Bypassed: 0.6cfs to ex. 15' inlet

Street Capacity: Street slope = 2.0%, capacity = 18cfs, okay

(100-year storm)

Tributary Basins: C1.3
Upstream flowby: 1.9cfs

Inlet/MH Number: Inlet DP4
Total Street Flow: 21.6cfs

Flow Intercepted: 18.0cfs
Inlet Size: 20' type R, on-grade

Flow Bypassed: 3.6cfs to ex. 15' inlet

Street Capacity: Street slope = 2.0%, capacity = 50cfs (half street) is okay

The existing 15' inlet was designed to accept 10cfs of upstream flow in the 100-year storm. See final drainage report for CDR 20-007 at Design Point 1b and 1.

Design Point 5

Design Point 5 is the storm sewer pipe flow from Design Pt's 3 and 4. The total pipe flow is 17.2cfs/36.1cfs in the 5/100-year storm events in the storm sewer.

Design Point 6

Design Point 6 is located at the SE of Lorson Boulevard and Walleye Drive and accepts flows from Lorson Boulevard (Basin C1.5).

(5-year storm)

Tributary Basins: C1.5
Upstream flowby:

Inlet/MH Number: Inlet DP6
Total Street Flow: 3.0cfs

Flow Intercepted: 3.0cfs
Inlet Size: 10' type R, on-grade

Flow Bypassed: 0cfs in curb downstream

Street Capacity: Street slope = 2.0%, capacity = 18cfs, okay

(100-year storm)

Tributary Basins: C1.5
Upstream flowby:

Inlet/MH Number: Inlet DP6
Total Street Flow: 6.6cfs

Flow Intercepted: 5.7cfs
Inlet Size: 10' type R, on-grade

Flow Bypassed: 0.9cfs in curb downstream

Street Capacity: Street slope = 2.0%, capacity = 50cfs (half street) is okay

Design Point 7

Design Point 7 is the existing 36" storm sewer pipe flow located in Lorson Boulevard. The total pipe flow is 36.8cfs/65.8cfs in the 5/100-year storm events in the storm sewer. Per the drainage report for CDR 20-007 the allowable flow in the existing 36" is 37.1cfs/65.3cfs.

Design Points 8-11 are not used

Design Point 12

Design Point 12 is located at the SE corner of Split Mountain Drive and Mission Peak Place and accepts flows from Basin C3.1.

(5-year storm)

Tributary Basins: C3.1

Upstream flowby:

Inlet/MH Number: Inlet DP12

Total Street Flow: 9.9cfs

Flow Intercepted: 9.3cfs

Inlet Size: 15' type R, on-grade

Flow Bypassed: 0.6cfs in curb downstream

Street Capacity: Street slope = 2.6%, capacity = 14.4cfs, okay

(100-year storm)

Tributary Basins: C3.1

Upstream flowby:

Inlet/MH Number: Inlet DP12

Total Street Flow: 21.8cfs

Flow Intercepted: 14.8cfs

Inlet Size: 15' type R, on-grade

Flow Bypassed: 7.0cfs in curb downstream

Street Capacity: Street slope = 2.6%, capacity = 40.7cfs (half street) is okay

Design Point 13

Design Point 13 is located at the SE corner of Split Mountain Drive and Pearsoll Street and accepts flows from Basin C3.2.

(5-year storm)

Tributary Basins: C3.2

Upstream flowby: 0.6cfs from Des. Pt 12

Inlet/MH Number: Inlet DP13

Total Street Flow: 8.5cfs

Flow Intercepted: 8.3cfs

Inlet Size: 15' type R, on-grade

Flow Bypassed: 0.2cfs in curb downstream

Street Capacity: Street slope = 2.2%, capacity = 13.3cfs, okay

(100-year storm)

Tributary Basins: C3.2

Upstream flowby: 7.0cfs from Des. Pt 12

Inlet/MH Number: Inlet DP13

Total Street Flow: 24.3cfs

Flow Intercepted: 15.6cfs

Inlet Size: 15' type R, on-grade

Flow Bypassed: 8.7cfs in curb downstream

Street Capacity: Street slope = 2.2%, capacity = 42.8cfs (half street) is okay

Design Point 14

Design Point 14 is the storm sewer pipe flow from Design Pt's 12 and 13. The total pipe flow is 17.6cfs/30.4cfs in the 5/100-year storm events in the storm sewer.

Design Point 15

Design Point 15 is located at the SE corner of Split Mountain Drive and Lost Peak Lane and accepts flows from Basin C3.3.

<u>(5-year storm)</u>	
Tributary Basins: C3.3	Inlet/MH Number: Inlet DP15
Upstream flowby: 0.2cfs from Des. Pt 13	Total Street Flow: 8.7cfs
Flow Intercepted: 8.4cfs	Flow Bypassed: 0.3cfs in curb downstream
Inlet Size: 15' type R, on-grade	
Street Capacity: Street slope = 1.9%, capacity = 12.2cfs, okay	
<u>(100-year storm)</u>	
Tributary Basins: C3.3	Inlet/MH Number: Inlet DP15
Upstream flowby: 8.7cfs from Des. Pt 13	Total Street Flow: 27.3cfs
Flow Intercepted: 16.5cfs	Flow Bypassed: 10.8cfs in curb downstream
Inlet Size: 15' type R, on-grade	
Street Capacity: Street slope = 1.9%, capacity = 44.0cfs (half street) is okay	

Design Point 16

Design Point 16 is the storm sewer pipe flow from Design Pt's 14 and 15. The total pipe flow is 26.0cfs/46.9cfs in the 5/100-year storm events in the storm sewer.

Design Point 17

Design Point 17 is located at the SE corner of Split Mountain Drive and Lake Trout Dr and accepts flows from Basin C3.4.

<u>(5-year storm)</u>	
Tributary Basins: C3.4	Inlet/MH Number: Inlet DP17
Upstream flowby: 0.3cfs from Des. Pt 15	Total Street Flow: 7.5cfs
Flow Intercepted: 7.5cfs	Flow Bypassed: 0cfs in curb downstream
Inlet Size: 20' type R, on-grade	
Street Capacity: Street slope = 3.4%, capacity = 16.5cfs, okay	
<u>(100-year storm)</u>	
Tributary Basins: C3.4	Inlet/MH Number: Inlet DP17
Upstream flowby: 10.8cfs from Des. Pt 15	Total Street Flow: 26.7cfs
Flow Intercepted: 20.4cfs	Flow Bypassed: 6.3cfs in curb downstream
Inlet Size: 20' type R, on-grade	
Street Capacity: Street slope = 3.4%, capacity = 37.0cfs (half street) is okay	

Design Point 18

Design Point 18 is the storm sewer pipe flow from Design Pt's 16 and 17. The total pipe flow is 33.5cfs/67.3cfs in the 5/100-year storm events in the storm sewer.

Design Point 19

Design Point 19 is located at the SW corner of Split Mountain Drive and Lake Trout Dr and accepts flows from Basin C3.5.

(5-year storm)

Tributary Basins: C3.5
Upstream flowby:

Inlet/MH Number: Inlet DP19
Total Street Flow: 10.3cfs

Flow Intercepted: 10.3cfs
Inlet Size: 20' type R, on-grade

Flow Bypassed: 0cfs in curb downstream

Street Capacity: Street slope = 2.6%, capacity = 14.4cfs, okay

(100-year storm)

Tributary Basins: C3.5
Upstream flowby: 6.3cfs from Des. Pt 17

Inlet/MH Number: Inlet DP19
Total Street Flow: 28.8cfs

Flow Intercepted: 21.2cfs
Inlet Size: 20' type R, on-grade

Flow Bypassed: 7.6cfs in curb downstream

Street Capacity: Street slope = 2.6%, capacity = 40.7cfs (half street) is okay

Design Point 20

Design Point 20 is the storm sewer pipe flow from Design Pt's 18 and 19. The total pipe flow is 43.8cfs/88.5cfs in the 5/100-year storm events in the storm sewer.

Design Point 20a

Design Point 20a is located at the NE corner of Lookout Peak Lane and Lake Trout Dr and accepts flows from Basin C3.6a.

(5-year storm)

Tributary Basins: C3.6a
Upstream flowby:

Inlet/MH Number: Inlet DP20a
Total Street Flow: 5.6cfs

Flow Intercepted: 5.6cfs
Inlet Size: 15' type R, on-grade

Flow Bypassed: 0

Street Capacity: Street slope = 2.1%, capacity = 13.0cfs, okay

(100-year storm)

Tributary Basins: C3.6a
Upstream flowby:

Inlet/MH Number: Inlet DP20a
Total Street Flow: 12.3cfs

Flow Intercepted: 10.7cfs
Inlet Size: 15' type R, on-grade

Flow Bypassed: 1.6cfs in curb downstream

Street Capacity: Street slope = 2.1%, capacity = 42.0cfs (half street) is okay

Design Point 20b

Design Point 20b is the storm sewer pipe flow from Design Pt's 20a and 20. The total pipe flow is 49.4cfs/99.2cfs in the 5/100-year storm events in the storm sewer.

Design Point 21

Design Point 21 is located at the NW corner of Lookout Peak Lane and Lake Trout Dr and accepts flows from Basin C3.6b.

(5-year storm)

Tributary Basins: C3.6b

Upstream flowby:

Inlet/MH Number: Inlet DP21

Total Street Flow: 7.2cfs

Flow Intercepted: 7.2cfs

Inlet Size: 15' type R, on-grade

Flow Bypassed:

Street Capacity: Street slope = 2.1%, capacity = 13.0cfs, okay

(100-year storm)

Tributary Basins: C3.6b

Upstream flowby: 1.6cfs from Des. Pt 20a

Inlet/MH Number: Inlet DP21

Total Street Flow: 17.5cfs

Flow Intercepted: 13.1cfs

Inlet Size: 15' type R, on-grade

Flow Bypassed: 4.4cfs in curb downstream

Street Capacity: Street slope = 2.1%, capacity = 42.0cfs (half street) is okay

Design Point 22 not used

Design Point 23

Design Point 23 is located at the SW corner of Dragontail Terrace and Lake Trout Dr and accepts flows from Basin C3.7.

(5-year storm)

Tributary Basins: C3.7

Upstream flowby:

Inlet/MH Number: Inlet DP23

Total Street Flow: 8.7cfs

Flow Intercepted: 8.4cfs

Inlet Size: 15' type R, on-grade

Flow Bypassed: 0.3cfs in curb downstream

Street Capacity: Street slope = 2.0%, capacity = 13.0cfs, okay

(100-year storm)

Tributary Basins: C3.7

Upstream flowby: 7.6cfs from Des. Pt 19

Inlet/MH Number: Inlet DP23

Total Street Flow: 26.7cfs

Flow Intercepted: 16.3cfs

Inlet Size: 15' type R, on-grade

Flow Bypassed: 10.4cfs in curb downstream

Street Capacity: Street slope = 2.0%, capacity = 42.0cfs (half street) is okay

Design Point 24

Design Point 24 is the storm sewer pipe flow from Design Pt's 20b and 23. The total pipe flow is 57.8cfs/115.5cfs in the 5/100-year storm events in the storm sewer.

Design Point 24a

Design Point 24a is the storm sewer pipe flow from Design Pt's 21 and 24. The total pipe flow is 65cfs/118.6cfs in the 5/100-year storm events in the storm sewer.

Design Point 25

Design Point 25 is located at the NW corner of Nystrom Terr and Lake Trout Dr and accepts flows from Basin C3.8.

(5-year storm)

Tributary Basins: C3.8

Inlet/MH Number: Inlet DP25

Upstream flowby:

Total Street Flow: 10.0cfs

Flow Intercepted: 7.2cfs

Flow Bypassed: 2.9cfs in curb downstream

Inlet Size: 10' type R, on-grade

Street Capacity: Street slope = 1.1%, capacity = 10.1cfs, okay

(100-year storm)

Tributary Basins: C3.8

Inlet/MH Number: Inlet DP25

Upstream flowby: 4.4cfs from Des. Pt 21

Total Street Flow: 26.4cfs

Flow Intercepted: 11.3cfs

Flow Bypassed: 15.1cfs in curb downstream

Inlet Size: 10' type R, on-grade

Street Capacity: Street slope = 1.1%, capacity = 39.0cfs (half street) is okay

Design Point 26 – not used

Design Point 27

Design Point 27 is located at the SW corner of Raven Ridge Terrace and Lake Trout Dr and accepts flows from Basin C3.9.

(5-year storm)

Tributary Basins: C3.9

Inlet/MH Number: Inlet DP27

Upstream flowby: 0.3cfs from Des.Pt. 23

Total Street Flow: 8.4cfs

Flow Intercepted: 8.4cfs

Flow Bypassed: 0cfs in curb downstream

Inlet Size: 20' type R, on-grade

Street Capacity: Street slope = 1.7%, capacity = 11.9cfs, okay

(100-year storm)

Tributary Basins: C3.9

Inlet/MH Number: Inlet DP27

Upstream flowby: 10.4cfs from Des. Pt 23

Total Street Flow: 28.3cfs

Flow Intercepted: 20.7cfs

Flow Bypassed: 7.6cfs in curb downstream

Inlet Size: 20' type R, on-grade

Street Capacity: Street slope = 1.7%, capacity = 45.0cfs (half street) is okay

Design Point 28

Design Point 28 is the storm sewer pipe flow from Design Pt's 27 and 24a. The total pipe flow is 73.4cfs/132.7cfs in the 5/100-year storm events in the storm sewer.

Design Point 28a

Design Point 28a is the storm sewer pipe flow from Design Pt's 28 and 25. The total pipe flow is 80.6cfs/133.4cfs in the 5/100-year storm events in the storm sewer.

Design Point 29

Design Point 29 is located at the SW corner of Nystrom Terrace and Lake Trout Dr and accepts flows from Basin C3.10.

(5-year storm)

Tributary Basins: C3.10

Inlet/MH Number: Inlet DP29

Upstream flowby: 0.3cfs from Des.Pt. 27

Total Street Flow: 9.2cfs

Flow Intercepted: 9.2cfs

Flow Bypassed: 0cfs in curb downstream

Inlet Size: 20' type R, on-grade

Street Capacity: Street slope = 1.0%, capacity = 9.2cfs, okay

(100-year storm)

Tributary Basins: C3.10

Inlet/MH Number: Inlet DP29

Upstream flowby: 7.6cfs from Des. Pt 27

Total Street Flow: 27.8cfs

Flow Intercepted: 20.5cfs

Flow Bypassed: 7.3cfs in curb downstream

Inlet Size: 20' type R, on-grade

Street Capacity: Street slope = 1.0%, capacity = 37.3cfs (half street) is okay

Design Point 30

Design Point 30 is the storm sewer pipe flow from Design Pt's 28a and 29. The total pipe flow is 89.8cfs/153.9cfs in the 5/100-year storm events in the storm sewer.

Design Point 31

Design Point 31 is located east of Walleye Drive on the south side of Fontaine Boulevard and accepts flows from Basin C4.1 and C4.2.

<u>(5-year storm)</u>	
Tributary Basins: C4.1+C4.2	Inlet/MH Number: Inlet DP31
Upstream flowby:	Total Street Flow: 10.5cfs
Flow Intercepted: 9.7cfs	Flow Bypassed: 0.8cfs in curb downstream
Inlet Size: 15' type R, on-grade	
Street Capacity: Street slope = 4.8%, capacity = 15.7cfs, okay	
<u>(100-year storm)</u>	
Tributary Basins: C4.1+C4.2	Inlet/MH Number: Inlet DP31
Upstream flowby:	Total Street Flow: 23.2cfs
Flow Intercepted: 15.3cfs	Flow Bypassed: 7.9cfs in curb downstream
Inlet Size: 15' type R, on-grade	
Street Capacity: Street slope = 4.8%, capacity = 38.3cfs (half street) is okay	

Design Point 32 is located on the north end of Nystrom Terr in a cul-de-sac and accepts flows from Basin C4.3

<u>(5-year storm)</u>	
Tributary Basins: C4.3	Inlet/MH Number: Inlet DP32
Upstream flowby: 2.8cfs from Des. Pt.25	Total Street Flow: 10.3 cfs
Flow Intercepted: 10.3cfs	Flow Bypassed:
Inlet Size: 20' type R, sump	
Street Capacity: Street slope = 1.0%, capacity = 9.2cfs, okay	
<u>(100-year storm)</u>	
Tributary Basins: C4.3	Inlet/MH Number: Inlet DP32
Upstream flowby: 15.1cfs from Des.Pt. 25	Total Street Flow: 27.5cfs
Flow Intercepted: 27.5cfs	Flow Bypassed:
Inlet Size: 20' type R, sump	
Street Capacity: Street slope = 1.0%, capacity = 37.3cfs (half street) is okay	

Design Point 32a

Design Point 32a is the storm sewer pipe flow from Design Pt's 31 and 32. The total pipe flow is 18.2cfs/42.8cfs in the 5/100-year storm events in the storm sewer.

Design Point 33

Design Point 33 is located on Walleye Drive south of Fontaine Boulevard and is an existing 25' type R inlet in a sump condition constructed as part of CDR 20-007.

<u>(5-year storm)</u>	
Tributary Basins: C4.4	Inlet/MH Number: ex. 25' inlet DP33
Upstream flowby: 0.8cfs from Des.Pt. 31	Total Street Flow: 7.0cfs
Flow Intercepted: 7.0cfs	Flow Bypassed:
Inlet Size: ex 25' type R, sump	
Street Capacity: Street slope = 0.7%, capacity = 11.5cfs, okay	
<u>(100-year storm)</u>	
Tributary Basins: C4.4	Inlet/MH Number: ex. 25' inlet DP33
Upstream flowby: 7.3cfs from Des.Pt. 29 7.9cfs from Des. Pt. 31	Total Street Flow: 28.7cfs
Flow Intercepted: 28.7cfs	Flow Bypassed:
Inlet Size: ex 25' type R, sump	
Street Capacity: Street slope = 0.7%, capacity = 34.6cfs (half street) is okay	

Design Point 34

Design Point 34 is the storm sewer pipe flow from Design Pt's 30, 32a, and 33. The total pipe flow is 115.0cfs/225.4cfs in the 5/100-year storm events in the existing 54" storm sewer constructed as part of CDR 20-007. The revised calculated flow in the existing 54" storm sewer is slightly more than the design flow in CDR 20-007 of 101.2cfs/218.6cfs in the 5/100-year storm events but the HGL's are not above the top of the 54" storm sewer.

Design Point 35a

Design Point 35a is located at the NW corner of Kingston Peak Place and Lorson Boulevard and accepts flows from Basin F1.4.

<u>(5-year storm)</u>	
Tributary Basins: F1.4	Inlet/MH Number: Inlet DP29
Upstream flowby:	Total Street Flow: 5.9cfs
Flow Intercepted: 5.9cfs	Flow Bypassed: 0cfs in curb downstream
Inlet Size: 15' type R, on-grade	
Street Capacity: Street slope = 0.9%, capacity = 9.2cfs, okay	
<u>(100-year storm)</u>	
Tributary Basins: F1.4	Inlet/MH Number: Inlet DP29
Upstream flowby:	Total Street Flow: 13.2cfs
Flow Intercepted: 11.3cfs	Flow Bypassed: 1.9cfs in curb downstream
Inlet Size: 15' type R, on-grade	
Street Capacity: Street slope = 0.9%, capacity = 37.3cfs (half street) is okay	

Design Point 35b

Design Point 35b is located at the NE corner of Kingston Peak Place and Lorson Boulevard and accepts flows from Basin F1.3.

<u>(5-year storm)</u>	
Tributary Basins: F1.3	Inlet/MH Number: Inlet DP29
Upstream flowby:	Total Street Flow: 1.9cfs
Flow Intercepted: 1.9cfs	Flow Bypassed: 0cfs in curb downstream
Inlet Size: 5' type R, sump	
Street Capacity: Street slope = 0.9%, capacity = 9.2cfs, okay	
<u>(100-year storm)</u>	
Tributary Basins: F1.3	Inlet/MH Number: Inlet DP29
Upstream flowby:	Total Street Flow: 4.6cfs
Flow Intercepted: 4.4cfs	Flow Bypassed: 0.2cfs
Inlet Size: 5' type R, sump	
Street Capacity: Street slope = 0.9%, capacity = 37.3cfs (half street) is okay	

Design Point 35c

Design Point 35c is the storm sewer pipe flow from Design Pt's 35a and 35b. The total pipe flow is 7.8cfs/15.7cfs in the 5/100-year storm events in the storm sewer. Stormwater enters WQ Pond F where it will be treated and released. WQ Pond F has been sized for water quality and the 5-100-year storm runoff will be allowed to flow through the pond with minimal detention.

Design Point 35

Design Point 35 is located on the east side of this site and is the total flow from Basins F1.1, F1.2, and Design Point 35d. The total flow from these basins and the WQ pond (Des.Pt. 35d) is 15.5cfs/69.5cfs in the 5/100-year storm events. The existing flow calculated at Design Point 2x flowing east offsite is 12.4cfs/72.7cfs in the 5/100-year storm events. The developed flow will remain sheet flow into the Upper Williams Creek Drainage Basin for the majority of the runoff along the east boundary of Lorson Ranch as in existing conditions and will discharge the same runoff rates as in existing flows. BJ Ranches, LLC is the downstream offsite landowner located east of Lorson Ranch. Lorson Ranch will try to secure a letter of understanding with the downstream landowner to address maintenance of any erosion issues should they occur on the offsite area and to acknowledge the manner of which drainage enters the offsite property has changed at the Pond F outfall. A spreader is proposed at the pond outfall to convert point discharges into sheet flow. See Design Point 35d for discussion of concentrated runoff from WQ Pond F.

Design Point 35d

Design Point 35d is located at the storm sewer outfall from WQ Pond F. The total pipe flow is 1.9cfs/8.4cfs in the 5/100-year storm events in the storm sewer per the full spectrum excel spreadsheets. Equation GB-1 from the Grass Buffer worksheet determines the length of the spreader ($W=Q^2/0.05$) required to convert point discharges into sheet flow to reduce the erosion potential. For a flow of 8.4cfs, the length of the spreader from the storm sewer outfall is required to be 168' long with 1.5" wide openings every 2' along the curb spreader. The curb spreader will be 4' wide with 8" tall curbs. In addition to the curb spreader, the flows will drain and additional 100' overland before exiting the Lorson Ranch property.

Design Point 35e

Design Point 35e is located on the south property line of Lorson Ranch and is the total flow from Basin G1 which is 2.5cfs/18.2cfs in the 5/100-year storm events. The existing flow at this design point (Basin EX-G) is 2.9cfs/21.6cfs in the 5/100-year storm events. The runoff at the south property line of Lorson Ranch was reduced slightly due to grading north of Lorson Boulevard. The discharge is only slightly less than existing flows resulting in no negative impacts downstream.

Design Point 35f

Design Point 35f is located on the south property line of Lorson Ranch and is the total flow from Basin H1 which is 6.0cfs/40.2cfs in the 5/100-year storm events. The existing flow at this design point (Basin EX-H) is 6.1cfs/42.9cfs in the 5/100-year storm events. The runoff at the south property line of Lorson Ranch was reduced slightly due to grading north of Lorson Boulevard. The discharge is slightly less than existing flows resulting in no negative impacts downstream.

Design Point 36

Design Point 36 is located on the north side of Gray Wolf Court and accepts flows from Basin C5.1b

<u>(5-year storm)</u>	
Tributary Basins: C5.1b	Inlet/MH Number: Inlet DP36
Upstream flowby:	Total Street Flow: 11.4cfs
Flow Intercepted: 4.1cfs	Flow Bypassed: 7.3cfs in curb downstream
Inlet Size: 5' type R, on-grade	
Street Capacity: Street slope = 2.7%, capacity = 14.4cfs, okay	
<u>(100-year storm)</u>	
Tributary Basins: C5.1b	Inlet/MH Number: Inlet DP36
Upstream flowby:	Total Street Flow: 25.2cfs
Flow Intercepted: 5.7cfs	Flow Bypassed: 19.5cfs in curb downstream
Inlet Size: 5' type R, on-grade	
Street Capacity: Street slope = 2.7%, capacity = 40.7cfs (half street) is okay	

Design Point 37

Design Point 37 is located on the south side of Gray Wolf Court and accepts flows from Basin C5.1c

<u>(5-year storm)</u>	
Tributary Basins: C5.1c	Inlet/MH Number: Inlet DP37
Upstream flowby:	Total Street Flow: 7.4cfs
Flow Intercepted: 3.4cfs	Flow Bypassed: 4.0cfs in curb downstream
Inlet Size: 5' type R, on-grade	
Street Capacity: Street slope = 2.0%, capacity = 12.5cfs, okay	
<u>(100-year storm)</u>	
Tributary Basins: C5.1c	Inlet/MH Number: Inlet DP37
Upstream flowby:	Total Street Flow: 16.3cfs
Flow Intercepted: 4.8cfs	Flow Bypassed: 11.5cfs in curb downstream
Inlet Size: 5' type R, on-grade	
Street Capacity: Street slope = 2.0%, capacity = 44.0cfs (half street) is okay	

Design Point 38

Design Point 38 is the storm sewer pipe flow from Design Pt's 36 and 37. The total pipe flow is 7.5cfs/10.5cfs in the 5/100-year storm events in the storm sewer.

Design Point 39

Design Point 39 is located at the southeast corner of Gray Wolf Court and Donnas Drive and accepts flows from Basin C5.1a.

<u>(5-year storm)</u>	
Tributary Basins: C5.1a,b,c	Inlet/MH Number: Inlet DP39
Upstream flowby: 20.2cfs – 4.1(inlet DP36) – 3.4(inlet DP37)	Total Street Flow: 12.7cfs
Flow Intercepted: 12.7cfs	Flow Bypassed:
Inlet Size: 25' type R, on-grade	
Street Capacity: Street slope = 1.9%, capacity = 14cfs, okay	
<u>(100-year storm)</u>	
Tributary Basins: C5.1a,b,c	Inlet/MH Number: Inlet DP39
Total flow in street: 44.5cfs – 5.7(inlet DP36) – 4.8(inlet DP37)	Total Street Flow: 34.0cfs
Flow Intercepted: 27.0cfs	Flow Bypassed: 7.0cfs in curb downstream
Inlet Size: 25' type R, on-grade	
Street Capacity: Street slope = 1.9%, capacity = 45.4cfs (half street) is okay	

Design Point 40

Design Point 40 is the storm sewer pipe flow from Design Pt's 38 and 39. The total pipe flow is 23.0cfs/37.0cfs in the 5/100-year storm events in the storm sewer.

Design Point 41

Design Point 41 is located south of Gray Wolf Court on the east side of Donnas Drive and accepts flows from Basin C5.1d.

(5-year storm)

Tributary Basins: C5.1d
Upstream flowby:

Inlet/MH Number: Inlet DP41
Total Street Flow: 9.3cfs

Flow Intercepted: 9.3cfs
Inlet Size: 20' type R, SUMP

Flow Bypassed:

Street Capacity: Street slope = 1.4%, capacity = 10.5cfs, okay

(100-year storm)

Tributary Basins: C5.1d
Upstream flowby: 7.0cfs from Des.Pt.39

Inlet/MH Number: Inlet DP41
Total Street Flow: 27.7cfs

Flow Intercepted: 25.1cfs
Inlet Size: 20' type R, SUMP (inlet overtops to Des. Pt. 43)

Flow Bypassed: 2.6cfs to DP43

Street Capacity: Street slope = 1.4%, capacity = 44.1cfs (half street) is okay

Design Point 42

Design Point 42 is the storm sewer pipe flow from Design Pt's 40 and 41. The total pipe flow is 32.3cfs/62.1cfs in the 5/100-year storm events in the storm sewer.

Design Point 43

Design Point 43 is located south of Gray Wolf Court on the west side of Donnas Drive and accepts flows from Basin C5.1e and flowby from Des. Pt. 41. See Des.Pt. 44 for overflow conveyance.

(5-year storm)

Tributary Basins: C5.1e
Upstream flowby:

Inlet/MH Number: Inlet DP41
Total Street Flow: 10.0cfs

Flow Intercepted: 10.0cfs
Inlet Size: 20' type R, SUMP

Flow Bypassed:

Street Capacity: Street slope = 1.4%, capacity = 10.5cfs, okay

(100-year storm)

Tributary Basins: C5.1e
Upstream flowby: 2.6cfs from Des.Pt.41

Inlet/MH Number: Inlet DP41
Total Street Flow: 24.5cfs

Flow Intercepted: 24.5cfs
Inlet Size: 20' type R, SUMP

Flow Bypassed:

Street Capacity: Street slope = 1.4%, capacity = 44.1cfs (half street) is okay

Design Point 44

Design Point 44 is the storm sewer pipe flow from Design Pt's 42 and 43. The total pipe flow is 42.3cfs/87.1cfs in the 5/100-year storm events in the storm sewer. The FDR for CDR20-007 (Design Point 16a) was designed to accept 42.3cfs/92.5cfs in the existing 36" RCP stub in Fontaine Boulevard. This design point is also at a low point in Donnas Drive and in the event the inlet at Design Point 43 is clogged, runoff will flow overland through Tract G which has a 25' wide swale (depression) which is 1' lower than the adjacent lots.

Design Points 45 & 46

Design Points 45 & 46 are located at the NE corner of Walleye Drive and Fontaine Boulevard and is an existing 15' type R inlet in a sump condition constructed as part of CDR 20-007

(5-year storm)

Tributary Basins: C5.2 & C5.3

Upstream flowby:

Inlet/MH Number: ex. 15' inlet

Total Street Flow: 7.7cfs

Flow Intercepted: 7.7cfs

Inlet Size: ex 15' type R, sump

Flow Bypassed:

Street Capacity: Street slope = 1.0%, capacity = 13.7cfs, okay

(100-year storm)

Tributary Basins: C5.2 & C5.3

Upstream flowby:

Inlet/MH Number: ex. 15' inlet

Total Street Flow: 17.1cfs

Flow Intercepted: 17.1cfs

Inlet Size: ex 15' type R, sump

Flow Bypassed:

Street Capacity: Street slope = 1.0%, capacity = 41.4cfs (half street) is okay

The FDR for CDR 20-007 designed the existing inlet to accept 7.9cfs/17.7cfs in the 5/100 year storm events.

Design Point 47

Design Point 47 is located in the SE corner of Meridith Ridge Way and Donnas Drive and accepts flows from Basin C8.1a.

(5-year storm)

Tributary Basins: C8.1a
Upstream flowby:

Inlet/MH Number: Inlet DP47
Total Street Flow: 7.5cfs

Flow Intercepted: 6.1cfs
Inlet Size: 10' type R, on-grade

Flow Bypassed: 1.4cfs

Street Capacity: Street slope = 1.0%, capacity = 9.0cfs, okay

(100-year storm)

Tributary Basins: C8.1a
Upstream flowby:

Inlet/MH Number: Inlet DP47
Total Street Flow: 16.4cfs

Flow Intercepted: 9.1cfs
Inlet Size: 10' type R, on-grade

Flow Bypassed: 7.3cfs

Street Capacity: Street slope = 1.0%, capacity = 37.3cfs (half street) is okay

Design Point 48

Design Point 48 is located in the NE corner of Sanderling Street and Donnas Drive and accepts flows from Basin C8.1c.

(5-year storm)

Tributary Basins: C8.1c
Upstream flowby:

Inlet/MH Number: Inlet DP48
Total Street Flow: 3.4cfs

Flow Intercepted: 3.4cfs
Inlet Size: 10' type R, on-grade

Flow Bypassed:

Street Capacity: Street slope = 1.5%, capacity = 11.0 cfs, okay

(100-year storm)

Tributary Basins: C8.1c
Upstream flowby:

Inlet/MH Number: Inlet DP48
Total Street Flow: 7.6cfs

Flow Intercepted: 6.2cfs
Inlet Size: 10' type R, on-grade

Flow Bypassed: 1.4cfs

Street Capacity: Street slope = 1.5%, capacity = 44.5cfs (half street) is okay

Design Point 49

Design Point 49 is located in the NW corner of Sanderling Street and Donnas Drive and accepts flows from Basin C8.1b.

(5-year storm)

Tributary Basins: C8.1b
Upstream flowby: 1.4cfs from Des.Pt. 47

Inlet/MH Number: Inlet DP49
Total Street Flow: 7.7 cfs

Flow Intercepted: 7.7cfs
Inlet Size: 20' type R, on-grade

Flow Bypassed:

Street Capacity: Street slope = 2.8%, capacity = 14.4cfs, okay

(100-year storm)

Tributary Basins: C8.1b
Upstream flowby: 7.3cfs from Des.Pt.47
1.4cfs from Des.Pt.48
5.1cfs from Des.Pt.57

Inlet/MH Number: Inlet DP49
Total Street Flow: 27.7cfs

Flow Intercepted: 20.8cfs
Inlet Size: 20' type R, on-grade

Flow Bypassed: 6.9cfs

Street Capacity: Street slope = 2.8%, capacity = 40.7cfs (half street) is okay

Design Point 50

Design Point 50 is the storm sewer pipe flow from Design Pt's 48 and 49. The total pipe flow is 11.1cfs/27.0cfs in the 5/100-year storm events in the storm sewer. The FDR for CDR20-007 (Design Point 31a) was designed to accept 8.9cfs/20.9cfs in the existing 30" RCP stub from Walleye Drive at Sanderling Street. However, the existing pipe has capacity to handle the additional pipe flow based on the HGL. See Design Point 52.

Design Point 51

Design Point 51 is located at an existing 25' type R inlet in the SW corner of Grayling Drive and Walleye Drive and accepts flows from Basin C8.2.

(5-year storm)

Tributary Basins: C8.2

Upstream flowby:

Inlet/MH Number: existing 25'

Total Street Flow: 4.5 cfs

Flow Intercepted: 4.5cfs

Inlet Size: ex 25' type R, SUMP

Flow Bypassed:

Street Capacity: Street slope (collector) = 1.0%, capacity = 13.7cfs, okay

(100-year storm)

Tributary Basins: C8.2

Upstream flowby: 6.9cfs from Des.Pt.49

9.1cfs from Des.Pt.56

Inlet/MH Number: existing 25'

Total Street Flow: 26.0cfs

Flow Intercepted: 26.0cfs

Inlet Size: ex 25' type R, SUMP

Flow Bypassed:

Street Capacity: Street slope = 1.0% (collector) , capacity = 41.4cfs (half street) is okay

The FDR for CDR 20-007 (Des.Pt. 31) designed the existing inlet to accept 14.5cfs/30.0cfs in the 5/100 year storm events.

Design Point 52

Design Point 52 is the storm sewer pipe flow from Design Pt's 50 and 51 in an existing 36" storm sewer in Walleye Drive. The total pipe flow is 15.6cfs/53.0cfs in the 5/100-year storm events in the storm sewer. The FDR for CDR20-007 (Design Point 31c) designed the storm sewer to accept 23.4cfs/50.9cfs in the existing 36" RCP storm sewer in Walleye Drive. The existing pipe has capacity to handle the slight increase in pipe flow in the 100yr storm event.

Design Point 53

Design Point 53 is located in the SE corner of Danis Drive and Walleye Drive and accepts flows from Basin C8.3a. Basin OS-C4a existing and future flows will be diverted north to Des. Pt. 63a.

<u>(5-year storm)</u>	
Tributary Basins: C8.3a	Inlet/MH Number: Inlet DP53
Upstream flowby:	Total Street Flow: 10.6cfs
Flow Intercepted: 9.7cfs	Flow Bypassed: 0.9cfs
Inlet Size: 15' type R, on-grade	
Street Capacity: Street slope = 1.4%, capacity = 10.5cfs, okay	
<u>(100-year storm)</u>	
Tributary Basins: C8.3a	Inlet/MH Number: Inlet DP53
Upstream flowby:	Total Street Flow: 26.5cfs
Flow Intercepted: 16.2cfs	Flow Bypassed: 10.3cfs
Inlet Size: 15' type R, on-grade	
Street Capacity: Street slope = 1.4%, capacity = 44.1cfs (half street) is okay	

Design Point 54

Design Point 54 is located in the NE corner of Donnas Drive and Walleye Drive and accepts flows from Basin C8.3b& C8.3c.

<u>(5-year storm)</u>	
Tributary Basins: C8.3b & C8.3c	Inlet/MH Number: Inlet DP54
Upstream flowby: 0.9cfs from Des.Pt.53	Total Street Flow: 11.8cfs
Flow Intercepted: 11.7cfs	Flow Bypassed: 0.1cfs
Inlet Size: 20' type R, on-grade	
Street Capacity: Street slope = 1.5%, capacity = 11.8cfs, okay	
<u>(100-year storm)</u>	
Tributary Basins: C8.3b & C8.3c	Inlet/MH Number: Inlet DP54
Upstream flowby: 10.3cfs from Des.Pt.53	Total Street Flow: 37.6cfs
Flow Intercepted: 24.0cfs	Flow Bypassed: 13.6cfs
Inlet Size: 20' type R, on-grade	
Street Capacity: Street slope = 1.5%, capacity = 45.0cfs (half street) is okay	

Design Point 55

Design Point 55 is the storm sewer pipe flow from Design Pt's 53 and 54. The total pipe flow is 21.4cfs/40.2cfs in the 5/100-year storm events in the storm sewer.

Design Point 56

Design Point 56 is located on Walleye Drive south of Donnas Drive and accepts flows from Basin C8.3d

<u>(5-year storm)</u>	
Tributary Basins: C8.3d	Inlet/MH Number: Inlet DP56
Upstream flowby: 0.1cfs from Des.Pt.54	Total Street Flow: 9.0cfs
Flow Intercepted: 9.0cfs	Flow Bypassed:
Inlet Size: 20' type R, on-grade	
Street Capacity: Street slope = 1.2%, capacity = 10.0cfs, okay	
<u>(100-year storm)</u>	
Tributary Basins: C8.3d	Inlet/MH Number: Inlet DP56
Upstream flowby: 13.6cfs from Des.Pt.54	Total Street Flow: 32.8cfs
Flow Intercepted: 32.8cfs	Flow Bypassed: 9.1cfs
Inlet Size: 20' type R, on-grade	
Street Capacity: Street slope = 1.2%, capacity = 38.0cfs (half street) is okay	

Design Point 57

Design Point 57 is located at the NE corner of Donnas Drive and Meridith Ridge Way and accepts flows from Basin C8.4

<u>(5-year storm)</u>	
Tributary Basins: C8.4	Inlet/MH Number: Inlet DP57
Upstream flowby:	Total Street Flow: 11.0cfs
Flow Intercepted: 11.0cfs	Flow Bypassed:
Inlet Size: 20' type R, on-grade	
Street Capacity: Street slope = 1.0%, capacity = 9.0cfs, okay	
<u>(100-year storm)</u>	
Tributary Basins: C8.4	Inlet/MH Number: Inlet DP57
Upstream flowby:	Total Street Flow: 24.1cfs
Flow Intercepted: 19.0cfs	Flow Bypassed: 5.1cfs to DP49
Inlet Size: 20' type R, on-grade	
Street Capacity: Street slope = 1.0%, capacity = 37.3cfs (half street) is okay	

Design Point 58

Design Point 58 is the storm sewer pipe flow from Design Pt's 57 and 47. The total pipe flow is 17.1cfs/28.1cfs in the 5/100-year storm events in the storm sewer.

Design Point 59

Design Point 59 is located on the north side of Walleye Drive south of Broken Top Drive and accepts flows from Basin C8.5

(5-year storm)

Tributary Basins: C8.5
Upstream flowby:

Inlet/MH Number: Inlet DP59
Total Street Flow: 7.0cfs

Flow Intercepted: 5.9cfs
Inlet Size: 10' type R, on-grade

Flow Bypassed: 1.1cfs

Street Capacity: Street slope = 1.2%, capacity = 10.0cfs, okay

(100-year storm)

Tributary Basins: C8.5
Upstream flowby:

Inlet/MH Number: Inlet DP59
Total Street Flow: 15.5cfs

Flow Intercepted: 8.9cfs
Inlet Size: 10' type R, on-grade

Flow Bypassed: 6.6cfs

Street Capacity: Street slope = 1.2%, capacity = 38.0cfs (half street) is okay

Design Point 60

Design Point 60 is the storm sewer pipe flow from Design Pt's 55, 56 and 59. The total pipe flow is 32.7cfs/73.3cfs in the 5/100-year storm events in the storm sewer.

Design Point 61

Design Point 61 is the storm sewer pipe flow from Design Pt's 52, 58 and 60 from the C8.1, C8.3, C8.4, and C8.5 basins. The total pipe flow is 44.9cfs/104.1cfs in the 5/100-year storm events in the storm sewer. The FDR for CDR20-007 (Design Point 32) designed the storm sewer to accept 45.1cfs/105.4cfs in the existing 42" RCP storm sewer in Walleye Drive.

Design Point 62

Design Point 62 is located in the NE corner of Grayling Drive and Reagan Ridge Drive and accepts flows from Basin C8.6 & C8.7e.

<u>(5-year storm)</u>	
Tributary Basins: C8.6 & C8.7e	Inlet/MH Number: Inlet DP62
Upstream flowby: 1.1 cfs from Des.Pt.59	Total Street Flow: 14.3cfs
Flow Intercepted: 14.3cfs	Flow Bypassed:
Inlet Size: 25' type R, SUMP	
Street Capacity: Street slope = 2.5%, capacity = 14.2cfs, okay	
<u>(100-year storm)</u>	
Tributary Basins: C8.6 & C8.7e	Inlet/MH Number: Inlet DP62
Upstream flowby: 6.6cfs from Des.Pt.59 2.7cfs from Des.Pt.66	Total Street Flow: 37.4cfs
Flow Intercepted: 37.4cfs	Flow Bypassed:
Inlet Size: 25' type R, SUMP	
Street Capacity: Street slope = 2.5%, capacity = 41.4cfs (half street) is okay	

Design Point 63

Design Point 63 is located at the SE corner of Reagan Ridge Drive and Logans Ridge Lane and accepts flows from Basin C8.7a&b

<u>(5-year storm)</u>	
Tributary Basins: C8.7a&b	Inlet/MH Number: Inlet DP63
Upstream flowby:	Total Street Flow: 11.5cfs
Flow Intercepted: 10.2cfs	Flow Bypassed: 1.3cfs
Inlet Size: 15' type R, on-grade	
Street Capacity: Street slope = 1.6%, capacity = 11.5cfs, okay	
<u>(100-year storm)</u>	
Tributary Basins: C8.7a&b	Inlet/MH Number: Inlet DP63
Upstream flowby:	Total Street Flow: 25.6cfs
Flow Intercepted: 15.9cfs	Flow Bypassed: 9.7cfs
Inlet Size: 15' type R, on-grade	
Street Capacity: Street slope = 1.6%, capacity = 45.0cfs (half street) is okay	

Design Point 63a

Design Point 63a is the existing offsite flow from areas west of Lorson Ranch from offsite Basins OS-B1, OS-C4a, and OS-C4b. These offsite basins will be routed north in a wide shallow swale onto adjacent land owned by Lorson Ranch. The proposed total flow in the swale is 7.3cfs/42.2cfs in the 5/100-year storm events which is less than existing total flow onto the adjacent property at Design Point 1x which is 9.7cfs/54.2cfs in the 5/100-year storm events (see existing conditions). Two rip rap pads will be constructed at the north end of the shallow swale to disperse the concentrated flow as it flows

north onto the adjacent property owned by Lorson Ranch. Lorson Ranch owns the downstream offsite land (to the north) and a letter of understanding will be secured at the final plat stage to address maintenance of any erosion issues should they occur on the offsite area and to acknowledge the manner of which drainage enters the offsite property has changed.

Design Point 64

Design Point 64 is located at the SE corner of Reagan Ridge Drive and Cody Ridge Way and accepts flows from Basin C8.7c

<u>(5-year storm)</u>		
Tributary Basins:	C8.7c	Inlet/MH Number: Inlet DP64
Upstream flowby:	1.3cfs from Des.Pt.63	Total Street Flow: 10.7cfs
Flow Intercepted:	9.8cfs	Flow Bypassed: 0.9cfs
Inlet Size:	15' type R, on-grade	
Street Capacity: Street slope = 4.0%, capacity = 17.9cfs, okay		
<u>(100-year storm)</u>		
Tributary Basins:	C8.7c	Inlet/MH Number: Inlet DP64
Upstream flowby:	9.7cfs from Des.Pt.63	Total Street Flow: 30.6cfs
Flow Intercepted:	17.5cfs	Flow Bypassed: 13.1cfs
Inlet Size:	15' type R, on-grade	
Street Capacity: Street slope = 4.0%, capacity = 35.7cfs (half street) is okay		

Design Point 65

Design Point 65 is the storm sewer pipe flow from Design Pt's 63 and 64. The total pipe flow is 20.0cfs/33.4cfs in the 5/100-year storm events in the storm sewer.

Design Point 66

Design Point 66 is located at the NE corner of Reagan Ridge Drive and Broken Top Drive and accepts flows from Basin C8.7d

<u>(5-year storm)</u>		
Tributary Basins:	C8.7d	Inlet/MH Number: Inlet DP66
Upstream flowby:	0.9cfs from Des.Pt.64	Total Street Flow: 1.5cfs
Flow Intercepted:	1.5cfs	Flow Bypassed:
Inlet Size:	15' type R, on-grade	
Street Capacity: Street slope = 2.0%, capacity = 12.5cfs, okay		
<u>(100-year storm)</u>		
Tributary Basins:	C8.7d	Inlet/MH Number: Inlet DP66
Upstream flowby:	13.1cfs from Des.Pt.64	Total Street Flow: 14.5cfs
Flow Intercepted:	11.8cfs	Flow Bypassed: 2.7cfs
Inlet Size:	15' type R, on-grade	
Street Capacity: Street slope = 2.0%, capacity = 44.0cfs (half street) is okay		

Design Point 67

Design Point 67 is the storm sewer pipe flow from Design Pt's 65 and 66. The total pipe flow is 21.5cfs/45.2cfs in the 5/100-year storm events in the storm sewer.

Design Point 68

Design Point 68 is the storm sewer pipe flow from Basins C8.6-C8.7e and runby from Des.Pt. 59. The total pipe flow is 33.0cfs/76.5cfs in the 5/100-year storm events in the storm sewer.

Design Point 69

Design Point 69 is located at the NW corner of Reagan Ridge Drive and Walleye Drive at an existing 25' Type R sump inlet and accepts flows from Basin OS-B1 & C8.8a

<u>(5-year storm)</u>	
Tributary Basins: C8.8a	Inlet/MH Number: Inlet DP69
Upstream flowby:	Total Street Flow: 7.9cfs
Flow Intercepted: 7.9cfs	Flow Bypassed:
Inlet Size: Ex 25' type R, SUMP	
Street Capacity: Street slope = 2.0%, capacity = 12.5cfs, okay	
<u>(100-year storm)</u>	
Tributary Basins: C8.8a	Inlet/MH Number: Inlet DP69
Upstream flowby:	Total Street Flow: 17.3cfs
Flow Intercepted: 17.3cfs	Flow Bypassed:
Inlet Size: Ex 25' type R, SUMP	
Street Capacity: Street slope = 2.0%, capacity = 44.0cfs (half street) is okay	

Design Point 70

Design Point 70 is the storm sewer pipe flow from the offsite basins, C8.7's, and C8.8a basins and runby from Des.Pt.59. The total pipe flow is 34.5cfs/86.3cfs in the 5/100-year storm events in the storm sewer from the xcel spreadsheet calculations. The FDR for CDR20-007 (Design Point 34a) designed the storm sewer to accept 38.2cfs/84.5cfs in the existing 42" RCP storm sewer in Walleye Drive. The storm sewer has capacity for these basins.

6.0 DETENTION AND WATER QUALITY PONDS

Detention and Storm Water Quality for The Ridge at Lorson Ranch is required per El Paso County criteria. We have implemented the Full Spectrum approach for detention for the Denver Urban Drainage Districts specifications. There are four permanent full spectrum ponds previously constructed in The Hills at Lorson Ranch for this development which will incorporate storm water quality features and comply with the Lorson Ranch East MDDP. In addition, one WQ pond will drain eastward as in existing condition into the Upper Williams Creek Drainage Basin required to match existing conditions. The ponds have been sized and include access roads, outlet pipes, overflow structures, and low flow channels. This drainage report provides design information on the outlet structure, trickle channel, and the forebays.

revise to "structures"
(plural)

Full Spectrum Pond Construction Requirements

All four of the detention ponds required for this project have been previously graded as part of The Hills at Lorson Ranch (PUDSP 20-003) and include Pond C1, C2.1, C2.2, and C4. The Hills at Lorson Ranch constructed Existing Pond C1 and C2.2 which are complete full spectrum ponds that do not need to be modified and include the full spectrum outlet structure, forebays, outfall storm sewer, and low flow channels. Existing Pond C2.1 and Pond C4 were graded and constructed with forebays, outfall storm sewers, and low flow channels but did not include the full spectrum outlet structure. The outlet structure for these two ponds will be discussed in this section including what type of structure is proposed. Per the Lorson East MDDP, these four ponds and downstream Pond C5 (at Fontaine/East tributary) are part of an overall storm water system to be constructed by Lorson Ranch. Existing Pond C5 (including the final configuration of the orifice plate) was completed with Lorson Ranch East Filing No. 1 in 2018 and the entire stormwater system tributary to Pond C5 will be completed with this subdivision.

Re-phrase to clarify that all applicable runoff must be treated unless excluded per ECM App I.7.1.

Design calculations for Pond C2.1 and Pond C4 spectrum outlet structures are included in this report. The existing ponds currently have a 15' wide gravel access road at a maximum 10% slope to the pond bottom, forebay, storm sewer outfall, and concrete low flow channels. The final design of the Pond C2.1 and Pond C4 will consist of a full spectrum outlet structure and overflow weirs. Soil borings, embankment, slope, and compaction requirements for detention ponds can be found in the geotechnical report for the The Hills at Lorson Ranch prepared by RMG.

WQ Pond Construction Requirements

In addition to the four detention ponds Lorson Ranch is required to discharge the same runoff rates eastward into the Upper Williams which will require one WQ Pond to be constructed for a small area draining eastward. The WQ pond will have a 15' wide gravel access road at a maximum 10% slope to the pond bottom, forebay, and a concrete low flow channel.

Detention Pond C1 (existing pond for information only, See CDR20-007)

This is an existing permanent full spectrum detention pond that includes water quality and discharges downstream to a storm sewer system in Fontaine Boulevard. Pond C1 is designed in the UDCF Full Spectrum spreadsheets for Water Quality and EURV volumes. The 5-year and 100-year flow rates meet the Lorson East MDDP and have been modeled in the full spectrum worksheets. The outlet structure is a standard full spectrum extended detention basin structure and will include an emergency overflow spillway. See map in appendix for watershed areas.

- Watershed Area: 71.1 acres
- Watershed Imperviousness: 55%
- Hydrologic Soils Group B
- Zone 1 WQCV: 1.307ac-ft, WSEL: 5746.97
- Zone 2 EURV: 4.212ac-ft, WSEL: 5749.02, Top outlet structure set at 5749.50, 3'x6' outlet structure
- (5-yr): 4.691ac-ft, WSEL: 5749.33, 6.4cfs
- Zone 3 (100-yr): 9.954ac-ft, WSEL: 5752.39, 17.7cfs
- Pipe Outlet: 18" RCP at 0.5%
- Overflow Spillway: 28' wide bottom, elevation=5753.40, 4:1 side slopes, flow depth=1.37' 1.16' freeboard
- Micropool Elevation: 5743.40

Detention Pond C2.2 (existing pond for information only, see CDR 20-007)

This is a permanent full spectrum detention pond that includes water quality and discharges downstream to an existing storm sewer in Fontaine Boulevard. Inflow to this pond is from direct

tributary development and outflow from Pond C3. The inflow hydrograph has been modeled in the full spectrum spreadsheets by adding the direct tributary area CUHP hydrograph to the upstream pond outflow hydrograph of Pond C3. The outlet structure, overflow wall, pond forebay and low flow channel will be built as part of the CDR 20-007 project. Pond C2.2 is designed in the UDCF Full Spectrum spreadsheets for Water Quality and EURV volumes. The 5-year and 100-year flow rates meet the Lorson East MDDP and have been modeled in the modeled in the full spectrum worksheets. The outlet structure is a standard full spectrum extended detention basin structure and will include an emergency overflow spillway. See map in appendix for watershed areas.

- Watershed Area: 45.0 acres
- Watershed Imperviousness: 55%
- Hydrologic Soils Group B (95%), Group C/D (5%)
- Zone 1 WQCV: 0.829ac-ft, WSEL: 5747.25
- Zone 2 EURV: 2.658ac-ft, WSEL: 5749.17, Top outlet structure set at 5751.00, 8'x6' outlet structure
- (5-yr): 4.475ac-ft, WSEL: 5760.88, 2.7cfs
- Zone 3 (100-yr): 6.67ac-ft, WSEL: 5752.75, 42.9cfs
- Pipe Outlet: 30" RCP
- Overflow Spillway: 20' wide bottom, elevation=5754.00, 4:1 side slopes, flow depth=1.51' 1.49' freeboard
- Micropool Elevation: 5744.00

Detention Pond C2.1

This is a permanent full spectrum detention pond that includes water quality and discharges downstream to Pond C2.3. The outlet Structure and overflow wall will be built as part of the final plat for this project. The pond forebay and low flow channel were built as part of the CDR 20-007 project. Pond C2.1 is designed in the UDCF Full Spectrum spreadsheets for Water Quality and EURV volumes. The 5-year and 100-year flow rates meet the Lorson East MDDP and have been modeled in the modeled in the full spectrum worksheets. The outlet structure is a standard full spectrum extended detention basin structure and will include an emergency overflow spillway. The full spectrum print outs are in the appendix of this report. See map in appendix for watershed areas.

- Watershed Area: 74.5 acres
- Watershed Imperviousness: 55%
- Hydrologic Soils Group B
- Zone 1 WQCV: 1.377ac-ft, WSEL: 5763.42
- Zone 2 EURV: 4.415ac-ft, WSEL: 5766.20, Top outlet structure set at 5766.20, 8'x6' outlet structure
- (5-yr): 4.694ac-ft, WSEL: 5766.44, 12.8cfs
- Zone 3 (100-yr): 7.829ac-ft, WSEL: 5768.80, 65.0cfs
- Pipe Outlet: 30" RCP at 0.5%
- Overflow Spillway: 25' wide bottom, elevation=5769.30, 4:1 side slopes, flow depth=1.69' 1.01' freeboard
- Micropool Elevation: 5760.00

Detention Pond C4

This is a permanent full spectrum detention pond that includes water quality and discharges downstream to Pond C3. Pond C4 has been graded. The outlet Structure and overflow wall will be built with the final plat of this project. The pond forebay and low flow channel were built as part of the CDR 20-007 project. Pond C4 is designed in the UDCF Full Spectrum spreadsheets for Water Quality and EURV volumes. The 5-year and 100-year flow rates meet the Lorson East MDDP and have been modeled in the modeled in the full spectrum worksheets. The outlet structure is a standard full

spectrum extended detention basin structure and will include an emergency overflow spillway. The full spectrum print outs are in the appendix of this report. See map in appendix for watershed areas.

- Watershed Area: 81.00 acres
- Watershed Imperviousness: 55%
- Hydrologic Soils Group B (40%), Group C/D (60%)
- Zone 1 WQCV: 1.488ac-ft, WSEL: 5767.97
- Zone 2 EURV: 4.477ac-ft, WSEL: 5770.41, Top outlet structure set at 5770.50, 6'x6' outlet structure
- (5-yr): 3.934ac-ft, WSEL: 5770.84, 16.5cfs
- Zone 3 (100-yr): 10.152ac-ft, WSEL: 5774.34, 43.7cfs
- Pipe Outlet: 24" RCP at 0.5%
- Overflow Spillway: 30' wide bottom, elevation=5775.00, 4:1 side slopes, flow depth=1.87' 1.13' freeboard
- Micropool Elevation: 5765.00

Note that all RPA areas will need to be within a no build/drainage easement and discussed in the maintenance agreement and O&M manual. Also show easement on GEC Plan.

Water Quality for Basin F1.1 (4.23ac) - - - backyards of lots draining east offsite

Developed runoff from this basin flows east offsite (shallow sheet flow) and does not include a water quality pond. Runoff from this basin is from a standard 50'x110' lot with the back 90 feet of the residential lots which flows overland east across a 145' wide open space tract prior to discharging to the east. The Runoff Reduction Method procedure from the Mile High Flood Control District spreadsheet (UD-BMP-V3.07) calculations have been applied to a standard 50' wide lot to address water quality provisions for development in this basin (see appendix). The UIA area is 4500sf (50'x90') and the RPA area is 7250sf (50'x145') per lot which can then be applied to the remaining lots within the basin. The large 145' wide open space tract provides a 100% reduction in the water quality requirements for this basin. Grading within this basin should not channelize flow from backyards and flow should be allowed to pass under any backyard fencing without obstructing or channelizing the overland flow.

Water Quality Pond F (4.9ac)

This is a permanent water quality pond that discharges eastward overland into the Upper Williams Creek drainage basin. The pond forebay, low flow channel, and outlet structure will be built as part of this project. WQ Pond F is designed in the UDCF Full Spectrum spreadsheets for Water Quality. In order to maintain existing discharge rates to the east (see Design Pt. 35), this pond allow the 5-year and 100-year storms to discharge undetained through the pond outlet structure and discharge overland to the east. The outlet structure is a standard extended detention basin structure with an orifice plate. Point discharge of stormwater from the outlet pipe will be dispersed by a slotted concrete channel (See Des. Pt. 35d). In addition, the slotted channel is located 100' west of the Lorson Ranch property line and the sheet flow will drain across a 100' wide open space tract on Lorson Ranch before entering the offsite property. Lorson Ranch will try to secure a letter of understanding with the downstream landowner to address maintenance of any erosion issues should they occur on the offsite area and to acknowledge the manner in which drainage enters the offsite property has changed at the Pond F outfall. The pond print outs are in the appendix of this report. See map in appendix for watershed areas.

- Watershed Area: 4.90 acres
- Watershed Imperviousness: 55%
- Hydrologic Soils Group B (100%)
- Zone 1 WQCV: 0.09ac-ft, WSEL: 5845.04
- Zone 2 EURV: not used
- (5-yr): not used
- Zone 3 (100-yr): not used
- Micropool Elevation: 5842.77

7.0 DRAINAGE AND BRIDGE FEES

The Ridge at Lorson Ranch is located within the Jimmy Camp Creek drainage basin which is currently a fee basin in El Paso County. Current El Paso County regulations require drainage and bridge fees to be paid for platting of land as part of the plat recordation process.

The Ridge at Lorson Ranch Filing No. 1 contains 107.820acres. The 2022 drainage fees are \$19,752, bridge fees are \$924 and Drainage Surety fees are \$7,285 per impervious acre per Resolution. The drainage and bridge fees are calculated when the final plat is submitted and are due at plat recordation. Lorson Ranch intends to use the Bridge Fee credits for the bridge fees and pay drainage/surety fees unless the Jimmy Camp Creek DBPS drainage fee structure is updated by El Paso County. The following table details the drainage fees for this filing:

Table 1a: Filing No. 1 2021 Drainage/Bridge Fees (107.820ac)

Type of Land Use	Total Area (ac)	Imperviousness	Drainage Fee	Bridge Fee	Surety Fee
Residential Area	91.497	51%	\$921,696	\$43,117	\$339,943
Open Space, Landscape Tracts,	16.323	2%	\$6,448	\$301	\$2,378
Total			\$928,144	\$43,418	\$342,321

Table 1b: Filing No. 2 2021 Drainage/Bridge Fees (57.898ac)

Type of Land Use	Total Area (ac)	Imperviousness	Drainage Fee	Bridge Fee	Surety Fee
Residential Area	50.744	51%	\$511,170	\$23,912	\$188,531
Open Space, Landscape Tracts,	7.154	2%	\$2,826	\$132	\$1,042
Total			\$513,996	\$24,044	\$189,573

Table 1c: Filing No. 3 2021 Drainage/Bridge Fees (40.755ac)

Type of Land Use	Total Area (ac)	Imperviousness	Drainage Fee	Bridge Fee	Surety Fee
Residential Area	27.592	51%	\$277,948	\$13,002	\$102,513
Open Space, Landscape Tracts,	13.163	2%	\$5,199	\$243	\$1,917
Total			\$283,147	\$13,245	\$104,430

Table 7.1: Public Drainage Facility Costs (Filing 1-3, non-reimbursable)

Item	Quantity	Unit	Unit Cost	Item Total
Inlets/Manholes	65	EA	\$5000/EA	\$325,000
18" Storm	1820	LF	\$35	\$63,700
24" Storm	720	LF	\$40	\$28,800
30" Storm	1330	LF	\$45	\$59,850
36" Storm	1130	LF	\$55	\$62,150
42" Storm	245	LF	\$65	\$15,925
48" Storm	400	LF	\$85	\$34,000
			Subtotal	\$589,425
			Eng/Cont (10%)	\$58,942
			Total Est. Cost	\$648,367

Table 7.2: Lorson Ranch Metro District Drainage Facility Costs (Filing 1-3, non-reimbursable)

Item	Quantity	Unit	Unit Cost	Item Total
Full Spectrum Outlets	2	LS	\$20,000	\$40,000
WQ Pond	1	LS	\$20,000	\$20,000
			Subtotal	\$60,000
			Eng/Cont (15%)	\$9,000
			Total Est. Cost	\$69,000

8.0 FOUR STEP PROCESS

The site has been developed to minimize wherever possible the rate of developed runoff that will leave the site and to provide water quality management for the runoff produced by the site as proposed on the development plan. The following four step process should be considered and incorporated into the storm water collection system and storage facilities where applicable.

Step 1: Employ Runoff Reduction Practices

The Ridge at Lorson Ranch has employed several methods of reducing runoff.

- The street configuration was laid out to minimize the length of streets. Many streets are straight and perpendicular resulting in lots with less wasted space.
- There are large open space buffers under the 325' wide electric transmission easement and on the east side
- Construct outlet structures for two Full Spectrum Detention Ponds. The full spectrum detention mimics existing storm discharges and includes water quality.

Step 2: Stabilize Drainageways

East Tributary of Jimmy Camp Creek is a major drainageway located west of this site. In 2014 and in 2018 the East Tributary of JCC was reconstructed and stabilized per county criteria. The design included a natural sand bottom and armored sides.

Step 3: Provide Water Quality Capture Volume

Treatment of the water quality capture volume (WQCV) is required for all new developments. The Ridge at Lorson Ranch will construct two full spectrum stormwater extended detention basins and one WQ pond which include Water Quality Volumes and WQ outlet structures.

Step 4: Consider Need for Industrial and Commercial BMP's

There are no commercial or industrial areas within this site.

9.0 CONCLUSIONS

This drainage report has been prepared in accordance with the City of Colorado Springs/El Paso County Drainage Criteria Manual. The proposed development and drainage infrastructure will not cause adverse impacts to adjacent properties or properties located downstream. Several key aspects of the development discussed above are summarized as follows:

- Developed runoff will be conveyed via curb/gutter and storm sewer facilities
- The East Tributary of Jimmy Camp Creek has been reconstructed west of this study area
- Bridges over the East Tributary at Lorson Boulevard and Fontaine Boulevard and have been constructed providing access to this site.
- Detention and water quality for this site area will be provided in four permanent ponds and one runoff reduction area, and one WQ Pond.

10.0 REFERENCES

1. City of Colorado Springs/El Paso County Drainage Criteria Manual DCM, dated November, 1991
2. Soil Survey of El Paso County Area, Colorado by USDA, SCS
3. Jimmy Camp Creek Drainage Basin Planning Study, Dated March 9, 2015, by Kiowa Engineering Corporation
4. City of Colorado Springs "Drainage Criteria Manual, Volume 2
5. El Paso County "Engineering Criteria Manual"
6. Lorson Ranch East MDDP, June 30, 2017 by Core Engineering.
7. El Paso County Resolution #15-042, El Paso County adoption of Chapter 6 and Section 3.2.1 of the City of Colorado Springs Drainage Criteria Manual dated May, 2014.
8. Lorson Ranch East MDDP prepared by Core Engineering Group, dated November 27, 2017
9. Final Drainage Report for CDR 20-007 prepared by Core Engineering Group, dated October 22, 2020
10. Final Drainage Report for The Hills at Lorson Ranch Filing No. 1 prepared by Core Engineering Group, Reference SF 21-010

APPENDIX A – VICINTIY MAP, SOILS MAP, FEMA MAP

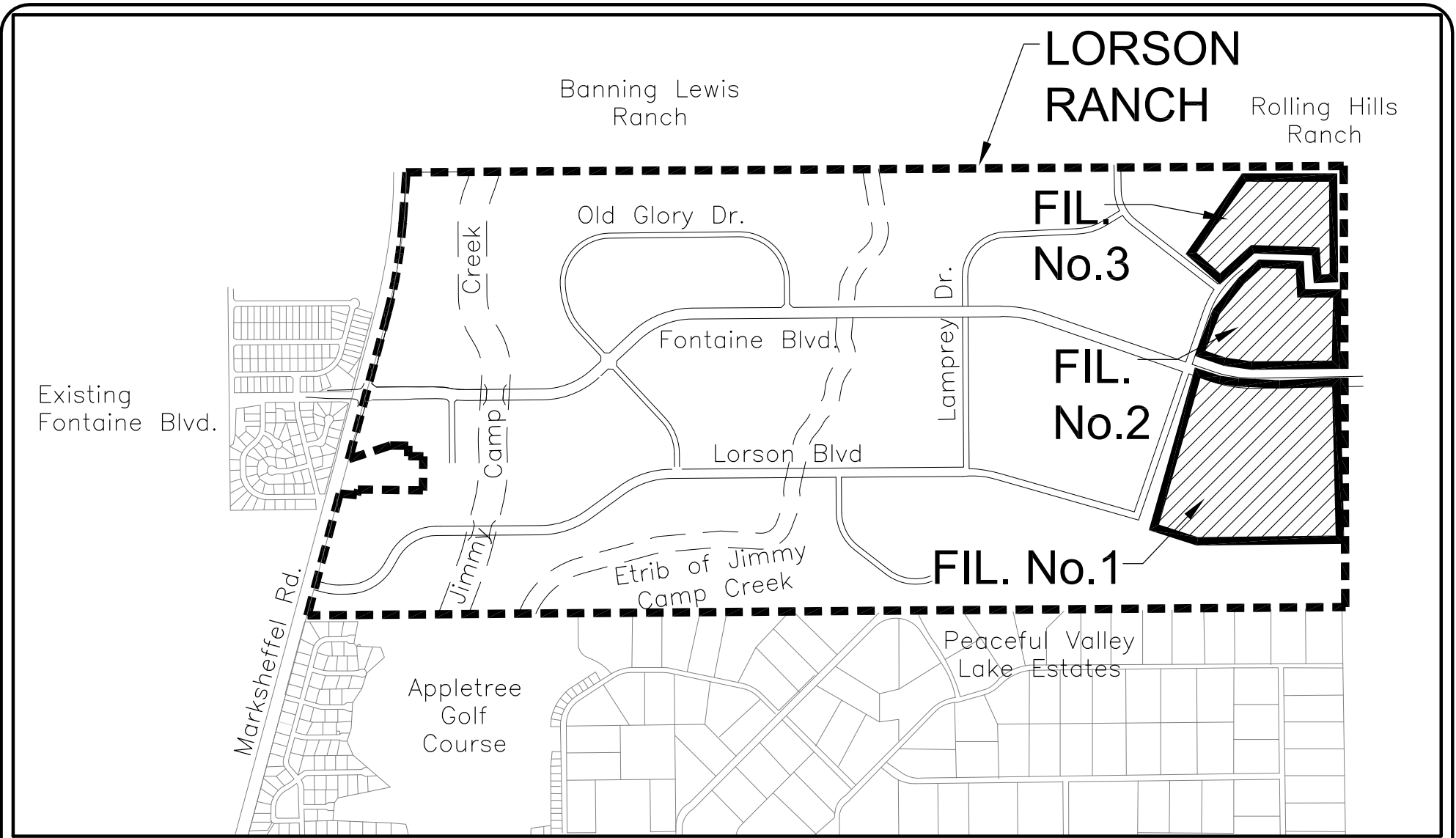

VICINITY MAP
NO SCALE



CORE
ENGINEERING GROUP

15004 1ST AVE. S.
BURNSVILLE, MN 55306
PH: 719.570.1100

CONTACT: RICHARD L. SCHINDLER, P.E.
EMAIL: Rich@ceg1.com

THE RIDGE AT LORSON RANCH
VICINITY MAP

SCALE:
NTS

DATE:
NOV, 2021

FIGURE NO.
--

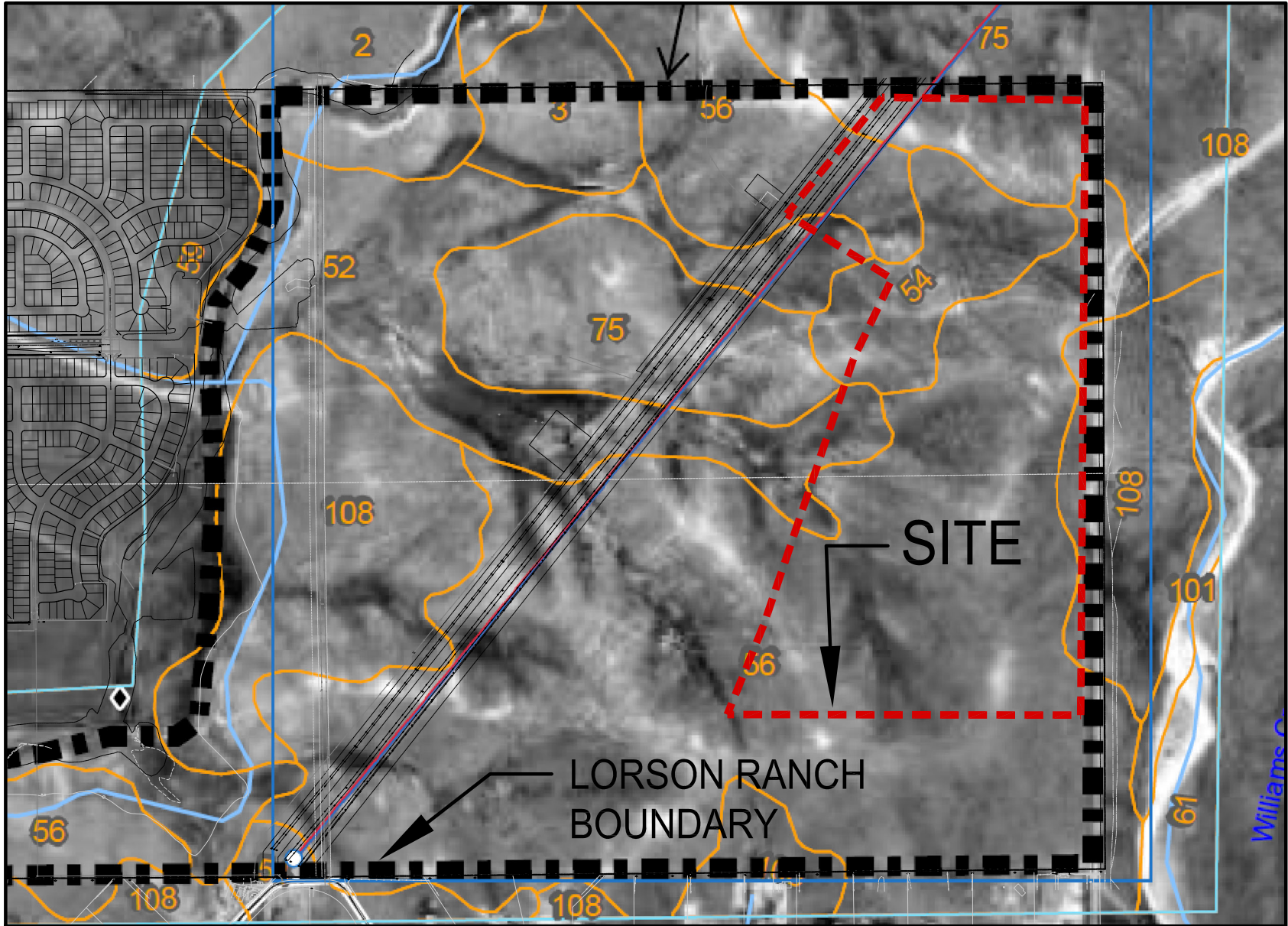

CORE
ENGINEERING GROUP

15004 1ST AVENUE S.
BURNSVILLE, MN 55306
PH: 719.570.1100
CONTACT: RICHARD L. SCHINDLER, P.E.
EMAIL: Rich@ceg1.com

**THE RIDGE AT LORSON RANCH
SOILS MAP**

SCALE:
NTS

DATE:
APRIL, 2021

FIGURE NO.
--

CITY OF COLORADO SPRINGS
080060

LOMR 19-08-0605P
eff. 5/4/2020

FLOODWAY
Zone AE Zone AE

EL PASO COUNTY
080059
08041C0957 G
eff. 12/7/2018

AREA OF MINIMAL FLOOD HAZARD
Zone X

08041C0976 G
eff. 12/7/2018

site

080060



November 5, 2021

Letter of Understanding
The Ridge at Lorson Ranch Grading and Drainage Improvements

This Letter of Understanding (“LOU”) is entered into in good faith between Lorson Ranch Metropolitan District and BJ Ranches, LLC, otherwise referred to as the Party or Parties. The intent of the LOU is to ensure the drainage flowing onto property owned by BJ Ranches, LLC (Parcel # 4500000082) located adjacent to and East of The Ridge at Lorson Ranch, is maintained at or below existing rates and to acknowledge the proposed grading in The Ridge at Lorson Ranch changes the manner in which drainage enters the unimproved subject property owned by BJ Ranches, LLC.

It is the intent of the Parties to minimize changes to the existing drainage patterns flowing from Lorson Ranch onto the subject property and to mimic the existing rate and sheet flow characteristics of drainage flowing onto the subject property as much as possible.

It is, however, acknowledged by the Parties that drainage from Lorson Ranch flowing downstream onto the subject property may cause erosion on the subject property after construction has occurred. The Lorson Ranch Metropolitan District or its assigns will be responsible for the mitigation and restoration of the subject property substantially to its existing condition.

Downstream Erosion Mitigation Protocol.

1. The Lorson Ranch Metropolitan District representative and/or engineer and contractor will meet with the BJ Ranches, LLC representative and engineer; and County storm water inspector prior to the start of construction of the development and review the condition of the land at the property boundary and downstream of Lorson Ranch on the subject property.
2. The existing condition will be documented with photos/video and a written description to establish the baseline condition to be shared and documented between the Parties.
3. The condition of the BJ Ranches, LLC property will be monitored as required by the permits obtained by The Ridge at Lorson Ranch from the State and El Paso County. A BJ Ranches, LLC property representative may also make inspections with each storm event.
4. The inspections will be conducted until the upstream grading is complete is fully stabilized and vegetated as required by the permits referenced herein.
5. If erosion or sediment transmission impacts are measurable, the Parties shall meet on-site to mutually determine the best course of mitigation action. The mitigation will be conducted within 30 days of the event. If the Parties are not in agreement with the course of mitigation action, the Parties shall seek a final opinion from an engineering representative from El Paso County. The Parties shall then agree with whatever determination is made by these governing authorities.

6. If the mitigation is not undertaken within the 30-day period BJ Ranches, LLC or its assigns will undertake the necessary actions to return the area to its existing condition and Lorson Ranch Metropolitan District will be billed for reimbursement of the work, which bill will be paid within 30 days after receipt of the bill. If not timely paid, the amount due will accrue interest at the rate of 18% per annum from the date due.
7. In any action brought before a court or judge to enforce this LOU or collect damages on account of a party's breach of their obligations hereunder, the prevailing party shall be awarded their costs and reasonable attorney's fees. This shall include any action brought by BJ Ranches, LLC whereby the district is the prevailing party in which case District shall be awarded reasonable attorney's fees.

BJ Ranches, LLC

Lorson Ranch Metropolitan District
Jeff Mark, Manager

Draft

APPENDIX B – HYDROLOGY CALCULATIONS



Standard Form SF-2. Storm Drainage System Design (Rational Method Procedure)

Calculated By: Leonard Beasley
 Date: Feb. 17, 2021
 Checked By: Leonard Beasley

Job No: 100.064
 Project: The Ridge at Lorson Ranch
 Design Storm: **5 - Year Event (Current)**

Street or Basin	Design Point	Direct Runoff							Total Runoff				Street		Pipe			Travel Time			Remarks
		Area Design	Area (A)	Runoff Coeff. (C)	t _c	CA	i	Q	t _c	Σ(CA)	i	Q	Slope	Street Flow	Design Flow	Slope	Pipe Size	Length	Velocity	t _t	
			ac.			min.		in/hr	cfs	min		in/hr	cfs	%	cfs	cfs	%	in	ft	ft/sec	
EX-B1			14.42	0.15	28.1	2.16	2.58	5.6													
OS-B1.1			11.47	0.15	21.0	1.72	3.02	5.2													
EX-B	1X	25.89							29.7	3.88	2.50	9.7									
C1.1-ex			12.49	0.09	23.8	1.12	2.83	3.2													
C2.1-ex			26.58	0.10	33.6	2.66	2.31	6.1													
C2.2-ex			60.28	0.09	35.1	5.43	2.25	12.2													
C3.1-ex			8.36	0.12	28.6	1.00	2.55	2.6													
OS-C4.1			3.90	0.10	20.7	0.39	3.04	1.2													
C4.2-ex			47.93	0.13	31.6	6.23	2.41	15.0													
C4-ex	4X	51.83							34.1	6.62	2.29	15.2									
EX-F1			22.36	0.12	33.1	2.68	2.33	6.3													
EX-F2			17.49	0.15	15.4	2.62	3.48	9.1													
EX-F	2X	39.85							33.1	5.31	2.33	12.4									
EX-G			13.65	0.08	26.0	1.09	2.70	2.9													
Basin G1			10.61	0.08	22.3	0.85	2.93	2.5													
EX-H			28.13	0.08	27.8	2.33	2.60	6.1													
Basin H1			27.96	0.09	32.1	2.52	2.38	6.0													



Standard Form SF-2. Storm Drainage System Design (Rational Method Procedure)

Calculated By: Leonard Beasley

Job No: 100.064

Date: Feb. 17, 2021

Project: The Ridge at Lorson Ranch

Checked By: Leonard Beasley

Design Storm: **100-Year Event (Current)**

Street or Basin	Design Point	Direct Runoff							Total Runoff				Street		Pipe			Travel Time			Remarks
		Area Design	Area (A)	Runoff Coeff. (C)	t_c	CA	i	Q	t_c	Σ (CA)	i	Q	Slope	Street Flow	Design Flow	Slope	Pipe Size	Length	Velocity	t_t	
			ac.			min.		in/hr	cfs	min		in/hr	cfs	%	cfs	cfs	%	in	ft	ft/sec	
EX-B1			14.42	0.50	28.1	7.21	4.33	31.2													
OS-B1.1			11.47	0.50	21.0	5.74	5.06	29.0													
EX-B	1X	25.89							29.7	12.95	4.19	54.2									
C1.1-ex			12.49	0.36	23.8	4.50	4.75	21.4													
C2.1-ex			26.58	0.39	33.6	10.37	3.88	40.2													
C2.2-ex			60.28	0.36	35.1	21.70	3.77	81.8													
C3.1-ex			8.36	0.42	28.6	3.51	4.28	15.0													
C4.1-ex			3.90	0.39	20.7	1.52	5.10	7.8													
C4.2-ex			47.93	0.44	31.6	21.09	4.04	85.1													
C4-ex	4X	51.83							34.1	22.61	3.84	86.9									
EX-F1			22.36	0.44	33.1	9.84	3.91	38.5													
EX-F2			17.49	0.50	15.4	8.75	5.84	51.1													
EX-F	2X	39.85							33.1	18.58	3.91	72.7									
EX-G			13.65	0.35	26.0	4.78	4.52	21.6													
Basin G1			10.61	0.35	22.3	3.71	4.91	18.2													
EX-H			28.13	0.35	27.8	9.85	4.36	42.9													
Basin H1			27.96	0.36	32.1	10.07	3.99	40.2													



Standard Form SF-2. Storm Drainage System Design (Rational Method Procedure)

Calculated By: Leonard Beasley
 Date: Feb. 18, 2021
 Checked By: Leonard Beasley

Job No: 100.064
 Project: The Ridge at Lorson Ranch
 Design Storm: **5 - Year Event (Proposed)**

Street or Basin	Design Point	Direct Runoff							Total Runoff				Street		Pipe			Travel Time			Remarks
		Area Design	Area (A)	Runoff Coeff. (C)	t _c	CA	i	Q	t _c	Σ (CA)	i	Q	Slope	Street Flow	Design Flow	Slope	Pipe Size	Length	Velocity	t _t	
C1.1	I-1		3.18	0.45	11.8	1.43	3.89	5.6													
C1.2	I-2		1.52	0.45	11.5	0.68	3.92	2.7													
C1.1-C1.2	3	4.70							11.8	2.12	3.89	8.2									
C1.3	I-4		6.71	0.45	21.8	3.02	2.96	8.9													
C1.1-C1.3	5	11.41							26.1	5.13	2.69	13.8									
C1.4			2.51	0.45	13.2	1.13	3.72	4.2													
C1.5	I-6		1.61	0.45	9.9	0.72	4.14	3.0													
C1.6			9.35	0.45	20.5	4.21	3.05	12.8													
C1.5-C1.6	7	10.96							20.5	6.06	3.05	18.5									
C3.1	I-12		6.20	0.45	14.7	2.79	3.55	9.9													
C3.2	I-13		5.01	0.45	15.3	2.25	3.49	7.9													
C3.1-C3.2	14	11.21							16.1	5.04	3.41	17.2									
C3.3	I-15		4.75	0.45	11.2	2.14	3.96	8.5													
C3.1-C3.3	16	15.96							18.1	7.18	3.24	23.3									
C3.4	I-17		3.77	0.45	9.4	1.70	4.23	7.2													
C3.1-C3.4	18	19.73							18.9	8.88	3.17	28.2									
C3.5	I-19		6.32	0.45	14.1	2.84	3.62	10.3													
C3.1-C3.5	20	26.05							19.9	11.72	3.10	36.3									
C3.6a	I-20a		3.15	0.45	11.2	1.42	3.96	5.6													
C3.1-C3.6a	20b	29.20							20.0	13.14	3.09	40.6									
C3.6b	I-21		4.80	0.45	16.8	2.16	3.35	7.2													
C3.7	I-23		4.58	0.45	9.4	2.06	4.22	8.7													
C3.1-C3.7	24	38.58							21.0	17.36	3.02	52.4									
C3.8	I-25		6.51	0.45	16.1	2.93	3.41	10.0													
C3.9	I-27		4.55	0.45	11.1	2.05	3.97	8.1													
C3.1-C3.9	28	49.64							22.3	22.34	2.93	65.4									
C3.10	I-29		6.01	0.45	16.4	2.70	3.39	9.2													
C3.1-C3.10	30	55.65							24.4	25.04	2.79	69.9									
C4.1			4.61	0.45	20.3	2.07	3.07	6.4													
C4.2			3.08	0.45	15.7	1.39	3.45	4.8													
C4.1-C4.2	31	7.69							20.6	3.46	3.04	10.5									
C4.3			3.07	0.46	10.7	1.41	4.02	5.7													



Standard Form SF-2. Storm Drainage System Design (Rational Method Procedure)

Calculated By: Leonard Beasley
 Date: Feb. 18, 2021
 Checked By: Leonard Beasley

Job No: 100.064
 Project: The Ridge at Lorson Ranch
 Design Storm: **5 - Year Event (Proposed)**

Street or Basin	Design Point	Direct Runoff							Total Runoff				Street		Pipe			Travel Time			Remarks
		Area Design	Area (A)	Runoff Coeff. (C)	t _c	CA	i	Q	t _c	Σ (CA)	i	Q	Slope	Street Flow	Design Flow	Slope	Pipe Size	Length	Velocity	t _t	
			ac.			min.		in/hr	cfs	min		in/hr	cfs	%	cfs	cfs	%	in	ft	ft/sec	
C4.4			3.29	0.46	10.4	1.51	4.07	6.2													
C4.1-C4.4	34	14.05							22.6	6.39	2.91	18.6									
C4.5			0.63	0.90	5.0	0.57	5.17	2.9													
F1.1			4.23	0.45	11.3	1.90	3.94	7.5													
F1.2			19.06	0.08	11.0	1.52	3.98	6.1													
F1.3			1.15	0.46	13.6	0.53	3.67	1.9													
F1.4			3.75	0.45	15.3	1.69	3.49	5.9													
F1.1-F1.4	35	28.19							15.3	3.43	3.49	12.0									
C5.1a	I-39		2.33	0.47	12.5	1.10	3.79	4.2													
C5.1b	I-36		6.32	0.45	10.8	2.84	4.02	11.4													
C5.1c	I-37		3.78	0.45	8.6	1.70	4.35	7.4													
C5.1b-C5.1c	38	10.10							10.8	4.55	4.02	18.3									
C5.1a-C5.1c	I-39 & 40	12.43							14.4	5.64	3.58	20.2									
C5.1d	I-41		5.67	0.45	14.0	2.58	3.62	9.3													
C5.1a-C5.1d	42	18.10							14.4	4.28	3.58	15.3									
C5.1e	I-43		6.44	0.46	16.5	2.96	3.38	10.0													
C5.1a-C5.1e	44	24.54							16.5	11.18	3.38	37.8									
C5.2			1.71	0.49	8.5	0.84	4.37	3.7													
C5.3			2.26	0.46	10.3	1.04	4.09	4.3													
C5.2-C5.3	I-45 & 46	3.97							10.3	1.88	4.09	7.7									
C8.1a	I-47		4.12	0.45	10.7	1.85	4.03	7.5													
C8.1b	I-49		3.69	0.48	14.6	1.77	3.56	6.3													
C8.1c	I-48		1.88	0.46	11.3	0.86	3.94	3.4													
C8.1	I-49	9.69							14.6	4.49	3.56	16.0									
C8.2	I-51		2.12	0.49	8.9	1.04	4.31	4.5													
OS-C4a			3.40	0.09	11.8	0.31	3.88	1.2													
C8.3a	I-53		5.88	0.46	11.8	2.70	3.89	10.5													
OS-C4a-C8.3a	I-54	9.28							14.0	3.01	3.62	10.9									



Standard Form SF-2. Storm Drainage System Design (Rational Method Procedure)

Calculated By: Leonard Beasley
 Date: Feb. 18, 2021
 Checked By: Leonard Beasley

Job No: 100.064
 Project: The Ridge at Lorson Ranch
 Design Storm: **5 - Year Event (Proposed)**

Street or Basin	Design Point	Direct Runoff							Total Runoff			Street		Pipe			Travel Time			Remarks	
		Area Design	Area (A)	Runoff Coeff. (C)	t _c	CA	i	Q	t _c	Σ (CA)	i	Q	Slope	Street Flow	Design Flow	Slope	Pipe Size	Length	Velocity		t _t
			ac.																		
OS-C4b			2.10	0.11	12.7	0.23	3.78	0.9													
C8.3b			3.46	0.48	14.2	1.66	3.61	6.0													
C8.3c (OS-C4b-C8.3c)	I-54	7.89	2.33	0.48	10.7	1.12	4.03	4.5	14.2	3.01	3.61	10.9									
OS-C4a-C8.3c	I-54	16.06							20.0	5.92	3.09	18.3									
C8.3d	I-56		5.26	0.48	15.1	2.52	3.51	8.9													
OS-C4a-C8.3d	I-56	21.32							20.6	8.45	3.05	25.7									
C8.4	I-57		6.70	0.46	14.5	3.08	3.57	11.0													
C8.1-C8.4	I-51	39.83							21.1	12.57	3.01	37.9									
C8.5	I-59		3.84	0.49	13.4	1.88	3.69	7.0													
C8.6			0.79	0.90	5.6	0.71	5.58	4.0													
C8.7a			4.52	0.49	13.7	2.21	3.66	8.1													
C8.7b	I-63		1.77	0.49	11.3	0.87	3.94	3.4													
C8.7a-C8.7b	I-63	6.29							13.9	3.08	3.63	11.2									
C8.7c	I-64		4.94	0.49	11.7	2.42	3.90	9.4													
C8.7a-C8.7c	I-64	11.23							14.4	5.50	3.59	19.7									
C8.7d	I-66		0.27	0.46	5.0	0.12	5.17	0.6													
C8.7e			6.09	0.47	11.9	2.86	3.87	11.1													
C8.6+C8.7e	I-62								13.4	3.57	3.69	13.2									
C8.7a-C8.7e		17.59							15.4	8.49	3.48	29.5									
C8.6-C8.7e	I-68	18.38							15.5	9.20	3.47	31.9									
OS-B1			5.11	0.15	12.7	0.77	3.77	2.9													
C8.8a			5.65	0.49	23.4	2.77	2.86	7.9													
OS-B1-C8.8a	I-69	10.76							27.3	3.54	2.62	9.3									
68+69	I-70	29.14							27.3	12.74	2.62	33.4									
C8.8			7.80	0.22	15.6	1.72	3.46	5.9													
C8			73.39	0.43	27.5	31.46	2.61	82.2													



Standard Form SF-2. Storm Drainage System Design (Rational Method Procedure)

Calculated By: Leonard Beasley
 Date: Feb. 19, 2021
 Checked By: Leonard Beasley

Job No: 100.064
 Project: The Ridge at Lorson Ranch
 Design Storm: **100 - Year Event (Proposed)**

Street or Basin	Design Point	Direct Runoff							Total Runoff			Street		Pipe			Travel Time			Remarks	
		Area Design	Area (A)	Runoff Coeff. (C)	t _c	CA	i	Q	t _c	Σ (CA)	i	Q	Slope	Street Flow	Design Flow	Slope	Pipe Size	Length	Velocity		t _t
			ac.		min.		in/hr	cfs	min		in/hr	cfs	%	cfs	cfs	%	in	ft	ft/sec		min
C1.1	I-1		3.18	0.59	11.8	1.88	6.52	12.2													
C1.2	I-2		1.52	0.59	11.5	0.90	6.58	5.9													
C1.1-C1.2	3	4.70							11.8	2.77	6.52	18.1									
C1.3	I-4		6.71	0.59	21.8	3.96	4.97	19.7													
C1.1-C1.3	5	11.41							26.1	6.73	4.52	30.4									
C1.4			2.51	0.59	13.2	1.48	6.24	9.2													
C1.5	I-6		1.61	0.59	9.9	0.95	6.96	6.6													
C1.6			9.35	0.59	20.5	5.52	5.12	28.3													
C1.5-C1.6	7	10.96							20.5	7.95	5.12	40.7									
C3.1	I-12		6.20	0.59	14.7	3.66	5.96	21.8													
C3.2	I-13		5.01	0.59	15.3	2.96	5.86	17.3													
C3.1-C3.2	14	11.21							16.1	6.61	5.73	37.9									
C3.3	I-15		4.75	0.59	11.2	2.80	6.65	18.6													
C3.1-C3.3	16	15.96							18.1	9.42	5.44	51.3									
C3.4	I-17		3.77	0.59	9.4	2.22	7.10	15.8													
C3.1-C3.4	18	19.73							18.9	11.64	5.32	62.0									
C3.5	I-19		6.32	0.59	14.1	3.73	6.07	22.6													
C3.1-C3.5	20	26.05							19.9	15.37	5.20	80.0									
C3.6a	I-20a		3.15	0.59	11.2	1.86	6.64	12.3													
C3.1-C3.6a	20b	29.20							20.0	17.23	5.19	89.3									
C3.6b	I-21		4.80	0.59	16.8	2.83	5.63	15.9													
C3.7	I-23		4.58	0.59	9.4	2.70	7.08	19.1													
C3.1-C3.7	24	38.58							21.0	22.76	5.06	115.2									
C3.8	I-25		6.51	0.59	16.1	3.84	5.73	22.0													
C3.9	I-27		4.55	0.59	11.1	2.68	6.66	17.9													
C3.1-C3.9	28	49.64							22.3	29.29	4.92	144.0									
C3.10	I-29		6.01	0.59	16.4	3.55	5.69	20.2													
C3.1-C3.10	30	55.65							24.4	32.83	4.69	153.9									
C4.1			4.61	0.59	20.3	2.72	5.15	14.0													
C4.2			3.08	0.59	15.7	1.82	5.79	10.5													
C4.1-C4.2	31	7.69							20.6	4.54	5.11	23.2									
C4.3			3.07	0.60	10.7	1.84	6.76	12.4													
C4.4			3.29	0.60	10.4	1.97	6.84	13.5													
C4.1-C4.4	34	14.05							22.6	8.35	4.88	40.8									



Standard Form SF-2. Storm Drainage System Design (Rational Method Procedure)

Calculated By: Leonard Beasley
 Date: Feb. 19, 2021
 Checked By: Leonard Beasley

Job No: 100.064
 Project: The Ridge at Lorson Ranch
 Design Storm: **100 - Year Event (Proposed)**

Street or Basin	Design Point	Direct Runoff							Total Runoff				Street		Pipe			Travel Time			Remarks
		Area Design	Area (A) ac.	Runoff Coeff. (C)	t _c min.	CA	i in/hr	Q cfs	t _c min	Σ(CA)	i in/hr	Q cfs	Slope %	Street Flow cfs	Design Flow cfs	Slope %	Pipe Size in	Length ft	Velocity ft/sec	t _t min	
C4.5			0.63	0.96	5.0	0.60	8.68	5.2													
F1.1			4.23	0.59	11.3	2.50	6.62	16.5													
F1.2			19.06	0.35	11.0	6.67	6.68	44.6													
F1.3			1.15	0.65	13.6	0.75	6.16	4.6													
F1.4			3.75	0.60	15.3	2.25	5.86	13.2													
F1.1-F4.4	35								15.3	12.16	5.86	71.3									
C5.1a	I-39		2.33	0.62	12.5	1.44	6.36	9.2													
C5.1b	I-36		6.32	0.59	10.8	3.73	6.75	25.2													
C5.1c	I-37		3.78	0.59	8.6	2.23	7.30	16.3													
C5.1b-C5.1c	38	10.10							10.8	5.96	6.75	40.2									
C5.1a-C5.1c	I-39 & 40	12.43							14.4	7.40	6.01	44.5									
C5.1d	I-41		5.67	0.60	14.0	3.40	6.08	20.7													
C5.1a-C5.1d	42	18.10							14.4	10.81	6.01	64.9									
C5.1e	I-43		6.44	0.60	16.5	3.86	5.68	21.9													
C5.1a-C5.1e	44	24.54							16.5	14.67	5.68	83.3									
C5.2			1.71	0.65	8.5	1.11	7.33	8.2													
C5.3			2.26	0.61	10.3	1.38	6.87	9.5													
C5.2-C5.3	I-45 & 46	3.97							10.3	2.49	6.87	17.1									
C8.1a	I-47		4.12	0.59	10.7	2.43	6.76	16.4													
C8.1b	I-49		3.69	0.63	14.6	2.32	5.97	13.9													
C8.1c	I-48		1.88	0.61	11.3	1.15	6.62	7.6													
C8.1	I-49	9.69							14.6	5.90	5.97	35.3									
C8.2	I-51		2.12	0.65	8.9	1.38	7.23	10.0													
OS-C4a			3.40	0.35	11.8	1.19	6.51	7.7													



Standard Form SF-2. Storm Drainage System Design (Rational Method Procedure)

Calculated By: Leonard Beasley
 Date: Feb. 19, 2021
 Checked By: Leonard Beasley

Job No: 100.064
 Project: The Ridge at Lorson Ranch
 Design Storm: **100 - Year Event (Proposed)**

Street or Basin	Design Point	Direct Runoff							Total Runoff				Street		Pipe			Travel Time			Remarks
		Area Design	Area (A)	Runoff Coeff. (C)	t _c	CA	i	Q	t _c	Σ (CA)	i	Q	Slope	Street Flow	Design Flow	Slope	Pipe Size	Length	Velocity	t	
C8.3a	I-53		5.88	0.60	11.8	3.53	6.53	23.0													
OS-C4a-C8.3a	I-54	8.17							14.0	4.35	6.08	26.5									
OS-C4b			2.10	0.41	12.7	0.86	6.34	5.5													
C8.3b			3.46	0.63	14.2	2.18	6.06	13.2													
C8.3c (OS-C4b-C8.3c)	I-54	7.89	2.33	0.63	10.7	1.47	6.76	9.9	14.2	4.51	6.06	27.3									
OS-C4a-C8.3c	I-54	16.06							20.0	8.86	5.18	45.9									
C8.3d	I-56		5.26	0.62	15.1	3.26	5.89	19.2													
OS-C4a-C8.3d	I-56	21.32							20.6	11.30	5.12	57.8									
C8.4	I-57		6.70	0.60	14.5	4.02	5.99	24.1													
C8.1-C8.4	I-51	39.83							21.1	17.52	5.06	88.6									
C8.5	I-59		3.84	0.65	13.4	2.50	6.20	15.5													
C8.6			0.79	0.96	5.6	0.76	8.40	6.4													
C8.7a			4.52	0.65	13.7	2.94	6.14	18.0													
C8.7b	I-63		1.77	0.65	11.3	1.15	6.62	7.6													
C8.7a-C8.7b	I-63	6.29							13.9	4.09	6.10	24.9									
C8.7c	I-64		4.94	0.65	11.7	3.21	6.55	21.0													
C8.7a-C8.7c	I-64	11.23							14.4	7.30	6.01	43.8									
C8.7d			0.27	0.61	5.0	0.16	8.68	1.4													
C8.7a-C8.7d	I-66	11.50							15.0	7.46	5.91	44.1									
C8.7e			6.09	0.62	11.9	3.78	6.50	24.5													
C8.6+C8.7e	I-62								13.4	4.53	6.19	28.1									
C8.7a-C8.7e		17.59							15.4	11.24	5.84	65.7									
C8.6-C8.7e	I-68	18.38							15.5	12.00	5.83	69.9									
OS-B1			5.11	0.49	12.7	2.50	6.33	15.8													
C8.8a			5.65	0.64	23.4	3.62	4.80	17.3													
OS-B1-C8.8a	I-69	10.76							27.3	6.12	4.40	26.9									
68+69	I-70	29.14							27.3	18.12	4.40	79.7									
C8.8			7.80	0.48	15.6	3.74	5.81	21.8													
C8			73.39	0.60	27.5	44.16	4.39	193.7													

Preliminary Drainage Plan
CURRENT CONDITIONS COEFFICIENT "C" CALCULATIONS

BASIN	Soil No.	Hydro Group	Area	Cover (%)	C5	Wtd. C5	C100	Wtd. C100	Impervious	Type of Cover
C2.1-ex	56	B	20.95	78.82%	0.09	0.07	0.36	0.28	100%	Undeveloped
	52/54	C	5.63	21.18%	0.16	0.03	0.51	0.11	80%	Undeveloped
			26.58	100.00%		0.10		0.39		
C2.2-ex	56	B	58.51	97.06%	0.09	0.09	0.36	0.35	10%	Undeveloped
	52	C	1.77	2.94%	0.16	0.00	0.51	0.01	10%	Undeveloped
			60.28	100.00%		0.09		0.36		
C3.1-ex	56	B	4.95	59.21%	0.09	0.05	0.36	0.21	10%	Undeveloped
	54	D	3.41	40.79%	0.16	0.07	0.51	0.21	10%	Undeveloped
			8.36	100.00%		0.12		0.42		
C4.1-ex	56	B	3.54	80.64%	0.09	0.07	0.36	0.29	10%	Undeveloped
	75	D	0.85	19.36%	0.16	0.03	0.51	0.10	10%	Undeveloped
			4.39	100.00%		0.10		0.39		
C4.2-ex	56/108	B	21.23	44.29%	0.09	0.04	0.36	0.16	10%	Undeveloped
	52/54/75	D	26.70	55.71%	0.16	0.09	0.51	0.28	10%	Undeveloped
			47.93	100.00%		0.13		0.44		
EX-F1	56/108	B	8.74	39.09%	0.08	0.03	0.35	0.14	10%	Undeveloped
	52	C	13.62	60.91%	0.15	0.09	0.50	0.30	10%	Undeveloped
			22.36	100.00%		0.12		0.44		
EX-F2	56/108	B	0.23	1.32%	0.08	0.00	0.35	0.00	10%	Undeveloped
	52	C	17.26	98.68%	0.15	0.15	0.50	0.49	10%	Undeveloped
			17.49	100.00%		0.15		0.50		
EX-G	56/108	B	13.27	100.00%	0.08	0.08	0.35	0.35	10%	Undeveloped
	52	C	0.00	0.00%	0.15	0.00	0.50	0.00	10%	Undeveloped
			13.27	100.00%		0.08		0.35		
EX-H	56/108	B	28.13	100.00%	0.08	0.08	0.35	0.35	10%	Undeveloped
	52	C	0.00	0.00%	0.15	0.00	0.50	0.00	10%	Undeveloped
			28.13	100.00%		0.08		0.35		



Standard Form SF-1. Time of Concentration-Current

Calculated By: Leonard Beasley
 Date: Feb. 17, 2021
 Checked By: Leonard Beasley

Job No: 100.064
 Project: The Ridge at Lorson Ranch

Sub-Basin Data				Initial Overland Time (t _i)				Travel Time (t _t)					Final t _c
BASIN or DESIGN	C _s	AREA (A) acres	NRCS Convey.	LENGTH (L) feet	SLOPE (S) %	VELOCITY (V) ft/sec	t _i minutes	LENGTH (L) feet	SLOPE (S) %	VELOCITY (V) ft/sec	t _t minutes	Computed t _c Minutes	USDCM Recommended t _c =t _i +t _t (min)
EX-B1	0.15	14.42	7.0	300.00	4.00%	0.27	18.80	575.00	4.00%	1.40	6.85		
			20.0					375.00	1.60%	2.53	2.47	28.12	28.12
OS-B1.1	0.15	11.47	20.0	300.00	4.00%	0.27	18.80	550.00	4.40%	4.20	2.19	20.99	20.99
(EX-B) 1X	0.15	20.06	20.0	300.00	2.00%	0.21	23.63	650.00	0.80%	1.79	6.06	29.69	29.69
C1.1-ex	0.09	12.49	7.0	300.00	5.40%	0.28	18.16	434.00	5.50%	1.64	4.41		
			15.0					225.00	4.44%	3.16	1.19	23.75	23.75
C2.1-ex	0.10	26.58	7.0	300.00	5.33%	0.28	18.06	1347.00	5.72%	1.67	13.41		
			15.0					266.00	1.88%	2.06	2.16	33.62	33.62
C2.2-ex	0.09	60.28	7.0	140.00	3.57%	0.16	14.22	1216.00	4.28%	1.45	13.99		
			15.0					1123.00	3.29%	2.72	6.88	35.10	35.10
C3.1-ex	0.12	8.36	7.0	300.00	6.00%	0.29	17.01	1052.00	6.10%	1.73	10.14		
			15.0					152.00	1.32%	1.72	1.47	28.63	28.63
OS-C4.1	0.10	4.39	7.0	300.00	4.50%	0.26	19.10	143.00	4.60%	1.50	1.59	20.68	20.68
C4.2-ex	0.13	47.93	7.0	300.00	5.25%	0.28	17.60	500.00	5.25%	1.60	5.20		
			15.0					1307.00	2.75%	2.49	8.76	31.55	31.55



Standard Form SF-1. Time of Concentration-Current

Calculated By: Leonard Beasley
 Date: Feb. 17, 2021
 Checked By: Leonard Beasley

Job No: 100.064
 Project: The Ridge at Lorson Ranch

Sub-Basin Data				Initial Overland Time (ti)				Travel Time (tt)					Final tc
BASIN or DESIGN	C _s	AREA (A) acres	NRCS Convey.	LENGTH (L) feet	SLOPE (S) %	VELOCITY (V) ft/sec	ti minutes	LENGTH (L) feet	SLOPE (S) %	VELOCITY (V) ft/sec	tt minutes	Computed tc Minutes	USDCM Recommended tc=ti+tt (min)
(C4-ex) 4X	0.13	52.32	7.0	300.00	4.50%	0.27	18.52	143.00	4.60%	1.50	1.59		
			7.0					500.00	5.25%	1.60	5.20		
			15.0					1307.00	2.75%	2.49	8.76	34.06	34.06
EX-F1	0.12	22.36	7.0	300.00	3.30%	0.24	20.67	950.00	3.30%	1.27	12.45	33.12	33.12
EX-F2	0.15	17.49	15.0	221.00	6.80%	0.27	13.55	406.00	5.90%	3.64	1.86	15.40	15.40
(EX-F) 2X	0.13	39.85	7.0	300.00	3.30%	0.24	20.46	390.00	3.30%	1.27	5.11	25.57	25.57
EX-G	0.08	13.27	7.0	300.00	4.80%	0.26	19.07	640.00	4.80%	1.53	6.96	26.02	26.02
Basin G1	0.08	10.61	7.0	300.00	4.80%	0.26	19.07	300.00	4.80%	1.53	3.26	22.33	22.33
EX-H	0.08	28.13	7.0	300.00	4.80%	0.26	19.07	800.00	4.80%	1.53	8.69	27.76	27.76
Basin H1	0.09	27.96	7.0	30.00	2.00%	0.06	7.98	880.00	1.20%	0.77	19.13		
			15.0					1000.00	5.00%	3.35	4.97	32.07	32.07



15004 1st Avenue South
Burnsville, MN 55306

PROJECT NAME: The Ridge at Lorson Ranch
PROJECT NUMBER: 100.064
ENGINEER: LAB
DATE: Feb. 19, 2021

Preliminary Drainage Plan
PROPOSED CONDITIONS COEFFICIENT "C" CALCULATIONS

BASIN	Soil No.	Hydro Group	Area	Cover (%)	C5	Wtd. C5	C100	Wtd. C100	Impervious	Type of Cover
C1.1	56	B	3.18		0.45		0.59		65%	1/8 ac. Single Family
C1.2	56	B	1.52		0.45		0.59		65%	1/8 ac. Single Family
C1.3	56	B	13.47		0.45		0.59		65%	1/8 ac. Single Family
C1.4	56	B	5.19		0.45		0.59		65%	1/8 ac. Single Family
C1.5	56	B	0.70		0.45		0.59		65%	1/8 ac. Single Family
C1.6	56/108	B	9.35		0.45		0.59		65%	1/8 ac. Single Family
C3.1	56	B	6.20		0.45		0.59		65%	1/8 ac. Single Family
C3.2	56	B	5.01		0.45		0.59		65%	1/8 ac. Single Family
C3.3	56	B	4.75		0.45		0.59		65%	1/8 ac. Single Family
C3.4	56	B	3.77		0.45		0.59		65%	1/8 ac. Single Family
C3.5	56	B	6.32		0.45		0.59		65%	1/8 ac. Single Family
C3.6a	56	B	3.15		0.45		0.59		65%	1/8 ac. Single Family
C3.6b	56	B	4.80		0.45		0.59		65%	1/8 ac. Single Family
C3.7	56	B	4.58		0.45		0.59		65%	1/8 ac. Single Family
C3.8	56	B	6.51		0.45		0.59		65%	1/8 ac. Single Family
C3.9	56	B	4.55		0.45		0.59		65%	1/8 ac. Single Family
C3.10	56	B	6.01		0.45		0.59		65%	1/8 ac. Single Family
C4.1	56	B	4.61		0.45		0.59		65%	1/8 ac. Single Family
C4.2	56	B	3.08		0.45		0.59		65%	1/8 ac. Single Family
C4.3	56	B	2.46	80.13%	0.45	0.36	0.59	0.47	65%	1/8 ac. Single Family
	52	C	0.61	19.87%	0.49	0.10	0.65	0.13	65%	1/8 ac. Single Family
			3.07	100.00%		0.46		0.60		
C4.1	56	B	4.61		0.45		0.59		65%	1/8 ac. Single Family
C4.2	56	B	3.08		0.45		0.59		65%	1/8 ac. Single Family
C4.3	56	B	2.46	80.13%	0.45	0.36	0.59	0.47	65%	1/8 ac. Single Family
	52	C	0.61	19.87%	0.49	0.10	0.65	0.13	65%	1/8 ac. Single Family
			3.07	100.00%		0.46		0.60		



CORE
ENGINEERING GROUP

15004 1st Avenue South
Burnsville, MN 55306

PROJECT NAME: The Ridge at Lorson Ranch

PROJECT NUMBER: 100.064

ENGINEER: LAB

DATE: Feb. 19, 2021

Preliminary Drainage Plan

PROPOSED CONDITIONS COEFFICIENT "C" CALCULATIONS

C4.4	56	B	2.56	77.81%	0.45	0.35	0.59	0.46	65%	1/8 ac. Single Family
	52	C	0.73	22.19%	0.49	0.11	0.65	0.14	65%	1/8 ac. Single Family
			3.29	100.00%		0.46		0.60		
C4.5	56	B	0.26	41.27%	0.90	0.37	0.96	0.40	100%	Roadway
	52	C	0.37	58.73%	0.90	0.53	0.96	0.56	100%	Roadway
			0.63	100.00%		0.90		0.96		
C5.1a	56	B	1.34	57.51%	0.45	0.26	0.59	0.34	65%	1/8 ac. Single Family
	54/52	D/C	0.99	42.49%	0.49	0.21	0.65	0.28	65%	1/8 ac. Single Family
			2.33	100.00%		0.47		0.62		
C5.1b	56	B	5.96	94.30%	0.45	0.42	0.59	0.56	65%	1/8 ac. Single Family
	52	C	0.36	5.70%	0.49	0.03	0.65	0.04	65%	1/8 ac. Single Family
			6.32	100.00%		0.45		0.59		
C5.1c	56	B	3.54	93.65%	0.45	0.42	0.59	0.55	65%	1/8 ac. Single Family
	52	C	0.24	6.35%	0.49	0.03	0.65	0.04	65%	1/8 ac. Single Family
			3.78	100.00%		0.45		0.59		
C5.1d	56	B	4.98	87.83%	0.45	0.40	0.59	0.52	65%	1/8 ac. Single Family
	52	C	0.69	12.17%	0.49	0.06	0.65	0.08	65%	1/8 ac. Single Family
			5.67	100.00%		0.45		0.60		
C5.1e	56	B	5.44	84.47%	0.45	0.38	0.59	0.50	65%	1/8 ac. Single Family
	52	C	1.00	15.53%	0.49	0.08	0.65	0.10	65%	1/8 ac. Single Family
			6.44	100.00%		0.46		0.60		
C5.2	52	C	1.71		0.49		0.65		65%	1/8 ac. Single Family
C5.3	56	B	1.50	66.37%	0.45	0.30	0.59	0.39	65%	1/8 ac. Single Family
	52	C	0.76	33.63%	0.49	0.16	0.65	0.22	65%	1/8 ac. Single Family
			2.26	100.00%		0.46		0.61		



CORE
ENGINEERING GROUP

15004 1st Avenue South
Burnsville, MN 55306

PROJECT NAME: The Ridge at Lorson Ranch

PROJECT NUMBER: 100.064

ENGINEER: LAB

DATE: Feb. 19, 2021

Preliminary Drainage Plan

PROPOSED CONDITIONS COEFFICIENT "C" CALCULATIONS

C8.1a	56	B	3.81	92.48%	0.45	0.42	0.59	0.55	65%	1/8 ac. Single Family
	54	D	0.31	7.52%	0.49	0.04	0.65	0.05	65%	1/8 ac. Single Family
			4.12	100.00%		0.45		0.59		
C8.1b	56	B	1.36	36.86%	0.45	0.17	0.59	0.22	65%	1/8 ac. Single Family
	54	D	2.33	63.14%	0.49	0.31	0.65	0.41	65%	1/8 ac. Single Family
			3.69	100.00%		0.48		0.63		
C8.1c	56	B	1.31	69.68%	0.45	0.31	0.59	0.41	65%	1/8 ac. Single Family
	54	D	0.57	30.32%	0.49	0.15	0.65	0.20	65%	1/8 ac. Single Family
			1.88	100.00%		0.46		0.61		
C8.2	52	C	2.12		0.49		0.65		65%	1/8 ac. Single Family
OS-C4a	56	B	2.29		0.09		0.36		10%	Undeveloped
C8.3a	56	B	4.88	82.99%	0.45	0.37	0.59	0.49	65%	1/8 ac. Single Family
	54	C/D	1.00	17.01%	0.49	0.08	0.65	0.11	65%	1/8 ac. Single Family
			5.88	100.00%		0.46		0.60		
OS-C4b	56	B	1.36	64.76%	0.09	0.06	0.36	0.23	10%	Undeveloped
	75	D	0.74	35.24%	0.16	0.06	0.51	0.18	10%	Undeveloped
			2.10	100.00%		0.11		0.41		
C8.3b	56	B	1.09	31.50%	0.45	0.14	0.59	0.19	65%	1/8 ac. Single Family
	54	D	2.37	68.50%	0.49	0.34	0.65	0.45	65%	1/8 ac. Single Family
			3.46	100.00%		0.48		0.63		
C8.3c	56	B	0.87	37.34%	0.45	0.17	0.59	0.22	65%	1/8 ac. Single Family
	54	D	1.46	62.66%	0.49	0.31	0.65	0.41	65%	1/8 ac. Single Family
			2.33	100.00%		0.48		0.63		
DP-54	56	B	6.84	58.61%	0.45	0.26	0.59	0.35	65%	1/8 ac. Single Family



CORE
ENGINEERING GROUP

15004 1st Avenue South
Burnsville, MN 55306

PROJECT NAME: The Ridge at Lorson Ranch

PROJECT NUMBER: 100.064

ENGINEER: LAB

DATE: Feb. 19, 2021

Preliminary Drainage Plan

PROPOSED CONDITIONS COEFFICIENT "C" CALCULATIONS

	54	D	4.83	41.39%	0.49	0.20	0.65	0.27	65%	1/8 ac. Single Family
			11.67	100.00%		0.47		0.61		
C8.3d	56	B	0.81	15.40%	0.45	0.07	0.59	0.09	65%	1/8 ac. Single Family
	54	D	4.45	84.60%	0.49	0.41	0.65	0.55	65%	1/8 ac. Single Family
			5.26	100.00%		0.48		0.64		
C8.4	56	B	5.25	78.36%	0.45	0.35	0.59	0.46	65%	1/8 ac. Single Family
	54	D	1.45	21.64%	0.49	0.11	0.65	0.14	65%	1/8 ac. Single Family
			6.70	100.00%		0.46		0.60		
C8.5	54/75	D	3.84		0.49		0.65		100%	1/8 ac. Single Family
C8.6	54	D	0.79		0.90		0.96		100%	Street
C8.7a	75	D	6.29		0.49		0.65		100%	1/8 ac. Single Family
C8.7b	54/75	D	4.94		0.49		0.65		100%	1/8 ac. Single Family
C8.7c	75	D	4.94		0.49		0.65		100%	1/8 ac. Single Family
C8.7d	56	B	0.17	62.96%	0.45	0.28	0.59	0.37	65%	1/8 ac. Single Family
	54	D	0.10	37.04%	0.49	0.18	0.65	0.24	65%	1/8 ac. Single Family
			0.27	100.00%		0.46		0.61		
C8.7e	56	B	2.56	42.04%	0.45	0.19	0.59	0.25	65%	1/8 ac. Single Family
	52/54	C/D	3.53	57.96%	0.49	0.28	0.65	0.38	65%	1/8 ac. Single Family
			6.09	100.00%		0.47		0.62		
OS-B1	56	B	0.75	14.68%	0.09	0.01	0.36	0.05	10%	Undeveloped
	75	D	4.36	85.32%	0.16	0.14	0.51	0.44	10%	Undeveloped
			5.11	100.00%		0.15		0.49		
C8.8a	56	B	0.70	12.39%	0.45	0.06	0.59	0.07	65%	1/8 ac. Single Family
	52/54/75	C/D	4.95	87.61%	0.49	0.43	0.65	0.57	65%	1/8 ac. Single Family
			5.65	100.00%		0.49		0.64		
C8.8	56	B	3.85	49.36%	0.16	0.08	0.41	0.20	13%	Pond / Open Space
	52	C	3.08	39.49%	0.23	0.09	0.54	0.21	13%	Pond / Open Space



15004 1st Avenue South
Burnsville, MN 55306

PROJECT NAME: The Ridge at Lorson Ranch

PROJECT NUMBER: 100.064

ENGINEER: LAB

DATE: Feb. 19, 2021

Preliminary Drainage Plan

PROPOSED CONDITIONS COEFFICIENT "C" CALCULATIONS

	56	B	0.63	8.08%	0.45	0.04	0.59	0.05	65%	1/8 ac. Single Family
	52	C	0.24	3.08%	0.49	0.02	0.65	0.02	65%	1/8 ac. Single Family
			7.80	100.00%		0.22		0.48		
C8.4	56	B	4.89	72.99%	0.45	0.33	0.59	0.43	65%	1/8 ac. Single Family
	54	C	1.81	27.01%	0.49	0.13	0.65	0.18	65%	1/8 ac. Single Family
			6.70	100.00%		0.46		0.61		
C8.5	75	D	3.49		0.49		0.65		100%	1/8 ac. Single Family
C8.6	54	D	0.79		0.90		0.96		100%	Street
C8.7	56	B	3.68	15.59%	0.45	0.07	0.59	0.09	65%	1/8 ac. Single Family
	52/54/75	C/D	19.93	84.41%	0.49	0.41	0.65	0.55	65%	1/8 ac. Single Family
			23.61	100.00%		0.48		0.64		
C8.8	56	B	3.85	49.36%	0.16	0.08	0.41	0.20	13%	Pond / Open Space
	52	C	3.08	39.49%	0.23	0.09	0.54	0.21	13%	Pond / Open Space
	56	B	0.63	8.08%	0.45	0.04	0.59	0.05	65%	1/8 ac. Single Family
	52	C	0.24	3.08%	0.49	0.02	0.65	0.02	65%	1/8 ac. Single Family
			7.80	100.00%		0.22		0.48		
	52/75	C/D	0.93	10.65%	0.49	0.05	0.65	0.07	65%	1/8 ac. Single Family
			8.73	110.65%		0.27		0.55		
H1	56	B	27.64	98.86%	0.08	0.08	0.35	0.35	13%	Open Space
	56	B	0.32	1.14%	0.90	0.01	0.96	0.01	65%	Roadway
			27.96	100.00%		0.09		0.36		



Standard Form SF-1. Time of Concentration-Proposed

Calculated By: Leonard Beasley
 Date: Feb. 19, 2021
 Checked By: Leonard Beasley

Job No: 100.064
 Project: The Ridge at Lorson Ranch

Sub-Basin Data				Initial Overland Time (ti)				Travel Time (tt)					tc Check (urbanized Basins)		Final tc
BASIN or DESIGN	C ₅	AREA (A) acres	NRCS Convey.	LENGTH (L) feet	SLOPE (S) %	VELOCITY (V) ft/sec	Ti minutes	LENGTH (L) feet	SLOPE (S) %	VELOCITY (V) ft/sec	Tt minutes	Computed tc Minutes	TOTAL LENGTH (L) feet	Regional tc tc=(L/180)+10 minutes	USDCM Recommended tc=ti+tt (min)
C1.1	0.45	3.18	7.0	100.00	3.00%	0.20	8.20	90.00	2.60%	1.13	1.33				
			20.0					350.00	1.71%	2.62	2.23	11.76	540.00	13.00	11.76
C1.2	0.45	1.52	20.0	67.00	2.00%	0.15	7.67	417.00	0.83%	1.82	3.81	11.49	484.00	12.69	11.49
DP-3	0.45	4.70	7.0	100.00	3.00%	0.20	8.20	90.00	2.60%	1.13	1.33				
			20.0					350.00	1.71%	2.62	2.23	11.76	540.00	13.00	11.76
C1.3	0.45	6.71	7.0	80.00	2.00%	0.16	8.38	87.00	1.40%	0.83	1.75				
			20.0					1400.00	1.39%	2.36	9.90				
			20.0					552.00	5.25%	4.58	2.01	22.04	2119.00	21.77	21.77
DP-5	0.45	16.31	7.0	100.00	2.00%	0.18	9.37	87.00	1.40%	0.83	1.75				
			20.0					2158.00	1.39%	2.36	15.25				
			20.0					552.00	5.25%	4.58	2.01	28.38	2897.00	26.09	26.09
C1.4	0.45	2.51	20.0	51.00	2.00%	0.13	6.69	685.00	2.10%	2.90	3.94				
			20.0					302.00	1.00%	2.00	2.52	13.15	1038.00	15.77	13.15
C1.5	0.45	1.61	20.0	23.00	2.00%	0.09	4.50	1220.00	3.52%	3.75	5.42	9.91	1243.00	16.91	9.91
C1.6	0.45	9.35	20.0	81.00	2.90%	0.18	7.46	2102.00	1.80%	2.68	13.06	20.52	2183.00	22.13	20.52
C3.1	0.45	6.20	7.0	100.00	2.00%	0.18	9.37	20.00	2.10%	1.01	0.33				
			20.0					395.00	3.92%	3.96	1.66				
			20.0					440.00	1.82%	2.70	2.72				
			20.0					150.00	3.67%	3.83	0.65	14.73	1105.00	16.14	14.73
C3.2	0.45	5.01	7.0	100.00	2.00%	0.18	9.37	120.00	2.20%	1.04	1.93				
			20.0					940.00	3.80%	3.90	4.02	15.32	1160.00	16.44	15.32
DP-14	0.45	11.21	7.0	100.00	2.00%	0.18	9.37	2.00	2.10%	1.01	0.03				
			20.0					395.00	3.92%	3.96	1.66				
			20.0					440.00	1.82%	2.70	2.72				
			20.0					150.00	3.67%	3.83	0.65				
			20.0					255.00	1.57%	2.51	1.70	16.13	1342.00	17.46	16.13
C3.3	0.45	4.75	7.0	55.00	7.82%	0.21	4.43	165.00	2.79%	1.17	2.35				
			20.0					631.00	4.90%	4.43	2.38				
			20.0					286.00	1.40%	2.37	2.01	11.17	1137.00	16.32	11.17
DP-16	0.45	15.96	7.0	100.00	2.00%	0.18	9.37	20.00	2.10%	1.01	0.33				
			20.0					395.00	3.92%	3.96	1.66				
			20.0					440.00	1.82%	2.70	2.72				



Standard Form SF-1. Time of Concentration-Proposed

Calculated By: Leonard Beasley
 Date: Feb. 19, 2021
 Checked By: Leonard Beasley

Job No: 100.064
 Project: The Ridge at Lorson Ranch

Sub-Basin Data				Initial Overland Time (ti)				Travel Time (Tt)					Tc Check (urbanized Basins)		Final tc
BASIN or DESIGN	C ₅	AREA (A) acres	NRCS Convey.	LENGTH (L) feet	SLOPE (S) %	VELOCITY (V) ft/sec	Ti minutes	LENGTH (L) feet	SLOPE (S) %	VELOCITY (V) ft/sec	Tt minutes	Computed tc Minutes	TOTAL LENGTH (L) feet	Regional tc tc=(L/180)+10 minutes	USDCM Recommended tc=ti+tt (min)
			20.0					150.00	3.67%	3.83	0.65				
			20.0					255.00	1.57%	2.51	1.70				
			20.0					247.00	1.62%	2.55	1.62	18.05	1607.00	18.93	18.05
C3.4	0.45	3.77	7.0	45.00	9.33%	0.20	3.78	130.00	2.31%	1.06	2.04				
			20.0					601.00	4.74%	4.35	2.30				
			20.0					225.00	2.22%	2.98	1.26	9.37	1001.00	15.56	9.37
DP-18	0.45	19.73	7.0	100.00	2.00%	0.18	9.37	20.00	2.10%	1.01	0.33				
			20.0					395.00	3.92%	3.96	1.66				
			20.0					440.00	1.82%	2.70	2.72				
			20.0					150.00	3.67%	3.83	0.65				
			20.0					255.00	1.57%	2.51	1.70				
			20.0					247.00	1.62%	2.55	1.62				
			20.0					166.00	2.41%	3.10	0.89	18.94	1773.00	19.85	18.94
C3.5	0.45	6.32	7.0	82.00	6.22%	0.23	5.83	100.00	2.80%	1.17	1.42				
			20.0					535.00	1.16%	2.15	4.14				
			20.0					559.00	5.01%	4.48	2.08				
			20.0					114.00	2.63%	3.24	0.59	14.06	1390.00	17.72	14.06
DP-20	0.45	26.05	7.0	100.00	2.00%	0.18	9.37	20.00	2.10%	1.01	0.33				
			20.0					395.00	3.92%	3.96	1.66				
			20.0					440.00	1.82%	2.70	2.72				
			20.0					150.00	3.67%	3.83	0.65				
			20.0					255.00	1.57%	2.51	1.70				
			20.0					247.00	1.62%	2.55	1.62				
			20.0					166.00	2.41%	3.10	0.89				
			20.0					162.00	2.16%	2.94	0.92	19.86	1935.00	20.75	19.86
C3.6a	0.45	3.15	20.0	63.00	2.00%	0.14	7.44	915.00	4.07%	4.03	3.78	11.22	978.00	15.43	11.22
C3.6b	0.45	4.80	7.0	100.00	2.00%	0.18	9.37	65.00	2.00%	0.99	1.09				
			20.0					301.00	0.90%	1.90	2.64				
			20.0					515.00	5.24%	4.58	1.87				
			20.0					318.00	2.20%	2.97	1.79	16.77	1299.00	17.22	16.77
C3.7	0.45	4.58	20.0	30.00	2.33%	0.10	4.88	364.00	1.73%	2.63	2.31				
			20.0					386.00	5.96%	4.88	1.32				
			20.0					154.00	1.95%	2.79	0.92	9.42	934.00	15.19	9.42
DP-24	0.45	38.58	7.0	100.00	2.00%	0.18	9.37	20.00	2.10%	1.01	0.33				
			20.0					395.00	3.92%	3.96	1.66				
			20.0					440.00	1.82%	2.70	2.72				



Standard Form SF-1. Time of Concentration-Proposed

Calculated By: Leonard Beasley
 Date: Feb. 19, 2021
 Checked By: Leonard Beasley

Job No: 100.064
 Project: The Ridge at Lorson Ranch

Sub-Basin Data				Initial Overland Time (ti)				Travel Time (tt)					tc Check (urbanized Basins)		Final tc
BASIN or DESIGN	C ₅	AREA (A) acres	NRCS Convey.	LENGTH (L) feet	SLOPE (S) %	VELOCITY (V) ft/sec	Ti minutes	LENGTH (L) feet	SLOPE (S) %	VELOCITY (V) ft/sec	Tt minutes	Computed tc Minutes	TOTAL LENGTH (L) feet	Regional tc tc=(L/180)+10 minutes	USDCM Recommended tc=ti+tt (min)
			20.0					150.00	3.67%	3.83	0.65				
			20.0					255.00	1.57%	2.51	1.70				
			20.0					247.00	1.62%	2.55	1.62				
			20.0					166.00	2.41%	3.10	0.89				
			20.0					162.00	2.16%	2.94	0.92				
			20.0					236.00	2.97%	3.45	1.14	21.00	2171.00	22.06	21.00
C3.8	0.45	6.51	20.0	39.00	2.00%	0.11	5.85	569.00	1.28%	2.26	4.19				
			20.0					600.00	4.83%	4.40	2.28				
			20.0					539.00	1.39%	2.36	3.81	16.13	1747.00	19.71	16.13
C3.9	0.45	4.55	20.0	54.00	2.78%	0.15	6.18	1063.00	3.20%	3.58	4.95	11.13	1117.00	16.21	11.13
DP-28	0.45	45.09	7.0	100.00	2.00%	0.18	9.37	20.00	2.10%	1.01	0.33				
			20.0					395.00	3.92%	3.96	1.66				
			20.0					440.00	1.82%	2.70	2.72				
			20.0					150.00	3.67%	3.83	0.65				
			20.0					255.00	1.57%	2.51	1.70				
			20.0					247.00	1.62%	2.55	1.62				
			20.0					166.00	2.41%	3.10	0.89				
			20.0					162.00	2.16%	2.94	0.92				
			20.0					236.00	2.97%	3.45	1.14				
			20.0					246.00	2.64%	3.25	1.26	22.26	2417.00	23.43	22.26
C3.10	0.45	6.01	7.0	66.00	3.79%	0.18	6.16	118.00	2.37%	1.08	1.82				
			20.0					1076.00	2.39%	3.09	5.80				
			20.0					343.00	3.79%	3.89	1.47				
			20.0					146.00	1.23%	2.22	1.10	16.35	1749.00	19.72	16.35
DP-30	0.45	51.10	7.0	100.00	2.00%	0.18	9.37	20.00	2.10%	1.01	0.33				
			20.0					395.00	3.92%	3.96	1.66				
			20.0					440.00	1.82%	2.70	2.72				
			20.0					150.00	3.67%	3.83	0.65				
			20.0					255.00	1.57%	2.51	1.70				
			20.0					247.00	1.62%	2.55	1.62				
			20.0					166.00	2.41%	3.10	0.89				
			20.0					162.00	2.16%	2.94	0.92				
			20.0					236.00	2.97%	3.45	1.14				



Standard Form SF-1. Time of Concentration-Proposed

Calculated By: Leonard Beasley
 Date: Feb. 19, 2021
 Checked By: Leonard Beasley

Job No: 100.064
 Project: The Ridge at Lorson Ranch

Sub-Basin Data				Initial Overland Time (ti)				Travel Time (tt)					tc Check (urbanized Basins)		Final tc
BASIN or DESIGN	C ₅	AREA (A) acres	NRCS Convey.	LENGTH (L) feet	SLOPE (S) %	VELOCITY (V) ft/sec	Ti minutes	LENGTH (L) feet	SLOPE (S) %	VELOCITY (V) ft/sec	Tt minutes	Computed tc Minutes	TOTAL LENGTH (L) feet	Regional tc tc=(L/180)+10 minutes	USDCM Recommended tc=ti+tt (min)
			20.0					246.00	2.64%	3.25	1.26				
			20.0					245.00	0.94%	1.94	2.11	24.37	2662.00	24.79	24.37
C4.1	0.45	4.61	7.0	45.00	10.00%	0.20	3.69	128.00	2.58%	1.12	1.90				
			20.0					1680.00	1.45%	1.36	20.59	26.18	1853.00	20.29	20.29
C4.2	0.45	3.08	20.0	43.00	2.80%	0.13	5.50	124.00	2.72%	3.30	0.63				
			20.0					865.00	4.44%	1.36	10.60	16.73	1032.00	15.73	15.73
DP-31	0.45	7.69	7.0	45.00	10.00%	0.20	3.69	128.00	2.58%	1.12	1.90				
			20.0					1680.00	1.45%	2.41	11.63				
			20.0					865.00	4.44%	4.21	3.42	20.64	2718.00	25.10	20.64
C4.3	0.46	3.07	7.0	100.00	2.00%	0.18	9.23	85.00	2.00%	0.99	1.43				
			20.0					5.07	1.12%	1.36	0.06	10.72	190.07	11.06	10.72
C4.4	0.46	3.29	20.0	34.00	3.82%	0.13	4.34	900.00	3.08%	3.51	4.27				
			20.0					144.00	1.32%	1.36	1.76	10.38	1078.00	15.99	10.38
DP-33	0.45	14.05	7.0	45.00	10.00%	0.20	3.66	128.00	2.58%	1.12	1.90				
			20.0					1680.00	1.45%	2.41	11.63				
			20.0					1170.00	4.27%	4.13	4.72				
			20.0					84.00	1.07%	2.07	0.68	22.58	3107.00	27.26	22.58
C4.5	0.90	0.63	20.0	56.00	3.93%	0.54	1.73	384.00	2.86%	3.38	1.89	3.62	440.00	12.44	3.62
F1.1	0.45	4.23	15.0	88.00	20.00%	0.36	4.10	150.00	2.50%	2.37	1.05	5.16	238.00	11.32	11.32
F1.2	0.08	19.06	7.0	37.00	19.19%	0.15	4.23	150.00	2.50%	1.11	2.26	6.49	187.00	11.04	11.04
F1.3	0.46	1.15	7.0	10.00	2.00%	0.06	2.92	30.00	2.00%	0.99	0.51				
			20.0					830.00	1.00%	1.36	10.17	13.59	870.00	14.83	13.59
F1.4	0.46	3.75	7.0	50.00	2.00%	0.13	6.53	100.00	2.00%	0.99	1.68				
			20.0					580.00	1.00%	1.36	7.11	15.32	730.00	14.06	15.32
C5.1a & I-39	0.47	2.33	7.0	87.00	12.76%	0.32	4.59	141.00	2.13%	1.02	2.30				
			20.0					1159.00	5.13%	4.53	4.26				
			20.0					296.00	3.14%	3.54	1.39	12.54	1683.00	19.35	12.54
C5.1b & I-36	0.45	6.32	7.0	45.00	24.44%	0.27	2.75	255.00	3.53%	1.32	3.23				
			20.0					1212.00	5.07%	4.50	4.49				
			20.0					62.00	3.23%	3.59	0.29	10.75	1574.00	18.74	10.75
C5.1c & I-37	0.45	3.78	7.0	44.00	20.45%	0.25	2.88	47.00	2.55%	1.12	0.70				
			20.0					1335.00	4.85%	4.40	5.05	8.63	1426.00	17.92	8.63



Standard Form SF-1. Time of Concentration-Proposed

Calculated By: Leonard Beasley
 Date: Feb. 19, 2021
 Checked By: Leonard Beasley

Job No: 100.064
 Project: The Ridge at Lorson Ranch

Sub-Basin Data				Initial Overland Time (ti)				Travel Time (tt)					tc Check (urbanized Basins)		Final tc
BASIN or DESIGN	C ₅	AREA (A) acres	NRCS Convey.	LENGTH (L) feet	SLOPE (S) %	VELOCITY (V) ft/sec	Ti minutes	LENGTH (L) feet	SLOPE (S) %	VELOCITY (V) ft/sec	Tt minutes	Computed tc Minutes	TOTAL LENGTH (L) feet	Regional tc tc=(L/180)+10 minutes	USDCM Recommended tc=ti+tt (min)
C5.1d & I-41	0.45	5.67	7.0	83.00	15.30%	0.32	4.32	228.00	2.68%	1.15	3.32				
			20.0				1356.00	4.23%	4.11	5.49					
			20.0				115.00	1.13%	2.13	0.90	14.03	1782.00	19.90	14.03	
DP-42	0.46	12.43	7.0	87.00	12.76%	0.31	4.66	141.00	2.13%	1.02	2.30				
			20.0				1159.00	5.13%	4.53	4.26					
			20.0				375.00	2.61%	3.23	1.93					
			20.0					123.00	0.65%	1.61	1.27	14.43	1885.00	20.47	14.43
C5.1e & DP-44	0.46	6.44	7.0	100.00	7.00%	0.27	6.13	191.00	6.00%	1.71	1.86				
			20.0				742.00	1.62%	2.55	4.86					
			20.0				786.00	4.58%	4.28	3.06					
			20.0					104.00	2.40%	3.10	0.56	16.47	1923.00	20.68	16.47
C5.2	0.49	1.71	20.0	38.00	2.63%	0.13	4.95	677.00	2.48%	3.15	3.58	8.53	715.00	13.97	8.53
C5.3	0.46	2.26	20.0	42.00	2.00%	0.12	5.98	1115.00	4.68%	4.33	4.30	10.28	1157.00	16.43	10.28
C8.1a	0.45	4.12	7.0	60.00	7.67%	0.21	4.65	163.00	2.45%	1.10	2.48				
			20.0				966.00	5.12%	4.53	3.56	10.69	1189.00	16.61	10.69	
C8.1b	0.48	3.69	20.0	73.00	2.00%	0.16	7.64	929.00	5.30%	4.60	3.36				
			20.0				465.00	1.08%	2.08	3.73	14.73	1467.00	18.15	14.73	
C8.1c	0.46	1.88	20.0	63.00	2.00%	0.14	7.30	1119.00	5.36%	4.63	4.03	11.32	1182.00	16.57	11.32
C8.1	0.45	9.68	7.0	57.00	8.07%	0.21	4.43	163.00	2.45%	1.10	2.48				
			20.0				1018.00	4.93%	4.44	3.82					
			20.0				363.00	1.29%	2.27	2.66	13.39	1601.00	18.89	13.39	
C8.2	0.49	2.12	20.0	50.00	4.20%	0.17	4.87	385.00	0.64%	1.60	4.01	8.88	435.00	12.42	8.88
OS-C4a	0.09	2.29	7.0	100.00	4.30%	0.15	11.30	227.00	4.40%	1.47	2.58	13.88	327.00	11.82	11.82
C8.3a	0.46	5.88	7.0	61.00	18.85%	0.30	3.43	123.00	2.60%	1.13	1.82				
			20.0				1390.00	3.17%	3.56	6.51	11.75	1574.00	18.74	11.75	
DP-53	0.38	8.17	7.0	100.00	4.30%	0.21	8.06	377.00	5.60%	1.66	3.79				
			20.0				548.00	4.50%	4.24	2.15	14.00	1025.00	15.69	14.00	
OS-C4b	0.11	2.10	7.0	100.00	4.00%	0.15	11.35	378.00	5.00%	1.57	4.02	15.37	478.00	12.66	12.66
C8.3b	0.48	3.46	7.0	100.00	4.50%	0.24	6.84	28.00	16.00%	2.80	0.17				
			7.0				108.00	2.00%	0.99	1.82					
			20.0				672.00	2.40%	3.10	3.61	12.44	908.00	15.04	12.44	
C8.3c	0.48	2.33	7.0	60.00	11.17%	0.26	3.92	148.00	2.36%	1.08	2.29				
			20.0				900.00	3.50%	3.74	4.01					
			20.0				93.00	2.69%	3.28	0.47	10.69	1201.00	16.67	10.69	



Standard Form SF-1. Time of Concentration-Proposed

Calculated By: Leonard Beasley
 Date: Feb. 19, 2021
 Checked By: Leonard Beasley

Job No: 100.064
 Project: The Ridge at Lorson Ranch

Sub-Basin Data				Initial Overland Time (ti)				Travel Time (Tt)					Tc Check (urbanized Basins)		Final tc
BASIN or DESIGN	C ₅	AREA (A) acres	NRCS Convey.	LENGTH (L) feet	SLOPE (S) %	VELOCITY (V) ft/sec	Ti minutes	LENGTH (L) feet	SLOPE (S) %	VELOCITY (V) ft/sec	Tt minutes	Computed tc Minutes	TOTAL LENGTH (L) feet	Regional tc tc=(L/180)+10 minutes	USDCM Recommended tc=Ti+Tt (min)
DP-54	0.36	16.06	7.0	100.00	4.00%	0.20	8.48	616.00	4.91%	1.55	6.62				
			20.0					1085.00	3.24%	3.60	5.02	20.13	1801.00	20.01	20.01
C8.3d	0.48	5.26	20.0	76.00	2.00%	0.16	7.79	700.00	5.19%	4.56	2.56				
			20.0					664.00	1.36%	2.33	4.74	15.10	1440.00	18.00	15.10
DP-56	0.44	21.32	7.0	100.00	4.00%	0.22	7.57	616.00	4.91%	1.55	6.62				
			20.0					1310.00	2.92%	3.42	6.39	20.57	2026.00	21.26	20.57
C8.4	0.46	6.70	7.0	42.00	1.19%	0.10	7.16	157.00	4.14%	1.42	1.84				
			20.0					89.00	3.37%	3.67	0.40				
			20.0					697.00	5.16%	4.54	2.56				
			20.0					374.00	1.48%	2.43	2.56	14.52	1359.00	17.55	14.52
DP-51	0.46	39.82	7.0	100.00	4.00%	0.23	7.34	616.00	4.91%	1.55	6.62				
			20.0					1310.00	2.92%	3.42	6.39				
			20.0					391.00	1.20%	9.15	0.71	21.06	2417.00	23.43	21.06
C8.5	0.49	3.84	7.0	45.00	2.20%	0.13	5.72	160.00	1.88%	0.96	2.78				
			20.0					683.00	4.25%	4.12	2.76				
			20.0					320.00	1.60%	2.53	2.11	13.36	1208.00	16.71	13.36
C8.6	0.90	0.79	20.0	25.00	2.00%	0.29	1.44	342.00	1.67%	2.58	2.21				
			20.0					400.00	2.98%	3.45	1.93	5.58	767.00	14.26	5.58
C8.7a	0.49	4.52	7.0	75.00	6.67%	0.24	5.11	108.00	2.50%	1.11	1.63				
			20.0					857.00	1.05%	2.05	6.97	13.71	1040.00	15.78	13.71
C8.7b	0.49	1.77	20.0	33.00	2.00%	0.11	5.05	1040.00	1.92%	2.77	6.25	11.31	1073.00	15.96	11.31
DP-63	0.49	6.29	7.0	75.00	6.67%	0.24	5.11	108.00	2.50%	1.11	1.63				
			20.0					885.00	1.05%	2.05	7.20	13.94	1068.00	15.93	13.94
C8.7c	0.49	4.94	20.0	60.00	2.10%	0.15	6.70	817.00	3.11%	3.53	3.86				
			20.0					172.00	1.74%	2.64	1.09	11.65	1049.00	15.83	11.65
DP-64	0.49	11.23	7.0	75.00	6.67%	0.24	5.11	108.00	2.50%	1.11	1.63				
			20.0					885.00	1.05%	2.05	7.20				
			RCP					270.00	1.00%	10.63	0.42	14.36	1338.00	17.43	14.36
C8.7d	0.46	0.27	7.0	20.00	16.50%	0.16	2.05	166.00	3.31%	1.27	2.17	4.23	186.00	11.03	4.23
C8.7e	0.47	6.09	7.0	40.00	20.00%	0.25	2.68	290.00	2.83%	1.18	4.10				
			20.0					293.00	1.06%	2.06	2.37				
			20.0					577.00	3.14%	3.54	2.71	11.87	1200.00	16.67	11.87
DP-62 C3.7a-e	0.48	17.59	7.0	75.00	6.67%	0.24	5.20	108.00	2.50%	1.11	1.63				
			20.0					885.00	1.05%	2.05	7.20				
			RCP					270.00	1.00%	10.63	0.42				
			RCP					777.00	3.40%	13.28	0.98	15.42	2115.00	21.75	15.42



Standard Form SF-1. Time of Concentration-Proposed

Calculated By: Leonard Beasley
 Date: Feb. 19, 2021
 Checked By: Leonard Beasley

Job No: 100.064
 Project: The Ridge at Lorson Ranch

Sub-Basin Data				Initial Overland Time (t _i)				Travel Time (t _t)					t _c Check (urbanized Basins)		Final t _c
BASIN or DESIGN	C _s	AREA (A) acres	NRCS Convey.	LENGTH (L) feet	SLOPE (S) %	VELOCITY (V) ft/sec	t _i minutes	LENGTH (L) feet	SLOPE (S) %	VELOCITY (V) ft/sec	t _t minutes	Computed t _c Minutes	TOTAL LENGTH (L) feet	Regional t _c =(L/180)+10 minutes	USDCM Recommended t _c =t _i +t _t (min)
DP-62 C3.5-C3.7	0.50	22.22	7.0	45.00	2.20%	0.13	5.62	160.00	1.88%	0.96	2.78				
			20.0					683.00	4.25%	4.12	2.76				
			20.0					320.00	1.60%	2.53	2.11				
			20.0					342.00	1.67%	2.58	2.21				
			20.0					400.00	2.98%	3.45	1.93	17.41	1950.00	20.83	17.41
OS-B1	0.15	5.11	7.0	100.00	4.40%	0.16	10.55	388.00	4.30%	1.45	4.46	15.01	488.00	12.71	12.71
C8.8a	0.49	5.65	7.0	100.00	4.60%	0.25	6.68	133.00	4.36%	1.46	1.52				
			20.0					1457.00	1.41%	2.37	10.23				
			20.0					427.00	3.75%	3.87	1.84				
			20.0					650.00	3.06%	3.50	3.10	23.35	2767.00	25.37	23.35
DP-68	0.33	10.76	7.0	100.00	4.50%	0.20	8.49	488.00	2.42%	1.09	7.47				
			20.0					1457.00	1.41%	2.37	10.23				
			20.0					427.00	3.75%	3.87	1.84				
			20.0					650.00	0.60%	1.55	6.99	35.01	3122.00	27.34	27.34
C8.8	0.22	7.80	7.0	100.00	2.00%	0.13	12.69	611.00	5.48%	1.64	6.21				
			7.0					53.00	33.00%	4.02	0.22				
			7.0					245.00	0.60%	0.54	7.53	26.65	1009.00	15.61	15.61
C8	0.43	73.39	7.0	20.00	18.50%	0.16	2.07	99.00	2.42%	1.09	1.52				
			20.0					2654.00	2.15%	2.93	15.08				
			RCP					566.00	5.30%	21.72	0.43				
			7.0					272.00	0.60%	0.54	8.36	27.46	3611.00	30.06	27.46

APPENDIX C – HYDRAULIC CALCULATIONS

Channel Report

Hydraflow Express by Intelisolve

Thursday, Jun 17 2021, 9:45 AM

EAST SWALE 3%

Trapezoidal

Bottom Width (ft) = 10.00
Side Slope (z:1) = 10.00
Total Depth (ft) = 1.00
Invert Elev (ft) = 100.00
Slope (%) = 3.00
N-Value = 0.020

Highlighted

Depth (ft) = 0.50
Q (cfs) = 47.31
Area (sqft) = 6.88
Velocity (ft/s) = 6.88
Wetted Perim (ft) = 17.57
Crit Depth, Y_c (ft) = 0.59
Top Width (ft) = 17.50
EGL (ft) = 1.24

Calculations

Compute by: Q vs Depth
No. Increments = 10

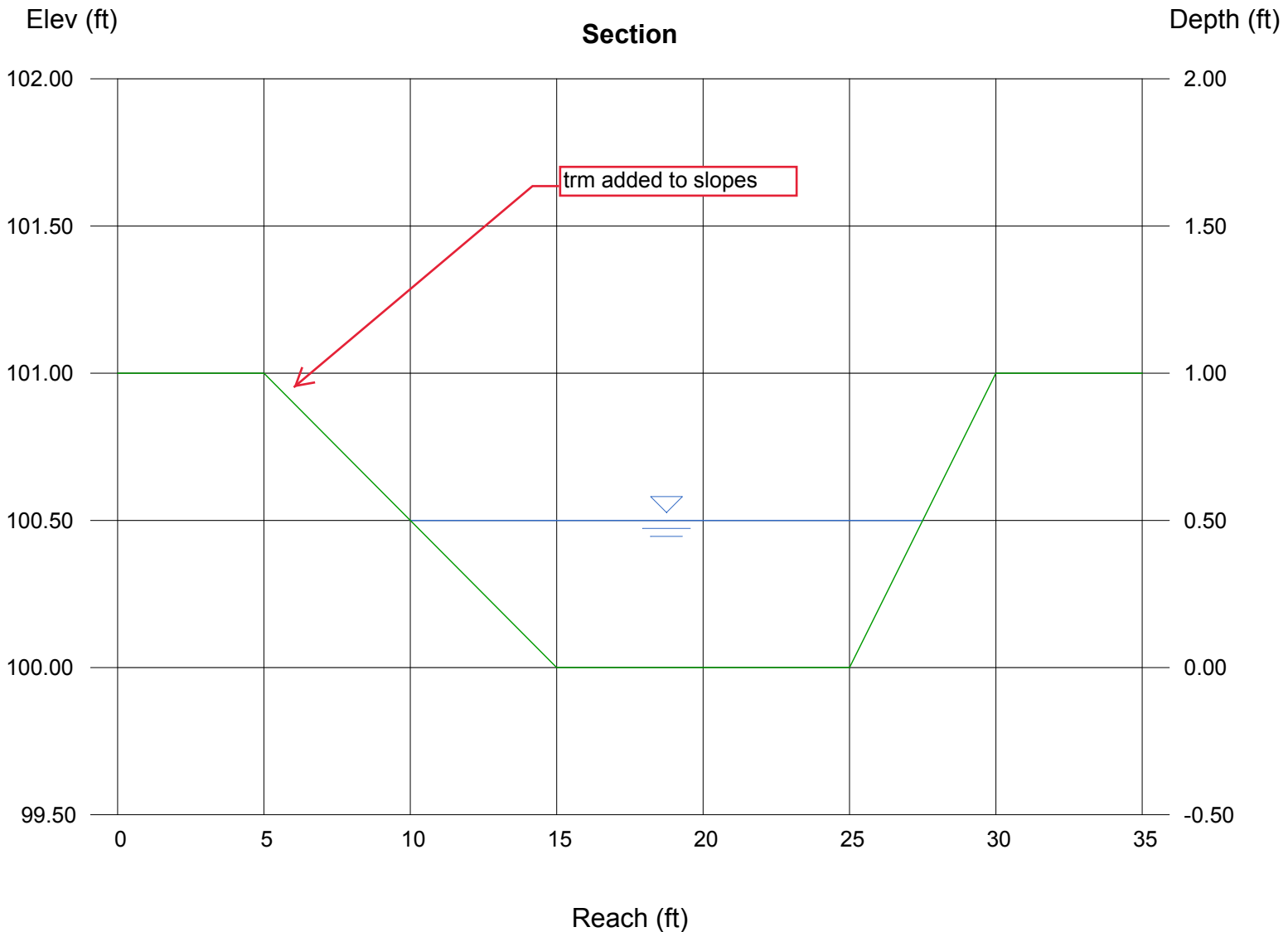

Channel Report

Hydraflow Express by Intelisolve

Wednesday, Sep 29 2021, 9:32 AM

EAST SWALE BY CUT/FILL (0.52%)

Triangular

Side Slope (z:1) = 4.00
Total Depth (ft) = 2.00

Invert Elev (ft) = 100.00
Slope (%) = 0.52
N-Value = 0.020

Calculations

Compute by: Q vs Depth
No. Increments = 10

Highlighted

Depth (ft) = 1.00
Q (cfs) = 13.23
Area (sqft) = 4.00
Velocity (ft/s) = 3.31
Wetted Perim (ft) = 8.25
Crit Depth, Y_c (ft) = 0.73
Top Width (ft) = 8.00
EGL (ft) = 1.17

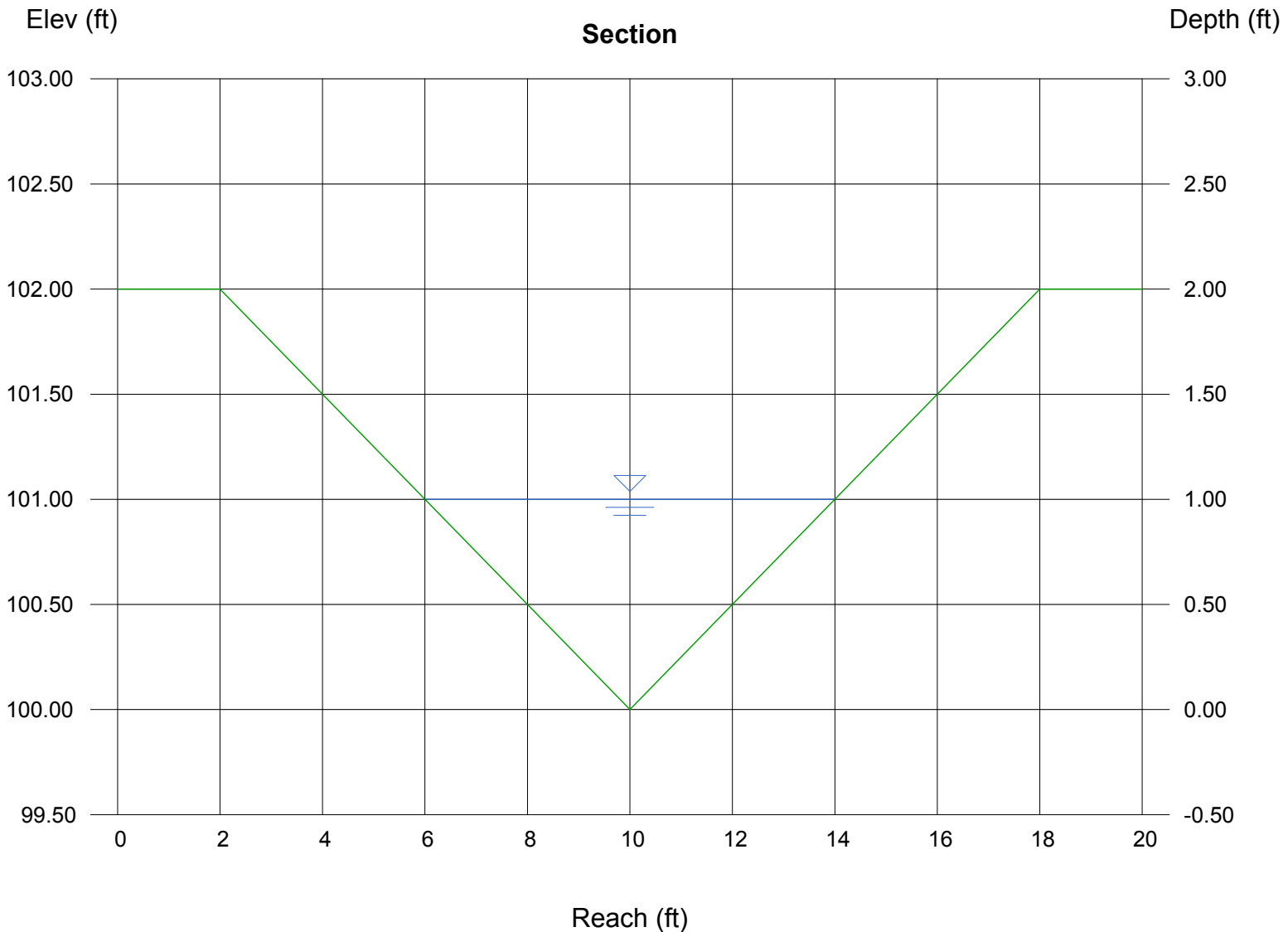

Channel Report

Hydraflow Express by Intelisolve

Wednesday, Sep 29 2021, 9:34 AM

EAST SWALE BY CUT/FILL (5.0%)

Triangular

Side Slope (z:1) = 4.00
Total Depth (ft) = 2.00

Invert Elev (ft) = 100.00
Slope (%) = 5.00
N-Value = 0.020

Calculations

Compute by: Known Q
Known Q (cfs) = 13.20

Highlighted

Depth (ft) = 0.66
Q (cfs) = 13.20
Area (sqft) = 1.74
Velocity (ft/s) = 7.58
Wetted Perim (ft) = 5.44
Crit Depth, Yc (ft) = 0.93
Top Width (ft) = 5.28
EGL (ft) = 1.55

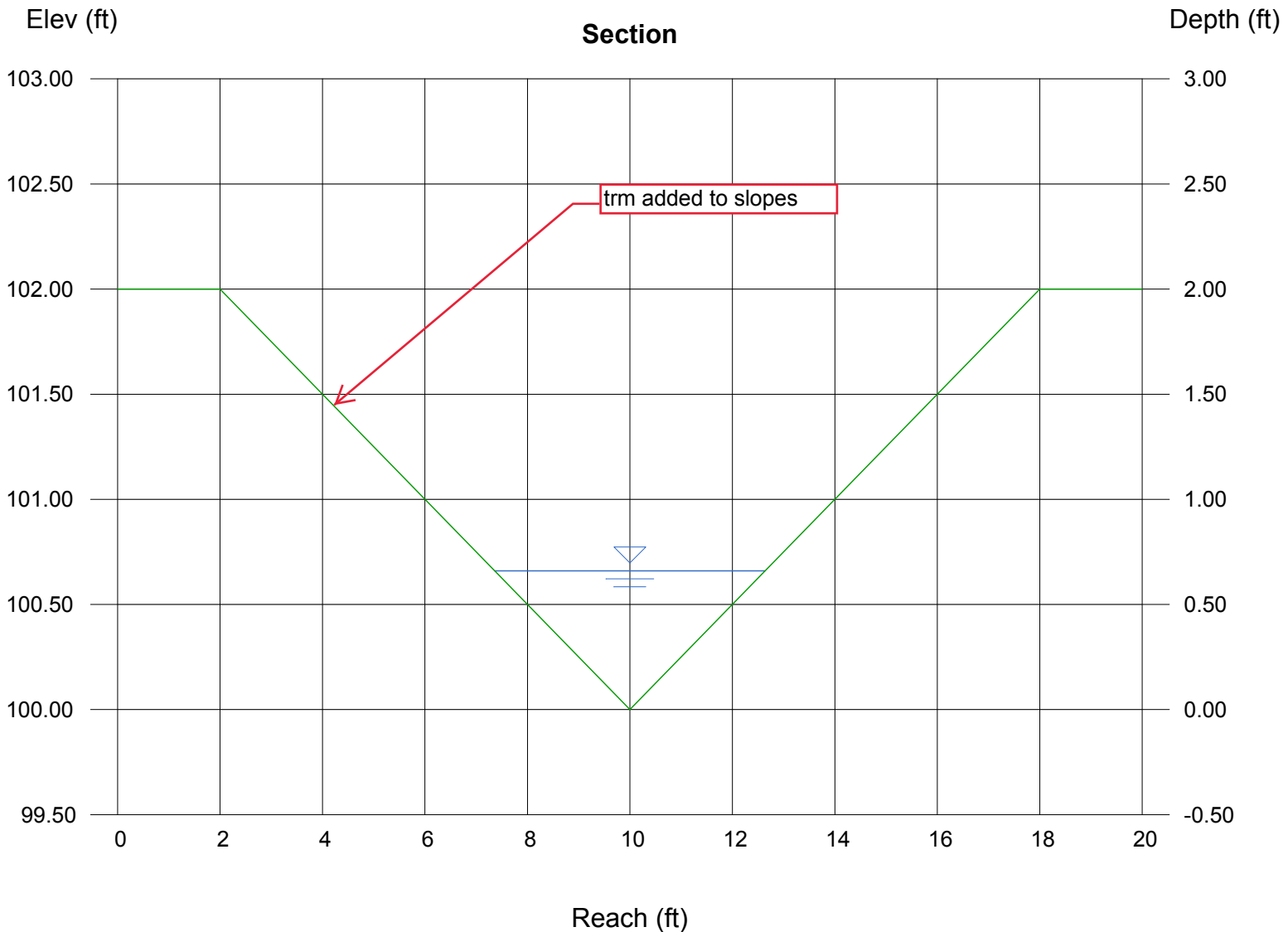

Channel Report

Hydraflow Express by Intelisolve

Friday, Nov 5 2021, 10:47 AM

Pond F spreader - 8-in curbhead

Rectangular

Bottom Width (ft) = 4.00
Total Depth (ft) = 0.67

Invert Elev (ft) = 100.00
Slope (%) = 0.60
N-Value = 0.013

Calculations

Compute by: Known Q
Known Q (cfs) = 8.40

Highlighted

Depth (ft) = 0.46
Q (cfs) = 8.400
Area (sqft) = 1.84
Velocity (ft/s) = 4.57
Wetted Perim (ft) = 4.92
Crit Depth, Y_c (ft) = 0.52
Top Width (ft) = 4.00
EGL (ft) = 0.78

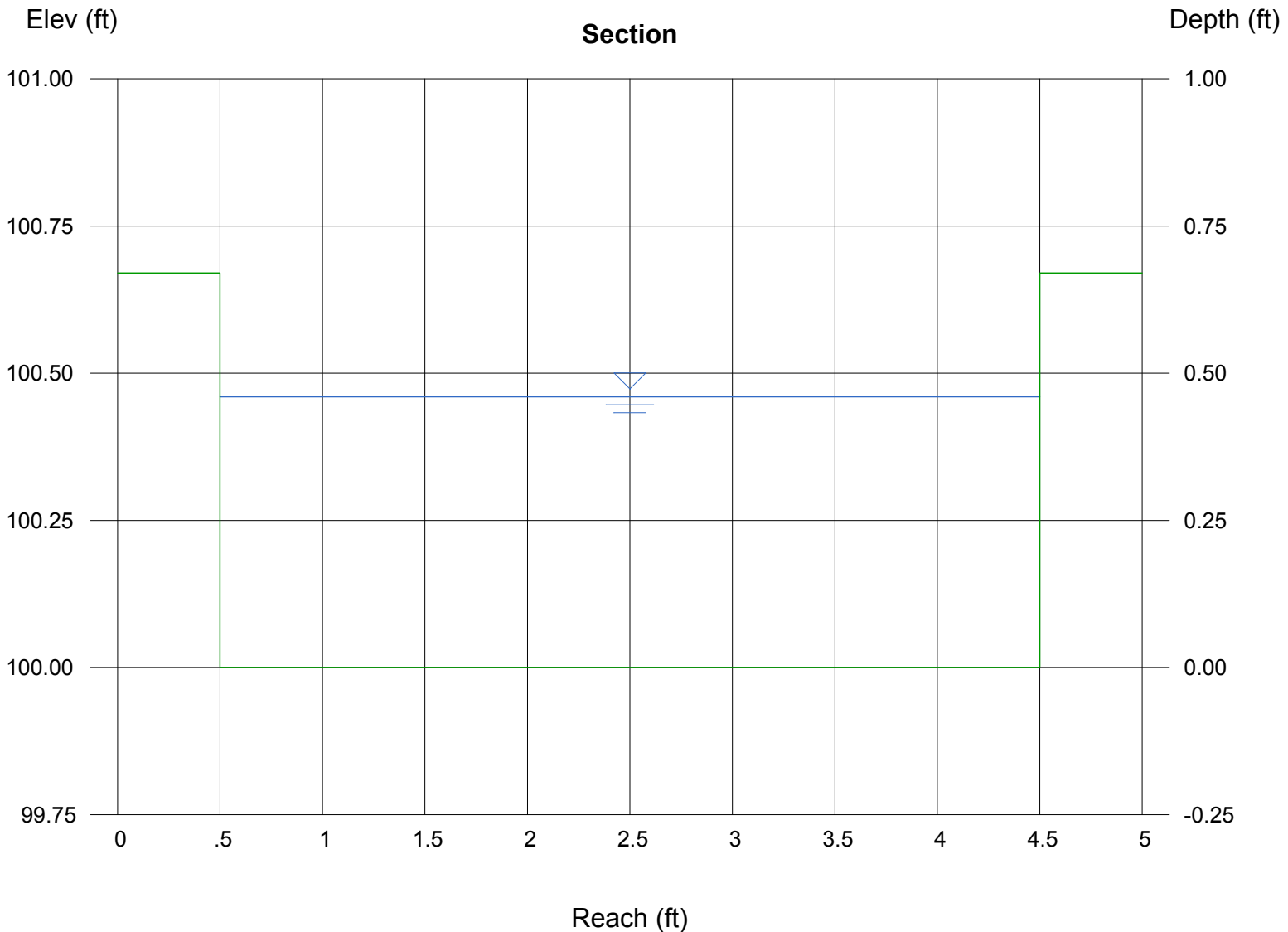

ALLOWABLE CAPACITY FOR ONE-HALF OF STREET (Minor & Major Storm)

(Based on Regulated Criteria for Maximum Allowable Flow Depth and Spread)

Project: The Ridge at Lorson Ranch, #100.064
 Inlet ID: Inlet DP-1



Gutter Geometry (Enter data in the blue cells)										
Maximum Allowable Width for Spread Behind Curb	$T_{BACK} = 8.0$ ft									
Side Slope Behind Curb (leave blank for no conveyance credit behind curb)	$S_{BACK} = 0.020$ ft/ft									
Manning's Roughness Behind Curb (typically between 0.012 and 0.020)	$n_{BACK} = 0.015$									
Height of Curb at Gutter Flow Line	$H_{CURB} = 6.00$ inches									
Distance from Curb Face to Street Crown	$T_{CROWN} = 17.0$ ft									
Gutter Width	$W = 2.00$ ft									
Street Transverse Slope	$S_x = 0.020$ ft/ft									
Gutter Cross Slope (typically 2 inches over 24 inches or 0.083 ft/ft)	$S_w = 0.083$ ft/ft									
Street Longitudinal Slope - Enter 0 for sump condition	$S_o = 0.000$ ft/ft									
Manning's Roughness for Street Section (typically between 0.012 and 0.020)	$n_{STREET} = 0.017$									
Max. Allowable Spread for Minor & Major Storm	<table border="1"> <thead> <tr> <th>Minor Storm</th> <th>Major Storm</th> <th>ft</th> </tr> </thead> <tbody> <tr> <td>$T_{MAX} = 17.0$</td> <td>$T_{MAX} = 17.0$</td> <td></td> </tr> <tr> <td>$d_{MAX} = 5.6$</td> <td>$d_{MAX} = 7.9$</td> <td>inches</td> </tr> </tbody> </table>	Minor Storm	Major Storm	ft	$T_{MAX} = 17.0$	$T_{MAX} = 17.0$		$d_{MAX} = 5.6$	$d_{MAX} = 7.9$	inches
Minor Storm	Major Storm	ft								
$T_{MAX} = 17.0$	$T_{MAX} = 17.0$									
$d_{MAX} = 5.6$	$d_{MAX} = 7.9$	inches								
Max. Allowable Depth at Gutter Flowline for Minor & Major Storm										
Check boxes are not applicable in SUMP conditions	<input type="checkbox"/> <input type="checkbox"/>									

Maximum Capacity for 1/2 Street based On Allowable Spread	
Water Depth without Gutter Depression (Eq. ST-2)	$y = 4.08$ inches
Vertical Depth between Gutter Lip and Gutter Flowline (usually 2")	$d_c = 2.0$ inches
Gutter Depression ($d_c - (W * S_x * 12)$)	$a = 1.51$ inches
Water Depth at Gutter Flowline	$d = 5.59$ inches
Allowable Spread for Discharge outside the Gutter Section W (T - W)	$T_x = 15.0$ ft
Gutter Flow to Design Flow Ratio by FHWA HEC-22 method (Eq. ST-7)	$E_o = 0.350$
Discharge outside the Gutter Section W, carried in Section T_x	$Q_x = 0.0$ cfs
Discharge within the Gutter Section W ($Q_t - Q_x$)	$Q_w = 0.0$ cfs
Discharge Behind the Curb (e.g., sidewalk, driveways, & lawns)	$Q_{BACK} = 0.0$ cfs
Maximum Flow Based On Allowable Spread	$Q_t = \text{SUMP}$ cfs
Flow Velocity within the Gutter Section	$V = 0.0$ fps
$V*d$ Product: Flow Velocity times Gutter Flowline Depth	$V*d = 0.0$

Maximum Capacity for 1/2 Street based on Allowable Depth	
Theoretical Water Spread	$T_{TH} = 17.0$ ft
Theoretical Spread for Discharge outside the Gutter Section W (T - W)	$T_{XTH} = 15.0$ ft
Gutter Flow to Design Flow Ratio by FHWA HEC-22 method (Eq. ST-7)	$E_o = 0.349$
Theoretical Discharge outside the Gutter Section W, carried in Section T_{XTH}	$Q_{XTH} = 0.0$ cfs
Actual Discharge outside the Gutter Section W, (limited by distance T_{CROWN})	$Q_x = 0.0$ cfs
Discharge within the Gutter Section W ($Q_d - Q_x$)	$Q_w = 0.0$ cfs
Discharge Behind the Curb (e.g., sidewalk, driveways, & lawns)	$Q_{BACK} = 0.0$ cfs
Total Discharge for Major & Minor Storm (Pre-Safety Factor)	$Q = 0.0$ cfs
Average Flow Velocity Within the Gutter Section	$V = 0.0$ fps
$V*d$ Product: Flow Velocity Times Gutter Flowline Depth	$V*d = 0.0$
Slope-Based Depth Safety Reduction Factor for Major & Minor ($d \geq 6"$) Storm	$R = \text{SUMP}$
Max Flow Based on Allowable Depth (Safety Factor Applied)	$Q_d = \text{SUMP}$ cfs
Resultant Flow Depth at Gutter Flowline (Safety Factor Applied)	$d =$ inches
Resultant Flow Depth at Street Crown (Safety Factor Applied)	$d_{CROWN} =$ inches

MINOR STORM Allowable Capacity is based on Depth Criterion	
MAJOR STORM Allowable Capacity is based on Depth Criterion	$Q_{ALLOW} = \text{SUMP}$ cfs

INLET IN A SUMP OR SAG LOCATION

Version 4.05 Released March 2017

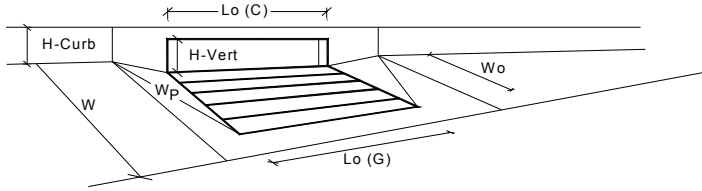

Design Information (Input)	MINOR MAJOR	
Type of Inlet	CDOT Type R Curb Opening	
Local Depression (additional to continuous gutter depression 'a' from above)	Type =	CDOT Type R Curb Opening
Number of Unit Inlets (Grate or Curb Opening)	a_{local} =	3.00 3.00 inches
Water Depth at Flowline (outside of local depression)	No =	1 1
Grate Information	Ponding Depth =	5.2 7.0 inches
Length of a Unit Grate		<input checked="" type="checkbox"/> Override Depths
Width of a Unit Grate	L_o (G) =	MINOR: N/A MAJOR: N/A feet
Area Opening Ratio for a Grate (typical values 0.15-0.90)	W_o =	N/A N/A feet
Clogging Factor for a Single Grate (typical value 0.50 - 0.70)	A_{ratio} =	N/A N/A
Grate Weir Coefficient (typical value 2.15 - 3.60)	C_r (G) =	N/A N/A
Grate Orifice Coefficient (typical value 0.60 - 0.80)	C_w (G) =	N/A N/A
Curb Opening Information	C_o (G) =	N/A N/A
Length of a Unit Curb Opening		<input checked="" type="checkbox"/> Override Depths
Height of Vertical Curb Opening in Inches	L_o (C) =	MINOR: 10.00 MAJOR: 10.00 feet
Height of Curb Orifice Throat in Inches	H_{vert} =	6.00 6.00 inches
Angle of Throat (see USDCM Figure ST-5)	H_{throat} =	6.00 6.00 inches
Side Width for Depression Pan (typically the gutter width of 2 feet)	Theta =	63.40 63.40 degrees
Clogging Factor for a Single Curb Opening (typical value 0.10)	W_p =	2.00 2.00 feet
Curb Opening Weir Coefficient (typical value 2.3-3.7)	C_r (C) =	0.10 0.10
Curb Opening Orifice Coefficient (typical value 0.60 - 0.70)	C_w (C) =	3.60 3.60
Low Head Performance Reduction (Calculated)	C_o (C) =	0.67 0.67
Depth for Grate Midwidth		
Depth for Curb Opening Weir Equation	d_{grate} =	MINOR: N/A MAJOR: N/A ft
Combination Inlet Performance Reduction Factor for Long Inlets	d_{curb} =	0.27 0.42 ft
Curb Opening Performance Reduction Factor for Long Inlets	RF _{Combination} =	0.49 0.66
Grated Inlet Performance Reduction Factor for Long Inlets	RF _{Curb} =	0.88 0.99
	RF _{Grate} =	N/A N/A
Total Inlet Interception Capacity (assumes clogged condition)		
Inlet Capacity IS GOOD for Minor and Major Storms(>Q PEAK)	Q_a =	MINOR: 5.6 MAJOR: 12.2 cfs
	$Q_{PEAK\ REQUIRED}$ =	5.6 12.2 cfs

ALLOWABLE CAPACITY FOR ONE-HALF OF STREET (Minor & Major Storm)

(Based on Regulated Criteria for Maximum Allowable Flow Depth and Spread)

Project: The Ridge at Lorson Ranch, #100.064
 Inlet ID: Inlet DP-2

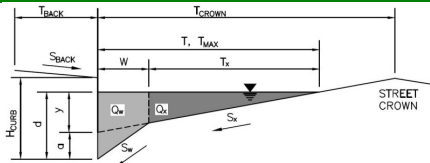

Gutter Geometry (Enter data in the blue cells)													
Maximum Allowable Width for Spread Behind Curb	$T_{BACK} = $ <input style="width: 50px;" type="text" value="8.0"/> ft												
Side Slope Behind Curb (leave blank for no conveyance credit behind curb)	$S_{BACK} = $ <input style="width: 50px;" type="text" value="0.020"/> ft/ft												
Manning's Roughness Behind Curb (typically between 0.012 and 0.020)	$n_{BACK} = $ <input style="width: 50px;" type="text" value="0.015"/>												
Height of Curb at Gutter Flow Line	$H_{CURB} = $ <input style="width: 50px;" type="text" value="6.00"/> inches												
Distance from Curb Face to Street Crown	$T_{CROWN} = $ <input style="width: 50px;" type="text" value="17.0"/> ft												
Gutter Width	$W = $ <input style="width: 50px;" type="text" value="2.00"/> ft												
Street Transverse Slope	$S_X = $ <input style="width: 50px;" type="text" value="0.020"/> ft/ft												
Gutter Cross Slope (typically 2 inches over 24 inches or 0.083 ft/ft)	$S_W = $ <input style="width: 50px;" type="text" value="0.083"/> ft/ft												
Street Longitudinal Slope - Enter 0 for sump condition	$S_O = $ <input style="width: 50px;" type="text" value="0.000"/> ft/ft												
Manning's Roughness for Street Section (typically between 0.012 and 0.020)	$n_{STREET} = $ <input style="width: 50px;" type="text" value="0.017"/>												
Max. Allowable Spread for Minor & Major Storm	<table style="width: 100%; border-collapse: collapse;"> <thead> <tr> <th style="width: 50%;"></th> <th style="width: 25%; text-align: center;">Minor Storm</th> <th style="width: 25%; text-align: center;">Major Storm</th> <th style="width: 10%;"></th> </tr> </thead> <tbody> <tr> <td>$T_{MAX} =$</td> <td style="text-align: center;"><input style="width: 40px;" type="text" value="17.0"/></td> <td style="text-align: center;"><input style="width: 40px;" type="text" value="17.0"/></td> <td style="text-align: right;">ft</td> </tr> <tr> <td>$d_{MAX} =$</td> <td style="text-align: center;"><input style="width: 40px;" type="text" value="5.6"/></td> <td style="text-align: center;"><input style="width: 40px;" type="text" value="7.9"/></td> <td style="text-align: right;">inches</td> </tr> </tbody> </table>		Minor Storm	Major Storm		$T_{MAX} = $	<input style="width: 40px;" type="text" value="17.0"/>	<input style="width: 40px;" type="text" value="17.0"/>	ft	$d_{MAX} = $	<input style="width: 40px;" type="text" value="5.6"/>	<input style="width: 40px;" type="text" value="7.9"/>	inches
	Minor Storm	Major Storm											
$T_{MAX} = $	<input style="width: 40px;" type="text" value="17.0"/>	<input style="width: 40px;" type="text" value="17.0"/>	ft										
$d_{MAX} = $	<input style="width: 40px;" type="text" value="5.6"/>	<input style="width: 40px;" type="text" value="7.9"/>	inches										
Max. Allowable Depth at Gutter Flowline for Minor & Major Storm													
Check boxes are not applicable in SUMP conditions	<table style="width: 100%; border-collapse: collapse;"> <tr> <td style="width: 50%; text-align: center;"><input type="checkbox"/></td> <td style="width: 50%; text-align: center;"><input type="checkbox"/></td> </tr> </table>	<input type="checkbox"/>	<input type="checkbox"/>										
<input type="checkbox"/>	<input type="checkbox"/>												
MINOR STORM Allowable Capacity is based on Depth Criterion													
MAJOR STORM Allowable Capacity is based on Depth Criterion	<table style="width: 100%; border-collapse: collapse;"> <thead> <tr> <th style="width: 50%;"></th> <th style="width: 25%; text-align: center;">Minor Storm</th> <th style="width: 25%; text-align: center;">Major Storm</th> <th style="width: 10%;"></th> </tr> </thead> <tbody> <tr> <td>$Q_{allow} =$</td> <td style="text-align: center;"><input style="width: 40px;" type="text" value="SUMP"/></td> <td style="text-align: center;"><input style="width: 40px;" type="text" value="SUMP"/></td> <td style="text-align: right;">cfs</td> </tr> </tbody> </table>		Minor Storm	Major Storm		$Q_{allow} = $	<input style="width: 40px;" type="text" value="SUMP"/>	<input style="width: 40px;" type="text" value="SUMP"/>	cfs				
	Minor Storm	Major Storm											
$Q_{allow} = $	<input style="width: 40px;" type="text" value="SUMP"/>	<input style="width: 40px;" type="text" value="SUMP"/>	cfs										

INLET IN A SUMP OR SAG LOCATION

Version 4.05 Released March 2017

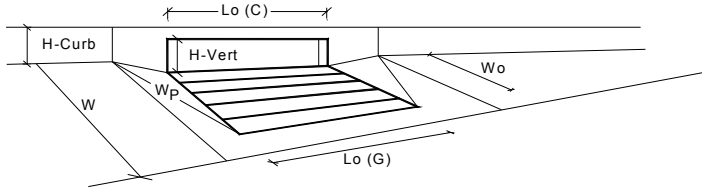

Design Information (Input)	MINOR	MAJOR	
Type of Inlet	CDOT Type R Curb Opening		
Local Depression (additional to continuous gutter depression 'a' from above)	3.00	3.00	inches
Number of Unit Inlets (Grate or Curb Opening)	1	1	
Water Depth at Flowline (outside of local depression)	4.6	6.3	inches
Grate Information	MINOR	MAJOR	<input checked="" type="checkbox"/> Override Depths
Length of a Unit Grate	N/A	N/A	feet
Width of a Unit Grate	N/A	N/A	feet
Area Opening Ratio for a Grate (typical values 0.15-0.90)	N/A	N/A	
Clogging Factor for a Single Grate (typical value 0.50 - 0.70)	N/A	N/A	
Grate Weir Coefficient (typical value 2.15 - 3.60)	N/A	N/A	
Grate Orifice Coefficient (typical value 0.60 - 0.80)	N/A	N/A	
Curb Opening Information	MINOR	MAJOR	
Length of a Unit Curb Opening	5.00	5.00	feet
Height of Vertical Curb Opening in Inches	6.00	6.00	inches
Height of Curb Orifice Throat in Inches	6.00	6.00	inches
Angle of Throat (see USDCM Figure ST-5)	63.40	63.40	degrees
Side Width for Depression Pan (typically the gutter width of 2 feet)	2.00	2.00	feet
Clogging Factor for a Single Curb Opening (typical value 0.10)	0.10	0.10	
Curb Opening Weir Coefficient (typical value 2.3-3.7)	3.60	3.60	
Curb Opening Orifice Coefficient (typical value 0.60 - 0.70)	0.67	0.67	
Low Head Performance Reduction (Calculated)	MINOR	MAJOR	
Depth for Grate Midwidth	N/A	N/A	ft
Depth for Curb Opening Weir Equation	0.21	0.36	ft
Combination Inlet Performance Reduction Factor for Long Inlets	0.58	0.80	
Curb Opening Performance Reduction Factor for Long Inlets	1.00	1.00	
Grated Inlet Performance Reduction Factor for Long Inlets	N/A	N/A	
Total Inlet Interception Capacity (assumes clogged condition)	MINOR	MAJOR	
Q_a	2.7	5.9	cfs
Q _{PEAK REQUIRED}	2.7	5.9	cfs

Inlet Capacity IS GOOD for Minor and Major Storms(>Q PEAK)

ALLOWABLE CAPACITY FOR ONE-HALF OF STREET (Minor & Major Storm)

(Based on Regulated Criteria for Maximum Allowable Flow Depth and Spread)

Project: The Ridge at Lorson Ranch, #100.064
 Inlet ID: Inlet DP-4



Gutter Geometry (Enter data in the blue cells)							
Maximum Allowable Width for Spread Behind Curb	$T_{BACK} = 10.0$ ft						
Side Slope Behind Curb (leave blank for no conveyance credit behind curb)	$S_{BACK} = 0.020$ ft/ft						
Manning's Roughness Behind Curb (typically between 0.012 and 0.020)	$n_{BACK} = 0.015$						
Height of Curb at Gutter Flow Line	$H_{CURB} = 6.00$ inches						
Distance from Curb Face to Street Crown	$T_{CROWN} = 22.0$ ft						
Gutter Width	$W = 2.00$ ft						
Street Transverse Slope	$S_x = 0.020$ ft/ft						
Gutter Cross Slope (typically 2 inches over 24 inches or 0.083 ft/ft)	$S_w = 0.083$ ft/ft						
Street Longitudinal Slope - Enter 0 for sump condition	$S_o = 0.026$ ft/ft						
Manning's Roughness for Street Section (typically between 0.012 and 0.020)	$n_{STREET} = 0.017$						
Max. Allowable Spread for Minor & Major Storm	<table border="1"> <thead> <tr> <th>Minor Storm</th> <th>Major Storm</th> <th>ft</th> </tr> </thead> <tbody> <tr> <td>$T_{MAX} = 22.0$</td> <td>$T_{MAX} = 22.0$</td> <td></td> </tr> </tbody> </table>	Minor Storm	Major Storm	ft	$T_{MAX} = 22.0$	$T_{MAX} = 22.0$	
Minor Storm	Major Storm	ft					
$T_{MAX} = 22.0$	$T_{MAX} = 22.0$						
Max. Allowable Depth at Gutter Flowline for Minor & Major Storm	<table border="1"> <thead> <tr> <th>Minor Storm</th> <th>Major Storm</th> <th>inches</th> </tr> </thead> <tbody> <tr> <td>$d_{MAX} = 6.0$</td> <td>$d_{MAX} = 8.4$</td> <td></td> </tr> </tbody> </table>	Minor Storm	Major Storm	inches	$d_{MAX} = 6.0$	$d_{MAX} = 8.4$	
Minor Storm	Major Storm	inches					
$d_{MAX} = 6.0$	$d_{MAX} = 8.4$						
Allow Flow Depth at Street Crown (leave blank for no)	<input type="checkbox"/> Minor Storm <input checked="" type="checkbox"/> Major Storm check = yes						
MINOR STORM Allowable Capacity is based on Depth Criterion							
MAJOR STORM Allowable Capacity is based on Depth Criterion							
Minor storm max. allowable capacity GOOD - greater than the design flow given on sheet 'Inlet Management'	<table border="1"> <thead> <tr> <th>Minor Storm</th> <th>Major Storm</th> <th>cfs</th> </tr> </thead> <tbody> <tr> <td>$Q_{allow} = 17.5$</td> <td>$Q_{allow} = 44.5$</td> <td></td> </tr> </tbody> </table>	Minor Storm	Major Storm	cfs	$Q_{allow} = 17.5$	$Q_{allow} = 44.5$	
Minor Storm	Major Storm	cfs					
$Q_{allow} = 17.5$	$Q_{allow} = 44.5$						
Major storm max. allowable capacity GOOD - greater than the design flow given on sheet 'Inlet Management'							

INLET ON A CONTINUOUS GRADE

Version 4.05 Released March 2017

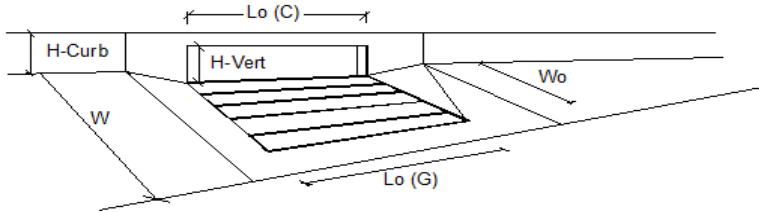

Design Information (Input)	MINOR	MAJOR	
Type of Inlet	CDOT Type R Curb Opening		
Local Depression (additional to continuous gutter depression 'a')	3.0	3.0	inches
Total Number of Units in the Inlet (Grate or Curb Opening)	1	1	
Length of a Single Unit Inlet (Grate or Curb Opening)	20.00	20.00	ft
Width of a Unit Grate (cannot be greater than W, Gutter Width)	N/A	N/A	ft
Clogging Factor for a Single Unit Grate (typical min. value = 0.5)	N/A	N/A	
Clogging Factor for a Single Unit Curb Opening (typical min. value = 0.1)	0.10	0.10	
Street Hydraulics: OK - Q < Allowable Street Capacity			
Design Discharge for Half of Street (from Sheet Inlet Management)	8.9	21.6	cfs
Water Spread Width	13.3	19.0	ft
Water Depth at Flowline (outside of local depression)	4.7	6.1	inches
Water Depth at Street Crown (or at T _{MAX})	0.0	0.0	inches
Ratio of Gutter Flow to Design Flow	0.448	0.312	
Discharge outside the Gutter Section W, carried in Section T _x	4.9	14.9	cfs
Discharge within the Gutter Section W	4.0	6.7	cfs
Discharge Behind the Curb Face	0.0	0.0	cfs
Flow Area within the Gutter Section W	0.62	0.85	sq ft
Velocity within the Gutter Section W	6.5	8.0	fps
Water Depth for Design Condition	7.7	9.1	inches
Grate Analysis (Calculated)			
Total Length of Inlet Grate Opening	N/A	N/A	ft
Ratio of Grate Flow to Design Flow	N/A	N/A	
Under No-Clogging Condition			
Minimum Velocity Where Grate Splash-Over Begins	N/A	N/A	fps
Interception Rate of Frontal Flow	N/A	N/A	
Interception Rate of Side Flow	N/A	N/A	
Interception Capacity	N/A	N/A	cfs
Under Clogging Condition			
Clogging Coefficient for Multiple-unit Grate Inlet	N/A	N/A	
Clogging Factor for Multiple-unit Grate Inlet	N/A	N/A	
Effective (unclogged) Length of Multiple-unit Grate Inlet	N/A	N/A	ft
Minimum Velocity Where Grate Splash-Over Begins	N/A	N/A	fps
Interception Rate of Frontal Flow	N/A	N/A	
Interception Rate of Side Flow	N/A	N/A	
Actual Interception Capacity	N/A	N/A	cfs
Carry-Over Flow = Q _o - Q _a (to be applied to curb opening or next d/s inlet)	N/A	N/A	cfs
Curb or Slotted Inlet Opening Analysis (Calculated)			
Equivalent Slope S _e (based on grate carry-over)	0.104	0.079	ft/ft
Required Length L _T to Have 100% Interception	17.27	30.89	ft
Under No-Clogging Condition			
Effective Length of Curb Opening or Slotted Inlet (minimum of L, L _T)	17.27	20.00	ft
Interception Capacity	8.9	18.3	cfs
Under Clogging Condition			
Clogging Coefficient	1.33	1.33	
Clogging Factor for Multiple-unit Curb Opening or Slotted Inlet	0.03	0.03	
Effective (Unclogged) Length	17.34	17.34	ft
Actual Interception Capacity	8.9	18.0	cfs
Carry-Over Flow = Q _{b(GRATE)} - Q _a	0.0	3.6	cfs
Summary			
Total Inlet Interception Capacity	8.9	18.0	cfs
Total Inlet Carry-Over Flow (flow bypassing inlet)	0.0	3.6	cfs
Capture Percentage = Q _a /Q _o =	100	83	%

ALLOWABLE CAPACITY FOR ONE-HALF OF STREET (Minor & Major Storm)

(Based on Regulated Criteria for Maximum Allowable Flow Depth and Spread)

Project: The Ridge at Lorson Ranch, #100.064
 Inlet ID: Inlet DP-6



Gutter Geometry (Enter data in the blue cells)													
Maximum Allowable Width for Spread Behind Curb	$T_{BACK} = 10.0$ ft												
Side Slope Behind Curb (leave blank for no conveyance credit behind curb)	$S_{BACK} = 0.020$ ft/ft												
Manning's Roughness Behind Curb (typically between 0.012 and 0.020)	$n_{BACK} = 0.015$												
Height of Curb at Gutter Flow Line	$H_{CURB} = 6.00$ inches												
Distance from Curb Face to Street Crown	$T_{CROWN} = 22.0$ ft												
Gutter Width	$W = 2.00$ ft												
Street Transverse Slope	$S_X = 0.020$ ft/ft												
Gutter Cross Slope (typically 2 inches over 24 inches or 0.083 ft/ft)	$S_W = 0.083$ ft/ft												
Street Longitudinal Slope - Enter 0 for sump condition	$S_O = 0.025$ ft/ft												
Manning's Roughness for Street Section (typically between 0.012 and 0.020)	$n_{STREET} = 0.017$												
Max. Allowable Spread for Minor & Major Storm	<table border="1"> <thead> <tr> <th></th> <th>Minor Storm</th> <th>Major Storm</th> <th></th> </tr> </thead> <tbody> <tr> <td>$T_{MAX} =$</td> <td>18.5</td> <td>22.0</td> <td>ft</td> </tr> <tr> <td>$d_{MAX} =$</td> <td>6.0</td> <td>8.4</td> <td>inches</td> </tr> </tbody> </table>		Minor Storm	Major Storm		$T_{MAX} =$	18.5	22.0	ft	$d_{MAX} =$	6.0	8.4	inches
	Minor Storm	Major Storm											
$T_{MAX} =$	18.5	22.0	ft										
$d_{MAX} =$	6.0	8.4	inches										
Max. Allowable Depth at Gutter Flowline for Minor & Major Storm													
Allow Flow Depth at Street Crown (leave blank for no)	<input type="checkbox"/> <input checked="" type="checkbox"/> check = yes												
MINOR STORM Allowable Capacity is based on Depth Criterion													
MAJOR STORM Allowable Capacity is based on Depth Criterion													
Minor storm max. allowable capacity GOOD - greater than the design flow given on sheet 'Inlet Management'													
Major storm max. allowable capacity GOOD - greater than the design flow given on sheet 'Inlet Management'													
	<table border="1"> <thead> <tr> <th></th> <th>Minor Storm</th> <th>Major Storm</th> <th></th> </tr> </thead> <tbody> <tr> <td>$Q_{allow} =$</td> <td>17.7</td> <td>44.8</td> <td>cfs</td> </tr> </tbody> </table>		Minor Storm	Major Storm		$Q_{allow} =$	17.7	44.8	cfs				
	Minor Storm	Major Storm											
$Q_{allow} =$	17.7	44.8	cfs										

INLET ON A CONTINUOUS GRADE

Version 4.05 Released March 2017

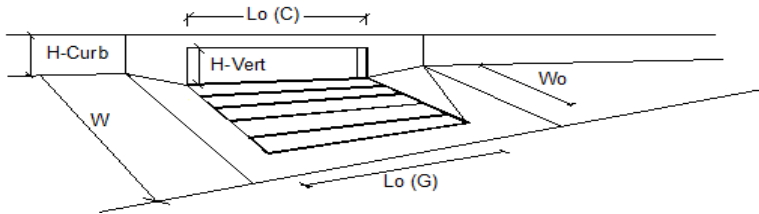

Design Information (Input)	MINOR	MAJOR	
Type of Inlet	CDOT Type R Curb Opening		
Local Depression (additional to continuous gutter depression 'a')	3.0	3.0	inches
Total Number of Units in the Inlet (Grate or Curb Opening)	1	1	
Length of a Single Unit Inlet (Grate or Curb Opening)	10.00	10.00	ft
Width of a Unit Grate (cannot be greater than W, Gutter Width)	N/A	N/A	ft
Clogging Factor for a Single Unit Grate (typical min. value = 0.5)	N/A	N/A	
Clogging Factor for a Single Unit Curb Opening (typical min. value = 0.1)	0.10	0.10	
Street Hydraulics: OK - Q < Allowable Street Capacity*			
Total Inlet Interception Capacity	3.0	5.7	cfs
Total Inlet Carry-Over Flow (flow bypassing inlet)	0.0	0.9	cfs
Capture Percentage = Q_i/Q_c =	100	86	%

ALLOWABLE CAPACITY FOR ONE-HALF OF STREET (Minor & Major Storm)

(Based on Regulated Criteria for Maximum Allowable Flow Depth and Spread)

Project: The Ridge at Lorson Ranch, #100.064
 Inlet ID: Inlet DP-12

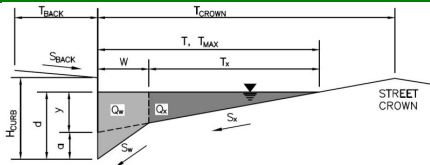

Gutter Geometry (Enter data in the blue cells)													
Maximum Allowable Width for Spread Behind Curb	$T_{BACK} = 8.0$ ft												
Side Slope Behind Curb (leave blank for no conveyance credit behind curb)	$S_{BACK} = 0.020$ ft/ft												
Manning's Roughness Behind Curb (typically between 0.012 and 0.020)	$n_{BACK} = 0.015$												
Height of Curb at Gutter Flow Line	$H_{CURB} = 6.00$ inches												
Distance from Curb Face to Street Crown	$T_{CROWN} = 17.0$ ft												
Gutter Width	$W = 2.00$ ft												
Street Transverse Slope	$S_x = 0.020$ ft/ft												
Gutter Cross Slope (typically 2 inches over 24 inches or 0.083 ft/ft)	$S_w = 0.083$ ft/ft												
Street Longitudinal Slope - Enter 0 for sump condition	$S_o = 0.026$ ft/ft												
Manning's Roughness for Street Section (typically between 0.012 and 0.020)	$n_{STREET} = 0.017$												
Max. Allowable Spread for Minor & Major Storm	<table border="1"> <thead> <tr> <th></th> <th>Minor Storm</th> <th>Major Storm</th> <th></th> </tr> </thead> <tbody> <tr> <td>$T_{MAX} =$</td> <td>17.0</td> <td>17.0</td> <td>ft</td> </tr> <tr> <td>$d_{MAX} =$</td> <td>5.6</td> <td>7.9</td> <td>inches</td> </tr> </tbody> </table>		Minor Storm	Major Storm		$T_{MAX} =$	17.0	17.0	ft	$d_{MAX} =$	5.6	7.9	inches
	Minor Storm	Major Storm											
$T_{MAX} =$	17.0	17.0	ft										
$d_{MAX} =$	5.6	7.9	inches										
Max. Allowable Depth at Gutter Flowline for Minor & Major Storm													
Allow Flow Depth at Street Crown (leave blank for no)	<input type="checkbox"/> <input checked="" type="checkbox"/> check = yes												
MINOR STORM Allowable Capacity is based on Spread Criterion													
MAJOR STORM Allowable Capacity is based on Depth Criterion													
	<table border="1"> <thead> <tr> <th></th> <th>Minor Storm</th> <th>Major Storm</th> <th></th> </tr> </thead> <tbody> <tr> <td>$Q_{allow} =$</td> <td>16.3</td> <td>34.6</td> <td>cfs</td> </tr> </tbody> </table>		Minor Storm	Major Storm		$Q_{allow} =$	16.3	34.6	cfs				
	Minor Storm	Major Storm											
$Q_{allow} =$	16.3	34.6	cfs										
<p>Minor storm max. allowable capacity GOOD - greater than the design flow given on sheet 'Inlet Management'</p> <p>Major storm max. allowable capacity GOOD - greater than the design flow given on sheet 'Inlet Management'</p>													

INLET ON A CONTINUOUS GRADE

Version 4.05 Released March 2017

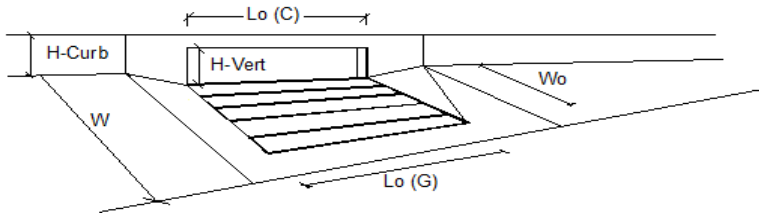

Design Information (Input)	MINOR	MAJOR	
Type of Inlet	CDOT Type R Curb Opening		
Local Depression (additional to continuous gutter depression 'a')	3.0	3.0	inches
Total Number of Units in the Inlet (Grate or Curb Opening)	1	1	
Length of a Single Unit Inlet (Grate or Curb Opening)	15.00	15.00	ft
Width of a Unit Grate (cannot be greater than W, Gutter Width)	N/A	N/A	ft
Clogging Factor for a Single Unit Grate (typical min. value = 0.5)	N/A	N/A	
Clogging Factor for a Single Unit Curb Opening (typical min. value = 0.1)	0.10	0.10	
Street Hydraulics: OK - Q < Allowable Street Capacity*			
Total Inlet Interception Capacity	9.3	14.8	cfs
Total Inlet Carry-Over Flow (flow bypassing inlet)	0.6	7.0	cfs
Capture Percentage = Q_i/Q_c =	94	68	%

ALLOWABLE CAPACITY FOR ONE-HALF OF STREET (Minor & Major Storm)

(Based on Regulated Criteria for Maximum Allowable Flow Depth and Spread)

Project: The Ridge at Lorson Ranch, #100.064
 Inlet ID: Inlet DP-13

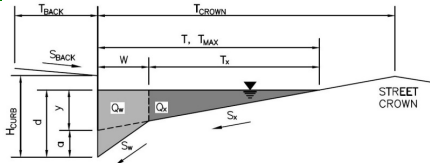

Gutter Geometry (Enter data in the blue cells)							
Maximum Allowable Width for Spread Behind Curb	$T_{BACK} = $ <input style="width: 50px;" type="text" value="8.0"/> ft						
Side Slope Behind Curb (leave blank for no conveyance credit behind curb)	$S_{BACK} = $ <input style="width: 50px;" type="text" value="0.020"/> ft/ft						
Manning's Roughness Behind Curb (typically between 0.012 and 0.020)	$n_{BACK} = $ <input style="width: 50px;" type="text" value="0.015"/>						
Height of Curb at Gutter Flow Line	$H_{CURB} = $ <input style="width: 50px;" type="text" value="6.00"/> inches						
Distance from Curb Face to Street Crown	$T_{CROWN} = $ <input style="width: 50px;" type="text" value="17.0"/> ft						
Gutter Width	$W = $ <input style="width: 50px;" type="text" value="2.00"/> ft						
Street Transverse Slope	$S_x = $ <input style="width: 50px;" type="text" value="0.020"/> ft/ft						
Gutter Cross Slope (typically 2 inches over 24 inches or 0.083 ft/ft)	$S_w = $ <input style="width: 50px;" type="text" value="0.083"/> ft/ft						
Street Longitudinal Slope - Enter 0 for sump condition	$S_o = $ <input style="width: 50px;" type="text" value="0.022"/> ft/ft						
Manning's Roughness for Street Section (typically between 0.012 and 0.020)	$n_{STREET} = $ <input style="width: 50px;" type="text" value="0.017"/>						
Max. Allowable Spread for Minor & Major Storm	<table border="1" style="display: inline-table; border-collapse: collapse;"> <tr> <th style="padding: 2px;">Minor Storm</th> <th style="padding: 2px;">Major Storm</th> <th style="padding: 2px;">ft</th> </tr> <tr> <td style="text-align: center;"><input style="width: 40px;" type="text" value="17.0"/></td> <td style="text-align: center;"><input style="width: 40px;" type="text" value="17.0"/></td> <td></td> </tr> </table>	Minor Storm	Major Storm	ft	<input style="width: 40px;" type="text" value="17.0"/>	<input style="width: 40px;" type="text" value="17.0"/>	
Minor Storm	Major Storm	ft					
<input style="width: 40px;" type="text" value="17.0"/>	<input style="width: 40px;" type="text" value="17.0"/>						
Max. Allowable Depth at Gutter Flowline for Minor & Major Storm	<table border="1" style="display: inline-table; border-collapse: collapse;"> <tr> <th style="padding: 2px;">Minor Storm</th> <th style="padding: 2px;">Major Storm</th> <th style="padding: 2px;">inches</th> </tr> <tr> <td style="text-align: center;"><input style="width: 40px;" type="text" value="5.6"/></td> <td style="text-align: center;"><input style="width: 40px;" type="text" value="7.9"/></td> <td></td> </tr> </table>	Minor Storm	Major Storm	inches	<input style="width: 40px;" type="text" value="5.6"/>	<input style="width: 40px;" type="text" value="7.9"/>	
Minor Storm	Major Storm	inches					
<input style="width: 40px;" type="text" value="5.6"/>	<input style="width: 40px;" type="text" value="7.9"/>						
Allow Flow Depth at Street Crown (leave blank for no)	<input type="checkbox"/> <input checked="" type="checkbox"/> check = yes						
MINOR STORM Allowable Capacity is based on Spread Criterion							
MAJOR STORM Allowable Capacity is based on Depth Criterion							
Minor storm max. allowable capacity GOOD - greater than the design flow given on sheet 'Inlet Management'	<table border="1" style="display: inline-table; border-collapse: collapse;"> <tr> <th style="padding: 2px;">Minor Storm</th> <th style="padding: 2px;">Major Storm</th> <th style="padding: 2px;">cfs</th> </tr> <tr> <td style="text-align: center;"><input style="width: 40px;" type="text" value="15.2"/></td> <td style="text-align: center;"><input style="width: 40px;" type="text" value="36.0"/></td> <td></td> </tr> </table>	Minor Storm	Major Storm	cfs	<input style="width: 40px;" type="text" value="15.2"/>	<input style="width: 40px;" type="text" value="36.0"/>	
Minor Storm	Major Storm	cfs					
<input style="width: 40px;" type="text" value="15.2"/>	<input style="width: 40px;" type="text" value="36.0"/>						
Major storm max. allowable capacity GOOD - greater than the design flow given on sheet 'Inlet Management'							

INLET ON A CONTINUOUS GRADE

Version 4.05 Released March 2017

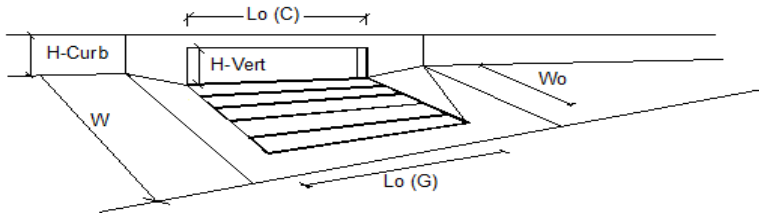

Design Information (Input)	MINOR	MAJOR	
Type of Inlet	CDOT Type R Curb Opening		
Local Depression (additional to continuous gutter depression 'a')	3.0	3.0	inches
Total Number of Units in the Inlet (Grate or Curb Opening)	1	1	
Length of a Single Unit Inlet (Grate or Curb Opening)	15.00	15.00	ft
Width of a Unit Grate (cannot be greater than W, Gutter Width)	N/A	N/A	ft
Clogging Factor for a Single Unit Grate (typical min. value = 0.5)	N/A	N/A	
Clogging Factor for a Single Unit Curb Opening (typical min. value = 0.1)	0.10	0.10	
Street Hydraulics: OK - Q < Allowable Street Capacity*			
Total Inlet Interception Capacity	8.3	15.6	cfs
Total Inlet Carry-Over Flow (flow bypassing inlet)	0.2	8.7	cfs
Capture Percentage = Q_i/Q_c =	97	64	%

ALLOWABLE CAPACITY FOR ONE-HALF OF STREET (Minor & Major Storm)

(Based on Regulated Criteria for Maximum Allowable Flow Depth and Spread)

Project: The Ridge at Lorson Ranch, #100.064
 Inlet ID: Inlet DP-15



Gutter Geometry (Enter data in the blue cells)													
Maximum Allowable Width for Spread Behind Curb	$T_{BACK} = 8.0$ ft												
Side Slope Behind Curb (leave blank for no conveyance credit behind curb)	$S_{BACK} = 0.020$ ft/ft												
Manning's Roughness Behind Curb (typically between 0.012 and 0.020)	$n_{BACK} = 0.015$												
Height of Curb at Gutter Flow Line	$H_{CURB} = 6.00$ inches												
Distance from Curb Face to Street Crown	$T_{CROWN} = 17.0$ ft												
Gutter Width	$W = 2.00$ ft												
Street Transverse Slope	$S_X = 0.020$ ft/ft												
Gutter Cross Slope (typically 2 inches over 24 inches or 0.083 ft/ft)	$S_W = 0.083$ ft/ft												
Street Longitudinal Slope - Enter 0 for sump condition	$S_O = 0.019$ ft/ft												
Manning's Roughness for Street Section (typically between 0.012 and 0.020)	$n_{STREET} = 0.017$												
Max. Allowable Spread for Minor & Major Storm	<table border="1"> <thead> <tr> <th></th> <th>Minor Storm</th> <th>Major Storm</th> <th></th> </tr> </thead> <tbody> <tr> <td>$T_{MAX} =$</td> <td>17.0</td> <td>17.0</td> <td>ft</td> </tr> <tr> <td>$d_{MAX} =$</td> <td>5.6</td> <td>7.9</td> <td>inches</td> </tr> </tbody> </table>		Minor Storm	Major Storm		$T_{MAX} =$	17.0	17.0	ft	$d_{MAX} =$	5.6	7.9	inches
	Minor Storm	Major Storm											
$T_{MAX} =$	17.0	17.0	ft										
$d_{MAX} =$	5.6	7.9	inches										
Max. Allowable Depth at Gutter Flowline for Minor & Major Storm													
Allow Flow Depth at Street Crown (leave blank for no)	<input type="checkbox"/> <input checked="" type="checkbox"/> check = yes												
MINOR STORM Allowable Capacity is based on Spread Criterion													
MAJOR STORM Allowable Capacity is based on Depth Criterion													
Minor storm max. allowable capacity GOOD - greater than the design flow given on sheet 'Inlet Management'	<table border="1"> <thead> <tr> <th></th> <th>Minor Storm</th> <th>Major Storm</th> <th></th> </tr> </thead> <tbody> <tr> <td>$Q_{allow} =$</td> <td>14.1</td> <td>37.8</td> <td>cfs</td> </tr> </tbody> </table>		Minor Storm	Major Storm		$Q_{allow} =$	14.1	37.8	cfs				
	Minor Storm	Major Storm											
$Q_{allow} =$	14.1	37.8	cfs										
Major storm max. allowable capacity GOOD - greater than the design flow given on sheet 'Inlet Management'													

INLET ON A CONTINUOUS GRADE

Version 4.05 Released March 2017

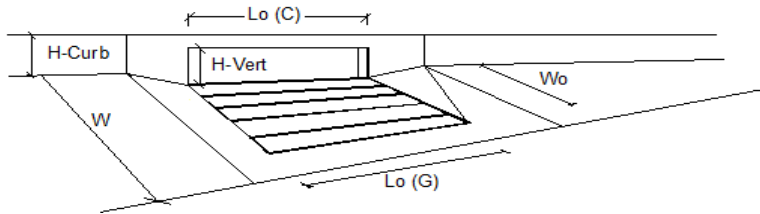

Design Information (Input)	MINOR	MAJOR	
Type of Inlet	CDOT Type R Curb Opening		
Local Depression (additional to continuous gutter depression 'a')	3.0	3.0	inches
Total Number of Units in the Inlet (Grate or Curb Opening)	1	1	
Length of a Single Unit Inlet (Grate or Curb Opening)	15.00	15.00	ft
Width of a Unit Grate (cannot be greater than W, Gutter Width)	N/A	N/A	ft
Clogging Factor for a Single Unit Grate (typical min. value = 0.5)	N/A	N/A	
Clogging Factor for a Single Unit Curb Opening (typical min. value = 0.1)	0.10	0.10	
Street Hydraulics: OK - Q < Allowable Street Capacity			
Total Inlet Interception Capacity	8.4	16.5	cfs
Total Inlet Carry-Over Flow (flow bypassing inlet)	0.3	10.8	cfs
Capture Percentage = Q_i/Q_c =	97	60	%

ALLOWABLE CAPACITY FOR ONE-HALF OF STREET (Minor & Major Storm)

(Based on Regulated Criteria for Maximum Allowable Flow Depth and Spread)

Project: The Ridge at Lorson Ranch, #100.064
 Inlet ID: Inlet DP-17

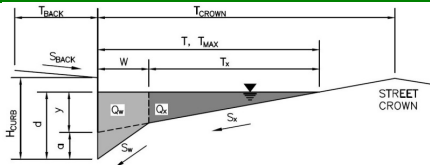

Gutter Geometry (Enter data in the blue cells)							
Maximum Allowable Width for Spread Behind Curb	$T_{BACK} = 8.0$ ft						
Side Slope Behind Curb (leave blank for no conveyance credit behind curb)	$S_{BACK} = 0.020$ ft/ft						
Manning's Roughness Behind Curb (typically between 0.012 and 0.020)	$n_{BACK} = 0.015$						
Height of Curb at Gutter Flow Line	$H_{CURB} = 6.00$ inches						
Distance from Curb Face to Street Crown	$T_{CROWN} = 17.0$ ft						
Gutter Width	$W = 2.00$ ft						
Street Transverse Slope	$S_x = 0.020$ ft/ft						
Gutter Cross Slope (typically 2 inches over 24 inches or 0.083 ft/ft)	$S_w = 0.083$ ft/ft						
Street Longitudinal Slope - Enter 0 for sump condition	$S_o = 0.034$ ft/ft						
Manning's Roughness for Street Section (typically between 0.012 and 0.020)	$n_{STREET} = 0.017$						
Max. Allowable Spread for Minor & Major Storm	<table border="1"> <tr> <th>Minor Storm</th> <th>Major Storm</th> <th>ft</th> </tr> <tr> <td>$T_{MAX} = 17.0$</td> <td>$T_{MAX} = 17.0$</td> <td></td> </tr> </table>	Minor Storm	Major Storm	ft	$T_{MAX} = 17.0$	$T_{MAX} = 17.0$	
Minor Storm	Major Storm	ft					
$T_{MAX} = 17.0$	$T_{MAX} = 17.0$						
Max. Allowable Depth at Gutter Flowline for Minor & Major Storm	<table border="1"> <tr> <th>Minor Storm</th> <th>Major Storm</th> <th>inches</th> </tr> <tr> <td>$d_{MAX} = 5.6$</td> <td>$d_{MAX} = 7.9$</td> <td></td> </tr> </table>	Minor Storm	Major Storm	inches	$d_{MAX} = 5.6$	$d_{MAX} = 7.9$	
Minor Storm	Major Storm	inches					
$d_{MAX} = 5.6$	$d_{MAX} = 7.9$						
Allow Flow Depth at Street Crown (leave blank for no)	<input type="checkbox"/> Minor Storm <input checked="" type="checkbox"/> Major Storm check = yes						
MINOR STORM Allowable Capacity is based on Depth Criterion							
MAJOR STORM Allowable Capacity is based on Depth Criterion							
Minor storm max. allowable capacity GOOD - greater than the design flow given on sheet 'Inlet Management'	<table border="1"> <tr> <th>Minor Storm</th> <th>Major Storm</th> <th>cfs</th> </tr> <tr> <td>$Q_{allow} = 16.0$</td> <td>$Q_{allow} = 31.6$</td> <td></td> </tr> </table>	Minor Storm	Major Storm	cfs	$Q_{allow} = 16.0$	$Q_{allow} = 31.6$	
Minor Storm	Major Storm	cfs					
$Q_{allow} = 16.0$	$Q_{allow} = 31.6$						
Major storm max. allowable capacity GOOD - greater than the design flow given on sheet 'Inlet Management'							

INLET ON A CONTINUOUS GRADE

Version 4.05 Released March 2017

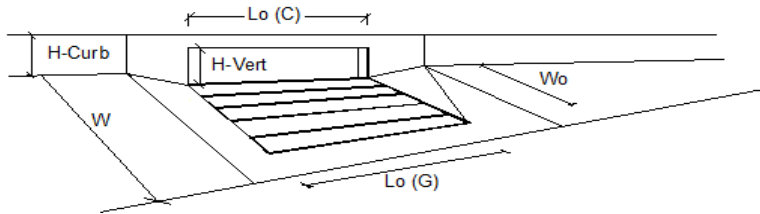

Design Information (Input)	MINOR	MAJOR	
Type of Inlet	CDOT Type R Curb Opening		
Local Depression (additional to continuous gutter depression 'a')	3.0	3.0	inches
Total Number of Units in the Inlet (Grate or Curb Opening)	1	1	
Length of a Single Unit Inlet (Grate or Curb Opening)	20.00	20.00	ft
Width of a Unit Grate (cannot be greater than W, Gutter Width)	N/A	N/A	ft
Clogging Factor for a Single Unit Grate (typical min. value = 0.5)	N/A	N/A	
Clogging Factor for a Single Unit Curb Opening (typical min. value = 0.1)	0.10	0.10	
Street Hydraulics: OK - Q < Allowable Street Capacity			
Total Inlet Interception Capacity	7.5	20.4	cfs
Total Inlet Carry-Over Flow (flow bypassing inlet)	0.0	6.3	cfs
Capture Percentage = Q_i/Q_c =	100	77	%

ALLOWABLE CAPACITY FOR ONE-HALF OF STREET (Minor & Major Storm)

(Based on Regulated Criteria for Maximum Allowable Flow Depth and Spread)

Project: The Ridge at Lorson Ranch, #100.064
 Inlet ID: Inlet DP-19

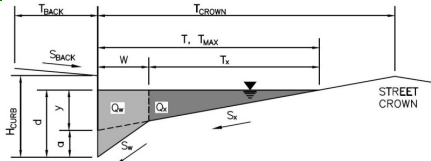

Gutter Geometry (Enter data in the blue cells)										
Maximum Allowable Width for Spread Behind Curb	$T_{BACK} = $ <input style="width: 50px;" type="text" value="8.0"/> ft									
Side Slope Behind Curb (leave blank for no conveyance credit behind curb)	$S_{BACK} = $ <input style="width: 50px;" type="text" value="0.020"/> ft/ft									
Manning's Roughness Behind Curb (typically between 0.012 and 0.020)	$n_{BACK} = $ <input style="width: 50px;" type="text" value="0.015"/>									
Height of Curb at Gutter Flow Line	$H_{CURB} = $ <input style="width: 50px;" type="text" value="6.00"/> inches									
Distance from Curb Face to Street Crown	$T_{CROWN} = $ <input style="width: 50px;" type="text" value="17.0"/> ft									
Gutter Width	$W = $ <input style="width: 50px;" type="text" value="2.00"/> ft									
Street Transverse Slope	$S_x = $ <input style="width: 50px;" type="text" value="0.020"/> ft/ft									
Gutter Cross Slope (typically 2 inches over 24 inches or 0.083 ft/ft)	$S_w = $ <input style="width: 50px;" type="text" value="0.083"/> ft/ft									
Street Longitudinal Slope - Enter 0 for sump condition	$S_o = $ <input style="width: 50px;" type="text" value="0.026"/> ft/ft									
Manning's Roughness for Street Section (typically between 0.012 and 0.020)	$n_{STREET} = $ <input style="width: 50px;" type="text" value="0.017"/>									
Max. Allowable Spread for Minor & Major Storm	<table border="1" style="display: inline-table; border-collapse: collapse;"> <thead> <tr> <th style="padding: 2px;">Minor Storm</th> <th style="padding: 2px;">Major Storm</th> <th style="padding: 2px;">ft</th> </tr> </thead> <tbody> <tr> <td style="width: 50px; text-align: center;">$T_{MAX} =$ <input style="width: 40px;" type="text" value="17.0"/></td> <td style="width: 50px; text-align: center;"><input style="width: 40px;" type="text" value="17.0"/></td> <td style="width: 20px;"></td> </tr> <tr> <td style="text-align: center;">$d_{MAX} =$ <input style="width: 40px;" type="text" value="5.6"/></td> <td style="text-align: center;"><input style="width: 40px;" type="text" value="7.9"/></td> <td style="text-align: center;">inches</td> </tr> </tbody> </table>	Minor Storm	Major Storm	ft	$T_{MAX} = $ <input style="width: 40px;" type="text" value="17.0"/>	<input style="width: 40px;" type="text" value="17.0"/>		$d_{MAX} = $ <input style="width: 40px;" type="text" value="5.6"/>	<input style="width: 40px;" type="text" value="7.9"/>	inches
Minor Storm	Major Storm	ft								
$T_{MAX} = $ <input style="width: 40px;" type="text" value="17.0"/>	<input style="width: 40px;" type="text" value="17.0"/>									
$d_{MAX} = $ <input style="width: 40px;" type="text" value="5.6"/>	<input style="width: 40px;" type="text" value="7.9"/>	inches								
Max. Allowable Depth at Gutter Flowline for Minor & Major Storm	<table border="1" style="display: inline-table; border-collapse: collapse;"> <thead> <tr> <th style="padding: 2px;">Minor Storm</th> <th style="padding: 2px;">Major Storm</th> <th style="padding: 2px;">inches</th> </tr> </thead> <tbody> <tr> <td style="width: 50px; text-align: center;">$d_{MAX} =$ <input style="width: 40px;" type="text" value="5.6"/></td> <td style="width: 50px; text-align: center;"><input style="width: 40px;" type="text" value="7.9"/></td> <td style="width: 20px;"></td> </tr> </tbody> </table>	Minor Storm	Major Storm	inches	$d_{MAX} = $ <input style="width: 40px;" type="text" value="5.6"/>	<input style="width: 40px;" type="text" value="7.9"/>				
Minor Storm	Major Storm	inches								
$d_{MAX} = $ <input style="width: 40px;" type="text" value="5.6"/>	<input style="width: 40px;" type="text" value="7.9"/>									
Allow Flow Depth at Street Crown (leave blank for no)	<input type="checkbox"/> <input checked="" type="checkbox"/> check = yes									
MINOR STORM Allowable Capacity is based on Spread Criterion										
MAJOR STORM Allowable Capacity is based on Depth Criterion										
Minor storm max. allowable capacity GOOD - greater than the design flow given on sheet 'Inlet Management'	<table border="1" style="display: inline-table; border-collapse: collapse;"> <thead> <tr> <th style="padding: 2px;">Minor Storm</th> <th style="padding: 2px;">Major Storm</th> <th style="padding: 2px;">cfs</th> </tr> </thead> <tbody> <tr> <td style="width: 50px; text-align: center;">$Q_{allow} =$ <input style="width: 40px;" type="text" value="16.4"/></td> <td style="width: 50px; text-align: center;"><input style="width: 40px;" type="text" value="34.5"/></td> <td style="width: 20px;"></td> </tr> </tbody> </table>	Minor Storm	Major Storm	cfs	$Q_{allow} = $ <input style="width: 40px;" type="text" value="16.4"/>	<input style="width: 40px;" type="text" value="34.5"/>				
Minor Storm	Major Storm	cfs								
$Q_{allow} = $ <input style="width: 40px;" type="text" value="16.4"/>	<input style="width: 40px;" type="text" value="34.5"/>									
Major storm max. allowable capacity GOOD - greater than the design flow given on sheet 'Inlet Management'										

INLET ON A CONTINUOUS GRADE

Version 4.05 Released March 2017

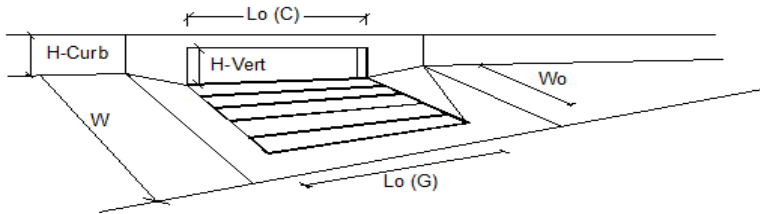

Design Information (Input)	MINOR	MAJOR	
Type of Inlet	CDOT Type R Curb Opening		
Local Depression (additional to continuous gutter depression 'a')	3.0	3.0	inches
Total Number of Units in the Inlet (Grate or Curb Opening)	1	1	
Length of a Single Unit Inlet (Grate or Curb Opening)	20.00	20.00	ft
Width of a Unit Grate (cannot be greater than W, Gutter Width)	N/A	N/A	ft
Clogging Factor for a Single Unit Grate (typical min. value = 0.5)	N/A	N/A	
Clogging Factor for a Single Unit Curb Opening (typical min. value = 0.1)	0.10	0.10	
Street Hydraulics: OK - Q < Allowable Street Capacity			
Total Inlet Interception Capacity	10.3	21.2	cfs
Total Inlet Carry-Over Flow (flow bypassing inlet)	0.0	7.6	cfs
Capture Percentage = Q_i/Q_c =	100	74	%

ALLOWABLE CAPACITY FOR ONE-HALF OF STREET (Minor & Major Storm)

(Based on Regulated Criteria for Maximum Allowable Flow Depth and Spread)

Project: The Ridge at Lorson Ranch, #100.064
 Inlet ID: Inlet DP-20a



Gutter Geometry (Enter data in the blue cells)													
Maximum Allowable Width for Spread Behind Curb	$T_{BACK} = 8.0$ ft												
Side Slope Behind Curb (leave blank for no conveyance credit behind curb)	$S_{BACK} = 0.020$ ft/ft												
Manning's Roughness Behind Curb (typically between 0.012 and 0.020)	$n_{BACK} = 0.015$												
Height of Curb at Gutter Flow Line	$H_{CURB} = 6.00$ inches												
Distance from Curb Face to Street Crown	$T_{CROWN} = 17.0$ ft												
Gutter Width	$W = 2.00$ ft												
Street Transverse Slope	$S_x = 0.020$ ft/ft												
Gutter Cross Slope (typically 2 inches over 24 inches or 0.083 ft/ft)	$S_w = 0.083$ ft/ft												
Street Longitudinal Slope - Enter 0 for sump condition	$S_o = 0.030$ ft/ft												
Manning's Roughness for Street Section (typically between 0.012 and 0.020)	$n_{STREET} = 0.017$												
Max. Allowable Spread for Minor & Major Storm	<table border="1" style="display: inline-table; border-collapse: collapse;"> <thead> <tr> <th style="width: 50%;">Minor Storm</th> <th style="width: 50%;">Major Storm</th> <th style="width: 50%;"></th> </tr> </thead> <tbody> <tr> <td style="text-align: center;">$T_{MAX} = 17.0$</td> <td style="text-align: center;">$T_{MAX} = 17.0$</td> <td style="text-align: right;">ft</td> </tr> <tr> <td style="text-align: center;">$d_{MAX} = 5.6$</td> <td style="text-align: center;">$d_{MAX} = 7.9$</td> <td style="text-align: right;">inches</td> </tr> <tr> <td style="text-align: center;"><input type="checkbox"/></td> <td style="text-align: center;"><input checked="" type="checkbox"/></td> <td style="text-align: right;">check = yes</td> </tr> </tbody> </table>	Minor Storm	Major Storm		$T_{MAX} = 17.0$	$T_{MAX} = 17.0$	ft	$d_{MAX} = 5.6$	$d_{MAX} = 7.9$	inches	<input type="checkbox"/>	<input checked="" type="checkbox"/>	check = yes
Minor Storm	Major Storm												
$T_{MAX} = 17.0$	$T_{MAX} = 17.0$	ft											
$d_{MAX} = 5.6$	$d_{MAX} = 7.9$	inches											
<input type="checkbox"/>	<input checked="" type="checkbox"/>	check = yes											
Max. Allowable Depth at Gutter Flowline for Minor & Major Storm													
Allow Flow Depth at Street Crown (leave blank for no)													
MINOR STORM Allowable Capacity is based on Depth Criterion													
MAJOR STORM Allowable Capacity is based on Depth Criterion													
Minor storm max. allowable capacity GOOD - greater than the design flow given on sheet 'Inlet Management'	<table border="1" style="display: inline-table; border-collapse: collapse;"> <thead> <tr> <th style="width: 50%;">Minor Storm</th> <th style="width: 50%;">Major Storm</th> <th style="width: 50%;"></th> </tr> </thead> <tbody> <tr> <td style="text-align: center;">$Q_{allow} = 16.7$</td> <td style="text-align: center;">$Q_{allow} = 32.9$</td> <td style="text-align: right;">cfs</td> </tr> </tbody> </table>	Minor Storm	Major Storm		$Q_{allow} = 16.7$	$Q_{allow} = 32.9$	cfs						
Minor Storm	Major Storm												
$Q_{allow} = 16.7$	$Q_{allow} = 32.9$	cfs											
Major storm max. allowable capacity GOOD - greater than the design flow given on sheet 'Inlet Management'													

INLET ON A CONTINUOUS GRADE

Version 4.05 Released March 2017

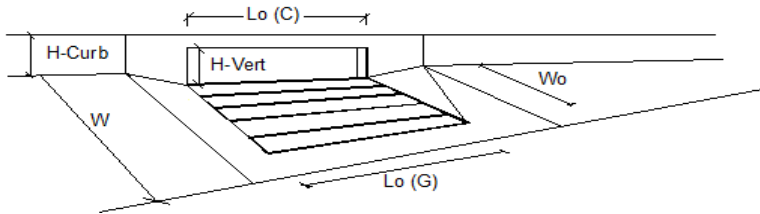

Design Information (Input)	MINOR	MAJOR	
Type of Inlet	CDOT Type R Curb Opening		
Local Depression (additional to continuous gutter depression 'a')	3.0	3.0	inches
Total Number of Units in the Inlet (Grate or Curb Opening)	1	1	
Length of a Single Unit Inlet (Grate or Curb Opening)	15.00	15.00	ft
Width of a Unit Grate (cannot be greater than W, Gutter Width)	N/A	N/A	ft
Clogging Factor for a Single Unit Grate (typical min. value = 0.5)	N/A	N/A	
Clogging Factor for a Single Unit Curb Opening (typical min. value = 0.1)	0.10	0.10	
Street Hydraulics: OK - Q < Allowable Street Capacity			
Total Inlet Interception Capacity	5.6	10.7	cfs
Total Inlet Carry-Over Flow (flow bypassing inlet)	0.0	1.6	cfs
Capture Percentage = Q_i/Q_c =	100	87	%

ALLOWABLE CAPACITY FOR ONE-HALF OF STREET (Minor & Major Storm)

(Based on Regulated Criteria for Maximum Allowable Flow Depth and Spread)

Project: The Ridge at Lorson Ranch, #100.064
 Inlet ID: Inlet DP-21

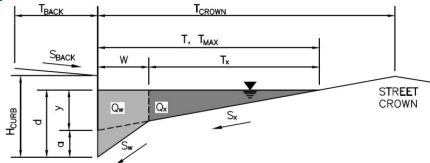

Gutter Geometry (Enter data in the blue cells)							
Maximum Allowable Width for Spread Behind Curb	$T_{BACK} = 8.0$ ft						
Side Slope Behind Curb (leave blank for no conveyance credit behind curb)	$S_{BACK} = 0.020$ ft/ft						
Manning's Roughness Behind Curb (typically between 0.012 and 0.020)	$n_{BACK} = 0.015$						
Height of Curb at Gutter Flow Line	$H_{CURB} = 6.00$ inches						
Distance from Curb Face to Street Crown	$T_{CROWN} = 17.0$ ft						
Gutter Width	$W = 2.00$ ft						
Street Transverse Slope	$S_x = 0.020$ ft/ft						
Gutter Cross Slope (typically 2 inches over 24 inches or 0.083 ft/ft)	$S_w = 0.083$ ft/ft						
Street Longitudinal Slope - Enter 0 for sump condition	$S_o = 0.021$ ft/ft						
Manning's Roughness for Street Section (typically between 0.012 and 0.020)	$n_{STREET} = 0.017$						
Max. Allowable Spread for Minor & Major Storm	<table border="1"> <tr> <th>Minor Storm</th> <th>Major Storm</th> <th>ft</th> </tr> <tr> <td>$T_{MAX} = 17.0$</td> <td>$T_{MAX} = 17.0$</td> <td></td> </tr> </table>	Minor Storm	Major Storm	ft	$T_{MAX} = 17.0$	$T_{MAX} = 17.0$	
Minor Storm	Major Storm	ft					
$T_{MAX} = 17.0$	$T_{MAX} = 17.0$						
Max. Allowable Depth at Gutter Flowline for Minor & Major Storm	<table border="1"> <tr> <th>Minor Storm</th> <th>Major Storm</th> <th>inches</th> </tr> <tr> <td>$d_{MAX} = 5.6$</td> <td>$d_{MAX} = 7.9$</td> <td></td> </tr> </table>	Minor Storm	Major Storm	inches	$d_{MAX} = 5.6$	$d_{MAX} = 7.9$	
Minor Storm	Major Storm	inches					
$d_{MAX} = 5.6$	$d_{MAX} = 7.9$						
Allow Flow Depth at Street Crown (leave blank for no)	<input type="checkbox"/> Minor Storm <input checked="" type="checkbox"/> Major Storm check = yes						
MINOR STORM Allowable Capacity is based on Spread Criterion							
MAJOR STORM Allowable Capacity is based on Depth Criterion							
Minor storm max. allowable capacity GOOD - greater than the design flow given on sheet 'Inlet Management'	<table border="1"> <tr> <th>Minor Storm</th> <th>Major Storm</th> <th>cfs</th> </tr> <tr> <td>$Q_{allow} = 14.8$</td> <td>$Q_{allow} = 36.6$</td> <td></td> </tr> </table>	Minor Storm	Major Storm	cfs	$Q_{allow} = 14.8$	$Q_{allow} = 36.6$	
Minor Storm	Major Storm	cfs					
$Q_{allow} = 14.8$	$Q_{allow} = 36.6$						
Major storm max. allowable capacity GOOD - greater than the design flow given on sheet 'Inlet Management'							

INLET ON A CONTINUOUS GRADE

Version 4.05 Released March 2017

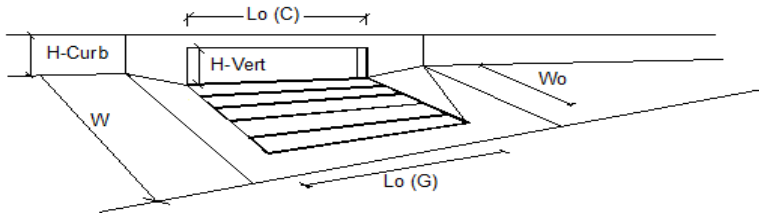

Design Information (Input)	MINOR	MAJOR	
Type of Inlet	CDOT Type R Curb Opening		
Local Depression (additional to continuous gutter depression 'a')	3.0	3.0	inches
Total Number of Units in the Inlet (Grate or Curb Opening)	1	1	
Length of a Single Unit Inlet (Grate or Curb Opening)	15.00	15.00	ft
Width of a Unit Grate (cannot be greater than W, Gutter Width)	N/A	N/A	ft
Clogging Factor for a Single Unit Grate (typical min. value = 0.5)	N/A	N/A	
Clogging Factor for a Single Unit Curb Opening (typical min. value = 0.1)	0.10	0.10	
Street Hydraulics: OK - Q < Allowable Street Capacity			
Total Inlet Interception Capacity	7.2	13.1	cfs
Total Inlet Carry-Over Flow (flow bypassing inlet)	0.0	4.4	cfs
Capture Percentage = Q_i/Q_c =	100	75	%

ALLOWABLE CAPACITY FOR ONE-HALF OF STREET (Minor & Major Storm)

(Based on Regulated Criteria for Maximum Allowable Flow Depth and Spread)

Project: The Ridge at Lorson Ranch, #100.064
 Inlet ID: Inlet DP-23

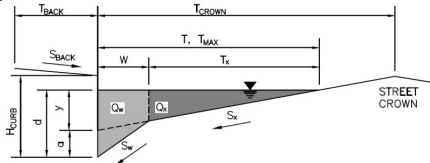

Gutter Geometry (Enter data in the blue cells)							
Maximum Allowable Width for Spread Behind Curb	$T_{BACK} = 8.0$ ft						
Side Slope Behind Curb (leave blank for no conveyance credit behind curb)	$S_{BACK} = 0.020$ ft/ft						
Manning's Roughness Behind Curb (typically between 0.012 and 0.020)	$n_{BACK} = 0.015$						
Height of Curb at Gutter Flow Line	$H_{CURB} = 6.00$ inches						
Distance from Curb Face to Street Crown	$T_{CROWN} = 17.0$ ft						
Gutter Width	$W = 2.00$ ft						
Street Transverse Slope	$S_x = 0.020$ ft/ft						
Gutter Cross Slope (typically 2 inches over 24 inches or 0.083 ft/ft)	$S_w = 0.083$ ft/ft						
Street Longitudinal Slope - Enter 0 for sump condition	$S_o = 0.020$ ft/ft						
Manning's Roughness for Street Section (typically between 0.012 and 0.020)	$n_{STREET} = 0.017$						
Max. Allowable Spread for Minor & Major Storm	<table border="1" style="margin-left: auto; margin-right: auto;"> <tr> <th style="padding: 2px;">Minor Storm</th> <th style="padding: 2px;">Major Storm</th> <th style="padding: 2px;">ft</th> </tr> <tr> <td style="text-align: center;">17.0</td> <td style="text-align: center;">17.0</td> <td></td> </tr> </table>	Minor Storm	Major Storm	ft	17.0	17.0	
Minor Storm	Major Storm	ft					
17.0	17.0						
Max. Allowable Depth at Gutter Flowline for Minor & Major Storm	<table border="1" style="margin-left: auto; margin-right: auto;"> <tr> <th style="padding: 2px;">Minor Storm</th> <th style="padding: 2px;">Major Storm</th> <th style="padding: 2px;">inches</th> </tr> <tr> <td style="text-align: center;">5.6</td> <td style="text-align: center;">7.9</td> <td></td> </tr> </table>	Minor Storm	Major Storm	inches	5.6	7.9	
Minor Storm	Major Storm	inches					
5.6	7.9						
Allow Flow Depth at Street Crown (leave blank for no)	<input type="checkbox"/> <input checked="" type="checkbox"/> check = yes						
MINOR STORM Allowable Capacity is based on Spread Criterion							
MAJOR STORM Allowable Capacity is based on Depth Criterion							
	<table border="1" style="margin-left: auto; margin-right: auto;"> <tr> <th style="padding: 2px;">Minor Storm</th> <th style="padding: 2px;">Major Storm</th> <th style="padding: 2px;">cfs</th> </tr> <tr> <td style="text-align: center;">14.5</td> <td style="text-align: center;">37.1</td> <td></td> </tr> </table>	Minor Storm	Major Storm	cfs	14.5	37.1	
Minor Storm	Major Storm	cfs					
14.5	37.1						
Minor storm max. allowable capacity GOOD - greater than the design flow given on sheet 'Inlet Management' Major storm max. allowable capacity GOOD - greater than the design flow given on sheet 'Inlet Management'							

INLET ON A CONTINUOUS GRADE

Version 4.05 Released March 2017

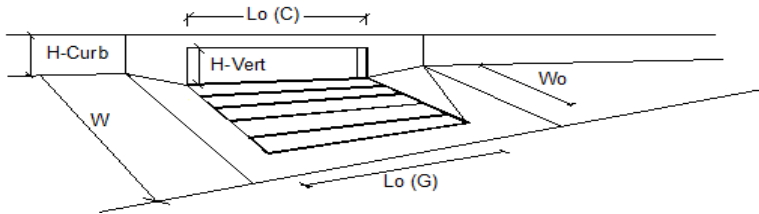

Design Information (Input)	MINOR	MAJOR	
Type of Inlet	CDOT Type R Curb Opening		
Local Depression (additional to continuous gutter depression 'a')	3.0	3.0	inches
Total Number of Units in the Inlet (Grate or Curb Opening)	1	1	
Length of a Single Unit Inlet (Grate or Curb Opening)	15.00	15.00	ft
Width of a Unit Grate (cannot be greater than W, Gutter Width)	N/A	N/A	ft
Clogging Factor for a Single Unit Grate (typical min. value = 0.5)	N/A	N/A	
Clogging Factor for a Single Unit Curb Opening (typical min. value = 0.1)	0.10	0.10	
Street Hydraulics: OK - Q < Allowable Street Capacity			
Total Inlet Interception Capacity	8.4	16.3	cfs
Total Inlet Carry-Over Flow (flow bypassing inlet)	0.3	10.4	cfs
Capture Percentage = Q_i/Q_c =	97	61	%

ALLOWABLE CAPACITY FOR ONE-HALF OF STREET (Minor & Major Storm)

(Based on Regulated Criteria for Maximum Allowable Flow Depth and Spread)

Project: The Ridge at Lorson Ranch, #100.064
 Inlet ID: Inlet DP-25



Gutter Geometry (Enter data in the blue cells)							
Maximum Allowable Width for Spread Behind Curb	$T_{BACK} = 8.0$ ft						
Side Slope Behind Curb (leave blank for no conveyance credit behind curb)	$S_{BACK} = 0.020$ ft/ft						
Manning's Roughness Behind Curb (typically between 0.012 and 0.020)	$n_{BACK} = 0.015$						
Height of Curb at Gutter Flow Line	$H_{CURB} = 6.00$ inches						
Distance from Curb Face to Street Crown	$T_{CROWN} = 17.0$ ft						
Gutter Width	$W = 2.00$ ft						
Street Transverse Slope	$S_x = 0.020$ ft/ft						
Gutter Cross Slope (typically 2 inches over 24 inches or 0.083 ft/ft)	$S_w = 0.083$ ft/ft						
Street Longitudinal Slope - Enter 0 for sump condition	$S_o = 0.011$ ft/ft						
Manning's Roughness for Street Section (typically between 0.012 and 0.020)	$n_{STREET} = 0.017$						
Max. Allowable Spread for Minor & Major Storm	<table border="1" style="display: inline-table; border-collapse: collapse;"> <tr> <th style="padding: 2px;">Minor Storm</th> <th style="padding: 2px;">Major Storm</th> <th style="padding: 2px;">ft</th> </tr> <tr> <td style="text-align: center; padding: 2px;">17.0</td> <td style="text-align: center; padding: 2px;">17.0</td> <td></td> </tr> </table>	Minor Storm	Major Storm	ft	17.0	17.0	
Minor Storm	Major Storm	ft					
17.0	17.0						
Max. Allowable Depth at Gutter Flowline for Minor & Major Storm	<table border="1" style="display: inline-table; border-collapse: collapse;"> <tr> <th style="padding: 2px;">Minor Storm</th> <th style="padding: 2px;">Major Storm</th> <th style="padding: 2px;">inches</th> </tr> <tr> <td style="text-align: center; padding: 2px;">5.6</td> <td style="text-align: center; padding: 2px;">7.9</td> <td></td> </tr> </table>	Minor Storm	Major Storm	inches	5.6	7.9	
Minor Storm	Major Storm	inches					
5.6	7.9						
Allow Flow Depth at Street Crown (leave blank for no)	<input type="checkbox"/> <input checked="" type="checkbox"/> check = yes						
MINOR STORM Allowable Capacity is based on Spread Criterion							
MAJOR STORM Allowable Capacity is based on Depth Criterion							
Minor storm max. allowable capacity GOOD - greater than the design flow given on sheet 'Inlet Management'	<table border="1" style="display: inline-table; border-collapse: collapse;"> <tr> <th style="padding: 2px;">Minor Storm</th> <th style="padding: 2px;">Major Storm</th> <th style="padding: 2px;">cfs</th> </tr> <tr> <td style="text-align: center; padding: 2px;">10.7</td> <td style="text-align: center; padding: 2px;">33.0</td> <td></td> </tr> </table>	Minor Storm	Major Storm	cfs	10.7	33.0	
Minor Storm	Major Storm	cfs					
10.7	33.0						
Major storm max. allowable capacity GOOD - greater than the design flow given on sheet 'Inlet Management'							

INLET ON A CONTINUOUS GRADE

Version 4.05 Released March 2017

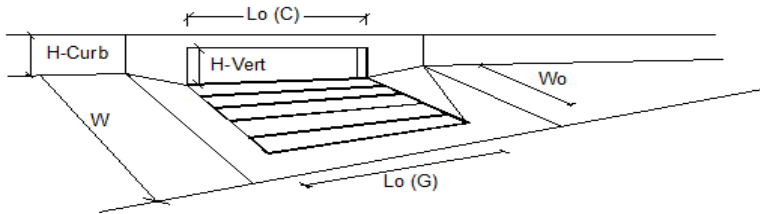

Design Information (Input)	MINOR	MAJOR	
Type of Inlet	CDOT Type R Curb Opening		
Local Depression (additional to continuous gutter depression 'a')	3.0	3.0	inches
Total Number of Units in the Inlet (Grate or Curb Opening)	1	1	
Length of a Single Unit Inlet (Grate or Curb Opening)	10.00	10.00	ft
Width of a Unit Grate (cannot be greater than W, Gutter Width)	N/A	N/A	ft
Clogging Factor for a Single Unit Grate (typical min. value = 0.5)	N/A	N/A	
Clogging Factor for a Single Unit Curb Opening (typical min. value = 0.1)	0.10	0.10	
Street Hydraulics: OK - Q < Allowable Street Capacity*			
Total Inlet Interception Capacity	7.2	11.3	cfs
Total Inlet Carry-Over Flow (flow bypassing inlet)	2.9	15.1	cfs
Capture Percentage = Q_i/Q_c =	71	43	%

ALLOWABLE CAPACITY FOR ONE-HALF OF STREET (Minor & Major Storm)

(Based on Regulated Criteria for Maximum Allowable Flow Depth and Spread)

Project: The Ridge at Lorson Ranch, #100.064
 Inlet ID: Inlet DP-27



Gutter Geometry (Enter data in the blue cells)							
Maximum Allowable Width for Spread Behind Curb	$T_{BACK} = 8.0$ ft						
Side Slope Behind Curb (leave blank for no conveyance credit behind curb)	$S_{BACK} = 0.020$ ft/ft						
Manning's Roughness Behind Curb (typically between 0.012 and 0.020)	$n_{BACK} = 0.015$						
Height of Curb at Gutter Flow Line	$H_{CURB} = 6.00$ inches						
Distance from Curb Face to Street Crown	$T_{CROWN} = 17.0$ ft						
Gutter Width	$W = 2.00$ ft						
Street Transverse Slope	$S_x = 0.020$ ft/ft						
Gutter Cross Slope (typically 2 inches over 24 inches or 0.083 ft/ft)	$S_w = 0.083$ ft/ft						
Street Longitudinal Slope - Enter 0 for sump condition	$S_o = 0.011$ ft/ft						
Manning's Roughness for Street Section (typically between 0.012 and 0.020)	$n_{STREET} = 0.017$						
Max. Allowable Spread for Minor & Major Storm	<table border="1"> <thead> <tr> <th>Minor Storm</th> <th>Major Storm</th> <th>ft</th> </tr> </thead> <tbody> <tr> <td>$T_{MAX} = 17.0$</td> <td>$T_{MAX} = 17.0$</td> <td></td> </tr> </tbody> </table>	Minor Storm	Major Storm	ft	$T_{MAX} = 17.0$	$T_{MAX} = 17.0$	
Minor Storm	Major Storm	ft					
$T_{MAX} = 17.0$	$T_{MAX} = 17.0$						
Max. Allowable Depth at Gutter Flowline for Minor & Major Storm	<table border="1"> <thead> <tr> <th>Minor Storm</th> <th>Major Storm</th> <th>inches</th> </tr> </thead> <tbody> <tr> <td>$d_{MAX} = 5.6$</td> <td>$d_{MAX} = 7.9$</td> <td></td> </tr> </tbody> </table>	Minor Storm	Major Storm	inches	$d_{MAX} = 5.6$	$d_{MAX} = 7.9$	
Minor Storm	Major Storm	inches					
$d_{MAX} = 5.6$	$d_{MAX} = 7.9$						
Allow Flow Depth at Street Crown (leave blank for no)	<input type="checkbox"/> Minor Storm <input checked="" type="checkbox"/> Major Storm check = yes						
MINOR STORM Allowable Capacity is based on Spread Criterion							
MAJOR STORM Allowable Capacity is based on Depth Criterion							
Minor storm max. allowable capacity GOOD - greater than the design flow given on sheet 'Inlet Management'	<table border="1"> <thead> <tr> <th>Minor Storm</th> <th>Major Storm</th> <th>cfs</th> </tr> </thead> <tbody> <tr> <td>$Q_{allow} = 10.7$</td> <td>$Q_{allow} = 33.0$</td> <td></td> </tr> </tbody> </table>	Minor Storm	Major Storm	cfs	$Q_{allow} = 10.7$	$Q_{allow} = 33.0$	
Minor Storm	Major Storm	cfs					
$Q_{allow} = 10.7$	$Q_{allow} = 33.0$						
Major storm max. allowable capacity GOOD - greater than the design flow given on sheet 'Inlet Management'							

INLET ON A CONTINUOUS GRADE

Version 4.05 Released March 2017

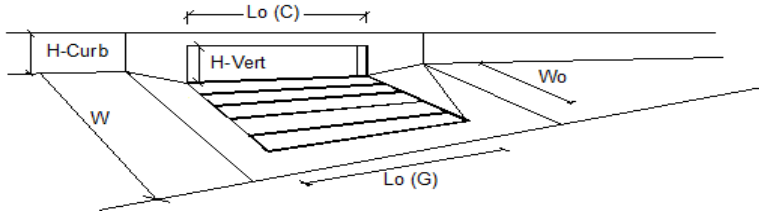

Design Information (Input)	MINOR	MAJOR	
Type of Inlet	CDOT Type R Curb Opening		
Local Depression (additional to continuous gutter depression 'a')	3.0	3.0	inches
Total Number of Units in the Inlet (Grate or Curb Opening)	1	1	
Length of a Single Unit Inlet (Grate or Curb Opening)	20.00	20.00	ft
Width of a Unit Grate (cannot be greater than W, Gutter Width)	N/A	N/A	ft
Clogging Factor for a Single Unit Grate (typical min. value = 0.5)	N/A	N/A	
Clogging Factor for a Single Unit Curb Opening (typical min. value = 0.1)	0.10	0.10	
Street Hydraulics: OK - Q < Allowable Street Capacity*			
Total Inlet Interception Capacity	8.4	20.7	cfs
Total Inlet Carry-Over Flow (flow bypassing inlet)	0.0	7.6	cfs
Capture Percentage = Q_i/Q_c =	100	73	%

ALLOWABLE CAPACITY FOR ONE-HALF OF STREET (Minor & Major Storm)

(Based on Regulated Criteria for Maximum Allowable Flow Depth and Spread)

Project: The Ridge at Lorson Ranch, #100.064
 Inlet ID: Inlet DP-29



Gutter Geometry (Enter data in the blue cells)							
Maximum Allowable Width for Spread Behind Curb	$T_{BACK} = 8.0$ ft						
Side Slope Behind Curb (leave blank for no conveyance credit behind curb)	$S_{BACK} = 0.020$ ft/ft						
Manning's Roughness Behind Curb (typically between 0.012 and 0.020)	$n_{BACK} = 0.015$						
Height of Curb at Gutter Flow Line	$H_{CURB} = 6.00$ inches						
Distance from Curb Face to Street Crown	$T_{CROWN} = 17.0$ ft						
Gutter Width	$W = 2.00$ ft						
Street Transverse Slope	$S_x = 0.020$ ft/ft						
Gutter Cross Slope (typically 2 inches over 24 inches or 0.083 ft/ft)	$S_w = 0.083$ ft/ft						
Street Longitudinal Slope - Enter 0 for sump condition	$S_o = 0.010$ ft/ft						
Manning's Roughness for Street Section (typically between 0.012 and 0.020)	$n_{STREET} = 0.017$						
Max. Allowable Spread for Minor & Major Storm	<table border="1"> <thead> <tr> <th>Minor Storm</th> <th>Major Storm</th> <th>ft</th> </tr> </thead> <tbody> <tr> <td>$T_{MAX} = 17.0$</td> <td>$T_{MAX} = 17.0$</td> <td></td> </tr> </tbody> </table>	Minor Storm	Major Storm	ft	$T_{MAX} = 17.0$	$T_{MAX} = 17.0$	
Minor Storm	Major Storm	ft					
$T_{MAX} = 17.0$	$T_{MAX} = 17.0$						
Max. Allowable Depth at Gutter Flowline for Minor & Major Storm	<table border="1"> <thead> <tr> <th>Minor Storm</th> <th>Major Storm</th> <th>inches</th> </tr> </thead> <tbody> <tr> <td>$d_{MAX} = 5.6$</td> <td>$d_{MAX} = 7.9$</td> <td></td> </tr> </tbody> </table>	Minor Storm	Major Storm	inches	$d_{MAX} = 5.6$	$d_{MAX} = 7.9$	
Minor Storm	Major Storm	inches					
$d_{MAX} = 5.6$	$d_{MAX} = 7.9$						
Allow Flow Depth at Street Crown (leave blank for no)	<input type="checkbox"/> Minor Storm <input checked="" type="checkbox"/> Major Storm check = yes						
MINOR STORM Allowable Capacity is based on Spread Criterion							
MAJOR STORM Allowable Capacity is based on Depth Criterion							
Minor storm max. allowable capacity GOOD - greater than the design flow given on sheet 'Inlet Management'	<table border="1"> <thead> <tr> <th>Minor Storm</th> <th>Major Storm</th> <th>cfs</th> </tr> </thead> <tbody> <tr> <td>$Q_{allow} = 10.2$</td> <td>$Q_{allow} = 31.8$</td> <td></td> </tr> </tbody> </table>	Minor Storm	Major Storm	cfs	$Q_{allow} = 10.2$	$Q_{allow} = 31.8$	
Minor Storm	Major Storm	cfs					
$Q_{allow} = 10.2$	$Q_{allow} = 31.8$						
Major storm max. allowable capacity GOOD - greater than the design flow given on sheet 'Inlet Management'							

INLET ON A CONTINUOUS GRADE

Version 4.05 Released March 2017

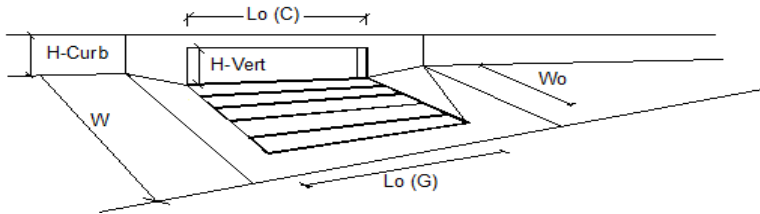

Design Information (Input)	MINOR	MAJOR	
Type of Inlet	CDOT Type R Curb Opening		
Local Depression (additional to continuous gutter depression 'a')	3.0	3.0	inches
Total Number of Units in the Inlet (Grate or Curb Opening)	1	1	
Length of a Single Unit Inlet (Grate or Curb Opening)	20.00	20.00	ft
Width of a Unit Grate (cannot be greater than W, Gutter Width)	N/A	N/A	ft
Clogging Factor for a Single Unit Grate (typical min. value = 0.5)	N/A	N/A	
Clogging Factor for a Single Unit Curb Opening (typical min. value = 0.1)	0.10	0.10	
Street Hydraulics: OK - Q < Allowable Street Capacity			
Total Inlet Interception Capacity	9.2	20.5	cfs
Total Inlet Carry-Over Flow (flow bypassing inlet)	0.0	7.3	cfs
Capture Percentage = Q_i/Q_c =	100	74	%

ALLOWABLE CAPACITY FOR ONE-HALF OF STREET (Minor & Major Storm)

(Based on Regulated Criteria for Maximum Allowable Flow Depth and Spread)

Project: The Ridge at Lorson Ranch, #100.064
 Inlet ID: Inlet DP-31

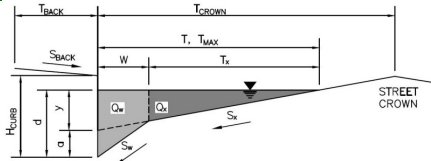

Gutter Geometry (Enter data in the blue cells)							
Maximum Allowable Width for Spread Behind Curb	$T_{BACK} = 24.0$ ft						
Side Slope Behind Curb (leave blank for no conveyance credit behind curb)	$S_{BACK} = 0.020$ ft/ft						
Manning's Roughness Behind Curb (typically between 0.012 and 0.020)	$n_{BACK} = 0.015$						
Height of Curb at Gutter Flow Line	$H_{CURB} = 6.00$ inches						
Distance from Curb Face to Street Crown	$T_{CROWN} = 26.0$ ft						
Gutter Width	$W = 2.00$ ft						
Street Transverse Slope	$S_x = 0.020$ ft/ft						
Gutter Cross Slope (typically 2 inches over 24 inches or 0.083 ft/ft)	$S_w = 0.083$ ft/ft						
Street Longitudinal Slope - Enter 0 for sump condition	$S_o = 0.048$ ft/ft						
Manning's Roughness for Street Section (typically between 0.012 and 0.020)	$n_{STREET} = 0.017$						
Max. Allowable Spread for Minor & Major Storm	<table border="1" style="margin-left: auto; margin-right: auto;"> <tr> <th style="padding: 2px;">Minor Storm</th> <th style="padding: 2px;">Major Storm</th> <th style="padding: 2px;">ft</th> </tr> <tr> <td style="text-align: center; padding: 2px;">$T_{MAX} = 26.0$</td> <td style="text-align: center; padding: 2px;">26.0</td> <td style="padding: 2px;"></td> </tr> </table>	Minor Storm	Major Storm	ft	$T_{MAX} = 26.0$	26.0	
Minor Storm	Major Storm	ft					
$T_{MAX} = 26.0$	26.0						
Max. Allowable Depth at Gutter Flowline for Minor & Major Storm	<table border="1" style="margin-left: auto; margin-right: auto;"> <tr> <th style="padding: 2px;">Minor Storm</th> <th style="padding: 2px;">Major Storm</th> <th style="padding: 2px;">inches</th> </tr> <tr> <td style="text-align: center; padding: 2px;">$d_{MAX} = 6.0$</td> <td style="text-align: center; padding: 2px;">11.8</td> <td style="padding: 2px;"></td> </tr> </table>	Minor Storm	Major Storm	inches	$d_{MAX} = 6.0$	11.8	
Minor Storm	Major Storm	inches					
$d_{MAX} = 6.0$	11.8						
Allow Flow Depth at Street Crown (leave blank for no)	<input type="checkbox"/> <input checked="" type="checkbox"/> check = yes						
MINOR STORM Allowable Capacity is based on Depth Criterion							
MAJOR STORM Allowable Capacity is based on Depth Criterion							
	<table border="1" style="margin-left: auto; margin-right: auto;"> <tr> <th style="padding: 2px;">Minor Storm</th> <th style="padding: 2px;">Major Storm</th> <th style="padding: 2px;">cfs</th> </tr> <tr> <td style="text-align: center; padding: 2px;">$Q_{allow} = 14.5$</td> <td style="text-align: center; padding: 2px;">115.2</td> <td style="padding: 2px;"></td> </tr> </table>	Minor Storm	Major Storm	cfs	$Q_{allow} = 14.5$	115.2	
Minor Storm	Major Storm	cfs					
$Q_{allow} = 14.5$	115.2						
Minor storm max. allowable capacity GOOD - greater than the design flow given on sheet 'Inlet Management' Major storm max. allowable capacity GOOD - greater than the design flow given on sheet 'Inlet Management'							

INLET ON A CONTINUOUS GRADE

Version 4.05 Released March 2017

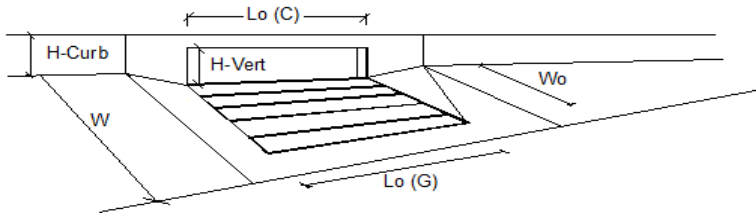

Design Information (Input)	MINOR	MAJOR	
Type of Inlet	Type = CDOT Type R Curb Opening		
Local Depression (additional to continuous gutter depression 'a')	$a_{LOCAL} = 3.0$	3.0	inches
Total Number of Units in the Inlet (Grate or Curb Opening)	No = 1	1	
Length of a Single Unit Inlet (Grate or Curb Opening)	$L_o = 15.00$	15.00	ft
Width of a Unit Grate (cannot be greater than W, Gutter Width)	$W_o = N/A$	N/A	ft
Clogging Factor for a Single Unit Grate (typical min. value = 0.5)	$C_{T-G} = N/A$	N/A	
Clogging Factor for a Single Unit Curb Opening (typical min. value = 0.1)	$C_{T-C} = 0.10$	0.10	
Street Hydraulics: OK - Q < Allowable Street Capacity			
Design Discharge for Half of Street (from Sheet Inlet Management)			
Water Spread Width	$Q_o = 10.5$	23.2	cfs
Water Depth at Flowline (outside of local depression)	T = 12.4	17.2	ft
Water Depth at Street Crown (or at T_{MAX})	d = 4.5	5.6	inches
Ratio of Gutter Flow to Design Flow	$d_{CROWN} = 0.0$	0.0	inches
Discharge outside the Gutter Section W, carried in Section T_x	$E_o = 0.477$	0.346	
Discharge within the Gutter Section W	$Q_x = 5.5$	15.2	cfs
Discharge Behind the Curb Face	$Q_w = 5.0$	8.0	cfs
Flow Area within the Gutter Section W	$Q_{BACK} = 0.0$	0.0	cfs
Velocity within the Gutter Section W	$A_w = 0.58$	0.77	sq ft
Water Depth for Design Condition	$V_w = 8.6$	10.4	fps
	$d_{LOCAL} = 7.5$	8.6	inches
Grate Analysis (Calculated)			
Total Length of Inlet Grate Opening	L = N/A	N/A	ft
Ratio of Grate Flow to Design Flow	$E_{o-GRATE} = N/A$	N/A	
Under No-Clogging Condition			
Minimum Velocity Where Grate Splash-Over Begins	$V_o = N/A$	N/A	fps
Interception Rate of Frontal Flow	$R_f = N/A$	N/A	
Interception Rate of Side Flow	$R_s = N/A$	N/A	
Interception Capacity	$Q_i = N/A$	N/A	cfs
Under Clogging Condition			
Clogging Coefficient for Multiple-unit Grate Inlet	GrateCoef = N/A	N/A	
Clogging Factor for Multiple-unit Grate Inlet	GrateClog = N/A	N/A	
Effective (unclogged) Length of Multiple-unit Grate Inlet	$L_e = N/A$	N/A	ft
Minimum Velocity Where Grate Splash-Over Begins	$V_o = N/A$	N/A	fps
Interception Rate of Frontal Flow	$R_f = N/A$	N/A	
Interception Rate of Side Flow	$R_s = N/A$	N/A	
Actual Interception Capacity	$Q_a = N/A$	N/A	cfs
Carry-Over Flow = $Q_o - Q_a$ (to be applied to curb opening or next d/s inlet)	$Q_b = N/A$	N/A	cfs
Curb or Slotted Inlet Opening Analysis (Calculated)			
Equivalent Slope S_e (based on grate carry-over)	$S_e = 0.110$	0.085	ft/ft
Required Length L_T to Have 100% Interception	$L_T = 19.05$	32.09	ft
Under No-Clogging Condition			
Effective Length of Curb Opening or Slotted Inlet (minimum of L, L_T)	L = 15.00	15.00	ft
Interception Capacity	$Q_i = 9.9$	15.7	cfs
Under Clogging Condition			
Clogging Coefficient	CurbCoef = 1.31	1.31	
Clogging Factor for Multiple-unit Curb Opening or Slotted Inlet	CurbClog = 0.04	0.04	
Effective (Unclogged) Length	$L_e = 13.03$	13.03	ft
Actual Interception Capacity	$Q_a = 9.7$	15.3	cfs
Carry-Over Flow = $Q_b(GRATE) - Q_a$	$Q_b = 0.8$	7.9	cfs
Summary			
Total Inlet Interception Capacity	Q = 9.7	15.3	cfs
Total Inlet Carry-Over Flow (flow bypassing inlet)	$Q_b = 0.8$	7.9	cfs
Capture Percentage = $Q_i/Q_o =$	C% = 92	66	%

ALLOWABLE CAPACITY FOR ONE-HALF OF STREET (Minor & Major Storm)

(Based on Regulated Criteria for Maximum Allowable Flow Depth and Spread)

Project: The Ridge at Lorson Ranch, #100.064
 Inlet ID: Inlet DP-32



Gutter Geometry (Enter data in the blue cells)							
Maximum Allowable Width for Spread Behind Curb	$T_{BACK} = 8.0$ ft						
Side Slope Behind Curb (leave blank for no conveyance credit behind curb)	$S_{BACK} = 0.020$ ft/ft						
Manning's Roughness Behind Curb (typically between 0.012 and 0.020)	$n_{BACK} = 0.015$						
Height of Curb at Gutter Flow Line	$H_{CURB} = 6.00$ inches						
Distance from Curb Face to Street Crown	$T_{CROWN} = 17.0$ ft						
Gutter Width	$W = 2.00$ ft						
Street Transverse Slope	$S_x = 0.020$ ft/ft						
Gutter Cross Slope (typically 2 inches over 24 inches or 0.083 ft/ft)	$S_w = 0.083$ ft/ft						
Street Longitudinal Slope - Enter 0 for sump condition	$S_o = 0.000$ ft/ft						
Manning's Roughness for Street Section (typically between 0.012 and 0.020)	$n_{STREET} = 0.017$						
Max. Allowable Spread for Minor & Major Storm	<table border="1"> <thead> <tr> <th>Minor Storm</th> <th>Major Storm</th> <th>ft</th> </tr> </thead> <tbody> <tr> <td>$T_{MAX} = 17.0$</td> <td>$T_{MAX} = 17.0$</td> <td></td> </tr> </tbody> </table>	Minor Storm	Major Storm	ft	$T_{MAX} = 17.0$	$T_{MAX} = 17.0$	
Minor Storm	Major Storm	ft					
$T_{MAX} = 17.0$	$T_{MAX} = 17.0$						
Max. Allowable Depth at Gutter Flowline for Minor & Major Storm	<table border="1"> <thead> <tr> <th>Minor Storm</th> <th>Major Storm</th> <th>inches</th> </tr> </thead> <tbody> <tr> <td>$d_{MAX} = 5.6$</td> <td>$d_{MAX} = 7.9$</td> <td></td> </tr> </tbody> </table>	Minor Storm	Major Storm	inches	$d_{MAX} = 5.6$	$d_{MAX} = 7.9$	
Minor Storm	Major Storm	inches					
$d_{MAX} = 5.6$	$d_{MAX} = 7.9$						
Check boxes are not applicable in SUMP conditions	<input type="checkbox"/> <input type="checkbox"/>						
MINOR STORM Allowable Capacity is based on Depth Criterion							
MAJOR STORM Allowable Capacity is based on Depth Criterion							
Allowable Capacity	<table border="1"> <thead> <tr> <th>Minor Storm</th> <th>Major Storm</th> <th>cfs</th> </tr> </thead> <tbody> <tr> <td>$Q_{allow} = \text{SUMP}$</td> <td>$Q_{allow} = \text{SUMP}$</td> <td></td> </tr> </tbody> </table>	Minor Storm	Major Storm	cfs	$Q_{allow} = \text{SUMP}$	$Q_{allow} = \text{SUMP}$	
Minor Storm	Major Storm	cfs					
$Q_{allow} = \text{SUMP}$	$Q_{allow} = \text{SUMP}$						

INLET IN A SUMP OR SAG LOCATION

Version 4.05 Released March 2017

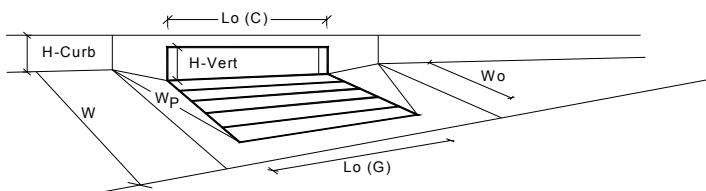

Design Information (Input)	MINOR	MAJOR	
Type of Inlet	CDOT Type R Curb Opening		
Local Depression (additional to continuous gutter depression 'a' from above)	3.00	3.00	inches
Number of Unit Inlets (Grate or Curb Opening)	1	1	
Water Depth at Flowline (outside of local depression)	5.6	8.4	inches
Grate Information	MINOR	MAJOR	<input checked="" type="checkbox"/> Override Depths
Length of a Unit Grate	N/A	N/A	feet
Width of a Unit Grate	N/A	N/A	feet
Area Opening Ratio for a Grate (typical values 0.15-0.90)	N/A	N/A	
Clogging Factor for a Single Grate (typical value 0.50 - 0.70)	N/A	N/A	
Grate Weir Coefficient (typical value 2.15 - 3.60)	N/A	N/A	
Grate Orifice Coefficient (typical value 0.60 - 0.80)	N/A	N/A	
Curb Opening Information	MINOR	MAJOR	
Length of a Unit Curb Opening	20.00	20.00	feet
Height of Vertical Curb Opening in Inches	6.00	6.00	inches
Height of Curb Orifice Throat in Inches	6.00	6.00	inches
Angle of Throat (see USDCM Figure ST-5)	63.40	63.40	degrees
Side Width for Depression Pan (typically the gutter width of 2 feet)	2.00	2.00	feet
Clogging Factor for a Single Curb Opening (typical value 0.10)	0.10	0.10	
Curb Opening Weir Coefficient (typical value 2.3-3.7)	3.60	3.60	
Curb Opening Orifice Coefficient (typical value 0.60 - 0.70)	0.67	0.67	
Low Head Performance Reduction (Calculated)	MINOR	MAJOR	
Depth for Grate Midwidth	N/A	N/A	ft
Depth for Curb Opening Weir Equation	0.30	0.53	ft
Combination Inlet Performance Reduction Factor for Long Inlets	0.53	0.79	
Curb Opening Performance Reduction Factor for Long Inlets	0.76	0.91	
Grated Inlet Performance Reduction Factor for Long Inlets	N/A	N/A	
Total Inlet Interception Capacity (assumes clogged condition)	MINOR	MAJOR	
Q_a	10.3	29.2	cfs
Q_{PEAK REQUIRED}	8.6	27.5	cfs

Inlet Capacity IS GOOD for Minor and Major Storms(>Q PEAK)

ALLOWABLE CAPACITY FOR ONE-HALF OF STREET (Minor & Major Storm)

(Based on Regulated Criteria for Maximum Allowable Flow Depth and Spread)

Project: The Ridge at Lorson Ranch, #100.064
 Inlet ID: Inlet DP-33 (Exist. 25' Type "R")

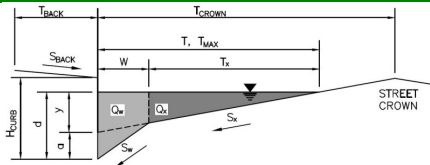

Gutter Geometry (Enter data in the blue cells)							
Maximum Allowable Width for Spread Behind Curb	$T_{BACK} = 8.0$ ft						
Side Slope Behind Curb (leave blank for no conveyance credit behind curb)	$S_{BACK} = 0.020$ ft/ft						
Manning's Roughness Behind Curb (typically between 0.012 and 0.020)	$n_{BACK} = 0.015$						
Height of Curb at Gutter Flow Line	$H_{CURB} = 6.00$ inches						
Distance from Curb Face to Street Crown	$T_{CROWN} = 17.0$ ft						
Gutter Width	$W = 2.00$ ft						
Street Transverse Slope	$S_x = 0.020$ ft/ft						
Gutter Cross Slope (typically 2 inches over 24 inches or 0.083 ft/ft)	$S_w = 0.083$ ft/ft						
Street Longitudinal Slope - Enter 0 for sump condition	$S_o = 0.000$ ft/ft						
Manning's Roughness for Street Section (typically between 0.012 and 0.020)	$n_{STREET} = 0.017$						
Max. Allowable Spread for Minor & Major Storm	<table border="1"> <thead> <tr> <th>Minor Storm</th> <th>Major Storm</th> <th>ft</th> </tr> </thead> <tbody> <tr> <td>17.0</td> <td>17.0</td> <td></td> </tr> </tbody> </table>	Minor Storm	Major Storm	ft	17.0	17.0	
Minor Storm	Major Storm	ft					
17.0	17.0						
Max. Allowable Depth at Gutter Flowline for Minor & Major Storm	<table border="1"> <thead> <tr> <th>Minor Storm</th> <th>Major Storm</th> <th>inches</th> </tr> </thead> <tbody> <tr> <td>5.6</td> <td>7.9</td> <td></td> </tr> </tbody> </table>	Minor Storm	Major Storm	inches	5.6	7.9	
Minor Storm	Major Storm	inches					
5.6	7.9						
Check boxes are not applicable in SUMP conditions	<input type="checkbox"/> <input type="checkbox"/>						
MINOR STORM Allowable Capacity is based on Depth Criterion							
MAJOR STORM Allowable Capacity is based on Depth Criterion							
	<table border="1"> <thead> <tr> <th>Minor Storm</th> <th>Major Storm</th> <th>cfs</th> </tr> </thead> <tbody> <tr> <td>SUMP</td> <td>SUMP</td> <td></td> </tr> </tbody> </table>	Minor Storm	Major Storm	cfs	SUMP	SUMP	
Minor Storm	Major Storm	cfs					
SUMP	SUMP						

INLET IN A SUMP OR SAG LOCATION

Version 4.05 Released March 2017

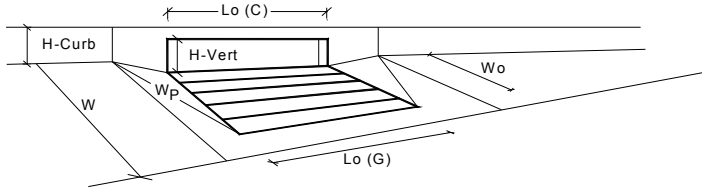

Design Information (Input)	MINOR	MAJOR	
Type of Inlet	CDOT Type R Curb Opening		
Local Depression (additional to continuous gutter depression 'a' from above)	3.00	3.00	inches
Number of Unit Inlets (Grate or Curb Opening)	1	1	
Water Depth at Flowline (outside of local depression)	4.6	7.7	inches
Grate Information	MINOR	MAJOR	<input checked="" type="checkbox"/> Override Depths
Length of a Unit Grate	N/A	N/A	feet
Width of a Unit Grate	N/A	N/A	feet
Area Opening Ratio for a Grate (typical values 0.15-0.90)	N/A	N/A	
Clogging Factor for a Single Grate (typical value 0.50 - 0.70)	N/A	N/A	
Grate Weir Coefficient (typical value 2.15 - 3.60)	N/A	N/A	
Grate Orifice Coefficient (typical value 0.60 - 0.80)	N/A	N/A	
Curb Opening Information	MINOR	MAJOR	
Length of a Unit Curb Opening	25.00	25.00	feet
Height of Vertical Curb Opening in Inches	6.00	6.00	inches
Height of Curb Orifice Throat in Inches	6.00	6.00	inches
Angle of Throat (see USDCM Figure ST-5)	63.40	63.40	degrees
Side Width for Depression Pan (typically the gutter width of 2 feet)	2.00	2.00	feet
Clogging Factor for a Single Curb Opening (typical value 0.10)	0.10	0.10	
Curb Opening Weir Coefficient (typical value 2.3-3.7)	3.60	3.60	
Curb Opening Orifice Coefficient (typical value 0.60 - 0.70)	0.67	0.67	
Low Head Performance Reduction (Calculated)	MINOR	MAJOR	
Depth for Grate Midwidth	N/A	N/A	ft
Depth for Curb Opening Weir Equation	0.22	0.47	ft
Combination Inlet Performance Reduction Factor for Long Inlets	0.43	0.72	
Curb Opening Performance Reduction Factor for Long Inlets	0.69	0.88	
Grated Inlet Performance Reduction Factor for Long Inlets	N/A	N/A	
Total Inlet Interception Capacity (assumes clogged condition)	MINOR	MAJOR	
Q_a	7.0	28.7	cfs
Q_{PEAK REQUIRED}	7.0	28.7	cfs

Inlet Capacity IS GOOD for Minor and Major Storms(>Q PEAK)

ALLOWABLE CAPACITY FOR ONE-HALF OF STREET (Minor & Major Storm)

(Based on Regulated Criteria for Maximum Allowable Flow Depth and Spread)

Project: The Ridge at Lorson Ranch, #100.064
 Inlet ID: Inlet DP-35a

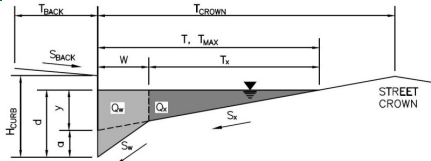

Gutter Geometry (Enter data in the blue cells)							
Maximum Allowable Width for Spread Behind Curb	$T_{BACK} = $ <input style="width: 50px;" type="text" value="8.0"/> ft						
Side Slope Behind Curb (leave blank for no conveyance credit behind curb)	$S_{BACK} = $ <input style="width: 50px;" type="text" value="0.020"/> ft/ft						
Manning's Roughness Behind Curb (typically between 0.012 and 0.020)	$n_{BACK} = $ <input style="width: 50px;" type="text" value="0.015"/>						
Height of Curb at Gutter Flow Line	$H_{CURB} = $ <input style="width: 50px;" type="text" value="6.00"/> inches						
Distance from Curb Face to Street Crown	$T_{CROWN} = $ <input style="width: 50px;" type="text" value="17.0"/> ft						
Gutter Width	$W = $ <input style="width: 50px;" type="text" value="2.00"/> ft						
Street Transverse Slope	$S_x = $ <input style="width: 50px;" type="text" value="0.020"/> ft/ft						
Gutter Cross Slope (typically 2 inches over 24 inches or 0.083 ft/ft)	$S_w = $ <input style="width: 50px;" type="text" value="0.083"/> ft/ft						
Street Longitudinal Slope - Enter 0 for sump condition	$S_o = $ <input style="width: 50px;" type="text" value="0.090"/> ft/ft						
Manning's Roughness for Street Section (typically between 0.012 and 0.020)	$n_{STREET} = $ <input style="width: 50px;" type="text" value="0.017"/>						
Max. Allowable Spread for Minor & Major Storm	<table border="1" style="margin-left: auto; margin-right: auto;"> <tr> <th style="padding: 2px;">Minor Storm</th> <th style="padding: 2px;">Major Storm</th> <th style="padding: 2px;">ft</th> </tr> <tr> <td style="text-align: center;"><input style="width: 50px;" type="text" value="17.0"/></td> <td style="text-align: center;"><input style="width: 50px;" type="text" value="17.0"/></td> <td></td> </tr> </table>	Minor Storm	Major Storm	ft	<input style="width: 50px;" type="text" value="17.0"/>	<input style="width: 50px;" type="text" value="17.0"/>	
Minor Storm	Major Storm	ft					
<input style="width: 50px;" type="text" value="17.0"/>	<input style="width: 50px;" type="text" value="17.0"/>						
Max. Allowable Depth at Gutter Flowline for Minor & Major Storm	<table border="1" style="margin-left: auto; margin-right: auto;"> <tr> <th style="padding: 2px;">Minor Storm</th> <th style="padding: 2px;">Major Storm</th> <th style="padding: 2px;">inches</th> </tr> <tr> <td style="text-align: center;"><input style="width: 50px;" type="text" value="5.6"/></td> <td style="text-align: center;"><input style="width: 50px;" type="text" value="7.9"/></td> <td></td> </tr> </table>	Minor Storm	Major Storm	inches	<input style="width: 50px;" type="text" value="5.6"/>	<input style="width: 50px;" type="text" value="7.9"/>	
Minor Storm	Major Storm	inches					
<input style="width: 50px;" type="text" value="5.6"/>	<input style="width: 50px;" type="text" value="7.9"/>						
Allow Flow Depth at Street Crown (leave blank for no)	<input type="checkbox"/> <input type="checkbox"/> check = yes						
MINOR STORM Allowable Capacity is based on Depth Criterion							
MAJOR STORM Allowable Capacity is based on Depth Criterion							
Minor storm max. allowable capacity GOOD - greater than the design flow given on sheet 'Inlet Management'	$Q_{allow} = $ <input style="width: 50px;" type="text" value="12.0"/> <input style="width: 50px;" type="text" value="23.5"/> cfs						
Major storm max. allowable capacity GOOD - greater than the design flow given on sheet 'Inlet Management'							

INLET ON A CONTINUOUS GRADE

Version 4.05 Released March 2017

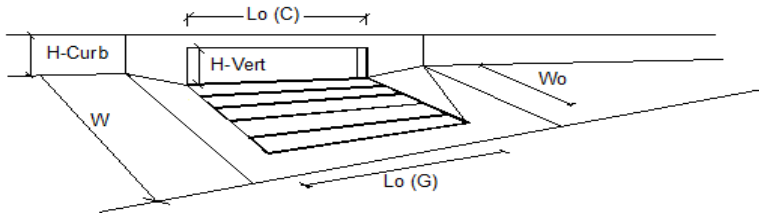

Design Information (Input)	MINOR	MAJOR	
Type of Inlet	CDOT Type R Curb Opening		
Local Depression (additional to continuous gutter depression 'a')	3.0	3.0	inches
Total Number of Units in the Inlet (Grate or Curb Opening)	1	1	
Length of a Single Unit Inlet (Grate or Curb Opening)	15.00	15.00	ft
Width of a Unit Grate (cannot be greater than W, Gutter Width)	N/A	N/A	ft
Clogging Factor for a Single Unit Grate (typical min. value = 0.5)	N/A	N/A	
Clogging Factor for a Single Unit Curb Opening (typical min. value = 0.1)	0.10	0.10	
Street Hydraulics: OK - Q < Allowable Street Capacity			
Total Inlet Interception Capacity	5.9	11.3	cfs
Total Inlet Carry-Over Flow (flow bypassing inlet)	0.0	1.9	cfs
Capture Percentage = Q_i/Q_c =	100	86	%

ALLOWABLE CAPACITY FOR ONE-HALF OF STREET (Minor & Major Storm)

(Based on Regulated Criteria for Maximum Allowable Flow Depth and Spread)

Project: The Ridge at Lorson Ranch, #100.064
 Inlet ID: Inlet DP-35b



Gutter Geometry (Enter data in the blue cells)							
Maximum Allowable Width for Spread Behind Curb	$T_{BACK} = 8.0$ ft						
Side Slope Behind Curb (leave blank for no conveyance credit behind curb)	$S_{BACK} = 0.020$ ft/ft						
Manning's Roughness Behind Curb (typically between 0.012 and 0.020)	$n_{BACK} = 0.015$						
Height of Curb at Gutter Flow Line	$H_{CURB} = 6.00$ inches						
Distance from Curb Face to Street Crown	$T_{CROWN} = 17.0$ ft						
Gutter Width	$W = 2.00$ ft						
Street Transverse Slope	$S_x = 0.020$ ft/ft						
Gutter Cross Slope (typically 2 inches over 24 inches or 0.083 ft/ft)	$S_w = 0.083$ ft/ft						
Street Longitudinal Slope - Enter 0 for sump condition	$S_o = 0.006$ ft/ft						
Manning's Roughness for Street Section (typically between 0.012 and 0.020)	$n_{STREET} = 0.017$						
Max. Allowable Spread for Minor & Major Storm	<table border="1" style="display: inline-table; border-collapse: collapse;"> <tr> <th style="padding: 2px;">Minor Storm</th> <th style="padding: 2px;">Major Storm</th> <th style="padding: 2px;">ft</th> </tr> <tr> <td style="text-align: center; padding: 2px;">17.0</td> <td style="text-align: center; padding: 2px;">17.0</td> <td></td> </tr> </table>	Minor Storm	Major Storm	ft	17.0	17.0	
Minor Storm	Major Storm	ft					
17.0	17.0						
Max. Allowable Depth at Gutter Flowline for Minor & Major Storm	<table border="1" style="display: inline-table; border-collapse: collapse;"> <tr> <th style="padding: 2px;">Minor Storm</th> <th style="padding: 2px;">Major Storm</th> <th style="padding: 2px;">inches</th> </tr> <tr> <td style="text-align: center; padding: 2px;">5.6</td> <td style="text-align: center; padding: 2px;">7.9</td> <td></td> </tr> </table>	Minor Storm	Major Storm	inches	5.6	7.9	
Minor Storm	Major Storm	inches					
5.6	7.9						
Allow Flow Depth at Street Crown (leave blank for no)	<input type="checkbox"/> <input checked="" type="checkbox"/> check = yes						
MINOR STORM Allowable Capacity is based on Spread Criterion							
MAJOR STORM Allowable Capacity is based on Depth Criterion							
Minor storm max. allowable capacity GOOD - greater than the design flow given on sheet 'Inlet Management'	<table border="1" style="display: inline-table; border-collapse: collapse;"> <tr> <th style="padding: 2px;">Minor Storm</th> <th style="padding: 2px;">Major Storm</th> <th style="padding: 2px;">cfs</th> </tr> <tr> <td style="text-align: center; padding: 2px;">7.9</td> <td style="text-align: center; padding: 2px;">24.2</td> <td></td> </tr> </table>	Minor Storm	Major Storm	cfs	7.9	24.2	
Minor Storm	Major Storm	cfs					
7.9	24.2						
Major storm max. allowable capacity GOOD - greater than the design flow given on sheet 'Inlet Management'							

INLET ON A CONTINUOUS GRADE

Version 4.05 Released March 2017

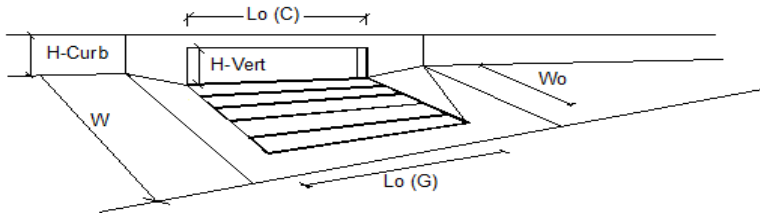

Design Information (Input)	MINOR	MAJOR	
Type of Inlet	CDOT Type R Curb Opening		
Local Depression (additional to continuous gutter depression 'a')	3.0	3.0	inches
Total Number of Units in the Inlet (Grate or Curb Opening)	1	1	
Length of a Single Unit Inlet (Grate or Curb Opening)	10.00	10.00	ft
Width of a Unit Grate (cannot be greater than W, Gutter Width)	N/A	N/A	ft
Clogging Factor for a Single Unit Grate (typical min. value = 0.5)	N/A	N/A	
Clogging Factor for a Single Unit Curb Opening (typical min. value = 0.1)	0.10	0.10	
Street Hydraulics: OK - Q < Allowable Street Capacity			
Total Inlet Interception Capacity	1.9	4.4	cfs
Total Inlet Carry-Over Flow (flow bypassing inlet)	0.0	0.2	cfs
Capture Percentage = Q_i/Q_c =	100	96	%

ALLOWABLE CAPACITY FOR ONE-HALF OF STREET (Minor & Major Storm)

(Based on Regulated Criteria for Maximum Allowable Flow Depth and Spread)

Project: The Ridge at Lorson Ranch, #100.064
 Inlet ID: Inlet DP-36



Gutter Geometry (Enter data in the blue cells)							
Maximum Allowable Width for Spread Behind Curb	$T_{BACK} = 8.0$ ft						
Side Slope Behind Curb (leave blank for no conveyance credit behind curb)	$S_{BACK} = 0.020$ ft/ft						
Manning's Roughness Behind Curb (typically between 0.012 and 0.020)	$n_{BACK} = 0.015$						
Height of Curb at Gutter Flow Line	$H_{CURB} = 6.00$ inches						
Distance from Curb Face to Street Crown	$T_{CROWN} = 17.0$ ft						
Gutter Width	$W = 2.00$ ft						
Street Transverse Slope	$S_x = 0.020$ ft/ft						
Gutter Cross Slope (typically 2 inches over 24 inches or 0.083 ft/ft)	$S_w = 0.083$ ft/ft						
Street Longitudinal Slope - Enter 0 for sump condition	$S_o = 0.027$ ft/ft						
Manning's Roughness for Street Section (typically between 0.012 and 0.020)	$n_{STREET} = 0.017$						
Max. Allowable Spread for Minor & Major Storm	<table border="1" style="display: inline-table; border-collapse: collapse;"> <tr> <th style="padding: 2px;">Minor Storm</th> <th style="padding: 2px;">Major Storm</th> <th style="padding: 2px;">ft</th> </tr> <tr> <td style="text-align: center; padding: 2px;">17.0</td> <td style="text-align: center; padding: 2px;">17.0</td> <td></td> </tr> </table>	Minor Storm	Major Storm	ft	17.0	17.0	
Minor Storm	Major Storm	ft					
17.0	17.0						
Max. Allowable Depth at Gutter Flowline for Minor & Major Storm	<table border="1" style="display: inline-table; border-collapse: collapse;"> <tr> <th style="padding: 2px;">Minor Storm</th> <th style="padding: 2px;">Major Storm</th> <th style="padding: 2px;">inches</th> </tr> <tr> <td style="text-align: center; padding: 2px;">5.6</td> <td style="text-align: center; padding: 2px;">7.9</td> <td></td> </tr> </table>	Minor Storm	Major Storm	inches	5.6	7.9	
Minor Storm	Major Storm	inches					
5.6	7.9						
Allow Flow Depth at Street Crown (leave blank for no)	<input type="checkbox"/> <input checked="" type="checkbox"/> check = yes						
MINOR STORM Allowable Capacity is based on Spread Criterion							
MAJOR STORM Allowable Capacity is based on Depth Criterion							
Minor storm max. allowable capacity GOOD - greater than the design flow given on sheet 'Inlet Management'	<table border="1" style="display: inline-table; border-collapse: collapse;"> <tr> <th style="padding: 2px;">Minor Storm</th> <th style="padding: 2px;">Major Storm</th> <th style="padding: 2px;">cfs</th> </tr> <tr> <td style="text-align: center; padding: 2px;">16.8</td> <td style="text-align: center; padding: 2px;">34.0</td> <td></td> </tr> </table>	Minor Storm	Major Storm	cfs	16.8	34.0	
Minor Storm	Major Storm	cfs					
16.8	34.0						
Major storm max. allowable capacity GOOD - greater than the design flow given on sheet 'Inlet Management'							

INLET ON A CONTINUOUS GRADE

Version 4.05 Released March 2017

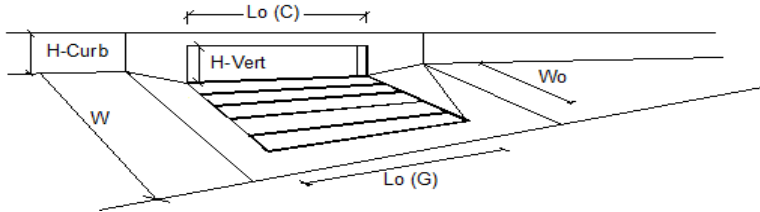

Design Information (Input)	MINOR	MAJOR	
Type of Inlet	CDOT Type R Curb Opening		
Local Depression (additional to continuous gutter depression 'a')	3.0	3.0	inches
Total Number of Units in the Inlet (Grate or Curb Opening)	1	1	
Length of a Single Unit Inlet (Grate or Curb Opening)	5.00	5.00	ft
Width of a Unit Grate (cannot be greater than W, Gutter Width)	N/A	N/A	ft
Clogging Factor for a Single Unit Grate (typical min. value = 0.5)	N/A	N/A	
Clogging Factor for a Single Unit Curb Opening (typical min. value = 0.1)	0.10	0.10	
Street Hydraulics: OK - Q < Allowable Street Capacity*			
Total Inlet Interception Capacity	4.1	5.7	cfs
Total Inlet Carry-Over Flow (flow bypassing inlet)	7.3	19.5	cfs
Capture Percentage = Q_i/Q_c =	36	22	%

ALLOWABLE CAPACITY FOR ONE-HALF OF STREET (Minor & Major Storm)

(Based on Regulated Criteria for Maximum Allowable Flow Depth and Spread)

Project: The Ridge at Lorson Ranch, #100.064
 Inlet ID: Inlet DP-37



Gutter Geometry (Enter data in the blue cells)							
Maximum Allowable Width for Spread Behind Curb	$T_{BACK} = 8.0$ ft						
Side Slope Behind Curb (leave blank for no conveyance credit behind curb)	$S_{BACK} = 0.020$ ft/ft						
Manning's Roughness Behind Curb (typically between 0.012 and 0.020)	$n_{BACK} = 0.015$						
Height of Curb at Gutter Flow Line	$H_{CURB} = 6.00$ inches						
Distance from Curb Face to Street Crown	$T_{CROWN} = 17.0$ ft						
Gutter Width	$W = 2.00$ ft						
Street Transverse Slope	$S_x = 0.020$ ft/ft						
Gutter Cross Slope (typically 2 inches over 24 inches or 0.083 ft/ft)	$S_w = 0.083$ ft/ft						
Street Longitudinal Slope - Enter 0 for sump condition	$S_o = 0.020$ ft/ft						
Manning's Roughness for Street Section (typically between 0.012 and 0.020)	$n_{STREET} = 0.017$						
Max. Allowable Spread for Minor & Major Storm	<table border="1"> <thead> <tr> <th>Minor Storm</th> <th>Major Storm</th> <th>ft</th> </tr> </thead> <tbody> <tr> <td>17.0</td> <td>17.0</td> <td></td> </tr> </tbody> </table>	Minor Storm	Major Storm	ft	17.0	17.0	
Minor Storm	Major Storm	ft					
17.0	17.0						
Max. Allowable Depth at Gutter Flowline for Minor & Major Storm	<table border="1"> <thead> <tr> <th>Minor Storm</th> <th>Major Storm</th> <th>inches</th> </tr> </thead> <tbody> <tr> <td>5.6</td> <td>7.9</td> <td></td> </tr> </tbody> </table>	Minor Storm	Major Storm	inches	5.6	7.9	
Minor Storm	Major Storm	inches					
5.6	7.9						
Allow Flow Depth at Street Crown (leave blank for no)	<input type="checkbox"/> Minor Storm <input checked="" type="checkbox"/> Major Storm check = yes						
MINOR STORM Allowable Capacity is based on Spread Criterion							
MAJOR STORM Allowable Capacity is based on Depth Criterion							
Minor storm max. allowable capacity GOOD - greater than the design flow given on sheet 'Inlet Management'	<table border="1"> <thead> <tr> <th>Minor Storm</th> <th>Major Storm</th> <th>cfs</th> </tr> </thead> <tbody> <tr> <td>14.5</td> <td>37.2</td> <td></td> </tr> </tbody> </table>	Minor Storm	Major Storm	cfs	14.5	37.2	
Minor Storm	Major Storm	cfs					
14.5	37.2						
Major storm max. allowable capacity GOOD - greater than the design flow given on sheet 'Inlet Management'							

INLET ON A CONTINUOUS GRADE

Version 4.05 Released March 2017

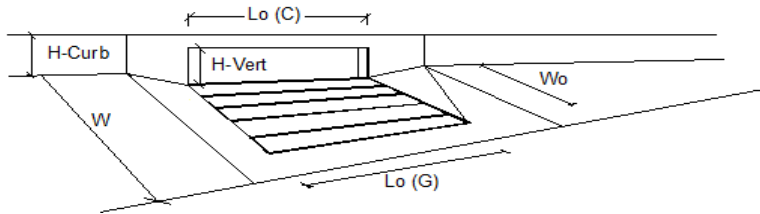

Design Information (Input)	MINOR	MAJOR	
Type of Inlet	CDOT Type R Curb Opening		
Local Depression (additional to continuous gutter depression 'a')	3.0	3.0	inches
Total Number of Units in the Inlet (Grate or Curb Opening)	1	1	
Length of a Single Unit Inlet (Grate or Curb Opening)	5.00	5.00	ft
Width of a Unit Grate (cannot be greater than W, Gutter Width)	N/A	N/A	ft
Clogging Factor for a Single Unit Grate (typical min. value = 0.5)	N/A	N/A	
Clogging Factor for a Single Unit Curb Opening (typical min. value = 0.1)	0.10	0.10	
Street Hydraulics: OK - Q < Allowable Street Capacity*			
Total Inlet Interception Capacity	3.4	4.8	cfs
Total Inlet Carry-Over Flow (flow bypassing inlet)	4.0	11.5	cfs
Capture Percentage = Q_i/Q_c =	46	29	%

ALLOWABLE CAPACITY FOR ONE-HALF OF STREET (Minor & Major Storm)

(Based on Regulated Criteria for Maximum Allowable Flow Depth and Spread)

Project: The Ridge at Lorson Ranch, #100.064
 Inlet ID: Inlet DP-39

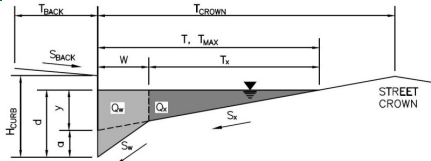

Gutter Geometry (Enter data in the blue cells)							
Maximum Allowable Width for Spread Behind Curb	$T_{BACK} = 8.0$ ft						
Side Slope Behind Curb (leave blank for no conveyance credit behind curb)	$S_{BACK} = 0.020$ ft/ft						
Manning's Roughness Behind Curb (typically between 0.012 and 0.020)	$n_{BACK} = 0.015$						
Height of Curb at Gutter Flow Line	$H_{CURB} = 6.00$ inches						
Distance from Curb Face to Street Crown	$T_{CROWN} = 17.0$ ft						
Gutter Width	$W = 2.00$ ft						
Street Transverse Slope	$S_X = 0.020$ ft/ft						
Gutter Cross Slope (typically 2 inches over 24 inches or 0.083 ft/ft)	$S_W = 0.083$ ft/ft						
Street Longitudinal Slope - Enter 0 for sump condition	$S_O = 0.019$ ft/ft						
Manning's Roughness for Street Section (typically between 0.012 and 0.020)	$n_{STREET} = 0.017$						
Max. Allowable Spread for Minor & Major Storm	<table border="1"> <tr> <th>Minor Storm</th> <th>Major Storm</th> <th>ft</th> </tr> <tr> <td>$T_{MAX} = 17.0$</td> <td>$T_{MAX} = 17.0$</td> <td></td> </tr> </table>	Minor Storm	Major Storm	ft	$T_{MAX} = 17.0$	$T_{MAX} = 17.0$	
Minor Storm	Major Storm	ft					
$T_{MAX} = 17.0$	$T_{MAX} = 17.0$						
Max. Allowable Depth at Gutter Flowline for Minor & Major Storm	<table border="1"> <tr> <th>Minor Storm</th> <th>Major Storm</th> <th>inches</th> </tr> <tr> <td>$d_{MAX} = 5.6$</td> <td>$d_{MAX} = 7.9$</td> <td></td> </tr> </table>	Minor Storm	Major Storm	inches	$d_{MAX} = 5.6$	$d_{MAX} = 7.9$	
Minor Storm	Major Storm	inches					
$d_{MAX} = 5.6$	$d_{MAX} = 7.9$						
Allow Flow Depth at Street Crown (leave blank for no)	<input type="checkbox"/> Minor Storm <input checked="" type="checkbox"/> Major Storm check = yes						
MINOR STORM Allowable Capacity is based on Spread Criterion							
MAJOR STORM Allowable Capacity is based on Depth Criterion							
Minor storm max. allowable capacity GOOD - greater than the design flow given on sheet 'Inlet Management'	<table border="1"> <tr> <th>Minor Storm</th> <th>Major Storm</th> <th>cfs</th> </tr> <tr> <td>$Q_{allow} = 14.1$</td> <td>$Q_{allow} = 38.0$</td> <td></td> </tr> </table>	Minor Storm	Major Storm	cfs	$Q_{allow} = 14.1$	$Q_{allow} = 38.0$	
Minor Storm	Major Storm	cfs					
$Q_{allow} = 14.1$	$Q_{allow} = 38.0$						
Major storm max. allowable capacity GOOD - greater than the design flow given on sheet 'Inlet Management'							

INLET ON A CONTINUOUS GRADE

Version 4.05 Released March 2017

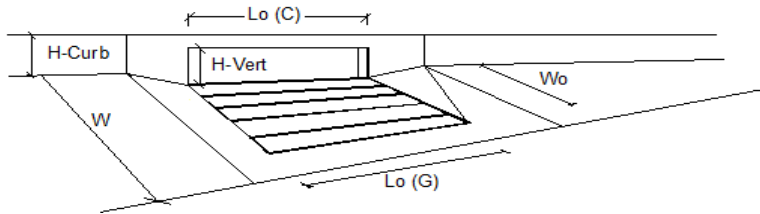

Design Information (Input)	MINOR	MAJOR	
Type of Inlet	CDOT Type R Curb Opening		
Local Depression (additional to continuous gutter depression 'a')	3.0	3.0	inches
Total Number of Units in the Inlet (Grate or Curb Opening)	1	1	
Length of a Single Unit Inlet (Grate or Curb Opening)	25.00	25.00	ft
Width of a Unit Grate (cannot be greater than W, Gutter Width)	N/A	N/A	ft
Clogging Factor for a Single Unit Grate (typical min. value = 0.5)	N/A	N/A	
Clogging Factor for a Single Unit Curb Opening (typical min. value = 0.1)	0.10	0.10	
Street Hydraulics: OK - Q < Allowable Street Capacity			
Total Inlet Interception Capacity	12.7	27.0	cfs
Total Inlet Carry-Over Flow (flow bypassing inlet)	0.0	7.0	cfs
Capture Percentage = Q_i/Q_c =	100	79	%

ALLOWABLE CAPACITY FOR ONE-HALF OF STREET (Minor & Major Storm)

(Based on Regulated Criteria for Maximum Allowable Flow Depth and Spread)

Project: The Ridge at Lorson Ranch, #100.064
 Inlet ID: Inlet DP-41



Gutter Geometry (Enter data in the blue cells)													
Maximum Allowable Width for Spread Behind Curb	$T_{BACK} = $ <input style="width: 50px;" type="text" value="8.0"/> ft												
Side Slope Behind Curb (leave blank for no conveyance credit behind curb)	$S_{BACK} = $ <input style="width: 50px;" type="text" value="0.020"/> ft/ft												
Manning's Roughness Behind Curb (typically between 0.012 and 0.020)	$n_{BACK} = $ <input style="width: 50px;" type="text" value="0.015"/>												
Height of Curb at Gutter Flow Line	$H_{CURB} = $ <input style="width: 50px;" type="text" value="6.00"/> inches												
Distance from Curb Face to Street Crown	$T_{CROWN} = $ <input style="width: 50px;" type="text" value="17.0"/> ft												
Gutter Width	$W = $ <input style="width: 50px;" type="text" value="2.00"/> ft												
Street Transverse Slope	$S_x = $ <input style="width: 50px;" type="text" value="0.020"/> ft/ft												
Gutter Cross Slope (typically 2 inches over 24 inches or 0.083 ft/ft)	$S_w = $ <input style="width: 50px;" type="text" value="0.083"/> ft/ft												
Street Longitudinal Slope - Enter 0 for sump condition	$S_o = $ <input style="width: 50px;" type="text" value="0.000"/> ft/ft												
Manning's Roughness for Street Section (typically between 0.012 and 0.020)	$n_{STREET} = $ <input style="width: 50px;" type="text" value="0.017"/>												
Max. Allowable Spread for Minor & Major Storm	<table style="width: 100%; border-collapse: collapse;"> <tr> <th style="width: 50%;"></th> <th style="width: 25%; text-align: center;">Minor Storm</th> <th style="width: 25%; text-align: center;">Major Storm</th> <th style="width: 10%;"></th> </tr> <tr> <td style="padding: 5px;">$T_{MAX} =$</td> <td style="text-align: center;"><input style="width: 50px;" type="text" value="17.0"/></td> <td style="text-align: center;"><input style="width: 50px;" type="text" value="17.0"/></td> <td style="text-align: right;">ft</td> </tr> <tr> <td style="padding: 5px;">$d_{MAX} =$</td> <td style="text-align: center;"><input style="width: 50px;" type="text" value="5.6"/></td> <td style="text-align: center;"><input style="width: 50px;" type="text" value="7.9"/></td> <td style="text-align: right;">inches</td> </tr> </table>		Minor Storm	Major Storm		$T_{MAX} = $	<input style="width: 50px;" type="text" value="17.0"/>	<input style="width: 50px;" type="text" value="17.0"/>	ft	$d_{MAX} = $	<input style="width: 50px;" type="text" value="5.6"/>	<input style="width: 50px;" type="text" value="7.9"/>	inches
	Minor Storm	Major Storm											
$T_{MAX} = $	<input style="width: 50px;" type="text" value="17.0"/>	<input style="width: 50px;" type="text" value="17.0"/>	ft										
$d_{MAX} = $	<input style="width: 50px;" type="text" value="5.6"/>	<input style="width: 50px;" type="text" value="7.9"/>	inches										
Max. Allowable Depth at Gutter Flowline for Minor & Major Storm													
Check boxes are not applicable in SUMP conditions	<table style="width: 100%; border-collapse: collapse;"> <tr> <td style="width: 50%; text-align: center;"><input type="checkbox"/></td> <td style="width: 50%; text-align: center;"><input type="checkbox"/></td> </tr> </table>	<input type="checkbox"/>	<input type="checkbox"/>										
<input type="checkbox"/>	<input type="checkbox"/>												
MINOR STORM Allowable Capacity is based on Depth Criterion													
MAJOR STORM Allowable Capacity is based on Depth Criterion	<table style="width: 100%; border-collapse: collapse;"> <tr> <th style="width: 50%;"></th> <th style="width: 25%; text-align: center;">Minor Storm</th> <th style="width: 25%; text-align: center;">Major Storm</th> <th style="width: 10%;"></th> </tr> <tr> <td style="padding: 5px;">$Q_{allow} =$</td> <td style="text-align: center;"><input style="width: 50px;" type="text" value="SUMP"/></td> <td style="text-align: center;"><input style="width: 50px;" type="text" value="SUMP"/></td> <td style="text-align: right;">cfs</td> </tr> </table>		Minor Storm	Major Storm		$Q_{allow} = $	<input style="width: 50px;" type="text" value="SUMP"/>	<input style="width: 50px;" type="text" value="SUMP"/>	cfs				
	Minor Storm	Major Storm											
$Q_{allow} = $	<input style="width: 50px;" type="text" value="SUMP"/>	<input style="width: 50px;" type="text" value="SUMP"/>	cfs										

INLET IN A SUMP OR SAG LOCATION

Version 4.05 Released March 2017

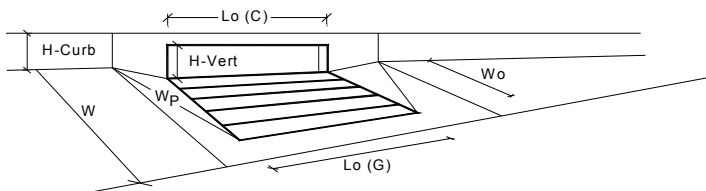

Design Information (Input)	MINOR	MAJOR	
Type of Inlet	CDOT Type R Curb Opening		
Local Depression (additional to continuous gutter depression 'a' from above)	3.00	3.00	inches
Number of Unit Inlets (Grate or Curb Opening)	1	1	
Water Depth at Flowline (outside of local depression)	5.6	7.9	inches
Grate Information	MINOR	MAJOR	<input checked="" type="checkbox"/> Override Depths
Length of a Unit Grate	N/A	N/A	feet
Width of a Unit Grate	N/A	N/A	feet
Area Opening Ratio for a Grate (typical values 0.15-0.90)	N/A	N/A	
Clogging Factor for a Single Grate (typical value 0.50 - 0.70)	N/A	N/A	
Grate Weir Coefficient (typical value 2.15 - 3.60)	N/A	N/A	
Grate Orifice Coefficient (typical value 0.60 - 0.80)	N/A	N/A	
Curb Opening Information	MINOR	MAJOR	
Length of a Unit Curb Opening	20.00	20.00	feet
Height of Vertical Curb Opening in Inches	6.00	6.00	inches
Height of Curb Orifice Throat in Inches	6.00	6.00	inches
Angle of Throat (see USDCM Figure ST-5)	63.40	63.40	degrees
Side Width for Depression Pan (typically the gutter width of 2 feet)	2.00	2.00	feet
Clogging Factor for a Single Curb Opening (typical value 0.10)	0.10	0.10	
Curb Opening Weir Coefficient (typical value 2.3-3.7)	3.60	3.60	
Curb Opening Orifice Coefficient (typical value 0.60 - 0.70)	0.67	0.67	
Low Head Performance Reduction (Calculated)	MINOR	MAJOR	
Depth for Grate Midwidth	N/A	N/A	ft
Depth for Curb Opening Weir Equation	0.30	0.49	ft
Combination Inlet Performance Reduction Factor for Long Inlets	0.53	0.74	
Curb Opening Performance Reduction Factor for Long Inlets	0.76	0.89	
Grated Inlet Performance Reduction Factor for Long Inlets	N/A	N/A	
Total Inlet Interception Capacity (assumes clogged condition)	MINOR	MAJOR	
Q_a	10.3	25.1	cfs
Q_{PEAK REQUIRED}	9.3	27.7	cfs

WARNING: Inlet Capacity less than Q Peak for Major Storm

inlet overtops and flows to Inlet DP-43

ALLOWABLE CAPACITY FOR ONE-HALF OF STREET (Minor & Major Storm)

(Based on Regulated Criteria for Maximum Allowable Flow Depth and Spread)

Project: The Ridge at Lorson Ranch, #100.064
 Inlet ID: Inlet DP-43

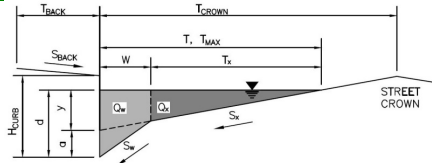

Gutter Geometry (Enter data in the blue cells)							
Maximum Allowable Width for Spread Behind Curb	$T_{BACK} = $ <input style="width: 50px;" type="text" value="8.0"/> ft						
Side Slope Behind Curb (leave blank for no conveyance credit behind curb)	$S_{BACK} = $ <input style="width: 50px;" type="text" value="0.020"/> ft/ft						
Manning's Roughness Behind Curb (typically between 0.012 and 0.020)	$n_{BACK} = $ <input style="width: 50px;" type="text" value="0.015"/>						
Height of Curb at Gutter Flow Line	$H_{CURB} = $ <input style="width: 50px;" type="text" value="6.00"/> inches						
Distance from Curb Face to Street Crown	$T_{CROWN} = $ <input style="width: 50px;" type="text" value="35.0"/> ft						
Gutter Width	$W = $ <input style="width: 50px;" type="text" value="2.00"/> ft						
Street Transverse Slope	$S_x = $ <input style="width: 50px;" type="text" value="0.020"/> ft/ft						
Gutter Cross Slope (typically 2 inches over 24 inches or 0.083 ft/ft)	$S_w = $ <input style="width: 50px;" type="text" value="0.083"/> ft/ft						
Street Longitudinal Slope - Enter 0 for sump condition	$S_o = $ <input style="width: 50px;" type="text" value="0.000"/> ft/ft						
Manning's Roughness for Street Section (typically between 0.012 and 0.020)	$n_{STREET} = $ <input style="width: 50px;" type="text" value="0.017"/>						
Max. Allowable Spread for Minor & Major Storm	<table style="width: 100%; border-collapse: collapse;"> <tr> <td style="text-align: center; padding: 2px;">Minor Storm</td> <td style="text-align: center; padding: 2px;">Major Storm</td> <td style="padding: 2px;"></td> </tr> <tr> <td style="padding: 2px;">$T_{MAX} =$ <input style="width: 50px;" type="text" value="35.0"/></td> <td style="padding: 2px;"><input style="width: 50px;" type="text" value="35.0"/></td> <td style="padding: 2px;">ft</td> </tr> </table>	Minor Storm	Major Storm		$T_{MAX} = $ <input style="width: 50px;" type="text" value="35.0"/>	<input style="width: 50px;" type="text" value="35.0"/>	ft
Minor Storm	Major Storm						
$T_{MAX} = $ <input style="width: 50px;" type="text" value="35.0"/>	<input style="width: 50px;" type="text" value="35.0"/>	ft					
Max. Allowable Depth at Gutter Flowline for Minor & Major Storm	<table style="width: 100%; border-collapse: collapse;"> <tr> <td style="text-align: center; padding: 2px;">Minor Storm</td> <td style="text-align: center; padding: 2px;">Major Storm</td> <td style="padding: 2px;"></td> </tr> <tr> <td style="padding: 2px;">$d_{MAX} =$ <input style="width: 50px;" type="text" value="6.0"/></td> <td style="padding: 2px;"><input style="width: 50px;" type="text" value="7.9"/></td> <td style="padding: 2px;">inches</td> </tr> </table>	Minor Storm	Major Storm		$d_{MAX} = $ <input style="width: 50px;" type="text" value="6.0"/>	<input style="width: 50px;" type="text" value="7.9"/>	inches
Minor Storm	Major Storm						
$d_{MAX} = $ <input style="width: 50px;" type="text" value="6.0"/>	<input style="width: 50px;" type="text" value="7.9"/>	inches					
Check boxes are not applicable in SUMP conditions	<table style="width: 100%; border-collapse: collapse;"> <tr> <td style="text-align: center; padding: 2px;"><input type="checkbox"/></td> <td style="text-align: center; padding: 2px;"><input type="checkbox"/></td> </tr> </table>	<input type="checkbox"/>	<input type="checkbox"/>				
<input type="checkbox"/>	<input type="checkbox"/>						
MINOR STORM Allowable Capacity is based on Depth Criterion							
MAJOR STORM Allowable Capacity is based on Depth Criterion	<table style="width: 100%; border-collapse: collapse;"> <tr> <td style="text-align: center; padding: 2px;">Minor Storm</td> <td style="text-align: center; padding: 2px;">Major Storm</td> <td style="padding: 2px;"></td> </tr> <tr> <td style="padding: 2px;">$Q_{allow} =$ <input style="width: 50px;" type="text" value="SUMP"/></td> <td style="padding: 2px;"><input style="width: 50px;" type="text" value="SUMP"/></td> <td style="padding: 2px;">cfs</td> </tr> </table>	Minor Storm	Major Storm		$Q_{allow} = $ <input style="width: 50px;" type="text" value="SUMP"/>	<input style="width: 50px;" type="text" value="SUMP"/>	cfs
Minor Storm	Major Storm						
$Q_{allow} = $ <input style="width: 50px;" type="text" value="SUMP"/>	<input style="width: 50px;" type="text" value="SUMP"/>	cfs					

INLET IN A SUMP OR SAG LOCATION

Version 4.05 Released March 2017

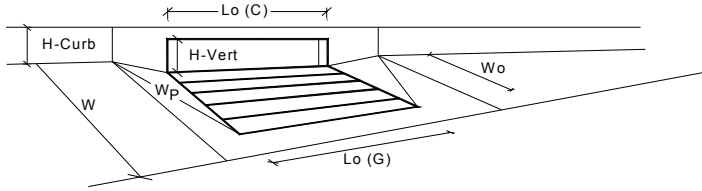

Design Information (Input)	MINOR	MAJOR	
Type of Inlet	CDOT Type R Curb Opening		
Local Depression (additional to continuous gutter depression 'a' from above)	3.00	3.00	inches
Number of Unit Inlets (Grate or Curb Opening)	1	1	
Water Depth at Flowline (outside of local depression)	5.6	7.9	inches
Grate Information	MINOR	MAJOR	<input checked="" type="checkbox"/> Override Depths
Length of a Unit Grate	N/A	N/A	feet
Width of a Unit Grate	N/A	N/A	feet
Area Opening Ratio for a Grate (typical values 0.15-0.90)	N/A	N/A	
Clogging Factor for a Single Grate (typical value 0.50 - 0.70)	N/A	N/A	
Grate Weir Coefficient (typical value 2.15 - 3.60)	N/A	N/A	
Grate Orifice Coefficient (typical value 0.60 - 0.80)	N/A	N/A	
Curb Opening Information	MINOR	MAJOR	
Length of a Unit Curb Opening	20.00	20.00	feet
Height of Vertical Curb Opening in Inches	6.00	6.00	inches
Height of Curb Orifice Throat in Inches	6.00	6.00	inches
Angle of Throat (see USDCM Figure ST-5)	63.40	63.40	degrees
Side Width for Depression Pan (typically the gutter width of 2 feet)	2.00	2.00	feet
Clogging Factor for a Single Curb Opening (typical value 0.10)	0.10	0.10	
Curb Opening Weir Coefficient (typical value 2.3-3.7)	3.60	3.60	
Curb Opening Orifice Coefficient (typical value 0.60 - 0.70)	0.67	0.67	
Low Head Performance Reduction (Calculated)	MINOR	MAJOR	
Depth for Grate Midwidth	N/A	N/A	ft
Depth for Curb Opening Weir Equation	0.30	0.49	ft
Combination Inlet Performance Reduction Factor for Long Inlets	0.53	0.74	
Curb Opening Performance Reduction Factor for Long Inlets	0.76	0.89	
Grated Inlet Performance Reduction Factor for Long Inlets	N/A	N/A	
Total Inlet Interception Capacity (assumes clogged condition)	MINOR	MAJOR	
Q_a	10.3	25.0	cfs
Q _{PEAK REQUIRED}	10.0	24.5	cfs

Inlet Capacity IS GOOD for Minor and Major Storms(>Q PEAK)

ALLOWABLE CAPACITY FOR ONE-HALF OF STREET (Minor & Major Storm)

(Based on Regulated Criteria for Maximum Allowable Flow Depth and Spread)

Project: The Ridge at Lorson Ranch, #100.064
 Inlet ID: Inlet DP-47



Gutter Geometry (Enter data in the blue cells)							
Maximum Allowable Width for Spread Behind Curb	$T_{BACK} = 8.0$ ft						
Side Slope Behind Curb (leave blank for no conveyance credit behind curb)	$S_{BACK} = 0.020$ ft/ft						
Manning's Roughness Behind Curb (typically between 0.012 and 0.020)	$n_{BACK} = 0.015$						
Height of Curb at Gutter Flow Line	$H_{CURB} = 6.00$ inches						
Distance from Curb Face to Street Crown	$T_{CROWN} = 17.0$ ft						
Gutter Width	$W = 2.00$ ft						
Street Transverse Slope	$S_x = 0.020$ ft/ft						
Gutter Cross Slope (typically 2 inches over 24 inches or 0.083 ft/ft)	$S_w = 0.083$ ft/ft						
Street Longitudinal Slope - Enter 0 for sump condition	$S_o = 0.010$ ft/ft						
Manning's Roughness for Street Section (typically between 0.012 and 0.020)	$n_{STREET} = 0.017$						
Max. Allowable Spread for Minor & Major Storm	<table border="1" style="display: inline-table; border-collapse: collapse;"> <tr> <th style="padding: 2px;">Minor Storm</th> <th style="padding: 2px;">Major Storm</th> <th style="padding: 2px;">ft</th> </tr> <tr> <td style="text-align: center; padding: 2px;">17.0</td> <td style="text-align: center; padding: 2px;">17.0</td> <td></td> </tr> </table>	Minor Storm	Major Storm	ft	17.0	17.0	
Minor Storm	Major Storm	ft					
17.0	17.0						
Max. Allowable Depth at Gutter Flowline for Minor & Major Storm	<table border="1" style="display: inline-table; border-collapse: collapse;"> <tr> <th style="padding: 2px;">Minor Storm</th> <th style="padding: 2px;">Major Storm</th> <th style="padding: 2px;">inches</th> </tr> <tr> <td style="text-align: center; padding: 2px;">5.6</td> <td style="text-align: center; padding: 2px;">7.9</td> <td></td> </tr> </table>	Minor Storm	Major Storm	inches	5.6	7.9	
Minor Storm	Major Storm	inches					
5.6	7.9						
Allow Flow Depth at Street Crown (leave blank for no)	<input type="checkbox"/> <input checked="" type="checkbox"/> check = yes						
MINOR STORM Allowable Capacity is based on Spread Criterion							
MAJOR STORM Allowable Capacity is based on Depth Criterion							
Minor storm max. allowable capacity GOOD - greater than the design flow given on sheet 'Inlet Management'	<table border="1" style="display: inline-table; border-collapse: collapse;"> <tr> <th style="padding: 2px;">Minor Storm</th> <th style="padding: 2px;">Major Storm</th> <th style="padding: 2px;">cfs</th> </tr> <tr> <td style="text-align: center; padding: 2px;">10.2</td> <td style="text-align: center; padding: 2px;">31.5</td> <td></td> </tr> </table>	Minor Storm	Major Storm	cfs	10.2	31.5	
Minor Storm	Major Storm	cfs					
10.2	31.5						
Major storm max. allowable capacity GOOD - greater than the design flow given on sheet 'Inlet Management'							

INLET ON A CONTINUOUS GRADE

Version 4.05 Released March 2017

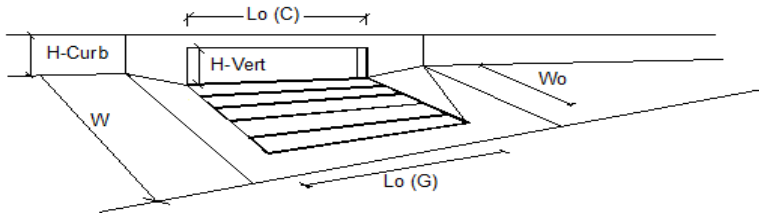

Design Information (Input)	MINOR	MAJOR	
Type of Inlet	CDOT Type R Curb Opening		
Local Depression (additional to continuous gutter depression 'a')	3.0	3.0	inches
Total Number of Units in the Inlet (Grate or Curb Opening)	1	1	
Length of a Single Unit Inlet (Grate or Curb Opening)	10.00	10.00	ft
Width of a Unit Grate (cannot be greater than W, Gutter Width)	N/A	N/A	ft
Clogging Factor for a Single Unit Grate (typical min. value = 0.5)	N/A	N/A	
Clogging Factor for a Single Unit Curb Opening (typical min. value = 0.1)	0.10	0.10	
Street Hydraulics: OK - Q < Allowable Street Capacity*			
Total Inlet Interception Capacity	6.1	9.1	cfs
Total Inlet Carry-Over Flow (flow bypassing inlet)	1.4	7.3	cfs
Capture Percentage = Q_i/Q_c =	81	56	%

ALLOWABLE CAPACITY FOR ONE-HALF OF STREET (Minor & Major Storm)

(Based on Regulated Criteria for Maximum Allowable Flow Depth and Spread)

Project: The Ridge at Lorson Ranch, #100.064
 Inlet ID: Inlet DP-48



Gutter Geometry (Enter data in the blue cells)							
Maximum Allowable Width for Spread Behind Curb	$T_{BACK} = 8.0$ ft						
Side Slope Behind Curb (leave blank for no conveyance credit behind curb)	$S_{BACK} = 0.020$ ft/ft						
Manning's Roughness Behind Curb (typically between 0.012 and 0.020)	$n_{BACK} = 0.015$						
Height of Curb at Gutter Flow Line	$H_{CURB} = 6.00$ inches						
Distance from Curb Face to Street Crown	$T_{CROWN} = 17.0$ ft						
Gutter Width	$W = 2.00$ ft						
Street Transverse Slope	$S_x = 0.020$ ft/ft						
Gutter Cross Slope (typically 2 inches over 24 inches or 0.083 ft/ft)	$S_w = 0.083$ ft/ft						
Street Longitudinal Slope - Enter 0 for sump condition	$S_o = 0.015$ ft/ft						
Manning's Roughness for Street Section (typically between 0.012 and 0.020)	$n_{STREET} = 0.017$						
Max. Allowable Spread for Minor & Major Storm	<table border="1"> <thead> <tr> <th>Minor Storm</th> <th>Major Storm</th> <th>ft</th> </tr> </thead> <tbody> <tr> <td>$T_{MAX} = 17.0$</td> <td>$T_{MAX} = 17.0$</td> <td></td> </tr> </tbody> </table>	Minor Storm	Major Storm	ft	$T_{MAX} = 17.0$	$T_{MAX} = 17.0$	
Minor Storm	Major Storm	ft					
$T_{MAX} = 17.0$	$T_{MAX} = 17.0$						
Max. Allowable Depth at Gutter Flowline for Minor & Major Storm	<table border="1"> <thead> <tr> <th>Minor Storm</th> <th>Major Storm</th> <th>inches</th> </tr> </thead> <tbody> <tr> <td>$d_{MAX} = 5.6$</td> <td>$d_{MAX} = 7.9$</td> <td></td> </tr> </tbody> </table>	Minor Storm	Major Storm	inches	$d_{MAX} = 5.6$	$d_{MAX} = 7.9$	
Minor Storm	Major Storm	inches					
$d_{MAX} = 5.6$	$d_{MAX} = 7.9$						
Allow Flow Depth at Street Crown (leave blank for no)	<input type="checkbox"/> Minor Storm <input checked="" type="checkbox"/> Major Storm check = yes						
MINOR STORM Allowable Capacity is based on Spread Criterion							
MAJOR STORM Allowable Capacity is based on Depth Criterion							
Minor storm max. allowable capacity GOOD - greater than the design flow given on sheet 'Inlet Management'	<table border="1"> <thead> <tr> <th>Minor Storm</th> <th>Major Storm</th> <th>cfs</th> </tr> </thead> <tbody> <tr> <td>$Q_{allow} = 12.6$</td> <td>$Q_{allow} = 38.8$</td> <td></td> </tr> </tbody> </table>	Minor Storm	Major Storm	cfs	$Q_{allow} = 12.6$	$Q_{allow} = 38.8$	
Minor Storm	Major Storm	cfs					
$Q_{allow} = 12.6$	$Q_{allow} = 38.8$						
Major storm max. allowable capacity GOOD - greater than the design flow given on sheet 'Inlet Management'							

INLET ON A CONTINUOUS GRADE

Version 4.05 Released March 2017

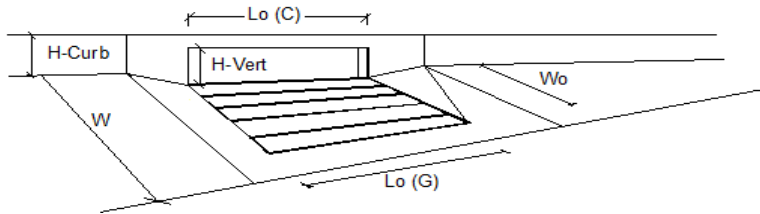

Design Information (Input)	MINOR	MAJOR	
Type of Inlet	CDOT Type R Curb Opening		
Local Depression (additional to continuous gutter depression 'a')	3.0	3.0	inches
Total Number of Units in the Inlet (Grate or Curb Opening)	1	1	
Length of a Single Unit Inlet (Grate or Curb Opening)	10.00	10.00	ft
Width of a Unit Grate (cannot be greater than W, Gutter Width)	N/A	N/A	ft
Clogging Factor for a Single Unit Grate (typical min. value = 0.5)	N/A	N/A	
Clogging Factor for a Single Unit Curb Opening (typical min. value = 0.1)	0.10	0.10	
Street Hydraulics: OK - Q < Allowable Street Capacity			
Total Inlet Interception Capacity	3.4	6.2	cfs
Total Inlet Carry-Over Flow (flow bypassing inlet)	0.0	1.4	cfs
Capture Percentage = Q_i/Q_c =	100	81	%

ALLOWABLE CAPACITY FOR ONE-HALF OF STREET (Minor & Major Storm)

(Based on Regulated Criteria for Maximum Allowable Flow Depth and Spread)

Project: The Ridge at Lorson Ranch, #100.064
 Inlet ID: Inlet DP-49



Gutter Geometry (Enter data in the blue cells)							
Maximum Allowable Width for Spread Behind Curb	$T_{BACK} = 8.0$ ft						
Side Slope Behind Curb (leave blank for no conveyance credit behind curb)	$S_{BACK} = 0.020$ ft/ft						
Manning's Roughness Behind Curb (typically between 0.012 and 0.020)	$n_{BACK} = 0.015$						
Height of Curb at Gutter Flow Line	$H_{CURB} = 6.00$ inches						
Distance from Curb Face to Street Crown	$T_{CROWN} = 17.0$ ft						
Gutter Width	$W = 2.00$ ft						
Street Transverse Slope	$S_x = 0.020$ ft/ft						
Gutter Cross Slope (typically 2 inches over 24 inches or 0.083 ft/ft)	$S_w = 0.083$ ft/ft						
Street Longitudinal Slope - Enter 0 for sump condition	$S_o = 0.028$ ft/ft						
Manning's Roughness for Street Section (typically between 0.012 and 0.020)	$n_{STREET} = 0.017$						
Max. Allowable Spread for Minor & Major Storm	<table border="1" style="display: inline-table; border-collapse: collapse;"> <thead> <tr> <th style="padding: 2px;">Minor Storm</th> <th style="padding: 2px;">Major Storm</th> <th style="padding: 2px;">ft</th> </tr> </thead> <tbody> <tr> <td style="text-align: center; padding: 2px;">$T_{MAX} = 17.0$</td> <td style="text-align: center; padding: 2px;">17.0</td> <td style="padding: 2px;"></td> </tr> </tbody> </table>	Minor Storm	Major Storm	ft	$T_{MAX} = 17.0$	17.0	
Minor Storm	Major Storm	ft					
$T_{MAX} = 17.0$	17.0						
Max. Allowable Depth at Gutter Flowline for Minor & Major Storm	<table border="1" style="display: inline-table; border-collapse: collapse;"> <thead> <tr> <th style="padding: 2px;">Minor Storm</th> <th style="padding: 2px;">Major Storm</th> <th style="padding: 2px;">inches</th> </tr> </thead> <tbody> <tr> <td style="text-align: center; padding: 2px;">$d_{MAX} = 5.6$</td> <td style="text-align: center; padding: 2px;">7.9</td> <td style="padding: 2px;"></td> </tr> </tbody> </table>	Minor Storm	Major Storm	inches	$d_{MAX} = 5.6$	7.9	
Minor Storm	Major Storm	inches					
$d_{MAX} = 5.6$	7.9						
Allow Flow Depth at Street Crown (leave blank for no)	<input type="checkbox"/> <input checked="" type="checkbox"/> check = yes						
MINOR STORM Allowable Capacity is based on Depth Criterion							
MAJOR STORM Allowable Capacity is based on Depth Criterion							
Minor storm max. allowable capacity GOOD - greater than the design flow given on sheet 'Inlet Management'	<table border="1" style="display: inline-table; border-collapse: collapse;"> <thead> <tr> <th style="padding: 2px;">Minor Storm</th> <th style="padding: 2px;">Major Storm</th> <th style="padding: 2px;">cfs</th> </tr> </thead> <tbody> <tr> <td style="text-align: center; padding: 2px;">$Q_{allow} = 17.0$</td> <td style="text-align: center; padding: 2px;">33.6</td> <td style="padding: 2px;"></td> </tr> </tbody> </table>	Minor Storm	Major Storm	cfs	$Q_{allow} = 17.0$	33.6	
Minor Storm	Major Storm	cfs					
$Q_{allow} = 17.0$	33.6						
Major storm max. allowable capacity GOOD - greater than the design flow given on sheet 'Inlet Management'							

INLET ON A CONTINUOUS GRADE

Version 4.05 Released March 2017

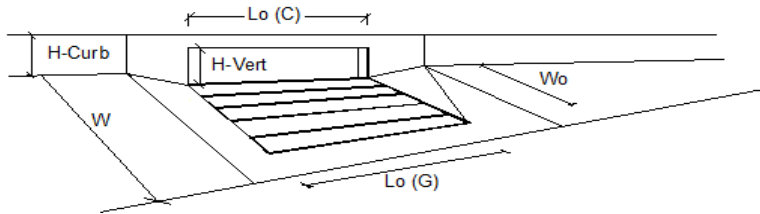

Design Information (Input)	MINOR	MAJOR	
Type of Inlet	CDOT Type R Curb Opening		
Local Depression (additional to continuous gutter depression 'a')	3.0	3.0	inches
Total Number of Units in the Inlet (Grate or Curb Opening)	1	1	
Length of a Single Unit Inlet (Grate or Curb Opening)	20.00	20.00	ft
Width of a Unit Grate (cannot be greater than W, Gutter Width)	N/A	N/A	ft
Clogging Factor for a Single Unit Grate (typical min. value = 0.5)	N/A	N/A	
Clogging Factor for a Single Unit Curb Opening (typical min. value = 0.1)	0.10	0.10	
Street Hydraulics: OK - Q < Allowable Street Capacity			
Total Inlet Interception Capacity	7.7	20.8	cfs
Total Inlet Carry-Over Flow (flow bypassing inlet)	0.0	6.9	cfs
Capture Percentage = Q_i/Q_c =	100	75	%

ALLOWABLE CAPACITY FOR ONE-HALF OF STREET (Minor & Major Storm)

(Based on Regulated Criteria for Maximum Allowable Flow Depth and Spread)

Project: The Ridge at Lorson Ranch, #100.064
 Inlet ID: Inlet DP-51



Gutter Geometry (Enter data in the blue cells)							
Maximum Allowable Width for Spread Behind Curb	$T_{BACK} = $ <input style="width: 50px;" type="text" value="8.0"/> ft						
Side Slope Behind Curb (leave blank for no conveyance credit behind curb)	$S_{BACK} = $ <input style="width: 50px;" type="text" value="0.020"/> ft/ft						
Manning's Roughness Behind Curb (typically between 0.012 and 0.020)	$n_{BACK} = $ <input style="width: 50px;" type="text" value="0.015"/>						
Height of Curb at Gutter Flow Line	$H_{CURB} = $ <input style="width: 50px;" type="text" value="6.00"/> inches						
Distance from Curb Face to Street Crown	$T_{CROWN} = $ <input style="width: 50px;" type="text" value="17.0"/> ft						
Gutter Width	$W = $ <input style="width: 50px;" type="text" value="2.00"/> ft						
Street Transverse Slope	$S_x = $ <input style="width: 50px;" type="text" value="0.020"/> ft/ft						
Gutter Cross Slope (typically 2 inches over 24 inches or 0.083 ft/ft)	$S_w = $ <input style="width: 50px;" type="text" value="0.083"/> ft/ft						
Street Longitudinal Slope - Enter 0 for sump condition	$S_o = $ <input style="width: 50px;" type="text" value="0.000"/> ft/ft						
Manning's Roughness for Street Section (typically between 0.012 and 0.020)	$n_{STREET} = $ <input style="width: 50px;" type="text" value="0.017"/>						
Max. Allowable Spread for Minor & Major Storm	<table style="width: 100%; border-collapse: collapse;"> <tr> <td style="text-align: center; padding: 2px;">Minor Storm</td> <td style="text-align: center; padding: 2px;">Major Storm</td> <td style="padding: 2px;"></td> </tr> <tr> <td style="padding: 2px;">$T_{MAX} =$ <input style="width: 50px;" type="text" value="17.0"/></td> <td style="padding: 2px;"><input style="width: 50px;" type="text" value="17.0"/></td> <td style="padding: 2px;">ft</td> </tr> </table>	Minor Storm	Major Storm		$T_{MAX} = $ <input style="width: 50px;" type="text" value="17.0"/>	<input style="width: 50px;" type="text" value="17.0"/>	ft
Minor Storm	Major Storm						
$T_{MAX} = $ <input style="width: 50px;" type="text" value="17.0"/>	<input style="width: 50px;" type="text" value="17.0"/>	ft					
Max. Allowable Depth at Gutter Flowline for Minor & Major Storm	<table style="width: 100%; border-collapse: collapse;"> <tr> <td style="text-align: center; padding: 2px;">Minor Storm</td> <td style="text-align: center; padding: 2px;">Major Storm</td> <td style="padding: 2px;"></td> </tr> <tr> <td style="padding: 2px;">$d_{MAX} =$ <input style="width: 50px;" type="text" value="5.6"/></td> <td style="padding: 2px;"><input style="width: 50px;" type="text" value="7.9"/></td> <td style="padding: 2px;">inches</td> </tr> </table>	Minor Storm	Major Storm		$d_{MAX} = $ <input style="width: 50px;" type="text" value="5.6"/>	<input style="width: 50px;" type="text" value="7.9"/>	inches
Minor Storm	Major Storm						
$d_{MAX} = $ <input style="width: 50px;" type="text" value="5.6"/>	<input style="width: 50px;" type="text" value="7.9"/>	inches					
Check boxes are not applicable in SUMP conditions	<table style="width: 100%; border-collapse: collapse;"> <tr> <td style="text-align: center; padding: 2px;"><input type="checkbox"/></td> <td style="text-align: center; padding: 2px;"><input type="checkbox"/></td> </tr> </table>	<input type="checkbox"/>	<input type="checkbox"/>				
<input type="checkbox"/>	<input type="checkbox"/>						
MINOR STORM Allowable Capacity is based on Depth Criterion							
MAJOR STORM Allowable Capacity is based on Depth Criterion	<table style="width: 100%; border-collapse: collapse;"> <tr> <td style="text-align: center; padding: 2px;">Minor Storm</td> <td style="text-align: center; padding: 2px;">Major Storm</td> <td style="padding: 2px;"></td> </tr> <tr> <td style="padding: 2px;">$Q_{allow} =$ <input style="width: 50px;" type="text" value="SUMP"/></td> <td style="padding: 2px;"><input style="width: 50px;" type="text" value="SUMP"/></td> <td style="padding: 2px;">cfs</td> </tr> </table>	Minor Storm	Major Storm		$Q_{allow} = $ <input style="width: 50px;" type="text" value="SUMP"/>	<input style="width: 50px;" type="text" value="SUMP"/>	cfs
Minor Storm	Major Storm						
$Q_{allow} = $ <input style="width: 50px;" type="text" value="SUMP"/>	<input style="width: 50px;" type="text" value="SUMP"/>	cfs					

INLET IN A SUMP OR SAG LOCATION

Version 4.05 Released March 2017

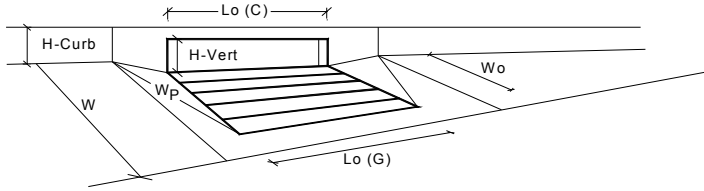

Design Information (Input)	MINOR	MAJOR	
Type of Inlet	CDOT Type R Curb Opening		
Local Depression (additional to continuous gutter depression 'a' from above)	3.00	3.00	inches
Number of Unit Inlets (Grate or Curb Opening)	1	1	
Water Depth at Flowline (outside of local depression)	4.0	7.1	inches
Grate Information	MINOR	MAJOR	<input checked="" type="checkbox"/> Override Depths
Length of a Unit Grate	N/A	N/A	feet
Width of a Unit Grate	N/A	N/A	feet
Area Opening Ratio for a Grate (typical values 0.15-0.90)	N/A	N/A	
Clogging Factor for a Single Grate (typical value 0.50 - 0.70)	N/A	N/A	
Grate Weir Coefficient (typical value 2.15 - 3.60)	N/A	N/A	
Grate Orifice Coefficient (typical value 0.60 - 0.80)	N/A	N/A	
Curb Opening Information	MINOR	MAJOR	
Length of a Unit Curb Opening	25.00	25.00	feet
Height of Vertical Curb Opening in Inches	6.00	6.00	inches
Height of Curb Orifice Throat in Inches	6.00	6.00	inches
Angle of Throat (see USDCM Figure ST-5)	63.40	63.40	degrees
Side Width for Depression Pan (typically the gutter width of 2 feet)	2.00	2.00	feet
Clogging Factor for a Single Curb Opening (typical value 0.10)	0.10	0.10	
Curb Opening Weir Coefficient (typical value 2.3-3.7)	3.60	3.60	
Curb Opening Orifice Coefficient (typical value 0.60 - 0.70)	0.67	0.67	
Low Head Performance Reduction (Calculated)	MINOR	MAJOR	
Depth for Grate Midwidth	N/A	N/A	ft
Depth for Curb Opening Weir Equation	0.17	0.43	ft
Combination Inlet Performance Reduction Factor for Long Inlets	0.38	0.67	
Curb Opening Performance Reduction Factor for Long Inlets	0.64	0.85	
Grated Inlet Performance Reduction Factor for Long Inlets	N/A	N/A	
Total Inlet Interception Capacity (assumes clogged condition)	MINOR	MAJOR	
Q_a	4.5	24.0	cfs
$Q_{PEAK\ REQUIRED}$	4.5	26.0	cfs

WARNING: Inlet Capacity less than Q Peak for Major Storm

ALLOWABLE CAPACITY FOR ONE-HALF OF STREET (Minor & Major Storm)

(Based on Regulated Criteria for Maximum Allowable Flow Depth and Spread)

Project: The Ridge at Lorson Ranch, #100.064
 Inlet ID: Inlet DP-53



Gutter Geometry (Enter data in the blue cells)													
Maximum Allowable Width for Spread Behind Curb	$T_{BACK} = 8.0$ ft												
Side Slope Behind Curb (leave blank for no conveyance credit behind curb)	$S_{BACK} = 0.020$ ft/ft												
Manning's Roughness Behind Curb (typically between 0.012 and 0.020)	$n_{BACK} = 0.015$												
Height of Curb at Gutter Flow Line	$H_{CURB} = 6.00$ inches												
Distance from Curb Face to Street Crown	$T_{CROWN} = 17.0$ ft												
Gutter Width	$W = 2.00$ ft												
Street Transverse Slope	$S_x = 0.020$ ft/ft												
Gutter Cross Slope (typically 2 inches over 24 inches or 0.083 ft/ft)	$S_w = 0.083$ ft/ft												
Street Longitudinal Slope - Enter 0 for sump condition	$S_o = 0.014$ ft/ft												
Manning's Roughness for Street Section (typically between 0.012 and 0.020)	$n_{STREET} = 0.017$												
Max. Allowable Spread for Minor & Major Storm	<table border="1"> <thead> <tr> <th></th> <th>Minor Storm</th> <th>Major Storm</th> <th></th> </tr> </thead> <tbody> <tr> <td>$T_{MAX} =$</td> <td>17.0</td> <td>17.0</td> <td>ft</td> </tr> <tr> <td>$d_{MAX} =$</td> <td>5.6</td> <td>7.9</td> <td>inches</td> </tr> </tbody> </table>		Minor Storm	Major Storm		$T_{MAX} =$	17.0	17.0	ft	$d_{MAX} =$	5.6	7.9	inches
	Minor Storm	Major Storm											
$T_{MAX} =$	17.0	17.0	ft										
$d_{MAX} =$	5.6	7.9	inches										
Max. Allowable Depth at Gutter Flowline for Minor & Major Storm													
Allow Flow Depth at Street Crown (leave blank for no)	<input type="checkbox"/> <input checked="" type="checkbox"/> check = yes												
MINOR STORM Allowable Capacity is based on Spread Criterion													
MAJOR STORM Allowable Capacity is based on Depth Criterion													
	<table border="1"> <thead> <tr> <th></th> <th>Minor Storm</th> <th>Major Storm</th> <th></th> </tr> </thead> <tbody> <tr> <td>$Q_{allow} =$</td> <td>12.3</td> <td>37.8</td> <td>cfs</td> </tr> </tbody> </table>		Minor Storm	Major Storm		$Q_{allow} =$	12.3	37.8	cfs				
	Minor Storm	Major Storm											
$Q_{allow} =$	12.3	37.8	cfs										
<p>Minor storm max. allowable capacity GOOD - greater than the design flow given on sheet 'Inlet Management'</p> <p>Major storm max. allowable capacity GOOD - greater than the design flow given on sheet 'Inlet Management'</p>													

INLET ON A CONTINUOUS GRADE

Version 4.05 Released March 2017

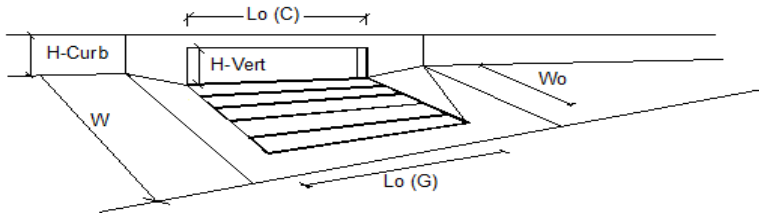

Design Information (Input)	MINOR	MAJOR	
Type of Inlet	CDOT Type R Curb Opening		
Local Depression (additional to continuous gutter depression 'a')	3.0	3.0	inches
Total Number of Units in the Inlet (Grate or Curb Opening)	1	1	
Length of a Single Unit Inlet (Grate or Curb Opening)	15.00	15.00	ft
Width of a Unit Grate (cannot be greater than W, Gutter Width)	N/A	N/A	ft
Clogging Factor for a Single Unit Grate (typical min. value = 0.5)	N/A	N/A	
Clogging Factor for a Single Unit Curb Opening (typical min. value = 0.1)	0.10	0.10	
Street Hydraulics: OK - Q < Allowable Street Capacity			
Total Inlet Interception Capacity	9.7	16.2	cfs
Total Inlet Carry-Over Flow (flow bypassing inlet)	0.9	10.3	cfs
Capture Percentage = Q_i/Q_c =	91	61	%

ALLOWABLE CAPACITY FOR ONE-HALF OF STREET (Minor & Major Storm)

(Based on Regulated Criteria for Maximum Allowable Flow Depth and Spread)

Project: The Ridge at Lorson Ranch, #100.064
 Inlet ID: Inlet DP-54

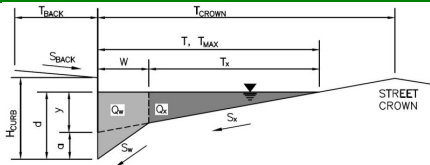

Gutter Geometry (Enter data in the blue cells)													
Maximum Allowable Width for Spread Behind Curb	$T_{BACK} = 8.0$ ft												
Side Slope Behind Curb (leave blank for no conveyance credit behind curb)	$S_{BACK} = 0.020$ ft/ft												
Manning's Roughness Behind Curb (typically between 0.012 and 0.020)	$n_{BACK} = 0.015$												
Height of Curb at Gutter Flow Line	$H_{CURB} = 6.00$ inches												
Distance from Curb Face to Street Crown	$T_{CROWN} = 17.0$ ft												
Gutter Width	$W = 2.00$ ft												
Street Transverse Slope	$S_x = 0.020$ ft/ft												
Gutter Cross Slope (typically 2 inches over 24 inches or 0.083 ft/ft)	$S_w = 0.083$ ft/ft												
Street Longitudinal Slope - Enter 0 for sump condition	$S_o = 0.015$ ft/ft												
Manning's Roughness for Street Section (typically between 0.012 and 0.020)	$n_{STREET} = 0.017$												
Max. Allowable Spread for Minor & Major Storm	<table border="1" style="display: inline-table; border-collapse: collapse;"> <thead> <tr> <th style="width: 50%;">Minor Storm</th> <th style="width: 50%;">Major Storm</th> <th style="width: 50%;"></th> </tr> </thead> <tbody> <tr> <td style="text-align: center;">$T_{MAX} = 17.0$</td> <td style="text-align: center;">$T_{MAX} = 17.0$</td> <td style="text-align: right;">ft</td> </tr> <tr> <td style="text-align: center;">$d_{MAX} = 5.6$</td> <td style="text-align: center;">$d_{MAX} = 7.9$</td> <td style="text-align: right;">inches</td> </tr> <tr> <td style="text-align: center;"><input type="checkbox"/></td> <td style="text-align: center;"><input checked="" type="checkbox"/></td> <td style="text-align: right;">check = yes</td> </tr> </tbody> </table>	Minor Storm	Major Storm		$T_{MAX} = 17.0$	$T_{MAX} = 17.0$	ft	$d_{MAX} = 5.6$	$d_{MAX} = 7.9$	inches	<input type="checkbox"/>	<input checked="" type="checkbox"/>	check = yes
Minor Storm	Major Storm												
$T_{MAX} = 17.0$	$T_{MAX} = 17.0$	ft											
$d_{MAX} = 5.6$	$d_{MAX} = 7.9$	inches											
<input type="checkbox"/>	<input checked="" type="checkbox"/>	check = yes											
Max. Allowable Depth at Gutter Flowline for Minor & Major Storm													
Allow Flow Depth at Street Crown (leave blank for no)													
MINOR STORM Allowable Capacity is based on Spread Criterion													
MAJOR STORM Allowable Capacity is based on Depth Criterion													
Minor storm max. allowable capacity GOOD - greater than the design flow given on sheet 'Inlet Management'	<table border="1" style="display: inline-table; border-collapse: collapse;"> <thead> <tr> <th style="width: 50%;">Minor Storm</th> <th style="width: 50%;">Major Storm</th> <th style="width: 50%;"></th> </tr> </thead> <tbody> <tr> <td style="text-align: center;">$Q_{allow} = 12.5$</td> <td style="text-align: center;">$Q_{allow} = 38.6$</td> <td style="text-align: right;">cfs</td> </tr> </tbody> </table>	Minor Storm	Major Storm		$Q_{allow} = 12.5$	$Q_{allow} = 38.6$	cfs						
Minor Storm	Major Storm												
$Q_{allow} = 12.5$	$Q_{allow} = 38.6$	cfs											
Major storm max. allowable capacity GOOD - greater than the design flow given on sheet 'Inlet Management'													

INLET ON A CONTINUOUS GRADE

Version 4.05 Released March 2017

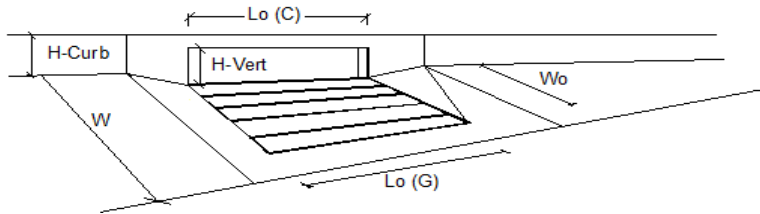

Design Information (Input)	MINOR	MAJOR	
Type of Inlet	CDOT Type R Curb Opening		
Local Depression (additional to continuous gutter depression 'a')	3.0	3.0	inches
Total Number of Units in the Inlet (Grate or Curb Opening)	1	1	
Length of a Single Unit Inlet (Grate or Curb Opening)	20.00	20.00	ft
Width of a Unit Grate (cannot be greater than W, Gutter Width)	N/A	N/A	ft
Clogging Factor for a Single Unit Grate (typical min. value = 0.5)	N/A	N/A	
Clogging Factor for a Single Unit Curb Opening (typical min. value = 0.1)	0.10	0.10	
Street Hydraulics: OK - Q < Allowable Street Capacity			
Total Inlet Interception Capacity	11.7	24.0	cfs
Total Inlet Carry-Over Flow (flow bypassing inlet)	0.1	13.6	cfs
Capture Percentage = Q_i/Q_c =	99	64	%

ALLOWABLE CAPACITY FOR ONE-HALF OF STREET (Minor & Major Storm)

(Based on Regulated Criteria for Maximum Allowable Flow Depth and Spread)

Project: The Ridge at Lorson Ranch, #100.064
 Inlet ID: Inlet DP-56

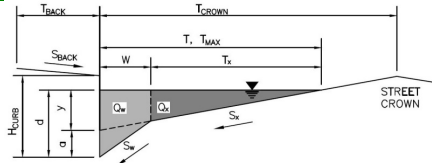

Gutter Geometry (Enter data in the blue cells)							
Maximum Allowable Width for Spread Behind Curb	$T_{BACK} = $ <input style="width: 80px;" type="text" value="8.0"/> ft						
Side Slope Behind Curb (leave blank for no conveyance credit behind curb)	$S_{BACK} = $ <input style="width: 80px;" type="text" value="0.020"/> ft/ft						
Manning's Roughness Behind Curb (typically between 0.012 and 0.020)	$n_{BACK} = $ <input style="width: 80px;" type="text" value="0.015"/>						
Height of Curb at Gutter Flow Line	$H_{CURB} = $ <input style="width: 80px;" type="text" value="6.00"/> inches						
Distance from Curb Face to Street Crown	$T_{CROWN} = $ <input style="width: 80px;" type="text" value="17.0"/> ft						
Gutter Width	$W = $ <input style="width: 80px;" type="text" value="2.00"/> ft						
Street Transverse Slope	$S_x = $ <input style="width: 80px;" type="text" value="0.020"/> ft/ft						
Gutter Cross Slope (typically 2 inches over 24 inches or 0.083 ft/ft)	$S_w = $ <input style="width: 80px;" type="text" value="0.083"/> ft/ft						
Street Longitudinal Slope - Enter 0 for sump condition	$S_o = $ <input style="width: 80px;" type="text" value="1.210"/> ft/ft						
Manning's Roughness for Street Section (typically between 0.012 and 0.020)	$n_{STREET} = $ <input style="width: 80px;" type="text" value="0.017"/>						
Max. Allowable Spread for Minor & Major Storm	<table style="margin-left: auto; margin-right: auto;"> <thead> <tr> <th style="padding: 5px;">Minor Storm</th> <th style="padding: 5px;">Major Storm</th> <th style="padding: 5px;">ft</th> </tr> </thead> <tbody> <tr> <td style="padding: 5px;"><input style="width: 60px;" type="text" value="17.0"/></td> <td style="padding: 5px;"><input style="width: 60px;" type="text" value="17.0"/></td> <td style="padding: 5px;"></td> </tr> </tbody> </table>	Minor Storm	Major Storm	ft	<input style="width: 60px;" type="text" value="17.0"/>	<input style="width: 60px;" type="text" value="17.0"/>	
Minor Storm	Major Storm	ft					
<input style="width: 60px;" type="text" value="17.0"/>	<input style="width: 60px;" type="text" value="17.0"/>						
Max. Allowable Depth at Gutter Flowline for Minor & Major Storm	<table style="margin-left: auto; margin-right: auto;"> <thead> <tr> <th style="padding: 5px;">Minor Storm</th> <th style="padding: 5px;">Major Storm</th> <th style="padding: 5px;">inches</th> </tr> </thead> <tbody> <tr> <td style="padding: 5px;"><input style="width: 60px;" type="text" value="5.6"/></td> <td style="padding: 5px;"><input style="width: 60px;" type="text" value="7.9"/></td> <td style="padding: 5px;"></td> </tr> </tbody> </table>	Minor Storm	Major Storm	inches	<input style="width: 60px;" type="text" value="5.6"/>	<input style="width: 60px;" type="text" value="7.9"/>	
Minor Storm	Major Storm	inches					
<input style="width: 60px;" type="text" value="5.6"/>	<input style="width: 60px;" type="text" value="7.9"/>						
Allow Flow Depth at Street Crown (leave blank for no)	<table style="margin-left: auto; margin-right: auto;"> <tbody> <tr> <td style="padding: 5px;"><input type="checkbox"/></td> <td style="padding: 5px;"><input checked="" type="checkbox"/></td> <td style="padding: 5px;">check = yes</td> </tr> </tbody> </table>	<input type="checkbox"/>	<input checked="" type="checkbox"/>	check = yes			
<input type="checkbox"/>	<input checked="" type="checkbox"/>	check = yes					
MINOR STORM Allowable Capacity is based on Depth Criterion							
MAJOR STORM Allowable Capacity is based on Depth Criterion							
	<table style="margin-left: auto; margin-right: auto;"> <thead> <tr> <th style="padding: 5px;">Minor Storm</th> <th style="padding: 5px;">Major Storm</th> <th style="padding: 5px;">cfs</th> </tr> </thead> <tbody> <tr> <td style="padding: 5px;"><input style="width: 60px;" type="text" value="5.5"/></td> <td style="padding: 5px;"><input style="width: 60px;" type="text" value="10.9"/></td> <td style="padding: 5px;"></td> </tr> </tbody> </table>	Minor Storm	Major Storm	cfs	<input style="width: 60px;" type="text" value="5.5"/>	<input style="width: 60px;" type="text" value="10.9"/>	
Minor Storm	Major Storm	cfs					
<input style="width: 60px;" type="text" value="5.5"/>	<input style="width: 60px;" type="text" value="10.9"/>						
WARNING: MINOR STORM max. allowable capacity is less than the design flow given on sheet 'Inlet Management'							
WARNING: MAJOR STORM max. allowable capacity is less than the design flow given on sheet 'Inlet Management'							

INLET ON A CONTINUOUS GRADE

Version 4.05 Released March 2017

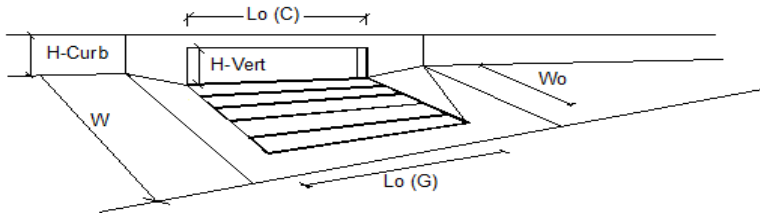

Design Information (Input)	MINOR	MAJOR	
Type of Inlet	CDOT Type R Curb Opening		
Local Depression (additional to continuous gutter depression 'a')	3.0	3.0	inches
Total Number of Units in the Inlet (Grate or Curb Opening)	1	1	
Length of a Single Unit Inlet (Grate or Curb Opening)	20.00	20.00	ft
Width of a Unit Grate (cannot be greater than W, Gutter Width)	N/A	N/A	ft
Clogging Factor for a Single Unit Grate (typical min. value = 0.5)	N/A	N/A	
Clogging Factor for a Single Unit Curb Opening (typical min. value = 0.1)	0.10	0.10	
Street Hydraulics: WARNING: Q > ALLOWABLE Q FOR MINOR & MAJOR STORM			
Total Inlet Interception Capacity	9.0	23.7	cfs
Total Inlet Carry-Over Flow (flow bypassing inlet)	0.0	9.1	cfs
Capture Percentage = Q_i/Q_c =	100	72	%

ALLOWABLE CAPACITY FOR ONE-HALF OF STREET (Minor & Major Storm)

(Based on Regulated Criteria for Maximum Allowable Flow Depth and Spread)

Project: The Ridge at Lorson Ranch, #100.064
 Inlet ID: Inlet DP-57

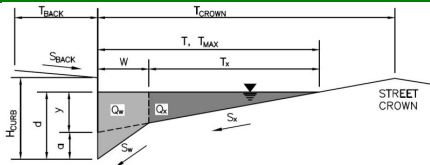

Gutter Geometry (Enter data in the blue cells)							
Maximum Allowable Width for Spread Behind Curb	$T_{BACK} = 8.0$ ft						
Side Slope Behind Curb (leave blank for no conveyance credit behind curb)	$S_{BACK} = 0.020$ ft/ft						
Manning's Roughness Behind Curb (typically between 0.012 and 0.020)	$n_{BACK} = 0.015$						
Height of Curb at Gutter Flow Line	$H_{CURB} = 6.00$ inches						
Distance from Curb Face to Street Crown	$T_{CROWN} = 17.0$ ft						
Gutter Width	$W = 2.00$ ft						
Street Transverse Slope	$S_X = 0.020$ ft/ft						
Gutter Cross Slope (typically 2 inches over 24 inches or 0.083 ft/ft)	$S_W = 0.083$ ft/ft						
Street Longitudinal Slope - Enter 0 for sump condition	$S_O = 0.010$ ft/ft						
Manning's Roughness for Street Section (typically between 0.012 and 0.020)	$n_{STREET} = 0.017$						
Max. Allowable Spread for Minor & Major Storm	<table border="1" style="display: inline-table; border-collapse: collapse;"> <tr> <th style="padding: 2px;">Minor Storm</th> <th style="padding: 2px;">Major Storm</th> <th style="padding: 2px;">ft</th> </tr> <tr> <td style="text-align: center; padding: 2px;">17.0</td> <td style="text-align: center; padding: 2px;">17.0</td> <td></td> </tr> </table>	Minor Storm	Major Storm	ft	17.0	17.0	
Minor Storm	Major Storm	ft					
17.0	17.0						
Max. Allowable Depth at Gutter Flowline for Minor & Major Storm	<table border="1" style="display: inline-table; border-collapse: collapse;"> <tr> <th style="padding: 2px;">Minor Storm</th> <th style="padding: 2px;">Major Storm</th> <th style="padding: 2px;">inches</th> </tr> <tr> <td style="text-align: center; padding: 2px;">5.6</td> <td style="text-align: center; padding: 2px;">7.9</td> <td></td> </tr> </table>	Minor Storm	Major Storm	inches	5.6	7.9	
Minor Storm	Major Storm	inches					
5.6	7.9						
Allow Flow Depth at Street Crown (leave blank for no)	<input type="checkbox"/> <input checked="" type="checkbox"/> check = yes						
MINOR STORM Allowable Capacity is based on Spread Criterion							
MAJOR STORM Allowable Capacity is based on Depth Criterion							
	<table border="1" style="display: inline-table; border-collapse: collapse;"> <tr> <th style="padding: 2px;">Minor Storm</th> <th style="padding: 2px;">Major Storm</th> <th style="padding: 2px;">cfs</th> </tr> <tr> <td style="text-align: center; padding: 2px;">10.2</td> <td style="text-align: center; padding: 2px;">31.5</td> <td></td> </tr> </table>	Minor Storm	Major Storm	cfs	10.2	31.5	
Minor Storm	Major Storm	cfs					
10.2	31.5						
WARNING: MINOR STORM max. allowable capacity is less than the design flow given on sheet 'Inlet Management' Major storm max. allowable capacity GOOD - greater than the design flow given on sheet 'Inlet Management'							

INLET ON A CONTINUOUS GRADE

Version 4.05 Released March 2017

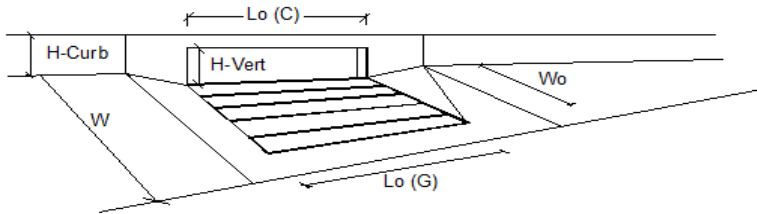

Design Information (Input)	MINOR	MAJOR	
Type of Inlet	CDOT Type R Curb Opening		
Local Depression (additional to continuous gutter depression 'a')	3.0	3.0	inches
Total Number of Units in the Inlet (Grate or Curb Opening)	1	1	
Length of a Single Unit Inlet (Grate or Curb Opening)	20.00	20.00	ft
Width of a Unit Grate (cannot be greater than W, Gutter Width)	N/A	N/A	ft
Clogging Factor for a Single Unit Grate (typical min. value = 0.5)	N/A	N/A	
Clogging Factor for a Single Unit Curb Opening (typical min. value = 0.1)	0.10	0.10	
Street Hydraulics: WARNING: Q > ALLOWABLE Q FOR MINOR STORM!			
Total Inlet Interception Capacity	11.0	19.0	cfs
Total Inlet Carry-Over Flow (flow bypassing inlet)	0.0	5.1	cfs
Capture Percentage = Q_c/Q_o =	100	79	%

ALLOWABLE CAPACITY FOR ONE-HALF OF STREET (Minor & Major Storm)

(Based on Regulated Criteria for Maximum Allowable Flow Depth and Spread)

Project: The Ridge at Lorson Ranch, #100.064
 Inlet ID: Inlet DP-62



Gutter Geometry (Enter data in the blue cells)																	
Maximum Allowable Width for Spread Behind Curb	$T_{BACK} = $ <input style="width: 50px;" type="text" value="8.0"/> ft																
Side Slope Behind Curb (leave blank for no conveyance credit behind curb)	$S_{BACK} = $ <input style="width: 50px;" type="text" value="0.020"/> ft/ft																
Manning's Roughness Behind Curb (typically between 0.012 and 0.020)	$n_{BACK} = $ <input style="width: 50px;" type="text" value="0.015"/>																
Height of Curb at Gutter Flow Line	$H_{CURB} = $ <input style="width: 50px;" type="text" value="6.00"/> inches																
Distance from Curb Face to Street Crown	$T_{CROWN} = $ <input style="width: 50px;" type="text" value="17.0"/> ft																
Gutter Width	$W = $ <input style="width: 50px;" type="text" value="2.00"/> ft																
Street Transverse Slope	$S_x = $ <input style="width: 50px;" type="text" value="0.020"/> ft/ft																
Gutter Cross Slope (typically 2 inches over 24 inches or 0.083 ft/ft)	$S_w = $ <input style="width: 50px;" type="text" value="0.083"/> ft/ft																
Street Longitudinal Slope - Enter 0 for sump condition	$S_o = $ <input style="width: 50px;" type="text" value="0.000"/> ft/ft																
Manning's Roughness for Street Section (typically between 0.012 and 0.020)	$n_{STREET} = $ <input style="width: 50px;" type="text" value="0.017"/>																
Max. Allowable Spread for Minor & Major Storm	<table style="width: 100%; border-collapse: collapse;"> <thead> <tr> <th style="width: 50%;"></th> <th style="width: 25%; text-align: center;">Minor Storm</th> <th style="width: 25%; text-align: center;">Major Storm</th> <th style="width: 10%;"></th> </tr> </thead> <tbody> <tr> <td>$T_{MAX} =$</td> <td style="text-align: center;"><input style="width: 40px;" type="text" value="17.0"/></td> <td style="text-align: center;"><input style="width: 40px;" type="text" value="17.0"/></td> <td style="text-align: right;">ft</td> </tr> <tr> <td>$d_{MAX} =$</td> <td style="text-align: center;"><input style="width: 40px;" type="text" value="5.6"/></td> <td style="text-align: center;"><input style="width: 40px;" type="text" value="7.9"/></td> <td style="text-align: right;">inches</td> </tr> <tr> <td></td> <td style="text-align: center;"><input type="checkbox"/></td> <td style="text-align: center;"><input type="checkbox"/></td> <td></td> </tr> </tbody> </table>		Minor Storm	Major Storm		$T_{MAX} = $	<input style="width: 40px;" type="text" value="17.0"/>	<input style="width: 40px;" type="text" value="17.0"/>	ft	$d_{MAX} = $	<input style="width: 40px;" type="text" value="5.6"/>	<input style="width: 40px;" type="text" value="7.9"/>	inches		<input type="checkbox"/>	<input type="checkbox"/>	
	Minor Storm	Major Storm															
$T_{MAX} = $	<input style="width: 40px;" type="text" value="17.0"/>	<input style="width: 40px;" type="text" value="17.0"/>	ft														
$d_{MAX} = $	<input style="width: 40px;" type="text" value="5.6"/>	<input style="width: 40px;" type="text" value="7.9"/>	inches														
	<input type="checkbox"/>	<input type="checkbox"/>															
Max. Allowable Depth at Gutter Flowline for Minor & Major Storm																	
Check boxes are not applicable in SUMP conditions																	
MINOR STORM Allowable Capacity is based on Depth Criterion																	
MAJOR STORM Allowable Capacity is based on Depth Criterion																	
$Q_{allow} = $	<table style="width: 100%; border-collapse: collapse;"> <thead> <tr> <th style="width: 50%;"></th> <th style="width: 25%; text-align: center;">Minor Storm</th> <th style="width: 25%; text-align: center;">Major Storm</th> <th style="width: 10%;"></th> </tr> </thead> <tbody> <tr> <td></td> <td style="text-align: center;"><input style="width: 40px;" type="text" value="SUMP"/></td> <td style="text-align: center;"><input style="width: 40px;" type="text" value="SUMP"/></td> <td style="text-align: right;">cfs</td> </tr> </tbody> </table>		Minor Storm	Major Storm			<input style="width: 40px;" type="text" value="SUMP"/>	<input style="width: 40px;" type="text" value="SUMP"/>	cfs								
	Minor Storm	Major Storm															
	<input style="width: 40px;" type="text" value="SUMP"/>	<input style="width: 40px;" type="text" value="SUMP"/>	cfs														

INLET IN A SUMP OR SAG LOCATION

Version 4.05 Released March 2017

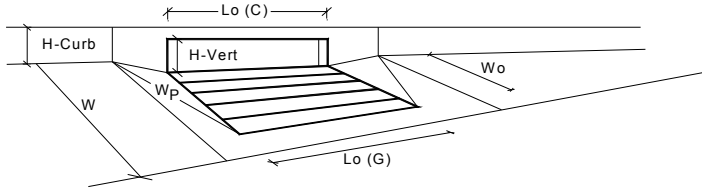

Design Information (Input)	MINOR	MAJOR	
Type of Inlet	CDOT Type R Curb Opening		
Local Depression (additional to continuous gutter depression 'a' from above)	3.00	3.00	inches
Number of Unit Inlets (Grate or Curb Opening)	1	1	
Water Depth at Flowline (outside of local depression)	5.6	8.0	inches
Grate Information	MINOR	MAJOR	<input checked="" type="checkbox"/> Override Depths
Length of a Unit Grate	N/A	N/A	feet
Width of a Unit Grate	N/A	N/A	feet
Area Opening Ratio for a Grate (typical values 0.15-0.90)	N/A	N/A	
Clogging Factor for a Single Grate (typical value 0.50 - 0.70)	N/A	N/A	
Grate Weir Coefficient (typical value 2.15 - 3.60)	N/A	N/A	
Grate Orifice Coefficient (typical value 0.60 - 0.80)	N/A	N/A	
Curb Opening Information	MINOR	MAJOR	
Length of a Unit Curb Opening	30.00	30.00	feet
Height of Vertical Curb Opening in Inches	6.00	6.00	inches
Height of Curb Orifice Throat in Inches	6.00	6.00	inches
Angle of Throat (see USDCM Figure ST-5)	63.40	63.40	degrees
Side Width for Depression Pan (typically the gutter width of 2 feet)	2.00	2.00	feet
Clogging Factor for a Single Curb Opening (typical value 0.10)	0.10	0.10	
Curb Opening Weir Coefficient (typical value 2.3-3.7)	3.60	3.60	
Curb Opening Orifice Coefficient (typical value 0.60 - 0.70)	0.67	0.67	
Low Head Performance Reduction (Calculated)	MINOR	MAJOR	
Depth for Grate Midwidth	N/A	N/A	ft
Depth for Curb Opening Weir Equation	0.30	0.50	ft
Combination Inlet Performance Reduction Factor for Long Inlets	0.53	0.75	
Curb Opening Performance Reduction Factor for Long Inlets	0.76	0.89	
Grated Inlet Performance Reduction Factor for Long Inlets	N/A	N/A	
Total Inlet Interception Capacity (assumes clogged condition)	MINOR	MAJOR	
Q_a	14.9	37.4	cfs
Q_{PEAK REQUIRED}	14.3	37.4	cfs

Inlet Capacity IS GOOD for Minor and Major Storms(>Q PEAK)

ALLOWABLE CAPACITY FOR ONE-HALF OF STREET (Minor & Major Storm)

(Based on Regulated Criteria for Maximum Allowable Flow Depth and Spread)

Project: The Ridge at Lorson Ranch, #100.064
 Inlet ID: Inlet DP-63



Gutter Geometry (Enter data in the blue cells)							
Maximum Allowable Width for Spread Behind Curb	$T_{BACK} = 8.0$ ft						
Side Slope Behind Curb (leave blank for no conveyance credit behind curb)	$S_{BACK} = 0.020$ ft/ft						
Manning's Roughness Behind Curb (typically between 0.012 and 0.020)	$n_{BACK} = 0.015$						
Height of Curb at Gutter Flow Line	$H_{CURB} = 6.00$ inches						
Distance from Curb Face to Street Crown	$T_{CROWN} = 17.0$ ft						
Gutter Width	$W = 2.00$ ft						
Street Transverse Slope	$S_x = 0.020$ ft/ft						
Gutter Cross Slope (typically 2 inches over 24 inches or 0.083 ft/ft)	$S_w = 0.083$ ft/ft						
Street Longitudinal Slope - Enter 0 for sump condition	$S_o = 0.016$ ft/ft						
Manning's Roughness for Street Section (typically between 0.012 and 0.020)	$n_{STREET} = 0.017$						
Max. Allowable Spread for Minor & Major Storm	<table border="1"> <thead> <tr> <th>Minor Storm</th> <th>Major Storm</th> <th>ft</th> </tr> </thead> <tbody> <tr> <td>$T_{MAX} = 17.0$</td> <td>$T_{MAX} = 17.0$</td> <td></td> </tr> </tbody> </table>	Minor Storm	Major Storm	ft	$T_{MAX} = 17.0$	$T_{MAX} = 17.0$	
Minor Storm	Major Storm	ft					
$T_{MAX} = 17.0$	$T_{MAX} = 17.0$						
Max. Allowable Depth at Gutter Flowline for Minor & Major Storm	<table border="1"> <thead> <tr> <th>Minor Storm</th> <th>Major Storm</th> <th>inches</th> </tr> </thead> <tbody> <tr> <td>$d_{MAX} = 5.6$</td> <td>$d_{MAX} = 7.9$</td> <td></td> </tr> </tbody> </table>	Minor Storm	Major Storm	inches	$d_{MAX} = 5.6$	$d_{MAX} = 7.9$	
Minor Storm	Major Storm	inches					
$d_{MAX} = 5.6$	$d_{MAX} = 7.9$						
Allow Flow Depth at Street Crown (leave blank for no)	<input type="checkbox"/> Minor Storm <input checked="" type="checkbox"/> Major Storm check = yes						
MINOR STORM Allowable Capacity is based on Spread Criterion							
MAJOR STORM Allowable Capacity is based on Depth Criterion							
Minor storm max. allowable capacity GOOD - greater than the design flow given on sheet 'Inlet Management'	<table border="1"> <thead> <tr> <th>Minor Storm</th> <th>Major Storm</th> <th>cfs</th> </tr> </thead> <tbody> <tr> <td>$Q_{allow} = 13.1$</td> <td>$Q_{allow} = 39.4$</td> <td></td> </tr> </tbody> </table>	Minor Storm	Major Storm	cfs	$Q_{allow} = 13.1$	$Q_{allow} = 39.4$	
Minor Storm	Major Storm	cfs					
$Q_{allow} = 13.1$	$Q_{allow} = 39.4$						
Major storm max. allowable capacity GOOD - greater than the design flow given on sheet 'Inlet Management'							

INLET ON A CONTINUOUS GRADE

Version 4.05 Released March 2017

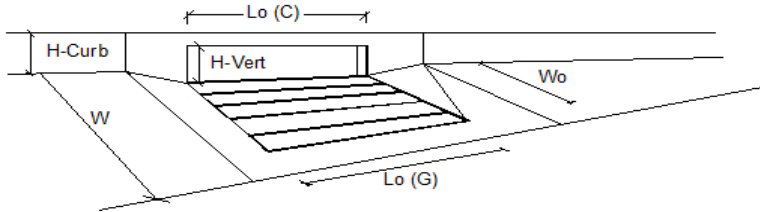

Design Information (Input)	MINOR	MAJOR	
Type of Inlet	CDOT Type R Curb Opening		
Local Depression (additional to continuous gutter depression 'a')	3.0	3.0	inches
Total Number of Units in the Inlet (Grate or Curb Opening)	1	1	
Length of a Single Unit Inlet (Grate or Curb Opening)	15.00	15.00	ft
Width of a Unit Grate (cannot be greater than W, Gutter Width)	N/A	N/A	ft
Clogging Factor for a Single Unit Grate (typical min. value = 0.5)	N/A	N/A	
Clogging Factor for a Single Unit Curb Opening (typical min. value = 0.1)	0.10	0.10	
Street Hydraulics: OK - Q < Allowable Street Capacity*			
Total Inlet Interception Capacity	10.2	15.9	cfs
Total Inlet Carry-Over Flow (flow bypassing inlet)	1.3	9.7	cfs
Capture Percentage = Q_i/Q_c =	89	62	%

ALLOWABLE CAPACITY FOR ONE-HALF OF STREET (Minor & Major Storm)

(Based on Regulated Criteria for Maximum Allowable Flow Depth and Spread)

Project: The Ridge at Lorson Ranch, #100.064
 Inlet ID: Inlet DP-64

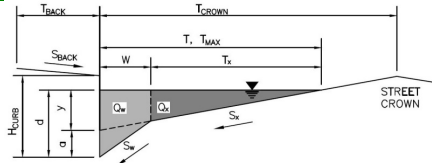

Gutter Geometry (Enter data in the blue cells)							
Maximum Allowable Width for Spread Behind Curb	$T_{BACK} = $ <input style="width: 50px;" type="text" value="8.0"/> ft						
Side Slope Behind Curb (leave blank for no conveyance credit behind curb)	$S_{BACK} = $ <input style="width: 50px;" type="text" value="0.020"/> ft/ft						
Manning's Roughness Behind Curb (typically between 0.012 and 0.020)	$n_{BACK} = $ <input style="width: 50px;" type="text" value="0.015"/>						
Height of Curb at Gutter Flow Line	$H_{CURB} = $ <input style="width: 50px;" type="text" value="6.00"/> inches						
Distance from Curb Face to Street Crown	$T_{CROWN} = $ <input style="width: 50px;" type="text" value="17.0"/> ft						
Gutter Width	$W = $ <input style="width: 50px;" type="text" value="2.00"/> ft						
Street Transverse Slope	$S_x = $ <input style="width: 50px;" type="text" value="0.020"/> ft/ft						
Gutter Cross Slope (typically 2 inches over 24 inches or 0.083 ft/ft)	$S_w = $ <input style="width: 50px;" type="text" value="0.083"/> ft/ft						
Street Longitudinal Slope - Enter 0 for sump condition	$S_o = $ <input style="width: 50px;" type="text" value="0.040"/> ft/ft						
Manning's Roughness for Street Section (typically between 0.012 and 0.020)	$n_{STREET} = $ <input style="width: 50px;" type="text" value="0.017"/>						
Max. Allowable Spread for Minor & Major Storm	<table border="1" style="margin-left: auto; margin-right: auto;"> <thead> <tr> <th style="padding: 2px;">Minor Storm</th> <th style="padding: 2px;">Major Storm</th> <th style="padding: 2px;">ft</th> </tr> </thead> <tbody> <tr> <td style="text-align: center;"><input style="width: 40px;" type="text" value="17.0"/></td> <td style="text-align: center;"><input style="width: 40px;" type="text" value="17.0"/></td> <td></td> </tr> </tbody> </table>	Minor Storm	Major Storm	ft	<input style="width: 40px;" type="text" value="17.0"/>	<input style="width: 40px;" type="text" value="17.0"/>	
Minor Storm	Major Storm	ft					
<input style="width: 40px;" type="text" value="17.0"/>	<input style="width: 40px;" type="text" value="17.0"/>						
Max. Allowable Depth at Gutter Flowline for Minor & Major Storm	<table border="1" style="margin-left: auto; margin-right: auto;"> <thead> <tr> <th style="padding: 2px;">Minor Storm</th> <th style="padding: 2px;">Major Storm</th> <th style="padding: 2px;">inches</th> </tr> </thead> <tbody> <tr> <td style="text-align: center;"><input style="width: 40px;" type="text" value="5.6"/></td> <td style="text-align: center;"><input style="width: 40px;" type="text" value="7.9"/></td> <td></td> </tr> </tbody> </table>	Minor Storm	Major Storm	inches	<input style="width: 40px;" type="text" value="5.6"/>	<input style="width: 40px;" type="text" value="7.9"/>	
Minor Storm	Major Storm	inches					
<input style="width: 40px;" type="text" value="5.6"/>	<input style="width: 40px;" type="text" value="7.9"/>						
Allow Flow Depth at Street Crown (leave blank for no)	<table border="1" style="margin-left: auto; margin-right: auto;"> <tbody> <tr> <td style="text-align: center;"><input type="checkbox"/></td> <td style="text-align: center;"><input checked="" type="checkbox"/></td> <td style="padding-left: 10px;">check = yes</td> </tr> </tbody> </table>	<input type="checkbox"/>	<input checked="" type="checkbox"/>	check = yes			
<input type="checkbox"/>	<input checked="" type="checkbox"/>	check = yes					
MINOR STORM Allowable Capacity is based on Depth Criterion							
MAJOR STORM Allowable Capacity is based on Depth Criterion							
	<table border="1" style="margin-left: auto; margin-right: auto;"> <thead> <tr> <th style="padding: 2px;">Minor Storm</th> <th style="padding: 2px;">Major Storm</th> <th style="padding: 2px;">cfs</th> </tr> </thead> <tbody> <tr> <td style="text-align: center;"><input style="width: 40px;" type="text" value="15.3"/></td> <td style="text-align: center;"><input style="width: 40px;" type="text" value="30.2"/></td> <td></td> </tr> </tbody> </table>	Minor Storm	Major Storm	cfs	<input style="width: 40px;" type="text" value="15.3"/>	<input style="width: 40px;" type="text" value="30.2"/>	
Minor Storm	Major Storm	cfs					
<input style="width: 40px;" type="text" value="15.3"/>	<input style="width: 40px;" type="text" value="30.2"/>						
Minor storm max. allowable capacity GOOD - greater than the design flow given on sheet 'Inlet Management' WARNING: MAJOR STORM max. allowable capacity is less than the design flow given on sheet 'Inlet Management'							

INLET ON A CONTINUOUS GRADE

Version 4.05 Released March 2017

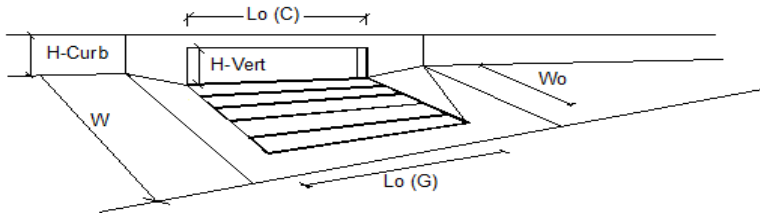

Design Information (Input)	MINOR	MAJOR	
Type of Inlet	CDOT Type R Curb Opening		
Local Depression (additional to continuous gutter depression 'a')	3.0	3.0	inches
Total Number of Units in the Inlet (Grate or Curb Opening)	1	1	
Length of a Single Unit Inlet (Grate or Curb Opening)	15.00	15.00	ft
Width of a Unit Grate (cannot be greater than W, Gutter Width)	N/A	N/A	ft
Clogging Factor for a Single Unit Grate (typical min. value = 0.5)	N/A	N/A	
Clogging Factor for a Single Unit Curb Opening (typical min. value = 0.1)	0.10	0.10	
Street Hydraulics: WARNING: Q > ALLOWABLE Q FOR MAJOR STORM			
Total Inlet Interception Capacity	9.8	17.5	cfs
Total Inlet Carry-Over Flow (flow bypassing inlet)	0.9	13.1	cfs
Capture Percentage = Q_i/Q_c =	92	57	%

ALLOWABLE CAPACITY FOR ONE-HALF OF STREET (Minor & Major Storm)

(Based on Regulated Criteria for Maximum Allowable Flow Depth and Spread)

Project: The Ridge at Lorson Ranch, #100.064
 Inlet ID: Inlet DP-66

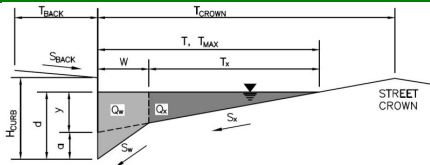

Gutter Geometry (Enter data in the blue cells)							
Maximum Allowable Width for Spread Behind Curb	$T_{BACK} = 8.0$ ft						
Side Slope Behind Curb (leave blank for no conveyance credit behind curb)	$S_{BACK} = 0.020$ ft/ft						
Manning's Roughness Behind Curb (typically between 0.012 and 0.020)	$n_{BACK} = 0.015$						
Height of Curb at Gutter Flow Line	$H_{CURB} = 6.00$ inches						
Distance from Curb Face to Street Crown	$T_{CROWN} = 17.0$ ft						
Gutter Width	$W = 2.00$ ft						
Street Transverse Slope	$S_x = 0.020$ ft/ft						
Gutter Cross Slope (typically 2 inches over 24 inches or 0.083 ft/ft)	$S_w = 0.083$ ft/ft						
Street Longitudinal Slope - Enter 0 for sump condition	$S_o = 0.020$ ft/ft						
Manning's Roughness for Street Section (typically between 0.012 and 0.020)	$n_{STREET} = 0.017$						
Max. Allowable Spread for Minor & Major Storm	<table border="1"> <thead> <tr> <th>Minor Storm</th> <th>Major Storm</th> <th>ft</th> </tr> </thead> <tbody> <tr> <td>$T_{MAX} = 17.0$</td> <td>$T_{MAX} = 17.0$</td> <td></td> </tr> </tbody> </table>	Minor Storm	Major Storm	ft	$T_{MAX} = 17.0$	$T_{MAX} = 17.0$	
Minor Storm	Major Storm	ft					
$T_{MAX} = 17.0$	$T_{MAX} = 17.0$						
Max. Allowable Depth at Gutter Flowline for Minor & Major Storm	<table border="1"> <thead> <tr> <th>Minor Storm</th> <th>Major Storm</th> <th>inches</th> </tr> </thead> <tbody> <tr> <td>$d_{MAX} = 5.6$</td> <td>$d_{MAX} = 7.9$</td> <td></td> </tr> </tbody> </table>	Minor Storm	Major Storm	inches	$d_{MAX} = 5.6$	$d_{MAX} = 7.9$	
Minor Storm	Major Storm	inches					
$d_{MAX} = 5.6$	$d_{MAX} = 7.9$						
Allow Flow Depth at Street Crown (leave blank for no)	<input type="checkbox"/> Minor Storm <input checked="" type="checkbox"/> Major Storm check = yes						
MINOR STORM Allowable Capacity is based on Spread Criterion							
MAJOR STORM Allowable Capacity is based on Depth Criterion							
Minor storm max. allowable capacity GOOD - greater than the design flow given on sheet 'Inlet Management'	<table border="1"> <thead> <tr> <th>Minor Storm</th> <th>Major Storm</th> <th>cfs</th> </tr> </thead> <tbody> <tr> <td>$Q_{allow} = 14.5$</td> <td>$Q_{allow} = 37.2$</td> <td></td> </tr> </tbody> </table>	Minor Storm	Major Storm	cfs	$Q_{allow} = 14.5$	$Q_{allow} = 37.2$	
Minor Storm	Major Storm	cfs					
$Q_{allow} = 14.5$	$Q_{allow} = 37.2$						
Major storm max. allowable capacity GOOD - greater than the design flow given on sheet 'Inlet Management'							

INLET ON A CONTINUOUS GRADE

Version 4.05 Released March 2017

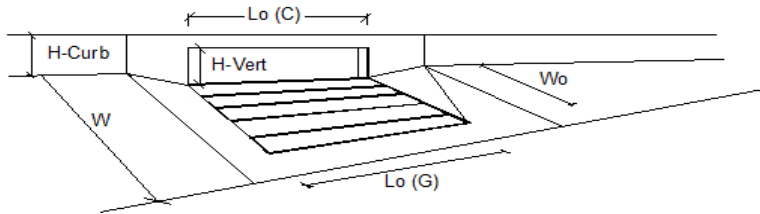

Design Information (Input)	MINOR	MAJOR	
Type of Inlet	CDOT Type R Curb Opening		
Local Depression (additional to continuous gutter depression 'a')	3.0	3.0	inches
Total Number of Units in the Inlet (Grate or Curb Opening)	1	1	
Length of a Single Unit Inlet (Grate or Curb Opening)	15.00	15.00	ft
Width of a Unit Grate (cannot be greater than W, Gutter Width)	N/A	N/A	ft
Clogging Factor for a Single Unit Grate (typical min. value = 0.5)	N/A	N/A	
Clogging Factor for a Single Unit Curb Opening (typical min. value = 0.1)	0.10	0.10	
Street Hydraulics: OK - Q < Allowable Street Capacity			
Total Inlet Interception Capacity	1.5	11.8	cfs
Total Inlet Carry-Over Flow (flow bypassing inlet)	0.0	2.7	cfs
Capture Percentage = Q_i/Q_c =	100	81	%

ALLOWABLE CAPACITY FOR ONE-HALF OF STREET (Minor & Major Storm)

(Based on Regulated Criteria for Maximum Allowable Flow Depth and Spread)

Project: The Ridge at Lorson Ranch, #100.064
 Inlet ID: Inlet DP-69



Gutter Geometry (Enter data in the blue cells)							
Maximum Allowable Width for Spread Behind Curb	$T_{BACK} = 8.0$ ft						
Side Slope Behind Curb (leave blank for no conveyance credit behind curb)	$S_{BACK} = 0.020$ ft/ft						
Manning's Roughness Behind Curb (typically between 0.012 and 0.020)	$n_{BACK} = 0.015$						
Height of Curb at Gutter Flow Line	$H_{CURB} = 6.00$ inches						
Distance from Curb Face to Street Crown	$T_{CROWN} = 17.0$ ft						
Gutter Width	$W = 2.00$ ft						
Street Transverse Slope	$S_x = 0.020$ ft/ft						
Gutter Cross Slope (typically 2 inches over 24 inches or 0.083 ft/ft)	$S_w = 0.083$ ft/ft						
Street Longitudinal Slope - Enter 0 for sump condition	$S_o = 0.000$ ft/ft						
Manning's Roughness for Street Section (typically between 0.012 and 0.020)	$n_{STREET} = 0.017$						
Max. Allowable Spread for Minor & Major Storm	<table border="1" style="display: inline-table; border-collapse: collapse;"> <tr> <th style="padding: 2px;">Minor Storm</th> <th style="padding: 2px;">Major Storm</th> <th style="padding: 2px;">ft</th> </tr> <tr> <td style="text-align: center; padding: 2px;">17.0</td> <td style="text-align: center; padding: 2px;">17.0</td> <td></td> </tr> </table>	Minor Storm	Major Storm	ft	17.0	17.0	
Minor Storm	Major Storm	ft					
17.0	17.0						
Max. Allowable Depth at Gutter Flowline for Minor & Major Storm	<table border="1" style="display: inline-table; border-collapse: collapse;"> <tr> <th style="padding: 2px;">Minor Storm</th> <th style="padding: 2px;">Major Storm</th> <th style="padding: 2px;">inches</th> </tr> <tr> <td style="text-align: center; padding: 2px;">5.6</td> <td style="text-align: center; padding: 2px;">7.9</td> <td></td> </tr> </table>	Minor Storm	Major Storm	inches	5.6	7.9	
Minor Storm	Major Storm	inches					
5.6	7.9						
Check boxes are not applicable in SUMP conditions	<input type="checkbox"/> <input type="checkbox"/>						
MINOR STORM Allowable Capacity is based on Depth Criterion							
MAJOR STORM Allowable Capacity is based on Depth Criterion							
Q _{allow}	<table border="1" style="display: inline-table; border-collapse: collapse;"> <tr> <th style="padding: 2px;">Minor Storm</th> <th style="padding: 2px;">Major Storm</th> <th style="padding: 2px;">cfs</th> </tr> <tr> <td style="text-align: center; padding: 2px;">SUMP</td> <td style="text-align: center; padding: 2px;">SUMP</td> <td></td> </tr> </table>	Minor Storm	Major Storm	cfs	SUMP	SUMP	
Minor Storm	Major Storm	cfs					
SUMP	SUMP						

INLET IN A SUMP OR SAG LOCATION

Version 4.05 Released March 2017

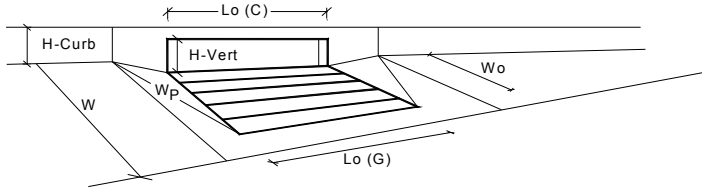

Design Information (Input)	MINOR	MAJOR	
Type of Inlet	CDOT Type R Curb Opening		
Local Depression (additional to continuous gutter depression 'a' from above)	3.00	3.00	inches
Number of Unit Inlets (Grate or Curb Opening)	1	1	
Water Depth at Flowline (outside of local depression)	5.5	7.8	inches
Grate Information	MINOR	MAJOR	<input checked="" type="checkbox"/> Override Depths
Length of a Unit Grate	N/A	N/A	feet
Width of a Unit Grate	N/A	N/A	feet
Area Opening Ratio for a Grate (typical values 0.15-0.90)	N/A	N/A	
Clogging Factor for a Single Grate (typical value 0.50 - 0.70)	N/A	N/A	
Grate Weir Coefficient (typical value 2.15 - 3.60)	N/A	N/A	
Grate Orifice Coefficient (typical value 0.60 - 0.80)	N/A	N/A	
Curb Opening Information	MINOR	MAJOR	
Length of a Unit Curb Opening	25.00	25.00	feet
Height of Vertical Curb Opening in Inches	6.00	6.00	inches
Height of Curb Orifice Throat in Inches	6.00	6.00	inches
Angle of Throat (see USDCM Figure ST-5)	63.40	63.40	degrees
Side Width for Depression Pan (typically the gutter width of 2 feet)	2.00	2.00	feet
Clogging Factor for a Single Curb Opening (typical value 0.10)	0.10	0.10	
Curb Opening Weir Coefficient (typical value 2.3-3.7)	3.60	3.60	
Curb Opening Orifice Coefficient (typical value 0.60 - 0.70)	0.67	0.67	
Low Head Performance Reduction (Calculated)	MINOR	MAJOR	
Depth for Grate Midwidth	N/A	N/A	ft
Depth for Curb Opening Weir Equation	0.29	0.48	ft
Combination Inlet Performance Reduction Factor for Long Inlets	0.52	0.74	
Curb Opening Performance Reduction Factor for Long Inlets	0.75	0.88	
Grated Inlet Performance Reduction Factor for Long Inlets	N/A	N/A	
Total Inlet Interception Capacity (assumes clogged condition)	MINOR	MAJOR	
Q_a	12.0	29.8	cfs
Q_{PEAK REQUIRED}	7.9	17.3	cfs

Inlet Capacity IS GOOD for Minor and Major Storms(>Q PEAK)

APPENDIX D – POND AND ROUTING CALCULATIONS

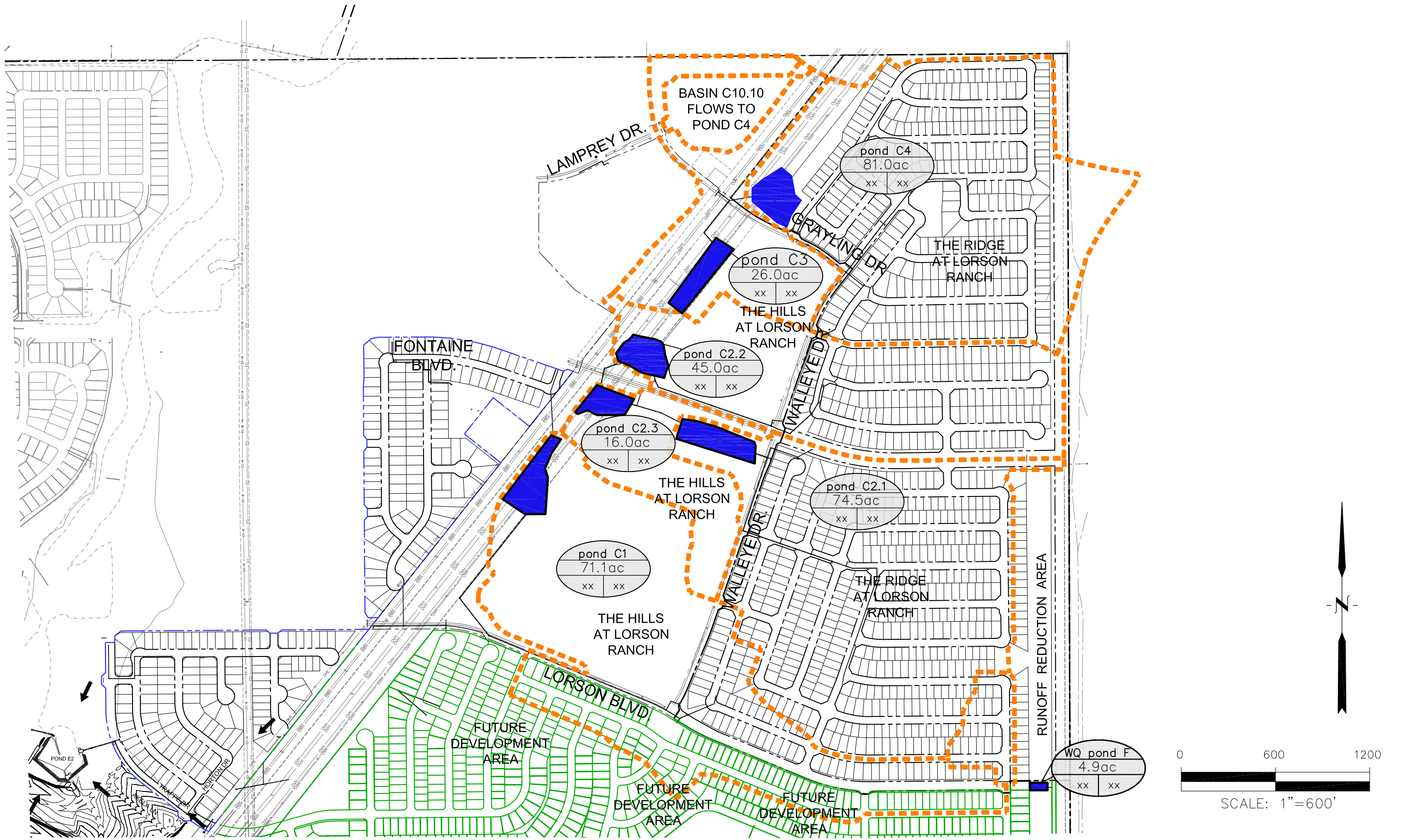

**CORE
ENGINEERING GROUP**

15004 1ST AVENUE S.
BURNSVILLE, MN 55306
PH: 719.570.1100
CONTACT: RICHARD L. SCHINDLER, P.E.
EMAIL: Rich@ceg1.com

**THE RIDGE AT LORSON RANCH
WATER QUALITY & POND TRIBUTARY AREAS**

SCALE:
NTS

DATE:
SEPT, 2021

FIGURE NO.
1

Design Procedure Form: Runoff Reduction

UD-BMP (Version 3.07, March 2018)

Sheet 1 of 1

Designer: Richard Schindler
Company: Core Engineering Group
Date: March 18, 2021
Project: The Ridge at Lorson Ranch
Location: Basin F1

SITE INFORMATION (User Input in Blue Cells)

WQCV Rainfall Depth = 0.60 inches
 Depth of Average Runoff Producing Storm, d_0 = 0.43 inches (for Watersheds Outside of the Denver Region, Figure 3-1 in USDCM Vol. 3)

Area Type	UIA:RPA																			
Area ID	res. Lot																			
Downstream Design Point ID	1																			
Downstream BMP Type	None																			
DCIA (ft ²)	--																			
UIA (ft ²)	4,500																			
RPA (ft ²)	7,250																			
SPA (ft ²)	--																			
HSG A (%)	0%																			
HSG B (%)	100%																			
HSG C/D (%)	0%																			
Average Slope of RPA (ft/ft)	0.060																			
UIA:RPA Interface Width (ft)	145.00																			

CALCULATED RUNOFF RESULTS

Area ID	res. Lot																			
UIA:RPA Area (ft ²)	11,750																			
L / W Ratio	0.56																			
UIA / Area	0.3830																			
Runoff (in)	0.00																			
Runoff (ft ³)	0																			
Runoff Reduction (ft ³)	188																			

CALCULATED WQCV RESULTS

Area ID	res. Lot																			
WQCV (ft ³)	188																			
WQCV Reduction (ft ³)	188																			
WQCV Reduction (%)	100%																			
Untreated WQCV (ft ³)	0																			

CALCULATED DESIGN POINT RESULTS (sums results from all columns with the same Downstream Design Point ID)

Downstream Design Point ID	1																			
DCIA (ft ²)	0																			
UIA (ft ²)	4,500																			
RPA (ft ²)	7,250																			
SPA (ft ²)	0																			
Total Area (ft ²)	11,750																			
Total Impervious Area (ft ²)	4,500																			
WQCV (ft ³)	188																			
WQCV Reduction (ft ³)	188																			
WQCV Reduction (%)	100%																			
Untreated WQCV (ft ³)	0																			

CALCULATED SITE RESULTS (sums results from all columns in worksheet)

Total Area (ft ²)	11,750
Total Impervious Area (ft ²)	4,500
WQCV (ft ³)	188
WQCV Reduction (ft ³)	188
WQCV Reduction (%)	100%
Untreated WQCV (ft ³)	0

DETENTION BASIN STAGE-STORAGE TABLE BUILDER

MHFD-Detention, Version 4.02 (February 2020)

Project: **The Hills at Lorson Ranch**

Basin ID: **Pond C1**

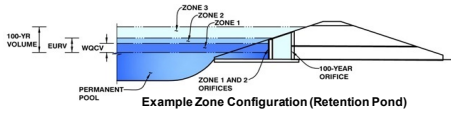

pond bottom=5743.40

Watershed Information

Selected BMP Type =	EDB	
Watershed Area =	71.10	acres
Watershed Length =	4,800	ft
Watershed Length to Centroid =	2,100	ft
Watershed Slope =	0.040	ft/ft
Watershed Imperviousness =	55.00%	percent
Percentage Hydrologic Soil Group A =	0.0%	percent
Percentage Hydrologic Soil Group B =	100.0%	percent
Percentage Hydrologic Soil Groups C/D =	0.0%	percent
Target WQCV Drain Time =	40.0	hours
Location for 1-hr Rainfall Depths =	User Input	

After providing required inputs above including 1-hour rainfall depths, click "Run CUHP" to generate runoff hydrographs using the embedded Colorado Urban Hydrograph Procedure.

Optional User Overrides

Water Quality Capture Volume (WQCV) =	1.306	acre-feet	
Excess Urban Runoff Volume (EURV) =	4.212	acre-feet	
2-yr Runoff Volume (P1 = 1.19 in.) =	3.975	acre-feet	1.19 inches
5-yr Runoff Volume (P1 = 1.5 in.) =	5.580	acre-feet	1.50 inches
10-yr Runoff Volume (P1 = 1.75 in.) =	6.975	acre-feet	1.75 inches
25-yr Runoff Volume (P1 = 2 in.) =	8.792	acre-feet	2.00 inches
50-yr Runoff Volume (P1 = 2.25 in.) =	10.293	acre-feet	2.25 inches
100-yr Runoff Volume (P1 = 2.52 in.) =	12.175	acre-feet	2.52 inches
500-yr Runoff Volume (P1 = 3.14 in.) =	16.033	acre-feet	
Approximate 2-yr Detention Volume =	3.210	acre-feet	
Approximate 5-yr Detention Volume =	4.365	acre-feet	
Approximate 10-yr Detention Volume =	5.698	acre-feet	
Approximate 25-yr Detention Volume =	6.193	acre-feet	
Approximate 50-yr Detention Volume =	6.465	acre-feet	
Approximate 100-yr Detention Volume =	7.133	acre-feet	

Define Zones and Basin Geometry

Zone 1 Volume (WQCV) =	1.306	acre-feet
Zone 2 Volume (EURV - Zone 1) =	2.906	acre-feet
Zone 3 (100yr + 1 / 2 WQCV - Zones 1 & 2) =	3.574	acre-feet
Total Detention Basin Volume =	7.786	acre-feet
Initial Surcharge Volume (ISV) =	user	ft ³
Initial Surcharge Depth (ISD) =	user	ft
Total Available Detention Depth (H _{total}) =	user	ft
Depth of Trickle Channel (H _{TC}) =	user	ft
Slope of Trickle Channel (S _{TC}) =	user	ft/ft
Slopes of Main Basin Sides (S _{main}) =	user	H:V
Basin Length-to-Width Ratio (R _{L/W}) =	user	
Initial Surcharge Area (A _{ISV}) =	user	ft ²
Surcharge Volume Length (L _{ISV}) =	user	ft
Surcharge Volume Width (W _{ISV}) =	user	ft
Depth of Basin Floor (H _{FLOOR}) =	user	ft
Length of Basin Floor (L _{FLOOR}) =	user	ft
Width of Basin Floor (W _{FLOOR}) =	user	ft
Area of Basin Floor (A _{FLOOR}) =	user	ft ²
Volume of Basin Floor (V _{FLOOR}) =	user	ft ³
Depth of Main Basin (H _{MAIN}) =	user	ft
Length of Main Basin (L _{MAIN}) =	user	ft
Width of Main Basin (W _{MAIN}) =	user	ft
Area of Main Basin (A _{MAIN}) =	user	ft ²
Volume of Main Basin (V _{MAIN}) =	user	ft ³
Calculated Total Basin Volume (V _{total}) =	user	acre-feet

Stage - Storage Description	Stage (ft)	Optional Override Stage (ft)	Length (ft)	Width (ft)	Area (ft ²)	Optional Override Area (ft ²)	Area (acre)	Volume (ft ³)	Volume (ac-ft)
Top of Micropool	--	0.00	--	--	--	40	0.001		
5743.73	--	0.33	--	--	--	52	0.001	15	0.000
5744	--	0.60	--	--	--	300	0.007	63	0.001
5745	--	1.60	--	--	--	4,017	0.092	2,221	0.051
5746	--	2.60	--	--	--	26,320	0.604	17,389	0.399
5747	--	3.60	--	--	--	56,078	1.287	58,588	1.345
5748	--	4.60	--	--	--	62,238	1.429	117,746	2.703
5749	--	5.60	--	--	--	66,563	1.528	182,147	4.182
5750	--	6.60	--	--	--	70,969	1.629	250,913	5.760
5751	--	7.60	--	--	--	75,495	1.733	324,145	7.441
5752	--	8.60	--	--	--	80,136	1.840	401,960	9.228
5753	--	9.60	--	--	--	85,057	1.953	484,557	11.124
5754	--	10.60	--	--	--	90,000	2.066	572,085	13.133
5755	--	11.60	--	--	--	95,000	2.181	664,585	15.257
5756	--	12.60	--	--	--	100,000	2.296	762,085	17.495

DETENTION BASIN OUTLET STRUCTURE DESIGN

MHFD-Detention, Version 4.02 (February 2020)

Project: The Hills at Lorson Ranch
Basin ID: Pond C1

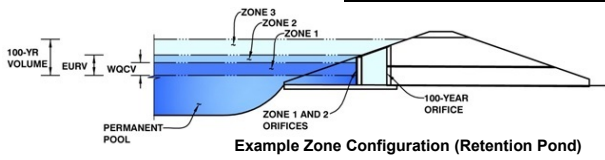

	Estimated Stage (ft)	Estimated Volume (ac-ft)	Outlet Type
Zone 1 (WQCV)	3.57	1.306	Orifice Plate
Zone 2 (EURV)	5.63	2.906	Rectangular Orifice
Zone 3 (100+1/2WQCV)	7.80	3.574	Weir&Pipe (Restrict)
Total (all zones)		7.786	

User Input: Orifice at Underdrain Outlet (typically used to drain WQCV in a Filtration BMP)

Underdrain Orifice Invert Depth = ft (distance below the filtration media surface)
 Underdrain Orifice Diameter = inches

Calculated Parameters for Underdrain

Underdrain Orifice Area = ft²
 Underdrain Orifice Centroid = feet

User Input: Orifice Plate with one or more orifices or Elliptical Slot Weir (typically used to drain WQCV and/or EURV in a sedimentation BMP)

Invert of Lowest Orifice = 0.00 ft (relative to basin bottom at Stage = 0 ft)
 Depth at top of Zone using Orifice Plate = 3.57 ft (relative to basin bottom at Stage = 0 ft)
 Orifice Plate: Orifice Vertical Spacing = 14.60 inches
 Orifice Plate: Orifice Area per Row = 3.55 sq. inches (use rectangular openings)

Calculated Parameters for Plate

WQ Orifice Area per Row = 2.465E-02 ft²
 Elliptical Half-Width = N/A feet
 Elliptical Slot Centroid = N/A feet
 Elliptical Slot Area = N/A ft²

User Input: Stage and Total Area of Each Orifice Row (numbered from lowest to highest)

	Row 1 (required)	Row 2 (optional)	Row 3 (optional)	Row 4 (optional)	Row 5 (optional)	Row 6 (optional)	Row 7 (optional)	Row 8 (optional)
Stage of Orifice Centroid (ft)	0.00	1.20	2.40					
Orifice Area (sq. inches)	3.55	3.55	3.55					

	Row 9 (optional)	Row 10 (optional)	Row 11 (optional)	Row 12 (optional)	Row 13 (optional)	Row 14 (optional)	Row 15 (optional)	Row 16 (optional)
Stage of Orifice Centroid (ft)								
Orifice Area (sq. inches)								

User Input: Vertical Orifice (Circular or Rectangular)

	Zone 2 Rectangular	Not Selected	
Invert of Vertical Orifice =	3.64	N/A	ft (relative to basin bottom at Stage = 0 ft)
Depth at top of Zone using Vertical Orifice =	5.63	N/A	ft (relative to basin bottom at Stage = 0 ft)
Vertical Orifice Height =	6.00	N/A	inches
Vertical Orifice Width =	19.74		inches

Calculated Parameters for Vertical Orific

	Zone 2 Rectangular	Not Selected
Vertical Orifice Area =	0.82	N/A
Vertical Orifice Centroid =	0.25	N/A

User Input: Overflow Weir (Dropbox with Flat or Sloped Gate and Outlet Pipe OR Rectangular/Trapezoidal Weir (and No Outlet Pipe)

	Zone 3 Weir	Not Selected	
Overflow Weir Front Edge Height, Ho =	6.10	N/A	ft (relative to basin bottom at Stage = 0 ft)
Overflow Weir Front Edge Length =	5.66	N/A	feet
Overflow Weir Gate Slope =	0.00	N/A	H:V
Horiz. Length of Weir Sides =	3.00	N/A	feet
Overflow Gate Open Area % =	70%	N/A	% gate open area/total area
Debris Clogging % =	50%	N/A	%

Calculated Parameters for Overflow Weir

	Zone 3 Weir	Not Selected
Height of Gate Upper Edge, H ₁ =	6.10	N/A
Overflow Weir Slope Length =	3.00	N/A
Gate Open Area / 100-yr Orifice Area =	9.41	N/A
Overflow Gate Open Area w/o Debris =	11.89	N/A
Overflow Gate Open Area w/ Debris =	5.94	N/A

User Input: Outlet Pipe w/ Flow Restriction Plate (Circular Orifice, Restrictor Plate, or Rectangular Orifice)

	Zone 3 Restrictor	Not Selected	
Depth to Invert of Outlet Pipe =	0.00	N/A	ft (distance below basin bottom at Stage = 0 ft)
Outlet Pipe Diameter =	18.00	N/A	inches
Restrictor Plate Height Above Pipe Invert =	12.10		inches

Calculated Parameters for Outlet Pipe w/ Flow Restriction Plate

	Zone 3 Restrictor	Not Selected
Outlet Orifice Area =	1.26	N/A
Outlet Orifice Centroid =	0.57	N/A
Half-Central Angle of Restrictor Plate on Pipe =	1.92	N/A

User Input: Emergency Spillway (Rectangular or Trapezoidal)

Spillway Invert Stage =	10.00	ft (relative to basin bottom at Stage = 0 ft)
Spillway Crest Length =	28.00	feet
Spillway End Slopes =	4.00	H:V
Freeboard above Max Water Surface =	1.16	feet

Calculated Parameters for Spillway

Spillway Design Flow Depth =	1.37	feet
Stage at Top of Freeboard =	12.53	feet
Basin Area at Top of Freeboard =	2.29	acres
Basin Volume at Top of Freeboard =	17.33	acre-ft

micropool = 0 = 5743.40

Routed Hydrograph Results

The user can override the default CUHP hydrographs and runoff volumes by entering new values in the Inflow Hydrographs table (Columns W through AF)

	WQCV	EURV	2 Year	5 Year	10 Year	25 Year	50 Year	100 Year
Design Storm Return Period =	N/A	N/A	1.19	1.50	1.75	2.00	2.25	2.52
One-Hour Rainfall Depth (in) =	N/A	N/A	1.19	1.50	1.75	2.00	2.25	2.52
CUHP Runoff Volume (acre-ft) =	1.306	4.212	3.975	5.580	6.975	8.792	10.293	12.175
Inflow Hydrograph Volume (acre-ft) =	N/A	N/A	3.975	5.580	6.975	8.792	10.293	12.175
CUHP Predevelopment Peak Q (cfs) =	N/A	N/A	5.2	14.7	22.8	41.9	52.7	68.0
OPTIONAL Override Predevelopment Peak Q (cfs) =	N/A	N/A						
Predevelopment Unit Peak Flow, q (cfs/acre) =	N/A	N/A	0.07	0.21	0.32	0.59	0.74	0.96
Peak Inflow Q (cfs) =	N/A	N/A	48.9	69.1	84.1	113.0	132.4	155.9
Peak Outflow Q (cfs) =	0.5	5.9	4.9	6.4	14.8	15.8	16.7	17.7
Ratio Peak Outflow to Predevelopment Q =	N/A	N/A	N/A	0.4	0.6	0.4	0.3	0.3
Structure Controlling Flow =	Plate	Vertical Orifice 1	Vertical Orifice 1	Vertical Orifice 1	Outlet Plate 1	Outlet Plate 1	Outlet Plate 1	Outlet Plate 1
Max Velocity through Gate 1 (fps) =	N/A	N/A	N/A	N/A	0.6	0.6	0.6	0.6
Max Velocity through Gate 2 (fps) =	N/A	N/A	N/A	N/A	N/A	N/A	N/A	N/A
Time to Drain 97% of Inflow Volume (hours) =	38	50	51	51	51	50	49	48
Time to Drain 99% of Inflow Volume (hours) =	40	54	54	56	57	57	57	58
Maximum Ponding Depth (ft) =	3.57	5.62	5.04	5.93	6.48	7.33	8.06	8.99
Area at Maximum Ponding Depth (acres) =	1.27	1.53	1.47	1.56	1.62	1.71	1.78	1.88
Maximum Volume Stored (acre-ft) =	1.307	4.212	3.327	4.691	5.549	6.977	8.250	9.954

DETENTION BASIN OUTLET STRUCTURE DESIGN

MHFD-Depotion, Version 4.00 (December 2019)

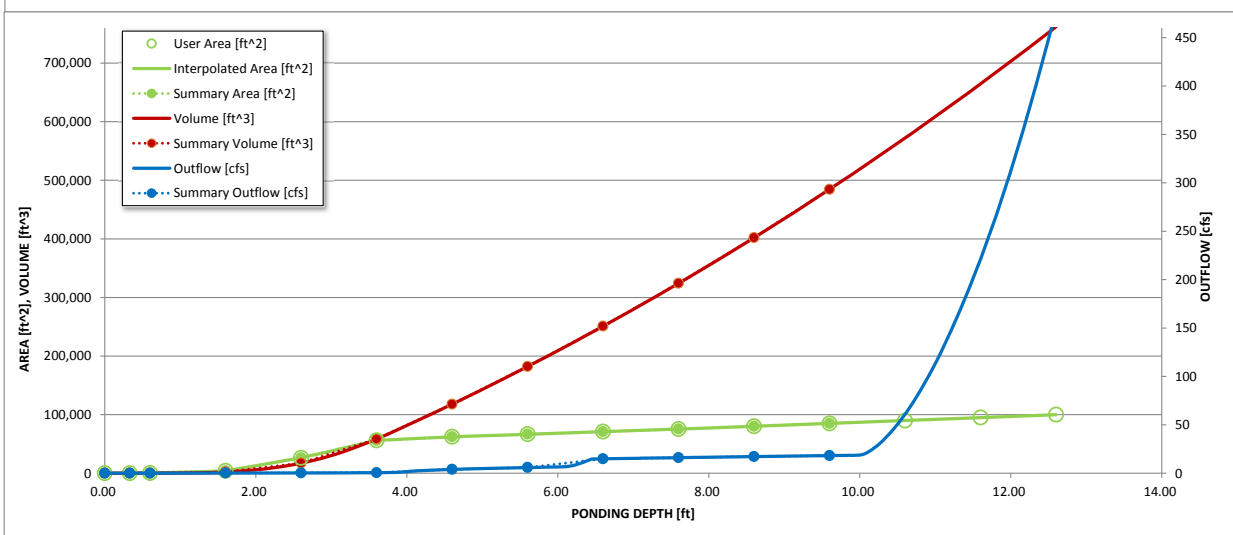
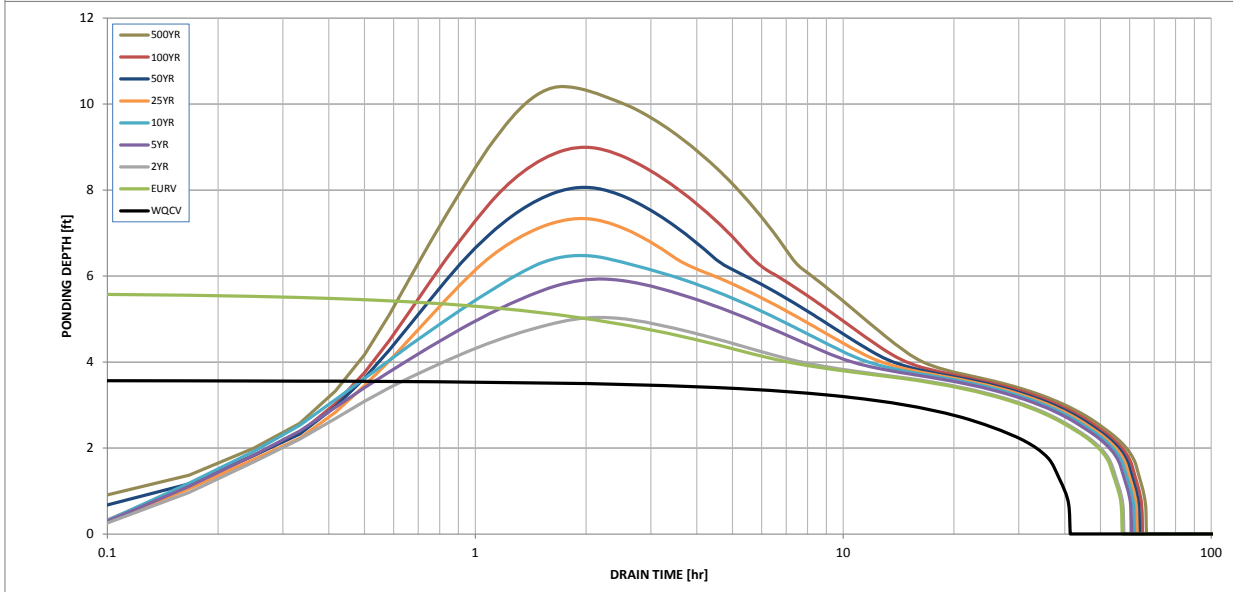
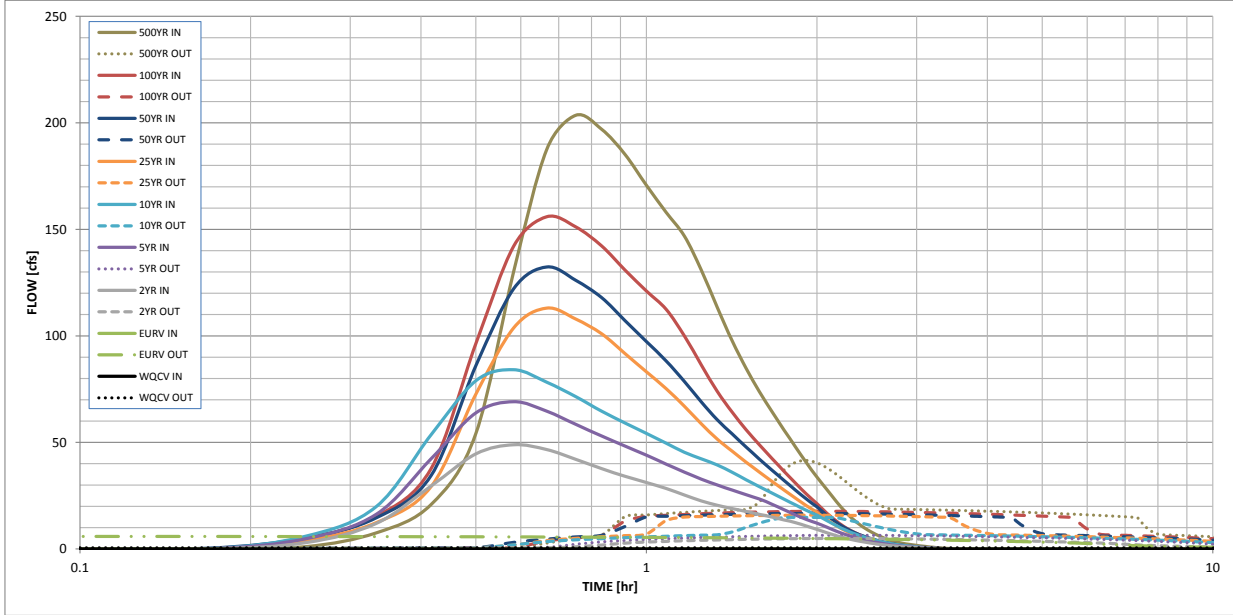

S-A-V-D Chart Axis Override	X-axis	Left Y-Axis	Right Y-Axis
minimum bound			
maximum bound			

Design Procedure Form: Extended Detention Basin (EDB)

UD-BMP (Version 3.07, March 2018)

Sheet 1 of 3

Designer: Richard Schindler
Company: Core Engineering Group
Date: April 30, 2020
Project: The Hills at Lorson Ranch
Location: Pond C1

<p>1. Basin Storage Volume</p> <p>A) Effective Imperviousness of Tributary Area, I_a</p> <p>B) Tributary Area's Imperviousness Ratio ($i = I_a / 100$)</p> <p>C) Contributing Watershed Area</p> <p>D) For Watersheds Outside of the Denver Region, Depth of Average Runoff Producing Storm</p> <p>E) Design Concept (Select EURV when also designing for flood control)</p> <p>F) Design Volume (WQCV) Based on 40-hour Drain Time ($V_{DESIGN} = (1.0 * (0.91 * i^3 - 1.19 * i^2 + 0.78 * i) / 12 * Area)$)</p> <p>G) For Watersheds Outside of the Denver Region, Water Quality Capture Volume (WQCV) Design Volume ($V_{WQCV\ OTHER} = (d_6 * (V_{DESIGN} * 0.43))$)</p> <p>H) User Input of Water Quality Capture Volume (WQCV) Design Volume (Only if a different WQCV Design Volume is desired)</p> <p>I) NRCS Hydrologic Soil Groups of Tributary Watershed i) Percentage of Watershed consisting of Type A Soils ii) Percentage of Watershed consisting of Type B Soils iii) Percentage of Watershed consisting of Type C/D Soils</p> <p>J) Excess Urban Runoff Volume (EURV) Design Volume For HSG A: $EURV_A = 1.68 * i^{1.28}$ For HSG B: $EURV_B = 1.36 * i^{1.08}$ For HSG C/D: $EURV_{C/D} = 1.20 * i^{1.08}$</p> <p>K) User Input of Excess Urban Runoff Volume (EURV) Design Volume (Only if a different EURV Design Volume is desired)</p>	<p>$I_a =$ <input type="text" value="55.0"/> %</p> <p>$i =$ <input type="text" value="0.550"/></p> <p>Area = <input type="text" value="76.000"/> ac</p> <p>$d_6 =$ <input type="text" value=""/></p> <div style="border: 1px solid black; padding: 5px; margin: 5px 0;"> <p>Choose One</p> <p><input checked="" type="radio"/> Water Quality Capture Volume (WQCV)</p> <p><input type="radio"/> Excess Urban Runoff Volume (EURV)</p> </div> <p>$V_{DESIGN} =$ <input type="text" value="1.396"/> ac-ft</p> <p>$V_{DESIGN\ OTHER} =$ <input type="text" value=""/> ac-ft</p> <p>$V_{DESIGN\ USER} =$ <input type="text" value=""/> ac-ft</p> <p>HSG _A = <input type="text" value=""/> %</p> <p>HSG _B = <input type="text" value=""/> %</p> <p>HSG _{C/D} = <input type="text" value=""/> %</p> <p>$EURV_{DESIGN} =$ <input type="text" value=""/> ac-ft</p> <p>$EURV_{DESIGN\ USER} =$ <input type="text" value=""/> ac-ft</p>
<p>2. Basin Shape: Length to Width Ratio (A basin length to width ratio of at least 2:1 will improve TSS reduction.)</p>	<p>L : W = <input type="text" value="2.0"/> : 1</p>
<p>3. Basin Side Slopes</p> <p>A) Basin Maximum Side Slopes (Horizontal distance per unit vertical, 4:1 or flatter preferred)</p>	<p>Z = <input type="text" value="3.00"/> ft / ft</p> <p align="center">DIFFICULT TO MAINTAIN, INCREASE WHERE POSSIBLE</p>
<p>4. Inlet</p> <p>A) Describe means of providing energy dissipation at concentrated inflow locations:</p>	<p>_____</p> <p>_____</p> <p>_____</p>
<p>5. Forebay</p> <p>A) Minimum Forebay Volume ($V_{MIN} =$ <input type="text" value="3%"/> of the WQCV)</p> <p>B) Actual Forebay Volume</p> <p>C) Forebay Depth ($D_F =$ <input type="text" value="30"/> inch maximum)</p> <p>D) Forebay Discharge</p> <p>i) Undetained 100-year Peak Discharge</p> <p>ii) Forebay Discharge Design Flow ($Q_F = 0.02 * Q_{100}$)</p> <p>E) Forebay Discharge Design</p> <p>F) Discharge Pipe Size (minimum 8-inches)</p> <p>G) Rectangular Notch Width</p>	<p>$V_{MIN} =$ <input type="text" value="0.042"/> ac-ft</p> <p>$V_F =$ <input type="text" value="0.045"/> ac-ft</p> <p>$D_F =$ <input type="text" value="24.0"/> in</p> <p>$Q_{100} =$ <input type="text" value="170.00"/> cfs</p> <p>$Q_F =$ <input type="text" value="3.40"/> cfs</p> <div style="border: 1px solid black; padding: 5px; margin: 5px 0;"> <p>Choose One</p> <p><input type="radio"/> Berm With Pipe</p> <p><input checked="" type="radio"/> Wall with Rect. Notch</p> <p><input type="radio"/> Wall with V-Notch Weir</p> </div> <p>Calculated $D_P =$ <input type="text" value=""/> in</p> <p>Calculated $W_N =$ <input type="text" value="9.1"/> in</p>

Design Procedure Form: Extended Detention Basin (EDB)

Designer: Richard Schindler
Company: Core Engineering Group
Date: April 30, 2020
Project: The Hills at Lorson Ranch
Location: Pond C1

<p>6. Trickle Channel</p> <p>A) Type of Trickle Channel</p> <p>F) Slope of Trickle Channel</p>	<div style="border: 1px solid black; padding: 2px; margin-bottom: 5px;"> Choose One <input checked="" type="radio"/> Concrete <input type="radio"/> Soft Bottom </div> <p>S = <input type="text" value="0.0050"/> ft / ft</p>
<p>7. Micropool and Outlet Structure</p> <p>A) Depth of Micropool (2.5-foot minimum)</p> <p>B) Surface Area of Micropool (10 ft² minimum)</p> <p>C) Outlet Type</p> <p>D) Smallest Dimension of Orifice Opening Based on Hydrograph Routing (Use UD-Detention)</p> <p>E) Total Outlet Area</p>	<p>D_M = <input type="text" value="2.5"/> ft</p> <p>A_M = <input type="text" value="50"/> sq ft</p> <div style="border: 1px solid black; padding: 2px; margin-bottom: 5px;"> Choose One <input checked="" type="radio"/> Orifice Plate <input type="radio"/> Other (Describe): </div> <hr/> <hr/> <p>D_{orifice} = <input type="text" value="1.93"/> inches</p> <p>A_{orifice} = <input type="text" value="6.45"/> square inches</p>
<p>8. Initial Surcharge Volume</p> <p>A) Depth of Initial Surcharge Volume (Minimum recommended depth is 4 inches)</p> <p>B) Minimum Initial Surcharge Volume (Minimum volume of 0.3% of the WQCV)</p> <p>C) Initial Surcharge Provided Above Micropool</p>	<p>D_{IS} = <input type="text" value="4"/> in</p> <p>V_{IS} = <input type="text" value="182"/> cu ft</p> <p>V_s = <input type="text" value="16.7"/> cu ft</p>
<p>9. Trash Rack</p> <p>A) Water Quality Screen Open Area: $A_t = A_{ot} * 38.5 * (e^{-0.095D})$</p> <p>B) Type of Screen (If specifying an alternative to the materials recommended in the USDCM, indicate "other" and enter the ratio of the total open area to the total screen area for the material specified.)</p> <p style="text-align: right;">Other (Y/N): <input type="text" value="y"/></p> <p>C) Ratio of Total Open Area to Total Area (only for type 'Other')</p> <p>D) Total Water Quality Screen Area (based on screen type)</p> <p>E) Depth of Design Volume (EURV or WQCV) (Based on design concept chosen under 1E)</p> <p>F) Height of Water Quality Screen (H_{TR})</p> <p>G) Width of Water Quality Screen Opening (W_{opening}) (Minimum of 12 inches is recommended)</p>	<p>A_t = <input type="text" value="207"/> square inches</p> <div style="border: 1px solid black; padding: 2px; margin-bottom: 5px;"> Other (Please describe below) </div> <p>wellscreen stainless</p> <hr/> <hr/> <p>User Ratio = <input type="text" value="0.6"/></p> <p>A_{total} = <input type="text" value="345"/> sq. in. Based on type 'Other' screen ratio</p> <p>H = <input type="text" value="3.64"/> feet</p> <p>H_{TR} = <input type="text" value="71.68"/> inches</p> <p>W_{opening} = <input type="text" value="12.0"/> inches VALUE LESS THAN RECOMMENDED MIN. WIDTH. WIDTH HAS BEEN SET TO 12 INCHES.</p>

Weir Report

Pond C1 forebay overflow

Rectangular Weir

Crest = Sharp
Bottom Length (ft) = 9.00
Total Depth (ft) = 0.50

Highlighted

Depth (ft) = 0.23
Q (cfs) = 3.400
Area (sqft) = 2.11
Velocity (ft/s) = 1.61
Top Width (ft) = 9.00

Calculations

Weir Coeff. Cw = 3.33
Compute by: Known Q
Known Q (cfs) = 3.40

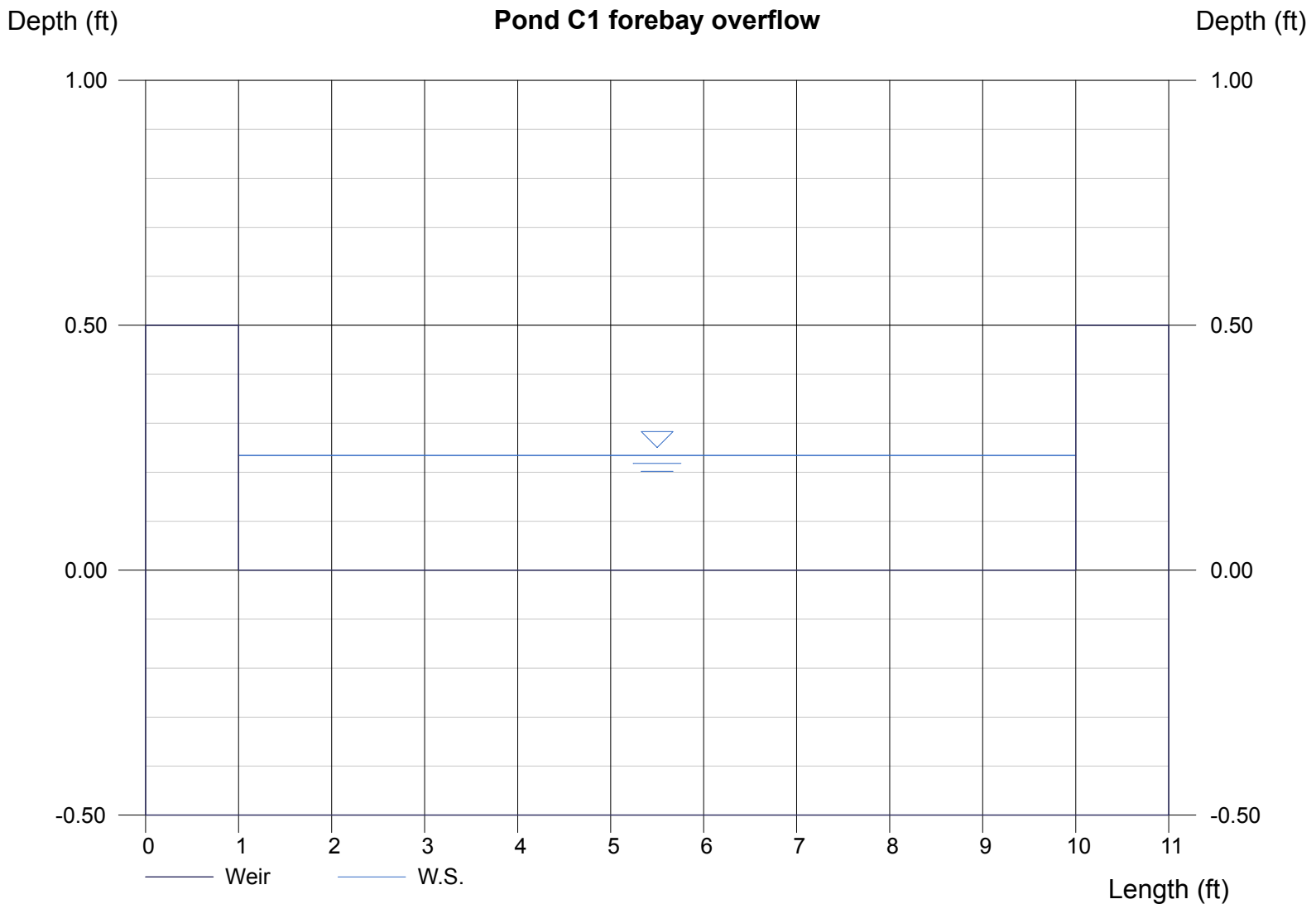

Channel Report

Hydraflow Express by Intelisolve

Friday, May 1 2020, 6:2 AM

pond C1 low flow channel (2 x forebay release = 6.8cfs)

Rectangular

Bottom Width (ft) = 4.00
Total Depth (ft) = 0.50

Invert Elev (ft) = 100.00
Slope (%) = 0.50
N-Value = 0.013

Calculations

Compute by: Known Q
Known Q (cfs) = 6.80

Highlighted

Depth (ft) = 0.43
Q (cfs) = 6.800
Area (sqft) = 1.72
Velocity (ft/s) = 3.95
Wetted Perim (ft) = 4.86
Crit Depth, Y_c (ft) = 0.45
Top Width (ft) = 4.00
EGL (ft) = 0.67

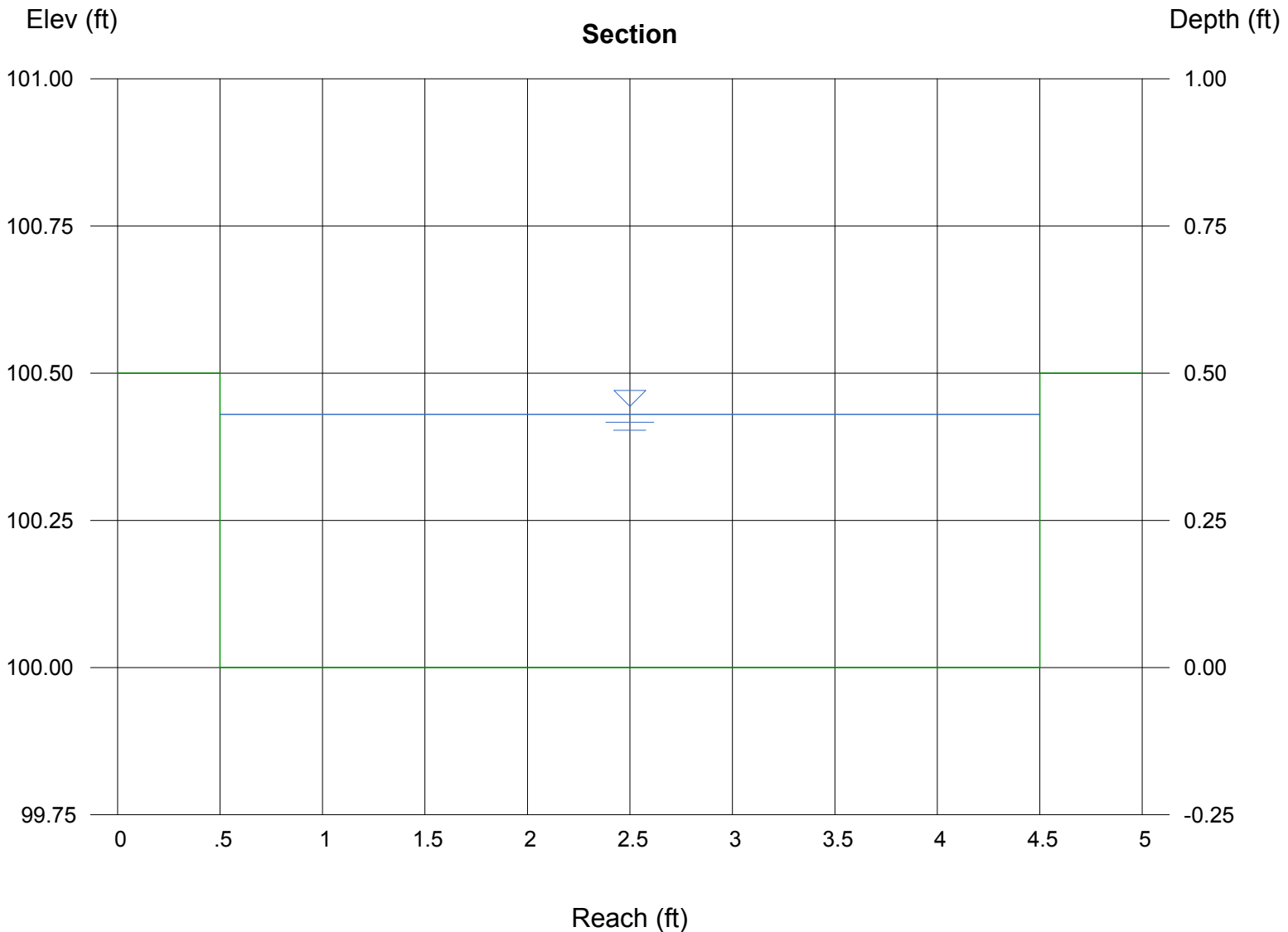

DETENTION BASIN OUTLET STRUCTURE DESIGN

MHFD-Detention, Version 4.02 (February 2020)

Project: The Hills at Lorson Ranch
Basin ID: Pond C2.1

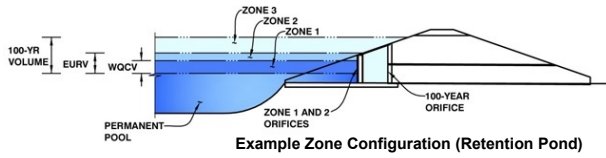

	Estimated Stage (ft)	Estimated Volume (ac-ft)	Outlet Type
Zone 1 (WQCV)	3.42	1.368	Orifice Plate
Zone 2 (EURV)	6.20	3.045	Rectangular Orifice
Zone 3 (100+1/2WQCV)	9.04	3.745	Weir&Pipe (Restrict)
Total (all zones)		8.159	

User Input: Orifice at Underdrain Outlet (typically used to drain WQCV in a Filtration BMP)

Underdrain Orifice Invert Depth =	N/A	ft (distance below the filtration media surface)
Underdrain Orifice Diameter =	N/A	inches

Calculated Parameters for Underdrain	
Underdrain Orifice Area =	N/A ft ²
Underdrain Orifice Centroid =	N/A feet

User Input: Orifice Plate with one or more orifices or Elliptical Slot Weir (typically used to drain WQCV and/or EURV in a sedimentation BMP)

Invert of Lowest Orifice =	0.00	ft (relative to basin bottom at Stage = 0 ft)
Depth at top of Zone using Orifice Plate =	3.42	ft (relative to basin bottom at Stage = 0 ft)
Orifice Plate: Orifice Vertical Spacing =	13.70	inches
Orifice Plate: Orifice Area per Row =	4.06	sq. inches (use rectangular openings)

Calculated Parameters for Plate	
WQ Orifice Area per Row =	2.819E-02 ft ²
Elliptical Half-Width =	N/A feet
Elliptical Slot Centroid =	N/A feet
Elliptical Slot Area =	N/A ft ²

User Input: Stage and Total Area of Each Orifice Row (numbered from lowest to highest)

	Row 1 (required)	Row 2 (optional)	Row 3 (optional)	Row 4 (optional)	Row 5 (optional)	Row 6 (optional)	Row 7 (optional)	Row 8 (optional)
Stage of Orifice Centroid (ft)	0.00	1.14	2.28					
Orifice Area (sq. inches)	4.06	4.06	4.06					

	Row 9 (optional)	Row 10 (optional)	Row 11 (optional)	Row 12 (optional)	Row 13 (optional)	Row 14 (optional)	Row 15 (optional)	Row 16 (optional)
Stage of Orifice Centroid (ft)								
Orifice Area (sq. inches)								

User Input: Vertical Orifice (Circular or Rectangular)

	Zone 2 Rectangular	Not Selected	
Invert of Vertical Orifice =	3.42	N/A	ft (relative to basin bottom at Stage = 0 ft)
Depth at top of Zone using Vertical Orifice =	6.20	N/A	ft (relative to basin bottom at Stage = 0 ft)
Vertical Orifice Height =	6.00	N/A	inches
Vertical Orifice Width =	14.59		inches

Calculated Parameters for Vertical Orific	
Zone 2 Rectangular	Not Selected
Vertical Orifice Area =	0.61 N/A
Vertical Orifice Centroid =	0.25 N/A

User Input: Overflow Weir (Dropbox with Flat or Sloped Gate and Outlet Pipe OR Rectangular/Trapezoidal Weir (and No Outlet Pipe)

	Zone 3 Weir	Not Selected	
Overflow Weir Front Edge Height, Ho =	6.20	N/A	ft (relative to basin bottom at Stage = 0 ft)
Overflow Weir Front Edge Length =	8.00	N/A	feet
Overflow Weir Gate Slope =	0.00	N/A	H:V
Horiz. Length of Weir Sides =	6.00	N/A	feet
Overflow Gate Open Area % =	70%	N/A	% gate open area/total area
Debris Clogging % =	50%	N/A	%

Calculated Parameters for Overflow Weir	
Zone 3 Weir	Not Selected
Height of Gate Upper Edge, H ₁ =	6.20 N/A
Overflow Weir Slope Length =	6.00 N/A
Gate Open Area / 100-yr Orifice Area =	6.84 N/A
Overflow Gate Open Area w/o Debris =	33.60 N/A
Overflow Gate Open Area w/ Debris =	16.80 N/A

User Input: Outlet Pipe w/ Flow Restriction Plate (Circular Orifice, Restrictor Plate, or Rectangular Orifice)

	Zone 3 Restrictor	Not Selected	
Depth to Invert of Outlet Pipe =	0.00	N/A	ft (distance below basin bottom at Stage = 0 ft)
Outlet Pipe Diameter =	30.00	N/A	inches
Restrictor Plate Height Above Pipe Invert =	30.00		inches

Calculated Parameters for Outlet Pipe w/ Flow Restriction Plate	
Zone 3 Restrictor	Not Selected
Outlet Orifice Area =	4.91 N/A
Outlet Orifice Centroid =	1.25 N/A
Half-Central Angle of Restrictor Plate on Pipe =	3.14 N/A

User Input: Emergency Spillway (Rectangular or Trapezoidal)

Spillway Invert Stage =	9.30	ft (relative to basin bottom at Stage = 0 ft)
Spillway Crest Length =	25.00	feet
Spillway End Slopes =	4.00	H:V
Freeboard above Max Water Surface =	1.01	feet

Calculated Parameters for Spillway	
Spillway Design Flow Depth =	1.69 feet
Stage at Top of Freeboard =	12.00 feet
Basin Area at Top of Freeboard =	1.71 acres
Basin Volume at Top of Freeboard =	12.83 acre-ft

top micropool = 5761= stage 0

Routed Hydrograph Results

The user can override the default CUHP hydrographs and runoff volumes by entering new values in the Inflow Hydrographs table (Columns W through AF)

	WQCV	EURV	2 Year	5 Year	10 Year	25 Year	50 Year	100 Year
Design Storm Return Period =	N/A	N/A	1.19	1.50	1.75	2.00	2.25	2.52
One-Hour Rainfall Depth (in) =	1.368	4.414	4.152	5.828	7.285	9.182	10.750	12.716
CUHP Runoff Volume (acre-ft) =	N/A	N/A	4.152	5.828	7.285	9.182	10.750	12.716
Inflow Hydrograph Volume (acre-ft) =	N/A	N/A	7.5	21.2	32.2	57.6	72.4	92.1
CUHP Predevelopment Peak Q (cfs) =	N/A	N/A						
OPTIONAL Override Predevelopment Peak Q (cfs) =	N/A	N/A						
Predevelopment Unit Peak Flow, q (cfs/acre) =	N/A	N/A	0.10	0.28	0.43	0.77	0.97	1.24
Peak Inflow Q (cfs) =	N/A	N/A	63.8	91.4	112.2	146.0	171.6	201.7
Peak Outflow Q (cfs) =	0.6	5.6	4.8	12.8	31.2	57.7	60.5	65.0
Ratio Peak Outflow to Predevelopment Q =	N/A	N/A	N/A	0.6	1.0	1.0	0.8	0.7
Structure Controlling Flow =	Vertical Orifice 1	Overflow Weir 1	Vertical Orifice 1	Overflow Weir 1	Overflow Weir 1	Outlet Plate 1	Outlet Plate 1	Outlet Plate 1
Max Velocity through Gate 1 (fps) =	N/A	N/A	N/A	0.2	0.8	1.5	1.6	1.7
Max Velocity through Gate 2 (fps) =	N/A	N/A	N/A	N/A	N/A	N/A	N/A	N/A
Time to Drain 97% of Inflow Volume (hours) =	38	48	48	49	47	45	43	41
Time to Drain 99% of Inflow Volume (hours) =	40	52	53	54	53	52	52	51
Maximum Ponding Depth (ft) =	3.42	6.20	5.45	6.44	6.76	7.20	7.79	8.80
Area at Maximum Ponding Depth (acres) =	0.98	1.20	1.14	1.22	1.25	1.29	1.34	1.42
Maximum Volume Stored (acre-ft) =	1.377	4.415	3.534	4.694	5.090	5.661	6.435	7.829

DETENTION BASIN OUTLET STRUCTURE DESIGN

MHFD-Detention, Version 4.00 (December 2019)

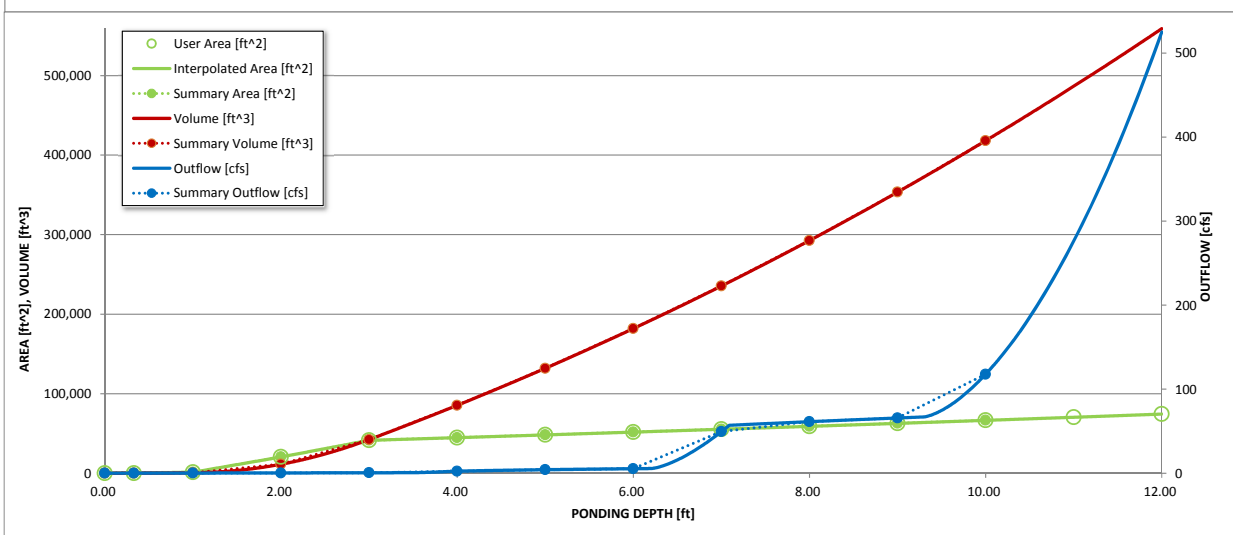
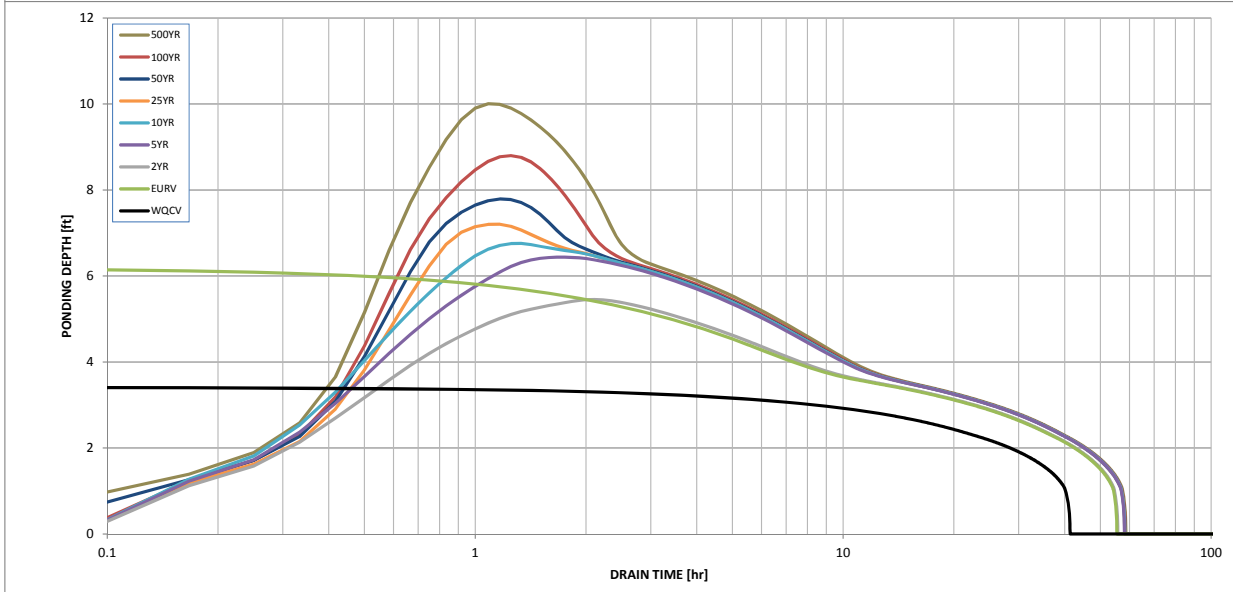
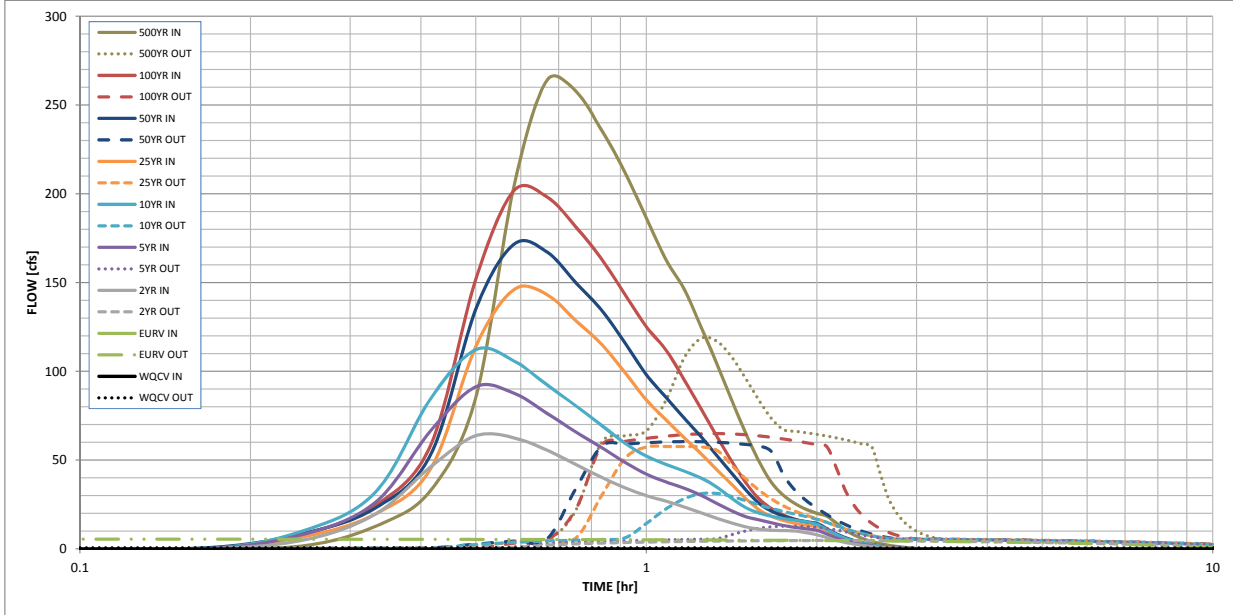

S-A-V-D Chart Axis Override	X-axis	Left Y-Axis	Right Y-Axis
minimum bound			
maximum bound			

Design Procedure Form: Extended Detention Basin (EDB)

UD-BMP (Version 3.07, March 2018)

Sheet 1 of 3

Designer: Richard Schindler
Company: Core Engineering Group
Date: May 2, 2020
Project: The Hills at Lorson Ranch
Location: Pond C2.1

<p>1. Basin Storage Volume</p> <p>A) Effective Imperviousness of Tributary Area, I_a</p> <p>B) Tributary Area's Imperviousness Ratio ($i = I_a / 100$)</p> <p>C) Contributing Watershed Area</p> <p>D) For Watersheds Outside of the Denver Region, Depth of Average Runoff Producing Storm</p> <p>E) Design Concept (Select EURV when also designing for flood control)</p> <p>F) Design Volume (WQCV) Based on 40-hour Drain Time ($V_{DESIGN} = (1.0 * (0.91 * i^3 - 1.19 * i^2 + 0.78 * i) / 12 * Area)$)</p> <p>G) For Watersheds Outside of the Denver Region, Water Quality Capture Volume (WQCV) Design Volume ($V_{WQCV\ OTHER} = (d_6 * V_{DESIGN} / 0.43)$)</p> <p>H) User Input of Water Quality Capture Volume (WQCV) Design Volume (Only if a different WQCV Design Volume is desired)</p> <p>I) NRCS Hydrologic Soil Groups of Tributary Watershed i) Percentage of Watershed consisting of Type A Soils ii) Percentage of Watershed consisting of Type B Soils iii) Percentage of Watershed consisting of Type C/D Soils</p> <p>J) Excess Urban Runoff Volume (EURV) Design Volume For HSG A: $EURV_A = 1.68 * i^{1.28}$ For HSG B: $EURV_B = 1.36 * i^{1.08}$ For HSG C/D: $EURV_{C/D} = 1.20 * i^{1.08}$</p> <p>K) User Input of Excess Urban Runoff Volume (EURV) Design Volume (Only if a different EURV Design Volume is desired)</p>	<p>$I_a =$ <input type="text" value="55.0"/> %</p> <p>$i =$ <input type="text" value="0.550"/></p> <p>Area = <input type="text" value="74.500"/> ac</p> <p>$d_6 =$ <input type="text" value=""/></p> <div style="border: 1px solid black; padding: 5px; margin: 5px 0;"> Choose One <input checked="" type="radio"/> Water Quality Capture Volume (WQCV) <input type="radio"/> Excess Urban Runoff Volume (EURV) </div> <p>$V_{DESIGN} =$ <input type="text" value="1.368"/> ac-ft</p> <p>$V_{DESIGN\ OTHER} =$ <input type="text" value=""/> ac-ft</p> <p>$V_{DESIGN\ USER} =$ <input type="text" value=""/> ac-ft</p> <p>HSG _A = <input type="text" value=""/> % HSG _B = <input type="text" value=""/> % HSG _{C/D} = <input type="text" value=""/> %</p> <p>EURV_{DESIGN} = <input type="text" value=""/> ac-ft</p> <p>EURV_{DESIGN\ USER} = <input type="text" value=""/> ac-ft</p>
<p>2. Basin Shape: Length to Width Ratio (A basin length to width ratio of at least 2:1 will improve TSS reduction.)</p>	<p>L : W = <input type="text" value="2.0"/> : 1</p>
<p>3. Basin Side Slopes</p> <p>A) Basin Maximum Side Slopes (Horizontal distance per unit vertical, 4:1 or flatter preferred)</p>	<p>Z = <input type="text" value="3.00"/> ft / ft DIFFICULT TO MAINTAIN, INCREASE WHERE POSSIBLE</p>
<p>4. Inlet</p> <p>A) Describe means of providing energy dissipation at concentrated inflow locations:</p>	<p>_____</p> <p>_____</p> <p>_____</p>
<p>5. Forebay</p> <p>A) Minimum Forebay Volume ($V_{MIN} =$ <input type="text" value="3%"/> of the WQCV)</p> <p>B) Actual Forebay Volume</p> <p>C) Forebay Depth ($D_F =$ <input type="text" value="30"/> inch maximum)</p> <p>D) Forebay Discharge</p> <p style="margin-left: 20px;">i) Undetained 100-year Peak Discharge</p> <p style="margin-left: 20px;">ii) Forebay Discharge Design Flow ($Q_F = 0.02 * Q_{100}$)</p> <p>E) Forebay Discharge Design</p> <p style="margin-left: 20px;">F) Discharge Pipe Size (minimum 8-inches)</p> <p>G) Rectangular Notch Width</p>	<p>$V_{MIN} =$ <input type="text" value="0.041"/> ac-ft</p> <p>$V_F =$ <input type="text" value="0.045"/> ac-ft</p> <p>$D_F =$ <input type="text" value="24.0"/> in</p> <p>$Q_{100} =$ <input type="text" value="202.00"/> cfs</p> <p>$Q_F =$ <input type="text" value="4.04"/> cfs</p> <div style="border: 1px solid black; padding: 5px; margin: 5px 0;"> Choose One <input type="radio"/> Berm With Pipe <input checked="" type="radio"/> Wall with Rect. Notch <input type="radio"/> Wall with V-Notch Weir </div> <p>Calculated $D_P =$ <input type="text" value=""/> in</p> <p>Calculated $W_N =$ <input type="text" value="9.9"/> in</p>

Design Procedure Form: Extended Detention Basin (EDB)

Designer: Richard Schindler
Company: Core Engineering Group
Date: May 2, 2020
Project: The Hills at Lorson Ranch
Location: Pond C2.1

<p>6. Trickle Channel</p> <p>A) Type of Trickle Channel</p> <p>F) Slope of Trickle Channel</p>	<div style="border: 1px solid black; padding: 2px; margin-bottom: 5px;"> Choose One <input checked="" type="radio"/> Concrete <input type="radio"/> Soft Bottom </div> <p>S = <input type="text" value="0.0050"/> ft / ft</p>
<p>7. Micropool and Outlet Structure</p> <p>A) Depth of Micropool (2.5-foot minimum)</p> <p>B) Surface Area of Micropool (10 ft² minimum)</p> <p>C) Outlet Type</p> <p>D) Smallest Dimension of Orifice Opening Based on Hydrograph Routing (Use UD-Detention)</p> <p>E) Total Outlet Area</p>	<p>D_M = <input type="text" value="2.5"/> ft</p> <p>A_M = <input type="text" value="50"/> sq ft</p> <div style="border: 1px solid black; padding: 2px; margin-bottom: 5px;"> Choose One <input checked="" type="radio"/> Orifice Plate <input type="radio"/> Other (Describe): </div> <hr/> <hr/> <p>D_{orifice} = <input type="text" value="2.01"/> inches</p> <p>A_{orifice} = <input type="text" value="12.60"/> square inches</p>
<p>8. Initial Surcharge Volume</p> <p>A) Depth of Initial Surcharge Volume (Minimum recommended depth is 4 inches)</p> <p>B) Minimum Initial Surcharge Volume (Minimum volume of 0.3% of the WQCV)</p> <p>C) Initial Surcharge Provided Above Micropool</p>	<p>D_{IS} = <input type="text" value="4"/> in</p> <p>V_{IS} = <input type="text" value="179"/> cu ft</p> <p>V_s = <input type="text" value="16.7"/> cu ft</p>
<p>9. Trash Rack</p> <p>A) Water Quality Screen Open Area: $A_t = A_{ot} * 38.5 * (e^{-0.095D})$</p> <p>B) Type of Screen (If specifying an alternative to the materials recommended in the USDCM, indicate "other" and enter the ratio of the total open area to the total screen area for the material specified.)</p> <p style="margin-left: 40px;">Other (Y/N): <input type="text" value="y"/></p> <p>C) Ratio of Total Open Area to Total Area (only for type 'Other')</p> <p>D) Total Water Quality Screen Area (based on screen type)</p> <p>E) Depth of Design Volume (EURV or WQCV) (Based on design concept chosen under 1E)</p> <p>F) Height of Water Quality Screen (H_{TR})</p> <p>G) Width of Water Quality Screen Opening (W_{opening}) (Minimum of 12 inches is recommended)</p>	<p>A_t = <input type="text" value="401"/> square inches</p> <div style="border: 1px solid black; padding: 2px; margin-bottom: 5px; width: fit-content;"> Other (Please describe below) </div> <p>wellscreen stainless</p> <hr/> <hr/> <p>User Ratio = <input type="text" value="0.6"/></p> <p>A_{total} = <input type="text" value="668"/> sq. in. Based on type 'Other' screen ratio</p> <p>H = <input type="text" value="3.42"/> feet</p> <p>H_{TR} = <input type="text" value="69.04"/> inches</p> <p>W_{opening} = <input type="text" value="12.0"/> inches VALUE LESS THAN RECOMMENDED MIN. WIDTH. WIDTH HAS BEEN SET TO 12 INCHES.</p>

Design Procedure Form: Extended Detention Basin (EDB)

Designer: Richard Schindler
Company: Core Engineering Group
Date: May 2, 2020
Project: The Hills at Lorson Ranch
Location: Pond C2.1

<p>10. Overflow Embankment</p> <p>A) Describe embankment protection for 100-year and greater overtopping:</p> <p>B) Slope of Overflow Embankment (Horizontal distance per unit vertical, 4:1 or flatter preferred)</p>	<p>_____</p> <p>_____</p> <p>_____</p> <p>Ze = <input type="text" value=""/> ft / ft</p>
<p>11. Vegetation</p>	<p>Choose One</p> <p><input type="radio"/> Irrigated</p> <p><input type="radio"/> Not Irrigated</p>
<p>12. Access</p> <p>A) Describe Sediment Removal Procedures</p>	<p>_____</p> <p>_____</p> <p>_____</p> <p>_____</p> <p>_____</p>

Notes: _____

Channel Report

Hydraflow Express by Intelisolve

Saturday, May 2 2020, 7:49 AM

pond C2.1 low flow channel (2 x forebay release = 8.08cfs)

Rectangular

Bottom Width (ft) = 6.00
Total Depth (ft) = 0.50

Invert Elev (ft) = 100.00
Slope (%) = 0.50
N-Value = 0.013

Highlighted

Depth (ft) = 0.36
Q (cfs) = 8.080
Area (sqft) = 2.16
Velocity (ft/s) = 3.74
Wetted Perim (ft) = 6.72
Crit Depth, Yc (ft) = 0.39
Top Width (ft) = 6.00
EGL (ft) = 0.58

Calculations

Compute by: Known Q
Known Q (cfs) = 8.08

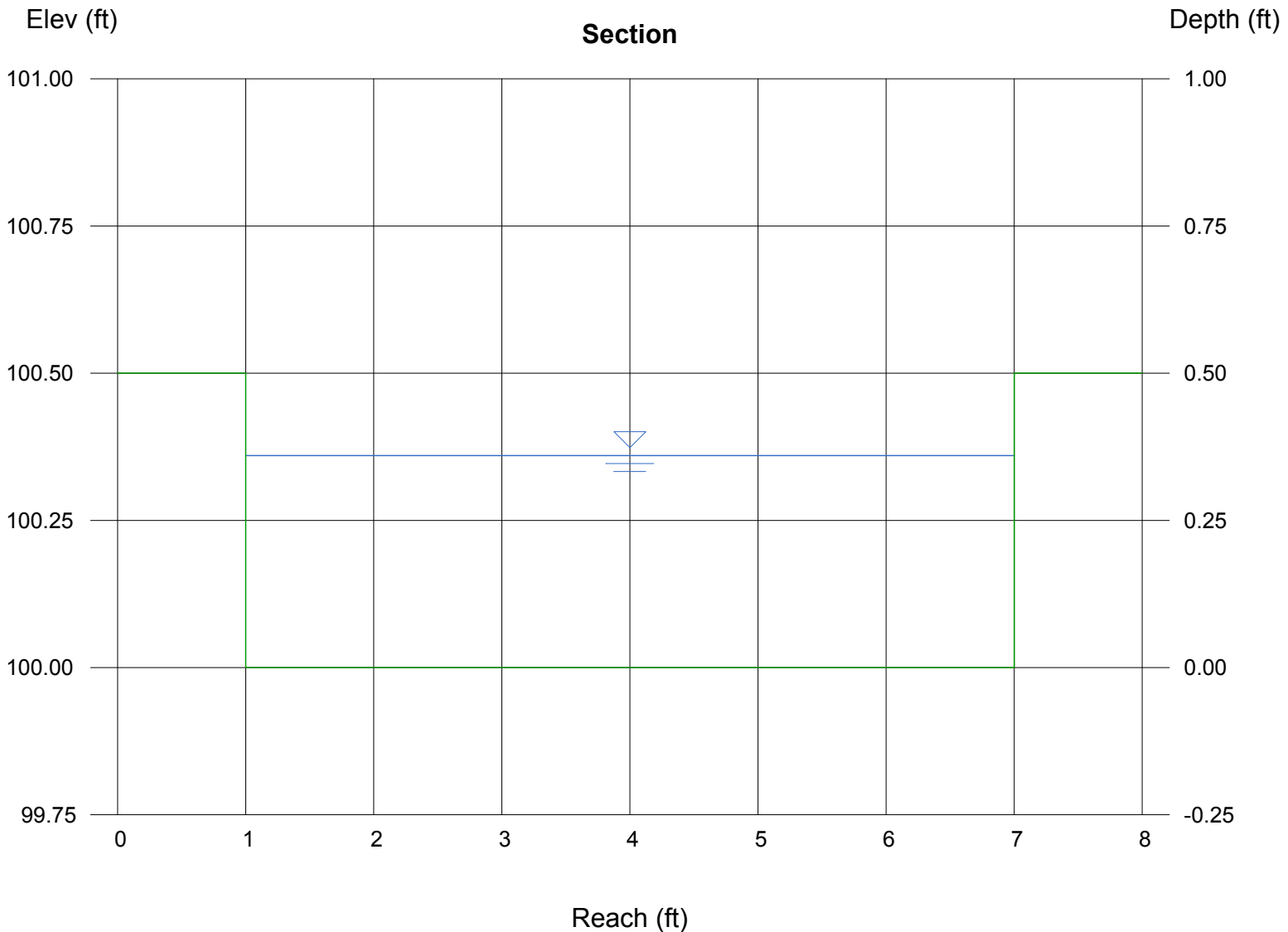

Weir Report

Hydraflow Express by Intelisolve

Saturday, May 2 2020, 7:52 AM

Pond C2.1 forebay overflow

Rectangular Weir

Crest = Sharp
Bottom Length (ft) = 9.00
Total Depth (ft) = 0.50

Highlighted

Depth (ft) = 0.26
Q (cfs) = 4.040
Area (sqft) = 2.36
Velocity (ft/s) = 1.71
Top Width (ft) = 9.00

Calculations

Weir Coeff. Cw = 3.33
Compute by: Known Q
Known Q (cfs) = 4.04

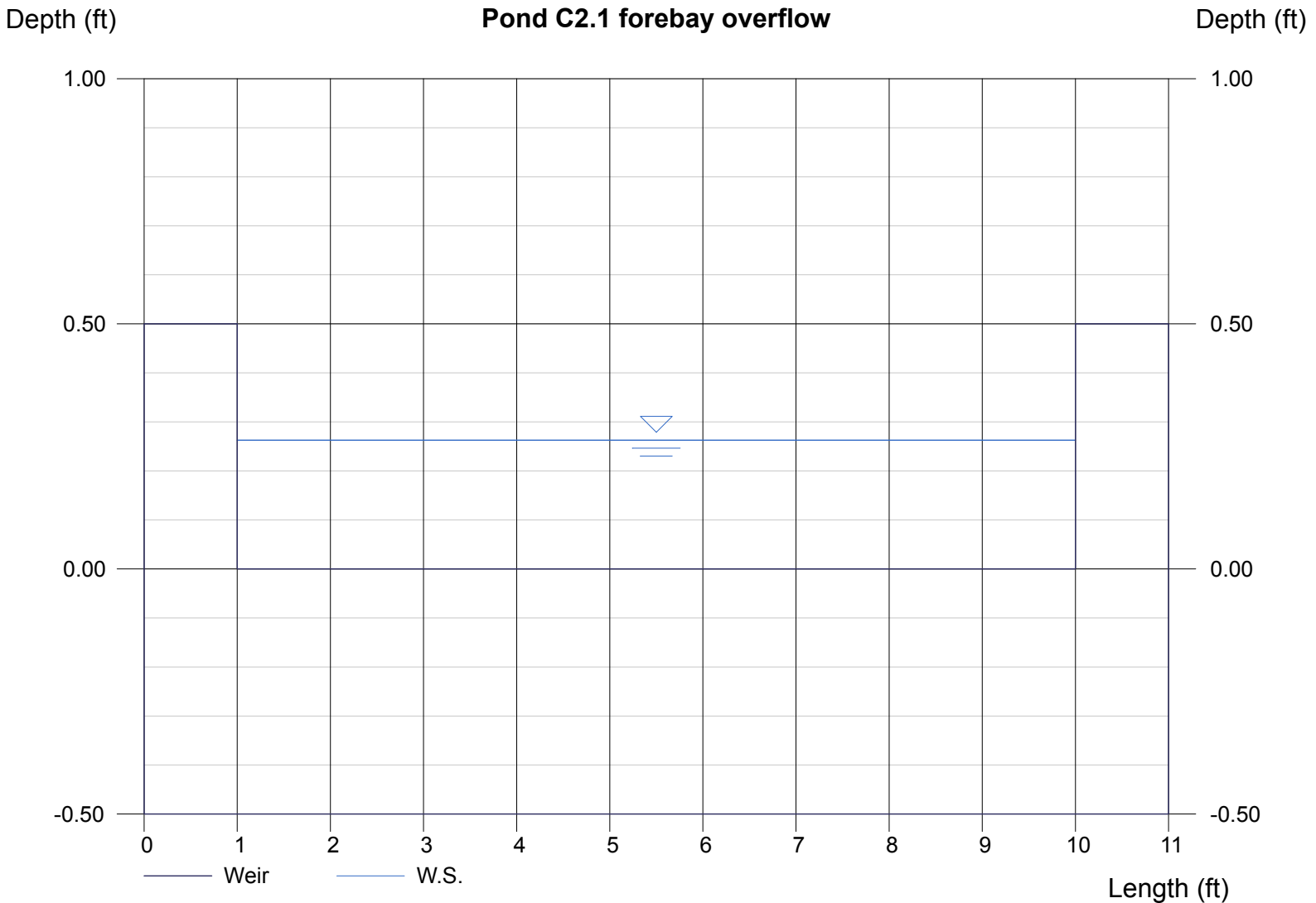

Pond C2.2 Developed Inflow Hydrograph---- Pond C3 outflow + C5 Basin + C7 Basin

Time [hr]	Time [min]	2 Year		5yr		10yr		25yr		50yr		100yr		500yr	
		Pond C3 Outflow2 - [cfs]	CUHP	Combined Hydrograph	Pond C3 Outflow2 - [cfs]	CUHP	Combined Hydrograph	Pond C3 Outflow2 - [cfs]	CUHP	Combined Hydrograph	Pond C3 Outflow2 - [cfs]	CUHP	Combined Hydrograph	Pond C3 Outflow2 - [cfs]	CUHP
0.00	0.00	0.00	0.00	0.00	0.00	0.00	0.00	0.00	0.00	0.00	0.00	0.00	0.00	0.00	0.00
0.08	5.00	0.03	0.00	0.03	0.03	0.00	0.03	0.00	0.03	0.00	0.03	0.00	0.04	0.00	0.03
0.17	10.00	0.06	0.00	0.06	0.07	0.00	0.07	0.08	0.00	0.08	0.07	0.00	0.07	0.04	0.11
0.25	15.00	0.10	3.74	3.84	0.11	6.11	6.22	0.11	7.57	7.68	0.10	5.09	5.19	0.10	6.38
0.33	20.00	0.14	13.60	13.74	0.16	18.00	18.16	0.17	21.92	22.09	0.14	13.38	13.52	0.15	15.61
0.42	25.00	0.17	31.11	31.28	0.20	45.07	45.27	0.52	57.54	58.06	0.19	30.50	30.69	0.24	35.87
0.50	30.00	0.24	40.82	41.06	1.21	58.25	59.46	1.95	71.19	73.14	1.68	76.90	78.58	2.14	91.05
0.58	35.00	0.87	38.60	39.47	2.10	53.89	55.99	2.57	65.04	67.61	2.72	92.11	94.83	3.16	108.06
0.67	40.00	1.66	33.84	35.50	2.52	46.24	48.76	2.99	55.88	58.87	3.44	88.47	91.91	3.89	103.22
0.75	45.00	2.01	28.43	30.44	2.81	39.40	42.21	3.35	48.41	51.76	3.99	77.76	81.75	4.43	90.67
0.83	50.00	2.25	23.82	26.07	3.03	33.85	36.88	3.70	41.10	44.80	4.43	69.49	73.92	4.85	81.04
0.92	55.00	2.44	20.11	22.55	3.21	28.41	31.62	4.03	34.74	38.77	4.78	58.63	63.41	5.19	68.45
1.00	60.00	2.59	17.63	20.22	3.38	24.74	28.12	4.33	30.90	35.23	5.08	48.90	53.98	5.49	57.23
1.08	65.00	2.70	15.89	18.59	3.55	22.20	25.75	4.58	28.16	32.74	5.33	42.78	48.11	6.30	50.23
1.17	70.00	2.79	13.63	16.42	3.70	19.91	23.61	4.81	25.58	30.39	5.55	36.41	41.96	14.94	42.84
1.25	75.00	2.87	11.46	14.33	3.84	17.10	20.94	5.01	23.01	28.02	6.25	30.66	36.91	24.32	36.16
1.33	80.00	2.93	9.51	12.44	3.97	14.14	18.11	5.18	19.48	24.66	12.33	24.76	37.09	29.87	29.17
1.42	85.00	2.99	7.93	10.92	4.09	11.69	15.78	5.32	15.58	20.90	19.28	19.60	38.88	30.07	23.03
1.50	90.00	3.05	6.97	10.02	4.20	10.29	14.49	5.44	13.16	18.60	25.17	14.82	39.99	30.25	17.32
1.58	95.00	3.10	6.50	9.60	4.30	9.58	13.88	5.55	11.74	17.29	29.61	11.96	41.57	30.41	13.95
1.67	100.00	3.15	6.27	9.42	4.40	8.56	12.96	5.64	10.76	16.40	29.92	10.21	40.13	30.56	11.85
1.75	105.00	3.20	6.14	9.34	4.48	7.72	12.20	6.07	10.05	16.12	30.03	9.08	39.11	30.69	10.48
1.83	110.00	3.24	6.04	9.28	4.55	7.11	11.66	6.15	9.57	17.72	30.13	8.29	38.42	30.82	9.52
1.92	115.00	3.28	5.34	8.62	4.62	6.67	11.29	10.36	8.98	19.34	30.22	7.79	38.01	30.93	8.90
2.00	120.00	3.32	4.68	8.00	4.67	6.16	10.83	12.00	8.10	20.10	30.31	7.44	37.75	31.04	8.45
2.08	125.00	3.35	3.59	6.94	4.71	4.72	9.43	12.85	6.16	19.01	30.35	5.71	36.06	31.13	6.47
2.17	130.00	3.37	2.65	6.02	4.75	3.44	8.19	13.03	4.45	17.48	30.34	4.14	34.48	31.20	4.68
2.25	135.00	3.39	1.95	5.34	4.77	2.52	7.29	12.75	3.22	15.97	30.26	3.01	33.27	31.26	3.40
2.33	140.00	3.41	1.42	4.83	4.79	1.83	6.62	12.18	2.34	14.52	30.12	2.20	32.32	31.31	2.48
2.42	145.00	3.43	1.02	4.45	4.80	1.28	6.08	11.47	1.67	13.14	29.95	1.56	31.51	31.35	1.75
2.50	150.00	3.44	0.71	4.15	4.81	0.88	5.69	10.72	1.17	11.89	28.62	1.10	29.72	31.39	1.23
2.58	155.00	3.46	0.49	3.95	4.81	0.61	5.42	10.00	0.82	10.82	23.64	0.79	24.43	31.37	0.88
2.67	160.00	3.47	0.31	3.78	4.82	0.41	5.23	9.36	0.53	9.89	19.85	0.52	20.37	31.27	0.59
2.75	165.00	3.48	0.17	3.65	4.82	0.24	5.06	8.83	0.31	9.14	16.93	0.32	17.25	31.13	0.35
2.83	170.00	3.50	0.08	3.58	4.83	0.12	4.95	8.39	0.15	8.54	14.67	0.16	14.83	30.96	0.18
2.92	175.00	3.51	0.03	3.54	4.83	0.04	4.87	8.03	0.05	8.08	12.93	0.05	12.98	30.76	0.06
3.00	180.00	3.52	0.00	3.52	4.84	0.00	4.84	7.72	0.00	7.72	11.61	0.00	11.61	30.54	0.00
3.08	185.00	3.53		3.53	4.84	0.00	4.84	7.47	0.00	7.47	10.59	0.00	10.59	30.31	0.00
3.17	190.00	3.54		3.54	4.85		4.85	7.25		7.25	9.79	0.00	9.79	30.07	0.00
3.25	195.00	3.55		3.55	4.85		4.85	7.06		7.06	9.15	0.00	9.15	29.82	0.00
3.33	200.00	3.56		3.56	4.86		4.86	6.90		6.90	8.63	0.00	8.63	23.98	0.00
3.42	205.00	3.57		3.57	4.86		4.86	6.76		6.76	8.21	0.00	8.21	19.59	0.00
3.50	210.00	3.58		3.58	4.86		4.86	6.63		6.63	7.86		7.86	16.49	0.00
3.58	215.00	3.59		3.59	4.87		4.87	6.52		6.52	7.57		7.57	14.25	0.00
3.67	220.00	3.59		3.59	4.87		4.87	6.42		6.42	7.32		7.32	12.58	0.00
3.75	225.00	3.60		3.60	4.87		4.87	6.32		6.32	7.11		7.11	11.31	0.00
3.83	230.00	3.61		3.61	4.88		4.88	6.24		6.24	6.92		6.92	10.33	0.00
3.92	235.00	3.61		3.61	4.88		4.88	6.17		6.17	6.76		6.76	9.56	0.00
4.00	240.00	3.62		3.62	4.88		4.88	6.10		6.10	6.62		6.62	8.94	0.00
4.08	245.00	3.63		3.63	4.88		4.88	6.04		6.04	6.50		6.50	8.44	0.00
4.17	250.00	3.63		3.63	4.88		4.88	5.98		5.98	6.39		6.39	8.03	0.00
4.25	255.00	3.64		3.64	4.88		4.88	5.93		5.93	6.29		6.29	7.69	0.00
4.33	260.00	3.64		3.64	4.89		4.89	5.88		5.88	6.21		6.21	7.41	0.00
4.42	265.00	3.65		3.65	4.89		4.89	5.84		5.84	6.13		6.13	7.17	0.00
4.50	270.00	3.65		3.65	4.89		4.89	5.80		5.80	6.05		6.05	6.96	0.00
4.58	275.00	3.65		3.65	4.89		4.89	5.76		5.76	5.99		5.99	6.78	0.00
4.67	280.00	3.66		3.66	4.89		4.89	5.74		5.74	5.93		5.93	6.63	0.00
4.75	285.00	3.66		3.66	4.89		4.89	5.71		5.71	5.88		5.88	6.49	0.00
4.83	290.00	3.66		3.66	4.89		4.89	5.70		5.70	5.83		5.83	6.37	0.00
4.92	295.00	3.67		3.67	4.89		4.89	5.69		5.69	5.79		5.79	6.27	0.00
5.00	300.00	3.67		3.67	4.89		4.89	5.69		5.69	5.75		5.75	6.17	0.00
5.08	305.00	3.67		3.67	4.89		4.89	5.69		5.69	5.73		5.73	6.09	0.00
5.17	310.00	3.67		3.67	4.89		4.89	5.68		5.68	5.70		5.70	6.01	0.00
5.25	315.00	3.67		3.67	4.89		4.89	5.68		5.68	5.69		5.69	5.94	0.00
5.33	320.00	3.67		3.67	4.89		4.89	5.68		5.68	5.69		5.69	5.88	0.00
5.42	325.00	3.67		3.67	4.88		4.88	5.67		5.67	5.69		5.69	5.83	0.00
5.50	330.00	3.67		3.67	4.88		4.88	5.67		5.67	5.68		5.68	5.78	0.00
5.58	335.00	3.67		3.67	4.88		4.88	5.66		5.66	5.68		5.68	5.75	0.00
5.67	340.00	3.67		3.67	4.88		4.88	5.66		5.66	5.68		5.68	5.72	0.00
5.75	345.00	3.67		3.67	4.88		4.88	5.65		5.65	5.67		5.67	5.70	0.00

DETENTION BASIN OUTLET STRUCTURE DESIGN

MHFD-Detention, Version 4.02 (February 2020)

Project: The Hills at Lorson Ranch
Basin ID: Pond C2.2

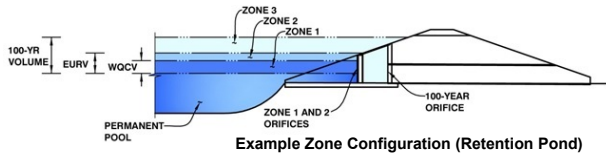

	Estimated Stage (ft)	Estimated Volume (ac-ft)	Outlet Type
Zone 1 (WQCV)	3.25	0.827	Orifice Plate
Zone 2 (EURV)	5.17	1.824	Rectangular Orifice
Zone 3 (100+1/2WQCV)	7.28	2.269	Weir&Pipe (Restrict)
Total (all zones)		4.920	

User Input: Orifice at Underdrain Outlet (typically used to drain WQCV in a Filtration BMP)

Underdrain Orifice Invert Depth =	N/A	ft (distance below the filtration media surface)
Underdrain Orifice Diameter =	N/A	inches

Calculated Parameters for Underdrain	
Underdrain Orifice Area =	N/A ft ²
Underdrain Orifice Centroid =	N/A feet

User Input: Orifice Plate with one or more orifices or Elliptical Slot Weir (typically used to drain WQCV and/or EURV in a sedimentation BMP)

Invert of Lowest Orifice =	0.00	ft (relative to basin bottom at Stage = 0 ft)
Depth at top of Zone using Orifice Plate =	3.25	ft (relative to basin bottom at Stage = 0 ft)
Orifice Plate: Orifice Vertical Spacing =	13.00	inches
Orifice Plate: Orifice Area per Row =	2.21	sq. inches (diameter = 1-11/16 inches)

Calculated Parameters for Plate	
WQ Orifice Area per Row =	1.535E-02 ft ²
Elliptical Half-Width =	N/A feet
Elliptical Slot Centroid =	N/A feet
Elliptical Slot Area =	N/A ft ²

User Input: Stage and Total Area of Each Orifice Row (numbered from lowest to highest)

	Row 1 (required)	Row 2 (optional)	Row 3 (optional)	Row 4 (optional)	Row 5 (optional)	Row 6 (optional)	Row 7 (optional)	Row 8 (optional)
Stage of Orifice Centroid (ft)	0.00	1.08	2.17					
Orifice Area (sq. inches)	2.21	2.21	2.21					

	Row 9 (optional)	Row 10 (optional)	Row 11 (optional)	Row 12 (optional)	Row 13 (optional)	Row 14 (optional)	Row 15 (optional)	Row 16 (optional)
Stage of Orifice Centroid (ft)								
Orifice Area (sq. inches)								

User Input: Vertical Orifice (Circular or Rectangular)

	Zone 2 Rectangular	Not Selected	
Invert of Vertical Orifice =	3.25	N/A	ft (relative to basin bottom at Stage = 0 ft)
Depth at top of Zone using Vertical Orifice =	5.17	N/A	ft (relative to basin bottom at Stage = 0 ft)
Vertical Orifice Height =	6.00	N/A	inches
Vertical Orifice Width =	6.00	N/A	inches

Calculated Parameters for Vertical Orific	
Zone 2 Rectangular	Not Selected
Vertical Orifice Area =	0.25 N/A
Vertical Orifice Centroid =	0.25 N/A

User Input: Overflow Weir (Dropbox with Flat or Sloped Grate and Outlet Pipe OR Rectangular/Trapezoidal Weir (and No Outlet Pipe))

	Zone 3 Weir	Not Selected	
Overflow Weir Front Edge Height, Ho =	7.00	N/A	ft (relative to basin bottom at Stage = 0 ft)
Overflow Weir Front Edge Length =	8.00	N/A	feet
Overflow Weir Grate Slope =	0.00	N/A	H:V
Horiz. Length of Weir Sides =	6.00	N/A	feet
Overflow Grate Open Area % =	70%	N/A	%, grate open area/total area
Debris Clogging % =	50%	N/A	%

Calculated Parameters for Overflow Weir	
Zone 3 Weir	Not Selected
Height of Grate Upper Edge, H ₁ =	7.00 N/A
Overflow Weir Slope Length =	6.00 N/A
Grate Open Area / 100-yr Orifice Area =	10.58 N/A
Overflow Grate Open Area w/o Debris =	33.60 N/A
Overflow Grate Open Area w/ Debris =	16.80 N/A

User Input: Outlet Pipe w/ Flow Restriction Plate (Circular Orifice, Restrictor Plate, or Rectangular Orifice)

	Zone 3 Restrictor	Not Selected	
Depth to Invert of Outlet Pipe =	0.00	N/A	ft (distance below basin bottom at Stage = 0 ft)
Outlet Pipe Diameter =	30.00	N/A	inches
Restrictor Plate Height Above Pipe Invert =	18.50	N/A	inches

Calculated Parameters for Outlet Pipe w/ Flow Restriction Plate	
Zone 3 Restrictor	Not Selected
Outlet Orifice Area =	3.18 N/A
Outlet Orifice Centroid =	0.87 N/A
Half-Central Angle of Restrictor Plate on Pipe =	1.81 N/A

User Input: Emergency Spillway (Rectangular or Trapezoidal)

Spillway Invert Stage =	10.00	ft (relative to basin bottom at Stage = 0 ft)
Spillway Crest Length =	20.00	feet
Spillway End Slopes =	4.00	H:V
Freeboard above Max Water Surface =	1.49	feet

Calculated Parameters for Spillway	
Spillway Design Flow Depth =	1.51 feet
Stage at Top of Freeboard =	13.00 feet
Basin Area at Top of Freeboard =	1.33 acres
Basin Volume at Top of Freeboard =	8.28 acre-ft

micropool = 0 = 5744.00

Routed Hydrograph Results

The user can override the default CUHP hydrographs and runoff volumes by entering new values in the Inflow Hydrographs table (Columns W through AF)

	WQCV	EURV	2 Year	5 Year	10 Year	25 Year	50 Year	100 Year
Design Storm Return Period =	N/A	N/A	1.19	1.50	1.75	2.00	2.25	2.52
One-Hour Rainfall Depth (in) =	N/A	N/A	2.510	3.521	4.403	5.541	6.487	7.671
CUHP Runoff Volume (acre-ft) =	0.827	2.651	2.510	3.521	4.403	5.541	6.487	7.671
User Override Inflow Hydrograph Volume (acre-ft) =	N/A	N/A	4.034	5.603	7.467	11.034	14.029	17.717
CUHP Predevelopment Peak Q (cfs) =	N/A	N/A	5.0	13.5	20.5	36.5	45.7	58.2
OPTIONAL Override Predevelopment Peak Q (cfs) =	N/A	N/A						
Predevelopment Unit Peak Flow, q (cfs/acre) =	N/A	N/A	0.11	0.30	0.46	0.81	1.02	1.29
Peak Inflow Q (cfs) =	N/A	N/A	41.1	59.5	73.1	94.8	111.2	131.3
Peak Outflow Q (cfs) =	0.3	2.0	2.2	2.7	11.7	37.5	40.7	42.9
Ratio Peak Outflow to Predevelopment Q =	N/A	N/A	N/A	0.2	0.6	1.0	0.9	0.7
Structure Controlling Flow =	Plate	Vertical Orifice 1	Vertical Orifice 1	Vertical Orifice 1	Overflow Weir 1	Overflow Weir 1	Outlet Plate 1	Outlet Plate 1
Max Velocity through Gate 1 (fps) =	N/A	N/A	N/A	N/A	0.3	1.0	1.1	1.2
Max Velocity through Gate 2 (fps) =	N/A	N/A	N/A	N/A	N/A	N/A	N/A	N/A
Time to Drain 97% of Inflow Volume (hours) =	38	56	62	66	64	59	55	50
Time to Drain 99% of Inflow Volume (hours) =	40	61	68	73	73	71	69	67
Maximum Ponding Depth (ft) =	3.25	5.17	5.64	6.88	7.28	7.69	7.97	8.75
Area at Maximum Ponding Depth (acres) =	0.90	1.01	1.04	1.12	1.14	1.17	1.19	1.24
Maximum Volume Stored (acre-ft) =	0.829	2.658	3.139	4.475	4.916	5.390	5.720	6.666

DETENTION BASIN OUTLET STRUCTURE DESIGN

MHFD-Detention, Version 4.00 (December 2019)

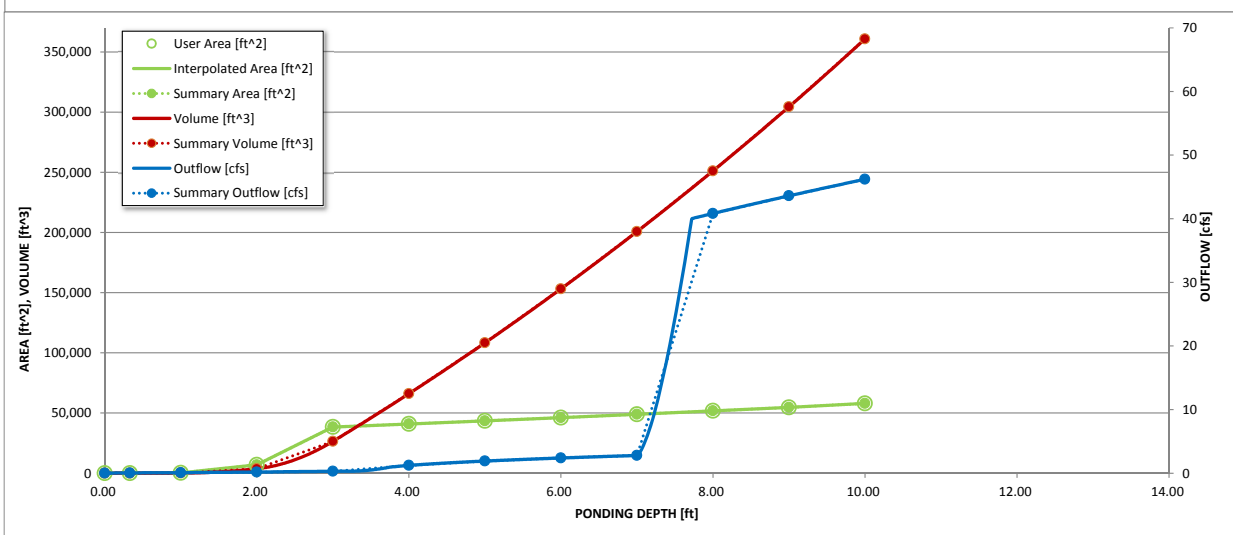
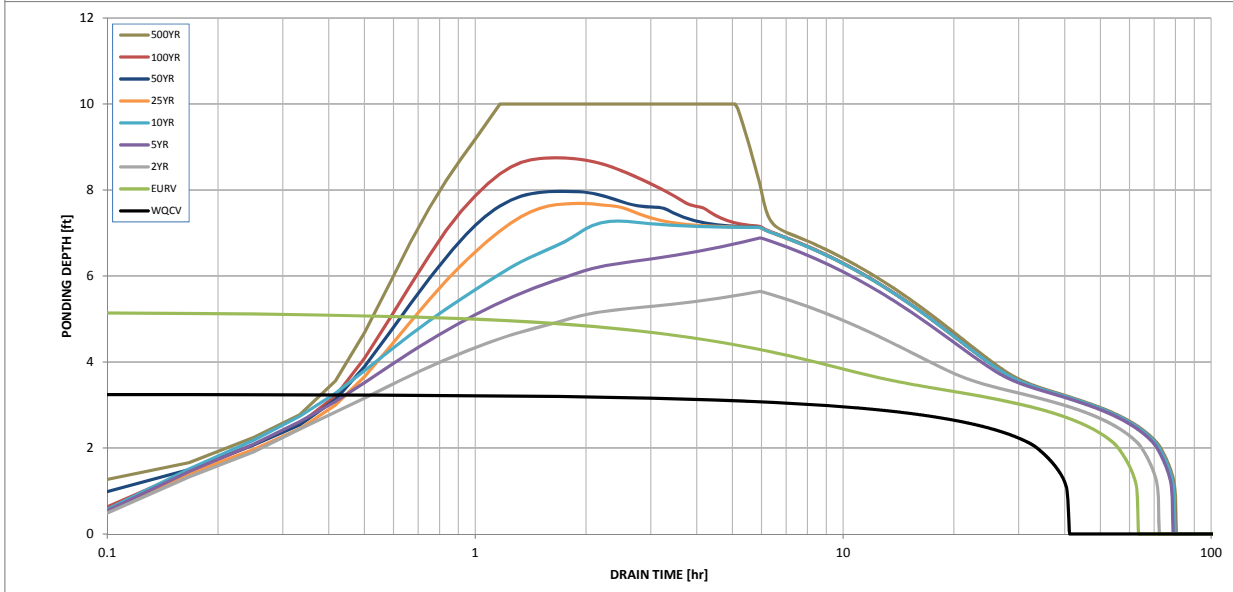
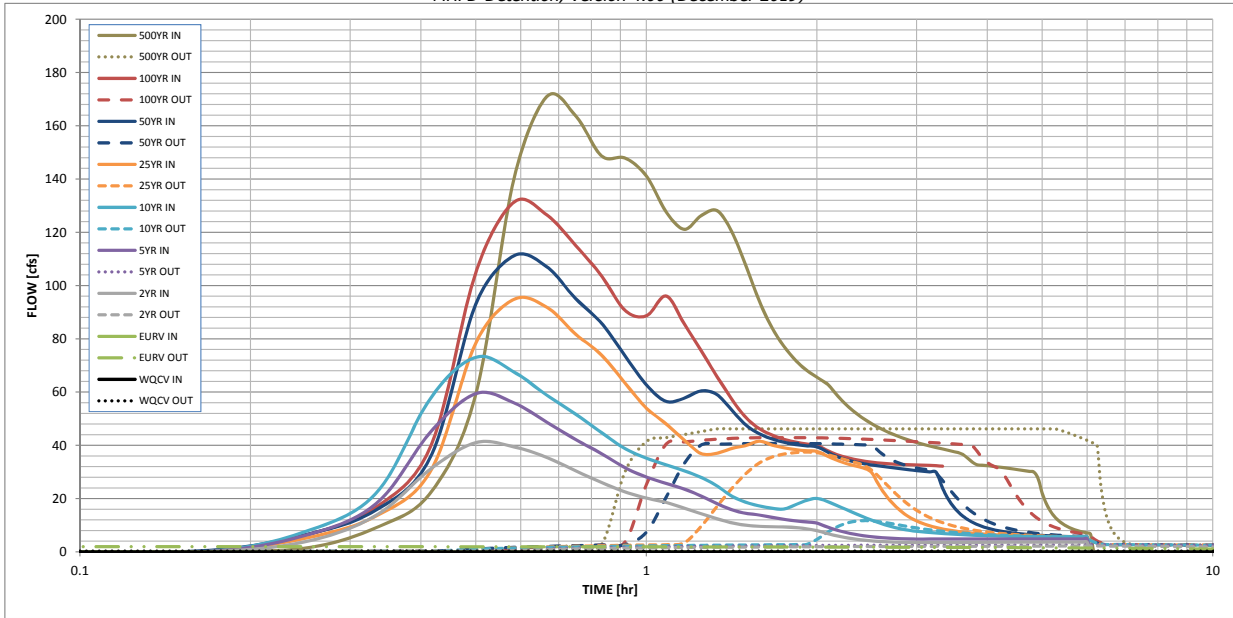

S-A-V-D Chart Axis Override	X-axis	Left Y-Axis	Right Y-Axis
minimum bound			
maximum bound			

DETENTION BASIN OUTLET STRUCTURE DESIGN

Outflow Hydrograph Workbook Filename: _____

Inflow Hydrographs

The user can override the calculated inflow hydrographs from this workbook with inflow hydrographs developed in a separate program.

Time Interval	SOURCE	CUHP	CUHP	USER	USER	USER	USER	USER	USER	USER
	TIME	WQCV [cfs]	EURV [cfs]	2 Year [cfs]	5 Year [cfs]	10 Year [cfs]	25 Year [cfs]	50 Year [cfs]	100 Year [cfs]	500 Year [cfs]
5.00 min	0:00:00	0.00	0.00	0.00	0.00	0.00	0.00	0.03	0.02	0.03
	0:05:00	0.00	0.00	0.03	0.03	0.03	0.03	0.04	0.03	0.04
	0:10:00	0.00	0.00	0.06	0.07	0.08	0.07	0.50	0.11	1.45
	0:15:00	0.00	0.00	3.84	6.22	7.68	5.19	6.48	6.30	9.13
	0:20:00	0.00	0.00	13.74	18.16	22.09	13.52	15.76	16.84	22.46
	0:25:00	0.00	0.00	31.28	45.27	58.06	30.69	36.11	40.02	59.40
	0:30:00	0.00	0.00	41.06	59.46	73.14	78.58	93.19	105.11	139.94
	0:35:00	0.00	0.00	39.47	55.99	67.61	94.83	111.22	131.32	170.94
	0:40:00	0.00	0.00	35.50	48.76	58.87	91.91	107.11	126.58	163.75
	0:45:00	0.00	0.00	30.44	42.21	51.76	81.75	95.10	115.09	148.71
	0:50:00	0.00	0.00	26.07	36.88	44.80	73.92	85.89	103.64	147.91
	0:55:00	0.00	0.00	22.55	31.62	38.77	63.41	73.64	90.72	141.15
	1:00:00	0.00	0.00	20.22	28.12	35.23	53.98	62.72	88.66	127.73
	1:05:00	0.00	0.00	18.59	25.75	32.74	48.11	56.53	96.09	121.15
	1:10:00	0.00	0.00	16.42	23.61	30.39	41.96	57.78	85.55	126.33
	1:15:00	0.00	0.00	14.33	20.94	28.02	36.91	60.48	75.50	128.13
	1:20:00	0.00	0.00	12.44	18.11	24.66	37.09	59.04	65.72	120.01
	1:25:00	0.00	0.00	10.92	15.78	20.90	38.88	53.10	57.24	107.22
	1:30:00	0.00	0.00	10.02	14.49	18.60	39.99	47.57	50.31	94.07
	1:35:00	0.00	0.00	9.60	13.88	17.29	41.57	44.36	46.27	84.16
	1:40:00	0.00	0.00	9.42	12.96	16.40	40.13	42.41	43.92	77.14
	1:45:00	0.00	0.00	9.34	12.20	16.12	39.11	41.17	42.30	72.01
	1:50:00	0.00	0.00	9.28	11.66	17.72	38.42	40.34	41.24	68.29
	1:55:00	0.00	0.00	8.62	11.29	19.34	38.01	39.83	40.52	65.51
	2:00:00	0.00	0.00	8.00	10.83	20.10	37.75	39.49	40.03	63.22
	2:05:00	0.00	0.00	6.94	9.43	19.01	36.06	37.60	38.17	59.07
	2:10:00	0.00	0.00	6.02	8.19	17.48	34.48	35.88	36.60	55.39
	2:15:00	0.00	0.00	5.34	7.29	15.97	33.27	34.66	35.51	52.45
	2:20:00	0.00	0.00	4.83	6.62	14.52	32.32	33.79	34.73	50.10
	2:25:00	0.00	0.00	4.45	6.08	13.14	31.51	33.10	34.12	48.09
	2:30:00	0.00	0.00	4.15	5.69	11.89	29.72	32.62	33.67	46.42
	2:35:00	0.00	0.00	3.95	5.42	10.82	24.43	32.25	33.38	45.06
	2:40:00	0.00	0.00	3.78	5.23	9.89	20.37	31.86	33.14	43.85
	2:45:00	0.00	0.00	3.65	5.06	9.14	17.25	31.48	32.95	42.78
	2:50:00	0.00	0.00	3.58	4.95	8.54	14.83	31.14	32.81	41.86
	2:55:00	0.00	0.00	3.54	4.87	8.08	12.98	30.82	32.72	41.05
	3:00:00	0.00	0.00	3.52	4.84	7.72	11.61	30.54	32.67	40.37
	3:05:00	0.00	0.00	3.53	4.84	7.47	10.59	30.31	32.62	39.78
	3:10:00	0.00	0.00	3.54	4.85	7.25	9.79	30.07	32.51	39.21
	3:15:00	0.00	0.00	3.55	4.85	7.06	9.15	29.82	32.37	38.66
	3:20:00	0.00	0.00	3.56	4.86	6.90	8.63	23.98	32.19	38.13
	3:25:00	0.00	0.00	3.57	4.86	6.76	8.21	19.59	31.99	37.60
	3:30:00	0.00	0.00	3.58	4.86	6.63	7.86	16.49	31.78	37.04
	3:35:00	0.00	0.00	3.59	4.87	6.52	7.57	14.25	31.55	35.80
	3:40:00	0.00	0.00	3.59	4.87	6.42	7.32	12.58	31.31	33.93
	3:45:00	0.00	0.00	3.60	4.87	6.32	7.11	11.31	31.07	32.74
	3:50:00	0.00	0.00	3.61	4.88	6.24	6.92	10.33	30.82	32.57
	3:55:00	0.00	0.00	3.61	4.88	6.17	6.76	9.56	30.57	32.38
	4:00:00	0.00	0.00	3.62	4.88	6.10	6.62	8.94	30.32	32.17
	4:05:00	0.00	0.00	3.63	4.88	6.04	6.50	8.44	30.07	31.94
	4:10:00	0.00	0.00	3.63	4.88	5.98	6.39	8.03	29.77	31.71
	4:15:00	0.00	0.00	3.64	4.88	5.93	6.29	7.69	23.75	31.47
	4:20:00	0.00	0.00	3.64	4.89	5.88	6.21	7.41	19.39	31.22
	4:25:00	0.00	0.00	3.65	4.89	5.84	6.13	7.17	16.31	30.98
	4:30:00	0.00	0.00	3.65	4.89	5.80	6.05	6.96	14.07	30.73
	4:35:00	0.00	0.00	3.65	4.89	5.76	5.99	6.78	12.41	30.48
	4:40:00	0.00	0.00	3.66	4.89	5.74	5.93	6.63	11.14	30.22
	4:45:00	0.00	0.00	3.66	4.89	5.71	5.88	6.49	10.17	29.97
	4:50:00	0.00	0.00	3.66	4.89	5.70	5.83	6.37	9.40	27.51
	4:55:00	0.00	0.00	3.67	4.89	5.69	5.79	6.27	8.78	21.96
	5:00:00	0.00	0.00	3.67	4.89	5.69	5.75	6.17	8.29	18.12
	5:05:00	0.00	0.00	3.67	4.89	5.69	5.73	6.09	7.88	15.38
	5:10:00	0.00	0.00	3.67	4.89	5.68	5.70	6.01	7.54	13.38
	5:15:00	0.00	0.00	3.67	4.89	5.68	5.69	5.94	7.26	11.87
	5:20:00	0.00	0.00	3.67	4.89	5.68	5.69	5.88	7.02	10.72
	5:25:00	0.00	0.00	3.67	4.88	5.67	5.69	5.83	6.81	9.83
	5:30:00	0.00	0.00	3.67	4.88	5.67	5.68	5.78	6.64	9.12
	5:35:00	0.00	0.00	3.67	4.88	5.66	5.68	5.75	6.48	8.55
	5:40:00	0.00	0.00	3.67	4.88	5.66	5.68	5.72	6.35	8.09
	5:45:00	0.00	0.00	3.67	4.88	5.65	5.67	5.70	6.23	7.71
	5:50:00	0.00	0.00	3.67	4.87	5.65	5.67	5.69	6.13	7.39
	5:55:00	0.00	0.00	3.67	4.87	5.64	5.66	5.69	6.04	7.13
	6:00:00	0.00	0.00	3.65	4.86	5.63	5.65	5.68	5.81	6.62

Design Procedure Form: Extended Detention Basin (EDB)

UD-BMP (Version 3.07, March 2018)

Sheet 1 of 3

Designer: Richard Schindler
Company: Core Engineering Group
Date: May 2, 2020
Project: The Hills at Lorson Ranch
Location: Pond C2.2

<p>1. Basin Storage Volume</p> <p>A) Effective Imperviousness of Tributary Area, I_a</p> <p>B) Tributary Area's Imperviousness Ratio ($i = I_a / 100$)</p> <p>C) Contributing Watershed Area</p> <p>D) For Watersheds Outside of the Denver Region, Depth of Average Runoff Producing Storm</p> <p>E) Design Concept (Select EURV when also designing for flood control)</p> <p>F) Design Volume (WQCV) Based on 40-hour Drain Time ($V_{DESIGN} = (1.0 * (0.91 * i^3 - 1.19 * i^2 + 0.78 * i) / 12 * Area)$)</p> <p>G) For Watersheds Outside of the Denver Region, Water Quality Capture Volume (WQCV) Design Volume ($V_{WQCV\ OTHER} = (d_6 * (V_{DESIGN} * 0.43))$)</p> <p>H) User Input of Water Quality Capture Volume (WQCV) Design Volume (Only if a different WQCV Design Volume is desired)</p> <p>I) NRCS Hydrologic Soil Groups of Tributary Watershed i) Percentage of Watershed consisting of Type A Soils ii) Percentage of Watershed consisting of Type B Soils iii) Percentage of Watershed consisting of Type C/D Soils</p> <p>J) Excess Urban Runoff Volume (EURV) Design Volume For HSG A: $EURV_A = 1.68 * i^{1.28}$ For HSG B: $EURV_B = 1.36 * i^{1.08}$ For HSG C/D: $EURV_{C/D} = 1.20 * i^{1.08}$</p> <p>K) User Input of Excess Urban Runoff Volume (EURV) Design Volume (Only if a different EURV Design Volume is desired)</p>	<p>$I_a =$ <input type="text" value="55.0"/> %</p> <p>$i =$ <input type="text" value="0.550"/></p> <p>Area = <input type="text" value="45.000"/> ac</p> <p>$d_6 =$ <input type="text" value=""/></p> <div style="border: 1px solid black; padding: 5px; margin: 5px 0;"> <p>Choose One</p> <p><input checked="" type="radio"/> Water Quality Capture Volume (WQCV)</p> <p><input type="radio"/> Excess Urban Runoff Volume (EURV)</p> </div> <p>$V_{DESIGN} =$ <input type="text" value="0.827"/> ac-ft</p> <p>$V_{DESIGN\ OTHER} =$ <input type="text" value=""/> ac-ft</p> <p>$V_{DESIGN\ USER} =$ <input type="text" value=""/> ac-ft</p> <p>HSG _A = <input type="text" value=""/> % HSG _B = <input type="text" value=""/> % HSG _{C/D} = <input type="text" value=""/> %</p> <p>EURV_{DESIGN} = <input type="text" value=""/> ac-ft</p> <p>EURV_{DESIGN\ USER} = <input type="text" value=""/> ac-ft</p>
<p>2. Basin Shape: Length to Width Ratio (A basin length to width ratio of at least 2:1 will improve TSS reduction.)</p>	<p>L : W = <input type="text" value="2.0"/> : 1</p>
<p>3. Basin Side Slopes</p> <p>A) Basin Maximum Side Slopes (Horizontal distance per unit vertical, 4:1 or flatter preferred)</p>	<p>Z = <input type="text" value="3.00"/> ft / ft</p> <p align="center">DIFFICULT TO MAINTAIN, INCREASE WHERE POSSIBLE</p>
<p>4. Inlet</p> <p>A) Describe means of providing energy dissipation at concentrated inflow locations:</p>	<p>_____</p> <p>_____</p> <p>_____</p>
<p>5. Forebay</p> <p>A) Minimum Forebay Volume ($V_{MIN} =$ <input type="text" value="3%"/> of the WQCV)</p> <p>B) Actual Forebay Volume</p> <p>C) Forebay Depth ($D_F =$ <input type="text" value="30"/> inch maximum)</p> <p>D) Forebay Discharge</p> <p>i) Undetained 100-year Peak Discharge</p> <p>ii) Forebay Discharge Design Flow ($Q_F = 0.02 * Q_{100}$)</p> <p>E) Forebay Discharge Design</p> <p>F) Discharge Pipe Size (minimum 8-inches)</p> <p>G) Rectangular Notch Width</p>	<p>$V_{MIN} =$ <input type="text" value="0.025"/> ac-ft</p> <p>$V_F =$ <input type="text" value="0.028"/> ac-ft</p> <p>$D_F =$ <input type="text" value="24.0"/> in</p> <p>$Q_{100} =$ <input type="text" value="131.00"/> cfs</p> <p>$Q_F =$ <input type="text" value="2.62"/> cfs</p> <div style="border: 1px solid black; padding: 5px; margin: 5px 0;"> <p>Choose One</p> <p><input type="radio"/> Berm With Pipe</p> <p><input checked="" type="radio"/> Wall with Rect. Notch</p> <p><input type="radio"/> Wall with V-Notch Weir</p> </div> <p>Calculated $D_P =$ <input type="text" value=""/> in</p> <p>Calculated $W_N =$ <input type="text" value="8.1"/> in</p>

Design Procedure Form: Extended Detention Basin (EDB)

Sheet 2 of 3

Designer: Richard Schindler
Company: Core Engineering Group
Date: May 2, 2020
Project: The Hills at Lorson Ranch
Location: Pond C2.2

<p>6. Trickle Channel</p> <p>A) Type of Trickle Channel</p> <p>F) Slope of Trickle Channel</p>	<div style="border: 1px solid black; padding: 2px; margin-bottom: 5px;"> Choose One <input checked="" type="radio"/> Concrete <input type="radio"/> Soft Bottom </div> <p>S = <input type="text" value="0.0050"/> ft / ft</p>
<p>7. Micropool and Outlet Structure</p> <p>A) Depth of Micropool (2.5-foot minimum)</p> <p>B) Surface Area of Micropool (10 ft² minimum)</p> <p>C) Outlet Type</p> <p>D) Smallest Dimension of Orifice Opening Based on Hydrograph Routing (Use UD-Detention)</p> <p>E) Total Outlet Area</p>	<p>D_M = <input type="text" value="2.5"/> ft</p> <p>A_M = <input type="text" value="50"/> sq ft</p> <div style="border: 1px solid black; padding: 2px; margin-bottom: 5px;"> Choose One <input checked="" type="radio"/> Orifice Plate <input type="radio"/> Other (Describe): </div> <hr/> <hr/> <p>D_{orifice} = <input type="text" value="1.48"/> inches</p> <p>A_{orifice} = <input type="text" value="6.63"/> square inches</p>
<p>8. Initial Surcharge Volume</p> <p>A) Depth of Initial Surcharge Volume (Minimum recommended depth is 4 inches)</p> <p>B) Minimum Initial Surcharge Volume (Minimum volume of 0.3% of the WQCV)</p> <p>C) Initial Surcharge Provided Above Micropool</p>	<p>D_{IS} = <input type="text" value="4"/> in</p> <p>V_{IS} = <input type="text" value="108"/> cu ft</p> <p>V_s = <input type="text" value="16.7"/> cu ft</p>
<p>9. Trash Rack</p> <p>A) Water Quality Screen Open Area: $A_t = A_{ot} * 38.5 * (e^{-0.095D})$</p> <p>B) Type of Screen (If specifying an alternative to the materials recommended in the USDCM, indicate "other" and enter the ratio of the total open area to the total screen area for the material specified.)</p> <p style="margin-left: 40px;">Other (Y/N): <input type="text" value="y"/></p> <p>C) Ratio of Total Open Area to Total Area (only for type 'Other')</p> <p>D) Total Water Quality Screen Area (based on screen type)</p> <p>E) Depth of Design Volume (EURV or WQCV) (Based on design concept chosen under 1E)</p> <p>F) Height of Water Quality Screen (H_{TR})</p> <p>G) Width of Water Quality Screen Opening (W_{opening}) (Minimum of 12 inches is recommended)</p>	<p>A_t = <input type="text" value="222"/> square inches</p> <div style="border: 1px solid black; padding: 2px; margin-bottom: 5px; width: fit-content;"> Other (Please describe below) </div> <p>wellscreen stainless</p> <hr/> <hr/> <p>User Ratio = <input type="text" value="0.6"/></p> <p>A_{total} = <input type="text" value="370"/> sq. in. Based on type 'Other' screen ratio</p> <p>H = <input type="text" value="3.25"/> feet</p> <p>H_{TR} = <input type="text" value="67"/> inches</p> <p>W_{opening} = <input type="text" value="12.0"/> inches VALUE LESS THAN RECOMMENDED MIN. WIDTH. WIDTH HAS BEEN SET TO 12 INCHES.</p>

Channel Report

Hydraflow Express by Intelisolve

Saturday, May 2 2020, 9:18 AM

pond C2.2 low flow channel (2 x forebay release = 5.24cfs)

Rectangular

Bottom Width (ft) = 6.00
Total Depth (ft) = 0.50

Invert Elev (ft) = 100.00
Slope (%) = 0.50
N-Value = 0.013

Highlighted

Depth (ft) = 0.28
Q (cfs) = 5.240
Area (sqft) = 1.68
Velocity (ft/s) = 3.12
Wetted Perim (ft) = 6.56
Crit Depth, Y_c (ft) = 0.29
Top Width (ft) = 6.00
EGL (ft) = 0.43

Calculations

Compute by: Known Q
Known Q (cfs) = 5.24

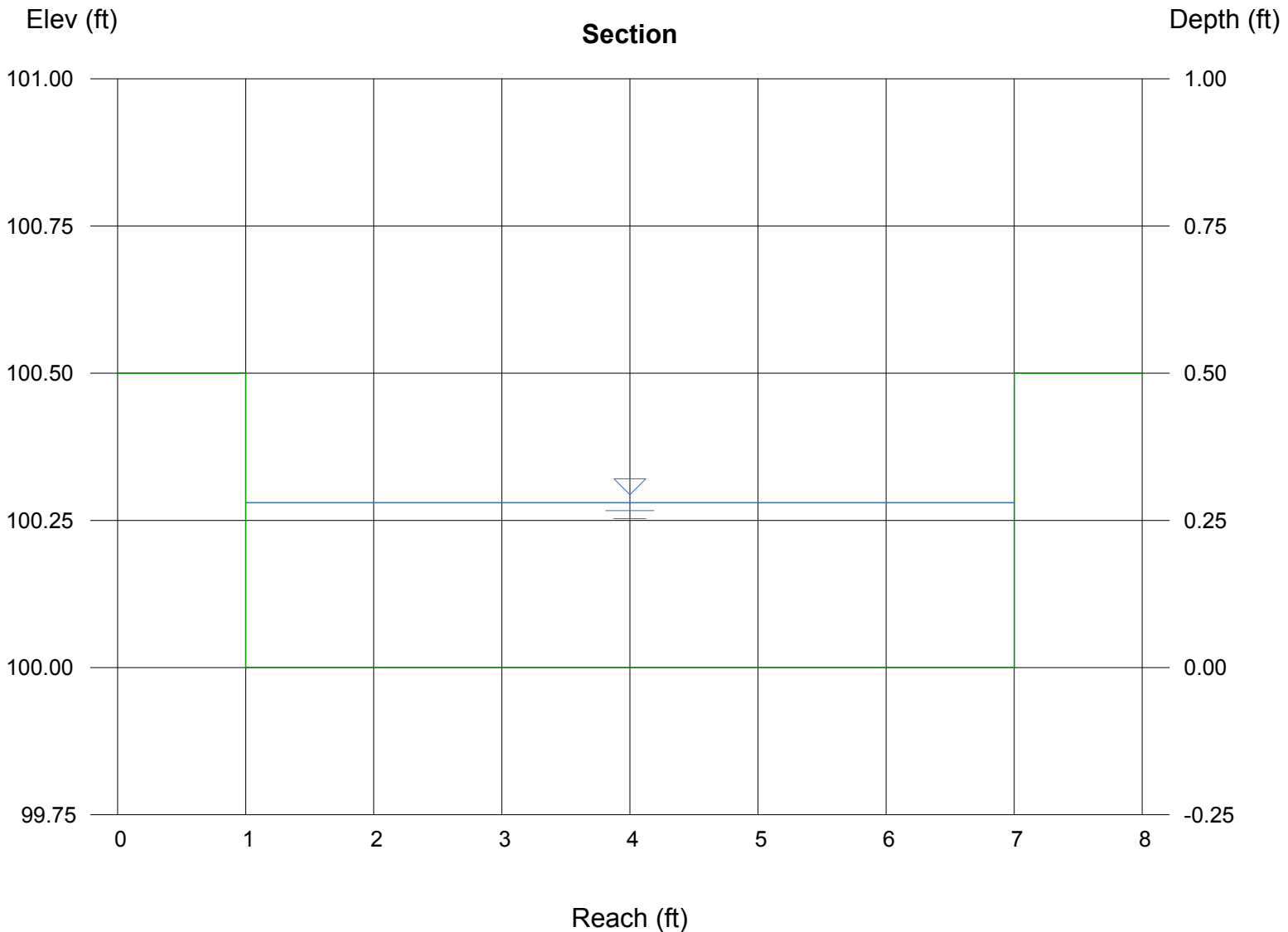

Weir Report

Pond C2.2 forebay overflow

Rectangular Weir

Crest = Sharp
Bottom Length (ft) = 9.00
Total Depth (ft) = 0.50

Highlighted

Depth (ft) = 0.26
Q (cfs) = 4.040
Area (sqft) = 2.36
Velocity (ft/s) = 1.71
Top Width (ft) = 9.00

Calculations

Weir Coeff. Cw = 3.33
Compute by: Known Q
Known Q (cfs) = 4.04

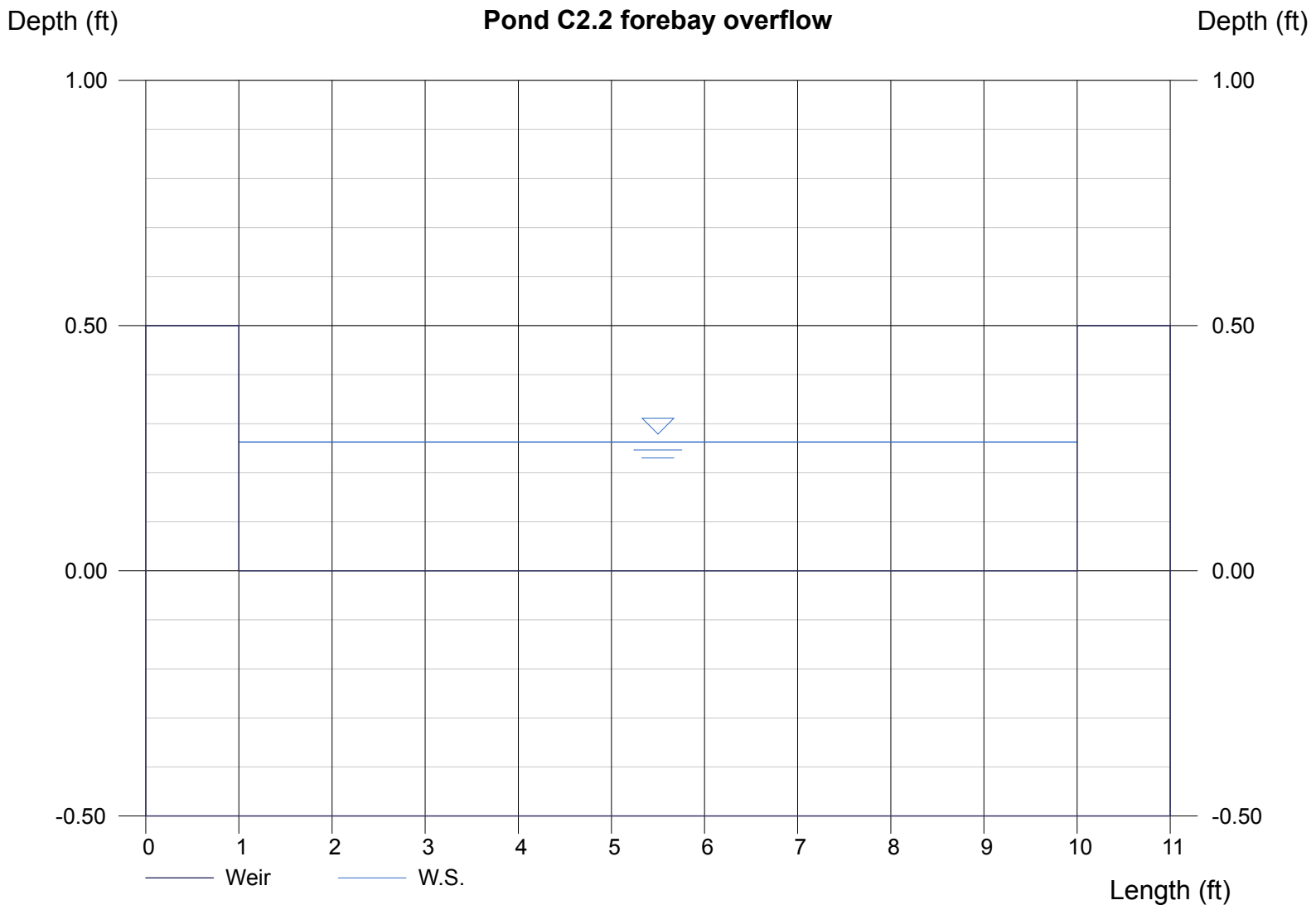

DETENTION BASIN OUTLET STRUCTURE DESIGN

MHFD-Detention, Version 4.02 (February 2020)

Project: The Hills at Lorson Ranch
Basin ID: Pond C4

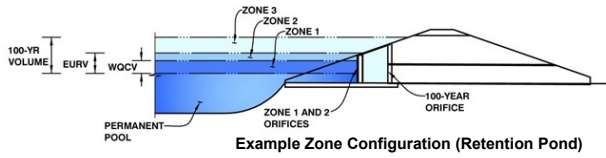

	Estimated Stage (ft)	Estimated Volume (ac-ft)	Outlet Type
Zone 1 (WQCV)	2.97	1.488	Orifice Plate
Zone 2 (EURV)	5.41	2.980	Rectangular Orifice
Zone 3 (100+1/2WQCV)	8.40	4.225	Weir&Pipe (Restrict)
Total (all zones)		8.692	

User Input: Orifice at Underdrain Outlet (typically used to drain WQCV in a Filtration BMP)

Underdrain Orifice Invert Depth =	N/A	ft (distance below the filtration media surface)
Underdrain Orifice Diameter =	N/A	inches

Calculated Parameters for Underdrain

Underdrain Orifice Area =	N/A	ft ²
Underdrain Orifice Centroid =	N/A	feet

User Input: Orifice Plate with one or more orifices or Elliptical Slot Weir (typically used to drain WQCV and/or EURV in a sedimentation BMP)

Invert of Lowest Orifice =	0.00	ft (relative to basin bottom at Stage = 0 ft)
Depth at top of Zone using Orifice Plate =	2.97	ft (relative to basin bottom at Stage = 0 ft)
Orifice Plate: Orifice Vertical Spacing =	11.90	inches
Orifice Plate: Orifice Area per Row =	4.68	sq. inches (use rectangular openings)

Calculated Parameters for Plate

WQ Orifice Area per Row =	3.250E-02	ft ²
Elliptical Half-Width =	N/A	feet
Elliptical Slot Centroid =	N/A	feet
Elliptical Slot Area =	N/A	ft ²

User Input: Stage and Total Area of Each Orifice Row (numbered from lowest to highest)

	Row 1 (required)	Row 2 (optional)	Row 3 (optional)	Row 4 (optional)	Row 5 (optional)	Row 6 (optional)	Row 7 (optional)	Row 8 (optional)
Stage of Orifice Centroid (ft)	0.00	0.99	1.98					
Orifice Area (sq. inches)	4.68	4.68	4.68					

	Row 9 (optional)	Row 10 (optional)	Row 11 (optional)	Row 12 (optional)	Row 13 (optional)	Row 14 (optional)	Row 15 (optional)	Row 16 (optional)
Stage of Orifice Centroid (ft)								
Orifice Area (sq. inches)								

User Input: Vertical Orifice (Circular or Rectangular)

	Zone 2 Rectangular	Not Selected	
Invert of Vertical Orifice =	2.97	N/A	ft (relative to basin bottom at Stage = 0 ft)
Depth at top of Zone using Vertical Orifice =	5.41	N/A	ft (relative to basin bottom at Stage = 0 ft)
Vertical Orifice Height =	6.00	N/A	inches
Vertical Orifice Width =	16.39	N/A	inches

Calculated Parameters for Vertical Orific

	Zone 2 Rectangular	Not Selected
Vertical Orifice Area =	0.68	N/A
Vertical Orifice Centroid =	0.25	N/A

User Input: Overflow Weir (Dropbox with Flat or Sloped Gate and Outlet Pipe OR Rectangular/Trapezoidal Weir (and No Outlet Pipe))

	Zone 3 Weir	Not Selected	
Overflow Weir Front Edge Height, Ho =	5.50	N/A	ft (relative to basin bottom at Stage = 0 ft)
Overflow Weir Front Edge Length =	6.00	N/A	feet
Overflow Weir Gate Slope =	0.00	N/A	H:V
Horiz. Length of Weir Sides =	6.00	N/A	feet
Overflow Gate Open Area % =	70%	N/A	% gate open area/total area
Debris Clogging % =	50%	N/A	%

Calculated Parameters for Overflow Weir

	Zone 3 Weir	Not Selected
Height of Gate Upper Edge, H ₁ =	5.50	N/A
Overflow Weir Slope Length =	6.00	N/A
Gate Open Area / 100-yr Orifice Area =	8.02	N/A
Overflow Gate Open Area w/o Debris =	25.20	N/A
Overflow Gate Open Area w/ Debris =	12.60	N/A

User Input: Outlet Pipe w/ Flow Restriction Plate (Circular Orifice, Restrictor Plate, or Rectangular Orifice)

	Zone 3 Restrictor	Not Selected	
Depth to Invert of Outlet Pipe =	0.00	N/A	ft (distance below basin bottom at Stage = 0 ft)
Outlet Pipe Diameter =	24.00	N/A	inches
Restrictor Plate Height Above Pipe Invert =	24.00	N/A	inches

Calculated Parameters for Outlet Pipe w/ Flow Restriction Plate

	Zone 3 Restrictor	Not Selected
Outlet Orifice Area =	3.14	N/A
Outlet Orifice Centroid =	1.00	N/A
Half-Central Angle of Restrictor Plate on Pipe =	3.14	N/A

User Input: Emergency Spillway (Rectangular or Trapezoidal)

Spillway Invert Stage =	10.00	ft (relative to basin bottom at Stage = 0 ft)
Spillway Crest Length =	30.00	feet
Spillway End Slopes =	4.00	H:V
Freeboard above Max Water Surface =	1.13	feet

Calculated Parameters for Spillway

Spillway Design Flow Depth =	1.87	feet
Stage at Top of Freeboard =	13.00	feet
Basin Area at Top of Freeboard =	1.72	acres
Basin Volume at Top of Freeboard =	12.89	acre-ft

micropool = 0 = 5765

Routed Hydrograph Results

The user can override the default CUHP hydrographs and runoff volumes by entering new values in the Inflow Hydrographs table (Columns W through AF)

	WQCV	EURV	2 Year	5 Year	10 Year	25 Year	50 Year	100 Year
Design Storm Return Period =	N/A	N/A	1.19	1.50	1.75	2.00	2.25	2.52
One-Hour Rainfall Depth (in) =	1.488	4.468	4.607	6.475	8.109	10.045	11.748	13.830
CUHP Runoff Volume (acre-ft) =	N/A	N/A	4.607	6.475	8.109	10.045	11.748	13.830
Inflow Hydrograph Volume (acre-ft) =	N/A	N/A	17.5	39.6	56.8	90.6	111.9	138.5
OPTIONAL CUHP Predevelopment Peak Q (cfs) =	N/A	N/A						
Predevelopment Unit Peak Flow, q (cfs/acre) =	N/A	N/A	0.22	0.49	0.70	1.12	1.38	1.71
Peak Inflow Q (cfs) =	N/A	N/A	93.5	131.6	158.6	200.0	232.9	277.2
Peak Outflow Q (cfs) =	0.6	5.8	5.3	16.5	34.4	38.0	40.5	43.7
Ratio Peak Outflow to Predevelopment Q =	N/A	N/A	N/A	0.4	0.6	0.4	0.4	0.3
Structure Controlling Flow =	Vertical Orifice 1	Vertical Orifice 1	Vertical Orifice 1	Overflow Weir 1	Outlet Plate 1	Outlet Plate 1	Outlet Plate 1	Outlet Plate 1
Max Velocity through Gate 1 (fps) =	N/A	N/A	N/A	0.4	1.1	1.2	1.3	1.4
Max Velocity through Gate 2 (fps) =	N/A	N/A	N/A	N/A	N/A	N/A	N/A	N/A
Time to Drain 97% of Inflow Volume (hours) =	39	48	49	49	47	45	44	42
Time to Drain 99% of Inflow Volume (hours) =	40	52	53	54	53	53	53	52
Maximum Ponding Depth (ft) =	2.97	5.41	5.00	5.84	6.17	7.31	8.15	9.34
Area at Maximum Ponding Depth (acres) =	1.14	1.31	1.28	1.34	1.36	1.44	1.50	1.59
Maximum Volume Stored (acre-ft) =	1.488	4.477	3.934	5.031	5.476	7.083	8.317	10.152

DETENTION BASIN OUTLET STRUCTURE DESIGN

MHFD-Detention, Version 4.00 (December 2019)

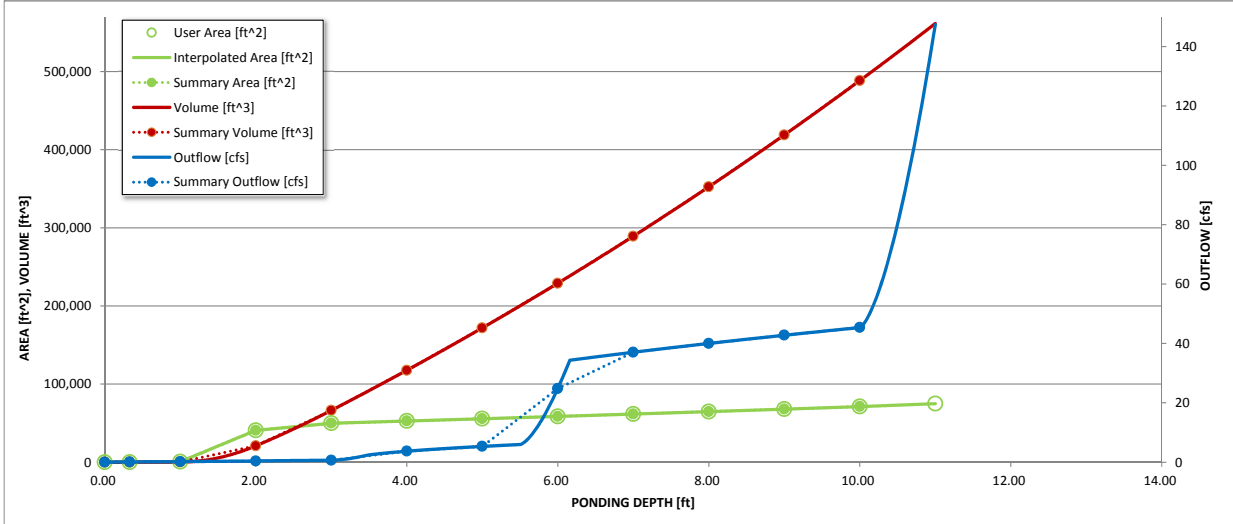
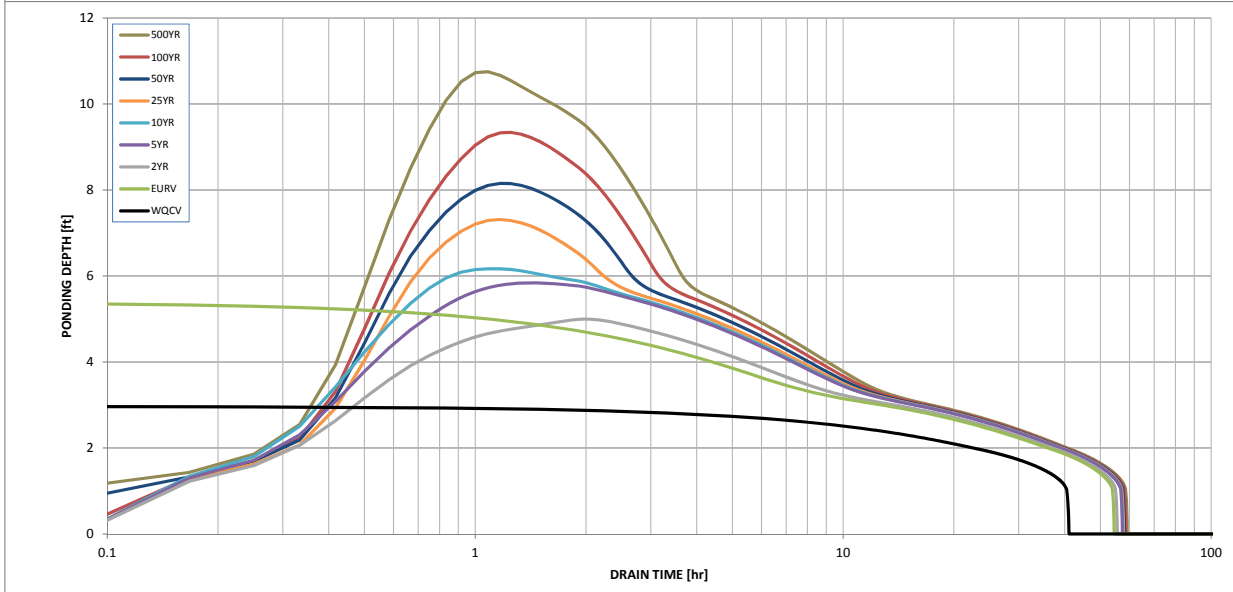
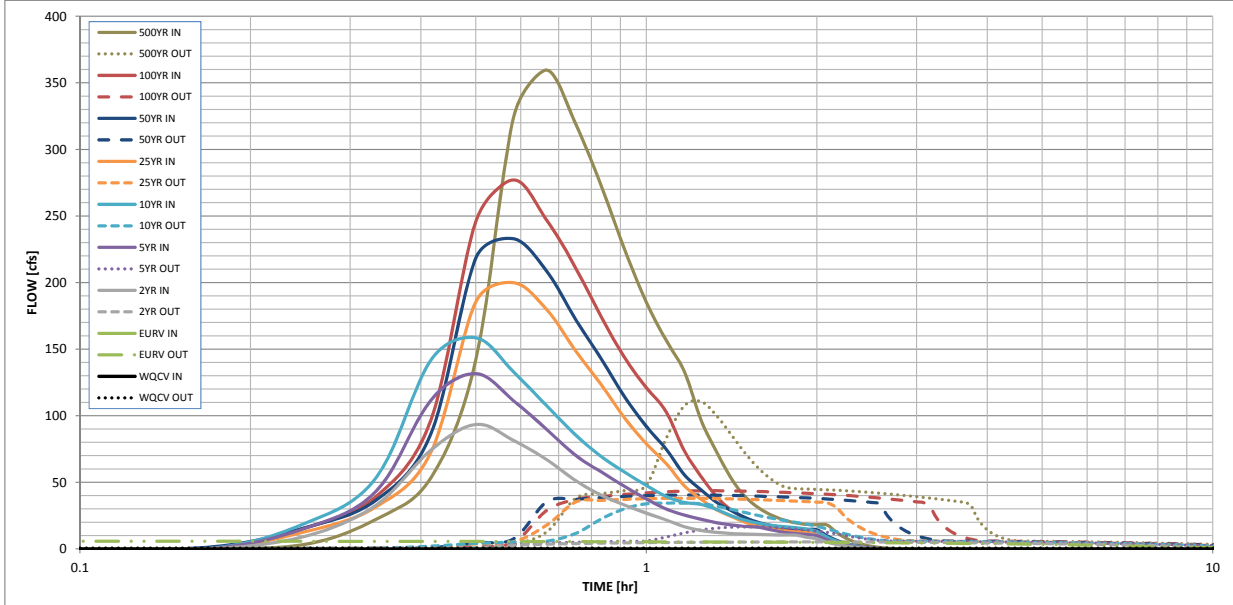

S-A-V-D Chart Axis Override	X-axis	Left Y-Axis	Right Y-Axis
minimum bound			
maximum bound			

Design Procedure Form: Extended Detention Basin (EDB)

UD-BMP (Version 3.07, March 2018)

Sheet 1 of 3

Designer: Richard Schindler
Company: Core Engineering Group
Date: May 4, 2020
Project: The Hills at Lorson Ranch
Location: Pond C4

<p>1. Basin Storage Volume</p> <p>A) Effective Imperviousness of Tributary Area, I_a</p> <p>B) Tributary Area's Imperviousness Ratio ($i = I_a / 100$)</p> <p>C) Contributing Watershed Area</p> <p>D) For Watersheds Outside of the Denver Region, Depth of Average Runoff Producing Storm</p> <p>E) Design Concept (Select EURV when also designing for flood control)</p> <p>F) Design Volume (WQCV) Based on 40-hour Drain Time ($V_{DESIGN} = (1.0 * (0.91 * i^3 - 1.19 * i^2 + 0.78 * i) / 12 * Area)$)</p> <p>G) For Watersheds Outside of the Denver Region, Water Quality Capture Volume (WQCV) Design Volume ($V_{WQCV\ OTHER} = (d_6 * (V_{DESIGN} * 0.43))$)</p> <p>H) User Input of Water Quality Capture Volume (WQCV) Design Volume (Only if a different WQCV Design Volume is desired)</p> <p>I) NRCS Hydrologic Soil Groups of Tributary Watershed i) Percentage of Watershed consisting of Type A Soils ii) Percentage of Watershed consisting of Type B Soils iii) Percentage of Watershed consisting of Type C/D Soils</p> <p>J) Excess Urban Runoff Volume (EURV) Design Volume For HSG A: $EURV_A = 1.68 * i^{1.28}$ For HSG B: $EURV_B = 1.36 * i^{1.08}$ For HSG C/D: $EURV_{C/D} = 1.20 * i^{1.08}$</p> <p>K) User Input of Excess Urban Runoff Volume (EURV) Design Volume (Only if a different EURV Design Volume is desired)</p>	<p>$I_a =$ <input type="text" value="55.0"/> %</p> <p>$i =$ <input type="text" value="0.550"/></p> <p>Area = <input type="text" value="81.000"/> ac</p> <p>$d_6 =$ <input type="text" value=""/></p> <div style="border: 1px solid black; padding: 5px; margin: 5px 0;"> <p>Choose One</p> <p><input checked="" type="radio"/> Water Quality Capture Volume (WQCV)</p> <p><input type="radio"/> Excess Urban Runoff Volume (EURV)</p> </div> <p>$V_{DESIGN} =$ <input type="text" value="1.488"/> ac-ft</p> <p>$V_{DESIGN\ OTHER} =$ <input type="text" value=""/> ac-ft</p> <p>$V_{DESIGN\ USER} =$ <input type="text" value=""/> ac-ft</p> <p>HSG $A =$ <input type="text" value=""/> % HSG $B =$ <input type="text" value=""/> % HSG $C/D =$ <input type="text" value=""/> %</p> <p>EURV$_{DESIGN} =$ <input type="text" value=""/> ac-ft</p> <p>EURV$_{DESIGN\ USER} =$ <input type="text" value=""/> ac-ft</p>
<p>2. Basin Shape: Length to Width Ratio (A basin length to width ratio of at least 2:1 will improve TSS reduction.)</p>	<p>L : W = <input type="text" value="2.0"/> : 1</p>
<p>3. Basin Side Slopes</p> <p>A) Basin Maximum Side Slopes (Horizontal distance per unit vertical, 4:1 or flatter preferred)</p>	<p>Z = <input type="text" value="3.00"/> ft / ft</p> <p align="center">DIFFICULT TO MAINTAIN, INCREASE WHERE POSSIBLE</p>
<p>4. Inlet</p> <p>A) Describe means of providing energy dissipation at concentrated inflow locations:</p>	<p>_____</p> <p>_____</p> <p>_____</p>
<p>5. Forebay</p> <p>A) Minimum Forebay Volume ($V_{MIN} =$ <input type="text" value="3%"/> of the WQCV)</p> <p>B) Actual Forebay Volume</p> <p>C) Forebay Depth ($D_F =$ <input type="text" value="30"/> inch maximum)</p> <p>D) Forebay Discharge</p> <p>i) Undetained 100-year Peak Discharge</p> <p>ii) Forebay Discharge Design Flow ($Q_F = 0.02 * Q_{100}$)</p> <p>E) Forebay Discharge Design</p> <p>F) Discharge Pipe Size (minimum 8-inches)</p> <p>G) Rectangular Notch Width</p>	<p>$V_{MIN} =$ <input type="text" value="0.045"/> ac-ft</p> <p>$V_F =$ <input type="text" value="0.050"/> ac-ft</p> <p>$D_F =$ <input type="text" value="24.0"/> in</p> <p>$Q_{100} =$ <input type="text" value="277.00"/> cfs</p> <p>$Q_F =$ <input type="text" value="5.54"/> cfs</p> <div style="border: 1px solid black; padding: 5px; margin: 5px 0;"> <p>Choose One</p> <p><input type="radio"/> Berm With Pipe</p> <p><input checked="" type="radio"/> Wall with Rect. Notch</p> <p><input type="radio"/> Wall with V-Notch Weir</p> </div> <p>Calculated $D_P =$ <input type="text" value=""/> in</p> <p>Calculated $W_N =$ <input type="text" value="11.9"/> in</p>

Design Procedure Form: Extended Detention Basin (EDB)

Designer: Richard Schindler
Company: Core Engineering Group
Date: May 4, 2020
Project: The Hills at Lorson Ranch
Location: Pond C4

<p>6. Trickle Channel</p> <p>A) Type of Trickle Channel</p> <p>F) Slope of Trickle Channel</p>	<div style="border: 1px solid black; padding: 2px; margin-bottom: 5px;"> Choose One <input checked="" type="radio"/> Concrete <input type="radio"/> Soft Bottom </div> <p>S = <input type="text" value="0.0050"/> ft / ft</p>
<p>7. Micropool and Outlet Structure</p> <p>A) Depth of Micropool (2.5-foot minimum)</p> <p>B) Surface Area of Micropool (10 ft² minimum)</p> <p>C) Outlet Type</p> <p>D) Smallest Dimension of Orifice Opening Based on Hydrograph Routing (Use UD-Detention)</p> <p>E) Total Outlet Area</p>	<p>D_M = <input type="text" value="2.5"/> ft</p> <p>A_M = <input type="text" value="50"/> sq ft</p> <div style="border: 1px solid black; padding: 2px; margin-bottom: 5px;"> Choose One <input checked="" type="radio"/> Orifice Plate <input type="radio"/> Other (Describe): </div> <hr/> <hr/> <p>D_{orifice} = <input type="text" value="2.16"/> inches</p> <p>A_{orifice} = <input type="text" value="14.04"/> square inches</p>
<p>8. Initial Surcharge Volume</p> <p>A) Depth of Initial Surcharge Volume (Minimum recommended depth is 4 inches)</p> <p>B) Minimum Initial Surcharge Volume (Minimum volume of 0.3% of the WQCV)</p> <p>C) Initial Surcharge Provided Above Micropool</p>	<p>D_{IS} = <input type="text" value="4"/> in</p> <p>V_{IS} = <input type="text" value="194"/> cu ft</p> <p>V_s = <input type="text" value="16.7"/> cu ft</p>
<p>9. Trash Rack</p> <p>A) Water Quality Screen Open Area: $A_t = A_{ot} * 38.5 * (e^{-0.095D})$</p> <p>B) Type of Screen (If specifying an alternative to the materials recommended in the USDCM, indicate "other" and enter the ratio of the total open area to the total screen area for the material specified.)</p> <p style="margin-left: 40px;">Other (Y/N): <input type="text" value="y"/></p> <p>C) Ratio of Total Open Area to Total Area (only for type 'Other')</p> <p>D) Total Water Quality Screen Area (based on screen type)</p> <p>E) Depth of Design Volume (EURV or WQCV) (Based on design concept chosen under 1E)</p> <p>F) Height of Water Quality Screen (H_{TR})</p> <p>G) Width of Water Quality Screen Opening (W_{opening}) (Minimum of 12 inches is recommended)</p>	<p>A_t = <input type="text" value="440"/> square inches</p> <div style="border: 1px solid black; padding: 2px; margin-bottom: 5px; width: fit-content;"> Other (Please describe below) </div> <p>wellscreen stainless</p> <hr/> <hr/> <p>User Ratio = <input type="text" value="0.6"/></p> <p>A_{total} = <input type="text" value="734"/> sq. in. Based on type 'Other' screen ratio</p> <p>H = <input type="text" value="2.97"/> feet</p> <p>H_{TR} = <input type="text" value="63.64"/> inches</p> <p>W_{opening} = <input type="text" value="12.0"/> inches VALUE LESS THAN RECOMMENDED MIN. WIDTH. WIDTH HAS BEEN SET TO 12 INCHES.</p>

Channel Report

Hydraflow Express by Intelisolve

Monday, May 4 2020, 6:54 AM

pond C4 low flow channel (2 x forebay release = 11.08cfs)

Rectangular

Bottom Width (ft) = 8.00
Total Depth (ft) = 0.50

Invert Elev (ft) = 100.00
Slope (%) = 0.50
N-Value = 0.013

Highlighted

Depth (ft) = 0.36
Q (cfs) = 11.08
Area (sqft) = 2.88
Velocity (ft/s) = 3.85
Wetted Perim (ft) = 8.72
Crit Depth, Y_c (ft) = 0.40
Top Width (ft) = 8.00
EGL (ft) = 0.59

Calculations

Compute by: Known Q
Known Q (cfs) = 11.08

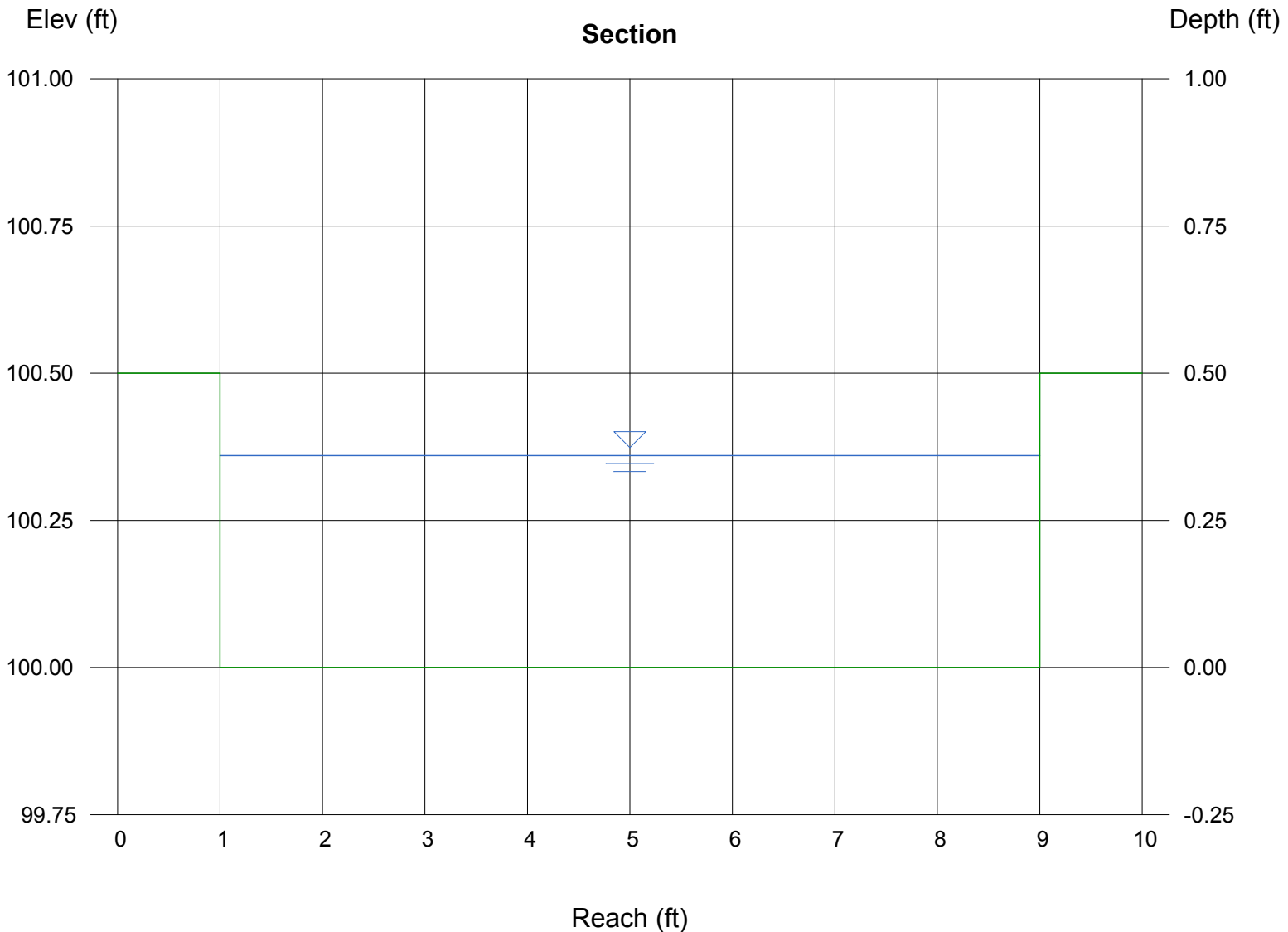

Weir Report

Pond C4 forebay overflow

Rectangular Weir

Crest = Sharp
Bottom Length (ft) = 8.00
Total Depth (ft) = 0.50

Highlighted

Depth (ft) = 0.35
Q (cfs) = 5.540
Area (sqft) = 2.81
Velocity (ft/s) = 1.97
Top Width (ft) = 8.00

Calculations

Weir Coeff. Cw = 3.33
Compute by: Known Q
Known Q (cfs) = 5.54

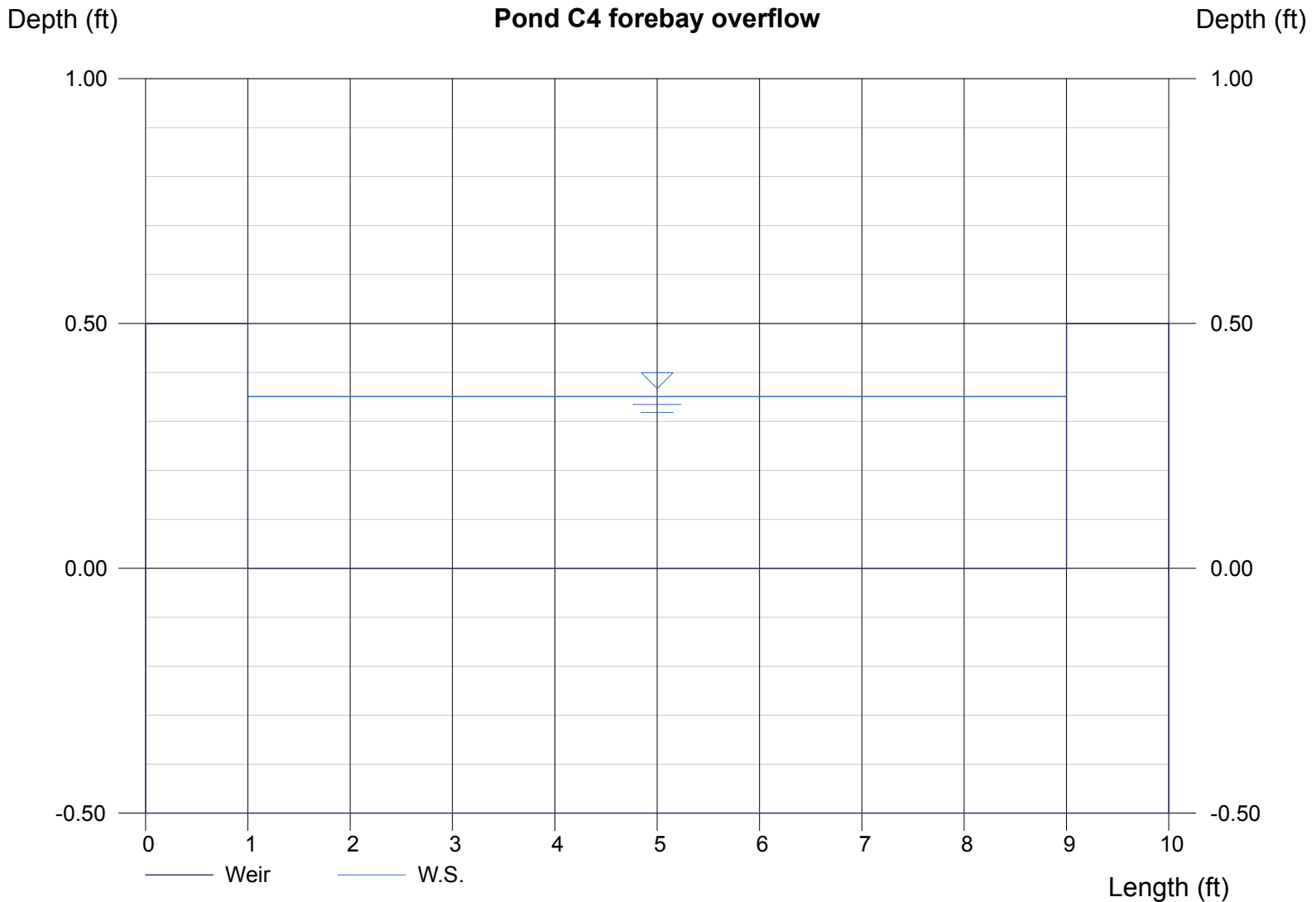

DETENTION BASIN OUTLET STRUCTURE DESIGN

MHFD-Detention, Version 4.02 (February 2020)

Project: The Ridge at Lorson Ranch

Basin ID: Pond F

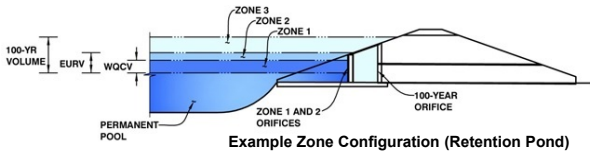

	Estimated Stage (ft)	Estimated Volume (ac-ft)	Outlet Type
Zone 1 (WQCV)	2.27	0.090	Orifice Plate
Zone 2 (EURV)	3.69	0.200	Rectangular Orifice
Zone 3 (100+1/2WQCV)	4.98	0.246	Weir&Pipe (Restrict)
Total (all zones)		0.537	

User Input: Orifice at Underdrain Outlet (typically used to drain WQCV in a Filtration BMP)

Underdrain Orifice Invert Depth = ft (distance below the filtration media surface)
 Underdrain Orifice Diameter = inches

Calculated Parameters for Underdrain

Underdrain Orifice Area = ft²
 Underdrain Orifice Centroid = feet

User Input: Orifice Plate with one or more orifices or Elliptical Slot Weir (typically used to drain WQCV and/or EURV in a sedimentation BMP)

Invert of Lowest Orifice = ft (relative to basin bottom at Stage = 0 ft)
 Depth at top of Zone using Orifice Plate = ft (relative to basin bottom at Stage = 0 ft)
 Orifice Plate: Orifice Vertical Spacing = inches
 Orifice Plate: Orifice Area per Row = sq. inches (diameter = 11/16 inch)

Calculated Parameters for Plate

WQ Orifice Area per Row = ft²
 Elliptical Half-Width = feet
 Elliptical Slot Centroid = feet
 Elliptical Slot Area = ft²

User Input: Stage and Total Area of Each Orifice Row (numbered from lowest to highest)

	Row 1 (required)	Row 2 (optional)	Row 3 (optional)	Row 4 (optional)	Row 5 (optional)	Row 6 (optional)	Row 7 (optional)	Row 8 (optional)
Stage of Orifice Centroid (ft)	0.00	0.76	1.51					
Orifice Area (sq. inches)	0.37	0.37	0.37					

	Row 9 (optional)	Row 10 (optional)	Row 11 (optional)	Row 12 (optional)	Row 13 (optional)	Row 14 (optional)	Row 15 (optional)	Row 16 (optional)
Stage of Orifice Centroid (ft)								
Orifice Area (sq. inches)								

User Input: Vertical Orifice (Circular or Rectangular)

	Zone 2 Rectangular	Not Selected	
Invert of Vertical Orifice =	2.27	N/A	ft (relative to basin bottom at Stage = 0 ft)
Depth at top of Zone using Vertical Orifice =	3.69	N/A	ft (relative to basin bottom at Stage = 0 ft)
Vertical Orifice Height =	1.00	N/A	inches
Vertical Orifice Width =	12.00		inches

Calculated Parameters for Vertical Orifice

	Zone 2 Rectangular	Not Selected	
Vertical Orifice Area =	0.08	N/A	ft ²
Vertical Orifice Centroid =	0.04	N/A	feet

User Input: Overflow Weir (Dropbox with Flat or Sloped Gate and Outlet Pipe OR Rectangular/Trapezoidal Weir (and No Outlet Pipe))

	Zone 3 Weir	Not Selected	
Overflow Weir Front Edge Height, H _o =	3.23	N/A	ft (relative to basin bottom at Stage = 0 ft)
Overflow Weir Front Edge Length =	3.00	N/A	feet
Overflow Weir Gate Slope =	0.00	N/A	H:V
Horiz. Length of Weir Sides =	6.00	N/A	feet
Overflow Gate Open Area % =	50%	N/A	%, gate open area/total area
Debris Clogging % =	50%	N/A	%

Calculated Parameters for Overflow Weir

	Zone 3 Weir	Not Selected	
Height of Gate Upper Edge, H _u =	3.23	N/A	feet
Overflow Weir Slope Length =	6.00	N/A	feet
Gate Open Area / 100-yr Orifice Area =	5.09	N/A	
Overflow Gate Open Area w/o Debris =	9.00	N/A	ft ²
Overflow Gate Open Area w/ Debris =	4.50	N/A	ft ²

User Input: Outlet Pipe w/ Flow Restriction Plate (Circular Orifice, Restrictor Plate, or Rectangular Orifice)

	Zone 3 Restrictor	Not Selected	
Depth to Invert of Outlet Pipe =	0.00	N/A	ft (distance below basin bottom at Stage = 0 ft)
Outlet Pipe Diameter =	18.00	N/A	inches
Restrictor Plate Height Above Pipe Invert =	18.00		inches

Calculated Parameters for Outlet Pipe w/ Flow Restriction Plate

	Zone 3 Restrictor	Not Selected	
Outlet Orifice Area =	1.77	N/A	ft ²
Outlet Orifice Centroid =	0.75	N/A	feet
Half-Central Angle of Restrictor Plate on Pipe =	3.14	N/A	radians

User Input: Emergency Spillway (Rectangular or Trapezoidal)

Spillway Invert Stage =	4.23	ft (relative to basin bottom at Stage = 0 ft)
Spillway Crest Length =	10.00	feet
Spillway End Slopes =	4.00	H:V
Freeboard above Max Water Surface =	0.50	feet

Calculated Parameters for Spillway

Spillway Design Flow Depth =	0.44	feet
Stage at Top of Freeboard =	5.17	feet
Basin Area at Top of Freeboard =	0.22	acres
Basin Volume at Top of Freeboard =	0.58	acre-ft

top micropool = 5842.77 = stage 0

Routed Hydrograph Results

The user can override the default CUHP hydrographs and runoff volumes by entering new values in the Inflow Hydrographs table (Columns W through AF).

	WQCV	EURV	2 Year	5 Year	10 Year	25 Year	50 Year	100 Year	500 Year
Design Storm Return Period =									
One-Hour Rainfall Depth (in) =	N/A	N/A	1.19	1.50	1.75	2.00	2.25	2.52	3.14
CUHP Runoff Volume (acre-ft) =	0.090	0.290	0.270	0.379	0.474	0.597	0.699	0.827	1.089
Inflow Hydrograph Volume (acre-ft) =	N/A	N/A	0.270	0.379	0.474	0.597	0.699	0.827	1.089
CUHP Predevelopment Peak Q (cfs) =	N/A	N/A	0.3	1.0	1.5	2.8	3.5	4.5	6.3
OPTIONAL Override Predevelopment Peak Q (cfs) =	N/A	N/A							
Predevelopment Unit Peak Flow, q (cfs/acre) =	N/A	N/A	0.07	0.20	0.31	0.57	0.72	0.92	1.29
Peak Inflow Q (cfs) =	N/A	N/A	3.2	4.5	5.5	7.4	8.6	10.2	13.3
Peak Outflow Q (cfs) =	0.0	5.8	0.4	1.9	2.9	5.1	6.5	8.4	11.7
Ratio Peak Outflow to Predevelopment Q =	N/A	N/A	N/A	1.9	2.0	1.8	1.9	1.9	1.9
Structure Controlling Flow =	Vertical Orifice 1	Overflow Weir 1	Vertical Orifice 1	Overflow Weir 1	Overflow Weir 1	Overflow Weir 1	Overflow Weir 1	Overflow Weir 1	Overflow Weir 1
Max Velocity through Gate 1 (fps) =	N/A	0.96	N/A	0.2	0.3	0.5	0.7	0.9	1.2
Max Velocity through Gate 2 (fps) =	N/A	N/A	N/A	N/A	N/A	N/A	N/A	N/A	N/A
Time to Drain 97% of Inflow Volume (hours) =	37	38	40	38	36	34	33	31	28
Time to Drain 99% of Inflow Volume (hours) =	40	45	46	45	44	43	42	40	39
Maximum Ponding Depth (ft) =	2.27	3.69	3.20	3.37	3.43	3.53	3.59	3.66	3.77
Area at Maximum Ponding Depth (acres) =	0.11	0.17	0.15	0.16	0.16	0.16	0.16	0.17	0.17
Maximum Volume Stored (acre-ft) =	0.091	0.291	0.213	0.238	0.247	0.265	0.275	0.286	0.305

Design Procedure Form: Extended Detention Basin (EDB)

UD-BMP (Version 3.07, March 2018)

Sheet 1 of 3

Designer: Richard Schindler
Company: Core Engineering Group
Date: July 17, 2021
Project: The ridge at Lorson Ranch
Location: Pond F

<p>1. Basin Storage Volume</p> <p>A) Effective Imperviousness of Tributary Area, I_a</p> <p>B) Tributary Area's Imperviousness Ratio ($i = I_a / 100$)</p> <p>C) Contributing Watershed Area</p> <p>D) For Watersheds Outside of the Denver Region, Depth of Average Runoff Producing Storm</p> <p>E) Design Concept (Select EURV when also designing for flood control)</p> <p>F) Design Volume (WQCV) Based on 40-hour Drain Time ($V_{DESIGN} = (1.0 * (0.91 * i^3 - 1.19 * i^2 + 0.78 * i) / 12 * Area)$)</p> <p>G) For Watersheds Outside of the Denver Region, Water Quality Capture Volume (WQCV) Design Volume ($V_{WQCV\ OTHER} = (d_6 * V_{DESIGN} * 0.43)$)</p> <p>H) User Input of Water Quality Capture Volume (WQCV) Design Volume (Only if a different WQCV Design Volume is desired)</p> <p>I) NRCS Hydrologic Soil Groups of Tributary Watershed i) Percentage of Watershed consisting of Type A Soils ii) Percentage of Watershed consisting of Type B Soils iii) Percentage of Watershed consisting of Type C/D Soils</p> <p>J) Excess Urban Runoff Volume (EURV) Design Volume For HSG A: $EURV_A = 1.68 * i^{1.28}$ For HSG B: $EURV_B = 1.36 * i^{1.08}$ For HSG C/D: $EURV_{C/D} = 1.20 * i^{1.08}$</p> <p>K) User Input of Excess Urban Runoff Volume (EURV) Design Volume (Only if a different EURV Design Volume is desired)</p>	<p>$I_a =$ <input type="text" value="55.0"/> %</p> <p>$i =$ <input type="text" value="0.550"/></p> <p>Area = <input type="text" value="4.900"/> ac</p> <p>$d_6 =$ <input type="text" value=""/></p> <div style="border: 1px solid black; padding: 5px; margin: 5px 0;"> <p>Choose One</p> <p><input checked="" type="radio"/> Water Quality Capture Volume (WQCV)</p> <p><input type="radio"/> Excess Urban Runoff Volume (EURV)</p> </div> <p>$V_{DESIGN} =$ <input type="text" value=""/> ac-ft</p> <p>$V_{DESIGN\ OTHER} =$ <input type="text" value=""/> ac-ft</p> <p>$V_{DESIGN\ USER} =$ <input type="text" value="0.120"/> ac-ft</p> <p>HSG $A =$ <input type="text" value=""/> % HSG $B =$ <input type="text" value=""/> % HSG $C/D =$ <input type="text" value=""/> %</p> <p>$EURV_{DESIGN} =$ <input type="text" value=""/> ac-ft</p> <p>$EURV_{DESIGN\ USER} =$ <input type="text" value=""/> ac-ft</p>
<p>2. Basin Shape: Length to Width Ratio (A basin length to width ratio of at least 2:1 will improve TSS reduction.)</p>	<p>L : W = <input type="text" value="2.0"/> : 1</p>
<p>3. Basin Side Slopes</p> <p>A) Basin Maximum Side Slopes (Horizontal distance per unit vertical, 4:1 or flatter preferred)</p>	<p>Z = <input type="text" value="4.00"/> ft / ft</p>
<p>4. Inlet</p> <p>A) Describe means of providing energy dissipation at concentrated inflow locations:</p>	<p>_____</p> <p>_____</p> <p>_____</p>
<p>5. Forebay</p> <p>A) Minimum Forebay Volume ($V_{MIN} =$ <input type="text" value="2%"/> of the WQCV)</p> <p>B) Actual Forebay Volume</p> <p>C) Forebay Depth ($D_F =$ <input type="text" value="18"/> inch maximum)</p> <p>D) Forebay Discharge</p> <p>i) Undetained 100-year Peak Discharge</p> <p>ii) Forebay Discharge Design Flow ($Q_F = 0.02 * Q_{100}$)</p> <p>E) Forebay Discharge Design</p> <p>F) Discharge Pipe Size (minimum 8-inches)</p> <p>G) Rectangular Notch Width</p>	<p>$V_{MIN} =$ <input type="text" value="0.002"/> ac-ft</p> <p>$V_F =$ <input type="text" value="0.004"/> ac-ft</p> <p>$D_F =$ <input type="text" value="18.0"/> in</p> <p>$Q_{100} =$ <input type="text" value="17.60"/> cfs</p> <p>$Q_F =$ <input type="text" value="0.35"/> cfs</p> <div style="border: 1px solid black; padding: 5px; margin: 5px 0;"> <p>Choose One</p> <p><input type="radio"/> Berm With Pipe</p> <p><input checked="" type="radio"/> Wall with Rect. Notch</p> <p><input type="radio"/> Wall with V-Notch Weir</p> </div> <p>Flow too small for berm w/ pipe</p> <p>Calculated $D_P =$ <input type="text" value=""/> in</p> <p>Calculated $W_N =$ <input type="text" value="4.3"/> in</p>

Design Procedure Form: Extended Detention Basin (EDB)

Sheet 2 of 3

Designer: Richard Schindler
Company: Core Engineering Group
Date: July 17, 2021
Project: The ridge at Lorson Ranch
Location: Pond F

<p>6. Trickle Channel</p> <p>A) Type of Trickle Channel</p> <p>F) Slope of Trickle Channel</p>	<div style="border: 1px solid black; padding: 2px; margin-bottom: 5px;"> Choose One <input checked="" type="radio"/> Concrete <input type="radio"/> Soft Bottom </div> <p>S = <input style="width: 50px;" type="text" value="0.0050"/> ft / ft</p>
<p>7. Micropool and Outlet Structure</p> <p>A) Depth of Micropool (2.5-foot minimum)</p> <p>B) Surface Area of Micropool (10 ft² minimum)</p> <p>C) Outlet Type</p> <p>D) Smallest Dimension of Orifice Opening Based on Hydrograph Routing (Use UD-Detention)</p> <p>E) Total Outlet Area</p>	<p>D_M = <input style="width: 50px;" type="text" value="2.5"/> ft</p> <p>A_M = <input style="width: 50px;" type="text" value="50"/> sq ft</p> <div style="border: 1px solid black; padding: 2px; margin-bottom: 5px;"> Choose One <input checked="" type="radio"/> Orifice Plate <input type="radio"/> Other (Describe): </div> <hr/> <hr/> <p>D_{orifice} = <input style="width: 50px;" type="text" value="2.01"/> inches</p> <p>A_{orifice} = <input style="width: 50px;" type="text" value="12.60"/> square inches</p>
<p>8. Initial Surcharge Volume</p> <p>A) Depth of Initial Surcharge Volume (Minimum recommended depth is 4 inches)</p> <p>B) Minimum Initial Surcharge Volume (Minimum volume of 0.3% of the WQCV)</p> <p>C) Initial Surcharge Provided Above Micropool</p>	<p>D_{IS} = <input style="width: 50px;" type="text" value="4"/> in</p> <p>V_{IS} = <input style="width: 50px;" type="text"/> cu ft</p> <p>V_s = <input style="width: 50px;" type="text" value="16.7"/> cu ft</p>
<p>9. Trash Rack</p> <p>A) Water Quality Screen Open Area: $A_t = A_{ot} * 38.5 * (e^{-0.095D})$</p> <p>B) Type of Screen (If specifying an alternative to the materials recommended in the USDCM, indicate "other" and enter the ratio of the total open area to the total screen area for the material specified.)</p> <p style="margin-left: 40px;">Other (Y/N): <input style="width: 80px;" type="text" value="y"/></p> <p>C) Ratio of Total Open Area to Total Area (only for type 'Other')</p> <p>D) Total Water Quality Screen Area (based on screen type)</p> <p>E) Depth of Design Volume (EURV or WQCV) (Based on design concept chosen under 1E)</p> <p>F) Height of Water Quality Screen (H_{TR})</p> <p>G) Width of Water Quality Screen Opening (W_{opening}) (Minimum of 12 inches is recommended)</p>	<p>A_t = <input style="width: 50px;" type="text" value="401"/> square inches</p> <div style="border: 1px solid black; padding: 2px; margin-bottom: 5px; width: 100%;"> Other (Please describe below) </div> <p>wellscreen stainless</p> <hr/> <hr/> <p>User Ratio = <input style="width: 50px;" type="text" value="0.6"/></p> <p>A_{total} = <input style="width: 50px;" type="text" value="668"/> sq. in. Based on type 'Other' screen ratio</p> <p>H = <input style="width: 50px;" type="text" value="2.14"/> feet</p> <p>H_{TR} = <input style="width: 50px;" type="text" value="53.68"/> inches</p> <p>W_{opening} = <input style="width: 50px;" type="text" value="12.4"/> inches</p>

Design Procedure Form: Extended Detention Basin (EDB)

Sheet 3 of 3

Designer: R. Schindler
Company: Core Engineering Group
Date: November 5, 2021
Project: The Ridge at Lorson Ranch
Location: Pond F - WQ pond only

<p>10. Overflow Embankment</p> <p>A) Describe embankment protection for 100-year and greater overtopping:</p> <p>B) Slope of Overflow Embankment (Horizontal distance per unit vertical, 4:1 or flatter preferred)</p>	<p>TRM added to emergency overflow. All of 100-year flows will enter outlet structure before entering emergency overflow.</p> <p>Ze = <input type="text" value="4.00"/> ft / ft</p>
<p>11. Vegetation</p>	<p>Choose One</p> <p><input type="radio"/> Irrigated</p> <p><input type="radio"/> Not Irrigated</p>
<p>12. Access</p> <p>A) Describe Sediment Removal Procedures</p>	<p>_____</p> <p>_____</p> <p>_____</p> <p>_____</p> <p>_____</p>
<p>Notes: _____</p> <p>_____</p> <p>_____</p> <p>_____</p>	

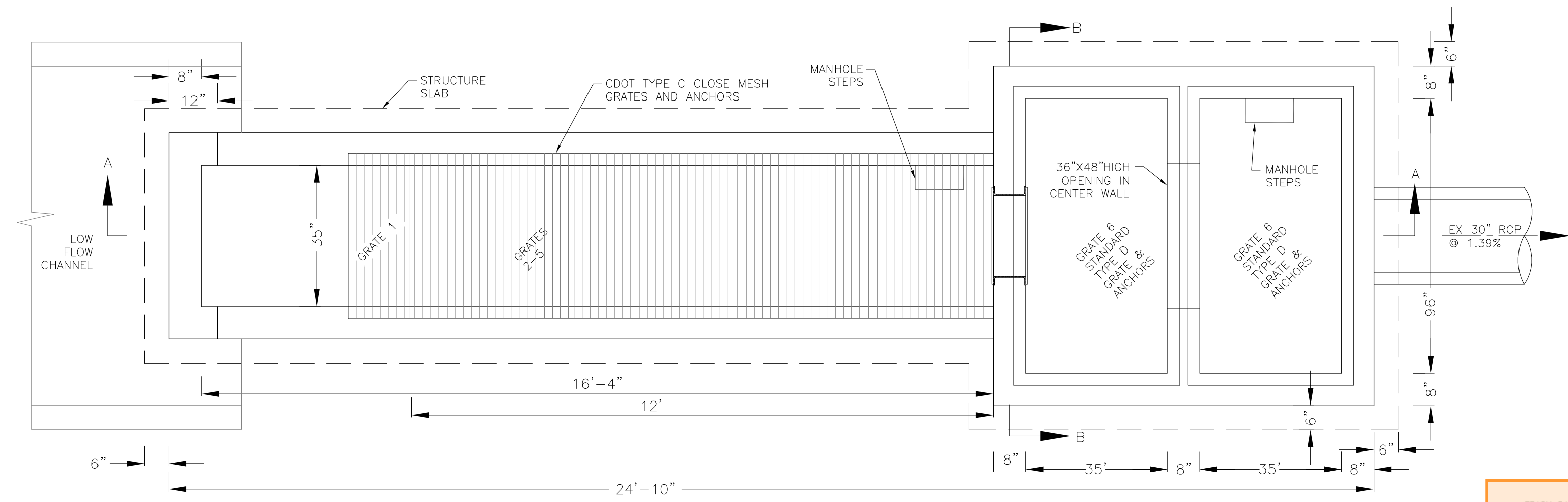
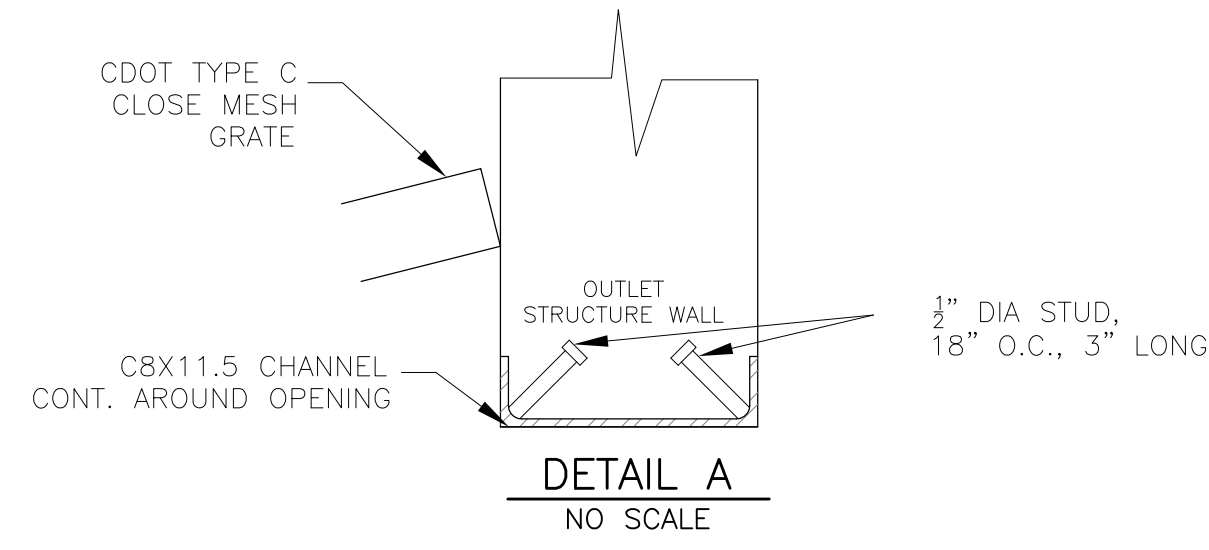

This sheet and the other two sheets below this one need to be included in the CD's.

NOTE: AFTER CONCRETE STRUCTURE HAS BEEN POURED ALL GRATE DIMENSIONS SHALL BE FIELD VERIFIED PRIOR TO GRATE CONSTRUCTION

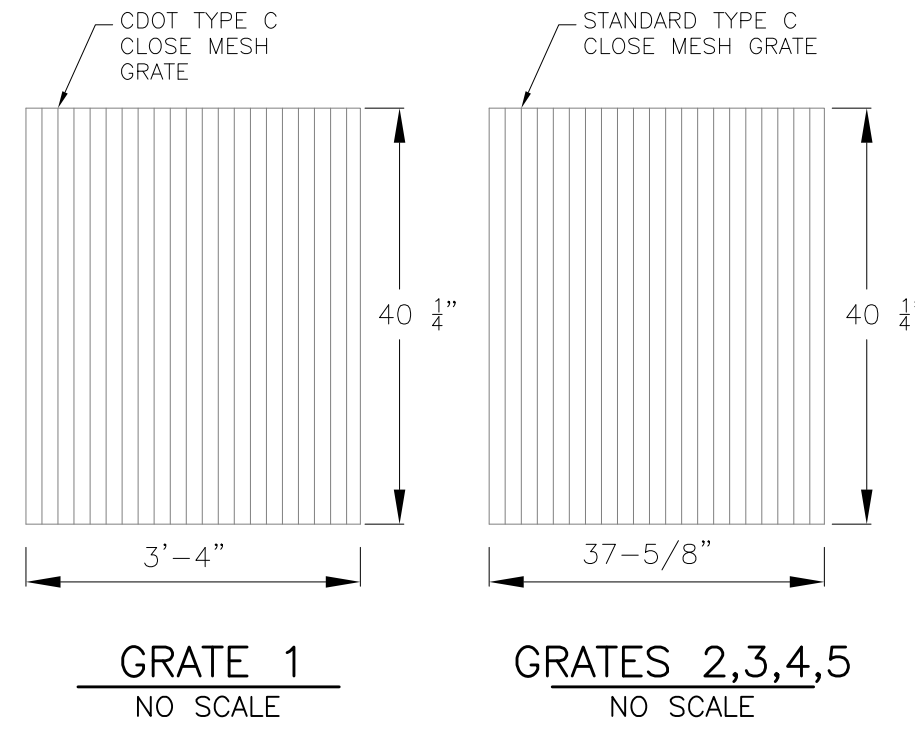

OUTLET STRUCTURE DETAIL - PLAN VIEW
NO SCALE

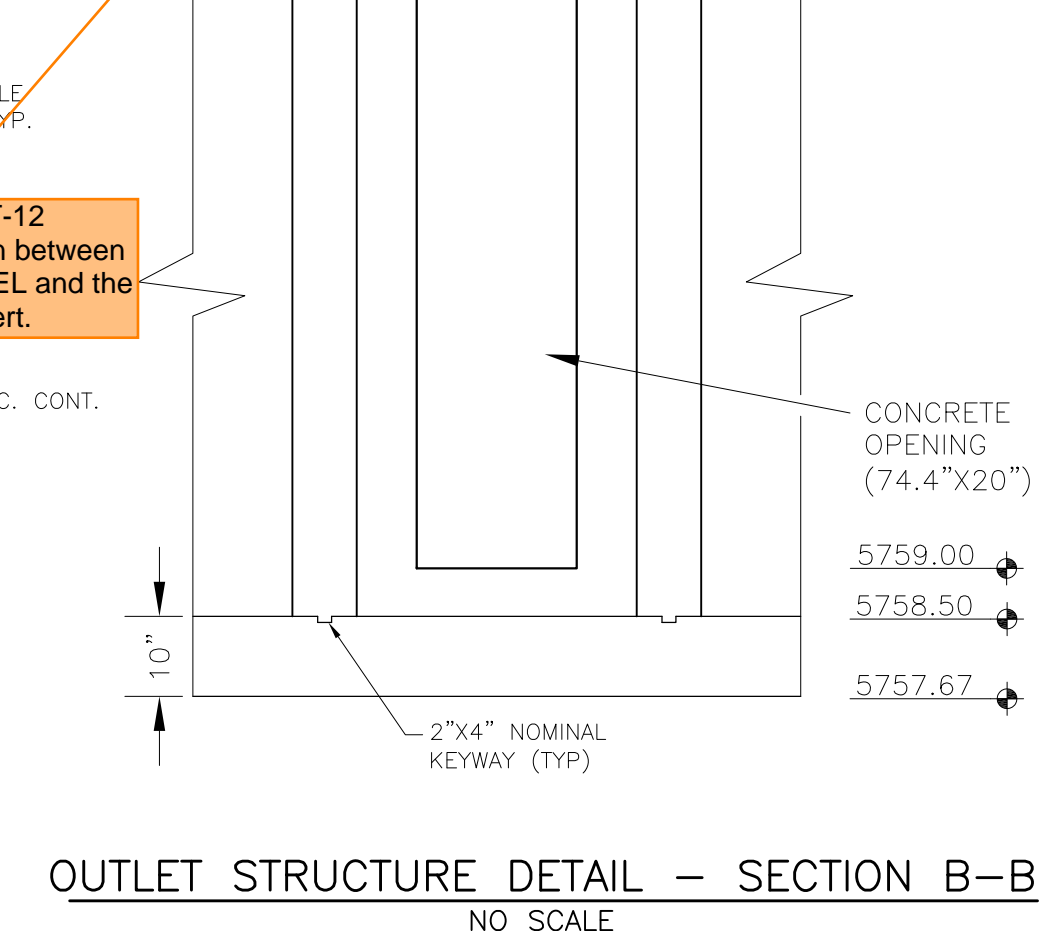
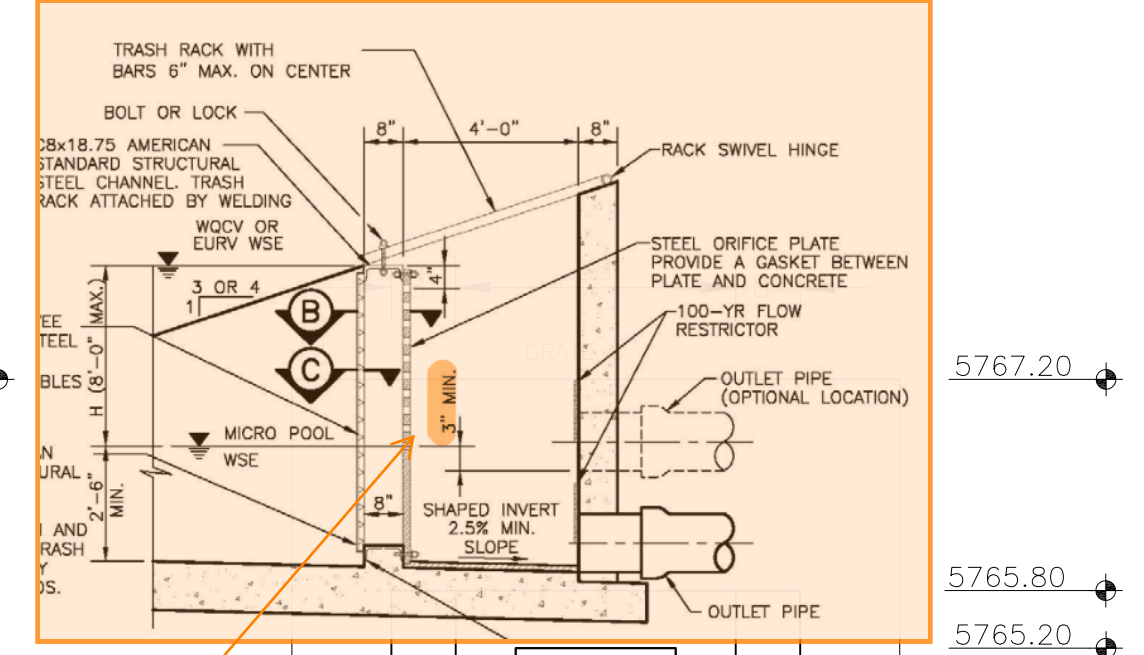
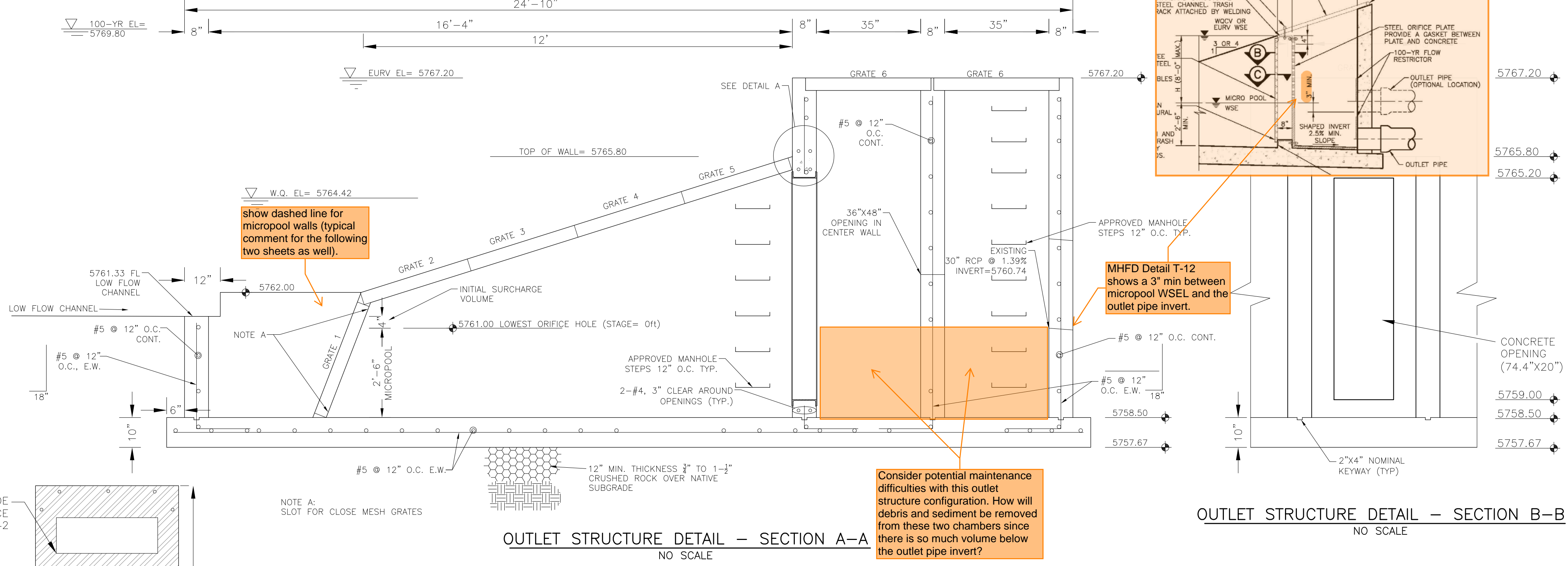

show dashed line for micropool walls (typical comment for the following two sheets as well).

MHFD Detail T-12 shows a 3\"/>

Consider potential maintenance difficulties with this outlet structure configuration. How will debris and sediment be removed from these two chambers since there is so much volume below the outlet pipe invert?

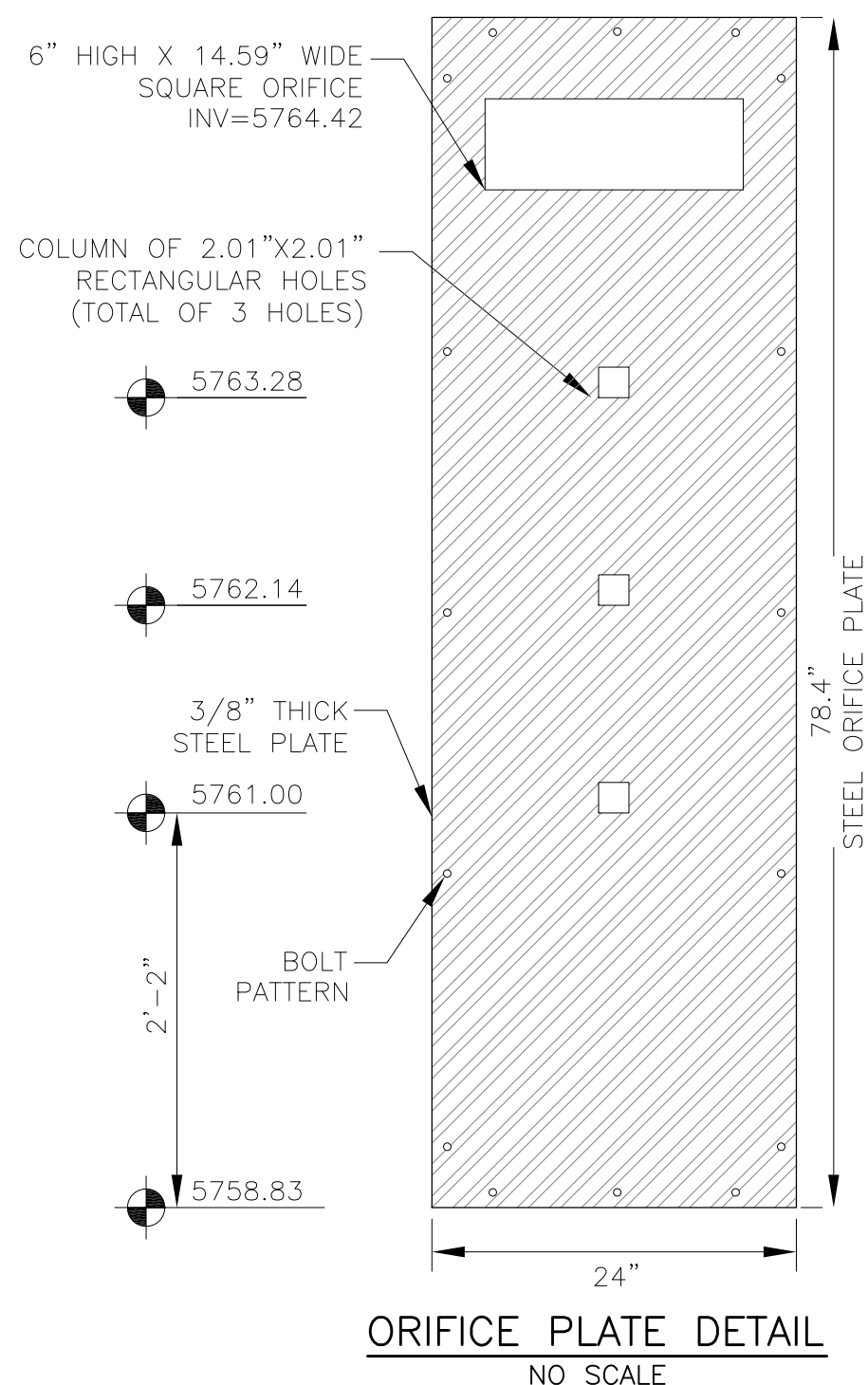
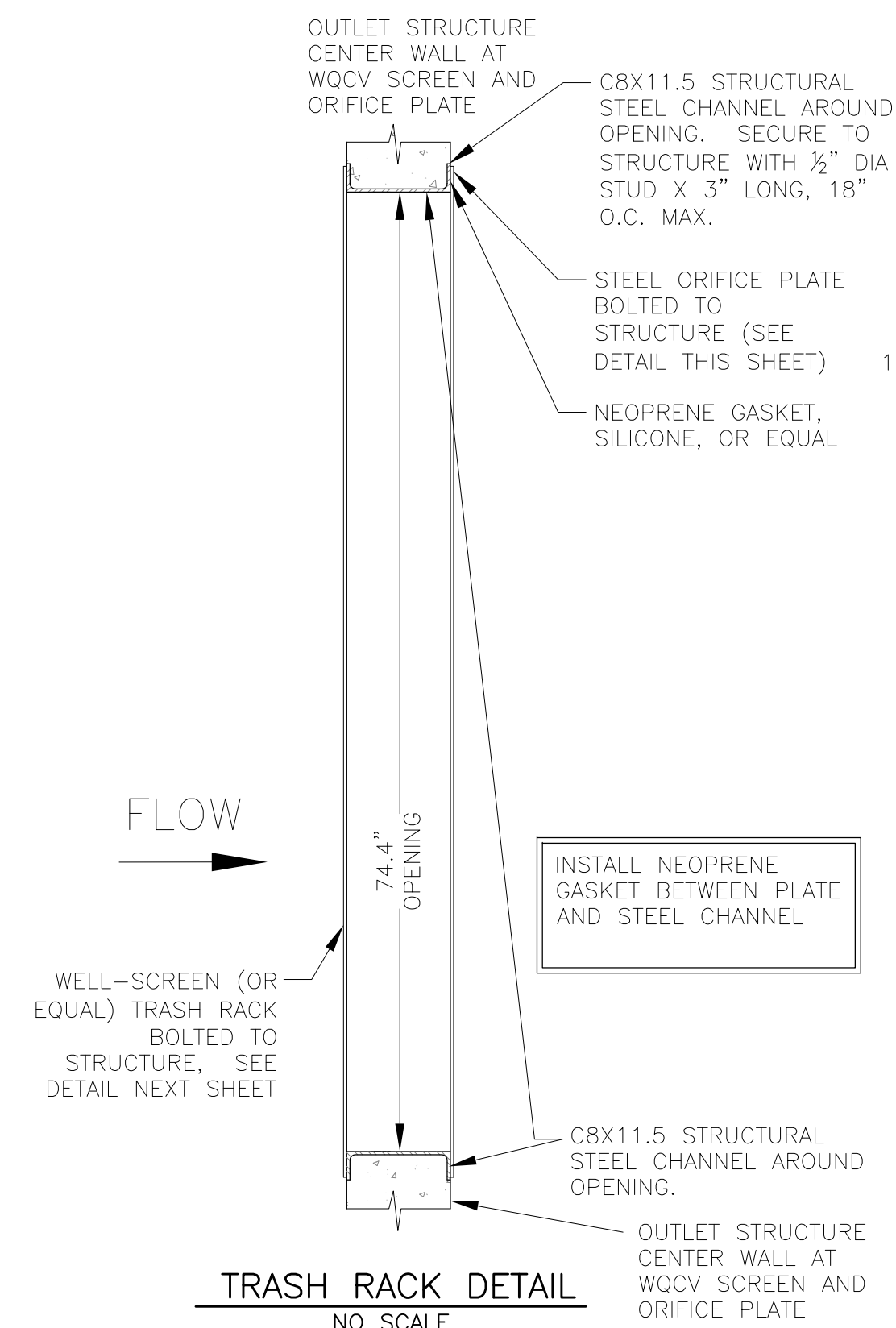

OUTLET STRUCTURE, FOREBAY, AND DRAIN CHANNEL NOTES:

- PRIOR TO CONSTRUCTION, CONTRACTOR SHALL PROVIDE SHOP DRAWINGS FOR ALL COMPONENTS OF THE OUTLET STRUCTURE.
 - GRADE 60 REINFORCING STEEL REQUIRED. SEE TABLE FOR THE MINIMUM LAP SPLICE LENGTH FOR REINFORCING BARS. ALL REINFORCING STEEL SHALL HAVE A TWO-INCH MINIMUM CLEARANCE FROM EDGE OF CONCRETE, UNLESS OTHERWISE NOTED.
- | BAR SIZE | #4 | #5 | #6 |
|--------------------|-------|-------|-------|
| MIN. SPLICE LENGTH | 1'-3" | 1'-7" | 2'-0" |
- CONCRETE FOR THE OUTLET STRUCTURE AND FOREBAY SHALL BE CDOT CLASS D CONCRETE.
 - CONCRETE FOR DRAIN CHANNELS SHALL BE CDOT CLASS B CONCRETE
 - EXPANSION JOINT MATERIAL SHALL MEET AASHTO SPECIFICATION M-213. EXPANSION JOINT MATERIAL SHALL BE 1/2" THICK, SHALL EXTEND THE FULL DEPTH OF CONTACT SURFACE AND THE JOINT SHALL BE SEALED, REFER TO DETAILS.
 - ALL EXPOSED CONCRETE CORNERS SHALL HAVE A 3/8" CHAMFER UNLESS OTHERWISE NOTED.
 - SUBGRADE TO BE 12" THICK CLEAN FILL COMPACTED TO 95% STANDARD PROCTOR DENSITY PER ASTM M698 UNDER STRUCTURE.
 - REFER TO POND DETAILS FOR PRESEDIMENTATION/FOREBAY DESIGN.
 - ENGINEER SHALL BE NOTIFIED PRIOR TO BEGINNING CONSTRUCTION OF OUTLET STRUCTURE TO SCHEDULE OBSERVATION VISITS FOR STRUCTURES.

- WQCV WELL-SCREEN NOTES:
- Well-Screen shall be stainless steel and attached by stainless steel bolts along edge of the mounting frame.
 - WQCV Well Screen
 - Type of Screen: Stainless steel #93 Vee Wire (Johnson Vee Wire (tm) Stainless Steel Screen or equivalent with 60% open area)
 - Screen slot opening dimension: 0.139" (Screen #93 Vee Wire Slot Opening)
 - Type and Size of Support Rod: TE 0.074"x0.50"
 - Spacing of Support Rod (O.C.): 1.0 Inch
 - Total Screen Thickness: 0.655"
 - Carbon Steel Holding Frame Type: 3/4" x 1.0" angle

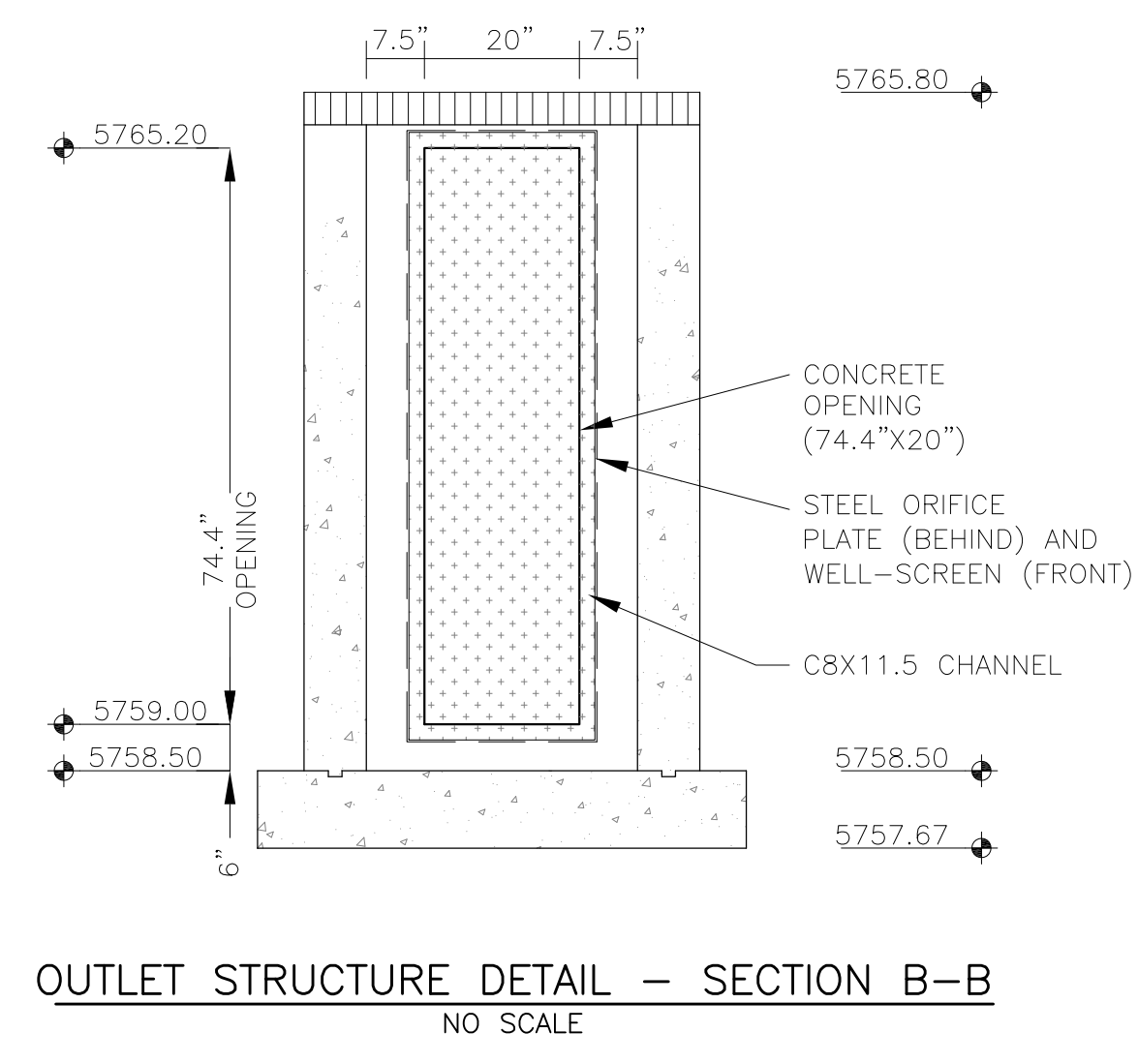

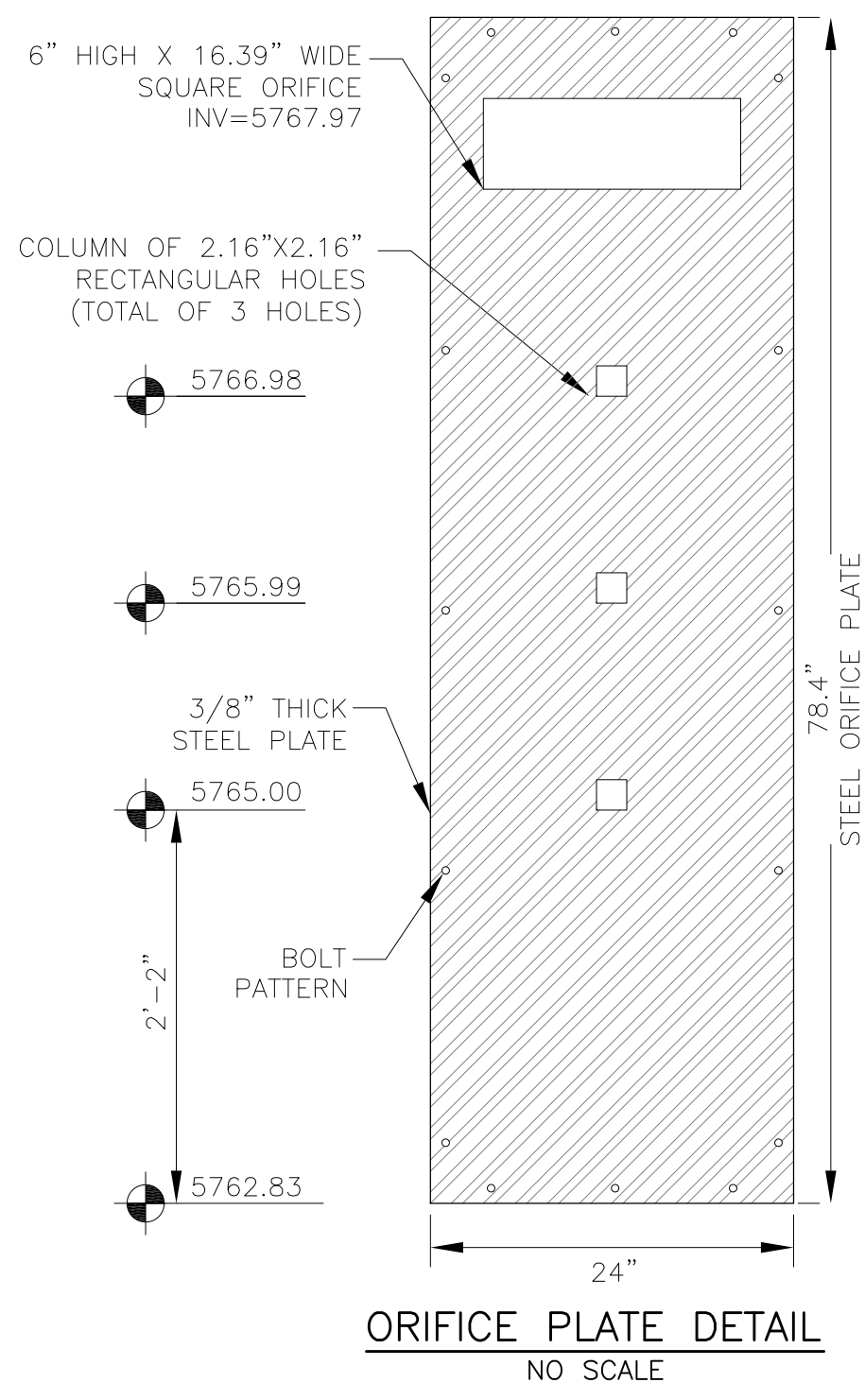
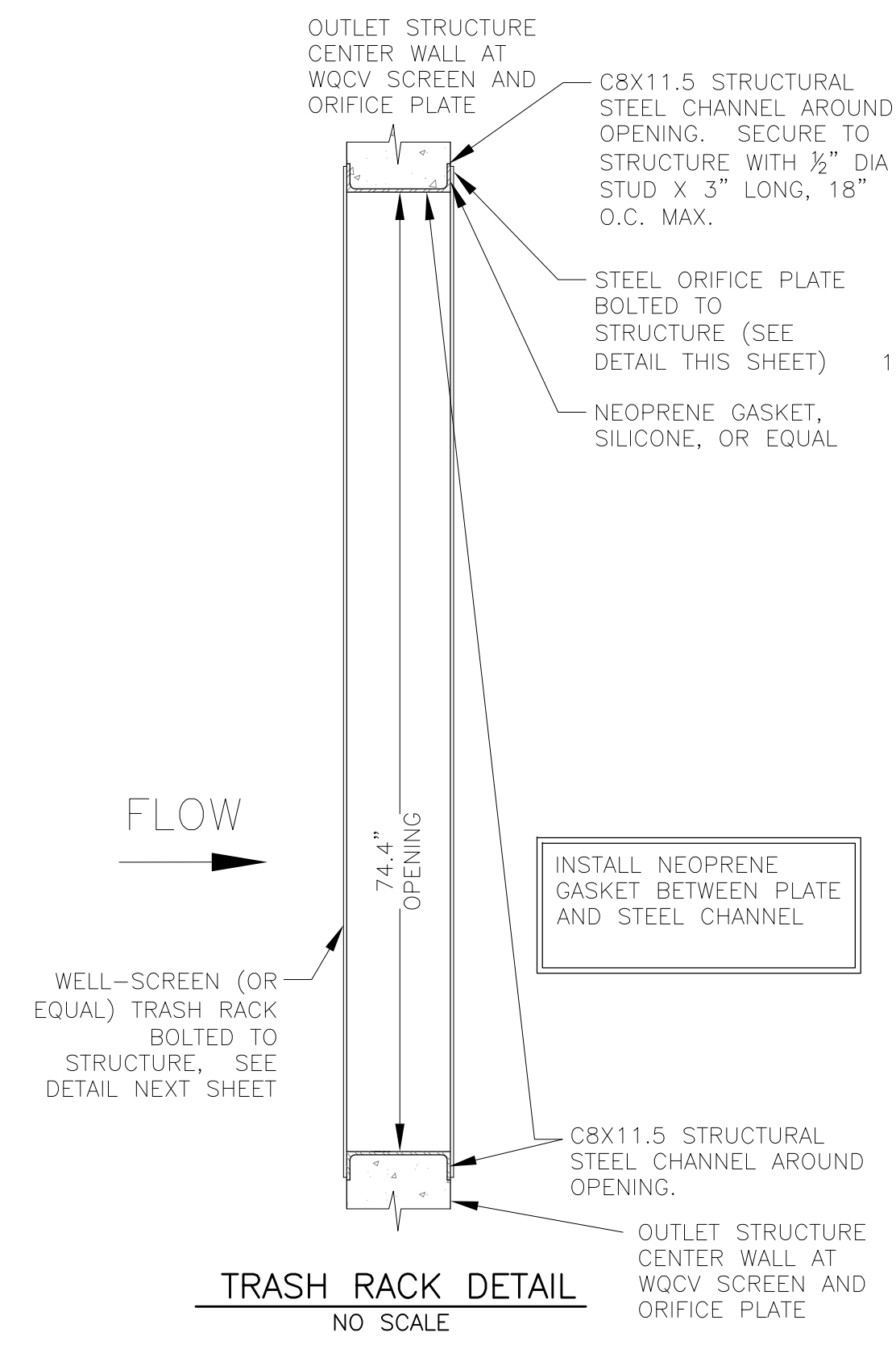
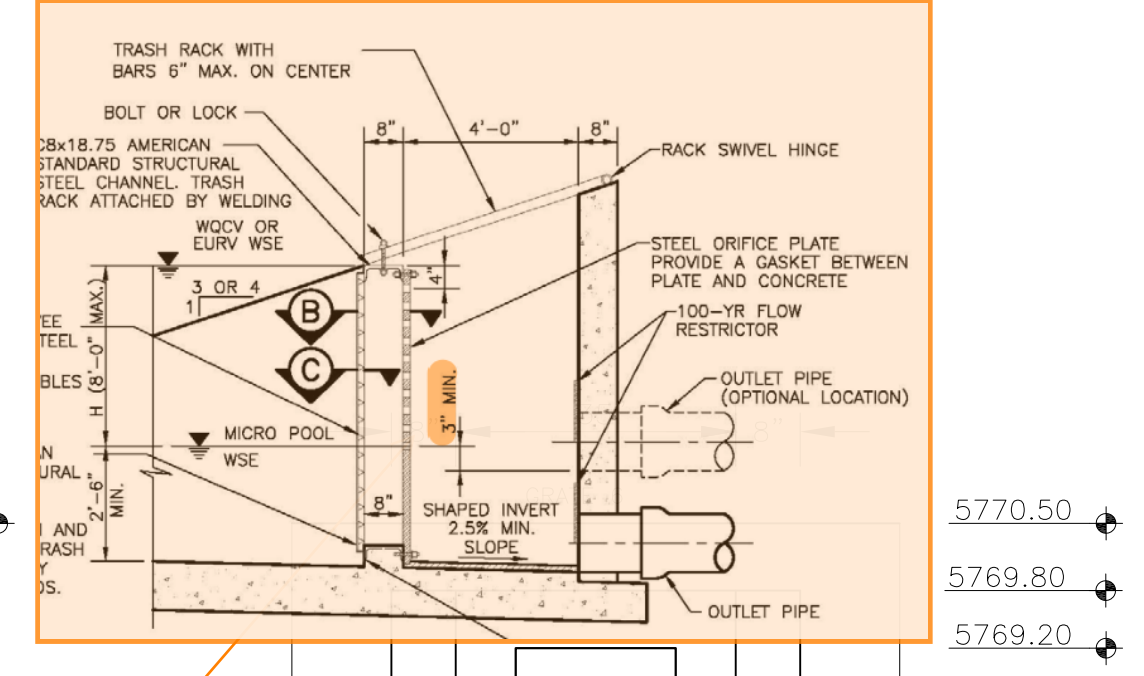
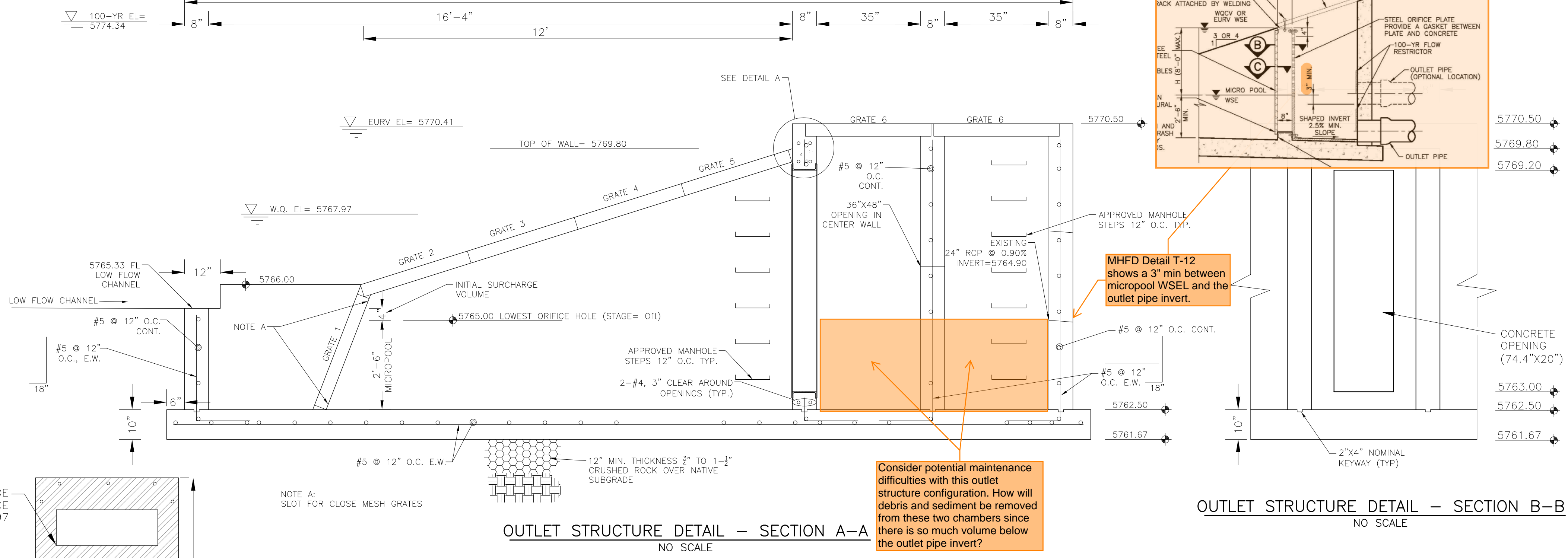
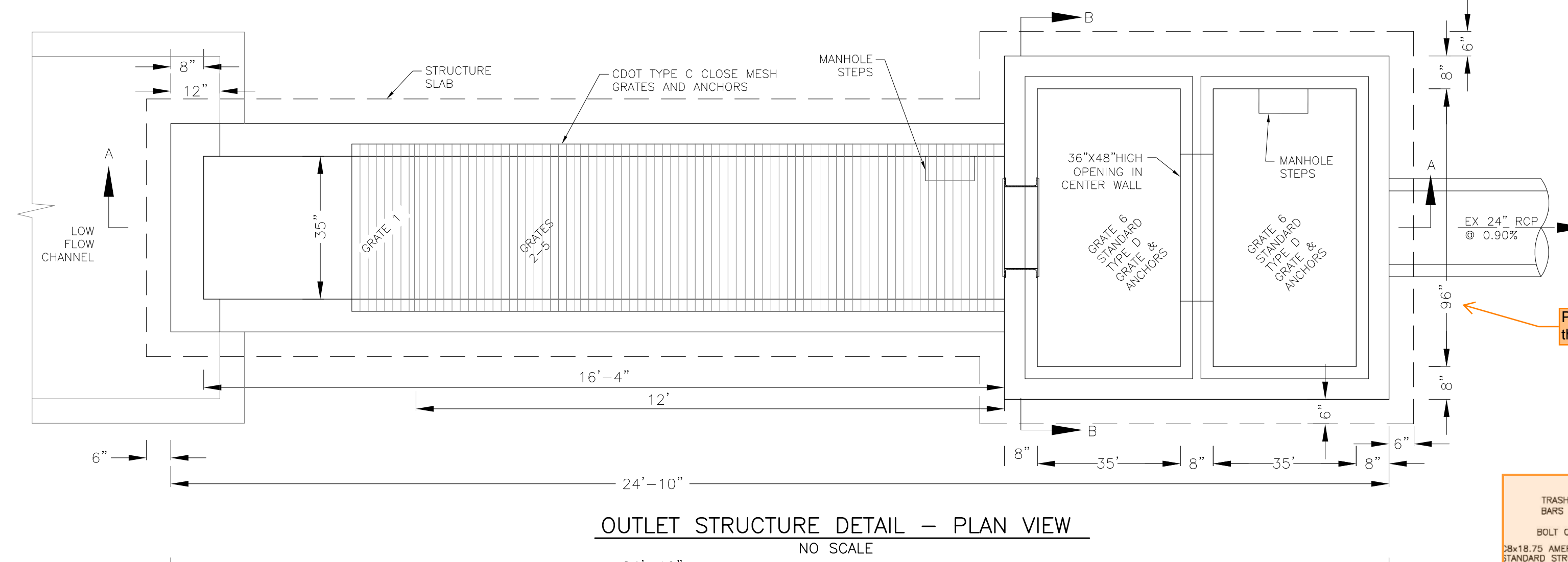
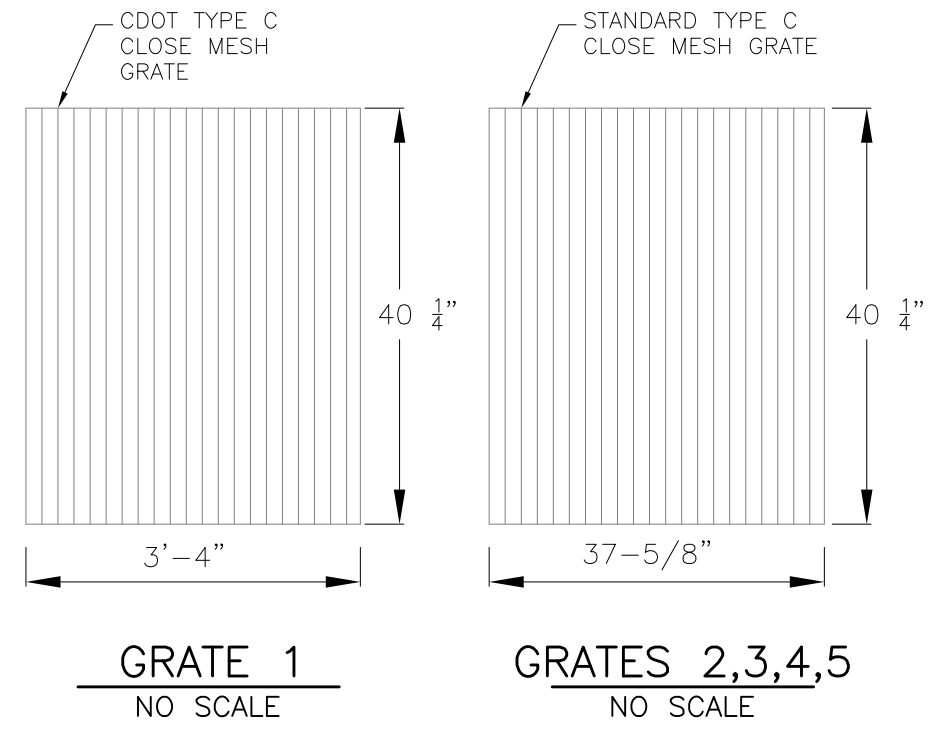
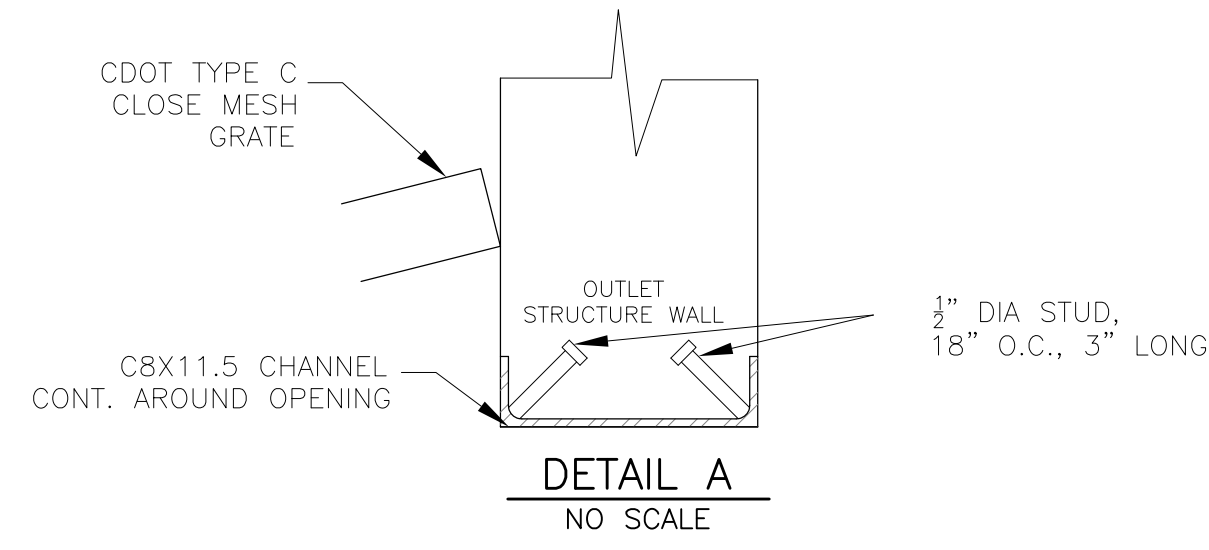

OUTLET STRUCTURE, FOREBAY, AND DRAIN CHANNEL NOTES:

- PRIOR TO CONSTRUCTION, CONTRACTOR SHALL PROVIDE SHOP DRAWINGS FOR ALL COMPONENTS OF THE OUTLET STRUCTURE.
 - GRADE 60 REINFORCING STEEL REQUIRED. SEE TABLE FOR THE MINIMUM LAP SPLICE LENGTH FOR REINFORCING BARS. ALL REINFORCING STEEL SHALL HAVE A TWO-INCH MINIMUM CLEARANCE FROM EDGE OF CONCRETE, UNLESS OTHERWISE NOTED.
- | BAR SIZE | #4 | #5 | #6 |
|--------------------|-------|-------|-------|
| MIN. SPLICE LENGTH | 1'-3" | 1'-7" | 2'-0" |
- CONCRETE FOR THE OUTLET STRUCTURE AND FOREBAY SHALL BE CDOT CLASS D CONCRETE.
 - CONCRETE FOR DRAIN CHANNELS SHALL BE CDOT CLASS B CONCRETE.
 - EXPANSION JOINT MATERIAL SHALL MEET AASHTO SPECIFICATION M-213. EXPANSION JOINT MATERIAL SHALL BE 1/2" THICK, SHALL EXTEND THE FULL DEPTH OF CONTACT SURFACE AND THE JOINT SHALL BE SEALED, REFER TO DETAILS.
 - ALL EXPOSED CONCRETE CORNERS SHALL HAVE A 3/8" CHAMFER UNLESS OTHERWISE NOTED.
 - SUBGRADE TO BE 12" THICK CLEAN FILL COMPACTED TO 95% STANDARD PROCTOR DENSITY PER ASTM M698 UNDER STRUCTURE.
 - REFER TO POND DETAILS FOR PRESEDIMENTATION/FOREBAY DESIGN.
 - ENGINEER SHALL BE NOTIFIED PRIOR TO BEGINNING CONSTRUCTION OF OUTLET STRUCTURE TO SCHEDULE OBSERVATION VISITS FOR STRUCTURES.

- WQCV WELL-SCREEN NOTES:**
- Well-Screen shall be stainless steel and attached by stainless steel bolts along edge of the mounting frame.
 - WQCV Well Screen
 - Type of Screen: Stainless steel #93 Vee Wire
 - (Johnson Vee Wire (tm) Stainless Steel Screen or equivalent with 60% open area)
 - Screen slot opening dimension: 0.139" (Screen #93 Vee Wire Slot Opening)
 - Type and Size of Support Rod: TE 0.074"x0.50"
 - Spacing of Support Rod (O.C.): 1.0 Inch
 - Total Screen Thickness: 0.655"
 - Carbon Steel Holding Frame Type: 3/4" x 1.0" angle

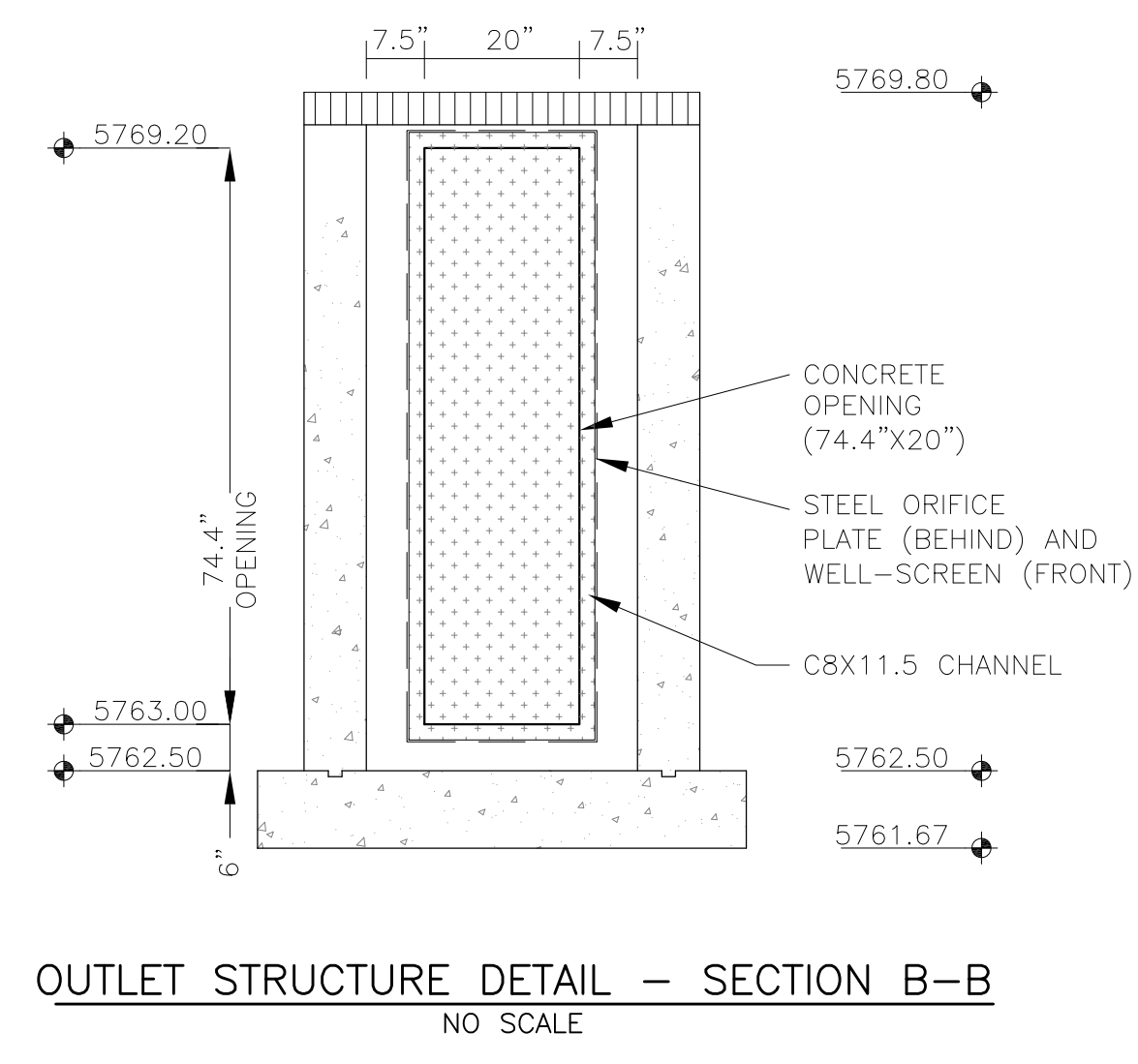

Pg 190 above shows that this should be 72"

MHFD Detail T-12 shows a 3" min between micropool WSEL and the outlet pipe invert.

Consider potential maintenance difficulties with this outlet structure configuration. How will debris and sediment be removed from these two chambers since there is so much volume below the outlet pipe invert?

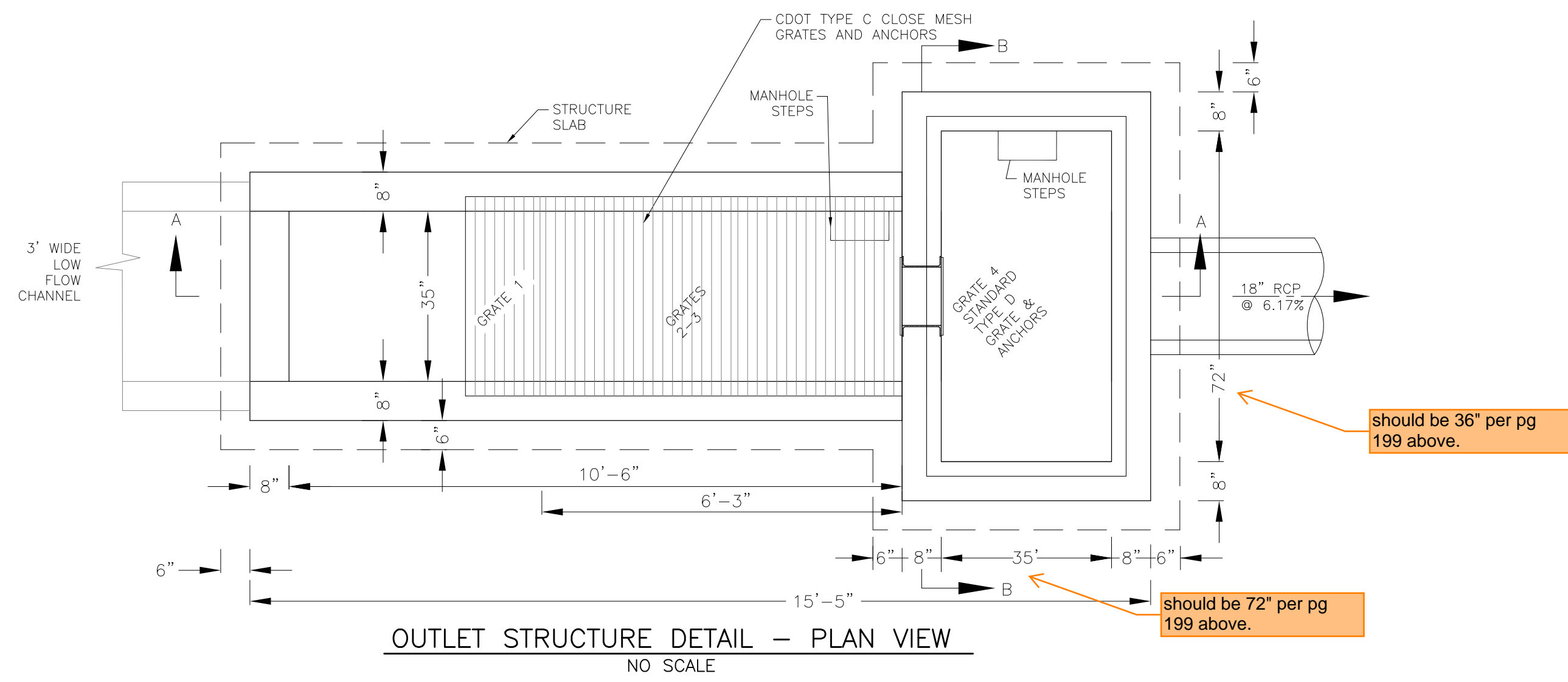
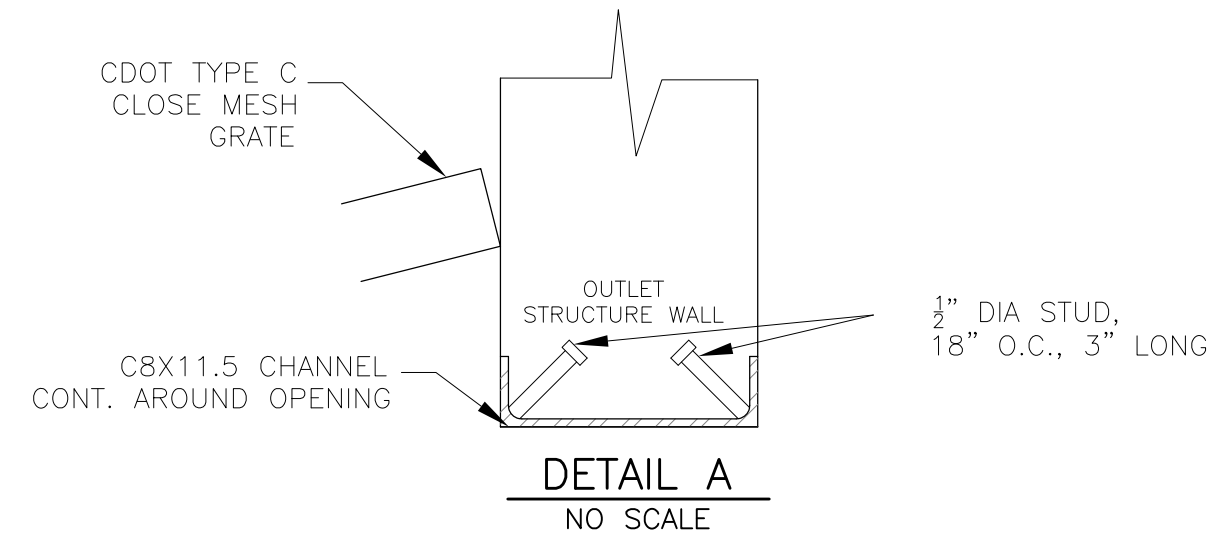

NOTE:
AFTER CONCRETE STRUCTURE HAS BEEN POURED
ALL GRATE DIMENSIONS SHALL BE FIELD VERIFIED
PRIOR TO GRATE CONSTRUCTION

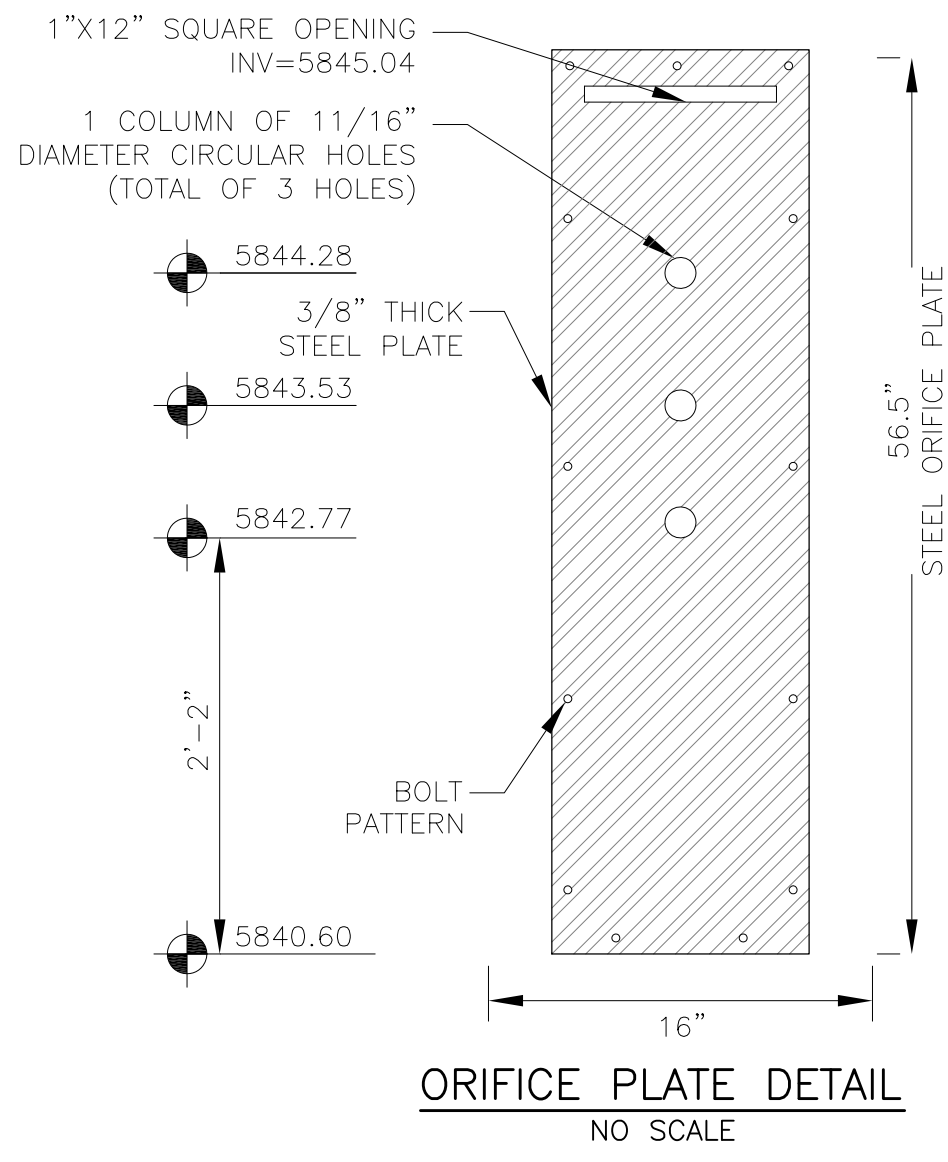
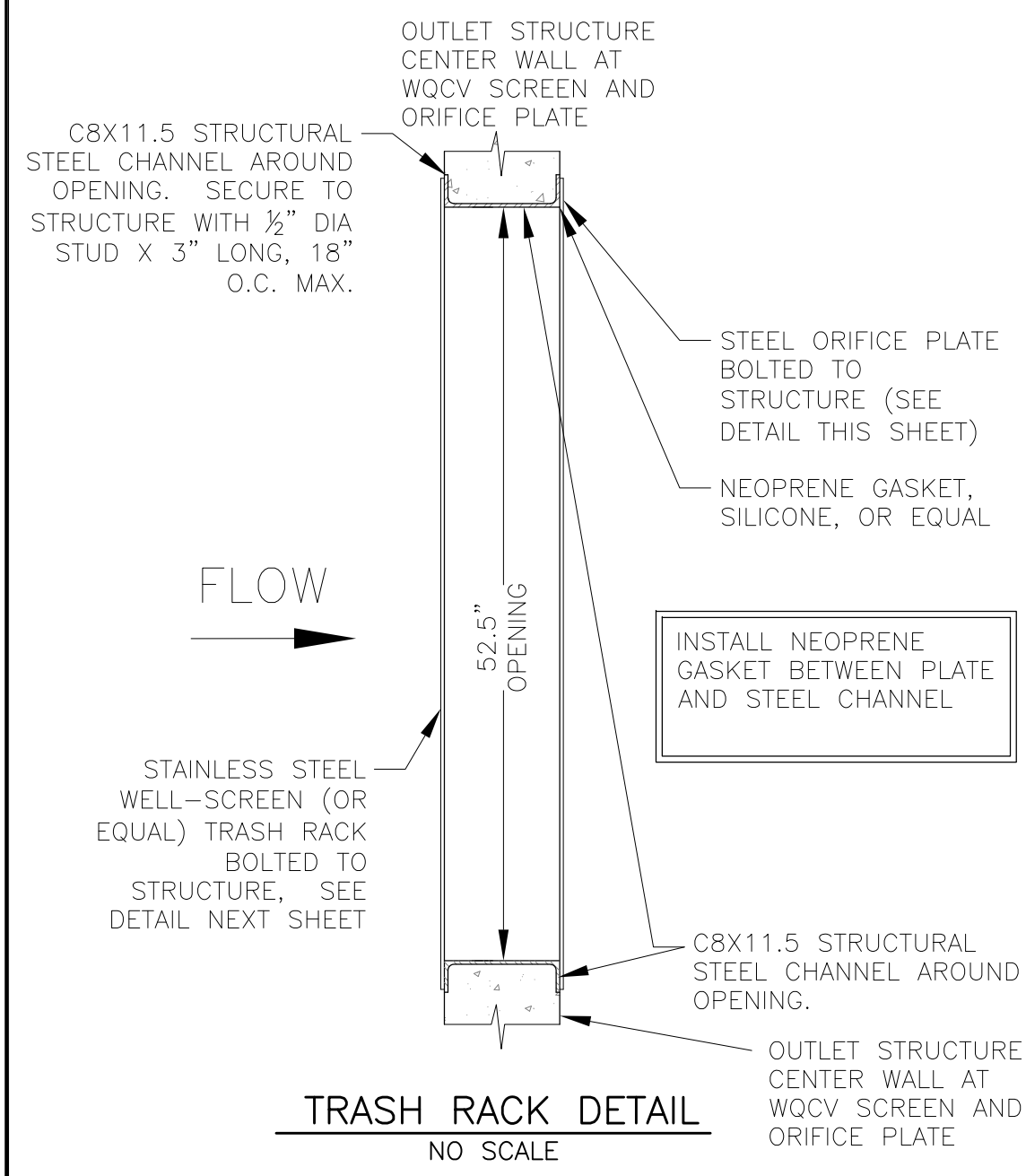
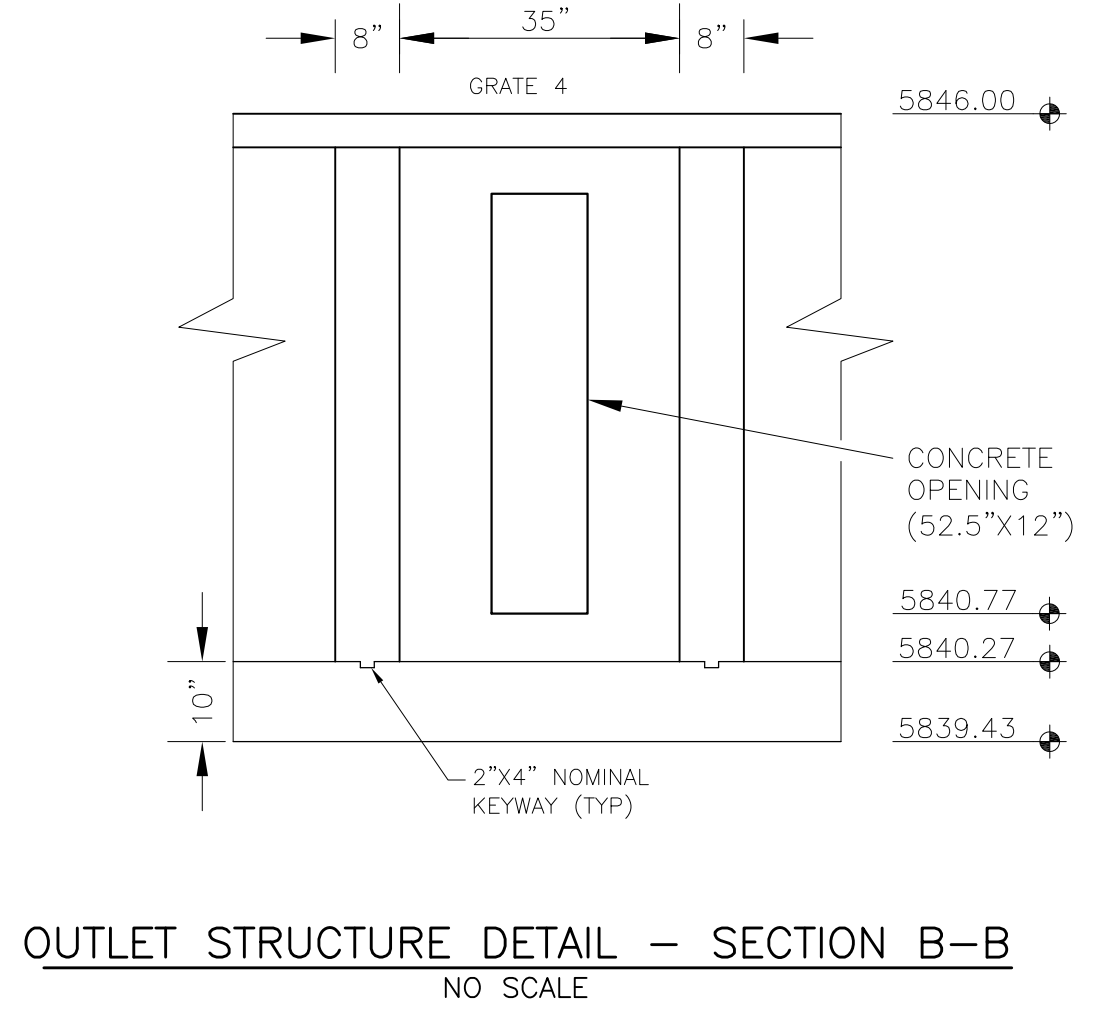
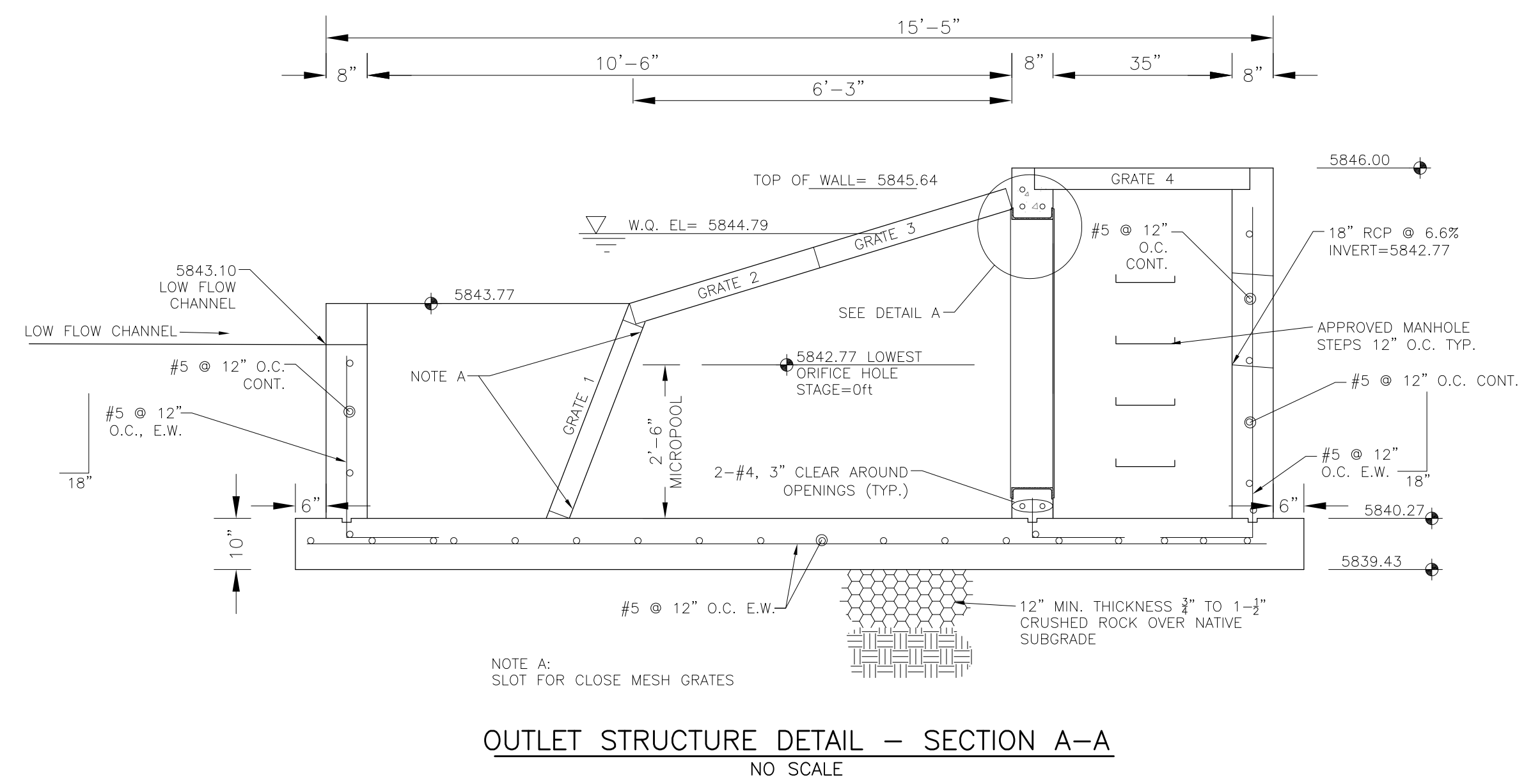
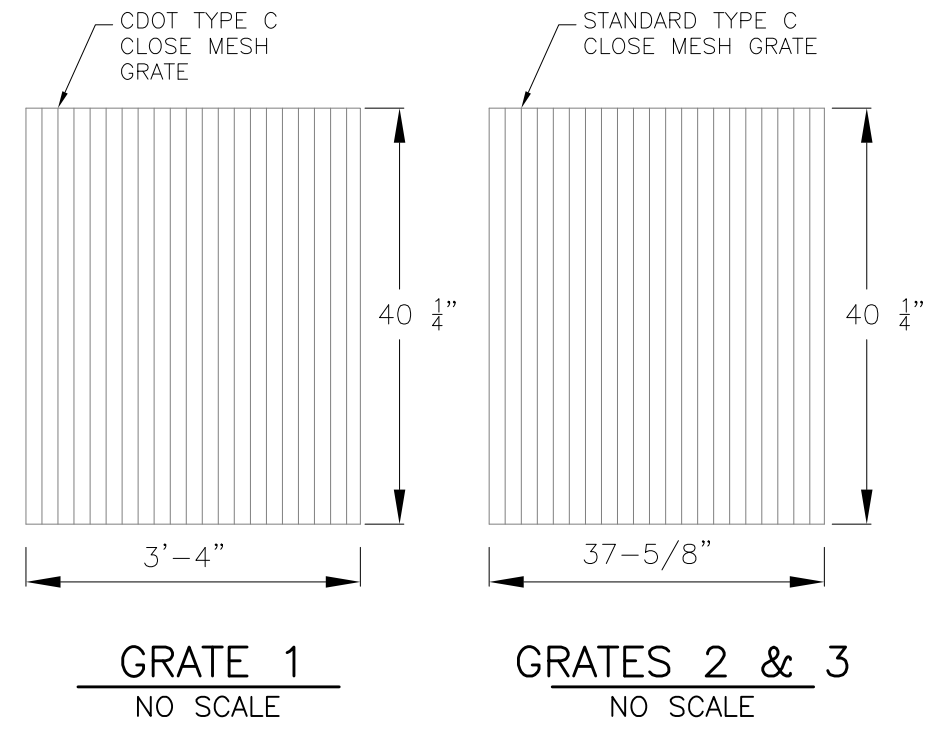

OUTLET STRUCTURE, FOREBAY, AND DRAIN CHANNEL NOTES:

- PRIOR TO CONSTRUCTION, CONTRACTOR SHALL PROVIDE SHOP DRAWINGS FOR ALL COMPONENTS OF THE OUTLET STRUCTURE.
 - GRADE 60 REINFORCING STEEL REQUIRED. SEE TABLE FOR THE MINIMUM LAP SPLICE LENGTH FOR REINFORCING BARS. ALL REINFORCING STEEL SHALL HAVE A TWO-INCH MINIMUM CLEARANCE FROM EDGE OF CONCRETE, UNLESS OTHERWISE NOTED.
- | BAR SIZE | #4 | #5 | #6 |
|--------------------|-------|-------|-------|
| MIN. SPLICE LENGTH | 1'-3" | 1'-7" | 2'-0" |
- CONCRETE FOR THE OUTLET STRUCTURE AND FOREBAY SHALL BE CDOT CLASS D CONCRETE.
 - CONCRETE FOR DRAIN CHANNELS SHALL BE CDOT CLASS B CONCRETE
 - EXPANSION JOINT MATERIAL SHALL MEET AASHTO SPECIFICATION M-213. EXPANSION JOINT MATERIAL SHALL BE 1/2" THICK, SHALL EXTEND THE FULL DEPTH OF CONTACT SURFACE AND THE JOINT SHALL BE SEALED, REFER TO DETAILS.
 - ALL EXPOSED CONCRETE CORNERS SHALL HAVE A 3/8" CHAMFER UNLESS OTHERWISE NOTED.
 - SUBGRADE TO BE 12" THICK CLEAN FILL COMPACTED TO 95% STANDARD PROCTOR DENSITY PER ASTM M698 UNDER STRUCTURE.
 - REFER TO POND DETAILS FOR PRESEDIMENTATION/FOREBAY DESIGN.
 - ENGINEER SHALL BE NOTIFIED PRIOR TO BEGINNING CONSTRUCTION OF OUTLET STRUCTURE TO SCHEDULE OBSERVATION VISITS FOR STRUCTURES.

- WQCV WELL-SCREEN NOTES:
- Well-Screen shall be stainless steel and attached by stainless steel bolts along edge of the mounting frame.
 - WQCV Well Screen
 - Type of Screen: Stainless steel #93 Vee Wire
 - (Johnson Vee Wire (tm) Stainless Steel Screen or equivalent with 60% open area)
 - Screen slot opening dimension: 0.139" (Screen #93 Vee Wire Slot Opening)
 - Type and Size of Support Rod: 1E 0.074"x0.50"
 - Spacing of Support Rod (O.C.): 1.0 Inch
 - Total Screen Thickness: 0.655"
 - Carbon Steel Holding Frame Type: 3/4" x 1.0" angle

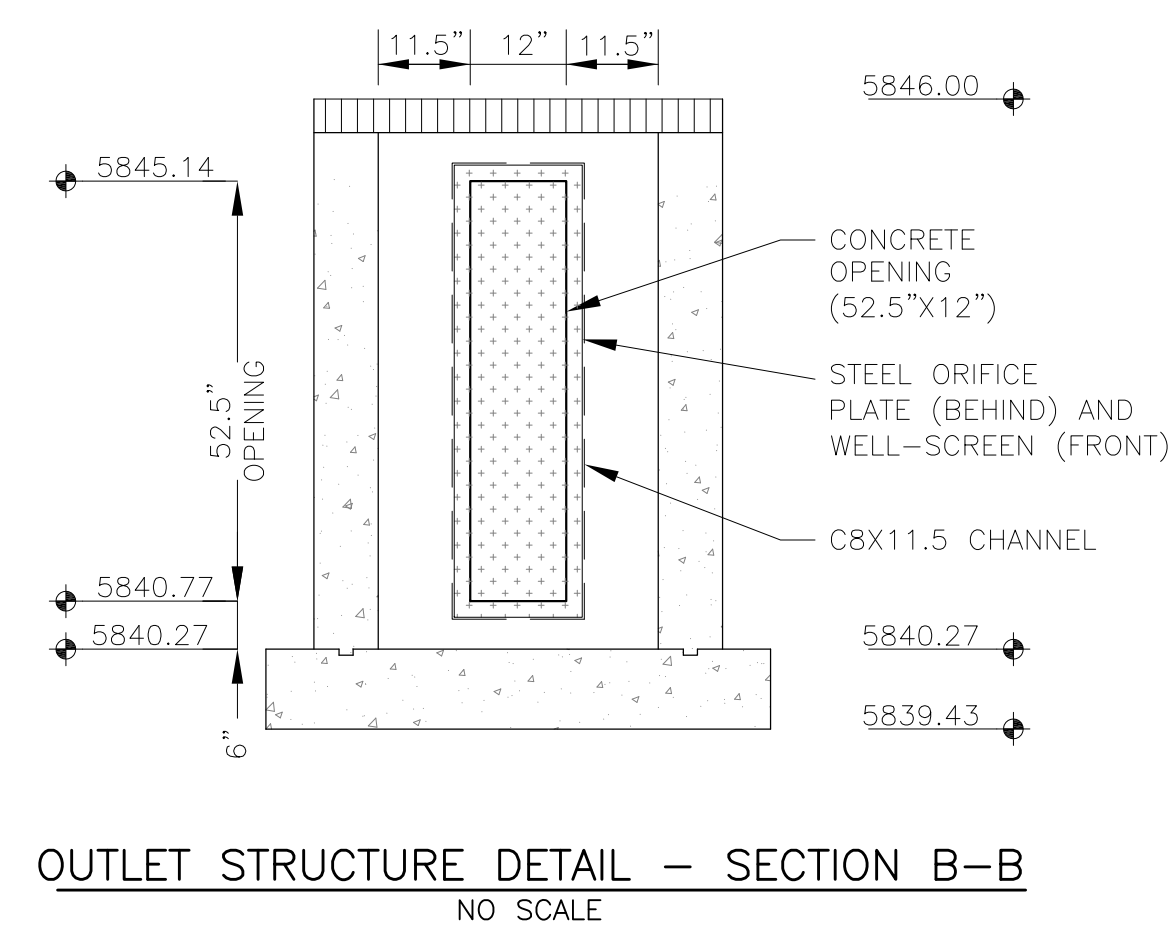

CORE
ENGINEERING GROUP
15004 1ST AVENUE S.
DENVER, CO 80202
PH: 719.570.1100
CONTACT: RICHARD L. SCHINDLER, P.E.
EMAIL: Rich@cog1.com

DATE: NOV 30, 2021
DESCRIPTION: MODIFY CIRCULAR HOLES IN ORIFICE PLATE
PREPARED FOR: LORSON, LLC
212 N. WAHSATCH AVE, SUITE 301
COLORADO SPRINGS, COLORADO 80903
CONTACT: JEFF MARK

PROJECT: THE RIDGE AT LORSON RANCH
FONTAINE BLVD. - WALLEYE DR
COLORADO SPRINGS, COLORADO

DRAWN: RLS
DESIGNED: RLS
CHECKED: RLS

POND F
WQ POND
OUTLET STRUCTURE DETAILS



DATE: NOV 5, 2021

PROJECT NO. 100.064

SHEET NUMBER C9.6

TOTAL SHEETS: 23

BASINS C1 STORM SCHEMATIC

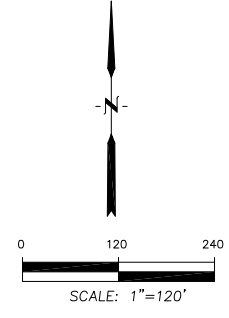
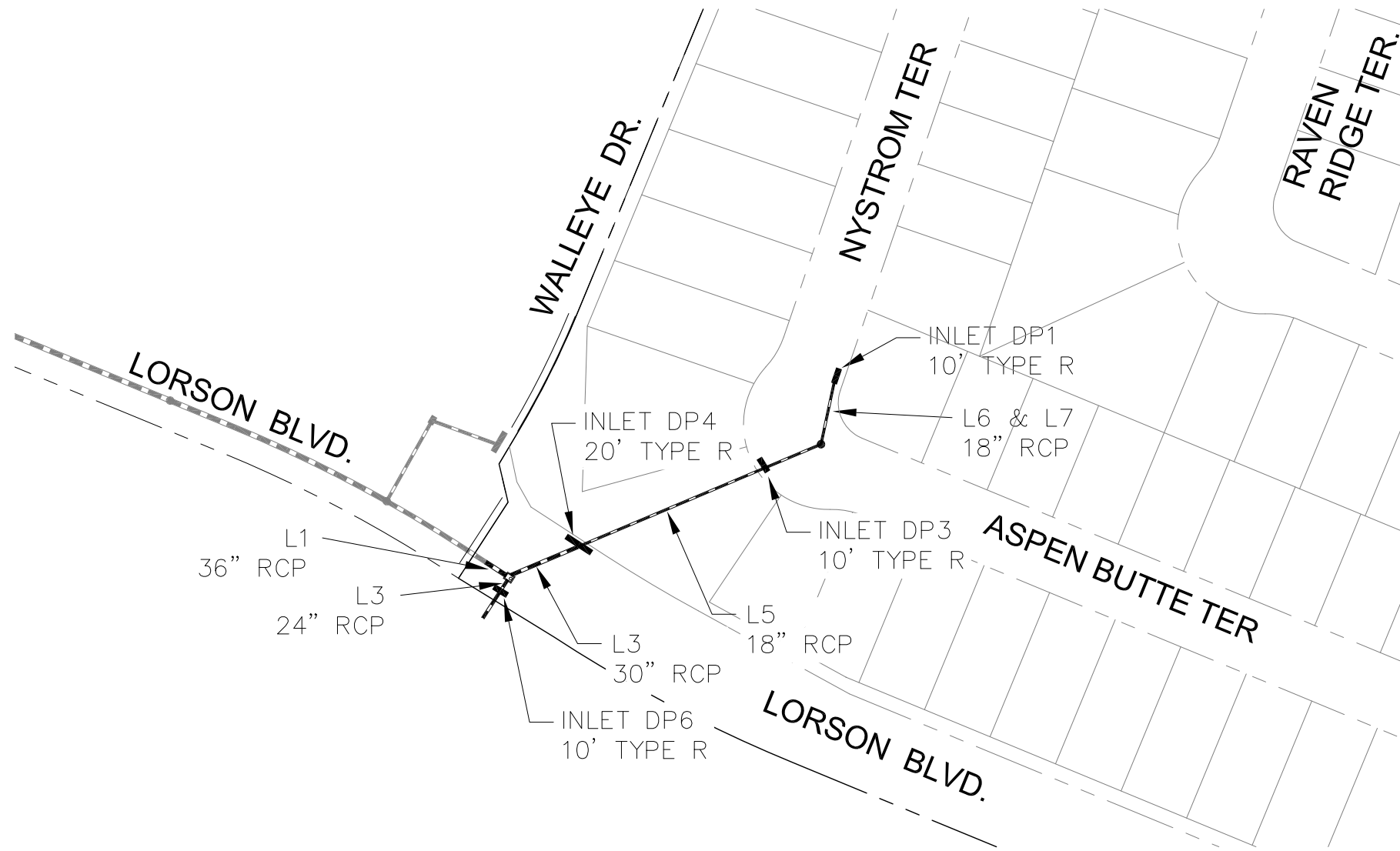

P: 100.100.064_ebriocoye-100.064-storm_schematic.dwg, Mar. 19, 2021, 8:02am

 CORE ENGINEERING GROUP 15004 1ST AVE. S. BURNSVILLE, MN 55306 PH: 719.570.1100 CONTACT: RICHARD L. SCHINDLER, P.E. EMAIL: Rich@cegi.com	
DATE	
DESCRIPTION	
NO.	
PROJECT:	THE RIDGE AT LORSON RANCH FONTAINE BLVD, WALLEYE DR EL PASO COUNTY, COLORADO
PREPARED FOR:	LORSON, LLC 212 N. WAHSATCH AVE., SUITE 301 COLORADO SPRINGS, COLORADO 80903 CONTRACT: JEFF MARK
DRAWN:	RLS
DESIGNED:	LAB
CHECKED:	LAB
STORM SEWER SCHEMATIC BASINS C1 THE RIDGE AT LORSON RANCH	
DATE	MARCH, 2021
PROJECT NO.	100.064
SHEET NUMBER	1
TOTAL SHEETS:	1

Storm Sewer Summary Report

Line No.	Line ID	Flow rate (cfs)	Line size (in)	Line length (ft)	Invert EL Dn (ft)	Invert EL Up (ft)	Line slope (%)	HGL down (ft)	HGL up (ft)	Minor loss (ft)	HGL Junct (ft)	Dns line No.
1	1	36.80	36 c	20.5	5798.38	5798.69	1.509	5800.33	5800.62	0.91	5800.62	End
2	2	15.00	24 c	8.0	5799.69	5799.81	1.525	5801.18	5801.18	n/a	5801.18	1
3	3	12.00	24 c	25.2	5799.91	5800.16	0.992	5801.62	5801.58	0.39	5801.97	2
4	4	21.80	30 c	51.4	5799.19	5799.70	0.993	5801.23	5801.26	n/a	5801.26 j	1
5	5	8.30	18 c	149.1	5800.70	5811.21	7.049	5801.63	5812.31	n/a	5812.31	4
6	6	5.60	18 c	39.8	5811.71	5812.09	0.953	5812.71	5812.99	n/a	5812.99 j	5
7	7	5.60	18 c	46.3	5812.49	5812.95	0.993	5813.27	5813.86	0.39	5814.25	6

C1 basins 5yr storm	Number of lines: 7	Run Date: 03-18-2021
----------------------------	--------------------	----------------------

NOTES: c = cir; e = ellip; b = box; Return period = 5 Yrs. ; j - Line contains hyd. jump.

Storm Sewer Summary Report

Line No.	Line ID	Flow rate (cfs)	Line size (in)	Line length (ft)	Invert EL Dn (ft)	Invert EL Up (ft)	Line slope (%)	HGL down (ft)	HGL up (ft)	Minor loss (ft)	HGL Junct (ft)	Dns line No.
1	1	65.80	36 c	20.5	5798.38	5798.69	1.509	5801.00	5801.29	1.59	5801.29	End
2	2	25.70	24 c	8.0	5799.69	5799.81	1.512	5801.84*	5801.94*	0.52	5802.46	1
3	3	20.00	24 c	25.2	5800.00	5800.25	0.992	5802.87*	5803.07*	0.63	5803.70	2
4	4	40.10	30 c	51.4	5799.19	5799.70	0.993	5801.84*	5802.33*	0.52	5802.85	1
5	5	18.10	18 c	149.1	5801.20	5811.71	7.049	5802.85	5813.16	n/a	5813.16 j	4
6	6	12.20	18 c	39.8	5811.71	5812.11	1.001	5814.08*	5814.62*	0.64	5815.26	5
7	7	12.20	18 c	46.3	5812.49	5812.96	1.014	5815.26*	5815.89*	0.74	5816.63	6

C1 basins 100yr storm	Number of lines: 7	Run Date: 03-18-2021
------------------------------	--------------------	----------------------

NOTES: c = cir; e = ellip; b = box; Return period = 100 Yrs. ; *Surcharged (HGL above crown). ; j - Line contains hyd. jump.

Line No.	Flow Rate (cfs)	Line Size (in)	Line Type	Invert Dn (ft)	Invert Up (ft)	Line Slope (%)	HGL Dn (ft)	HGL Up (ft)	Minor Loss (ft)	HGL Jnct (ft)	Depth Up (ft)	Vel Dn (ft/s)
1	65.80	36	Cir	5798.38	5798.69	1.51	5801.00	5801.29	1.59	5801.29	2.60**	10.05
2	25.70	24	Cir	5799.69	5799.81	1.51	5801.84	5801.94	0.52	5802.46	2.00	8.18
3	20.00	24	Cir	5800.00	5800.25	0.99	5802.87	5803.07	0.63	5803.70	2.00	6.37
4	40.10	30	Cir	5799.19	5799.70	0.99	5801.84	5802.33	0.52	5802.85	2.50	8.17
5	18.10	18	Cir	5801.20	5811.71	7.05	5802.85	5813.16 j	n/a	5813.16	1.45**	10.24
6	12.20	18	Cir	5811.71	5812.11	1.00	5814.08	5814.62	0.64	5815.26	1.50	6.91
7	12.20	18	Cir	5812.49	5812.96	1.01	5815.26	5815.89	0.74	5816.63	1.50	6.91

C1 basins 100yr storm	Number of lines: 7	Date: 09-30-2021
------------------------------	--------------------	------------------

NOTES: ** Critical depth

BASINS C3 STORM SCHEMATIC



CORE ENGINEERING GROUP
 15004 1ST AVE. S.
 BURNSVILLE, MN 55306
 PH: 719.570.1100
 CONTACT: RICHARD L. SCHINDLER, P.E.
 EMAIL: Rich@cegi.com

NO.	DESCRIPTION	DATE

PREPARED FOR: **LORSON, LLC**
 212 N. WAHSATCH AVE., SUITE 301
 COLORADO SPRINGS, COLORADO 80903
 CONTACT: JEFF MARK

DRAWN: RLS
 DESIGNED: LAB
 CHECKED: LAB

STORM SEWER SCHEMATIC BASINS C3 THE RIDGE AT LORSON RANCH

DATE	MARCH, 2021
PROJECT NO.	100.064
SHEET NUMBER	1
TOTAL SHEETS:	1

P: 100.100.064_ebriocage-100.064-storm_schematic.dwg, Mar. 19, 2021, 8:29am

Storm Sewer Summary Report

Line No.	Line ID	Flow rate (cfs)	Line size (in)	Line length (ft)	Invert EL Dn (ft)	Invert EL Up (ft)	Line slope (%)	HGL down (ft)	HGL up (ft)	Minor loss (ft)	HGL Junct (ft)	Dns line No.
1	1	115.0	54 c	38.4	5775.60	5776.70	2.869	5779.89	5779.78	1.53	5779.78	End
2	2	89.80	48 c	183.5	5777.70	5780.82	1.700	5780.51	5783.62	n/a	5783.62	1
3	3	89.80	48 c	307.6	5781.12	5790.01	2.890	5784.25	5792.81	n/a	5792.81	2
4	4	89.80	48 c	110.3	5790.30	5791.62	1.197	5793.44	5794.42	n/a	5794.42	3
5	5	80.60	48 c	102.4	5791.82	5793.05	1.201	5795.20	5795.71	n/a	5795.71	4
6	6	73.40	48 c	142.7	5793.05	5794.76	1.198	5796.46	5797.29	0.12	5797.29	5
7	7	65.00	42 c	104.4	5795.36	5796.61	1.197	5797.77	5799.08	n/a	5799.08	6
8	8	57.80	42 c	141.7	5796.92	5801.92	3.530	5799.77	5804.25	0.22	5804.25	7
9	9	49.40	36 c	135.8	5802.38	5805.38	2.209	5804.61	5807.62	n/a	5807.62	8
10	10	43.80	36 c	98.2	5805.58	5809.02	3.502	5808.21	5811.13	n/a	5811.13 j	9
11	11	33.50	36 c	57.5	5809.32	5810.48	2.016	5811.84	5812.33	n/a	5812.33 j	10
12	12	33.50	36 c	66.7	5810.69	5812.02	1.996	5812.82	5813.87	n/a	5813.87 j	11
13	13	33.50	36 c	35.9	5812.02	5812.74	2.005	5814.36	5814.59	n/a	5814.59 j	12
14	14	26.00	30 c	165.8	5813.24	5817.72	2.702	5814.99	5819.42	n/a	5819.42 j	13
15	15	17.60	24 c	245.7	5818.20	5822.14	1.604	5819.76	5823.63	n/a	5823.63 j	14
16	16	9.30	18 c	245.6	5822.64	5830.50	3.201	5823.96	5831.66	n/a	5831.66 j	15
17	17	9.20	18 c	7.9	5794.12	5794.44	4.057	5795.42	5795.60	n/a	5795.60	4
18	18	7.20	18 c	27.3	5795.76	5796.03	0.990	5796.73	5797.05	0.20	5797.05	5
19	19	8.40	18 c	8.0	5797.26	5797.58	4.003	5798.13	5798.69	0.56	5798.69	6
20	20	7.20	18 c	27.3	5798.78	5799.05	0.991	5800.07	5800.08	n/a	5800.27 j	7
21	21	8.40	18 c	8.0	5803.88	5804.20	4.020	5805.02	5805.31	0.00	5805.31	8
22	22	10.30	18 c	7.4	5810.82	5811.52	9.416	5811.66	5812.75	0.34	5813.09	10
23	23	7.50	18 c	7.5	5814.24	5814.54	4.004	5815.14	5815.59	0.51	5815.59	13
24	24	8.40	18 c	7.6	5818.70	5818.78	1.046	5819.90	5819.89	0.56	5820.45	14
25	25	8.30	18 c	10.1	5822.64	5822.74	0.996	5823.84	5823.84	0.55	5824.40	15
26	26	5.60	18 c	28.0	5807.28	5807.54	0.933	5808.65	5808.65	0.02	5808.68	9
27	27	7.00	24 c	17.8	5779.20	5779.94	4.149	5781.08	5780.88	0.14	5781.03	1
28	28	18.20	30 c	64.4	5778.80	5779.44	0.994	5781.10	5781.02	0.10	5781.12	1
29	29	18.20	30 c	172.1	5780.00	5786.88	3.997	5781.38	5788.31	n/a	5788.31	28
30	30	9.70	18 c	123.9	5787.88	5791.52	2.939	5788.66	5792.71	0.26	5792.71	29
31	31	8.50	24 c	15.9	5787.98	5788.30	2.005	5788.81	5789.33	0.17	5789.33	29

C3 basins 5yr storm Number of lines: 31 Run Date: 03-18-2021

NOTES: c = cir; e = ellip; b = box; Return period = 5 Yrs. ; j - Line contains hyd. jump.

Storm Sewer Summary Report

Line No.	Line ID	Flow rate (cfs)	Line size (in)	Line length (ft)	Invert EL Dn (ft)	Invert EL Up (ft)	Line slope (%)	HGL down (ft)	HGL up (ft)	Minor loss (ft)	HGL Junct (ft)	Dns line No.
1	1	225.4	54 c	38.4	5775.60	5776.70	2.869	5779.89	5780.88	n/a	5780.88	End
2	2	153.9	48 c	183.5	5777.70	5780.82	1.700	5781.88	5784.45	0.38	5784.45	1
3	3	153.9	48 c	307.6	5781.12	5790.01	2.890	5784.68	5793.64	1.28	5793.64	2
4	4	153.9	48 c	110.3	5790.30	5791.62	1.197	5793.87	5795.25	0.26	5795.25	3
5	5	133.4	48 c	102.4	5791.82	5793.05	1.201	5796.06	5796.78	0.19	5796.97	4
6	6	132.7	48 c	142.7	5793.05	5794.76	1.198	5797.09	5798.21	n/a	5798.21	5
7	7	118.6	42 c	104.4	5795.36	5796.61	1.197	5798.86*	5800.31*	0.24	5800.55	6
8	8	115.5	42 c	141.7	5796.92	5801.92	3.530	5800.67	5805.14	n/a	5805.14	7
9	9	99.20	36 c	135.8	5802.38	5805.38	2.209	5805.14	5808.28	0.63	5808.28	8
10	10	88.50	36 c	98.2	5805.58	5809.02	3.502	5808.97	5811.86	0.76	5811.86	9
11	11	67.30	36 c	57.5	5809.32	5810.48	2.016	5812.99*	5813.58*	1.41	5814.99	10
12	12	67.30	36 c	66.7	5810.69	5812.02	1.996	5814.99*	5815.67*	0.21	5815.88	11
13	13	67.30	36 c	35.9	5812.02	5812.74	2.005	5815.88*	5816.24*	0.70	5816.95	12
14	14	46.90	30 c	165.8	5813.24	5817.72	2.702	5816.95	5819.98	n/a	5819.98	13
15	15	30.40	24 c	245.7	5818.20	5822.14	1.604	5820.09	5824.12	0.73	5824.85	14
16	16	14.80	18 c	245.6	5822.64	5830.50	3.201	5825.22	5831.90	n/a	5831.90 j	15
17	17	20.50	18 c	7.9	5794.12	5794.44	4.057	5795.72*	5796.02*	2.09	5798.12	4
18	18	11.30	18 c	27.3	5795.76	5796.03	0.990	5798.19*	5798.51*	0.25	5798.76	5
19	19	20.70	18 c	8.0	5797.26	5797.58	4.003	5798.47*	5799.51*	2.13	5801.64	6
20	20	13.10	18 c	27.3	5798.78	5799.05	0.991	5802.06*	5802.48*	0.34	5802.82	7
21	21	16.30	18 c	8.0	5803.88	5804.20	4.020	5806.24*	5806.43*	0.00	5806.43	8
22	22	21.20	18 c	7.4	5810.82	5811.12	4.033	5812.16*	5812.72*	2.24	5814.96	10
23	23	20.40	18 c	7.5	5814.24	5814.54	4.004	5816.95*	5817.23*	2.07	5819.30	13
24	24	16.50	18 c	7.6	5818.70	5818.78	1.046	5820.20*	5820.39*	1.36	5821.74	14
25	25	15.60	18 c	10.1	5822.64	5822.74	0.996	5825.10*	5825.32*	1.21	5826.53	15
26	26	10.70	18 c	28.0	5806.88	5807.14	0.929	5810.84*	5811.13*	0.06	5811.18	9
27	27	28.70	24 c	17.8	5779.20	5779.94	4.149	5782.91*	5783.20*	0.52	5783.72	1
28	28	42.80	30 c	64.4	5778.80	5779.44	0.994	5783.03*	5783.73*	0.24	5783.97	1
29	29	42.80	30 c	172.1	5780.00	5786.88	3.997	5783.97	5789.07	0.14	5789.07	28
30	30	15.30	18 c	123.9	5787.88	5791.52	2.939	5789.27	5792.93	0.49	5792.93	29
31	31	27.50	24 c	15.9	5787.98	5788.30	2.005	5789.41*	5790.54*	0.48	5791.01	29

C3 basins 100yr storm Number of lines: 31 Run Date: 03-18-2021

NOTES: c = cir; e = ellip; b = box; Return period = 100 Yrs. ; *Surcharged (HGL above crown). ; j - Line contains hyd. jump.

Line No.	Flow Rate (cfs)	Line Size (in)	Line Type	Invert Dn (ft)	Invert Up (ft)	Line Slope (%)	HGL Dn (ft)	HGL Up (ft)	Minor Loss (ft)	HGL Jnct (ft)	Depth Up (ft)	Vel Dn (ft/s)
1	225.40	54	Cir	5775.60	5776.70	2.87	5779.89	5780.88	n/a	5780.88	4.18**	14.42
2	153.90	48	Cir	5777.70	5780.82	1.70	5781.88	5784.45	0.38	5784.45	3.63**	12.25
3	153.90	48	Cir	5781.12	5790.01	2.89	5784.68	5793.64	1.28	5793.64	3.63**	13.02
4	153.90	48	Cir	5790.30	5791.62	1.20	5793.87	5795.25	0.26	5795.25	3.63**	13.00
5	133.40	48	Cir	5791.82	5793.05	1.20	5796.06	5796.78	0.19	5796.97	3.73	10.62
6	132.70	48	Cir	5793.05	5794.76	1.20	5797.09	5798.21	n/a	5798.21	3.45**	10.56
7	118.60	42	Cir	5795.36	5796.61	1.20	5798.86	5800.31	0.24	5800.55	3.50	12.33
8	115.50	42	Cir	5796.92	5801.92	3.53	5800.67	5805.14	n/a	5805.14	3.22**	12.01
9	99.20	36	Cir	5802.38	5805.38	2.21	5805.14	5808.28	0.63	5808.28	2.90**	14.57
10	88.50	36	Cir	5805.58	5809.02	3.50	5808.97	5811.86	0.76	5811.86	2.84**	12.52
11	67.30	36	Cir	5809.32	5810.48	2.02	5812.99	5813.58	1.41	5814.99	3.00	9.52
12	67.30	36	Cir	5810.69	5812.02	2.00	5814.99	5815.67	0.21	5815.88	3.00	9.52
13	67.30	36	Cir	5812.02	5812.74	2.00	5815.88	5816.24	0.70	5816.95	3.00	9.52
14	46.90	30	Cir	5813.24	5817.72	2.70	5816.95	5819.98	n/a	5819.98	2.26**	9.56
15	30.40	24	Cir	5818.20	5822.14	1.60	5820.09	5824.12	0.73	5824.85	1.98	9.88
16	14.80	18	Cir	5822.64	5830.50	3.20	5825.22	5831.90 j	n/a	5831.90	1.40**	8.38
17	20.50	18	Cir	5794.12	5794.44	4.06	5795.72	5796.02	2.09	5798.12	1.50	11.60
18	11.30	18	Cir	5795.76	5796.03	0.99	5798.19	5798.51	0.25	5798.76	1.50	6.40
19	20.70	18	Cir	5797.26	5797.58	4.00	5798.47	5799.51	2.13	5801.64	1.50	13.55
20	13.10	18	Cir	5798.78	5799.05	0.99	5802.06	5802.48	0.34	5802.82	1.50	7.41
21	16.30	18	Cir	5803.88	5804.20	4.02	5806.24	5806.43	0.00	5806.43	1.50	9.23

C3 basins 100yr storm	Number of lines: 31	Date: 09-30-2021
------------------------------	---------------------	------------------

NOTES: ** Critical depth

Line No.	Flow Rate (cfs)	Line Size (in)	Line Type	Invert Dn (ft)	Invert Up (ft)	Line Slope (%)	HGL Dn (ft)	HGL Up (ft)	Minor Loss (ft)	HGL Jnct (ft)	Depth Up (ft)	Vel Dn (ft/s)
22	21.20	18	Cir	5810.82	5811.12	4.03	5812.16	5812.72	2.24	5814.96	1.50	12.71
23	20.40	18	Cir	5814.24	5814.54	4.00	5816.95	5817.23	2.07	5819.30	1.50	11.55
24	16.50	18	Cir	5818.70	5818.78	1.05	5820.20	5820.39	1.36	5821.74	1.50	9.34
25	15.60	18	Cir	5822.64	5822.74	1.00	5825.10	5825.32	1.21	5826.53	1.50	8.83
26	10.70	18	Cir	5806.88	5807.14	0.93	5810.84	5811.13	0.06	5811.18	1.50	6.06
27	28.70	24	Cir	5779.20	5779.94	4.15	5782.91	5783.20	0.52	5783.72	2.00	9.14
28	42.80	30	Cir	5778.80	5779.44	0.99	5783.03	5783.73	0.24	5783.97	2.50	8.72
29	42.80	30	Cir	5780.00	5786.88	4.00	5783.97	5789.07	0.14	5789.07	2.19**	8.72
30	15.30	18	Cir	5787.88	5791.52	2.94	5789.27	5792.93	0.49	5792.93	1.41**	8.93
31	27.50	24	Cir	5787.98	5788.30	2.01	5789.41	5790.54	0.48	5791.01	2.00	11.46

C3 basins 100yr storm	Number of lines: 31	Date: 09-30-2021
------------------------------	---------------------	------------------

NOTES: ** Critical depth

BASINS C5 STORM SCHEMATIC

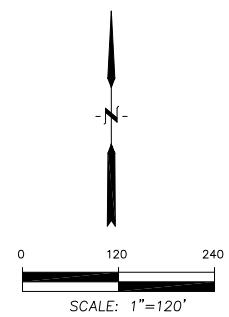
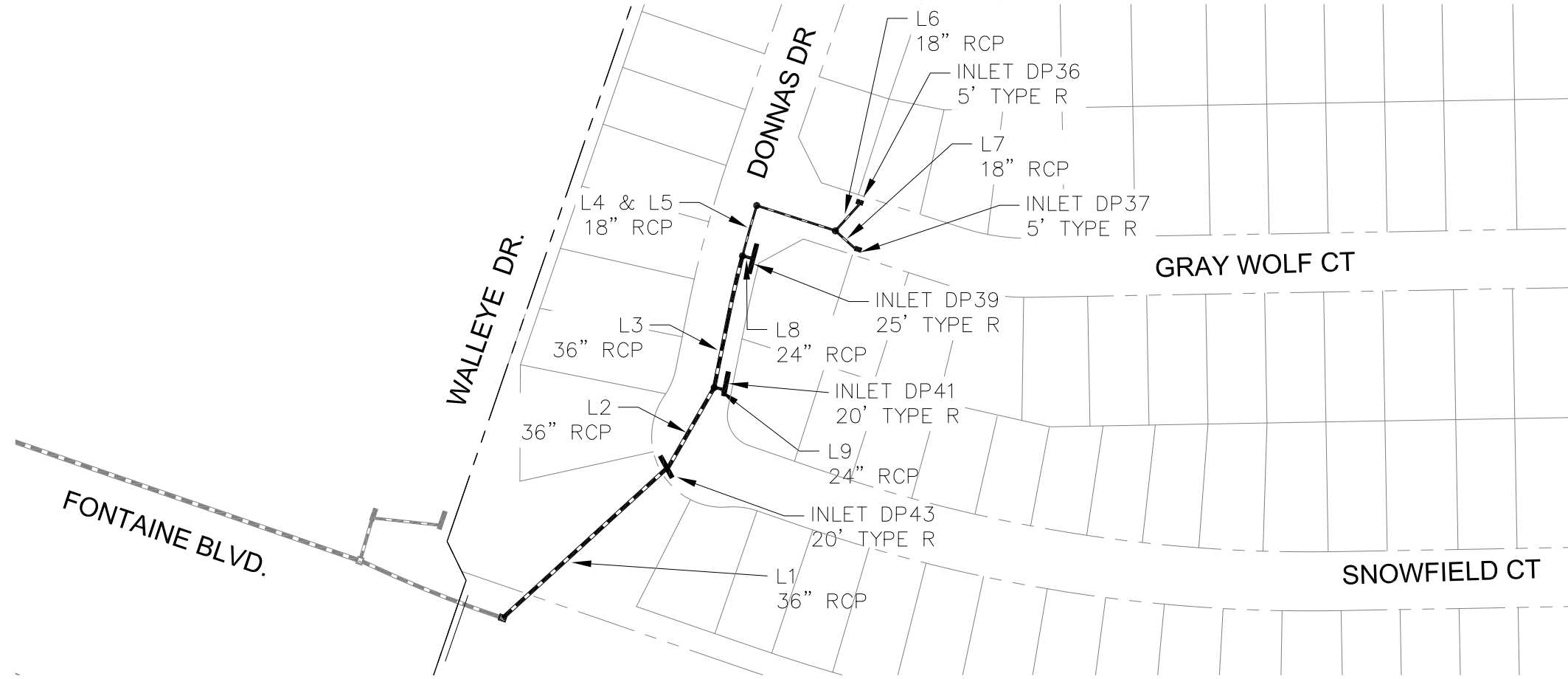

CORE ENGINEERING GROUP
 15004 1ST AVE. S.
 BURNSVILLE, MN 55306
 PH: 719.570.1100
 CONTACT: RICHARD L. SCHINDLER, P.E.
 EMAIL: Rich@cegi.com

NO.	DESCRIPTION	DATE

PREPARED FOR: **LORSON, LLC**
 212 N. WAHSATCH AVE., SUITE 301
 COLORADO SPRINGS, COLORADO 80903
 CONTRACT: JEFF MARK

PROJECT: **THE RIDGE AT LORSON RANCH**
 FONTAINE BLVD, WALLEYE DR
 EL PASO COUNTY, COLORADO

DRAWN: RLS
 DESIGNED: LAB
 CHECKED: LAB

STORM SEWER SCHEMATIC
BASINS C5
THE RIDGE AT LORSON RANCH

DATE	MARCH, 2021
PROJECT NO.	100.064
SHEET NUMBER	1
TOTAL SHEETS:	1

P: 100.100.064_ebriocoye-100.064-storm_schematic.dwg Mar_23_2021 - 11:10am

Storm Sewer Summary Report

Line No.	Line ID	Flow rate (cfs)	Line size (in)	Line length (ft)	Invert EL Dn (ft)	Invert EL Up (ft)	Line slope (%)	HGL down (ft)	HGL up (ft)	Minor loss (ft)	HGL Junct (ft)	Dns line No.
1		42.30	36 c	190.8	5782.00	5788.40	3.354	5784.83	5790.47	n/a	5790.47 j	End
2		32.30	36 c	77.0	5789.50	5790.37	1.130	5791.17	5792.18	0.80	5792.18	1
3		23.00	36 c	121.5	5790.47	5791.49	0.839	5792.83	5793.02	n/a	5793.02 j	2
4		7.50	18 c	38.1	5793.00	5793.38	0.998	5793.94	5794.43	0.50	5794.93	3
5		7.50	18 c	70.0	5793.58	5794.28	1.000	5795.15	5795.39	0.41	5795.80	4
6		4.10	18 c	30.4	5794.48	5794.82	1.119	5796.14	5796.17	0.09	5796.27	5
7		3.40	18 c	23.5	5794.48	5794.81	1.406	5796.17	5796.19	0.06	5796.25	5
8		15.50	24 c	10.8	5792.50	5792.62	1.109	5793.68	5794.30	0.47	5794.77	3
9		9.30	24 c	14.0	5791.37	5791.65	2.002	5792.86	5792.73	n/a	5792.73 j	2

C5 basins 5yr storm	Number of lines: 9	Run Date: 03-18-2021
----------------------------	--------------------	----------------------

NOTES: c = cir; e = ellip; b = box; Return period = 5 Yrs. ; j - Line contains hyd. jump.

Storm Sewer Summary Report

Line No.	Line ID	Flow rate (cfs)	Line size (in)	Line length (ft)	Invert EL Dn (ft)	Invert EL Up (ft)	Line slope (%)	HGL down (ft)	HGL up (ft)	Minor loss (ft)	HGL Junct (ft)	Dns line No.
1		87.10	36 c	190.8	5782.00	5787.80	3.039	5784.83	5790.63	1.38	5790.63	End
2		62.10	36 c	77.0	5788.70	5790.37	2.169	5791.90	5792.88	n/a	5792.88	1
3		37.00	36 c	121.5	5790.47	5791.44	0.797	5793.75	5794.03	0.50	5794.54	2
4		10.50	18 c	38.1	5793.00	5793.38	0.998	5794.54	5794.87	0.55	5795.42	3
5		10.50	18 c	70.0	5793.58	5794.28	1.000	5795.42*	5796.12*	0.50	5796.63	4
6		5.70	18 c	30.4	5794.48	5794.82	1.119	5797.02*	5797.10*	0.16	5797.27	5
7		4.80	18 c	23.5	5794.48	5794.81	1.406	5797.06*	5797.11*	0.11	5797.23	5
8		26.50	24 c	10.8	5792.50	5792.72	2.034	5794.54	5794.65	1.13	5795.78	3
9		25.10	24 c	14.0	5791.37	5791.65	2.002	5793.39	5793.42	1.13	5794.55	2

C5 basins 100yr storm	Number of lines: 9	Run Date: 03-18-2021
------------------------------	--------------------	----------------------

NOTES: c = cir; e = ellip; b = box; Return period = 100 Yrs. ; *Surcharged (HGL above crown).

Line No.	Flow Rate (cfs)	Line Size (in)	Line Type	Invert Dn (ft)	Invert Up (ft)	Line Slope (%)	HGL Dn (ft)	HGL Up (ft)	Minor Loss (ft)	HGL Jnct (ft)	Depth Up (ft)	Vel Dn (ft/s)
1	87.10	36	Cir	5782.00	5787.80	3.04	5784.83	5790.63	1.38	5790.63	2.83**	12.61
2	62.10	36	Cir	5788.70	5790.37	2.17	5791.90	5792.88	n/a	5792.88	2.51**	8.79
3	37.00	36	Cir	5790.47	5791.44	0.80	5793.75	5794.03	0.50	5794.54	2.59	5.24
4	10.50	18	Cir	5793.00	5793.38	1.00	5794.54	5794.87	0.55	5795.42	1.49	5.94
5	10.50	18	Cir	5793.58	5794.28	1.00	5795.42	5796.12	0.50	5796.63	1.50	5.94
6	5.70	18	Cir	5794.48	5794.82	1.12	5797.02	5797.10	0.16	5797.27	1.50	3.23
7	4.80	18	Cir	5794.48	5794.81	1.41	5797.06	5797.11	0.11	5797.23	1.50	2.72
8	26.50	24	Cir	5792.50	5792.72	2.03	5794.54	5794.65	1.13	5795.78	1.93	8.44
9	25.10	24	Cir	5791.37	5791.65	2.00	5793.39	5793.42	1.13	5794.55	1.77**	7.99

C5 basins 100yr storm	Number of lines: 9	Date: 09-30-2021
------------------------------	--------------------	------------------

NOTES: ** Critical depth

BASINS C8.1 & C8.4 STORM SCHEMATIC

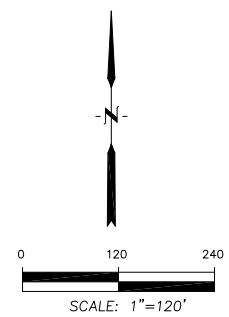
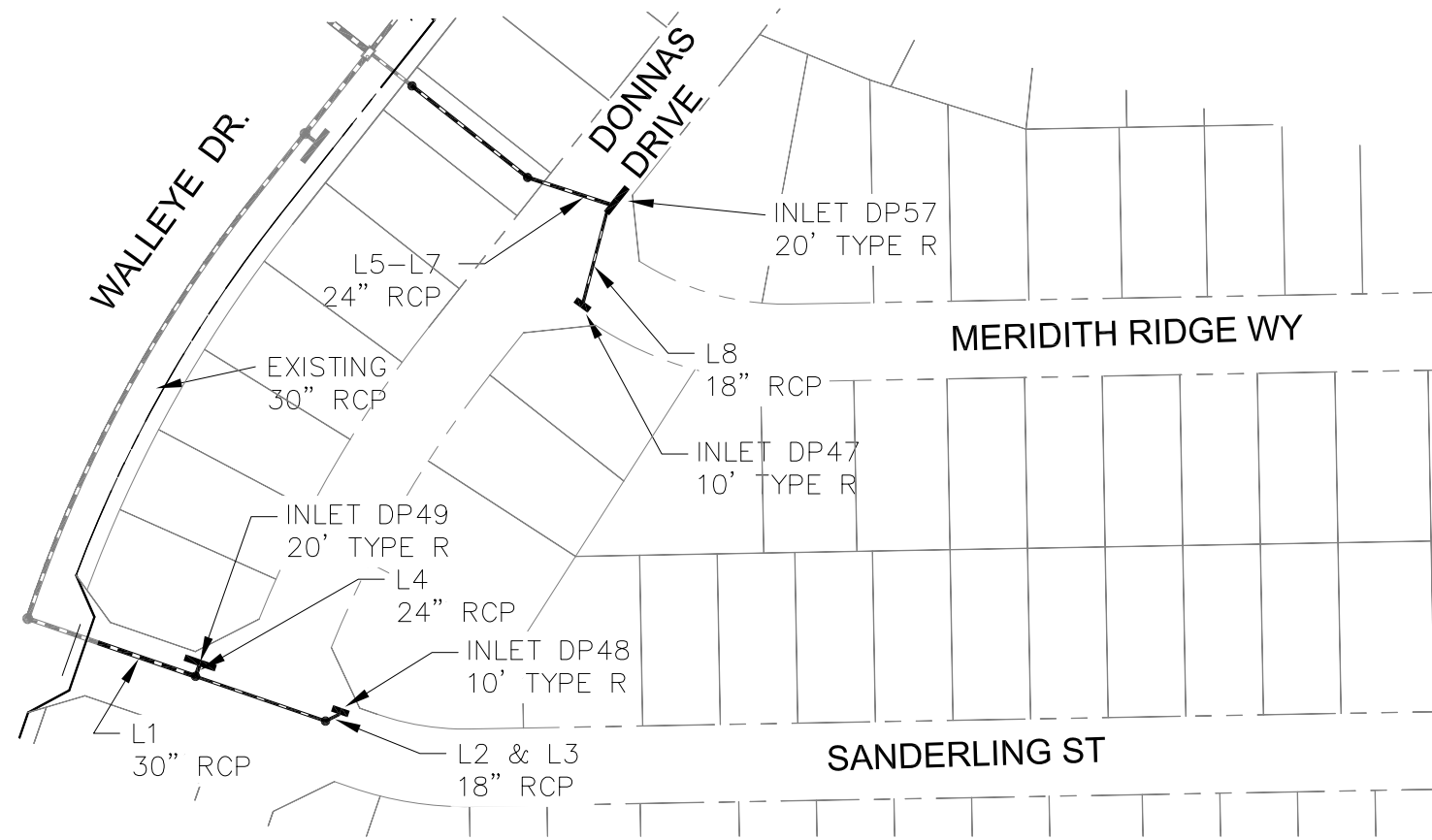

NO.	DESCRIPTION	DATE

PROJECT: THE RIDGE AT LORSON RANCH
 FONTAINE BLVD., WALLEYE DR
 EL PASO COUNTY, COLORADO
 PREPARED FOR: LORSON, LLC
 212 N. WAHSATCH AVE., SUITE 301
 COLORADO SPRINGS, COLORADO 80903
 CONTRACT: JEFF MARK

DRAWN: RLS
 DESIGNED: LAB
 CHECKED: LAB

STORM SEWER SCHEMATIC
BASINS C8.1 & C8.4
THE RIDGE AT LORSON RANCH

DATE	MARCH, 2021
PROJECT NO.	100.064
SHEET NUMBER	1
TOTAL SHEETS:	1



CORE ENGINEERING GROUP
 15004 1ST AVE. S.
 BURNSVILLE, MN 55306
 PH: 719.570.1100
 CONTACT: RICHARD L. SCHINDLER, P.E.
 EMAIL: Rich@cegi.com

P: 100.100.064_ebriocopy-100.064-storm_schematic.dwg Mar_23_2021 11:11am

Storm Sewer Summary Report

Line No.	Line ID	Flow rate (cfs)	Line size (in)	Line length (ft)	Invert EL Dn (ft)	Invert EL Up (ft)	Line slope (%)	HGL down (ft)	HGL up (ft)	Minor loss (ft)	HGL Junct (ft)	Dns line No.
1		11.10	30 c	67.8	5796.22	5796.92	1.032	5798.38	5798.33	0.24	5798.56	End
2		3.40	18 c	70.9	5798.90	5800.32	2.003	5799.39	5801.02	n/a	5801.02	1
3		3.40	18 c	14.9	5800.52	5800.82	2.012	5801.24	5801.52	n/a	5801.52 j	2
4		7.70	24 c	9.5	5798.10	5798.48	3.987	5798.71	5800.16	0.12	5800.27	1
5		17.10	24 c	36.5	5792.52	5793.43	2.492	5794.44	5794.90	n/a	5794.90 j	End
6		17.10	24 c	94.9	5793.88	5801.00	7.504	5795.18	5802.47	0.31	5802.47	5
7		17.10	24 c	55.5	5801.30	5802.13	1.496	5802.75	5803.60	1.12	5803.60	6
8		6.10	18 c	68.5	5803.23	5803.92	1.007	5804.16	5804.86	0.42	5804.86	7

C8.1 basins 5yr storm	Number of lines: 8	Run Date: 03-18-2021
------------------------------	--------------------	----------------------

NOTES: c = cir; e = ellip; b = box; Return period = 5 Yrs. ; j - Line contains hyd. jump.

Storm Sewer Summary Report

Line No.	Line ID	Flow rate (cfs)	Line size (in)	Line length (ft)	Invert EL Dn (ft)	Invert EL Up (ft)	Line slope (%)	HGL down (ft)	HGL up (ft)	Minor loss (ft)	HGL Junct (ft)	Dns line No.
1		27.00	30 c	67.8	5796.22	5796.92	1.032	5798.38	5798.66	n/a	5798.66 j	End
2		6.20	18 c	70.9	5798.90	5800.32	2.003	5799.58	5801.27	n/a	5801.27	1
3		6.20	18 c	14.9	5800.52	5800.82	2.012	5801.51	5801.77	n/a	5801.77 j	2
4		20.80	24 c	9.5	5798.40	5798.78	3.997	5799.35*	5801.99*	0.68	5802.67	1
5		28.10	24 c	36.5	5792.52	5793.43	2.492	5794.44	5795.26	n/a	5795.26 j	End
6		28.10	24 c	94.9	5793.88	5801.00	7.504	5795.37	5802.83	0.57	5802.83	5
7		28.10	24 c	55.5	5801.30	5802.13	1.496	5802.97	5804.02	1.95	5805.97	6
8		9.10	18 c	68.5	5803.23	5803.92	1.007	5806.86*	5807.37*	0.41	5807.79	7

C8.1 basins 100yr storm	Number of lines: 8	Run Date: 03-18-2021
--------------------------------	--------------------	----------------------

NOTES: c = cir; e = ellip; b = box; Return period = 100 Yrs. ; *Surcharged (HGL above crown). ; j - Line contains hyd. jump.

Line No.	Flow Rate	Line Size	Line Type	Invert Dn	Invert Up	Line Slope	HGL Dn	HGL Up	Minor Loss	HGL Jnct	Depth Up	Vel Dn	
	(cfs)	(in)		(ft)	(ft)	(%)	(ft)	(ft)	(ft)	(ft)	(ft)	(ft/s)	
1	27.00	30	Cir	5796.22	5796.92	1.03	5798.38	5798.66 j	n/a	5798.66	1.74**	5.99	
2	6.20	18	Cir	5798.90	5800.32	2.00	5799.58	5801.27	n/a	5801.27	0.95**	8.03	
3	6.20	18	Cir	5800.52	5800.82	2.01	5801.51	5801.77 j	n/a	5801.77	0.95**	5.03	
4	20.80	24	Cir	5798.40	5798.78	4.00	5799.35	5801.99	0.68	5802.67	2.00	14.09	
5	28.10	24	Cir	5792.52	5793.43	2.49	5794.44	5795.26 j	n/a	5795.26	1.83**	9.07	
6	28.10	24	Cir	5793.88	5801.00	7.50	5795.37	5802.83	0.57	5802.83	1.83**	11.20	
7	28.10	24	Cir	5801.30	5802.13	1.50	5802.97	5804.02	1.95	5805.97	1.89	10.03	
8	9.10	18	Cir	5803.23	5803.92	1.01	5806.86	5807.37	0.41	5807.79	1.50	5.15	

C8.1 basins 100yr storm	Number of lines: 8	Date: 09-30-2021
--------------------------------	--------------------	------------------

NOTES: ** Critical depth

BASINS C8.3 STORM SCHEMATIC

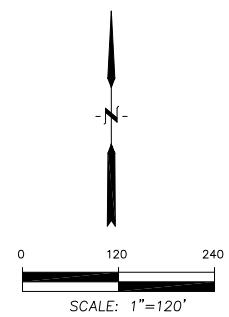
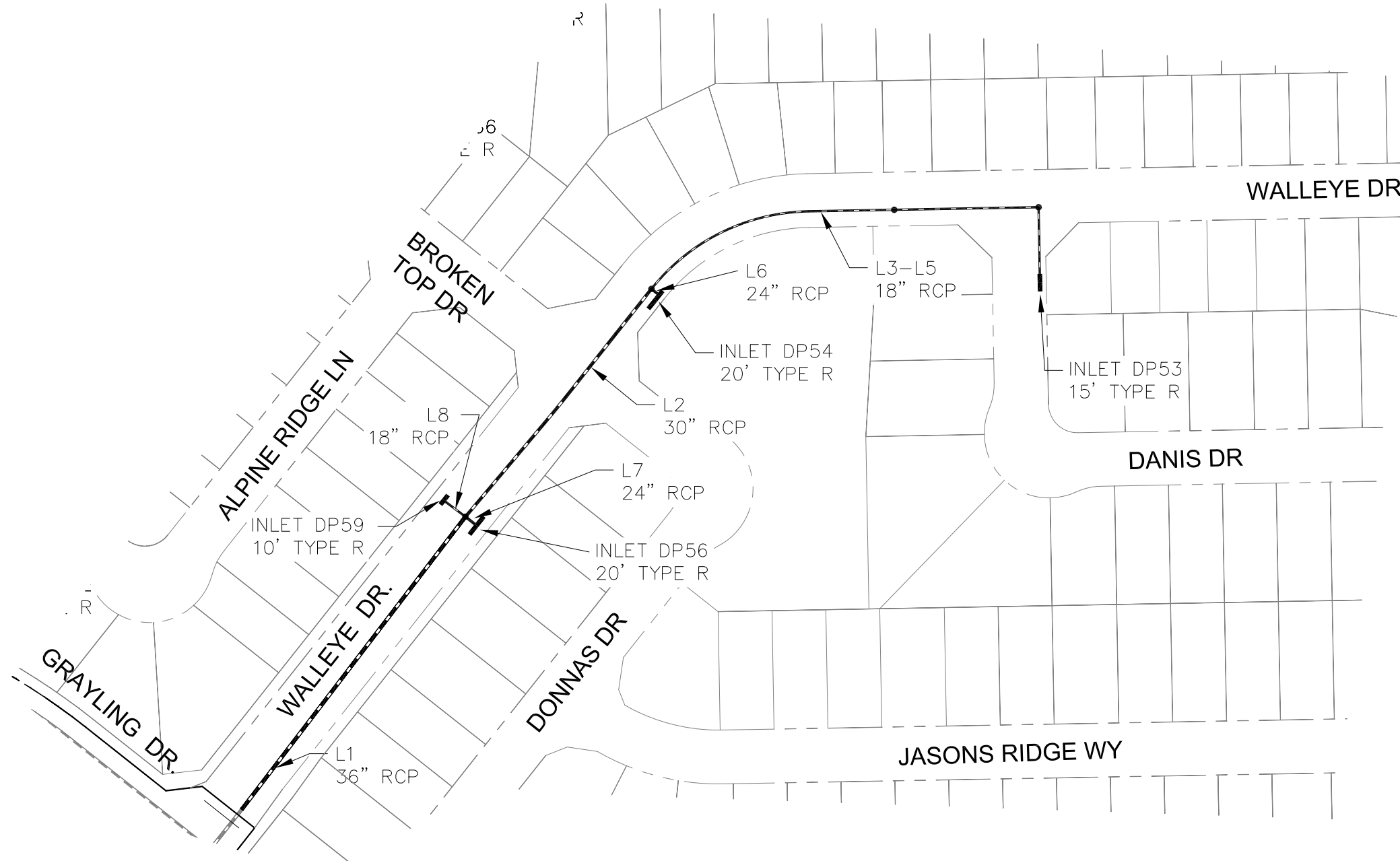

CORE ENGINEERING GROUP
 15004 1ST AVE. S.
 BURNSVILLE, MN 55306
 PH: 719.570.1100
 CONTACT: RICHARD L. SCHINDLER, P.E.
 EMAIL: Rich@cegi.com

NO.	DESCRIPTION	DATE

PREPARED FOR: **LORSON, LLC**
 212 N. WAHSATCH AVE., SUITE 301
 COLORADO SPRINGS, COLORADO 80903
 CONTRACT: JEFF MARK

DRAWN: RLS
 DESIGNED: LAB
 CHECKED: LAB

STORM SEWER SCHEMATIC
BASINS C8.3
THE RIDGE AT LORSON RANCH

DATE	MARCH, 2021
PROJECT NO.	100.064
SHEET NUMBER	1
TOTAL SHEETS:	1

P: 100.100.064_ebschong - 100.064-storm_schematic.dwg, Mar. 23, 2021, 11:12am

Storm Sewer Summary Report

Line No.	Line ID	Flow rate (cfs)	Line size (in)	Line length (ft)	Invert EL Dn (ft)	Invert EL Up (ft)	Line slope (%)	HGL down (ft)	HGL up (ft)	Minor loss (ft)	HGL Junct (ft)	Dns line No.
1		32.70	36 c	388.3	5792.00	5797.44	1.401	5794.98	5799.26	n/a	5799.26 j	End
2		21.40	30 c	218.5	5797.94	5800.62	1.227	5799.79	5802.17	n/a	5802.17 j	1
3		9.70	18 c	212.9	5801.62	5809.62	3.758	5802.40	5810.81	0.38	5810.81	2
4		9.70	18 c	213.7	5809.82	5817.64	3.660	5810.99	5818.83	0.65	5818.83	3
5		9.70	18 c	61.5	5817.95	5818.86	1.480	5819.01	5820.05	0.65	5820.05	4
6		11.70	24 c	8.0	5801.50	5801.74	3.003	5802.65	5802.95	n/a	5802.95	2
7		9.00	24 c	9.9	5798.44	5798.64	2.028	5799.96	5799.87	0.31	5800.18	1
8		5.90	18 c	25.1	5798.94	5799.19	0.997	5799.91	5800.12	0.41	5800.12	1

C8.3 basins 5yr storm	Number of lines: 8	Run Date: 03-18-2021
------------------------------	--------------------	----------------------

NOTES: c = cir; e = ellip; b = box; Return period = 5 Yrs. ; j - Line contains hyd. jump.

Storm Sewer Summary Report

Line No.	Line ID	Flow rate (cfs)	Line size (in)	Line length (ft)	Invert EL Dn (ft)	Invert EL Up (ft)	Line slope (%)	HGL down (ft)	HGL up (ft)	Minor loss (ft)	HGL Junct (ft)	Dns line No.
1		73.30	36 c	388.3	5792.00	5797.44	1.401	5794.98	5800.15	n/a	5800.15	End
2		40.20	30 c	218.5	5797.94	5800.62	1.227	5800.96	5802.78	1.24	5804.02	1
3		16.20	18 c	212.9	5801.62	5809.62	3.758	5804.02	5811.05	n/a	5811.05 j	2
4		16.20	18 c	213.7	5809.82	5817.64	3.660	5811.10	5819.07	1.35	5819.07	3
5		16.20	18 c	61.5	5817.95	5818.86	1.480	5819.45*	5820.91*	1.31	5822.22	4
6		24.00	24 c	8.0	5801.50	5801.74	3.003	5804.35*	5804.44*	0.91	5805.34	2
7		32.80	24 c	9.9	5798.44	5798.64	2.028	5800.31	5800.55	1.75	5802.30	1
8		8.90	18 c	25.1	5798.94	5799.19	0.997	5801.61*	5801.79*	0.39	5802.18	1

C8.3 basins 100yr storm	Number of lines: 8	Run Date: 03-18-2021
--------------------------------	--------------------	----------------------

NOTES: c = cir; e = ellip; b = box; Return period = 100 Yrs. ; *Surcharged (HGL above crown). ; j - Line contains hyd. jump.

Line No.	Flow Rate (cfs)	Line Size (in)	Line Type	Invert Dn (ft)	Invert Up (ft)	Line Slope (%)	HGL Dn (ft)	HGL Up (ft)	Minor Loss (ft)	HGL Jnct (ft)	Depth Up (ft)	Vel Dn (ft/s)
1	73.30	36	Cir	5792.00	5797.44	1.40	5794.98	5800.15	n/a	5800.15	2.71**	10.38
2	40.20	30	Cir	5797.94	5800.62	1.23	5800.96	5802.78	1.24	5804.02	2.16	8.19
3	16.20	18	Cir	5801.62	5809.62	3.76	5804.02	5811.05 j	n/a	5811.05	1.43**	9.17
4	16.20	18	Cir	5809.82	5817.64	3.66	5811.10	5819.07	1.35	5819.07	1.43**	10.12
5	16.20	18	Cir	5817.95	5818.86	1.48	5819.45	5820.91	1.31	5822.22	1.50	9.17
6	24.00	24	Cir	5801.50	5801.74	3.00	5804.35	5804.44	0.91	5805.34	2.00	7.64
7	32.80	24	Cir	5798.44	5798.64	2.03	5800.31	5800.55	1.75	5802.30	1.91**	10.75
8	8.90	18	Cir	5798.94	5799.19	1.00	5801.61	5801.79	0.39	5802.18	1.50	5.04

C8.3 basins 100yr storm	Number of lines: 8	Date: 09-30-2021
--------------------------------	--------------------	------------------

NOTES: ** Critical depth

BASINS C8.7 STORM SCHEMATIC

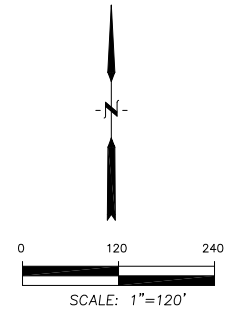
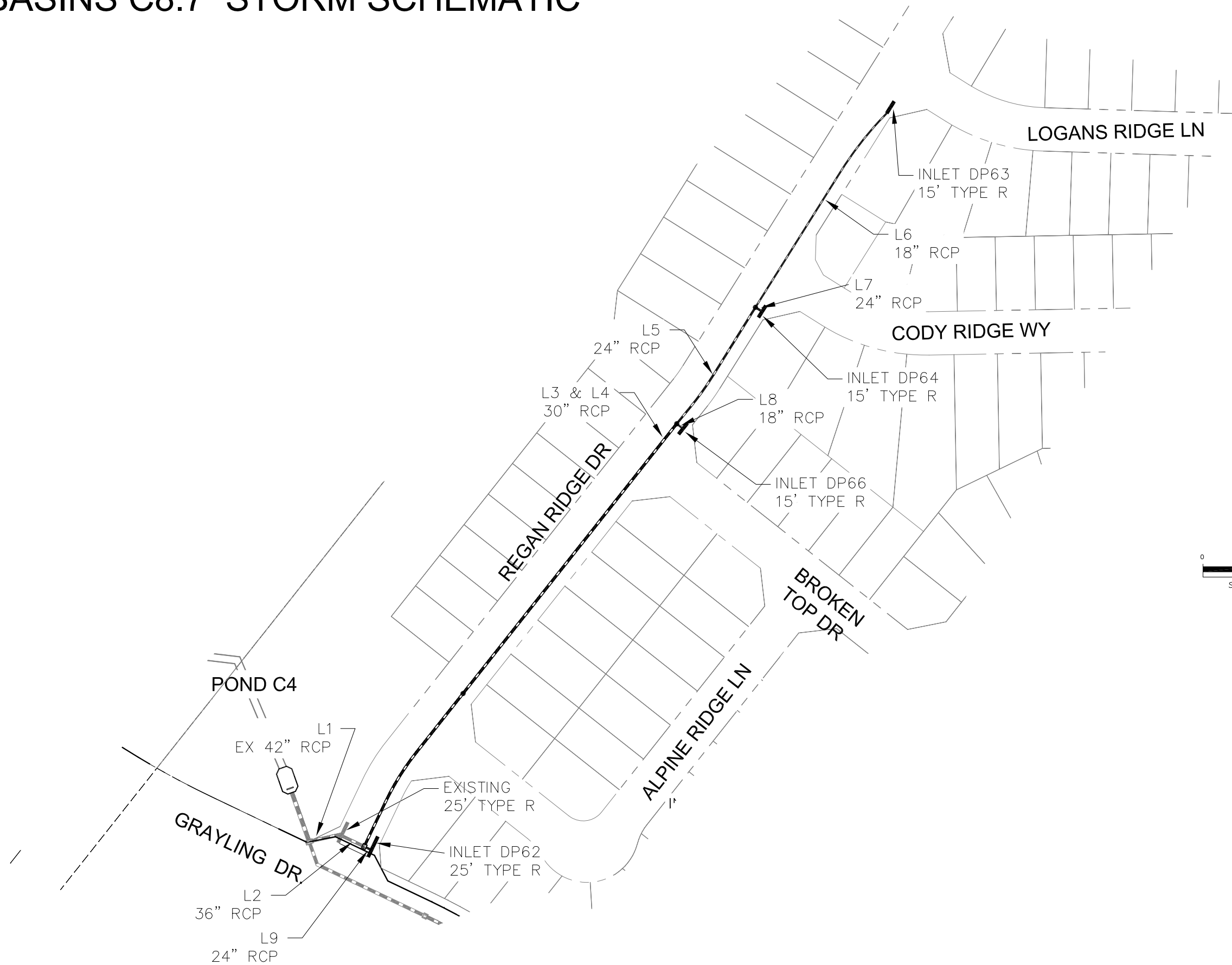

CORE ENGINEERING GROUP
 15004 1ST AVE. S.
 BURNSVILLE, MN 55306
 PH: 719.570.1100
 CONTACT: RICHARD L. SCHINDLER, P.E.
 EMAIL: Rich@cegi.com

NO.	DESCRIPTION	DATE

PREPARED FOR: **LORSON, LLC**
 212 N. WAHSATCH AVE., SUITE 301
 COLORADO SPRINGS, COLORADO 80903
 CONTRACT: JEFF MARK

DRAWN: RLS
 DESIGNED: LAB
 CHECKED: LAB

STORM SEWER SCHEMATIC
BASINS C8.7
THE RIDGE AT LORSON RANCH

DATE	MARCH, 2021
PROJECT NO.	100.064
SHEET NUMBER	1
TOTAL SHEETS:	1

P: 100.100.064_ebriocspg-100.064-storm_schematic.dwg, Mar. 23, 2021, 11:12am

Storm Sewer Summary Report

Line No.	Line ID	Flow rate (cfs)	Line size (in)	Line length (ft)	Invert EL Dn (ft)	Invert EL Up (ft)	Line slope (%)	HGL down (ft)	HGL up (ft)	Minor loss (ft)	HGL Junct (ft)	Dns line No.
1		34.50	42 c	36.0	5778.08	5779.02	2.611	5781.58	5781.47	0.28	5781.75	End
2		33.00	36 c	31.0	5779.52	5779.89	1.194	5781.77	5781.72	0.33	5781.72	1
3		21.50	30 c	211.2	5780.39	5784.82	2.098	5782.25	5786.37	n/a	5786.37 j	2
4		21.50	30 c	394.6	5785.15	5798.76	3.449	5786.78	5800.31	n/a	5800.31 j	3
5		20.00	24 c	168.5	5799.30	5806.04	3.999	5800.38	5807.62	0.87	5807.62	4
6		10.20	18 c	269.2	5807.50	5816.38	3.298	5808.28	5817.60	0.68	5817.60	5
7		9.80	24 c	11.2	5807.10	5807.32	1.968	5808.35	5808.43	0.47	5808.43	5
8		1.50	18 c	10.7	5799.80	5800.01	1.956	5800.98	5800.97	0.02	5801.00	4
9		14.30	24 c	7.3	5780.39	5780.46	0.955	5782.14	5782.14	0.40	5782.54	2

C8.7 basins 5yr storm	Number of lines: 9	Run Date: 03-18-2021
------------------------------	--------------------	----------------------

NOTES: c = cir; e = ellip; b = box; Return period = 5 Yrs. ; j - Line contains hyd. jump.

Storm Sewer Summary Report

Line No.	Line ID	Flow rate (cfs)	Line size (in)	Line length (ft)	Invert EL Dn (ft)	Invert EL Up (ft)	Line slope (%)	HGL down (ft)	HGL up (ft)	Minor loss (ft)	HGL Junct (ft)	Dns line No.
1		86.30	42 c	36.0	5778.08	5779.02	2.611	5781.58	5781.87	1.30	5781.87	End
2		76.50	36 c	31.0	5779.52	5779.89	1.194	5782.14	5782.70	0.77	5783.47	1
3		45.20	30 c	211.2	5780.39	5784.82	2.098	5784.07	5787.05	n/a	5787.05	2
4		45.20	30 c	394.6	5785.15	5798.76	3.449	5787.22	5800.99	n/a	5800.99	3
5		33.40	24 c	168.5	5799.30	5806.04	3.999	5800.99	5807.95	n/a	5807.95	4
6		15.90	18 c	269.2	5807.50	5816.38	3.298	5808.55	5817.81	n/a	5817.81	5
7		17.50	24 c	11.2	5807.10	5807.32	1.968	5809.27	5809.32	0.48	5809.80	5
8		11.80	18 c	10.7	5799.80	5800.01	1.956	5801.78*	5801.92*	0.69	5802.61	4
9		37.40	24 c	7.3	5780.39	5780.46	0.955	5783.47*	5783.67*	2.20	5785.87	2

C8.7 basins 100yr storm	Number of lines: 9	Run Date: 03-18-2021
--------------------------------	--------------------	----------------------

NOTES: c = cir; e = ellip; b = box; Return period = 100 Yrs. ; *Surcharged (HGL above crown).

Line No.	Flow Rate (cfs)	Line Size (in)	Line Type	Invert Dn (ft)	Invert Up (ft)	Line Slope (%)	HGL Dn (ft)	HGL Up (ft)	Minor Loss (ft)	HGL Jnct (ft)	Depth Up (ft)	Vel Dn (ft/s)
1	86.30	42	Cir	5778.08	5779.02	2.61	5781.58	5781.87	1.30	5781.87	2.84**	8.97
2	76.50	36	Cir	5779.52	5779.89	1.19	5782.14	5782.70	0.77	5783.47	2.81	11.68
3	45.20	30	Cir	5780.39	5784.82	2.10	5784.07	5787.05	n/a	5787.05	2.23**	9.21
4	45.20	30	Cir	5785.15	5798.76	3.45	5787.22	5800.99	n/a	5800.99	2.23**	10.41
5	33.40	24	Cir	5799.30	5806.04	4.00	5800.99	5807.95	n/a	5807.95	1.91**	11.78
6	15.90	18	Cir	5807.50	5816.38	3.30	5808.55	5817.81	n/a	5817.81	1.42**	12.07
7	17.50	24	Cir	5807.10	5807.32	1.97	5809.27	5809.32	0.48	5809.80	2.00	5.57
8	11.80	18	Cir	5799.80	5800.01	1.96	5801.78	5801.92	0.69	5802.61	1.50	6.68
9	37.40	24	Cir	5780.39	5780.46	0.95	5783.47	5783.67	2.20	5785.87	2.00	11.91

C8.7 basins 100yr storm	Number of lines: 9	Date: 09-30-2021
--------------------------------	--------------------	------------------

NOTES: ** Critical depth

BASINS F1 STORM SCHEMATIC

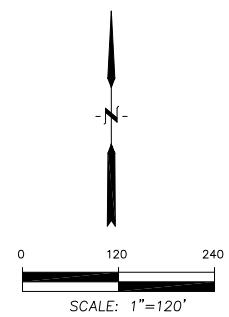
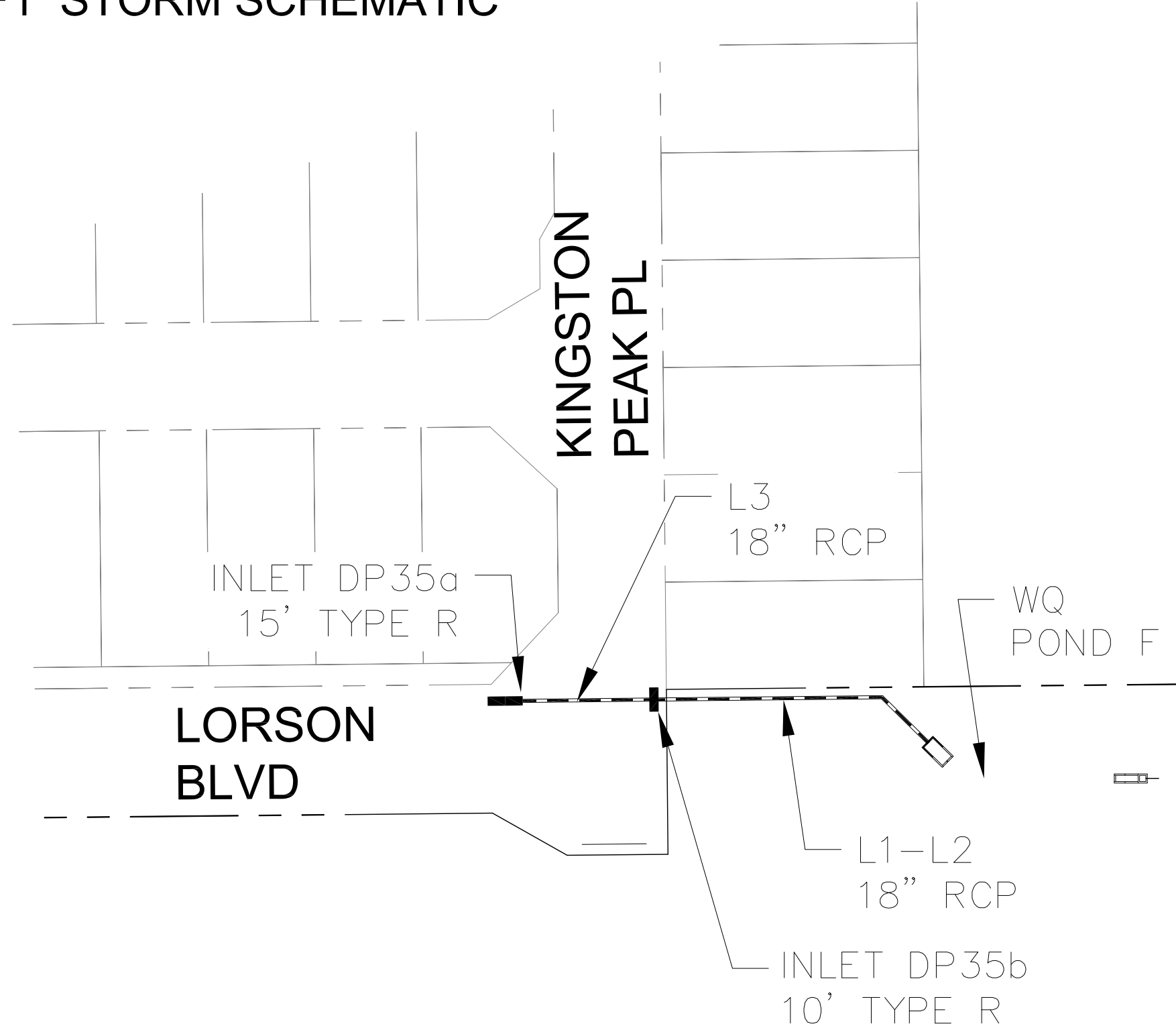

<p>CORE ENGINEERING GROUP 15004 1ST AVE. S. BURNSVILLE, MN 55306 PH: 719.570.1100 CONTACT: RICHARD L. SCHINDLER, P.E. EMAIL: Rich@cegi.com</p>	
DATE	MARCH, 2021
DESCRIPTION	STORM SEWER SCHEMATIC BASINS F1 THE RIDGE AT LORSON RANCH
PROJECT	THE RIDGE AT LORSON RANCH FONTAINE BLVD, WALLEE DR EL PASO COUNTY, COLORADO
PREPARED FOR	LORSON, LLC 212 N. WAHSATCH AVE., SUITE 301 COLORADO SPRINGS, COLORADO 80903 CONTACT: JEFF MARK
DRAWN	RLS
DESIGNED	LAB
CHECKED	LAB
<p>STORM SEWER SCHEMATIC BASINS F1 THE RIDGE AT LORSON RANCH</p>	
DATE	MARCH, 2021
PROJECT NO.	100.064
SHEET NUMBER	1
TOTAL SHEETS:	1

P: 100.100.064_ebrincopg-100.064-storm_schematic.dwg Jul 17, 2021 -- 8:55am

Storm Sewer Summary Report

Line No.	Line ID	Flow rate (cfs)	Line size (in)	Line length (ft)	Invert EL Dn (ft)	Invert EL Up (ft)	Line slope (%)	HGL down (ft)	HGL up (ft)	Minor loss (ft)	HGL Junct (ft)	Dns line No.
1	3	7.80	18 c	51.1	5844.50	5845.52	1.997	5845.57	5846.59	n/a	5846.59 j	End
2		7.80	18 c	106.7	5845.52	5854.05	7.998	5846.81	5855.12	n/a	5855.12 j	1
3		5.90	18 c	82.6	5854.38	5855.21	1.006	5855.47	5856.14	n/a	5856.14 j	2

F1 basins 5yr storm	Number of lines: 3	Run Date: 07-17-2021
----------------------------	--------------------	----------------------

NOTES: c = cir; e = ellip; b = box; Return period = 5 Yrs. ; j - Line contains hyd. jump.

Storm Sewer Summary Report

Line No.	Line ID	Flow rate (cfs)	Line size (in)	Line length (ft)	Invert EL Dn (ft)	Invert EL Up (ft)	Line slope (%)	HGL down (ft)	HGL up (ft)	Minor loss (ft)	HGL Junct (ft)	Dns line No.
1	3	15.70	18 c	51.1	5844.50	5845.52	1.997	5845.95	5847.01	0.85	5847.86	End
2		15.70	18 c	106.7	5845.52	5854.05	7.998	5847.86	5855.47	n/a	5855.47 j	1
3		11.30	18 c	82.6	5854.38	5855.21	1.006	5856.11*	5857.07*	0.64	5857.71	2

F1 basins 100yr storm	Number of lines: 3	Run Date: 09-29-2021
------------------------------	--------------------	----------------------

NOTES: c = cir; e = ellip; b = box; Return period = 100 Yrs. ; *Surcharged (HGL above crown). ; j - Line contains hyd. jump.

Line No.	Flow Rate (cfs)	Line Size (in)	Line Type	Invert Dn (ft)	Invert Up (ft)	Line Slope (%)	HGL Dn (ft)	HGL Up (ft)	Minor Loss (ft)	HGL Jnct (ft)	Depth Up (ft)	Vel Dn (ft/s)
1	15.70	18	Cir	5844.50	5845.52	2.00	5845.95	5847.01	0.85	5847.86	1.49	8.98
2	15.70	18	Cir	5845.52	5854.05	8.00	5847.86	5855.47 j	n/a	5855.47	1.42**	8.89
3	11.30	18	Cir	5854.38	5855.21	1.01	5856.11	5857.07	0.64	5857.71	1.50	6.40

F1 basins 100yr storm	Number of lines: 3	Date: 09-30-2021
------------------------------	--------------------	------------------

NOTES: ** Critical depth

MAP POCKET

DESIGN POINT SUMMARY TABLE					
DESIGN POINT	Basin	DRAINAGE AREA (AC)	RUNOFF 5 YR (CFS)	RUNOFF 100 YR (CFS)	COMMENT
1X	EX-B	25.89	9.7cfs	54.2cfs	EX. FLOW OFFSITE TO ROLLING HILLS RANCH
2X	EX-F	39.85	12.4cfs	72.7cfs	EX. FLOW OFFSITE TO THE EAST
4X	C4-ex	52.32	15.3cfs	87.7cfs	EX. FLOW

- LEGEND**
- PUD BOUNDARY
 - BASIN BOUNDARY-MAJOR
 - BASIN BOUNDARY-MINOR
 - BASIN DESIGN POINT
 - BASIN I.D. ACREAGE 5 YR/100 YR CFS
 - DIRECTION OF FLOW
 - EXISTING CONTOUR
 - EXISTING ROW/LORSON RANCH BOUNDARY
 - EXISTING STORM SEWER
 - EXISTING OVERHEAD TRANSMISSION LINES
 - TIME OF CONCENTRATION

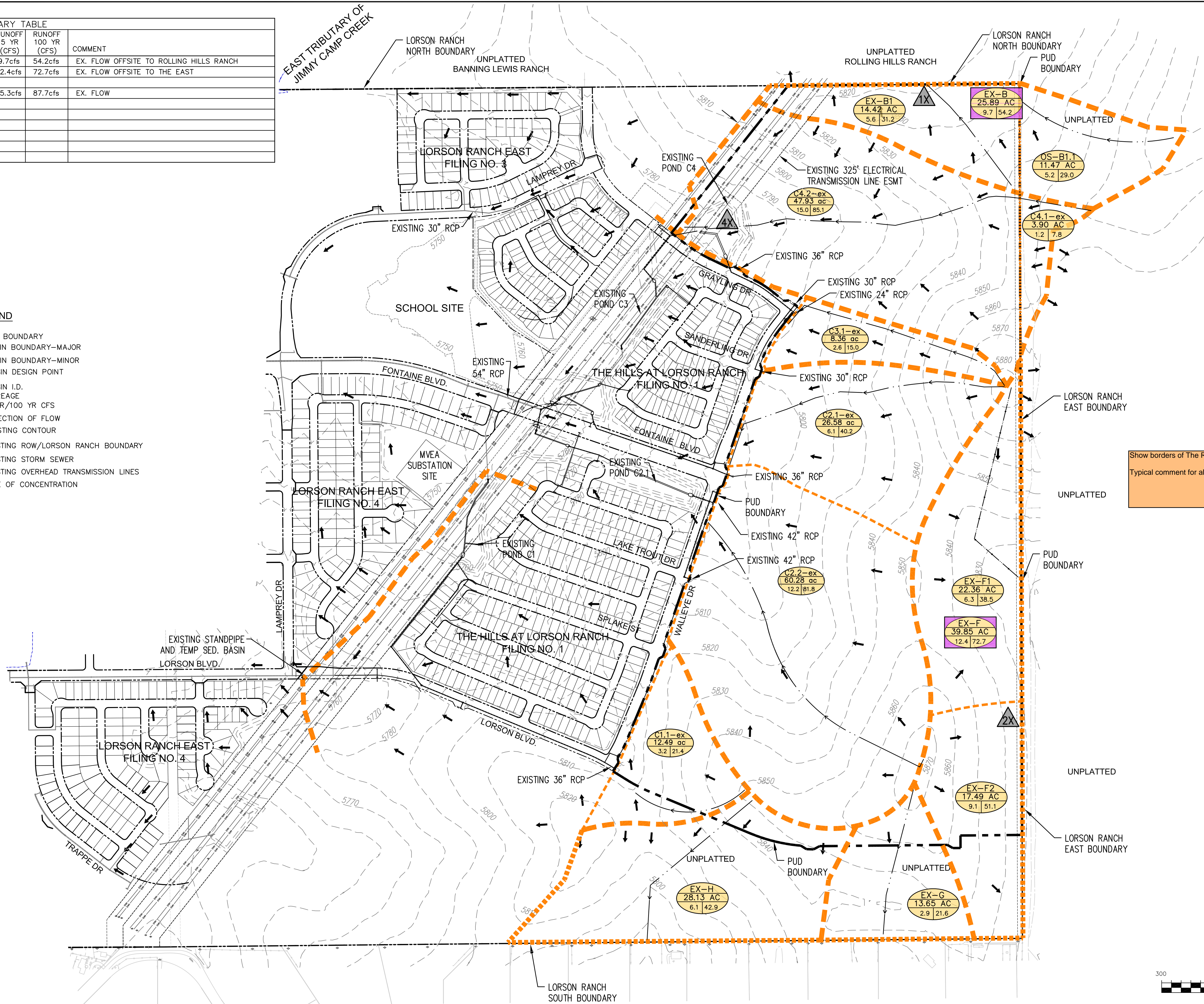

Show borders of The Ridge Filings 1, 2, and 3.
Typical comment for all subsequent maps.

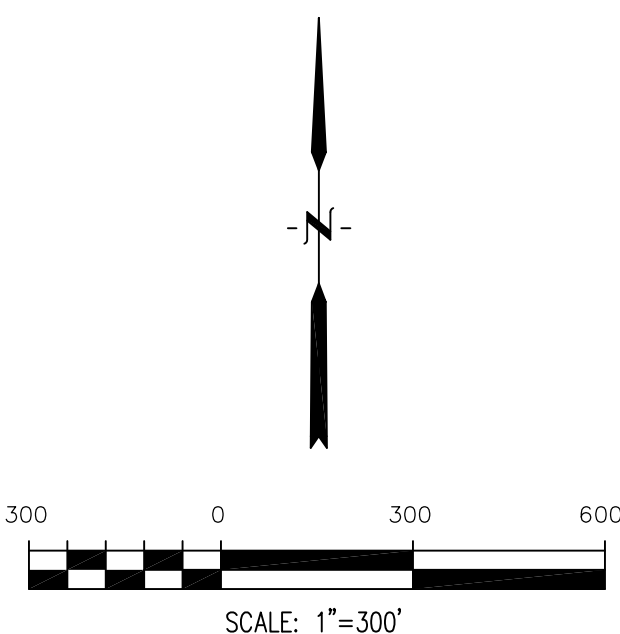

CORE ENGINEERING GROUP
 15004 1ST AVENUE S.
 P.O. BOX 100
 COLORADO SPRINGS, COLORADO 80903 (719) 635-3200
 CONTACT: RICHARD L. SCHINDLER, P.E.
 EMAIL: Rich@cegi.com

DATE: _____
 DESCRIPTION: _____
 NO. _____
 PROJECT: THE RIDGE AT LORSON RANCH
 PREPARED FOR: LORSON LLC
 212 NORTH WAHATCH AVE, SUITE 301
 COLORADO SPRINGS, COLORADO 80903 (719) 635-3200
 CONTACT: JEFF MARK

DRAWN: RLS
 DESIGNED: RLS
 CHECKED: RLS

**EXISTING CONDITIONS
 PUD / PRELIMINARY PLAN
 THE RIDGE AT LORSON RANCH**

DATE: SEPT, 2021
 PROJECT NO. 100.064
 SHEET NUMBER 1
 TOTAL SHEETS: 1

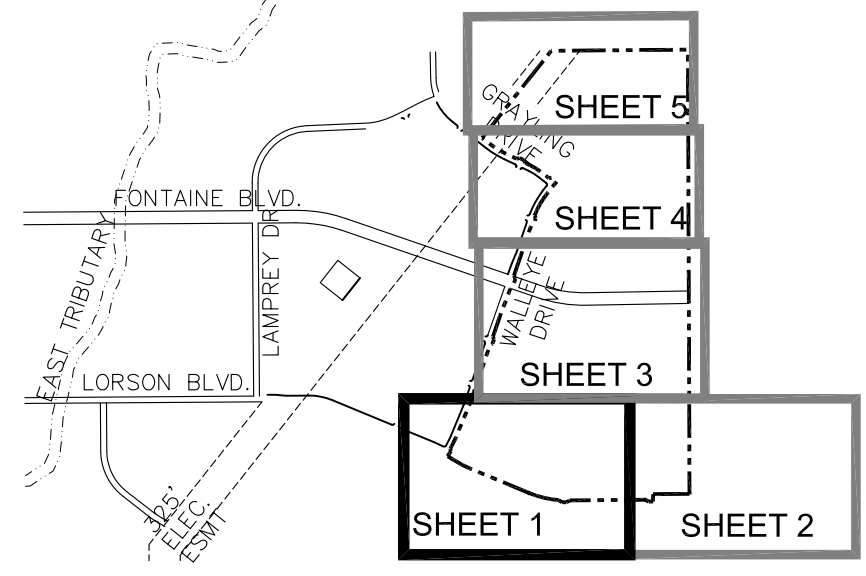

KEY MAP
NO SCALE

LEGEND

- PUD BOUNDARY
- BASIN BOUNDARY
- BASIN DESIGN POINT
- BASIN I.D. ACREAGE
- DIRECTION OF FLOW
- EXISTING CONTOUR
- PROPOSED CONTOUR
- ROW/LORSON RANCH BOUNDARY
- EXISTING STORM SEWER
- EXISTING OVERHEAD TRANSMISSION LINES
- PROPOSED STORM SEWER
- TIME OF CONCENTRATION
- HIGH POINT
- LOW POINT

DETENTION POND AREAS:

1. C1 BASINS DRAIN TO POND C1
2. C3 & C4 BASINS DRAIN TO POND C2.1
3. C5 BASINS DRAIN TO POND C2.2
4. C8 BASINS DRAIN TO POND C4
5. F1.3-F1.4 BASINS DRAIN TO WQ POND F (NO DETENTION, WQ ONLY)

*ALL DETENTION PONDS HAVE BEEN CONSTRUCTED PER SF 21-010 AND EGP 20-005 (THE HILLS AT LORSON RANCH) EXCEPT WQ POND F

**SEE POND EXHIBIT FOR POND LOCATIONS

RUNOFF SUMMARY			
D.P.	5 YEAR cfs	100 YEAR cfs	NOTES
10a	12.8	28.3	FUTURE FLOW IN 24" STUB
1	5.6	12.2	STREET FLOW
2	2.7	5.9	STREET FLOW
3	8.3	18.1	FLOW IN STORM SEWER
4	8.9	21.6	STREET FLOW
5	17.2	36.1	FLOW IN STORM SEWER
6	3.0	6.6	STREET FLOW
7	36.8	65.8	FLOW IN EX. 36" STM
12	9.9	21.8	STREET FLOW
13	8.5	24.3	STREET FLOW
14	17.6	30.4	FLOW IN STORM SEWER
15	8.7	27.3	STREET FLOW
16	26.0	46.9	FLOW IN STORM SEWER
17	7.5	26.7	STREET FLOW
18	33.5	67.3	FLOW IN STORM SEWER
19	10.3	28.8	STREET FLOW
20	43.8	88.5	FLOW IN STORM SEWER

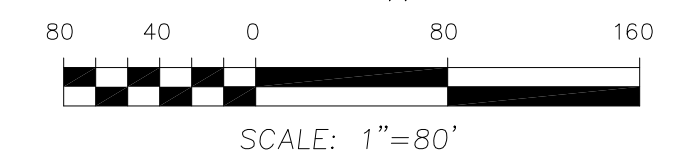
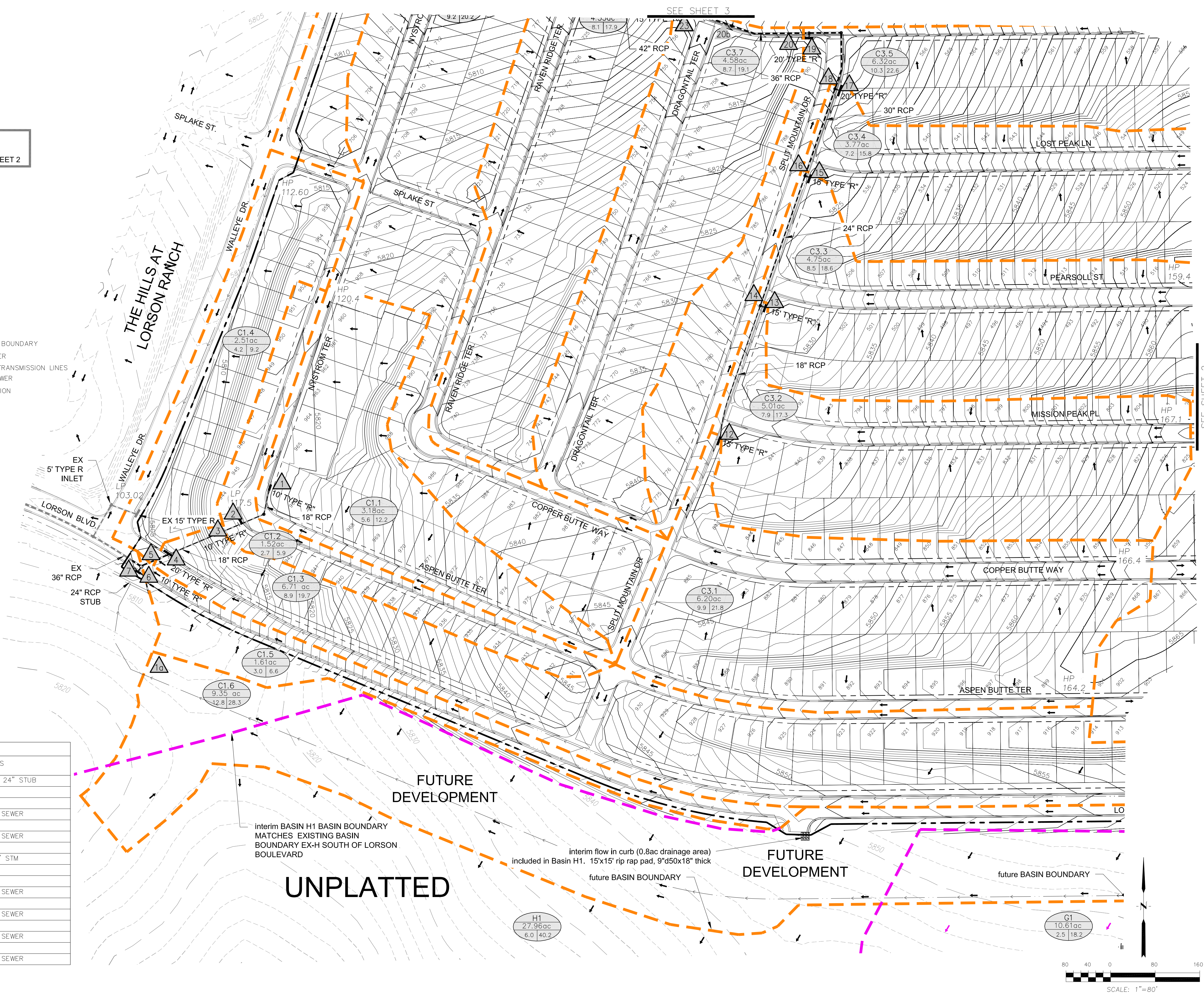

SEE SHEET 2

CORE ENGINEERING GROUP
 15004 1ST AVE. S.
 BURNSVILLE, MN 55306
 PH: 763-570-1100
 FAX: 763-570-1100
 EMAIL: Rich@cegg.com

DATE: _____
 DESCRIPTION: _____
 NO: _____
 PREPARED FOR: **LORSON, LLC**
 PROJECT: **THE RIDGE AT LORSON RANCH**
 212 N. WAHSAUCH AVE. SUITE 301
 COLORADO SPRINGS, COLORADO 80903
 EL PASO COUNTY, COLORADO
 CONTACT: JEFF MARK

DEVELOPED CONDITIONS
THE RIDGE AT LORSON RANCH
 X

DATE: **SEPT, 2021**
 PROJECT NO: **100.064**
 SHEET NUMBER: **1**
 TOTAL SHEETS: **5**

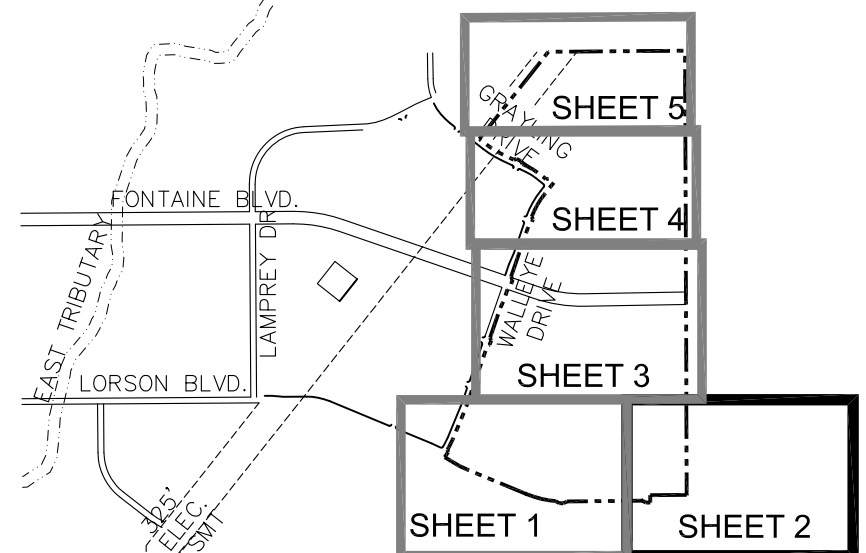

DETENTION POND AREAS:

1. C1 BASINS DRAIN TO POND C1
2. C3 & C4 BASINS DRAIN TO POND C2.1
3. C5 BASINS DRAIN TO POND C2.2
4. C8 BASINS DRAIN TO POND C4
5. F1.3-F1.4 BASINS DRAIN TO WQ POND F (NO DETENTION, WQ ONLY)

*ALL DETENTION PONDS HAVE BEEN CONSTRUCTED PER SF 21-010 AND EGP 20-005 (THE HILLS AT LORSON RANCH) EXCEPT WQ POND F

**SEE POND EXHIBIT FOR POND LOCATIONS

KEY MAP
NO SCALE

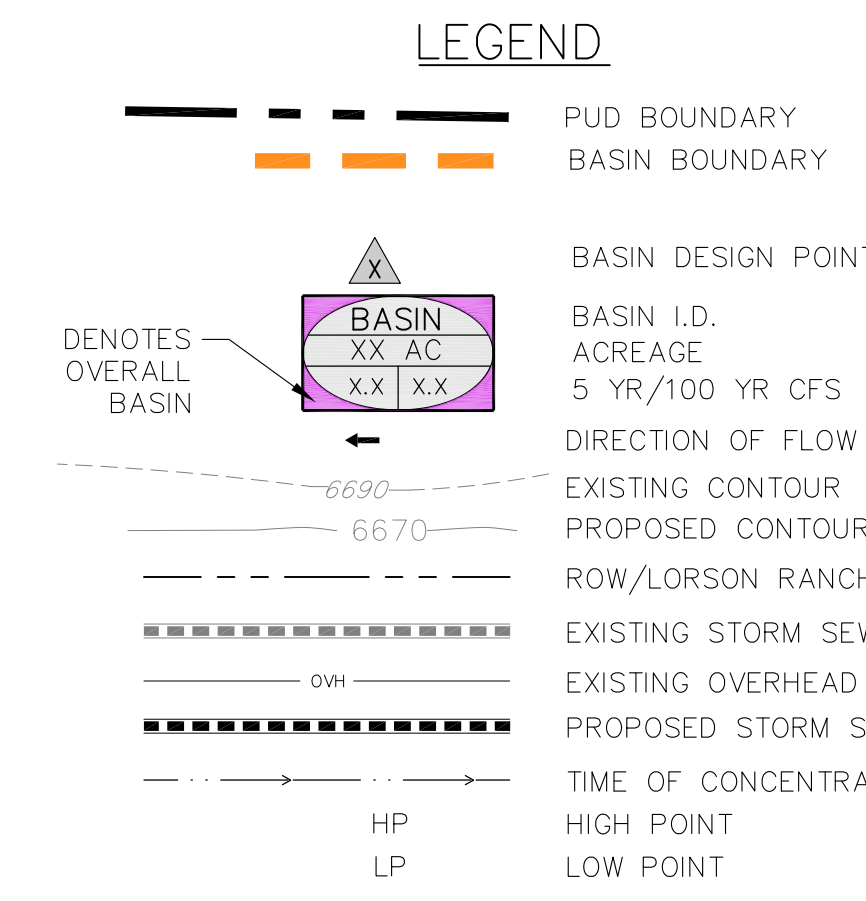

RUNOFF SUMMARY			
D.P.	5 YEAR cfs	100 YEAR cfs	NOTES
12	9.9	21.8	STREET FLOW
13	8.5	24.3	STREET FLOW
14	17.6	30.4	FLOW IN STORM SEWER
15	8.7	27.3	STREET FLOW
16	26.0	46.9	FLOW IN STORM SEWER
17	7.5	26.7	STREET FLOW
18	33.5	67.3	FLOW IN STORM SEWER
19	10.3	28.8	STREET FLOW
20	43.8	88.5	FLOW IN STORM SEWER
35a	5.9	13.2	STREET FLOW
35b	1.9	4.6	STREET FLOW
35c	7.8	15.7	FLOW STORM SEWER
35d	1.9	8.4	FLOW FROM WQ POND F
35e	2.5	18.2	FLOW OFFSITE TO SOUTH
35f	6.0	40.2	FLOW OFFSITE TO THE SOUTH
35	15.5	69.5	FLOW OFFSITE TO THE EAST

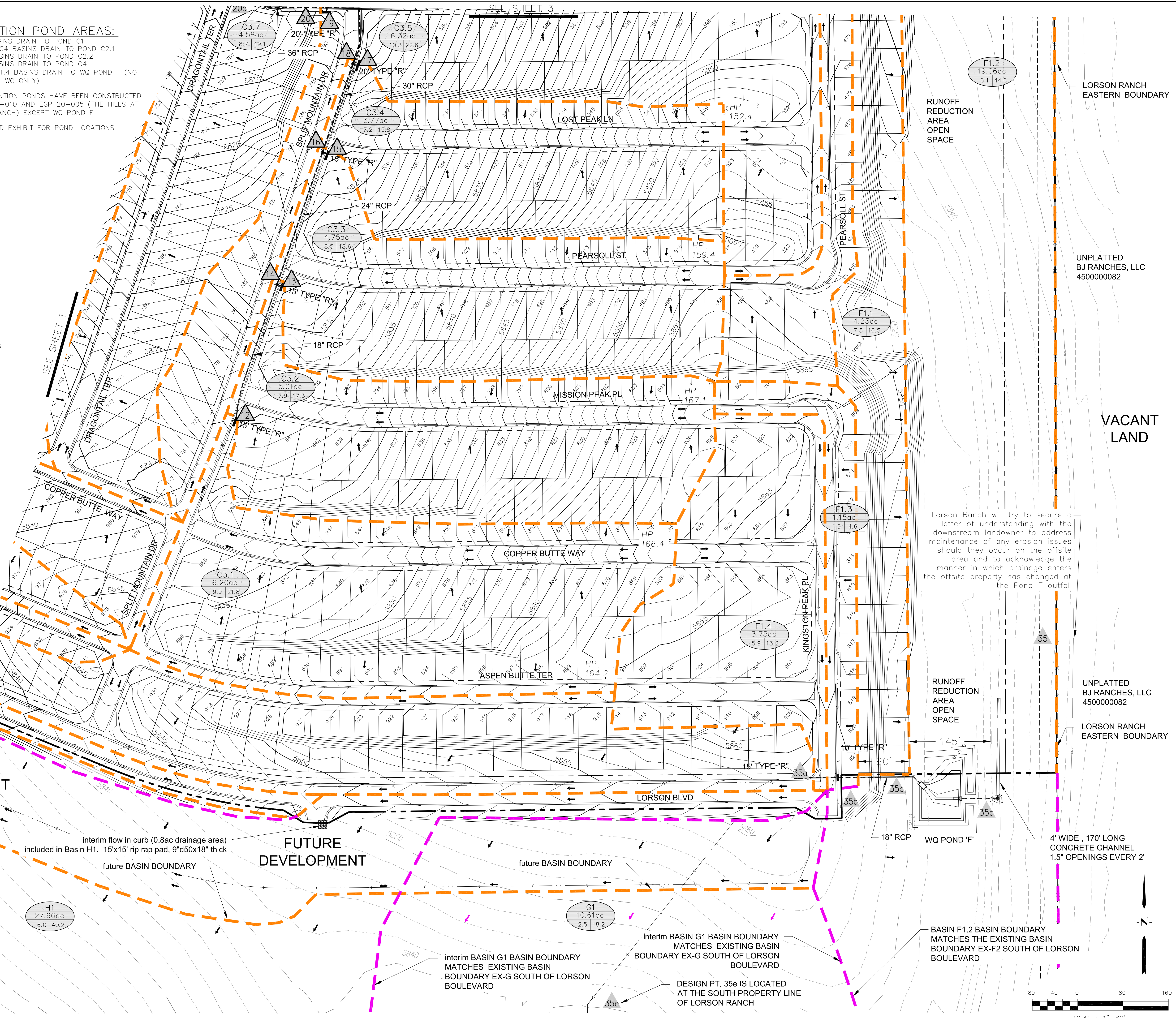

Lorson Ranch will try to secure a letter of understanding with the downstream landowner to address maintenance of any erosion issues should they occur on the offsite area and to acknowledge the manner in which drainage enters the offsite property has changed at the Pond F outfall

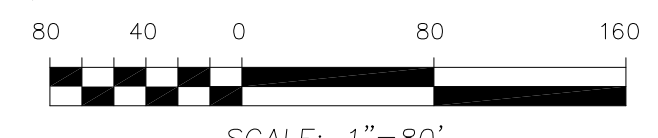

CORE ENGINEERING GROUP
15004 1ST AVE. S.
BURNSVILLE, MN 55306
PH: 763-570-1100
FAX: 763-570-1100
EMAIL: Rich@ceeg.com

DATE: _____
DESCRIPTION: _____
NO: _____
DRAWN: RL6
DESIGNED: LAB
CHECKED: LAB

PREPARED FOR:
LORSON, LLC
212 N. WAHSAKCH AVE. SUITE 301
COLORADO SPRINGS, COLORADO 80903
(719) 635-3200
CONTACT: JEFF MARK

PROJECT:
THE RIDGE AT LORSON RANCH
FONTAINE BLVD. - WALLEYE DRIVE
EL PASO COUNTY, COLORADO

DEVELOPED CONDITIONS
THE RIDGE AT LORSON RANCH

DATE: SEPT, 2021
PROJECT NO: 100.064
SHEET NUMBER: 2
TOTAL SHEETS: 5

UNPLATTED BJ RANCHES, LLC 4500000082

RUNOFF SUMMARY			
D.P.	5 YEAR cfs	100 YEAR cfs	NOTES
17	7.5	26.7	STREET FLOW
18	33.5	67.3	FLOW IN STORM SEWER
19	10.3	28.8	STREET FLOW
20	43.8	88.5	FLOW IN STORM SEWER
20a	5.6	12.3	STREET FLOW
20b	49.4	99.2	FLOW IN STORM SEWER
21	7.2	17.5	STREET FLOW
23	8.7	26.7	STREET FLOW
24	57.8	115.5	FLOW IN STORM SEWER
24a	65.0	118.6	FLOW IN STORM SEWER
25	10.0	26.4	STREET FLOW
27	8.4	28.3	STREET FLOW
28	73.4	132.7	FLOW IN STORM SEWER
28a	80.6	133.4	FLOW IN STORM SEWER
29	9.2	27.8	STREET FLOW
30	89.8	153.9	FLOW IN STORM SEWER

RUNOFF SUMMARY			
D.P.	5 YEAR cfs	100 YEAR cfs	NOTES
31	10.5	23.2	STREET FLOW
32	10.3	27.5	STREET FLOW
32a	18.2	42.8	FLOW IN STORM SEWER
33	7.0	28.7	STREET FLOW AT EX. INLET
34	115.0	225.4	FLOW IN EX. 54" STM
36	11.4	25.2	STREET FLOW
37	7.4	16.3	STREET FLOW
38	7.5	10.5	FLOW IN STORM SEWER
39	12.7	34.0	STREET FLOW
40	23.0	37.0	FLOW IN STORM SEWER
41	9.3	27.7	STREET FLOW
42	32.3	62.1	FLOW IN STORM SEWER
43	10.0	24.5	STREET FLOW
44	42.3	87.1	FLOW INTO EX. STORM SEWER
45	7.7	17.1	STREET FLOW AT EX. INLET

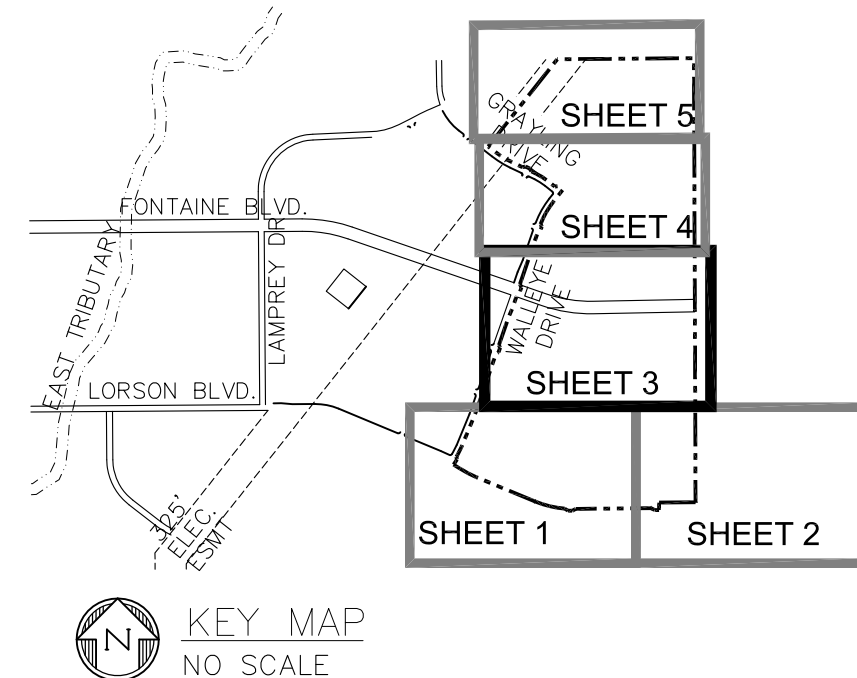

DETENTION POND AREAS:

- C1 BASINS DRAIN TO POND C1
- C3 & C4 BASINS DRAIN TO POND C2.1
- C5 BASINS DRAIN TO POND C2.2
- C8 BASINS DRAIN TO POND C4
- F1.3-F1.4 BASINS DRAIN TO WQ POND F (NO DETENTION, WQ ONLY)

*ALL DETENTION PONDS HAVE BEEN CONSTRUCTED PER SF 21-010 AND EGP 20-005 (THE HILLS AT LORSON RANCH) EXCEPT WQ POND F

**SEE POND EXHIBIT FOR POND LOCATIONS

LEGEND

- PUD BOUNDARY
- - - BASIN BOUNDARY
- ▲ BASIN DESIGN POINT
- △ BASIN I.D.
- XX AC ACREAGE
- XX.XX 5-YR/100-YR CFS
- DIRECTION OF FLOW
- - - EXISTING CONTOUR
- - - PROPOSED CONTOUR
- - - ROW/LORSON RANCH BOUNDARY
- - - EXISTING STORM SEWER
- - - EXISTING OVERHEAD TRANSMISSION LINES
- - - PROPOSED STORM SEWER
- HP HIGH POINT
- LP LOW POINT



CORE ENGINEERING GROUP
 15004 1ST AVE. S.
 BURNSVILLE, MN 55306
 PH: 763-570-1100
 FAX: 763-570-1100
 EMAIL: Rich@cegroup.com

DATE: _____
 DESCRIPTION: _____
 NO. _____

PROJECT: THE RIDGE AT LORSON RANCH
 FONTAINE BLVD. - WALLEYE DRIVE
 EL PASO COUNTY, COLORADO

PREPARED FOR: LORSON, LLC
 212 N. WAHSAKCHA AVE. SUITE 301
 COLORADO SPRINGS, COLORADO 80903
 CONTACT: JEFF MARK

DRAWN: RL6
 DESIGNED: LB
 CHECKED: LB

DEVELOPED CONDITIONS
 THE RIDGE AT LORSON RANCH
 X

DATE: SEPT, 2021
 PROJECT NO: 100.064
 SHEET NUMBER: 3
 TOTAL SHEETS: 5

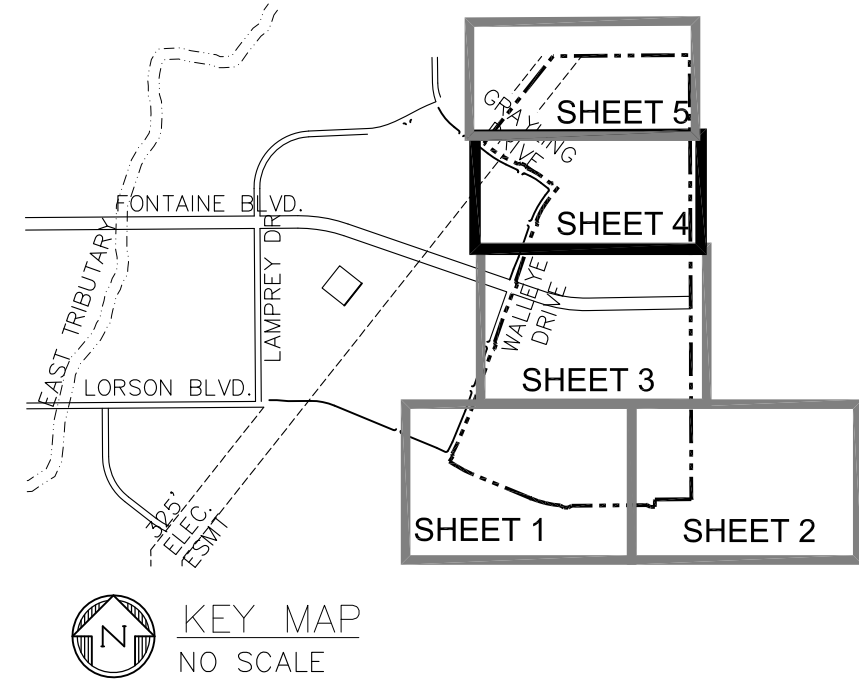

RUNOFF SUMMARY			
D.P.	5 YEAR cfs	100 YEAR cfs	NOTES
36	11.4	25.2	STREET FLOW
37	7.4	16.3	STREET FLOW
38	7.5	10.5	FLOW IN STORM SEWER
39	12.7	34.0	STREET FLOW
40	23.0	37.0	FLOW IN STORM SEWER
41	9.3	27.7	STREET FLOW
42	32.3	62.1	FLOW IN STORM SEWER
43	10.0	24.5	STREET FLOW
44	42.3	87.1	FLOW INTO EX. STORM SEWER
45	7.7	17.1	STREET FLOW AT EX. INLET
47	7.5	16.4	STREET FLOW
48	3.4	7.6	STREET FLOW

RUNOFF SUMMARY			
D.P.	5 YEAR cfs	100 YEAR cfs	NOTES
49	7.7	27.7	STREET FLOW
50	11.1	27.0	FLOW INTO EX. STORM SEWER
51	4.5	26.0	STREET FLOW AT EX. INLET
52	15.6	53.0	FLOW IN EX. STORM SEWER
53	10.6	26.5	STREET FLOW
54	11.8	37.6	STREET FLOW
55	21.4	40.2	FLOW IN STORM SEWER
56	9.0	32.8	STREET FLOW
57	11.0	24.1	STREET FLOW
58	17.1	28.1	FLOW IN STORM SEWER
59	7.0	15.5	STREET FLOW
60	32.7	73.3	FLOW IN STORM SEWER

DETENTION POND AREAS:

1. C1 BASINS DRAIN TO POND C1
2. C3 & C4 BASINS DRAIN TO POND C2.1
3. C5 BASINS DRAIN TO POND C2.2
4. C8 BASINS DRAIN TO POND C4
5. F1.3-F1.4 BASINS DRAIN TO WQ POND F (NO DETENTION, WQ ONLY)

*ALL DETENTION PONDS HAVE BEEN CONSTRUCTED PER SF 21-010 AND EGP 20-005 (THE HILLS AT LORSON RANCH) EXCEPT WQ POND F

**SEE POND EXHIBIT FOR POND LOCATIONS

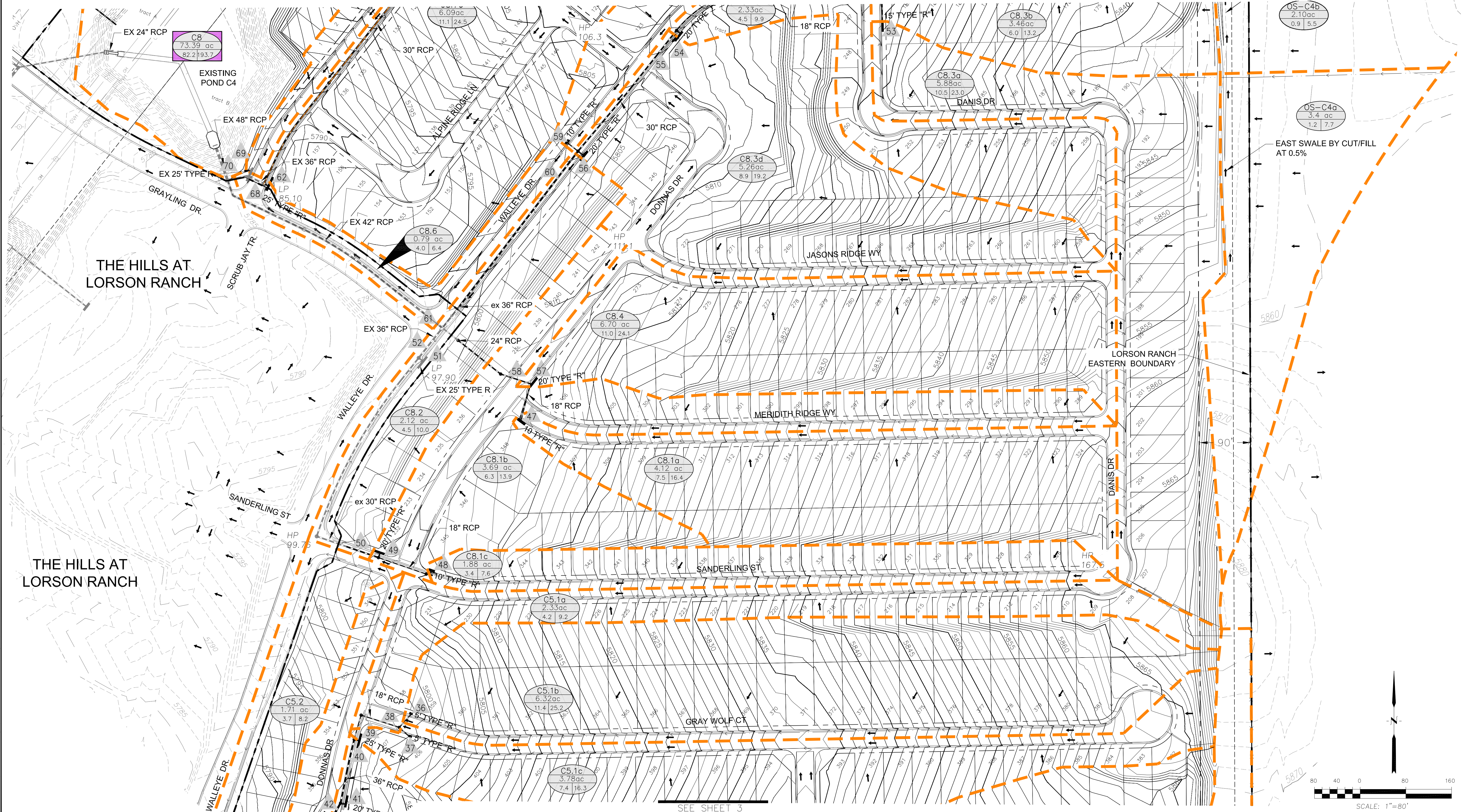
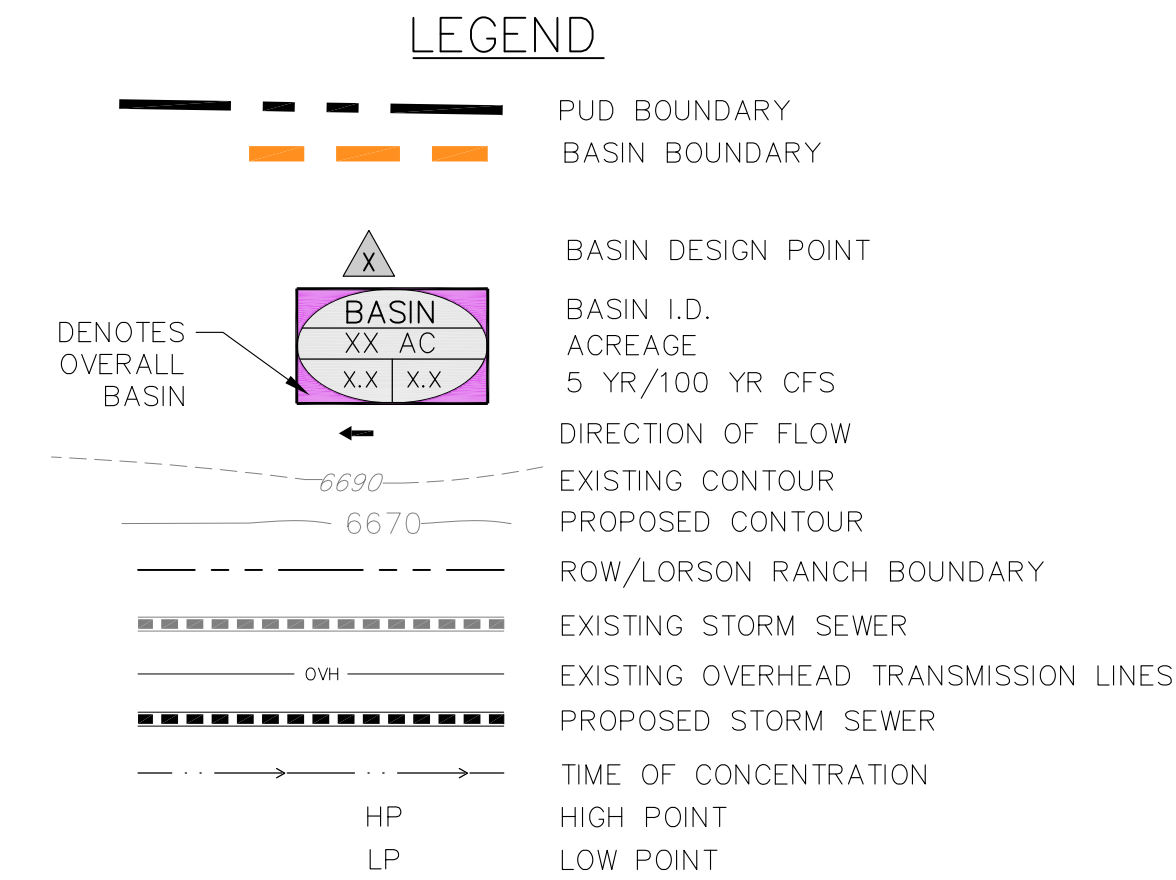

CORE ENGINEERING GROUP
 15004 1ST AVE. S.
 BURNSVILLE, MN 55306
 PH: 763-570-1100
 FAX: 763-570-1100
 EMAIL: Rich@cegroup.com



DATE: _____
 DESCRIPTION: _____
 NO. _____
 DRAWN: RL6
 DESIGNED: LB
 CHECKED: LB

PREPARED FOR:
LORSON, LLC
 212 N. WAHSAUCH AVE. SUITE 301
 COLORADO SPRINGS, COLORADO 80903
 (719) 635-3200
 CONTACT: JEFF MARK

DEVELOPED CONDITIONS
 THE RIDGE AT LORSON RANCH
 X

DATE: SEPT, 2021
 PROJECT NO: 100.064
 SHEET NUMBER: 4
 TOTAL SHEETS: 5

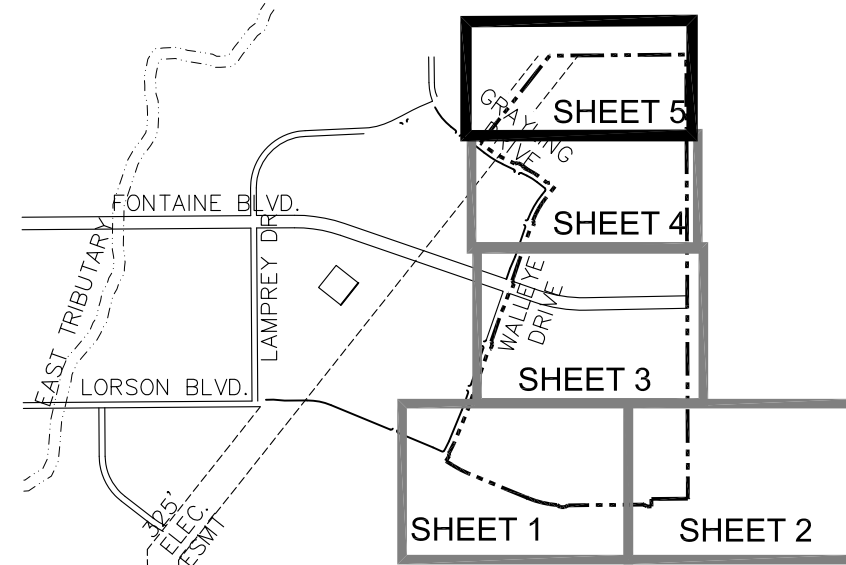

RUNOFF SUMMARY			
D.P.	5 YEAR cfs	100 YEAR cfs	NOTES
62	14.3	37.4	STREET FLOW
63	11.5	25.6	STREET FLOW
63a	7.3	42.2	OFFSITE FLOW ROUTED NORTH
64	10.7	30.6	STREET FLOW
65	20.0	33.4	FLOW IN STORM SEWER
66	1.5	14.5	STREET FLOW
67	21.5	45.2	FLOW IN STORM SEWER
68	33.0	76.5	FLOW INTO EX. STORM SEWER
69	9.3	26.9	STREET FLOW AT EX. INLET
70	34.5	86.3	FLOW IN EX. 42" STORM SEWER

DETENTION POND AREAS:

1. C1 BASINS DRAIN TO POND C1
2. C3 & C4 BASINS DRAIN TO POND C2.1
3. C5 BASINS DRAIN TO POND C2.2
4. C8 BASINS DRAIN TO POND C4
5. F1.3-F1.4 BASINS DRAIN TO WQ POND F (NO DETENTION, WQ ONLY)

*ALL DETENTION PONDS HAVE BEEN CONSTRUCTED PER SF 21-010 AND EGP 20-005 (THE HILLS AT LORSON RANCH) EXCEPT WQ POND F

**SEE POND EXHIBIT FOR POND LOCATIONS

LEGEND

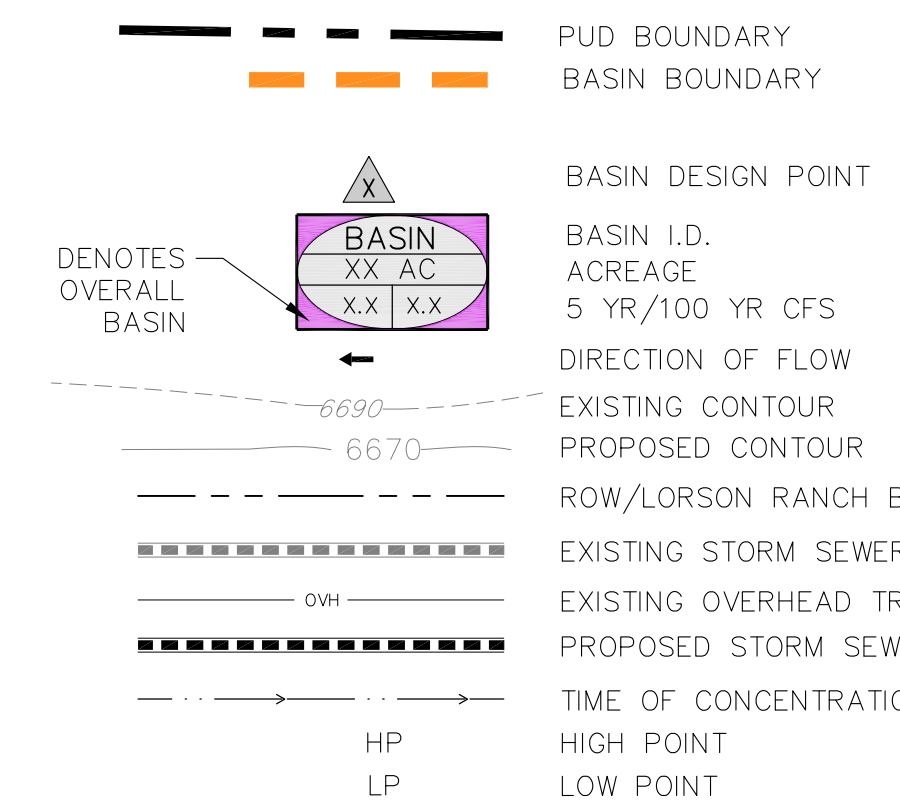

UNPLATTED ROLLING HILLS RANCH

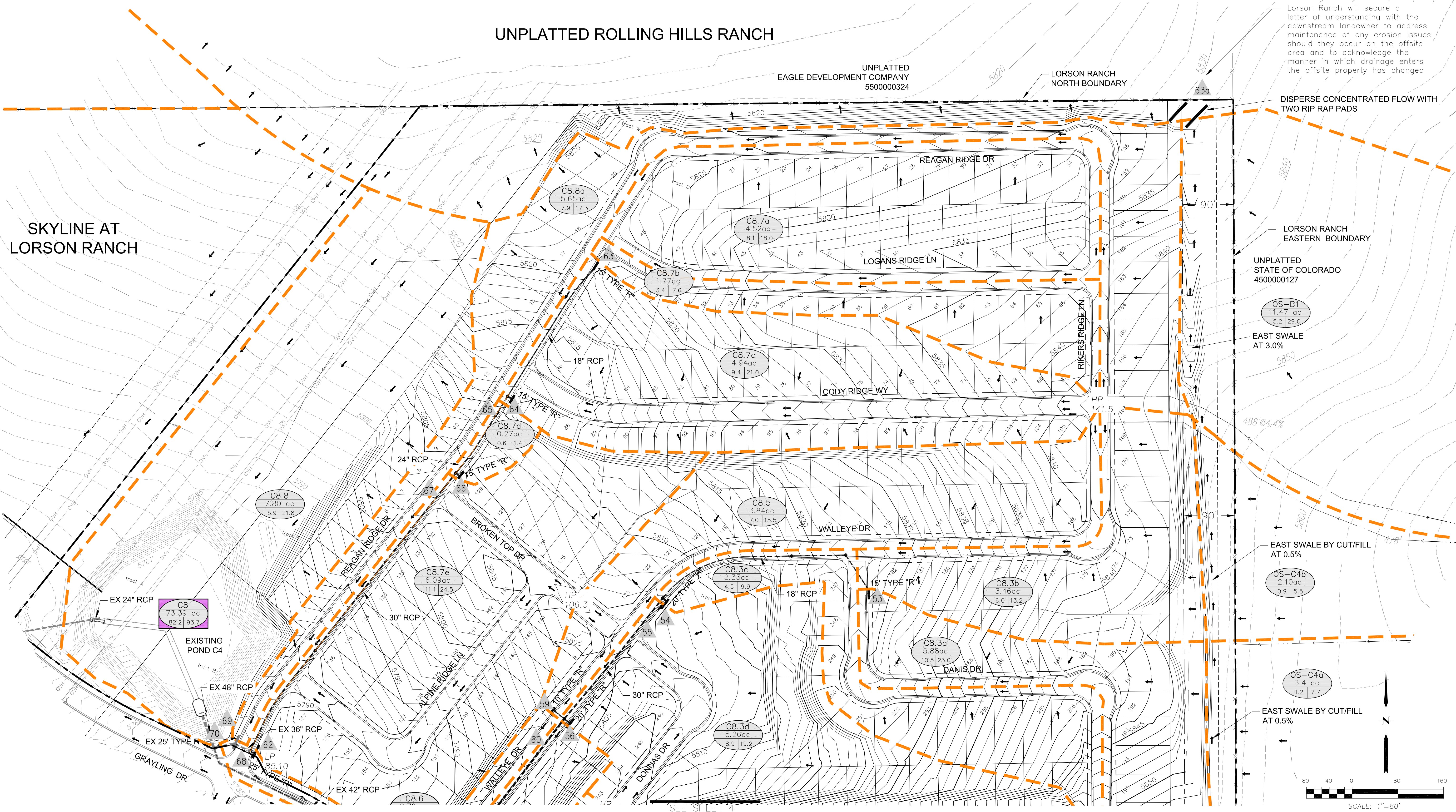

Lorson Ranch will secure a letter of understanding with the downstream landowner to address maintenance of any erosion issues should they occur on the offsite area and to acknowledge the manner in which drainage enters the offsite property has changed

DISPERSE CONCENTRATED FLOW WITH TWO RIP RAP PADS

LORSON RANCH EASTERN BOUNDARY

UNPLATTED STATE OF COLORADO 4500000127

OS-B1 11.47 ac 5.2 29.0

EAST SWALE AT 3.0%

OS-C4b 2.10 ac 0.9 5.5

OS-C4a 3.4 ac 1.2 7.7

EAST SWALE BY CUT/FILL AT 0.5%

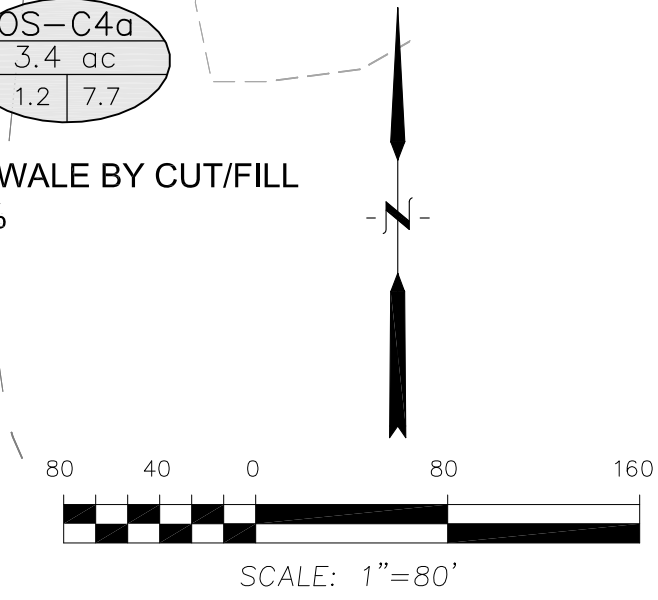

CORE ENGINEERING GROUP
 15004 1ST AVE. S.
 BURNSVILLE, MN 55306
 PH: 763-570-1100
 FAX: 763-570-1100
 EMAIL: Rich@cegroup.com

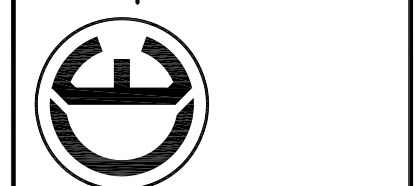

DATE: _____
 DESCRIPTION: _____
 NO. _____
 PREPARED FOR: **LORSON, LLC**
 PROJECT: **THE RIDGE AT LORSON RANCH**
 212 N. WAHSAKCHA AVE. SUITE 301
 COLORADO SPRINGS, COLORADO 80903
 CONTACT: JEFF MARK

DRAWN: RL6
 DESIGNED: LB
 CHECKED: LB

DEVELOPED CONDITIONS
THE RIDGE AT LORSON RANCH
 X

DATE: **SEPT, 2021**
 PROJECT NO: **100.064**
 SHEET NUMBER: **5**
 TOTAL SHEETS: **5**

ENG-SF22007-FDR-R1-Redlines.pdf Markup Summary

Glenn Reese - EPC Stormwater (23)

Since this drainage report is the same as that submitted for Filing No. 1, my comments are the same.

FINAL

Subject: SW - Textbox
Page Label: 1
Author: Glenn Reese - EPC Stormwater
Date: 2/28/2022 9:47:02 PM
Status:
Color: ■
Layer:
Space:

Since this drainage report is the same as that submitted for Filing No. 1, my comments are the same.

X
X
X

SF225

Subject: SW - Textbox with Arrow
Page Label: 1
Author: Glenn Reese - EPC Stormwater
Date: 2/28/2022 9:47:07 PM
Status:
Color: ■
Layer:
Space:

SF225

X
X

SF227

Subject: SW - Textbox with Arrow
Page Label: 1
Author: Glenn Reese - EPC Stormwater
Date: 2/28/2022 9:47:07 PM
Status:
Color: ■
Layer:
Space:

SF227

ANCH
X
X

SF224

Subject: SW - Textbox with Arrow
Page Label: 1
Author: Glenn Reese - EPC Stormwater
Date: 2/28/2022 9:47:07 PM
Status:
Color: ■
Layer:
Space:

SF224

revise to "structures" (plural)

Full Spectrum Pond Construction Requirements
All four of the detention ponds required for this project at Lorson Ranch (PJDISP 20,000) and include Ph Ranch constructed Existing Pond C1 and C2.2 all need to be modified and include the full spectrum low flow channels. Existing Pond C2.1 and Phose outlet stills sewers, and low flow channels but do outlet structure for these two ponds will be discuss proposed. For the Lorson East MDDP, these four

Subject: SW - Textbox with Arrow
Page Label: 40
Author: Glenn Reese - EPC Stormwater
Date: 2/28/2022 9:47:18 PM
Status:
Color: ■
Layer:
Space:

revise to "structures" (plural)

ECM 1.7.1 and 1.7.2 shall not require for separate ponds but do not require for separate ponds. However, when ponds are used for detention, they shall be designed to meet the requirements of ECM 1.7.1 and 1.7.2. The design shall include the full spectrum low flow channels. Existing Pond C2.1 and Phose outlet stills sewers, and low flow channels but do outlet structure for these two ponds will be discuss proposed. For the Lorson East MDDP, these four

Subject: SW - Textbox with Arrow
Page Label: 40
Author: Glenn Reese - EPC Stormwater
Date: 2/28/2022 9:47:18 PM
Status:
Color: ■
Layer:
Space:

Re-phrase to clarify that all applicable runoff must be treated unless excluded per ECM App 1.7.1.

v flow channels.
t fall storm sewer
tlet structure for
posed. Per the
utary) are part c

Subject: SW - Highlight
Page Label: 40
Author: Glenn Reese - EPC Stormwater
Date: 2/28/2022 9:47:25 PM
Status:
Color: ■
Layer:
Space:

structure



Subject: SW - Highlight
Page Label: 40
Author: Glenn Reese - EPC Stormwater
Date: 2/28/2022 9:47:31 PM
Status:
Color: ■
Layer:
Space:

In addition to the four detention ponds Lorson Ranch is required to discharge the same runoff rates eastward into the Upper Williams which will require one WQ Pond to be constructed

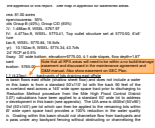

Subject: SW - Textbox with Arrow
Page Label: 42
Author: Glenn Reese - EPC Stormwater
Date: 2/28/2022 9:47:39 PM
Status:
Color: ■
Layer:
Space:

Note that all RPA areas will need to be within a no build/drainage easement and discussed in the maintenance agreement and O&M manual. Also show easement on GEC Plan.

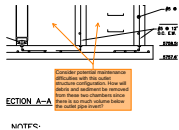

Subject: SW - Textbox with Arrow
Page Label: 203
Author: Glenn Reese - EPC Stormwater
Date: 2/28/2022 9:47:47 PM
Status:
Color: ■
Layer:
Space:

Consider potential maintenance difficulties with this outlet structure configuration. How will debris and sediment be removed from these two chambers since there is so much volume below the outlet pipe invert?

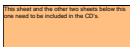

Subject: SW - Textbox
Page Label: 203
Author: Glenn Reese - EPC Stormwater
Date: 2/28/2022 9:47:47 PM
Status:
Color: ■
Layer:
Space:

This sheet and the other two sheets below this one need to be included in the CD's.

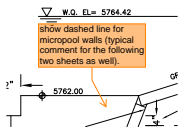

Subject: SW - Textbox with Arrow
Page Label: 203
Author: Glenn Reese - EPC Stormwater
Date: 2/28/2022 9:47:47 PM
Status:
Color: ■
Layer:
Space:

show dashed line for micropool walls (typical comment for the following two sheets as well).

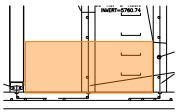

Subject: Rectangle
Page Label: 203
Author: Glenn Reese - EPC Stormwater
Date: 2/28/2022 9:47:47 PM
Status:
Color: ■
Layer:
Space:

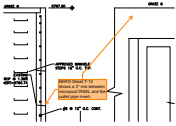

Subject: SW - Textbox with Arrow
Page Label: 203
Author: Glenn Reese - EPC Stormwater
Date: 2/28/2022 9:47:47 PM
Status:
Color: ■
Layer:
Space:

MHFD Detail T-12 shows a 3" min between micropool WSEL and the outlet pipe invert.

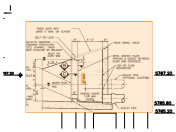

Subject: Image
Page Label: 203
Author: Glenn Reese - EPC Stormwater
Date: 2/28/2022 9:47:47 PM
Status:
Color: ■
Layer:
Space:

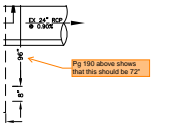

Subject: SW - Textbox with Arrow
Page Label: 204
Author: Glenn Reese - EPC Stormwater
Date: 2/28/2022 9:47:56 PM
Status:
Color: ■
Layer:
Space:

Pg 190 above shows that this should be 72"

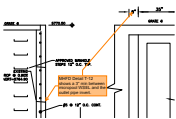

Subject: SW - Textbox with Arrow
Page Label: 204
Author: Glenn Reese - EPC Stormwater
Date: 2/28/2022 9:47:56 PM
Status:
Color: ■
Layer:
Space:

MHFD Detail T-12 shows a 3" min between micropool WSEL and the outlet pipe invert.

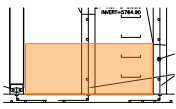

Subject: Rectangle
Page Label: 204
Author: Glenn Reese - EPC Stormwater
Date: 2/28/2022 9:47:56 PM
Status:
Color: ■
Layer:
Space:

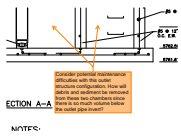

Subject: SW - Textbox with Arrow
Page Label: 204
Author: Glenn Reese - EPC Stormwater
Date: 2/28/2022 9:47:56 PM
Status:
Color: ■
Layer:
Space:

Consider potential maintenance difficulties with this outlet structure configuration. How will debris and sediment be removed from these two chambers since there is so much volume below the outlet pipe invert?

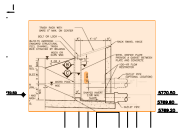

Subject: Image
Page Label: 204
Author: Glenn Reese - EPC Stormwater
Date: 2/28/2022 9:47:56 PM
Status:
Color: ■
Layer:
Space:

should be 72" per pg 199 above.

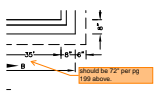

Subject: SW - Textbox with Arrow
Page Label: 205
Author: Glenn Reese - EPC Stormwater
Date: 2/28/2022 9:48:04 PM
Status:
Color: ■
Layer:
Space:

should be 36" per pg 199 above.

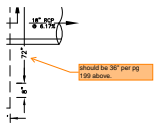

Subject: SW - Textbox with Arrow
Page Label: 205
Author: Glenn Reese - EPC Stormwater
Date: 2/28/2022 9:48:04 PM
Status:
Color: ■
Layer:
Space:

Show borders of The Ridge Filings 1, 2, and 3.



Subject: SW - Textbox
Page Label: 237
Author: Glenn Reese - EPC Stormwater
Date: 2/28/2022 9:48:09 PM
Status:
Color: ■
Layer:
Space:

Typical comment for all subsequent maps.