

TRAFFIC IMPACT STUDY

For

**Jones Road Property
El Paso County, Colorado**

September 2023

Prepared for:

P760 Land LLC
13395 Voyager Parkway, Suite 130
Colorado Springs, Colorado 80921

Prepared by:



SM ROCHA, LLC
TRAFFIC AND TRANSPORTATION CONSULTANTS

8700 Turnpike Drive, Suite 240
Westminster, Colorado 80031
(303) 458-9798

6 South Tejon Street, Suite 618
Colorado Springs, Colorado 80903
(719) 203-6639

Project Engineer:
Megan Bock, EIT

Engineer in Responsible Charge:
Fred Lantz, PE



23-061915

Traffic Engineer's Statement

The attached traffic report and supporting information were prepared under my responsible charge and they comport with the standard of care. So far as is consistent with the standard of care, said report was prepared in general conformance with the criteria established by the County for traffic reports.



Fred Lantz, P.E. #23410

09/27/2023

Date

Developer's Statement

I, the Developer, have read and will comply with all commitments made on my behalf within this report.

Alex Kuhnke
P760 Land LLC
13395 Voyager Parkway, Suite 130
Colorado Springs, Colorado 80921

Date

Table of Contents

I. Introduction 1

 Project Overview..... 1

 Study Area Boundaries 1

 Site Description..... 1

 Existing and Committed Surface Transportation Network.....4

II. Existing Traffic Conditions 5

 Peak Hour Intersection Levels of Service – Existing Traffic.....8

 Existing Traffic Analysis Results9

III. Future Traffic Conditions Without Proposed Development..... 10

 Peak Hour Intersection Levels of Service – Background Traffic 15

 Background Traffic Analysis Results – Year 2025 16

 Background Traffic Analysis Results – Year 2043 17

IV. Proposed Project Traffic 18

 Trip Generation..... 18

 Adjustments to Trip Generation Rates 19

 Trip Distribution..... 19

 Trip Assignment..... 19

V. Future Traffic Conditions With Proposed Developments 21

VI. Project Impacts 26

 Peak Hour Intersection Levels of Service – Total Traffic 26

 Total Traffic Analysis Results Upon Development Build-Out 28

 Pedestrian Circulation & Safety Analysis 29

VII. Conclusion 30

List of Figures

Figure 1 – Location.....	2
Figure 2 – Conceptual Site Plan.....	3
Figure 3 – Existing Traffic Volumes.....	6
Figure 3a – Existing Traffic Intersection Geometry.....	7
Figure 4 – Background Traffic Volumes – Year 2025.....	11
Figure 4a – Background Traffic Intersection Geometry – Year 2025.....	12
Figure 5 – Background Traffic Volumes – Year 2043.....	13
Figure 5a – Background Traffic Intersection Geometry – Year 2043.....	14
Figure 6 – Distribution and Site-Generated Assignment.....	20
Figure 7 – Total Traffic Volumes – Year 2025.....	22
Figure 7a – Total Traffic Intersection Geometry – Year 2025.....	23
Figure 8 – Total Traffic Volumes – Year 2043.....	24
Figure 8a – Total Traffic Intersection Geometry – Year 2043.....	25

List of Tables

Table 1 – Intersection Capacity Analysis Summary – Existing Traffic.....	9
Table 2 – Intersection Capacity Analysis Summary – Background Traffic – Year 2025.....	15
Table 3 – Intersection Capacity Analysis Summary – Background Traffic – Year 2043.....	16
Table 4 – Trip Generation Rates.....	18
Table 5 – Trip Generation Summary.....	18
Table 6 – Intersection Capacity Analysis Summary – Total Traffic – Year 2025.....	27
Table 7 – Intersection Capacity Analysis Summary – Total Traffic – Year 2043.....	28

Appendices

APPENDIX A	TRAFFIC COUNT DATA
APPENDIX B	LEVEL OF SERVICE DEFINITIONS
APPENDIX C	CAPACITY WORKSHEETS

I. Introduction

Project Overview

This traffic impact study is provided as a planning document and addresses the capacity, geometric, and control requirements associated with the development entitled Jones Road Property.

This proposed residential development consists of a single-family home community on approximately 753 acres of land. The development is located north of Jones Road and east of Murr Road in El Paso County, Colorado.

Study Area Boundaries

The study area to be examined in this analysis encompasses the Jones Road intersections with Curtis Road, Murr Road, and Peyton Highway, the Peyton Highway intersections with State Highway 94 and Falcon Highway, the Falcon Highway intersection with Murr Road, and includes site access drives.

Figure 1 illustrates location of the site and study intersections.

Site Description

Land for the development is currently vacant and zoned as A-35 (Agricultural), a zoning district intended to accommodate rural communities and lifestyles. The area is surrounded by open space and residential land uses.

The proposed development will rezone into the RR-2.5 (Residential Rural) zoning district, intended to accommodate 2.5-acre, low-density, rural, single-family residential developments. While the proposed zoning district allows for a potential maximum of approximately 300 residential lots, the site plan is conceptual. However, for purposes of this analysis, there is assumed to be construction for approximately 244 single-family residential lots.

Proposed access to the development is provided via two full-movement accesses onto Jones Road (referred to as Access A and Access B). Access drives internal to the overall development area were not included in this analysis as internal intersection operations are expected to be comparable to, or better than, those projected for the above-described intersections.

For purposes of this study, it is anticipated that development construction would be completed by end of Year 2025.

General site and access locations are shown on Figure 1.

A conceptual site plan, as prepared by N.E.S. Inc., is shown on Figure 2. This plan is provided for illustrative purposes only.

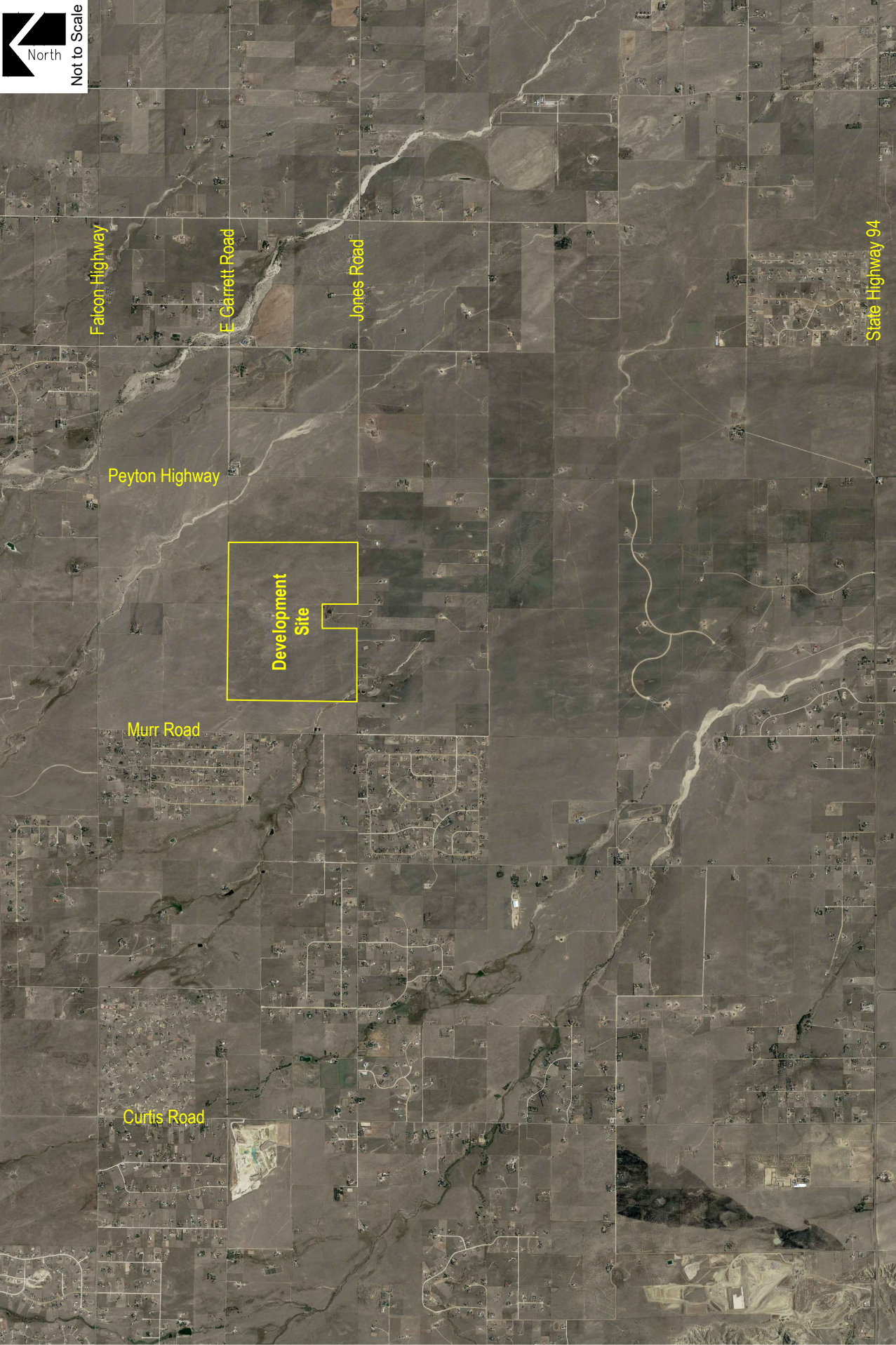
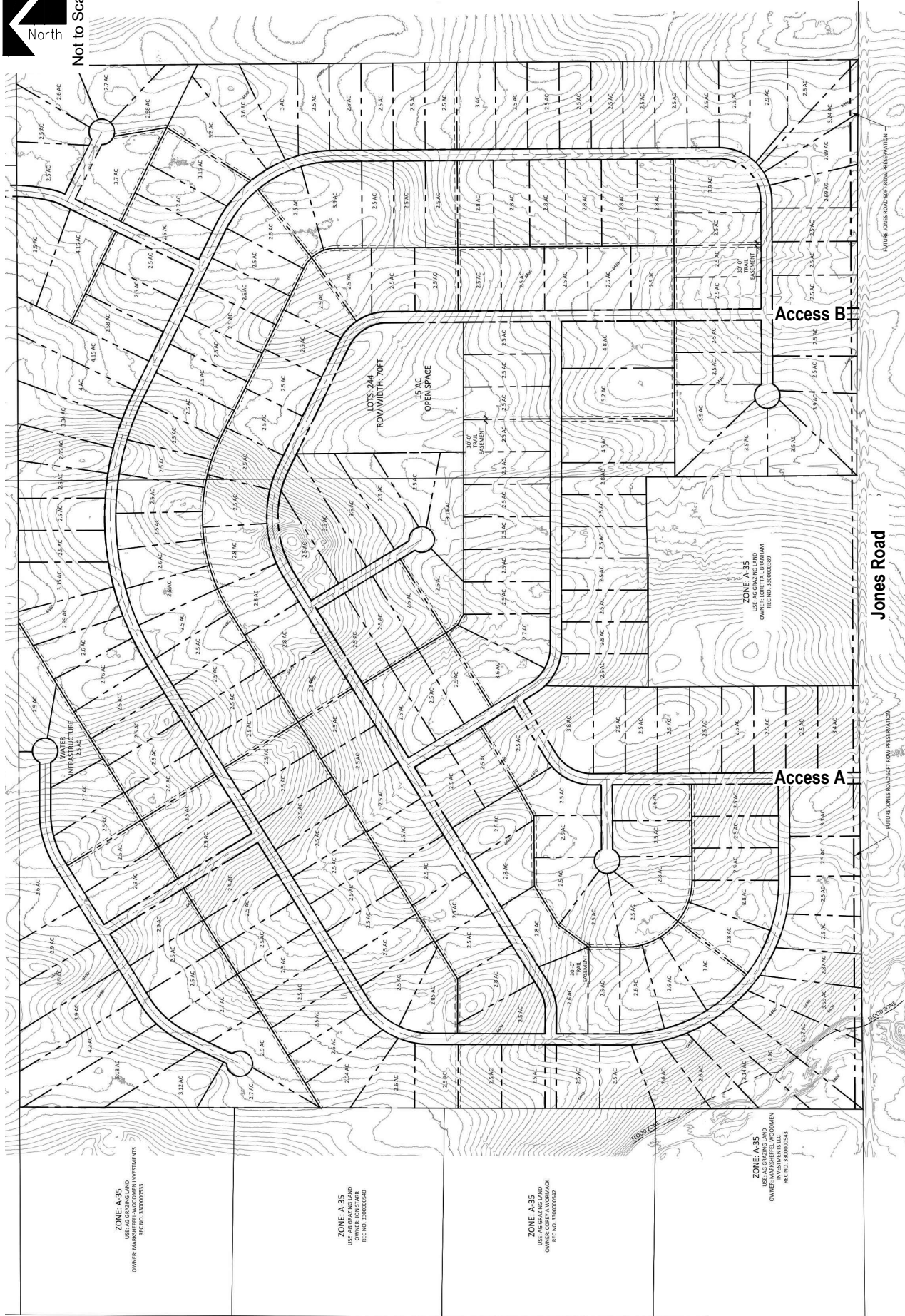

Figure 1
SITE LOCATION





Not to Scale



JONES ROAD PROPERTY
Traffic Impact Study

SM ROCHA, LLC
Traffic and Transportation Consultants



Figure 2
CONCEPTUAL SITE PLAN

September 2023
Page 3

Existing and Committed Surface Transportation Network

Within the study area, Jones Road is the primary roadway that will accommodate traffic to and from the proposed development. The secondary roadways include Curtis Road, Murr Road, Peyton Highway, Falcon Highway, and State Highway 94. A brief description of each roadway, based on the County's 2016 Major Transportation Corridors Plan (MTCP)¹, is provided below:

Jones Road is an east-west minor arterial roadway having two through lanes (one lane in each direction) with shared turn lanes at the intersections within the study area. Jones Road provides a posted speed limit of 45 MPH.

Curtis Road is a north-south principal arterial roadway having two through lanes (one lane in each direction) with shared turn lanes at the intersection within the study area. Curtis Road provides a posted speed limit of 45 MPH.

Murr Road is a north-south local roadway having two through lanes (one lane in each direction) with shared turn lanes at the intersections within the study area. Murr Road provides a posted speed limit of 30 MPH.

Peyton Highway is a north-south minor arterial roadway having two through lanes (one lane in each direction) with shared turn lanes at the intersections within the study area. Peyton Highway provides a posted speed limit of 55 MPH.

Falcon Highway is an east-west minor arterial roadway having two through lanes (one lane in each direction) with shared turn lanes at the intersections within the study area. Falcon Highway provides a posted speed limit of 55 MPH.

State Highway 94 is an east-west principal arterial roadway having two through lanes (one lane in each direction) with a combination of shared and exclusive turn lanes at the intersection within the study area. The Colorado Department of Transportation (CDOT) categorizes the adjacent segment of State Highway 94 as a Non-Rural Principal Highway (NR-A) and provides a posted speed limit of 65 MPH.

All study intersections operate under a stop-controlled condition. A stop-controlled intersection is defined as a roadway intersection where vehicle rights-of-way are controlled by one or more "STOP" signs.

Comparison of existing roadway cross-sections of State Highway 94 and Curtis Road to the County's Engineering Criteria Manual (ECM)² concludes that each roadway is not built to its ultimate width for accommodation of future regional transportation demands. Pursuant to Section 2.4.4 of the County's ECM, each roadway is envisioned to become a four-lane roadway (two through-lanes in each direction) upon buildout.

¹ El Paso County 2016 Major Transportation Corridors Plan Update, Felsburg Holt & Ullevig, December 2016.

² El Paso County Engineering Criteria Manual, El Paso County, October 2020.

II. Existing Traffic Conditions

Morning (AM) and afternoon (PM) peak hour traffic counts were collected at the Jones Road intersections with Curtis Road, Murr Road, and Peyton Highway, the Peyton Highway intersections with State Highway 94 and Falcon Highway, and the Falcon Highway intersection with Murr Road. Average daily traffic (ADT) volumes were collected over a 24-hour period on Jones Road. Counts were collected on Tuesday, June 27, 2023, with AM peak hour counts being collected during the period of 7:00 a.m. to 9:00 a.m. and PM peak hour counts being collected during the period of 4:00 p.m. to 6:00 p.m.

Existing traffic volumes are shown on Figure 3. Existing intersection geometry is shown on Figure 3a. Traffic count data is included for reference in Appendix A.

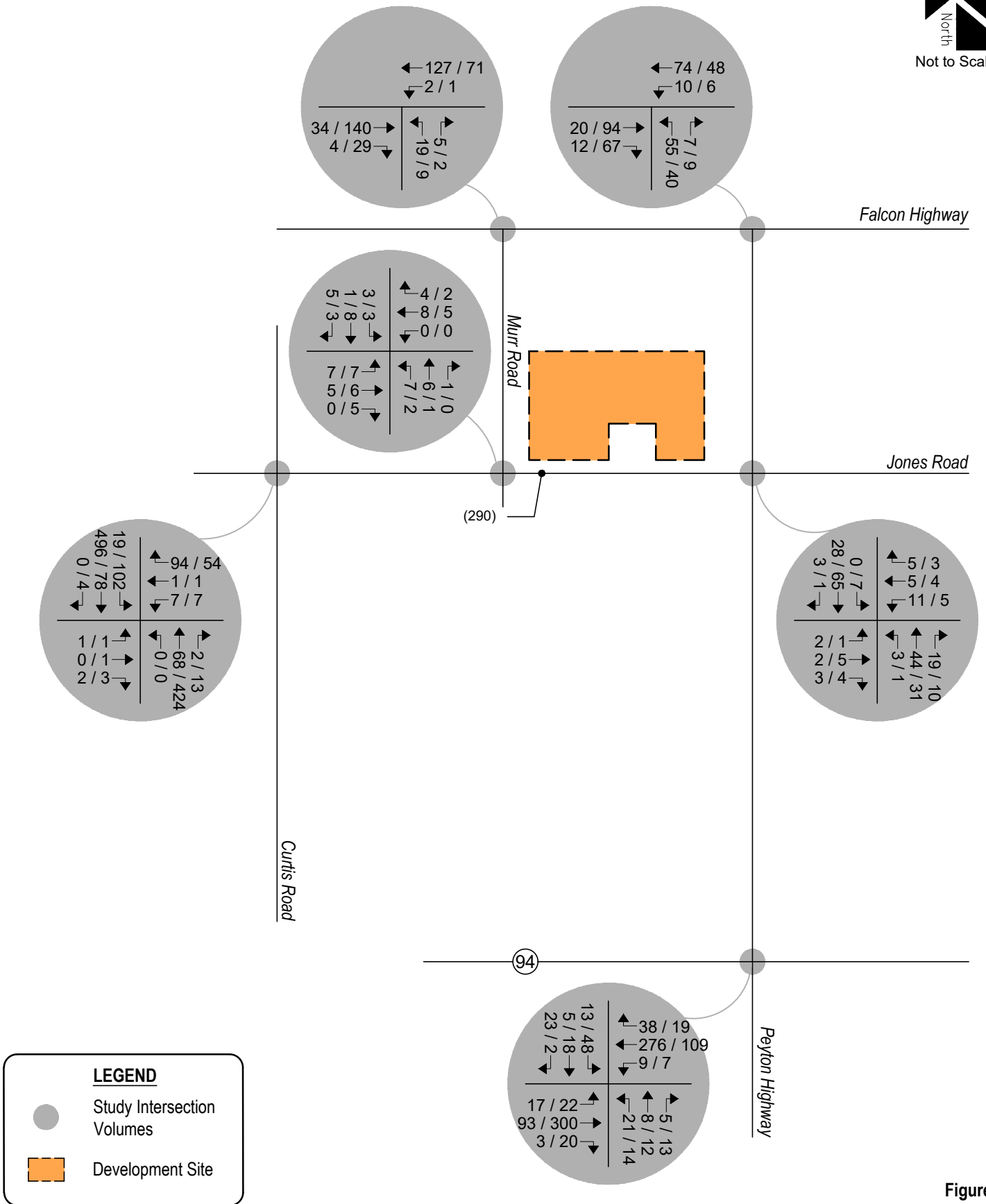
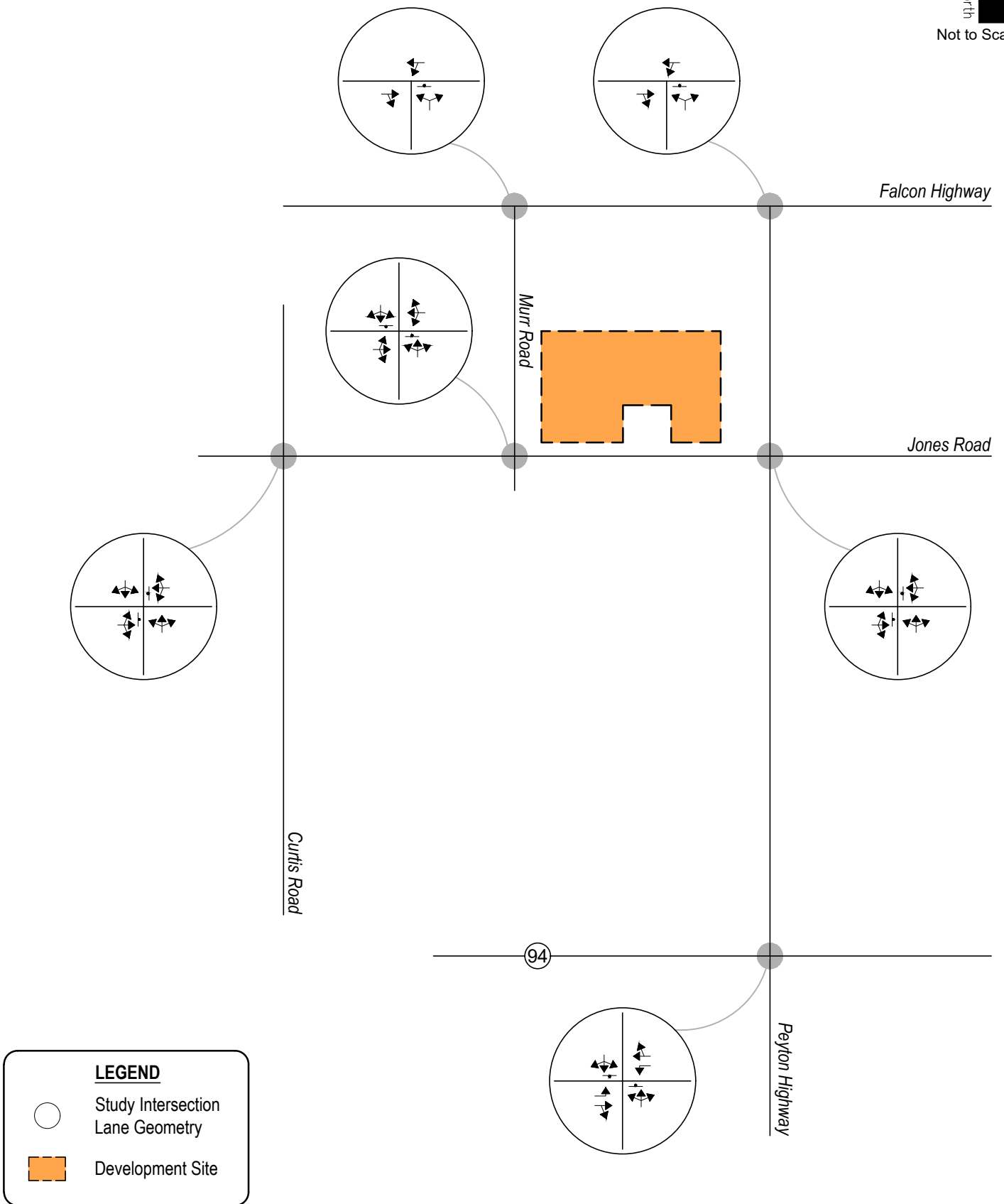

Figure 3
EXISTING TRAFFIC
Volumes

AM / PM Peak Hour
(ADT) : Average Daily Traffic



Peak Hour Intersection Levels of Service – Existing Traffic

The Unsignalized Intersection Analysis technique, as published in the Highway Capacity Manual (HCM), 6th Edition, by the Transportation Research Board and as incorporated into the SYNCHRO computer program, was used to analyze the study intersections for existing and future traffic conditions. This nationally accepted technique allows for the determination of intersection level of service (LOS) based on the congestion and delay of each traffic movement.

Pursuant to Section B.4.1.A of the County’s ECM, the design objective for each scenario of this study shall be level of service “D”. Level of service is a method of measurement used by transportation professionals to quantify a driver’s perception of travel conditions that include travel time, number of stops, and total amount of stopped delay experienced on a roadway network. The HCM categorizes level of service into a range from “A” which indicates little, if any, vehicle delay, to “F” which indicates a level of operation considered unacceptable to most drivers. These levels of service grades with brief descriptions of the operating condition, for unsignalized and signalized intersections, are included for reference in Appendix B and have been used throughout this study.

The level of service analyses results for existing conditions are summarized in Table 1.

Intersection capacity worksheets developed for this study are provided in Appendix C.

Table 1 – Intersection Capacity Analysis Summary – Existing Traffic

INTERSECTION LANE GROUPS	LEVEL OF SERVICE	
	AM PEAK HOUR	PM PEAK HOUR
Falcon Highway / Murr Road (Stop-Controlled) Westbound Left and Through Northbound Left and Right	A A	A A
Falcon Highway / Peyton Highway (Stop-Controlled) Westbound Left and Through Northbound Left and Right	A A	A A
Curtis Road / Jones Road (Stop-Controlled) Eastbound Left, Through, and Right Westbound Left, Through, and Right Northbound Left, Through, and Right Southbound Left, Through, and Right	B A A A	B B A A
Jones Road / Murr Road (Stop-Controlled) Eastbound Left, Through, and Right Westbound Left, Through, and Right Northbound Left, Through, and Right Southbound Left, Through, and Right	A A A A	A A A A
Peyton Highway / Jones Road (Stop-Controlled) Eastbound Left, Through, and Right Westbound Left, Through, and Right Northbound Left, Through, and Right Southbound Left, Through, and Right	A A A A	A A A A
State Highway 94 / Peyton Highway (Stop-Controlled) Eastbound Left Westbound Left Northbound Left, Through, and Right Southbound Left, Through, and Right	A A B B	A A B C

Key: Stop-Controlled Intersection: Level of Service

Existing Traffic Analysis Results

Under existing conditions, operational analysis shows that the stop-controlled intersections of Falcon Highway with Murr Road and Peyton Highway have turn movement operations at LOS A during the morning and afternoon peak traffic hours.

The stop-controlled intersection of Curtis Road with Jones Road has turn movement operations at LOS B or better during both peak traffic hours.

The stop-controlled intersections of Jones Road with Murr Road and Peyton Highway have turn movement operations at LOS A during both peak traffic hours.

The stop-controlled intersection of State Highway 94 with Peyton Highway has turn movement operations at LOS B or better during the AM peak traffic hour and LOS C or better during the PM peak traffic hour.

III. Future Traffic Conditions Without Proposed Development

Background traffic is the traffic projected to be on area roadways without consideration of the proposed development. Background traffic includes traffic generated by development of vacant parcels in the area.

To account for projected increases in background traffic for Years 2025 and 2043, a compounded annual growth rate was determined using historical traffic data provided by CDOT's Online Transportation Information System (OTIS) along the adjacent segment of State Highway 94, which anticipates a 20-year growth rate between one and two percent. Therefore, in order to provide for a conservative analysis, a growth rate of two percent was applied to existing traffic volumes. This annual growth rate is also considered to be consistent with regional growth projections and the level of in-fill development expected within the area.

Pursuant to the roadway improvements discussed in Section I, Year 2025 and Year 2043 background traffic conditions assume no roadway improvements to accommodate regional transportation demands. This assumption provides for a conservative analysis.

Projected background traffic volumes and intersection geometry for Year 2025 are shown on Figure 4 and Figure 4a, respectively.

Projected background traffic volumes and intersection geometry for Year 2043 are shown on Figure 5 and Figure 5a, respectively.

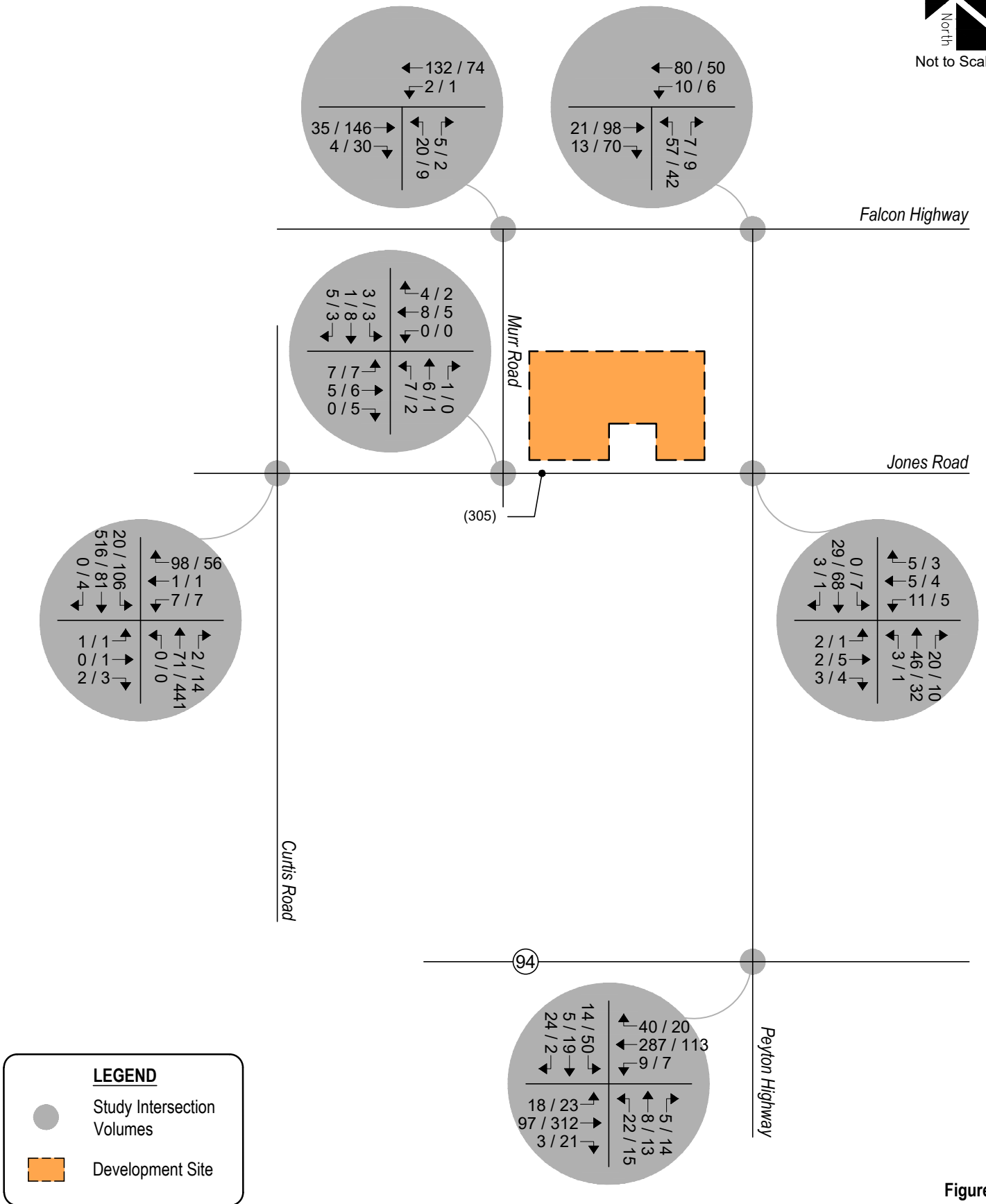

Figure 4
BACKGROUND TRAFFIC - YEAR 2025
Volumes
AM / PM Peak Hour
(ADT) : Average Daily Traffic

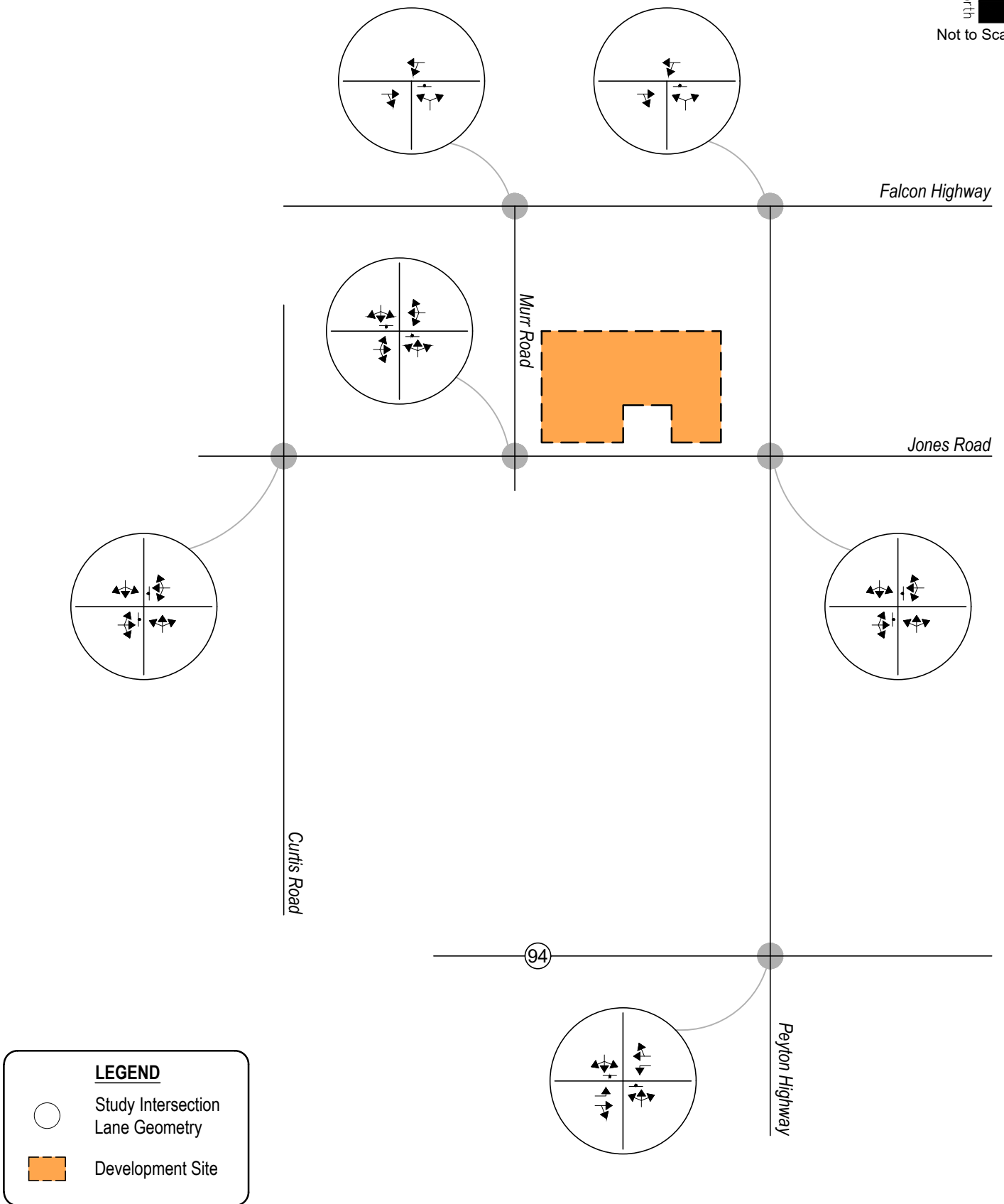

Figure 4a
BACKGROUND TRAFFIC - YEAR 2025
Intersection Geometry

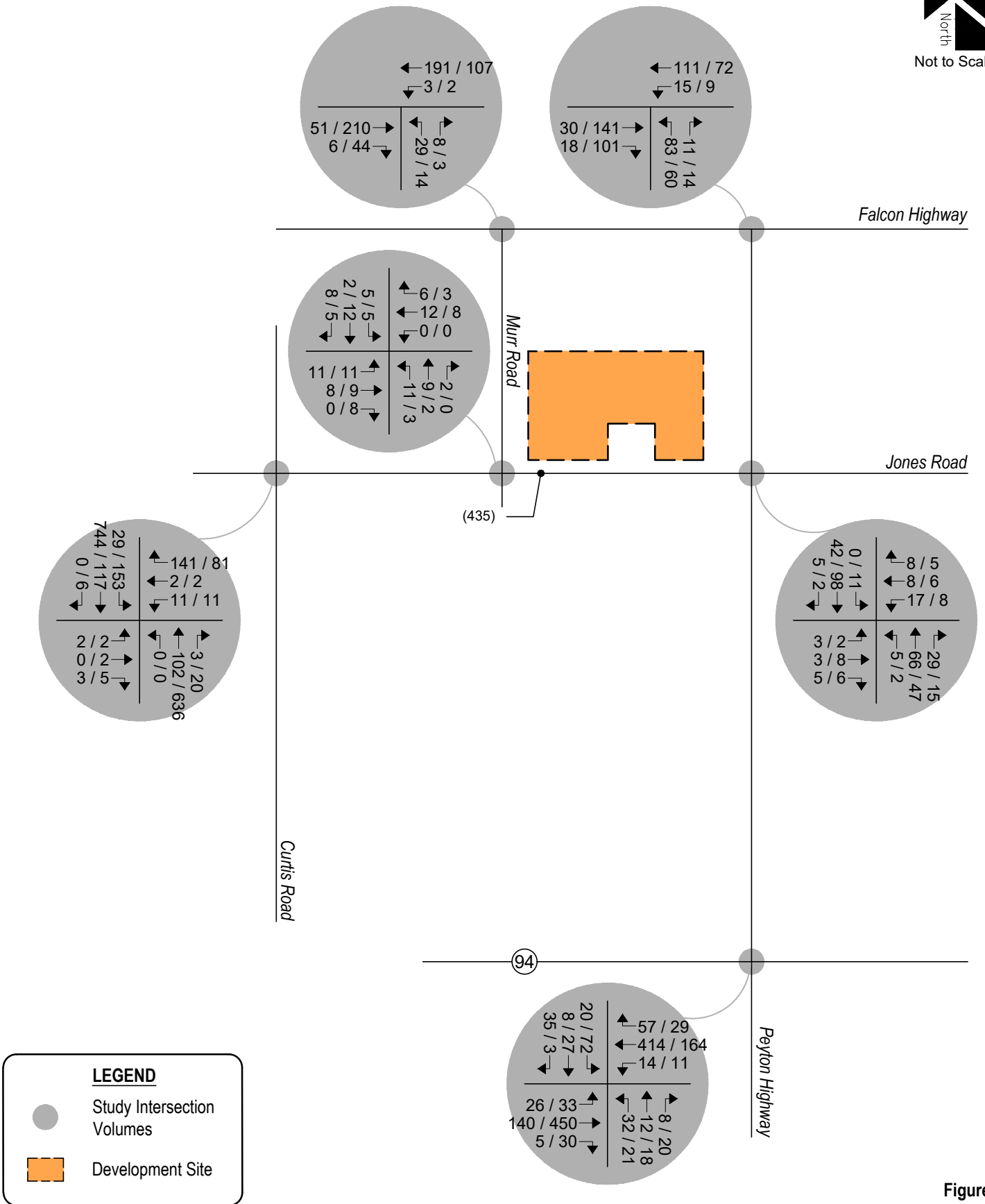
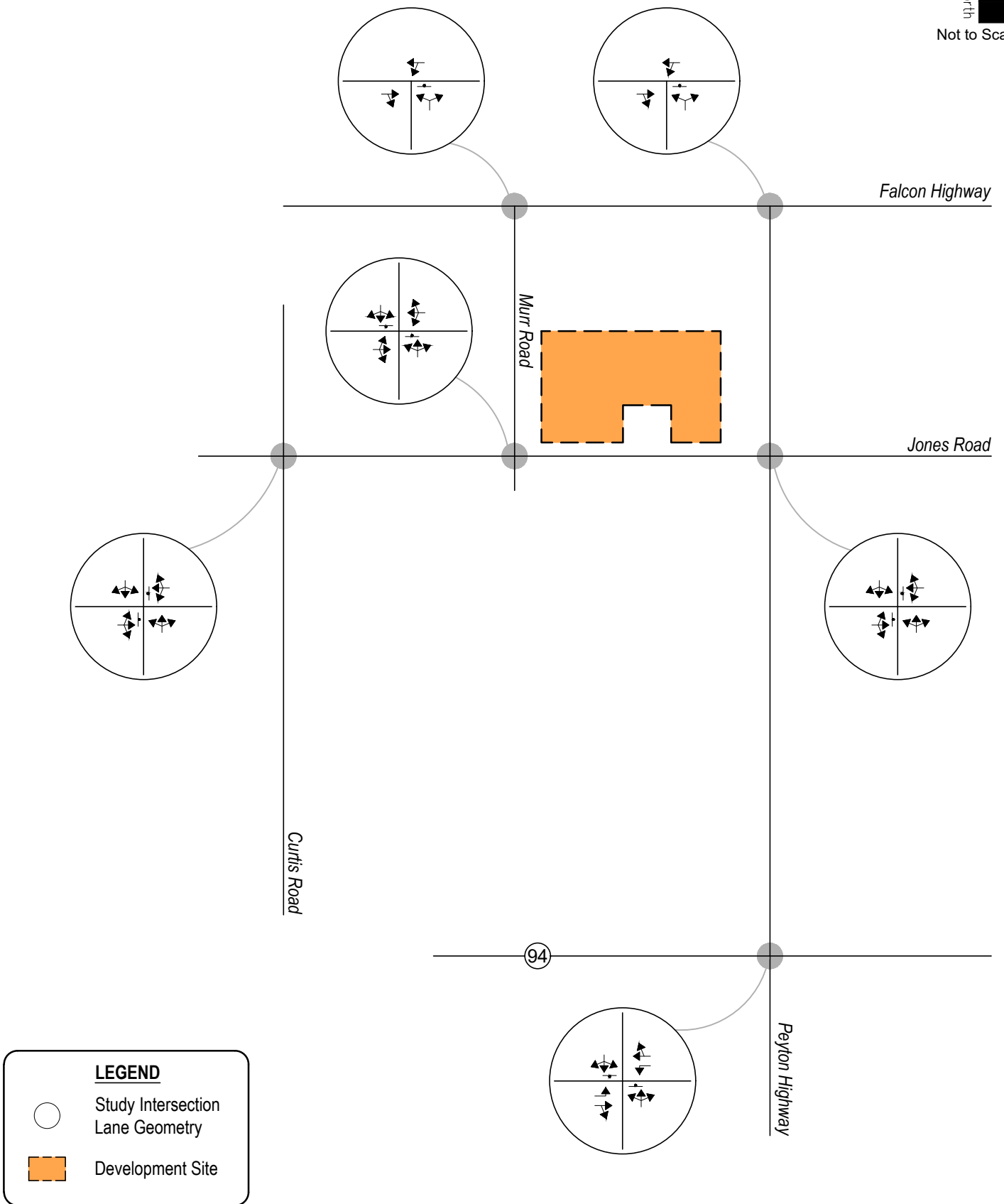

Figure 5
BACKGROUND TRAFFIC - YEAR 2043
Volumes
AM / PM Peak Hour
(ADT) : Average Daily Traffic



Peak Hour Intersection Levels of Service – Background Traffic

As with existing traffic conditions, the operations of study intersections were analyzed under background conditions, without the proposed development, using the SYNCHRO computer program.

Background traffic level of service analysis results for Year 2025 are listed in Table 2. Year 2043 operational results are summarized in Table 3.

Definitions of levels of service are given in Appendix B. Intersection capacity worksheets are provided in Appendix C.

Table 2 – Intersection Capacity Analysis Summary – Background Traffic – Year 2025

INTERSECTION LANE GROUPS	LEVEL OF SERVICE	
	AM PEAK HOUR	PM PEAK HOUR
Falcon Highway / Murr Road (Stop-Controlled) Westbound Left and Through Northbound Left and Right	A A	A A
Falcon Highway / Peyton Highway (Stop-Controlled) Westbound Left and Through Northbound Left and Right	A A	A A
Curtis Road / Jones Road (Stop-Controlled) Eastbound Left, Through, and Right Westbound Left, Through, and Right Northbound Left, Through, and Right Southbound Left, Through, and Right	B A A A	B B A A
Jones Road / Murr Road (Stop-Controlled) Eastbound Left, Through, and Right Westbound Left, Through, and Right Northbound Left, Through, and Right Southbound Left, Through, and Right	A A A A	A A A A
Peyton Highway / Jones Road (Stop-Controlled) Eastbound Left, Through, and Right Westbound Left, Through, and Right Northbound Left, Through, and Right Southbound Left, Through, and Right	A A A A	A A A A
State Highway 94 / Peyton Highway (Stop-Controlled) Eastbound Left Westbound Left Northbound Left, Through, and Right Southbound Left, Through, and Right	A A B B	A A B C

Key: Stop-Controlled Intersection: Level of Service

Background Traffic Analysis Results – Year 2025

Year 2025 background traffic analysis indicates that the stop-controlled intersections of Falcon Highway with Murr Road and Peyton Highway have turn movement operations at LOS A during the morning and afternoon peak traffic hours.

The stop-controlled intersection of Curtis Road with Jones Road projects turn movement operations at LOS B or better during both peak traffic hours.

The stop-controlled intersections of Jones Road with Murr Road and Peyton Highway expect turn movement operations at LOS A during both peak traffic hours.

The stop-controlled intersection of State Highway 94 with Peyton Highway predicts turn movement operations at LOS B or better during the AM peak traffic hour and LOS C or better during the PM peak traffic hour.

Table 3 – Intersection Capacity Analysis Summary – Background Traffic – Year 2043

INTERSECTION LANE GROUPS	LEVEL OF SERVICE	
	AM PEAK HOUR	PM PEAK HOUR
Falcon Highway / Murr Road (Stop-Controlled) Westbound Left and Through Northbound Left and Right	A B	A B
Falcon Highway / Peyton Highway (Stop-Controlled) Westbound Left and Through Northbound Left and Right	A B	A B
Curtis Road / Jones Road (Stop-Controlled) Eastbound Left, Through, and Right Westbound Left, Through, and Right Northbound Left, Through, and Right Southbound Left, Through, and Right	C B A A	C C A A
Jones Road / Murr Road (Stop-Controlled) Eastbound Left, Through, and Right Westbound Left, Through, and Right Northbound Left, Through, and Right Southbound Left, Through, and Right	A A A A	A A A A
Peyton Highway / Jones Road (Stop-Controlled) Eastbound Left, Through, and Right Westbound Left, Through, and Right Northbound Left, Through, and Right Southbound Left, Through, and Right	A A A A	A A A A
State Highway 94 / Peyton Highway (Stop-Controlled) Eastbound Left Westbound Left Northbound Left, Through, and Right Southbound Left, Through, and Right	A A C C	A A C D

Key: Stop-Controlled Intersection: Level of Service

Background Traffic Analysis Results – Year 2043

By Year 2043 and without the proposed development, the stop-controlled intersections of Falcon Highway with Murr Road and Peyton Highway have turn movement operations at LOS B or better during the morning and afternoon peak traffic hours.

The stop-controlled intersection of Curtis Road with Jones Road projects turn movement operations at LOS C or better during both peak traffic hours.

The stop-controlled intersections of Jones Road with Murr Road and Peyton Highway expect turn movement operations at LOS A during both peak traffic hours.

The stop-controlled intersection of State Highway 94 with Peyton Highway predicts turn movement operations at LOS C or better during the AM peak traffic hour and LOS D or better during the PM peak traffic hour.

IV. Proposed Project Traffic

Trip Generation

Standard traffic generation characteristics compiled by the Institute of Transportation Engineers (ITE) in their report entitled Trip Generation Manual, 11th Edition, were applied to the proposed land use in order to estimate average daily traffic (ADT), AM Peak Hour, and PM Peak Hour vehicle trips. A vehicle trip is defined as a one-way vehicle movement from a point of origin to a point of destination.

The ITE land use code 210 (Single-Family Detached Housing) was used for estimating trip generation because of its conservative rates and best fit to the proposed land use description.

As actual land uses, densities, or site plans become defined over time, it is expected that traffic generation characteristics considered within this study will need to be updated by more specific traffic analyses or studies to help assess if transportation improvements are needed to mitigate potential traffic impacts.

Trip generation rates used in this study are presented in Table 4.

Table 4 – Trip Generation Rates

ITE CODE	LAND USE	UNIT	TRIP GENERATION RATES						
			24 HOUR	AM PEAK HOUR			PM PEAK HOUR		
				ENTER	EXIT	TOTAL	ENTER	EXIT	TOTAL
210	Single-Family Detached Housing	DU	9.43	0.18	0.53	0.70	0.59	0.35	0.94

Key: DU = Dwelling Units.

Note: All data and calculations above are subject to being rounded to nearest value.

Table 5 illustrates projected ADT, AM Peak Hour, and PM Peak Hour traffic volumes likely generated by the proposed development upon build-out.

Table 5 – Trip Generation Summary

ITE CODE	LAND USE	SIZE	TOTAL TRIPS GENERATED						
			24 HOUR	AM PEAK HOUR			PM PEAK HOUR		
				ENTER	EXIT	TOTAL	ENTER	EXIT	TOTAL
210	Single-Family Detached Housing	244 DU	2,301	43	128	171	144	85	229
<i>Total:</i>			2,301	43	128	171	144	85	229

Key: DU = Dwelling Units.

Note: All data and calculations above are subject to being rounded to nearest value.

Upon build-out, Table 5 illustrates that the proposed development has the potential to generate approximately 2,301 daily vehicle trips with 171 of those occurring during the morning peak hour and 229 during the afternoon peak hour.

Adjustments to Trip Generation Rates

A development of this type is not likely to attract trips from within area land uses nor pass-by or diverted link trips from the adjacent roadway system, therefore no trip reduction was taken in this analysis.

Trip Distribution

The overall directional distribution of site-generated traffic was determined based on the location of the development site within the County, proposed and existing area land uses, allowed turning movements, available roadway network, and in reference to historical traffic count data provided by CDOT's Traffic Count Database System (TCDS)³.

Overall trip distribution patterns for the development are shown on Figure 6.

Trip Assignment

Trip assignment is how generated and distributed vehicle trips are expected to be loaded onto the available roadway network.

Applying trip distribution patterns to site-generated traffic provides the overall site-generated trip assignments shown on Figure 6.

³ Transportation Data Management System, MS2, 2022.

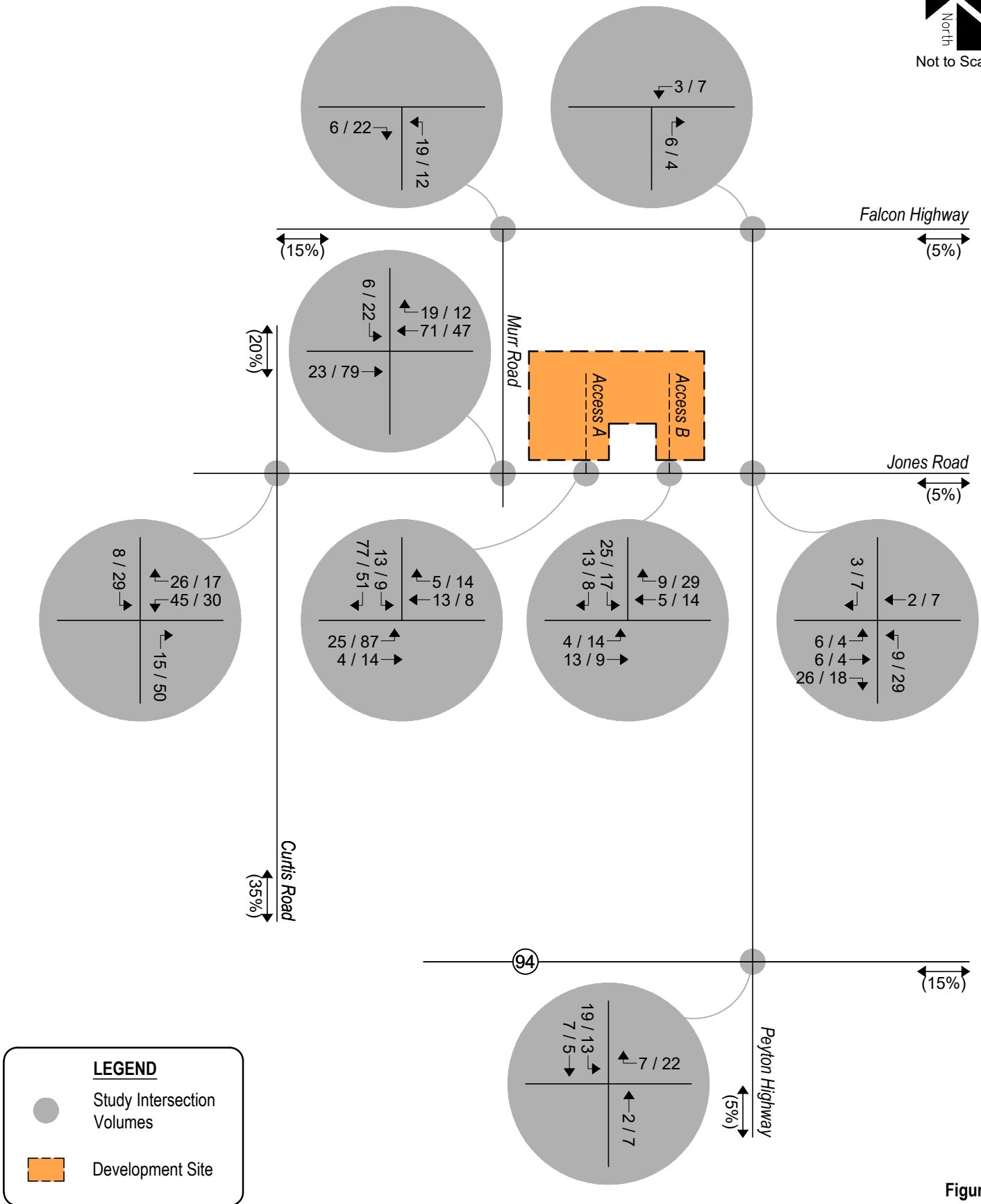

Figure 6
SITE DEVELOPMENT DISTRIBUTION
(%) : Overall
SITE-GENERATED
AM / PM Peak Hour

V. Future Traffic Conditions With Proposed Developments

Total traffic is the traffic projected to be on area roadways with consideration of the proposed development. Total traffic includes background traffic projections for Years 2025 and 2043 with consideration of site-generated traffic. For analysis purposes, it was assumed that development construction would be completed by end of Year 2025.

Pursuant to area roadway improvement discussions provided in Section III, Year 2025 and Year 2043 total traffic conditions assume no roadway improvements to accommodate regional transportation demands. Roadway improvements associated with site development are expected to be limited to site access and frontage as required by the governing agency.

Projected Year 2025 total traffic volumes and intersection geometry are shown in Figure 7 and Figure 7a, respectively.

Figure 8 and Figure 8a shows projected total traffic volumes and intersection geometry for Year 2043, respectively.

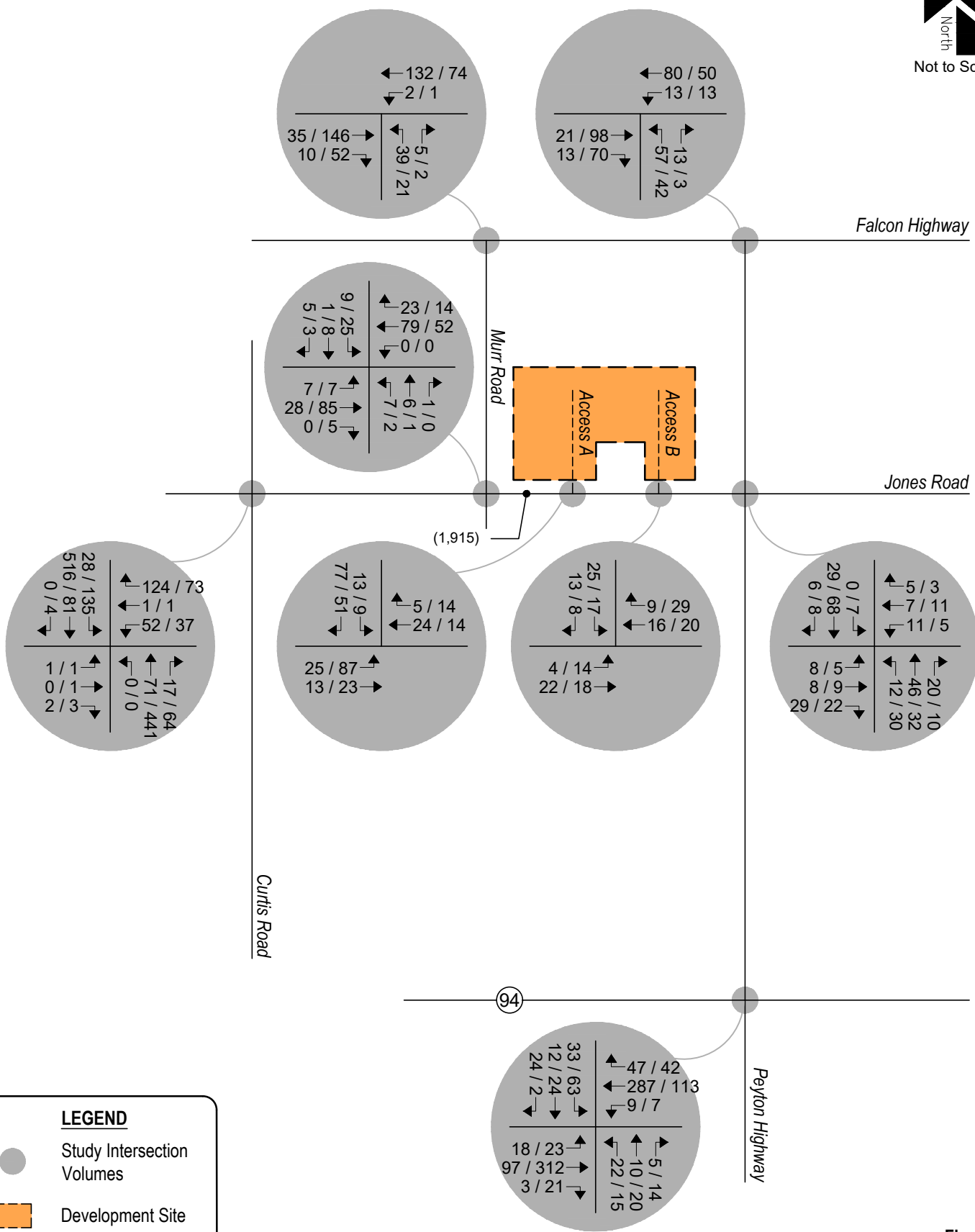

LEGEND

- Study Intersection Volumes
- Development Site

Figure 7
TOTAL TRAFFIC - YEAR 2025
 Volumes
 AM / PM Peak Hour
 (ADT) : Average Daily Traffic

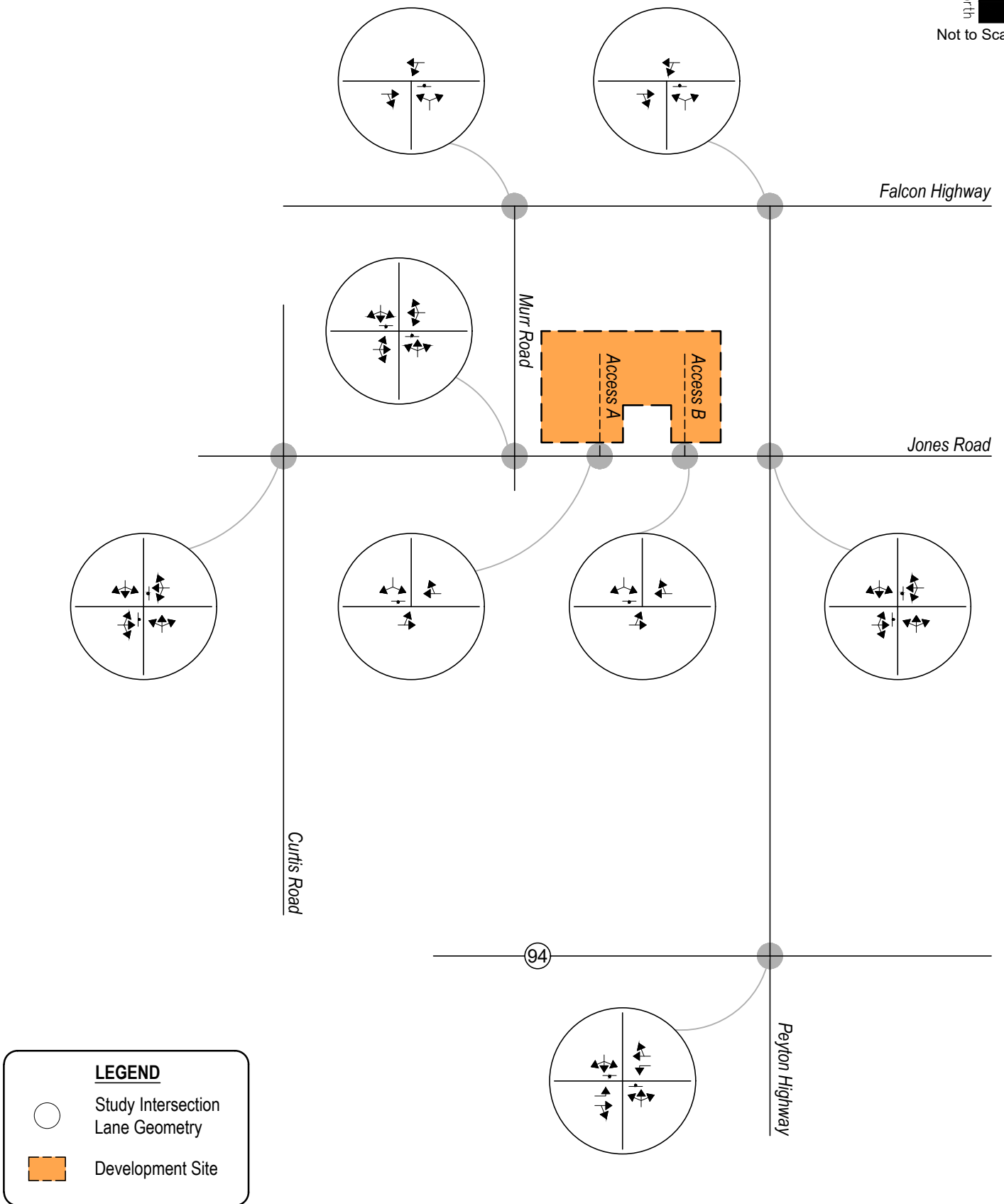

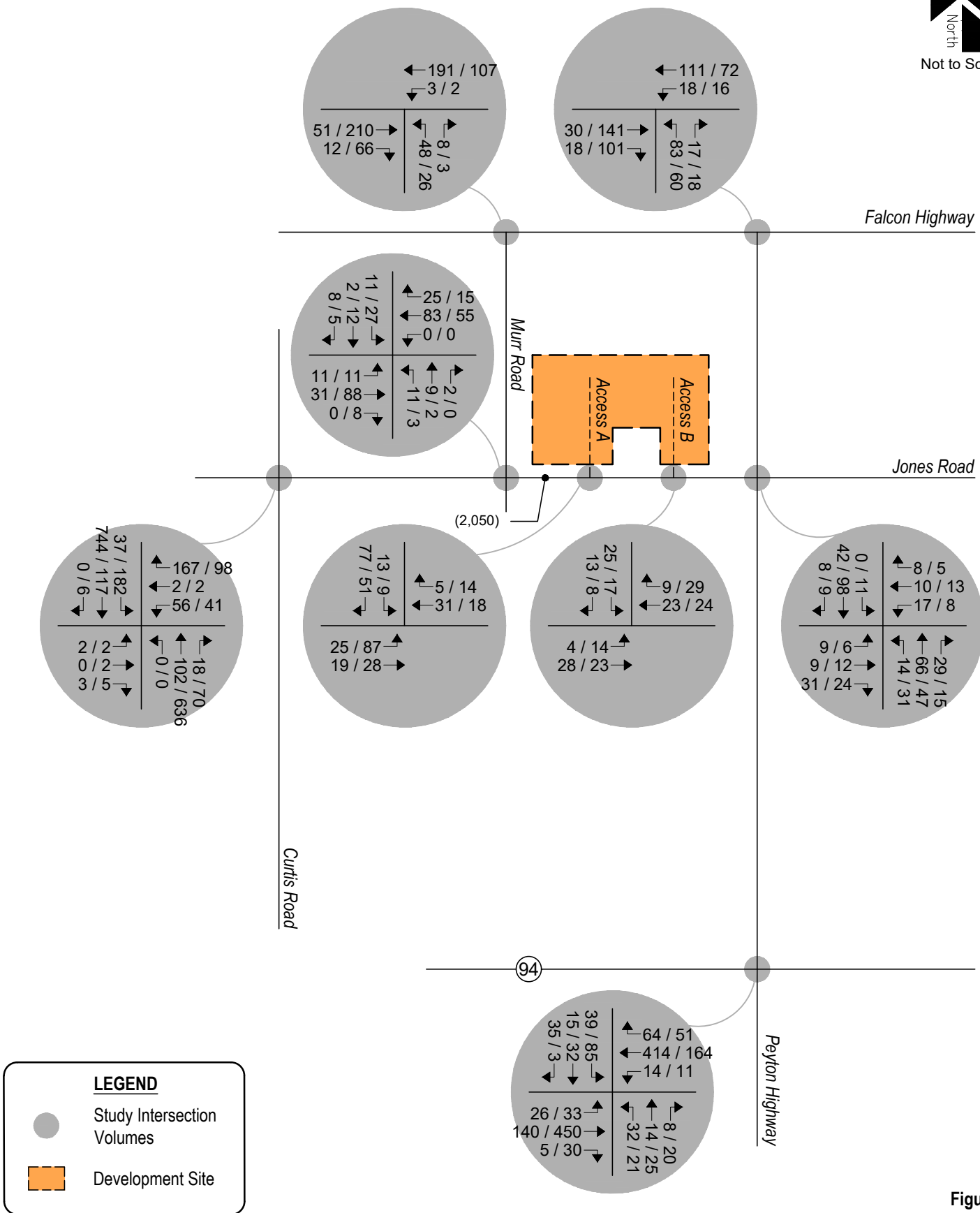
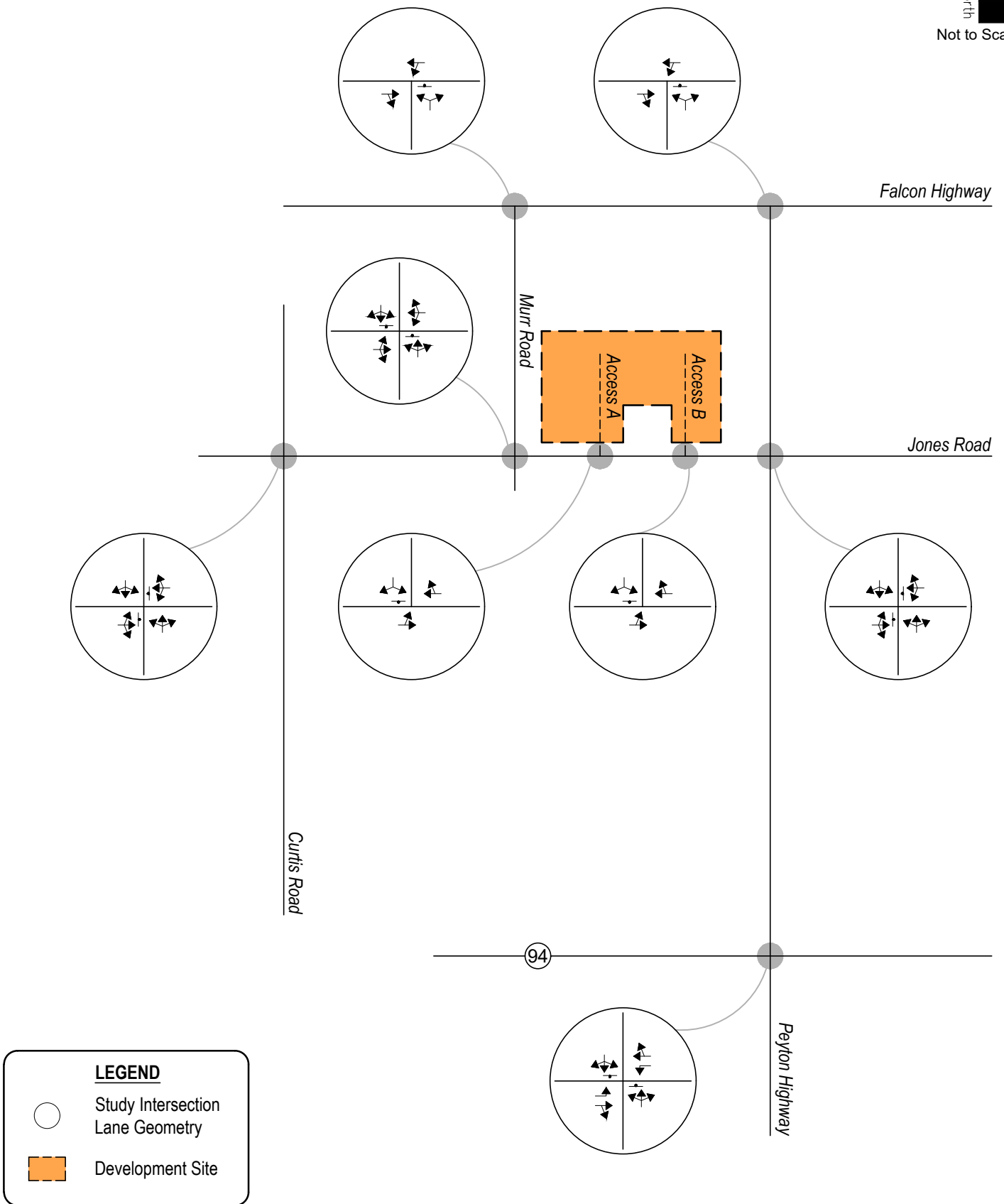

Figure 8
TOTAL TRAFFIC - YEAR 2043
 Volumes
 AM / PM Peak Hour
 (ADT) : Average Daily Traffic



LEGEND

- Study Intersection Lane Geometry
- Development Site

VI. Project Impacts

The analyses and procedures described in this study were performed in accordance with the latest HCM and are based upon the worst-case conditions that occur during a typical weekday upon build-out of site development and analyzed land uses. Therefore, study intersections are likely to operate with traffic conditions better than those described within this study, which represent the peak hours of weekday operations only.

Peak Hour Intersection Levels of Service – Total Traffic

As with background traffic, the operations of the study intersections were analyzed under projected total traffic conditions using the SYNCHRO computer program. Total traffic level of service analysis results for Years 2025 and 2043 are summarized in Table 6 and Table 7, respectively.

Definitions of levels of service are given in Appendix B. Intersection capacity worksheets are provided in Appendix C.

Table 6 – Intersection Capacity Analysis Summary – Total Traffic – Year 2025

INTERSECTION LANE GROUPS	LEVEL OF SERVICE	
	AM PEAK HOUR	PM PEAK HOUR
Falcon Highway / Murr Road (Stop-Controlled) Westbound Left and Through Northbound Left and Right	A A	A B
Falcon Highway / Peyton Highway (Stop-Controlled) Westbound Left and Through Northbound Left and Right	A A	A B
Curtis Road / Jones Road (Stop-Controlled) Eastbound Left, Through, and Right Westbound Left, Through, and Right Northbound Left, Through, and Right Southbound Left, Through, and Right	B B A A	B C A A
Jones Road / Murr Road (Stop-Controlled) Eastbound Left, Through, and Right Westbound Left, Through, and Right Northbound Left, Through, and Right Southbound Left, Through, and Right	A A A A	A A A A
Peyton Highway / Jones Road (Stop-Controlled) Eastbound Left, Through, and Right Westbound Left, Through, and Right Northbound Left, Through, and Right Southbound Left, Through, and Right	A A A A	A B A A
State Highway 94 / Peyton Highway (Stop-Controlled) Eastbound Left Westbound Left Northbound Left, Through, and Right Southbound Left, Through, and Right	A A B B	A A B C
Access A / Jones Road Eastbound Left and Through Southbound Left and Right	A A	A A
Access B / Jones Road Eastbound Left and Through Southbound Left and Right	A A	A A

Key: Stop-Controlled Intersection: Level of Service

Table 7 – Intersection Capacity Analysis Summary – Total Traffic – Year 2043

INTERSECTION LANE GROUPS	LEVEL OF SERVICE	
	AM PEAK HOUR	PM PEAK HOUR
Falcon Highway / Murr Road (Stop-Controlled) Westbound Left and Through Northbound Left and Right	A B	A B
Falcon Highway / Peyton Highway (Stop-Controlled) Westbound Left and Through Northbound Left and Right	A B	A B
Curtis Road / Jones Road (Stop-Controlled) Eastbound Left, Through, and Right Westbound Left, Through, and Right Northbound Left, Through, and Right Southbound Left, Through, and Right	C C A A	C E A B
Jones Road / Murr Road (Stop-Controlled) Eastbound Left, Through, and Right Westbound Left, Through, and Right Northbound Left, Through, and Right Southbound Left, Through, and Right	A A A A	A A B B
Peyton Highway / Jones Road (Stop-Controlled) Eastbound Left, Through, and Right Westbound Left, Through, and Right Northbound Left, Through, and Right Southbound Left, Through, and Right	A A A A	A B A A
State Highway 94 / Peyton Highway (Stop-Controlled) Eastbound Left Westbound Left Northbound Left, Through, and Right Southbound Left, Through, and Right	A A C C	A A C D
Access A / Jones Road Eastbound Left and Through Southbound Left and Right	A A	A A
Access B / Jones Road Eastbound Left and Through Southbound Left and Right	A A	A A

Key: Stop-Controlled Intersection: Level of Service

Total Traffic Analysis Results Upon Development Build-Out

Table 7 illustrates how, by Year 2043 and upon development build-out, the stop-controlled intersections of Falcon Highway with Murr Road and Peyton Highway have turn movement operations at LOS B or better during the morning and afternoon peak traffic hours.

The stop-controlled intersection of Curtis Road with Jones Road projects turn movement operations at LOS C or better during both peak traffic hours. Exceptions would include the westbound turning movements which operate at LOS E during the PM peak traffic hour. The LOS E operation is attributed to the through traffic volume along Curtis Road and the stop-controlled nature of the intersection.

The stop-controlled intersections of Jones Road with Murr Road and Peyton Highway expect turn movement operations at LOS A during the AM peak traffic hour and LOS B or better during the PM peak traffic hour.

The stop-controlled intersection of State Highway 94 with Peyton Highway predicts turn movement operations at LOS C or better during the AM peak traffic hour and LOS D or better during the PM peak traffic hour.

The stop-controlled intersections of Access A and Access B with Jones Road project turn movement operations at LOS A during both peak traffic hours.

It is to be noted that it is not uncommon for unsignalized movements to or from an arterial roadway, in urban areas, to operate with noticeable delays during peak traffic hours. It is, however, likely that turn movements will operate better than the results obtained with this HCM Two-Way Stop-Control (TWSC) level of service analysis would indicate, as the HCM analysis may not accurately account for the effect of vehicle platooning and gaps caused by upstream signals. The upstream signal control on Curtis Road will tend to create additional gaps in the traffic stream for turning movements at Jones Road and will most likely provide mitigation to the LOS E operation projected during the PM peak traffic hour.

Compared to the background traffic analysis, the traffic generated by the proposed development is not expected to significantly change the operations of the study intersections. These intersection operations are similar to background conditions.

Pedestrian Circulation & Safety Analysis

In accordance with Section B.2.4.B of the County's ECM, an assessment to pedestrian connectivity and safety was considered.

Due to the conceptual nature of the site plan, it is unknown at this time how the proposed development would accommodate pedestrians and bicyclists.

With the assumption that future site plans are designed per the County's ECM, and pursuant to the Federal Highway Administration's (FHWA) Guide for Improving Pedestrian Safety at Uncontrolled Crossing Locations⁴, pedestrian safety is not expected to be of concern. Moreover, traffic calming and pedestrian crossing treatments are not applicable, and traffic calming is not recommended for the proposed conditions.

⁴ Guide for Improving Pedestrian Safety at Uncontrolled Crossing Locations, Federal Highway Administration, July 2018.

VII. Conclusion

This traffic impact study addressed the capacity, geometric, and control requirements associated with the development entitled Jones Road Property. This proposed residential development consists of a single-family home community on approximately 753 acres of land. The development is located north of Jones Road and east of Murr Road in El Paso County, Colorado.

The study area examined in this analysis encompassed the Jones Road intersections with Curtis Road, Murr Road, and Peyton Highway, the Peyton Highway intersections with State Highway 94 and Falcon Highway, the Falcon Highway intersection with Murr Road, and includes site access drives.

Analysis was conducted for critical AM Peak Hour and PM Peak Hour traffic operations for existing traffic conditions, Year 2025 and Year 2043 background traffic conditions, and Year 2025 and Year 2043 total traffic conditions.

Analysis of existing traffic conditions indicates that the stop-controlled intersections of Falcon Highway with Murr Road and Peyton Highway have turn movement operations at LOS A during the morning and afternoon peak traffic hours. The stop-controlled intersection of Curtis Road with Jones Road has turn movement operations at LOS B or better during both peak traffic hours. The stop-controlled intersections of Jones Road with Murr Road and Peyton Highway have turn movement operations at LOS A during both peak traffic hours. The stop-controlled intersection of State Highway 94 with Peyton Highway has turn movement operations at LOS B or better during the AM peak traffic hour and LOS C or better during the PM peak traffic hour.

Without the proposed development, Year 2025 background operational analysis shows that the stop-controlled intersections of Falcon Highway with Murr Road and Peyton Highway have turn movement operations at LOS A during the morning and afternoon peak traffic hours. The stop-controlled intersection of Curtis Road with Jones Road projects turn movement operations at LOS B or better during both peak traffic hours. The stop-controlled intersections of Jones Road with Murr Road and Peyton Highway expect turn movement operations at LOS A during both peak traffic hours. The stop-controlled intersection of State Highway 94 with Peyton Highway predicts turn movement operations at LOS B or better during the AM peak traffic hour and LOS C or better during the PM peak traffic hour.

By Year 2043 and without the proposed development, the stop-controlled intersections of Falcon Highway with Murr Road and Peyton Highway have turn movement operations at LOS B or better during the morning and afternoon peak traffic hours. The stop-controlled intersection of Curtis Road with Jones Road projects turn movement operations at LOS C or better during both peak traffic hours. The stop-controlled intersections of Jones Road with Murr Road and Peyton Highway expect turn movement operations at LOS A during both peak traffic hours. The stop-controlled intersection of State Highway 94 with Peyton Highway predicts turn movement operations at LOS C or better during the AM peak traffic hour and LOS D or better during the PM peak traffic hour.

Analysis of future traffic conditions indicates that the addition of site-generated traffic is expected to create minimal negative impact to traffic operations for the existing and surrounding roadway system. With all conservative assumptions defined in this analysis, the study intersections are projected to operate at future levels of service comparable to Year 2043 background traffic conditions. Proposed site accesses have long-term operations at LOS A during peak traffic periods and upon build-out.

APPENDIX A

Traffic Count Data

Location: 1 CURTIS ROAD & JONES ROAD AM

Date: Tuesday, June 27, 2023

Peak Hour: 07:00 AM - 08:00 AM

Peak 15-Minutes: 07:15 AM - 07:30 AM

Peak Hour - Motorized Vehicles

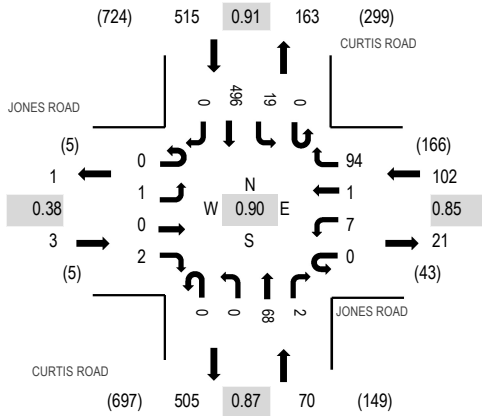

Peak Hour - Bicycles

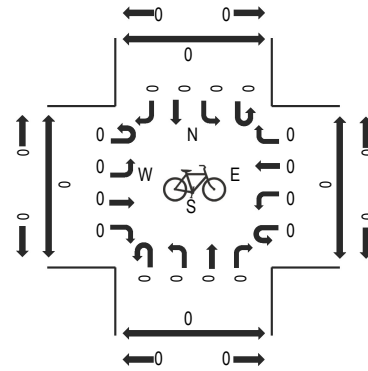

Peak Hour - Pedestrians

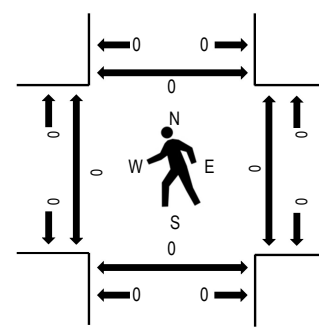

Note: Total study counts contained in parentheses.

Traffic Counts - Motorized Vehicles

Interval Start Time	JONES ROAD Eastbound				JONES ROAD Westbound				CURTIS ROAD Northbound				CURTIS ROAD Southbound				Total	Rolling Hour	Pedestrian Crossings			
	U-Turn	Left	Thru	Right	U-Turn	Left	Thru	Right	U-Turn	Left	Thru	Right	U-Turn	Left	Thru	Right			West	East	South	North
7:00 AM	0	1	0	1	0	2	1	27	0	0	13	0	0	2	140	0	187	690	0	0	0	0
7:15 AM	0	0	0	0	0	2	0	23	0	0	24	0	0	5	137	0	191	621	0	0	0	0
7:30 AM	0	0	0	1	0	2	0	23	0	0	14	1	0	7	134	0	182	517	0	0	0	0
7:45 AM	0	0	0	0	0	1	0	21	0	0	17	1	0	5	85	0	130	421	0	0	0	0
8:00 AM	0	0	0	1	0	2	0	17	0	1	21	0	0	2	74	0	118	354	0	0	0	0
8:15 AM	0	0	0	0	0	1	0	12	0	0	20	2	0	9	43	0	87		0	0	0	0
8:30 AM	0	0	0	0	0	0	0	17	0	1	24	0	0	5	37	2	86		0	0	0	0
8:45 AM	0	1	0	0	0	1	0	14	0	0	10	0	0	4	33	0	63		0	0	0	0
Count Total	0	2	0	3	0	11	1	154	0	2	143	4	0	39	683	2	1,044		0	0	0	0
Peak Hour	0	1	0	2	0	7	1	94	0	0	68	2	0	19	496	0	690		0	0	0	0

Location: 1 CURTIS ROAD & JONES ROAD PM

Date: Tuesday, June 27, 2023

Peak Hour: 04:15 PM - 05:15 PM

Peak 15-Minutes: 04:15 PM - 04:30 PM

Peak Hour - Motorized Vehicles

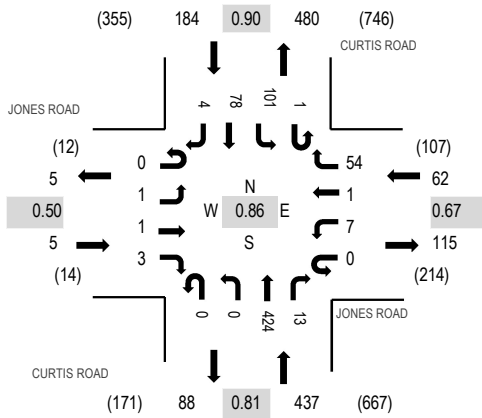

Peak Hour - Bicycles

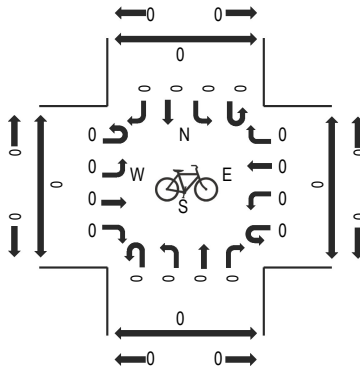

Peak Hour - Pedestrians

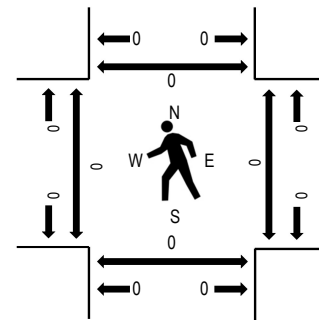

Note: Total study counts contained in parentheses.

Traffic Counts - Motorized Vehicles

Interval Start Time	JONES ROAD Eastbound				JONES ROAD Westbound				CURTIS ROAD Northbound				CURTIS ROAD Southbound				Total	Rolling Hour	Pedestrian Crossings			
	U-Turn	Left	Thru	Right	U-Turn	Left	Thru	Right	U-Turn	Left	Thru	Right	U-Turn	Left	Thru	Right			West	East	South	North
4:00 PM	0	4	0	0	0	2	0	8	0	1	88	3	0	18	16	1	141	684	0	0	0	0
4:15 PM	0	1	0	2	0	2	0	8	0	0	137	4	1	24	20	0	199	688	0	0	0	0
4:30 PM	0	0	0	0	0	0	0	17	0	0	114	2	0	31	19	1	184	612	0	0	0	0
4:45 PM	0	0	0	1	0	1	0	10	0	0	105	5	0	22	14	2	160	542	0	0	0	0
5:00 PM	0	0	1	0	0	4	1	19	0	0	68	2	0	24	25	1	145	459	0	0	0	0
5:15 PM	0	1	0	0	0	1	0	11	0	1	54	1	0	34	17	3	123		0	0	0	0
5:30 PM	0	3	1	0	0	2	0	6	0	0	50	0	0	19	33	0	114		0	0	0	0
5:45 PM	0	0	0	0	0	3	1	11	0	0	30	2	0	21	9	0	77		0	0	0	0
Count Total	0	9	2	3	0	15	2	90	0	2	646	19	1	193	153	8	1,143		0	0	0	0
Peak Hour	0	1	1	3	0	7	1	54	0	0	424	13	1	101	78	4	688		0	0	0	0

Location: 2 MURR ROAD & JONES ROAD AM

Date: Tuesday, June 27, 2023

Peak Hour: 07:00 AM - 08:00 AM

Peak 15-Minutes: 07:30 AM - 07:45 AM

Peak Hour - Motorized Vehicles

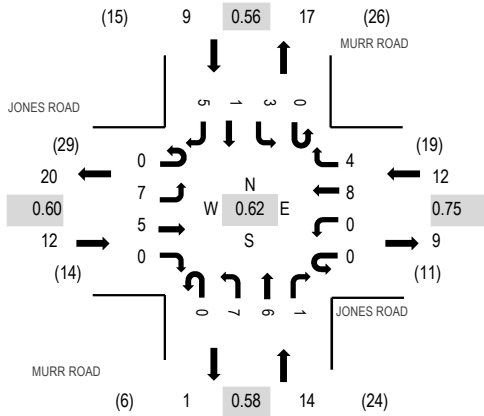

Peak Hour - Bicycles

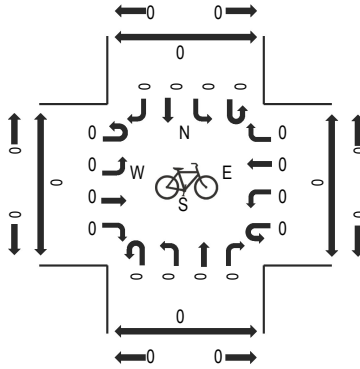

Peak Hour - Pedestrians

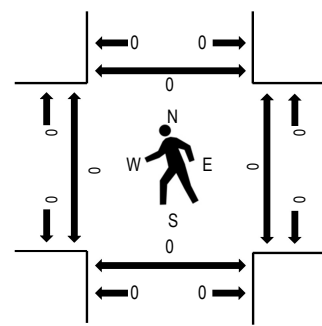

Note: Total study counts contained in parentheses.

Traffic Counts - Motorized Vehicles

Interval Start Time	JONES ROAD Eastbound				JONES ROAD Westbound				MURR ROAD Northbound				MURR ROAD Southbound				Total	Rolling Hour	Pedestrian Crossings			
	U-Turn	Left	Thru	Right	U-Turn	Left	Thru	Right	U-Turn	Left	Thru	Right	U-Turn	Left	Thru	Right			West	East	South	North
7:00 AM	0	3	1	0	0	0	1	2	0	3	2	0	0	1	0	2	15	47	0	0	0	0
7:15 AM	0	0	1	0	0	0	0	2	0	2	0	0	0	0	0	0	5	37	0	0	0	0
7:30 AM	0	3	2	0	0	0	4	0	0	2	4	0	0	1	1	2	19	40	0	0	0	0
7:45 AM	0	1	1	0	0	0	3	0	0	0	1	0	0	1	0	1	8	27	0	0	0	0
8:00 AM	0	0	0	0	0	1	0	1	0	1	2	0	0	0	0	0	5	25	0	0	0	0
8:15 AM	0	0	2	0	0	1	1	0	0	0	2	0	0	0	2	0	8		0	0	0	0
8:30 AM	0	0	0	0	0	0	1	1	0	0	2	0	0	0	0	2	6		0	0	0	0
8:45 AM	0	0	0	0	0	0	0	1	0	3	0	0	0	0	1	1	6		0	0	0	0
Count Total	0	7	7	0	0	2	10	7	0	11	12	1	0	3	4	8	72		0	0	0	0
Peak Hour	0	7	5	0	0	0	8	4	0	7	6	1	0	3	1	5	47		0	0	0	0

Location: 2 MURR ROAD & JONES ROAD PM

Date: Tuesday, June 27, 2023

Peak Hour: 05:00 PM - 06:00 PM

Peak 15-Minutes: 05:15 PM - 05:30 PM

Peak Hour - Motorized Vehicles

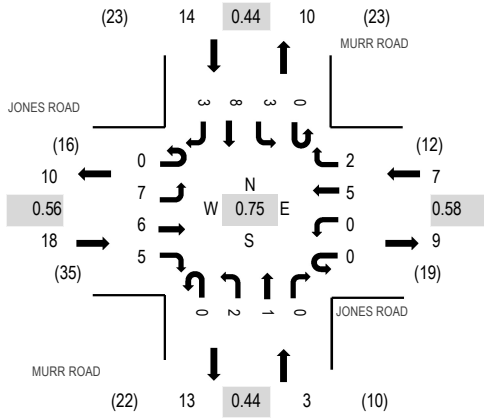

Peak Hour - Bicycles

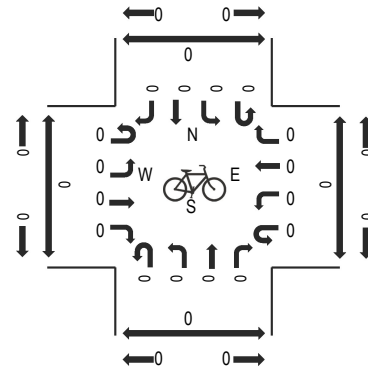

Peak Hour - Pedestrians

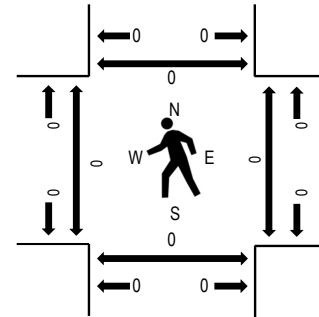

Note: Total study counts contained in parentheses.

Traffic Counts - Motorized Vehicles

Interval Start Time	JONES ROAD Eastbound				JONES ROAD Westbound				MURR ROAD Northbound				MURR ROAD Southbound				Total	Rolling Hour	Pedestrian Crossings			
	U-Turn	Left	Thru	Right	U-Turn	Left	Thru	Right	U-Turn	Left	Thru	Right	U-Turn	Left	Thru	Right			West	East	South	North
4:00 PM	0	1	2	0	0	1	0	1	0	0	0	0	0	1	2	1	9	38	0	0	0	0
4:15 PM	0	2	2	2	0	0	0	1	0	1	3	0	0	1	0	0	12	35	0	0	0	0
4:30 PM	0	3	2	1	0	0	2	0	0	0	1	0	0	1	1	0	11	37	0	0	0	0
4:45 PM	0	1	0	1	0	0	0	0	0	2	0	0	0	1	1	0	6	36	0	0	0	0
5:00 PM	0	0	0	2	0	0	2	0	0	0	0	0	0	1	1	0	6	42	0	0	0	0
5:15 PM	0	3	3	2	0	0	1	2	0	1	0	0	0	0	1	1	14		0	0	0	0
5:30 PM	0	2	3	1	0	0	0	0	0	1	1	0	0	1	1	0	10		0	0	0	0
5:45 PM	0	2	0	0	0	0	2	0	0	0	0	0	0	1	5	2	12		0	0	0	0
Count Total	0	14	12	9	0	1	7	4	0	5	5	0	0	7	12	4	80		0	0	0	0
Peak Hour	0	7	6	5	0	0	5	2	0	2	1	0	0	3	8	3	42		0	0	0	0

Location: 3 NORTH PEYTON HIGHWAY & JONES ROAD AM

Date: Tuesday, June 27, 2023

Peak Hour: 07:30 AM - 08:30 AM

Peak 15-Minutes: 07:45 AM - 08:00 AM

Peak Hour - Motorized Vehicles

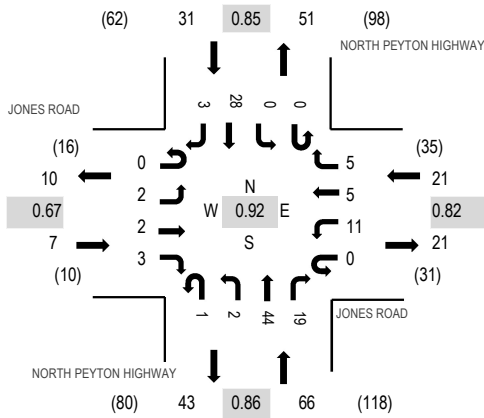

Peak Hour - Bicycles

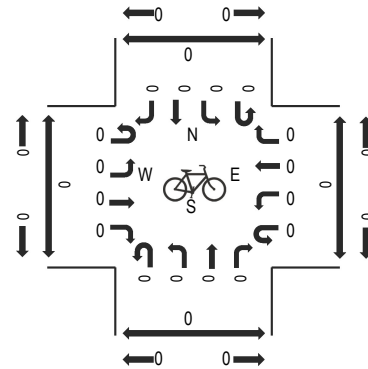

Peak Hour - Pedestrians

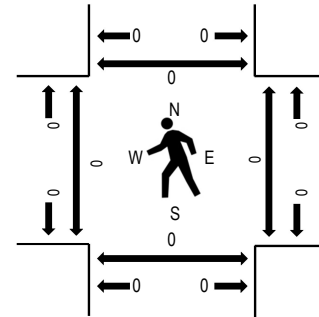

Note: Total study counts contained in parentheses.

Traffic Counts - Motorized Vehicles

Interval Start Time	JONES ROAD Eastbound				JONES ROAD Westbound			NORTH PEYTON HIGHWAY Northbound			NORTH PEYTON HIGHWAY Southbound				Total	Rolling Hour	Pedestrian Crossings					
	U-Turn	Left	Thru	Right	U-Turn	Left	Thru	Right	U-Turn	Left	Thru	Right	U-Turn	Left			Thru	Right	West	East	South	North
7:00 AM	0	0	1	1	0	3	0	1	0	1	12	0	0	2	3	1	25	114	0	0	0	0
7:15 AM	0	1	0	0	0	3	0	3	0	1	15	0	0	0	2	0	25	121	0	0	0	0
7:30 AM	0	0	1	2	0	4	3	0	0	1	9	4	0	0	6	0	30	125	0	0	0	0
7:45 AM	0	0	1	1	0	4	1	1	0	1	15	3	0	0	6	1	34	125	0	0	0	0
8:00 AM	0	0	0	0	0	1	1	2	0	0	10	10	0	0	8	0	32	111	0	0	0	0
8:15 AM	0	2	0	0	0	2	0	2	1	0	10	2	0	0	8	2	29		0	0	0	0
8:30 AM	0	0	0	0	0	3	1	0	0	1	8	5	0	0	12	0	30		0	0	0	0
8:45 AM	0	0	0	0	0	0	0	0	0	1	7	1	0	1	10	0	20		0	0	0	0
Count Total	0	3	3	4	0	20	6	9	1	6	86	25	0	3	55	4	225		0	0	0	0
Peak Hour	0	2	2	3	0	11	5	5	1	2	44	19	0	0	28	3	125		0	0	0	0

Location: 3 NORTH PEYTON HIGHWAY & JONES ROAD PM

Date: Tuesday, June 27, 2023

Peak Hour: 05:00 PM - 06:00 PM

Peak 15-Minutes: 05:30 PM - 05:45 PM

Peak Hour - Motorized Vehicles

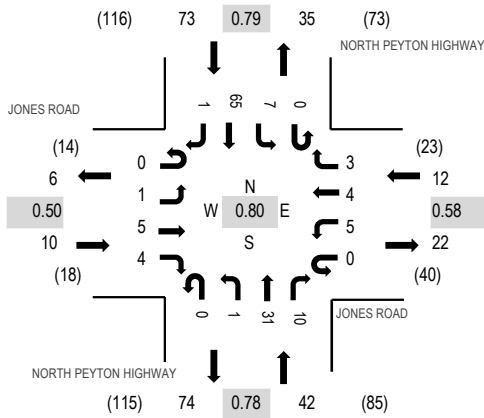

Peak Hour - Bicycles

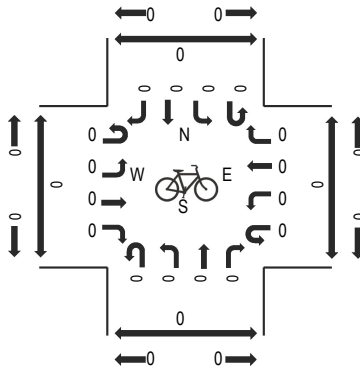

Peak Hour - Pedestrians

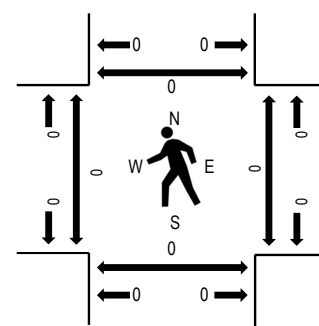

Note: Total study counts contained in parentheses.

Traffic Counts - Motorized Vehicles

Interval Start Time	JONES ROAD Eastbound				JONES ROAD Westbound				NORTH PEYTON HIGHWAY Northbound				NORTH PEYTON HIGHWAY Southbound				Total	Rolling Hour	Pedestrian Crossings			
	U-Turn	Left	Thru	Right	U-Turn	Left	Thru	Right	U-Turn	Left	Thru	Right	U-Turn	Left	Thru	Right			West	East	South	North
4:00 PM	0	0	0	2	0	1	0	0	0	0	9	1	0	1	7	1	22	105	0	0	0	0
4:15 PM	0	0	3	0	0	3	0	3	0	2	10	2	0	2	7	0	32	110	0	0	0	0
4:30 PM	0	2	1	0	0	1	0	0	0	1	4	1	0	1	10	0	21	113	0	0	0	0
4:45 PM	0	0	0	0	0	2	0	1	0	1	9	3	0	3	8	3	30	135	0	0	0	0
5:00 PM	0	0	1	0	0	2	1	1	0	0	8	2	0	0	11	1	27	137	0	0	0	0
5:15 PM	0	0	3	0	0	2	0	0	0	0	7	2	0	2	19	0	35		0	0	0	0
5:30 PM	0	0	1	4	0	0	0	0	0	1	10	4	0	0	23	0	43		0	0	0	0
5:45 PM	0	1	0	0	0	1	3	2	0	0	6	2	0	5	12	0	32		0	0	0	0
Count Total	0	3	9	6	0	12	4	7	0	5	63	17	0	14	97	5	242		0	0	0	0
Peak Hour	0	1	5	4	0	5	4	3	0	1	31	10	0	7	65	1	137		0	0	0	0

Peak Hour - Motorized Vehicles

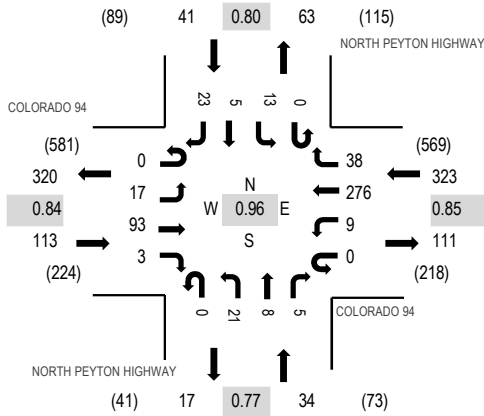

Peak Hour - Bicycles

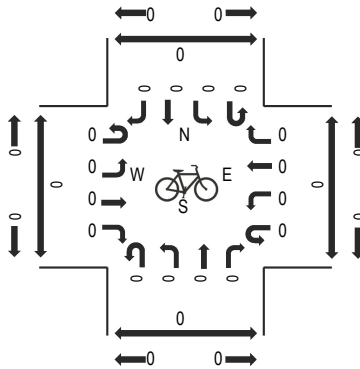

Peak Hour - Pedestrians

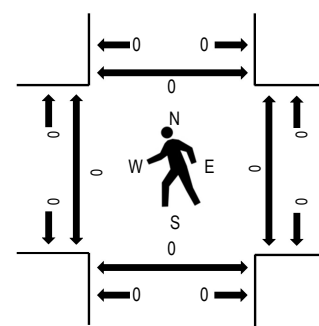

Note: Total study counts contained in parentheses.

Traffic Counts - Motorized Vehicles

Interval Start Time	COLORADO 94 Eastbound				COLORADO 94 Westbound				NORTH PEYTON HIGHWAY Northbound				NORTH PEYTON HIGHWAY Southbound				Total	Rolling Hour	Pedestrian Crossings			
	U-Turn	Left	Thru	Right	U-Turn	Left	Thru	Right	U-Turn	Left	Thru	Right	U-Turn	Left	Thru	Right			West	East	South	North
7:00 AM	0	2	28	1	0	2	74	10	0	4	1	0	0	3	0	6	131	511	0	0	0	0
7:15 AM	0	3	16	1	0	4	82	9	0	5	3	3	0	2	1	4	133	497	0	0	0	0
7:30 AM	0	5	28	0	0	1	65	7	0	4	3	1	0	4	4	5	127	486	0	0	0	0
7:45 AM	0	7	21	1	0	2	55	12	0	8	1	1	0	4	0	8	120	454	0	0	0	0
8:00 AM	0	6	20	2	0	1	59	6	0	10	2	2	0	4	0	5	117	444	0	0	0	0
8:15 AM	0	7	30	1	0	3	52	9	0	5	0	2	0	1	1	11	122		0	0	0	0
8:30 AM	0	2	18	2	0	1	49	4	0	5	2	1	0	3	3	5	95		0	0	0	0
8:45 AM	0	1	18	4	0	2	50	10	0	4	3	3	0	5	4	6	110		0	0	0	0
Count Total	0	33	179	12	0	16	486	67	0	45	15	13	0	26	13	50	955		0	0	0	0
Peak Hour	0	17	93	3	0	9	276	38	0	21	8	5	0	13	5	23	511		0	0	0	0

Location: 4 NORTH PEYTON HIGHWAY & COLORADO 94 PM

Date: Tuesday, June 27, 2023

Peak Hour: 05:00 PM - 06:00 PM

Peak 15-Minutes: 05:30 PM - 05:45 PM

Peak Hour - Motorized Vehicles

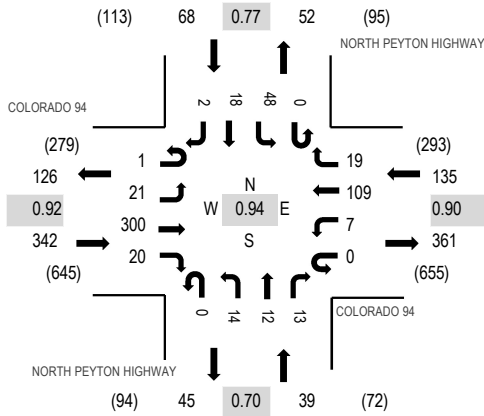

Peak Hour - Bicycles

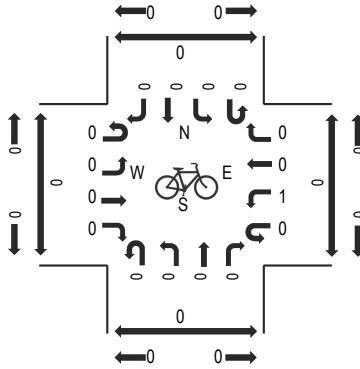

Peak Hour - Pedestrians

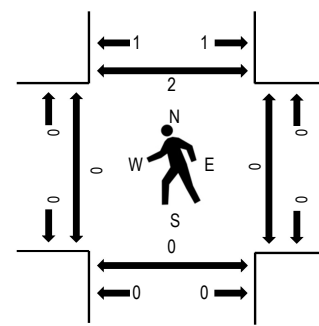

Note: Total study counts contained in parentheses.

Traffic Counts - Motorized Vehicles

Interval Start Time	COLORADO 94 Eastbound				COLORADO 94 Westbound			NORTH PEYTON HIGHWAY Northbound				NORTH PEYTON HIGHWAY Southbound				Total	Rolling Hour	Pedestrian Crossings					
	U-Turn	Left	Thru	Right	U-Turn	Left	Thru	Right	U-Turn	Left	Thru	Right	U-Turn	Left	Thru			Right	West	East	South	North	
4:00 PM	0	4	62	11	0	2	37	5	0	3	4	0	0	0	10	3	2	143	539	0	0	0	0
4:15 PM	0	5	51	7	0	1	39	2	0	5	3	2	0	5	2	5	127	528	0	0	0	0	
4:30 PM	0	4	83	7	0	4	26	3	0	3	1	4	0	6	5	0	146	547	0	0	0	0	
4:45 PM	0	2	62	5	0	1	31	7	0	1	3	4	0	5	1	1	123	557	0	0	0	0	
5:00 PM	0	5	66	4	0	2	29	3	0	2	4	5	0	9	2	1	132	584	0	0	0	0	
5:15 PM	1	8	72	6	0	1	31	3	0	1	5	2	0	14	2	0	146		0	0	0	2	
5:30 PM	0	3	82	2	0	3	32	6	0	4	1	1	0	16	6	0	156		0	0	0	0	
5:45 PM	0	5	80	8	0	1	17	7	0	7	2	5	0	9	8	1	150		0	0	0	0	
Count Total	1	36	558	50	0	15	242	36	0	26	23	23	0	74	29	10	1,123		0	0	0	2	
Peak Hour	1	21	300	20	0	7	109	19	0	14	12	13	0	48	18	2	584		0	0	0	2	

Location: 5 NORTH PEYTON HIGHWAY & FALCON HIGHWAY AM

Date: Tuesday, June 27, 2023

Peak Hour: 07:00 AM - 08:00 AM

Peak 15-Minutes: 07:00 AM - 07:15 AM

Peak Hour - Motorized Vehicles

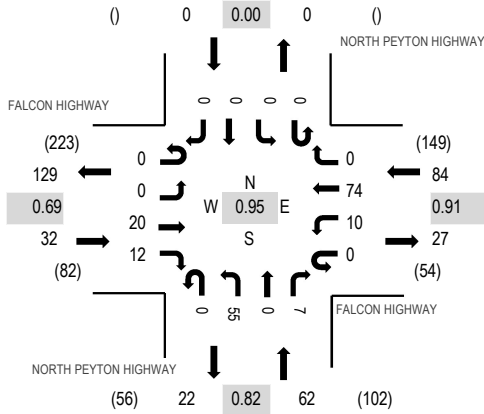

Peak Hour - Bicycles

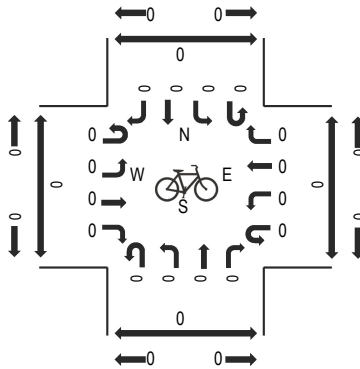

Peak Hour - Pedestrians

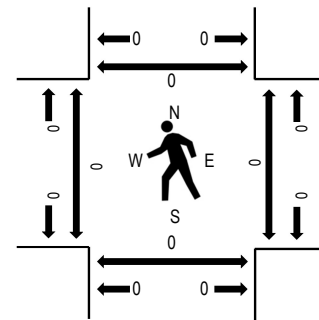

Note: Total study counts contained in parentheses.

Traffic Counts - Motorized Vehicles

Interval Start Time	FALCON HIGHWAY Eastbound				FALCON HIGHWAY Westbound				NORTH PEYTON HIGHWAY Northbound				NORTH PEYTON HIGHWAY Southbound				Total	Rolling Hour	Pedestrian Crossings							
	U-Turn	Left	Thru	Right	U-Turn	Left	Thru	Right	U-Turn	Left	Thru	Right	U-Turn	Left	Thru	Right			West	East	South	North				
	7:00 AM	0	0	3	7	0	2	20	0	0	14	0	1	0	0	0			0	0	0	0	0	47	178	0
7:15 AM	0	0	3	1	0	2	21	0	0	16	0	3	0	0	0	0	0	0	0	0	46	176	0	0	0	0
7:30 AM	0	0	9	3	0	3	20	0	0	10	0	1	0	0	0	0	0	0	0	0	46	160	0	0	0	0
7:45 AM	0	0	5	1	0	3	13	0	0	15	0	2	0	0	0	0	0	0	0	0	39	163	0	0	0	0
8:00 AM	0	0	8	6	0	2	16	0	0	13	0	0	0	0	0	0	0	0	0	0	45	155	0	0	0	0
8:15 AM	0	0	3	2	0	0	13	0	0	10	0	2	0	0	0	0	0	0	0	0	30		0	0	0	0
8:30 AM	0	0	7	11	0	3	17	0	0	9	0	2	0	0	0	0	0	0	0	0	49		0	0	0	0
8:45 AM	0	0	5	8	0	2	12	0	0	4	0	0	0	0	0	0	0	0	0	0	31		0	0	0	0
Count Total	0	0	43	39	0	17	132	0	0	91	0	11	0	0	0	0	0	0	0	0	333		0	0	0	0
Peak Hour	0	0	20	12	0	10	74	0	0	55	0	7	0	0	0	0	0	0	0	0	178		0	0	0	0

Location: 5 NORTH PEYTON HIGHWAY & FALCON HIGHWAY PM

Date: Tuesday, June 27, 2023

Peak Hour: 05:00 PM - 06:00 PM

Peak 15-Minutes: 05:00 PM - 05:15 PM

Peak Hour - Motorized Vehicles

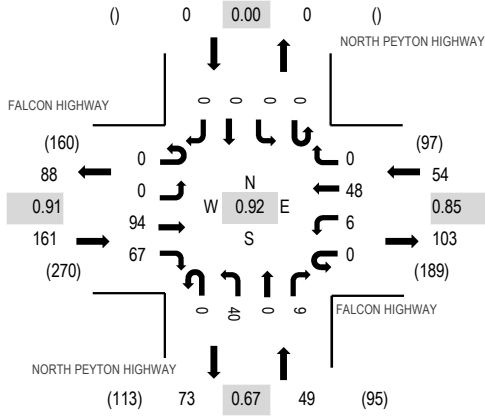

Peak Hour - Bicycles

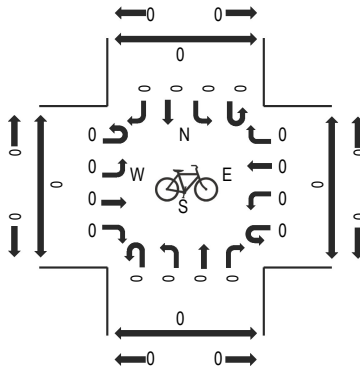

Peak Hour - Pedestrians

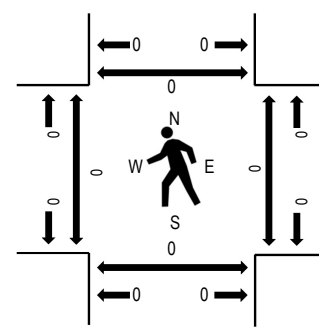

Note: Total study counts contained in parentheses.

Traffic Counts - Motorized Vehicles

Interval Start Time	FALCON HIGHWAY Eastbound				FALCON HIGHWAY Westbound				NORTH PEYTON HIGHWAY Northbound				NORTH PEYTON HIGHWAY Southbound				Total	Rolling Hour	Pedestrian Crossings			
	U-Turn	Left	Thru	Right	U-Turn	Left	Thru	Right	U-Turn	Left	Thru	Right	U-Turn	Left	Thru	Right			West	East	South	North
	4:00 PM	0	0	19	7	0	0	13	0	0	10	0	4	0	0	0			0	53	198	0
4:15 PM	0	0	19	11	0	1	7	0	0	11	0	4	0	0	0	0	53	217	0	0	0	0
4:30 PM	0	0	14	9	0	1	5	0	0	7	0	2	0	0	0	0	38	221	0	0	0	0
4:45 PM	0	0	22	8	0	3	13	0	0	6	0	2	0	0	0	0	54	250	0	0	0	0
5:00 PM	0	0	22	14	0	1	16	0	0	18	0	1	0	0	0	0	72	264	0	0	0	0
5:15 PM	0	0	23	14	0	2	13	0	0	4	0	1	0	0	0	0	57		0	0	0	0
5:30 PM	0	0	23	21	0	2	8	0	0	9	0	4	0	0	0	0	67		0	0	0	0
5:45 PM	0	0	26	18	0	1	11	0	0	9	0	3	0	0	0	0	68		0	0	0	0
Count Total	0	0	168	102	0	11	86	0	0	74	0	21	0	0	0	0	462		0	0	0	0
Peak Hour	0	0	94	67	0	6	48	0	0	40	0	9	0	0	0	0	264		0	0	0	0

Location: 6 MURR ROAD & FALCON HIGHWAY AM

Date: Tuesday, June 27, 2023

Peak Hour: 07:00 AM - 08:00 AM

Peak 15-Minutes: 07:30 AM - 07:45 AM

Peak Hour - Motorized Vehicles

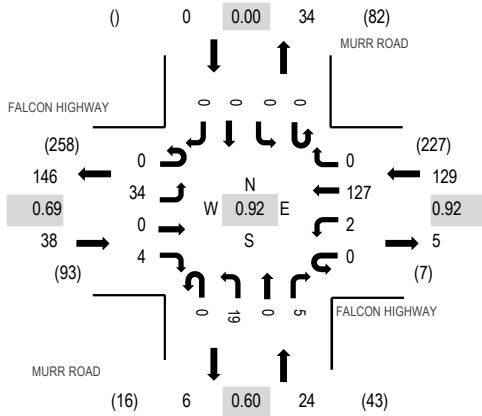

Peak Hour - Bicycles

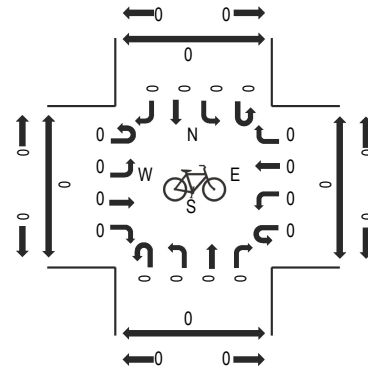

Peak Hour - Pedestrians

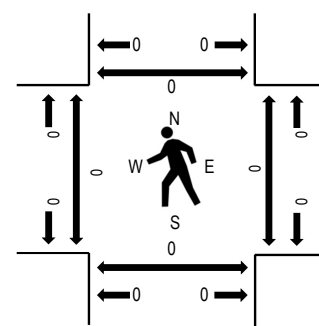

Note: Total study counts contained in parentheses.

Traffic Counts - Motorized Vehicles

Interval Start Time	FALCON HIGHWAY Eastbound				FALCON HIGHWAY Westbound				MURR ROAD Northbound				MURR ROAD Southbound				Total	Rolling Hour	Pedestrian Crossings			
	U-Turn	Left	Thru	Right	U-Turn	Left	Thru	Right	U-Turn	Left	Thru	Right	U-Turn	Left	Thru	Right			West	East	South	North
7:00 AM	0	10	0	2	0	0	26	0	0	8	0	2	0	0	0	0	48	191	0	0	0	0
7:15 AM	0	7	0	0	0	0	35	0	0	5	0	0	0	0	0	0	47	180	0	0	0	0
7:30 AM	0	10	0	0	0	1	34	0	0	5	0	2	0	0	0	0	52	171	0	0	0	0
7:45 AM	0	7	0	2	0	1	32	0	0	1	0	1	0	0	0	0	44	170	0	0	0	0
8:00 AM	0	11	0	0	0	0	24	0	0	2	0	0	0	0	0	0	37	172	0	0	0	0
8:15 AM	0	4	0	2	0	0	24	0	0	8	0	0	0	0	0	0	38		0	0	0	0
8:30 AM	0	17	0	1	0	2	24	0	0	5	0	2	0	0	0	0	51		0	0	0	0
8:45 AM	0	16	0	4	0	1	23	0	0	2	0	0	0	0	0	0	46		0	0	0	0
Count Total	0	82	0	11	0	5	222	0	0	36	0	7	0	0	0	0	363		0	0	0	0
Peak Hour	0	34	0	4	0	2	127	0	0	19	0	5	0	0	0	0	191		0	0	0	0

Location: 6 MURR ROAD & FALCON HIGHWAY PM

Date: Tuesday, June 27, 2023

Peak Hour: 04:45 PM - 05:45 PM

Peak 15-Minutes: 05:15 PM - 05:30 PM

Peak Hour - Motorized Vehicles

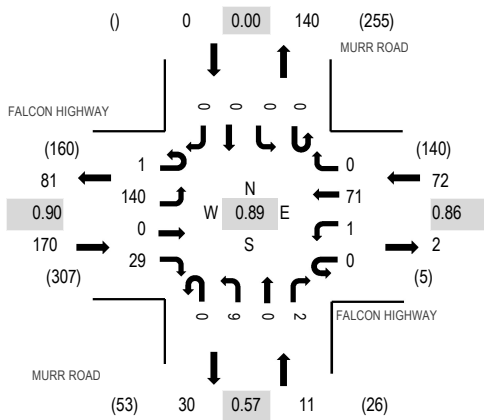

Peak Hour - Bicycles

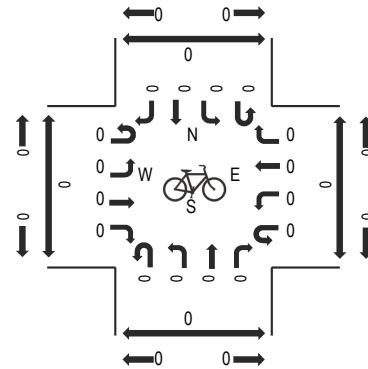

Peak Hour - Pedestrians

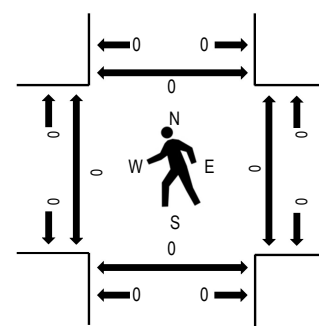

Note: Total study counts contained in parentheses.

Traffic Counts - Motorized Vehicles

Interval Start Time	FALCON HIGHWAY Eastbound				FALCON HIGHWAY Westbound				MURR ROAD Northbound				MURR ROAD Southbound				Total	Rolling Hour	Pedestrian Crossings			
	U-Turn	Left	Thru	Right	U-Turn	Left	Thru	Right	U-Turn	Left	Thru	Right	U-Turn	Left	Thru	Right			West	East	South	North
4:00 PM	0	24	0	6	0	0	20	0	0	5	0	2	0	0	0	0	57	221	0	0	0	0
4:15 PM	0	32	0	2	0	0	21	0	0	4	0	0	0	0	0	0	59	223	0	0	0	0
4:30 PM	0	22	0	9	0	0	12	0	0	2	0	0	0	0	0	0	45	235	0	0	0	0
4:45 PM	0	33	0	6	0	1	17	0	0	3	0	0	0	0	0	0	60	253	0	0	0	0
5:00 PM	0	33	0	6	0	0	17	0	0	3	0	0	0	0	0	0	59	252	0	0	0	0
5:15 PM	1	37	0	10	0	0	21	0	0	2	0	0	0	0	0	0	71		0	0	0	0
5:30 PM	0	37	0	7	0	0	16	0	0	1	0	2	0	0	0	0	63		0	0	0	0
5:45 PM	0	37	0	5	0	1	14	0	0	1	0	1	0	0	0	0	59		0	0	0	0
Count Total	1	255	0	51	0	2	138	0	0	21	0	5	0	0	0	0	473		0	0	0	0
Peak Hour	1	140	0	29	0	1	71	0	0	9	0	2	0	0	0	0	253		0	0	0	0



All Traffic Data Services

7. JONES ROAD EAST OF MURR ROAD

Time	EB	WB	Total
6/27/2023	1	0	1
6/27/2023 12:15:00 AM	0	0	0
6/27/2023 12:30:00 AM	0	1	1
6/27/2023 12:45:00 AM	0	0	0
6/27/2023 1:00:00 AM	0	0	0
6/27/2023 1:15:00 AM	1	0	1
6/27/2023 1:30:00 AM	0	0	0
6/27/2023 1:45:00 AM	0	0	0
6/27/2023 2:00:00 AM	0	0	0
6/27/2023 2:15:00 AM	0	0	0
6/27/2023 2:30:00 AM	0	0	0
6/27/2023 2:45:00 AM	0	1	1
6/27/2023 3:00:00 AM	0	0	0
6/27/2023 3:15:00 AM	0	0	0
6/27/2023 3:30:00 AM	0	0	0
6/27/2023 3:45:00 AM	0	0	0
6/27/2023 4:00:00 AM	0	0	0
6/27/2023 4:15:00 AM	0	1	1
6/27/2023 4:30:00 AM	0	1	1
6/27/2023 4:45:00 AM	0	1	1
6/27/2023 5:00:00 AM	0	0	0
6/27/2023 5:15:00 AM	0	2	2
6/27/2023 5:30:00 AM	0	2	2
6/27/2023 5:45:00 AM	0	1	1
6/27/2023 6:00:00 AM	1	1	2
6/27/2023 6:15:00 AM	2	5	7
6/27/2023 6:30:00 AM	0	3	3
6/27/2023 6:45:00 AM	2	3	5
6/27/2023 7:00:00 AM	2	3	5
6/27/2023 7:15:00 AM	1	2	3
6/27/2023 7:30:00 AM	3	4	7
6/27/2023 7:45:00 AM	3	3	6
6/27/2023 8:00:00 AM	0	2	2
6/27/2023 8:15:00 AM	2	2	4
6/27/2023 8:30:00 AM	0	2	2
6/27/2023 8:45:00 AM	0	1	1
6/27/2023 9:00:00 AM	0	0	0
6/27/2023 9:15:00 AM	1	1	2
6/27/2023 9:30:00 AM	1	1	2
6/27/2023 9:45:00 AM	1	1	2
6/27/2023 10:00:00 AM	2	6	8
6/27/2023 10:15:00 AM	5	3	8
6/27/2023 10:30:00 AM	0	2	2
6/27/2023 10:45:00 AM	3	3	6
6/27/2023 11:00:00 AM	4	1	5
6/27/2023 11:15:00 AM	1	4	5
6/27/2023 11:30:00 AM	1	3	4
6/27/2023 11:45:00 AM	0	1	1
Total	37	67	104
Percentage	35.6%	64.4%	
Peak Hour	10:15 AM	6:15 AM	10:00 AM
Volume	12	14	24
PHF	0.600	0.700	0.750



All Traffic Data Services

7. JONES ROAD EAST OF MURR ROAD

Time	EB	WB	Total
6/27/2023 12:00:00 PM	4	0	4
6/27/2023 12:15:00 PM	2	6	8
6/27/2023 12:30:00 PM	2	2	4
6/27/2023 12:45:00 PM	3	3	6
6/27/2023 1:00:00 PM	3	2	5
6/27/2023 1:15:00 PM	2	3	5
6/27/2023 1:30:00 PM	3	3	6
6/27/2023 1:45:00 PM	3	3	6
6/27/2023 2:00:00 PM	2	1	3
6/27/2023 2:15:00 PM	5	2	7
6/27/2023 2:30:00 PM	3	1	4
6/27/2023 2:45:00 PM	4	3	7
6/27/2023 3:00:00 PM	1	1	2
6/27/2023 3:15:00 PM	1	3	4
6/27/2023 3:30:00 PM	3	1	4
6/27/2023 3:45:00 PM	6	1	7
6/27/2023 4:00:00 PM	3	2	5
6/27/2023 4:15:00 PM	3	1	4
6/27/2023 4:30:00 PM	3	2	5
6/27/2023 4:45:00 PM	1	0	1
6/27/2023 5:00:00 PM	1	2	3
6/27/2023 5:15:00 PM	3	3	6
6/27/2023 5:30:00 PM	4	0	4
6/27/2023 5:45:00 PM	1	2	3
6/27/2023 6:00:00 PM	3	1	4
6/27/2023 6:15:00 PM	7	2	9
6/27/2023 6:30:00 PM	8	1	9
6/27/2023 6:45:00 PM	5	4	9
6/27/2023 7:00:00 PM	3	0	3
6/27/2023 7:15:00 PM	2	1	3
6/27/2023 7:30:00 PM	4	0	4
6/27/2023 7:45:00 PM	1	1	2
6/27/2023 8:00:00 PM	4	1	5
6/27/2023 8:15:00 PM	3	1	4
6/27/2023 8:30:00 PM	3	0	3
6/27/2023 8:45:00 PM	1	1	2
6/27/2023 9:00:00 PM	2	2	4
6/27/2023 9:15:00 PM	1	3	4
6/27/2023 9:30:00 PM	1	2	3
6/27/2023 9:45:00 PM	0	2	2
6/27/2023 10:00:00 PM	1	0	1
6/27/2023 10:15:00 PM	0	0	0
6/27/2023 10:30:00 PM	1	0	1
6/27/2023 10:45:00 PM	0	1	1
6/27/2023 11:00:00 PM	0	0	0
6/27/2023 11:15:00 PM	0	0	0
6/27/2023 11:30:00 PM	0	0	0
6/27/2023 11:45:00 PM	1	0	1
Total	117	70	187
Percentage	62.6%	37.4%	
Peak Hour	6:00 PM	12:15 PM	6:00 PM
Volume	23	13	31
PHF	0.719	0.542	0.861
Grand Total	154	137	291
Percentage	52.9%	47.1%	

APPENDIX B

Level of Service Definitions

The following information is referenced from the Highway Capacity Manual: A Guide for Multimodal Mobility Analysis, 6th Edition, Transportation Research Board, 2016: Chapter 19 – Signalized Intersections.

Motorized Vehicle Level of Service (LOS) for Signalized Intersections

Levels of service are defined to represent reasonable ranges in control delay.

LOS A Describes operations with a control delay of 10 s/veh or less and a volume-to-capacity ratio no greater than 1.0. This level is typically assigned when the volume-to-capacity ratio is low and either progression is exceptionally favorable or the cycle length is very short. If it is due to favorable progression, most vehicles arrive during the green indication and travel through the intersection without stopping.

LOS B Describes operations with control delay between 10 and 20 s/veh and a volume-to-capacity ratio no greater than 1.0. This level is typically assigned when the volume-to-capacity ratio is low and either progression is highly favorable or the cycle length is short. More vehicles stop than with LOS A.

LOS C Describes operations with control delay between 20 and 35 s/veh and a volume-to-capacity ratio no greater than 1.0. This level is typically assigned when progression is favorable or the cycle length is moderate. Individual *cycle failures* (i.e., one or more queued vehicles are not able to depart as a result of insufficient capacity during the cycle) may begin to appear at this level. The number of vehicles stopping is significant, although many vehicles still pass through the intersection without stopping.

LOS D Describes operations with control delay between 35 and 55 s/veh and a volume-to-capacity ratio no greater than 1.0. This level is typically assigned when the volume-to-capacity ratio is high and either progression is ineffective or the cycle length is long. Many vehicles stop and individual cycle failures are noticeable.

LOS E Describes operations with control delay between 55 and 80 s/veh and a volume-to-capacity ratio no greater than 1.0. This level is typically assigned when the volume-to-capacity ratio is high, progression is unfavorable, and the cycle length is long. Individual cycle failures are frequent.

LOS F Describes operations with control delay exceeding 80 s/veh or a volume-to-capacity ratio greater than 1.0. This level is typically assigned when the volume-to-capacity ratio is very high, progression is very poor, and the cycle length is long. Most cycles fail to clear the queue.

Control Delay (s/veh)	LOS by Volume-to-Capacity Ratio ^a	
	$v/c \leq 1.0$	$v/c > 1.0$
≤ 10	A	F
> 10 – 20	B	F
> 20 – 35	C	F
> 35 – 55	D	F
> 55 – 80	E	F
> 80	F	F

Note: ^a For approach-based and intersectionwide assessments, LOS is defined solely by control delay.

The following information is referenced from the Highway Capacity Manual: A Guide for Multimodal Mobility Analysis, 6th Edition, Transportation Research Board, 2016: Chapter 20 – Two-Way Stop-Controlled Intersections, Chapter 21 – All-Way Stop-Controlled Intersections, and Chapter 22 - Roundabouts.

Motorized Vehicle Level of Service (LOS) for Unsignalized & Roundabout Intersections

LOS is a quantitative stratification of performance measure(s) representing quality of service. Quality of service describes how well a transportation facility or service operates from a traveler’s perspective. LOS is measured on an A – F scale, with LOS A representing the best operating conditions from a traveler’s perspective.

Control Delay (s/veh)	LOS by Volume-to-Capacity Ratio ^a	
	v/c ≤ 1.0	v/c > 1.0
0 – 10	A	F
> 10 – 15	B	F
> 15 – 25	C	F
> 25 – 35	D	F
> 35 – 50	E	F
> 50	F	F

Note: The LOS criteria apply to each lane on a given approach and to each approach on the minor street. LOS is not calculated for major-street approaches or for the intersection as a whole.

^a For approaches and intersectionwide assessment, LOS is defined solely by control delay.

APPENDIX C

Capacity Worksheets

Intersection						
Int Delay, s/veh	1.2					
Movement	EBT	EBR	WBL	WBT	NBL	NBR
Lane Configurations	↔		↔		↔	
Traffic Vol, veh/h	34	4	2	127	19	5
Future Vol, veh/h	34	4	2	127	19	5
Conflicting Peds, #/hr	0	0	0	0	0	0
Sign Control	Free	Free	Free	Free	Stop	Stop
RT Channelized	-	None	-	None	-	None
Storage Length	-	-	-	-	0	-
Veh in Median Storage, #	0	-	-	0	0	-
Grade, %	0	-	-	0	0	-
Peak Hour Factor	92	92	92	92	92	92
Heavy Vehicles, %	2	2	2	2	2	2
Mvmt Flow	37	4	2	138	21	5

Major/Minor	Major1	Major2	Minor1	Minor2	Minor3
Conflicting Flow All	0	0	41	0	181
Stage 1	-	-	-	-	39
Stage 2	-	-	-	-	142
Critical Hdwy	-	-	4.12	-	6.42
Critical Hdwy Stg 1	-	-	-	-	5.42
Critical Hdwy Stg 2	-	-	-	-	5.42
Follow-up Hdwy	-	-	2.218	-	3.518
Pot Cap-1 Maneuver	-	-	1568	-	808
Stage 1	-	-	-	-	983
Stage 2	-	-	-	-	885
Platoon blocked, %	-	-	-	-	-
Mov Cap-1 Maneuver	-	-	1568	-	807
Mov Cap-2 Maneuver	-	-	-	-	807
Stage 1	-	-	-	-	983
Stage 2	-	-	-	-	884

Approach	EB	WB	NB
HCM Control Delay, s	0	0.1	9.4
HCM LOS			A

Minor Lane/Major Mvmt	NBLn1	EBT	EBR	WBL	WBT
Capacity (veh/h)	846	-	-	1568	-
HCM Lane V/C Ratio	0.031	-	-	0.001	-
HCM Control Delay (s)	9.4	-	-	7.3	0
HCM Lane LOS	A	-	-	A	A
HCM 95th %tile Q(veh)	0.1	-	-	0	-

HCM 6th TWSC
2: Peyton Highway & Falcon Highway

Existing Traffic Conditions
AM Peak Hour

Intersection						
Int Delay, s/veh	3.7					
Movement	EBT	EBR	WBL	WBT	NBL	NBR
Lane Configurations	↔		↔		↔	
Traffic Vol, veh/h	20	12	10	74	55	7
Future Vol, veh/h	20	12	10	74	55	7
Conflicting Peds, #/hr	0	0	0	0	0	0
Sign Control	Free	Free	Free	Free	Stop	Stop
RT Channelized	-	None	-	None	-	None
Storage Length	-	-	-	-	0	-
Veh in Median Storage, #	0	-	-	0	0	-
Grade, %	0	-	-	0	0	-
Peak Hour Factor	92	92	92	92	92	92
Heavy Vehicles, %	2	2	2	2	2	2
Mvmt Flow	22	13	11	80	60	8

Major/Minor	Major1	Major2	Minor1	Minor2	Minor3
Conflicting Flow All	0	0	35	0	131
Stage 1	-	-	-	-	29
Stage 2	-	-	-	-	102
Critical Hdwy	-	-	4.12	-	6.42
Critical Hdwy Stg 1	-	-	-	-	5.42
Critical Hdwy Stg 2	-	-	-	-	5.42
Follow-up Hdwy	-	-	2.218	-	3.518
Pot Cap-1 Maneuver	-	-	1576	-	863
Stage 1	-	-	-	-	994
Stage 2	-	-	-	-	922
Platoon blocked, %	-	-	-	-	-
Mov Cap-1 Maneuver	-	-	1576	-	857
Mov Cap-2 Maneuver	-	-	-	-	857
Stage 1	-	-	-	-	994
Stage 2	-	-	-	-	916

Approach	EB	WB	NB
HCM Control Delay, s	0	0.9	9.5
HCM LOS			A

Minor Lane/Major Mvmt	NBLn1	EBT	EBR	WBL	WBT
Capacity (veh/h)	875	-	-	1576	-
HCM Lane V/C Ratio	0.077	-	-	0.007	-
HCM Control Delay (s)	9.5	-	-	7.3	0
HCM Lane LOS	A	-	-	A	A
HCM 95th %tile Q(veh)	0.2	-	-	0	-

HCM 6th TWSC
3: Curtis Road & Jones Road

Existing Traffic Conditions
AM Peak Hour

Intersection												
Int Delay, s/veh	1.7											
Movement	EBL	EBT	EBR	WBL	WBT	WBR	NBL	NBT	NBR	SBL	SBT	SBR
Lane Configurations	↕			↕			↕			↕		
Traffic Vol, veh/h	1	0	2	7	1	94	0	68	2	19	496	0
Future Vol, veh/h	1	0	2	7	1	94	0	68	2	19	496	0
Conflicting Peds, #/hr	0	0	0	0	0	0	0	0	0	0	0	0
Sign Control	Stop	Stop	Stop	Stop	Stop	Stop	Free	Free	Free	Free	Free	Free
RT Channelized	-	-	None	-	-	None	-	-	None	-	-	None
Storage Length	-	-	-	-	-	-	-	-	-	-	-	-
Veh in Median Storage, #	-	0	-	-	0	-	-	0	-	-	0	-
Grade, %	-	0	-	-	0	-	-	0	-	-	0	-
Peak Hour Factor	92	92	92	92	92	92	92	92	92	92	92	92
Heavy Vehicles, %	2	2	2	2	2	2	2	2	2	2	2	2
Mvmt Flow	1	0	2	8	1	102	0	74	2	21	539	0

Major/Minor	Minor2		Minor1		Major1		Major2					
Conflicting Flow All	708	657	539	657	656	75	539	0	0	76	0	0
Stage 1	581	581	-	75	75	-	-	-	-	-	-	-
Stage 2	127	76	-	582	581	-	-	-	-	-	-	-
Critical Hdwy	7.12	6.52	6.22	7.12	6.52	6.22	4.12	-	-	4.12	-	-
Critical Hdwy Stg 1	6.12	5.52	-	6.12	5.52	-	-	-	-	-	-	-
Critical Hdwy Stg 2	6.12	5.52	-	6.12	5.52	-	-	-	-	-	-	-
Follow-up Hdwy	3.518	4.018	3.318	3.518	4.018	3.318	2.218	-	-	2.218	-	-
Pot Cap-1 Maneuver	350	385	542	378	385	986	1029	-	-	1523	-	-
Stage 1	499	500	-	934	833	-	-	-	-	-	-	-
Stage 2	877	832	-	499	500	-	-	-	-	-	-	-
Platoon blocked, %	-	-	-	-	-	-	-	-	-	-	-	-
Mov Cap-1 Maneuver	308	377	542	371	377	986	1029	-	-	1523	-	-
Mov Cap-2 Maneuver	308	377	-	371	377	-	-	-	-	-	-	-
Stage 1	499	490	-	934	833	-	-	-	-	-	-	-
Stage 2	785	832	-	487	490	-	-	-	-	-	-	-

Approach	EB		WB		NB		SB	
HCM Control Delay, s	13.4		9.7		0		0.3	
HCM LOS	B		A					

Minor Lane/Major Mvmt	NBL	NBT	NBR	EBLn1WBLn1	SBL	SBT	SBR
Capacity (veh/h)	1029	-	-	432	873	1523	-
HCM Lane V/C Ratio	-	-	-	0.008	0.127	0.014	-
HCM Control Delay (s)	0	-	-	13.4	9.7	7.4	0
HCM Lane LOS	A	-	-	B	A	A	A
HCM 95th %tile Q(veh)	0	-	-	0	0.4	0	-

HCM 6th TWSC
4: Murr Road & Jones Road

Existing Traffic Conditions
AM Peak Hour

Intersection												
Int Delay, s/veh	5.4											
Movement	EBL	EBT	EBR	WBL	WBT	WBR	NBL	NBT	NBR	SBL	SBT	SBR
Lane Configurations	↕			↕			↕			↕		
Traffic Vol, veh/h	7	5	0	0	8	4	7	6	1	3	1	5
Future Vol, veh/h	7	5	0	0	8	4	7	6	1	3	1	5
Conflicting Peds, #/hr	0	0	0	0	0	0	0	0	0	0	0	0
Sign Control	Free	Free	Free	Free	Free	Free	Stop	Stop	Stop	Stop	Stop	Stop
RT Channelized	-	-	None	-	-	None	-	-	None	-	-	None
Storage Length	-	-	-	-	-	-	-	-	-	-	-	-
Veh in Median Storage, #	-	0	-	-	0	-	-	0	-	-	0	-
Grade, %	-	0	-	-	0	-	-	0	-	-	0	-
Peak Hour Factor	92	92	92	92	92	92	92	92	92	92	92	92
Heavy Vehicles, %	2	2	2	2	2	2	2	2	2	2	2	2
Mvmt Flow	8	5	0	0	9	4	8	7	1	3	1	5

Major/Minor	Major1		Major2		Minor1		Minor2					
Conflicting Flow All	13	0	0	5	0	0	35	34	5	36	32	11
Stage 1	-	-	-	-	-	-	21	21	-	11	11	-
Stage 2	-	-	-	-	-	-	14	13	-	25	21	-
Critical Hdwy	4.12	-	-	4.12	-	-	7.12	6.52	6.22	7.12	6.52	6.22
Critical Hdwy Stg 1	-	-	-	-	-	-	6.12	5.52	-	6.12	5.52	-
Critical Hdwy Stg 2	-	-	-	-	-	-	6.12	5.52	-	6.12	5.52	-
Follow-up Hdwy	2.218	-	-	2.218	-	-	3.518	4.018	3.318	3.518	4.018	3.318
Pot Cap-1 Maneuver	1606	-	-	1616	-	-	971	859	1078	970	861	1070
Stage 1	-	-	-	-	-	-	998	878	-	1010	886	-
Stage 2	-	-	-	-	-	-	1006	885	-	993	878	-
Platoon blocked, %	-	-	-	-	-	-	-	-	-	-	-	-
Mov Cap-1 Maneuver	1606	-	-	1616	-	-	961	855	1078	959	857	1070
Mov Cap-2 Maneuver	-	-	-	-	-	-	961	855	-	959	857	-
Stage 1	-	-	-	-	-	-	993	874	-	1005	886	-
Stage 2	-	-	-	-	-	-	1000	885	-	980	874	-

Approach	EB	WB	NB	SB
HCM Control Delay, s	4.2	0	9	8.6
HCM LOS			A	A

Minor Lane/Major Mvmt	NBLn1	EBL	EBT	EBR	WBL	WBT	WBR	SBLn1
Capacity (veh/h)	919	1606	-	-	1616	-	-	1004
HCM Lane V/C Ratio	0.017	0.005	-	-	-	-	-	0.01
HCM Control Delay (s)	9	7.3	0	-	0	-	-	8.6
HCM Lane LOS	A	A	A	-	A	-	-	A
HCM 95th %tile Q(veh)	0.1	0	-	-	0	-	-	0

HCM 6th TWSC
5: Peyton Highway & Jones Road

Existing Traffic Conditions
AM Peak Hour

Intersection												
Int Delay, s/veh	2.2											
Movement	EBL	EBT	EBR	WBL	WBT	WBR	NBL	NBT	NBR	SBL	SBT	SBR
Lane Configurations	↕			↕			↕			↕		
Traffic Vol, veh/h	2	2	3	11	5	5	3	44	19	0	28	3
Future Vol, veh/h	2	2	3	11	5	5	3	44	19	0	28	3
Conflicting Peds, #/hr	0	0	0	0	0	0	0	0	0	0	0	0
Sign Control	Stop	Stop	Stop	Stop	Stop	Stop	Free	Free	Free	Free	Free	Free
RT Channelized	-	-	None	-	-	None	-	-	None	-	-	None
Storage Length	-	-	-	-	-	-	-	-	-	-	-	-
Veh in Median Storage, #	-	0	-	-	0	-	-	0	-	-	0	-
Grade, %	-	0	-	-	0	-	-	0	-	-	0	-
Peak Hour Factor	92	92	92	92	92	92	92	92	92	92	92	92
Heavy Vehicles, %	2	2	2	2	2	2	2	2	2	2	2	2
Mvmt Flow	2	2	3	12	5	5	3	48	21	0	30	3

Major/Minor	Minor2		Minor1		Major1			Major2				
Conflicting Flow All	102	107	32	99	98	59	33	0	0	69	0	0
Stage 1	32	32	-	65	65	-	-	-	-	-	-	-
Stage 2	70	75	-	34	33	-	-	-	-	-	-	-
Critical Hdwy	7.12	6.52	6.22	7.12	6.52	6.22	4.12	-	-	4.12	-	-
Critical Hdwy Stg 1	6.12	5.52	-	6.12	5.52	-	-	-	-	-	-	-
Critical Hdwy Stg 2	6.12	5.52	-	6.12	5.52	-	-	-	-	-	-	-
Follow-up Hdwy	3.518	4.018	3.318	3.518	4.018	3.318	2.218	-	-	2.218	-	-
Pot Cap-1 Maneuver	879	783	1042	883	792	1007	1579	-	-	1532	-	-
Stage 1	984	868	-	946	841	-	-	-	-	-	-	-
Stage 2	940	833	-	982	868	-	-	-	-	-	-	-
Platoon blocked, %	-	-	-	-	-	-	-	-	-	-	-	-
Mov Cap-1 Maneuver	868	781	1042	877	790	1007	1579	-	-	1532	-	-
Mov Cap-2 Maneuver	868	781	-	877	790	-	-	-	-	-	-	-
Stage 1	982	868	-	944	839	-	-	-	-	-	-	-
Stage 2	927	831	-	976	868	-	-	-	-	-	-	-

Approach	EB		WB		NB		SB	
HCM Control Delay, s	9		9.2		0.3		0	
HCM LOS	A		A					

Minor Lane/Major Mvmt	NBL	NBT	NBR	EBLn1	WBLn1	SBL	SBT	SBR
Capacity (veh/h)	1579	-	-	904	881	1532	-	-
HCM Lane V/C Ratio	0.002	-	-	0.008	0.026	-	-	-
HCM Control Delay (s)	7.3	0	-	9	9.2	0	-	-
HCM Lane LOS	A	A	-	A	A	A	-	-
HCM 95th %tile Q(veh)	0	-	-	0	0.1	0	-	-

HCM 6th TWSC
6: Peyton Highway & State Highway 94

Existing Traffic Conditions
AM Peak Hour

Intersection												
Int Delay, s/veh	2.2											
Movement	EBL	EBT	EBR	WBL	WBT	WBR	NBL	NBT	NBR	SBL	SBT	SBR
Lane Configurations	↖	↗		↖	↗			↕			↕	
Traffic Vol, veh/h	17	93	3	9	276	38	21	8	5	13	5	23
Future Vol, veh/h	17	93	3	9	276	38	21	8	5	13	5	23
Conflicting Peds, #/hr	0	0	0	0	0	0	0	0	0	0	0	0
Sign Control	Free	Free	Free	Free	Free	Free	Stop	Stop	Stop	Stop	Stop	Stop
RT Channelized	-	-	None	-	-	None	-	-	None	-	-	None
Storage Length	515	-	-	525	-	-	-	-	-	-	-	-
Veh in Median Storage, #	-	0	-	-	0	-	-	0	-	-	0	-
Grade, %	-	0	-	-	0	-	-	0	-	-	0	-
Peak Hour Factor	92	92	92	92	92	92	92	92	92	92	92	92
Heavy Vehicles, %	2	2	2	2	2	2	2	2	2	2	2	2
Mvmt Flow	18	101	3	10	300	41	23	9	5	14	5	25

Major/Minor	Major1			Major2			Minor1			Minor2		
Conflicting Flow All	341	0	0	104	0	0	495	500	103	487	481	321
Stage 1	-	-	-	-	-	-	139	139	-	341	341	-
Stage 2	-	-	-	-	-	-	356	361	-	146	140	-
Critical Hdwy	4.12	-	-	4.12	-	-	7.12	6.52	6.22	7.12	6.52	6.22
Critical Hdwy Stg 1	-	-	-	-	-	-	6.12	5.52	-	6.12	5.52	-
Critical Hdwy Stg 2	-	-	-	-	-	-	6.12	5.52	-	6.12	5.52	-
Follow-up Hdwy	2.218	-	-	2.218	-	-	3.518	4.018	3.318	3.518	4.018	3.318
Pot Cap-1 Maneuver	1218	-	-	1488	-	-	485	473	952	491	485	720
Stage 1	-	-	-	-	-	-	864	782	-	674	639	-
Stage 2	-	-	-	-	-	-	661	626	-	857	781	-
Platoon blocked, %	-	-	-	-	-	-	-	-	-	-	-	-
Mov Cap-1 Maneuver	1218	-	-	1488	-	-	456	463	952	473	474	720
Mov Cap-2 Maneuver	-	-	-	-	-	-	456	463	-	473	474	-
Stage 1	-	-	-	-	-	-	851	770	-	664	635	-
Stage 2	-	-	-	-	-	-	628	622	-	830	769	-

Approach	EB			WB			NB			SB		
HCM Control Delay, s	1.2			0.2			12.8			11.6		
HCM LOS							B			B		

Minor Lane/Major Mvmt	NBLn1	EBL	EBT	EBR	WBL	WBT	WBR	SBLn1
Capacity (veh/h)	496	1218	-	-	1488	-	-	586
HCM Lane V/C Ratio	0.075	0.015	-	-	0.007	-	-	0.076
HCM Control Delay (s)	12.8	8	-	-	7.4	-	-	11.6
HCM Lane LOS	B	A	-	-	A	-	-	B
HCM 95th %tile Q(veh)	0.2	0	-	-	0	-	-	0.2

HCM 6th TWSC
1: Murr Road & Falcon Highway

Existing Traffic Conditions
PM Peak Hour

Intersection						
Int Delay, s/veh	0.5					
Movement	EBT	EBR	WBL	WBT	NBL	NBR
Lane Configurations	↔			↔		↔
Traffic Vol, veh/h	140	29	1	71	9	2
Future Vol, veh/h	140	29	1	71	9	2
Conflicting Peds, #/hr	0	0	0	0	0	0
Sign Control	Free	Free	Free	Free	Stop	Stop
RT Channelized	-	None	-	None	-	None
Storage Length	-	-	-	-	0	-
Veh in Median Storage, #	0	-	-	0	0	-
Grade, %	0	-	-	0	0	-
Peak Hour Factor	92	92	92	92	92	92
Heavy Vehicles, %	2	2	2	2	2	2
Mvmt Flow	152	32	1	77	10	2

Major/Minor	Major1	Major2	Minor1	Minor2	Minor3
Conflicting Flow All	0	0	184	0	247
Stage 1	-	-	-	-	168
Stage 2	-	-	-	-	79
Critical Hdwy	-	-	4.12	-	6.42
Critical Hdwy Stg 1	-	-	-	-	5.42
Critical Hdwy Stg 2	-	-	-	-	5.42
Follow-up Hdwy	-	-	2.218	-	3.518
Pot Cap-1 Maneuver	-	-	1391	-	741
Stage 1	-	-	-	-	862
Stage 2	-	-	-	-	944
Platoon blocked, %	-	-	-	-	-
Mov Cap-1 Maneuver	-	-	1391	-	740
Mov Cap-2 Maneuver	-	-	-	-	740
Stage 1	-	-	-	-	862
Stage 2	-	-	-	-	943

Approach	EB	WB	NB
HCM Control Delay, s	0	0.1	9.8
HCM LOS			A

Minor Lane/Major Mvmt	NBLn1	EBT	EBR	WBL	WBT
Capacity (veh/h)	761	-	-	1391	-
HCM Lane V/C Ratio	0.016	-	-	0.001	-
HCM Control Delay (s)	9.8	-	-	7.6	0
HCM Lane LOS	A	-	-	A	A
HCM 95th %tile Q(veh)	0	-	-	0	-

HCM 6th TWSC
2: Peyton Highway & Falcon Highway

Existing Traffic Conditions
PM Peak Hour

Intersection						
Int Delay, s/veh	2					
Movement	EBT	EBR	WBL	WBT	NBL	NBR
Lane Configurations	↔			↔		↔
Traffic Vol, veh/h	94	67	6	48	40	9
Future Vol, veh/h	94	67	6	48	40	9
Conflicting Peds, #/hr	0	0	0	0	0	0
Sign Control	Free	Free	Free	Free	Stop	Stop
RT Channelized	-	None	-	None	-	None
Storage Length	-	-	-	-	0	-
Veh in Median Storage, #	0	-	-	0	0	-
Grade, %	0	-	-	0	0	-
Peak Hour Factor	92	92	92	92	92	92
Heavy Vehicles, %	2	2	2	2	2	2
Mvmt Flow	102	73	7	52	43	10

Major/Minor	Major1	Major2	Minor1		
Conflicting Flow All	0	0	175	0	205
Stage 1	-	-	-	-	139
Stage 2	-	-	-	-	66
Critical Hdwy	-	-	4.12	-	6.42
Critical Hdwy Stg 1	-	-	-	-	5.42
Critical Hdwy Stg 2	-	-	-	-	5.42
Follow-up Hdwy	-	-	2.218	-	3.518
Pot Cap-1 Maneuver	-	-	1401	-	783
Stage 1	-	-	-	-	888
Stage 2	-	-	-	-	957
Platoon blocked, %	-	-	-	-	-
Mov Cap-1 Maneuver	-	-	1401	-	779
Mov Cap-2 Maneuver	-	-	-	-	779
Stage 1	-	-	-	-	888
Stage 2	-	-	-	-	952

Approach	EB	WB	NB
HCM Control Delay, s	0	0.8	9.8
HCM LOS			A

Minor Lane/Major Mvmt	NBLn1	EBT	EBR	WBL	WBT
Capacity (veh/h)	800	-	-	1401	-
HCM Lane V/C Ratio	0.067	-	-	0.005	-
HCM Control Delay (s)	9.8	-	-	7.6	0
HCM Lane LOS	A	-	-	A	A
HCM 95th %tile Q(veh)	0.2	-	-	0	-

HCM 6th TWSC
3: Curtis Road & Jones Road

Existing Traffic Conditions
PM Peak Hour

Intersection												
Int Delay, s/veh	2.5											
Movement	EBL	EBT	EBR	WBL	WBT	WBR	NBL	NBT	NBR	SBL	SBT	SBR
Lane Configurations	↕			↕			↕			↕		
Traffic Vol, veh/h	1	1	3	7	1	54	0	424	13	102	78	4
Future Vol, veh/h	1	1	3	7	1	54	0	424	13	102	78	4
Conflicting Peds, #/hr	0	0	0	0	0	0	0	0	0	0	0	0
Sign Control	Stop	Stop	Stop	Stop	Stop	Stop	Free	Free	Free	Free	Free	Free
RT Channelized	-	-	None	-	-	None	-	-	None	-	-	None
Storage Length	-	-	-	-	-	-	-	-	-	-	-	-
Veh in Median Storage, #	-	0	-	-	0	-	-	0	-	-	0	-
Grade, %	-	0	-	-	0	-	-	0	-	-	0	-
Peak Hour Factor	92	92	92	92	92	92	92	92	92	92	92	92
Heavy Vehicles, %	2	2	2	2	2	2	2	2	2	2	2	2
Mvmt Flow	1	1	3	8	1	59	0	461	14	111	85	4

Major/Minor	Minor2		Minor1		Major1			Major2				
Conflicting Flow All	807	784	87	779	779	468	89	0	0	475	0	0
Stage 1	309	309	-	468	468	-	-	-	-	-	-	-
Stage 2	498	475	-	311	311	-	-	-	-	-	-	-
Critical Hdwy	7.12	6.52	6.22	7.12	6.52	6.22	4.12	-	-	4.12	-	-
Critical Hdwy Stg 1	6.12	5.52	-	6.12	5.52	-	-	-	-	-	-	-
Critical Hdwy Stg 2	6.12	5.52	-	6.12	5.52	-	-	-	-	-	-	-
Follow-up Hdwy	3.518	4.018	3.318	3.518	4.018	3.318	2.218	-	-	2.218	-	-
Pot Cap-1 Maneuver	300	325	971	313	327	595	1506	-	-	1087	-	-
Stage 1	701	660	-	575	561	-	-	-	-	-	-	-
Stage 2	554	557	-	699	658	-	-	-	-	-	-	-
Platoon blocked, %	-	-	-	-	-	-	-	-	-	-	-	-
Mov Cap-1 Maneuver	248	290	971	285	292	595	1506	-	-	1087	-	-
Mov Cap-2 Maneuver	248	290	-	285	292	-	-	-	-	-	-	-
Stage 1	701	589	-	575	561	-	-	-	-	-	-	-
Stage 2	498	557	-	621	588	-	-	-	-	-	-	-

Approach	EB		WB		NB		SB	
HCM Control Delay, s	12.7		12.9		0		4.8	
HCM LOS	B		B					

Minor Lane/Major Mvmt	NBL	NBT	NBR	EBLn1	WBLn1	SBL	SBT	SBR
Capacity (veh/h)	1506	-	-	473	522	1087	-	-
HCM Lane V/C Ratio	-	-	-	0.011	0.129	0.102	-	-
HCM Control Delay (s)	0	-	-	12.7	12.9	8.7	0	-
HCM Lane LOS	A	-	-	B	B	A	A	-
HCM 95th %tile Q(veh)	0	-	-	0	0.4	0.3	-	-

HCM 6th TWSC
4: Murr Road & Jones Road

Existing Traffic Conditions
PM Peak Hour

Intersection												
Int Delay, s/veh	4.8											
Movement	EBL	EBT	EBR	WBL	WBT	WBR	NBL	NBT	NBR	SBL	SBT	SBR
Lane Configurations	↕			↕			↕			↕		
Traffic Vol, veh/h	7	6	5	0	5	2	2	1	0	3	8	3
Future Vol, veh/h	7	6	5	0	5	2	2	1	0	3	8	3
Conflicting Peds, #/hr	0	0	0	0	0	0	0	0	0	0	0	0
Sign Control	Free	Free	Free	Free	Free	Free	Stop	Stop	Stop	Stop	Stop	Stop
RT Channelized	-	-	None	-	-	None	-	-	None	-	-	None
Storage Length	-	-	-	-	-	-	-	-	-	-	-	-
Veh in Median Storage, #	-	0	-	-	0	-	-	0	-	-	0	-
Grade, %	-	0	-	-	0	-	-	0	-	-	0	-
Peak Hour Factor	92	92	92	92	92	92	92	92	92	92	92	92
Heavy Vehicles, %	2	2	2	2	2	2	2	2	2	2	2	2
Mvmt Flow	8	7	5	0	5	2	2	1	0	3	9	3

Major/Minor	Major1			Major2			Minor1			Minor2		
Conflicting Flow All	7	0	0	12	0	0	38	33	10	32	34	6
Stage 1	-	-	-	-	-	-	26	26	-	6	6	-
Stage 2	-	-	-	-	-	-	12	7	-	26	28	-
Critical Hdwy	4.12	-	-	4.12	-	-	7.12	6.52	6.22	7.12	6.52	6.22
Critical Hdwy Stg 1	-	-	-	-	-	-	6.12	5.52	-	6.12	5.52	-
Critical Hdwy Stg 2	-	-	-	-	-	-	6.12	5.52	-	6.12	5.52	-
Follow-up Hdwy	2.218	-	-	2.218	-	-	3.518	4.018	3.318	3.518	4.018	3.318
Pot Cap-1 Maneuver	1614	-	-	1607	-	-	967	860	1071	976	859	1077
Stage 1	-	-	-	-	-	-	992	874	-	1016	891	-
Stage 2	-	-	-	-	-	-	1009	890	-	992	872	-
Platoon blocked, %	-	-	-	-	-	-	-	-	-	-	-	-
Mov Cap-1 Maneuver	1614	-	-	1607	-	-	952	856	1071	971	855	1077
Mov Cap-2 Maneuver	-	-	-	-	-	-	952	856	-	971	855	-
Stage 1	-	-	-	-	-	-	987	870	-	1011	891	-
Stage 2	-	-	-	-	-	-	996	890	-	986	868	-

Approach	EB			WB			NB			SB		
HCM Control Delay, s	2.8			0			8.9			9		
HCM LOS							A			A		

Minor Lane/Major Mvmt	NBLn1	EBL	EBT	EBR	WBL	WBT	WBR	SBLn1
Capacity (veh/h)	918	1614	-	-	1607	-	-	919
HCM Lane V/C Ratio	0.004	0.005	-	-	-	-	-	0.017
HCM Control Delay (s)	8.9	7.2	0	-	0	-	-	9
HCM Lane LOS	A	A	A	-	A	-	-	A
HCM 95th %tile Q(veh)	0	0	-	-	0	-	-	0.1

HCM 6th TWSC
5: Peyton Highway & Jones Road

Existing Traffic Conditions
PM Peak Hour

Intersection												
Int Delay, s/veh	1.9											
Movement	EBL	EBT	EBR	WBL	WBT	WBR	NBL	NBT	NBR	SBL	SBT	SBR
Lane Configurations	↕			↕			↕			↕		
Traffic Vol, veh/h	1	5	4	5	4	3	1	31	10	7	65	1
Future Vol, veh/h	1	5	4	5	4	3	1	31	10	7	65	1
Conflicting Peds, #/hr	0	0	0	0	0	0	0	0	0	0	0	0
Sign Control	Stop	Stop	Stop	Stop	Stop	Stop	Free	Free	Free	Free	Free	Free
RT Channelized	-	-	None	-	-	None	-	-	None	-	-	None
Storage Length	-	-	-	-	-	-	-	-	-	-	-	-
Veh in Median Storage, #	-	0	-	-	0	-	-	0	-	-	0	-
Grade, %	-	0	-	-	0	-	-	0	-	-	0	-
Peak Hour Factor	92	92	92	92	92	92	92	92	92	92	92	92
Heavy Vehicles, %	2	2	2	2	2	2	2	2	2	2	2	2
Mvmt Flow	1	5	4	5	4	3	1	34	11	8	71	1

Major/Minor	Minor2		Minor1		Major1			Major2				
Conflicting Flow All	133	135	72	134	130	40	72	0	0	45	0	0
Stage 1	88	88	-	42	42	-	-	-	-	-	-	-
Stage 2	45	47	-	92	88	-	-	-	-	-	-	-
Critical Hdwy	7.12	6.52	6.22	7.12	6.52	6.22	4.12	-	-	4.12	-	-
Critical Hdwy Stg 1	6.12	5.52	-	6.12	5.52	-	-	-	-	-	-	-
Critical Hdwy Stg 2	6.12	5.52	-	6.12	5.52	-	-	-	-	-	-	-
Follow-up Hdwy	3.518	4.018	3.318	3.518	4.018	3.318	2.218	-	-	2.218	-	-
Pot Cap-1 Maneuver	839	756	990	838	761	1031	1528	-	-	1563	-	-
Stage 1	920	822	-	972	860	-	-	-	-	-	-	-
Stage 2	969	856	-	915	822	-	-	-	-	-	-	-
Platoon blocked, %	-	-	-	-	-	-	-	-	-	-	-	-
Mov Cap-1 Maneuver	829	751	990	826	756	1031	1528	-	-	1563	-	-
Mov Cap-2 Maneuver	829	751	-	826	756	-	-	-	-	-	-	-
Stage 1	919	818	-	971	859	-	-	-	-	-	-	-
Stage 2	960	855	-	900	818	-	-	-	-	-	-	-

Approach	EB		WB		NB		SB	
HCM Control Delay, s	9.3		9.3		0.2		0.7	
HCM LOS	A		A					

Minor Lane/Major Mvmt	NBL	NBT	NBR	EBLn1	WBLn1	SBL	SBT	SBR
Capacity (veh/h)	1528	-	-	840	842	1563	-	-
HCM Lane V/C Ratio	0.001	-	-	0.013	0.015	0.005	-	-
HCM Control Delay (s)	7.4	0	-	9.3	9.3	7.3	0	-
HCM Lane LOS	A	A	-	A	A	A	A	-
HCM 95th %tile Q(veh)	0	-	-	0	0	0	-	-

HCM 6th TWSC
6: Peyton Highway & State Highway 94

Existing Traffic Conditions
PM Peak Hour

Intersection												
Int Delay, s/veh	3											
Movement	EBL	EBT	EBR	WBL	WBT	WBR	NBL	NBT	NBR	SBL	SBT	SBR
Lane Configurations	↖	↗		↖	↗			↕			↕	
Traffic Vol, veh/h	22	300	20	7	109	19	14	12	13	48	18	2
Future Vol, veh/h	22	300	20	7	109	19	14	12	13	48	18	2
Conflicting Peds, #/hr	0	0	0	0	0	0	0	0	0	0	0	0
Sign Control	Free	Free	Free	Free	Free	Free	Stop	Stop	Stop	Stop	Stop	Stop
RT Channelized	-	-	None	-	-	None	-	-	None	-	-	None
Storage Length	515	-	-	525	-	-	-	-	-	-	-	-
Veh in Median Storage, #	-	0	-	-	0	-	-	0	-	-	0	-
Grade, %	-	0	-	-	0	-	-	0	-	-	0	-
Peak Hour Factor	92	92	92	92	92	92	92	92	92	92	92	92
Heavy Vehicles, %	2	2	2	2	2	2	2	2	2	2	2	2
Mvmt Flow	24	326	22	8	118	21	15	13	14	52	20	2

Major/Minor	Major1		Major2		Minor1			Minor2				
Conflicting Flow All	139	0	0	348	0	0	541	540	337	544	541	129
Stage 1	-	-	-	-	-	-	385	385	-	145	145	-
Stage 2	-	-	-	-	-	-	156	155	-	399	396	-
Critical Hdwy	4.12	-	-	4.12	-	-	7.12	6.52	6.22	7.12	6.52	6.22
Critical Hdwy Stg 1	-	-	-	-	-	-	6.12	5.52	-	6.12	5.52	-
Critical Hdwy Stg 2	-	-	-	-	-	-	6.12	5.52	-	6.12	5.52	-
Follow-up Hdwy	2.218	-	-	2.218	-	-	3.518	4.018	3.318	3.518	4.018	3.318
Pot Cap-1 Maneuver	1445	-	-	1211	-	-	452	449	705	450	448	921
Stage 1	-	-	-	-	-	-	638	611	-	858	777	-
Stage 2	-	-	-	-	-	-	846	769	-	627	604	-
Platoon blocked, %	-	-	-	-	-	-	-	-	-	-	-	-
Mov Cap-1 Maneuver	1445	-	-	1211	-	-	428	438	705	423	437	921
Mov Cap-2 Maneuver	-	-	-	-	-	-	428	438	-	423	437	-
Stage 1	-	-	-	-	-	-	627	601	-	843	772	-
Stage 2	-	-	-	-	-	-	817	764	-	591	594	-

Approach	EB	WB	NB	SB
HCM Control Delay, s	0.5	0.4	12.9	15
HCM LOS			B	C

Minor Lane/Major Mvmt	NBLn1	EBL	EBT	EBR	WBL	WBT	WBR	SBLn1
Capacity (veh/h)	497	1445	-	-	1211	-	-	434
HCM Lane V/C Ratio	0.085	0.017	-	-	0.006	-	-	0.17
HCM Control Delay (s)	12.9	7.5	-	-	8	-	-	15
HCM Lane LOS	B	A	-	-	A	-	-	C
HCM 95th %tile Q(veh)	0.3	0.1	-	-	0	-	-	0.6

HCM 6th TWSC
1: Murr Road & Falcon Highway

Background Traffic Conditions
AM Peak Hour - Year 2025

Intersection						
Int Delay, s/veh	1.3					
Movement	EBT	EBR	WBL	WBT	NBL	NBR
Lane Configurations	↔			↔		↔
Traffic Vol, veh/h	35	4	2	132	20	5
Future Vol, veh/h	35	4	2	132	20	5
Conflicting Peds, #/hr	0	0	0	0	0	0
Sign Control	Free	Free	Free	Free	Stop	Stop
RT Channelized	-	None	-	None	-	None
Storage Length	-	-	-	-	0	-
Veh in Median Storage, #	0	-	-	0	0	-
Grade, %	0	-	-	0	0	-
Peak Hour Factor	92	92	92	92	92	92
Heavy Vehicles, %	2	2	2	2	2	2
Mvmt Flow	38	4	2	143	22	5

Major/Minor	Major1	Major2	Minor1	Minor2	Minor3
Conflicting Flow All	0	0	42	0	187
Stage 1	-	-	-	-	40
Stage 2	-	-	-	-	147
Critical Hdwy	-	-	4.12	-	6.42
Critical Hdwy Stg 1	-	-	-	-	5.42
Critical Hdwy Stg 2	-	-	-	-	5.42
Follow-up Hdwy	-	-	2.218	-	3.518
Pot Cap-1 Maneuver	-	-	1567	-	802
Stage 1	-	-	-	-	982
Stage 2	-	-	-	-	880
Platoon blocked, %	-	-	-	-	-
Mov Cap-1 Maneuver	-	-	1567	-	801
Mov Cap-2 Maneuver	-	-	-	-	801
Stage 1	-	-	-	-	982
Stage 2	-	-	-	-	879

Approach	EB	WB	NB
HCM Control Delay, s	0	0.1	9.4
HCM LOS			A

Minor Lane/Major Mvmt	NBLn1	EBT	EBR	WBL	WBT
Capacity (veh/h)	838	-	-	1567	-
HCM Lane V/C Ratio	0.032	-	-	0.001	-
HCM Control Delay (s)	9.4	-	-	7.3	0
HCM Lane LOS	A	-	-	A	A
HCM 95th %tile Q(veh)	0.1	-	-	0	-

HCM 6th TWSC
2: Peyton Highway & Falcon Highway

Background Traffic Conditions
AM Peak Hour - Year 2025

Intersection						
Int Delay, s/veh	3.6					
Movement	EBT	EBR	WBL	WBT	NBL	NBR
Lane Configurations	↔		↔		↔	
Traffic Vol, veh/h	21	13	10	80	57	7
Future Vol, veh/h	21	13	10	80	57	7
Conflicting Peds, #/hr	0	0	0	0	0	0
Sign Control	Free	Free	Free	Free	Stop	Stop
RT Channelized	-	None	-	None	-	None
Storage Length	-	-	-	-	0	-
Veh in Median Storage, #	0	-	-	0	0	-
Grade, %	0	-	-	0	0	-
Peak Hour Factor	92	92	92	92	92	92
Heavy Vehicles, %	2	2	2	2	2	2
Mvmt Flow	23	14	11	87	62	8

Major/Minor	Major1	Major2	Minor1		
Conflicting Flow All	0	0	37	0	139 30
Stage 1	-	-	-	-	30 -
Stage 2	-	-	-	-	109 -
Critical Hdwy	-	-	4.12	-	6.42 6.22
Critical Hdwy Stg 1	-	-	-	-	5.42 -
Critical Hdwy Stg 2	-	-	-	-	5.42 -
Follow-up Hdwy	-	-	2.218	-	3.518 3.318
Pot Cap-1 Maneuver	-	-	1574	-	854 1044
Stage 1	-	-	-	-	993 -
Stage 2	-	-	-	-	916 -
Platoon blocked, %	-	-	-	-	-
Mov Cap-1 Maneuver	-	-	1574	-	848 1044
Mov Cap-2 Maneuver	-	-	-	-	848 -
Stage 1	-	-	-	-	993 -
Stage 2	-	-	-	-	910 -

Approach	EB	WB	NB
HCM Control Delay, s	0	0.8	9.5
HCM LOS			A

Minor Lane/Major Mvmt	NBLn1	EBT	EBR	WBL	WBT
Capacity (veh/h)	866	-	-	1574	-
HCM Lane V/C Ratio	0.08	-	-	0.007	-
HCM Control Delay (s)	9.5	-	-	7.3	0
HCM Lane LOS	A	-	-	A	A
HCM 95th %tile Q(veh)	0.3	-	-	0	-

HCM 6th TWSC
3: Curtis Road & Jones Road

Background Traffic Conditions
AM Peak Hour - Year 2025

Intersection												
Int Delay, s/veh	1.7											
Movement	EBL	EBT	EBR	WBL	WBT	WBR	NBL	NBT	NBR	SBL	SBT	SBR
Lane Configurations	↕			↕			↕			↕		
Traffic Vol, veh/h	1	0	2	7	1	98	0	71	2	20	516	0
Future Vol, veh/h	1	0	2	7	1	98	0	71	2	20	516	0
Conflicting Peds, #/hr	0	0	0	0	0	0	0	0	0	0	0	0
Sign Control	Stop	Stop	Stop	Stop	Stop	Stop	Free	Free	Free	Free	Free	Free
RT Channelized	-	-	None	-	-	None	-	-	None	-	-	None
Storage Length	-	-	-	-	-	-	-	-	-	-	-	-
Veh in Median Storage, #	-	0	-	-	0	-	-	0	-	-	0	-
Grade, %	-	0	-	-	0	-	-	0	-	-	0	-
Peak Hour Factor	92	92	92	92	92	92	92	92	92	92	92	92
Heavy Vehicles, %	2	2	2	2	2	2	2	2	2	2	2	2
Mvmt Flow	1	0	2	8	1	107	0	77	2	22	561	0

Major/Minor	Minor2		Minor1		Major1		Major2					
Conflicting Flow All	737	684	561	684	683	78	561	0	0	79	0	0
Stage 1	605	605	-	78	78	-	-	-	-	-	-	-
Stage 2	132	79	-	606	605	-	-	-	-	-	-	-
Critical Hdwy	7.12	6.52	6.22	7.12	6.52	6.22	4.12	-	-	4.12	-	-
Critical Hdwy Stg 1	6.12	5.52	-	6.12	5.52	-	-	-	-	-	-	-
Critical Hdwy Stg 2	6.12	5.52	-	6.12	5.52	-	-	-	-	-	-	-
Follow-up Hdwy	3.518	4.018	3.318	3.518	4.018	3.318	2.218	-	-	2.218	-	-
Pot Cap-1 Maneuver	334	371	527	363	372	983	1010	-	-	1519	-	-
Stage 1	485	487	-	931	830	-	-	-	-	-	-	-
Stage 2	871	829	-	484	487	-	-	-	-	-	-	-
Platoon blocked, %	-	-	-	-	-	-	-	-	-	-	-	-
Mov Cap-1 Maneuver	292	363	527	356	364	983	1010	-	-	1519	-	-
Mov Cap-2 Maneuver	292	363	-	356	364	-	-	-	-	-	-	-
Stage 1	485	477	-	931	830	-	-	-	-	-	-	-
Stage 2	776	829	-	472	477	-	-	-	-	-	-	-

Approach	EB		WB		NB		SB	
HCM Control Delay, s	13.7		9.8		0		0.3	
HCM LOS	B		A					

Minor Lane/Major Mvmt	NBL	NBT	NBR	EBLn1	WBLn1	SBL	SBT	SBR
Capacity (veh/h)	1010	-	-	416	868	1519	-	-
HCM Lane V/C Ratio	-	-	-	0.008	0.133	0.014	-	-
HCM Control Delay (s)	0	-	-	13.7	9.8	7.4	0	-
HCM Lane LOS	A	-	-	B	A	A	A	-
HCM 95th %tile Q(veh)	0	-	-	0	0.5	0	-	-

HCM 6th TWSC
4: Murr Road & Jones Road

Background Traffic Conditions
AM Peak Hour - Year 2025

Intersection												
Int Delay, s/veh	5.4											
Movement	EBL	EBT	EBR	WBL	WBT	WBR	NBL	NBT	NBR	SBL	SBT	SBR
Lane Configurations	↕			↕			↕			↕		
Traffic Vol, veh/h	7	5	0	0	8	4	7	6	1	3	1	5
Future Vol, veh/h	7	5	0	0	8	4	7	6	1	3	1	5
Conflicting Peds, #/hr	0	0	0	0	0	0	0	0	0	0	0	0
Sign Control	Free	Free	Free	Free	Free	Free	Stop	Stop	Stop	Stop	Stop	Stop
RT Channelized	-	-	None	-	-	None	-	-	None	-	-	None
Storage Length	-	-	-	-	-	-	-	-	-	-	-	-
Veh in Median Storage, #	-	0	-	-	0	-	-	0	-	-	0	-
Grade, %	-	0	-	-	0	-	-	0	-	-	0	-
Peak Hour Factor	92	92	92	92	92	92	92	92	92	92	92	92
Heavy Vehicles, %	2	2	2	2	2	2	2	2	2	2	2	2
Mvmt Flow	8	5	0	0	9	4	8	7	1	3	1	5

Major/Minor	Major1		Major2		Minor1		Minor2					
Conflicting Flow All	13	0	0	5	0	0	35	34	5	36	32	11
Stage 1	-	-	-	-	-	-	21	21	-	11	11	-
Stage 2	-	-	-	-	-	-	14	13	-	25	21	-
Critical Hdwy	4.12	-	-	4.12	-	-	7.12	6.52	6.22	7.12	6.52	6.22
Critical Hdwy Stg 1	-	-	-	-	-	-	6.12	5.52	-	6.12	5.52	-
Critical Hdwy Stg 2	-	-	-	-	-	-	6.12	5.52	-	6.12	5.52	-
Follow-up Hdwy	2.218	-	-	2.218	-	-	3.518	4.018	3.318	3.518	4.018	3.318
Pot Cap-1 Maneuver	1606	-	-	1616	-	-	971	859	1078	970	861	1070
Stage 1	-	-	-	-	-	-	998	878	-	1010	886	-
Stage 2	-	-	-	-	-	-	1006	885	-	993	878	-
Platoon blocked, %	-	-	-	-	-	-	-	-	-	-	-	-
Mov Cap-1 Maneuver	1606	-	-	1616	-	-	961	855	1078	959	857	1070
Mov Cap-2 Maneuver	-	-	-	-	-	-	961	855	-	959	857	-
Stage 1	-	-	-	-	-	-	993	874	-	1005	886	-
Stage 2	-	-	-	-	-	-	1000	885	-	980	874	-

Approach	EB	WB	NB	SB
HCM Control Delay, s	4.2	0	9	8.6
HCM LOS			A	A

Minor Lane/Major Mvmt	NBLn1	EBL	EBT	EBR	WBL	WBT	WBR	SBLn1
Capacity (veh/h)	919	1606	-	-	1616	-	-	1004
HCM Lane V/C Ratio	0.017	0.005	-	-	-	-	-	0.01
HCM Control Delay (s)	9	7.3	0	-	0	-	-	8.6
HCM Lane LOS	A	A	A	-	A	-	-	A
HCM 95th %tile Q(veh)	0.1	0	-	-	0	-	-	0

HCM 6th TWSC
5: Peyton Highway & Jones Road

Background Traffic Conditions
AM Peak Hour - Year 2025

Intersection												
Int Delay, s/veh	2.1											
Movement	EBL	EBT	EBR	WBL	WBT	WBR	NBL	NBT	NBR	SBL	SBT	SBR
Lane Configurations	↕			↕			↕			↕		
Traffic Vol, veh/h	2	2	3	11	5	5	3	46	20	0	29	3
Future Vol, veh/h	2	2	3	11	5	5	3	46	20	0	29	3
Conflicting Peds, #/hr	0	0	0	0	0	0	0	0	0	0	0	0
Sign Control	Stop	Stop	Stop	Stop	Stop	Stop	Free	Free	Free	Free	Free	Free
RT Channelized	-	-	None	-	-	None	-	-	None	-	-	None
Storage Length	-	-	-	-	-	-	-	-	-	-	-	-
Veh in Median Storage, #	-	0	-	-	0	-	-	0	-	-	0	-
Grade, %	-	0	-	-	0	-	-	0	-	-	0	-
Peak Hour Factor	92	92	92	92	92	92	92	92	92	92	92	92
Heavy Vehicles, %	2	2	2	2	2	2	2	2	2	2	2	2
Mvmt Flow	2	2	3	12	5	5	3	50	22	0	32	3

Major/Minor	Minor2		Minor1		Major1			Major2				
Conflicting Flow All	106	112	34	103	102	61	35	0	0	72	0	0
Stage 1	34	34	-	67	67	-	-	-	-	-	-	-
Stage 2	72	78	-	36	35	-	-	-	-	-	-	-
Critical Hdwy	7.12	6.52	6.22	7.12	6.52	6.22	4.12	-	-	4.12	-	-
Critical Hdwy Stg 1	6.12	5.52	-	6.12	5.52	-	-	-	-	-	-	-
Critical Hdwy Stg 2	6.12	5.52	-	6.12	5.52	-	-	-	-	-	-	-
Follow-up Hdwy	3.518	4.018	3.318	3.518	4.018	3.318	2.218	-	-	2.218	-	-
Pot Cap-1 Maneuver	873	778	1039	877	788	1004	1576	-	-	1528	-	-
Stage 1	982	867	-	943	839	-	-	-	-	-	-	-
Stage 2	938	830	-	980	866	-	-	-	-	-	-	-
Platoon blocked, %	-	-	-	-	-	-	-	-	-	-	-	-
Mov Cap-1 Maneuver	863	776	1039	871	786	1004	1576	-	-	1528	-	-
Mov Cap-2 Maneuver	863	776	-	871	786	-	-	-	-	-	-	-
Stage 1	980	867	-	941	837	-	-	-	-	-	-	-
Stage 2	925	828	-	974	866	-	-	-	-	-	-	-

Approach	EB		WB		NB		SB	
HCM Control Delay, s	9		9.2		0.3		0	
HCM LOS	A		A					

Minor Lane/Major Mvmt	NBL	NBT	NBR	EBLn1	WBLn1	SBL	SBT	SBR
Capacity (veh/h)	1576	-	-	899	876	1528	-	-
HCM Lane V/C Ratio	0.002	-	-	0.008	0.026	-	-	-
HCM Control Delay (s)	7.3	0	-	9	9.2	0	-	-
HCM Lane LOS	A	A	-	A	A	A	-	-
HCM 95th %tile Q(veh)	0	-	-	0	0.1	0	-	-

HCM 6th TWSC
6: Peyton Highway & State Highway 94

Background Traffic Conditions
AM Peak Hour - Year 2025

Intersection												
Int Delay, s/veh	2.2											
Movement	EBL	EBT	EBR	WBL	WBT	WBR	NBL	NBT	NBR	SBL	SBT	SBR
Lane Configurations	↖	↗		↖	↗			↕			↕	
Traffic Vol, veh/h	18	97	3	9	287	40	22	8	5	14	5	24
Future Vol, veh/h	18	97	3	9	287	40	22	8	5	14	5	24
Conflicting Peds, #/hr	0	0	0	0	0	0	0	0	0	0	0	0
Sign Control	Free	Free	Free	Free	Free	Free	Stop	Stop	Stop	Stop	Stop	Stop
RT Channelized	-	-	None	-	-	None	-	-	None	-	-	None
Storage Length	515	-	-	525	-	-	-	-	-	-	-	-
Veh in Median Storage, #	-	0	-	-	0	-	-	0	-	-	0	-
Grade, %	-	0	-	-	0	-	-	0	-	-	0	-
Peak Hour Factor	92	92	92	92	92	92	92	92	92	92	92	92
Heavy Vehicles, %	2	2	2	2	2	2	2	2	2	2	2	2
Mvmt Flow	20	105	3	10	312	43	24	9	5	15	5	26

Major/Minor	Major1			Major2			Minor1			Minor2		
Conflicting Flow All	355	0	0	108	0	0	516	522	107	508	502	334
Stage 1	-	-	-	-	-	-	147	147	-	354	354	-
Stage 2	-	-	-	-	-	-	369	375	-	154	148	-
Critical Hdwy	4.12	-	-	4.12	-	-	7.12	6.52	6.22	7.12	6.52	6.22
Critical Hdwy Stg 1	-	-	-	-	-	-	6.12	5.52	-	6.12	5.52	-
Critical Hdwy Stg 2	-	-	-	-	-	-	6.12	5.52	-	6.12	5.52	-
Follow-up Hdwy	2.218	-	-	2.218	-	-	3.518	4.018	3.318	3.518	4.018	3.318
Pot Cap-1 Maneuver	1204	-	-	1483	-	-	470	459	947	475	471	708
Stage 1	-	-	-	-	-	-	856	775	-	663	630	-
Stage 2	-	-	-	-	-	-	651	617	-	848	775	-
Platoon blocked, %	-	-	-	-	-	-	-	-	-	-	-	-
Mov Cap-1 Maneuver	1204	-	-	1483	-	-	441	448	947	457	460	708
Mov Cap-2 Maneuver	-	-	-	-	-	-	441	448	-	457	460	-
Stage 1	-	-	-	-	-	-	841	762	-	652	626	-
Stage 2	-	-	-	-	-	-	617	613	-	820	762	-

Approach	EB			WB			NB			SB		
HCM Control Delay, s	1.2			0.2			13.2			11.9		
HCM LOS							B			B		

Minor Lane/Major Mvmt	NBLn1	EBL	EBT	EBR	WBL	WBT	WBR	SBLn1
Capacity (veh/h)	479	1204	-	-	1483	-	-	570
HCM Lane V/C Ratio	0.079	0.016	-	-	0.007	-	-	0.082
HCM Control Delay (s)	13.2	8	-	-	7.4	-	-	11.9
HCM Lane LOS	B	A	-	-	A	-	-	B
HCM 95th %tile Q(veh)	0.3	0.1	-	-	0	-	-	0.3

Intersection						
Int Delay, s/veh	0.4					
Movement	EBT	EBR	WBL	WBT	NBL	NBR
Lane Configurations	↔			↔		↔
Traffic Vol, veh/h	146	30	1	74	9	2
Future Vol, veh/h	146	30	1	74	9	2
Conflicting Peds, #/hr	0	0	0	0	0	0
Sign Control	Free	Free	Free	Free	Stop	Stop
RT Channelized	-	None	-	None	-	None
Storage Length	-	-	-	-	0	-
Veh in Median Storage, #	0	-	-	0	0	-
Grade, %	0	-	-	0	0	-
Peak Hour Factor	92	92	92	92	92	92
Heavy Vehicles, %	2	2	2	2	2	2
Mvmt Flow	159	33	1	80	10	2

Major/Minor	Major1	Major2	Minor1		
Conflicting Flow All	0	0	192	0	258
Stage 1	-	-	-	-	176
Stage 2	-	-	-	-	82
Critical Hdwy	-	-	4.12	-	6.42
Critical Hdwy Stg 1	-	-	-	-	5.42
Critical Hdwy Stg 2	-	-	-	-	5.42
Follow-up Hdwy	-	-	2.218	-	3.518
Pot Cap-1 Maneuver	-	-	1381	-	731
Stage 1	-	-	-	-	855
Stage 2	-	-	-	-	941
Platoon blocked, %	-	-	-	-	-
Mov Cap-1 Maneuver	-	-	1381	-	730
Mov Cap-2 Maneuver	-	-	-	-	730
Stage 1	-	-	-	-	855
Stage 2	-	-	-	-	940

Approach	EB	WB	NB
HCM Control Delay, s	0	0.1	9.9
HCM LOS			A

Minor Lane/Major Mvmt	NBLn1	EBT	EBR	WBL	WBT
Capacity (veh/h)	752	-	-	1381	-
HCM Lane V/C Ratio	0.016	-	-	0.001	-
HCM Control Delay (s)	9.9	-	-	7.6	0
HCM Lane LOS	A	-	-	A	A
HCM 95th %tile Q(veh)	0	-	-	0	-

HCM 6th TWSC
2: Peyton Highway & Falcon Highway

Background Traffic Conditions
PM Peak Hour - Year 2025

Intersection						
Int Delay, s/veh	2					
Movement	EBT	EBR	WBL	WBT	NBL	NBR
Lane Configurations	↔			↔		↔
Traffic Vol, veh/h	98	70	6	50	42	9
Future Vol, veh/h	98	70	6	50	42	9
Conflicting Peds, #/hr	0	0	0	0	0	0
Sign Control	Free	Free	Free	Free	Stop	Stop
RT Channelized	-	None	-	None	-	None
Storage Length	-	-	-	-	0	-
Veh in Median Storage, #	0	-	-	0	0	-
Grade, %	0	-	-	0	0	-
Peak Hour Factor	92	92	92	92	92	92
Heavy Vehicles, %	2	2	2	2	2	2
Mvmt Flow	107	76	7	54	46	10

Major/Minor	Major1	Major2	Minor1		
Conflicting Flow All	0	0	183	0	213
Stage 1	-	-	-	-	145
Stage 2	-	-	-	-	68
Critical Hdwy	-	-	4.12	-	6.42
Critical Hdwy Stg 1	-	-	-	-	5.42
Critical Hdwy Stg 2	-	-	-	-	5.42
Follow-up Hdwy	-	-	2.218	-	3.518
Pot Cap-1 Maneuver	-	-	1392	-	775
Stage 1	-	-	-	-	882
Stage 2	-	-	-	-	955
Platoon blocked, %	-	-	-	-	-
Mov Cap-1 Maneuver	-	-	1392	-	771
Mov Cap-2 Maneuver	-	-	-	-	771
Stage 1	-	-	-	-	882
Stage 2	-	-	-	-	950

Approach	EB	WB	NB
HCM Control Delay, s	0	0.8	9.9
HCM LOS			A

Minor Lane/Major Mvmt	NBLn1	EBT	EBR	WBL	WBT
Capacity (veh/h)	791	-	-	1392	-
HCM Lane V/C Ratio	0.07	-	-	0.005	-
HCM Control Delay (s)	9.9	-	-	7.6	0
HCM Lane LOS	A	-	-	A	A
HCM 95th %tile Q(veh)	0.2	-	-	0	-

HCM 6th TWSC
3: Curtis Road & Jones Road

Background Traffic Conditions
PM Peak Hour - Year 2025

Intersection												
Int Delay, s/veh	2.6											
Movement	EBL	EBT	EBR	WBL	WBT	WBR	NBL	NBT	NBR	SBL	SBT	SBR
Lane Configurations	↕			↕			↕			↕		
Traffic Vol, veh/h	1	1	3	7	1	56	0	441	14	106	81	4
Future Vol, veh/h	1	1	3	7	1	56	0	441	14	106	81	4
Conflicting Peds, #/hr	0	0	0	0	0	0	0	0	0	0	0	0
Sign Control	Stop	Stop	Stop	Stop	Stop	Stop	Free	Free	Free	Free	Free	Free
RT Channelized	-	-	None	-	-	None	-	-	None	-	-	None
Storage Length	-	-	-	-	-	-	-	-	-	-	-	-
Veh in Median Storage, #	-	0	-	-	0	-	-	0	-	-	0	-
Grade, %	-	0	-	-	0	-	-	0	-	-	0	-
Peak Hour Factor	92	92	92	92	92	92	92	92	92	92	92	92
Heavy Vehicles, %	2	2	2	2	2	2	2	2	2	2	2	2
Mvmt Flow	1	1	3	8	1	61	0	479	15	115	88	4

Major/Minor	Minor2		Minor1		Major1			Major2				
Conflicting Flow All	838	814	90	809	809	487	92	0	0	494	0	0
Stage 1	320	320	-	487	487	-	-	-	-	-	-	-
Stage 2	518	494	-	322	322	-	-	-	-	-	-	-
Critical Hdwy	7.12	6.52	6.22	7.12	6.52	6.22	4.12	-	-	4.12	-	-
Critical Hdwy Stg 1	6.12	5.52	-	6.12	5.52	-	-	-	-	-	-	-
Critical Hdwy Stg 2	6.12	5.52	-	6.12	5.52	-	-	-	-	-	-	-
Follow-up Hdwy	3.518	4.018	3.318	3.518	4.018	3.318	2.218	-	-	2.218	-	-
Pot Cap-1 Maneuver	286	312	968	299	314	581	1503	-	-	1070	-	-
Stage 1	692	652	-	562	550	-	-	-	-	-	-	-
Stage 2	541	546	-	690	651	-	-	-	-	-	-	-
Platoon blocked, %	-	-	-	-	-	-	-	-	-	-	-	-
Mov Cap-1 Maneuver	233	277	968	271	279	581	1503	-	-	1070	-	-
Mov Cap-2 Maneuver	233	277	-	271	279	-	-	-	-	-	-	-
Stage 1	692	578	-	562	550	-	-	-	-	-	-	-
Stage 2	483	546	-	609	577	-	-	-	-	-	-	-

Approach	EB		WB		NB		SB	
HCM Control Delay, s	13		13.2		0		4.9	
HCM LOS	B		B					

Minor Lane/Major Mvmt	NBL	NBT	NBR	EBLn1	WBLn1	SBL	SBT	SBR
Capacity (veh/h)	1503	-	-	454	509	1070	-	-
HCM Lane V/C Ratio	-	-	-	0.012	0.137	0.108	-	-
HCM Control Delay (s)	0	-	-	13	13.2	8.8	0	-
HCM Lane LOS	A	-	-	B	B	A	A	-
HCM 95th %tile Q(veh)	0	-	-	0	0.5	0.4	-	-

HCM 6th TWSC
4: Murr Road & Jones Road

Background Traffic Conditions
PM Peak Hour - Year 2025

Intersection												
Int Delay, s/veh	4.8											
Movement	EBL	EBT	EBR	WBL	WBT	WBR	NBL	NBT	NBR	SBL	SBT	SBR
Lane Configurations	↕			↕			↕			↕		
Traffic Vol, veh/h	7	6	5	0	5	2	2	1	0	3	8	3
Future Vol, veh/h	7	6	5	0	5	2	2	1	0	3	8	3
Conflicting Peds, #/hr	0	0	0	0	0	0	0	0	0	0	0	0
Sign Control	Free	Free	Free	Free	Free	Free	Stop	Stop	Stop	Stop	Stop	Stop
RT Channelized	-	-	None	-	-	None	-	-	None	-	-	None
Storage Length	-	-	-	-	-	-	-	-	-	-	-	-
Veh in Median Storage, #	-	0	-	-	0	-	-	0	-	-	0	-
Grade, %	-	0	-	-	0	-	-	0	-	-	0	-
Peak Hour Factor	92	92	92	92	92	92	92	92	92	92	92	92
Heavy Vehicles, %	2	2	2	2	2	2	2	2	2	2	2	2
Mvmt Flow	8	7	5	0	5	2	2	1	0	3	9	3

Major/Minor	Major1			Major2			Minor1			Minor2		
Conflicting Flow All	7	0	0	12	0	0	38	33	10	32	34	6
Stage 1	-	-	-	-	-	-	26	26	-	6	6	-
Stage 2	-	-	-	-	-	-	12	7	-	26	28	-
Critical Hdwy	4.12	-	-	4.12	-	-	7.12	6.52	6.22	7.12	6.52	6.22
Critical Hdwy Stg 1	-	-	-	-	-	-	6.12	5.52	-	6.12	5.52	-
Critical Hdwy Stg 2	-	-	-	-	-	-	6.12	5.52	-	6.12	5.52	-
Follow-up Hdwy	2.218	-	-	2.218	-	-	3.518	4.018	3.318	3.518	4.018	3.318
Pot Cap-1 Maneuver	1614	-	-	1607	-	-	967	860	1071	976	859	1077
Stage 1	-	-	-	-	-	-	992	874	-	1016	891	-
Stage 2	-	-	-	-	-	-	1009	890	-	992	872	-
Platoon blocked, %	-	-	-	-	-	-	-	-	-	-	-	-
Mov Cap-1 Maneuver	1614	-	-	1607	-	-	952	856	1071	971	855	1077
Mov Cap-2 Maneuver	-	-	-	-	-	-	952	856	-	971	855	-
Stage 1	-	-	-	-	-	-	987	870	-	1011	891	-
Stage 2	-	-	-	-	-	-	996	890	-	986	868	-

Approach	EB			WB			NB			SB		
HCM Control Delay, s	2.8			0			8.9			9		
HCM LOS							A			A		

Minor Lane/Major Mvmt	NBLn1	EBL	EBT	EBR	WBL	WBT	WBR	SBLn1
Capacity (veh/h)	918	1614	-	-	1607	-	-	919
HCM Lane V/C Ratio	0.004	0.005	-	-	-	-	-	0.017
HCM Control Delay (s)	8.9	7.2	0	-	0	-	-	9
HCM Lane LOS	A	A	A	-	A	-	-	A
HCM 95th %tile Q(veh)	0	0	-	-	0	-	-	0.1

HCM 6th TWSC
5: Peyton Highway & Jones Road

Background Traffic Conditions
PM Peak Hour - Year 2025

Intersection												
Int Delay, s/veh	1.9											
Movement	EBL	EBT	EBR	WBL	WBT	WBR	NBL	NBT	NBR	SBL	SBT	SBR
Lane Configurations	↕			↕			↕			↕		
Traffic Vol, veh/h	1	5	4	5	4	3	1	32	10	7	68	1
Future Vol, veh/h	1	5	4	5	4	3	1	32	10	7	68	1
Conflicting Peds, #/hr	0	0	0	0	0	0	0	0	0	0	0	0
Sign Control	Stop	Stop	Stop	Stop	Stop	Stop	Free	Free	Free	Free	Free	Free
RT Channelized	-	-	None	-	-	None	-	-	None	-	-	None
Storage Length	-	-	-	-	-	-	-	-	-	-	-	-
Veh in Median Storage, #	-	0	-	-	0	-	-	0	-	-	0	-
Grade, %	-	0	-	-	0	-	-	0	-	-	0	-
Peak Hour Factor	92	92	92	92	92	92	92	92	92	92	92	92
Heavy Vehicles, %	2	2	2	2	2	2	2	2	2	2	2	2
Mvmt Flow	1	5	4	5	4	3	1	35	11	8	74	1

Major/Minor	Minor2		Minor1		Major1			Major2				
Conflicting Flow All	137	139	75	138	134	41	75	0	0	46	0	0
Stage 1	91	91	-	43	43	-	-	-	-	-	-	-
Stage 2	46	48	-	95	91	-	-	-	-	-	-	-
Critical Hdwy	7.12	6.52	6.22	7.12	6.52	6.22	4.12	-	-	4.12	-	-
Critical Hdwy Stg 1	6.12	5.52	-	6.12	5.52	-	-	-	-	-	-	-
Critical Hdwy Stg 2	6.12	5.52	-	6.12	5.52	-	-	-	-	-	-	-
Follow-up Hdwy	3.518	4.018	3.318	3.518	4.018	3.318	2.218	-	-	2.218	-	-
Pot Cap-1 Maneuver	834	752	986	833	757	1030	1524	-	-	1562	-	-
Stage 1	916	820	-	971	859	-	-	-	-	-	-	-
Stage 2	968	855	-	912	820	-	-	-	-	-	-	-
Platoon blocked, %	-	-	-	-	-	-	-	-	-	-	-	-
Mov Cap-1 Maneuver	824	747	986	821	752	1030	1524	-	-	1562	-	-
Mov Cap-2 Maneuver	824	747	-	821	752	-	-	-	-	-	-	-
Stage 1	915	816	-	970	858	-	-	-	-	-	-	-
Stage 2	959	854	-	897	816	-	-	-	-	-	-	-

Approach	EB		WB		NB		SB	
HCM Control Delay, s	9.4		9.4		0.2		0.7	
HCM LOS	A		A					

Minor Lane/Major Mvmt	NBL	NBT	NBR	EBLn1	WBLn1	SBL	SBT	SBR
Capacity (veh/h)	1524	-	-	836	838	1562	-	-
HCM Lane V/C Ratio	0.001	-	-	0.013	0.016	0.005	-	-
HCM Control Delay (s)	7.4	0	-	9.4	9.4	7.3	0	-
HCM Lane LOS	A	A	-	A	A	A	A	-
HCM 95th %tile Q(veh)	0	-	-	0	0	0	-	-

HCM 6th TWSC
6: Peyton Highway & State Highway 94

Background Traffic Conditions
PM Peak Hour - Year 2025

Intersection												
Int Delay, s/veh	3.1											
Movement	EBL	EBT	EBR	WBL	WBT	WBR	NBL	NBT	NBR	SBL	SBT	SBR
Lane Configurations	↖	↗		↖	↗			↕			↕	
Traffic Vol, veh/h	23	312	21	7	113	20	15	13	14	50	19	2
Future Vol, veh/h	23	312	21	7	113	20	15	13	14	50	19	2
Conflicting Peds, #/hr	0	0	0	0	0	0	0	0	0	0	0	0
Sign Control	Free	Free	Free	Free	Free	Free	Stop	Stop	Stop	Stop	Stop	Stop
RT Channelized	-	-	None	-	-	None	-	-	None	-	-	None
Storage Length	515	-	-	525	-	-	-	-	-	-	-	-
Veh in Median Storage, #	-	0	-	-	0	-	-	0	-	-	0	-
Grade, %	-	0	-	-	0	-	-	0	-	-	0	-
Peak Hour Factor	92	92	92	92	92	92	92	92	92	92	92	92
Heavy Vehicles, %	2	2	2	2	2	2	2	2	2	2	2	2
Mvmt Flow	25	339	23	8	123	22	16	14	15	54	21	2

Major/Minor	Major1			Major2			Minor1			Minor2		
Conflicting Flow All	145	0	0	362	0	0	563	562	351	565	562	134
Stage 1	-	-	-	-	-	-	401	401	-	150	150	-
Stage 2	-	-	-	-	-	-	162	161	-	415	412	-
Critical Hdwy	4.12	-	-	4.12	-	-	7.12	6.52	6.22	7.12	6.52	6.22
Critical Hdwy Stg 1	-	-	-	-	-	-	6.12	5.52	-	6.12	5.52	-
Critical Hdwy Stg 2	-	-	-	-	-	-	6.12	5.52	-	6.12	5.52	-
Follow-up Hdwy	2.218	-	-	2.218	-	-	3.518	4.018	3.318	3.518	4.018	3.318
Pot Cap-1 Maneuver	1437	-	-	1197	-	-	437	436	692	436	436	915
Stage 1	-	-	-	-	-	-	626	601	-	853	773	-
Stage 2	-	-	-	-	-	-	840	765	-	615	594	-
Platoon blocked, %	-	-	-	-	-	-	-	-	-	-	-	-
Mov Cap-1 Maneuver	1437	-	-	1197	-	-	412	426	692	408	426	915
Mov Cap-2 Maneuver	-	-	-	-	-	-	412	426	-	408	426	-
Stage 1	-	-	-	-	-	-	615	591	-	838	768	-
Stage 2	-	-	-	-	-	-	810	760	-	577	584	-

Approach	EB			WB			NB			SB		
HCM Control Delay, s	0.5			0.4			13.2			15.5		
HCM LOS							B			C		

Minor Lane/Major Mvmt	NBLn1	EBL	EBT	EBR	WBL	WBT	WBR	SBLn1
Capacity (veh/h)	482	1437	-	-	1197	-	-	419
HCM Lane V/C Ratio	0.095	0.017	-	-	0.006	-	-	0.184
HCM Control Delay (s)	13.2	7.5	-	-	8	-	-	15.5
HCM Lane LOS	B	A	-	-	A	-	-	C
HCM 95th %tile Q(veh)	0.3	0.1	-	-	0	-	-	0.7

HCM 6th TWSC
1: Murr Road & Falcon Highway

Background Traffic Conditions
AM Peak Hour - Year 2043

Intersection						
Int Delay, s/veh	1.4					
Movement	EBT	EBR	WBL	WBT	NBL	NBR
Lane Configurations						
Traffic Vol, veh/h	51	6	3	191	29	8
Future Vol, veh/h	51	6	3	191	29	8
Conflicting Peds, #/hr	0	0	0	0	0	0
Sign Control	Free	Free	Free	Free	Stop	Stop
RT Channelized	-	None	-	None	-	None
Storage Length	-	-	-	-	0	-
Veh in Median Storage, #	0	-	-	0	0	-
Grade, %	0	-	-	0	0	-
Peak Hour Factor	92	92	92	92	92	92
Heavy Vehicles, %	2	2	2	2	2	2
Mvmt Flow	55	7	3	208	32	9

Major/Minor	Major1	Major2	Minor1		
Conflicting Flow All	0	0	62	0	273 59
Stage 1	-	-	-	-	59 -
Stage 2	-	-	-	-	214 -
Critical Hdwy	-	-	4.12	-	6.42 6.22
Critical Hdwy Stg 1	-	-	-	-	5.42 -
Critical Hdwy Stg 2	-	-	-	-	5.42 -
Follow-up Hdwy	-	-	2.218	-	3.518 3.318
Pot Cap-1 Maneuver	-	-	1541	-	716 1007
Stage 1	-	-	-	-	964 -
Stage 2	-	-	-	-	822 -
Platoon blocked, %	-	-	-	-	-
Mov Cap-1 Maneuver	-	-	1541	-	715 1007
Mov Cap-2 Maneuver	-	-	-	-	715 -
Stage 1	-	-	-	-	964 -
Stage 2	-	-	-	-	820 -

Approach	EB	WB	NB
HCM Control Delay, s	0	0.1	10
HCM LOS			B

Minor Lane/Major Mvmt	NBLn1	EBT	EBR	WBL	WBT
Capacity (veh/h)	763	-	-	1541	-
HCM Lane V/C Ratio	0.053	-	-	0.002	-
HCM Control Delay (s)	10	-	-	7.3	0
HCM Lane LOS	B	-	-	A	A
HCM 95th %tile Q(veh)	0.2	-	-	0	-

HCM 6th TWSC
2: Peyton Highway & Falcon Highway

Background Traffic Conditions
AM Peak Hour - Year 2043

Intersection						
Int Delay, s/veh	4					
Movement	EBT	EBR	WBL	WBT	NBL	NBR
Lane Configurations	T		T		T	
Traffic Vol, veh/h	30	18	15	111	83	11
Future Vol, veh/h	30	18	15	111	83	11
Conflicting Peds, #/hr	0	0	0	0	0	0
Sign Control	Free	Free	Free	Free	Stop	Stop
RT Channelized	-	None	-	None	-	None
Storage Length	-	-	-	-	0	-
Veh in Median Storage, #	0	-	-	0	0	-
Grade, %	0	-	-	0	0	-
Peak Hour Factor	92	92	92	92	92	92
Heavy Vehicles, %	2	2	2	2	2	2
Mvmt Flow	33	20	16	121	90	12

Major/Minor	Major1	Major2	Minor1	Minor2	Minor3
Conflicting Flow All	0	0	53	0	196
Stage 1	-	-	-	-	43
Stage 2	-	-	-	-	153
Critical Hdwy	-	-	4.12	-	6.42
Critical Hdwy Stg 1	-	-	-	-	5.42
Critical Hdwy Stg 2	-	-	-	-	5.42
Follow-up Hdwy	-	-	2.218	-	3.518
Pot Cap-1 Maneuver	-	-	1553	-	793
Stage 1	-	-	-	-	979
Stage 2	-	-	-	-	875
Platoon blocked, %	-	-	-	-	-
Mov Cap-1 Maneuver	-	-	1553	-	784
Mov Cap-2 Maneuver	-	-	-	-	784
Stage 1	-	-	-	-	979
Stage 2	-	-	-	-	865

Approach	EB	WB	NB
HCM Control Delay, s	0	0.9	10.1
HCM LOS	B		

Minor Lane/Major Mvmt	NBLn1	EBT	EBR	WBL	WBT
Capacity (veh/h)	806	-	-	1553	-
HCM Lane V/C Ratio	0.127	-	-	0.01	-
HCM Control Delay (s)	10.1	-	-	7.3	0
HCM Lane LOS	B	-	-	A	A
HCM 95th %tile Q(veh)	0.4	-	-	0	-

HCM 6th TWSC
3: Curtis Road & Jones Road

Background Traffic Conditions
AM Peak Hour - Year 2043

Intersection												
Int Delay, s/veh	2											
Movement	EBL	EBT	EBR	WBL	WBT	WBR	NBL	NBT	NBR	SBL	SBT	SBR
Lane Configurations	↕↔			↕↔			↕↔			↕↔		
Traffic Vol, veh/h	2	0	3	11	2	141	0	102	3	29	744	0
Future Vol, veh/h	2	0	3	11	2	141	0	102	3	29	744	0
Conflicting Peds, #/hr	0	0	0	0	0	0	0	0	0	0	0	0
Sign Control	Stop	Stop	Stop	Stop	Stop	Stop	Free	Free	Free	Free	Free	Free
RT Channelized	-	-	None	-	-	None	-	-	None	-	-	None
Storage Length	-	-	-	-	-	-	-	-	-	-	-	-
Veh in Median Storage, #	-	0	-	-	0	-	-	0	-	-	0	-
Grade, %	-	0	-	-	0	-	-	0	-	-	0	-
Peak Hour Factor	92	92	92	92	92	92	92	92	92	92	92	92
Heavy Vehicles, %	2	2	2	2	2	2	2	2	2	2	2	2
Mvmt Flow	2	0	3	12	2	153	0	111	3	32	809	0

Major/Minor	Minor2		Minor1		Major1		Major2					
Conflicting Flow All	1063	987	809	988	986	113	809	0	0	114	0	0
Stage 1	873	873	-	113	113	-	-	-	-	-	-	-
Stage 2	190	114	-	875	873	-	-	-	-	-	-	-
Critical Hdwy	7.12	6.52	6.22	7.12	6.52	6.22	4.12	-	-	4.12	-	-
Critical Hdwy Stg 1	6.12	5.52	-	6.12	5.52	-	-	-	-	-	-	-
Critical Hdwy Stg 2	6.12	5.52	-	6.12	5.52	-	-	-	-	-	-	-
Follow-up Hdwy	3.518	4.018	3.318	3.518	4.018	3.318	2.218	-	-	2.218	-	-
Pot Cap-1 Maneuver	201	247	380	226	248	940	817	-	-	1475	-	-
Stage 1	345	368	-	892	802	-	-	-	-	-	-	-
Stage 2	812	801	-	344	368	-	-	-	-	-	-	-
Platoon blocked, %	-	-	-	-	-	-	-	-	-	-	-	-
Mov Cap-1 Maneuver	162	237	380	217	238	940	817	-	-	1475	-	-
Mov Cap-2 Maneuver	162	237	-	217	238	-	-	-	-	-	-	-
Stage 1	345	354	-	892	802	-	-	-	-	-	-	-
Stage 2	678	801	-	328	354	-	-	-	-	-	-	-

Approach	EB		WB		NB		SB	
HCM Control Delay, s	19.9		11.3		0		0.3	
HCM LOS	C		B					

Minor Lane/Major Mvmt	NBL	NBT	NBR	EBLn1WBLn1	SBL	SBT	SBR
Capacity (veh/h)	817	-	-	247	737	1475	-
HCM Lane V/C Ratio	-	-	-	0.022	0.227	0.021	-
HCM Control Delay (s)	0	-	-	19.9	11.3	7.5	0
HCM Lane LOS	A	-	-	C	B	A	A
HCM 95th %tile Q(veh)	0	-	-	0.1	0.9	0.1	-

HCM 6th TWSC
4: Murr Road & Jones Road

Background Traffic Conditions
AM Peak Hour - Year 2043

Intersection												
Int Delay, s/veh	5.5											
Movement	EBL	EBT	EBR	WBL	WBT	WBR	NBL	NBT	NBR	SBL	SBT	SBR
Lane Configurations	↕			↕			↕			↕		
Traffic Vol, veh/h	11	8	0	0	12	6	11	9	2	5	2	8
Future Vol, veh/h	11	8	0	0	12	6	11	9	2	5	2	8
Conflicting Peds, #/hr	0	0	0	0	0	0	0	0	0	0	0	0
Sign Control	Free	Free	Free	Free	Free	Free	Stop	Stop	Stop	Stop	Stop	Stop
RT Channelized	-	-	None	-	-	None	-	-	None	-	-	None
Storage Length	-	-	-	-	-	-	-	-	-	-	-	-
Veh in Median Storage, #	-	0	-	-	0	-	-	0	-	-	0	-
Grade, %	-	0	-	-	0	-	-	0	-	-	0	-
Peak Hour Factor	92	92	92	92	92	92	92	92	92	92	92	92
Heavy Vehicles, %	2	2	2	2	2	2	2	2	2	2	2	2
Mvmt Flow	12	9	0	0	13	7	12	10	2	5	2	9

Major/Minor	Major1			Major2			Minor1			Minor2		
Conflicting Flow All	20	0	0	9	0	0	55	53	9	56	50	17
Stage 1	-	-	-	-	-	-	33	33	-	17	17	-
Stage 2	-	-	-	-	-	-	22	20	-	39	33	-
Critical Hdwy	4.12	-	-	4.12	-	-	7.12	6.52	6.22	7.12	6.52	6.22
Critical Hdwy Stg 1	-	-	-	-	-	-	6.12	5.52	-	6.12	5.52	-
Critical Hdwy Stg 2	-	-	-	-	-	-	6.12	5.52	-	6.12	5.52	-
Follow-up Hdwy	2.218	-	-	2.218	-	-	3.518	4.018	3.318	3.518	4.018	3.318
Pot Cap-1 Maneuver	1596	-	-	1611	-	-	943	838	1073	941	841	1062
Stage 1	-	-	-	-	-	-	983	868	-	1002	881	-
Stage 2	-	-	-	-	-	-	996	879	-	976	868	-
Platoon blocked, %	-	-	-	-	-	-	-	-	-	-	-	-
Mov Cap-1 Maneuver	1596	-	-	1611	-	-	928	831	1073	925	834	1062
Mov Cap-2 Maneuver	-	-	-	-	-	-	928	831	-	925	834	-
Stage 1	-	-	-	-	-	-	975	861	-	994	881	-
Stage 2	-	-	-	-	-	-	985	879	-	955	861	-

Approach	EB			WB			NB			SB		
HCM Control Delay, s	4.2			0			9.1			8.7		
HCM LOS							A			A		

Minor Lane/Major Mvmt	NBLn1	EBL	EBT	EBR	WBL	WBT	WBR	SBLn1
Capacity (veh/h)	896	1596	-	-	1611	-	-	978
HCM Lane V/C Ratio	0.027	0.007	-	-	-	-	-	0.017
HCM Control Delay (s)	9.1	7.3	0	-	0	-	-	8.7
HCM Lane LOS	A	A	A	-	A	-	-	A
HCM 95th %tile Q(veh)	0.1	0	-	-	0	-	-	0.1

HCM 6th TWSC
5: Peyton Highway & Jones Road

Background Traffic Conditions
AM Peak Hour - Year 2043

Intersection												
Int Delay, s/veh	2.4											
Movement	EBL	EBT	EBR	WBL	WBT	WBR	NBL	NBT	NBR	SBL	SBT	SBR
Lane Configurations	↕			↕			↕			↕		
Traffic Vol, veh/h	3	3	5	17	8	8	5	66	29	0	42	5
Future Vol, veh/h	3	3	5	17	8	8	5	66	29	0	42	5
Conflicting Peds, #/hr	0	0	0	0	0	0	0	0	0	0	0	0
Sign Control	Stop	Stop	Stop	Stop	Stop	Stop	Free	Free	Free	Free	Free	Free
RT Channelized	-	-	None	-	-	None	-	-	None	-	-	None
Storage Length	-	-	-	-	-	-	-	-	-	-	-	-
Veh in Median Storage, #	-	0	-	-	0	-	-	0	-	-	0	-
Grade, %	-	0	-	-	0	-	-	0	-	-	0	-
Peak Hour Factor	92	92	92	92	92	92	92	92	92	92	92	92
Heavy Vehicles, %	2	2	2	2	2	2	2	2	2	2	2	2
Mvmt Flow	3	3	5	18	9	9	5	72	32	0	46	5

Major/Minor	Minor2		Minor1		Major1			Major2				
Conflicting Flow All	156	163	49	151	149	88	51	0	0	104	0	0
Stage 1	49	49	-	98	98	-	-	-	-	-	-	-
Stage 2	107	114	-	53	51	-	-	-	-	-	-	-
Critical Hdwy	7.12	6.52	6.22	7.12	6.52	6.22	4.12	-	-	4.12	-	-
Critical Hdwy Stg 1	6.12	5.52	-	6.12	5.52	-	-	-	-	-	-	-
Critical Hdwy Stg 2	6.12	5.52	-	6.12	5.52	-	-	-	-	-	-	-
Follow-up Hdwy	3.518	4.018	3.318	3.518	4.018	3.318	2.218	-	-	2.218	-	-
Pot Cap-1 Maneuver	810	729	1020	816	743	970	1555	-	-	1488	-	-
Stage 1	964	854	-	908	814	-	-	-	-	-	-	-
Stage 2	898	801	-	960	852	-	-	-	-	-	-	-
Platoon blocked, %	-	-	-	-	-	-	-	-	-	-	-	-
Mov Cap-1 Maneuver	794	727	1020	807	741	970	1555	-	-	1488	-	-
Mov Cap-2 Maneuver	794	727	-	807	741	-	-	-	-	-	-	-
Stage 1	961	854	-	905	812	-	-	-	-	-	-	-
Stage 2	878	799	-	951	852	-	-	-	-	-	-	-

Approach	EB		WB		NB		SB	
HCM Control Delay, s	9.3		9.6		0.4		0	
HCM LOS	A		A					

Minor Lane/Major Mvmt	NBL	NBT	NBR	EBLn1	WBLn1	SBL	SBT	SBR
Capacity (veh/h)	1555	-	-	859	823	1488	-	-
HCM Lane V/C Ratio	0.003	-	-	0.014	0.044	-	-	-
HCM Control Delay (s)	7.3	0	-	9.3	9.6	0	-	-
HCM Lane LOS	A	A	-	A	A	A	-	-
HCM 95th %tile Q(veh)	0	-	-	0	0.1	0	-	-

HCM 6th TWSC
6: Peyton Highway & State Highway 94

Background Traffic Conditions
AM Peak Hour - Year 2043

Intersection												
Int Delay, s/veh	2.8											
Movement	EBL	EBT	EBR	WBL	WBT	WBR	NBL	NBT	NBR	SBL	SBT	SBR
Lane Configurations	↖	↗		↖	↗			↕			↕	
Traffic Vol, veh/h	26	140	5	14	414	57	32	12	8	20	8	35
Future Vol, veh/h	26	140	5	14	414	57	32	12	8	20	8	35
Conflicting Peds, #/hr	0	0	0	0	0	0	0	0	0	0	0	0
Sign Control	Free	Free	Free	Free	Free	Free	Stop	Stop	Stop	Stop	Stop	Stop
RT Channelized	-	-	None	-	-	None	-	-	None	-	-	None
Storage Length	515	-	-	525	-	-	-	-	-	-	-	-
Veh in Median Storage, #	-	0	-	-	0	-	-	0	-	-	0	-
Grade, %	-	0	-	-	0	-	-	0	-	-	0	-
Peak Hour Factor	92	92	92	92	92	92	92	92	92	92	92	92
Heavy Vehicles, %	2	2	2	2	2	2	2	2	2	2	2	2
Mvmt Flow	28	152	5	15	450	62	35	13	9	22	9	38

Major/Minor	Major1			Major2			Minor1			Minor2		
Conflicting Flow All	512	0	0	157	0	0	746	753	155	733	724	481
Stage 1	-	-	-	-	-	-	211	211	-	511	511	-
Stage 2	-	-	-	-	-	-	535	542	-	222	213	-
Critical Hdwy	4.12	-	-	4.12	-	-	7.12	6.52	6.22	7.12	6.52	6.22
Critical Hdwy Stg 1	-	-	-	-	-	-	6.12	5.52	-	6.12	5.52	-
Critical Hdwy Stg 2	-	-	-	-	-	-	6.12	5.52	-	6.12	5.52	-
Follow-up Hdwy	2.218	-	-	2.218	-	-	3.518	4.018	3.318	3.518	4.018	3.318
Pot Cap-1 Maneuver	1053	-	-	1423	-	-	330	339	891	336	352	585
Stage 1	-	-	-	-	-	-	791	728	-	545	537	-
Stage 2	-	-	-	-	-	-	529	520	-	780	726	-
Platoon blocked, %	-	-	-	-	-	-	-	-	-	-	-	-
Mov Cap-1 Maneuver	1053	-	-	1423	-	-	294	326	891	313	339	585
Mov Cap-2 Maneuver	-	-	-	-	-	-	294	326	-	313	339	-
Stage 1	-	-	-	-	-	-	770	708	-	530	531	-
Stage 2	-	-	-	-	-	-	481	514	-	738	706	-

Approach	EB			WB			NB			SB		
HCM Control Delay, s	1.3			0.2			17.9			15		
HCM LOS							C			C		

Minor Lane/Major Mvmt	NBLn1	EBL	EBT	EBR	WBL	WBT	WBR	SBLn1
Capacity (veh/h)	336	1053	-	-	1423	-	-	428
HCM Lane V/C Ratio	0.168	0.027	-	-	0.011	-	-	0.16
HCM Control Delay (s)	17.9	8.5	-	-	7.6	-	-	15
HCM Lane LOS	C	A	-	-	A	-	-	C
HCM 95th %tile Q(veh)	0.6	0.1	-	-	0	-	-	0.6

Intersection						
Int Delay, s/veh	0.5					
Movement	EBT	EBR	WBL	WBT	NBL	NBR
Lane Configurations	↔			↔		↔
Traffic Vol, veh/h	210	44	2	107	14	3
Future Vol, veh/h	210	44	2	107	14	3
Conflicting Peds, #/hr	0	0	0	0	0	0
Sign Control	Free	Free	Free	Free	Stop	Stop
RT Channelized	-	None	-	None	-	None
Storage Length	-	-	-	-	0	-
Veh in Median Storage, #	0	-	-	0	0	-
Grade, %	0	-	-	0	0	-
Peak Hour Factor	92	92	92	92	92	92
Heavy Vehicles, %	2	2	2	2	2	2
Mvmt Flow	228	48	2	116	15	3

Major/Minor	Major1	Major2	Minor1	Minor2	Minor3
Conflicting Flow All	0	0	276	0	372
Stage 1	-	-	-	-	252
Stage 2	-	-	-	-	120
Critical Hdwy	-	-	4.12	-	6.42
Critical Hdwy Stg 1	-	-	-	-	5.42
Critical Hdwy Stg 2	-	-	-	-	5.42
Follow-up Hdwy	-	-	2.218	-	3.518
Pot Cap-1 Maneuver	-	-	1287	-	629
Stage 1	-	-	-	-	790
Stage 2	-	-	-	-	905
Platoon blocked, %	-	-	-	-	-
Mov Cap-1 Maneuver	-	-	1287	-	628
Mov Cap-2 Maneuver	-	-	-	-	628
Stage 1	-	-	-	-	790
Stage 2	-	-	-	-	903

Approach	EB	WB	NB
HCM Control Delay, s	0	0.1	10.7
HCM LOS			B

Minor Lane/Major Mvmt	NBLn1	EBT	EBR	WBL	WBT
Capacity (veh/h)	651	-	-	1287	-
HCM Lane V/C Ratio	0.028	-	-	0.002	-
HCM Control Delay (s)	10.7	-	-	7.8	0
HCM Lane LOS	B	-	-	A	A
HCM 95th %tile Q(veh)	0.1	-	-	0	-

HCM 6th TWSC
2: Peyton Highway & Falcon Highway

Background Traffic Conditions
PM Peak Hour - Year 2043

Intersection						
Int Delay, s/veh	2.2					
Movement	EBT	EBR	WBL	WBT	NBL	NBR
Lane Configurations	↔			↔		↔
Traffic Vol, veh/h	141	101	9	72	60	14
Future Vol, veh/h	141	101	9	72	60	14
Conflicting Peds, #/hr	0	0	0	0	0	0
Sign Control	Free	Free	Free	Free	Stop	Stop
RT Channelized	-	None	-	None	-	None
Storage Length	-	-	-	-	0	-
Veh in Median Storage, #	0	-	-	0	0	-
Grade, %	0	-	-	0	0	-
Peak Hour Factor	92	92	92	92	92	92
Heavy Vehicles, %	2	2	2	2	2	2
Mvmt Flow	153	110	10	78	65	15

Major/Minor	Major1	Major2	Minor1	Minor2	Minor3
Conflicting Flow All	0	0	263	0	306
Stage 1	-	-	-	-	208
Stage 2	-	-	-	-	98
Critical Hdwy	-	-	4.12	-	6.42
Critical Hdwy Stg 1	-	-	-	-	5.42
Critical Hdwy Stg 2	-	-	-	-	5.42
Follow-up Hdwy	-	-	2.218	-	3.518
Pot Cap-1 Maneuver	-	-	1301	-	686
Stage 1	-	-	-	-	827
Stage 2	-	-	-	-	926
Platoon blocked, %	-	-	-	-	-
Mov Cap-1 Maneuver	-	-	1301	-	681
Mov Cap-2 Maneuver	-	-	-	-	681
Stage 1	-	-	-	-	827
Stage 2	-	-	-	-	919

Approach	EB	WB	NB
HCM Control Delay, s	0	0.9	10.8
HCM LOS			B

Minor Lane/Major Mvmt	NBLn1	EBT	EBR	WBL	WBT
Capacity (veh/h)	705	-	-	1301	-
HCM Lane V/C Ratio	0.114	-	-	0.008	-
HCM Control Delay (s)	10.8	-	-	7.8	0
HCM Lane LOS	B	-	-	A	A
HCM 95th %tile Q(veh)	0.4	-	-	0	-

HCM 6th TWSC
3: Curtis Road & Jones Road

Background Traffic Conditions
PM Peak Hour - Year 2043

Intersection												
Int Delay, s/veh	3.5											
Movement	EBL	EBT	EBR	WBL	WBT	WBR	NBL	NBT	NBR	SBL	SBT	SBR
Lane Configurations	↕			↕			↕			↕		
Traffic Vol, veh/h	2	2	5	11	2	81	0	636	20	153	117	6
Future Vol, veh/h	2	2	5	11	2	81	0	636	20	153	117	6
Conflicting Peds, #/hr	0	0	0	0	0	0	0	0	0	0	0	0
Sign Control	Stop	Stop	Stop	Stop	Stop	Stop	Free	Free	Free	Free	Free	Free
RT Channelized	-	-	None	-	-	None	-	-	None	-	-	None
Storage Length	-	-	-	-	-	-	-	-	-	-	-	-
Veh in Median Storage, #	-	0	-	-	0	-	-	0	-	-	0	-
Grade, %	-	0	-	-	0	-	-	0	-	-	0	-
Peak Hour Factor	92	92	92	92	92	92	92	92	92	92	92	92
Heavy Vehicles, %	2	2	2	2	2	2	2	2	2	2	2	2
Mvmt Flow	2	2	5	12	2	88	0	691	22	166	127	7

Major/Minor	Minor2		Minor1		Major1		Major2					
Conflicting Flow All	1210	1176	131	1168	1168	702	134	0	0	713	0	0
Stage 1	463	463	-	702	702	-	-	-	-	-	-	-
Stage 2	747	713	-	466	466	-	-	-	-	-	-	-
Critical Hdwy	7.12	6.52	6.22	7.12	6.52	6.22	4.12	-	-	4.12	-	-
Critical Hdwy Stg 1	6.12	5.52	-	6.12	5.52	-	-	-	-	-	-	-
Critical Hdwy Stg 2	6.12	5.52	-	6.12	5.52	-	-	-	-	-	-	-
Follow-up Hdwy	3.518	4.018	3.318	3.518	4.018	3.318	2.218	-	-	2.218	-	-
Pot Cap-1 Maneuver	159	191	919	170	193	438	1451	-	-	887	-	-
Stage 1	579	564	-	429	440	-	-	-	-	-	-	-
Stage 2	405	435	-	577	562	-	-	-	-	-	-	-
Platoon blocked, %								-	-	-	-	-
Mov Cap-1 Maneuver	106	152	919	141	154	438	1451	-	-	887	-	-
Mov Cap-2 Maneuver	106	152	-	141	154	-	-	-	-	-	-	-
Stage 1	579	450	-	429	440	-	-	-	-	-	-	-
Stage 2	322	435	-	456	448	-	-	-	-	-	-	-

Approach	EB		WB		NB		SB	
HCM Control Delay, s	20.6		20		0		5.5	
HCM LOS	C		C					

Minor Lane/Major Mvmt	NBL	NBT	NBR	EBLn1	WBLn1	SBL	SBT	SBR
Capacity (veh/h)	1451	-	-	240	341	887	-	-
HCM Lane V/C Ratio	-	-	-	0.041	0.3	0.187	-	-
HCM Control Delay (s)	0	-	-	20.6	20	10	0	-
HCM Lane LOS	A	-	-	C	C	A	A	-
HCM 95th %tile Q(veh)	0	-	-	0.1	1.2	0.7	-	-

HCM 6th TWSC
4: Murr Road & Jones Road

Background Traffic Conditions
PM Peak Hour - Year 2043

Intersection												
Int Delay, s/veh	5											
Movement	EBL	EBT	EBR	WBL	WBT	WBR	NBL	NBT	NBR	SBL	SBT	SBR
Lane Configurations	↕			↕			↕			↕		
Traffic Vol, veh/h	11	9	8	0	8	3	3	2	0	5	12	5
Future Vol, veh/h	11	9	8	0	8	3	3	2	0	5	12	5
Conflicting Peds, #/hr	0	0	0	0	0	0	0	0	0	0	0	0
Sign Control	Free	Free	Free	Free	Free	Free	Stop	Stop	Stop	Stop	Stop	Stop
RT Channelized	-	-	None	-	-	None	-	-	None	-	-	None
Storage Length	-	-	-	-	-	-	-	-	-	-	-	-
Veh in Median Storage, #	-	0	-	-	0	-	-	0	-	-	0	-
Grade, %	-	0	-	-	0	-	-	0	-	-	0	-
Peak Hour Factor	92	92	92	92	92	92	92	92	92	92	92	92
Heavy Vehicles, %	2	2	2	2	2	2	2	2	2	2	2	2
Mvmt Flow	12	10	9	0	9	3	3	2	0	5	13	5

Major/Minor	Major1			Major2			Minor1			Minor2		
Conflicting Flow All	12	0	0	19	0	0	59	51	15	51	54	11
Stage 1	-	-	-	-	-	-	39	39	-	11	11	-
Stage 2	-	-	-	-	-	-	20	12	-	40	43	-
Critical Hdwy	4.12	-	-	4.12	-	-	7.12	6.52	6.22	7.12	6.52	6.22
Critical Hdwy Stg 1	-	-	-	-	-	-	6.12	5.52	-	6.12	5.52	-
Critical Hdwy Stg 2	-	-	-	-	-	-	6.12	5.52	-	6.12	5.52	-
Follow-up Hdwy	2.218	-	-	2.218	-	-	3.518	4.018	3.318	3.518	4.018	3.318
Pot Cap-1 Maneuver	1607	-	-	1597	-	-	937	840	1065	948	837	1070
Stage 1	-	-	-	-	-	-	976	862	-	1010	886	-
Stage 2	-	-	-	-	-	-	999	886	-	975	859	-
Platoon blocked, %	-	-	-	-	-	-	-	-	-	-	-	-
Mov Cap-1 Maneuver	1607	-	-	1597	-	-	915	833	1065	940	830	1070
Mov Cap-2 Maneuver	-	-	-	-	-	-	915	833	-	940	830	-
Stage 1	-	-	-	-	-	-	968	855	-	1002	886	-
Stage 2	-	-	-	-	-	-	979	886	-	965	852	-

Approach	EB	WB	NB	SB
HCM Control Delay, s	2.9	0	9.1	9.1
HCM LOS			A	A

Minor Lane/Major Mvmt	NBLn1	EBL	EBT	EBR	WBL	WBT	WBR	SBLn1
Capacity (veh/h)	880	1607	-	-	1597	-	-	900
HCM Lane V/C Ratio	0.006	0.007	-	-	-	-	-	0.027
HCM Control Delay (s)	9.1	7.3	0	-	0	-	-	9.1
HCM Lane LOS	A	A	A	-	A	-	-	A
HCM 95th %tile Q(veh)	0	0	-	-	0	-	-	0.1

HCM 6th TWSC
5: Peyton Highway & Jones Road

Background Traffic Conditions
PM Peak Hour - Year 2043

Intersection												
Int Delay, s/veh	2.1											
Movement	EBL	EBT	EBR	WBL	WBT	WBR	NBL	NBT	NBR	SBL	SBT	SBR
Lane Configurations	↕			↕			↕			↕		
Traffic Vol, veh/h	2	8	6	8	6	5	2	47	15	11	98	2
Future Vol, veh/h	2	8	6	8	6	5	2	47	15	11	98	2
Conflicting Peds, #/hr	0	0	0	0	0	0	0	0	0	0	0	0
Sign Control	Stop	Stop	Stop	Stop	Stop	Stop	Free	Free	Free	Free	Free	Free
RT Channelized	-	-	None	-	-	None	-	-	None	-	-	None
Storage Length	-	-	-	-	-	-	-	-	-	-	-	-
Veh in Median Storage, #	-	0	-	-	0	-	-	0	-	-	0	-
Grade, %	-	0	-	-	0	-	-	0	-	-	0	-
Peak Hour Factor	92	92	92	92	92	92	92	92	92	92	92	92
Heavy Vehicles, %	2	2	2	2	2	2	2	2	2	2	2	2
Mvmt Flow	2	9	7	9	7	5	2	51	16	12	107	2

Major/Minor	Minor2		Minor1		Major1			Major2				
Conflicting Flow All	201	203	108	203	196	59	109	0	0	67	0	0
Stage 1	132	132	-	63	63	-	-	-	-	-	-	-
Stage 2	69	71	-	140	133	-	-	-	-	-	-	-
Critical Hdwy	7.12	6.52	6.22	7.12	6.52	6.22	4.12	-	-	4.12	-	-
Critical Hdwy Stg 1	6.12	5.52	-	6.12	5.52	-	-	-	-	-	-	-
Critical Hdwy Stg 2	6.12	5.52	-	6.12	5.52	-	-	-	-	-	-	-
Follow-up Hdwy	3.518	4.018	3.318	3.518	4.018	3.318	2.218	-	-	2.218	-	-
Pot Cap-1 Maneuver	757	693	946	755	699	1007	1481	-	-	1535	-	-
Stage 1	871	787	-	948	842	-	-	-	-	-	-	-
Stage 2	941	836	-	863	786	-	-	-	-	-	-	-
Platoon blocked, %												
Mov Cap-1 Maneuver	743	687	946	738	693	1007	1481	-	-	1535	-	-
Mov Cap-2 Maneuver	743	687	-	738	693	-	-	-	-	-	-	-
Stage 1	870	781	-	947	841	-	-	-	-	-	-	-
Stage 2	928	835	-	841	780	-	-	-	-	-	-	-

Approach	EB		WB		NB		SB	
HCM Control Delay, s	9.8		9.8		0.2		0.7	
HCM LOS	A		A					

Minor Lane/Major Mvmt	NBL	NBT	NBR	EBLn1	WBLn1	SBL	SBT	SBR
Capacity (veh/h)	1481	-	-	774	777	1535	-	-
HCM Lane V/C Ratio	0.001	-	-	0.022	0.027	0.008	-	-
HCM Control Delay (s)	7.4	0	-	9.8	9.8	7.4	0	-
HCM Lane LOS	A	A	-	A	A	A	A	-
HCM 95th %tile Q(veh)	0	-	-	0.1	0.1	0	-	-

HCM 6th TWSC
6: Peyton Highway & State Highway 94

Background Traffic Conditions
PM Peak Hour - Year 2043

Intersection												
Int Delay, s/veh	4.7											
Movement	EBL	EBT	EBR	WBL	WBT	WBR	NBL	NBT	NBR	SBL	SBT	SBR
Lane Configurations	↶	↷		↶	↷			↕			↕	
Traffic Vol, veh/h	33	450	30	11	164	29	21	18	20	72	27	3
Future Vol, veh/h	33	450	30	11	164	29	21	18	20	72	27	3
Conflicting Peds, #/hr	0	0	0	0	0	0	0	0	0	0	0	0
Sign Control	Free	Free	Free	Free	Free	Free	Stop	Stop	Stop	Stop	Stop	Stop
RT Channelized	-	-	None	-	-	None	-	-	None	-	-	None
Storage Length	515	-	-	525	-	-	-	-	-	-	-	-
Veh in Median Storage, #	-	0	-	-	0	-	-	0	-	-	0	-
Grade, %	-	0	-	-	0	-	-	0	-	-	0	-
Peak Hour Factor	92	92	92	92	92	92	92	92	92	92	92	92
Heavy Vehicles, %	2	2	2	2	2	2	2	2	2	2	2	2
Mvmt Flow	36	489	33	12	178	32	23	20	22	78	29	3

Major/Minor	Major1		Major2		Minor1		Minor2					
Conflicting Flow All	210	0	0	522	0	0	812	812	506	817	812	194
Stage 1	-	-	-	-	-	-	578	578	-	218	218	-
Stage 2	-	-	-	-	-	-	234	234	-	599	594	-
Critical Hdwy	4.12	-	-	4.12	-	-	7.12	6.52	6.22	7.12	6.52	6.22
Critical Hdwy Stg 1	-	-	-	-	-	-	6.12	5.52	-	6.12	5.52	-
Critical Hdwy Stg 2	-	-	-	-	-	-	6.12	5.52	-	6.12	5.52	-
Follow-up Hdwy	2.218	-	-	2.218	-	-	3.518	4.018	3.318	3.518	4.018	3.318
Pot Cap-1 Maneuver	1361	-	-	1044	-	-	298	313	566	295	313	847
Stage 1	-	-	-	-	-	-	501	501	-	784	723	-
Stage 2	-	-	-	-	-	-	769	711	-	488	493	-
Platoon blocked, %	-	-	-	-	-	-	-	-	-	-	-	-
Mov Cap-1 Maneuver	1361	-	-	1044	-	-	267	301	566	262	301	847
Mov Cap-2 Maneuver	-	-	-	-	-	-	267	301	-	262	301	-
Stage 1	-	-	-	-	-	-	488	488	-	764	715	-
Stage 2	-	-	-	-	-	-	726	703	-	439	480	-

Approach	EB		WB		NB		SB	
HCM Control Delay, s	0.5		0.5		18.1		26.4	
HCM LOS					C		D	

Minor Lane/Major Mvmt	NBLn1	EBL	EBT	EBR	WBL	WBT	WBR	SBLn1
Capacity (veh/h)	339	1361	-	-	1044	-	-	277
HCM Lane V/C Ratio	0.189	0.026	-	-	0.011	-	-	0.4
HCM Control Delay (s)	18.1	7.7	-	-	8.5	-	-	26.4
HCM Lane LOS	C	A	-	-	A	-	-	D
HCM 95th %tile Q(veh)	0.7	0.1	-	-	0	-	-	1.8

HCM 6th TWSC
1: Murr Road & Falcon Highway

Total Traffic Conditions
AM Peak Hour - Year 2025

Intersection						
Int Delay, s/veh	2					
Movement	EBT	EBR	WBL	WBT	NBL	NBR
Lane Configurations	↔		↔		↔	
Traffic Vol, veh/h	35	10	2	132	39	5
Future Vol, veh/h	35	10	2	132	39	5
Conflicting Peds, #/hr	0	0	0	0	0	0
Sign Control	Free	Free	Free	Free	Stop	Stop
RT Channelized	-	None	-	None	-	None
Storage Length	-	-	-	-	0	-
Veh in Median Storage, #	0	-	-	0	0	-
Grade, %	0	-	-	0	0	-
Peak Hour Factor	92	92	92	92	92	92
Heavy Vehicles, %	2	2	2	2	2	2
Mvmt Flow	38	11	2	143	42	5

Major/Minor	Major1	Major2	Minor1	Minor2	Minor3
Conflicting Flow All	0	0	49	0	191
Stage 1	-	-	-	-	44
Stage 2	-	-	-	-	147
Critical Hdwy	-	-	4.12	-	6.42
Critical Hdwy Stg 1	-	-	-	-	5.42
Critical Hdwy Stg 2	-	-	-	-	5.42
Follow-up Hdwy	-	-	2.218	-	3.518
Pot Cap-1 Maneuver	-	-	1558	-	798
Stage 1	-	-	-	-	978
Stage 2	-	-	-	-	880
Platoon blocked, %	-	-	-	-	-
Mov Cap-1 Maneuver	-	-	1558	-	797
Mov Cap-2 Maneuver	-	-	-	-	797
Stage 1	-	-	-	-	978
Stage 2	-	-	-	-	879

Approach	EB	WB	NB
HCM Control Delay, s	0	0.1	9.7
HCM LOS			A

Minor Lane/Major Mvmt	NBLn1	EBT	EBR	WBL	WBT
Capacity (veh/h)	818	-	-	1558	-
HCM Lane V/C Ratio	0.058	-	-	0.001	-
HCM Control Delay (s)	9.7	-	-	7.3	0
HCM Lane LOS	A	-	-	A	A
HCM 95th %tile Q(veh)	0.2	-	-	0	-

HCM 6th TWSC
2: Peyton Highway & Falcon Highway

Total Traffic Conditions
AM Peak Hour - Year 2025

Intersection						
Int Delay, s/veh	3.8					
Movement	EBT	EBR	WBL	WBT	NBL	NBR
Lane Configurations	↔		↔		↔	
Traffic Vol, veh/h	21	13	13	80	57	13
Future Vol, veh/h	21	13	13	80	57	13
Conflicting Peds, #/hr	0	0	0	0	0	0
Sign Control	Free	Free	Free	Free	Stop	Stop
RT Channelized	-	None	-	None	-	None
Storage Length	-	-	-	-	0	-
Veh in Median Storage, #	0	-	-	0	0	-
Grade, %	0	-	-	0	0	-
Peak Hour Factor	92	92	92	92	92	92
Heavy Vehicles, %	2	2	2	2	2	2
Mvmt Flow	23	14	14	87	62	14

Major/Minor	Major1	Major2	Minor1	Minor2	Minor3
Conflicting Flow All	0	0	37	0	145
Stage 1	-	-	-	-	30
Stage 2	-	-	-	-	115
Critical Hdwy	-	-	4.12	-	6.42
Critical Hdwy Stg 1	-	-	-	-	5.42
Critical Hdwy Stg 2	-	-	-	-	5.42
Follow-up Hdwy	-	-	2.218	-	3.518
Pot Cap-1 Maneuver	-	-	1574	-	847
Stage 1	-	-	-	-	993
Stage 2	-	-	-	-	910
Platoon blocked, %	-	-	-	-	-
Mov Cap-1 Maneuver	-	-	1574	-	839
Mov Cap-2 Maneuver	-	-	-	-	839
Stage 1	-	-	-	-	993
Stage 2	-	-	-	-	902

Approach	EB	WB	NB
HCM Control Delay, s	0	1	9.5
HCM LOS			A

Minor Lane/Major Mvmt	NBLn1	EBT	EBR	WBL	WBT
Capacity (veh/h)	871	-	-	1574	-
HCM Lane V/C Ratio	0.087	-	-	0.009	-
HCM Control Delay (s)	9.5	-	-	7.3	0
HCM Lane LOS	A	-	-	A	A
HCM 95th %tile Q(veh)	0.3	-	-	0	-

HCM 6th TWSC
3: Curtis Road & Jones Road

Total Traffic Conditions
AM Peak Hour - Year 2025

Intersection												
Int Delay, s/veh	3.2											
Movement	EBL	EBT	EBR	WBL	WBT	WBR	NBL	NBT	NBR	SBL	SBT	SBR
Lane Configurations	↕			↕			↕			↕		
Traffic Vol, veh/h	1	0	2	52	1	124	0	71	17	28	516	0
Future Vol, veh/h	1	0	2	52	1	124	0	71	17	28	516	0
Conflicting Peds, #/hr	0	0	0	0	0	0	0	0	0	0	0	0
Sign Control	Stop	Stop	Stop	Stop	Stop	Stop	Free	Free	Free	Free	Free	Free
RT Channelized	-	-	None	-	-	None	-	-	None	-	-	None
Storage Length	-	-	-	-	-	-	-	-	-	-	-	-
Veh in Median Storage, #	-	0	-	-	0	-	-	0	-	-	0	-
Grade, %	-	0	-	-	0	-	-	0	-	-	0	-
Peak Hour Factor	92	92	92	92	92	92	92	92	92	92	92	92
Heavy Vehicles, %	2	2	2	2	2	2	2	2	2	2	2	2
Mvmt Flow	1	0	2	57	1	135	0	77	18	30	561	0

Major/Minor	Minor2		Minor1		Major1		Major2					
Conflicting Flow All	775	716	561	708	707	86	561	0	0	95	0	0
Stage 1	621	621	-	86	86	-	-	-	-	-	-	-
Stage 2	154	95	-	622	621	-	-	-	-	-	-	-
Critical Hdwy	7.12	6.52	6.22	7.12	6.52	6.22	4.12	-	-	4.12	-	-
Critical Hdwy Stg 1	6.12	5.52	-	6.12	5.52	-	-	-	-	-	-	-
Critical Hdwy Stg 2	6.12	5.52	-	6.12	5.52	-	-	-	-	-	-	-
Follow-up Hdwy	3.518	4.018	3.318	3.518	4.018	3.318	2.218	-	-	2.218	-	-
Pot Cap-1 Maneuver	315	356	527	350	360	973	1010	-	-	1499	-	-
Stage 1	475	479	-	922	824	-	-	-	-	-	-	-
Stage 2	848	816	-	474	479	-	-	-	-	-	-	-
Platoon blocked, %	-	-	-	-	-	-	-	-	-	-	-	-
Mov Cap-1 Maneuver	265	346	527	341	350	973	1010	-	-	1499	-	-
Mov Cap-2 Maneuver	265	346	-	341	350	-	-	-	-	-	-	-
Stage 1	475	465	-	922	824	-	-	-	-	-	-	-
Stage 2	730	816	-	458	465	-	-	-	-	-	-	-

Approach	EB		WB		NB		SB	
HCM Control Delay, s	14.2		13.3		0		0.4	
HCM LOS	B		B					

Minor Lane/Major Mvmt	NBL	NBT	NBR	EBLn1	WBLn1	SBL	SBT	SBR
Capacity (veh/h)	1010	-	-	396	626	1499	-	-
HCM Lane V/C Ratio	-	-	-	0.008	0.307	0.02	-	-
HCM Control Delay (s)	0	-	-	14.2	13.3	7.5	0	-
HCM Lane LOS	A	-	-	B	B	A	A	-
HCM 95th %tile Q(veh)	0	-	-	0	1.3	0.1	-	-

HCM 6th TWSC
4: Murr Road & Jones Road

Total Traffic Conditions
AM Peak Hour - Year 2025

Intersection												
Int Delay, s/veh	2											
Movement	EBL	EBT	EBR	WBL	WBT	WBR	NBL	NBT	NBR	SBL	SBT	SBR
Lane Configurations	↕			↕			↕			↕		
Traffic Vol, veh/h	7	28	0	0	79	23	7	6	1	9	1	5
Future Vol, veh/h	7	28	0	0	79	23	7	6	1	9	1	5
Conflicting Peds, #/hr	0	0	0	0	0	0	0	0	0	0	0	0
Sign Control	Free	Free	Free	Free	Free	Free	Stop	Stop	Stop	Stop	Stop	Stop
RT Channelized	-	-	None	-	-	None	-	-	None	-	-	None
Storage Length	-	-	-	-	-	-	-	-	-	-	-	-
Veh in Median Storage, #	-	0	-	-	0	-	-	0	-	-	0	-
Grade, %	-	0	-	-	0	-	-	0	-	-	0	-
Peak Hour Factor	92	92	92	92	92	92	92	92	92	92	92	92
Heavy Vehicles, %	2	2	2	2	2	2	2	2	2	2	2	2
Mvmt Flow	8	30	0	0	86	25	8	7	1	10	1	5

Major/Minor	Major1			Major2			Minor1			Minor2		
Conflicting Flow All	111	0	0	30	0	0	148	157	30	149	145	99
Stage 1	-	-	-	-	-	-	46	46	-	99	99	-
Stage 2	-	-	-	-	-	-	102	111	-	50	46	-
Critical Hdwy	4.12	-	-	4.12	-	-	7.12	6.52	6.22	7.12	6.52	6.22
Critical Hdwy Stg 1	-	-	-	-	-	-	6.12	5.52	-	6.12	5.52	-
Critical Hdwy Stg 2	-	-	-	-	-	-	6.12	5.52	-	6.12	5.52	-
Follow-up Hdwy	2.218	-	-	2.218	-	-	3.518	4.018	3.318	3.518	4.018	3.318
Pot Cap-1 Maneuver	1479	-	-	1583	-	-	820	735	1044	819	746	957
Stage 1	-	-	-	-	-	-	968	857	-	907	813	-
Stage 2	-	-	-	-	-	-	904	804	-	963	857	-
Platoon blocked, %	-	-	-	-	-	-	-	-	-	-	-	-
Mov Cap-1 Maneuver	1479	-	-	1583	-	-	811	731	1044	809	742	957
Mov Cap-2 Maneuver	-	-	-	-	-	-	811	731	-	809	742	-
Stage 1	-	-	-	-	-	-	962	852	-	902	813	-
Stage 2	-	-	-	-	-	-	898	804	-	949	852	-

Approach	EB			WB			NB			SB		
HCM Control Delay, s	1.5			0			9.7			9.3		
HCM LOS							A			A		

Minor Lane/Major Mvmt	NBLn1	EBL	EBT	EBR	WBL	WBT	WBR	SBLn1
Capacity (veh/h)	787	1479	-	-	1583	-	-	848
HCM Lane V/C Ratio	0.019	0.005	-	-	-	-	-	0.019
HCM Control Delay (s)	9.7	7.4	0	-	0	-	-	9.3
HCM Lane LOS	A	A	A	-	A	-	-	A
HCM 95th %tile Q(veh)	0.1	0	-	-	0	-	-	0.1

HCM 6th TWSC
5: Peyton Highway & Jones Road

Total Traffic Conditions
AM Peak Hour - Year 2025

Intersection												
Int Delay, s/veh	4											
Movement	EBL	EBT	EBR	WBL	WBT	WBR	NBL	NBT	NBR	SBL	SBT	SBR
Lane Configurations	↕↕			↕↕			↕↕			↕↕		
Traffic Vol, veh/h	8	8	29	11	7	5	12	46	20	0	29	6
Future Vol, veh/h	8	8	29	11	7	5	12	46	20	0	29	6
Conflicting Peds, #/hr	0	0	0	0	0	0	0	0	0	0	0	0
Sign Control	Stop	Stop	Stop	Stop	Stop	Stop	Free	Free	Free	Free	Free	Free
RT Channelized	-	-	None	-	-	None	-	-	None	-	-	None
Storage Length	-	-	-	-	-	-	-	-	-	-	-	-
Veh in Median Storage, #	-	0	-	-	0	-	-	0	-	-	0	-
Grade, %	-	0	-	-	0	-	-	0	-	-	0	-
Peak Hour Factor	92	92	92	92	92	92	92	92	92	92	92	92
Heavy Vehicles, %	2	2	2	2	2	2	2	2	2	2	2	2
Mvmt Flow	9	9	32	12	8	5	13	50	22	0	32	7

Major/Minor	Minor2		Minor1		Major1			Major2				
Conflicting Flow All	130	134	36	143	126	61	39	0	0	72	0	0
Stage 1	36	36	-	87	87	-	-	-	-	-	-	-
Stage 2	94	98	-	56	39	-	-	-	-	-	-	-
Critical Hdwy	7.12	6.52	6.22	7.12	6.52	6.22	4.12	-	-	4.12	-	-
Critical Hdwy Stg 1	6.12	5.52	-	6.12	5.52	-	-	-	-	-	-	-
Critical Hdwy Stg 2	6.12	5.52	-	6.12	5.52	-	-	-	-	-	-	-
Follow-up Hdwy	3.518	4.018	3.318	3.518	4.018	3.318	2.218	-	-	2.218	-	-
Pot Cap-1 Maneuver	843	757	1037	826	764	1004	1571	-	-	1528	-	-
Stage 1	980	865	-	921	823	-	-	-	-	-	-	-
Stage 2	913	814	-	956	862	-	-	-	-	-	-	-
Platoon blocked, %												
Mov Cap-1 Maneuver	826	750	1037	788	757	1004	1571	-	-	1528	-	-
Mov Cap-2 Maneuver	826	750	-	788	757	-	-	-	-	-	-	-
Stage 1	971	865	-	913	816	-	-	-	-	-	-	-
Stage 2	891	807	-	918	862	-	-	-	-	-	-	-

Approach	EB		WB		NB			SB		
HCM Control Delay, s	9.1		9.6		1.1			0		
HCM LOS	A		A							

Minor Lane/Major Mvmt	NBL	NBT	NBR	EBLn1	WBLn1	SBL	SBT	SBR
Capacity (veh/h)	1571	-	-	931	816	1528	-	-
HCM Lane V/C Ratio	0.008	-	-	0.053	0.031	-	-	-
HCM Control Delay (s)	7.3	0	-	9.1	9.6	0	-	-
HCM Lane LOS	A	A	-	A	A	A	-	-
HCM 95th %tile Q(veh)	0	-	-	0.2	0.1	0	-	-

HCM 6th TWSC
6: Peyton Highway & State Highway 94

Total Traffic Conditions
AM Peak Hour - Year 2025

Intersection												
Int Delay, s/veh	2.8											
Movement	EBL	EBT	EBR	WBL	WBT	WBR	NBL	NBT	NBR	SBL	SBT	SBR
Lane Configurations	↖	↗		↖	↗			↕			↕	
Traffic Vol, veh/h	18	97	3	9	287	47	22	10	5	33	12	24
Future Vol, veh/h	18	97	3	9	287	47	22	10	5	33	12	24
Conflicting Peds, #/hr	0	0	0	0	0	0	0	0	0	0	0	0
Sign Control	Free	Free	Free	Free	Free	Free	Stop	Stop	Stop	Stop	Stop	Stop
RT Channelized	-	-	None	-	-	None	-	-	None	-	-	None
Storage Length	515	-	-	525	-	-	-	-	-	-	-	-
Veh in Median Storage, #	-	0	-	-	0	-	-	0	-	-	0	-
Grade, %	-	0	-	-	0	-	-	0	-	-	0	-
Peak Hour Factor	92	92	92	92	92	92	92	92	92	92	92	92
Heavy Vehicles, %	2	2	2	2	2	2	2	2	2	2	2	2
Mvmt Flow	20	105	3	10	312	51	24	11	5	36	13	26

Major/Minor	Major1			Major2			Minor1			Minor2		
Conflicting Flow All	363	0	0	108	0	0	524	530	107	513	506	338
Stage 1	-	-	-	-	-	-	147	147	-	358	358	-
Stage 2	-	-	-	-	-	-	377	383	-	155	148	-
Critical Hdwy	4.12	-	-	4.12	-	-	7.12	6.52	6.22	7.12	6.52	6.22
Critical Hdwy Stg 1	-	-	-	-	-	-	6.12	5.52	-	6.12	5.52	-
Critical Hdwy Stg 2	-	-	-	-	-	-	6.12	5.52	-	6.12	5.52	-
Follow-up Hdwy	2.218	-	-	2.218	-	-	3.518	4.018	3.318	3.518	4.018	3.318
Pot Cap-1 Maneuver	1196	-	-	1483	-	-	464	455	947	472	469	704
Stage 1	-	-	-	-	-	-	856	775	-	660	628	-
Stage 2	-	-	-	-	-	-	644	612	-	847	775	-
Platoon blocked, %	-	-	-	-	-	-	-	-	-	-	-	-
Mov Cap-1 Maneuver	1196	-	-	1483	-	-	429	444	947	452	458	704
Mov Cap-2 Maneuver	-	-	-	-	-	-	429	444	-	452	458	-
Stage 1	-	-	-	-	-	-	841	762	-	649	624	-
Stage 2	-	-	-	-	-	-	603	608	-	816	762	-

Approach	EB			WB			NB			SB		
HCM Control Delay, s	1.2			0.2			13.4			13.1		
HCM LOS							B			B		

Minor Lane/Major Mvmt	NBLn1	EBL	EBT	EBR	WBL	WBT	WBR	SBLn1
Capacity (veh/h)	468	1196	-	-	1483	-	-	518
HCM Lane V/C Ratio	0.086	0.016	-	-	0.007	-	-	0.145
HCM Control Delay (s)	13.4	8.1	-	-	7.4	-	-	13.1
HCM Lane LOS	B	A	-	-	A	-	-	B
HCM 95th %tile Q(veh)	0.3	0.1	-	-	0	-	-	0.5

HCM 6th TWSC
7: Jones Road & Access A

Total Traffic Conditions
AM Peak Hour - Year 2025

Intersection						
Int Delay, s/veh	6.3					
Movement	EBL	EBT	WBT	WBR	SBL	SBR
Lane Configurations		↕	↕		↕	
Traffic Vol, veh/h	25	13	24	5	13	77
Future Vol, veh/h	25	13	24	5	13	77
Conflicting Peds, #/hr	0	0	0	0	0	0
Sign Control	Free	Free	Free	Free	Stop	Stop
RT Channelized	-	None	-	None	-	None
Storage Length	-	-	-	-	0	-
Veh in Median Storage, #	-	0	0	-	0	-
Grade, %	-	0	0	-	0	-
Peak Hour Factor	92	92	92	92	92	92
Heavy Vehicles, %	2	2	2	2	2	2
Mvmt Flow	27	14	26	5	14	84

Major/Minor	Major1	Major2	Minor2		
Conflicting Flow All	31	0	-	0	97 29
Stage 1	-	-	-	-	29 -
Stage 2	-	-	-	-	68 -
Critical Hdwy	4.12	-	-	-	6.42 6.22
Critical Hdwy Stg 1	-	-	-	-	5.42 -
Critical Hdwy Stg 2	-	-	-	-	5.42 -
Follow-up Hdwy	2.218	-	-	-	3.518 3.318
Pot Cap-1 Maneuver	1582	-	-	-	902 1046
Stage 1	-	-	-	-	994 -
Stage 2	-	-	-	-	955 -
Platoon blocked, %		-	-	-	
Mov Cap-1 Maneuver	1582	-	-	-	887 1046
Mov Cap-2 Maneuver	-	-	-	-	887 -
Stage 1	-	-	-	-	977 -
Stage 2	-	-	-	-	955 -

Approach	EB	WB	SB
HCM Control Delay, s	4.8	0	8.9
HCM LOS			A

Minor Lane/Major Mvmt	EBL	EBT	WBT	WBR	SBLn1
Capacity (veh/h)	1582	-	-	-	1020
HCM Lane V/C Ratio	0.017	-	-	-	0.096
HCM Control Delay (s)	7.3	0	-	-	8.9
HCM Lane LOS	A	A	-	-	A
HCM 95th %tile Q(veh)	0.1	-	-	-	0.3

HCM 6th TWSC
8: Jones Road & Access B

Total Traffic Conditions
AM Peak Hour - Year 2025

Intersection						
Int Delay, s/veh	4.1					
Movement	EBL	EBT	WBT	WBR	SBL	SBR
Lane Configurations		↕	↕		↕	
Traffic Vol, veh/h	4	22	16	9	25	13
Future Vol, veh/h	4	22	16	9	25	13
Conflicting Peds, #/hr	0	0	0	0	0	0
Sign Control	Free	Free	Free	Free	Stop	Stop
RT Channelized	-	None	-	None	-	None
Storage Length	-	-	-	-	0	-
Veh in Median Storage, #	-	0	0	-	0	-
Grade, %	-	0	0	-	0	-
Peak Hour Factor	92	92	92	92	92	92
Heavy Vehicles, %	2	2	2	2	2	2
Mvmt Flow	4	24	17	10	27	14

Major/Minor	Major1	Major2	Minor2		
Conflicting Flow All	27	0	-	0	54 22
Stage 1	-	-	-	-	22 -
Stage 2	-	-	-	-	32 -
Critical Hdwy	4.12	-	-	-	6.42 6.22
Critical Hdwy Stg 1	-	-	-	-	5.42 -
Critical Hdwy Stg 2	-	-	-	-	5.42 -
Follow-up Hdwy	2.218	-	-	-	3.518 3.318
Pot Cap-1 Maneuver	1587	-	-	-	954 1055
Stage 1	-	-	-	-	1001 -
Stage 2	-	-	-	-	991 -
Platoon blocked, %		-	-	-	
Mov Cap-1 Maneuver	1587	-	-	-	951 1055
Mov Cap-2 Maneuver	-	-	-	-	951 -
Stage 1	-	-	-	-	998 -
Stage 2	-	-	-	-	991 -

Approach	EB	WB	SB
HCM Control Delay, s	1.1	0	8.8
HCM LOS			A

Minor Lane/Major Mvmt	EBL	EBT	WBT	WBR	SBLn1
Capacity (veh/h)	1587	-	-	-	984
HCM Lane V/C Ratio	0.003	-	-	-	0.042
HCM Control Delay (s)	7.3	0	-	-	8.8
HCM Lane LOS	A	A	-	-	A
HCM 95th %tile Q(veh)	0	-	-	-	0.1

HCM 6th TWSC
1: Murr Road & Falcon Highway

Total Traffic Conditions
PM Peak Hour - Year 2025

Intersection						
Int Delay, s/veh	0.8					
Movement	EBT	EBR	WBL	WBT	NBL	NBR
Lane Configurations	↔			↔		↔
Traffic Vol, veh/h	146	52	1	74	21	2
Future Vol, veh/h	146	52	1	74	21	2
Conflicting Peds, #/hr	0	0	0	0	0	0
Sign Control	Free	Free	Free	Free	Stop	Stop
RT Channelized	-	None	-	None	-	None
Storage Length	-	-	-	-	0	-
Veh in Median Storage, #	0	-	-	0	0	-
Grade, %	0	-	-	0	0	-
Peak Hour Factor	92	92	92	92	92	92
Heavy Vehicles, %	2	2	2	2	2	2
Mvmt Flow	159	57	1	80	23	2

Major/Minor	Major1	Major2	Minor1		
Conflicting Flow All	0	0	216	0	270
Stage 1	-	-	-	-	188
Stage 2	-	-	-	-	82
Critical Hdwy	-	-	4.12	-	6.42
Critical Hdwy Stg 1	-	-	-	-	5.42
Critical Hdwy Stg 2	-	-	-	-	5.42
Follow-up Hdwy	-	-	2.218	-	3.518
Pot Cap-1 Maneuver	-	-	1354	-	719
Stage 1	-	-	-	-	844
Stage 2	-	-	-	-	941
Platoon blocked, %	-	-	-	-	-
Mov Cap-1 Maneuver	-	-	1354	-	718
Mov Cap-2 Maneuver	-	-	-	-	718
Stage 1	-	-	-	-	844
Stage 2	-	-	-	-	940

Approach	EB	WB	NB
HCM Control Delay, s	0	0.1	10.1
HCM LOS			B

Minor Lane/Major Mvmt	NBLn1	EBT	EBR	WBL	WBT
Capacity (veh/h)	728	-	-	1354	-
HCM Lane V/C Ratio	0.034	-	-	0.001	-
HCM Control Delay (s)	10.1	-	-	7.7	0
HCM Lane LOS	B	-	-	A	A
HCM 95th %tile Q(veh)	0.1	-	-	0	-

HCM 6th TWSC
2: Peyton Highway & Falcon Highway

Total Traffic Conditions
PM Peak Hour - Year 2025

Intersection						
Int Delay, s/veh	2					
Movement	EBT	EBR	WBL	WBT	NBL	NBR
Lane Configurations	↔			↔		↔
Traffic Vol, veh/h	98	70	13	50	42	3
Future Vol, veh/h	98	70	13	50	42	3
Conflicting Peds, #/hr	0	0	0	0	0	0
Sign Control	Free	Free	Free	Free	Stop	Stop
RT Channelized	-	None	-	None	-	None
Storage Length	-	-	-	-	0	-
Veh in Median Storage, #	0	-	-	0	0	-
Grade, %	0	-	-	0	0	-
Peak Hour Factor	92	92	92	92	92	92
Heavy Vehicles, %	2	2	2	2	2	2
Mvmt Flow	107	76	14	54	46	3

Major/Minor	Major1	Major2	Minor1		
Conflicting Flow All	0	0	183	0	227
Stage 1	-	-	-	-	145
Stage 2	-	-	-	-	82
Critical Hdwy	-	-	4.12	-	6.42
Critical Hdwy Stg 1	-	-	-	-	5.42
Critical Hdwy Stg 2	-	-	-	-	5.42
Follow-up Hdwy	-	-	2.218	-	3.518
Pot Cap-1 Maneuver	-	-	1392	-	761
Stage 1	-	-	-	-	882
Stage 2	-	-	-	-	941
Platoon blocked, %	-	-	-	-	-
Mov Cap-1 Maneuver	-	-	1392	-	753
Mov Cap-2 Maneuver	-	-	-	-	753
Stage 1	-	-	-	-	882
Stage 2	-	-	-	-	932

Approach	EB	WB	NB
HCM Control Delay, s	0	1.6	10.1
HCM LOS			B

Minor Lane/Major Mvmt	NBLn1	EBT	EBR	WBL	WBT
Capacity (veh/h)	761	-	-	1392	-
HCM Lane V/C Ratio	0.064	-	-	0.01	-
HCM Control Delay (s)	10.1	-	-	7.6	0
HCM Lane LOS	B	-	-	A	A
HCM 95th %tile Q(veh)	0.2	-	-	0	-

HCM 6th TWSC
3: Curtis Road & Jones Road

Total Traffic Conditions
PM Peak Hour - Year 2025

Intersection												
Int Delay, s/veh	4.1											
Movement	EBL	EBT	EBR	WBL	WBT	WBR	NBL	NBT	NBR	SBL	SBT	SBR
Lane Configurations	↕			↕			↕			↕		
Traffic Vol, veh/h	1	1	3	37	1	73	0	441	64	135	81	4
Future Vol, veh/h	1	1	3	37	1	73	0	441	64	135	81	4
Conflicting Peds, #/hr	0	0	0	0	0	0	0	0	0	0	0	0
Sign Control	Stop	Stop	Stop	Stop	Stop	Stop	Free	Free	Free	Free	Free	Free
RT Channelized	-	-	None	-	-	None	-	-	None	-	-	None
Storage Length	-	-	-	-	-	-	-	-	-	-	-	-
Veh in Median Storage, #	-	0	-	-	0	-	-	0	-	-	0	-
Grade, %	-	0	-	-	0	-	-	0	-	-	0	-
Peak Hour Factor	92	92	92	92	92	92	92	92	92	92	92	92
Heavy Vehicles, %	2	2	2	2	2	2	2	2	2	2	2	2
Mvmt Flow	1	1	3	40	1	79	0	479	70	147	88	4

Major/Minor	Minor2		Minor1		Major1			Major2				
Conflicting Flow All	938	933	90	900	900	514	92	0	0	549	0	0
Stage 1	384	384	-	514	514	-	-	-	-	-	-	-
Stage 2	554	549	-	386	386	-	-	-	-	-	-	-
Critical Hdwy	7.12	6.52	6.22	7.12	6.52	6.22	4.12	-	-	4.12	-	-
Critical Hdwy Stg 1	6.12	5.52	-	6.12	5.52	-	-	-	-	-	-	-
Critical Hdwy Stg 2	6.12	5.52	-	6.12	5.52	-	-	-	-	-	-	-
Follow-up Hdwy	3.518	4.018	3.318	3.518	4.018	3.318	2.218	-	-	2.218	-	-
Pot Cap-1 Maneuver	244	266	968	259	278	560	1503	-	-	1021	-	-
Stage 1	639	611	-	543	535	-	-	-	-	-	-	-
Stage 2	517	516	-	637	610	-	-	-	-	-	-	-
Platoon blocked, %												
Mov Cap-1 Maneuver	184	226	968	227	236	560	1503	-	-	1021	-	-
Mov Cap-2 Maneuver	184	226	-	227	236	-	-	-	-	-	-	-
Stage 1	639	518	-	543	535	-	-	-	-	-	-	-
Stage 2	443	516	-	537	517	-	-	-	-	-	-	-

Approach	EB		WB		NB		SB	
HCM Control Delay, s	14.5		19.2		0		5.6	
HCM LOS	B		C					

Minor Lane/Major Mvmt	NBL	NBT	NBR	EBLn1	WBLn1	SBL	SBT	SBR
Capacity (veh/h)	1503	-	-	386	373	1021	-	-
HCM Lane V/C Ratio	-	-	-	0.014	0.323	0.144	-	-
HCM Control Delay (s)	0	-	-	14.5	19.2	9.1	0	-
HCM Lane LOS	A	-	-	B	C	A	A	-
HCM 95th %tile Q(veh)	0	-	-	0	1.4	0.5	-	-

HCM 6th TWSC
4: Murr Road & Jones Road

Total Traffic Conditions
PM Peak Hour - Year 2025

Intersection												
Int Delay, s/veh	2.2											
Movement	EBL	EBT	EBR	WBL	WBT	WBR	NBL	NBT	NBR	SBL	SBT	SBR
Lane Configurations	↕			↕			↕			↕		
Traffic Vol, veh/h	7	85	5	0	52	14	2	1	0	25	8	3
Future Vol, veh/h	7	85	5	0	52	14	2	1	0	25	8	3
Conflicting Peds, #/hr	0	0	0	0	0	0	0	0	0	0	0	0
Sign Control	Free	Free	Free	Free	Free	Free	Stop	Stop	Stop	Stop	Stop	Stop
RT Channelized	-	-	None	-	-	None	-	-	None	-	-	None
Storage Length	-	-	-	-	-	-	-	-	-	-	-	-
Veh in Median Storage, #	-	0	-	-	0	-	-	0	-	-	0	-
Grade, %	-	0	-	-	0	-	-	0	-	-	0	-
Peak Hour Factor	92	92	92	92	92	92	92	92	92	92	92	92
Heavy Vehicles, %	2	2	2	2	2	2	2	2	2	2	2	2
Mvmt Flow	8	92	5	0	57	15	2	1	0	27	9	3

Major/Minor	Major1			Major2			Minor1			Minor2		
Conflicting Flow All	72	0	0	97	0	0	182	183	95	176	178	65
Stage 1	-	-	-	-	-	-	111	111	-	65	65	-
Stage 2	-	-	-	-	-	-	71	72	-	111	113	-
Critical Hdwy	4.12	-	-	4.12	-	-	7.12	6.52	6.22	7.12	6.52	6.22
Critical Hdwy Stg 1	-	-	-	-	-	-	6.12	5.52	-	6.12	5.52	-
Critical Hdwy Stg 2	-	-	-	-	-	-	6.12	5.52	-	6.12	5.52	-
Follow-up Hdwy	2.218	-	-	2.218	-	-	3.518	4.018	3.318	3.518	4.018	3.318
Pot Cap-1 Maneuver	1528	-	-	1496	-	-	779	711	962	786	716	999
Stage 1	-	-	-	-	-	-	894	804	-	946	841	-
Stage 2	-	-	-	-	-	-	939	835	-	894	802	-
Platoon blocked, %	-	-	-	-	-	-	-	-	-	-	-	-
Mov Cap-1 Maneuver	1528	-	-	1496	-	-	766	707	962	781	712	999
Mov Cap-2 Maneuver	-	-	-	-	-	-	766	707	-	781	712	-
Stage 1	-	-	-	-	-	-	889	799	-	940	841	-
Stage 2	-	-	-	-	-	-	926	835	-	887	797	-

Approach	EB			WB			NB			SB		
HCM Control Delay, s	0.5			0			9.9			9.9		
HCM LOS							A			A		

Minor Lane/Major Mvmt	NBLn1	EBL	EBT	EBR	WBL	WBT	WBR	SBLn1
Capacity (veh/h)	745	1528	-	-	1496	-	-	778
HCM Lane V/C Ratio	0.004	0.005	-	-	-	-	-	0.05
HCM Control Delay (s)	9.9	7.4	0	-	0	-	-	9.9
HCM Lane LOS	A	A	A	-	A	-	-	A
HCM 95th %tile Q(veh)	0	0	-	-	0	-	-	0.2

HCM 6th TWSC
5: Peyton Highway & Jones Road

Total Traffic Conditions
PM Peak Hour - Year 2025

Intersection												
Int Delay, s/veh	3.9											
Movement	EBL	EBT	EBR	WBL	WBT	WBR	NBL	NBT	NBR	SBL	SBT	SBR
Lane Configurations	↕			↕			↕			↕		
Traffic Vol, veh/h	5	9	22	5	11	3	30	32	10	7	68	8
Future Vol, veh/h	5	9	22	5	11	3	30	32	10	7	68	8
Conflicting Peds, #/hr	0	0	0	0	0	0	0	0	0	0	0	0
Sign Control	Stop	Stop	Stop	Stop	Stop	Stop	Free	Free	Free	Free	Free	Free
RT Channelized	-	-	None	-	-	None	-	-	None	-	-	None
Storage Length	-	-	-	-	-	-	-	-	-	-	-	-
Veh in Median Storage, #	-	0	-	-	0	-	-	0	-	-	0	-
Grade, %	-	0	-	-	0	-	-	0	-	-	0	-
Peak Hour Factor	92	92	92	92	92	92	92	92	92	92	92	92
Heavy Vehicles, %	2	2	2	2	2	2	2	2	2	2	2	2
Mvmt Flow	5	10	24	5	12	3	33	35	11	8	74	9

Major/Minor	Minor2		Minor1		Major1		Major2					
Conflicting Flow All	209	207	79	219	206	41	83	0	0	46	0	0
Stage 1	95	95	-	107	107	-	-	-	-	-	-	-
Stage 2	114	112	-	112	99	-	-	-	-	-	-	-
Critical Hdwy	7.12	6.52	6.22	7.12	6.52	6.22	4.12	-	-	4.12	-	-
Critical Hdwy Stg 1	6.12	5.52	-	6.12	5.52	-	-	-	-	-	-	-
Critical Hdwy Stg 2	6.12	5.52	-	6.12	5.52	-	-	-	-	-	-	-
Follow-up Hdwy	3.518	4.018	3.318	3.518	4.018	3.318	2.218	-	-	2.218	-	-
Pot Cap-1 Maneuver	748	690	981	737	691	1030	1514	-	-	1562	-	-
Stage 1	912	816	-	898	807	-	-	-	-	-	-	-
Stage 2	891	803	-	893	813	-	-	-	-	-	-	-
Platoon blocked, %	-	-	-	-	-	-	-	-	-	-	-	-
Mov Cap-1 Maneuver	720	671	981	696	672	1030	1514	-	-	1562	-	-
Mov Cap-2 Maneuver	720	671	-	696	672	-	-	-	-	-	-	-
Stage 1	892	812	-	878	789	-	-	-	-	-	-	-
Stage 2	855	785	-	856	809	-	-	-	-	-	-	-

Approach	EB		WB		NB		SB	
HCM Control Delay, s	9.5		10.2		3.1		0.6	
HCM LOS	A		B					

Minor Lane/Major Mvmt	NBL	NBT	NBR	EBLn1	WBLn1	SBL	SBT	SBR
Capacity (veh/h)	1514	-	-	841	718	1562	-	-
HCM Lane V/C Ratio	0.022	-	-	0.047	0.029	0.005	-	-
HCM Control Delay (s)	7.4	0	-	9.5	10.2	7.3	0	-
HCM Lane LOS	A	A	-	A	B	A	A	-
HCM 95th %tile Q(veh)	0.1	-	-	0.1	0.1	0	-	-

HCM 6th TWSC
6: Peyton Highway & State Highway 94

Total Traffic Conditions
PM Peak Hour - Year 2025

Intersection												
Int Delay, s/veh	3.6											
Movement	EBL	EBT	EBR	WBL	WBT	WBR	NBL	NBT	NBR	SBL	SBT	SBR
Lane Configurations	↖	↗		↖	↗			↕			↕	
Traffic Vol, veh/h	23	312	21	7	113	42	15	20	14	63	24	2
Future Vol, veh/h	23	312	21	7	113	42	15	20	14	63	24	2
Conflicting Peds, #/hr	0	0	0	0	0	0	0	0	0	0	0	0
Sign Control	Free	Free	Free	Free	Free	Free	Stop	Stop	Stop	Stop	Stop	Stop
RT Channelized	-	-	None	-	-	None	-	-	None	-	-	None
Storage Length	515	-	-	525	-	-	-	-	-	-	-	-
Veh in Median Storage, #	-	0	-	-	0	-	-	0	-	-	0	-
Grade, %	-	0	-	-	0	-	-	0	-	-	0	-
Peak Hour Factor	92	92	92	92	92	92	92	92	92	92	92	92
Heavy Vehicles, %	2	2	2	2	2	2	2	2	2	2	2	2
Mvmt Flow	25	339	23	8	123	46	16	22	15	68	26	2

Major/Minor	Major1			Major2			Minor1			Minor2		
Conflicting Flow All	169	0	0	362	0	0	577	586	351	581	574	146
Stage 1	-	-	-	-	-	-	401	401	-	162	162	-
Stage 2	-	-	-	-	-	-	176	185	-	419	412	-
Critical Hdwy	4.12	-	-	4.12	-	-	7.12	6.52	6.22	7.12	6.52	6.22
Critical Hdwy Stg 1	-	-	-	-	-	-	6.12	5.52	-	6.12	5.52	-
Critical Hdwy Stg 2	-	-	-	-	-	-	6.12	5.52	-	6.12	5.52	-
Follow-up Hdwy	2.218	-	-	2.218	-	-	3.518	4.018	3.318	3.518	4.018	3.318
Pot Cap-1 Maneuver	1409	-	-	1197	-	-	428	422	692	425	429	901
Stage 1	-	-	-	-	-	-	626	601	-	840	764	-
Stage 2	-	-	-	-	-	-	826	747	-	612	594	-
Platoon blocked, %	-	-	-	-	-	-	-	-	-	-	-	-
Mov Cap-1 Maneuver	1409	-	-	1197	-	-	399	411	692	391	418	901
Mov Cap-2 Maneuver	-	-	-	-	-	-	399	411	-	391	418	-
Stage 1	-	-	-	-	-	-	615	590	-	825	759	-
Stage 2	-	-	-	-	-	-	790	742	-	566	583	-

Approach	EB			WB			NB			SB		
HCM Control Delay, s	0.5			0.3			13.8			16.7		
HCM LOS							B			C		

Minor Lane/Major Mvmt	NBLn1	EBL	EBT	EBR	WBL	WBT	WBR	SBLn1
Capacity (veh/h)	460	1409	-	-	1197	-	-	403
HCM Lane V/C Ratio	0.116	0.018	-	-	0.006	-	-	0.24
HCM Control Delay (s)	13.8	7.6	-	-	8	-	-	16.7
HCM Lane LOS	B	A	-	-	A	-	-	C
HCM 95th %tile Q(veh)	0.4	0.1	-	-	0	-	-	0.9

HCM 6th TWSC
7: Jones Road & Access A

Total Traffic Conditions
PM Peak Hour - Year 2025

Intersection						
Int Delay, s/veh	6					
Movement	EBL	EBT	WBT	WBR	SBL	SBR
Lane Configurations		↕	↕		↕	
Traffic Vol, veh/h	87	23	14	14	9	51
Future Vol, veh/h	87	23	14	14	9	51
Conflicting Peds, #/hr	0	0	0	0	0	0
Sign Control	Free	Free	Free	Free	Stop	Stop
RT Channelized	-	None	-	None	-	None
Storage Length	-	-	-	-	0	-
Veh in Median Storage, #	-	0	0	-	0	-
Grade, %	-	0	0	-	0	-
Peak Hour Factor	92	92	92	92	92	92
Heavy Vehicles, %	2	2	2	2	2	2
Mvmt Flow	95	25	15	15	10	55

Major/Minor	Major1	Major2	Minor2		
Conflicting Flow All	30	0	-	0	238 23
Stage 1	-	-	-	-	23 -
Stage 2	-	-	-	-	215 -
Critical Hdwy	4.12	-	-	-	6.42 6.22
Critical Hdwy Stg 1	-	-	-	-	5.42 -
Critical Hdwy Stg 2	-	-	-	-	5.42 -
Follow-up Hdwy	2.218	-	-	-	3.518 3.318
Pot Cap-1 Maneuver	1583	-	-	-	750 1054
Stage 1	-	-	-	-	1000 -
Stage 2	-	-	-	-	821 -
Platoon blocked, %		-	-	-	
Mov Cap-1 Maneuver	1583	-	-	-	704 1054
Mov Cap-2 Maneuver	-	-	-	-	704 -
Stage 1	-	-	-	-	939 -
Stage 2	-	-	-	-	821 -

Approach	EB	WB	SB
HCM Control Delay, s	5.9	0	8.9
HCM LOS			A

Minor Lane/Major Mvmt	EBL	EBT	WBT	WBR	SBLn1
Capacity (veh/h)	1583	-	-	-	981
HCM Lane V/C Ratio	0.06	-	-	-	0.066
HCM Control Delay (s)	7.4	0	-	-	8.9
HCM Lane LOS	A	A	-	-	A
HCM 95th %tile Q(veh)	0.2	-	-	-	0.2

HCM 6th TWSC
8: Jones Road & Access B

Total Traffic Conditions
PM Peak Hour - Year 2025

Intersection						
Int Delay, s/veh	3.1					
Movement	EBL	EBT	WBT	WBR	SBL	SBR
Lane Configurations		↕	↕		↕	
Traffic Vol, veh/h	14	18	20	29	17	8
Future Vol, veh/h	14	18	20	29	17	8
Conflicting Peds, #/hr	0	0	0	0	0	0
Sign Control	Free	Free	Free	Free	Stop	Stop
RT Channelized	-	None	-	None	-	None
Storage Length	-	-	-	-	0	-
Veh in Median Storage, #	-	0	0	-	0	-
Grade, %	-	0	0	-	0	-
Peak Hour Factor	92	92	92	92	92	92
Heavy Vehicles, %	2	2	2	2	2	2
Mvmt Flow	15	20	22	32	18	9

Major/Minor	Major1	Major2	Minor2		
Conflicting Flow All	54	0	-	0	88 38
Stage 1	-	-	-	-	38 -
Stage 2	-	-	-	-	50 -
Critical Hdwy	4.12	-	-	-	6.42 6.22
Critical Hdwy Stg 1	-	-	-	-	5.42 -
Critical Hdwy Stg 2	-	-	-	-	5.42 -
Follow-up Hdwy	2.218	-	-	-	3.518 3.318
Pot Cap-1 Maneuver	1551	-	-	-	913 1034
Stage 1	-	-	-	-	984 -
Stage 2	-	-	-	-	972 -
Platoon blocked, %		-	-	-	
Mov Cap-1 Maneuver	1551	-	-	-	904 1034
Mov Cap-2 Maneuver	-	-	-	-	904 -
Stage 1	-	-	-	-	974 -
Stage 2	-	-	-	-	972 -

Approach	EB	WB	SB
HCM Control Delay, s	3.2	0	8.9
HCM LOS			A

Minor Lane/Major Mvmt	EBL	EBT	WBT	WBR	SBLn1
Capacity (veh/h)	1551	-	-	-	942
HCM Lane V/C Ratio	0.01	-	-	-	0.029
HCM Control Delay (s)	7.3	0	-	-	8.9
HCM Lane LOS	A	A	-	-	A
HCM 95th %tile Q(veh)	0	-	-	-	0.1

HCM 6th TWSC
1: Murr Road & Falcon Highway

Total Traffic Conditions
AM Peak Hour - Year 2043

Intersection						
Int Delay, s/veh	1.9					
Movement	EBT	EBR	WBL	WBT	NBL	NBR
Lane Configurations	↔			↔		↔
Traffic Vol, veh/h	51	12	3	191	48	8
Future Vol, veh/h	51	12	3	191	48	8
Conflicting Peds, #/hr	0	0	0	0	0	0
Sign Control	Free	Free	Free	Free	Stop	Stop
RT Channelized	-	None	-	None	-	None
Storage Length	-	-	-	-	0	-
Veh in Median Storage, #	0	-	-	0	0	-
Grade, %	0	-	-	0	0	-
Peak Hour Factor	92	92	92	92	92	92
Heavy Vehicles, %	2	2	2	2	2	2
Mvmt Flow	55	13	3	208	52	9

Major/Minor	Major1	Major2	Minor1		
Conflicting Flow All	0	0	68	0	276 62
Stage 1	-	-	-	-	62 -
Stage 2	-	-	-	-	214 -
Critical Hdwy	-	-	4.12	-	6.42 6.22
Critical Hdwy Stg 1	-	-	-	-	5.42 -
Critical Hdwy Stg 2	-	-	-	-	5.42 -
Follow-up Hdwy	-	-	2.218	-	3.518 3.318
Pot Cap-1 Maneuver	-	-	1533	-	714 1003
Stage 1	-	-	-	-	961 -
Stage 2	-	-	-	-	822 -
Platoon blocked, %	-	-	-	-	-
Mov Cap-1 Maneuver	-	-	1533	-	713 1003
Mov Cap-2 Maneuver	-	-	-	-	713 -
Stage 1	-	-	-	-	961 -
Stage 2	-	-	-	-	820 -

Approach	EB	WB	NB
HCM Control Delay, s	0	0.1	10.3
HCM LOS			B

Minor Lane/Major Mvmt	NBLn1	EBT	EBR	WBL	WBT
Capacity (veh/h)	744	-	-	1533	-
HCM Lane V/C Ratio	0.082	-	-	0.002	-
HCM Control Delay (s)	10.3	-	-	7.4	0
HCM Lane LOS	B	-	-	A	A
HCM 95th %tile Q(veh)	0.3	-	-	0	-

HCM 6th TWSC
2: Peyton Highway & Falcon Highway

Total Traffic Conditions
AM Peak Hour - Year 2043

Intersection						
Int Delay, s/veh	4.1					
Movement	EBT	EBR	WBL	WBT	NBL	NBR
Lane Configurations	↔		↔		↔	
Traffic Vol, veh/h	30	18	18	111	83	17
Future Vol, veh/h	30	18	18	111	83	17
Conflicting Peds, #/hr	0	0	0	0	0	0
Sign Control	Free	Free	Free	Free	Stop	Stop
RT Channelized	-	None	-	None	-	None
Storage Length	-	-	-	-	0	-
Veh in Median Storage, #	0	-	-	0	0	-
Grade, %	0	-	-	0	0	-
Peak Hour Factor	92	92	92	92	92	92
Heavy Vehicles, %	2	2	2	2	2	2
Mvmt Flow	33	20	20	121	90	18

Major/Minor	Major1	Major2	Minor1	Minor2	Minor3
Conflicting Flow All	0	0	53	0	204
Stage 1	-	-	-	-	43
Stage 2	-	-	-	-	161
Critical Hdwy	-	-	4.12	-	6.42
Critical Hdwy Stg 1	-	-	-	-	5.42
Critical Hdwy Stg 2	-	-	-	-	5.42
Follow-up Hdwy	-	-	2.218	-	3.518
Pot Cap-1 Maneuver	-	-	1553	-	784
Stage 1	-	-	-	-	979
Stage 2	-	-	-	-	868
Platoon blocked, %	-	-	-	-	-
Mov Cap-1 Maneuver	-	-	1553	-	773
Mov Cap-2 Maneuver	-	-	-	-	773
Stage 1	-	-	-	-	979
Stage 2	-	-	-	-	856

Approach	EB	WB	NB
HCM Control Delay, s	0	1	10.2
HCM LOS			B

Minor Lane/Major Mvmt	NBLn1	EBT	EBR	WBL	WBT
Capacity (veh/h)	807	-	-	1553	-
HCM Lane V/C Ratio	0.135	-	-	0.013	-
HCM Control Delay (s)	10.2	-	-	7.3	0
HCM Lane LOS	B	-	-	A	A
HCM 95th %tile Q(veh)	0.5	-	-	0	-

HCM 6th TWSC
3: Curtis Road & Jones Road

Total Traffic Conditions
AM Peak Hour - Year 2043

Intersection												
Int Delay, s/veh	4.2											
Movement	EBL	EBT	EBR	WBL	WBT	WBR	NBL	NBT	NBR	SBL	SBT	SBR
Lane Configurations	↕			↕			↕			↕		
Traffic Vol, veh/h	2	0	3	56	2	167	0	102	18	37	744	0
Future Vol, veh/h	2	0	3	56	2	167	0	102	18	37	744	0
Conflicting Peds, #/hr	0	0	0	0	0	0	0	0	0	0	0	0
Sign Control	Stop	Stop	Stop	Stop	Stop	Stop	Free	Free	Free	Free	Free	Free
RT Channelized	-	-	None	-	-	None	-	-	None	-	-	None
Storage Length	-	-	-	-	-	-	-	-	-	-	-	-
Veh in Median Storage, #	-	0	-	-	0	-	-	0	-	-	0	-
Grade, %	-	0	-	-	0	-	-	0	-	-	0	-
Peak Hour Factor	92	92	92	92	92	92	92	92	92	92	92	92
Heavy Vehicles, %	2	2	2	2	2	2	2	2	2	2	2	2
Mvmt Flow	2	0	3	61	2	182	0	111	20	40	809	0

Major/Minor	Minor2		Minor1		Major1		Major2					
Conflicting Flow All	1102	1020	809	1012	1010	121	809	0	0	131	0	0
Stage 1	889	889	-	121	121	-	-	-	-	-	-	-
Stage 2	213	131	-	891	889	-	-	-	-	-	-	-
Critical Hdwy	7.12	6.52	6.22	7.12	6.52	6.22	4.12	-	-	4.12	-	-
Critical Hdwy Stg 1	6.12	5.52	-	6.12	5.52	-	-	-	-	-	-	-
Critical Hdwy Stg 2	6.12	5.52	-	6.12	5.52	-	-	-	-	-	-	-
Follow-up Hdwy	3.518	4.018	3.318	3.518	4.018	3.318	2.218	-	-	2.218	-	-
Pot Cap-1 Maneuver	189	237	380	218	240	930	817	-	-	1454	-	-
Stage 1	338	361	-	883	796	-	-	-	-	-	-	-
Stage 2	789	788	-	337	361	-	-	-	-	-	-	-
Platoon blocked, %	-	-	-	-	-	-	-	-	-	-	-	-
Mov Cap-1 Maneuver	145	225	380	208	228	930	817	-	-	1454	-	-
Mov Cap-2 Maneuver	145	225	-	208	228	-	-	-	-	-	-	-
Stage 1	338	343	-	883	796	-	-	-	-	-	-	-
Stage 2	633	788	-	317	343	-	-	-	-	-	-	-

Approach	EB		WB		NB		SB	
HCM Control Delay, s	21		19.3		0		0.4	
HCM LOS	C		C					

Minor Lane/Major Mvmt	NBL	NBT	NBR	EBLn1	WBLn1	SBL	SBT	SBR
Capacity (veh/h)	817	-	-	231	492	1454	-	-
HCM Lane V/C Ratio	-	-	-	0.024	0.497	0.028	-	-
HCM Control Delay (s)	0	-	-	21	19.3	7.5	0	-
HCM Lane LOS	A	-	-	C	C	A	A	-
HCM 95th %tile Q(veh)	0	-	-	0.1	2.7	0.1	-	-

HCM 6th TWSC
4: Murr Road & Jones Road

Total Traffic Conditions
AM Peak Hour - Year 2043

Intersection												
Int Delay, s/veh	2.6											
Movement	EBL	EBT	EBR	WBL	WBT	WBR	NBL	NBT	NBR	SBL	SBT	SBR
Lane Configurations	↕			↕			↕			↕		
Traffic Vol, veh/h	11	31	0	0	83	25	11	9	2	11	2	8
Future Vol, veh/h	11	31	0	0	83	25	11	9	2	11	2	8
Conflicting Peds, #/hr	0	0	0	0	0	0	0	0	0	0	0	0
Sign Control	Free	Free	Free	Free	Free	Free	Stop	Stop	Stop	Stop	Stop	Stop
RT Channelized	-	-	None	-	-	None	-	-	None	-	-	None
Storage Length	-	-	-	-	-	-	-	-	-	-	-	-
Veh in Median Storage, #	-	0	-	-	0	-	-	0	-	-	0	-
Grade, %	-	0	-	-	0	-	-	0	-	-	0	-
Peak Hour Factor	92	92	92	92	92	92	92	92	92	92	92	92
Heavy Vehicles, %	2	2	2	2	2	2	2	2	2	2	2	2
Mvmt Flow	12	34	0	0	90	27	12	10	2	12	2	9

Major/Minor	Major1			Major2			Minor1			Minor2		
Conflicting Flow All	117	0	0	34	0	0	167	175	34	168	162	104
Stage 1	-	-	-	-	-	-	58	58	-	104	104	-
Stage 2	-	-	-	-	-	-	109	117	-	64	58	-
Critical Hdwy	4.12	-	-	4.12	-	-	7.12	6.52	6.22	7.12	6.52	6.22
Critical Hdwy Stg 1	-	-	-	-	-	-	6.12	5.52	-	6.12	5.52	-
Critical Hdwy Stg 2	-	-	-	-	-	-	6.12	5.52	-	6.12	5.52	-
Follow-up Hdwy	2.218	-	-	2.218	-	-	3.518	4.018	3.318	3.518	4.018	3.318
Pot Cap-1 Maneuver	1471	-	-	1578	-	-	797	718	1039	796	730	951
Stage 1	-	-	-	-	-	-	954	847	-	902	809	-
Stage 2	-	-	-	-	-	-	896	799	-	947	847	-
Platoon blocked, %	-	-	-	-	-	-	-	-	-	-	-	-
Mov Cap-1 Maneuver	1471	-	-	1578	-	-	783	712	1039	781	724	951
Mov Cap-2 Maneuver	-	-	-	-	-	-	783	712	-	781	724	-
Stage 1	-	-	-	-	-	-	946	840	-	895	809	-
Stage 2	-	-	-	-	-	-	885	799	-	927	840	-

Approach	EB			WB			NB			SB		
HCM Control Delay, s	2			0			9.8			9.5		
HCM LOS							A			A		

Minor Lane/Major Mvmt	NBLn1	EBL	EBT	EBR	WBL	WBT	WBR	SBLn1
Capacity (veh/h)	769	1471	-	-	1578	-	-	831
HCM Lane V/C Ratio	0.031	0.008	-	-	-	-	-	0.027
HCM Control Delay (s)	9.8	7.5	0	-	0	-	-	9.5
HCM Lane LOS	A	A	A	-	A	-	-	A
HCM 95th %tile Q(veh)	0.1	0	-	-	0	-	-	0.1

HCM 6th TWSC
5: Peyton Highway & Jones Road

Total Traffic Conditions
AM Peak Hour - Year 2043

Intersection												
Int Delay, s/veh	3.7											
Movement	EBL	EBT	EBR	WBL	WBT	WBR	NBL	NBT	NBR	SBL	SBT	SBR
Lane Configurations	↕			↕			↕			↕		
Traffic Vol, veh/h	9	9	31	17	10	8	14	66	29	0	42	8
Future Vol, veh/h	9	9	31	17	10	8	14	66	29	0	42	8
Conflicting Peds, #/hr	0	0	0	0	0	0	0	0	0	0	0	0
Sign Control	Stop	Stop	Stop	Stop	Stop	Stop	Free	Free	Free	Free	Free	Free
RT Channelized	-	-	None	-	-	None	-	-	None	-	-	None
Storage Length	-	-	-	-	-	-	-	-	-	-	-	-
Veh in Median Storage, #	-	0	-	-	0	-	-	0	-	-	0	-
Grade, %	-	0	-	-	0	-	-	0	-	-	0	-
Peak Hour Factor	92	92	92	92	92	92	92	92	92	92	92	92
Heavy Vehicles, %	2	2	2	2	2	2	2	2	2	2	2	2
Mvmt Flow	10	10	34	18	11	9	15	72	32	0	46	9

Major/Minor	Minor2		Minor1		Major1			Major2				
Conflicting Flow All	179	185	51	191	173	88	55	0	0	104	0	0
Stage 1	51	51	-	118	118	-	-	-	-	-	-	-
Stage 2	128	134	-	73	55	-	-	-	-	-	-	-
Critical Hdwy	7.12	6.52	6.22	7.12	6.52	6.22	4.12	-	-	4.12	-	-
Critical Hdwy Stg 1	6.12	5.52	-	6.12	5.52	-	-	-	-	-	-	-
Critical Hdwy Stg 2	6.12	5.52	-	6.12	5.52	-	-	-	-	-	-	-
Follow-up Hdwy	3.518	4.018	3.318	3.518	4.018	3.318	2.218	-	-	2.218	-	-
Pot Cap-1 Maneuver	783	709	1017	769	720	970	1550	-	-	1488	-	-
Stage 1	962	852	-	887	798	-	-	-	-	-	-	-
Stage 2	876	785	-	937	849	-	-	-	-	-	-	-
Platoon blocked, %	-	-	-	-	-	-	-	-	-	-	-	-
Mov Cap-1 Maneuver	761	702	1017	730	713	970	1550	-	-	1488	-	-
Mov Cap-2 Maneuver	761	702	-	730	713	-	-	-	-	-	-	-
Stage 1	952	852	-	878	790	-	-	-	-	-	-	-
Stage 2	848	777	-	896	849	-	-	-	-	-	-	-

Approach	EB		WB		NB		SB	
HCM Control Delay, s	9.3		9.9		0.9		0	
HCM LOS	A		A					

Minor Lane/Major Mvmt	NBL	NBT	NBR	EBLn1	WBLn1	SBL	SBT	SBR
Capacity (veh/h)	1550	-	-	889	768	1488	-	-
HCM Lane V/C Ratio	0.01	-	-	0.06	0.05	-	-	-
HCM Control Delay (s)	7.3	0	-	9.3	9.9	0	-	-
HCM Lane LOS	A	A	-	A	A	A	-	-
HCM 95th %tile Q(veh)	0	-	-	0.2	0.2	0	-	-

HCM 6th TWSC
6: Peyton Highway & State Highway 94

Total Traffic Conditions
AM Peak Hour - Year 2043

Intersection												
Int Delay, s/veh	3.6											
Movement	EBL	EBT	EBR	WBL	WBT	WBR	NBL	NBT	NBR	SBL	SBT	SBR
Lane Configurations	↖	↗		↖	↗			↕			↕	
Traffic Vol, veh/h	26	140	5	14	414	64	32	14	8	39	15	35
Future Vol, veh/h	26	140	5	14	414	64	32	14	8	39	15	35
Conflicting Peds, #/hr	0	0	0	0	0	0	0	0	0	0	0	0
Sign Control	Free	Free	Free	Free	Free	Free	Stop	Stop	Stop	Stop	Stop	Stop
RT Channelized	-	-	None	-	-	None	-	-	None	-	-	None
Storage Length	515	-	-	525	-	-	-	-	-	-	-	-
Veh in Median Storage, #	-	0	-	-	0	-	-	0	-	-	0	-
Grade, %	-	0	-	-	0	-	-	0	-	-	0	-
Peak Hour Factor	92	92	92	92	92	92	92	92	92	92	92	92
Heavy Vehicles, %	2	2	2	2	2	2	2	2	2	2	2	2
Mvmt Flow	28	152	5	15	450	70	35	15	9	42	16	38

Major/Minor	Major1		Major2		Minor1			Minor2				
Conflicting Flow All	520	0	0	157	0	0	753	761	155	738	728	485
Stage 1	-	-	-	-	-	-	211	211	-	515	515	-
Stage 2	-	-	-	-	-	-	542	550	-	223	213	-
Critical Hdwy	4.12	-	-	4.12	-	-	7.12	6.52	6.22	7.12	6.52	6.22
Critical Hdwy Stg 1	-	-	-	-	-	-	6.12	5.52	-	6.12	5.52	-
Critical Hdwy Stg 2	-	-	-	-	-	-	6.12	5.52	-	6.12	5.52	-
Follow-up Hdwy	2.218	-	-	2.218	-	-	3.518	4.018	3.318	3.518	4.018	3.318
Pot Cap-1 Maneuver	1046	-	-	1423	-	-	326	335	891	334	350	582
Stage 1	-	-	-	-	-	-	791	728	-	543	535	-
Stage 2	-	-	-	-	-	-	525	516	-	780	726	-
Platoon blocked, %	-	-	-	-	-	-	-	-	-	-	-	-
Mov Cap-1 Maneuver	1046	-	-	1423	-	-	285	322	891	310	337	582
Mov Cap-2 Maneuver	-	-	-	-	-	-	285	322	-	310	337	-
Stage 1	-	-	-	-	-	-	770	708	-	528	529	-
Stage 2	-	-	-	-	-	-	471	510	-	736	706	-

Approach	EB		WB		NB		SB	
HCM Control Delay, s	1.3		0.2		18.4		17.4	
HCM LOS					C		C	

Minor Lane/Major Mvmt	NBLn1	EBL	EBT	EBR	WBL	WBT	WBR	SBLn1
Capacity (veh/h)	328	1046	-	-	1423	-	-	386
HCM Lane V/C Ratio	0.179	0.027	-	-	0.011	-	-	0.251
HCM Control Delay (s)	18.4	8.5	-	-	7.6	-	-	17.4
HCM Lane LOS	C	A	-	-	A	-	-	C
HCM 95th %tile Q(veh)	0.6	0.1	-	-	0	-	-	1

HCM 6th TWSC
7: Jones Road & Access A

Total Traffic Conditions
AM Peak Hour - Year 2043

Intersection						
Int Delay, s/veh	5.9					
Movement	EBL	EBT	WBT	WBR	SBL	SBR
Lane Configurations		↕	↕		↕	
Traffic Vol, veh/h	25	19	31	5	13	77
Future Vol, veh/h	25	19	31	5	13	77
Conflicting Peds, #/hr	0	0	0	0	0	0
Sign Control	Free	Free	Free	Free	Stop	Stop
RT Channelized	-	None	-	None	-	None
Storage Length	-	-	-	-	0	-
Veh in Median Storage, #	-	0	0	-	0	-
Grade, %	-	0	0	-	0	-
Peak Hour Factor	92	92	92	92	92	92
Heavy Vehicles, %	2	2	2	2	2	2
Mvmt Flow	27	21	34	5	14	84

Major/Minor	Major1	Major2	Minor2		
Conflicting Flow All	39	0	-	0	112 37
Stage 1	-	-	-	-	37 -
Stage 2	-	-	-	-	75 -
Critical Hdwy	4.12	-	-	-	6.42 6.22
Critical Hdwy Stg 1	-	-	-	-	5.42 -
Critical Hdwy Stg 2	-	-	-	-	5.42 -
Follow-up Hdwy	2.218	-	-	-	3.518 3.318
Pot Cap-1 Maneuver	1571	-	-	-	885 1035
Stage 1	-	-	-	-	985 -
Stage 2	-	-	-	-	948 -
Platoon blocked, %		-	-	-	
Mov Cap-1 Maneuver	1571	-	-	-	870 1035
Mov Cap-2 Maneuver	-	-	-	-	870 -
Stage 1	-	-	-	-	968 -
Stage 2	-	-	-	-	948 -

Approach	EB	WB	SB
HCM Control Delay, s	4.2	0	9
HCM LOS			A

Minor Lane/Major Mvmt	EBL	EBT	WBT	WBR	SBLn1
Capacity (veh/h)	1571	-	-	-	1007
HCM Lane V/C Ratio	0.017	-	-	-	0.097
HCM Control Delay (s)	7.3	0	-	-	9
HCM Lane LOS	A	A	-	-	A
HCM 95th %tile Q(veh)	0.1	-	-	-	0.3

HCM 6th TWSC
8: Jones Road & Access B

Total Traffic Conditions
AM Peak Hour - Year 2043

Intersection						
Int Delay, s/veh	3.6					
Movement	EBL	EBT	WBT	WBR	SBL	SBR
Lane Configurations		↕	↕		↕	
Traffic Vol, veh/h	4	28	23	9	25	13
Future Vol, veh/h	4	28	23	9	25	13
Conflicting Peds, #/hr	0	0	0	0	0	0
Sign Control	Free	Free	Free	Free	Stop	Stop
RT Channelized	-	None	-	None	-	None
Storage Length	-	-	-	-	0	-
Veh in Median Storage, #	-	0	0	-	0	-
Grade, %	-	0	0	-	0	-
Peak Hour Factor	92	92	92	92	92	92
Heavy Vehicles, %	2	2	2	2	2	2
Mvmt Flow	4	30	25	10	27	14

Major/Minor	Major1	Major2	Minor2		
Conflicting Flow All	35	0	-	0	68 30
Stage 1	-	-	-	-	30 -
Stage 2	-	-	-	-	38 -
Critical Hdwy	4.12	-	-	-	6.42 6.22
Critical Hdwy Stg 1	-	-	-	-	5.42 -
Critical Hdwy Stg 2	-	-	-	-	5.42 -
Follow-up Hdwy	2.218	-	-	-	3.518 3.318
Pot Cap-1 Maneuver	1576	-	-	-	937 1044
Stage 1	-	-	-	-	993 -
Stage 2	-	-	-	-	984 -
Platoon blocked, %		-	-	-	
Mov Cap-1 Maneuver	1576	-	-	-	934 1044
Mov Cap-2 Maneuver	-	-	-	-	934 -
Stage 1	-	-	-	-	990 -
Stage 2	-	-	-	-	984 -

Approach	EB	WB	SB
HCM Control Delay, s	0.9	0	8.9
HCM LOS			A

Minor Lane/Major Mvmt	EBL	EBT	WBT	WBR	SBLn1
Capacity (veh/h)	1576	-	-	-	969
HCM Lane V/C Ratio	0.003	-	-	-	0.043
HCM Control Delay (s)	7.3	0	-	-	8.9
HCM Lane LOS	A	A	-	-	A
HCM 95th %tile Q(veh)	0	-	-	-	0.1

HCM 6th TWSC
1: Murr Road & Falcon Highway

Total Traffic Conditions
PM Peak Hour - Year 2043

Intersection						
Int Delay, s/veh	0.8					
Movement	EBT	EBR	WBL	WBT	NBL	NBR
Lane Configurations	↔			↔		↔
Traffic Vol, veh/h	210	66	2	107	26	3
Future Vol, veh/h	210	66	2	107	26	3
Conflicting Peds, #/hr	0	0	0	0	0	0
Sign Control	Free	Free	Free	Free	Stop	Stop
RT Channelized	-	None	-	None	-	None
Storage Length	-	-	-	-	0	-
Veh in Median Storage, #	0	-	-	0	0	-
Grade, %	0	-	-	0	0	-
Peak Hour Factor	92	92	92	92	92	92
Heavy Vehicles, %	2	2	2	2	2	2
Mvmt Flow	228	72	2	116	28	3

Major/Minor	Major1	Major2	Minor1		
Conflicting Flow All	0	0	300	0	384
Stage 1	-	-	-	-	264
Stage 2	-	-	-	-	120
Critical Hdwy	-	-	4.12	-	6.42
Critical Hdwy Stg 1	-	-	-	-	5.42
Critical Hdwy Stg 2	-	-	-	-	5.42
Follow-up Hdwy	-	-	2.218	-	3.518
Pot Cap-1 Maneuver	-	-	1261	-	619
Stage 1	-	-	-	-	780
Stage 2	-	-	-	-	905
Platoon blocked, %	-	-	-	-	-
Mov Cap-1 Maneuver	-	-	1261	-	618
Mov Cap-2 Maneuver	-	-	-	-	618
Stage 1	-	-	-	-	780
Stage 2	-	-	-	-	903

Approach	EB	WB	NB
HCM Control Delay, s	0	0.1	11
HCM LOS			B

Minor Lane/Major Mvmt	NBLn1	EBT	EBR	WBL	WBT
Capacity (veh/h)	631	-	-	1261	-
HCM Lane V/C Ratio	0.05	-	-	0.002	-
HCM Control Delay (s)	11	-	-	7.9	0
HCM Lane LOS	B	-	-	A	A
HCM 95th %tile Q(veh)	0.2	-	-	0	-

HCM 6th TWSC
2: Peyton Highway & Falcon Highway

Total Traffic Conditions
PM Peak Hour - Year 2043

Intersection						
Int Delay, s/veh	2.4					
Movement	EBT	EBR	WBL	WBT	NBL	NBR
Lane Configurations	↔		↔		↔	
Traffic Vol, veh/h	141	101	16	72	60	18
Future Vol, veh/h	141	101	16	72	60	18
Conflicting Peds, #/hr	0	0	0	0	0	0
Sign Control	Free	Free	Free	Free	Stop	Stop
RT Channelized	-	None	-	None	-	None
Storage Length	-	-	-	-	0	-
Veh in Median Storage, #	0	-	-	0	0	-
Grade, %	0	-	-	0	0	-
Peak Hour Factor	92	92	92	92	92	92
Heavy Vehicles, %	2	2	2	2	2	2
Mvmt Flow	153	110	17	78	65	20

Major/Minor	Major1	Major2	Minor1	Minor2	Minor3
Conflicting Flow All	0	0	263	0	320
Stage 1	-	-	-	-	208
Stage 2	-	-	-	-	112
Critical Hdwy	-	-	4.12	-	6.42
Critical Hdwy Stg 1	-	-	-	-	5.42
Critical Hdwy Stg 2	-	-	-	-	5.42
Follow-up Hdwy	-	-	2.218	-	3.518
Pot Cap-1 Maneuver	-	-	1301	-	673
Stage 1	-	-	-	-	827
Stage 2	-	-	-	-	913
Platoon blocked, %	-	-	-	-	-
Mov Cap-1 Maneuver	-	-	1301	-	664
Mov Cap-2 Maneuver	-	-	-	-	664
Stage 1	-	-	-	-	827
Stage 2	-	-	-	-	900

Approach	EB	WB	NB
HCM Control Delay, s	0	1.4	10.9
HCM LOS	B		

Minor Lane/Major Mvmt	NBLn1	EBT	EBR	WBL	WBT
Capacity (veh/h)	696	-	-	1301	-
HCM Lane V/C Ratio	0.122	-	-	0.013	-
HCM Control Delay (s)	10.9	-	-	7.8	0
HCM Lane LOS	B	-	-	A	A
HCM 95th %tile Q(veh)	0.4	-	-	0	-

HCM 6th TWSC
3: Curtis Road & Jones Road

Total Traffic Conditions
PM Peak Hour - Year 2043

Intersection												
Int Delay, s/veh	7.3											
Movement	EBL	EBT	EBR	WBL	WBT	WBR	NBL	NBT	NBR	SBL	SBT	SBR
Lane Configurations	↕			↕			↕			↕		
Traffic Vol, veh/h	2	2	5	41	2	98	0	636	70	182	117	6
Future Vol, veh/h	2	2	5	41	2	98	0	636	70	182	117	6
Conflicting Peds, #/hr	0	0	0	0	0	0	0	0	0	0	0	0
Sign Control	Stop	Stop	Stop	Stop	Stop	Stop	Free	Free	Free	Free	Free	Free
RT Channelized	-	-	None	-	-	None	-	-	None	-	-	None
Storage Length	-	-	-	-	-	-	-	-	-	-	-	-
Veh in Median Storage, #	-	0	-	-	0	-	-	0	-	-	0	-
Grade, %	-	0	-	-	0	-	-	0	-	-	0	-
Peak Hour Factor	92	92	92	92	92	92	92	92	92	92	92	92
Heavy Vehicles, %	2	2	2	2	2	2	2	2	2	2	2	2
Mvmt Flow	2	2	5	45	2	107	0	691	76	198	127	7

Major/Minor	Minor2		Minor1		Major1			Major2				
Conflicting Flow All	1311	1294	131	1259	1259	729	134	0	0	767	0	0
Stage 1	527	527	-	729	729	-	-	-	-	-	-	-
Stage 2	784	767	-	530	530	-	-	-	-	-	-	-
Critical Hdwy	7.12	6.52	6.22	7.12	6.52	6.22	4.12	-	-	4.12	-	-
Critical Hdwy Stg 1	6.12	5.52	-	6.12	5.52	-	-	-	-	-	-	-
Critical Hdwy Stg 2	6.12	5.52	-	6.12	5.52	-	-	-	-	-	-	-
Follow-up Hdwy	3.518	4.018	3.318	3.518	4.018	3.318	2.218	-	-	2.218	-	-
Pot Cap-1 Maneuver	136	163	919	147	171	423	1451	-	-	847	-	-
Stage 1	535	528	-	414	428	-	-	-	-	-	-	-
Stage 2	386	411	-	533	527	-	-	-	-	-	-	-
Platoon blocked, %	-	-	-	-	-	-	-	-	-	-	-	-
Mov Cap-1 Maneuver	81	122	919	116	128	423	1451	-	-	847	-	-
Mov Cap-2 Maneuver	81	122	-	116	128	-	-	-	-	-	-	-
Stage 1	535	394	-	414	428	-	-	-	-	-	-	-
Stage 2	287	411	-	394	394	-	-	-	-	-	-	-

Approach	EB		WB		NB		SB	
HCM Control Delay, s	24.6		45.1		0		6.3	
HCM LOS	C		E					

Minor Lane/Major Mvmt	NBL	NBT	NBR	EBLn1	WBLn1	SBL	SBT	SBR
Capacity (veh/h)	1451	-	-	193	235	847	-	-
HCM Lane V/C Ratio	-	-	-	0.051	0.652	0.234	-	-
HCM Control Delay (s)	0	-	-	24.6	45.1	10.5	0	-
HCM Lane LOS	A	-	-	C	E	B	A	-
HCM 95th %tile Q(veh)	0	-	-	0.2	4	0.9	-	-

HCM 6th TWSC
4: Murr Road & Jones Road

Total Traffic Conditions
PM Peak Hour - Year 2043

Intersection												
Int Delay, s/veh	2.6											
Movement	EBL	EBT	EBR	WBL	WBT	WBR	NBL	NBT	NBR	SBL	SBT	SBR
Lane Configurations	↕			↕			↕			↕		
Traffic Vol, veh/h	11	88	8	0	55	15	3	2	0	27	12	5
Future Vol, veh/h	11	88	8	0	55	15	3	2	0	27	12	5
Conflicting Peds, #/hr	0	0	0	0	0	0	0	0	0	0	0	0
Sign Control	Free	Free	Free	Free	Free	Free	Stop	Stop	Stop	Stop	Stop	Stop
RT Channelized	-	-	None	-	-	None	-	-	None	-	-	None
Storage Length	-	-	-	-	-	-	-	-	-	-	-	-
Veh in Median Storage, #	-	0	-	-	0	-	-	0	-	-	0	-
Grade, %	-	0	-	-	0	-	-	0	-	-	0	-
Peak Hour Factor	92	92	92	92	92	92	92	92	92	92	92	92
Heavy Vehicles, %	2	2	2	2	2	2	2	2	2	2	2	2
Mvmt Flow	12	96	9	0	60	16	3	2	0	29	13	5

Major/Minor	Major1		Major2		Minor1			Minor2				
Conflicting Flow All	76	0	0	105	0	0	202	201	101	194	197	68
Stage 1	-	-	-	-	-	-	125	125	-	68	68	-
Stage 2	-	-	-	-	-	-	77	76	-	126	129	-
Critical Hdwy	4.12	-	-	4.12	-	-	7.12	6.52	6.22	7.12	6.52	6.22
Critical Hdwy Stg 1	-	-	-	-	-	-	6.12	5.52	-	6.12	5.52	-
Critical Hdwy Stg 2	-	-	-	-	-	-	6.12	5.52	-	6.12	5.52	-
Follow-up Hdwy	2.218	-	-	2.218	-	-	3.518	4.018	3.318	3.518	4.018	3.318
Pot Cap-1 Maneuver	1523	-	-	1486	-	-	756	695	954	765	699	995
Stage 1	-	-	-	-	-	-	879	792	-	942	838	-
Stage 2	-	-	-	-	-	-	932	832	-	878	789	-
Platoon blocked, %	-	-	-	-	-	-	-	-	-	-	-	-
Mov Cap-1 Maneuver	1523	-	-	1486	-	-	736	689	954	759	693	995
Mov Cap-2 Maneuver	-	-	-	-	-	-	736	689	-	759	693	-
Stage 1	-	-	-	-	-	-	872	786	-	934	838	-
Stage 2	-	-	-	-	-	-	912	832	-	869	783	-

Approach	EB	WB	NB	SB
HCM Control Delay, s	0.8	0	10.1	10.1
HCM LOS			B	B

Minor Lane/Major Mvmt	NBLn1	EBL	EBT	EBR	WBL	WBT	WBR	SBLn1
Capacity (veh/h)	716	1523	-	-	1486	-	-	760
HCM Lane V/C Ratio	0.008	0.008	-	-	-	-	-	0.063
HCM Control Delay (s)	10.1	7.4	0	-	0	-	-	10.1
HCM Lane LOS	B	A	A	-	A	-	-	B
HCM 95th %tile Q(veh)	0	0	-	-	0	-	-	0.2

HCM 6th TWSC
5: Peyton Highway & Jones Road

Total Traffic Conditions
PM Peak Hour - Year 2043

Intersection												
Int Delay, s/veh	3.6											
Movement	EBL	EBT	EBR	WBL	WBT	WBR	NBL	NBT	NBR	SBL	SBT	SBR
Lane Configurations	↕			↕			↕			↕		
Traffic Vol, veh/h	6	12	24	8	13	5	31	47	15	11	98	9
Future Vol, veh/h	6	12	24	8	13	5	31	47	15	11	98	9
Conflicting Peds, #/hr	0	0	0	0	0	0	0	0	0	0	0	0
Sign Control	Stop	Stop	Stop	Stop	Stop	Stop	Free	Free	Free	Free	Free	Free
RT Channelized	-	-	None	-	-	None	-	-	None	-	-	None
Storage Length	-	-	-	-	-	-	-	-	-	-	-	-
Veh in Median Storage, #	-	0	-	-	0	-	-	0	-	-	0	-
Grade, %	-	0	-	-	0	-	-	0	-	-	0	-
Peak Hour Factor	92	92	92	92	92	92	92	92	92	92	92	92
Heavy Vehicles, %	2	2	2	2	2	2	2	2	2	2	2	2
Mvmt Flow	7	13	26	9	14	5	34	51	16	12	107	10

Major/Minor	Minor2		Minor1		Major1		Major2					
Conflicting Flow All	273	271	112	283	268	59	117	0	0	67	0	0
Stage 1	136	136	-	127	127	-	-	-	-	-	-	-
Stage 2	137	135	-	156	141	-	-	-	-	-	-	-
Critical Hdwy	7.12	6.52	6.22	7.12	6.52	6.22	4.12	-	-	4.12	-	-
Critical Hdwy Stg 1	6.12	5.52	-	6.12	5.52	-	-	-	-	-	-	-
Critical Hdwy Stg 2	6.12	5.52	-	6.12	5.52	-	-	-	-	-	-	-
Follow-up Hdwy	3.518	4.018	3.318	3.518	4.018	3.318	2.218	-	-	2.218	-	-
Pot Cap-1 Maneuver	679	636	941	669	638	1007	1471	-	-	1535	-	-
Stage 1	867	784	-	877	791	-	-	-	-	-	-	-
Stage 2	866	785	-	846	780	-	-	-	-	-	-	-
Platoon blocked, %	-	-	-	-	-	-	-	-	-	-	-	-
Mov Cap-1 Maneuver	648	616	941	624	618	1007	1471	-	-	1535	-	-
Mov Cap-2 Maneuver	648	616	-	624	618	-	-	-	-	-	-	-
Stage 1	846	778	-	856	772	-	-	-	-	-	-	-
Stage 2	825	766	-	802	774	-	-	-	-	-	-	-

Approach	EB		WB		NB		SB	
HCM Control Delay, s	9.9		10.6		2.5		0.7	
HCM LOS	A		B					

Minor Lane/Major Mvmt	NBL	NBT	NBR	EBLn1WBLn1	SBL	SBT	SBR
Capacity (veh/h)	1471	-	-	774	670	1535	-
HCM Lane V/C Ratio	0.023	-	-	0.059	0.042	0.008	-
HCM Control Delay (s)	7.5	0	-	9.9	10.6	7.4	0
HCM Lane LOS	A	A	-	A	B	A	A
HCM 95th %tile Q(veh)	0.1	-	-	0.2	0.1	0	-

HCM 6th TWSC
6: Peyton Highway & State Highway 94

Total Traffic Conditions
PM Peak Hour - Year 2043

Intersection												
Int Delay, s/veh	5.8											
Movement	EBL	EBT	EBR	WBL	WBT	WBR	NBL	NBT	NBR	SBL	SBT	SBR
Lane Configurations	↖	↗		↖	↗			↕			↕	
Traffic Vol, veh/h	33	450	30	11	164	51	21	25	20	85	32	3
Future Vol, veh/h	33	450	30	11	164	51	21	25	20	85	32	3
Conflicting Peds, #/hr	0	0	0	0	0	0	0	0	0	0	0	0
Sign Control	Free	Free	Free	Free	Free	Free	Stop	Stop	Stop	Stop	Stop	Stop
RT Channelized	-	-	None	-	-	None	-	-	None	-	-	None
Storage Length	515	-	-	525	-	-	-	-	-	-	-	-
Veh in Median Storage, #	-	0	-	-	0	-	-	0	-	-	0	-
Grade, %	-	0	-	-	0	-	-	0	-	-	0	-
Peak Hour Factor	92	92	92	92	92	92	92	92	92	92	92	92
Heavy Vehicles, %	2	2	2	2	2	2	2	2	2	2	2	2
Mvmt Flow	36	489	33	12	178	55	23	27	22	92	35	3

Major/Minor	Major1			Major2			Minor1			Minor2		
Conflicting Flow All	233	0	0	522	0	0	827	835	506	832	824	206
Stage 1	-	-	-	-	-	-	578	578	-	230	230	-
Stage 2	-	-	-	-	-	-	249	257	-	602	594	-
Critical Hdwy	4.12	-	-	4.12	-	-	7.12	6.52	6.22	7.12	6.52	6.22
Critical Hdwy Stg 1	-	-	-	-	-	-	6.12	5.52	-	6.12	5.52	-
Critical Hdwy Stg 2	-	-	-	-	-	-	6.12	5.52	-	6.12	5.52	-
Follow-up Hdwy	2.218	-	-	2.218	-	-	3.518	4.018	3.318	3.518	4.018	3.318
Pot Cap-1 Maneuver	1335	-	-	1044	-	-	291	304	566	288	308	835
Stage 1	-	-	-	-	-	-	501	501	-	773	714	-
Stage 2	-	-	-	-	-	-	755	695	-	486	493	-
Platoon blocked, %	-	-	-	-	-	-	-	-	-	-	-	-
Mov Cap-1 Maneuver	1335	-	-	1044	-	-	256	292	566	250	296	835
Mov Cap-2 Maneuver	-	-	-	-	-	-	256	292	-	250	296	-
Stage 1	-	-	-	-	-	-	487	487	-	752	706	-
Stage 2	-	-	-	-	-	-	707	687	-	429	480	-

Approach	EB			WB			NB			SB		
HCM Control Delay, s	0.5			0.4			19.2			30.9		
HCM LOS							C			D		

Minor Lane/Major Mvmt	NBLn1	EBL	EBT	EBR	WBL	WBT	WBR	SBLn1
Capacity (veh/h)	325	1335	-	-	1044	-	-	266
HCM Lane V/C Ratio	0.221	0.027	-	-	0.011	-	-	0.49
HCM Control Delay (s)	19.2	7.8	-	-	8.5	-	-	30.9
HCM Lane LOS	C	A	-	-	A	-	-	D
HCM 95th %tile Q(veh)	0.8	0.1	-	-	0	-	-	2.5

HCM 6th TWSC
7: Jones Road & Access A

Total Traffic Conditions
PM Peak Hour - Year 2043

Intersection						
Int Delay, s/veh	5.7					
Movement	EBL	EBT	WBT	WBR	SBL	SBR
Lane Configurations		↕	↕		↕	
Traffic Vol, veh/h	87	28	18	14	9	51
Future Vol, veh/h	87	28	18	14	9	51
Conflicting Peds, #/hr	0	0	0	0	0	0
Sign Control	Free	Free	Free	Free	Stop	Stop
RT Channelized	-	None	-	None	-	None
Storage Length	-	-	-	-	0	-
Veh in Median Storage, #	-	0	0	-	0	-
Grade, %	-	0	0	-	0	-
Peak Hour Factor	92	92	92	92	92	92
Heavy Vehicles, %	2	2	2	2	2	2
Mvmt Flow	95	30	20	15	10	55

Major/Minor	Major1	Major2	Minor2		
Conflicting Flow All	35	0	-	0	248 28
Stage 1	-	-	-	-	28 -
Stage 2	-	-	-	-	220 -
Critical Hdwy	4.12	-	-	-	6.42 6.22
Critical Hdwy Stg 1	-	-	-	-	5.42 -
Critical Hdwy Stg 2	-	-	-	-	5.42 -
Follow-up Hdwy	2.218	-	-	-	3.518 3.318
Pot Cap-1 Maneuver	1576	-	-	-	740 1047
Stage 1	-	-	-	-	995 -
Stage 2	-	-	-	-	817 -
Platoon blocked, %		-	-	-	
Mov Cap-1 Maneuver	1576	-	-	-	695 1047
Mov Cap-2 Maneuver	-	-	-	-	695 -
Stage 1	-	-	-	-	934 -
Stage 2	-	-	-	-	817 -

Approach	EB	WB	SB
HCM Control Delay, s	5.6	0	9
HCM LOS			A

Minor Lane/Major Mvmt	EBL	EBT	WBT	WBR	SBLn1
Capacity (veh/h)	1576	-	-	-	973
HCM Lane V/C Ratio	0.06	-	-	-	0.067
HCM Control Delay (s)	7.4	0	-	-	9
HCM Lane LOS	A	A	-	-	A
HCM 95th %tile Q(veh)	0.2	-	-	-	0.2

HCM 6th TWSC
8: Jones Road & Access B

Total Traffic Conditions
PM Peak Hour - Year 2043

Intersection						
Int Delay, s/veh	2.9					
Movement	EBL	EBT	WBT	WBR	SBL	SBR
Lane Configurations		↕	↕		↕	
Traffic Vol, veh/h	14	23	24	29	17	8
Future Vol, veh/h	14	23	24	29	17	8
Conflicting Peds, #/hr	0	0	0	0	0	0
Sign Control	Free	Free	Free	Free	Stop	Stop
RT Channelized	-	None	-	None	-	None
Storage Length	-	-	-	-	0	-
Veh in Median Storage, #	-	0	0	-	0	-
Grade, %	-	0	0	-	0	-
Peak Hour Factor	92	92	92	92	92	92
Heavy Vehicles, %	2	2	2	2	2	2
Mvmt Flow	15	25	26	32	18	9

Major/Minor	Major1	Major2	Minor2		
Conflicting Flow All	58	0	0	97	42
Stage 1	-	-	-	42	-
Stage 2	-	-	-	55	-
Critical Hdwy	4.12	-	-	6.42	6.22
Critical Hdwy Stg 1	-	-	-	5.42	-
Critical Hdwy Stg 2	-	-	-	5.42	-
Follow-up Hdwy	2.218	-	-	3.518	3.318
Pot Cap-1 Maneuver	1546	-	-	902	1029
Stage 1	-	-	-	980	-
Stage 2	-	-	-	968	-
Platoon blocked, %	-	-	-	-	-
Mov Cap-1 Maneuver	1546	-	-	893	1029
Mov Cap-2 Maneuver	-	-	-	893	-
Stage 1	-	-	-	970	-
Stage 2	-	-	-	968	-

Approach	EB	WB	SB
HCM Control Delay, s	2.8	0	9
HCM LOS			A

Minor Lane/Major Mvmt	EBL	EBT	WBT	WBR	SBLn1
Capacity (veh/h)	1546	-	-	-	932
HCM Lane V/C Ratio	0.01	-	-	-	0.029
HCM Control Delay (s)	7.4	0	-	-	9
HCM Lane LOS	A	A	-	-	A
HCM 95th %tile Q(veh)	0	-	-	-	0.1