



**ENTECH**  
ENGINEERING, INC.

505 ELKTON DRIVE  
COLORADO SPRINGS, CO 80907  
PHONE (719) 531-5599  
FAX (719) 531-5238

**PRELIMINARY SOIL, GEOLOGY, GEOLOGIC HAZARD,  
AND WASTEWATER STUDY,  
WINSOME SUBDIVISION  
PARCEL NO. 51000-00-493  
17480 MERIDIAN ROAD NORTH  
EL PASO COUNTY, COLORADO**

Prepared for

**Proterra Properties, LLC**  
1864 Woodmoor Drive, Suite 100  
Monument, Colorado 80132

Attn: Joe DesJardin

October 2, 2018  
Revised January 11, 2019

Respectfully Submitted,

ENTECH ENGINEERING, INC.

Logan L. Langford, P.G.  
Geologist

Kristen A. Andrew-Hoeser, P.G.  
Engineering Geologist

LLL/nc

Encl.

Entech Job No. 181459  
AAprojects/2018/181459 countysoil/geo/ww

Reviewed by:

Joseph C. Goode, Jr., P.E.  
President

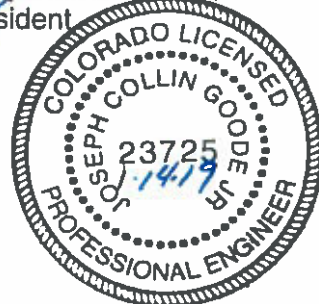

PCD Fil No. SP-18-006

**TABLE OF CONTENTS**

1.0 SUMMARY ..... 1  
2.0 GENERAL SITE CONDITIONS AND PROJECT DESCRIPTION ..... 2  
3.0 SCOPE OF THE REPORT ..... 2  
4.0 FIELD INVESTIGATION ..... 3  
5.0 SOIL, GEOLOGY AND ENGINEERING GEOLOGY ..... 3  
    5.1 General Geology ..... 3  
    5.2 Soil Conservation Survey ..... 4  
    5.3 Site Stratigraphy ..... 5  
    5.4 Soil Conditions ..... 6  
    5.5 Groundwater ..... 7  
6.0 ENGINEERING GEOLOGY – IDENTIFICATION AND MITIGATION OF GEOLOGIC HAZARDS ..... 8  
    6.1 Relevance of Geologic Conditions to Land Use Planning ..... 11  
7.0 ON-SITE DISPOSAL OF WASTEWATER ..... 13  
8.0 ECONOMIC MINERAL RESOURCES ..... 14  
9.0 EROSION CONTROL ..... 15  
10.0 CLOSURE ..... 16  
BIBLIOGRAPHY ..... 17

**TABLES**

- Table 1: Summary of Laboratory Test Results
- Table 2: Summary of Tactile Test Pits Results

**FIGURES**

- Figure 1: Vicinity Map
- Figure 2: USGS Map
- Figure 3: Site Plan/Testing Location Map
- Figure 4: Soil Survey Map
- Figure 5: Eastonville Quadrangle Geology Map
- Figure 6: Geology Map/Engineering Geology
- Figure 7: Floodplain Map
- Figure 8: Typical Perimeter Drain Details
- Figure 9: Septic Suitability Map

- APPENDIX A: Site Photographs
- APPENDIX B: Test Boring Logs and Test Pit Logs
- APPENDIX C: Laboratory Test Results
- APPENDIX D: Soil Survey Descriptions

## **1.0 SUMMARY**

### ***Project Location***

The project site lies in Section 24 and a portion of the S½ of Section 13, Township 11 South, Range 65 West of the 6<sup>th</sup> Principal Meridian, and a portion of the W½ of Section 19, Township 11 South, Range 64 West of the 6<sup>th</sup> Principal Meridian in El Paso County, Colorado. The site is located approximately 12 miles east of Monument, Colorado, northwest of Hodgen Road and Meridian Road North.

### ***Project Description***

Total acreage involved in the project is approximately 766 acres. The proposed site development consists of one-hundred and forty-three single-family rural residential lots and one commercial lot. The development will utilize individual wells and on-site wastewater treatment systems.

### ***Scope of Report***

This report presents the results of our geologic evaluation, treatment of engineering geologic hazard study and wastewater study for individual on-site wastewater treatment systems.

### ***Land Use and Engineering Geology***

This site was found to be suitable for the proposed development. Areas were encountered where the geologic conditions will impose some constraints on development and land use. These include areas of artificial fill, potentially expansive soils, potentially unstable slopes, downslope creep areas, floodplain, potentially seasonal shallow groundwater, and seasonal shallow groundwater areas. Based on the proposed development plan, it appears that these areas will have some impact on the development. These conditions will be discussed in greater detail in the report.

In general, it is our opinion that the development can be achieved if the observed geologic conditions on site are either avoided or properly mitigated. All recommendations are subject to the limitations discussed in the report.

## **2.0 GENERAL SITE CONDITIONS AND PROJECT DESCRIPTION**

The site is located in Section 24 and a portion of the S½ of Section 13, Township 11 South, Range 65 West of the 6<sup>th</sup> Principal Meridian, and a portion of the W½ of Section 19, Township 11 South, Range 64 West of the 6<sup>th</sup> Principal Meridian in El Paso County, Colorado. The site is located approximately 12 miles east of Monument, Colorado, northwest of Hodgen Road and Meridian Road North. The location of the site is as shown on the Vicinity Map, Figure 1.

The topography of the site consists of rolling hills that vary from gradually to moderately sloping generally to the southeast and northwest. West Kiowa Creek bisects the site. Steep slopes are located along some of the drainages on the site. The drainages on site flow in a northeasterly direction through the central portion of the site. Water was observed in West Kiowa Creek at the time of this investigation. The site boundaries are indicated on the USGS Map, Figure 2. Previous land uses have included grazing and pasture land. The site contains primarily field grasses and weeds. Site photographs, taken September 12 and 15, 2018, are included in Appendix A.

Total acreage involved in the proposed development is approximately 766 acres. One hundred and forty-three single-family rural residential lots and one commercial lot are proposed. The proposed residential lots are approximately 2.5 to 10 acres each, and the commercial lot is 7.2 acres. The area will be serviced by individual wells and on-site wastewater treatment systems. The proposed Site Plan/Testing Location Map is presented in Figure 3.

## **3.0 SCOPE OF THE REPORT**

The scope of the report will include the following:

- A general geologic analysis utilizing published geologic data. Detailed site-specific mapping will be conducted to obtain general information in respect to major geographic and geologic features, geologic descriptions and their effects on the development of the property.
- The site will be evaluated for individual on-site wastewater treatment systems in accordance with El Paso Land Development Code.

## **4.0 FIELD INVESTIGATION**

Our field investigation consisted of the preparation of a geologic map of any bedrock features and significant surficial deposits. The Natural Resource Conservation Service (NRCS), previously the Soil Conservation Service (SCS) survey was also reviewed to evaluate the site. The position of mappable units within the subject property are shown on the Geologic Map. Our mapping procedures involved both field reconnaissance and measurements and air photo reconnaissance and interpretation. The same mapping procedures have also been utilized to produce the Geology/Engineering Geology Map which identified pertinent geologic conditions affecting development. The field mapping was performed by personnel of Entech Engineering, Inc. on September 12 and 15, 2018.

Five (5) test borings, and ten (10) tactile test pits were performed on the site to determine general suitability of the site for the use of on-site wastewater treatment systems. The locations of the test borings, and test pits are indicated on the Site Plan/Testing Location Map, Figure 3. The Test Boring and Test Pit Logs are presented in Appendix B. Results of this testing will be discussed later in this report.

Laboratory testing was also performed on some of the soils to classify and determine the soils engineering characteristics. Laboratory tests included grain-size analysis, ASTM D-422, and Atterberg Limits, ASTM D-4318. Results of the laboratory testing are included in Appendix C. A Summary of Laboratory Test Results is presented in Table 1.

## **5.0 SOIL, GEOLOGY AND ENGINEERING GEOLOGY**

### ***5.1 General Geology***

Physiographically, the site lies in the western portion of the Great Plains Physiographic Province, north of the Palmer Divide. Approximately 16 miles to the west is a major structural feature known as the Rampart Range Fault. This fault marks the boundary between the Great Plains Physiographic Province and the Southern Rocky Mountain Province. The site exists within the southeastern edge of a large structural feature known as the Denver Basin. Bedrock in the area tends to be very gently dipping in a northwesterly direction (Reference 1). The rocks in the area

of the site are sedimentary in nature and typically Tertiary to Upper Cretaceous in age. The bedrock underlying the site consists of the Dawson Arkose Formation. Overlying this formation are unconsolidated deposits of residual soils, man-made, and alluvial soils of the Quaternary Age. The residual soils are produced by the in-situ action of weathering of the bedrock on site. The alluvial soils were deposited by water in the major drainage on the site and as stream terrace deposits. Man-made soils exist as erosion berms. The site's stratigraphy will be discussed in more detail in Section 5.3.

**5.2 Soil Conservation Survey**

The Natural Resource Conservation Service (Reference 2), previously the Soil Conservation Service (Reference 3) has mapped ten soil types on the site (Figure 4). In general, they vary from loam, loamy sands, and sandy loam. The soils are described as follows:

<u>Type</u>	<u>Description</u>
1	Alamosa Loam, 1-3% slopes
15	Brussett Loam, 3 to 5% slopes
21	Cruckton Sandy Loam, 1 to 9% slopes
25	Elbeth Sandy Loam, 3 to 8% slopes
26	Elbeth Sandy Loam, 8 to 15% slopes
36	Holderness Loam, 8 to 15% slopes
67	Peyton Sandy Loam, 5-9% slopes
68	Peyton-Pring Complex, 3-8% slopes
71	Pring Coarse Sandy Loam, 3 to 8% slopes
92	Tomah-Crowfoot Loamy Sands, 3 to 8% slopes

Complete descriptions of each soil type are presented in Appendix D. The soils have generally been described to typically have slow to rapid permeabilities. The majority of the soils have moderate permeabilities. Limitations described for the soils include shrink-swell potential on Soil Type Nos. 15, 25, 26, and 36, slope on Soil Type Nos. 26 and 36, and the hazard of flooding on Soil Type No. 1. Soil Type No. 1 is mapped in the floodplain zone that is designated as open space. Roads may need to be designed to minimize frost-heave potential. Possible hazards with soil erosion are present on the site. The erosion potential can be controlled with vegetation. The majority of the soils have been described to have moderate erosion hazards.

### 5.3 Site Stratigraphy

The Eastonville Quadrangle Geology Map showing the site is presented in Figure 5 (Reference 4). The Geology Map prepared for the site is presented in Figure 6. Seven mappable units were identified on this site which are described as follows:

- Qaf Recent Artificial Fill of Holocene Age:** These are man-made fill deposits associated with erosion berms on-site.
- Qal Recent Alluvium of Late Holocene Age:** These materials consist of water deposited sands located along some of the minor drainages across the site.
- Qp Piney Creek Alluvium (Alluvium One and Two) of Early Holocene Age:** These materials consist of low stream-terrace deposits above the current stream channel. The materials typically consist of silty to well graded sand.
- Qb Broadway Alluvium (Alluvium Three) of Late Pleistocene Age:** These materials consist of middle stream terrace deposits. The materials typically consist of silty to clayey gravelly sands.
- Qlo Louviers Alluvium (Alluvium Four) Late Middle Pleistocene Age:** These materials consist of upper stream terrace deposits. The materials typically consist of light brown silty sands which contain an abundance of gravels.
- Qsw Sheetwash Deposits of Holocene to Late Pleistocene Age:** These materials consist of silty to clayey sands with some cobbles and boulders. The material was deposited by the action of sheetwash and gravity.
- Qc/Tkd Colluvium of Quaternary Age overlying Dawson Formation of Tertiary to Cretaceous Age:** The Dawson Formation typically consists of arkosic sandstone with interbedded fine-grained sandstone, siltstone and claystone. Overlying this formation is a variable layer of residual soil. The residual soils were derived from the in-situ weathering of the bedrock materials on-site. These soils consisted of silty to clayey sands, sandy clays and sandy silts.

The soils listed above were mapped from site-specific mapping, the *Geologic Map of the Eastonville Quadrangle* distributed by the Colorado Geological Survey in 2012 (Reference 4), and the *Geologic Map of the Denver 1<sup>0</sup> x 2<sup>0</sup> Quadrangle*, distributed by the US Geological Survey in 1981 (Reference 5). The Test Pits and Profile Holes were also used in evaluating the site and are included in Appendix B. The Geology Map prepared for the site is presented in Figure 6.

#### **5.4 Soil Conditions**

The soils encountered in the Test Borings and Test Pits can be grouped into four general soil and rock types. The Test Boring soils were classified using the Unified Soil Classification System (USCS). The soils encountered in the Test Pits can be grouped into three general soil types. The test pit soils were classified using the USDA Textural Soil Classification.

Soil Type 1 is a slightly silty to silty and clayey sand (SM-SW, SM, SC). This material was encountered in the test borings and in nine of the test pits. The sand was encountered at depths ranging from the existing surface to 12 to 15 feet bgs and extended to the termination of the Test Boring Nos. 2, 3 and 5 (20 feet). These soils were encountered at loose to medium dense states and at dry to moist conditions. Samples tested had 7 to 34 percent of the soil sized particles passing the No. 200 Sieve. Atterberg Limits Testing resulted in the sand being non-plastic. FHA Swell Testing on a sample of the sand resulted in an expansion of 30 psf, indicating a low expansion potential.

Soil Type 2 is a sandy clay (CL). This material was encountered in Test Pit No. 1 and Test Boring No. 2. The clays were encountered at depths of the existing surface grade in the test pit and at 19 feet in the test boring and extended to depths up to 8 feet bgs to the termination of the test boring (20 feet). The clays were encountered at firm consistencies and moist conditions. The sample tested had 75 percent of the soil sized particles passing the No. 200 sieve. Atterberg Limits Testing resulted in a liquid limit of 30 and a plastic index of 10.

Soil Type 3 is a silty to clayey sandstone and very clayey sandstone (SM, SC, SC-SM, CL-SC). This material was encountered Test Boring No. 4 and in Test Pit Nos. 2, 3, 6, 7 and 8. The sandstone was encountered at depths ranging from 3 to 16 feet bgs and extended to the termination of the boring and pits (7 to 20 feet). The sandstone was encountered at very dense states and moist conditions. Samples tested had 14 to 54 percent of the soil sized particles



passing the No. 200 sieve. Atterberg Limits Testing resulted in liquid limits of 21 to 31 and plastic indexes of 7 to 14. FHA Swell Testing resulted in an expansion pressure of 350 psf, indicating a low expansion potential. Highly expansive clayey sandstone and claystone are commonly interbedded in the sandstone in the area.

Soil Type 4 is a sandy claystone (CL). This material was encountered Test Boring No. 1 at 12 feet bgs and extended to the termination of the boring (20 feet). The claystone was encountered at hard consistencies and moist conditions. Samples tested had 73 percent of the soil sized particles passing the No. 200 sieve. Swell/Consolidation Testing resulted in a volume change of 2.5 percent, indicating a moderate to high expansion potential.

The Test Boring Logs and Test Pit Logs are presented in Appendix B. Laboratory Test Results are presented in Appendix C. A Summary of Laboratory Test Results is presented in Table 1.

### ***5.5 Groundwater***

Groundwater was encountered in Test Boring No. 3 at 16.5 feet. Groundwater was not encountered in the remaining test borings which were drilled to 20 feet. Areas of seasonal and potentially seasonal shallow groundwater have been mapped in low-lying areas and in the drainages on-site. These areas are discussed in the following section. Fluctuation in groundwater conditions may occur due to variations in rainfall and other factors not readily apparent at this time.

It should be noted that in the sandy materials on site, some groundwater conditions might be encountered due to the variability in the soil profile. Isolated sand and gravel layers within the soils, sometimes only a few feet in thickness and width, can carry water in the subsurface. Groundwater may also flow on top of the underlying bedrock. Builders and planners should be cognizant of the potential for the occurrence of such subsurface water features during construction on-site and deal with each individual problem as necessary at the time of construction.

## 6.0 ENGINEERING GEOLOGY – IDENTIFICATION AND MITIGATION OF GEOLOGIC HAZARDS

As mentioned previously, detailed mapping has been performed on this site to produce an Geology/Engineering Geology Map (Figure 6). This map shows the location of various geologic conditions of which the developers should be cognizant during the planning, design and construction stages of the project. These hazards and the recommended mitigation techniques are as follows:

### Artificial Fill

These are man-made fill deposits associated with erosion berms on-site.

Mitigation: The small erosion berms can easily be removed or penetrated by foundations. Should any uncontrolled fill be encountered beneath foundations, removal and recompaction at 95% of its maximum Modified Proctor Dry Density, ASTM D-1557 will be required.

### Loose or Collapsible Soils

Loose soils were encountered in one of the test borings. Any loose or collapsible soils encountered beneath foundations or floor slabs will require mitigation.

Mitigation: Any loose or collapsible soils encountered beneath foundations or floor slabs should be overexcavated 2 to 3 feet, moisture-conditioned and recompacted. The soils should be recompacted to 95 percent of the soils maximum Modified Proctor Dry Density ASTM D-1557 at  $\pm 2$  percent of optimum moisture content. The reconditioned soils on this site should be observed and tested to verify adequate compaction. Areas requiring recompaction should be determined during the excavation observation.

### Expansive Soils

Expansive soils were encountered in the test borings drilled and test pits excavated on-site. Expansive claystone is commonly encountered within the Dawson Formation. These occurrences are typically sporadic; therefore, none have been indicated on the maps. These expansive soils, if encountered beneath foundations, can cause differential movement in the structure foundation. These occurrences should be identified and mitigated on an individual basis.

**Mitigation:** Should expansive soils be encountered beneath the foundation, mitigation will be necessary. Mitigation of expansive soils will require special foundation design. Overexcavation and replacement with non-expansive soils at a minimum of 95% of its maximum Modified Proctor Dry Density, ASTM D-1557 is a suitable mitigation, which is common in the area. Another alternative in areas of highly expansive soils is the use of drilled pier foundation systems. Typical minimum pier depths are on the order of 25 feet or more and require penetration into the bedrock material a minimum of 4 to 6 feet, depending upon building loads. Floor slabs on expansive soils should be expected to experience movement. Overexcavation and replacement has been successful in minimizing slab movements. The use of structural floors should be considered for basement construction on highly expansive clays. Final recommendations should be determined after additional investigation of each building site.

**Slope Stability and Landslide Hazard**

The majority of the slopes in the building areas on site are gently to moderately sloping and do not exhibit any past or potential unstable slopes or landslides. However, the steeply sloping areas along the drainage in the central portion of the site have been identified as potentially unstable slopes. Additionally, areas of downslope creep have been mapped on the site. These areas are identified on the Geology/Engineering Geology Map, Figure 6. The recommendations for these areas are as follows:

- **Potentially Unstable Slope Area**

The area identified with this hazard is located along a portion of a minor drainage where cut banks have created potentially unstable slopes. Considerable care must be exercised in these areas not to create a condition which would tend to activate instability.

**Mitigation:** Building should be avoided in these areas. The lots most significantly affected by potentially unstable slopes are Lot 54 and 55. The structures on these lots should be set back a minimum of 30 feet from the crest of these slopes. The recommended setback lies within the proposed no build area. It appears there is sufficient room on the lots to avoid this hazard. Proper control of drainage at both the surface above the slope and the subsurface is extremely important. Areas of ponded water at the surface should be avoided. Utility trenches, basement excavations and other subsurface features should not be permitted to become water traps which may promote saturation of the subsurface materials. Drainage

should not be permitted over the potentially unstable slope but directed in a non-erosive manner away from the slope. Irrigation above these slopes should be kept to a minimum to prevent saturation of the subsurface soils. The use of xeriscape landscaping utilizing native plantings is recommended to reduce the need for irrigation.

- *Downslope Creep Area*

The areas identified with this hazard includes some of the steeper slopes on site, particularly in the northwest portion of the site. In these areas, we would anticipate lateral and vertical movement of the near surface soils in the downslope direction. These areas are acceptable as building sites with the following constraints on construction.

Mitigation: Building is possible in these areas if the following engineering and construction mitigation steps are taken: This type of movement will increase lateral pressures against foundation walls on the uphill side of structures. The design of foundations in these areas should account for this additional pressure. Additionally, the foundation should be designed to withstand pressures where steeper areas slope away from the foundation. Tie beams and buttresses are recommended to stiffen the foundation system.

### Floodplain and Drainage Areas

Portions of the site associated with the West Kiowa Creek drainage are mapped within a floodplain zone according to the FEMA Map No. 08041CO350F, dated March 17, 1997 (Figure 7, Reference 6). Water was observed flowing in West Kiowa Creek. The floodplain areas have been designated as open space and/or can be avoided by construction. Additionally, areas of seasonal and potentially seasonal shallow groundwater were observed across the site. In these areas, we would anticipate the potential for periodically high subsurface moisture conditions and frost heave potential. These areas lie within low-lying areas along the drainage in the southeastern portion of the site and in the low-lying areas and minor drainages across the site. Water was not observed in any of the minor drainages at the time of our site investigation. These areas can likely be avoided or properly mitigated by development. The floodplain should be avoided by construction unless site-specific floodplain determination and drainage studies are performed. The potential exists for high groundwater levels during high moisture periods and should structures encroach on these areas the following precautions should be followed.

Mitigation: Foundations must have a minimum 30-inch depth for frost protection. In areas where high subsurface moisture conditions are anticipated periodically, subsurface perimeter drains are recommended to help prevent the intrusion of water into areas below grade. Typical drain details are presented in Figure 8. Some of the minor drainage swales can be avoided or regraded. The main drainage that bisects the site is designated as open space and will be avoided. Any grading in these areas should be done to direct surface flow around construction to avoid areas of ponded water. Finished floors must be located at least one foot above floodplain levels. Specific drainage studies and exact floodplain locations are beyond the scope of this report.

### ***6.1 Relevance of Geologic Conditions to Land Use Planning***

We understand that the development will be rural residential lots and a commercial lot. It is our opinion that the existing geologic and engineering geologic conditions will impose some constraints on the proposed development and construction. The most significant problems affecting development will be those associated with the drainages on site that can be avoided or properly mitigated during construction on each lot. Other hazards on site may be satisfactorily mitigated through proper engineering design and construction practices or avoidance.

The upper materials are typically at medium dense to dense states. Areas of loose soils were encountered that may require recompaction. The medium dense to dense granular soils encountered in the upper soil profiles of the test borings and test pits should provide good support for foundations. Loose soils, if encountered beneath foundations or slabs, will require removal of the upper 2 to 3 feet of material and recompaction. Expansive soils, although sporadic, were encountered. Expansive clayey sandstone and claystone are common in the Dawson Formation, and may require mitigation. Foundations anticipated for the site are standard spread footings possibly in conjunction with overexcavation in areas of expansive soils or loose soils. Areas of artificial fill, if encountered beneath foundations will require penetration or recompaction. Areas containing arkosic sandstone will have high allowable bearing conditions. Expansive layers may also be encountered in the soil and bedrock on this site. Expansive soils, if encountered, will require special foundation design and/or overexcavation. These soils will not prohibit development.

A potentially unstable slope exists along portions of the site where the drainages have eroded cut banks. A 30-foot building setback is recommended from the crest of the potentially unstable slope. Septic fields should not be located within the building setback as well. The slopes primarily affect Lot 54 and 55. It appears there is sufficient room on the lots to avoid the potentially unstable slopes. Additionally, minor areas of downslope creep have been mapped on the site. Many of these areas can be avoided by construction, however, Lot 44 may be affected. These areas are acceptable as building sites with mitigation for the sloping conditions taken into consideration. Additional reinforcement may be necessary in the foundation to account for additional pressures due to sloping conditions. Tie-beams and/or buttresses may be necessary, depending on site conditions and grading plans.

Areas of seasonal shallow groundwater and potentially seasonal shallow groundwater were encountered on site. Additionally, portions of the site have been mapped in a floodplain zone associated with West Kiowa Creek. The floodplain area is in the designated open space area and can be avoided by development. Water was observed in the West Kiowa Creek floodplain, however, water was not observed in the minor drainages on-site during our site investigation. Due to the size of the lots and the proposed development, the majority of these areas can be avoided by construction on the lots. The lot boundaries in the area of Lots 87 and 111 may require adjustments to accommodate the minor drainages that bisects the lots. Regrading can also mitigate some minor drainages on some of the lots. Structures should not block drainages. Any site grading should be done in such a manner as to not create areas of ponded water around structures or septic fields. Finished floor levels must be a minimum of one foot above the floodplain level. Septic fields should not be located in drainage areas due to the potential for periodic high groundwater conditions. Specific floodplain locations and drainage studies are beyond the scope of this report.

In summary, development of the site can be achieved if the items mentioned above are mitigated. These items can be mitigated through proper design and construction or through avoidance. Investigation on each lot is recommended prior to construction.

## **7.0 ON-SITE WASTEWATER TREATMENT**

The site was evaluated for individual and commercial on-site wastewater treatment systems in accordance with El Paso Land Development Code. Ten (10) tactile test pits were performed on the property. The test pits were located in potential locations of future systems. The approximate locations of the percolation tests are indicated on Figure 3, on the Geology/Engineering Geology Map, Figure 6, and on the Septic Suitability Map, Figure 9. A table showing the results of the Tactile Test Pits is presented in Table 2. Test Pit Logs are included in Appendix B.

The Natural Resource Conservation Service (Reference 2), previously the Soil Conservation Service (Reference 3) has been mapped with ten soil descriptions. The Soil Survey Map (Reference 2) is presented in Figure 4, and the Soil Survey Descriptions are presented in Appendix D. The soils are described as having slow to rapid percolation rates. The majority of the soils have been described with moderate permeabilities.

Soils encountered in the tactile test pits consisted of loamy sand, sandy clay loam and sandy clay. Bedrock was not encountered in the test pits which were excavated to 7 to 8 feet. The limiting layers encountered in the test pits are the sandy loam (Soil Type 2), and sandy clay (Soil Type 4A) which corresponds to LTAR values of 0.80 to 0.15 gallons per day per square foot. The conditions encountered in the Test Pit Nos. 1 through 4 and 6 through 8 will require a designed system. Additional investigation may identify areas where suitable for conventional systems could be used.

In summary, it is our opinion the site is suitable for individual on-site wastewater treatment systems (OWTS) and that contamination of surface and subsurface water resources should not occur provided the OWTS sites are evaluated and installed according to El Paso County and State Guidelines and properly maintained. Based on the testing performed as part of this investigation designed systems will likely be required for the majority of the lots. A Septic Suitability Map is presented in Figure 9. Areas where OWTS sites are not recommended are indicated on Figure 9. Individual soil testing is required on the lots prior to construction. Absorption fields must be located a minimum of 100 feet from any well, including those on adjacent properties. Absorption fields must also be located a minimum of 50 feet from any drainages, floodplains or ponded areas and 25 feet from dry gulches.

## 8.0 ECONOMIC MINERAL RESOURCES

Some of the sandy materials on-site could be considered a low-grade sand resource. According to the *El Paso County Aggregate Resource Evaluation Map* (Reference 7), the area is mapped with floodplain, valley fill and upland deposits. According to the *Atlas of Sand, Gravel and Quarry Aggregate Resources, Colorado Front Range Counties* distributed by the Colorado Geological Survey (Reference 8), areas of the site are mapped with upland and floodplain deposits: sand and probable aggregate resource (U3, U4 and F4). According to the *Evaluation of Mineral and Mineral Fuel Potential* (Reference 9), the area of the site has been mapped as "Good" for industrial minerals. However, considering the abundance of similar materials through the region and the close proximity to developed land, they would be considered to have little significance as an economic resource.

According to the *Evaluation of Mineral and Mineral Fuel Potential of El Paso County State Mineral Lands* (Reference 9), the site is mapped within the Denver Basin Coal Region. However, the area of the site has been mapped as "Poor" for coal resources. No active or inactive mines have been mapped in the area of the site. No metallic mineral resources have been mapped on the site (Reference 9).

The site has been mapped as "Fair" for oil and gas resources (Reference 9). No oil or gas fields have been discovered in the area of the site. The sedimentary rocks in the area may lack the geologic structure for trapping oil or gas; therefore, it may not be considered a significant resource. Hydraulic fracturing is a new method that is being used to extract oil and gas from rocks. It utilizes pressurized fluid to extract oil and gas from rocks that would not normally be productive. The area of the site has not been explored to determine if the rocks underlying the site would be commercially viable utilizing hydraulic fracturing. The practice of hydraulic fracturing has come under review due to concerns about environmental impacts, health and safety.



## **9.0 EROSION CONTROL**

The soil types observed on the site are mildly to highly susceptible to wind erosion, and moderately to highly susceptible to water erosion. A minor wind erosion and dust problem may be created for a short time during and immediately after construction. Should the problem be considered severe enough during this time, watering of the cut areas or the use of chemical palliative may be required to control dust. However, once construction has been completed and vegetation re-established, the potential for wind erosion should be considerably reduced.

With regard to water erosion, loosely compacted soils will be the most susceptible to water erosion, residually weathered soils and weathered bedrock materials become increasingly less susceptible to water erosion. For the typical soils observed on site, allowable velocities or unvegetated and unlined earth channels would be on the order of 3 to 4 feet/second, depending upon the sediment load carried by the water. Permissible velocities may be increased through the use of vegetation to something on the order of 4 to 7 feet/second, depending upon the type of vegetation established. Should the anticipated velocities exceed these values, some form of channel lining material may be required to reduce erosion potential. These might consist of some of the synthetic channel lining materials on the market or conventional riprap. In cases where ditch-lining materials are still insufficient to control erosion, small check dams or sediment traps may be required. The check dams will serve to reduce flow velocities, as well as provide small traps for containing sediment. The determination of the amount, location and placement of ditch linings, check dams and of the special erosion control features should be performed by or in conjunction with the drainage engineer who is more familiar with the flow quantities and velocities.

Cut and fill slope areas will be subjected primarily to sheetwash and rill erosion. Unchecked rill erosion can eventually lead to concentrated flows of water and gully erosion. The best means to combat this type of erosion is, where possible, the adequate re-vegetation of cut and fill slopes. Cut and fill slopes having gradients more than three (3) horizontal to one (1) vertical become increasingly more difficult to revegetate successfully. Therefore, recommendations pertaining to the vegetation of the cut and fill slopes may require input from a qualified landscape architect and/or the Soil Conservation Service.

## **10.0 CLOSURE**

It is our opinion that the existing geologic engineering and geologic conditions will impose some minor constraints on development and construction of the site. The majority of these conditions can be avoided by construction. Others can be mitigated through proper engineering design and construction practices. The proposed development and use is consistent with anticipated geologic and engineering geologic conditions.

It should be pointed out that because of the nature of data obtained by random sampling of such variable and non-homogeneous materials as soil and rock, it is important that we be informed of any differences observed between surface and subsurface conditions encountered in construction and those assumed in the body of this report. Individual investigations for building sites and septic systems will be required prior to construction. Construction and design personnel should be made familiar with the contents of this report. Reporting such discrepancies to Entech Engineering, Inc. soon after they are discovered would be greatly appreciated and could possibly help avoid construction and development problems.

This report has been prepared for Proterra Properties, LLC for application to the proposed project in accordance with generally accepted geologic soil and engineering practices. No other warranty expressed or implied is made.

We trust that this report has provided you with all the information that you required. Should you require additional information, please do not hesitate to contact Entech Engineering, Inc.

## BIBLIOGRAPHY

1. Bryant, Bruce; McGrew, Laura W, and Wobus, Reinhard A. 1981. *Geologic Structure Map of the Denver 1° x 2° Quadrangle, North-Central Colorado*. Sheet 2. U.S. Geologic Survey. Map I-1163.
2. Natural Resource Conservation Service, September 23, 2016. *Web Soil Survey*. United States Department Agriculture, <http://websoilsurvey.sc.egov.usda.gov/App/HomePage.htm>.
3. United States Department of Agriculture Soil Conservation Service. June 1981. *Soil Survey of El Paso County Area, Colorado*.
4. Morgan, Matthew L. and Barkmann, Peter E., 2012. *Geologic Map of the Eastonville Quadrangle, El Paso and Elbert Counties, Colorado*. Colorado Geological Survey. Open-File Report 12-03.
5. Bryant, Bruce; McGrew, Laura W. and Wobus, Reinhard A. 1981. *Geologic Map of the Denver 1° x 2° Quadrangle, North-Central Colorado*. U.S. Geologic Survey. Map 1-1163.
6. Federal Emergency Management Agency. March 17, 1997. *Flood Insurance Rate Maps for the City of Colorado Springs, Colorado*. Map Number 08041CO350F
7. El Paso County Planning Development. December 1995. *El Paso County Aggregate Resource Evaluation Maps*.
8. Schwochow, S.D.; Shroba, R.R. and Wicklein, P.C. 1974. *Atlas of Sand, Gravel, and Quarry Aggregate Resources, Colorado Front Range Counties*. Colorado Geological Survey. Special Publication 5-B.
9. Keller, John W.; TerBest, Harry and Garrison, Rachel E. 2003. *Evaluation of Mineral and Mineral Fuel Potential of El Paso County State Mineral Lands Administered by the Colorado State Land Board*. Colorado Geological Survey. Open-File Report 03-07.

## TABLES

**TABLE 1**

**SUMMARY OF LABORATORY TEST RESULTS**

CLIENT PROTERRA PROPERTIES  
 PROJECT WINSOME SUBDIVISION  
 JOB NO. 181459

SOIL TYPE	TEST BORING NO.	DEPTH (FT)	WATER (%)	DRY DENSITY (PCF)	PASSING NO. 200 SIEVE (%)	LIQUID LIMIT (%)	PLASTIC INDEX (%)	SULFATE (WT %)	FHA SWELL (PSF)	SWELL/CONSOL (%)	UNIFIED CLASSIFICATION	SOIL DESCRIPTION
1	2	2-3			12.1	NV	NP				SM	SAND, SILTY
1	3	10			6.5			<0.01			SM-SW	SAND, SLIGHTLY SILTY
1	5	5			17.3						SM	SAND, SILTY
1	TP-3	2-3			23.7						SM	SAND, SILTY
1	TP-4	5-6			15.3						SM	SAND, SILTY
1	TP-5	2-3			19.2						SM	SAND, SILTY
1	TP-7	2-3			33.5						SM	SAND, SILTY
1	TP-9	5-6			21.3				30		SM	SAND, SILTY
1	TP-10	2-3			32.0						SM	SAND, SILTY
2	TP-1	5-6			74.8	30	10				CL	CLAY, SANDY
3	TP-2	5-6			14.0	30	9				SM	SANDSTONE, SILTY
3	TP-8	5-6			21.1	33	14				SC	SANDSTONE, CLAYEY
3	TP-6	5-6			54.2				350		CL-SC	SANDSTONE, VERY CLAYEY
3	4	20			18.6	21	7	<0.01			SC-SM	SANDSTONE, SILTY, CLAYEY
4	1	15	13.4	120.4	73.2	35	13	<0.01		2.5	CL	CLAYSTONE, SANDY

**Table 2: Summary Tactile Test Pit Results**

<b>Test Pit No.</b>	<b>USDA Soil Type</b>	<b>LTAR Value</b>	<b>Depth to Bedrock (ft.)</b>	<b>Depth to Seasonally Occurring Groundwater (ft.)</b>
1	4A*	0.15*	N/A	N/A
2	3A*	0.30*	3*	N/A
3	3A*	0.30*	3*	N/A
4	4A*	0.15*	N/A	N/A
5	1	0.80	N/A	N/A
6	4A*	0.15*	3.5*	7'
7	4A*	0.15*	3.5*	7'
8	4A*	0.15*	3*	6'
9	3	0.35	N/A	N/A
10	3	0.35	N/A	N/A

\*- Conditions that will require an engineered OWTS

## FIGURES

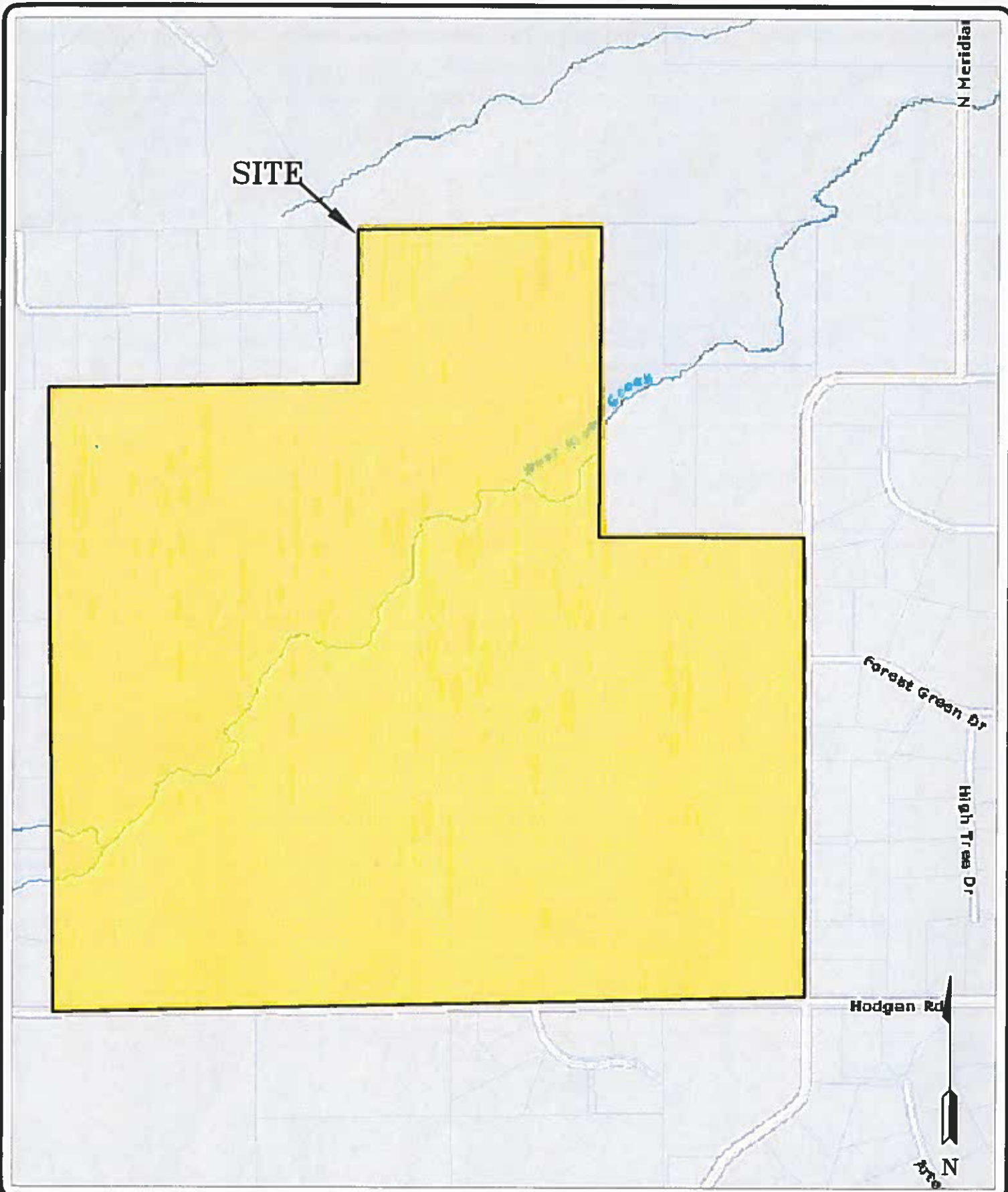

**ENTECH**  
**ENGINEERING, INC.**  
505 ELKTON DRIVE  
 COLORADO SPRINGS, CO. 80907 (719) 531-3399

VICINITY MAP  
 WINSOME RANCH SUBDIVISION  
 17480 MERIDIAN ROAD NORTH  
 EL PASO COUNTY, CO.  
 FOR: PROTERRA PROPERTIES, LLC

DRAWN:  
 LLL

DATE:  
 1/7/19

CHECKED:

DATE:

JOB NO.:  
 181459

FIG NO.:  
 1



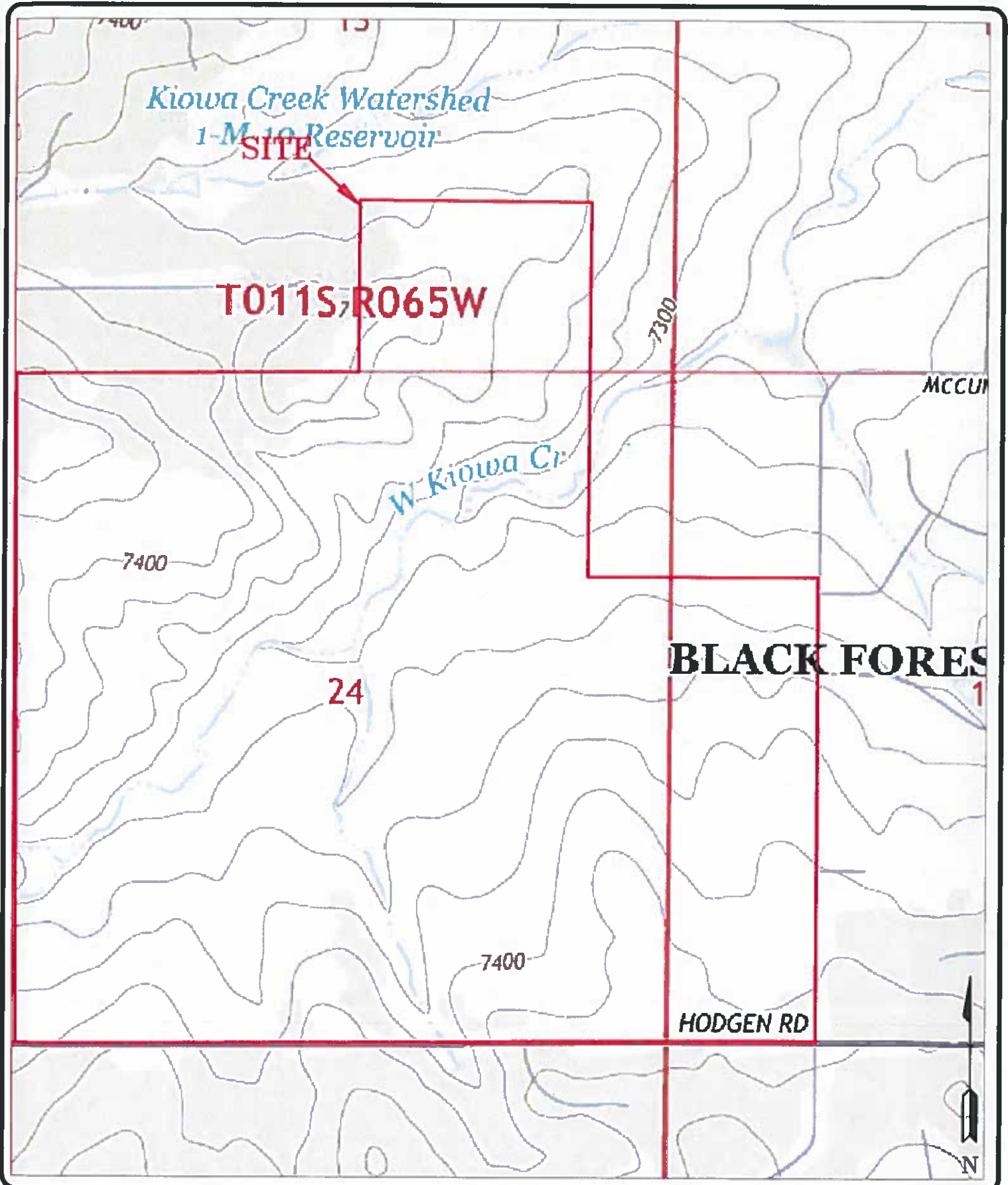

**ENTECH**  
**ENGINEERING, INC.**  
305 ELKTON DRIVE  
 COLORADO SPRINGS, CO. 80907 (719) 531-3599

USGS MAP  
 WINSOME RANCH SUBDIVISION  
 17480 MERIDIAN ROAD NORTH  
 EL PASO COUNTY, CO.  
 FOR: PROTERRA PROPERTIES, LLC

DRAWN:  
 LLL

DATE:  
 1/7/19

CHECKED:

DATE:

JOB NO.:  
 181459

FIG NO.:  
 2



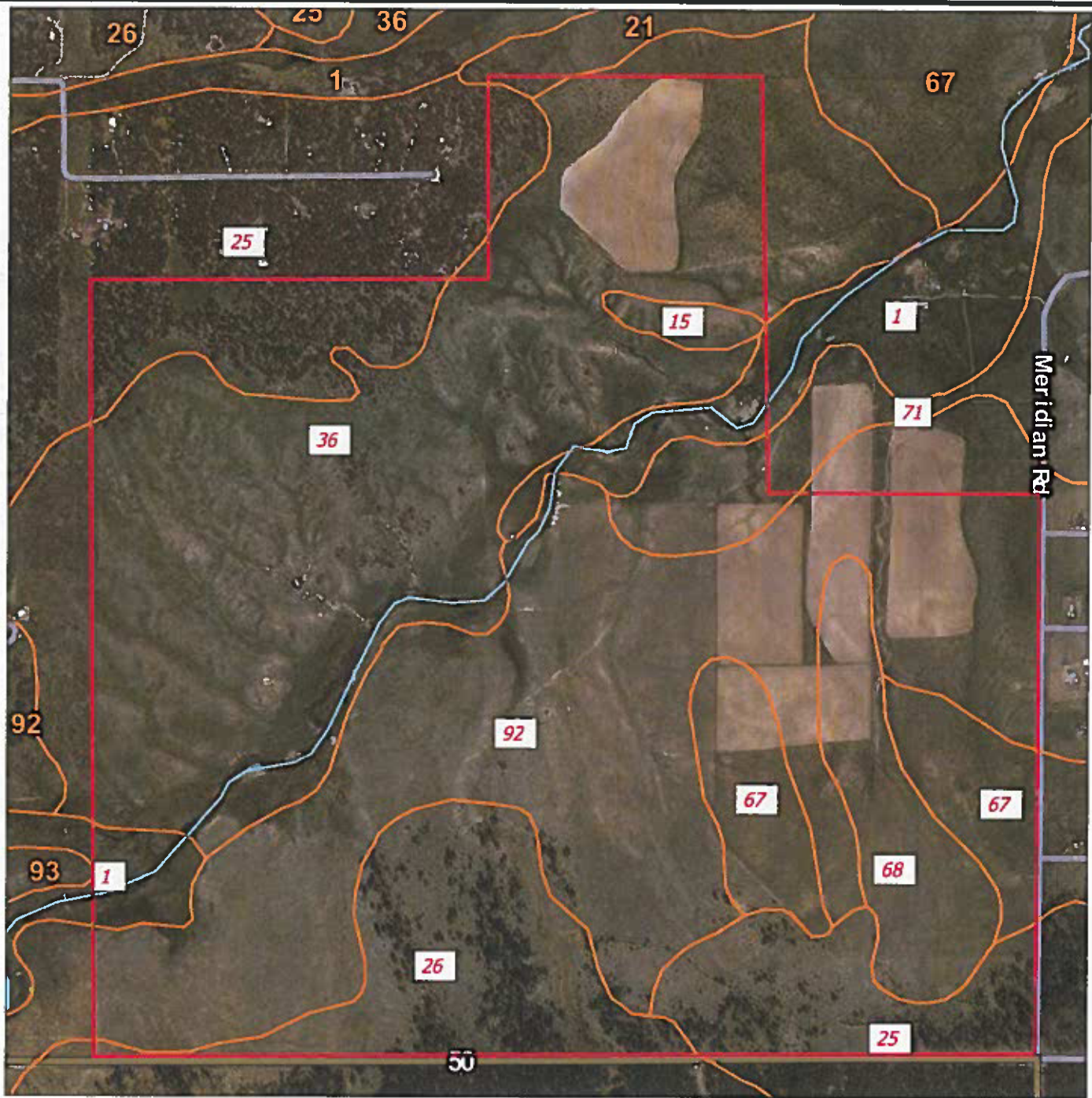

**ENTECH**  
**ENGINEERING, INC.**  
585 ELKTON DRIVE  
 COLORADO SPRINGS, CO. 80907 (719) 531-3399

**SOIL SURVEY MAP**  
**WINSOME SUBDIVISION**  
**17480 MERIDIAN ROAD NORTH**  
**EL PASO COUNTY, CO.**  
**FOR: PROTERRA PROPERTIES, LLC**

**DRAWN:**  
**LLL**

**DATE:**  
**1/7/19**

**CHECKED:**

**DATE:**

**JOB NO.:**  
**181459**

**FIG NO.:**  
**4**

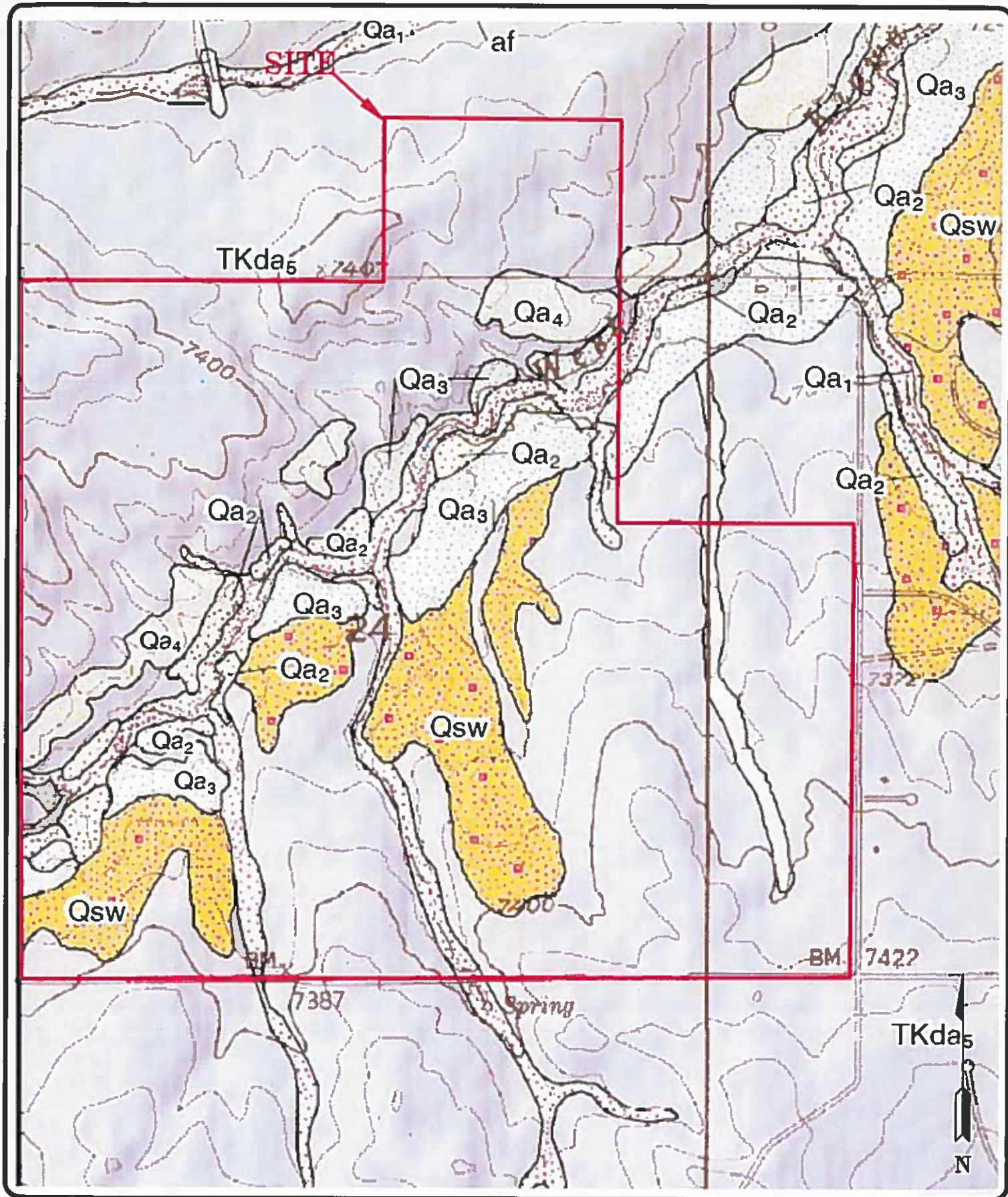

**ENTECH**  
**ENGINEERING, INC.**  
 303 ELKTON DRIVE  
 COLORADO SPRINGS, CO. 80907 (719) 531-3299

**EASTONVILLE QUADRANGLE GEOLOGIC MAP**  
**WINSOME SUBDIVISION**  
 17480 MERIDIAN ROAD NORTH  
 EL PASO COUNTY, CO.  
 FOR: PROTERRA PROPERTIES, LLC

JOB NO.:  
 181459

FIG NO.:  
 5

DRAWN:  
 LLL

DATE:  
 1/7/19

CHECKED:

DATE:

- LEGEND:**
- Qaf - Artificial Fill of Holocene Age:  
artificial fill associated with erosion berms
  - Qal - Recent Alluvium of Holocene Age:  
recent alluvium located in several of the minor drainages on-site
  - Qp - Piney Creek Alluvium Two of Early Holocene Age:  
low stream terrace deposits above current stream channel
  - Qb - Broadway Alluvium of Late Pleistocene Age:  
stream terrace deposited sands
  - Qlo - Louviers Alluvium of Late Middle Pleistocene Age:  
stream terrace deposited sands
  - Qsw - Sheetwash of Holocene to Late Pleistocene Age:  
silty to clayey sand sheetwash deposits
  - QcTKa - Colluvium of Quaternary Age overlying Dawson Formation  
of Tertiary to Cretaceous Age:  
colluvium and residual soils overlying arkosic sandstone  
with interbedded fine-grained sandstone, siltstone and claystone
  - dsc - downslope creep area
  - fp - floodplain
  - pu - potentially unstable slope
  - psw - potentially seasonal shallow groundwater area
  - sw - seasonal shallow groundwater area
  - w - flowing water
  - ⊕ - approximate test boring location
  - ⊕ - approximate test pit location

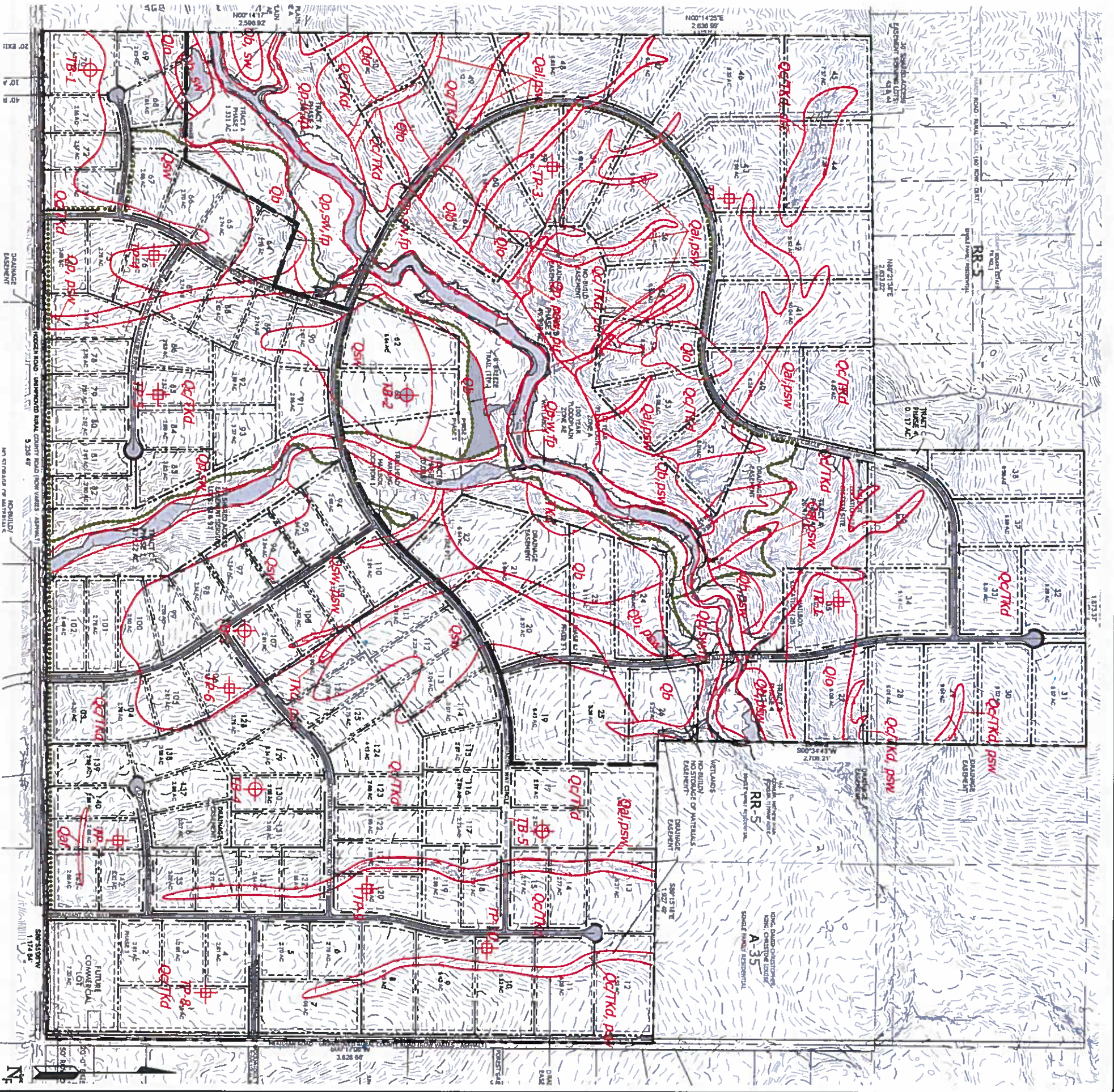

DATE	1/7/19
CHECKED	AS SHOWN
DRAWN	181459
SCALE	AS SHOWN
PROJECT	181459
NO.	6

**GEOLOGY/ENGINEERING GEOLOGY MAP**  
**WINSOME SUBDIVISION**  
 17480 MERIDIAN ROAD NORTH  
 EL PASO COUNTY, CO.  
 FOR: PROTERRA PROPERTIES, LLC



**ENTECH**  
**ENGINEERING, INC.**  
 505 ELKTON DRIVE  
 COLORADO SPRINGS, CO. 80907 (719) 531-5399

REVISION	BY



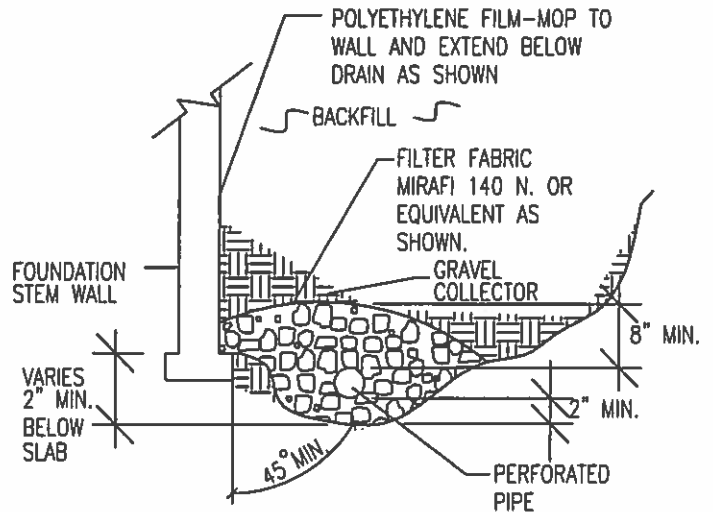
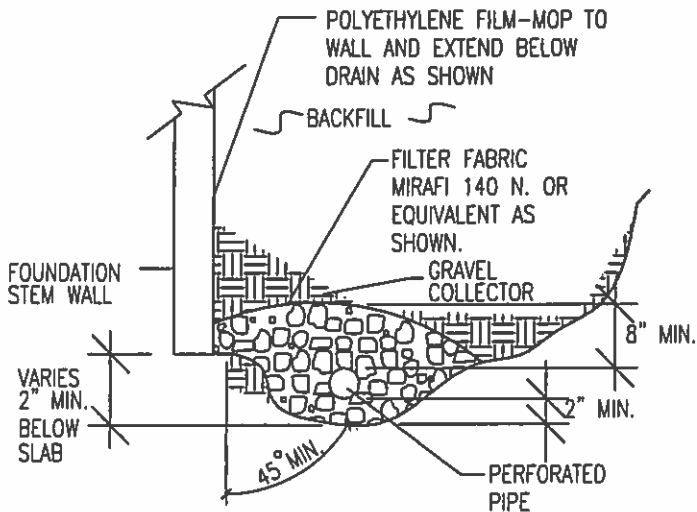

**NOTES:**

-GRAVEL SIZE IS RELATED TO DIAMETER OF PIPE PERFORATIONS-85% GRAVEL GREATER THAN 2x PERFORATION DIAMETER.

-PIPE DIAMETER DEPENDS UPON EXPECTED SEEPAGE. 4-INCH DIAMETER IS MOST OFTEN USED.

-ALL PIPE SHALL BE PERFORATED PLASTIC. THE DISCHARGE PORTION OF THE PIPE SHOULD BE NON-PERFORATED PIPE.

-FLEXIBLE PIPE MAY BE USED UP TO 8 FEET IN DEPTH, IF SUCH PIPE IS DESIGNED TO WITHSTAND THE PRESSURES. RIGID PLASTIC PIPE WOULD OTHERWISE BE REQUIRED.

-MINIMUM GRADE FOR DRAIN PIPE TO BE 1% OR 3 INCHES OF FALL IN 25 FEET.

-DRAIN TO BE PROVIDED WITH A FREE GRAVITY OUTFALL, IF POSSIBLE. A SUMP AND PUMP MAY BE USED IF GRAVITY OUF FALL IS NOT AVAILABLE.



**ENTECH**  
ENGINEERING, INC.  
505 ELKTON DRIVE  
COLORADO SPRINGS, CO. 80907 (719) 531-5599

*PERIMETER DRAIN DETAIL*

DRAWN:

DATE:

9/26/18

DESIGNED:

DS

CHECKED:

*[Signature]*

JOB NO.:

18149

FIG NO.:

8



**LEGEND:**

- AREAS THAT ARE NOT SUITABLE FOR ON-SITE WASTE WATER TREATMENT SYSTEMS
- \* WATER WELLS MUST BE A MINIMUM OF 100 FT FROM OWTS ABSORPTION FIELDS

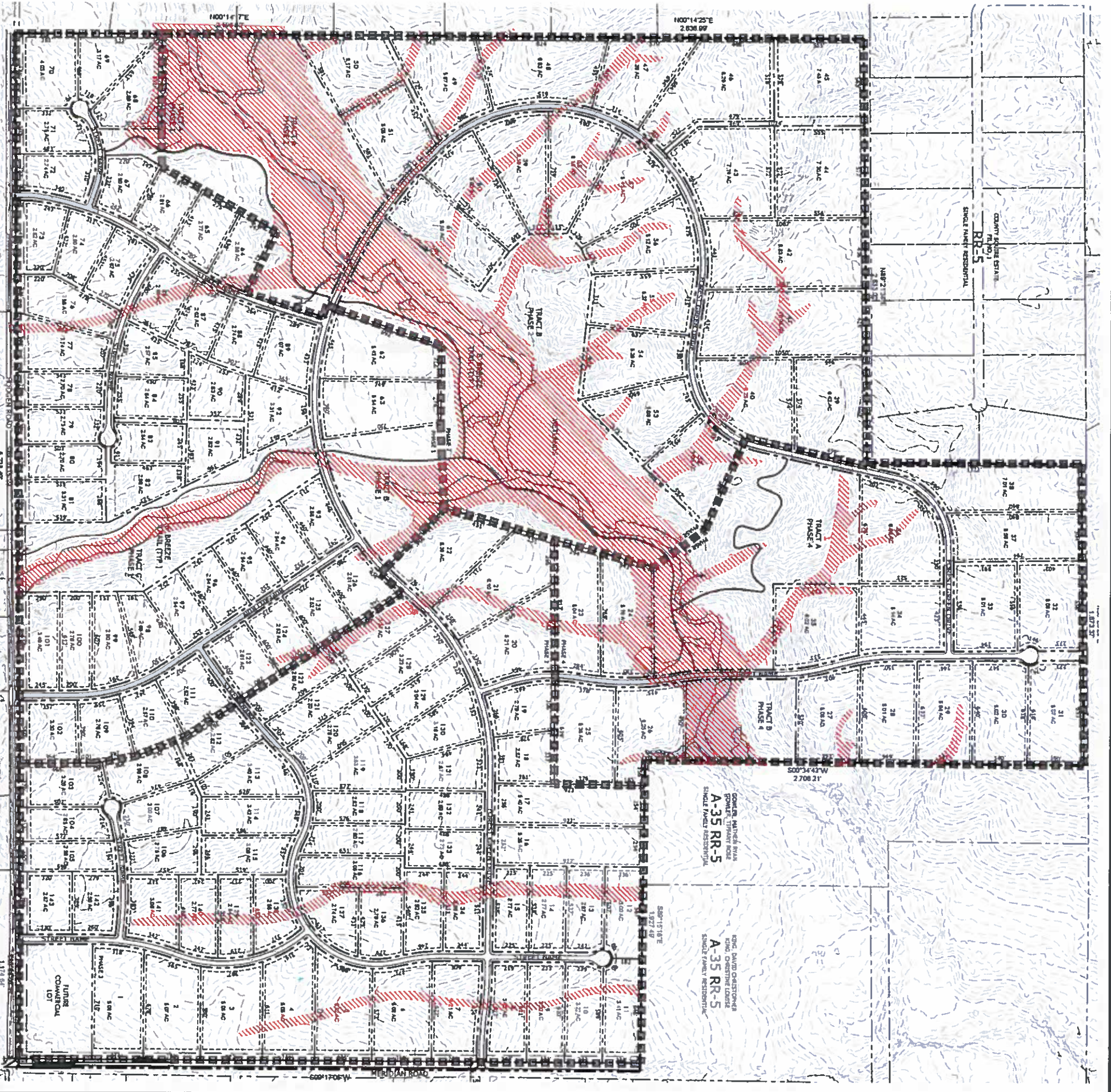

DATE	1/7/19
CHECKED	AS SHOWN
DRAWN	10/4/18
BY	10/4/18
9	

SEPTIC SUITABILITY MAP  
 WINSOME SUBDIVISION  
 17480 MERIDIAN ROAD NORTH  
 EL PASO COUNTY, CO.  
 FOR: PROTERRA PROPERTIES, LLC



**ENTECH**  
 ENGINEERING, INC.  
 505 ELKTON DRIVE  
 COLORADO SPRINGS, CO. 80907 (719) 531-5599

REVISION	BY



## **APPENDIX A: Site Photographs**

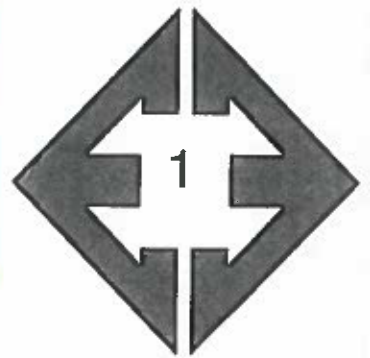

**Looking southwest  
from the northern  
portion of the site.**

September 12, 2018

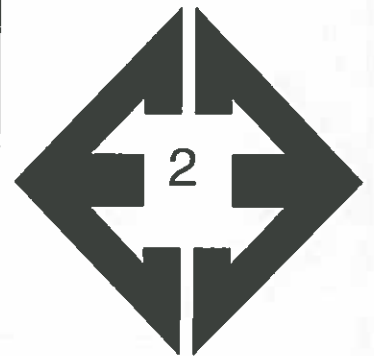

**Looking south from  
the northern portion of  
the site.**

September 12, 2018

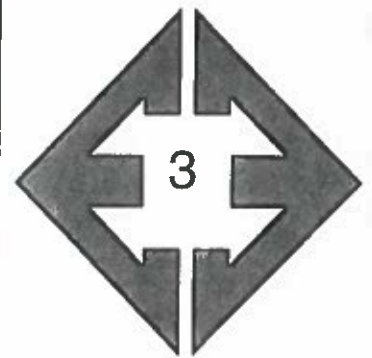

**Looking west from the northern portion of the site.**

September 12, 2018



**Looking east along drainage in the northern portion of the site.**

September 12, 2018

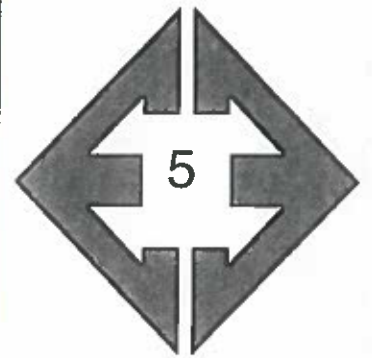

**Looking south from  
the western portion of  
the site.**

September 12, 2018

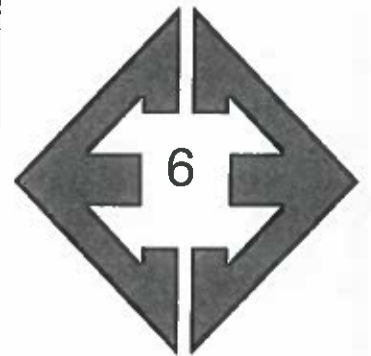

**Looking north along  
small drainage in the  
western portion of the  
site.**

September 12, 2018



**Looking northeast  
from the central  
portion of the site.**

September 12, 2018



**Looking east towards  
W. Kiowa Creek in the  
central portion of the  
site.**

September 12, 2018

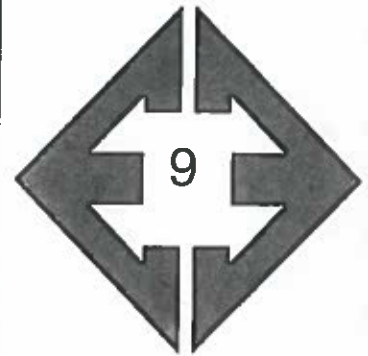

**Looking north from the southwestern portion of the site.**

September 12, 2018

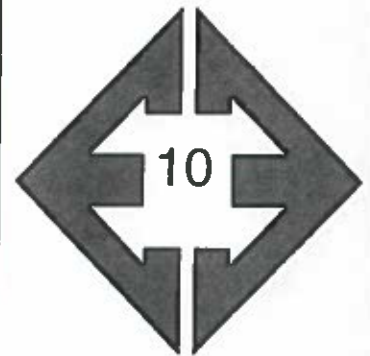

**Looking east from the southwestern portion of the site.**

September 12, 2018

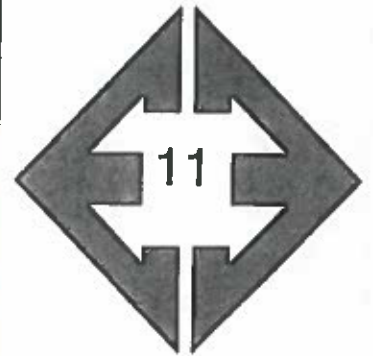
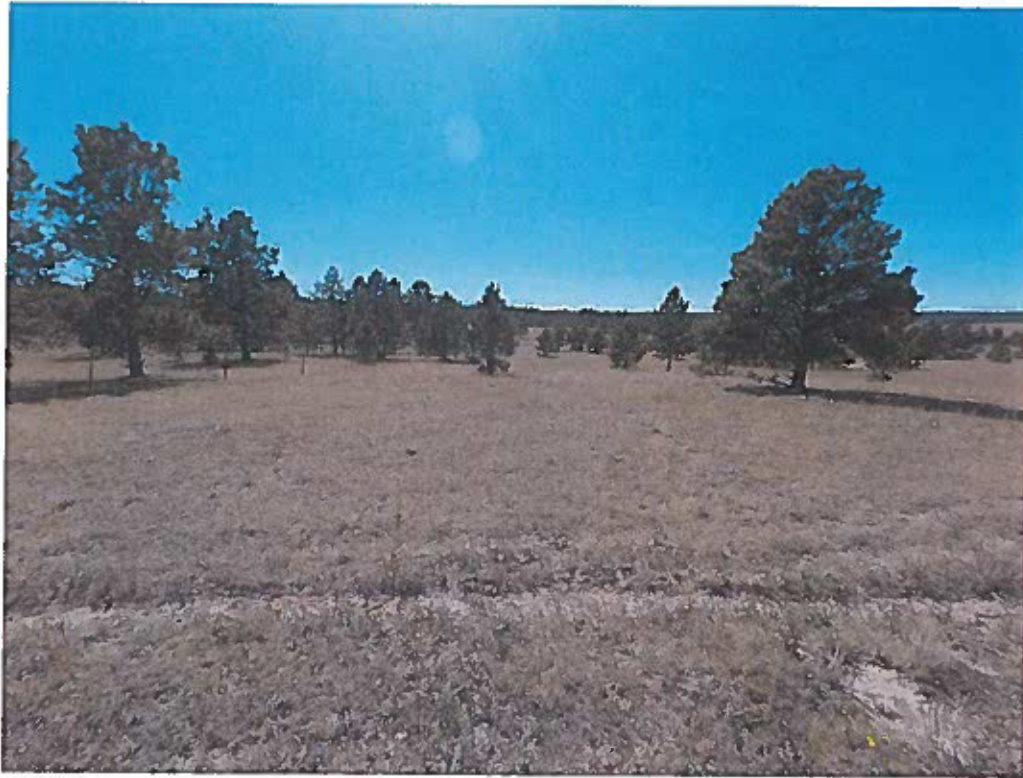

**Looking west from the southeastern portion of the site.**

September 12, 2018

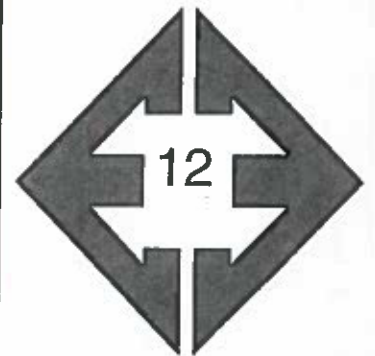

**Looking northwest from the southeast portion of the site.**

September 12, 2018

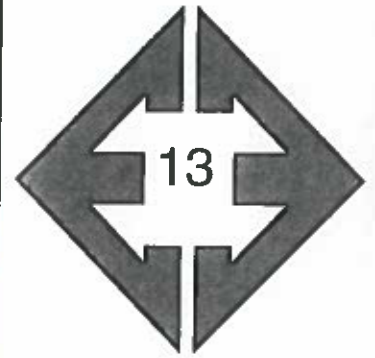

**Looking north along  
drainage in the  
northeastern portion of  
the site.**

September 15, 2018

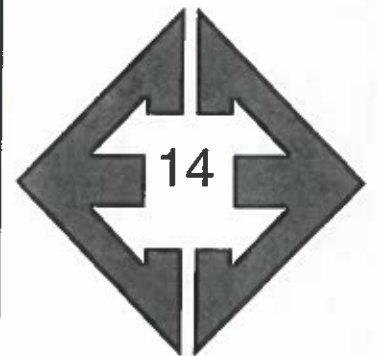

**Looking south from  
the southeastern  
portion of the site.**

September 15, 2018



## **APPENDIX B: Test Boring Logs and Test Pit Logs**

TEST BORING NO 1  
 DATE DRILLED 9/18/2018  
 Job # 181459

TEST BORING NO 2  
 DATE DRILLED 9/18/2018  
 CLIENT PROTERRA PROPERTIES  
 LOCATION WINSOME SUBDIVISION

REMARKS

REMARKS

DRY TO 20', 9/19/18

SAND, SILTY, FINE TO  
 COARSE GRAINED, TAN,  
 MEDIUM DENSE, MOIST

SAND, CLAYEY, FINE TO  
 COARSE GRAINED, TAN,  
 MEDIUM DENSE, MOIST

CLAYSTONE, SANDY, TAN,  
 HARD, MOIST

Depth (ft)	Symbol	Samples	Blows per foot	Watercontent %	Soil Type
5			29	3.7	1
5			17	4.7	1
10			15	11.1	1
15			50 11"	12.4	4
20			50 7"	12.8	4

DRY TO 17.5', 9/19/18

SAND, SILTY, FINE TO COARSE  
 GRAINED, TAN, MEDIUM DENSE,  
 DRY TO MOIST

CLAY, SANDY, BROWN, FIRM,  
 MOIST

Depth (ft)	Symbol	Samples	Blows per foot	Watercontent %	Soil Type
5			12	1.5	1
5			16	2.4	1
10			24	3.3	1
15			25	3.1	1
20			13	13.2	2



**ENTECH**  
**ENGINEERING, INC.**

505 ELKTON DRIVE  
 COLORADO SPRINGS, COLORADO 80907

TEST BORING LOG

DRAWN:	DATE	CHECKED: LLL	DATE 1/7/19
--------	------	-----------------	----------------

JOB NO:  
181459

FIG NO:

B-1

TEST BORING NO 3  
 DATE DRILLED 9/18/2018  
 Job # 181459

TEST BORING NO 4  
 DATE DRILLED 9/18/2018  
 CLIENT PROTERRA PROPERTIES  
 LOCATION WINSOME SUBDIVISION

REMARKS

REMARKS

WATER @ 16.5', 9/19/18

SAND, SILTY TO SLIGHTLY  
 SILTY, FINE TO COARSE  
 GRAINED, TAN, DENSE TO  
 MEDIUM DENSE, DRY TO WET

Depth (ft)	Symbol	Samples	Blows per foot	Watercontent %	Soil Type
5			35	1.7	1
			16	3.0	1
10			28	3.9	1
15			24	3.6	1
20			17	10.7	1



DRY TO 20', 9/19/18

SAND, SILTY, FINE TO COARSE  
 GRAINED, TAN, MEDIUM  
 DENSE, MOIST

SANDSTONE, SILTY, CLAYEY,  
 FINE TO COARSE GRAINED,  
 TAN, VERY DENSE, MOIST

Depth (ft)	Symbol	Samples	Blows per foot	Watercontent %	Soil Type
5			29	2.5	1
			26	5.0	1
10			16	3.7	1
15			27	6.9	1
20			50	6.2	3
			10"		



**ENTECH**  
**ENGINEERING, INC.**

505 ELKTON DRIVE  
 COLORADO SPRINGS, COLORADO 80907

TEST BORING LOG

DRAWN:	DATE:	CHECKED:	DATE:
		LLL	1/7/19

JOB NO.:  
 181459

FIG NO.:

B-2

TEST BORING NO 5  
 DATE DRILLED 9/18/2018  
 Job # 181459

TEST BORING NO.  
 DATE DRILLED  
 CLIENT PROTERRA PROPERTIES  
 LOCATION WINSOME SUBDIVISION

REMARKS

REMARKS

DRY TO 20', 9/19/18

SAND, SILTY, FINE TO COARSE  
 GRAINED, BROWN TO TAN,  
 LOOSE TO MEDIUM DENSE,  
 MOIST

Depth (ft)	Symbol	Samples	Blows per foot	Watercontent %	Soil Type	Depth (ft)	Symbol	Samples	Blows per foot	Watercontent %	Soil Type
5			5	3.8	1	5					
			5	6.0	1						
10			14	6.2	1	10					
15			10	8.1	1	15					
20			27	7.8	1	20					



**ENTECH**  
**ENGINEERING, INC.**

505 ELKTON DRIVE  
 COLORADO SPRINGS, COLORADO 80907

TEST BORING LOG

DRAWN:	DATE:	CHECKED: LLL	DATE: 1/7/19
--------	-------	-----------------	-----------------

JOB NO:  
181459

FIG NO:

B-3

TEST PIT NO. 1  
 DATE EXCAVATED 9/12/2018  
 Job # 181459

TEST PIT NO. 2  
 DATE EXCAVATED 9/12/2018  
 CLIENT PROTERRA PROPERTIES, LLC  
 LOCATION WINSOME SUBDIVISION

REMARKS	Depth (ft)	Symbol	Samples	Soil Structure Shape	Soil Structure Grade	USDA Soil Type	REMARKS	Depth (ft)	Symbol	Samples	Soil Structure Shape	Soil Structure Grade	USDA Soil Type
topsoil sandy clay loam, brown	1	[Symbol]					topsoil sandy loam, brown	1	[Symbol]				
sandy clay loam, light brown	2	[Symbol]		bl	m	3	sandy loam, fine to coarse light brown	2	[Symbol]		gr	m	2
	3	[Symbol]						3	[Symbol]				
	4	[Symbol]					weathered to formational silty sandstone	4	[Symbol]		ma		3A
sandy clay, light brown	5	[Symbol]		gr	w	4A		5	[Symbol]				
	6	[Symbol]						6	[Symbol]				
	7	[Symbol]						7	[Symbol]				
	8	[Symbol]						8	[Symbol]				
	9	[Symbol]						9	[Symbol]				
	10	[Symbol]						10	[Symbol]				

Soil Structure Shape

- granular - gr
- platy - pl
- blocky - bl
- prismatic - pr
- single grain - sg
- massive - ma

Soil Structure Grade

- weak - w
- moderate - m
- strong - s
- loose - l



**ENTECH**  
**ENGINEERING, INC.**

505 ELKTON DRIVE  
 COLORADO SPRINGS, COLORADO 80907

**TEST PIT LOG**

DRAWN:	DATE:	CHECKED:	DATE:
		LLL	1/7/19

JOB NO.:  
 181459  
 FIG NO.:  
 B-4

TEST PIT NO. 3  
 DATE EXCAVATED 9/12/2018  
 Job # 181459

TEST PIT NO. 4  
 DATE EXCAVATED 9/12/2018  
 CLIENT PROTERRA PROPERTIES, LLC  
 LOCATION WINSOME SUBDIVISION

REMARKS						REMARKS					
Depth (ft)	Symbol	Samples	Soil Structure Shape	Soil Structure Grade	USDA Soil Type	Depth (ft)	Symbol	Samples	Soil Structure Shape	Soil Structure Grade	USDA Soil Type
1						1					
2			gr	m	2	2			gr	m	2
3						3					
4			ma		4A	4			sg		1
5						5					
6						6					
7						7					
8						8			ma		4A
9						9					
10						10					

Soil Structure Shape  
 granular - gr  
 platy - pl  
 blocky - bl  
 prismatic - pr  
 single grain - sg  
 massive - ma

Soil Structure Grade  
 weak - w  
 moderate - m  
 strong - s  
 loose - l



**ENTECH**  
**ENGINEERING, INC.**

505 ELKTON DRIVE  
 COLORADO SPRINGS, COLORADO 80907

**TEST PIT LOG**

DRAWN:

DATE:

CHECKED:  
 LLL

DATE:  
 11/7/19

JOB NO.:  
 181459  
 FIG NO.:  
 B-5

TEST PIT NO. 5  
 DATE EXCAVATED 9/12/2018  
 Job # 181459

TEST PIT NO. 6  
 DATE EXCAVATED 9/12/2018  
 CLIENT PROTERRA PROPERTIES, LLC  
 LOCATION WINSOME SUBDIVISION

REMARKS						REMARKS					
Depth (ft)	Symbol	Samples	Soil Structure Shape	Soil Structure Grade	USDA Soil Type	Depth (ft)	Symbol	Samples	Soil Structure Shape	Soil Structure Grade	USDA Soil Type
1						1					
2			sg		1	2					3
3						3					
4			sg		1	4					4A
5						5					
6						6					
7						7					
8						8					
9						9					
10						10					

Soil Structure Shape  
 granular - gr  
 platy - pl  
 blocky - bl  
 prismatic - pr  
 single grain - sg  
 massive - ma

Soil Structure Grade  
 weak - w  
 moderate - m  
 strong - s  
 loose - l



**ENTECH  
 ENGINEERING, INC.**

505 ELKTON DRIVE  
 COLORADO SPRINGS, COLORADO 80907

**TEST PIT LOG**

DRAWN:

DATE:

CHECKED:  
 LLL

DATE:  
 1/7/19

JOB NO.:

181459

FIG NO.:

B-6

TEST PIT NO. 7  
 DATE EXCAVATED 9/12/2018  
 Job # 181459

TEST PIT NO. 8  
 DATE EXCAVATED 9/15/2018  
 CLIENT PROTERRA PROPERTIES, LLC  
 LOCATION WINSOME SUBDIVISION

REMARKS						REMARKS					
Depth (ft)	Symbol	Samples	Soil Structure Shape	Soil Structure Grade	USDA Soil Type	Depth (ft)	Symbol	Samples	Soil Structure Shape	Soil Structure Grade	USDA Soil Type
1						1					
2			gr	w	2A	2			gr	w	3A
3						3					
4			ma		3A	4			ma		4A
5						5					
6			ma		4A	6					
7						7					
8						8					
9						9					
10						10					

Soil Structure Shape

granular - gr  
 platy - pl  
 blocky - bl  
 prismatic - pr  
 single grain - sg  
 massive - ma

Soil Structure Grade

weak - w  
 moderate - m  
 strong - s  
 loose - l



**ENTECH**  
**ENGINEERING, INC.**

505 ELKTON DRIVE  
 COLORADO SPRINGS, COLORADO 80907

**TEST PIT LOG**

DRAWN:

DATE:

CHECKED:  
 LLL

DATE:  
 1/7/19

JOB NO:

181459

FIG NO:

B-7



TEST PIT NO. 9  
 DATE EXCAVATED 9/15/2018  
 Job # 181459

TEST PIT NO. 10  
 DATE EXCAVATED 9/15/2018  
 CLIENT PROTERRA PROPERTIES, LLC  
 LOCATION WINSOME SUBDIVISION

REMARKS						REMARKS					
Depth (ft)	Symbol	Samples	Soil Structure Shape	Soil Structure Grade	USDA Soil Type	Depth (ft)	Symbol	Samples	Soil Structure Shape	Soil Structure Grade	USDA Soil Type
1			gr	m	3	1			gr	m	3
2						2					
3						3					
4						4					
5			gr	w	2A	5			gr	w	2A
6						6					
7						7					
8						8					
9						9					
10						10					

Soil Structure Shape

- granular - gr
- platy - pl
- blocky - bl
- prismatic - pr
- single grain - sg
- massive - ma

Soil Structure Grade

- weak - w
- moderate - m
- strong - s
- loose - l



**ENTECH  
 ENGINEERING, INC.**

505 ELKTON DRIVE  
 COLORADO SPRINGS, COLORADO 80907

**TEST PIT LOG**

DRAWN:

DATE:

CHECKED:  
 LLL

DATE:  
 11/7/19

JOB NO.:

181459

FIG NO.:

6-8

## **APPENDIX C: Laboratory Test Results**

**UNIFIED CLASSIFICATION** SM  
**SOIL TYPE #** 1  
**TEST BORING #** 2  
**DEPTH (FT)** 2-3

**CLIENT** PROTERRA PROPERTIES  
**PROJECT** WINSOME SUBDIVISION  
**JOB NO.** 181459  
**TEST BY** BL

**Sieve Analysis  
Grain Size Distribution**

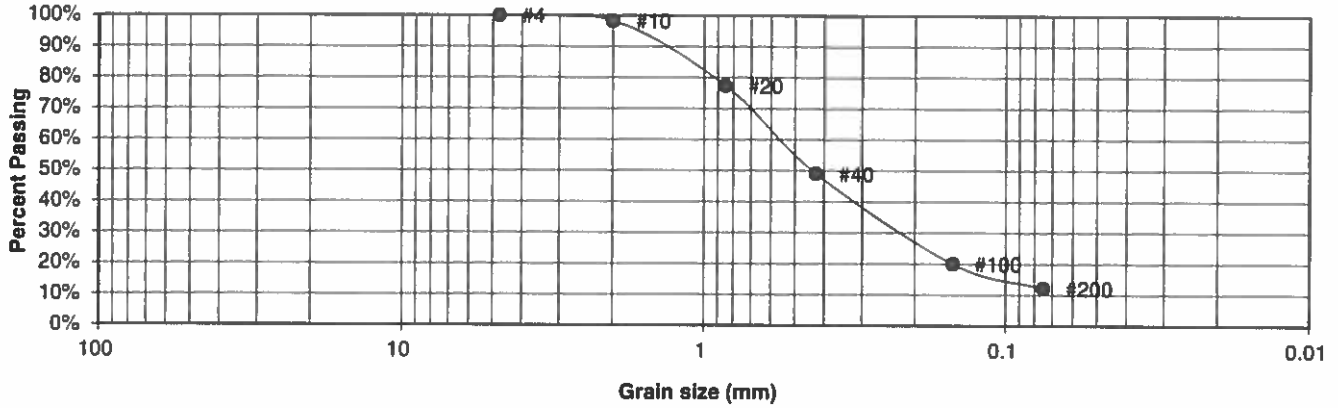

U.S. Sieve #	Percent Finer
3"	
1 1/2"	
3/4"	
1/2"	
3/8"	
4	100.0%
10	98.3%
20	77.4%
40	49.0%
100	20.0%
200	12.1%

**Atterberg Limits**  
 Plastic Limit NP  
 Liquid Limit NV  
 Plastic Index NP

**Swell**  
 Moisture at start  
 Moisture at finish  
 Moisture increase  
 Initial dry density (pcf)  
 Swell (psf)



**ENTECH  
ENGINEERING, INC.**

505 ELKTON DRIVE  
COLORADO SPRINGS, COLORADO 80907

**LABORATORY TEST  
RESULTS**

DRAWN:	DATE:	CHECKED: LLL	DATE: 1/7/19
--------	-------	-----------------	-----------------

JOB NO.:  
181459

FIG NO.:  
C-1

<b>UNIFIED CLASSIFICATION</b>	SM-SW	<b>CLIENT</b>	PROTERRA PROPERTIES
<b>SOIL TYPE #</b>	1	<b>PROJECT</b>	WINSOME SUBDIVISION
<b>TEST BORING #</b>	3	<b>JOB NO.</b>	181459
<b>DEPTH (FT)</b>	10	<b>TEST BY</b>	BL

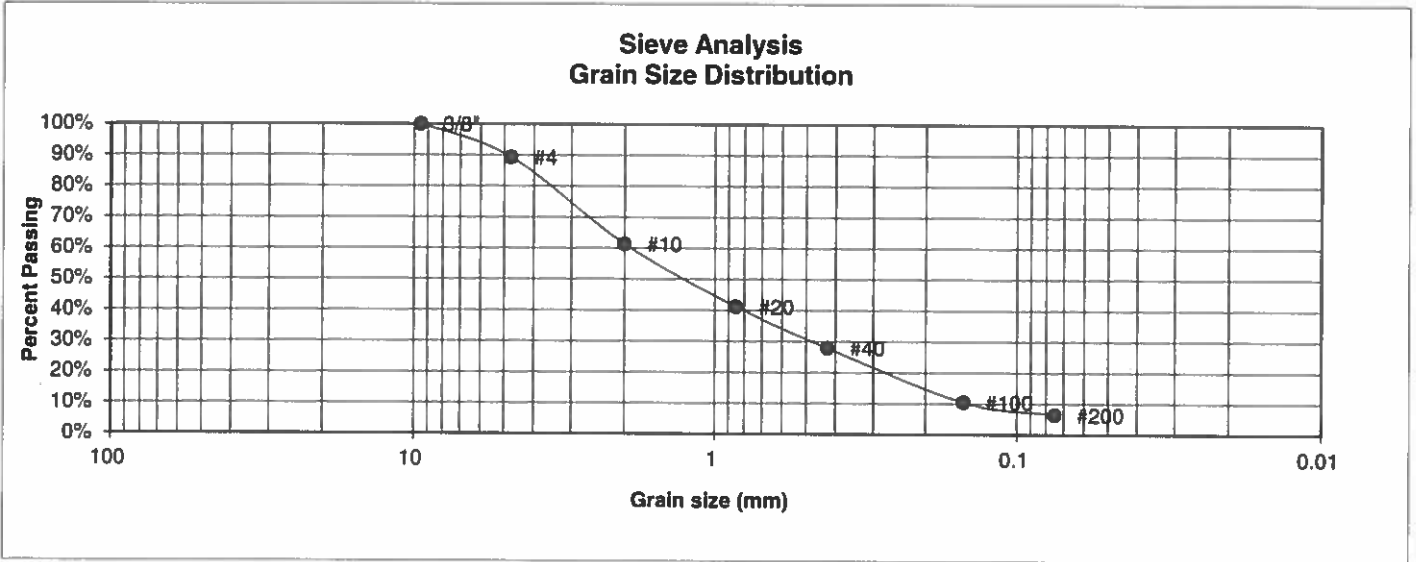

U.S. Sieve #	Percent Finer
3"	
1 1/2"	
3/4"	
1/2"	
3/8"	100.0%
4	89.3%
10	61.3%
20	41.2%
40	27.9%
100	10.5%
200	6.5%

**Atterberg Limits**  
 Plastic Limit  
 Liquid Limit  
 Plastic Index

**Swell**  
 Moisture at start  
 Moisture at finish  
 Moisture increase  
 Initial dry density (pcf)  
 Swell (psf)



**ENTECH  
ENGINEERING, INC.**

505 ELKTON DRIVE  
COLORADO SPRINGS, COLORADO 80907

**LABORATORY TEST  
RESULTS**

<b>DRAWN:</b>	<b>DATE:</b>	<b>CHECKED:</b> LLL	<b>DATE:</b> 1/7/19
---------------	--------------	------------------------	------------------------

JOB NO.:  
181459

FIG NO.:  
C-2

**UNIFIED CLASSIFICATION** SM  
**SOIL TYPE #** 1  
**TEST BORING #** 5  
**DEPTH (FT)** 5

**CLIENT** PROTERRA PROPERTIES  
**PROJECT** WINSOME SUBDIVISION  
**JOB NO.** 181459  
**TEST BY** BL

**Sieve Analysis  
Grain Size Distribution**

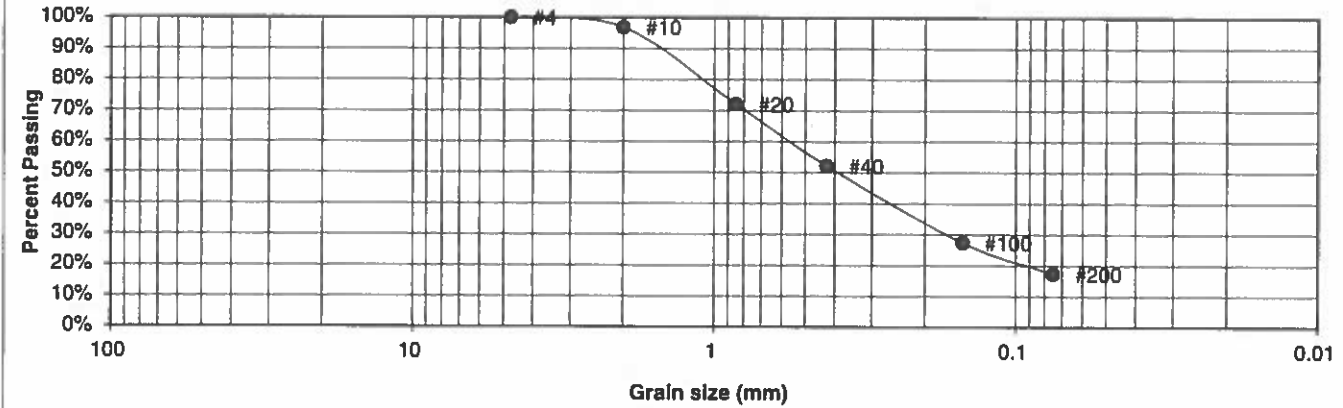

U.S. Sieve #	Percent Finer
3"	
1 1/2"	
3/4"	
1/2"	
3/8"	
4	100.0%
10	96.9%
20	72.1%
40	52.2%
100	27.4%
200	17.3%

**Atterberg Limits**  
 Plastic Limit  
 Liquid Limit  
 Plastic Index

**Swell**  
 Moisture at start  
 Moisture at finish  
 Moisture increase  
 Initial dry density (pcf)  
 Swell (psf)



**ENTECH  
ENGINEERING, INC.**

505 ELKTON DRIVE  
COLORADO SPRINGS, COLORADO 80907

**LABORATORY TEST  
RESULTS**

DRAWN:	DATE:	CHECKED: LLL	DATE: 1/7/19
--------	-------	-----------------	-----------------

JOB NO.:  
181459

FIG NO.:  
C-3

<b>UNIFIED CLASSIFICATION</b>	SM	<b>CLIENT</b>	PROTERRA PROPERTIES
<b>SOIL TYPE #</b>	1	<b>PROJECT</b>	WINSOME SUBDIVISION
<b>TEST BORING #</b>	TP-3	<b>JOB NO.</b>	181459
<b>DEPTH (FT)</b>	2-3	<b>TEST BY</b>	BL

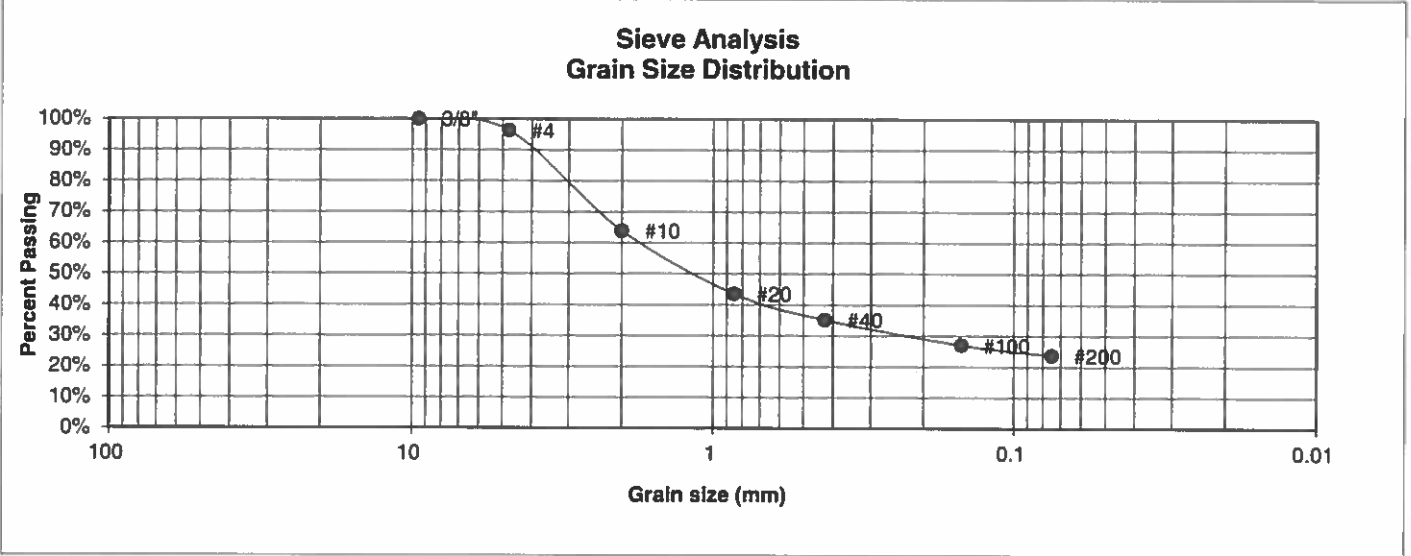

<u>U.S. Sieve #</u>	<u>Percent Finer</u>
3"	
1 1/2"	
3/4"	
1/2"	
3/8"	100.0%
4	96.3%
10	63.9%
20	43.5%
40	35.2%
100	27.0%
200	23.7%

**Atterberg Limits**  
 Plastic Limit  
 Liquid Limit  
 Plastic Index

**Swell**  
 Moisture at start  
 Moisture at finish  
 Moisture increase  
 Initial dry density (pcf)  
 Swell (psf)



**ENTECH  
ENGINEERING, INC.**

505 ELKTON DRIVE  
COLORADO SPRINGS, COLORADO 80907

**LABORATORY TEST  
RESULTS**

<b>DRAWN:</b>	<b>DATE:</b>	<b>CHECKED:</b> LLL	<b>DATE:</b> 1/7/19
---------------	--------------	------------------------	------------------------

JOB NO.:  
181459

FIG NO.:  
C-4

<b>UNIFIED CLASSIFICATION</b>	SM	<b>CLIENT</b>	PROTERRA PROPERTIES
<b>SOIL TYPE #</b>	1	<b>PROJECT</b>	WINSOME SUBDIVISION
<b>TEST BORING #</b>	TP-4	<b>JOB NO.</b>	181459
<b>DEPTH (FT)</b>	5-6	<b>TEST BY</b>	BL

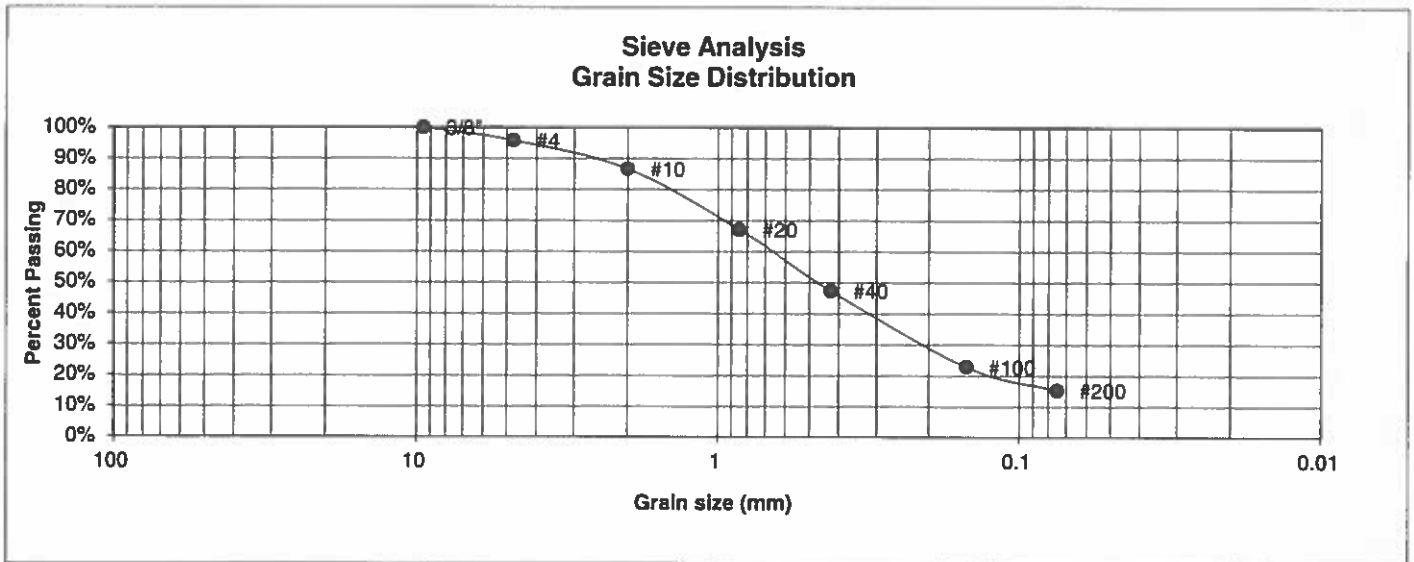

U.S. Sieve #	Percent Finer
3"	
1 1/2"	
3/4"	
1/2"	
3/8"	100.0%
4	95.8%
10	86.7%
20	67.2%
40	47.4%
100	22.9%
200	15.3%

**Atterberg Limits**  
 Plastic Limit  
 Liquid Limit  
 Plastic Index

**Swell**  
 Moisture at start  
 Moisture at finish  
 Moisture increase  
 Initial dry density (pcf)  
 Swell (psf)



**ENTECH  
ENGINEERING, INC.**  
 505 ELKTON DRIVE  
 COLORADO SPRINGS, COLORADO 80907

**LABORATORY TEST  
RESULTS**

<b>DRAWN:</b>	<b>DATE</b>	<b>CHECKED:</b> LLL	<b>DATE:</b> 1/7/19
---------------	-------------	------------------------	------------------------

JOB NO.:  
181459

FIG NO.:  
6-5

<b>UNIFIED CLASSIFICATION</b>	SM	<b>CLIENT</b>	PROTERRA PROPERTIES
<b>SOIL TYPE #</b>	1	<b>PROJECT</b>	WINSOME SUBDIVISION
<b>TEST BORING #</b>	TP-5	<b>JOB NO.</b>	181459
<b>DEPTH (FT)</b>	2-3	<b>TEST BY</b>	BL

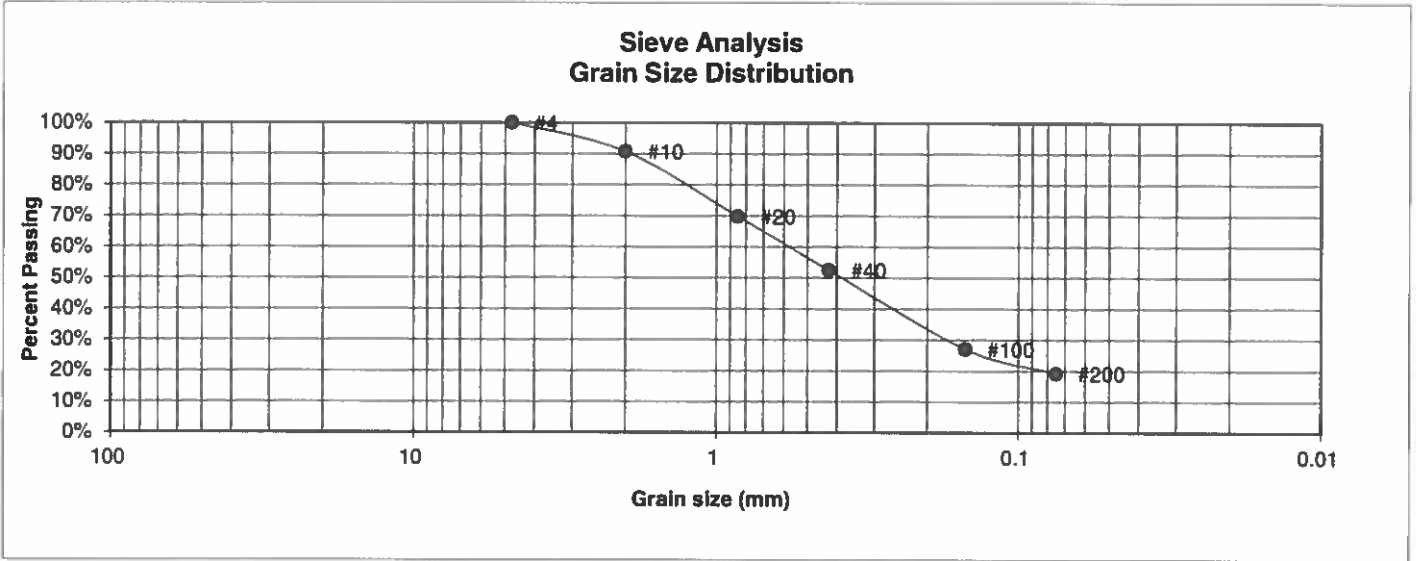

U.S. Sieve #	Percent Finer
3"	
1 1/2"	
3/4"	
1/2"	
3/8"	
4	100.0%
10	90.8%
20	69.8%
40	52.5%
100	27.1%
200	19.2%

**Atterberg Limits**  
 Plastic Limit  
 Liquid Limit  
 Plastic Index

**Swell**  
 Moisture at start  
 Moisture at finish  
 Moisture increase  
 Initial dry density (pcf)  
 Swell (psf)



**ENTECH  
ENGINEERING, INC.**

505 ELKTON DRIVE  
COLORADO SPRINGS, COLORADO 80907

**LABORATORY TEST  
RESULTS**

DRAWN:	DATE:	CHECKED: LLL	DATE: 1/7/19
--------	-------	-----------------	-----------------

JOB NO.:  
181459

FIG NO.:  
C-6



<b>UNIFIED CLASSIFICATION</b>	SM	<b>CLIENT</b>	PROTERRA PROPERTIES
<b>SOIL TYPE #</b>	1	<b>PROJECT</b>	WINSOME SUBDIVISION
<b>TEST BORING #</b>	TP-7	<b>JOB NO.</b>	181459
<b>DEPTH (FT)</b>	2-3	<b>TEST BY</b>	BL

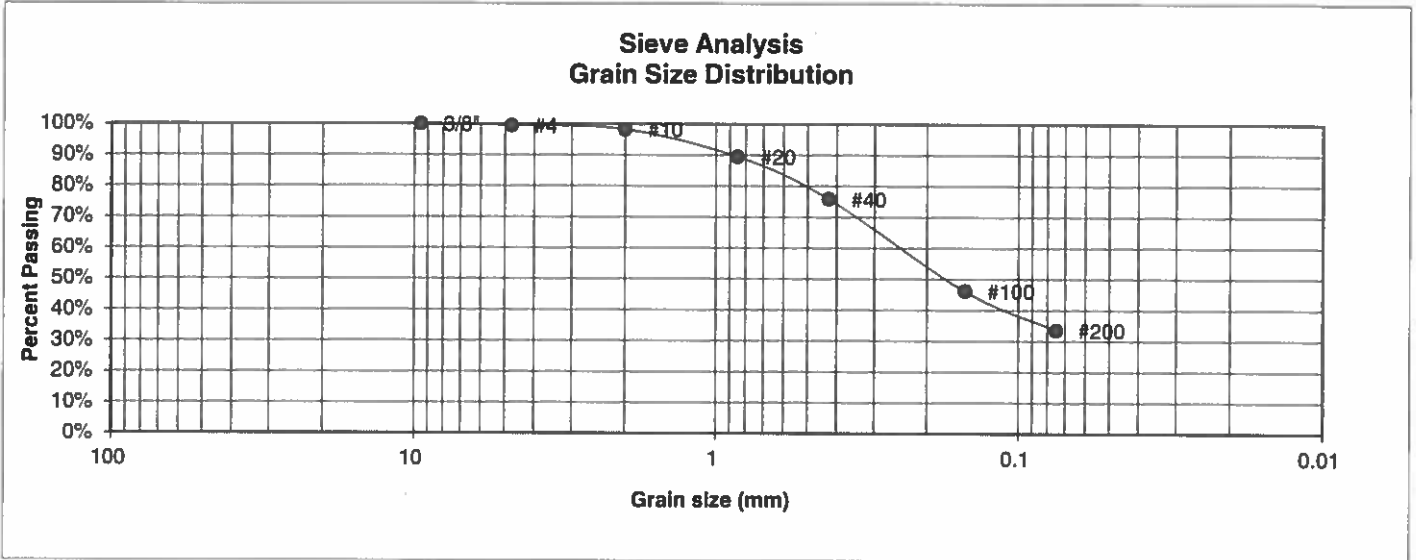

U.S. Sieve #	Percent Finer
3"	
1 1/2"	
3/4"	
1/2"	
3/8"	100.0%
4	99.5%
10	98.3%
20	89.5%
40	75.8%
100	46.1%
200	33.5%

**Atterberg Limits**  
 Plastic Limit  
 Liquid Limit  
 Plastic Index

**Swell**  
 Moisture at start  
 Moisture at finish  
 Moisture increase  
 Initial dry density (pcf)  
 Swell (psf)



**ENTECH  
ENGINEERING, INC.**

505 ELKTON DRIVE  
COLORADO SPRINGS, COLORADO 80907

**LABORATORY TEST  
RESULTS**

DRAWN:	DATE:	CHECKED: LLL	DATE: 1/7/19
--------	-------	-----------------	-----------------

JOB NO:  
181459

FIG NO:

6-7

<b>UNIFIED CLASSIFICATION</b>	SM	<b>CLIENT</b>	PROTERRA PROPERTIES
<b>SOIL TYPE #</b>	1	<b>PROJECT</b>	WINSOME SUBDIVISION
<b>TEST BORING #</b>	TP-9	<b>JOB NO.</b>	181459
<b>DEPTH (FT)</b>	5-6	<b>TEST BY</b>	BL

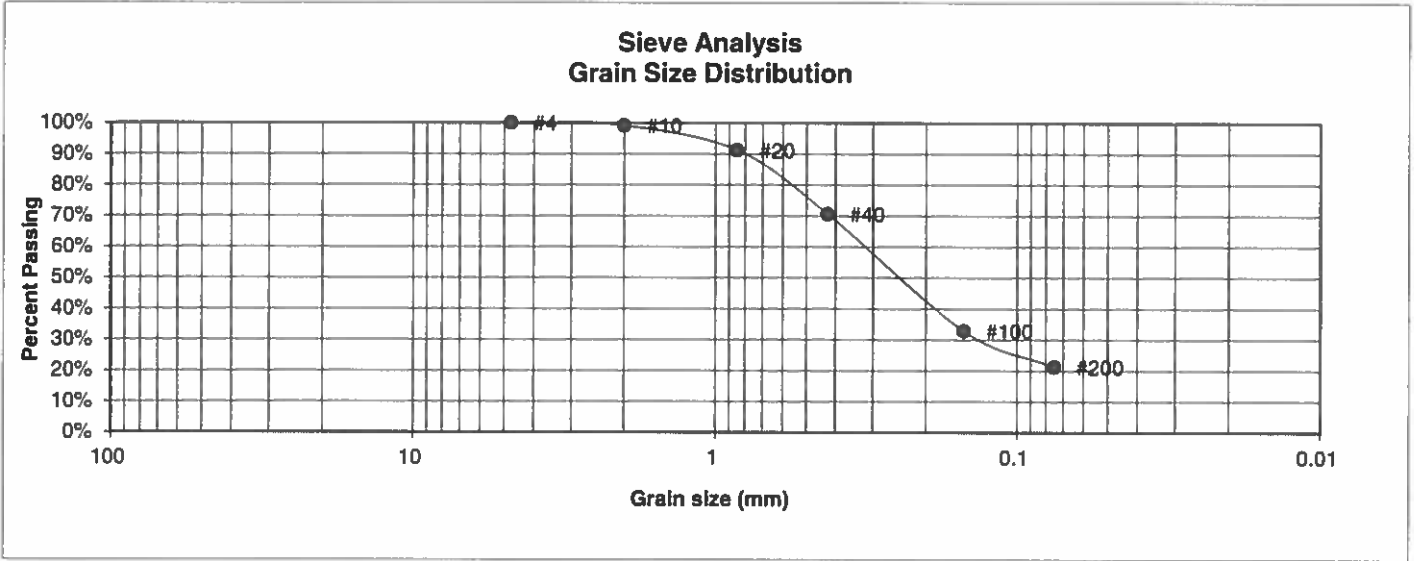

U.S. Sieve #	Percent Finer
3"	
1 1/2"	
3/4"	
1/2"	
3/8"	
4	100.0%
10	99.2%
20	91.2%
40	70.6%
100	32.9%
200	21.3%

**Atterberg Limits**  
 Plastic Limit  
 Liquid Limit  
 Plastic Index

<b>Swell</b>	
Moisture at start	12.7%
Moisture at finish	22.9%
Moisture increase	10.1%
Initial dry density (pcf)	98
Swell (psf)	30



**ENTECH  
ENGINEERING, INC.**

505 ELKTON DRIVE  
COLORADO SPRINGS, COLORADO 80907

**LABORATORY TEST  
RESULTS**

DRAWN:	DATE:	CHECKED:	DATE:
		LLB	1/7/19

JOB NO:  
181459

FIG NO:  
L-8

<b>UNIFIED CLASSIFICATION</b>	SM	<b>CLIENT</b>	PROTERRA PROPERTIES
<b>SOIL TYPE #</b>	1	<b>PROJECT</b>	WINSOME SUBDIVISION
<b>TEST BORING #</b>	TP-10	<b>JOB NO.</b>	181459
<b>DEPTH (FT)</b>	2-3	<b>TEST BY</b>	BL

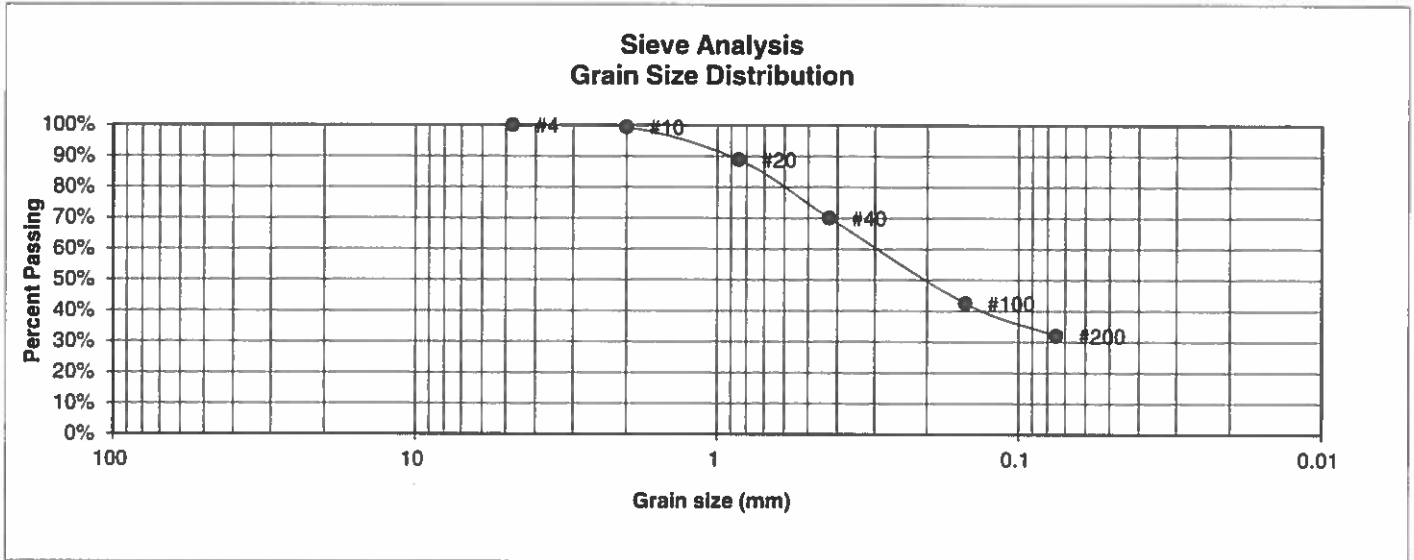

U.S. Sieve #	Percent Finer
3"	
1 1/2"	
3/4"	
1/2"	
3/8"	
4	100.0%
10	99.4%
20	88.9%
40	70.0%
100	42.6%
200	32.0%

**Atterberg Limits**  
 Plastic Limit  
 Liquid Limit  
 Plastic Index

**Swell**  
 Moisture at start  
 Moisture at finish  
 Moisture increase  
 Initial dry density (pcf)  
 Swell (psf)



**ENTECH  
ENGINEERING, INC.**

505 ELKTON DRIVE  
COLORADO SPRINGS, COLORADO 80907

**LABORATORY TEST  
RESULTS**

DRAWN:	DATE:	CHECKED: LLL	DATE: 1/7/19
--------	-------	-----------------	-----------------

JOB NO.:  
181459

FIG NO.:

L-9

<b>UNIFIED CLASSIFICATION</b>	CL	<b>CLIENT</b>	PROTERRA PROPERTIES
<b>SOIL TYPE #</b>	2	<b>PROJECT</b>	WINSOME SUBDIVISION
<b>TEST BORING #</b>	TP-1	<b>JOB NO.</b>	181459
<b>DEPTH (FT)</b>	5-6	<b>TEST BY</b>	BL

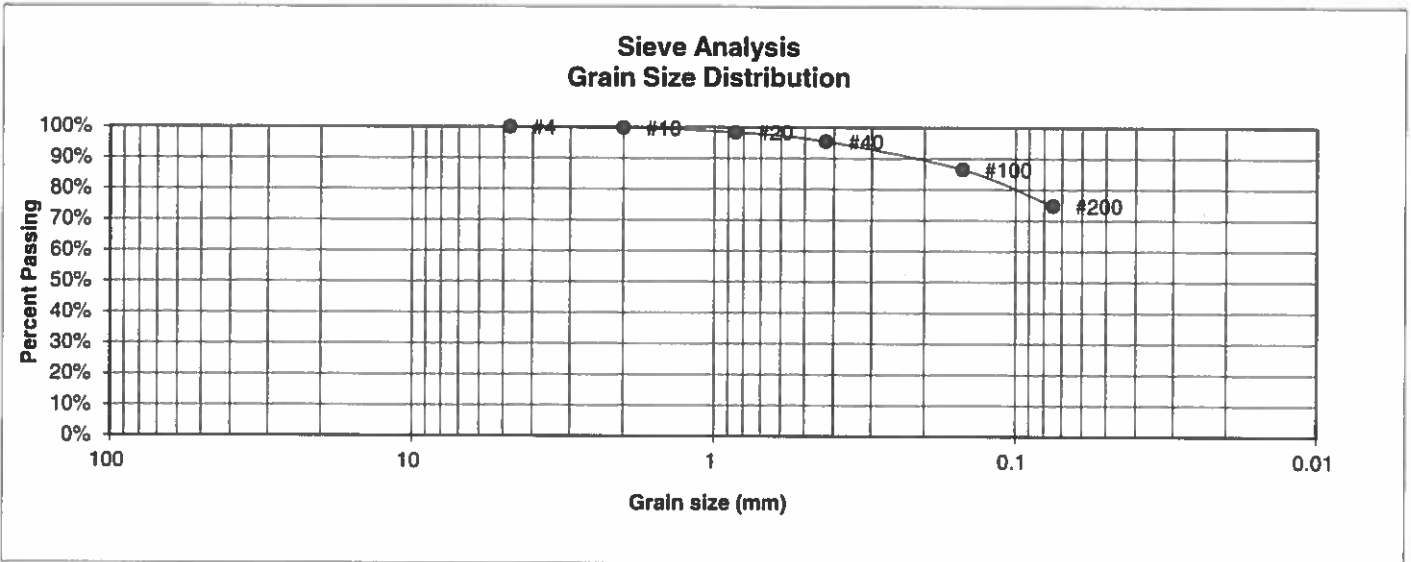

U.S. Sieve #	Percent Finer
3"	
1 1/2"	
3/4"	
1/2"	
3/8"	
4	100.0%
10	99.8%
20	98.4%
40	95.4%
100	86.5%
200	74.8%

Atterberg Limits	
Plastic Limit	20
Liquid Limit	30
Plastic Index	10

Swell	
Moisture at start	
Moisture at finish	
Moisture increase	
Initial dry density (pcf)	
Swell (psf)	



**ENTECH  
ENGINEERING, INC.**

505 ELKTON DRIVE  
COLORADO SPRINGS, COLORADO 80907

**LABORATORY TEST  
RESULTS**

DRAWN:	DATE:	CHECKED: LLL	DATE: 1/7/19
--------	-------	-----------------	-----------------

JOB NO.:  
181459

FIG NO:

C-10

<b>UNIFIED CLASSIFICATION</b>	SM	<b>CLIENT</b>	PROTERRA PROPERTIES
<b>SOIL TYPE #</b>	3	<b>PROJECT</b>	WINSOME SUBDIVISION
<b>TEST BORING #</b>	TP-2	<b>JOB NO.</b>	181459
<b>DEPTH (FT)</b>	5-6	<b>TEST BY</b>	BL

**Sieve Analysis  
Grain Size Distribution**

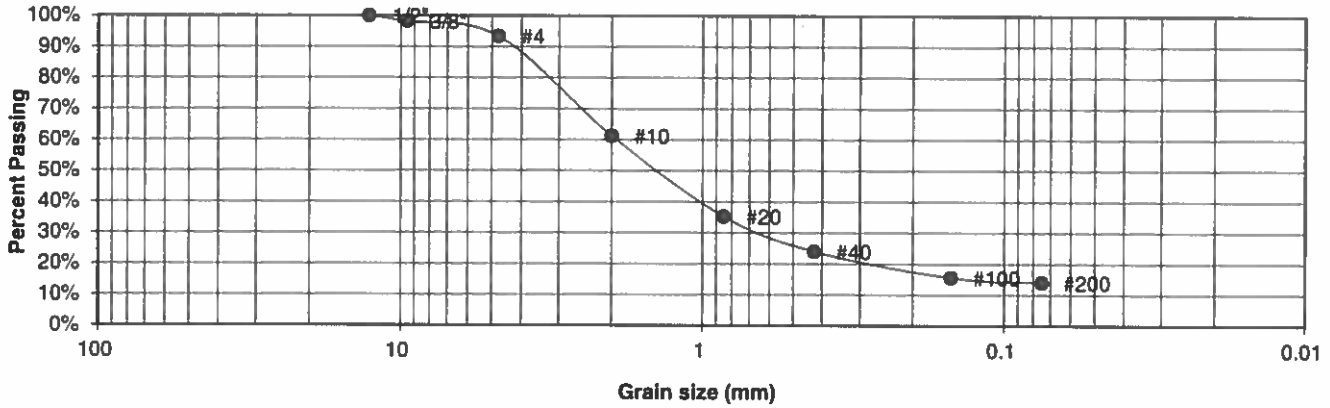

U.S. Sieve #	Percent Finer
3"	
1 1/2"	
3/4"	
1/2"	100.0%
3/8"	98.2%
4	93.4%
10	61.2%
20	35.3%
40	24.0%
100	15.6%
200	14.0%

Atterberg Limits	
Plastic Limit	21
Liquid Limit	30
Plastic Index	9

Swell	
Moisture at start	
Moisture at finish	
Moisture increase	
Initial dry density (pcf)	
Swell (psf)	



**ENTECH  
ENGINEERING, INC.**

505 ELKTON DRIVE  
COLORADO SPRINGS, COLORADO 80907

**LABORATORY TEST  
RESULTS**

DRAWN:	DATE:	CHECKED:	DATE:
		LLL	1/7/19

JOB NO.:  
181459

FIG NO.:  
C-11

<b>UNIFIED CLASSIFICATION</b>	SC	<b>CLIENT</b>	PROTERRA PROPERTIES
<b>SOIL TYPE #</b>	3	<b>PROJECT</b>	WINSOME SUBDIVISION
<b>TEST BORING #</b>	TP-8	<b>JOB NO.</b>	181459
<b>DEPTH (FT)</b>	5-6	<b>TEST BY</b>	BL

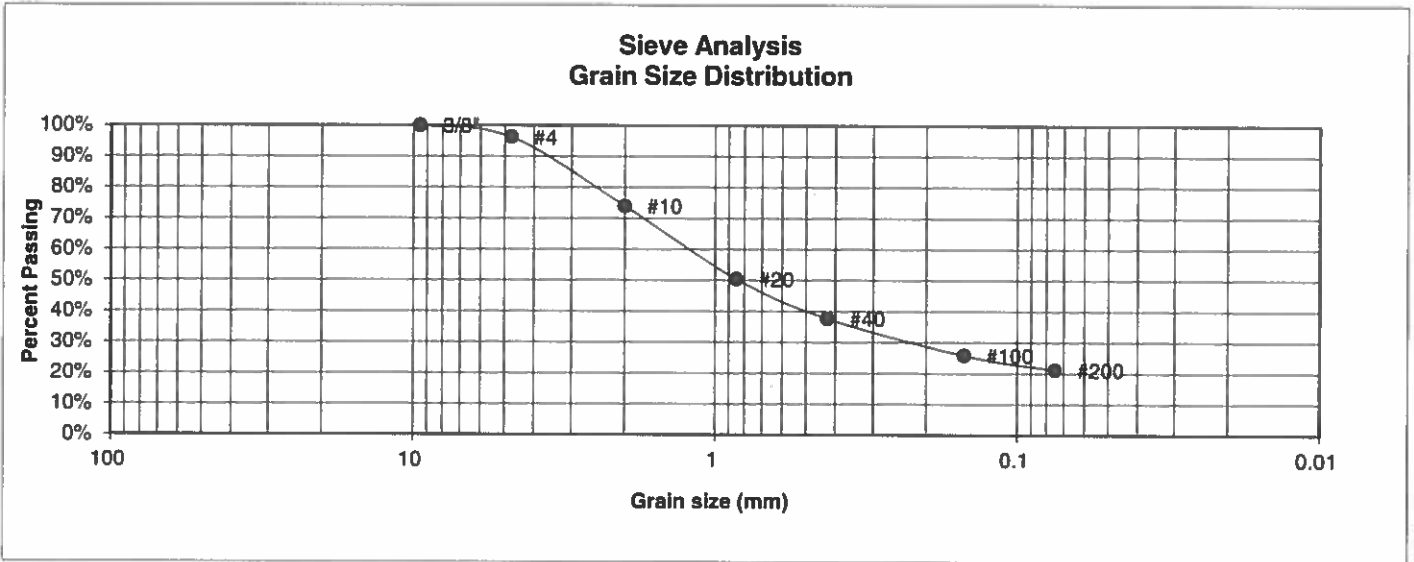

<u>U.S. Sieve #</u>	<u>Percent Finer</u>
3"	
1 1/2"	
3/4"	
1/2"	
3/8"	100.0%
4	96.2%
10	74.0%
20	50.4%
40	37.7%
100	25.8%
200	21.1%

<u>Atterberg Limits</u>	
Plastic Limit	19
Liquid Limit	33
Plastic Index	14

<u>Swell</u>	
Moisture at start	
Moisture at finish	
Moisture increase	
Initial dry density (pcf)	
Swell (psf)	



**ENTECH  
ENGINEERING, INC.**

505 ELKTON DRIVE  
COLORADO SPRINGS, COLORADO 80907

**LABORATORY TEST  
RESULTS**

<b>DRAWN:</b>	<b>DATE:</b>	<b>CHECKED:</b>	<b>DATE:</b>
		LLL	1/7/19

JOB NO.:  
181459

FIG NO.:  
C-12

<b>UNIFIED CLASSIFICATION</b>	CL-SC	<b>CLIENT</b>	PROTERRA PROPERTIES
<b>SOIL TYPE #</b>	3	<b>PROJECT</b>	WINSOME SUBDIVISION
<b>TEST BORING #</b>	TP-6	<b>JOB NO.</b>	181459
<b>DEPTH (FT)</b>	5-6	<b>TEST BY</b>	BL

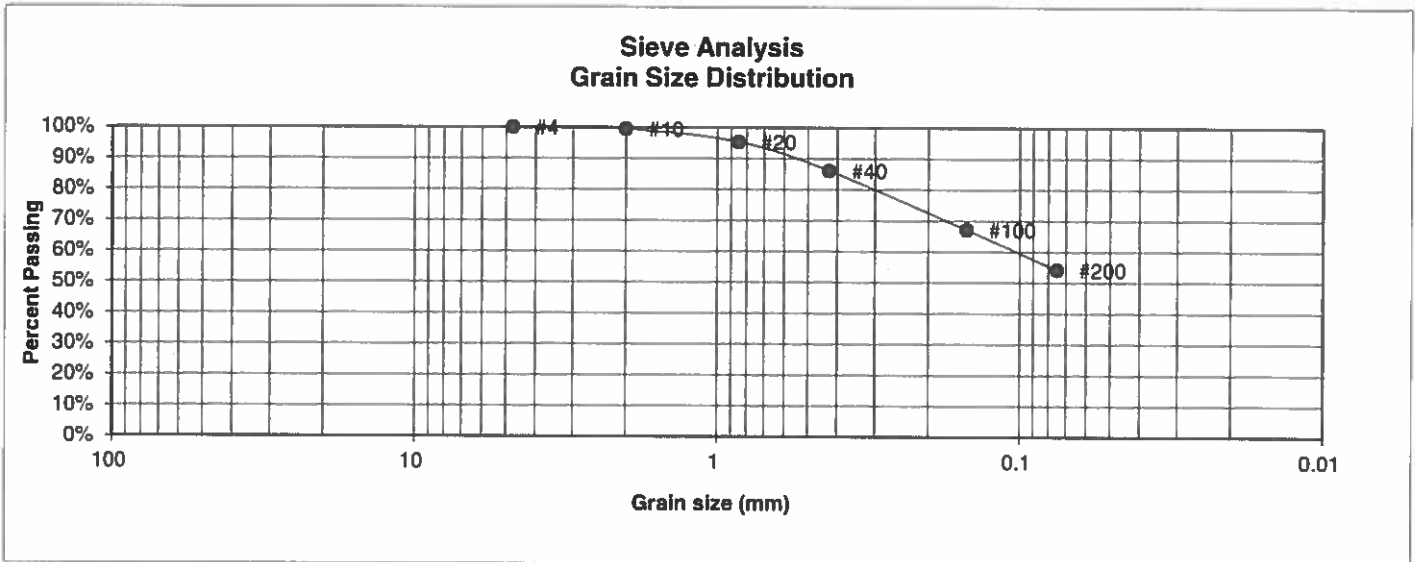

U.S. Sieve #	Percent Finer
3"	
1 1/2"	
3/4"	
1/2"	
3/8"	
4	100.0%
10	99.5%
20	95.4%
40	86.1%
100	67.1%
200	54.2%

**Atterberg Limits**  
 Plastic Limit  
 Liquid Limit  
 Plastic Index

**Swell**

Moisture at start	8.4%
Moisture at finish	20.4%
Moisture increase	12.0%
Initial dry density (pcf)	101
Swell (psf)	350



**ENTECH  
ENGINEERING, INC.**

505 ELKTON DRIVE  
COLORADO SPRINGS, COLORADO 80907

**LABORATORY TEST  
RESULTS**

DRAWN:	DATE:	CHECKED:	DATE:
		LLL	1/7/19

JOB NO.:  
181459

FIG NO.:  
C-13

<b>UNIFIED CLASSIFICATION</b>	SC-SM	<b>CLIENT</b>	PROTERRA PROPERTIES
<b>SOIL TYPE #</b>	3	<b>PROJECT</b>	WINSOME SUBDIVISION
<b>TEST BORING #</b>	4	<b>JOB NO.</b>	181459
<b>DEPTH (FT)</b>	20	<b>TEST BY</b>	BL

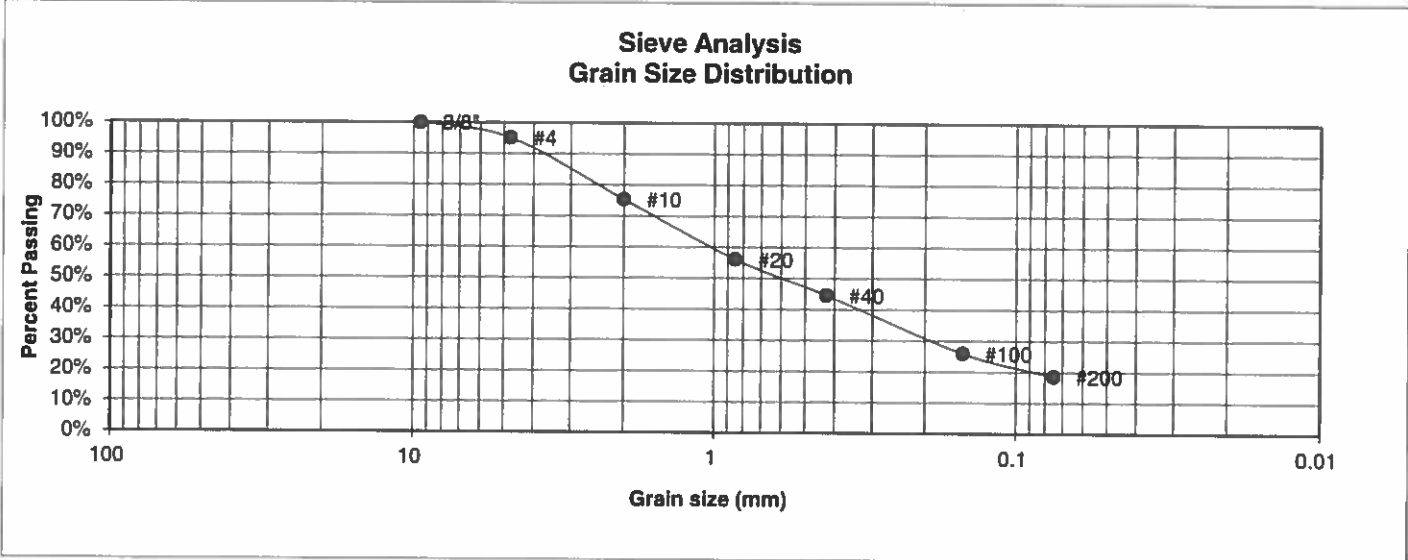

U.S. Sieve #	Percent Finer
3"	
1 1/2"	
3/4"	
1/2"	
3/8"	100.0%
4	95.1%
10	75.3%
20	56.1%
40	44.6%
100	26.0%
200	18.6%

Atterberg Limits	
Plastic Limit	14
Liquid Limit	21
Plastic Index	7

Swell	
Moisture at start	
Moisture at finish	
Moisture increase	
Initial dry density (pcf)	
Swell (psf)	



**ENTECH  
ENGINEERING, INC.**

505 ELKTON DRIVE  
COLORADO SPRINGS, COLORADO 80907

**LABORATORY TEST  
RESULTS**

DRAWN:	DATE:	CHECKED: LLL	DATE: 1/7/19
--------	-------	-----------------	-----------------

JOB NO.:  
181459

FIG NO.:  
C-19



<b>UNIFIED CLASSIFICATION</b>	CL	<b>CLIENT</b>	PROTERRA PROPERTIES
<b>SOIL TYPE #</b>	4	<b>PROJECT</b>	WINSOME SUBDIVISION
<b>TEST BORING #</b>	1	<b>JOB NO.</b>	181459
<b>DEPTH (FT)</b>	15	<b>TEST BY</b>	BL

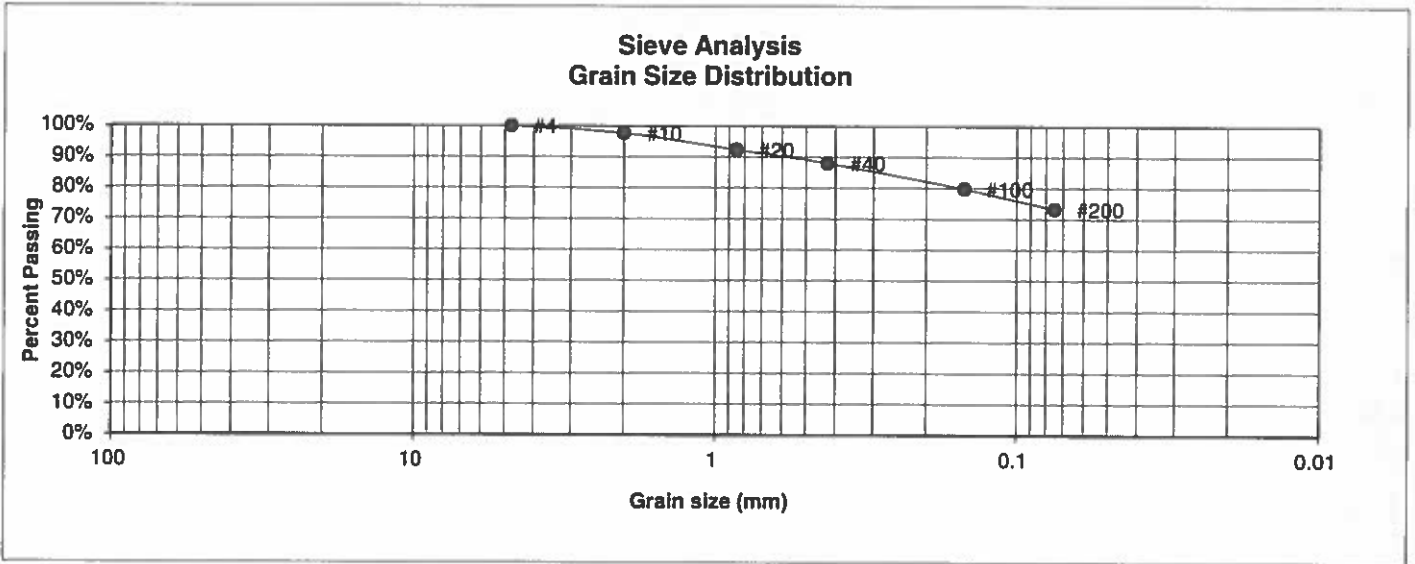

U.S. Sieve #	Percent Finer
3"	
1 1/2"	
3/4"	
1/2"	
3/8"	
4	100.0%
10	97.7%
20	92.3%
40	88.0%
100	79.8%
200	73.2%

Atterberg Limits	
Plastic Limit	22
Liquid Limit	35
Plastic Index	13

Swell	
Moisture at start	
Moisture at finish	
Moisture increase	
Initial dry density (pcf)	
Swell (psf)	



**ENTECH  
ENGINEERING, INC.**

505 ELKTON DRIVE  
COLORADO SPRINGS, COLORADO 80907

**LABORATORY TEST  
RESULTS**

DRAWN:	DATE:	CHECKED: LLL	DATE: 1/7/19
--------	-------	-----------------	-----------------

JOB NO.:  
181459

FIG NO.:  
L-15

**CONSOLIDATION TEST RESULTS**

TEST BORING #	1	DEPTH(ft)	15
DESCRIPTION	CL	SOIL TYPE	4
NATURAL UNIT DRY WEIGHT (PCF)			120
NATURAL MOISTURE CONTENT			13.4%
SWELL/CONSOLIDATION (%)			2.5%

JOB NO. 181459  
 CLIENT PROTERRA PROPERTIES  
 PROJECT WINSOME SUBDIVISION

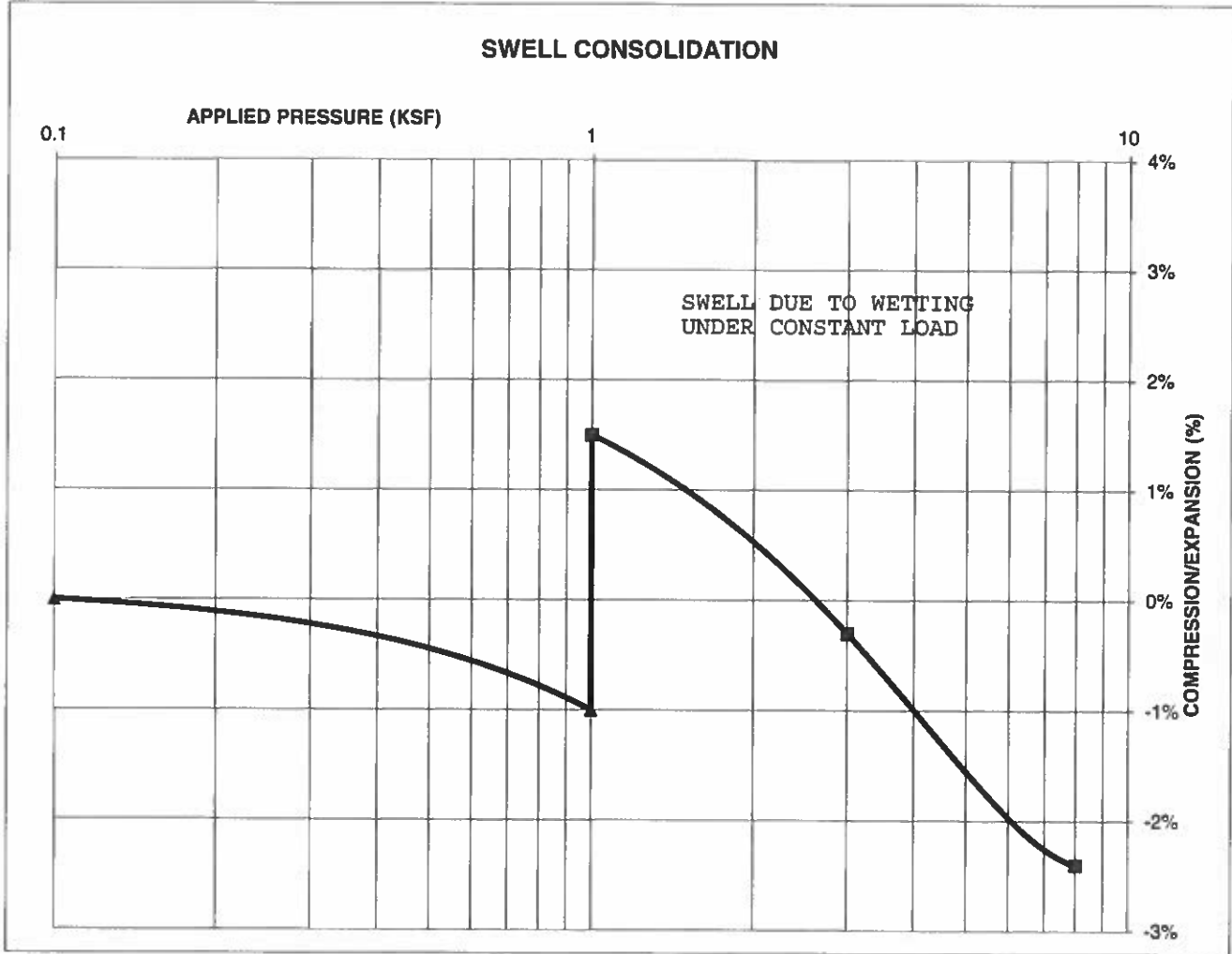

**ENTECH**  
**ENGINEERING, INC.**

505 ELKTON DRIVE  
 COLORADO SPRINGS, COLORADO 80907

**SWELL CONSOLIDATION  
 TEST RESULTS**

DRAWN:

DATE:

CHECKED:

DATE:

LLH

1/7/19

JOB NO.:  
 181459

FIG NO.:  
 C-16

CLIENT	PROTERRA PROPERTIES	JOB NO.	181459
PROJECT	WINSOME SUBDIVISION	DATE	9/24/2018
LOCATION	WINSOME SUBDIVISION	TEST BY	BL

BORING NUMBER	DEPTH, (ft)	SOIL TYPE NUMBER	UNIFIED CLASSIFICATION	WATER SOLUBLE SULFATE, (wt%)
TB-1	15	4	CL	<0.01
TB-3	10	1	SM-SW	<0.01
TB-4	20	3	SC-SM	<0.01

QC BLANK PASS



**ENTECH**  
**ENGINEERING, INC.**  
 505 ELKTON DRIVE  
 COLORADO SPRINGS, COLORADO 80907

**LABORATORY TEST  
 SULFATE RESULTS**

DRAWN:	DATE:	CHECKED: LLL	DATE: 1/7/19
--------	-------	-----------------	-----------------

JOB NO.:  
181459

FIG NO.:  
C-17

## **APPENDIX D: Soil Survey Descriptions**

## El Paso County Area, Colorado

### 1—Alamosa loam, 1 to 3 percent slopes

#### Map Unit Setting

*National map unit symbol:* 3670

*Elevation:* 7,200 to 7,700 feet

*Farmland classification:* Prime farmland if irrigated and reclaimed of excess salts and sodium

#### Map Unit Composition

*Alamosa and similar soils:* 85 percent

*Estimates are based on observations, descriptions, and transects of the mapunit.*

#### Description of Alamosa

##### Setting

*Landform:* Flood plains, fans

*Down-slope shape:* Linear

*Across-slope shape:* Linear

*Parent material:* Alluvium

##### Typical profile

*A - 0 to 6 inches:* loam

*Bt - 6 to 14 inches:* clay loam

*Btk - 14 to 33 inches:* clay loam

*Cg1 - 33 to 53 inches:* sandy clay loam

*Cg2 - 53 to 60 inches:* sandy loam

##### Properties and qualities

*Slope:* 1 to 3 percent

*Depth to restrictive feature:* More than 80 inches

*Natural drainage class:* Poorly drained

*Runoff class:* Very high

*Capacity of the most limiting layer to transmit water (Ksat):*

Moderately high (0.20 to 0.60 in/hr)

*Depth to water table:* About 12 to 18 inches

*Frequency of flooding:* Frequent

*Frequency of ponding:* None

*Calcium carbonate, maximum in profile:* 5 percent

*Salinity, maximum in profile:* Very slightly saline to strongly saline  
(2.0 to 16.0 mmhos/cm)

*Available water storage in profile:* High (about 10.2 inches)

##### Interpretive groups

*Land capability classification (irrigated):* None specified

*Land capability classification (nonirrigated):* 5w

*Hydrologic Soil Group:* D

*Ecological site:* Mountain Meadow (R048AY241CO)

*Hydric soil rating:* Yes

**Minor Components**

**Other soils**

*Percent of map unit:*

*Hydric soil rating:* No

**Data Source Information**

Soil Survey Area: El Paso County Area, Colorado

Survey Area Data: Version 15, Oct 10, 2017

## El Paso County Area, Colorado

### 15—Brussett loam, 3 to 5 percent slopes

#### Map Unit Setting

*National map unit symbol:* 367k  
*Elevation:* 7,200 to 7,500 feet  
*Frost-free period:* 115 to 125 days  
*Farmland classification:* Prime farmland if irrigated

#### Map Unit Composition

*Brussett and similar soils:* 85 percent  
*Estimates are based on observations, descriptions, and transects of the mapunit.*

#### Description of Brussett

##### Setting

*Landform:* Hills  
*Landform position (three-dimensional):* Side slope  
*Down-slope shape:* Linear  
*Across-slope shape:* Linear  
*Parent material:* Eolian deposits

##### Typical profile

*A - 0 to 8 inches:* loam  
*BA - 8 to 12 inches:* loam  
*Bt - 12 to 26 inches:* clay loam  
*Bk - 26 to 60 inches:* silt loam

##### Properties and qualities

*Slope:* 3 to 5 percent  
*Depth to restrictive feature:* More than 80 inches  
*Natural drainage class:* Well drained  
*Runoff class:* Low  
*Capacity of the most limiting layer to transmit water (Ksat):*  
Moderately high (0.20 to 0.60 in/hr)  
*Depth to water table:* More than 80 inches  
*Frequency of flooding:* None  
*Frequency of ponding:* None  
*Calcium carbonate, maximum in profile:* 5 percent  
*Salinity, maximum in profile:* Nonsaline to very slightly saline (0.0 to 2.0 mmhos/cm)  
*Available water storage in profile:* High (about 9.1 inches)

##### Interpretive groups

*Land capability classification (irrigated):* None specified  
*Land capability classification (nonirrigated):* 4e  
*Hydrologic Soil Group:* B  
*Ecological site:* Loamy Park (R048AY222CO)  
*Hydric soil rating:* No

**Minor Components**

**Other soils**

*Percent of map unit:*

*Hydric soil rating:* No

**Data Source Information**

Soil Survey Area: El Paso County Area, Colorado

Survey Area Data: Version 15, Oct 10, 2017



## El Paso County Area, Colorado

### 21—Cruckton sandy loam, 1 to 9 percent slopes

#### Map Unit Setting

*National map unit symbol:* 367s  
*Elevation:* 7,200 to 7,600 feet  
*Mean annual precipitation:* 16 to 18 inches  
*Mean annual air temperature:* 42 to 46 degrees F  
*Frost-free period:* 110 to 120 days  
*Farmland classification:* Not prime farmland

#### Map Unit Composition

*Cruckton and similar soils:* 85 percent  
*Estimates are based on observations, descriptions, and transects of the mapunit.*

#### Description of Cruckton

##### Setting

*Landform:* Flats, hills  
*Landform position (three-dimensional):* Side slope, talf  
*Down-slope shape:* Linear  
*Across-slope shape:* Linear  
*Parent material:* Alluvium derived from arkose

##### Typical profile

*A - 0 to 11 inches:* sandy loam  
*Bt - 11 to 28 inches:* sandy loam  
*C - 28 to 60 inches:* loamy coarse sand

##### Properties and qualities

*Slope:* 1 to 9 percent  
*Depth to restrictive feature:* More than 80 inches  
*Natural drainage class:* Well drained  
*Runoff class:* Medium  
*Capacity of the most limiting layer to transmit water (Ksat):*  
Moderately high to high (0.60 to 2.00 in/hr)  
*Depth to water table:* More than 80 inches  
*Frequency of flooding:* None  
*Frequency of ponding:* None  
*Available water storage in profile:* Low (about 5.9 inches)

##### Interpretive groups

*Land capability classification (irrigated):* None specified  
*Land capability classification (nonirrigated):* 4e  
*Hydrologic Soil Group:* B  
*Ecological site:* Sandy Divide (R049BY216CO)  
*Hydric soil rating:* No

### Minor Components

#### Other soils

*Percent of map unit:*

*Hydric soil rating:* No

### Data Source Information

Soil Survey Area: El Paso County Area, Colorado

Survey Area Data: Version 15, Oct 10, 2017

## El Paso County Area, Colorado

### 25—Elbeth sandy loam, 3 to 8 percent slopes

#### Map Unit Setting

*National map unit symbol:* 367x  
*Elevation:* 7,300 to 7,600 feet  
*Farmland classification:* Not prime farmland

#### Map Unit Composition

*Elbeth and similar soils:* 85 percent  
*Estimates are based on observations, descriptions, and transects of the mapunit.*

#### Description of Elbeth

##### Setting

*Landform:* Hills  
*Landform position (three-dimensional):* Side slope  
*Down-slope shape:* Linear  
*Across-slope shape:* Linear  
*Parent material:* Alluvium derived from arkose

##### Typical profile

*A - 0 to 3 inches:* sandy loam  
*E - 3 to 23 inches:* loamy sand  
*Bt - 23 to 68 inches:* sandy clay loam  
*C - 68 to 74 inches:* sandy clay loam

##### Properties and qualities

*Slope:* 3 to 8 percent  
*Depth to restrictive feature:* More than 80 inches  
*Natural drainage class:* Well drained  
*Runoff class:* Medium  
*Capacity of the most limiting layer to transmit water (Ksat):*  
Moderately high (0.20 to 0.60 in/hr)  
*Depth to water table:* More than 80 inches  
*Frequency of flooding:* None  
*Frequency of ponding:* None  
*Available water storage in profile:* Moderate (about 7.1 inches)

##### Interpretive groups

*Land capability classification (irrigated):* None specified  
*Land capability classification (nonirrigated):* 4e  
*Hydrologic Soil Group:* B  
*Hydric soil rating:* No

#### Minor Components

##### Other soils

*Percent of map unit:*

*Hydric soil rating:* No

## Data Source Information

Soil Survey Area: El Paso County Area, Colorado  
Survey Area Data: Version 15, Oct 10, 2017

## El Paso County Area, Colorado

### 26—Elbeth sandy loam, 8 to 15 percent slopes

#### Map Unit Setting

*National map unit symbol:* 367y

*Elevation:* 7,300 to 7,600 feet

*Farmland classification:* Not prime farmland

#### Map Unit Composition

*Elbeth and similar soils:* 85 percent

*Estimates are based on observations, descriptions, and transects of the mapunit.*

#### Description of Elbeth

##### Setting

*Landform:* Hills

*Landform position (three-dimensional):* Side slope

*Down-slope shape:* Linear

*Across-slope shape:* Linear

*Parent material:* Alluvium derived from arkose

##### Typical profile

*A - 0 to 3 inches:* sandy loam

*E - 3 to 23 inches:* loamy sand

*Bt - 23 to 68 inches:* sandy clay loam

*C - 68 to 74 inches:* sandy clay loam

##### Properties and qualities

*Slope:* 8 to 15 percent

*Depth to restrictive feature:* More than 80 inches

*Natural drainage class:* Well drained

*Runoff class:* Medium

*Capacity of the most limiting layer to transmit water (Ksat):*

Moderately high (0.20 to 0.60 in/hr)

*Depth to water table:* More than 80 inches

*Frequency of flooding:* None

*Frequency of ponding:* None

*Available water storage in profile:* Moderate (about 7.1 inches)

##### Interpretive groups

*Land capability classification (irrigated):* None specified

*Land capability classification (nonirrigated):* 4e

*Hydrologic Soil Group:* B

*Hydric soil rating:* No

##### Minor Components

##### Other soils

*Percent of map unit:*

*Hydric soil rating:* No

**Pleasant**

*Percent of map unit:*

*Landform:* Depressions

*Hydric soil rating:* Yes

**Data Source Information**

Soil Survey Area: El Paso County Area, Colorado

Survey Area Data: Version 15, Oct 10, 2017

## El Paso County Area, Colorado

### 36—Holderness loam, 8 to 15 percent slopes

#### Map Unit Setting

*National map unit symbol:* 3689

*Elevation:* 7,200 to 7,400 feet

*Farmland classification:* Not prime farmland

#### Map Unit Composition

*Holderness and similar soils:* 85 percent

*Estimates are based on observations, descriptions, and transects of the mapunit.*

#### Description of Holderness

##### Setting

*Landform:* Hills

*Landform position (three-dimensional):* Side slope

*Down-slope shape:* Linear

*Across-slope shape:* Linear

*Parent material:* Loamy alluvium derived from arkose

##### Typical profile

*A - 0 to 9 inches:* loam

*Bt - 9 to 43 inches:* clay loam

*C - 43 to 60 inches:* gravelly sandy clay loam

##### Properties and qualities

*Slope:* 8 to 15 percent

*Depth to restrictive feature:* More than 80 inches

*Natural drainage class:* Well drained

*Runoff class:* Medium

*Capacity of the most limiting layer to transmit water (Ksat):*

Moderately low to moderately high (0.06 to 0.20 in/hr)

*Depth to water table:* More than 80 inches

*Frequency of flooding:* None

*Frequency of ponding:* None

*Calcium carbonate, maximum in profile:* 5 percent

*Salinity, maximum in profile:* Nonsaline to very slightly saline (0.0 to 2.0 mmhos/cm)

*Available water storage in profile:* High (about 9.6 inches)

##### Interpretive groups

*Land capability classification (irrigated):* 4e

*Land capability classification (nonirrigated):* 4e

*Hydrologic Soil Group:* C

*Ecological site:* Loamy Park (R048AY222CO)

*Hydric soil rating:* No

**Minor Components**

**Other soils**

*Percent of map unit:*

*Hydric soil rating:* No

**Data Source Information**

Soil Survey Area: El Paso County Area, Colorado

Survey Area Data: Version 15, Oct 10, 2017



## El Paso County Area, Colorado

### 67—Peyton sandy loam, 5 to 9 percent slopes

#### Map Unit Setting

*National map unit symbol:* 369d  
*Elevation:* 6,800 to 7,600 feet  
*Mean annual air temperature:* 43 to 45 degrees F  
*Frost-free period:* 115 to 125 days  
*Farmland classification:* Not prime farmland

#### Map Unit Composition

*Peyton and similar soils:* 85 percent  
*Estimates are based on observations, descriptions, and transects of the mapunit.*

#### Description of Peyton

##### Setting

*Landform:* Hills  
*Landform position (three-dimensional):* Side slope  
*Down-slope shape:* Linear  
*Across-slope shape:* Linear  
*Parent material:* Arkosic alluvium derived from sedimentary rock and/or arkosic residuum weathered from sedimentary rock

##### Typical profile

*A - 0 to 12 inches:* sandy loam  
*Bt - 12 to 25 inches:* sandy clay loam  
*BC - 25 to 35 inches:* sandy loam  
*C - 35 to 60 inches:* sandy loam

##### Properties and qualities

*Slope:* 5 to 9 percent  
*Depth to restrictive feature:* More than 80 inches  
*Natural drainage class:* Well drained  
*Runoff class:* Medium  
*Capacity of the most limiting layer to transmit water (Ksat):*  
Moderately high (0.20 to 0.60 in/hr)  
*Depth to water table:* More than 80 inches  
*Frequency of flooding:* None  
*Frequency of ponding:* None  
*Available water storage in profile:* Moderate (about 7.3 inches)

##### Interpretive groups

*Land capability classification (irrigated):* None specified  
*Land capability classification (nonirrigated):* 4e  
*Hydrologic Soil Group:* B  
*Ecological site:* Sandy Divide (R049BY216CO)  
*Hydric soil rating:* No

### Minor Components

#### Other soils

*Percent of map unit:*

*Hydric soil rating:* No

#### Pleasant

*Percent of map unit:*

*Landform:* Depressions

*Hydric soil rating:* Yes

### Data Source Information

Soil Survey Area: El Paso County Area, Colorado

Survey Area Data: Version 15, Oct 10, 2017

## El Paso County Area, Colorado

### 68—Peyton-Pring complex, 3 to 8 percent slopes

#### Map Unit Setting

*National map unit symbol:* 369f  
*Elevation:* 6,800 to 7,600 feet  
*Farmland classification:* Not prime farmland

#### Map Unit Composition

*Peyton and similar soils:* 40 percent  
*Pring and similar soils:* 30 percent  
*Estimates are based on observations, descriptions, and transects of the mapunit.*

#### Description of Peyton

##### Setting

*Landform:* Hills  
*Landform position (three-dimensional):* Side slope  
*Down-slope shape:* Linear  
*Across-slope shape:* Linear  
*Parent material:* Arkosic alluvium derived from sedimentary rock and/or arkosic residuum weathered from sedimentary rock

##### Typical profile

*A - 0 to 12 inches:* sandy loam  
*Bt - 12 to 25 inches:* sandy clay loam  
*BC - 25 to 35 inches:* sandy loam  
*C - 35 to 60 inches:* sandy loam

##### Properties and qualities

*Slope:* 3 to 5 percent  
*Depth to restrictive feature:* More than 80 inches  
*Natural drainage class:* Well drained  
*Runoff class:* Low  
*Capacity of the most limiting layer to transmit water (Ksat):*  
Moderately high (0.20 to 0.60 in/hr)  
*Depth to water table:* More than 80 inches  
*Frequency of flooding:* None  
*Frequency of ponding:* None  
*Available water storage in profile:* Moderate (about 7.3 inches)

##### Interpretive groups

*Land capability classification (irrigated):* None specified  
*Land capability classification (nonirrigated):* 4c  
*Hydrologic Soil Group:* B  
*Ecological site:* Sandy Divide (R049BY216CO)  
*Hydric soil rating:* No

## Description of Pring

### Setting

*Landform:* Hills  
*Landform position (three-dimensional):* Side slope  
*Down-slope shape:* Linear  
*Across-slope shape:* Linear  
*Parent material:* Arkosic alluvium derived from sedimentary rock

### Typical profile

*A - 0 to 14 inches:* coarse sandy loam  
*C - 14 to 60 inches:* gravelly sandy loam

### Properties and qualities

*Slope:* 3 to 8 percent  
*Depth to restrictive feature:* More than 80 inches  
*Natural drainage class:* Well drained  
*Runoff class:* Low  
*Capacity of the most limiting layer to transmit water (Ksat):* High  
(2.00 to 6.00 in/hr)  
*Depth to water table:* More than 80 inches  
*Frequency of flooding:* None  
*Frequency of ponding:* None  
*Available water storage in profile:* Low (about 6.0 inches)

### Interpretive groups

*Land capability classification (irrigated):* None specified  
*Land capability classification (nonirrigated):* 3e  
*Hydrologic Soil Group:* B  
*Ecological site:* Loamy Park (R048AY222CO)  
*Hydric soil rating:* No

### Minor Components

#### Other soils

*Percent of map unit:*  
*Hydric soil rating:* No

#### Pleasant

*Percent of map unit:*  
*Landform:* Depressions  
*Hydric soil rating:* Yes

## Data Source Information

Soil Survey Area: El Paso County Area, Colorado  
Survey Area Data: Version 15, Oct 10, 2017

## El Paso County Area, Colorado

### 71—Pring coarse sandy loam, 3 to 8 percent slopes

#### Map Unit Setting

*National map unit symbol:* 369k  
*Elevation:* 6,800 to 7,600 feet  
*Farmland classification:* Not prime farmland

#### Map Unit Composition

*Pring and similar soils:* 85 percent  
*Estimates are based on observations, descriptions, and transects of the mapunit.*

#### Description of Pring

##### Setting

*Landform:* Hills  
*Landform position (three-dimensional):* Side slope  
*Down-slope shape:* Linear  
*Across-slope shape:* Linear  
*Parent material:* Arkosic alluvium derived from sedimentary rock

##### Typical profile

*A - 0 to 14 inches:* coarse sandy loam  
*C - 14 to 60 inches:* gravelly sandy loam

##### Properties and qualities

*Slope:* 3 to 8 percent  
*Depth to restrictive feature:* More than 80 inches  
*Natural drainage class:* Well drained  
*Runoff class:* Low  
*Capacity of the most limiting layer to transmit water (Ksat):* High  
(2.00 to 6.00 in/hr)  
*Depth to water table:* More than 80 inches  
*Frequency of flooding:* None  
*Frequency of ponding:* None  
*Available water storage in profile:* Low (about 6.0 inches)

##### Interpretive groups

*Land capability classification (irrigated):* None specified  
*Land capability classification (nonirrigated):* 3e  
*Hydrologic Soil Group:* B  
*Ecological site:* Loamy Park (R048AY222CO)  
*Hydric soil rating:* No

#### Minor Components

##### Other soils

*Percent of map unit:*  
*Hydric soil rating:* No

**Pleasant**

*Percent of map unit:*

*Landform:* Depressions

*Hydric soil rating:* Yes

**Data Source Information**

Soil Survey Area: El Paso County Area, Colorado

Survey Area Data: Version 15, Oct 10, 2017

## El Paso County Area, Colorado

### 92—Tomah-Crowfoot loamy sands, 3 to 8 percent slopes

#### Map Unit Setting

*National map unit symbol:* 36b9  
*Elevation:* 7,300 to 7,600 feet  
*Farmland classification:* Not prime farmland

#### Map Unit Composition

*Tomah and similar soils:* 50 percent  
*Crowfoot and similar soils:* 30 percent  
*Estimates are based on observations, descriptions, and transects of the mapunit.*

#### Description of Tomah

##### Setting

*Landform:* Alluvial fans, hills  
*Landform position (three-dimensional):* Side slope, crest  
*Down-slope shape:* Linear  
*Across-slope shape:* Linear  
*Parent material:* Alluvium derived from arkose and/or residuum weathered from arkose

##### Typical profile

*A - 0 to 10 inches:* loamy sand  
*E - 10 to 22 inches:* coarse sand  
*C - 48 to 60 inches:* coarse sand

##### Properties and qualities

*Slope:* 3 to 8 percent  
*Depth to restrictive feature:* More than 80 inches  
*Natural drainage class:* Well drained  
*Runoff class:* Medium  
*Capacity of the most limiting layer to transmit water (Ksat):*  
Moderately high to high (0.60 to 2.00 in/hr)  
*Depth to water table:* More than 80 inches  
*Frequency of flooding:* None  
*Frequency of ponding:* None  
*Available water storage in profile:* Very low (about 2.0 inches)

##### Interpretive groups

*Land capability classification (irrigated):* None specified  
*Land capability classification (nonirrigated):* 4e  
*Hydrologic Soil Group:* B  
*Ecological site:* Sandy Divide (R049BY216CO)  
*Hydric soil rating:* No

#### Description of Crowfoot

##### Setting

*Landform:* Alluvial fans, hills

*Landform position (three-dimensional):* Side slope, crest  
*Down-slope shape:* Linear  
*Across-slope shape:* Linear  
*Parent material:* Alluvium

**Typical profile**

*A - 0 to 12 inches:* loamy sand  
*E - 12 to 23 inches:* sand  
*Bt - 23 to 36 inches:* sandy clay loam  
*C - 36 to 60 inches:* coarse sand

**Properties and qualities**

*Slope:* 3 to 8 percent  
*Depth to restrictive feature:* More than 80 inches  
*Natural drainage class:* Well drained  
*Runoff class:* Medium  
*Capacity of the most limiting layer to transmit water (Ksat):*  
Moderately high to high (0.60 to 2.00 in/hr)  
*Depth to water table:* More than 80 inches  
*Frequency of flooding:* None  
*Frequency of ponding:* None  
*Available water storage in profile:* Low (about 4.7 inches)

**Interpretive groups**

*Land capability classification (irrigated):* None specified  
*Land capability classification (nonirrigated):* 4e  
*Hydrologic Soil Group:* B  
*Ecological site:* Sandy Divide (R049BY216CO)  
*Hydric soil rating:* No

**Minor Components**

**Other soils**

*Percent of map unit:*  
*Hydric soil rating:* No

**Pleasant**

*Percent of map unit:*  
*Landform:* Depressions  
*Hydric soil rating:* Yes

## Data Source Information

Soil Survey Area: El Paso County Area, Colorado  
Survey Area Data: Version 15, Oct 10, 2017