



LSC TRANSPORTATION CONSULTANTS, INC.  
545 East Pikes Peak Avenue, Suite 210  
Colorado Springs, CO 80903  
(719) 633-2868  
FAX (719) 633-5430  
E-mail: [lsc@lsctrans.com](mailto:lsc@lsctrans.com)  
Website: <http://www.lsctrans.com>

WindingWalk at Meridian Ranch  
The Enclave at Stonebridge at Meridian Ranch  
Updated Traffic Impact Analysis  
PCD File No: PUDSP-18-002 & SF-18-002  
(LSC #174750)  
April 13, 2018

**Traffic Engineer's Statement**

This traffic report and supporting information were prepared under my responsible charge and they comport with the standard of care. So far as is consistent with the standard of care, said report was prepared in general conformance with the criteria established by the County for traffic reports.



**Developer's Statement**

I, the Developer, have read and will comply with all commitments made on my behalf within this report.

GTL, INC.

  
\_\_\_\_\_  
Raul Guzman, Vice President

April 13, 2018  
\_\_\_\_\_  
Date



LSC TRANSPORTATION CONSULTANTS, INC.  
545 East Pikes Peak Avenue, Suite 210  
Colorado Springs, CO 80903  
(719) 633-2868  
FAX (719) 633-5430  
E-mail: [lsc@lscetrans.com](mailto:lsc@lscetrans.com)  
Website: <http://www.lscetrans.com>

April 13, 2018

Mr. Raul Guzman  
Tech Contractors  
P.O. Box 80036  
San Diego, CA 92138

RE: WindingWalk at Meridian Ranch and  
The Enclave at Stonebridge at Meridian Ranch  
El Paso County, Colorado  
Updated Traffic Impact Analysis  
EPC PCD File No. PUDSP-18-002 & SF-18-002  
LSC #174750

Dear Mr. Guzman:

In response to your request, LSC Transportation Consultants, Inc. has prepared this updated traffic impact analysis for the WindingWalk at Meridian Ranch Filings 1 and 2 and The Enclave at Stonebridge at Meridian Ranch residential developments in El Paso County, Colorado. As shown in Figure 1, the site is located north of Stapleton Drive and west of Eastonville Road in El Paso County, Colorado. LSC completed a study for the recently-approved Meridian Ranch Sketch Plan amendment. The supporting traffic report date is October 3, 2017.

## REPORT CONTENTS

This report is being prepared as part of a submittal to El Paso County. It identifies the traffic impacts of the WindingWalk at Meridian Ranch Filings 1 and 2 and The Enclave at Stonebridge at Meridian Ranch residential developments. The report contains the following:

- The traffic count data and street conditions.
- Short-term, intermediate-term, and 2040 baseline/background traffic volume estimates.
- The projected average weekday and peak-hour vehicle-trips to be generated by each filing.
- The assignment of the site's projected traffic volumes to the key area streets and intersections for the short, intermediate, and long term and the resulting total traffic volumes for the short, intermediate and long term.
- The resulting traffic impacts including level of service analysis at key intersections.
- The recommended street classifications for the internal streets within the proposed developments.

- The project's obligation (if any) to the County roadway improvement fee program.

### **Previous Traffic Reports Completed in the Area**

A list of other traffic studies in the area of study completed within the past five years (that LSC is aware of) is attached for reference. This study accounts for the land use, trip generation and the roadway network included in these studies.

### **LAND USE AND ACCESS**

#### **Land Use**

The three currently proposed Meridian Ranch filings are located north of Stapleton Drive and west of Eastonville Road. Figure 2 shows the proposed site plan and location of each filing. Phase 1, WindingWalk at Meridian Ranch Filing 1, is planned to include 345 single-family homes. Phase 2, The Enclave at Stonebridge at Meridian Ranch, is planned to contain 184 single-family homes. Phase 3, WindingWalk at Meridian Ranch Filing 2, is planned to include 60 single-family homes.

#### **Access**

Figure 3 shows the proposed access phasing plan. With Phase 1 Rainbow Bridge Drive is planned to be extended south to Lambert Road and Lambert Road is planned to be constructed south from Rainbow Bridge to Stapleton Drive but not north to Stone Valley Drive. Two full-movement site access points are proposed to Lambert Road for WindingWalk at Meridian Ranch Filing 1. The first access point would align with Rainbow Bridge Drive and the second is located about 850 feet to the southwest (about 750 feet northeast of Stapleton Drive). A full-movement access point is also proposed to Rainbow Bridge Drive about 575 feet north of Lambert Road.

With Phase 2 three additional full-movement access points are proposed to Rainbow Bridge Drive for The Enclave at Stonebridge at Meridian Ranch. Figure 2 shows the location of these access points. No additional road connections are planned with this phase.

With Phase 3 Lambert Road is planned to be constructed north from Rainbow Bridge Drive to Stone Valley Drive. Two additional access points are planned to Rainbow Bridge for WindingWalk at Meridian Ranch Filing 2. Figure 2 shows the location of these access points.

### **ROADWAY AND TRAFFIC CONDITIONS**

#### **Area Roadways**

The major roadways in the site's vicinity are shown on Figure 1 and are described below.

- **Londonderry Drive** is a two-lane Urban Residential Collector extending east from the Falcon Hills neighborhood to Eastonville Road. East of Meridian Road within the Meridian Ranch development, Londonderry Drive has one through lane in each direction and a raised, landscaped center median with left-turn lanes. The posted speed limit is 35 miles per hour (mph).
- **Stapleton Drive** is shown as an Urban four-lane Principal Arterial on the El Paso County *Major Transportation Corridors Plan (MTCP)* and El Paso County *Corridor Preservation Plan (CPP)*. Stapleton Drive extends east from Towner Drive to US Highway (US) 24. Stapleton continues southeast, then south as Curtis Road. It is planned to be ultimately extended west to connect with the Briargate Parkway extension. Stapleton drive currently has one through lane in each direction adjacent to the site. Stapleton Drive adjacent to the site is currently a half-section of a four-lane Principal Arterial street. Meridian Ranch has met its obligation for off-site roadway improvement construction and/or participation. Therefore, Meridian Ranch will not be required to complete the second half-section of Stapleton. The existing right-of-way is 130 feet, which meets the ECM-prescribed right-of-way for an Urban Four-Lane Principal Arterial.

**Eastonville Road** is shown as a two-lane Minor Arterial on the El Paso County *Major Transportation Corridors Plan (MTCP)*. Eastonville Road is a two-lane roadway extending northeast from Meridian Road to past Hodgen Road. The Eastonville Road cross section south of Stapleton Drive is consistent with a two-lane Urban Collector cross section. The section north of Stapleton Drive has been identified as a two-lane Rural Minor Arterial on the MTCP. However, the actual design has yet to be completed and the design could potentially identify a cross section different from the standard ECM Rural Minor Arterial cross section. Regarding the right-of-way, the existing right-of-way in the northeast corner of WindingWalk Filing No. 1 is 80 feet. Consistent with the Vistas at Meridian Ranch Filing No. 2, at least 40 feet of frontage will be placed in a Meridian Ranch Metro District tract so as not to preclude future right-of-way needs for Eastonville Road. The ECM-prescribed right-of-way for a Rural Minor Arterial classification is 100 feet.

### **Study Area Intersections**

The following addresses study area intersections not specifically included in this report. This section addresses timing of further study of these intersections.

- The Rex Road intersections with Eastonville and Meridian Road will be addressed with the Preliminary Plan for the future development areas north of Londonderry. These intersections were also addressed recently in the updated report for the sketch plan amendment report dated October 23, 2017.
- Londonderry/Meridian Intersection: The change in traffic on Londonderry Drive west of Rainbow Bridge (which included the change in buildout trips traveling to/from the intersection of Londonderry Drive/Meridian Road) was addressed in the recent sketch plan amendment traffic report. Londonderry/Meridian intersection will be addressed with the final plats **after** Winding

Walk Filing No. 1. The intersection is signalized with right and left turn deceleration lanes on all approaches. The subdivisions after Filing 1 will address the westbound left turn at Meridian/Londonderry as has been addressed in applicable previous reports. Filing No. 1 is the southernmost of these filings and as such, the westbound left turn at Meridian/Londonderry is likely to see negligible traffic from Winding Walk Filing 1. Moreover, the connection of Rainbow Bridge south to Stapleton will likely remove some trips from the westbound left turn movement at Meridian/Londonderry.

- The intersection of Stapleton/Meridian will see additional traffic from this Preliminary Plan, however this intersection is signalized with left and right turn deceleration lanes on all approaches. Moreover, as indicated in the report, Meridian Ranch has met its obligation for off-site roadway improvement construction and/or participation. Therefore, Meridian Ranch will not be required to complete the second half-section of Stapleton.

### **Existing Traffic Volumes**

Figure 4 shows the existing traffic volumes at intersections of Rainbow Bridge/Londonderry, Lambert/Londonderry, Stapleton/Lambert, and Stapleton/Eastonville. These volumes are based on manual intersection turning movement counts conducted by LSC in December 2016 and May 2017. The count data sheets are attached for reference.

### **Existing Levels of Service**

Level of service (LOS) is a quantitative measure of the level of delay at an intersection. Level of service is indicated on a scale from "A" to "F." LOS A represents control delay of less than 10 seconds for unsignalized and signalized intersections. LOS F represents control delay of more than 50 seconds for unsignalized intersections and more than 80 seconds for signalized intersections. Table 1 shows the level of service delay ranges.

<b>Table 1</b>			
<b>Intersection Levels of Service Delay Ranges</b>			
<b>Level of Service</b>	<b>Signalized Intersections</b>		<b>Unsignalized Intersections</b>
	<b>Average Control Delay (seconds per vehicle)</b>	<b>V/C<sup>(1)</sup></b>	<b>Average Control Delay (seconds per vehicle)<sup>(2)</sup></b>
A	10.0 sec or less	less than 0.60	10.0 sec or less
B	10.1-20.0 sec	0.60-0.69	10.1-15.0 sec
C	20.1-35.0 sec	0.70-0.79	15.1-25.0 sec
D	35.1-55.0 sec	0.80-0.89	25.1-35.0 sec
E	55.1-80.0 sec	0.90-0.99	35.1-50.0 sec
F	80.1 sec or more	1.00 and greater	50.1 sec or more

(1) Source: *Transportation Research Circular 212*  
 (2) For unsignalized intersections if V/C ratio is greater than 1.0 the level of service is LOS F regardless of the projected average control delay per vehicle.

Figure 4 presents the results of the existing intersection level of service analysis. Levels of service are based on the unsignalized method of analysis procedures from the *Highway Capacity Manual, 6<sup>th</sup> Edition* by the Transportation Research Board. The level of service reports are attached.

The southbound left-turn movement at the intersection of Rainbow Bridge/Londonderry is currently operating at LOS F during the morning peak hour and LOS B during the afternoon peak hour. All other movements are currently operating at LOS D or better during the peak hours.

The southbound left-turn movement at the intersection of Lambert/Londonderry is currently operating at LOS D during the morning peak hour and LOS B during the afternoon peak hour. All other movements are currently operating at LOS B or better during the peak hours.

The eastbound approach at the intersection of Stapleton/Eastonville is currently operating at LOS E during the morning peak hour. All other movements are currently operating at a LOS D or better during the peak hours.

All movements at the intersection of Stapleton/Lambert are currently operating at LOS B or better during peak hours.

**SHORT-TERM (YEAR 2018) BACKGROUND TRAFFIC**

Figure 5a shows the projected background traffic volumes for the short term (2018). These background traffic volumes have been based on the existing traffic volumes (from Figure 4) plus buildout of Meridian Ranch Filings 1-3 and Filings 6-8, Estates Filings 2-3, Meridian Ranch Filing

11, Stonebridge Filings 1, 2, and 3, Meridian Ranch Filing 9, and the Vistas at Meridian Ranch Filing 1. The short-term background traffic volumes do not include traffic from WindingWalk at Meridian Ranch Filings 1 and 2 and The Enclave at Stonebridge at Meridian Ranch.

The short-term background analysis assumes Rainbow Bridge Drive extended south to Lambert Road and Lambert Road extended south from Rainbow Bridge Drive to Stapleton Drive but not north to Stone Valley Drive. The background through traffic on Eastonville Road assumes the future Waterbury connection to Eastonville is not constructed by 2018.

Figure 5b shows the lane geometry, traffic control, and level of service at the key area intersections of based on the short-term background volumes.

### **INTERMEDIATE-TERM (YEAR 2022) BACKGROUND TRAFFIC**

Figure 6a shows the projected background traffic volumes for the intermediate term (2022). These background traffic volumes have been based on the short-term total traffic volumes plus increases in traffic due to regional growth including buildout of existing and currently proposed subdivisions within the Waterbury development located northeast of the intersection of Eastonville/Stapleton. The short-term background traffic volumes do not include traffic from WindingWalk at Meridian Ranch Filings 1 and 2 and The Enclave at Stonebridge at Meridian Ranch. The intermediate-term background analysis assumes Lambert Road been constructed between Rainbow Bridge Drive and Stone Valley Drive.

Figure 6b shows the lane geometry, traffic control, and level of service at the key area intersections based on the intermediate-term background volumes.

### **2040 BACKGROUND TRAFFIC**

Figure 7a shows the projected 20-year background traffic volumes for the year 2040. The 2040 background/baseline traffic volumes are based on the *Meridian Ranch Sketch Plan Amendment Traffic Impact Analysis* dated October 3, 2017 and assume buildout of the Meridian Ranch development. The 2040 background traffic volumes do not include traffic from WindingWalk at Meridian Ranch Filings 1 and 2 and The Enclave at Stonebridge at Meridian Ranch.

Figure 7b shows the lane geometry, traffic control, and level of service at the intersections in the vicinity of the site based on the 2040 background volumes.

### **TRIP GENERATION**

The site-generated vehicle-trips were estimated using the nationally published trip generation rates from *Trip Generation, 10th Edition, 2017* by the Institute of Transportation Engineers (ITE). Table 2 shows the trip generation estimates by phase.

WindingWalk at Meridian Ranch Filing 1 is expected to generate about 3,257 vehicle-trips on the average weekday, with about half entering and half exiting the site during a 24-hour period. During the morning peak hour, which generally occurs for one hour between 6:30 and 8:30 a.m., about 64 vehicles would enter and 191 vehicles would exit the site. During the afternoon peak hour, which generally occurs for one hour between 4:15 and 6:15 p.m., about 215 vehicles would enter and 126 vehicles would exit the site.

The Enclave at Stonebridge at Meridian Ranch is expected to generate about 1,737 vehicle-trips on the average weekday, with about half entering and half exiting the site during a 24-hour period. During the morning peak hour about 34 vehicles would enter and 102 vehicles would exit the site. During the afternoon peak hour about 115 vehicles would enter and 67 vehicles would exit the site.

WindingWalk at Meridian Ranch Filing 2 is expected to generate about 566 vehicle-trips on the average weekday, with about half entering and half exiting the site during a 24-hour period. During the morning peak hour about 11 vehicles would enter and 33 vehicles would exit the site. During the afternoon peak hour about 37 vehicles would enter and 22 vehicles would exit the site.

## **DIRECTIONAL DISTRIBUTION**

The directional distribution of the site-generated traffic volumes on the area roadways is an important factor in determining the site's traffic impacts. Figure 8 shows the short-term, intermediate-term, and long-term external directional distribution estimates for the site-generated traffic volumes. The estimates have been based on the following factors: the recent traffic count data; the site's location with respect to the nearby employment, commercial, and activity centers and the balance of the Falcon and Colorado Springs metropolitan area; the site's proposed land use; the site's proposed access points; and the phasing of the existing and future roadway system serving the site. The short- and intermediate-term distribution assumes Rainbow Bridge Drive has been extended south to Lambert Road and Lambert Road has been extended south to Stapleton Drive. The long-term distribution is based on the distribution estimate shown in the study for the most recent Meridian Ranch Sketch Plan amendment dated October 3, 2017 and takes into account the future extension of Stapleton west to Briargate Parkway and extension of Rex Road east to Eastonville Road.

## **SITE-GENERATED TRAFFIC**

The site-generated traffic volumes were calculated by applying the directional distribution percentages (from Figure 8) to the trip generation estimates from Table 2. Internal trips within the overall Meridian Ranch development have been assigned separately based on the location of the neighborhood commercial parcel, schools, parks, and community centers.



Figures 9 through 11 show the projected site-generated traffic volumes due to WindingWalk at Meridian Ranch Filing 1. Figure 9 shows the short-term site-generated traffic volumes assuming Rainbow Bridge Drive has been extended south to Lambert Road and Lambert Road has been constructed from Rainbow Bridge Drive south to Stapleton Drive but not north to Stone Valley Drive. Figure 10 shows the intermediate site-generated traffic volumes assuming Lambert Road has been constructed between Rainbow Bridge Drive and Stone Valley Drive. Figure 11 shows the long-term site-generated traffic volumes, which assumes buildout of the Meridian Ranch street network and land uses including future school and park sites north of the intersection of Londonderry Drive and Lambert Road.

Figures 12 and 13 show the projected site-generated traffic volumes due to The Enclave at Stonebridge at Meridian Ranch Filing 1. Figure 12 shows the short- and intermediate-term site-generated traffic volumes assuming Rainbow Bridge Drive has been extended south to Lambert Road and Lambert Road has been constructed from Rainbow Bridge Drive south to Stapleton Drive but not north to Stone Valley Drive. A separate intermediate-term figure has not been included for this filing as no traffic is projected to use the section of Lambert Road between Rainbow Bridge Drive and Stone Valley Drive. Figure 13 shows the long-term site-generated traffic volumes, which assumes buildout of the Meridian Ranch street network and land uses including future school and park sites north of the intersection of Londonderry Drive and Lambert Road.

Figures 14 and 15 show the projected site-generated traffic volumes due to WindingWalk at Meridian Ranch Filing 1. Figure 14 shows the intermediate site-generated traffic volumes, which assume Rainbow Bridge Drive has been extended south to Lambert Road and Lambert Road has been constructed from Rainbow Bridge Drive south to Stapleton Drive and north to Stone Valley Drive. Figure 15 shows the long-term site-generated traffic volumes, which assumes buildout of the Meridian Ranch street network and land uses including future school and park sites north of the intersection of Londonderry Drive and Lambert Road.

#### **SHORT-TERM (YEAR 2018) TOTAL TRAFFIC**

Figure 16a shows the projected short-term total traffic volumes following buildout of Phase 1 only. The short-term total traffic volumes are the sum of the short-term background traffic volumes (from Figure 5a) plus the short-term site-generated traffic volumes due to WindingWalk at Meridian Ranch Filing 1 from Figure 9.

Figure 16b shows the projected level of service based on the short-term total volumes following Phase 1 for the key intersections in the vicinity of the site.

Figure 17a shows the projected short-term total traffic volumes following buildout of Phase 2. The short-term total traffic volumes are the sum of the short-term background traffic volumes (from Figure 5a) plus the short-term site-generated traffic volumes due to WindingWalk at

Meridian Ranch Filing 1 from Figure 9 plus the short-term site-generated traffic volumes due to The Enclave at Stonebridge at Meridian Ranch from Figure 12.

Figure 17b shows the projected level of service based on the short-term total volumes following Phase 2 for the key intersections in the vicinity of the site.

### **INTERMEDIATE-TERM (YEAR 2022) TOTAL TRAFFIC**

Figure 18a shows the projected intermediate-term total traffic volumes. The intermediate-term total traffic volumes are the sum of the intermediate-term background traffic volumes (from Figure 6a) plus the intermediate-term site-generated traffic volumes due to WindingWalk at Meridian Ranch Filing 1 from Figure 10 plus the intermediate-term site-generated traffic volumes due to The Enclave at Stonebridge at Meridian Ranch from Figure 12 plus the intermediate-term site-generated traffic volumes due to WindingWalk at Meridian Ranch Filing 2 from Figure 14.

Figure 18b shows the projected level of service based on the intermediate-term total volumes for the key intersections in the vicinity of the site.

### **2040 TOTAL TRAFFIC**

Figures 19a shows the projected total traffic volumes at the key area intersections for the year 2040. Figure 19b shows the projected total traffic volumes at the site access points to Lambert Road and Rainbow Bridge Drive for the year 2040. The 2040 total traffic volumes are the sum of the long-term background traffic volumes (from Figure 7a) plus the long-term site-generated traffic volumes due to WindingWalk at Meridian Ranch Filing 1 from Figure 11 plus the long-term site-generated traffic volumes due to The Enclave at Stonebridge at Meridian Ranch from Figure 13 plus the intermediate-term site-generated traffic volumes due to WindingWalk at Meridian Ranch Filing 2 from Figure 15.

Figure 19c shows the projected level of service based on the 2040 total volumes for the key intersections in the vicinity of the site. Figure 19d shows the projected level of service based on the 2040 total volumes for the site access points to Lambert Road and Rainbow Bridge Drive.

### **PROJECTED LEVELS OF SERVICE**

The key area intersections and site access points have been analyzed to determine the projected future levels of service based on the unsignalized method of analysis procedures from the *Highway Capacity Manual, 2010 Edition* by the Transportation Research Board and Synchro signalized intersection procedures. Figures 5b, 6b, 7b, 16b, 17b, 18b, 19c, and 19d show the level of service analysis results. The laneage and traffic control assumed in the analysis are depicted on the figures. The level of service reports are attached.

### **Londonderry/Rainbow Bridge**

The intersection of Londonderry/Rainbow Bridge is currently two-way, Stop-sign controlled. The southbound left-turn movement at the intersection of Londonderry/Rainbow Bridge is currently operating at a LOS F during the morning peak hour. This intersection is planned to be converted to an all-way, Stop-sign controlled intersection. All movements at the intersection of Londonderry/Rainbow Bridge are projected to operate at a satisfactory level of service (LOS D or better) based on the short-term, intermediate-term, and 2040 total traffic volumes assuming all-way Stop-sign control.

### **Londonderry/Lambert**

The intersection of Londonderry/Lambert is projected to operate at LOS F for the southbound left-turn movement and LOS E for the northbound left-turn and through movements during the morning peak hour based on the projected intermediate-term total traffic volumes assuming this intersection remains two-way Stop-sign controlled. If this intersection were to be converted to all-way, Stop-sign control, all movements are projected to operate at LOS D or better during the peak hours based on the projected intermediate-term total traffic volumes. By 2040 this intersection was assumed to be signal controlled. All movements are projected to operate at LOS D or better based on the projected 2040 total traffic volumes.

### **Stapleton/Eastonville**

The eastbound approach at the intersection of Stapleton/Eastonville is currently operating at LOS E during the morning peak hour. The eastbound and westbound approaches are projected to operate at LOS F during the morning peak hour based on the short-term background and total (background plus WindingWalk Phase 1) projected traffic volumes. It is not uncommon for the minor approach volumes to operate at LOS E or LOS F during the peak hours as the volumes approach the thresholds for a traffic signal warrant. This intersection is planned to be signalized in the future; however, a traffic signal warrant may not be met in the short term. Once signalized, all movements at this intersection are projected to operate at level of service D or better based on the projected short-term, intermediate-term, and 2040 total traffic volumes.

### **Stapleton/Lambert**

All movements at the intersection of Stapleton/Lambert are projected to operate at LOS D or better during the peak hours based on the projected short-term total traffic volumes assuming this intersection remains two-way, Stop-sign controlled in the short term. The northbound and southbound left-turn movements at this intersection are projected to operate at LOS F during the afternoon peak hour based on the projected intermediate-term total traffic volumes. If this intersection is signalized, all movements are projected to operate at LOS D or better based on the projected intermediate-term and 2040 total traffic volumes.

### **Rainbow Bridge/Lambert and Site Access/Lambert**

All movements at the intersection of Rainbow Bridge/Lambert and the site access to Lambert Road are projected to operate at LOS B or better during the peak hours based on the projected short-term and intermediate-term total traffic volumes assuming these intersections are two-way, Stop-sign controlled. Based on the HCM method of analysis, some of the movements at the intersection of Rainbow Bridge/Lambert and the site access point to Lambert Road are projected to operate at LOS E or LOS F during the peak hours by 2040. The future upstream signal at Lambert/Stapleton will create gaps in northeast-bound traffic. A SimTraffic simulation was run to better analyze the operational effects of the adjacent signal-controlled intersection. The projected 2040 peak-hour volumes were entered into the model and the model was run five times. The results were then averaged. The average projected delay for all movements were within or lower than the LOS D ranges shown in Table 1.

### **Site Access Points to Rainbow Bridge**

The proposed site access points to Rainbow Bridge are projected to operate at LOS B or better for all movements based on the projected 2040 peak-hour traffic volumes assuming these access points are two-way Stop-sign controlled.

### **ALL-WAY STOP-SIGN CONTROL WARRANT**

The intersections of Rainbow Bridge Drive/Londonderry Drive and Lambert Road/Londonderry Drive were analyzed to determine if all-way, Stop-sign control would be warranted. Based on the criteria contained in the *Manual of Uniform Traffic Control Devices 2009 Edition* published by the US Department of Transportation Federal Highway Administration, multi-way stop control could be considered when the vehicular volume entering the intersection from the major street approaches averages at least 300 vehicles per hour for any eight hours of an average day; and the combined vehicular, pedestrian, and bicycle volumes entering the intersection from the minor street approaches (total of both approaches) averages at least 200 units per hour for the same eight hours.

### **Rainbow Bridge/Londonderry**

Table 3A shows the results of the analysis for the intersection of Rainbow Bridge/Londonderry based on the projected morning and afternoon peak-hour volumes. As shown in Table 3A, based on the existing traffic volumes shown in Figure 3 the thresholds are just met during the morning peak hour and are not met during the afternoon peak hour. Based on the projected short-term background traffic, which assumes the extension of Rainbow Bridge Drive to Lambert Road and Lambert Road from Rainbow Bridge Drive to Stapleton Road, the projected minor approach volume is projected to meet or exceed the thresholds during both the morning and afternoon peak hours.

This analysis using the peak hours is intended to provide an indication that a warrant may be met or is close to being met. In order for this warrant to be satisfied, the volume thresholds would need to be met for six additional hours of the day. Table 3B shows the results of the analysis for six hours based on the projected short-term background plus Phase 1 site-generated traffic volumes. This analysis is based on traffic counts conducted in January 2016. Additional counts will be taken and a report supplement will be prepared and submitted as soon as possible. Additional off-peak traffic volumes are estimates by LSC based on time-of-day distribution data for single-family detached housing found in the *Trip Generation, 10th Edition, 2017* by the Institute of Transportation Engineers (ITE). As shown on Table 3B, five of the six hours analyzed will clearly meet the thresholds. From 1:45 to 2:45 p.m. the minor street volume is projected to be eight vehicles shy of the 200-vehicle per hour threshold; however, the criteria for an all-way stop includes the pedestrian and bicycle volumes in the minor approach volumes, which were not included in this analysis as they are difficult to predict. It is likely that there will be a high number of pedestrians in the 1:45 to 2:45 p.m. time period as the Meridian Ranch Elementary School dismissal time is at 2:40 p.m. In order for this warrant to be satisfied, the volume thresholds would need to be met for two additional hours.

Alternately, all-way Stop-sign control could be considered under Section 2B.07 Option 5B, “An intersection of two residential neighborhood collector (through) streets of similar design and operating characteristics where multi-way stop control would improve traffic operational characteristics of the intersection.”

### **Lambert/Londonderry**

Table 4 shows the results of the analysis for the intersection of Lambert/Londonderry. As shown in Table 4, based on the intermediate-term total traffic volumes shown in Figure 17a the thresholds are met during the morning peak hour but not during the afternoon peak hour. The thresholds are projected to be met during both the morning and afternoon peak hours based on the projected 2040 background and total traffic volumes. In order for this warrant to be satisfied, the volume thresholds would need to be met for two additional hours. Additional counts will be taken, and a report supplement will be prepared and submitted as soon as possible. Note: Analysis of time periods outside of the peak hours are dependent on the location and access plan for the proposed school north of Falcon High School. Also, the criteria for an all-way stop includes the pedestrian and bicycle volumes in the minor approach volumes, which were not included in this analysis as they are difficult to predict.

Alternately, all-way stop-sign control could be considered under Section 2B.07 Option 5B, “An intersection of two residential neighborhood collector (through) streets of similar design and operating characteristics where multi-way stop control would improve traffic operational characteristics of the intersection.” The conversion to all-way stop control could also be considered as part of the pedestrian control plan.

### **Rainbow Bridge/Lambert**

Based on the peak-hour volumes, it is unlikely that all-way stop control criteria would be met. Moreover, most of the projected peak-hour side street approach volume is for the southeast-bound right turn—thus, striping the southeast-bound approach for a separate right-turn and a shared left/through lane would be beneficial.

Alternately, all-way stop-sign control could be considered under Section 2B.07 Option 5B, “An intersection of two residential neighborhood collector (through) streets of similar design and operating characteristics where multi-way stop control would improve traffic operational characteristics of the intersection.” The conversion to all-way stop control could also be considered as part of the pedestrian control plan.

### **TRAFFIC SIGNAL WARRANT ANALYSIS**

The intersections of Stapleton/Eastonville, Stapleton/Lambert and Londonderry/Lambert were analyzed to determine when Four-Hour Vehicular Volume Traffic Signal Warrant thresholds would be reached or exceeded based on the projected peak-hour traffic volumes. This analysis using the peak hours is intended to provide an indication that a warrant may be met or is close to being met. In order for a Four-Hour Traffic Signal Warrant to be satisfied, the volume threshold would need to be met for two additional hours of the day. For example, the four-hour warrant would be satisfied with the volume thresholds met for one hour in the morning, two hours (instead of the one-hour peak) during the afternoon peak period, and an hour during the mid-afternoon.

#### **Stapleton/Eastonville**

Table 5 shows the results of the analysis for the intersection of Stapleton/Eastonville. The minor approach volumes were assumed to include either the eastbound left-turn, through, and right-turn movements or the westbound left-turn and through movements (the right-turn movements were excluded as there is an exclusive right-turn lane). Even if the threshold is met based on both the eastbound and westbound approaches it would only be considered to be met once for that hour. As shown in the Table 5, the thresholds for a Four-Hour Vehicular Volume Traffic Signal Warrant are projected to be exceeded based on the morning peak hour but not the afternoon peak hour based on the projected short-term total traffic volumes following development of Phase 2 (WindingWalk at Meridian Ranch Filing 1 and The Enclave at Stonebridge at Meridian Ranch). The thresholds are projected to be met for both the morning and afternoon peak hours based on the projected intermediate-term total traffic volumes.

#### **Stapleton/Lambert**

Table 6 shows the results of the analysis for the intersection of Stapleton/Lambert. The minor approach volumes were assumed to include either the northbound left-turn, through, and right-

turn movements or the southbound left-turn and through movements (the right-turn movements were excluded as it was assumed an exclusive right-turn lane will be provided at this intersection). Even if the threshold is met based on both the southbound and northbound approaches it would only be considered to be met once for that hour. As shown in Table 6, the thresholds are projected to be met for both the morning and afternoon peak hours based on the projected intermediate-term total traffic volumes.

### **Londonderry/Lambert**

Table 7 shows the results of the analysis for the intersection of Londonderry/Lambert. The minor approach volumes were assumed to include either the northbound left-turn and through movements or the southbound left-turn and through movements. Even if the threshold is met based on both the southbound and northbound approaches it would only be considered to be met once for that hour. As shown in the Table 6, the thresholds are projected to **not** be met for either the morning or the afternoon peak hour based on the projected 2040 total traffic volumes. Although this intersection is not projected to meet a Four-Hour Vehicular Volume Traffic Signal Warrant it may meet another signal warrant such as Warrant 5, School Crossing. The School Crossing Warrant is based on the frequency and adequacy of gaps in the vehicular traffic stream as related to the number and size of groups of school children. LSC recommends this intersection be monitored as development to the south proceeds as these criteria are best analyzed based on field data/observation. The warrant also indicates that before the decision is made to install a traffic signal, consideration of remedial measures such as those shown in Figure 24 be considered. Also, use of a crossing guard should remain a consideration, either before or after the development of the proposed school north of Falcon High School.

### **Rainbow Bridge and Lambert**

Based on the projected peak-hour traffic volumes, it is unlikely that a traffic signal would be warranted at this intersection.

### **TRAFFIC SIGNAL ESCROW PERCENTAGES/AMOUNTS**

As shown in Table 5 and described above, the peak-hour volumes at the intersection of Stapleton/Eastonville are projected to meet the four-hour volume warrant thresholds based on the projected intermediate-term traffic volumes. Table 8 shows the intermediate-term volumes that were used to calculate a fair share contribution toward a future signal at this intersection. Assuming a total signal cost of \$300,000, a fair share contribution towards a future signal at this intersection would be \$41,494 for WindingWalk at Meridian Ranch Filing No. 1, \$20,270 for The Enclave at Stonebridge at Meridian Ranch, and \$7,631 for Winding Walk at Meridian Ranch Filing No. 2.

## PEDESTRIAN AND BICYCLE ROUTE ANALYSIS

Figure 21 shows the short-term pedestrian and bicycle school routing analysis. This analysis assumes Lambert Road has not been constructed between Rainbow Bridge Drive and Stone Valley Drive.

Figure 22 shows the long-term pedestrian and bicycle school routing analysis. This analysis assumes Lambert Road has been constructed between Rainbow Bridge Drive and Stone Valley Drive.

Once the **Londonderry/Rainbow Bridge intersection** control is converted to all-way, Stop-sign control (AWSC), stop bars and crosswalk bars should be added on all legs of the intersection. As home construction continues south of Londonderry, this intersection should be monitored for the potential need for an established school crossing. Prior to the conversion to AWSC, this would likely include north/south crosswalk bars, school crossing warning signs on Londonderry Drive and a possibly a 20-mph school zone speed limit signs – this is not to suggest that this should be a developer responsibility. The use of a school crossing guard may also be needed at this location to serve elementary school students residing south of Londonderry Drive.

**The Lambert/Londonderry intersection** should be monitored for the potential need for a school crossing guard, either before or after the development of the proposed school north of Falcon High School – this is not to suggest that this is a developer responsibility. It is our understanding that the County Public Works will be installing crosswalk markings and any necessary school zone related signs.

Regarding the intersection of **Lambert and Rainbow Bridge**, the likely best location for a future pedestrian crossing, once needed (and only after the Lambert connection between Rainbow Bridge and Londonderry) would be on the northeast leg of the intersection as this would not conflict with high projected vehicle turning movements between the northwest (Rainbow Bridge) leg of the intersection and the southwest (Lambert) leg of the intersection. In conjunction with any future designated pedestrian crossing, the use of a school crossing guard could also be considered at this location in the future to serve elementary school students who may reside in WindingWalk Phase 1 east of Lambert or the south portion of The Vistas (also located east of Lambert).

Regarding the intersection of Stapleton/Lambert, Figure 22 shows a school pedestrian route along the east side of Lambert between the north side of Stapleton and the Londonderry/Lambert intersection. The D-49 neighborhood elementary school boundary map shows Stapleton as a dividing line for neighborhood schools – therefore elementary students do not need to cross Stapleton. Once Lambert is connected between Stapleton and Londonderry, there is the potential for Falcon High School students to walk or bicycle from the residential areas south of Stapleton and the High School. In the future, once this occurs, LSC recommends



coordination between County Public Works and the school district to identify if a pedestrian crossing is needed (if the Lambert/Stapleton signal is not yet installed at that time).

## **CONCLUSIONS AND RECOMMENDATIONS**

### **Trip Generation**

- WindingWalk at Meridian Ranch Filing 1 is expected to generate about 3,257 vehicle-trips on the average weekday, with about half entering and half exiting the site during a 24-hour period. During the morning peak hour about 64 vehicles would enter and 191 vehicles would exit the site. During the afternoon peak hour about 215 vehicles would enter and 126 vehicles would exit the site.
- The Enclave at Stonebridge at Meridian Ranch is expected to generate about 1,737 vehicle-trips on the average weekday, with about half entering and half exiting the site during a 24-hour period. During the morning peak hour about 34 vehicles would enter and 102 vehicles would exit the site. During the afternoon peak hour about 115 vehicles would enter and 67 vehicles would exit the site.
- WindingWalk at Meridian Ranch Filing 2 is expected to generate about 566 vehicle-trips on the average weekday, with about half entering and half exiting the site during a 24-hour period. During the morning peak hour about 11 vehicles would enter and 33 vehicles would exit the site. During the afternoon peak hour about 37 vehicles would enter and 22 vehicles would exit the site.

### **Required Improvements**

- A list of all improvements in the vicinity of the site is presented in Table 9.
- Based on the short-term background and total traffic volumes and the criteria contained in the *El Paso County Engineering Criteria Manual (ECM)*, a northbound left-turn lane is projected to be warranted on Eastonville Road approaching Stapleton Drive. Based on ECM criteria, the prescribed lane length is 405 feet long plus a 160-foot taper. A Subdivision Improvement Agreement has been reached that includes an agreement that the Meridian Ranch developer will provide the engineering design and construction plans for the PPRTA-funded Eastonville Road improvements adjacent to the Meridian Ranch development area in lieu of constructing the Stapleton Drive and Eastonville Road intersection improvements.
- Based on the existing traffic volumes and the criteria contained in the ECM, an eastbound left-turn lane is currently warranted on Stapleton Drive approaching Eastonville Road and a westbound left-turn lane is very close to being warranted. However, these approaches are currently stop-sign controlled. The westbound left-turn lane, which has already been constructed as part of the northern half-section of Stapleton, will be able to be placed into

service with the completion of the southern (eastbound) half of the intersection. The future construction of the eastbound left-turn lane will be completed with the south (eastbound) half of the intersection.

- Based on the projected short-term plus Phase 1 traffic volumes and the criteria contained in the El Paso County *Engineering Criteria Manual*, left-turn lanes would be required on Stapleton Drive approaching Lambert. There is currently a painted median on Stapleton Drive at this intersection. Please refer to the improvements Table 9 for details.
- Based on the projected 2040 total traffic volumes and the criteria contained in the El Paso County *Engineering Criteria Manual*, left-turn lanes would be required on Lambert Road approaching the full-movement site access and Rainbow Bridge Drive. The non-residential collector standard cross section includes a center two-way left-turn lane. Therefore, the requirement for this turn lane would be satisfied without any additional street width.
- Based on the projected 2040 total traffic volumes and the criteria contained in the *El Paso County Engineering Criteria Manual*, right-turn deceleration lanes would not be required on Lambert Road approaching the full-movement site access and Rainbow Bridge Drive.
- Based on the projected 2040 total traffic volumes and the criteria contained in the *El Paso County Engineering Criteria Manual*, a southbound right-turn deceleration lane would be required on Lambert Road approaching Stapleton Drive. The non-residential collector standard cross section includes a center two-way left-turn lane. This lane should be 155 feet long plus a 160-foot taper.
- Based on the projected 2040 total traffic volumes and the criteria contained in the *El Paso County Engineering Criteria Manual*, right-turn deceleration lanes would not be required on Rainbow Bridge Drive approaching the full-movement site access points.

### **Street Classifications**

- Figure 20 shows the recommended internal street classifications based on the projected buildout traffic volumes for WindingWalk at Meridian Ranch Filings 1 and 2 and The Enclave at Stonebridge at Meridian Ranch.

### **Stapleton Drive**

- Stapleton Drive adjacent to the site is currently a half-section of an Urban four-lane Principal Arterial street. Meridian Ranch has met its obligation for off-site roadway improvement construction and/or participation. Therefore, Meridian Ranch will not be required to complete the second half-section of Stapleton.

- The projected intermediate-term total daily traffic on Stapleton Drive is under 10,000 vehicles per day. This projected ADT would not exceed the ECM design ADT of a two-lane Urban Collector, to which the existing Stapleton half-section is similar.

#### **Anticipated Deviation Requests**

- Length of cul-de-sac for Filing 1 of Winding Walk.
- Pavement design deviation with ESALs for different ADT ranges on local streets.
- Intersection spacing north of Rainbow Bridge and Lambert.
- Broken Back Curve on Porch Swing.
- Potentially for the eastbound left-turn lane striping on Stapleton approaching Lambert.

#### **Transportation Improvement Fee Program**

- WindingWalk at Meridian Ranch Filing 1 and The Enclave at Stonebridge at Meridian Ranch will not be required to participate in the Countywide Transportation Improvement Fee Program as Meridian Ranch is located within the Woodmen Road Metropolitan District.

\* \* \* \* \*

Please contact me if you have any questions or need further assistance.

Sincerely,

LSC TRANSPORTATION CONSULTANTS, INC.

By 

Jeffrey C. Hodsdon, P.E., PTOE  
Principal

JCH:KDF:bjwb

Enclosures: Tables 2-9  
Figures 1-24  
List of Recent Traffic Studies in the Area  
Traffic Count Reports  
Level of Service Reports

**Table 2**  
**Trip Generation Estimate**  
**WindingWalk at Meridian Ranch and The Enclaves at Stonebridge at Meridian Ranch**

Phase	Subdivision	Land Use Code	Land Use Description	Trip Generation Units	Trip Generation Rates <sup>(1)</sup>				Total Trips Generated					
					Average Weekday Traffic	Morning Peak Hour		Afternoon Peak Hour		Average Weekday Traffic	Morning Peak Hour		Afternoon Peak Hour	
						In	Out	In	Out		In	Out	In	Out
1	WindingWalk at Meridian Ranch Filing 1	210	Single-Family Detached Housing	345 DU <sup>(2)</sup>	9.44	0.19	0.56	0.62	0.37	3,257	64	191	215	126
2	The Enclaves at Stonebridge at Meridian Ranch	210	Single-Family Detached Housing	184 DU	9.44	0.19	0.56	0.62	0.37	1,737	34	102	115	67
<b>Total Phases 1 and 2</b>										<b>4,994</b>	<b>98</b>	<b>293</b>	<b>330</b>	<b>193</b>
3	WindingWalk at Meridian Ranch Filing 2	210	Single-Family Detached Housing	60 DU	9.44	0.19	0.56	0.62	0.37	566	11	33	37	22
<b>Total Phases 1, 2 and 3</b>										<b>5,560</b>	<b>109</b>	<b>326</b>	<b>367</b>	<b>215</b>

Notes:

(1) Source: "Trip Generation, 10th Edition, 2017" by the Institute of Transportation Engineers (ITE)

(2) DU = dwelling units

Source: LSC Transportation Consultants, Inc.

**Table 3A**  
**WindingWalk at Meridian Ranch and The Enclave at Stonebridge**  
**All-Way Stop-Sign Control Warrant**  
**Peak Hour Analysis**  
**Rainbow Bridge Dr & Londonderry Drive**

Phase	Traffic Volumes				All-Way Stop-Sign Control Criteria							
					AM				PM			
	AM		PM		Major Street Minimum	Met?	Minor Street Minimum	Met?	Major Street Minimum	Met?	Minor Street Minimum	Met?
	Major <sup>(1)</sup>	Minor <sup>(2)</sup>	Major	Minor								
Existing	701	214	346	114	300	Yes	200	Yes	300	Yes	200	No
Short-Term Background <sup>(3)</sup>	876	334	571	262	300	Yes	200	Yes	300	Yes	200	Yes
Short-Term Background Plus Phase 1	887	382	592	279	300	Yes	200	Yes	300	Yes	200	Yes

Notes:

(1) The major street volumes include all eastbound and westbound (left/through/right) movements on Londonderry Dr.

(2) The minor street volumes includes all northbound and southbound (left/through/right-turn) movements on Rainbow Bridge Dr.

(3) Assumes Rainbow Bridge Dr. has been extended to the future Lambert Rd. and Lambert Rd. has been constructed from Rainbow Bridge Dr. to Stapleton Dr.

Source: LSC Transportation Consultants, Inc.

**Table 3B**  
**WindingWalk at Meridian Ranch and The Enclave at Stonebridge**  
**All-Way Stop-Sign Control Warrant**  
**Short-Term Background Plus Phase 1-Generated Traffic Six Hour Analysis**  
**Rainbow Bridge Dr & Londonderry Drive**

Time	Existing		Background		Phase 1		Short-Term Plus Phase 1		All-Way Stop-Sign Control Criteria			
	Major <sup>(2)</sup>	Minor <sup>(3)</sup>	Major	Minor	Major	Minor	Major	Minor	Major Street Minimum	Met?	Minor Street Minimum	Met?
<b>6:45-7:45 AM</b>	701	214	149	102	9	41	859	357	300	<b>Yes</b>	200	<b>Yes</b>
<b>7:45-8:45 AM</b>	308	303	158	108	10	43	476	454	300	<b>Yes</b>	200	<b>Yes</b>
<b>1:45-2:45 PM</b>	236	78	155	102	14	12	405	192	300	<b>Yes</b>	200	(4)
<b>2:45-3:45 PM</b>	627	138	178	117	17	13	822	268	300	<b>Yes</b>	200	<b>Yes</b>
<b>4:15-5:15 PM</b>	328	139	223	146	21	17	572	302	300	<b>Yes</b>	200	<b>Yes</b>
<b>5:15-6:15 PM</b>	348	108	215	141	20	16	583	265	300	<b>Yes</b>	200	<b>Yes</b>

Notes:

- (1) To meet this warrant the thresholds will need to be met for two additional hours. Data for additional hours was not available at the time this report was prepared.
- (2) The major street volumes include all eastbound and westbound (left/through/right) movements on Londonderry Dr.
- (3) The minor street volumes includes all northbound and southbound (left/through/right-turn) movements on Rainbow Bridge Dr.
- (4) The criteria for an all-way stop includes the pedestiran and bicylce volume in the minor approach volumes, however, as these volumes are difficult to predict they were not included in the analysis. It is likely that there will be a high number of pedestrians in the 1:45 to 2:45 time period as the Meridian Ranch Elementary School dismissal time is at 2:40 PM. If there are more than 8 pedestrians during this time period the threshold will be met.

Source: LSC Transportation Consultants, Inc.

**Table 4**  
**WindingWalk at Meridian Ranch and The Enclave at Stonebridge**  
**All-Way Stop-Sign Control Warrant**  
**Peak Hour Analysis**  
**Lambert Road & Londonderry Drive**

Phase	Traffic Volumes				All-Way Stop-Sign Control Criteria							
					AM				PM			
	AM		PM		Major Street Minimum	Met?	Minor Street Minimum	Met?	Major Street Minimum	Met?	Minor Street Minimum	Met?
	Major <sup>(1)</sup>	Minor <sup>(2)</sup>	Major	Minor								
Intermediate Background <sup>(3)</sup>	688	347	486	73	300	Yes	200	Yes	300	Yes	200	No
Intermediate Total	697	374	490	82	300	Yes	200	Yes	300	Yes	200	No
2040 Background	627	840	576	471	300	Yes	200	Yes	300	Yes	200	Yes
2040 Total	645	912	515	500	300	Yes	200	Yes	300	Yes	200	Yes

Notes:

- (1) The major street volumes include all eastbound and westbound (left/through/right) movements on Londonderry Dr.
- (2) The minor street volumes includes all northbound and southbound (left/through/right-turn) movements on Lambert Rd.
- (3) Assumes Rainbow Bridge Dr. has been extended to the future Lambert Rd. and Lambert Rd. has been constructed from Londonderry Dr. to Stapleton Dr.

Source: LSC Transportation Consultants, Inc.

**Table 5**  
**WindingWalk at Meridian Ranch and The Enclave at Stonebridge**  
**Traffic Signal Warrant Analysis of Eastonville/Stapleton**  
**Peak-Hour Four-Hour Vehicular Volume Evaluation**

Phase	AM Peak Hour						PM Peak Hour					
	Peak-Hour Traffic Volumes			Volume Evaluation <sup>(1)</sup>			Peak-Hour Traffic Volumes			Volume Evaluation <sup>(1)</sup>		
	Major <sup>(2)</sup>	Minor		Minor St Minimum	EB Met?	WB Met?	Major <sup>(2)</sup>	Minor		Minor St Minimum	EB Met?	WB Met?
		EB <sup>(3)</sup>	WB <sup>(4)</sup>					EB <sup>(3)</sup>	WB <sup>(4)</sup>			
Short-Term Background	724	218	78	238	No	No	422	179	174	379	No	No
Short-Term Background Plus Phase 1	732	287	89	234	Yes	No	463	227	222	359	No	No
Short-Term Background Plus Phase 1	732	287	89	234	Yes	No	463	227	222	359	No	No
Short-Term Background Plus Phase 2	735	319	95	233	Yes	No	472	248	248	354	No	No
Intermediate-Term Background	671	278	176	262	Yes	No	426	222	291	377	No	No
Intermediate-Term Total	684	389	194	256	Yes	No	482	299	373	349	No	Yes

Notes:

- (1) Based on 2 lanes on major approach and 1 lane on minor approach.
- (2) The major street volumes include all (left/through/right) movements on Eastonville Road.
- (3) The EB minor street volumes includes all easbound movements (left, through and right) on Stapleton Drive.
- (4) The WB minor street volumes includes only the left and through westbound movements on Stapleton Dr. The right-turn movements have been excluded because there is an existing exclusive right-turn lane on this approach.

Source: LSC Transportation Consultants, Inc.



**Table 6**  
**WindingWalk at Meridian Ranch and The Enclave at Stonebridge**  
**Traffic Signal Warrant Analysis of Lambert/Stapleton**  
**Peak-Hour Four-Hour Vehicular Volume Evaluation**

Phase	AM Peak Hour						PM Peak Hour					
	Peak-Hour Traffic Volumes			Volume Evaluation <sup>(1)</sup>			Peak-Hour Traffic Volumes			Volume Evaluation <sup>(1)</sup>		
	Major <sup>(2)</sup>	Minor		Minor St Minimum	SB Met?	NB Met?	Major <sup>(2)</sup>	Minor		Minor St Minimum	SB Met?	NB Met?
		SB <sup>(3)</sup>	NB <sup>(4)</sup>					SB <sup>(3)</sup>	NB <sup>(4)</sup>			
Short-Term Background	337	97	56	331	No	No	487	67	51	233	No	No
Short-Term Background Plus Phase 1	380	170	57	303	No	No	674	118	57	149	No	No
Short-Term Background Plus Phase 2	399	210	58	291	No	No	759	145	66	119	Yes	No
Intermediate-Term Background	443	137	56	262	No	No	647	88	51	159	No	No
Intermediate-Term Total	512	262	60	219	Yes	No	949	174	67	80	Yes	No

Notes:

- (1) Based on 70% factor with 2 lanes on major approach and 2 lanes on minor approach.
- (2) The major street volumes include all (left/through/right) movements on Stapleton Dr.
- (3) The SB minor street volumes includes the southbound left-turn and through movements only on Lambert Rd.
- (4) The NB minor street volumes includes all northbound movements (left, through and right) on Lambert Rd. excluded because there is an existing exclusive right-turn lane on this approach.

Source: LSC Transportation Consultants, Inc.

**Table 7**  
**WindingWalk at Meridian Ranch and The Enclave at Stonebridge**  
**Traffic Signal Warrant Analysis of Lambert/Londonderry**  
**Peak-Hour Four-Hour Vehicular Volume Evaluation**

Phase	AM Peak Hour						PM Peak Hour					
	Peak-Hour Traffic Volumes			Volume Evaluation <sup>(1)</sup>			Peak-Hour Traffic Volumes			Volume Evaluation <sup>(1)</sup>		
	Major <sup>(2)</sup>	Minor		Minor St Minimum	SB Met?	NB Met?	Major <sup>(2)</sup>	Minor		Minor St Minimum	SB Met?	NB Met?
		SB <sup>(3)</sup>	NB <sup>(4)</sup>					SB <sup>(3)</sup>	NB <sup>(4)</sup>			
<b>Intermediate-Term Background</b>	688	76	95	346	No	No	486	21	22	470	No	No
<b>Intermediate-Term Total</b>	697	84	113	342	No	No	490	25	26	467	No	No
<b>2040 Background</b>	625	304	271	378	No	No	502	176	184	459	No	No
<b>2040 Total</b>	625	304	271	378	No	No	502	176	184	459	No	No

Notes:

- (1) Based on 2 lanes on major approach and 2 lanes on minor approach.
- (2) The major street volumes include all (left/through/right) movements on Londonderry Dr.
- (3) The SB minor street volumes include the southbound left-turn and through movements on Lambert Rd.
- (4) The NB minor street volumes include the northbound left-turn and through movements on Lambert Rd.

Source: LSC Transportation Consultants, Inc.

**Table 8  
Stapleton/Eastonville Future Traffic Signal Contributions  
WindingWalk at Meridian Ranch and The Enclave at Stonebridge**

<b>Development</b>		<b>EB LT</b>	<b>EB TH</b>	<b>EB RT</b>	<b>WB LT</b>	<b>WB TH</b>	<b>TOTAL veh/hr</b>	<b>Signal Contribution %</b>	<b>\$</b>
AM	Intermediate Background Traffic	6	194	78	37	139	454	77.5%	
	Winding Walk at Meridian Ranch Fil No. 1	0	39	29	0	11	79	13.5%	
	The Enclaves at Stonebridge	0	21	11	0	6	38	6.5%	
	Winding Walk at Meridian Ranch Fil No. 2	0	7	6	0	2	15	2.6%	
		<b>6</b>	<b>261</b>	<b>124</b>	<b>37</b>	<b>158</b>	<b>586</b>		
PM	Intermediate Background Traffic	18	153	51	32	259	513	76.3%	
	Winding Walk at Meridian Ranch Fil No. 1	0	27	20	0	48	95	14.1%	
	The Enclaves at Stonebridge	0	14	7	0	26	47	7.0%	
	Winding Walk at Meridian Ranch Fil No. 2	0	5	4	0	8	17	2.5%	
		<b>18</b>	<b>199</b>	<b>82</b>	<b>32</b>	<b>341</b>	<b>672</b>		
AM + PM	Intermediate Background Traffic	24	347	129	69	398	967	76.9%	\$230,604
	Winding Walk at Meridian Ranch Fil No. 1	0	66	49	0	59	174	13.8%	\$41,494
	The Enclaves at Stonebridge	0	35	18	0	32	85	6.8%	\$20,270
	Winding Walk at Meridian Ranch Fil No. 2	0	12	10	0	10	32	2.5%	\$7,631
		<b>24</b>	<b>460</b>	<b>206</b>	<b>69</b>	<b>499</b>	<b>1258</b>		<b>\$300,000</b>

Source: LSC Transportation Consultants, Inc.

**Table 9  
WindingWalk at Meridian Ranch  
Roadway Improvements**

Item #	Improvement	Timing	Responsibility
1	Construct Rainbow Bridge Dr. as a Residential Collector from Stone Valley Drive to Lambert Rd.	Winding Walk at Meridian Ranch Fil 1	Meridian Ranch
2	Construct Lambert Road as a Non-Residential Collector from Rainbow Bridge Drive to Stapleton Dr. with a three-lane cross-section (one through lane in each direction plus a center two-way left-turn lane)	Winding Walk at Meridian Ranch Fil 1	Meridian Ranch
4	Construct Lambert Road as a Non-Residential Collector from Rainbow Bridge Drive to Stone Valley Dr. with a three-lane cross-section (one through lane in each direction plus a center two-way left-turn lane)	Winding Walk at Meridian Ranch Fil 2	Meridian Ranch
5	Construct a 155-foot southbound right-turn deceleration lane plus 160-foot taper on Lambert Road approaching Stapleton Dr.	Winding Walk at Meridian Ranch Fil 1	Meridian Ranch
6	Restripe the center median on Stapleton Dr. approaching Lambert Rd to provide a 400-foot-long eastbound left-turn lane; restripe for a lane transition taper within the redirect taper. Phases 2 and 3 - the deceleration plus stacking distance lane length per the ECM is projected to be 448 feet for Phase 2 and 515 feet for Phase 3. Phase 2 and Phase 3 verification of and potential update to the necessary lane length and how the necessary lane design elements can be achieved (if this lane is not addressed as part of a County or PPRTA project for this section of Stapleton Road) should be revisited at the final plat(s) for phases 2 and 3.	Winding Walk at Meridian Ranch Fil 1; Phases 2 and 3.	It is our understanding that the further improvements to Stapleton Drive are the responsibility of the County because Meridian Ranch has met its offsite roadway improvement obligation.
7	Restripe the center median on Stapleton Dr. to provide a 290-foot westbound left-turn lane plus 180-foot taper approaching Lambert Rd.	Winding Walk at Meridian Ranch Fil 1	El Paso County
8	Complete southern (eastbound) half of Stapleton Drive.	Future	El Paso County
9	Construct northbound and southbound left-turn lanes on Eastonville Rd. approaching Stapleton Dr.	Short-Term	PPRTA/El Paso County <sup>(1)</sup>
10	Convert the two-way, stop-sign controlled intersection of Rainbow Bridge Dr./Londonderry Dr. to all-way, Stop-sign control (AWSC). Add stop bars and crosswalk bars on all legs of the intersection.	Winding Walk at Meridian Ranch Fil 1; Decision on timing of conversion to AWSC rests with El Paso County Public Works.	Meridian Ranch
11	Convert the two-way, stop-sign controlled intersection of Lambert Rd./Londonderry Dr. to all-way, Stop-sign control (AWSC);	Winding Walk at Meridian Ranch Fil 2; The decision on timing of conversion to AWSC rests with El Paso County Public Works.	Meridian Ranch
	Pedestrian crossing improvements at the intersection of Londonderry/Lambert.	Short-Term	El Paso County - separate from WindingWalk 1 by agreement with EPC.
12	Signalization of the intersection of Stapleton/Eastonville	Intermediate-Term (Winding Walk at Meridian Ranch Fil 2); Once warrants are met, and the decision on timing of traffic signal installation rests with El Paso County Public Works.	PPRTA, or if not included with the Eastonville PPRTA project, EPC w/ participation via escrow collected by area developments impacting this intersection, including Meridian Ranch
13	Signalization of the intersection of Stapleton/Lambert	Intermediate-Term (Winding Walk at Meridian Ranch Fil 2); Once warrants are met, and the decision on timing of traffic signal installation rests with El Paso County Public Works.	El Paso County with Meridian Ranch participation via escrow with plats.
Notes:			
(1) The design of Eastonville Road is being performed by the Meridian Ranch developer. The project will be constructed by El Paso County as PPRTA project.			
Source: LSC Transportation Consultants, Inc.			



Approximate Scale  
Scale: 1" = 2,000'

Figure 1  
**Vicinity  
Map**

WindingWalk at Meridian Ranch and The Enclave at Stonebridge at Meridian Ranch (LSC #174750)

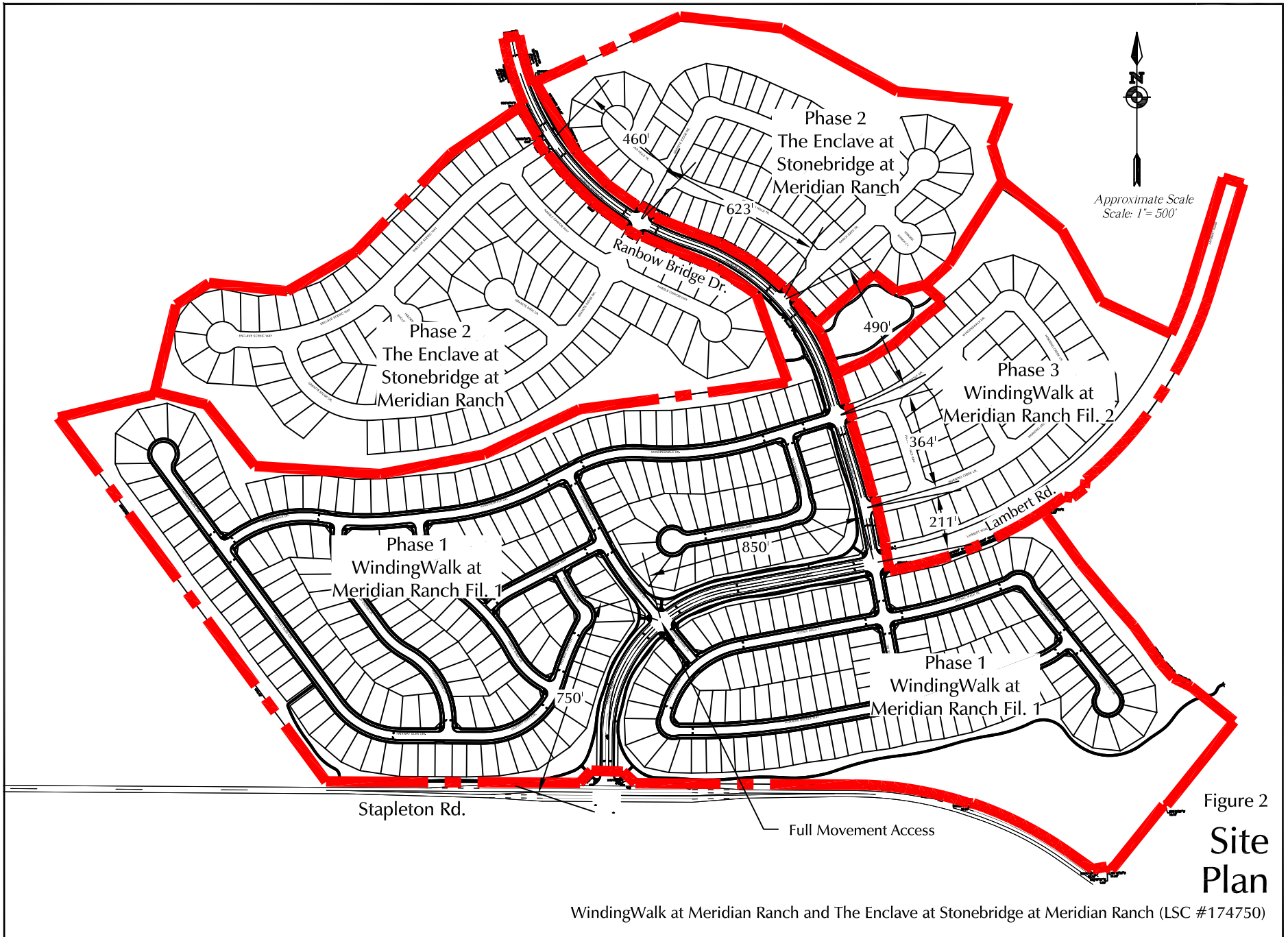

Figure 2  
**Site Plan**  
WindingWalk at Meridian Ranch and The Enclave at Stonebridge at Meridian Ranch (LSC #174750)

Londonderry Dr.



Approximate Scale  
Scale: 1" = 600'



LEGEND:





-  = Existing/Approved
-  = Phase 1
-  = Phase 2
-  = Phase 3

Figure 3

# Street Phasing Plan

WindingWalk at Meridian Ranch and The Enclave at Stonebridge at Meridian Ranch (LSC #174750)



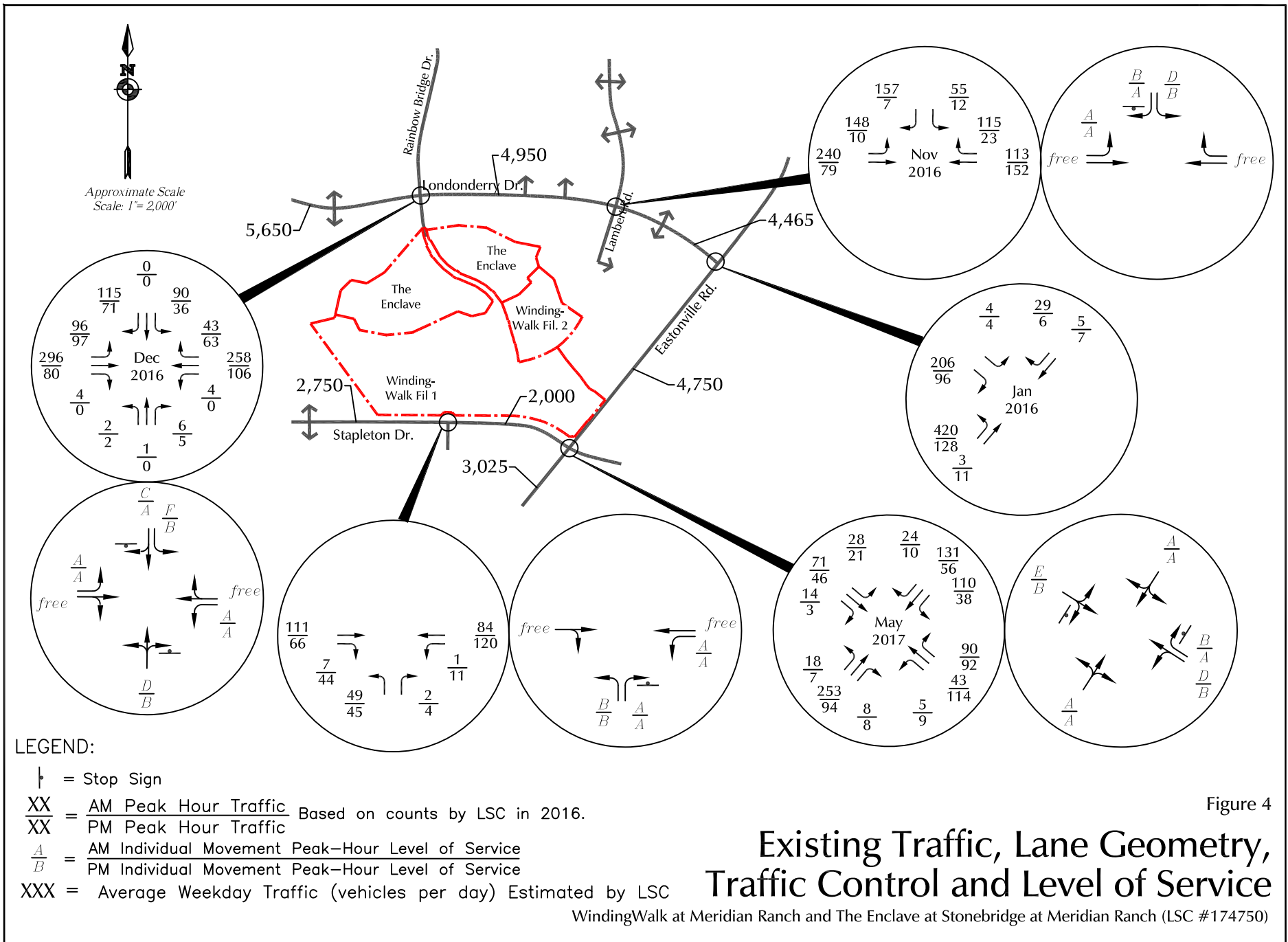

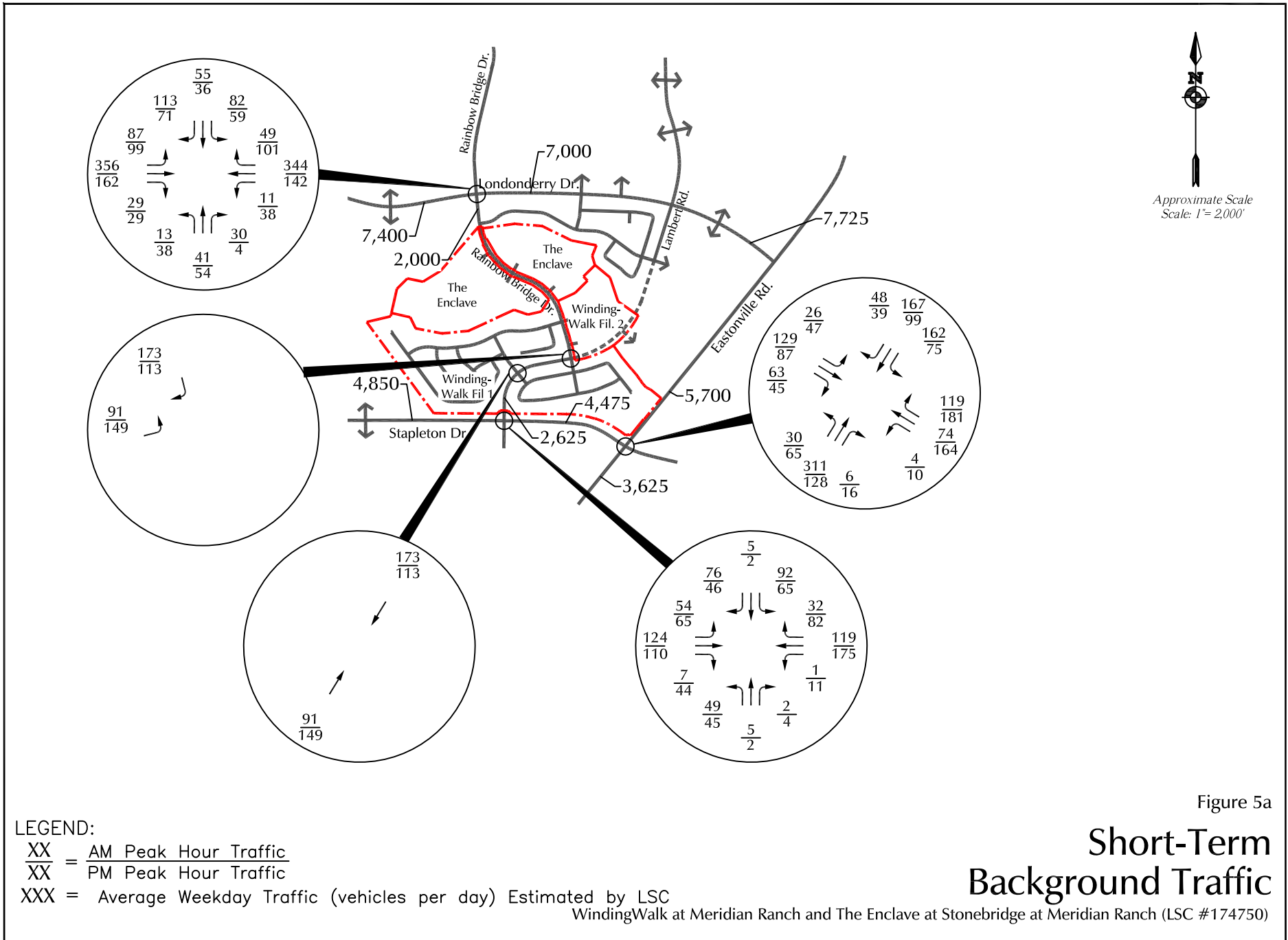

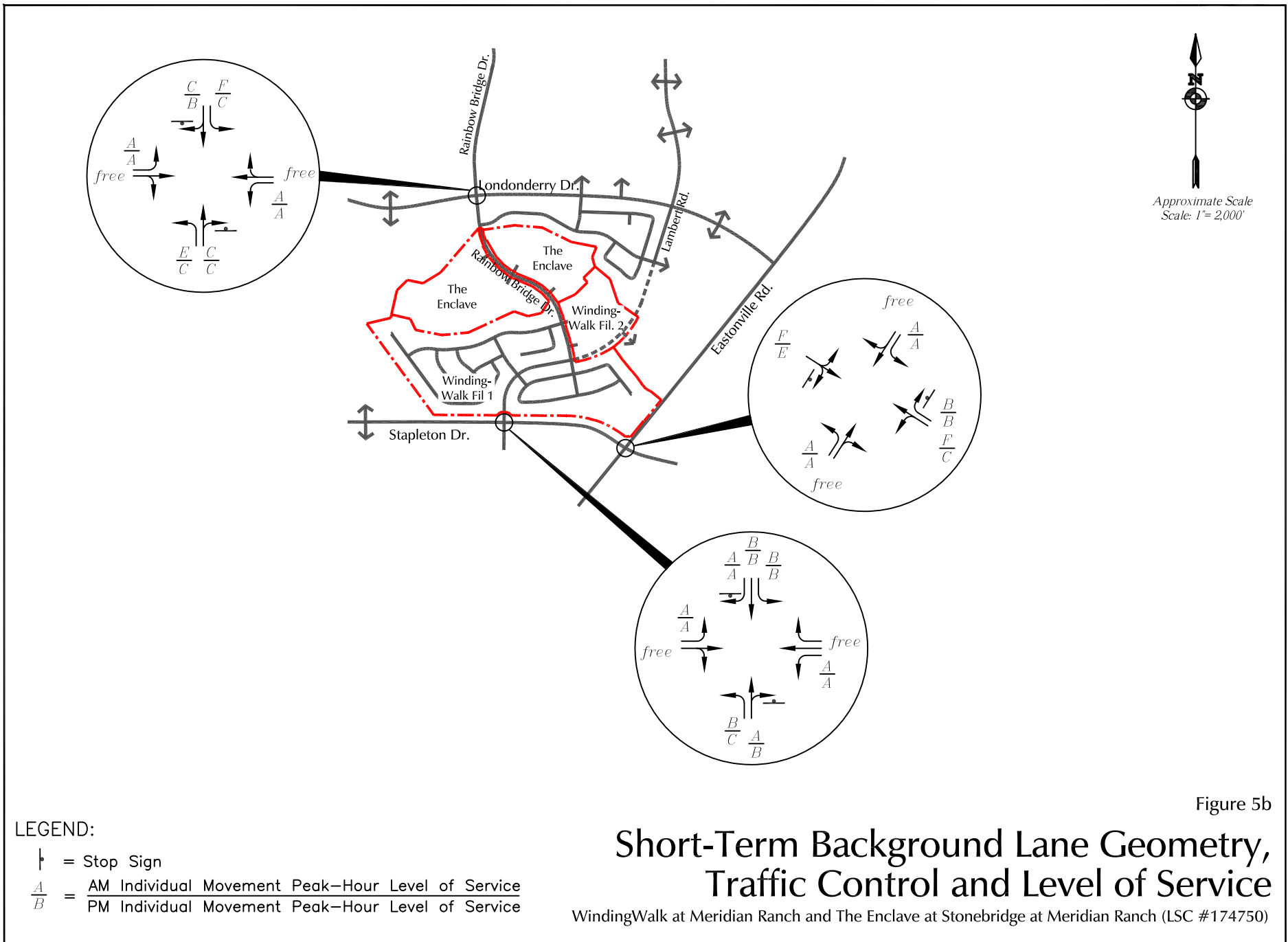

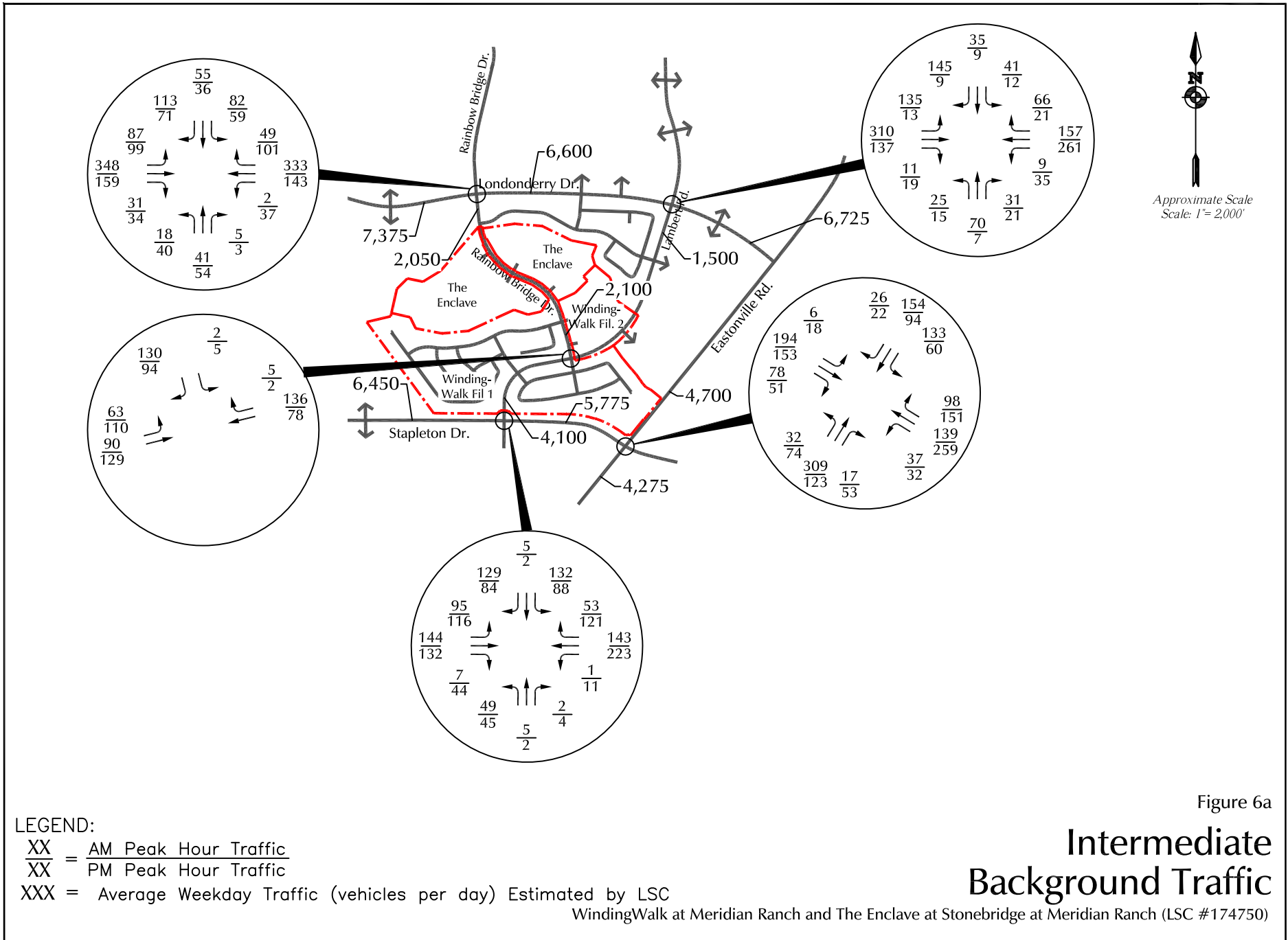

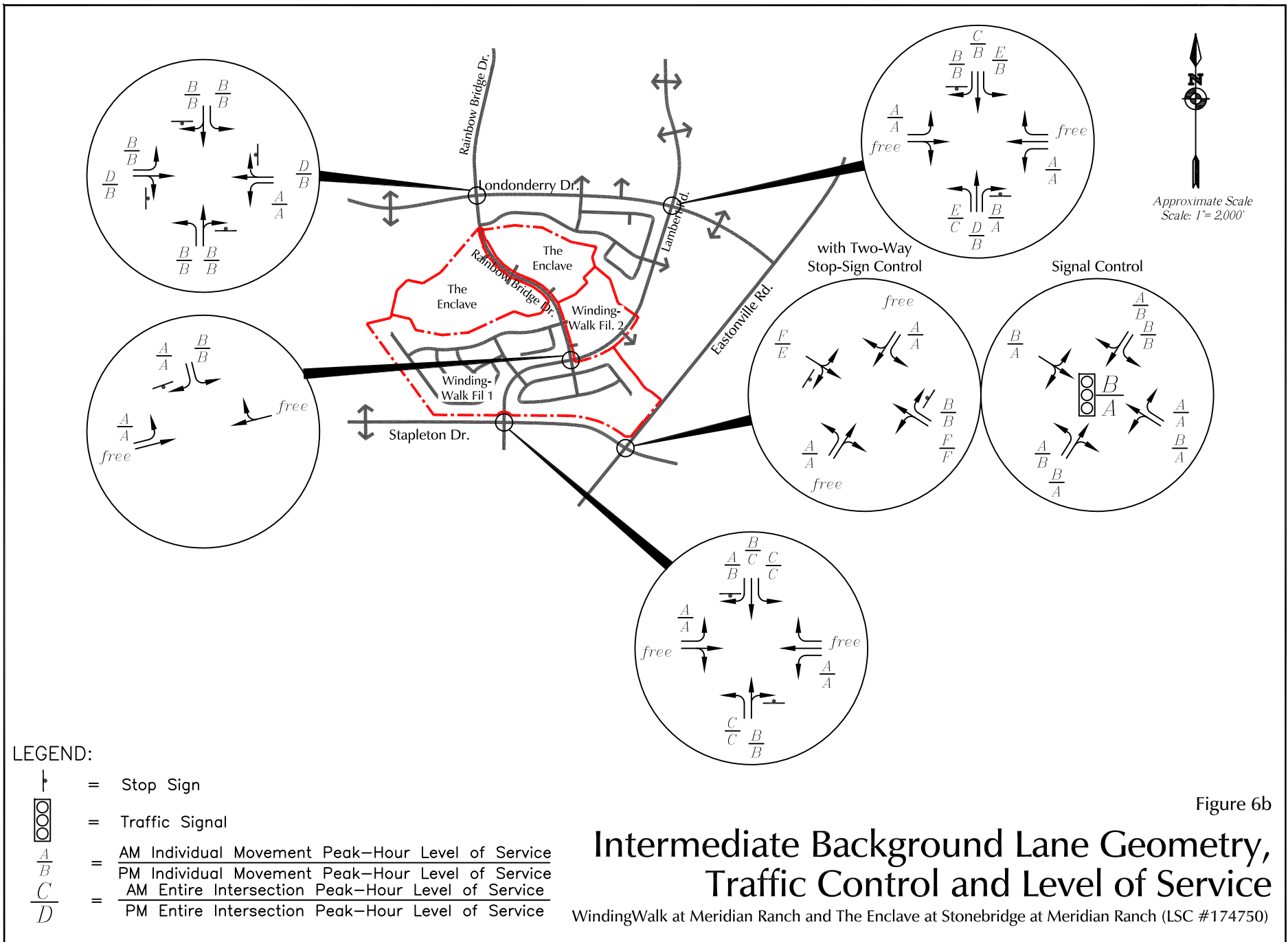

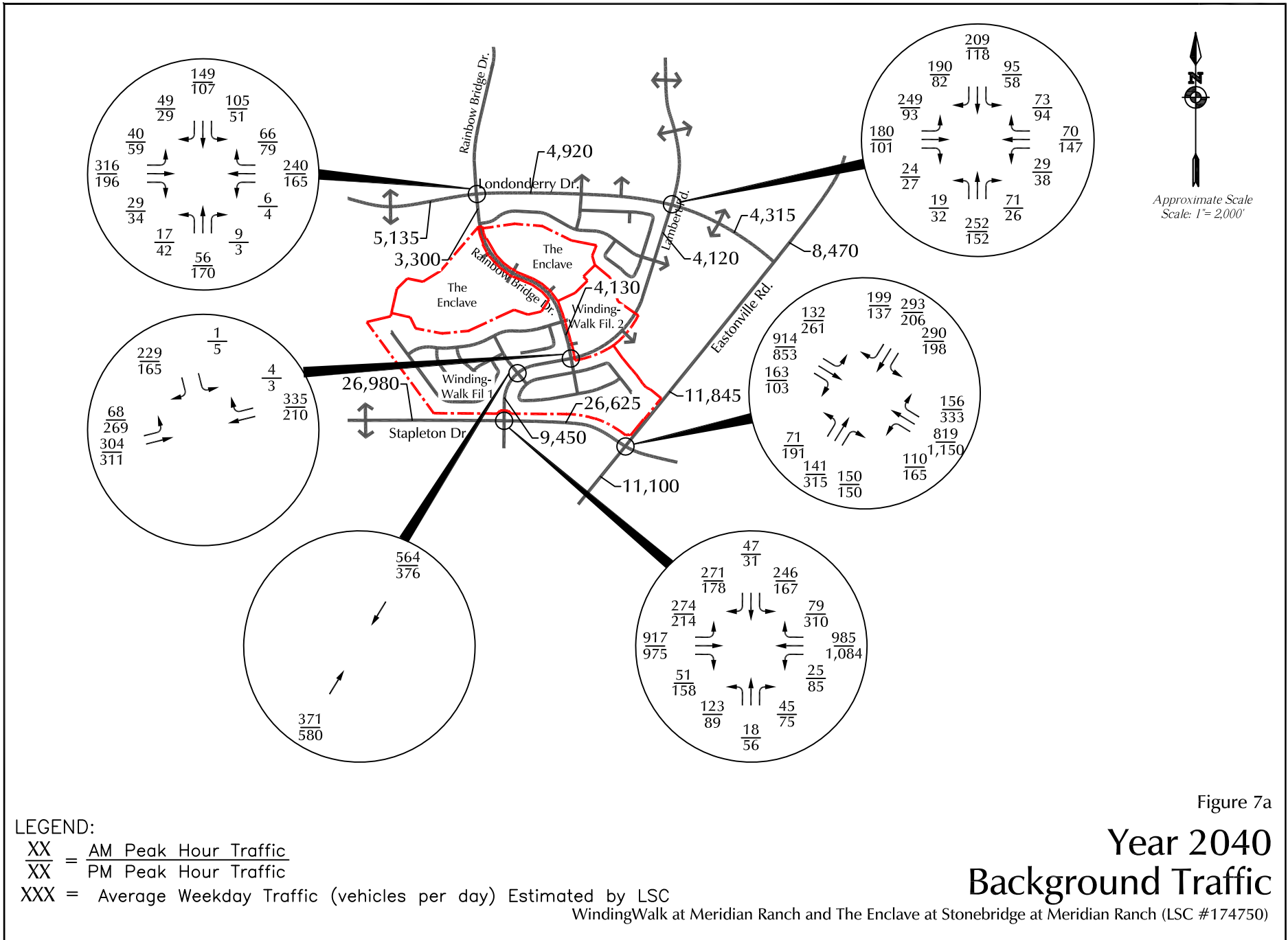

Approximate Scale  
Scale: 1" = 2,000'

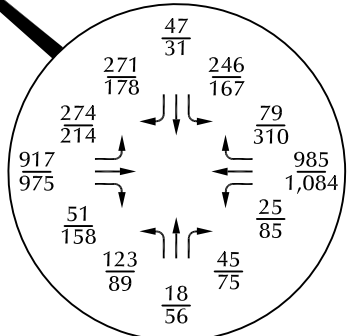
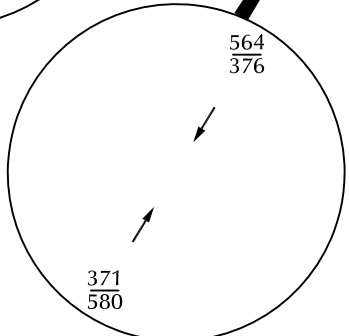
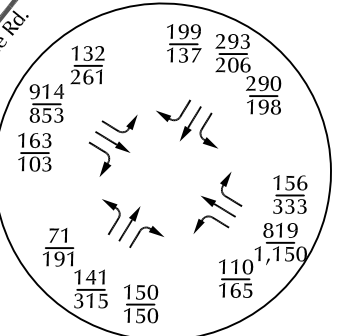
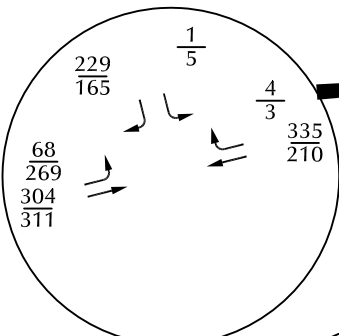
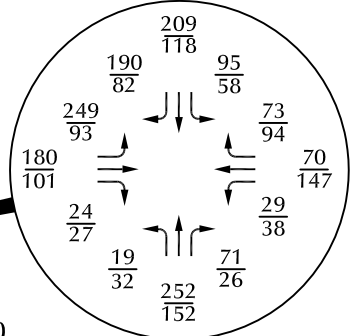
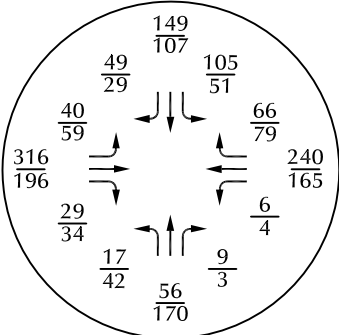

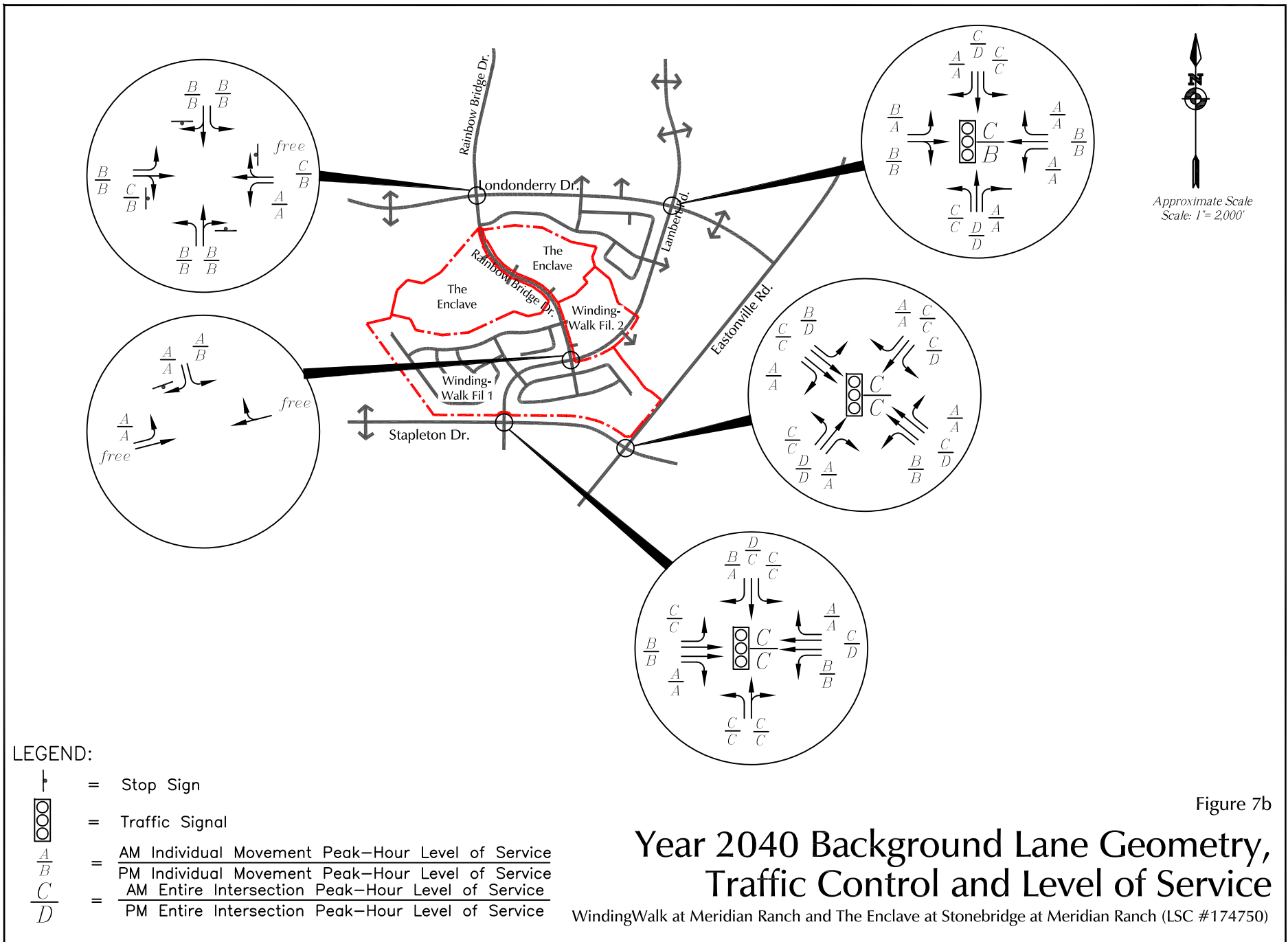

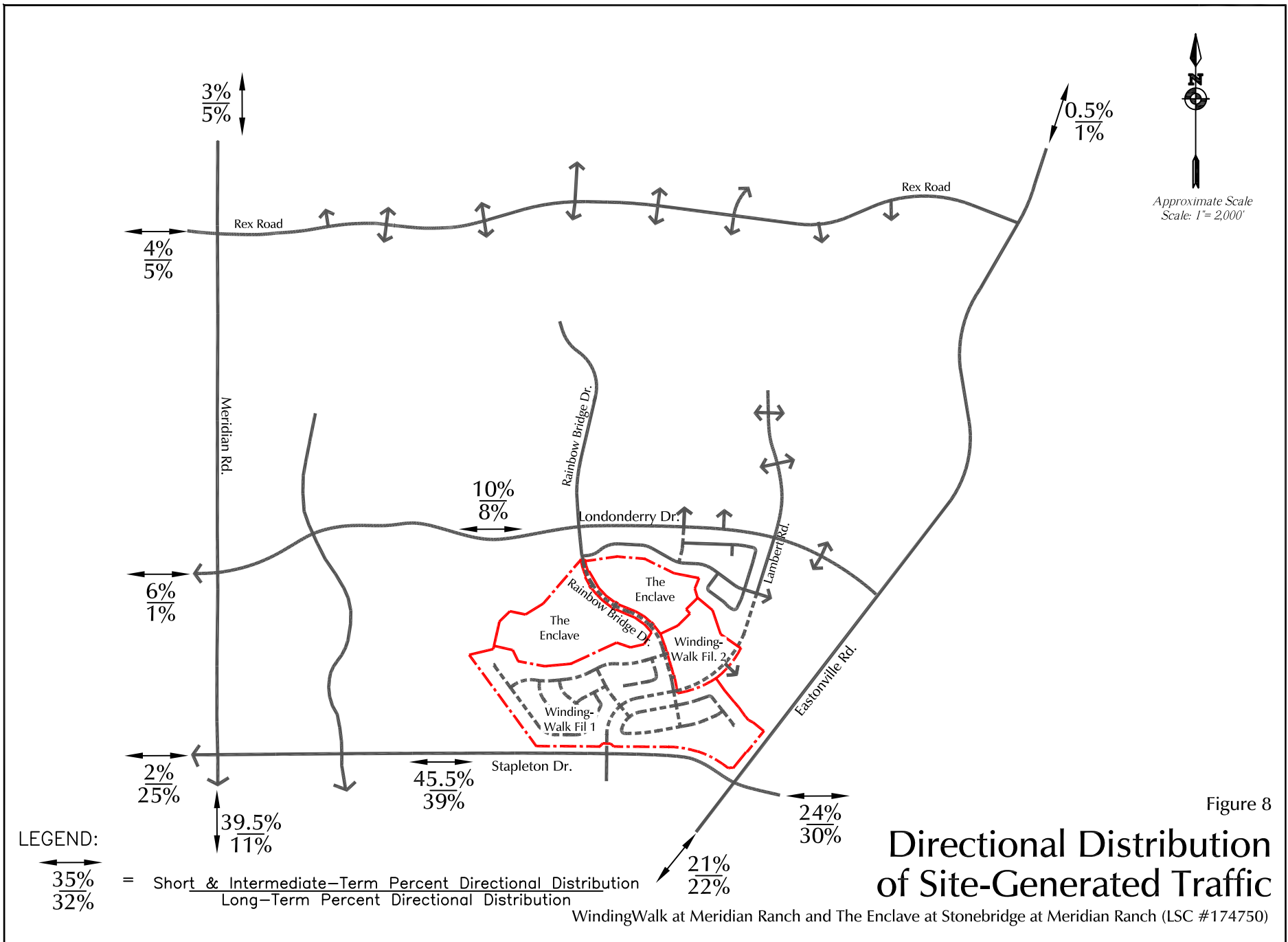

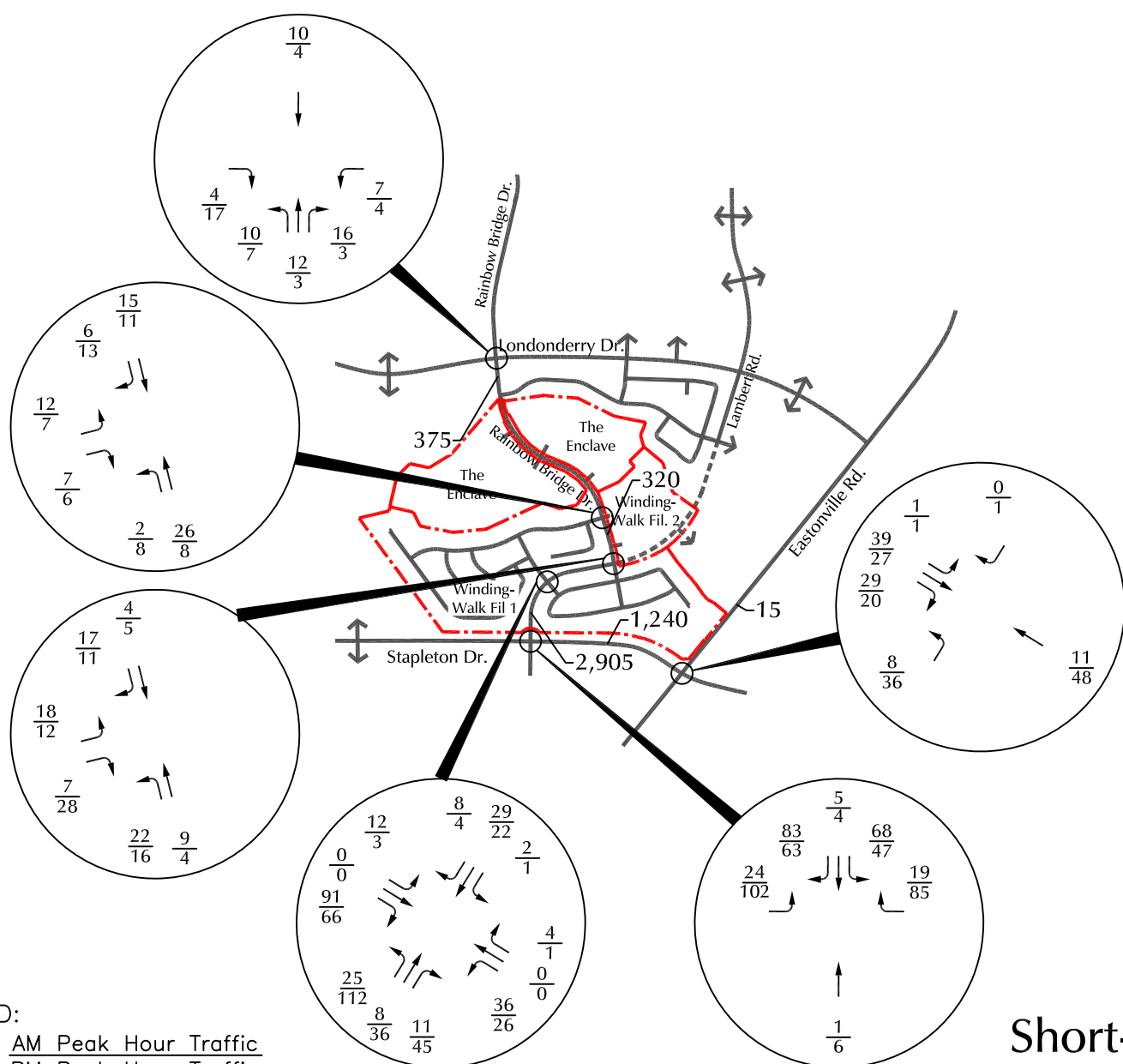
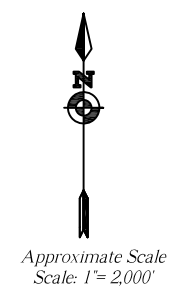

LEGEND:  
 $\frac{XX}{XX}$  = AM Peak Hour Traffic  
 $\frac{XX}{XX}$  = PM Peak Hour Traffic  
 XXX = Average Weekday Traffic (vehicles per day) Estimated by LSC

Figure 9  
**Short-Term Assignment  
 of Winding Walk Filing No. 1**  
 WindingWalk at Meridian Ranch and The Enclave at Stonebridge at Meridian Ranch (LSC #174750)



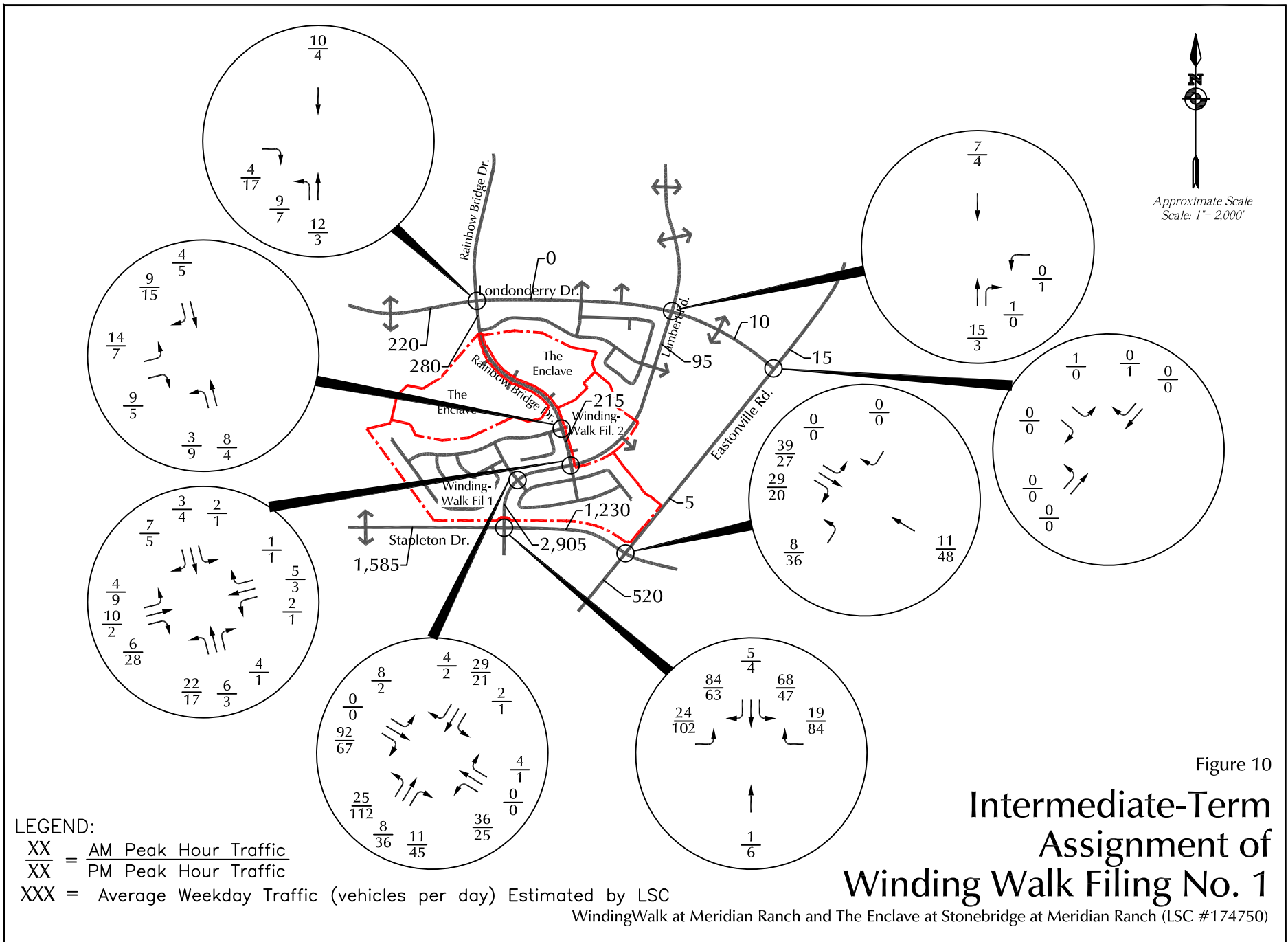

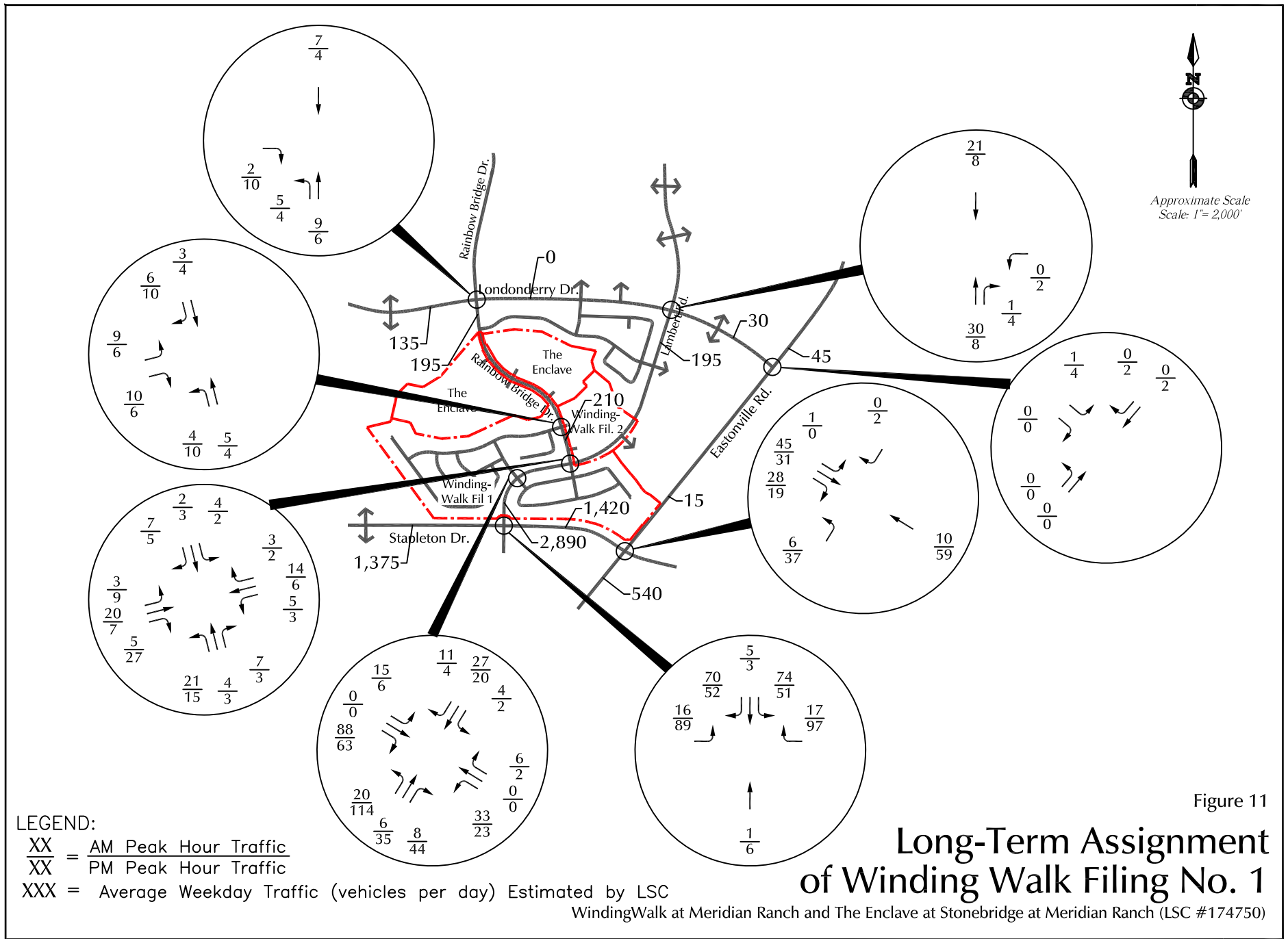

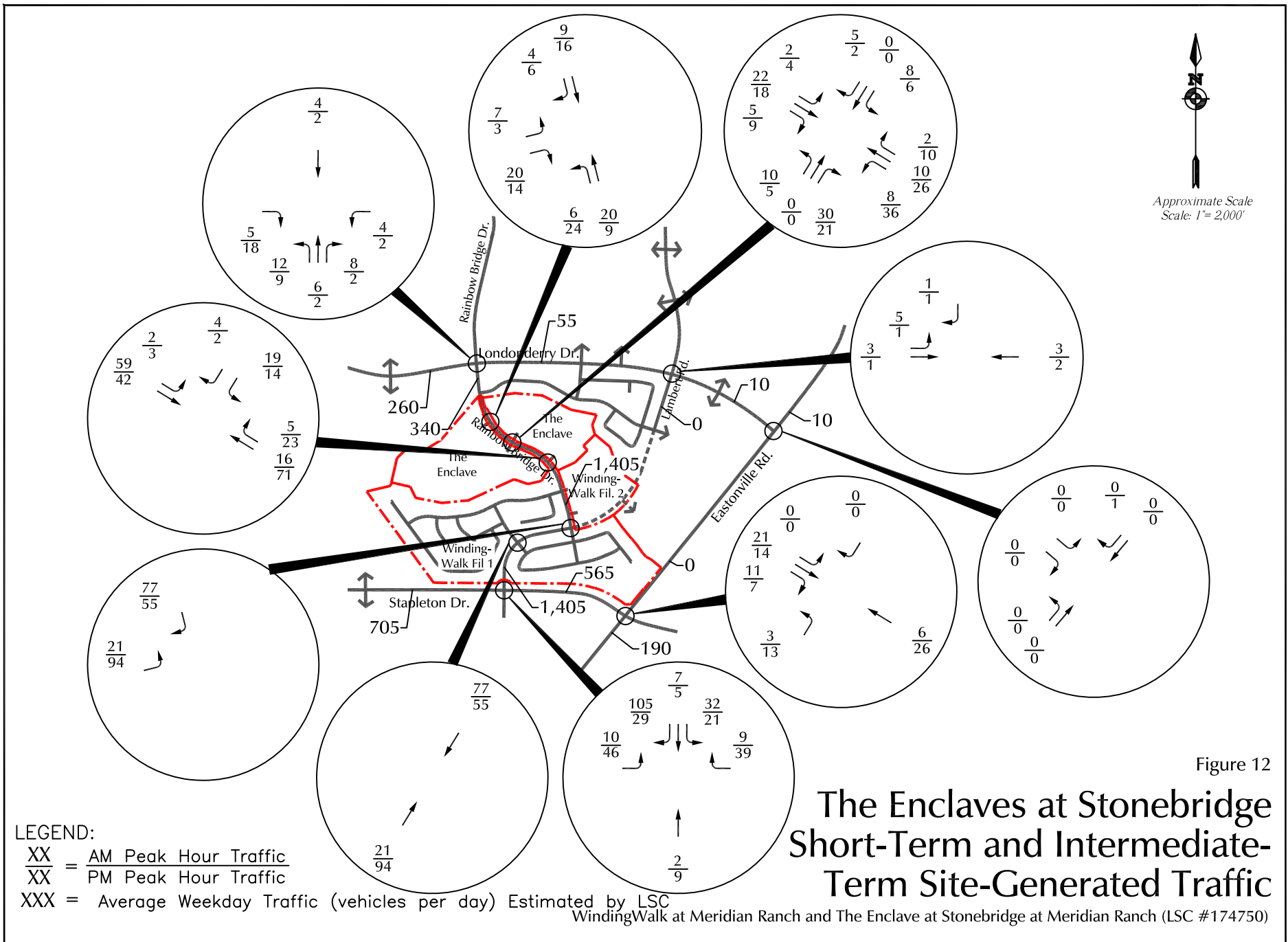

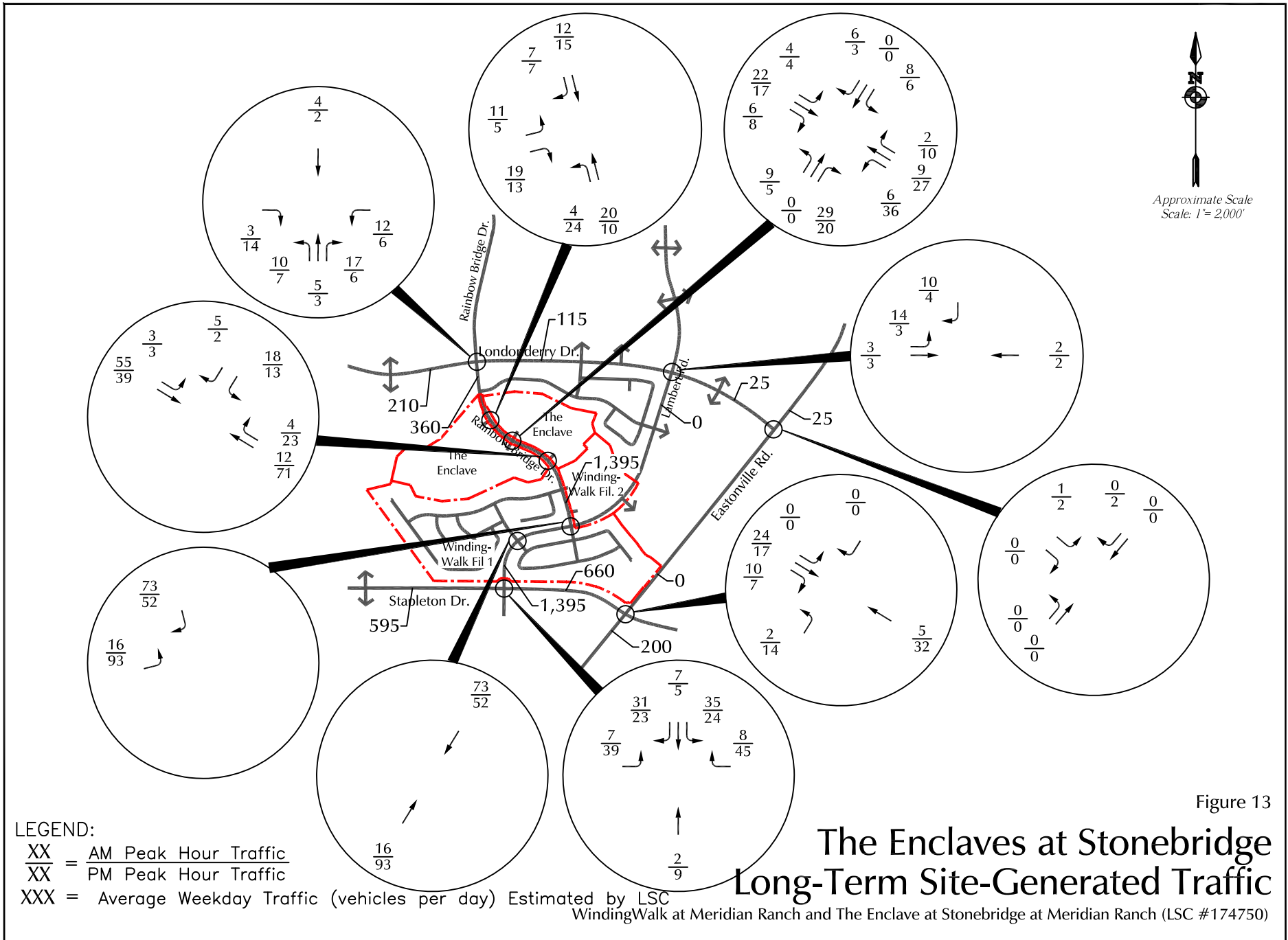

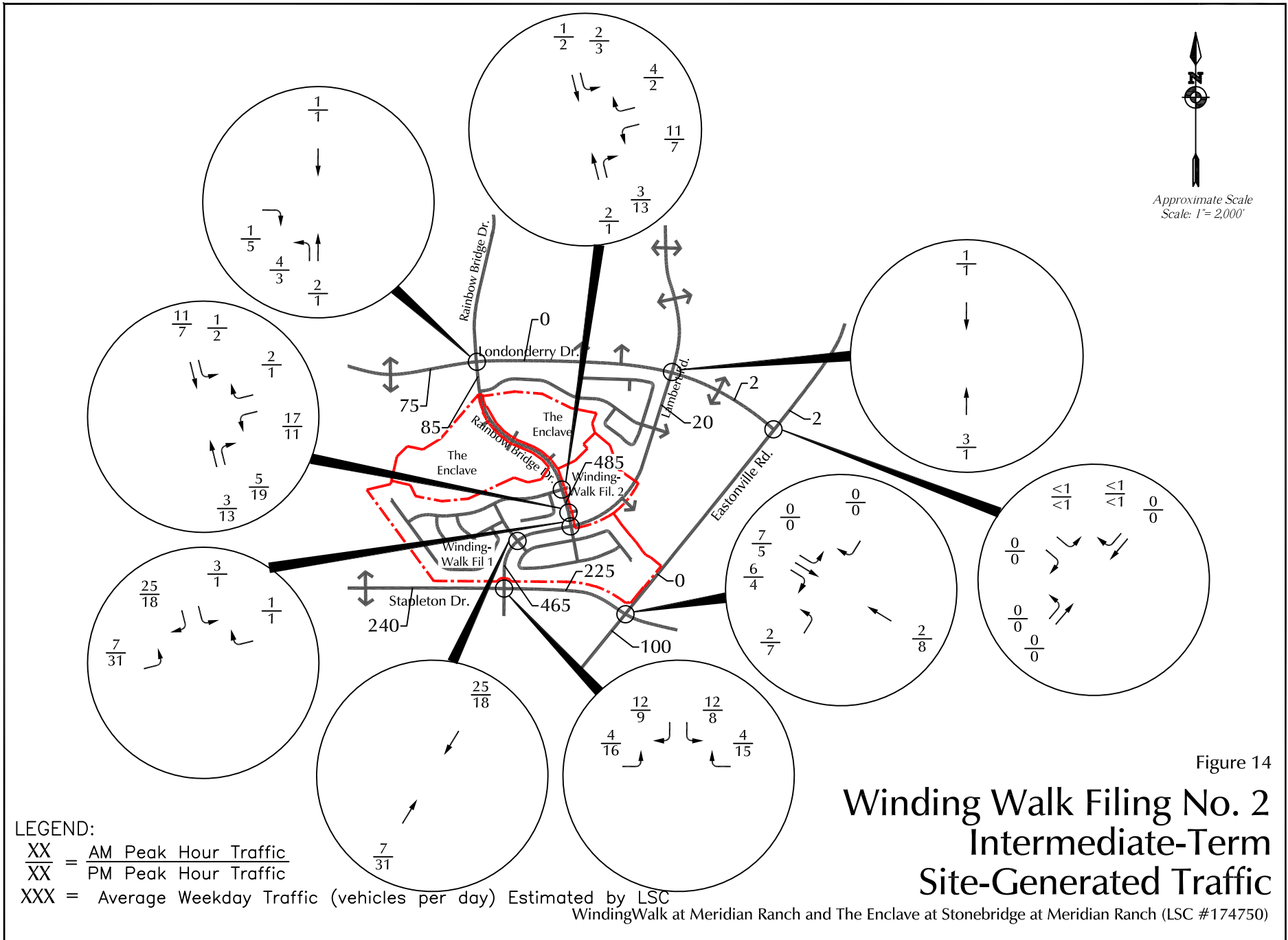

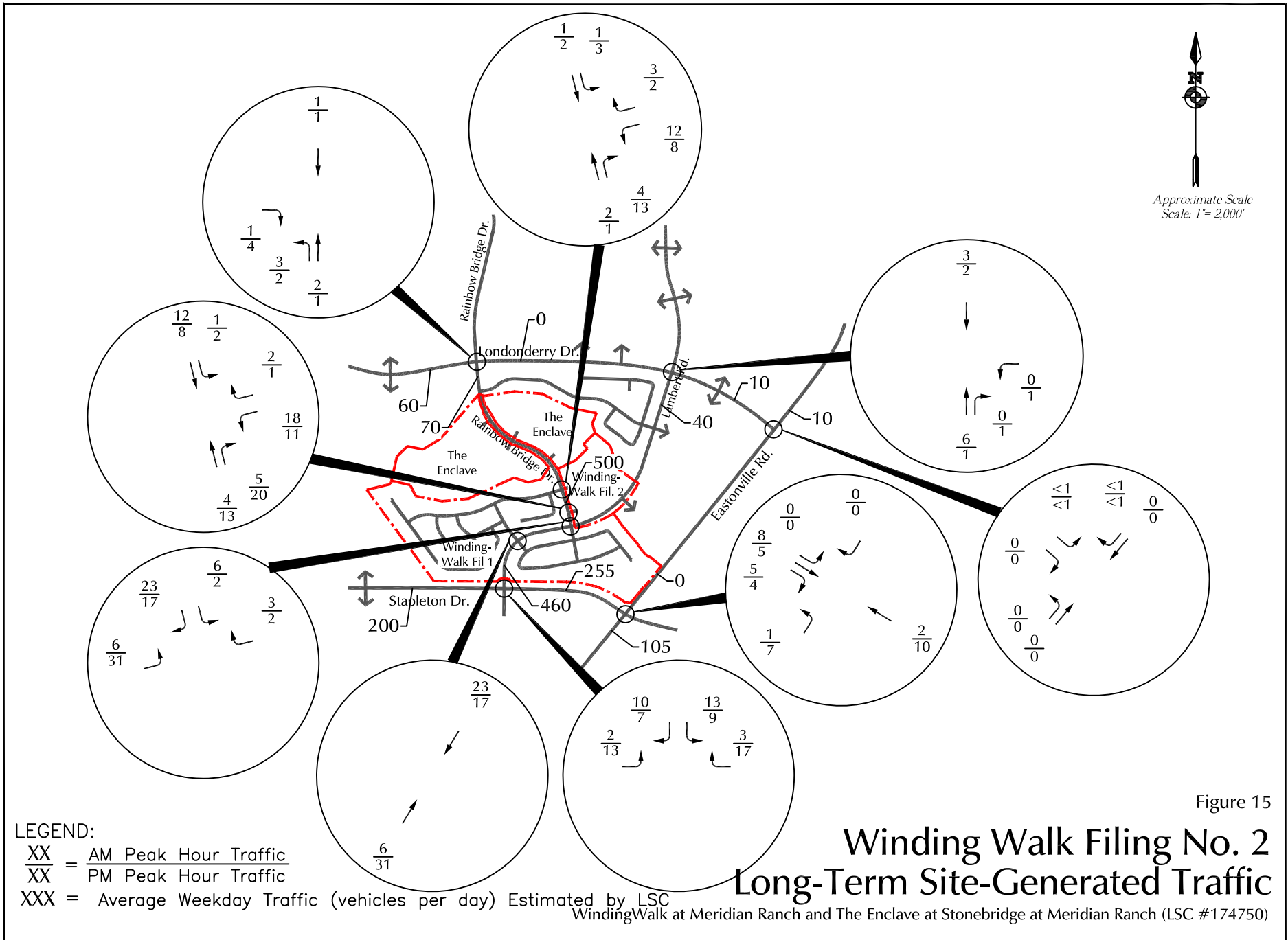

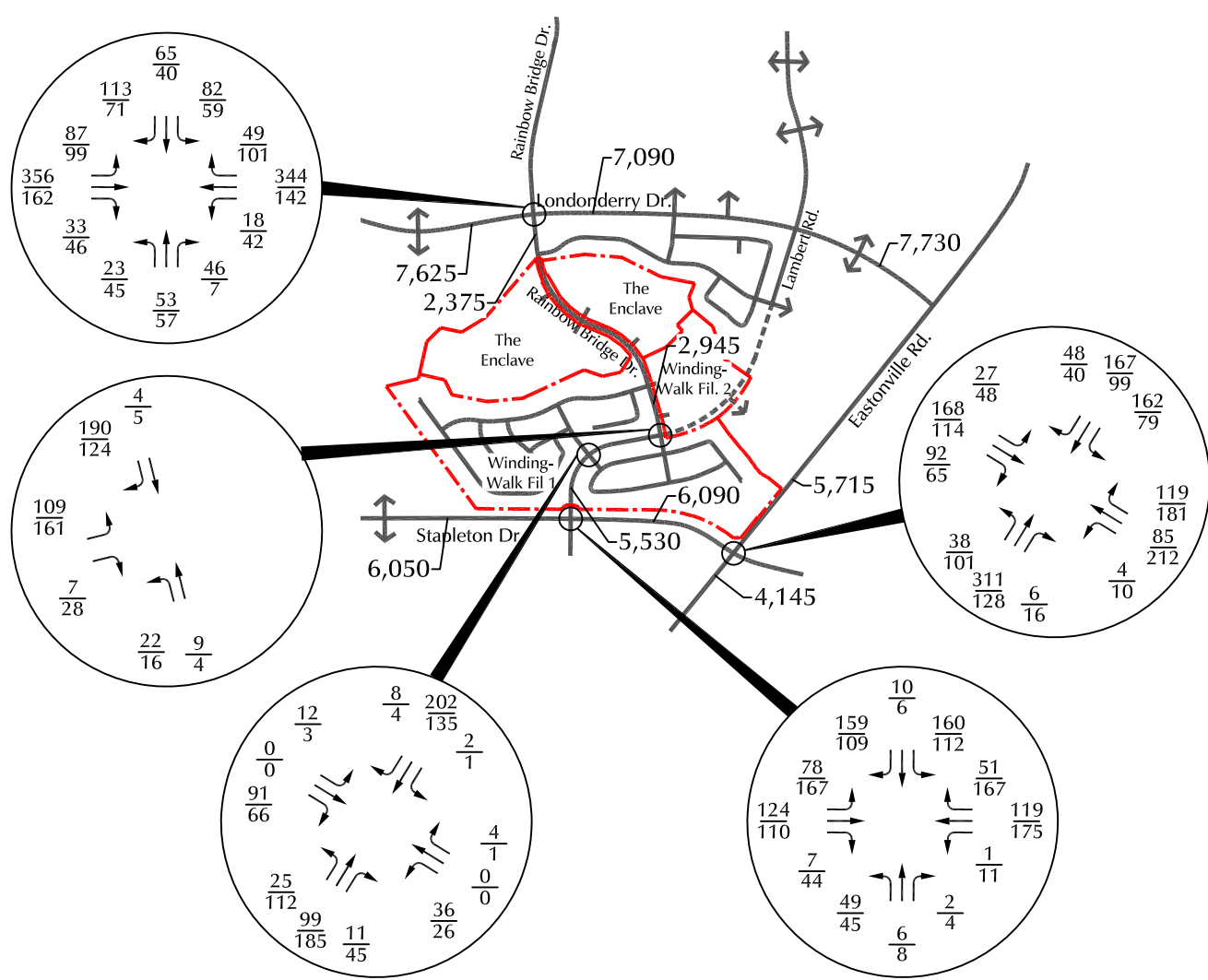
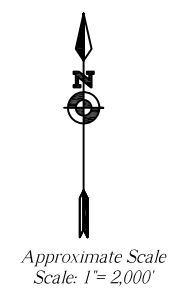

**LEGEND:**  
 XX = AM Peak Hour Traffic  
 XX = PM Peak Hour Traffic  
 XXX = Average Weekday Traffic (vehicles per day) Estimated by LSC

## Short-Term Background + Phase 1 Generated Traffic

WindingWalk at Meridian Ranch and The Enclave at Stonebridge at Meridian Ranch (LSC #174750)

Figure 16a

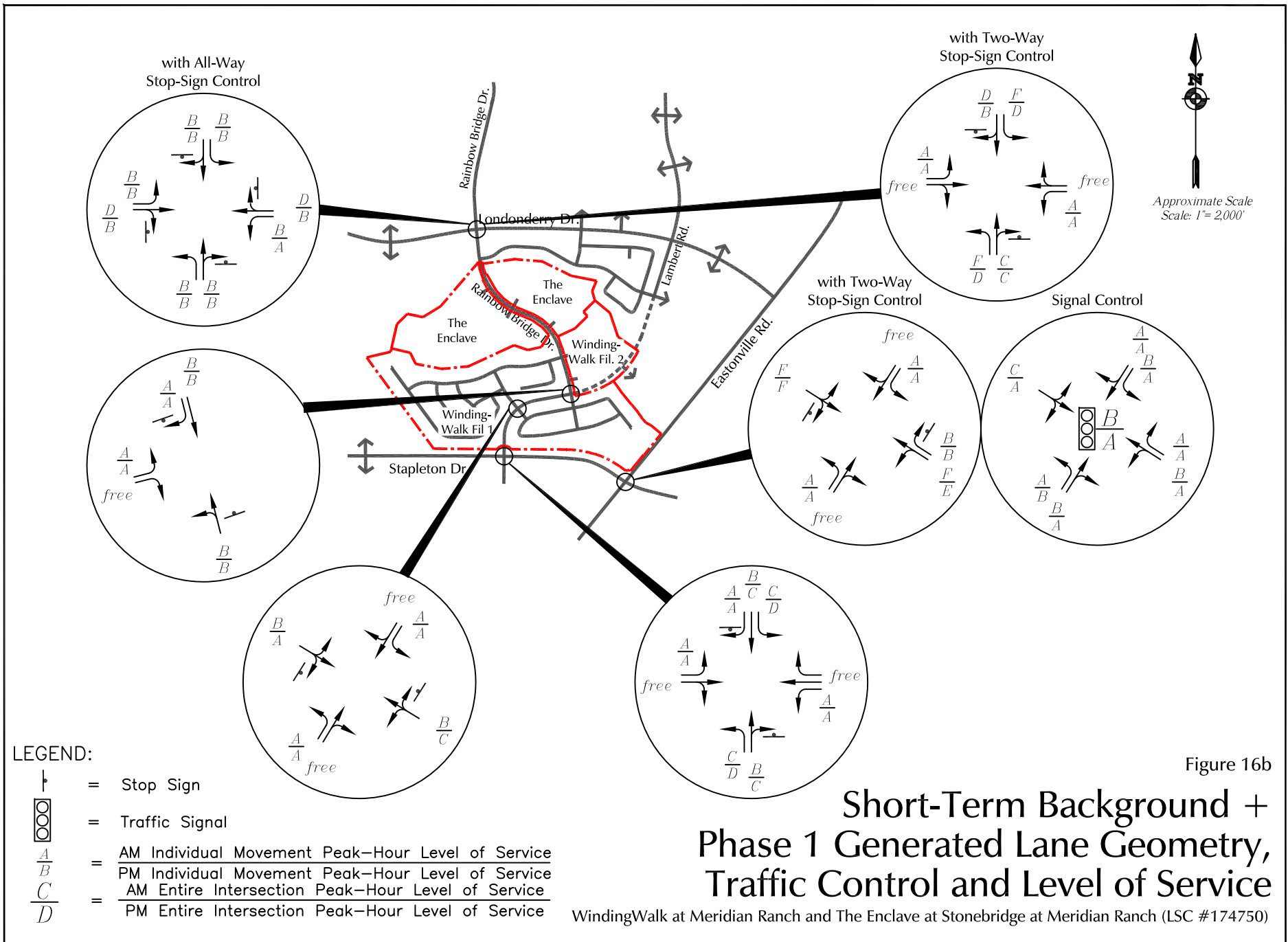



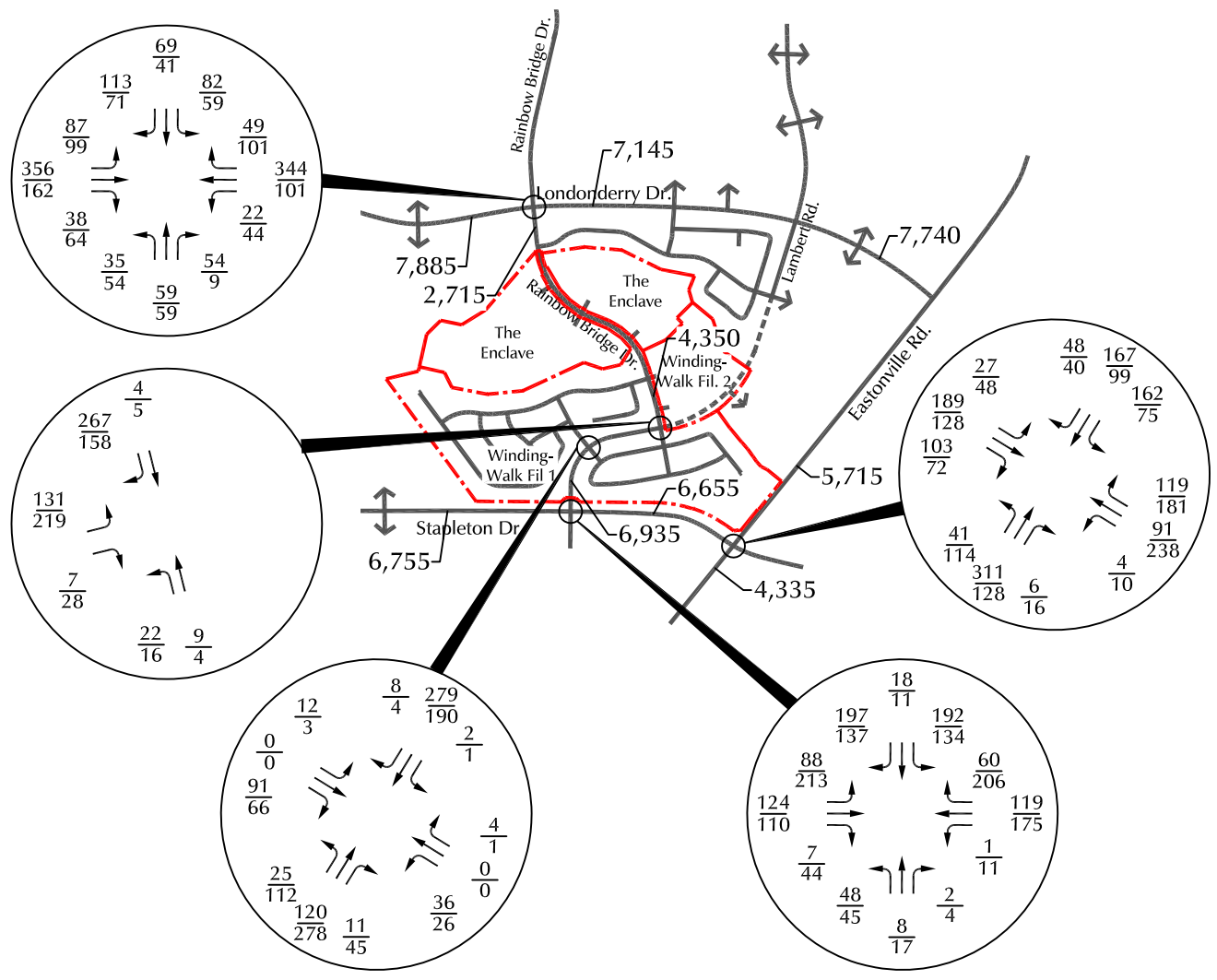
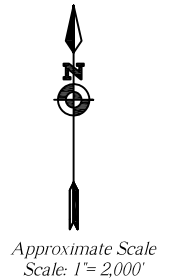

**LEGEND:**

- $\frac{XX}{XX}$  = AM Peak Hour Traffic
- $\frac{XX}{XX}$  = PM Peak Hour Traffic
- XXX = Average Weekday Traffic (vehicles per day) Estimated by LSC

## Short-Term Background + Phase 2 Generated Traffic

WindingWalk at Meridian Ranch and The Enclave at Stonebridge at Meridian Ranch (LSC #174750)

Figure 17a

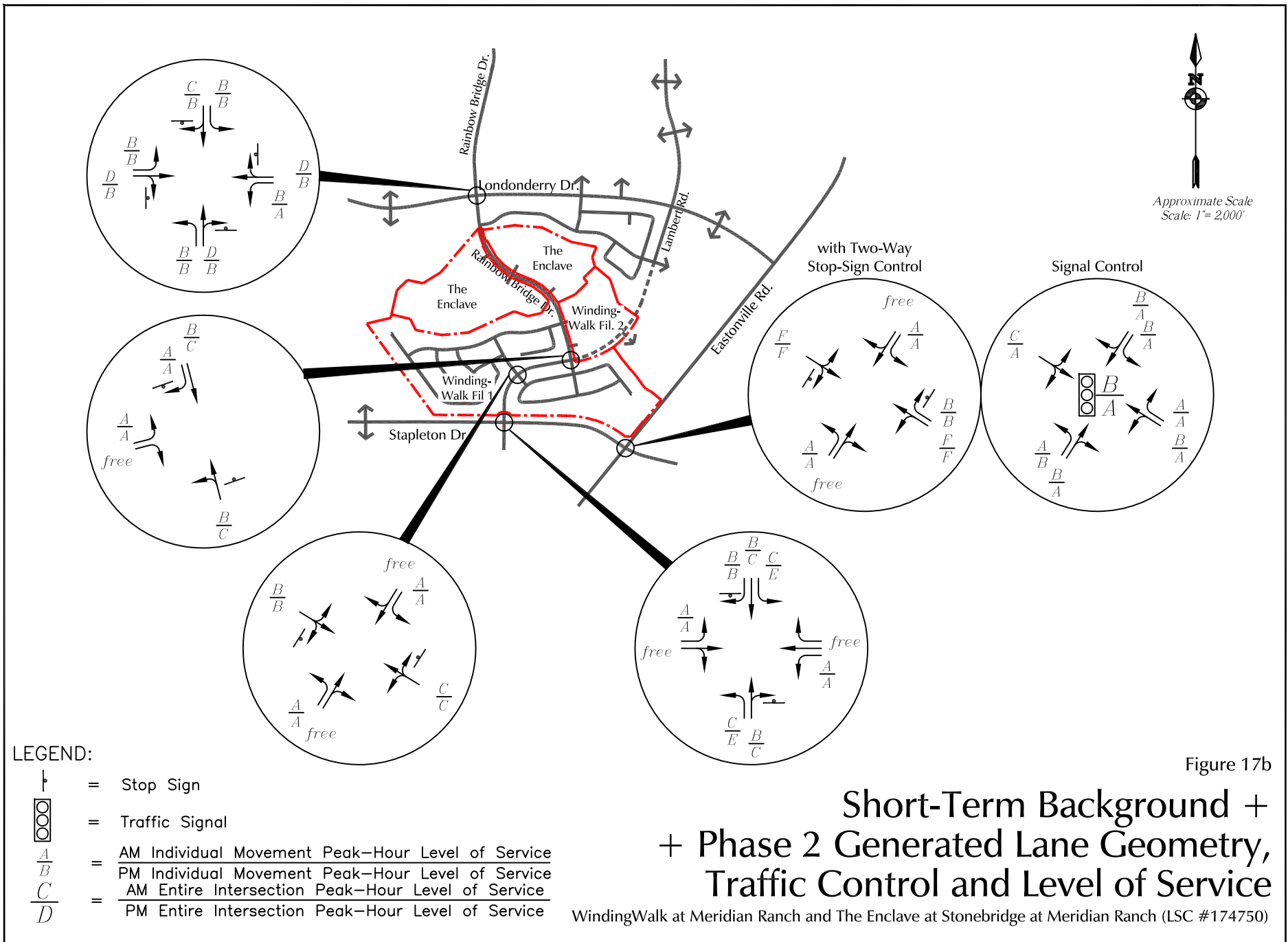

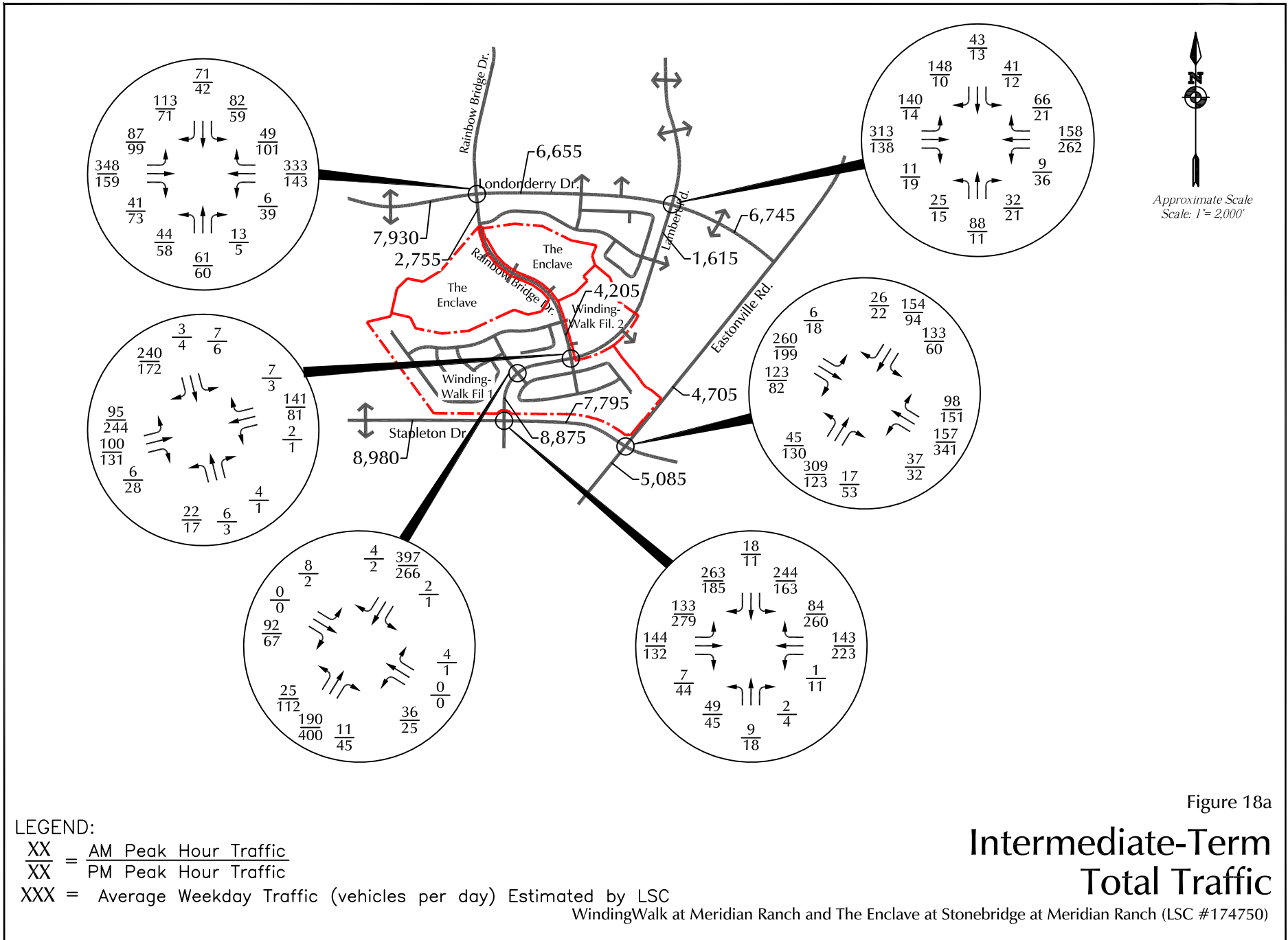

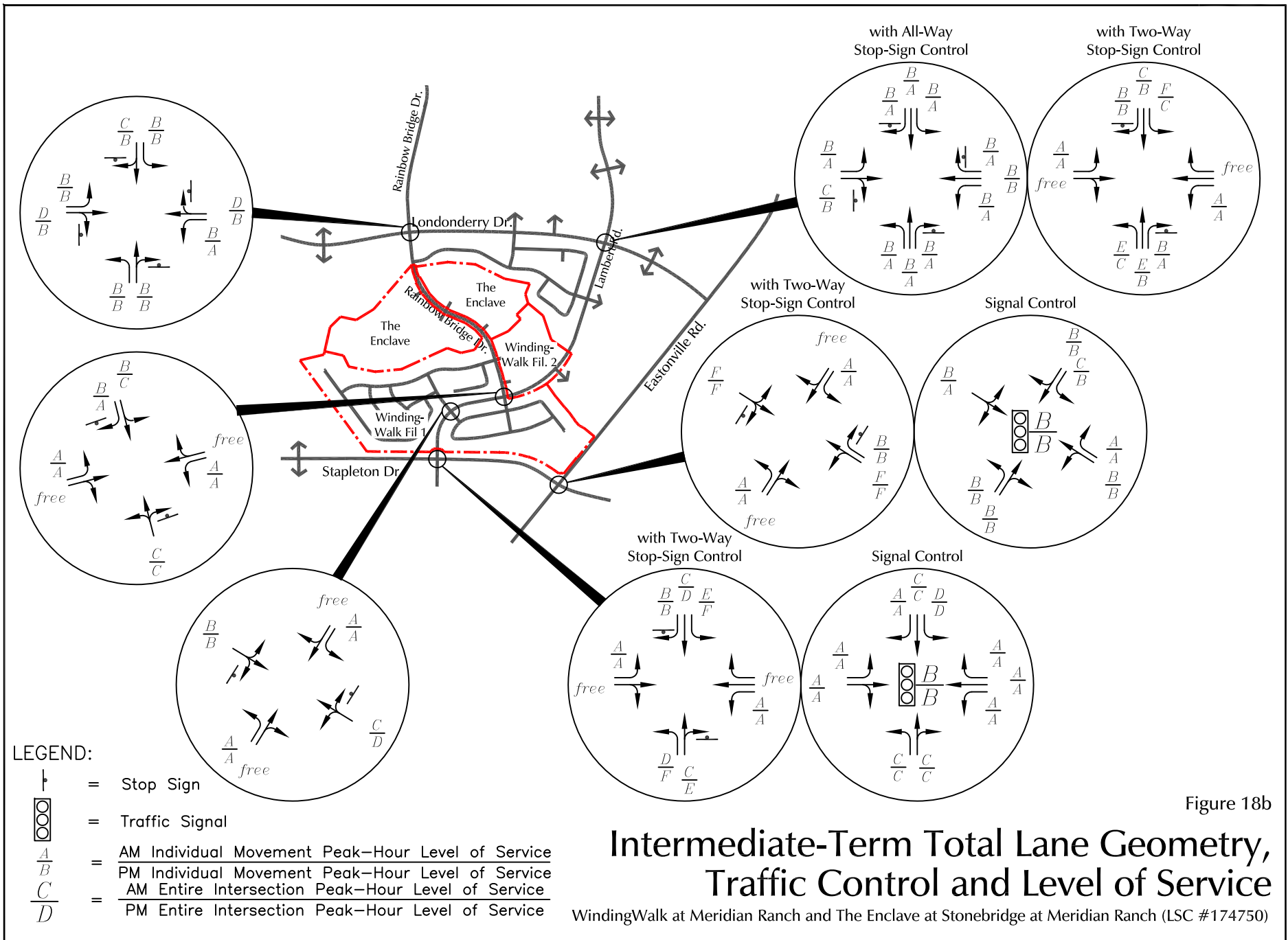

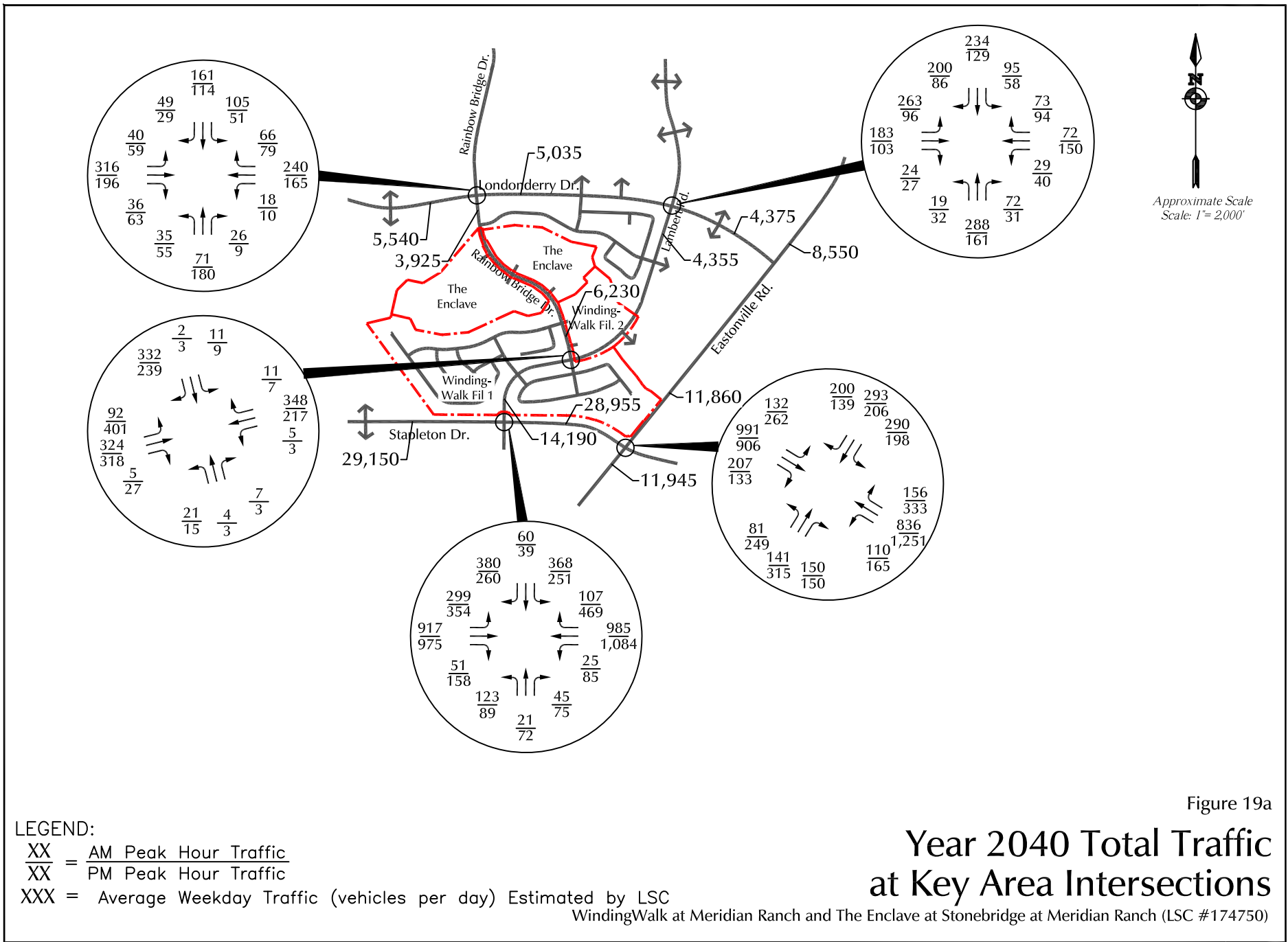

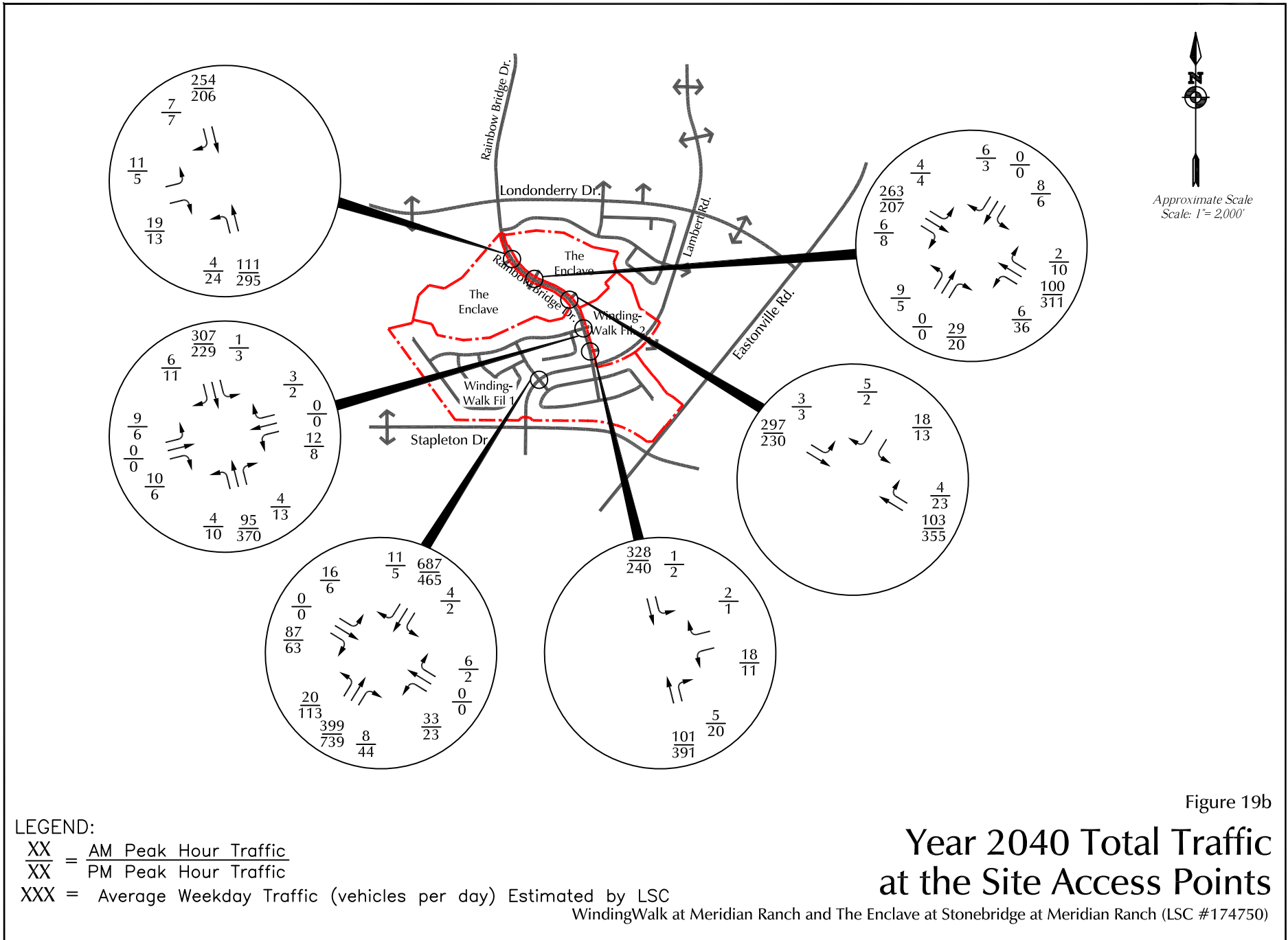

Approximate Scale  
 Scale: 1"= 2,000'

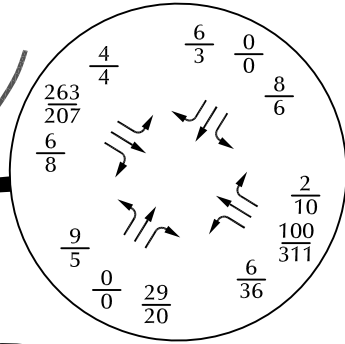
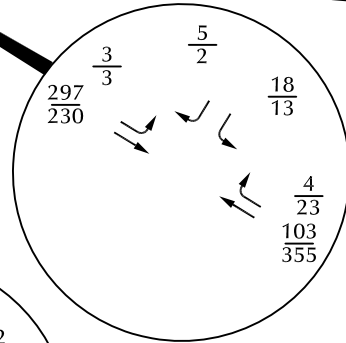
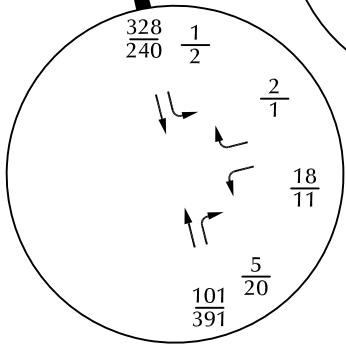
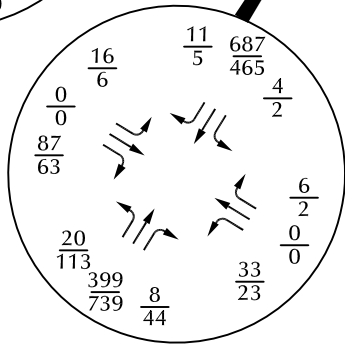
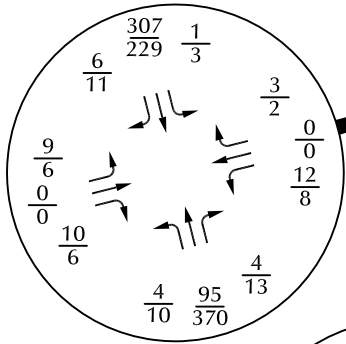
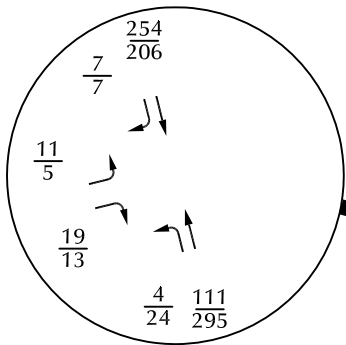

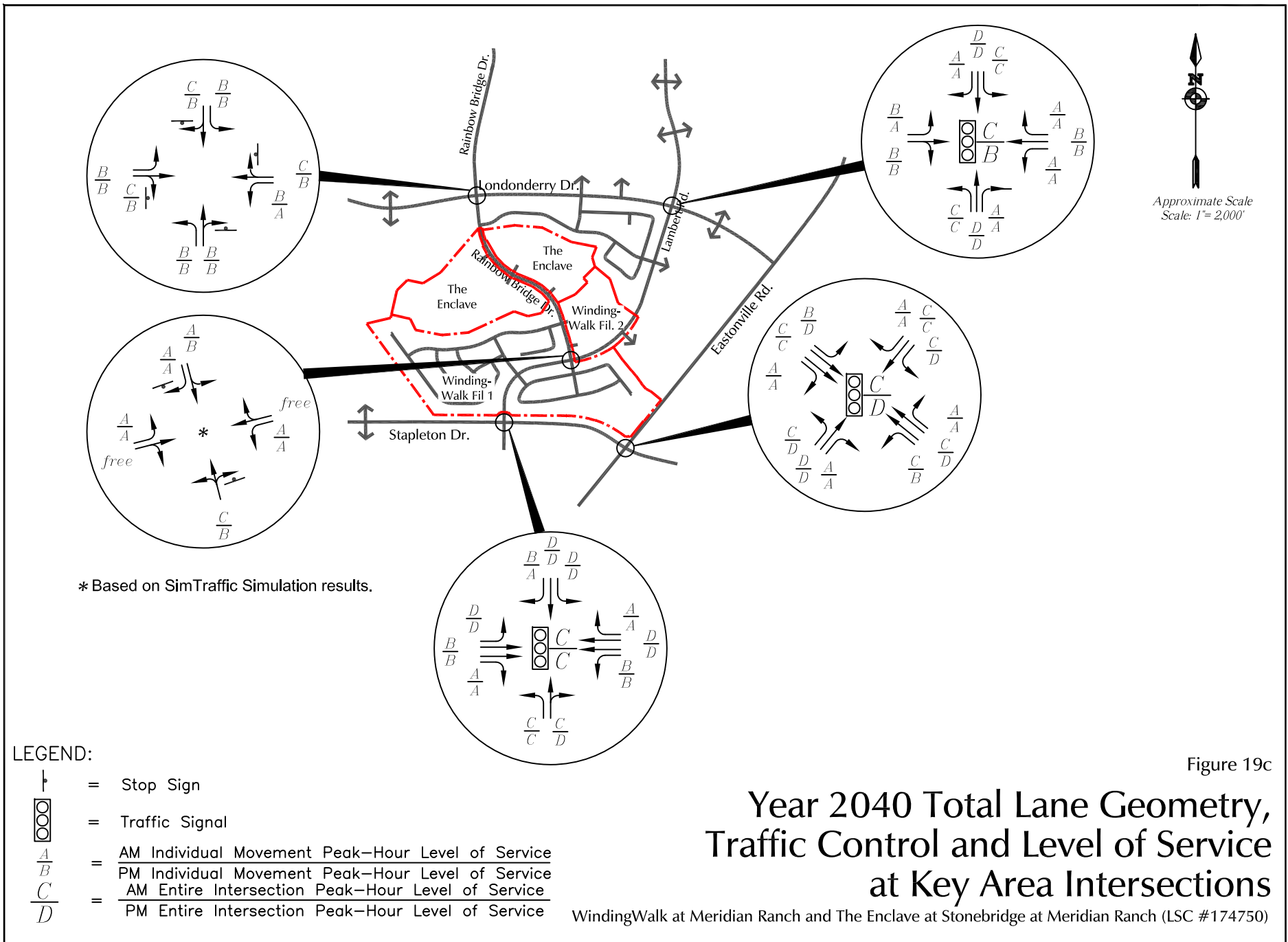

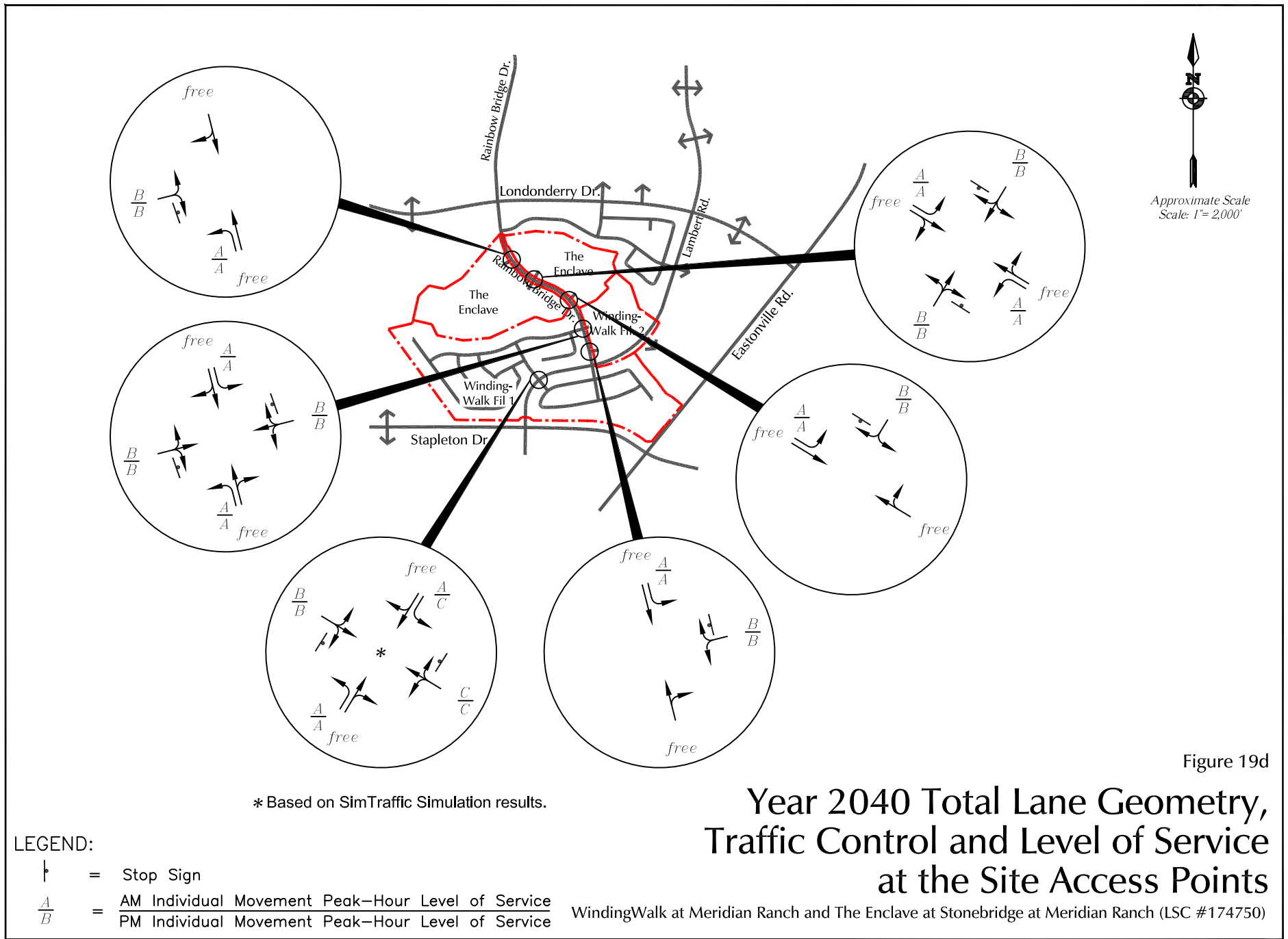

Approximate Scale  
Scale: 1" = 2,000'

\* Based on SimTraffic Simulation results.

Figure 19d  
Year 2040 Total Lane Geometry,  
Traffic Control and Level of Service  
at the Site Access Points  
WindingWalk at Meridian Ranch and The Enclave at Stonebridge at Meridian Ranch (LSC #174750)

LEGEND:  
 † = Stop Sign  
 $\frac{A}{B}$  = AM Individual Movement Peak-Hour Level of Service  
 $\frac{A}{B}$  = PM Individual Movement Peak-Hour Level of Service





Approximate Scale  
Scale: 1" = 500'

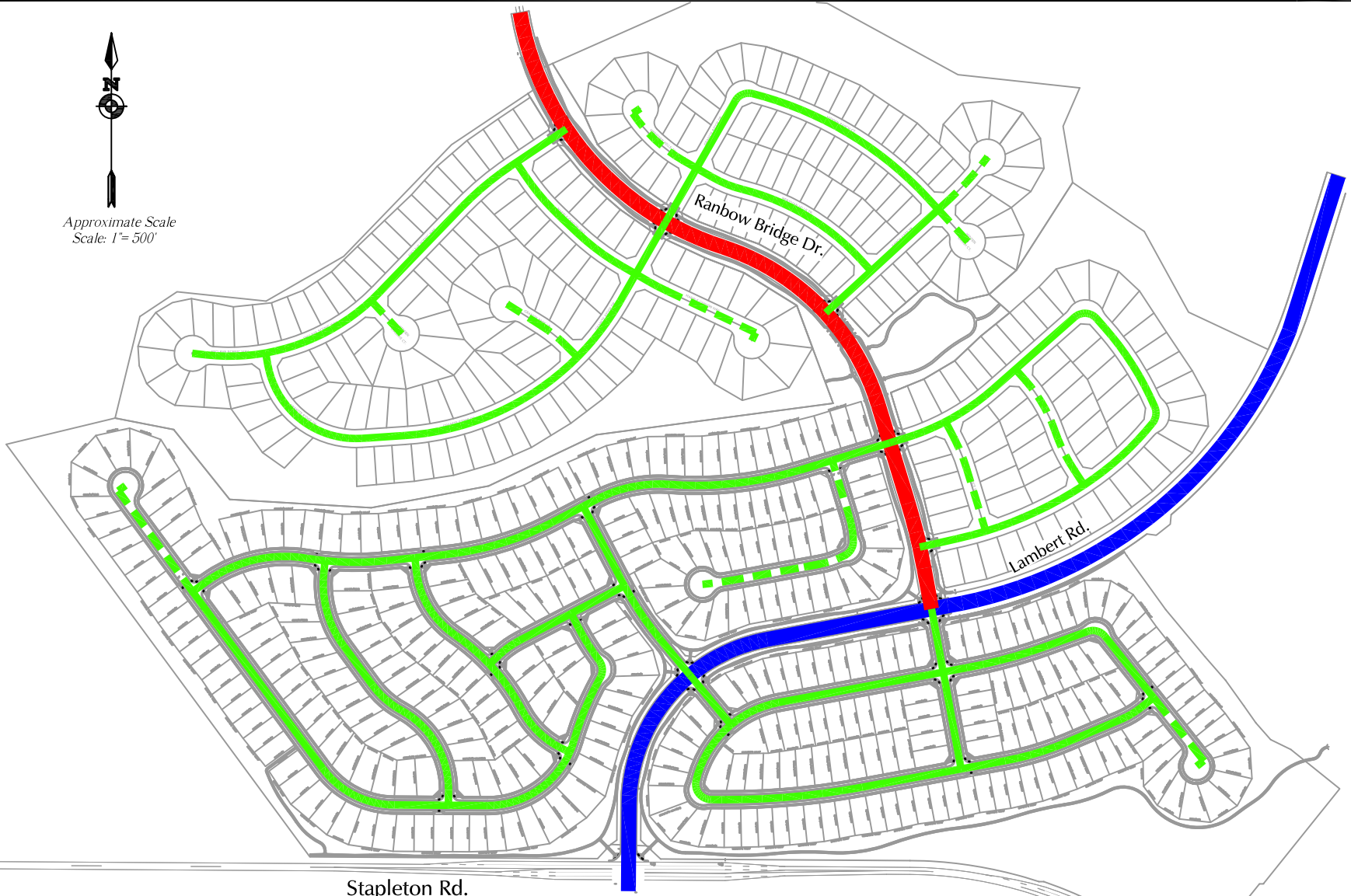

LEGEND:





-  = 2-Lane Non-Residential Collector
-  = 2-Lane Residential Collector
-  = Local
-  = Local (Low Volume)

Figure 20

# Recommended Street Classification

WindingWalk at Meridian Ranch and The Enclave at Stonebridge at Meridian Ranch (LSC #174750)

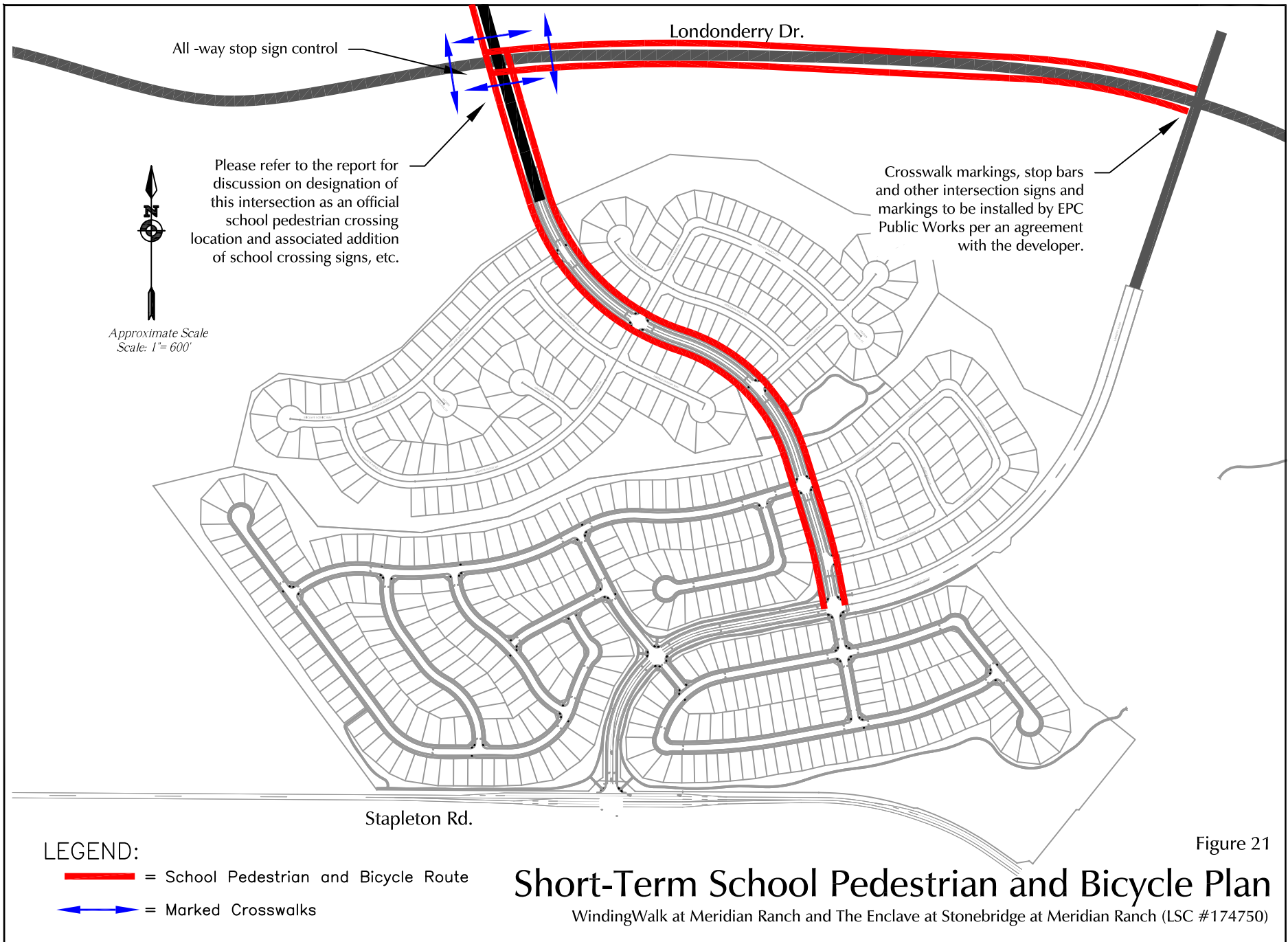

Figure 21

**LEGEND:**

- = School Pedestrian and Bicycle Route
- ↔ = Marked Crosswalks

# Short-Term School Pedestrian and Bicycle Plan

WindingWalk at Meridian Ranch and The Enclave at Stonebridge at Meridian Ranch (LSC #174750)

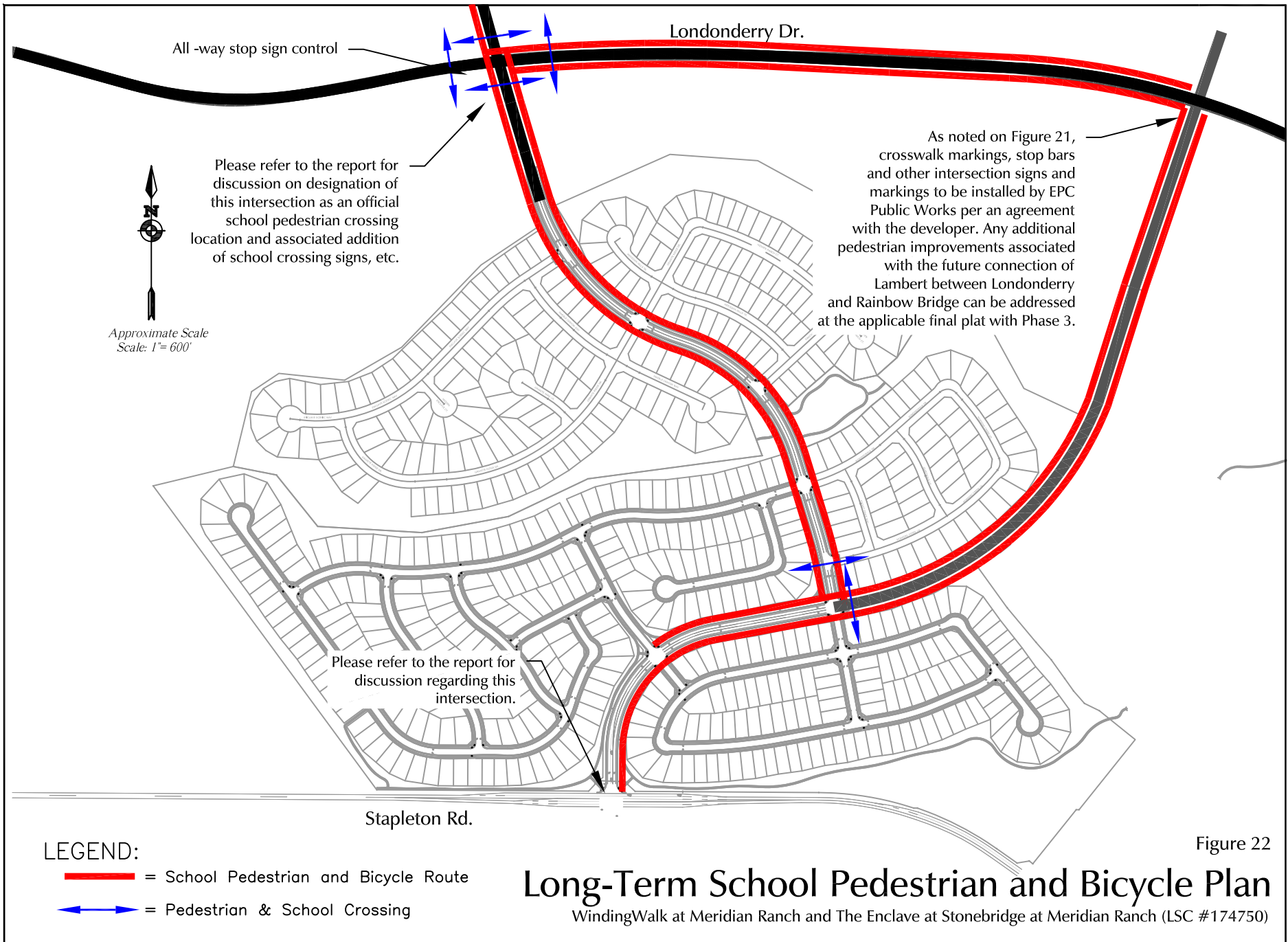

**Recent Traffic Studies in the Meridian Ranch Area**

<b>Project</b>	<b>Date</b>	<b>Site Land Use</b>
<i>Meridian Ranch Sketch Plan TIA</i>	04/11/11	Mix of Single Family and Business Park
<i>Waterbury PUD Development Plan Updated TIA</i>	01/10/13	Mix of Single Family and Business Park
<i>Waterbury Preliminary Plan No. 1 Updated TIA</i>	06/05/13	Mix of Single Family and Business Park
<i>Meridian Ranch Filing 11 Updated TIA</i>	11/26/13	Mix of Single Family and Business Park
<i>Stonebridge at Meridian Ranch Filing No. 1 Updated TIA</i>	04/23/14	Mix of Single Family and Business Park
<i>Stonebridge at Meridian Ranch Transportation Memorandum</i>	07/28/15	Mix of Single Family and Business Park
<i>Meridian Ranch Filing 8 Updated TIA</i>	12/23/14	Mix of Single Family and Business Park
<i>Meridian Ranch Filing 9 Updated TIA</i>	05/21/15	Mix of Single Family and Business Park
<i>Meridian Ranch Sketch Plan 2015 Amendment TIA</i>	07/30/15	Mix of Single Family and Business Park (Reduced Size)
<i>The Vistas at Meridian Ranch TIA</i>	03/24/16	Mix of Single Family and Business Park (Reduced Size)
<i>The Vistas at Meridian Ranch Updated Transportation Memorandum</i>	06/20/17	Mix of Single Family and Business Park (Reduced Size)
<i>Londonderry Drive Pedestrian Operations and Safety Study</i>	02/08/17	
<i>Stonebridge Filing 3 at Meridian Ranch Updated TIA</i>	03/20/17	Mix of Single Family and Business Park (Reduced Size)
<i>Waterbury Phase 2 Preliminary Plan</i>	08/03/17	Mix of Single Family and Business Park (Reduced Size)
<i>Meridian Ranch Sketch Plan 2017 Amendment TIA</i>	10/03/17	All Single Family
<i>Waterbury Phase 1 Filing Nos. 2 and 3</i>	10/16/17	All Single Family

*Source: LSC Transportation Consultants, Inc.*

Counts by LSC

LSC Transportation Consultants, Inc.

File Name : Eastonville Rd - Stapleton Dr 5-23-17 AM

Site Code : 00174350

Start Date : 05/23/2017

Page No : 1

Groups Printed- Unshifted

Start Time	Eastonville Rd From North				Stapleton Dr From East				Eastonville Rd From South				Stapleton Dr From West				Int. Total
	Right	Thru	Left	Peds	Right	Thru	Left	Peds	Right	Thru	Left	Peds	Right	Thru	Left	Peds	
Factor	1.0	1.0	1.0	1.0	1.0	1.0	1.0	1.0	1.0	1.0	1.0	1.0	1.0	1.0	1.0	1.0	
06:30 AM	1	11	18	0	9	1	0	0	0	30	1	0	1	12	5	0	89
06:45 AM	2	16	25	0	19	5	2	0	0	42	3	0	4	17	8	0	143
07:00 AM	10	46	24	0	35	9	1	0	0	111	6	0	6	19	18	0	285
07:15 AM	10	54	37	0	25	20	1	0	7	75	7	0	2	16	6	0	260
07:30 AM	2	14	19	0	7	25	2	0	2	3	3	0	2	21	5	0	105
07:45 AM	4	7	11	0	11	15	2	0	0	8	2	0	4	29	2	0	95
08:00 AM	0	11	11	0	14	11	1	0	0	9	0	1	0	25	2	0	85
08:15 AM	3	11	22	0	7	10	1	0	1	10	2	0	0	11	2	0	80
Grand Total	32	170	167	0	127	96	10	0	10	288	24	1	19	150	48	0	1142
Apprch %	8.7	46.1	45.3	0.0	54.5	41.2	4.3	0.0	3.1	89.2	7.4	0.3	8.8	69.1	22.1	0.0	
Total %	2.8	14.9	14.6	0.0	11.1	8.4	0.9	0.0	0.9	25.2	2.1	0.1	1.7	13.1	4.2	0.0	

Counts by LSC

File Name : Eastonville Rd - Stapleton Dr 5-23-17 AM  
 Site Code : 00174350  
 Start Date : 05/23/2017  
 Page No : 2

Start Time	Eastonville Rd From North					Stapleton Dr From East					Eastonville Rd From South					Stapleton Dr From West					Int. Total
	Rig ht	Thru	Lef t	Pe ds	App. Total	Rig ht	Thru	Lef t	Pe ds	App. Total	Rig ht	Thru	Lef t	Pe ds	App. Total	Rig ht	Thru	Lef t	Pe ds	App. Total	
Peak Hour From 06:30 AM to 08:25 AM - Peak 1 of 1																					
Intersection	06:35 AM																				
Volume	24	13	10	0	264	90	43	5	0	138	8	25	18	0	279	14	71	38	0	123	804
Percent	9.1	49.6	41.3	0.0		65.2	31.2	3.6	0.0		2.9	90.7	6.5	0.0		11.4	57.7	30.9	0.0		
07:10 Volume	3	18	8	0	29	15	4	0	0	19	0	38	1	0	39	2	6	7	0	15	102
Peak Factor																					0.657
High Int.	07:25 AM																				
Volume	2	23	14	0	39	15	4	0	0	19	0	39	3	0	42	3	7	5	0	15	
Peak Factor					0.56					0.60					0.55					0.68	
					4					5					4					3	

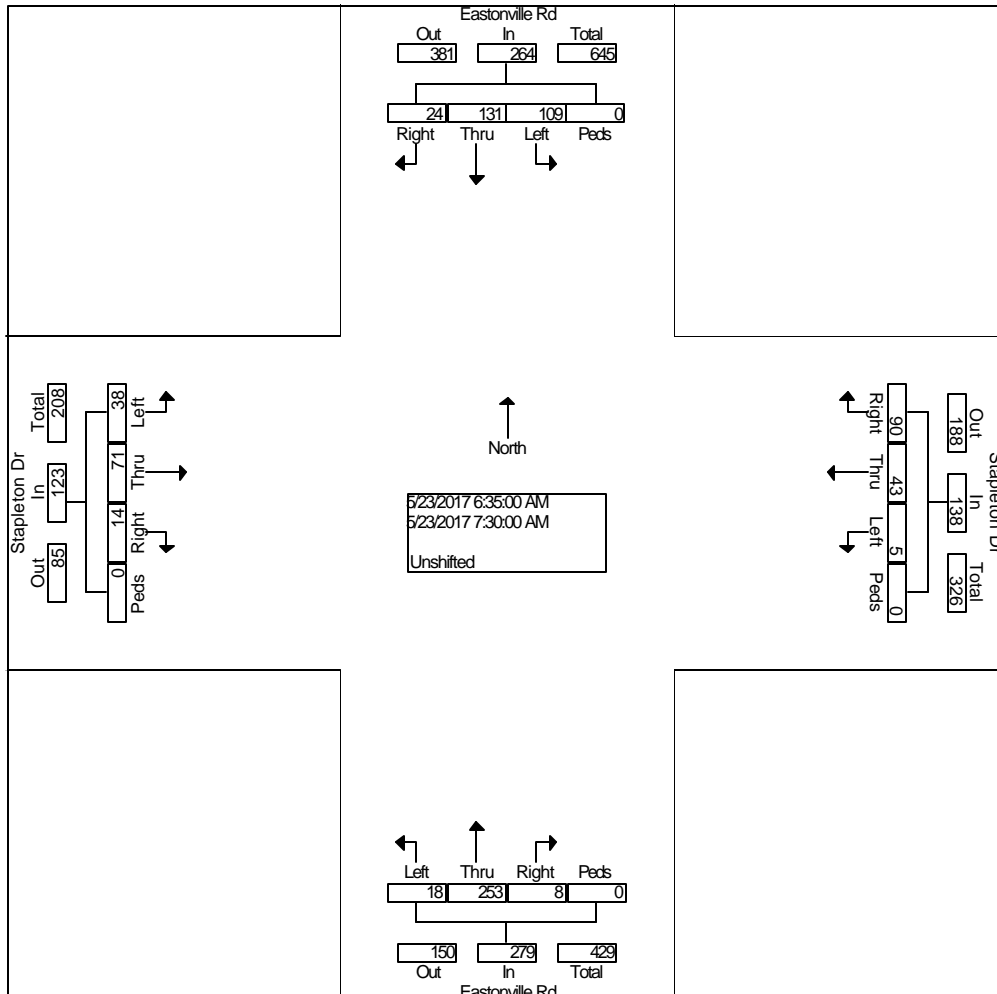

Counts by LSC

LSC Transportation Consultants, Inc.

File Name : Eastonville Rd - Stapleton Dr PM  
 Site Code : 00174350  
 Start Date : 05/11/2017  
 Page No : 1

Groups Printed- Unshifted

Start Time	Eastonville Rd From North				Stapleton Dr From East				Eastonville Rd From South				Stapleton Dr From West				Int. Total
	Right	Thru	Left	Peds	Right	Thru	Left	Peds	Right	Thru	Left	Peds	Right	Thru	Left	Peds	
Factor	1.0	1.0	1.0	1.0	1.0	1.0	1.0	1.0	1.0	1.0	1.0	1.0	1.0	1.0	1.0	1.0	1.0
04:00 PM	2	19	12	0	16	19	1	0	1	23	1	0	1	13	2	0	110
04:15 PM	0	12	5	0	24	25	3	0	1	19	4	0	1	5	6	0	105
04:30 PM	3	16	12	0	16	35	5	0	2	19	3	0	2	9	9	0	131
04:45 PM	4	9	7	0	23	29	2	0	4	34	1	0	1	9	8	0	131
Total	9	56	36	0	79	108	11	0	8	95	9	0	5	36	25	0	477
05:00 PM	2	18	11	0	28	27	2	0	1	20	3	0	0	9	2	0	123
05:15 PM	1	13	8	0	25	23	0	0	1	21	0	0	0	19	2	0	113
05:30 PM	1	19	1	0	12	14	2	0	3	37	3	0	1	13	1	0	107
05:45 PM	1	16	1	0	11	13	1	0	2	31	1	0	1	9	1	0	88
Total	5	66	21	0	76	77	5	0	7	109	7	0	2	50	6	0	431
Grand Total	14	122	57	0	155	185	16	0	15	204	16	0	7	86	31	0	908
Apprch %	7.3	63.2	29.5	0.0	43.5	52.0	4.5	0.0	6.4	86.8	6.8	0.0	5.6	69.4	25.0	0.0	
Total %	1.5	13.4	6.3	0.0	17.1	20.4	1.8	0.0	1.7	22.5	1.8	0.0	0.8	9.5	3.4	0.0	

Counts by LSC

File Name : Eastonville Rd - Stapleton Dr PM  
 Site Code : 00174350  
 Start Date : 05/11/2017  
 Page No : 2

Start Time	Eastonville Rd From North					Stapleton Dr From East					Eastonville Rd From South					Stapleton Dr From West					Int. Total
	Rig ht	Thru	Lef t	Pe ds	App. Total	Rig ht	Thru	Lef t	Pe ds	App. Total	Rig ht	Thru	Lef t	Pe ds	App. Total	Rig ht	Thru	Lef t	Pe ds	App. Total	
Peak Hour From 04:00 PM to 05:45 PM - Peak 1 of 1																					
Intersection	04:30 PM																				
Volume	10	56	38	0	104	92	11	9	0	215	8	94	7	0	109	3	46	21	0	70	498
Percent	9.6	53.8	36.5	0.0		42.8	53.0	4.2	0.0		7.3	86.2	6.4	0.0		4.3	65.7	30.0	0.0		
04:45 Volume	4	9	7	0	20	23	29	2	0	54	4	34	1	0	39	1	9	8	0	18	131
Peak Factor	0.950																				
High Int.	04:30 PM																				
Volume	3	16	12	0	31	28	27	2	0	57	4	34	1	0	39	0	19	2	0	21	0.83
Peak Factor	0.83																				
						05:00 PM					04:45 PM					05:15 PM					

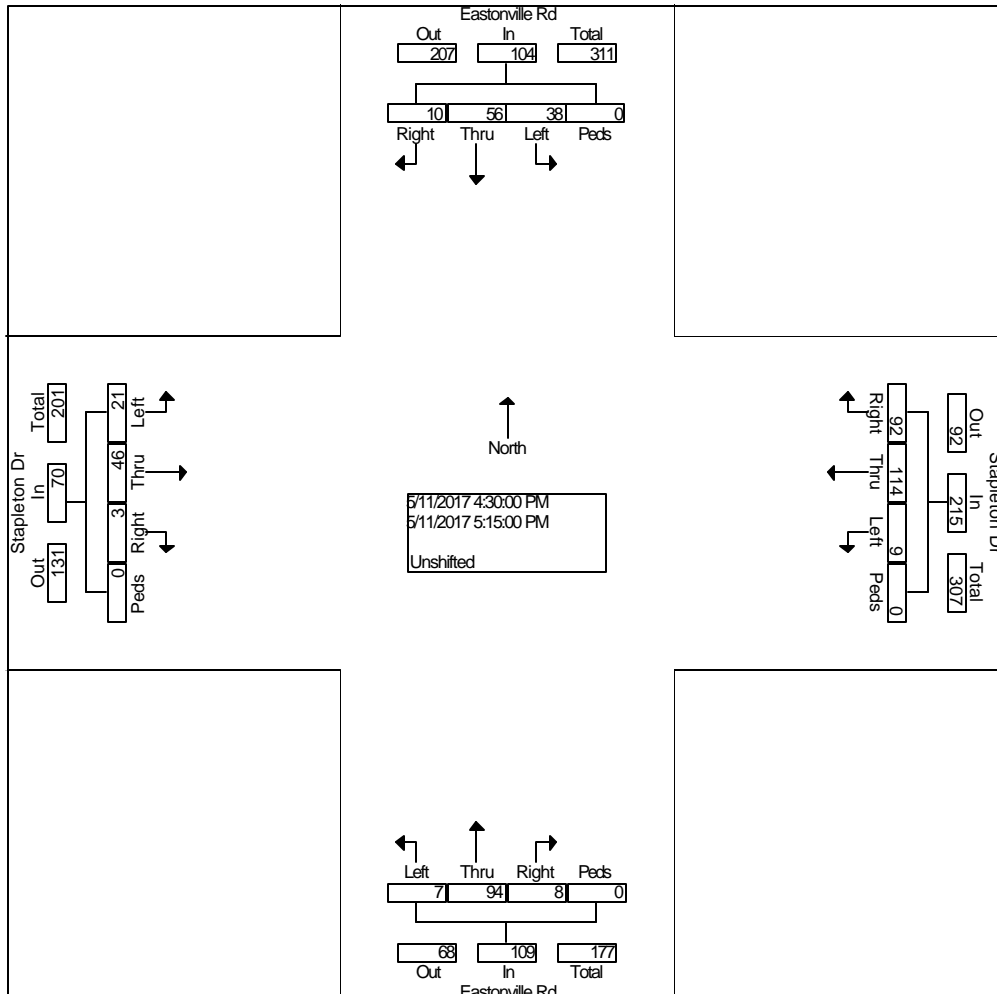



LSC Transportation Consultants, Inc.

516 N. Tejon St.

Colorado Springs, CO

(719) 633-2868

LSC Transportation Consultants, Inc.

File Name : Lambert Rd-Stapleton Dr AM

Site Code : 00154350

Start Date : 06/11/2015

Page No : 1

Groups Printed- Unshifted

Start Time	From North				Stapleton Dr From East				Lambert Rd From South				Stapleton Dr From West				Int. Total
	Right	Thru	Left	Peds	Right	Thru	Left	Peds	Right	Thru	Left	Peds	Right	Thru	Left	Peds	
Factor	1.0	1.0	1.0	1.0	1.0	1.0	1.0	1.0	1.0	1.0	1.0	1.0	1.0	1.0	1.0	1.0	1.0
06:30 AM	0	0	0	0	0	2	0	0	0	0	11	0	1	4	0	0	18
06:45 AM	0	0	0	0	0	5	0	0	2	0	11	0	1	9	0	0	28
Total	0	0	0	0	0	7	0	0	2	0	22	0	2	13	0	0	46
07:00 AM	0	0	0	0	0	2	0	0	0	0	12	0	3	4	0	0	21
07:15 AM	0	0	0	0	0	3	1	0	0	0	15	0	2	4	0	1	26
07:30 AM	0	0	0	0	0	2	1	0	0	0	6	0	1	6	0	0	16
07:45 AM	0	0	0	0	0	2	0	0	0	0	8	0	2	8	0	0	20
Total	0	0	0	0	0	9	2	0	0	0	41	0	8	22	0	1	83
08:00 AM	0	0	0	0	0	6	0	0	0	0	12	1	1	10	0	0	30
08:15 AM	0	0	0	0	0	4	1	0	0	0	10	0	1	6	0	0	22
Grand Total	0	0	0	0	0	26	3	0	2	0	85	1	12	51	0	1	181
Apprch %	0.0	0.0	0.0	0.0	0.0	89.7	10.3	0.0	2.3	0.0	96.6	1.1	18.8	79.7	0.0	1.6	
Total %	0.0	0.0	0.0	0.0	0.0	14.4	1.7	0.0	1.1	0.0	47.0	0.6	6.6	28.2	0.0	0.6	

LSC Transportation Consultants, Inc.  
 516 N. Tejon St.  
 Colorado Springs, CO  
 (719) 633-2868

File Name : Lambert Rd-Stapleton Dr AM  
 Site Code : 00154350  
 Start Date : 06/11/2015  
 Page No : 2

Start Time	From North					Stapleton Dr From East					Lambert Rd From South					Stapleton Dr From West					Int. Total
	Rig ht	Thru	Left	Ped s	App. Total	Rig ht	Thru	Left	Ped s	App. Total	Rig ht	Thru	Left	Ped s	App. Total	Rig ht	Thru	Left	Ped s	App. Total	
Peak Hour From 06:30 AM to 08:15 AM - Peak 1 of 1																					
Intersection	06:30 AM																				
Volume	0	0	0	0	0	0	12	1	0	13	2	0	49	0	51	7	21	0	1	29	93
Percent	0.0	0.0	0.0	0.0		0.0	92.3	7.7	0.0		3.9	0.0	96.1	0.0		24.1	72.4	0.0	3.4		
06:45 Volume Peak Factor	0	0	0	0	0	0	5	0	0	5	2	0	11	0	13	1	9	0	0	10	28
High Int. Volume Peak Factor	6:15:00 AM					06:45 AM					07:15 AM					06:45 AM					0.830
	0	0	0	0	0	0	5	0	0	5	0	0	15	0	15	1	9	0	0	10	10
										0.65					0.85					0.72	5
										0					0					5	

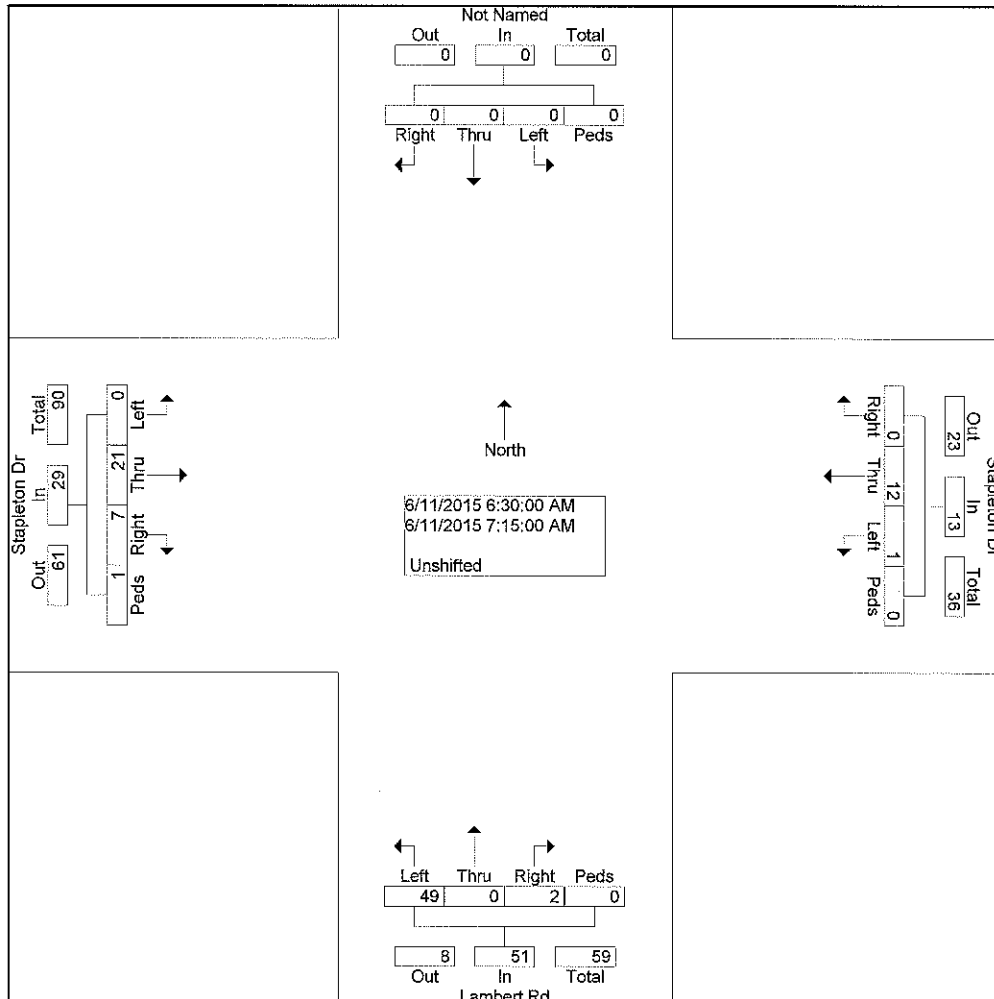

LSC Transportation Consultants, Inc.

516 N. Tejon St.

Colorado Springs, CO

(719) 633-2868

LSC Transportation Consultants, Inc.

File Name : Lambert Rd-Stapleton Dr PM

Site Code : 00154350

Start Date : 06/10/2015

Page No : 1

Groups Printed- Unshifted

Start Time	From North				Stapleton Dr From East				Lambert Rd From South				Stapleton Dr From West				Int. Total	
	Right	Thru	Left	Peds	Right	Thru	Left	Peds	Right	Thru	Left	Peds	Right	Thru	Left	Peds		
Factor	1.0	1.0	1.0	1.0	1.0	1.0	1.0	1.0	1.0	1.0	1.0	1.0	1.0	1.0	1.0	1.0	1.0	
04:00 PM	0	0	0	0	0	5	1	0	1	0	2	0	13	10	0	0		32
04:15 PM	0	0	0	0	0	10	3	0	2	0	9	1	11	6	0	0		42
04:30 PM	0	0	0	0	0	10	3	0	1	0	10	0	10	8	0	0		42
04:45 PM	0	0	0	0	0	10	3	0	1	0	9	0	11	9	0	0		43
Total	0	0	0	0	0	35	10	0	5	0	30	1	45	33	0	0		159
05:00 PM	0	0	0	0	0	10	2	0	1	0	12	0	12	7	0	0		44
05:15 PM	0	0	0	0	0	9	3	0	1	0	14	0	11	5	0	0		43
05:30 PM	0	0	0	0	0	11	0	0	0	0	10	0	11	9	0	0		41
05:45 PM	0	0	0	0	0	9	2	0	1	0	8	0	9	7	0	0		36
Total	0	0	0	0	0	39	7	0	3	0	44	0	43	28	0	0		164
Grand Total	0	0	0	0	0	74	17	0	8	0	74	1	88	61	0	0		323
Apprch %	0.0	0.0	0.0	0.0	0.0	81.3	18.7	0.0	9.6	0.0	89.2	1.2	59.1	40.9	0.0	0.0		
Total %	0.0	0.0	0.0	0.0	0.0	22.9	5.3	0.0	2.5	0.0	22.9	0.3	27.2	18.9	0.0	0.0		

LSC Transportation Consultants, Inc.  
 516 N. Tejon St.  
 Colorado Springs, CO  
 (719) 633-2868

**File Name : Lambert Rd-Stapleton Dr PM**  
**Site Code : 00154350**  
**Start Date : 06/10/2015**  
**Page No : 2**

Start Time	From North					Stapleton Dr From East					Lambert Rd From South					Stapleton Dr From West					Int. Total
	Rig ht	Thru	Left	Ped s	App. Total	Rig ht	Thru	Left	Ped s	App. Total	Rig ht	Thru	Left	Ped s	App. Total	Rig ht	Thru	Left	Ped s	App. Total	
Peak Hour From 04:00 PM to 05:45 PM - Peak 1 of 1																					
Intersection	04:30 PM																				
Volume	0	0	0	0	0	0	39	11	0	50	4	0	45	0	49	44	29	0	0	73	172
Percent	0.0	0.0	0.0	0.0		0.0	78.0	22.0	0.0		8.2	0.0	91.8	0.0		60.3	39.7	0.0	0.0		
05:00 Volume	0	0	0	0	0	0	10	2	0	12	1	0	12	0	13	12	7	0	0	19	44
Peak Factor	0.977																				
High Int. Volume	3:45:00 PM					04:30 PM					05:15 PM					04:45 PM					
Peak Factor	0	0	0	0	0	0	10	3	0	13	1	0	14	0	15	11	9	0	0	20	0.913

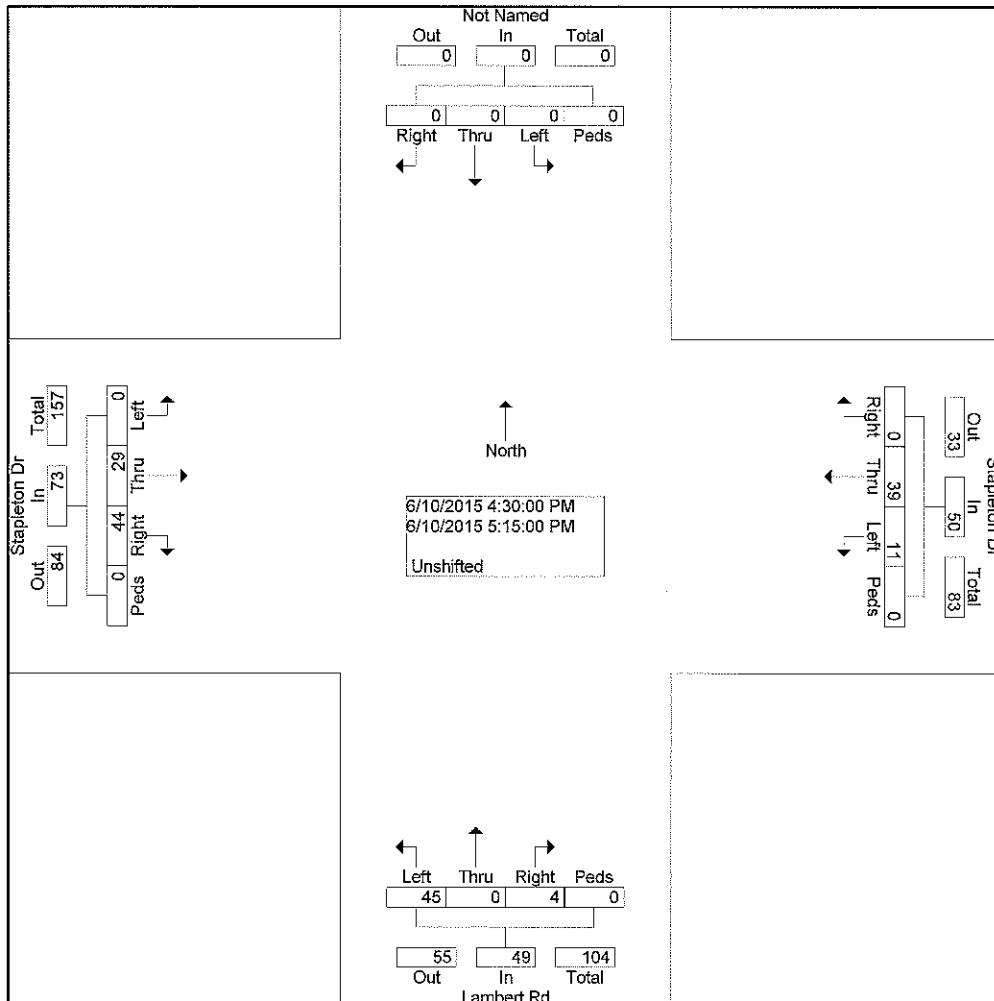

LSC Transportation Consultants, Inc.  
**545 E. Pikes Peak Ave., #210**

LSC Transportation Consultants, Inc. Colorado Springs, CO 80903 : Rainbow Bridge Dr - Londonderry AM  
 Site Code : 00164900  
 (719) 633-2868 Start Date : 12/01/2016

Page No : 1

Groups Printed- Unshifted

Start Time	Rainbow Bridge Dr From North				Londonderry Dr From East				Rainbow Bridge Dr From South				Londonderry Dr From West				Int. Total
	Right	Thru	Left	Peds	Right	Thru	Left	Peds	Right	Thru	Left	Peds	Right	Thru	Left	Peds	
Factor	1.0	1.0	1.0	1.0	1.0	1.0	1.0	1.0	1.0	1.0	1.0	1.0	1.0	1.0	1.0	1.0	1.0
06:45 AM	20	0	22	0	4	22	1	0	1	1	0	0	1	51	15	0	138
Total	20	0	22	0	4	22	1	0	1	1	0	0	1	51	15	0	138
07:00 AM	25	0	29	0	13	73	1	0	2	0	0	0	0	118	22	0	283
07:15 AM	45	0	22	0	21	143	2	0	2	0	1	0	1	118	28	0	383
07:30 AM	25	0	17	0	5	20	0	0	1	0	1	0	2	9	31	0	111
07:45 AM	21	1	12	1	10	11	1	0	1	0	0	0	0	12	29	0	99
Total	116	1	80	1	49	247	4	0	6	0	2	0	3	257	110	0	876
08:00 AM	43	0	12	2	13	13	2	0	1	1	1	0	0	18	61	0	167
08:15 AM	144	1	25	0	19	9	1	0	1	1	0	0	2	9	64	0	276
08:30 AM	27	0	10	0	4	8	1	0	1	0	0	0	2	10	9	0	72
Grand Total	350	2	149	3	89	299	9	0	10	3	3	0	8	345	259	0	1529
Apprch %	69.4	0.4	29.6	0.6	22.4	75.3	2.3	0.0	62.5	18.8	18.8	0.0	1.3	56.4	42.3	0.0	
Total %	22.9	0.1	9.7	0.2	5.8	19.6	0.6	0.0	0.7	0.2	0.2	0.0	0.5	22.6	16.9	0.0	

LSC Transportation Consultants, Inc.  
 545 E. Pikes Peak Ave., #210  
 Colorado Springs, CO 80903  
 (719) 633-2868

Site Code : 00164900  
 Start Date : 12/01/2016  
 Page No : 2

Start Time	Rainbow Bridge Dr From North					Londonderry Dr From East					Rainbow Bridge Dr From South					Londonderry Dr From West					Int. Total
	Rig ht	Thr u	Lef t	Pe ds	App. Total	Rig ht	Thr u	Lef t	Pe ds	App. Total	Rig ht	Thr u	Lef t	Pe ds	App. Total	Rig ht	Thr u	Lef t	Pe ds	App. Total	
Peak Hour From 06:45 AM to 08:30 AM - Peak 1 of 1																					
Intersection	06:45 AM																				
Volume	115	0	90	0	205	43	258	4	0	305	6	1	2	0	9	4	296	96	0	396	915
Percent	56.1	0.0	43.9	0.0		14.1	84.6	1.3	0.0		66.7	11.1	22.2	0.0		1.0	74.7	24.2	0.0		
07:15 Volume	45	0	22	0	67	21	143	2	0	166	2	0	1	0	3	1	118	28	0	147	383
Peak Factor	0.597																				
High Int.	07:15 AM																				
Volume	45	0	22	0	67	21	143	2	0	166	2	0	1	0	3	1	118	28	0	147	
Peak Factor	0.765					0.459					0.750					0.673					

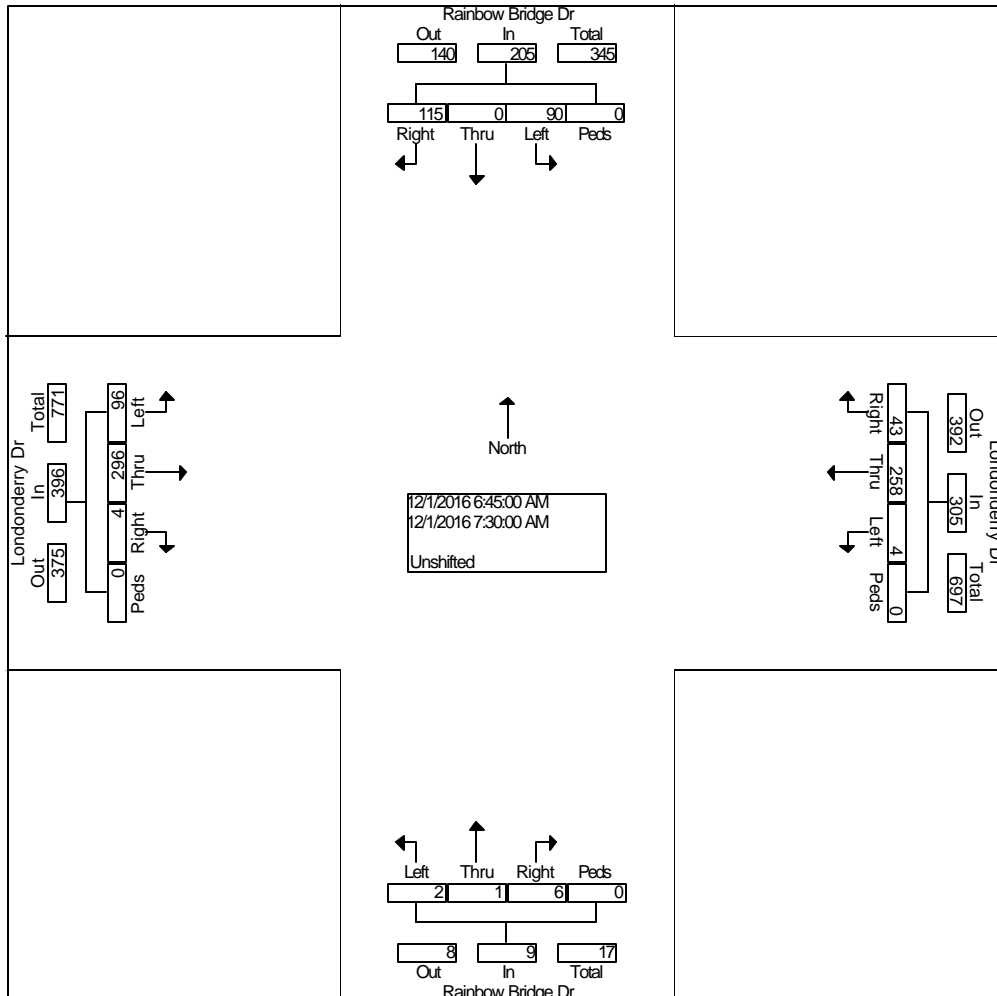

LSC Transportation Consultants, Inc.  
**545 E. Pikes Peak Ave., #210**

LSC Transportation Consultants, Inc. **Colorado Springs, CO 80903** : Rainbow Bridge Dr - Londonderry PM  
 Site Code : 00164900  
 Start Date : 12/01/2016  
 Page No : 1

Groups Printed- Unshifted

Start Time	Rainbow Bridge Dr From North				Londonderry Dr From East				Rainbow Bridge Dr From South				Londonderry Dr From West				Int. Total	
	Right	Thru	Left	Peds	Right	Thru	Left	Peds	Right	Thru	Left	Peds	Right	Thru	Left	Peds		
Factor	1.0	1.0	1.0	1.0	1.0	1.0	1.0	1.0	1.0	1.0	1.0	1.0	1.0	1.0	1.0	1.0	1.0	
04:15 PM	30	0	6	1	16	22	0	0	1	0	0	0	0	21	20	0	0	117
04:30 PM	25	1	5	1	17	24	1	1	0	0	0	0	0	24	22	0	0	121
04:45 PM	24	0	11	0	20	18	2	0	1	1	0	0	0	9	24	0	0	110
Total	79	1	22	2	53	64	3	1	2	1	0	0	0	54	66	0	0	348
05:00 PM	22	0	9	0	16	35	0	0	2	0	1	0	0	16	21	0	0	122
05:15 PM	12	0	9	0	15	29	0	0	1	0	0	0	0	11	20	0	0	97
05:30 PM	18	0	6	0	17	21	0	0	1	0	1	0	0	23	24	0	0	111
05:45 PM	19	0	12	0	15	21	0	0	1	0	0	0	0	30	32	0	0	130
Total	71	0	36	0	63	106	0	0	5	0	2	0	0	80	97	0	0	460
06:00 PM	17	0	10	0	14	19	0	0	1	0	0	0	0	28	29	0	0	118
Grand Total	167	1	68	2	130	189	3	1	8	1	2	0	0	162	192	0	0	926
Apprch %	70.2	0.4	28.6	0.8	40.2	58.5	0.9	0.3	72.7	9.1	18.2	0.0	0.0	45.8	54.2	0.0	0.0	
Total %	18.0	0.1	7.3	0.2	14.0	20.4	0.3	0.1	0.9	0.1	0.2	0.0	0.0	17.5	20.7	0.0	0.0	

LSC Transportation Consultants, Inc.  
 545 E. Pikes Peak Ave., #210  
 Colorado Springs, CO 80903  
 (719) 633-2868

Site Code : 00164900  
 Start Date : 12/01/2016  
 Page No : 2

Start Time	Rainbow Bridge Dr From North					Londonderry Dr From East					Rainbow Bridge Dr From South					Londonderry Dr From West					Int. Total
	Rig ht	Thr u	Lef t	Pe ds	App. Total	Rig ht	Thr u	Lef t	Pe ds	App. Total	Rig ht	Thr u	Lef t	Pe ds	App. Total	Rig ht	Thr u	Lef t	Pe ds	App. Total	
Peak Hour From 04:15 PM to 06:00 PM - Peak 1 of 1																					
Intersection	04:15 PM																				
Volume	101	1	31	2	135	69	99	3	1	172	4	1	1	0	6	0	70	87	0	157	470
Percent	74.8	0.7	23.0	1.5		40.1	57.6	1.7	0.6		66.7	16.7	16.7	0.0		0.0	44.6	55.4	0.0		
05:00 Volume	22	0	9	0	31	16	35	0	0	51	2	0	1	0	3	0	16	21	0	37	122
Peak Factor	0.963																				
High Int. Volume	04:15 PM					05:00 PM					05:00 PM					04:30 PM					
Peak Factor	0.91					0.84					0.50					0.85					
	2					3					0					3					

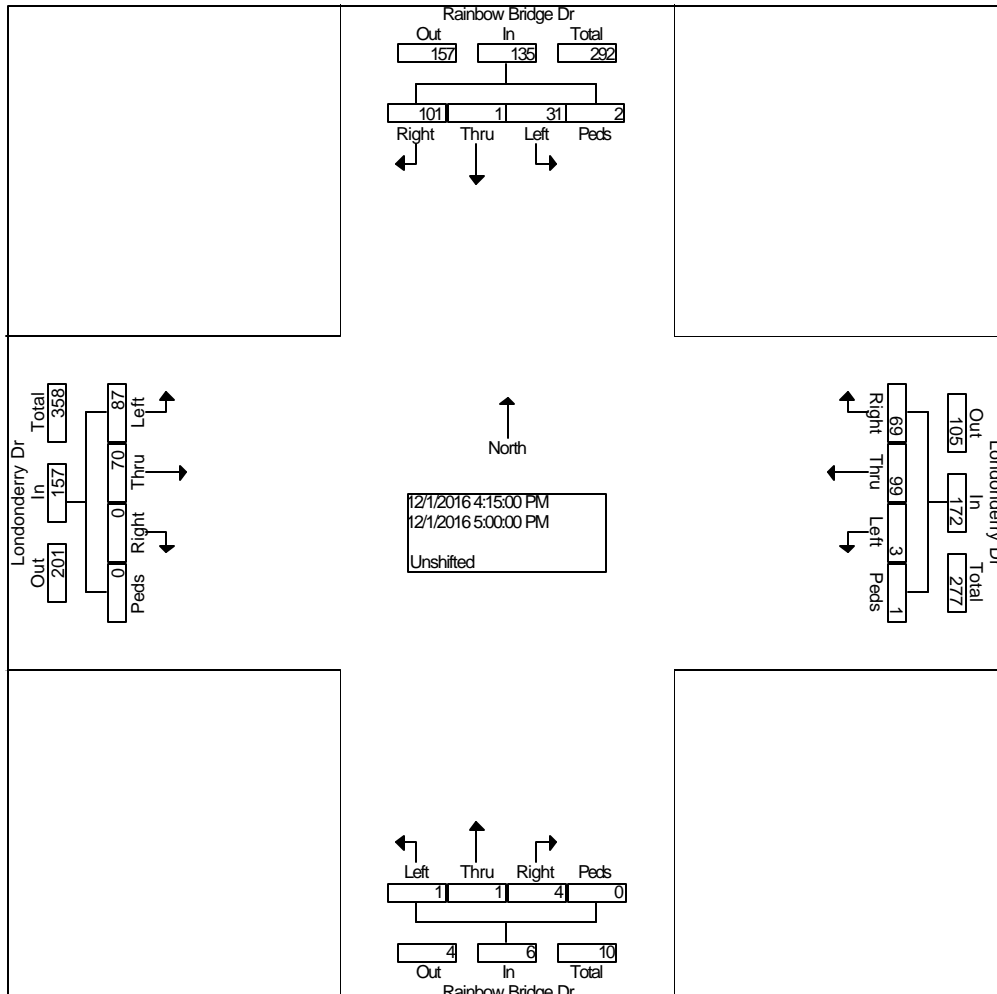



HCM 6th TWSC  
3: Londonderry Dr & Rainbow Bridge Dr

Existing Traffic  
AM Peak Hour

Intersection

Int Delay, s/veh 8.9

Movement	EBL	EBT	EBR	WBL	WBT	WBR	NBL	NBT	NBR	SBL	SBT	SBR
Lane Configurations	↖	↗		↖	↗		↔			↖	↗	
Traffic Vol, veh/h	96	296	4	4	258	43	2	1	6	90	0	115
Future Vol, veh/h	96	296	4	4	258	43	2	1	6	90	0	115
Conflicting Peds, #/hr	0	0	0	0	0	0	0	0	0	0	0	0
Sign Control	Free	Free	Free	Free	Free	Free	Stop	Stop	Stop	Stop	Stop	Stop
RT Channelized	-	-	None	-	-	None	-	-	None	-	-	None
Storage Length	155	-	-	150	-	-	-	-	-	0	-	-
Veh in Median Storage, #	-	0	-	-	0	-	-	0	-	-	0	-
Grade, %	-	0	-	-	0	-	-	0	-	-	0	-
Peak Hour Factor	86	63	100	50	45	51	50	100	75	100	92	64
Heavy Vehicles, %	2	2	2	2	2	2	2	2	2	2	2	2
Mvmt Flow	112	470	4	8	573	84	4	1	8	90	0	180

Major/Minor	Major1	Major2	Minor1	Minor2
Conflicting Flow All	657	0	0	474
Stage 1	-	-	-	-
Stage 2	-	-	-	-
Critical Hdwy	4.12	-	-	4.12
Critical Hdwy Stg 1	-	-	-	-
Critical Hdwy Stg 2	-	-	-	-
Follow-up Hdwy	2.218	-	-	2.218
Pot Cap-1 Maneuver	931	-	-	1088
Stage 1	-	-	-	-
Stage 2	-	-	-	-
Platoon blocked, %	-	-	-	-
Mov Cap-1 Maneuver	931	-	-	1088
Mov Cap-2 Maneuver	-	-	-	-
Stage 1	-	-	-	-
Stage 2	-	-	-	-

Approach	EB	WB	NB	SB
HCM Control Delay, s	1.8	0.1	29.6	44.8
HCM LOS			D	E

Minor Lane/Major Mvmt	NBLn1	EBL	EBT	EBR	WBL	WBT	WBR	SBLn1	SBLn2
Capacity (veh/h)	159	931	-	-	1088	-	-	116	491
HCM Lane V/C Ratio	0.082	0.12	-	-	0.007	-	-	0.776	0.366
HCM Control Delay (s)	29.6	9.4	-	-	8.3	-	-	101.3	16.5
HCM Lane LOS	D	A	-	-	A	-	-	F	C
HCM 95th %tile Q(veh)	0.3	0.4	-	-	0	-	-	4.4	1.7

Intersection						
Int Delay, s/veh	6.6					
Movement	EBL	EBT	WBT	WBR	SBL	SBR
Lane Configurations	↘	↗	↗	↘	↘	↘
Traffic Vol, veh/h	148	240	113	115	55	157
Future Vol, veh/h	148	240	113	115	55	157
Conflicting Peds, #/hr	0	0	0	0	0	0
Sign Control	Free	Free	Free	Free	Stop	Stop
RT Channelized	-	None	-	None	-	None
Storage Length	200	-	-	200	285	0
Veh in Median Storage, #	-	0	0	-	0	-
Grade, %	-	0	0	-	0	-
Peak Hour Factor	61	67	64	76	69	44
Heavy Vehicles, %	2	2	2	2	2	2
Mvmt Flow	243	358	177	151	80	357

Major/Minor	Major1	Major2	Minor2		
Conflicting Flow All	328	0	-	0	1021 177
Stage 1	-	-	-	-	177 -
Stage 2	-	-	-	-	844 -
Critical Hdwy	4.12	-	-	-	6.42 6.22
Critical Hdwy Stg 1	-	-	-	-	5.42 -
Critical Hdwy Stg 2	-	-	-	-	5.42 -
Follow-up Hdwy	2.218	-	-	-	3.518 3.318
Pot Cap-1 Maneuver	1232	-	-	-	262 866
Stage 1	-	-	-	-	854 -
Stage 2	-	-	-	-	422 -
Platoon blocked, %		-	-	-	
Mov Cap-1 Maneuver	1232	-	-	-	210 866
Mov Cap-2 Maneuver	-	-	-	-	210 -
Stage 1	-	-	-	-	686 -
Stage 2	-	-	-	-	422 -

Approach	EB	WB	SB
HCM Control Delay, s	3.5	0	15.7
HCM LOS			C

Minor Lane/Major Mvmt	EBL	EBT	WBT	WBR	SBLn1	SBLn2
Capacity (veh/h)	1232	-	-	-	210	866
HCM Lane V/C Ratio	0.197	-	-	-	0.38	0.412
HCM Control Delay (s)	8.6	-	-	-	32.3	12
HCM Lane LOS	A	-	-	-	D	B
HCM 95th %tile Q(veh)	0.7	-	-	-	1.7	2

Intersection												
Int Delay, s/veh	8.8											
Movement	EBL	EBT	EBR	WBL	WBT	WBR	NBL	NBT	NBR	SBL	SBT	SBR
Lane Configurations		↕			↕	↕		↕			↕	
Traffic Vol, veh/h	40	64	10	4	38	93	6	290	6	84	103	24
Future Vol, veh/h	40	64	10	4	38	93	6	290	6	84	103	24
Conflicting Peds, #/hr	0	0	0	0	0	0	0	0	0	0	0	0
Sign Control	Stop	Stop	Stop	Stop	Stop	Stop	Free	Free	Free	Free	Free	Free
RT Channelized	-	-	None	-	-	None	-	-	None	-	-	None
Storage Length	-	-	-	-	-	260	-	-	-	-	-	-
Veh in Median Storage, #	-	0	-	-	0	-	-	0	-	-	0	-
Grade, %	-	0	-	-	0	-	-	0	-	-	0	-
Peak Hour Factor	91	80	100	50	45	97	100	73	100	100	50	50
Heavy Vehicles, %	2	2	2	2	2	2	2	2	2	2	2	2
Mvmt Flow	44	80	10	8	84	96	6	397	6	84	206	48

Major/Minor	Minor2		Minor1		Major1			Major2				
Conflicting Flow All	900	813	230	855	834	400	254	0	0	403	0	0
Stage 1	398	398	-	412	412	-	-	-	-	-	-	-
Stage 2	502	415	-	443	422	-	-	-	-	-	-	-
Critical Hdwy	7.12	6.52	6.22	7.12	6.52	6.22	4.12	-	-	4.12	-	-
Critical Hdwy Stg 1	6.12	5.52	-	6.12	5.52	-	-	-	-	-	-	-
Critical Hdwy Stg 2	6.12	5.52	-	6.12	5.52	-	-	-	-	-	-	-
Follow-up Hdwy	3.518	4.018	3.318	3.518	4.018	3.318	2.218	-	-	2.218	-	-
Pot Cap-1 Maneuver	259	313	809	278	304	650	1311	-	-	1156	-	-
Stage 1	628	603	-	617	594	-	-	-	-	-	-	-
Stage 2	552	592	-	594	588	-	-	-	-	-	-	-
Platoon blocked, %								-	-	-	-	-
Mov Cap-1 Maneuver	158	285	809	201	277	650	1311	-	-	1156	-	-
Mov Cap-2 Maneuver	158	285	-	201	277	-	-	-	-	-	-	-
Stage 1	624	552	-	613	590	-	-	-	-	-	-	-
Stage 2	401	588	-	459	538	-	-	-	-	-	-	-

Approach	EB		WB		NB		SB	
HCM Control Delay, s	39.2		18.3		0.1		2.1	
HCM LOS	E		C					

Minor Lane/Major Mvmt	NBL	NBT	NBR	EBLn1	WBLn1	WBLn2	SBL	SBT	SBR
Capacity (veh/h)	1311	-	-	234	268	650	1156	-	-
HCM Lane V/C Ratio	0.005	-	-	0.572	0.345	0.148	0.073	-	-
HCM Control Delay (s)	7.8	0	-	39.2	25.3	11.5	8.4	0	-
HCM Lane LOS	A	A	-	E	D	B	A	A	-
HCM 95th %tile Q(veh)	0	-	-	3.2	1.5	0.5	0.2	-	-

Intersection						
Int Delay, s/veh	1.7					
Movement	EBT	EBR	WBL	WBT	NBL	NBR
Lane Configurations						
Traffic Vol, veh/h	112	7	1	67	49	2
Future Vol, veh/h	112	7	1	67	49	2
Conflicting Peds, #/hr	0	0	0	0	0	0
Sign Control	Free	Free	Free	Free	Stop	Stop
RT Channelized	-	None	-	None	-	None
Storage Length	-	-	320	-	0	0
Veh in Median Storage, #	0	-	-	0	0	-
Grade, %	0	-	-	0	0	-
Peak Hour Factor	70	70	65	65	98	98
Heavy Vehicles, %	2	2	2	2	2	2
Mvmt Flow	160	10	2	103	50	2

Major/Minor	Major1	Major2	Minor1		
Conflicting Flow All	0	0	170	0	272
Stage 1	-	-	-	-	165
Stage 2	-	-	-	-	107
Critical Hdwy	-	-	4.12	-	6.42
Critical Hdwy Stg 1	-	-	-	-	5.42
Critical Hdwy Stg 2	-	-	-	-	5.42
Follow-up Hdwy	-	-	2.218	-	3.518
Pot Cap-1 Maneuver	-	-	1407	-	717
Stage 1	-	-	-	-	864
Stage 2	-	-	-	-	917
Platoon blocked, %	-	-	-	-	-
Mov Cap-1 Maneuver	-	-	1407	-	716
Mov Cap-2 Maneuver	-	-	-	-	716
Stage 1	-	-	-	-	863
Stage 2	-	-	-	-	917

Approach	EB	WB	NB
HCM Control Delay, s	0	0.1	10.3
HCM LOS			B

Minor Lane/Major Mvmt	NBLn1	NBLn2	EBT	EBR	WBL	WBT
Capacity (veh/h)	716	879	-	-	1407	-
HCM Lane V/C Ratio	0.07	0.002	-	-	0.001	-
HCM Control Delay (s)	10.4	9.1	-	-	7.6	-
HCM Lane LOS	B	A	-	-	A	-
HCM 95th %tile Q(veh)	0.2	0	-	-	0	-

HCM 6th TWSC  
3: Londonderry Dr & Rainbow Bridge Dr

Existing Traffic  
PM Peak Hour

Intersection												
Int Delay, s/veh	4.6											
Movement	EBL	EBT	EBR	WBL	WBT	WBR	NBL	NBT	NBR	SBL	SBT	SBR
Lane Configurations	↖	↗		↖	↗			↔		↖	↗	
Traffic Vol, veh/h	97	80	0	0	106	63	2	0	5	36	0	71
Future Vol, veh/h	97	80	0	0	106	63	2	0	5	36	0	71
Conflicting Peds, #/hr	0	0	0	0	0	0	0	0	0	0	0	0
Sign Control	Free	Free	Free	Free	Free	Free	Stop	Stop	Stop	Stop	Stop	Stop
RT Channelized	-	-	None	-	-	None	-	-	None	-	-	None
Storage Length	155	-	-	150	-	-	-	-	-	0	-	-
Veh in Median Storage, #	-	0	-	-	0	-	-	0	-	-	0	-
Grade, %	-	0	-	-	0	-	-	0	-	-	0	-
Peak Hour Factor	71	71	71	100	100	100	100	100	100	86	86	86
Heavy Vehicles, %	2	2	2	2	2	2	2	2	2	2	2	2
Mvmt Flow	137	113	0	0	106	63	2	0	5	42	0	83

Major/Minor	Major1			Major2			Minor1			Minor2		
Conflicting Flow All	169	0	0	113	0	0	566	556	113	528	525	138
Stage 1	-	-	-	-	-	-	387	387	-	138	138	-
Stage 2	-	-	-	-	-	-	179	169	-	390	387	-
Critical Hdwy	4.12	-	-	4.12	-	-	7.12	6.52	6.22	7.12	6.52	6.22
Critical Hdwy Stg 1	-	-	-	-	-	-	6.12	5.52	-	6.12	5.52	-
Critical Hdwy Stg 2	-	-	-	-	-	-	6.12	5.52	-	6.12	5.52	-
Follow-up Hdwy	2.218	-	-	2.218	-	-	3.518	4.018	3.318	3.518	4.018	3.318
Pot Cap-1 Maneuver	1409	-	-	1476	-	-	435	439	940	461	458	910
Stage 1	-	-	-	-	-	-	637	610	-	865	782	-
Stage 2	-	-	-	-	-	-	823	759	-	634	610	-
Platoon blocked, %	-	-	-	-	-	-	-	-	-	-	-	-
Mov Cap-1 Maneuver	1409	-	-	1476	-	-	366	396	940	425	414	910
Mov Cap-2 Maneuver	-	-	-	-	-	-	366	396	-	425	414	-
Stage 1	-	-	-	-	-	-	575	551	-	781	782	-
Stage 2	-	-	-	-	-	-	748	759	-	569	551	-

Approach	EB	WB	NB	SB
HCM Control Delay, s	4.3	0	10.6	11.1
HCM LOS			B	B

Minor Lane/Major Mvmt	NBLn1	EBL	EBT	EBR	WBL	WBT	WBR	SBLn1	SBLn2
Capacity (veh/h)	649	1409	-	-	1476	-	-	425	910
HCM Lane V/C Ratio	0.011	0.097	-	-	-	-	-	0.098	0.091
HCM Control Delay (s)	10.6	7.8	-	-	0	-	-	14.4	9.4
HCM Lane LOS	B	A	-	-	A	-	-	B	A
HCM 95th %tile Q(veh)	0	0.3	-	-	0	-	-	0.3	0.3

**Intersection**

Int Delay, s/veh 0.8

Movement	EBL	EBT	WBT	WBR	SBL	SBR
Lane Configurations	↘	↗	↗	↘	↘	↘
Traffic Vol, veh/h	10	79	152	23	12	7
Future Vol, veh/h	10	79	152	23	12	7
Conflicting Peds, #/hr	0	0	0	0	0	0
Sign Control	Free	Free	Free	Free	Stop	Stop
RT Channelized	-	None	-	None	-	None
Storage Length	200	-	-	200	285	0
Veh in Median Storage, #	-	0	0	-	0	-
Grade, %	-	0	0	-	0	-
Peak Hour Factor	100	100	76	76	100	100
Heavy Vehicles, %	2	2	2	2	2	2
Mvmt Flow	10	79	200	30	12	7

**Major/Minor**

	Major1	Major2	Minor2		
Conflicting Flow All	230	0	-	0	299
Stage 1	-	-	-	-	200
Stage 2	-	-	-	-	99
Critical Hdwy	4.12	-	-	-	6.42
Critical Hdwy Stg 1	-	-	-	-	5.42
Critical Hdwy Stg 2	-	-	-	-	5.42
Follow-up Hdwy	2.218	-	-	-	3.518
Pot Cap-1 Maneuver	1338	-	-	-	692
Stage 1	-	-	-	-	834
Stage 2	-	-	-	-	925
Platoon blocked, %	-	-	-	-	-
Mov Cap-1 Maneuver	1338	-	-	-	687
Mov Cap-2 Maneuver	-	-	-	-	687
Stage 1	-	-	-	-	828
Stage 2	-	-	-	-	925

**Approach**

	EB	WB	SB
HCM Control Delay, s	0.9	0	9.9
HCM LOS			A

**Minor Lane/Major Mvmt**

	EBL	EBT	WBT	WBR	SBLn1	SBLn2
Capacity (veh/h)	1338	-	-	-	687	841
HCM Lane V/C Ratio	0.007	-	-	-	0.017	0.008
HCM Control Delay (s)	7.7	-	-	-	10.3	9.3
HCM Lane LOS	A	-	-	-	B	A
HCM 95th %tile Q(veh)	0	-	-	-	0.1	0

HCM 6th TWSC  
127: Eastonville Rd & Stapleton Dr

Existing Traffic  
PM Peak Hour

Intersection												
Int Delay, s/veh	7.2											
Movement	EBL	EBT	EBR	WBL	WBT	WBR	NBL	NBT	NBR	SBL	SBT	SBR
Lane Configurations		↕			↕	↕		↕			↕	
Traffic Vol, veh/h	21	46	3	9	114	92	7	94	8	38	56	10
Future Vol, veh/h	21	46	3	9	114	92	7	94	8	38	56	10
Conflicting Peds, #/hr	0	0	0	0	0	0	0	0	0	0	0	0
Sign Control	Stop	Stop	Stop	Stop	Stop	Stop	Free	Free	Free	Free	Free	Free
RT Channelized	-	-	None	-	-	None	-	-	None	-	-	None
Storage Length	-	-	-	-	-	260	-	-	-	-	-	-
Veh in Median Storage, #	-	0	-	-	0	-	-	0	-	-	0	-
Grade, %	-	0	-	-	0	-	-	0	-	-	0	-
Peak Hour Factor	88	88	88	96	96	96	100	100	100	84	84	84
Heavy Vehicles, %	2	2	2	2	2	2	2	2	2	2	2	2
Mvmt Flow	24	52	3	9	119	96	7	94	8	45	67	12

Major/Minor	Minor2		Minor1		Major1			Major2				
Conflicting Flow All	383	279	73	303	281	98	79	0	0	102	0	0
Stage 1	163	163	-	112	112	-	-	-	-	-	-	-
Stage 2	220	116	-	191	169	-	-	-	-	-	-	-
Critical Hdwy	7.12	6.52	6.22	7.12	6.52	6.22	4.12	-	-	4.12	-	-
Critical Hdwy Stg 1	6.12	5.52	-	6.12	5.52	-	-	-	-	-	-	-
Critical Hdwy Stg 2	6.12	5.52	-	6.12	5.52	-	-	-	-	-	-	-
Follow-up Hdwy	3.518	4.018	3.318	3.518	4.018	3.318	2.218	-	-	2.218	-	-
Pot Cap-1 Maneuver	575	629	989	649	627	958	1519	-	-	1490	-	-
Stage 1	839	763	-	893	803	-	-	-	-	-	-	-
Stage 2	782	800	-	811	759	-	-	-	-	-	-	-
Platoon blocked, %								-	-	-	-	-
Mov Cap-1 Maneuver	427	606	989	587	604	958	1519	-	-	1490	-	-
Mov Cap-2 Maneuver	427	606	-	587	604	-	-	-	-	-	-	-
Stage 1	835	739	-	889	799	-	-	-	-	-	-	-
Stage 2	596	796	-	727	735	-	-	-	-	-	-	-

Approach	EB		WB		NB		SB	
HCM Control Delay, s	12.7		11.1		0.5		2.7	
HCM LOS	B		B					

Minor Lane/Major Mvmt	NBL	NBT	NBR	EBLn1	WBLn1	WBLn2	SBL	SBT	SBR
Capacity (veh/h)	1519	-	-	546	603	958	1490	-	-
HCM Lane V/C Ratio	0.005	-	-	0.146	0.212	0.1	0.03	-	-
HCM Control Delay (s)	7.4	0	-	12.7	12.6	9.2	7.5	0	-
HCM Lane LOS	A	A	-	B	B	A	A	A	-
HCM 95th %tile Q(veh)	0	-	-	0.5	0.8	0.3	0.1	-	-

Intersection						
Int Delay, s/veh	2					
Movement	EBT	EBR	WBL	WBT	NBL	NBR
Lane Configurations						
Traffic Vol, veh/h	66	44	11	120	45	4
Future Vol, veh/h	66	44	11	120	45	4
Conflicting Peds, #/hr	0	0	0	0	0	0
Sign Control	Free	Free	Free	Free	Stop	Stop
RT Channelized	-	None	-	None	-	None
Storage Length	-	-	320	-	0	0
Veh in Median Storage, #	0	-	-	0	0	-
Grade, %	0	-	-	0	0	-
Peak Hour Factor	96	96	100	100	94	94
Heavy Vehicles, %	2	2	2	2	2	2
Mvmt Flow	69	46	11	120	48	4

Major/Minor	Major1	Major2	Minor1		
Conflicting Flow All	0	0	115	0	234 92
Stage 1	-	-	-	-	92 -
Stage 2	-	-	-	-	142 -
Critical Hdwy	-	-	4.12	-	6.42 6.22
Critical Hdwy Stg 1	-	-	-	-	5.42 -
Critical Hdwy Stg 2	-	-	-	-	5.42 -
Follow-up Hdwy	-	-	2.218	-	3.518 3.318
Pot Cap-1 Maneuver	-	-	1474	-	754 965
Stage 1	-	-	-	-	932 -
Stage 2	-	-	-	-	885 -
Platoon blocked, %	-	-	-	-	-
Mov Cap-1 Maneuver	-	-	1474	-	749 965
Mov Cap-2 Maneuver	-	-	-	-	749 -
Stage 1	-	-	-	-	925 -
Stage 2	-	-	-	-	885 -

Approach	EB	WB	NB
HCM Control Delay, s	0	0.6	10
HCM LOS			B

Minor Lane/Major Mvmt	NBLn1	NBLn2	EBT	EBR	WBL	WBT
Capacity (veh/h)	749	965	-	-	1474	-
HCM Lane V/C Ratio	0.064	0.004	-	-	0.007	-
HCM Control Delay (s)	10.1	8.7	-	-	7.5	-
HCM Lane LOS	B	A	-	-	A	-
HCM 95th %tile Q(veh)	0.2	0	-	-	0	-



Intersection												
Int Delay, s/veh	9.4											
Movement	EBL	EBT	EBR	WBL	WBT	WBR	NBL	NBT	NBR	SBL	SBT	SBR
Lane Configurations	↖	↗		↖	↗		↖	↗		↖	↗	
Traffic Vol, veh/h	87	356	29	11	344	49	13	41	30	82	55	113
Future Vol, veh/h	87	356	29	11	344	49	13	41	30	82	55	113
Conflicting Peds, #/hr	0	0	0	0	0	0	0	0	0	0	0	0
Sign Control	Free	Free	Free	Free	Free	Free	Stop	Stop	Stop	Stop	Stop	Stop
RT Channelized	-	-	None	-	-	None	-	-	None	-	-	None
Storage Length	155	-	-	150	-	-	0	-	-	0	-	-
Veh in Median Storage, #	-	0	-	-	0	-	-	0	-	-	0	-
Grade, %	-	0	-	-	0	-	-	0	-	-	0	-
Peak Hour Factor	92	93	92	92	93	92	92	92	92	92	92	92
Heavy Vehicles, %	2	2	2	2	2	2	2	2	2	2	2	2
Mvmt Flow	95	383	32	12	370	53	14	45	33	89	60	123

Major/Minor	Major1			Major2			Minor1			Minor2		
Conflicting Flow All	423	0	0	415	0	0	1101	1036	399	1049	1026	397
Stage 1	-	-	-	-	-	-	589	589	-	421	421	-
Stage 2	-	-	-	-	-	-	512	447	-	628	605	-
Critical Hdwy	4.12	-	-	4.12	-	-	7.12	6.52	6.22	7.12	6.52	6.22
Critical Hdwy Stg 1	-	-	-	-	-	-	6.12	5.52	-	6.12	5.52	-
Critical Hdwy Stg 2	-	-	-	-	-	-	6.12	5.52	-	6.12	5.52	-
Follow-up Hdwy	2.218	-	-	2.218	-	-	3.518	4.018	3.318	3.518	4.018	3.318
Pot Cap-1 Maneuver	1136	-	-	1144	-	-	189	232	651	205	235	652
Stage 1	-	-	-	-	-	-	494	495	-	610	589	-
Stage 2	-	-	-	-	-	-	545	573	-	471	487	-
Platoon blocked, %	-	-	-	-	-	-	-	-	-	-	-	-
Mov Cap-1 Maneuver	1136	-	-	1144	-	-	112	210	651	152	213	652
Mov Cap-2 Maneuver	-	-	-	-	-	-	112	210	-	152	213	-
Stage 1	-	-	-	-	-	-	453	453	-	559	583	-
Stage 2	-	-	-	-	-	-	393	567	-	370	446	-

Approach	EB			WB			NB			SB		
HCM Control Delay, s	1.6			0.2			24.6			33.8		
HCM LOS							C			D		

Minor Lane/Major Mvmt	NBLn1	NBLn2	EBL	EBT	EBR	WBL	WBT	WBR	SBLn1	SBLn2
Capacity (veh/h)	112	294	1136	-	-	1144	-	-	152	389
HCM Lane V/C Ratio	0.126	0.262	0.083	-	-	0.01	-	-	0.586	0.469
HCM Control Delay (s)	41.7	21.5	8.5	-	-	8.2	-	-	57.7	22.2
HCM Lane LOS	E	C	A	-	-	A	-	-	F	C
HCM 95th %tile Q(veh)	0.4	1	0.3	-	-	0	-	-	3.1	2.4

Intersection												
Int Delay, s/veh	144.3											
Movement	EBL	EBT	EBR	WBL	WBT	WBR	NBL	NBT	NBR	SBL	SBT	SBR
Lane Configurations		↕			↕	↕	↕	↕		↕	↕	
Traffic Vol, veh/h	26	129	63	4	74	119	30	311	6	162	167	48
Future Vol, veh/h	26	129	63	4	74	119	30	311	6	162	167	48
Conflicting Peds, #/hr	0	0	0	0	0	0	0	0	0	0	0	0
Sign Control	Stop	Stop	Stop	Stop	Stop	Stop	Free	Free	Free	Free	Free	Free
RT Channelized	-	-	None	-	-	None	-	-	None	-	-	None
Storage Length	-	-	-	-	-	160	150	-	-	150	-	-
Veh in Median Storage, #	-	0	-	-	0	-	-	0	-	-	0	-
Grade, %	-	0	-	-	0	-	-	0	-	-	0	-
Peak Hour Factor	86	86	86	72	72	72	74	74	74	67	67	67
Heavy Vehicles, %	2	2	2	2	2	2	2	2	2	2	2	2
Mvmt Flow	30	150	73	6	103	165	41	420	8	242	249	72

Major/Minor	Minor2		Minor1		Major1		Major2					
Conflicting Flow All	1409	1279	285	1387	1311	424	321	0	0	428	0	0
Stage 1	769	769	-	506	506	-	-	-	-	-	-	-
Stage 2	640	510	-	881	805	-	-	-	-	-	-	-
Critical Hdwy	7.12	6.52	6.22	7.12	6.52	6.22	4.12	-	-	4.12	-	-
Critical Hdwy Stg 1	6.12	5.52	-	6.12	5.52	-	-	-	-	-	-	-
Critical Hdwy Stg 2	6.12	5.52	-	6.12	5.52	-	-	-	-	-	-	-
Follow-up Hdwy	3.518	4.018	3.318	3.518	4.018	3.318	2.218	-	-	2.218	-	-
Pot Cap-1 Maneuver	116	166	754	120	159	630	1239	-	-	1131	-	-
Stage 1	394	411	-	549	540	-	-	-	-	-	-	-
Stage 2	464	538	-	341	395	-	-	-	-	-	-	-
Platoon blocked, %								-	-	-	-	-
Mov Cap-1 Maneuver	~ 21	~ 126	754	-	121	630	1239	-	-	1131	-	-
Mov Cap-2 Maneuver	~ 21	~ 126	-	-	121	-	-	-	-	-	-	-
Stage 1	381	323	-	531	522	-	-	-	-	-	-	-
Stage 2	266	520	-	130	310	-	-	-	-	-	-	-

Approach	EB	WB	NB	SB
HCM Control Delay, s	877.2		0.7	3.9
HCM LOS	F	-		

Minor Lane/Major Mvmt	NBL	NBT	NBR	EBLn1	WBLn1	WBLn2	SBL	SBT	SBR
Capacity (veh/h)	1239	-	-	93	-	630	1131	-	-
HCM Lane V/C Ratio	0.033	-	-	2.726	-	0.262	0.214	-	-
HCM Control Delay (s)	8	-	-	877.2	-	12.7	9	-	-
HCM Lane LOS	A	-	-	F	-	B	A	-	-
HCM 95th %tile Q(veh)	0.1	-	-	24	-	1	0.8	-	-

Notes  
 ~: Volume exceeds capacity    \$: Delay exceeds 300s    +: Computation Not Defined    \*: All major volume in platoon

Intersection												
Int Delay, s/veh	5.6											
Movement	EBL	EBT	EBR	WBL	WBT	WBR	NBL	NBT	NBR	SBL	SBT	SBR
Lane Configurations	↖	↗		↖	↗	↖	↖	↗		↖	↗	↖
Traffic Vol, veh/h	54	124	7	1	119	32	49	5	2	92	5	76
Future Vol, veh/h	54	124	7	1	119	32	49	5	2	92	5	76
Conflicting Peds, #/hr	0	0	0	0	0	0	0	0	0	0	0	0
Sign Control	Free	Free	Free	Free	Free	Free	Stop	Stop	Stop	Stop	Stop	Stop
RT Channelized	-	-	None	-	-	None	-	-	None	-	-	None
Storage Length	210	-	-	320	-	190	0	-	-	205	-	205
Veh in Median Storage, #	-	0	-	-	0	-	-	0	-	-	0	-
Grade, %	-	0	-	-	0	-	-	0	-	-	0	-
Peak Hour Factor	92	92	92	92	92	92	92	92	92	92	92	92
Heavy Vehicles, %	2	2	2	2	2	2	2	2	2	2	2	2
Mvmt Flow	59	135	8	1	129	35	53	5	2	100	5	83

Major/Minor	Major1		Major2		Minor1			Minor2				
Conflicting Flow All	164	0	0	143	0	0	450	423	139	392	392	129
Stage 1	-	-	-	-	-	-	257	257	-	131	131	-
Stage 2	-	-	-	-	-	-	193	166	-	261	261	-
Critical Hdwy	4.12	-	-	4.12	-	-	7.12	6.52	6.22	7.12	6.52	6.22
Critical Hdwy Stg 1	-	-	-	-	-	-	6.12	5.52	-	6.12	5.52	-
Critical Hdwy Stg 2	-	-	-	-	-	-	6.12	5.52	-	6.12	5.52	-
Follow-up Hdwy	2.218	-	-	2.218	-	-	3.518	4.018	3.318	3.518	4.018	3.318
Pot Cap-1 Maneuver	1414	-	-	1440	-	-	519	522	909	567	544	921
Stage 1	-	-	-	-	-	-	748	695	-	873	788	-
Stage 2	-	-	-	-	-	-	809	761	-	744	692	-
Platoon blocked, %	-	-	-	-	-	-	-	-	-	-	-	-
Mov Cap-1 Maneuver	1414	-	-	1440	-	-	454	500	909	543	521	921
Mov Cap-2 Maneuver	-	-	-	-	-	-	454	500	-	543	521	-
Stage 1	-	-	-	-	-	-	717	666	-	836	787	-
Stage 2	-	-	-	-	-	-	731	760	-	705	663	-

Approach	EB	WB	NB	SB
HCM Control Delay, s	2.2	0	13.7	11.4
HCM LOS			B	B

Minor Lane/Major Mvmt	NBLn1	NBLn2	EBL	EBT	EBR	WBL	WBT	WBR	SBLn1	SBLn2	SBLn3
Capacity (veh/h)	454	574	1414	-	-	1440	-	-	543	521	921
HCM Lane V/C Ratio	0.117	0.013	0.042	-	-	0.001	-	-	0.184	0.01	0.09
HCM Control Delay (s)	14	11.4	7.7	-	-	7.5	-	-	13.1	12	9.3
HCM Lane LOS	B	B	A	-	-	A	-	-	B	B	A
HCM 95th %tile Q(veh)	0.4	0	0.1	-	-	0	-	-	0.7	0	0.3

Intersection												
Int Delay, s/veh	7.2											
Movement	EBL	EBT	EBR	WBL	WBT	WBR	NBL	NBT	NBR	SBL	SBT	SBR
Lane Configurations	↖	↗		↖	↗		↖	↗		↖	↗	
Traffic Vol, veh/h	99	162	29	38	142	101	38	54	4	59	36	71
Future Vol, veh/h	99	162	29	38	142	101	38	54	4	59	36	71
Conflicting Peds, #/hr	0	0	0	0	0	0	0	0	0	0	0	0
Sign Control	Free	Free	Free	Free	Free	Free	Stop	Stop	Stop	Stop	Stop	Stop
RT Channelized	-	-	None	-	-	None	-	-	None	-	-	None
Storage Length	155	-	-	150	-	-	0	-	-	0	-	-
Veh in Median Storage, #	-	0	-	-	0	-	-	0	-	-	0	-
Grade, %	-	0	-	-	0	-	-	0	-	-	0	-
Peak Hour Factor	92	92	92	92	92	92	92	92	92	86	86	86
Heavy Vehicles, %	2	2	2	2	2	2	2	2	2	2	2	2
Mvmt Flow	108	176	32	41	154	110	41	59	4	69	42	83

Major/Minor	Major1			Major2			Minor1			Minor2		
Conflicting Flow All	264	0	0	208	0	0	762	754	192	731	715	209
Stage 1	-	-	-	-	-	-	408	408	-	291	291	-
Stage 2	-	-	-	-	-	-	354	346	-	440	424	-
Critical Hdwy	4.12	-	-	4.12	-	-	7.12	6.52	6.22	7.12	6.52	6.22
Critical Hdwy Stg 1	-	-	-	-	-	-	6.12	5.52	-	6.12	5.52	-
Critical Hdwy Stg 2	-	-	-	-	-	-	6.12	5.52	-	6.12	5.52	-
Follow-up Hdwy	2.218	-	-	2.218	-	-	3.518	4.018	3.318	3.518	4.018	3.318
Pot Cap-1 Maneuver	1300	-	-	1363	-	-	322	338	850	337	356	831
Stage 1	-	-	-	-	-	-	620	597	-	717	672	-
Stage 2	-	-	-	-	-	-	663	635	-	596	587	-
Platoon blocked, %	-	-	-	-	-	-	-	-	-	-	-	-
Mov Cap-1 Maneuver	1300	-	-	1363	-	-	239	300	850	262	316	831
Mov Cap-2 Maneuver	-	-	-	-	-	-	239	300	-	262	316	-
Stage 1	-	-	-	-	-	-	569	547	-	657	652	-
Stage 2	-	-	-	-	-	-	542	616	-	485	538	-

Approach	EB	WB	NB	SB
HCM Control Delay, s	2.7	1	20.8	17.2
HCM LOS			C	C

Minor Lane/Major Mvmt	NBLn1	NBLn2	EBL	EBT	EBR	WBL	WBT	WBR	SBLn1	SBLn2
Capacity (veh/h)	239	314	1300	-	-	1363	-	-	262	537
HCM Lane V/C Ratio	0.173	0.201	0.083	-	-	0.03	-	-	0.262	0.232
HCM Control Delay (s)	23.2	19.3	8	-	-	7.7	-	-	23.5	13.7
HCM Lane LOS	C	C	A	-	-	A	-	-	C	B
HCM 95th %tile Q(veh)	0.6	0.7	0.3	-	-	0.1	-	-	1	0.9

Intersection												
Int Delay, s/veh	15											
Movement	EBL	EBT	EBR	WBL	WBT	WBR	NBL	NBT	NBR	SBL	SBT	SBR
Lane Configurations		↕			↕	↕	↕	↕		↕	↕	
Traffic Vol, veh/h	47	87	45	10	164	181	65	128	16	75	99	39
Future Vol, veh/h	47	87	45	10	164	181	65	128	16	75	99	39
Conflicting Peds, #/hr	0	0	0	0	0	0	0	0	0	0	0	0
Sign Control	Stop	Stop	Stop	Stop	Stop	Stop	Free	Free	Free	Free	Free	Free
RT Channelized	-	-	None	-	-	None	-	-	None	-	-	None
Storage Length	-	-	-	-	-	160	150	-	-	150	-	-
Veh in Median Storage, #	-	0	-	-	0	-	-	0	-	-	0	-
Grade, %	-	0	-	-	0	-	-	0	-	-	0	-
Peak Hour Factor	86	92	92	90	92	90	92	92	92	96	96	96
Heavy Vehicles, %	2	2	2	2	2	2	2	2	2	2	2	2
Mvmt Flow	55	95	49	11	178	201	71	139	17	78	103	41

Major/Minor	Minor2		Minor1		Major1		Major2					
Conflicting Flow All	759	578	124	642	590	148	144	0	0	156	0	0
Stage 1	280	280	-	290	290	-	-	-	-	-	-	-
Stage 2	479	298	-	352	300	-	-	-	-	-	-	-
Critical Hdwy	7.12	6.52	6.22	7.12	6.52	6.22	4.12	-	-	4.12	-	-
Critical Hdwy Stg 1	6.12	5.52	-	6.12	5.52	-	-	-	-	-	-	-
Critical Hdwy Stg 2	6.12	5.52	-	6.12	5.52	-	-	-	-	-	-	-
Follow-up Hdwy	3.518	4.018	3.318	3.518	4.018	3.318	2.218	-	-	2.218	-	-
Pot Cap-1 Maneuver	323	427	927	387	420	899	1438	-	-	1424	-	-
Stage 1	727	679	-	718	672	-	-	-	-	-	-	-
Stage 2	568	667	-	665	666	-	-	-	-	-	-	-
Platoon blocked, %								-	-	-	-	-
Mov Cap-1 Maneuver	147	384	927	275	378	899	1438	-	-	1424	-	-
Mov Cap-2 Maneuver	147	384	-	275	378	-	-	-	-	-	-	-
Stage 1	691	642	-	683	639	-	-	-	-	-	-	-
Stage 2	302	634	-	508	629	-	-	-	-	-	-	-

Approach	EB		WB		NB		SB	
HCM Control Delay, s	39		17.1		2.4		2.7	
HCM LOS	E		C					

Minor Lane/Major Mvmt	NBL	NBT	NBR	EBLn1	WBLn1	WBLn2	SBL	SBT	SBR
Capacity (veh/h)	1438	-	-	295	370	899	1424	-	-
HCM Lane V/C Ratio	0.049	-	-	0.672	0.512	0.224	0.055	-	-
HCM Control Delay (s)	7.6	-	-	39	24.5	10.2	7.7	-	-
HCM Lane LOS	A	-	-	E	C	B	A	-	-
HCM 95th %tile Q(veh)	0.2	-	-	4.5	2.8	0.9	0.2	-	-

Intersection												
Int Delay, s/veh	4.3											
Movement	EBL	EBT	EBR	WBL	WBT	WBR	NBL	NBT	NBR	SBL	SBT	SBR
Lane Configurations	↖	↗		↖	↗	↖	↖	↗		↖	↗	↖
Traffic Vol, veh/h	65	110	44	11	175	82	45	2	4	65	2	46
Future Vol, veh/h	65	110	44	11	175	82	45	2	4	65	2	46
Conflicting Peds, #/hr	0	0	0	0	0	0	0	0	0	0	0	0
Sign Control	Free	Free	Free	Free	Free	Free	Stop	Stop	Stop	Stop	Stop	Stop
RT Channelized	-	-	None	-	-	None	-	-	None	-	-	None
Storage Length	210	-	-	320	-	190	0	-	-	205	-	205
Veh in Median Storage, #	-	0	-	-	0	-	-	0	-	-	0	-
Grade, %	-	0	-	-	0	-	-	0	-	-	0	-
Peak Hour Factor	92	96	96	100	100	92	94	92	94	92	92	92
Heavy Vehicles, %	2	2	2	2	2	2	2	2	2	2	2	2
Mvmt Flow	71	115	46	11	175	89	48	2	4	71	2	50

Major/Minor	Major1			Major2			Minor1			Minor2		
Conflicting Flow All	264	0	0	161	0	0	548	566	138	480	500	175
Stage 1	-	-	-	-	-	-	280	280	-	197	197	-
Stage 2	-	-	-	-	-	-	268	286	-	283	303	-
Critical Hdwy	4.12	-	-	4.12	-	-	7.12	6.52	6.22	7.12	6.52	6.22
Critical Hdwy Stg 1	-	-	-	-	-	-	6.12	5.52	-	6.12	5.52	-
Critical Hdwy Stg 2	-	-	-	-	-	-	6.12	5.52	-	6.12	5.52	-
Follow-up Hdwy	2.218	-	-	2.218	-	-	3.518	4.018	3.318	3.518	4.018	3.318
Pot Cap-1 Maneuver	1300	-	-	1418	-	-	447	434	910	496	473	868
Stage 1	-	-	-	-	-	-	727	679	-	805	738	-
Stage 2	-	-	-	-	-	-	738	675	-	724	664	-
Platoon blocked, %	-	-	-	-	-	-	-	-	-	-	-	-
Mov Cap-1 Maneuver	1300	-	-	1418	-	-	400	407	910	468	443	868
Mov Cap-2 Maneuver	-	-	-	-	-	-	400	407	-	468	443	-
Stage 1	-	-	-	-	-	-	687	642	-	761	732	-
Stage 2	-	-	-	-	-	-	688	670	-	679	627	-

Approach	EB			WB			NB			SB		
HCM Control Delay, s	2.4			0.3			14.7			12.2		
HCM LOS							B			B		

Minor Lane/Major Mvmt	NBLn1	NBLn2	EBL	EBT	EBR	WBL	WBT	WBR	SBLn1	SBLn2	SBLn3
Capacity (veh/h)	400	642	1300	-	-	1418	-	-	468	443	868
HCM Lane V/C Ratio	0.12	0.01	0.054	-	-	0.008	-	-	0.151	0.005	0.058
HCM Control Delay (s)	15.2	10.7	7.9	-	-	7.6	-	-	14.1	13.2	9.4
HCM Lane LOS	C	B	A	-	-	A	-	-	B	B	A
HCM 95th %tile Q(veh)	0.4	0	0.2	-	-	0	-	-	0.5	0	0.2

Intersection	
Intersection Delay, s/veh	25.3
Intersection LOS	D

Movement	EBL	EBT	EBR	WBL	WBT	WBR	NBL	NBT	NBR	SBL	SBT	SBR
Lane Configurations	↰	↱		↰	↱		↰	↱		↰	↱	
Traffic Vol, veh/h	87	356	33	18	344	49	23	53	46	82	65	113
Future Vol, veh/h	87	356	33	18	344	49	23	53	46	82	65	113
Peak Hour Factor	0.92	0.93	0.92	0.92	0.93	0.92	0.92	0.92	0.92	0.92	0.92	0.92
Heavy Vehicles, %	2	2	2	2	2	2	2	2	2	2	2	2
Mvmt Flow	95	383	36	20	370	53	25	58	50	89	71	123
Number of Lanes	1	1	0	1	1	0	1	1	0	1	1	0

Approach	EB	WB	NB	SB
Opposing Approach	WB	EB	SB	NB
Opposing Lanes	2	2	2	2
Conflicting Approach Left	SB	NB	EB	WB
Conflicting Lanes Left	2	2	2	2
Conflicting Approach Right	NB	SB	WB	EB
Conflicting Lanes Right	2	2	2	2
HCM Control Delay	28.2	32.6	13	14.4
HCM LOS	D	D	B	B

Lane	NBLn1	NBLn2	EBLn1	EBLn2	WBLn1	WBLn2	SBLn1	SBLn2
Vol Left, %	100%	0%	100%	0%	100%	0%	100%	0%
Vol Thru, %	0%	54%	0%	92%	0%	88%	0%	37%
Vol Right, %	0%	46%	0%	8%	0%	12%	0%	63%
Sign Control	Stop	Stop	Stop	Stop	Stop	Stop	Stop	Stop
Traffic Vol by Lane	23	99	87	389	18	393	82	178
LT Vol	23	0	87	0	18	0	82	0
Through Vol	0	53	0	356	0	344	0	65
RT Vol	0	46	0	33	0	49	0	113
Lane Flow Rate	25	108	95	419	20	423	89	193
Geometry Grp	7	7	7	7	7	7	7	7
Degree of Util (X)	0.061	0.237	0.196	0.799	0.041	0.815	0.207	0.396
Departure Headway (Hd)	8.788	7.933	7.446	6.874	7.537	6.936	8.346	7.372
Convergence, Y/N	Yes	Yes	Yes	Yes	Yes	Yes	Yes	Yes
Cap	407	451	481	528	474	520	430	488
Service Time	6.564	5.709	5.205	4.633	5.296	4.695	6.109	5.135
HCM Lane V/C Ratio	0.061	0.239	0.198	0.794	0.042	0.813	0.207	0.395
HCM Control Delay	12.1	13.2	12	31.8	10.6	33.6	13.3	14.9
HCM Lane LOS	B	B	B	D	B	D	B	B
HCM 95th-tile Q	0.2	0.9	0.7	7.6	0.1	7.9	0.8	1.9

Intersection												
Int Delay, s/veh	8.7											
Movement	EBL	EBT	EBR	WBL	WBT	WBR	NBL	NBT	NBR	SBL	SBT	SBR
Lane Configurations												
Traffic Vol, veh/h	109	0	7	0	0	0	22	9	0	0	4	190
Future Vol, veh/h	109	0	7	0	0	0	22	9	0	0	4	190
Conflicting Peds, #/hr	0	0	0	0	0	0	0	0	0	0	0	0
Sign Control	Free	Free	Free	Free	Free	Free	Stop	Stop	Stop	Stop	Stop	Stop
RT Channelized	-	-	None	-	-	None	-	-	None	-	-	None
Storage Length	250	-	-	0	-	-	-	-	-	-	-	0
Veh in Median Storage, #	-	0	-	-	0	-	-	0	-	-	0	-
Grade, %	-	0	-	-	0	-	-	0	-	-	0	-
Peak Hour Factor	92	92	92	92	92	92	92	92	92	92	92	92
Heavy Vehicles, %	2	2	2	2	2	2	2	2	2	2	2	2
Mvmt Flow	118	0	8	0	0	0	24	10	0	0	4	207

Major/Minor	Major1			Major2			Minor1			Minor2		
Conflicting Flow All	1	0	0	8	0	0	347	241	4	246	245	1
Stage 1	-	-	-	-	-	-	240	240	-	1	1	-
Stage 2	-	-	-	-	-	-	107	1	-	245	244	-
Critical Hdwy	4.12	-	-	4.12	-	-	7.12	6.52	6.22	7.12	6.52	6.22
Critical Hdwy Stg 1	-	-	-	-	-	-	6.12	5.52	-	6.12	5.52	-
Critical Hdwy Stg 2	-	-	-	-	-	-	6.12	5.52	-	6.12	5.52	-
Follow-up Hdwy	2.218	-	-	2.218	-	-	3.518	4.018	3.318	3.518	4.018	3.318
Pot Cap-1 Maneuver	1622	-	-	1612	-	-	607	660	1080	708	657	1084
Stage 1	-	-	-	-	-	-	763	707	-	1022	895	-
Stage 2	-	-	-	-	-	-	898	895	-	759	704	-
Platoon blocked, %	-	-	-	-	-	-	-	-	-	-	-	-
Mov Cap-1 Maneuver	1622	-	-	1612	-	-	461	612	1080	661	609	1084
Mov Cap-2 Maneuver	-	-	-	-	-	-	461	612	-	661	609	-
Stage 1	-	-	-	-	-	-	707	655	-	947	895	-
Stage 2	-	-	-	-	-	-	723	895	-	693	653	-

Approach	EB	WB	NB	SB
HCM Control Delay, s	6.9	0	12.8	9.1
HCM LOS			B	A

Minor Lane/Major Mvmt	NBLn1	EBL	EBT	EBR	WBL	WBT	WBR	SBLn1	SBLn2
Capacity (veh/h)	497	1622	-	-	1612	-	-	609	1084
HCM Lane V/C Ratio	0.068	0.073	-	-	-	-	-	0.007	0.191
HCM Control Delay (s)	12.8	7.4	-	-	0	-	-	11	9.1
HCM Lane LOS	B	A	-	-	A	-	-	B	A
HCM 95th %tile Q(veh)	0.2	0.2	-	-	0	-	-	0	0.7



Intersection												
Int Delay, s/veh	1.6											
Movement	EBL	EBT	EBR	WBL	WBT	WBR	NBL	NBT	NBR	SBL	SBT	SBR
Lane Configurations		↕↔			↕↔	↕↔	↕↔	↕↔		↕↔	↕↔	
Traffic Vol, veh/h	27	168	92	4	85	119	38	311	6	162	167	48
Future Vol, veh/h	27	168	92	4	85	119	38	311	6	162	167	48
Conflicting Peds, #/hr	0	0	0	0	0	0	0	0	0	0	0	0
Sign Control	Stop	Stop	Stop	Stop	Stop	Stop	Free	Free	Free	Free	Free	Free
RT Channelized	-	-	None	-	-	None	-	-	None	-	-	None
Storage Length	-	-	-	-	-	160	150	-	-	150	-	-
Veh in Median Storage, #	-	0	-	-	0	-	-	0	-	-	0	-
Grade, %	-	0	-	-	0	-	-	0	-	-	0	-
Peak Hour Factor	86	86	86	72	72	72	74	74	74	67	67	67
Heavy Vehicles, %	2	2	2	2	2	2	2	2	2	2	2	2
Mvmt Flow	31	195	107	6	118	165	51	420	8	242	249	72

Major/Minor	Minor2		Minor1		Major1		Major2					
Conflicting Flow All	1437	1299	285	1446	1331	424	321	0	0	428	0	0
Stage 1	769	769	-	526	526	-	-	-	-	-	-	-
Stage 2	668	530	-	920	805	-	-	-	-	-	-	-
Critical Hdwy	7.12	6.52	6.22	7.12	6.52	6.22	4.12	-	-	4.12	-	-
Critical Hdwy Stg 1	6.12	5.52	-	6.12	5.52	-	-	-	-	-	-	-
Critical Hdwy Stg 2	6.12	5.52	-	6.12	5.52	-	-	-	-	-	-	-
Follow-up Hdwy	3.518	4.018	3.318	3.518	4.018	3.318	2.218	-	-	2.218	-	-
Pot Cap-1 Maneuver	111	~ 161	754	109	154	630	1239	-	-	1131	-	-
Stage 1	394	411	-	535	529	-	-	-	-	-	-	-
Stage 2	448	527	-	325	395	-	-	-	-	-	-	-
Platoon blocked, %	-	-	-	-	-	-	-	-	-	-	-	-
Mov Cap-1 Maneuver	-	~ 121	754	-	~ 116	630	1239	-	-	1131	-	-
Mov Cap-2 Maneuver	-	~ 121	-	-	~ 116	-	-	-	-	-	-	-
Stage 1	378	323	-	513	507	-	-	-	-	-	-	-
Stage 2	243	505	-	87	310	-	-	-	-	-	-	-

Approach	EB		WB		NB		SB	
HCM Control Delay, s					0.9		3.9	
HCM LOS	-		-					

Minor Lane/Major Mvmt	NBL	NBT	NBR	EBLn1	WBLn1	WBLn2	SBL	SBT	SBR
Capacity (veh/h)	1239	-	-	-	-	-	630	1131	-
HCM Lane V/C Ratio	0.041	-	-	-	-	-	0.262	0.214	-
HCM Control Delay (s)	8	-	-	-	-	-	12.7	9	-
HCM Lane LOS	A	-	-	-	-	-	B	A	-
HCM 95th %tile Q(veh)	0.1	-	-	-	-	-	1	0.8	-

Notes  
 ~: Volume exceeds capacity    \$: Delay exceeds 300s    +: Computation Not Defined    \*: All major volume in platoon

Intersection												
Int Delay, s/veh	7.6											
Movement	EBL	EBT	EBR	WBL	WBT	WBR	NBL	NBT	NBR	SBL	SBT	SBR
Lane Configurations	↖	↗		↖	↗	↖	↖	↗		↖	↗	↖
Traffic Vol, veh/h	78	124	7	1	119	51	49	6	2	160	10	159
Future Vol, veh/h	78	124	7	1	119	51	49	6	2	160	10	159
Conflicting Peds, #/hr	0	0	0	0	0	0	0	0	0	0	0	0
Sign Control	Free	Free	Free	Free	Free	Free	Stop	Stop	Stop	Stop	Stop	Stop
RT Channelized	-	-	None	-	-	None	-	-	None	-	-	None
Storage Length	210	-	-	320	-	190	0	-	-	205	-	205
Veh in Median Storage, #	-	0	-	-	0	-	-	0	-	-	0	-
Grade, %	-	0	-	-	0	-	-	0	-	-	0	-
Peak Hour Factor	92	92	92	92	92	92	92	92	92	92	92	92
Heavy Vehicles, %	2	2	2	2	2	2	2	2	2	2	2	2
Mvmt Flow	85	135	8	1	129	55	53	7	2	174	11	173

Major/Minor	Major1			Major2			Minor1			Minor2		
Conflicting Flow All	184	0	0	143	0	0	560	495	139	445	444	129
Stage 1	-	-	-	-	-	-	309	309	-	131	131	-
Stage 2	-	-	-	-	-	-	251	186	-	314	313	-
Critical Hdwy	4.12	-	-	4.12	-	-	7.12	6.52	6.22	7.12	6.52	6.22
Critical Hdwy Stg 1	-	-	-	-	-	-	6.12	5.52	-	6.12	5.52	-
Critical Hdwy Stg 2	-	-	-	-	-	-	6.12	5.52	-	6.12	5.52	-
Follow-up Hdwy	2.218	-	-	2.218	-	-	3.518	4.018	3.318	3.518	4.018	3.318
Pot Cap-1 Maneuver	1391	-	-	1440	-	-	439	476	909	523	508	921
Stage 1	-	-	-	-	-	-	701	660	-	873	788	-
Stage 2	-	-	-	-	-	-	753	746	-	697	657	-
Platoon blocked, %	-	-	-	-	-	-	-	-	-	-	-	-
Mov Cap-1 Maneuver	1391	-	-	1440	-	-	334	446	909	492	477	921
Mov Cap-2 Maneuver	-	-	-	-	-	-	334	446	-	492	477	-
Stage 1	-	-	-	-	-	-	658	620	-	820	787	-
Stage 2	-	-	-	-	-	-	603	745	-	646	617	-

Approach	EB			WB			NB			SB		
HCM Control Delay, s	2.9			0			17			13		
HCM LOS							C			B		

Minor Lane/Major Mvmt	NBLn1	NBLn2	EBL	EBT	EBR	WBL	WBT	WBR	SBLn1	SBLn2	SBLn3
Capacity (veh/h)	334	511	1391	-	-	1440	-	-	492	477	921
HCM Lane V/C Ratio	0.159	0.017	0.061	-	-	0.001	-	-	0.353	0.023	0.188
HCM Control Delay (s)	17.8	12.2	7.8	-	-	7.5	-	-	16.3	12.7	9.8
HCM Lane LOS	C	B	A	-	-	A	-	-	C	B	A
HCM 95th %tile Q(veh)	0.6	0.1	0.2	-	-	0	-	-	1.6	0.1	0.7

Intersection												
Int Delay, s/veh	3.7											
Movement	EBL	EBT	EBR	WBL	WBT	WBR	NBL	NBT	NBR	SBL	SBT	SBR
Lane Configurations		↕			↕		↕	↕		↕	↕	
Traffic Vol, veh/h	12	0	91	36	0	4	25	99	11	2	202	8
Future Vol, veh/h	12	0	91	36	0	4	25	99	11	2	202	8
Conflicting Peds, #/hr	0	0	0	0	0	0	0	0	0	0	0	0
Sign Control	Stop	Stop	Stop	Stop	Stop	Stop	Free	Free	Free	Free	Free	Free
RT Channelized	-	-	None	-	-	None	-	-	None	-	-	None
Storage Length	-	-	-	-	-	-	150	-	-	150	-	-
Veh in Median Storage, #	-	0	-	-	0	-	-	0	-	-	0	-
Grade, %	-	0	-	-	0	-	-	0	-	-	0	-
Peak Hour Factor	92	92	92	92	92	92	92	92	92	92	92	92
Heavy Vehicles, %	2	2	2	2	2	2	2	2	2	2	2	2
Mvmt Flow	13	0	99	39	0	4	27	108	12	2	220	9

Major/Minor	Minor2		Minor1		Major1		Major2					
Conflicting Flow All	399	403	225	446	401	114	229	0	0	120	0	0
Stage 1	229	229	-	168	168	-	-	-	-	-	-	-
Stage 2	170	174	-	278	233	-	-	-	-	-	-	-
Critical Hdwy	7.12	6.52	6.22	7.12	6.52	6.22	4.12	-	-	4.12	-	-
Critical Hdwy Stg 1	6.12	5.52	-	6.12	5.52	-	-	-	-	-	-	-
Critical Hdwy Stg 2	6.12	5.52	-	6.12	5.52	-	-	-	-	-	-	-
Follow-up Hdwy	3.518	4.018	3.318	3.518	4.018	3.318	2.218	-	-	2.218	-	-
Pot Cap-1 Maneuver	561	536	814	523	538	939	1339	-	-	1468	-	-
Stage 1	774	715	-	834	759	-	-	-	-	-	-	-
Stage 2	832	755	-	728	712	-	-	-	-	-	-	-
Platoon blocked, %								-	-	-	-	-
Mov Cap-1 Maneuver	549	525	814	452	527	939	1339	-	-	1468	-	-
Mov Cap-2 Maneuver	549	525	-	452	527	-	-	-	-	-	-	-
Stage 1	759	714	-	817	744	-	-	-	-	-	-	-
Stage 2	811	740	-	639	711	-	-	-	-	-	-	-

Approach	EB		WB		NB		SB	
HCM Control Delay, s	10.5		13.3		1.4		0.1	
HCM LOS	B		B					

Minor Lane/Major Mvmt	NBL	NBT	NBR	EBLn1WBLn1	SBL	SBT	SBR
Capacity (veh/h)	1339	-	-	771	477	1468	-
HCM Lane V/C Ratio	0.02	-	-	0.145	0.091	0.001	-
HCM Control Delay (s)	7.7	-	-	10.5	13.3	7.5	-
HCM Lane LOS	A	-	-	B	B	A	-
HCM 95th %tile Q(veh)	0.1	-	-	0.5	0.3	0	-

Intersection	
Intersection Delay, s/veh	11.4
Intersection LOS	B

Movement	EBL	EBT	EBR	WBL	WBT	WBR	NBL	NBT	NBR	SBL	SBT	SBR
Lane Configurations	↶	↷		↶	↷		↶	↷		↶	↷	
Traffic Vol, veh/h	99	162	46	42	142	101	45	57	7	59	40	71
Future Vol, veh/h	99	162	46	42	142	101	45	57	7	59	40	71
Peak Hour Factor	0.92	0.92	0.92	0.92	0.92	0.92	0.92	0.92	0.92	0.86	0.86	0.86
Heavy Vehicles, %	2	2	2	2	2	2	2	2	2	2	2	2
Mvmt Flow	108	176	50	46	154	110	49	62	8	69	47	83
Number of Lanes	1	1	0	1	1	0	1	1	0	1	1	0

Approach	EB	WB	NB	SB
Opposing Approach	WB	EB	SB	NB
Opposing Lanes	2	2	2	2
Conflicting Approach Left	SB	NB	EB	WB
Conflicting Lanes Left	2	2	2	2
Conflicting Approach Right	NB	SB	WB	EB
Conflicting Lanes Right	2	2	2	2
HCM Control Delay	11.5	12.1	10.5	10.6
HCM LOS	B	B	B	B

Lane	NBLn1	NBLn2	EBLn1	EBLn2	WBLn1	WBLn2	SBLn1	SBLn2
Vol Left, %	100%	0%	100%	0%	100%	0%	100%	0%
Vol Thru, %	0%	89%	0%	78%	0%	58%	0%	36%
Vol Right, %	0%	11%	0%	22%	0%	42%	0%	64%
Sign Control	Stop	Stop	Stop	Stop	Stop	Stop	Stop	Stop
Traffic Vol by Lane	45	64	99	208	42	243	59	111
LT Vol	45	0	99	0	42	0	59	0
Through Vol	0	57	0	162	0	142	0	40
RT Vol	0	7	0	46	0	101	0	71
Lane Flow Rate	49	70	108	226	46	264	69	129
Geometry Grp	7	7	7	7	7	7	7	7
Degree of Util (X)	0.097	0.127	0.193	0.364	0.083	0.419	0.134	0.217
Departure Headway (Hd)	7.158	6.572	6.466	5.803	6.511	5.711	7.017	6.054
Convergence, Y/N	Yes	Yes	Yes	Yes	Yes	Yes	Yes	Yes
Cap	500	545	554	619	550	629	510	592
Service Time	4.912	4.325	4.212	3.549	4.257	3.455	4.765	3.802
HCM Lane V/C Ratio	0.098	0.128	0.195	0.365	0.084	0.42	0.135	0.218
HCM Control Delay	10.7	10.3	10.8	11.9	9.8	12.5	10.9	10.5
HCM Lane LOS	B	B	B	B	A	B	B	B
HCM 95th-tile Q	0.3	0.4	0.7	1.7	0.3	2.1	0.5	0.8

Intersection												
Int Delay, s/veh	7.7											
Movement	EBL	EBT	EBR	WBL	WBT	WBR	NBL	NBT	NBR	SBL	SBT	SBR
Lane Configurations												
Traffic Vol, veh/h	161	0	28	0	0	0	16	4	0	0	5	124
Future Vol, veh/h	161	0	28	0	0	0	16	4	0	0	5	124
Conflicting Peds, #/hr	0	0	0	0	0	0	0	0	0	0	0	0
Sign Control	Free	Free	Free	Free	Free	Free	Stop	Stop	Stop	Stop	Stop	Stop
RT Channelized	-	-	None	-	-	None	-	-	None	-	-	None
Storage Length	250	-	-	0	-	-	-	-	-	-	-	0
Veh in Median Storage, #	-	0	-	-	0	-	-	0	-	-	0	-
Grade, %	-	0	-	-	0	-	-	0	-	-	0	-
Peak Hour Factor	95	92	95	92	92	92	95	95	92	92	95	95
Heavy Vehicles, %	2	2	2	2	2	2	2	2	2	2	2	2
Mvmt Flow	169	0	29	0	0	0	17	4	0	0	5	131

Major/Minor	Major1			Major2			Minor1			Minor2		
Conflicting Flow All	1	0	0	29	0	0	422	354	15	356	368	1
Stage 1	-	-	-	-	-	-	353	353	-	1	1	-
Stage 2	-	-	-	-	-	-	69	1	-	355	367	-
Critical Hdwy	4.12	-	-	4.12	-	-	7.12	6.52	6.22	7.12	6.52	6.22
Critical Hdwy Stg 1	-	-	-	-	-	-	6.12	5.52	-	6.12	5.52	-
Critical Hdwy Stg 2	-	-	-	-	-	-	6.12	5.52	-	6.12	5.52	-
Follow-up Hdwy	2.218	-	-	2.218	-	-	3.518	4.018	3.318	3.518	4.018	3.318
Pot Cap-1 Maneuver	1622	-	-	1584	-	-	542	571	1065	599	561	1084
Stage 1	-	-	-	-	-	-	664	631	-	1022	895	-
Stage 2	-	-	-	-	-	-	941	895	-	662	622	-
Platoon blocked, %	-	-	-	-	-	-	-	-	-	-	-	-
Mov Cap-1 Maneuver	1622	-	-	1584	-	-	435	512	1065	548	503	1084
Mov Cap-2 Maneuver	-	-	-	-	-	-	435	512	-	548	503	-
Stage 1	-	-	-	-	-	-	595	565	-	916	895	-
Stage 2	-	-	-	-	-	-	823	895	-	589	557	-

Approach	EB	WB	NB	SB
HCM Control Delay, s	6.4	0	13.4	8.9
HCM LOS			B	A

Minor Lane/Major Mvmt	NBLn1	EBL	EBT	EBR	WBL	WBT	WBR	SBLn1	SBLn2
Capacity (veh/h)	448	1622	-	-	1584	-	-	503	1084
HCM Lane V/C Ratio	0.047	0.104	-	-	-	-	-	0.01	0.12
HCM Control Delay (s)	13.4	7.5	-	-	0	-	-	12.2	8.8
HCM Lane LOS	B	A	-	-	A	-	-	B	A
HCM 95th %tile Q(veh)	0.1	0.3	-	-	0	-	-	0	0.4

Intersection												
Int Delay, s/veh	40.7											
Movement	EBL	EBT	EBR	WBL	WBT	WBR	NBL	NBT	NBR	SBL	SBT	SBR
Lane Configurations		↕↔			↕↔	↕↔	↕↔	↕↔		↕↔	↕↔	
Traffic Vol, veh/h	48	114	65	10	212	181	101	128	16	75	99	40
Future Vol, veh/h	48	114	65	10	212	181	101	128	16	75	99	40
Conflicting Peds, #/hr	0	0	0	0	0	0	0	0	0	0	0	0
Sign Control	Stop	Stop	Stop	Stop	Stop	Stop	Free	Free	Free	Free	Free	Free
RT Channelized	-	-	None	-	-	None	-	-	None	-	-	None
Storage Length	-	-	-	-	-	160	150	-	-	150	-	-
Veh in Median Storage, #	-	0	-	-	0	-	-	0	-	-	0	-
Grade, %	-	0	-	-	0	-	-	0	-	-	0	-
Peak Hour Factor	86	92	92	90	92	90	92	92	92	96	96	96
Heavy Vehicles, %	2	2	2	2	2	2	2	2	2	2	2	2
Mvmt Flow	56	124	71	11	230	201	110	139	17	78	103	42

Major/Minor	Minor2		Minor1		Major1		Major2					
Conflicting Flow All	863	656	124	746	669	148	145	0	0	156	0	0
Stage 1	280	280	-	368	368	-	-	-	-	-	-	-
Stage 2	583	376	-	378	301	-	-	-	-	-	-	-
Critical Hdwy	7.12	6.52	6.22	7.12	6.52	6.22	4.12	-	-	4.12	-	-
Critical Hdwy Stg 1	6.12	5.52	-	6.12	5.52	-	-	-	-	-	-	-
Critical Hdwy Stg 2	6.12	5.52	-	6.12	5.52	-	-	-	-	-	-	-
Follow-up Hdwy	3.518	4.018	3.318	3.518	4.018	3.318	2.218	-	-	2.218	-	-
Pot Cap-1 Maneuver	275	385	927	330	379	899	1437	-	-	1424	-	-
Stage 1	727	679	-	652	621	-	-	-	-	-	-	-
Stage 2	498	616	-	644	665	-	-	-	-	-	-	-
Platoon blocked, %								-	-	-	-	-
Mov Cap-1 Maneuver	85	336	927	198	330	899	1437	-	-	1424	-	-
Mov Cap-2 Maneuver	85	336	-	198	330	-	-	-	-	-	-	-
Stage 1	671	642	-	602	573	-	-	-	-	-	-	-
Stage 2	213	569	-	454	628	-	-	-	-	-	-	-

Approach	EB		WB		NB		SB	
HCM Control Delay, s	135.7		28.6		3.2		2.7	
HCM LOS	F		D					

Minor Lane/Major Mvmt	NBL	NBT	NBR	EBLn1	WBLn1	WBLn2	SBL	SBT	SBR
Capacity (veh/h)	1437	-	-	227	320	899	1424	-	-
HCM Lane V/C Ratio	0.076	-	-	1.103	0.755	0.224	0.055	-	-
HCM Control Delay (s)	7.7	-	-	135.7	43.9	10.2	7.7	-	-
HCM Lane LOS	A	-	-	F	E	B	A	-	-
HCM 95th %tile Q(veh)	0.2	-	-	11.3	5.8	0.9	0.2	-	-

Intersection												
Int Delay, s/veh	7.3											
Movement	EBL	EBT	EBR	WBL	WBT	WBR	NBL	NBT	NBR	SBL	SBT	SBR
Lane Configurations	↖	↗		↖	↗	↖	↖	↗		↖	↗	↖
Traffic Vol, veh/h	167	110	44	11	175	167	45	8	4	112	6	109
Future Vol, veh/h	167	110	44	11	175	167	45	8	4	112	6	109
Conflicting Peds, #/hr	0	0	0	0	0	0	0	0	0	0	0	0
Sign Control	Free	Free	Free	Free	Free	Free	Stop	Stop	Stop	Stop	Stop	Stop
RT Channelized	-	-	None	-	-	None	-	-	None	-	-	None
Storage Length	210	-	-	320	-	190	0	-	-	205	-	205
Veh in Median Storage, #	-	0	-	-	0	-	-	0	-	-	0	-
Grade, %	-	0	-	-	0	-	-	0	-	-	0	-
Peak Hour Factor	92	96	96	100	100	92	94	92	94	92	92	92
Heavy Vehicles, %	2	2	2	2	2	2	2	2	2	2	2	2
Mvmt Flow	182	115	46	11	175	182	48	9	4	122	7	118

Major/Minor	Major1			Major2			Minor1			Minor2		
Conflicting Flow All	357	0	0	161	0	0	853	881	138	706	722	175
Stage 1	-	-	-	-	-	-	502	502	-	197	197	-
Stage 2	-	-	-	-	-	-	351	379	-	509	525	-
Critical Hdwy	4.12	-	-	4.12	-	-	7.12	6.52	6.22	7.12	6.52	6.22
Critical Hdwy Stg 1	-	-	-	-	-	-	6.12	5.52	-	6.12	5.52	-
Critical Hdwy Stg 2	-	-	-	-	-	-	6.12	5.52	-	6.12	5.52	-
Follow-up Hdwy	2.218	-	-	2.218	-	-	3.518	4.018	3.318	3.518	4.018	3.318
Pot Cap-1 Maneuver	1202	-	-	1418	-	-	279	285	910	351	353	868
Stage 1	-	-	-	-	-	-	552	542	-	805	738	-
Stage 2	-	-	-	-	-	-	666	615	-	547	529	-
Platoon blocked, %	-	-	-	-	-	-	-	-	-	-	-	-
Mov Cap-1 Maneuver	1202	-	-	1418	-	-	208	240	910	299	297	868
Mov Cap-2 Maneuver	-	-	-	-	-	-	208	240	-	299	297	-
Stage 1	-	-	-	-	-	-	469	460	-	683	732	-
Stage 2	-	-	-	-	-	-	566	610	-	453	449	-

Approach	EB			WB			NB			SB		
HCM Control Delay, s	4.5			0.2			25.1			17.5		
HCM LOS							D			C		

Minor Lane/Major Mvmt	NBLn1	NBLn2	EBL	EBT	EBR	WBL	WBT	WBR	SBLn1	SBLn2	SBLn3
Capacity (veh/h)	208	317	1202	-	-	1418	-	-	299	297	868
HCM Lane V/C Ratio	0.23	0.041	0.151	-	-	0.008	-	-	0.407	0.022	0.136
HCM Control Delay (s)	27.4	16.8	8.5	-	-	7.6	-	-	25.1	17.4	9.8
HCM Lane LOS	D	C	A	-	-	A	-	-	D	C	A
HCM 95th %tile Q(veh)	0.9	0.1	0.5	-	-	0	-	-	1.9	0.1	0.5

Intersection												
Int Delay, s/veh	3.4											
Movement	EBL	EBT	EBR	WBL	WBT	WBR	NBL	NBT	NBR	SBL	SBT	SBR
Lane Configurations		↔			↔		↗	↘		↗	↘	
Traffic Vol, veh/h	3	0	66	26	0	1	112	185	45	1	135	4
Future Vol, veh/h	3	0	66	26	0	1	112	185	45	1	135	4
Conflicting Peds, #/hr	0	0	0	0	0	0	0	0	0	0	0	0
Sign Control	Stop	Stop	Stop	Stop	Stop	Stop	Free	Free	Free	Free	Free	Free
RT Channelized	-	-	None	-	-	None	-	-	None	-	-	None
Storage Length	-	-	-	-	-	-	150	-	-	150	-	-
Veh in Median Storage, #	-	0	-	-	0	-	-	0	-	-	0	-
Grade, %	-	0	-	-	0	-	-	0	-	-	0	-
Peak Hour Factor	95	95	95	95	95	95	95	95	95	95	95	95
Heavy Vehicles, %	2	2	2	2	2	2	2	2	2	2	2	2
Mvmt Flow	3	0	69	27	0	1	118	195	47	1	142	4

Major/Minor	Minor2		Minor1		Major1		Major2					
Conflicting Flow All	601	624	144	636	603	219	146	0	0	242	0	0
Stage 1	146	146	-	455	455	-	-	-	-	-	-	-
Stage 2	455	478	-	181	148	-	-	-	-	-	-	-
Critical Hdwy	7.12	6.52	6.22	7.12	6.52	6.22	4.12	-	-	4.12	-	-
Critical Hdwy Stg 1	6.12	5.52	-	6.12	5.52	-	-	-	-	-	-	-
Critical Hdwy Stg 2	6.12	5.52	-	6.12	5.52	-	-	-	-	-	-	-
Follow-up Hdwy	3.518	4.018	3.318	3.518	4.018	3.318	2.218	-	-	2.218	-	-
Pot Cap-1 Maneuver	412	402	903	391	413	821	1436	-	-	1324	-	-
Stage 1	857	776	-	585	569	-	-	-	-	-	-	-
Stage 2	585	556	-	821	775	-	-	-	-	-	-	-
Platoon blocked, %								-	-	-	-	-
Mov Cap-1 Maneuver	385	369	903	338	379	821	1436	-	-	1324	-	-
Mov Cap-2 Maneuver	385	369	-	338	379	-	-	-	-	-	-	-
Stage 1	787	775	-	537	522	-	-	-	-	-	-	-
Stage 2	536	510	-	757	774	-	-	-	-	-	-	-

Approach	EB		WB		NB		SB	
HCM Control Delay, s	9.6		16.3		2.5		0.1	
HCM LOS	A		C					

Minor Lane/Major Mvmt	NBL	NBT	NBR	EBLn1WBLn1	SBL	SBT	SBR
Capacity (veh/h)	1436	-	-	853	346	1324	-
HCM Lane V/C Ratio	0.082	-	-	0.085	0.082	0.001	-
HCM Control Delay (s)	7.7	-	-	9.6	16.3	7.7	-
HCM Lane LOS	A	-	-	A	C	A	-
HCM 95th %tile Q(veh)	0.3	-	-	0.3	0.3	0	-



Intersection												
Int Delay, s/veh	12.3											
Movement	EBL	EBT	EBR	WBL	WBT	WBR	NBL	NBT	NBR	SBL	SBT	SBR
Lane Configurations	↶	↷		↶	↷		↶	↷		↶	↷	
Traffic Vol, veh/h	87	356	33	18	344	49	23	53	46	82	65	113
Future Vol, veh/h	87	356	33	18	344	49	23	53	46	82	65	113
Conflicting Peds, #/hr	0	0	0	0	0	0	0	0	0	0	0	0
Sign Control	Free	Free	Free	Free	Free	Free	Stop	Stop	Stop	Stop	Stop	Stop
RT Channelized	-	-	None	-	-	None	-	-	None	-	-	None
Storage Length	155	-	-	150	-	-	0	-	-	0	-	-
Veh in Median Storage, #	-	0	-	-	0	-	-	0	-	-	0	-
Grade, %	-	0	-	-	0	-	-	0	-	-	0	-
Peak Hour Factor	92	93	92	92	93	92	92	92	92	92	92	92
Heavy Vehicles, %	2	2	2	2	2	2	2	2	2	2	2	2
Mvmt Flow	95	383	36	20	370	53	25	58	50	89	71	123

Major/Minor	Major1			Major2			Minor1			Minor2		
Conflicting Flow All	423	0	0	419	0	0	1125	1054	401	1082	1046	397
Stage 1	-	-	-	-	-	-	591	591	-	437	437	-
Stage 2	-	-	-	-	-	-	534	463	-	645	609	-
Critical Hdwy	4.12	-	-	4.12	-	-	7.12	6.52	6.22	7.12	6.52	6.22
Critical Hdwy Stg 1	-	-	-	-	-	-	6.12	5.52	-	6.12	5.52	-
Critical Hdwy Stg 2	-	-	-	-	-	-	6.12	5.52	-	6.12	5.52	-
Follow-up Hdwy	2.218	-	-	2.218	-	-	3.518	4.018	3.318	3.518	4.018	3.318
Pot Cap-1 Maneuver	1136	-	-	1140	-	-	182	226	649	195	228	652
Stage 1	-	-	-	-	-	-	493	494	-	598	579	-
Stage 2	-	-	-	-	-	-	530	564	-	461	485	-
Platoon blocked, %	-	-	-	-	-	-	-	-	-	-	-	-
Mov Cap-1 Maneuver	1136	-	-	1140	-	-	100	203	649	130	205	652
Mov Cap-2 Maneuver	-	-	-	-	-	-	100	203	-	130	205	-
Stage 1	-	-	-	-	-	-	452	453	-	548	569	-
Stage 2	-	-	-	-	-	-	370	554	-	340	444	-

Approach	EB			WB			NB			SB		
HCM Control Delay, s	1.6			0.4			29.2			42.3		
HCM LOS							D			E		

Minor Lane/Major Mvmt	NBLn1	NBLn2	EBL	EBT	EBR	WBL	WBT	WBR	SBLn1	SBLn2
Capacity (veh/h)	100	298	1136	-	-	1140	-	-	130	363
HCM Lane V/C Ratio	0.25	0.361	0.083	-	-	0.017	-	-	0.686	0.533
HCM Control Delay (s)	52.6	23.8	8.5	-	-	8.2	-	-	78.4	25.7
HCM Lane LOS	F	C	A	-	-	A	-	-	F	D
HCM 95th %tile Q(veh)	0.9	1.6	0.3	-	-	0.1	-	-	3.8	3

Timings  
127: Eastonville Dr & Stapleton Dr

Short-Term Background + Phase 1 Traffic  
AM Peak Hour



Lane Group	EBL	EBT	WBL	WBT	WBR	NBL	NBT	SBL	SBT
Lane Configurations		↕		↕	↕	↕	↕	↕	↕
Traffic Volume (vph)	27	168	4	85	119	38	311	162	167
Future Volume (vph)	27	168	4	85	119	38	311	162	167
Turn Type	Perm	NA	Perm	NA	Perm	Perm	NA	Perm	NA
Protected Phases		4		8			2		6
Permitted Phases	4		8		8	2		6	
Detector Phase	4	4	8	8	8	2	2	6	6
Switch Phase									
Minimum Initial (s)	4.0	4.0	4.0	4.0	4.0	4.0	4.0	4.0	4.0
Minimum Split (s)	9.0	9.0	9.0	9.0	9.0	9.0	9.0	9.0	9.0
Total Split (s)	45.0	45.0	45.0	45.0	45.0	45.0	45.0	45.0	45.0
Total Split (%)	50.0%	50.0%	50.0%	50.0%	50.0%	50.0%	50.0%	50.0%	50.0%
Yellow Time (s)	3.0	3.0	3.0	3.0	3.0	3.0	3.0	3.0	3.0
All-Red Time (s)	2.0	2.0	2.0	2.0	2.0	2.0	2.0	2.0	2.0
Lost Time Adjust (s)		0.0		0.0	0.0	0.0	0.0	0.0	0.0
Total Lost Time (s)		5.0		5.0	5.0	5.0	5.0	5.0	5.0
Lead/Lag									
Lead-Lag Optimize?									
Recall Mode	None	None	None	None	None	None	None	None	None
Act Effct Green (s)		15.8		15.8	15.8	24.8	24.8	24.8	24.8
Actuated g/C Ratio		0.31		0.31	0.31	0.48	0.48	0.48	0.48
v/c Ratio		0.61		0.22	0.28	0.10	0.48	0.60	0.37
Control Delay		20.8		16.9	4.9	8.4	11.2	17.6	9.4
Queue Delay		0.0		0.0	0.0	0.0	0.0	0.0	0.0
Total Delay		20.8		16.9	4.9	8.4	11.2	17.6	9.4
LOS		C		B	A	A	B	B	A
Approach Delay		20.8		10.0			10.9		12.9
Approach LOS		C		B			B		B

Intersection Summary

Cycle Length: 90	
Actuated Cycle Length: 51.7	
Natural Cycle: 40	
Control Type: Actuated-Uncoordinated	
Maximum v/c Ratio: 0.61	
Intersection Signal Delay: 13.4	Intersection LOS: B
Intersection Capacity Utilization 60.8%	ICU Level of Service B
Analysis Period (min) 15	

Splits and Phases: 127: Eastonville Dr & Stapleton Dr

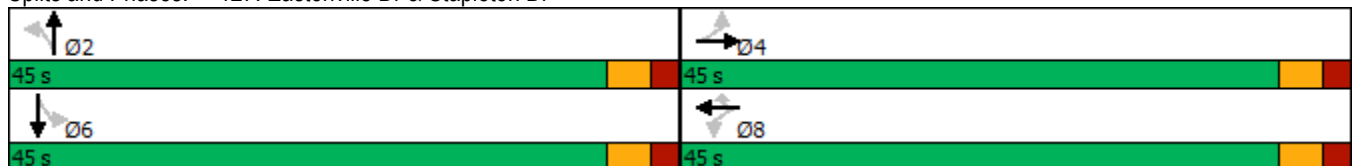



Intersection												
Int Delay, s/veh	7.7											
Movement	EBL	EBT	EBR	WBL	WBT	WBR	NBL	NBT	NBR	SBL	SBT	SBR
Lane Configurations	↖	↗		↖	↗		↖	↗		↖	↗	
Traffic Vol, veh/h	99	162	46	42	142	101	45	57	7	59	40	71
Future Vol, veh/h	99	162	46	42	142	101	45	57	7	59	40	71
Conflicting Peds, #/hr	0	0	0	0	0	0	0	0	0	0	0	0
Sign Control	Free	Free	Free	Free	Free	Free	Stop	Stop	Stop	Stop	Stop	Stop
RT Channelized	-	-	None	-	-	None	-	-	None	-	-	None
Storage Length	155	-	-	150	-	-	0	-	-	0	-	-
Veh in Median Storage, #	-	0	-	-	0	-	-	0	-	-	0	-
Grade, %	-	0	-	-	0	-	-	0	-	-	0	-
Peak Hour Factor	92	92	92	92	92	92	92	92	92	86	86	86
Heavy Vehicles, %	2	2	2	2	2	2	2	2	2	2	2	2
Mvmt Flow	108	176	50	46	154	110	49	62	8	69	47	83

Major/Minor	Major1			Major2			Minor1			Minor2		
Conflicting Flow All	264	0	0	226	0	0	783	773	201	753	743	209
Stage 1	-	-	-	-	-	-	417	417	-	301	301	-
Stage 2	-	-	-	-	-	-	366	356	-	452	442	-
Critical Hdwy	4.12	-	-	4.12	-	-	7.12	6.52	6.22	7.12	6.52	6.22
Critical Hdwy Stg 1	-	-	-	-	-	-	6.12	5.52	-	6.12	5.52	-
Critical Hdwy Stg 2	-	-	-	-	-	-	6.12	5.52	-	6.12	5.52	-
Follow-up Hdwy	2.218	-	-	2.218	-	-	3.518	4.018	3.318	3.518	4.018	3.318
Pot Cap-1 Maneuver	1300	-	-	1342	-	-	311	330	840	326	343	831
Stage 1	-	-	-	-	-	-	613	591	-	708	665	-
Stage 2	-	-	-	-	-	-	653	629	-	587	576	-
Platoon blocked, %	-	-	-	-	-	-	-	-	-	-	-	-
Mov Cap-1 Maneuver	1300	-	-	1342	-	-	226	292	840	247	304	831
Mov Cap-2 Maneuver	-	-	-	-	-	-	226	292	-	247	304	-
Stage 1	-	-	-	-	-	-	562	542	-	649	642	-
Stage 2	-	-	-	-	-	-	527	608	-	472	528	-

Approach	EB			WB			NB			SB		
HCM Control Delay, s	2.6			1.1			22			18.1		
HCM LOS							C			C		

Minor Lane/Major Mvmt	NBLn1	NBLn2	EBL	EBT	EBR	WBL	WBT	WBR	SBLn1	SBLn2
Capacity (veh/h)	226	314	1300	-	-	1342	-	-	247	511
HCM Lane V/C Ratio	0.216	0.222	0.083	-	-	0.034	-	-	0.278	0.253
HCM Control Delay (s)	25.3	19.7	8	-	-	7.8	-	-	25.1	14.4
HCM Lane LOS	D	C	A	-	-	A	-	-	D	B
HCM 95th %tile Q(veh)	0.8	0.8	0.3	-	-	0.1	-	-	1.1	1

Timings  
127: Eastonville Dr & Stapleton Dr

Short-Term Background + Phase 1 Traffic  
PM Peak Hour



Lane Group	EBL	EBT	WBL	WBT	WBR	NBL	NBT	SBL	SBT
Lane Configurations		↔		↕	↕	↕	↕	↕	↕
Traffic Volume (vph)	48	114	10	212	181	101	128	75	99
Future Volume (vph)	48	114	10	212	181	101	128	75	99
Turn Type	Perm	NA	Perm	NA	Perm	Perm	NA	Perm	NA
Protected Phases		4		8			2		6
Permitted Phases	4		8		8	2		6	
Detector Phase	4	4	8	8	8	2	2	6	6
Switch Phase									
Minimum Initial (s)	4.0	4.0	4.0	4.0	4.0	4.0	4.0	4.0	4.0
Minimum Split (s)	9.0	9.0	9.0	9.0	9.0	9.0	9.0	9.0	9.0
Total Split (s)	45.0	45.0	45.0	45.0	45.0	45.0	45.0	45.0	45.0
Total Split (%)	50.0%	50.0%	50.0%	50.0%	50.0%	50.0%	50.0%	50.0%	50.0%
Yellow Time (s)	3.0	3.0	3.0	3.0	3.0	3.0	3.0	3.0	3.0
All-Red Time (s)	2.0	2.0	2.0	2.0	2.0	2.0	2.0	2.0	2.0
Lost Time Adjust (s)		0.0		0.0	0.0	0.0	0.0	0.0	0.0
Total Lost Time (s)		5.0		5.0	5.0	5.0	5.0	5.0	5.0
Lead/Lag									
Lead-Lag Optimize?									
Recall Mode	None	None	None	None	None	None	None	None	None
Act Effect Green (s)		10.2		10.2	10.2	8.9	8.9	8.8	8.8
Actuated g/C Ratio		0.39		0.39	0.39	0.34	0.34	0.34	0.34
v/c Ratio		0.40		0.34	0.27	0.26	0.25	0.19	0.23
Control Delay		8.8		8.7	2.7	10.0	8.8	9.3	7.8
Queue Delay		0.0		0.0	0.0	0.0	0.0	0.0	0.0
Total Delay		8.8		8.7	2.7	10.0	8.8	9.3	7.8
LOS		A		A	A	B	A	A	A
Approach Delay		8.8		6.0			9.3		8.3
Approach LOS		A		A			A		A

Intersection Summary

Cycle Length: 90	
Actuated Cycle Length: 26	
Natural Cycle: 40	
Control Type: Actuated-Uncoordinated	
Maximum v/c Ratio: 0.40	
Intersection Signal Delay: 7.8	Intersection LOS: A
Intersection Capacity Utilization 54.2%	ICU Level of Service A
Analysis Period (min) 15	

Splits and Phases: 127: Eastonville Dr & Stapleton Dr

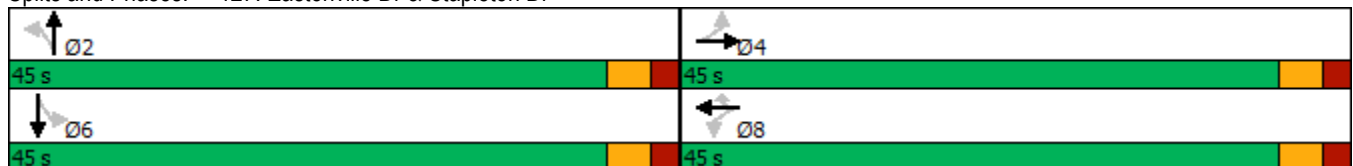



Intersection	
Intersection Delay, s/veh	26.1
Intersection LOS	D

Movement	EBL	EBT	EBR	WBL	WBT	WBR	NBL	NBT	NBR	SBL	SBT	SBR
Lane Configurations	↶	↷		↶	↷		↶	↷		↶	↷	
Traffic Vol, veh/h	87	356	38	22	344	49	35	59	54	82	69	113
Future Vol, veh/h	87	356	38	22	344	49	35	59	54	82	69	113
Peak Hour Factor	0.94	0.94	0.94	0.94	0.94	0.94	0.94	0.94	0.94	0.94	0.94	0.94
Heavy Vehicles, %	2	2	2	2	2	2	2	2	2	2	2	2
Mvmt Flow	93	379	40	23	366	52	37	63	57	87	73	120
Number of Lanes	1	1	0	1	1	0	1	1	0	1	1	0

Approach	EB	WB	NB	SB
Opposing Approach	WB	EB	SB	NB
Opposing Lanes	2	2	2	2
Conflicting Approach Left	SB	NB	EB	WB
Conflicting Lanes Left	2	2	2	2
Conflicting Approach Right	NB	SB	WB	EB
Conflicting Lanes Right	2	2	2	2
HCM Control Delay	30	33.5	13.3	14.7
HCM LOS	D	D	B	B

Lane	NBLn1	NBLn2	EBLn1	EBLn2	WBLn1	WBLn2	SBLn1	SBLn2
Vol Left, %	100%	0%	100%	0%	100%	0%	100%	0%
Vol Thru, %	0%	52%	0%	90%	0%	88%	0%	38%
Vol Right, %	0%	48%	0%	10%	0%	12%	0%	62%
Sign Control	Stop	Stop	Stop	Stop	Stop	Stop	Stop	Stop
Traffic Vol by Lane	35	113	87	394	22	393	82	182
LT Vol	35	0	87	0	22	0	82	0
Through Vol	0	59	0	356	0	344	0	69
RT Vol	0	54	0	38	0	49	0	113
Lane Flow Rate	37	120	93	419	23	418	87	194
Geometry Grp	7	7	7	7	7	7	7	7
Degree of Util (X)	0.091	0.266	0.195	0.815	0.05	0.821	0.205	0.403
Departure Headway (Hd)	8.829	7.964	7.579	6.998	7.67	7.068	8.465	7.5
Convergence, Y/N	Yes	Yes	Yes	Yes	Yes	Yes	Yes	Yes
Cap	404	450	472	516	466	510	423	478
Service Time	6.612	5.746	5.343	4.761	5.434	4.832	6.239	5.274
HCM Lane V/C Ratio	0.092	0.267	0.197	0.812	0.049	0.82	0.206	0.406
HCM Control Delay	12.5	13.6	12.2	33.9	10.8	34.8	13.4	15.3
HCM Lane LOS	B	B	B	D	B	D	B	C
HCM 95th-tile Q	0.3	1.1	0.7	7.9	0.2	8	0.8	1.9

Intersection												
Int Delay, s/veh	9.1											
Movement	EBL	EBT	EBR	WBL	WBT	WBR	NBL	NBT	NBR	SBL	SBT	SBR
Lane Configurations												
Traffic Vol, veh/h	131	0	7	0	0	0	22	9	0	0	4	267
Future Vol, veh/h	131	0	7	0	0	0	22	9	0	0	4	267
Conflicting Peds, #/hr	0	0	0	0	0	0	0	0	0	0	0	0
Sign Control	Free	Free	Free	Free	Free	Free	Stop	Stop	Stop	Stop	Stop	Stop
RT Channelized	-	-	None	-	-	None	-	-	None	-	-	None
Storage Length	250	-	-	0	-	-	-	-	-	-	-	0
Veh in Median Storage, #	-	0	-	-	0	-	-	0	-	-	0	-
Grade, %	-	0	-	-	0	-	-	0	-	-	0	-
Peak Hour Factor	92	92	92	92	92	92	92	92	92	92	92	92
Heavy Vehicles, %	2	2	2	2	2	2	2	2	2	2	2	2
Mvmt Flow	142	0	8	0	0	0	24	10	0	0	4	290

Major/Minor	Major1			Major2			Minor1			Minor2		
Conflicting Flow All	1	0	0	8	0	0	436	289	4	294	293	1
Stage 1	-	-	-	-	-	-	288	288	-	1	1	-
Stage 2	-	-	-	-	-	-	148	1	-	293	292	-
Critical Hdwy	4.12	-	-	4.12	-	-	7.12	6.52	6.22	7.12	6.52	6.22
Critical Hdwy Stg 1	-	-	-	-	-	-	6.12	5.52	-	6.12	5.52	-
Critical Hdwy Stg 2	-	-	-	-	-	-	6.12	5.52	-	6.12	5.52	-
Follow-up Hdwy	2.218	-	-	2.218	-	-	3.518	4.018	3.318	3.518	4.018	3.318
Pot Cap-1 Maneuver	1622	-	-	1612	-	-	531	621	1080	658	618	1084
Stage 1	-	-	-	-	-	-	720	674	-	1022	895	-
Stage 2	-	-	-	-	-	-	855	895	-	715	671	-
Platoon blocked, %	-	-	-	-	-	-	-	-	-	-	-	-
Mov Cap-1 Maneuver	1622	-	-	1612	-	-	361	566	1080	606	564	1084
Mov Cap-2 Maneuver	-	-	-	-	-	-	361	566	-	606	564	-
Stage 1	-	-	-	-	-	-	657	615	-	932	895	-
Stage 2	-	-	-	-	-	-	623	895	-	642	612	-

Approach	EB	WB	NB	SB
HCM Control Delay, s	7.1	0	14.7	9.5
HCM LOS			B	A

Minor Lane/Major Mvmt	NBLn1	EBL	EBT	EBR	WBL	WBT	WBR	SBLn1	SBLn2
Capacity (veh/h)	403	1622	-	-	1612	-	-	564	1084
HCM Lane V/C Ratio	0.084	0.088	-	-	-	-	-	0.008	0.268
HCM Control Delay (s)	14.7	7.4	-	-	0	-	-	11.4	9.5
HCM Lane LOS	B	A	-	-	A	-	-	B	A
HCM 95th %tile Q(veh)	0.3	0.3	-	-	0	-	-	0	1.1



Intersection												
Int Delay, s/veh	1.5											
Movement	EBL	EBT	EBR	WBL	WBT	WBR	NBL	NBT	NBR	SBL	SBT	SBR
Lane Configurations		↕↔			↕↔	↕↔	↕↔	↕↔		↕↔	↕↔	
Traffic Vol, veh/h	27	189	103	4	91	119	41	311	6	162	167	48
Future Vol, veh/h	27	189	103	4	91	119	41	311	6	162	167	48
Conflicting Peds, #/hr	0	0	0	0	0	0	0	0	0	0	0	0
Sign Control	Stop	Stop	Stop	Stop	Stop	Stop	Free	Free	Free	Free	Free	Free
RT Channelized	-	-	None	-	-	None	-	-	None	-	-	None
Storage Length	-	-	-	-	-	160	150	-	-	150	-	-
Veh in Median Storage, #	-	0	-	-	0	-	-	0	-	-	0	-
Grade, %	-	0	-	-	0	-	-	0	-	-	0	-
Peak Hour Factor	86	86	86	72	72	72	74	74	74	67	67	67
Heavy Vehicles, %	2	2	2	2	2	2	2	2	2	2	2	2
Mvmt Flow	31	220	120	6	126	165	55	420	8	242	249	72

Major/Minor	Minor2		Minor1		Major1		Major2					
Conflicting Flow All	1449	1307	285	1473	1339	424	321	0	0	428	0	0
Stage 1	769	769	-	534	534	-	-	-	-	-	-	-
Stage 2	680	538	-	939	805	-	-	-	-	-	-	-
Critical Hdwy	7.12	6.52	6.22	7.12	6.52	6.22	4.12	-	-	4.12	-	-
Critical Hdwy Stg 1	6.12	5.52	-	6.12	5.52	-	-	-	-	-	-	-
Critical Hdwy Stg 2	6.12	5.52	-	6.12	5.52	-	-	-	-	-	-	-
Follow-up Hdwy	3.518	4.018	3.318	3.518	4.018	3.318	2.218	-	-	2.218	-	-
Pot Cap-1 Maneuver	109	~ 160	754	105	153	630	1239	-	-	1131	-	-
Stage 1	394	411	-	530	524	-	-	-	-	-	-	-
Stage 2	441	522	-	317	395	-	-	-	-	-	-	-
Platoon blocked, %	-	-	-	-	-	-	-	-	-	-	-	-
Mov Cap-1 Maneuver	-	~ 120	754	-	~ 115	630	1239	-	-	1131	-	-
Mov Cap-2 Maneuver	-	~ 120	-	-	~ 115	-	-	-	-	-	-	-
Stage 1	377	323	-	507	501	-	-	-	-	-	-	-
Stage 2	232	499	-	67	310	-	-	-	-	-	-	-

Approach	EB		WB		NB		SB	
HCM Control Delay, s					0.9		3.9	
HCM LOS	-		-					

Minor Lane/Major Mvmt	NBL	NBT	NBR	EBLn1	WBLn1	WBLn2	SBL	SBT	SBR
Capacity (veh/h)	1239	-	-	-	-	-	630	1131	-
HCM Lane V/C Ratio	0.045	-	-	-	-	-	0.262	0.214	-
HCM Control Delay (s)	8	-	-	-	-	-	12.7	9	-
HCM Lane LOS	A	-	-	-	-	-	B	A	-
HCM 95th %tile Q(veh)	0.1	-	-	-	-	-	1	0.8	-

Notes  
 ~: Volume exceeds capacity    \$: Delay exceeds 300s    +: Computation Not Defined    \*: All major volume in platoon

Intersection												
Int Delay, s/veh	8.8											
Movement	EBL	EBT	EBR	WBL	WBT	WBR	NBL	NBT	NBR	SBL	SBT	SBR
Lane Configurations	↖	↗		↖	↗	↖	↖	↗		↖	↗	↖
Traffic Vol, veh/h	88	124	7	1	119	60	49	8	2	192	18	197
Future Vol, veh/h	88	124	7	1	119	60	49	8	2	192	18	197
Conflicting Peds, #/hr	0	0	0	0	0	0	0	0	0	0	0	0
Sign Control	Free	Free	Free	Free	Free	Free	Stop	Stop	Stop	Stop	Stop	Stop
RT Channelized	-	-	None	-	-	None	-	-	None	-	-	None
Storage Length	210	-	-	320	-	190	0	-	-	205	-	205
Veh in Median Storage, #	-	0	-	-	0	-	-	0	-	-	0	-
Grade, %	-	0	-	-	0	-	-	0	-	-	0	-
Peak Hour Factor	92	92	92	92	92	92	92	92	92	92	92	92
Heavy Vehicles, %	2	2	2	2	2	2	2	2	2	2	2	2
Mvmt Flow	96	135	8	1	129	65	53	9	2	209	20	214

Major/Minor	Major1		Major2		Minor1			Minor2				
Conflicting Flow All	194	0	0	143	0	0	612	527	139	468	466	129
Stage 1	-	-	-	-	-	-	331	331	-	131	131	-
Stage 2	-	-	-	-	-	-	281	196	-	337	335	-
Critical Hdwy	4.12	-	-	4.12	-	-	7.12	6.52	6.22	7.12	6.52	6.22
Critical Hdwy Stg 1	-	-	-	-	-	-	6.12	5.52	-	6.12	5.52	-
Critical Hdwy Stg 2	-	-	-	-	-	-	6.12	5.52	-	6.12	5.52	-
Follow-up Hdwy	2.218	-	-	2.218	-	-	3.518	4.018	3.318	3.518	4.018	3.318
Pot Cap-1 Maneuver	1379	-	-	1440	-	-	405	456	909	505	494	921
Stage 1	-	-	-	-	-	-	682	645	-	873	788	-
Stage 2	-	-	-	-	-	-	726	739	-	677	643	-
Platoon blocked, %	-	-	-	-	-	-	-	-	-	-	-	-
Mov Cap-1 Maneuver	1379	-	-	1440	-	-	285	424	909	469	459	921
Mov Cap-2 Maneuver	-	-	-	-	-	-	285	424	-	469	459	-
Stage 1	-	-	-	-	-	-	634	600	-	812	787	-
Stage 2	-	-	-	-	-	-	543	738	-	619	598	-

Approach	EB	WB	NB	SB
HCM Control Delay, s	3.1	0	19.2	14.3
HCM LOS			C	B

Minor Lane/Major Mvmt	NBLn1	NBLn2	EBL	EBT	EBR	WBL	WBT	WBR	SBLn1	SBLn2	SBLn3
Capacity (veh/h)	285	475	1379	-	-	1440	-	-	469	459	921
HCM Lane V/C Ratio	0.187	0.023	0.069	-	-	0.001	-	-	0.445	0.043	0.232
HCM Control Delay (s)	20.5	12.8	7.8	-	-	7.5	-	-	18.7	13.2	10.1
HCM Lane LOS	C	B	A	-	-	A	-	-	C	B	B
HCM 95th %tile Q(veh)	0.7	0.1	0.2	-	-	0	-	-	2.2	0.1	0.9

Intersection												
Int Delay, s/veh	3.4											
Movement	EBL	EBT	EBR	WBL	WBT	WBR	NBL	NBT	NBR	SBL	SBT	SBR
Lane Configurations		↕			↕		↕	↕		↕	↕	
Traffic Vol, veh/h	12	0	91	36	0	4	25	120	11	2	279	8
Future Vol, veh/h	12	0	91	36	0	4	25	120	11	2	279	8
Conflicting Peds, #/hr	0	0	0	0	0	0	0	0	0	0	0	0
Sign Control	Stop	Stop	Stop	Stop	Stop	Stop	Free	Free	Free	Free	Free	Free
RT Channelized	-	-	None	-	-	None	-	-	None	-	-	None
Storage Length	-	-	-	-	-	-	150	-	-	150	-	-
Veh in Median Storage, #	-	0	-	-	0	-	-	0	-	-	0	-
Grade, %	-	0	-	-	0	-	-	0	-	-	0	-
Peak Hour Factor	92	92	92	92	92	92	92	92	92	92	92	92
Heavy Vehicles, %	2	2	2	2	2	2	2	2	2	2	2	2
Mvmt Flow	13	0	99	39	0	4	27	130	12	2	303	9

Major/Minor	Minor2		Minor1		Major1		Major2					
Conflicting Flow All	504	508	308	551	506	136	312	0	0	142	0	0
Stage 1	312	312	-	190	190	-	-	-	-	-	-	-
Stage 2	192	196	-	361	316	-	-	-	-	-	-	-
Critical Hdwy	7.12	6.52	6.22	7.12	6.52	6.22	4.12	-	-	4.12	-	-
Critical Hdwy Stg 1	6.12	5.52	-	6.12	5.52	-	-	-	-	-	-	-
Critical Hdwy Stg 2	6.12	5.52	-	6.12	5.52	-	-	-	-	-	-	-
Follow-up Hdwy	3.518	4.018	3.318	3.518	4.018	3.318	2.218	-	-	2.218	-	-
Pot Cap-1 Maneuver	478	468	732	445	469	913	1248	-	-	1441	-	-
Stage 1	699	658	-	812	743	-	-	-	-	-	-	-
Stage 2	810	739	-	657	655	-	-	-	-	-	-	-
Platoon blocked, %								-	-	-	-	-
Mov Cap-1 Maneuver	467	457	732	378	458	913	1248	-	-	1441	-	-
Mov Cap-2 Maneuver	467	457	-	378	458	-	-	-	-	-	-	-
Stage 1	684	657	-	794	727	-	-	-	-	-	-	-
Stage 2	789	723	-	567	654	-	-	-	-	-	-	-

Approach	EB		WB		NB		SB	
HCM Control Delay, s	11.3		15		1.3		0.1	
HCM LOS	B		C					

Minor Lane/Major Mvmt	NBL	NBT	NBR	EBLn1WBLn1	SBL	SBT	SBR
Capacity (veh/h)	1248	-	-	687	402	1441	-
HCM Lane V/C Ratio	0.022	-	-	0.163	0.108	0.002	-
HCM Control Delay (s)	7.9	-	-	11.3	15	7.5	-
HCM Lane LOS	A	-	-	B	C	A	-
HCM 95th %tile Q(veh)	0.1	-	-	0.6	0.4	0	-

Intersection	
Intersection Delay, s/veh	11.7
Intersection LOS	B

Movement	EBL	EBT	EBR	WBL	WBT	WBR	NBL	NBT	NBR	SBL	SBT	SBR
Lane Configurations	↶	↷		↶	↷		↶	↷		↶	↷	
Traffic Vol, veh/h	99	162	64	44	142	101	54	59	9	59	41	71
Future Vol, veh/h	99	162	64	44	142	101	54	59	9	59	41	71
Peak Hour Factor	0.92	0.92	0.92	0.92	0.92	0.92	0.92	0.92	0.92	0.86	0.86	0.86
Heavy Vehicles, %	2	2	2	2	2	2	2	2	2	2	2	2
Mvmt Flow	108	176	70	48	154	110	59	64	10	69	48	83
Number of Lanes	1	1	0	1	1	0	1	1	0	1	1	0

Approach	EB	WB	NB	SB
Opposing Approach	WB	EB	SB	NB
Opposing Lanes	2	2	2	2
Conflicting Approach Left	SB	NB	EB	WB
Conflicting Lanes Left	2	2	2	2
Conflicting Approach Right	NB	SB	WB	EB
Conflicting Lanes Right	2	2	2	2
HCM Control Delay	11.9	12.4	10.7	10.8
HCM LOS	B	B	B	B

Lane	NBLn1	NBLn2	EBLn1	EBLn2	WBLn1	WBLn2	SBLn1	SBLn2
Vol Left, %	100%	0%	100%	0%	100%	0%	100%	0%
Vol Thru, %	0%	87%	0%	72%	0%	58%	0%	37%
Vol Right, %	0%	13%	0%	28%	0%	42%	0%	63%
Sign Control	Stop	Stop	Stop	Stop	Stop	Stop	Stop	Stop
Traffic Vol by Lane	54	68	99	226	44	243	59	112
LT Vol	54	0	99	0	44	0	59	0
Through Vol	0	59	0	162	0	142	0	41
RT Vol	0	9	0	64	0	101	0	71
Lane Flow Rate	59	74	108	246	48	264	69	130
Geometry Grp	7	7	7	7	7	7	7	7
Degree of Util (X)	0.118	0.136	0.196	0.398	0.088	0.426	0.136	0.223
Departure Headway (Hd)	7.231	6.628	6.542	5.834	6.608	5.806	7.114	6.154
Convergence, Y/N	Yes	Yes	Yes	Yes	Yes	Yes	Yes	Yes
Cap	494	539	548	614	541	618	503	581
Service Time	4.998	4.394	4.294	3.586	4.361	3.559	4.875	3.914
HCM Lane V/C Ratio	0.119	0.137	0.197	0.401	0.089	0.427	0.137	0.224
HCM Control Delay	11	10.4	10.9	12.4	10	12.8	11	10.7
HCM Lane LOS	B	B	B	B	A	B	B	B
HCM 95th-tile Q	0.4	0.5	0.7	1.9	0.3	2.1	0.5	0.8

Intersection												
Int Delay, s/veh	8.2											
Movement	EBL	EBT	EBR	WBL	WBT	WBR	NBL	NBT	NBR	SBL	SBT	SBR
Lane Configurations	↖	↗		↖	↗			↕			↖	↗
Traffic Vol, veh/h	255	0	28	0	0	0	16	4	0	0	5	180
Future Vol, veh/h	255	0	28	0	0	0	16	4	0	0	5	180
Conflicting Peds, #/hr	0	0	0	0	0	0	0	0	0	0	0	0
Sign Control	Free	Free	Free	Free	Free	Free	Stop	Stop	Stop	Stop	Stop	Stop
RT Channelized	-	-	None	-	-	None	-	-	None	-	-	None
Storage Length	250	-	-	0	-	-	-	-	-	-	-	0
Veh in Median Storage, #	-	0	-	-	0	-	-	0	-	-	0	-
Grade, %	-	0	-	-	0	-	-	0	-	-	0	-
Peak Hour Factor	95	92	95	92	92	92	95	95	92	92	95	95
Heavy Vehicles, %	2	2	2	2	2	2	2	2	2	2	2	2
Mvmt Flow	268	0	29	0	0	0	17	4	0	0	5	189

Major/Minor	Major1			Major2			Minor1			Minor2		
Conflicting Flow All	1	0	0	29	0	0	649	552	15	554	566	1
Stage 1	-	-	-	-	-	-	551	551	-	1	1	-
Stage 2	-	-	-	-	-	-	98	1	-	553	565	-
Critical Hdwy	4.12	-	-	4.12	-	-	7.12	6.52	6.22	7.12	6.52	6.22
Critical Hdwy Stg 1	-	-	-	-	-	-	6.12	5.52	-	6.12	5.52	-
Critical Hdwy Stg 2	-	-	-	-	-	-	6.12	5.52	-	6.12	5.52	-
Follow-up Hdwy	2.218	-	-	2.218	-	-	3.518	4.018	3.318	3.518	4.018	3.318
Pot Cap-1 Maneuver	1622	-	-	1584	-	-	383	442	1065	443	434	1084
Stage 1	-	-	-	-	-	-	519	515	-	1022	895	-
Stage 2	-	-	-	-	-	-	908	895	-	517	508	-
Platoon blocked, %	-	-	-	-	-	-	-	-	-	-	-	-
Mov Cap-1 Maneuver	1622	-	-	1584	-	-	273	369	1065	384	362	1084
Mov Cap-2 Maneuver	-	-	-	-	-	-	273	369	-	384	362	-
Stage 1	-	-	-	-	-	-	433	430	-	853	895	-
Stage 2	-	-	-	-	-	-	745	895	-	427	424	-

Approach	EB	WB	NB	SB
HCM Control Delay, s	6.9	0	18.5	9.2
HCM LOS			C	A

Minor Lane/Major Mvmt	NBLn1	EBL	EBT	EBR	WBL	WBT	WBR	SBLn1	SBLn2
Capacity (veh/h)	288	1622	-	-	1584	-	-	362	1084
HCM Lane V/C Ratio	0.073	0.165	-	-	-	-	-	0.015	0.175
HCM Control Delay (s)	18.5	7.7	-	-	0	-	-	15.1	9
HCM Lane LOS	C	A	-	-	A	-	-	C	A
HCM 95th %tile Q(veh)	0.2	0.6	-	-	0	-	-	0	0.6

Intersection												
Int Delay, s/veh	82.4											
Movement	EBL	EBT	EBR	WBL	WBT	WBR	NBL	NBT	NBR	SBL	SBT	SBR
Lane Configurations		↕			↕	↕	↕	↕		↕	↕	
Traffic Vol, veh/h	48	128	72	10	238	181	114	128	16	75	99	40
Future Vol, veh/h	48	128	72	10	238	181	114	128	16	75	99	40
Conflicting Peds, #/hr	0	0	0	0	0	0	0	0	0	0	0	0
Sign Control	Stop	Stop	Stop	Stop	Stop	Stop	Free	Free	Free	Free	Free	Free
RT Channelized	-	-	None	-	-	None	-	-	None	-	-	None
Storage Length	-	-	-	-	-	160	150	-	-	150	-	-
Veh in Median Storage, #	-	0	-	-	0	-	-	0	-	-	0	-
Grade, %	-	0	-	-	0	-	-	0	-	-	0	-
Peak Hour Factor	86	92	92	90	92	90	92	92	92	96	96	96
Heavy Vehicles, %	2	2	2	2	2	2	2	2	2	2	2	2
Mvmt Flow	56	139	78	11	259	201	124	139	17	78	103	42

Major/Minor	Minor2		Minor1		Major1		Major2					
Conflicting Flow All	906	684	124	785	697	148	145	0	0	156	0	0
Stage 1	280	280	-	396	396	-	-	-	-	-	-	-
Stage 2	626	404	-	389	301	-	-	-	-	-	-	-
Critical Hdwy	7.12	6.52	6.22	7.12	6.52	6.22	4.12	-	-	4.12	-	-
Critical Hdwy Stg 1	6.12	5.52	-	6.12	5.52	-	-	-	-	-	-	-
Critical Hdwy Stg 2	6.12	5.52	-	6.12	5.52	-	-	-	-	-	-	-
Follow-up Hdwy	3.518	4.018	3.318	3.518	4.018	3.318	2.218	-	-	2.218	-	-
Pot Cap-1 Maneuver	257	371	927	310	365	899	1437	-	-	1424	-	-
Stage 1	727	679	-	629	604	-	-	-	-	-	-	-
Stage 2	472	599	-	635	665	-	-	-	-	-	-	-
Platoon blocked, %								-	-	-	-	-
Mov Cap-1 Maneuver	57	321	927	170	315	899	1437	-	-	1424	-	-
Mov Cap-2 Maneuver	57	321	-	170	315	-	-	-	-	-	-	-
Stage 1	664	642	-	575	552	-	-	-	-	-	-	-
Stage 2	178	547	-	430	628	-	-	-	-	-	-	-

Approach	EB		WB		NB		SB	
HCM Control Delay, s	299		41.5		3.4		2.7	
HCM LOS	F		E					

Minor Lane/Major Mvmt	NBL	NBT	NBR	EBLn1	WBLn1	WBLn2	SBL	SBT	SBR
Capacity (veh/h)	1437	-	-	182	304	899	1424	-	-
HCM Lane V/C Ratio	0.086	-	-	1.501	0.888	0.224	0.055	-	-
HCM Control Delay (s)	7.7	-	-	299	64.8	10.2	7.7	-	-
HCM Lane LOS	A	-	-	F	F	B	A	-	-
HCM 95th %tile Q(veh)	0.3	-	-	17.3	8.1	0.9	0.2	-	-

Intersection												
Int Delay, s/veh	10.7											
Movement	EBL	EBT	EBR	WBL	WBT	WBR	NBL	NBT	NBR	SBL	SBT	SBR
Lane Configurations	↖	↗		↖	↗	↖	↖	↗		↖	↗	↖
Traffic Vol, veh/h	213	110	44	11	175	206	45	17	4	134	11	137
Future Vol, veh/h	213	110	44	11	175	206	45	17	4	134	11	137
Conflicting Peds, #/hr	0	0	0	0	0	0	0	0	0	0	0	0
Sign Control	Free	Free	Free	Free	Free	Free	Stop	Stop	Stop	Stop	Stop	Stop
RT Channelized	-	-	None	-	-	None	-	-	None	-	-	None
Storage Length	210	-	-	320	-	190	0	-	-	205	-	205
Veh in Median Storage, #	-	0	-	-	0	-	-	0	-	-	0	-
Grade, %	-	0	-	-	0	-	-	0	-	-	0	-
Peak Hour Factor	92	96	96	100	100	92	94	92	94	92	92	92
Heavy Vehicles, %	2	2	2	2	2	2	2	2	2	2	2	2
Mvmt Flow	232	115	46	11	175	224	48	18	4	146	12	149

Major/Minor	Major1			Major2			Minor1			Minor2		
Conflicting Flow All	399	0	0	161	0	0	992	1023	138	810	822	175
Stage 1	-	-	-	-	-	-	602	602	-	197	197	-
Stage 2	-	-	-	-	-	-	390	421	-	613	625	-
Critical Hdwy	4.12	-	-	4.12	-	-	7.12	6.52	6.22	7.12	6.52	6.22
Critical Hdwy Stg 1	-	-	-	-	-	-	6.12	5.52	-	6.12	5.52	-
Critical Hdwy Stg 2	-	-	-	-	-	-	6.12	5.52	-	6.12	5.52	-
Follow-up Hdwy	2.218	-	-	2.218	-	-	3.518	4.018	3.318	3.518	4.018	3.318
Pot Cap-1 Maneuver	1160	-	-	1418	-	-	225	236	910	298	309	868
Stage 1	-	-	-	-	-	-	486	489	-	805	738	-
Stage 2	-	-	-	-	-	-	634	589	-	480	477	-
Platoon blocked, %	-	-	-	-	-	-	-	-	-	-	-	-
Mov Cap-1 Maneuver	1160	-	-	1418	-	-	151	187	910	231	245	868
Mov Cap-2 Maneuver	-	-	-	-	-	-	151	187	-	231	245	-
Stage 1	-	-	-	-	-	-	389	391	-	644	732	-
Stage 2	-	-	-	-	-	-	513	584	-	364	382	-

Approach	EB			WB			NB			SB		
HCM Control Delay, s	5.2			0.2			34.3			26.5		
HCM LOS							D			D		

Minor Lane/Major Mvmt	NBLn1	NBLn2	EBL	EBT	EBR	WBL	WBT	WBR	SBLn1	SBLn2	SBLn3
Capacity (veh/h)	151	220	1160	-	-	1418	-	-	231	245	868
HCM Lane V/C Ratio	0.317	0.103	0.2	-	-	0.008	-	-	0.631	0.049	0.172
HCM Control Delay (s)	39.5	23.2	8.9	-	-	7.6	-	-	43.9	20.4	10
HCM Lane LOS	E	C	A	-	-	A	-	-	E	C	B
HCM 95th %tile Q(veh)	1.3	0.3	0.7	-	-	0	-	-	3.8	0.2	0.6

Intersection												
Int Delay, s/veh	2.9											
Movement	EBL	EBT	EBR	WBL	WBT	WBR	NBL	NBT	NBR	SBL	SBT	SBR
Lane Configurations		↕			↕		↕	↕		↕	↕	
Traffic Vol, veh/h	3	0	66	26	0	1	112	278	45	1	190	4
Future Vol, veh/h	3	0	66	26	0	1	112	278	45	1	190	4
Conflicting Peds, #/hr	0	0	0	0	0	0	0	0	0	0	0	0
Sign Control	Stop	Stop	Stop	Stop	Stop	Stop	Free	Free	Free	Free	Free	Free
RT Channelized	-	-	None	-	-	None	-	-	None	-	-	None
Storage Length	-	-	-	-	-	-	150	-	-	150	-	-
Veh in Median Storage, #	-	0	-	-	0	-	-	0	-	-	0	-
Grade, %	-	0	-	-	0	-	-	0	-	-	0	-
Peak Hour Factor	95	95	95	95	95	95	95	95	95	95	95	95
Heavy Vehicles, %	2	2	2	2	2	2	2	2	2	2	2	2
Mvmt Flow	3	0	69	27	0	1	118	293	47	1	200	4

Major/Minor	Minor2		Minor1		Major1		Major2					
Conflicting Flow All	757	780	202	792	759	317	204	0	0	340	0	0
Stage 1	204	204	-	553	553	-	-	-	-	-	-	-
Stage 2	553	576	-	239	206	-	-	-	-	-	-	-
Critical Hdwy	7.12	6.52	6.22	7.12	6.52	6.22	4.12	-	-	4.12	-	-
Critical Hdwy Stg 1	6.12	5.52	-	6.12	5.52	-	-	-	-	-	-	-
Critical Hdwy Stg 2	6.12	5.52	-	6.12	5.52	-	-	-	-	-	-	-
Follow-up Hdwy	3.518	4.018	3.318	3.518	4.018	3.318	2.218	-	-	2.218	-	-
Pot Cap-1 Maneuver	324	327	839	307	336	724	1368	-	-	1219	-	-
Stage 1	798	733	-	517	514	-	-	-	-	-	-	-
Stage 2	517	502	-	764	731	-	-	-	-	-	-	-
Platoon blocked, %								-	-	-	-	-
Mov Cap-1 Maneuver	302	299	839	263	307	724	1368	-	-	1219	-	-
Mov Cap-2 Maneuver	302	299	-	263	307	-	-	-	-	-	-	-
Stage 1	729	732	-	473	470	-	-	-	-	-	-	-
Stage 2	472	459	-	700	730	-	-	-	-	-	-	-

Approach	EB		WB		NB		SB	
HCM Control Delay, s	10.1		20		2		0	
HCM LOS	B		C					

Minor Lane/Major Mvmt	NBL	NBT	NBR	EBLn1	WBLn1	SBL	SBT	SBR
Capacity (veh/h)	1368	-	-	779	269	1219	-	-
HCM Lane V/C Ratio	0.086	-	-	0.093	0.106	0.001	-	-
HCM Control Delay (s)	7.9	-	-	10.1	20	8	-	-
HCM Lane LOS	A	-	-	B	C	A	-	-
HCM 95th %tile Q(veh)	0.3	-	-	0.3	0.4	0	-	-



Timings  
127: Eastonville Dr & Stapleton Dr

Short-Term Background + Phase 2 Traffic  
AM Peak Hour



Lane Group	EBL	EBT	WBL	WBT	WBR	NBL	NBT	SBL	SBT
Lane Configurations		↕		↕	↕	↕	↕	↕	↕
Traffic Volume (vph)	27	189	4	91	119	41	311	162	167
Future Volume (vph)	27	189	4	91	119	41	311	162	167
Turn Type	Perm	NA	Perm	NA	Perm	Perm	NA	Perm	NA
Protected Phases		4		8			2		6
Permitted Phases	4		8		8	2		6	
Detector Phase	4	4	8	8	8	2	2	6	6
Switch Phase									
Minimum Initial (s)	4.0	4.0	4.0	4.0	4.0	4.0	4.0	4.0	4.0
Minimum Split (s)	9.0	9.0	9.0	9.0	9.0	9.0	9.0	9.0	9.0
Total Split (s)	45.0	45.0	45.0	45.0	45.0	45.0	45.0	45.0	45.0
Total Split (%)	50.0%	50.0%	50.0%	50.0%	50.0%	50.0%	50.0%	50.0%	50.0%
Yellow Time (s)	3.0	3.0	3.0	3.0	3.0	3.0	3.0	3.0	3.0
All-Red Time (s)	2.0	2.0	2.0	2.0	2.0	2.0	2.0	2.0	2.0
Lost Time Adjust (s)		0.0		0.0	0.0	0.0	0.0	0.0	0.0
Total Lost Time (s)		5.0		5.0	5.0	5.0	5.0	5.0	5.0
Lead/Lag									
Lead-Lag Optimize?									
Recall Mode	None	None	None	None	None	None	None	None	None
Act Effect Green (s)		17.4		17.4	17.4	25.5	25.5	25.5	25.5
Actuated g/C Ratio		0.32		0.32	0.32	0.47	0.47	0.47	0.47
v/c Ratio		0.64		0.22	0.27	0.11	0.49	0.62	0.37
Control Delay		21.5		16.7	4.6	9.3	12.2	19.6	10.2
Queue Delay		0.0		0.0	0.0	0.0	0.0	0.0	0.0
Total Delay		21.5		16.7	4.6	9.3	12.2	19.6	10.2
LOS		C		B	A	A	B	B	B
Approach Delay		21.5		10.0			11.8		14.2
Approach LOS		C		B			B		B

Intersection Summary

Cycle Length: 90	
Actuated Cycle Length: 54	
Natural Cycle: 45	
Control Type: Actuated-Uncoordinated	
Maximum v/c Ratio: 0.64	
Intersection Signal Delay: 14.4	Intersection LOS: B
Intersection Capacity Utilization 62.6%	ICU Level of Service B
Analysis Period (min) 15	

Splits and Phases: 127: Eastonville Dr & Stapleton Dr

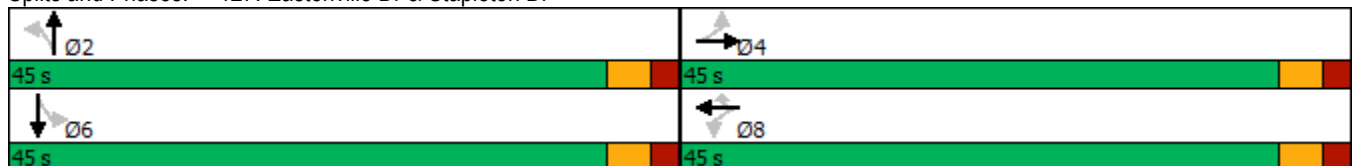

Timings  
127: Eastonville Dr & Stapleton Dr

Short-Term Background + Phase 2 Traffic  
PM Peak Hour



Lane Group	EBL	EBT	WBL	WBT	WBR	NBL	NBT	SBL	SBT
Lane Configurations		↔		↑	↑	↑	↑	↑	↑
Traffic Volume (vph)	48	128	10	238	181	114	128	75	99
Future Volume (vph)	48	128	10	238	181	114	128	75	99
Turn Type	Perm	NA	Perm	NA	Perm	Perm	NA	Perm	NA
Protected Phases		4		8			2		6
Permitted Phases	4		8		8	2		6	
Detector Phase	4	4	8	8	8	2	2	6	6
Switch Phase									
Minimum Initial (s)	4.0	4.0	4.0	4.0	4.0	4.0	4.0	4.0	4.0
Minimum Split (s)	9.0	9.0	9.0	9.0	9.0	9.0	9.0	9.0	9.0
Total Split (s)	45.0	45.0	45.0	45.0	45.0	45.0	45.0	45.0	45.0
Total Split (%)	50.0%	50.0%	50.0%	50.0%	50.0%	50.0%	50.0%	50.0%	50.0%
Yellow Time (s)	3.0	3.0	3.0	3.0	3.0	3.0	3.0	3.0	3.0
All-Red Time (s)	2.0	2.0	2.0	2.0	2.0	2.0	2.0	2.0	2.0
Lost Time Adjust (s)		0.0		0.0	0.0	0.0	0.0	0.0	0.0
Total Lost Time (s)		5.0		5.0	5.0	5.0	5.0	5.0	5.0
Lead/Lag									
Lead-Lag Optimize?									
Recall Mode	None	None	None	None	None	None	None	None	None
Act Effct Green (s)		13.4		13.4	13.4	9.7	9.7	9.5	9.5
Actuated g/C Ratio		0.49		0.49	0.49	0.35	0.35	0.35	0.35
v/c Ratio		0.35		0.30	0.23	0.28	0.24	0.18	0.23
Control Delay		8.5		8.6	2.5	10.6	9.0	9.5	8.0
Queue Delay		0.0		0.0	0.0	0.0	0.0	0.0	0.0
Total Delay		8.5		8.6	2.5	10.6	9.0	9.5	8.0
LOS		A		A	A	B	A	A	A
Approach Delay		8.5		6.0			9.7		8.5
Approach LOS		A		A			A		A

Intersection Summary

Cycle Length: 90  
 Actuated Cycle Length: 27.4  
 Natural Cycle: 40  
 Control Type: Actuated-Uncoordinated  
 Maximum v/c Ratio: 0.35  
 Intersection Signal Delay: 7.8  
 Intersection Capacity Utilization 57.5%  
 Analysis Period (min) 15

Intersection LOS: A  
 ICU Level of Service B

Splits and Phases: 127: Eastonville Dr & Stapleton Dr

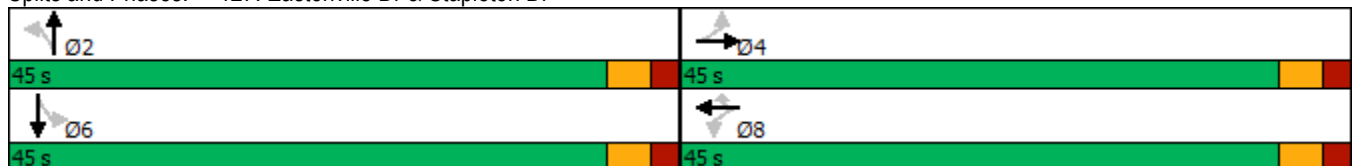

Intersection	
Intersection Delay, s/veh	21.6
Intersection LOS	C

Movement	EBL	EBT	EBR	WBL	WBT	WBR	NBL	NBT	NBR	SBL	SBT	SBR
Lane Configurations	↶	↷		↶	↷		↶	↷		↶	↷	
Traffic Vol, veh/h	87	348	31	2	333	49	18	41	5	82	55	113
Future Vol, veh/h	87	348	31	2	333	49	18	41	5	82	55	113
Peak Hour Factor	0.92	0.92	0.92	0.92	0.92	0.92	0.92	0.92	0.92	0.86	0.86	0.86
Heavy Vehicles, %	2	2	2	2	2	2	2	2	2	2	2	2
Mvmt Flow	95	378	34	2	362	53	20	45	5	95	64	131
Number of Lanes	1	1	0	1	1	0	1	1	0	1	1	0

Approach	EB	WB	NB	SB
Opposing Approach	WB	EB	SB	NB
Opposing Lanes	2	2	2	2
Conflicting Approach Left	SB	NB	EB	WB
Conflicting Lanes Left	2	2	2	2
Conflicting Approach Right	NB	SB	WB	EB
Conflicting Lanes Right	2	2	2	2
HCM Control Delay	23.2	27	11.7	13.5
HCM LOS	C	D	B	B

Lane	NBLn1	NBLn2	EBLn1	EBLn2	WBLn1	WBLn2	SBLn1	SBLn2
Vol Left, %	100%	0%	100%	0%	100%	0%	100%	0%
Vol Thru, %	0%	89%	0%	92%	0%	87%	0%	33%
Vol Right, %	0%	11%	0%	8%	0%	13%	0%	67%
Sign Control	Stop	Stop	Stop	Stop	Stop	Stop	Stop	Stop
Traffic Vol by Lane	18	46	87	379	2	382	82	168
LT Vol	18	0	87	0	2	0	82	0
Through Vol	0	41	0	348	0	333	0	55
RT Vol	0	5	0	31	0	49	0	113
Lane Flow Rate	20	50	95	412	2	415	95	195
Geometry Grp	7	7	7	7	7	7	7	7
Degree of Util (X)	0.047	0.111	0.186	0.746	0.004	0.758	0.21	0.377
Departure Headway (Hd)	8.569	7.973	7.089	6.521	7.176	6.574	7.935	6.939
Convergence, Y/N	Yes	Yes	Yes	Yes	Yes	Yes	Yes	Yes
Cap	418	449	510	560	499	552	453	518
Service Time	6.328	5.732	4.789	4.221	4.915	4.313	5.681	4.684
HCM Lane V/C Ratio	0.048	0.111	0.186	0.736	0.004	0.752	0.21	0.376
HCM Control Delay	11.8	11.7	11.4	25.9	9.9	27.1	12.8	13.8
HCM Lane LOS	B	B	B	D	A	D	B	B
HCM 95th-tile Q	0.1	0.4	0.7	6.4	0	6.7	0.8	1.7

Intersection												
Int Delay, s/veh	8.7											
Movement	EBL	EBT	EBR	WBL	WBT	WBR	NBL	NBT	NBR	SBL	SBT	SBR
Lane Configurations	↖	↗		↖	↗	↖	↖	↗	↖	↖	↗	↖
Traffic Vol, veh/h	135	310	11	9	157	66	25	70	31	41	35	145
Future Vol, veh/h	135	310	11	9	157	66	25	70	31	41	35	145
Conflicting Peds, #/hr	0	0	0	0	0	0	0	0	0	0	0	0
Sign Control	Free	Free	Free	Free	Free	Free	Stop	Stop	Stop	Stop	Stop	Stop
RT Channelized	-	-	None	-	-	None	-	-	None	-	-	None
Storage Length	200	-	-	200	-	200	0	-	0	285	-	0
Veh in Median Storage, #	-	0	-	-	0	-	-	0	-	-	0	-
Grade, %	-	0	-	-	0	-	-	0	-	-	0	-
Peak Hour Factor	75	92	92	92	92	75	92	92	92	75	92	75
Heavy Vehicles, %	2	2	2	2	2	2	2	2	2	2	2	2
Mvmt Flow	180	337	12	10	171	88	27	76	34	55	38	193

Major/Minor	Major1		Major2		Minor1			Minor2				
Conflicting Flow All	259	0	0	349	0	0	1054	982	343	949	900	171
Stage 1	-	-	-	-	-	-	703	703	-	191	191	-
Stage 2	-	-	-	-	-	-	351	279	-	758	709	-
Critical Hdwy	4.12	-	-	4.12	-	-	7.12	6.52	6.22	7.12	6.52	6.22
Critical Hdwy Stg 1	-	-	-	-	-	-	6.12	5.52	-	6.12	5.52	-
Critical Hdwy Stg 2	-	-	-	-	-	-	6.12	5.52	-	6.12	5.52	-
Follow-up Hdwy	2.218	-	-	2.218	-	-	3.518	4.018	3.318	3.518	4.018	3.318
Pot Cap-1 Maneuver	1306	-	-	1210	-	-	204	249	700	240	278	873
Stage 1	-	-	-	-	-	-	428	440	-	811	742	-
Stage 2	-	-	-	-	-	-	666	680	-	399	437	-
Platoon blocked, %	-	-	-	-	-	-	-	-	-	-	-	-
Mov Cap-1 Maneuver	1306	-	-	1210	-	-	124	213	700	148	238	873
Mov Cap-2 Maneuver	-	-	-	-	-	-	124	213	-	148	238	-
Stage 1	-	-	-	-	-	-	369	379	-	699	736	-
Stage 2	-	-	-	-	-	-	488	675	-	262	377	-

Approach	EB		WB		NB		SB	
HCM Control Delay, s	2.8		0.3		28.1		18.2	
HCM LOS					D		C	

Minor Lane/Major Mvmt	NBLn1	NBLn2	NBLn3	EBL	EBT	EBR	WBL	WBT	WBR	SBLn1	SBLn2	SBLn3
Capacity (veh/h)	124	213	700	1306	-	-	1210	-	-	148	238	873
HCM Lane V/C Ratio	0.219	0.357	0.048	0.138	-	-	0.008	-	-	0.369	0.16	0.221
HCM Control Delay (s)	42	31	10.4	8.2	-	-	8	-	-	42.9	23	10.3
HCM Lane LOS	E	D	B	A	-	-	A	-	-	E	C	B
HCM 95th %tile Q(veh)	0.8	1.5	0.2	0.5	-	-	0	-	-	1.6	0.6	0.8

Intersection						
Int Delay, s/veh	4.2					
Movement	EBL	EBT	WBT	WBR	SBL	SBR
Lane Configurations	↙	↑	↘		↙	↘
Traffic Vol, veh/h	63	90	136	5	2	130
Future Vol, veh/h	63	90	136	5	2	130
Conflicting Peds, #/hr	0	0	0	0	0	0
Sign Control	Free	Free	Free	Free	Stop	Stop
RT Channelized	-	None	-	None	-	None
Storage Length	250	-	-	-	250	0
Veh in Median Storage, #	-	0	0	-	0	-
Grade, %	-	0	0	-	0	-
Peak Hour Factor	92	92	92	92	92	92
Heavy Vehicles, %	2	2	2	2	2	2
Mvmt Flow	68	98	148	5	2	141

Major/Minor	Major1	Major2	Minor2		
Conflicting Flow All	153	0	-	0	385 151
Stage 1	-	-	-	-	151 -
Stage 2	-	-	-	-	234 -
Critical Hdwy	4.12	-	-	-	6.42 6.22
Critical Hdwy Stg 1	-	-	-	-	5.42 -
Critical Hdwy Stg 2	-	-	-	-	5.42 -
Follow-up Hdwy	2.218	-	-	-	3.518 3.318
Pot Cap-1 Maneuver	1428	-	-	-	618 895
Stage 1	-	-	-	-	877 -
Stage 2	-	-	-	-	805 -
Platoon blocked, %		-	-	-	
Mov Cap-1 Maneuver	1428	-	-	-	588 895
Mov Cap-2 Maneuver	-	-	-	-	588 -
Stage 1	-	-	-	-	835 -
Stage 2	-	-	-	-	805 -

Approach	EB	WB	SB
HCM Control Delay, s	3.1	0	9.8
HCM LOS			A

Minor Lane/Major Mvmt	EBL	EBT	WBT	WBR	SBLn1	SBLn2
Capacity (veh/h)	1428	-	-	-	588	895
HCM Lane V/C Ratio	0.048	-	-	-	0.004	0.158
HCM Control Delay (s)	7.6	-	-	-	11.1	9.8
HCM Lane LOS	A	-	-	-	B	A
HCM 95th %tile Q(veh)	0.2	-	-	-	0	0.6

Intersection												
Int Delay, s/veh	1.3											
Movement	EBL	EBT	EBR	WBL	WBT	WBR	NBL	NBT	NBR	SBL	SBT	SBR
Lane Configurations		↕			↕	↕	↕	↕		↕	↕	
Traffic Vol, veh/h	6	194	78	37	139	98	32	309	17	133	154	26
Future Vol, veh/h	6	194	78	37	139	98	32	309	17	133	154	26
Conflicting Peds, #/hr	0	0	0	0	0	0	0	0	0	0	0	0
Sign Control	Stop	Stop	Stop	Stop	Stop	Stop	Free	Free	Free	Free	Free	Free
RT Channelized	-	-	None	-	-	None	-	-	None	-	-	None
Storage Length	-	-	-	-	-	160	150	-	-	150	-	-
Veh in Median Storage, #	-	0	-	-	0	-	-	0	-	-	0	-
Grade, %	-	0	-	-	0	-	-	0	-	-	0	-
Peak Hour Factor	86	86	86	72	72	72	74	74	74	67	67	67
Heavy Vehicles, %	2	2	2	2	2	2	2	2	2	2	2	2
Mvmt Flow	7	226	91	51	193	136	43	418	23	199	230	39

Major/Minor	Minor2		Minor1		Major1		Major2					
Conflicting Flow All	1328	1175	250	1322	1183	430	269	0	0	441	0	0
Stage 1	648	648	-	516	516	-	-	-	-	-	-	-
Stage 2	680	527	-	806	667	-	-	-	-	-	-	-
Critical Hdwy	7.12	6.52	6.22	7.12	6.52	6.22	4.12	-	-	4.12	-	-
Critical Hdwy Stg 1	6.12	5.52	-	6.12	5.52	-	-	-	-	-	-	-
Critical Hdwy Stg 2	6.12	5.52	-	6.12	5.52	-	-	-	-	-	-	-
Follow-up Hdwy	3.518	4.018	3.318	3.518	4.018	3.318	2.218	-	-	2.218	-	-
Pot Cap-1 Maneuver	132	~ 192	789	133	~ 189	625	1295	-	-	1119	-	-
Stage 1	459	466	-	542	534	-	-	-	-	-	-	-
Stage 2	441	528	-	376	457	-	-	-	-	-	-	-
Platoon blocked, %								-	-	-	-	-
Mov Cap-1 Maneuver	-	~ 153	789	-	~ 150	625	1295	-	-	1119	-	-
Mov Cap-2 Maneuver	-	~ 153	-	-	~ 150	-	-	-	-	-	-	-
Stage 1	444	383	-	524	516	-	-	-	-	-	-	-
Stage 2	209	511	-	112	376	-	-	-	-	-	-	-

Approach	EB		WB		NB		SB	
HCM Control Delay, s					0.7		3.8	
HCM LOS	-		-					

Minor Lane/Major Mvmt	NBL	NBT	NBR	EBLn1	WBLn1	WBLn2	SBL	SBT	SBR
Capacity (veh/h)	1295	-	-	-	-	625	1119	-	-
HCM Lane V/C Ratio	0.033	-	-	-	-	0.218	0.177	-	-
HCM Control Delay (s)	7.9	-	-	-	-	12.4	8.9	-	-
HCM Lane LOS	A	-	-	-	-	B	A	-	-
HCM 95th %tile Q(veh)	0.1	-	-	-	-	0.8	0.6	-	-

Notes  
 ~: Volume exceeds capacity    \$: Delay exceeds 300s    +: Computation Not Defined    \*: All major volume in platoon

Intersection												
Int Delay, s/veh	7.1											
Movement	EBL	EBT	EBR	WBL	WBT	WBR	NBL	NBT	NBR	SBL	SBT	SBR
Lane Configurations	↖	↗		↖	↗	↖	↖	↗		↖	↗	↖
Traffic Vol, veh/h	95	144	7	1	143	53	49	5	2	132	5	129
Future Vol, veh/h	95	144	7	1	143	53	49	5	2	132	5	129
Conflicting Peds, #/hr	0	0	0	0	0	0	0	0	0	0	0	0
Sign Control	Free	Free	Free	Free	Free	Free	Stop	Stop	Stop	Stop	Stop	Stop
RT Channelized	-	-	None	-	-	None	-	-	None	-	-	None
Storage Length	210	-	-	320	-	190	0	-	-	205	-	205
Veh in Median Storage, #	-	0	-	-	0	-	-	0	-	-	0	-
Grade, %	-	0	-	-	0	-	-	0	-	-	0	-
Peak Hour Factor	92	92	92	92	92	92	92	92	92	92	92	92
Heavy Vehicles, %	2	2	2	2	2	2	2	2	2	2	2	2
Mvmt Flow	103	157	8	1	155	58	53	5	2	143	5	140

Major/Minor	Major1			Major2			Minor1			Minor2		
Conflicting Flow All	213	0	0	165	0	0	626	582	161	528	528	155
Stage 1	-	-	-	-	-	-	367	367	-	157	157	-
Stage 2	-	-	-	-	-	-	259	215	-	371	371	-
Critical Hdwy	4.12	-	-	4.12	-	-	7.12	6.52	6.22	7.12	6.52	6.22
Critical Hdwy Stg 1	-	-	-	-	-	-	6.12	5.52	-	6.12	5.52	-
Critical Hdwy Stg 2	-	-	-	-	-	-	6.12	5.52	-	6.12	5.52	-
Follow-up Hdwy	2.218	-	-	2.218	-	-	3.518	4.018	3.318	3.518	4.018	3.318
Pot Cap-1 Maneuver	1357	-	-	1413	-	-	397	425	884	461	456	891
Stage 1	-	-	-	-	-	-	653	622	-	845	768	-
Stage 2	-	-	-	-	-	-	746	725	-	649	620	-
Platoon blocked, %	-	-	-	-	-	-	-	-	-	-	-	-
Mov Cap-1 Maneuver	1357	-	-	1413	-	-	312	392	884	428	421	891
Mov Cap-2 Maneuver	-	-	-	-	-	-	312	392	-	428	421	-
Stage 1	-	-	-	-	-	-	603	575	-	781	767	-
Stage 2	-	-	-	-	-	-	624	724	-	593	573	-

Approach	EB			WB			NB			SB		
HCM Control Delay, s	3			0			18.2			13.7		
HCM LOS							C			B		

Minor Lane/Major Mvmt	NBLn1	NBLn2	EBL	EBT	EBR	WBL	WBT	WBR	SBLn1	SBLn2	SBLn3
Capacity (veh/h)	312	466	1357	-	-	1413	-	-	428	421	891
HCM Lane V/C Ratio	0.171	0.016	0.076	-	-	0.001	-	-	0.335	0.013	0.157
HCM Control Delay (s)	18.9	12.9	7.9	-	-	7.5	-	-	17.6	13.7	9.8
HCM Lane LOS	C	B	A	-	-	A	-	-	C	B	A
HCM 95th %tile Q(veh)	0.6	0.1	0.2	-	-	0	-	-	1.5	0	0.6

Intersection	
Intersection Delay, s/veh	11.2
Intersection LOS	B

Movement	EBL	EBT	EBR	WBL	WBT	WBR	NBL	NBT	NBR	SBL	SBT	SBR
Lane Configurations	↶	↷		↶	↷		↶	↷		↶	↷	
Traffic Vol, veh/h	99	159	34	37	143	101	40	54	3	59	36	71
Future Vol, veh/h	99	159	34	37	143	101	40	54	3	59	36	71
Peak Hour Factor	0.92	0.92	0.92	0.92	0.92	0.92	0.92	0.92	0.92	0.86	0.86	0.86
Heavy Vehicles, %	2	2	2	2	2	2	2	2	2	2	2	2
Mvmt Flow	108	173	37	40	155	110	43	59	3	69	42	83
Number of Lanes	1	1	0	1	1	0	1	1	0	1	1	0

Approach	EB	WB	NB	SB
Opposing Approach	WB	EB	SB	NB
Opposing Lanes	2	2	2	2
Conflicting Approach Left	SB	NB	EB	WB
Conflicting Lanes Left	2	2	2	2
Conflicting Approach Right	NB	SB	WB	EB
Conflicting Lanes Right	2	2	2	2
HCM Control Delay	11.1	12	10.3	10.4
HCM LOS	B	B	B	B

Lane	NBLn1	NBLn2	EBLn1	EBLn2	WBLn1	WBLn2	SBLn1	SBLn2
Vol Left, %	100%	0%	100%	0%	100%	0%	100%	0%
Vol Thru, %	0%	95%	0%	82%	0%	59%	0%	34%
Vol Right, %	0%	5%	0%	18%	0%	41%	0%	66%
Sign Control	Stop	Stop	Stop	Stop	Stop	Stop	Stop	Stop
Traffic Vol by Lane	40	57	99	193	37	244	59	107
LT Vol	40	0	99	0	37	0	59	0
Through Vol	0	54	0	159	0	143	0	36
RT Vol	0	3	0	34	0	101	0	71
Lane Flow Rate	43	62	108	210	40	265	69	124
Geometry Grp	7	7	7	7	7	7	7	7
Degree of Util (X)	0.085	0.112	0.191	0.335	0.072	0.414	0.132	0.205
Departure Headway (Hd)	7.075	6.529	6.383	5.753	6.416	5.617	6.92	5.941
Convergence, Y/N	Yes	Yes	Yes	Yes	Yes	Yes	Yes	Yes
Cap	506	548	563	625	559	642	518	603
Service Time	4.825	4.278	4.119	3.489	4.151	3.352	4.665	3.685
HCM Lane V/C Ratio	0.085	0.113	0.192	0.336	0.072	0.413	0.133	0.206
HCM Control Delay	10.5	10.1	10.6	11.4	9.7	12.3	10.7	10.2
HCM Lane LOS	B	B	B	B	A	B	B	B
HCM 95th-tile Q	0.3	0.4	0.7	1.5	0.2	2	0.5	0.8



**Intersection**

Int Delay, s/veh 2.1

Movement	EBL	EBT	EBR	WBL	WBT	WBR	NBL	NBT	NBR	SBL	SBT	SBR
Lane Configurations	↖	↗		↖	↗	↖	↖	↗	↖	↖	↗	↖
Traffic Vol, veh/h	13	137	19	35	261	21	15	7	21	12	9	9
Future Vol, veh/h	13	137	19	35	261	21	15	7	21	12	9	9
Conflicting Peds, #/hr	0	0	0	0	0	0	0	0	0	0	0	0
Sign Control	Free	Free	Free	Free	Free	Free	Stop	Stop	Stop	Stop	Stop	Stop
RT Channelized	-	-	None	-	-	None	-	-	None	-	-	None
Storage Length	200	-	-	200	-	200	0	-	0	285	-	0
Veh in Median Storage, #	-	0	-	-	0	-	-	0	-	-	0	-
Grade, %	-	0	-	-	0	-	-	0	-	-	0	-
Peak Hour Factor	100	100	92	92	76	76	92	92	92	100	92	100
Heavy Vehicles, %	2	2	2	2	2	2	2	2	2	2	2	2
Mvmt Flow	13	137	21	38	343	28	16	8	23	12	10	9

Major/Minor	Major1	Major2	Minor1	Minor2
Conflicting Flow All	371	0	0	158
Stage 1	-	-	-	-
Stage 2	-	-	-	-
Critical Hdwy	4.12	-	-	4.12
Critical Hdwy Stg 1	-	-	-	-
Critical Hdwy Stg 2	-	-	-	-
Follow-up Hdwy	2.218	-	-	2.218
Pot Cap-1 Maneuver	1188	-	-	1422
Stage 1	-	-	-	-
Stage 2	-	-	-	-
Platoon blocked, %	-	-	-	-
Mov Cap-1 Maneuver	1188	-	-	1422
Mov Cap-2 Maneuver	-	-	-	-
Stage 1	-	-	-	-
Stage 2	-	-	-	-

Approach	EB	WB	NB	SB
HCM Control Delay, s	0.6	0.7	12	13.3
HCM LOS			B	B

Minor Lane/Major Mvmt	NBLn1	NBLn2	NBLn3	EBL	EBT	EBR	WBL	WBT	WBR	SBLn1	SBLn2	SBLn3
Capacity (veh/h)	378	388	899	1188	-	-	1422	-	-	381	397	700
HCM Lane V/C Ratio	0.043	0.02	0.025	0.011	-	-	0.027	-	-	0.031	0.025	0.013
HCM Control Delay (s)	15	14.5	9.1	8.1	-	-	7.6	-	-	14.8	14.3	10.2
HCM Lane LOS	C	B	A	A	-	-	A	-	-	B	B	B
HCM 95th %tile Q(veh)	0.1	0.1	0.1	0	-	-	0.1	-	-	0.1	0.1	0

**Intersection**

Int Delay, s/veh 4.1

Movement	EBL	EBT	WBT	WBR	SBL	SBR
Lane Configurations						
Traffic Vol, veh/h	110	129	78	2	5	94
Future Vol, veh/h	110	129	78	2	5	94
Conflicting Peds, #/hr	0	0	0	0	0	0
Sign Control	Free	Free	Free	Free	Stop	Stop
RT Channelized	-	None	-	None	-	None
Storage Length	250	-	-	-	250	0
Veh in Median Storage, #	-	0	0	-	0	-
Grade, %	-	0	0	-	0	-
Peak Hour Factor	95	92	92	92	92	95
Heavy Vehicles, %	2	2	2	2	2	2
Mvmt Flow	116	140	85	2	5	99

Major/Minor	Major1	Major2	Minor2
Conflicting Flow All	87	0	0 458 86
Stage 1	-	-	- - 86 -
Stage 2	-	-	- - 372 -
Critical Hdwy	4.12	-	- - 6.42 6.22
Critical Hdwy Stg 1	-	-	- - 5.42 -
Critical Hdwy Stg 2	-	-	- - 5.42 -
Follow-up Hdwy	2.218	-	- - 3.518 3.318
Pot Cap-1 Maneuver	1509	-	- - 561 973
Stage 1	-	-	- - 937 -
Stage 2	-	-	- - 697 -
Platoon blocked, %	-	-	-
Mov Cap-1 Maneuver	1509	-	- - 518 973
Mov Cap-2 Maneuver	-	-	- - 518 -
Stage 1	-	-	- - 865 -
Stage 2	-	-	- - 697 -

Approach	EB	WB	SB
HCM Control Delay, s	3.4	0	9.3
HCM LOS			A

Minor Lane/Major Mvmt	EBL	EBT	WBT	WBR	SBLn1	SBLn2
Capacity (veh/h)	1509	-	-	-	518	973
HCM Lane V/C Ratio	0.077	-	-	-	0.01	0.102
HCM Control Delay (s)	7.6	-	-	-	12	9.1
HCM Lane LOS	A	-	-	-	B	A
HCM 95th %tile Q(veh)	0.2	-	-	-	0	0.3

Intersection												
Int Delay, s/veh	25.8											
Movement	EBL	EBT	EBR	WBL	WBT	WBR	NBL	NBT	NBR	SBL	SBT	SBR
Lane Configurations		↕			↕	↕	↕	↕		↕	↕	
Traffic Vol, veh/h	18	153	51	32	259	151	74	123	53	60	94	22
Future Vol, veh/h	18	153	51	32	259	151	74	123	53	60	94	22
Conflicting Peds, #/hr	0	0	0	0	0	0	0	0	0	0	0	0
Sign Control	Stop	Stop	Stop	Stop	Stop	Stop	Free	Free	Free	Free	Free	Free
RT Channelized	-	-	None	-	-	None	-	-	None	-	-	None
Storage Length	-	-	-	-	-	160	150	-	-	150	-	-
Veh in Median Storage, #	-	0	-	-	0	-	-	0	-	-	0	-
Grade, %	-	0	-	-	0	-	-	0	-	-	0	-
Peak Hour Factor	86	92	92	90	92	90	92	92	92	96	96	96
Heavy Vehicles, %	2	2	2	2	2	2	2	2	2	2	2	2
Mvmt Flow	21	166	55	36	282	168	80	134	58	63	98	23

Major/Minor	Minor2		Minor1		Major1			Major2				
Conflicting Flow All	784	588	110	669	570	163	121	0	0	192	0	0
Stage 1	236	236	-	323	323	-	-	-	-	-	-	-
Stage 2	548	352	-	346	247	-	-	-	-	-	-	-
Critical Hdwy	7.12	6.52	6.22	7.12	6.52	6.22	4.12	-	-	4.12	-	-
Critical Hdwy Stg 1	6.12	5.52	-	6.12	5.52	-	-	-	-	-	-	-
Critical Hdwy Stg 2	6.12	5.52	-	6.12	5.52	-	-	-	-	-	-	-
Follow-up Hdwy	3.518	4.018	3.318	3.518	4.018	3.318	2.218	-	-	2.218	-	-
Pot Cap-1 Maneuver	311	421	943	371	431	882	1467	-	-	1381	-	-
Stage 1	767	710	-	689	650	-	-	-	-	-	-	-
Stage 2	521	632	-	670	702	-	-	-	-	-	-	-
Platoon blocked, %								-	-	-	-	-
Mov Cap-1 Maneuver	97	380	943	214	389	882	1467	-	-	1381	-	-
Mov Cap-2 Maneuver	97	380	-	214	389	-	-	-	-	-	-	-
Stage 1	725	677	-	651	614	-	-	-	-	-	-	-
Stage 2	216	597	-	454	670	-	-	-	-	-	-	-

Approach	EB		WB		NB		SB	
HCM Control Delay, s	37.8		41.9		2.2		2.6	
HCM LOS	E		E					

Minor Lane/Major Mvmt	NBL	NBT	NBR	EBLn1	WBLn1	WBLn2	SBL	SBT	SBR
Capacity (veh/h)	1467	-	-	341	356	882	1381	-	-
HCM Lane V/C Ratio	0.055	-	-	0.712	0.891	0.19	0.045	-	-
HCM Control Delay (s)	7.6	-	-	37.8	58.8	10	7.7	-	-
HCM Lane LOS	A	-	-	E	F	B	A	-	-
HCM 95th %tile Q(veh)	0.2	-	-	5.2	8.7	0.7	0.1	-	-

Intersection												
Int Delay, s/veh	5.5											
Movement	EBL	EBT	EBR	WBL	WBT	WBR	NBL	NBT	NBR	SBL	SBT	SBR
Lane Configurations	↔	↔		↔	↔	↔	↔	↔		↔	↔	↔
Traffic Vol, veh/h	116	132	44	11	223	121	45	2	4	86	2	84
Future Vol, veh/h	116	132	44	11	223	121	45	2	4	86	2	84
Conflicting Peds, #/hr	0	0	0	0	0	0	0	0	0	0	0	0
Sign Control	Free	Free	Free	Free	Free	Free	Stop	Stop	Stop	Stop	Stop	Stop
RT Channelized	-	-	None	-	-	None	-	-	None	-	-	None
Storage Length	210	-	-	320	-	190	0	-	-	205	-	205
Veh in Median Storage, #	-	0	-	-	0	-	-	0	-	-	0	-
Grade, %	-	0	-	-	0	-	-	0	-	-	0	-
Peak Hour Factor	92	96	96	100	100	92	94	92	94	92	92	92
Heavy Vehicles, %	2	2	2	2	2	2	2	2	2	2	2	2
Mvmt Flow	126	138	46	11	223	132	48	2	4	93	2	91

Major/Minor	Major1			Major2			Minor1			Minor2		
Conflicting Flow All	355	0	0	184	0	0	771	790	161	661	681	223
Stage 1	-	-	-	-	-	-	413	413	-	245	245	-
Stage 2	-	-	-	-	-	-	358	377	-	416	436	-
Critical Hdwy	4.12	-	-	4.12	-	-	7.12	6.52	6.22	7.12	6.52	6.22
Critical Hdwy Stg 1	-	-	-	-	-	-	6.12	5.52	-	6.12	5.52	-
Critical Hdwy Stg 2	-	-	-	-	-	-	6.12	5.52	-	6.12	5.52	-
Follow-up Hdwy	2.218	-	-	2.218	-	-	3.518	4.018	3.318	3.518	4.018	3.318
Pot Cap-1 Maneuver	1204	-	-	1391	-	-	317	322	884	376	373	817
Stage 1	-	-	-	-	-	-	616	594	-	759	703	-
Stage 2	-	-	-	-	-	-	660	616	-	614	580	-
Platoon blocked, %	-	-	-	-	-	-	-	-	-	-	-	-
Mov Cap-1 Maneuver	1204	-	-	1391	-	-	256	286	884	340	331	817
Mov Cap-2 Maneuver	-	-	-	-	-	-	256	286	-	340	331	-
Stage 1	-	-	-	-	-	-	551	532	-	679	697	-
Stage 2	-	-	-	-	-	-	580	611	-	545	519	-

Approach	EB			WB			NB			SB		
HCM Control Delay, s	3.4			0.2			21.1			14.9		
HCM LOS							C			B		

Minor Lane/Major Mvmt	NBLn1	NBLn2	EBL	EBT	EBR	WBL	WBT	WBR	SBLn1	SBLn2	SBLn3
Capacity (veh/h)	256	518	1204	-	-	1391	-	-	340	331	817
HCM Lane V/C Ratio	0.187	0.012	0.105	-	-	0.008	-	-	0.275	0.007	0.112
HCM Control Delay (s)	22.3	12	8.3	-	-	7.6	-	-	19.6	15.9	10
HCM Lane LOS	C	B	A	-	-	A	-	-	C	C	B
HCM 95th %tile Q(veh)	0.7	0	0.4	-	-	0	-	-	1.1	0	0.4

Timings  
127: Eastonville Dr & Stapleton Dr

Intermediate-Term Background Traffic  
AM Peak Hour



Lane Group	EBL	EBT	WBL	WBT	WBR	NBL	NBT	SBL	SBT
Lane Configurations		↔		↑	↑	↑	↑	↑	↑
Traffic Volume (vph)	6	194	37	139	98	32	309	133	154
Future Volume (vph)	6	194	37	139	98	32	309	133	154
Turn Type	Perm	NA	Perm	NA	Perm	Perm	NA	Perm	NA
Protected Phases		4		8			2		6
Permitted Phases	4		8		8	2		6	
Detector Phase	4	4	8	8	8	2	2	6	6
Switch Phase									
Minimum Initial (s)	4.0	4.0	4.0	4.0	4.0	4.0	4.0	4.0	4.0
Minimum Split (s)	9.0	9.0	9.0	9.0	9.0	9.0	9.0	9.0	9.0
Total Split (s)	45.0	45.0	45.0	45.0	45.0	45.0	45.0	45.0	45.0
Total Split (%)	50.0%	50.0%	50.0%	50.0%	50.0%	50.0%	50.0%	50.0%	50.0%
Yellow Time (s)	3.0	3.0	3.0	3.0	3.0	3.0	3.0	3.0	3.0
All-Red Time (s)	2.0	2.0	2.0	2.0	2.0	2.0	2.0	2.0	2.0
Lost Time Adjust (s)		0.0		0.0	0.0	0.0	0.0	0.0	0.0
Total Lost Time (s)		5.0		5.0	5.0	5.0	5.0	5.0	5.0
Lead/Lag									
Lead-Lag Optimize?									
Recall Mode	None	None	None	None	None	None	None	None	None
Act Effect Green (s)		14.5		14.5	14.5	19.6	19.6	19.6	19.6
Actuated g/C Ratio		0.32		0.32	0.32	0.43	0.43	0.43	0.43
v/c Ratio		0.55		0.46	0.23	0.09	0.55	0.57	0.34
Control Delay		17.4		17.5	4.7	8.3	12.3	17.4	9.4
Queue Delay		0.0		0.0	0.0	0.0	0.0	0.0	0.0
Total Delay		17.4		17.5	4.7	8.3	12.3	17.4	9.4
LOS		B		B	A	A	B	B	A
Approach Delay		17.4		12.9			12.0		12.8
Approach LOS		B		B			B		B

Intersection Summary

Cycle Length: 90	
Actuated Cycle Length: 45.3	
Natural Cycle: 40	
Control Type: Actuated-Uncoordinated	
Maximum v/c Ratio: 0.57	
Intersection Signal Delay: 13.5	Intersection LOS: B
Intersection Capacity Utilization 65.4%	ICU Level of Service C
Analysis Period (min) 15	

Splits and Phases: 127: Eastonville Dr & Stapleton Dr

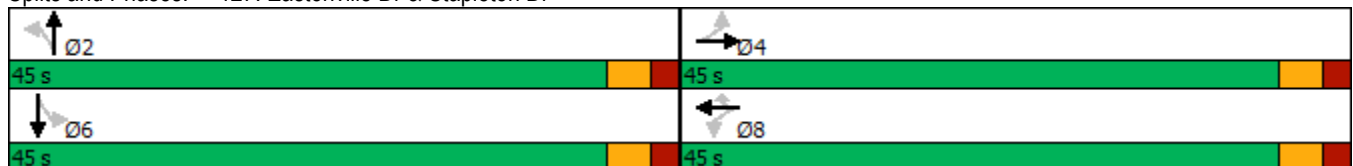

Timings  
127: Eastonville Dr & Stapleton Dr

Intermediate-Term Background Traffic  
PM Peak Hour



Lane Group	EBL	EBT	WBL	WBT	WBR	NBL	NBT	SBL	SBT
Lane Configurations		↔		↑	↑	↑	↑	↑	↑
Traffic Volume (vph)	18	153	32	259	151	74	123	60	94
Future Volume (vph)	18	153	32	259	151	74	123	60	94
Turn Type	Perm	NA	Perm	NA	Perm	Perm	NA	Perm	NA
Protected Phases		4		8			2		6
Permitted Phases	4		8		8	2		6	
Detector Phase	4	4	8	8	8	2	2	6	6
Switch Phase									
Minimum Initial (s)	4.0	4.0	4.0	4.0	4.0	4.0	4.0	4.0	4.0
Minimum Split (s)	9.0	9.0	9.0	9.0	9.0	9.0	9.0	9.0	9.0
Total Split (s)	45.0	45.0	45.0	45.0	45.0	45.0	45.0	45.0	45.0
Total Split (%)	50.0%	50.0%	50.0%	50.0%	50.0%	50.0%	50.0%	50.0%	50.0%
Yellow Time (s)	3.0	3.0	3.0	3.0	3.0	3.0	3.0	3.0	3.0
All-Red Time (s)	2.0	2.0	2.0	2.0	2.0	2.0	2.0	2.0	2.0
Lost Time Adjust (s)		0.0		0.0	0.0	0.0	0.0	0.0	0.0
Total Lost Time (s)		5.0		5.0	5.0	5.0	5.0	5.0	5.0
Lead/Lag									
Lead-Lag Optimize?									
Recall Mode	None	None	None	None	None	None	None	None	None
Act Effect Green (s)		14.2		14.2	14.2	9.4	9.4	9.2	9.2
Actuated g/C Ratio		0.51		0.51	0.51	0.34	0.34	0.33	0.33
v/c Ratio		0.28		0.36	0.19	0.19	0.31	0.16	0.20
Control Delay		7.4		8.6	2.3	10.3	9.4	10.1	8.9
Queue Delay		0.0		0.0	0.0	0.0	0.0	0.0	0.0
Total Delay		7.4		8.6	2.3	10.3	9.4	10.1	8.9
LOS		A		A	A	B	A	B	A
Approach Delay		7.4		6.4			9.7		9.3
Approach LOS		A		A			A		A

Intersection Summary

Cycle Length: 90	
Actuated Cycle Length: 28	
Natural Cycle: 40	
Control Type: Actuated-Uncoordinated	
Maximum v/c Ratio: 0.36	
Intersection Signal Delay: 7.8	Intersection LOS: A
Intersection Capacity Utilization 52.1%	ICU Level of Service A
Analysis Period (min) 15	

Splits and Phases: 127: Eastonville Dr & Stapleton Dr

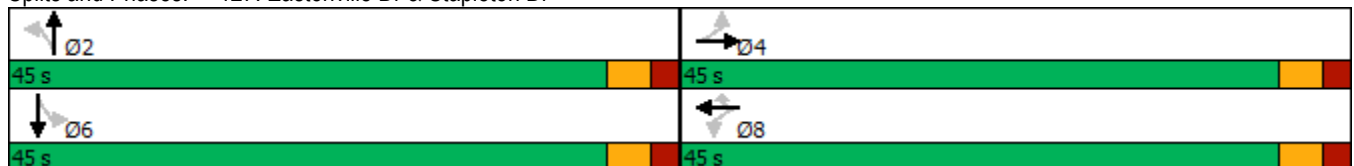

HCM 6th AWSC  
3: Londonderry Dr & Rainbow Bridge Dr

Intermediate-Term Total Traffic  
AM Peak Hour

Intersection	
Intersection Delay, s/veh	25.9
Intersection LOS	D

Movement	EBL	EBT	EBR	WBL	WBT	WBR	NBL	NBT	NBR	SBL	SBT	SBR
Lane Configurations	↰	↱		↰	↱		↰	↱		↰	↱	
Traffic Vol, veh/h	87	348	41	6	333	49	44	61	13	82	71	113
Future Vol, veh/h	87	348	41	6	333	49	44	61	13	82	71	113
Peak Hour Factor	0.92	0.92	0.92	0.92	0.92	0.92	0.92	0.92	0.92	0.86	0.86	0.86
Heavy Vehicles, %	2	2	2	2	2	2	2	2	2	2	2	2
Mvmt Flow	95	378	45	7	362	53	48	66	14	95	83	131
Number of Lanes	1	1	0	1	1	0	1	1	0	1	1	0

Approach	EB	WB	NB	SB
Opposing Approach	WB	EB	SB	NB
Opposing Lanes	2	2	2	2
Conflicting Approach Left	SB	NB	EB	WB
Conflicting Lanes Left	2	2	2	2
Conflicting Approach Right	NB	SB	WB	EB
Conflicting Lanes Right	2	2	2	2
HCM Control Delay	29.6	33.3	12.9	15.1
HCM LOS	D	D	B	C

Lane	NBLn1	NBLn2	EBLn1	EBLn2	WBLn1	WBLn2	SBLn1	SBLn2
Vol Left, %	100%	0%	100%	0%	100%	0%	100%	0%
Vol Thru, %	0%	82%	0%	89%	0%	87%	0%	39%
Vol Right, %	0%	18%	0%	11%	0%	13%	0%	61%
Sign Control	Stop	Stop	Stop	Stop	Stop	Stop	Stop	Stop
Traffic Vol by Lane	44	74	87	389	6	382	82	184
LT Vol	44	0	87	0	6	0	82	0
Through Vol	0	61	0	348	0	333	0	71
RT Vol	0	13	0	41	0	49	0	113
Lane Flow Rate	48	80	95	423	7	415	95	214
Geometry Grp	7	7	7	7	7	7	7	7
Degree of Util (X)	0.118	0.184	0.198	0.814	0.014	0.812	0.221	0.438
Departure Headway (Hd)	8.865	8.219	7.52	6.932	7.647	7.043	8.337	7.378
Convergence, Y/N	Yes	Yes	Yes	Yes	Yes	Yes	Yes	Yes
Cap	403	435	477	520	467	515	430	486
Service Time	6.647	6.001	5.281	4.693	5.409	4.804	6.105	5.146
HCM Lane V/C Ratio	0.119	0.184	0.199	0.813	0.015	0.806	0.221	0.44
HCM Control Delay	12.8	12.9	12.1	33.5	10.5	33.7	13.5	15.8
HCM Lane LOS	B	B	B	D	B	D	B	C
HCM 95th-tile Q	0.4	0.7	0.7	7.9	0	7.8	0.8	2.2

Intersection												
Int Delay, s/veh	10.2											
Movement	EBL	EBT	EBR	WBL	WBT	WBR	NBL	NBT	NBR	SBL	SBT	SBR
Lane Configurations	↖	↗		↖	↗	↖	↖	↗	↖	↖	↗	↖
Traffic Vol, veh/h	140	313	11	9	158	66	25	88	32	41	43	148
Future Vol, veh/h	140	313	11	9	158	66	25	88	32	41	43	148
Conflicting Peds, #/hr	0	0	0	0	0	0	0	0	0	0	0	0
Sign Control	Free	Free	Free	Free	Free	Free	Stop	Stop	Stop	Stop	Stop	Stop
RT Channelized	-	-	None	-	-	None	-	-	None	-	-	None
Storage Length	200	-	-	200	-	200	0	-	0	285	-	0
Veh in Median Storage, #	-	0	-	-	0	-	-	0	-	-	0	-
Grade, %	-	0	-	-	0	-	-	0	-	-	0	-
Peak Hour Factor	75	92	92	92	92	75	92	92	92	75	92	75
Heavy Vehicles, %	2	2	2	2	2	2	2	2	2	2	2	2
Mvmt Flow	187	340	12	10	172	88	27	96	35	55	47	197

Major/Minor	Major1			Major2			Minor1			Minor2		
Conflicting Flow All	260	0	0	352	0	0	1078	1000	346	978	918	172
Stage 1	-	-	-	-	-	-	720	720	-	192	192	-
Stage 2	-	-	-	-	-	-	358	280	-	786	726	-
Critical Hdwy	4.12	-	-	4.12	-	-	7.12	6.52	6.22	7.12	6.52	6.22
Critical Hdwy Stg 1	-	-	-	-	-	-	6.12	5.52	-	6.12	5.52	-
Critical Hdwy Stg 2	-	-	-	-	-	-	6.12	5.52	-	6.12	5.52	-
Follow-up Hdwy	2.218	-	-	2.218	-	-	3.518	4.018	3.318	3.518	4.018	3.318
Pot Cap-1 Maneuver	1304	-	-	1207	-	-	196	243	697	230	272	872
Stage 1	-	-	-	-	-	-	419	432	-	810	742	-
Stage 2	-	-	-	-	-	-	660	679	-	385	430	-
Platoon blocked, %	-	-	-	-	-	-	-	-	-	-	-	-
Mov Cap-1 Maneuver	1304	-	-	1207	-	-	114	207	697	125	231	872
Mov Cap-2 Maneuver	-	-	-	-	-	-	114	207	-	125	231	-
Stage 1	-	-	-	-	-	-	359	370	-	694	736	-
Stage 2	-	-	-	-	-	-	474	674	-	232	369	-

Approach	EB			WB			NB			SB		
HCM Control Delay, s	2.8			0.3			32.4			20.6		
HCM LOS							D			C		

Minor Lane/Major Mvmt	NBLn1	NBLn2	NBLn3	EBL	EBT	EBR	WBL	WBT	WBR	SBLn1	SBLn2	SBLn3
Capacity (veh/h)	114	207	697	1304	-	-	1207	-	-	125	231	872
HCM Lane V/C Ratio	0.238	0.462	0.05	0.143	-	-	0.008	-	-	0.437	0.202	0.226
HCM Control Delay (s)	46.2	36.5	10.4	8.2	-	-	8	-	-	54.5	24.5	10.3
HCM Lane LOS	E	E	B	A	-	-	A	-	-	F	C	B
HCM 95th %tile Q(veh)	0.9	2.2	0.2	0.5	-	-	0	-	-	1.9	0.7	0.9



Intersection												
Int Delay, s/veh	6.3											
Movement	EBL	EBT	EBR	WBL	WBT	WBR	NBL	NBT	NBR	SBL	SBT	SBR
Lane Configurations	↖	↗		↖	↗			↕			↖	↗
Traffic Vol, veh/h	95	100	6	2	141	7	22	6	4	7	3	240
Future Vol, veh/h	95	100	6	2	141	7	22	6	4	7	3	240
Conflicting Peds, #/hr	0	0	0	0	0	0	0	0	0	0	0	0
Sign Control	Free	Free	Free	Free	Free	Free	Stop	Stop	Stop	Stop	Stop	Stop
RT Channelized	-	-	None	-	-	None	-	-	None	-	-	None
Storage Length	250	-	-	0	-	-	-	-	-	-	-	0
Veh in Median Storage, #	-	0	-	-	0	-	-	0	-	-	0	-
Grade, %	-	0	-	-	0	-	-	0	-	-	0	-
Peak Hour Factor	92	92	92	92	92	92	92	92	92	92	92	92
Heavy Vehicles, %	2	2	2	2	2	2	2	2	2	2	2	2
Mvmt Flow	103	109	7	2	153	8	24	7	4	8	3	261

Major/Minor	Major1			Major2			Minor1			Minor2		
Conflicting Flow All	161	0	0	116	0	0	612	484	113	485	483	157
Stage 1	-	-	-	-	-	-	319	319	-	161	161	-
Stage 2	-	-	-	-	-	-	293	165	-	324	322	-
Critical Hdwy	4.12	-	-	4.12	-	-	7.12	6.52	6.22	7.12	6.52	6.22
Critical Hdwy Stg 1	-	-	-	-	-	-	6.12	5.52	-	6.12	5.52	-
Critical Hdwy Stg 2	-	-	-	-	-	-	6.12	5.52	-	6.12	5.52	-
Follow-up Hdwy	2.218	-	-	2.218	-	-	3.518	4.018	3.318	3.518	4.018	3.318
Pot Cap-1 Maneuver	1418	-	-	1473	-	-	405	483	940	492	483	889
Stage 1	-	-	-	-	-	-	693	653	-	841	765	-
Stage 2	-	-	-	-	-	-	715	762	-	688	651	-
Platoon blocked, %	-	-	-	-	-	-	-	-	-	-	-	-
Mov Cap-1 Maneuver	1418	-	-	1473	-	-	269	447	940	457	447	889
Mov Cap-2 Maneuver	-	-	-	-	-	-	269	447	-	457	447	-
Stage 1	-	-	-	-	-	-	642	605	-	780	764	-
Stage 2	-	-	-	-	-	-	502	761	-	628	603	-

Approach	EB			WB			NB			SB		
HCM Control Delay, s	3.7			0.1			17.5			10.8		
HCM LOS							C			B		

Minor Lane/Major Mvmt	NBLn1	EBL	EBT	EBR	WBL	WBT	WBR	SBLn1	SBLn2
Capacity (veh/h)	322	1418	-	-	1473	-	-	454	889
HCM Lane V/C Ratio	0.108	0.073	-	-	0.001	-	-	0.024	0.293
HCM Control Delay (s)	17.5	7.7	-	-	7.4	-	-	13.1	10.7
HCM Lane LOS	C	A	-	-	A	-	-	B	B
HCM 95th %tile Q(veh)	0.4	0.2	-	-	0	-	-	0.1	1.2

Intersection												
Int Delay, s/veh	1.2											
Movement	EBL	EBT	EBR	WBL	WBT	WBR	NBL	NBT	NBR	SBL	SBT	SBR
Lane Configurations		↕			↕	↕	↕	↕		↕	↕	
Traffic Vol, veh/h	6	260	123	37	157	98	45	309	17	133	154	26
Future Vol, veh/h	6	260	123	37	157	98	45	309	17	133	154	26
Conflicting Peds, #/hr	0	0	0	0	0	0	0	0	0	0	0	0
Sign Control	Stop	Stop	Stop	Stop	Stop	Stop	Free	Free	Free	Free	Free	Free
RT Channelized	-	-	None	-	-	None	-	-	None	-	-	None
Storage Length	-	-	-	-	-	160	150	-	-	150	-	-
Veh in Median Storage, #	-	0	-	-	0	-	-	0	-	-	0	-
Grade, %	-	0	-	-	0	-	-	0	-	-	0	-
Peak Hour Factor	86	86	86	72	72	72	74	74	74	67	67	67
Heavy Vehicles, %	2	2	2	2	2	2	2	2	2	2	2	2
Mvmt Flow	7	302	143	51	218	136	61	418	23	199	230	39

Major/Minor	Minor2		Minor1		Major1		Major2					
Conflicting Flow All	1377	1211	250	1422	1219	430	269	0	0	441	0	0
Stage 1	648	648	-	552	552	-	-	-	-	-	-	-
Stage 2	729	563	-	870	667	-	-	-	-	-	-	-
Critical Hdwy	7.12	6.52	6.22	7.12	6.52	6.22	4.12	-	-	4.12	-	-
Critical Hdwy Stg 1	6.12	5.52	-	6.12	5.52	-	-	-	-	-	-	-
Critical Hdwy Stg 2	6.12	5.52	-	6.12	5.52	-	-	-	-	-	-	-
Follow-up Hdwy	3.518	4.018	3.318	3.518	4.018	3.318	2.218	-	-	2.218	-	-
Pot Cap-1 Maneuver	122	~ 182	789	114	~ 180	625	1295	-	-	1119	-	-
Stage 1	459	466	-	518	515	-	-	-	-	-	-	-
Stage 2	414	509	-	346	457	-	-	-	-	-	-	-
Platoon blocked, %								-	-	-	-	-
Mov Cap-1 Maneuver	-	~ 143	789	-	~ 141	625	1295	-	-	1119	-	-
Mov Cap-2 Maneuver	-	~ 143	-	-	~ 141	-	-	-	-	-	-	-
Stage 1	437	383	-	494	491	-	-	-	-	-	-	-
Stage 2	172	485	-	~ 49	376	-	-	-	-	-	-	-

Approach	EB		WB		NB		SB	
HCM Control Delay, s					1		3.8	
HCM LOS	-		-					

Minor Lane/Major Mvmt	NBL	NBT	NBR	EBLn1	WBLn1	WBLn2	SBL	SBT	SBR
Capacity (veh/h)	1295	-	-	-	-	625	1119	-	-
HCM Lane V/C Ratio	0.047	-	-	-	-	0.218	0.177	-	-
HCM Control Delay (s)	7.9	-	-	-	-	12.4	8.9	-	-
HCM Lane LOS	A	-	-	-	-	B	A	-	-
HCM 95th %tile Q(veh)	0.1	-	-	-	-	0.8	0.6	-	-

Notes  
 ~: Volume exceeds capacity    \$: Delay exceeds 300s    +: Computation Not Defined    \*: All major volume in platoon

Intersection												
Int Delay, s/veh	14											
Movement	EBL	EBT	EBR	WBL	WBT	WBR	NBL	NBT	NBR	SBL	SBT	SBR
Lane Configurations	↖	↗		↖	↗	↖	↖	↗		↖	↗	↖
Traffic Vol, veh/h	133	144	7	1	143	84	49	9	2	244	18	263
Future Vol, veh/h	133	144	7	1	143	84	49	9	2	244	18	263
Conflicting Peds, #/hr	0	0	0	0	0	0	0	0	0	0	0	0
Sign Control	Free	Free	Free	Free	Free	Free	Stop	Stop	Stop	Stop	Stop	Stop
RT Channelized	-	-	None	-	-	None	-	-	None	-	-	None
Storage Length	210	-	-	320	-	190	0	-	-	205	-	205
Veh in Median Storage, #	-	0	-	-	0	-	-	0	-	-	0	-
Grade, %	-	0	-	-	0	-	-	0	-	-	0	-
Peak Hour Factor	92	92	92	92	92	92	92	92	92	92	92	92
Heavy Vehicles, %	2	2	2	2	2	2	2	2	2	2	2	2
Mvmt Flow	145	157	8	1	155	91	53	10	2	265	20	286

Major/Minor	Major1			Major2			Minor1			Minor2		
Conflicting Flow All	246	0	0	165	0	0	807	699	161	614	612	155
Stage 1	-	-	-	-	-	-	451	451	-	157	157	-
Stage 2	-	-	-	-	-	-	356	248	-	457	455	-
Critical Hdwy	4.12	-	-	4.12	-	-	7.12	6.52	6.22	7.12	6.52	6.22
Critical Hdwy Stg 1	-	-	-	-	-	-	6.12	5.52	-	6.12	5.52	-
Critical Hdwy Stg 2	-	-	-	-	-	-	6.12	5.52	-	6.12	5.52	-
Follow-up Hdwy	2.218	-	-	2.218	-	-	3.518	4.018	3.318	3.518	4.018	3.318
Pot Cap-1 Maneuver	1320	-	-	1413	-	-	300	364	884	404	408	891
Stage 1	-	-	-	-	-	-	588	571	-	845	768	-
Stage 2	-	-	-	-	-	-	661	701	-	583	569	-
Platoon blocked, %	-	-	-	-	-	-	-	-	-	-	-	-
Mov Cap-1 Maneuver	1320	-	-	1413	-	-	179	324	884	360	363	891
Mov Cap-2 Maneuver	-	-	-	-	-	-	179	324	-	360	363	-
Stage 1	-	-	-	-	-	-	523	508	-	752	767	-
Stage 2	-	-	-	-	-	-	437	700	-	508	506	-

Approach	EB			WB			NB			SB		
HCM Control Delay, s	3.8			0			30.1			23.8		
HCM LOS							D			C		

Minor Lane/Major Mvmt	NBLn1	NBLn2	EBL	EBT	EBR	WBL	WBT	WBR	SBLn1	SBLn2	SBLn3
Capacity (veh/h)	179	366	1320	-	-	1413	-	-	360	363	891
HCM Lane V/C Ratio	0.298	0.033	0.11	-	-	0.001	-	-	0.737	0.054	0.321
HCM Control Delay (s)	33.4	15.2	8.1	-	-	7.5	-	-	38.4	15.5	10.9
HCM Lane LOS	D	C	A	-	-	A	-	-	E	C	B
HCM 95th %tile Q(veh)	1.2	0.1	0.4	-	-	0	-	-	5.7	0.2	1.4

Intersection												
Int Delay, s/veh	2.9											
Movement	EBL	EBT	EBR	WBL	WBT	WBR	NBL	NBT	NBR	SBL	SBT	SBR
Lane Configurations		↕			↕		↗	↘		↗	↘	
Traffic Vol, veh/h	8	0	92	36	0	4	25	190	11	2	397	4
Future Vol, veh/h	8	0	92	36	0	4	25	190	11	2	397	4
Conflicting Peds, #/hr	0	0	0	0	0	0	0	0	0	0	0	0
Sign Control	Stop	Stop	Stop	Stop	Stop	Stop	Free	Free	Free	Free	Free	Free
RT Channelized	-	-	None	-	-	None	-	-	None	-	-	None
Storage Length	-	-	-	-	-	-	150	-	-	150	-	-
Veh in Median Storage, #	-	0	-	-	0	-	-	0	-	-	0	-
Grade, %	-	0	-	-	0	-	-	0	-	-	0	-
Peak Hour Factor	92	92	92	92	92	92	92	92	92	92	92	92
Heavy Vehicles, %	2	2	2	2	2	2	2	2	2	2	2	2
Mvmt Flow	9	0	100	39	0	4	27	207	12	2	432	4

Major/Minor	Minor2		Minor1		Major1			Major2				
Conflicting Flow All	707	711	434	755	707	213	436	0	0	219	0	0
Stage 1	438	438	-	267	267	-	-	-	-	-	-	-
Stage 2	269	273	-	488	440	-	-	-	-	-	-	-
Critical Hdwy	7.12	6.52	6.22	7.12	6.52	6.22	4.12	-	-	4.12	-	-
Critical Hdwy Stg 1	6.12	5.52	-	6.12	5.52	-	-	-	-	-	-	-
Critical Hdwy Stg 2	6.12	5.52	-	6.12	5.52	-	-	-	-	-	-	-
Follow-up Hdwy	3.518	4.018	3.318	3.518	4.018	3.318	2.218	-	-	2.218	-	-
Pot Cap-1 Maneuver	350	358	622	325	360	827	1124	-	-	1350	-	-
Stage 1	597	579	-	738	688	-	-	-	-	-	-	-
Stage 2	737	684	-	561	578	-	-	-	-	-	-	-
Platoon blocked, %								-	-	-	-	-
Mov Cap-1 Maneuver	341	349	622	267	351	827	1124	-	-	1350	-	-
Mov Cap-2 Maneuver	341	349	-	267	351	-	-	-	-	-	-	-
Stage 1	583	578	-	720	671	-	-	-	-	-	-	-
Stage 2	716	668	-	470	577	-	-	-	-	-	-	-

Approach	EB		WB		NB		SB	
HCM Control Delay, s	12.6		19.8		0.9		0	
HCM LOS	B		C					

Minor Lane/Major Mvmt	NBL	NBT	NBR	EBLn1WBLn1	SBL	SBT	SBR
Capacity (veh/h)	1124	-	-	584	286	1350	-
HCM Lane V/C Ratio	0.024	-	-	0.186	0.152	0.002	-
HCM Control Delay (s)	8.3	-	-	12.6	19.8	7.7	-
HCM Lane LOS	A	-	-	B	C	A	-
HCM 95th %tile Q(veh)	0.1	-	-	0.7	0.5	0	-

HCM 6th AWSC  
3: Londonderry Dr & Rainbow Bridge Dr

Intermediate-Term Total Traffic  
PM Peak Hour

Intersection	
Intersection Delay, s/veh	11.8
Intersection LOS	B

Movement	EBL	EBT	EBR	WBL	WBT	WBR	NBL	NBT	NBR	SBL	SBT	SBR
Lane Configurations	↶	↷		↶	↷		↶	↷		↶	↷	
Traffic Vol, veh/h	99	159	73	39	143	101	58	60	5	59	42	71
Future Vol, veh/h	99	159	73	39	143	101	58	60	5	59	42	71
Peak Hour Factor	0.92	0.92	0.92	0.92	0.92	0.92	0.92	0.92	0.92	0.86	0.86	0.86
Heavy Vehicles, %	2	2	2	2	2	2	2	2	2	2	2	2
Mvmt Flow	108	173	79	42	155	110	63	65	5	69	49	83
Number of Lanes	1	1	0	1	1	0	1	1	0	1	1	0

Approach	EB	WB	NB	SB
Opposing Approach	WB	EB	SB	NB
Opposing Lanes	2	2	2	2
Conflicting Approach Left	SB	NB	EB	WB
Conflicting Lanes Left	2	2	2	2
Conflicting Approach Right	NB	SB	WB	EB
Conflicting Lanes Right	2	2	2	2
HCM Control Delay	12.1	12.5	10.8	10.8
HCM LOS	B	B	B	B

Lane	NBLn1	NBLn2	EBLn1	EBLn2	WBLn1	WBLn2	SBLn1	SBLn2
Vol Left, %	100%	0%	100%	0%	100%	0%	100%	0%
Vol Thru, %	0%	92%	0%	69%	0%	59%	0%	37%
Vol Right, %	0%	8%	0%	31%	0%	41%	0%	63%
Sign Control	Stop	Stop	Stop	Stop	Stop	Stop	Stop	Stop
Traffic Vol by Lane	58	65	99	232	39	244	59	113
LT Vol	58	0	99	0	39	0	59	0
Through Vol	0	60	0	159	0	143	0	42
RT Vol	0	5	0	73	0	101	0	71
Lane Flow Rate	63	71	108	252	42	265	69	131
Geometry Grp	7	7	7	7	7	7	7	7
Degree of Util (X)	0.127	0.131	0.196	0.408	0.078	0.43	0.136	0.225
Departure Headway (Hd)	7.246	6.682	6.55	5.82	6.631	5.83	7.129	6.173
Convergence, Y/N	Yes	Yes	Yes	Yes	Yes	Yes	Yes	Yes
Cap	494	535	547	618	539	615	502	579
Service Time	5.011	4.446	4.3	3.57	4.382	3.581	4.889	3.933
HCM Lane V/C Ratio	0.128	0.133	0.197	0.408	0.078	0.431	0.137	0.226
HCM Control Delay	11.1	10.5	10.9	12.6	9.9	12.9	11	10.7
HCM Lane LOS	B	B	B	B	A	B	B	B
HCM 95th-tile Q	0.4	0.4	0.7	2	0.3	2.2	0.5	0.9

**Intersection**

Int Delay, s/veh 2.3

Movement	EBL	EBT	EBR	WBL	WBT	WBR	NBL	NBT	NBR	SBL	SBT	SBR
Lane Configurations	↖	↗		↖	↗	↖	↖	↗	↖	↖	↗	↖
Traffic Vol, veh/h	14	138	19	36	262	21	15	11	21	12	13	10
Future Vol, veh/h	14	138	19	36	262	21	15	11	21	12	13	10
Conflicting Peds, #/hr	0	0	0	0	0	0	0	0	0	0	0	0
Sign Control	Free	Free	Free	Free	Free	Free	Stop	Stop	Stop	Stop	Stop	Stop
RT Channelized	-	-	None	-	-	None	-	-	None	-	-	None
Storage Length	200	-	-	200	-	200	0	-	0	285	-	0
Veh in Median Storage, #	-	0	-	-	0	-	-	0	-	-	0	-
Grade, %	-	0	-	-	0	-	-	0	-	-	0	-
Peak Hour Factor	100	100	92	92	76	76	92	92	92	100	92	100
Heavy Vehicles, %	2	2	2	2	2	2	2	2	2	2	2	2
Mvmt Flow	14	138	21	39	345	28	16	12	23	12	14	10

Major/Minor	Major1	Major2	Minor1	Minor2
Conflicting Flow All	373	0	0	159
Stage 1	-	-	-	-
Stage 2	-	-	-	-
Critical Hdwy	4.12	-	-	4.12
Critical Hdwy Stg 1	-	-	-	-
Critical Hdwy Stg 2	-	-	-	-
Follow-up Hdwy	2.218	-	-	2.218
Pot Cap-1 Maneuver	1185	-	-	1420
Stage 1	-	-	-	-
Stage 2	-	-	-	-
Platoon blocked, %	-	-	-	-
Mov Cap-1 Maneuver	1185	-	-	1420
Mov Cap-2 Maneuver	-	-	-	-
Stage 1	-	-	-	-
Stage 2	-	-	-	-

Approach	EB	WB	NB	SB
HCM Control Delay, s	0.7	0.7	12.4	13.5
HCM LOS			B	B

Minor Lane/Major Mvmt	NBLn1	NBLn2	NBLn3	EBL	EBT	EBR	WBL	WBT	WBR	SBLn1	SBLn2	SBLn3
Capacity (veh/h)	369	384	898	1185	-	-	1420	-	-	371	393	698
HCM Lane V/C Ratio	0.044	0.031	0.025	0.012	-	-	0.028	-	-	0.032	0.036	0.014
HCM Control Delay (s)	15.2	14.7	9.1	8.1	-	-	7.6	-	-	15	14.5	10.2
HCM Lane LOS	C	B	A	A	-	-	A	-	-	C	B	B
HCM 95th %tile Q(veh)	0.1	0.1	0.1	0	-	-	0.1	-	-	0.1	0.1	0

Intersection												
Int Delay, s/veh	6.1											
Movement	EBL	EBT	EBR	WBL	WBT	WBR	NBL	NBT	NBR	SBL	SBT	SBR
Lane Configurations												
Traffic Vol, veh/h	244	131	28	1	81	3	17	3	1	6	4	172
Future Vol, veh/h	244	131	28	1	81	3	17	3	1	6	4	172
Conflicting Peds, #/hr	0	0	0	0	0	0	0	0	0	0	0	0
Sign Control	Free	Free	Free	Free	Free	Free	Stop	Stop	Stop	Stop	Stop	Stop
RT Channelized	-	-	None	-	-	None	-	-	None	-	-	None
Storage Length	250	-	-	0	-	-	-	-	-	-	-	0
Veh in Median Storage, #	-	0	-	-	0	-	-	0	-	-	0	-
Grade, %	-	0	-	-	0	-	-	0	-	-	0	-
Peak Hour Factor	95	92	95	92	92	92	95	95	92	92	95	95
Heavy Vehicles, %	2	2	2	2	2	2	2	2	2	2	2	2
Mvmt Flow	257	142	29	1	88	3	18	3	1	7	4	181

Major/Minor	Major1			Major2			Minor1			Minor2		
Conflicting Flow All	91	0	0	171	0	0	855	764	157	765	777	90
Stage 1	-	-	-	-	-	-	671	671	-	92	92	-
Stage 2	-	-	-	-	-	-	184	93	-	673	685	-
Critical Hdwy	4.12	-	-	4.12	-	-	7.12	6.52	6.22	7.12	6.52	6.22
Critical Hdwy Stg 1	-	-	-	-	-	-	6.12	5.52	-	6.12	5.52	-
Critical Hdwy Stg 2	-	-	-	-	-	-	6.12	5.52	-	6.12	5.52	-
Follow-up Hdwy	2.218	-	-	2.218	-	-	3.518	4.018	3.318	3.518	4.018	3.318
Pot Cap-1 Maneuver	1504	-	-	1406	-	-	278	334	889	320	328	968
Stage 1	-	-	-	-	-	-	446	455	-	915	819	-
Stage 2	-	-	-	-	-	-	818	818	-	445	448	-
Platoon blocked, %	-	-	-	-	-	-	-	-	-	-	-	-
Mov Cap-1 Maneuver	1504	-	-	1406	-	-	194	277	889	275	272	968
Mov Cap-2 Maneuver	-	-	-	-	-	-	194	277	-	275	272	-
Stage 1	-	-	-	-	-	-	370	377	-	759	818	-
Stage 2	-	-	-	-	-	-	661	817	-	365	371	-

Approach	EB			WB			NB			SB		
HCM Control Delay, s	4.7			0.1			24.1			10.1		
HCM LOS							C			B		

Minor Lane/Major Mvmt	NBLn1	EBL	EBT	EBR	WBL	WBT	WBR	SBLn1	SBLn2
Capacity (veh/h)	211	1504	-	-	1406	-	-	274	968
HCM Lane V/C Ratio	0.105	0.171	-	-	0.001	-	-	0.039	0.187
HCM Control Delay (s)	24.1	7.9	-	-	7.6	-	-	18.7	9.6
HCM Lane LOS	C	A	-	-	A	-	-	C	A
HCM 95th %tile Q(veh)	0.3	0.6	-	-	0	-	-	0.1	0.7

Intersection												
Int Delay, s/veh	84											
Movement	EBL	EBT	EBR	WBL	WBT	WBR	NBL	NBT	NBR	SBL	SBT	SBR
Lane Configurations		↕			↕	↕	↕	↕		↕	↕	
Traffic Vol, veh/h	18	199	82	32	341	151	130	123	53	60	94	22
Future Vol, veh/h	18	199	82	32	341	151	130	123	53	60	94	22
Conflicting Peds, #/hr	0	0	0	0	0	0	0	0	0	0	0	0
Sign Control	Stop	Stop	Stop	Stop	Stop	Stop	Free	Free	Free	Free	Free	Free
RT Channelized	-	-	None	-	-	None	-	-	None	-	-	None
Storage Length	-	-	-	-	-	160	150	-	-	150	-	-
Veh in Median Storage, #	-	0	-	-	0	-	-	0	-	-	0	-
Grade, %	-	0	-	-	0	-	-	0	-	-	0	-
Peak Hour Factor	86	92	92	90	92	90	92	92	92	96	96	96
Heavy Vehicles, %	2	2	2	2	2	2	2	2	2	2	2	2
Mvmt Flow	21	216	89	36	371	168	141	134	58	63	98	23

Major/Minor	Minor2		Minor1		Major1			Major2				
Conflicting Flow All	951	710	110	833	692	163	121	0	0	192	0	0
Stage 1	236	236	-	445	445	-	-	-	-	-	-	-
Stage 2	715	474	-	388	247	-	-	-	-	-	-	-
Critical Hdwy	7.12	6.52	6.22	7.12	6.52	6.22	4.12	-	-	4.12	-	-
Critical Hdwy Stg 1	6.12	5.52	-	6.12	5.52	-	-	-	-	-	-	-
Critical Hdwy Stg 2	6.12	5.52	-	6.12	5.52	-	-	-	-	-	-	-
Follow-up Hdwy	3.518	4.018	3.318	3.518	4.018	3.318	2.218	-	-	2.218	-	-
Pot Cap-1 Maneuver	240	359	943	288	~ 367	882	1467	-	-	1381	-	-
Stage 1	767	710	-	592	575	-	-	-	-	-	-	-
Stage 2	422	558	-	636	702	-	-	-	-	-	-	-
Platoon blocked, %	-	-	-	-	-	-	-	-	-	-	-	-
Mov Cap-1 Maneuver	-	309	943	103	~ 316	882	1467	-	-	1381	-	-
Mov Cap-2 Maneuver	-	309	-	103	~ 316	-	-	-	-	-	-	-
Stage 1	693	677	-	535	520	-	-	-	-	-	-	-
Stage 2	89	504	-	374	670	-	-	-	-	-	-	-

Approach	EB	WB	NB	SB
HCM Control Delay, s		204.5	3.3	2.6
HCM LOS	-	F		

Minor Lane/Major Mvmt	NBL	NBT	NBR	EBLn1	WBLn1	WBLn2	SBL	SBT	SBR
Capacity (veh/h)	1467	-	-	-	268	882	1381	-	-
HCM Lane V/C Ratio	0.096	-	-	-	1.516	0.19	0.045	-	-
HCM Control Delay (s)	7.7	-	-	-	284.9	10	7.7	-	-
HCM Lane LOS	A	-	-	-	F	B	A	-	-
HCM 95th %tile Q(veh)	0.3	-	-	-	23.7	0.7	0.1	-	-

Notes  
 ~: Volume exceeds capacity    \$: Delay exceeds 300s    +: Computation Not Defined    \*: All major volume in platoon



**Intersection**

Int Delay, s/veh 33.1

Movement	EBL	EBT	EBR	WBL	WBT	WBR	NBL	NBT	NBR	SBL	SBT	SBR
Lane Configurations	↖	↗		↖	↗	↖	↖	↗		↖	↗	↖
Traffic Vol, veh/h	279	132	44	11	223	260	45	18	4	163	11	185
Future Vol, veh/h	279	132	44	11	223	260	45	18	4	163	11	185
Conflicting Peds, #/hr	0	0	0	0	0	0	0	0	0	0	0	0
Sign Control	Free	Free	Free	Free	Free	Free	Stop	Stop	Stop	Stop	Stop	Stop
RT Channelized	-	-	None	-	-	None	-	-	None	-	-	None
Storage Length	210	-	-	320	-	190	0	-	-	205	-	205
Veh in Median Storage, #	-	0	-	-	0	-	-	0	-	-	0	-
Grade, %	-	0	-	-	0	-	-	0	-	-	0	-
Peak Hour Factor	92	96	96	100	100	92	94	92	94	92	92	92
Heavy Vehicles, %	2	2	2	2	2	2	2	2	2	2	2	2
Mvmt Flow	303	138	46	11	223	283	48	20	4	177	12	201

Major/Minor	Major1	Major2	Minor1	Minor2
Conflicting Flow All	506	0	0	184
Stage 1	-	-	-	-
Stage 2	-	-	-	-
Critical Hdwy	4.12	-	-	4.12
Critical Hdwy Stg 1	-	-	-	-
Critical Hdwy Stg 2	-	-	-	-
Follow-up Hdwy	2.218	-	-	2.218
Pot Cap-1 Maneuver	1059	-	-	1391
Stage 1	-	-	-	-
Stage 2	-	-	-	-
Platoon blocked, %	-	-	-	-
Mov Cap-1 Maneuver	1059	-	-	1391
Mov Cap-2 Maneuver	-	-	-	-
Stage 1	-	-	-	-
Stage 2	-	-	-	-

Approach	EB	WB	NB	SB
HCM Control Delay, s	6.1	0.2	79	102
HCM LOS			F	F

Minor Lane/Major Mvmt	NBLn1	NBLn2	EBL	EBT	EBR	WBL	WBT	WBR	SBLn1	SBLn2	SBLn3
Capacity (veh/h)	81	136	1059	-	-	1391	-	-	144	164	817
HCM Lane V/C Ratio	0.591	0.175	0.286	-	-	0.008	-	-	1.23	0.073	0.246
HCM Control Delay (s)	99.9	37	9.8	-	-	7.6	-	-	210.4	28.7	10.8
HCM Lane LOS	F	E	A	-	-	A	-	-	F	D	B
HCM 95th %tile Q(veh)	2.6	0.6	1.2	-	-	0	-	-	10.5	0.2	1

**Notes**

~: Volume exceeds capacity    \$: Delay exceeds 300s    +: Computation Not Defined    \*: All major volume in platoon

Intersection												
Int Delay, s/veh	2.5											
Movement	EBL	EBT	EBR	WBL	WBT	WBR	NBL	NBT	NBR	SBL	SBT	SBR
Lane Configurations		↕			↕		↕	↕		↕	↕	
Traffic Vol, veh/h	2	0	67	25	0	1	112	400	45	1	266	2
Future Vol, veh/h	2	0	67	25	0	1	112	400	45	1	266	2
Conflicting Peds, #/hr	0	0	0	0	0	0	0	0	0	0	0	0
Sign Control	Stop	Stop	Stop	Stop	Stop	Stop	Free	Free	Free	Free	Free	Free
RT Channelized	-	-	None	-	-	None	-	-	None	-	-	None
Storage Length	-	-	-	-	-	-	150	-	-	150	-	-
Veh in Median Storage, #	-	0	-	-	0	-	-	0	-	-	0	-
Grade, %	-	0	-	-	0	-	-	0	-	-	0	-
Peak Hour Factor	95	95	95	95	95	95	95	95	95	95	95	95
Heavy Vehicles, %	2	2	2	2	2	2	2	2	2	2	2	2
Mvmt Flow	2	0	71	26	0	1	118	421	47	1	280	2

Major/Minor	Minor2		Minor1		Major1		Major2					
Conflicting Flow All	964	987	281	1000	965	445	282	0	0	468	0	0
Stage 1	283	283	-	681	681	-	-	-	-	-	-	-
Stage 2	681	704	-	319	284	-	-	-	-	-	-	-
Critical Hdwy	7.12	6.52	6.22	7.12	6.52	6.22	4.12	-	-	4.12	-	-
Critical Hdwy Stg 1	6.12	5.52	-	6.12	5.52	-	-	-	-	-	-	-
Critical Hdwy Stg 2	6.12	5.52	-	6.12	5.52	-	-	-	-	-	-	-
Follow-up Hdwy	3.518	4.018	3.318	3.518	4.018	3.318	2.218	-	-	2.218	-	-
Pot Cap-1 Maneuver	235	247	758	222	255	613	1280	-	-	1094	-	-
Stage 1	724	677	-	440	450	-	-	-	-	-	-	-
Stage 2	440	440	-	693	676	-	-	-	-	-	-	-
Platoon blocked, %								-	-	-	-	-
Mov Cap-1 Maneuver	218	224	758	187	231	613	1280	-	-	1094	-	-
Mov Cap-2 Maneuver	218	224	-	187	231	-	-	-	-	-	-	-
Stage 1	657	676	-	400	409	-	-	-	-	-	-	-
Stage 2	399	400	-	628	675	-	-	-	-	-	-	-

Approach	EB		WB		NB		SB	
HCM Control Delay, s	10.7		26.8		1.6		0	
HCM LOS	B		D					

Minor Lane/Major Mvmt	NBL	NBT	NBR	EBLn1WBLn1	SBL	SBT	SBR
Capacity (veh/h)	1280	-	-	707	192	1094	-
HCM Lane V/C Ratio	0.092	-	-	0.103	0.143	0.001	-
HCM Control Delay (s)	8.1	-	-	10.7	26.8	8.3	-
HCM Lane LOS	A	-	-	B	D	A	-
HCM 95th %tile Q(veh)	0.3	-	-	0.3	0.5	0	-

Intersection	
Intersection Delay, s/veh	16.1
Intersection LOS	C

Movement	EBL	EBT	EBR	WBL	WBT	WBR	NBL	NBT	NBR	SBL	SBT	SBR
Lane Configurations	↶	↷		↶	↷	↶	↶	↷	↶	↶	↷	↷
Traffic Vol, veh/h	140	313	11	9	158	66	25	88	32	41	43	148
Future Vol, veh/h	140	313	11	9	158	66	25	88	32	41	43	148
Peak Hour Factor	0.75	0.92	0.92	0.92	0.92	0.75	0.92	0.92	0.92	0.75	0.92	0.75
Heavy Vehicles, %	2	2	2	2	2	2	2	2	2	2	2	2
Mvmt Flow	187	340	12	10	172	88	27	96	35	55	47	197
Number of Lanes	1	1	0	1	1	1	1	1	1	1	1	1

Approach	EB	WB	NB	SB
Opposing Approach	WB	EB	SB	NB
Opposing Lanes	3	2	3	3
Conflicting Approach Left	SB	NB	EB	WB
Conflicting Lanes Left	3	3	2	3
Conflicting Approach Right	NB	SB	WB	EB
Conflicting Lanes Right	3	3	3	2
HCM Control Delay	20	13.4	12.4	13.3
HCM LOS	C	B	B	B

Lane	NBLn1	NBLn2	NBLn3	EBLn1	EBLn2	WBLn1	WBLn2	WBLn3	SBLn1	SBLn2	SBLn3
Vol Left, %	100%	0%	0%	100%	0%	100%	0%	0%	100%	0%	0%
Vol Thru, %	0%	100%	0%	0%	97%	0%	100%	0%	0%	100%	0%
Vol Right, %	0%	0%	100%	0%	3%	0%	0%	100%	0%	0%	100%
Sign Control	Stop	Stop	Stop	Stop	Stop	Stop	Stop	Stop	Stop	Stop	Stop
Traffic Vol by Lane	25	88	32	140	324	9	158	66	41	43	148
LT Vol	25	0	0	140	0	9	0	0	41	0	0
Through Vol	0	88	0	0	313	0	158	0	0	43	0
RT Vol	0	0	32	0	11	0	0	66	0	0	148
Lane Flow Rate	27	96	35	187	352	10	172	88	55	47	197
Geometry Grp	8	8	8	8	8	8	8	8	8	8	8
Degree of Util (X)	0.065	0.216	0.071	0.384	0.674	0.022	0.364	0.169	0.125	0.1	0.385
Departure Headway (Hd)	8.622	8.112	7.398	7.411	6.888	8.139	7.634	6.926	8.242	7.733	7.021
Convergence, Y/N	Yes	Yes	Yes	Yes	Yes	Yes	Yes	Yes	Yes	Yes	Yes
Cap	415	442	483	485	525	440	471	517	435	463	513
Service Time	6.377	5.867	5.152	5.151	4.628	5.889	5.384	4.677	5.99	5.481	4.769
HCM Lane V/C Ratio	0.065	0.217	0.072	0.386	0.67	0.023	0.365	0.17	0.126	0.102	0.384
HCM Control Delay	12	13.1	10.7	14.7	22.8	11.1	14.7	11.1	12.2	11.3	14.1
HCM Lane LOS	B	B	B	B	C	B	B	B	B	B	B
HCM 95th-tile Q	0.2	0.8	0.2	1.8	5	0.1	1.6	0.6	0.4	0.3	1.8

Timings  
127: Eastonville Dr & Stapleton Dr

Intermediate-Term Total Traffic  
AM Peak Hour



Lane Group	EBL	EBT	WBL	WBT	WBR	NBL	NBT	SBL	SBT
Lane Configurations		↔		↑	↑	↑	↑	↑	↑
Traffic Volume (vph)	6	260	37	157	98	45	309	133	154
Future Volume (vph)	6	260	37	157	98	45	309	133	154
Turn Type	Perm	NA	Perm	NA	Perm	Perm	NA	Perm	NA
Protected Phases		4		8			2		6
Permitted Phases	4		8		8	2		6	
Detector Phase	4	4	8	8	8	2	2	6	6
Switch Phase									
Minimum Initial (s)	4.0	4.0	4.0	4.0	4.0	4.0	4.0	4.0	4.0
Minimum Split (s)	9.0	9.0	9.0	9.0	9.0	9.0	9.0	9.0	9.0
Total Split (s)	45.0	45.0	45.0	45.0	45.0	45.0	45.0	45.0	45.0
Total Split (%)	50.0%	50.0%	50.0%	50.0%	50.0%	50.0%	50.0%	50.0%	50.0%
Yellow Time (s)	3.0	3.0	3.0	3.0	3.0	3.0	3.0	3.0	3.0
All-Red Time (s)	2.0	2.0	2.0	2.0	2.0	2.0	2.0	2.0	2.0
Lost Time Adjust (s)		0.0		0.0	0.0	0.0	0.0	0.0	0.0
Total Lost Time (s)		5.0		5.0	5.0	5.0	5.0	5.0	5.0
Lead/Lag									
Lead-Lag Optimize?									
Recall Mode	None	None	None	None	None	None	None	None	None
Act Effct Green (s)		19.6		19.6	19.6	21.9	21.9	21.9	21.9
Actuated g/C Ratio		0.37		0.37	0.37	0.41	0.41	0.41	0.41
v/c Ratio		0.67		0.44	0.20	0.13	0.57	0.65	0.35
Control Delay		19.7		16.8	4.1	11.4	15.6	24.6	12.1
Queue Delay		0.0		0.0	0.0	0.0	0.0	0.0	0.0
Total Delay		19.7		16.8	4.1	11.4	15.6	24.6	12.1
LOS		B		B	A	B	B	C	B
Approach Delay		19.7		12.5			15.1		17.4
Approach LOS		B		B			B		B

Intersection Summary

Cycle Length: 90  
 Actuated Cycle Length: 52.8  
 Natural Cycle: 45  
 Control Type: Actuated-Uncoordinated  
 Maximum v/c Ratio: 0.67  
 Intersection Signal Delay: 16.3  
 Intersection Capacity Utilization 68.4%  
 Analysis Period (min) 15  
 Intersection LOS: B  
 ICU Level of Service C

Splits and Phases: 127: Eastonville Dr & Stapleton Dr

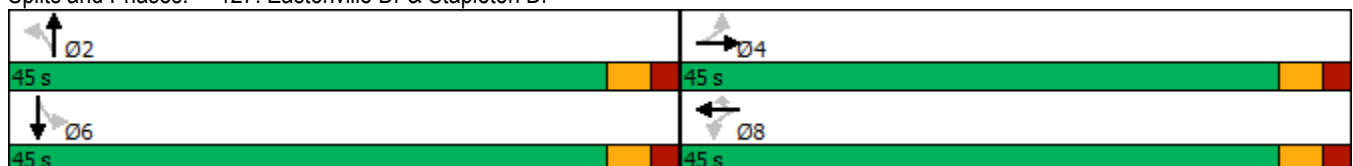

Timings  
130: Lambert Rd & Stapleton Dr

Intermediate-Term Total Traffic  
AM Peak Hour



Lane Group	EBL	EBT	WBL	WBT	WBR	NBL	NBT	SBL	SBT	SBR
Lane Configurations										
Traffic Volume (vph)	133	144	1	143	84	49	9	244	18	263
Future Volume (vph)	133	144	1	143	84	49	9	244	18	263
Turn Type	Perm	NA	Perm	NA	Perm	Perm	NA	Perm	NA	Perm
Protected Phases		4		8			2		6	
Permitted Phases	4		8		8	2		6		6
Detector Phase	4	4	8	8	8	2	2	6	6	6
Switch Phase										
Minimum Initial (s)	4.0	4.0	4.0	4.0	4.0	4.0	4.0	4.0	4.0	4.0
Minimum Split (s)	21.0	21.0	21.0	21.0	21.0	21.0	21.0	21.0	21.0	21.0
Total Split (s)	60.0	60.0	60.0	60.0	60.0	30.0	30.0	30.0	30.0	30.0
Total Split (%)	66.7%	66.7%	66.7%	66.7%	66.7%	33.3%	33.3%	33.3%	33.3%	33.3%
Yellow Time (s)	3.0	3.0	3.0	3.0	3.0	3.0	3.0	3.0	3.0	3.0
All-Red Time (s)	2.0	2.0	2.0	2.0	2.0	2.0	2.0	2.0	2.0	2.0
Lost Time Adjust (s)	0.0	0.0	0.0	0.0	0.0	0.0	0.0	0.0	0.0	0.0
Total Lost Time (s)	5.0	5.0	5.0	5.0	5.0	5.0	5.0	5.0	5.0	5.0
Lead/Lag										
Lead-Lag Optimize?										
Recall Mode	Max	Max	Max	Max	Max	None	None	None	None	None
Act Effct Green (s)	55.2	55.2	55.2	55.2	55.2	20.3	20.3	20.3	20.3	20.3
Actuated g/C Ratio	0.65	0.65	0.65	0.65	0.65	0.24	0.24	0.24	0.24	0.24
v/c Ratio	0.18	0.14	0.00	0.13	0.09	0.16	0.03	0.80	0.05	0.48
Control Delay	7.7	6.9	7.0	7.0	1.9	26.3	22.2	48.9	24.4	6.3
Queue Delay	0.0	0.0	0.0	0.0	0.0	0.0	0.0	0.0	0.0	0.0
Total Delay	7.7	6.9	7.0	7.0	1.9	26.3	22.2	48.9	24.4	6.3
LOS	A	A	A	A	A	C	C	D	C	A
Approach Delay		7.3		5.1			25.6		26.7	
Approach LOS		A		A			C		C	

Intersection Summary

Cycle Length: 90  
 Actuated Cycle Length: 85.5  
 Natural Cycle: 45  
 Control Type: Semi Act-Uncoord  
 Maximum v/c Ratio: 0.80  
 Intersection Signal Delay: 17.1  
 Intersection Capacity Utilization 47.6%  
 Analysis Period (min) 15  
 Intersection LOS: B  
 ICU Level of Service A

Splits and Phases: 130: Lambert Rd & Stapleton Dr





Intersection	
Intersection Delay, s/veh	11.2
Intersection LOS	B

Movement	EBL	EBT	EBR	WBL	WBT	WBR	NBL	NBT	NBR	SBL	SBT	SBR
Lane Configurations	↖	↗		↖	↗	↖	↖	↗	↖	↖	↗	↖
Traffic Vol, veh/h	14	138	19	36	262	21	15	11	21	12	13	10
Future Vol, veh/h	14	138	19	36	262	21	15	11	21	12	13	10
Peak Hour Factor	1.00	1.00	0.92	0.92	0.76	0.76	0.92	0.92	0.92	1.00	0.92	1.00
Heavy Vehicles, %	2	2	2	2	2	2	2	2	2	2	2	2
Mvmt Flow	14	138	21	39	345	28	16	12	23	12	14	10
Number of Lanes	1	1	0	1	1	1	1	1	1	1	1	1

Approach	EB	WB	NB	SB
Opposing Approach	WB	EB	SB	NB
Opposing Lanes	3	2	3	3
Conflicting Approach Left	SB	NB	EB	WB
Conflicting Lanes Left	3	3	2	3
Conflicting Approach Right	NB	SB	WB	EB
Conflicting Lanes Right	3	3	3	2
HCM Control Delay	10	12.1	9	9.1
HCM LOS	A	B	A	A

Lane	NBLn1	NBLn2	NBLn3	EBLn1	EBLn2	WBLn1	WBLn2	WBLn3	SBLn1	SBLn2	SBLn3
Vol Left, %	100%	0%	0%	100%	0%	100%	0%	0%	100%	0%	0%
Vol Thru, %	0%	100%	0%	0%	88%	0%	100%	0%	0%	100%	0%
Vol Right, %	0%	0%	100%	0%	12%	0%	0%	100%	0%	0%	100%
Sign Control	Stop	Stop	Stop	Stop	Stop	Stop	Stop	Stop	Stop	Stop	Stop
Traffic Vol by Lane	15	11	21	14	157	36	262	21	12	13	10
LT Vol	15	0	0	14	0	36	0	0	12	0	0
Through Vol	0	11	0	0	138	0	262	0	0	13	0
RT Vol	0	0	21	0	19	0	0	21	0	0	10
Lane Flow Rate	16	12	23	14	159	39	345	28	12	14	10
Geometry Grp	8	8	8	8	8	8	8	8	8	8	8
Degree of Util (X)	0.03	0.021	0.035	0.024	0.243	0.062	0.495	0.034	0.022	0.024	0.015
Departure Headway (Hd)	6.679	6.175	5.47	6.092	5.507	5.67	5.17	4.469	6.712	6.208	5.503
Convergence, Y/N	Yes	Yes	Yes	Yes	Yes	Yes	Yes	Yes	Yes	Yes	Yes
Cap	532	575	648	585	649	630	693	797	529	571	643
Service Time	4.47	3.966	3.261	3.855	3.271	3.424	2.923	2.222	4.508	4.004	3.298
HCM Lane V/C Ratio	0.03	0.021	0.035	0.024	0.245	0.062	0.498	0.035	0.023	0.025	0.016
HCM Control Delay	9.7	9.1	8.5	9	10.1	8.8	12.9	7.4	9.7	9.2	8.4
HCM Lane LOS	A	A	A	A	B	A	B	A	A	A	A
HCM 95th-tile Q	0.1	0.1	0.1	0.1	0.9	0.2	2.8	0.1	0.1	0.1	0

Timings  
127: Eastonville Dr & Stapleton Dr

Intermediate-Term Total Traffic  
PM Peak Hour



Lane Group	EBL	EBT	WBL	WBT	WBR	NBL	NBT	SBL	SBT
Lane Configurations		↔		↕	↕	↕	↕	↕	↕
Traffic Volume (vph)	18	199	32	341	151	130	123	60	94
Future Volume (vph)	18	199	32	341	151	130	123	60	94
Turn Type	Perm	NA	Perm	NA	Perm	Perm	NA	Perm	NA
Protected Phases		4		8			2		6
Permitted Phases	4		8		8	2		6	
Detector Phase	4	4	8	8	8	2	2	6	6
Switch Phase									
Minimum Initial (s)	4.0	4.0	4.0	4.0	4.0	4.0	4.0	4.0	4.0
Minimum Split (s)	9.0	9.0	9.0	9.0	9.0	9.0	9.0	9.0	9.0
Total Split (s)	45.0	45.0	45.0	45.0	45.0	45.0	45.0	45.0	45.0
Total Split (%)	50.0%	50.0%	50.0%	50.0%	50.0%	50.0%	50.0%	50.0%	50.0%
Yellow Time (s)	3.0	3.0	3.0	3.0	3.0	3.0	3.0	3.0	3.0
All-Red Time (s)	2.0	2.0	2.0	2.0	2.0	2.0	2.0	2.0	2.0
Lost Time Adjust (s)		0.0		0.0	0.0	0.0	0.0	0.0	0.0
Total Lost Time (s)		5.0		5.0	5.0	5.0	5.0	5.0	5.0
Lead/Lag									
Lead-Lag Optimize?									
Recall Mode	None	None	None	None	None	None	None	None	None
Act Effect Green (s)		14.0		14.0	14.0	10.3	10.3	10.3	10.3
Actuated g/C Ratio		0.40		0.40	0.40	0.30	0.30	0.30	0.30
v/c Ratio		0.46		0.57	0.23	0.38	0.35	0.18	0.22
Control Delay		9.8		12.2	2.6	14.1	10.9	11.7	10.2
Queue Delay		0.0		0.0	0.0	0.0	0.0	0.0	0.0
Total Delay		9.8		12.2	2.6	14.1	10.9	11.7	10.2
LOS		A		B	A	B	B	B	B
Approach Delay		9.8		9.4			12.3		10.7
Approach LOS		A		A			B		B

Intersection Summary

Cycle Length: 90  
 Actuated Cycle Length: 34.9  
 Natural Cycle: 40  
 Control Type: Actuated-Uncoordinated  
 Maximum v/c Ratio: 0.57  
 Intersection Signal Delay: 10.3  
 Intersection Capacity Utilization 56.8%  
 Analysis Period (min) 15  
 Intersection LOS: B  
 ICU Level of Service B

Splits and Phases: 127: Eastonville Dr & Stapleton Dr

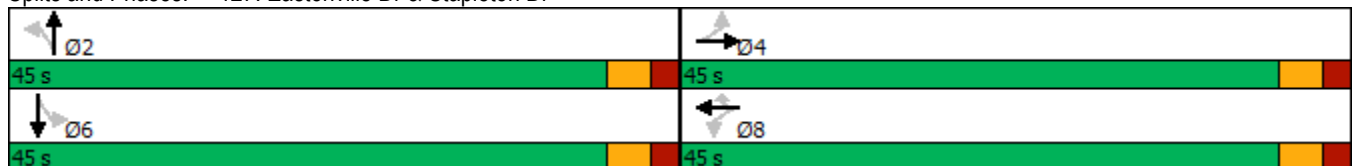



Timings  
130: Lambert Rd & Stapleton Dr

Intermediate-Term Total Traffic  
PM Peak Hour



Lane Group	EBL	EBT	WBL	WBT	WBR	NBL	NBT	SBL	SBT	SBR
Lane Configurations										
Traffic Volume (vph)	279	132	11	223	260	45	18	163	11	185
Future Volume (vph)	279	132	11	223	260	45	18	163	11	185
Turn Type	Perm	NA	Perm	NA	Perm	Perm	NA	Perm	NA	Perm
Protected Phases		4		8			2		6	
Permitted Phases	4		8		8	2		6		6
Detector Phase	4	4	8	8	8	2	2	6	6	6
Switch Phase										
Minimum Initial (s)	4.0	4.0	4.0	4.0	4.0	4.0	4.0	4.0	4.0	4.0
Minimum Split (s)	21.0	21.0	21.0	21.0	21.0	21.0	21.0	21.0	21.0	21.0
Total Split (s)	65.0	65.0	65.0	65.0	65.0	25.0	25.0	25.0	25.0	25.0
Total Split (%)	72.2%	72.2%	72.2%	72.2%	72.2%	27.8%	27.8%	27.8%	27.8%	27.8%
Yellow Time (s)	3.0	3.0	3.0	3.0	3.0	3.0	3.0	3.0	3.0	3.0
All-Red Time (s)	2.0	2.0	2.0	2.0	2.0	2.0	2.0	2.0	2.0	2.0
Lost Time Adjust (s)	0.0	0.0	0.0	0.0	0.0	0.0	0.0	0.0	0.0	0.0
Total Lost Time (s)	5.0	5.0	5.0	5.0	5.0	5.0	5.0	5.0	5.0	5.0
Lead/Lag										
Lead-Lag Optimize?										
Recall Mode	Max	Max	Max	Max	Max	None	None	None	None	None
Act Effect Green (s)	61.2	61.2	61.2	61.2	61.2	15.7	15.7	15.7	15.7	15.7
Actuated g/C Ratio	0.70	0.70	0.70	0.70	0.70	0.18	0.18	0.18	0.18	0.18
v/c Ratio	0.37	0.14	0.01	0.17	0.24	0.19	0.07	0.71	0.04	0.45
Control Delay	7.4	4.1	5.0	5.3	1.2	30.9	25.2	49.1	28.1	7.9
Queue Delay	0.0	0.0	0.0	0.0	0.0	0.0	0.0	0.0	0.0	0.0
Total Delay	7.4	4.1	5.0	5.3	1.2	30.9	25.2	49.1	28.1	7.9
LOS	A	A	A	A	A	C	C	D	C	A
Approach Delay		6.2		3.0			29.0		27.2	
Approach LOS		A		A			C		C	

Intersection Summary

Cycle Length: 90  
 Actuated Cycle Length: 86.9  
 Natural Cycle: 45  
 Control Type: Semi Act-Uncoord  
 Maximum v/c Ratio: 0.71  
 Intersection Signal Delay: 11.8  
 Intersection Capacity Utilization 55.4%  
 Analysis Period (min) 15  
 Intersection LOS: B  
 ICU Level of Service B

Splits and Phases: 130: Lambert Rd & Stapleton Dr





Intersection	
Intersection Delay, s/veh	16.3
Intersection LOS	C

Movement	EBL	EBT	EBR	WBL	WBT	WBR	NBL	NBT	NBR	SBL	SBT	SBR
Lane Configurations	↶	↷		↶	↷		↶	↷		↶	↷	
Traffic Vol, veh/h	40	316	29	6	240	66	17	56	9	105	149	49
Future Vol, veh/h	40	316	29	6	240	66	17	56	9	105	149	49
Peak Hour Factor	0.95	0.95	0.95	0.95	0.95	0.95	0.95	0.95	0.95	0.95	0.95	0.95
Heavy Vehicles, %	2	2	2	2	2	2	2	2	2	2	2	2
Mvmt Flow	42	333	31	6	253	69	18	59	9	111	157	52
Number of Lanes	1	1	0	1	1	0	1	1	0	1	1	0

Approach	EB	WB	NB	SB
Opposing Approach	WB	EB	SB	NB
Opposing Lanes	2	2	2	2
Conflicting Approach Left	SB	NB	EB	WB
Conflicting Lanes Left	2	2	2	2
Conflicting Approach Right	NB	SB	WB	EB
Conflicting Lanes Right	2	2	2	2
HCM Control Delay	18.9	17.3	11.3	13.3
HCM LOS	C	C	B	B

Lane	NBLn1	NBLn2	EBLn1	EBLn2	WBLn1	WBLn2	SBLn1	SBLn2
Vol Left, %	100%	0%	100%	0%	100%	0%	100%	0%
Vol Thru, %	0%	86%	0%	92%	0%	78%	0%	75%
Vol Right, %	0%	14%	0%	8%	0%	22%	0%	25%
Sign Control	Stop	Stop	Stop	Stop	Stop	Stop	Stop	Stop
Traffic Vol by Lane	17	65	40	345	6	306	105	198
LT Vol	17	0	40	0	6	0	105	0
Through Vol	0	56	0	316	0	240	0	149
RT Vol	0	9	0	29	0	66	0	49
Lane Flow Rate	18	68	42	363	6	322	111	208
Geometry Grp	7	7	7	7	7	7	7	7
Degree of Util (X)	0.04	0.142	0.081	0.64	0.012	0.57	0.227	0.389
Departure Headway (Hd)	8.06	7.446	6.911	6.343	7.033	6.37	7.399	6.713
Convergence, Y/N	Yes	Yes	Yes	Yes	Yes	Yes	Yes	Yes
Cap	447	484	515	567	505	560	482	531
Service Time	5.76	5.146	4.704	4.135	4.831	4.168	5.197	4.51
HCM Lane V/C Ratio	0.04	0.14	0.082	0.64	0.012	0.575	0.23	0.392
HCM Control Delay	11.1	11.4	10.3	19.9	9.9	17.4	12.4	13.8
HCM Lane LOS	B	B	B	C	A	C	B	B
HCM 95th-tile Q	0.1	0.5	0.3	4.5	0	3.6	0.9	1.8

Timings  
43: Lambert Rd & Londonderry Dr

2040 Background Traffic  
AM Peak Hour

Lane Group	EBL	EBT	WBL	WBT	WBR	NBL	NBT	NBR	SBL	SBT	SBR	
Lane Configurations												
Traffic Volume (vph)	249	180	29	70	73	19	252	71	95	209	190	
Future Volume (vph)	249	180	29	70	73	19	252	71	95	209	190	
Turn Type	pm+pt	NA	pm+pt	NA	Perm	pm+pt	NA	Perm	pm+pt	NA	Perm	
Protected Phases	7	4	3	8		5	2		1	6		
Permitted Phases	4		8		8	2		2	6		6	
Detector Phase	7	4	3	8	8	5	2	2	1	6	6	
Switch Phase												
Minimum Initial (s)	4.0	4.0	4.0	4.0	4.0	4.0	4.0	4.0	4.0	4.0	4.0	
Minimum Split (s)	9.0	21.0	9.0	21.0	21.0	9.0	21.0	21.0	9.0	21.0	21.0	
Total Split (s)	10.0	45.0	10.0	45.0	45.0	10.0	25.0	25.0	10.0	25.0	25.0	
Total Split (%)	11.1%	50.0%	11.1%	50.0%	50.0%	11.1%	27.8%	27.8%	11.1%	27.8%	27.8%	
Yellow Time (s)	3.0	3.0	3.0	3.0	3.0	3.0	3.0	3.0	3.0	3.0	3.0	
All-Red Time (s)	2.0	2.0	2.0	2.0	2.0	2.0	2.0	2.0	2.0	2.0	2.0	
Lost Time Adjust (s)	0.0	0.0	0.0	0.0	0.0	0.0	0.0	0.0	0.0	0.0	0.0	
Total Lost Time (s)	5.0	5.0	5.0	5.0	5.0	5.0	5.0	5.0	5.0	5.0	5.0	
Lead/Lag	Lead	Lag	Lead	Lag	Lag	Lead	Lag	Lag	Lead	Lag	Lag	
Lead-Lag Optimize?	Yes	Yes	Yes	Yes	Yes	Yes	Yes	Yes	Yes	Yes	Yes	
Recall Mode	None	Max	None	Max	Max	None	None	None	None	None	None	
Act Effct Green (s)	47.1	44.2	45.1	40.0	40.0	21.5	16.5	16.5	24.6	22.7	22.7	
Actuated g/C Ratio	0.54	0.51	0.52	0.46	0.46	0.25	0.19	0.19	0.28	0.26	0.26	
v/c Ratio	0.46	0.23	0.05	0.09	0.12	0.08	0.75	0.18	0.54	0.57	0.42	
Control Delay	14.5	13.9	9.2	14.4	1.2	21.3	46.6	0.9	32.6	34.4	6.5	
Queue Delay	0.0	0.0	0.0	0.0	0.0	0.0	0.0	0.0	0.0	0.0	0.0	
Total Delay	14.5	13.9	9.2	14.4	1.2	21.3	46.6	0.9	32.6	34.4	6.5	
LOS	B	B	A	B	A	C	D	A	C	C	A	
Approach Delay		14.2		7.3			35.7			23.3		
Approach LOS		B		A			D			C		

Intersection Summary

Cycle Length: 90  
 Actuated Cycle Length: 86.6  
 Natural Cycle: 60  
 Control Type: Actuated-Uncoordinated  
 Maximum v/c Ratio: 0.75  
 Intersection Signal Delay: 21.2  
 Intersection Capacity Utilization 52.7%  
 Analysis Period (min) 15  
 Intersection LOS: C  
 ICU Level of Service A

Splits and Phases: 43: Lambert Rd & Londonderry Dr

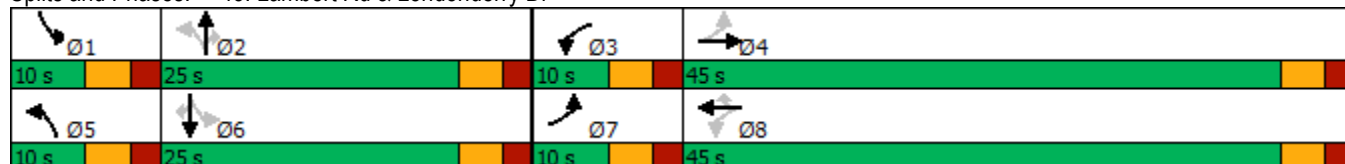

Timings  
127: Eastonville Rd & Stapleton Dr

2040 Background Traffic  
AM Peak Hour

Lane Group	EBL	EBT	EBR	WBL	WBT	WBR	NBL	NBT	NBR	SBL	SBT	SBR
Lane Configurations												
Traffic Volume (vph)	132	914	163	110	819	156	71	141	150	290	293	199
Future Volume (vph)	132	914	163	110	819	156	71	141	150	290	293	199
Turn Type	pm+pt	NA	Perm	pm+pt	NA	Perm	pm+pt	NA	Perm	pm+pt	NA	Perm
Protected Phases	7	4		3	8		5	2		1	6	
Permitted Phases	4		4	8		8	2		2	6		6
Detector Phase	7	4	4	3	8	8	5	2	2	1	6	6
Switch Phase												
Minimum Initial (s)	4.0	4.0	4.0	4.0	4.0	4.0	4.0	4.0	4.0	4.0	4.0	4.0
Minimum Split (s)	8.0	9.0	9.0	8.0	9.0	9.0	8.0	9.0	9.0	8.0	9.0	9.0
Total Split (s)	13.0	38.0	38.0	11.0	36.0	36.0	8.0	21.0	21.0	20.0	33.0	33.0
Total Split (%)	14.4%	42.2%	42.2%	12.2%	40.0%	40.0%	8.9%	23.3%	23.3%	22.2%	36.7%	36.7%
Yellow Time (s)	3.0	3.0	3.0	3.0	3.0	3.0	3.0	3.0	3.0	3.0	3.0	3.0
All-Red Time (s)	1.0	2.0	2.0	1.0	2.0	2.0	1.0	2.0	2.0	1.0	2.0	2.0
Lost Time Adjust (s)	0.0	0.0	0.0	0.0	0.0	0.0	0.0	0.0	0.0	0.0	0.0	0.0
Total Lost Time (s)	4.0	5.0	5.0	4.0	5.0	5.0	4.0	5.0	5.0	4.0	5.0	5.0
Lead/Lag	Lead	Lag	Lag	Lead	Lag	Lag	Lead	Lag	Lag	Lead	Lag	Lag
Lead-Lag Optimize?	Yes	Yes	Yes	Yes	Yes	Yes	Yes	Yes	Yes	Yes	Yes	Yes
Recall Mode	None	None	None	None	None	None	None	Max	Max	None	Max	Max
Act Effct Green (s)	38.6	30.9	30.9	34.8	26.9	26.9	21.8	16.7	16.7	35.8	28.7	28.7
Actuated g/C Ratio	0.46	0.37	0.37	0.41	0.32	0.32	0.26	0.20	0.20	0.43	0.34	0.34
v/c Ratio	0.52	0.74	0.25	0.49	0.76	0.26	0.24	0.40	0.35	0.57	0.49	0.31
Control Delay	19.7	28.2	4.3	19.8	30.9	4.5	20.3	35.5	7.1	22.6	27.2	4.9
Queue Delay	0.0	0.0	0.0	0.0	0.0	0.0	0.0	0.0	0.0	0.0	0.0	0.0
Total Delay	19.7	28.2	4.3	19.8	30.9	4.5	20.3	35.5	7.1	22.6	27.2	4.9
LOS	B	C	A	B	C	A	C	D	A	C	C	A
Approach Delay		24.0			26.0			20.7			19.8	
Approach LOS		C			C			C			B	

Intersection Summary

Cycle Length: 90  
 Actuated Cycle Length: 84.2  
 Natural Cycle: 60  
 Control Type: Actuated-Uncoordinated  
 Maximum v/c Ratio: 0.76  
 Intersection Signal Delay: 23.3  
 Intersection LOS: C  
 Intersection Capacity Utilization 69.8%  
 ICU Level of Service C  
 Analysis Period (min) 15

Splits and Phases: 127: Eastonville Rd & Stapleton Dr

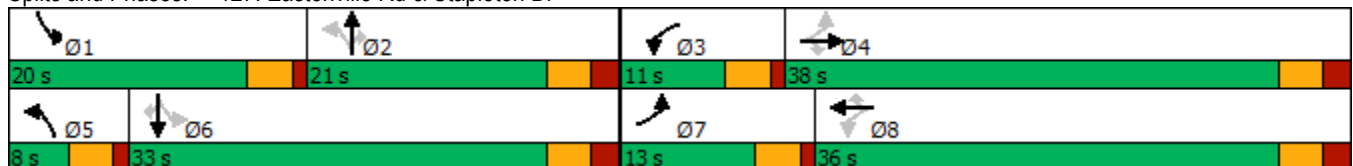

Timings  
130: Lambert Rd & Stapleton Dr

2040 Background Traffic  
AM Peak Hour

Lane Group	EBL	EBT	EBR	WBL	WBT	WBR	NBL	NBT	SBL	SBT	SBR	
Lane Configurations												
Traffic Volume (vph)	274	917	51	25	985	79	123	18	246	47	271	
Future Volume (vph)	274	917	51	25	985	79	123	18	246	47	271	
Turn Type	pm+pt	NA	Perm	pm+pt	NA	Perm	pm+pt	NA	pm+pt	NA	Perm	
Protected Phases	5	2		1	6		3	8	7	4		
Permitted Phases	2		2	6		6	8		4		4	
Detector Phase	5	2	2	1	6	6	3	8	7	4	4	
Switch Phase												
Minimum Initial (s)	4.0	4.0	4.0	4.0	4.0	4.0	4.0	4.0	4.0	4.0	4.0	
Minimum Split (s)	10.0	10.0	10.0	10.0	10.0	10.0	10.0	10.0	10.0	10.0	10.0	
Total Split (s)	20.0	46.0	46.0	10.0	36.0	36.0	18.0	10.0	24.0	16.0	16.0	
Total Split (%)	22.2%	51.1%	51.1%	11.1%	40.0%	40.0%	20.0%	11.1%	26.7%	17.8%	17.8%	
Yellow Time (s)	3.0	3.0	3.0	3.0	3.0	3.0	3.0	3.0	3.0	3.0	3.0	
All-Red Time (s)	2.0	2.0	2.0	2.0	2.0	2.0	2.0	2.0	2.0	2.0	2.0	
Lost Time Adjust (s)	0.0	0.0	0.0	0.0	0.0	0.0	0.0	0.0	0.0	0.0	0.0	
Total Lost Time (s)	5.0	5.0	5.0	5.0	5.0	5.0	5.0	5.0	5.0	5.0	5.0	
Lead/Lag	Lead	Lag	Lag	Lead	Lag	Lag	Lead	Lag	Lead	Lag	Lag	
Lead-Lag Optimize?	Yes	Yes	Yes	Yes	Yes	Yes	Yes	Yes	Yes	Yes	Yes	
Recall Mode	None	None	None	None	None	None	None	None	None	None	None	
Act Effct Green (s)	48.0	44.4	44.4	33.6	28.4	28.4	13.7	5.2	22.8	11.0	11.0	
Actuated g/C Ratio	0.59	0.55	0.55	0.41	0.35	0.35	0.17	0.06	0.28	0.14	0.14	
v/c Ratio	0.73	0.50	0.06	0.08	0.84	0.11	0.42	0.44	0.63	0.19	0.62	
Control Delay	30.2	14.7	0.1	10.4	32.6	0.3	27.9	28.0	31.9	36.9	11.4	
Queue Delay	0.0	0.0	0.0	0.0	0.0	0.0	0.0	0.0	0.0	0.0	0.0	
Total Delay	30.2	14.7	0.1	10.4	32.6	0.3	27.9	28.0	31.9	36.9	11.4	
LOS	C	B	A	B	C	A	C	C	C	D	B	
Approach Delay		17.5			29.8			27.9		22.4		
Approach LOS		B			C			C		C		

Intersection Summary

Cycle Length: 90  
 Actuated Cycle Length: 81.1  
 Natural Cycle: 60  
 Control Type: Actuated-Uncoordinated  
 Maximum v/c Ratio: 0.84  
 Intersection Signal Delay: 23.4  
 Intersection Capacity Utilization 75.2%  
 Analysis Period (min) 15  
 Intersection LOS: C  
 ICU Level of Service D

Splits and Phases: 130: Lambert Rd & Stapleton Dr

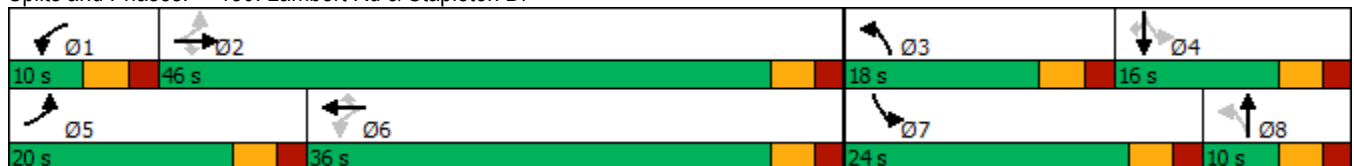



Intersection	
Intersection Delay, s/veh	12.5
Intersection LOS	B

Movement	EBL	EBT	EBR	WBL	WBT	WBR	NBL	NBT	NBR	SBL	SBT	SBR
Lane Configurations	↶	↷		↶	↷		↶	↷		↶	↷	
Traffic Vol, veh/h	59	196	34	4	165	79	42	170	3	51	107	29
Future Vol, veh/h	59	196	34	4	165	79	42	170	3	51	107	29
Peak Hour Factor	0.95	0.95	0.95	0.95	0.95	0.95	0.95	0.95	0.95	0.95	0.95	0.95
Heavy Vehicles, %	2	2	2	2	2	2	2	2	2	2	2	2
Mvmt Flow	62	206	36	4	174	83	44	179	3	54	113	31
Number of Lanes	1	1	0	1	1	0	1	1	0	1	1	0

Approach	EB	WB	NB	SB
Opposing Approach	WB	EB	SB	NB
Opposing Lanes	2	2	2	2
Conflicting Approach Left	SB	NB	EB	WB
Conflicting Lanes Left	2	2	2	2
Conflicting Approach Right	NB	SB	WB	EB
Conflicting Lanes Right	2	2	2	2
HCM Control Delay	12.7	13.6	12.2	11.3
HCM LOS	B	B	B	B

Lane	NBLn1	NBLn2	EBLn1	EBLn2	WBLn1	WBLn2	SBLn1	SBLn2
Vol Left, %	100%	0%	100%	0%	100%	0%	100%	0%
Vol Thru, %	0%	98%	0%	85%	0%	68%	0%	79%
Vol Right, %	0%	2%	0%	15%	0%	32%	0%	21%
Sign Control	Stop	Stop	Stop	Stop	Stop	Stop	Stop	Stop
Traffic Vol by Lane	42	173	59	230	4	244	51	136
LT Vol	42	0	59	0	4	0	51	0
Through Vol	0	170	0	196	0	165	0	107
RT Vol	0	3	0	34	0	79	0	29
Lane Flow Rate	44	182	62	242	4	257	54	143
Geometry Grp	7	7	7	7	7	7	7	7
Degree of Util (X)	0.087	0.332	0.117	0.416	0.008	0.438	0.107	0.258
Departure Headway (Hd)	7.085	6.564	6.806	6.193	6.878	6.14	7.15	6.489
Convergence, Y/N	Yes	Yes	Yes	Yes	Yes	Yes	Yes	Yes
Cap	504	544	525	579	518	583	499	551
Service Time	4.858	4.336	4.575	3.962	4.648	3.91	4.925	4.263
HCM Lane V/C Ratio	0.087	0.335	0.118	0.418	0.008	0.441	0.108	0.26
HCM Control Delay	10.5	12.6	10.5	13.3	9.7	13.7	10.8	11.5
HCM Lane LOS	B	B	B	B	A	B	B	B
HCM 95th-tile Q	0.3	1.4	0.4	2	0	2.2	0.4	1



Timings  
43: Lambert Rd & Londonderry Dr

2040 Background Traffic  
PM Peak Hour

Lane Group	EBL	EBT	WBL	WBT	WBR	NBL	NBT	NBR	SBL	SBT	SBR	
Lane Configurations												
Traffic Volume (vph)	93	101	38	147	94	32	152	26	58	118	82	
Future Volume (vph)	93	101	38	147	94	32	152	26	58	118	82	
Turn Type	pm+pt	NA	pm+pt	NA	Perm	pm+pt	NA	Perm	pm+pt	NA	Perm	
Protected Phases	7	4	3	8		5	2		1	6		
Permitted Phases	4		8		8	2		2	6		6	
Detector Phase	7	4	3	8	8	5	2	2	1	6	6	
Switch Phase												
Minimum Initial (s)	4.0	4.0	4.0	4.0	4.0	4.0	4.0	4.0	4.0	4.0	4.0	
Minimum Split (s)	9.0	21.0	9.0	21.0	21.0	9.0	21.0	21.0	9.0	21.0	21.0	
Total Split (s)	10.0	45.0	10.0	45.0	45.0	10.0	25.0	25.0	10.0	25.0	25.0	
Total Split (%)	11.1%	50.0%	11.1%	50.0%	50.0%	11.1%	27.8%	27.8%	11.1%	27.8%	27.8%	
Yellow Time (s)	3.0	3.0	3.0	3.0	3.0	3.0	3.0	3.0	3.0	3.0	3.0	
All-Red Time (s)	2.0	2.0	2.0	2.0	2.0	2.0	2.0	2.0	2.0	2.0	2.0	
Lost Time Adjust (s)	0.0	0.0	0.0	0.0	0.0	0.0	0.0	0.0	0.0	0.0	0.0	
Total Lost Time (s)	5.0	5.0	5.0	5.0	5.0	5.0	5.0	5.0	5.0	5.0	5.0	
Lead/Lag	Lead	Lag	Lead	Lag	Lag	Lead	Lag	Lag	Lead	Lag	Lag	
Lead-Lag Optimize?	Yes	Yes	Yes	Yes	Yes	Yes	Yes	Yes	Yes	Yes	Yes	
Recall Mode	None	Max	None	Max	Max	None	None	None	None	None	None	
Act Effct Green (s)	46.3	43.5	45.3	41.5	41.5	15.9	12.2	12.2	16.9	14.1	14.1	
Actuated g/C Ratio	0.59	0.55	0.57	0.53	0.53	0.20	0.15	0.15	0.21	0.18	0.18	
v/c Ratio	0.17	0.13	0.05	0.16	0.14	0.12	0.56	0.07	0.30	0.47	0.27	
Control Delay	8.3	10.8	7.8	13.0	2.3	23.0	39.9	0.4	25.9	35.6	4.4	
Queue Delay	0.0	0.0	0.0	0.0	0.0	0.0	0.0	0.0	0.0	0.0	0.0	
Total Delay	8.3	10.8	7.8	13.0	2.3	23.0	39.9	0.4	25.9	35.6	4.4	
LOS	A	B	A	B	A	C	D	A	C	D	A	
Approach Delay		9.6		8.1			32.4			23.5		
Approach LOS		A		A			C			C		

Intersection Summary

Cycle Length: 90  
 Actuated Cycle Length: 79  
 Natural Cycle: 60  
 Control Type: Actuated-Uncoordinated  
 Maximum v/c Ratio: 0.56  
 Intersection Signal Delay: 17.8  
 Intersection Capacity Utilization 40.9%  
 Analysis Period (min) 15  
 Intersection LOS: B  
 ICU Level of Service A

Splits and Phases: 43: Lambert Rd & Londonderry Dr

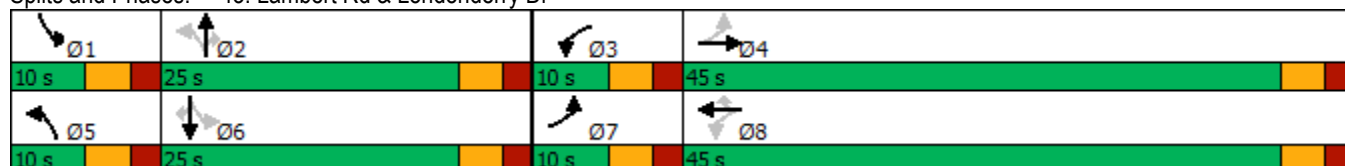

Timings  
127: Eastonville Rd & Stapleton Dr

2040 Background Traffic  
PM Peak Hour

Lane Group	EBL	EBT	EBR	WBL	WBT	WBR	NBL	NBT	NBR	SBL	SBT	SBR
Lane Configurations												
Traffic Volume (vph)	261	853	103	165	1150	333	191	315	150	198	206	137
Future Volume (vph)	261	853	103	165	1150	333	191	315	150	198	206	137
Turn Type	pm+pt	NA	Perm	pm+pt	NA	Perm	pm+pt	NA	Perm	pm+pt	NA	Perm
Protected Phases	7	4		3	8		5	2		1	6	
Permitted Phases	4		4	8		8	2		2	6		6
Detector Phase	7	4	4	3	8	8	5	2	2	1	6	6
Switch Phase												
Minimum Initial (s)	4.0	4.0	4.0	4.0	4.0	4.0	4.0	4.0	4.0	4.0	4.0	4.0
Minimum Split (s)	9.0	9.0	9.0	9.0	9.0	9.0	9.0	9.0	9.0	9.0	9.0	9.0
Total Split (s)	15.0	38.0	38.0	14.0	37.0	37.0	10.0	26.0	26.0	12.0	28.0	28.0
Total Split (%)	16.7%	42.2%	42.2%	15.6%	41.1%	41.1%	11.1%	28.9%	28.9%	13.3%	31.1%	31.1%
Yellow Time (s)	3.0	3.0	3.0	3.0	3.0	3.0	3.0	3.0	3.0	3.0	3.0	3.0
All-Red Time (s)	1.0	2.0	2.0	1.0	2.0	2.0	1.0	2.0	2.0	1.0	2.0	2.0
Lost Time Adjust (s)	0.0	0.0	0.0	0.0	0.0	0.0	0.0	0.0	0.0	0.0	0.0	0.0
Total Lost Time (s)	4.0	5.0	5.0	4.0	5.0	5.0	4.0	5.0	5.0	4.0	5.0	5.0
Lead/Lag	Lead	Lag	Lag	Lead	Lag	Lag	Lead	Lag	Lag	Lead	Lag	Lag
Lead-Lag Optimize?	Yes	Yes	Yes	Yes	Yes	Yes	Yes	Yes	Yes	Yes	Yes	Yes
Recall Mode	None	None	None	None	None	None	None	None	None	None	None	None
Act Effct Green (s)	45.5	33.6	33.6	41.6	31.6	31.6	25.7	18.7	18.7	29.7	20.7	20.7
Actuated g/C Ratio	0.52	0.38	0.38	0.48	0.36	0.36	0.29	0.21	0.21	0.34	0.24	0.24
v/c Ratio	0.88	0.66	0.16	0.55	0.92	0.45	0.57	0.81	0.34	0.76	0.49	0.30
Control Delay	50.6	25.7	3.8	17.8	39.7	5.9	28.9	49.3	7.2	40.6	33.0	6.6
Queue Delay	0.0	0.0	0.0	0.0	0.0	0.0	0.0	0.0	0.0	0.0	0.0	0.0
Total Delay	50.6	25.7	3.8	17.8	39.7	5.9	28.9	49.3	7.2	40.6	33.0	6.6
LOS	D	C	A	B	D	A	C	D	A	D	C	A
Approach Delay		29.2			30.5			33.5			29.1	
Approach LOS		C			C			C			C	

Intersection Summary

Cycle Length: 90  
 Actuated Cycle Length: 87.3  
 Natural Cycle: 70  
 Control Type: Actuated-Uncoordinated  
 Maximum v/c Ratio: 0.92  
 Intersection Signal Delay: 30.4  
 Intersection LOS: C  
 Intersection Capacity Utilization 88.8%  
 ICU Level of Service E  
 Analysis Period (min) 15

Splits and Phases: 127: Eastonville Rd & Stapleton Dr

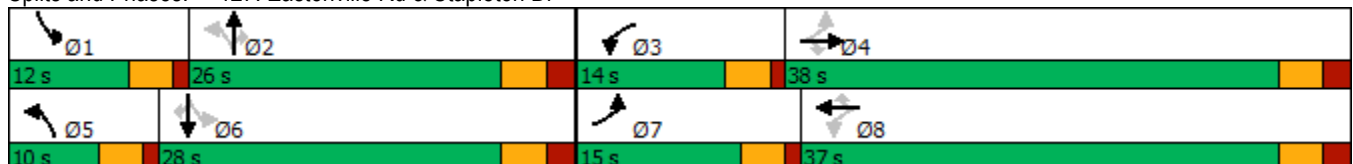

Timings  
130: Lambert Rd & Stapleton Dr

2040 Background Traffic  
PM Peak Hour

Lane Group	EBL	EBT	EBR	WBL	WBT	WBR	NBL	NBT	SBL	SBT	SBR	
Lane Configurations												
Traffic Volume (vph)	214	975	158	85	1084	310	89	56	167	31	178	
Future Volume (vph)	214	975	158	85	1084	310	89	56	167	31	178	
Turn Type	pm+pt	NA	Perm	pm+pt	NA	Perm	pm+pt	NA	pm+pt	NA	Perm	
Protected Phases	5	2		1	6		3	8	7	4		
Permitted Phases	2		2	6		6	8		4		4	
Detector Phase	5	2	2	1	6	6	3	8	7	4	4	
Switch Phase												
Minimum Initial (s)	4.0	4.0	4.0	4.0	4.0	4.0	4.0	4.0	4.0	4.0	4.0	
Minimum Split (s)	10.0	10.0	10.0	10.0	10.0	10.0	10.0	10.0	10.0	10.0	10.0	
Total Split (s)	23.0	48.0	48.0	10.0	35.0	35.0	15.0	15.0	17.0	17.0	17.0	
Total Split (%)	25.6%	53.3%	53.3%	11.1%	38.9%	38.9%	16.7%	16.7%	18.9%	18.9%	18.9%	
Yellow Time (s)	3.0	3.0	3.0	3.0	3.0	3.0	3.0	3.0	3.0	3.0	3.0	
All-Red Time (s)	2.0	2.0	2.0	2.0	2.0	2.0	2.0	2.0	2.0	2.0	2.0	
Lost Time Adjust (s)	0.0	0.0	0.0	0.0	0.0	0.0	0.0	0.0	0.0	0.0	0.0	
Total Lost Time (s)	5.0	5.0	5.0	5.0	5.0	5.0	5.0	5.0	5.0	5.0	5.0	
Lead/Lag	Lead	Lag	Lag	Lead	Lag	Lag	Lead	Lag	Lead	Lag	Lag	
Lead-Lag Optimize?	Yes	Yes	Yes	Yes	Yes	Yes	Yes	Yes	Yes	Yes	Yes	
Recall Mode	None	None	None	None	None	None	None	None	None	None	None	
Act Effct Green (s)	47.1	39.4	39.4	34.6	29.6	29.6	16.6	8.3	22.2	13.3	13.3	
Actuated g/C Ratio	0.58	0.48	0.48	0.43	0.36	0.36	0.20	0.10	0.27	0.16	0.16	
v/c Ratio	0.62	0.60	0.19	0.33	0.89	0.42	0.29	0.60	0.51	0.11	0.43	
Control Delay	21.8	18.1	2.9	13.5	35.6	4.4	25.0	33.5	28.8	34.0	7.7	
Queue Delay	0.0	0.0	0.0	0.0	0.0	0.0	0.0	0.0	0.0	0.0	0.0	
Total Delay	21.8	18.1	2.9	13.5	35.6	4.4	25.0	33.5	28.8	34.0	7.7	
LOS	C	B	A	B	D	A	C	C	C	C	A	
Approach Delay		16.9			27.8			30.0		19.3		
Approach LOS		B			C			C		B		

Intersection Summary

Cycle Length: 90  
 Actuated Cycle Length: 81.3  
 Natural Cycle: 60  
 Control Type: Actuated-Uncoordinated  
 Maximum v/c Ratio: 0.89  
 Intersection Signal Delay: 22.7  
 Intersection Capacity Utilization 75.3%  
 Analysis Period (min) 15  
 Intersection LOS: C  
 ICU Level of Service D

Splits and Phases: 130: Lambert Rd & Stapleton Dr





## SimTraffic Performance Report

### 126: Lambert Rd & Rainbow Bridge Dr Performance by lane Interval #1 7:00

Lane	EB	EB	WB	SB	All
Movements Served	L	T	TR	R	
Stop Del/Veh (s)	1.1	0.0	0.1	5.0	1.3

### 126: Lambert Rd & Rainbow Bridge Dr Performance by lane Interval #2 7:15

Lane	EB	EB	WB	SB	All
Movements Served	L	T	TR	R	
Stop Del/Veh (s)	1.9	0.0	0.1	5.6	1.7

### 126: Lambert Rd & Rainbow Bridge Dr Performance by lane Interval #3 7:30

Lane	EB	EB	WB	SB	SB	All
Movements Served	L	T	TR	L	R	
Stop Del/Veh (s)	1.2	0.0	0.1		4.9	1.2

### 126: Lambert Rd & Rainbow Bridge Dr Performance by lane Interval #4 7:45

Lane	EB	EB	WB	SB	SB	All
Movements Served	L	T	TR	L	R	
Stop Del/Veh (s)	1.5	0.0	0.1		5.5	1.5

### 126: Lambert Rd & Rainbow Bridge Dr Performance by lane Entire Run

Lane	EB	EB	WB	SB	SB	All
Movements Served	L	T	TR	L	R	
Stop Del/Veh (s)	1.5	0.0	0.1		5.3	1.5

### Total Zone Performance By Interval

Interval Start	7:00	7:15	7:30	7:45	All
Stop Del/Veh (s)	97.5	58.1	39.8	116.5	331.8

## SimTraffic Performance Report

## 126: Lambert Rd &amp; Rainbow Bridge Dr Performance by lane Interval #1 4:30

Lane	EB	EB	WB	SB	SB	All
Movements Served	L	T	TR	L	R	
Stop Del/Veh (s)	0.7	0.0	0.1	10.4	3.3	0.8

## 126: Lambert Rd &amp; Rainbow Bridge Dr Performance by lane Interval #2 4:45

Lane	EB	EB	WB	SB	SB	All
Movements Served	L	T	TR	L	R	
Stop Del/Veh (s)	1.4	0.0	0.1	6.0	3.5	1.1

## 126: Lambert Rd &amp; Rainbow Bridge Dr Performance by lane Interval #3 5:00

Lane	EB	EB	WB	SB	SB	All
Movements Served	L	T	TR	L	R	
Stop Del/Veh (s)	0.8	0.0	0.1	10.6	3.6	0.9

## 126: Lambert Rd &amp; Rainbow Bridge Dr Performance by lane Interval #4 5:15

Lane	EB	EB	WB	SB	SB	All
Movements Served	L	T	TR	L	R	
Stop Del/Veh (s)	1.0	0.0	0.1	5.0	3.4	0.9

## 126: Lambert Rd &amp; Rainbow Bridge Dr Performance by lane Entire Run

Lane	EB	EB	WB	SB	SB	All
Movements Served	L	T	TR	L	R	
Stop Del/Veh (s)	1.0	0.0	0.1	7.6	3.5	0.9

## Total Zone Performance By Interval

Interval Start	4:30	4:45	5:00	5:15	All
Stop Del/Veh (s)	22.2	55.1	36.2	35.6	129.5

Intersection	
Intersection Delay, s/veh	18.2
Intersection LOS	C

Movement	EBL	EBT	EBR	WBL	WBT	WBR	NBL	NBT	NBR	SBL	SBT	SBR
Lane Configurations	↶	↷		↶	↷		↶	↷		↶	↷	
Traffic Vol, veh/h	40	316	36	18	240	66	35	71	26	105	161	49
Future Vol, veh/h	40	316	36	18	240	66	35	71	26	105	161	49
Peak Hour Factor	0.95	0.95	0.95	0.95	0.95	0.95	0.95	0.95	0.95	0.95	0.95	0.95
Heavy Vehicles, %	2	2	2	2	2	2	2	2	2	2	2	2
Mvmt Flow	42	333	38	19	253	69	37	75	27	111	169	52
Number of Lanes	1	1	0	1	1	0	1	1	0	1	1	0

Approach	EB	WB	NB	SB
Opposing Approach	WB	EB	SB	NB
Opposing Lanes	2	2	2	2
Conflicting Approach Left	SB	NB	EB	WB
Conflicting Lanes Left	2	2	2	2
Conflicting Approach Right	NB	SB	WB	EB
Conflicting Lanes Right	2	2	2	2
HCM Control Delay	22.4	19.2	12.2	14.5
HCM LOS	C	C	B	B

Lane	NBLn1	NBLn2	EBLn1	EBLn2	WBLn1	WBLn2	SBLn1	SBLn2
Vol Left, %	100%	0%	100%	0%	100%	0%	100%	0%
Vol Thru, %	0%	73%	0%	90%	0%	78%	0%	77%
Vol Right, %	0%	27%	0%	10%	0%	22%	0%	23%
Sign Control	Stop	Stop	Stop	Stop	Stop	Stop	Stop	Stop
Traffic Vol by Lane	35	97	40	352	18	306	105	210
LT Vol	35	0	40	0	18	0	105	0
Through Vol	0	71	0	316	0	240	0	161
RT Vol	0	26	0	36	0	66	0	49
Lane Flow Rate	37	102	42	371	19	322	111	221
Geometry Grp	7	7	7	7	7	7	7	7
Degree of Util (X)	0.085	0.215	0.086	0.696	0.039	0.61	0.24	0.437
Departure Headway (Hd)	8.283	7.575	7.351	6.767	7.482	6.816	7.801	7.121
Convergence, Y/N	Yes	Yes	Yes	Yes	Yes	Yes	Yes	Yes
Cap	432	473	487	534	478	528	460	506
Service Time	6.043	5.334	5.097	4.513	5.23	4.564	5.551	4.871
HCM Lane V/C Ratio	0.086	0.216	0.086	0.695	0.04	0.61	0.241	0.437
HCM Control Delay	11.8	12.4	10.8	23.7	10.5	19.7	13	15.3
HCM Lane LOS	B	B	B	C	B	C	B	C
HCM 95th-tile Q	0.3	0.8	0.3	5.4	0.1	4.1	0.9	2.2

Timings  
43: Lambert Rd & Londonderry Dr

2040 Total Traffic  
AM Peak Hour

Lane Group	EBL	EBT	WBL	WBT	WBR	NBL	NBT	NBR	SBL	SBT	SBR
Lane Configurations											
Traffic Volume (vph)	263	183	29	72	73	19	288	72	95	234	200
Future Volume (vph)	263	183	29	72	73	19	288	72	95	234	200
Turn Type	pm+pt	NA	pm+pt	NA	Perm	pm+pt	NA	Perm	pm+pt	NA	Perm
Protected Phases	7	4	3	8		5	2		1	6	
Permitted Phases	4		8		8	2		2	6		6
Detector Phase	7	4	3	8	8	5	2	2	1	6	6
Switch Phase											
Minimum Initial (s)	4.0	4.0	4.0	4.0	4.0	4.0	4.0	4.0	4.0	4.0	4.0
Minimum Split (s)	9.0	21.0	9.0	21.0	21.0	9.0	21.0	21.0	9.0	21.0	21.0
Total Split (s)	10.0	45.0	10.0	45.0	45.0	10.0	25.0	25.0	10.0	25.0	25.0
Total Split (%)	11.1%	50.0%	11.1%	50.0%	50.0%	11.1%	27.8%	27.8%	11.1%	27.8%	27.8%
Yellow Time (s)	3.0	3.0	3.0	3.0	3.0	3.0	3.0	3.0	3.0	3.0	3.0
All-Red Time (s)	2.0	2.0	2.0	2.0	2.0	2.0	2.0	2.0	2.0	2.0	2.0
Lost Time Adjust (s)	0.0	0.0	0.0	0.0	0.0	0.0	0.0	0.0	0.0	0.0	0.0
Total Lost Time (s)	5.0	5.0	5.0	5.0	5.0	5.0	5.0	5.0	5.0	5.0	5.0
Lead/Lag	Lead	Lag	Lead	Lag	Lag	Lead	Lag	Lag	Lead	Lag	Lag
Lead-Lag Optimize?	Yes	Yes	Yes	Yes	Yes	Yes	Yes	Yes	Yes	Yes	Yes
Recall Mode	None	Max	None	Max	Max	None	None	None	None	None	None
Act Effct Green (s)	47.1	44.2	45.0	40.0	40.0	22.8	17.8	17.8	25.9	23.9	23.9
Actuated g/C Ratio	0.54	0.50	0.51	0.46	0.46	0.26	0.20	0.20	0.29	0.27	0.27
v/c Ratio	0.50	0.24	0.05	0.09	0.12	0.08	0.80	0.17	0.57	0.62	0.43
Control Delay	15.6	14.4	9.4	14.8	1.2	21.3	50.3	1.0	34.7	35.7	6.3
Queue Delay	0.0	0.0	0.0	0.0	0.0	0.0	0.0	0.0	0.0	0.0	0.0
Total Delay	15.6	14.4	9.4	14.8	1.2	21.3	50.3	1.0	34.7	35.7	6.3
LOS	B	B	A	B	A	C	D	A	C	D	A
Approach Delay		15.1		7.5			39.4			24.4	
Approach LOS		B		A			D			C	

Intersection Summary

Cycle Length: 90  
 Actuated Cycle Length: 87.9  
 Natural Cycle: 60  
 Control Type: Actuated-Uncoordinated  
 Maximum v/c Ratio: 0.80  
 Intersection Signal Delay: 23.0  
 Intersection LOS: C  
 Intersection Capacity Utilization 55.4%  
 ICU Level of Service B  
 Analysis Period (min) 15

Splits and Phases: 43: Lambert Rd & Londonderry Dr

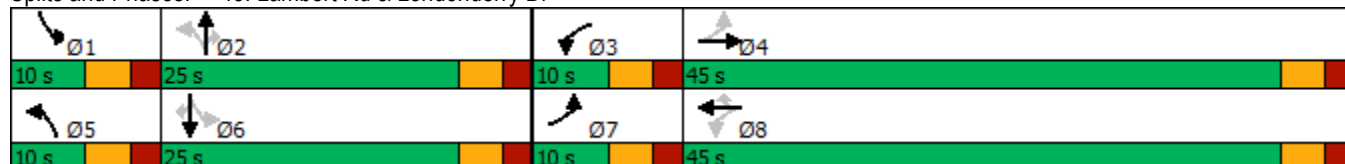



Timings  
127: Eastonville Rd & Stapleton Dr

2040 Total Traffic  
AM Peak Hour

Lane Group	EBL	EBT	EBR	WBL	WBT	WBR	NBL	NBT	NBR	SBL	SBT	SBR
Lane Configurations												
Traffic Volume (vph)	132	991	207	110	836	156	81	141	150	290	293	200
Future Volume (vph)	132	991	207	110	836	156	81	141	150	290	293	200
Turn Type	pm+pt	NA	Perm	pm+pt	NA	Perm	pm+pt	NA	Perm	pm+pt	NA	Perm
Protected Phases	7	4		3	8		5	2		1	6	
Permitted Phases	4		4	8		8	2		2	6		6
Detector Phase	7	4	4	3	8	8	5	2	2	1	6	6
Switch Phase												
Minimum Initial (s)	4.0	4.0	4.0	4.0	4.0	4.0	4.0	4.0	4.0	4.0	4.0	4.0
Minimum Split (s)	8.0	9.0	9.0	8.0	9.0	9.0	8.0	9.0	9.0	8.0	9.0	9.0
Total Split (s)	13.0	38.0	38.0	11.0	36.0	36.0	8.0	21.0	21.0	20.0	33.0	33.0
Total Split (%)	14.4%	42.2%	42.2%	12.2%	40.0%	40.0%	8.9%	23.3%	23.3%	22.2%	36.7%	36.7%
Yellow Time (s)	3.0	3.0	3.0	3.0	3.0	3.0	3.0	3.0	3.0	3.0	3.0	3.0
All-Red Time (s)	1.0	2.0	2.0	1.0	2.0	2.0	1.0	2.0	2.0	1.0	2.0	2.0
Lost Time Adjust (s)	0.0	0.0	0.0	0.0	0.0	0.0	0.0	0.0	0.0	0.0	0.0	0.0
Total Lost Time (s)	4.0	5.0	5.0	4.0	5.0	5.0	4.0	5.0	5.0	4.0	5.0	5.0
Lead/Lag	Lead	Lag	Lag	Lead	Lag	Lag	Lead	Lag	Lag	Lead	Lag	Lag
Lead-Lag Optimize?	Yes	Yes	Yes	Yes	Yes	Yes	Yes	Yes	Yes	Yes	Yes	Yes
Recall Mode	None	None	None	None	None	None	None	Max	Max	None	Max	Max
Act Effct Green (s)	39.7	32.0	32.0	35.8	28.0	28.0	21.7	16.6	16.6	35.8	28.7	28.7
Actuated g/C Ratio	0.47	0.38	0.38	0.42	0.33	0.33	0.25	0.19	0.19	0.42	0.34	0.34
v/c Ratio	0.52	0.79	0.30	0.50	0.76	0.26	0.28	0.41	0.36	0.57	0.49	0.31
Control Delay	19.6	29.7	4.1	20.6	30.6	4.4	21.5	36.1	7.2	23.2	27.7	4.9
Queue Delay	0.0	0.0	0.0	0.0	0.0	0.0	0.0	0.0	0.0	0.0	0.0	0.0
Total Delay	19.6	29.7	4.1	20.6	30.6	4.4	21.5	36.1	7.2	23.2	27.7	4.9
LOS	B	C	A	C	C	A	C	D	A	C	C	A
Approach Delay		24.7			25.9			21.2			20.2	
Approach LOS		C			C			C			C	

Intersection Summary

Cycle Length: 90  
 Actuated Cycle Length: 85.3  
 Natural Cycle: 60  
 Control Type: Actuated-Uncoordinated  
 Maximum v/c Ratio: 0.79  
 Intersection Signal Delay: 23.7  
 Intersection LOS: C  
 Intersection Capacity Utilization 72.0%  
 ICU Level of Service C  
 Analysis Period (min) 15

Splits and Phases: 127: Eastonville Rd & Stapleton Dr

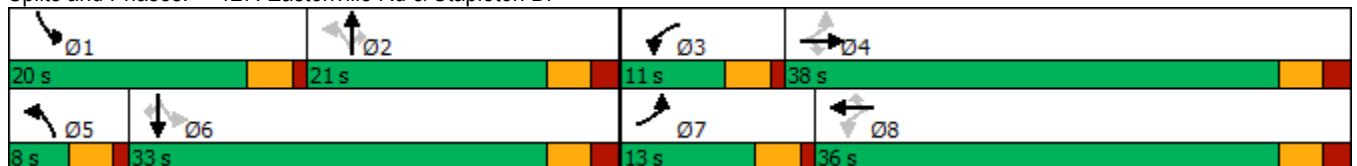

Timings  
130: Lambert Rd & Stapleton Dr

2040 Total Traffic  
AM Peak Hour

Lane Group	EBL	EBT	EBR	WBL	WBT	WBR	NBL	NBT	SBL	SBT	SBR	
Lane Configurations												
Traffic Volume (vph)	299	917	51	25	985	107	123	21	368	60	380	
Future Volume (vph)	299	917	51	25	985	107	123	21	368	60	380	
Turn Type	pm+pt	NA	Perm	pm+pt	NA	Perm	pm+pt	NA	pm+pt	NA	Perm	
Protected Phases	5	2		1	6		3	8	7	4		
Permitted Phases	2		2	6		6	8		4		4	
Detector Phase	5	2	2	1	6	6	3	8	7	4	4	
Switch Phase												
Minimum Initial (s)	4.0	4.0	4.0	4.0	4.0	4.0	4.0	4.0	4.0	4.0	4.0	
Minimum Split (s)	10.0	10.0	10.0	10.0	10.0	10.0	10.0	10.0	10.0	10.0	10.0	
Total Split (s)	20.0	46.0	46.0	10.0	36.0	36.0	18.0	10.0	24.0	16.0	16.0	
Total Split (%)	22.2%	51.1%	51.1%	11.1%	40.0%	40.0%	20.0%	11.1%	26.7%	17.8%	17.8%	
Yellow Time (s)	3.0	3.0	3.0	3.0	3.0	3.0	3.0	3.0	3.0	3.0	3.0	
All-Red Time (s)	2.0	2.0	2.0	2.0	2.0	2.0	2.0	2.0	2.0	2.0	2.0	
Lost Time Adjust (s)	0.0	0.0	0.0	0.0	0.0	0.0	0.0	0.0	0.0	0.0	0.0	
Total Lost Time (s)	5.0	5.0	5.0	5.0	5.0	5.0	5.0	5.0	5.0	5.0	5.0	
Lead/Lag	Lead	Lag	Lag	Lead	Lag	Lag	Lead	Lag	Lead	Lag	Lag	
Lead-Lag Optimize?	Yes	Yes	Yes	Yes	Yes	Yes	Yes	Yes	Yes	Yes	Yes	
Recall Mode	None	None	None	None	None	None	None	None	None	None	None	
Act Effct Green (s)	48.9	45.1	45.1	34.1	29.0	29.0	13.8	5.1	25.9	13.9	13.9	
Actuated g/C Ratio	0.58	0.53	0.53	0.40	0.34	0.34	0.16	0.06	0.31	0.16	0.16	
v/c Ratio	0.82	0.51	0.06	0.09	0.86	0.16	0.44	0.48	0.85	0.21	0.75	
Control Delay	39.0	15.6	0.1	10.6	35.1	0.5	28.6	30.4	45.4	36.8	18.9	
Queue Delay	0.0	0.0	0.0	0.0	0.0	0.0	0.0	0.0	0.0	0.0	0.0	
Total Delay	39.0	15.6	0.1	10.6	35.1	0.5	28.6	30.4	45.4	36.8	18.9	
LOS	D	B	A	B	D	A	C	C	D	D	B	
Approach Delay		20.5			31.2			29.2		32.3		
Approach LOS		C			C			C		C		

Intersection Summary

Cycle Length: 90  
 Actuated Cycle Length: 84.9  
 Natural Cycle: 80  
 Control Type: Actuated-Uncoordinated  
 Maximum v/c Ratio: 0.86  
 Intersection Signal Delay: 27.3  
 Intersection Capacity Utilization 83.3%  
 Analysis Period (min) 15  
 Intersection LOS: C  
 ICU Level of Service E

Splits and Phases: 130: Lambert Rd & Stapleton Dr



Intersection												
Int Delay, s/veh	1.4											
Movement	EBL	EBT	EBR	WBL	WBT	WBR	NBL	NBT	NBR	SBL	SBT	SBR
Lane Configurations		↕			↕		↕	↕		↕	↕	
Traffic Vol, veh/h	9	0	29	8	0	6	6	100	2	4	263	6
Future Vol, veh/h	9	0	29	8	0	6	6	100	2	4	263	6
Conflicting Peds, #/hr	0	0	0	0	0	0	0	0	0	0	0	0
Sign Control	Stop	Stop	Stop	Stop	Stop	Stop	Free	Free	Free	Free	Free	Free
RT Channelized	-	-	None	-	-	None	-	-	None	-	-	None
Storage Length	-	-	-	-	-	-	100	-	-	100	-	-
Veh in Median Storage, #	-	0	-	-	0	-	-	0	-	-	0	-
Grade, %	-	0	-	-	0	-	-	0	-	-	0	-
Peak Hour Factor	95	95	95	95	95	95	95	95	95	95	95	95
Heavy Vehicles, %	2	2	2	2	2	2	2	2	2	2	2	2
Mvmt Flow	9	0	31	8	0	6	6	105	2	4	277	6

Major/Minor	Minor2		Minor1		Major1		Major2					
Conflicting Flow All	409	407	280	422	409	106	283	0	0	107	0	0
Stage 1	288	288	-	118	118	-	-	-	-	-	-	-
Stage 2	121	119	-	304	291	-	-	-	-	-	-	-
Critical Hdwy	7.12	6.52	6.22	7.12	6.52	6.22	4.12	-	-	4.12	-	-
Critical Hdwy Stg 1	6.12	5.52	-	6.12	5.52	-	-	-	-	-	-	-
Critical Hdwy Stg 2	6.12	5.52	-	6.12	5.52	-	-	-	-	-	-	-
Follow-up Hdwy	3.518	4.018	3.318	3.518	4.018	3.318	2.218	-	-	2.218	-	-
Pot Cap-1 Maneuver	553	533	759	542	532	948	1279	-	-	1484	-	-
Stage 1	720	674	-	887	798	-	-	-	-	-	-	-
Stage 2	883	797	-	705	672	-	-	-	-	-	-	-
Platoon blocked, %								-	-	-	-	-
Mov Cap-1 Maneuver	546	529	759	517	528	948	1279	-	-	1484	-	-
Mov Cap-2 Maneuver	546	529	-	517	528	-	-	-	-	-	-	-
Stage 1	716	672	-	883	794	-	-	-	-	-	-	-
Stage 2	873	793	-	675	670	-	-	-	-	-	-	-

Approach	EB		WB		NB		SB	
HCM Control Delay, s	10.5		10.7		0.4		0.1	
HCM LOS	B		B					

Minor Lane/Major Mvmt	NBL	NBT	NBR	EBLn1WBLn1	SBL	SBT	SBR
Capacity (veh/h)	1279	-	-	695	642	1484	-
HCM Lane V/C Ratio	0.005	-	-	0.058	0.023	0.003	-
HCM Control Delay (s)	7.8	-	-	10.5	10.7	7.4	-
HCM Lane LOS	A	-	-	B	B	A	-
HCM 95th %tile Q(veh)	0	-	-	0.2	0.1	0	-

**Intersection**

Int Delay, s/veh 0.9

Movement	EBL	EBT	EBR	WBL	WBT	WBR	NBL	NBT	NBR	SBL	SBT	SBR
Lane Configurations		↕			↕		↕	↕		↕	↕	
Traffic Vol, veh/h	9	0	10	12	0	3	4	95	4	1	307	6
Future Vol, veh/h	9	0	10	12	0	3	4	95	4	1	307	6
Conflicting Peds, #/hr	0	0	0	0	0	0	0	0	0	0	0	0
Sign Control	Stop	Stop	Stop	Stop	Stop	Stop	Free	Free	Free	Free	Free	Free
RT Channelized	-	-	None	-	-	None	-	-	None	-	-	None
Storage Length	-	-	-	-	-	-	100	-	-	100	-	-
Veh in Median Storage, #	-	0	-	-	0	-	-	0	-	-	0	-
Grade, %	-	0	-	-	0	-	-	0	-	-	0	-
Peak Hour Factor	95	95	95	95	95	95	95	95	95	95	95	95
Heavy Vehicles, %	2	2	2	2	2	2	2	2	2	2	2	2
Mvmt Flow	9	0	11	13	0	3	4	100	4	1	323	6

Major/Minor	Minor2		Minor1		Major1			Major2				
Conflicting Flow All	440	440	326	444	441	102	329	0	0	104	0	0
Stage 1	328	328	-	110	110	-	-	-	-	-	-	-
Stage 2	112	112	-	334	331	-	-	-	-	-	-	-
Critical Hdwy	7.12	6.52	6.22	7.12	6.52	6.22	4.12	-	-	4.12	-	-
Critical Hdwy Stg 1	6.12	5.52	-	6.12	5.52	-	-	-	-	-	-	-
Critical Hdwy Stg 2	6.12	5.52	-	6.12	5.52	-	-	-	-	-	-	-
Follow-up Hdwy	3.518	4.018	3.318	3.518	4.018	3.318	2.218	-	-	2.218	-	-
Pot Cap-1 Maneuver	527	511	715	524	510	953	1231	-	-	1488	-	-
Stage 1	685	647	-	895	804	-	-	-	-	-	-	-
Stage 2	893	803	-	680	645	-	-	-	-	-	-	-
Platoon blocked, %								-	-	-	-	-
Mov Cap-1 Maneuver	524	509	715	515	508	953	1231	-	-	1488	-	-
Mov Cap-2 Maneuver	524	509	-	515	508	-	-	-	-	-	-	-
Stage 1	683	646	-	892	802	-	-	-	-	-	-	-
Stage 2	887	801	-	670	644	-	-	-	-	-	-	-

Approach	EB		WB		NB		SB	
HCM Control Delay, s	11.1		11.5		0.3		0	
HCM LOS	B		B					

Minor Lane/Major Mvmt	NBL	NBT	NBR	EBLn1	WBLn1	SBL	SBT	SBR
Capacity (veh/h)	1231	-	-	610	567	1488	-	-
HCM Lane V/C Ratio	0.003	-	-	0.033	0.028	0.001	-	-
HCM Control Delay (s)	7.9	-	-	11.1	11.5	7.4	-	-
HCM Lane LOS	A	-	-	B	B	A	-	-
HCM 95th %tile Q(veh)	0	-	-	0.1	0.1	0	-	-

Intersection						
Int Delay, s/veh	0.8					
Movement	EBL	EBR	NBL	NBT	SBT	SBR
Lane Configurations	Y		Y	↑	↑	
Traffic Vol, veh/h	11	19	4	111	254	7
Future Vol, veh/h	11	19	4	111	254	7
Conflicting Peds, #/hr	0	0	0	0	0	0
Sign Control	Stop	Stop	Free	Free	Free	Free
RT Channelized	-	None	-	None	-	None
Storage Length	0	-	100	-	-	-
Veh in Median Storage, #	0	-	-	0	0	-
Grade, %	0	-	-	0	0	-
Peak Hour Factor	95	95	95	95	95	95
Heavy Vehicles, %	2	2	2	2	2	2
Mvmt Flow	12	20	4	117	267	7

Major/Minor	Minor2	Major1	Major2			
Conflicting Flow All	396	271	274	0	-	0
Stage 1	271	-	-	-	-	-
Stage 2	125	-	-	-	-	-
Critical Hdwy	6.42	6.22	4.12	-	-	-
Critical Hdwy Stg 1	5.42	-	-	-	-	-
Critical Hdwy Stg 2	5.42	-	-	-	-	-
Follow-up Hdwy	3.518	3.318	2.218	-	-	-
Pot Cap-1 Maneuver	609	768	1289	-	-	-
Stage 1	775	-	-	-	-	-
Stage 2	901	-	-	-	-	-
Platoon blocked, %				-	-	-
Mov Cap-1 Maneuver	607	768	1289	-	-	-
Mov Cap-2 Maneuver	651	-	-	-	-	-
Stage 1	773	-	-	-	-	-
Stage 2	901	-	-	-	-	-

Approach	EB	NB	SB
HCM Control Delay, s	10.2	0.3	0
HCM LOS	B		

Minor Lane/Major Mvmt	NBL	NBT	EBLn1	SBT	SBR
Capacity (veh/h)	1289	-	721	-	-
HCM Lane V/C Ratio	0.003	-	0.044	-	-
HCM Control Delay (s)	7.8	-	10.2	-	-
HCM Lane LOS	A	-	B	-	-
HCM 95th %tile Q(veh)	0	-	0.1	-	-

HCM 6th TWSC  
 297: Rainbow Bridge Dr & Enclaves South Access

2040 Total Traffic  
 AM Peak Hour

Intersection						
Int Delay, s/veh	0.6					
Movement	WBL	WBR	NBT	NBR	SBL	SBT
Lane Configurations	↔		↔		↔	↔
Traffic Vol, veh/h	18	5	103	4	3	297
Future Vol, veh/h	18	5	103	4	3	297
Conflicting Peds, #/hr	0	0	0	0	0	0
Sign Control	Stop	Stop	Free	Free	Free	Free
RT Channelized	-	None	-	None	-	None
Storage Length	0	-	-	-	100	-
Veh in Median Storage, #	0	-	0	-	-	0
Grade, %	0	-	0	-	-	0
Peak Hour Factor	95	95	95	95	95	95
Heavy Vehicles, %	2	2	2	2	2	2
Mvmt Flow	19	5	108	4	3	313

Major/Minor	Minor1	Major1	Major2			
Conflicting Flow All	429	110	0	0	112	0
Stage 1	110	-	-	-	-	-
Stage 2	319	-	-	-	-	-
Critical Hdwy	6.42	6.22	-	-	4.12	-
Critical Hdwy Stg 1	5.42	-	-	-	-	-
Critical Hdwy Stg 2	5.42	-	-	-	-	-
Follow-up Hdwy	3.518	3.318	-	-	2.218	-
Pot Cap-1 Maneuver	583	943	-	-	1478	-
Stage 1	915	-	-	-	-	-
Stage 2	737	-	-	-	-	-
Platoon blocked, %						
Mov Cap-1 Maneuver	582	943	-	-	1478	-
Mov Cap-2 Maneuver	626	-	-	-	-	-
Stage 1	913	-	-	-	-	-
Stage 2	737	-	-	-	-	-

Approach	WB	NB	SB
HCM Control Delay, s	10.5	0	0.1
HCM LOS	B		

Minor Lane/Major Mvmt	NBT	NBRWBLn1	SBL	SBT
Capacity (veh/h)	-	-	675	1478
HCM Lane V/C Ratio	-	-	0.036	0.002
HCM Control Delay (s)	-	-	10.5	7.4
HCM Lane LOS	-	-	B	A
HCM 95th %tile Q(veh)	-	-	0.1	0

Intersection						
Int Delay, s/veh	0.5					
Movement	WBL	WBR	NBT	NBR	SBL	SBT
Lane Configurations	↔		↔		↔	↔
Traffic Vol, veh/h	18	2	101	5	1	328
Future Vol, veh/h	18	2	101	5	1	328
Conflicting Peds, #/hr	0	0	0	0	0	0
Sign Control	Stop	Stop	Free	Free	Free	Free
RT Channelized	-	None	-	None	-	None
Storage Length	0	-	-	-	100	-
Veh in Median Storage, #	0	-	0	-	-	0
Grade, %	0	-	0	-	-	0
Peak Hour Factor	95	95	95	95	95	95
Heavy Vehicles, %	2	2	2	2	2	2
Mvmt Flow	19	2	106	5	1	345

Major/Minor	Minor1	Major1	Major2			
Conflicting Flow All	456	109	0	0	111	0
Stage 1	109	-	-	-	-	-
Stage 2	347	-	-	-	-	-
Critical Hdwy	6.42	6.22	-	-	4.12	-
Critical Hdwy Stg 1	5.42	-	-	-	-	-
Critical Hdwy Stg 2	5.42	-	-	-	-	-
Follow-up Hdwy	3.518	3.318	-	-	2.218	-
Pot Cap-1 Maneuver	562	945	-	-	1479	-
Stage 1	916	-	-	-	-	-
Stage 2	716	-	-	-	-	-
Platoon blocked, %			-	-		-
Mov Cap-1 Maneuver	561	945	-	-	1479	-
Mov Cap-2 Maneuver	561	-	-	-	-	-
Stage 1	915	-	-	-	-	-
Stage 2	716	-	-	-	-	-

Approach	WB	NB	SB
HCM Control Delay, s	11.4	0	0
HCM LOS	B		

Minor Lane/Major Mvmt	NBT	NBRWBLn1	SBL	SBT
Capacity (veh/h)	-	-	585	1479
HCM Lane V/C Ratio	-	-	0.036	0.001
HCM Control Delay (s)	-	-	11.4	7.4
HCM Lane LOS	-	-	B	A
HCM 95th %tile Q(veh)	-	-	0.1	0

HCM 6th AWSC  
3: Rainbow Bridge Dr & Londonderry Dr

2040 Total Traffic  
PM Peak Hour

Intersection	
Intersection Delay, s/veh	13.4
Intersection LOS	B

Movement	EBL	EBT	EBR	WBL	WBT	WBR	NBL	NBT	NBR	SBL	SBT	SBR
Lane Configurations	↶	↷		↶	↷		↶	↷		↶	↷	
Traffic Vol, veh/h	59	196	63	10	165	79	55	180	9	51	114	29
Future Vol, veh/h	59	196	63	10	165	79	55	180	9	51	114	29
Peak Hour Factor	0.95	0.95	0.95	0.95	0.95	0.95	0.95	0.95	0.95	0.95	0.95	0.95
Heavy Vehicles, %	2	2	2	2	2	2	2	2	2	2	2	2
Mvmt Flow	62	206	66	11	174	83	58	189	9	54	120	31
Number of Lanes	1	1	0	1	1	0	1	1	0	1	1	0

Approach	EB	WB	NB	SB
Opposing Approach	WB	EB	SB	NB
Opposing Lanes	2	2	2	2
Conflicting Approach Left	SB	NB	EB	WB
Conflicting Lanes Left	2	2	2	2
Conflicting Approach Right	NB	SB	WB	EB
Conflicting Lanes Right	2	2	2	2
HCM Control Delay	14	14.2	12.9	11.8
HCM LOS	B	B	B	B

Lane	NBLn1	NBLn2	EBLn1	EBLn2	WBLn1	WBLn2	SBLn1	SBLn2
Vol Left, %	100%	0%	100%	0%	100%	0%	100%	0%
Vol Thru, %	0%	95%	0%	76%	0%	68%	0%	80%
Vol Right, %	0%	5%	0%	24%	0%	32%	0%	20%
Sign Control	Stop	Stop	Stop	Stop	Stop	Stop	Stop	Stop
Traffic Vol by Lane	55	189	59	259	10	244	51	143
LT Vol	55	0	59	0	10	0	51	0
Through Vol	0	180	0	196	0	165	0	114
RT Vol	0	9	0	63	0	79	0	29
Lane Flow Rate	58	199	62	273	11	257	54	151
Geometry Grp	7	7	7	7	7	7	7	7
Degree of Util (X)	0.117	0.371	0.12	0.477	0.021	0.453	0.11	0.28
Departure Headway (Hd)	7.249	6.705	6.979	6.297	7.089	6.349	7.36	6.705
Convergence, Y/N	Yes	Yes	Yes	Yes	Yes	Yes	Yes	Yes
Cap	492	533	511	567	501	562	484	531
Service Time	5.041	4.497	4.767	4.085	4.881	4.141	5.159	4.503
HCM Lane V/C Ratio	0.118	0.373	0.121	0.481	0.022	0.457	0.112	0.284
HCM Control Delay	11	13.5	10.7	14.8	10	14.4	11.1	12.1
HCM Lane LOS	B	B	B	B	A	B	B	B
HCM 95th-tile Q	0.4	1.7	0.4	2.6	0.1	2.3	0.4	1.1



Timings  
43: Lambert Rd & Londonderry Dr

2040 Total Traffic  
PM Peak Hour

Lane Group	EBL	EBT	WBL	WBT	WBR	NBL	NBT	NBR	SBL	SBT	SBR
Lane Configurations											
Traffic Volume (vph)	96	103	40	150	94	32	161	31	58	129	86
Future Volume (vph)	96	103	40	150	94	32	161	31	58	129	86
Turn Type	pm+pt	NA	pm+pt	NA	Perm	pm+pt	NA	Perm	pm+pt	NA	Perm
Protected Phases	7	4	3	8		5	2		1	6	
Permitted Phases	4		8		8	2		2	6		6
Detector Phase	7	4	3	8	8	5	2	2	1	6	6
Switch Phase											
Minimum Initial (s)	4.0	4.0	4.0	4.0	4.0	4.0	4.0	4.0	4.0	4.0	4.0
Minimum Split (s)	9.0	21.0	9.0	21.0	21.0	9.0	21.0	21.0	9.0	21.0	21.0
Total Split (s)	10.0	45.0	10.0	45.0	45.0	10.0	25.0	25.0	10.0	25.0	25.0
Total Split (%)	11.1%	50.0%	11.1%	50.0%	50.0%	11.1%	27.8%	27.8%	11.1%	27.8%	27.8%
Yellow Time (s)	3.0	3.0	3.0	3.0	3.0	3.0	3.0	3.0	3.0	3.0	3.0
All-Red Time (s)	2.0	2.0	2.0	2.0	2.0	2.0	2.0	2.0	2.0	2.0	2.0
Lost Time Adjust (s)	0.0	0.0	0.0	0.0	0.0	0.0	0.0	0.0	0.0	0.0	0.0
Total Lost Time (s)	5.0	5.0	5.0	5.0	5.0	5.0	5.0	5.0	5.0	5.0	5.0
Lead/Lag	Lead	Lag	Lead	Lag	Lag	Lead	Lag	Lag	Lead	Lag	Lag
Lead-Lag Optimize?	Yes	Yes	Yes	Yes	Yes	Yes	Yes	Yes	Yes	Yes	Yes
Recall Mode	None	Max	None	Max	Max	None	None	None	None	None	None
Act Effct Green (s)	46.0	43.2	45.0	41.3	41.3	16.6	12.8	12.8	17.6	14.8	14.8
Actuated g/C Ratio	0.58	0.54	0.57	0.52	0.52	0.21	0.16	0.16	0.22	0.19	0.19
v/c Ratio	0.18	0.14	0.06	0.16	0.14	0.12	0.56	0.09	0.29	0.50	0.28
Control Delay	8.8	11.2	8.2	13.5	2.4	22.7	39.3	0.5	25.5	35.7	5.0
Queue Delay	0.0	0.0	0.0	0.0	0.0	0.0	0.0	0.0	0.0	0.0	0.0
Total Delay	8.8	11.2	8.2	13.5	2.4	22.7	39.3	0.5	25.5	35.7	5.0
LOS	A	B	A	B	A	C	D	A	C	D	A
Approach Delay		10.0		8.5			31.5			23.8	
Approach LOS		B		A			C			C	

Intersection Summary

Cycle Length: 90  
 Actuated Cycle Length: 79.4  
 Natural Cycle: 60  
 Control Type: Actuated-Uncoordinated  
 Maximum v/c Ratio: 0.56  
 Intersection Signal Delay: 18.1  
 Intersection Capacity Utilization 41.7%  
 Analysis Period (min) 15  
 Intersection LOS: B  
 ICU Level of Service A

Splits and Phases: 43: Lambert Rd & Londonderry Dr

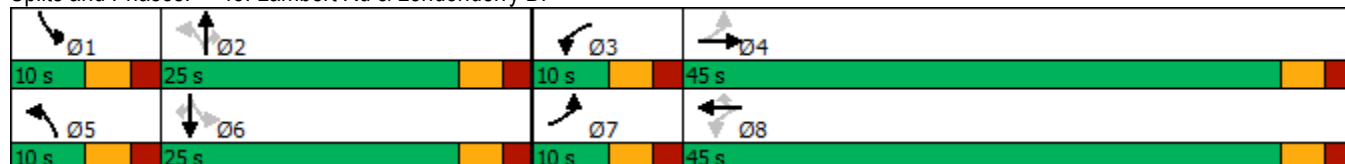

Timings  
127: Eastonville Rd & Stapleton Dr

2040 Total Traffic  
PM Peak Hour

Lane Group	EBL	EBT	EBR	WBL	WBT	WBR	NBL	NBT	NBR	SBL	SBT	SBR
Lane Configurations												
Traffic Volume (vph)	262	906	133	165	1251	333	249	315	150	198	206	139
Future Volume (vph)	262	906	133	165	1251	333	249	315	150	198	206	139
Turn Type	pm+pt	NA	Perm	pm+pt	NA	Perm	pm+pt	NA	Perm	pm+pt	NA	Perm
Protected Phases	7	4		3	8		5	2		1	6	
Permitted Phases	4		4	8		8	2		2	6		6
Detector Phase	7	4	4	3	8	8	5	2	2	1	6	6
Switch Phase												
Minimum Initial (s)	4.0	4.0	4.0	4.0	4.0	4.0	4.0	4.0	4.0	4.0	4.0	4.0
Minimum Split (s)	9.0	9.0	9.0	9.0	9.0	9.0	9.0	9.0	9.0	9.0	9.0	9.0
Total Split (s)	15.0	38.0	38.0	15.0	38.0	38.0	10.0	26.0	26.0	11.0	27.0	27.0
Total Split (%)	16.7%	42.2%	42.2%	16.7%	42.2%	42.2%	11.1%	28.9%	28.9%	12.2%	30.0%	30.0%
Yellow Time (s)	3.0	3.0	3.0	3.0	3.0	3.0	3.0	3.0	3.0	3.0	3.0	3.0
All-Red Time (s)	1.0	2.0	2.0	1.0	2.0	2.0	1.0	2.0	2.0	1.0	2.0	2.0
Lost Time Adjust (s)	0.0	0.0	0.0	0.0	0.0	0.0	0.0	0.0	0.0	0.0	0.0	0.0
Total Lost Time (s)	4.0	5.0	5.0	4.0	5.0	5.0	4.0	5.0	5.0	4.0	5.0	5.0
Lead/Lag	Lead	Lag	Lag	Lead	Lag	Lag	Lead	Lag	Lag	Lead	Lag	Lag
Lead-Lag Optimize?	Yes	Yes	Yes	Yes	Yes	Yes	Yes	Yes	Yes	Yes	Yes	Yes
Recall Mode	None	None	None	None	None	None	None	None	None	None	None	None
Act Effct Green (s)	46.6	34.6	34.6	43.4	33.0	33.0	26.0	19.0	19.0	28.0	20.0	20.0
Actuated g/C Ratio	0.53	0.39	0.39	0.49	0.38	0.38	0.30	0.22	0.22	0.32	0.23	0.23
v/c Ratio	0.90	0.69	0.20	0.56	0.99	0.45	0.78	0.83	0.34	0.85	0.51	0.31
Control Delay	53.0	26.0	4.3	17.7	52.0	6.1	42.0	51.4	7.1	54.4	34.4	6.9
Queue Delay	0.0	0.0	0.0	0.0	0.0	0.0	0.0	0.0	0.0	0.0	0.0	0.0
Total Delay	53.0	26.0	4.3	17.7	52.0	6.1	42.0	51.4	7.1	54.4	34.4	6.9
LOS	D	C	A	B	D	A	D	D	A	D	C	A
Approach Delay		29.3			40.0			38.8			34.7	
Approach LOS		C			D			D			C	

Intersection Summary

Cycle Length: 90  
 Actuated Cycle Length: 88  
 Natural Cycle: 70  
 Control Type: Actuated-Uncoordinated  
 Maximum v/c Ratio: 0.99  
 Intersection Signal Delay: 35.9  
 Intersection LOS: D  
 Intersection Capacity Utilization 91.6%  
 ICU Level of Service F  
 Analysis Period (min) 15

Splits and Phases: 127: Eastonville Rd & Stapleton Dr

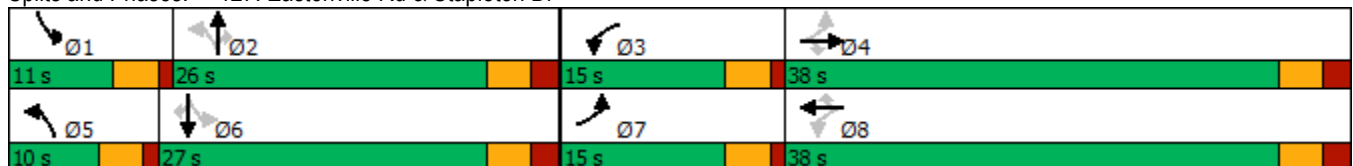

Timings  
130: Lambert Rd & Stapleton Dr

2040 Total Traffic  
PM Peak Hour

Lane Group	EBL	EBT	EBR	WBL	WBT	WBR	NBL	NBT	SBL	SBT	SBR	
Lane Configurations												
Traffic Volume (vph)	354	975	158	85	1084	469	89	72	251	39	260	
Future Volume (vph)	354	975	158	85	1084	469	89	72	251	39	260	
Turn Type	pm+pt	NA	Perm	pm+pt	NA	Perm	pm+pt	NA	pm+pt	NA	Perm	
Protected Phases	5	2		1	6		3	8	7	4		
Permitted Phases	2		2	6		6	8		4		4	
Detector Phase	5	2	2	1	6	6	3	8	7	4	4	
Switch Phase												
Minimum Initial (s)	4.0	4.0	4.0	4.0	4.0	4.0	4.0	4.0	4.0	4.0	4.0	
Minimum Split (s)	10.0	10.0	10.0	10.0	10.0	10.0	10.0	10.0	10.0	10.0	10.0	
Total Split (s)	23.0	48.0	48.0	10.0	35.0	35.0	15.0	15.0	17.0	17.0	17.0	
Total Split (%)	25.6%	53.3%	53.3%	11.1%	38.9%	38.9%	16.7%	16.7%	18.9%	18.9%	18.9%	
Yellow Time (s)	3.0	3.0	3.0	3.0	3.0	3.0	3.0	3.0	3.0	3.0	3.0	
All-Red Time (s)	2.0	2.0	2.0	2.0	2.0	2.0	2.0	2.0	2.0	2.0	2.0	
Lost Time Adjust (s)	0.0	0.0	0.0	0.0	0.0	0.0	0.0	0.0	0.0	0.0	0.0	
Total Lost Time (s)	5.0	5.0	5.0	5.0	5.0	5.0	5.0	5.0	5.0	5.0	5.0	
Lead/Lag	Lead	Lag	Lag	Lead	Lag	Lag	Lead	Lag	Lead	Lag	Lag	
Lead-Lag Optimize?	Yes	Yes	Yes	Yes	Yes	Yes	Yes	Yes	Yes	Yes	Yes	
Recall Mode	None	None	None	None	None	None	None	None	None	None	None	
Act Effct Green (s)	52.6	44.7	44.7	35.0	30.0	30.0	17.5	9.0	24.3	14.8	14.8	
Actuated g/C Ratio	0.59	0.50	0.50	0.40	0.34	0.34	0.20	0.10	0.27	0.17	0.17	
v/c Ratio	0.86	0.57	0.19	0.33	0.95	0.57	0.30	0.71	0.81	0.13	0.56	
Control Delay	42.2	17.8	2.8	13.7	46.9	5.1	26.6	45.5	48.1	35.6	9.6	
Queue Delay	0.0	0.0	0.0	0.0	0.0	0.0	0.0	0.0	0.0	0.0	0.0	
Total Delay	42.2	17.8	2.8	13.7	46.9	5.1	26.6	45.5	48.1	35.6	9.6	
LOS	D	B	A	B	D	A	C	D	D	D	A	
Approach Delay		22.0			33.2			38.4		29.0		
Approach LOS		C			C			D		C		

Intersection Summary

Cycle Length: 90  
 Actuated Cycle Length: 88.6  
 Natural Cycle: 90  
 Control Type: Actuated-Uncoordinated  
 Maximum v/c Ratio: 0.95  
 Intersection Signal Delay: 28.7  
 Intersection LOS: C  
 Intersection Capacity Utilization 88.5%  
 ICU Level of Service E  
 Analysis Period (min) 15

Splits and Phases: 130: Lambert Rd & Stapleton Dr



Intersection												
Int Delay, s/veh	1.1											
Movement	EBL	EBT	EBR	WBL	WBT	WBR	NBL	NBT	NBR	SBL	SBT	SBR
Lane Configurations		↕			↕		↕	↕		↕	↕	
Traffic Vol, veh/h	5	0	20	6	0	3	36	311	10	4	207	8
Future Vol, veh/h	5	0	20	6	0	3	36	311	10	4	207	8
Conflicting Peds, #/hr	0	0	0	0	0	0	0	0	0	0	0	0
Sign Control	Stop	Stop	Stop	Stop	Stop	Stop	Free	Free	Free	Free	Free	Free
RT Channelized	-	-	None	-	-	None	-	-	None	-	-	None
Storage Length	-	-	-	-	-	-	100	-	-	100	-	-
Veh in Median Storage, #	-	0	-	-	0	-	-	0	-	-	0	-
Grade, %	-	0	-	-	0	-	-	0	-	-	0	-
Peak Hour Factor	95	95	95	95	95	95	95	95	95	95	95	95
Heavy Vehicles, %	2	2	2	2	2	2	2	2	2	2	2	2
Mvmt Flow	5	0	21	6	0	3	38	327	11	4	218	8

Major/Minor	Minor2		Minor1		Major1		Major2					
Conflicting Flow All	640	644	222	650	643	333	226	0	0	338	0	0
Stage 1	230	230	-	409	409	-	-	-	-	-	-	-
Stage 2	410	414	-	241	234	-	-	-	-	-	-	-
Critical Hdwy	7.12	6.52	6.22	7.12	6.52	6.22	4.12	-	-	4.12	-	-
Critical Hdwy Stg 1	6.12	5.52	-	6.12	5.52	-	-	-	-	-	-	-
Critical Hdwy Stg 2	6.12	5.52	-	6.12	5.52	-	-	-	-	-	-	-
Follow-up Hdwy	3.518	4.018	3.318	3.518	4.018	3.318	2.218	-	-	2.218	-	-
Pot Cap-1 Maneuver	388	391	818	382	392	709	1342	-	-	1221	-	-
Stage 1	773	714	-	619	596	-	-	-	-	-	-	-
Stage 2	619	593	-	762	711	-	-	-	-	-	-	-
Platoon blocked, %								-	-	-	-	-
Mov Cap-1 Maneuver	377	379	818	363	380	709	1342	-	-	1221	-	-
Mov Cap-2 Maneuver	377	379	-	363	380	-	-	-	-	-	-	-
Stage 1	751	712	-	602	579	-	-	-	-	-	-	-
Stage 2	599	576	-	740	709	-	-	-	-	-	-	-

Approach	EB		WB		NB		SB	
HCM Control Delay, s	10.7		13.5		0.8		0.1	
HCM LOS	B		B					

Minor Lane/Major Mvmt	NBL	NBT	NBR	EBLn1	WBLn1	SBL	SBT	SBR
Capacity (veh/h)	1342	-	-	663	434	1221	-	-
HCM Lane V/C Ratio	0.028	-	-	0.04	0.022	0.003	-	-
HCM Control Delay (s)	7.8	-	-	10.7	13.5	8	-	-
HCM Lane LOS	A	-	-	B	B	A	-	-
HCM 95th %tile Q(veh)	0.1	-	-	0.1	0.1	0	-	-

Intersection												
Int Delay, s/veh	0.6											
Movement	EBL	EBT	EBR	WBL	WBT	WBR	NBL	NBT	NBR	SBL	SBT	SBR
Lane Configurations		↕			↕		↕	↕		↕	↕	
Traffic Vol, veh/h	6	0	6	8	0	2	10	370	13	3	229	11
Future Vol, veh/h	6	0	6	8	0	2	10	370	13	3	229	11
Conflicting Peds, #/hr	0	0	0	0	0	0	0	0	0	0	0	0
Sign Control	Stop	Stop	Stop	Stop	Stop	Stop	Free	Free	Free	Free	Free	Free
RT Channelized	-	-	None	-	-	None	-	-	None	-	-	None
Storage Length	-	-	-	-	-	-	100	-	-	100	-	-
Veh in Median Storage, #	-	0	-	-	0	-	-	0	-	-	0	-
Grade, %	-	0	-	-	0	-	-	0	-	-	0	-
Peak Hour Factor	95	95	95	95	95	95	95	95	95	95	95	95
Heavy Vehicles, %	2	2	2	2	2	2	2	2	2	2	2	2
Mvmt Flow	6	0	6	8	0	2	11	389	14	3	241	12

Major/Minor	Minor2		Minor1		Major1			Major2				
Conflicting Flow All	672	678	247	674	677	396	253	0	0	403	0	0
Stage 1	253	253	-	418	418	-	-	-	-	-	-	-
Stage 2	419	425	-	256	259	-	-	-	-	-	-	-
Critical Hdwy	7.12	6.52	6.22	7.12	6.52	6.22	4.12	-	-	4.12	-	-
Critical Hdwy Stg 1	6.12	5.52	-	6.12	5.52	-	-	-	-	-	-	-
Critical Hdwy Stg 2	6.12	5.52	-	6.12	5.52	-	-	-	-	-	-	-
Follow-up Hdwy	3.518	4.018	3.318	3.518	4.018	3.318	2.218	-	-	2.218	-	-
Pot Cap-1 Maneuver	370	374	792	368	375	653	1312	-	-	1156	-	-
Stage 1	751	698	-	612	591	-	-	-	-	-	-	-
Stage 2	612	586	-	749	694	-	-	-	-	-	-	-
Platoon blocked, %								-	-	-	-	-
Mov Cap-1 Maneuver	366	370	792	362	371	653	1312	-	-	1156	-	-
Mov Cap-2 Maneuver	366	370	-	362	371	-	-	-	-	-	-	-
Stage 1	745	696	-	607	586	-	-	-	-	-	-	-
Stage 2	605	581	-	741	692	-	-	-	-	-	-	-

Approach	EB		WB		NB		SB	
HCM Control Delay, s	12.4		14.3		0.2		0.1	
HCM LOS	B		B					

Minor Lane/Major Mvmt	NBL	NBT	NBR	EBLn1WBLn1	SBL	SBT	SBR
Capacity (veh/h)	1312	-	-	501	397	1156	-
HCM Lane V/C Ratio	0.008	-	-	0.025	0.027	0.003	-
HCM Control Delay (s)	7.8	-	-	12.4	14.3	8.1	-
HCM Lane LOS	A	-	-	B	B	A	-
HCM 95th %tile Q(veh)	0	-	-	0.1	0.1	0	-

Intersection						
Int Delay, s/veh	0.7					
Movement	EBL	EBR	NBL	NBT	SBT	SBR
Lane Configurations	↔		↔	↑	↑	
Traffic Vol, veh/h	5	13	24	295	206	7
Future Vol, veh/h	5	13	24	295	206	7
Conflicting Peds, #/hr	0	0	0	0	0	0
Sign Control	Stop	Stop	Free	Free	Free	Free
RT Channelized	-	None	-	None	-	None
Storage Length	0	-	100	-	-	-
Veh in Median Storage, #	0	-	-	0	0	-
Grade, %	0	-	-	0	0	-
Peak Hour Factor	95	95	95	95	95	95
Heavy Vehicles, %	2	2	2	2	2	2
Mvmt Flow	5	14	25	311	217	7

Major/Minor	Minor2	Major1	Major2			
Conflicting Flow All	582	221	224	0	-	0
Stage 1	221	-	-	-	-	-
Stage 2	361	-	-	-	-	-
Critical Hdwy	6.42	6.22	4.12	-	-	-
Critical Hdwy Stg 1	5.42	-	-	-	-	-
Critical Hdwy Stg 2	5.42	-	-	-	-	-
Follow-up Hdwy	3.518	3.318	2.218	-	-	-
Pot Cap-1 Maneuver	475	819	1345	-	-	-
Stage 1	816	-	-	-	-	-
Stage 2	705	-	-	-	-	-
Platoon blocked, %				-	-	-
Mov Cap-1 Maneuver	466	819	1345	-	-	-
Mov Cap-2 Maneuver	545	-	-	-	-	-
Stage 1	800	-	-	-	-	-
Stage 2	705	-	-	-	-	-

Approach	EB	NB	SB
HCM Control Delay, s	10.1	0.6	0
HCM LOS	B		

Minor Lane/Major Mvmt	NBL	NBT	EBLn1	SBT	SBR
Capacity (veh/h)	1345	-	719	-	-
HCM Lane V/C Ratio	0.019	-	0.026	-	-
HCM Control Delay (s)	7.7	-	10.1	-	-
HCM Lane LOS	A	-	B	-	-
HCM 95th %tile Q(veh)	0.1	-	0.1	-	-

Intersection						
Int Delay, s/veh	0.3					
Movement	WBL	WBR	NBT	NBR	SBL	SBT
Lane Configurations	↔		↔		↔	↔
Traffic Vol, veh/h	13	2	355	23	3	230
Future Vol, veh/h	13	2	355	23	3	230
Conflicting Peds, #/hr	0	0	0	0	0	0
Sign Control	Stop	Stop	Free	Free	Free	Free
RT Channelized	-	None	-	None	-	None
Storage Length	0	-	-	-	100	-
Veh in Median Storage, #	0	-	0	-	-	0
Grade, %	0	-	0	-	-	0
Peak Hour Factor	95	95	95	95	95	95
Heavy Vehicles, %	2	2	2	2	2	2
Mvmt Flow	14	2	374	24	3	242

Major/Minor	Minor1	Major1	Major2		
Conflicting Flow All	634	386	0	0	398
Stage 1	386	-	-	-	-
Stage 2	248	-	-	-	-
Critical Hdwy	6.42	6.22	-	-	4.12
Critical Hdwy Stg 1	5.42	-	-	-	-
Critical Hdwy Stg 2	5.42	-	-	-	-
Follow-up Hdwy	3.518	3.318	-	-	2.218
Pot Cap-1 Maneuver	443	662	-	-	1161
Stage 1	687	-	-	-	-
Stage 2	793	-	-	-	-
Platoon blocked, %					
Mov Cap-1 Maneuver	442	662	-	-	1161
Mov Cap-2 Maneuver	534	-	-	-	-
Stage 1	685	-	-	-	-
Stage 2	793	-	-	-	-

Approach	WB	NB	SB
HCM Control Delay, s	11.8	0	0.1
HCM LOS	B		

Minor Lane/Major Mvmt	NBT	NBRWBLn1	SBL	SBT
Capacity (veh/h)	-	-	548	1161
HCM Lane V/C Ratio	-	-	0.029	0.003
HCM Control Delay (s)	-	-	11.8	8.1
HCM Lane LOS	-	-	B	A
HCM 95th %tile Q(veh)	-	-	0.1	0

Intersection						
Int Delay, s/veh	0.3					
Movement	WBL	WBR	NBT	NBR	SBL	SBT
Lane Configurations	↔		↔		↔	↔
Traffic Vol, veh/h	11	1	391	20	2	240
Future Vol, veh/h	11	1	391	20	2	240
Conflicting Peds, #/hr	0	0	0	0	0	0
Sign Control	Stop	Stop	Free	Free	Free	Free
RT Channelized	-	None	-	None	-	None
Storage Length	0	-	-	-	100	-
Veh in Median Storage, #	0	-	0	-	-	0
Grade, %	0	-	0	-	-	0
Peak Hour Factor	95	95	95	95	95	95
Heavy Vehicles, %	2	2	2	2	2	2
Mvmt Flow	12	1	412	21	2	253

Major/Minor	Minor1	Major1	Major2		
Conflicting Flow All	680	423	0	0	433
Stage 1	423	-	-	-	-
Stage 2	257	-	-	-	-
Critical Hdwy	6.42	6.22	-	-	4.12
Critical Hdwy Stg 1	5.42	-	-	-	-
Critical Hdwy Stg 2	5.42	-	-	-	-
Follow-up Hdwy	3.518	3.318	-	-	2.218
Pot Cap-1 Maneuver	417	631	-	-	1127
Stage 1	661	-	-	-	-
Stage 2	786	-	-	-	-
Platoon blocked, %					
Mov Cap-1 Maneuver	416	631	-	-	1127
Mov Cap-2 Maneuver	416	-	-	-	-
Stage 1	660	-	-	-	-
Stage 2	786	-	-	-	-

Approach	WB	NB	SB
HCM Control Delay, s	13.7	0	0.1
HCM LOS	B		

Minor Lane/Major Mvmt	NBT	NBRWBLn1	SBL	SBT
Capacity (veh/h)	-	-	428	1127
HCM Lane V/C Ratio	-	-	0.03	0.002
HCM Control Delay (s)	-	-	13.7	8.2
HCM Lane LOS	-	-	B	A
HCM 95th %tile Q(veh)	-	-	0.1	0



SimTraffic Performance Report

126: Rainbow Bridge Dr & Lambert Rd Performance by lane Interval #1 7:00

Lane	EB	EB	WB	WB	NB	SB	SB	All
Movements Served	L	TR	L	TR	LTR	LT	R	
Stop Del/Veh (s)	3.7	0.1	0.8	0.1	8.5	10.0	9.6	3.9

126: Rainbow Bridge Dr & Lambert Rd Performance by lane Interval #2 7:15

Lane	EB	EB	WB	WB	NB	SB	SB	All
Movements Served	L	TR	L	TR	LTR	LT	R	
Stop Del/Veh (s)	0.4	0.0	3.6	0.1	8.0	3.8	6.0	2.5

126: Rainbow Bridge Dr & Lambert Rd Performance by lane Interval #3 7:30

Lane	EB	EB	WB	NB	SB	SB	All
Movements Served	L	TR	TR	LTR	LT	R	
Stop Del/Veh (s)	0.8	0.1	0.1	7.3	9.8	10.5	3.3

126: Rainbow Bridge Dr & Lambert Rd Performance by lane Interval #4 7:45

Lane	EB	EB	WB	NB	SB	SB	All
Movements Served	L	TR	TR	LTR	LT	R	
Stop Del/Veh (s)	0.9	0.0	0.1	15.7	9.2	9.2	3.8

126: Rainbow Bridge Dr & Lambert Rd Performance by lane Entire Run

Lane	EB	EB	WB	WB	NB	SB	SB	All
Movements Served	L	TR	L	TR	LTR	LT	R	
Stop Del/Veh (s)	1.6	0.0	1.5	0.1	9.4	8.9	9.0	3.5

152: Lambert Rd & Winding Walk Access Performance by lane Interval #1 7:00

Lane	EB	WB	NB	NB	SB	SB	All
Movements Served	LTR	LTR	L	TR	L	TR	
Stop Del/Veh (s)	10.9	16.8	0.0	0.3	2.4	0.3	1.8

152: Lambert Rd & Winding Walk Access Performance by lane Interval #2 7:15

Lane	EB	WB	NB	NB	SB	SB	All
Movements Served	LTR	LTR	L	TR	L	TR	
Stop Del/Veh (s)	8.8	7.7	3.1	0.4	1.0	0.3	1.5

152: Lambert Rd & Winding Walk Access Performance by lane Interval #3 7:30

Lane	EB	WB	NB	NB	SB	SB	All
Movements Served	LTR	LTR	L	TR	L	TR	
Stop Del/Veh (s)	6.9	13.7	1.8	0.3	3.7	0.3	1.3

## SimTraffic Performance Report

### 152: Lambert Rd & Winding Walk Access Performance by lane Interval #4 7:45

Lane	EB	WB	NB	NB	SB	SB	All
Movements Served	LTR	LTR	L	TR	L	TR	
Stop Del/Veh (s)	7.4	10.8	1.5	0.3	1.0	0.3	1.3

### 152: Lambert Rd & Winding Walk Access Performance by lane Entire Run

Lane	EB	WB	NB	NB	SB	SB	All
Movements Served	LTR	LTR	L	TR	L	TR	
Stop Del/Veh (s)	8.8	11.9	2.1	0.3	2.2	0.3	1.5

### Total Zone Performance By Interval

Interval Start	7:00	7:15	7:30	7:45	All
Stop Del/Veh (s)	150.6	66.6	76.1	107.3	339.7

SimTraffic Performance Report

126: Rainbow Bridge Dr & Lambert Rd Performance by lane Interval #1 5:00

Lane	EB	EB	WB	NB	SB	SB	All
Movements Served	L	TR	TR	LTR	LT	R	
Stop Del/Veh (s)	0.6	0.0	0.1	13.3	11.9	4.1	1.7

126: Rainbow Bridge Dr & Lambert Rd Performance by lane Interval #2 5:15

Lane	EB	EB	WB	WB	NB	SB	SB	All
Movements Served	L	TR	L	TR	LTR	LT	R	
Stop Del/Veh (s)	1.6	0.0	0.0	0.0	9.3		4.1	1.5

126: Rainbow Bridge Dr & Lambert Rd Performance by lane Interval #3 5:30

Lane	EB	EB	WB	WB	NB	SB	SB	All
Movements Served	L	TR	L	TR	LTR	LT	R	
Stop Del/Veh (s)	1.5	0.0	4.1	0.1	4.7	8.5	6.2	1.8

126: Rainbow Bridge Dr & Lambert Rd Performance by lane Interval #4 5:45

Lane	EB	EB	WB	WB	NB	SB	SB	All
Movements Served	L	TR	L	TR	LTR	LT	R	
Stop Del/Veh (s)	0.5	0.0	4.1	0.1	8.8	7.7	3.4	1.1

126: Rainbow Bridge Dr & Lambert Rd Performance by lane Entire Run

Lane	EB	EB	WB	WB	NB	SB	SB	All
Movements Served	L	TR	L	TR	LTR	LT	R	
Stop Del/Veh (s)	1.0	0.0	2.0	0.1	10.4	11.5	4.4	1.5

152: Lambert Rd & Winding Walk Access Performance by lane Interval #1 5:00

Lane	EB	WB	NB	NB	SB	All
Movements Served	LTR	LTR	L	TR	TR	
Stop Del/Veh (s)	5.4	21.0	2.3	0.4	0.3	1.2

152: Lambert Rd & Winding Walk Access Performance by lane Interval #2 5:15

Lane	EB	WB	NB	NB	SB	All
Movements Served	LTR	LTR	L	TR	TR	
Stop Del/Veh (s)	4.8	14.4	1.3	0.3	0.2	0.8

152: Lambert Rd & Winding Walk Access Performance by lane Interval #3 5:30

Lane	EB	WB	NB	NB	SB	SB	All
Movements Served	LTR	LTR	L	TR	L	TR	
Stop Del/Veh (s)	8.7	17.6	2.7	0.3	0.0	0.2	1.1

SimTraffic Performance Report

152: Lambert Rd & Winding Walk Access Performance by lane Interval #4 5:45

Lane	EB	WB	NB	NB	SB	SB	All
Movements Served	LTR	LTR	L	TR	L	TR	
Stop Del/Veh (s)	12.0	23.6	1.2	0.3	17.1	0.3	1.6

152: Lambert Rd & Winding Walk Access Performance by lane Entire Run

Lane	EB	WB	NB	NB	SB	SB	All
Movements Served	LTR	LTR	L	TR	L	TR	
Stop Del/Veh (s)	8.4	19.5	1.9	0.3	8.6	0.3	1.2

Total Zone Performance By Interval

Interval Start	5:00	5:15	5:30	5:45	All
Stop Del/Veh (s)	72.9	34.8	41.8	52.0	182.2