

# CORRAL BLUFFS COL02029



## CELL SITE RF MODIFICATIONS MRUTH064321

**FA #: 10093745 CROWN CASTLE BU: 855759**  
**GUYED TOWER**

### PROJECT DESCRIPTION

AT&T WIRELESS PROPOSES TO MODIFY AN EXISTING WIRELESS INSTALLATION. THE SCOPE WILL CONSIST OF THE FOLLOWING:

#### GUYED TOWER WORK:

- REMOVE (3) PANEL ANTENNAS
- REMOVE (3) TMAs
- REMOVE (9) REMOTE RADIO HEADS (RRHs)
- REMOVE (3) SECTOR FRAMES
- INSTALL (3) AIR 6419 B77G ANTENNAS (TOP)
- INSTALL (3) AIR 6419 B77D ANTENNAS (BOTTOM)
- INSTALL (9) REMOTE RADIO UNITS (RRUs)
- INSTALL (6) BACK TO BACK RRH MOUNTS
- INSTALL (1) SURGE SUPPRESSOR (DC9)
- INSTALL (3) SECTOR FRAMES
- INSTALL (1) DC POWER TRUNK
- INSTALL (1) FIBER TRUNK (24 PAIR)

#### GROUND WORK:

- REMOVE (2) FSM4 UNITS
- REMOVE (5) CONVERTERS
- INSTALL (1) GEN2 SURGE SUPPRESSOR (DC12)
- INSTALL (1) ERICSSON BASE BAND UNIT
- INSTALL (9) CONVERTERS IN EXISTING DC POWER PLANT
- INSTALL (1) NETSURE 7100 RETROFIT CONVERSION KIT
- INSTALL (1) POWERSHIFT CONVERTER IN EXISTING DC POWER PLANT
- INSTALL (1) RECTIFIER IN EXISTING DC POWER PLANT
- INSTALL (4) 190AH BATTERIES IN EXISTING BATTERY RACK

### ENGINEERING

2021 INTERNATIONAL BUILDING CODE OR LATEST ADOPTED EDITION  
2020 NATIONAL ELECTRIC CODE OR LATEST ADOPTED EDITION  
TIA/EIA-222-H OR LATEST EDITION  
2023 PIKES PEAK REGIONAL BUILDING CODE

### SITE INFORMATION

PROPERTY OWNER: WASTE MANAGEMENT OF COLO INC.  
ADDRESS: PO BOX 1450  
CHICAGO, IL 60690-1450

SITE ADDRESS: BLANEY ROAD  
COLORADO SPRINGS, CO 80929

FA: 10093745

GUYED TOWER OWNER: CROWN CASTLE

CELL SITE RF MODIFICATIONS PACE #: MRUTH064321

COUNTY: EL PASO

LATITUDE (NAD83): 38.86668  
LONGITUDE (NAD83): -104.57627

GROUND ELEVATION: 6,645' AMSL

ZONING JURISDICTION: COUNTY OF EL PASO

ZONING DISTRICT: NA

PARCEL NUMBER: 4405001001

OCCUPANCY GROUP: U

CONSTRUCTION TYPE: V-B

POWER COMPANY: MOUNTAIN VIEW ELECTRIC

TELEPHONE COMPANY: CENTURYLINK

SITE ACQUISITION MANAGER: KEVIN THOMPSON  
(952) 896-0859

CONSTRUCTION MANAGER: JOHN RUTKOWITZ  
(303) 264-0523

RF ENGINEER: SHAD RYDALCH  
(208) 371-0011

### CONTACT INFORMATION

ENGINEER: BLACK & VEATCH CORPORATION  
4600 SOUTH SYRACUSE STREET, SUITE 800  
DENVER, CO 80237

CONTACT: CAMERON LOUCKS

PHONE: (303) 264-0581

### VICINITY MAP

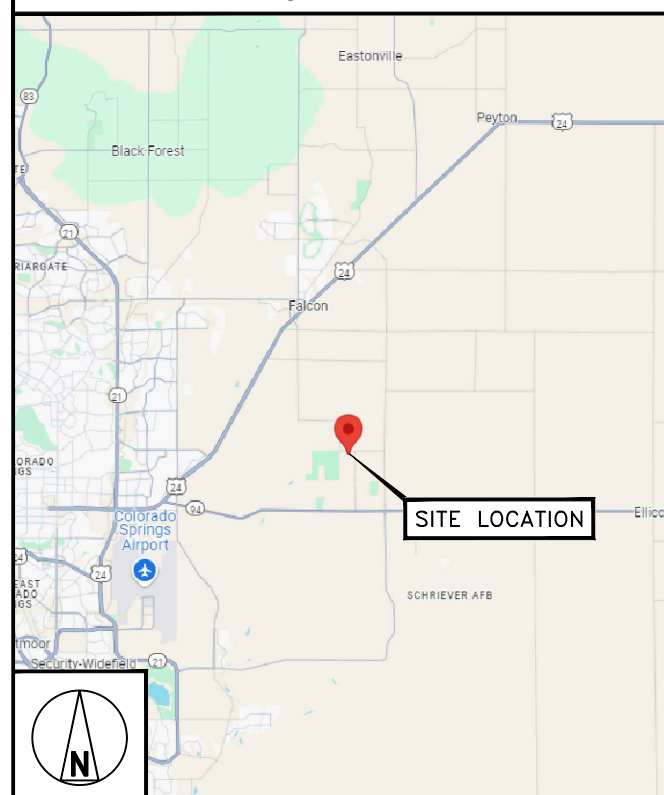

### LOCAL MAP

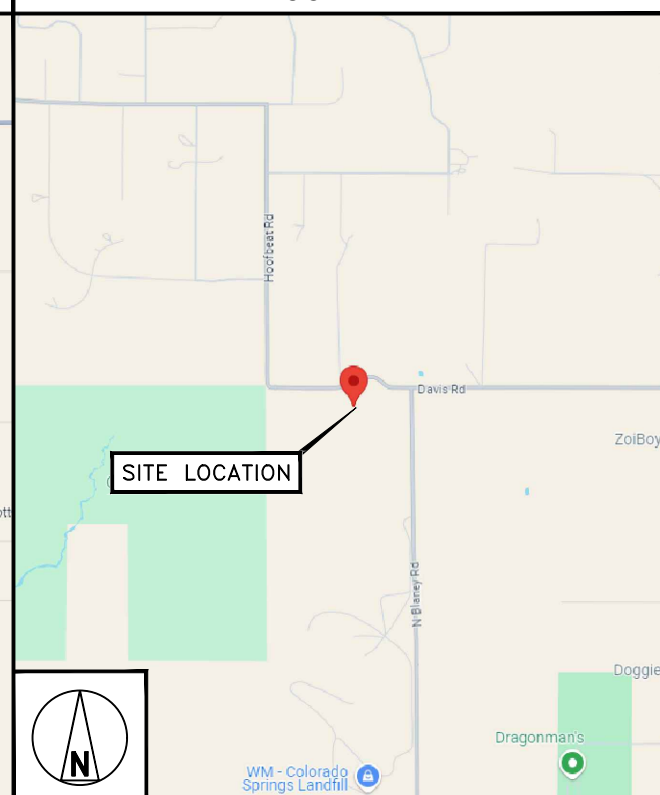

NO SCALE

### DRIVING DIRECTIONS

#### DIRECTIONS FROM AT&T OFFICE

GET ON I-25 S IN LONE TREE FROM INVERNESS DR W AND E COUNTY LINE RD, HEAD SOUTH TOWARD INVERNESS DR W, TURN LEFT TOWARD INVERNESS DR W, TURN RIGHT TOWARD INVERNESS DR W, TURN LEFT TOWARD INVERNESS DR W, TURN LEFT ONTO INVERNESS DR W, USE THE RIGHT 2 LANES TO TURN RIGHT ONTO E COUNTY LINE RD, SLIGHT RIGHT TO MERGE WITH I-25 S TOWARD COLO SPGS, MERGE WITH I-25 S, TAKE EXIT 153 FOR INTERQUEST PKWY, CONTINUE ONTO INTERQUEST PKWY, TURN RIGHT ONTO CO-21 S, TAKE EXIT 149 FOR WOODMEN ROAD, USE THE LEFT 2 LANES TO TAKE THE EXIT TOWARD E WOODMEN RD, USE ANY LANE TO TURN LEFT ONTO E WOODMEN RD, TURN RIGHT ONTO MERIDIAN RD, TURN LEFT ONTO GARRETT RD, TURN RIGHT ONTO E BLANEY RD, TURN LEFT ONTO BLANEY RD S, TURN RIGHT ONTO HOOPBEAT RD, CONTINUE ONTO DAVIS RD, SITE WILL BE ON THE RIGHT.

### GENERAL NOTES

THE FACILITY IS UNMANNED AND NOT FOR HUMAN HABITATION. A TECHNICIAN WILL VISIT THE SITE AS REQUIRED FOR ROUTINE MAINTENANCE. THE PROJECT WILL NOT RESULT IN ANY SIGNIFICANT DISTURBANCE OR EFFECT ON DRAINAGE. NO SANITARY SEWER SERVICE, POTABLE WATER, OR TRASH DISPOSAL IS REQUIRED AND NO COMMERCIAL SIGNAGE IS PROPOSED.

### DRAWING INDEX

SHEET NO.	SHEET TITLE
T-1	TITLE SHEET
C-1	SITE PLAN
C-1.1	ENLARGED SITE PLAN
C-2	EQUIPMENT LAYOUTS
C-3	ELEVATIONS
C-4	ANTENNA SCHEDULE & LAYOUTS
C-5	EQUIPMENT DETAILS
C-6	EQUIPMENT DETAILS
E-1	ELECTRICAL AC ONE-LINE DIAGRAM
E-2	ELECTRICAL DC ONE-LINE DIAGRAM
G-1	GROUNDING ONE-LINE DIAGRAM
G-2	GROUNDING DETAILS
GN-1	LEGEND & ABBREVIATIONS
GN-2	GENERAL CONSTRUCTION NOTES
GN-3	GENERAL SITE WORK & DRAINAGE NOTES
GN-4	GENERAL CONCRETE WORK NOTES
GN-5	GENERAL STRUCTURAL STEEL NOTES
GN-6	GENERAL ELECTRICAL NOTES
GN-7	BATTERY SAFETY NOTES

11"x17" PLOT WILL BE HALF SCALE UNLESS OTHERWISE NOTED

CONTRACTOR SHALL VERIFY ALL PLANS, EXISTING DIMENSIONS, AND CONDITIONS ON THE JOB SITE, AND SHALL IMMEDIATELY NOTIFY THE ENGINEER IN WRITING OF ANY DISCREPANCIES BEFORE PROCEEDING WITH THE WORK.



**UNDERGROUND SERVICE ALERT**  
**UTILITY NOTIFICATION CENTER OF COLORADO**  
(800) 922-1987  
**WWW.UNCC.ORG**

3 WORKING DAYS UTILITY NOTIFICATION PRIOR TO CONSTRUCTION



188 INVERNESS DRIVE WEST  
SUITE 400  
ENGLEWOOD, CO 80112



4600 SOUTH SYRACUSE STREET  
SUITE 800  
DENVER, COLORADO 80237

PROJECT/PHASE NO: 129551/1399

DRAWN BY: GS

CHECKED BY: JMH

RFDS:

REV	DATE	DESCRIPTION
0	05/13/24	ISSUED FOR CONSTRUCTION



IT IS A VIOLATION OF LAW FOR ANY PERSON, UNLESS THEY ARE ACTING UNDER THE DIRECTION OF A LICENSED PROFESSIONAL ENGINEER, TO ALTER THIS DOCUMENT.

CORRAL BLUFFS  
COL02029  
BLANEY ROAD  
COLORADO SPRINGS, CO 80929  
CELL SITE RF MODIFICATIONS

SHEET TITLE  
TITLE SHEET

SHEET NUMBER

**T-1**

NOTES

1. CONTRACTOR SHALL FIELD VERIFY ALL DIMENSIONS.
2. ANTENNAS AND MOUNTS OMITTED FOR CLARITY.



188 INVERNESS DRIVE WEST  
SUITE 400  
ENGLEWOOD, CO 80112



**BLACK & VEATCH**

4600 SOUTH SYRACUSE STREET  
SUITE 800  
DENVER, COLORADO 80237

PROJECT/PHASE NO: 129551/1399

DRAWN BY: GS

CHECKED BY: JMH

RFDS:

REV	DATE	DESCRIPTION
0	05/13/24	ISSUED FOR CONSTRUCTION

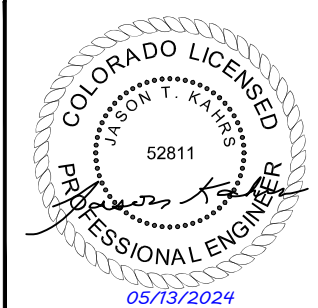

IT IS A VIOLATION OF LAW FOR ANY PERSON, UNLESS THEY ARE ACTING UNDER THE DIRECTION OF A LICENSED PROFESSIONAL ENGINEER, TO ALTER THIS DOCUMENT.

CORRAL BLUFFS  
COLO2029  
BLANEY ROAD  
COLORADO SPRINGS, CO 80929  
CELL SITE RF MODIFICATIONS

SHEET TITLE  
SITE PLAN

SHEET NUMBER

**C-1**

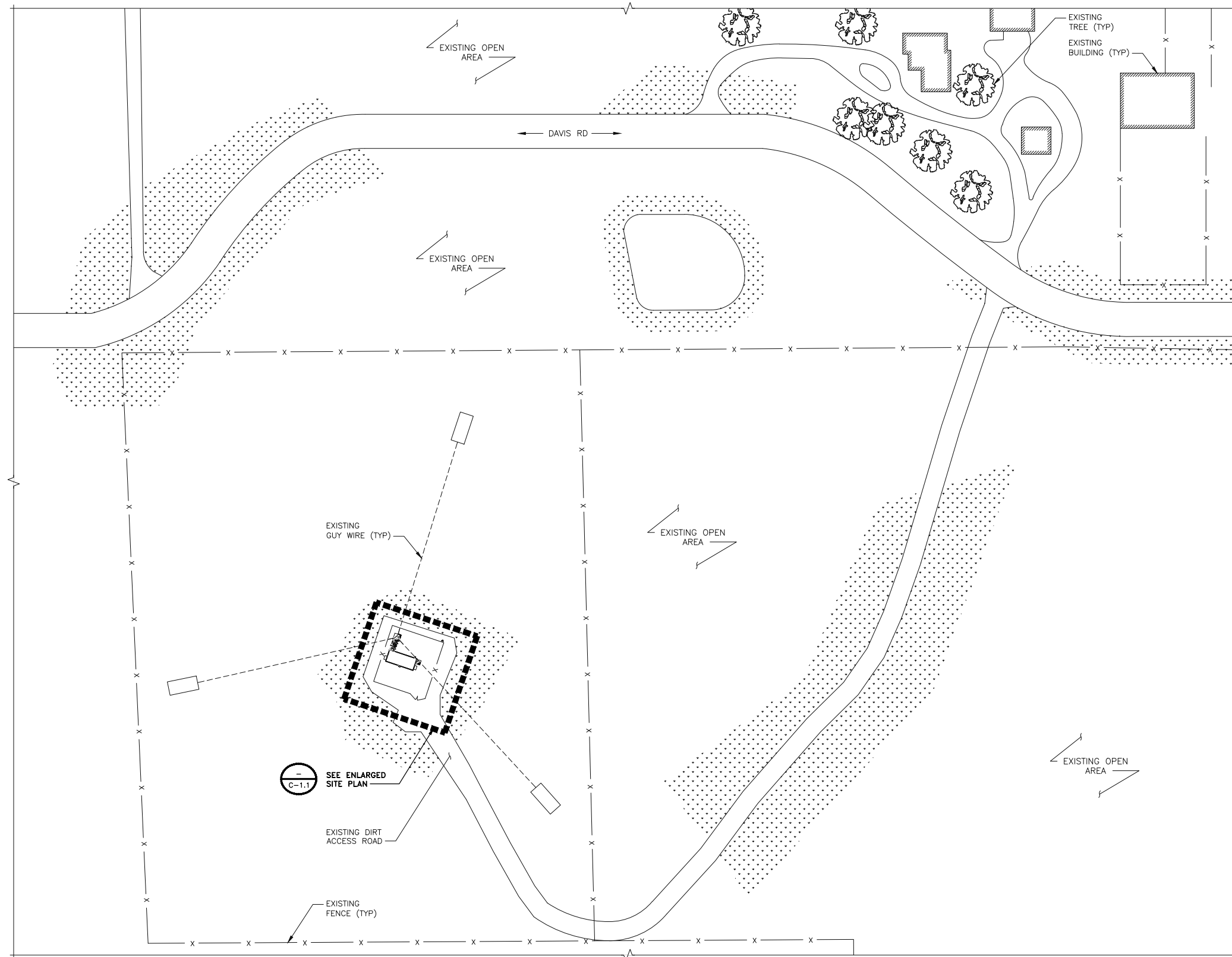

SITE PLAN

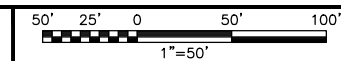
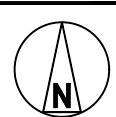

**COAX & CABLE INFORMATION**

- (6) EXISTING 1 5/8" COAX CABLES
- (4) EXISTING #8 AWG DC POWER TRUNKS
- (1) EXISTING 12-PAIR FIBER TRUNK
- (1) EXISTING 18-PAIR FIBER TRUNK
- (1) PROPOSED #6 AWG DC TRUNK
- (1) PROPOSED 24-PAIR FIBER TRUNK ROUTED ON EXISTING GUYED TOWER

**NOTES**

1. CONTRACTOR SHALL FIELD VERIFY ALL DIMENSIONS.
2. ANTENNAS AND MOUNTS OMITTED FOR CLARITY.



188 INVERNESS DRIVE WEST  
SUITE 400  
ENGLEWOOD, CO 80112



**BLACK & VEATCH**

4600 SOUTH SYRACUSE STREET  
SUITE 800  
DENVER, COLORADO 80237

PROJECT/PHASE NO: 129551/1399

DRAWN BY: GS

CHECKED BY: JMH

RFDS: \_\_\_\_\_

REV	DATE	DESCRIPTION
0	05/13/24	ISSUED FOR CONSTRUCTION



IT IS A VIOLATION OF LAW FOR ANY PERSON, UNLESS THEY ARE ACTING UNDER THE DIRECTION OF A LICENSED PROFESSIONAL ENGINEER, TO ALTER THIS DOCUMENT.

CORRAL BLUFFS  
COLO2029  
BLANEY ROAD  
COLORADO SPRINGS, CO 80929  
CELL SITE RF MODIFICATIONS

SHEET TITLE  
ENLARGED SITE PLAN

SHEET NUMBER

**C-1.1**

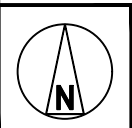
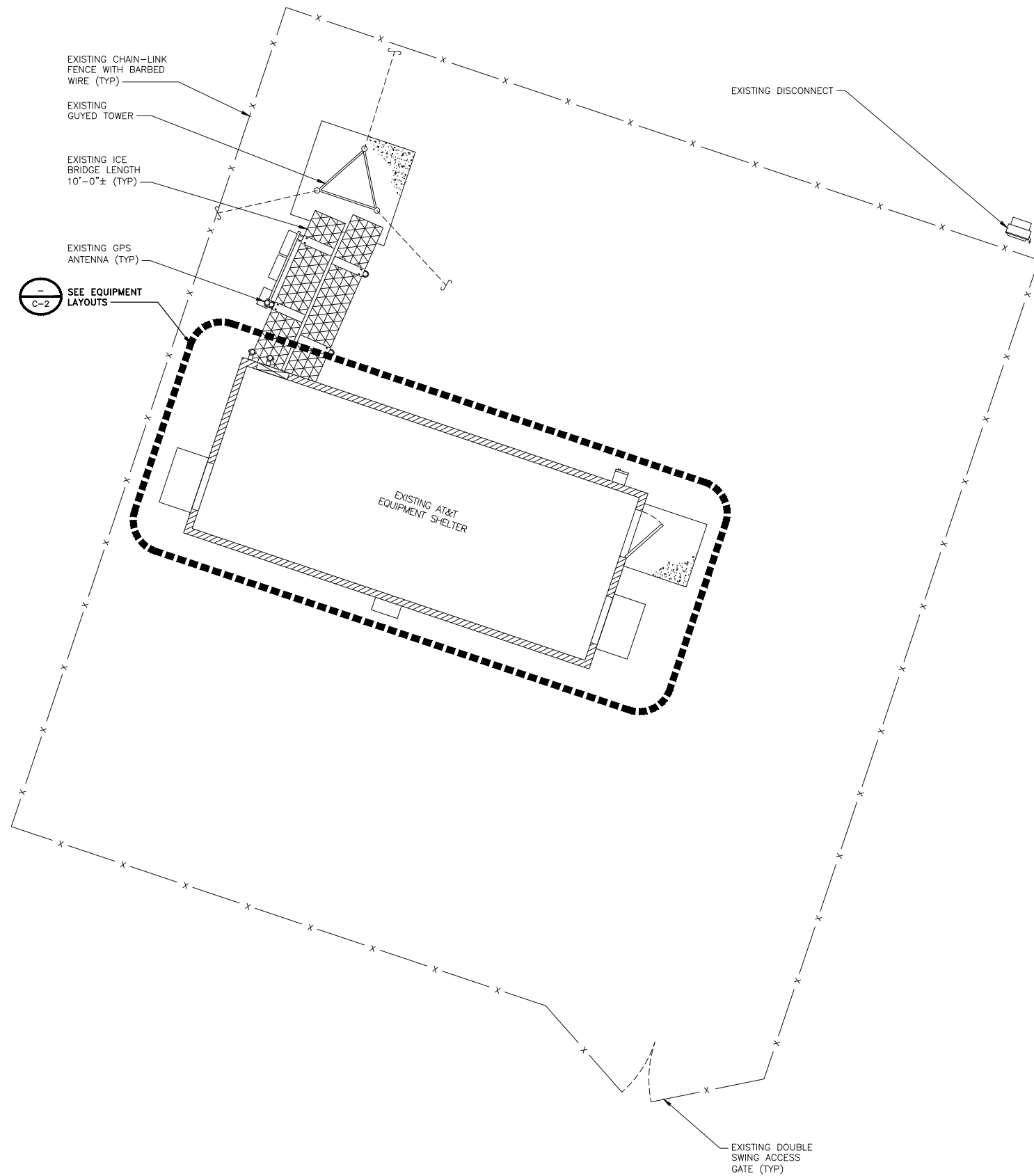

ENLARGED SITE PLAN

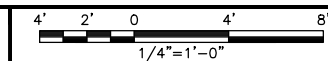

NOTES

1. CONTRACTOR SHALL FIELD VERIFY ALL DIMENSIONS.
2. IFC 608 & IMC 502.4 CODE ANALYSIS & BATTERY COMPLIANCE INFORMATION SHOWN ON SHEET GN-7.
3. THERE WILL BE A TOTAL OF 42.8 GALLONS OF ELECTROLYTE WITH THE 4 PROPOSED LEAD-ACID BATTERIES THAT ARE BEING ADDED.
4. ON-SITE BATTERY SPILL CLEAN-UP KIT SHALL BE CAPABLE OF NEUTRALIZING A MINIMUM OF 1.284 GALLONS.
5. ALL EXISTING EQUIPMENT TO REMAIN UNLESS NOTED OTHERWISE.
6. TOTAL ELECTROLYTE IS 42.8 GAL. WHICH IS LESS THAN 50 GAL. REQUIRED TO MEET IFC COMPLIANCE STANDARD.



188 INVERNESS DRIVE WEST  
SUITE 400  
ENGLEWOOD, CO 80112



**BLACK & VEATCH**

4600 SOUTH SYRACUSE STREET  
SUITE 800  
DENVER, COLORADO 80237

PROJECT/PHASE NO: 129551/1399

DRAWN BY: GS

CHECKED BY: JMH

RFDS:

REV	DATE	DESCRIPTION
0	05/13/24	ISSUED FOR CONSTRUCTION

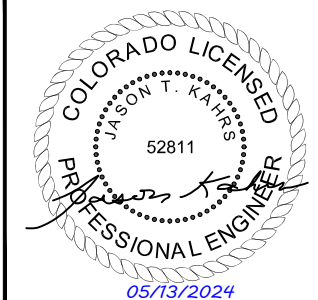

IT IS A VIOLATION OF LAW FOR ANY PERSON, UNLESS THEY ARE ACTING UNDER THE DIRECTION OF A LICENSED PROFESSIONAL ENGINEER, TO ALTER THIS DOCUMENT.

CORRAL BLUFFS  
COLO2029  
BLANEY ROAD  
COLORADO SPRINGS, CO 80929  
CELL SITE RF MODIFICATIONS

SHEET TITLE  
EQUIPMENT LAYOUT

SHEET NUMBER

**C-2**

- EXISTING NETSURE 7100 DC POWER PLANT WITH  
(9) EXISTING RECTIFIERS  
(12) EXISTING 170AH BATTERIES  
(5) EXISTING CONVERTERS TO BE REMOVED  
(1) PROPOSED NETSURE 7100 RETROFIT CONVERSION FIT  
(9) PROPOSED CONVERTERS  
(1) PROPOSED POWERSHIFT CONVERTER  
(1) PROPOSED RECTIFIER

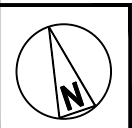
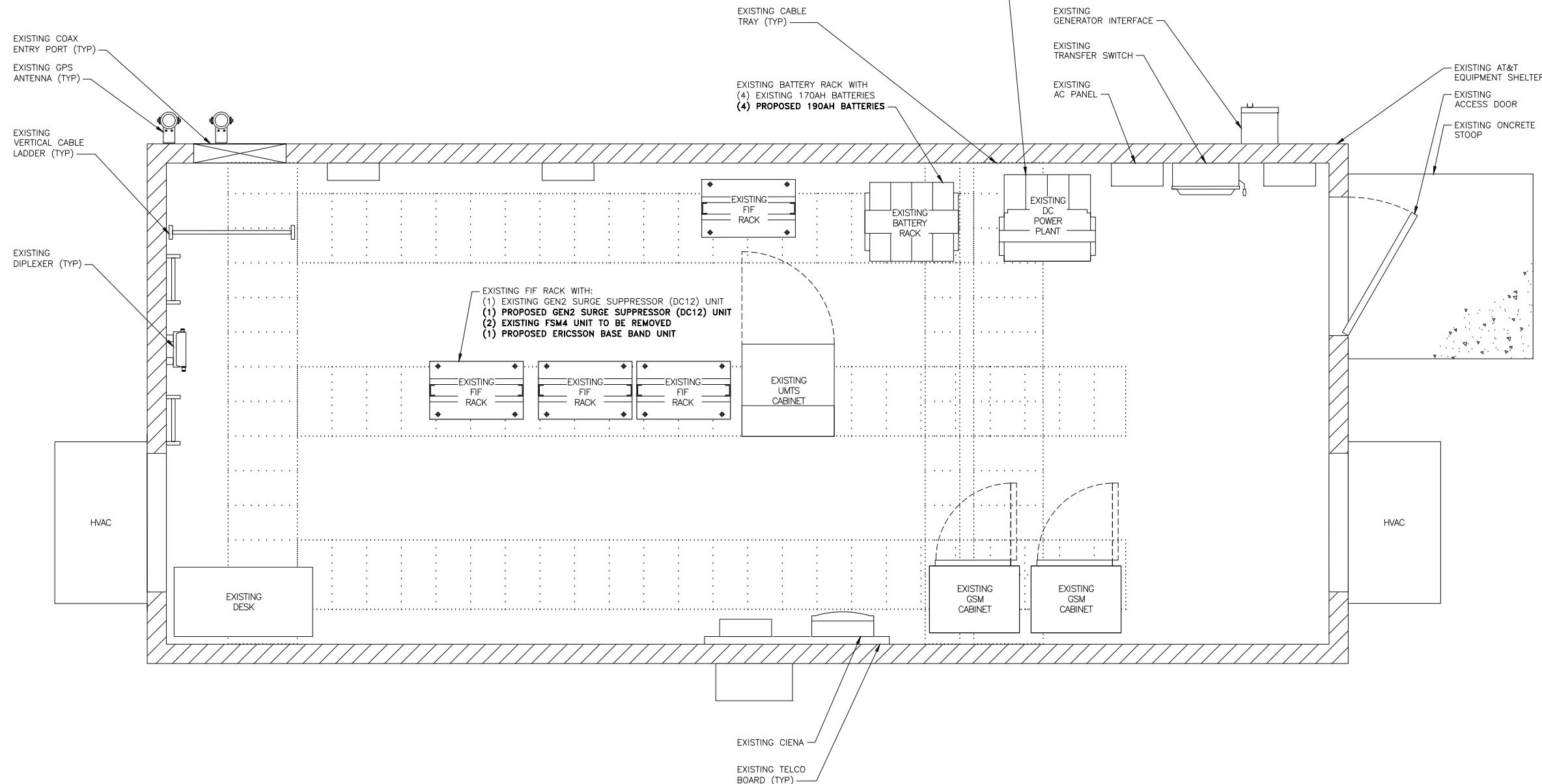

**NOTES**

1. THE EXISTING GUYED TOWER IS CURRENTLY BEING ANALYZED BY OTHERS TO DETERMINE ITS STRUCTURAL CAPACITY TO CARRY THE PROPOSED NEW COAX & ANTENNAS. THESE DRAWINGS HAVE BEEN CREATED BASED ON THE ASSUMPTION THAT THE STRUCTURAL ANALYSIS WILL SHOW THAT THE GUYED TOWER HAS SUFFICIENT CAPACITY TO SUPPORT THE PROPOSED NEW LOADS. INSTALLATION OF THE COAX & ANTENNAS SHALL NOT COMMENCE UNTIL AN APPROVED STRUCTURAL ANALYSIS HAS BEEN RECEIVED BY THE OWNER OR AT&T, & HAS BEEN REVIEWED BY BLACK & VEATCH.
2. THE CONDITIONAL PASSING ANTENNA MOUNT ANALYSIS FOR THE PROPOSED SABRE MOUNT P/N C10857007C WAS COMPLETED BY BLACK & VEATCH ON APRIL 08, 2024. THE PROPOSED MOUNT HAS SUFFICIENT CAPACITY FOR THE EXISTING AND PROPOSED LOADINGS OBSERVED ON THESE CONSTRUCTION DRAWINGS BASED ON THE CONDITION THE CONTRACTOR INSTALLS:
  - 1) INSTALL SABRE 12' SECTOR FRAMES P/N: C10857007C WITH 2.9" O.D. MOUNT PIPES.
  - 2) CONTRACTOR SHALL INSTALL ALL EXISTING/PROPOSED LOADING TO BE CENTERED WITH THE RECOMMENDED REPLACEMENT MOUNT CENTERLINE WITH A ±6" VERTICAL TOLERANCE (SECTOR FRAME CENTERLINE LOCATED EQUIDISTANT BETWEEN TOP & BOTTOM BOOM).

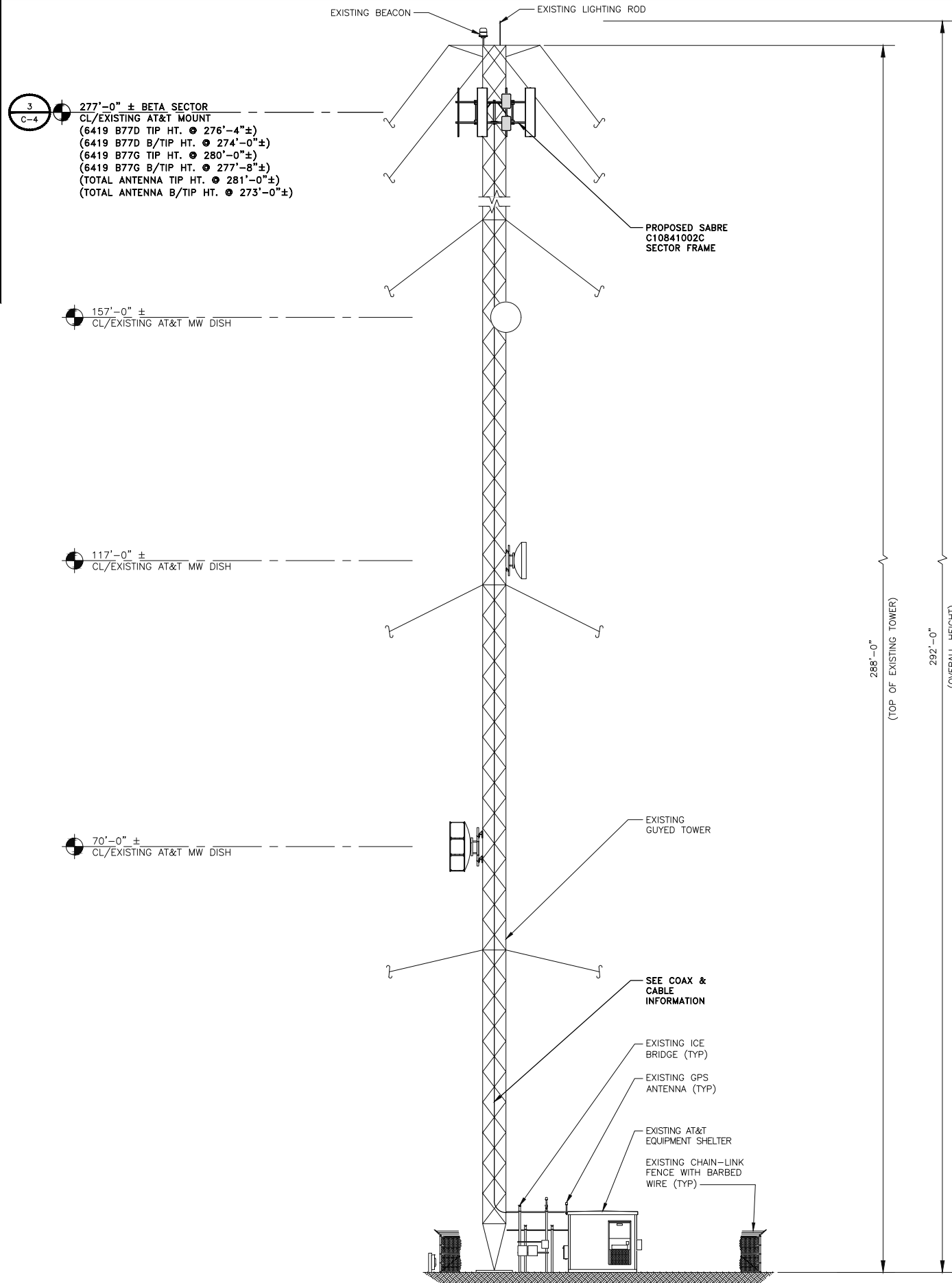

**COAX & CABLE INFORMATION**

- (6) EXISTING 1 5/8" COAX CABLES
- (4) EXISTING #8 AWG DC POWER TRUNKS
- (1) EXISTING 12-PAIR FIBER TRUNK
- (1) EXISTING 18-PAIR FIBER TRUNK
- (1) PROPOSED #6 AWG DC TRUNK
- (1) PROPOSED 24-PAIR FIBER TRUNK ROUTED ON EXISTING GUYED TOWER

**CABLE SUPPORT HANGER NOTE**

- CONTRACTOR SHALL FIELD VERIFY EXISTING CABLE HOIST GRIPS SUPPORT METHOD. CONTRACTOR SHALL NOTE ANY EXISTING INSTALLATION NOT CONFORMING TO THE REQUIREMENTS BELOW TO CONSTRUCTION MANAGER FOR REMEDIATION APPROVAL. CONTRACTOR SHALL MAINTAIN A SUPPLY OF REMEDIATION HARDWARE WITH TOWER CREWS FOR ON-SITE REMEDIATION, WHEN APPROVED, WITHOUT REMOVAL. INSTALL ALL HARDWARE PER MANUFACTURER REQUIREMENTS.
- ALL HOIST GRIPS SHALL BE SECURED TO TOWER STRUCTURE
  - WRAPPING HOIST GRIPS OVER TOWER STEEL IS NOT PERMITTED
  - USE OF SHACKLES IS PREFERRED
  - BEAM CLAMPS OR ANGLE ADAPTERS ARE NOT PERMITTED FOR HOIST GRIPS
  - HOIST GRIPS SHALL BE INSTALLED EVERY 200 FT OR PER CABLE MANUFACTURER REQUIREMENTS
  - CHAIN NOT PERMITTED FOR HOIST GRIP SUPPORT

188 INVERNESS DRIVE WEST  
SUITE 400  
ENGLEWOOD, CO 80112

4600 SOUTH SYRACUSE STREET  
SUITE 800  
DENVER, COLORADO 80237

PROJECT/PHASE NO:	129551/1399
DRAWN BY:	GS
CHECKED BY:	JMH
RFDS:	

REV	DATE	DESCRIPTION
0	05/13/24	ISSUED FOR CONSTRUCTION

IT IS A VIOLATION OF LAW FOR ANY PERSON, UNLESS THEY ARE ACTING UNDER THE DIRECTION OF A LICENSED PROFESSIONAL ENGINEER, TO ALTER THIS DOCUMENT.

CORRAL BLUFFS  
COL02029  
BLANEY ROAD  
COLORADO SPRINGS, CO 80929  
CELL SITE RF MODIFICATIONS

SHEET TITLE  
**ELEVATIONS**

SHEET NUMBER  
**C-3**

**FINAL NORTHWEST ELEVATION**

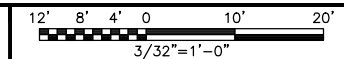



**COAX & CABLE INFORMATION**

- (6) EXISTING 1 5/8" COAX CABLES
- (4) EXISTING #8 AWG DC POWER TRUNKS
- (1) EXISTING 12-PAIR FIBER TRUNK
- (1) EXISTING 18-PAIR FIBER TRUNK
- (1) PROPOSED #6 AWG DC TRUNK
- (1) PROPOSED 24-PAIR FIBER TRUNK ROUTED ON EXISTING GUYED TOWER

SECTOR	TECH.		ANTENNA MODEL		AZIMUTH		RAD CENTER		RRH/RRU MODEL & RELATED EQUIPMENT	
	EXIST.	FINAL	EXIST.	FINAL	EXIST.	FINAL	EXIST.	FINAL	EXIST.	FINAL
A1	UMTS	LTE	*P65-15-XLH-RR	TPA65R-BUBDA-K	60°	60°	279'-0"	277'-0"	*TT19-08BP111-001	4490 B5/B12A
A2	LTE	LTE	TPA65R-BUBDA-K	6419 B77G+6419 B77D STACKED	60°	60°	277'-0"	277'-0"	*4T4R B5 160W AHCA	INTEGRATED WITHIN: ERICSSON 6419 B77G INTEGRATED WITHIN: ERICSSON 6419 B77D
A3	-	LTE	-	TPA65R-BUBDA-K	-	60°	-	277'-0"	-	4478 B14 4890 B25/B66
A4	LTE	-	TPA65R-BUBDA-K	-	60°	-	277'-0"	-	*B25 RRH4X30-4R *4T4R B12/14 320W AHLBA	-
B1	UMTS	LTE	*P65-15-XLH-RR	TPA65R-BUBDA-K	170°	170°	279'-0"	277'-0"	*TT19-08BP111-001	4490 B5/B12A
B2	LTE	LTE	TPA65R-BUBDA-K	6419 B77G+6419 B77D STACKED	170°	170°	277'-0"	277'-0"	*4T4R B5 160W AHCA	INTEGRATED WITHIN: ERICSSON 6419 B77G INTEGRATED WITHIN: ERICSSON 6419 B77D
B3	-	LTE	-	TPA65R-BUBDA-K	-	170°	-	277'-0"	-	4478 B14 4890 B25/B66
B4	LTE	-	TPA65R-BUBDA-K	-	170°	-	277'-0"	-	*B25 RRH4X30-4R *4T4R B12/14 320W AHLBA	-
C1	UMTS	LTE	*P65-15-XLH-RR	TPA65R-BUBDA-K	300°	300°	279'-0"	277'-0"	*TT19-08BP111-001	4490 B5/B12A
C2	LTE	LTE	TPA65R-BUBDA-K	6419 B77G+6419 B77D STACKED	300°	300°	277'-0"	277'-0"	*4T4R B5 160W AHCA	INTEGRATED WITHIN: ERICSSON 6419 B77G INTEGRATED WITHIN: ERICSSON 6419 B77D
C3	-	LTE	-	TPA65R-BUBDA-K	-	300°	-	277'-0"	-	4478 B14 4890 B25/B66
C4	LTE	-	TPA65R-BUBDA-K	-	300°	-	277'-0"	-	*B25 RRH4X30-4R *4T4R B12/14 320W AHLBA	-

\*TO BE REMOVED



188 INVERNESS DRIVE WEST  
SUITE 400  
ENGLEWOOD, CO 80112



4600 SOUTH SYRACUSE STREET  
SUITE 800  
DENVER, COLORADO 80237

PROJECT/PHASE NO: 129551/1399

DRAWN BY: GS

CHECKED BY: JMH

RFDS:

REV	DATE	DESCRIPTION
0	05/13/24	ISSUED FOR CONSTRUCTION

**ANTENNA SCHEDULE**

NO SCALE

1

**NOTE**

1. ALL EXISTING EQUIPMENT TO REMAIN UNLESS NOTED OTHERWISE.

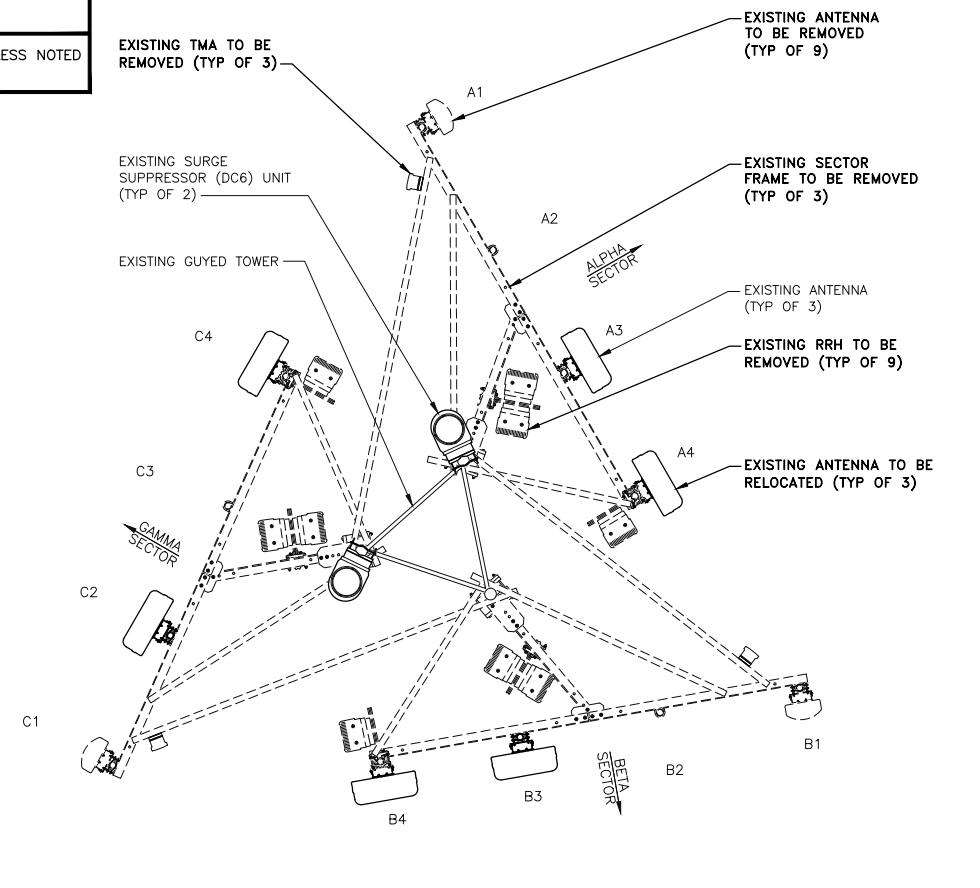

EXISTING ANTENNA LAYOUT

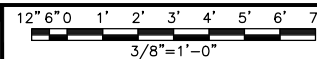

2

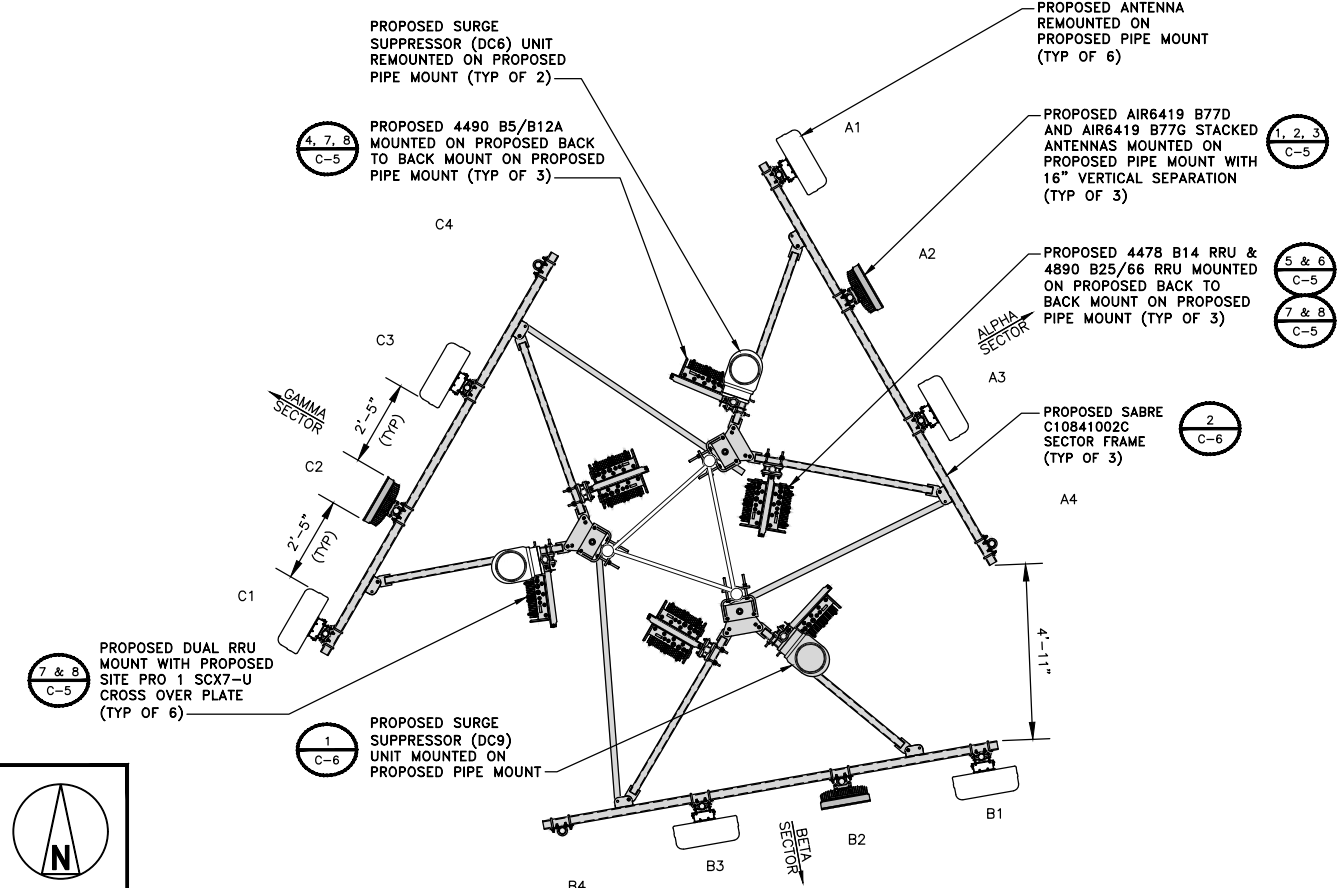

PROPOSED ANTENNA LAYOUT

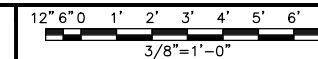

3



CORRAL BLUFFS  
COLO2029  
BLANEY ROAD  
COLORADO SPRINGS, CO 80929  
CELL SITE RF MODIFICATIONS

SHEET TITLE  
ANTENNA SCHEDULE &  
LAYOUTS

SHEET NUMBER  
**C-4**

**ERICSSON AIR 6419 B77D**  
 DIMENSIONS, WxDxH: 16.1"x7.2"x28.2"  
 (mm) 409x183x717mm  
 POWER CONSUMPTION: 1135 WATTS @ 100% LOAD  
 TOTAL WEIGHT: 63 lbs  
 PORTS: 3 x 10/25 GBPS eCPRI PORTS

**ERICSSON AIR 6419 B77G**  
 DIMENSIONS, WxDxH: 16.1"x7.9"x28.3"  
 (mm) 409x201x719mm  
 POWER CONSUMPTION: 1200 WATTS @ MAX LOAD  
 TOTAL WEIGHT: 66.1 lbs  
 PORTS: 2 x 10/25 GBPS eCPRI PORTS

**CROSSOVER PLATES**  
 -ROUND MEMBER HORIZONTAL FACE PIPES SHALL USE SITEPRO1# SCX7-U (OR APPROVED EQUIVALENT)  
 -SQUARE MEMBER HORIZONTAL FACE PIPES SHALL USE SITEPRO1# STCX45-K (OR APPROVED EQUIVALENT)  
 -(1) PER HORIZONTAL PIPE

HORIZONTAL FACE PIPE  
 -TYP. TOP & BOTTOM

ANTENNA MOUNTING PIPE FOR STACKED AIR6419 ANTENNAS SHALL BE P2.5 STD (2-7/8" O.D.) SABRE# C10900802 / ANT.46141 (OR APPROVED EQUIVALENT)

**CROSSOVER PLATE NOTE:**  
 FOR MOUNT REPLACEMENTS, IF CROSSOVER PLATES OF EQUIVALENT SIZE ARE SUPPLIED WITH THE, THOSE CROSSOVER PLATES SHALL BE USED

PROPOSED ANTENNA SPECIFICATIONS NO SCALE 1

PROPOSED ANTENNA SPECIFICATIONS NO SCALE 2

ANTENNA PIPE MOUNTING DETAIL NO SCALE 3

**ERICSSON RADIO 4490 B5/12A**  
 DIMENSIONS, HxWxD: 20.6"x15.6"x7"  
 (mm) 524x397x178mm  
 POWER CONSUMPTION: 480W  
 TOTAL WEIGHT: 65 lbs

**ERICSSON RADIO 4478 B14**  
 DIMENSIONS, WxDxH: 13.4"x8.26"x18.1"  
 (mm) 342x210x460mm  
 POWER CONSUMPTION: 650W  
 TOTAL WEIGHT: 59.4 lbs

**ERICSSON RADIO 4890 B25/66**  
 DIMENSIONS, HxWxD: 17.5"x15.1"x6.9"  
 (mm) 444x384x176mm  
 POWER CONSUMPTION: 480 WATTS  
 TOTAL WEIGHT: 68 lbs

RRU SPECIFICATIONS NO SCALE 4

RRU SPECIFICATIONS NO SCALE 5

RRU SPECIFICATIONS NO SCALE 6

**COMMSCOPE RR-FA2 RRU MOUNT W/ 86067769-001 RRU BRACKET**  
 TOTAL WEIGHT (UNFINISHED): 35.88 lbs  
 ROUND LEGS: 1/2" DIA. TO 5.6" DIA.  
 60 DEGREE ANGLE LEGS: 1" DIA. TO 6.0" DIA.  
 90 DEGREE ANGLE LEGS: 1" DIA. TO 4.5" DIA.

**SITE PRO 1 SCX7-U CROSS OVER PLATE**  
 WEIGHT: 16.98 lbs.

ANTENNA MOUNTING PIPE  
 -SEE INSTALLER NOTE 3  
 MOUNTING BRACKET (SUPPLIED W/ ANTENNA)

**CROSSOVER PLATES**  
 -ROUND MEMBER HORIZONTAL FACE PIPES SHALL USE SITEPRO1# SCX7-U (OR APPROVED EQUIVALENT)  
 -SQUARE MEMBER HORIZONTAL FACE PIPES SHALL USE SITEPRO1# STCX45-K (OR APPROVED EQUIVALENT)  
 -(1) PER HORIZONTAL PIPE

HORIZONTAL FACE PIPE  
 -TYP. TOP & BOTTOM

**CROSSOVER PLATE NOTE:**  
 FOR MOUNT REPLACEMENTS, IF CROSSOVER PLATES OF EQUIVALENT SIZE ARE SUPPLIED WITH THE, THOSE CROSSOVER PLATES SHALL BE USED

**INSTALLER NOTES:**  
 1. ALL PIPES, BRACKETS, AND MISCELLANEOUS HARDWARE TO BE GALVANIZED UNLESS NOTED OTHERWISE  
 2. REFER TO ANTENNA MANUFACTURER INSTALLATION MANUAL FOR ASSEMBLY AND BOLT TORQUE SPECS.  
 3. ANY NEW MOUNT PIPES PROPOSED FOR PASSIVE ANTENNAS, INCLUDING NEW MOUNTS OR MOUNT REPLACEMENTS, SHALL BE P2.5 STD (2-7/8" O.D.) SABRE# C10900802 / ANT 46141 (OR APPROVED EQUIVALENT) PASSIVE ANTENNA MOUNT PIPES FOR EXISTING MOUNTS MAY REMAIN, UNLESS OTHERWISE NOTED IN MOUNT ANALYSIS

DUAL RRU MOUNTING DETAIL NO SCALE 7

CROSSOVER PLATE DETAIL NO SCALE 8

ANTENNA MOUNTING DETAIL NO SCALE 9

188 INVERNESS DRIVE WEST  
 SUITE 400  
 ENGLEWOOD, CO 80112

4600 SOUTH SYRACUSE STREET  
 SUITE 800  
 DENVER, COLORADO 80237

PROJECT/PHASE NO: 129551/1399

DRAWN BY: GS

CHECKED BY: JMH

RFDS:

REV	DATE	DESCRIPTION
0	05/13/24	ISSUED FOR CONSTRUCTION

IT IS A VIOLATION OF LAW FOR ANY PERSON, UNLESS THEY ARE ACTING UNDER THE DIRECTION OF A LICENSED PROFESSIONAL ENGINEER, TO ALTER THIS DOCUMENT.

CORRAL BLUFFS  
 COLO2029  
 BLANEY ROAD  
 COLORADO SPRINGS, CO 80929  
 CELL SITE RF MODIFICATIONS

SHEET TITLE  
 EQUIPMENT DETAILS

SHEET NUMBER  
**C-5**

**RAYCAP DC9-48-60-24-8C-EV**

DIMENSIONS, WxDxH: 11"x18.5"x31.25" (280x470x794mm)  
 NOMINAL OPERATING VOLTAGE: 48 VDC  
 NOMINAL DISCHARGE CURRENT: 20 kA 8/20µs  
 MAXIMUM DISCHARGE CURRENT: 60 kA 8/20µs  
 MAXIMUM CONTINUOUS OPERATING VOLTAGE: 75 VDC  
 VOLTAGE PROTECTION RATING: 600 V  
 WIND LOADING: 150 MPH SUSTAINED (105.7 lbs)  
 195 MPH GUST (213.6 lbs)  
 TOTAL WEIGHT: 26.2 lbs (11.87 kg)

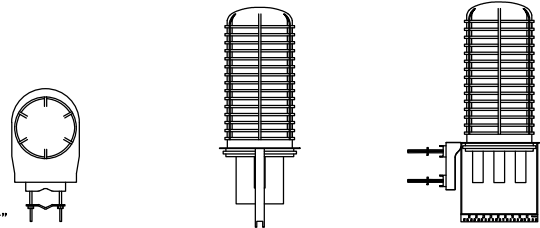
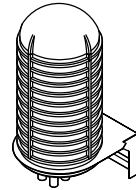

**NOTES:**  
 CONTRACTOR TO USE "THREAD LUBRICANT"  
 ON MOUNTING BOLTS DURING INSTALLATION

**SABRE C10841002C**

MANUFACTURER PART NO.	DESCRIPTION	WEIGHT (lbs)
SABRE C10841002C	12'-0" EHD V-BOOM ASSEMBLY W/TIEBACK (5' STANDOFF) W/NO MOUNTING PIPES	567

**NOTES**

1. THIS DETAIL IS INCLUDED FOR INFORMATIONAL PURPOSES ONLY. CONTRACTOR SHALL REFER TO MANUFACTURER DETAILS FOR SPECIFIC PART ORDERING AND INSTALLATION.

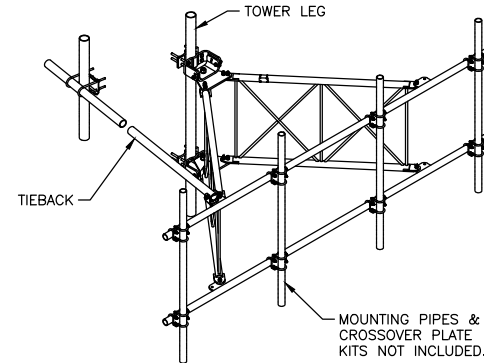

188 INVERNESS DRIVE WEST  
 SUITE 400  
 ENGLEWOOD, CO 80112



**BLACK & VEATCH**

4600 SOUTH SYRACUSE STREET  
 SUITE 800  
 DENVER, COLORADO 80237

DC SURGE SUPPRESSOR DETAIL

NO SCALE

1

SECTOR FRAME DETAIL

NO SCALE

2

NOT USED

NO SCALE

3

**PROPOSED BATTERIES:**

Battery Type	Number of Cells	Nominal Voltage (V)	Nominal Capacity		Nominal Dimensions				Electrolyte (1.300 S.G.)				Pure Acid (H2SO4)												
			8hr. Rate	10hr. Rate	Length		Width		Height		Volume		Weight		Lead Weight										
			1.75Vpc @ 77°F	1.80Vpc @ 20°C	in	mm	in	mm	in	mm	lbs	kg	gal	L	lbs	kg	lbs	kg							
SBS 190F	6	12	190	190	22.1	561	4.92	125	12.4	316	132	60.0	3990	3.20	M6 M	2.34	8.86	25.3	11.5	0.66	2.49	10.1	4.56	95.8	43.4

BATTERY SPECIFICATIONS DETAIL

NO SCALE

4

NOT USED

NO SCALE

5

PROJECT/PHASE NO: 129551/1399

DRAWN BY: GS

CHECKED BY: JMH

RFDS:

REV	DATE	DESCRIPTION
0	05/13/24	ISSUED FOR CONSTRUCTION



IT IS A VIOLATION OF LAW FOR ANY PERSON, UNLESS THEY ARE ACTING UNDER THE DIRECTION OF A LICENSED PROFESSIONAL ENGINEER, TO ALTER THIS DOCUMENT.

CORRAL BLUFFS  
 COLO2029  
 BLANEY ROAD  
 COLORADO SPRINGS, CO 80929  
 CELL SITE RF MODIFICATIONS

SHEET TITLE  
 EQUIPMENT DETAILS

SHEET NUMBER

**C-6**

NOT USED

NO SCALE

6

NOT USED

NO SCALE

7

NOT USED

NO SCALE

8



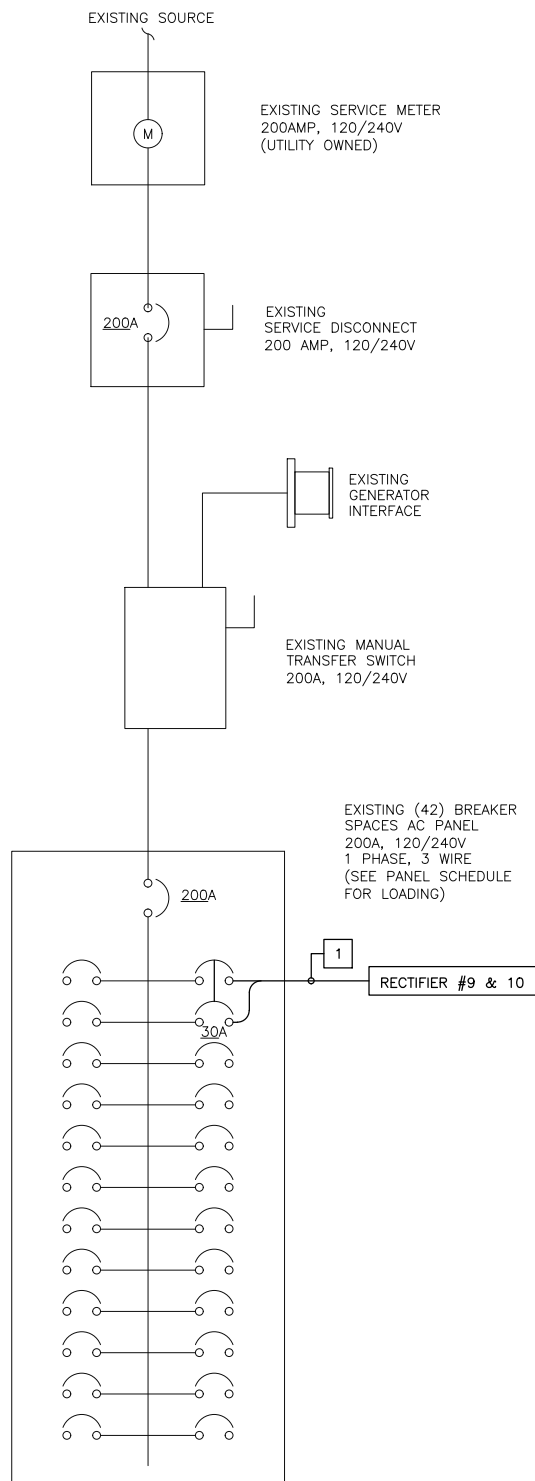

AC CIRCUIT SCHEDULE			
NO.	FROM	TO	CONFIGURATION
1	AC LOAD CENTER	RECTIFIER #9 & 10	EXISTING

**NOTE:**

- PER THE POWER PLANT MANUFACTURER EACH 30A 2-POLE AC CIRCUIT BREAKER WILL FEED 2 RECTIFIERS. EXISTING RECTIFIER #9 AND PROPOSED RECTIFIER #10 WILL SHARE EXISTING CIRCUIT BREAKER.

- CONTRACTOR SHALL INSPECT THE EXISTING CONDITIONS PRIOR TO SUBMITTING A BID. ANY QUESTIONS ARISING DURING THE BID PERIOD IN REGARDS TO THE CONTRACTOR'S FUNCTIONS, THE SCOPE OF WORK, OR ANY OTHER ISSUE RELATED TO THIS PROJECT SHALL BE BROUGHT UP DURING THE BID PERIOD WITH THE PROJECT MANAGER FOR CLARIFICATION, NOT AFTER THE CONTRACT HAS BEEN AWARDED.
- ALL ELECTRICAL WORK SHALL BE DONE IN ACCORDANCE WITH CURRENT NATIONAL ELECTRICAL CODES AND ALL STATE AND LOCAL CODES, LAWS, AND ORDINANCES. PROVIDE ALL COMPONENTS AND WIRING SIZES AS REQUIRED TO MEET NEC STANDARDS.
- LOCATION OF EQUIPMENT, CONDUIT AND DEVICES SHOWN ON THE DRAWINGS ARE APPROXIMATE AND SHALL BE COORDINATED WITH FIELD CONDITIONS PRIOR TO CONSTRUCTION.
- CONDUIT ROUGH-IN SHALL BE COORDINATED WITH THE MECHANICAL EQUIPMENT TO AVOID LOCATION CONFLICTS. VERIFY WITH THE MECHANICAL EQUIPMENT CONTRACTOR AND COMPLY AS REQUIRED.
- CONTRACTOR SHALL PROVIDE ALL BREAKERS, CONDUITS AND CIRCUITS AS REQUIRED FOR A COMPLETE SYSTEM.
- CONTRACTOR SHALL PROVIDE PULL BOXES AND JUNCTION BOXES AS REQUIRED BY THE NEC ARTICLE 314.
- CONTRACTOR SHALL PROVIDE ALL STRAIN RELIEF AND CABLE SUPPORTS FOR ALL CABLE ASSEMBLIES. INSTALLATION SHALL BE IN ACCORDANCE WITH MANUFACTURER'S SPECIFICATIONS AND RECOMMENDATIONS.
- ALL DISCONNECTS AND CONTROLLING DEVICES SHALL BE PROVIDED WITH ENGRAVED PHENOLIC NAMEPLATES INDICATING EQUIPMENT CONTROLLED, BRANCH CIRCUITS INSTALLED ON, AND PANEL FIELD LOCATIONS FED FROM.
- INSTALL AN EQUIPMENT GROUNDING CONDUCTOR IN ALL CONDUITS PER THE SPECIFICATIONS AND NEC 250. THE EQUIPMENT GROUNDING CONDUCTORS SHALL BE BONDED AT ALL JUNCTION BOXES, PULL BOXES, AND ALL DISCONNECT SWITCHES, AND EQUIPMENT CABINETS.
- ALL NEW MATERIAL SHALL HAVE A U.L. LABEL.
- PANEL SCHEDULE LOADING AND CIRCUIT ARRANGEMENTS REFLECT POST-CONSTRUCTION EQUIPMENT.
- CONTRACTOR SHALL BE RESPONSIBLE FOR AS-BUILT PANEL SCHEDULE AND SITE DRAWINGS.
- AIR CONDITIONING SYSTEM IS COMPRISED OF TWO COMPRESSOR/CONDENSER AND AIR HANDLING UNITS. THE ELECTRICAL CONTROLLER FOR THE AIR CONDITIONING SYSTEM WILL ONLY ALLOW PERMISSION FOR ONE HVAC TO BE ENERGIZED AT ANY GIVEN TIME. IN EXAMPLE ONE, IF HVAC #1 HAS A FAILURE, HVAC #2 WILL BE ENERGIZED. IN EXAMPLE TWO, WHEN HVAC CYCLE, THE CONTROLLER WILL DE-ENERGIZE FOR IT'S TIMED CYCLE.



188 INVERNESS DRIVE WEST  
SUITE 400  
ENGLEWOOD, CO 80112



4600 SOUTH SYRACUSE STREET  
SUITE 800  
DENVER, COLORADO 80237

CIRCUIT SCHEDULE	2	NOTES	3
------------------	---	-------	---

Site Name:		CORRAL BLUFFS		MODEL NUMBER:		CUTLER-HAMMER		WIRE:		3									
SITE NUMBER:		COL02029		PHASE:		1		WIRE:		3									
VOLTAGE:		240 /120		Volts AC															
MAIN BREAKER:		200 AMPS		BUS RATING:		200		AMPS											
MOUNT:		SURFACE																	
ENCLOSURE TYPE:		NEMA 1																	
PANEL STATUS:		EXISTING																	
CKT	LOAD DESCRIPTION	BREAKER AMPS	BREAKER POLES	BREAKER STATUS	SERVICE LOAD VA	Demand Factor	USAGE FACTOR	PHASE A VA	PHASE B VA	USAGE FACTOR	Demand Factor	SERVICE LOAD VA	BREAKER STATUS	BREAKER POLES	BREAKER AMPS	LOAD DESCRIPTION	CKT		
1	HVAC	50	2	ON	2500	1.00	1.00	2500		1.00	1.00	0	OFF	2	50	SPARE	2		
3					2500	1.00	1.00		2500	1.00	1.00	0							4
5	INT/EXT LIGHTS	20	1	ON	400	1.00	1.00	600		1.00	1.00	200	ON	1	20	BEACON / TOWER LTS	6		
7	RECEPTACLES	20	1	ON	1080	1.00	1.00		1330	1.00	1.00	250	ON	1	20	AIR DRIER	8		
9	ENV. PNL	20	1	ON	120	1.00	1.00	145		1.00	1.00	25	ON	1	20	SMOKE DETECTOR	10		
11	RECTIFIER #1 & 2	30	2	ON	2000	1.00	1.00		2000	1.00	1.00	0	OFF	1	20	SPARE	12		
13					2000	1.00	1.00		2000	1.00	1.00	0	OFF	1	20	SPARE	14		
15	RECTIFIER #3 & 4	30	2	ON	2000	1.00	1.00		2000	1.00	1.00	0	OFF	1	20	FIBER TOWER	16		
17					2000	1.00	1.00		4000	1.00	1.00	2000	ON	2	30	RECTIFIER #7 & 8	18		
19	HALON CNTL PNL	30		OFF	0	1.00	1.00		2000	1.00	1.00	2000					20		
21	RECTIFIER #5 & 6	30	2	ON	2000	1.00	1.00		4000	1.00	1.00	2000	ON/NEW	2	30	RECTIFIER #9 & 10	22		
23					2000	1.00	1.00		4000	1.00	1.00	2000							24
25	POWER FAIL RELAY	20	2	ON	10	1.00	1.00		10								26		
27					10	1.00	1.00		10										28
29	SPARE	30	2	OFF	0	1.00	1.00		0	1.00	1.00	0	OFF	2	30	SPARE	30		
31					0	1.00	1.00		0	1.00	1.00	0	OFF	2	30	SPARE	32		
33	SPARE	30	2	OFF	0	1.00	1.00		0	1.00	1.00	0	OFF	2	30	SPARE	34		
35					0	1.00	1.00		0	1.00	1.00	0	OFF	2	30	SPARE	36		
37	SPARE	30	2	OFF	0	1.00	1.00		0								38		
39					0	1.00	1.00		0										40
41									0								42		
								PHASE A	PHASE B										
								13255	13840	VA									
								<b>TOTAL</b>		KVA	27.10								
										AMPS	112.90								
																≤ 80% OF MAIN BREAKER			

PROJECT/PHASE NO: 129551/1399

DRAWN BY: GS

CHECKED BY: JMH

RFDS:

REV	DATE	DESCRIPTION
0	05/13/24	ISSUED FOR CONSTRUCTION

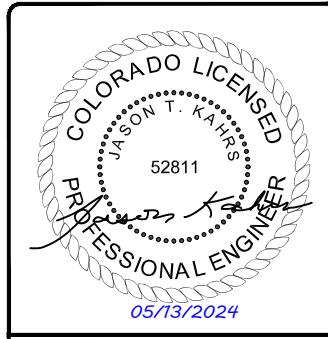

IT IS A VIOLATION OF LAW FOR ANY PERSON, UNLESS THEY ARE ACTING UNDER THE DIRECTION OF A LICENSED PROFESSIONAL ENGINEER, TO ALTER THIS DOCUMENT.

CORRAL BLUFFS  
COL02029  
BLANEY ROAD  
COLORADO SPRINGS, CO 80929  
CELL SITE RF MODIFICATIONS

SHEET TITLE  
ELECTRICAL AC ONE-LINE  
DIAGRAM

SHEET NUMBER  
**E-1**

DC CIRCUIT SCHEDULE			
NO.	FROM	TO	CONFIGURATION
①	EXISTING -48VDC DISTRIBUTION PANEL	PROPOSED BASE BAND UNIT	(2) 1-#12 TELCOFLEX III DC CABLE
②	EXISTING -48VDC DISTRIBUTION PANEL	PROPOSED RAYCAP SURGE SUPPRESSOR DC12-48-60-RM	(6) 1-#8 TELCOFLEX IV DC CABLE
③	PROPOSED RAYCAP SURGE SUPPRESSOR DC12-48-60-RM	PROPOSED RAYCAP SURGE SUPPRESSOR (DC9-48-60-24-8C-EV)	(2) 6-#6 THHN/THWN/VW-1 TYPE TC-ER DC CABLE
④	EXISTING RAYCAP SURGE SUPPRESSOR (DC6-48-60-18-8F)	PROPOSED REMOTE RADIO UNIT (RRU)	(1) 2-#8 THHN/THWN/VW-1 TYPE TC-ER DC CABLE
⑤	PROPOSED RAYCAP SURGE SUPPRESSOR (DC9-48-60-24-8C-EV)	PROPOSED REMOTE RADIO UNIT (RRU)	(1) 2-#8 THHN/THWN/VW-1 TYPE TC-ER DC CABLE

**NOTES**

- DC POWER WIRING SHALL BE COLOR CODED AT EACH END FOR IDENTIFYING +24V AND -48V CONDUCTORS. RED MARKINGS SHALL IDENTIFY +24V AND BLUE MARKINGS SHALL IDENTIFY -48V. REFER TO ATT-002-290-701.
- NON-LTE DC POWER WIRING SIZE 14 AWG TO 10 AWG SHALL BE TELCOFLEX III. DC POWER WIRING 8 AWG AND LARGER SHALL BE TELCOFLEX IV.
- LTE POWER WIRING SHALL BE IN ACCORDANCE WITH ATT-002-290-531.
- DC ELECTRICAL DEMAND FOR THE PROPOSED ADDITIONS WERE INCLUDED IN AC LOAD CALCULATIONS.
- CONNECT ALL PROPOSED ERICSSON RRU SECOND CPRI TO SURGE SUPPRESSOR FOR FUTURE USE.
- CONTRACTOR TO RECONNECT ALL EXISTING EQUIPMENT TO PROPOSED POWER PLANT.

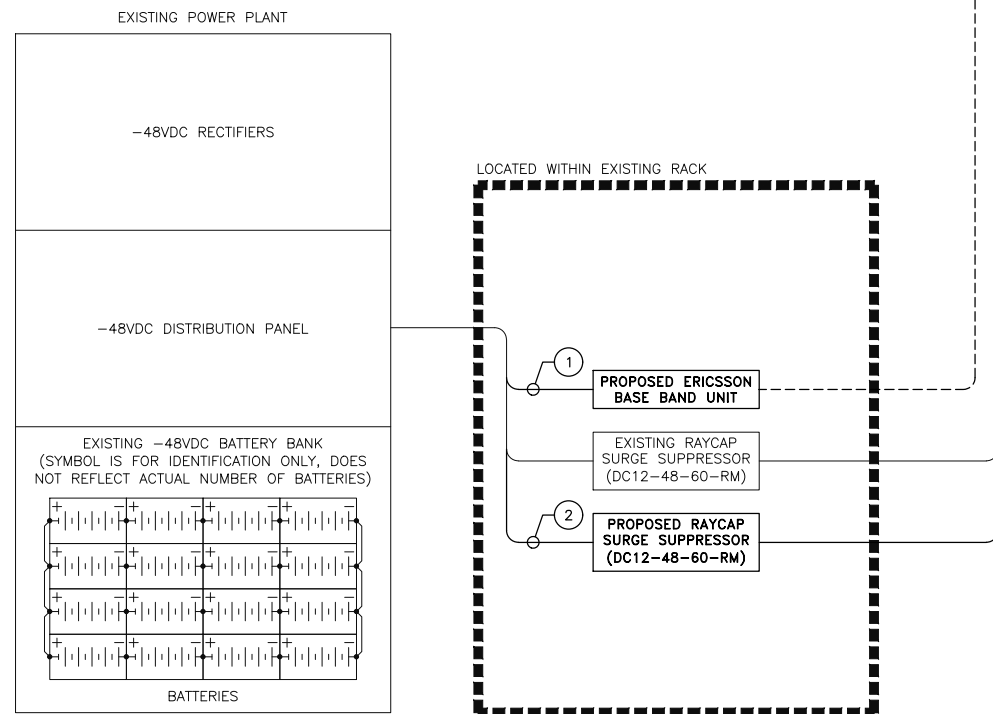
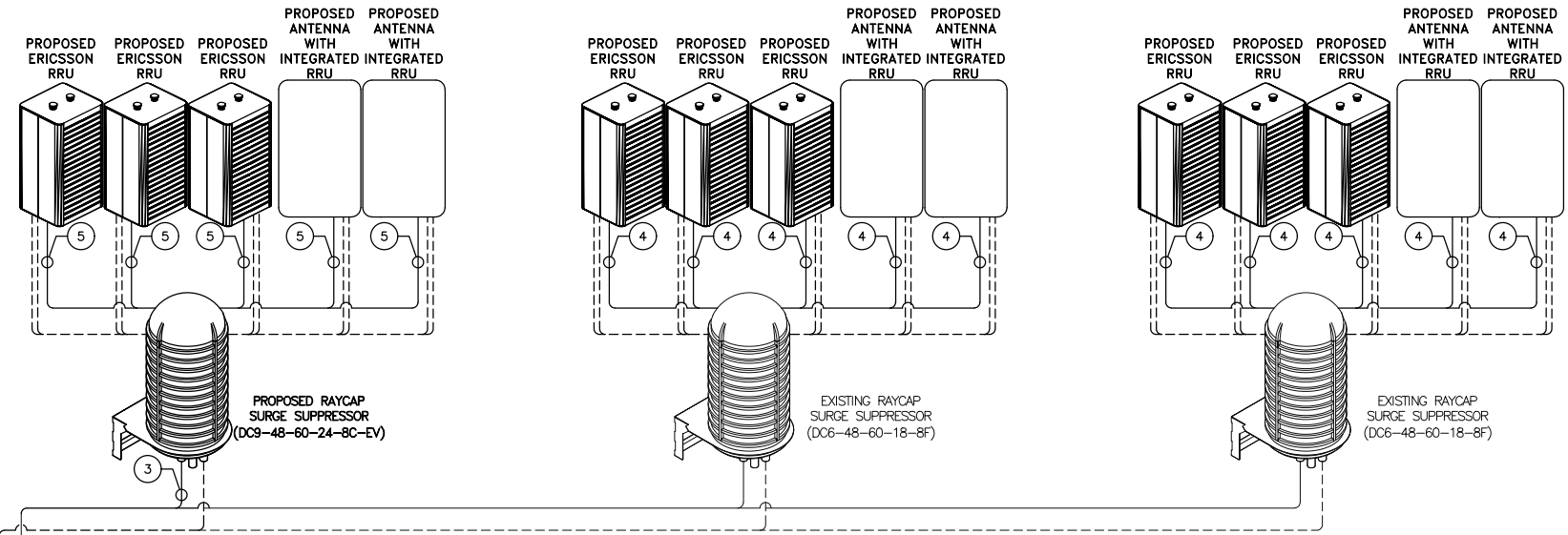

ELECTRICAL DC ONE-LINE DIAGRAM

NO SCALE



188 INVERNESS DRIVE WEST  
SUITE 400  
ENGLEWOOD, CO 80112



**BLACK & VEATCH**

4600 SOUTH SYRACUSE STREET  
SUITE 800  
DENVER, COLORADO 80237

PROJECT/PHASE NO: 129551/1399

DRAWN BY: GS

CHECKED BY: JMH

RFDS:

REV	DATE	DESCRIPTION
0	05/13/24	ISSUED FOR CONSTRUCTION



IT IS A VIOLATION OF LAW FOR ANY PERSON, UNLESS THEY ARE ACTING UNDER THE DIRECTION OF A LICENSED PROFESSIONAL ENGINEER, TO ALTER THIS DOCUMENT.

CORRAL BLUFFS  
COL02029  
BLANEY ROAD  
COLORADO SPRINGS, CO 80929  
CELL SITE RF MODIFICATIONS

SHEET TITLE  
ELECTRICAL DC ONE-LINE  
DIAGRAM

SHEET NUMBER  
**E-2**

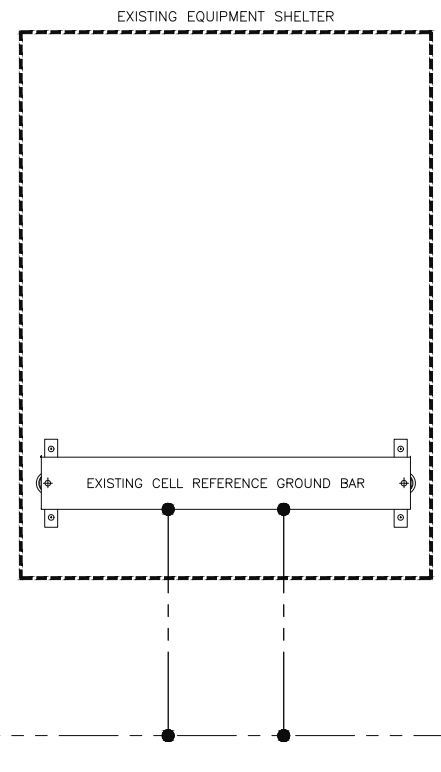
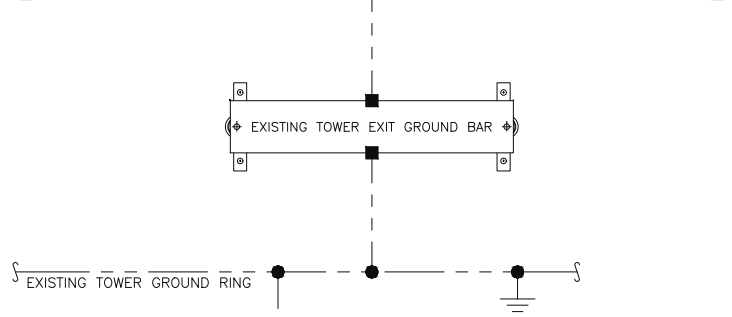
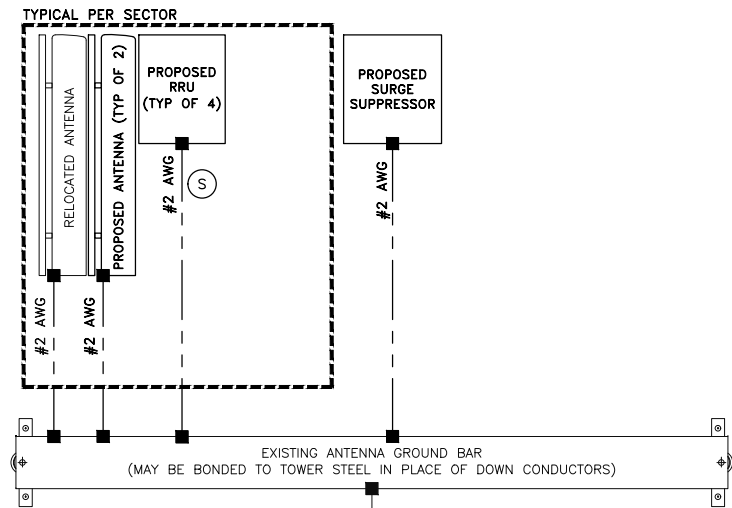

GROUNDING ONE-LINE DIAGRAM

NO SCALE

- EXOTHERMIC CONNECTION
- MECHANICAL CONNECTION
- ⊥ GROUND ROD
- ⊥ T TEST GROUND ROD WITH INSPECTION SLEEVE

**LEGEND**

1. GROUNDING IS SHOWN DIAGRAMMATICALLY ONLY.
2. CONTRACTOR SHALL GROUND ALL EQUIPMENT AS A COMPLETE SYSTEM. GROUNDING SHALL BE IN COMPLIANCE WITH NEC SECTION 250 AND AT&T GROUNDING AND BONDING REQUIREMENTS (ATT-TP-76416) AND MANUFACTURER'S SPECIFICATIONS.
3. ALL GROUND CONDUCTORS SHALL BE COPPER; NO ALUMINUM CONDUCTORS SHALL BE USED.

**NOTES**

- (A) **EXTERIOR GROUND RING:** #2 AWG SOLID COPPER, BURIED AT A DEPTH OF AT LEAST 30 INCHES BELOW GRADE, OR 6 INCHES BELOW THE FROST LINE AND APPROXIMATELY 24 INCHES FROM THE EXTERIOR WALL OR FOOTING. (ATT-TP-76416 2.2.3.5 / 7.5.1)
- (B) **TOWER GROUND RING:** THE GROUND RING SYSTEM SHALL BE INSTALLED AROUND AN ANTENNA TOWER'S LEGS, AND/OR GUY ANCHORS. WHERE SEPARATE SYSTEMS HAVE BEEN PROVIDED FOR THE TOWER AND THE BUILDING, AT LEAST TWO BONDS SHALL BE MADE BETWEEN THE TOWER RING GROUND SYSTEM AND THE BUILDING RING GROUND SYSTEM USING MINIMUM #2 AWG SOLID COPPER CONDUCTORS. (ATT-TP-76416 / 7.5.1)
- (C) **INTERIOR GROUND RING:** #2 AWG STRANDED GREEN INSULATED COPPER CONDUCTOR EXTENDED AROUND THE PERIMETER OF THE EQUIPMENT AREA. ALL NON-TELECOMMUNICATIONS RELATED METALLIC OBJECTS FOUND WITHIN A SITE SHALL BE GROUNDED TO THE INTERIOR GROUND RING WITH #6 AWG STRANDED GREEN INSULATED CONDUCTOR. (ATT-TP-76416 / 7.6.4)
- (D) **BOND TO INTERIOR GROUND RING:** #2 AWG SOLID TINNED COPPER WIRE PRIMARY BONDS SHALL BE PROVIDED AT LEAST AT FOUR POINTS ON THE INTERIOR GROUND RING, LOCATED AT THE CORNERS OF THE BUILDING. (ATT-TP-76416 7.5.2.2)
- (E) **GROUND ROD:** UL LISTED COPPER CLAD STEEL. MINIMUM 5/8" DIAMETER BY EIGHT FEET LONG. GROUND RODS SHALL BE INSTALLED WITH INSPECTION SLEEVES. GROUND RODS SHALL BE DRIVEN TO THE DEPTH OF GROUND RING CONDUCTOR. (ATT-TP-76416)
- (F) **CELL REFERENCE GROUND BAR:** POINT OF GROUND REFERENCE FOR ALL COMMUNICATIONS EQUIPMENT FRAMES. ALL BONDS ARE MADE WITH #2 AWG UNLESS NOTED OTHERWISE STRANDED GREEN INSULATED COPPER CONDUCTORS. BOND TO GROUND RING WITH (2) #2 SOLID TINNED COPPER CONDUCTORS. (ATT-TP-76416 / 7.6.7)
- (G) **HATCH PLATE GROUND BAR:** BOND TO THE INTERIOR GROUND RING WITH TWO #2 AWG STRANDED GREEN INSULATED COPPER CONDUCTORS. WHEN A HATCH-PLATE AND A CELL REFERENCE GROUND BAR ARE BOTH PRESENT, THE CRGB MUST BE CONNECTED TO THE HATCH-PLATE AND TO THE INTERIOR GROUND RING USING (2) TWO #2 AWG STRANDED GREEN INSULATED COPPER CONDUCTORS EACH.
- (H) **EXTERIOR CABLE ENTRY PORT GROUND BARS:** LOCATED AT THE ENTRANCE TO THE CELL SITE BUILDING. BOND TO GROUND RING WITH A #2 AWG SOLID TINNED COPPER CONDUCTORS WITH AN EXOTHERMIC WELD AND INSPECTION SLEEVE. (ATT-TP-76416 / 7.6.7.2)
- (J) **TOWER EXIT GROUND BAR:** #2 AWG SOLID TINNED COPPER BOND TO THE TOWER GROUND RING. (ATT-TP-76416 / 7.4.2.6)
- (K) **TELCO GROUND BAR:** BOND TO BOTH CELL REFERENCE GROUND BAR AND EXTERIOR GROUND RING. (ATT-TP-76416 / 7.6.8)
- (L) **FRAME BONDING:** THE BONDING POINT FOR TELECOM EQUIPMENT FRAMES SHALL BE THE GROUND BUS THAT IS NOT ISOLATED FROM THE EQUIPMENTS METAL FRAMEWORK. BOND THE FRAME GROUND TO THE "1" SECTION OF THE CELL REFERENCE GROUND BAR OR SUPPLEMENTARY CONDUCTOR. (ATT-TP-76416 6.5.3 AND 7.8)
- (M) **INTERIOR UNIT BONDS:** METAL FRAMES, CABINETS AND INDIVIDUAL METALLIC UNITS LOCATED WITH THE AREA OF THE INTERIOR GROUND RING REQUIRE A #6 AWG STRANDED GREEN INSULATED COPPER BOND TO THE INTERIOR GROUND RING. (ATT-TP-76416 / 7.12.3.1)
- (N) **FENCE AND GATE GROUNDING:** METAL FENCES WITHIN 7 FEET OF THE EXTERIOR GROUND RING OR OBJECTS BONDED TO THE EXTERIOR GROUND RING SHALL BE BONDED TO THE GROUND RING WITH A #2 AWG SOLID TINNED COPPER CONDUCTOR AT AN INTERVAL NOT EXCEEDING 25 FEET. BONDS SHALL BE MADE AT EACH GATE POST AND ACROSS GATE OPENINGS. (ATT-TP-76416 / 7.12.2.2)
- (P) **EXTERIOR UNIT BONDS:** METALLIC OBJECTS, EXTERNAL TO OR MOUNTED TO THE BUILDING, SHALL BE BONDED TO THE EXTERIOR GROUND RING. (ATT-TP-76416 7.12.2)
- (Q) **ICE BRIDGE SUPPORTS:** EACH ICE BRIDGE LEG SHALL BE BONDED TO THE GROUND RING WITH #2 AWG BARE TINNED COPPER CONDUCTOR. PROVIDE EXOTHERMIC WELDS AT BOTH THE ICE BRIDGE LEG AND BURIED GROUND RING. (ATT-TP-76416 / 7.4.2.6)
- (R) DURING ALL DC POWER SYSTEM CHANGES INCLUDING DC SYSTEM CHANGE OUTS, RECTIFIER REPLACEMENTS OR ADDITIONS, BREAKER DISTRIBUTION CHANGES, BATTERY ADDITIONS, BATTERY REPLACEMENTS AND INSTALLATIONS OR CHANGES TO DC CONVERTER SYSTEMS IT SHALL BE REQUIRED THAT SERVICE CONTRACTORS VERIFY ALL DC POWER SYSTEMS ARE EQUIPPED WITH A MASTER DC SYSTEM RETURN GROUND CONDUCTOR FROM THE DC POWER SYSTEM COMMON RETURN BUS DIRECTLY CONNECTED TO THE CELL SITE REFERENCE GROUND BAR (CRGB) PER TP76300 SECTION H 6 AND TP76416 FIGURE 7-11 REQUIREMENTS.
- (S) **OUTDOOR GROUNDING CONDUCTORS:** GROUNDING CONDUCTORS INSTALLED OUTDOORS AND RUN ENTIRELY ABOVE GRADE SHALL BE TINNED STRANDED COPPER AND BE SUNLIGHT RESISTANT.

GROUNDING KEY NOTES

188 INVERNESS DRIVE WEST  
SUITE 400  
ENGLEWOOD, CO 80112

4600 SOUTH SYRACUSE STREET  
SUITE 800  
DENVER, COLORADO 80237

PROJECT/PHASE NO:	129551/1399
DRAWN BY:	GS
CHECKED BY:	JMH
RFDS:	

REV	DATE	DESCRIPTION
0	05/13/24	ISSUED FOR CONSTRUCTION

05/13/2024

IT IS A VIOLATION OF LAW FOR ANY PERSON, UNLESS THEY ARE ACTING UNDER THE DIRECTION OF A LICENSED PROFESSIONAL ENGINEER, TO ALTER THIS DOCUMENT.

CORRAL BLUFFS  
COLO2029  
BLANEY ROAD  
COLORADO SPRINGS, CO 80929  
CELL SITE RF MODIFICATIONS

SHEET TITLE  
GROUNDING ONE-LINE  
DIAGRAM

SHEET NUMBER  
**G-1**



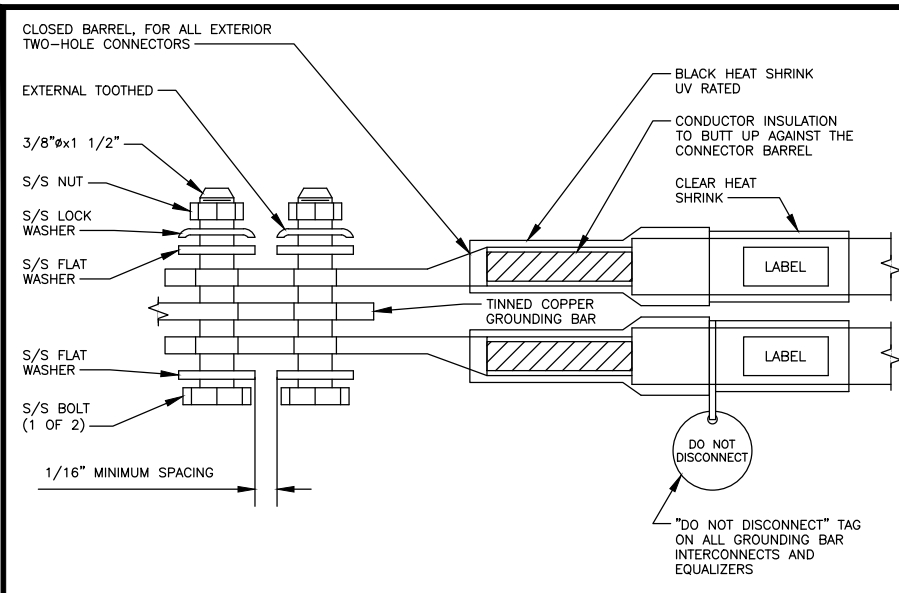

INTERIOR TWO HOLE LUG

NO SCALE

1

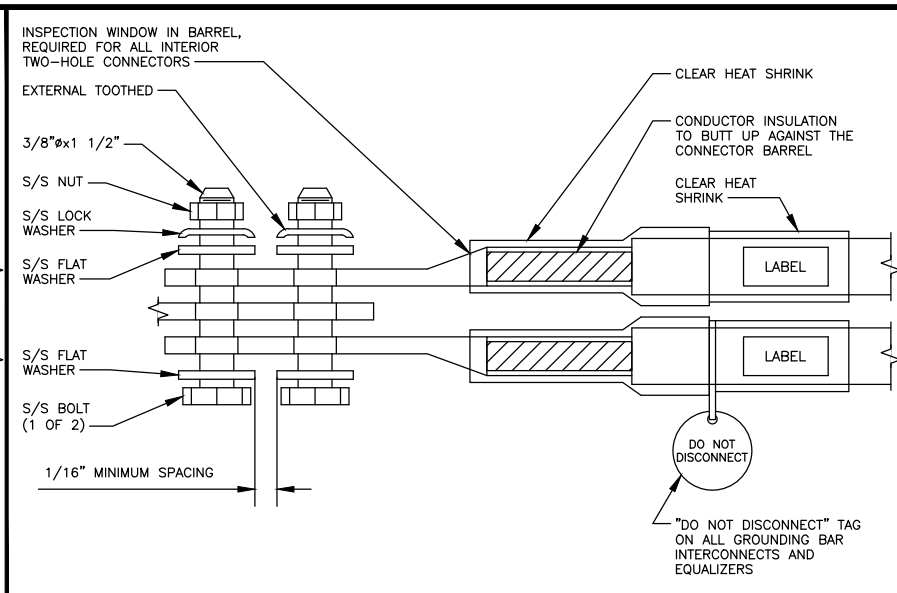

EXTERIOR TWO HOLE LUG

NO SCALE

2

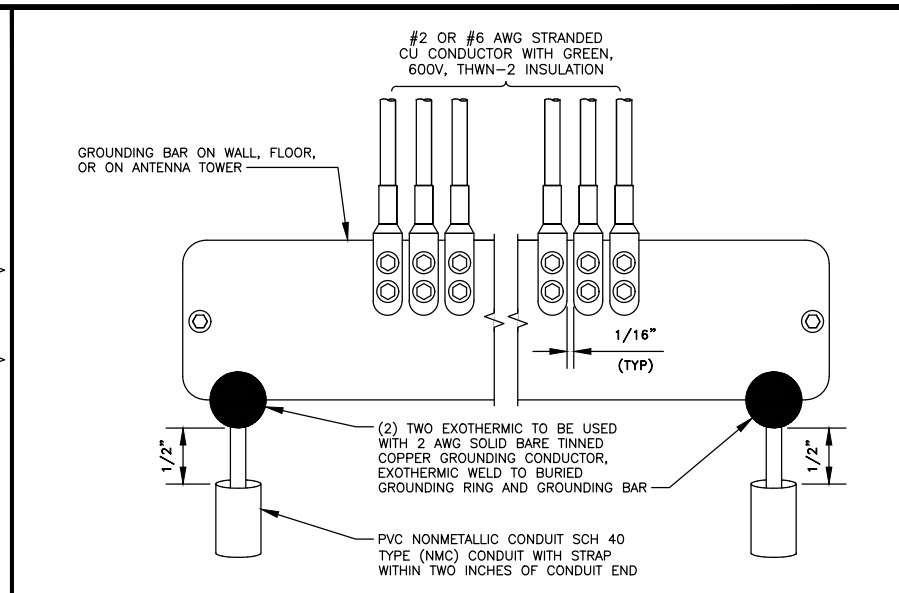

INSTALLATION OF GROUNDING CONDUCTOR TO GROUNDING BAR

NO SCALE

3

**EACH GROUND CONDUCTOR TERMINATING ON ANY GROUND BAR SHALL HAVE AN IDENTIFICATION TAG ATTACHED AT EACH END THAT WILL IDENTIFY ITS ORIGIN AND DESTINATION**

**SECTION "P" - SURGE PROTECTORS**

- (EC) CABLE ENTRY PORTS (HATCH PLATES) (#2)
- (EC) TELCO GROUND BAR (#2)
- (EC) COMMERCIAL POWER COMMON NEUTRAL/GROUND BOND (#2)
- (AT&T) CELL SITE +24V POWER SUPPLY RETURN BAR (#2)
- (AT&T) CELL SITE -48V POWER SUPPLY RETURN BAR (#2)
- (EC) GENERATOR FRAMEWORK (IF AVAILABLE) (#2)
- (AT&T) RECTIFIER FRAMES
- (AT&T) ANTENNA SUPPRESSION

**SECTION "A" - SURGE ABSORBERS**

- (EC) INTERIOR GROUND RING (#2)
- (EC) EXTERNAL EARTH GROUND FIELD (BURIED GROUND RING) (#2)
- (EC) METALLIC COLD WATER PIPE (IF AVAILABLE) (#2)
- (EC) BUILDING STEEL (IF AVAILABLE) (#2)

**SECTION "I" - ISOLATED GROUNDING ZONE**

- (AT&T) ALL CELL SITE COMMUNICATIONS EQUIPMENT FRAMES

**DETAIL NOTES**

1. EXOTHERMICALLY WELD #2 AWG BARE TINNED SOLID COPPER CONDUCTOR TO GROUND BAR. ROUTE CONDUCTOR TO BURIED GROUND RING AND PROVIDE PARALLEL EXOTHERMIC WELD.
2. EC SHALL PERMANENTLY MARK THE LINES BETWEEN EACH SECTION AND LABEL EACH SECTION ("P", "A", "I") WITH 1" HIGH LETTERS.
3. GROUND BAR SHALL BE ENGRAVED PER AT&T SPECIFICATIONS TO PREVENT THEFT.

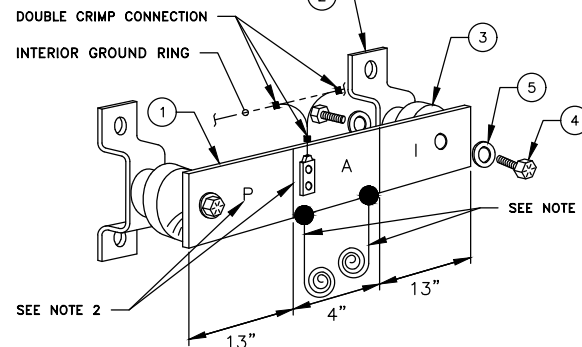

1. ALL MAIN CABLES WILL BE GROUNDED W/ COAXIAL CABLE GROUND KITS AT:
  - A. THE ANTENNA LEVEL.
  - B. MID LEVEL IF TOWER IS OVER 200'.
  - C. BASE OF TOWER PRIOR TO TURNING HORIZONTAL.
  - D. OUTSIDE THE EQUIPMENT SHELTER AT ENTRY PORT.
  - E. INSIDE THE EQUIPMENT SHELTER AT THE ENTRY PORT.
2. ALL PROPOSED GROUND BAR DOWNLOADS ARE TO BE CADWELDED TO THE EXISTING ADJACENT GROUND BAR DOWNLOADS A MINIMUM DISTANCE OF FOUR FEET BELOW GROUND BAR.
3. IT IS THE CONTRACTOR'S RESPONSIBILITY TO VERIFY ANTENNA AND COAX CONFIGURATION, MAKE AND MODELS PRIOR TO INSTALLATION.
4. DO NOT ALLOW THE COPPER CONDUCTOR TO TOUCH THE GALVANIZED GUY WIRE AT THE CONNECTION POINT OR AT ANY OTHER POINT. NO EXOTHERMICALLY WELDED CONNECTION SHALL BE MADE TO THE GUY WIRE.
5. SUBCONTRACTOR SHALL GROUND ALL EQUIPMENT INCLUDING ANTENNAS, RET MOTORS, TMA'S, COAX CABLES, AND RET CONTROL CABLES AS A COMPLETE SYSTEM. GROUNDING SHALL BE EXECUTED BY QUALIFIED PERSONNEL IN COMPLIANCE WITH MANUFACTURER'S SPECIFICATIONS AND RECOMMENDATIONS.
6. DO NOT INSTALL CABLE GROUNDING KIT AT A BEND AND ALWAYS DIRECT GROUNDING CONDUCTOR DOWN TO GROUNDING BAR.
7. GROUNDING KIT SHALL BE TYPE AND PART NUMBER AS SUPPLIED OR RECOMMENDED BY CABLE MANUFACTURER.
8. WEATHERPROOFING SHALL BE TYPE AND PART NUMBER AS SUPPLIED OR RECOMMENDED BY CABLE MANUFACTURER.
9. ALL EXTERIOR HEAT SHRINK OR HEAT SHRINK EXPOSED TO U/V LIGHT SHALL BE BLACK. ALL INTERIOR HEAT SHRINK SHALL BE CLEAR.
10. NUMBER OF GROUNDING BARS MAY VARY DEPENDING ON THE TYPE OF TOWER, ANTENNA LOCATION, AND CONNECTION ORIENTATION. THE SUBCONTRACTOR SHALL BE RESPONSIBLE FOR INSTALLING ADDITIONAL GROUNDING BAR AS REQUIRED, PROVIDING 50% SPARE CONNECTION POINTS.
11. PROVIDE GROUNDING KIT 6" BEFORE TURN TRANSITION FROM TOWER TO ICE BRIDGE.

(MGB) REFERENCE GROUNDING BAR

NO SCALE

4

NOTES

NO SCALE

5

**NEWTON INSTRUMENT COMPANY, INC. BUTNER, NC**

NO	REQUIRED	PART NUMBER	DESCRIPTION
1	1	1/4"x4"x30"	SOLID GROUND BAR
2	2	A-6056	WALL MOUNTING BRACKET
3	2	3061-4	INSULATORS
4	4	3012-1	5/8"-11x1" H.H.C.S.
5	4	3015-8	5/8" LOCKWASHER



188 INVERNESS DRIVE WEST  
SUITE 400  
ENGLEWOOD, CO 80112



4600 SOUTH SYRACUSE STREET  
SUITE 800  
DENVER, COLORADO 80237

PROJECT/PHASE NO: 129551/1399

DRAWN BY: GS

CHECKED BY: JMH

RFDS:

REV	DATE	DESCRIPTION
0	05/13/24	ISSUED FOR CONSTRUCTION



IT IS A VIOLATION OF LAW FOR ANY PERSON, UNLESS THEY ARE ACTING UNDER THE DIRECTION OF A LICENSED PROFESSIONAL ENGINEER, TO ALTER THIS DOCUMENT.

CORRAL BLUFFS  
COLO2029  
BLANEY ROAD  
COLORADO SPRINGS, CO 80929  
CELL SITE RF MODIFICATIONS

SHEET TITLE  
GROUNDING DETAILS

SHEET NUMBER

**G-2**

NOT USED

NO SCALE

6

NOT USED

NO SCALE





















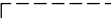



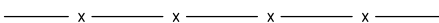
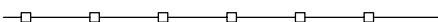



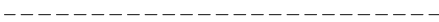

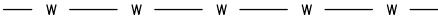

7

NOT USED

NO SCALE

8



- EXOTHERMIC CONNECTION 
- MECHANICAL CONNECTION 
- CHEMICAL ELECTROLYTIC GROUNDING SYSTEM 
- TEST CHEMICAL ELECTROLYTIC GROUNDING SYSTEM 
- EXOTHERMIC WITH INSPECTION SLEEVE 
- GROUNDING BAR 
- GROUND ROD 
- TEST GROUND ROD WITH INSPECTION SLEEVE 
- SINGLE POLE SWITCH 
- DUPLEX RECEPTACLE 
- DUPLEX GFCI RECEPTACLE 
- FLUORESCENT LIGHTING FIXTURE (2) TWO LAMPS 48-T8 
- SMOKE DETECTION (DC) 
- EMERGENCY LIGHTING (DC) 
- SECURITY LIGHT W/PHOTOCELL LITHONIA ALXW LED-1-25A400/51K-SR4-120-PE-DBBTXD 
- CHAIN LINK FENCE 
- WOOD/WROUGHT IRON FENCE 
- WALL STRUCTURE 
- LEASE AREA 
- PROPERTY LINE (PL) 
- SETBACKS 
- ICE BRIDGE 
- CABLE TRAY 
- WATER LINE 
- UNDERGROUND POWER 
- UNDERGROUND TELCO 
- OVERHEAD POWER 
- OVERHEAD TELCO 
- UNDERGROUND TELCO/POWER 
- ABOVE GROUND POWER 
- ABOVE GROUND TELCO 
- ABOVE GROUND TELCO/POWER 
- WORKPOINT 
- SECTION REFERENCE 
- DETAIL REFERENCE 

- AB ANCHOR BOLT
- ABV ABOVE
- AC ALTERNATING CURRENT
- ADDL ADDITIONAL
- AFF ABOVE FINISHED FLOOR
- AFG ABOVE FINISHED GRADE
- AGL ABOVE GROUND LEVEL
- AIC AMPERAGE INTERRUPTION CAPACITY
- ALUM ALUMINUM
- ALT ALTERNATE
- ANT ANTENNA
- APPROX APPROXIMATE
- ARCH ARCHITECTURAL
- ATS AUTOMATIC TRANSFER SWITCH
- AWG AMERICAN WIRE GAUGE
- BATT BATTERY
- BLDG BUILDING
- BLK BLOCK
- BLKG BLOCKING
- BM BEAM
- BTC BARE TINNED COPPER CONDUCTOR
- BOF BOTTOM OF FOOTING
- CAB CABINET
- CANT CANTILEVERED
- CHG CHARGING
- CLG CEILING
- CLR CLEAR
- COL COLUMN
- COMM COMMON
- CONC CONCRETE
- CONSTR CONSTRUCTION
- DBL DOUBLE
- DC DIRECT CURRENT
- DEPT DEPARTMENT
- DF DOUGLAS FIR
- DIA DIAMETER
- DIAG DIAGONAL
- DIM DIMENSION
- DWG DRAWING
- DWL DOWEL
- EA EACH
- EC ELECTRICAL CONDUCTOR
- EL ELEVATION
- ELEC ELECTRICAL
- EMT ELECTRICAL METALLIC TUBING
- ENG ENGINEER
- EQ EQUAL
- EXP EXPANSION
- EXT EXTERIOR
- EW EACH WAY
- FAB FABRICATION
- FF FINISH FLOOR
- FG FINISH GRADE
- FIF FACILITY INTERFACE FRAME
- FIN FINISH(ED)
- FLR FLOOR
- FDN FOUNDATION
- FOC FACE OF CONCRETE
- FOM FACE OF MASONRY
- FOS FACE OF STUD
- FOW FACE OF WALL
- FS FINISH SURFACE
- FT FOOT
- FTG FOOTING
- GA GAUGE
- GEN GENERATOR
- GFCI GROUND FAULT CIRCUIT INTERRUPTER
- GLB GLUE LAMINATED BEAM
- GLV GALVANIZED
- GPS GLOBAL POSITIONING SYSTEM
- GND GROUND
- GSM GLOBAL SYSTEM FOR MOBILE
- HDG HOT DIPPED GALVANIZED
- HDR HEADER
- HGR HANGER
- HVAC HEAT/VENTILATION/AIR CONDITIONING
- HT HEIGHT
- IGR INTERIOR GROUND RING
- IN INCH
- INT INTERIOR
- LB(S) POUND(S)
- LF LINEAR FEET
- LTE LONG TERM EVOLUTION
- MAS MASONRY
- MAX MAXIMUM
- MB MACHINE BOLT
- MECH MECHANICAL
- MFR MANUFACTURER
- MGB MASTER GROUND BAR
- MIN MINIMUM
- MISC MISCELLANEOUS
- MTL METAL
- MTS MANUAL TRANSFER SWITCH
- MW MICROWAVE
- NEC NATIONAL ELECTRIC CODE
- NM NEWTON METERS
- NO. NUMBER
- # NUMBER
- NTS NOT TO SCALE
- OC ON-CENTER
- OSHA OCCUPATIONAL SAFETY AND HEALTH ADMINISTRATION
- OPNG OPENING
- P/C PRECAST CONCRETE
- PCS PERSONAL COMMUNICATION SERVICES
- PCU PRIMARY CONTROL UNIT
- PRC PRIMARY RADIO CABINET
- PP POLARIZING PRESERVING
- PSF POUNDS PER SQUARE FOOT
- PSI POUNDS PER SQUARE INCH
- PT PRESSURE TREATED
- PWR POWER CABINET
- QTY QUANTITY
- RAD RADIUS
- RECT RECTIFIER
- REF REFERENCE
- REINF REINFORCEMENT
- REQ'D REQUIRED
- RET REMOTE ELECTRIC TILT
- RF RADIO FREQUENCY
- RMC RIGID METALLIC CONDUIT
- RRH REMOTE RADIO HEAD
- RRU REMOTE RADIO UNIT
- RWY RACEWAY
- SCH SCHEDULE
- SHT SHEET
- SIAD SMART INTEGRATED ACCESS DEVICE
- SIM SIMILAR
- SPEC SPECIFICATION
- SQ SQUARE
- SS STAINLESS STEEL
- STD STANDARD
- STL STEEL
- TEMP TEMPORARY
- THK THICKNESS
- TMA TOWER MOUNTED AMPLIFIER
- TN TOE NAIL
- TOA TOP OF ANTENNA
- TOC TOP OF CURB
- TOF TOP OF FOUNDATION
- TOP TOP OF PLATE (PARAPET)
- TOS TOP OF STEEL
- TOW TOP OF WALL
- TVSS TRANSIENT VOLTAGE SURGE SUPPRESSION
- TYP TYPICAL
- UG UNDERGROUND
- UL UNDERWRITERS LABORATORY
- UNO UNLESS NOTED OTHERWISE
- UMTS UNIVERSAL MOBILE TELECOMMUNICATIONS SYSTEM
- UPS UNINTERRUPTIBLE POWER SYSTEM (DC POWER PLANT)
- VIF VERIFIED IN FIELD
- W WIDE
- W/ WITH
- WD WOOD
- WP WEATHERPROOF
- WT WEIGHT

**LEGEND**

**ABBREVIATIONS**



188 INVERNESS DRIVE WEST  
SUITE 400  
ENGLEWOOD, CO 80112



4600 SOUTH SYRACUSE STREET  
SUITE 800  
DENVER, COLORADO 80237

PROJECT/PHASE NO:	129551/1399
DRAWN BY:	GS
CHECKED BY:	JMH
RFDS:	

REV	DATE	DESCRIPTION
0	05/13/24	ISSUED FOR CONSTRUCTION



IT IS A VIOLATION OF LAW FOR ANY PERSON, UNLESS THEY ARE ACTING UNDER THE DIRECTION OF A LICENSED PROFESSIONAL ENGINEER, TO ALTER THIS DOCUMENT.

CORRAL BLUFFS  
COL02029  
BLANEY ROAD  
COLORADO SPRINGS, CO 80929  
CELL SITE RF MODIFICATIONS

SHEET TITLE  
**LEGEND & ABBREVIATIONS**

SHEET NUMBER  
**GN-1**





**GENERAL SITE WORK AND DRAINAGE NOTES**

**PART 1 – GENERAL**

CONTRACTOR SHALL PROVIDE CLEARING, GRUBBING, STRIPPING, EROSION CONTROL, SURVEY, LAYOUT, SUBGRADE PREPARATION, AND FINISH GRADING AS REQUIRED TO COMPLETE THE PROPOSED WORK SHOWN IN THESE PLANS.

**1.1 REFERENCES:**

- A. DOT (STATE DEPARTMENT OF TRANSPORTATION STANDARD SPECIFICATIONS FOR HIGHWAY CONSTRUCTION, CURRENT EDITION)
- B. ASTM (AMERICAN SOCIETY FOR TESTING AND MATERIALS)
- C. OSHA (OCCUPATION SAFETY AND HEALTH ADMINISTRATION)

**1.2 INSPECTION AND TESTING:**

- A. FIELD TESTING OF EARTHWORK COMPACTION AND CONCRETE CYLINDERS SHALL BE PERFORMED BY AN INDEPENDENT TESTING LAB. THIS WORK SHALL BE COORDINATED BY THE SUBCONTRACTOR.
- B. ALL WORK SHALL BE INSPECTED AND RELEASED BY THE GENERAL CONTRACTOR. THE INSPECTIONS SHALL BE CARRIED OUT WITH SPECIFIC CONCERN FOR PROPER PERFORMANCE OF THE WORK AS SPECIFIED AND/OR CALLED FOR ON THE PLAN. IT IS THE SUBCONTRACTOR'S RESPONSIBILITY TO REQUEST THE REQUIRED INSPECTIONS PRIOR TO PROCEEDING WITH FURTHER WORK THAT WOULD MAKE PARTS OF WORK INACCESSIBLE OR DIFFICULT TO INSPECT.

**1.3 SITE MAINTENANCE AND PROTECTION:**

- A. PROVIDE ALL NECESSARY JOB SITE MAINTENANCE FROM COMMENCEMENT OF WORK UNTIL COMPLETION OF THE SUBCONTRACT.
- B. AVOID DAMAGE TO THE SITE AND TO EXISTING FACILITIES, STRUCTURES, TREES, AND SHRUBS DESIGNATED TO REMAIN. TAKE PROTECTIVE MEASURES TO PREVENT DAMAGED TO EXISTING FACILITIES THAT ARE NOT DESIGNATED FOR MODIFICATION OR REMOVAL.
- C. KEEP SITE FREE OF PONDING WATER.
- D. PROVIDE EROSION CONTROL MEASURES IN ACCORDANCE WITH STATE DOT AND EPA REQUIREMENTS.
- E. PROVIDE AND MAINTAIN ALL TEMPORARY FENCING, BARRICADES, WARNING SIGNS, AND SIMILAR DEVICES NECESSARY TO PROTECT AGAINST THEFT FROM PROPERTY DURING THE ENTIRE DURATION OF CONSTRUCTION. REMOVE ALL SUCH DEVICES UPON COMPLETION OF THE WORK.
- F. DO NOT INTERRUPT EXISTING UTILITIES SERVING FACILITIES OCCUPIED BY THE OWNER OR OTHERS, EXCEPT WHEN PERMITTED IN WRITING BY THE ENGINEER AND THEN ONLY AFTER ACCEPTABLE TEMPORARY UTILITY SERVICES HAVE BEEN PROVIDED.
  - 1. NOTICE TO ENGINEER SHALL BE PROVIDED A MINIMUM OF 48 HOURS PRIOR TO OUTAGE.

**PART 2 – PRODUCTS**

- 2.1 SUITABLE BACKFILL: ASTM D2321 (CLASS I, II, III OR IVA) FREE FROM FROZEN LUMPS, REFUSE, STONES OR ROCKS LARGER THAN THREE (3) INCHES IN ANY DIMENSION.
- 2.2 NON-POROUS GRANULAR EMBANKMENT AND BACKFILL: ASTM D2321 (CLASS III, IVA OR IVB) COARSE AGGREGATE. FREE FROM FROZEN LUMPS, REFUSE, STONES OR ROCKS LARGER THAN THREE (3) INCHES IN ANY DIMENSION.
- 2.3 POROUS GRANULAR EMBANKMENT AND BACKFILL: ASTM D2321 (CLASS IA, IB OR II) COARSE AGGREGATE FREE FROM FROZEN LUMPS, REFUSE, STONES, OR ROCKS LARGER THAN THREE (3) INCHES IN DIAMETER, OR OTHER MATERIAL THAT MAY MAKE THE INORGANIC MATERIAL UNSUITABLE FOR BACKFILL.
- 2.4 SELECT STRUCTURAL FILL: GRANULAR FILL MATERIAL MEETING THE REQUIREMENTS OF ASTM E850-95. FOR USE AROUND AND UNDER STRUCTURES WHERE STRUCTURAL FILL MATERIAL IS REQUIRED.
- 2.5 GRANULAR BEDDING AND TRENCH BACKFILL: WELL-GRADED SAND MEETING THE GRADATION REQUIREMENTS OF ASTM D2487 (CLASSIFIED AS SE OR SW-SM SOILS).
- 2.6 COARSE AGGREGATE FOR ACCESS ROAD SUBBASE COURSE SHALL CONFORM TO ASTM D2940.
- 2.7 UNSUITABLE MATERIAL: HIGH AND MODERATELY PLASTIC SILTS AND CLAYS (LL>45), MATERIAL CONTAINING REFUSE, FROZEN LUMPS, DEMOLISHED BITUMINOUS MATERIAL, VEGETATIVE MATTER, WOOD, STONES IN EXCESS OF 3 INCHES IN DIAMETER, AND DEBRIS. THESE WILL BE SOILS CLASSIFIED BY ASTM AS PT, MH, CH, OH, ML, AND OL.
- 2.8 GEOTEXTILE FABRIC: MIRAFI 500X OR APPROVED EQUIVALENT.
- 2.9 PLASTIC MARKING TAPE SHALL BE ACID AND ALKALI RESISTANT POLYETHYLENE FILM SPECIFICALLY MANUFACTURED FOR MARKING AND LOCATING UNDERGROUND UTILITIES, SIX (6) INCHES WIDE WITH A MINIMUM THICKNESS OF 0.004" TAPE SHALL HAVE MINIMUM STRENGTH OF 1,500 PSI IN BOTH DIRECTIONS AND MANUFACTURED WITH INTEGRAL CONDUCTORS, FOIL BACKING OR OTHER MEANS TO ENABLE DETECTION BY A METAL DETECTOR WHEN BURIED UP TO 3 FEET DEEP. THE METALLIC CORE OF THE TAPE SHALL BE ENCASED IN A PROTECTIVE JACKET OR PROVIDED WITH OTHER MEANS TO PROTECT IT FROM CORROSION. TAPE COLOR SHALL BE RED FOR ELECTRIC UTILITIES AND ORANGE FOR TELECOMMUNICATION UTILITIES.

**PART 3 – EXECUTION**

**3.1 GENERAL:**

- A. BEFORE STARTING GENERAL SITE PREPARATION ACTIVITIES, INSTALL EROSION AND SEDIMENT CONTROL MEASURES. THE WORK AREA SHALL BE CONSTRUCTED AND MAINTAINED IN SUCH CONDITION THAT IN THE EVENT OF A RAIN EVENT, THE SITE CAN PROPERLY DRAIN AT ANY TIME.
- B. PRIOR TO SURVEY, LAYOUT, STAKING, AND MARKING, ESTABLISH AND MAINTAIN ALL LINES, GRADES, ELEVATIONS, AND BENCHMARKS NEEDED FOR EXECUTION OF THE WORK.
- C. CLEAR AND GRUB THE AREA WITHIN THE LIMITS OF THE SITE. REMOVE TREES, BRUSH, STUMPS, RUBBISH, OTHER DEBRIS, AND VEGETATION RESTING ON OR PROTRUDING THROUGH THE GROUND SURFACE.
  - 1. REMOVE THE FOLLOWING MATERIALS TO A DEPTH OF NO LESS THAN 12 INCHES BELOW THE ORIGINAL GROUND SURFACE: ROOTS, STUMPS, BRUSH, REFUSE, AND OTHER DEBRIS EMBEDDED IN OR PROTRUDING THROUGH THE GROUND SURFACE. RAKE, DISK, OR PLOW THE AREA TO A DEPTH OF NO LESS THAN 6 INCHES, AND REMOVE MATERIAL TO A DEPTH OF 12 INCHES BELOW THE BOTTOM DEPTH OF ROOTS AND OTHER DEBRIS.
  - 2. REMOVE TOPSOIL MATERIAL COMPLETELY FROM THE SURFACE UNTIL THE SOIL NO LONGER MEETS THE DEFINITION OF TOPSOIL. AVOID MIXING TOPSOIL WITH SUBSOIL OR OTHER UNDESIRABLE MATERIALS.
  - 3. EXCEPT WHERE EXCAVATION TO GREATER DEPTH IS INDICATED, FILL DEPRESSIONS RESULTING FROM CLEARING, GRUBBING, AND DEMOLITION WORK COMPLETELY WITH SUITABLE FILL.
- D. ALL DEBRIS RESULTING FROM CLEARING AND GRUBBING OPERATIONS SHALL BE REMOVED FROM THE SITE AND DISPOSED OF IN AN AUTHORIZED LANDFILL. BURNING OF DEBRIS WILL NOT BE PERMITTED.
- E. PRIOR TO EXCAVATING, THOROUGHLY EXAMINE THE AREA TO BE EXCAVATED AND/OR TRENCHED TO VERIFY THE LOCATIONS OF FEATURES INDICATED ON THE DRAWINGS AND TO ASCERTAIN THE EXISTENCE AND LOCATION OF ANY STRUCTURE, UNDERGROUND STRUCTURE, OR OTHER ITEM NOT SHOWN THAT MIGHT INTERFERE WITH THE PROPOSED CONSTRUCTION. NOTIFY THE CONSTRUCTION MANAGER OF ANY OBSTRUCTIONS THAT WILL PREVENT ACCOMPLISHMENT OF THE WORK AS INDICATED ON THE PLANS.
- F. SEPARATE AND STOCKPILE ALL EXCAVATED MATERIALS SUITABLE FOR BACKFILL. ALL EXCESS EXCAVATED AND UNSUITABLE MATERIALS SHALL BE DISPOSED OF OFF-SITE IN A LEGAL MANNER.

**3.2 BACKFILL:**

- A. AFTER COMPLETING CONSTRUCTION OF A STRUCTURE, INCLUDING EXPIRATION OF THE SPECIFIED MINIMUM CURING PERIOD FOR CAST-IN-PLACE CONCRETE, BACKFILL THE EXCAVATION WITH APPROVED MATERIAL TO RESTORE THE REQUIRED FINISHED GRADE.
  - 1. PRIOR TO PLACING BACKFILL AROUND STRUCTURES, ALL FORMS SHALL BE REMOVED AND THE EXCAVATION CLEANED OF ALL TRASH, DEBRIS, AND UNSUITABLE MATERIALS.
  - 2. BACKFILL BY PLACING AND COMPACTING SUITABLE BACKFILL MATERIAL IN UNIFORM HORIZONTAL LAYERS OF NO GREATER THAN 8-INCHES LOOSE THICKNESS. WHERE HAND OPERATED COMPACTORS ARE USED, THE FILL MATERIAL SHALL BE PLACED IN LIFTS NOT TO EXCEED 4 INCHES IN LOOSE DEPTH.
  - 3. IF THE DENSITY TESTING INDICATES THAT THE CONTRACTOR HAS NOT OBTAINED THE SPECIFIED DENSITY, THE SUCCEEDING LAYER SHALL NOT BE PLACED UNTIL THE SPECIFICATION REQUIREMENTS ARE MET UNLESS OTHERWISE AUTHORIZED BY THE GEOTECHNICAL ENGINEER. THE CONTRACTOR SHALL TAKE WHATEVER APPROPRIATE ACTION IS NECESSARY, SUCH AS DISKING AND DRYING, ADDING WATER, OR INCREASING THE COMPACTIVE EFFORT TO MEET THE MINIMUM COMPACTION REQUIREMENTS.
- B. THOROUGHLY COMPACT EACH LAYER OF BACKFILL TO A MINIMUM OF 95 PERCENT OF THE MAXIMUM DRY DENSITY AS PROVIDED BY THE STANDARD PROCTOR TEST, ASTM D698.

**3.3 TRENCH EXCAVATION:**

- A. UTILITY TRENCHES SHALL BE EXCAVATED AT LOCATIONS, DEPTHS, AND WIDTHS SHOWN ON PLAN, OR AS DIRECTED BY THE GENERAL CONTRACTOR. EXCAVATION CONTRACTOR SHALL PROVIDE SHORING, SHEETING, AND BRACING AS REQUIRED TO PREVENT CAVING OR SLOUGHING OF THE TRENCH WALLS.
- B. THE TRENCH WIDTH SHALL EXTEND A MINIMUM OF 6 INCHES BEYOND THE OUTSIDE EDGE OF THE OUTERMOST CONDUIT.

**3.4 TRENCH BACKFILL:**

- A. NOTIFY THE GENERAL CONTRACTOR 24 HOURS IN ADVANCE OF BACKFILLING.
- B. PROVIDE GRANULAR BEDDING MATERIAL IN ACCORDANCE WITH THE PLAN AND THE UTILITY REQUIREMENTS.
- C. CONDUCT UTILITY CHECK TESTS BEFORE BACKFILLING. BACKFILL AND COMPACT TRENCH BEFORE ACCEPTANCE TESTING.
- D. PLACE GRANULAR TRENCH BACKFILL UNIFORMLY ON BOTH SIDES OF THE CONDUITS IN 6-INCH UNCOMPACTED LIFTS AND TO 12 INCHES OVER THE CONDUITS. SOLIDLY RAM AND TAMP BACKFILL INTO SPACE AROUND CONDUITS.
- E. PROTECT CONDUIT FROM LATERAL MOVEMENT, IMPACT DAMAGE, OR UNBALANCED LOADING.
- F. ABOVE THE CONDUIT EMBEDMENT ZONE, PLACE AND COMPACT THE BACKFILL MATERIAL IN MAXIMUM 8-INCH THICK LOOSE LIFTS TO RESTORE THE REQUIRED FINISHED SURFACE GRADE.
- G. COMPACT THE TRENCH BACKFILL A MINIMUM OF 95 PERCENT OF THE MAXIMUM DRY DENSITY AS PROVIDED BY THE STANDARD PROCTOR TEST, ASTM D698.

**3.5 AGGREGATE ACCESS ROAD:**

- A. CLEAR, GRUB, STRIP, AND EXCAVATE FOR THE ACCESS ROAD AS SHOWN ON PLAN. SCARIFY TO A DEPTH OF 6 INCHES AND PROOF-ROLL. ALL HOLES, RUTS, SOFT PLACES, AND OTHER DEFECTS SHALL BE CORRECTED.
  - B. THE SUBGRADE OF THE DISTURBED AREA SHALL BE COMPACTED TO NOT LESS THAN 95 PERCENT OF THE MAXIMUM DRY DENSITY AS PROVIDED BY THE MODIFIED PROCTOR TEST, ASTM D1557.
  - C. AFTER PREPARATION OF THE ROAD SUBGRADE IS COMPLETE, INSTALL THE GEOTEXTILE FABRIC (MIRAFI 500X) AT LOCATIONS INDICATED ON THE PLAN BY ROLLING THE FABRIC OUT LONGITUDINALLY ALONG THE ROADWAY. THE FABRIC SHALL NOT BE DRAGGED ACROSS THE SUBGRADE. PLACE THE ENTIRE ROLL IN A SINGLE OPERATION AND ROLL IT OUT AS SMOOTHLY AS POSSIBLE.
    - 1. GEOTEXTILE FABRIC OVERLAPS THAT ARE PARALLEL TO THE ROADWAY WILL BE PERMITTED ALONG THE CENTERLINE OF THE ROAD AND AT LOCATIONS BEYOND THE ROADWAY SURFACE WIDTH (I.E. WITHIN THE SHOULDER WIDTH) ONLY. NO LONGITUDINAL OVERLAPS SHALL BE LOCATED BETWEEN THE CENTERLINE AND THE SHOULDER. PARALLEL OVERLAPS SHALL BE A MINIMUM OF 3 FEET WIDE.
    - 2. TRANSVERSE (PERPENDICULAR TO THE ROADWAY) GEOTEXTILE FABRIC OVERLAPS AT THE END OF A ROLL SHALL OVERLAP IN THE DIRECTION OF THE AGGREGATE PLACEMENT WITH THE PREVIOUS ROLL ON TOP OF THE NEW ROLL, AND SHALL HAVE A MINIMUM LENGTH OF 3 FEET.
    - 3. ALL GEOTEXTILE FABRIC OVERLAPS SHALL BE PINNED WITH STAPLES OR NAILS A MINIMUM OF 10 INCHES LONG TO INSURE PROPER POSITIONING DURING PLACEMENT OF AGGREGATE. PIN LONGITUDINAL SEAMS AT A MINIMUM OF 25-FOOT INTERVALS AND TRANSVERSE SEAMS AT A MINIMUM OF 5-FOOT INTERVALS.
  - D. THE AGGREGATE BASE AND SURFACE AGGREGATE SHALL BE CONSTRUCTED IN LAYERS NOT MORE THAN 4 INCHES (COMPACTED) IN THICKNESS. AGGREGATE TO BE PLACED ON GEOTEXTILE FABRIC SHALL BE END-DUMPED ON THE FABRIC FROM THE FREE END OF THE FABRIC OR OVER PREVIOUSLY PLACED AGGREGATE. THE FIRST LIFT SHALL BE BLADED DOWN TO A THICKNESS OF 8 INCHES PRIOR TO COMPACTION. AT NO TIME SHALL EQUIPMENT, EITHER TRANSPORTING THE AGGREGATE OR GRADING THE AGGREGATE, BE PERMITTED ON THE ROADWAY WITH LESS THAN 4 INCHES OF MATERIAL COVERING THE GEOTEXTILE FABRIC.
  - E. THE AGGREGATE SHALL BE IMMEDIATELY COMPACTED TO NOT LESS THAN 95 PERCENT OF THE MAXIMUM DRY DENSITY AS DETERMINED BY THE MODIFIED PROCTOR TEST, ASTM D1557. A TAMPING ROLLER, PNEUMATIC-TIRED ROLLER, OR VIBRATORY MACHINE, OR ANY COMBINATION THEREOF MAY BE USED FOR COMPACTION PROCEDURES. THE TOP LAYER SHALL BE GIVEN A FINAL ROLLING WITH A THREE-WHEEL OR TANDEM ROLLER.
- 3.6 FINISH GRADING:**
- A. PERFORM ALL GRADING TO PROVIDE POSITIVE DRAINAGE AWAY FROM STRUCTURES AND SMOOTH SURFACE DRAINAGE OF THE ENTIRE AREA WITHIN THE LIMITS OF CONSTRUCTION. GRADING SHALL PROPERLY BLEND WITH SURROUNDING TOPOGRAPHY AND STRUCTURES.
  - B. IF DEEMED SUITABLE PER GEOTECHNICAL ENGINEER, UTILIZE FILL MATERIAL RESULTING FROM EXCAVATION FOR THE CONSTRUCTION OF FILLS, EMBANKMENTS, AND FOR REPLACEMENT OF REMOVED UNSUITABLE MATERIALS.
  - C. ACHIEVE FINISHED GRADE BY PLACING A MINIMUM OF 4 INCHES OF 1/2" - 3/4" CRUSHED STONE ON IF APPLICABLE, TOP OF SOIL STABILIZER FABRIC.
  - D. REPAIR ALL ACCESS ROADS AND SURROUNDING AREAS DISTURBED DURING THE COURSE OF THIS WORK TO THEIR ORIGINAL CONDITION.
- 3.7 ASPHALT PAVING:** SHALL BE PERFORMED PER COLORADO DEPARTMENT OF TRANSPORTATION (CDOT), DIVISION 400 - CDOT PAVEMENT STANDARDS AND SPECIFICATIONS.



188 INVERNESS DRIVE WEST  
SUITE 400  
ENGLEWOOD, CO 80112



4600 SOUTH SYRACUSE STREET  
SUITE 800  
DENVER, COLORADO 80237

PROJECT/PHASE NO:	129551/1399
DRAWN BY:	GS
CHECKED BY:	JMH
RFDS:	-----

REV	DATE	DESCRIPTION
0	05/13/24	ISSUED FOR CONSTRUCTION

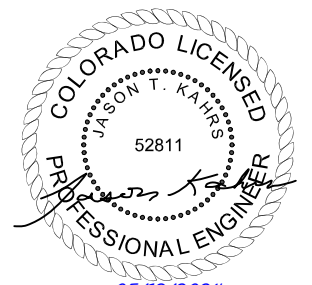

IT IS A VIOLATION OF LAW FOR ANY PERSON, UNLESS THEY ARE ACTING UNDER THE DIRECTION OF A LICENSED PROFESSIONAL ENGINEER, TO ALTER THIS DOCUMENT.

CORRAL BLUFFS  
COLO2029  
BLANEY ROAD  
COLORADO SPRINGS, CO 80929  
CELL SITE RF MODIFICATIONS

SHEET TITLE  
GENERAL SITE WORK &  
DRAINAGE NOTES

SHEET NUMBER  
**GN-3**







## GENERAL ELECTRICAL NOTES

### PART 1 - GENERAL

#### 1.1 GENERAL CONDITIONS:

- CONTRACTOR SHALL INSPECT THE EXISTING SITE CONDITIONS PRIOR TO PERFORMING WORK. ANY QUESTIONS ARISING DURING THE BID PERIOD REGARDING THE CONTRACTORS FUNCTIONS, THE SCOPE OF WORK, OR ANY OTHER ISSUE RELATED TO THIS PROJECT SHALL BE BROUGHT UP DURING THE BID PERIOD WITH THE PROJECT MANAGER FOR CLARIFICATION, PRIOR TO THE AWARD OF THE CONTRACT.
- THE CONTRACTOR SHALL OBTAIN PERMITS, LICENSES, MAKE ALL DEPOSITS, AND PAY ALL FEES REQUIRED FOR THE CONSTRUCTION PERFORMANCE OF THE WORK UNDER THIS SECTION.
- THE CONTRACTOR SHALL VERIFY ALL DIMENSIONS. DRAWING SHALL NOT BE SCALED TO DETERMINE DIMENSIONS. DRAWINGS SHOW THE GENERAL ARRANGEMENT OF ALL SYSTEMS AND COMPONENTS COVERED UNDER THIS SECTION.

#### 1.2 LAWS, REGULATIONS, ORDINANCES, STATUTES, AND CODES:

- ALL WORK SHALL BE INSTALLED IN ACCORDANCE WITH THE LATEST EDITION OF THE NATIONAL ELECTRICAL CODE, AND ALL APPLICABLE LOCAL LAWS, REGULATIONS, ORDINANCES, STATUTES, AND CODES. CONDUIT BENDS SHALL BE THE RADIUS BEND FOR THE TRADE SIZE OF CONDUIT IN COMPLIANCE WITH THE LATEST EDITIONS OF NEC.

#### 1.3 REFERENCES:

- THE PUBLICATIONS LISTED BELOW ARE PART OF THIS SPECIFICATION. EACH PUBLICATION SHALL BE THE LATEST REVISION AND ADDENDUM IN EFFECT ON THE DATE OF CONSTRUCTION. EXCEPT AS MODIFIED BY THE REQUIREMENT SPECIFIED HEREIN OR THE DETAILS OF THE DRAWINGS, WORK INCLUDED IN THIS SPECIFICATION SHALL CONFORM TO THE APPLICABLE PROVISION OF THESE PUBLICATIONS.

- ANSI/IEEE (AMERICAN NATIONAL STANDARDS INSTITUTE)
- ASTM (AMERICAN SOCIETY FOR TESTING AND MATERIALS)
- ICE (INSULATED CABLE ENGINEERS ASSOCIATION)
- NEMA (NATIONAL ELECTRICAL MANUFACTURER'S ASSOCIATION)
- NFPA (NATIONAL FIRE PROTECTION ASSOCIATION)
- OSHA (OCCUPATIONAL SAFETY AND HEALTH ADMINISTRATION)
- UL (UNDERWRITERS LABORATORIES. INC.)
- AT&T GROUNDING AND BONDING STANDARDS TP-76416

#### 1.4 SCOPE OF WORK:

- WORK UNDER THIS SECTION SHALL CONSIST OF FURNISHING ALL LABOR, MATERIAL, AND ASSOCIATED SERVICES REQUIRED TO COMPLETE REQUIRED CONSTRUCTION AND TO ACHIEVE OPERATIONAL STATUS.
- ALL ELECTRICAL EQUIPMENT UNDER THIS CONTRACT SHALL BE PROPERLY TESTED, ADJUSTED, AND ALIGNED BY THE CONTRACTOR.
- THE CONTRACTOR SHALL BE RESPONSIBLE FOR ALL EXCAVATING, DRAINING, TRENCHING, BACKFILLING, AND REMOVAL OF EXCESS SOIL, FILL, AND DEBRIS.
- THE CONTRACTOR SHALL FURNISH THE OWNER WITH CERTIFICATES OF A FINAL INSPECTION AND APPROVAL FROM THE JURISDICTIONAL AUTHORITIES.
- IF APPLICABLE, THE CONTRACTOR SHALL PREPARE A COMPLETE SET OF AS-BUILT DRAWINGS TO DOCUMENT ALL WIRING EQUIPMENT CONDITIONS AND CHANGES WHILE COMPLETING THIS CONTRACT. THE AS-BUILT DRAWINGS SHALL BE SUBMITTED AT COMPLETION OF THE PROJECT TO THE APPROPRIATE PARTY.

### PART 2 - PRODUCTS

#### 2.1 GENERAL:

- ALL MATERIALS AND EQUIPMENT SHALL BE NEW, UL LISTED, AND FREE FROM DEFECTS.
- ALL EQUIPMENT SHALL BEAR THE UNDERWRITERS LABORATORIES (UL) LABEL OF APPROVAL AND SHALL CONFORM TO REQUIREMENT OF THE NATIONAL ELECTRICAL CODE.
- ALL ITEMS, MATERIALS, AND EQUIPMENT SHALL BE ACCEPTABLE TO THE JURISDICTIONAL AUTHORITY AND SUITABLE FOR THE USE INTENDED.
- ALL OVERCURRENT DEVICES SHALL HAVE AN INTERRUPTING CURRENT RATING OF GREATER THAN THE SHORT CIRCUIT CURRENT TO WHICH THEY ARE SUBJECTED (10,000 AIC MINIMUM). CONTRACTOR SHALL VERIFY THAT AVAILABLE SHORT CIRCUIT CURRENT DOES NOT EXCEED THE RATING OF ELECTRICAL EQUIPMENT IN ACCORDANCE WITH ARTICLE 110.24 NEC OR THE MOST CURRENT ADOPTED CODE PER THE GOVERNING JURISDICTION.

#### 2.2 MATERIALS AND EQUIPMENT:

- CONDUIT:
  - RIGID METAL CONDUIT (RMC) SHALL BE HOT-DIPPED GALVANIZED INSIDE AND OUTSIDE INCLUDING ENDS AND THREADS, AND ENAMELED OR LACQUERED INSIDE IN ADDITION TO GALVANIZING.
  - LIQUIDTIGHT FLEXIBLE METAL CONDUIT SHALL BE UL LISTED.
  - CONDUIT CLAMPS, STRAPS, AND SUPPORTS SHALL BE STEEL OR MALLEABLE IRON. ALL FITTINGS SHALL BE COMPRESSION AND CONCRETE-TIGHT TYPE. GROUNDING BUSHINGS WITH INSULATED THROATS SHALL BE INSTALLED ON ALL CONDUIT TERMINATIONS.
  - NONMETALLIC CONDUIT AND FITTINGS SHALL BE SCHEDULE 40 PVC AND INSTALLED USING SOLVENT-CEMENT-TYPE JOINTS AS RECOMMENDED BY THE MANUFACTURER.
- CONDUCTORS AND CABLE:
  - CONDUCTORS AND CABLE SHALL BE FLAME-RETARDANT, MOISTURE AND HEAT RESISTANT THERMOPLASTIC, SINGLE CONDUCTOR, COPPER, TYPE THHN/THWN-2, 600 VOLT, SIZE AS INDICATED, ON PLANS THE MINIMUM SIZE CONDUCTOR USED SHALL BE #12 AWG.
  - #10 AWG AND SMALLER CONDUCTOR SHALL BE SOLID OR STRANDED. #8 AWG AND LARGER CONDUCTORS SHALL BE STRANDED.
  - SOLDERLESS COMPRESSION TYPE CONNECTORS SHALL BE USED FOR TERMINATION OF ALL STRANDED CONDUCTORS.
  - STRAIN-RELIEF SUPPORTS GRIPS SHALL BE HUBBELL KELLEMS OR APPROVED EQUAL. CABLES SHALL BE SUPPORTED IN ACCORDANCE WITH THE NEC AND CABLE MANUFACTURER'S RECOMMENDATIONS.
  - ALL CONDUCTORS SHALL BE TAGGED AT BOTH ENDS OF THE CONDUCTOR, AT ALL PULL BOXES, J-BOXES, EQUIPMENT, CABINETS SHALL BE IDENTIFIED WITH APPROVED PLASTIC TAGS (ACTION CRAFT, BRADY, OR APPROVED EQUAL).
- DISCONNECT SWITCHES:
  - DISCONNECT SWITCHES SHALL BE HEAVY DUTY, DEAD-FRONT, QUICK-MAKE, QUICK-BREAK, EXTERNALLY OPERABLE, HANDLE LOCKABLE, INTERLOCK WITH COVER IN CLOSED POSITION, RATING AS INDICATED, UL LABELED, FURNISHED IN NEMA 3R ENCLOSURE, SQUARE-D, OR ENGINEERED APPROVED EQUAL.

#### D. CHEMICAL ELECTROLYTIC GROUNDING SYSTEM:

- INSTALL CHEMICAL GROUNDING AS REQUIRED. THE SYSTEM SHALL BE ELECTROLYTIC MAINTENANCE FREE ELECTRODE CONSISTING OF RODS WITH A MINIMUM #2 AWG CU EXOTHERMALLY WELDED PIGTAIL, PROTECTIVE BOXES, AND BACKFILL MATERIAL. MANUFACTURER SHALL BE LYNCOLE XIT GROUNDING ROD TYPES K2-(\*)CS OR K2L-(\*)CS (\*) LENGTH AS REQUIRED.
- GROUND ACCESS BOX SHALL BE A POLYPLASTIC BOX FOR NON-TRAFFIC APPLICATIONS, INCLUDING BOLT DOWN FLUSH COVER WITH "BREATHER" HOLES, XIT MODEL #XB-22. ALL DISCONNECT SWITCHES AND CONTROLLING DEVICES SHALL BE PROVIDED WITH ENGRAVED LAMICOID NAMEPLATES INDICATING EQUIPMENT CONTROLLED, BRANCH CIRCUITS IDENTIFICATION NUMBERING, AND THE ELECTRICAL POWER SOURCE.
- BACKFILL MATERIAL SHALL BE LYNCONITE AND LYNCOLE GROUNDING GRAVEL.

#### E. SYSTEM GROUNDING:

- ALL GROUNDING COMPONENTS SHALL BE TINNED AND GROUNDING CONDUCTOR SHALL BE #2 AWG BARE, SOLID, TINNED COPPER. ABOVE-GRADE GROUNDING CONDUCTORS SHALL BE INSULATED WHERE NOTED.
- GROUNDING BUSES SHALL BE BARE, TINNED, ANNEALED COPPER BARS OF RECTANGULAR CROSS SECTION. STANDARD BUS BARS MGB SHALL BE FURNISHED AND INSTALLED BY THE CONTRACTOR AND THEY SHALL NOT BE FABRICATED OR MODIFIED IN THE FIELD. ALL GROUNDING BUSES SHALL BE IDENTIFIED WITH MINIMUM 3/4" LETTERS BY STENCILING OR DESIGNATION PLATE.
- CONNECTORS SHALL BE HIGH CONDUCTIVITY, HEAVY DUTY, LISTED AND LABELED AS GROUNDING CONNECTORS FOR THE MATERIALS USED. USE TWO-HOLE COMPRESSION LUGS WITH CLEAR HEAT SHRINK FOR MECHANICAL CONNECTIONS. USE TWO-HOLE COMPRESSION LUGS WITH INSPECTION WINDOW AND CLEAR HEAT SHRINK FOR INTERIOR AND BLACK HEAT SHRINK FOR EXTERIOR.
- EXOTHERMIC WELDED CONNECTIONS SHALL BE PROVIDED IN KIT FORM AND SELECTED FOR THE SPECIFIC TYPES, SIZES, AND COMBINATIONS OF CONDUCTORS AND OTHER ITEMS TO BE CONNECTED.
- GROUND RODS SHALL BE ERICO #615800, COPPER-CLAD STEEL WITH HIGH STRENGTH STEEL CORE AND ELECTROLYTIC GRADE COPPER OUTER SHEATH, MOLTEN WELDED TO CORE, AND 5/8"x10'-0". ALL GROUNDING RODS SHALL BE INSTALLED WITH INSPECTION SLEEVES AS SHOWN ON DRAWINGS.
- INSTALL AN EQUIPMENT GROUNDING CONDUCTOR IN ALL CONDUITS IN COMPLIANCE WITH THE AT&T SPECIFICATIONS AND NEC. THE EQUIPMENT GROUNDING CONDUCTORS SHALL BE BONDED AT ALL JUNCTION BOXES, PULLBOXES, DISCONNECT SWITCHES, STARTERS, AND EQUIPMENT CABINETS.

#### F. OTHER MATERIALS:

- THE CONTRACTOR SHALL PROVIDE OTHER MATERIALS, THOUGH NOT SPECIFICALLY DESCRIBED, WHICH ARE REQUIRED FOR A COMPLETELY OPERATIONAL SYSTEM AND PROPER INSTALLATION OF THE WORK.
- PROVIDE PULL BOXES AND JUNCTION BOXES WHERE SHOWN OR REQUIRED BY NEC.

#### G. PANELS AND LOAD CENTERS:

- ALL PANEL DIRECTORIES SHALL BE TYPEWRITTEN.

### PART 3 - EXECUTION

#### 3.1 GENERAL:

- ALL MATERIAL AND EQUIPMENT SHALL BE INSTALLED IN STRICT ACCORDANCE WITH THE MANUFACTURER'S RECOMMENDATIONS.
- DURING INSTALLATION AND CONSTRUCTION PERIODS EQUIPMENT SHALL BE TIGHTLY COVERED AND PROTECTED AGAINST DIRT, WATER, AND CHEMICAL OR MECHANICAL INJURY.

#### 3.2 LABOR AND WORKMANSHIP:

- ALL LABOR FOR THE INSTALLATION OF MATERIALS AND EQUIPMENT FURNISHED FOR THE ELECTRICAL SYSTEM SHALL BE INSTALLED BY EXPERIENCED WIREMEN IN A NEAT AND WORKMAN-LIKE MANNER.
- ALL ELECTRICAL EQUIPMENT SHALL BE ADJUSTED, ALIGNED, AND TESTED BY THE CONTRACTOR AS REQUIRED TO CONFIRM THE INTENDED PERFORMANCE.
- UPON COMPLETION OF WORK, THE CONTRACTOR SHALL THOROUGHLY CLEAN ALL EXPOSED EQUIPMENT, REMOVE ALL NECESSARY LABELS, DEBRIS, CRATING, OR CARTONS, AND LEAVE THE INSTALLATION FINISHED AND READY FOR OPERATION.

#### 3.3 COORDINATION:

- THE CONTRACTOR SHALL COORDINATE THE INSTALLATION OF ELECTRICAL ITEMS WITH THE OWNER-FURNISHED EQUIPMENT DELIVERY SCHEDULE TO PREVENT UNNECESSARY DELAYS IN THE SCHEDULED WORK.

#### 3.4 INSTALLATION:

- CONDUIT:
  - ALL ELECTRICAL WIRING SHALL BE INSTALLED IN CONDUIT AS SPECIFIED. NO CONDUIT OR TUBING OF LESS THAN 3/4" TRADE SIZE SHALL BE UTILIZED.
  - PROVIDE RIGID PVC SCHEDULE 80 CONDUITS FOR ALL RISERS UNLESS OTHERWISE NOTED. EMT MAY BE INSTALLED FOR EXTERIOR CONDUITS WHERE NOT SUBJECT TO PHYSICAL DAMAGE.
  - INSTALL SCHEDULE 40 PVC CONDUIT WITH A MINIMUM COVER OF 24" UNDER ROADWAYS, PARKING LOTS, STREETS, AND ALLEYS. CONDUIT SHALL HAVE A MINIMUM COVER OF 18" IN ALL NON-TRAFFIC APPLICATIONS (REFER TO 2020 OR LATEST NEC, TABLE 300.5).
  - USE GALVANIZED FLEXIBLE STEEL CONDUIT AT LOCATIONS OF DIRECT CONNECTION TO EQUIPMENT THAT MOVES OR VIBRATES, OR FOR EASE OF MAINTENANCE. USE LIQUID TIGHT, FLEXIBLE METAL CONDUIT FOR OUTDOOR APPLICATIONS. INSTALL GALVANIZED FLEXIBLE STEEL CONDUIT AT ALL POINTS OF CONNECTION TO EQUIPMENT MOUNTED ON SUPPORTS TO ALLOW FOR EXPANSION AND CONTRACTION.
  - A RUN OF CONDUIT BETWEEN BOXES OR EQUIPMENT SHALL NOT CONTAIN MORE THAN THE EQUIVALENT OF THREE QUARTER-BENDS. CONDUIT BEND SHALL BE MADE WITH THE UL LISTED BENDER OR FACTORY 90 DEGREE ELBOWS MAY BE USED.
  - FIELD FABRICATED CONDUITS SHALL BE CUT SQUARE WITH A CONDUIT CUTTING TOOL AND REAMED TO PROVIDE A SMOOTH INSIDE SURFACE.
  - CONTRACTOR IS RESPONSIBLE FOR PROTECTING ALL CONDUITS DURING CONSTRUCTION. TEMPORARY OPENINGS IN THE CONDUIT SYSTEM SHALL BE PLUGGED OR CAPPED TO PREVENT ENTRANCE OF MOISTURE OR FOREIGN MATTER. CONTRACTOR SHALL REPLACE ANY CONDUITS CONTAINING FOREIGN MATERIALS THAT CANNOT BE REMOVED.
  - ALL CONDUITS SHALL BE SWABBED CLEAN BY PULLING AN APPROPRIATE SIZE MANDREL THROUGH THE CONDUIT BEFORE INSTALLATION OF CONDUCTORS OR CABLES. CONDUIT SHALL BE FREE OF DIRT AND DEBRIS.
  - INSTALL PULL STRINGS IN ALL CLEAN EMPTY CONDUITS. IDENTIFY PULL STRINGS AT EACH END.
  - INSTALL 2" HIGHLY VISIBLE AND DETECTABLE TAPE 12" ABOVE ALL UNDERGROUND CONDUITS AND CONDUCTORS.
  - CONDUITS SHALL BE INSTALLED IN SUCH A MANNER AS TO INSURE AGAINST COLLECTION OF TRAPPED CONDENSATION.

- PROVIDE CORE DRILLING AS NECESSARY FOR PENETRATIONS TO ALLOW FOR RACEWAYS AND CABLES TO BE ROUTED THROUGH THE BUILDING. DO NOT PENETRATE STRUCTURAL MEMBERS. SLEEVES AND/OR PENETRATIONS IN FIRE RATED CONSTRUCTION SHALL BE EFFECTIVELY SEALED WITH FIRE RATED MATERIAL WHICH SHALL MAINTAIN THE FIRE RATING OF THE WALL OR STRUCTURE. FIRE STOPS AT FLOOR PENETRATIONS SHALL BE INSTALLED TO PREVENT PASSAGE OF WATER, SMOKE, FIRE, AND FUMES. ALL MATERIAL SHALL BE UL APPROVED FOR THIS PURPOSE.

#### B. CONDUCTORS AND CABLE:

- ALL POWER WIRING SHALL BE COLOR CODED AS FOLLOWS:

DESCRIPTION	208/240/120 VOLT SYSTEMS
PHASE A	BLACK
PHASE B	RED
PHASE C	BLUE
NEUTRAL	WHITE
GROUNDING	GREEN

- SPLICES SHALL BE MADE ONLY AT OUTLETS, JUNCTION BOXES, OR ACCESSIBLE RACEWAY CONDULETS APPROVED FOR THIS PURPOSE.

- PULLING LUBRICANTS SHALL BE UL APPROVED. CONTRACTOR SHALL USE NYLON OR HEMP ROPE FOR PULLING CONDUCTOR OR CABLES INTO THE CONDUIT.

- CABLES SHALL BE NEATLY TRAINED, WITHOUT INTERLACING, AND BE OF SUFFICIENT LENGTH IN ALL BOXES AND EQUIPMENT TO ALLOW FOR A NEAT ARRANGEMENT. CABLES SHALL BE SECURED IN A MANNER TO AVOID TENSION ON CONDUCTORS AND/OR TERMINALS. CONDUCTORS SHALL BE PROTECTED FROM MECHANICAL INJURY AND MOISTURE. SHARP BENDS OVER CONDUIT BUSHINGS ARE PROHIBITED. DAMAGED CABLES SHALL BE REPLACED AT THE CONTRACTOR'S EXPENSE.

#### C. DISCONNECT SWITCHES:

- INSTALL DISCONNECT SWITCHES LEVEL AND PLUMB, AND CONNECT TO WIRING SYSTEM AND GROUNDING SYSTEM AS REQUIRED.

#### D. GROUNDING:

- ALL METALLIC PARTS OF ELECTRICAL EQUIPMENT WHICH DO NOT CARRY CURRENT SHALL BE GROUNDED IN ACCORDANCE WITH THE REQUIREMENTS OF THE BUILDING MANUFACTURER, AT&T GROUNDING AND BONDING STANDARDS TP-76416, TP-76300, AND THE NATIONAL ELECTRICAL CODE.

- PROVIDE ELECTRICAL GROUNDING AND BONDING SYSTEM WITH ASSEMBLY OF MATERIALS, INCLUDING GROUNDING ELECTRODES, BONDING JUMPERS, AND ADDITIONAL ACCESSORIES AS REQUIRED FOR A COMPLETE INSTALLATION.

- ALL GROUNDING CONDUCTORS SHALL PROVIDE A STRAIGHT DOWNWARD PATH TO GROUND. GROUNDING CONDUCTORS SHALL NOT BE LOOPED OR SHARPLY BENT. ROUTE GROUNDING CONNECTIONS AND CONDUCTORS TO GROUND IN THE SHORTEST AND STRAIGHTEST PATHS POSSIBLE TO MINIMIZE TRANSIENT VOLTAGE RISES.

- AT BUILDINGS AND/OR NEW TOWERS GREATER THAN 75 FEET IN HEIGHT AND WHERE THE MAIN GROUNDING CONDUCTORS ARE REQUIRED TO BE ROUTED TO GRADE, THE CONTRACTOR SHALL ROUTE TWO GROUNDING CONDUCTORS FROM THE ROOFTOP, TOWERS, AND WATER TOWER GROUND RING, TO THE EXISTING GROUNDING SYSTEM. THE GROUNDING CONDUCTORS SHALL NOT BE SMALLER THAN #2 AWG COPPER. ROOFTOP GROUND RING SHALL BE BONDED TO THE EXISTING GROUNDING SYSTEM, THE BUILDING STEEL COLUMNS, THE LIGHTNING PROTECTION SYSTEM, AND/OR THE BUILDING MAIN WATER LINE (FERROUS OR NONFERROUS METAL PIPING ONLY). SEE STANDARD 6.3.2.2.

- TIGHTEN GROUNDING AND BONDING CONNECTORS, INCLUDING SCREWS AND BOLTS, IN ACCORDANCE WITH MANUFACTURER'S PUBLISHED TORQUE TIGHTENING SPECIFICATIONS. WHERE MANUFACTURER'S TORQUING REQUIREMENTS ARE NOT AVAILABLE, TIGHTEN CONNECTIONS TO COMPLY WITH TIGHTENING TORQUE VALUES SPECIFIED IN UL TO ASSURE PERMANENT AND EFFECTIVE GROUNDING.

- CONTRACTOR SHALL VERIFY THE LOCATIONS OF GROUNDING TIE-IN POINTS TO THE EXISTING GROUNDING SYSTEM. ALL UNDERGROUND GROUNDING CONNECTIONS SHALL BE MADE BY THE EXOTHERMIC WELD PROCESS AND INSTALLED IN ACCORDANCE WITH THE MANUFACTURER'S INSTRUCTIONS.

- ALL GROUNDING CONNECTIONS SHALL BE INSPECTED FOR TIGHTNESS. EXOTHERMIC WELDED CONNECTIONS SHALL BE APPROVED BY THE INSPECTOR HAVING JURISDICTION PRIOR TO PERMANENT CONCEALMENT.

- APPLY CORROSION-RESISTANCE FINISH TO FIELD CONNECTIONS AND AREAS/COMPONENTS WHERE FACTORY APPLIED PROTECTIVE COATINGS HAVE BEEN DESTROYED.

- A SEPARATE, CONTINUOUS, INSULATED EQUIPMENT GROUNDING CONDUCTOR SHALL BE INSTALLED IN ALL FEEDER AND BRANCH CIRCUITS.

- BOND ALL INSULATED GROUNDING BUSHINGS WITH A BARE #6 AWG GROUNDING CONDUCTOR TO A GROUND BUS.

- DIRECT-BURIED GROUNDING CONDUCTORS SHALL BE INSTALLED AT A NOMINAL DEPTH OF 30" MINIMUM BELOW GRADE, OR 6" MINIMUM BELOW THE FROST LINE, USING THE GREATER OF THE TWO DISTANCES.

- ALL GROUNDING CONDUCTORS EMBEDDED IN OR PENETRATING CONCRETE SHALL BE INSTALLED IN SCHEDULE 40 PVC CONDUIT.

- THE INSTALLATION OF A CHEMICAL ELECTROLYTIC GROUNDING SYSTEM IN STRICT ACCORDANCE WITH MANUFACTURER'S INSTRUCTIONS. REMOVE SEALING TAPE FROM LEACHING AND BREATHING HOLES. INSTALL THE PROTECTIVE BOX FLUSH WITH GRADE.

- IF COAX ON THE ICE BRIDGE IS MORE THAN 6 FEET FROM THE GROUND BAR AT THE BASE OF THE TOWER, INSTALL A SECOND GROUND BAR AT THE END OF THE ICE BRIDGE TO GROUND THE COAX CABLE GROUNDING KITS AND IN-LINE ARRESTORS.

- CONTRACTOR SHALL REPAIR, AND/OR REPLACE, EXISTING GROUNDING SYSTEM COMPONENTS DAMAGED DURING CONSTRUCTION AT THE CONTRACTOR'S EXPENSE.

#### 3.5 ACCEPTANCE TESTING:

- CERTIFIED PERSONNEL USING CERTIFIED EQUIPMENT SHALL PERFORM REQUIRED TESTS AND SUBMIT WRITTEN TEST REPORTS UPON COMPLETION.

- WHEN MATERIAL AND/OR WORKMANSHIP IS FOUND TO BE NON-COMPLIANT WITH THE SPECIFIED REQUIREMENTS, THE NON-COMPLIANT ITEMS/ELEMENTS SHALL BE PROMPTLY REMOVED FROM THE PROJECT SITE AND REPLACED WITH ITEMS COMPLYING WITH THE SPECIFIED REQUIREMENTS.

#### C. TEST PROCEDURES:

- ALL FEEDERS SHALL HAVE INSULATION TESTED AFTER INSTALLATION, BEFORE CONNECTION TO DEVICES. THE CONDUCTORS SHALL TEST FREE FROM SHORT CIRCUITS AND GROUNDS. TESTING SHALL BE FOR ONE MINUTE USING 1,000VOLT DC.

- PRIOR TO ENERGIZING CIRCUITRY, TEST WIRING DEVICES FOR ELECTRICAL CONTINUITY AND PROPER POLARITY CONNECTIONS.

- MEASURE AND RECORD VOLTAGES BETWEEN PHASES AND BETWEEN PHASE CONDUCTORS AND NEUTRALS. SUBMIT A REPORT OF MAXIMUM AND MINIMUM VOLTAGES TO APPROPRIATE PARTS.

- PERFORM GROUNDING TEST TO MEASURE RESISTANCE OF GROUNDING SYSTEM USING THE IEEE STANDARD 3-POINT "FALL-OFF-POTENTIAL" METHOD. PROVIDE PLOTTED TEST VALUES AND LOCATION SKETCH. NOTIFY THE ENGINEER IMMEDIATELY IF MEASURED VALUE IS OVER 5 OHMS.



188 INVERNESS DRIVE WEST  
SUITE 400  
ENGLEWOOD, CO 80112



**BLACK & VEATCH**

4600 SOUTH SYRACUSE STREET  
SUITE 800  
DENVER, COLORADO 80237

PROJECT/PHASE NO: 129551/1399

DRAWN BY: GS

CHECKED BY: JMH

RFDS: \_\_\_\_\_

REV	DATE	DESCRIPTION
0	05/13/24	ISSUED FOR CONSTRUCTION



IT IS A VIOLATION OF LAW FOR ANY PERSON, UNLESS THEY ARE ACTING UNDER THE DIRECTION OF A LICENSED PROFESSIONAL ENGINEER, TO ALTER THIS DOCUMENT.

CORRAL BLUFFS  
COLO2029  
BLANEY ROAD  
COLORADO SPRINGS, CO 80929  
CELL SITE RF MODIFICATIONS

SHEET TITLE  
GENERAL ELECTRICAL  
NOTES

SHEET NUMBER

**GN-6**



