



LSC TRANSPORTATION CONSULTANTS, INC.
2504 East Pikes Peak Avenue, Suite 304
Colorado Springs, CO 80909
(719) 633-2868
FAX (719) 633-5430
E-mail: lsc@lsctrans.com
Website: <http://www.lsctrans.com>

Davis Ranch Subdivision
Master Traffic Impact Study
(LSC #S224640)
July 7, 2023

Add PCD File No. SKP232

Traffic Engineer's Statement

This traffic report and supporting information were prepared under my responsible charge and they comport with the standard of care. So far as is consistent with the standard of care, said report was prepared in general conformance with the criteria established by the County for traffic reports.

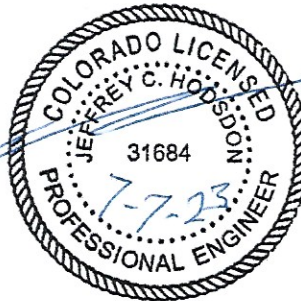

Developer's Statement

I, the Developer, have read and will comply with all commitments made on my behalf within this report.

A handwritten signature in blue ink, written over a horizontal line. The signature is stylized and appears to be 'M. A. D. S.'.

7-12-23
Date

Davis Subdivision

Master Traffic Impact Study

Prepared for:
Bill Guman, PLA, ASLA, APA
William Guman & Associates, Ltd.
731 North Weber Street, Suite 10
Colorado Springs, CO 80903

JULY 7, 2023

LSC Transportation Consultants, Inc.
Prepared by: Jeffrey C. Hodsdon, P.E.

LSC #S224640



CONTENTS

REPORT CONTENTS..... 1

LIST OF OTHER TRAFFIC REPORTS USED IN THE PREPARATION OF THIS REPORT..... 2

LAND USE AND ACCESS..... 2

 Proposed Land Uses..... 2

 Access and Circulation 3

SIGHT DISTANCE..... 3

ROAD AND TRAFFIC CONDITIONS AND MTCP CLASSIFICATION..... 3

 Existing Traffic Volumes..... 4

PEDESTRIAN AND BICYCLE FACILITIES 5

TRIP GENERATION..... 5

 Pass-By and Diverted Trips 6

TRIP DISTRIBUTION AND ASSIGNMENT 7

 Trip Directional Distribution 7

 Site-Generated Traffic..... 7

 Short-Term Total Traffic Volumes..... 7

 2043 Background Traffic Volumes 8

 2043 Total Traffic Volumes 8

LEVEL OF SERVICE ANALYSIS 8

 Stapleton Road/Proposed Northwest Site Access..... 9

 Judge Orr Road/Proposed Southeast Site Access..... 9

 Elbert Road/Proposed East Site Access 9

 Elbert Road/Proposed Northeast Site Access..... 9

 Judge Orr Road/Curtis Road 9

 Short Term 9

 Long Term 9

 US Highway 24/Stapleton Road..... 10

 Short-Term 10

 Long-Term..... 10

 US Highway 24/Judge Orr Road..... 10

 Short Term 10

 Long-Term..... 11

US Highway 24/Elbert Road	11
Short Term	11
ROADWAY IMPROVEMENTS	11
Auxiliary Turn-Lane Thresholds	11
Stapleton Road/Proposed Northwest Site Access	12
Judge Orr Road/Proposed Southeast Site Access	12
Elbert Road/Proposed East Site Access	12
Elbert Road/Proposed Northeast Site Access	12
US Highway 24/Judge Orr Road	13
Intersection Configuration and Traffic Control	13
ROADWAY CLASSIFICATIONS	13
COUNTY ROAD IMPROVEMENT FEE PROGRAM	14
Transportation Impact Fees	14
Reimbursable Improvements	14
MULTI-MODAL TRANSPORTATION AND TDM OPPORTUNITIES	14
Pedestrian and Bicycle Accommodations	14
DEVIATIONS	15
Potentially-Required Deviations	15
Approved Deviations (for Reference)	15
Judge Orr Road	15
Curtis Road	16
CDOT PROCESS AND REQUIREMENTS	16
FINDINGS AND CONCLUSIONS	16
Enclosures:	17
Table 4	
LOS Tables 1-12	
Figures 1-3	
Vistro Reports	
Traffic Count Reports	
Synchro LOS Reports	



LSC TRANSPORTATION CONSULTANTS, INC.
2504 E. Pikes Peak Ave., Suite 304
Colorado Springs, CO 80909
(719) 633-2868
FAX (719) 633-5430
E-mail: lsc@lsctrans.com
Website: <http://www.lsctrans.com>

July 7, 2023

Bill Guman, PLA, ASLA, APA
William Guman & Associates, Ltd.
731 North Weber Street, Suite 10
Colorado Springs, CO 80903

RE: Davis Ranch Subdivision
El Paso County, CO
Master Traffic Impact Study
LSC #S224640

Dear Mr. Guman,

LSC Transportation Consultants, Inc. has prepared this Master Traffic Impact Study for the proposed 398.91-acre Davis Ranch Subdivision Sketch Plan in El Paso County, Colorado. The site is bordered to the south by Judge Orr Road, to the east by Elbert Road, and to the west by Stapleton Road. Approximately 92 single-family dwelling units and approximately 8 acres of commercial uses are planned for the site. Access to the site is proposed to Judge Orr Road, Curtis Road and Elbert Road.

This report has been prepared for submittal to El Paso County.

REPORT CONTENTS

The preparation of this report included the following:

- An inventory of existing roadway and traffic conditions on major thoroughfares adjacent to the site, including surface conditions, functional classification, widths, pavement markings, traffic-control signs, posted speed limits, intersection and access spacing, roadway and intersection alignments, roadway grades, and auxiliary turn lanes;
- Weekday peak-hour turning-movement traffic counts at the following study-area intersections:
 - US Highway 24/Stapleton Road
 - US Highway 24/Judge Orr Road
 - US Highway 24/Elbert Road
 - Judge Orr Road/Curtis Road/Stapleton Road
 - Judge Orr Road/Elbert Road

- Estimated average daily traffic (ADT) volumes adjacent to the proposed development on the following roadway segments: US Highway 24, Judge Orr Road, Stapleton Road, Curtis Road, Elbert Road;
- Projections of 20-year background traffic volumes on the following roadways adjacent to the site: US 2 Highway 4, Judge Orr Road, Stapleton Road, Curtis Road, Elbert Road;
- The proposed site land use and access plan;
- Estimates of average weekday and weekday peak-hour trip generation for the proposed development and the estimated directional distribution of site-generated vehicle trips on roadways and intersections adjacent to and in the vicinity of the site;
- Projected site-generated and resulting total peak-hour intersection traffic volumes at the following study-area intersections:
 - US Highway 24/Stapleton Road
 - US Highway 24/Judge Orr Road
 - US Highway 24/Elbert Road
 - Judge Orr Road/Curtis Road/Stapleton Road
 - Judge Orr Road/Elbert Road
 - Stapleton Road/proposed west access (full movement)
 - Judge Orr/proposed southeast access (full-movement)
 - Elbert/proposed northeast access (full-movement)
 - Elbert/proposed east access (full-movement)
 - Projected total daily and peak-hour traffic volumes at the study-area intersections;
- Intersection level of service (LOS) analysis at the study-area intersections;
- Evaluation of short- and long-term projected intersection volumes to determine potential requirements for any auxiliary right-/left-turn lanes at the proposed site access points, based on the criteria in El Paso County's *Engineering Criteria Manual (ECM)*. Also included are potential long-term lane requirements; and
- Findings and recommendations for submittal to El Paso County.

LIST OF OTHER TRAFFIC REPORTS USED IN THE PREPARATION OF THIS REPORT

The following previously-completed traffic reports are located adjacent to the proposed Davis Ranch subdivision and were used to provide reference and background information:

- Saddlehorn Ranch - Several
- Meadowlake Industrial Park

LAND USE AND ACCESS

Proposed Land Uses

Figure 1 shows the site location relative to the adjacent and nearby roadways. The proposed 398.91-acre Davis Ranch Subdivision Sketch Plan in El Paso County, Colorado is bordered to the south by Judge Orr Road, to the east by Elbert Road, and to the west by Stapleton Road. Approximately 92 single-family dwelling units and approximately 8 acres of commercial uses are

note shown on the sketch plan.
Please coordinate with the planning consultant so that the sketch plan and TIS are consistent

Please revise the traffic analysis as it was determined that no access would be allowed along Stapleton as 1/2 mile spacing is not met and access proposed is not identified on the Stapleton corridor plan.

planned for the site. For purposes of estimating trip generation, this report assumes 32,500 square feet of building square footage for the commercial uses.

Access and Circulation

The Sketch Plan shows the following proposed public roadway intersection spacings:

- Full-movement intersection/access on Stapleton Road **one-quarter mile** north of Judge Orr
- Full-movement access on Judge Orr Road 300feet west of Elbert Road (**Note: LSC recommends this access be shifted to a location about 1,000 feet west of Elbert Road** – depending on acceptable sight distance and/or other factors).
- Full-movement access on Elbert Road a quarter mile north of Judge Orr Road
- Full-movement access on Elbert Road a half mile north of Judge Orr Road

Figure 2 contains the proposed Sketch Plan showing the proposed general land uses, on-site roadway network, and proposed access points. Access points may be private street/driveway connections or they may be developed as public streets. This will be determined later, but this report treats them as potential public street connections.

SIGHT DISTANCE

Please state that site distance analysis will be provided when access layout is finalized

Intersection sight distance at all proposed public road/site access intersection locations on Judge Orr Road, Stapleton Road, and Elbert Road shown in the site plan must meet intersection sight distance requirements in *ECM* Table 2-21. Intersections not meeting sight distance may need to be shifted or otherwise mitigated for sight distance. Lines of sight for all public road intersections/access points will need to be kept clear of any sight distance obstructions, including landscaping, signage, etc.

ROAD AND TRAFFIC CONDITIONS AND MTCP CLASSIFICATION

Figure 1 shows the roads adjacent to and in the vicinity of the site. Adjacent roads serving the site are identified below followed by a brief description of each:

US Highway 24 (US Hwy 24) is a state highway extending locally from the City of Colorado Springs to Peyton in a northeasterly direction and then continuing east. US Hwy 24 is planned to be widened to four lanes through the Falcon area and is classified as an E-X – Expressway by the Colorado Department of Transportation (CDOT) and a 4-lane Principal Arterial on the *El Paso County Major Transportation Corridors Plan (MTCP)*. The posted speed limit on US Hwy 24 at Stapleton Road is 65 miles per hour (mph). Auxiliary left-turn lanes currently exist on the northbound and southbound approaches at the signalized intersections of Stapleton/US Hwy 24 and US Hwy 24/Judge Orr.

Judge Orr Road is a two-lane roadway that extends east from Eastonville Road across most of El Paso County. It is shown on the *El Paso County 2040 Major Transportation Corridors Plan* and

Hwy 24/Stapleton is not signalized.
Revise accordingly

The section south of Hwy 24 which is labeled as Stapleton is a 4-lane Principal arterial in the 2040 plan. Revise accordingly the description of Curtis and/or Stapleton Rd accordingly.

July 7, 2023

Final Traffic Impact Study

the *Preserved Corridor Network Plan* as a four-lane Minor Arterial adjacent to the site (and west of Curtis Road). Posted speed limits adjacent to the site range from 45 to 55 mph. West of Curtis Road, the speed limit is 45 mph, while it generally increases to 55 mph east of Curtis Road. The intersection of US Hwy 24/Judge Orr is currently signalized. Due to the oblique angle of this intersection, the eastbound and westbound approaches are split-phased. The *US 24 Access Control Plan/PEL Study* shows future plans for realignment of Judge Orr at US Hwy 24 to improve the intersection and provide an intersection angle closer to 90 degrees.

Curtis Road is a two-lane roadway that extends south from the intersection of US Hwy 24/Stapleton Road intersection to Drennan Road. It is shown as a two-lane, rural Principal Arterial on El Paso County's *2040 Major Transportation Corridors Plan* and a four-lane Principal Arterial on the *Preserved Corridor Network Plan*. Adjacent to the site, the posted speed limit is 45 mph. Both intersections of Curtis Road/Judge Orr Road and Curtis Road/Falcon Highway are two-way, stop-sign controlled. The newer section north of Judge Orr (adjacent to this site) was constructed to current *ECM* standards with paved shoulders, etc. Generally, Curtis Road is an "unimproved," two-lane paved road between Judge Orr and Falcon Highway. However, upgrades are planned as part of the Saddlehorn Development.

Stapleton Road is shown as an Urban four-lane Principal Arterial on the El Paso County *Major Transportation Corridors Plan (MTCP)* and El Paso County *Corridor Preservation Plan (CPP)*. Stapleton Road extends east from Towner Drive to US Hwy 24. Stapleton continues southeast then south as Curtis Road. It is planned to be ultimately extended west to connect with the Briargate Parkway extension. Stapleton Road currently is a half-section of a four-lane Principal Arterial (one through lane in each direction) between Meridian Road and US Hwy 24.

Elbert Road is a two-lane roadway that extends north from Judge Orr Road in El Paso County to State Highway 86 in Elbert Road. Shown on the *El Paso County 2040 Major Transportation Corridors Plan* as a four-lane Minor Arterial, the posted speed on Elbert Road is 55 mph. Elbert Road is paved without shoulders in the vicinity of the site (paved, unimproved roadway).

Existing Traffic Volumes

Vehicular turning-movement counts were conducted for the following dates and times at the following intersections. Raw count data is attached:

- Judge Orr Road/Elbert Road
 - Wednesday, January 11, 2023 from 6:30 – 8:30 a.m.
 - Wednesday, January 11, 2023 from 4:00 – 6:00 p.m.
- Judge Orr Road/Curtis Road
 - Thursday, April 21, 2022 from 6:30 – 8:30 a.m.
 - Thursday, April 21, 2022 from 4:00 – 6:00 p.m.
- US Hwy 24/Elbert Road
 - Tuesday, January 17, 2023 from 6:30 – 8:30 a.m.
 - Tuesday, January 17, 2023 from 4:00 – 6:00 p.m.
- US Hwy 24/Judge Orr Road
 - Tuesday, May 10, 2022 from 6:30 – 8:30 a.m.
 - Tuesday, May 10, 2022 from 4:00 – 6:00 p.m.
- US Hwy 24/Stapleton Road
 - Tuesday, January 10, 2023 from 6:30 – 8:30 a.m.
 - Tuesday, January 10, 2023 from 4:00 – 6:00 p.m.

Provide up to date counts as these are greater than a year old. Refer to ECM App. B.3.1.A

PEDESTRIAN AND BICYCLE FACILITIES

Judge Orr Road, Stapleton Road, and Elbert Road do not currently have sidewalks. Stapleton Road between Judge Orr and US Highway 24 has paved outside shoulders, which accommodate bicycles. Proposed subdivision roads are likely to be primarily Rural Local roadways and, per *ECM* criteria, would not require sidewalks.

TRIP GENERATION

Estimates of the vehicle trips projected to be generated by the proposed Davis Subdivision residential development have been made using the nationally published trip-generation rates from *Trip Generation, 11th Edition, 2021* by the Institute of Transportation Engineers (ITE). Corresponding trip-generation rates from ITE Land Use category “210 – Single-Family Detached Housing” have been used to develop trip-generation estimates for the proposed 92-dwelling units. ITE Land Use category “821 – Strip Retail Plaza without a Supermarket (40-150 KSF)” was used to estimate potential trip generation for the approximately 8 acres of commercial space on the property (on two separate parcels). LSC has assumed that a 15-percent floor-area-ratio for the 8 total acres of commercial space.

Table 1 below presents a summary of the estimated site trip generation. A detailed trip-generation estimate for the site, including ITE rates land uses, is presented in Table 4 (attached). The proposed sketch plan is attached for reference.

The sketch plan land uses are projected to generate about 4,479 total vehicle trips on the average weekday during a 24-hour period, with approximately half entering and half exiting the site. During the morning peak hour, approximately 74 entering vehicles and 86 exiting vehicles are estimated to be generated. Approximately 191 entering and 173 exiting vehicles are estimated to be generated by the site during the afternoon peak hour.

Table 1: Estimated Site Vehicle-Trip Generation

Analysis Period	Total Driveway Trips		
	In	Out	Total
Morning Peak Hour	74	86	160
Afternoon Peak Hour	191	173	364
Daily/24-hour	2240	2240	4479
Analysis Period	Primary Trips		
	In	Out	Total
Morning Peak Hour	42	66	107
Afternoon Peak Hour	114	92	206
Daily/24-hour	1212	1212	2423
Analysis Period	Pass-By Trips		
	In	Out	Total
Morning Peak Hour	19	12	31
Afternoon Peak Hour	45	47	93
Daily/24-hour	603	603	1205
Analysis Period	Diverted Trips		
	In	Out	Total
Morning Peak Hour	14	8	22
Afternoon Peak Hour	32	33	65
Daily/24-hour	425	425	851

Pass-By and Diverted Trips

The ITE total trip-generation estimate for the southeast parcel site has also been aggregated by trip type to account for pass-by trips. A pass-by trip is one made by a motorist who would already be on an adjacent street regardless of the proposed development, but who stops in at the site while passing by. That pass-by motorist would then continue on his or her way to a destination in the original direction. Table 4 (attached) shows the percent of the trips generated that were assumed to be pass-by trips.

Analysis also accounts for diverted trips from nearby US Hwy 24, Curtis Road (in the case of the east commercial parcel), and Falcon Highway. Recommended ITE-average percent diverted trips for retail-related land uses were used for this study, as summarized in Table 4. Resulting primary and non-primary trips are shown in the table.

Average pass-by trip percentages from the *Trip Generation Handbook – An ITE Proposed Recommended Practice, 3rd Edition, 2014* by ITE have been assumed.

TRIP DISTRIBUTION AND ASSIGNMENT

Trip Directional Distribution

The directional-distribution estimate of site-generated vehicle trips to the study-area roads and intersections is a necessary component in determining the site's traffic impacts. The Vistro reports show the percentages of the site-generated vehicle trips projected to be oriented to and from the site's major approaches. Estimates have been based on the following factors: the proposed new land uses, the area roadway system serving the site, and the site's geographic location relative to the overall greater El Paso County/Colorado Springs area. The attached Vistro reports show estimated distribution splits.

Site-Generated Traffic

Site-generated traffic volumes have been estimated at the following intersections:

- US Hwy 24/Stapleton Road
- US Hwy 24/Judge Orr Road
- US Hwy 24/Elbert Road
- Judge Orr Road/Curtis Road/Stapleton Road
- Judge Orr Road/Elbert Road
- Stapleton Road/proposed west access (full movement)
- Judge Orr/proposed southeast access (full-movement)
- Elbert/proposed northeast access (full-movement)
- Elbert/proposed east access (full-movement)

Site-generated volumes have been calculated by applying the directional-distribution percentages estimated by LSC (from the attached Vistro tables) to the trip-generation estimates (from Table 4). The attached Vistro printouts show the projected short-term site-generated traffic volumes for the weekday morning and afternoon peak hours.

Short-Term Total Traffic Volumes

The attached Vistro reports show the sum of the short-term total traffic volumes and short-term site-generated peak-hour traffic volumes. These volumes represent the projected short-term total traffic following site buildout. Laneage and traffic control at the study-area intersections following site buildout are shown in the attached Synchro reports.

Note: short-term background traffic volumes assume buildout of the entire Saddlehorn residential development to the south.

2043 Background Traffic Volumes

Long-term background traffic volumes are estimates by LSC, based on projected 2043 volumes adjacent to the site shown in Map 9 of the *MTCP*. Additionally, traffic generated by planned adjacent and nearby developments, such as Saddlehorn Ranch, Meadowlake Ranch, Meadowlake Industrial Park, and Falcon Crossing, has been included in 2043 background traffic volumes. Please refer to the attached Vistro reports for estimated long-term background volumes and assumed laneage at the study-area intersections.

Projected long-term background traffic volume projections in this vicinity have been based on LSC's recent Saddlehorn and Meadowlake Industrial Park traffic studies. Site-generated traffic from other nearby planned developments has also been considered.

Note: long-term background traffic volumes assume buildout of the entire Saddlehorn residential development to the south and estimates of future residential development to the southeast.

2043 Total Traffic Volumes

The attached Vistro reports show the sum of 2043 background traffic volumes plus long-term site-generated traffic volumes.

LEVEL OF SERVICE ANALYSIS

Level of service (LOS) is a quantitative measure of the level of congestion or delay at an intersection and is indicated on a scale from "A" to "F." LOS A is indicative of little congestion or delay. LOS F indicates a high level of congestion or delay. Table 2 shows the level of service delay ranges for signalized and unsignalized intersections.

Table 2: Intersection Levels of Service Delay Ranges

Level of Service	Signalized Intersections	Unsignalized Intersections
	Average Control Delay (seconds per vehicle)	Average Control Delay (seconds per vehicle) ¹
A	10.0 sec or less	10.0 sec or less
B	10.1-20.0 sec	10.1-15.0 sec
C	20.1-35.0 sec	15.1-25.0 sec
D	35.1-55.0 sec	25.1-35.0 sec
E	55.1-80.0 sec	35.1-50.0 sec
F	80.1 sec or more	50.1 sec or more

¹ For unsignalized intersections, if V/C ratio is greater than 1.0 the level of service is LOS F, regardless of the projected average control delay per vehicle.

The attached **LOS Tables** 1-12 show the LOS values results for the weekday morning and afternoon peak hours for the proposed site-access intersections and off-site intersections in the study area. All LOS calculations for long-term scenarios were based upon the recommended lane geometries and traffic controls outlined in the Synchro reports.

Stapleton Road/Proposed Northwest Site Access

Please clarify that this is proposed/analyzed as a signalized intersection as shown in the figures provided.

All individual turning movements and approaches are projected to operate at LOS C or better through the long term with the addition of site-generated traffic.

Judge Orr Road/Proposed Southeast Site Access

All individual turning movements and approaches are projected to operate at LOS B or better through the long term with the addition of site-generated traffic.

Please update the LOS analysis accordingly as access to Stapleton would not be allowed.

Elbert Road/Proposed East Site Access

All single-lane approaches are projected to operate at LOS A through the long term with the addition of site-generated traffic.

Elbert Road/Proposed Northeast Site Access

All single-lane approaches are projected to operate at LOS A through the long term with the addition of site-generated traffic.

Judge Orr Road/Curtis Road

Short Term

All individual turning movements are projected to operate at LOS C or better during the short term with the addition of site-generated traffic. Short-term analysis assumes two-way stop-sign control (TWSC) at Judge Orr/Curtis.

Long Term

Assuming the intersection of Judge Orr/Curtis is converted from TWSC to a two-lane roundabout in the future, all individual turning movements would operate at LOS B or better during both peak hours of the long-term buildout scenario. This intersection improvement was previously recommended in the *Saddlehorn Ranch* traffic study. Additionally, eastbound and westbound approaches on Judge Orr Road and the southbound approach on Curtis Road are assumed to be two through lanes in each direction (per the 2040 *MTCP*).

Please indicate what this developments possible responsibility is for upgrading the intersection to satisfactory conditions. Is it providing escrow? or does this development trigger the signal warrants? please address.

US Highway 24/Stapleton Road

Short-Term

Currently, the intersection of US Hwy 24/Stapleton is two-way stop-sign-controlled (TWSC). The following turning movements currently operate at LOS E or worse, with or without the addition of site-generated traffic: northwest-bound left, northwest-bound through, southeast-bound left, and southeast-bound through.

Once signalized, all individual turning movements and the intersection overall are projected to operate at and are projected to operate at LOS C or better during both short-term peak hours, with or without the addition of site-generated traffic. CDOT has indicated that this intersection is on the list of intersections programmed for signalization.

Long-Term

Based on the long-term scenario analyzed in this report, dual left-turn lanes are projected to be constructed to all approaches at the intersection of US Hwy 24/Stapleton Road. Additionally, all approaches on US Hwy 24 and Stapleton Road would be improved to two through lanes in each direction. Assuming the planned future traffic-signal control, the northeast-left and southwest-left turn lanes are projected to operate at LOS E during the AM and PM peak hours.

All other individual turning movements and the intersection overall are projected to operate at LOS D or better during both long-term peak hours, with or without the addition of site-generated traffic. Please refer to the attached Synchro sheets for anticipated/assumed future lane geometry and LOS at this intersection.

US Highway 24/Judge Orr Road

Short Term

The intersection of US Hwy 24/Judge Orr is currently signalized. The *US 24 Access Control Plan* shows this intersection realigned to one of two alternate alignments that would provide an intersection angle closer to 90 degrees. All movements at this intersection except for the westbound-through movement are currently operating at LOS D or better during both peak hours.

what is the LOS for this movement

Short-term analysis assumes the proposed realignment has not yet been constructed, nor does it assume that the future southbound right-turn deceleration, a southbound right-turn acceleration, and an eastbound right-turn lane would be constructed in the short term. These turn lanes are shown at the intersection of US Hwy 24/Judge Orr in CDOT's *US 24 Planning & Environmental Linkages (PEL) Study*.

Highway 24 is an expressway.
Staff assumption is that the minor
movements indicated are along
Judge Orr as opposed to hwy 24.
Please clarify.

Long-Term

By 2043, it was assumed that this intersection would be realigned and both Judge Orr Road and US Hwy 24 would be widened to provide two through lanes in each direction. Based on the projected 2043 background and total traffic volumes and lane geometry shown in the Synchro reports, this intersection is projected to operate at an overall LOS C during the peak hours. Some minor movements are projected to operate at LOS E during the peak hours simply because of the likelihood of arrival at the traffic signal at the beginning of the red phase at an intersection with many phases and a long cycle length. These movements would not be considered “failing” since the volume-to-capacity ratios would be less than 1.0. The justification is that to progress through traffic along an arterial corridor, the traffic signal offsets and left-turn and side street phase times have been adjusted to favor the through traffic band, which can often result in higher delay for the left-turn movements even though there is sufficient capacity for them.

US Highway 24/Elbert Road

Short Term

Please also provide
long term analysis.

All individual turning movements are projected to operate at LOS D or better during the short-term with the addition of site-generated traffic. Short-term analysis assumes two-way stop-sign control (TWSC) at US Hwy 24/Elbert Road.

Judge Orr Road/Elbert Road

All single-lane approaches are projected to operate at LOS A through the long term with the addition of site-generated traffic.

ROADWAY IMPROVEMENTS

Auxiliary Turn-Lane Thresholds

Section 2.3.7.D of the *ECM* lists ingress/egress volume thresholds in which exclusive right- or left-turn lanes would be required, by classification:

- Principal Arterial
 - Left-turn deceleration lane – 10 vehicles per hour (vph) or greater
 - Right-turn deceleration lane – 25 vph or greater
 - Right-turn acceleration lane – 50 vph or greater (if speed limit greater than 40 mph)
- Minor Arterial
 - Left-turn deceleration lane – 25 vph or greater
 - Right-turn deceleration lane – 50 vph or greater
 - Right-turn acceleration lane – not generally required

Major roadways in the study area have the following 2040 *ECM* roadway classifications:

- Stapleton Road – Principal Arterial
- Judge Orr Road – Minor Arterial
- Elbert Road – Minor Arterial

All proposed auxiliary turn lanes would be required to meet design criteria outlined in Section 2.3.7.E of the *ECM*.

Stapleton Road/Proposed Northwest Site Access

Based on projected left-turn and right-turn peak-hour turning volumes, the following auxiliary turn lanes would be required at the proposed northwest site access on Stapleton Road:

- Northbound-left-turn deceleration lane
- Southbound-left-turn deceleration lane
- Southbound-right-turn deceleration lane

The following auxiliary turn lanes would **not** be required at the proposed northwest site access on Stapleton Road:

- Northbound-right-turn deceleration lane
- Westbound-to-northbound-right-turn acceleration lane
- Eastbound-to-southbound-right-turn acceleration lane

revise accordingly for the intersection in question

Judge Orr Road/Proposed Southeast Site Access

Based on projected left-turn and right-turn peak-hour turning volumes, the following auxiliary turn lane would be required at the proposed southeast site access on Judge Orr Road:

- Eastbound-left-turn deceleration lane

The following auxiliary turn lanes would **not** be required at the proposed **northwest** site access on **Stapleton Road**:

- Westbound-right-turn deceleration lane
- Southbound-to-westbound-right-turn acceleration lane

indicate whether a southbound right turn lane or left turn lane along the proposed collector roadway will be required.

Elbert Road/Proposed East Site Access

Based on projected northbound-left and southbound-right peak-hour turning volumes, no auxiliary turn lanes would be required at the proposed east site access on Elbert Road.

Elbert Road/Proposed Northeast Site Access

Based on projected northbound-left and southbound-right peak-hour turning volumes, no auxiliary turn lanes would be required at the proposed northeast site access on Elbert Road.

Bill Guman
 Davis Ranch Subdivision

provide auxiliary lane analysis for Elbert Rd/Judge Orr and for Stapleton/Judge Orr. For Stapleton/Judge Orr, indicate whether any additional turn lanes or changes to the existing turn lanes are necessary.

US Highway 24/Judge Orr Road

Auxiliary turn lanes are planned to be added at this intersection as part of El Paso County intersection improvement project C14. This roadway improvement project has been identified as being needed by the year 2040 per Map 13 and Table 4 of El Paso County’s 2016 *MTCP*:

- C14 – Judge Orr Road from Eastonville Road to Peyton Highway (\$38,248,000)
- Existing conditions – 2-lane Rural Minor Arterial
- Future conditions – 4-lane Rural Minor Arterial

As such, no modifications would be required by the applicant at the intersection of US Hwy 24/Judge Orr as a result of additional site-generated traffic from this development.

Intersection Configuration and Traffic Control

All proposed site-access points would be two-way stop sign-controlled intersections.

ROADWAY CLASSIFICATIONS

Generally, roadways within the sketch plan should be classified as Rural Local as projected ADT volumes are below 750 vehicles per day. These recommended classifications can be revisited at the preliminary plan stage when commercial land uses are more defined relative to trip generation. Also, more information may be known at that time about potential development on adjacent parcels. Based on estimated daily traffic volumes and other factors, the following internal roadway classifications are recommended by LSC (as shown in Table 3 and graphically shown in Figure 3):

Table 3: Roadway Classifications at Proposed Site Access Points

Major Road	Access Location	Side of Road	Projected ADT	Recommended Classification
Stapleton Rd	Northwest	West	1600	Rural Major Collector
Stapleton Rd	Northwest	East	575	Rural Minor Collector
Judge Orr Rd	Southeast	North	2000	Rural Major Collector*
Elbert Rd	East	West	300	Rural Minor Collector
Elbert Rd	Northeast	West	150	Rural Local
Other Internal Roads			Varies	Rural Local

* Along the commercial site; Rural Minor Collector north to east/west street connecting to Elbert Road.

Date: 7/7/2023

COUNTY ROAD IMPROVEMENT FEE PROGRAM

Transportation Impact Fees

Per *ECM* Appendix B:

State what the current applicable Transportation Impact Fees are and what option the developer will be selecting for payment.

The applicant will be required to participate in this program. The PID option will be identified with a future Preliminary Plan/Plat submittal(s).

Reimbursable Improvements

The following roadway improvement projects have been identified as being needed by the year 2040 per Map 13 and Table 4 of El Paso County's 2016 *MTCP*:

- C12 – Stapleton Road from Towner to Judge Orr Road (\$41,076,000)
 - Existing conditions – 2-lane Urban Principal Arterial
 - Future conditions – 4-lane Urban Principal Arterial
- C14 – Judge Orr Road from Eastonville Road to Peyton Highway (\$38,248,000)
 - Existing conditions – 2-lane Rural Minor Arterial
 - Future conditions – 4-lane Rural Minor Arterial

See the attached *MTCP* maps for reference.

MULTI-MODAL TRANSPORTATION AND TDM OPPORTUNITIES

The following roadway improvement projects have been identified as being needed by the year 2040 per Map 15 and Table 5 of El Paso County's 2016 *MTCP*:

- M7 – Elbert Road from Judge Orr Road to US Hwy 24
 - Bicycle improvements (7.00 miles)
- M8 – Judge Orr Road from Eastonville Road to South Peyton Highway
 - Bicycle improvements (2.98 miles)

Pedestrian and Bicycle Accommodations

There are no existing public schools located within two miles of the site, except Falcon High School and Liberty Tree Academy. Both of these are about two miles away, but they are located across US Hwy 24. Moreover, the travel distance is greater than two miles along roadways (road distance).

The following is a list of known and planned multi-modal and pedestrian accommodations in the vicinity of the site:

- A park-and-ride facility has been constructed near Meridian Road and US Highway 24.
- The Rock Island Regional Trail passes near the site to the north.
- Many of the area County roads have been or will be upgraded to provide paved shoulders for cyclists. Stapleton is shown as a future “bike route.”
- The Highway 24 PEL study also includes multi-modal elements.

DEVIATIONS

Potentially-Required Deviations

The following are deviations that may be required based on this Sketch Plan.

- The proposed public-road intersection spacing along Curtis Road is less than one-half mile, which does **not** meet *ECM* criteria for intersection spacing along a Principal Arterial Roadway. As such, deviation request(s) would be required for this proposed site public road intersection location.
- The proposed public road intersection spacing along Judge Orr Road is less than one-quarter mile, which does **not** meet *ECM* criteria for intersection spacing along a Minor Arterial Roadway. As such, deviation request(s) would be required for this proposed site public road intersection location. LSC recommends this access/roadway connection to Judge Orr be shifted to a location about 1,000 feet west of Elbert Road (depending on acceptable sight distance and/or other factors).

Deviations will be submitted with the zoning or Preliminary Plan.

Approved Deviations (for Reference)

Judge Orr Road



Please also identify what this developments requirements are for the north side of Judge Orr Road along the property frontage. It may be provided in a separate section of the report as this section is identifying previous deviations.

As part of the Saddlehorn Ranch development, a deviation (by JR Engineering, dated September 4, 2020) was approved for modification to the standard *ECM* cross section of Judge Orr Road, which has a 2040 classification of Rural Four-Lane, Minor Arterial roadway (*ECM* Section 2.2.4 criteria). Although Judge Orr Road is shown as a four-lane Rural Minor Arterial in the 2040 *MTCP*, the *ECM* does not have a standard cross-section for this type of roadway functional classification. The deviation shows an interim four-lane Rural Minor Arterial cross-section with an additional eastbound 12-foot travel lane on the south side (Saddlehorn side).

Additional ROW would be required for completion of the full 4-lane section, but additional ROW is not available (not controlled by this development) on the north side of Judge Orr. Currently, Saddlehorn Ranch is dedicating an additional 40 feet of ROW to facilitate this in the future.

Identify whether any improvements such as additional shoulder width to Stapleton/Curtis Rd north of Judge Orr is required due to this developments impacts.

Curtis Road

As part of the Saddlehorn Ranch development, a deviation (by JR Engineering, dated September 28, 2020) was approved for modification to the standard *ECM* cross section of Curtis Road south of Judge Orr Road, a Rural Two-Lane, Principal Arterial roadway (*ECM* Section 2.2.4 criteria). The *ECM* requires that Rural Principal Arterial cross-sections consist of 12-foot travel lanes with 8-foot paved, outside shoulders. The approved deviation shows the modified interim cross section with a 2-foot paved, outside shoulder on the west side of the roadway instead of an 8-foot shoulder, as this is the maximum that can fit within the existing western right-of-way (ROW) without needing to acquire additional ROW from the adjacent property owners. The east side of the roadway will be constructed with an 8-foot outside shoulder.

CDOT PROCESS AND REQUIREMENTS

The following is for information only, as this is a sketch plan application. The following can be revisited at the next stage of the process.

- US Hwy 24/Stapleton is planned to be signalized. The CDOT has indicated for other area projects a requirement to escrow a fair share amount toward this future traffic signal.
- The “formula” for calculating the development responsibility has been based on the average AM & PM site-generated passenger cars directly impacting the 4-hour warrant, the development would be responsible an amount based on the number of site-generated new vehicles / 60 vehicles-to-warrant x ~\$700K/signal cost.
- **LSC Note:** There are a number of developments – in progress and future/planned – in the area which will also add traffic to this intersection and impact the 4-hour warrant. As CDOT collects escrow for other developments, LSC recommends that as the collective impact trips (directly impacting the 4-hour warrant volumes) by area developments begins to exceed the 60-vehicle-per-hour denominator, fair-share recalculation of pro-rata share escrow amounts and credit be provided to developments according to the updated fair-share calculations. Also, once the signal is installed, credit should be provided from the Countywide Fee Program based on a ratio of fee program unit signal cost divided by the \$700K signal cost.

Please identify that it is the applicants responsibility to go before the road impact fee advisory committee for any possible credits from the fee program.

FINDINGS AND CONCLUSIONS

- The site is projected to generate about 4,479 new driveway vehicle-trips on the average weekday.
- During the weekday morning peak hour of adjacent street traffic, 74 vehicles would enter the site while 86 vehicles would exit.
- During the weekday afternoon peak hour of adjacent street traffic, 191 vehicles would enter the site while 173 vehicles would exit.
- Projected levels of service would be LOS C or better at all proposed site access locations. Please refer to the “Level of Service” section above for detailed LOS results and discussion regarding all study-area intersections.

- Please refer to the “Auxiliary Turn-Lane Analysis” section for evaluation of potential turn-lane needs at the study-area intersections.
- All internal site access roadways are proposed to be public streets.
- Deviations are not included with this submittal.

* * * * *

Please contact me if you have any questions regarding this report.

Respectfully Submitted,

LSC TRANSPORTATION CONSULTANTS, INC.

By: Jeffrey C. Hodsdon, P.E.
Principal

JCH/JAB:jas

Enclosures: Table 4
LOS Tables 1-12
Figures 1-3
Vistro Reports
Traffic Count Reports
Synchro LOS Reports

Table 4

Table content is missing or blank.



Table 4: Detailed Trip Generation Estimate

ITE		Value ³	Units ¹	Trip Generation Rates ²					Driveway Trips Generated					% Primary	% Pass-By	% Diverted	External Trips Generated				
Code	Description			Average Weekday	A.M.		P.M.		Average Weekday	A.M.		P.M.					Average Weekday	A.M.		P.M.	
					In	Out	In	Out		In	Out	In	Out					In	Out		
210	Single-Family (Attached) Housing	92	DU	10.16	0.20	0.56	0.63	0.37	935	18	51	58	34	100%	0%	0%	935	18	51	58	34
821	Strip Retail Plaza w/o Supermarket (40-150 KSF)	52.500	KSF	67.52	1.07	0.66	2.54	2.65	3545	56	35	134	139	42%	34%	24%	1489	24	14	56	58
								Total	4479	74	86	191	173			Total	2423	42	66	114	92

¹ DU = dwelling units, KSF = 1,000 square feet, VPF = vehicle fueling positions

² Source: *Trip Generation, 11th Edition (2021)* by the Institute of Transportation Engineers (ITE)

³ Assumes 15% floor-area ratio for retail land uses

LOS Tables 1-12



Table 1: LOS Summary – US 24 + Judge Orr Road (Short Term)

Traffic Control	Signal		Signal	
	ST Baseline		ST Baseline + Site	
	AM	PM	AM	PM
SWT/R	D	C	D	C
SWL	B	B	B	C
WB	D	D	E	D
NET/R	B	C	B	C
NEL	B	B	B	C
EB	D	D	D	D
Overall	C	C	D	D

Table 2: LOS Summary – US 24 + Judge Orr Road (Long Term)

Traffic Control	Signal		Signal	
	2043 BG		2043 BG + Site	
	AM	PM	AM	PM
SWR	A	C	A	A
SWT	D	D	C	C
SWL	B	E	B	E
NWR	A	A	A	A
NWT	D	D	D	D
NWL	D	C	E	E
NER	A	A	A	A
NET	B	C	B	C
NEL	D	D	D	E
SER	C	C	C	C
SET	D	D	D	D
SEL	C	D	C	D
Overall	C	D	C	D

Table 3: LOS Summary – US 24 + Stapleton Road

Traffic Control	TWSC		TWSC		Signal		Signal	
Turn	ST Baseline		ST Baseline + Site		2043 BG		2043 BG + Site	
	AM	PM	AM	PM	AM	PM	AM	PM
SWR	free		free		A	A	B	C
SWT	free		free		D	D	D	D
SWL	A	A	A	A	E	B	E	E
NWR	B	B	B	B	A	A	A	A
NWT	E	F	F	F	D	D	D	E
NWL	F	F	F	F	C	D	C	C
NER	free		free		A	A	A	A
NET	free		free		C	B	C	C
NEL	A	A	A	A	E	D	E	D
SER	A	B	B	B	B	C	C	D
SET	B	E	F	F	C	D	D	D
SEL	E	F	F	F	C	C	C	D
Overall					C	D	C	D

Table 4: LOS Summary – US 24 + Elbert Road

Traffic Control	TWSC		TWSC	
Turn	ST Baseline		ST Baseline + Site	
	AM	PM	AM	PM
SWR	free		free	
SWT	free		free	
SWL	A	A	A	A
NWR	A	A	A	A
NWT	C	C	C	D
NWL	C	D	C	D
NER	free		free	
NET	free		free	
NEL	A	A	A	A
SER	A	A	A	A
SET	C	C	C	D
SEL	C	D	C	D

Table 5: LOS Summary – Elbert Road + Northeast Access

Traffic Control	Free		TWSC		Free		TWSC	
Turn	ST Baseline		ST Baseline + Site		2043 BG		2043 BG + Site	
	AM	PM	AM	PM	AM	PM	AM	PM
SB	free		free		free		free	
NB	free		A	A	free		A	A
EB			A	A			A	A

Table 6: LOS Summary – Elbert Road + East Access

Traffic Control	Free		TWSC		Free		TWSC	
Turn	ST Baseline		ST Baseline + Site		2043 BG		2043 BG + Site	
	AM	PM	AM	PM	AM	PM	AM	PM
SB	free		free		free		free	
NB	free		A	A	free		A	A
EB			A	A			A	A

Table 7: LOS Summary – Judge Orr Road + Elbert Road (Short Term)

Traffic Control	TWSC		TWSC	
Turn	ST Baseline		ST Baseline + Site	
	AM	PM	AM	PM
SB	A	A	A	A
WB	free		free	
EB	A	A	A	A

Table 8: LOS Summary – Judge Orr Road + Elbert Road (Long Term)

Traffic Control	TWSC		TWSC	
Turn	2043 BG		2043 BG + Site	
	AM	PM	AM	PM
SB	B	C	B	C
WBR	free		free	
WB T/L	A	A	A	A
NB	B	C	B	D
EBR	free		free	

Table 9: LOS Summary – Judge Orr Road + Southeast Access

Traffic Control	TWSC		TWSC		TWSC		TWSC	
Turn	ST Baseline		ST Baseline + Site		2043 BG		2043 BG + Site	
	AM	PM	AM	PM	AM	PM	AM	PM
SB			A	B			B	B
WB	free		free		free		free	
EB	free		A	A			A	A

Table 10: LOS Summary – Judge Orr Road + Curtis Road/Stapleton Road (Short Term)

Traffic Control	TWSC		TWSC	
	ST Baseline		ST Baseline + Site	
	AM	PM	AM	PM
SB T/R	C	B	B	C
SBL	B	B	C	B
WB T/R	free		free	
WBL	A	A	A	A
NB T/R	B	B	B	C
NBL	C	B	C	C
EBR	free		free	
EB T/L	A	A	A	A

Table 11: LOS Summary – Judge Orr Road + Curtis Road/Stapleton Road (LongTerm)

Traffic Control	Roundabout		Roundabout	
	2043 BG		2043 BG + Site	
	AM	PM	AM	PM
SB T/L	A	A	A	A
SB T/R	A	A	A	A
WB T/L	A	A	A	B
WB T/R	A	A	A	A
NB T/L	A	B	A	B
NB T/R	A	B	A	B
EB T/L	A	A	A	A
EB T/R	A	A	A	A
Overall	A	A	A	A

Table 12: LOS Summary – Curtis Road + Northwest Access

Traffic Control	Free		TWSC		Free		TWSC	
	ST Baseline		ST Baseline + Site		2043 BG		2043 BG + Site	
	AM	PM	AM	PM	AM	PM	AM	PM
SB T/R	free		free		free		free	
SBL			A	A			A	A
WB			B	B			C	C
NBR			free				free	
NBT	free		free		free		free	
NBL			A	A			A	A
EB			B	B			B	C

Figures 1-3



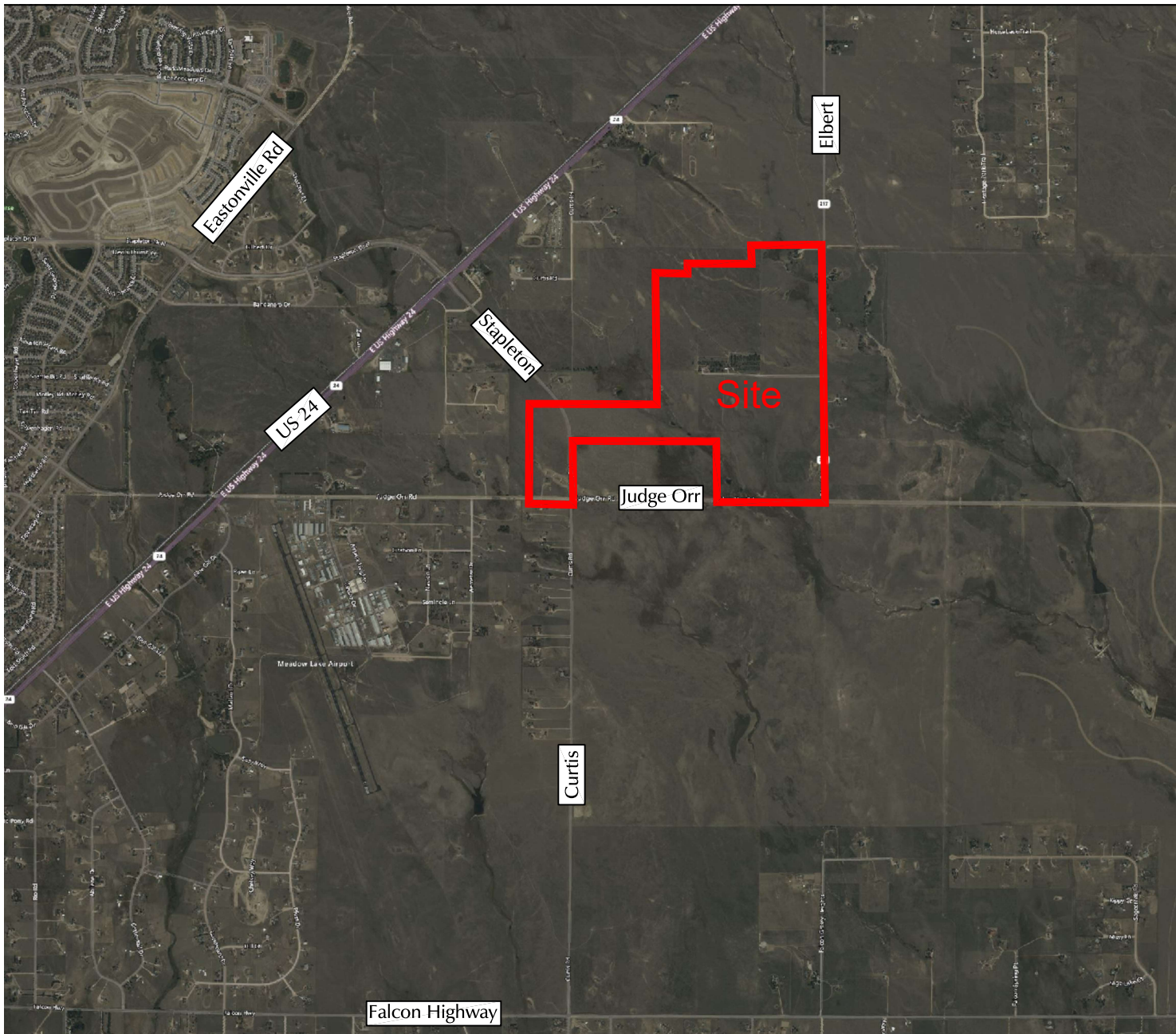
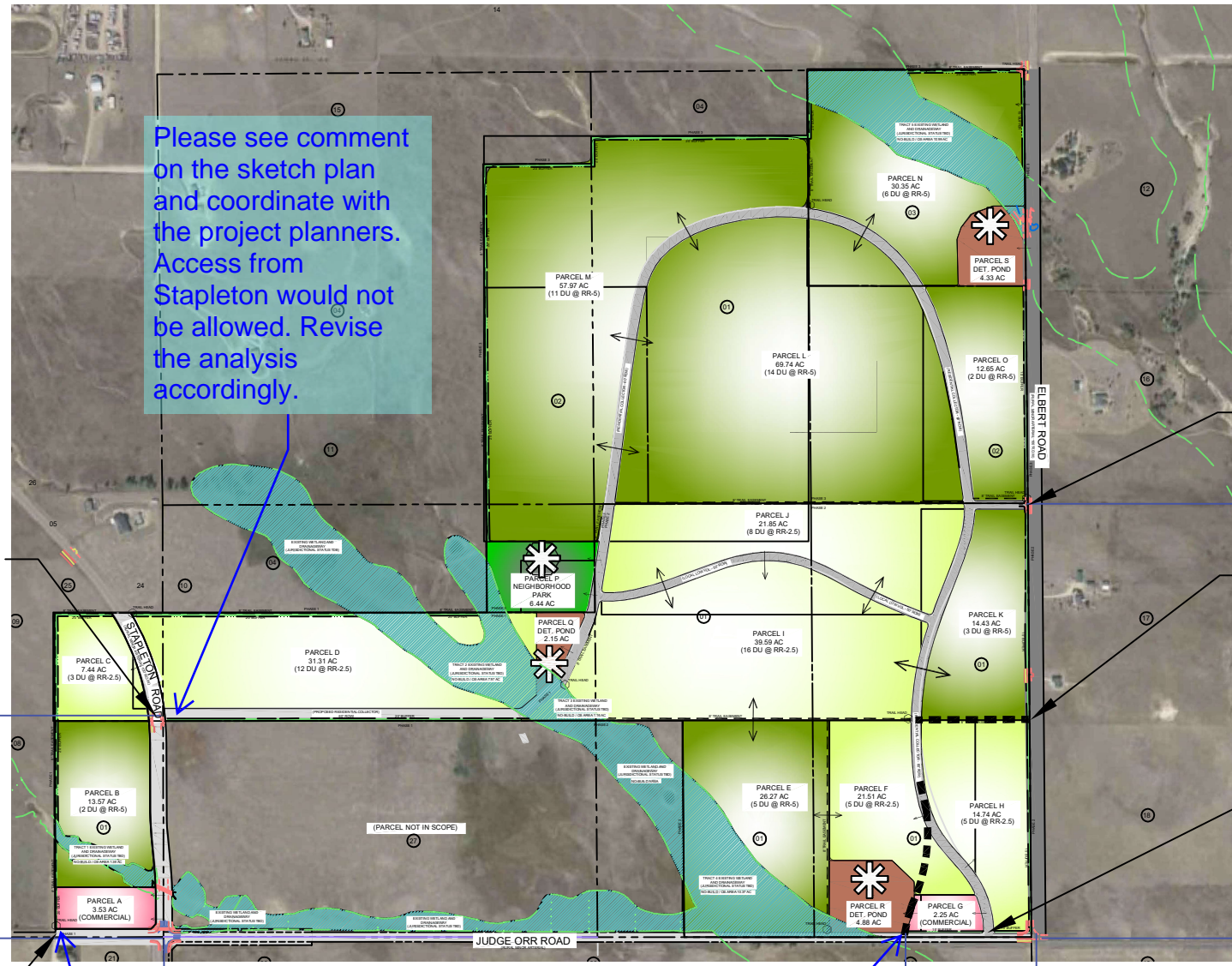

Figure 1
Vicinity Map
Davis Ranch Sketch Plan (LSC# S224640)



Approximate Scale
1" = 1,000'



Please see comment on the sketch plan and coordinate with the project planners. Access from Stapleton would not be allowed. Revise the analysis accordingly.

Proposed street connections to Stapleton Road (east and west sides)*

Proposed street connection to Elbert Rd

A street connection at this location would meet spacing criteria. This report assumes this street, although addition of this will depend on sight distance and other factors.

LSC recommends shifting this proposed street connection to Judge Orr Road to the west, about 700* (depending on sight distance and other factors).

No access proposed

access may be permitted on Judge Orr at this location as shown on the Stapleton Corridor Study

Staff recommends that this access be shifted as far west as possible as it appears that there may be sufficient space to meet criteria prior to encroaching onto the floodplain

*Deviation will be required with the Preliminary Plan.

Figure 2
Site Plan

Davis Ranch Sketch Plan (LSC# S224640)



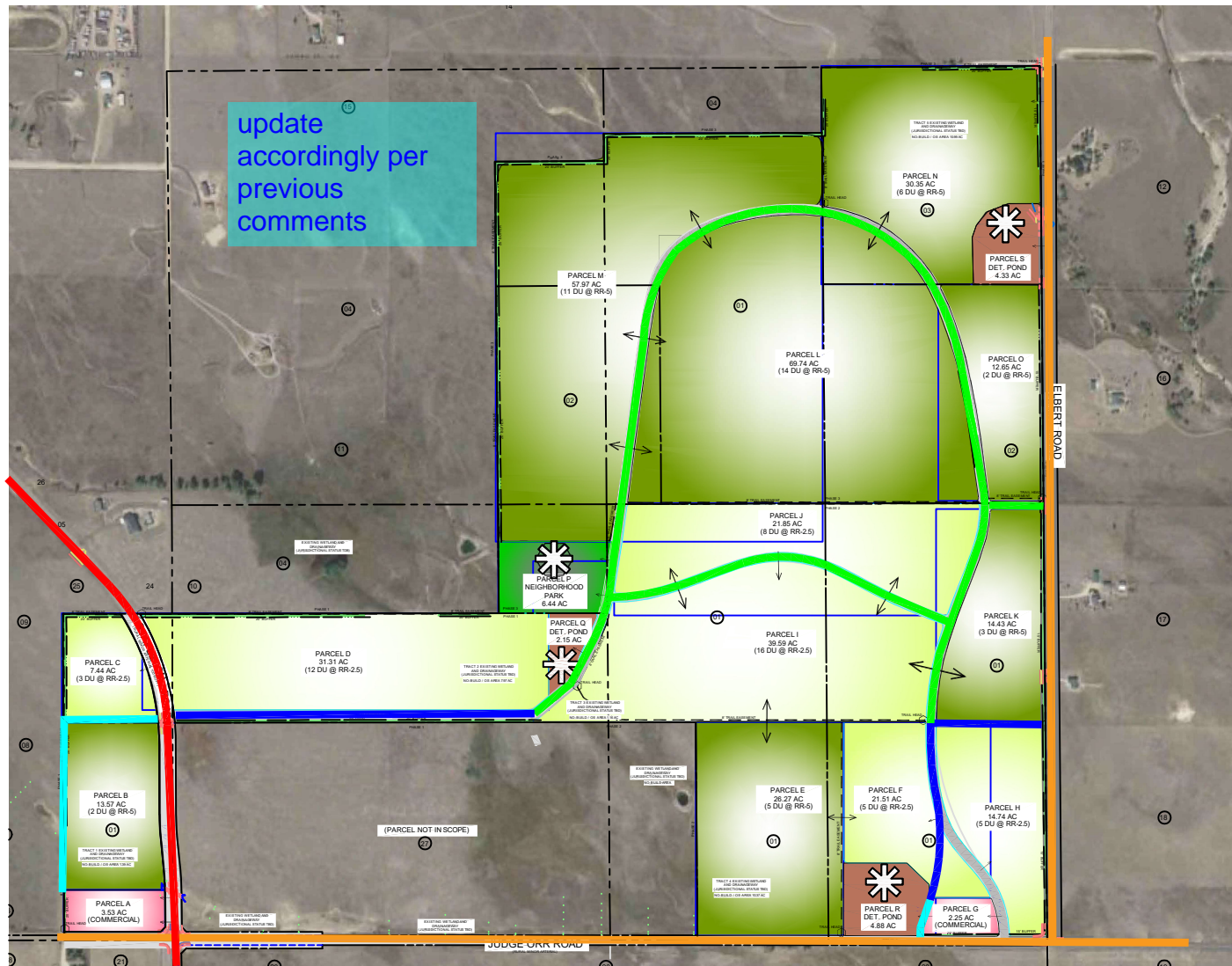

- | | | | |
|--|-----------------------|--|-----------------------|
| | Rural Local | | Principal Arterial |
| | Rural Minor Collector | | Rural Major Collector |
| | Rural Minor Arterial | | |

Figure 3
Roadway Classifications

Davis Ranch Sketch Plan (LSC# S224640)

Vistro Reports



Vistro Traffic Model

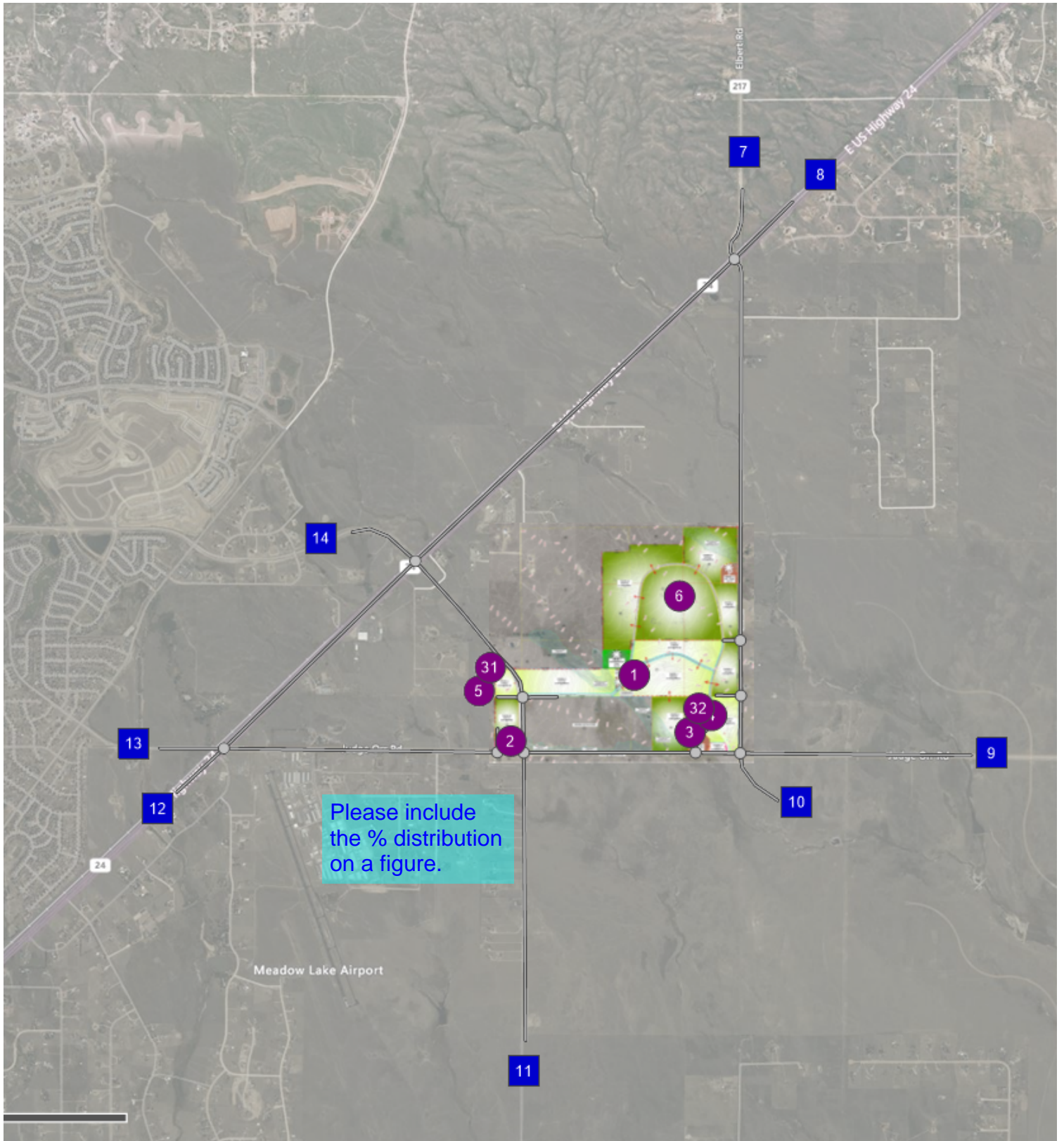

Davis Ranch Sketch Plan

Vistro File: G:\...\Davis Subdivision -- Vistro.vistro

Scenario 1 2023 AM

Report File: G:\...\2023 AM REV.pdf

7/7/2023

Trip Distribution summary

Zone / Gate	Zone 1: Zone			
	To Zone:		From Zone:	
	Share %	Trips	Share %	Trips
2: Zone	0.00	0	0.00	0
3: Zone	0.00	0	0.00	0
4: Zone	0.00	0	0.00	0
5: Zone	0.00	0	0.00	0
6: Zone	0.00	0	0.00	0
31: Zone	0.00	0	0.00	0
32: Zone	0.00	0	0.00	0
7: Gate	2.00	0	2.00	0
8: Gate	3.00	0	3.00	1
9: Gate	2.00	0	2.00	0
10: Gate	1.00	0	1.00	0
11: Gate	5.00	0	5.00	1
12: Gate	62.00	5	62.00	15
13: Gate	5.00	0	5.00	1
14: Gate	20.00	2	20.00	4
Total	100.00	7	100.00	22

Zone / Gate	Zone 2: Zone			
	To Zone:		From Zone:	
	Share %	Trips	Share %	Trips
1: Zone	0.00	0	0.00	0
3: Zone	0.00	0	0.00	0
4: Zone	0.00	0	0.00	0
5: Zone	0.00	0	0.00	0
6: Zone	0.00	0	0.00	0
31: Zone	0.00	0	0.00	0
32: Zone	0.00	0	0.00	0
7: Gate	3.00	0	3.00	0
8: Gate	7.00	1	7.00	0
9: Gate	5.00	1	5.00	0
10: Gate	1.00	0	1.00	0
11: Gate	11.00	1	11.00	1
12: Gate	10.00	1	10.00	1
13: Gate	28.00	3	28.00	2
14: Gate	35.00	4	35.00	2
Total	100.00	11	100.00	6

Zone / Gate	Zone 3: Zone			
	To Zone:		From Zone:	
	Share %	Trips	Share %	Trips
1: Zone	0.00	0	0.00	0
2: Zone	0.00	0	0.00	0
4: Zone	0.00	0	0.00	0
5: Zone	0.00	0	0.00	0
6: Zone	0.00	0	0.00	0
31: Zone	0.00	0	0.00	0
32: Zone	0.00	0	0.00	0
7: Gate	5.00	1	5.00	0
8: Gate	15.00	2	15.00	1
9: Gate	12.00	2	12.00	1
10: Gate	4.00	1	4.00	0
11: Gate	12.00	2	12.00	1
12: Gate	7.00	1	7.00	1
13: Gate	20.00	3	20.00	2
14: Gate	25.00	3	25.00	2
Total	100.00	15	100.00	8

Zone / Gate	Zone 4: Zone			
	To Zone:		From Zone:	
	Share %	Trips	Share %	Trips
1: Zone	0.00	0	0.00	0
2: Zone	0.00	0	0.00	0
3: Zone	0.00	0	0.00	0
5: Zone	0.00	0	0.00	0
6: Zone	0.00	0	0.00	0
31: Zone	0.00	0	0.00	0
32: Zone	0.00	0	0.00	0
7: Gate	2.00	0	2.00	0
8: Gate	3.00	0	3.00	0
9: Gate	2.00	0	2.00	0
10: Gate	1.00	0	1.00	0
11: Gate	5.00	0	5.00	0
12: Gate	62.00	2	62.00	6
13: Gate	5.00	0	5.00	0
14: Gate	20.00	1	20.00	2
Total	100.00	3	100.00	8

Zone / Gate	Zone 5: Zone			
	To Zone:		From Zone:	
	Share %	Trips	Share %	Trips
1: Zone	0.00	0	0.00	0
2: Zone	0.00	0	0.00	0
3: Zone	0.00	0	0.00	0
4: Zone	0.00	0	0.00	0
6: Zone	0.00	0	0.00	0
31: Zone	0.00	0	0.00	0
32: Zone	0.00	0	0.00	0

Zone / Gate	Zone 6: Zone			
	To Zone:		From Zone:	
	Share %	Trips	Share %	Trips
1: Zone	0.00	0	0.00	0
2: Zone	0.00	0	0.00	0
3: Zone	0.00	0	0.00	0
4: Zone	0.00	0	0.00	0
5: Zone	0.00	0	0.00	0
31: Zone	0.00	0	0.00	0
32: Zone	0.00	0	0.00	0

Version 2023 (SP 0-7)

7: Gate	2.00	0	2.00	0
8: Gate	3.00	0	3.00	0
9: Gate	2.00	0	2.00	0
10: Gate	1.00	0	1.00	0
11: Gate	5.00	0	5.00	0
12: Gate	62.00	1	62.00	2
13: Gate	5.00	0	5.00	0
14: Gate	20.00	0	20.00	1
Total	100.00	1	100.00	3

7: Gate	2.00	0	2.00	0
8: Gate	3.00	0	3.00	1
9: Gate	2.00	0	2.00	0
10: Gate	1.00	0	1.00	0
11: Gate	5.00	0	5.00	1
12: Gate	62.00	4	62.00	11
13: Gate	5.00	0	5.00	1
14: Gate	20.00	1	20.00	4
Total	100.00	5	100.00	18

Zone / Gate	Zone 31: Zone			
	To Zone:		From Zone:	
	Share %	Trips	Share %	Trips
1: Zone	0.00	0	0.00	0
2: Zone	0.00	0	0.00	0
3: Zone	0.00	0	0.00	0
4: Zone	0.00	0	0.00	0
5: Zone	0.00	0	0.00	0
6: Zone	0.00	0	0.00	0
32: Zone	0.00	0	0.00	0
7: Gate	5.00	0	1.00	0
8: Gate	35.00	2	25.00	1
9: Gate	15.00	1	5.00	0
10: Gate	0.00	0	0.00	0
11: Gate	0.00	0	0.00	0
12: Gate	25.00	2	59.00	3
13: Gate	0.00	0	0.00	0
14: Gate	20.00	1	10.00	0
Total	100.00	6	100.00	4

Zone / Gate	Zone 32: Zone			
	To Zone:		From Zone:	
	Share %	Trips	Share %	Trips
1: Zone	0.00	0	0.00	0
2: Zone	0.00	0	0.00	0
3: Zone	0.00	0	0.00	0
4: Zone	0.00	0	0.00	0
5: Zone	0.00	0	0.00	0
6: Zone	0.00	0	0.00	0
31: Zone	0.00	0	0.00	0
7: Gate	15.00	1	5.00	0
8: Gate	25.00	2	10.00	1
9: Gate	30.00	2	10.00	1
10: Gate	0.00	0	0.00	0
11: Gate	10.00	1	15.00	1
12: Gate	5.00	0	50.00	1
13: Gate	0.00	0	0.00	0
14: Gate	15.00	1	10.00	1
Total	100.00	7	100.00	5

Lane Configuration and Traffic Control

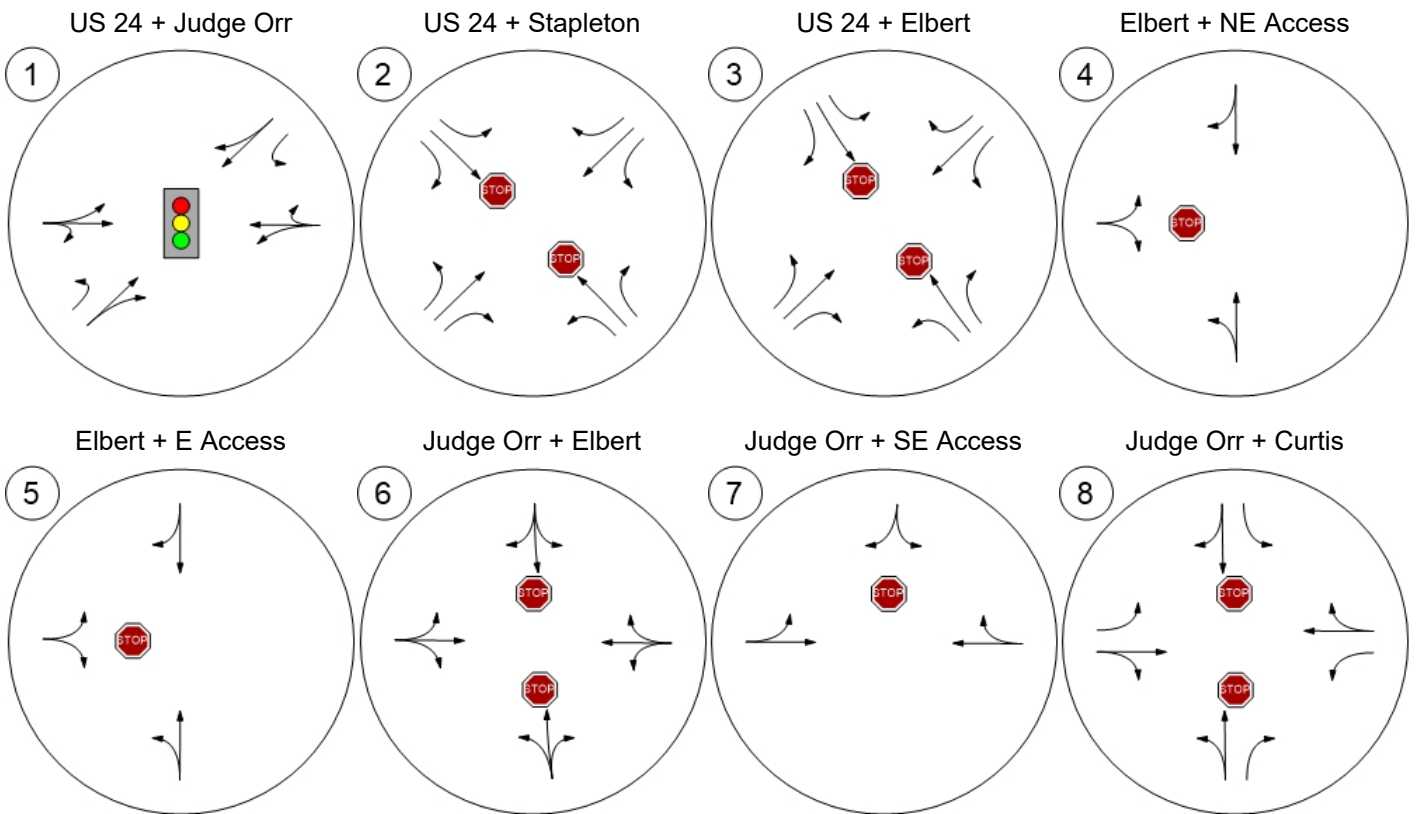

Lane Configuration and Traffic Control

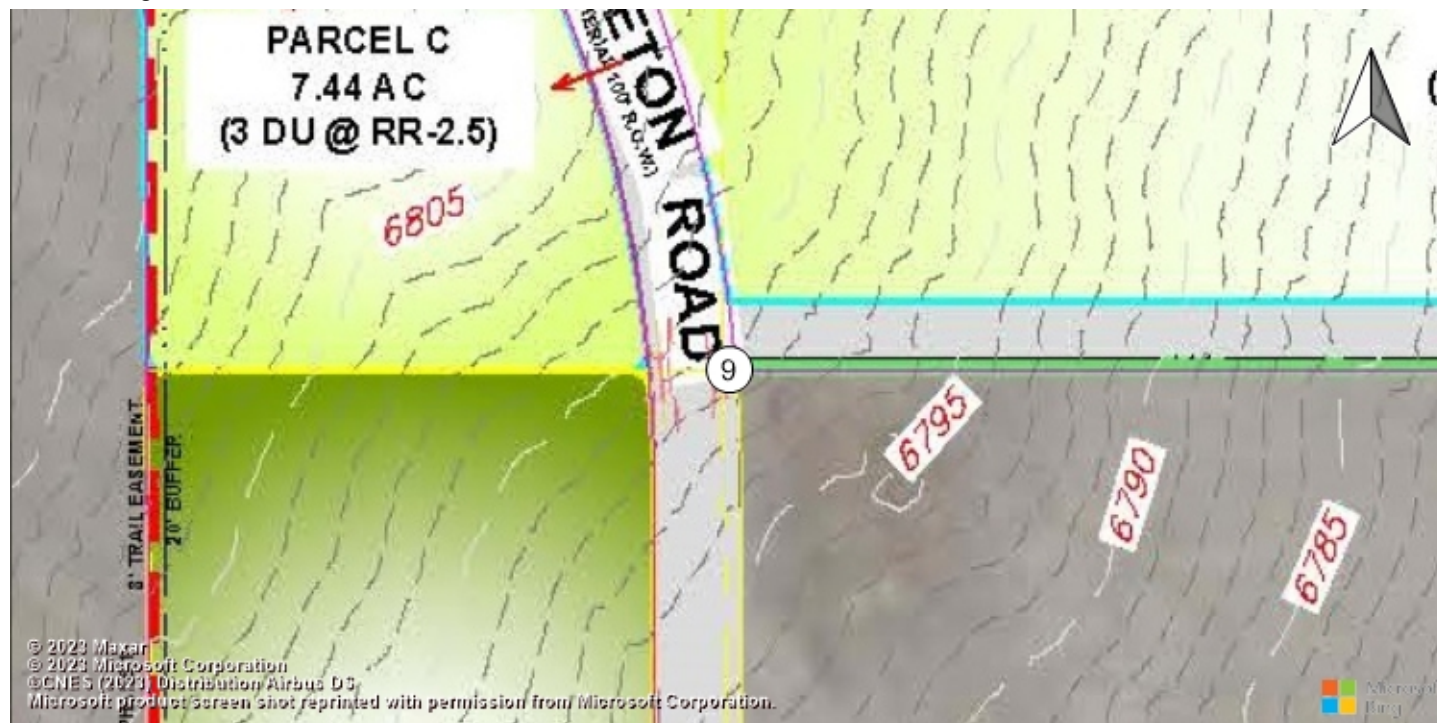

Stapleton + W Access

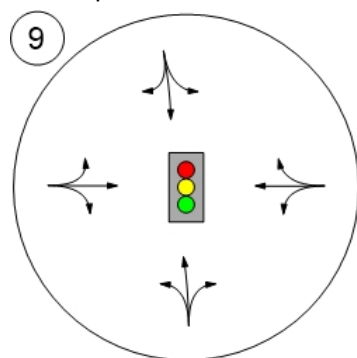

Please clarify that the base volume is existing counts and future total volume is existing (including short term background) + site trips. This can be done in the narrative.

Traffic Volume - Base Volume

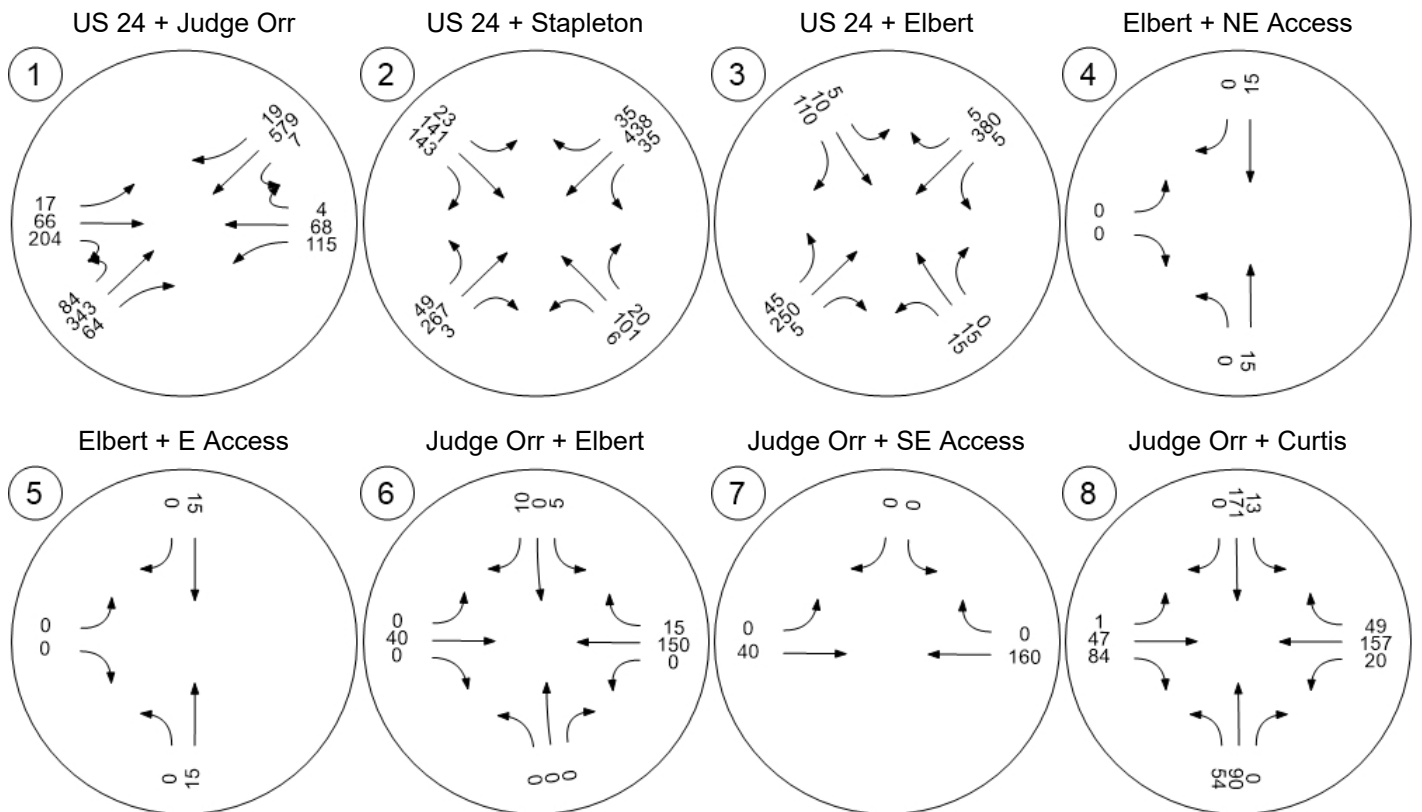

Traffic Volume - Base Volume

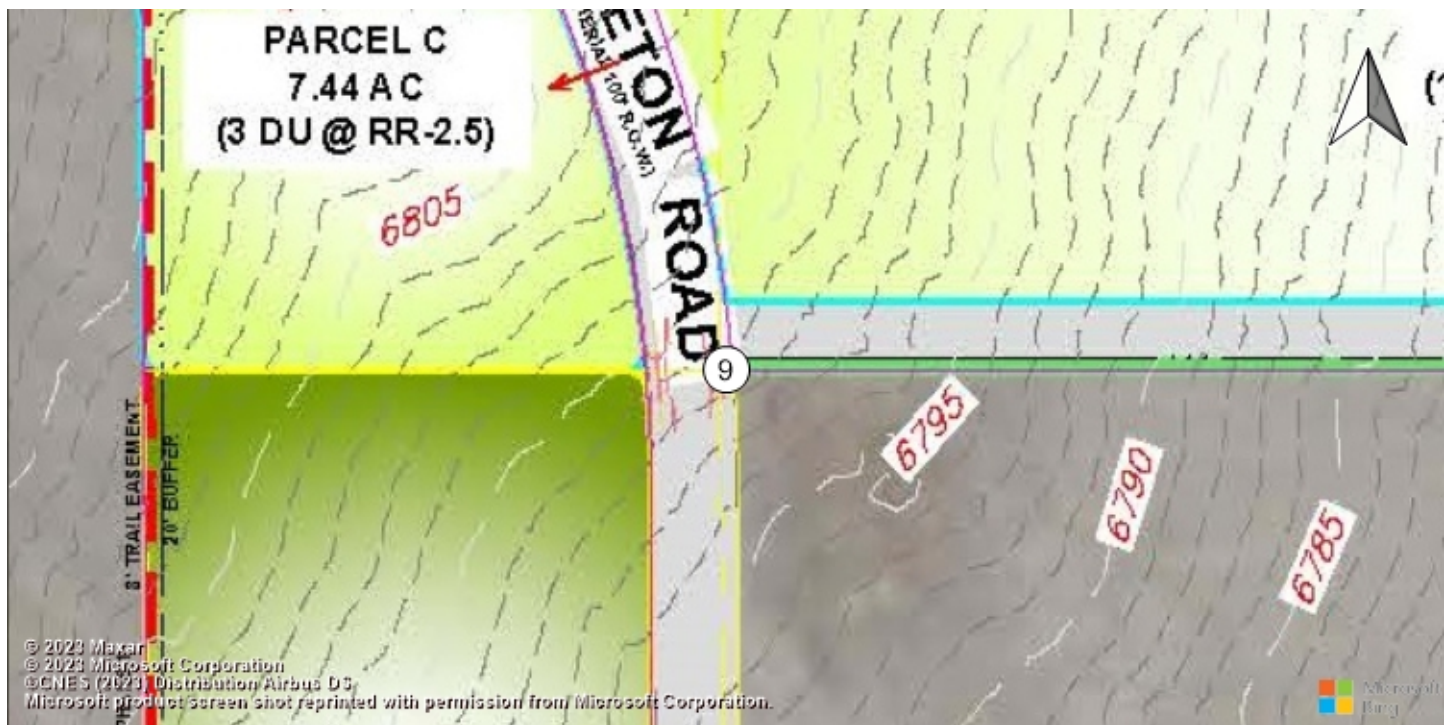

Stapleton + W Access

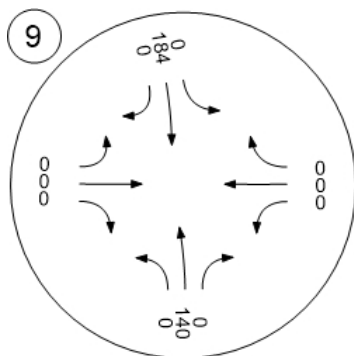

Traffic Volume - Net New Site Trips

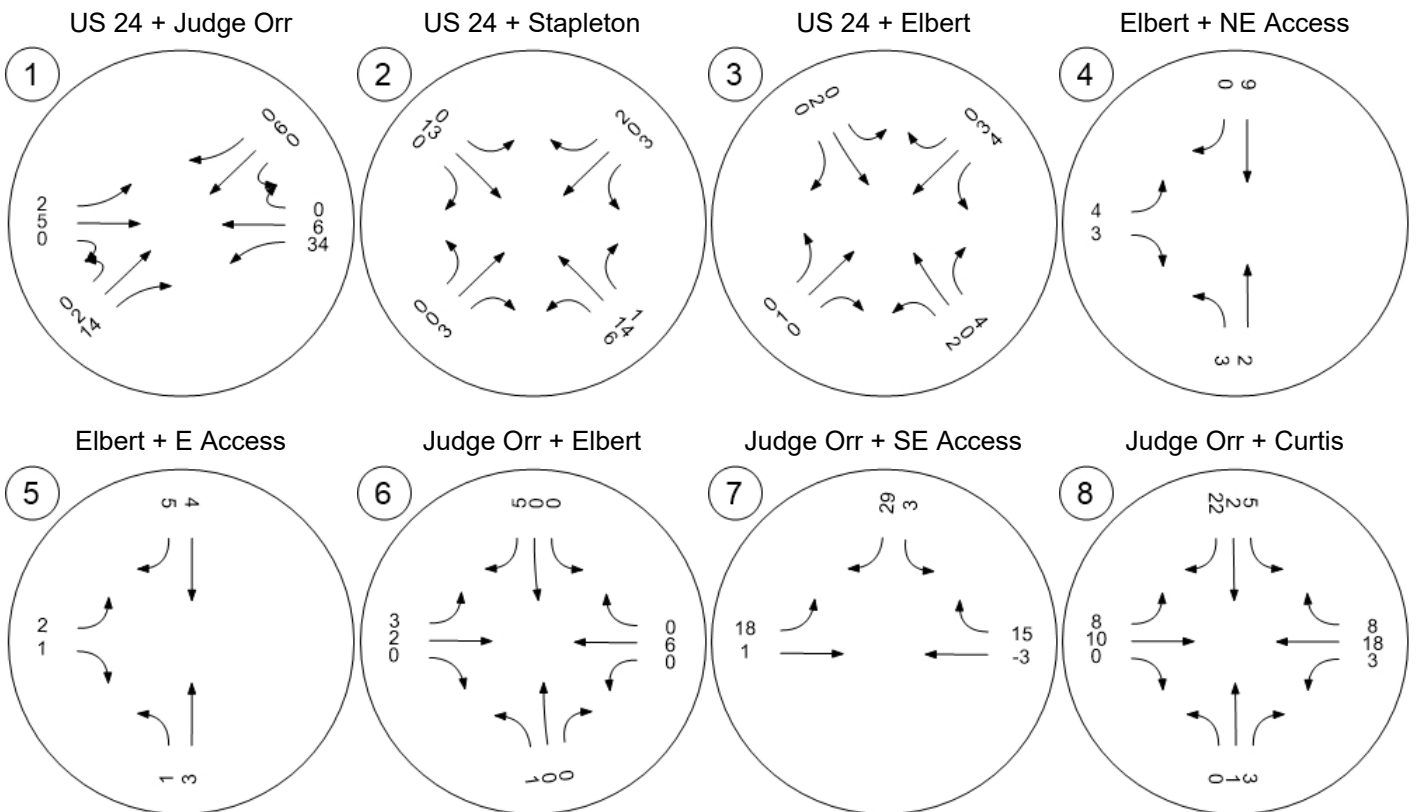

Traffic Volume - Net New Site Trips

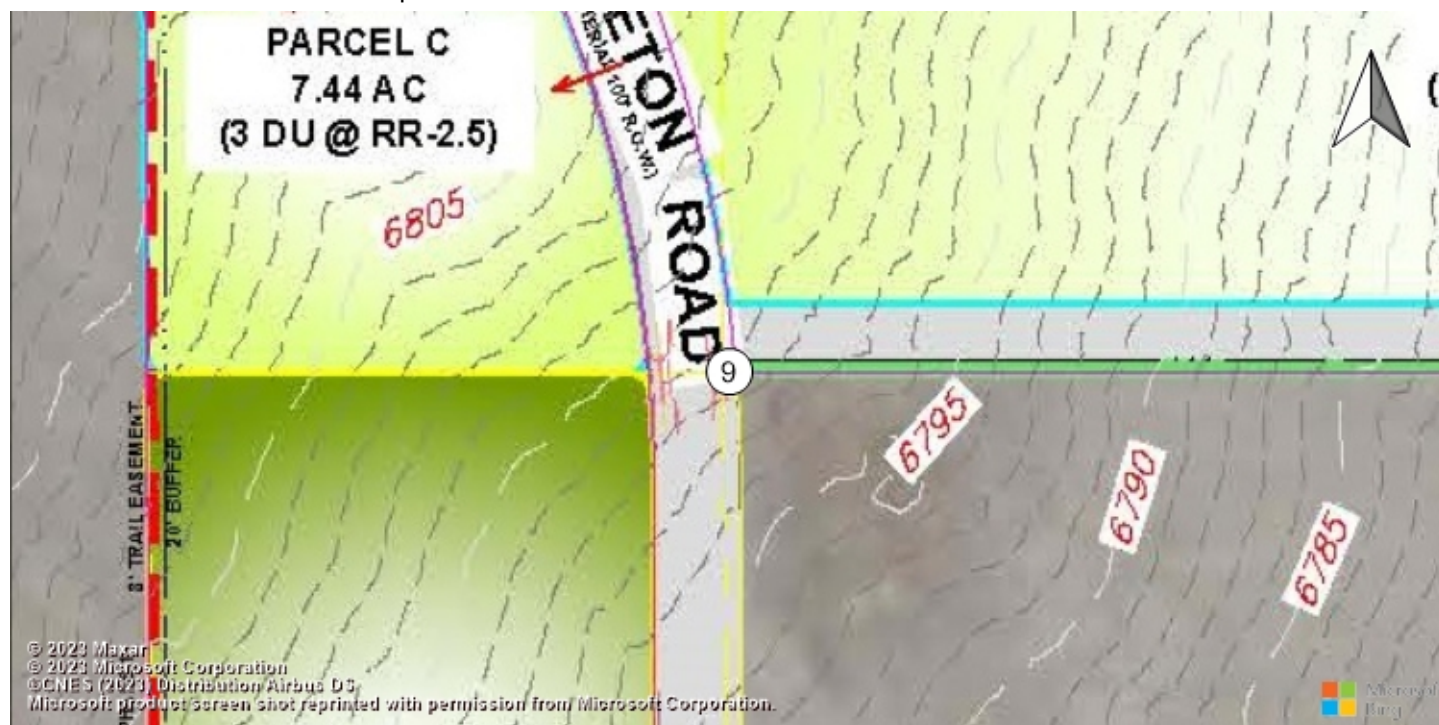

Stapleton + W Access

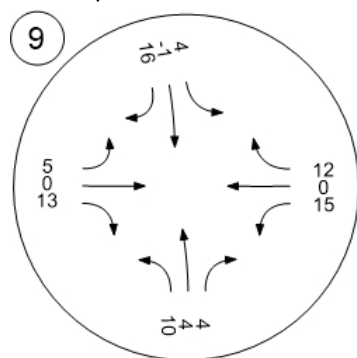

Traffic Volume - Future Total Volume

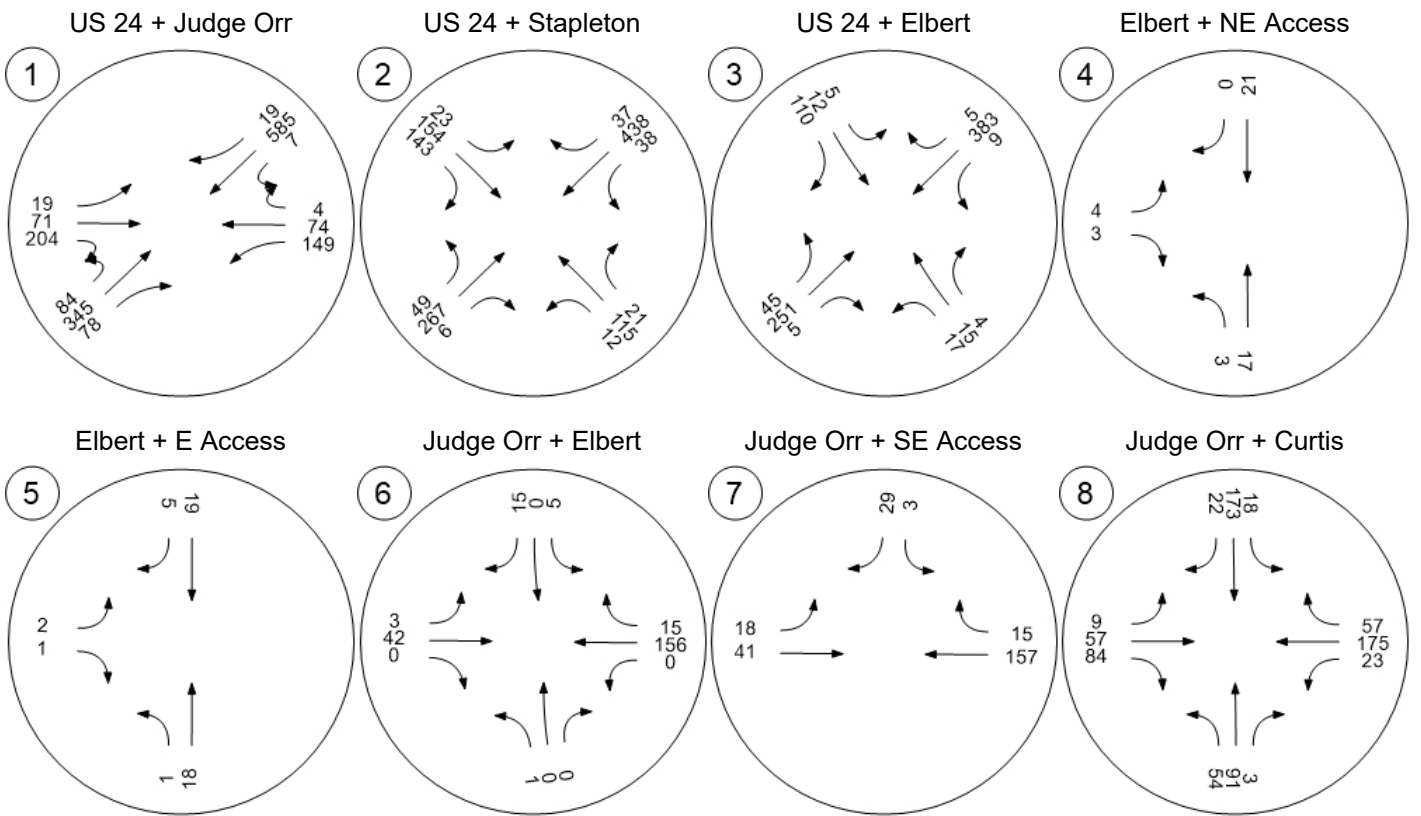

Traffic Volume - Future Total Volume

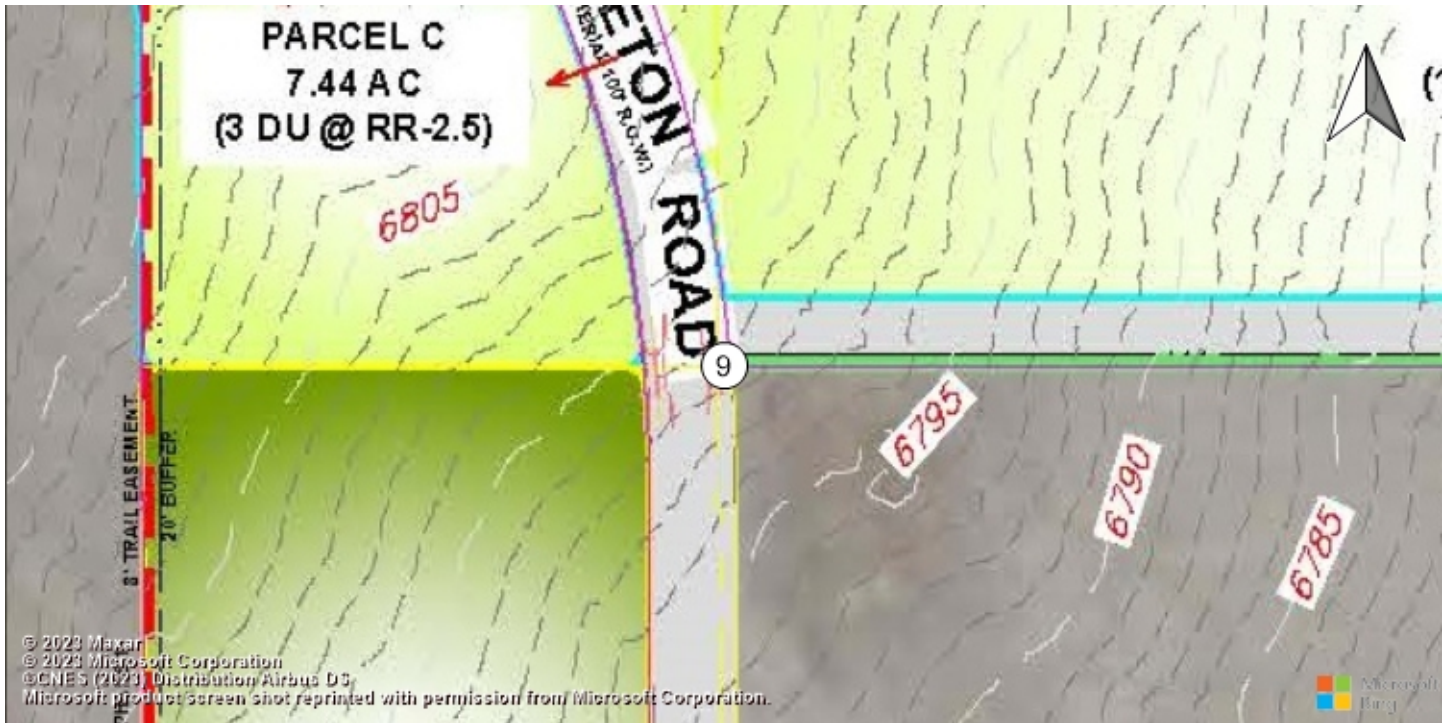

Stapleton + W Access

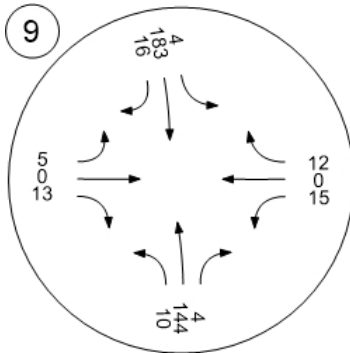

Davis Ranch Sketch Plan

Vistro File: G:\...\Davis Subdivision -- Vistro.vistro

Scenario 2 2023 PM

Report File: G:\...\2023 PM.pdf

7/7/2023

Trip Distribution summary

Zone / Gate	Zone 1: Zone			
	To Zone:		From Zone:	
	Share %	Trips	Share %	Trips
2: Zone	0.00	0	0.00	0
3: Zone	0.00	0	0.00	0
4: Zone	0.00	0	0.00	0
5: Zone	0.00	0	0.00	0
6: Zone	0.00	0	0.00	0
31: Zone	0.00	0	0.00	0
32: Zone	0.00	0	0.00	0
7: Gate	2.00	1	2.00	0
8: Gate	3.00	1	3.00	0
9: Gate	2.00	1	2.00	0
10: Gate	1.00	0	1.00	0
11: Gate	5.00	1	5.00	1
12: Gate	62.00	16	62.00	9
13: Gate	5.00	1	5.00	1
14: Gate	20.00	5	20.00	3
Total	100.00	26	100.00	14

Zone / Gate	Zone 2: Zone			
	To Zone:		From Zone:	
	Share %	Trips	Share %	Trips
1: Zone	0.00	0	0.00	0
3: Zone	0.00	0	0.00	0
4: Zone	0.00	0	0.00	0
5: Zone	0.00	0	0.00	0
6: Zone	0.00	0	0.00	0
31: Zone	0.00	0	0.00	0
32: Zone	0.00	0	0.00	0
7: Gate	3.00	1	3.00	1
8: Gate	7.00	2	7.00	2
9: Gate	5.00	1	5.00	1
10: Gate	1.00	0	1.00	0
11: Gate	11.00	3	11.00	3
12: Gate	10.00	3	10.00	3
13: Gate	28.00	7	28.00	7
14: Gate	35.00	9	35.00	9
Total	100.00	26	100.00	26

Zone / Gate	Zone 3: Zone			
	To Zone:		From Zone:	
	Share %	Trips	Share %	Trips
1: Zone	0.00	0	0.00	0
2: Zone	0.00	0	0.00	0
4: Zone	0.00	0	0.00	0
5: Zone	0.00	0	0.00	0
6: Zone	0.00	0	0.00	0
31: Zone	0.00	0	0.00	0
32: Zone	0.00	0	0.00	0
7: Gate	5.00	2	5.00	2
8: Gate	15.00	5	15.00	5
9: Gate	12.00	4	12.00	4
10: Gate	4.00	1	4.00	1
11: Gate	12.00	4	12.00	4
12: Gate	7.00	2	7.00	2
13: Gate	20.00	6	20.00	7
14: Gate	25.00	8	25.00	8
Total	100.00	32	100.00	33

Zone / Gate	Zone 4: Zone			
	To Zone:		From Zone:	
	Share %	Trips	Share %	Trips
1: Zone	0.00	0	0.00	0
2: Zone	0.00	0	0.00	0
3: Zone	0.00	0	0.00	0
5: Zone	0.00	0	0.00	0
6: Zone	0.00	0	0.00	0
31: Zone	0.00	0	0.00	0
32: Zone	0.00	0	0.00	0
7: Gate	2.00	0	2.00	0
8: Gate	3.00	0	3.00	0
9: Gate	2.00	0	2.00	0
10: Gate	1.00	0	1.00	0
11: Gate	5.00	0	5.00	0
12: Gate	62.00	6	62.00	5
13: Gate	5.00	0	5.00	0
14: Gate	20.00	2	20.00	1
Total	100.00	8	100.00	6

Zone / Gate	Zone 5: Zone			
	To Zone:		From Zone:	
	Share %	Trips	Share %	Trips
1: Zone	0.00	0	0.00	0
2: Zone	0.00	0	0.00	0
3: Zone	0.00	0	0.00	0
4: Zone	0.00	0	0.00	0
6: Zone	0.00	0	0.00	0
31: Zone	0.00	0	0.00	0
32: Zone	0.00	0	0.00	0

Zone / Gate	Zone 6: Zone			
	To Zone:		From Zone:	
	Share %	Trips	Share %	Trips
1: Zone	0.00	0	0.00	0
2: Zone	0.00	0	0.00	0
3: Zone	0.00	0	0.00	0
4: Zone	0.00	0	0.00	0
5: Zone	0.00	0	0.00	0
31: Zone	0.00	0	0.00	0
32: Zone	0.00	0	0.00	0

Version 2023 (SP 0-7)

7: Gate	2.00	0	2.00	0
8: Gate	3.00	0	3.00	0
9: Gate	2.00	0	2.00	0
10: Gate	1.00	0	1.00	0
11: Gate	5.00	0	5.00	0
12: Gate	62.00	2	62.00	2
13: Gate	5.00	0	5.00	0
14: Gate	20.00	1	20.00	0
Total	100.00	3	100.00	2

7: Gate	2.00	0	2.00	0
8: Gate	3.00	1	3.00	0
9: Gate	2.00	0	2.00	0
10: Gate	1.00	0	1.00	0
11: Gate	5.00	1	5.00	1
12: Gate	62.00	13	62.00	8
13: Gate	5.00	1	5.00	1
14: Gate	20.00	4	20.00	2
Total	100.00	20	100.00	12

Zone / Gate	Zone 31: Zone			
	To Zone:		From Zone:	
	Share %	Trips	Share %	Trips
1: Zone	0.00	0	0.00	0
2: Zone	0.00	0	0.00	0
3: Zone	0.00	0	0.00	0
4: Zone	0.00	0	0.00	0
5: Zone	0.00	0	0.00	0
6: Zone	0.00	0	0.00	0
32: Zone	0.00	0	0.00	0
7: Gate	1.00	0	5.00	1
8: Gate	15.00	2	30.00	4
9: Gate	5.00	1	25.00	4
10: Gate	0.00	0	0.00	0
11: Gate	0.00	0	15.00	2
12: Gate	64.00	9	15.00	2
13: Gate	0.00	0	5.00	1
14: Gate	15.00	2	5.00	1
Total	100.00	14	100.00	15

Zone / Gate	Zone 32: Zone			
	To Zone:		From Zone:	
	Share %	Trips	Share %	Trips
1: Zone	0.00	0	0.00	0
2: Zone	0.00	0	0.00	0
3: Zone	0.00	0	0.00	0
4: Zone	0.00	0	0.00	0
5: Zone	0.00	0	0.00	0
6: Zone	0.00	0	0.00	0
31: Zone	0.00	0	0.00	0
7: Gate	2.00	0	5.00	1
8: Gate	10.00	2	25.00	5
9: Gate	20.00	4	30.00	5
10: Gate	0.00	0	0.00	0
11: Gate	28.00	5	15.00	3
12: Gate	35.00	6	15.00	3
13: Gate	0.00	0	0.00	0
14: Gate	5.00	1	10.00	2
Total	100.00	18	100.00	19

Lane Configuration and Traffic Control

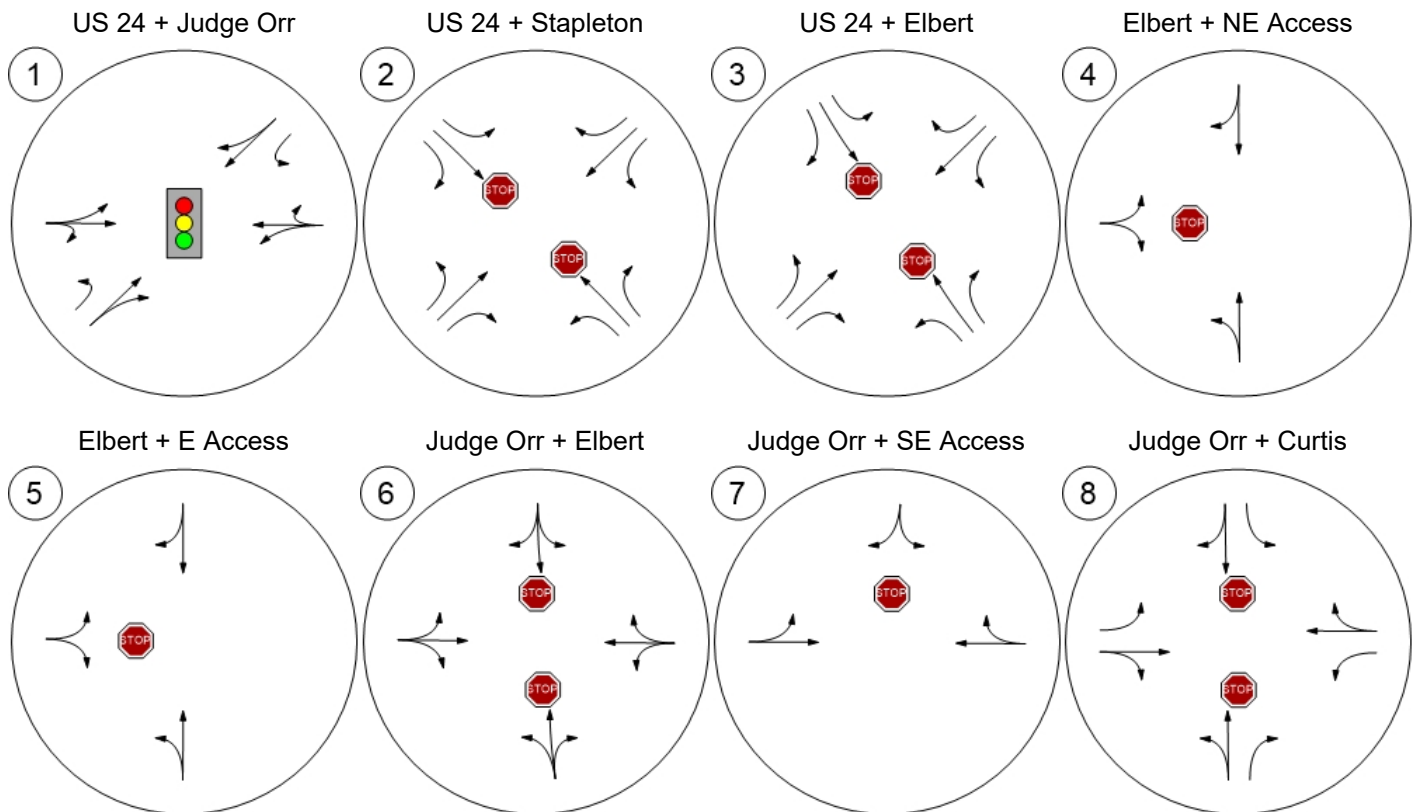

Lane Configuration and Traffic Control

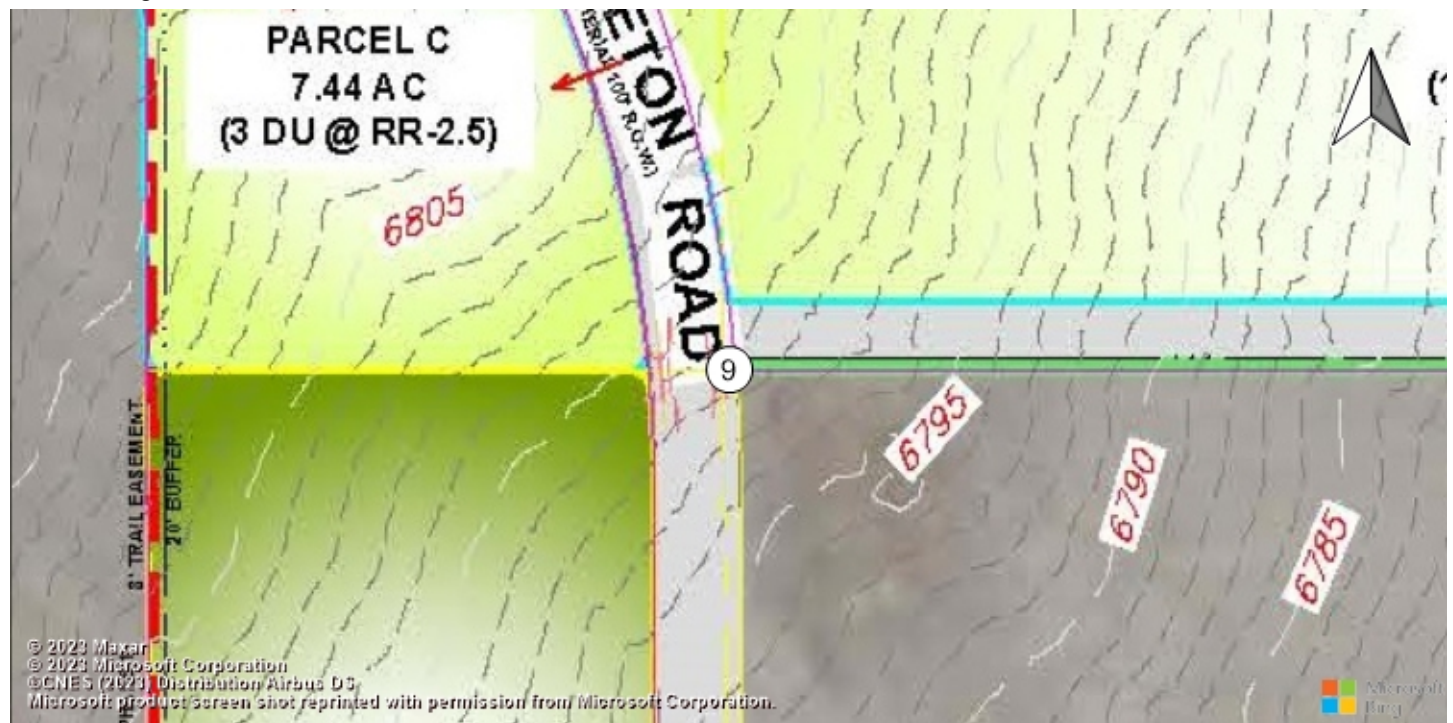

Stapleton + W Access

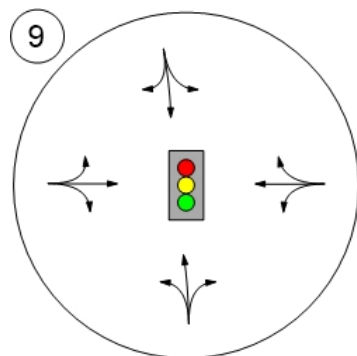

Traffic Volume - Base Volume

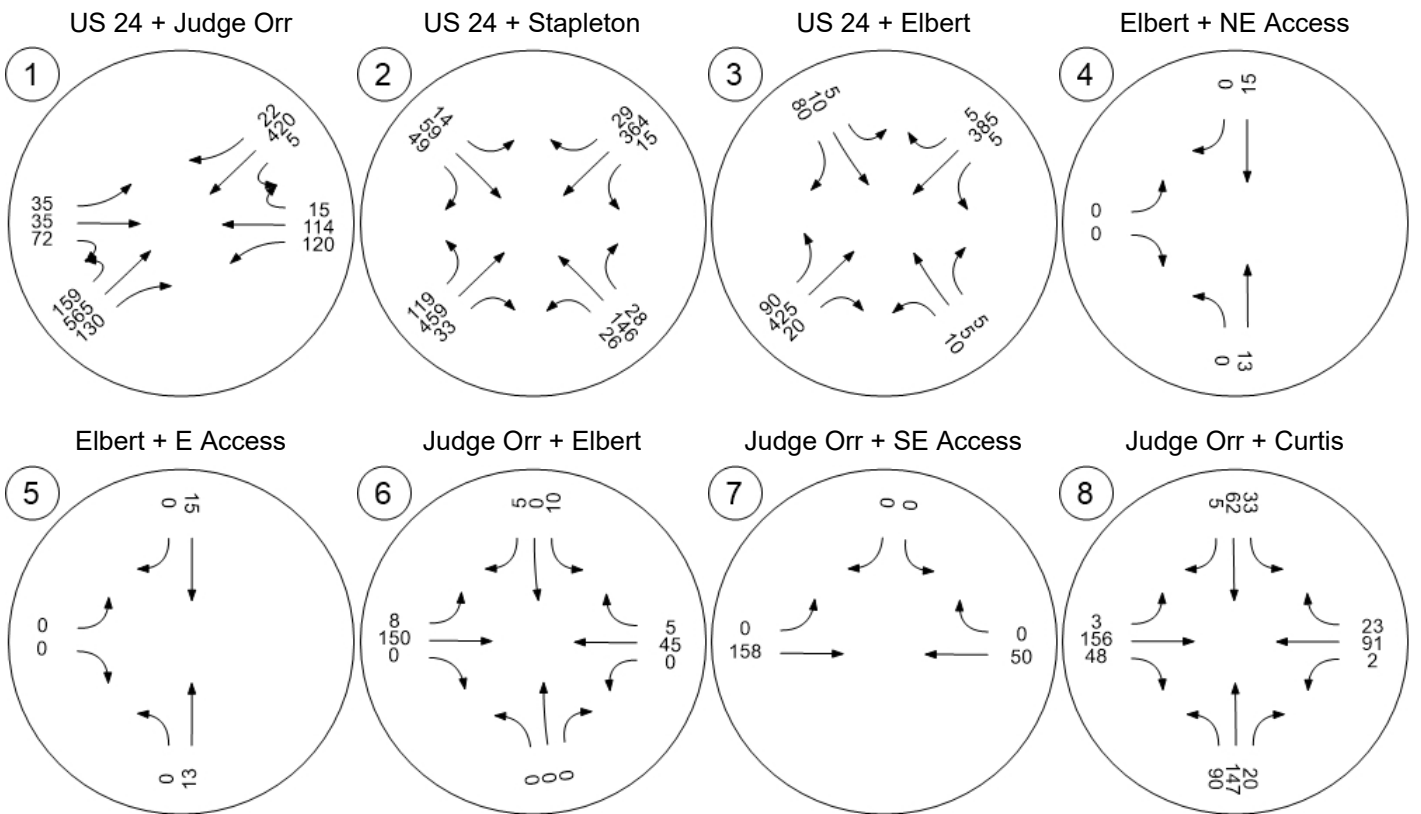

Traffic Volume - Base Volume

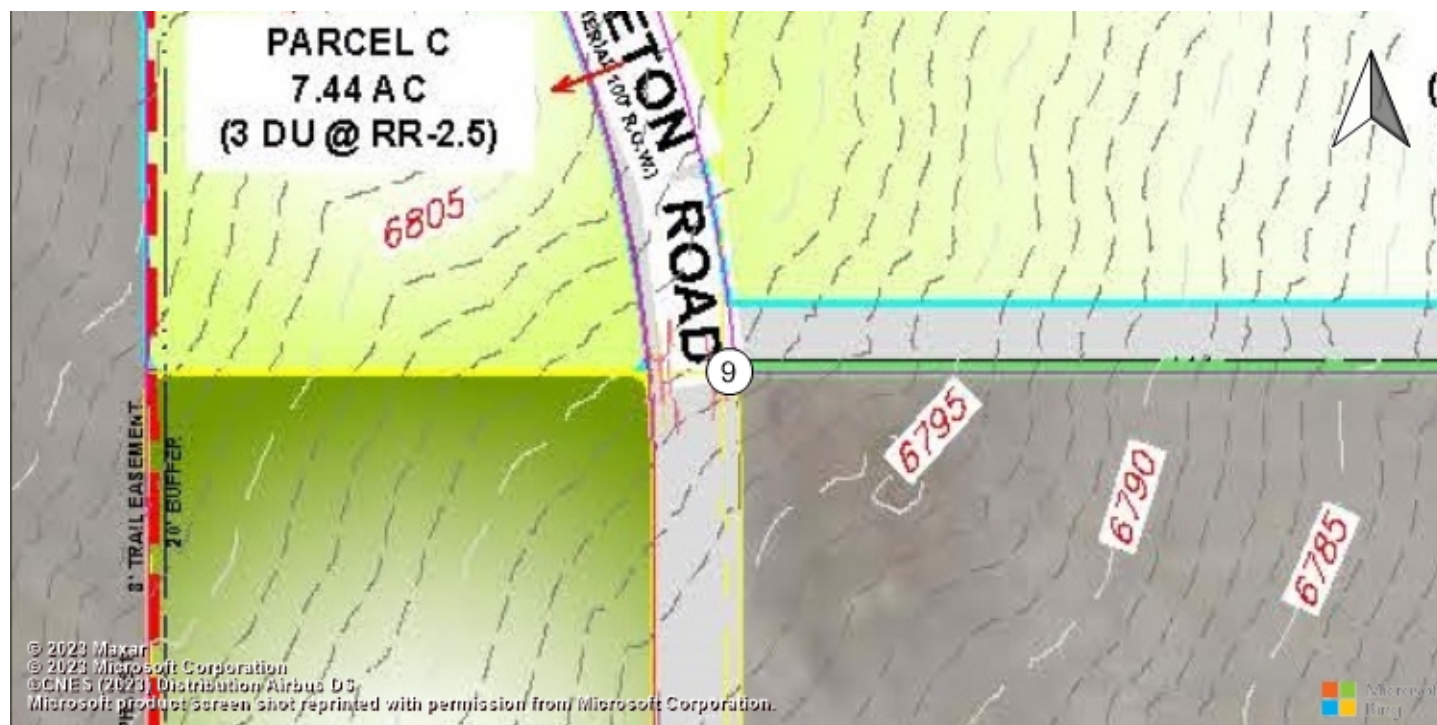

Stapleton + W Access

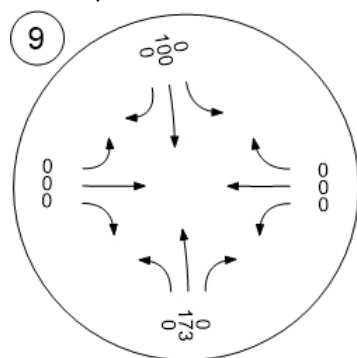

Traffic Volume - Net New Site Trips

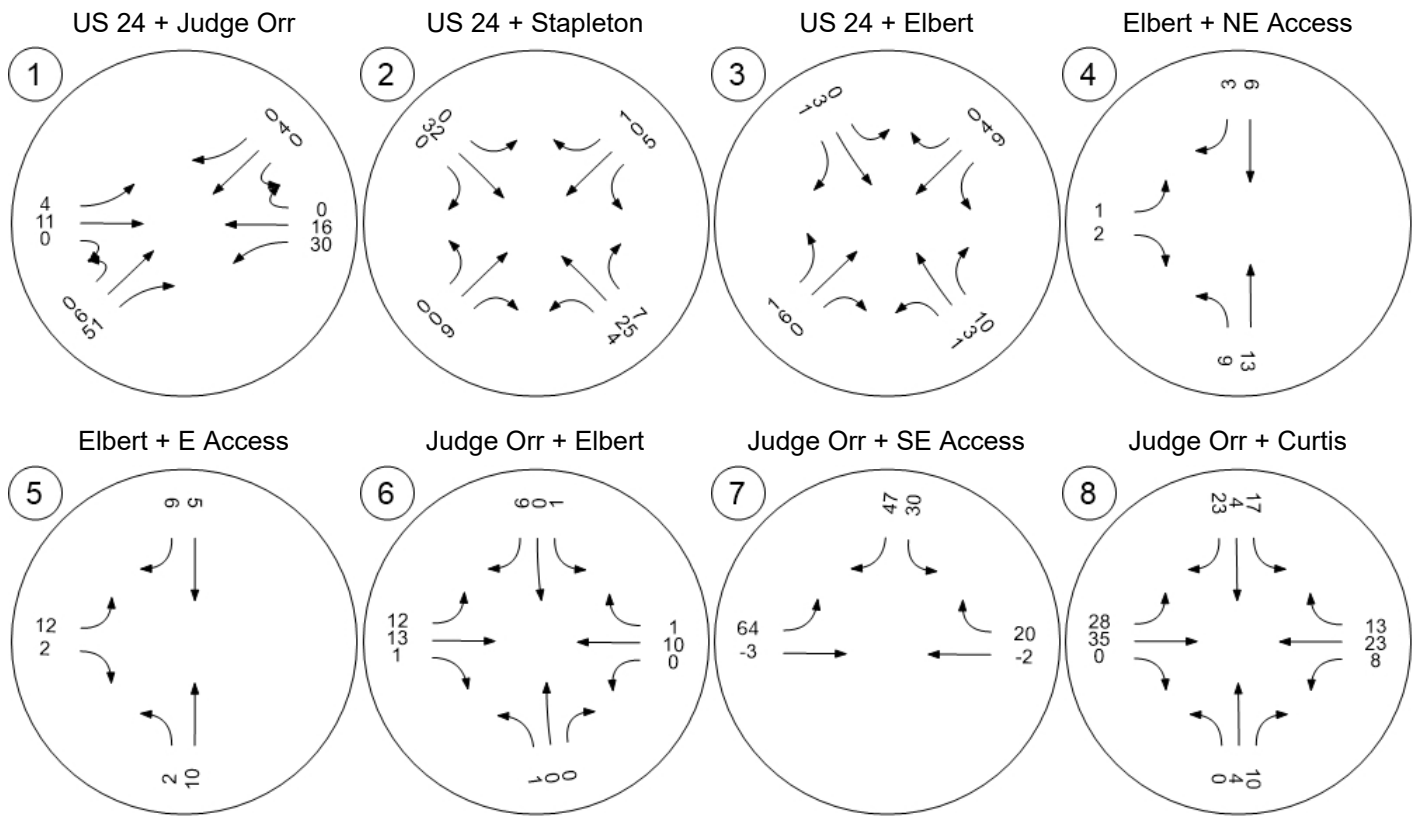

Traffic Volume - Net New Site Trips

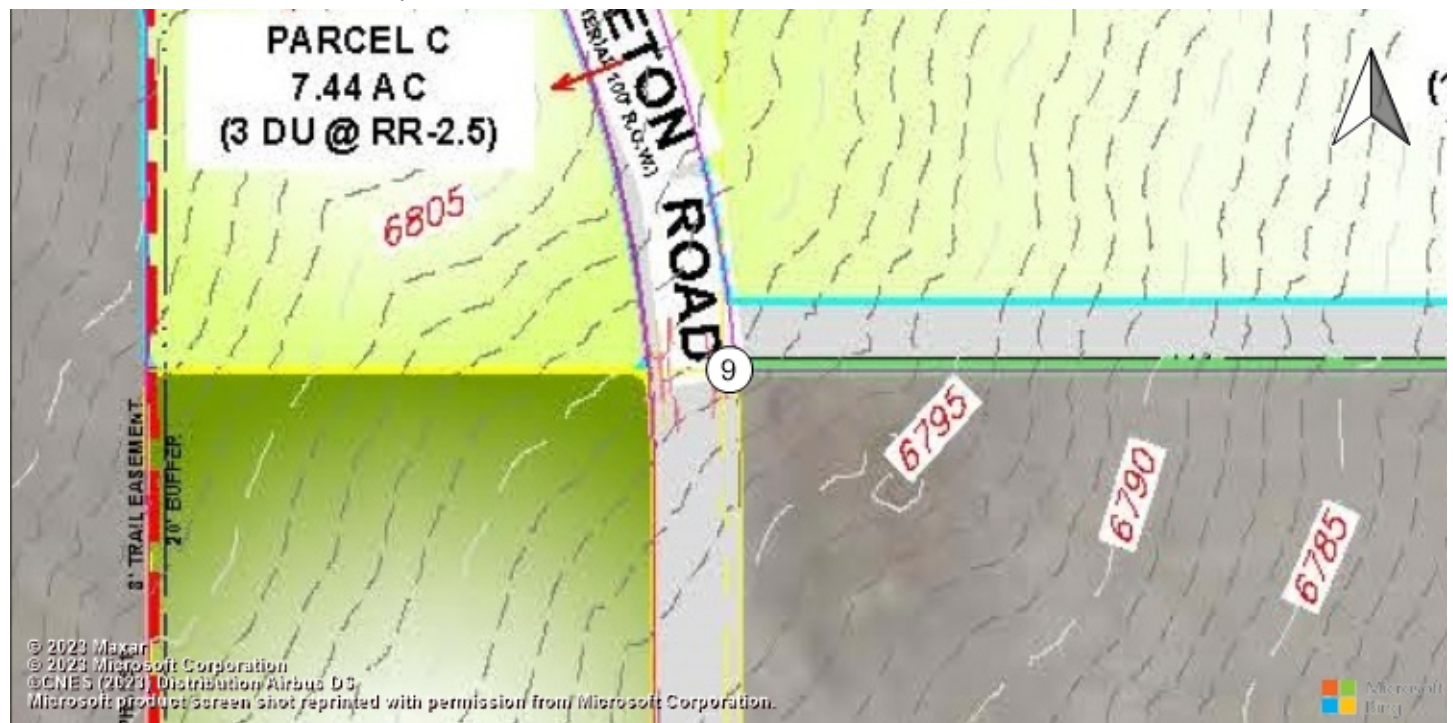

Stapleton + W Access

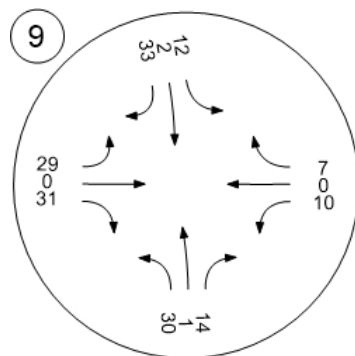

Traffic Volume - Future Total Volume

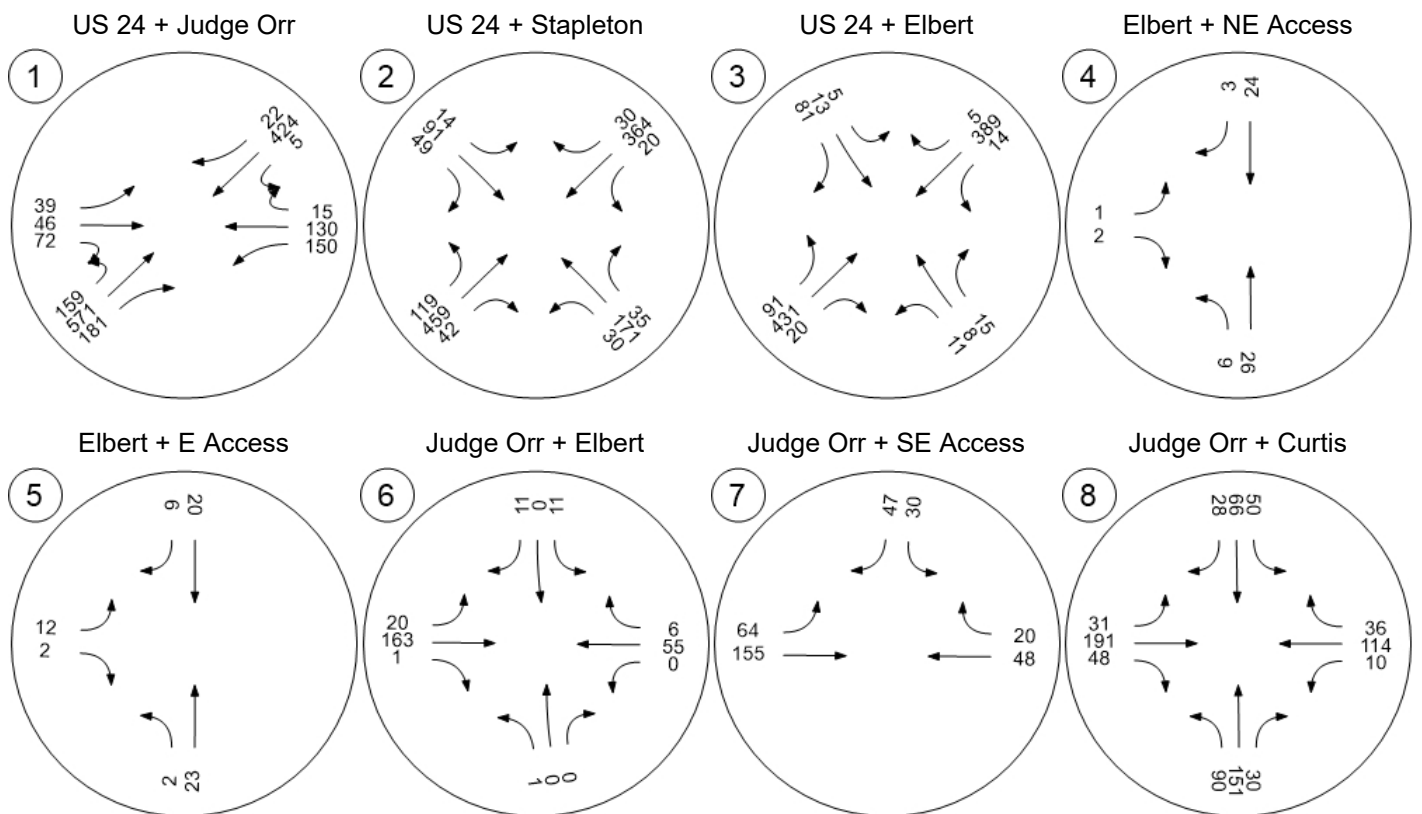

Traffic Volume - Future Total Volume

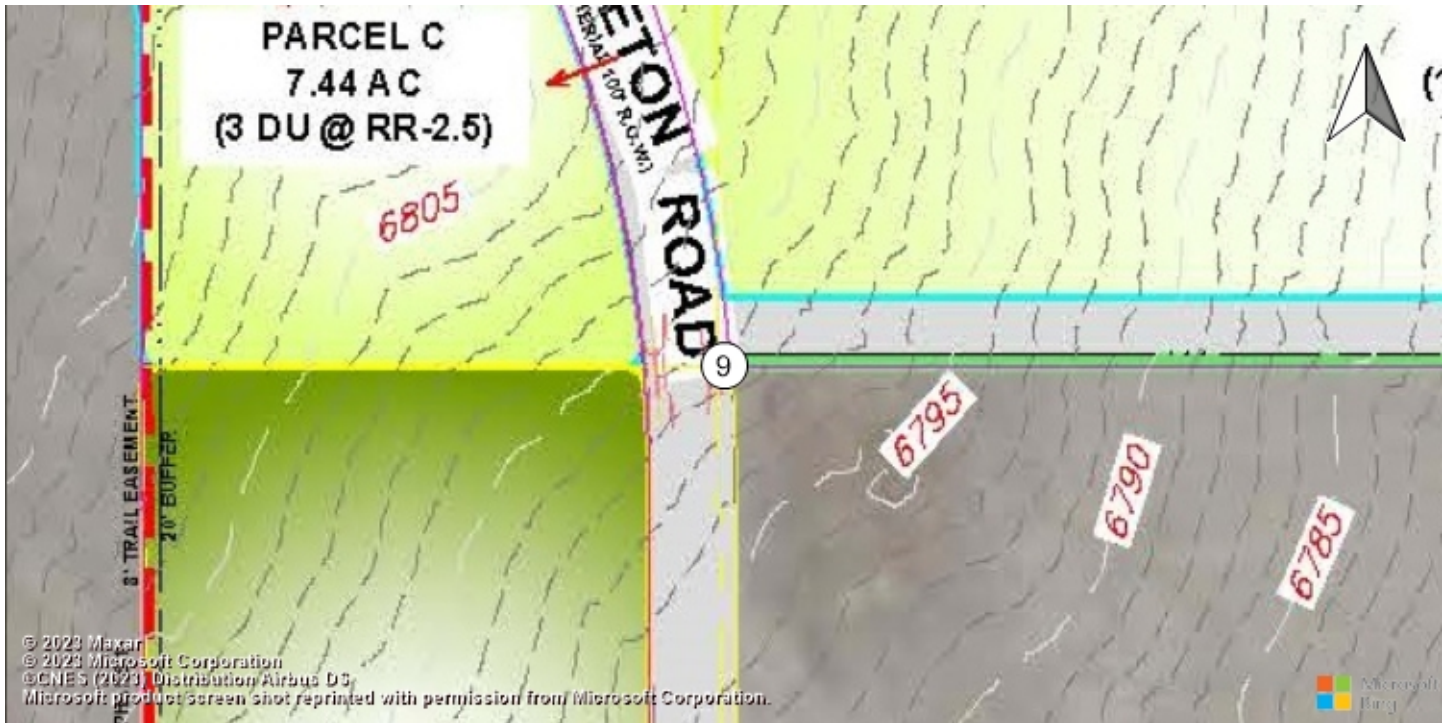

Stapleton + W Access

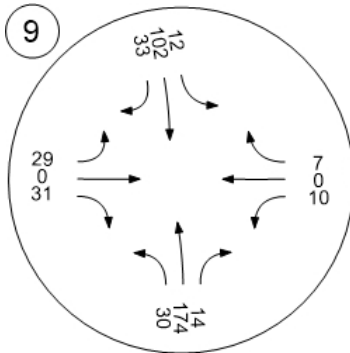

Davis Ranch Sketch Plan

Vistro File: G:\...\Davis Subdivision -- Vistro.vistro

Scenario 3 2043 AM

Report File: G:\...\2043 AM.pdf

7/7/2023

Trip Distribution summary

Zone / Gate	Zone 1: Zone			
	To Zone:		From Zone:	
	Share %	Trips	Share %	Trips
2: Zone	0.00	0	0.00	0
3: Zone	0.00	0	0.00	0
4: Zone	0.00	0	0.00	0
5: Zone	0.00	0	0.00	0
6: Zone	0.00	0	0.00	0
31: Zone	0.00	0	0.00	0
32: Zone	0.00	0	0.00	0
7: Gate	2.00	0	2.00	0
8: Gate	3.00	0	3.00	1
9: Gate	2.00	0	2.00	0
10: Gate	1.00	0	1.00	0
11: Gate	5.00	0	5.00	1
12: Gate	62.00	5	62.00	15
13: Gate	5.00	0	5.00	1
14: Gate	20.00	2	20.00	4
Total	100.00	7	100.00	22

Zone / Gate	Zone 2: Zone			
	To Zone:		From Zone:	
	Share %	Trips	Share %	Trips
1: Zone	0.00	0	0.00	0
3: Zone	0.00	0	0.00	0
4: Zone	0.00	0	0.00	0
5: Zone	0.00	0	0.00	0
6: Zone	0.00	0	0.00	0
31: Zone	0.00	0	0.00	0
32: Zone	0.00	0	0.00	0
7: Gate	3.00	0	3.00	0
8: Gate	7.00	1	7.00	0
9: Gate	5.00	1	5.00	0
10: Gate	1.00	0	1.00	0
11: Gate	11.00	1	11.00	1
12: Gate	10.00	1	10.00	1
13: Gate	28.00	3	28.00	2
14: Gate	35.00	4	35.00	2
Total	100.00	11	100.00	6

Zone / Gate	Zone 3: Zone			
	To Zone:		From Zone:	
	Share %	Trips	Share %	Trips
1: Zone	0.00	0	0.00	0
2: Zone	0.00	0	0.00	0
4: Zone	0.00	0	0.00	0
5: Zone	0.00	0	0.00	0
6: Zone	0.00	0	0.00	0
31: Zone	0.00	0	0.00	0
32: Zone	0.00	0	0.00	0
7: Gate	5.00	1	5.00	0
8: Gate	15.00	2	15.00	1
9: Gate	12.00	2	12.00	1
10: Gate	4.00	1	4.00	0
11: Gate	12.00	2	12.00	1
12: Gate	7.00	1	7.00	1
13: Gate	20.00	3	20.00	2
14: Gate	25.00	3	25.00	2
Total	100.00	15	100.00	8

Zone / Gate	Zone 4: Zone			
	To Zone:		From Zone:	
	Share %	Trips	Share %	Trips
1: Zone	0.00	0	0.00	0
2: Zone	0.00	0	0.00	0
3: Zone	0.00	0	0.00	0
5: Zone	0.00	0	0.00	0
6: Zone	0.00	0	0.00	0
31: Zone	0.00	0	0.00	0
32: Zone	0.00	0	0.00	0
7: Gate	2.00	0	2.00	0
8: Gate	3.00	0	3.00	0
9: Gate	2.00	0	2.00	0
10: Gate	1.00	0	1.00	0
11: Gate	5.00	0	5.00	0
12: Gate	62.00	2	62.00	6
13: Gate	5.00	0	5.00	0
14: Gate	20.00	1	20.00	2
Total	100.00	3	100.00	8

Zone / Gate	Zone 5: Zone			
	To Zone:		From Zone:	
	Share %	Trips	Share %	Trips
1: Zone	0.00	0	0.00	0
2: Zone	0.00	0	0.00	0
3: Zone	0.00	0	0.00	0
4: Zone	0.00	0	0.00	0
6: Zone	0.00	0	0.00	0
31: Zone	0.00	0	0.00	0
32: Zone	0.00	0	0.00	0

Zone / Gate	Zone 6: Zone			
	To Zone:		From Zone:	
	Share %	Trips	Share %	Trips
1: Zone	0.00	0	0.00	0
2: Zone	0.00	0	0.00	0
3: Zone	0.00	0	0.00	0
4: Zone	0.00	0	0.00	0
5: Zone	0.00	0	0.00	0
31: Zone	0.00	0	0.00	0
32: Zone	0.00	0	0.00	0

Version 2023 (SP 0-7)

7: Gate	2.00	0	2.00	0
8: Gate	3.00	0	3.00	0
9: Gate	2.00	0	2.00	0
10: Gate	1.00	0	1.00	0
11: Gate	5.00	0	5.00	0
12: Gate	62.00	1	62.00	2
13: Gate	5.00	0	5.00	0
14: Gate	20.00	0	20.00	1
Total	100.00	1	100.00	3

7: Gate	2.00	0	2.00	0
8: Gate	3.00	0	3.00	1
9: Gate	2.00	0	2.00	0
10: Gate	1.00	0	1.00	0
11: Gate	5.00	0	5.00	1
12: Gate	62.00	4	62.00	11
13: Gate	5.00	0	5.00	1
14: Gate	20.00	1	20.00	4
Total	100.00	5	100.00	18

Zone / Gate	Zone 31: Zone			
	To Zone:		From Zone:	
	Share %	Trips	Share %	Trips
1: Zone	0.00	0	0.00	0
2: Zone	0.00	0	0.00	0
3: Zone	0.00	0	0.00	0
4: Zone	0.00	0	0.00	0
5: Zone	0.00	0	0.00	0
6: Zone	0.00	0	0.00	0
32: Zone	0.00	0	0.00	0
7: Gate	5.00	0	1.00	0
8: Gate	35.00	2	25.00	1
9: Gate	15.00	1	5.00	0
10: Gate	0.00	0	0.00	0
11: Gate	0.00	0	0.00	0
12: Gate	25.00	2	59.00	3
13: Gate	0.00	0	0.00	0
14: Gate	20.00	1	10.00	0
Total	100.00	6	100.00	4

Zone / Gate	Zone 32: Zone			
	To Zone:		From Zone:	
	Share %	Trips	Share %	Trips
1: Zone	0.00	0	0.00	0
2: Zone	0.00	0	0.00	0
3: Zone	0.00	0	0.00	0
4: Zone	0.00	0	0.00	0
5: Zone	0.00	0	0.00	0
6: Zone	0.00	0	0.00	0
31: Zone	0.00	0	0.00	0
7: Gate	15.00	1	5.00	0
8: Gate	25.00	2	10.00	1
9: Gate	30.00	2	10.00	1
10: Gate	0.00	0	0.00	0
11: Gate	10.00	1	15.00	1
12: Gate	5.00	0	50.00	1
13: Gate	0.00	0	0.00	0
14: Gate	15.00	1	10.00	1
Total	100.00	7	100.00	5

Lane Configuration and Traffic Control

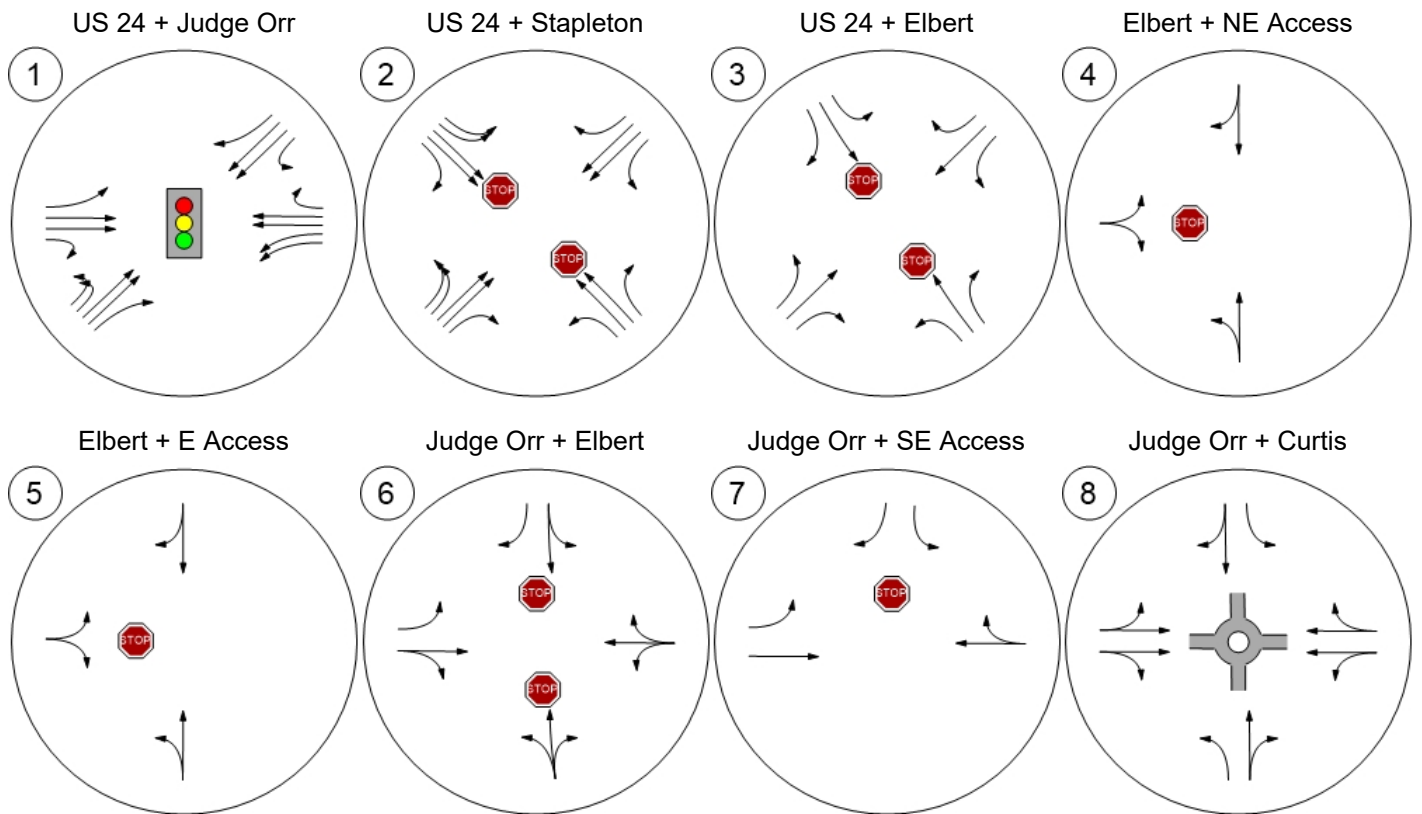

Lane Configuration and Traffic Control

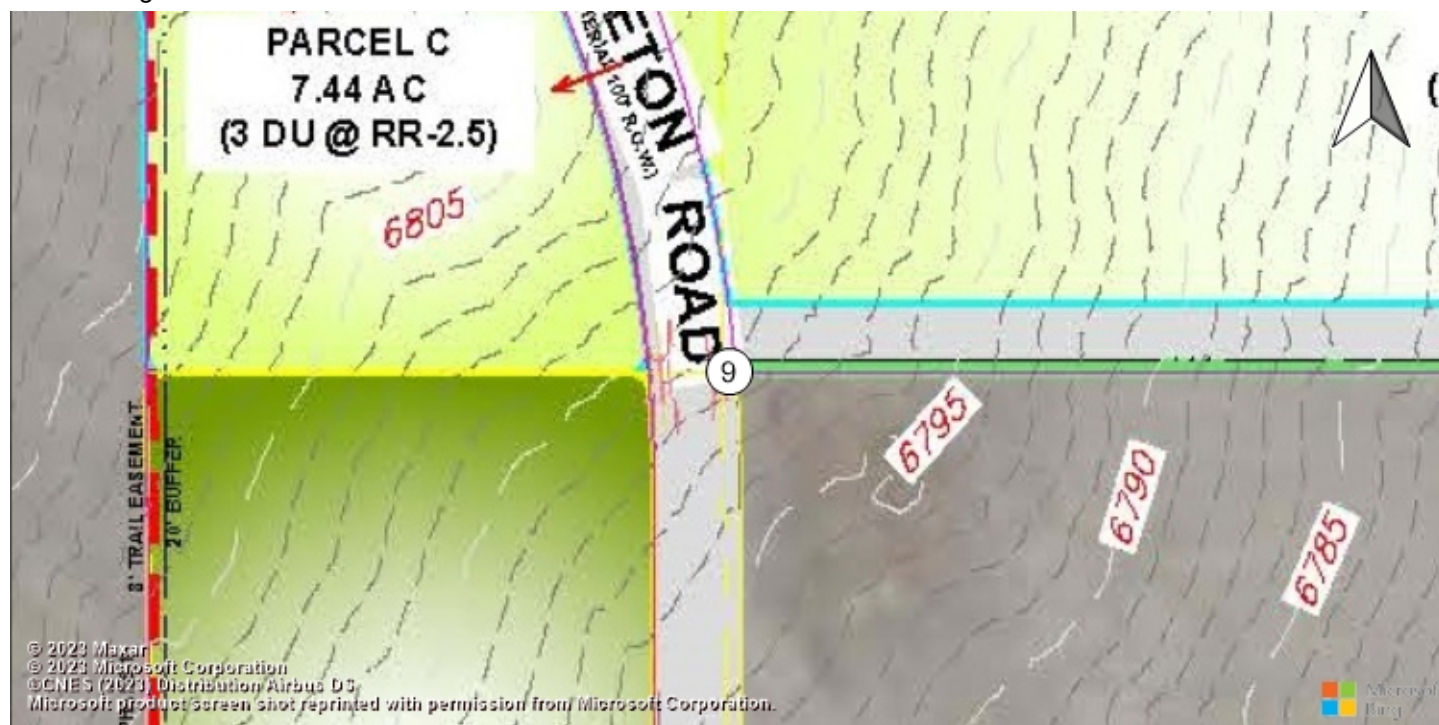

Stapleton + W Access

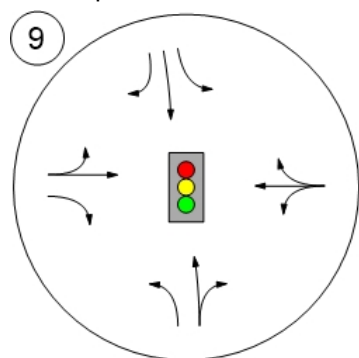

Traffic Volume - Base Volume

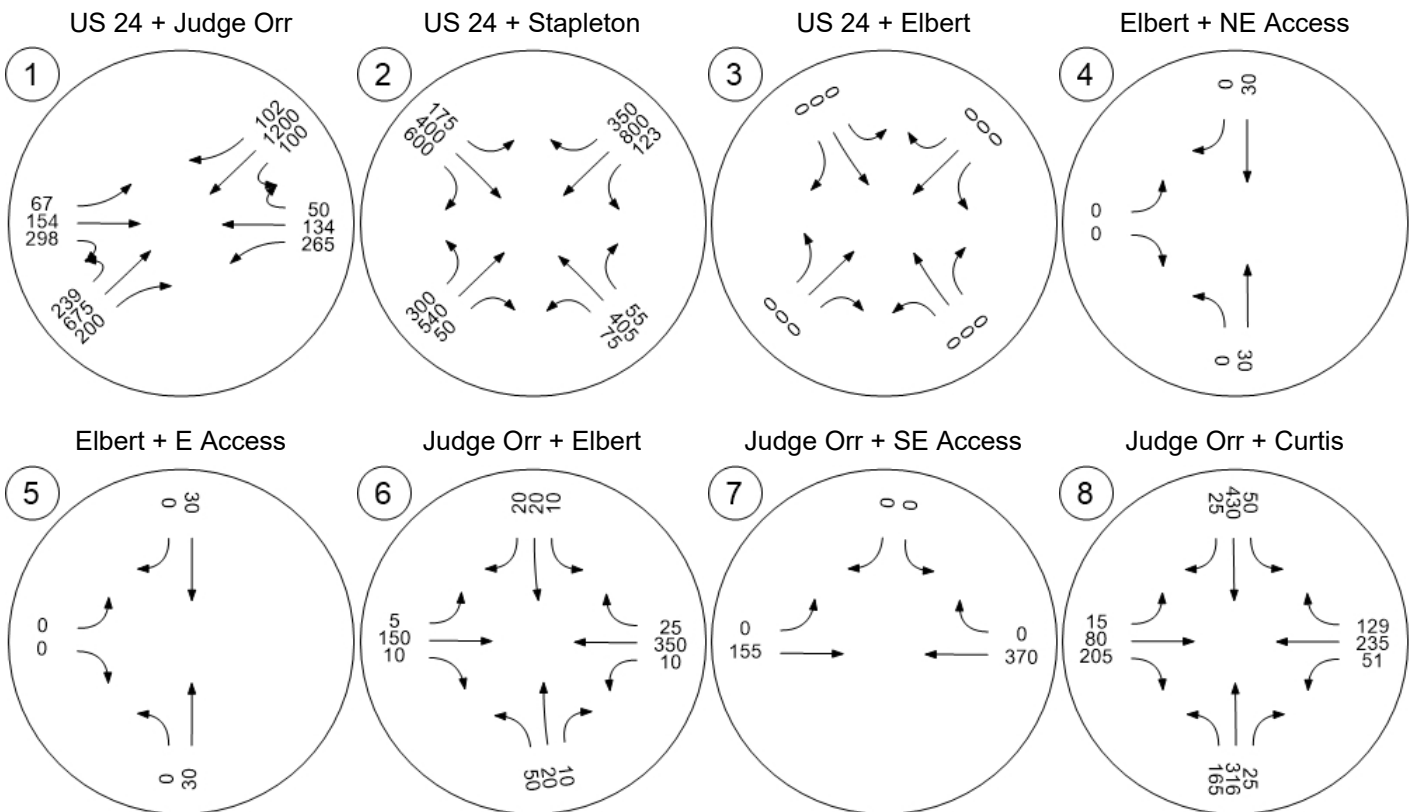

Traffic Volume - Base Volume

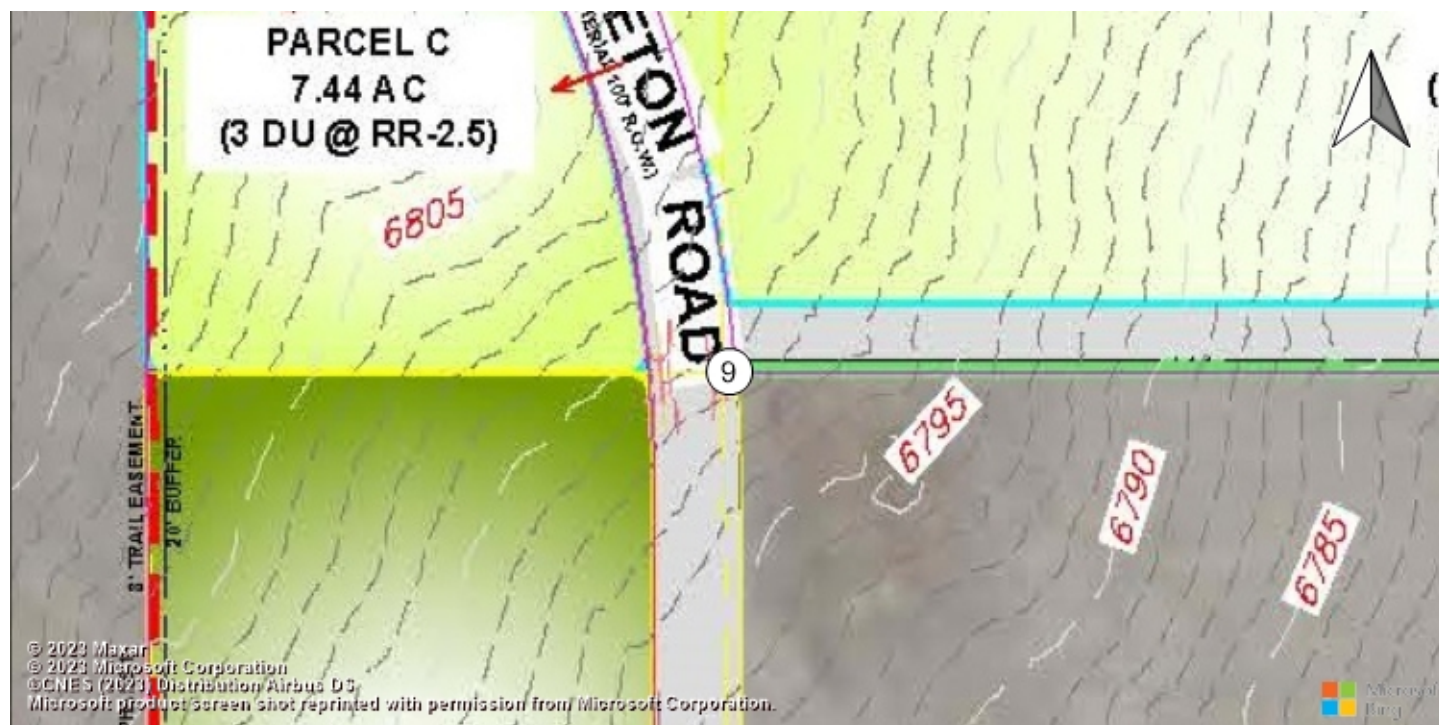

Stapleton + W Access

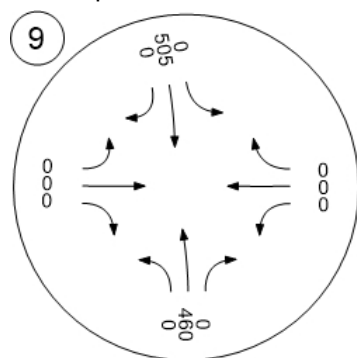

Traffic Volume - Net New Site Trips

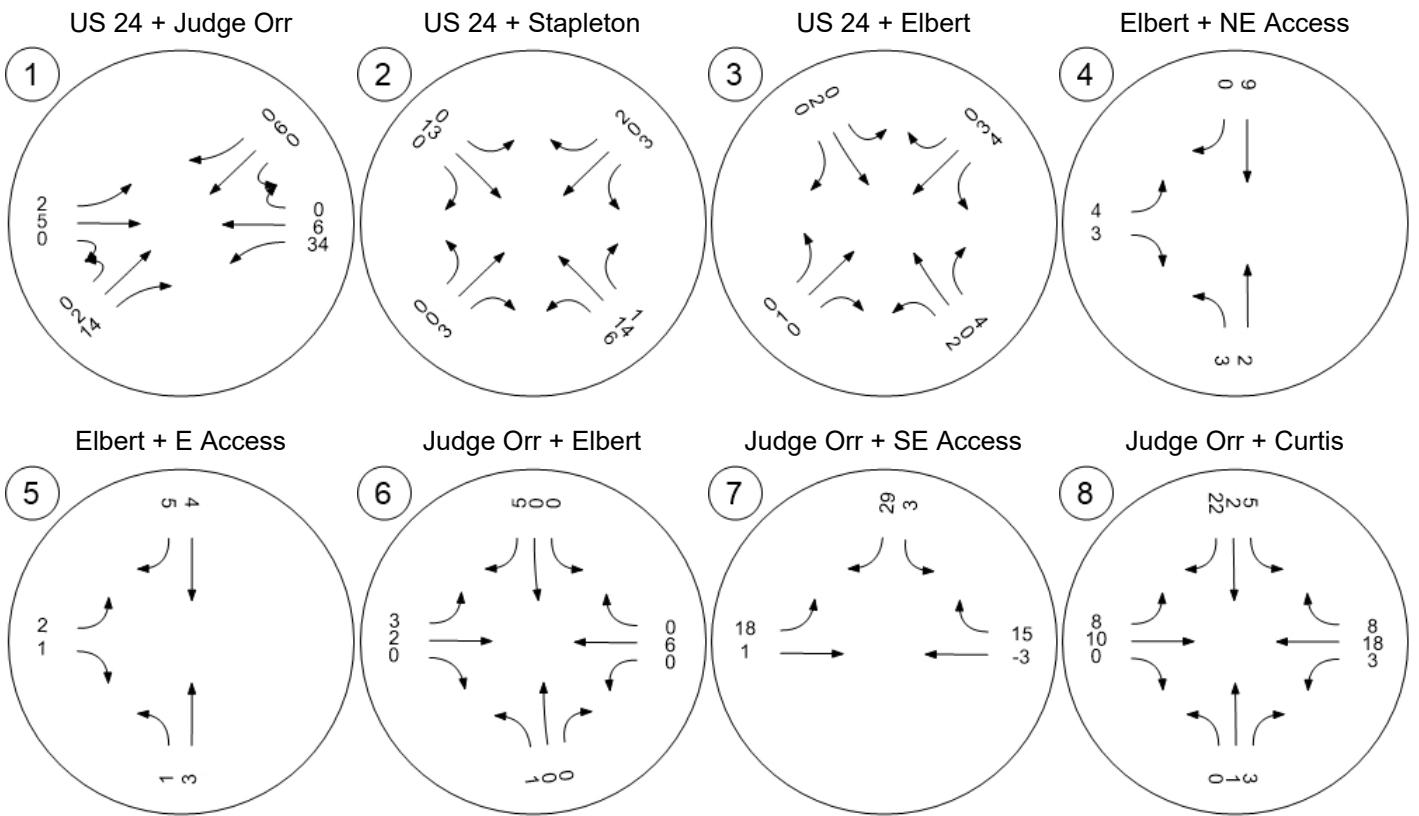

Traffic Volume - Net New Site Trips

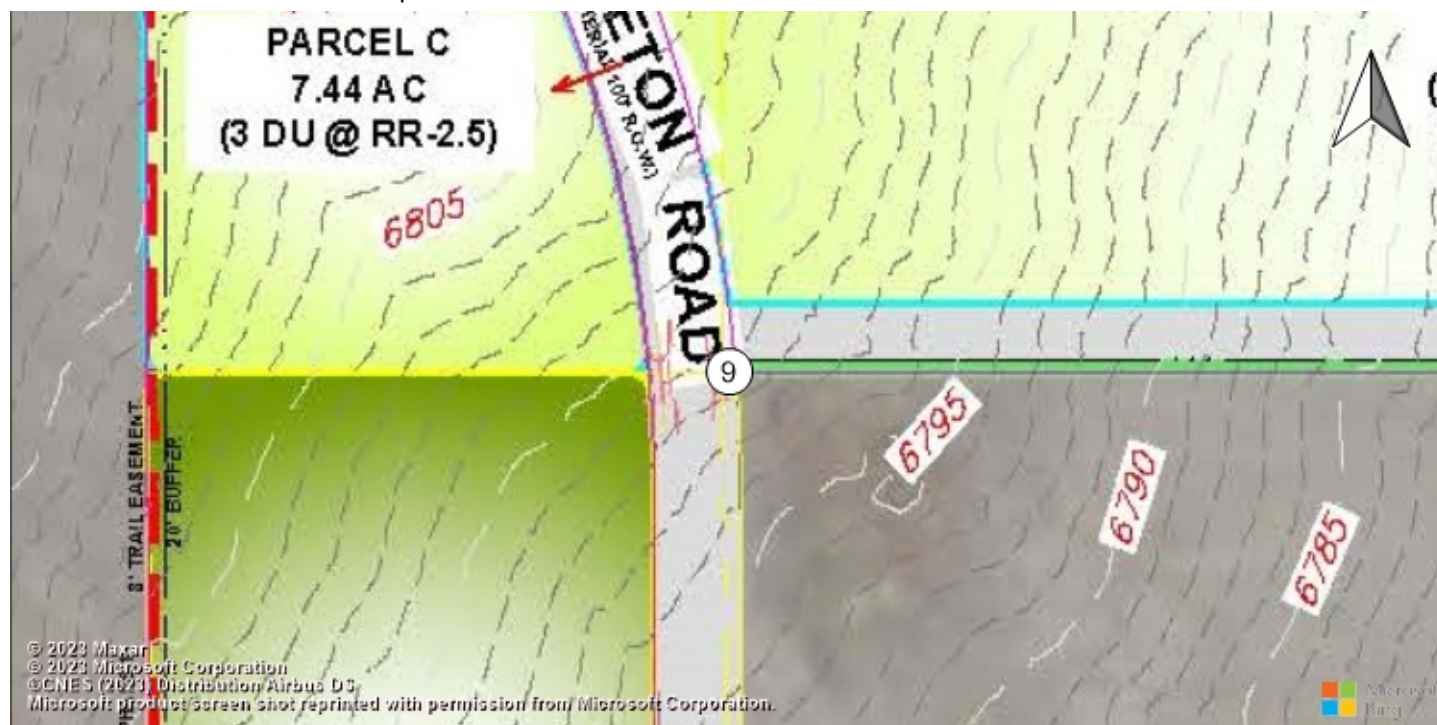

Stapleton + W Access

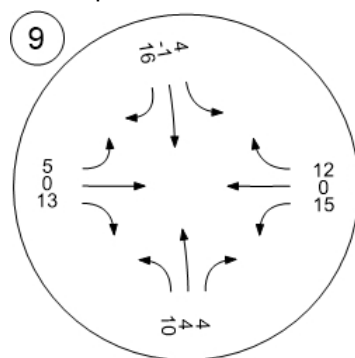

Traffic Volume - Future Total Volume

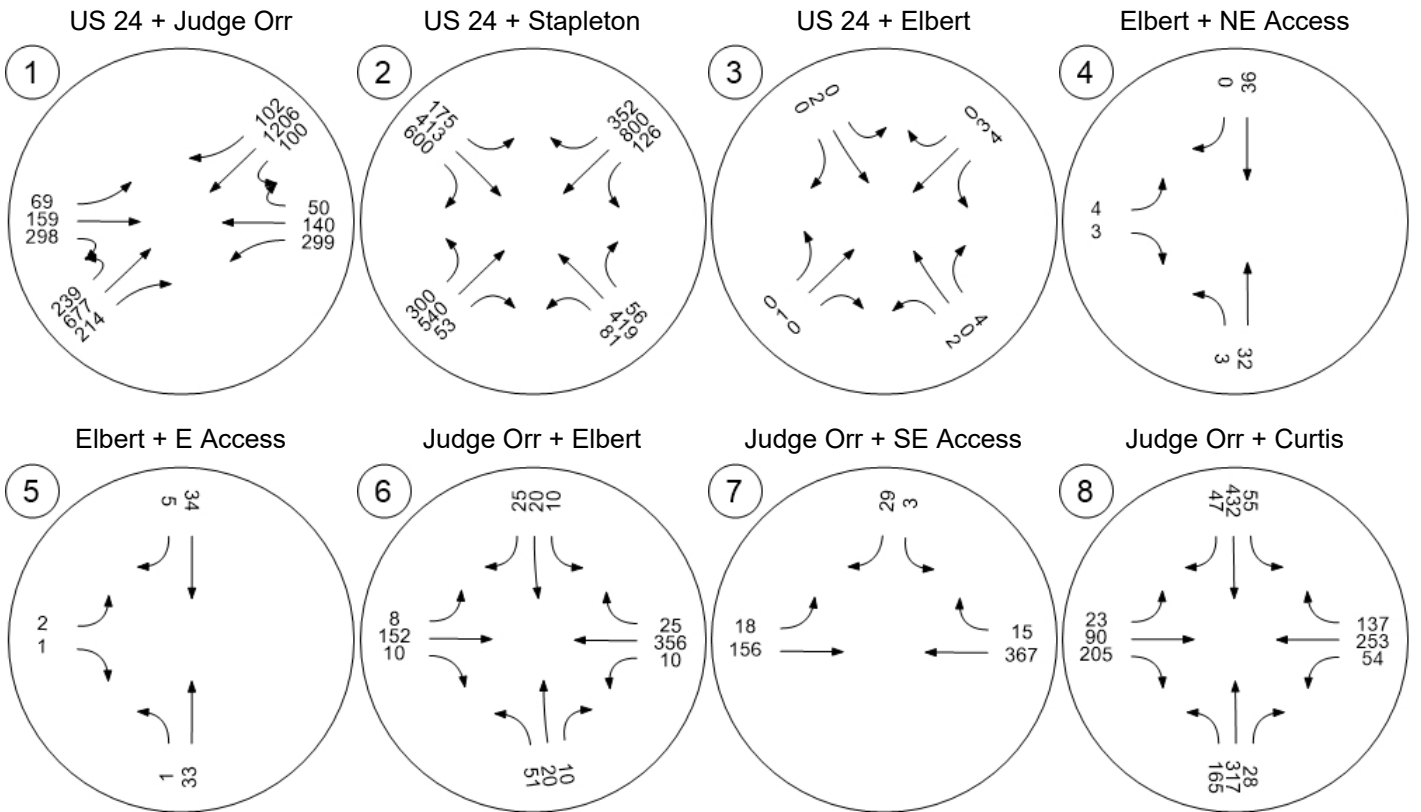

Traffic Volume - Future Total Volume

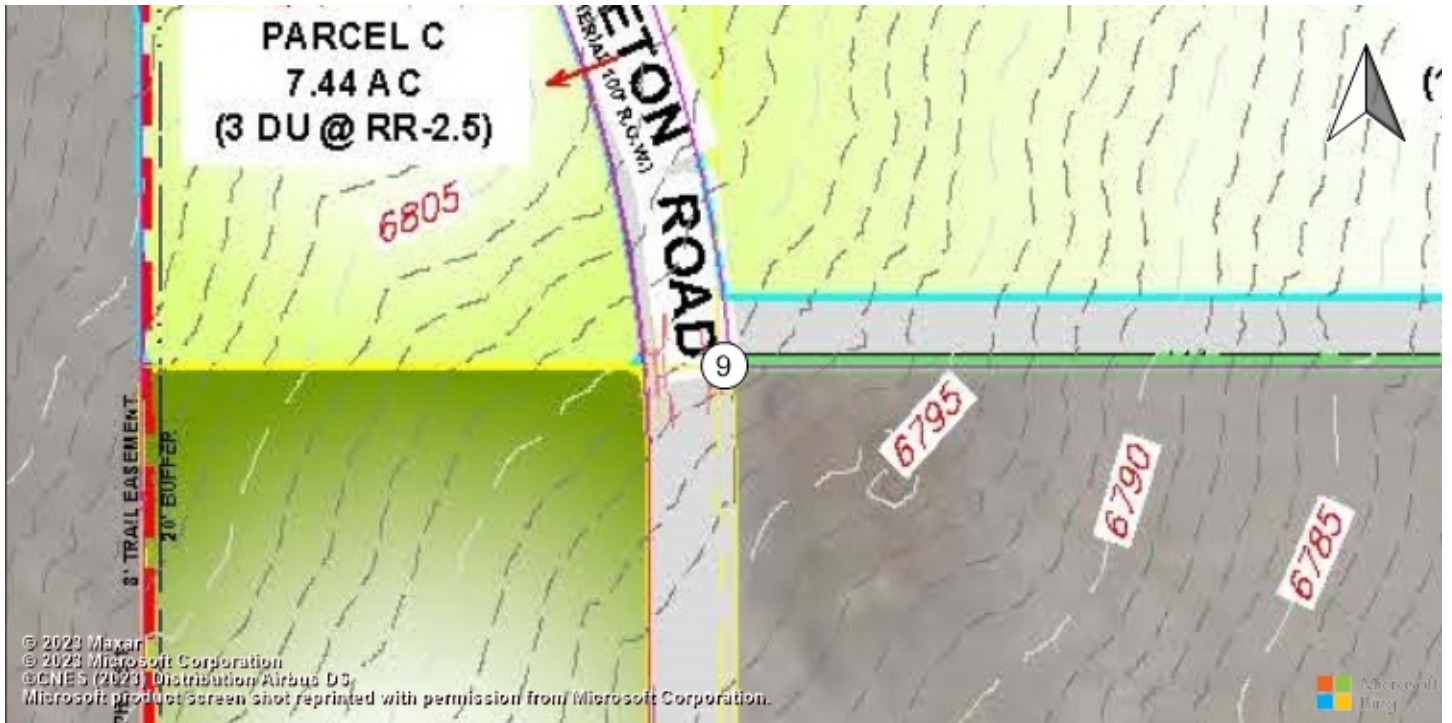

Stapleton + W Access

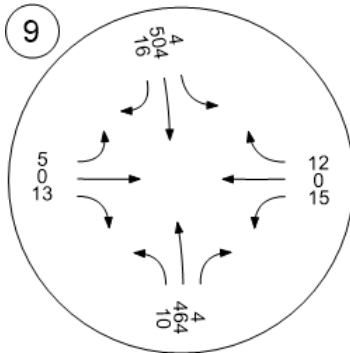

Davis Ranch Sketch Plan

Vistro File: G:\...\Davis Subdivision -- Vistro.vistro

Scenario 4 2043 PM

Report File: G:\...\2043 PM.pdf

7/7/2023

Trip Distribution summary

Zone / Gate	Zone 1: Zone			
	To Zone:		From Zone:	
	Share %	Trips	Share %	Trips
2: Zone	0.00	0	0.00	0
3: Zone	0.00	0	0.00	0
4: Zone	0.00	0	0.00	0
5: Zone	0.00	0	0.00	0
6: Zone	0.00	0	0.00	0
31: Zone	0.00	0	0.00	0
32: Zone	0.00	0	0.00	0
7: Gate	2.00	1	2.00	0
8: Gate	3.00	1	3.00	0
9: Gate	2.00	1	2.00	0
10: Gate	1.00	0	1.00	0
11: Gate	5.00	1	5.00	1
12: Gate	62.00	16	62.00	9
13: Gate	5.00	1	5.00	1
14: Gate	20.00	5	20.00	3
Total	100.00	26	100.00	14

Zone / Gate	Zone 2: Zone			
	To Zone:		From Zone:	
	Share %	Trips	Share %	Trips
1: Zone	0.00	0	0.00	0
3: Zone	0.00	0	0.00	0
4: Zone	0.00	0	0.00	0
5: Zone	0.00	0	0.00	0
6: Zone	0.00	0	0.00	0
31: Zone	0.00	0	0.00	0
32: Zone	0.00	0	0.00	0
7: Gate	3.00	1	3.00	1
8: Gate	7.00	2	7.00	2
9: Gate	5.00	1	5.00	1
10: Gate	1.00	0	1.00	0
11: Gate	11.00	3	11.00	3
12: Gate	10.00	3	10.00	3
13: Gate	28.00	7	28.00	7
14: Gate	35.00	9	35.00	9
Total	100.00	26	100.00	26

Zone / Gate	Zone 3: Zone			
	To Zone:		From Zone:	
	Share %	Trips	Share %	Trips
1: Zone	0.00	0	0.00	0
2: Zone	0.00	0	0.00	0
4: Zone	0.00	0	0.00	0
5: Zone	0.00	0	0.00	0
6: Zone	0.00	0	0.00	0
31: Zone	0.00	0	0.00	0
32: Zone	0.00	0	0.00	0
7: Gate	5.00	2	5.00	2
8: Gate	15.00	5	15.00	5
9: Gate	12.00	4	12.00	4
10: Gate	4.00	1	4.00	1
11: Gate	12.00	4	12.00	4
12: Gate	7.00	2	7.00	2
13: Gate	20.00	6	20.00	7
14: Gate	25.00	8	25.00	8
Total	100.00	32	100.00	33

Zone / Gate	Zone 4: Zone			
	To Zone:		From Zone:	
	Share %	Trips	Share %	Trips
1: Zone	0.00	0	0.00	0
2: Zone	0.00	0	0.00	0
3: Zone	0.00	0	0.00	0
5: Zone	0.00	0	0.00	0
6: Zone	0.00	0	0.00	0
31: Zone	0.00	0	0.00	0
32: Zone	0.00	0	0.00	0
7: Gate	2.00	0	2.00	0
8: Gate	3.00	0	3.00	0
9: Gate	2.00	0	2.00	0
10: Gate	1.00	0	1.00	0
11: Gate	5.00	0	5.00	0
12: Gate	62.00	6	62.00	5
13: Gate	5.00	0	5.00	0
14: Gate	20.00	2	20.00	1
Total	100.00	8	100.00	6

Zone / Gate	Zone 5: Zone			
	To Zone:		From Zone:	
	Share %	Trips	Share %	Trips
1: Zone	0.00	0	0.00	0
2: Zone	0.00	0	0.00	0
3: Zone	0.00	0	0.00	0
4: Zone	0.00	0	0.00	0
6: Zone	0.00	0	0.00	0
31: Zone	0.00	0	0.00	0
32: Zone	0.00	0	0.00	0

Zone / Gate	Zone 6: Zone			
	To Zone:		From Zone:	
	Share %	Trips	Share %	Trips
1: Zone	0.00	0	0.00	0
2: Zone	0.00	0	0.00	0
3: Zone	0.00	0	0.00	0
4: Zone	0.00	0	0.00	0
5: Zone	0.00	0	0.00	0
31: Zone	0.00	0	0.00	0
32: Zone	0.00	0	0.00	0

Version 2023 (SP 0-7)

7: Gate	2.00	0	2.00	0
8: Gate	3.00	0	3.00	0
9: Gate	2.00	0	2.00	0
10: Gate	1.00	0	1.00	0
11: Gate	5.00	0	5.00	0
12: Gate	62.00	2	62.00	2
13: Gate	5.00	0	5.00	0
14: Gate	20.00	1	20.00	0
Total	100.00	3	100.00	2

7: Gate	2.00	0	2.00	0
8: Gate	3.00	1	3.00	0
9: Gate	2.00	0	2.00	0
10: Gate	1.00	0	1.00	0
11: Gate	5.00	1	5.00	1
12: Gate	62.00	13	62.00	8
13: Gate	5.00	1	5.00	1
14: Gate	20.00	4	20.00	2
Total	100.00	20	100.00	12

Zone / Gate	Zone 31: Zone			
	To Zone:		From Zone:	
	Share %	Trips	Share %	Trips
1: Zone	0.00	0	0.00	0
2: Zone	0.00	0	0.00	0
3: Zone	0.00	0	0.00	0
4: Zone	0.00	0	0.00	0
5: Zone	0.00	0	0.00	0
6: Zone	0.00	0	0.00	0
32: Zone	0.00	0	0.00	0
7: Gate	1.00	0	5.00	1
8: Gate	15.00	2	30.00	4
9: Gate	5.00	1	25.00	4
10: Gate	0.00	0	0.00	0
11: Gate	0.00	0	15.00	2
12: Gate	64.00	9	15.00	2
13: Gate	0.00	0	5.00	1
14: Gate	15.00	2	5.00	1
Total	100.00	14	100.00	15

Zone / Gate	Zone 32: Zone			
	To Zone:		From Zone:	
	Share %	Trips	Share %	Trips
1: Zone	0.00	0	0.00	0
2: Zone	0.00	0	0.00	0
3: Zone	0.00	0	0.00	0
4: Zone	0.00	0	0.00	0
5: Zone	0.00	0	0.00	0
6: Zone	0.00	0	0.00	0
31: Zone	0.00	0	0.00	0
7: Gate	2.00	0	5.00	1
8: Gate	10.00	2	25.00	5
9: Gate	20.00	4	30.00	5
10: Gate	0.00	0	0.00	0
11: Gate	28.00	5	15.00	3
12: Gate	35.00	6	15.00	3
13: Gate	0.00	0	0.00	0
14: Gate	5.00	1	10.00	2
Total	100.00	18	100.00	19

Lane Configuration and Traffic Control

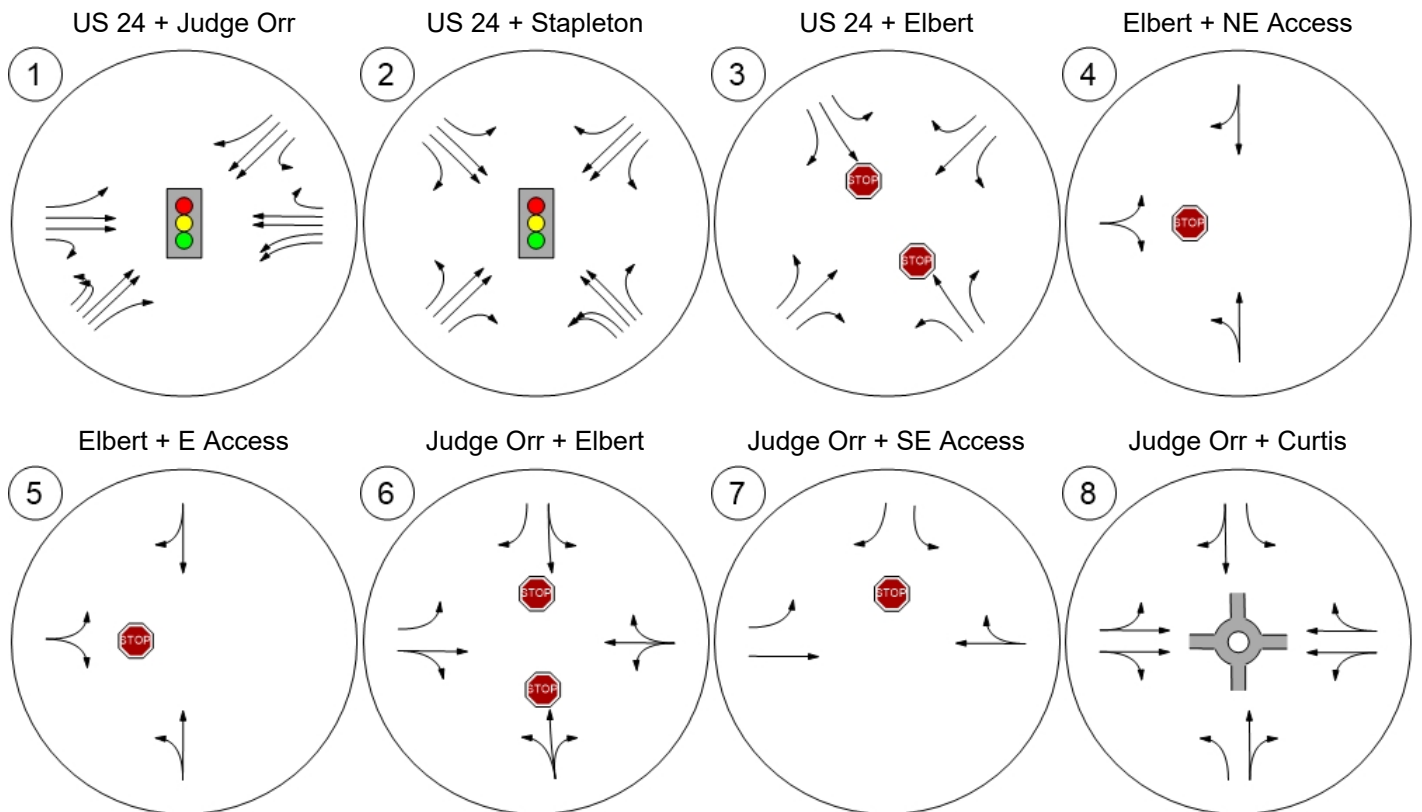

Lane Configuration and Traffic Control

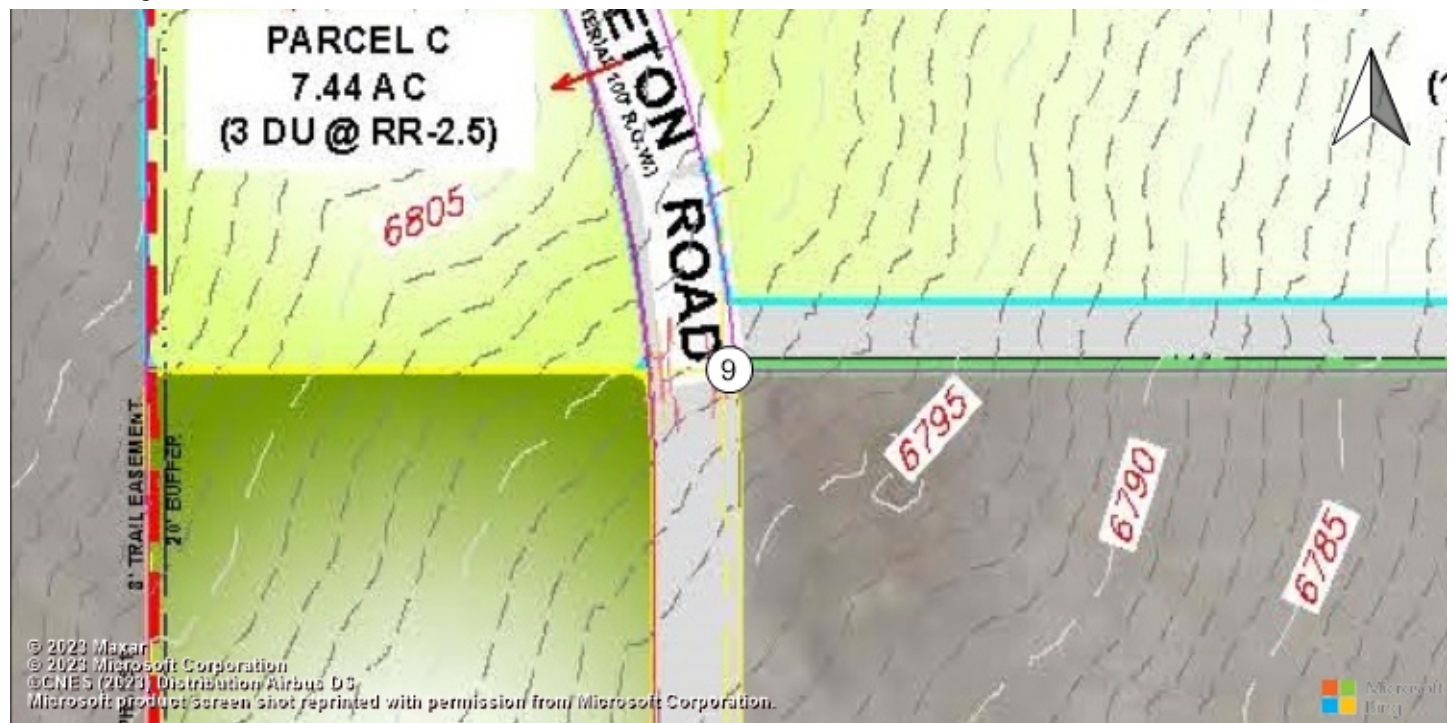

Stapleton + W Access

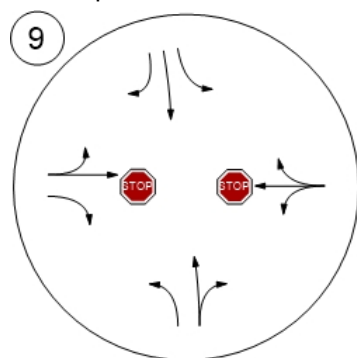

Traffic Volume - Base Volume

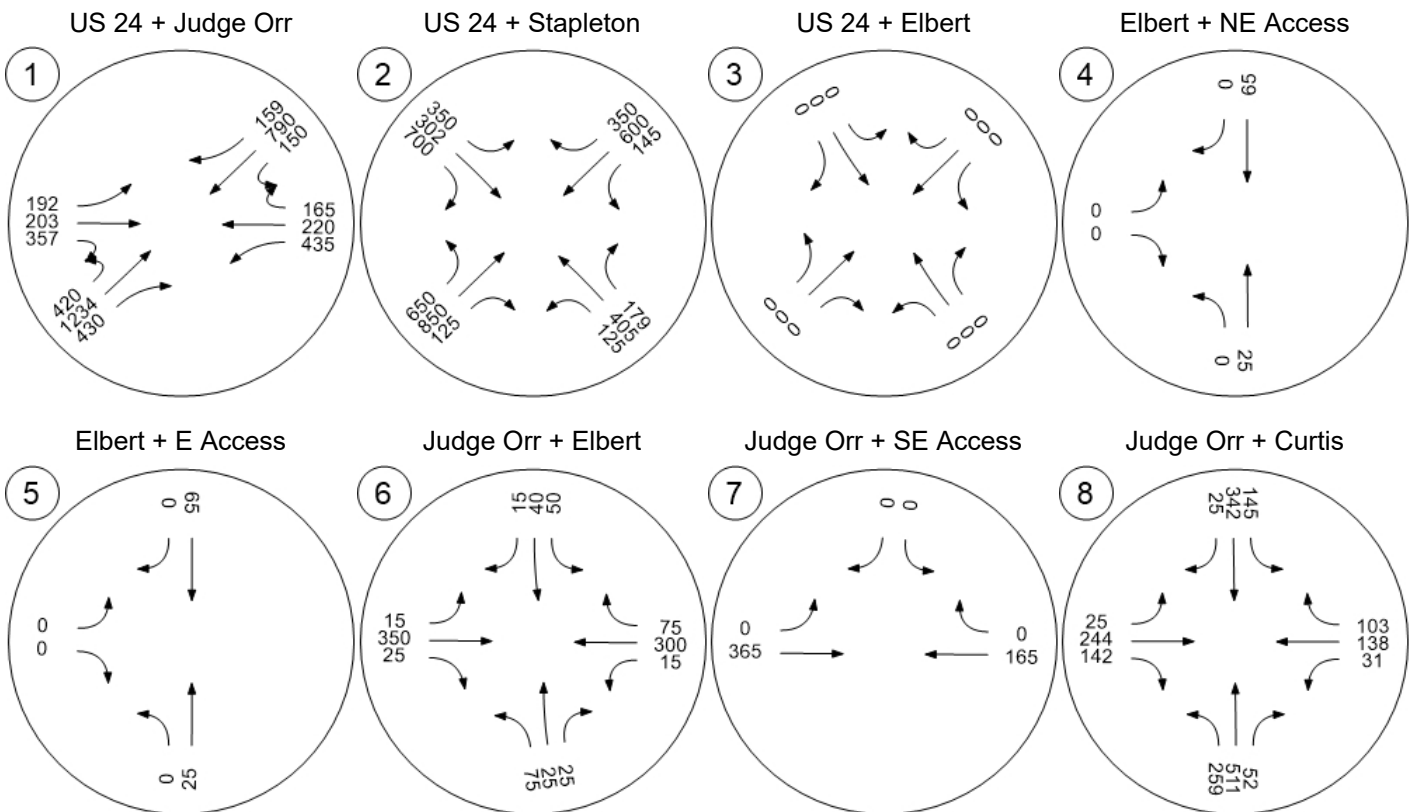

Traffic Volume - Base Volume

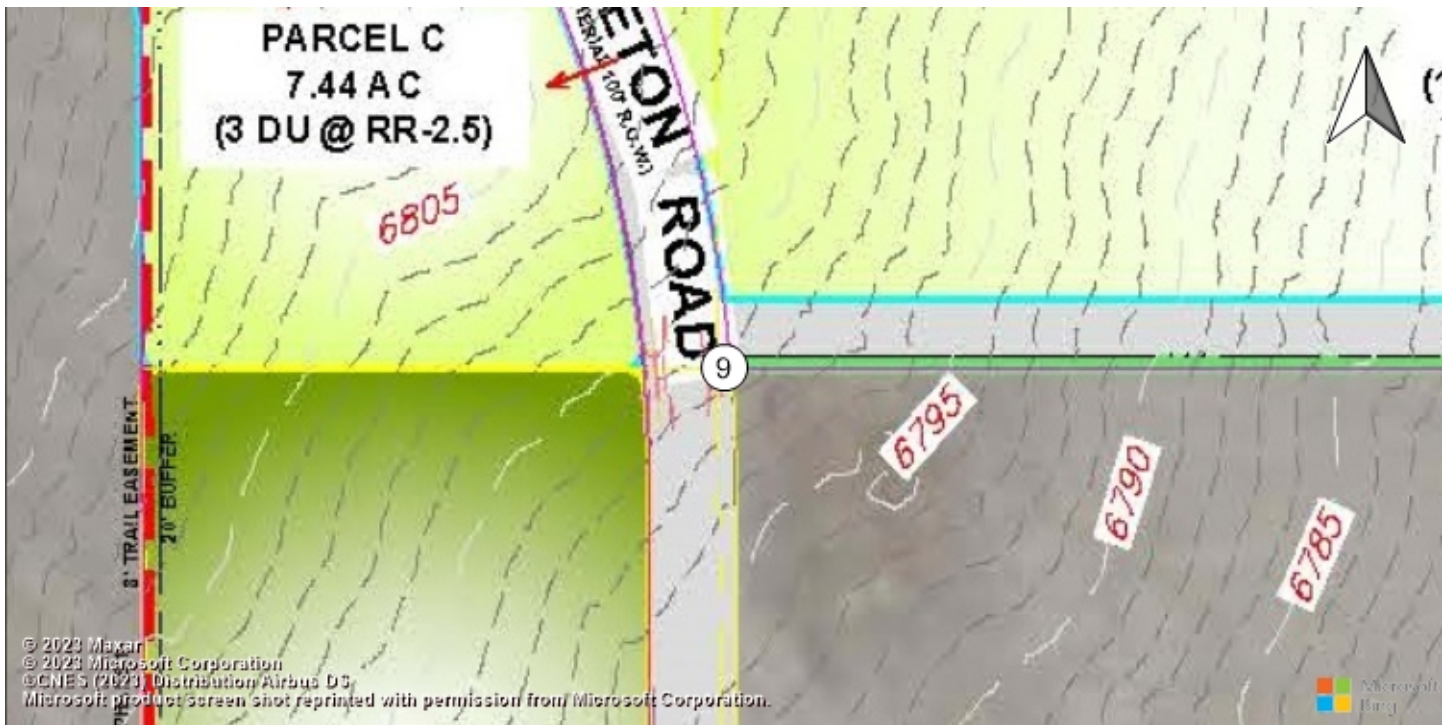

Stapleton + W Access

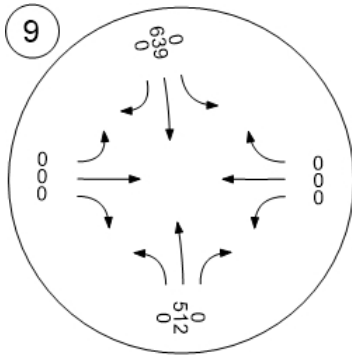

Traffic Volume - Net New Site Trips

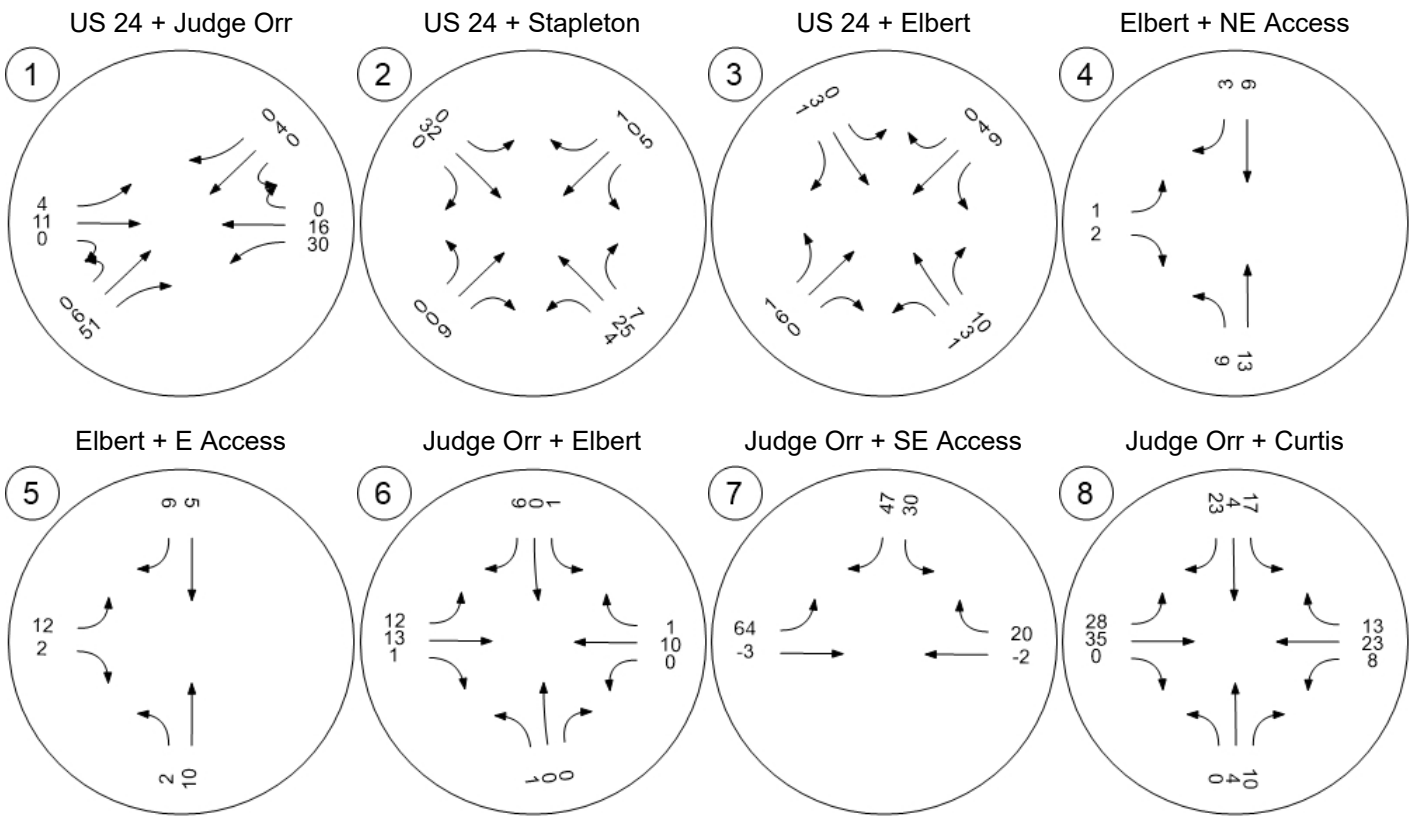

Traffic Volume - Net New Site Trips

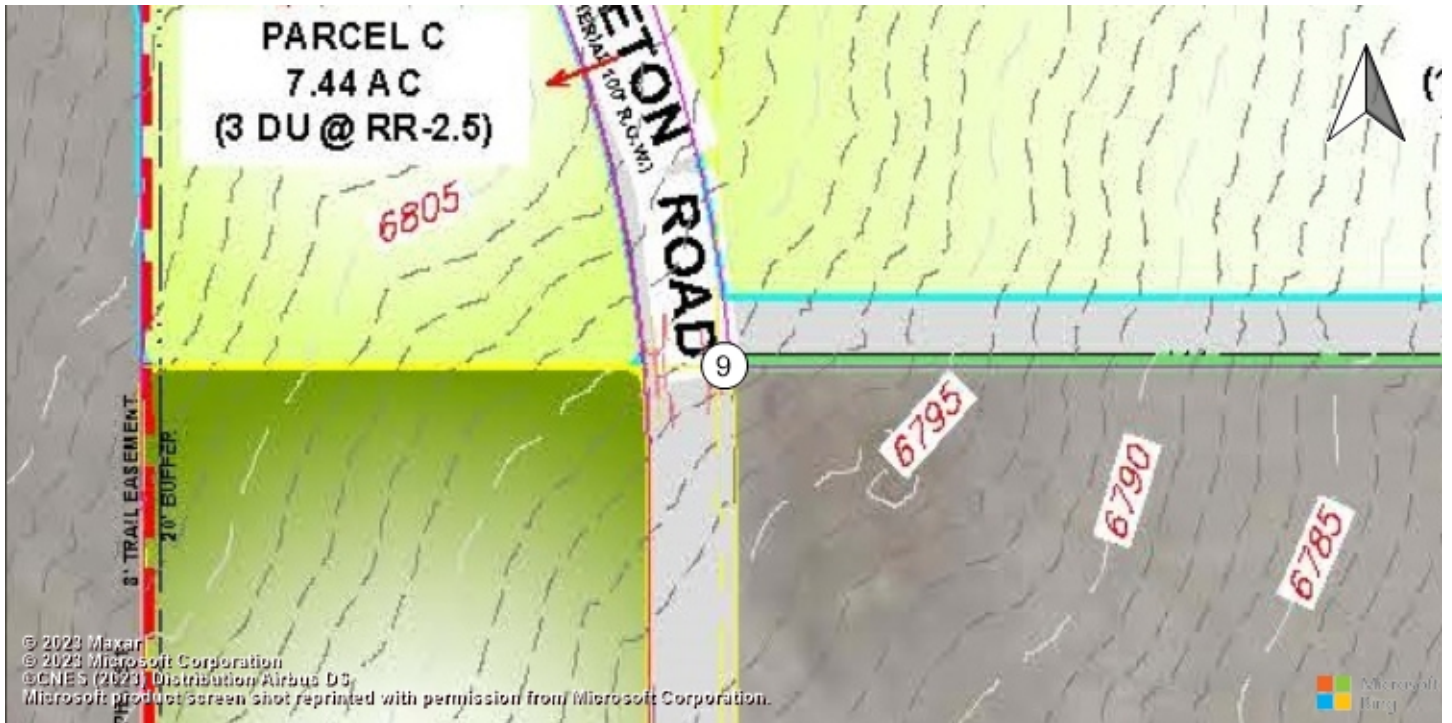

Stapleton + W Access

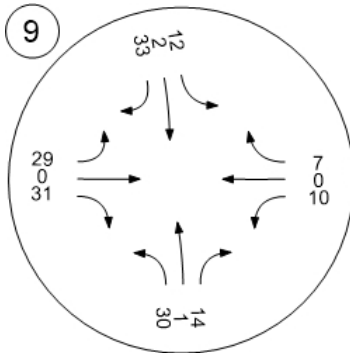

Traffic Volume - Future Total Volume

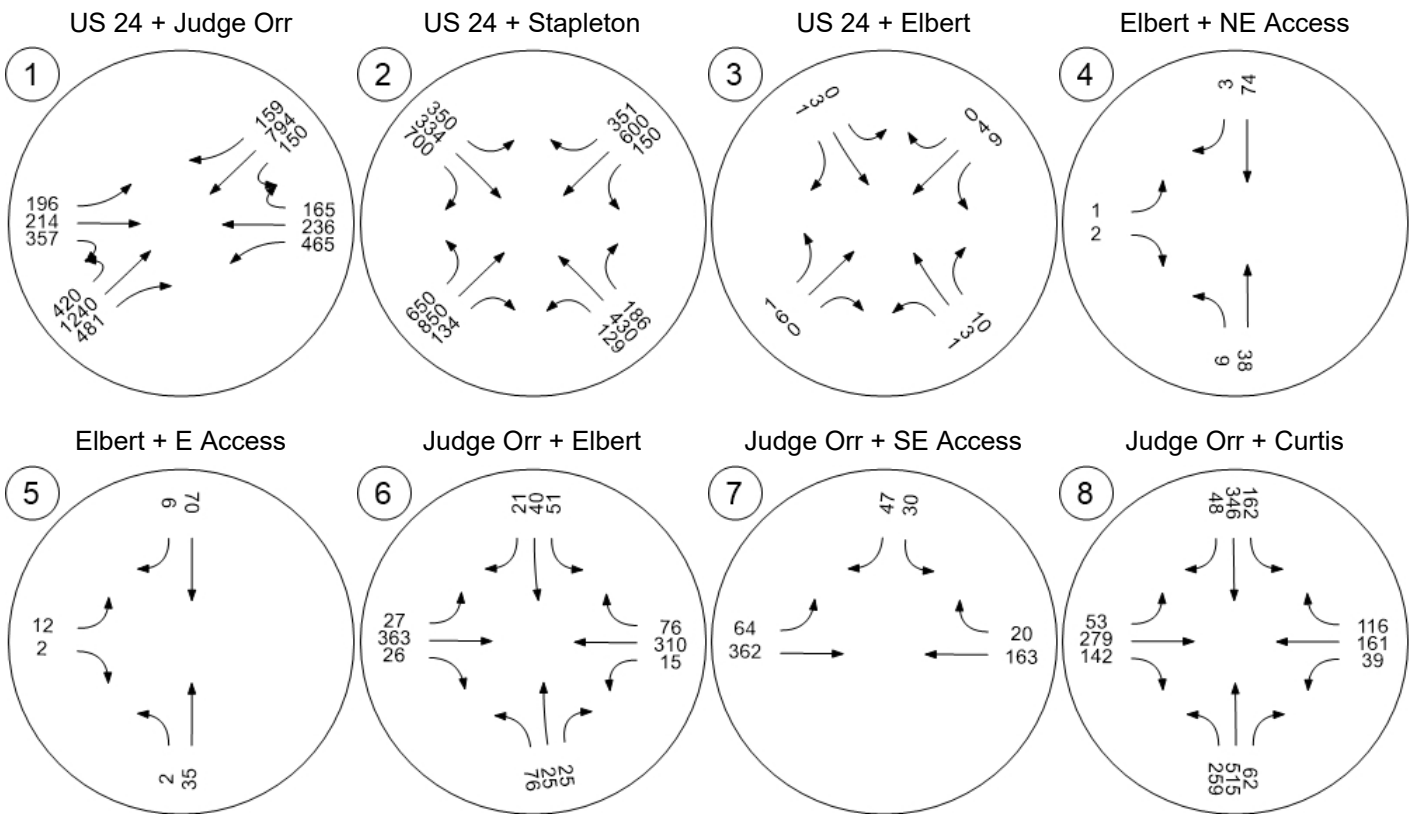

Traffic Volume - Future Total Volume

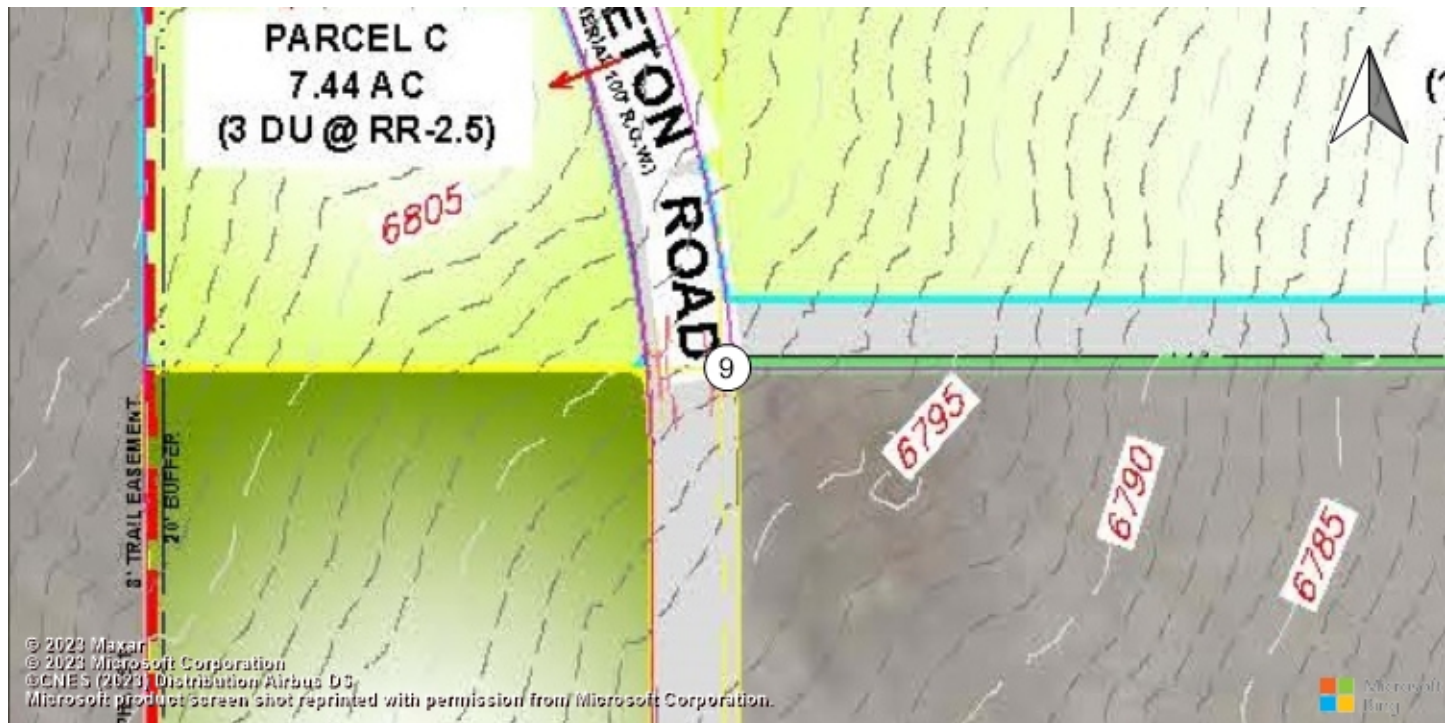

Stapleton + W Access

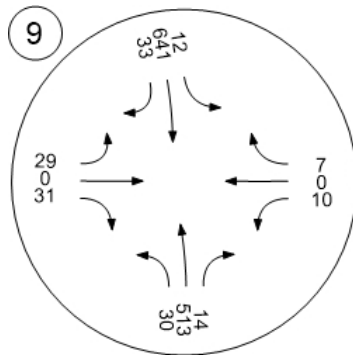

Traffic Count Reports



LSC Transportation Consultants, Inc.

2504 E. Pikes Peak Ave, Suite 304
 Colorado Springs, CO 80909
 719-633-2868

File Name : Curtis Rd - Judge Orr Rd AM
 Site Code : S214950
 Start Date : 4/21/2022
 Page No : 1

Groups Printed- Unshifted

Start Time	Curtis Rd Southbound					Judge Orr Rd Westbound					Curtis Rd Northbound					Judge Orr Rd Eastbound					Int. Total	
	Right	Thru	Left	Peds	App. Total	Right	Thru	Left	Peds	App. Total	Right	Thru	Left	Peds	App. Total	Right	Thru	Left	Peds	App. Total		
06:30	0	15	0	0	15	1	8	0	0	9	0	3	1	0	4	4	2	0	0	6	6	34
06:35	0	13	1	0	14	1	10	1	0	12	0	2	2	0	4	6	1	0	0	7	7	37
06:40	0	14	0	0	14	0	11	1	0	12	0	4	1	0	5	4	2	0	0	6	6	37
06:45	0	12	1	0	13	2	12	1	0	15	0	5	3	0	8	5	1	0	0	6	6	42
06:50	0	14	0	0	14	4	6	0	0	10	0	5	1	0	6	4	5	0	0	9	9	39
06:55	0	14	2	0	16	0	9	4	0	13	0	2	2	0	4	4	3	0	0	7	7	40
Total	0	82	4	0	86	8	56	7	0	71	0	21	10	0	31	27	14	0	0	41	229	
07:00	0	13	0	0	13	1	9	2	0	12	0	11	2	0	13	4	4	0	0	8	8	46
07:05	0	13	0	0	13	5	16	2	0	23	0	6	3	0	9	6	3	0	0	9	9	54
07:10	0	18	0	0	18	2	9	1	0	12	0	9	4	0	13	9	3	0	0	12	12	55
07:15	0	16	0	0	16	6	11	4	0	21	0	9	2	0	11	7	3	0	0	10	10	58
07:20	0	15	0	0	15	1	9	1	0	11	0	9	4	0	13	7	3	0	0	10	10	49
07:25	0	9	1	0	10	5	11	1	0	17	0	7	4	0	11	8	2	0	0	10	10	48
07:30	0	20	0	0	20	1	8	1	0	10	0	4	2	0	6	7	4	1	0	12	12	48
07:35	0	9	1	0	10	3	7	2	0	12	0	5	3	0	8	9	1	0	0	10	10	40
07:40	0	13	3	0	16	3	9	0	0	12	0	5	5	0	10	9	2	0	0	11	11	49
07:45	0	18	0	0	18	1	7	1	0	9	0	3	2	0	5	5	1	1	0	7	7	39
07:50	0	13	1	0	14	0	12	0	0	12	0	3	1	0	4	4	2	0	0	6	6	36
07:55	1	11	1	0	13	2	13	1	0	16	1	5	5	0	11	3	2	0	0	5	5	45
Total	1	168	7	0	176	30	121	16	0	167	1	76	37	0	114	78	30	2	0	110	567	
08:00	1	8	1	0	10	1	4	1	0	6	0	3	3	0	6	2	2	0	0	4	4	26
08:05	0	8	3	0	11	2	6	1	0	9	0	2	0	0	2	1	2	0	0	3	3	25
08:10	0	1	3	0	4	1	8	0	0	9	0	3	0	0	3	2	3	1	0	6	6	22
08:15	0	7	1	0	8	0	6	1	0	7	0	3	1	0	4	1	4	0	0	5	5	24
08:20	0	6	2	0	8	3	9	0	0	12	0	7	1	0	8	4	3	0	0	7	7	35
08:25	1	4	0	0	5	0	6	0	0	6	2	4	0	0	6	2	6	0	0	8	8	25
Grand Total	3	284	21	0	308	45	216	26	0	287	3	119	52	0	174	117	64	3	0	184	953	
Apprch %	1	92.2	6.8	0		15.7	75.3	9.1	0		1.7	68.4	29.9	0		63.6	34.8	1.6	0			
Total %	0.3	29.8	2.2	0	32.3	4.7	22.7	2.7	0	30.1	0.3	12.5	5.5	0	18.3	12.3	6.7	0.3	0	19.3		

LSC Transportation Consultants, Inc.

2504 E. Pikes Peak Ave, Suite 304
 Colorado Springs, CO 80909
 719-633-2868

File Name : Curtis Rd - Judge Orr Rd AM

Site Code : S214950

Start Date : 4/21/2022

Page No : 2

Start Time	Curtis Rd Southbound					Judge Orr Rd Westbound					Curtis Rd Northbound					Judge Orr Rd Eastbound					Int. Total
	Right	Thru	Left	Peds	App. Total	Right	Thru	Left	Peds	App. Total	Right	Thru	Left	Peds	App. Total	Right	Thru	Left	Peds	App. Total	
Peak Hour Analysis From 06:30 to 08:25 - Peak 1 of 1																					
Peak Hour for Entire Intersection Begins at 06:45																					
06:45	0	12	1	0	13	2	12	1	0	15	0	5	3	0	8	5	1	0	0	6	42
06:50	0	14	0	0	14	4	6	0	0	10	0	5	1	0	6	4	5	0	0	9	39
06:55	0	14	2	0	16	0	9	4	0	13	0	2	2	0	4	4	3	0	0	7	40
07:00	0	13	0	0	13	1	9	2	0	12	0	11	2	0	13	4	4	0	0	8	46
07:05	0	13	0	0	13	5	16	2	0	23	0	6	3	0	9	6	3	0	0	9	54
07:10	0	18	0	0	18	2	9	1	0	12	0	9	4	0	13	9	3	0	0	12	55
07:15	0	16	0	0	16	6	11	4	0	21	0	9	2	0	11	7	3	0	0	10	58
07:20	0	15	0	0	15	1	9	1	0	11	0	9	4	0	13	7	3	0	0	10	49
07:25	0	9	1	0	10	5	11	1	0	17	0	7	4	0	11	8	2	0	0	10	48
07:30	0	20	0	0	20	1	8	1	0	10	0	4	2	0	6	7	4	1	0	12	48
07:35	0	9	1	0	10	3	7	2	0	12	0	5	3	0	8	9	1	0	0	10	40
07:40	0	13	3	0	16	3	9	0	0	12	0	5	5	0	10	9	2	0	0	11	49
Total Volume	0	166	8	0	174	33	116	19	0	168	0	77	35	0	112	79	34	1	0	114	568
% App. Total	0	95.4	4.6	0		19.6	69	11.3	0		0	68.8	31.2	0		69.3	29.8	0.9	0		
PHF	.000	.692	.222	.000	.725	.458	.604	.396	.000	.609	.000	.583	.583	.000	.718	.731	.567	.083	.000	.792	.816

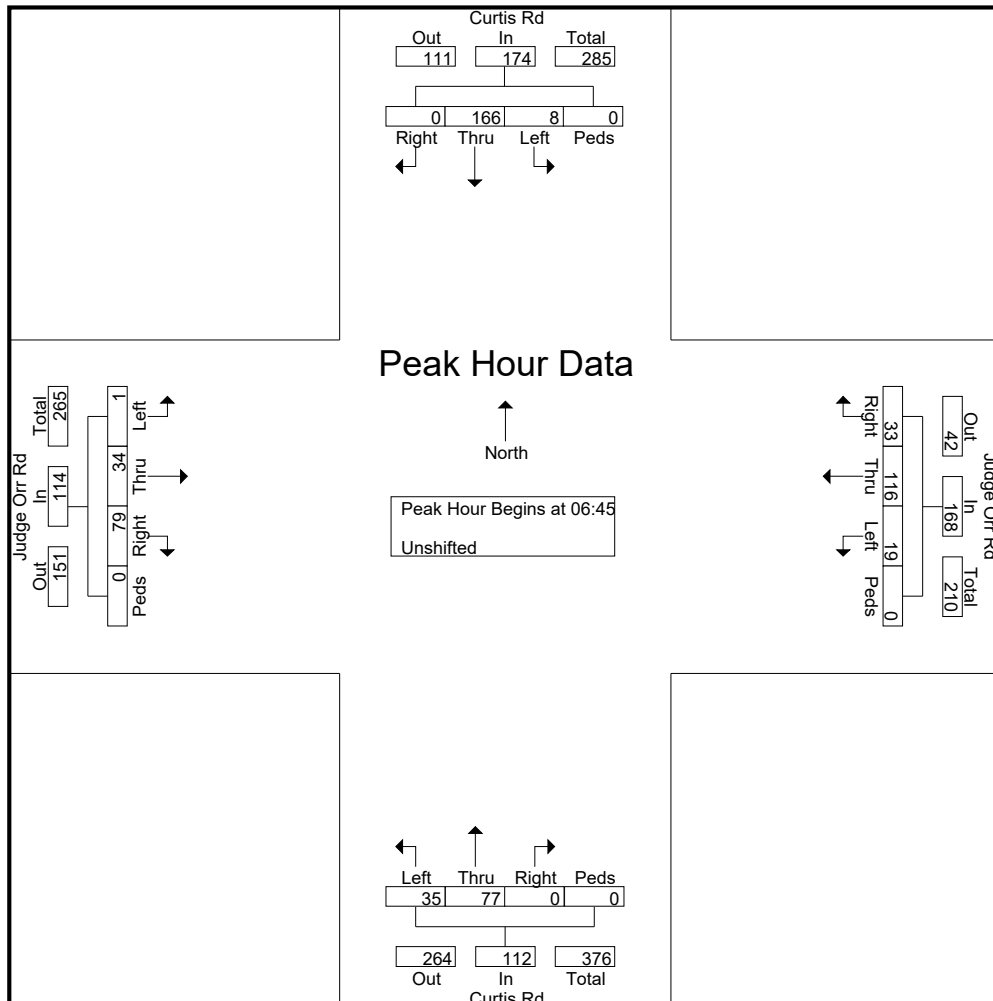

LSC Transportation Consultants, Inc.

2504 E. Pikes Peak Ave, Suite 304
 Colorado Springs, CO 80909
 719-633-2868

File Name : Curtis Rd - Judge Orr Rd AM
 Site Code : S214950
 Start Date : 4/21/2022
 Page No : 3

Start Time	Curtis Rd Southbound					Judge Orr Rd Westbound					Curtis Rd Northbound					Judge Orr Rd Eastbound					Int. Total
	Right	Thru	Left	Peds	App. Total	Right	Thru	Left	Peds	App. Total	Right	Thru	Left	Peds	App. Total	Right	Thru	Left	Peds	App. Total	
Peak Hour Analysis From 06:30 to 08:25 - Peak 1 of 1																					
Peak Hour for Each Approach Begins at:																					
	06:50					06:35					07:00					06:50					
+0 mins.	0	14	0	0	14	1	10	1	0	12	0	11	2	0	13	4	5	0	0	9	
+5 mins.	0	14	2	0	16	0	11	1	0	12	0	6	3	0	9	4	3	0	0	7	
+10 mins.	0	13	0	0	13	2	12	1	0	15	0	9	4	0	13	4	4	0	0	8	
+15 mins.	0	13	0	0	13	4	6	0	0	10	0	9	2	0	11	6	3	0	0	9	
+20 mins.	0	18	0	0	18	0	9	4	0	13	0	9	4	0	13	9	3	0	0	12	
+25 mins.	0	16	0	0	16	1	9	2	0	12	0	7	4	0	11	7	3	0	0	10	
+30 mins.	0	15	0	0	15	5	16	2	0	23	0	4	2	0	6	7	3	0	0	10	
+35 mins.	0	9	1	0	10	2	9	1	0	12	0	5	3	0	8	8	2	0	0	10	
+40 mins.	0	20	0	0	20	6	11	4	0	21	0	5	5	0	10	7	4	1	0	12	
+45 mins.	0	9	1	0	10	1	9	1	0	11	0	3	2	0	5	9	1	0	0	10	
+50 mins.	0	13	3	0	16	5	11	1	0	17	0	3	1	0	4	9	2	0	0	11	
+55 mins.	0	18	0	0	18	1	8	1	0	10	1	5	5	0	11	5	1	1	0	7	
Total Volume	0	172	7	0	179	28	121	19	0	168	1	76	37	0	114	79	34	2	0	115	
% App. Total	0	96.1	3.9	0		16.7	72	11.3	0		0.9	66.7	32.5	0		68.7	29.6	1.7	0		
PHF	.000	.717	.194	.000	.746	.389	.630	.396	.000	.609	.083	.576	.617	.000	.731	.731	.567	.167	.000	.799	

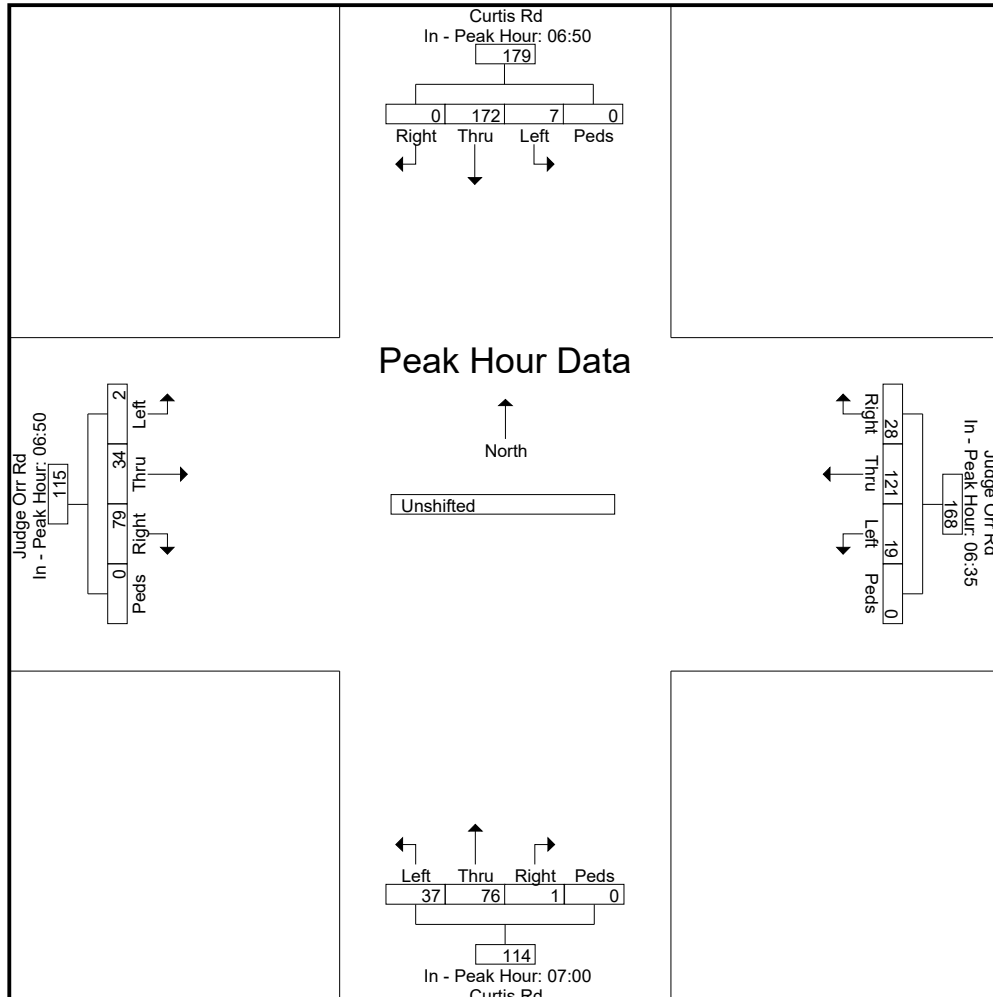

LSC Transportation Consultants, Inc.

2504 E. Pikes Peak Ave, Suite 304

Colorado Springs, CO 80909

719-633-2868

LSC Transportation Consultants, Inc.

2504 E. Pikes Peak Ave, Suite 304
 Colorado Springs, CO 80909
 719-633-2868

File Name : Curtis Rd - Judge Orr Rd PM
 Site Code : S214950
 Start Date : 4/21/2022
 Page No : 1

Groups Printed- Unshifted

Start Time	Curtis Rd Southbound					Judge Orr Rd Westbound					Curtis Rd Northbound					Judge Orr Rd Eastbound					Int. Total
	Right	Thru	Left	Peds	App. Total	Right	Thru	Left	Peds	App. Total	Right	Thru	Left	Peds	App. Total	Right	Thru	Left	Peds	App. Total	
16:00	1	4	1	0	6	0	7	0	0	7	0	11	4	0	15	3	10	0	0	13	41
16:05	1	5	2	1	9	1	8	0	0	9	0	12	8	0	20	2	9	0	0	11	49
16:10	0	3	1	0	4	0	10	1	0	11	2	10	3	0	15	4	12	0	0	16	46
16:15	0	4	1	0	5	1	3	1	0	5	1	11	3	0	15	3	8	0	0	11	36
16:20	1	5	0	0	6	1	5	0	0	6	3	11	9	0	23	3	10	0	0	13	48
16:25	0	1	1	0	2	2	5	0	0	7	0	16	6	0	22	3	3	0	0	6	37
16:30	0	4	2	0	6	2	6	0	0	8	1	9	5	0	15	1	16	1	0	18	47
16:35	0	1	1	0	2	1	3	0	0	4	1	13	3	0	17	4	9	1	0	14	37
16:40	0	6	2	0	8	2	2	0	0	4	3	8	5	0	16	2	5	0	0	7	35
16:45	0	7	1	0	8	1	3	0	0	4	3	9	5	0	17	1	7	0	0	8	37
16:50	1	4	3	0	8	2	7	0	0	9	1	15	10	0	26	2	14	1	0	17	60
16:55	1	3	1	0	5	0	5	0	0	5	3	12	5	0	20	1	7	0	0	8	38
Total	5	47	16	1	69	13	64	2	0	79	18	137	66	0	221	29	110	3	0	142	511
17:00	0	3	2	0	5	0	4	0	0	4	2	9	3	0	14	4	11	0	0	15	38
17:05	0	2	1	0	3	4	4	0	0	8	3	21	3	0	27	0	5	0	0	5	43
17:10	0	4	1	0	5	0	2	0	0	2	1	11	5	0	17	1	16	1	0	18	42
17:15	1	7	0	0	8	0	4	0	0	4	1	8	3	0	12	2	8	0	0	10	34
17:20	0	6	2	0	8	2	5	0	0	7	1	9	3	0	13	3	8	1	0	12	40
17:25	0	2	0	0	2	1	6	0	0	7	0	6	5	0	11	3	6	0	0	9	29
17:30	0	1	2	0	3	2	3	0	0	5	0	7	1	0	8	3	15	0	0	18	34
17:35	0	5	4	0	9	1	3	0	0	4	0	7	2	0	9	3	7	0	0	10	32
17:40	1	4	3	0	8	2	5	0	0	7	2	3	3	0	8	0	14	0	0	14	37
17:45	1	4	5	0	10	0	9	0	0	9	0	7	2	0	9	3	12	0	0	15	43
17:50	0	6	2	0	8	0	7	1	0	8	0	3	2	0	5	0	4	1	0	5	26
17:55	0	3	2	0	5	0	3	0	0	3	1	8	0	0	9	0	7	0	0	7	24
Total	3	47	24	0	74	12	55	1	0	68	11	99	32	0	142	22	113	3	0	138	422
Grand Total	8	94	40	1	143	25	119	3	0	147	29	236	98	0	363	51	223	6	0	280	933
Apprch %	5.6	65.7	28	0.7		17	81	2	0		8	65	27	0		18.2	79.6	2.1	0		
Total %	0.9	10.1	4.3	0.1	15.3	2.7	12.8	0.3	0	15.8	3.1	25.3	10.5	0	38.9	5.5	23.9	0.6	0	30	

LSC Transportation Consultants, Inc.

2504 E. Pikes Peak Ave, Suite 304
 Colorado Springs, CO 80909
 719-633-2868

File Name : Curtis Rd - Judge Orr Rd PM

Site Code : S214950

Start Date : 4/21/2022

Page No : 2

Start Time	Curtis Rd Southbound					Judge Orr Rd Westbound					Curtis Rd Northbound					Judge Orr Rd Eastbound					Int. Total
	Right	Thru	Left	Peds	App. Total	Right	Thru	Left	Peds	App. Total	Right	Thru	Left	Peds	App. Total	Right	Thru	Left	Peds	App. Total	
Peak Hour Analysis From 16:00 to 17:55 - Peak 1 of 1																					
Peak Hour for Entire Intersection Begins at 16:00																					
16:00	1	4	1	0	6	0	7	0	0	7	0	11	4	0	15	3	10	0	0	13	41
16:05	1	5	2	1	9	1	8	0	0	9	0	12	8	0	20	2	9	0	0	11	49
16:10	0	3	1	0	4	0	10	1	0	11	2	10	3	0	15	4	12	0	0	16	46
16:15	0	4	1	0	5	1	3	1	0	5	1	11	3	0	15	3	8	0	0	11	36
16:20	1	5	0	0	6	1	5	0	0	6	3	11	9	0	23	3	10	0	0	13	48
16:25	0	1	1	0	2	2	5	0	0	7	0	16	6	0	22	3	3	0	0	6	37
16:30	0	4	2	0	6	2	6	0	0	8	1	9	5	0	15	1	16	1	0	18	47
16:35	0	1	1	0	2	1	3	0	0	4	1	13	3	0	17	4	9	1	0	14	37
16:40	0	6	2	0	8	2	2	0	0	4	3	8	5	0	16	2	5	0	0	7	35
16:45	0	7	1	0	8	1	3	0	0	4	3	9	5	0	17	1	7	0	0	8	37
16:50	1	4	3	0	8	2	7	0	0	9	1	15	10	0	26	2	14	1	0	17	60
16:55	1	3	1	0	5	0	5	0	0	5	3	12	5	0	20	1	7	0	0	8	38
Total Volume	5	47	16	1	69	13	64	2	0	79	18	137	66	0	221	29	110	3	0	142	511
% App. Total	7.2	68.1	23.2	1.4		16.5	81	2.5	0		8.1	62	29.9	0		20.4	77.5	2.1	0		
PHF	.417	.560	.444	.083	.639	.542	.533	.167	.000	.598	.500	.714	.550	.000	.708	.604	.573	.250	.000	.657	.710

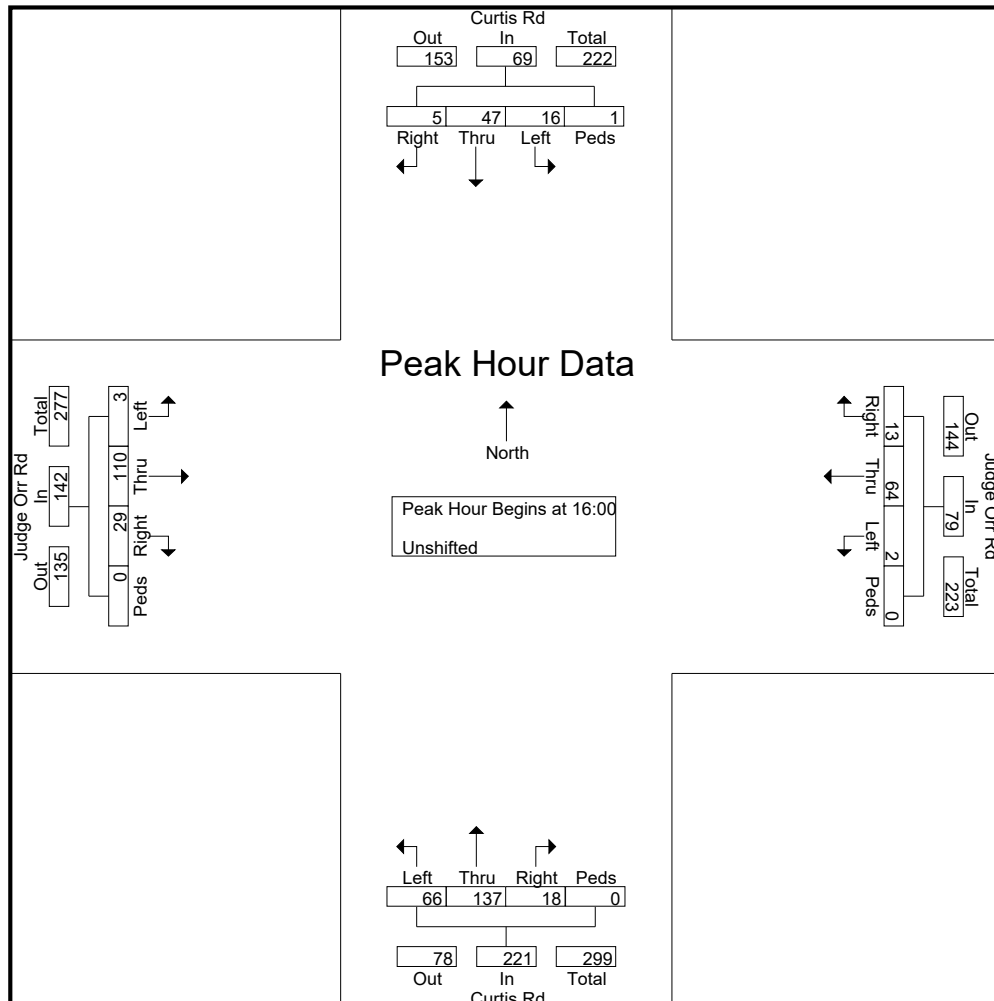

LSC Transportation Consultants, Inc.

2504 E. Pikes Peak Ave, Suite 304
 Colorado Springs, CO 80909
 719-633-2868

File Name : Curtis Rd - Judge Orr Rd PM

Site Code : S214950

Start Date : 4/21/2022

Page No : 3

Start Time	Curtis Rd Southbound					Judge Orr Rd Westbound					Curtis Rd Northbound					Judge Orr Rd Eastbound					Int. Total
	Right	Thru	Left	Peds	App. Total	Right	Thru	Left	Peds	App. Total	Right	Thru	Left	Peds	App. Total	Right	Thru	Left	Peds	App. Total	
Peak Hour Analysis From 16:00 to 17:55 - Peak 1 of 1																					
Peak Hour for Each Approach Begins at:																					
	16:50					16:00					16:15					16:50					
+0 mins.	1	4	3	0	8	0	7	0	0	7	1	11	3	0	15	2	14	1	0	17	
+5 mins.	1	3	1	0	5	1	8	0	0	9	3	11	9	0	23	1	7	0	0	8	
+10 mins.	0	3	2	0	5	0	10	1	0	11	0	16	6	0	22	4	11	0	0	15	
+15 mins.	0	2	1	0	3	1	3	1	0	5	1	9	5	0	15	0	5	0	0	5	
+20 mins.	0	4	1	0	5	1	5	0	0	6	1	13	3	0	17	1	16	1	0	18	
+25 mins.	1	7	0	0	8	2	5	0	0	7	3	8	5	0	16	2	8	0	0	10	
+30 mins.	0	6	2	0	8	2	6	0	0	8	3	9	5	0	17	3	8	1	0	12	
+35 mins.	0	2	0	0	2	1	3	0	0	4	1	15	10	0	26	3	6	0	0	9	
+40 mins.	0	1	2	0	3	2	2	0	0	4	3	12	5	0	20	3	15	0	0	18	
+45 mins.	0	5	4	0	9	1	3	0	0	4	2	9	3	0	14	3	7	0	0	10	
+50 mins.	1	4	3	0	8	2	7	0	0	9	3	21	3	0	27	0	14	0	0	14	
+55 mins.	1	4	5	0	10	0	5	0	0	5	1	11	5	0	17	3	12	0	0	15	
Total Volume	5	45	24	0	74	13	64	2	0	79	22	145	62	0	229	25	123	3	0	151	
% App. Total	6.8	60.8	32.4	0		16.5	81	2.5	0		9.6	63.3	27.1	0		16.6	81.5	2	0		
PHF	.417	.536	.400	.000	.617	.542	.533	.167	.000	.598	.611	.575	.517	.000	.707	.521	.641	.250	.000	.699	

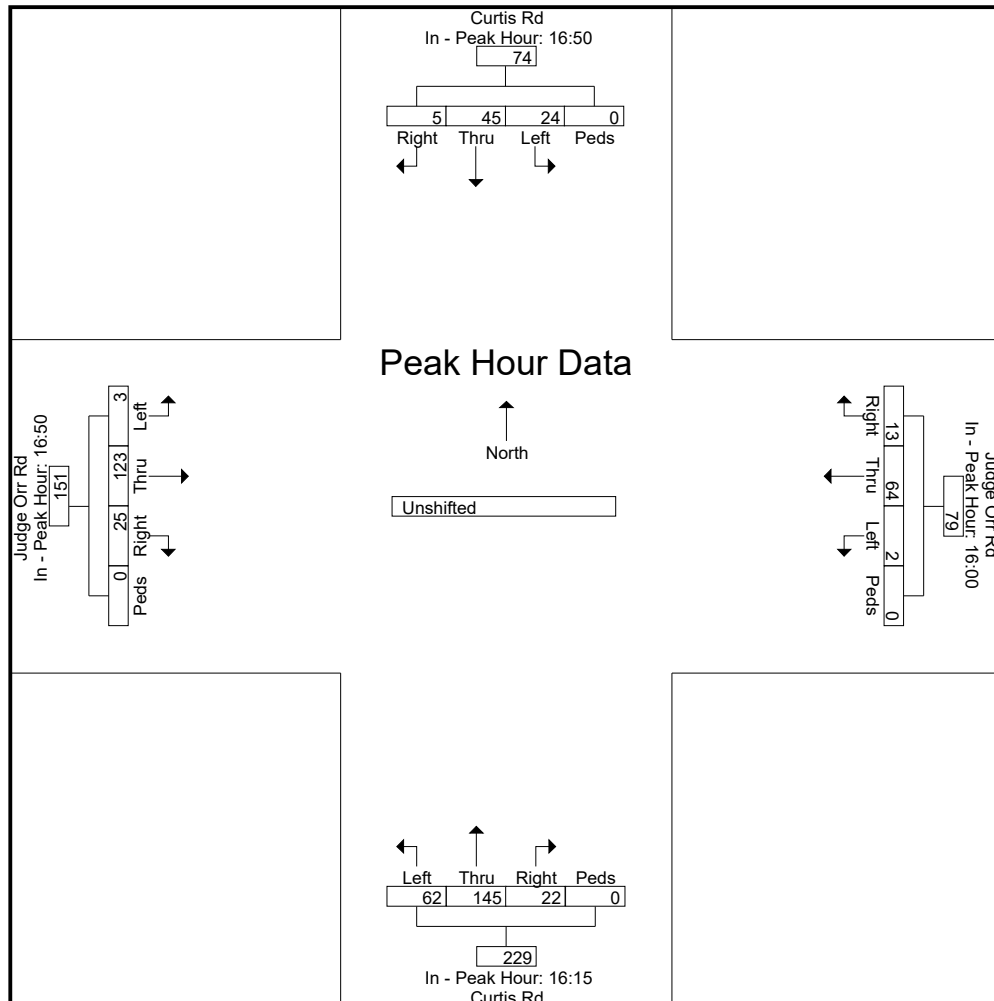

LSC Transportation Consultants, Inc.

2504 E. Pikes Peak Ave, Suite 304

Colorado Springs, CO 80909

719-633-2868

LSC Transportation Consultants, Inc.

2504 E. Pikes Peak Ave, Suite 304
 Colorado Springs, CO 80909
 719-633-2868

File Name : Elbert Rd - Judge Orr Rd AM 1-23

Site Code : S224640

Start Date : 1/11/2023

Page No : 1

Groups Printed- Unshifted

Start Time	Elbert Rd Southbound					Judge Orr Rd Westbound					Northbound					Judge Orr Rd Eastbound					Int. Total
	Right	Thru	Left	Peds	App. Total	Right	Thru	Left	Peds	App. Total	Right	Thru	Left	Peds	App. Total	Right	Thru	Left	Peds	App. Total	
06:30	1	0	1	0	2	0	15	0	0	15	0	0	0	0	0	0	3	0	0	3	20
06:35	0	0	1	0	1	1	6	0	0	7	0	0	0	0	0	0	1	0	0	1	9
06:40	0	0	0	0	0	1	14	0	0	15	0	0	0	0	0	0	1	1	0	2	17
06:45	0	0	2	0	2	0	11	0	0	11	0	0	0	0	0	0	1	0	0	1	14
06:50	0	0	0	0	0	3	8	0	0	11	0	0	0	0	0	0	1	0	0	1	12
06:55	1	0	0	0	1	2	8	0	0	10	0	0	0	0	0	0	3	0	0	3	14
Total	2	0	4	0	6	7	62	0	0	69	0	0	0	0	0	0	10	1	0	11	86
07:00	1	0	0	0	1	1	10	0	0	11	0	0	0	0	0	0	6	0	0	6	18
07:05	0	0	0	0	0	2	13	0	0	15	0	0	0	0	0	0	2	0	0	2	17
07:10	0	0	1	0	1	2	20	0	0	22	0	0	0	0	0	0	1	0	0	1	24
07:15	2	0	0	0	2	1	14	0	0	15	0	0	0	0	0	0	4	0	0	4	21
07:20	0	0	0	0	0	2	11	0	0	13	0	0	0	0	0	0	3	0	0	3	16
07:25	0	0	1	0	1	0	14	0	0	14	0	0	0	0	0	0	4	0	0	4	19
07:30	1	0	1	0	2	1	15	0	0	16	0	0	0	0	0	0	1	0	0	1	19
07:35	2	0	1	0	3	0	6	0	0	6	0	0	0	0	0	0	2	0	0	2	11
07:40	0	0	0	0	0	0	14	0	0	14	0	0	0	0	0	0	6	0	0	6	20
07:45	2	0	0	0	2	0	11	0	0	11	0	0	0	0	0	0	2	0	0	2	15
07:50	0	0	0	0	0	3	8	0	0	11	0	0	0	0	0	0	4	0	0	4	15
07:55	1	0	0	0	1	0	6	0	0	6	0	0	0	0	0	0	3	0	0	3	10
Total	9	0	4	0	13	12	142	0	0	154	0	0	0	0	0	0	38	0	0	38	205
08:00	1	0	0	0	1	3	5	0	0	8	0	0	0	0	0	0	3	0	0	3	12
08:05	0	0	0	0	0	0	7	0	0	7	0	0	0	0	0	0	2	0	0	2	9
08:10	1	0	0	0	1	1	12	0	0	13	0	0	0	0	0	0	4	0	0	4	18
08:15	0	0	0	0	0	0	9	0	0	9	0	0	0	0	0	0	1	1	0	2	11
08:20	0	0	1	0	1	0	9	0	0	9	0	0	0	0	0	0	4	1	0	5	15
08:25	1	0	0	0	1	2	5	0	0	7	0	0	0	0	0	0	3	0	0	3	11
Grand Total	14	0	9	0	23	25	251	0	0	276	0	0	0	0	0	0	65	3	0	68	367
Apprch %	60.9	0	39.1	0		9.1	90.9	0	0		0	0	0	0		0	95.6	4.4	0		
Total %	3.8	0	2.5	0	6.3	6.8	68.4	0	0	75.2	0	0	0	0	0	0	17.7	0.8	0	18.5	

LSC Transportation Consultants, Inc.

2504 E. Pikes Peak Ave, Suite 304
 Colorado Springs, CO 80909
 719-633-2868

File Name : Elbert Rd - Judge Orr Rd AM 1-23

Site Code : S224640

Start Date : 1/11/2023

Page No : 2

Start Time	Elbert Rd Southbound					Judge Orr Rd Westbound					Northbound					Judge Orr Rd Eastbound					Int. Total
	Right	Thru	Left	Peds	App. Total	Right	Thru	Left	Peds	App. Total	Right	Thru	Left	Peds	App. Total	Right	Thru	Left	Peds	App. Total	
Peak Hour Analysis From 06:30 to 08:25 - Peak 1 of 1																					
Peak Hour for Entire Intersection Begins at 06:55																					
06:55	1	0	0	0	1	2	8	0	0	10	0	0	0	0	0	0	3	0	0	3	14
07:00	1	0	0	0	1	1	10	0	0	11	0	0	0	0	0	0	6	0	0	6	18
07:05	0	0	0	0	0	2	13	0	0	15	0	0	0	0	0	0	2	0	0	2	17
07:10	0	0	1	0	1	2	20	0	0	22	0	0	0	0	0	0	1	0	0	1	24
07:15	2	0	0	0	2	1	14	0	0	15	0	0	0	0	0	0	4	0	0	4	21
07:20	0	0	0	0	0	2	11	0	0	13	0	0	0	0	0	0	3	0	0	3	16
07:25	0	0	1	0	1	0	14	0	0	14	0	0	0	0	0	0	4	0	0	4	19
07:30	1	0	1	0	2	1	15	0	0	16	0	0	0	0	0	0	1	0	0	1	19
07:35	2	0	1	0	3	0	6	0	0	6	0	0	0	0	0	0	2	0	0	2	11
07:40	0	0	0	0	0	0	14	0	0	14	0	0	0	0	0	0	6	0	0	6	20
07:45	2	0	0	0	2	0	11	0	0	11	0	0	0	0	0	0	2	0	0	2	15
07:50	0	0	0	0	0	3	8	0	0	11	0	0	0	0	0	0	4	0	0	4	15
Total Volume	9	0	4	0	13	14	144	0	0	158	0	0	0	0	0	0	38	0	0	38	209
% App. Total	69.2	0	30.8	0		8.9	91.1	0	0		0	0	0	0		0	100	0	0		
PHF	.375	.000	.333	.000	.361	.389	.600	.000	.000	.598	.000	.000	.000	.000	.000	.000	.528	.000	.000	.528	.726

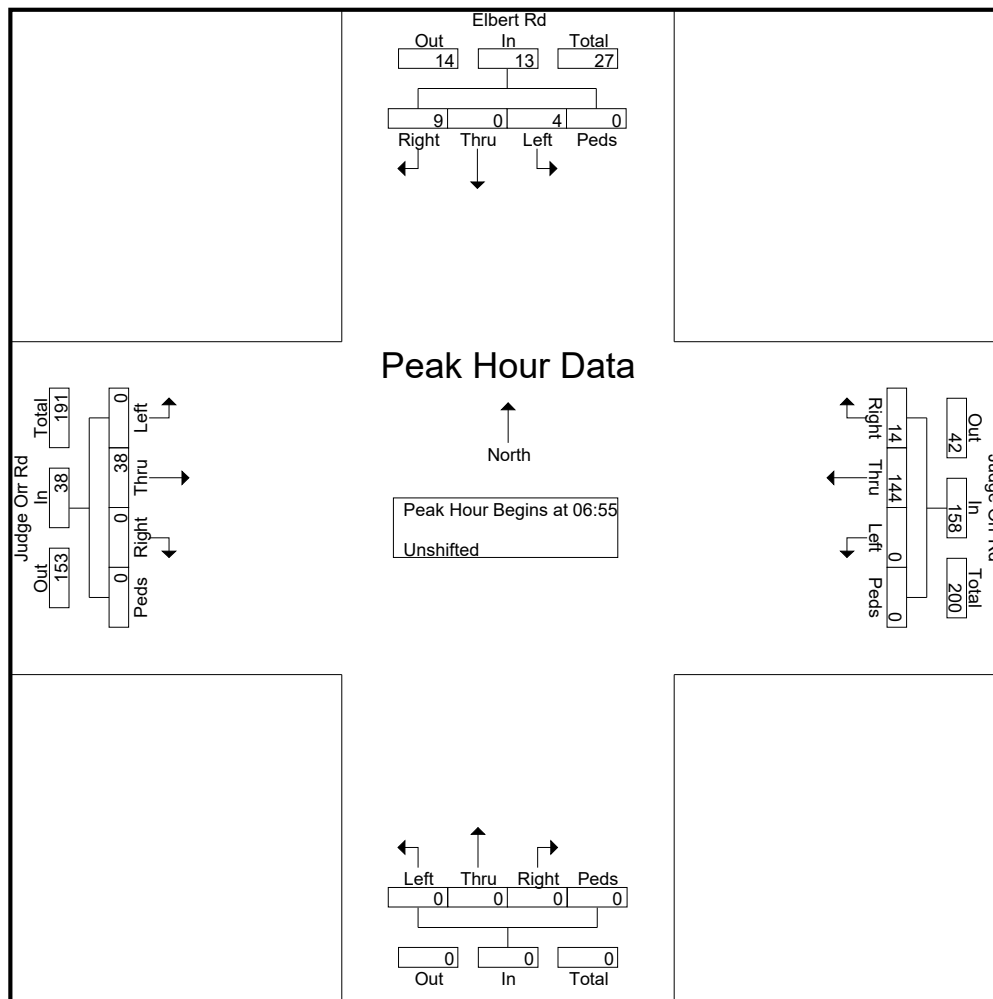

LSC Transportation Consultants, Inc.

2504 E. Pikes Peak Ave, Suite 304
 Colorado Springs, CO 80909
 719-633-2868

File Name : Elbert Rd - Judge Orr Rd AM 1-23

Site Code : S224640

Start Date : 1/11/2023

Page No : 3

Start Time	Elbert Rd Southbound					Judge Orr Rd Westbound					Northbound					Judge Orr Rd Eastbound					Int. Total
	Right	Thru	Left	Peds	App. Total	Right	Thru	Left	Peds	App. Total	Right	Thru	Left	Peds	App. Total	Right	Thru	Left	Peds	App. Total	

Peak Hour Analysis From 06:30 to 08:25 - Peak 1 of 1

Peak Hour for Each Approach Begins at:

	06:40					06:35					06:30					06:55				
+0 mins.	0	0	0	0	0	1	6	0	0	7	0	0	0	0	0	0	3	0	0	3
+5 mins.	0	0	2	0	2	1	14	0	0	15	0	0	0	0	0	0	6	0	0	6
+10 mins.	0	0	0	0	0	0	11	0	0	11	0	0	0	0	0	0	2	0	0	2
+15 mins.	1	0	0	0	1	3	8	0	0	11	0	0	0	0	0	0	1	0	0	1
+20 mins.	1	0	0	0	1	2	8	0	0	10	0	0	0	0	0	0	4	0	0	4
+25 mins.	0	0	0	0	0	1	10	0	0	11	0	0	0	0	0	0	3	0	0	3
+30 mins.	0	0	1	0	1	2	13	0	0	15	0	0	0	0	0	0	4	0	0	4
+35 mins.	2	0	0	0	2	2	20	0	0	22	0	0	0	0	0	0	1	0	0	1
+40 mins.	0	0	0	0	0	1	14	0	0	15	0	0	0	0	0	0	2	0	0	2
+45 mins.	0	0	1	0	1	2	11	0	0	13	0	0	0	0	0	0	6	0	0	6
+50 mins.	1	0	1	0	2	0	14	0	0	14	0	0	0	0	0	0	2	0	0	2
+55 mins.	2	0	1	0	3	1	15	0	0	16	0	0	0	0	0	0	4	0	0	4
Total Volume	7	0	6	0	13	16	144	0	0	160	0	0	0	0	0	0	38	0	0	38
% App. Total	53.8	0	46.2	0		10	90	0	0		0	0	0	0		0	100	0	0	
PHF	.292	.000	.250	.000	.361	.444	.600	.000	.000	.606	.000	.000	.000	.000	.000	.000	.528	.000	.000	.528

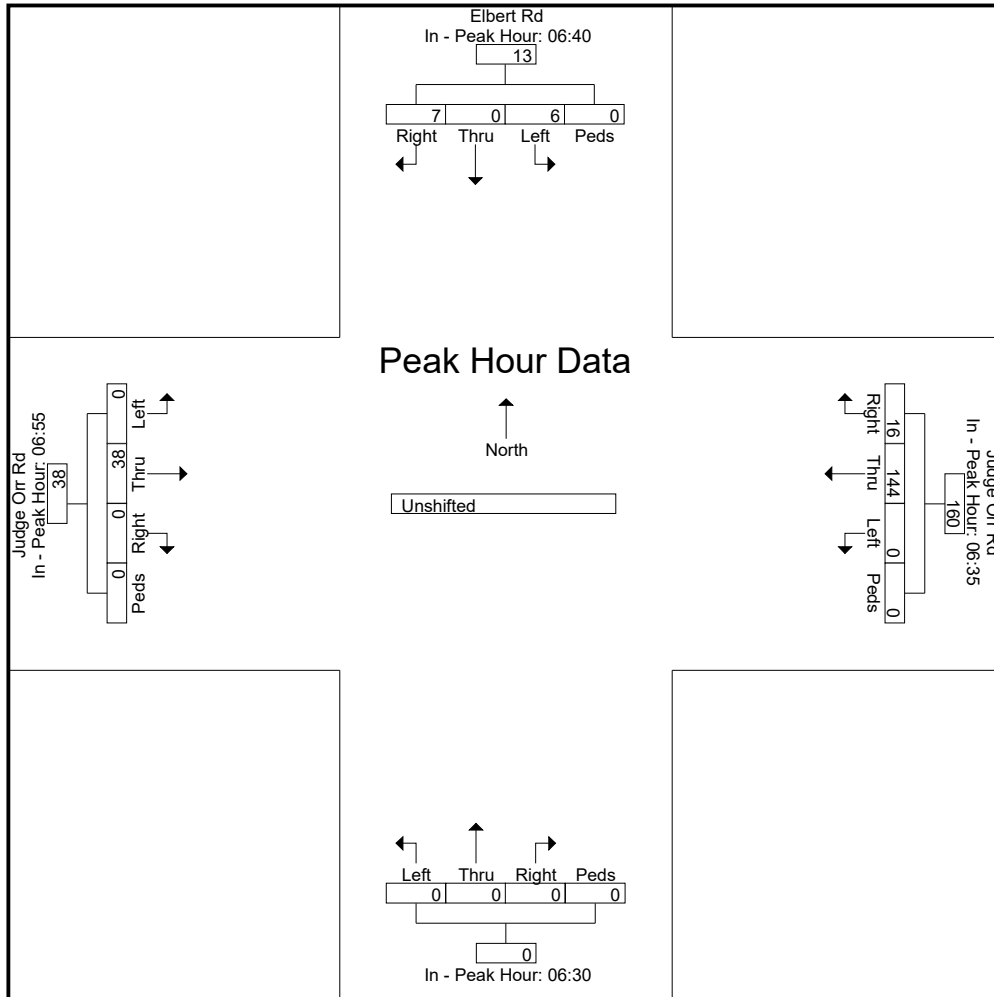

LSC Transportation Consultants, Inc.

2504 E. Pikes Peak Ave, Suite 304

Colorado Springs, CO 80909

719-633-2868

LSC Transportation Consultants, Inc.

2504 E. Pikes Peak Ave, Suite 304
 Colorado Springs, CO 80909
 719-633-2868

File Name : Elbert Rd - Judge Orr Rd AM PM

Site Code : S224640

Start Date : 1/11/2023

Page No : 1

Groups Printed- Unshifted

Start Time	Elbert Rd Southbound					Judge Orr Rd Westbound					Northbound					Judge Orr Rd Eastbound					Int. Total
	Right	Thru	Left	Peds	App. Total	Right	Thru	Left	Peds	App. Total	Right	Thru	Left	Peds	App. Total	Right	Thru	Left	Peds	App. Total	
06:30	1	0	1	0	2	0	15	0	0	15	0	0	0	0	0	0	3	0	0	3	20
06:35	0	0	1	0	1	1	6	0	0	7	0	0	0	0	0	0	1	0	0	1	9
06:40	0	0	0	0	0	1	14	0	0	15	0	0	0	0	0	0	1	1	0	2	17
06:45	0	0	2	0	2	0	11	0	0	11	0	0	0	0	0	0	1	0	0	1	14
06:50	0	0	0	0	0	3	8	0	0	11	0	0	0	0	0	0	1	0	0	1	12
06:55	1	0	0	0	1	2	8	0	0	10	0	0	0	0	0	0	3	0	0	3	14
Total	2	0	4	0	6	7	62	0	0	69	0	0	0	0	0	0	10	1	0	11	86
07:00	1	0	0	0	1	1	10	0	0	11	0	0	0	0	0	0	6	0	0	6	18
07:05	0	0	0	0	0	2	13	0	0	15	0	0	0	0	0	0	2	0	0	2	17
07:10	0	0	1	0	1	2	20	0	0	22	0	0	0	0	0	0	1	0	0	1	24
07:15	2	0	0	0	2	1	14	0	0	15	0	0	0	0	0	0	4	0	0	4	21
07:20	0	0	0	0	0	2	11	0	0	13	0	0	0	0	0	0	3	0	0	3	16
07:25	0	0	1	0	1	0	14	0	0	14	0	0	0	0	0	0	4	0	0	4	19
07:30	1	0	1	0	2	1	15	0	0	16	0	0	0	0	0	0	1	0	0	1	19
07:35	2	0	1	0	3	0	6	0	0	6	0	0	0	0	0	0	2	0	0	2	11
07:40	0	0	0	0	0	0	14	0	0	14	0	0	0	0	0	0	6	0	0	6	20
07:45	2	0	0	0	2	0	11	0	0	11	0	0	0	0	0	0	2	0	0	2	15
07:50	0	0	0	0	0	3	8	0	0	11	0	0	0	0	0	0	4	0	0	4	15
07:55	1	0	0	0	1	0	6	0	0	6	0	0	0	0	0	0	3	0	0	3	10
Total	9	0	4	0	13	12	142	0	0	154	0	0	0	0	0	0	38	0	0	38	205
08:00	1	0	0	0	1	3	5	0	0	8	0	0	0	0	0	0	3	0	0	3	12
08:05	0	0	0	0	0	0	7	0	0	7	0	0	0	0	0	0	2	0	0	2	9
08:10	1	0	0	0	1	1	12	0	0	13	0	0	0	0	0	0	4	0	0	4	18
08:15	0	0	0	0	0	0	9	0	0	9	0	0	0	0	0	0	1	1	0	2	11
08:20	0	0	1	0	1	0	9	0	0	9	0	0	0	0	0	0	4	1	0	5	15
08:25	1	0	0	0	1	2	5	0	0	7	0	0	0	0	0	0	3	0	0	3	11
*** BREAK ***																					
Total	3	0	1	0	4	6	47	0	0	53	0	0	0	0	0	0	17	2	0	19	76
16:00	0	0	1	0	1	1	6	0	0	7	0	0	0	0	0	0	9	1	0	10	18
16:05	0	0	1	0	1	1	4	0	0	5	0	0	0	0	0	0	7	0	0	7	13
16:10	0	0	1	0	1	1	4	0	0	5	0	0	0	0	0	0	8	0	0	8	14
16:15	0	0	1	0	1	0	2	0	0	2	0	0	0	0	0	0	16	0	0	16	19
16:20	1	0	1	0	2	1	5	0	0	6	0	0	0	0	0	0	9	0	0	9	17
16:25	1	0	1	0	2	0	4	0	0	4	0	0	0	0	0	0	13	0	0	13	19
16:30	0	0	0	0	0	0	6	0	0	6	0	0	0	0	0	0	16	1	0	17	23
16:35	0	0	0	0	0	0	3	0	0	3	0	0	0	0	0	0	14	1	0	15	18
16:40	0	0	0	0	0	0	4	0	0	4	0	0	0	0	0	0	14	1	0	15	19
16:45	1	0	0	0	1	0	3	0	0	3	0	0	0	0	0	0	16	1	0	17	21
16:50	0	0	1	0	1	0	4	0	0	4	0	0	0	0	0	0	7	1	0	8	13

LSC Transportation Consultants, Inc.

2504 E. Pikes Peak Ave, Suite 304
 Colorado Springs, CO 80909
 719-633-2868

File Name : Elbert Rd - Judge Orr Rd AM PM

Site Code : S224640

Start Date : 1/11/2023

Page No : 2

Groups Printed- Unshifted

Start Time	Elbert Rd Southbound					Judge Orr Rd Westbound					Northbound					Judge Orr Rd Eastbound					Int. Total
	Right	Thru	Left	Peds	App. Total	Right	Thru	Left	Peds	App. Total	Right	Thru	Left	Peds	App. Total	Right	Thru	Left	Peds	App. Total	
16:55	0	0	1	0	1	1	1	0	0	2	0	0	0	0	0	0	8	1	0	9	12
Total	3	0	8	0	11	5	46	0	0	51	0	0	0	0	0	0	137	7	0	144	206
17:00	1	0	0	0	1	0	1	0	0	1	0	0	0	0	0	0	13	1	0	14	16
17:05	0	0	4	0	4	0	3	0	0	3	0	0	0	0	0	0	14	0	0	14	21
17:10	0	0	1	0	1	0	6	0	0	6	0	0	0	0	0	0	5	0	0	5	12
17:15	0	0	0	0	0	1	1	0	0	2	0	0	0	0	0	0	9	1	0	10	12
17:20	1	0	0	0	1	2	5	0	0	7	0	0	0	0	0	0	12	0	0	12	20
17:25	0	0	0	0	0	0	2	0	0	2	0	0	0	0	0	0	5	0	0	5	7
17:30	0	0	2	0	2	1	6	0	0	7	0	0	0	0	0	0	12	0	0	12	21
17:35	0	0	0	0	0	1	6	0	0	7	0	0	0	0	0	0	6	0	0	6	13
17:40	0	0	1	0	1	0	1	0	0	1	0	0	0	0	0	0	19	0	0	19	21
17:45	0	0	1	0	1	0	1	0	0	1	0	0	0	0	0	0	2	0	0	2	4
17:50	0	0	1	0	1	0	1	0	0	1	0	0	0	0	0	0	5	0	0	5	7
17:55	0	0	2	0	2	0	3	0	0	3	0	0	0	0	0	0	3	0	0	3	8
Total	2	0	12	0	14	5	36	0	0	41	0	0	0	0	0	0	105	2	0	107	162
Grand Total	19	0	29	0	48	35	333	0	0	368	0	0	0	0	0	0	307	12	0	319	735
Apprch %	39.6	0	60.4	0		9.5	90.5	0	0		0	0	0	0		0	96.2	3.8	0		
Total %	2.6	0	3.9	0	6.5	4.8	45.3	0	0	50.1	0	0	0	0	0	0	41.8	1.6	0	43.4	

LSC Transportation Consultants, Inc.

2504 E. Pikes Peak Ave, Suite 304
 Colorado Springs, CO 80909
 719-633-2868

File Name : Elbert Rd - Judge Orr Rd AM PM

Site Code : S224640

Start Date : 1/11/2023

Page No : 3

Start Time	Elbert Rd Southbound					Judge Orr Rd Westbound					Northbound					Judge Orr Rd Eastbound					Int. Total
	Right	Thru	Left	Peds	App. Total	Right	Thru	Left	Peds	App. Total	Right	Thru	Left	Peds	App. Total	Right	Thru	Left	Peds	App. Total	
Peak Hour Analysis From 06:30 to 17:55 - Peak 1 of 1																					
Peak Hour for Entire Intersection Begins at 16:10																					
16:10	0	0	1	0	1	1	4	0	0	5	0	0	0	0	0	0	8	0	0	8	14
16:15	0	0	1	0	1	0	2	0	0	2	0	0	0	0	0	0	16	0	0	16	19
16:20	1	0	1	0	2	1	5	0	0	6	0	0	0	0	0	0	9	0	0	9	17
16:25	1	0	1	0	2	0	4	0	0	4	0	0	0	0	0	0	13	0	0	13	19
16:30	0	0	0	0	0	0	6	0	0	6	0	0	0	0	0	0	16	1	0	17	23
16:35	0	0	0	0	0	0	3	0	0	3	0	0	0	0	0	0	14	1	0	15	18
16:40	0	0	0	0	0	0	4	0	0	4	0	0	0	0	0	0	14	1	0	15	19
16:45	1	0	0	0	1	0	3	0	0	3	0	0	0	0	0	0	16	1	0	17	21
16:50	0	0	1	0	1	0	4	0	0	4	0	0	0	0	0	0	7	1	0	8	13
16:55	0	0	1	0	1	1	1	0	0	2	0	0	0	0	0	0	8	1	0	9	12
17:00	1	0	0	0	1	0	1	0	0	1	0	0	0	0	0	0	13	1	0	14	16
17:05	0	0	4	0	4	0	3	0	0	3	0	0	0	0	0	0	14	0	0	14	21
Total Volume	4	0	10	0	14	3	40	0	0	43	0	0	0	0	0	0	148	7	0	155	212
% App. Total	28.6	0	71.4	0		7	93	0	0		0	0	0	0		0	95.5	4.5	0		
PHF	.333	.000	.208	.000	.292	.250	.556	.000	.000	.597	.000	.000	.000	.000	.000	.000	.771	.583	.000	.760	.768

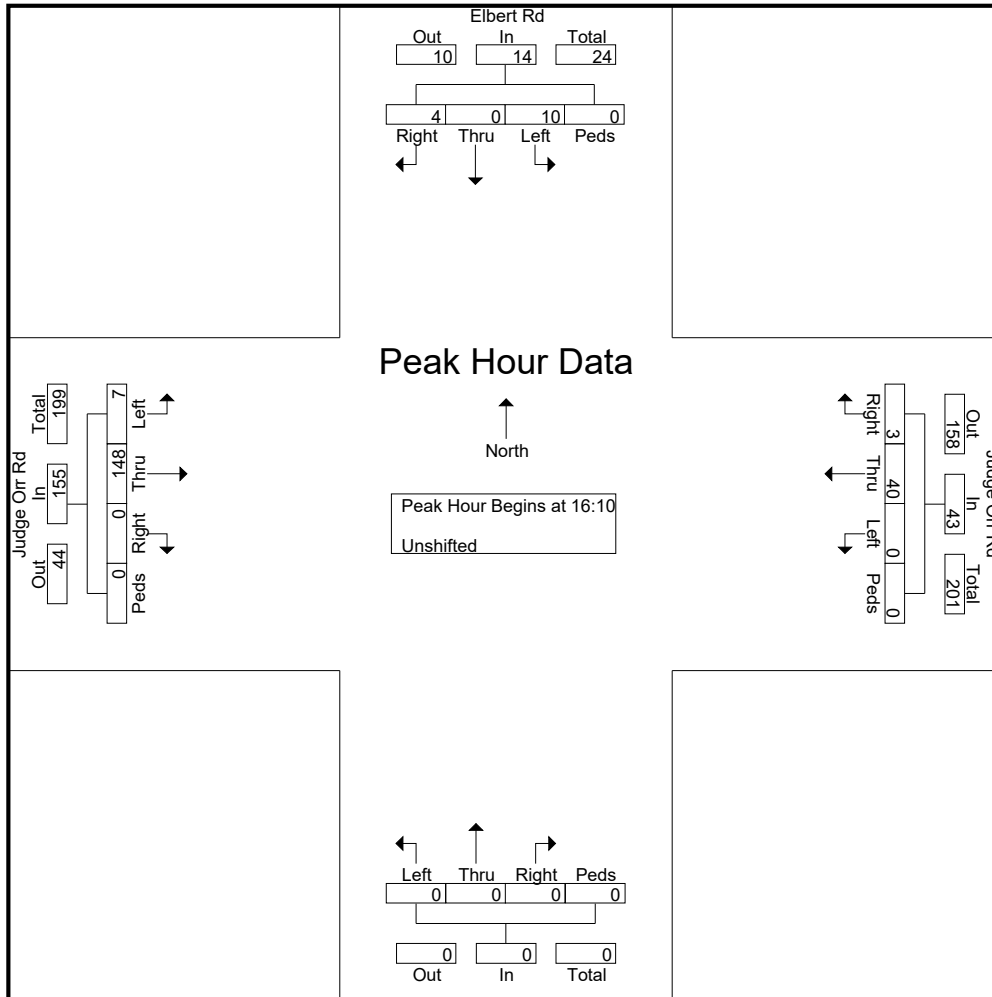

LSC Transportation Consultants, Inc.

2504 E. Pikes Peak Ave, Suite 304
 Colorado Springs, CO 80909
 719-633-2868

File Name : Elbert Rd - Judge Orr Rd AM PM

Site Code : S224640

Start Date : 1/11/2023

Page No : 4

Start Time	Elbert Rd Southbound					Judge Orr Rd Westbound					Northbound					Judge Orr Rd Eastbound					Int. Total
	Right	Thru	Left	Peds	App. Total	Right	Thru	Left	Peds	App. Total	Right	Thru	Left	Peds	App. Total	Right	Thru	Left	Peds	App. Total	

Peak Hour Analysis From 06:30 to 17:55 - Peak 1 of 1

Peak Hour for Each Approach Begins at:

	16:10					06:35					06:30					16:10				
+0 mins.	0	0	1	0	1	1	6	0	0	7	0	0	0	0	0	0	8	0	0	8
+5 mins.	0	0	1	0	1	1	14	0	0	15	0	0	0	0	0	0	16	0	0	16
+10 mins.	1	0	1	0	2	0	11	0	0	11	0	0	0	0	0	0	9	0	0	9
+15 mins.	1	0	1	0	2	3	8	0	0	11	0	0	0	0	0	0	13	0	0	13
+20 mins.	0	0	0	0	0	2	8	0	0	10	0	0	0	0	0	0	16	1	0	17
+25 mins.	0	0	0	0	0	1	10	0	0	11	0	0	0	0	0	0	14	1	0	15
+30 mins.	0	0	0	0	0	2	13	0	0	15	0	0	0	0	0	0	14	1	0	15
+35 mins.	1	0	0	0	1	2	20	0	0	22	0	0	0	0	0	0	16	1	0	17
+40 mins.	0	0	1	0	1	1	14	0	0	15	0	0	0	0	0	0	7	1	0	8
+45 mins.	0	0	1	0	1	2	11	0	0	13	0	0	0	0	0	0	8	1	0	9
+50 mins.	1	0	0	0	1	0	14	0	0	14	0	0	0	0	0	0	13	1	0	14
+55 mins.	0	0	4	0	4	1	15	0	0	16	0	0	0	0	0	0	14	0	0	14
Total Volume	4	0	10	0	14	16	144	0	0	160	0	0	0	0	0	0	148	7	0	155
% App. Total	28.6	0	71.4	0		10	90	0	0		0	0	0	0		0	95.5	4.5	0	
PHF	.333	.000	.208	.000	.292	.444	.600	.000	.000	.606	.000	.000	.000	.000	.000	.000	.771	.583	.000	.760

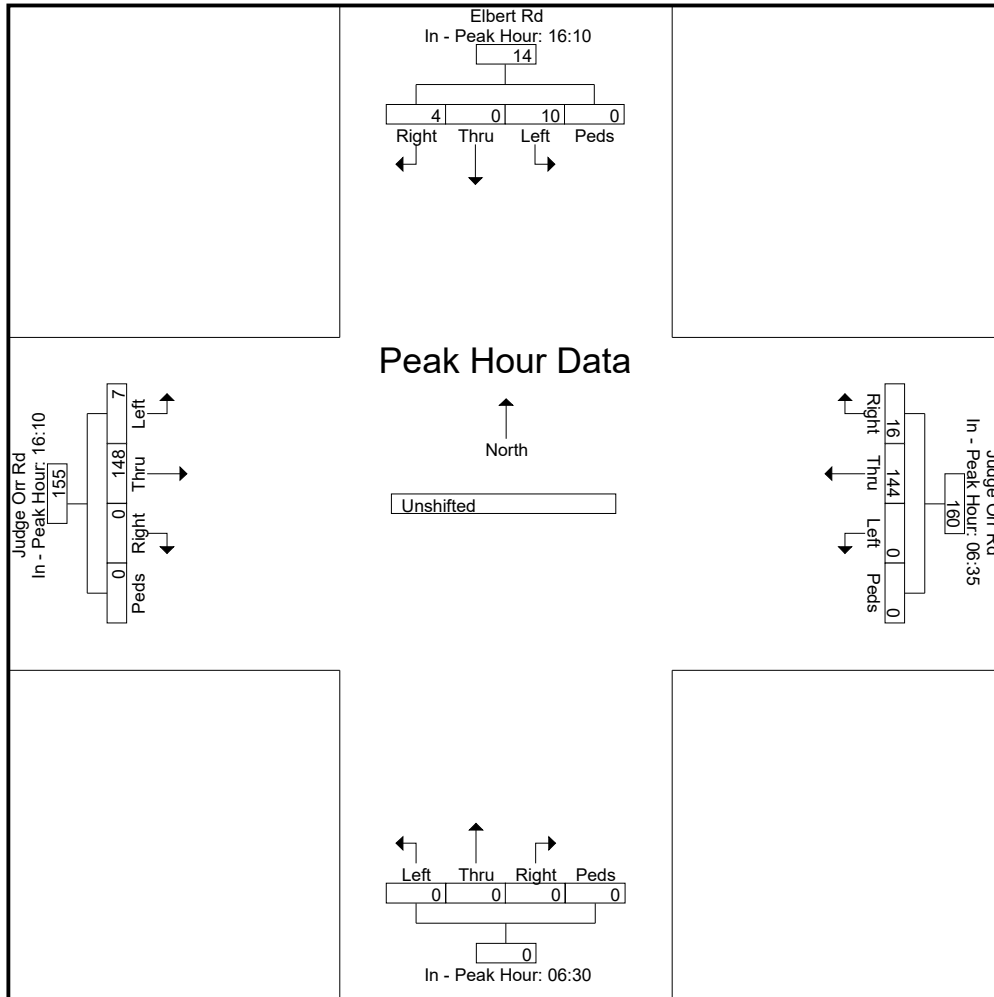

LSC Transportation Consultants, Inc.

2504 E. Pikes Peak Ave, Suite 304

Colorado Springs, CO 80909

719-633-2868

LSC Transportation Consultants, Inc.

2504 E. Pikes Peak Ave, Suite 304
 Colorado Springs, CO 80909
 719-633-2868

File Name : Hwy 24 - Judge Orr Rd AM

Site Code : S214950

Start Date : 5/10/2022

Page No : 1

Groups Printed- Unshifted

Start Time	Hwy 24 Southbound					Judge Orr Rd Westbound					Hwy 24 Northbound					Judge Orr Rd Eastbound					Int. Total
	Right	Thru	Left	Peds	App. Total	Right	Thru	Left	Peds	App. Total	Right	Thru	Left	Peds	App. Total	Right	Thru	Left	Peds	App. Total	
06:30	1	130	0	0	131	1	7	36	0	44	4	66	8	0	78	43	14	2	0	59	312
06:45	4	173	3	0	180	0	10	20	0	30	18	92	8	0	118	34	10	4	0	48	376
Total	5	303	3	0	311	1	17	56	0	74	22	158	16	0	196	77	24	6	0	107	688
07:00	2	132	0	0	134	3	7	39	0	49	18	98	23	0	139	50	16	9	0	75	397
07:15	3	137	2	0	142	1	23	26	0	50	19	82	18	0	119	43	16	2	0	61	372
07:30	9	137	2	0	148	0	17	30	0	47	9	71	24	0	104	51	20	0	0	71	370
07:45	1	102	1	0	104	1	15	15	0	31	21	67	17	0	105	21	15	3	0	39	279
Total	15	508	5	0	528	5	62	110	0	177	67	318	82	0	467	165	67	14	0	246	1418
08:00	2	108	1	0	111	1	8	22	0	31	23	68	12	1	104	28	20	5	0	53	299
08:15	5	96	1	0	102	2	3	29	0	34	15	70	14	0	99	15	13	4	0	32	267
Grand Total	27	1015	10	0	1052	9	90	217	0	316	127	614	124	1	866	285	124	29	0	438	2672
Apprch %	2.6	96.5	1	0		2.8	28.5	68.7	0		14.7	70.9	14.3	0.1		65.1	28.3	6.6	0		
Total %	1	38	0.4	0	39.4	0.3	3.4	8.1	0	11.8	4.8	23	4.6	0	32.4	10.7	4.6	1.1	0	16.4	

LSC Transportation Consultants, Inc.

2504 E. Pikes Peak Ave, Suite 304
 Colorado Springs, CO 80909
 719-633-2868

File Name : Hwy 24 - Judge Orr Rd AM
 Site Code : S214950
 Start Date : 5/10/2022
 Page No : 2

Start Time	Hwy 24 Southbound					Judge Orr Rd Westbound					Hwy 24 Northbound					Judge Orr Rd Eastbound					Int. Total
	Right	Thru	Left	Peds	App. Total	Right	Thru	Left	Peds	App. Total	Right	Thru	Left	Peds	App. Total	Right	Thru	Left	Peds	App. Total	
Peak Hour Analysis From 6:30:00 AM to 8:15:00 AM - Peak 1 of 1																					
Peak Hour for Entire Intersection Begins at 6:45:00 AM																					
6:45:00 AM	4	173	3	0	180	0	10	20	0	30	18	92	8	0	118	34	10	4	0	48	376
7:00:00 AM	2	132	0	0	134	3	7	39	0	49	18	98	23	0	139	50	16	9	0	75	397
7:15:00 AM	3	137	2	0	142	1	23	26	0	50	19	82	18	0	119	43	16	2	0	61	372
7:30:00 AM	9	137	2	0	148	0	17	30	0	47	9	71	24	0	104	51	20	0	0	71	370
Total Volume	18	579	7	0	604	4	57	115	0	176	64	343	73	0	480	178	62	15	0	255	1515
% App. Total	3	95.9	1.2	0		2.3	32.4	65.3	0		13.3	71.5	15.2	0		69.8	24.3	5.9	0		
PHF	.500	.837	.583	.000	.839	.333	.620	.737	.000	.880	.842	.875	.760	.000	.863	.873	.775	.417	.000	.850	.954

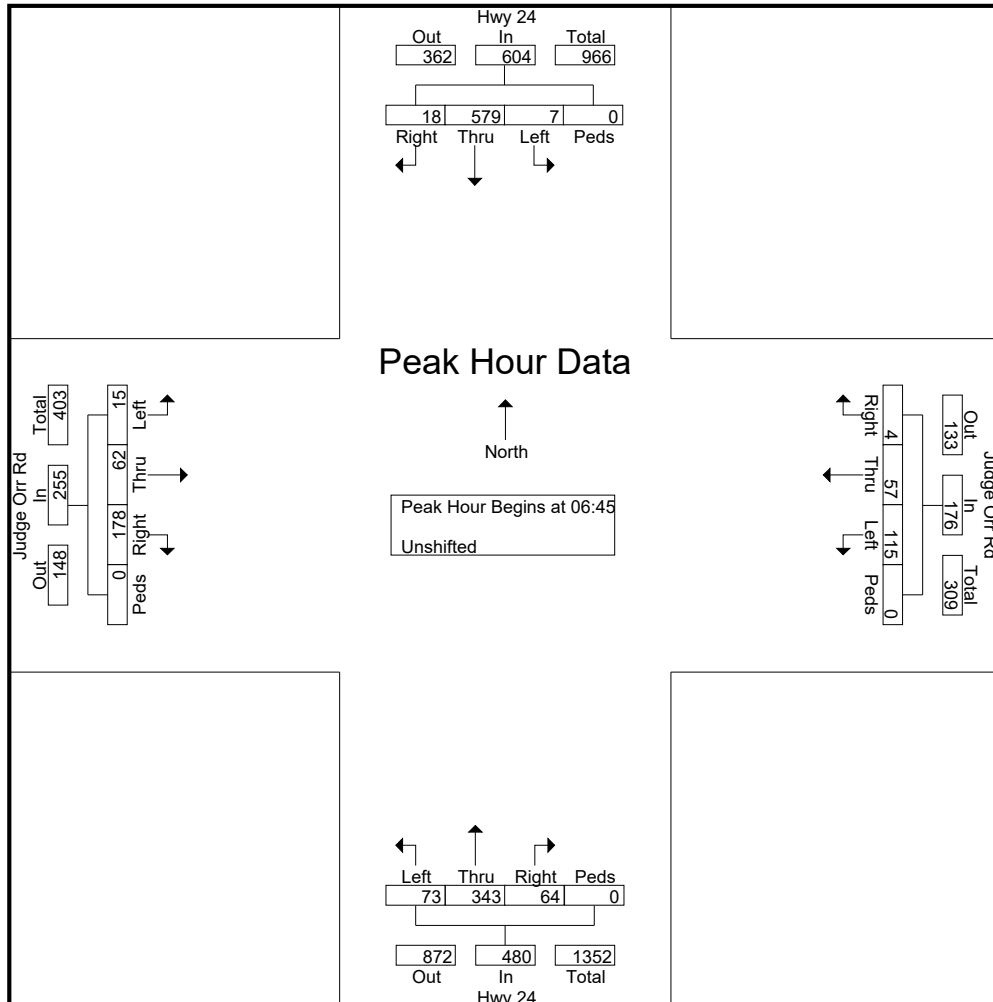

LSC Transportation Consultants, Inc.

2504 E. Pikes Peak Ave, Suite 304
 Colorado Springs, CO 80909
 719-633-2868

File Name : Hwy 24 - Judge Orr Rd AM
 Site Code : S214950
 Start Date : 5/10/2022
 Page No : 3

Start Time	Hwy 24 Southbound					Judge Orr Rd Westbound					Hwy 24 Northbound					Judge Orr Rd Eastbound					Int. Total
	Right	Thru	Left	Peds	App. Total	Right	Thru	Left	Peds	App. Total	Right	Thru	Left	Peds	App. Total	Right	Thru	Left	Peds	App. Total	
Peak Hour Analysis From 6:30:00 AM to 8:15:00 AM - Peak 1 of 1																					
Peak Hour for Each Approach Begins at:																					
	6:45:00 AM					7:00:00 AM					6:45:00 AM					6:45:00 AM					
+0 mins.	4	173	3	0	180	3	7	39	0	49	18	92	8	0	118	34	10	4	0	48	
+5 mins.	2	132	0	0	134	1	23	26	0	50	18	98	23	0	139	50	16	9	0	75	
+10 mins.	3	137	2	0	142	0	17	30	0	47	19	82	18	0	119	43	16	2	0	61	
+15 mins.	9	137	2	0	148	1	15	15	0	31	9	71	24	0	104	51	20	0	0	71	
Total Volume	18	579	7	0	604	5	62	110	0	177	64	343	73	0	480	178	62	15	0	255	
% App. Total	3	95.9	1.2	0		2.8	35	62.1	0		13.3	71.5	15.2	0		69.8	24.3	5.9	0		
PHF	.500	.837	.583	.000	.839	.417	.674	.705	.000	.885	.842	.875	.760	.000	.863	.873	.775	.417	.000	.850	

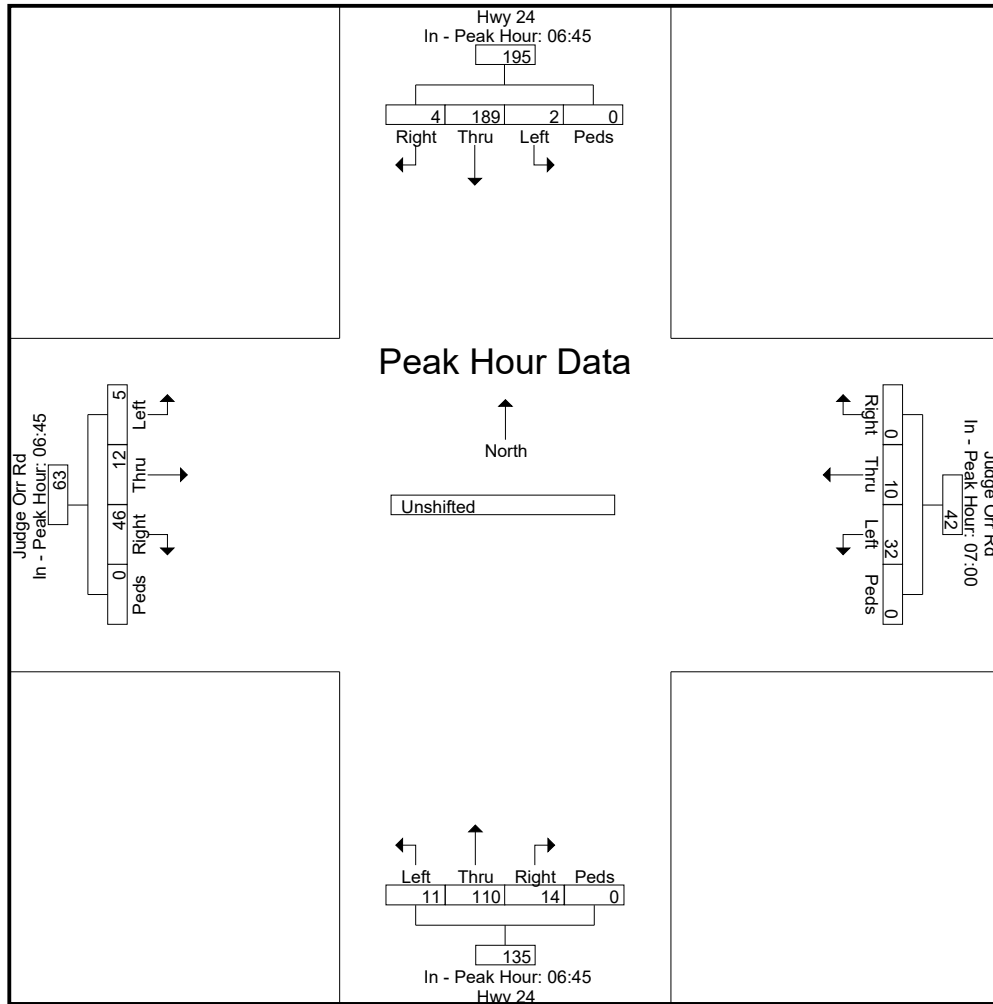

LSC Transportation Consultants, Inc.

2504 E. Pikes Peak Ave, Suite 304
 Colorado Springs, CO 80909
 719-633-2868

File Name : Hwy 24 - Judge Orr Rd PM

Site Code : S214950

Start Date : 5/10/2022

Page No : 1

Groups Printed- Unshifted

Start Time	Hwy 24 Southbound					Judge Orr Rd Westbound					Hwy 24 Northbound					Judge Orr Rd Eastbound					Int. Total
	Right	Thru	Left	Peds	App. Total	Right	Thru	Left	Peds	App. Total	Right	Thru	Left	Peds	App. Total	Right	Thru	Left	Peds	App. Total	
16:00	5	77	2	0	84	1	7	22	0	30	33	143	24	0	200	10	7	5	0	22	336
16:15	3	105	1	0	109	5	17	25	0	47	27	152	30	0	209	21	11	11	0	43	408
16:30	7	105	1	0	113	1	14	29	0	44	34	144	34	1	213	18	11	11	0	40	410
16:45	1	101	0	0	102	2	9	24	0	35	31	135	41	0	207	15	13	12	0	40	384
Total	16	388	4	0	408	9	47	100	0	156	125	574	129	1	829	64	42	39	0	145	1538
17:00	2	99	0	0	101	4	13	38	0	55	29	147	40	0	216	16	16	10	0	42	414
17:15	7	127	0	0	134	2	16	26	0	44	34	133	24	1	192	13	11	7	0	31	401
17:30	6	91	1	0	98	2	6	16	0	24	39	149	32	0	220	10	15	10	0	35	377
17:45	6	98	0	0	104	0	5	22	0	27	29	158	30	0	217	11	17	8	0	36	384
Total	21	415	1	0	437	8	40	102	0	150	131	587	126	1	845	50	59	35	0	144	1576
Grand Total	37	803	5	0	845	17	87	202	0	306	256	1161	255	2	1674	114	101	74	0	289	3114
Apprch %	4.4	95	0.6	0		5.6	28.4	66	0		15.3	69.4	15.2	0.1		39.4	34.9	25.6	0		
Total %	1.2	25.8	0.2	0	27.1	0.5	2.8	6.5	0	9.8	8.2	37.3	8.2	0.1	53.8	3.7	3.2	2.4	0	9.3	

LSC Transportation Consultants, Inc.

2504 E. Pikes Peak Ave, Suite 304
 Colorado Springs, CO 80909
 719-633-2868

File Name : Hwy 24 - Judge Orr Rd PM

Site Code : S214950

Start Date : 5/10/2022

Page No : 2

Start Time	Hwy 24 Southbound					Judge Orr Rd Westbound					Hwy 24 Northbound					Judge Orr Rd Eastbound					Int. Total
	Right	Thru	Left	Peds	App. Total	Right	Thru	Left	Peds	App. Total	Right	Thru	Left	Peds	App. Total	Right	Thru	Left	Peds	App. Total	
Peak Hour Analysis From 4:00:00 PM to 5:45:00 PM - Peak 1 of 1																					
Peak Hour for Entire Intersection Begins at 4:15:00 PM																					
4:15:00 PM	3	105	1	0	109	5	17	25	0	47	27	152	30	0	209	21	11	11	0	43	408
4:30:00 PM	7	105	1	0	113	1	14	29	0	44	34	144	34	1	213	18	11	11	0	40	410
4:45:00 PM	1	101	0	0	102	2	9	24	0	35	31	135	41	0	207	15	13	12	0	40	384
5:00:00 PM	2	99	0	0	101	4	13	38	0	55	29	147	40	0	216	16	16	10	0	42	414
Total Volume	13	410	2	0	425	12	53	116	0	181	121	578	145	1	845	70	51	44	0	165	1616
% App. Total	3.1	96.5	0.5	0		6.6	29.3	64.1	0		14.3	68.4	17.2	0.1		42.4	30.9	26.7	0		
PHF	.464	.976	.500	.000	.940	.600	.779	.763	.000	.823	.890	.951	.884	.250	.978	.833	.797	.917	.000	.959	.976

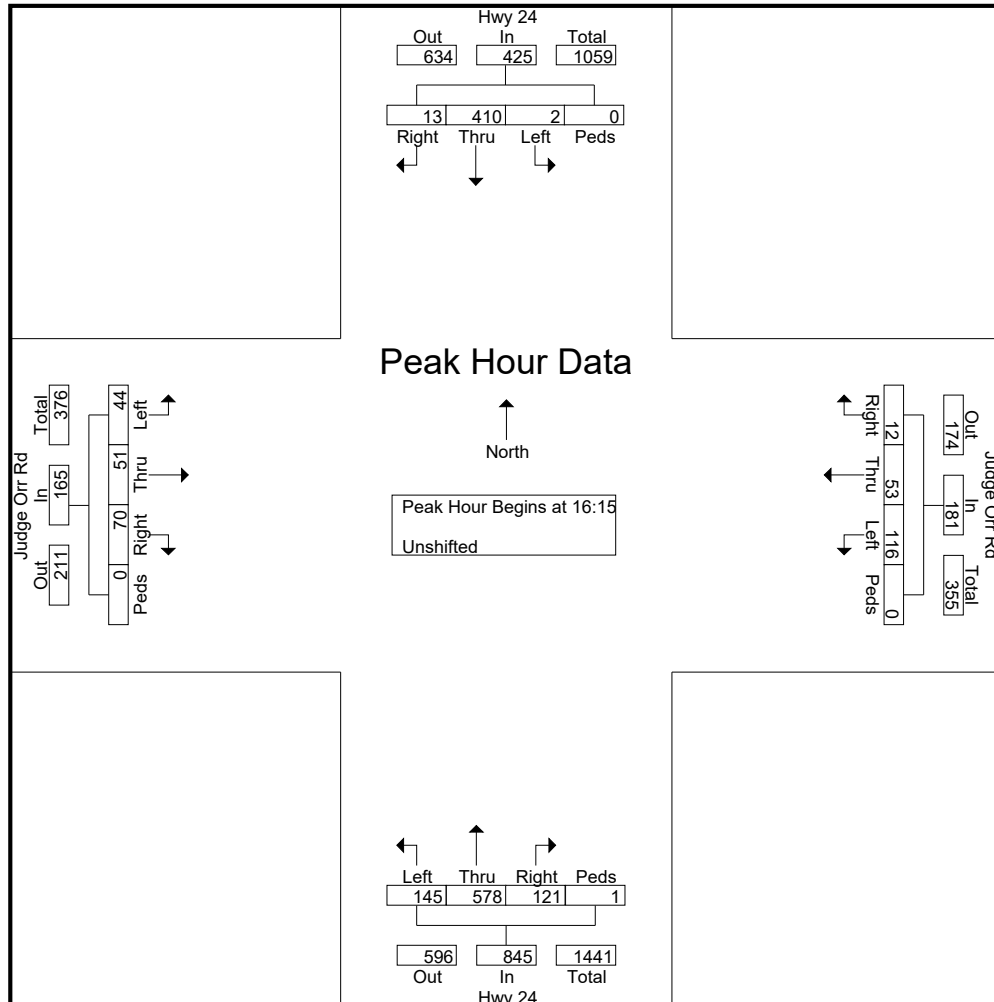

LSC Transportation Consultants, Inc.

2504 E. Pikes Peak Ave, Suite 304
 Colorado Springs, CO 80909
 719-633-2868

File Name : Hwy 24 - Judge Orr Rd PM

Site Code : S214950

Start Date : 5/10/2022

Page No : 3

Start Time	Hwy 24 Southbound					Judge Orr Rd Westbound					Hwy 24 Northbound					Judge Orr Rd Eastbound					Int. Total
	Right	Thru	Left	Peds	App. Total	Right	Thru	Left	Peds	App. Total	Right	Thru	Left	Peds	App. Total	Right	Thru	Left	Peds	App. Total	

Peak Hour Analysis From 4:00:00 PM to 5:45:00 PM - Peak 1 of 1

Peak Hour for Each Approach Begins at:

	4:30:00 PM					4:15:00 PM					4:15:00 PM					4:15:00 PM				
+0 mins.	7	105	1	0	113	5	17	25	0	47	27	152	30	0	209	21	11	11	0	43
+5 mins.	1	101	0	0	102	1	14	29	0	44	34	144	34	1	213	18	11	11	0	40
+10 mins.	2	99	0	0	101	2	9	24	0	35	31	135	41	0	207	15	13	12	0	40
+15 mins.	7	127	0	0	134	4	13	38	0	55	29	147	40	0	216	16	16	10	0	42
Total Volume	17	432	1	0	450	12	53	116	0	181	121	578	145	1	845	70	51	44	0	165
% App. Total	3.8	96	0.2	0		6.6	29.3	64.1	0		14.3	68.4	17.2	0.1		42.4	30.9	26.7	0	
PHF	.607	.850	.250	.000	.840	.600	.779	.763	.000	.823	.890	.951	.884	.250	.978	.833	.797	.917	.000	.959

LSC Transportation Consultants, Inc.

2504 E. Pikes Peak Ave, Suite 304
 Colorado Springs, CO 80909
 719-633-2868

File Name : Hwy 24 - Stapleton Rd AM PM

Site Code : S224640

Start Date : 1/10/2023

Page No : 1

Groups Printed- Unshifted

Start Time	Hwy 24 Southbound					Stapleton Dr Westbound					Hwy 24 Northbound					Stapleton Dr Eastbound					Int. Total
	Right	Thru	Left	Peds	App. Total	Right	Thru	Left	Peds	App. Total	Right	Thru	Left	Peds	App. Total	Right	Thru	Left	Peds	App. Total	
06:30	1	29	1	0	31	0	1	1	0	2	1	7	1	0	9	20	11	1	0	32	74
06:35	0	33	0	0	33	1	4	0	0	5	0	12	0	0	12	11	11	2	0	24	74
06:40	0	35	2	0	37	1	0	0	0	1	0	13	2	0	15	16	8	2	0	26	79
06:45	3	41	3	0	47	1	6	3	0	10	1	22	4	0	27	13	9	2	0	24	108
06:50	3	32	1	0	36	1	3	0	0	4	1	15	7	0	23	14	7	1	0	22	85
06:55	2	22	1	0	25	2	8	0	0	10	0	24	6	0	30	16	13	0	0	29	94
Total	9	192	8	0	209	6	22	4	0	32	3	93	20	0	116	90	59	8	0	157	514
07:00	4	35	3	0	42	2	6	0	0	8	0	29	2	0	31	7	13	1	0	21	102
07:05	4	33	4	0	41	1	10	0	0	11	0	22	4	0	26	7	11	6	0	24	102
07:10	0	33	3	0	36	4	11	1	0	16	0	30	5	0	35	15	12	2	0	29	116
07:15	2	36	2	0	40	4	14	1	0	19	0	29	7	0	36	13	15	3	0	31	126
07:20	4	46	1	0	51	1	6	0	0	7	0	30	4	0	34	11	13	1	0	25	117
07:25	5	51	8	0	64	0	7	0	0	7	0	28	0	0	28	10	7	1	0	18	117
07:30	2	34	2	0	38	0	7	0	0	7	1	16	6	0	23	9	20	2	0	31	99
07:35	6	40	5	0	51	0	9	1	0	10	0	9	2	0	11	12	7	2	0	21	93
07:40	4	31	1	0	36	0	7	2	0	9	0	9	3	0	12	5	9	0	0	14	71
07:45	1	31	1	0	33	2	5	1	0	8	0	13	6	0	19	6	17	2	0	25	85
07:50	3	21	4	0	28	0	5	0	0	5	1	18	1	0	20	10	15	2	0	27	80
07:55	2	15	3	0	20	1	1	0	0	2	0	16	4	0	20	8	5	1	0	14	56
Total	37	406	37	0	480	15	88	6	0	109	2	249	44	0	295	113	144	23	0	280	1164
08:00	3	39	2	0	44	0	6	0	0	6	0	10	5	0	15	4	10	2	0	16	81
08:05	1	30	0	0	31	1	2	1	0	4	2	19	5	0	26	4	6	4	0	14	75
08:10	2	27	2	0	31	2	2	1	0	5	0	13	4	0	17	5	6	0	0	11	64
08:15	4	31	0	0	35	5	1	2	0	8	0	7	5	0	12	8	5	2	0	15	70
08:20	5	22	3	0	30	1	7	0	0	8	0	3	3	0	6	7	4	1	0	12	56
08:25	4	34	1	0	39	0	2	0	0	2	1	14	0	0	15	4	7	5	0	16	72
*** BREAK ***																					
Total	19	183	8	0	210	9	20	4	0	33	3	66	22	0	91	32	38	14	0	84	418
*** BREAK ***																					
16:00	2	26	0	0	28	3	7	1	0	11	0	41	13	0	54	3	3	4	0	10	103
16:05	3	25	0	0	28	4	6	0	0	10	0	46	15	0	61	1	2	5	0	8	107
16:10	3	32	0	0	35	2	8	0	0	10	3	35	15	0	53	6	4	2	0	12	110
16:15	3	36	1	0	40	3	9	1	0	13	4	45	7	0	56	4	1	2	0	7	116
16:20	0	31	3	0	34	1	7	1	0	9	2	46	15	0	63	4	2	1	0	7	113
16:25	1	24	1	0	26	2	11	0	0	13	3	47	8	0	58	5	10	3	0	18	115
16:30	1	23	0	0	24	0	10	2	0	12	1	42	7	0	50	5	3	2	0	10	96
16:35	2	32	1	0	35	1	5	1	0	7	4	34	4	0	42	2	1	1	0	4	88
16:40	5	29	1	0	35	2	13	0	0	15	1	29	7	0	37	4	9	1	0	14	101
16:45	3	31	2	0	36	5	10	3	0	18	2	31	13	0	46	3	2	2	0	7	107
16:50	1	32	1	0	34	2	11	0	0	13	4	39	7	0	50	6	4	2	0	12	109

LSC Transportation Consultants, Inc.

2504 E. Pikes Peak Ave, Suite 304
 Colorado Springs, CO 80909
 719-633-2868

File Name : Hwy 24 - Stapleton Rd AM PM
 Site Code : S224640
 Start Date : 1/10/2023
 Page No : 2

Groups Printed- Unshifted

Start Time	Hwy 24 Southbound					Stapleton Dr Westbound					Hwy 24 Northbound					Stapleton Dr Eastbound					Int. Total
	Right	Thru	Left	Peds	App. Total	Right	Thru	Left	Peds	App. Total	Right	Thru	Left	Peds	App. Total	Right	Thru	Left	Peds	App. Total	
16:55	5	29	1	0	35	3	15	2	0	20	3	31	15	0	49	2	4	2	0	8	112
Total	29	350	11	0	390	28	112	11	0	151	27	466	126	0	619	45	45	27	0	117	1277
17:00	3	22	0	0	25	0	20	0	0	20	1	37	13	0	51	8	1	0	0	9	105
17:05	2	30	0	0	32	4	6	1	0	11	7	47	14	0	68	2	4	0	0	6	117
17:10	3	45	1	0	49	3	19	1	0	23	1	31	9	0	41	4	1	1	0	6	119
17:15	3	29	1	0	33	1	4	1	0	6	0	46	7	0	53	3	1	1	0	5	97
17:20	3	27	1	0	31	4	11	1	0	16	3	34	8	0	45	3	5	2	0	10	102
17:25	3	21	0	0	24	3	2	0	0	5	0	30	11	0	41	2	4	2	0	8	78
17:30	3	18	0	0	21	5	8	0	0	13	2	43	8	0	53	1	3	0	0	4	91
17:35	3	17	0	0	20	2	6	0	0	8	0	33	14	0	47	2	1	3	0	6	81
17:40	1	18	0	0	19	2	6	2	0	10	1	32	6	0	39	0	1	3	0	4	72
17:45	4	24	1	0	29	2	4	1	0	7	1	51	7	0	59	3	2	1	0	6	101
17:50	1	13	0	0	14	1	6	1	0	8	0	48	13	0	61	2	5	3	0	10	93
17:55	3	18	0	0	21	3	7	0	0	10	1	23	9	0	33	4	7	2	0	13	77
Total	32	282	4	0	318	30	99	8	0	137	17	455	119	0	591	34	35	18	0	87	1133
Grand Total	126	1413	68	0	1607	88	341	33	0	462	52	1329	331	0	1712	314	321	90	0	725	4506
Apprch %	7.8	87.9	4.2	0		19	73.8	7.1	0		3	77.6	19.3	0		43.3	44.3	12.4	0		
Total %	2.8	31.4	1.5	0	35.7	2	7.6	0.7	0	10.3	1.2	29.5	7.3	0	38	7	7.1	2	0	16.1	

LSC Transportation Consultants, Inc.

2504 E. Pikes Peak Ave, Suite 304
 Colorado Springs, CO 80909
 719-633-2868

File Name : Hwy 24 - Stapleton Rd AM PM
 Site Code : S224640
 Start Date : 1/10/2023
 Page No : 3

Start Time	Hwy 24 Southbound					Stapleton Dr Westbound					Hwy 24 Northbound					Stapleton Dr Eastbound					Int. Total
	Right	Thru	Left	Peds	App. Total	Right	Thru	Left	Peds	App. Total	Right	Thru	Left	Peds	App. Total	Right	Thru	Left	Peds	App. Total	
Peak Hour Analysis From 06:30 to 17:55 - Peak 1 of 1																					
Peak Hour for Entire Intersection Begins at 16:15																					
16:15	3	36	1	0	40	3	9	1	0	13	4	45	7	0	56	4	1	2	0	7	116
16:20	0	31	3	0	34	1	7	1	0	9	2	46	15	0	63	4	2	1	0	7	113
16:25	1	24	1	0	26	2	11	0	0	13	3	47	8	0	58	5	10	3	0	18	115
16:30	1	23	0	0	24	0	10	2	0	12	1	42	7	0	50	5	3	2	0	10	96
16:35	2	32	1	0	35	1	5	1	0	7	4	34	4	0	42	2	1	1	0	4	88
16:40	5	29	1	0	35	2	13	0	0	15	1	29	7	0	37	4	9	1	0	14	101
16:45	3	31	2	0	36	5	10	3	0	18	2	31	13	0	46	3	2	2	0	7	107
16:50	1	32	1	0	34	2	11	0	0	13	4	39	7	0	50	6	4	2	0	12	109
16:55	5	29	1	0	35	3	15	2	0	20	3	31	15	0	49	2	4	2	0	8	112
17:00	3	22	0	0	25	0	20	0	0	20	1	37	13	0	51	8	1	0	0	9	105
17:05	2	30	0	0	32	4	6	1	0	11	7	47	14	0	68	2	4	0	0	6	117
17:10	3	45	1	0	49	3	19	1	0	23	1	31	9	0	41	4	1	1	0	6	119
Total Volume	29	364	12	0	405	26	136	12	0	174	33	459	119	0	611	49	42	17	0	108	1298
% App. Total	7.2	89.9	3	0		14.9	78.2	6.9	0		5.4	75.1	19.5	0		45.4	38.9	15.7	0		
PHF	.483	.674	.333	.000	.689	.433	.567	.333	.000	.630	.393	.814	.661	.000	.749	.510	.350	.472	.000	.500	.909

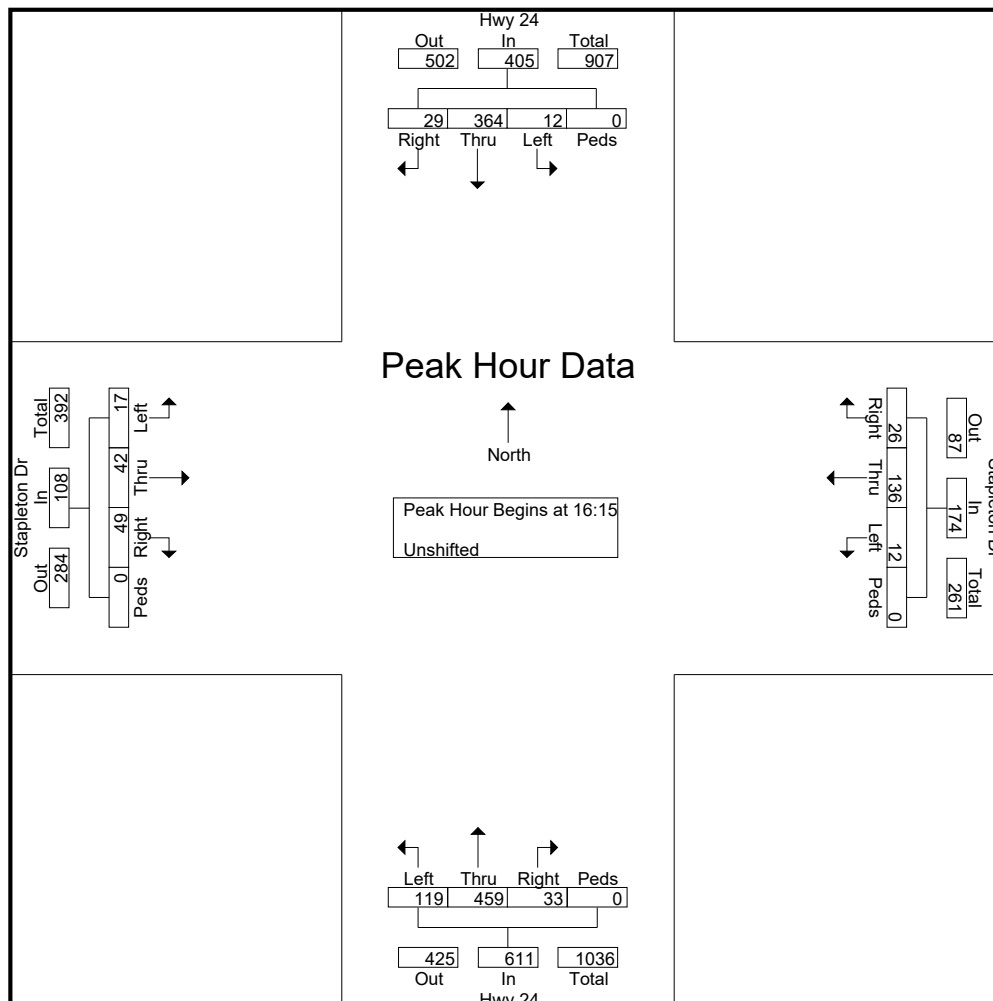

LSC Transportation Consultants, Inc.

2504 E. Pikes Peak Ave, Suite 304
 Colorado Springs, CO 80909
 719-633-2868

File Name : Hwy 24 - Stapleton Rd AM PM
 Site Code : S224640
 Start Date : 1/10/2023
 Page No : 4

Start Time	Hwy 24 Southbound					Stapleton Dr Westbound					Hwy 24 Northbound					Stapleton Dr Eastbound					Int. Total
	Right	Thru	Left	Peds	App. Total	Right	Thru	Left	Peds	App. Total	Right	Thru	Left	Peds	App. Total	Right	Thru	Left	Peds	App. Total	
Peak Hour Analysis From 06:30 to 17:55 - Peak 1 of 1																					
Peak Hour for Each Approach Begins at:																					
	06:40					16:15					16:10					06:30					
+0 mins.	0	35	2	0	37	3	9	1	0	13	3	35	15	0	53	20	11	1	0	32	
+5 mins.	3	41	3	0	47	1	7	1	0	9	4	45	7	0	56	11	11	2	0	24	
+10 mins.	3	32	1	0	36	2	11	0	0	13	2	46	15	0	63	16	8	2	0	26	
+15 mins.	2	22	1	0	25	0	10	2	0	12	3	47	8	0	58	13	9	2	0	24	
+20 mins.	4	35	3	0	42	1	5	1	0	7	1	42	7	0	50	14	7	1	0	22	
+25 mins.	4	33	4	0	41	2	13	0	0	15	4	34	4	0	42	16	13	0	0	29	
+30 mins.	0	33	3	0	36	5	10	3	0	18	1	29	7	0	37	7	13	1	0	21	
+35 mins.	2	36	2	0	40	2	11	0	0	13	2	31	13	0	46	7	11	6	0	24	
+40 mins.	4	46	1	0	51	3	15	2	0	20	4	39	7	0	50	15	12	2	0	29	
+45 mins.	5	51	8	0	64	0	20	0	0	20	3	31	15	0	49	13	15	3	0	31	
+50 mins.	2	34	2	0	38	4	6	1	0	11	1	37	13	0	51	11	13	1	0	25	
+55 mins.	6	40	5	0	51	3	19	1	0	23	7	47	14	0	68	10	7	1	0	18	
Total Volume	35	438	35	0	508	26	136	12	0	174	35	463	125	0	623	153	130	22	0	305	
% App. Total	6.9	86.2	6.9	0		14.9	78.2	6.9	0		5.6	74.3	20.1	0		50.2	42.6	7.2	0		
PHF	.486	.716	.365	.000	.661	.433	.567	.333	.000	.630	.417	.821	.694	.000	.763	.638	.722	.306	.000	.794	

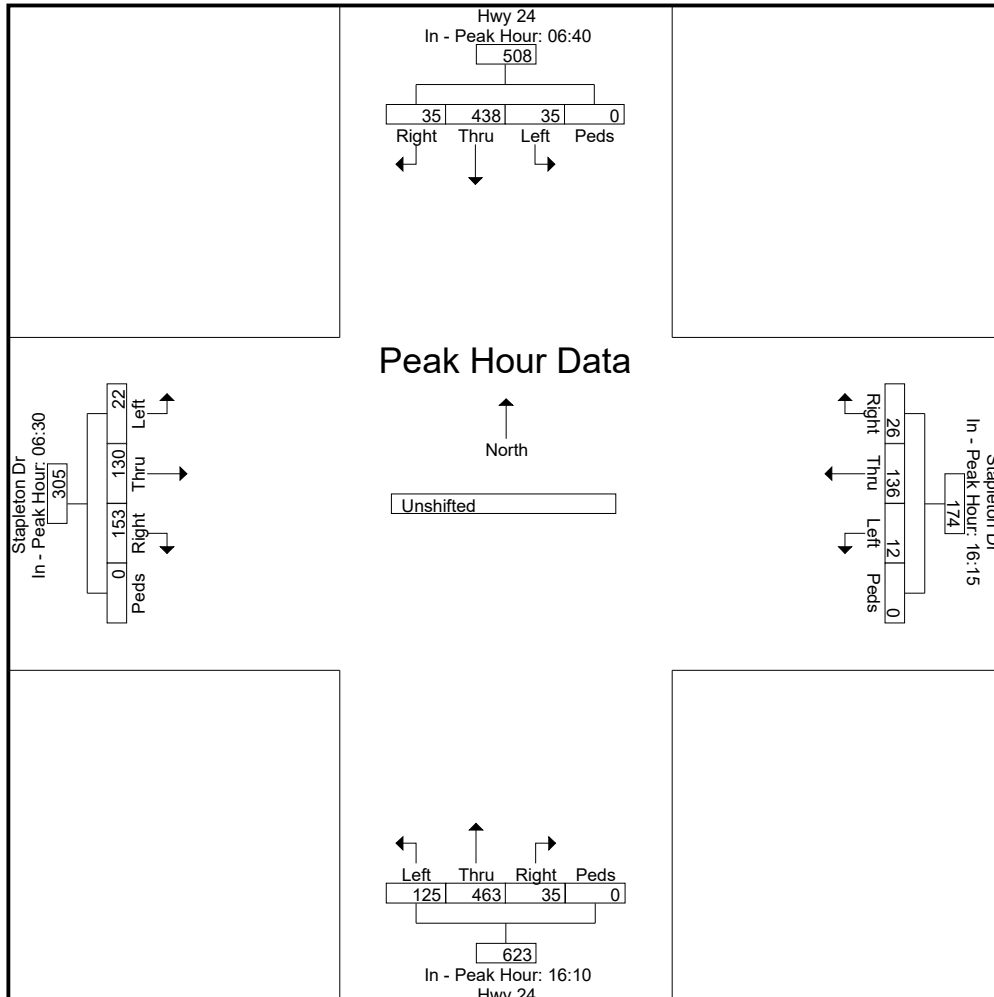

LSC Transportation Consultants, Inc.

2504 E. Pikes Peak Ave, Suite 304

Colorado Springs, CO 80909

719-633-2868

LSC Transportation Consultants, Inc.

2504 E. Pikes Peak Ave, Suite 304
 Colorado Springs, CO 80909
 719-633-2868

File Name : Elbert Rd - Hwy 24 PM

Site Code : S224640

Start Date : 1/17/2023

Page No : 1

Groups Printed- Unshifted

Start Time	Elbert Rd Southbound					Hwy 24 Westbound					Elbert Rd Northbound					Hwy 24 Eastbound					Int. Total
	Right	Thru	Left	Peds	App. Total	Right	Thru	Left	Peds	App. Total	Right	Thru	Left	Peds	App. Total	Right	Thru	Left	Peds	App. Total	
16:00	3	3	1	0	7	0	21	0	0	21	0	0	2	0	2	2	33	7	0	42	72
16:05	1	1	1	0	3	0	21	0	0	21	0	0	0	0	0	0	33	8	0	41	65
16:10	3	0	0	0	3	0	42	0	0	42	1	0	0	0	1	2	33	4	0	39	85
16:15	4	0	0	0	4	1	20	0	0	21	0	0	0	0	0	2	32	9	0	43	68
16:20	5	0	1	0	6	1	17	0	0	18	1	0	0	0	1	0	44	10	0	54	79
16:25	6	1	0	0	7	0	29	0	0	29	0	1	1	0	2	2	20	7	0	29	67
16:30	7	2	0	0	9	0	18	1	0	19	0	1	0	0	1	2	47	9	0	58	87
16:35	5	0	0	0	5	1	43	0	0	44	0	0	2	0	2	1	36	9	0	46	97
16:40	11	1	0	0	12	0	30	1	0	31	0	0	1	0	1	1	29	8	0	38	82
16:45	10	1	0	0	11	0	22	1	0	23	0	0	1	0	1	0	42	4	0	46	81
16:50	5	2	1	0	8	0	24	1	0	25	1	1	1	0	3	2	25	10	0	37	73
16:55	5	1	0	0	6	0	19	1	0	20	0	1	0	0	1	3	29	9	0	41	68
Total	65	12	4	0	81	3	306	5	0	314	3	4	8	0	15	17	403	94	0	514	924
17:00	9	0	0	0	9	0	16	0	0	16	1	0	1	0	2	0	38	2	0	40	67
17:05	5	0	1	0	6	0	24	0	0	24	0	0	0	0	0	2	39	7	0	48	78
17:10	6	1	1	0	8	0	20	0	0	20	1	0	0	0	1	0	34	12	0	46	75
17:15	5	0	1	0	6	0	24	1	0	25	1	0	0	0	1	3	36	3	0	42	74
17:20	3	1	0	0	4	0	16	0	0	16	0	1	0	0	1	3	32	5	0	40	61
17:25	3	4	0	0	7	0	14	0	0	14	0	1	0	0	1	1	39	7	0	47	69
17:30	4	2	0	0	6	0	11	0	0	11	0	1	0	0	1	0	39	12	0	51	69
17:35	3	1	1	0	5	0	21	0	0	21	0	0	2	0	2	1	50	11	0	62	90
17:40	5	1	0	0	6	1	14	0	0	15	1	0	2	0	3	2	28	9	0	39	63
17:45	4	2	0	0	6	0	17	0	0	17	0	1	0	0	1	2	45	9	0	56	80
17:50	4	1	1	0	6	0	15	0	0	15	1	0	1	0	2	1	36	8	0	45	68
17:55	5	2	1	0	8	0	16	0	0	16	0	1	1	0	2	2	38	7	0	47	73
Total	56	15	6	0	77	1	208	1	0	210	5	5	7	0	17	17	454	92	0	563	867
Grand Total	121	27	10	0	158	4	514	6	0	524	8	9	15	0	32	34	857	186	0	1077	1791
Apprch %	76.6	17.1	6.3	0		0.8	98.1	1.1	0		25	28.1	46.9	0		3.2	79.6	17.3	0		
Total %	6.8	1.5	0.6	0	8.8	0.2	28.7	0.3	0	29.3	0.4	0.5	0.8	0	1.8	1.9	47.9	10.4	0	60.1	

LSC Transportation Consultants, Inc.

2504 E. Pikes Peak Ave, Suite 304
 Colorado Springs, CO 80909
 719-633-2868

File Name : Elbert Rd - Hwy 24 PM
 Site Code : S224640
 Start Date : 1/17/2023
 Page No : 2

Start Time	Elbert Rd Southbound					Hwy 24 Westbound					Elbert Rd Northbound					Hwy 24 Eastbound					Int. Total
	Right	Thru	Left	Peds	App. Total	Right	Thru	Left	Peds	App. Total	Right	Thru	Left	Peds	App. Total	Right	Thru	Left	Peds	App. Total	
Peak Hour Analysis From 16:00 to 17:55 - Peak 1 of 1																					
Peak Hour for Entire Intersection Begins at 16:10																					
16:10	3	0	0	0	3	0	42	0	0	42	1	0	0	0	1	2	33	4	0	39	85
16:15	4	0	0	0	4	1	20	0	0	21	0	0	0	0	0	2	32	9	0	43	68
16:20	5	0	1	0	6	1	17	0	0	18	1	0	0	0	1	0	44	10	0	54	79
16:25	6	1	0	0	7	0	29	0	0	29	0	1	1	0	2	2	20	7	0	29	67
16:30	7	2	0	0	9	0	18	1	0	19	0	1	0	0	1	2	47	9	0	58	87
16:35	5	0	0	0	5	1	43	0	0	44	0	0	2	0	2	1	36	9	0	46	97
16:40	11	1	0	0	12	0	30	1	0	31	0	0	1	0	1	1	29	8	0	38	82
16:45	10	1	0	0	11	0	22	1	0	23	0	0	1	0	1	0	42	4	0	46	81
16:50	5	2	1	0	8	0	24	1	0	25	1	1	1	0	3	2	25	10	0	37	73
16:55	5	1	0	0	6	0	19	1	0	20	0	1	0	0	1	3	29	9	0	41	68
17:00	9	0	0	0	9	0	16	0	0	16	1	0	1	0	2	0	38	2	0	40	67
17:05	5	0	1	0	6	0	24	0	0	24	0	0	0	0	0	2	39	7	0	48	78
Total Volume	75	8	3	0	86	3	304	5	0	312	4	4	7	0	15	17	414	88	0	519	932
% App. Total	87.2	9.3	3.5	0		1	97.4	1.6	0		26.7	26.7	46.7	0		3.3	79.8	17	0		
PHF	.568	.333	.250	.000	.597	.250	.589	.417	.000	.591	.333	.333	.292	.000	.417	.472	.734	.733	.000	.746	.801

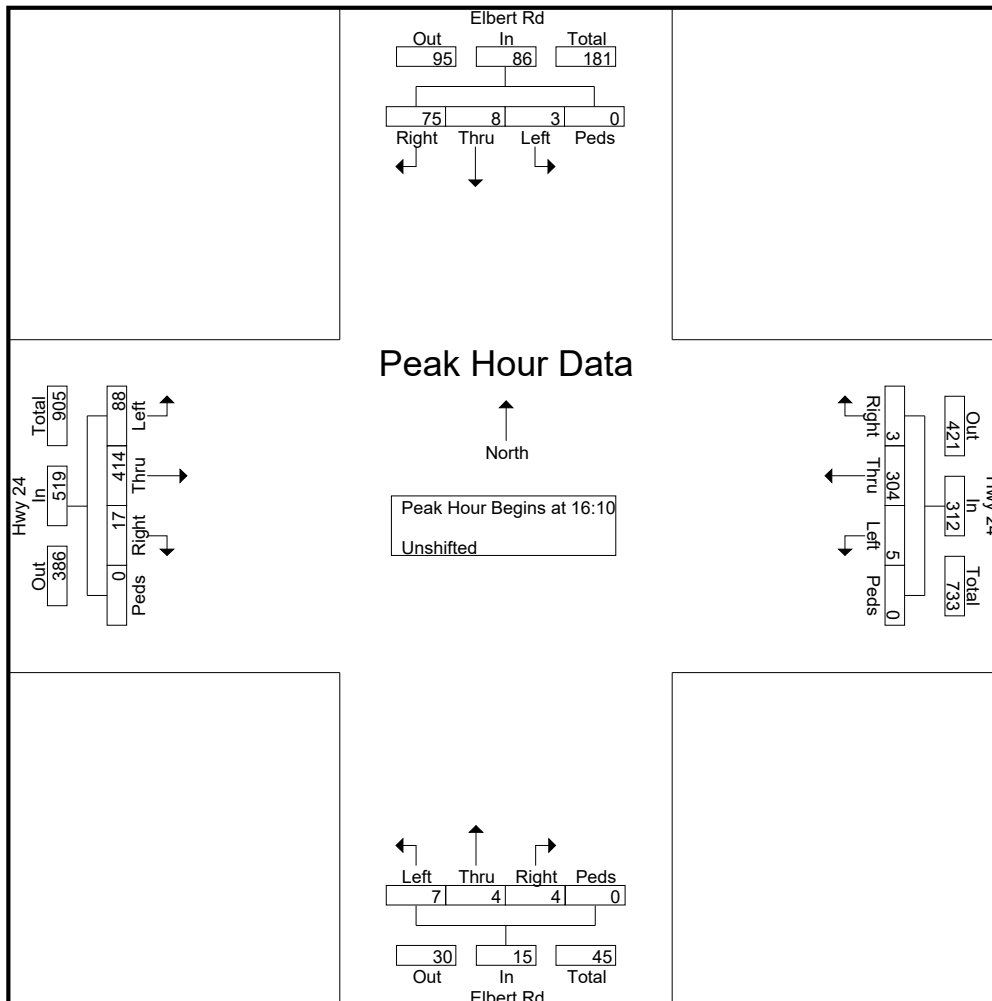

LSC Transportation Consultants, Inc.

2504 E. Pikes Peak Ave, Suite 304
 Colorado Springs, CO 80909
 719-633-2868

File Name : Elbert Rd - Hwy 24 PM
 Site Code : S224640
 Start Date : 1/17/2023
 Page No : 3

Start Time	Elbert Rd Southbound					Hwy 24 Westbound					Elbert Rd Northbound					Hwy 24 Eastbound					Int. Total
	Right	Thru	Left	Peds	App. Total	Right	Thru	Left	Peds	App. Total	Right	Thru	Left	Peds	App. Total	Right	Thru	Left	Peds	App. Total	
Peak Hour Analysis From 16:00 to 17:55 - Peak 1 of 1																					
Peak Hour for Each Approach Begins at:																					
	16:20					16:00					16:45					17:00					
+0 mins.	5	0	1	0	6	0	21	0	0	21	0	0	1	0	1	0	38	2	0	40	
+5 mins.	6	1	0	0	7	0	21	0	0	21	1	1	1	0	3	2	39	7	0	48	
+10 mins.	7	2	0	0	9	0	42	0	0	42	0	1	0	0	1	0	34	12	0	46	
+15 mins.	5	0	0	0	5	1	20	0	0	21	1	0	1	0	2	3	36	3	0	42	
+20 mins.	11	1	0	0	12	1	17	0	0	18	0	0	0	0	0	3	32	5	0	40	
+25 mins.	10	1	0	0	11	0	29	0	0	29	1	0	0	0	1	1	39	7	0	47	
+30 mins.	5	2	1	0	8	0	18	1	0	19	1	0	0	0	1	0	39	12	0	51	
+35 mins.	5	1	0	0	6	1	43	0	0	44	0	1	0	0	1	1	50	11	0	62	
+40 mins.	9	0	0	0	9	0	30	1	0	31	0	1	0	0	1	2	28	9	0	39	
+45 mins.	5	0	1	0	6	0	22	1	0	23	0	1	0	0	1	2	45	9	0	56	
+50 mins.	6	1	1	0	8	0	24	1	0	25	0	0	2	0	2	1	36	8	0	45	
+55 mins.	5	0	1	0	6	0	19	1	0	20	1	0	2	0	3	2	38	7	0	47	
Total Volume	79	9	5	0	93	3	306	5	0	314	5	5	7	0	17	17	454	92	0	563	
% App. Total	84.9	9.7	5.4	0		1	97.5	1.6	0		29.4	29.4	41.2	0		3	80.6	16.3	0		
PHF	.598	.375	.417	.000	.646	.250	.593	.417	.000	.595	.417	.417	.292	.000	.472	.472	.757	.639	.000	.757	

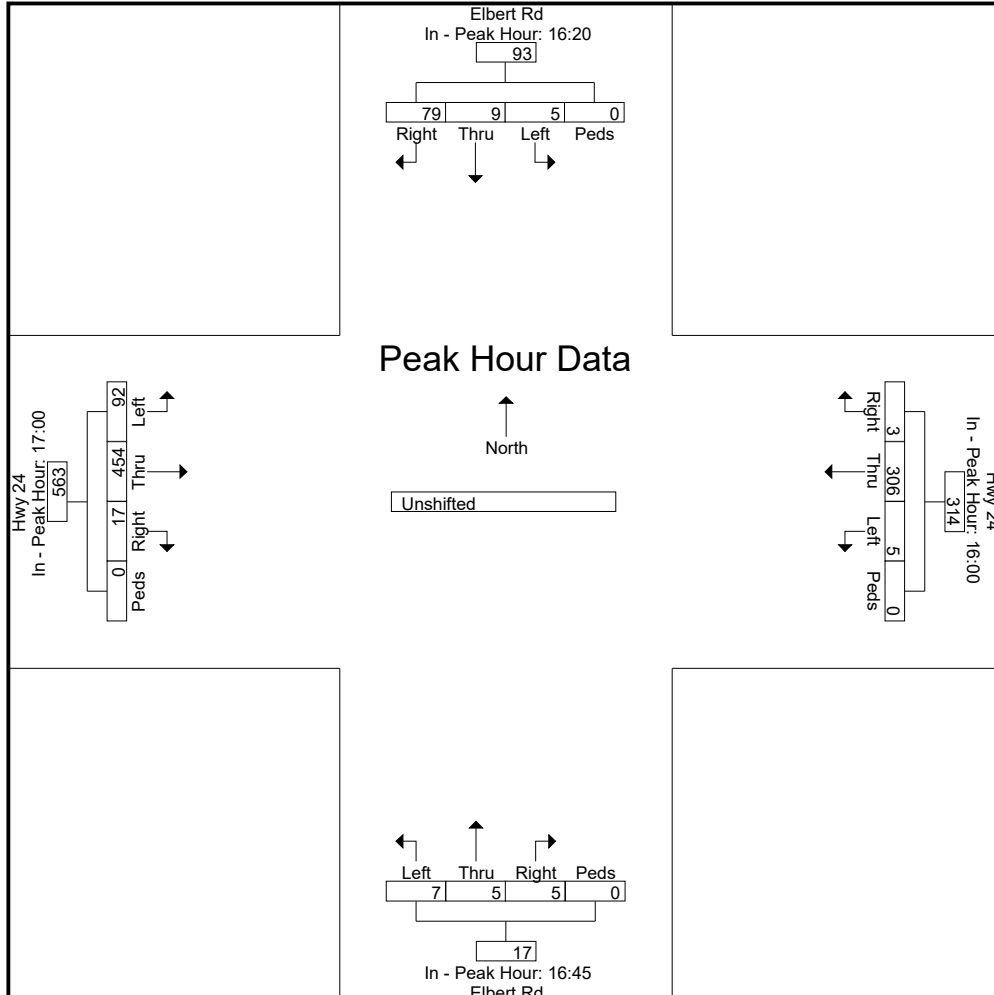

LSC Transportation Consultants, Inc.

2504 E. Pikes Peak Ave, Suite 304

Colorado Springs, CO 80909

719-633-2868

LSC Transportation Consultants, Inc.

2504 E. Pikes Peak Ave, Suite 304
Colorado Springs, CO 80909
719-633-2868

File Name : Elbert Rd - Hwy 24 AM

Site Code : S224640

Start Date : 1/17/2023

Page No : 1

Groups Printed- Unshifted

Start Time	Elbert Rd Southbound					Hwy 24 Westbound					Elbert Rd Northbound					Hwy 24 Eastbound					Int. Total
	Right	Thru	Left	Peds	App. Total	Right	Thru	Left	Peds	App. Total	Right	Thru	Left	Peds	App. Total	Right	Thru	Left	Peds	App. Total	
06:30	5	0	0	0	5	0	29	0	0	29	0	0	1	0	1	0	6	2	0	8	43
06:35	7	0	0	0	7	0	27	0	0	27	0	0	0	0	0	0	6	0	0	6	40
06:40	10	0	0	0	10	0	27	0	0	27	0	0	1	0	1	0	14	1	0	15	53
06:45	6	2	0	0	8	0	25	0	0	25	0	2	1	0	3	1	11	4	0	16	52
06:50	12	2	0	0	14	0	21	0	0	21	0	0	3	0	3	1	23	1	0	25	63
06:55	7	1	1	0	9	2	26	0	0	28	0	0	0	0	0	0	19	0	0	19	56
Total	47	5	1	0	53	2	155	0	0	157	0	2	6	0	8	2	79	8	0	89	307
07:00	12	1	1	0	14	1	31	0	0	32	0	0	4	0	4	1	23	6	0	30	80
07:05	6	1	0	0	7	0	31	1	0	32	0	1	1	0	2	0	25	4	0	29	70
07:10	5	0	0	0	5	0	40	0	0	40	0	3	0	0	3	0	25	2	0	27	75
07:15	16	0	1	0	17	0	32	0	0	32	0	2	1	0	3	0	28	4	0	32	84
07:20	8	0	0	0	8	1	28	0	0	29	0	2	0	0	2	0	26	6	0	32	71
07:25	7	0	0	0	7	0	40	0	0	40	0	2	0	0	2	0	19	9	0	28	77
07:30	4	2	0	0	6	0	35	1	0	36	0	1	1	0	2	0	19	5	0	24	68
07:35	3	1	0	0	4	0	36	1	0	37	0	0	0	0	0	0	15	1	0	16	57
07:40	19	0	0	0	19	0	35	0	0	35	0	1	2	0	3	0	11	0	0	11	68
07:45	4	0	0	0	4	0	26	0	0	26	0	1	1	0	2	0	12	2	0	14	46
07:50	8	2	0	0	10	0	20	0	0	20	0	2	2	0	4	1	16	3	0	20	54
07:55	6	1	1	0	8	1	21	0	0	22	0	1	4	0	5	0	18	2	0	20	55
Total	98	8	3	0	109	3	375	3	0	381	0	16	16	0	32	2	237	44	0	283	805
08:00	7	0	0	0	7	0	29	0	0	29	0	2	1	0	3	0	20	6	0	26	65
08:05	4	0	0	0	4	0	28	0	0	28	0	2	3	0	5	0	8	4	0	12	49
08:10	5	1	0	0	6	1	27	0	0	28	0	0	3	0	3	2	9	2	0	13	50
08:15	11	1	0	0	12	0	30	0	0	30	0	0	0	0	0	0	11	5	0	16	58
08:20	4	0	1	0	5	0	31	0	0	31	0	0	3	0	3	1	8	2	0	11	50
08:25	5	0	0	0	5	1	22	0	0	23	0	2	0	0	2	0	19	3	0	22	52
Grand Total	181	15	5	0	201	7	697	3	0	707	0	24	32	0	56	7	391	74	0	472	1436
Apprch %	90	7.5	2.5	0		1	98.6	0.4	0		0	42.9	57.1	0		1.5	82.8	15.7	0		
Total %	12.6	1	0.3	0	14	0.5	48.5	0.2	0	49.2	0	1.7	2.2	0	3.9	0.5	27.2	5.2	0	32.9	

LSC Transportation Consultants, Inc.

2504 E. Pikes Peak Ave, Suite 304
 Colorado Springs, CO 80909
 719-633-2868

File Name : Elbert Rd - Hwy 24 AM

Site Code : S224640

Start Date : 1/17/2023

Page No : 2

Start Time	Elbert Rd Southbound					Hwy 24 Westbound					Elbert Rd Northbound					Hwy 24 Eastbound					Int. Total
	Right	Thru	Left	Peds	App. Total	Right	Thru	Left	Peds	App. Total	Right	Thru	Left	Peds	App. Total	Right	Thru	Left	Peds	App. Total	
Peak Hour Analysis From 06:30 to 08:25 - Peak 1 of 1																					
Peak Hour for Entire Intersection Begins at 06:45																					
06:45	6	2	0	0	8	0	25	0	0	25	0	2	1	0	3	1	11	4	0	16	52
06:50	12	2	0	0	14	0	21	0	0	21	0	0	3	0	3	1	23	1	0	25	63
06:55	7	1	1	0	9	2	26	0	0	28	0	0	0	0	0	0	19	0	0	19	56
07:00	12	1	1	0	14	1	31	0	0	32	0	0	4	0	4	1	23	6	0	30	80
07:05	6	1	0	0	7	0	31	1	0	32	0	1	1	0	2	0	25	4	0	29	70
07:10	5	0	0	0	5	0	40	0	0	40	0	3	0	0	3	0	25	2	0	27	75
07:15	16	0	1	0	17	0	32	0	0	32	0	2	1	0	3	0	28	4	0	32	84
07:20	8	0	0	0	8	1	28	0	0	29	0	2	0	0	2	0	26	6	0	32	71
07:25	7	0	0	0	7	0	40	0	0	40	0	2	0	0	2	0	19	9	0	28	77
07:30	4	2	0	0	6	0	35	1	0	36	0	1	1	0	2	0	19	5	0	24	68
07:35	3	1	0	0	4	0	36	1	0	37	0	0	0	0	0	0	15	1	0	16	57
07:40	19	0	0	0	19	0	35	0	0	35	0	1	2	0	3	0	11	0	0	11	68
Total Volume	105	10	3	0	118	4	380	3	0	387	0	14	13	0	27	3	244	42	0	289	821
% App. Total	89	8.5	2.5	0		1	98.2	0.8	0		0	51.9	48.1	0		1	84.4	14.5	0		
PHF	.461	.417	.250	.000	.518	.167	.792	.250	.000	.806	.000	.389	.271	.000	.563	.250	.726	.389	.000	.753	.814

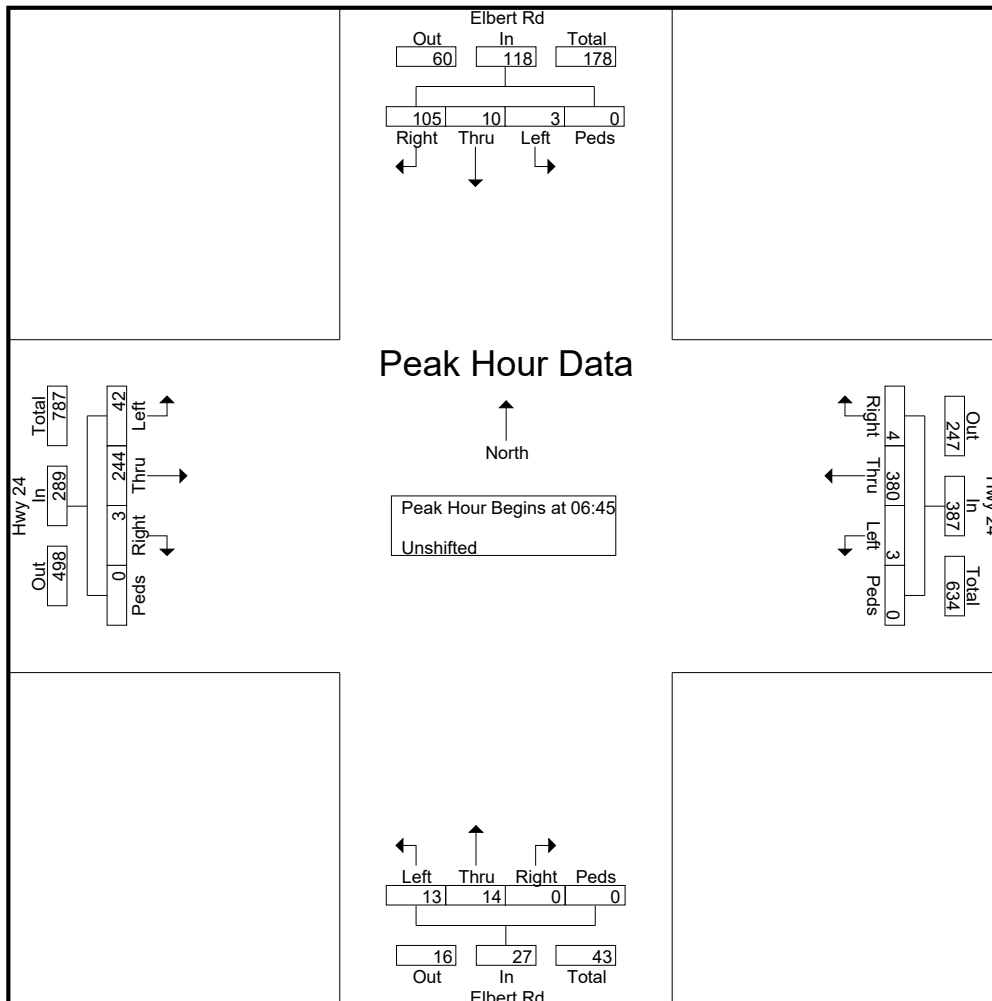

LSC Transportation Consultants, Inc.

2504 E. Pikes Peak Ave, Suite 304
 Colorado Springs, CO 80909
 719-633-2868

File Name : Elbert Rd - Hwy 24 AM

Site Code : S224640

Start Date : 1/17/2023

Page No : 3

Start Time	Elbert Rd Southbound					Hwy 24 Westbound					Elbert Rd Northbound					Hwy 24 Eastbound					Int. Total
	Right	Thru	Left	Peds	App. Total	Right	Thru	Left	Peds	App. Total	Right	Thru	Left	Peds	App. Total	Right	Thru	Left	Peds	App. Total	

Peak Hour Analysis From 06:30 to 08:25 - Peak 1 of 1

Peak Hour for Each Approach Begins at:

	06:45					06:50					07:10					06:40				
+0 mins.	6	2	0	0	8	0	21	0	0	21	0	3	0	0	3	0	14	1	0	15
+5 mins.	12	2	0	0	14	2	26	0	0	28	0	2	1	0	3	1	11	4	0	16
+10 mins.	7	1	1	0	9	1	31	0	0	32	0	2	0	0	2	1	23	1	0	25
+15 mins.	12	1	1	0	14	0	31	1	0	32	0	2	0	0	2	0	19	0	0	19
+20 mins.	6	1	0	0	7	0	40	0	0	40	0	1	1	0	2	1	23	6	0	30
+25 mins.	5	0	0	0	5	0	32	0	0	32	0	0	0	0	0	0	25	4	0	29
+30 mins.	16	0	1	0	17	1	28	0	0	29	0	1	2	0	3	0	25	2	0	27
+35 mins.	8	0	0	0	8	0	40	0	0	40	0	1	1	0	2	0	28	4	0	32
+40 mins.	7	0	0	0	7	0	35	1	0	36	0	2	2	0	4	0	26	6	0	32
+45 mins.	4	2	0	0	6	0	36	1	0	37	0	1	4	0	5	0	19	9	0	28
+50 mins.	3	1	0	0	4	0	35	0	0	35	0	2	1	0	3	0	19	5	0	24
+55 mins.	19	0	0	0	19	0	26	0	0	26	0	2	3	0	5	0	15	1	0	16
Total Volume	105	10	3	0	118	4	381	3	0	388	0	19	15	0	34	3	247	43	0	293
% App. Total	89	8.5	2.5	0		1	98.2	0.8	0		0	55.9	44.1	0		1	84.3	14.7	0	
PHF	.461	.417	.250	.000	.518	.167	.794	.250	.000	.808	.000	.528	.313	.000	.567	.250	.735	.398	.000	.763

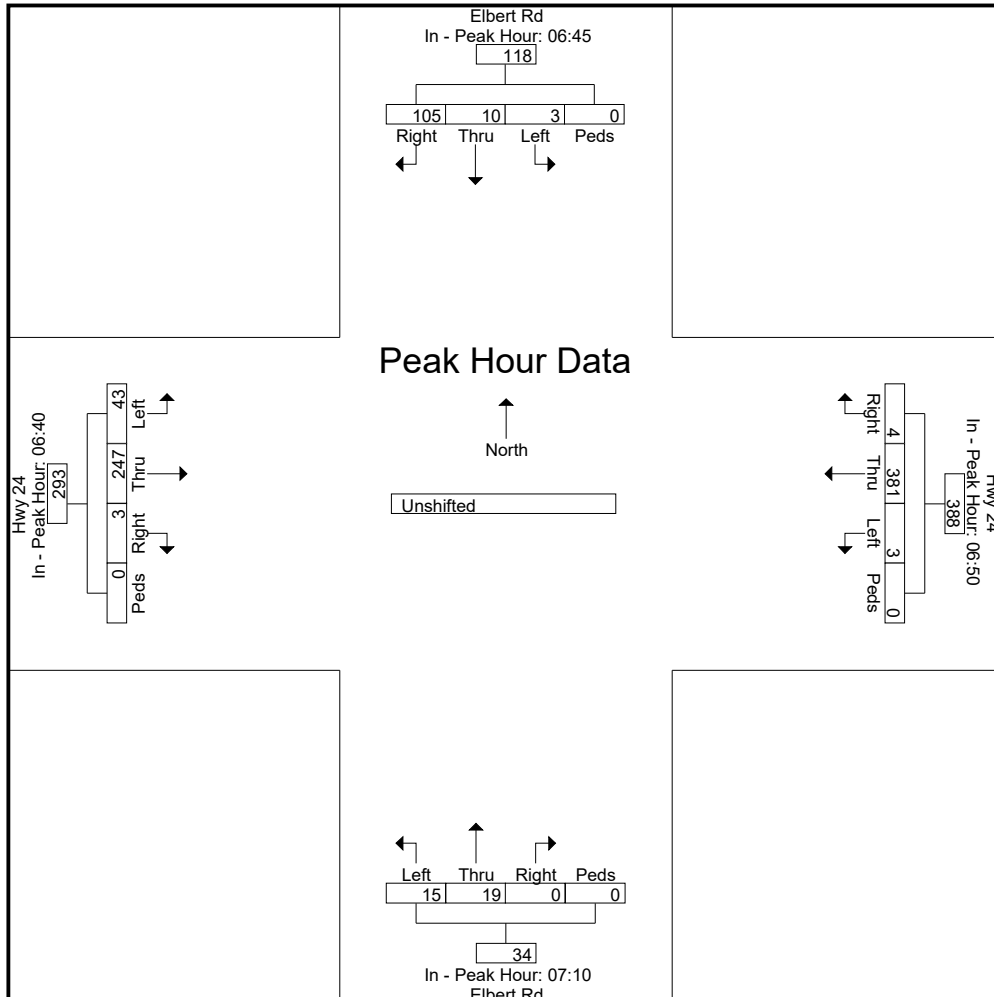

LSC Transportation Consultants, Inc.

2504 E. Pikes Peak Ave, Suite 304

Colorado Springs, CO 80909

719-633-2868

Synchro LOS Reports



Lanes, Volumes, Timings
1: US 24 & Judge Orr

Short-Term Baseline
AM



Lane Group	EBL	EBT	EBR	WBL	WBT	WBR	NEL	NET	NER	SWL	SWT	SWR
Lane Configurations		↕			↕		↕	↕		↕	↕	
Traffic Volume (vph)	17	66	204	115	68	4	84	343	64	7	579	19
Future Volume (vph)	17	66	204	115	68	4	84	343	64	7	579	19
Ideal Flow (vphpl)	1900	1900	1900	1900	1900	1900	1900	1900	1900	1900	1900	1900
Storage Length (ft)	0		0	0		0	870		0	695		0
Storage Lanes	0		0	0		0	1		0	1		0
Taper Length (ft)	25			25			300			280		
Lane Util. Factor	1.00	1.00	1.00	1.00	1.00	1.00	1.00	1.00	1.00	1.00	1.00	1.00
Frt		0.904			0.997			0.976			0.995	
Flt Protected		0.997			0.970		0.950			0.950		
Satd. Flow (prot)	0	1679	0	0	1801	0	1770	1818	0	1770	1853	0
Flt Permitted		0.997			0.970		0.130			0.503		
Satd. Flow (perm)	0	1679	0	0	1801	0	242	1818	0	937	1853	0
Right Turn on Red			Yes			Yes			Yes			Yes
Satd. Flow (RTOR)		121			1			15				2
Link Speed (mph)		45			45			55				55
Link Distance (ft)		927			6659			1546				3606
Travel Time (s)		14.0			100.9			19.2				44.7
Peak Hour Factor	0.92	0.92	0.92	0.87	0.87	0.87	0.92	0.92	0.92	0.93	0.93	0.93
Adj. Flow (vph)	18	72	222	132	78	5	91	373	70	8	623	20
Shared Lane Traffic (%)												
Lane Group Flow (vph)	0	312	0	0	215	0	91	443	0	8	643	0
Enter Blocked Intersection	No	No	No	No	No	No	No	No	No	No	No	No
Lane Alignment	Left	Left	Right	Left	Left	Right	Left	Left	Right	Left	Left	Right
Median Width(ft)		0			0			12				12
Link Offset(ft)		0			0			0				0
Crosswalk Width(ft)		16			16			16				16
Two way Left Turn Lane												
Headway Factor	1.00	1.00	1.00	1.00	1.00	1.00	1.00	1.00	1.00	1.00	1.00	1.00
Turning Speed (mph)	60		60	60		60	60		60	60		60
Number of Detectors	1	2		1	2		1	2		1	2	
Detector Template	Left	Thru		Left	Thru		Left	Thru		Left	Thru	
Leading Detector (ft)	20	100		20	100		20	100		20	100	
Trailing Detector (ft)	0	0		0	0		0	0		0	0	
Detector 1 Position(ft)	0	0		0	0		0	0		0	0	
Detector 1 Size(ft)	20	6		20	6		20	6		20	6	
Detector 1 Type	Cl+Ex	Cl+Ex		Cl+Ex	Cl+Ex		Cl+Ex	Cl+Ex		Cl+Ex	Cl+Ex	
Detector 1 Channel												
Detector 1 Extend (s)	0.0	0.0		0.0	0.0		0.0	0.0		0.0	0.0	
Detector 1 Queue (s)	0.0	0.0		0.0	0.0		0.0	0.0		0.0	0.0	
Detector 1 Delay (s)	0.0	0.0		0.0	0.0		0.0	0.0		0.0	0.0	
Detector 2 Position(ft)		94			94			94				94
Detector 2 Size(ft)		6			6			6				6
Detector 2 Type		Cl+Ex			Cl+Ex			Cl+Ex				Cl+Ex
Detector 2 Channel												
Detector 2 Extend (s)		0.0			0.0			0.0				0.0
Turn Type	Split	NA		Split	NA		pm+pt	NA		Perm	NA	
Protected Phases	4	4		8	8		5	2				6
Permitted Phases							2			6		

Lanes, Volumes, Timings
1: US 24 & Judge Orr

Short-Term Baseline
AM



Lane Group	EBL	EBT	EBR	WBL	WBT	WBR	NEL	NET	NER	SWL	SWT	SWR
Detector Phase	4	4		8	8		5	2		6	6	
Switch Phase												
Minimum Initial (s)	5.0	5.0		5.0	5.0		5.0	5.0		5.0	5.0	
Minimum Split (s)	22.5	22.5		22.5	22.5		9.5	22.5		22.5	22.5	
Total Split (s)	21.0	21.0		21.0	21.0		10.0	48.0		38.0	38.0	
Total Split (%)	23.3%	23.3%		23.3%	23.3%		11.1%	53.3%		42.2%	42.2%	
Maximum Green (s)	16.5	16.5		16.5	16.5		5.5	43.5		33.5	33.5	
Yellow Time (s)	3.5	3.5		3.5	3.5		3.5	3.5		3.5	3.5	
All-Red Time (s)	1.0	1.0		1.0	1.0		1.0	1.0		1.0	1.0	
Lost Time Adjust (s)		0.0			0.0		0.0	0.0		0.0	0.0	
Total Lost Time (s)		4.5			4.5		4.5	4.5		4.5	4.5	
Lead/Lag							Lead			Lag	Lag	
Lead-Lag Optimize?							Yes			Yes	Yes	
Vehicle Extension (s)	3.0	3.0		3.0	3.0		3.0	3.0		3.0	3.0	
Recall Mode	None	None		None	None		None	Max		Max	Max	
Walk Time (s)	7.0	7.0		7.0	7.0			7.0		7.0	7.0	
Flash Dont Walk (s)	11.0	11.0		11.0	11.0			11.0		11.0	11.0	
Pedestrian Calls (#/hr)	0	0		0	0			0		0	0	
Act Effct Green (s)		14.0			14.0		43.7	43.7		35.9	35.9	
Actuated g/C Ratio		0.16			0.16		0.51	0.51		0.42	0.42	
v/c Ratio		0.83			0.72		0.41	0.47		0.02	0.82	
Control Delay		40.7			48.9		17.9	16.1		18.3	35.5	
Queue Delay		0.0			0.0		0.0	0.0		0.0	0.0	
Total Delay		40.7			48.9		17.9	16.1		18.3	35.5	
LOS		D			D		B	B		B	D	
Approach Delay		40.7			48.9			16.4			35.3	
Approach LOS		D			D			B			D	
Queue Length 50th (ft)		103			114		26	155		3	339	
Queue Length 95th (ft)		#229			182		53	242		12	#565	
Internal Link Dist (ft)		847			6579			1466			3526	
Turn Bay Length (ft)							870			695		
Base Capacity (vph)		423			350		223	938		394	781	
Starvation Cap Reductn		0			0		0	0		0	0	
Spillback Cap Reductn		0			0		0	0		0	0	
Storage Cap Reductn		0			0		0	0		0	0	
Reduced v/c Ratio		0.74			0.61		0.41	0.47		0.02	0.82	

Intersection Summary

Area Type: Other
 Cycle Length: 90
 Actuated Cycle Length: 85.3
 Natural Cycle: 90
 Control Type: Actuated-Uncoordinated
 Maximum v/c Ratio: 0.83
 Intersection Signal Delay: 32.1
 Intersection LOS: C
 Intersection Capacity Utilization 78.4%
 ICU Level of Service D
 Analysis Period (min) 15
 # 95th percentile volume exceeds capacity, queue may be longer.
 Queue shown is maximum after two cycles.

Splits and Phases: 1: US 24 & Judge Orr

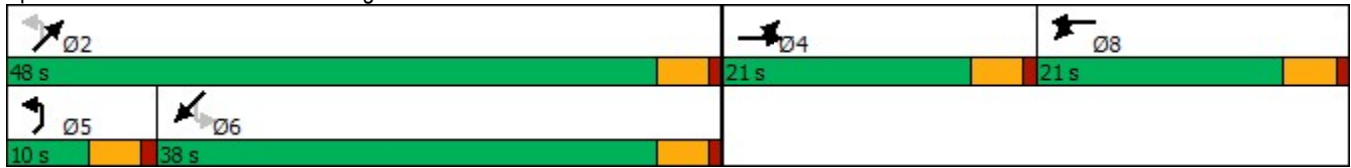

Intersection												
Int Delay, s/veh	11.4											
Movement	SEL	SET	SER	NWL	NWT	NWR	NEL	NET	NER	SWL	SWT	SWR
Lane Configurations	↖	↗	↖	↖	↗	↖	↖	↗	↖	↖	↗	↖
Traffic Vol, veh/h	23	141	143	6	101	20	49	267	3	35	438	35
Future Vol, veh/h	23	141	143	6	101	20	49	267	3	35	438	35
Conflicting Peds, #/hr	0	0	0	0	0	0	0	0	0	0	0	0
Sign Control	Stop	Stop	Stop	Stop	Stop	Stop	Free	Free	Free	Free	Free	Free
RT Channelized	-	-	None	-	-	None	-	-	None	-	-	None
Storage Length	190	-	325	215	-	215	890	-	1000	790	-	790
Veh in Median Storage, #	-	0	-	-	0	-	-	0	-	-	0	-
Grade, %	-	0	-	-	0	-	-	0	-	-	0	-
Peak Hour Factor	92	92	92	83	83	83	92	92	92	92	92	92
Heavy Vehicles, %	2	2	2	2	2	2	2	2	2	2	2	2
Mvmt Flow	25	153	155	7	122	24	53	290	3	38	476	38

Major/Minor	Minor2		Minor1		Major1			Major2				
Conflicting Flow All	1023	951	476	1121	986	290	514	0	0	293	0	0
Stage 1	552	552	-	396	396	-	-	-	-	-	-	-
Stage 2	471	399	-	725	590	-	-	-	-	-	-	-
Critical Hdwy	7.12	6.52	6.22	7.12	6.52	6.22	4.12	-	-	4.12	-	-
Critical Hdwy Stg 1	6.12	5.52	-	6.12	5.52	-	-	-	-	-	-	-
Critical Hdwy Stg 2	6.12	5.52	-	6.12	5.52	-	-	-	-	-	-	-
Follow-up Hdwy	3.518	4.018	3.318	3.518	4.018	3.318	2.218	-	-	2.218	-	-
Pot Cap-1 Maneuver	214	260	589	183	248	749	1052	-	-	1269	-	-
Stage 1	518	515	-	629	604	-	-	-	-	-	-	-
Stage 2	573	602	-	416	495	-	-	-	-	-	-	-
Platoon blocked, %	-	-	-	-	-	-	-	-	-	-	-	-
Mov Cap-1 Maneuver	114	240	589	62	229	749	1052	-	-	1269	-	-
Mov Cap-2 Maneuver	114	240	-	62	229	-	-	-	-	-	-	-
Stage 1	492	500	-	598	574	-	-	-	-	-	-	-
Stage 2	415	572	-	206	480	-	-	-	-	-	-	-

Approach	SE		NW		NE		SW	
HCM Control Delay, s	29.4		34.6		1.3		0.5	
HCM LOS	D		D					

Minor Lane/Major Mvmt	NEL	NET	NERN	NWLn1	NWLn2	NWLn3	SELn1	SELn2	SELn3	SWL	SWT	SWR
Capacity (veh/h)	1052	-	-	62	229	749	114	240	589	1269	-	-
HCM Lane V/C Ratio	0.051	-	-	0.117	0.531	0.032	0.219	0.639	0.264	0.03	-	-
HCM Control Delay (s)	8.6	-	-	70.6	37.3	10	45.2	43.2	13.3	7.9	-	-
HCM Lane LOS	A	-	-	F	E	B	E	E	B	A	-	-
HCM 95th %tile Q(veh)	0.2	-	-	0.4	2.8	0.1	0.8	3.9	1.1	0.1	-	-

Intersection												
Int Delay, s/veh	1.8											
Movement	SEL	SET	SER	NWL	NWT	NWR	NEL	NET	NER	SWL	SWT	SWR
Lane Configurations	↘	↑	↗	↘	↑	↗	↘	↑	↗	↘	↑	↗
Traffic Vol, veh/h	5	10	110	15	15	0	45	250	5	5	380	5
Future Vol, veh/h	5	10	110	15	15	0	45	250	5	5	380	5
Conflicting Peds, #/hr	0	0	0	0	0	0	0	0	0	0	0	0
Sign Control	Stop	Stop	Stop	Stop	Stop	Stop	Free	Free	Free	Free	Free	Free
RT Channelized	-	-	Free	-	-	Free	-	-	Yield	-	-	Yield
Storage Length	120	-	240	85	-	25	600	-	480	495	-	485
Veh in Median Storage, #	-	0	-	-	0	-	-	0	-	-	0	-
Grade, %	-	0	-	-	0	-	-	0	-	-	0	-
Peak Hour Factor	83	83	83	78	78	78	92	92	92	92	92	92
Heavy Vehicles, %	2	2	2	2	2	2	2	2	2	2	2	2
Mvmt Flow	6	12	133	19	19	0	49	272	5	5	413	5

Major/Minor	Minor2		Minor1		Major1			Major2				
Conflicting Flow All	803	793	-	799	793	-	413	0	0	272	0	0
Stage 1	423	423	-	370	370	-	-	-	-	-	-	-
Stage 2	380	370	-	429	423	-	-	-	-	-	-	-
Critical Hdwy	7.12	6.52	-	7.12	6.52	-	4.12	-	-	4.12	-	-
Critical Hdwy Stg 1	6.12	5.52	-	6.12	5.52	-	-	-	-	-	-	-
Critical Hdwy Stg 2	6.12	5.52	-	6.12	5.52	-	-	-	-	-	-	-
Follow-up Hdwy	3.518	4.018	-	3.518	4.018	-	2.218	-	-	2.218	-	-
Pot Cap-1 Maneuver	302	321	0	304	321	0	1146	-	-	1291	-	-
Stage 1	609	588	0	650	620	0	-	-	-	-	-	-
Stage 2	642	620	0	604	588	0	-	-	-	-	-	-
Platoon blocked, %												
Mov Cap-1 Maneuver	278	306	-	285	306	-	1146	-	-	1291	-	-
Mov Cap-2 Maneuver	278	306	-	285	306	-	-	-	-	-	-	-
Stage 1	583	586	-	622	593	-	-	-	-	-	-	-
Stage 2	595	593	-	589	586	-	-	-	-	-	-	-

Approach	SE		NW		NE		SW	
HCM Control Delay, s	17.5		18.1		1.2		0.1	
HCM LOS	C		C					

Minor Lane/Major Mvmt	NEL	NET	NERN	NWLn1	NWLn2	NWLn3	SELn1	SELn2	SELn3	SWL	SWT	SWR
Capacity (veh/h)	1146	-	-	285	306	-	278	306	-	1291	-	-
HCM Lane V/C Ratio	0.043	-	-	0.067	0.063	-	0.022	0.039	-	0.004	-	-
HCM Control Delay (s)	8.3	-	-	18.5	17.6	0	18.2	17.2	0	7.8	-	-
HCM Lane LOS	A	-	-	C	C	A	C	C	A	A	-	-
HCM 95th %tile Q(veh)	0.1	-	-	0.2	0.2	-	0.1	0.1	-	0	-	-

Intersection						
Int Delay, s/veh	0.7					
Movement	EBL	EBT	WBT	WBR	SBL	SBR
Lane Configurations		↶	↷		↶	
Traffic Vol, veh/h	0	40	150	15	5	10
Future Vol, veh/h	0	40	150	15	5	10
Conflicting Peds, #/hr	0	0	0	0	0	0
Sign Control	Free	Free	Free	Free	Stop	Stop
RT Channelized	-	None	-	None	-	None
Storage Length	-	-	-	-	0	-
Veh in Median Storage, #	-	0	0	-	0	-
Grade, %	-	0	0	-	0	-
Peak Hour Factor	83	83	87	87	78	78
Heavy Vehicles, %	2	2	2	2	2	2
Mvmt Flow	0	48	172	17	6	13

Major/Minor	Major1	Major2	Minor2		
Conflicting Flow All	189	0	-	0	229 181
Stage 1	-	-	-	-	181 -
Stage 2	-	-	-	-	48 -
Critical Hdwy	4.12	-	-	-	6.42 6.22
Critical Hdwy Stg 1	-	-	-	-	5.42 -
Critical Hdwy Stg 2	-	-	-	-	5.42 -
Follow-up Hdwy	2.218	-	-	-	3.518 3.318
Pot Cap-1 Maneuver	1385	-	-	-	759 862
Stage 1	-	-	-	-	850 -
Stage 2	-	-	-	-	974 -
Platoon blocked, %		-	-	-	
Mov Cap-1 Maneuver	1385	-	-	-	759 862
Mov Cap-2 Maneuver	-	-	-	-	759 -
Stage 1	-	-	-	-	850 -
Stage 2	-	-	-	-	974 -

Approach	EB	WB	SB
HCM Control Delay, s	0	0	9.5
HCM LOS			A

Minor Lane/Major Mvmt	EBL	EBT	WBT	WBR	SBLn1
Capacity (veh/h)	1385	-	-	-	825
HCM Lane V/C Ratio	-	-	-	-	0.023
HCM Control Delay (s)	0	-	-	-	9.5
HCM Lane LOS	A	-	-	-	A
HCM 95th %tile Q(veh)	0	-	-	-	0.1

Intersection												
Int Delay, s/veh	7.5											
Movement	EBL	EBT	EBR	WBL	WBT	WBR	NBL	NBT	NBR	SBL	SBT	SBR
Lane Configurations		↖	↗	↖	↗		↖	↗		↖	↗	
Traffic Vol, veh/h	1	47	84	20	157	49	54	90	0	13	171	0
Future Vol, veh/h	1	47	84	20	157	49	54	90	0	13	171	0
Conflicting Peds, #/hr	0	0	0	0	0	0	0	0	0	0	0	0
Sign Control	Free	Free	Free	Free	Free	Free	Stop	Stop	Stop	Stop	Stop	Stop
RT Channelized	-	-	None	-	-	None	-	-	None	-	-	None
Storage Length	245	-	0	235	-	-	265	-	-	265	-	-
Veh in Median Storage, #	-	0	-	-	0	-	-	0	-	-	0	-
Grade, %	-	0	-	-	0	-	-	0	-	-	0	-
Peak Hour Factor	83	83	83	87	87	87	83	83	83	87	87	87
Heavy Vehicles, %	2	2	2	2	2	2	2	2	2	2	2	2
Mvmt Flow	1	57	101	23	180	56	65	108	0	15	197	0

Major/Minor	Major1			Major2			Minor1			Minor2		
Conflicting Flow All	236	0	0	158	0	0	412	341	57	418	414	208
Stage 1	-	-	-	-	-	-	59	59	-	254	254	-
Stage 2	-	-	-	-	-	-	353	282	-	164	160	-
Critical Hdwy	4.12	-	-	4.12	-	-	7.12	6.52	6.22	7.12	6.52	6.22
Critical Hdwy Stg 1	-	-	-	-	-	-	6.12	5.52	-	6.12	5.52	-
Critical Hdwy Stg 2	-	-	-	-	-	-	6.12	5.52	-	6.12	5.52	-
Follow-up Hdwy	2.218	-	-	2.218	-	-	3.518	4.018	3.318	3.518	4.018	3.318
Pot Cap-1 Maneuver	1331	-	-	1422	-	-	550	581	1009	545	529	832
Stage 1	-	-	-	-	-	-	953	846	-	750	697	-
Stage 2	-	-	-	-	-	-	664	678	-	838	766	-
Platoon blocked, %		-	-	-	-	-						
Mov Cap-1 Maneuver	1331	-	-	1422	-	-	383	571	1009	459	520	832
Mov Cap-2 Maneuver	-	-	-	-	-	-	383	571	-	459	520	-
Stage 1	-	-	-	-	-	-	952	845	-	749	686	-
Stage 2	-	-	-	-	-	-	466	667	-	730	765	-

Approach	EB			WB			NB			SB		
HCM Control Delay, s	0.1			0.7			14.1			15.9		
HCM LOS							B			C		

Minor Lane/Major Mvmt	NBLn1	NBLn2	EBL	EBT	EBR	WBL	WBT	WBR	SBLn1	SBLn2
Capacity (veh/h)	383	571	1331	-	-	1422	-	-	459	520
HCM Lane V/C Ratio	0.17	0.19	0.001	-	-	0.016	-	-	0.033	0.378
HCM Control Delay (s)	16.3	12.8	7.7	0	-	7.6	-	-	13.1	16.1
HCM Lane LOS	C	B	A	A	-	A	-	-	B	C
HCM 95th %tile Q(veh)	0.6	0.7	0	-	-	0	-	-	0.1	1.7

Lanes, Volumes, Timings
1: US 24 & Judge Orr

Short-Term Baseline
PM



Lane Group	EBL	EBT	EBR	WBL	WBT	WBR	NEL	NET	NER	SWL	SWT	SWR
Lane Configurations		↕			↕		↗	↘		↗	↘	
Traffic Volume (vph)	35	35	72	120	114	15	159	565	130	5	420	22
Future Volume (vph)	35	35	72	120	114	15	159	565	130	5	420	22
Ideal Flow (vphpl)	1900	1900	1900	1900	1900	1900	1900	1900	1900	1900	1900	1900
Storage Length (ft)	0		0	0		0	870		0	695		0
Storage Lanes	0		0	0		0	1		0	1		0
Taper Length (ft)	25			25			300			280		
Lane Util. Factor	1.00	1.00	1.00	1.00	1.00	1.00	1.00	1.00	1.00	1.00	1.00	1.00
Frt		0.931			0.992			0.972			0.993	
Flt Protected		0.988			0.976		0.950			0.950		
Satd. Flow (prot)	0	1713	0	0	1803	0	1770	1811	0	1770	1850	0
Flt Permitted		0.988			0.976		0.246			0.234		
Satd. Flow (perm)	0	1713	0	0	1803	0	458	1811	0	436	1850	0
Right Turn on Red			Yes			Yes			Yes			Yes
Satd. Flow (RTOR)		46			3			18			3	
Link Speed (mph)		45			45			55			55	
Link Distance (ft)		927			6659			1546			3606	
Travel Time (s)		14.0			100.9			19.2			44.7	
Peak Hour Factor	0.87	0.87	0.87	0.92	0.92	0.92	0.93	0.93	0.93	0.92	0.92	0.92
Adj. Flow (vph)	40	40	83	130	124	16	171	608	140	5	457	24
Shared Lane Traffic (%)												
Lane Group Flow (vph)	0	163	0	0	270	0	171	748	0	5	481	0
Enter Blocked Intersection	No	No	No	No	No	No	No	No	No	No	No	No
Lane Alignment	Left	Left	Right	Left	Left	Right	Left	Left	Right	Left	Left	Right
Median Width(ft)		0			0			12			12	
Link Offset(ft)		0			0			0			0	
Crosswalk Width(ft)		16			16			16			16	
Two way Left Turn Lane												
Headway Factor	1.00	1.00	1.00	1.00	1.00	1.00	1.00	1.00	1.00	1.00	1.00	1.00
Turning Speed (mph)	60		60	60		60	60		60	60		60
Number of Detectors	1	2		1	2		1	2		1	2	
Detector Template	Left	Thru		Left	Thru		Left	Thru		Left	Thru	
Leading Detector (ft)	20	100		20	100		20	100		20	100	
Trailing Detector (ft)	0	0		0	0		0	0		0	0	
Detector 1 Position(ft)	0	0		0	0		0	0		0	0	
Detector 1 Size(ft)	20	6		20	6		20	6		20	6	
Detector 1 Type	Cl+Ex	Cl+Ex		Cl+Ex	Cl+Ex		Cl+Ex	Cl+Ex		Cl+Ex	Cl+Ex	
Detector 1 Channel												
Detector 1 Extend (s)	0.0	0.0		0.0	0.0		0.0	0.0		0.0	0.0	
Detector 1 Queue (s)	0.0	0.0		0.0	0.0		0.0	0.0		0.0	0.0	
Detector 1 Delay (s)	0.0	0.0		0.0	0.0		0.0	0.0		0.0	0.0	
Detector 2 Position(ft)		94			94			94			94	
Detector 2 Size(ft)		6			6			6			6	
Detector 2 Type		Cl+Ex			Cl+Ex			Cl+Ex			Cl+Ex	
Detector 2 Channel												
Detector 2 Extend (s)		0.0			0.0			0.0			0.0	
Turn Type	Split	NA		Split	NA		pm+pt	NA		Perm	NA	
Protected Phases	4	4		8	8		5	2			6	
Permitted Phases							2			6		

Lanes, Volumes, Timings
1: US 24 & Judge Orr

Short-Term Baseline
PM



Lane Group	EBL	EBT	EBR	WBL	WBT	WBR	NEL	NET	NER	SWL	SWT	SWR
Detector Phase	4	4		8	8		5	2		6	6	
Switch Phase												
Minimum Initial (s)	5.0	5.0		5.0	5.0		5.0	5.0		5.0	5.0	
Minimum Split (s)	22.5	22.5		22.5	22.5		9.5	22.5		22.5	22.5	
Total Split (s)	14.0	14.0		28.0	28.0		11.0	48.0		37.0	37.0	
Total Split (%)	15.6%	15.6%		31.1%	31.1%		12.2%	53.3%		41.1%	41.1%	
Maximum Green (s)	9.5	9.5		23.5	23.5		6.5	43.5		32.5	32.5	
Yellow Time (s)	3.5	3.5		3.5	3.5		3.5	3.5		3.5	3.5	
All-Red Time (s)	1.0	1.0		1.0	1.0		1.0	1.0		1.0	1.0	
Lost Time Adjust (s)		0.0			0.0		0.0	0.0		0.0	0.0	
Total Lost Time (s)		4.5			4.5		4.5	4.5		4.5	4.5	
Lead/Lag							Lead			Lag	Lag	
Lead-Lag Optimize?							Yes			Yes	Yes	
Vehicle Extension (s)	3.0	3.0		3.0	3.0		3.0	3.0		3.0	3.0	
Recall Mode	None	None		None	None		None	Max		Max	Max	
Walk Time (s)	7.0	7.0		7.0	7.0			7.0		7.0	7.0	
Flash Dont Walk (s)	11.0	11.0		11.0	11.0			11.0		11.0	11.0	
Pedestrian Calls (#/hr)	0	0		0	0			0		0	0	
Act Effct Green (s)		8.9			17.2		43.7	43.7		32.6	32.6	
Actuated g/C Ratio		0.11			0.21		0.52	0.52		0.39	0.39	
v/c Ratio		0.73			0.72		0.50	0.78		0.03	0.66	
Control Delay		46.9			42.0		17.3	24.2		18.8	27.2	
Queue Delay		0.0			0.0		0.0	0.0		0.0	0.0	
Total Delay		46.9			42.0		17.3	24.2		18.8	27.2	
LOS		D			D		B	C		B	C	
Approach Delay		46.9			42.0			23.0			27.2	
Approach LOS		D			D			C			C	
Queue Length 50th (ft)		60			132		45	297		2	204	
Queue Length 95th (ft)		#151			212		92	#578		10	347	
Internal Link Dist (ft)		847			6579			1466			3526	
Turn Bay Length (ft)							870			695		
Base Capacity (vph)		236			512		343	958		170	726	
Starvation Cap Reductn		0			0		0	0		0	0	
Spillback Cap Reductn		0			0		0	0		0	0	
Storage Cap Reductn		0			0		0	0		0	0	
Reduced v/c Ratio		0.69			0.53		0.50	0.78		0.03	0.66	

Intersection Summary

Area Type: Other
 Cycle Length: 90
 Actuated Cycle Length: 83.3
 Natural Cycle: 90
 Control Type: Actuated-Uncoordinated
 Maximum v/c Ratio: 0.78
 Intersection Signal Delay: 29.0
 Intersection LOS: C
 Intersection Capacity Utilization 73.3%
 ICU Level of Service D
 Analysis Period (min) 15
 # 95th percentile volume exceeds capacity, queue may be longer.
 Queue shown is maximum after two cycles.

Splits and Phases: 1: US 24 & Judge Orr

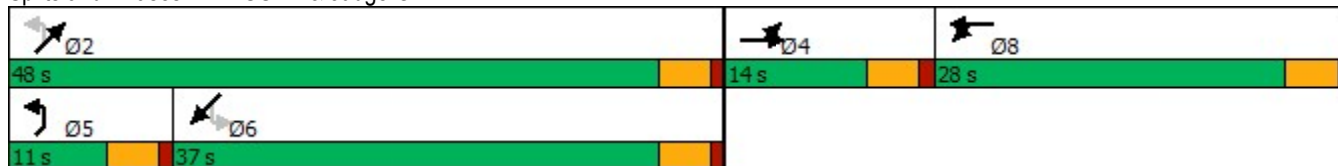

Intersection												
Int Delay, s/veh	18.8											
Movement	SEL	SET	SER	NWL	NWT	NWR	NEL	NET	NER	SWL	SWT	SWR
Lane Configurations	↖	↗	↖	↖	↗	↖	↖	↗	↖	↖	↗	↖
Traffic Vol, veh/h	14	59	49	26	146	28	119	459	33	15	364	29
Future Vol, veh/h	14	59	49	26	146	28	119	459	33	15	364	29
Conflicting Peds, #/hr	0	0	0	0	0	0	0	0	0	0	0	0
Sign Control	Stop	Stop	Stop	Stop	Stop	Stop	Free	Free	Free	Free	Free	Free
RT Channelized	-	-	None	-	-	None	-	-	None	-	-	None
Storage Length	190	-	325	215	-	215	890	-	1000	790	-	790
Veh in Median Storage, #	-	0	-	-	0	-	-	0	-	-	0	-
Grade, %	-	0	-	-	0	-	-	0	-	-	0	-
Peak Hour Factor	83	83	83	87	87	87	93	93	93	92	92	92
Heavy Vehicles, %	2	2	2	2	2	2	2	2	2	2	2	2
Mvmt Flow	17	71	59	30	168	32	128	494	35	16	396	32

Major/Minor	Minor2		Minor1		Major1		Major2					
Conflicting Flow All	1296	1213	396	1259	1210	494	428	0	0	529	0	0
Stage 1	428	428	-	750	750	-	-	-	-	-	-	-
Stage 2	868	785	-	509	460	-	-	-	-	-	-	-
Critical Hdwy	7.12	6.52	6.22	7.12	6.52	6.22	4.12	-	-	4.12	-	-
Critical Hdwy Stg 1	6.12	5.52	-	6.12	5.52	-	-	-	-	-	-	-
Critical Hdwy Stg 2	6.12	5.52	-	6.12	5.52	-	-	-	-	-	-	-
Follow-up Hdwy	3.518	4.018	3.318	3.518	4.018	3.318	2.218	-	-	2.218	-	-
Pot Cap-1 Maneuver	139	182	653	147	183	575	1131	-	-	1038	-	-
Stage 1	605	585	-	403	419	-	-	-	-	-	-	-
Stage 2	347	404	-	547	566	-	-	-	-	-	-	-
Platoon blocked, %	-	-	-	-	-	-	-	-	-	-	-	-
Mov Cap-1 Maneuver	-	159	653	79 ~ 160	575	1131	-	-	-	1038	-	-
Mov Cap-2 Maneuver	-	159	-	79 ~ 160	-	-	-	-	-	-	-	-
Stage 1	537	576	-	357	372	-	-	-	-	-	-	-
Stage 2	159	358	-	429	558	-	-	-	-	-	-	-

Approach	SE	NW	NE	SW
HCM Control Delay, s		115.2	1.7	0.3
HCM LOS	-	F		

Minor Lane/Major Mvmt	NEL	NET	NERN	NWLn1	NWLn2	NWLn3	SELn1	SELn2	SELn3	SWL	SWT	SWR
Capacity (veh/h)	1131	-	-	79	160	575	-	159	653	1038	-	-
HCM Lane V/C Ratio	0.113	-	-	0.378	1.049	0.056	-	0.447	0.09	0.016	-	-
HCM Control Delay (s)	8.6	-	-	76	142.1	11.6	-	44.8	11.1	8.5	-	-
HCM Lane LOS	A	-	-	F	F	B	-	E	B	A	-	-
HCM 95th %tile Q(veh)	0.4	-	-	1.5	8.4	0.2	-	2	0.3	0	-	-

Notes
 ~: Volume exceeds capacity \$: Delay exceeds 300s +: Computation Not Defined *: All major volume in platoon

Intersection												
Int Delay, s/veh	1.7											
Movement	SEL	SET	SER	NWL	NWT	NWR	NEL	NET	NER	SWL	SWT	SWR
Lane Configurations	↘	↑	↗	↘	↑	↗	↘	↑	↗	↘	↑	↗
Traffic Vol, veh/h	5	10	80	10	5	5	90	425	20	5	385	5
Future Vol, veh/h	5	10	80	10	5	5	90	425	20	5	385	5
Conflicting Peds, #/hr	0	0	0	0	0	0	0	0	0	0	0	0
Sign Control	Stop	Stop	Stop	Stop	Stop	Stop	Free	Free	Free	Free	Free	Free
RT Channelized	-	-	Free	-	-	Free	-	-	Yield	-	-	Yield
Storage Length	120	-	240	85	-	25	600	-	480	495	-	485
Veh in Median Storage, #	-	0	-	-	0	-	-	0	-	-	0	-
Grade, %	-	0	-	-	0	-	-	0	-	-	0	-
Peak Hour Factor	83	83	83	78	78	78	92	92	92	92	92	92
Heavy Vehicles, %	2	2	2	2	2	2	2	2	2	2	2	2
Mvmt Flow	6	12	96	13	6	6	98	462	22	5	418	5

Major/Minor	Minor2		Minor1		Major1			Major2				
Conflicting Flow All	1089	1086	-	1092	1086	-	418	0	0	462	0	0
Stage 1	428	428	-	658	658	-	-	-	-	-	-	-
Stage 2	661	658	-	434	428	-	-	-	-	-	-	-
Critical Hdwy	7.12	6.52	-	7.12	6.52	-	4.12	-	-	4.12	-	-
Critical Hdwy Stg 1	6.12	5.52	-	6.12	5.52	-	-	-	-	-	-	-
Critical Hdwy Stg 2	6.12	5.52	-	6.12	5.52	-	-	-	-	-	-	-
Follow-up Hdwy	3.518	4.018	-	3.518	4.018	-	2.218	-	-	2.218	-	-
Pot Cap-1 Maneuver	193	216	0	192	216	0	1141	-	-	1099	-	-
Stage 1	605	585	0	453	461	0	-	-	-	-	-	-
Stage 2	452	461	0	600	585	0	-	-	-	-	-	-
Platoon blocked, %								-	-	-	-	-
Mov Cap-1 Maneuver	175	196	-	170	196	-	1141	-	-	1099	-	-
Mov Cap-2 Maneuver	175	196	-	170	196	-	-	-	-	-	-	-
Stage 1	553	582	-	414	421	-	-	-	-	-	-	-
Stage 2	407	421	-	585	582	-	-	-	-	-	-	-

Approach	SE		NW		NE		SW	
HCM Control Delay, s	25.2		26.6		1.4		0.1	
HCM LOS	D		D					

Minor Lane/Major Mvmt	NEL	NET	NERN	NWLn1	NWLn2	NWLn3	SELn1	SELn2	SELn3	SWL	SWT	SWR
Capacity (veh/h)	1141	-	-	170	196	-	175	196	-	1099	-	-
HCM Lane V/C Ratio	0.086	-	-	0.075	0.033	-	0.034	0.061	-	0.005	-	-
HCM Control Delay (s)	8.5	-	-	27.9	24	0	26.3	24.6	0	8.3	-	-
HCM Lane LOS	A	-	-	D	C	A	D	C	A	A	-	-
HCM 95th %tile Q(veh)	0.3	-	-	0.2	0.1	-	0.1	0.2	-	0	-	-

Intersection						
Int Delay, s/veh	1					
Movement	EBL	EBT	WBT	WBR	SBL	SBR
Lane Configurations		↶	↷		↶	↷
Traffic Vol, veh/h	8	150	45	5	10	5
Future Vol, veh/h	8	150	45	5	10	5
Conflicting Peds, #/hr	0	0	0	0	0	0
Sign Control	Free	Free	Free	Free	Stop	Stop
RT Channelized	-	None	-	None	-	None
Storage Length	-	-	-	-	0	-
Veh in Median Storage, #	-	0	0	-	0	-
Grade, %	-	0	0	-	0	-
Peak Hour Factor	87	87	83	83	78	78
Heavy Vehicles, %	2	2	2	2	2	2
Mvmt Flow	9	172	54	6	13	6

Major/Minor	Major1	Major2	Minor2		
Conflicting Flow All	60	0	-	0	247 57
Stage 1	-	-	-	-	57 -
Stage 2	-	-	-	-	190 -
Critical Hdwy	4.12	-	-	-	6.42 6.22
Critical Hdwy Stg 1	-	-	-	-	5.42 -
Critical Hdwy Stg 2	-	-	-	-	5.42 -
Follow-up Hdwy	2.218	-	-	-	3.518 3.318
Pot Cap-1 Maneuver	1544	-	-	-	741 1009
Stage 1	-	-	-	-	966 -
Stage 2	-	-	-	-	842 -
Platoon blocked, %		-	-	-	
Mov Cap-1 Maneuver	1544	-	-	-	737 1009
Mov Cap-2 Maneuver	-	-	-	-	737 -
Stage 1	-	-	-	-	960 -
Stage 2	-	-	-	-	842 -

Approach	EB	WB	SB
HCM Control Delay, s	0.4	0	9.6
HCM LOS			A

Minor Lane/Major Mvmt	EBL	EBT	WBT	WBR	SBLn1
Capacity (veh/h)	1544	-	-	-	810
HCM Lane V/C Ratio	0.006	-	-	-	0.024
HCM Control Delay (s)	7.3	0	-	-	9.6
HCM Lane LOS	A	A	-	-	A
HCM 95th %tile Q(veh)	0	-	-	-	0.1

Intersection												
Int Delay, s/veh	6.9											
Movement	EBL	EBT	EBR	WBL	WBT	WBR	NBL	NBT	NBR	SBL	SBT	SBR
Lane Configurations		↖	↗	↖	↗		↖	↗		↖	↗	
Traffic Vol, veh/h	3	156	48	2	91	23	90	147	20	33	62	5
Future Vol, veh/h	3	156	48	2	91	23	90	147	20	33	62	5
Conflicting Peds, #/hr	0	0	0	0	0	0	0	0	0	0	0	0
Sign Control	Free	Free	Free	Free	Free	Free	Stop	Stop	Stop	Stop	Stop	Stop
RT Channelized	-	-	None	-	-	None	-	-	None	-	-	None
Storage Length	245	-	0	235	-	-	265	-	-	265	-	-
Veh in Median Storage, #	-	0	-	-	0	-	-	0	-	-	0	-
Grade, %	-	0	-	-	0	-	-	0	-	-	0	-
Peak Hour Factor	87	87	87	83	83	83	92	92	92	83	83	83
Heavy Vehicles, %	2	2	2	2	2	2	2	2	2	2	2	2
Mvmt Flow	3	179	55	2	110	28	98	160	22	40	75	6

Major/Minor	Major1			Major2			Minor1			Minor2		
Conflicting Flow All	138	0	0	234	0	0	354	327	179	432	368	124
Stage 1	-	-	-	-	-	-	185	185	-	128	128	-
Stage 2	-	-	-	-	-	-	169	142	-	304	240	-
Critical Hdwy	4.12	-	-	4.12	-	-	7.12	6.52	6.22	7.12	6.52	6.22
Critical Hdwy Stg 1	-	-	-	-	-	-	6.12	5.52	-	6.12	5.52	-
Critical Hdwy Stg 2	-	-	-	-	-	-	6.12	5.52	-	6.12	5.52	-
Follow-up Hdwy	2.218	-	-	2.218	-	-	3.518	4.018	3.318	3.518	4.018	3.318
Pot Cap-1 Maneuver	1446	-	-	1333	-	-	601	591	864	534	561	927
Stage 1	-	-	-	-	-	-	817	747	-	876	790	-
Stage 2	-	-	-	-	-	-	833	779	-	705	707	-
Platoon blocked, %	-	-	-	-	-	-	-	-	-	-	-	-
Mov Cap-1 Maneuver	1446	-	-	1333	-	-	534	589	864	411	559	927
Mov Cap-2 Maneuver	-	-	-	-	-	-	534	589	-	411	559	-
Stage 1	-	-	-	-	-	-	815	746	-	874	788	-
Stage 2	-	-	-	-	-	-	748	777	-	539	706	-

Approach	EB			WB			NB			SB		
HCM Control Delay, s	0.1			0.1			13.3			13.1		
HCM LOS							B			B		

Minor Lane/Major Mvmt	NBLn1	NBLn2	EBL	EBT	EBR	WBL	WBT	WBR	SBLn1	SBLn2
Capacity (veh/h)	534	612	1446	-	-	1333	-	-	411	576
HCM Lane V/C Ratio	0.183	0.297	0.002	-	-	0.002	-	-	0.097	0.14
HCM Control Delay (s)	13.2	13.3	7.5	0	-	7.7	-	-	14.7	12.3
HCM Lane LOS	B	B	A	A	-	A	-	-	B	B
HCM 95th %tile Q(veh)	0.7	1.2	0	-	-	0	-	-	0.3	0.5

Lanes, Volumes, Timings
1: US 24 & Judge Orr

Short-Term Baseline + Site
AM



Lane Group	EBL	EBT	EBR	WBL	WBT	WBR	NEL	NET	NER	SWL	SWT	SWR
Lane Configurations		↕			↕		↗	↖		↗	↖	
Traffic Volume (vph)	19	71	204	149	74	4	84	345	78	7	585	19
Future Volume (vph)	19	71	204	149	74	4	84	345	78	7	585	19
Ideal Flow (vphpl)	1900	1900	1900	1900	1900	1900	1900	1900	1900	1900	1900	1900
Storage Length (ft)	0		0	0		0	870		0	695		0
Storage Lanes	0		0	0		0	1		0	1		0
Taper Length (ft)	25			25			300			280		
Lane Util. Factor	1.00	1.00	1.00	1.00	1.00	1.00	1.00	1.00	1.00	1.00	1.00	1.00
Frt		0.906			0.997			0.972			0.995	
Flt Protected		0.997			0.968		0.950			0.950		
Satd. Flow (prot)	0	1683	0	0	1798	0	1770	1811	0	1770	1853	0
Flt Permitted		0.997			0.968		0.113			0.476		
Satd. Flow (perm)	0	1683	0	0	1798	0	210	1811	0	887	1853	0
Right Turn on Red			Yes			Yes			Yes			Yes
Satd. Flow (RTOR)		111			1			18				2
Link Speed (mph)		45			45			55				55
Link Distance (ft)		927			6659			1546				3606
Travel Time (s)		14.0			100.9			19.2				44.7
Peak Hour Factor	0.92	0.92	0.92	0.87	0.87	0.87	0.92	0.92	0.92	0.93	0.93	0.93
Adj. Flow (vph)	21	77	222	171	85	5	91	375	85	8	629	20
Shared Lane Traffic (%)												
Lane Group Flow (vph)	0	320	0	0	261	0	91	460	0	8	649	0
Enter Blocked Intersection	No	No	No	No	No	No	No	No	No	No	No	No
Lane Alignment	Left	Left	Right	Left	Left	Right	Left	Left	Right	Left	Left	Right
Median Width(ft)		0			0			12				12
Link Offset(ft)		0			0			0				0
Crosswalk Width(ft)		16			16			16				16
Two way Left Turn Lane												
Headway Factor	1.00	1.00	1.00	1.00	1.00	1.00	1.00	1.00	1.00	1.00	1.00	1.00
Turning Speed (mph)	60		60	60		60	60		60	60		60
Number of Detectors	1	2		1	2		1	2		1	2	
Detector Template	Left	Thru		Left	Thru		Left	Thru		Left	Thru	
Leading Detector (ft)	20	100		20	100		20	100		20	100	
Trailing Detector (ft)	0	0		0	0		0	0		0	0	
Detector 1 Position(ft)	0	0		0	0		0	0		0	0	
Detector 1 Size(ft)	20	6		20	6		20	6		20	6	
Detector 1 Type	Cl+Ex	Cl+Ex		Cl+Ex	Cl+Ex		Cl+Ex	Cl+Ex		Cl+Ex	Cl+Ex	
Detector 1 Channel												
Detector 1 Extend (s)	0.0	0.0		0.0	0.0		0.0	0.0		0.0	0.0	
Detector 1 Queue (s)	0.0	0.0		0.0	0.0		0.0	0.0		0.0	0.0	
Detector 1 Delay (s)	0.0	0.0		0.0	0.0		0.0	0.0		0.0	0.0	
Detector 2 Position(ft)		94			94			94			94	
Detector 2 Size(ft)		6			6			6			6	
Detector 2 Type		Cl+Ex			Cl+Ex			Cl+Ex			Cl+Ex	
Detector 2 Channel												
Detector 2 Extend (s)		0.0			0.0			0.0			0.0	
Turn Type	Split	NA		Split	NA		pm+pt	NA		Perm	NA	
Protected Phases	4	4		8	8		5	2				6
Permitted Phases							2			6		

Lanes, Volumes, Timings
1: US 24 & Judge Orr

Short-Term Baseline + Site
AM



Lane Group	EBL	EBT	EBR	WBL	WBT	WBR	NEL	NET	NER	SWL	SWT	SWR
Detector Phase	4	4		8	8		5	2		6	6	
Switch Phase												
Minimum Initial (s)	5.0	5.0		5.0	5.0		5.0	5.0		5.0	5.0	
Minimum Split (s)	22.5	22.5		22.5	22.5		9.5	22.5		22.5	22.5	
Total Split (s)	21.0	21.0		21.0	21.0		10.0	48.0		38.0	38.0	
Total Split (%)	23.3%	23.3%		23.3%	23.3%		11.1%	53.3%		42.2%	42.2%	
Maximum Green (s)	16.5	16.5		16.5	16.5		5.5	43.5		33.5	33.5	
Yellow Time (s)	3.5	3.5		3.5	3.5		3.5	3.5		3.5	3.5	
All-Red Time (s)	1.0	1.0		1.0	1.0		1.0	1.0		1.0	1.0	
Lost Time Adjust (s)		0.0			0.0		0.0	0.0		0.0	0.0	
Total Lost Time (s)		4.5			4.5		4.5	4.5		4.5	4.5	
Lead/Lag							Lead			Lag	Lag	
Lead-Lag Optimize?							Yes			Yes	Yes	
Vehicle Extension (s)	3.0	3.0		3.0	3.0		3.0	3.0		3.0	3.0	
Recall Mode	None	None		None	None		None	Max		Max	Max	
Walk Time (s)	7.0	7.0		7.0	7.0			7.0		7.0	7.0	
Flash Dont Walk (s)	11.0	11.0		11.0	11.0			11.0		11.0	11.0	
Pedestrian Calls (#/hr)	0	0		0	0			0		0	0	
Act Effct Green (s)		14.6			15.3		43.6	43.6		35.8	35.8	
Actuated g/C Ratio		0.17			0.18		0.50	0.50		0.41	0.41	
v/c Ratio		0.86			0.82		0.45	0.50		0.02	0.85	
Control Delay		45.4			57.1		19.7	17.0		18.3	38.3	
Queue Delay		0.0			0.0		0.0	0.0		0.0	0.0	
Total Delay		45.4			57.1		19.7	17.0		18.3	38.3	
LOS		D			E		B	B		B	D	
Approach Delay		45.4			57.1			17.4			38.1	
Approach LOS		D			E			B			D	
Queue Length 50th (ft)		115			143		27	166		3	349	
Queue Length 95th (ft)		#250			#249		53	253		12	#574	
Internal Link Dist (ft)		847			6579			1466			3526	
Turn Bay Length (ft)							870			695		
Base Capacity (vph)		409			342		203	916		365	763	
Starvation Cap Reductn		0			0		0	0		0	0	
Spillback Cap Reductn		0			0		0	0		0	0	
Storage Cap Reductn		0			0		0	0		0	0	
Reduced v/c Ratio		0.78			0.76		0.45	0.50		0.02	0.85	

Intersection Summary

Area Type: Other
 Cycle Length: 90
 Actuated Cycle Length: 87.1
 Natural Cycle: 90
 Control Type: Actuated-Uncoordinated
 Maximum v/c Ratio: 0.86
 Intersection Signal Delay: 35.8
 Intersection LOS: D
 Intersection Capacity Utilization 81.3%
 ICU Level of Service D
 Analysis Period (min) 15
 # 95th percentile volume exceeds capacity, queue may be longer.
 Queue shown is maximum after two cycles.

Splits and Phases: 1: US 24 & Judge Orr

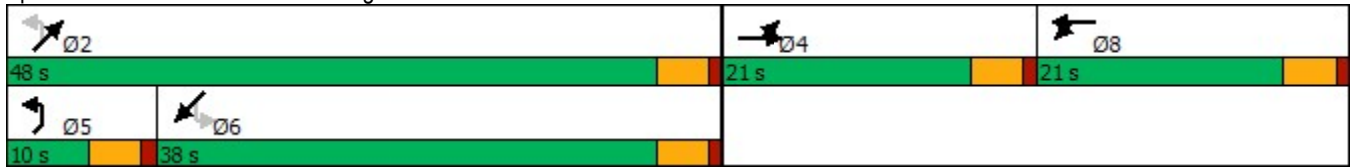

Intersection												
Int Delay, s/veh	14.2											
Movement	SEL	SET	SER	NWL	NWT	NWR	NEL	NET	NER	SWL	SWT	SWR
Lane Configurations	↖	↗	↖	↖	↗	↖	↖	↗	↖	↖	↗	↖
Traffic Vol, veh/h	23	154	143	12	115	21	49	267	6	38	438	37
Future Vol, veh/h	23	154	143	12	115	21	49	267	6	38	438	37
Conflicting Peds, #/hr	0	0	0	0	0	0	0	0	0	0	0	0
Sign Control	Stop	Stop	Stop	Stop	Stop	Stop	Free	Free	Free	Free	Free	Free
RT Channelized	-	-	None	-	-	None	-	-	None	-	-	None
Storage Length	190	-	325	215	-	215	890	-	1000	790	-	790
Veh in Median Storage, #	-	0	-	-	0	-	-	0	-	-	0	-
Grade, %	-	0	-	-	0	-	-	0	-	-	0	-
Peak Hour Factor	92	92	92	83	83	83	92	92	92	92	92	92
Heavy Vehicles, %	2	2	2	2	2	2	2	2	2	2	2	2
Mvmt Flow	25	167	155	14	139	25	53	290	7	41	476	40

Major/Minor	Minor2		Minor1		Major1			Major2				
Conflicting Flow All	1040	961	476	1135	994	290	516	0	0	297	0	0
Stage 1	558	558	-	396	396	-	-	-	-	-	-	-
Stage 2	482	403	-	739	598	-	-	-	-	-	-	-
Critical Hdwy	7.12	6.52	6.22	7.12	6.52	6.22	4.12	-	-	4.12	-	-
Critical Hdwy Stg 1	6.12	5.52	-	6.12	5.52	-	-	-	-	-	-	-
Critical Hdwy Stg 2	6.12	5.52	-	6.12	5.52	-	-	-	-	-	-	-
Follow-up Hdwy	3.518	4.018	3.318	3.518	4.018	3.318	2.218	-	-	2.218	-	-
Pot Cap-1 Maneuver	208	256	589	179	245	749	1050	-	-	1264	-	-
Stage 1	514	512	-	629	604	-	-	-	-	-	-	-
Stage 2	565	600	-	409	491	-	-	-	-	-	-	-
Platoon blocked, %	-	-	-	-	-	-	-	-	-	-	-	-
Mov Cap-1 Maneuver	97	236	589	53	225	749	1050	-	-	1264	-	-
Mov Cap-2 Maneuver	97	236	-	53	225	-	-	-	-	-	-	-
Stage 1	488	496	-	598	574	-	-	-	-	-	-	-
Stage 2	393	570	-	193	475	-	-	-	-	-	-	-

Approach	SE		NW		NE		SW			
HCM Control Delay, s	34.2		43.2		1.3		0.6			
HCM LOS	D		E							

Minor Lane/Major Mvmt	NEL	NET	NERNWLn1	NWLn2	NWLn3	SELn1	SELn2	SELn3	SWL	SWT	SWR	
Capacity (veh/h)	1050	-	-	53	225	749	97	236	589	1264	-	-
HCM Lane V/C Ratio	0.051	-	-	0.273	0.616	0.034	0.258	0.709	0.264	0.033	-	-
HCM Control Delay (s)	8.6	-	-	96.7	43.7	10	54.5	50.5	13.3	7.9	-	-
HCM Lane LOS	A	-	-	F	E	B	F	F	B	A	-	-
HCM 95th %tile Q(veh)	0.2	-	-	0.9	3.6	0.1	0.9	4.7	1.1	0.1	-	-

Intersection												
Int Delay, s/veh	2											
Movement	SEL	SET	SER	NWL	NWT	NWR	NEL	NET	NER	SWL	SWT	SWR
Lane Configurations	↘	↗	↗	↘	↗	↗	↘	↗	↗	↘	↗	↗
Traffic Vol, veh/h	5	12	110	17	15	4	45	251	5	9	383	5
Future Vol, veh/h	5	12	110	17	15	4	45	251	5	9	383	5
Conflicting Peds, #/hr	0	0	0	0	0	0	0	0	0	0	0	0
Sign Control	Stop	Stop	Stop	Stop	Stop	Stop	Free	Free	Free	Free	Free	Free
RT Channelized	-	-	Free	-	-	Free	-	-	Yield	-	-	Yield
Storage Length	120	-	240	85	-	25	600	-	480	495	-	485
Veh in Median Storage, #	-	0	-	-	0	-	-	0	-	-	0	-
Grade, %	-	0	-	-	0	-	-	0	-	-	0	-
Peak Hour Factor	83	83	83	78	78	78	92	92	92	92	92	92
Heavy Vehicles, %	2	2	2	2	2	2	2	2	2	2	2	2
Mvmt Flow	6	14	133	22	19	5	49	273	5	10	416	5

Major/Minor	Minor2		Minor1		Major1			Major2				
Conflicting Flow All	817	807	-	814	807	-	416	0	0	273	0	0
Stage 1	436	436	-	371	371	-	-	-	-	-	-	-
Stage 2	381	371	-	443	436	-	-	-	-	-	-	-
Critical Hdwy	7.12	6.52	-	7.12	6.52	-	4.12	-	-	4.12	-	-
Critical Hdwy Stg 1	6.12	5.52	-	6.12	5.52	-	-	-	-	-	-	-
Critical Hdwy Stg 2	6.12	5.52	-	6.12	5.52	-	-	-	-	-	-	-
Follow-up Hdwy	3.518	4.018	-	3.518	4.018	-	2.218	-	-	2.218	-	-
Pot Cap-1 Maneuver	295	315	0	297	315	0	1143	-	-	1290	-	-
Stage 1	599	580	0	649	620	0	-	-	-	-	-	-
Stage 2	641	620	0	594	580	0	-	-	-	-	-	-
Platoon blocked, %								-	-	-	-	-
Mov Cap-1 Maneuver	270	299	-	275	299	-	1143	-	-	1290	-	-
Mov Cap-2 Maneuver	270	299	-	275	299	-	-	-	-	-	-	-
Stage 1	573	575	-	621	593	-	-	-	-	-	-	-
Stage 2	594	593	-	575	575	-	-	-	-	-	-	-

Approach	SE		NW		NE		SW	
HCM Control Delay, s	18		18.6		1.2		0.2	
HCM LOS	C		C					

Minor Lane/Major Mvmt	NEL	NET	NERN	NWLn1	NWLn2	NWLn3	SELn1	SELn2	SELn3	SWL	SWT	SWR
Capacity (veh/h)	1143	-	-	275	299	-	270	299	-	1290	-	-
HCM Lane V/C Ratio	0.043	-	-	0.079	0.064	-	0.022	0.048	-	0.008	-	-
HCM Control Delay (s)	8.3	-	-	19.2	17.9	0	18.6	17.7	0	7.8	-	-
HCM Lane LOS	A	-	-	C	C	A	C	C	A	A	-	-
HCM 95th %tile Q(veh)	0.1	-	-	0.3	0.2	-	0.1	0.2	-	0	-	-

Intersection						
Int Delay, s/veh	1					
Movement	EBL	EBT	WBT	WBR	SBL	SBR
Lane Configurations		↶	↷		↶	
Traffic Vol, veh/h	3	42	156	15	5	15
Future Vol, veh/h	3	42	156	15	5	15
Conflicting Peds, #/hr	0	0	0	0	0	0
Sign Control	Free	Free	Free	Free	Stop	Stop
RT Channelized	-	None	-	None	-	None
Storage Length	-	-	-	-	0	-
Veh in Median Storage, #	-	0	0	-	0	-
Grade, %	-	0	0	-	0	-
Peak Hour Factor	78	78	87	87	78	78
Heavy Vehicles, %	2	2	2	2	2	2
Mvmt Flow	4	54	179	17	6	19

Major/Minor	Major1	Major2	Minor2		
Conflicting Flow All	196	0	-	0	250 188
Stage 1	-	-	-	-	188 -
Stage 2	-	-	-	-	62 -
Critical Hdwy	4.12	-	-	-	6.42 6.22
Critical Hdwy Stg 1	-	-	-	-	5.42 -
Critical Hdwy Stg 2	-	-	-	-	5.42 -
Follow-up Hdwy	2.218	-	-	-	3.518 3.318
Pot Cap-1 Maneuver	1377	-	-	-	739 854
Stage 1	-	-	-	-	844 -
Stage 2	-	-	-	-	961 -
Platoon blocked, %		-	-	-	
Mov Cap-1 Maneuver	1377	-	-	-	737 854
Mov Cap-2 Maneuver	-	-	-	-	737 -
Stage 1	-	-	-	-	841 -
Stage 2	-	-	-	-	961 -

Approach	EB	WB	SB
HCM Control Delay, s	0.5	0	9.5
HCM LOS			A

Minor Lane/Major Mvmt	EBL	EBT	WBT	WBR	SBLn1
Capacity (veh/h)	1377	-	-	-	821
HCM Lane V/C Ratio	0.003	-	-	-	0.031
HCM Control Delay (s)	7.6	0	-	-	9.5
HCM Lane LOS	A	A	-	-	A
HCM 95th %tile Q(veh)	0	-	-	-	0.1

Intersection												
Int Delay, s/veh	8.3											
Movement	EBL	EBT	EBR	WBL	WBT	WBR	NBL	NBT	NBR	SBL	SBT	SBR
Lane Configurations		↖	↗	↖	↗		↖	↗		↖	↗	
Traffic Vol, veh/h	9	57	84	23	175	57	54	91	3	18	173	22
Future Vol, veh/h	9	57	84	23	175	57	54	91	3	18	173	22
Conflicting Peds, #/hr	0	0	0	0	0	0	0	0	0	0	0	0
Sign Control	Free	Free	Free	Free	Free	Free	Stop	Stop	Stop	Stop	Stop	Stop
RT Channelized	-	-	None	-	-	None	-	-	None	-	-	None
Storage Length	245	-	0	235	-	-	265	-	-	265	-	-
Veh in Median Storage, #	-	0	-	-	0	-	-	0	-	-	0	-
Grade, %	-	0	-	-	0	-	-	0	-	-	0	-
Peak Hour Factor	83	83	83	87	87	87	83	83	83	87	87	87
Heavy Vehicles, %	2	2	2	2	2	2	2	2	2	2	2	2
Mvmt Flow	11	69	101	26	201	66	65	110	4	21	199	25

Major/Minor	Major1			Major2			Minor1			Minor2		
Conflicting Flow All	267	0	0	170	0	0	489	410	69	485	478	234
Stage 1	-	-	-	-	-	-	91	91	-	286	286	-
Stage 2	-	-	-	-	-	-	398	319	-	199	192	-
Critical Hdwy	4.12	-	-	4.12	-	-	7.12	6.52	6.22	7.12	6.52	6.22
Critical Hdwy Stg 1	-	-	-	-	-	-	6.12	5.52	-	6.12	5.52	-
Critical Hdwy Stg 2	-	-	-	-	-	-	6.12	5.52	-	6.12	5.52	-
Follow-up Hdwy	2.218	-	-	2.218	-	-	3.518	4.018	3.318	3.518	4.018	3.318
Pot Cap-1 Maneuver	1297	-	-	1407	-	-	489	531	994	492	486	805
Stage 1	-	-	-	-	-	-	916	820	-	721	675	-
Stage 2	-	-	-	-	-	-	628	653	-	803	742	-
Platoon blocked, %	-	-	-	-	-	-	-	-	-	-	-	-
Mov Cap-1 Maneuver	1297	-	-	1407	-	-	312	517	994	402	473	805
Mov Cap-2 Maneuver	-	-	-	-	-	-	312	517	-	402	473	-
Stage 1	-	-	-	-	-	-	908	813	-	715	663	-
Stage 2	-	-	-	-	-	-	418	641	-	686	735	-

Approach	EB			WB			NB			SB		
HCM Control Delay, s	0.5			0.7			15.9			17.8		
HCM LOS							C			C		

Minor Lane/Major Mvmt	NBLn1	NBLn2	EBL	EBT	EBR	WBL	WBT	WBR	SBLn1	SBLn2
Capacity (veh/h)	312	525	1297	-	-	1407	-	-	402	496
HCM Lane V/C Ratio	0.209	0.216	0.008	-	-	0.019	-	-	0.051	0.452
HCM Control Delay (s)	19.6	13.7	7.8	0	-	7.6	-	-	14.4	18.1
HCM Lane LOS	C	B	A	A	-	A	-	-	B	C
HCM 95th %tile Q(veh)	0.8	0.8	0	-	-	0.1	-	-	0.2	2.3

Intersection						
Int Delay, s/veh	1.7					
Movement	EBL	EBR	NBL	NBT	SBT	SBR
Lane Configurations	T			T		
Traffic Vol, veh/h	4	3	3	17	21	0
Future Vol, veh/h	4	3	3	17	21	0
Conflicting Peds, #/hr	0	0	0	0	0	0
Sign Control	Stop	Stop	Free	Free	Free	Free
RT Channelized	-	None	-	None	-	None
Storage Length	0	-	-	-	-	-
Veh in Median Storage, #	0	-	-	0	0	-
Grade, %	0	-	-	0	0	-
Peak Hour Factor	78	78	78	78	78	78
Heavy Vehicles, %	2	2	2	2	2	2
Mvmt Flow	5	4	4	22	27	0

Major/Minor	Minor2	Major1		Major2	
Conflicting Flow All	57	27	27	0	0
Stage 1	27	-	-	-	-
Stage 2	30	-	-	-	-
Critical Hdwy	6.42	6.22	4.12	-	-
Critical Hdwy Stg 1	5.42	-	-	-	-
Critical Hdwy Stg 2	5.42	-	-	-	-
Follow-up Hdwy	3.518	3.318	2.218	-	-
Pot Cap-1 Maneuver	950	1048	1587	-	-
Stage 1	996	-	-	-	-
Stage 2	993	-	-	-	-
Platoon blocked, %				-	-
Mov Cap-1 Maneuver	947	1048	1587	-	-
Mov Cap-2 Maneuver	947	-	-	-	-
Stage 1	993	-	-	-	-
Stage 2	993	-	-	-	-

Approach	EB	NB	SB
HCM Control Delay, s	8.7	1.1	0
HCM LOS	A		

Minor Lane/Major Mvmt	NBL	NBT	EBLn1	SBT	SBR
Capacity (veh/h)	1587	-	988	-	-
HCM Lane V/C Ratio	0.002	-	0.009	-	-
HCM Control Delay (s)	7.3	0	8.7	-	-
HCM Lane LOS	A	A	A	-	-
HCM 95th %tile Q(veh)	0	-	0	-	-

Intersection						
Int Delay, s/veh	0.7					
Movement	EBL	EBR	NBL	NBT	SBT	SBR
Lane Configurations	T			T		T
Traffic Vol, veh/h	2	1	1	18	19	5
Future Vol, veh/h	2	1	1	18	19	5
Conflicting Peds, #/hr	0	0	0	0	0	0
Sign Control	Stop	Stop	Free	Free	Free	Free
RT Channelized	-	None	-	None	-	None
Storage Length	0	-	-	-	-	-
Veh in Median Storage, #	0	-	-	0	0	-
Grade, %	0	-	-	0	0	-
Peak Hour Factor	78	78	78	78	78	78
Heavy Vehicles, %	2	2	2	2	2	2
Mvmt Flow	3	1	1	23	24	6

Major/Minor	Minor2	Major1		Major2	
Conflicting Flow All	52	27	30	0	0
Stage 1	27	-	-	-	-
Stage 2	25	-	-	-	-
Critical Hdwy	6.42	6.22	4.12	-	-
Critical Hdwy Stg 1	5.42	-	-	-	-
Critical Hdwy Stg 2	5.42	-	-	-	-
Follow-up Hdwy	3.518	3.318	2.218	-	-
Pot Cap-1 Maneuver	957	1048	1583	-	-
Stage 1	996	-	-	-	-
Stage 2	998	-	-	-	-
Platoon blocked, %				-	-
Mov Cap-1 Maneuver	956	1048	1583	-	-
Mov Cap-2 Maneuver	956	-	-	-	-
Stage 1	995	-	-	-	-
Stage 2	998	-	-	-	-

Approach	EB	NB	SB
HCM Control Delay, s	8.7	0.4	0
HCM LOS	A		

Minor Lane/Major Mvmt	NBL	NBT	EBLn1	SBT	SBR
Capacity (veh/h)	1583	-	985	-	-
HCM Lane V/C Ratio	0.001	-	0.004	-	-
HCM Control Delay (s)	7.3	0	8.7	-	-
HCM Lane LOS	A	A	A	-	-
HCM 95th %tile Q(veh)	0	-	0	-	-

Intersection						
Int Delay, s/veh	1.8					
Movement	EBL	EBT	WBT	WBR	SBL	SBR
Lane Configurations						
Traffic Vol, veh/h	18	41	157	15	3	29
Future Vol, veh/h	18	41	157	15	3	29
Conflicting Peds, #/hr	0	0	0	0	0	0
Sign Control	Free	Free	Free	Free	Stop	Stop
RT Channelized	-	None	-	None	-	None
Storage Length	235	-	-	-	0	-
Veh in Median Storage, #	-	0	0	-	0	-
Grade, %	-	0	0	-	0	-
Peak Hour Factor	83	83	87	87	78	78
Heavy Vehicles, %	2	2	2	2	2	2
Mvmt Flow	22	49	180	17	4	37

Major/Minor	Major1	Major2	Minor2		
Conflicting Flow All	197	0	-	0	282 189
Stage 1	-	-	-	-	189 -
Stage 2	-	-	-	-	93 -
Critical Hdwy	4.12	-	-	-	6.42 6.22
Critical Hdwy Stg 1	-	-	-	-	5.42 -
Critical Hdwy Stg 2	-	-	-	-	5.42 -
Follow-up Hdwy	2.218	-	-	-	3.518 3.318
Pot Cap-1 Maneuver	1376	-	-	-	708 853
Stage 1	-	-	-	-	843 -
Stage 2	-	-	-	-	931 -
Platoon blocked, %		-	-	-	
Mov Cap-1 Maneuver	1376	-	-	-	697 853
Mov Cap-2 Maneuver	-	-	-	-	697 -
Stage 1	-	-	-	-	830 -
Stage 2	-	-	-	-	931 -

Approach	EB	WB	SB
HCM Control Delay, s	2.3	0	9.5
HCM LOS			A

Minor Lane/Major Mvmt	EBL	EBT	WBT	WBR	SBLn1
Capacity (veh/h)	1376	-	-	-	835
HCM Lane V/C Ratio	0.016	-	-	-	0.049
HCM Control Delay (s)	7.7	-	-	-	9.5
HCM Lane LOS	A	-	-	-	A
HCM 95th %tile Q(veh)	0	-	-	-	0.2

Intersection												
Int Delay, s/veh	1.5											
Movement	EBL	EBT	EBR	WBL	WBT	WBR	NBL	NBT	NBR	SBL	SBT	SBR
Lane Configurations		↕			↕		↕	↕		↕	↕	↕
Traffic Vol, veh/h	5	0	13	15	0	12	10	144	4	4	183	16
Future Vol, veh/h	5	0	13	15	0	12	10	144	4	4	183	16
Conflicting Peds, #/hr	0	0	0	0	0	0	0	0	0	0	0	0
Sign Control	Stop	Stop	Stop	Stop	Stop	Stop	Free	Free	Free	Free	Free	Free
RT Channelized	-	-	None	-	-	None	-	-	None	-	-	None
Storage Length	-	-	-	-	-	-	235	-	-	235	-	235
Veh in Median Storage, #	-	0	-	-	0	-	-	0	-	-	0	-
Grade, %	-	0	-	-	0	-	-	0	-	-	0	-
Peak Hour Factor	78	78	78	78	78	78	87	87	87	87	87	87
Heavy Vehicles, %	2	2	2	2	2	2	2	2	2	2	2	2
Mvmt Flow	6	0	17	19	0	15	11	166	5	5	210	18

Major/Minor	Minor2		Minor1		Major1		Major2					
Conflicting Flow All	418	413	210	429	429	169	228	0	0	171	0	0
Stage 1	220	220	-	191	191	-	-	-	-	-	-	-
Stage 2	198	193	-	238	238	-	-	-	-	-	-	-
Critical Hdwy	7.12	6.52	6.22	7.12	6.52	6.22	4.12	-	-	4.12	-	-
Critical Hdwy Stg 1	6.12	5.52	-	6.12	5.52	-	-	-	-	-	-	-
Critical Hdwy Stg 2	6.12	5.52	-	6.12	5.52	-	-	-	-	-	-	-
Follow-up Hdwy	3.518	4.018	3.318	3.518	4.018	3.318	2.218	-	-	2.218	-	-
Pot Cap-1 Maneuver	545	529	830	536	518	875	1340	-	-	1406	-	-
Stage 1	782	721	-	811	742	-	-	-	-	-	-	-
Stage 2	804	741	-	765	708	-	-	-	-	-	-	-
Platoon blocked, %								-	-	-	-	-
Mov Cap-1 Maneuver	531	523	830	520	512	875	1340	-	-	1406	-	-
Mov Cap-2 Maneuver	531	523	-	520	512	-	-	-	-	-	-	-
Stage 1	776	718	-	805	736	-	-	-	-	-	-	-
Stage 2	783	735	-	747	705	-	-	-	-	-	-	-

Approach	EB		WB		NB		SB	
HCM Control Delay, s	10.2		11		0.5		0.1	
HCM LOS	B		B					

Minor Lane/Major Mvmt	NBL	NBT	NBR	EBLn1	WBLn1	SBL	SBT	SBR
Capacity (veh/h)	1340	-	-	718	634	1406	-	-
HCM Lane V/C Ratio	0.009	-	-	0.032	0.055	0.003	-	-
HCM Control Delay (s)	7.7	-	-	10.2	11	7.6	-	-
HCM Lane LOS	A	-	-	B	B	A	-	-
HCM 95th %tile Q(veh)	0	-	-	0.1	0.2	0	-	-

Lanes, Volumes, Timings
1: US 24 & Judge Orr

Short-Term Baseline + Site
PM



Lane Group	EBL	EBT	EBR	WBL	WBT	WBR	NEL	NET	NER	SWL	SWT	SWR
Lane Configurations		↕			↕		↗	↘		↗	↘	
Traffic Volume (vph)	39	46	72	150	130	15	159	571	181	5	424	22
Future Volume (vph)	39	46	72	150	130	15	159	571	181	5	424	22
Ideal Flow (vphpl)	1900	1900	1900	1900	1900	1900	1900	1900	1900	1900	1900	1900
Storage Length (ft)	0		0	0		0	870		0	695		0
Storage Lanes	0		0	0		0	1		0	1		0
Taper Length (ft)	25			25			300			280		
Lane Util. Factor	1.00	1.00	1.00	1.00	1.00	1.00	1.00	1.00	1.00	1.00	1.00	1.00
Frt		0.938			0.993			0.964			0.993	
Flt Protected		0.988			0.975		0.950			0.950		
Satd. Flow (prot)	0	1726	0	0	1803	0	1770	1796	0	1770	1850	0
Flt Permitted		0.988			0.975		0.226			0.145		
Satd. Flow (perm)	0	1726	0	0	1803	0	421	1796	0	270	1850	0
Right Turn on Red			Yes			Yes			Yes			Yes
Satd. Flow (RTOR)		39			3			25			3	
Link Speed (mph)		45			45			55			55	
Link Distance (ft)		927			6659			1546			3606	
Travel Time (s)		14.0			100.9			19.2			44.7	
Peak Hour Factor	0.87	0.87	0.87	0.92	0.92	0.92	0.93	0.93	0.93	0.92	0.92	0.92
Adj. Flow (vph)	45	53	83	163	141	16	171	614	195	5	461	24
Shared Lane Traffic (%)												
Lane Group Flow (vph)	0	181	0	0	320	0	171	809	0	5	485	0
Enter Blocked Intersection	No	No	No	No	No	No	No	No	No	No	No	No
Lane Alignment	Left	Left	Right	Left	Left	Right	Left	Left	Right	Left	Left	Right
Median Width(ft)		0			0			12			12	
Link Offset(ft)		0			0			0			0	
Crosswalk Width(ft)		16			16			16			16	
Two way Left Turn Lane												
Headway Factor	1.00	1.00	1.00	1.00	1.00	1.00	1.00	1.00	1.00	1.00	1.00	1.00
Turning Speed (mph)	60		60	60		60	60		60	60		60
Number of Detectors	1	2		1	2		1	2		1	2	
Detector Template	Left	Thru		Left	Thru		Left	Thru		Left	Thru	
Leading Detector (ft)	20	100		20	100		20	100		20	100	
Trailing Detector (ft)	0	0		0	0		0	0		0	0	
Detector 1 Position(ft)	0	0		0	0		0	0		0	0	
Detector 1 Size(ft)	20	6		20	6		20	6		20	6	
Detector 1 Type	Cl+Ex	Cl+Ex		Cl+Ex	Cl+Ex		Cl+Ex	Cl+Ex		Cl+Ex	Cl+Ex	
Detector 1 Channel												
Detector 1 Extend (s)	0.0	0.0		0.0	0.0		0.0	0.0		0.0	0.0	
Detector 1 Queue (s)	0.0	0.0		0.0	0.0		0.0	0.0		0.0	0.0	
Detector 1 Delay (s)	0.0	0.0		0.0	0.0		0.0	0.0		0.0	0.0	
Detector 2 Position(ft)		94			94			94			94	
Detector 2 Size(ft)		6			6			6			6	
Detector 2 Type		Cl+Ex			Cl+Ex			Cl+Ex			Cl+Ex	
Detector 2 Channel												
Detector 2 Extend (s)		0.0			0.0			0.0			0.0	
Turn Type	Split	NA		Split	NA		pm+pt	NA		Perm	NA	
Protected Phases	4	4		8	8		5	2			6	
Permitted Phases							2			6		

Lanes, Volumes, Timings
1: US 24 & Judge Orr

Short-Term Baseline + Site
PM



Lane Group	EBL	EBT	EBR	WBL	WBT	WBR	NEL	NET	NER	SWL	SWT	SWR
Detector Phase	4	4		8	8		5	2		6	6	
Switch Phase												
Minimum Initial (s)	5.0	5.0		5.0	5.0		5.0	5.0		5.0	5.0	
Minimum Split (s)	22.5	22.5		22.5	22.5		9.5	22.5		22.5	22.5	
Total Split (s)	16.0	16.0		26.0	26.0		11.0	48.0		37.0	37.0	
Total Split (%)	17.8%	17.8%		28.9%	28.9%		12.2%	53.3%		41.1%	41.1%	
Maximum Green (s)	11.5	11.5		21.5	21.5		6.5	43.5		32.5	32.5	
Yellow Time (s)	3.5	3.5		3.5	3.5		3.5	3.5		3.5	3.5	
All-Red Time (s)	1.0	1.0		1.0	1.0		1.0	1.0		1.0	1.0	
Lost Time Adjust (s)		0.0			0.0		0.0	0.0		0.0	0.0	
Total Lost Time (s)		4.5			4.5		4.5	4.5		4.5	4.5	
Lead/Lag							Lead			Lag	Lag	
Lead-Lag Optimize?							Yes			Yes	Yes	
Vehicle Extension (s)	3.0	3.0		3.0	3.0		3.0	3.0		3.0	3.0	
Recall Mode	None	None		None	None		None	Max		Max	Max	
Walk Time (s)	7.0	7.0		7.0	7.0			7.0		7.0	7.0	
Flash Dont Walk (s)	11.0	11.0		11.0	11.0			11.0		11.0	11.0	
Pedestrian Calls (#/hr)	0	0		0	0			0		0	0	
Act Effct Green (s)		10.5			18.8		43.7	43.7		32.6	32.6	
Actuated g/C Ratio		0.12			0.22		0.51	0.51		0.38	0.38	
v/c Ratio		0.74			0.81		0.54	0.88		0.05	0.69	
Control Delay		49.1			49.1		20.0	32.9		20.6	29.8	
Queue Delay		0.0			0.0		0.0	0.0		0.0	0.0	
Total Delay		49.1			49.1		20.0	32.9		20.6	29.8	
LOS		D			D		C	C		C	C	
Approach Delay		49.1			49.1			30.7			29.7	
Approach LOS		D			D			C			C	
Queue Length 50th (ft)		78			167		53	396		2	232	
Queue Length 95th (ft)		#161			#284		92	#658		10	350	
Internal Link Dist (ft)		847			6579			1466			3526	
Turn Bay Length (ft)							870			695		
Base Capacity (vph)		264			452		314	918		101	699	
Starvation Cap Reductn		0			0		0	0		0	0	
Spillback Cap Reductn		0			0		0	0		0	0	
Storage Cap Reductn		0			0		0	0		0	0	
Reduced v/c Ratio		0.69			0.71		0.54	0.88		0.05	0.69	

Intersection Summary

Area Type: Other
 Cycle Length: 90
 Actuated Cycle Length: 86.5
 Natural Cycle: 90
 Control Type: Actuated-Uncoordinated
 Maximum v/c Ratio: 0.88
 Intersection Signal Delay: 35.1
 Intersection LOS: D
 Intersection Capacity Utilization 79.2%
 ICU Level of Service D
 Analysis Period (min) 15
 # 95th percentile volume exceeds capacity, queue may be longer.
 Queue shown is maximum after two cycles.

Splits and Phases: 1: US 24 & Judge Orr

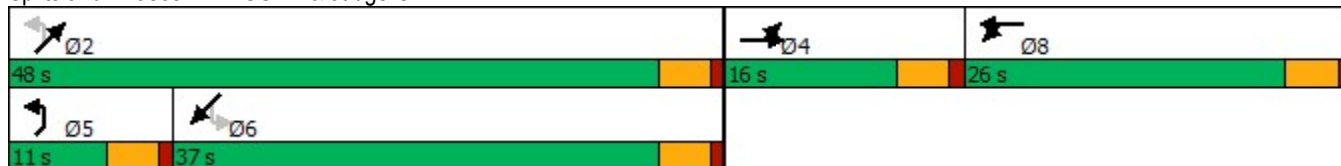

Intersection												
Int Delay, s/veh	32.3											
Movement	SEL	SET	SER	NWL	NWT	NWR	NEL	NET	NER	SWL	SWT	SWR
Lane Configurations	↖	↗	↖	↖	↗	↖	↖	↗	↖	↖	↗	↖
Traffic Vol, veh/h	14	91	49	30	171	35	119	459	42	20	364	30
Future Vol, veh/h	14	91	49	30	171	35	119	459	42	20	364	30
Conflicting Peds, #/hr	0	0	0	0	0	0	0	0	0	0	0	0
Sign Control	Stop	Stop	Stop	Stop	Stop	Stop	Free	Free	Free	Free	Free	Free
RT Channelized	-	-	None	-	-	None	-	-	None	-	-	None
Storage Length	190	-	325	215	-	215	890	-	1000	790	-	790
Veh in Median Storage, #	-	0	-	-	0	-	-	0	-	-	0	-
Grade, %	-	0	-	-	0	-	-	0	-	-	0	-
Peak Hour Factor	83	83	83	87	87	87	93	93	93	92	92	92
Heavy Vehicles, %	2	2	2	2	2	2	2	2	2	2	2	2
Mvmt Flow	17	110	59	34	197	40	128	494	45	22	396	33

Major/Minor	Minor2		Minor1		Major1		Major2					
Conflicting Flow All	1331	1235	396	1291	1223	494	429	0	0	539	0	0
Stage 1	440	440	-	750	750	-	-	-	-	-	-	-
Stage 2	891	795	-	541	473	-	-	-	-	-	-	-
Critical Hdwy	7.12	6.52	6.22	7.12	6.52	6.22	4.12	-	-	4.12	-	-
Critical Hdwy Stg 1	6.12	5.52	-	6.12	5.52	-	-	-	-	-	-	-
Critical Hdwy Stg 2	6.12	5.52	-	6.12	5.52	-	-	-	-	-	-	-
Follow-up Hdwy	3.518	4.018	3.318	3.518	4.018	3.318	2.218	-	-	2.218	-	-
Pot Cap-1 Maneuver	132	176	653	140	~ 179	575	1130	-	-	1029	-	-
Stage 1	596	578	-	403	419	-	-	-	-	-	-	-
Stage 2	337	399	-	525	558	-	-	-	-	-	-	-
Platoon blocked, %	-	-	-	-	-	-	-	-	-	-	-	-
Mov Cap-1 Maneuver	-	153	653	49	~ 155	575	1130	-	-	1029	-	-
Mov Cap-2 Maneuver	-	153	-	49	~ 155	-	-	-	-	-	-	-
Stage 1	529	566	-	357	372	-	-	-	-	-	-	-
Stage 2	131	354	-	377	546	-	-	-	-	-	-	-

Approach	SE	NW	NE	SW
HCM Control Delay, s		182.7	1.6	0.4
HCM LOS	-	F		

Minor Lane/Major Mvmt	NEL	NET	NERNWLn1	NWLn2	NWLn3	SELn1	SELn2	SELn3	SWL	SWT	SWR	
Capacity (veh/h)	1130	-	-	49	155	575	-	153	653	1029	-	-
HCM Lane V/C Ratio	0.113	-	-	0.704	1.268	0.07	-	0.717	0.09	0.021	-	-
HCM Control Delay (s)	8.6	-	-	178.3	218.5	11.7	-	72.7	11.1	8.6	-	-
HCM Lane LOS	A	-	-	F	F	B	-	F	B	A	-	-
HCM 95th %tile Q(veh)	0.4	-	-	2.8	11.6	0.2	-	4.3	0.3	0.1	-	-

Notes
 ~: Volume exceeds capacity \$: Delay exceeds 300s +: Computation Not Defined *: All major volume in platoon

Intersection												
Int Delay, s/veh	2.1											
Movement	SEL	SET	SER	NWL	NWT	NWR	NEL	NET	NER	SWL	SWT	SWR
Lane Configurations	↖	↗	↖	↖	↗	↖	↖	↗	↖	↖	↗	↖
Traffic Vol, veh/h	5	13	81	11	8	15	91	431	20	14	389	5
Future Vol, veh/h	5	13	81	11	8	15	91	431	20	14	389	5
Conflicting Peds, #/hr	0	0	0	0	0	0	0	0	0	0	0	0
Sign Control	Stop	Stop	Stop	Stop	Stop	Stop	Free	Free	Free	Free	Free	Free
RT Channelized	-	-	Free	-	-	Free	-	-	Yield	-	-	Yield
Storage Length	120	-	240	85	-	25	600	-	480	495	-	485
Veh in Median Storage, #	-	0	-	-	0	-	-	0	-	-	0	-
Grade, %	-	0	-	-	0	-	-	0	-	-	0	-
Peak Hour Factor	83	83	83	78	78	78	92	92	92	92	92	92
Heavy Vehicles, %	2	2	2	2	2	2	2	2	2	2	2	2
Mvmt Flow	6	16	98	14	10	19	99	468	22	15	423	5

Major/Minor	Minor2		Minor1		Major1			Major2				
Conflicting Flow All	1124	1119	-	1127	1119	-	423	0	0	468	0	0
Stage 1	453	453	-	666	666	-	-	-	-	-	-	-
Stage 2	671	666	-	461	453	-	-	-	-	-	-	-
Critical Hdwy	7.12	6.52	-	7.12	6.52	-	4.12	-	-	4.12	-	-
Critical Hdwy Stg 1	6.12	5.52	-	6.12	5.52	-	-	-	-	-	-	-
Critical Hdwy Stg 2	6.12	5.52	-	6.12	5.52	-	-	-	-	-	-	-
Follow-up Hdwy	3.518	4.018	-	3.518	4.018	-	2.218	-	-	2.218	-	-
Pot Cap-1 Maneuver	183	207	0	182	207	0	1136	-	-	1094	-	-
Stage 1	586	570	0	449	457	0	-	-	-	-	-	-
Stage 2	446	457	0	581	570	0	-	-	-	-	-	-
Platoon blocked, %								-	-	-	-	-
Mov Cap-1 Maneuver	162	186	-	157	186	-	1136	-	-	1094	-	-
Mov Cap-2 Maneuver	162	186	-	157	186	-	-	-	-	-	-	-
Stage 1	535	562	-	410	417	-	-	-	-	-	-	-
Stage 2	397	417	-	557	562	-	-	-	-	-	-	-

Approach	SE		NW		NE		SW	
HCM Control Delay, s	26.7		28.2		1.4		0.3	
HCM LOS	D		D					

Minor Lane/Major Mvmt	NEL	NET	NERN	NWLn1	NWLn2	NWLn3	SELn1	SELn2	SELn3	SWL	SWT	SWR
Capacity (veh/h)	1136	-	-	157	186	-	162	186	-	1094	-	-
HCM Lane V/C Ratio	0.087	-	-	0.09	0.055	-	0.037	0.084	-	0.014	-	-
HCM Control Delay (s)	8.5	-	-	30.2	25.5	0	28.1	26.1	0	8.3	-	-
HCM Lane LOS	A	-	-	D	D	A	D	D	A	A	-	-
HCM 95th %tile Q(veh)	0.3	-	-	0.3	0.2	-	0.1	0.3	-	0	-	-

Intersection						
Int Delay, s/veh	1.4					
Movement	EBL	EBT	WBT	WBR	SBL	SBR
Lane Configurations		↖	↗		↘	
Traffic Vol, veh/h	20	163	55	6	11	11
Future Vol, veh/h	20	163	55	6	11	11
Conflicting Peds, #/hr	0	0	0	0	0	0
Sign Control	Free	Free	Free	Free	Stop	Stop
RT Channelized	-	None	-	None	-	None
Storage Length	-	-	-	-	0	-
Veh in Median Storage, #	-	0	0	-	0	-
Grade, %	-	0	0	-	0	-
Peak Hour Factor	87	87	83	83	78	78
Heavy Vehicles, %	2	2	2	2	2	2
Mvmt Flow	23	187	66	7	14	14

Major/Minor	Major1	Major2	Minor2		
Conflicting Flow All	73	0	-	0	303 70
Stage 1	-	-	-	-	70 -
Stage 2	-	-	-	-	233 -
Critical Hdwy	4.12	-	-	-	6.42 6.22
Critical Hdwy Stg 1	-	-	-	-	5.42 -
Critical Hdwy Stg 2	-	-	-	-	5.42 -
Follow-up Hdwy	2.218	-	-	-	3.518 3.318
Pot Cap-1 Maneuver	1527	-	-	-	689 993
Stage 1	-	-	-	-	953 -
Stage 2	-	-	-	-	806 -
Platoon blocked, %		-	-	-	
Mov Cap-1 Maneuver	1527	-	-	-	677 993
Mov Cap-2 Maneuver	-	-	-	-	677 -
Stage 1	-	-	-	-	937 -
Stage 2	-	-	-	-	806 -

Approach	EB	WB	SB
HCM Control Delay, s	0.8	0	9.6
HCM LOS			A

Minor Lane/Major Mvmt	EBL	EBT	WBT	WBR	SBLn1
Capacity (veh/h)	1527	-	-	-	805
HCM Lane V/C Ratio	0.015	-	-	-	0.035
HCM Control Delay (s)	7.4	0	-	-	9.6
HCM Lane LOS	A	A	-	-	A
HCM 95th %tile Q(veh)	0	-	-	-	0.1

Intersection												
Int Delay, s/veh	8.4											
Movement	EBL	EBT	EBR	WBL	WBT	WBR	NBL	NBT	NBR	SBL	SBT	SBR
Lane Configurations		↖	↗	↖	↗		↖	↗		↖	↗	
Traffic Vol, veh/h	31	191	48	10	114	36	90	151	30	50	66	28
Future Vol, veh/h	31	191	48	10	114	36	90	151	30	50	66	28
Conflicting Peds, #/hr	0	0	0	0	0	0	0	0	0	0	0	0
Sign Control	Free	Free	Free	Free	Free	Free	Stop	Stop	Stop	Stop	Stop	Stop
RT Channelized	-	-	None	-	-	None	-	-	None	-	-	None
Storage Length	245	-	0	235	-	-	265	-	-	265	-	-
Veh in Median Storage, #	-	0	-	-	0	-	-	0	-	-	0	-
Grade, %	-	0	-	-	0	-	-	0	-	-	0	-
Peak Hour Factor	92	92	92	87	87	87	92	92	92	87	87	87
Heavy Vehicles, %	2	2	2	2	2	2	2	2	2	2	2	2
Mvmt Flow	34	208	52	11	131	41	98	164	33	57	76	32

Major/Minor	Major1			Major2			Minor1			Minor2		
Conflicting Flow All	172	0	0	260	0	0	504	470	208	575	502	152
Stage 1	-	-	-	-	-	-	276	276	-	174	174	-
Stage 2	-	-	-	-	-	-	228	194	-	401	328	-
Critical Hdwy	4.12	-	-	4.12	-	-	7.12	6.52	6.22	7.12	6.52	6.22
Critical Hdwy Stg 1	-	-	-	-	-	-	6.12	5.52	-	6.12	5.52	-
Critical Hdwy Stg 2	-	-	-	-	-	-	6.12	5.52	-	6.12	5.52	-
Follow-up Hdwy	2.218	-	-	2.218	-	-	3.518	4.018	3.318	3.518	4.018	3.318
Pot Cap-1 Maneuver	1405	-	-	1304	-	-	478	492	832	429	471	894
Stage 1	-	-	-	-	-	-	730	682	-	828	755	-
Stage 2	-	-	-	-	-	-	775	740	-	626	647	-
Platoon blocked, %	-	-	-	-	-	-	-	-	-	-	-	-
Mov Cap-1 Maneuver	1405	-	-	1304	-	-	391	474	832	293	454	894
Mov Cap-2 Maneuver	-	-	-	-	-	-	391	474	-	293	454	-
Stage 1	-	-	-	-	-	-	710	663	-	805	749	-
Stage 2	-	-	-	-	-	-	666	734	-	440	629	-

Approach	EB			WB			NB			SB		
HCM Control Delay, s	0.9			0.5			16.7			15.9		
HCM LOS							C			C		

Minor Lane/Major Mvmt	NBLn1	NBLn2	EBL	EBT	EBR	WBL	WBT	WBR	SBLn1	SBLn2
Capacity (veh/h)	391	510	1405	-	-	1304	-	-	293	532
HCM Lane V/C Ratio	0.25	0.386	0.024	-	-	0.009	-	-	0.196	0.203
HCM Control Delay (s)	17.3	16.4	7.6	0	-	7.8	-	-	20.3	13.5
HCM Lane LOS	C	C	A	A	-	A	-	-	C	B
HCM 95th %tile Q(veh)	1	1.8	0.1	-	-	0	-	-	0.7	0.8

Intersection						
Int Delay, s/veh	3.3					
Movement	EBL	EBR	NBL	NBT	SBT	SBR
Lane Configurations	T			T		T
Traffic Vol, veh/h	1	2	26	9	24	3
Future Vol, veh/h	1	2	26	9	24	3
Conflicting Peds, #/hr	0	0	0	0	0	0
Sign Control	Stop	Stop	Free	Free	Free	Free
RT Channelized	-	None	-	None	-	None
Storage Length	0	-	-	-	-	-
Veh in Median Storage, #	0	-	-	0	0	-
Grade, %	0	-	-	0	0	-
Peak Hour Factor	78	78	78	78	78	78
Heavy Vehicles, %	2	2	2	2	2	2
Mvmt Flow	1	3	33	12	31	4

Major/Minor	Minor2	Major1		Major2	
Conflicting Flow All	111	33	35	0	0
Stage 1	33	-	-	-	-
Stage 2	78	-	-	-	-
Critical Hdwy	6.42	6.22	4.12	-	-
Critical Hdwy Stg 1	5.42	-	-	-	-
Critical Hdwy Stg 2	5.42	-	-	-	-
Follow-up Hdwy	3.518	3.318	2.218	-	-
Pot Cap-1 Maneuver	886	1041	1576	-	-
Stage 1	989	-	-	-	-
Stage 2	945	-	-	-	-
Platoon blocked, %				-	-
Mov Cap-1 Maneuver	867	1041	1576	-	-
Mov Cap-2 Maneuver	867	-	-	-	-
Stage 1	968	-	-	-	-
Stage 2	945	-	-	-	-

Approach	EB	NB	SB
HCM Control Delay, s	8.7	5.4	0
HCM LOS	A		

Minor Lane/Major Mvmt	NBL	NBT	EBLn1	SBT	SBR
Capacity (veh/h)	1576	-	976	-	-
HCM Lane V/C Ratio	0.021	-	0.004	-	-
HCM Control Delay (s)	7.3	0	8.7	-	-
HCM Lane LOS	A	A	A	-	-
HCM 95th %tile Q(veh)	0.1	-	0	-	-

Intersection						
Int Delay, s/veh	2.1					
Movement	EBL	EBR	NBL	NBT	SBT	SBR
Lane Configurations	W			W	W	
Traffic Vol, veh/h	12	2	2	23	20	6
Future Vol, veh/h	12	2	2	23	20	6
Conflicting Peds, #/hr	0	0	0	0	0	0
Sign Control	Stop	Stop	Free	Free	Free	Free
RT Channelized	-	None	-	None	-	None
Storage Length	0	-	-	-	-	-
Veh in Median Storage, #	0	-	-	0	0	-
Grade, %	0	-	-	0	0	-
Peak Hour Factor	78	78	78	78	78	78
Heavy Vehicles, %	2	2	2	2	2	2
Mvmt Flow	15	3	3	29	26	8

Major/Minor	Minor2	Major1		Major2	
Conflicting Flow All	65	30	34	0	0
Stage 1	30	-	-	-	-
Stage 2	35	-	-	-	-
Critical Hdwy	6.42	6.22	4.12	-	-
Critical Hdwy Stg 1	5.42	-	-	-	-
Critical Hdwy Stg 2	5.42	-	-	-	-
Follow-up Hdwy	3.518	3.318	2.218	-	-
Pot Cap-1 Maneuver	941	1044	1578	-	-
Stage 1	993	-	-	-	-
Stage 2	987	-	-	-	-
Platoon blocked, %				-	-
Mov Cap-1 Maneuver	939	1044	1578	-	-
Mov Cap-2 Maneuver	939	-	-	-	-
Stage 1	991	-	-	-	-
Stage 2	987	-	-	-	-

Approach	EB	NB	SB
HCM Control Delay, s	8.9	0.6	0
HCM LOS	A		

Minor Lane/Major Mvmt	NBL	NBT	EBLn1	SBT	SBR
Capacity (veh/h)	1578	-	953	-	-
HCM Lane V/C Ratio	0.002	-	0.019	-	-
HCM Control Delay (s)	7.3	0	8.9	-	-
HCM Lane LOS	A	A	A	-	-
HCM 95th %tile Q(veh)	0	-	0.1	-	-

Intersection						
Int Delay, s/veh	3.5					
Movement	EBL	EBT	WBT	WBR	SBL	SBR
Lane Configurations						
Traffic Vol, veh/h	64	155	48	20	30	47
Future Vol, veh/h	64	155	48	20	30	47
Conflicting Peds, #/hr	0	0	0	0	0	0
Sign Control	Free	Free	Free	Free	Stop	Stop
RT Channelized	-	None	-	None	-	None
Storage Length	235	-	-	-	0	-
Veh in Median Storage, #	-	0	0	-	0	-
Grade, %	-	0	0	-	0	-
Peak Hour Factor	87	87	78	78	83	83
Heavy Vehicles, %	2	2	2	2	2	2
Mvmt Flow	74	178	62	26	36	57

Major/Minor	Major1	Major2	Minor2		
Conflicting Flow All	88	0	-	0	401 75
Stage 1	-	-	-	-	75 -
Stage 2	-	-	-	-	326 -
Critical Hdwy	4.12	-	-	-	6.42 6.22
Critical Hdwy Stg 1	-	-	-	-	5.42 -
Critical Hdwy Stg 2	-	-	-	-	5.42 -
Follow-up Hdwy	2.218	-	-	-	3.518 3.318
Pot Cap-1 Maneuver	1508	-	-	-	605 986
Stage 1	-	-	-	-	948 -
Stage 2	-	-	-	-	731 -
Platoon blocked, %		-	-	-	
Mov Cap-1 Maneuver	1508	-	-	-	575 986
Mov Cap-2 Maneuver	-	-	-	-	575 -
Stage 1	-	-	-	-	902 -
Stage 2	-	-	-	-	731 -

Approach	EB	WB	SB
HCM Control Delay, s	2.2	0	10.3
HCM LOS			B

Minor Lane/Major Mvmt	EBL	EBT	WBT	WBR	SBLn1
Capacity (veh/h)	1508	-	-	-	771
HCM Lane V/C Ratio	0.049	-	-	-	0.12
HCM Control Delay (s)	7.5	-	-	-	10.3
HCM Lane LOS	A	-	-	-	B
HCM 95th %tile Q(veh)	0.2	-	-	-	0.4

Intersection												
Int Delay, s/veh	2.7											
Movement	EBL	EBT	EBR	WBL	WBT	WBR	NBL	NBT	NBR	SBL	SBT	SBR
Lane Configurations		↕			↕		↕	↕		↕	↕	↕
Traffic Vol, veh/h	29	0	31	10	0	7	30	174	14	12	102	33
Future Vol, veh/h	29	0	31	10	0	7	30	174	14	12	102	33
Conflicting Peds, #/hr	0	0	0	0	0	0	0	0	0	0	0	0
Sign Control	Stop	Stop	Stop	Stop	Stop	Stop	Free	Free	Free	Free	Free	Free
RT Channelized	-	-	None	-	-	None	-	-	None	-	-	None
Storage Length	-	-	-	-	-	-	235	-	-	235	-	235
Veh in Median Storage, #	-	0	-	-	0	-	-	0	-	-	0	-
Grade, %	-	0	-	-	0	-	-	0	-	-	0	-
Peak Hour Factor	83	83	83	78	78	78	87	87	87	87	87	87
Heavy Vehicles, %	2	2	2	2	2	2	2	2	2	2	2	2
Mvmt Flow	35	0	37	13	0	9	34	200	16	14	117	38

Major/Minor	Minor2		Minor1		Major1			Major2				
Conflicting Flow All	426	429	117	459	459	208	155	0	0	216	0	0
Stage 1	145	145	-	276	276	-	-	-	-	-	-	-
Stage 2	281	284	-	183	183	-	-	-	-	-	-	-
Critical Hdwy	7.12	6.52	6.22	7.12	6.52	6.22	4.12	-	-	4.12	-	-
Critical Hdwy Stg 1	6.12	5.52	-	6.12	5.52	-	-	-	-	-	-	-
Critical Hdwy Stg 2	6.12	5.52	-	6.12	5.52	-	-	-	-	-	-	-
Follow-up Hdwy	3.518	4.018	3.318	3.518	4.018	3.318	2.218	-	-	2.218	-	-
Pot Cap-1 Maneuver	539	518	935	512	499	832	1425	-	-	1354	-	-
Stage 1	858	777	-	730	682	-	-	-	-	-	-	-
Stage 2	726	676	-	819	748	-	-	-	-	-	-	-
Platoon blocked, %								-	-	-	-	-
Mov Cap-1 Maneuver	520	500	935	479	482	832	1425	-	-	1354	-	-
Mov Cap-2 Maneuver	520	500	-	479	482	-	-	-	-	-	-	-
Stage 1	837	769	-	712	666	-	-	-	-	-	-	-
Stage 2	701	660	-	778	741	-	-	-	-	-	-	-

Approach	EB	WB	NB	SB
HCM Control Delay, s	11	11.4	1	0.6
HCM LOS	B	B		

Minor Lane/Major Mvmt	NBL	NBT	NBR	EBLn1	WBLn1	SBL	SBT	SBR
Capacity (veh/h)	1425	-	-	675	580	1354	-	-
HCM Lane V/C Ratio	0.024	-	-	0.107	0.038	0.01	-	-
HCM Control Delay (s)	7.6	-	-	11	11.4	7.7	-	-
HCM Lane LOS	A	-	-	B	B	A	-	-
HCM 95th %tile Q(veh)	0.1	-	-	0.4	0.1	0	-	-

Lanes, Volumes, Timings
1: US 24 & Judge Orr

2043 Background
AM

Lane Group	EBL	EBT	EBR	WBL	WBT	WBR	NEL	NET	NER	SWL	SWT	SWR
Lane Configurations												
Traffic Volume (vph)	67	154	298	265	134	50	239	675	200	100	1200	102
Future Volume (vph)	67	154	298	265	134	50	239	675	200	100	1200	102
Ideal Flow (vphpl)	1900	1900	1900	1900	1900	1900	1900	1900	1900	1900	1900	1900
Storage Length (ft)	235		0	235		235	860		290	695		290
Storage Lanes	1		1	2		1	2		1	1		1
Taper Length (ft)	200			200			300			300		
Lane Util. Factor	1.00	0.95	1.00	0.97	0.95	1.00	0.97	0.95	1.00	1.00	0.95	1.00
Frt			0.850			0.850			0.850			0.850
Flt Protected	0.950			0.950			0.950			0.950		
Satd. Flow (prot)	1770	3539	1583	3433	3539	1583	3433	3539	1583	1770	3539	1583
Flt Permitted	0.659			0.950			0.950			0.353		
Satd. Flow (perm)	1228	3539	1583	3433	3539	1583	3433	3539	1583	658	3539	1583
Right Turn on Red			Yes			Yes			Yes			Yes
Satd. Flow (RTOR)			248			149			211			149
Link Speed (mph)		45			45			55			55	
Link Distance (ft)		1222			928			1307			1572	
Travel Time (s)		18.5			14.1			16.2			19.5	
Peak Hour Factor	0.92	0.92	0.92	0.92	0.92	0.92	0.95	0.95	0.95	0.95	0.95	0.95
Adj. Flow (vph)	73	167	324	288	146	54	252	711	211	105	1263	107
Shared Lane Traffic (%)												
Lane Group Flow (vph)	73	167	324	288	146	54	252	711	211	105	1263	107
Enter Blocked Intersection	No	No	No	No	No	No	No	No	No	No	No	No
Lane Alignment	Left	Left	Right	Left	Left	Right	Left	Left	Right	Left	Left	Right
Median Width(ft)		24			24			24			24	
Link Offset(ft)		0			0			0			0	
Crosswalk Width(ft)		16			16			16			16	
Two way Left Turn Lane												
Headway Factor	1.00	1.00	1.00	1.00	1.00	1.00	1.00	1.00	1.00	1.00	1.00	1.00
Turning Speed (mph)	60		60	60		60	60		60	60		60
Number of Detectors	1	2	1	1	2	1	1	2	1	1	2	1
Detector Template	Left	Thru	Right	Left	Thru	Right	Left	Thru	Right	Left	Thru	Right
Leading Detector (ft)	20	100	20	20	100	20	20	100	20	20	100	20
Trailing Detector (ft)	0	0	0	0	0	0	0	0	0	0	0	0
Detector 1 Position(ft)	0	0	0	0	0	0	0	0	0	0	0	0
Detector 1 Size(ft)	20	6	20	20	6	20	20	6	20	20	6	20
Detector 1 Type	Cl+Ex	Cl+Ex	Cl+Ex	Cl+Ex	Cl+Ex	Cl+Ex	Cl+Ex	Cl+Ex	Cl+Ex	Cl+Ex	Cl+Ex	Cl+Ex
Detector 1 Channel												
Detector 1 Extend (s)	0.0	0.0	0.0	0.0	0.0	0.0	0.0	0.0	0.0	0.0	0.0	0.0
Detector 1 Queue (s)	0.0	0.0	0.0	0.0	0.0	0.0	0.0	0.0	0.0	0.0	0.0	0.0
Detector 1 Delay (s)	0.0	0.0	0.0	0.0	0.0	0.0	0.0	0.0	0.0	0.0	0.0	0.0
Detector 2 Position(ft)		94			94			94			94	
Detector 2 Size(ft)		6			6			6			6	
Detector 2 Type		Cl+Ex			Cl+Ex			Cl+Ex			Cl+Ex	
Detector 2 Channel												
Detector 2 Extend (s)		0.0			0.0			0.0			0.0	
Turn Type	pm+pt	NA	Perm	Prot	NA	Perm	Prot	NA	Perm	pm+pt	NA	Perm
Protected Phases	7	4		3	8		5	2		1	6	
Permitted Phases	4		4			8			2	6		6

Lanes, Volumes, Timings
1: US 24 & Judge Orr

2043 Background
AM



Lane Group	EBL	EBT	EBR	WBL	WBT	WBR	NEL	NET	NER	SWL	SWT	SWR
Detector Phase	7	4	4	3	8	8	5	2	2	1	6	6
Switch Phase												
Minimum Initial (s)	5.0	5.0	5.0	5.0	5.0	5.0	5.0	5.0	5.0	5.0	5.0	5.0
Minimum Split (s)	9.5	22.5	22.5	9.5	22.5	22.5	9.5	22.5	22.5	9.5	22.5	22.5
Total Split (s)	17.0	24.0	24.0	19.0	26.0	26.0	23.0	55.0	55.0	12.0	44.0	44.0
Total Split (%)	15.5%	21.8%	21.8%	17.3%	23.6%	23.6%	20.9%	50.0%	50.0%	10.9%	40.0%	40.0%
Maximum Green (s)	12.5	19.5	19.5	14.5	21.5	21.5	18.5	50.5	50.5	7.5	39.5	39.5
Yellow Time (s)	3.5	3.5	3.5	3.5	3.5	3.5	3.5	3.5	3.5	3.5	3.5	3.5
All-Red Time (s)	1.0	1.0	1.0	1.0	1.0	1.0	1.0	1.0	1.0	1.0	1.0	1.0
Lost Time Adjust (s)	0.0	0.0	0.0	0.0	0.0	0.0	0.0	0.0	0.0	0.0	0.0	0.0
Total Lost Time (s)	4.5	4.5	4.5	4.5	4.5	4.5	4.5	4.5	4.5	4.5	4.5	4.5
Lead/Lag	Lead	Lag	Lag	Lead	Lag	Lag	Lead	Lag	Lag	Lead	Lag	Lag
Lead-Lag Optimize?	Yes	Yes	Yes	Yes	Yes	Yes	Yes	Yes	Yes	Yes	Yes	Yes
Vehicle Extension (s)	3.0	3.0	3.0	3.0	3.0	3.0	3.0	3.0	3.0	3.0	3.0	3.0
Recall Mode	None	None	None	None	None	None	None	Max	Max	None	Max	Max
Walk Time (s)		7.0	7.0		7.0	7.0		7.0	7.0		7.0	7.0
Flash Dont Walk (s)		11.0	11.0		11.0	11.0		11.0	11.0		11.0	11.0
Pedestrian Calls (#/hr)		0	0		0	0		0	0		0	0
Act Effct Green (s)	20.9	12.4	12.4	12.8	19.0	19.0	12.7	50.7	50.7	52.2	45.1	45.1
Actuated g/C Ratio	0.21	0.12	0.12	0.13	0.19	0.19	0.13	0.50	0.50	0.52	0.45	0.45
v/c Ratio	0.24	0.38	0.79	0.66	0.22	0.13	0.58	0.40	0.23	0.25	0.80	0.14
Control Delay	28.0	43.3	25.8	50.8	36.9	0.6	47.9	17.5	3.1	11.6	30.8	1.8
Queue Delay	0.0	0.0	0.0	0.0	0.0	0.0	0.0	0.0	0.0	0.0	0.0	0.0
Total Delay	28.0	43.3	25.8	50.8	36.9	0.6	47.9	17.5	3.1	11.6	30.8	1.8
LOS	C	D	C	D	D	A	D	B	A	B	C	A
Approach Delay		31.2			41.1			21.5			27.3	
Approach LOS		C			D			C			C	
Queue Length 50th (ft)	35	53	46	91	43	0	79	144	0	25	355	0
Queue Length 95th (ft)	68	86	146	146	74	0	125	224	40	58	#602	16
Internal Link Dist (ft)		1142			848			1227			1492	
Turn Bay Length (ft)	235			235		235	860		290	695		290
Base Capacity (vph)	370	685	506	494	763	458	631	1775	899	425	1578	788
Starvation Cap Reductn	0	0	0	0	0	0	0	0	0	0	0	0
Spillback Cap Reductn	0	0	0	0	0	0	0	0	0	0	0	0
Storage Cap Reductn	0	0	0	0	0	0	0	0	0	0	0	0
Reduced v/c Ratio	0.20	0.24	0.64	0.58	0.19	0.12	0.40	0.40	0.23	0.25	0.80	0.14

Intersection Summary





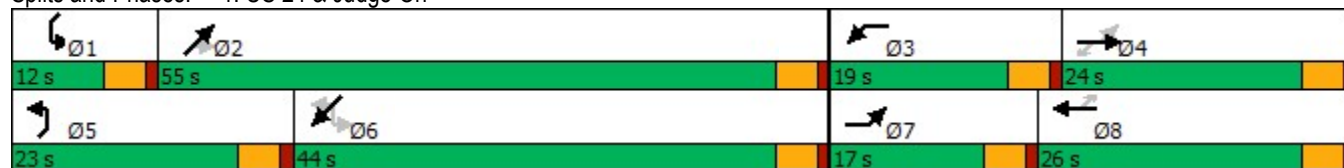



















Area Type: Other
 Cycle Length: 110
 Actuated Cycle Length: 101.1
 Natural Cycle: 90
 Control Type: Actuated-Uncoordinated
 Maximum v/c Ratio: 0.80
 Intersection Signal Delay: 27.9
 Intersection LOS: C
 Intersection Capacity Utilization 70.4%
 ICU Level of Service C
 Analysis Period (min) 15
 # 95th percentile volume exceeds capacity, queue may be longer.
 Queue shown is maximum after two cycles.

Splits and Phases: 1: US 24 & Judge Orr



Lanes, Volumes, Timings
2: US 24 & Stapleton

2043 Background
AM

													
Lane Group	SEL	SET	SER	NWL	NWT	NWR	NEL	NET	NER	SWL	SWT	SWR	
Lane Configurations													
Traffic Volume (vph)	175	400	600	75	405	55	300	540	50	123	800	350	
Future Volume (vph)	175	400	600	75	405	55	300	540	50	123	800	350	
Ideal Flow (vphpl)	1900	1900	1900	1900	1900	1900	1900	1900	1900	1900	1900	1900	
Storage Length (ft)	190		325	215		215	890		1000	790		790	
Storage Lanes	1		2	1		0	2		1	2		1	
Taper Length (ft)	240			200			190			190			
Lane Util. Factor	1.00	0.95	1.00	1.00	0.95	1.00	0.97	0.95	1.00	0.97	0.95	1.00	
Frt			0.850			0.850			0.850			0.850	
Flt Protected	0.950			0.950			0.950			0.950			
Satd. Flow (prot)	1770	3539	1583	1770	3539	1583	3433	3539	1583	3433	3539	1583	
Flt Permitted	0.344			0.493			0.950			0.950			
Satd. Flow (perm)	641	3539	1583	918	3539	1583	3433	3539	1583	3433	3539	1583	
Right Turn on Red			Yes			Yes			Yes			Yes	
Satd. Flow (RTOR)			483			136			95			315	
Link Speed (mph)		45			45			55				55	
Link Distance (ft)		1349			4231			1382				1435	
Travel Time (s)		20.4			64.1			17.1				17.8	
Peak Hour Factor	0.93	0.93	0.93	0.93	0.93	0.93	0.95	0.95	0.95	0.95	0.95	0.95	
Adj. Flow (vph)	188	430	645	81	435	59	316	568	53	129	842	368	
Shared Lane Traffic (%)													
Lane Group Flow (vph)	188	430	645	81	435	59	316	568	53	129	842	368	
Enter Blocked Intersection	No	No	No	No	No	No	No	No	No	No	No	No	
Lane Alignment	Left	Left	Right	Left	Left	Right	Left	Left	Right	Left	Left	Right	
Median Width(ft)		12			12			24				24	
Link Offset(ft)		0			0			0				0	
Crosswalk Width(ft)		16			16			16				16	
Two way Left Turn Lane													
Headway Factor	1.00	1.00	1.00	1.00	1.00	1.00	1.00	1.00	1.00	1.00	1.00	1.00	
Turning Speed (mph)	15		9	15		9	15		9	15		9	
Number of Detectors	1	2	1	1	2	1	1	2	1	1	2	1	
Detector Template	Left	Thru	Right	Left	Thru	Right	Left	Thru	Right	Left	Thru	Right	
Leading Detector (ft)	20	100	20	20	100	20	20	100	20	20	100	20	
Trailing Detector (ft)	0	0	0	0	0	0	0	0	0	0	0	0	
Detector 1 Position(ft)	0	0	0	0	0	0	0	0	0	0	0	0	
Detector 1 Size(ft)	20	6	20	20	6	20	20	6	20	20	6	20	
Detector 1 Type	Cl+Ex	Cl+Ex	Cl+Ex	Cl+Ex	Cl+Ex	Cl+Ex	Cl+Ex	Cl+Ex	Cl+Ex	Cl+Ex	Cl+Ex	Cl+Ex	
Detector 1 Channel													
Detector 1 Extend (s)	0.0	0.0	0.0	0.0	0.0	0.0	0.0	0.0	0.0	0.0	0.0	0.0	
Detector 1 Queue (s)	0.0	0.0	0.0	0.0	0.0	0.0	0.0	0.0	0.0	0.0	0.0	0.0	
Detector 1 Delay (s)	0.0	0.0	0.0	0.0	0.0	0.0	0.0	0.0	0.0	0.0	0.0	0.0	
Detector 2 Position(ft)		94			94			94				94	
Detector 2 Size(ft)		6			6			6				6	
Detector 2 Type		Cl+Ex			Cl+Ex			Cl+Ex				Cl+Ex	
Detector 2 Channel													
Detector 2 Extend (s)		0.0			0.0			0.0				0.0	
Turn Type	pm+pt	NA	Perm	pm+pt	NA	Perm	Prot	NA	Perm	Prot	NA	Perm	
Protected Phases	1	6		5	2		7	4		3	8		
Permitted Phases	6		6	2		2			4			8	

Splits and Phases: 2: US 24 & Stapleton



Intersection									
Intersection Delay, s/veh	6.7								
Intersection LOS	A								
Approach	EB		WB		NB		SB		
Entry Lanes	2		2		2		2		
Conflicting Circle Lanes	2		2		2		2		
Adj Approach Flow, veh/h	326		477		543		548		
Demand Flow Rate, veh/h	332		486		555		559		
Vehicles Circulating, veh/h	591		543		160		516		
Vehicles Exiting, veh/h	484		172		763		513		
Ped Vol Crossing Leg, #/h	0		0		0		0		
Ped Cap Adj	1.000		1.000		1.000		1.000		
Approach Delay, s/veh	6.8		7.4		5.1		7.7		
Approach LOS	A		A		A		A		
Lane	Left	Right	Left	Right	Left	Right	Left	Right	
Designated Moves	LT	TR	LT	TR	LT	TR	LT	TR	
Assumed Moves	LT	R	LT	TR	LT	TR	LT	TR	
RT Channelized									
Lane Util	0.316	0.684	0.469	0.531	0.470	0.530	0.470	0.530	
Follow-Up Headway, s	2.667	2.535	2.667	2.535	2.667	2.535	2.667	2.535	
Critical Headway, s	4.645	4.328	4.645	4.328	4.645	4.328	4.645	4.328	
Entry Flow, veh/h	105	227	228	258	261	294	263	296	
Cap Entry Lane, veh/h	784	859	819	895	1165	1240	840	916	
Entry HV Adj Factor	0.983	0.982	0.982	0.979	0.978	0.979	0.979	0.981	
Flow Entry, veh/h	103	223	224	253	255	288	257	290	
Cap Entry, veh/h	771	844	805	876	1140	1214	822	898	
V/C Ratio	0.134	0.264	0.278	0.288	0.224	0.237	0.313	0.323	
Control Delay, s/veh	6.1	7.1	7.6	7.2	5.2	5.1	7.9	7.5	
LOS	A	A	A	A	A	A	A	A	
95th %tile Queue, veh	0	1	1	1	1	1	1	1	

Intersection												
Int Delay, s/veh	3											
Movement	EBL	EBT	EBR	WBL	WBT	WBR	NBL	NBT	NBR	SBL	SBT	SBR
Lane Configurations		↕↕	↕		↕↕	↕		↕↕			↕↕	
Traffic Vol, veh/h	5	150	10	10	350	25	50	20	10	10	20	20
Future Vol, veh/h	5	150	10	10	350	25	50	20	10	10	20	20
Conflicting Peds, #/hr	0	0	0	0	0	0	0	0	0	0	0	0
Sign Control	Free	Free	Free	Free	Free	Free	Stop	Stop	Stop	Stop	Stop	Stop
RT Channelized	-	-	None	-	-	None	-	-	None	-	-	None
Storage Length	-	-	0	-	-	235	-	-	-	-	-	-
Veh in Median Storage, #	-	0	-	-	0	-	-	0	-	-	0	-
Grade, %	-	0	-	-	0	-	-	0	-	-	0	-
Peak Hour Factor	87	87	87	92	92	92	83	83	83	83	83	83
Heavy Vehicles, %	2	2	2	2	2	2	2	2	2	2	2	2
Mvmt Flow	6	172	11	11	380	27	60	24	12	12	24	24

Major/Minor	Major1			Major2			Minor1			Minor2		
Conflicting Flow All	407	0	0	183	0	0	408	613	86	512	597	190
Stage 1	-	-	-	-	-	-	184	184	-	402	402	-
Stage 2	-	-	-	-	-	-	224	429	-	110	195	-
Critical Hdwy	4.14	-	-	4.14	-	-	7.54	6.54	6.94	7.54	6.54	6.94
Critical Hdwy Stg 1	-	-	-	-	-	-	6.54	5.54	-	6.54	5.54	-
Critical Hdwy Stg 2	-	-	-	-	-	-	6.54	5.54	-	6.54	5.54	-
Follow-up Hdwy	2.22	-	-	2.22	-	-	3.52	4.02	3.32	3.52	4.02	3.32
Pot Cap-1 Maneuver	1148	-	-	1389	-	-	528	406	956	445	415	820
Stage 1	-	-	-	-	-	-	800	746	-	596	599	-
Stage 2	-	-	-	-	-	-	758	582	-	883	738	-
Platoon blocked, %	-	-	-	-	-	-	-	-	-	-	-	-
Mov Cap-1 Maneuver	1148	-	-	1389	-	-	484	400	956	414	408	820
Mov Cap-2 Maneuver	-	-	-	-	-	-	484	400	-	414	408	-
Stage 1	-	-	-	-	-	-	795	742	-	592	593	-
Stage 2	-	-	-	-	-	-	699	576	-	838	734	-

Approach	EB			WB			NB			SB		
HCM Control Delay, s	0.2			0.2			14.2			13		
HCM LOS							B			B		

Minor Lane/Major Mvmt	NBLn1	EBL	EBT	EBR	WBL	WBT	WBR	SBLn1
Capacity (veh/h)	489	1148	-	-	1389	-	-	512
HCM Lane V/C Ratio	0.197	0.005	-	-	0.008	-	-	0.118
HCM Control Delay (s)	14.2	8.2	0	-	7.6	0	-	13
HCM Lane LOS	B	A	A	-	A	A	-	B
HCM 95th %tile Q(veh)	0.7	0	-	-	0	-	-	0.4

Lanes, Volumes, Timings
1: US 24 & Judge Orr

2043 Background
PM

Lane Group	EBL	EBT	EBR	WBL	WBT	WBR	NEL	NET	NER	SWL	SWT	SWR
Lane Configurations												
Traffic Volume (vph)	69	159	298	299	140	50	239	677	214	100	1206	102
Future Volume (vph)	69	159	298	299	140	50	239	677	214	100	1206	102
Ideal Flow (vphpl)	1900	1900	1900	1900	1900	1900	1900	1900	1900	1900	1900	1900
Storage Length (ft)	235		0	235		235	860		290	695		290
Storage Lanes	1		1	2		1	2		1	1		1
Taper Length (ft)	200			200			300		300			
Lane Util. Factor	1.00	0.95	1.00	0.97	0.95	1.00	0.97	0.95	1.00	1.00	0.95	1.00
Frt			0.850				0.850		0.850			0.850
Flt Protected	0.950			0.950			0.950			0.950		
Satd. Flow (prot)	1770	3539	1583	3433	3539	1583	3433	3539	1583	1770	3539	1583
Flt Permitted	0.656			0.950			0.950			0.343		
Satd. Flow (perm)	1222	3539	1583	3433	3539	1583	3433	3539	1583	639	3539	1583
Right Turn on Red			Yes			Yes			Yes			Yes
Satd. Flow (RTOR)			216			149			233			149
Link Speed (mph)		45			45			55			55	
Link Distance (ft)		1222			928			1307			1572	
Travel Time (s)		18.5			14.1			16.2			19.5	
Peak Hour Factor	0.92	0.92	0.92	0.92	0.92	0.92	0.92	0.92	0.92	0.92	0.92	0.92
Adj. Flow (vph)	75	173	324	325	152	54	260	736	233	109	1311	111
Shared Lane Traffic (%)												
Lane Group Flow (vph)	75	173	324	325	152	54	260	736	233	109	1311	111
Enter Blocked Intersection	No	No	No	No	No	No	No	No	No	No	No	No
Lane Alignment	Left	Left	Right	Left	Left	Right	Left	Left	Right	Left	Left	Right
Median Width(ft)		24			24			24			24	
Link Offset(ft)		0			0			0			0	
Crosswalk Width(ft)		16			16			16			16	
Two way Left Turn Lane												
Headway Factor	1.00	1.00	1.00	1.00	1.00	1.00	1.00	1.00	1.00	1.00	1.00	1.00
Turning Speed (mph)	60		60	60		60	60		60	60		60
Number of Detectors	1	2	1	1	2	1	1	2	1	1	2	1
Detector Template	Left	Thru	Right	Left	Thru	Right	Left	Thru	Right	Left	Thru	Right
Leading Detector (ft)	20	100	20	20	100	20	20	100	20	20	100	20
Trailing Detector (ft)	0	0	0	0	0	0	0	0	0	0	0	0
Detector 1 Position(ft)	0	0	0	0	0	0	0	0	0	0	0	0
Detector 1 Size(ft)	20	6	20	20	6	20	20	6	20	20	6	20
Detector 1 Type	Cl+Ex	Cl+Ex	Cl+Ex	Cl+Ex	Cl+Ex	Cl+Ex	Cl+Ex	Cl+Ex	Cl+Ex	Cl+Ex	Cl+Ex	Cl+Ex
Detector 1 Channel												
Detector 1 Extend (s)	0.0	0.0	0.0	0.0	0.0	0.0	0.0	0.0	0.0	0.0	0.0	0.0
Detector 1 Queue (s)	0.0	0.0	0.0	0.0	0.0	0.0	0.0	0.0	0.0	0.0	0.0	0.0
Detector 1 Delay (s)	0.0	0.0	0.0	0.0	0.0	0.0	0.0	0.0	0.0	0.0	0.0	0.0
Detector 2 Position(ft)		94			94			94			94	
Detector 2 Size(ft)		6			6			6			6	
Detector 2 Type		Cl+Ex			Cl+Ex			Cl+Ex			Cl+Ex	
Detector 2 Channel												
Detector 2 Extend (s)		0.0			0.0			0.0			0.0	
Turn Type	pm+pt	NA	Perm	Prot	NA	Perm	Prot	NA	Perm	pm+pt	NA	Perm
Protected Phases	7	4		3	8		5	2		1	6	
Permitted Phases	4		4			8			2	6		6

Lanes, Volumes, Timings
1: US 24 & Judge Orr

2043 Background
PM











Lane Group	EBL	EBT	EBR	WBL	WBT	WBR	NEL	NET	NER	SWL	SWT	SWR
Detector Phase	7	4	4	3	8	8	5	2	2	1	6	6
Switch Phase												
Minimum Initial (s)	5.0	5.0	5.0	5.0	5.0	5.0	5.0	5.0	5.0	5.0	5.0	5.0
Minimum Split (s)	9.5	22.5	22.5	9.5	22.5	22.5	9.5	22.5	22.5	9.5	22.5	22.5
Total Split (s)	17.0	24.0	24.0	20.0	27.0	27.0	21.0	55.0	55.0	11.0	45.0	45.0
Total Split (%)	15.5%	21.8%	21.8%	18.2%	24.5%	24.5%	19.1%	50.0%	50.0%	10.0%	40.9%	40.9%
Maximum Green (s)	12.5	19.5	19.5	15.5	22.5	22.5	16.5	50.5	50.5	6.5	40.5	40.5
Yellow Time (s)	3.5	3.5	3.5	3.5	3.5	3.5	3.5	3.5	3.5	3.5	3.5	3.5
All-Red Time (s)	1.0	1.0	1.0	1.0	1.0	1.0	1.0	1.0	1.0	1.0	1.0	1.0
Lost Time Adjust (s)	0.0	0.0	0.0	0.0	0.0	0.0	0.0	0.0	0.0	0.0	0.0	0.0
Total Lost Time (s)	4.5	4.5	4.5	4.5	4.5	4.5	4.5	4.5	4.5	4.5	4.5	4.5
Lead/Lag	Lead	Lag	Lag	Lead	Lag	Lag	Lead	Lag	Lag	Lead	Lag	Lag
Lead-Lag Optimize?	Yes	Yes	Yes	Yes	Yes	Yes	Yes	Yes	Yes	Yes	Yes	Yes
Vehicle Extension (s)	3.0	3.0	3.0	3.0	3.0	3.0	3.0	3.0	3.0	3.0	3.0	3.0
Recall Mode	None	None	None	None	None	None	None	Max	Max	None	Max	Max
Walk Time (s)		7.0	7.0		7.0	7.0		7.0	7.0		7.0	7.0
Flash Dont Walk (s)		11.0	11.0		11.0	11.0		11.0	11.0		11.0	11.0
Pedestrian Calls (#/hr)		0	0		0	0		0	0		0	0
Act Effct Green (s)	22.0	13.4	13.4	13.8	21.0	21.0	12.9	50.7	50.7	50.7	44.3	44.3
Actuated g/C Ratio	0.21	0.13	0.13	0.13	0.20	0.20	0.13	0.49	0.49	0.49	0.43	0.43
v/c Ratio	0.24	0.37	0.82	0.70	0.21	0.12	0.60	0.42	0.26	0.28	0.86	0.14
Control Delay	27.1	42.7	32.4	51.9	35.7	0.6	49.1	18.4	3.1	12.9	35.2	2.0
Queue Delay	0.0	0.0	0.0	0.0	0.0	0.0	0.0	0.0	0.0	0.0	0.0	0.0
Total Delay	27.1	42.7	32.4	51.9	35.7	0.6	49.1	18.4	3.1	12.9	35.2	2.0
LOS	C	D	C	D	D	A	D	B	A	B	D	A
Approach Delay		34.8			42.1			22.0			31.2	
Approach LOS		C			D			C			C	
Queue Length 50th (ft)	35	55	68	106	45	0	85	159	0	29	407	0
Queue Length 95th (ft)	68	88	174	162	76	0	130	233	42	61	#647	18
Internal Link Dist (ft)		1142			848			1227			1492	
Turn Bay Length (ft)	235			235		235	860		290	695		290
Base Capacity (vph)	377	676	477	521	802	474	555	1752	901	388	1527	768
Starvation Cap Reductn	0	0	0	0	0	0	0	0	0	0	0	0
Spillback Cap Reductn	0	0	0	0	0	0	0	0	0	0	0	0
Storage Cap Reductn	0	0	0	0	0	0	0	0	0	0	0	0
Reduced v/c Ratio	0.20	0.26	0.68	0.62	0.19	0.11	0.47	0.42	0.26	0.28	0.86	0.14

Intersection Summary

























Area Type: Other
 Cycle Length: 110
 Actuated Cycle Length: 102.5
 Natural Cycle: 90
 Control Type: Actuated-Uncoordinated
 Maximum v/c Ratio: 0.86
 Intersection Signal Delay: 30.3
 Intersection LOS: C
 Intersection Capacity Utilization 71.6%
 ICU Level of Service C
 Analysis Period (min) 15
 # 95th percentile volume exceeds capacity, queue may be longer.
 Queue shown is maximum after two cycles.

Splits and Phases: 1: US 24 & Judge Orr

 Ø1	 Ø2	 Ø3	 Ø4
11 s	55 s	20 s	24 s
 Ø5	 Ø6	 Ø7	 Ø8
21 s	45 s	17 s	27 s

Lanes, Volumes, Timings
2: US 24 & Stapleton

2043 Background
PM

												
Lane Group	SEL	SET	SER	NWL	NWT	NWR	NEL	NET	NER	SWL	SWT	SWR
Lane Configurations												
Traffic Volume (vph)	350	302	700	125	405	179	650	850	125	145	600	350
Future Volume (vph)	350	302	700	125	405	179	650	850	125	145	600	350
Ideal Flow (vphpl)	1900	1900	1900	1900	1900	1900	1900	1900	1900	1900	1900	1900
Storage Length (ft)	190		325	215		215	890		1000	790		790
Storage Lanes	1		2	1		0	2		1	2		1
Taper Length (ft)	240			200			190			190		
Lane Util. Factor	1.00	0.95	1.00	1.00	0.95	1.00	0.97	0.95	1.00	0.97	0.95	1.00
Frt			0.850			0.850			0.850			0.850
Flt Protected	0.950			0.950			0.950			0.950		
Satd. Flow (prot)	1770	3539	1583	1770	3539	1583	3433	3539	1583	3433	3539	1583
Flt Permitted	0.250			0.419			0.950			0.950		
Satd. Flow (perm)	466	3539	1583	780	3539	1583	3433	3539	1583	3433	3539	1583
Right Turn on Red			Yes			Yes			Yes			Yes
Satd. Flow (RTOR)			477			192			132			225
Link Speed (mph)		45			45			55			55	
Link Distance (ft)		1349			4231			1382			1435	
Travel Time (s)		20.4			64.1			17.1			17.8	
Peak Hour Factor	0.95	0.95	0.95	0.93	0.93	0.93	0.95	0.95	0.95	0.95	0.95	0.95
Adj. Flow (vph)	368	318	737	134	435	192	684	895	132	153	632	368
Shared Lane Traffic (%)												
Lane Group Flow (vph)	368	318	737	134	435	192	684	895	132	153	632	368
Enter Blocked Intersection	No	No	No	No	No	No	No	No	No	No	No	No
Lane Alignment	Left	Left	Right	Left	Left	Right	Left	Left	Right	Left	Left	Right
Median Width(ft)		12			12			24			24	
Link Offset(ft)		0			0			0			0	
Crosswalk Width(ft)		16			16			16			16	
Two way Left Turn Lane												
Headway Factor	1.00	1.00	1.00	1.00	1.00	1.00	1.00	1.00	1.00	1.00	1.00	1.00
Turning Speed (mph)	15		9	15		9	15		9	15		9
Number of Detectors	1	2	1	1	2	1	1	2	1	1	2	1
Detector Template	Left	Thru	Right	Left	Thru	Right	Left	Thru	Right	Left	Thru	Right
Leading Detector (ft)	20	100	20	20	100	20	20	100	20	20	100	20
Trailing Detector (ft)	0	0	0	0	0	0	0	0	0	0	0	0
Detector 1 Position(ft)	0	0	0	0	0	0	0	0	0	0	0	0
Detector 1 Size(ft)	20	6	20	20	6	20	20	6	20	20	6	20
Detector 1 Type	Cl+Ex	Cl+Ex	Cl+Ex	Cl+Ex	Cl+Ex	Cl+Ex	Cl+Ex	Cl+Ex	Cl+Ex	Cl+Ex	Cl+Ex	Cl+Ex
Detector 1 Channel												
Detector 1 Extend (s)	0.0	0.0	0.0	0.0	0.0	0.0	0.0	0.0	0.0	0.0	0.0	0.0
Detector 1 Queue (s)	0.0	0.0	0.0	0.0	0.0	0.0	0.0	0.0	0.0	0.0	0.0	0.0
Detector 1 Delay (s)	0.0	0.0	0.0	0.0	0.0	0.0	0.0	0.0	0.0	0.0	0.0	0.0
Detector 2 Position(ft)		94			94			94			94	
Detector 2 Size(ft)		6			6			6			6	
Detector 2 Type		Cl+Ex			Cl+Ex			Cl+Ex			Cl+Ex	
Detector 2 Channel												
Detector 2 Extend (s)		0.0			0.0			0.0			0.0	
Turn Type	pm+pt	NA	Perm	pm+pt	NA	Perm	Prot	NA	Perm	Prot	NA	Perm
Protected Phases	1	6		5	2		7	4		3	8	
Permitted Phases	6		6	2		2			4			8

Lanes, Volumes, Timings
2: US 24 & Stapleton

2043 Background
PM



Lane Group	SEL	SET	SER	NWL	NWT	NWR	NEL	NET	NER	SWL	SWT	SWR
Detector Phase	1	6	6	5	2	2	7	4	4	3	8	8
Switch Phase												
Minimum Initial (s)	5.0	5.0	5.0	5.0	5.0	5.0	5.0	5.0	5.0	5.0	5.0	5.0
Minimum Split (s)	9.5	22.5	22.5	9.5	22.5	22.5	9.5	22.5	22.5	9.5	22.5	22.5
Total Split (s)	15.0	25.0	25.0	15.0	25.0	25.0	36.0	60.0	60.0	20.0	44.0	44.0
Total Split (%)	12.5%	20.8%	20.8%	12.5%	20.8%	20.8%	30.0%	50.0%	50.0%	16.7%	36.7%	36.7%
Maximum Green (s)	10.5	20.5	20.5	10.5	20.5	20.5	31.5	55.5	55.5	15.5	39.5	39.5
Yellow Time (s)	3.5	3.5	3.5	3.5	3.5	3.5	3.5	3.5	3.5	3.5	3.5	3.5
All-Red Time (s)	1.0	1.0	1.0	1.0	1.0	1.0	1.0	1.0	1.0	1.0	1.0	1.0
Lost Time Adjust (s)	0.0	0.0	0.0	0.0	0.0	0.0	0.0	0.0	0.0	0.0	0.0	0.0
Total Lost Time (s)	4.5	4.5	4.5	4.5	4.5	4.5	4.5	4.5	4.5	4.5	4.5	4.5
Lead/Lag	Lead	Lag	Lag	Lead	Lag	Lag	Lead	Lag	Lag	Lead	Lag	Lag
Lead-Lag Optimize?	Yes	Yes	Yes	Yes	Yes	Yes	Yes	Yes	Yes	Yes	Yes	Yes
Vehicle Extension (s)	3.0	3.0	3.0	3.0	3.0	3.0	3.0	3.0	3.0	3.0	3.0	3.0
Recall Mode	None	C-Min	C-Min	None	C-Min	C-Min	None	None	None	None	Max	Max
Act Effct Green (s)	31.5	21.0	21.0	30.5	20.5	20.5	28.2	60.3	60.3	10.7	42.8	42.8
Actuated g/C Ratio	0.26	0.18	0.18	0.25	0.17	0.17	0.24	0.50	0.50	0.09	0.36	0.36
v/c Ratio	1.56	0.51	1.10	0.48	0.72	0.45	0.85	0.50	0.15	0.50	0.50	0.52
Control Delay	300.8	48.5	82.6	38.7	54.7	9.6	54.4	21.4	3.3	57.5	32.5	14.7
Queue Delay	0.0	0.0	0.0	0.0	0.0	0.0	0.0	0.0	0.0	0.0	0.0	0.0
Total Delay	300.8	48.5	82.6	38.7	54.7	9.6	54.4	21.4	3.3	57.5	32.5	14.7
LOS	F	D	F	D	D	A	D	C	A	E	C	B
Approach Delay		131.4			40.5			33.2			30.2	
Approach LOS		F			D			C			C	
Queue Length 50th (ft)	~337	119	~324	79	169	0	260	235	0	59	202	81
Queue Length 95th (ft)	#537	167	#565	133	227	64	322	308	33	91	269	183
Internal Link Dist (ft)		1269			4151			1302			1355	
Turn Bay Length (ft)	190		325	215		215	890		1000	790		790
Base Capacity (vph)	236	618	670	288	604	429	901	1779	861	443	1262	709
Starvation Cap Reductn	0	0	0	0	0	0	0	0	0	0	0	0
Spillback Cap Reductn	0	0	0	0	0	0	0	0	0	0	0	0
Storage Cap Reductn	0	0	0	0	0	0	0	0	0	0	0	0
Reduced v/c Ratio	1.56	0.51	1.10	0.47	0.72	0.45	0.76	0.50	0.15	0.35	0.50	0.52

Intersection Summary

























Area Type:	Other
Cycle Length:	120
Actuated Cycle Length:	120
Offset:	0 (0%), Referenced to phase 2:NWTL and 6:SETL, Start of Green
Natural Cycle:	90
Control Type:	Actuated-Coordinated
Maximum v/c Ratio:	1.56
Intersection Signal Delay:	61.3
Intersection LOS:	E
Intersection Capacity Utilization:	80.7%
ICU Level of Service:	D
Analysis Period (min):	15
~	Volume exceeds capacity, queue is theoretically infinite. Queue shown is maximum after two cycles.
#	95th percentile volume exceeds capacity, queue may be longer. Queue shown is maximum after two cycles.

Splits and Phases: 2: US 24 & Stapleton



Lanes, Volumes, Timings
2: US 24 & Stapleton

2043 Background
PM

												
Lane Group	SEL	SET	SER	NWL	NWT	NWR	NEL	NET	NER	SWL	SWT	SWR
Lane Configurations												
Traffic Volume (vph)	350	302	700	125	405	179	650	850	125	145	600	350
Future Volume (vph)	350	302	700	125	405	179	650	850	125	145	600	350
Ideal Flow (vphpl)	1900	1900	1900	1900	1900	1900	1900	1900	1900	1900	1900	1900
Storage Length (ft)	190		325	215		215	890		1000	790		790
Storage Lanes	1		2	1		0	2		1	2		1
Taper Length (ft)	240			200			190			190		
Lane Util. Factor	1.00	0.95	1.00	1.00	0.95	1.00	0.97	0.95	1.00	0.97	0.95	1.00
Frt			0.850			0.850			0.850			0.850
Flt Protected	0.950			0.950			0.950			0.950		
Satd. Flow (prot)	1770	3539	1583	1770	3539	1583	3433	3539	1583	3433	3539	1583
Flt Permitted	0.208			0.559			0.950			0.950		
Satd. Flow (perm)	387	3539	1583	1041	3539	1583	3433	3539	1583	3433	3539	1583
Right Turn on Red			Yes			Yes			Yes			Yes
Satd. Flow (RTOR)			485			192			132			225
Link Speed (mph)		45			45			55			55	
Link Distance (ft)		1349			4231			1382			1435	
Travel Time (s)		20.4			64.1			17.1			17.8	
Peak Hour Factor	0.95	0.95	0.95	0.93	0.93	0.93	0.95	0.95	0.95	0.95	0.95	0.95
Adj. Flow (vph)	368	318	737	134	435	192	684	895	132	153	632	368
Shared Lane Traffic (%)												
Lane Group Flow (vph)	368	318	737	134	435	192	684	895	132	153	632	368
Enter Blocked Intersection	No	No	No	No	No	No	No	No	No	No	No	No
Lane Alignment	Left	Left	Right	Left	Left	Right	Left	Left	Right	Left	Left	Right
Median Width(ft)		12			12			24			24	
Link Offset(ft)		0			0			0			0	
Crosswalk Width(ft)		16			16			16			16	
Two way Left Turn Lane												
Headway Factor	1.00	1.00	1.00	1.00	1.00	1.00	1.00	1.00	1.00	1.00	1.00	1.00
Turning Speed (mph)	15		9	15		9	15		9	15		9
Number of Detectors	1	2	1	1	2	1	1	2	1	1	2	1
Detector Template	Left	Thru	Right	Left	Thru	Right	Left	Thru	Right	Left	Thru	Right
Leading Detector (ft)	20	100	20	20	100	20	20	100	20	20	100	20
Trailing Detector (ft)	0	0	0	0	0	0	0	0	0	0	0	0
Detector 1 Position(ft)	0	0	0	0	0	0	0	0	0	0	0	0
Detector 1 Size(ft)	20	6	20	20	6	20	20	6	20	20	6	20
Detector 1 Type	Cl+Ex	Cl+Ex	Cl+Ex	Cl+Ex	Cl+Ex	Cl+Ex	Cl+Ex	Cl+Ex	Cl+Ex	Cl+Ex	Cl+Ex	Cl+Ex
Detector 1 Channel												
Detector 1 Extend (s)	0.0	0.0	0.0	0.0	0.0	0.0	0.0	0.0	0.0	0.0	0.0	0.0
Detector 1 Queue (s)	0.0	0.0	0.0	0.0	0.0	0.0	0.0	0.0	0.0	0.0	0.0	0.0
Detector 1 Delay (s)	0.0	0.0	0.0	0.0	0.0	0.0	0.0	0.0	0.0	0.0	0.0	0.0
Detector 2 Position(ft)		94			94			94			94	
Detector 2 Size(ft)		6			6			6			6	
Detector 2 Type		Cl+Ex			Cl+Ex			Cl+Ex			Cl+Ex	
Detector 2 Channel												
Detector 2 Extend (s)		0.0			0.0			0.0			0.0	
Turn Type	pm+pt	NA	Perm	pm+pt	NA	Perm	Prot	NA	Perm	Prot	NA	Perm
Protected Phases	1	6		5	2		7	4		3	8	
Permitted Phases	6		6	2		2			4			8

Lanes, Volumes, Timings
2: US 24 & Stapleton

2043 Background
PM

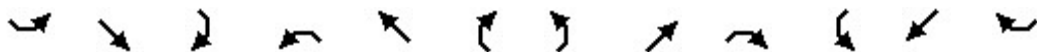

Lane Group	SEL	SET	SER	NWL	NWT	NWR	NEL	NET	NER	SWL	SWT	SWR
Detector Phase	1	6	6	5	2	2	7	4	4	3	8	8
Switch Phase												
Minimum Initial (s)	5.0	5.0	5.0	5.0	5.0	5.0	5.0	5.0	5.0	5.0	5.0	5.0
Minimum Split (s)	9.5	22.5	22.5	9.5	22.5	22.5	9.5	22.5	22.5	9.5	22.5	22.5
Total Split (s)	15.0	25.0	25.0	15.0	25.0	25.0	36.0	60.0	60.0	20.0	44.0	44.0
Total Split (%)	12.5%	20.8%	20.8%	12.5%	20.8%	20.8%	30.0%	50.0%	50.0%	16.7%	36.7%	36.7%
Maximum Green (s)	10.5	20.5	20.5	10.5	20.5	20.5	31.5	55.5	55.5	15.5	39.5	39.5
Yellow Time (s)	3.5	3.5	3.5	3.5	3.5	3.5	3.5	3.5	3.5	3.5	3.5	3.5
All-Red Time (s)	1.0	1.0	1.0	1.0	1.0	1.0	1.0	1.0	1.0	1.0	1.0	1.0
Lost Time Adjust (s)	0.0	0.0	0.0	0.0	0.0	0.0	0.0	0.0	0.0	0.0	0.0	0.0
Total Lost Time (s)	4.5	4.5	4.5	4.5	4.5	4.5	4.5	4.5	4.5	4.5	4.5	4.5
Lead/Lag	Lead	Lag	Lag	Lead	Lag	Lag	Lead	Lag	Lag	Lead	Lag	Lag
Lead-Lag Optimize?	Yes	Yes	Yes	Yes	Yes	Yes	Yes	Yes	Yes	Yes	Yes	Yes
Vehicle Extension (s)	3.0	3.0	3.0	3.0	3.0	3.0	3.0	3.0	3.0	3.0	3.0	3.0
Recall Mode	None	C-Min	C-Min	None	C-Min	C-Min	None	None	None	None	None	None
Walk Time (s)		7.0	7.0		7.0	7.0		7.0	7.0		7.0	7.0
Flash Dont Walk (s)		11.0	11.0		11.0	11.0		11.0	11.0		11.0	11.0
Pedestrian Calls (#/hr)		0	0		0	0		0	0		0	0
Act Effct Green (s)	48.4	33.8	33.8	31.5	20.5	20.5	28.2	46.6	46.6	10.7	29.0	29.0
Actuated g/C Ratio	0.40	0.28	0.28	0.26	0.17	0.17	0.24	0.39	0.39	0.09	0.24	0.24
v/c Ratio	0.85	0.32	0.93	0.39	0.72	0.45	0.85	0.65	0.19	0.50	0.74	0.67
Control Delay	50.0	38.0	34.6	30.1	54.7	9.6	54.4	32.0	4.0	57.5	47.1	20.9
Queue Delay	0.0	0.0	0.0	0.0	0.0	0.0	0.0	0.0	0.0	0.0	0.0	0.0
Total Delay	50.0	38.0	34.6	30.1	54.7	9.6	54.4	32.0	4.0	57.5	47.1	20.9
LOS	D	D	C	C	D	A	D	C	A	E	D	C
Approach Delay		39.3			39.0			38.8			40.1	
Approach LOS		D			D			D			D	
Queue Length 50th (ft)	212	104	229	66	169	0	260	291	0	59	238	97
Queue Length 95th (ft)	#521	167	#553	127	227	64	322	325	35	91	280	191
Internal Link Dist (ft)		1269			4151			1302			1355	
Turn Bay Length (ft)	190		325	215		215	890		1000	790		790
Base Capacity (vph)	435	995	794	352	604	429	901	1636	803	443	1164	672
Starvation Cap Reductn	0	0	0	0	0	0	0	0	0	0	0	0
Spillback Cap Reductn	0	0	0	0	0	0	0	0	0	0	0	0
Storage Cap Reductn	0	0	0	0	0	0	0	0	0	0	0	0
Reduced v/c Ratio	0.85	0.32	0.93	0.38	0.72	0.45	0.76	0.55	0.16	0.35	0.54	0.55

Intersection Summary

Area Type: Other
 Cycle Length: 120
 Actuated Cycle Length: 120
 Offset: 0 (0%), Referenced to phase 2:NWTL and 6:SETL, Start of Green
 Natural Cycle: 90
 Control Type: Actuated-Coordinated
 Maximum v/c Ratio: 0.93
 Intersection Signal Delay: 39.3 Intersection LOS: D
 Intersection Capacity Utilization 80.7% ICU Level of Service D
 Analysis Period (min) 15
 # 95th percentile volume exceeds capacity, queue may be longer.

Queue shown is maximum after two cycles.

Splits and Phases: 2: US 24 & Stapleton



Intersection									
Intersection Delay, s/veh	8.7								
Intersection LOS	A								
Approach	EB		WB		NB		SB		
Entry Lanes	2		2		2		2		
Conflicting Circle Lanes	2		2		2		2		
Adj Approach Flow, veh/h	446		296		883		551		
Demand Flow Rate, veh/h	455		302		901		562		
Vehicles Circulating, veh/h	569		872		457		472		
Vehicles Exiting, veh/h	465		486		567		702		
Ped Vol Crossing Leg, #/h	0		0		0		0		
Ped Cap Adj	1.000		1.000		1.000		1.000		
Approach Delay, s/veh	7.4		8.7		10.1		7.3		
Approach LOS	A		A		B		A		
Lane	Left	Right	Left	Right	Left	Right	Left	Right	
Designated Moves	LT	TR	LT	TR	LT	TR	LT	TR	
Assumed Moves	LT	TR	LT	TR	LT	TR	LT	TR	
RT Channelized									
Lane Util	0.470	0.530	0.470	0.530	0.469	0.531	0.470	0.530	
Follow-Up Headway, s	2.667	2.535	2.667	2.535	2.667	2.535	2.667	2.535	
Critical Headway, s	4.645	4.328	4.645	4.328	4.645	4.328	4.645	4.328	
Entry Flow, veh/h	214	241	142	160	423	478	264	298	
Cap Entry Lane, veh/h	800	875	605	677	887	963	874	951	
Entry HV Adj Factor	0.979	0.980	0.980	0.981	0.981	0.979	0.980	0.979	
Flow Entry, veh/h	209	236	139	157	415	468	259	292	
Cap Entry, veh/h	783	858	593	663	870	943	857	931	
V/C Ratio	0.268	0.275	0.235	0.236	0.477	0.496	0.302	0.313	
Control Delay, s/veh	7.6	7.2	9.1	8.3	10.2	10.0	7.5	7.2	
LOS	A	A	A	A	B	B	A	A	
95th %tile Queue, veh	1	1	1	1	3	3	1	1	

Intersection												
Int Delay, s/veh	0											
Movement	SEL	SET	SER	NWL	NWT	NWR	NEL	NET	NER	SWL	SWT	SWR
Lane Configurations	↘	↑	↗	↘	↑	↗	↘	↑↑	↗	↘	↑↑	↗
Traffic Vol, veh/h	0	0	0	0	0	0	0	0	0	0	0	0
Future Vol, veh/h	0	0	0	0	0	0	0	0	0	0	0	0
Conflicting Peds, #/hr	0	0	0	0	0	0	0	0	0	0	0	0
Sign Control	Stop	Stop	Stop	Stop	Stop	Stop	Free	Free	Free	Free	Free	Free
RT Channelized	-	-	None	-	-	None	-	-	None	-	-	None
Storage Length	235	-	235	235	-	235	235	-	235	235	-	235
Veh in Median Storage, #	-	0	-	-	0	-	-	0	-	-	0	-
Grade, %	-	0	-	-	0	-	-	0	-	-	0	-
Peak Hour Factor	92	92	92	92	92	92	92	92	92	92	92	92
Heavy Vehicles, %	2	2	2	2	2	2	2	2	2	2	2	2
Mvmt Flow	0	0	0	0	0	0	0	0	0	0	0	0

Major/Minor	Minor2		Minor1			Major1		Major2				
Conflicting Flow All	1	1	1	1	1	0	1	0	0	0	0	0
Stage 1	1	1	-	0	0	-	-	-	-	-	-	-
Stage 2	0	0	-	1	1	-	-	-	-	-	-	-
Critical Hdwy	7.54	6.54	6.94	7.54	6.54	6.94	4.14	-	-	4.14	-	-
Critical Hdwy Stg 1	6.54	5.54	-	6.54	5.54	-	-	-	-	-	-	-
Critical Hdwy Stg 2	6.54	5.54	-	6.54	5.54	-	-	-	-	-	-	-
Follow-up Hdwy	3.52	4.02	3.32	3.52	4.02	3.32	2.22	-	-	2.22	-	-
Pot Cap-1 Maneuver	1021	894	1083	1021	894	-	1620	-	-	-	-	-
Stage 1	1021	895	-	-	-	-	-	-	-	-	-	-
Stage 2	-	-	-	1021	895	-	-	-	-	-	-	-
Platoon blocked, %	-	-	-	-	-	-	-	-	-	-	-	-
Mov Cap-1 Maneuver	-	894	1083	1021	894	-	1620	-	-	-	-	-
Mov Cap-2 Maneuver	-	894	-	1021	894	-	-	-	-	-	-	-
Stage 1	1021	895	-	-	-	-	-	-	-	-	-	-
Stage 2	-	-	-	1021	895	-	-	-	-	-	-	-

Approach	SE	NW	NE	SW
HCM Control Delay, s	0	0	0	0
HCM LOS	A	A		

Minor Lane/Major Mvmt	NEL	NET	NERNWLn1	NWLn2	NWLn3	SELn1	SELn2	SELn3	SWL	SWT	SWR
Capacity (veh/h)	1620	-	-	-	-	-	-	-	-	-	-
HCM Lane V/C Ratio	-	-	-	-	-	-	-	-	-	-	-
HCM Control Delay (s)	0	-	-	0	0	0	0	0	0	0	-
HCM Lane LOS	A	-	-	A	A	A	A	A	A	A	-
HCM 95th %tile Q(veh)	0	-	-	-	-	-	-	-	-	-	-

Intersection												
Int Delay, s/veh	5.8											
Movement	EBL	EBT	EBR	WBL	WBT	WBR	NBL	NBT	NBR	SBL	SBT	SBR
Lane Configurations		↕↕	↗		↕↕	↗		↕↕			↕↕	
Traffic Vol, veh/h	15	350	25	15	300	75	75	25	25	50	40	15
Future Vol, veh/h	15	350	25	15	300	75	75	25	25	50	40	15
Conflicting Peds, #/hr	0	0	0	0	0	0	0	0	0	0	0	0
Sign Control	Free	Free	Free	Free	Free	Free	Stop	Stop	Stop	Stop	Stop	Stop
RT Channelized	-	-	None	-	-	None	-	-	None	-	-	None
Storage Length	-	-	0	-	-	235	-	-	-	-	-	-
Veh in Median Storage, #	-	0	-	-	0	-	-	0	-	-	0	-
Grade, %	-	0	-	-	0	-	-	0	-	-	0	-
Peak Hour Factor	92	92	92	92	92	92	83	83	83	83	83	83
Heavy Vehicles, %	2	2	2	2	2	2	2	2	2	2	2	2
Mvmt Flow	16	380	27	16	326	82	90	30	30	60	48	18

Major/Minor	Major1			Major2			Minor1			Minor2		
Conflicting Flow All	408	0	0	407	0	0	631	852	190	595	797	163
Stage 1	-	-	-	-	-	-	412	412	-	358	358	-
Stage 2	-	-	-	-	-	-	219	440	-	237	439	-
Critical Hdwy	4.14	-	-	4.14	-	-	7.54	6.54	6.94	7.54	6.54	6.94
Critical Hdwy Stg 1	-	-	-	-	-	-	6.54	5.54	-	6.54	5.54	-
Critical Hdwy Stg 2	-	-	-	-	-	-	6.54	5.54	-	6.54	5.54	-
Follow-up Hdwy	2.22	-	-	2.22	-	-	3.52	4.02	3.32	3.52	4.02	3.32
Pot Cap-1 Maneuver	1147	-	-	1148	-	-	366	295	820	388	318	853
Stage 1	-	-	-	-	-	-	588	593	-	633	626	-
Stage 2	-	-	-	-	-	-	763	576	-	745	576	-
Platoon blocked, %	-	-	-	-	-	-	-	-	-	-	-	-
Mov Cap-1 Maneuver	1147	-	-	1148	-	-	307	284	820	334	307	853
Mov Cap-2 Maneuver	-	-	-	-	-	-	307	284	-	334	307	-
Stage 1	-	-	-	-	-	-	577	582	-	622	615	-
Stage 2	-	-	-	-	-	-	676	566	-	668	566	-

Approach	EB			WB			NB			SB		
HCM Control Delay, s	0.4			0.4			23.3			20.8		
HCM LOS							C			C		

Minor Lane/Major Mvmt	NBLn1	EBL	EBT	EBR	WBL	WBT	WBR	SBLn1
Capacity (veh/h)	345	1147	-	-	1148	-	-	353
HCM Lane V/C Ratio	0.437	0.014	-	-	0.014	-	-	0.358
HCM Control Delay (s)	23.3	8.2	0.1	-	8.2	0.1	-	20.8
HCM Lane LOS	C	A	A	-	A	A	-	C
HCM 95th %tile Q(veh)	2.1	0	-	-	0	-	-	1.6

Lanes, Volumes, Timings
1: US 24 & Judge Orr

2043 Background + Site
AM

Lane Group	EBL	EBT	EBR	WBL	WBT	WBR	NEL	NET	NER	SWL	SWT	SWR
Lane Configurations												
Traffic Volume (vph)	69	159	298	299	140	50	239	677	214	100	1206	102
Future Volume (vph)	69	159	298	299	140	50	239	677	214	100	1206	102
Ideal Flow (vphpl)	1900	1900	1900	1900	1900	1900	1900	1900	1900	1900	1900	1900
Storage Length (ft)	235		0	235		235	860		290	695		290
Storage Lanes	1		1	2		1	2		1	1		1
Taper Length (ft)	200			200			300		300			
Lane Util. Factor	1.00	0.95	1.00	0.97	0.95	1.00	0.97	0.95	1.00	1.00	0.95	1.00
Frt			0.850			0.850			0.850			0.850
Flt Protected	0.950			0.950			0.950			0.950		
Satd. Flow (prot)	1770	3539	1583	3433	3539	1583	3433	3539	1583	1770	3539	1583
Flt Permitted	0.656			0.950			0.950			0.356		
Satd. Flow (perm)	1222	3539	1583	3433	3539	1583	3433	3539	1583	663	3539	1583
Right Turn on Red			Yes			Yes			Yes			Yes
Satd. Flow (RTOR)			273			149			225			149
Link Speed (mph)		45			45			55			55	
Link Distance (ft)		1222			928			1307			1572	
Travel Time (s)		18.5			14.1			16.2			19.5	
Peak Hour Factor	0.92	0.92	0.92	0.92	0.92	0.92	0.95	0.95	0.95	0.95	0.95	0.95
Adj. Flow (vph)	75	173	324	325	152	54	252	713	225	105	1269	107
Shared Lane Traffic (%)												
Lane Group Flow (vph)	75	173	324	325	152	54	252	713	225	105	1269	107
Enter Blocked Intersection	No	No	No	No	No	No	No	No	No	No	No	No
Lane Alignment	Left	Left	Right	Left	Left	Right	Left	Left	Right	Left	Left	Right
Median Width(ft)		24			24			24			24	
Link Offset(ft)		0			0			0			0	
Crosswalk Width(ft)		16			16			16			16	
Two way Left Turn Lane												
Headway Factor	1.00	1.00	1.00	1.00	1.00	1.00	1.00	1.00	1.00	1.00	1.00	1.00
Turning Speed (mph)	60		60	60		60	60		60	60		60
Number of Detectors	1	2	1	1	2	1	1	2	1	1	2	1
Detector Template	Left	Thru	Right	Left	Thru	Right	Left	Thru	Right	Left	Thru	Right
Leading Detector (ft)	20	100	20	20	100	20	20	100	20	20	100	20
Trailing Detector (ft)	0	0	0	0	0	0	0	0	0	0	0	0
Detector 1 Position(ft)	0	0	0	0	0	0	0	0	0	0	0	0
Detector 1 Size(ft)	20	6	20	20	6	20	20	6	20	20	6	20
Detector 1 Type	Cl+Ex	Cl+Ex	Cl+Ex	Cl+Ex	Cl+Ex	Cl+Ex	Cl+Ex	Cl+Ex	Cl+Ex	Cl+Ex	Cl+Ex	Cl+Ex
Detector 1 Channel												
Detector 1 Extend (s)	0.0	0.0	0.0	0.0	0.0	0.0	0.0	0.0	0.0	0.0	0.0	0.0
Detector 1 Queue (s)	0.0	0.0	0.0	0.0	0.0	0.0	0.0	0.0	0.0	0.0	0.0	0.0
Detector 1 Delay (s)	0.0	0.0	0.0	0.0	0.0	0.0	0.0	0.0	0.0	0.0	0.0	0.0
Detector 2 Position(ft)		94			94			94			94	
Detector 2 Size(ft)		6			6			6			6	
Detector 2 Type		Cl+Ex			Cl+Ex			Cl+Ex			Cl+Ex	
Detector 2 Channel												
Detector 2 Extend (s)		0.0			0.0			0.0			0.0	
Turn Type	pm+pt	NA	Perm	Prot	NA	Perm	Prot	NA	Perm	pm+pt	NA	Perm
Protected Phases	7	4		3	8		5	2		1	6	
Permitted Phases	4		4			8			2	6		6

Lanes, Volumes, Timings
1: US 24 & Judge Orr

2043 Background + Site
AM



Lane Group	EBL	EBT	EBR	WBL	WBT	WBR	NEL	NET	NER	SWL	SWT	SWR
Detector Phase	7	4	4	3	8	8	5	2	2	1	6	6
Switch Phase												
Minimum Initial (s)	5.0	5.0	5.0	5.0	5.0	5.0	5.0	5.0	5.0	5.0	5.0	5.0
Minimum Split (s)	9.5	22.5	22.5	9.5	22.5	22.5	9.5	22.5	22.5	9.5	22.5	22.5
Total Split (s)	15.0	24.0	24.0	17.0	26.0	26.0	25.0	57.0	57.0	12.0	44.0	44.0
Total Split (%)	13.6%	21.8%	21.8%	15.5%	23.6%	23.6%	22.7%	51.8%	51.8%	10.9%	40.0%	40.0%
Maximum Green (s)	10.5	19.5	19.5	12.5	21.5	21.5	20.5	52.5	52.5	7.5	39.5	39.5
Yellow Time (s)	3.5	3.5	3.5	3.5	3.5	3.5	3.5	3.5	3.5	3.5	3.5	3.5
All-Red Time (s)	1.0	1.0	1.0	1.0	1.0	1.0	1.0	1.0	1.0	1.0	1.0	1.0
Lost Time Adjust (s)	0.0	0.0	0.0	0.0	0.0	0.0	0.0	0.0	0.0	0.0	0.0	0.0
Total Lost Time (s)	4.5	4.5	4.5	4.5	4.5	4.5	4.5	4.5	4.5	4.5	4.5	4.5
Lead/Lag	Lead	Lag	Lag	Lead	Lag	Lag	Lead	Lag	Lag	Lead	Lag	Lag
Lead-Lag Optimize?	Yes	Yes	Yes	Yes	Yes	Yes	Yes	Yes	Yes	Yes	Yes	Yes
Vehicle Extension (s)	3.0	3.0	3.0	3.0	3.0	3.0	3.0	3.0	3.0	3.0	3.0	3.0
Recall Mode	None	None	None	None	None	None	None	Max	Max	None	Max	Max
Walk Time (s)		7.0	7.0		7.0	7.0		7.0	7.0		7.0	7.0
Flash Dont Walk (s)		11.0	11.0		11.0	11.0		11.0	11.0		11.0	11.0
Pedestrian Calls (#/hr)		0	0		0	0		0	0		0	0
Act Effct Green (s)	20.4	12.0	12.0	12.2	18.0	18.0	12.8	52.6	52.6	54.0	47.0	47.0
Actuated g/C Ratio	0.20	0.12	0.12	0.12	0.18	0.18	0.13	0.52	0.52	0.53	0.46	0.46
v/c Ratio	0.26	0.42	0.76	0.79	0.24	0.13	0.59	0.39	0.24	0.25	0.78	0.13
Control Delay	29.7	44.5	21.1	59.1	38.6	0.7	48.3	16.4	2.8	10.6	28.8	1.7
Queue Delay	0.0	0.0	0.0	0.0	0.0	0.0	0.0	0.0	0.0	0.0	0.0	0.0
Total Delay	29.7	44.5	21.1	59.1	38.6	0.7	48.3	16.4	2.8	10.6	28.8	1.7
LOS	C	D	C	E	D	A	D	B	A	B	C	A
Approach Delay		29.3			47.3			20.6			25.6	
Approach LOS		C			D			C			C	
Queue Length 50th (ft)	37	56	31	105	46	0	79	137	0	23	342	0
Queue Length 95th (ft)	71	88	124	#190	77	0	125	216	40	55	#583	15
Internal Link Dist (ft)		1142			848			1227			1492	
Turn Bay Length (ft)	235			235		235	860		290	695		290
Base Capacity (vph)	326	678	524	421	760	457	691	1825	925	435	1629	809
Starvation Cap Reductn	0	0	0	0	0	0	0	0	0	0	0	0
Spillback Cap Reductn	0	0	0	0	0	0	0	0	0	0	0	0
Storage Cap Reductn	0	0	0	0	0	0	0	0	0	0	0	0
Reduced v/c Ratio	0.23	0.26	0.62	0.77	0.20	0.12	0.36	0.39	0.24	0.24	0.78	0.13

Intersection Summary

Area Type:	Other
Cycle Length:	110
Actuated Cycle Length:	102
Natural Cycle:	90
Control Type:	Actuated-Uncoordinated
Maximum v/c Ratio:	0.79
Intersection Signal Delay:	27.6
Intersection LOS:	C
Intersection Capacity Utilization:	71.6%
ICU Level of Service:	C
Analysis Period (min):	15
# 95th percentile volume exceeds capacity, queue may be longer. Queue shown is maximum after two cycles.	

Splits and Phases: 1: US 24 & Judge Orr



Lanes, Volumes, Timings
2: US 24 & Stapleton

2043 Background + Site
AM

Lane Group	SEL	SET	SER	NWL	NWT	NWR	NEL	NET	NER	SWL	SWT	SWR
Lane Configurations												
Traffic Volume (vph)	175	413	600	81	419	56	300	540	53	126	800	352
Future Volume (vph)	175	413	600	81	419	56	300	540	53	126	800	352
Ideal Flow (vphpl)	1900	1900	1900	1900	1900	1900	1900	1900	1900	1900	1900	1900
Storage Length (ft)	190		325	215		215	890		1000	790		790
Storage Lanes	1		2	1		0	2		1	2		1
Taper Length (ft)	240			200			190			190		
Lane Util. Factor	1.00	0.95	1.00	1.00	0.95	1.00	0.97	0.95	1.00	0.97	0.95	1.00
Frt			0.850			0.850			0.850			0.850
Flt Protected	0.950			0.950			0.950			0.950		
Satd. Flow (prot)	1770	3539	1583	1770	3539	1583	3433	3539	1583	3433	3539	1583
Flt Permitted	0.324			0.452			0.950			0.950		
Satd. Flow (perm)	604	3539	1583	842	3539	1583	3433	3539	1583	3433	3539	1583
Right Turn on Red			Yes			Yes			Yes			Yes
Satd. Flow (RTOR)			374			136			95			289
Link Speed (mph)		45			45			55				55
Link Distance (ft)		1349			4231			1382				1435
Travel Time (s)		20.4			64.1			17.1				17.8
Peak Hour Factor	0.93	0.93	0.93	0.92	0.92	0.92	0.95	0.95	0.95	0.95	0.95	0.95
Adj. Flow (vph)	188	444	645	88	455	61	316	568	56	133	842	371
Shared Lane Traffic (%)												
Lane Group Flow (vph)	188	444	645	88	455	61	316	568	56	133	842	371
Enter Blocked Intersection	No	No	No	No	No	No	No	No	No	No	No	No
Lane Alignment	Left	Left	Right	Left	Left	Right	Left	Left	Right	Left	Left	Right
Median Width(ft)		12			12			24				24
Link Offset(ft)		0			0			0				0
Crosswalk Width(ft)		16			16			16				16
Two way Left Turn Lane												
Headway Factor	1.00	1.00	1.00	1.00	1.00	1.00	1.00	1.00	1.00	1.00	1.00	1.00
Turning Speed (mph)	15		9	15		9	15		9	15		9
Number of Detectors	1	2	1	1	2	1	1	2	1	1	2	1
Detector Template	Left	Thru	Right	Left	Thru	Right	Left	Thru	Right	Left	Thru	Right
Leading Detector (ft)	20	100	20	20	100	20	20	100	20	20	100	20
Trailing Detector (ft)	0	0	0	0	0	0	0	0	0	0	0	0
Detector 1 Position(ft)	0	0	0	0	0	0	0	0	0	0	0	0
Detector 1 Size(ft)	20	6	20	20	6	20	20	6	20	20	6	20
Detector 1 Type	Cl+Ex	Cl+Ex	Cl+Ex	Cl+Ex	Cl+Ex	Cl+Ex	Cl+Ex	Cl+Ex	Cl+Ex	Cl+Ex	Cl+Ex	Cl+Ex
Detector 1 Channel												
Detector 1 Extend (s)	0.0	0.0	0.0	0.0	0.0	0.0	0.0	0.0	0.0	0.0	0.0	0.0
Detector 1 Queue (s)	0.0	0.0	0.0	0.0	0.0	0.0	0.0	0.0	0.0	0.0	0.0	0.0
Detector 1 Delay (s)	0.0	0.0	0.0	0.0	0.0	0.0	0.0	0.0	0.0	0.0	0.0	0.0
Detector 2 Position(ft)		94			94			94				94
Detector 2 Size(ft)		6			6			6				6
Detector 2 Type		Cl+Ex			Cl+Ex			Cl+Ex				Cl+Ex
Detector 2 Channel												
Detector 2 Extend (s)		0.0			0.0			0.0				0.0
Turn Type	pm+pt	NA	Perm	pm+pt	NA	Perm	Prot	NA	Perm	Prot	NA	Perm
Protected Phases	1	6		5	2		7	4		3	8	
Permitted Phases	6		6	2		2			4			8

Queue shown is maximum after two cycles.

Splits and Phases: 2: US 24 & Stapleton

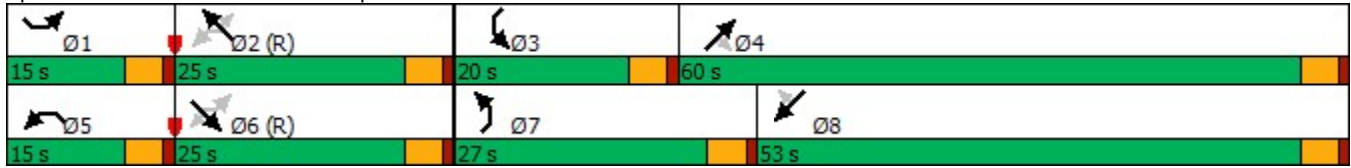

Intersection									
Intersection Delay, s/veh	6.9								
Intersection LOS	A								
Approach	EB		WB		NB		SB		
Entry Lanes	2		2		2		2		
Conflicting Circle Lanes	2		2		2		2		
Adj Approach Flow, veh/h	346		483		554		575		
Demand Flow Rate, veh/h	353		492		566		586		
Vehicles Circulating, veh/h	594		560		185		523		
Vehicles Exiting, veh/h	515		191		761		529		
Ped Vol Crossing Leg, #/h	0		0		0		0		
Ped Cap Adj	1.000		1.000		1.000		1.000		
Approach Delay, s/veh	6.9		7.6		5.3		8.0		
Approach LOS	A		A		A		A		
Lane	Left	Right	Left	Right	Left	Right	Left	Right	
Designated Moves	LT	TR	LT	TR	LT	TR	LT	TR	
Assumed Moves	LT	R	LT	TR	LT	TR	LT	TR	
RT Channelized									
Lane Util	0.357	0.643	0.470	0.530	0.470	0.530	0.469	0.531	
Follow-Up Headway, s	2.667	2.535	2.667	2.535	2.667	2.535	2.667	2.535	
Critical Headway, s	4.645	4.328	4.645	4.328	4.645	4.328	4.645	4.328	
Entry Flow, veh/h	126	227	231	261	266	300	275	311	
Cap Entry Lane, veh/h	782	857	806	882	1139	1213	834	910	
Entry HV Adj Factor	0.977	0.982	0.982	0.980	0.979	0.979	0.982	0.979	
Flow Entry, veh/h	123	223	227	256	260	294	270	305	
Cap Entry, veh/h	763	842	792	864	1115	1188	820	892	
V/C Ratio	0.161	0.265	0.286	0.296	0.234	0.247	0.330	0.342	
Control Delay, s/veh	6.4	7.1	7.8	7.4	5.4	5.3	8.2	7.8	
LOS	A	A	A	A	A	A	A	A	
95th %tile Queue, veh	1	1	1	1	1	1	1	2	

Intersection												
Int Delay, s/veh	0											
Movement	SEL	SET	SER	NWL	NWT	NWR	NEL	NET	NER	SWL	SWT	SWR
Lane Configurations	↘	↑	↗	↘	↑	↗	↘	↑↑	↗	↘	↑↑	↗
Traffic Vol, veh/h	0	0	0	0	0	0	0	0	0	0	0	0
Future Vol, veh/h	0	0	0	0	0	0	0	0	0	0	0	0
Conflicting Peds, #/hr	0	0	0	0	0	0	0	0	0	0	0	0
Sign Control	Stop	Stop	Stop	Stop	Stop	Stop	Free	Free	Free	Free	Free	Free
RT Channelized	-	-	None	-	-	None	-	-	None	-	-	None
Storage Length	235	-	235	235	-	235	235	-	235	235	-	235
Veh in Median Storage, #	-	0	-	-	0	-	-	0	-	-	0	-
Grade, %	-	0	-	-	0	-	-	0	-	-	0	-
Peak Hour Factor	92	92	92	92	92	92	92	92	92	92	92	92
Heavy Vehicles, %	2	2	2	2	2	2	2	2	2	2	2	2
Mvmt Flow	0	0	0	0	0	0	0	0	0	0	0	0

Major/Minor	Minor2		Minor1			Major1		Major2				
Conflicting Flow All	1	1	1	1	1	0	1	0	0	0	0	0
Stage 1	1	1	-	0	0	-	-	-	-	-	-	-
Stage 2	0	0	-	1	1	-	-	-	-	-	-	-
Critical Hdwy	7.54	6.54	6.94	7.54	6.54	6.94	4.14	-	-	4.14	-	-
Critical Hdwy Stg 1	6.54	5.54	-	6.54	5.54	-	-	-	-	-	-	-
Critical Hdwy Stg 2	6.54	5.54	-	6.54	5.54	-	-	-	-	-	-	-
Follow-up Hdwy	3.52	4.02	3.32	3.52	4.02	3.32	2.22	-	-	2.22	-	-
Pot Cap-1 Maneuver	1021	894	1083	1021	894	-	1620	-	-	-	-	-
Stage 1	1021	895	-	-	-	-	-	-	-	-	-	-
Stage 2	-	-	-	1021	895	-	-	-	-	-	-	-
Platoon blocked, %	-	-	-	-	-	-	-	-	-	-	-	-
Mov Cap-1 Maneuver	-	894	1083	1021	894	-	1620	-	-	-	-	-
Mov Cap-2 Maneuver	-	894	-	1021	894	-	-	-	-	-	-	-
Stage 1	1021	895	-	-	-	-	-	-	-	-	-	-
Stage 2	-	-	-	1021	895	-	-	-	-	-	-	-

Approach	SE		NW		NE		SW	
HCM Control Delay, s	0		0		0		0	
HCM LOS	A		A					

Minor Lane/Major Mvmt	NEL	NET	NERN	NWLn1	NWLn2	NWLn3	SELn1	SELn2	SELn3	SWL	SWT	SWR
Capacity (veh/h)	1620	-	-	-	-	-	-	-	-	-	-	-
HCM Lane V/C Ratio	-	-	-	-	-	-	-	-	-	-	-	-
HCM Control Delay (s)	0	-	-	0	0	0	0	0	0	0	-	-
HCM Lane LOS	A	-	-	A	A	A	A	A	A	A	-	-
HCM 95th %tile Q(veh)	0	-	-	-	-	-	-	-	-	-	-	-

Intersection												
Int Delay, s/veh	3.1											
Movement	EBL	EBT	EBR	WBL	WBT	WBR	NBL	NBT	NBR	SBL	SBT	SBR
Lane Configurations		↕↕	↕		↕↕	↕		↕↕			↕↕	
Traffic Vol, veh/h	8	152	10	10	356	25	51	20	10	10	20	25
Future Vol, veh/h	8	152	10	10	356	25	51	20	10	10	20	25
Conflicting Peds, #/hr	0	0	0	0	0	0	0	0	0	0	0	0
Sign Control	Free	Free	Free	Free	Free	Free	Stop	Stop	Stop	Stop	Stop	Stop
RT Channelized	-	-	None	-	-	None	-	-	None	-	-	None
Storage Length	-	-	0	-	-	235	-	-	-	-	-	-
Veh in Median Storage, #	-	0	-	-	0	-	-	0	-	-	0	-
Grade, %	-	0	-	-	0	-	-	0	-	-	0	-
Peak Hour Factor	87	87	87	92	92	92	83	83	83	83	83	83
Heavy Vehicles, %	2	2	2	2	2	2	2	2	2	2	2	2
Mvmt Flow	9	175	11	11	387	27	61	24	12	12	24	30

Major/Minor	Major1			Major2			Minor1			Minor2		
Conflicting Flow All	414	0	0	186	0	0	421	629	88	527	613	194
Stage 1	-	-	-	-	-	-	193	193	-	409	409	-
Stage 2	-	-	-	-	-	-	228	436	-	118	204	-
Critical Hdwy	4.14	-	-	4.14	-	-	7.54	6.54	6.94	7.54	6.54	6.94
Critical Hdwy Stg 1	-	-	-	-	-	-	6.54	5.54	-	6.54	5.54	-
Critical Hdwy Stg 2	-	-	-	-	-	-	6.54	5.54	-	6.54	5.54	-
Follow-up Hdwy	2.22	-	-	2.22	-	-	3.52	4.02	3.32	3.52	4.02	3.32
Pot Cap-1 Maneuver	1141	-	-	1386	-	-	517	398	953	434	406	815
Stage 1	-	-	-	-	-	-	790	740	-	590	594	-
Stage 2	-	-	-	-	-	-	754	578	-	874	732	-
Platoon blocked, %	-	-	-	-	-	-	-	-	-	-	-	-
Mov Cap-1 Maneuver	1141	-	-	1386	-	-	468	390	953	402	398	815
Mov Cap-2 Maneuver	-	-	-	-	-	-	468	390	-	402	398	-
Stage 1	-	-	-	-	-	-	783	733	-	585	588	-
Stage 2	-	-	-	-	-	-	689	572	-	827	725	-

Approach	EB			WB			NB			SB		
HCM Control Delay, s	0.4			0.2			14.6			12.9		
HCM LOS							B			B		

Minor Lane/Major Mvmt	NBLn1	EBL	EBT	EBR	WBL	WBT	WBR	SBLn1
Capacity (veh/h)	474	1141	-	-	1386	-	-	520
HCM Lane V/C Ratio	0.206	0.008	-	-	0.008	-	-	0.127
HCM Control Delay (s)	14.6	8.2	0	-	7.6	0	-	12.9
HCM Lane LOS	B	A	A	-	A	A	-	B
HCM 95th %tile Q(veh)	0.8	0	-	-	0	-	-	0.4

Intersection						
Int Delay, s/veh	1.1					
Movement	EBL	EBR	NBL	NBT	SBT	SBR
Lane Configurations						
Traffic Vol, veh/h	4	3	3	32	36	0
Future Vol, veh/h	4	3	3	32	36	0
Conflicting Peds, #/hr	0	0	0	0	0	0
Sign Control	Stop	Stop	Free	Free	Free	Free
RT Channelized	-	None	-	None	-	None
Storage Length	0	-	-	-	-	-
Veh in Median Storage, #	0	-	-	0	0	-
Grade, %	0	-	-	0	0	-
Peak Hour Factor	78	78	78	78	78	78
Heavy Vehicles, %	2	2	2	2	2	2
Mvmt Flow	5	4	4	41	46	0

Major/Minor	Minor2	Major1		Major2	
Conflicting Flow All	95	46	46	0	0
Stage 1	46	-	-	-	-
Stage 2	49	-	-	-	-
Critical Hdwy	6.42	6.22	4.12	-	-
Critical Hdwy Stg 1	5.42	-	-	-	-
Critical Hdwy Stg 2	5.42	-	-	-	-
Follow-up Hdwy	3.518	3.318	2.218	-	-
Pot Cap-1 Maneuver	905	1023	1562	-	0
Stage 1	976	-	-	-	0
Stage 2	973	-	-	-	0
Platoon blocked, %				-	-
Mov Cap-1 Maneuver	902	1023	1562	-	-
Mov Cap-2 Maneuver	902	-	-	-	-
Stage 1	973	-	-	-	-
Stage 2	973	-	-	-	-

Approach	EB	NB	SB
HCM Control Delay, s	8.8	0.6	0
HCM LOS	A		

Minor Lane/Major Mvmt	NBL	NBT	EBLn1	SBT
Capacity (veh/h)	1562	-	950	-
HCM Lane V/C Ratio	0.002	-	0.009	-
HCM Control Delay (s)	7.3	0	8.8	-
HCM Lane LOS	A	A	A	-
HCM 95th %tile Q(veh)	0	-	0	-

Intersection						
Int Delay, s/veh	0.4					
Movement	EBL	EBR	NBL	NBT	SBT	SBR
Lane Configurations	W			W	W	
Traffic Vol, veh/h	2	1	1	33	34	5
Future Vol, veh/h	2	1	1	33	34	5
Conflicting Peds, #/hr	0	0	0	0	0	0
Sign Control	Stop	Stop	Free	Free	Free	Free
RT Channelized	-	None	-	None	-	None
Storage Length	0	-	-	-	-	-
Veh in Median Storage, #	0	-	-	0	0	-
Grade, %	0	-	-	0	0	-
Peak Hour Factor	92	92	92	92	92	92
Heavy Vehicles, %	2	2	2	2	2	2
Mvmt Flow	2	1	1	36	37	5

Major/Minor	Minor2	Major1		Major2	
Conflicting Flow All	78	40	42	0	0
Stage 1	40	-	-	-	-
Stage 2	38	-	-	-	-
Critical Hdwy	6.42	6.22	4.12	-	-
Critical Hdwy Stg 1	5.42	-	-	-	-
Critical Hdwy Stg 2	5.42	-	-	-	-
Follow-up Hdwy	3.518	3.318	2.218	-	-
Pot Cap-1 Maneuver	925	1031	1567	-	-
Stage 1	982	-	-	-	-
Stage 2	984	-	-	-	-
Platoon blocked, %				-	-
Mov Cap-1 Maneuver	924	1031	1567	-	-
Mov Cap-2 Maneuver	924	-	-	-	-
Stage 1	981	-	-	-	-
Stage 2	984	-	-	-	-

Approach	EB	NB	SB
HCM Control Delay, s	8.8	0.2	0
HCM LOS	A		

Minor Lane/Major Mvmt	NBL	NBT	EBLn1	SBT	SBR
Capacity (veh/h)	1567	-	957	-	-
HCM Lane V/C Ratio	0.001	-	0.003	-	-
HCM Control Delay (s)	7.3	0	8.8	-	-
HCM Lane LOS	A	A	A	-	-
HCM 95th %tile Q(veh)	0	-	0	-	-

Intersection						
Int Delay, s/veh	0.9					
Movement	EBL	EBT	WBT	WBR	SBL	SBR
Lane Configurations		↑↑	↑↑		↑↑	
Traffic Vol, veh/h	18	156	367	15	3	29
Future Vol, veh/h	18	156	367	15	3	29
Conflicting Peds, #/hr	0	0	0	0	0	0
Sign Control	Free	Free	Free	Free	Stop	Stop
RT Channelized	-	None	-	None	-	None
Storage Length	-	-	-	-	0	-
Veh in Median Storage, #	-	0	0	-	0	-
Grade, %	-	0	0	-	0	-
Peak Hour Factor	87	87	92	92	78	78
Heavy Vehicles, %	2	2	2	2	2	2
Mvmt Flow	21	179	399	16	4	37

Major/Minor	Major1	Major2	Minor2		
Conflicting Flow All	415	0	-	0	539 208
Stage 1	-	-	-	-	407 -
Stage 2	-	-	-	-	132 -
Critical Hdwy	4.14	-	-	-	6.84 6.94
Critical Hdwy Stg 1	-	-	-	-	5.84 -
Critical Hdwy Stg 2	-	-	-	-	5.84 -
Follow-up Hdwy	2.22	-	-	-	3.52 3.32
Pot Cap-1 Maneuver	1140	-	-	-	473 798
Stage 1	-	-	-	-	641 -
Stage 2	-	-	-	-	880 -
Platoon blocked, %		-	-	-	
Mov Cap-1 Maneuver	1140	-	-	-	464 798
Mov Cap-2 Maneuver	-	-	-	-	464 -
Stage 1	-	-	-	-	628 -
Stage 2	-	-	-	-	880 -

Approach	EB	WB	SB
HCM Control Delay, s	0.9	0	10.1
HCM LOS			B

Minor Lane/Major Mvmt	EBL	EBT	WBT	WBR	SBLn1
Capacity (veh/h)	1140	-	-	-	748
HCM Lane V/C Ratio	0.018	-	-	-	0.055
HCM Control Delay (s)	8.2	0.1	-	-	10.1
HCM Lane LOS	A	A	-	-	B
HCM 95th %tile Q(veh)	0.1	-	-	-	0.2

Intersection												
Int Delay, s/veh	0.9											
Movement	EBL	EBT	EBR	WBL	WBT	WBR	NBL	NBT	NBR	SBL	SBT	SBR
Lane Configurations		↔			↔		↖	↑↑	↖		↖↑	↖
Traffic Vol, veh/h	5	0	13	15	0	12	10	464	4	4	504	16
Future Vol, veh/h	5	0	13	15	0	12	10	464	4	4	504	16
Conflicting Peds, #/hr	0	0	0	0	0	0	0	0	0	0	0	0
Sign Control	Stop	Stop	Stop	Stop	Stop	Stop	Free	Free	Free	Free	Free	Free
RT Channelized	-	-	None	-	-	None	-	-	None	-	-	None
Storage Length	-	-	-	-	-	-	235	-	235	-	-	235
Veh in Median Storage, #	-	0	-	-	0	-	-	0	-	-	0	-
Grade, %	-	0	-	-	0	-	-	0	-	-	0	-
Peak Hour Factor	78	78	78	78	78	78	92	92	92	92	92	92
Heavy Vehicles, %	2	2	2	2	2	2	2	2	2	2	2	2
Mvmt Flow	6	0	17	19	0	15	11	504	4	4	548	17

























Major/Minor	Minor2		Minor1			Major1			Major2			
Conflicting Flow All	830	1086	274	808	1099	252	565	0	0	508	0	0
Stage 1	556	556	-	526	526	-	-	-	-	-	-	-
Stage 2	274	530	-	282	573	-	-	-	-	-	-	-
Critical Hdwy	7.54	6.54	6.94	7.54	6.54	6.94	4.14	-	-	4.14	-	-
Critical Hdwy Stg 1	6.54	5.54	-	6.54	5.54	-	-	-	-	-	-	-
Critical Hdwy Stg 2	6.54	5.54	-	6.54	5.54	-	-	-	-	-	-	-
Follow-up Hdwy	3.52	4.02	3.32	3.52	4.02	3.32	2.22	-	-	2.22	-	-
Pot Cap-1 Maneuver	263	215	724	272	211	748	1003	-	-	1053	-	-
Stage 1	483	511	-	503	527	-	-	-	-	-	-	-
Stage 2	709	525	-	701	502	-	-	-	-	-	-	-
Platoon blocked, %								-	-	-	-	-
Mov Cap-1 Maneuver	254	211	724	262	207	748	1003	-	-	1053	-	-
Mov Cap-2 Maneuver	254	211	-	262	207	-	-	-	-	-	-	-
Stage 1	478	508	-	497	521	-	-	-	-	-	-	-
Stage 2	687	519	-	681	499	-	-	-	-	-	-	-

Approach	EB		WB			NB			SB		
HCM Control Delay, s	12.9		15.8			0.2			0.1		
HCM LOS	B		C								

Minor Lane/Major Mvmt	NBL	NBT	NBR	EBLn1	WBLn1	SBL	SBT	SBR
Capacity (veh/h)	1003	-	-	478	368	1053	-	-
HCM Lane V/C Ratio	0.011	-	-	0.048	0.094	0.004	-	-
HCM Control Delay (s)	8.6	-	-	12.9	15.8	8.4	0	-
HCM Lane LOS	A	-	-	B	C	A	A	-
HCM 95th %tile Q(veh)	0	-	-	0.2	0.3	0	-	-

Lanes, Volumes, Timings
1: US 24 & Judge Orr

2043 Background + Site
PM

												
Lane Group	EBL	EBT	EBR	WBL	WBT	WBR	NEL	NET	NER	SWL	SWT	SWR
Lane Configurations												
Traffic Volume (vph)	196	214	357	465	236	165	420	1240	481	150	794	159
Future Volume (vph)	196	214	357	465	236	165	420	1240	481	150	794	159
Ideal Flow (vphpl)	1900	1900	1900	1900	1900	1900	1900	1900	1900	1900	1900	1900
Storage Length (ft)	235		0	235		235	860		290	695		290
Storage Lanes	1		1	2		1	2		1	1		1
Taper Length (ft)	200			200			300			300		
Lane Util. Factor	1.00	0.95	1.00	0.97	0.95	1.00	0.97	0.95	1.00	1.00	0.95	1.00
Frt			0.850			0.850			0.850			0.850
Flt Protected	0.950			0.950			0.950			0.950		
Satd. Flow (prot)	1770	3539	1583	3433	3539	1583	3433	3539	1583	1770	3539	1583
Flt Permitted	0.595			0.950			0.950			0.115		
Satd. Flow (perm)	1108	3539	1583	3433	3539	1583	3433	3539	1583	214	3539	1583
Right Turn on Red			Yes			Yes			Yes			Yes
Satd. Flow (RTOR)			249			170			483			167
Link Speed (mph)		45			45			55			55	
Link Distance (ft)		1222			928			1307			1572	
Travel Time (s)		18.5			14.1			16.2			19.5	
Peak Hour Factor	0.93	0.93	0.93	0.93	0.93	0.93	0.95	0.95	0.95	0.95	0.95	0.95
Adj. Flow (vph)	211	230	384	500	254	177	442	1305	506	158	836	167
Shared Lane Traffic (%)												
Lane Group Flow (vph)	211	230	384	500	254	177	442	1305	506	158	836	167
Enter Blocked Intersection	No	No	No	No	No	No	No	No	No	No	No	No
Lane Alignment	Left	Left	Right	Left	Left	Right	Left	Left	Right	Left	Left	Right
Median Width(ft)		24			24			24			24	
Link Offset(ft)		0			0			0			0	
Crosswalk Width(ft)		16			16			16			16	
Two way Left Turn Lane												
Headway Factor	1.00	1.00	1.00	1.00	1.00	1.00	1.00	1.00	1.00	1.00	1.00	1.00
Turning Speed (mph)	15		9	15		9	15		9	15		9
Number of Detectors	1	2	1	1	2	1	1	2	1	1	2	1
Detector Template	Left	Thru	Right	Left	Thru	Right	Left	Thru	Right	Left	Thru	Right
Leading Detector (ft)	20	100	20	20	100	20	20	100	20	20	100	20
Trailing Detector (ft)	0	0	0	0	0	0	0	0	0	0	0	0
Detector 1 Position(ft)	0	0	0	0	0	0	0	0	0	0	0	0
Detector 1 Size(ft)	20	6	20	20	6	20	20	6	20	20	6	20
Detector 1 Type	Cl+Ex	Cl+Ex	Cl+Ex	Cl+Ex	Cl+Ex	Cl+Ex	Cl+Ex	Cl+Ex	Cl+Ex	Cl+Ex	Cl+Ex	Cl+Ex
Detector 1 Channel												
Detector 1 Extend (s)	0.0	0.0	0.0	0.0	0.0	0.0	0.0	0.0	0.0	0.0	0.0	0.0
Detector 1 Queue (s)	0.0	0.0	0.0	0.0	0.0	0.0	0.0	0.0	0.0	0.0	0.0	0.0
Detector 1 Delay (s)	0.0	0.0	0.0	0.0	0.0	0.0	0.0	0.0	0.0	0.0	0.0	0.0
Detector 2 Position(ft)		94			94			94			94	
Detector 2 Size(ft)		6			6			6			6	
Detector 2 Type		Cl+Ex			Cl+Ex			Cl+Ex			Cl+Ex	
Detector 2 Channel												
Detector 2 Extend (s)		0.0			0.0			0.0			0.0	
Turn Type	pm+pt	NA	Perm	Prot	NA	Perm	Prot	NA	Perm	pm+pt	NA	Perm
Protected Phases	7	4		3	8		5	2		1	6	
Permitted Phases	4		4			8			2	6		6

Lanes, Volumes, Timings
1: US 24 & Judge Orr

2043 Background + Site
PM











Lane Group	EBL	EBT	EBR	WBL	WBT	WBR	NEL	NET	NER	SWL	SWT	SWR
Detector Phase	7	4	4	3	8	8	5	2	2	1	6	6
Switch Phase												
Minimum Initial (s)	5.0	5.0	5.0	5.0	5.0	5.0	5.0	5.0	5.0	5.0	5.0	5.0
Minimum Split (s)	9.5	22.5	22.5	9.5	22.5	22.5	9.5	22.5	22.5	9.5	22.5	22.5
Total Split (s)	17.0	23.0	23.0	21.0	27.0	27.0	22.0	56.0	56.0	10.0	44.0	44.0
Total Split (%)	15.5%	20.9%	20.9%	19.1%	24.5%	24.5%	20.0%	50.9%	50.9%	9.1%	40.0%	40.0%
Maximum Green (s)	12.5	18.5	18.5	16.5	22.5	22.5	17.5	51.5	51.5	5.5	39.5	39.5
Yellow Time (s)	3.5	3.5	3.5	3.5	3.5	3.5	3.5	3.5	3.5	3.5	3.5	3.5
All-Red Time (s)	1.0	1.0	1.0	1.0	1.0	1.0	1.0	1.0	1.0	1.0	1.0	1.0
Lost Time Adjust (s)	0.0	0.0	0.0	0.0	0.0	0.0	0.0	0.0	0.0	0.0	0.0	0.0
Total Lost Time (s)	4.5	4.5	4.5	4.5	4.5	4.5	4.5	4.5	4.5	4.5	4.5	4.5
Lead/Lag	Lead	Lag	Lag	Lead	Lag	Lag	Lead	Lag	Lag	Lead	Lag	Lag
Lead-Lag Optimize?	Yes	Yes	Yes	Yes	Yes	Yes	Yes	Yes	Yes	Yes	Yes	Yes
Vehicle Extension (s)	3.0	3.0	3.0	3.0	3.0	3.0	3.0	3.0	3.0	3.0	3.0	3.0
Recall Mode	None	None	None	None	None	None	None	Max	Max	None	Max	Max
Walk Time (s)		7.0	7.0		7.0	7.0		7.0	7.0		7.0	7.0
Flash Dont Walk (s)		11.0	11.0		11.0	11.0		11.0	11.0		11.0	11.0
Pedestrian Calls (#/hr)		0	0		0	0		0	0		0	0
Act Effct Green (s)	27.1	15.1	15.1	16.5	19.7	19.7	16.7	51.6	51.6	46.0	40.4	40.4
Actuated g/C Ratio	0.25	0.14	0.14	0.15	0.18	0.18	0.16	0.48	0.48	0.43	0.38	0.38
v/c Ratio	0.59	0.46	0.88	0.94	0.39	0.41	0.83	0.76	0.50	0.92	0.62	0.24
Control Delay	34.7	44.8	37.5	73.0	40.0	9.6	58.0	26.8	3.9	73.2	30.3	4.7
Queue Delay	0.0	0.0	0.0	0.0	0.0	0.0	0.0	0.0	0.0	0.0	0.0	0.0
Total Delay	34.7	44.8	37.5	73.0	40.0	9.6	58.0	26.8	3.9	73.2	30.3	4.7
LOS	C	D	D	E	D	A	E	C	A	E	C	A
Approach Delay		38.8			51.9			27.8			32.4	
Approach LOS		D			D			C			C	
Queue Length 50th (ft)	107	76	92	182	81	4	156	395	9	54	257	0
Queue Length 95th (ft)	170	115	#247	#289	121	62	#229	488	66	#187	327	44
Internal Link Dist (ft)		1142			848			1227			1492	
Turn Bay Length (ft)	235			235		235	860		290	695		290
Base Capacity (vph)	364	614	480	531	746	468	563	1709	1014	172	1340	703
Starvation Cap Reductn	0	0	0	0	0	0	0	0	0	0	0	0
Spillback Cap Reductn	0	0	0	0	0	0	0	0	0	0	0	0
Storage Cap Reductn	0	0	0	0	0	0	0	0	0	0	0	0
Reduced v/c Ratio	0.58	0.37	0.80	0.94	0.34	0.38	0.79	0.76	0.50	0.92	0.62	0.24

Intersection Summary

Area Type:	Other
Cycle Length:	110
Actuated Cycle Length:	106.8
Natural Cycle:	90
Control Type:	Actuated-Uncoordinated
Maximum v/c Ratio:	0.94
Intersection Signal Delay:	34.9
Intersection LOS:	C
Intersection Capacity Utilization:	76.8%
ICU Level of Service:	D
Analysis Period (min):	15
# 95th percentile volume exceeds capacity, queue may be longer. Queue shown is maximum after two cycles.	

Splits and Phases: 1: US 24 & Judge Orr

 Ø1	 Ø2	 Ø3	 Ø4
10 s	56 s	21 s	23 s
 Ø5	 Ø6	 Ø7	 Ø8
22 s	44 s	17 s	27 s

Lanes, Volumes, Timings
2: US 24 & Stapleton

2043 Background + Site
PM

Lane Group	SEL	SET	SER	NWL	NWT	NWR	NEL	NET	NER	SWL	SWT	SWR
Lane Configurations												
Traffic Volume (vph)	350	334	700	129	430	186	650	850	134	150	600	351
Future Volume (vph)	350	334	700	129	430	186	650	850	134	150	600	351
Ideal Flow (vphpl)	1900	1900	1900	1900	1900	1900	1900	1900	1900	1900	1900	1900
Storage Length (ft)	190		325	215		215	890		1000	790		790
Storage Lanes	1		2	1		0	2		1	2		1
Taper Length (ft)	240			200			190			190		
Lane Util. Factor	1.00	0.95	1.00	1.00	0.95	1.00	0.97	0.95	1.00	0.97	0.95	1.00
Frt			0.850			0.850			0.850			0.850
Flt Protected	0.950			0.950			0.950			0.950		
Satd. Flow (prot)	1770	3539	1583	1770	3539	1583	3433	3539	1583	3433	3539	1583
Flt Permitted	0.184			0.541			0.950			0.950		
Satd. Flow (perm)	343	3539	1583	1008	3539	1583	3433	3539	1583	3433	3539	1583
Right Turn on Red			Yes			Yes			Yes			Yes
Satd. Flow (RTOR)			482			200			141			222
Link Speed (mph)		45			45			55				55
Link Distance (ft)		1349			4231			1382				1435
Travel Time (s)		20.4			64.1			17.1				17.8
Peak Hour Factor	0.95	0.95	0.95	0.93	0.93	0.93	0.95	0.95	0.95	0.95	0.95	0.95
Adj. Flow (vph)	368	352	737	139	462	200	684	895	141	158	632	369
Shared Lane Traffic (%)												
Lane Group Flow (vph)	368	352	737	139	462	200	684	895	141	158	632	369
Enter Blocked Intersection	No	No	No	No	No	No	No	No	No	No	No	No
Lane Alignment	Left	Left	Right	Left	Left	Right	Left	Left	Right	Left	Left	Right
Median Width(ft)		12			12			24				24
Link Offset(ft)		0			0			0				0
Crosswalk Width(ft)		16			16			16				16
Two way Left Turn Lane												
Headway Factor	1.00	1.00	1.00	1.00	1.00	1.00	1.00	1.00	1.00	1.00	1.00	1.00
Turning Speed (mph)	15		9	15		9	15		9	15		9
Number of Detectors	1	2	1	1	2	1	1	2	1	1	2	1
Detector Template	Left	Thru	Right	Left	Thru	Right	Left	Thru	Right	Left	Thru	Right
Leading Detector (ft)	20	100	20	20	100	20	20	100	20	20	100	20
Trailing Detector (ft)	0	0	0	0	0	0	0	0	0	0	0	0
Detector 1 Position(ft)	0	0	0	0	0	0	0	0	0	0	0	0
Detector 1 Size(ft)	20	6	20	20	6	20	20	6	20	20	6	20
Detector 1 Type	Cl+Ex	Cl+Ex	Cl+Ex	Cl+Ex	Cl+Ex	Cl+Ex	Cl+Ex	Cl+Ex	Cl+Ex	Cl+Ex	Cl+Ex	Cl+Ex
Detector 1 Channel												
Detector 1 Extend (s)	0.0	0.0	0.0	0.0	0.0	0.0	0.0	0.0	0.0	0.0	0.0	0.0
Detector 1 Queue (s)	0.0	0.0	0.0	0.0	0.0	0.0	0.0	0.0	0.0	0.0	0.0	0.0
Detector 1 Delay (s)	0.0	0.0	0.0	0.0	0.0	0.0	0.0	0.0	0.0	0.0	0.0	0.0
Detector 2 Position(ft)		94			94			94				94
Detector 2 Size(ft)		6			6			6				6
Detector 2 Type		Cl+Ex			Cl+Ex			Cl+Ex				Cl+Ex
Detector 2 Channel												
Detector 2 Extend (s)		0.0			0.0			0.0				0.0
Turn Type	pm+pt	NA	Perm	pm+pt	NA	Perm	Prot	NA	Perm	Prot	NA	Perm
Protected Phases	1	6		5	2		7	4		3	8	
Permitted Phases	6		6	2		2			4			8

Lanes, Volumes, Timings
2: US 24 & Stapleton

2043 Background + Site
PM



Lane Group	SEL	SET	SER	NWL	NWT	NWR	NEL	NET	NER	SWL	SWT	SWR
Detector Phase	1	6	6	5	2	2	7	4	4	3	8	8
Switch Phase												
Minimum Initial (s)	5.0	5.0	5.0	5.0	5.0	5.0	5.0	5.0	5.0	5.0	5.0	5.0
Minimum Split (s)	9.5	22.5	22.5	9.5	22.5	22.5	9.5	22.5	22.5	9.5	22.5	22.5
Total Split (s)	15.0	25.0	25.0	15.0	25.0	25.0	36.0	60.0	60.0	20.0	44.0	44.0
Total Split (%)	12.5%	20.8%	20.8%	12.5%	20.8%	20.8%	30.0%	50.0%	50.0%	16.7%	36.7%	36.7%
Maximum Green (s)	10.5	20.5	20.5	10.5	20.5	20.5	31.5	55.5	55.5	15.5	39.5	39.5
Yellow Time (s)	3.5	3.5	3.5	3.5	3.5	3.5	3.5	3.5	3.5	3.5	3.5	3.5
All-Red Time (s)	1.0	1.0	1.0	1.0	1.0	1.0	1.0	1.0	1.0	1.0	1.0	1.0
Lost Time Adjust (s)	0.0	0.0	0.0	0.0	0.0	0.0	0.0	0.0	0.0	0.0	0.0	0.0
Total Lost Time (s)	4.5	4.5	4.5	4.5	4.5	4.5	4.5	4.5	4.5	4.5	4.5	4.5
Lead/Lag	Lead	Lag	Lag	Lead	Lag	Lag	Lead	Lag	Lag	Lead	Lag	Lag
Lead-Lag Optimize?	Yes	Yes	Yes	Yes	Yes	Yes	Yes	Yes	Yes	Yes	Yes	Yes
Vehicle Extension (s)	3.0	3.0	3.0	3.0	3.0	3.0	3.0	3.0	3.0	3.0	3.0	3.0
Recall Mode	None	C-Min	C-Min	None	C-Min	C-Min	None	None	None	None	None	None
Walk Time (s)		7.0	7.0		7.0	7.0		7.0	7.0		7.0	7.0
Flash Dont Walk (s)		11.0	11.0		11.0	11.0		11.0	11.0		11.0	11.0
Pedestrian Calls (#/hr)		0	0		0	0		0	0		0	0
Act Effct Green (s)	48.4	33.6	33.6	31.7	20.5	20.5	28.2	46.4	46.4	10.8	29.0	29.0
Actuated g/C Ratio	0.40	0.28	0.28	0.26	0.17	0.17	0.24	0.39	0.39	0.09	0.24	0.24
v/c Ratio	0.86	0.36	0.93	0.41	0.76	0.46	0.85	0.65	0.20	0.51	0.74	0.67
Control Delay	52.5	38.6	35.5	30.4	56.8	9.6	54.4	32.1	3.9	57.6	47.1	21.4
Queue Delay	0.0	0.0	0.0	0.0	0.0	0.0	0.0	0.0	0.0	0.0	0.0	0.0
Total Delay	52.5	38.6	35.5	30.4	56.8	9.6	54.4	32.1	3.9	57.6	47.1	21.4
LOS	D	D	D	C	E	A	D	C	A	E	D	C
Approach Delay		40.5			40.4			38.7			40.3	
Approach LOS		D			D			D			D	
Queue Length 50th (ft)	218	116	234	69	181	0	260	291	0	61	238	101
Queue Length 95th (ft)	#534	184	#558	132	242	65	322	326	36	94	280	194
Internal Link Dist (ft)		1269			4151			1302			1355	
Turn Bay Length (ft)	190		325	215		215	890		1000	790		790
Base Capacity (vph)	426	990	790	349	604	436	901	1636	807	443	1164	669
Starvation Cap Reductn	0	0	0	0	0	0	0	0	0	0	0	0
Spillback Cap Reductn	0	0	0	0	0	0	0	0	0	0	0	0
Storage Cap Reductn	0	0	0	0	0	0	0	0	0	0	0	0
Reduced v/c Ratio	0.86	0.36	0.93	0.40	0.76	0.46	0.76	0.55	0.17	0.36	0.54	0.55

Intersection Summary

Area Type: Other
 Cycle Length: 120
 Actuated Cycle Length: 120
 Offset: 0 (0%), Referenced to phase 2:NWTL and 6:SETL, Start of Green
 Natural Cycle: 90
 Control Type: Actuated-Coordinated
 Maximum v/c Ratio: 0.93
 Intersection Signal Delay: 39.9 Intersection LOS: D
 Intersection Capacity Utilization 81.4% ICU Level of Service D
 Analysis Period (min) 15
 # 95th percentile volume exceeds capacity, queue may be longer.

Queue shown is maximum after two cycles.

Splits and Phases: 2: US 24 & Stapleton



Intersection									
Intersection Delay, s/veh	9.8								
Intersection LOS	A								
Approach	EB		WB		NB		SB		
Entry Lanes	2		2		2		2		
Conflicting Circle Lanes	2		2		2		2		
Adj Approach Flow, veh/h	515		363		899		598		
Demand Flow Rate, veh/h	525		371		917		609		
Vehicles Circulating, veh/h	602		908		545		519		
Vehicles Exiting, veh/h	526		554		582		760		
Ped Vol Crossing Leg, #/h	0		0		0		0		
Ped Cap Adj	1.000		1.000		1.000		1.000		
Approach Delay, s/veh	8.3		9.9		11.8		8.1		
Approach LOS	A		A		B		A		
Lane	Left	Right	Left	Right	Left	Right	Left	Right	
Designated Moves	LT	TR	LT	TR	LT	TR	LT	TR	
Assumed Moves	LT	TR	LT	TR	LT	TR	LT	TR	
RT Channelized									
Lane Util	0.470	0.530	0.469	0.531	0.470	0.530	0.470	0.530	
Follow-Up Headway, s	2.667	2.535	2.667	2.535	2.667	2.535	2.667	2.535	
Critical Headway, s	4.645	4.328	4.645	4.328	4.645	4.328	4.645	4.328	
Entry Flow, veh/h	247	278	174	197	431	486	286	323	
Cap Entry Lane, veh/h	776	851	586	656	818	894	837	913	
Entry HV Adj Factor	0.980	0.982	0.981	0.977	0.980	0.980	0.982	0.981	
Flow Entry, veh/h	242	273	171	193	422	476	281	317	
Cap Entry, veh/h	760	836	575	641	801	876	822	896	
V/C Ratio	0.318	0.327	0.297	0.300	0.527	0.544	0.342	0.354	
Control Delay, s/veh	8.5	8.0	10.4	9.5	12.0	11.6	8.3	8.0	
LOS	A	A	B	A	B	B	A	A	
95th %tile Queue, veh	1	1	1	1	3	3	2	2	

Intersection												
Int Delay, s/veh	0											
Movement	SEL	SET	SER	NWL	NWT	NWR	NEL	NET	NER	SWL	SWT	SWR
Lane Configurations	↘	↑	↗	↘	↑	↗	↘	↑↑	↗	↘	↑↑	↗
Traffic Vol, veh/h	0	0	0	0	0	0	0	0	0	0	0	0
Future Vol, veh/h	0	0	0	0	0	0	0	0	0	0	0	0
Conflicting Peds, #/hr	0	0	0	0	0	0	0	0	0	0	0	0
Sign Control	Stop	Stop	Stop	Stop	Stop	Stop	Free	Free	Free	Free	Free	Free
RT Channelized	-	-	None	-	-	None	-	-	None	-	-	None
Storage Length	235	-	235	235	-	235	235	-	235	235	-	235
Veh in Median Storage, #	-	0	-	-	0	-	-	0	-	-	0	-
Grade, %	-	0	-	-	0	-	-	0	-	-	0	-
Peak Hour Factor	92	92	92	92	92	92	92	92	92	92	92	92
Heavy Vehicles, %	2	2	2	2	2	2	2	2	2	2	2	2
Mvmt Flow	0	0	0	0	0	0	0	0	0	0	0	0

Major/Minor	Minor2		Minor1			Major1		Major2				
Conflicting Flow All	1	1	1	1	1	0	1	0	0	0	0	0
Stage 1	1	1	-	0	0	-	-	-	-	-	-	-
Stage 2	0	0	-	1	1	-	-	-	-	-	-	-
Critical Hdwy	7.54	6.54	6.94	7.54	6.54	6.94	4.14	-	-	4.14	-	-
Critical Hdwy Stg 1	6.54	5.54	-	6.54	5.54	-	-	-	-	-	-	-
Critical Hdwy Stg 2	6.54	5.54	-	6.54	5.54	-	-	-	-	-	-	-
Follow-up Hdwy	3.52	4.02	3.32	3.52	4.02	3.32	2.22	-	-	2.22	-	-
Pot Cap-1 Maneuver	1021	894	1083	1021	894	-	1620	-	-	-	-	-
Stage 1	1021	895	-	-	-	-	-	-	-	-	-	-
Stage 2	-	-	-	1021	895	-	-	-	-	-	-	-
Platoon blocked, %	-	-	-	-	-	-	-	-	-	-	-	-
Mov Cap-1 Maneuver	-	894	1083	1021	894	-	1620	-	-	-	-	-
Mov Cap-2 Maneuver	-	894	-	1021	894	-	-	-	-	-	-	-
Stage 1	1021	895	-	-	-	-	-	-	-	-	-	-
Stage 2	-	-	-	1021	895	-	-	-	-	-	-	-

Approach	SE	NW	NE	SW
HCM Control Delay, s	0	0	0	0
HCM LOS	A	A		

Minor Lane/Major Mvmt	NEL	NET	NERN	NWLn1	NWLn2	NWLn3	SELn1	SELn2	SELn3	SWL	SWT	SWR
Capacity (veh/h)	1620	-	-	-	-	-	-	-	-	-	-	-
HCM Lane V/C Ratio	-	-	-	-	-	-	-	-	-	-	-	-
HCM Control Delay (s)	0	-	-	0	0	0	0	0	0	0	-	-
HCM Lane LOS	A	-	-	A	A	A	A	A	A	A	-	-
HCM 95th %tile Q(veh)	0	-	-	-	-	-	-	-	-	-	-	-

Intersection												
Int Delay, s/veh	6.5											
Movement	EBL	EBT	EBR	WBL	WBT	WBR	NBL	NBT	NBR	SBL	SBT	SBR
Lane Configurations		↕↕	↗		↕↕	↗		↕↕			↕↕	
Traffic Vol, veh/h	27	363	26	15	310	76	76	25	25	51	40	21
Future Vol, veh/h	27	363	26	15	310	76	76	25	25	51	40	21
Conflicting Peds, #/hr	0	0	0	0	0	0	0	0	0	0	0	0
Sign Control	Free	Free	Free	Free	Free	Free	Stop	Stop	Stop	Stop	Stop	Stop
RT Channelized	-	-	None	-	-	None	-	-	None	-	-	None
Storage Length	-	-	0	-	-	235	-	-	-	-	-	-
Veh in Median Storage, #	-	0	-	-	0	-	-	0	-	-	0	-
Grade, %	-	0	-	-	0	-	-	0	-	-	0	-
Peak Hour Factor	92	92	92	92	92	92	83	83	83	83	83	83
Heavy Vehicles, %	2	2	2	2	2	2	2	2	2	2	2	2
Mvmt Flow	29	395	28	16	337	83	92	30	30	61	48	25

Major/Minor	Major1			Major2			Minor1			Minor2		
Conflicting Flow All	420	0	0	423	0	0	678	905	198	640	850	169
Stage 1	-	-	-	-	-	-	453	453	-	369	369	-
Stage 2	-	-	-	-	-	-	225	452	-	271	481	-
Critical Hdwy	4.14	-	-	4.14	-	-	7.54	6.54	6.94	7.54	6.54	6.94
Critical Hdwy Stg 1	-	-	-	-	-	-	6.54	5.54	-	6.54	5.54	-
Critical Hdwy Stg 2	-	-	-	-	-	-	6.54	5.54	-	6.54	5.54	-
Follow-up Hdwy	2.22	-	-	2.22	-	-	3.52	4.02	3.32	3.52	4.02	3.32
Pot Cap-1 Maneuver	1136	-	-	1133	-	-	338	275	810	360	296	845
Stage 1	-	-	-	-	-	-	556	568	-	623	619	-
Stage 2	-	-	-	-	-	-	757	569	-	712	552	-
Platoon blocked, %	-	-	-	-	-	-	-	-	-	-	-	-
Mov Cap-1 Maneuver	1136	-	-	1133	-	-	274	261	810	303	281	845
Mov Cap-2 Maneuver	-	-	-	-	-	-	274	261	-	303	281	-
Stage 1	-	-	-	-	-	-	537	549	-	602	607	-
Stage 2	-	-	-	-	-	-	663	558	-	626	533	-

Approach	EB			WB			NB			SB		
HCM Control Delay, s	0.6			0.4			27			22.9		
HCM LOS							D			C		

Minor Lane/Major Mvmt	NBLn1	EBL	EBT	EBR	WBL	WBT	WBR	SBLn1
Capacity (veh/h)	312	1136	-	-	1133	-	-	334
HCM Lane V/C Ratio	0.487	0.026	-	-	0.014	-	-	0.404
HCM Control Delay (s)	27	8.3	0.1	-	8.2	0.1	-	22.9
HCM Lane LOS	D	A	A	-	A	A	-	C
HCM 95th %tile Q(veh)	2.5	0.1	-	-	0	-	-	1.9

Intersection						
Int Delay, s/veh	0.8					
Movement	EBL	EBR	NBL	NBT	SBT	SBR
Lane Configurations	↔			↔	↑	
Traffic Vol, veh/h	1	2	9	38	74	3
Future Vol, veh/h	1	2	9	38	74	3
Conflicting Peds, #/hr	0	0	0	0	0	0
Sign Control	Stop	Stop	Free	Free	Free	Free
RT Channelized	-	None	-	None	-	None
Storage Length	0	-	-	-	-	-
Veh in Median Storage, #	0	-	-	0	0	-
Grade, %	0	-	-	0	0	-
Peak Hour Factor	78	78	78	78	83	83
Heavy Vehicles, %	2	2	2	2	2	2
Mvmt Flow	1	3	12	49	89	4

Major/Minor	Minor2	Major1		Major2	
Conflicting Flow All	164	91	93	0	0
Stage 1	91	-	-	-	-
Stage 2	73	-	-	-	-
Critical Hdwy	6.42	6.22	4.12	-	-
Critical Hdwy Stg 1	5.42	-	-	-	-
Critical Hdwy Stg 2	5.42	-	-	-	-
Follow-up Hdwy	3.518	3.318	2.218	-	-
Pot Cap-1 Maneuver	827	967	1501	-	-
Stage 1	933	-	-	-	-
Stage 2	950	-	-	-	-
Platoon blocked, %				-	-
Mov Cap-1 Maneuver	820	967	1501	-	-
Mov Cap-2 Maneuver	820	-	-	-	-
Stage 1	926	-	-	-	-
Stage 2	950	-	-	-	-

Approach	EB	NB	SB
HCM Control Delay, s	9	1.4	0
HCM LOS	A		

Minor Lane/Major Mvmt	NBL	NBT	EBLn1	SBT	SBR
Capacity (veh/h)	1501	-	912	-	-
HCM Lane V/C Ratio	0.008	-	0.004	-	-
HCM Control Delay (s)	7.4	0	9	-	-
HCM Lane LOS	A	A	A	-	-
HCM 95th %tile Q(veh)	0	-	0	-	-

Intersection						
Int Delay, s/veh	1.2					
Movement	EBL	EBR	NBL	NBT	SBT	SBR
Lane Configurations						
Traffic Vol, veh/h	12	2	2	35	70	6
Future Vol, veh/h	12	2	2	35	70	6
Conflicting Peds, #/hr	0	0	0	0	0	0
Sign Control	Stop	Stop	Free	Free	Free	Free
RT Channelized	-	None	-	None	-	None
Storage Length	0	-	-	-	-	-
Veh in Median Storage, #	0	-	-	0	0	-
Grade, %	0	-	-	0	0	-
Peak Hour Factor	78	78	78	78	83	83
Heavy Vehicles, %	2	2	2	2	2	2
Mvmt Flow	15	3	3	45	84	7

Major/Minor	Minor2	Major1		Major2	
Conflicting Flow All	139	88	91	0	0
Stage 1	88	-	-	-	-
Stage 2	51	-	-	-	-
Critical Hdwy	6.42	6.22	4.12	-	-
Critical Hdwy Stg 1	5.42	-	-	-	-
Critical Hdwy Stg 2	5.42	-	-	-	-
Follow-up Hdwy	3.518	3.318	2.218	-	-
Pot Cap-1 Maneuver	854	970	1504	-	-
Stage 1	935	-	-	-	-
Stage 2	971	-	-	-	-
Platoon blocked, %				-	-
Mov Cap-1 Maneuver	852	970	1504	-	-
Mov Cap-2 Maneuver	852	-	-	-	-
Stage 1	933	-	-	-	-
Stage 2	971	-	-	-	-

Approach	EB	NB	SB
HCM Control Delay, s	9.2	0.4	0
HCM LOS	A		

Minor Lane/Major Mvmt	NBL	NBT	EBLn1	SBT	SBR
Capacity (veh/h)	1504	-	867	-	-
HCM Lane V/C Ratio	0.002	-	0.021	-	-
HCM Control Delay (s)	7.4	0	9.2	-	-
HCM Lane LOS	A	A	A	-	-
HCM 95th %tile Q(veh)	0	-	0.1	-	-

Intersection						
Int Delay, s/veh	2.2					
Movement	EBL	EBT	WBT	WBR	SBL	SBR
Lane Configurations		↑↑	↑↑		↑↑	
Traffic Vol, veh/h	64	362	163	20	30	47
Future Vol, veh/h	64	362	163	20	30	47
Conflicting Peds, #/hr	0	0	0	0	0	0
Sign Control	Free	Free	Free	Free	Stop	Stop
RT Channelized	-	None	-	None	-	None
Storage Length	-	-	-	-	0	-
Veh in Median Storage, #	-	0	0	-	0	-
Grade, %	-	0	0	-	0	-
Peak Hour Factor	92	92	87	87	83	83
Heavy Vehicles, %	2	2	2	2	2	2
Mvmt Flow	70	393	187	23	36	57

Major/Minor	Major1	Major2	Minor2		
Conflicting Flow All	210	0	-	0	536 105
Stage 1	-	-	-	-	199 -
Stage 2	-	-	-	-	337 -
Critical Hdwy	4.14	-	-	-	6.84 6.94
Critical Hdwy Stg 1	-	-	-	-	5.84 -
Critical Hdwy Stg 2	-	-	-	-	5.84 -
Follow-up Hdwy	2.22	-	-	-	3.52 3.32
Pot Cap-1 Maneuver	1358	-	-	-	475 929
Stage 1	-	-	-	-	815 -
Stage 2	-	-	-	-	695 -
Platoon blocked, %		-	-	-	
Mov Cap-1 Maneuver	1358	-	-	-	444 929
Mov Cap-2 Maneuver	-	-	-	-	444 -
Stage 1	-	-	-	-	761 -
Stage 2	-	-	-	-	695 -

Approach	EB	WB	SB
HCM Control Delay, s	1.3	0	11.4
HCM LOS			B

Minor Lane/Major Mvmt	EBL	EBT	WBT	WBR	SBLn1
Capacity (veh/h)	1358	-	-	-	652
HCM Lane V/C Ratio	0.051	-	-	-	0.142
HCM Control Delay (s)	7.8	0.2	-	-	11.4
HCM Lane LOS	A	A	-	-	B
HCM 95th %tile Q(veh)	0.2	-	-	-	0.5

Intersection												
Int Delay, s/veh	1.8											
Movement	EBL	EBT	EBR	WBL	WBT	WBR	NBL	NBT	NBR	SBL	SBT	SBR
Lane Configurations		↕			↕		↕	↑↑	↕		↕↑	↕
Traffic Vol, veh/h	29	0	31	10	0	7	30	513	14	12	641	33
Future Vol, veh/h	29	0	31	10	0	7	30	513	14	12	641	33
Conflicting Peds, #/hr	0	0	0	0	0	0	0	0	0	0	0	0
Sign Control	Stop	Stop	Stop	Stop	Stop	Stop	Free	Free	Free	Free	Free	Free
RT Channelized	-	-	None	-	-	None	-	-	None	-	-	None
Storage Length	-	-	-	-	-	-	235	-	235	-	-	235
Veh in Median Storage, #	-	0	-	-	0	-	-	0	-	-	0	-
Grade, %	-	0	-	-	0	-	-	0	-	-	0	-
Peak Hour Factor	83	83	83	78	78	78	93	93	93	93	93	93
Heavy Vehicles, %	2	2	2	2	2	2	2	2	2	2	2	2
Mvmt Flow	35	0	37	13	0	9	32	552	15	13	689	35

Major/Minor	Minor2		Minor1		Major1		Major2					
Conflicting Flow All	1055	1346	345	987	1366	276	724	0	0	567	0	0
Stage 1	715	715	-	616	616	-	-	-	-	-	-	-
Stage 2	340	631	-	371	750	-	-	-	-	-	-	-
Critical Hdwy	7.54	6.54	6.94	7.54	6.54	6.94	4.14	-	-	4.14	-	-
Critical Hdwy Stg 1	6.54	5.54	-	6.54	5.54	-	-	-	-	-	-	-
Critical Hdwy Stg 2	6.54	5.54	-	6.54	5.54	-	-	-	-	-	-	-
Follow-up Hdwy	3.52	4.02	3.32	3.52	4.02	3.32	2.22	-	-	2.22	-	-
Pot Cap-1 Maneuver	180	150	651	202	146	721	874	-	-	1001	-	-
Stage 1	388	433	-	445	480	-	-	-	-	-	-	-
Stage 2	648	473	-	622	417	-	-	-	-	-	-	-
Platoon blocked, %								-	-	-	-	-
Mov Cap-1 Maneuver	170	141	651	182	138	721	874	-	-	1001	-	-
Mov Cap-2 Maneuver	170	141	-	182	138	-	-	-	-	-	-	-
Stage 1	374	423	-	429	462	-	-	-	-	-	-	-
Stage 2	617	455	-	573	408	-	-	-	-	-	-	-

Approach	EB		WB		NB		SB	
HCM Control Delay, s	22.7		19.9		0.5		0.2	
HCM LOS	C		C					

Minor Lane/Major Mvmt	NBL	NBT	NBR	EBLn1	WBLn1	SBL	SBT	SBR
Capacity (veh/h)	874	-	-	275	263	1001	-	-
HCM Lane V/C Ratio	0.037	-	-	0.263	0.083	0.013	-	-
HCM Control Delay (s)	9.3	-	-	22.7	19.9	8.6	0.1	-
HCM Lane LOS	A	-	-	C	C	A	A	-
HCM 95th %tile Q(veh)	0.1	-	-	1	0.3	0	-	-