

**FINAL DRAINAGE REPORT FOR
HOMESTEAD AT STERLING RANCH
FILING NO. 2**

EL PASO COUNTY, COLORADO

January 2020

Prepared for:
SR Land, LLC
20 Boulder Crescent, Suite 210
Colorado Springs, CO 80903

Prepared by:



CIVIL CONSULTANTS, INC.

20 Boulder Crescent, Suite 110
Colorado Springs, CO 80903
(719) 955-5485

Project #09-007
SF -19-004

Engineering Review

02/18/2020 7:17:10 PM

dsdrice

JeffRice@elpasoco.com

(719) 520-7877

**EPC Planning & Community
Development Department**

**FINAL DRAINAGE REPORT FOR
HOMESTEAD AT STERLING RANCH FILING NO. 2**

DRAINAGE PLAN STATEMENTS

ENGINEERS STATEMENT

The attached drainage plan and report was prepared under my direction and supervision and are correct to the best of my knowledge and belief. Said drainage report has been prepared according to the criteria established by the County for drainage reports and said report is in conformity with the master plan of the drainage basin. I accept responsibility for any liability caused by any negligent acts, errors or omissions on my part in preparing this report.

Virgil A. Sanchez, P.E. #37160
For and on Behalf of M&S Civil Consultants, Inc

DEVELOPER'S STATEMENT

I, the developer have read and will comply with all the requirements specified in this drainage report and plan.

BY: _____
James F Morley

TITLE: _____

DATE: _____

ADDRESS: SR Land, LLC
20 Boulder Crescent, Suite 210
Colorado Springs, CO 80903

EL PASO COUNTY'S STATEMENT

Filed in accordance with the requirements of El Paso County Land Development Code, Drainage Criteria Manual Volumes 1 and 2, and the Engineering Criteria Manual, as amended.

BY: _____ DATE: _____

Jennifer Irvine, P.E.
County Engineer / ECM Administrator

**FINAL DRAINAGE REPORT FOR
HOMESTEAD AT STERLING RANCH FILING NO. 2**

TABLE OF CONTENTS

PURPOSE	4
GENERAL LOCATION AND DESCRIPTION	4
SOILS	4
HYDROLOGIC CALCULATIONS	4
HYDRAULIC CALCULATIONS	5
FLOODPLAIN STATEMENT	5
DRAINAGE CRITERIA	5
FOUR STEP PROCESS	5
EXISTING DRAINAGE CONDITIONS	6
PROPOSED DRAINAGE CHARACTERISTICS	6
CHANNEL IMPROVEMENTS	9
WATER QUALITY PROVISIONS	9
EROSION CONTROL	10
CONSTRUCTION COST OPINION	10
DRAINAGE & BRIDGE FEES	11
STERLING RANCH FIL. NO.1 - SIA	11
SUMMARY	12
REFERENCES	13

APPENDIX

Vicinity Map
Soils Map
FIRM Panel W/ Revised LOMR
Hydrologic Calculations
Hydraulic Calculations
Drainage Maps

FINAL DRAINAGE REPORT FOR HOMESTEAD AT STERLING RANCH FILING NO. 2

PURPOSE

This document is the Final Drainage Report for Homestead at Sterling Ranch Filing No. 2. This report was previously discussed, as a preliminary drainage report, in the “Master Development Drainage Report for Sterling Ranch Filing Nos. 1&2, and Final Drainage Report for Sterling Ranch Filing No.1” prepared by MS Civil Consultants, dated April 2017. The purpose of this document is to identify and analyze the on and offsite drainage patterns and to ensure that post development runoff is routed through the site safely and in a manner that satisfies the requirements set forth by the El Paso County Drainage Criteria Manual. The following report is an analysis of the drainage for Homestead at Sterling Ranch Filing No. 2, single family lots, onsite and offsite drainage.

GENERAL LOCATION AND DESCRIPTION

Homestead at Sterling Ranch Filing No. 2 is located in the SE $\frac{1}{4}$ of the NW $\frac{1}{4}$, the SW $\frac{1}{4}$ of the NE $\frac{1}{4}$, and the NW $\frac{1}{4}$ of the NE $\frac{1}{4}$ of Section 33, Township 12 South, Range 65 West of the 6th Principal Meridian, and the NE $\frac{1}{4}$ of the SW $\frac{1}{4}$ of Section 33, Township 12 South, Range 65 West of the 6th Principal Meridian within unincorporated El Paso County, Colorado. The site is bound on the south by an existing detention pond, to the north by Briargate Parkway and to the east by Sand Creek. Existing Dines Boulevard runs along the western site boundary. An existing residential development, Homestead at Sterling Ranch Filing No. 1, bounds the site to the west and a future commercial parcel bounds the site to the northwest. Sterling Ranch lies within the Sand Creek Drainage Basin. Flows from this site are tributary to Sand Creek.

Homestead at Sterling Ranch Filing No. 2 consists of 29.658 acres and is presently undeveloped. Vegetation is sparse, consisting of native grasses. Existing site terrain generally slopes from north to southwest at grade rates that vary between 2% and 6%.

Land use for Homestead at Sterling Ranch Filing No. 2 is currently listed as AG (Grazing Land). Improvements proposed for the site include paved streets, trails, a full spectrum detention pond, and utilities as normally constructed for a residential development.

SOILS

Soils for this project are delineated by the map in the appendix as Pring Coarse Sandy Loam (71) and is characterized as Hydrologic Soil Types "B". Soils in the study area are shown as mapped by S.C.S. in the "Soils Survey of El Paso County Area". Vegetation is sparse, consisting of native grasses and weeds.

HYDROLOGIC CALCULATIONS

Hydrologic calculations were performed using the El Paso County and City of Colorado Storm Drainage Design Criteria manual and where applicable the Urban Storm Drainage Criteria Manual. The Rational Method was used to estimate stormwater runoff anticipated from design storms with 5-year and 100-year recurrence intervals.

HYDRAULIC CALCULATIONS

Hydraulic calculations were estimated using the Manning's Formula and the methods described in the El Paso County and City of Colorado Springs Storm Drainage Design Criteria manual. The relevant data sheets can be found in the "Master Development Drainage Report for Sterling Ranch Filing Nos. 1&2, and Final Drainage Report for Sterling Ranch Filing No.1" prepared by MS Civil Consultants, dated April 2017 and in the appendix of this report.

FLOODPLAIN STATEMENT

No portion of this site is within a designated F.E.M.A. floodplain as determined by the Federal Emergency Management Agency (FEMA) Flood Insurance Rate Map (FIRM) Panel No. 08041C0533 G, effective date December 7, 2018. An annotated FIRM Panel is included in the Appendix.

DRAINAGE CRITERIA

This drainage analysis has been prepared in accordance with the current City of Colorado Springs/El Paso County Drainage Criteria Manual, Volumes I & II, dated November 1991, including subsequent updates. El Paso County has also adopted Chapter 6 and Section 3.2.1 of Chapter 13 in the City of Colorado Springs & El Paso County Drainage Criteria Manual Volumes I and II, dated May 2014. (Appendix I of the El Paso County's Engineering Criteria Manual (ECM), 2008). In addition to the ECM, the Urban Storm Drainage Criteria Manuals, Volumes 1-3, published by the Urban Drainage and Flood Control District (Volumes 1 & 2 dated January 2016, Volume 3 dated November 2010 and updates. Calculations were performed to determine runoff quantities for the 5-year and 100-year frequency storms for developed conditions using the Rational Method. July 2019 ECM updated for MS4 permit.

FOUR STEP PROCESS

Step 1 Employ Runoff Reduction Practices. Roof drains will be directed to side yard swales and as possible to grass lined swales to aid in minimizing direct connection of impervious surfaces.

Step 2 Implement BMPs that provide a water quality capture volume with slow release. – An existing Full Spectrum Detention Facility (see Sterling Ranch Filing Nos. 1&2 MDDP, Pond 4) was planned and constructed to handle tributary flows for the southwest portion of the site. All remaining tributary areas from the site will be treated in a proposed temporary Full Spectrum Detention Facility, Interim Pond 1. Both ponds will incorporate water quality capture volumes that are intended to slowly drain in 40 hours and excess urban runoff volumes that are intended to drain within 72 hours.

Step 3 Stabilize streams. – With the full spectrum detention facilities in place, the runoff from the proposed residential development will be reduced to predevelopment conditions. The developed discharge from the site is less than existing and therefore is not anticipated to have negative effects on downstream drainageways. Additionally, the Sand Creek Channel will be reinforced with selected areas of rip rap bank protection, vegetative slope stabilization, check structures and drop structures.

Step 4 Consider need for Industrial and Commercial BMPs. – No industrial or commercial land uses are proposed with this development. The proposed residential development area will implement a Stormwater Management Plan (SWMP) incorporation proper housekeeping procedures. Onsite drainage will be routed through proposed private temporary Full Spectrum Detention Facility (FSD), Interim Pond 1, to minimize introduction of contaminants to the county's public drainage systems.

EXISTING DRAINAGE CONDITIONS

The Homestead at Sterling Ranch Filing No. 2 site consists of 29.658 acres and is situated west of the Sand Creek Watershed. This area was previously studied in the "Sand Creek Drainage Basin Planning Study" (DBPS) prepared by Kiowa Corporation, revised March 1996. More recently the area was studied in the "Master Development Drainage Report for Sterling Ranch Filing Nos. 1&2, and Final Drainage Report for Sterling Ranch Filing No.1" prepared by MS Civil Consultants, dated April 2017 (henceforth referred to as "Sterling Ranch Filing Nos. 1&2 MDDP").

See the Historic conditions map, the Homestead at Sterling Ranch Filing No. 2 site lies within the Basin EX-4 ($Q_5 = 71$ cfs, $Q_{100} = 352$ cfs) and is a 330 acre area of land located on the western portion of the site, including the Sand Creek channel. A portion of this basin extends off-site to the northwest of Vollmer Road, and at the time this map was created was undeveloped property. Runoff from the basin generally travels from north to south until it reaches the northern boundary of the site, being conveyed in the Sand Creek channel. Homestead at Sterling Ranch Filing No. 2 and the surrounding areas, with the exception of the existing Barbarick Subdivision; have already been graded during the overlot of the subdivision. Please refer to the Sterling Ranch Filing Nos. 1&2 MDDP by MS Civil Consultants for information on existing conditions and overlot drainage patterns. A copy of the historic and existing conditions map has been provided in the appendix.

PROPOSED DRAINAGE CHARACTERISTICS

General Concept Drainage Discussion

The following is a description of the onsite basins, offsite bypass flows and the overall drainage characteristics for the development of Sterling Ranch Filing No. 2. The development of Sterling Ranch Filing No. 2 consists of residential streets and cul-de-sacs, proposed storm drainage improvements, and lots located within the filing boundary. The proposed development results in drainage patterns and flow values that are the same or less than those in the Sterling Ranch Filing Nos. 1&2 MDDP. Surface flow is designated as Design Points (DP). The following DPs and Basins were determined using the Rational Method since this method offers a more conservative approach to drainage. It should be noted that all calculations and drainage basins have been revised to reflect the new criteria updates by the El Paso County/City of Colorado Springs Drainage Criteria Manual. For comparison, the **asterisk (*)** symbol in the detailed drainage discussions below represents each Basin or Design Point as labeled in the Sterling Ranch Filing Nos. 1&2 MDDP. Asterisk symbols on the Proposed Drainage Map in the appendix also represent Basins, Design Points and Pipe Runs as presented in the Sterling Ranch Filing Nos. 1&2 MDDP.

Detailed Drainage Discussion (Design Points)

DP2*, 5.39 acres, consists of Basin B* planned residential lots and streets with runoff coefficients of 0.38 for the 5-year and 0.55 for the 100-year. Developed runoff of $Q_5=8.0$ cfs and $Q_{100}=19.3$ cfs has been calculated for DP2*. The surface runoff is routed via overlot grading and planned swales to two existing 15' CDOT Type R at-grade inlets. The flows are routed east via a 36" RCP to DP5.

DP3*, 2.92 acres, consists of Basin C* residential lots within Homestead at Sterling Ranch Filing No. 1, and streets with runoff coefficients of 0.38 for the 5-year and 0.55 for the 100-year. Developed runoff of $Q_5=4.2$ cfs and $Q_{100}=10.1$ cfs has been calculated for DP3*. The surface runoff is routed via overlot grading and proposed swales to an existing 5' CDOT type R sump inlet. The flows captured by the inlet are routed to existing Detention Pond 4.

DP4*, 9.36 acres, consists of Basin D* and Basin E* residential lots within Homestead at Sterling Ranch Filing No. 1 and streets with runoff coefficients of 0.38 for the 5-year and 0.55 for the 100-year and Basin F* (Dines Boulevard) with runoff coefficients of 0.90 for the 5-year and 0.96 for the 100-year. Developed runoff of Q5=16.1 cfs and Q100=36.7 cfs has been calculated for DP4. The surface runoff is routed via overlot grading and curb and gutter to DP4* which will be collected by a 15' CDOT type R at-grade inlet. The intercepted flow (Q5=13.3 cfs and Q100=20.0 cfs) will combine with flows from DP3* and be routed east via a 30" RCP (PR6*, Q5=16.8 cfs and Q100=29.4 cfs) to existing Detention Pond 4.

DP5*, 0.80 acres, consists of Basin G* residential lots with runoff coefficients of 0.22 for the 5-year and 0.46 for the 100-year, Basin H* existing Dines Boulevard, with runoff coefficients of 0.90 for the 5-year and 0.96 for the 100-year and flowby from Sterling Ranch Filing Nos. 1&2 MDDP DP4*. Developed runoff of Q5=4.2 and Q100=19.7 cfs has been calculated for DP5*. The surface runoff is routed via overlot grading and curb and gutter to DP5* which is collected by an existing 15' CDOT type R at-grade inlet. DP5* has an intercepted flow of (Q5=4.2 cfs and Q100=14.7 cfs) and of flowby of (Q5=0.0 cfs and Q100=5.0 cfs). Flowby from DP5* continues on to Pond FSD13, east of Dines Boulevard. See, Sterling Ranch Filing MDDP Proposed Hydrologic Conditions Map.

DP6*, 4.68 acres, consists of Sterling Ranch Filing Nos. 1&2 MDDP Basins J* and K* planned residential lots with runoff coefficients of 0.22 for the 5-year and 0.46 for the 100-year, Sterling Ranch Filing Nos. 1&2 MDDP Basin I* (Wheatland Drive) and Basin L* (Dines Boulevard) with runoff coefficients of 0.90 for the 5-year and 0.96 for the 100-year. Developed runoff of Q5=14.1 cfs and Q100=26.7cfs has been calculated for DP6*. The surface runoff is routed via overlot grading and curb and gutter to DP6* which is collected by an existing 15' CDOT type R at-grade inlet. DP6* has an intercepted flow of (Q5=12.1 cfs and Q100=17.2 cfs) and of flowby of (Q5=2.0 cfs and Q100=9.5 cfs). Flowby from DP6* continues on to Pond FSD13, east of Dines Boulevard. See, Sterling Ranch Filing MDDP Proposed Hydrologic Conditions Map.

DP7, 4.42 acres, consists of Basin P proposed residential lots with runoff coefficients of 0.38 for the 5-year and 0.55 for the 100-year. Developed runoff of Q5=5.7 and Q100=13.8 cfs has been calculated for DP7. Surface runoff is routed via overlot grading and curb and gutter to DP7 which is collected by a proposed 10' CDOT type R sump inlet. Flows captured by the proposed 10' CDOT type R sump inlet are routed to existing Detention Pond 4 by proposed RCP storm sewer. The flows from DP7 were anticipated in the sizing of Pond 4 per the Sterling Ranch Filing No. 1 Final Drainage Report.

DP8, 3.78, acres, consists of Basin Q proposed residential lots with runoff coefficients of 0.38 for the 5-year and 0.55 for the 100-year. Developed runoff of Q5=4.9 and Q100=11.8 cfs has been calculated for DP8. Surface runoff is routed via overlot grading and curb and gutter to DP8 which is collected by a proposed 10' CDOT type R sump inlet. Flows captured by the proposed 10' CDOT type R sump inlet are routed to existing Detention Pond 4 by proposed RCP storm sewer. The flows from DP8 were anticipated in the sizing of Pond 4 per the Sterling Ranch Filing No. 1 Final Drainage Report.

DP9, acres, consists of Basin R proposed residential lots with runoff coefficients of 0.38 for the 5-year and 0.55 for the 100-year. Developed runoff of Q5=2.2 and Q100=5.4 cfs has been calculated for DP9. Surface runoff is routed via overlot grading and curb and gutter to DP9 which is collected by a proposed 5' CDOT type R sump inlet. Flows captured by the proposed 10' CDOT type R sump inlet combine with captured flows contributed from Design Points 7 & 8 and are routed to existing Detention Pond 4 by Pipe Run 4 (Q5=12.4 and Q100=30.1 cfs). Pipe Run 4 connects to existing Sterling Ranch Filing Nos. 1&2 MDDP Pipe Run 10* (Q5=12.5 and Q100=30.4 cfs) and is discharged into the forebay of existing Detention Pond 4. Flows contributed to the forebay of existing Pond 4 are approximately equal to those anticipated by the MDDP, therefore Pond 4 has the capacity for SWQ and Full Spectrum Detention for these flows.

DP10, 9.14 , acres, consists of Basin T proposed residential lots with runoff coefficients of 0.30 for the 5-year and 0.50 for the 100-year. Developed runoff of Q5=9.4 and Q100=15.6 cfs has been calculated for DP10. Surface runoff is routed via overlot grading and curb and gutter to DP10 which is collected by a

proposed 15' CDOT type R at-grade inlet. DP10 has an intercepted flow of (Q5=9.1 cfs and Q100=12.7 cfs) and of flowby of (Q5=0.3 cfs and Q100=2.9 cfs). Flows captured by the proposed 15' CDOT type R at-grade inlet are routed southwest to the proposed full spectrum detention Pond 1 by proposed RCP storm sewer.

DP11, 1.48 , acres, consists of Basin V1 proposed residential lots with runoff coefficients of 0.38 for the 5-year and 0.55 for the 100-year. Developed runoff of Q5=1.9 and Q100=15.6 cfs has been calculated for DP11. Surface runoff is routed via overlot grading and curb and gutter to DP11 which is collected by a proposed 15' CDOT type R at-grade inlet. DP11 has an intercepted flow of (Q5=1.9 cfs and Q100=12.7 cfs) and of flowby of (Q5=0.0 cfs and Q100=2.9 cfs). Flows captured by the proposed 15' CDOT type R at-grade inlet are routed southwest to the proposed full spectrum detention Pond 1 by proposed RCP storm sewer.

DP12, 4.50, acres, consists of Basin U proposed residential lots with runoff coefficients of 0.38 for the 5-year and 0.55 for the 100-year and flowby from DP10. Developed runoff of Q5=6.2 cfs and Q100=17.2 cfs has been calculated for DP12. Surface runoff is routed via overlot grading and curb and gutter to DP12 which is collected by a proposed 10' CDOT type R sump inlet. Flows captured by the proposed 10' CDOT type R sump inlet are routed to the proposed full spectrum detention Pond 1 by proposed RCP storm sewer.

DP13, 0.83, acres, consists of Basin V2 proposed residential lots with runoff coefficients of 0.38 for the 5-year and 0.55 for the 100-year and flowby from DP11. Developed runoff of Q5=1.2 and Q100=5.9 cfs has been calculated for DP13. Surface runoff is routed via overlot grading and curb and gutter to DP13 which is collected by a proposed modified 5' length by 4.5' wide CDOT type R sump inlet.

DP14, 0.56, acres, consists of Basin W3 proposed full spectrum detention Pond 1 with runoff coefficients of 0.08 for the 5-year and 0.35 for the 100-year and contributed flow from pipe run 9. Developed runoff of Q5=19.6 cfs and Q100=52.4 cfs has been calculated for DP14. All flows captured by inlets at Design Points DP10, DP11, DP12 and DP13 are routed by Pipe Run 9 (PR9, Q5=17.9 and Q100=47.1 cfs) to the forebay in Pond 1 and combine with surface runoff within Basin W1. An outlet structure with an orifice plate and restrictor plate regulates release rates and provides treatment to all flows tributary to DP14. See the Water Quality Provisions discussion in this report for more information on Pond 1.

Basins labeled on the Proposed Drainage Map marked with a "*", were previously analyzed and shown in the Final Drainage report for Sterling Ranch Filing No. 1. These basins are; B*, C*, D*, E*, F*, G*, H*, I*, L*, &S*. They are shown on the Proposed Drainage Map for continuity. Basins K & J additionally contribute to Design Points 3, 4, 5 &6. Therefore, the inlets sizing at these design points has been verified.

Detailed Drainage Discussion (Drainage Basins)

Basins X1, X2, W1, and Y1 (0.78, 1.04, 0.86 and 0.084 acres respectively), consists of proposed residential backyard lots located along the eastern boundary of the site with runoff coefficients of 0.22 for the 5-year and 0.46 for the 100-year. Developed runoff of (Q5=0.8, 1.1, 0.2, and 0.8 cfs and Q100=2.8, 3.7, 1.7, and 3.0 cfs respectively has been calculated for the basins. Runoff produced within the residential backyard lots, of Basins X1, X2, W1 and Y1 will be conveyed in backyard swales and as sheet flow to a Sand Filter Basin within each lot. The treated flows will be collected by private storm sewer systems and discharged into the Sand Creek Channel. A 20' wide typical drainage easement is provided within the lots to accommodate the BMP's. The facilities constructed are to be privately maintained by the Sterling Ranch metro district.

Basins X, W2, and Y (0.22, 0.26, and 0.09 acres respectively), consists primarily of vegetated tracts and portion of residential backyards that will discharge as sheet flow to the Sand Creek Channel. The developed flow rates from Basins X, W2, and Y are Q5=0.2, 0.1, 0.1 cfs and Q100=0.8, 0.8, and 0.3

respectively. The total combined developed area being discharge to the channel is less than one acre. It is not practicable to provide WQCV for these areas, as stated earlier in this paragraph, areas consists primarily of vegetated tracts with no development.

CHANNEL IMPROVEMENTS

Slope grading and intermittent channel bank lining has been proposed for portions of the developable areas adjacent to Sand Creek to protect the developed lots and prevent excessive erosion until the DBPS recommended Sand Creek Channel improvements are installed. The proposed slope grading is intended to reduce outer bank grades and bring uniformity to areas where significant riling and destabilization has occurred. Proposed channel stabilization improvements includes placement of soil riprap and turf reinforcement matting along embankment toes and along embankment slopes, both of which will function to retain soils and vegetation during heavy rains or larger flood flow events. All disturbed areas, not hardscaped will be re-vegetated with native species grasses, per El Paso County erosion control standards. Storm sewer outfalls into Sand Creek shall be protected by low-tailwater riprap basins. The outfall protection is shown on the accompanying drainage map in the appendix. Refer to the Homestead Filing No.2 Grading and Erosion Control Plans for riprap and turf reinforcement map placement and construction details.

Permanently installed check structures and rip-rap channel lining will be installed within Sand Creek Channel to handle the runoff from fully developed Sterling Ranch and up-gradient watershed in accordance with the Sand Creek DBPS. A discussion regarding the timing of these channel improvements is provided in a subsequent paragraph titled Sterling Ranch Filing No. 1 Subdivision Improvement agreement which follows the Construction Costs segment of this report. Financial Assurance shall be posted for the proposed Sand Creek Channel Improvements and Bank Stabilization (Slope Protection and grade control structures).

WATER QUALITY PROVISIONS

The proposed Full Spectrum Detention Facility, Pond 1 functions to provide detention storage and water quality facility for runoff produced onsite from tributary Basins T, U, V1, V2 and W3. This water quality facility is designed to treat 0.245 ac-ft of water quality storage (WQCV), 0.741 ac-feet of excess urban runoff volume (EURV) and 1.331 ac-ft of 100-year storage. A rolled erosion control blanketed emergency spillway, concrete forebay, trickle channel and outlet structure, and gravel maintenance access road has been designed for Pond 1.

A 24" RCP pipe extending from the proposed modified 6'x2.9' CDOT Type D sump inlet (see Design Point 13) will convey discharge from the pond to Sand Creek. Runoff discharged to Sand Creek is anticipated to reach peak flow rates of $Q_5=0.7$ cfs and $Q_{100}=23.4$ cfs. A soil riprap stilling basin has been provided at the termination of the pipe to arrest erosion.

Runoff produced within the residential backyard lots, of Basins X1, X2, W1 and Y1 will be conveyed in backyard swales and as sheet flow to a Sand Filter Basin within each lot. The treated flows will be collected by private storm sewer systems and discharged into the Sand Creek Channel. This water quality facility, for each Sand Filter Basin, is designed to treat 0.001 ac-ft of water quality storage (WQCV), 0.005 ac-feet of excess urban runoff volume (EURV) and 0.014 ac-ft of 100-year storage. A 20' wide typical drainage easement is provided within the lots to accommodate the BMP's. The facilities constructed are to be privately maintained by the Sterling Ranch metro district.

The WQCV and EURV required for the site has been determined using the guidelines set forth in the City of Colorado Springs/El Paso County Drainage Criteria Manual - Volume II. Refer to the water quality

facility sizing calculations located within the appendix of this report (see UD-Detention Worksheet in appendix).

As previously discussed, refer to Sterling Ranch Filing Nos. 1&2 MDDP for additional information regarding existing FSD Pond 4.

please indicate here when FSD Pond 4 will be (is) constructed, as part of this filing or already built?

EROSION CONTROL

It is the policy of the El Paso County that a grading and erosion control plan be submitted with the drainage report. EPC approved “Early Grading Plan for Sterling Ranch Phase I Onsite Grading & Erosion Control”, November 18, 2015. And “Early Grading Plan for Sterling Ranch Phase I Offsite Grading & Erosion Control”, December 3, 2015. Grading and Erosion control operations are currently underway (July 2019). Grading and Erosion Control will cease with the final development of the site in the next 6-12 months.

CONSTRUCTION COST OPINION – HOMESTEAD AT STERLING RANCH FIL. NO. 2

Drainage Facilities:

Drainage improvements are planned with the development of Homestead at Sterling Ranch Filing No. 2. A majority of the construction costs have been accounted for in the “Master Development Drainage Report for Sterling Ranch Filing Nos. 1&2, and Final Drainage Report for Sterling Ranch Filing No.1” prepared by MS Civil Consultants, dated April 2017. Any additional improvements and costs are listed below.

The following list of drainage improvements are **Non-Reimbursable**. The Reimbursable facilities are outlined in the Sterling Ranch Filing No. 1 Final Drainage Report and Sterling Ranch MDDP. Refer to the MDDP for Sterling Ranch Cost and Fee Analysis Report (February 2019).

Item	Description	Quantity	Unit Cost	Cost
1.	18" RCP	31 LF	\$40 /LF	\$1,240.00
2.	24" RCP	127 LF	\$50 /LF	\$6,350.00
3.	30" RCP	998 LF	\$85 /LF	\$84,830.00
4.	36" RCP	8 LF	\$105 /LF	\$840.00
5.	42" RCP	699 LF	\$185 /LF	\$129,315.00
6.	24" FES	1 EA	\$750 /EA	\$750.00
8.	42" FES	1 EA	\$1,250 /EA	\$1,250.00
9.	5.0'x4.5' CDOT Type R Sump Inlet	1 EA	\$4,000 /EA	\$4,000.00
10.	10' CDOT Type R Sump Inlet	4 EA	\$4,700 /EA	\$18,800.00
11.	15' CDOT Type R At-Grade Inlet	2 EA	\$6,000 /EA	\$12,000.00
12.	4.0' Type II MH	1 EA	\$3,500 /EA	\$3,500.00
13.	5.0' Type II MH	2 EA	\$4,000 /EA	\$8,000.00
14.	6.0' Type II MH	1 EA	\$4,500 /EA	\$4,500.00
17.	5.0'x6.0' MH	2 EA	\$6,500 /EA	\$13,000.00
18.	5.5'x5.5' MH	1 EA	\$6,500 /EA	\$6,500.00
19.	Headwall/Wingwall	1 EA	\$6,000 /EA	\$6,000.00
20.	Full Spectrum Det. Pond 1	1 EA	\$15,000 /EA	\$15,000.00
21.	FSD Pond 1 Outlet Structure	1 EA	\$12,600 /EA	\$12,600.00

22.	Ind. Lot Sand Filter Basins w/6" Pipe	26	EA	\$2,000	/EA	\$52,000.00
23	18" Drain Basin Manholes w/Lids	27	EA	\$1,000	/EA	27,000.00
24	12" ADS Pipe	1,658		\$26	/LF	43,108.00
Total \$						\$450,583.00

The following list of drainage improvements are **Reimbursable** for the improvements to the Sand Creek Channel adjacent to Homestead at Sterling Ranch Filing No.2.

Sand Creek Channel Improvements

Item	Description	Quantity	Unit Cost	Cost
1.	Rip Rap Protection	1,100 Ton	\$80 /Ton	\$88,000.00
2.	Drop/Check Structures	5 EA	\$50,000 /EA	\$250,000.00
3.	Slope Stabilization Blankets	5,698 SY	\$6 /SY	\$34,188.00
Total				\$372,188.00

DRAINAGE & BRIDGE FEES – HOMESTEAD AT STERLING RANCH FIL. NO. 2

This site is within the Sand Creek Drainage Basin. The 2019 Drainage and Bridge Fees per El Paso County for the HOMESTEAD AT STERLING RANCH FILING NO. 2 site are as follows:

Per Homestead at Sterling Ranch Filing No. 2 Plat – **Total Area 29.658 Acres**

HOMESTEAD AT STERLING RANCH FILING NO. 2 FEES:

Drainage Fees:	29.658	x	46%	\$	18,940.00	=	\$	258,392.36
Bridge Fees:	29.658	x	46%	\$	5,559.00	=	\$	75,839.66
Total								\$ 334,232.02

STERLING RANCH FILING NO. 1 - SUBDIVISION IMPROVEMENTS AGREEMENT

Sterling Ranch Filing No. 1 final plat and SIA has been recorded, and addressed the following drainage improvements Not located/and located in the Sand Creek Channel. The following SIA paragraphs outlined drainage for Sterling Ranch in the following manner;

*2. **Drainage and Landscaping Tracts:** Improvements on Tracts A, B, F, H, I, J, L, M, N, O, P, Q, R, S, T, U, V, W, X, Y, Z, AA and CC as identified on the final plat of Filing No. 1 will be completed to the satisfaction of the County and District and, upon said completion, the improvements will be dedicated to and accepted by the District. Improvements on Tract D (Sand Creek) will be completed to the satisfaction of the County and upon said completion; the improvements will be dedicated to and accepted by the County. The ownership and maintenance of storm drain facilities and structures not located on the foregoing tracts shall be determined as follows. All storm pipes shall be owned and maintained by the District except where located in County road rights of way (see Paragraph 5 below), in which case the County shall own and maintain the storm drain facilities and structures, including but not limited to, inlets and manholes. A typical cross section describing the ownership and maintenance responsibilities of drainage improvements within County rights of way is attached as Exhibit C hereto.*

7. *Timing of Construction and Acceptance:*

*a. **Drainage Improvements Not Located in Sand Creek Channel:** Except as set forth below in subsection 6.b. (drainage improvements located in Sand Creek Channel), all drainage improvements described in Exhibit A and constructed within the Drainage and Landscaping Tracts identified in paragraph 2 above shall be completed by the Subdivider and District, meeting all applicable standards for preliminary acceptance, prior to the recording of the first replat of Tracts C, E, G, K or BB. In the event that a portion of the drainage improvements are not completed*

prior to the recording of the first replat, then prior to such recording collateral sufficient in the opinion of the County to assure completion of the improvements must be posted by the Subdivider and a deadline by which such drainage improvements shall be completed shall be established by written agreement.

b. **Drainage Improvements Located in Sand Creek Channel (Tract D):** The District agrees that it will construct or cause the construction of all drainage improvements to be located in Tract D as well as future tracts within Sterling Ranch containing the Sand Creek Channel in accordance with the following:

- i. Bank stabilization of the Sand Creek channel shall be required prior to any replats or other final plats adjacent to the channel. The design and installation of said improvements shall be accomplished and guaranteed through the normal subdivision review and collateralization process.
- ii. Other drainage improvements in Tract D and future tracts containing the Sand Creek Channel, such as drop structures, check structures and similar stabilization or protection improvements, will be designed and constructed by the District with the final construction drawings to be approved by the County no later than the final platting of the 700th single family lot within the boundaries of the approved Sterling Ranch Sketch Plan and the completion of all said improvements no later than the 800th single family lot with the boundaries of the approved Sterling Ranch Sketch Plan.
- iii. In order to assure completion of the drainage improvements required in Subsection 6.b.ii above as well as a fair apportionment of the costs of said drainage improvements amongst adjacent Sterling Ranch subdividers, the District agrees to establish a Sand Creek Channel Drainage Fee to be paid into a District Escrow Fund by adjacent subdividers at the time of final platting. The amount of the fee shall be a minimum of One Thousand Dollars (\$1,000.00) per single family lot. The details of the proposed Sand Creek Channel Drainage Fee and the District Escrow Fund shall be agreed to by the parties in advance of the submittal of the first replat of or subdivision of the Master Pad Sites or other property located within Sterling Ranch.

A full copy of the recorded SIA is located in the files of El Paso County and EPC Clerk and Records office under Reception No. 218714151

SUMMARY

Development of this site will not adversely affect the surrounding development per this final drainage report with no negative impacts to the neighboring developments. The existing and proposed drainage facilities will adequately convey, detain and route runoff from tributary and onsite flows to the Sand Creek Drainage channel. Full Spectrum Detention and Water Quality Ponds will be used to discharge developed flows into Sand Creek per the Urban Drainage criteria flow rates, which are at or less than the historic flow. Care will be taken during construction to accommodate overland flow routes onsite and temporary drainage conditions. The development of the HOMESTEAD AT STERLING RANCH FILING NO. 2 project(s) shall not adversely affect adjacent or downstream property.



REFERENCES

- 1.) "El Paso County and City of Colorado Springs Drainage Criteria Manual, Vol I & II".
- 2.) "Urban Storm Drainage Criteria Manuals, Volumes 1-3"
- 3.) NRSC Web Soil Survey Map for El Paso County. <http://websoilsurvey.nrcs.usda.gov>
- 4.) Flood Insurance Rate Map (FIRM), Federal Emergency Management Agency, Effective date July 23, 2009. 12/7/2018
- 5.) "Sand Creek Drainage Basin Planning Study" (DBPS) prepared by Kiowa Corporation, revised March 1996
- 6.) "Sterling Ranch-Phase 1 Offsite Grading, Early Grading & Erosion Control Plans", prepared by M&S Civil Consultants, Inc., dated November 2015
- 7.) "Sterling Ranch-Phase 1 Onsite Grading, Early Grading & Erosion Control Plans", prepared by M&S Civil Consultants, Inc., dated November 2015
- 8.) "Master Development Drainage Report for Sterling Ranch Filing Nos. 1&2 and Final Drainage Report for Sterling Ranch Filing No. 1", prepared by M&S Civil Consultants, Inc., dated April 2017
- 9.) "Sterling Ranch Filing Nos. 1&2 MDDP" prepared by MS Civil Consultants, Inc., dated October 2018.

APPENDIX

VICINITY MAP

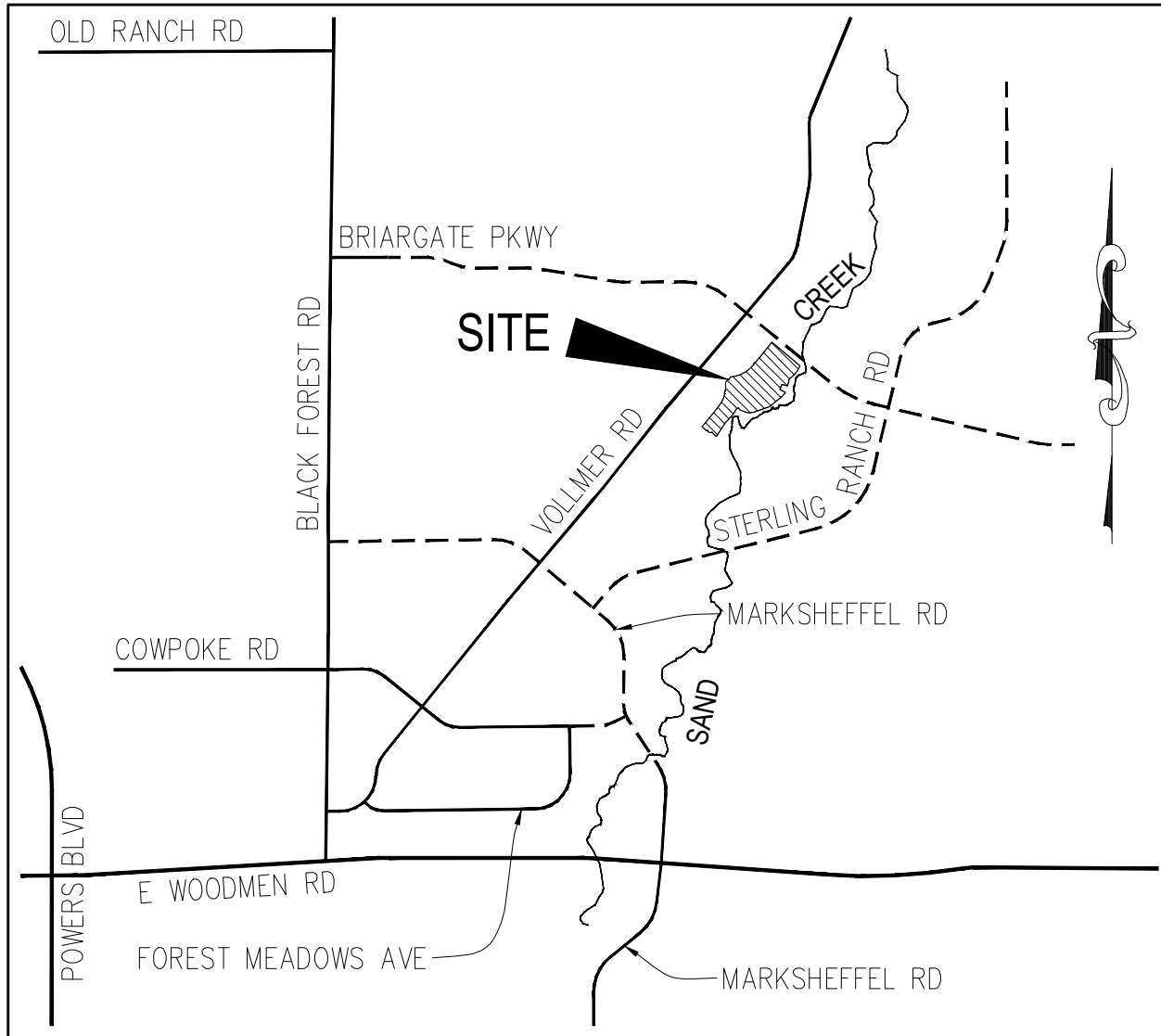

VICINITY MAP

N.T.S.

SOILS MAP



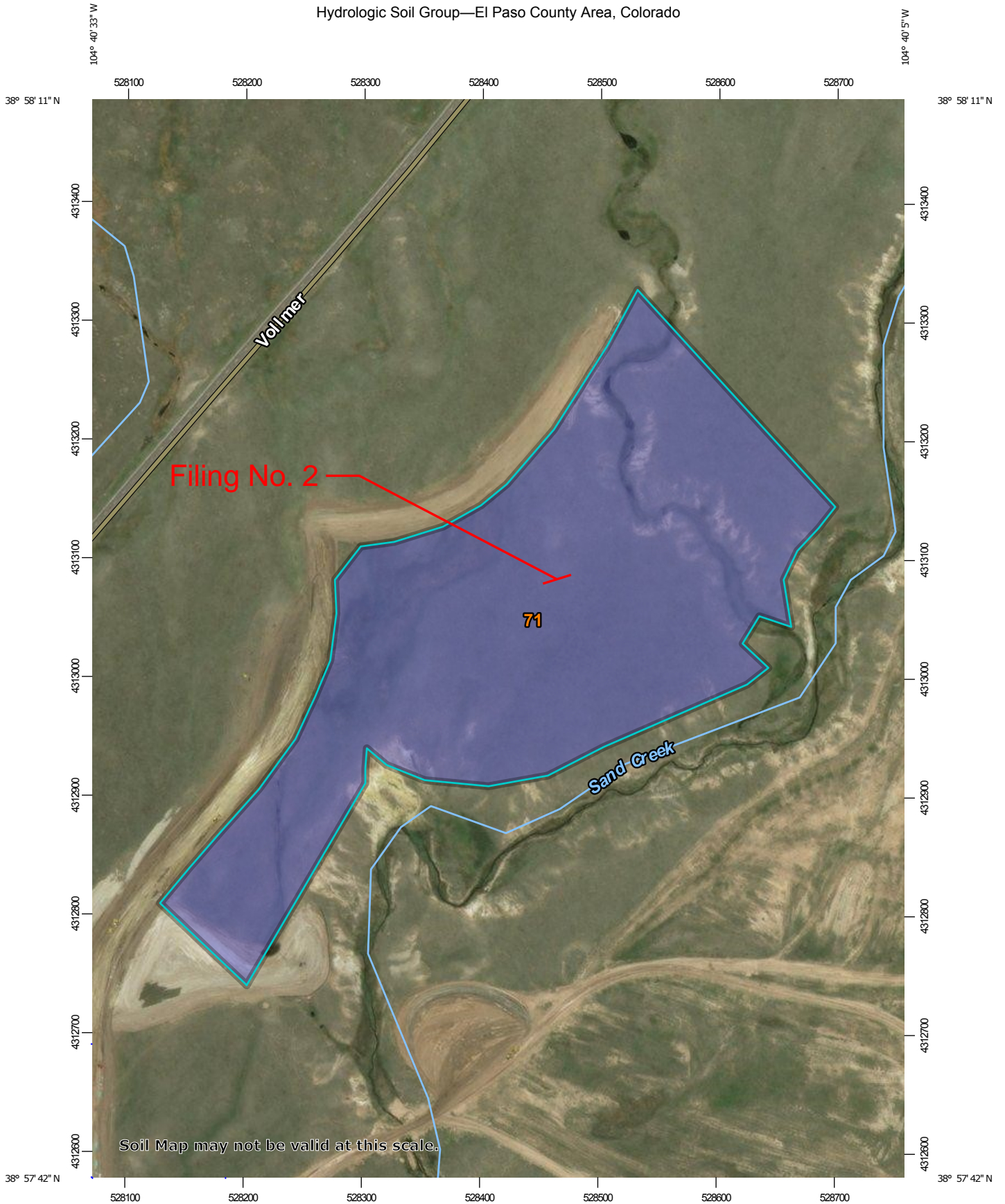



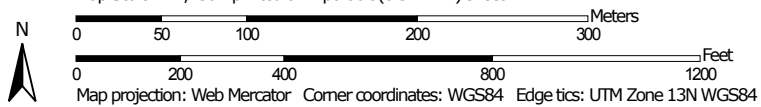

























Hydrologic Soil Group—El Paso County Area, Colorado



Map Scale: 1:4,430 if printed on A portrait (8.5" x 11") sheet.



MAP LEGEND

- Area of Interest (AOI)**
 -  Area of Interest (AOI)
- Soils**
 - Soil Rating Polygons**
 -  A
 -  A/D
 -  B
 -  B/D
 -  C
 -  C/D
 -  D
 -  Not rated or not available
 - Soil Rating Lines**
 -  A
 -  A/D
 -  B
 -  B/D
 -  C
 -  C/D
 -  D
 -  Not rated or not available
 - Soil Rating Points**
 -  A
 -  A/D
 -  B
 -  B/D
- Water Features**
 -  Streams and Canals
- Transportation**
 -  Rails
 -  Interstate Highways
 -  US Routes
 -  Major Roads
 -  Local Roads
- Background**
 -  Aerial Photography
- Other**
 -  C
 -  C/D
 -  D
 -  Not rated or not available

MAP INFORMATION

The soil surveys that comprise your AOI were mapped at 1:24,000.

Warning: Soil Map may not be valid at this scale.
 Enlargement of maps beyond the scale of mapping can cause misunderstanding of the detail of mapping and accuracy of soil line placement. The maps do not show the small areas of contrasting soils that could have been shown at a more detailed scale.

Please rely on the bar scale on each map sheet for map measurements.

Source of Map: Natural Resources Conservation Service
 Web Soil Survey URL:
 Coordinate System: Web Mercator (EPSG:3857)

Maps from the Web Soil Survey are based on the Web Mercator projection, which preserves direction and shape but distorts distance and area. A projection that preserves area, such as the Albers equal-area conic projection, should be used if more accurate calculations of distance or area are required.

This product is generated from the USDA-NRCS certified data as of the version date(s) listed below.

Soil Survey Area: El Paso County Area, Colorado
 Survey Area Data: Version 15, Oct 10, 2017

Soil map units are labeled (as space allows) for map scales 1:50,000 or larger.

Date(s) aerial images were photographed: May 22, 2016—Mar 9, 2017

The orthophoto or other base map on which the soil lines were compiled and digitized probably differs from the background imagery displayed on these maps. As a result, some minor shifting of map unit boundaries may be evident.

Hydrologic Soil Group

Map unit symbol	Map unit name	Rating	Acres in AOI	Percent of AOI
71	Pring coarse sandy loam, 3 to 8 percent slopes	B	29.0	100.0%
Totals for Area of Interest			29.0	100.0%

Description

Hydrologic soil groups are based on estimates of runoff potential. Soils are assigned to one of four groups according to the rate of water infiltration when the soils are not protected by vegetation, are thoroughly wet, and receive precipitation from long-duration storms.

The soils in the United States are assigned to four groups (A, B, C, and D) and three dual classes (A/D, B/D, and C/D). The groups are defined as follows:

Group A. Soils having a high infiltration rate (low runoff potential) when thoroughly wet. These consist mainly of deep, well drained to excessively drained sands or gravelly sands. These soils have a high rate of water transmission.

Group B. Soils having a moderate infiltration rate when thoroughly wet. These consist chiefly of moderately deep or deep, moderately well drained or well drained soils that have moderately fine texture to moderately coarse texture. These soils have a moderate rate of water transmission.

Group C. Soils having a slow infiltration rate when thoroughly wet. These consist chiefly of soils having a layer that impedes the downward movement of water or soils of moderately fine texture or fine texture. These soils have a slow rate of water transmission.

Group D. Soils having a very slow infiltration rate (high runoff potential) when thoroughly wet. These consist chiefly of clays that have a high shrink-swell potential, soils that have a high water table, soils that have a claypan or clay layer at or near the surface, and soils that are shallow over nearly impervious material. These soils have a very slow rate of water transmission.

If a soil is assigned to a dual hydrologic group (A/D, B/D, or C/D), the first letter is for drained areas and the second is for undrained areas. Only the soils that in their natural condition are in group D are assigned to dual classes.

Rating Options

Aggregation Method: Dominant Condition

Component Percent Cutoff: None Specified

Tie-break Rule: Higher

FIRM PANEL W/ REVISED LOMR

EL PASO COUNTY
UNINCORPORATED AREAS
080059

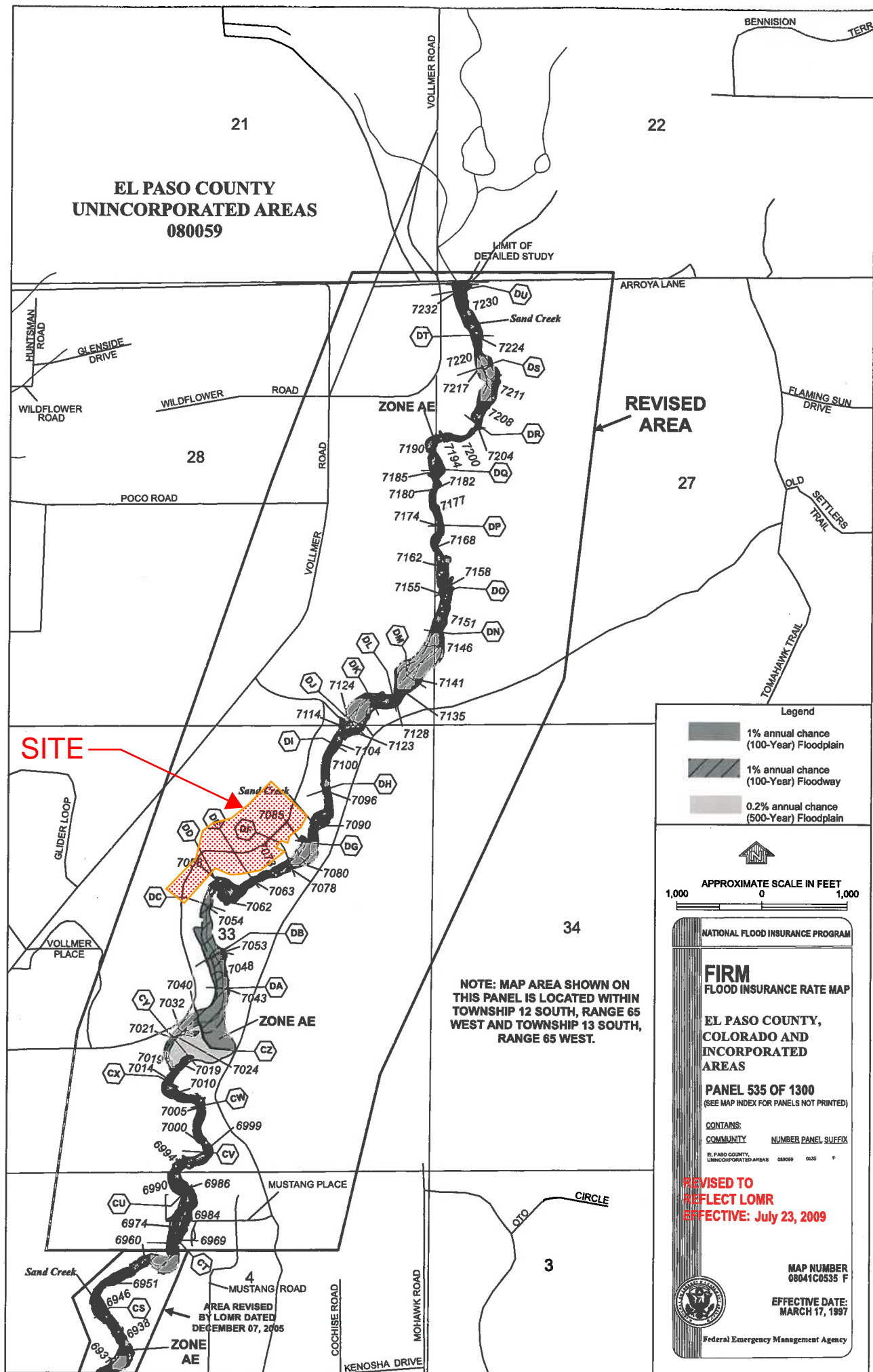

NOTE: MAP AREA SHOWN ON THIS PANEL IS LOCATED WITHIN TOWNSHIP 12 SOUTH, RANGE 65 WEST AND TOWNSHIP 13 SOUTH, RANGE 65 WEST.

AREA REVISED BY LOMR DATED DECEMBER 07, 2005

National Flood Hazard Layer FIRMette



38°58'7.45"N



0 250 500 1,000 1,500 2,000 Feet 1:6,000

USGS The National Map: Orthoimagery. Data refreshed October, 2017.

38°57'39.48"N

Legend

SEE FIS REPORT FOR DETAILED LEGEND AND INDEX MAP FOR FIRM PANEL LAYOUT

SPECIAL FLOOD HAZARD AREAS		Without Base Flood Elevation (BFE) Zone A, V, A99
		With BFE or Depth Zone AE, AO, AH, VE, AR
		Regulatory Floodway
OTHER AREAS OF FLOOD HAZARD		0.2% Annual Chance Flood Hazard, Areas of 1% annual chance flood with average depth less than one foot or with drainage areas of less than one square mile Zone X
		Future Conditions 1% Annual Chance Flood Hazard Zone X
		Area with Reduced Flood Risk due to Levee. See Notes. Zone X
		Area with Flood Risk due to Levee Zone D
OTHER AREAS		NO SCREEN Area of Minimal Flood Hazard Zone X
		Effective LOMRs
GENERAL STRUCTURES		Area of Undetermined Flood Hazard Zone D
		Channel, Culvert, or Storm Sewer
OTHER FEATURES		Levee, Dike, or Floodwall
		20.2 Cross Sections with 1% Annual Chance Water Surface Elevation
MAP PANELS		17.5 Coastal Transect
		Base Flood Elevation Line (BFE)
		Limit of Study
		Jurisdiction Boundary
		Coastal Transect Baseline
		Profile Baseline
		Hydrographic Feature
		Digital Data Available
		No Digital Data Available
		Unmapped



The pin displayed on the map is an approximate point selected by the user and does not represent an authoritative property location.

This map complies with FEMA's standards for the use of digital flood maps if it is not void as described below. The basemap shown complies with FEMA's basemap accuracy standards

The flood hazard information is derived directly from the authoritative NFHL web services provided by FEMA. This map was exported on 1/23/2019 at 7:09:44 PM and does not reflect changes or amendments subsequent to this date and time. The NFHL and effective information may change or become superseded by new data over time.

This map image is void if the one or more of the following map elements do not appear: basemap imagery, flood zone labels, legend, scale bar, map creation date, community identifiers, FIRM panel number, and FIRM effective date. Map images for unmapped and unmodernized areas cannot be used for regulatory purposes.



104°39'57.74"W

104°40'35.20"W

Questions concerning the VERTCON process may be mailed to [NGS](#)

Latitude: 38.964784

Longitude: 104.67180

NGVD 29 height:

Datum shift (NAVD 88 minus NGVD 29): 1.196 meter

1.196 meters = 3.92 feet

NAVD88 - 3.92 feet = NGVD29

STORM 4 Outfall to Sand Creek Channel

Cross Section DE = 7071.8 NAVD88

7071.8 NAVD88 - 3.92 feet = 7067.88 NGVD29

HYDROLOGIC CALCULATIONS

HOMESTEAD AT STERLING RANCH FILING NO. 2

FINAL DRAINAGE REPORT

(Area Drainage Summary)

<i>From Area Runoff Coefficient Summary</i>				OVERLAND				STREET / CHANNEL FLOW				Time of Travel (T_t)		INTENSITY **		TOTAL FLOWS	
BASIN	AREA TOTAL (Acres)	C ₅	C ₁₀₀	C ₅	Length (ft)	Height (ft)	T _C (min)	Length (ft)	Slope (%)	Velocity (fps)	T _t (min)	TOTAL (min)	CHECK (min)	I ₅ (in/hr)	I ₁₀₀ (in/hr)	Q ₅ (c.f.s.)	Q ₁₀₀ (c.f.s.)
		<small>From DCM Table 5-1</small>															
Proposed Area Drainage Summary																	
ONSITE BASINS																	
J	0.43	0.22	0.46	0.22	90	1.8	12.0	0	2.0%	3.0	0.0	12.0	10.5	4.1	6.8	0.4	1.3
K	0.61	0.22	0.46	0.22	75	1.5	10.9	0	2.0%	3.0	0.0	10.9	10.4	4.1	6.8	0.5	1.9
P	4.42	0.38	0.55	0.38	100	2	10.3	1100	2.5%	3.0	6.0	16.4	16.7	3.4	5.7	5.7	13.8
Q	3.78	0.38	0.55	0.38	100	2	10.3	1100	2.5%	3.0	6.0	16.4	16.7	3.4	5.7	4.9	11.8
R	1.57	0.38	0.55	0.38	100	2	10.3	450	1.6%	3.0	2.5	12.8	13.1	3.8	6.3	2.2	5.4
T	9.14	0.30	0.50	0.30	100	2	11.5	942	2.1%	3.0	5.2	16.7	15.8	3.4	5.8	9.4	26.4
U	4.50	0.38	0.55	0.38	100	2	10.3	457	1.5%	3.0	2.5	12.9	13.1	3.8	6.3	6.4	15.6
VI	1.48	0.38	0.55	0.38	100	2	10.3	600	2.0%	3.0	3.3	13.6	13.9	3.7	6.2	2.1	5.0
V2	0.83	0.38	0.55	0.38	100	2	10.3	360	1.6%	3.0	2.0	12.3	12.6	3.8	6.4	1.2	2.9
W1	0.86	0.22	0.46	0.22	80	6	7.3	0	0.0%	2.3	0.0	7.3	10.4	4.6	7.7	0.9	3.1
W2	0.26	0.08	0.35	0.08	35	8	3.9	0	0.3%	2.3	0.0	5.0	10.2	5.2	8.7	0.1	0.8
W3	0.56	0.08	0.35	0.08	35	8	3.9	160	0.5%	2.3	1.2	5.1	11.1	5.2	8.7	0.2	1.7
X	0.22	0.22	0.46	0.22	80	6	7.3	0	2.5%	2.3	0.0	7.3	10.4	4.6	7.7	0.2	0.8
XI	0.78	0.22	0.46	0.22	80	6	7.3	0	2.5%	2.3	0.0	7.3	10.4	4.6	7.7	0.8	2.8
X2	1.04	0.22	0.46	0.22	80	6	7.3	0	2.5%	2.3	0.0	7.3	10.4	4.6	7.7	1.1	3.7
Y	0.09	0.22	0.46	0.22	80	6	7.3	0	2.5%	2.3	0.0	7.3	10.4	4.6	7.7	0.1	0.3
Y1	0.84	0.22	0.46	0.22	80	6	7.3	0	2.5%	2.3	0.0	7.3	10.4	4.6	7.7	0.8	3.0
Y2	0.21	0.22	0.46	0.22	80	6	7.3	0	2.5%	2.3	0.0	7.3	10.4	4.6	7.7	0.2	0.7
OFFSITE BASINS*																	
B*	5.39	0.38	0.55	0.38	60	1.2	8.0	1381	2.8%	3.0	7.6	16.3	18.0	3.4	5.7	8.0	19.3
C*	2.92	0.38	0.55	0.38	100	1.2	12.2	411	3.0%	3.0	2.3	14.5	12.8	3.8	6.3	4.2	10.1
D*	2.90	0.38	0.55	0.38	100	2	10.3	245	2.1%	3.0	1.3	11.7	11.9	3.9	6.5	4.3	10.4
E*	5.34	0.38	0.55	0.38	100	2	10.3	61	3.3%	3.0	0.3	10.7	10.9	4.0	6.8	8.2	19.9
F*	1.12	0.90	0.96	0.90	10	0.2	0.9	1525	2.8%	3.0	8.4	9.3	18.5	4.2	7.1	4.3	7.7
G*	0.61	0.22	0.46	0.22	100	2	12.6	0	2.2%	3.0	0.0	12.6	10.6	4.0	6.8	0.5	1.9
H*	0.19	0.90	0.96	0.90	10	0.2	0.9	280	2.1%	3.0	1.5	5.0	11.6	5.2	8.7	0.9	1.6
I*	2.10	0.90	0.96	0.90	10	0.2	0.9	1082	2.5%	3.0	5.9	6.9	16.1	4.7	7.9	8.9	15.9
L*	1.54	0.90	0.96	0.90	10	0.2	0.9	1805	2.1%	3.0	9.9	10.8	20.1	4.0	6.7	5.6	10.0
S*	1.97	0.08	0.35	0.08	60	10	5.6	270	0.5%	2.3	2.0	7.6	11.8	4.5	7.6	0.7	5.3

* For detailed information on Desing Points, Basins, Flowby, or Pipe Runs see Sterling Ranch Filing Nos. 1&2 MDDP prepared by MS Civil Consultants, dated April 2017

** Intensity equations assume a minimum travel time of 5 minutes.

Calculated by: ET/CMN
Date: 1/14/2020
Checked by: VAS

HOMESTEAD AT STERLING RANCH FILING NO. 2
FINAL DRAINAGE REPORT
(Basin Routing Summary)

From Area Runoff Coefficient Summary				OVERLAND				PIPE / CHANNEL FLOW				Time of Travel (T _t)	INTENSITY **		TOTAL FLOWS		COMMENTS
DESIGN POINT	CONTRIBUTING BASINS	CA ₅	CA ₁₀₀	C ₅	Length (ft)	Height (ft)	T _C (min)	Length (ft)	Slope (%)	Velocity (fps)	T _t (min)	TOTAL (min)	I ₅ (in/hr)	I ₁₀₀ (in/hr)	Q ₅ (c.f.s.)	Q ₁₀₀ (c.f.s.)	
		PROPOSED DRAINAGE BASIN ROUTING SUMMARY															
2*	B*	2.34	3.39									16.3	3.4	5.7	8.0	19.3	(2) EX. 15' AT-GRADE INLETS
3*	C*	1.11	1.61									12.8	3.8	6.3	4.2	10.1	EX. 6' SUMP INLET
4*	D*, E*, F*	4.14	5.61									11.7	3.9	6.5	16.1	36.7	EX. 15' AT-GRADE INLET
5*	G*, H*, FLOWBY DP4*	1.07	3.02									11.7	3.9	6.5	4.2	19.7	EX. 15' AT-GRADE INLET
6*	I*, J, K, L*	3.50	3.97									10.8	4.0	6.7	14.1	26.7	EX. 15' AT-GRADE INLET
7	P	1.68	2.43									16.4	3.4	5.7	5.7	13.8	PROP. 10' SUMP INLET
8	Q	1.44	2.08									16.4	3.4	5.7	4.9	11.8	PROP. 10' SUMP INLET
9	R	0.60	0.86									12.8	3.8	6.3	2.2	5.4	PROP. 10' SUMP INLET
10	T	2.74	2.69									15.8	3.4	5.8	9.4	15.6	PROP. 15' AT-GRADE INLET Total CA100=3.86 Split Between DP10 & DP11 For Crown Overflow
11	VI	0.56	2.69									15.8	3.4	5.8	1.9	15.6	PROP. 15' AT-GRADE INLET Total CA100=3.86 Split Between DP10 & DP11 For Crown Overflow
12	U, FLOWBY DP10	1.80	2.98									15.8	3.4	5.8	6.2	17.2	PROP. 10' SUMP INLET
13	V2, FLOWBY DP11	0.32	0.96									13.6	3.7	6.2	1.2	5.9	PROP. MODIFIED 5'x4.5' SUMP INLET
14	W3, PR9	5.35	8.52									13.6	3.7	6.2	19.6	52.4	CUMULATIVE DETENTION POND

* For detailed information on Desing Points, Basins, Flowby, or Pipe Runs see Sterling Ranch Filing Nos. 1&2 MDDP prepared by MS Civil Consultants, dated April 2017

** Intensity equations assume a minimum travel time of 5 minutes.

Calculated by: ET/CMN
 Date: 1/14/2020
 Checked by: VAS

HOMESTEAD AT STERLING RANCH FILING NO. 2
DRAINAGE CALCULATIONS
(Storm Sewer Routing Summary)

PIPE RUN	Contributing Pipes/Design Points	Equivalent CA ₅	Equivalent CA ₁₀₀	Maximum T _C	Intensity**		Flow		PIPE SIZE
					I ₅	I ₁₀₀	Q ₅	Q ₁₀₀	
1	DP7	1.68	2.43	16.4	3.4	5.7	5.7	13.8	24" RCP
2	DP8	1.44	2.08	16.4	3.4	5.7	4.9	11.8	18" RCP
3	PR1, PR2	3.12	4.51	16.4	3.4	5.7	10.6	25.7	24" RCP
4	DP9, PR3	3.71	5.37	17.0	3.3	5.6	12.4	30.1	30" RCP
5	DP10	2.64	2.20	15.8	3.4	5.8	9.1	12.7	18" RCP
6	DP11	0.55	2.20	15.8	3.4	5.8	1.9	12.7	18" RCP
7	PR5, PR6	3.19	4.39	16.0	3.4	5.7	10.9	25.3	30" RCP
8	DP12	1.80	2.98	15.8	3.4	5.8	6.2	17.2	24" RCP
9	DP13, PR7, PR8	5.31	8.33	16.6	3.4	5.7	17.9	47.1	42" RCP
10	UD-Detention_v3.07						0.7	23.4	Outlet Structure & 18" CMP
11	Pipe Run continued from MDDP DP15* to Sand Creek. Flow values are that of MDDP Pipe Run 15* (PR15*).						42.1	76.8	42" RCP
12	Lots 36-41						0.0	1.3	12" ADS
13	Lots 28-35						0.0	1.6	12" ADS
14	Lots 19-24						0.0	1.5	12" ADS
15	Lots 13-18						0.0	1.4	12" ADS

* For detailed information on Desing Points, Basins, Flowby, or Pipe Runs see Sterling Ranch Filing Nos. 1&2 MDDP prepared by MS Civil Consultants, dated April 2017

** Intensity equations assume a minimum travel time of 5 minutes.

DP - Design Point
EX - Existing Design Point

FB- Flow By from Design Point
INT- Intercepted Flow from Design Point

Calculated by: CMN
Date: 1/14/2020
Checked by: VAS

HYDRAULIC CALCULATIONS

<i>Weighted Percent Imperviousness of FSD Pond 1</i>				
<i>Contributing Basins</i>	<i>Area (Acres)</i>	<i>C_s</i>	<i>Impervious % (I)</i>	<i>(Acres)*(I)</i>
<i>T</i>	9.14	0.30	40	365.60
<i>U</i>	4.50	0.38	53	238.50
<i>V1</i>	1.48	0.38	53	78.44
<i>V2</i>	0.83	0.38	53	43.99
<i>W1</i>	0.56	0.08	2	1.12
<i>Totals</i>	16.51			727.65
<i>Imperviousness of FSD Pond 1</i>	44.1	%		

DETENTION BASIN STAGE-STORAGE TABLE BUILDER

UD-Detention, Version 3.07 (February 2017)

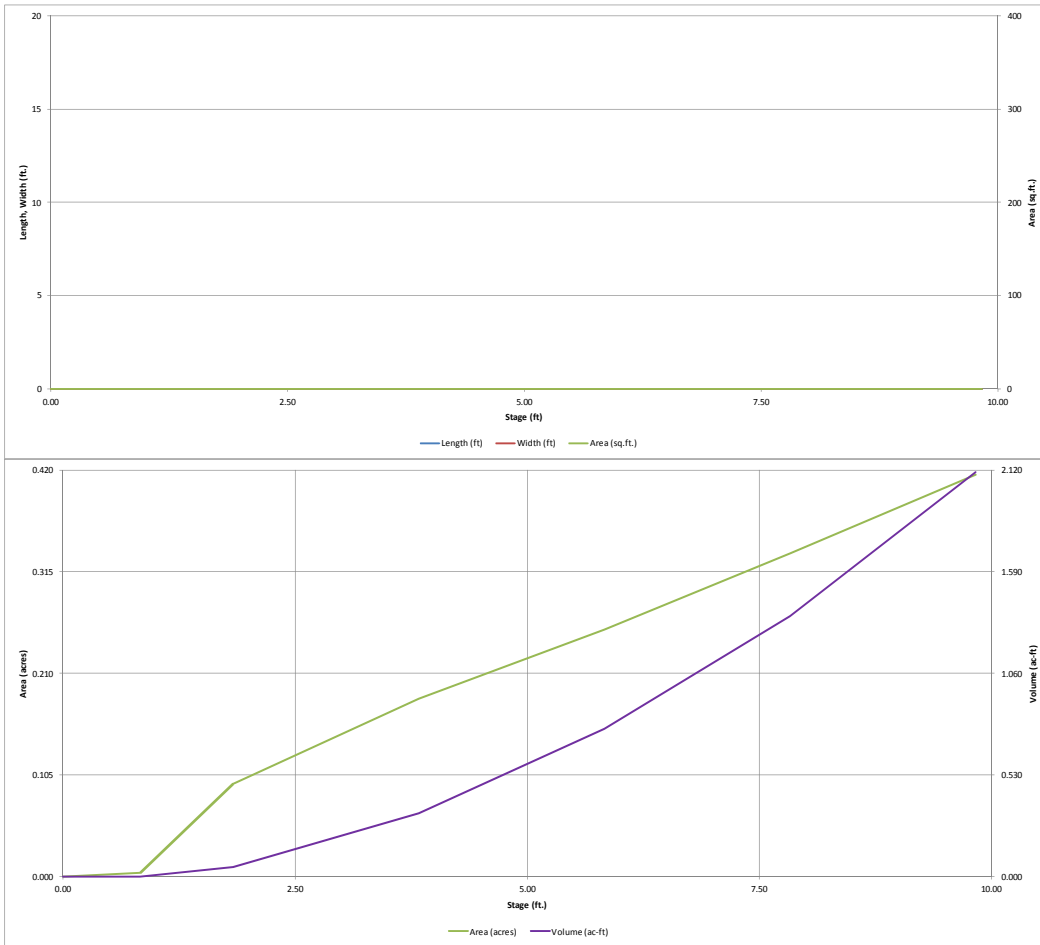

Detention Basin Outlet Structure Design

UD-Detention, Version 3.07 (February 2017)

Project: _____

Basin ID: _____

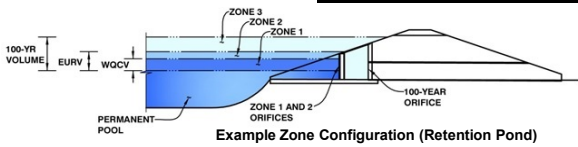

	Stage (ft)	Zone Volume (ac-ft)	Outlet Type
Zone 1 (WQCV)	3.45	0.262	Orifice Plate
Zone 2 (EURV)	5.84	0.508	Orifice Plate
Zone 3 (100-year)	8.00	0.642	Weir&Pipe (Restrict)
		1.412	Total

User Input: Orifice at Underdrain Outlet (typically used to drain WQCV in a Filtration BMP)

Underdrain Orifice Invert Depth = ft (distance below the filtration media surface)
 Underdrain Orifice Diameter = inches

Calculated Parameters for Underdrain

Underdrain Orifice Area = ft²
 Underdrain Orifice Centroid = feet

User Input: Orifice Plate with one or more orifices or Elliptical Slot Weir (typically used to drain WQCV and/or EURV in a sedimentation BMP)

Invert of Lowest Orifice = ft (relative to basin bottom at Stage = 0 ft)
 Depth at top of Zone using Orifice Plate = ft (relative to basin bottom at Stage = 0 ft)
 Orifice Plate: Orifice Vertical Spacing = inches
 Orifice Plate: Orifice Area per Row = sq. inches (diameter = 1-3/16 inches)

Calculated Parameters for Plate

WQ Orifice Area per Row = ft²
 Elliptical Half-Width = feet
 Elliptical Slot Centroid = feet
 Elliptical Slot Area = ft²

User Input: Stage and Total Area of Each Orifice Row (numbered from lowest to highest)

	Row 1 (required)	Row 2 (optional)	Row 3 (optional)	Row 4 (optional)	Row 5 (optional)	Row 6 (optional)	Row 7 (optional)	Row 8 (optional)
Stage of Orifice Centroid (ft)	0.00	1.95	3.89					
Orifice Area (sq. inches)	1.19	1.19	1.19					

	Row 9 (optional)	Row 10 (optional)	Row 11 (optional)	Row 12 (optional)	Row 13 (optional)	Row 14 (optional)	Row 15 (optional)	Row 16 (optional)
Stage of Orifice Centroid (ft)								
Orifice Area (sq. inches)								

User Input: Vertical Orifice (Circular or Rectangular)

	Not Selected	Not Selected	
Invert of Vertical Orifice =	<input type="text" value="N/A"/>	<input type="text" value="N/A"/>	ft (relative to basin bottom at Stage = 0 ft)
Depth at top of Zone using Vertical Orifice =	<input type="text" value="N/A"/>	<input type="text" value="N/A"/>	ft (relative to basin bottom at Stage = 0 ft)
Vertical Orifice Diameter =	<input type="text" value="N/A"/>	<input type="text" value="N/A"/>	inches

Calculated Parameters for Vertical Orifice

	Not Selected	Not Selected	
Vertical Orifice Area =	<input type="text" value="N/A"/>	<input type="text" value="N/A"/>	ft ²
Vertical Orifice Centroid =	<input type="text" value="N/A"/>	<input type="text" value="N/A"/>	feet

User Input: Overflow Weir (Dropbox) and Grate (Flat or Sloped)

	Zone 3 Weir	Not Selected	
Overflow Weir Front Edge Height, Ho =	5.84	N/A	ft (relative to basin bottom at Stage = 0 ft)
Overflow Weir Front Edge Length =	6.00	N/A	feet
Overflow Weir Slope =	3.00	N/A	H:V (enter zero for flat grate)
Horiz. Length of Weir Sides =	2.91	N/A	feet
Overflow Grate Open Area % =	70%	N/A	%, grate open area/total area
Debris Clogging % =	50%	N/A	%

Calculated Parameters for Overflow Weir

	Zone 3 Weir	Not Selected	
Height of Grate Upper Edge, H ₁ =	6.81	N/A	feet
Overflow Weir Slope Length =	3.07	N/A	feet
Grate Open Area / 100-yr Orifice Area =	7.21	N/A	should be ≥ 4
Overflow Grate Open Area w/o Debris =	12.88	N/A	ft ²
Overflow Grate Open Area w/ Debris =	6.44	N/A	ft ²

User Input: Outlet Pipe w/ Flow Restriction Plate (Circular Orifice, Restrictor Plate, or Rectangular Orifice)

	Zone 3 Restrictor	Not Selected	
Depth to Invert of Outlet Pipe =	0.25	N/A	ft (distance below basin bottom at Stage = 0 ft)
Outlet Pipe Diameter =	24.00	N/A	inches
Restrictor Plate Height Above Pipe Invert =	13.30		inches

Calculated Parameters for Outlet Pipe w/ Flow Restriction Plate

	Zone 3 Restrictor	Not Selected	
Outlet Orifice Area =	1.79	N/A	ft ²
Outlet Orifice Centroid =	0.63	N/A	feet
Half-Central Angle of Restrictor Plate on Pipe =	1.68	N/A	radians

User Input: Emergency Spillway (Rectangular or Trapezoidal)

Spillway Invert Stage = ft (relative to basin bottom at Stage = 0 ft)
 Spillway Crest Length = feet
 Spillway End Slopes = H:V
 Freeboard above Max Water Surface = feet

Calculated Parameters for Spillway

Spillway Design Flow Depth = feet
 Stage at Top of Freeboard = feet
 Basin Area at Top of Freeboard = acres

Routed Hydrograph Results

	WQCV	EURV	2 Year	5 Year	10 Year	25 Year	50 Year	100 Year	500 Year
Design Storm Return Period =									
One-Hour Rainfall Depth (in) =	0.53	1.07	1.19	1.50	1.75	2.00	2.25	2.52	0.00
Calculated Runoff Volume (acre-ft) =	0.262	0.771	0.614	0.847	1.177	1.710	2.073	2.550	0.000
OPTIONAL Override Runoff Volume (acre-ft) =									
Inflow Hydrograph Volume (acre-ft) =	0.262	0.771	0.614	0.847	1.176	1.710	2.074	2.551	#N/A
Predevelopment Unit Peak Flow, q (cfs/acre) =	0.00	0.00	0.02	0.03	0.27	0.84	1.16	1.55	0.00
Predevelopment Peak Q (cfs) =	0.0	0.0	0.3	0.4	4.4	13.9	19.2	25.5	0.0
Peak Inflow Q (cfs) =	5.3	15.5	12.4	17.0	23.5	34.1	41.2	50.5	#N/A
Peak Outflow Q (cfs) =	0.1	0.2	0.2	0.7	6.0	15.8	22.3	23.4	#N/A
Ratio Peak Outflow to Predevelopment Q =	N/A	N/A	N/A	1.5	1.4	1.1	1.2	0.9	#N/A
Structure Controlling Flow =	Plate	Plate	Plate	Overflow Grate 1	Overflow Grate 1	Overflow Grate 1	Outlet Plate 1	Outlet Plate 1	#N/A
Max Velocity through Grate 1 (fps) =	N/A	N/A	N/A	0.0	0.4	1.2	1.7	1.8	#N/A
Max Velocity through Grate 2 (fps) =	N/A	N/A	N/A	N/A	N/A	N/A	N/A	N/A	#N/A
Time to Drain 97% of Inflow Volume (hours) =	39	69	62	71	69	66	63	61	#N/A
Time to Drain 99% of Inflow Volume (hours) =	40	73	65	76	75	74	73	72	#N/A
Maximum Ponding Depth (ft) =	3.35	5.72	5.08	5.96	6.44	6.91	7.15	7.75	#N/A
Area at Maximum Ponding Depth (acres) =	0.16	0.25	0.23	0.26	0.28	0.30	0.31	0.33	#N/A
Maximum Volume Stored (acre-ft) =	0.245	0.741	0.588	0.802	0.932	1.067	1.137	1.331	#N/A

Detention Basin Outlet Structure Design

UD-Detention, Version 3.07 (February 2017)

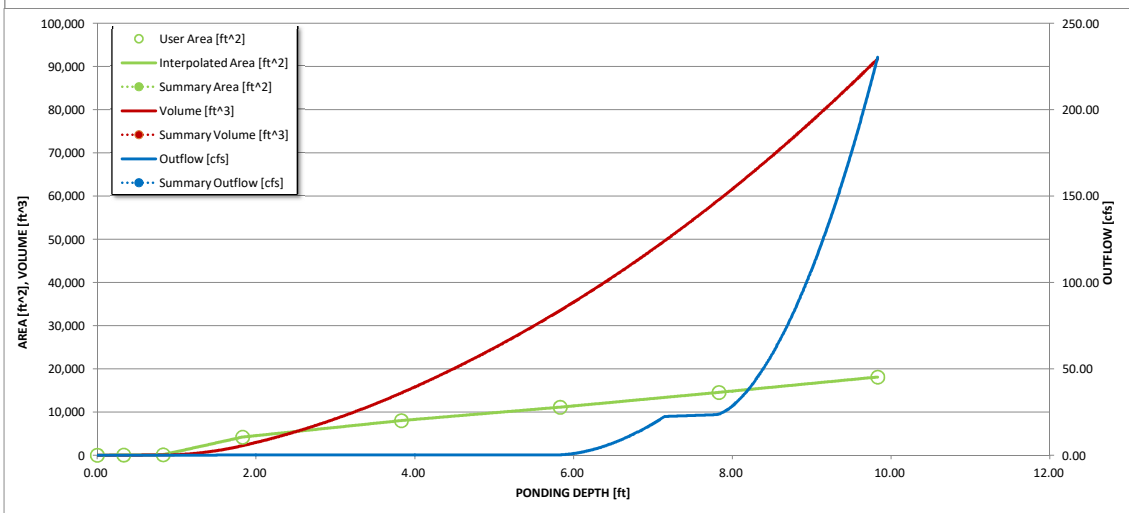
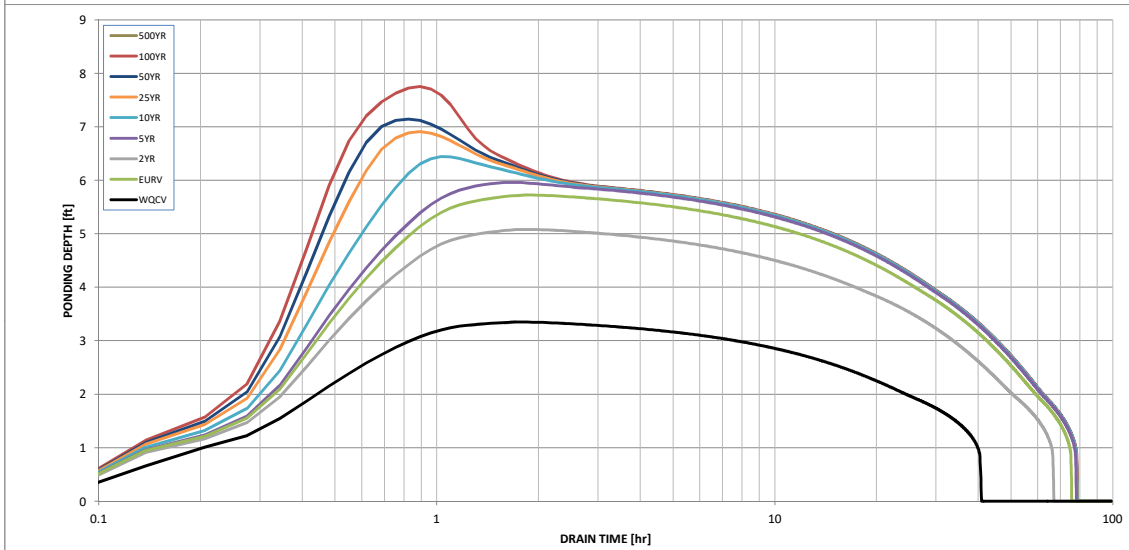
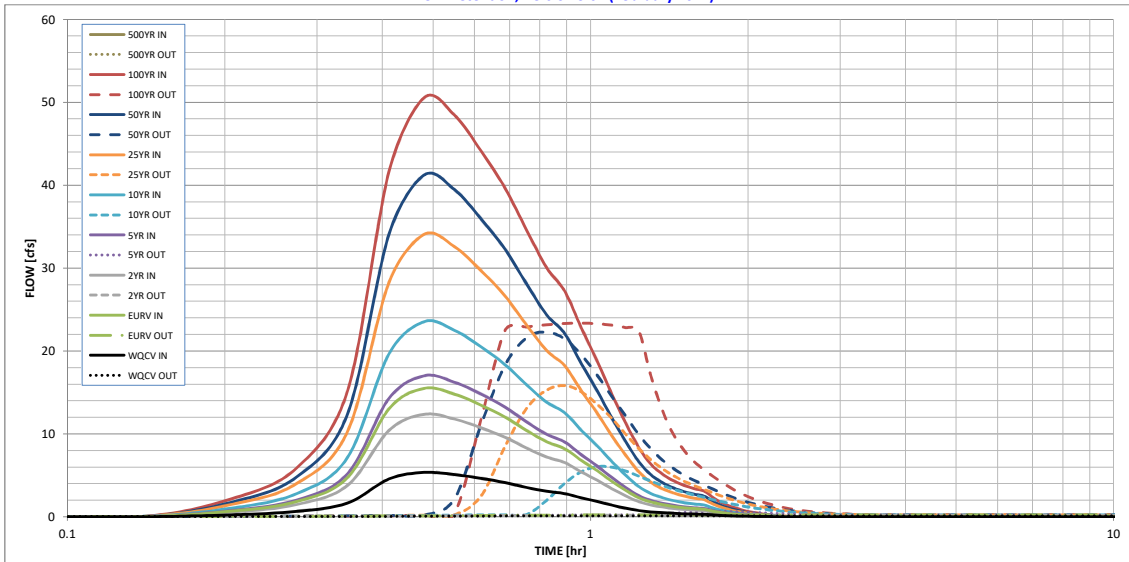

S-A-V-D Chart Axis Override	X-axis	Left Y-Axis	Right Y-Axis
minimum bound			
maximum bound			



PROJECT: Homestead Piling No. 2
 DATE: _____

Micropool Surface Area

$$TIA = I \times A$$

$$(0.441 \times 1651)$$

$$TIA = 7.3 \sim 8.0$$

From micropool sizing chart (SA) Micropool SA = 440 sf →

Tributary Area = 16.51 ac
 Imperviousness = 44.1%

Forebay Volume for F&D Pond

Tributary Area = 16.51 ac

Min. Forebay Volume = 3.0% of WQCV (WQFED T-5, EDB-4)

WQCV for F&D Pond = 0.262 ac-ft

$$\text{Total Volume Req'd} = 0.03 (0.262) \frac{43560}{1 \text{ ac-ft}} = 342 \text{ cf}$$

$$\text{Area} = 283 - 7 (\text{wall}) = 276 \text{ sf}$$

$$\begin{matrix} 276 & \times & 1.25 \text{ ht} & = & 345 & > & 342 & \text{ Forebay } 15" \text{ depth} \rightarrow \\ \text{(forebay area)} & & \text{(depth)} & & \text{(volume provided)} & & & \end{matrix}$$

Size notch in forebay to accommodate 2% of 100 yr. (WQFED T-5 EDB)

$$Q_{100} = 47.1 \text{ cfs} \Rightarrow 0.02 \times 47.1 = 0.94$$

$$\text{Using Ret. Weir Eqn. } Q = \frac{3.247 L \cdot H^{1.48} - 0.566 \cdot L^{1.9} H^{1.9}}{1 + 2L^{0.87}}$$

$$\text{Solve for } L = 2.6" \quad Q = 0.94$$

Use a 2.6" notch →

PROJECT: Homestead Filing No. 2

DATE: _____

Riprap Apron For Pond 1

Riprap Sizing

$Q_{100} = 47.1$ cfs (Pipe Run 9)

$D_c = 42" = 3.5'$

$\frac{Q}{D^{2.5}} < 6$ Then use Figure 9-38 (UDFCO Vol. 2)

$\frac{47.1}{(3.5)^{2.5}} = 2.05 < 6$ Therefore use Figure 9-38
and $\frac{1}{2} \sqrt{D_c} = 0.40 \phi \frac{Q}{D_{1.5}^{1.5}} = 7.19$

Use Type L $D_{50} = 9"$

Riprap Depth

$T = 2 D_{50}$
 $= 2(9")$
 $T = 18" \text{ or } 1.5'$

Low Tailwater Riprap Basin

42" Pipe

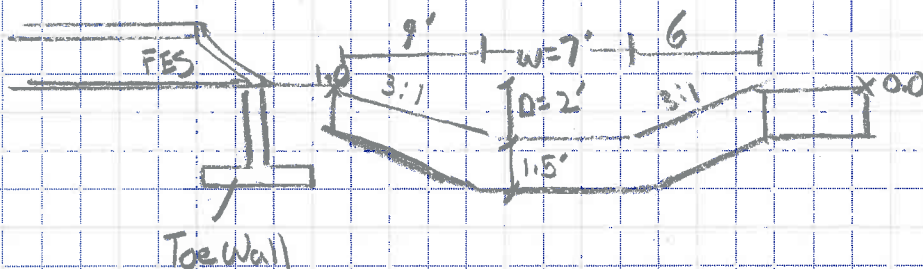

Detention Basin Outlet Structure Design

UD-Detention, Version 3.07 (February 2017)

Project: Homestead at Sterling Ranch Filing No.2

Basin ID: Lot 14, 15, 21-24, 41

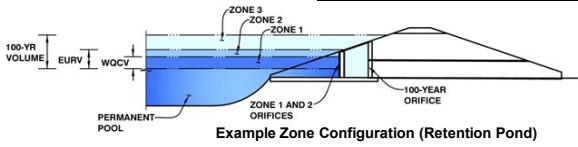

	Stage (ft)	Zone Volume (ac-ft)	Outlet Type
Zone 1 (WQCV)	0.71	0.002	Filtration Media
Zone 2 (EURV)	1.41	0.006	Rectangular Orifice
Zone 3 (100-year)	1.90	0.007	Rectangular Orifice
		0.015	Total

User Input: Orifice at Underdrain Outlet (typically used to drain WQCV in a Filtration BMP)

Underdrain Orifice Invert Depth =	2.10	ft (distance below the filtration media surface)
Underdrain Orifice Diameter =	0.13	inches

Calculated Parameters for Underdrain

Underdrain Orifice Area =	0.0	ft ²
Underdrain Orifice Centroid =	0.01	feet

User Input: Orifice Plate with one or more orifices or Elliptical Slot Weir (typically used to drain WQCV and/or EURV in a sedimentation BMP)

Invert of Lowest Orifice =	N/A	ft (relative to basin bottom at Stage = 0 ft)
Depth at top of Zone using Orifice Plate =	N/A	ft (relative to basin bottom at Stage = 0 ft)
Orifice Plate: Orifice Vertical Spacing =	N/A	inches
Orifice Plate: Orifice Area per Row =	N/A	inches

Calculated Parameters for Plate

WQ Orifice Area per Row =	N/A	ft ²
Elliptical Half-Width =	N/A	feet
Elliptical Slot Centroid =	N/A	feet
Elliptical Slot Area =	N/A	ft ²

User Input: Stage and Total Area of Each Orifice Row (numbered from lowest to highest)

	Row 1 (optional)	Row 2 (optional)	Row 3 (optional)	Row 4 (optional)	Row 5 (optional)	Row 6 (optional)	Row 7 (optional)	Row 8 (optional)
Stage of Orifice Centroid (ft)	N/A	N/A	N/A	N/A	N/A	N/A	N/A	N/A
Orifice Area (sq. inches)	N/A	N/A	N/A	N/A	N/A	N/A	N/A	N/A

	Row 9 (optional)	Row 10 (optional)	Row 11 (optional)	Row 12 (optional)	Row 13 (optional)	Row 14 (optional)	Row 15 (optional)	Row 16 (optional)
Stage of Orifice Centroid (ft)	N/A	N/A	N/A	N/A	N/A	N/A	N/A	N/A
Orifice Area (sq. inches)	N/A	N/A	N/A	N/A	N/A	N/A	N/A	N/A

User Input: Vertical Orifice (Circular or Rectangular)

	Zone 2 Rectangular	Zone 3 Rectangular	
Invert of Vertical Orifice =	0.71	1.41	ft (relative to basin bottom at Stage = 0 ft)
Depth at top of Zone using Vertical Orifice =	1.41	1.90	ft (relative to basin bottom at Stage = 0 ft)
Vertical Orifice Height =	2.00	2.00	inches
Vertical Orifice Width =	1.00	6.00	inches

Calculated Parameters for Vertical Orifice

	Zone 2 Rectangular	Zone 3 Rectangular	
Vertical Orifice Area =	0.01	0.08	ft ²
Vertical Orifice Centroid =	0.08	0.08	feet

User Input: Overflow Weir (Dropbox) and Grate (Flat or Sloped)

	Not Selected	Not Selected	
Overflow Weir Front Edge Height, H _o =	1.88	N/A	ft (relative to basin bottom at Stage = 0 ft)
Overflow Weir Front Edge Length =	1.00	N/A	feet
Overflow Weir Slope =	0.00	N/A	H:V (enter zero for flat grate)
Horiz. Length of Weir Sides =	1.00	N/A	feet
Overflow Grate Open Area % =	70%	N/A	% grate open area/total area
Debris Clogging % =	50%	N/A	%

Calculated Parameters for Overflow Weir

	Not Selected	Not Selected	
Height of Grate Upper Edge, H ₁ =	1.88	N/A	feet
Overflow Weir Slope Length =	1.00	N/A	feet
Grate Open Area / 100-yr Orifice Area =	N/A	N/A	should be ≥ 4
Overflow Grate Open Area w/o Debris =	0.70	N/A	ft ²
Overflow Grate Open Area w/ Debris =	0.35	N/A	ft ²

User Input: Outlet Pipe w/ Flow Restriction Plate (Circular Orifice, Restrictor Plate, or Rectangular Orifice)

	Not Selected	Not Selected	
Depth to Invert of Outlet Pipe =	N/A	N/A	ft (distance below basin bottom at Stage = 0 ft)
Circular Orifice Diameter =	N/A	N/A	inches

Calculated Parameters for Outlet Pipe w/ Flow Restriction Plate

	Not Selected	Not Selected	
Outlet Orifice Area =	N/A	N/A	ft ²
Outlet Orifice Centroid =	N/A	N/A	feet
Half-Central Angle of Restrictor Plate on Pipe =	N/A	N/A	radians

User Input: Emergency Spillway (Rectangular or Trapezoidal)

Spillway Invert Stage =	1.90	ft (relative to basin bottom at Stage = 0 ft)
Spillway Crest Length =	2.00	feet
Spillway End Slopes =	4.00	H:V
Freeboard above Max Water Surface =	0.25	feet

Calculated Parameters for Spillway

Spillway Design Flow Depth =	0.14	feet
Stage at Top of Freeboard =	2.29	feet
Basin Area at Top of Freeboard =	0.02	acres

Routed Hydrograph Results

	WQCV	EURV	2 Year	5 Year	10 Year	25 Year	50 Year	100 Year	500 Year
Design Storm Return Period =									
One-Hour Rainfall Depth (in) =	0.53	1.07	1.19	1.50	1.75	2.00	2.25	2.52	0.00
Calculated Runoff Volume (acre-ft) =	0.002	0.008	0.006	0.009	0.012	0.018	0.022	0.027	0.000
OPTIONAL Override Runoff Volume (acre-ft) =									
Inflow Hydrograph Volume (acre-ft) =	0.001	0.007	0.006	0.008	0.012	0.018	0.021	0.027	#N/A
Predevelopment Unit Peak Flow, q (cfs/acre) =	0.00	0.00	0.02	0.03	0.32	0.97	1.34	1.78	0.00
Predevelopment Peak Q (cfs) =	0.0	0.0	0.0	0.0	0.1	0.2	0.2	0.3	0.0
Peak Inflow Q (cfs) =	0.0	0.2	0.2	0.2	0.3	0.5	0.6	0.8	#N/A
Peak Outflow Q (cfs) =	0.0	0.0	0.0	0.0	0.1	0.2	0.3	0.3	#N/A
Ratio Peak Outflow to Predevelopment Q =	N/A	N/A	N/A	8.1	1.4	1.2	1.1	1.0	#N/A
Structure Controlling Flow =	Filtration Media	Vertical Orifice 1	Vertical Orifice 1	Vertical Orifice 1	Vertical Orifice 2	Vertical Orifice 2	Vertical Orifice 2	Vertical Orifice 2	#N/A
Max Velocity through Grate 1 (fps) =	N/A	N/A	N/A	N/A	N/A	N/A	N/A	N/A	#N/A
Max Velocity through Grate 2 (fps) =	N/A	N/A	N/A	N/A	N/A	N/A	N/A	N/A	#N/A
Time to Drain 97% of Inflow Volume (hours) =	12	40	40	39	38	35	33	30	#N/A
Time to Drain 99% of Inflow Volume (hours) =	12	43	43	43	43	42	41	40	#N/A
Maximum Ponding Depth (ft) =	0.27	1.17	1.01	1.24	1.47	1.62	1.72	1.88	#N/A
Area at Maximum Ponding Depth (acres) =	0.00	0.01	0.01	0.01	0.01	0.01	0.02	0.02	#N/A
Maximum Volume Stored (acre-ft) =	0.001	0.005	0.004	0.006	0.009	0.011	0.012	0.014	#N/A

Detention Basin Outlet Structure Design

UD-Detention, Version 3.07 (February 2017)

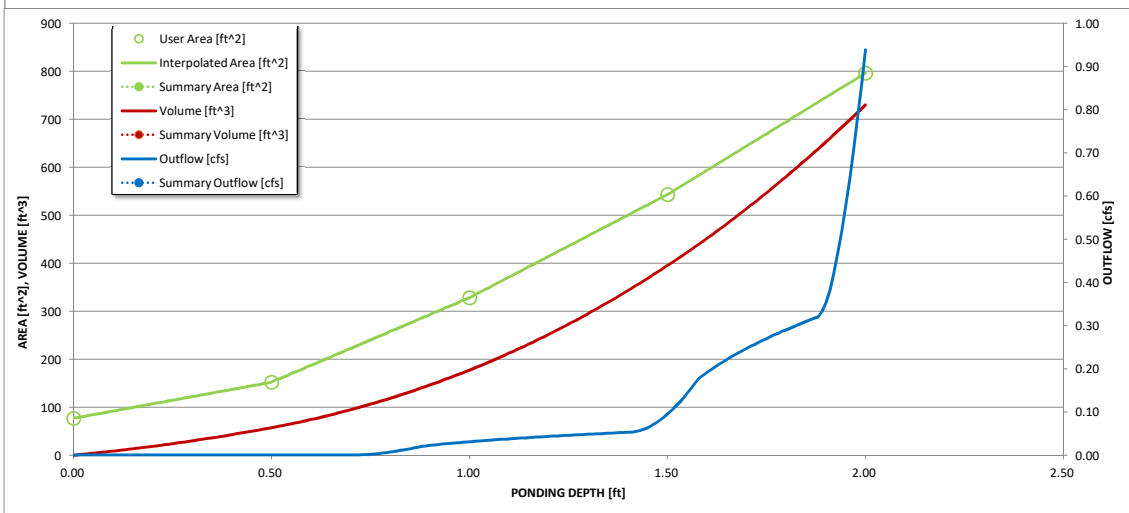
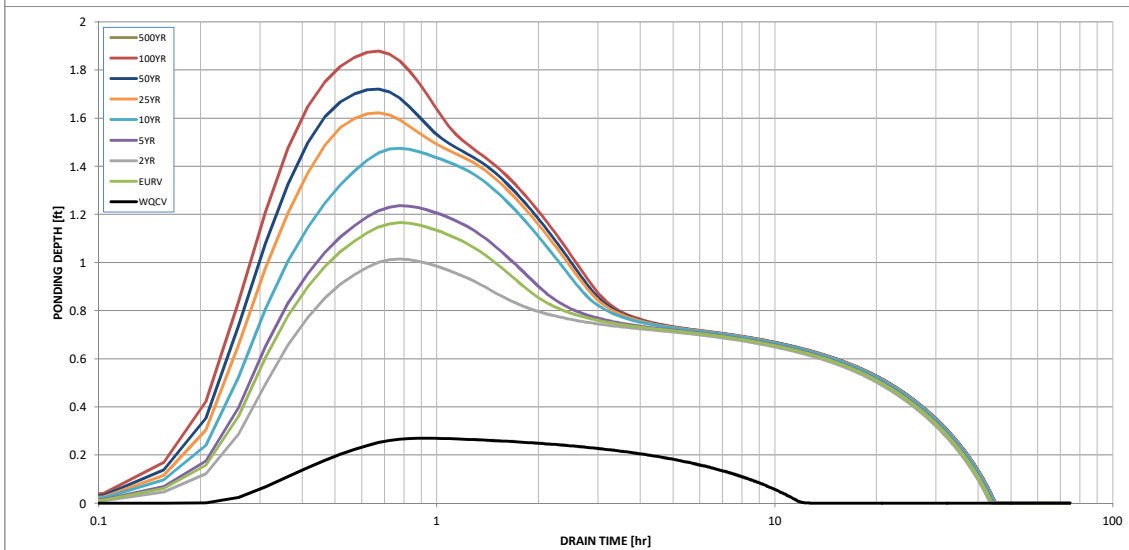
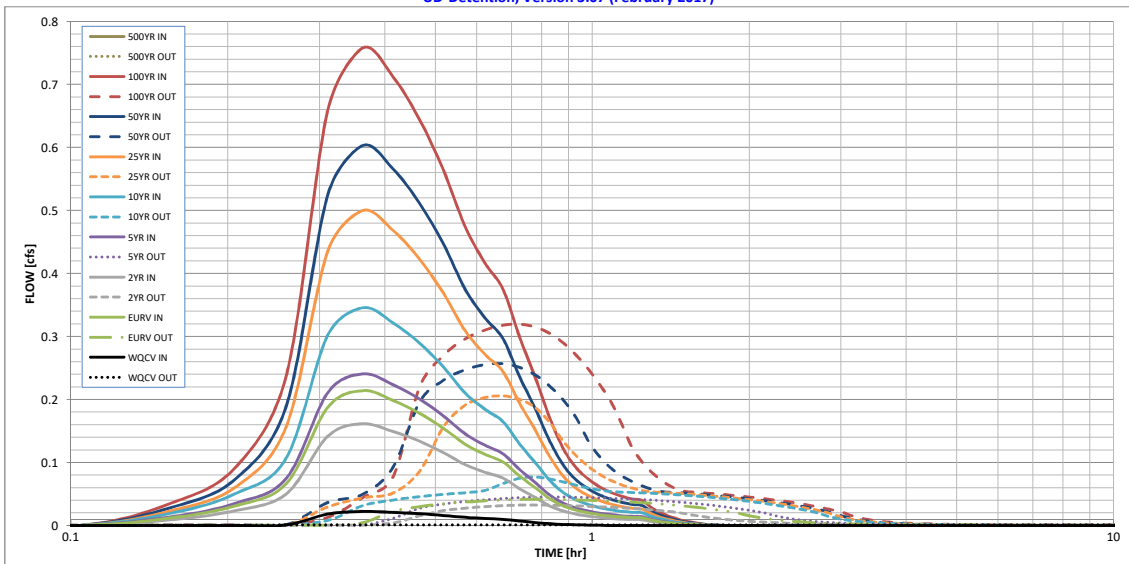

S-A-V-D Chart Axis Override	X-axis	Left Y-Axis	Right Y-Axis
minimum bound			
maximum bound			

Detention Basin Outlet Structure Design

UD-Detention, Version 3.07 (February 2017)

Project: Homestead at Sterling Ranch Filing No.2

Basin ID: Lots 13, 16-20, 28-40 Lots size 7,800 sq-ft -9830 sq-ft

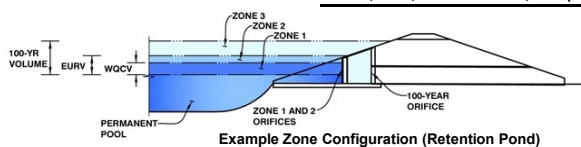

Example Zone Configuration (Retention Pond)

	Stage (ft)	Zone Volume (ac-ft)	Outlet Type
Zone 1 (WQCV)	0.40	0.002	Filtration Media
Zone 2 (EURV)	0.89	0.004	Rectangular Orifice
Zone 3 (100-year)	1.24	0.005	Rectangular Orifice
		0.010	Total

User Input: Orifice at Underdrain Outlet (typically used to drain WQCV in a Filtration BMP)

Underdrain Orifice Invert Depth =	2.10	ft (distance below the filtration media surface)
Underdrain Orifice Diameter =	0.13	inches

Calculated Parameters for Underdrain

Underdrain Orifice Area =	0.0	ft ²
Underdrain Orifice Centroid =	0.01	feet

User Input: Orifice Plate with one or more orifices or Elliptical Slot Weir (typically used to drain WQCV and/or EURV in a sedimentation BMP)

Invert of Lowest Orifice =	N/A	ft (relative to basin bottom at Stage = 0 ft)
Depth at top of Zone using Orifice Plate =	N/A	ft (relative to basin bottom at Stage = 0 ft)
Orifice Plate: Orifice Vertical Spacing =	N/A	inches
Orifice Plate: Orifice Area per Row =	N/A	inches

Calculated Parameters for Plate

WQ Orifice Area per Row =	N/A	ft ²
Elliptical Half-Width =	N/A	feet
Elliptical Slot Centroid =	N/A	feet
Elliptical Slot Area =	N/A	ft ²

User Input: Stage and Total Area of Each Orifice Row (numbered from lowest to highest)

	Row 1 (optional)	Row 2 (optional)	Row 3 (optional)	Row 4 (optional)	Row 5 (optional)	Row 6 (optional)	Row 7 (optional)	Row 8 (optional)
Stage of Orifice Centroid (ft)	N/A	N/A	N/A	N/A	N/A	N/A	N/A	N/A
Orifice Area (sq. inches)	N/A	N/A	N/A	N/A	N/A	N/A	N/A	N/A

	Row 9 (optional)	Row 10 (optional)	Row 11 (optional)	Row 12 (optional)	Row 13 (optional)	Row 14 (optional)	Row 15 (optional)	Row 16 (optional)
Stage of Orifice Centroid (ft)	N/A	N/A	N/A	N/A	N/A	N/A	N/A	N/A
Orifice Area (sq. inches)	N/A	N/A	N/A	N/A	N/A	N/A	N/A	N/A

User Input: Vertical Orifice (Circular or Rectangular)

	Zone 2 Rectangular	Zone 3 Rectangular	
Invert of Vertical Orifice =	0.40	0.89	ft (relative to basin bottom at Stage = 0 ft)
Depth at top of Zone using Vertical Orifice =	0.89	1.24	ft (relative to basin bottom at Stage = 0 ft)
Vertical Orifice Height =	2.00	2.00	inches
Vertical Orifice Width =	1.00	3.50	inches

Calculated Parameters for Vertical Orifice

	Zone 2 Rectangular	Zone 3 Rectangular	
Vertical Orifice Area =	0.01	0.05	ft ²
Vertical Orifice Centroid =	0.08	0.08	feet

User Input: Overflow Weir (Dropbox) and Grate (Flat or Sloped)

	Not Selected	Not Selected	
Overflow Weir Front Edge Height, Ho =	1.24	N/A	ft (relative to basin bottom at Stage = 0 ft)
Overflow Weir Front Edge Length =	1.00	N/A	feet
Overflow Weir Slope =	0.00	N/A	H:V (enter zero for flat grate)
Horiz. Length of Weir Sides =	1.00	N/A	feet
Overflow Grate Open Area % =	70%	N/A	% grate open area/total area
Debris Clogging % =	50%	N/A	%

Calculated Parameters for Overflow Weir

	Not Selected	Not Selected	
Height of Grate Upper Edge, H ₁ =	1.24	N/A	feet
Overflow Weir Slope Length =	1.00	N/A	feet
Grate Open Area / 100-yr Orifice Area =	N/A	N/A	should be ≥ 4
Overflow Grate Open Area w/o Debris =	0.70	N/A	ft ²
Overflow Grate Open Area w/ Debris =	0.35	N/A	ft ²

User Input: Outlet Pipe w/ Flow Restriction Plate (Circular Orifice, Restrictor Plate, or Rectangular Orifice)

	Not Selected	Not Selected	
Depth to Invert of Outlet Pipe =	N/A	N/A	ft (distance below basin bottom at Stage = 0 ft)
Circular Orifice Diameter =	N/A	N/A	inches

Calculated Parameters for Outlet Pipe w/ Flow Restriction Plate

	Not Selected	Not Selected	
Outlet Orifice Area =	N/A	N/A	ft ²
Outlet Orifice Centroid =	N/A	N/A	feet
Half-Central Angle of Restrictor Plate on Pipe =	N/A	N/A	radians

User Input: Emergency Spillway (Rectangular or Trapezoidal)

Spillway Invert Stage =	1.24	ft (relative to basin bottom at Stage = 0 ft)
Spillway Crest Length =	2.00	feet
Spillway End Slopes =	4.00	H:V
Freeboard above Max Water Surface =	0.25	feet

Calculated Parameters for Spillway

Spillway Design Flow Depth =	0.14	feet
Stage at Top of Freeboard =	1.63	feet
Basin Area at Top of Freeboard =	0.02	acres

Routed Hydrograph Results

	WQCV	EURV	2 Year	5 Year	10 Year	25 Year	50 Year	100 Year	500 Year
Design Storm Return Period =									
One-Hour Rainfall Depth (in) =	0.53	1.07	1.19	1.50	1.75	2.00	2.25	2.52	0.00
Calculated Runoff Volume (acre-ft) =	0.002	0.006	0.004	0.006	0.008	0.012	0.015	0.018	0.000
OPTIONAL Override Runoff Volume (acre-ft) =									
Inflow Hydrograph Volume (acre-ft) =	0.001	0.005	0.004	0.006	0.008	0.012	0.014	0.018	#N/A
Predevelopment Unit Peak Flow, q (cfs/acre) =	0.00	0.00	0.02	0.03	0.28	0.88	1.21	1.61	0.00
Predevelopment Peak Q (cfs) =	0.0	0.0	0.0	0.0	0.0	0.1	0.1	0.2	0.0
Peak Inflow Q (cfs) =	0.0	0.1	0.1	0.1	0.2	0.3	0.3	0.4	#N/A
Peak Outflow Q (cfs) =	0.0	0.0	0.0	0.0	0.0	0.1	0.1	0.2	#N/A
Ratio Peak Outflow to Predevelopment Q =	N/A	N/A	N/A	10.1	1.4	1.1	1.0	0.9	#N/A
Structure Controlling Flow =	Filtration Media	Vertical Orifice 1	Vertical Orifice 1	Vertical Orifice 1	Vertical Orifice 2	Vertical Orifice 2	Vertical Orifice 2	Vertical Orifice 2	#N/A
Max Velocity through Grate 1 (fps) =	N/A	N/A	N/A	N/A	N/A	N/A	N/A	N/A	#N/A
Max Velocity through Grate 2 (fps) =	N/A	N/A	N/A	N/A	N/A	N/A	N/A	N/A	#N/A
Time to Drain 97% of Inflow Volume (hours) =	12	31	31	30	29	28	27	25	#N/A
Time to Drain 99% of Inflow Volume (hours) =	12	32	32	32	33	32	32	31	#N/A
Maximum Ponding Depth (ft) =	0.20	0.65	0.58	0.71	0.91	1.05	1.10	1.21	#N/A
Area at Maximum Ponding Depth (acres) =	0.00	0.01	0.01	0.01	0.01	0.01	0.01	0.01	#N/A
Maximum Volume Stored (acre-ft) =	0.001	0.003	0.003	0.004	0.006	0.007	0.008	0.010	#N/A

Detention Basin Outlet Structure Design

UD-Detention, Version 3.07 (February 2017)

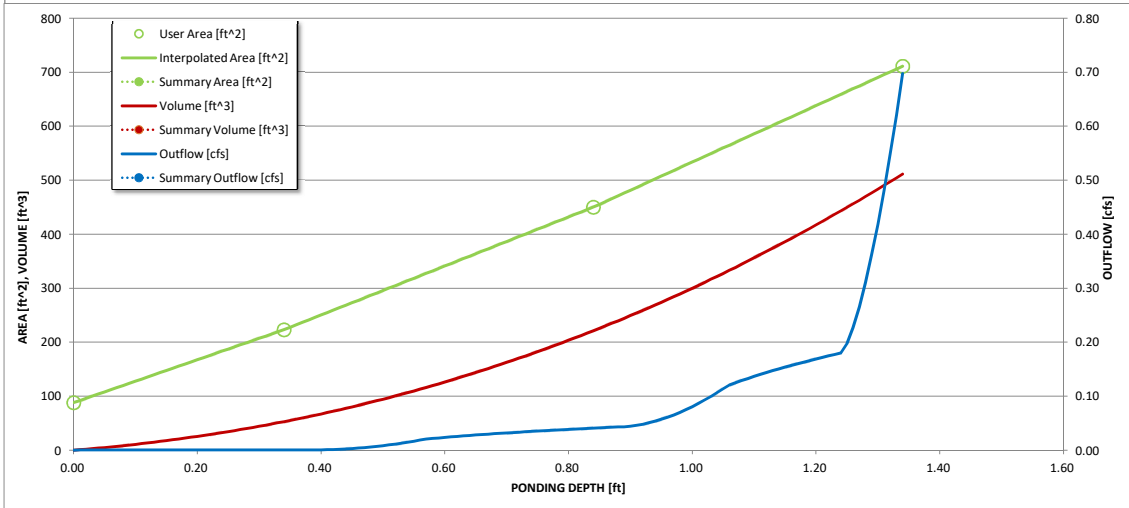
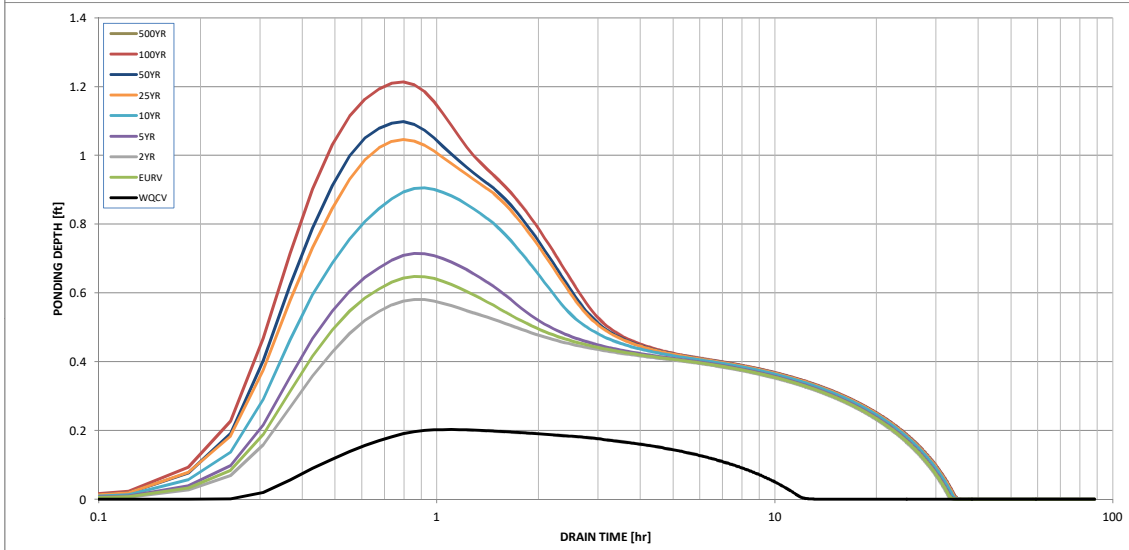
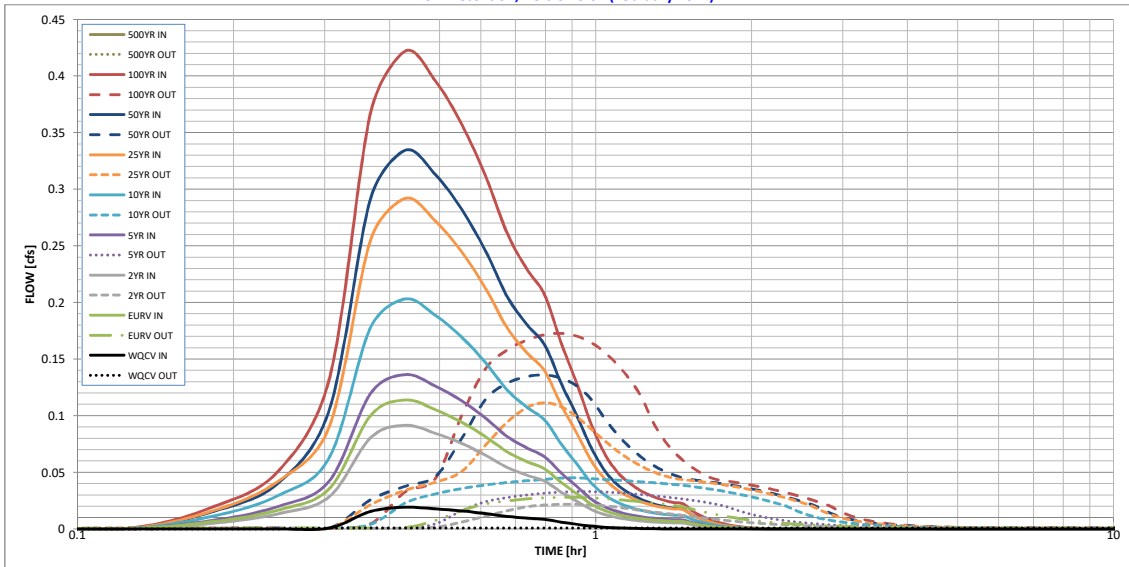

S-A-V-D Chart Axis Override	X-axis	Left Y-Axis	Right Y-Axis
minimum bound			
maximum bound			

Scenario: 100 yr
STRM 1 & 2

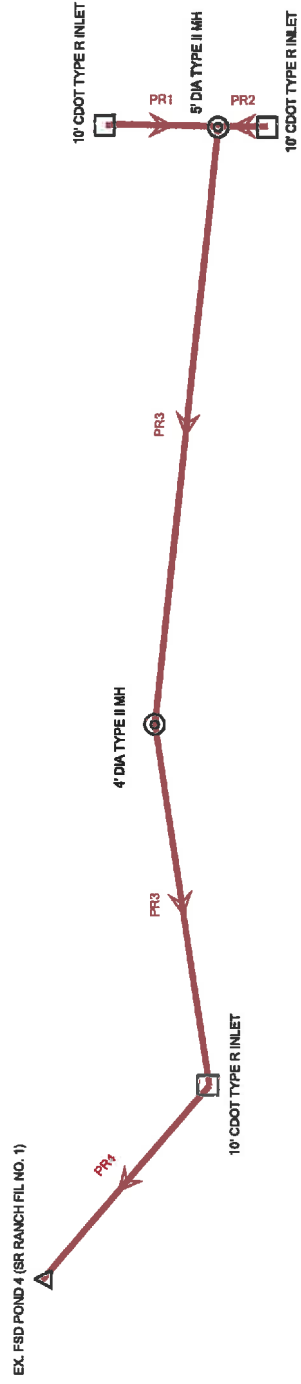

Conduit FlexTable: Table - 1 STRM 1&2

Label	Upstream Structure	Rise (ft)	Flow (cfs)	Flow / Capacity (Design) (%)	Length (Unified) (ft)	Velocity (ft/s)	Froude Number (Normal)	Depth (Normal) (ft)	Depth (Critical) (ft)
PR3	4' DIA TYPE II MH		25.70	62.7	213.1	8.82	1.432	1.43	1.73
PR4	10' CDOT TYPE R INLET		30.10	21.5	98.7	22.71	5.300	0.79	1.87
PR3	5' DIA TYPE II MH		25.70	58.4	254.1	9.31	1.557	1.37	1.73
PR2	10' CDOT TYPE R INLET		11.80	37.9	3.2	3.76	2.023	0.85	1.23
PR1	10' CDOT TYPE R INLET		13.80	26.6	27.2	13.97	3.425	0.70	1.34
Hydraulic Grade Line (In) (ft)	Hydraulic Grade Line (Out) (ft)	Headloss (ft)	Upstream Structure Hydraulic Grade Line (In) (ft)	Upstream Structure Velocity (In-Governing) (ft/s)	Upstream Structure Headloss Coefficient	Upstream Structure Headloss (ft)	Elevation Ground (Start) (ft)	Invert (Start) (ft)	Invert (Stop) (ft)
7,070.13	7,068.77	1.36	7,070.34	9.31	0.270	0.21	7,075.93	7,068.40	7,066.27
7,067.84	7,060.00	7.84	7,068.77	5.24	1.020	0.93	7,071.69	7,065.97	7,054.50
7,073.35	7,070.07	3.27	7,074.54	4.39	1.520	1.19	7,077.37	7,071.62	7,068.70
7,074.55	7,074.54	0.01	7,075.57	3.76	1.000	1.02	7,077.10	7,072.18	7,072.12
7,074.89	7,074.54	0.35	7,075.49	6.18	1.020	0.61	7,077.10	7,073.55	7,072.12

STORM 1 - 100 YR

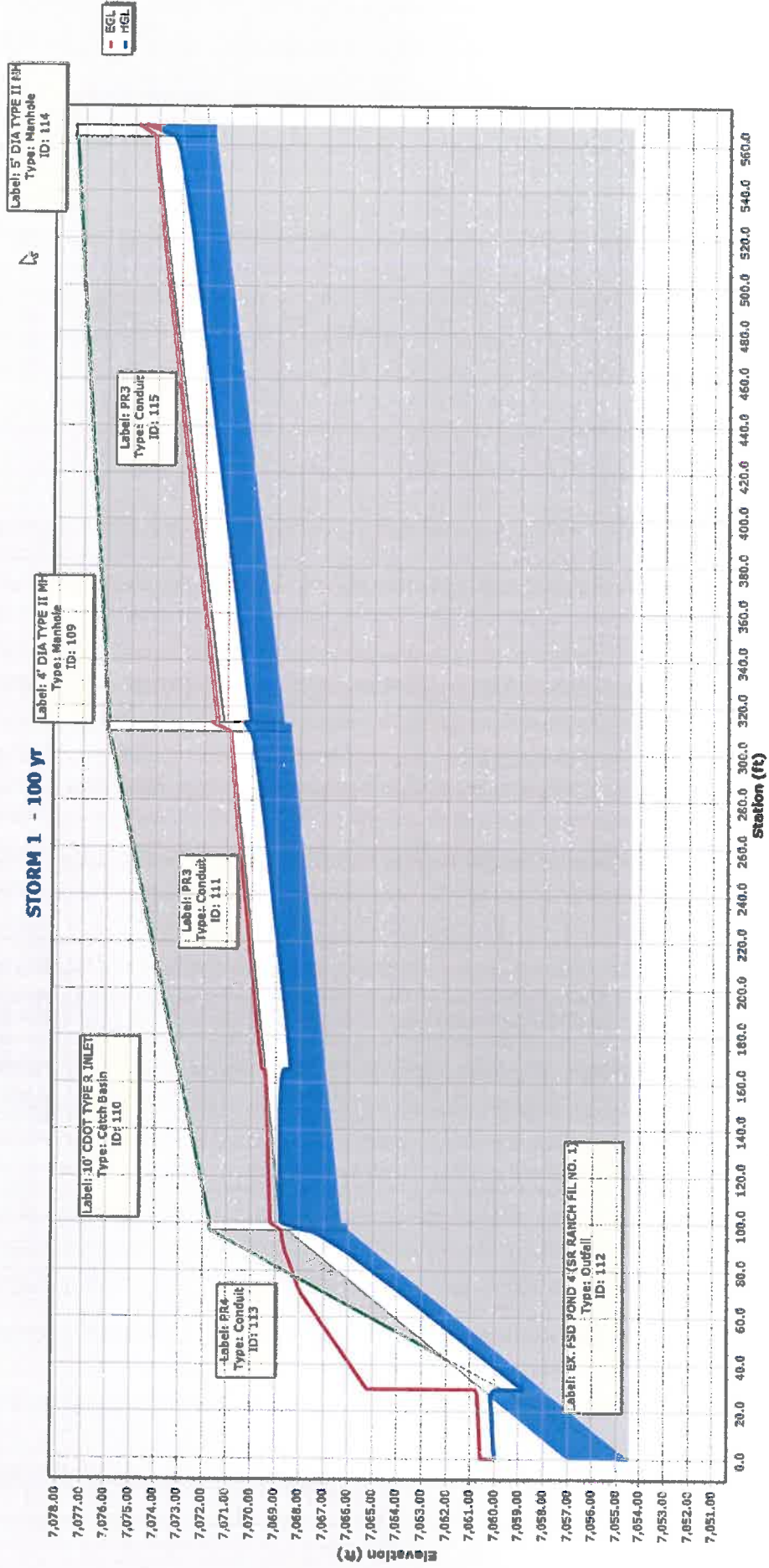

STORM 2 - 100 Yr

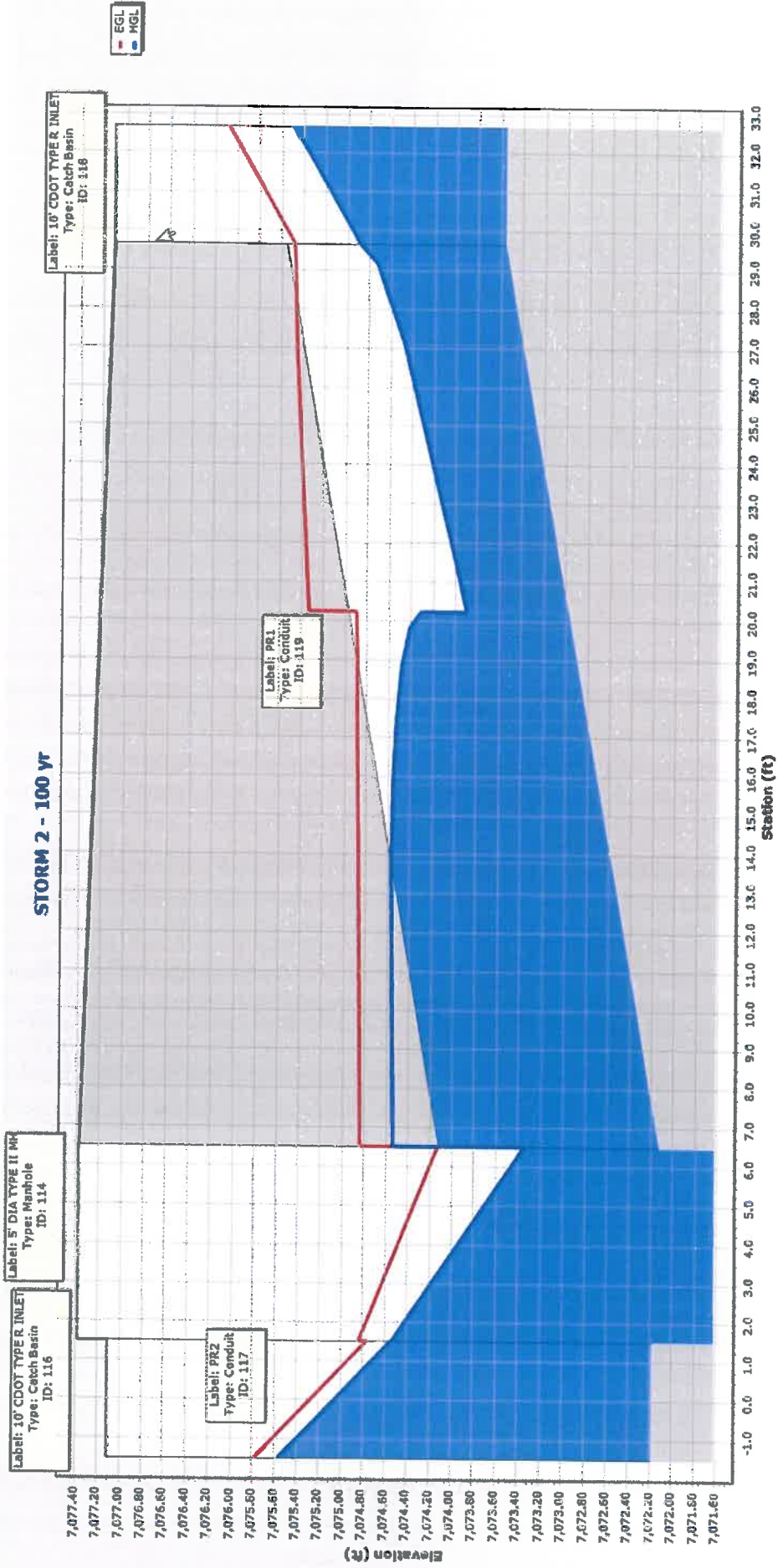

Scenario: 100 yr

Storm 3 incl Ex4Z" SR1

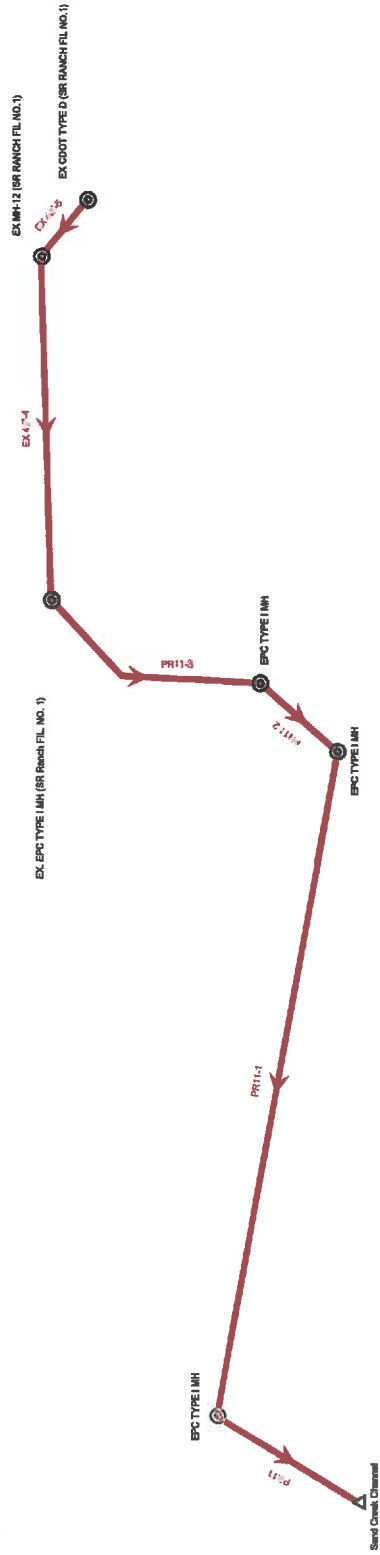

Conduit FlexTable: Table - 1 STRM 3 INCL 42" SR1

Label	Upstream Structure	Rise (ft)	Flow (cfs)	Flow / Capacity (Design) (%)	Length (Unified) (ft)	Velocity (ft/s)	Froude Number (Normal)	Depth (Normal) (ft)	Depth (Critical) (ft)
PR11-3	EX. EPC TYPE I MH (SR Ranch FIL NO.1)		76.80	76.4	138.4	11.50	1.432	2.29	2.74
PR11-2	EPC TYPE I MH		76.80	47.5	50.8	16.58	2.541	1.70	2.74
PR11-1	EPC TYPE I MH		76.80	48.1	341.2	16.43	2.507	1.71	2.74
PR11	EPC TYPE I MH		76.80	23.9	155.1	27.41	5.244	1.16	2.74
EX 42"-5	EX CDOT TYPE D (SR RANCH FIL NO.1)		76.80	58.8	110.4	14.12	1.992	1.93	2.74
EX 42"-4	EX MH-12 (SR RANCH FIL NO.1)		76.80	47.3	235.2	16.64	2.553	1.69	2.74
Hydraulic Grade Line (In) (ft)	Hydraulic Grade Line (Out) (ft)	Headloss (ft)	Upstream Structure Hydraulic Grade Line (In) (ft)	Upstream Structure Velocity (In-Governing) (ft/s)	Upstream Structure Headloss Coefficient	Upstream Structure Headloss (ft)	Elevation Ground (Start) (ft)	Invert (Start) (ft)	Invert (Stop) (ft)
7,084.23	7,082.43	1.80	7,084.61	9.24	0.270	0.38	7,088.97	7,081.49	7,080.11
7,082.05	7,080.82	1.23	7,082.43	11.32	0.270	0.38	7,086.56	7,079.31	7,078.00
7,080.44	7,072.98	7.46	7,080.82	9.24	0.270	0.38	7,085.36	7,077.70	7,069.11
7,071.55	7,056.70	14.85	7,072.98	7.98	1.020	1.43	7,077.40	7,068.81	7,053.00
7,092.81	7,091.03	1.78	7,095.29	9.50	1.770	2.48	7,095.00	7,090.07	7,088.21
7,090.65	7,084.61	6.04	7,091.03	9.24	0.270	0.38	7,094.77	7,087.91	7,081.79

STORM 3 INCL EX 42" SR1 - 100 Yr

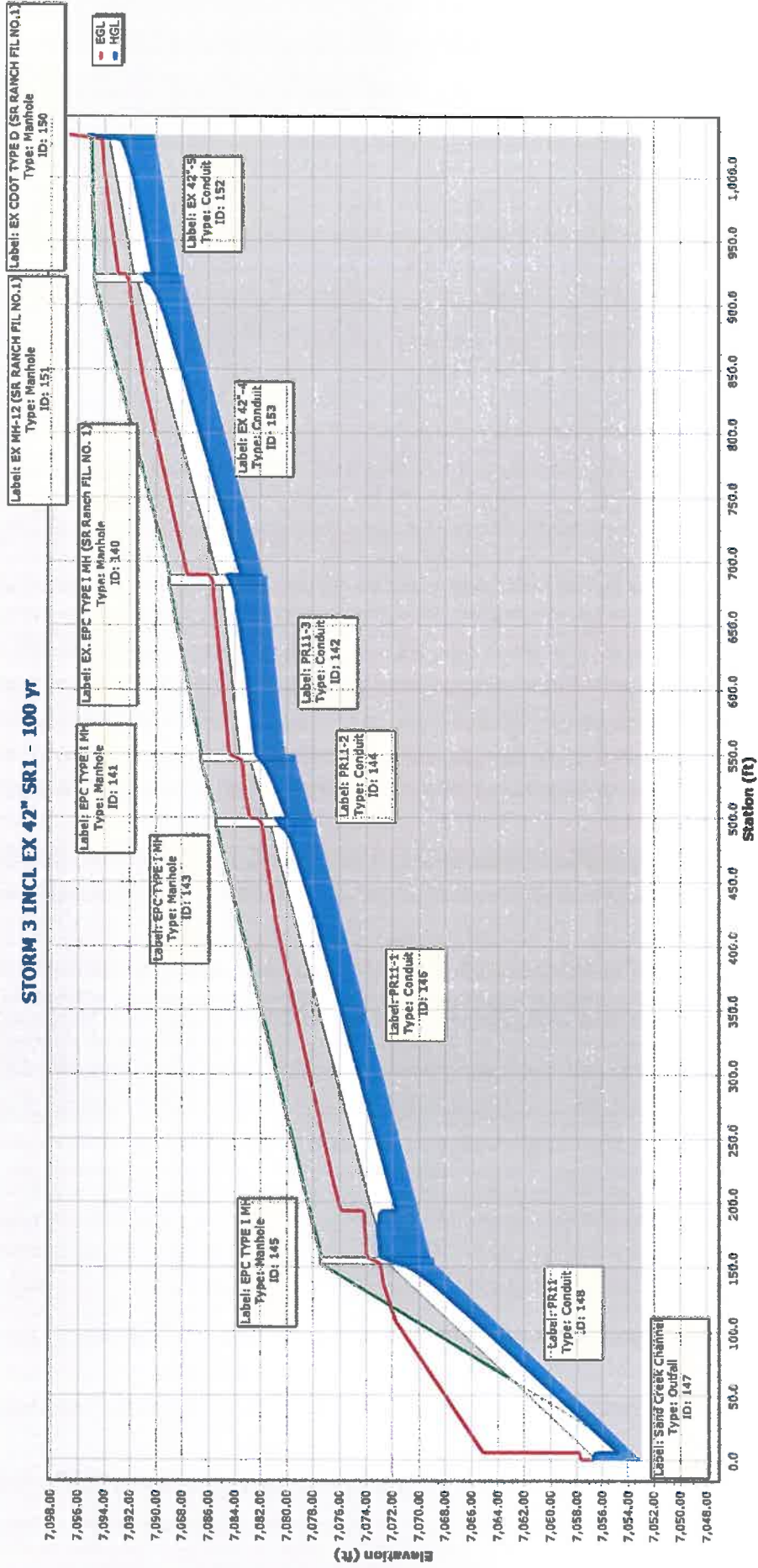

Scenario: 100 yr

STRM 5,6,7

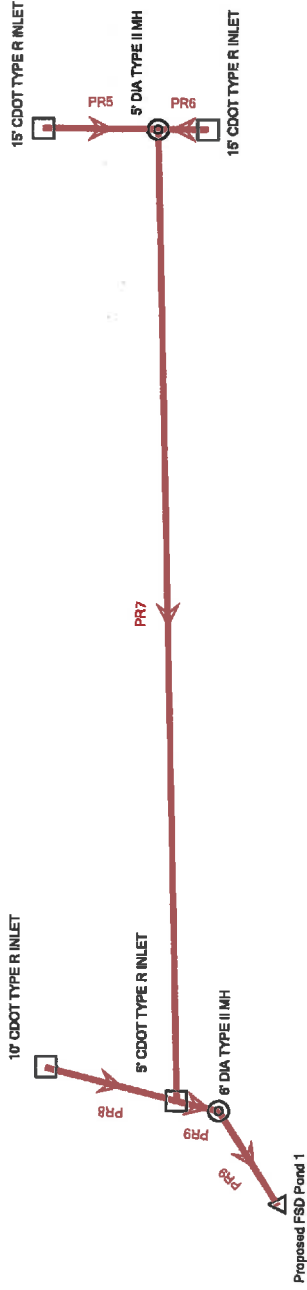

Conduit FlexTable: Table - 1 STRM 5,6,7

Label	Upstream Structure	Rise (ft)	Flow (cfs)	Flow / Capacity (Design) (%)	Length (Unified) (ft)	Velocity (ft/s)	Froude Number (Normal)	Depth (Normal) (ft)	Depth (Critical) (ft)
PR6	15' CDOT TYPE R INLET		12.70	85.5	2.5	7.19	1.674	1.07	1.34
PR5	15' CDOT TYPE R INLET		12.70	55.2	26.5	13.34	2.948	0.80	1.34
PR7	5' DIA TYPE II MH		25.30	49.2	475.5	10.43	1.867	1.24	1.71
PR9	5' CDOT TYPE R INLET		47.10	17.3	8.0	6.66	6.560	0.84	2.24
PR9-1	6' DIA TYPE II MH		47.10	42.6	34.9	4.90	1.755	1.60	2.14
PR8	10' CDOT TYPE R INLET		17.20	20.9	35.4	3.50	3.114	0.78	1.40
Hydraulic Grade Line (In) (ft)	Hydraulic Grade Line (Out) (ft)	Headloss (ft)	Upstream Structure Hydraulic Grade Line (In) (ft)	Upstream Structure Velocity (In-Governing) (ft/s)	Upstream Structure Headloss Coefficient	Upstream Structure Headloss (ft)	Elevation Ground (Start) (ft)	Invert (Start) (ft)	Invert (Stop) (ft)
7,090.47	7,090.43	0.04	7,091.28	7.19	1.020	0.82	7,093.41	7,088.59	7,088.54
7,091.15	7,090.43	0.72	7,092.07	7.62	1.020	0.92	7,093.57	7,089.81	7,088.54
7,089.25	7,084.94	4.31	7,090.43	7.19	1.520	1.17	7,093.68	7,087.54	7,080.07
7,084.06	7,084.02	0.04	7,084.94	3.50	1.280	0.88	7,086.36	7,079.57	7,078.23
7,083.85	7,083.77	0.08	7,084.02	6.66	0.470	0.18	7,086.18	7,077.73	7,077.31
7,085.01	7,084.94	0.06	7,085.34	3.50	1.770	0.34	7,086.34	7,081.49	7,080.07

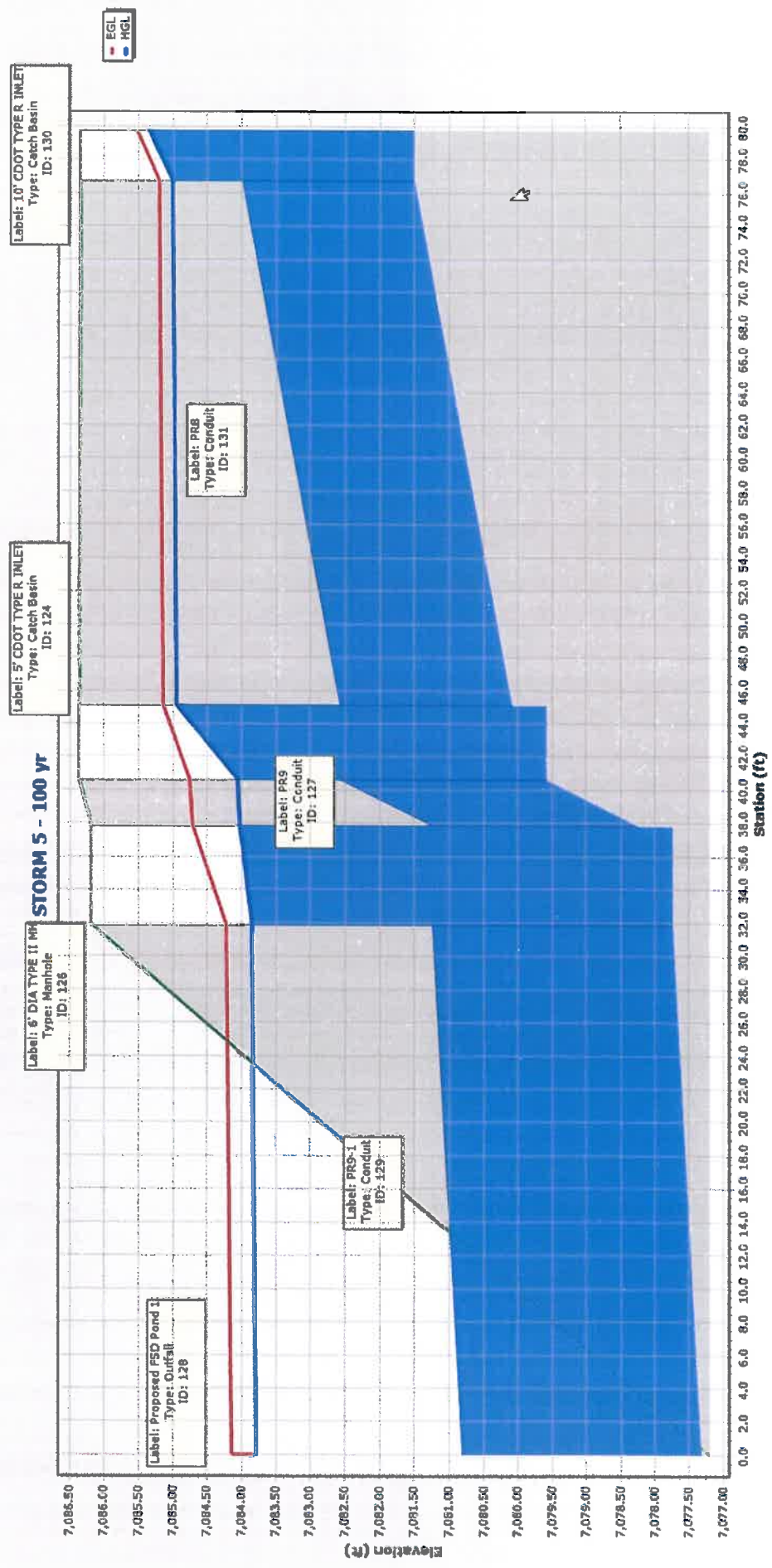

STORM 6 - 100 YR

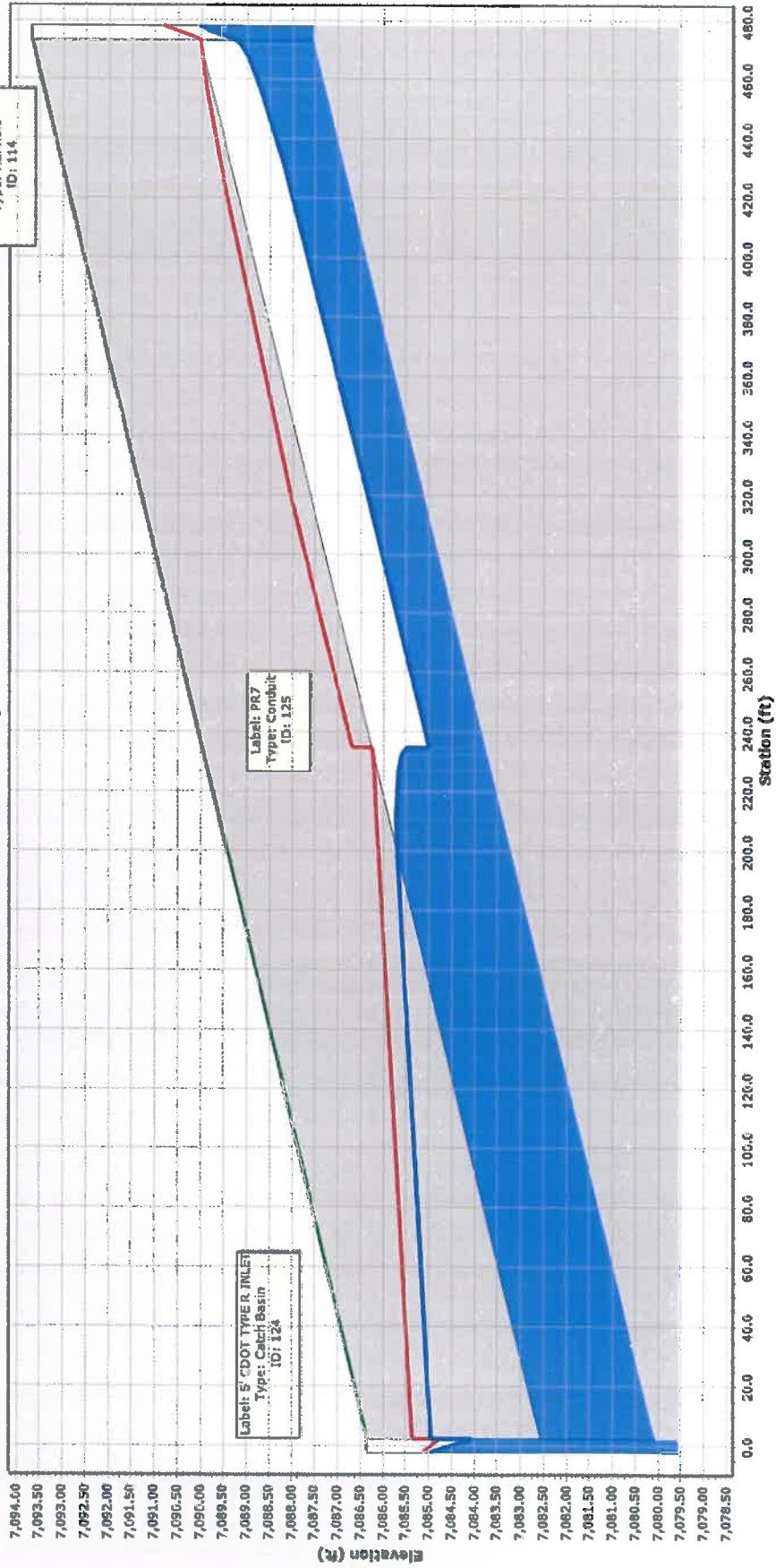

STORM 7 - 100 YR

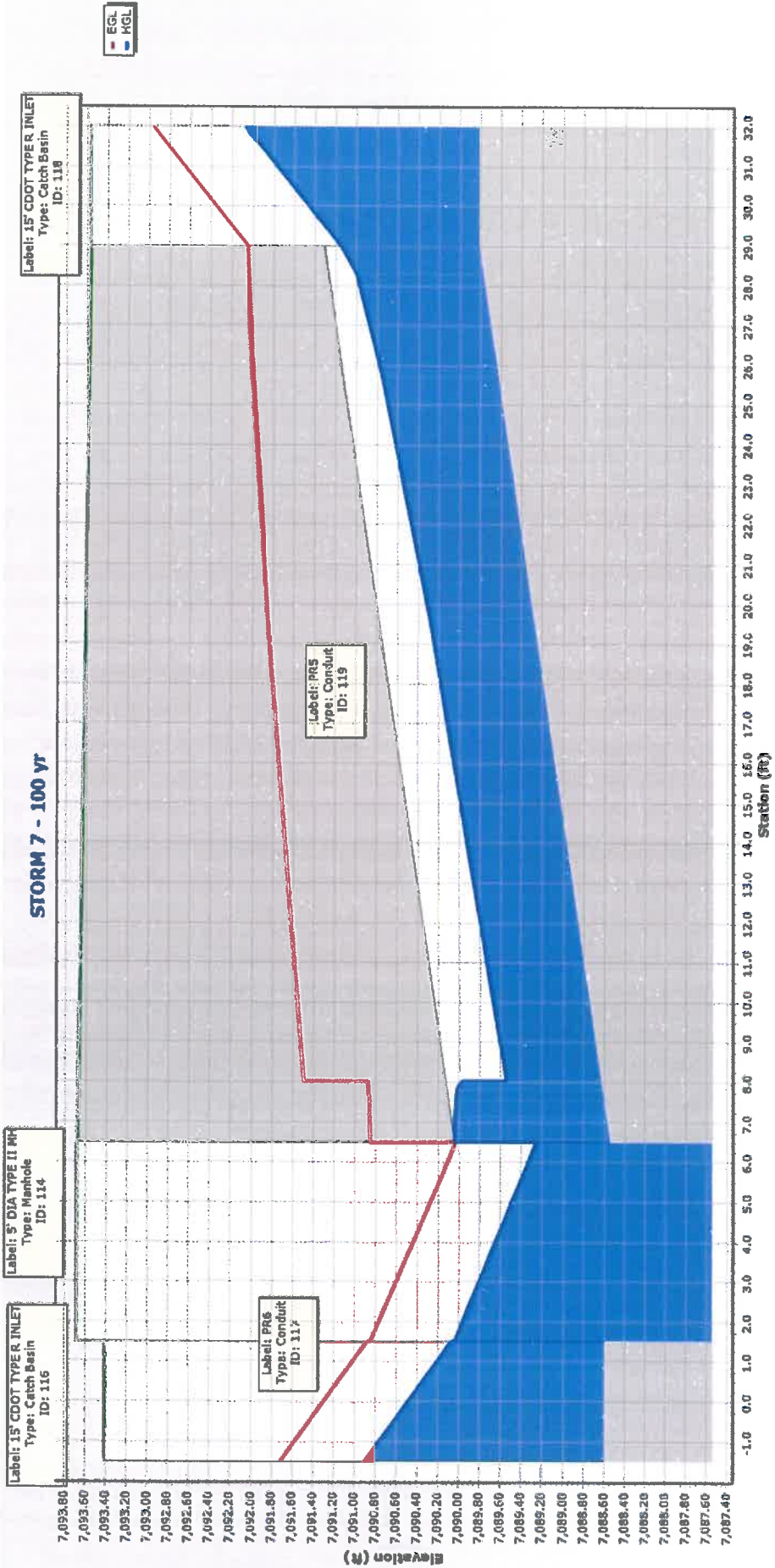

Label: 15' CDOT TYPED INLET
Type: Catch Basin
ID: 118

Label: 5' DIA TYPE II MH
Type: Manhole
ID: 114

Label: 15' CDOT TYPED INLET
Type: Catch Basin
ID: 116

Label: P45
Type: Conduit
ID: 119

Label: P46
Type: Conduit
ID: 117

EGL
HGL

STRM 4 POND 1 OUTFALL INDEX MAP

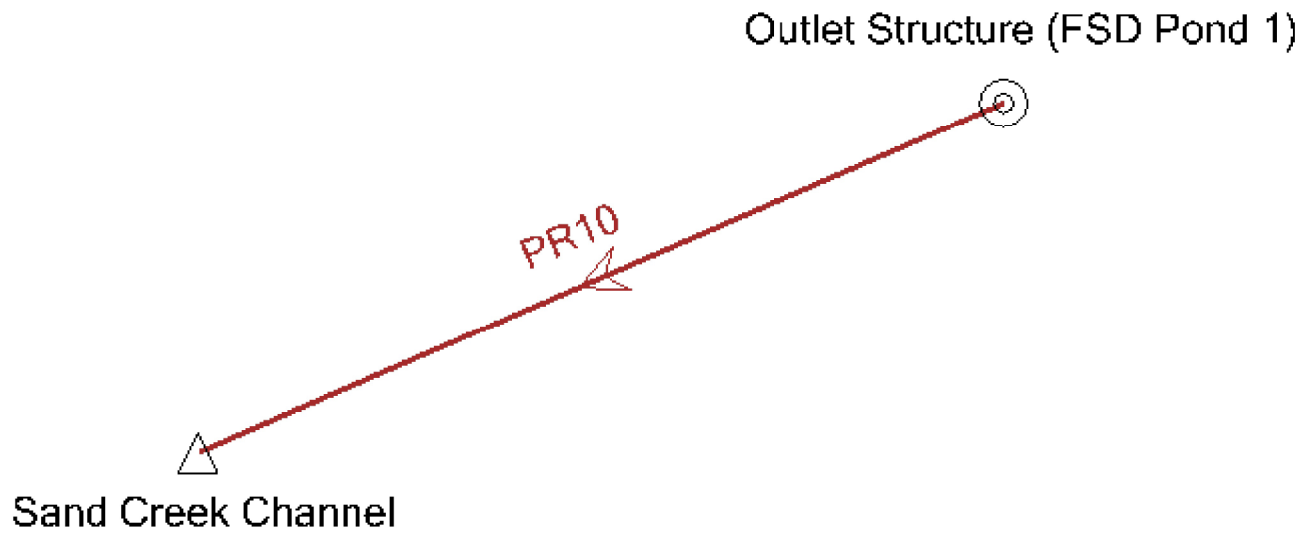

Conduit FlexTable: STRM 4 POND 1 7-30-19

Label	ID	Upstream Structure	Flow (cfs)	Flow / Capacity (Design) (%)	Length (Unified) (ft)	Velocity (ft/s)	Froude Number (Normal)	Depth (Normal) (ft)	Depth (Critical) (ft)	Energy Grade Line (In) (ft)	Energy Grade Line (Out) (ft)	Hydraulic Grade Line (In) (ft)	Hydraulic Grade Line (Out) (ft)	Headloss (ft)	Upstream Structure Hydraulic Grade Line (In) (ft)
PR10	129	Outlet Structure (FSD Pond 1)	23.50	40.3	78.2	17.56	3.772	0.88	1.72	7,078.68	7,074.39	7,077.64	7,069.91	7.73	7,079.20
Upstream Structure Velocity (In-Governing) (ft/s)	Upstream Structure Headloss Coefficient	Upstream Structure Headloss (ft)	Elevation Ground (Start) (ft)	Invert (Start) (ft)	Invert (Stop) (ft)										
8.17	1.500	1.56	7,083.40	7,075.92	7,069.00										

STORM 4 - 100 yr

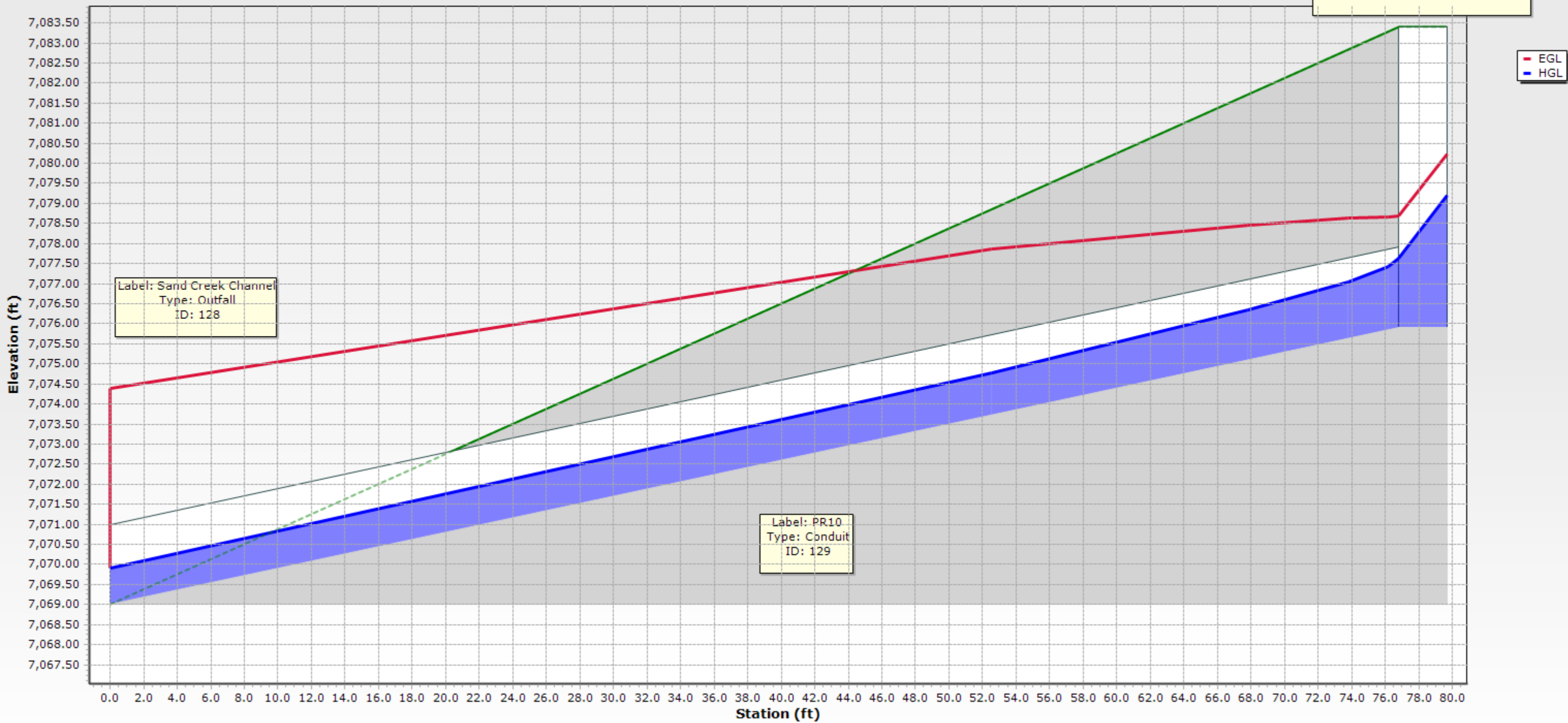

Label: Sand Creek Channel
Type: Outfall
ID: 128

Label: Outlet Structure (FSD Pond 1)
Type: Manhole
ID: 126

Label: PR10
Type: Conduit
ID: 129

EGL
HGL

LOTS 13-18 INDEX MAP

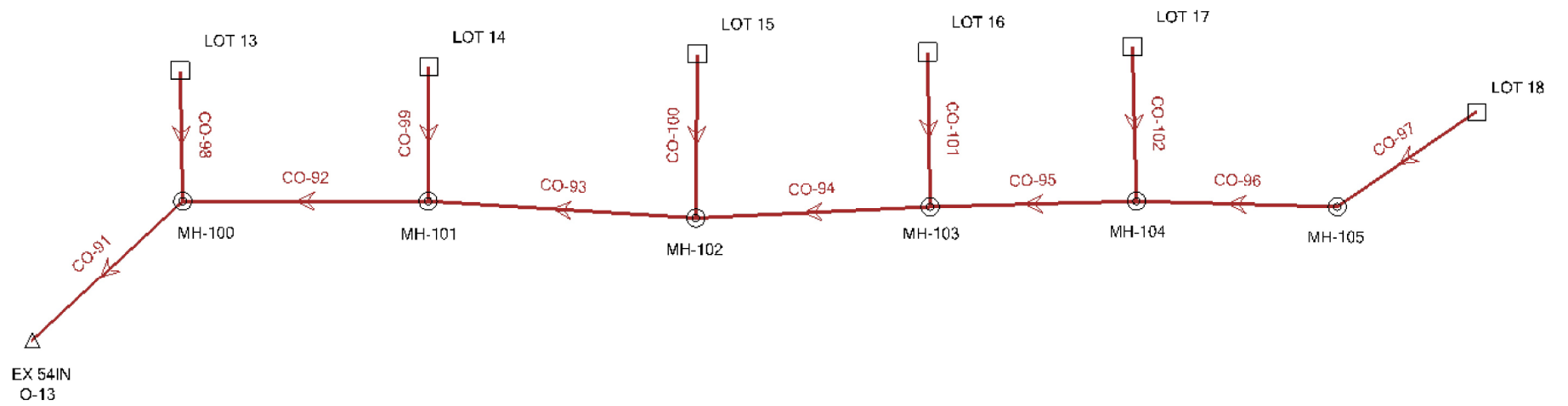

Conduit FlexTable: LOTS 13-18

Label	ID	Upstream Structure	Flow (cfs)	Flow / Capacity (Design) (%)	Length (Unified) (ft)	Velocity (ft/s)	Froude Number (Normal)	Depth (Normal) (ft)	Depth (Critical) (ft)	Energy Grade Line (In) (ft)	Energy Grade Line (Out) (ft)	Hydraulic Grade Line (In) (ft)	Hydraulic Grade Line (Out) (ft)	Headloss (ft)	Upstream Structure Hydraulic Grade Line (In) (ft)
CO-91	346	MH-100	1.40	11.5	48.7	10.34	4.544	0.23	0.50	7,057.60	7,054.83	7,057.40	7,054.78	2.62	7,057.60
CO-92	348	MH-101	1.20	14.0	92.5	7.71	3.213	0.25	0.46	7,062.23	7,057.69	7,062.05	7,057.60	4.45	7,062.23
CO-93	350	MH-102	0.90	23.2	68.5	4.02	1.450	0.33	0.40	7,062.93	7,062.30	7,062.78	7,062.23	0.54	7,062.93
CO-94	352	MH-103	0.60	15.5	63.7	3.58	1.447	0.27	0.32	7,063.56	7,062.98	7,063.44	7,062.93	0.51	7,063.56
CO-95	354	MH-104	0.40	10.4	70.3	3.17	1.431	0.22	0.26	7,064.27	7,063.61	7,064.18	7,063.56	0.62	7,064.28
CO-96	356	MH-105	0.20	5.2	59.0	2.59	1.396	0.15	0.18	7,064.86	7,064.30	7,064.79	7,064.28	0.52	7,064.86
CO-97	358	LOT 18	0.20	12.4	17.3	5.60	3.407	0.12	0.22	7,066.74	7,065.82	7,066.65	7,065.33	1.33	7,066.78
CO-98	360	LOT 13	0.20	19.4	13.4	9.18	6.057	0.10	0.25	7,061.24	7,058.91	7,061.11	7,057.60	3.51	7,061.30
CO-99	362	LOT 14	0.30	22.9	11.4	5.41	2.775	0.16	0.28	7,063.11	7,062.78	7,063.00	7,062.36	0.64	7,063.17
CO-100	364	LOT 15	0.30	35.6	11.4	3.94	1.763	0.21	0.28	7,063.59	7,063.42	7,063.48	7,063.19	0.29	7,063.65
CO-101	366	LOT 16	0.20	9.3	11.4	6.86	4.501	0.10	0.22	7,065.46	7,064.55	7,065.37	7,063.82	1.55	7,065.50
CO-102	368	LOT 17	0.20	9.1	11.4	6.94	4.577	0.10	0.22	7,066.31	7,065.37	7,066.22	7,064.62	1.60	7,066.35

Upstream Structure Velocity (In-Governing) (ft/s)	Upstream Structure Headloss Coefficient	Upstream Structure Headloss (ft)	Elevation Ground (Start) (ft)	Invert (Start) (ft)	Invert (Stop) (ft)
9.18	1.020	0.20	7,060.00	7,052.03	7,056.90
2.06	1.020	0.18	7,064.83	7,057.00	7,061.59
1.75	1.020	0.15	7,066.63	7,061.69	7,062.38
1.69	1.020	0.12	7,066.67	7,062.48	7,063.12
1.26	1.020	0.09	7,068.56	7,063.22	7,063.92
5.60	1.020	0.06	7,068.56	7,064.02	7,064.61
2.35	1.500	0.13	7,069.29	7,065.21	7,066.43
2.82	1.500	0.19	7,064.83	7,057.50	7,060.86
2.69	1.500	0.17	7,066.63	7,062.19	7,062.72
2.69	1.500	0.17	7,066.67	7,062.98	7,063.20
2.35	1.500	0.13	7,068.56	7,063.72	7,065.15
2.35	1.500	0.13	7,068.56	7,064.52	7,066.00

12" STRM LOTS 13-18 - 100 yr

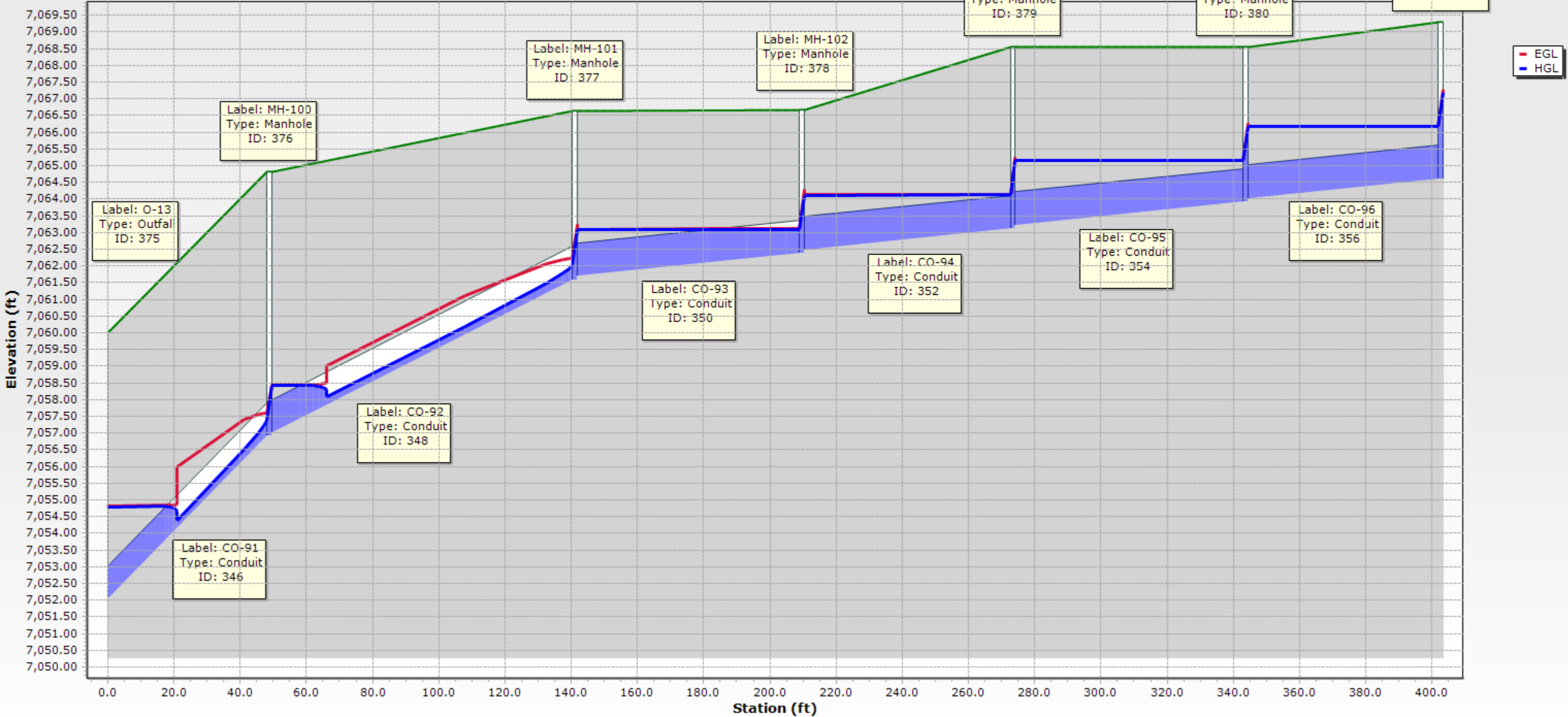

6" STRM LOT 13 - 100 yr

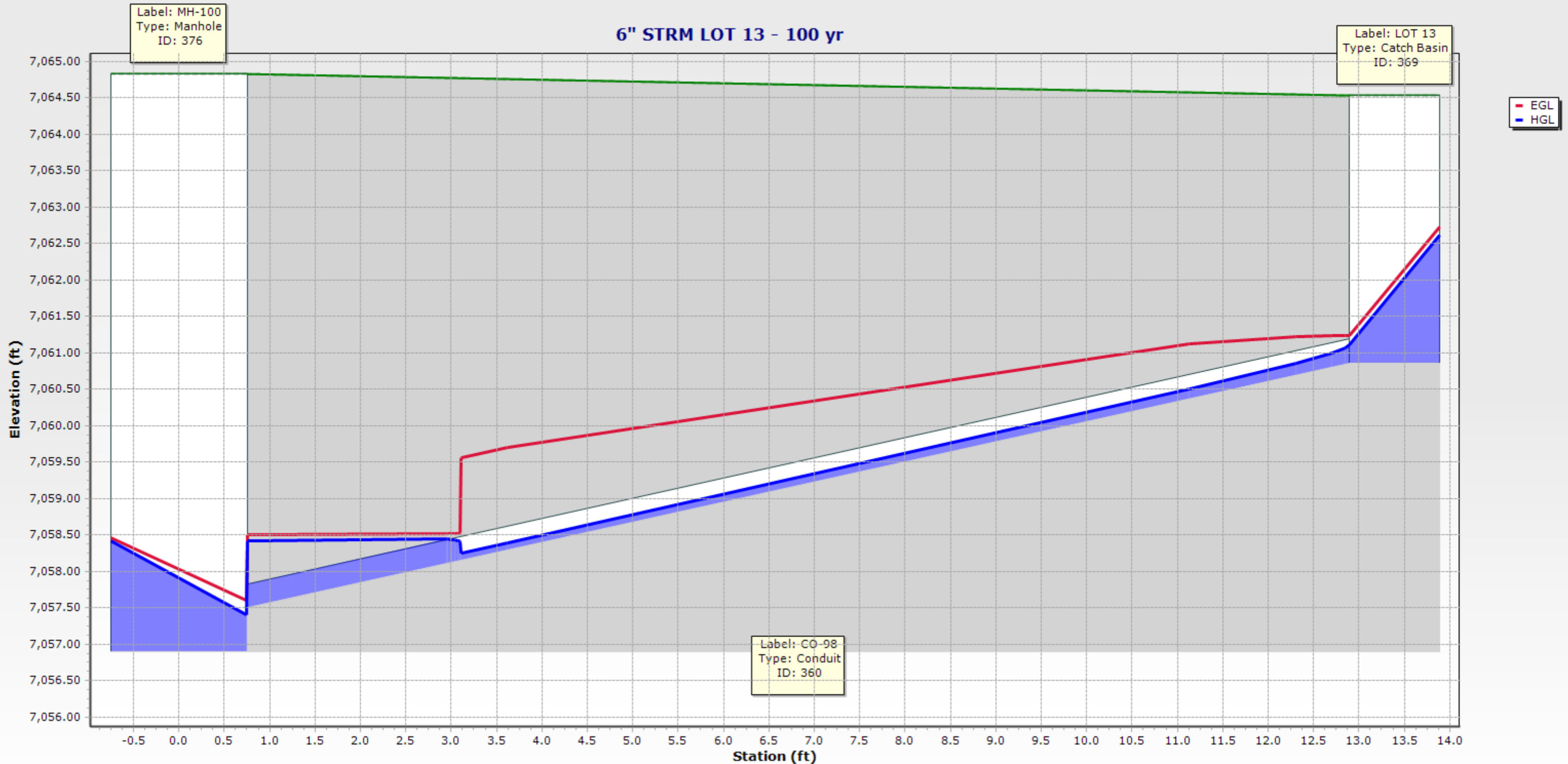

6" STRM LOT 14 - 100 yr

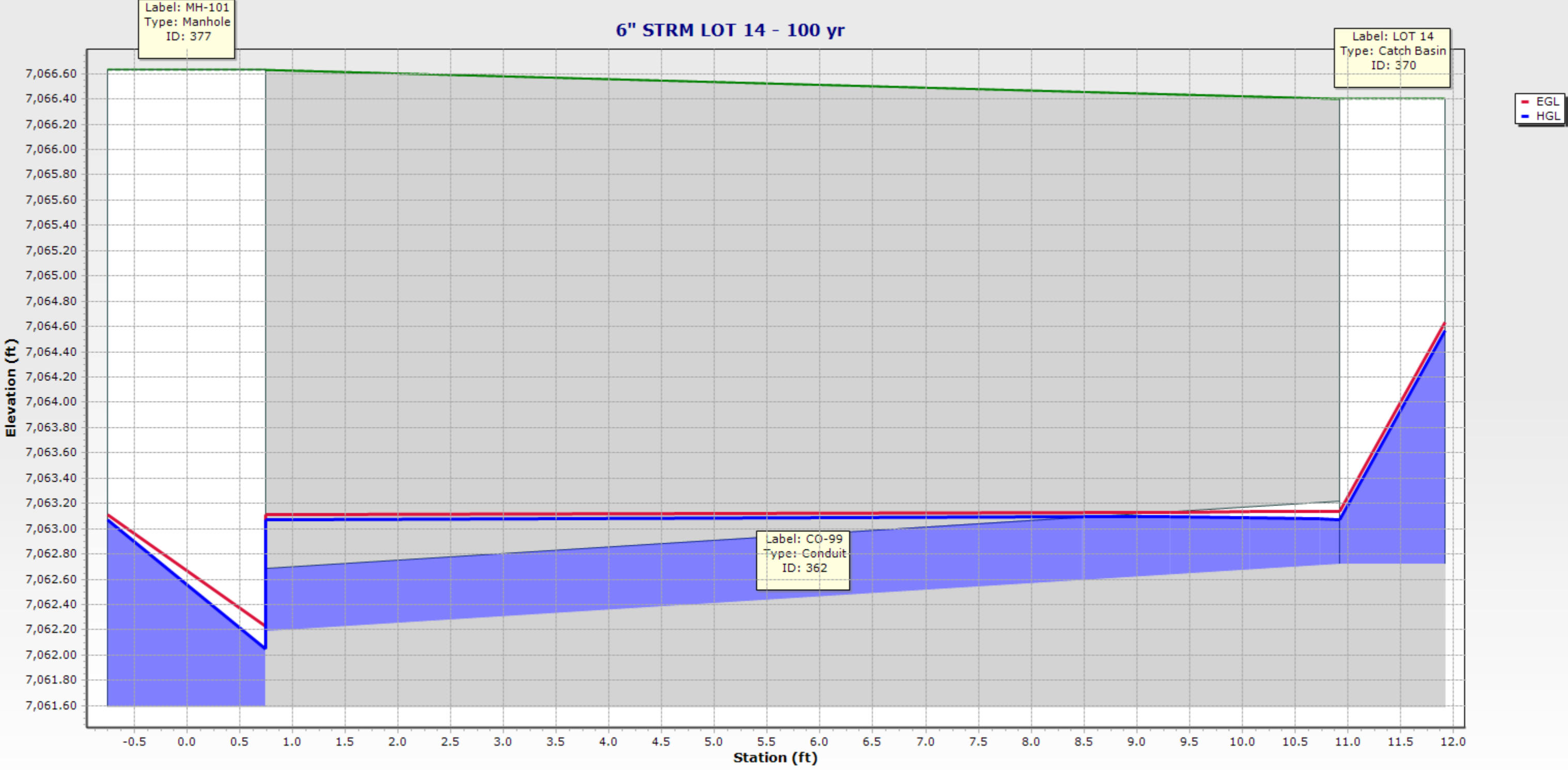

6" STRM LOT 15 - 100 yr

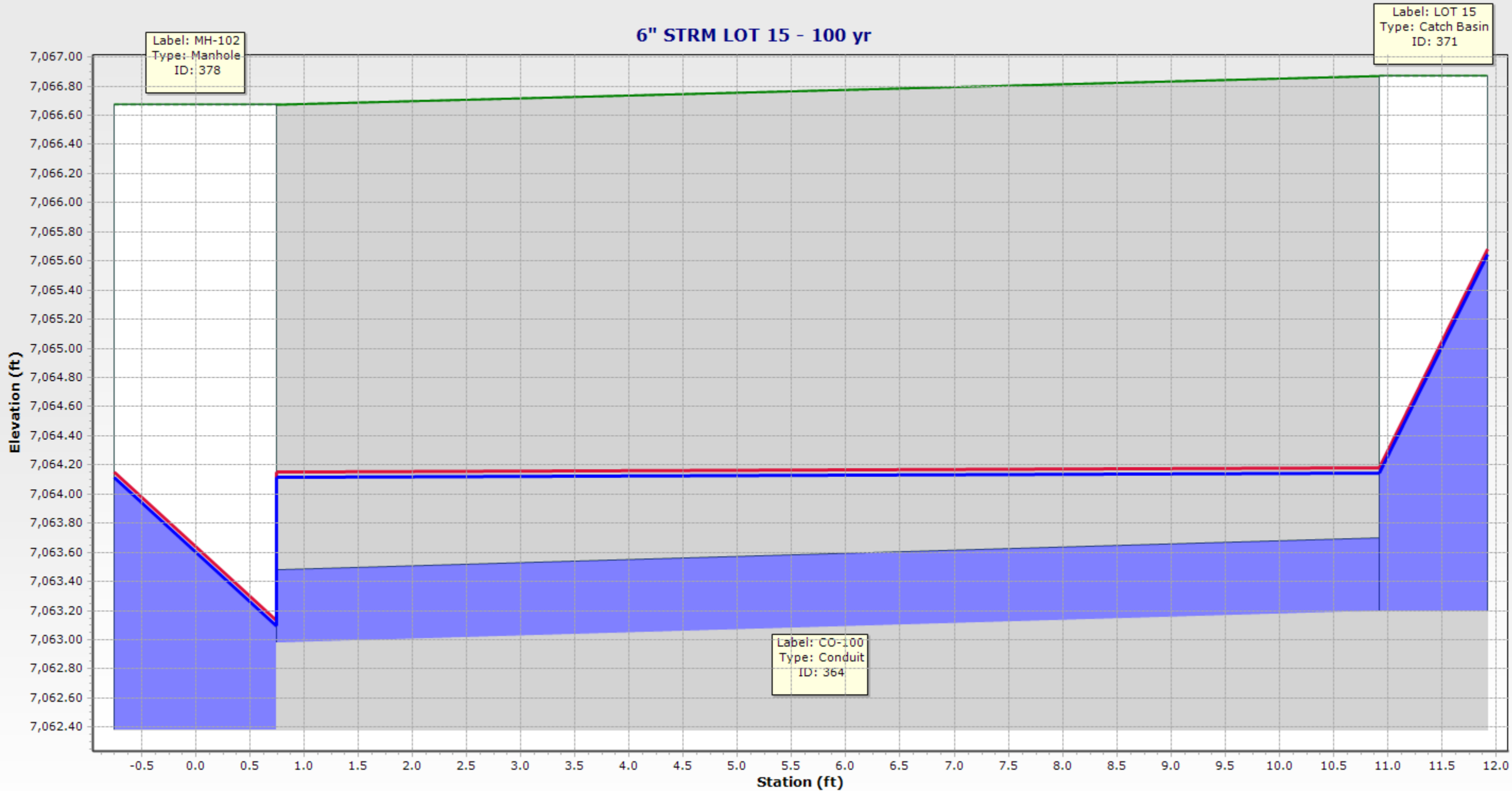

Label: MH-102
Type: Manhole
ID: 378

Label: LOT 15
Type: Catch Basin
ID: 371

EGL
HGL

Label: CO-100
Type: Conduit
ID: 364

6" STRM LOT 16 - 100 yr

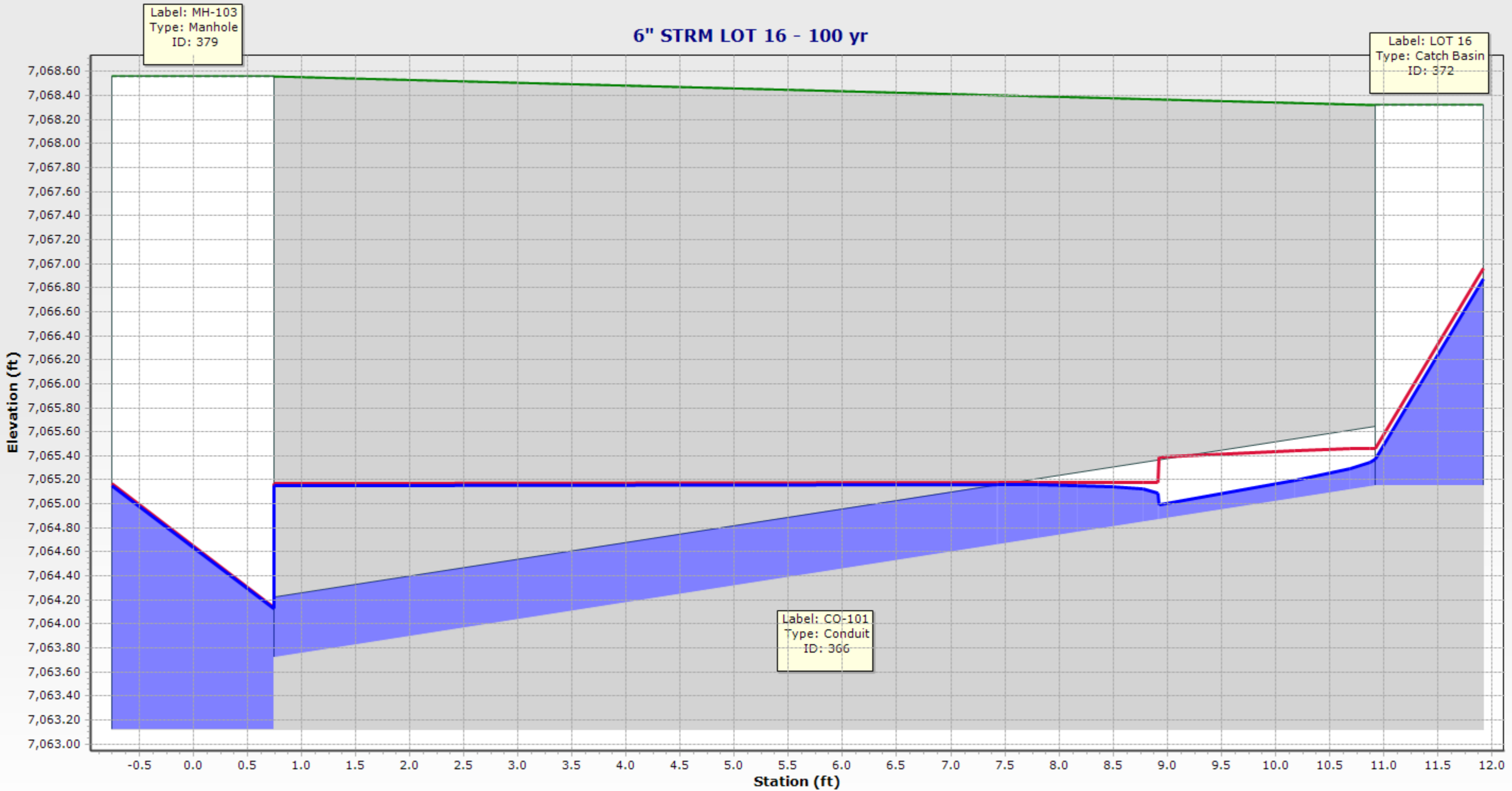

6" STRM LOT 17 - 100 yr

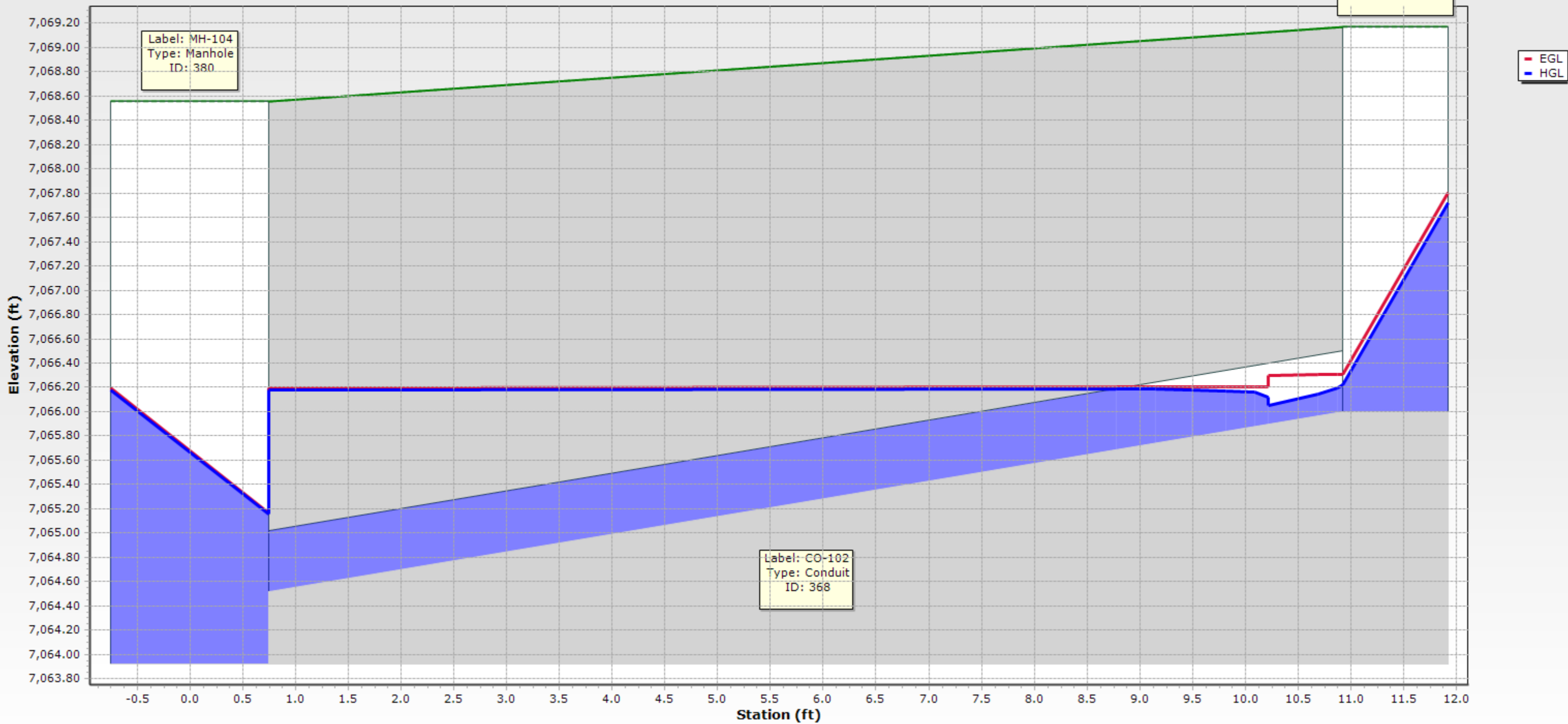

6" STRM LOT 18 - 100 yr

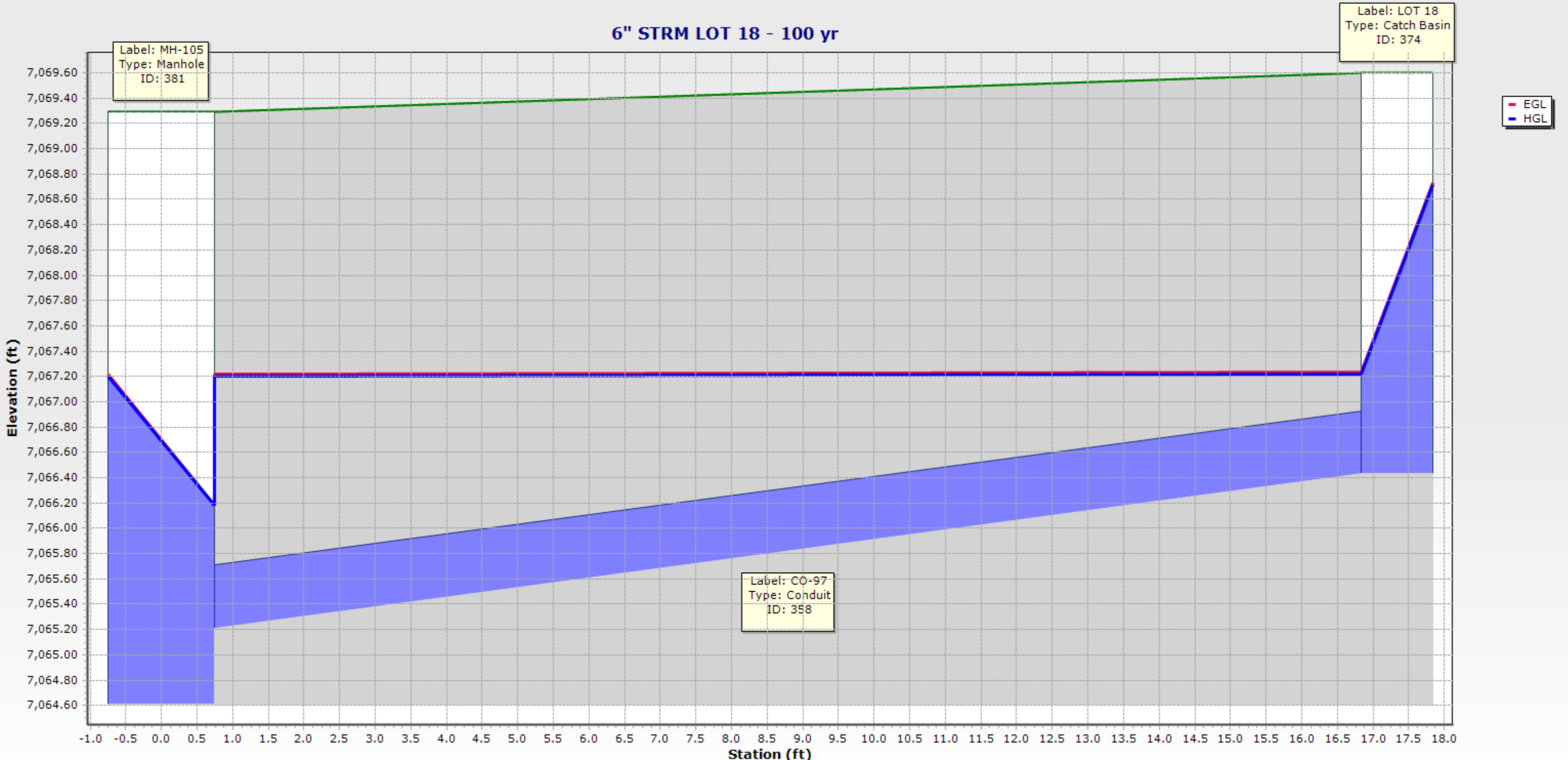

Label: MH-105
Type: Manhole
ID: 381

Label: LOT 18
Type: Catch Basin
ID: 374

EGL
HGL

Label: CO-97
Type: Conduit
ID: 358

LOTS 19-24 INDEX MAP

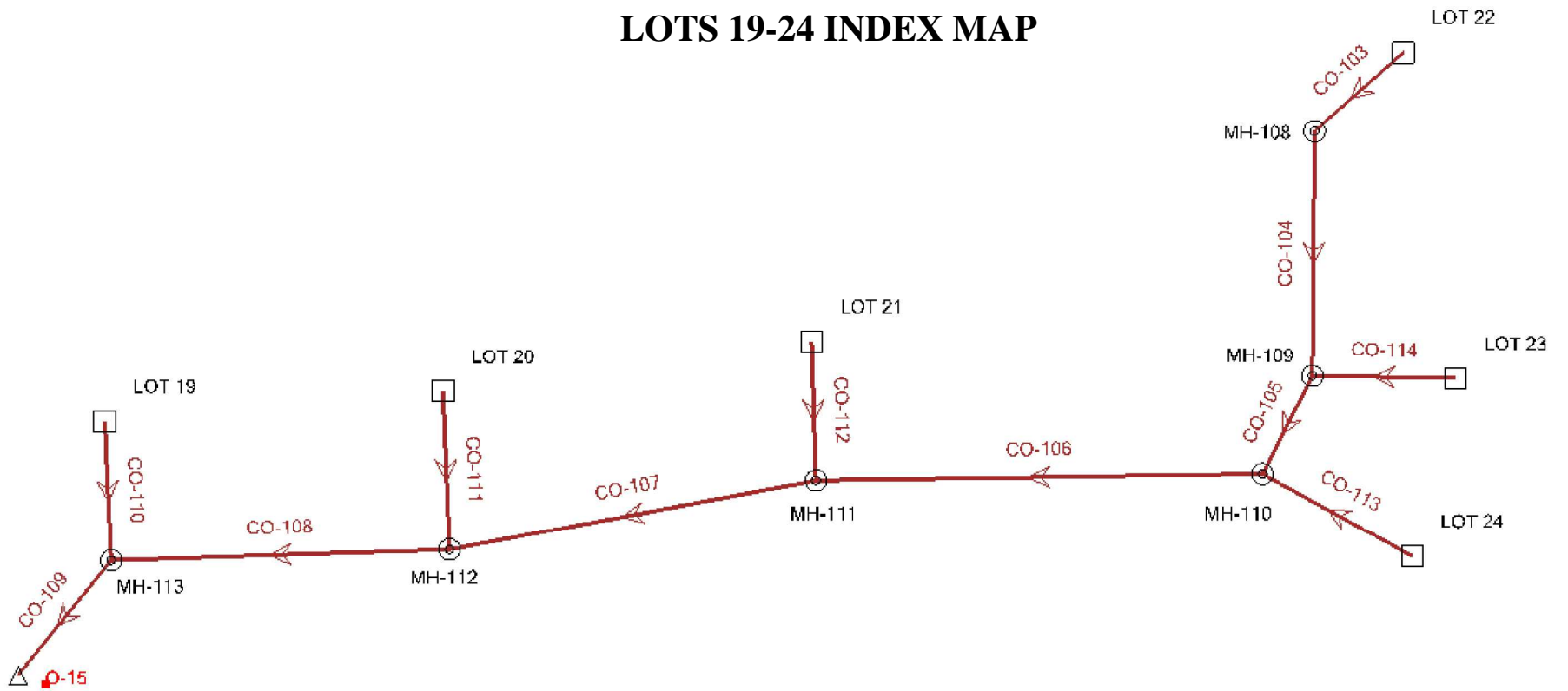

Conduit FlexTable: LOTS 19-24

Label	ID	Upstream Structure	Flow (cfs)	Flow / Capacity (Design) (%)	Length (Unified) (ft)	Velocity (ft/s)	Froude Number (Normal)	Depth (Normal) (ft)	Depth (Critical) (ft)	Energy Grade Line (In) (ft)	Energy Grade Line (Out) (ft)	Hydraulic Grade Line (In) (ft)	Hydraulic Grade Line (Out) (ft)	Headloss (ft)	Upstream Structure Hydraulic Grade Line (In) (ft)
CO-103	400	LOT 22	0.30	26.4	8.3	4.87	2.391	0.18	0.28	7,076.34	7,076.16	7,076.23	7,075.85	0.38	7,077.73
CO-104	402	MH-108	0.30	7.1	56.4	3.10	1.543	0.18	0.23	7,075.46	7,074.94	7,075.39	7,074.93	0.45	7,075.47
CO-105	404	MH-109	0.60	4.4	12.0	8.64	4.839	0.14	0.32	7,074.93	7,073.52	7,074.81	7,073.47	1.34	7,074.93
CO-106	406	MH-110	0.90	7.6	61.7	8.88	4.338	0.19	0.40	7,073.47	7,067.75	7,073.32	7,067.67	5.64	7,073.47
CO-107	408	MH-111	1.10	20.3	68.8	5.40	2.026	0.31	0.44	7,067.67	7,066.37	7,067.50	7,066.28	1.22	7,067.67
CO-108	410	MH-112	1.30	25.0	82.9	5.51	1.946	0.34	0.48	7,066.28	7,064.83	7,066.09	7,064.73	1.36	7,066.28
CO-109	412	MH-113	1.50	6.1	26.1	17.27	8.934	0.17	0.52	7,064.73	7,056.75	7,064.52	7,056.69	7.83	7,064.73
CO-110	414	LOT 19	0.20	1.4	11.3	6.41	4.758	0.08	0.18	7,066.60	7,065.32	7,066.53	7,064.68	1.85	7,066.63
CO-111	416	LOT 20	0.20	24.0	12.8	3.49	1.763	0.17	0.22	7,066.76	7,066.56	7,066.67	7,066.38	0.30	7,066.80
CO-112	418	LOT 21	0.20	24.0	12.7	3.49	1.768	0.17	0.22	7,068.21	7,068.02	7,068.12	7,067.83	0.30	7,068.25
CO-113	420	LOT 24	0.30	39.5	19.2	3.64	1.576	0.22	0.28	7,074.21	7,073.94	7,074.10	7,073.74	0.36	7,074.27
CO-114	422	LOT 23	0.30	11.2	4.6	8.98	5.603	0.11	0.28	7,076.36	7,076.07	7,076.25	7,075.22	1.03	7,076.42

Upstream Structure Velocity (In-Governing) (ft/s)	Upstream Structure Headloss Coefficient	Upstream Structure Headloss (ft)	Elevation Ground (Start) (ft)	Invert (Start) (ft)	Invert (Stop) (ft)
2.69	1.000	1.50	7,079.62	7,075.95	7,075.66
4.53	1.020	0.08	7,080.13	7,075.16	7,074.49
0.90	1.020	0.12	7,080.15	7,074.49	7,073.02
1.75	1.020	0.15	7,078.40	7,072.92	7,067.16
2.22	1.020	0.17	7,071.56	7,067.06	7,065.71
2.36	1.020	0.19	7,069.39	7,065.61	7,064.10
6.41	1.020	0.21	7,068.00	7,064.00	7,053.50
2.02	1.500	0.10	7,069.52	7,066.35	7,064.60
2.35	1.500	0.13	7,069.62	7,066.45	7,066.21
2.35	1.500	0.13	7,071.57	7,067.90	7,067.66
2.69	1.500	0.17	7,077.49	7,073.82	7,073.52
2.69	1.500	0.17	7,079.64	7,075.97	7,075.09

12" STRM LOTS19-24 - 100 yr

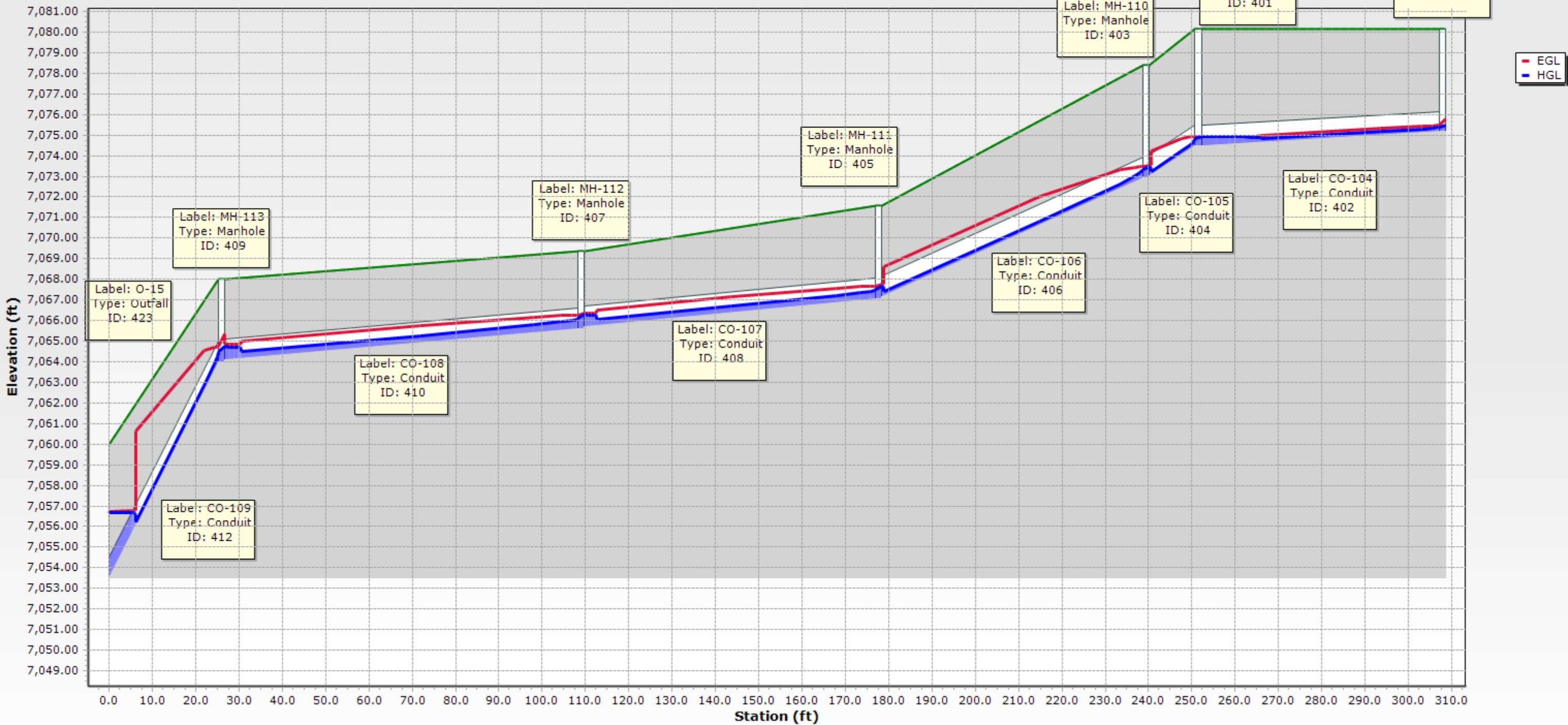

6" STRM LOT 19 - 100 yr

Label: LOT 19
Type: Catch Basin
ID: 424

EGL
HGL

Label: MH-113
Type: Manhole
ID: 409

Label: CO-110
Type: Conduit
ID: 414

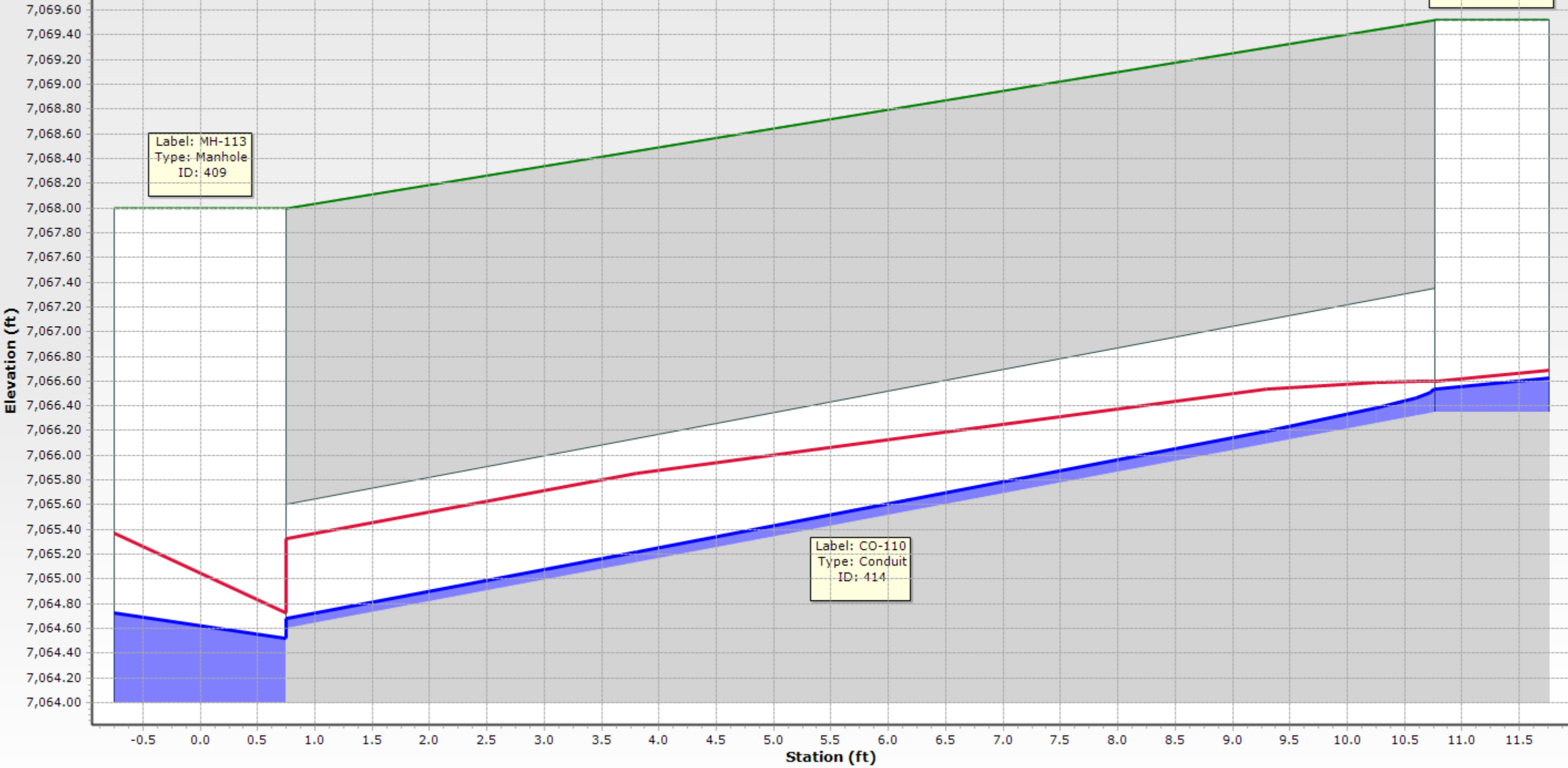

6" STRM LOT 20 - 100 yr

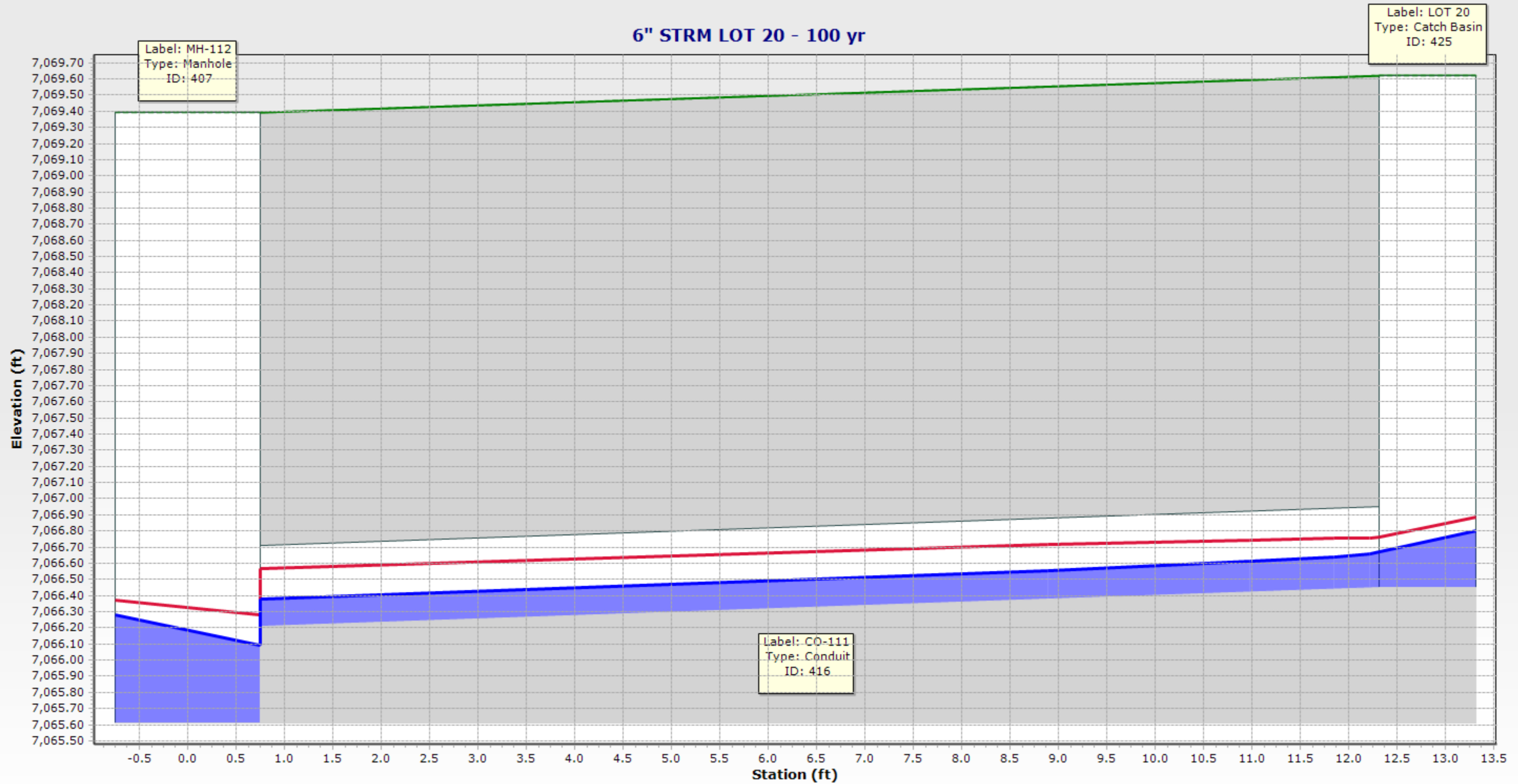

Label: MH-112
Type: Manhole
ID: 407

Label: LOT 20
Type: Catch Basin
ID: 425

Label: CO-111
Type: Conduit
ID: 416

EGL
HGL

6" STRM LOT 21 - 100 yr

Label: MH-111
Type: Manhole
ID: 405

Label: LOT 21
Type: Catch Basin
ID: 426

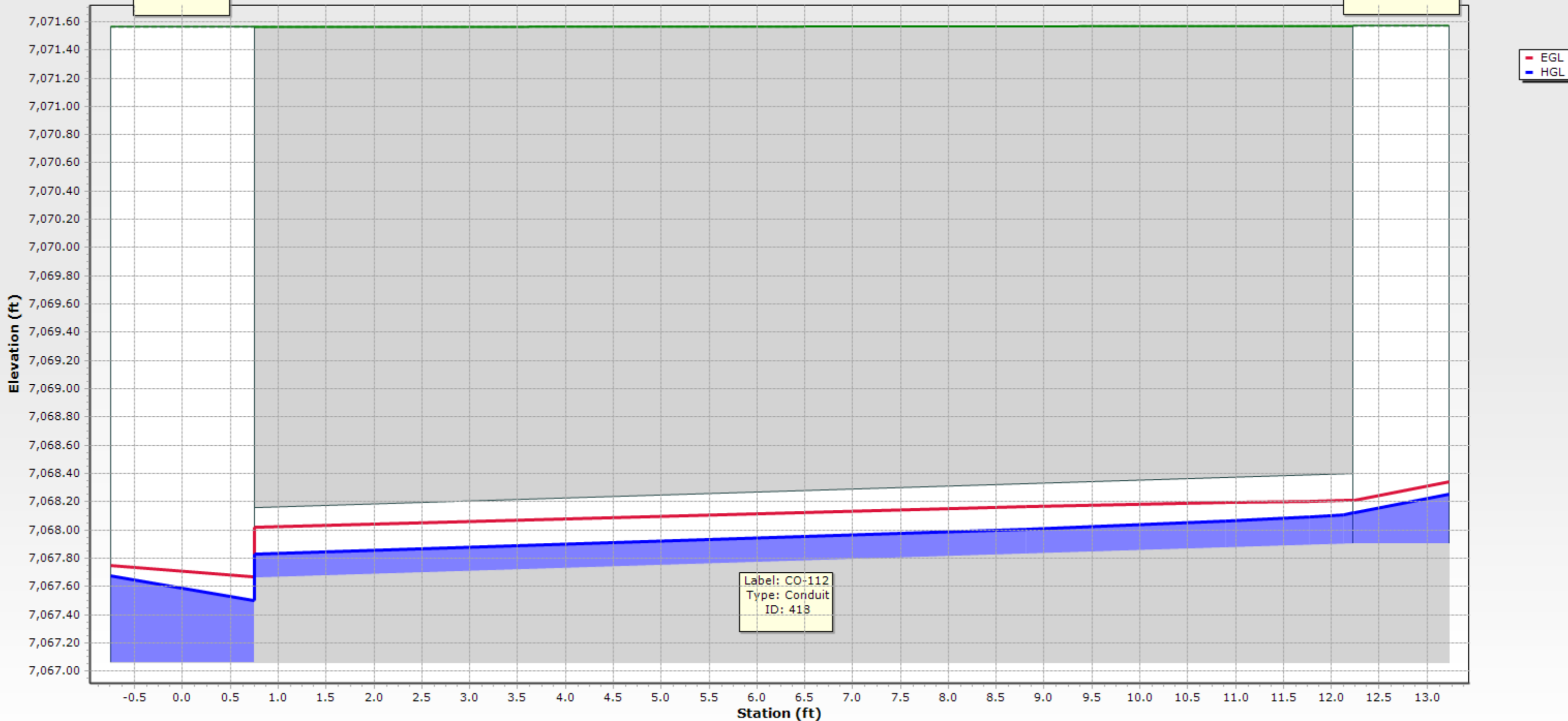

Label: CO-112
Type: Conduit
ID: 413

6" STRM LOT 22 - 100 yr

Label: MH-108
Type: Manhole
ID: 399

Label: LOT 22
Type: Catch Basin
ID: 427

EGL
HGL

Label: CO-103
Type: Conduit
ID: 400

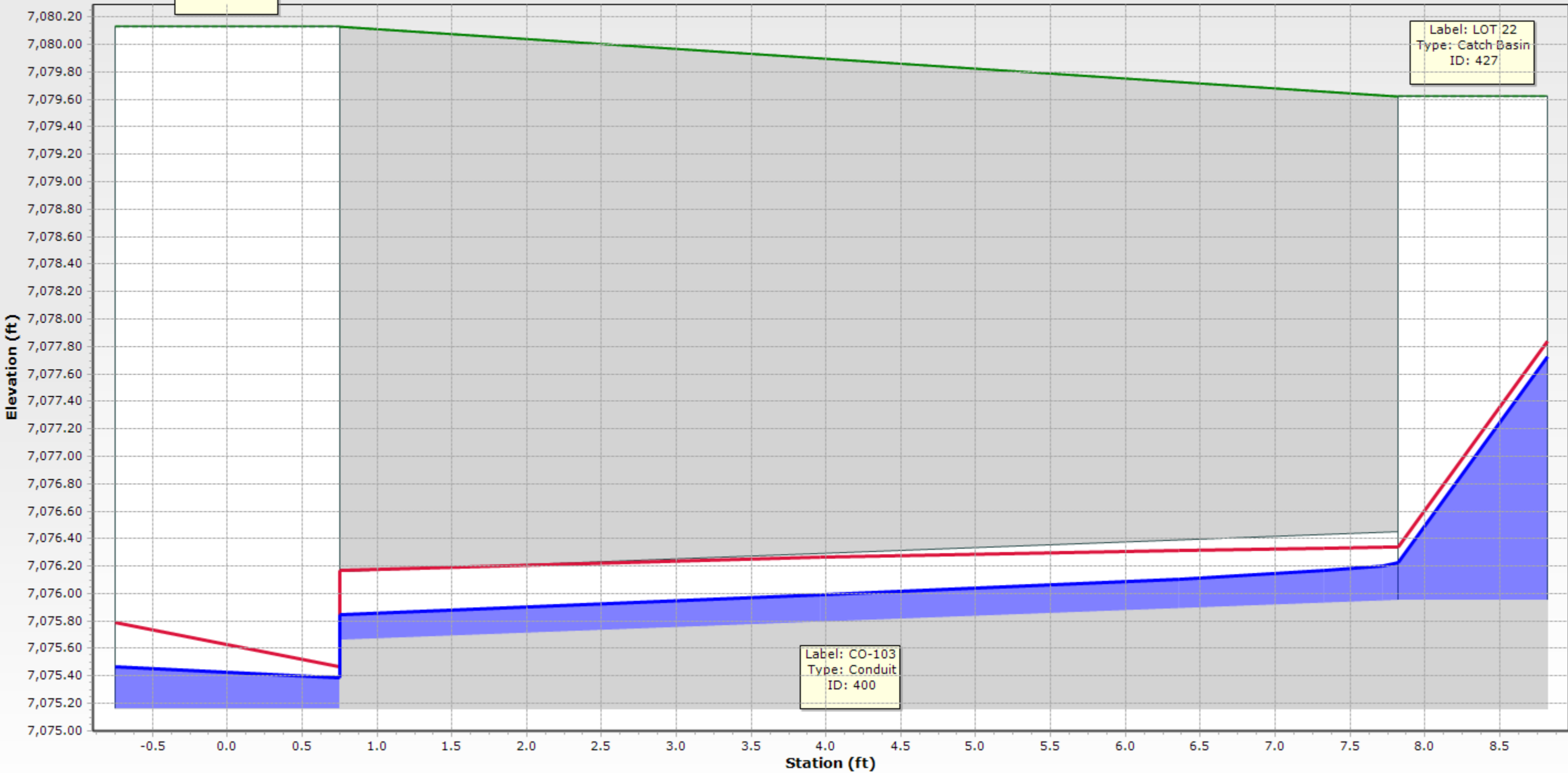

6" STRM LOT 23 - 100 yr

Label: MH-109
Type: Manhole
ID: 401

Label: LOT-23
Type: Catch Basin
ID: 428

Label: CO-114
Type: Conduit
ID: 422

EGL
HGL

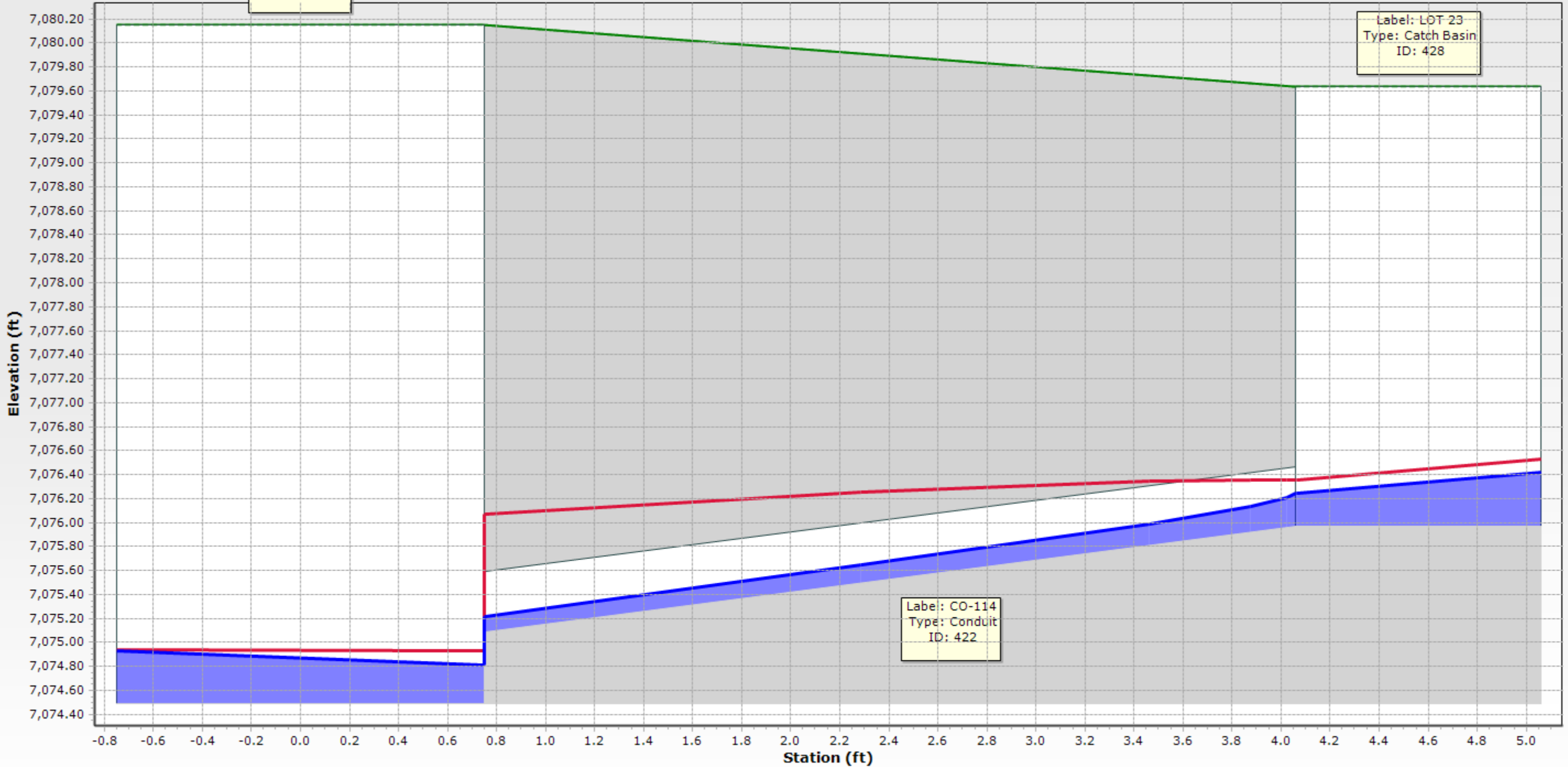

6" STRM LOT 24 - 100 yr

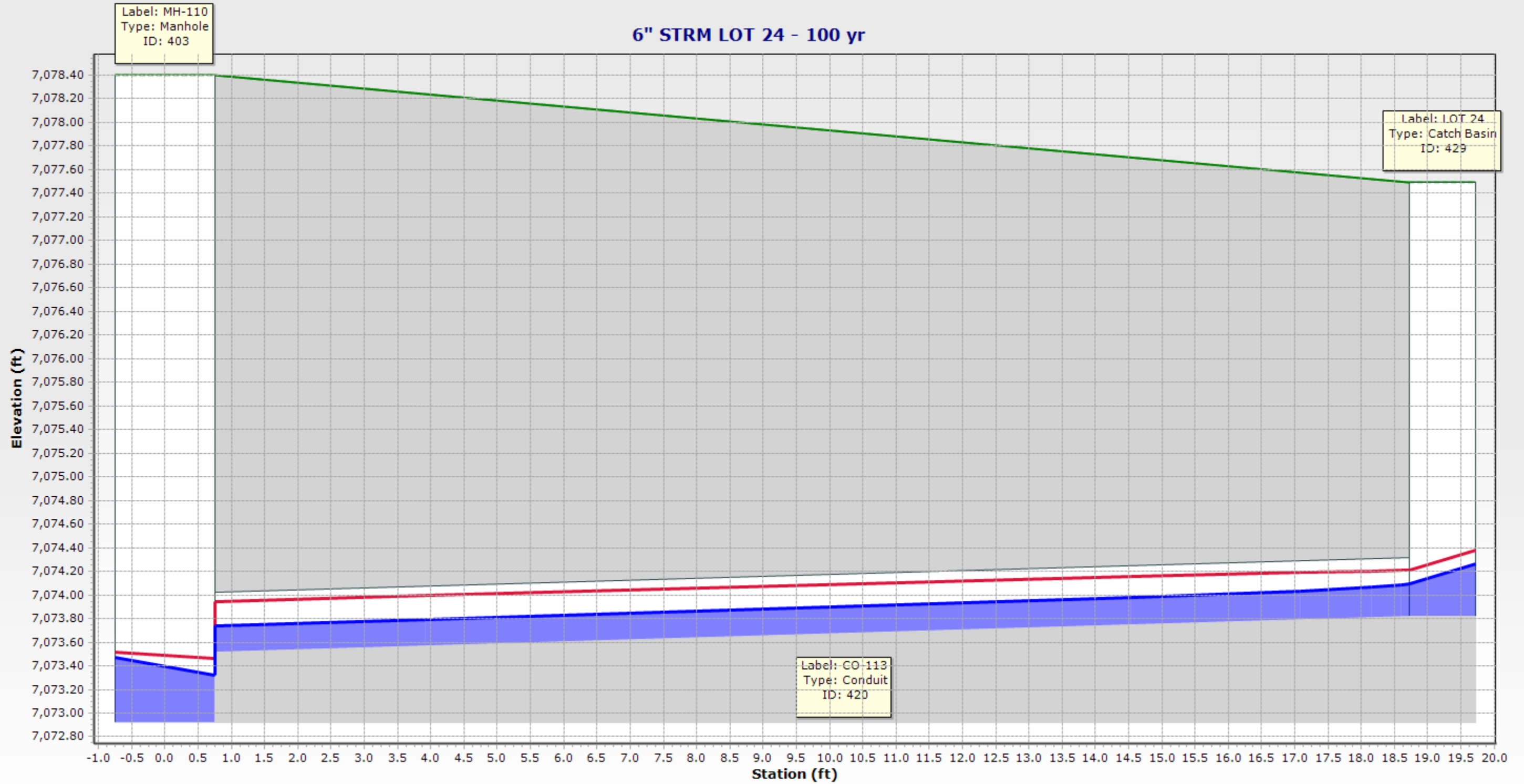

LOTS 28-35 INDEX MAP

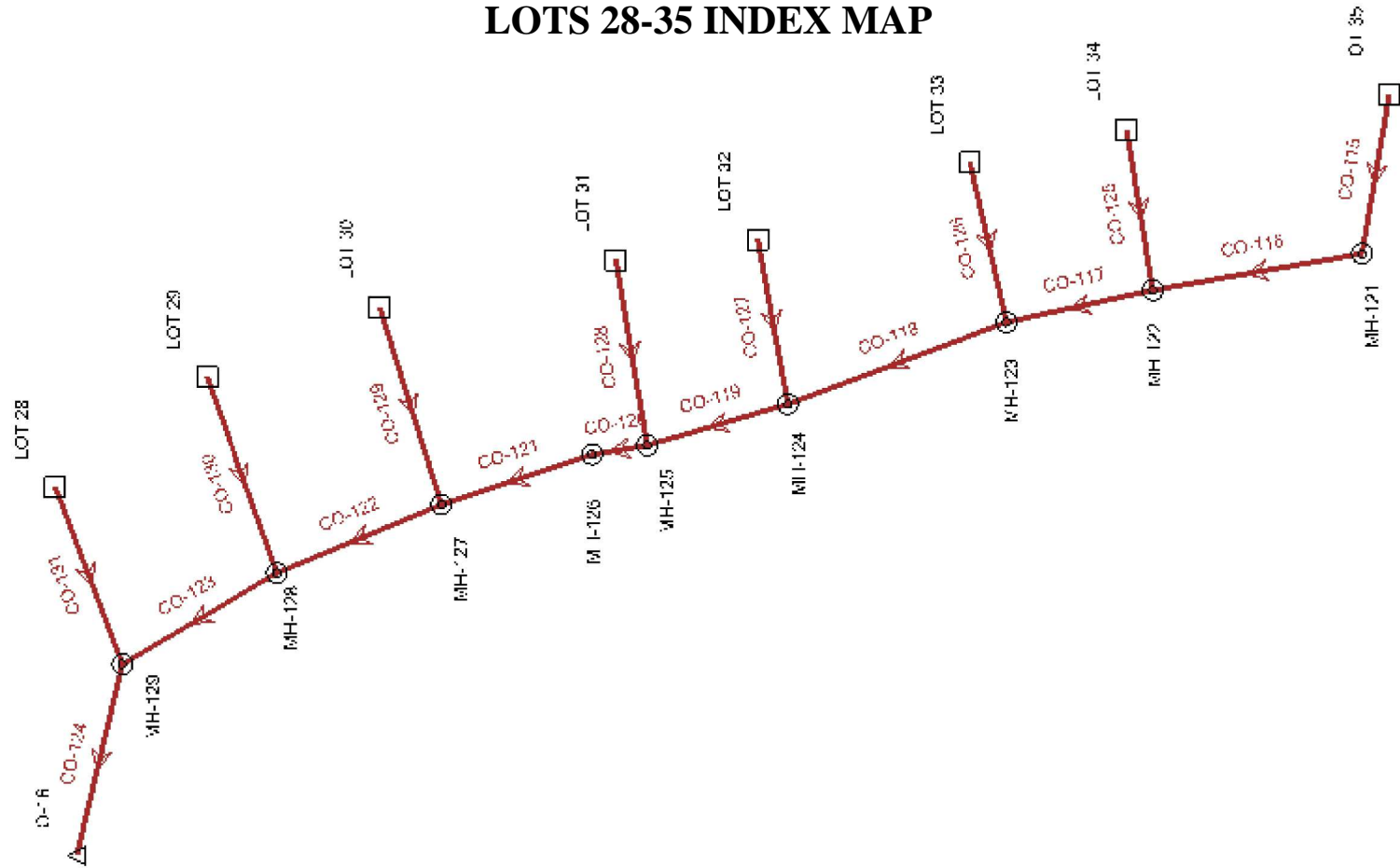

Conduit FlexTable: LOTS 28-35

Label	ID	Upstream Structure	Flow (cfs)	Flow / Capacity (Design) (%)	Length (Unified) (ft)	Velocity (ft/s)	Froude Number (Normal)	Depth (Normal) (ft)	Depth (Critical) (ft)	Energy Grade Line (In) (ft)	Energy Grade Line (Out) (ft)	Hydraulic Grade Line (In) (ft)	Hydraulic Grade Line (Out) (ft)	Headloss (ft)	Upstream Structure Hydraulic Grade Line (In) (ft)
CO-115	441	LOT 35	0.20	32.9	24.9	2.78	1.278	0.20	0.22	7,084.48	7,084.24	7,084.39	7,084.12	0.28	7,084.52
CO-116	443	MH-121	0.20	4.1	60.4	3.05	1.741	0.14	0.18	7,083.57	7,082.64	7,083.50	7,082.62	0.89	7,083.57
CO-117	445	MH-122	0.40	7.3	73.1	4.07	2.015	0.18	0.26	7,082.61	7,081.17	7,082.52	7,081.12	1.40	7,082.62
CO-118	447	MH-123	0.60	13.9	73.5	3.87	1.614	0.25	0.32	7,081.12	7,080.23	7,081.00	7,080.18	0.83	7,081.12
CO-119	449	MH-124	0.80	12.0	79.5	5.72	2.483	0.23	0.37	7,080.17	7,077.84	7,080.03	7,077.77	2.26	7,080.18
CO-120	451	MH-125	1.00	11.2	14.2	7.51	3.319	0.23	0.42	7,077.77	7,077.02	7,077.61	7,076.91	0.70	7,077.77
CO-121	453	MH-126	1.00	21.5	74.7	4.71	1.738	0.32	0.42	7,076.91	7,076.21	7,076.75	7,076.12	0.63	7,076.91
CO-122	455	MH-127	1.20	31.2	68.5	4.33	1.430	0.38	0.46	7,076.12	7,075.49	7,075.94	7,075.40	0.54	7,076.12
CO-123	457	MH-128	1.40	29.4	63.6	5.28	1.776	0.37	0.50	7,075.40	7,074.49	7,075.20	7,074.39	0.81	7,075.40
CO-124	459	MH-129	1.60	18.4	91.1	8.44	3.258	0.29	0.54	7,074.38	7,070.40	7,074.17	7,069.29	4.88	7,074.39
CO-125	462	LOT 34	0.20	32.6	11.8	2.80	1.288	0.20	0.22	7,083.29	7,083.18	7,083.20	7,083.06	0.15	7,083.33
CO-126	464	LOT 33	0.20	32.4	10.7	2.81	1.297	0.20	0.22	7,081.70	7,081.60	7,081.61	7,081.48	0.14	7,081.74
CO-127	466	LOT 32	0.20	23.8	11.0	3.51	1.779	0.17	0.22	7,080.78	7,080.61	7,080.69	7,080.43	0.27	7,080.82
CO-128	468	LOT 31	0.20	14.2	11.4	5.08	2.976	0.13	0.22	7,078.71	7,078.31	7,078.62	7,077.92	0.71	7,078.75
CO-129	470	LOT 30	0.20	7.4	11.5	8.06	5.616	0.09	0.22	7,078.64	7,077.18	7,078.55	7,076.17	2.38	7,078.68
CO-130	472	LOT 29	0.20	9.7	11.4	6.66	4.328	0.11	0.22	7,076.93	7,076.09	7,076.84	7,075.41	1.44	7,076.97
CO-131	474	LOT 28	0.20	28.0	11.5	3.12	1.509	0.18	0.22	7,074.65	7,074.56	7,074.56	7,074.41	0.15	7,074.69
Upstream Structure Velocity (In-Governing) (ft/s)	Upstream Structure Headloss Coefficient	Upstream Structure Headloss (ft)	Elevation Ground (Start) (ft)	Invert (Start) (ft)	Invert (Stop) (ft)										
2.35	1.500	0.13	7,087.44	7,084.17	7,083.92										
2.78	1.020	0.06	7,087.35	7,083.32	7,082.36										
1.26	1.020	0.09	7,086.48	7,082.26	7,080.78										
1.69	1.020	0.12	7,084.80	7,080.68	7,079.76										
1.95	1.020	0.14	7,084.14	7,079.66	7,077.29										
2.14	1.020	0.16	7,081.90	7,077.19	7,076.43										
2.67	1.020	0.16	7,080.33	7,076.33	7,075.58										
2.29	1.020	0.18	7,080.33	7,075.48	7,074.80										
2.43	1.020	0.20	7,080.00	7,074.70	7,073.73										
2.56	1.020	0.22	7,078.38	7,073.63	7,069.00										
2.35	1.500	0.13	7,086.25	7,082.98	7,082.86										
2.35	1.500	0.13	7,084.66	7,081.39	7,081.28										
2.35	1.500	0.13	7,083.74	7,080.47	7,080.26										
2.35	1.500	0.13	7,081.67	7,078.40	7,077.79										
2.35	1.500	0.13	7,081.60	7,078.33	7,076.08										
2.35	1.500	0.13	7,079.89	7,076.62	7,075.30										
2.35	1.500	0.13	7,078.11	7,074.34	7,074.23										

12" STRM LOTS 28-35 - 100 yr

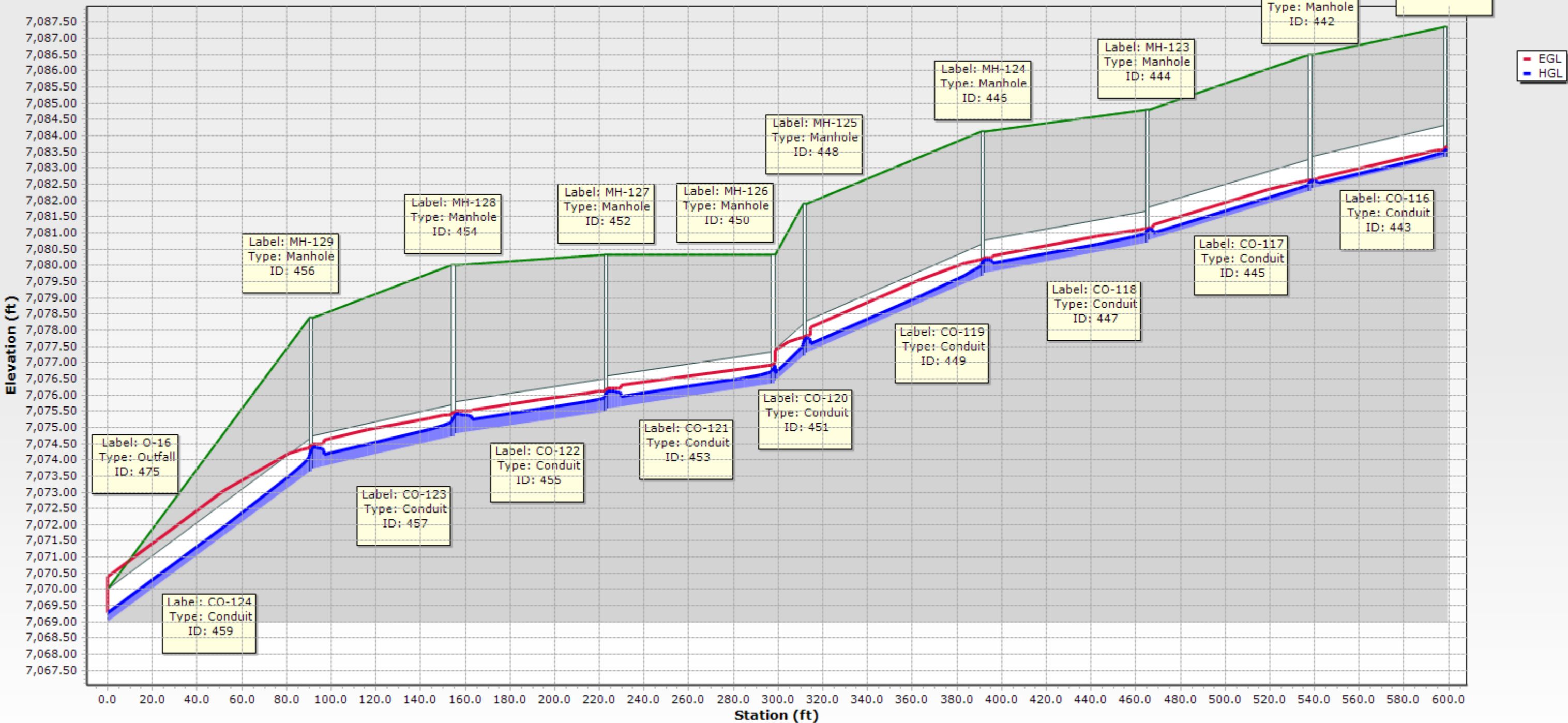

6" STRM LOT 28 - 100 yr

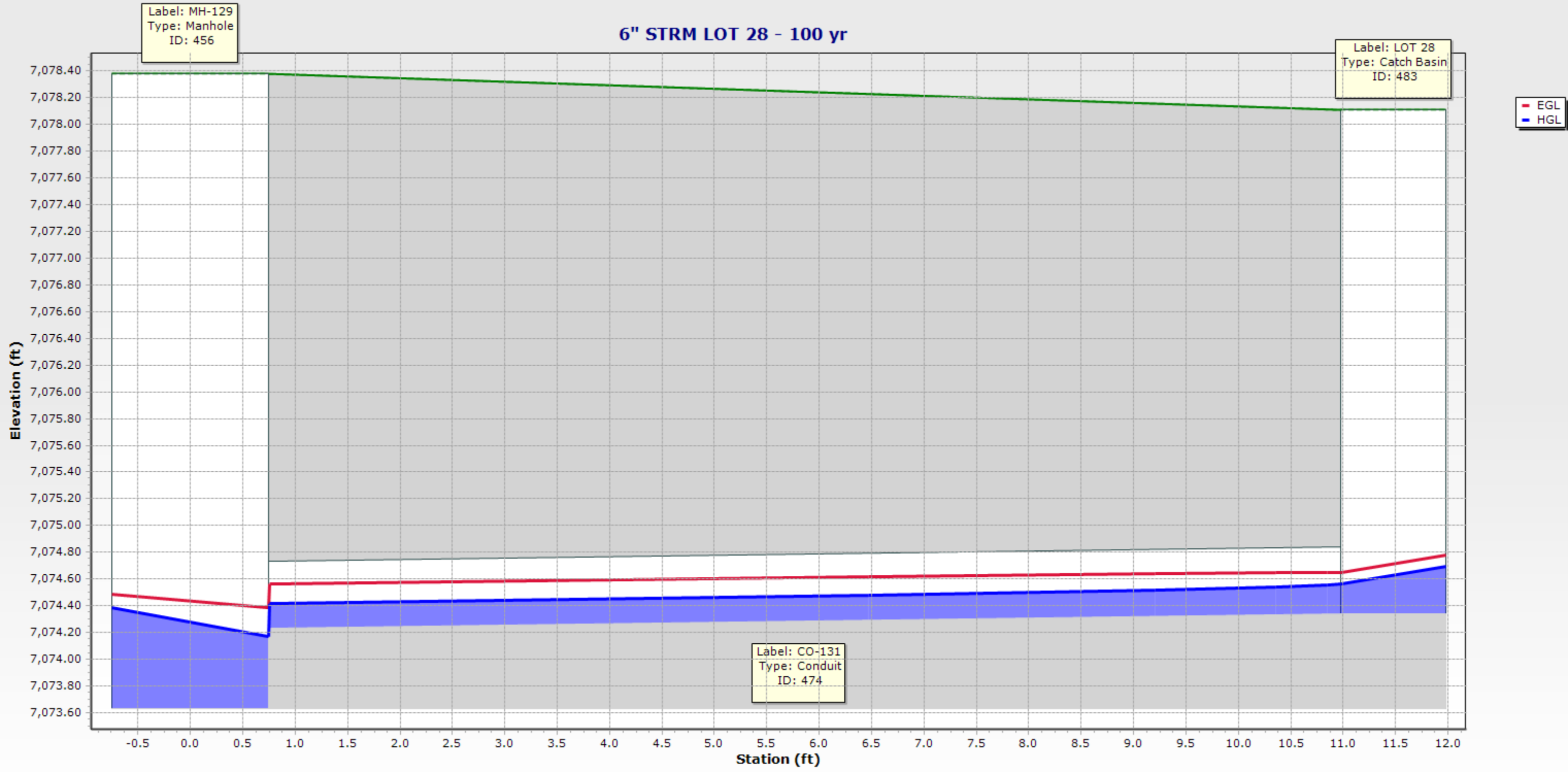

6" STRM LOT 29 - 100 yr

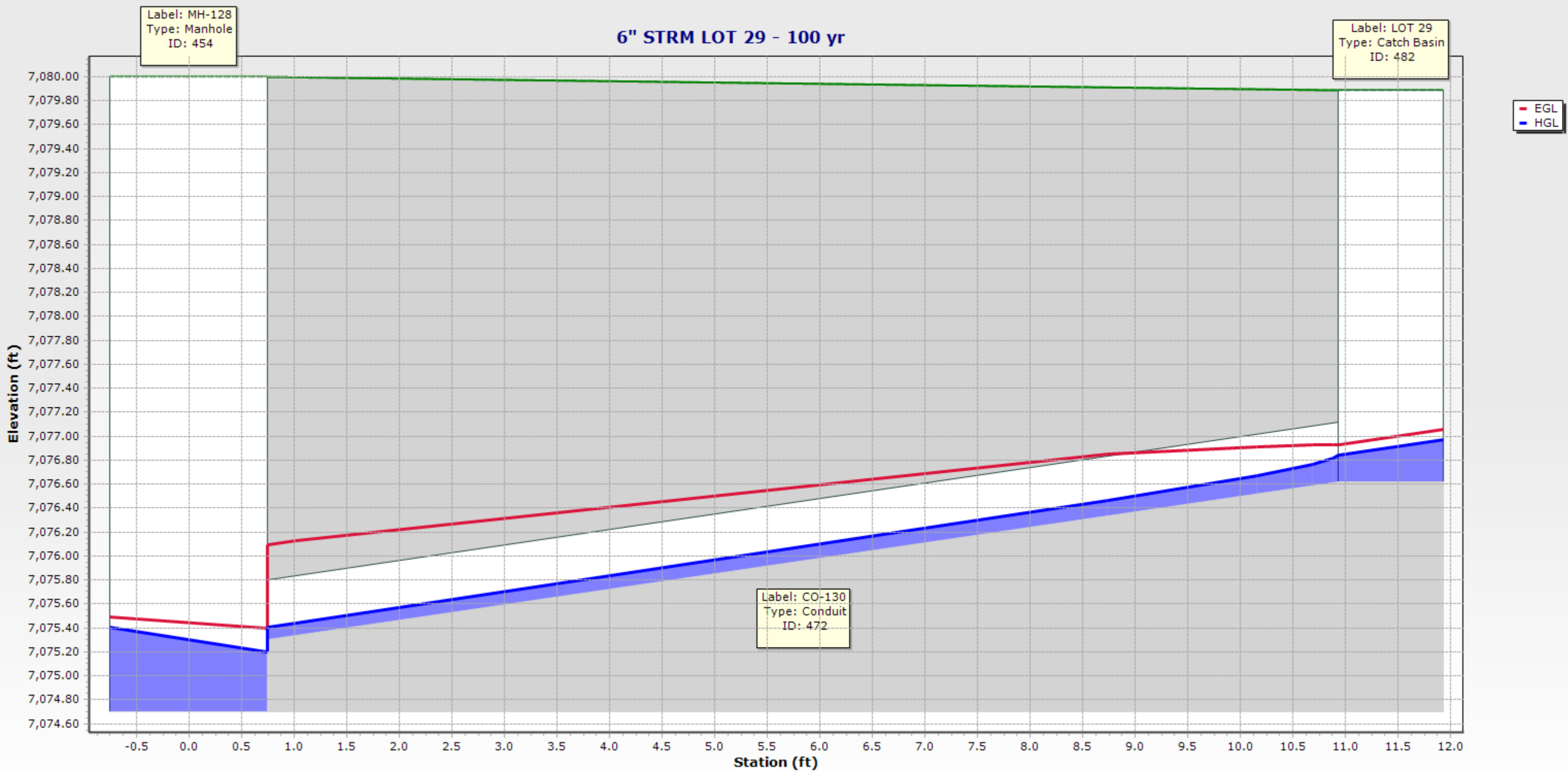

6" STRM LOT 30 - 100 yr

Label: LOT 30
Type: Catch Basin
ID: 481

EGL
HGL

Label: MH-127
Type: Manhole
ID: 452

Label: CO-129
Type: Conduit
ID: 470

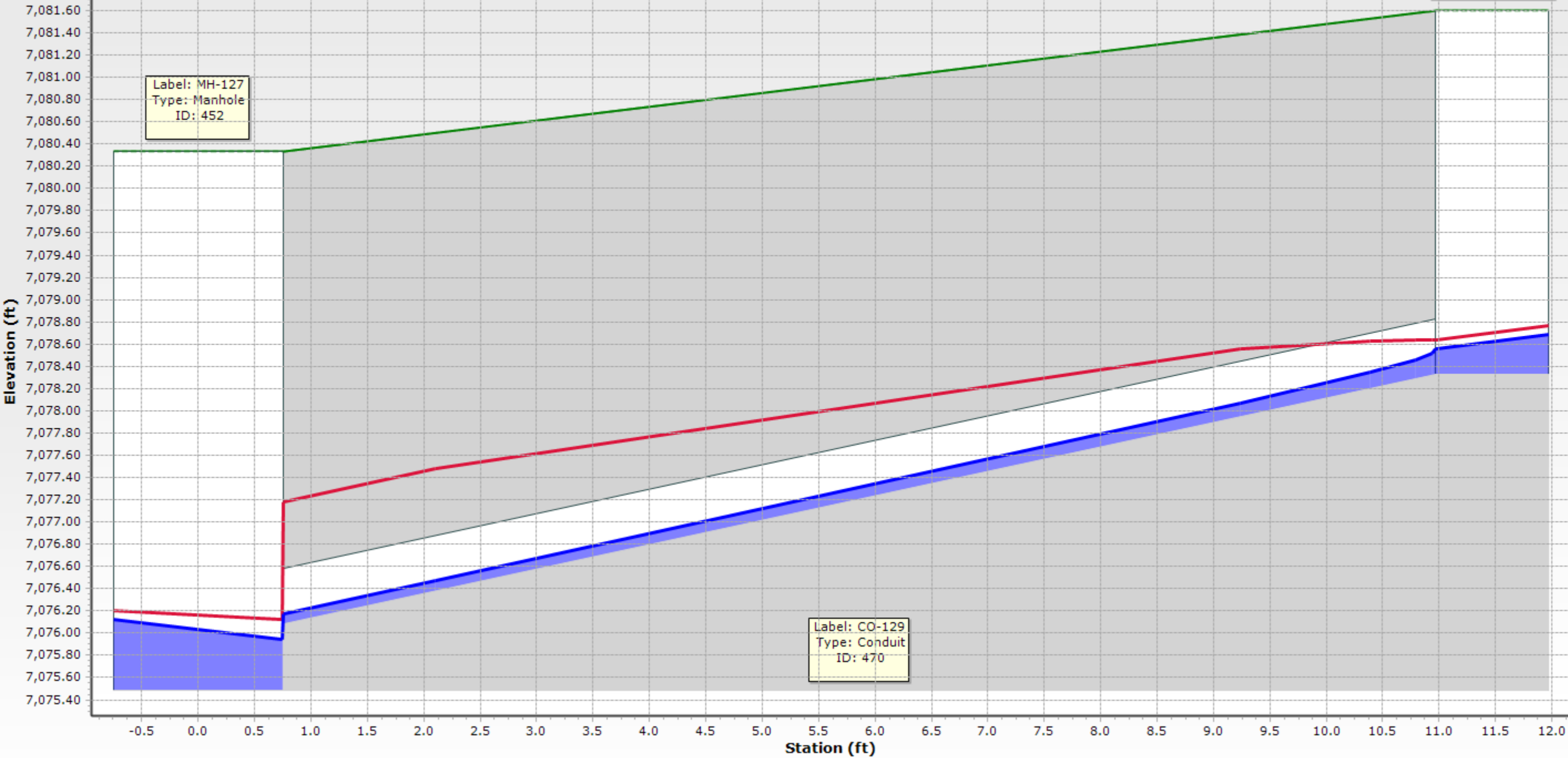

6" STRM LOT 31 - 100 yr

Label: MH-125
Type: Manhole
ID: 448

Label: LOT 31
Type: Catch Basin
ID: 480

EGL
HGL

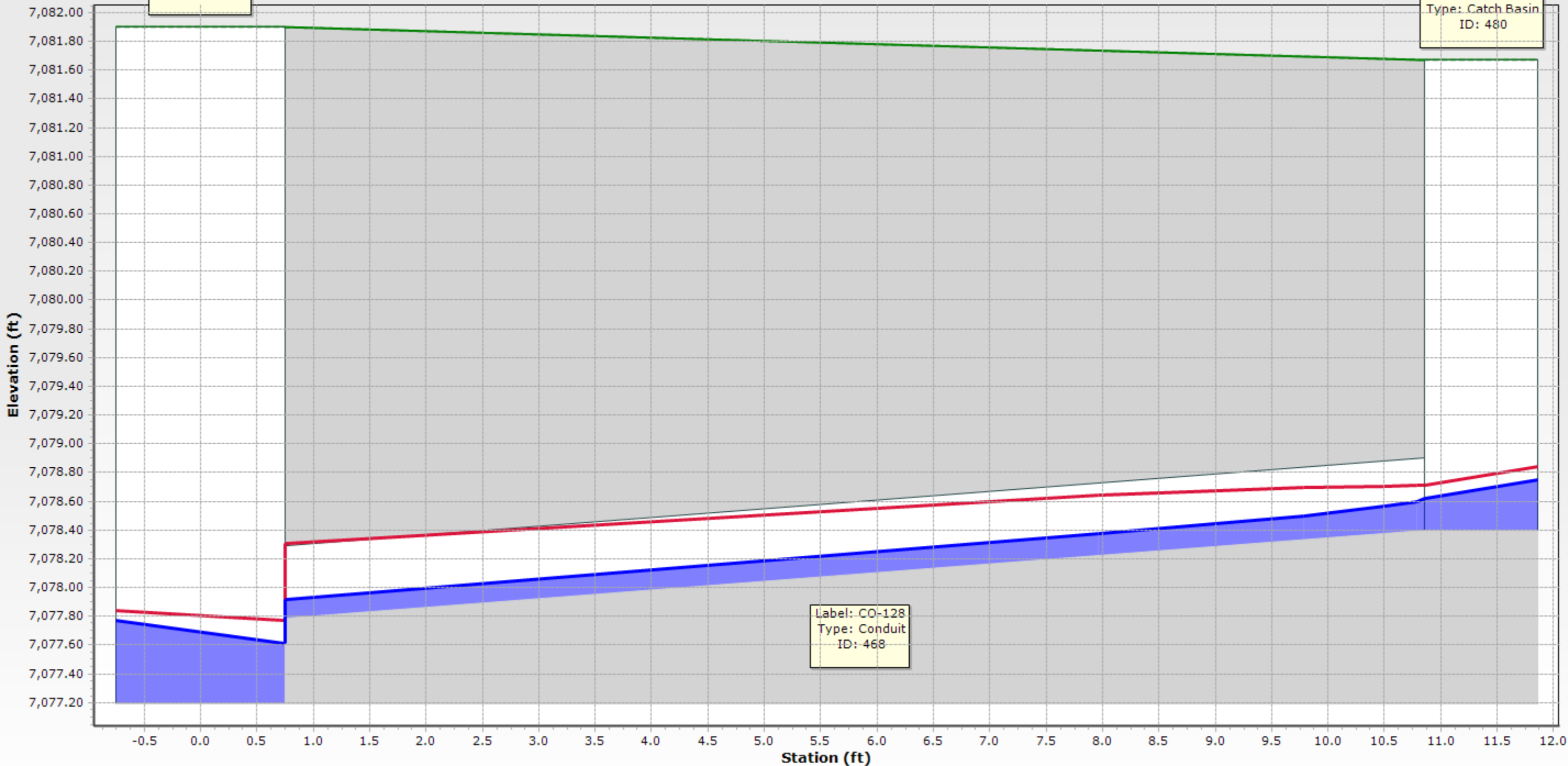

Label: CO-128
Type: Conduit
ID: 468

6" STRM LOT 32 - 100 yr

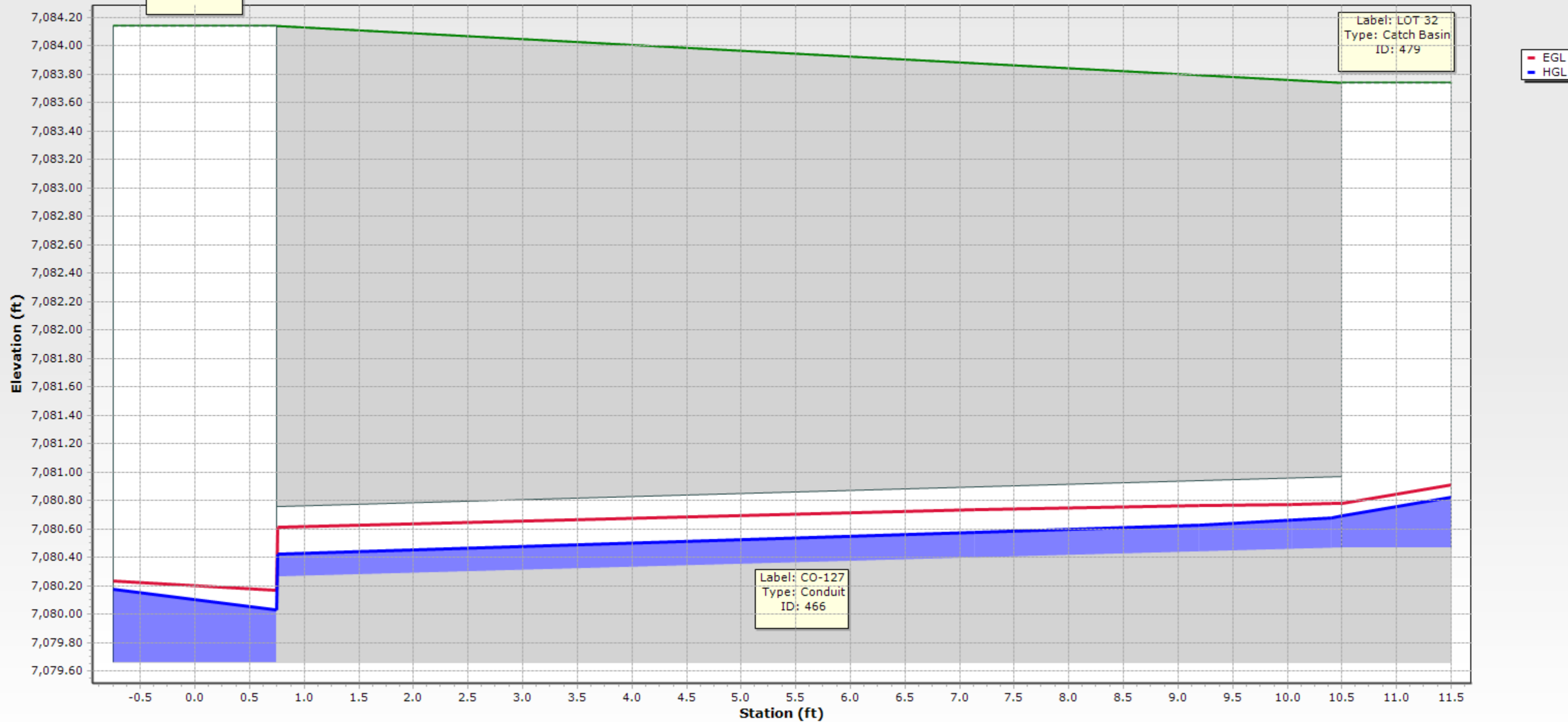

6" STRM LOT33 - 100 yr

Label: MH-123
Type: Manhole
ID: 444

Label: LOT 33
Type: Catch Basin
ID: 478

EGL
HGL

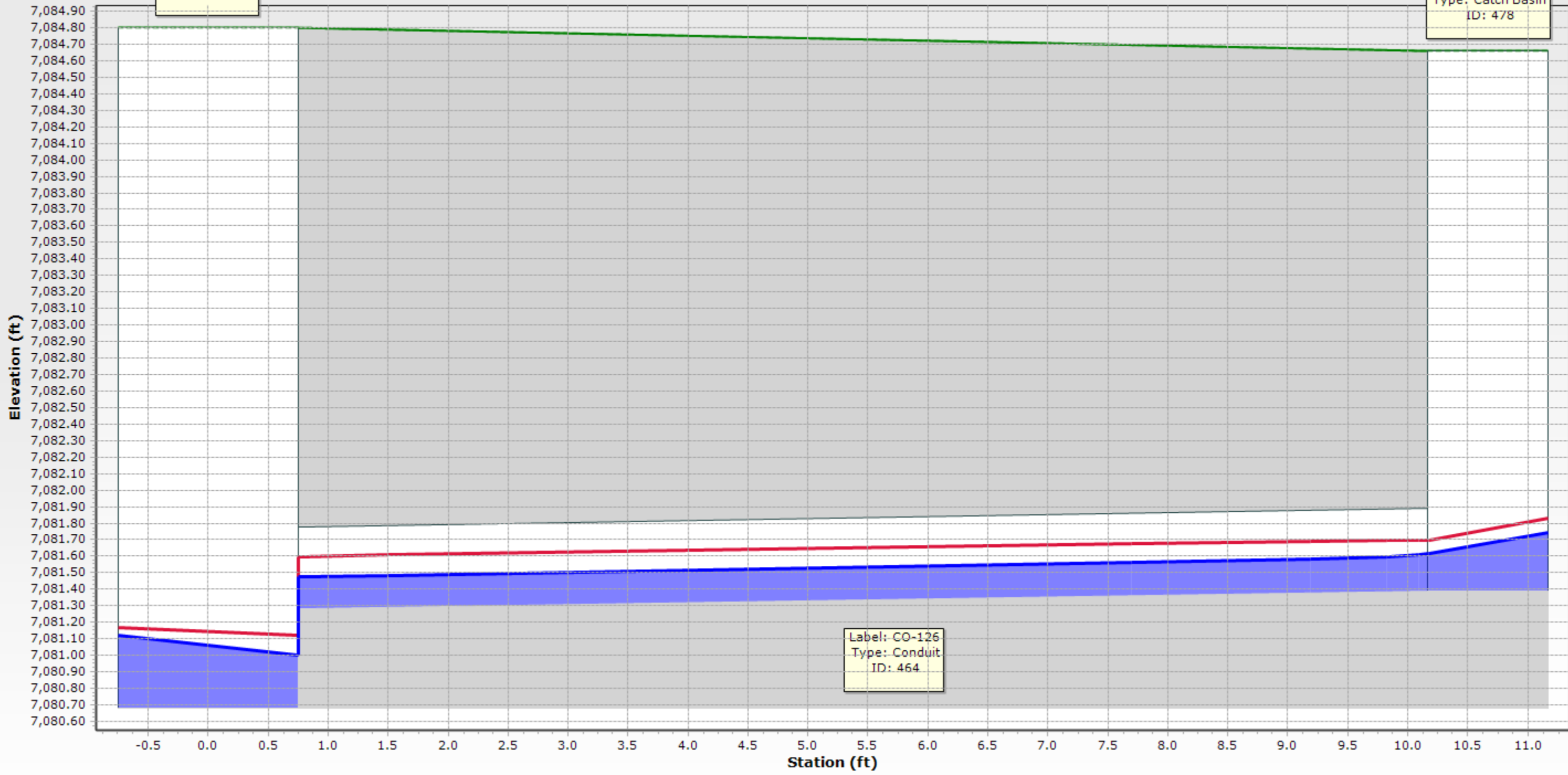

6" STRM LOT 34 - 100 yr

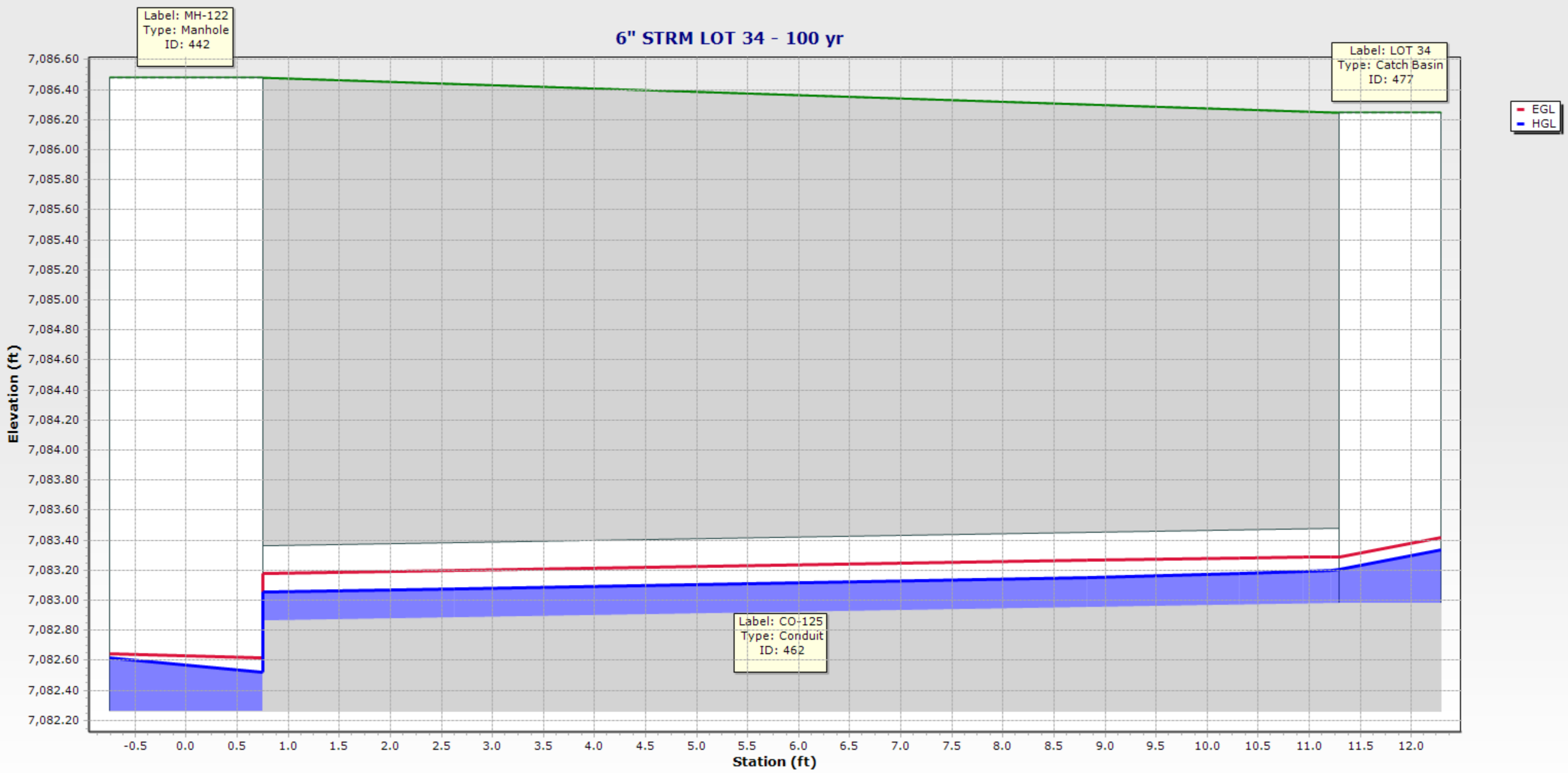

6" STRM LOT 35 - 100 yr

Label: MH-121
Type: Manhole
ID: 440

Label: LOT 35
Type: Catch Basin
ID: 476

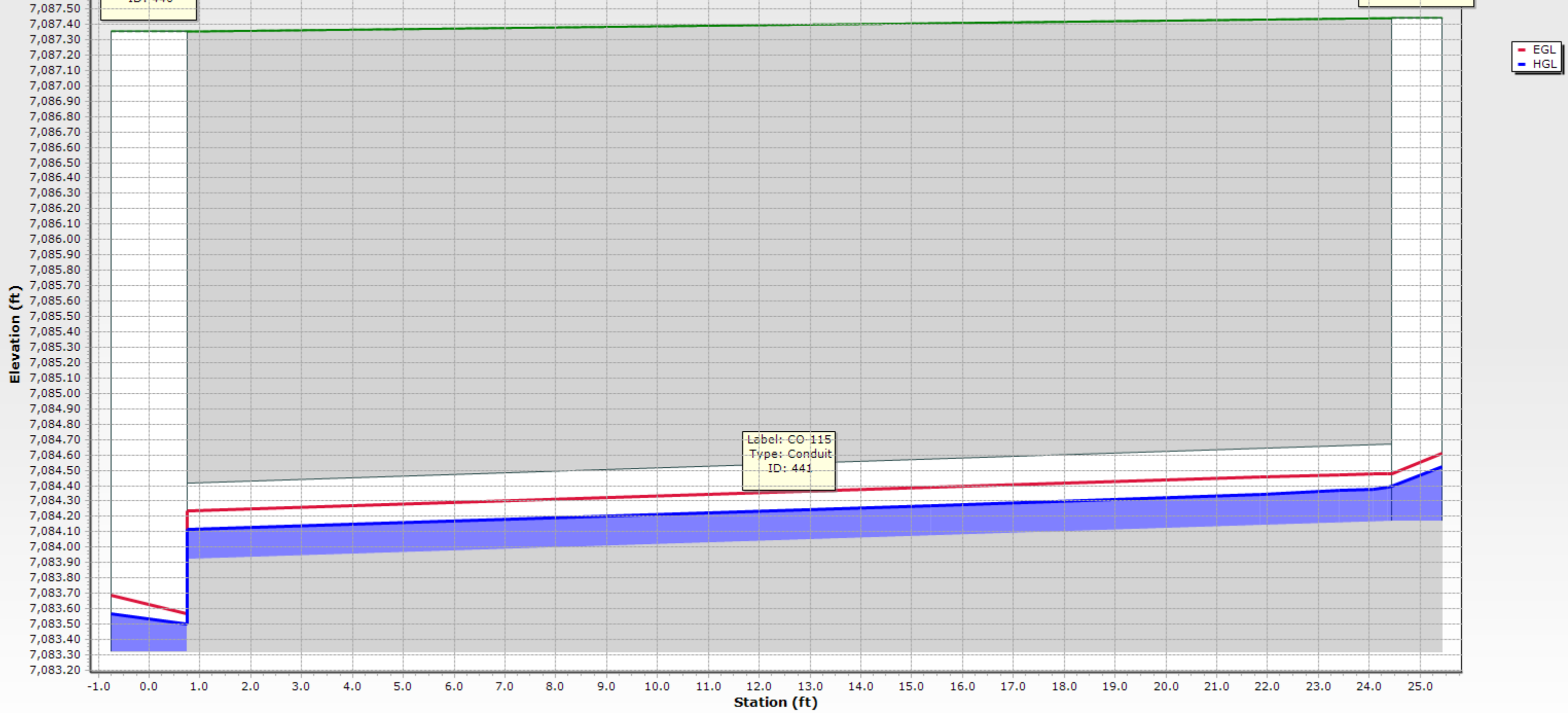

LOTS 36-41 INDEX MAP

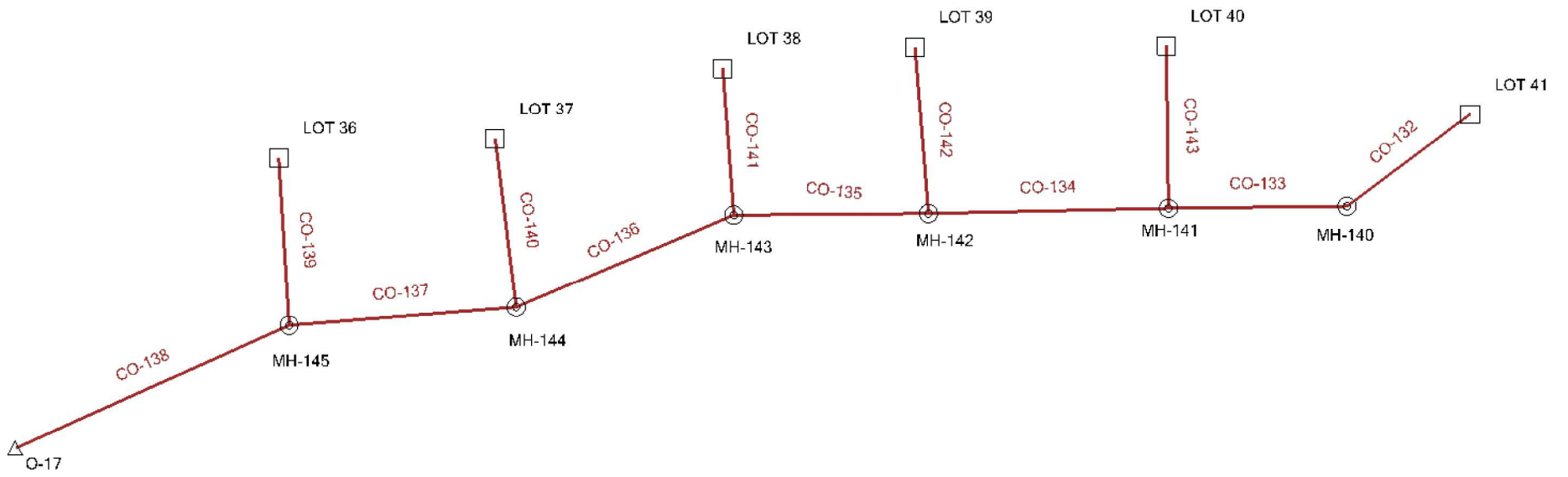

Conduit FlexTable: LOTS 36-41

Label	ID	Upstream Structure	Flow (cfs)	Flow / Capacity (Design) (%)	Length (Unified) (ft)	Velocity (ft/s)	Froude Number (Normal)	Depth (Normal) (ft)	Depth (Critical) (ft)	Energy Grade Line (In) (ft)	Energy Grade Line (Out) (ft)	Hydraulic Grade Line (In) (ft)	Hydraulic Grade Line (Out) (ft)	Headloss (ft)	Upstream Structure Hydraulic Grade Line (In) (ft)
CO-132	496	LOT 41	0.30	27.0	21.2	4.80	2.340	0.18	0.28	7,096.89	7,096.18	7,096.78	7,096.10	0.68	7,096.95
CO-133	498	MH-140	0.30	7.7	58.6	2.93	1.425	0.19	0.23	7,096.09	7,095.54	7,096.02	7,095.50	0.51	7,096.10
CO-134	500	MH-141	0.50	6.2	69.9	5.71	2.947	0.17	0.29	7,095.50	7,092.47	7,095.39	7,092.42	2.97	7,095.50
CO-135	502	MH-142	0.70	11.4	64.0	5.19	2.285	0.23	0.35	7,092.42	7,090.83	7,092.29	7,090.77	1.52	7,092.42
CO-136	504	MH-143	0.90	12.6	60.2	6.22	2.666	0.24	0.40	7,090.77	7,088.74	7,090.62	7,088.66	1.95	7,090.77
CO-137	506	MH-144	1.10	18.5	67.5	5.79	2.233	0.29	0.44	7,088.66	7,087.10	7,088.49	7,087.01	1.48	7,088.66
CO-138	508	MH-145	1.30	31.2	29.2	4.69	1.550	0.38	0.48	7,087.01	7,086.72	7,086.82	7,086.39	0.44	7,087.01
CO-139	510	LOT 36	0.20	32.2	11.5	2.83	1.307	0.19	0.22	7,087.37	7,087.26	7,087.28	7,087.13	0.15	7,087.41
CO-140	512	LOT 37	0.20	14.1	11.2	5.10	2.996	0.13	0.22	7,089.07	7,088.68	7,088.98	7,088.66	0.32	7,089.11
CO-141	514	LOT 38	0.20	32.2	11.5	2.83	1.307	0.19	0.22	7,091.25	7,091.14	7,091.16	7,091.01	0.15	7,091.29
CO-142	516	LOT 39	0.20	33.6	11.5	2.74	1.249	0.20	0.22	7,092.96	7,092.86	7,092.87	7,092.74	0.13	7,092.89
CO-143	518	LOT 40	0.20	13.0	12.4	5.38	3.227	0.12	0.22	7,096.80	7,096.27	7,096.71	7,095.82	0.89	7,096.84

Upstream Structure Velocity (In-Governing) (ft/s)	Upstream Structure Headloss Coefficient	Upstream Structure Headloss (ft)	Elevation Ground (Start) (ft)	Invert (Start) (ft)	Invert (Stop) (ft)
2.69	1.500	0.17	7,100.17	7,096.50	7,095.79
2.38	1.020	0.08	7,100.17	7,095.79	7,095.20
1.51	1.020	0.11	7,099.19	7,095.10	7,092.04
1.83	1.020	0.13	7,096.23	7,091.94	7,090.32
2.05	1.020	0.15	7,094.42	7,090.22	7,088.15
2.22	1.020	0.17	7,092.69	7,088.05	7,086.44
2.36	1.020	0.19	7,090.47	7,086.34	7,086.00
2.35	1.500	0.13	7,090.33	7,087.06	7,086.94
2.35	1.500	0.13	7,091.83	7,088.76	7,088.15
2.35	1.500	0.13	7,094.01	7,090.94	7,090.82
2.35	0.200	0.02	7,095.72	7,092.65	7,092.54
2.35	1.500	0.13	7,099.56	7,096.49	7,095.70

12" STRM LOTS 36-41 - 100 yr

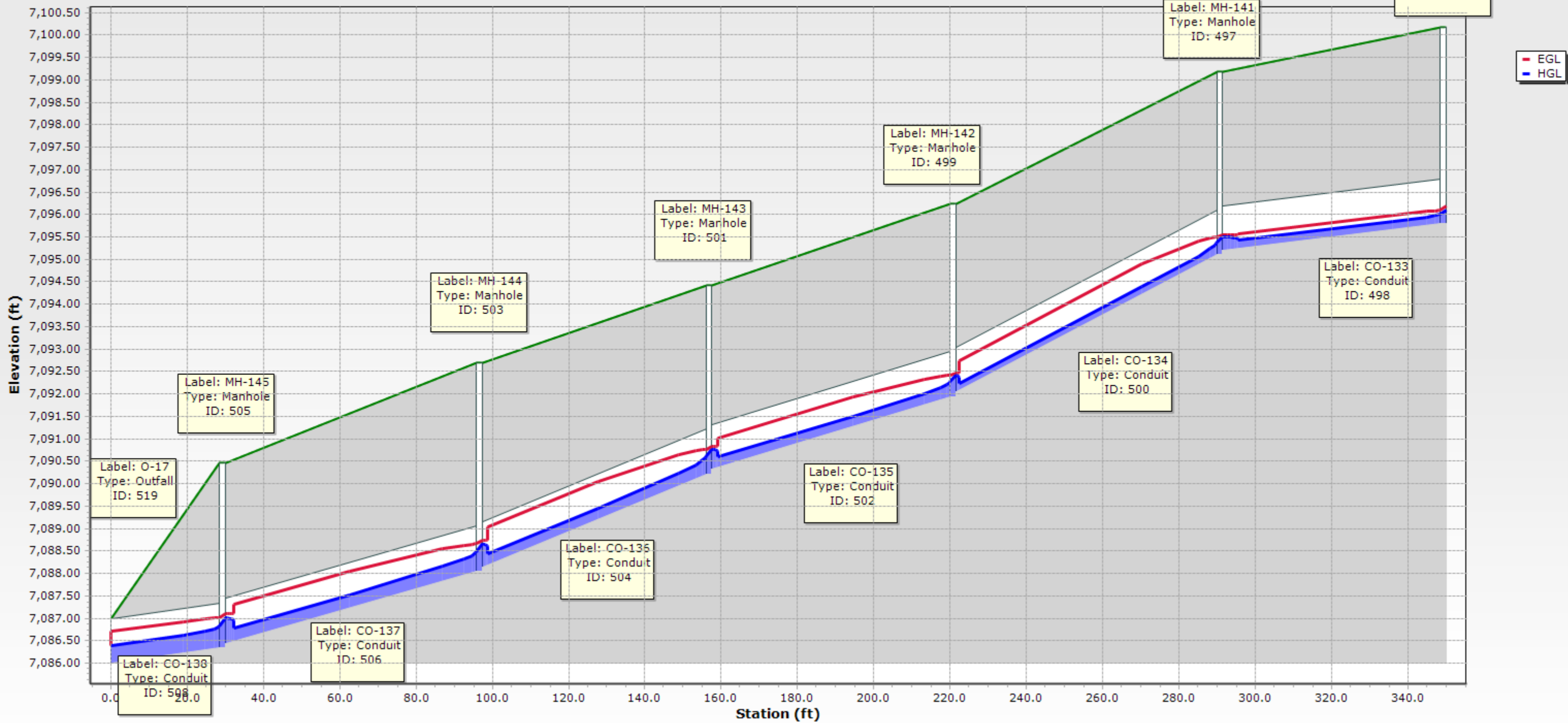

6" STRM LOT 36 - 100 yr

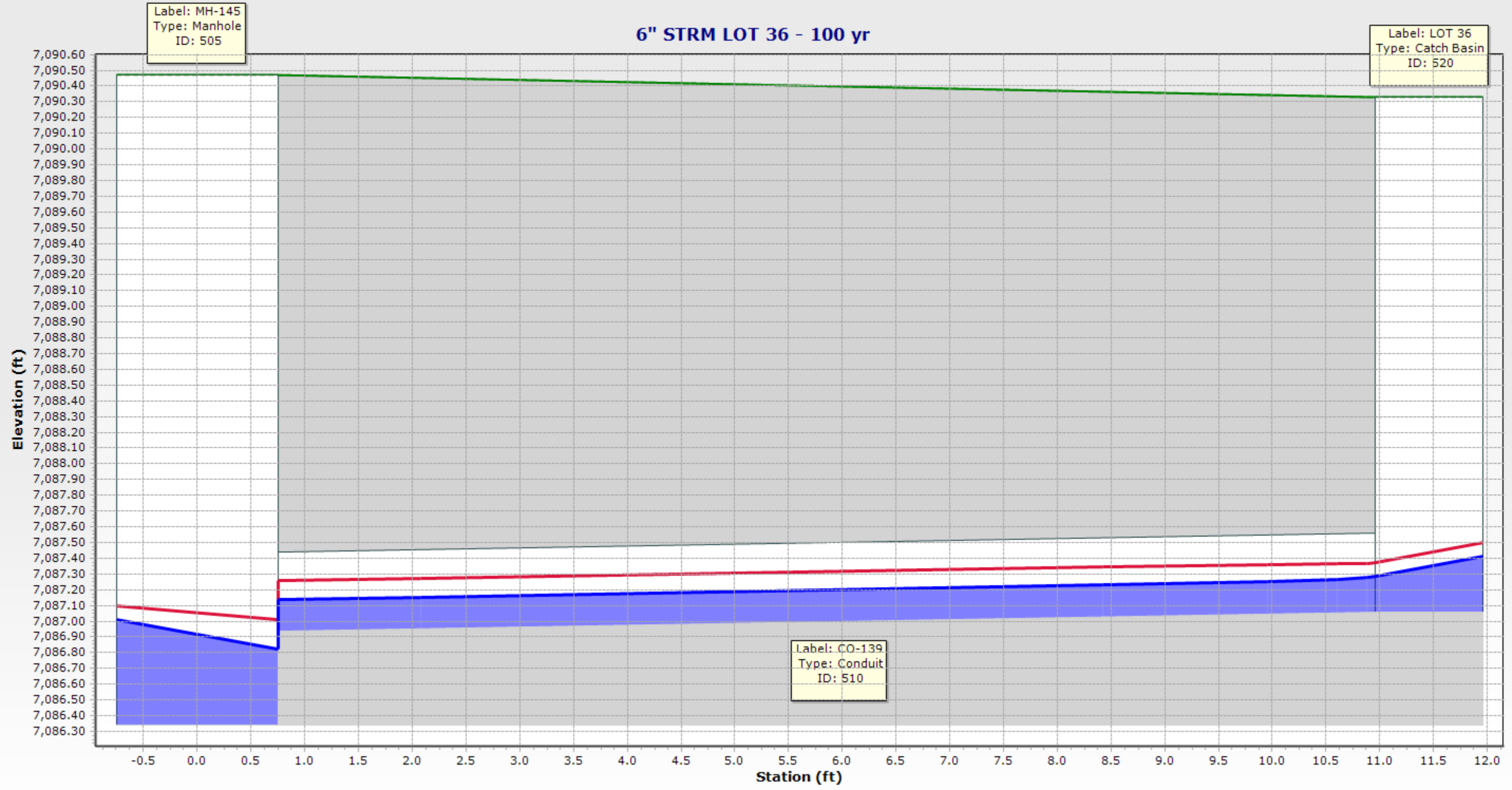

Label: MH-145
Type: Manhole
ID: 505

Label: LOT 36
Type: Catch Basin
ID: 520

Label: CO-139
Type: Conduit
ID: 510

EGL
HGL

6" STRM LOT 37 - 100 yr

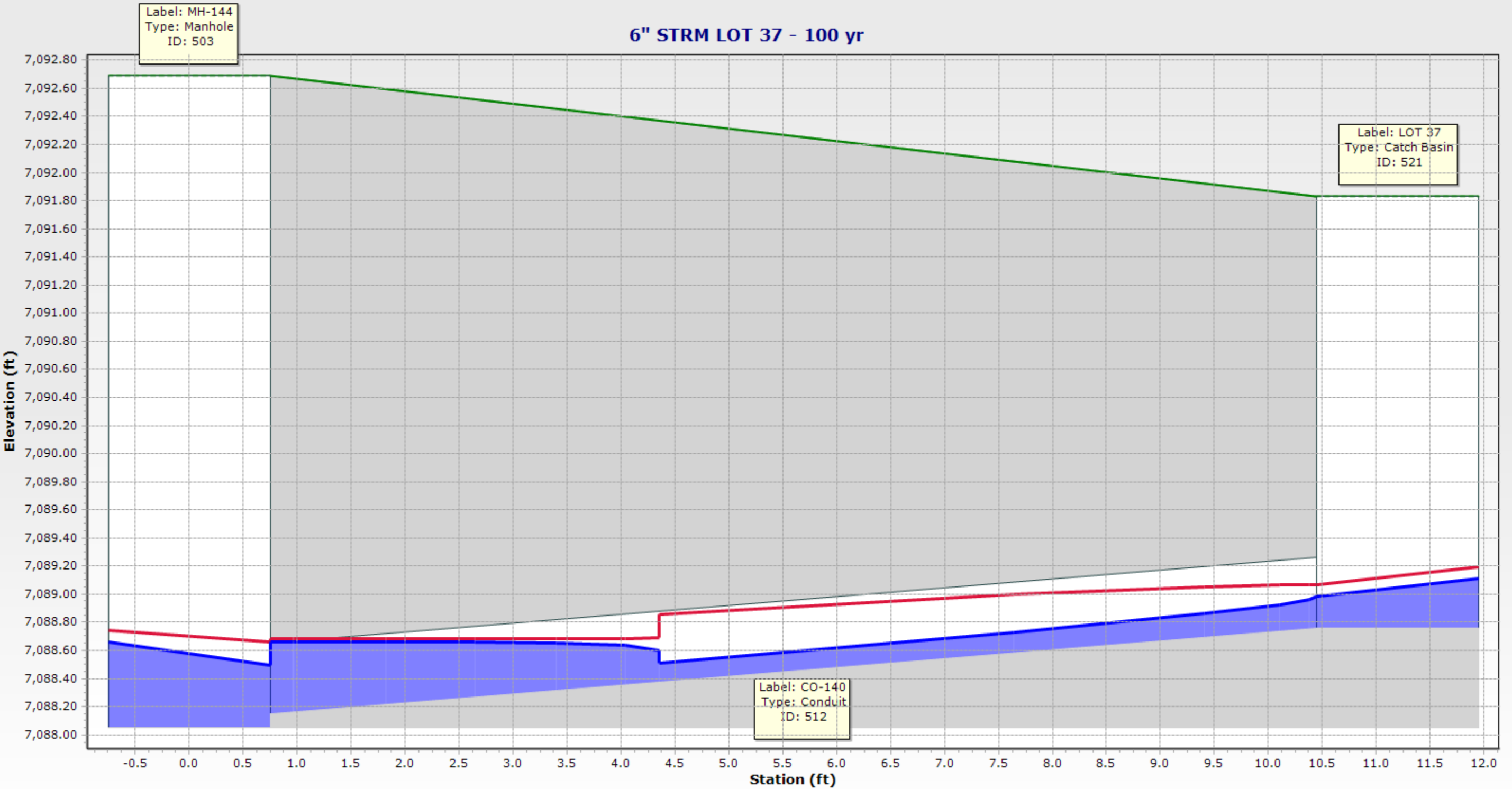

6" STRM LOT 38 - 100 yr

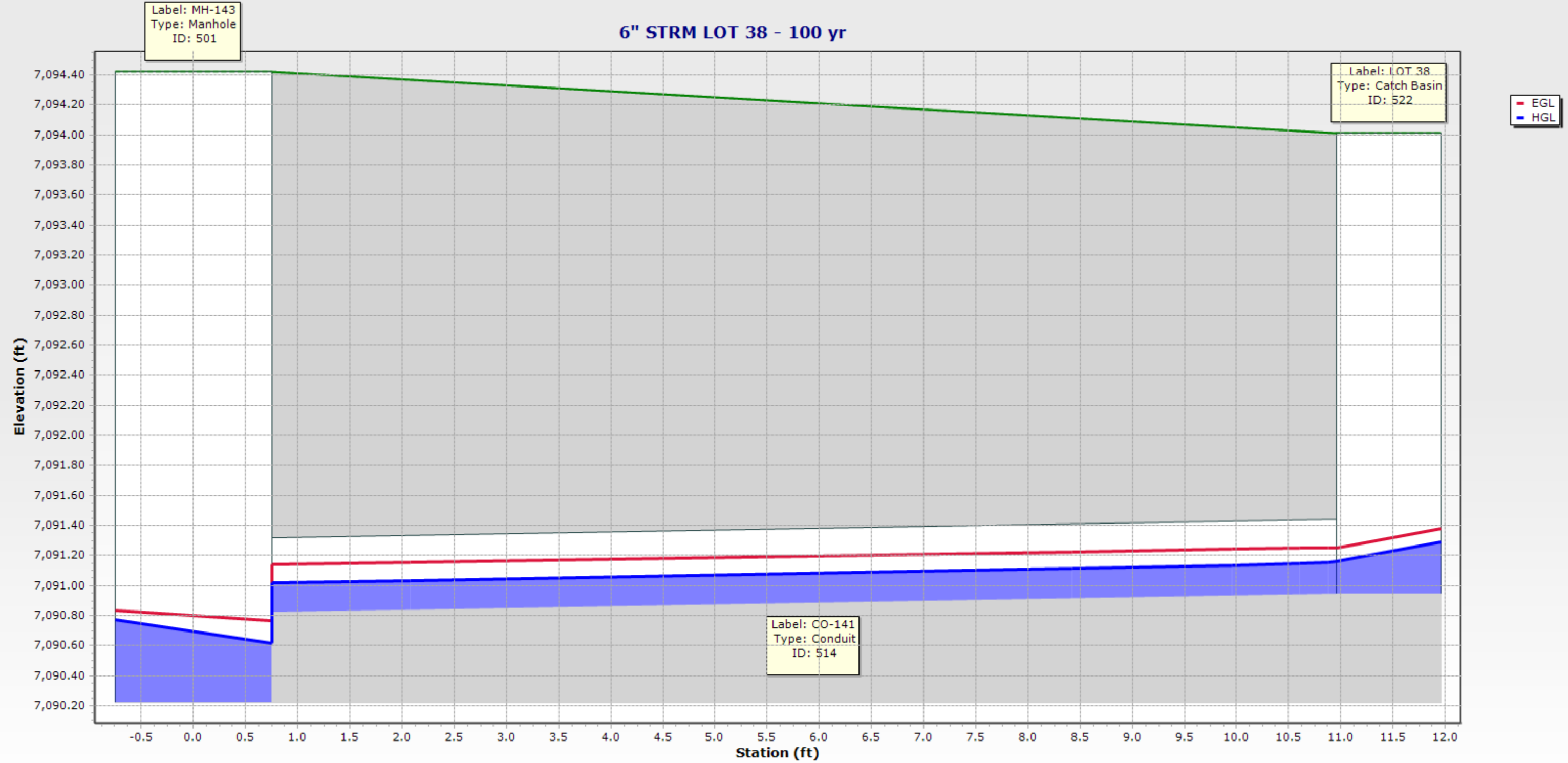

Label: MH-143
Type: Manhole
ID: 501

Label: LOT 38
Type: Catch Basin
ID: 522

Label: CO-141
Type: Conduit
ID: 514

EGL
HGL

6" STRM LOT 39 - 100 yr

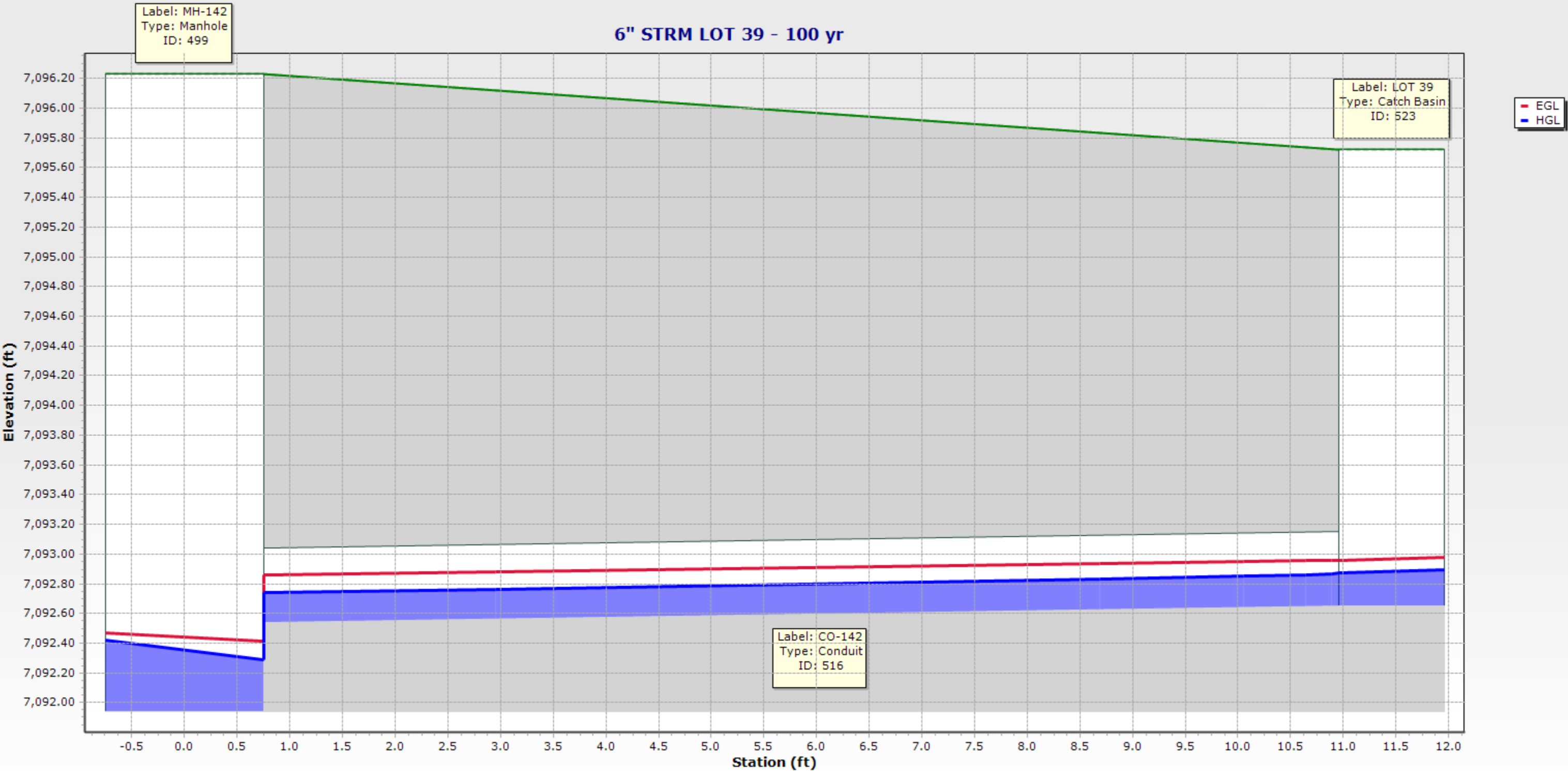

6" STRM LOT 40 - 100 yr

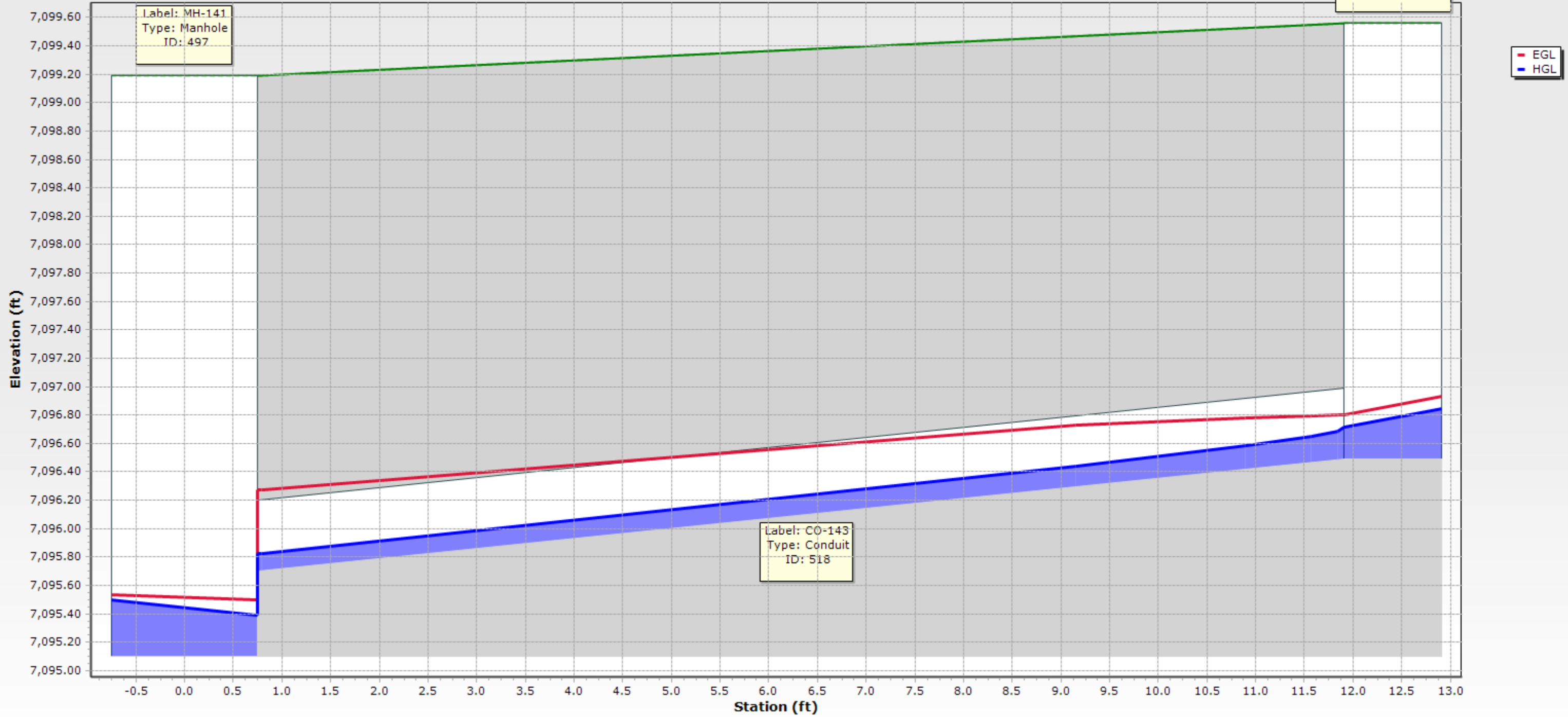

6" STRM LOT 41 - 100 yr

Label: MH-140
Type: Manhole
ID: 495

Label: LOT 41
Type: Catch Basin
ID: 525

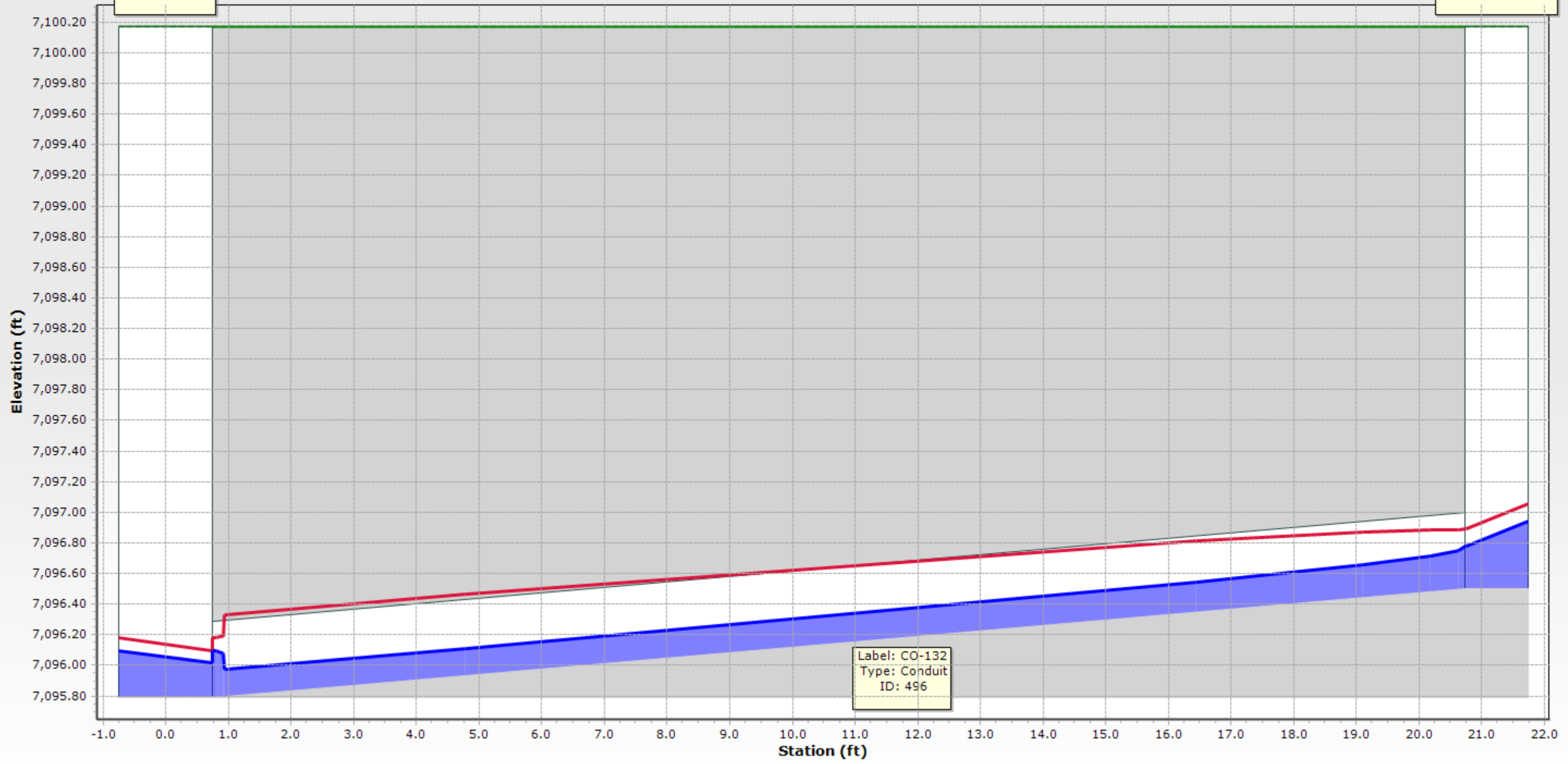

EGL
HGL

Label: CO-132
Type: Conduit
ID: 496

ALLOWABLE CAPACITY FOR ONE-HALF OF STREET (Minor & Major Storm)

(Based on Regulated Criteria for Maximum Allowable Flow Depth and Spread)

Project: _____
 Inlet ID: _____ **Inlet DP 7**

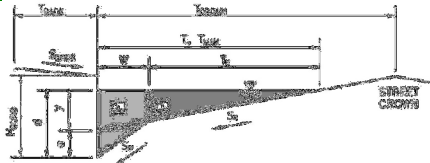

Gutter Geometry (Enter data in the blue cells)							
Maximum Allowable Width for Spread Behind Curb	$T_{BACK} = $ <input style="width: 50px;" type="text" value="8.0"/> ft						
Side Slope Behind Curb (leave blank for no conveyance credit behind curb)	$S_{BACK} = $ <input style="width: 50px;" type="text" value="0.020"/> ft/ft						
Manning's Roughness Behind Curb (typically between 0.012 and 0.020)	$n_{BACK} = $ <input style="width: 50px;" type="text" value="0.020"/>						
Height of Curb at Gutter Flow Line	$H_{CURB} = $ <input style="width: 50px;" type="text" value="6.00"/> inches						
Distance from Curb Face to Street Crown	$T_{CROWN} = $ <input style="width: 50px;" type="text" value="17.0"/> ft						
Gutter Width	$W = $ <input style="width: 50px;" type="text" value="2.00"/> ft						
Street Transverse Slope	$S_X = $ <input style="width: 50px;" type="text" value="0.020"/> ft/ft						
Gutter Cross Slope (typically 2 inches over 24 inches or 0.083 ft/ft)	$S_W = $ <input style="width: 50px;" type="text" value="0.083"/> ft/ft						
Street Longitudinal Slope - Enter 0 for sump condition	$S_O = $ <input style="width: 50px;" type="text" value="0.000"/> ft/ft						
Manning's Roughness for Street Section (typically between 0.012 and 0.020)	$n_{STREET} = $ <input style="width: 50px;" type="text" value="0.020"/>						
Max. Allowable Spread for Minor & Major Storm	<table style="width: 100%; border-collapse: collapse;"> <tr> <td style="text-align: center; padding: 2px;">Minor Storm</td> <td style="text-align: center; padding: 2px;">Major Storm</td> <td style="padding: 2px;"></td> </tr> <tr> <td style="padding: 2px;">$T_{MAX} =$ <input style="width: 50px;" type="text" value="17.0"/></td> <td style="padding: 2px;"><input style="width: 50px;" type="text" value="17.0"/></td> <td style="padding: 2px;">ft</td> </tr> </table>	Minor Storm	Major Storm		$T_{MAX} = $ <input style="width: 50px;" type="text" value="17.0"/>	<input style="width: 50px;" type="text" value="17.0"/>	ft
Minor Storm	Major Storm						
$T_{MAX} = $ <input style="width: 50px;" type="text" value="17.0"/>	<input style="width: 50px;" type="text" value="17.0"/>	ft					
Max. Allowable Depth at Gutter Flowline for Minor & Major Storm	<table style="width: 100%; border-collapse: collapse;"> <tr> <td style="text-align: center; padding: 2px;">Minor Storm</td> <td style="text-align: center; padding: 2px;">Major Storm</td> <td style="padding: 2px;"></td> </tr> <tr> <td style="padding: 2px;">$d_{MAX} =$ <input style="width: 50px;" type="text" value="5.1"/></td> <td style="padding: 2px;"><input style="width: 50px;" type="text" value="7.8"/></td> <td style="padding: 2px;">inches</td> </tr> </table>	Minor Storm	Major Storm		$d_{MAX} = $ <input style="width: 50px;" type="text" value="5.1"/>	<input style="width: 50px;" type="text" value="7.8"/>	inches
Minor Storm	Major Storm						
$d_{MAX} = $ <input style="width: 50px;" type="text" value="5.1"/>	<input style="width: 50px;" type="text" value="7.8"/>	inches					
Check boxes are not applicable in SUMP conditions	<table style="width: 100%; border-collapse: collapse;"> <tr> <td style="text-align: center; padding: 2px;"><input type="checkbox"/></td> <td style="text-align: center; padding: 2px;"><input type="checkbox"/></td> </tr> </table>	<input type="checkbox"/>	<input type="checkbox"/>				
<input type="checkbox"/>	<input type="checkbox"/>						
MINOR STORM Allowable Capacity is based on Depth Criterion							
MAJOR STORM Allowable Capacity is based on Depth Criterion	<table style="width: 100%; border-collapse: collapse;"> <tr> <td style="text-align: center; padding: 2px;">Minor Storm</td> <td style="text-align: center; padding: 2px;">Major Storm</td> <td style="padding: 2px;"></td> </tr> <tr> <td style="padding: 2px;">$Q_{allow} =$ <input style="width: 50px;" type="text" value="SUMP"/></td> <td style="padding: 2px;"><input style="width: 50px;" type="text" value="SUMP"/></td> <td style="padding: 2px;">cfs</td> </tr> </table>	Minor Storm	Major Storm		$Q_{allow} = $ <input style="width: 50px;" type="text" value="SUMP"/>	<input style="width: 50px;" type="text" value="SUMP"/>	cfs
Minor Storm	Major Storm						
$Q_{allow} = $ <input style="width: 50px;" type="text" value="SUMP"/>	<input style="width: 50px;" type="text" value="SUMP"/>	cfs					

INLET IN A SUMP OR SAG LOCATION

Version 4.05 Released March 2017

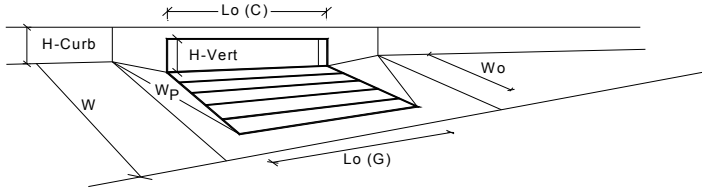

Design Information (Input)	MINOR	MAJOR	
Type of Inlet	CDOT Type R Curb Opening		
Local Depression (additional to continuous gutter depression 'a' from above)	3.00	3.00	inches
Number of Unit Inlets (Grate or Curb Opening)	2	2	
Water Depth at Flowline (outside of local depression)	5.1	7.8	inches
Grate Information	MINOR	MAJOR	<input checked="" type="checkbox"/> Override Depths
Length of a Unit Grate	N/A	N/A	feet
Width of a Unit Grate	N/A	N/A	feet
Area Opening Ratio for a Grate (typical values 0.15-0.90)	N/A	N/A	
Clogging Factor for a Single Grate (typical value 0.50 - 0.70)	N/A	N/A	
Grate Weir Coefficient (typical value 2.15 - 3.60)	N/A	N/A	
Grate Orifice Coefficient (typical value 0.60 - 0.80)	N/A	N/A	
Curb Opening Information	MINOR	MAJOR	
Length of a Unit Curb Opening	5.00	5.00	feet
Height of Vertical Curb Opening in Inches	6.00	6.00	inches
Height of Curb Orifice Throat in Inches	6.00	6.00	inches
Angle of Throat (see USDCM Figure ST-5)	63.40	63.40	degrees
Side Width for Depression Pan (typically the gutter width of 2 feet)	2.00	2.00	feet
Clogging Factor for a Single Curb Opening (typical value 0.10)	0.10	0.10	
Curb Opening Weir Coefficient (typical value 2.3-3.7)	3.60	3.60	
Curb Opening Orifice Coefficient (typical value 0.60 - 0.70)	0.67	0.67	
Low Head Performance Reduction (Calculated)	MINOR	MAJOR	
Depth for Grate Midwidth	N/A	N/A	ft
Depth for Curb Opening Weir Equation	0.26	0.48	ft
Combination Inlet Performance Reduction Factor for Long Inlets	0.48	0.74	
Curb Opening Performance Reduction Factor for Long Inlets	0.88	1.00	
Grated Inlet Performance Reduction Factor for Long Inlets	N/A	N/A	
Total Inlet Interception Capacity (assumes clogged condition)	MINOR	MAJOR	
Q_a	6.7	18.7	cfs
Q_{PEAK REQUIRED}	5.7	13.8	cfs

Inlet Capacity IS GOOD for Minor and Major Storms(>Q PEAK)

ALLOWABLE CAPACITY FOR ONE-HALF OF STREET (Minor & Major Storm)

(Based on Regulated Criteria for Maximum Allowable Flow Depth and Spread)

Project: _____
 Inlet ID: _____ Enter Your Project Name Here
Inlet DP 8

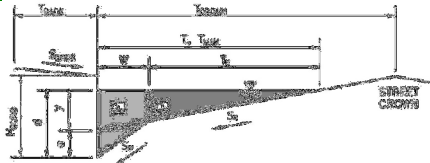

Gutter Geometry (Enter data in the blue cells)										
Maximum Allowable Width for Spread Behind Curb	T _{BACK} = <input style="width: 50px;" type="text" value="8.0"/> ft									
Side Slope Behind Curb (leave blank for no conveyance credit behind curb)	S _{BACK} = <input style="width: 50px;" type="text" value="0.020"/> ft/ft									
Manning's Roughness Behind Curb (typically between 0.012 and 0.020)	n _{BACK} = <input style="width: 50px;" type="text" value="0.020"/>									
Height of Curb at Gutter Flow Line	H _{CURB} = <input style="width: 50px;" type="text" value="6.00"/> inches									
Distance from Curb Face to Street Crown	T _{CROWN} = <input style="width: 50px;" type="text" value="17.0"/> ft									
Gutter Width	W = <input style="width: 50px;" type="text" value="2.00"/> ft									
Street Transverse Slope	S _X = <input style="width: 50px;" type="text" value="0.020"/> ft/ft									
Gutter Cross Slope (typically 2 inches over 24 inches or 0.083 ft/ft)	S _W = <input style="width: 50px;" type="text" value="0.083"/> ft/ft									
Street Longitudinal Slope - Enter 0 for sump condition	S _O = <input style="width: 50px;" type="text" value="0.000"/> ft/ft									
Manning's Roughness for Street Section (typically between 0.012 and 0.020)	n _{STREET} = <input style="width: 50px;" type="text" value="0.020"/>									
Max. Allowable Spread for Minor & Major Storm	<table border="1" style="display: inline-table; border-collapse: collapse;"> <thead> <tr> <th style="width: 50px;">Minor Storm</th> <th style="width: 50px;">Major Storm</th> <th style="width: 20px;"></th> </tr> </thead> <tbody> <tr> <td>T_{MAX} = <input style="width: 50px;" type="text" value="17.0"/></td> <td><input style="width: 50px;" type="text" value="17.0"/></td> <td>ft</td> </tr> <tr> <td>d_{MAX} = <input style="width: 50px;" type="text" value="5.1"/></td> <td><input style="width: 50px;" type="text" value="7.8"/></td> <td>inches</td> </tr> </tbody> </table>	Minor Storm	Major Storm		T _{MAX} = <input style="width: 50px;" type="text" value="17.0"/>	<input style="width: 50px;" type="text" value="17.0"/>	ft	d _{MAX} = <input style="width: 50px;" type="text" value="5.1"/>	<input style="width: 50px;" type="text" value="7.8"/>	inches
Minor Storm	Major Storm									
T _{MAX} = <input style="width: 50px;" type="text" value="17.0"/>	<input style="width: 50px;" type="text" value="17.0"/>	ft								
d _{MAX} = <input style="width: 50px;" type="text" value="5.1"/>	<input style="width: 50px;" type="text" value="7.8"/>	inches								
Max. Allowable Depth at Gutter Flowline for Minor & Major Storm										
Check boxes are not applicable in SUMP conditions	<input type="checkbox"/> <input type="checkbox"/>									
MINOR STORM Allowable Capacity is based on Depth Criterion										
MAJOR STORM Allowable Capacity is based on Depth Criterion										
Q _{allow} =	<table border="1" style="display: inline-table; border-collapse: collapse;"> <thead> <tr> <th style="width: 50px;">Minor Storm</th> <th style="width: 50px;">Major Storm</th> <th style="width: 20px;"></th> </tr> </thead> <tbody> <tr> <td><input style="width: 50px;" type="text" value="SUMP"/></td> <td><input style="width: 50px;" type="text" value="SUMP"/></td> <td>cfs</td> </tr> </tbody> </table>	Minor Storm	Major Storm		<input style="width: 50px;" type="text" value="SUMP"/>	<input style="width: 50px;" type="text" value="SUMP"/>	cfs			
Minor Storm	Major Storm									
<input style="width: 50px;" type="text" value="SUMP"/>	<input style="width: 50px;" type="text" value="SUMP"/>	cfs								

INLET IN A SUMP OR SAG LOCATION

Version 4.05 Released March 2017

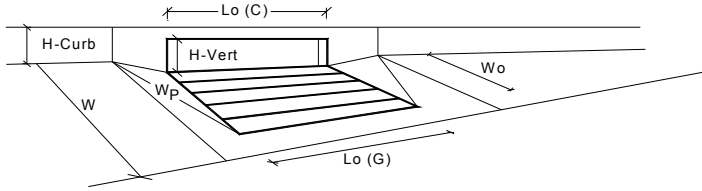

Design Information (Input)	MINOR	MAJOR	
Type of Inlet	CDOT Type R Curb Opening		
Local Depression (additional to continuous gutter depression 'a' from above)	3.00	3.00	inches
Number of Unit Inlets (Grate or Curb Opening)	2	2	
Water Depth at Flowline (outside of local depression)	5.1	7.8	inches
Grate Information	MINOR	MAJOR	<input checked="" type="checkbox"/> Override Depths
Length of a Unit Grate	N/A	N/A	feet
Width of a Unit Grate	N/A	N/A	feet
Area Opening Ratio for a Grate (typical values 0.15-0.90)	N/A	N/A	
Clogging Factor for a Single Grate (typical value 0.50 - 0.70)	N/A	N/A	
Grate Weir Coefficient (typical value 2.15 - 3.60)	N/A	N/A	
Grate Orifice Coefficient (typical value 0.60 - 0.80)	N/A	N/A	
Curb Opening Information	MINOR	MAJOR	
Length of a Unit Curb Opening	5.00	5.00	feet
Height of Vertical Curb Opening in Inches	6.00	6.00	inches
Height of Curb Orifice Throat in Inches	6.00	6.00	inches
Angle of Throat (see USDCM Figure ST-5)	63.40	63.40	degrees
Side Width for Depression Pan (typically the gutter width of 2 feet)	2.00	2.00	feet
Clogging Factor for a Single Curb Opening (typical value 0.10)	0.10	0.10	
Curb Opening Weir Coefficient (typical value 2.3-3.7)	3.60	3.60	
Curb Opening Orifice Coefficient (typical value 0.60 - 0.70)	0.67	0.67	
Low Head Performance Reduction (Calculated)	MINOR	MAJOR	
Depth for Grate Midwidth	N/A	N/A	ft
Depth for Curb Opening Weir Equation	0.26	0.48	ft
Combination Inlet Performance Reduction Factor for Long Inlets	0.48	0.74	
Curb Opening Performance Reduction Factor for Long Inlets	0.88	1.00	
Grated Inlet Performance Reduction Factor for Long Inlets	N/A	N/A	
Total Inlet Interception Capacity (assumes clogged condition)	MINOR	MAJOR	
Q_a	6.7	18.7	cfs
Q _{PEAK REQUIRED}	4.9	11.8	cfs

Inlet Capacity IS GOOD for Minor and Major Storms(>Q PEAK)

ALLOWABLE CAPACITY FOR ONE-HALF OF STREET (Minor & Major Storm)

(Based on Regulated Criteria for Maximum Allowable Flow Depth and Spread)

Project: _____
 Inlet ID: _____ Enter Your Project Name Here
Inlet DP 9

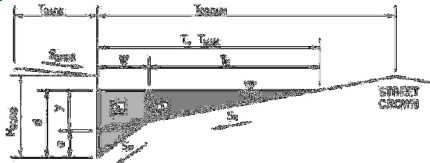

Gutter Geometry (Enter data in the blue cells)													
Maximum Allowable Width for Spread Behind Curb	$T_{BACK} = $ <input style="width: 50px;" type="text" value="8.0"/> ft												
Side Slope Behind Curb (leave blank for no conveyance credit behind curb)	$S_{BACK} = $ <input style="width: 50px;" type="text" value="0.020"/> ft/ft												
Manning's Roughness Behind Curb (typically between 0.012 and 0.020)	$n_{BACK} = $ <input style="width: 50px;" type="text" value="0.020"/>												
Height of Curb at Gutter Flow Line	$H_{CURB} = $ <input style="width: 50px;" type="text" value="6.00"/> inches												
Distance from Curb Face to Street Crown	$T_{CROWN} = $ <input style="width: 50px;" type="text" value="17.0"/> ft												
Gutter Width	$W = $ <input style="width: 50px;" type="text" value="2.00"/> ft												
Street Transverse Slope	$S_X = $ <input style="width: 50px;" type="text" value="0.020"/> ft/ft												
Gutter Cross Slope (typically 2 inches over 24 inches or 0.083 ft/ft)	$S_W = $ <input style="width: 50px;" type="text" value="0.083"/> ft/ft												
Street Longitudinal Slope - Enter 0 for sump condition	$S_O = $ <input style="width: 50px;" type="text" value="0.000"/> ft/ft												
Manning's Roughness for Street Section (typically between 0.012 and 0.020)	$n_{STREET} = $ <input style="width: 50px;" type="text" value="0.020"/>												
Max. Allowable Spread for Minor & Major Storm	<table style="width: 100%; border-collapse: collapse;"> <tr> <th style="width: 50%;"></th> <th style="width: 25%; text-align: center;">Minor Storm</th> <th style="width: 25%; text-align: center;">Major Storm</th> <th style="width: 10%;"></th> </tr> <tr> <td>$T_{MAX} =$</td> <td style="text-align: center;"><input style="width: 50px;" type="text" value="17.0"/></td> <td style="text-align: center;"><input style="width: 50px;" type="text" value="17.0"/></td> <td style="text-align: right;">ft</td> </tr> <tr> <td>$d_{MAX} =$</td> <td style="text-align: center;"><input style="width: 50px;" type="text" value="5.1"/></td> <td style="text-align: center;"><input style="width: 50px;" type="text" value="8.0"/></td> <td style="text-align: right;">inches</td> </tr> </table>		Minor Storm	Major Storm		$T_{MAX} = $	<input style="width: 50px;" type="text" value="17.0"/>	<input style="width: 50px;" type="text" value="17.0"/>	ft	$d_{MAX} = $	<input style="width: 50px;" type="text" value="5.1"/>	<input style="width: 50px;" type="text" value="8.0"/>	inches
	Minor Storm	Major Storm											
$T_{MAX} = $	<input style="width: 50px;" type="text" value="17.0"/>	<input style="width: 50px;" type="text" value="17.0"/>	ft										
$d_{MAX} = $	<input style="width: 50px;" type="text" value="5.1"/>	<input style="width: 50px;" type="text" value="8.0"/>	inches										
Max. Allowable Depth at Gutter Flowline for Minor & Major Storm													
Check boxes are not applicable in SUMP conditions	<table style="width: 100%; border-collapse: collapse;"> <tr> <td style="width: 50%; text-align: center;"><input type="checkbox"/></td> <td style="width: 50%; text-align: center;"><input type="checkbox"/></td> </tr> </table>	<input type="checkbox"/>	<input type="checkbox"/>										
<input type="checkbox"/>	<input type="checkbox"/>												
MINOR STORM Allowable Capacity is based on Depth Criterion													
MAJOR STORM Allowable Capacity is based on Depth Criterion	<table style="width: 100%; border-collapse: collapse;"> <tr> <th style="width: 50%;"></th> <th style="width: 25%; text-align: center;">Minor Storm</th> <th style="width: 25%; text-align: center;">Major Storm</th> <th style="width: 10%;"></th> </tr> <tr> <td>$Q_{allow} =$</td> <td style="text-align: center;"><input style="width: 50px;" type="text" value="SUMP"/></td> <td style="text-align: center;"><input style="width: 50px;" type="text" value="SUMP"/></td> <td style="text-align: right;">cfs</td> </tr> </table>		Minor Storm	Major Storm		$Q_{allow} = $	<input style="width: 50px;" type="text" value="SUMP"/>	<input style="width: 50px;" type="text" value="SUMP"/>	cfs				
	Minor Storm	Major Storm											
$Q_{allow} = $	<input style="width: 50px;" type="text" value="SUMP"/>	<input style="width: 50px;" type="text" value="SUMP"/>	cfs										

INLET IN A SUMP OR SAG LOCATION

Version 4.05 Released March 2017

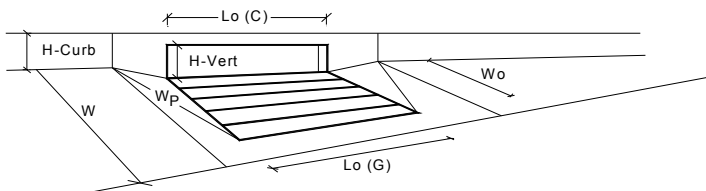

Design Information (Input)	MINOR	MAJOR	
Type of Inlet	CDOT Type R Curb Opening		
Local Depression (additional to continuous gutter depression 'a' from above)	3.00	3.00	inches
Number of Unit Inlets (Grate or Curb Opening)	1	1	
Water Depth at Flowline (outside of local depression)	5.1	7.8	inches
Grate Information	MINOR	MAJOR	<input checked="" type="checkbox"/> Override Depths
Length of a Unit Grate	N/A	N/A	feet
Width of a Unit Grate	N/A	N/A	feet
Area Opening Ratio for a Grate (typical values 0.15-0.90)	N/A	N/A	
Clogging Factor for a Single Grate (typical value 0.50 - 0.70)	N/A	N/A	
Grate Weir Coefficient (typical value 2.15 - 3.60)	N/A	N/A	
Grate Orifice Coefficient (typical value 0.60 - 0.80)	N/A	N/A	
Curb Opening Information	MINOR	MAJOR	
Length of a Unit Curb Opening	5.00	5.00	feet
Height of Vertical Curb Opening in Inches	6.00	6.00	inches
Height of Curb Orifice Throat in Inches	6.00	6.00	inches
Angle of Throat (see USDCM Figure ST-5)	63.40	63.40	degrees
Side Width for Depression Pan (typically the gutter width of 2 feet)	2.00	2.00	feet
Clogging Factor for a Single Curb Opening (typical value 0.10)	0.10	0.10	
Curb Opening Weir Coefficient (typical value 2.3-3.7)	3.60	3.60	
Curb Opening Orifice Coefficient (typical value 0.60 - 0.70)	0.67	0.67	
Low Head Performance Reduction (Calculated)	MINOR	MAJOR	
Depth for Grate Midwidth	N/A	N/A	ft
Depth for Curb Opening Weir Equation	0.26	0.48	ft
Combination Inlet Performance Reduction Factor for Long Inlets	0.65	1.00	
Curb Opening Performance Reduction Factor for Long Inlets	1.00	1.00	
Grated Inlet Performance Reduction Factor for Long Inlets	N/A	N/A	
Total Inlet Interception Capacity (assumes clogged condition)	MINOR	MAJOR	
Q_a	3.7	9.0	cfs
Q _{PEAK REQUIRED}	2.2	5.4	cfs

Inlet Capacity IS GOOD for Minor and Major Storms(>Q PEAK)

ALLOWABLE CAPACITY FOR ONE-HALF OF STREET (Minor & Major Storm)

(Based on Regulated Criteria for Maximum Allowable Flow Depth and Spread)

Project: _____
 Inlet ID: _____ Enter Your Project Name Here
Inlet DP 10

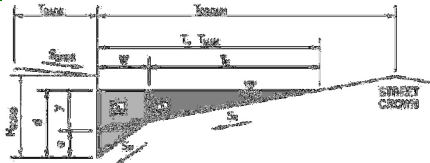

Gutter Geometry (Enter data in the blue cells)							
Maximum Allowable Width for Spread Behind Curb	T _{BACK} = 8.0 ft						
Side Slope Behind Curb (leave blank for no conveyance credit behind curb)	S _{BACK} = 0.020 ft/ft						
Manning's Roughness Behind Curb (typically between 0.012 and 0.020)	n _{BACK} = 0.020						
Height of Curb at Gutter Flow Line	H _{CURB} = 6.00 inches						
Distance from Curb Face to Street Crown	T _{CROWN} = 17.0 ft						
Gutter Width	W = 2.00 ft						
Street Transverse Slope	S _x = 0.020 ft/ft						
Gutter Cross Slope (typically 2 inches over 24 inches or 0.083 ft/ft)	S _w = 0.083 ft/ft						
Street Longitudinal Slope - Enter 0 for sump condition	S _o = 0.022 ft/ft						
Manning's Roughness for Street Section (typically between 0.012 and 0.020)	n _{STREET} = 0.020						
Max. Allowable Spread for Minor & Major Storm	<table border="1" style="display: inline-table; border-collapse: collapse;"> <tr> <th style="padding: 2px;">Minor Storm</th> <th style="padding: 2px;">Major Storm</th> <th style="padding: 2px;">ft</th> </tr> <tr> <td style="text-align: center;">17.0</td> <td style="text-align: center;">17.0</td> <td></td> </tr> </table>	Minor Storm	Major Storm	ft	17.0	17.0	
Minor Storm	Major Storm	ft					
17.0	17.0						
Max. Allowable Depth at Gutter Flowline for Minor & Major Storm	<table border="1" style="display: inline-table; border-collapse: collapse;"> <tr> <th style="padding: 2px;">Minor Storm</th> <th style="padding: 2px;">Major Storm</th> <th style="padding: 2px;">inches</th> </tr> <tr> <td style="text-align: center;">5.1</td> <td style="text-align: center;">7.8</td> <td></td> </tr> </table>	Minor Storm	Major Storm	inches	5.1	7.8	
Minor Storm	Major Storm	inches					
5.1	7.8						
Allow Flow Depth at Street Crown (leave blank for no)	<table border="1" style="display: inline-table; border-collapse: collapse;"> <tr> <td style="text-align: center;"><input type="checkbox"/></td> <td style="text-align: center;"><input checked="" type="checkbox"/></td> <td style="padding-left: 10px;">check = yes</td> </tr> </table>	<input type="checkbox"/>	<input checked="" type="checkbox"/>	check = yes			
<input type="checkbox"/>	<input checked="" type="checkbox"/>	check = yes					
MINOR STORM Allowable Capacity is based on Depth Criterion							
MAJOR STORM Allowable Capacity is based on Depth Criterion							
Minor storm max. allowable capacity GOOD - greater than the design flow given on sheet 'Inlet Management'	<table border="1" style="display: inline-table; border-collapse: collapse;"> <tr> <th style="padding: 2px;">Minor Storm</th> <th style="padding: 2px;">Major Storm</th> <th style="padding: 2px;">cfs</th> </tr> <tr> <td style="text-align: center;">9.4</td> <td style="text-align: center;">29.1</td> <td></td> </tr> </table>	Minor Storm	Major Storm	cfs	9.4	29.1	
Minor Storm	Major Storm	cfs					
9.4	29.1						
Major storm max. allowable capacity GOOD - greater than the design flow given on sheet 'Inlet Management'							

INLET ON A CONTINUOUS GRADE

Version 4.05 Released March 2017

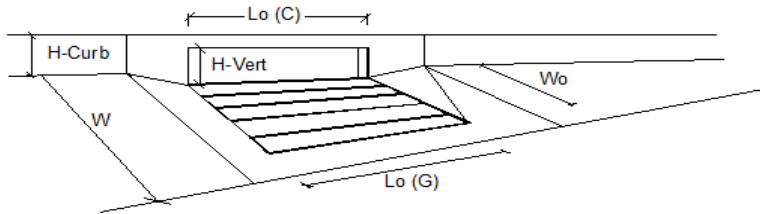

Design Information (Input)	MINOR	MAJOR	
Type of Inlet	CDOT Type R Curb Opening		
Local Depression (additional to continuous gutter depression 'a')	3.0	3.0	inches
Total Number of Units in the Inlet (Grate or Curb Opening)	1	1	
Length of a Single Unit Inlet (Grate or Curb Opening)	15.00	15.00	ft
Width of a Unit Grate (cannot be greater than W, Gutter Width)	N/A	N/A	ft
Clogging Factor for a Single Unit Grate (typical min. value = 0.5)	N/A	N/A	
Clogging Factor for a Single Unit Curb Opening (typical min. value = 0.1)	0.10	0.10	
Street Hydraulics: OK - Q < Allowable Street Capacity			
Total Inlet Interception Capacity	9.1	12.7	cfs
Total Inlet Carry-Over Flow (flow bypassing inlet)	0.3	2.9	cfs
Capture Percentage = Q_c/Q_o =	97	82	%

ALLOWABLE CAPACITY FOR ONE-HALF OF STREET (Minor & Major Storm)

(Based on Regulated Criteria for Maximum Allowable Flow Depth and Spread)

Project: _____
 Inlet ID: _____ Enter Your Project Name Here
Inlet DP 11

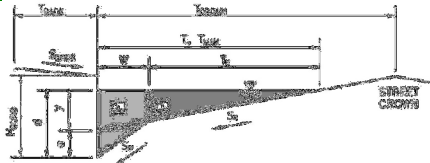

Gutter Geometry (Enter data in the blue cells)							
Maximum Allowable Width for Spread Behind Curb	T _{BACK} = 8.0 ft						
Side Slope Behind Curb (leave blank for no conveyance credit behind curb)	S _{BACK} = 0.020 ft/ft						
Manning's Roughness Behind Curb (typically between 0.012 and 0.020)	n _{BACK} = 0.020						
Height of Curb at Gutter Flow Line	H _{CURB} = 6.00 inches						
Distance from Curb Face to Street Crown	T _{CROWN} = 17.0 ft						
Gutter Width	W = 2.00 ft						
Street Transverse Slope	S _x = 0.020 ft/ft						
Gutter Cross Slope (typically 2 inches over 24 inches or 0.083 ft/ft)	S _w = 0.083 ft/ft						
Street Longitudinal Slope - Enter 0 for sump condition	S _o = 0.022 ft/ft						
Manning's Roughness for Street Section (typically between 0.012 and 0.020)	n _{STREET} = 0.020						
Max. Allowable Spread for Minor & Major Storm	<table border="1" style="display: inline-table; border-collapse: collapse;"> <tr> <th style="width: 50%;">Minor Storm</th> <th style="width: 50%;">Major Storm</th> </tr> <tr> <td>T_{MAX} = 17.0</td> <td>17.0</td> </tr> <tr> <td>d_{MAX} = 5.1</td> <td>7.8</td> </tr> </table>	Minor Storm	Major Storm	T _{MAX} = 17.0	17.0	d _{MAX} = 5.1	7.8
Minor Storm	Major Storm						
T _{MAX} = 17.0	17.0						
d _{MAX} = 5.1	7.8						
Max. Allowable Depth at Gutter Flowline for Minor & Major Storm							
Allow Flow Depth at Street Crown (leave blank for no)	<table border="1" style="display: inline-table; border-collapse: collapse;"> <tr> <th style="width: 50%;">Minor Storm</th> <th style="width: 50%;">Major Storm</th> </tr> <tr> <td style="text-align: center;"><input type="checkbox"/></td> <td style="text-align: center;"><input checked="" type="checkbox"/></td> </tr> </table> check = yes	Minor Storm	Major Storm	<input type="checkbox"/>	<input checked="" type="checkbox"/>		
Minor Storm	Major Storm						
<input type="checkbox"/>	<input checked="" type="checkbox"/>						
MINOR STORM Allowable Capacity is based on Depth Criterion							
MAJOR STORM Allowable Capacity is based on Depth Criterion							
Minor storm max. allowable capacity GOOD - greater than the design flow given on sheet 'Inlet Management'	<table border="1" style="display: inline-table; border-collapse: collapse;"> <tr> <th style="width: 50%;">Minor Storm</th> <th style="width: 50%;">Major Storm</th> </tr> <tr> <td>Q_{allow} = 9.4</td> <td>29.1</td> </tr> </table> cfs	Minor Storm	Major Storm	Q _{allow} = 9.4	29.1		
Minor Storm	Major Storm						
Q _{allow} = 9.4	29.1						
Major storm max. allowable capacity GOOD - greater than the design flow given on sheet 'Inlet Management'							

INLET ON A CONTINUOUS GRADE

Version 4.05 Released March 2017

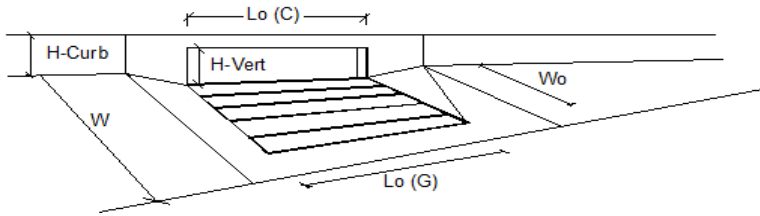

Design Information (Input)	MINOR	MAJOR	
Type of Inlet	CDOT Type R Curb Opening		
Local Depression (additional to continuous gutter depression 'a')	3.0	3.0	inches
Total Number of Units in the Inlet (Grate or Curb Opening)	1	1	
Length of a Single Unit Inlet (Grate or Curb Opening)	15.00	15.00	ft
Width of a Unit Grate (cannot be greater than W, Gutter Width)	N/A	N/A	ft
Clogging Factor for a Single Unit Grate (typical min. value = 0.5)	N/A	N/A	
Clogging Factor for a Single Unit Curb Opening (typical min. value = 0.1)	0.10	0.10	
Street Hydraulics: OK - Q < Allowable Street Capacity			
Total Inlet Interception Capacity	1.9	12.7	cfs
Total Inlet Carry-Over Flow (flow bypassing inlet)	0.0	2.9	cfs
Capture Percentage = Q_i/Q_c =	100	82	%

ALLOWABLE CAPACITY FOR ONE-HALF OF STREET (Minor & Major Storm)

(Based on Regulated Criteria for Maximum Allowable Flow Depth and Spread)

Project: _____
 Inlet ID: _____ Enter Your Project Name Here
Inlet DP 12

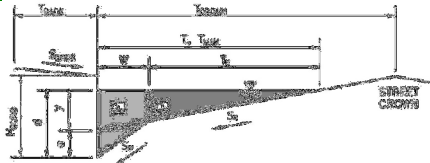

Gutter Geometry (Enter data in the blue cells)										
Maximum Allowable Width for Spread Behind Curb	$T_{BACK} = $ <input style="width: 50px;" type="text" value="8.0"/> ft									
Side Slope Behind Curb (leave blank for no conveyance credit behind curb)	$S_{BACK} = $ <input style="width: 50px;" type="text" value="0.020"/> ft/ft									
Manning's Roughness Behind Curb (typically between 0.012 and 0.020)	$n_{BACK} = $ <input style="width: 50px;" type="text" value="0.020"/>									
Height of Curb at Gutter Flow Line	$H_{CURB} = $ <input style="width: 50px;" type="text" value="6.00"/> inches									
Distance from Curb Face to Street Crown	$T_{CROWN} = $ <input style="width: 50px;" type="text" value="17.0"/> ft									
Gutter Width	$W = $ <input style="width: 50px;" type="text" value="2.00"/> ft									
Street Transverse Slope	$S_X = $ <input style="width: 50px;" type="text" value="0.020"/> ft/ft									
Gutter Cross Slope (typically 2 inches over 24 inches or 0.083 ft/ft)	$S_W = $ <input style="width: 50px;" type="text" value="0.083"/> ft/ft									
Street Longitudinal Slope - Enter 0 for sump condition	$S_O = $ <input style="width: 50px;" type="text" value="0.000"/> ft/ft									
Manning's Roughness for Street Section (typically between 0.012 and 0.020)	$n_{STREET} = $ <input style="width: 50px;" type="text" value="0.020"/>									
Max. Allowable Spread for Minor & Major Storm	<table border="1" style="width: 100%; text-align: center;"> <thead> <tr> <th style="width: 50%;">Minor Storm</th> <th style="width: 50%;">Major Storm</th> <th style="width: 50px;"></th> </tr> </thead> <tbody> <tr> <td>$T_{MAX} =$ <input style="width: 50px;" type="text" value="17.0"/></td> <td><input style="width: 50px;" type="text" value="17.0"/></td> <td>ft</td> </tr> <tr> <td>$d_{MAX} =$ <input style="width: 50px;" type="text" value="5.1"/></td> <td><input style="width: 50px;" type="text" value="7.8"/></td> <td>inches</td> </tr> </tbody> </table>	Minor Storm	Major Storm		$T_{MAX} = $ <input style="width: 50px;" type="text" value="17.0"/>	<input style="width: 50px;" type="text" value="17.0"/>	ft	$d_{MAX} = $ <input style="width: 50px;" type="text" value="5.1"/>	<input style="width: 50px;" type="text" value="7.8"/>	inches
Minor Storm	Major Storm									
$T_{MAX} = $ <input style="width: 50px;" type="text" value="17.0"/>	<input style="width: 50px;" type="text" value="17.0"/>	ft								
$d_{MAX} = $ <input style="width: 50px;" type="text" value="5.1"/>	<input style="width: 50px;" type="text" value="7.8"/>	inches								
Max. Allowable Depth at Gutter Flowline for Minor & Major Storm										
Check boxes are not applicable in SUMP conditions	<input type="checkbox"/> <input type="checkbox"/>									
MINOR STORM Allowable Capacity is based on Depth Criterion										
MAJOR STORM Allowable Capacity is based on Depth Criterion										
	<table border="1" style="width: 100%; text-align: center;"> <thead> <tr> <th style="width: 50%;">Minor Storm</th> <th style="width: 50%;">Major Storm</th> <th style="width: 50px;"></th> </tr> </thead> <tbody> <tr> <td>$Q_{allow} =$ <input style="width: 50px;" type="text" value="SUMP"/></td> <td><input style="width: 50px;" type="text" value="SUMP"/></td> <td>cfs</td> </tr> </tbody> </table>	Minor Storm	Major Storm		$Q_{allow} = $ <input style="width: 50px;" type="text" value="SUMP"/>	<input style="width: 50px;" type="text" value="SUMP"/>	cfs			
Minor Storm	Major Storm									
$Q_{allow} = $ <input style="width: 50px;" type="text" value="SUMP"/>	<input style="width: 50px;" type="text" value="SUMP"/>	cfs								

INLET IN A SUMP OR SAG LOCATION

Version 4.05 Released March 2017

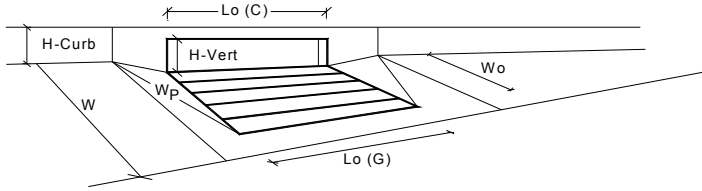

Design Information (Input)	MINOR	MAJOR	
Type of Inlet	CDOT Type R Curb Opening		
Local Depression (additional to continuous gutter depression 'a' from above)	3.00	3.00	inches
Number of Unit Inlets (Grate or Curb Opening)	2	2	
Water Depth at Flowline (outside of local depression)	5.1	7.8	inches
Grate Information	MINOR	MAJOR	<input checked="" type="checkbox"/> Override Depths
Length of a Unit Grate	N/A	N/A	feet
Width of a Unit Grate	N/A	N/A	feet
Area Opening Ratio for a Grate (typical values 0.15-0.90)	N/A	N/A	
Clogging Factor for a Single Grate (typical value 0.50 - 0.70)	N/A	N/A	
Grate Weir Coefficient (typical value 2.15 - 3.60)	N/A	N/A	
Grate Orifice Coefficient (typical value 0.60 - 0.80)	N/A	N/A	
Curb Opening Information	MINOR	MAJOR	
Length of a Unit Curb Opening	5.00	5.00	feet
Height of Vertical Curb Opening in Inches	6.00	6.00	inches
Height of Curb Orifice Throat in Inches	6.00	6.00	inches
Angle of Throat (see USDCM Figure ST-5)	63.40	63.40	degrees
Side Width for Depression Pan (typically the gutter width of 2 feet)	2.00	2.00	feet
Clogging Factor for a Single Curb Opening (typical value 0.10)	0.10	0.10	
Curb Opening Weir Coefficient (typical value 2.3-3.7)	3.60	3.60	
Curb Opening Orifice Coefficient (typical value 0.60 - 0.70)	0.67	0.67	
Low Head Performance Reduction (Calculated)	MINOR	MAJOR	
Depth for Grate Midwidth	N/A	N/A	ft
Depth for Curb Opening Weir Equation	0.26	0.48	ft
Combination Inlet Performance Reduction Factor for Long Inlets	0.48	0.74	
Curb Opening Performance Reduction Factor for Long Inlets	0.88	1.00	
Grated Inlet Performance Reduction Factor for Long Inlets	N/A	N/A	
Total Inlet Interception Capacity (assumes clogged condition)	MINOR	MAJOR	
Q_a	6.7	18.7	cfs
Q _{PEAK REQUIRED}	6.2	17.2	cfs

Inlet Capacity IS GOOD for Minor and Major Storms(>Q PEAK)

ALLOWABLE CAPACITY FOR ONE-HALF OF STREET (Minor & Major Storm)

(Based on Regulated Criteria for Maximum Allowable Flow Depth and Spread)

Project: _____
 Inlet ID: _____ Enter Your Project Name Here
Inlet DP 13

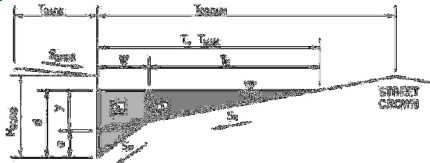

Gutter Geometry (Enter data in the blue cells)													
Maximum Allowable Width for Spread Behind Curb	$T_{BACK} = $ <input style="width: 50px;" type="text" value="8.0"/> ft												
Side Slope Behind Curb (leave blank for no conveyance credit behind curb)	$S_{BACK} = $ <input style="width: 50px;" type="text" value="0.020"/> ft/ft												
Manning's Roughness Behind Curb (typically between 0.012 and 0.020)	$n_{BACK} = $ <input style="width: 50px;" type="text" value="0.020"/>												
Height of Curb at Gutter Flow Line	$H_{CURB} = $ <input style="width: 50px;" type="text" value="6.00"/> inches												
Distance from Curb Face to Street Crown	$T_{CROWN} = $ <input style="width: 50px;" type="text" value="17.0"/> ft												
Gutter Width	$W = $ <input style="width: 50px;" type="text" value="2.00"/> ft												
Street Transverse Slope	$S_X = $ <input style="width: 50px;" type="text" value="0.020"/> ft/ft												
Gutter Cross Slope (typically 2 inches over 24 inches or 0.083 ft/ft)	$S_W = $ <input style="width: 50px;" type="text" value="0.083"/> ft/ft												
Street Longitudinal Slope - Enter 0 for sump condition	$S_O = $ <input style="width: 50px;" type="text" value="0.000"/> ft/ft												
Manning's Roughness for Street Section (typically between 0.012 and 0.020)	$n_{STREET} = $ <input style="width: 50px;" type="text" value="0.020"/>												
Max. Allowable Spread for Minor & Major Storm	<table style="width: 100%; border-collapse: collapse;"> <tr> <td style="text-align: center; padding: 2px;">Minor Storm</td> <td style="text-align: center; padding: 2px;">Major Storm</td> <td style="padding: 2px;"></td> </tr> <tr> <td style="padding: 2px;">$T_{MAX} =$ <input style="width: 50px;" type="text" value="17.0"/></td> <td style="padding: 2px;"><input style="width: 50px;" type="text" value="17.0"/></td> <td style="padding: 2px;">ft</td> </tr> <tr> <td style="padding: 2px;">$d_{MAX} =$ <input style="width: 50px;" type="text" value="5.1"/></td> <td style="padding: 2px;"><input style="width: 50px;" type="text" value="5.1"/></td> <td style="padding: 2px;">inches</td> </tr> <tr> <td style="text-align: center; padding: 2px;"><input type="checkbox"/></td> <td style="text-align: center; padding: 2px;"><input type="checkbox"/></td> <td style="padding: 2px;"></td> </tr> </table>	Minor Storm	Major Storm		$T_{MAX} = $ <input style="width: 50px;" type="text" value="17.0"/>	<input style="width: 50px;" type="text" value="17.0"/>	ft	$d_{MAX} = $ <input style="width: 50px;" type="text" value="5.1"/>	<input style="width: 50px;" type="text" value="5.1"/>	inches	<input type="checkbox"/>	<input type="checkbox"/>	
Minor Storm	Major Storm												
$T_{MAX} = $ <input style="width: 50px;" type="text" value="17.0"/>	<input style="width: 50px;" type="text" value="17.0"/>	ft											
$d_{MAX} = $ <input style="width: 50px;" type="text" value="5.1"/>	<input style="width: 50px;" type="text" value="5.1"/>	inches											
<input type="checkbox"/>	<input type="checkbox"/>												
Max. Allowable Depth at Gutter Flowline for Minor & Major Storm													
Check boxes are not applicable in SUMP conditions													
MINOR STORM Allowable Capacity is based on Depth Criterion													
MAJOR STORM Allowable Capacity is based on Depth Criterion													
$Q_{allow} = $	<table style="width: 100%; border-collapse: collapse;"> <tr> <td style="text-align: center; padding: 2px;">Minor Storm</td> <td style="text-align: center; padding: 2px;">Major Storm</td> <td style="padding: 2px;"></td> </tr> <tr> <td style="padding: 2px;"><input style="width: 50px;" type="text" value="SUMP"/></td> <td style="padding: 2px;"><input style="width: 50px;" type="text" value="SUMP"/></td> <td style="padding: 2px;">cfs</td> </tr> </table>	Minor Storm	Major Storm		<input style="width: 50px;" type="text" value="SUMP"/>	<input style="width: 50px;" type="text" value="SUMP"/>	cfs						
Minor Storm	Major Storm												
<input style="width: 50px;" type="text" value="SUMP"/>	<input style="width: 50px;" type="text" value="SUMP"/>	cfs											

INLET IN A SUMP OR SAG LOCATION

Version 4.05 Released March 2017

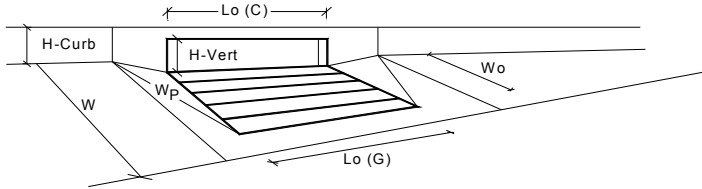

Design Information (Input)	MINOR	MAJOR	
Type of Inlet	CDOT Type R Curb Opening		
Local Depression (additional to continuous gutter depression 'a' from above)	3.00	3.00	inches
Number of Unit Inlets (Grate or Curb Opening)	1	1	
Water Depth at Flowline (outside of local depression)	5.1	7.8	inches
Grate Information	MINOR	MAJOR	<input checked="" type="checkbox"/> Override Depths
Length of a Unit Grate	N/A	N/A	feet
Width of a Unit Grate	N/A	N/A	feet
Area Opening Ratio for a Grate (typical values 0.15-0.90)	N/A	N/A	
Clogging Factor for a Single Grate (typical value 0.50 - 0.70)	N/A	N/A	
Grate Weir Coefficient (typical value 2.15 - 3.60)	N/A	N/A	
Grate Orifice Coefficient (typical value 0.60 - 0.80)	N/A	N/A	
Curb Opening Information	MINOR	MAJOR	
Length of a Unit Curb Opening	5.00	5.00	feet
Height of Vertical Curb Opening in Inches	6.00	6.00	inches
Height of Curb Orifice Throat in Inches	6.00	6.00	inches
Angle of Throat (see USDCM Figure ST-5)	63.40	63.40	degrees
Side Width for Depression Pan (typically the gutter width of 2 feet)	2.00	2.00	feet
Clogging Factor for a Single Curb Opening (typical value 0.10)	0.10	0.10	
Curb Opening Weir Coefficient (typical value 2.3-3.7)	3.60	3.60	
Curb Opening Orifice Coefficient (typical value 0.60 - 0.70)	0.67	0.67	
Low Head Performance Reduction (Calculated)	MINOR	MAJOR	
Depth for Grate Midwidth	N/A	N/A	ft
Depth for Curb Opening Weir Equation	0.26	0.48	ft
Combination Inlet Performance Reduction Factor for Long Inlets	0.65	1.00	
Curb Opening Performance Reduction Factor for Long Inlets	1.00	1.00	
Grated Inlet Performance Reduction Factor for Long Inlets	N/A	N/A	
Total Inlet Interception Capacity (assumes clogged condition)	MINOR	MAJOR	
Q_a	3.7	9.0	cfs
Q _{PEAK REQUIRED}	1.2	5.9	cfs

Inlet Capacity IS GOOD for Minor and Major Storms(>Q PEAK)

EDB AND SFB DETAILS

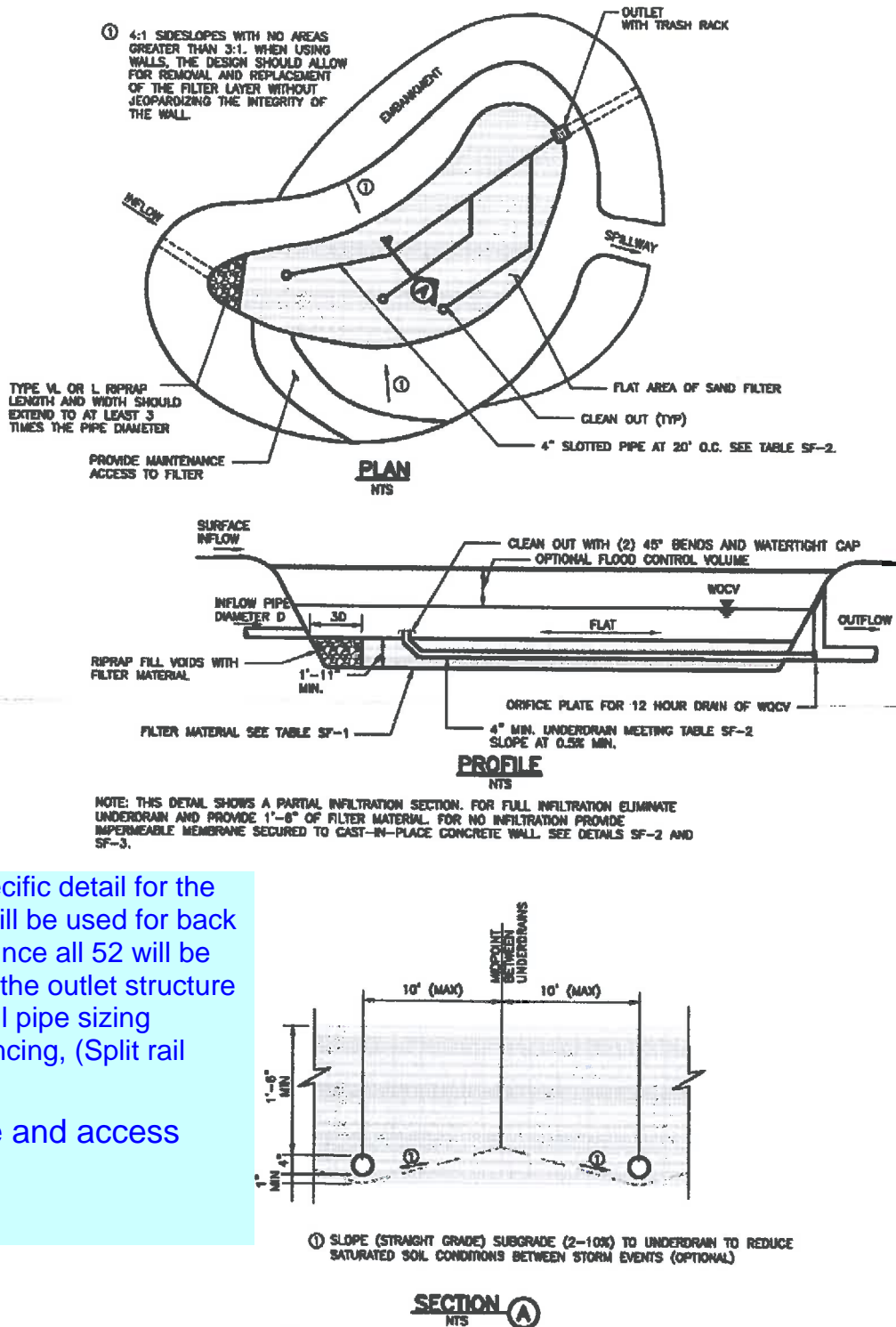

Add a more specific detail for the 52 SFB's that will be used for backyard WQCV. Since all 52 will be similar, provide the outlet structure detail, the outfall pipe sizing information, Fencing, (Split rail fence), etc.

And drainage and access easement.

Figure SF-1. Sand Filter Plan and Sections

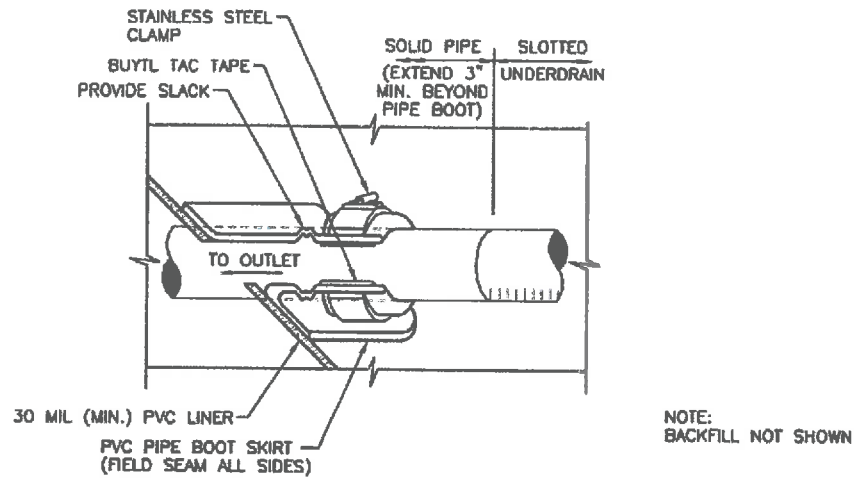

Figure SF-2. Geomembrane Liner/Underdrain Penetration Detail

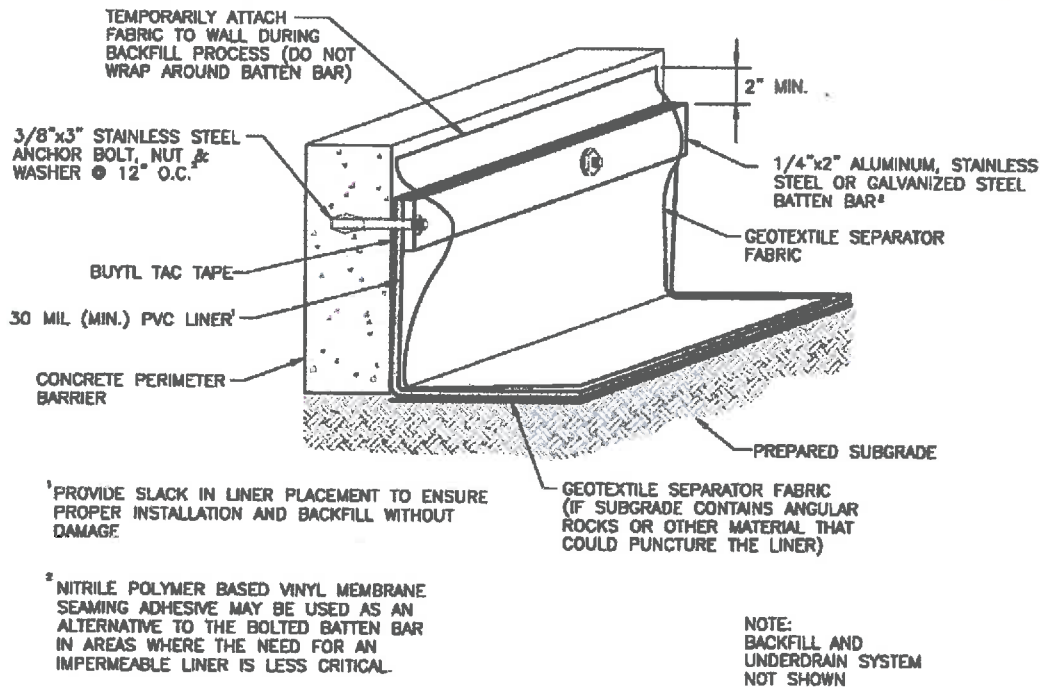

Figure SF-3. Geomembrane Liner/Concrete Connection Detail

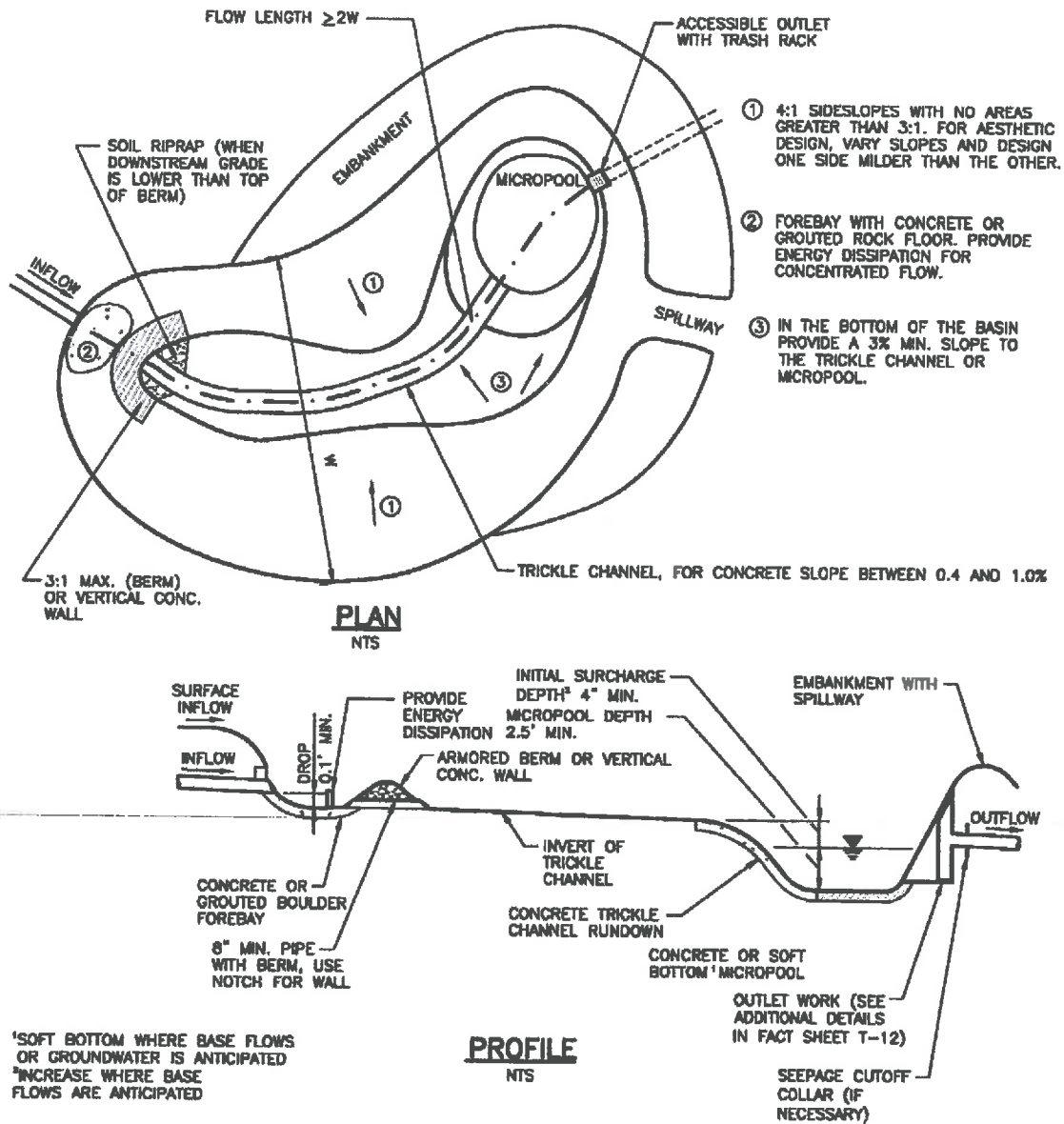
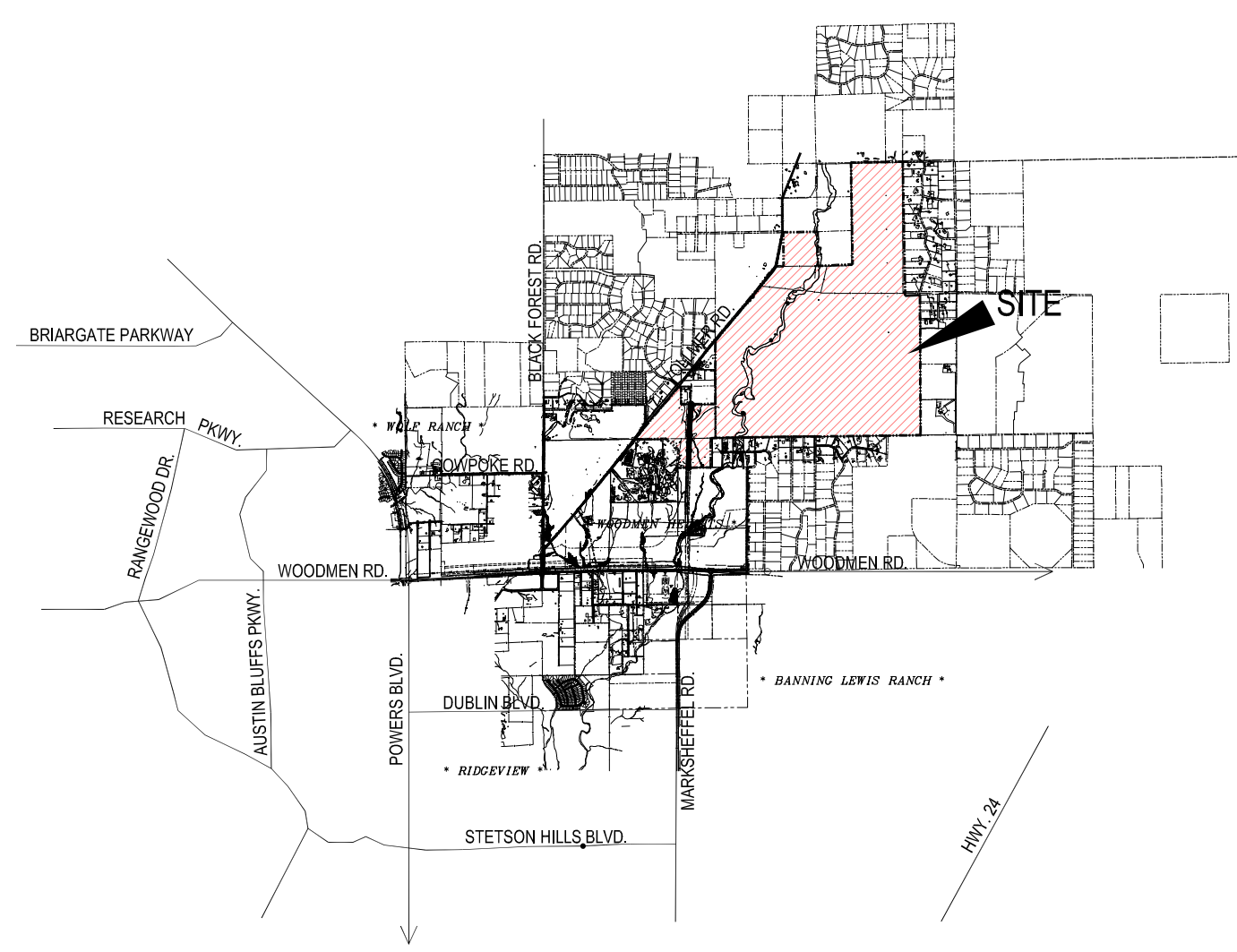

FIGURE EDB-3
EXTENDED DETENTION BASIN

Figure EDB-3. Extended Detention Basin (EDB) Plan and Profile

Additional Details are provided in BMP Fact Sheet T-12. This includes outlet structure details including orifice plates and trash racks.

HISTORIC, EXISTING AND PROPOSED DRAINAGE MAPS



STERLING RANCH
N.T.S.

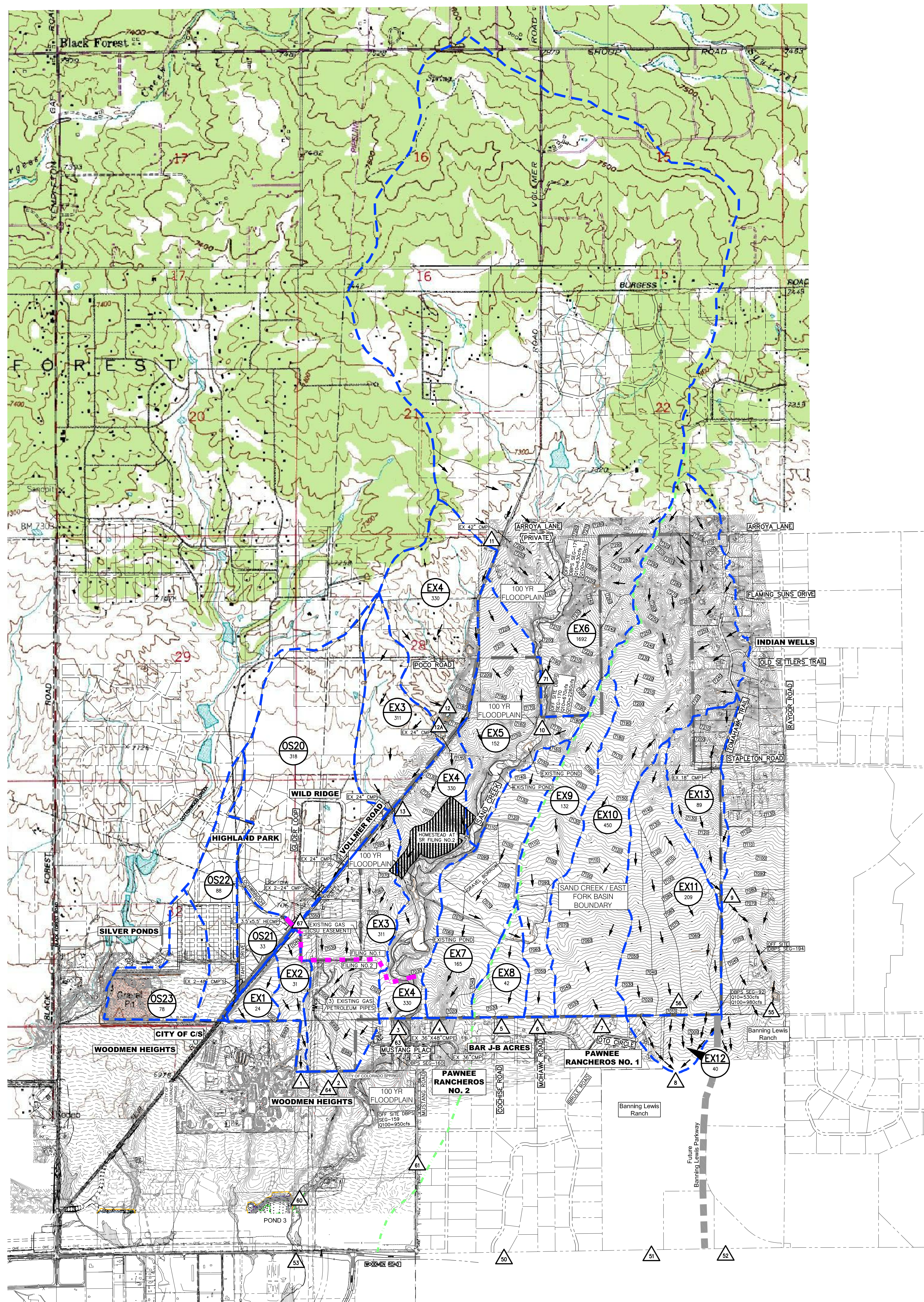

HISTORIC CONDITION

BASIN SUMMARY			
BASIN	AREA (ACRES)	Q _s (CFS)	Q ₁₀₀ (CFS)
EX-1	24	3	40
EX-2	31	3	45
EX-3	311	49	341
EX-4	330	71	352
EX-5	152	14	209
EX-6	1692	118	2168
EX-7	165	12	197
EX-8	42	4	64
EX-9	132	11	149
EX-10	450	48	474
EX-11	209	17	261
EX-12	40	5	65
EX-13	89	6	114
OS-20	318	61	310
OS-21	33	8	38
OS-22	88	18	91
OS-23	78	34	84

* NOTE: BASIN S OS-22 & OS-23 NOT PART OF THIS REPORT. FLOWS FOLLOW HISTORIC PATTERNS ON THE WEST SIDE OF VOLLER ROAD.

HISTORIC CONDITION

DESIGN POINT	DESIGN POINTS			
	SQ. MI.	Q _s (CFS)	Q ₁₀₀ (CFS)	DBPS
1	0.09	5	84	
2	0.49	49	341	0.74
3	0.52	139	2610	4.33
4	0.26	12	197	
5	0.07	4	64	
6	0.21	11	149	
7	0.70	48	474	
8	0.39	18	305	
9	0.14	6	114	
10	2.64	122	2245	3.27
11	0.09	5	83	
12A	0.01	3	16	
12	0.27	10	200	
13	0.17	6	126	

* NOTE: SQ. MI. ARE NOT CONSISTANT AT EACH DESIGN POINT DP-DBPS

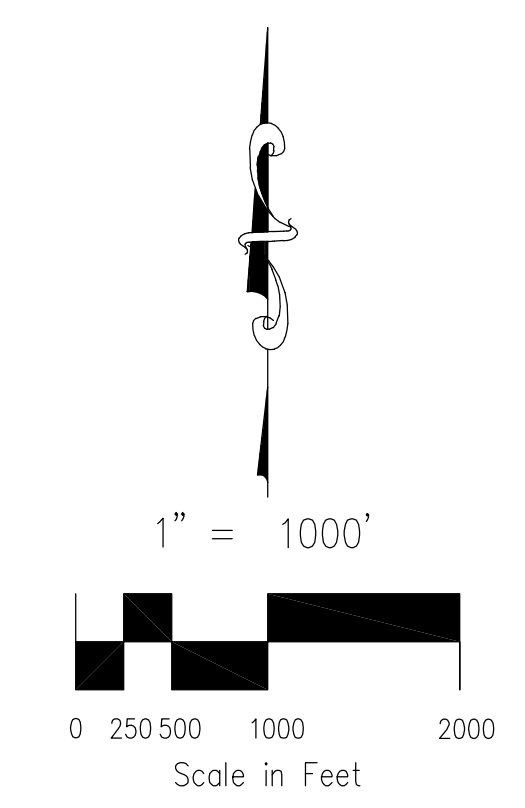

- LEGEND**
- EXISTING MDDP BASIN ACREAGE
 - EXISTING FLOW RELEASE POINT
 - FLOW DIRECTION
 - BASIN BOUNDARY
 - FILING NO.1 & NO.2 DIVISION LINE
 - PROPERTY BOUNDARY
 - EXISTING CONTOUR
 - CULVERT PIPE

MS
CIVIL CONSULTANTS, INC.
15 NORTH NEVADA AVENUE
COLORADO SPRINGS, CO 80903
(719) 955-5485, FAX (719) 471-4812

STERLING RANCH
HISTORIC - DRAINAGE MAP

PROJECT NO. 09-002 FILE: 0:\dwg\Eng Exhibits\MDDP HISTORIC

DESIGNED BY: VAS SCALE DATE: 2/6/17

DRAWN BY: VAS HORIZ: 1"=1000'

CHECKED BY: VAS VERT: N/A SHEET 1 OF 1

WLD RIDGE
FILING NO. 2
EPC

SUB-BASIN EX3

SUB-BASIN EX3

SUB-BASIN EX3

EPC
UNPLATTED

SUB-BASIN EX3

SUB-BASIN EX3

SUB-BASIN EX3

STERLING RANCH FILING NO. 1
PROPOSED FINAL DRAINAGE MAP
PROJECT NO. 09-002 DATE: 1/2/2018
SCALE: HORIZONTAL: 1"=100' VERTICAL: N/A
DESIGNED BY: ET DRAWN BY: BB CHECKED BY: GT
SHEET 4 OF 4 SHEET 4

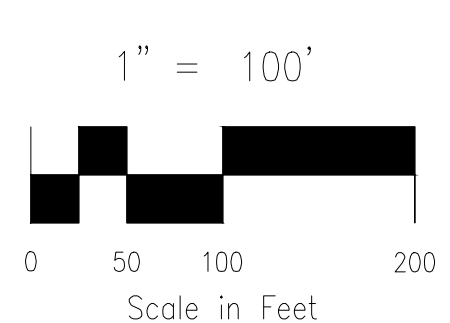
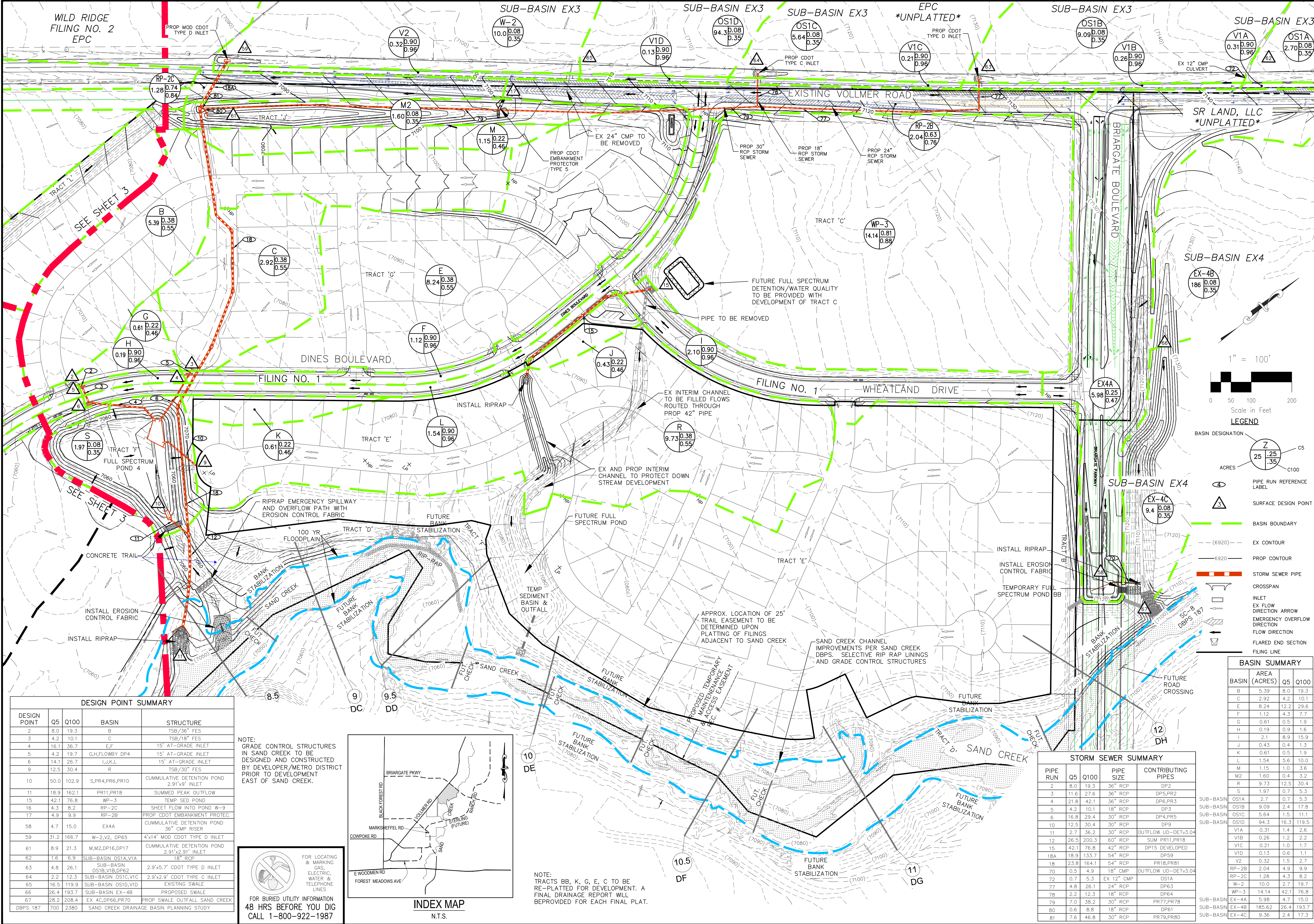

- LEGEND**
- Z BASIN DESIGNATION
 - 25 ACRES
 - .25 ACRES
 - .35 ACRES
 - C5
 - C100
 - PIPE RUN REFERENCE LABEL
 - SURFACE DESIGN POINT
 - BASIN BOUNDARY
 - EX CONTOUR
 - PROP CONTOUR
 - STORM SEWER PIPE
 - CROSSSPAN
 - INLET
 - EX FLOW DIRECTION ARROW
 - EMERGENCY OVERFLOW DIRECTION
 - FLOW DIRECTION
 - FLARED END SECTION
 - FILING LINE

BASIN SUMMARY

BASIN	AREA (ACRES)	Q5	Q100	
B	5.39	8.0	19.3	
C	2.92	4.2	10.1	
E	8.24	12.2	29.6	
F	1.12	4.3	7.7	
G	0.61	0.5	1.9	
H	0.19	0.9	1.6	
I	2.1	8.9	15.9	
J	0.43	0.4	1.3	
K	0.61	0.5	1.9	
L	1.54	5.6	10.0	
M	1.15	1.0	3.6	
M2	1.60	0.4	3.2	
R	9.73	12.5	30.4	
S	1.97	0.7	5.3	
SUB-BASIN	OS1A	2.7	0.7	5.3
SUB-BASIN	OS1B	9.09	2.4	17.8
SUB-BASIN	OS1C	5.64	1.5	11.1
SUB-BASIN	OS1D	94.3	16.3	119.5
SUB-BASIN	OS1E	9.09	2.4	17.8
SUB-BASIN	OS1F	0.31	1.4	2.6
SUB-BASIN	OS1G	0.26	1.2	2.2
SUB-BASIN	OS1H	0.21	1.0	1.7
SUB-BASIN	OS1I	0.13	0.6	1.1
SUB-BASIN	OS1J	0.2	1.5	2.7
SUB-BASIN	OS1K	0.26	4.9	9.9
SUB-BASIN	OS1L	1.28	4.3	8.2
SUB-BASIN	OS1M	4.8	2.1	7.7
SUB-BASIN	OS1N	2.12	1.3	3.2
SUB-BASIN	OS1O	2.8	1.3	3.2
SUB-BASIN	OS1P	7.0	3.2	8.2
SUB-BASIN	OS1Q	0.6	8.8	18.7
SUB-BASIN	OS1R	7.6	46.8	100.0

STORM SEWER SUMMARY

PIPE RUN	Q5	Q100	PIPE SIZE	CONTRIBUTING PIPES
2	8.0	19.3	36" RCP	DP2
3	11.6	27.6	36" RCP	DP5,PR2
4	21.8	42.1	36" RCP	DP6,PR3
5	4.2	10.1	18" RCP	DP3
6	16.8	29.4	30" RCP	DP4,PR5
10	12.5	30.4	30" RCP	DP9
11	2.7	36.2	30" RCP	OUTFLOW UD-DET-V3.04
12	26.5	200.3	60" RCP	SUM PR11,PR18
15	42.1	76.8	42" RCP	DP15 DEVELOPED
18A	18.9	133.7	54" RCP	DP59
18	23.8	164.1	54" RCP	PR18,PR1
70	0.5	4.9	18" CMP	OUTFLOW UD-DET-V3.04
72	0.7	5.3	EX 12" CMP	OS1A
77	4.8	26.1	24" RCP	DP63
78	2.2	12.3	18" RCP	DP64
79	7.0	38.2	30" RCP	PR77,PR78
80	0.6	8.8	18" RCP	DP61
81	7.6	46.8	30" RCP	PR79,PR80

DESIGN POINT SUMMARY

DESIGN POINT	Q5	Q100	BASIN	STRUCTURE
2	8.0	19.3	B	TSB/36" FES
3	4.2	10.1	C	TSB/18" FES
4	16.1	36.7	E,F	15" AT-GRADE INLET
5	4.2	19.7	G,H,FLOWBY DP4	15" AT-GRADE INLET
6	14.1	26.7	I,J,K,L	15" AT-GRADE INLET
9	12.5	30.4	R	TSB/30" FES
10	50.0	102.9	S,PR4,PR6,PR10	CUMULATIVE DETENTION POND 2.91'x9' INLET
11	18.9	162.1	PR11,PR18	SUMMED PEAK OUTFLOW
15	42.1	76.8	WP-3	TEMP SED POND
16	4.3	8.2	RP-2C	SHEET FLOW INTO POND W-9
17	4.9	9.9	RP-2B	PROP CDOT EMBANKMENT PROTEC.
58	4.7	15.0	EX4A	CUMULATIVE DETENTION POND 36" CMP RISER
59	31.2	166.7	W-2,V2, DP65	4'x14' MOD CDOT TYPE D INLET
61	8.9	21.3	M,M2,DP16,DP17	CUMULATIVE DETENTION POND 2.91'x2.91' INLET
62	1.6	6.9	SUB-BASIN OS1A,VIA	18" RCP
63	4.8	26.1	SUB-BASIN OS1B,VIB,DP62	2.9'x5.7' CDOT TYPE D INLET
64	2.2	12.3	SUB-BASIN OS1C,VIC	2.9'x2.9' CDOT TYPE C INLET
65	16.5	119.9	SUB-BASIN OS1D,VID	EXISTING SWALE
66	26.4	193.7	SUB-BASIN EX-4B	PROPOSED SWALE
67	28.2	208.4	EX 4C,DP66,PR70	PROP SWALE OUTFALL SAND CREEK
DBPS 187	700	2380	SAND CREEK DRAINAGE BASIN PLANNING STUDY	

NOTE: GRADE CONTROL STRUCTURES IN SAND CREEK TO BE DESIGNED AND CONSTRUCTED BY DEVELOPER/METRO DISTRICT PRIOR TO DEVELOPMENT EAST OF SAND CREEK.

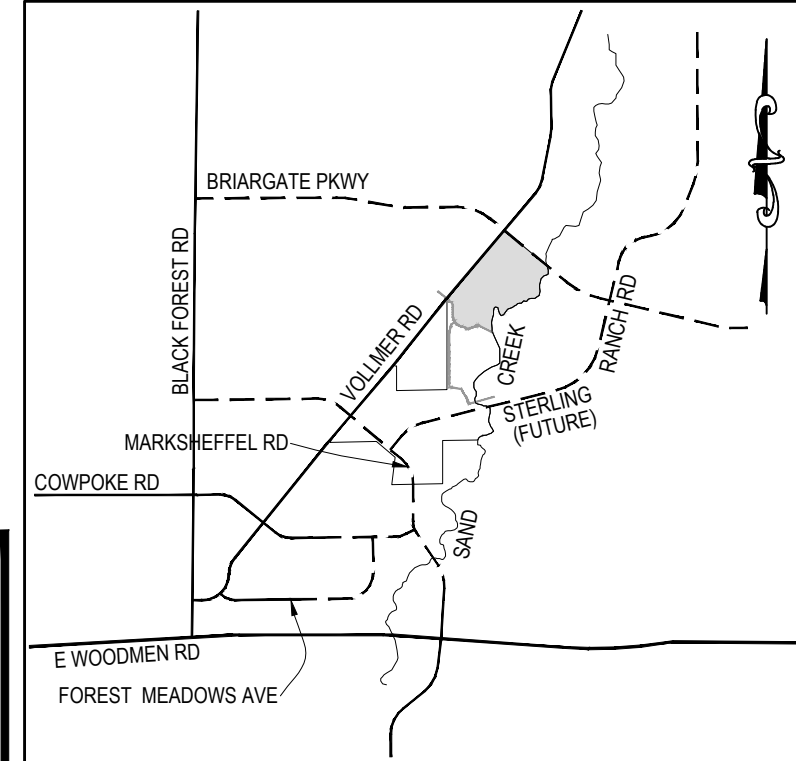

INDEX MAP
N.T.S.

NOTE: TRACTS BB, K, G, E, C TO BE RE-PLATTED FOR DEVELOPMENT. A FINAL DRAINAGE REPORT WILL BE PROVIDED FOR EACH FINAL PLAT.

File: C:\080026\Sterling Ranch District\Map\080026\080026-Filing-1-Drainage Map SHEET 4.dwg Plotstamp: 1/13/2020 4:41 PM

20 BOULDER CRESCENT SUITE 110
COLORADO SPRINGS, CO 80903
PHONE: 719.555.5485

CIVIL CONSULTANTS, INC.

FOR AND ON BEHALF OF
M&S CIVIL CONSULTANTS, INC.

REVISIONS: NO. DATE: BY: DESCRIPTION:

THE ENGINEER PREPARED THESE PLANS WILL NOT BE RESPONSIBLE FOR UNAUTHORIZED CHANGES TO OR USES OF THESE PLANS. ALL CHANGES TO THE PLANS MUST BE IN WRITING AND MUST BE APPROVED BY THE PREPARER OF THESE PLANS.

CAUTION

HOMESTEAD AT STERLING RANCH FILING NO. 2

COUNTY OF EL PASO, STATE OF COLORADO

PROPOSED DRAINAGE MAP

JANUARY 2020

LEGEND

- BASIN DESIGNATION: BASIN DESIGNATION
- PIPE RUN REFERENCE LABEL: PIPE RUN REFERENCE LABEL
- SURFACE DESIGN POINT: SURFACE DESIGN POINT
- BASIN BOUNDARY: BASIN BOUNDARY
- EXISTING CONTOUR: EXISTING CONTOUR
- PROP CONTOUR: PROP CONTOUR
- HOMESTEAD FILING NOS. 2&3 BOUNDARY: HOMESTEAD FILING NOS. 2&3 BOUNDARY
- PROPOSED STORM SEWER PIPE: PROPOSED STORM SEWER PIPE
- EXISTING STORM SEWER PIPE: EXISTING STORM SEWER PIPE
- CROSSSPAN: CROSSSPAN
- INLET: INLET
- EXISTING FLOW DIRECTION ARROW: EXISTING FLOW DIRECTION ARROW
- PROPOSED FLOW DIRECTION ARROW: PROPOSED FLOW DIRECTION ARROW
- FLARED END SECTION: FLARED END SECTION
- H.P. X: HIGH POINT
- L.P. X: LOW POINT

Provide a note referencing the initial channel design plans.

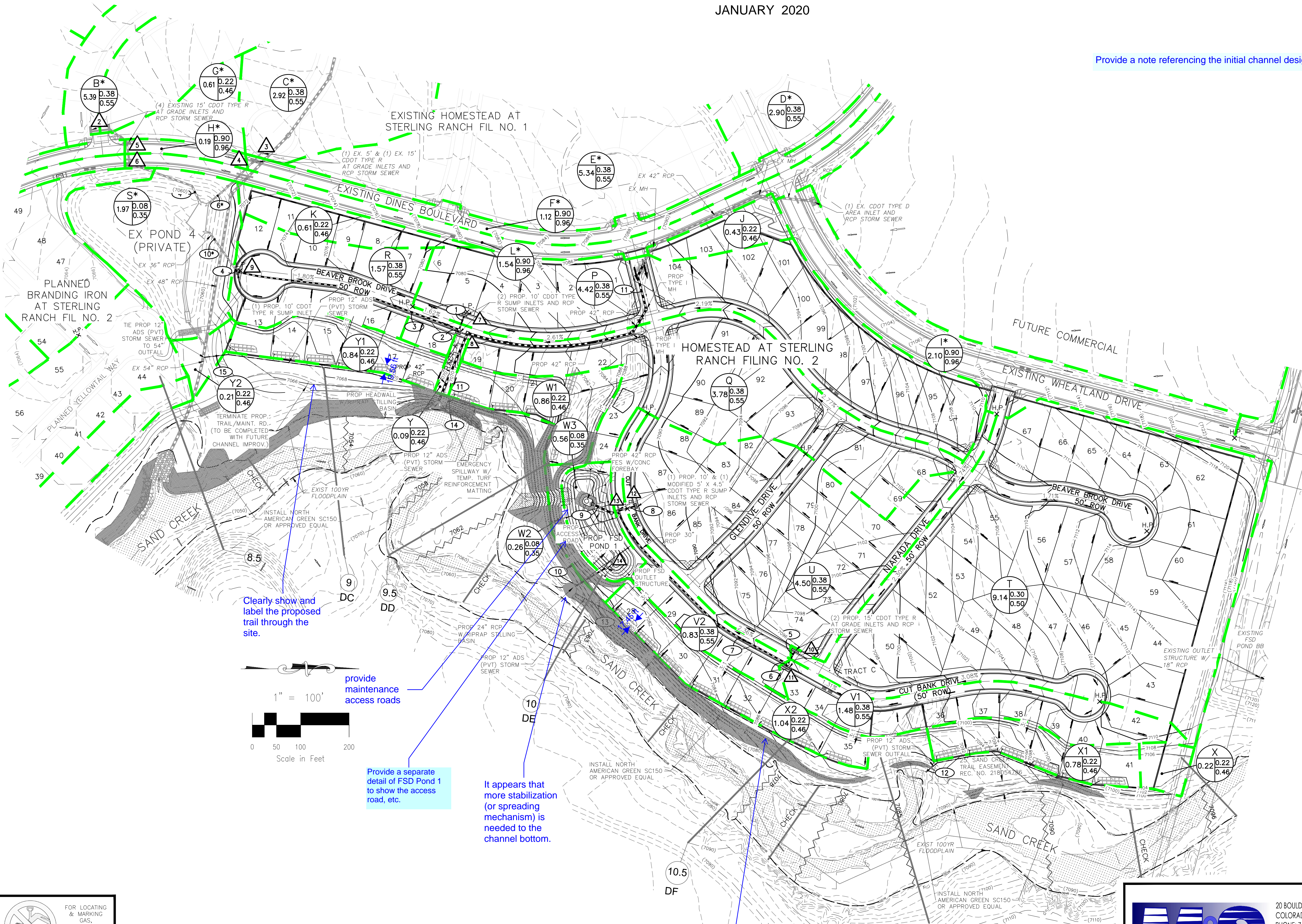

STORM SEWER SUMMARY			
PIPE RUN	Q _s	Q ₁₀₀	CONTRIBUTING PIPES/DESIGN POINTS
1	5.7	13.8	18" RCP DP7
2	4.9	11.8	18" RCP DP8
3	10.6	25.7	24" RCP PR1, PR2
4	12.4	30.1	30" RCP DP9, PR3
5	9.1	12.7	18" RCP DP10
6	1.9	12.7	18" RCP DP11
7	10.9	25.3	30" RCP PR5, PR6
8	6.2	17.2	24" RCP DP12
9	17.9	47.1	42" RCP DP13, PR7, PR8
10	0.7	23.5	24" RCP OUTLET STRUC.
11	42.1	76.8	42" RCP CONTINUED FROM MDDP PIPE#5
12	0.0	1.3	12" ADS LOTS 36-41
13	0.0	1.6	12" ADS LOTS 28-35
14	0.0	1.5	12" ADS LOTS 19-24
15	0.0	1.4	12" ADS LOTS 13-18
4*	21.8	42.1	36" RCP SEE MDDP*
6*	16.8	29.4	30" RCP SEE MDDP*
10*	12.5	30.4	30" RCP SEE MDDP*

BASIN SUMMARY			
BASIN	AREA (ACRES)	Q _s	Q ₁₀₀
ON-SITE BASINS			
J	0.43	0.4	1.3
K	0.61	0.5	1.9
P	4.42	5.7	13.8
Q	3.78	4.9	11.8
R	1.57	2.2	5.4
T	9.14	9.4	26.4
U	4.50	6.4	15.6
V1	1.48	2.1	5.0
V2	0.83	1.2	2.9
W1	0.56	0.2	1.7
W2	0.26	0.1	0.8
W3	0.56	0.2	1.7
X	0.22	0.2	0.8
X1	0.78	0.8	2.8
X2	1.04	1.1	3.7
Y	0.09	0.1	0.3
Y1	0.84	0.8	3.0
Y2	0.21	0.2	0.7
B*	5.39	8.0	19.3
C*	2.92	4.2	10.1
D*	2.90	4.3	10.4
E*	5.34	8.2	19.9
F*	1.12	0.9	2.2
G*	0.61	0.4	1.3
H*	0.19	0.2	0.5
I*	2.10	0.9	2.2
J*	0.43	0.2	0.5
K*	0.61	0.2	0.5
L*	1.54	0.9	2.2
M*	1.57	0.9	2.2
N*	1.54	0.9	2.2
O*	1.12	0.9	2.2
P*	4.42	0.9	2.2
Q*	3.78	0.9	2.2
R*	1.57	0.9	2.2
S*	1.97	0.9	2.2
T*	9.14	0.9	2.2
U*	4.50	0.9	2.2
V1*	1.48	0.9	2.2
V2*	0.83	0.9	2.2
W1*	0.56	0.9	2.2
W2*	0.26	0.9	2.2
W3*	0.56	0.9	2.2
X*	0.22	0.9	2.2
X1*	0.78	0.9	2.2
X2*	1.04	0.9	2.2
Y*	0.09	0.9	2.2
Y1*	0.84	0.9	2.2
Y2*	0.21	0.9	2.2

FULL SPECTRUM DETENTION INTERIM POND 1	
WQ VOLUME	0.245 AC-FT
EURY VOLUME	0.741 AC-FT
100 YR STORAGE VOLUME	1.331 AC-FT
100 YR WATER SURFACE EL	7083.91
SPILLWAY CREST EL	7084.16
TOP OF EMBANKMENT EL	7086.00
SPILLWAY DESIGN FLOW DEPTH	0.84 FT

DESIGN POINT SUMMARY			
DESIGN POINT	Q _s	Q ₁₀₀	STRUCTURE
2*	8.0	19.3	(2) EX. 15" AT-GRADE INLETS
3*	4.2	10.1	EX. 6" SUMP INLET
4*	16.1	36.7	D*, E*, F* EX. 15" AT-GRADE INLET
5*	4.2	19.7	G*, H*, FLOWBY DP4* EX. 15" AT-GRADE INLET
6*	14.1	26.7	I*, J*, K*, L* EX. 15" AT-GRADE INLET
7	5.7	13.8	P PROP. 10" SUMP INLET
8	4.9	11.8	Q PROP. 10" SUMP INLET
9	2.2	5.4	R PROP. 5" SUMP INLET
10	9.4	15.6	T PROP. 15" AT-GRADE INLET
11	1.9	15.6	V1 PROP. 15" AT-GRADE INLET
12	6.2	17.2	U, FLOWBY DP10 PROP. 10" SUMP INLET
13	1.2	5.9	V2, FLOWBY DP11 PROP. 5" SUMP INLET
14	19.6	52.4	W3, PR9 CUMULATIVE DETENTION POND

* For detailed information on Design Points, Basins, Flowby, or Pipe Runs see Sterling Ranch Filing Nos. 1&2 MDDP prepared by WS Civil Consultants, dated April 2017. Refer to Homestead at Sterling Ranch Filing No. 2 Grading and Erosion Control Plan for additional interim channel stabilization improvements. All elevations provided on map are referenced in NGVD29.

Clearly show and label the proposed trail through the site.

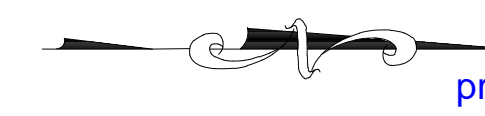

1" = 100'

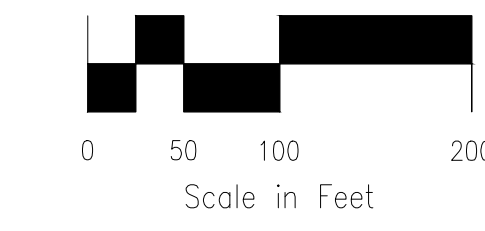

provide maintenance access roads

Provide a separate detail of FSD Pond 1 to show the access road, etc.

It appears that more stabilization (or spreading mechanism) is needed to the channel bottom.

Will the trail be utilized to access and maintain the SFBs?

FOR LOCATING & MARKING GAS, ELECTRIC, WATER & TELEPHONE LINES
FOR BURIED UTILITY INFORMATION
48 HRS BEFORE YOU DIG
CALL 1-800-922-1987



20 BOULDER CRESCENT, SUITE 110
COLORADO SPRINGS, CO 80903
PHONE: 719.955.5485

HOMESTEAD AT STERLING RANCH FIL. NO. 2			
PROPOSED DRAINAGE MAP			
PROJECT NO. 09-007	SCALE: HORIZONTAL: 1"=100'	DATE: 01/15/2020	PDM
DESIGNED BY: CMN	CHECKED BY: VAS	SHEET 1 OF 1	

File: 0:\080071\Sterling Ranch No 2\Map\Eng Exhibit\Prop. Drain. Map Homestead Fil. No 2.dwg Plotstamp: 1/15/2020 11:17 AM