



ENTECH
ENGINEERING, INC.

505 ELKTON DRIVE
COLORADO SPRINGS, CO 80907
PHONE (719) 531-5599

**SOILS AND GEOLOGY STUDY
RETREAT AT TIMBERRIDGE FILING NO. 4
PARCEL NO. 52220-00-023
EL PASO COUNTY, COLORADO**

Prepared for:
**TimberRidge Development Group, LLC
2138 Flying Horse Club Drive
Colorado Springs, CO 80921**

Attn: Loren Moreland

December 21, 2023
Revised June 17, 2024
Revised August 6, 2024

Respectfully Submitted,

ENTECH ENGINEERING, INC.

Logan L. Langford, P.G.
Sr. Geologist

Reviewed by:

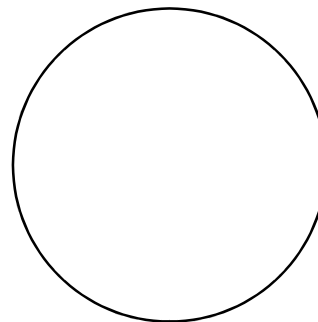

Joseph C. Goode Jr., P.E.
President

LLL

Table of Contents

1 SUMMARY..... 1

2 GENERAL SITE CONDITIONS AND PROJECT DESCRIPTION 2

3 SCOPE OF THE REPORT 2

4 FIELD INVESTIGATION 2

5 SOIL, GEOLOGY, AND ENGINEERING GEOLOGY..... 3

 5.1 General Geology 3

 5.2 Soil Conservation Survey 3

 5.3 Site Stratigraphy 4

 5.4 Soil Conditions 5

 5.5 Groundwater 5

6 ENGINEERING GEOLOGY – IDENTIFICATION AND MITIGATION OF GEOLOGIC HAZARDS..... 6

 6.1 Relevance of Geologic Conditions to Land Use Planning 9

7 ECONOMIC MINERAL RESOURCES 10

8 EROSION CONTROL 11

9 ROADWAY, EMBANKMENT, and STORMWATER DETENTION FACILITY CONSTRUCTION RECOMMENDATIONS..... 12

10 CLOSURE..... 13

11 REFERENCES..... 14

FIGURES

- Figure 1: Vicinity Map
- Figure 2: USGS Map
- Figure 3: Exploration and Site Plan
- Figure 4: Soil Survey Map
- Figure 5: Geologic Map of the Falcon NW Quadrangle
- Figure 6: Geology Map/Engineering Geology
- Figure 7: Floodplain Map
- Figure 8: Typical Perimeter Drain Details
- Figure 9: Underslab Drainage Layer (Capillary Break)
- Figure 10: Interceptor Drain Detail
- Figure 11: Overexcavation Drain Detail

- APPENDIX A: Site Photographs
- APPENDIX B: Test Boring and Test Pit Logs
- APPENDIX C: Laboratory Test Results
- APPENDIX D: Soil Survey Descriptions

1 SUMMARY

Project Location

The project lies in portions of the SW $\frac{1}{4}$ of Section 22 and the NE $\frac{1}{4}$ of Section 28, Township 12 South, Range 65 West of the 6th Principal Meridian in El Paso County, Colorado. The site is located approximately 3 miles northeast of Colorado Springs, Colorado.

Project Description

Ten rural residential 2.5+ acre lots are proposed on the 34.92-acre site. The proposed rural residential lots will be serviced by individual on-site wastewater treatment systems and individual water wells.

Scope of Report

This report presents the results of our geologic evaluation and treatment of engineering geologic hazard study.

Land Use and Engineering Geology

This site was found to be suitable for the proposed development. Areas were encountered where the geologic conditions will impose some constraints on development and land use. These include areas of expansive soils, shallow bedrock, and seasonal shallow groundwater and potentially seasonally shallow groundwater areas. Based on the proposed development plan, it appears that these areas will have some impact on the development. These conditions will be discussed in greater detail in the report.

In general, it is our opinion that the development can be achieved if the observed geologic conditions on site are either avoided or properly mitigated. All recommendations are subject to the limitations discussed in the report.

2 GENERAL SITE CONDITIONS AND PROJECT DESCRIPTION

The site is located in portions of the SW $\frac{1}{4}$ of Section 22 and the NE $\frac{1}{4}$ of Section 28, Township 15 South, Range 65 West of the 6th Principal Meridian in El Paso County, Colorado. The site is located approximately 3 miles northeast of Colorado Springs, Colorado, at Vollmer Road and Arroya Lane. The location of the site is as shown on the Vicinity Map, Figure 1.

Generally, the topography of the site is gradually to moderately sloping to the southwest towards Sand Creek. Minor drainage swales are located across the site that flow in a westerly direction. Water was not observed in the drainages on-site at the time of this investigation. The site boundaries are indicated on the USGS Map, Figure 2. Previous land uses have included equipment storage, a fill borrow area, and grazing and pasture land. The site contains primarily field grasses, weeds, cacti, and yuccas, mountain mahogany, and ponderosa pine. Site photographs, taken September 13, 2023, are included in Appendix A.

Ten rural residential 2.5+ acre lots are proposed on the 34.92-acre site. Preliminary grading plans indicate the site grading will be limited to the proposed roadway and detention pond in the southwestern corner of the site. The proposed grading is shown on Exploration and Site Plan presented in Figure 3.

3 SCOPE OF THE REPORT

The scope of the report includes a general geologic analysis utilizing published geologic data. Detailed site-specific mapping will be conducted to obtain general information in respect to major geographic and geologic features, geologic descriptions and their effects on the development of the property.

4 FIELD INVESTIGATION

Our field investigation consisted of the preparation of a geologic map of any bedrock features and significant surficial deposits. The Natural Resource Conservation Service (NRCS), previously the Soil Conservation Service (SCS) survey was also reviewed to evaluate the site. The position of mappable units within the subject property are shown on the Geologic Map. Our mapping procedures involved both field reconnaissance and measurements and air photo reconnaissance and interpretation. The same mapping procedures have also been utilized to produce the Engineering Geology Map which identified pertinent geologic conditions affecting development. The field mapping was performed by personnel of Entech Engineering, Inc. on August 9, 2023.

A Geologic Hazard Study was previously performed by Entech Engineering, Inc. for the Retreat at TimberRidge, April 17, 2017 (Reference 1). Test borings and test pits from the previous investigation were utilized for this report. The location of the test borings and test pits are indicated on Figures 3 and 6. Information from the report was used in evaluating the site. The Test Boring and Test Pit Logs are presented in Appendix B, and Summarized on Table B-1. Results of this testing will be discussed later in this report.

Laboratory testing was also performed on some of the soils to classify and determine the soils engineering characteristics. Laboratory tests included grain-size analysis ASTM D-422, Atterberg Limits ASTM D-4318, volume change testing using Swell/Consolidation test. Sulfate testing was performed on select samples to evaluate potential for below grade concrete degradation due to sulfate attack. Results of the laboratory testing are included in Appendix C. A Summary of Laboratory Test Results is presented in Table C-1.

5 SOIL, GEOLOGY, AND ENGINEERING GEOLOGY

5.1 General Geology

Physiographically, the site lies in the western portion of the Great Plains Physiographic Province. Approximately 12 miles to the west is a major structural feature known as the Rampart Range Fault. This fault marks the boundary between the Great Plains Physiographic Province and the Southern Rocky Mountain Province. The site exists within the southeastern edge of a large structural feature known as the Denver Basin. Bedrock in the area tends to be very gently dipping in a northeasterly direction (Reference 1). The rocks in the area of the site are sedimentary in nature and typically Upper Cretaceous in age. The bedrock underlying the site consists of the Dawson Formation. Overlying this formation are unconsolidated deposits of man-made, and alluvial soils of Quaternary Age. The alluvial soils were deposited by water on site and as stream deposits along the drainages on-site. The site's stratigraphy will be discussed in more detail in Section 5.3.

5.2 Soil Conservation Survey

The Natural Resource Conservation Service (Reference 2), previously the Soil Conservation Service (Reference 3) has mapped three soil types on the site (Figure 4). In general, the soils classify as gravelly loamy sand and coarse sandy loam. The soils are described as follows:

<u>Type</u>	<u>Description</u>
-------------	--------------------

40	Kettle gravelly loamy sand, 3 – 8% slopes
41	Kettle gravelly loamy sand, 8 – 40% slopes
71	Pring coarse sandy loam, 3 – 8% slopes

Complete descriptions of each soil type are presented in Appendix D. The soils have generally been described to have moderate to moderately rapid permeabilities. Possible hazards with soil erosion are present on the site. The erosion potential can be controlled with vegetation. The majority of the soils have been described to have slight to moderate erosion hazards.

5.3 Site Stratigraphy

The Geologic Map of the Falcon NW Quadrangle showing the site is presented in Figure 5 (Reference 5). The Geology Map prepared for the site is presented in Figure 6. Two mappable units were identified on this site which are described as follows:

Qal Recent alluvium of Holocene Age: These are recent deposits that have been deposited along the drainages on-site.

Tkd Dawson Formation of Tertiary to Cretaceous Age: The Dawson formation typically consists of arkosic sandstone with interbedded fine-grained sandstone, siltstone and claystone. Overlying this formation is a variable layer of residual and/or colluvial soils. The residual soils were derived from the in-situ weathering of the bedrock materials on-site. The colluvial soils have been transported by the action of sheetwash and gravity. These soils consisted of silty to clayey sands and sandy clays

The bedrock underlying the site consists of the Dawson Formation of Tertiary to Cretaceous Age. The Dawson Formation typically consists of arkosic sandstone with interbedded fine-grained sandstone, siltstone and claystone. Overlying this formation are variable layers of alluvial deposits, and residual soil. The residual soils were derived from the in-situ weathering of the bedrock materials on-site. These soils consisted of silty to clayey sands and sandy clays.

The soils listed above were mapped from site-specific mapping, the *Geologic Map of the Falcon NW Quadrangle* distributed by the Colorado Geological Survey in 2003 (Reference 5), the *Geologic Map of the Colorado Springs-Castle Rock Area*, distributed by the US Geological Survey in 1979 (Reference 6), and the *Geologic Map of the Pueblo 1⁰ x 2⁰ Quadrangle*, distributed by the US Geological Survey in 1978 (Reference 7). The test borings and test pits were also used in

evaluating the site and are included in Appendix B. The Geology Map prepared for the site is presented in Figure 6.

5.4 Soil Conditions

The soils encountered in the Test Borings can be grouped into three general soil types. The soils were classified using the Unified Soil Classification System (USCS).

Soil Type 1 clayey to very clayey sand and silty to slightly silty sand (SC, SM, SM-SW), encountered in both of Test Borings and all of the test pits at the existing ground surface and extending to depths ranging from 1 foot to 14 feet bgs. These soils were encountered at loose to dense states and at moist conditions. The majority of the soils were encountered and medium dense states. Samples tested had 11 to 34 percent passing the No. 200 Sieve.

Soil Type 2 silty sandstone and clayey to very clayey sandstone (SM, SC), encountered in both of Test Borings and all of the Test Pits at depths ranging from 1 foot to 14 feet bgs and extending to the termination of the test borings (15 to 20 feet). The sandstone was encountered at dense to very dense states and at moist conditions. Samples tested had 48 percent passing the No. 200 Sieve. Swell/Consolidation Testing on a sample of the very clayey sandstone resulted in a swell of 0.2 percent, which is in the low expansion range.

Soil Type 3 sandy claystone and siltstone (CL, MH), encountered in Test Pit No. 2 at depths ranging from 5 feet and extended to the termination test pit (8 feet). The claystone and siltstone were encountered at hard consistencies and at moist conditions. Samples tested had 60 to 77 percent passing the No. 200 Sieve. FHA Swell Testing resulted in an expansion pressure of 1280 psf, which is in the moderate expansion range.

The Test Boring Logs are presented in Appendix B. Laboratory Test Results are presented in Appendix C, and a Summary of Laboratory Test Results is presented in Table C-1.

5.5 Groundwater

Groundwater was encountered in test borings which were drilled to depths of 15 to 20 feet. Signs of seasonally occurring groundwater were observed in TP-2 at a depth of 5 feet. These areas are discussed in the following section. Fluctuation in groundwater conditions may occur due to variations in rainfall and other factors not readily apparent at this time. It should be noted that in the sandy materials on-site, some groundwater conditions might be encountered due to the variability in the soil profile. Isolated sand and gravel layers within the soils, sometimes only a

few feet in thickness and width, can carry water in the subsurface. Groundwater may also flow on top of the underlying bedrock. Builders and planners should be cognizant of the potential for the occurrence of such subsurface water features during construction on-site and deal with each individual problem as necessary at the time of construction.

6 ENGINEERING GEOLOGY – IDENTIFICATION AND MITIGATION OF GEOLOGIC HAZARDS

Detailed mapping has been performed on this site to produce an Engineering Geology Map Figure 7. This map shows the location of various geologic conditions of which the developers should be cognizant during the planning, design and construction stages of the project. These hazards and the recommended mitigation techniques are as follows:

Artificial Fill – Constraint

Fill was not observed on the site or encountered in the borings or test pits.

Mitigation: Any uncontrolled fill encountered beneath foundations will require removal and recompaction at a minimum of 95% of its maximum Modified Proctor Dry Density, ASTM D-1557.

Collapsible Soils – Constraint

The majority of the soils encountered on-site do not exhibit collapsible characteristics, however, areas of loose soils were encountered in some of the test borings drilled on site.

Mitigation: Should loose or collapsible soils be encountered beneath foundations, recompaction and moisture conditioning of the upper 2 feet of soil at 95% of its maximum Modified Proctor Dry Density ASTM D-1557 will be required. Exterior flatwork and parking areas may also experience movement. Proofrolling and recompaction of soft areas should be performed during site work.

Expansive Soils – Constraint

Expansive soils were encountered in the test borings drilled on site. These occurrences are typically sporadic; therefore, none have been indicated on the maps. The clays and claystone, if encountered at foundation grade, can cause differential movement in structures. These occurrences should be identified and dealt with on an individual basis.

Mitigation Should expansive soils be encountered beneath foundations; mitigation will be necessary. Mitigation of expansive soils will require special foundation design. Overexcavation 3 to 5 feet and replacement with non-expansive soils at a minimum of 95% of its maximum Modified Proctor Dry Density, ASTM D-1557 is a suitable mitigation, which is common in the area. Floor slabs on expansive soils should be expected to experience movement. Overexcavation and replacement has been successful in minimizing slab movements. The use of structural floors should be considered for basement construction on highly expansive clays. Final recommendations should be determined after additional investigation of each building site.

Shallow Bedrock – Constraint

Bedrock was encountered in five the test borings at depths ranging from 3 to 14 feet. A Summary of the Depth to Bedrock is included in Table B-1. Shallow bedrock will be encountered in some areas of this site. Where claystone or sandstone are encountered, excavation/grading may be difficult requiring track-mounted excavators. Bedrock will likely be encountered cuts for utility excavations.

Groundwater and Floodplain Areas – Constraint

Areas within the minor drainages on-site have been identified as areas of seasonally high groundwater areas. Water was not flowing in the any of the drainages at the time of this investigation. The site is not mapped within floodplain zones according to the FEMA Map No. 08041CO535G, (Reference 8, Figure 8). These areas are discussed as follows:

Potential Seasonally Shallow and Seasonally Shallow Groundwater Area – Constraint

In these areas, we would anticipate the potential for periodically high subsurface moisture conditions, frost heave potential and highly organic soils. These areas are associated with the minor drainages on the site. Preliminary grading plans indicated grading will be associated with the proposed roadway and the detention pond to be located in southwestern portion of the site in Tract A. The shallow groundwater areas lie within the minor drainage swales in the northern portion of the site. The potential seasonally shallow groundwater areas associated with the minor drainages across the site. A minimum separation of 3 feet between foundation components and groundwater levels are recommended.

Discuss where the foundation drains will discharge to. Groundwater intercepted should be recharge to the ground and not be conveyed to the Pond or Sand Creek.



Mitigation: Foundations must have a minimum 30-inch depth for frost protection. In areas where high subsurface moisture conditions are anticipated periodically, subsurface perimeter drains are recommended to help prevent the intrusion of water into areas below grade. Seasonally shallow groundwater areas are located in the northern portions of Lots 3 and 5. The potentially shallow groundwater areas have been identified across the site (building in these areas is not anticipated). In these areas we would anticipated the potential for higher groundwater levels. Fill added to these areas further raise foundations above groundwater levels if earthwork is proposed. Foundations should be kept as high as possible. Areas may experience higher groundwater levels during period of higher precipitation where water can flow through permeable sands on top of less permeable bedrock materials. Subsurface perimeter drains may be necessary to prevent the intrusion of water into areas below grade. Typical drain details are presented in Figure 8. **Where shallow groundwater is encountered, underslab drains or interceptor drains may be necessary.** Typical drain details are presented in Figures 9 and 11. It is anticipated that the shallow water areas will be avoided or mitigated with site grading and the installation of sewer underdrains. Specific recommendations should be made after additional investigation and site grading has been completed.

The northern side of the proposed embankment for the Extended Detention Basin (EDB) is located in a potential seasonal shallow groundwater area as indicated on the Geology/Engineering Geology Map, Figure 6. Areas receiving fill may require stabilization with rock or geogrid if shallow groundwater conditions are encountered. A private storm sewer that discharges to the EDB is proposed along a section of Nature Refuge Way and through the drainage easement on Lot 1. **Additional investigation of the pond is recommended as plans are finalized and prior to construction.**

Radon – Hazard

Radon levels for the area have been reported by the Colorado Geologic Survey in the open file, Report No. 91-4 (Reference 10). Average Radon levels for the 80908-zip code is 3.40 pCi/l. The following is a table of radon levels in this area:

Unresolved. See comments from v2, v3: The plans are close to approval and construction will commence once this item on the Soils Report is addressed and the project is accepted so groundwater needs to be addressed at this time. The potential for groundwater issues should be addressed in this report with design recommendations provided and incorporated into the proposed design.

<u>80908</u>	
0 < 4 pCi/l	50.00%
4 < 10 pCi/l	50.00%
10 < 20 pCi/l	0.00%
> 20 pCi/l	0.00%

Mitigation:

The potential for high radon levels is present for the site. Build-up of radon gas can usually be mitigated by providing increased ventilation of basement and crawlspace and sealing joints. Specific requirements for mitigation should be based on site specific testing.

6.1 Relevance of Geologic Conditions to Land Use Planning

We understand that the development will be rural residential 2.5 acre lots, and other associated site improvements. It is our opinion that the existing geologic and engineering geologic conditions will impose some minor constraints on the proposed development and construction. The constraints affecting development will be those associated with the expansive soils, shallow bedrock, and seasonal shallow groundwater and potentially seasonally shallow groundwater areas on the site that can be satisfactorily mitigated through proper engineering design and construction practices.

The upper materials are typically at loose to dense states. The granular soils encountered in the upper soil profiles of the test borings and test pits should provide good support for foundations. Loose soils if encountered at foundation depth will require mitigation. Foundations anticipated for the site are standard spread footings possibly in conjunction with overexcavation in areas of expansive soils or loose soils. Excavation is anticipated to be moderate with rubber tired equipment for the site sand materials, and will require track mounted equipment for the dense sandstone, and hard claystone and siltstone. Expansive layers may also be encountered in the soil and bedrock on this site. Areas of expansive soils encountered on site are sporadic; therefore, none have been indicated on the maps. Expansive soils, if encountered, will require special foundation design and mitigation. These soils will not prohibit development.

Areas of potential seasonally and seasonally shallow groundwater were observed on site. The seasonally shallow groundwater areas are located in the northern portions of Lots 3 and 5. The potentially shallow groundwater areas have been identified across the site, in these areas we would anticipated the potential for higher groundwater levels. Drains may be necessary for structures adjacent to these areas to help prevent the intrusion of water into areas below grade. Typical drain details are presented in Figures 9 to 11. The site does not lie within any floodplain zones according to the FEMA Map No. 08041CO535G, dated December 7, 2108 (Figure 8, Reference 8). Exact locations of floodplain and specific drainage studies are beyond the scope of this report.

Preliminary grading indicate that grading will be limited to the proposed roadway and the detention pond to be located on Tract A in the southwestern portion of the site.

Bedrock was encountered in five the test borings at depths ranging from 3 to 14 feet. A Summary of the Depth to Bedrock is included in Table B-1. Shallow bedrock will be encountered in some areas of this site. Where claystone or sandstone are encountered, excavation/grading may be difficult requiring track-mounted excavators. Bedrock will likely be encountered cuts for utility excavations.

In summary, development of the site can be achieved if the items mentioned above are mitigated. These items can be mitigated through proper design and construction or through avoidance. Additional investigation is recommended as grading and development plans are prepared.

7 ECONOMIC MINERAL RESOURCES

Some of the sandy materials on-site could be considered a low-grade sand resource. According to the *El Paso County Aggregate Resource Evaluation Map* (Reference 11), the area is not mapped with any aggregate deposits. According to the *Atlas of Sand, Gravel and Quarry Aggregate Resources, Colorado Front Range Counties* distributed by the Colorado Geological Survey (Reference 12), areas of the site are not mapped with any resources. According to the *Evaluation of Mineral and Mineral Fuel Potential* (Reference 13), the area of the site has been mapped as “Fair” for industrial minerals. However, considering the silty nature of much of these materials and abundance of similar materials through the region and the close proximity to developed land, they would be considered to have little significance as an economic resource.

According to *the Evaluation of Mineral and Mineral Fuel Potential of El Paso County State Mineral Lands* (Reference 13), the site is mapped within the Denver Basin Coal Region. However, the area of the site has been mapped as “Poor” for coal resources. No active or inactive mines have been mapped in the area of the site. No metallic mineral resources have been mapped on-site (Reference 13).

The site has been mapped as “Fair” for oil and gas resources (Reference 13). No oil or gas fields have been discovered in the area of the site. The sedimentary rocks in the area may lack the geologic structure for trapping oil or gas; therefore, it may not be considered a significant resource. Hydraulic fracturing is a new method that is being used to extract oil and gas from rocks. It utilizes pressurized fluid to extract oil and gas from rocks that would not normally be productive. The area of the site has not been explored to determine if the rocks underlying the site would be

commercially viable utilizing hydraulic fracturing. The practice of hydraulic fracturing has come under review due to concerns about environmental impacts, health and safety.

8 EROSION CONTROL

The soil types observed on the site are mildly to highly susceptible to wind erosion, and moderately to highly susceptible to water erosion. A minor wind erosion and dust problem may be created for a short time during and immediately after construction. Should the problem be considered severe enough during this time, watering of the cut areas or the use of chemical palliative may be required to control dust. However, once construction has been completed and vegetation re-established, the potential for wind erosion should be considerably reduced.

With regard to water erosion, loosely compacted soils will be the most susceptible to water erosion, residually weathered soils become increasingly less susceptible to water erosion. For the typical soils observed on-site, allowable velocities or unvegetated and unlined earth channels would be on the order of 3 to 4 feet/second, depending upon the sediment load carried by the water. Permissible velocities may be increased through the use of vegetation to something on the order of 4 to 7 feet/second, depending upon the type of vegetation established. Should the anticipated velocities exceed these values, some form of channel lining material may be required to reduce erosion potential. These might consist of some of the synthetic channel lining materials on the market or conventional riprap. In cases where ditch-lining materials are still insufficient to control erosion, small check dams or sediment traps may be required. The check dams will serve to reduce flow velocities, as well as provide small traps for containing sediment. The determination of the amount, location and placement of ditch linings, check dams and of the special erosion control features should be performed by or in conjunction with the drainage engineer who is more familiar with the flow quantities and velocities.

Cut and fill slope areas will be subjected primarily to sheetwash and rill erosion. Unchecked rill erosion can eventually lead to concentrated flows of water and gully erosion. The best means to combat this type of erosion is, where possible, the adequate re-vegetation of cut and fill slopes. Cut and fill slopes having gradients more than three (3) horizontal to one (1) vertical become increasingly more difficult to revegetate successfully. Therefore, recommendations pertaining to the vegetation of the cut and fill slopes may require input from a qualified landscape architect and/or the Soil Conservation Service.

9 ROADWAY, EMBANKMENT, and STORMWATER DETENTION FACILITY CONSTRUCTION RECOMMENDATIONS

In general, the site soils are suitable for the proposed roadways and embankments. The proposed detention pond at the southwest portion of the site can be constructed with site materials. Groundwater should be expected to be encountered in deeper cuts and along drainages and low-lying areas. If excavations encroach on the groundwater level unstable soil conditions may be encountered. Excavation of saturated soils will be difficult with rubber-tired equipment. Stabilization using shot rock or geogrids may be necessary.

The northern side of the proposed embankment for the EDB is located in a potential seasonal shallow groundwater area as indicated on the Geology/Engineering Geology Map, Figure 6. Based on the soils types and the gradual existing slopes near the EDB location lining of the EDB is not necessary. Any areas to receive fill should have all topsoil, organic material or debris removed. Prior to fill placement Entech should observe the subgrade. Fill must be properly benched and compacted to minimize potentially unstable conditions in slope areas. Fill slopes should be 3:1 or flatter. The subgrade should be scarified and moisture conditioned to within 2% of optimum moisture content and compacted to a minimum of 95% of its maximum Modified Proctor Dry Density, ASTM D-1557, prior to placing new fill. Areas receiving fill may require stabilization with rock or fabric if shallow groundwater conditions are encountered.

New fill should be placed in thin lifts not to exceed 6 inches after compaction while maintaining at least 95% of its maximum Modified Proctor Dry Density, ASTM D-1557. These materials should be placed at a moisture content conducive to compaction, usually 0 to $\pm 2\%$ of Proctor optimum moisture content. The placement and compaction of fill should be observed and tested by Entech during construction. Entech should approve any import materials prior to placing or hauling them to the site. Additional investigation will be required for pavement designs once roadway grading is completed and utilities are installed.

10 CLOSURE

It is our opinion that the existing geologic engineering and geologic conditions will impose some constraints on development and construction of the site. The majority of these conditions can be mitigated through proper engineering design and construction practices. The proposed development and use are consistent with anticipated geologic and engineering geologic conditions.

It should be pointed out that because of the nature of data obtained by random sampling of such variable and non-homogeneous materials as soil and rock, it is important that we be informed of any differences observed between surface and subsurface conditions encountered in construction and those assumed in the body of this report. Construction and design personnel should be made familiar with the contents of this report. Additional investigation is recommended as plans (grading and development) are finalized and at each structure location.

This report has been prepared for TimberRidge Development Group, LLC. for application to the proposed project in accordance with generally accepted geologic soil and engineering practices. No other warranty expressed or implied is made.

We trust that this report has provided you with all the information that you required. Should you require additional information, please do not hesitate to contact Entech Engineering, Inc.

11 REFERENCES

1. Entech Engineering, Inc. April 12, 202017. *Soil, Geology, and Geologic Hazard Study, The Retreat at TimberRidge 2.5+ Acre Lots, Vollmer Road and Arroya Lane, El Paso County, Colorado*. Entech Job No. 170209.
2. Scott, Glen R., Taylor, Richard B., Epis, Rudy C., and Wobus, Reinhard A. 1978. *Geologic Structure Map of the Pueblo 1° x 2° Quadrangle, North-Central Colorado*. Sheet 2. U.S. Geologic Survey. Map I-1022.
3. Natural Resource Conservation Service, September 22, 2015. *Web Soil Survey*. United States Department Agriculture, <http://websoilsurvey.sc.egov.usda.gov/App/HomePage.htm>.
4. United States Department of Agriculture Soil Conservation Service. June 1981. *Soil Survey of El Paso County Area, Colorado*.
5. Madole, Richard F., 2003. *Geologic Map of the Falcon NW Quadrangle, El Paso County, Colorado*. Colorado Geological Survey. Open-File Report 03-8.
6. Trimble, Donald E. and Machette, Michael N. 1979. *Geologic Map of the Colorado Springs-Castle Rock Area, Front Range Urban Corridor, Colorado*. USGS, Map I-857-F.
7. Scott, Glen R., Taylor, Richard B., Epis, Rudy C., and Wobus, Reinhard A. 1978. *Geologic Map of the Denver 1° x 2° Quadrangle, North-Central Colorado*. U.S. Geologic Survey. Map 1-1022.
8. Federal Emergency Management Agency. December 7, 2018. *Flood Insurance Rate Maps for El Paso County, Colorado and Incorporated Areas*. Map Number 08041CO535G.
9. Kirkman, Robert M. and Rogers, William P. 1981. *Earthquake Potential in Colorado*. Colorado Geological Survey. Bulletin 43.
10. Colorado Geological Survey. 1991. *Results of the 1987-88 EPA Supported Radon Study in Colorado*. Open-file Report 91-4.
11. El Paso County Planning Development. December 1995. *El Paso County Aggregate Resource Evaluation Maps*.
12. Schwochow, S.D.; Shroba, R.R. and Wicklein, P.C. 1974. *Atlas of Sand, Gravel, and Quarry Aggregate Resources, Colorado Front Range Counties*. Colorado Geological Survey. Special Publication 5-B.
13. Keller, John W.; TerBest, Harry and Garrison, Rachel E. 2003. *Evaluation of Mineral and Mineral Fuel Potential of El Paso County State Mineral Lands Administered by the Colorado State Land Board*. Colorado Geological Survey. Open-File Report 03-07.

FIGURES



VICINITY MAP

RETREAT AT TIMBERRIDGE FIL. NO. 4
 EL PASO COUNTY, CO
 TIMBERRIDGE DEVELOPMENT GROUP, LLC

JOB NO.
 231468

FIG. 1

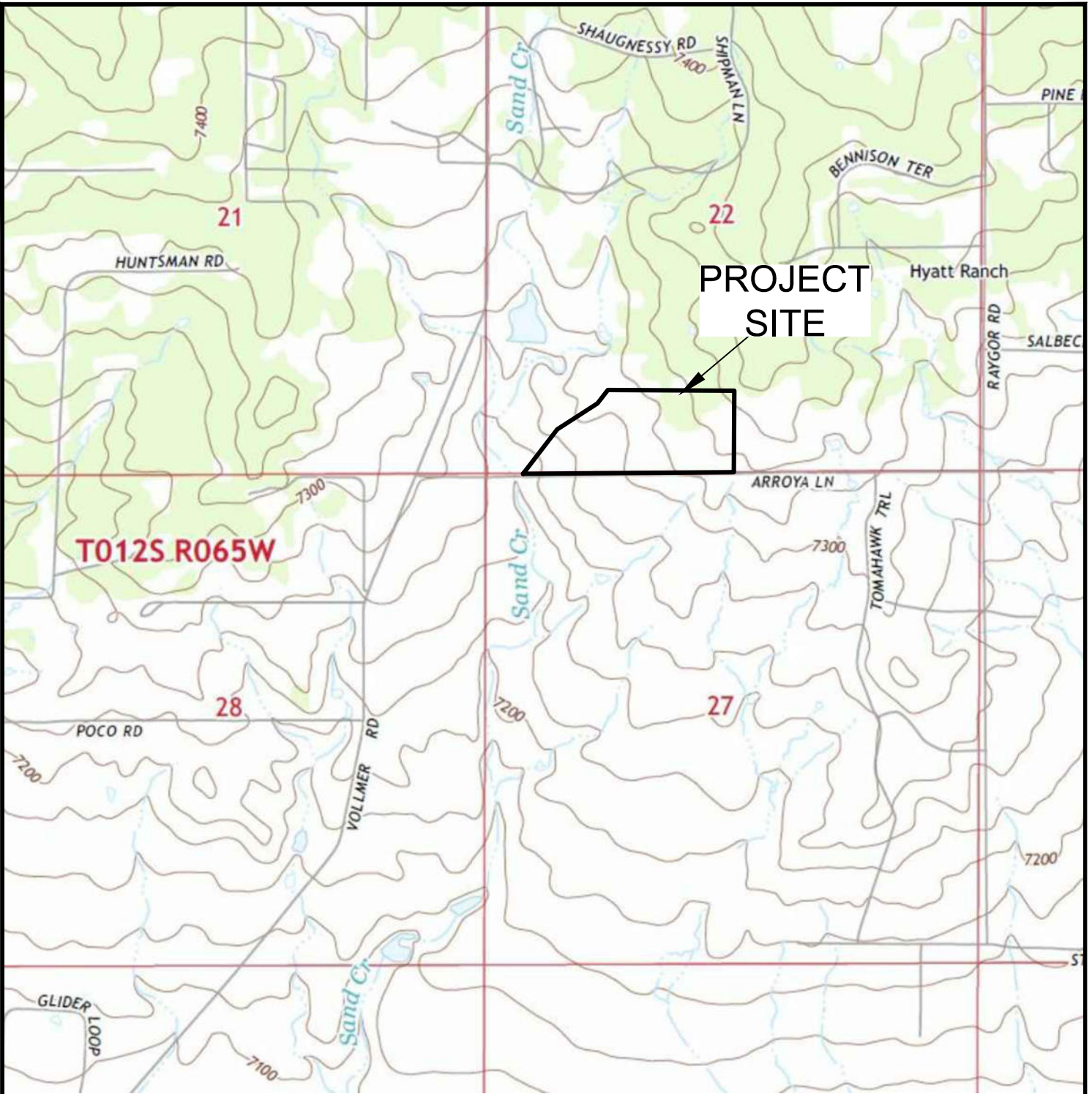





USGS TOPOGRAPHY MAP

RETREAT AT TIMBERRIDGE FIL. NO. 4
 EL PASO COUNTY, CO
 TIMBERRIDGE DEVELOPMENT GROUP, LLC

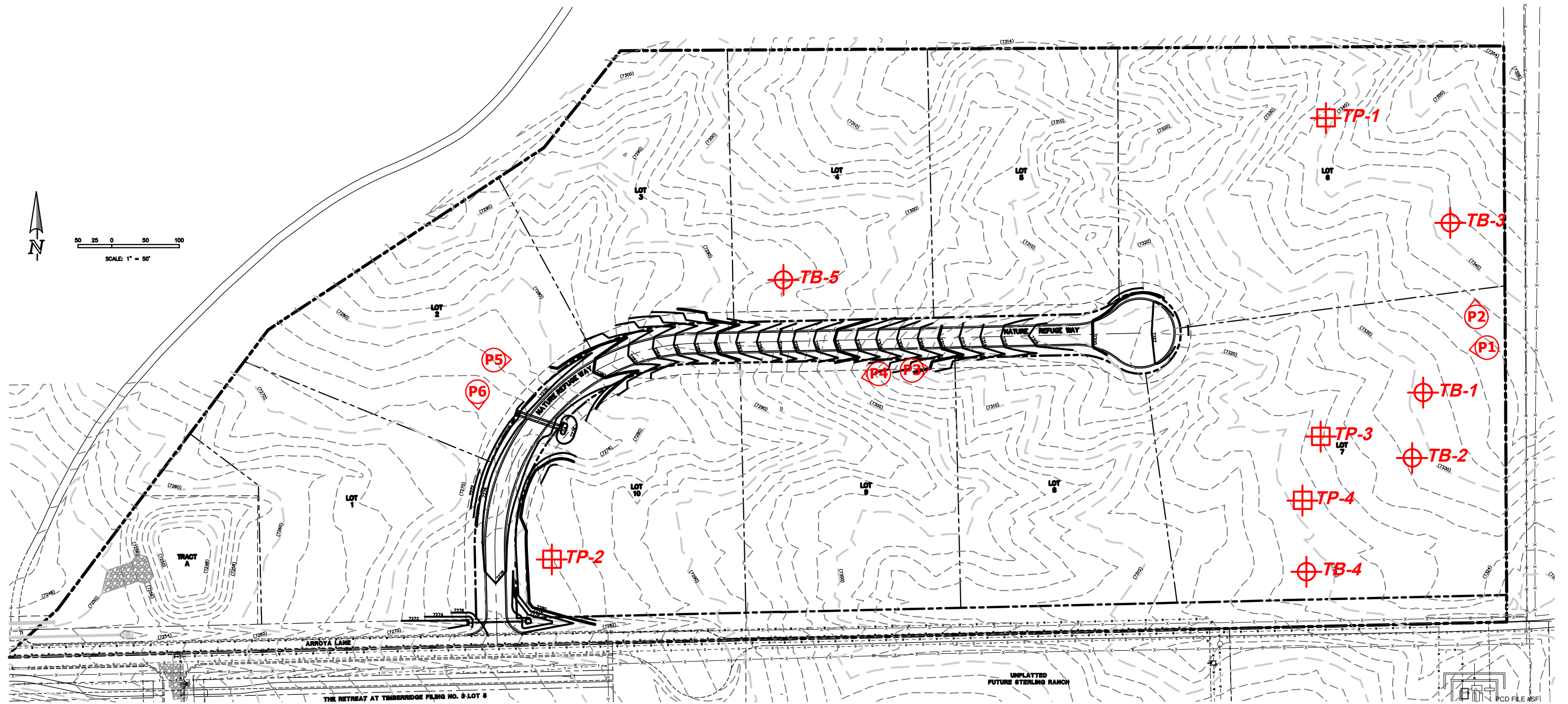
JOB NO.
 231468

FIG. 2



-  TB- APPROXIMATE TEST BORING LOCATION AND NUMBER
-  TP- APPROXIMATE TEST PIT LOCATION AND NUMBER
-  - APPROXIMATE PHOTOGRAPH LOCATION AND NUMBER



EXPLORATION AND SITE PLAN
 RETREAT AT TIMBERRIDGE FIL. NO. 4
 EL PASO COUNTY, CO
 TIMBERRIDGE DEVELOPMENT GROUP, LLC

JOB NO.
231468

FIG. 3

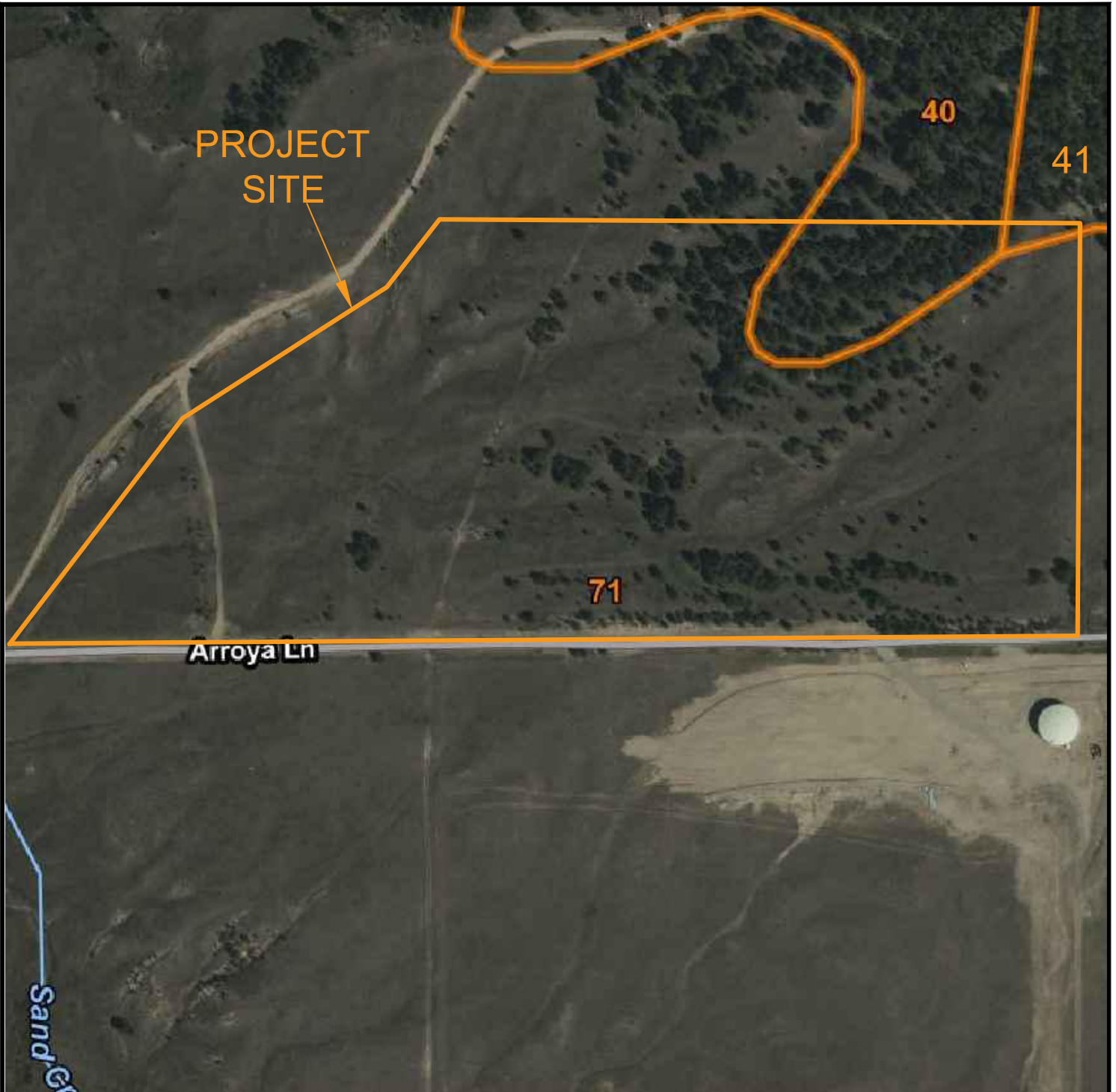

SOIL SURVEY MAP

RETREAT AT TIMBERRIDGE FIL. NO. 4
EL PASO COUNTY, CO
TIMBERRIDGE DEVELOPMENT GROUP, LLC

JOB NO.
231648

FIG. 4

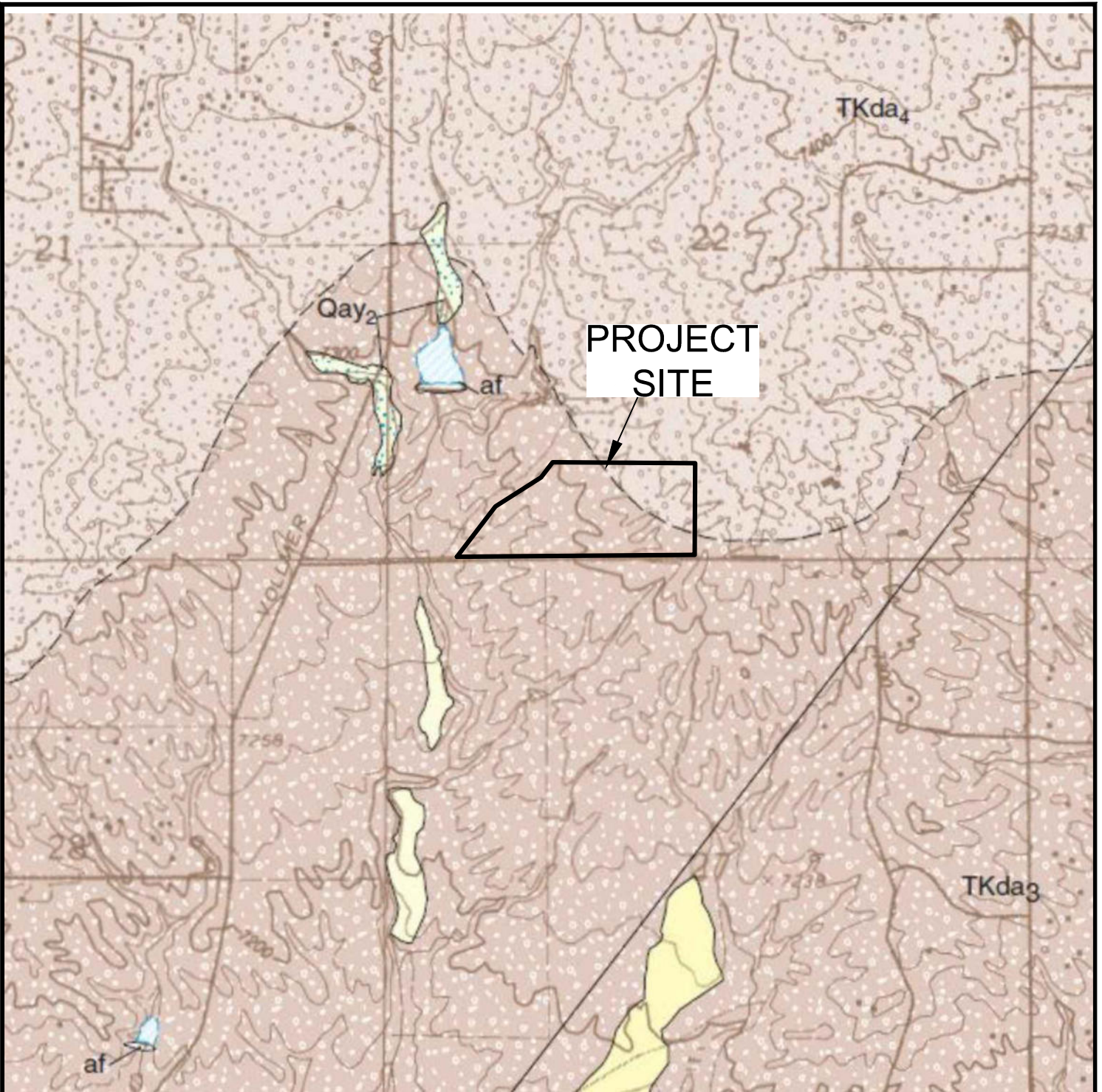

**GEOLOGIC MAP OF THE
FALCON NW QUADRANGLE**
RETREAT AT TIMBERRIDGE FIL. NO. 4
EL PASO COUNTY, CO
TIMBERRIDGE DEVELOPMENT GROUP, LLC

JOB NO.
231468

FIG. 5

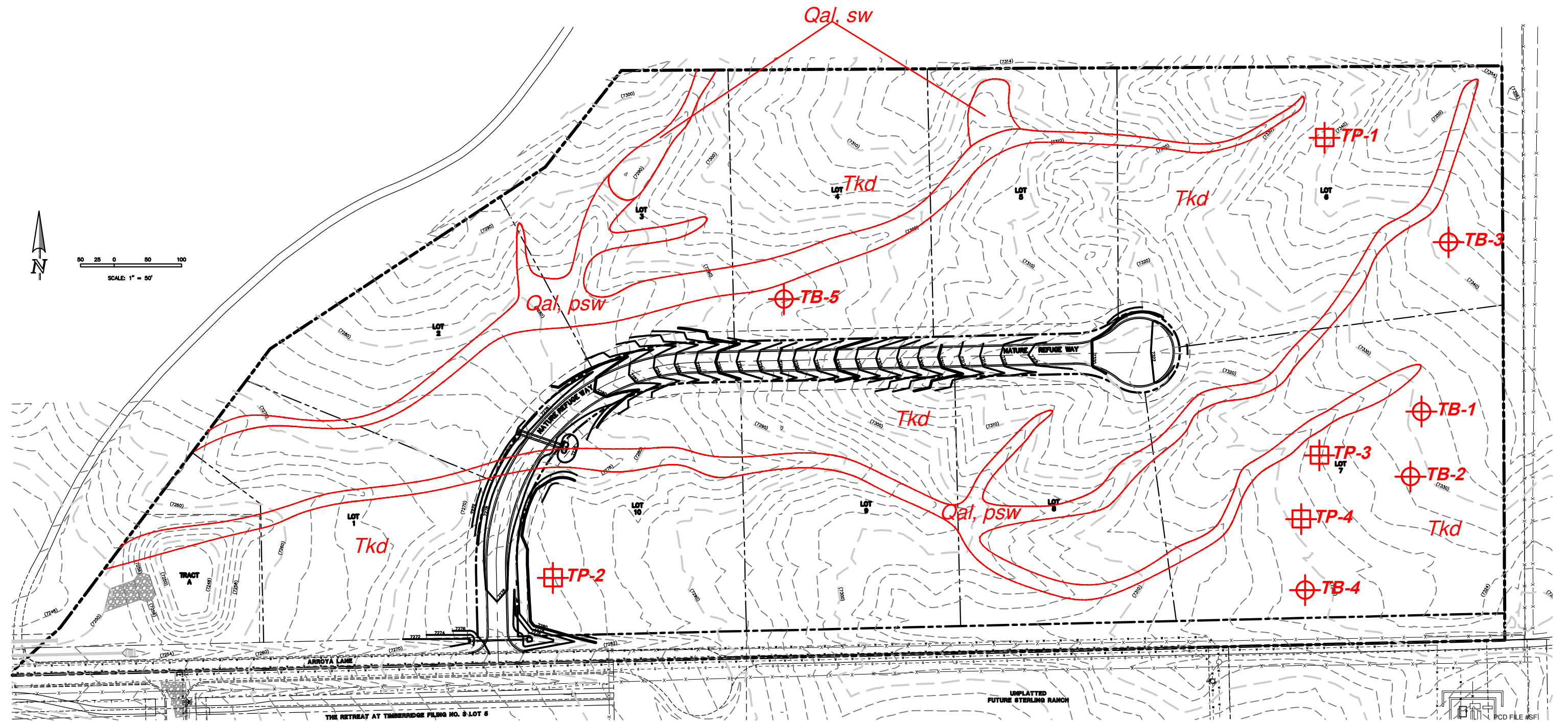

Legend:

- Qal - Recent Alluvium of Holocene Age:
recent water deposited materials
- Tkd - Dawson Formation of Tertiary to Cretaceous Age:
arkosic sandstone with interbedded claystone and siltstone
- psw - potential seasonally shallow groundwater area
- sw - seasonally shallow groundwater area



GEOLOGY / ENGINEERING MAP

RETREAT AT TIMBERRIDGE FIL. NO. 4
EL PASO COUNTY, CO
TIMBERRIDGE DEVELOPMENT GROUP, LLC

JOB NO.
231468

FIG. 6

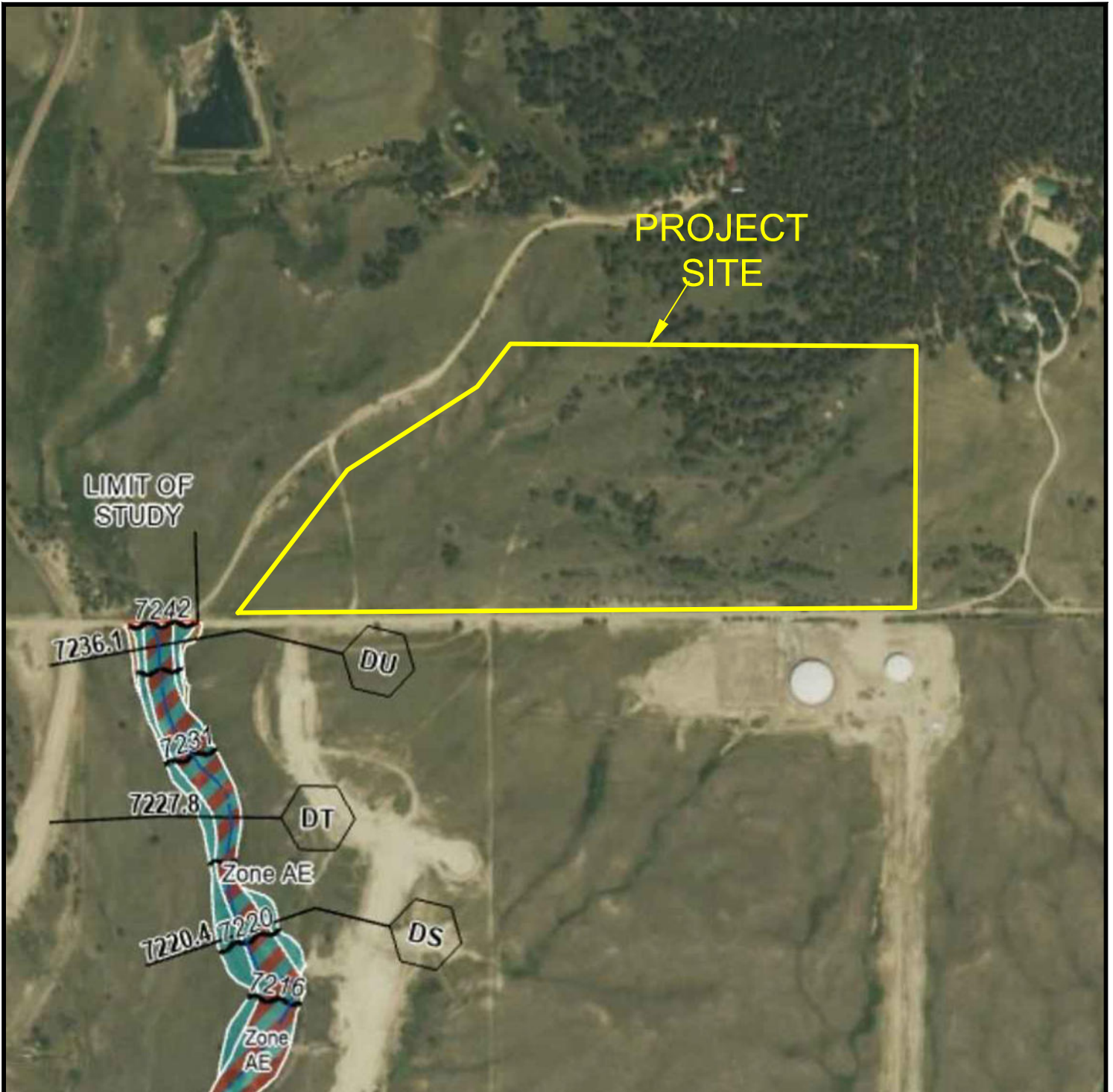

FEMA FLOODPLAIN MAP
 RETREAT AT TIMBERRIDGE FIL. NO. 4
 EL PASO COUNTY, CO
 TIMBERRIDGE DEVELOPMENT GROUP, LLC

JOB NO.
 231468

FIG. 7

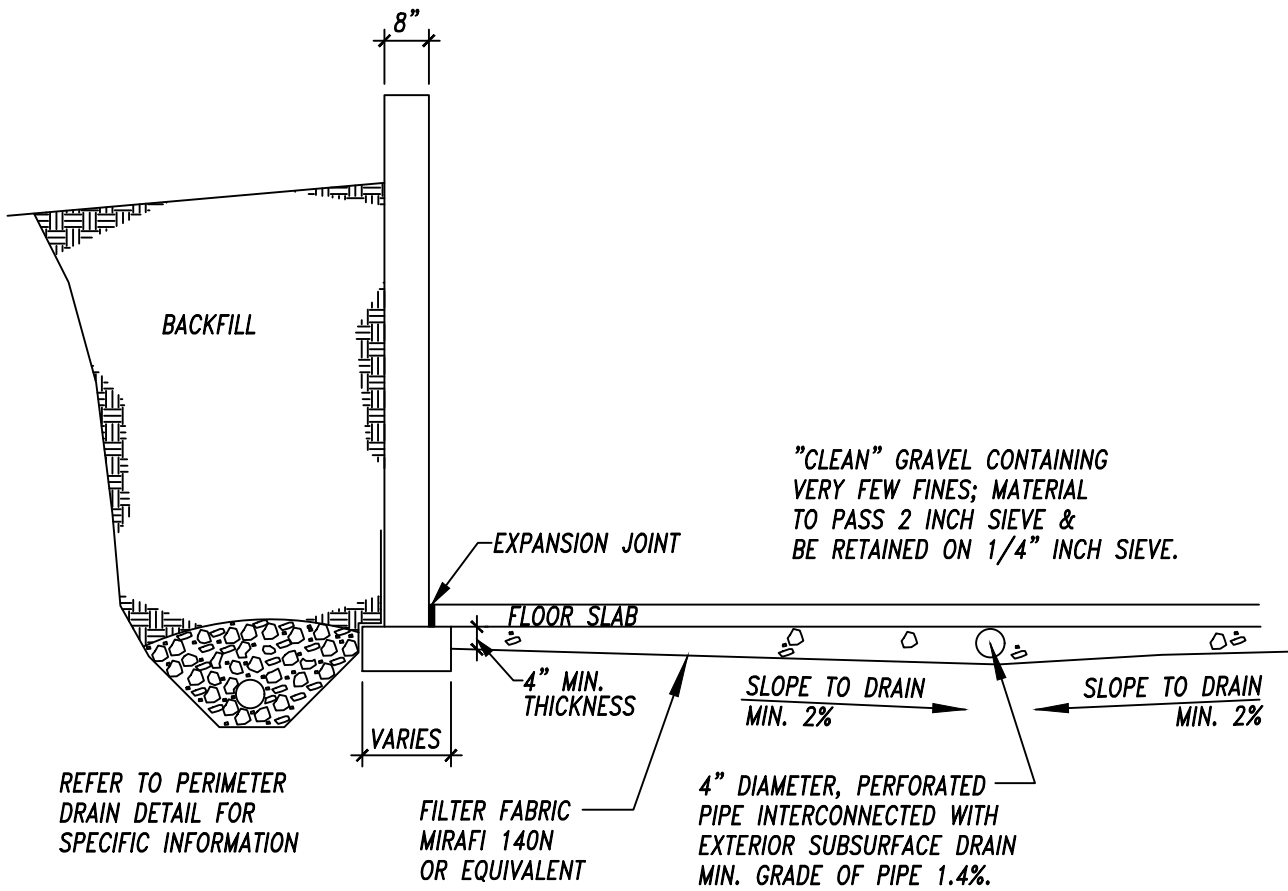

**TYP. UNDERSLAB DRAINAGE LAYER
(CAPILLARY BREAK)**
 RETREAT AT TIMBERRIDGE FIL. NO. 4
 EL PASO COUNTY, CO
 TIMBERRIDGE DEVELOPMENT GROUP, LLC

JOB NO.
231468

FIG. 9

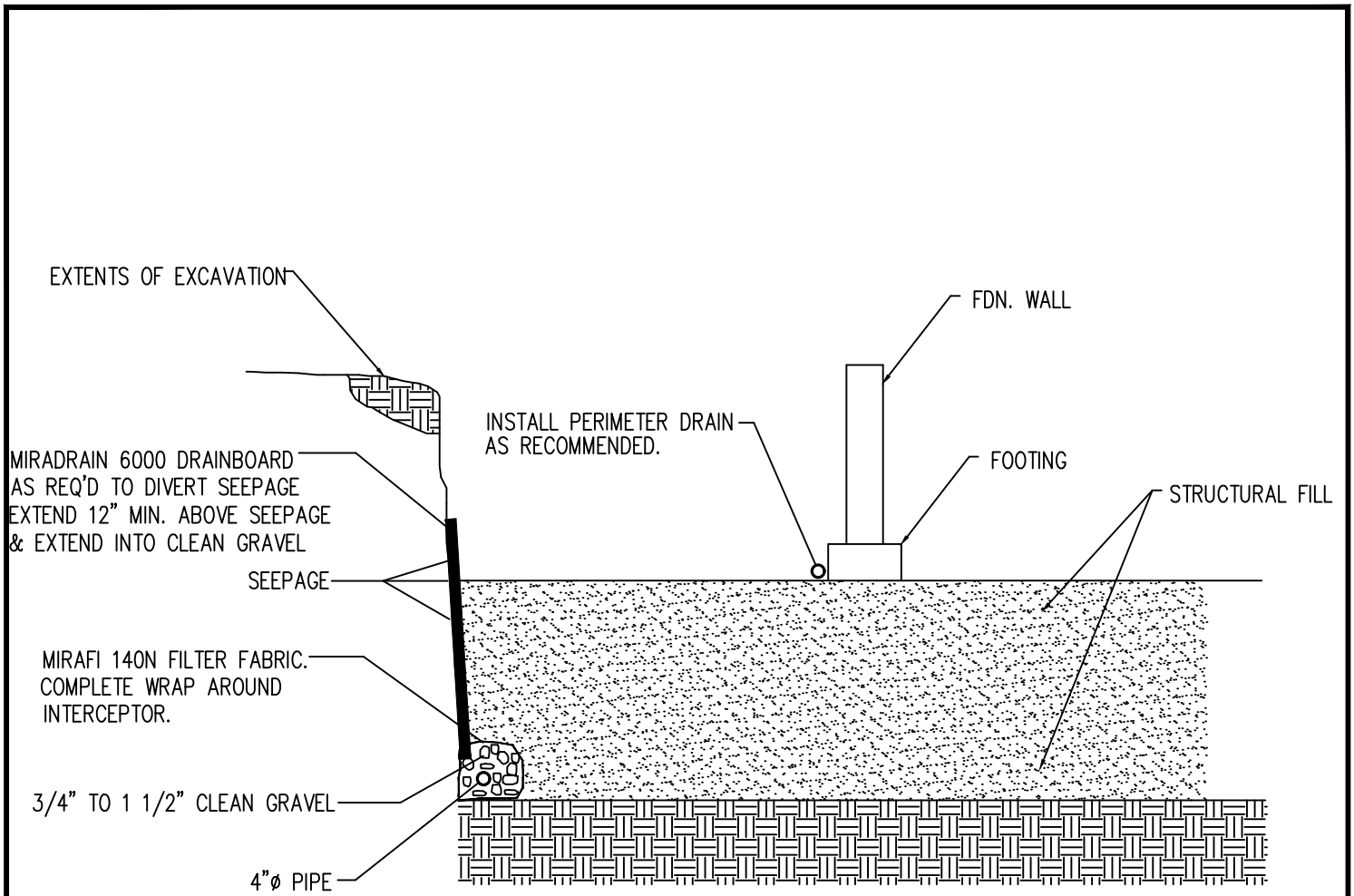

NOTE:
 EXTEND INTERCEPTOR DRAIN TO UNDERDRAIN OR TO SUMP.
 BENCH DRAIN INTO NATIVE SOILS 12 INCHES MINIMUM.

INTERCEPTOR DRAIN DETAIL

N.T.S.



INTERCEPTOR DRAIN DETAIL

RETREAT AT TIMBERRIDGE FIL. NO. 4
 EL PASO COUNTY, CO
 TIMBERRIDGE DEVELOPMENT GROUP, LLC

JOB NO.
 231468

FIG. 10

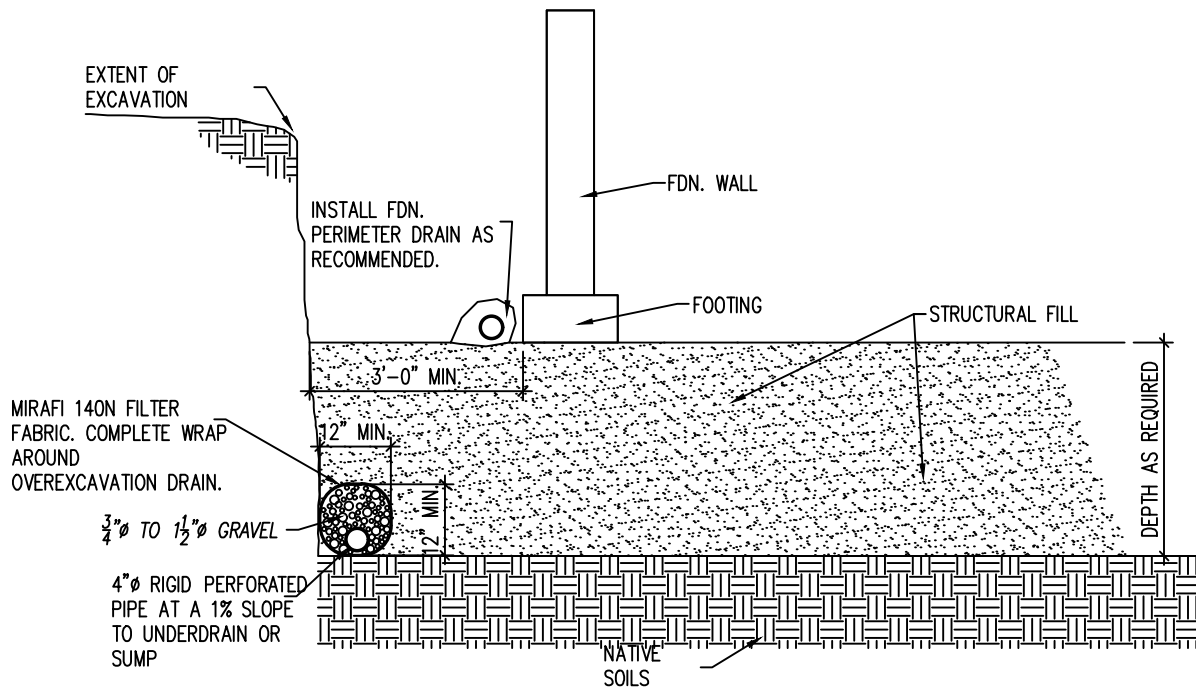

OVEREXCAVATION DRAIN DETAIL

N.T.S.

NOTE:
EXTEND DRAIN TO SUMP AS REQ'D.



OVEREXCAVATION DRAIN

RETREAT AT TIMBERRIDGE FIL. NO. 4
EL PASO COUNTY, CO
TIMBERRIDGE DEVELOPMENT GROUP, LLC

JOB NO.
231468

APPENDIX A: Site Photographs

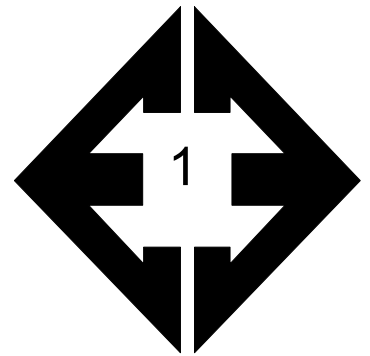

Looking west from the eastern side of the site.

September 13, 2023

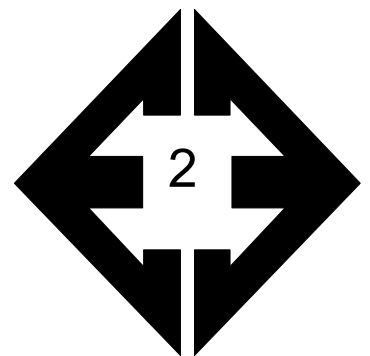

Looking north from the eastern side of the site.

September 13, 2023

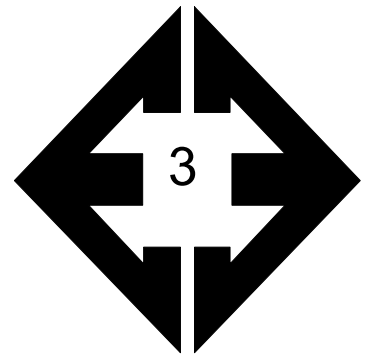

**Looking east towards
erosion feature eastern
side of site.**

September 13, 2023

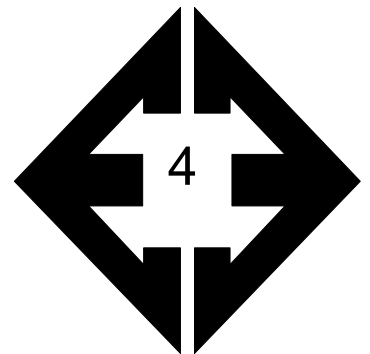

**Looking west from the
central portion of the
site.**

September 13, 2023

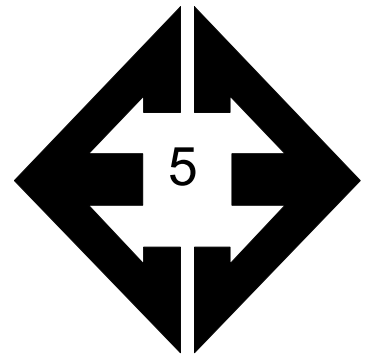

**Looking east from the
northwestern portion
of the site.**

September 13, 2023

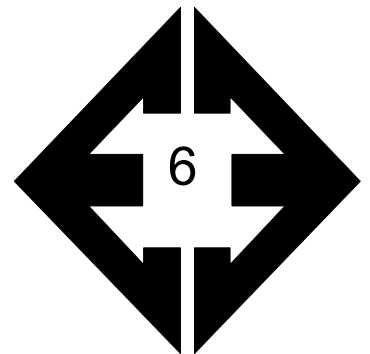

**Looking south from
the northwestern
portion of the site.**

September 13, 2023



APPENDIX B: Test Boring and Test Pit Logs

TABLE B-1
DEPTH TO BEDROCK

TEST BORING	DEPTH TO BEDROCK (ft.)
1	4
2	4
3	9
4	3
5	14

TEST BORING 1
 DATE DRILLED 6/4/2019

TEST BORING 2
 DATE DRILLED 6/4/2019

REMARKS

REMARKS

DRY TO 19', 6/5/19

DRY TO 14.5', 6/5/19

SAND, SILTY, BROWN, MEDIUM
 DENSE, MOIST

SAND, SILTY, BROWN, MEDIUM
 DENSE, MOIST

SANDSTONE, WEAK, BROWN,
 WEATHERED (SAND, SILTY, VERY
 DENSE, MOIST)

SANDSTONE, WEAK, GRAY,
 WEATHERED (SAND, CLAYEY,
 VERY DENSE, MOIST)

Depth (ft)	Symbol	Samples	Blows per foot	Watercontent %	Soil Type	Depth (ft)	Symbol	Samples	Blows per foot	Watercontent %	Soil Type
0-5	(Symbol)		28	6.1	1	0-5	(Symbol)		27	5.7	1
5-10	(Symbol)		50 9"	6.2	2	5-10	(Symbol)		50 11"	7.4	2
10-15	(Symbol)		50 7"	9.5	2	10-15	(Symbol)		50 8"	9.5	2
15-20	(Symbol)		50 5"	8.1	2	15-20	(Symbol)		50 6"	8.2	2
20-25	(Symbol)		50 6"	9.3	2	20-25	(Symbol)				



TEST BORING LOGS
 RETREAT AT TIMBERRIDER, F-4
 TIMBERRIDGE DEVELOPMENT

JOB NO.
 231468

FIG. B-1

TEST BORING 3
 DATE DRILLED 6/4/2019

TEST BORING 4
 DATE DRILLED 2/16/2017

REMARKS

REMARKS

DRY TO 19', 6/5/19

DRY TO 14.5',
 2/17/17

SAND, SILTY, TAN, LOOSE to
 MEDIUM DENSE, MOIST

SAND, CLAYEY, GREEN-GRAY,
 DENSE, MOIST

SANDSTONE, WEAK, GRAY,
 WEATHERED (SAND, SILTY, VERY
 DENSE, MOIST)

SANDSTONE, WEAK, GREEN-
 GRAY, WEATHERED (SAND,
 CLAYEY, VERY DENSE, MOIST)

Depth (ft)	Symbol	Samples	Blows per foot	Watercontent %	Soil Type	Depth (ft)	Symbol	Samples	Blows per foot	Watercontent %	Soil Type
5			8	5.3	1	5			30	13.0	1
5			23	7.2	1	5			<u>50</u> 11"	13.1	2
10			<u>50</u> 6"	10.3	2	10			<u>50</u> 7"	13.4	2
15			<u>50</u> 6"	9.8	2	15			<u>50</u> 7"	9.2	2
20			<u>50</u> 5"	8.4	2	20					



TEST BORING LOGS
 RETREAT AT TIMBERRIDER, F-4
 TIMBERRIDGE DEVELOPMENT

JOB NO.
 231468

FIG. B-2

TEST BORING 5
 DATE DRILLED 2/16/2017

REMARKS

DRY TO 14', 2/17/17

SAND, WITH SILT, TAN, MEDIUM
 DENSE to LOOSE, DRY to MOIST

SANDSTONE, WEAK, TAN,
 WEATHERED (SAND, CLAYEY,
 VERY DENSE, MOIST)

Depth (ft)	Symbol	Samples	Blows per foot	Watercontent %	Soil Type
5	(Dotted pattern)	19	2.3	1	
5	(Dotted pattern)	7	7.4	1	
10	(Dotted pattern)	6	5.5	1	
15	(Dotted pattern)	50	12.5	2	
20					



TEST BORING LOGS

RETREAT AT TIMBERRIDER, F-4
 TIMBERRIDGE DEVELOPMENT

JOB NO.
 231468

FIG. B-3

TEST PIT 1
 DATE EXCAVATED 2/15/2017
 REMARKS

TEST PIT 2
 DATE EXCAVATED 2/15/2017
 REMARKS

REMARKS	Depth (ft)	Symbol	Samples	Soil Structure Shape	Soil Structure Grade	Soil Type	REMARKS	Depth (ft)	Symbol	Samples	Soil Structure Shape	Soil Structure Grade	Soil Type
topsoil, sandy loam, brown	1	*		gr	w	2A	topsoil, sandy loam, brown	1	*		gr	w	2A
weathered to formational silty sandstone, fine to coarse grained, reddish-tan	2			ma		4A	gravelly loamy sand, fine to coarse grained, tan	2			sg		1
	3							3					
	4						weathered silty sandstone, fine to coarse grained, reddish-tan	4			ma		4A
	5						sandy claystone, olive-gray	5			ma		4A
	6							6					
	7						* - signs of seasonally occurring groundwater	7					
	8							8					
	9							9					
	10							10					

Soil Structure Shape

- granular - gr
- platy - pl
- blocky - bl
- prismatic - pr
- single grain - sg
- massive - ma

Soil Structure Grade

- weak - w
- moderate - m
- strong - s
- loose - l



TEST PIT LOGS

RETREAT AT TIMBERRIDGE, F-4
 TIMBERRIDGE DEVELOPMENT

JOB NO.
 231468

FIG. B-4

TEST PIT 3
DATE EXCAVATED 4/13/2019

TEST PIT 4
DATE EXCAVATED 4/13/2019

REMARKS

REMARKS

REMARKS	Depth (ft)	Symbol	Samples	Soil Structure Shape	Soil Structure Grade	Soil Type	REMARKS	Depth (ft)	Symbol	Samples	Soil Structure Shape	Soil Structure Grade	Soil Type
topsoil sandy clay loam, brown	1						topsoil sandy clay, brown	1					
	2			gr	m	3	very sandy clay, light brown	2			gr	w	4A
gravelly sandy clay loam, fine to coarse grained, light brown	3							3					
silty sandstone, fine to coarse grained, poorly cemented, reddish-brown	4			ma		4A	silty sandstone, fine to coarse grained, poorly cemented, light brown	4			ma		4A
	5							5					
	6						sandy claystone, olive gray	6			pl		5
	7							7					
	8							8					
	9							9					
	10							10					

Soil Structure Shape

granular - gr
platy - pl
blocky - bl
prismatic - pr
single grain - sg
massive - ma

Soil Structure Grade

weak - w
moderate - m
strong - s
loose - l



TEST PIT LOGS

RETREAT AT TIMBERRIDGE, F-4
TIMBERRIDGE DEVELOPMENT

JOB NO.
231468

FIG. B-5

APPENDIX C: Laboratory Test Results

**TABLE C-1
SUMMARY OF LABORATORY TEST RESULTS**

SOIL TYPE	TEST BORING NO.	DEPTH (FT)	PASSING NO. 200 SIEVE (%)	LIQUID LIMIT	PLASTIC LIMIT	PLASTIC INDEX	SULFATE (WT %)	USCS	SOIL DESCRIPTION
1	1	2-3	15.4	20	17	3		SM	SAND, SILTY
1	3	5	15.3				<0.01	SM	SAND, SILTY
1	4	2-3	34.3					SC	SAND, CLAYEY
1	4	5	47.6					SC	SAND, CLAYEY
1	5	2-3	11.2					SW-SM	SAND, WITH SILT
2	2	5	17.1	26	17	9		SC	SANDSTONE (SAND, CLAYEY)
2	3	10	12.1				<0.01	SM	SANDSTONE (SAND, SILTY)

TEST BORING 1
 DEPTH (FT) 2-3

SOIL DESCRIPTION SAND, SILTY
 SOIL TYPE 1

**Sieve Analysis
 Grain Size Distribution**

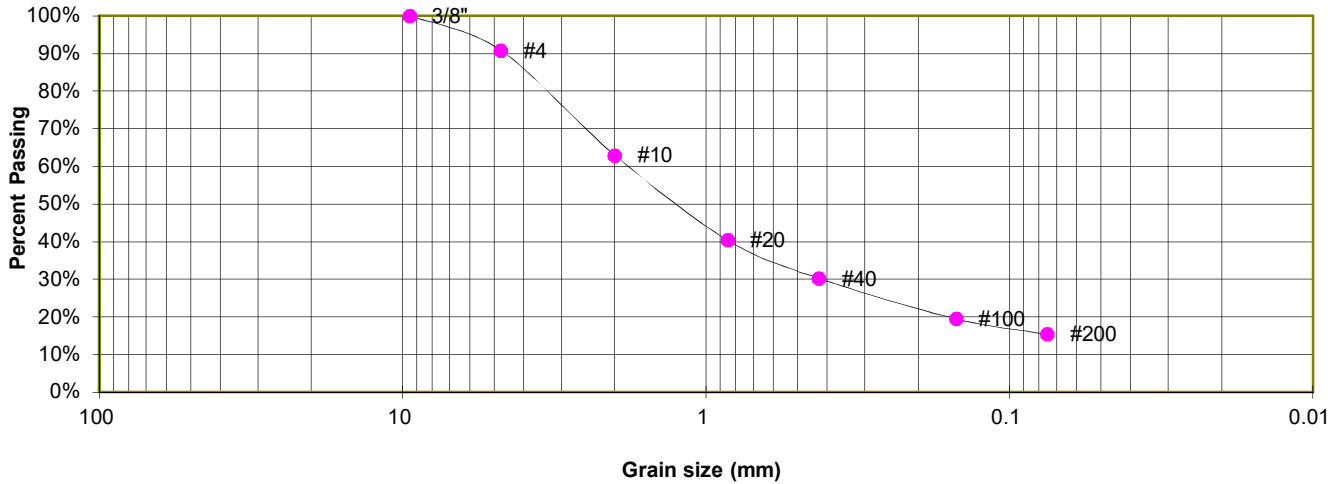

GRAIN SIZE ANALYSIS

U.S. Sieve #	Percent Finer
3"	
1 1/2"	
3/4"	
1/2"	
3/8"	100.0%
4	90.8%
10	63.0%
20	40.4%
40	30.3%
100	19.5%
200	15.4%

ATTERBERG LIMITS

Plastic Limit	17
Liquid Limit	20
Plastic Index	3

SOIL CLASSIFICATION

USCS CLASSIFICATION: SM



LABORATORY TEST RESULTS

RETREAT AT TIMBERRIDER, F-4
 TIMBERRIDGE DEVELOPMENT

JOB NO.
 231468

FIG. C-1

TEST BORING 3
 DEPTH (FT) 5

SOIL DESCRIPTION SAND, SILTY
 SOIL TYPE 1

**Sieve Analysis
 Grain Size Distribution**

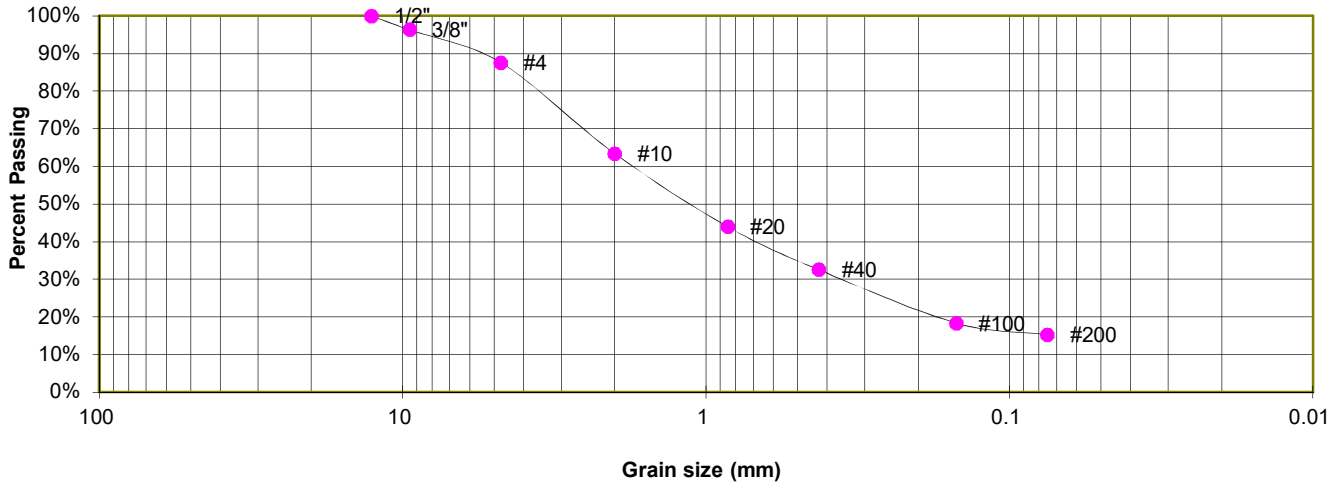

GRAIN SIZE ANALYSIS

U.S. Sieve #	Percent Finer
3"	
1 1/2"	
3/4"	
1/2"	100.0%
3/8"	96.3%
4	87.6%
10	63.4%
20	44.0%
40	32.6%
100	18.4%
200	15.3%

SOIL CLASSIFICATION

USCS CLASSIFICATION: SM



LABORATORY TEST RESULTS

RETREAT AT TIMBERRIDER, F-4
 TIMBERRIDGE DEVELOPMENT

JOB NO.
 231468

FIG. C-2

TEST BORING 4
 DEPTH (FT) 2-3

SOIL DESCRIPTION SAND, CLAYEY
 SOIL TYPE 1

**Sieve Analysis
 Grain Size Distribution**

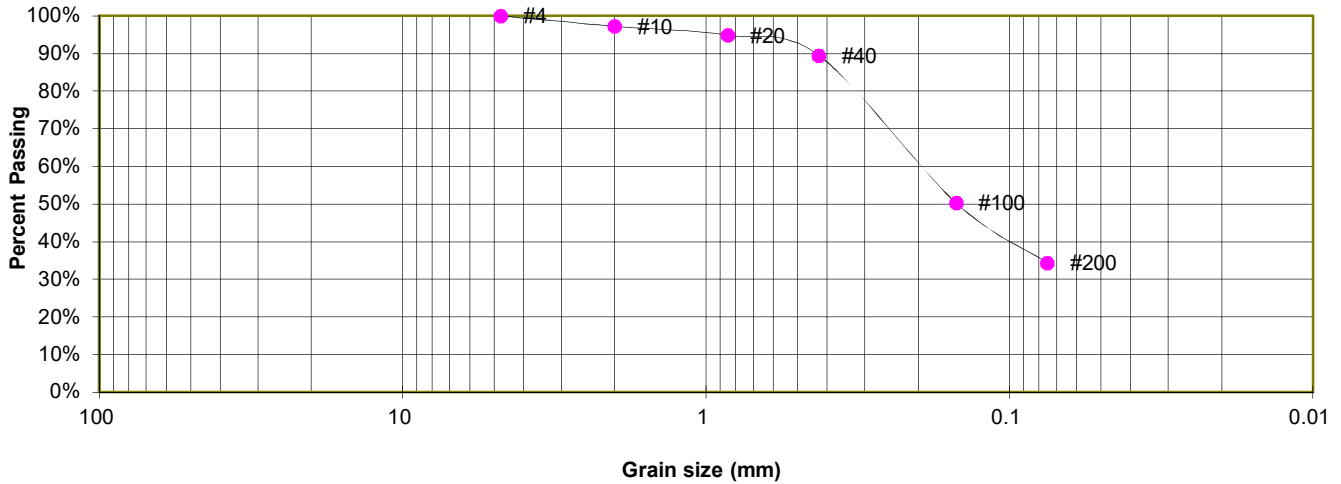

GRAIN SIZE ANALYSIS

U.S. Sieve #	Percent Finer
3"	
1 1/2"	
3/4"	
1/2"	
3/8"	
4	100.0%
10	97.2%
20	94.9%
40	89.5%
100	50.3%
200	34.3%

SOIL CLASSIFICATION

USCS CLASSIFICATION: SC



LABORATORY TEST RESULTS

RETREAT AT TIMBERRIDER, F-4
 TIMBERRIDGE DEVELOPMENT

JOB NO.
 231468

FIG. C-3

TEST BORING 4
DEPTH (FT) 5

SOIL DESCRIPTION SAND, CLAYEY
SOIL TYPE 1

**Sieve Analysis
Grain Size Distribution**

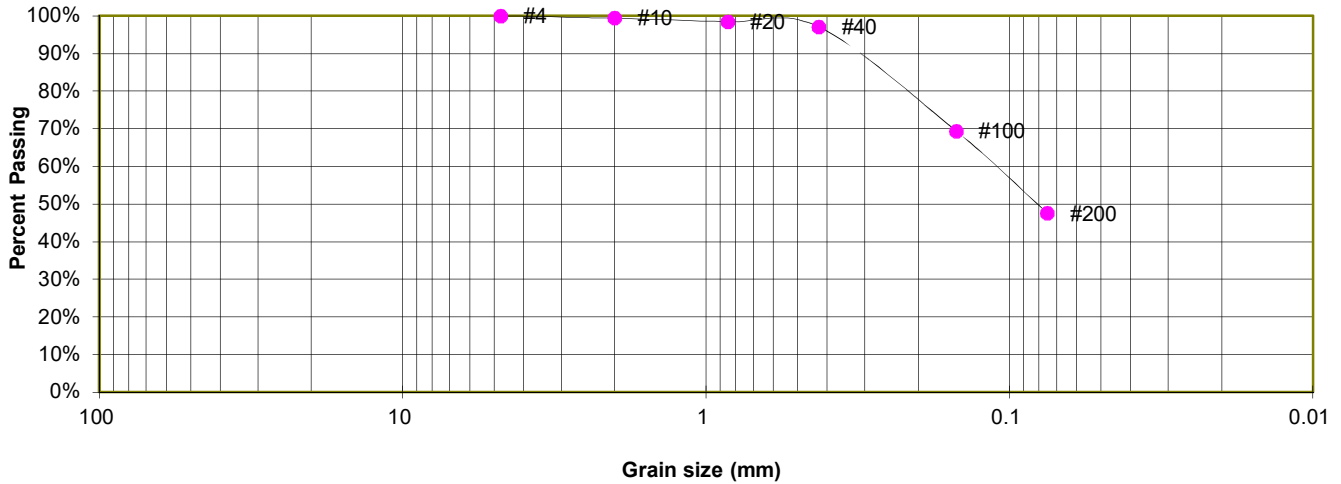

GRAIN SIZE ANALYSIS

U.S. Sieve #	Percent Finer
3"	
1 1/2"	
3/4"	
1/2"	
3/8"	
4	100.0%
10	99.4%
20	98.4%
40	97.1%
100	69.4%
200	47.6%

SOIL CLASSIFICATION

USCS CLASSIFICATION: SC



LABORATORY TEST RESULTS

RETREAT AT TIMBERRIDER, F-4
TIMBERRIDGE DEVELOPMENT

JOB NO.
231468

FIG. C-4

TEST BORING 5
DEPTH (FT) 2-3

SOIL DESCRIPTION SAND, WITH SILT
SOIL TYPE 1

Sieve Analysis Grain Size Distribution

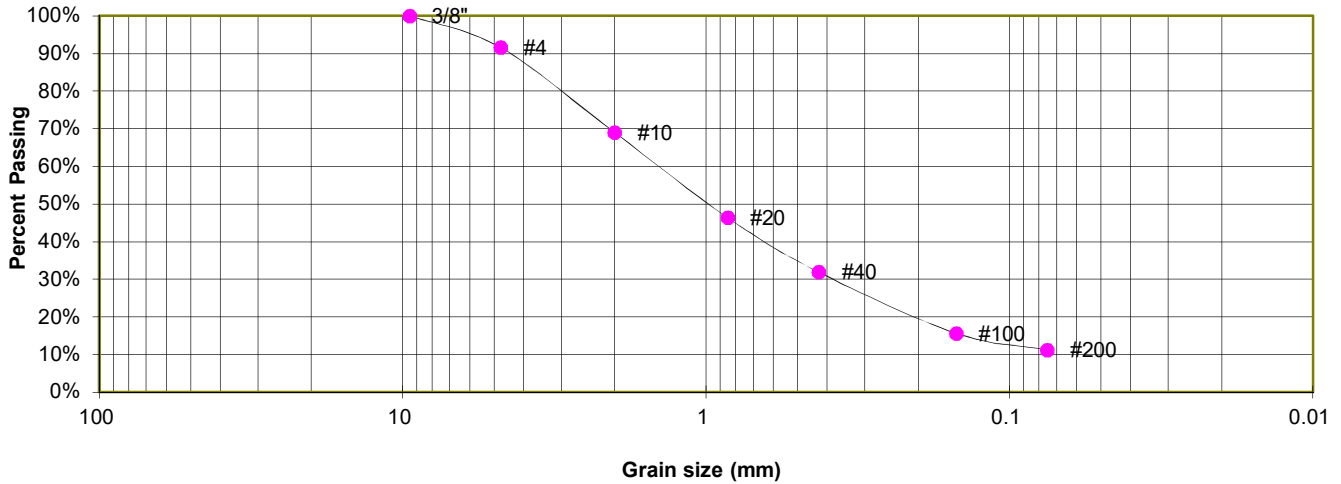

GRAIN SIZE ANALYSIS

U.S. Sieve #	Percent Finer
3"	
1 1/2"	
3/4"	
1/2"	
3/8"	100.0%
4	91.6%
10	69.0%
20	46.4%
40	31.9%
100	15.7%
200	11.2%

SOIL CLASSIFICATION

USCS CLASSIFICATION: SW-SM



LABORATORY TEST RESULTS

RETREAT AT TIMBERRIDER, F-4
TIMBERRIDGE DEVELOPMENT

JOB NO.
231468

FIG. C-5

TEST BORING 2
 DEPTH (FT) 5

SOIL DESCRIPTION SANDSTONE (SAND, CLAYEY)
 SOIL TYPE 2

**Sieve Analysis
 Grain Size Distribution**

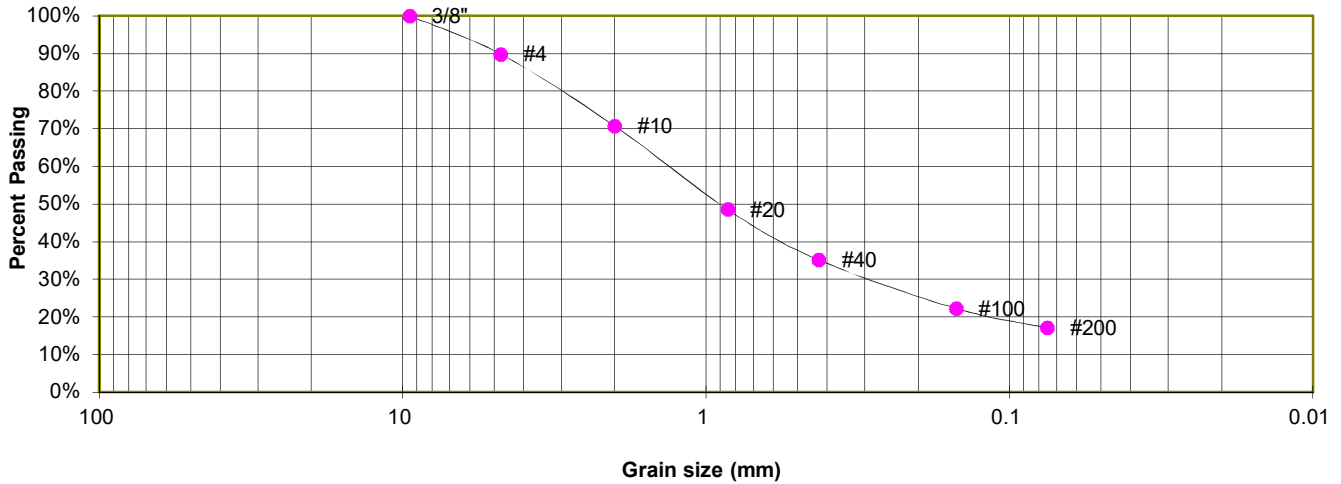

GRAIN SIZE ANALYSIS

U.S. Sieve #	Percent Finer
3"	
1 1/2"	
3/4"	
1/2"	
3/8"	100.0%
4	89.9%
10	70.7%
20	48.6%
40	35.1%
100	22.3%
200	17.1%

ATTERBERG LIMITS

Plastic Limit	17
Liquid Limit	26
Plastic Index	9

SOIL CLASSIFICATION

USCS CLASSIFICATION: SC



LABORATORY TEST RESULTS

RETREAT AT TIMBERRIDER, F-4
 TIMBERRIDGE DEVELOPMENT

JOB NO.
 231468

FIG. C-6

TEST BORING 3
DEPTH (FT) 10

SOIL DESCRIPTION SANDSTONE (SAND, SILTY)
SOIL TYPE 2

Sieve Analysis Grain Size Distribution

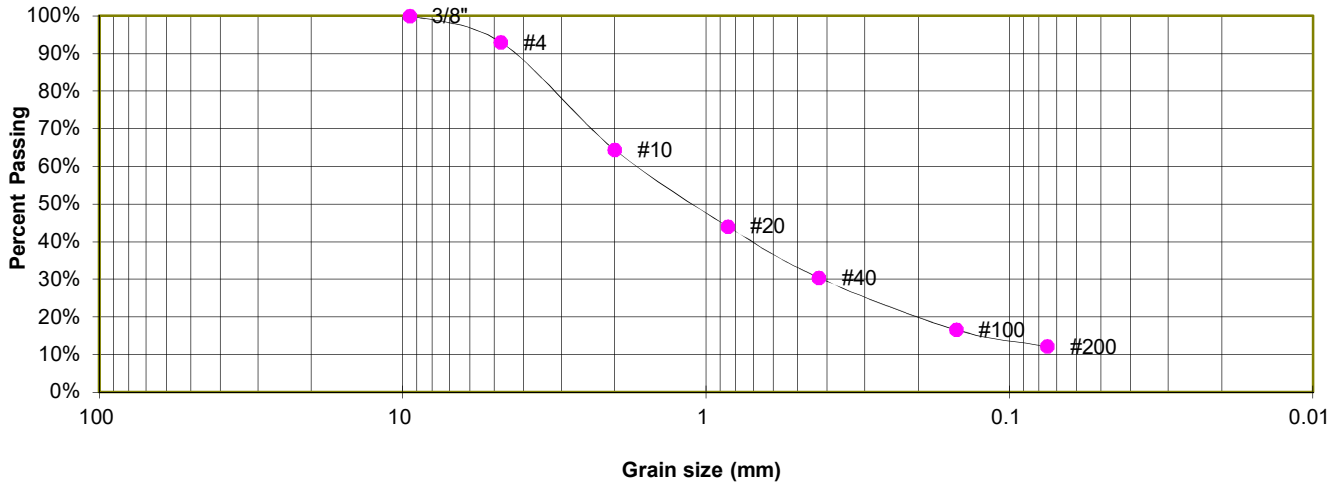

GRAIN SIZE ANALYSIS

U.S. Sieve #	Percent Finer
3"	
1 1/2"	
3/4"	
1/2"	
3/8"	100.0%
4	93.0%
10	64.4%
20	44.1%
40	30.4%
100	16.6%
200	12.1%

SOIL CLASSIFICATION

USCS CLASSIFICATION: SM



LABORATORY TEST RESULTS

RETREAT AT TIMBERRIDER, F-4
TIMBERRIDGE DEVELOPMENT

JOB NO.
231468

FIG. C-7



APPENDIX D: USDA Soil Survey Descriptions

El Paso County Area, Colorado

40—Kettle gravelly loamy sand, 3 to 8 percent slopes

Map Unit Setting

National map unit symbol: 368g

Elevation: 7,000 to 7,700 feet

Farmland classification: Not prime farmland

Map Unit Composition

Kettle and similar soils: 85 percent

Estimates are based on observations, descriptions, and transects of the mapunit.

Description of Kettle

Setting

Landform: Hills

Landform position (three-dimensional): Side slope

Down-slope shape: Linear

Across-slope shape: Linear

Parent material: Sandy alluvium derived from arkose

Typical profile

E - 0 to 16 inches: gravelly loamy sand

Bt - 16 to 40 inches: gravelly sandy loam

C - 40 to 60 inches: extremely gravelly loamy sand

Properties and qualities

Slope: 3 to 8 percent

Depth to restrictive feature: More than 80 inches

Drainage class: Somewhat excessively drained

Runoff class: Low

Capacity of the most limiting layer to transmit water (Ksat): High
(2.00 to 6.00 in/hr)

Depth to water table: More than 80 inches

Frequency of flooding: None

Frequency of ponding: None

Available water supply, 0 to 60 inches: Low (about 3.4 inches)

Interpretive groups

Land capability classification (irrigated): None specified

Land capability classification (nonirrigated): 4e

Hydrologic Soil Group: B

Ecological site: F048AY908CO - Mixed Conifer

Hydric soil rating: No

Minor Components

Other soils

Percent of map unit:

Hydric soil rating: No

Pleasant

Percent of map unit:

Landform: Depressions

Hydric soil rating: Yes

Data Source Information

Soil Survey Area: El Paso County Area, Colorado

Survey Area Data: Version 21, Aug 24, 2023

El Paso County Area, Colorado

41—Kettle gravelly loamy sand, 8 to 40 percent slopes

Map Unit Setting

National map unit symbol: 368h

Elevation: 7,000 to 7,700 feet

Farmland classification: Not prime farmland

Map Unit Composition

Kettle and similar soils: 85 percent

Estimates are based on observations, descriptions, and transects of the mapunit.

Description of Kettle

Setting

Landform: Hills

Landform position (three-dimensional): Side slope

Down-slope shape: Linear

Across-slope shape: Linear

Parent material: Sandy alluvium derived from arkose

Typical profile

E - 0 to 16 inches: gravelly loamy sand

Bt - 16 to 40 inches: gravelly sandy loam

C - 40 to 60 inches: extremely gravelly loamy sand

Properties and qualities

Slope: 8 to 40 percent

Depth to restrictive feature: More than 80 inches

Drainage class: Somewhat excessively drained

Runoff class: Medium

Capacity of the most limiting layer to transmit water (Ksat): High
(2.00 to 6.00 in/hr)

Depth to water table: More than 80 inches

Frequency of flooding: None

Frequency of ponding: None

Available water supply, 0 to 60 inches: Low (about 3.4 inches)

Interpretive groups

Land capability classification (irrigated): None specified

Land capability classification (nonirrigated): 7e

Hydrologic Soil Group: B

Ecological site: F048AY908CO - Mixed Conifer

Hydric soil rating: No

Minor Components

Other soils

Percent of map unit:

Hydric soil rating: No

Pleasant

Percent of map unit:

Landform: Depressions

Hydric soil rating: Yes

Data Source Information

Soil Survey Area: El Paso County Area, Colorado

Survey Area Data: Version 21, Aug 24, 2023

El Paso County Area, Colorado

71—Pring coarse sandy loam, 3 to 8 percent slopes

Map Unit Setting

National map unit symbol: 369k

Elevation: 6,800 to 7,600 feet

Farmland classification: Not prime farmland

Map Unit Composition

Pring and similar soils: 85 percent

Estimates are based on observations, descriptions, and transects of the mapunit.

Description of Pring

Setting

Landform: Hills

Landform position (three-dimensional): Side slope

Down-slope shape: Linear

Across-slope shape: Linear

Parent material: Arkosic alluvium derived from sedimentary rock

Typical profile

A - 0 to 14 inches: coarse sandy loam

C - 14 to 60 inches: gravelly sandy loam

Properties and qualities

Slope: 3 to 8 percent

Depth to restrictive feature: More than 80 inches

Drainage class: Well drained

Runoff class: Low

Capacity of the most limiting layer to transmit water (Ksat): High
(2.00 to 6.00 in/hr)

Depth to water table: More than 80 inches

Frequency of flooding: None

Frequency of ponding: None

Available water supply, 0 to 60 inches: Low (about 6.0 inches)

Interpretive groups

Land capability classification (irrigated): None specified

Land capability classification (nonirrigated): 3e

Hydrologic Soil Group: B

Ecological site: R048AY222CO - Loamy Park

Hydric soil rating: No

Minor Components

Pleasant

Percent of map unit:

Landform: Depressions

Hydric soil rating: Yes

Other soils

Percent of map unit:

Hydric soil rating: No

Data Source Information

Soil Survey Area: El Paso County Area, Colorado

Survey Area Data: Version 21, Aug 24, 2023

V4_Soils & Geology Report.pdf Markup Summary

Mikayla Hartford (4)

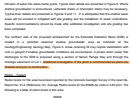

Subject: SW - Highlight
Page Label: [1] overex drain
Author: Mikayla Hartford
Date: 8/21/2024 1:27:58 PM
Status:
Color: ■
Layer:
Space:

Additional investigation of the pond is recommended as plans are finalized and prior to construction.

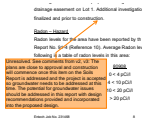

Subject: SW - Textbox with Arrow
Page Label: [1] overex drain
Author: Mikayla Hartford
Date: 8/21/2024 1:43:30 PM
Status:
Color: ■
Layer:
Space:

Unresolved. See comments from v2, v3: The plans are close to approval and construction will commence once this item on the Soils Report is addressed and the project is accepted so groundwater needs to be addressed at this time. The potential for groundwater issues should be addressed in this report with design recommendations provided and incorporated into the proposed design.



Subject: SW - Highlight
Page Label: [1] overex drain
Author: Mikayla Hartford
Date: 8/21/2024 1:44:30 PM
Status:
Color: ■
Layer:
Space:

Where shallow groundwater is encountered, underslab drains or interceptor drains may be necessary.



Subject: SW - Textbox with Arrow
Page Label: [1] overex drain
Author: Mikayla Hartford
Date: 8/21/2024 1:45:42 PM
Status:
Color: ■
Layer:
Space:

Discuss where the foundation drains will discharge to. Groundwater intercepted should be recharge to the ground and not be conveyed to the Pond or Sand Creek.