

**FINAL DRAINAGE REPORT
FOR
FOUNTAIN VALLEY SALVATION ARMY
208 CUNNINGHAM DRIVE
COLORADO SPRINGS, CO 80911**

Prepared for:

Fountain Valley Salvation Army CoBRs
208 Cunningham Drive
Colorado Springs, CO 80911
Phone: (719) 382-1182

Prepared by:

R&R Engineers-Surveyors



1635 W. 13th Ave., Suite 310
Denver, CO 80204
Contact: Tim Stackhouse, P.E.
Phone: 720-381-2439
FV21181

June 2, 2022
Revised: December 31, 2024

PCD Filing No.: CRD242

Signature Page – Fountain Valley Salvation Army

Design Engineer’s Statement:

The attached drainage plan and report were prepared under my direction and supervision and are correct to the best of my knowledge and belief. Said drainage report has been prepared according to the criteria established by the County for drainage reports and said report is in conformity with the applicable master plan of the drainage basin. I accept responsibility for any liability caused by any negligent acts, errors or omissions on my part in preparing this report.



Tim Stackhouse, P.E. #61924



10/29/24
Date

Owner/Developer’s Statement:

I, the owner/developer have read and will comply with all of the requirements specified in this drainage report and plan.

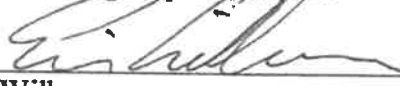

Eric Wilkerson
EDS Coordinator for Southern Colorado
The Salvation Army – El Paso County, Colorado

10/25/2024
Date

El Paso County:

Filed in accordance with the requirements of the Drainage Criteria Manual, Volumes 1 and 2, El Paso County Engineering Criteria Manual and Land Development Code as amended.

Joshua Palmer, P.E.
County Engineer / ECM Administrator

1/16/2025
Date

Conditions:

TABLE OF CONTENTS

1. General Location and Description 4
 a. Site Location 4
 b. Description of Property 4
2. Drainage Basins and Sub-Basins 4
 a. Major Basin Description 4
 b. Existing Sub-Basin Description 5
 c. Existing Site Runoff Concerns 5
 d. Proposed Sub-Basin Description 5
3. Drainage Design Criteria 6
 a. Four Step Process 6
4. Drainage Facility Design 7

- APPENDIX A- Vicinity Map, Soils Report, and FEMA map
- APPENDIX B- Existing Routing Calculations and Drainage Map
- APPENDIX C- Proposed Routing Calculations and Drainage Map
- APPENDIX D- Hydraulic Calculations

1. General Location and Description

a. Site Location

The existing Fountain Valley Salvation Army (hereafter, the Site) is located on Lot 4, Block 5, 1 Refill Security, Colorado Addition 4 within a portion of the Northeast Quarter of Section 11, Township 15 South, Range 66 West of the Sixth P.M., City of Colorado Springs, El Paso County, Colorado (see Vicinity Map in Appendix A). The Site is located at 208 Cunningham Drive and is approximately 2.04 acres in size.

The Site is bounded by Cunningham Drive to the east, Sproul Junior Highschool to the west, and adjacent residential properties to the north and south.

b. Description of Property

The total area of the property is 2.04 acres and the total area to be disturbed is 0.83 acres. The existing Site ground coverage consists primarily of native grasses, brush, and vegetation but also includes a gravel parking lot, and a building with associated concrete walks. Under existing conditions, the majority of the Site's stormwater runoff surface flows offsite to the south and west toward adjacent properties.

The Soil Survey of El Paso County Area, Colorado, prepared by the U.S. Department of Agriculture Soil Conservation Service, shows the Site is entirely underlain by Blakeland loamy sand – Hydrologic Group A. The existing terrain of the Site generally slopes from the north to south at grades ranging from 1% to 9%.

To the best of our knowledge, there are no existing irrigation facilities, canals, or existing storm infrastructure on and adjacent to the Site.

2. Drainage Basins and Sub-Basins

a. Major Basin Description

Existing available drainage studies that impact the Site are:

- The Site is located within Zone x, which has a 1% annual chance flood hazard. No floodplain impacts.
- Federal Emergency Management Agency (FEMA) Flood Insurance Rate Map (FIRM). El Paso County, Panel 763 Map No. 08041C0763G (December 2018).
- The project limits are within the Security FOF02900 drainage basin that ultimately drains to the Little Johnson DBPS.

b. Existing Sub-Basin Description

Sub-basin OS1 is 14.78 acres and comprised of existing residential homes, associated concrete driveways/sidewalks and existing landscaping/vegetation. Flows from this basin reach Design Point 1, collected via curb and gutter, and drain to Cunningham Drive ROW. The flows from this offsite basin bypass the site. The 5- and 100-years flows are 8.54 cfs and 24.13 cfs respectively.

Sub-basin EX1 is 2.02 acres and comprised of the Site, which includes the existing building, associated concrete driveways/sidewalks, existing landscaping/vegetation as well as a gravel lot. Flows from this basin reach Design Point 2. The 5- and 100-years flows are 0.69 cfs and 2.68 cfs respectively.

Sub-basin EX2 is 0.09 acres and comprised of Cunningham Drive ROW, which includes existing landscaping/vegetation, sidewalk, and gravel driveway. Flows from this basin reach Design Point 2. The 5- and 100-years flows are 0.02 cfs and 0.11 cfs respectively.

Sub-basin EX3 is 0.02 acres and comprised of a retaining wall and existing landscaping/vegetation. Flows from this basin reach Design Point 3 and flow offsite to Leta Drive ROW. The 5- and 100-years flows are 0.00 cfs and 0.02 cfs respectively.

c. Existing Site Runoff Concerns

The Salvation Army building has flooded twice during the summer of 2020 due to two high volume storm events. During these same events, the neighboring properties to the south have also experienced flooding when water discharges from the Site. The Site is located at the downhill (southern) end of Cunningham Drive. Runoff from this development discharge to a bioretention pond with full recovery. Flows from Cunningham Drive sheet flow to Leta Drive and discharge to the Security Creek drainage basin, with the ultimate outfall to Little Johnson.

A retaining wall was built by the neighbor to the south on the Salvation Army property. This retaining wall was built in an easement and is blocking flow from leaving the Site. This is a major cause of the flooding on the Site and neighboring sites.

d. Proposed Sub-Basin Description

Sub-Basin C1 is 1.97 acres and comprised of the existing salvation army building, existing landscaping/vegetation as well as the proposed asphalt parking lot and proposed porous landscape detention. The bioretention system will fully recover the 100-year storm event within 72 hrs. The 5- and 100-year flows entering the infiltration basin are 1.32 cfs and 3.80 cfs respectively. No outfall proposed.

Sub-Basin OFF-1C is an offsite basin that is 0.09 acres and comprised of Cunningham ROW, which includes existing landscaping/vegetation, sidewalk and the asphalt drive aisle. Flow will drain onsite and directed to the proposed bioretention basin. Flow will be captured by the bioretention basin and fully recover within 72 hrs. The 5- and 100-year flows of basin OFF-1C are 0.02 cfs and 0.11 cfs respectively. No outfall proposed.

Sub-Basin UD-1C is an onsite undetained basin that is 0.07 acres and comprised of an existing retaining wall and existing landscaping/vegetation. Flow will drain offsite undetained to Leta Drive ROW (Design Point 2). The 5- and 100-year flows of basin UD-1C are 0.02 cfs and 0.11 cfs respectively.

3. Drainage Design Criteria

a. Four Step Process

Step 1 – Employ Runoff Reduction Practices

In step 1 the applicant is asked to identify areas of the Site that can be used to reduce runoff and implement LID practices such as permeable pavement, green roofs, grass buffers, grass swales, and bioretention. To meet the requirements of step 1, the disconnection of impervious areas shall be implemented to the greatest extent possible. Runoff from the building's roofs will flow across grassed landscaped areas before flowing into the proposed BR. Runoff from the asphalt parking lot will flow directly to the BR.

Step 2 – Implement BMPs That Provide a Water Quality Capture volume with Slow Release

In step 2 the applicant is asked to treat the runoff from the Site through the capture and slow release of the WQCV. The runoff from the Site is collected by a proposed BR that will provide water quality by fully infiltrating the 100 yr storm event. The BR worksheet and calculations are included in Appendix D.

Step 3 – Stabilized Drainageways

In step 3 the applicant is asked to examine the downstream drainageways to ensure channel stability. The subject site lies within the Security Drainage Basin. Adjacent drainage ways will not be disturbed by this project.

Step 4 – Implement Site Specific and Other Source Control BMPs

In step 4 the applicant is asked to examine Site specific needs such as material storage or other Site operations that will require targeted source control BMPs. A full infiltration bioretention facility is proposed to reduce flow, mitigate offsite sediment transport, and provide water quality onsite.

4. Drainage Facility Design

A full infiltration bioretention pond will be proposed onsite to help with the flooding issues and combat the increase in impervious with the proposed parking lot onsite as well as to provide water quality. As seen in the proposed routing spreadsheet, the 100-year combined flow at design point 1 is 1.33 cfs. The WCV and 100-year volumes will be captured and fully infiltrated within 72 hrs. There is no outfall proposed for this bioretention pond. But an emergency grass lined spillway has been provided in the event of rainfall exceeding the 100-yr storm. In the event where clogging of the rain garden occurs, the emergency spillway has been designed to safely convey the 100-yr storm out of the bioretention pond to the southern corner of the site. From here the flow will leave the site and continue southeast until it reaches the Leta Drive R.O.W where it is conveyed to Security Creek Drainage Basin and ultimately outfalls to Little Johnson. Please see the details of the emergency spillway on sheet 2 in Appendix C and supporting calculations of the spillway in Appendix D.

The peak stage of the 100 year storm event is 5789.90, the top of embankment provides at least 1' of freeboard at elevation 5791. A 3" overflow structure is provided at the embankment. The pond is anticipated to recover in approximately 26 hours, and the additional freeboard volume within the pond provides a storage volume factor of 2.0 within the pond.

The existing soil matrix does not provide the infiltration results necessary for a full infiltration bioretention pond. Therefore, the plans indicate the contractor is required to over excavate 2' below the pond bottom and import clean sands. The infiltration calculations provided assume the amended soil matrix. The contractor is required to provide the EOR sieve analysis and permeability data on the import sand to ensure it meets the specifications required prior to installation.

The permeability data provided by the contractor will ensure the 1 inch/hour will be met or exceeded prior to installation. The groundwater depth is greater than 5 feet from the pond bottom, ensuring the full infiltration bioretention pond will function as designed and intended.

The proposed full infiltration bioretention pond will provide water quality and quantity to meet El Paso regulatory requirements and the design will not cause adverse impacts to surrounding properties

**APPENDIX A- VICINITY MAP, SOILS REPORT,
AND FEMA MAP**

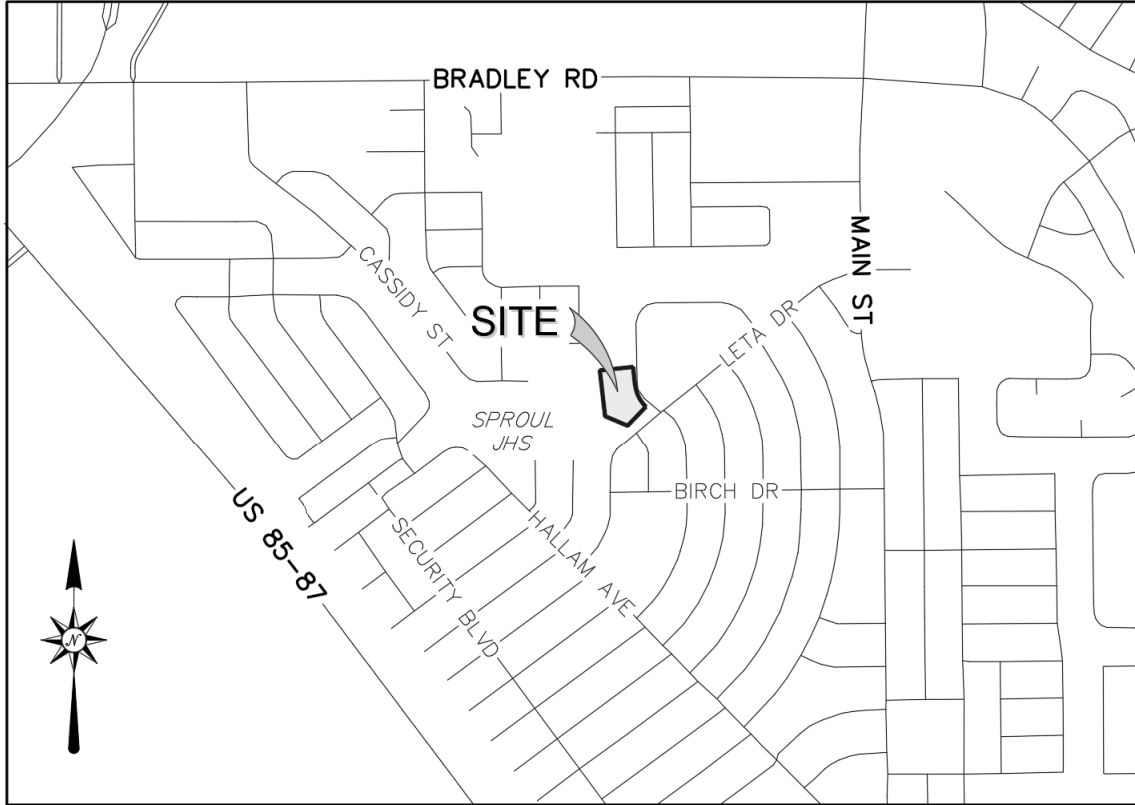

VICINITY MAP
SCALE: 1" = 1,000'



United States
Department of
Agriculture

NRCS

Natural
Resources
Conservation
Service

A product of the National
Cooperative Soil Survey,
a joint effort of the United
States Department of
Agriculture and other
Federal agencies, State
agencies including the
Agricultural Experiment
Stations, and local
participants

Custom Soil Resource Report for El Paso County Area, Colorado

Fountain Valley Salvation Army

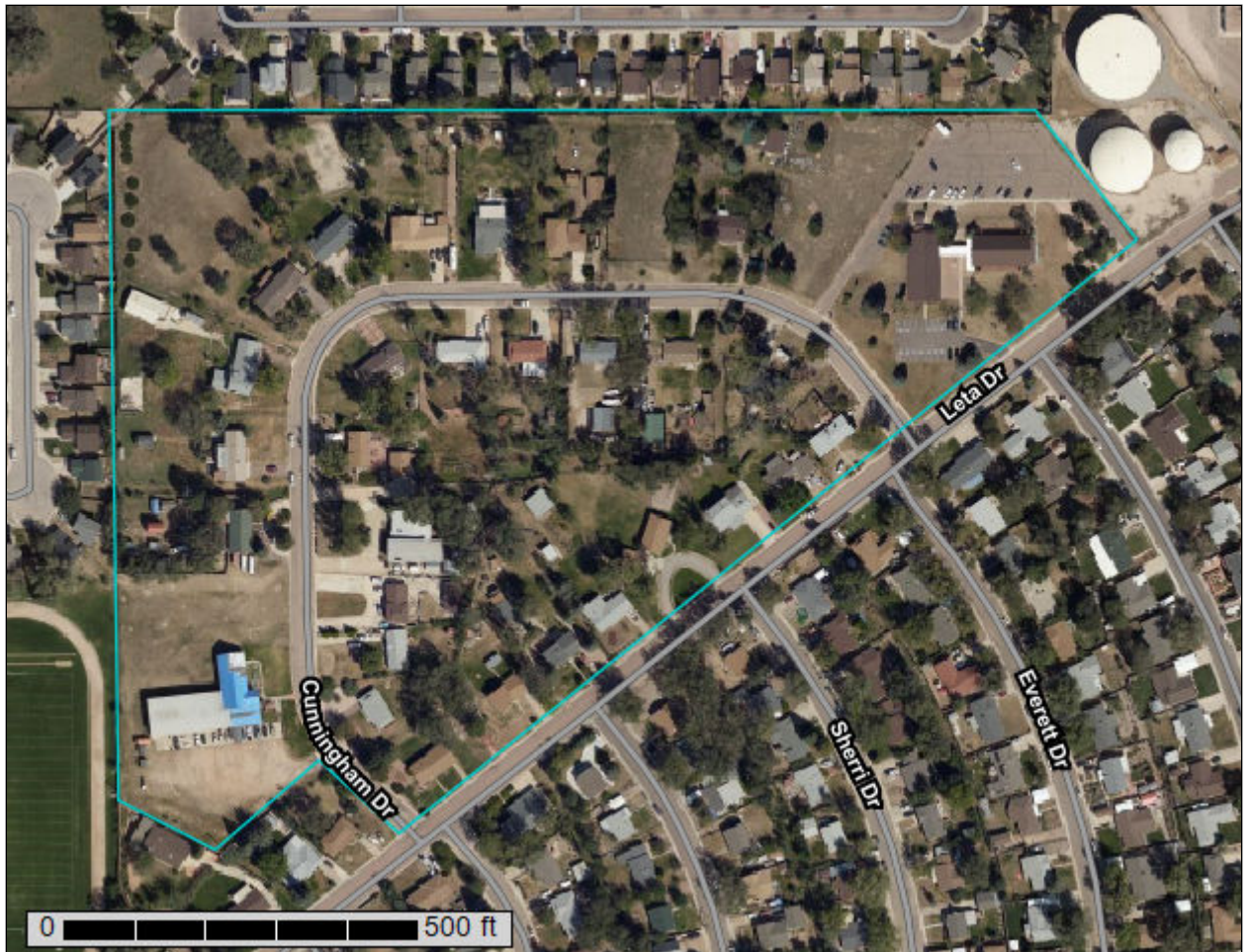

Preface

Soil surveys contain information that affects land use planning in survey areas. They highlight soil limitations that affect various land uses and provide information about the properties of the soils in the survey areas. Soil surveys are designed for many different users, including farmers, ranchers, foresters, agronomists, urban planners, community officials, engineers, developers, builders, and home buyers. Also, conservationists, teachers, students, and specialists in recreation, waste disposal, and pollution control can use the surveys to help them understand, protect, or enhance the environment.

Various land use regulations of Federal, State, and local governments may impose special restrictions on land use or land treatment. Soil surveys identify soil properties that are used in making various land use or land treatment decisions. The information is intended to help the land users identify and reduce the effects of soil limitations on various land uses. The landowner or user is responsible for identifying and complying with existing laws and regulations.

Although soil survey information can be used for general farm, local, and wider area planning, onsite investigation is needed to supplement this information in some cases. Examples include soil quality assessments (<http://www.nrcs.usda.gov/wps/portal/nrcs/main/soils/health/>) and certain conservation and engineering applications. For more detailed information, contact your local USDA Service Center (<https://offices.sc.egov.usda.gov/locator/app?agency=nrcs>) or your NRCS State Soil Scientist (http://www.nrcs.usda.gov/wps/portal/nrcs/detail/soils/contactus/?cid=nrcs142p2_053951).

Great differences in soil properties can occur within short distances. Some soils are seasonally wet or subject to flooding. Some are too unstable to be used as a foundation for buildings or roads. Clayey or wet soils are poorly suited to use as septic tank absorption fields. A high water table makes a soil poorly suited to basements or underground installations.

The National Cooperative Soil Survey is a joint effort of the United States Department of Agriculture and other Federal agencies, State agencies including the Agricultural Experiment Stations, and local agencies. The Natural Resources Conservation Service (NRCS) has leadership for the Federal part of the National Cooperative Soil Survey.

Information about soils is updated periodically. Updated information is available through the NRCS Web Soil Survey, the site for official soil survey information.

The U.S. Department of Agriculture (USDA) prohibits discrimination in all its programs and activities on the basis of race, color, national origin, age, disability, and where applicable, sex, marital status, familial status, parental status, religion, sexual orientation, genetic information, political beliefs, reprisal, or because all or a part of an individual's income is derived from any public assistance program. (Not all prohibited bases apply to all programs.) Persons with disabilities who require

alternative means for communication of program information (Braille, large print, audiotape, etc.) should contact USDA's TARGET Center at (202) 720-2600 (voice and TDD). To file a complaint of discrimination, write to USDA, Director, Office of Civil Rights, 1400 Independence Avenue, S.W., Washington, D.C. 20250-9410 or call (800) 795-3272 (voice) or (202) 720-6382 (TDD). USDA is an equal opportunity provider and employer.

Contents

Preface	2
How Soil Surveys Are Made	5
Soil Map	8
Soil Map.....	9
Legend.....	10
Map Unit Legend.....	11
Map Unit Descriptions.....	11
El Paso County Area, Colorado.....	13
8—Blakeland loamy sand, 1 to 9 percent slopes.....	13
References	15

How Soil Surveys Are Made

Soil surveys are made to provide information about the soils and miscellaneous areas in a specific area. They include a description of the soils and miscellaneous areas and their location on the landscape and tables that show soil properties and limitations affecting various uses. Soil scientists observed the steepness, length, and shape of the slopes; the general pattern of drainage; the kinds of crops and native plants; and the kinds of bedrock. They observed and described many soil profiles. A soil profile is the sequence of natural layers, or horizons, in a soil. The profile extends from the surface down into the unconsolidated material in which the soil formed or from the surface down to bedrock. The unconsolidated material is devoid of roots and other living organisms and has not been changed by other biological activity.

Currently, soils are mapped according to the boundaries of major land resource areas (MLRAs). MLRAs are geographically associated land resource units that share common characteristics related to physiography, geology, climate, water resources, soils, biological resources, and land uses (USDA, 2006). Soil survey areas typically consist of parts of one or more MLRA.

The soils and miscellaneous areas in a survey area occur in an orderly pattern that is related to the geology, landforms, relief, climate, and natural vegetation of the area. Each kind of soil and miscellaneous area is associated with a particular kind of landform or with a segment of the landform. By observing the soils and miscellaneous areas in the survey area and relating their position to specific segments of the landform, a soil scientist develops a concept, or model, of how they were formed. Thus, during mapping, this model enables the soil scientist to predict with a considerable degree of accuracy the kind of soil or miscellaneous area at a specific location on the landscape.

Commonly, individual soils on the landscape merge into one another as their characteristics gradually change. To construct an accurate soil map, however, soil scientists must determine the boundaries between the soils. They can observe only a limited number of soil profiles. Nevertheless, these observations, supplemented by an understanding of the soil-vegetation-landscape relationship, are sufficient to verify predictions of the kinds of soil in an area and to determine the boundaries.

Soil scientists recorded the characteristics of the soil profiles that they studied. They noted soil color, texture, size and shape of soil aggregates, kind and amount of rock fragments, distribution of plant roots, reaction, and other features that enable them to identify soils. After describing the soils in the survey area and determining their properties, the soil scientists assigned the soils to taxonomic classes (units). Taxonomic classes are concepts. Each taxonomic class has a set of soil characteristics with precisely defined limits. The classes are used as a basis for comparison to classify soils systematically. Soil taxonomy, the system of taxonomic classification used in the United States, is based mainly on the kind and character of soil properties and the arrangement of horizons within the profile. After the soil

Custom Soil Resource Report

scientists classified and named the soils in the survey area, they compared the individual soils with similar soils in the same taxonomic class in other areas so that they could confirm data and assemble additional data based on experience and research.

The objective of soil mapping is not to delineate pure map unit components; the objective is to separate the landscape into landforms or landform segments that have similar use and management requirements. Each map unit is defined by a unique combination of soil components and/or miscellaneous areas in predictable proportions. Some components may be highly contrasting to the other components of the map unit. The presence of minor components in a map unit in no way diminishes the usefulness or accuracy of the data. The delineation of such landforms and landform segments on the map provides sufficient information for the development of resource plans. If intensive use of small areas is planned, onsite investigation is needed to define and locate the soils and miscellaneous areas.

Soil scientists make many field observations in the process of producing a soil map. The frequency of observation is dependent upon several factors, including scale of mapping, intensity of mapping, design of map units, complexity of the landscape, and experience of the soil scientist. Observations are made to test and refine the soil-landscape model and predictions and to verify the classification of the soils at specific locations. Once the soil-landscape model is refined, a significantly smaller number of measurements of individual soil properties are made and recorded. These measurements may include field measurements, such as those for color, depth to bedrock, and texture, and laboratory measurements, such as those for content of sand, silt, clay, salt, and other components. Properties of each soil typically vary from one point to another across the landscape.

Observations for map unit components are aggregated to develop ranges of characteristics for the components. The aggregated values are presented. Direct measurements do not exist for every property presented for every map unit component. Values for some properties are estimated from combinations of other properties.

While a soil survey is in progress, samples of some of the soils in the area generally are collected for laboratory analyses and for engineering tests. Soil scientists interpret the data from these analyses and tests as well as the field-observed characteristics and the soil properties to determine the expected behavior of the soils under different uses. Interpretations for all of the soils are field tested through observation of the soils in different uses and under different levels of management. Some interpretations are modified to fit local conditions, and some new interpretations are developed to meet local needs. Data are assembled from other sources, such as research information, production records, and field experience of specialists. For example, data on crop yields under defined levels of management are assembled from farm records and from field or plot experiments on the same kinds of soil.

Predictions about soil behavior are based not only on soil properties but also on such variables as climate and biological activity. Soil conditions are predictable over long periods of time, but they are not predictable from year to year. For example, soil scientists can predict with a fairly high degree of accuracy that a given soil will have a high water table within certain depths in most years, but they cannot predict that a high water table will always be at a specific level in the soil on a specific date.

After soil scientists located and identified the significant natural bodies of soil in the survey area, they drew the boundaries of these bodies on aerial photographs and

Custom Soil Resource Report

identified each as a specific map unit. Aerial photographs show trees, buildings, fields, roads, and rivers, all of which help in locating boundaries accurately.

Soil Map

The soil map section includes the soil map for the defined area of interest, a list of soil map units on the map and extent of each map unit, and cartographic symbols displayed on the map. Also presented are various metadata about data used to produce the map, and a description of each soil map unit.

Custom Soil Resource Report Soil Map



Soil Map may not be valid at this scale.

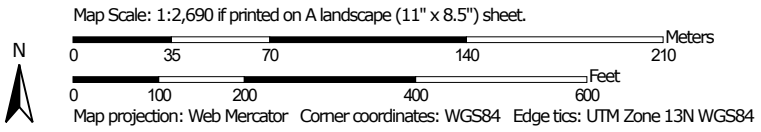





MAP LEGEND



















Area of Interest (AOI)







 Area of Interest (AOI)

Soils

 Soil Survey Areas
 Soil Map Unit Polygons
 Soil Map Unit Lines
 Soil Map Unit Points

Special Point Features





 Blowout
 Borrow Pit
 Clay Spot
 Closed Depression
 Gravel Pit
 Gravelly Spot
 Landfill
 Lava Flow
 Marsh or swamp
 Mine or Quarry
 Miscellaneous Water
 Perennial Water
 Rock Outcrop
 Saline Spot
 Sandy Spot
 Severely Eroded Spot
 Sinkhole
 Slide or Slip

 Sodic Spot
 Spoil Area
 Stony Spot
 Very Stony Spot
 Wet Spot
 Other
 Special Line Features

Water Features

 Streams and Canals

Transportation

 Rails
 Interstate Highways
 US Routes
 Major Roads
 Local Roads

Background

 Aerial Photography

MAP INFORMATION

The soil surveys that comprise your AOI were mapped at 1:24,000.

Warning: Soil Map may not be valid at this scale.

Enlargement of maps beyond the scale of mapping can cause misunderstanding of the detail of mapping and accuracy of soil line placement. The maps do not show the small areas of contrasting soils that could have been shown at a more detailed scale.

Please rely on the bar scale on each map sheet for map measurements.

Source of Map: Natural Resources Conservation Service
 Web Soil Survey URL:
 Coordinate System: Web Mercator (EPSG:3857)

Maps from the Web Soil Survey are based on the Web Mercator projection, which preserves direction and shape but distorts distance and area. A projection that preserves area, such as the Albers equal-area conic projection, should be used if more accurate calculations of distance or area are required.

This product is generated from the USDA-NRCS certified data as of the version date(s) listed below.

Soil Survey Area: El Paso County Area, Colorado
 Survey Area Data: Version 19, Aug 31, 2021

Soil map units are labeled (as space allows) for map scales 1:50,000 or larger.

Date(s) aerial images were photographed: Aug 19, 2018—Sep 23, 2018

The orthophoto or other base map on which the soil lines were compiled and digitized probably differs from the background imagery displayed on these maps. As a result, some minor shifting of map unit boundaries may be evident.

Map Unit Legend

Map Unit Symbol	Map Unit Name	Acres in AOI	Percent of AOI
8	Blakeland loamy sand, 1 to 9 percent slopes	23.3	100.0%
Totals for Area of Interest		23.3	100.0%

Map Unit Descriptions

The map units delineated on the detailed soil maps in a soil survey represent the soils or miscellaneous areas in the survey area. The map unit descriptions, along with the maps, can be used to determine the composition and properties of a unit.

A map unit delineation on a soil map represents an area dominated by one or more major kinds of soil or miscellaneous areas. A map unit is identified and named according to the taxonomic classification of the dominant soils. Within a taxonomic class there are precisely defined limits for the properties of the soils. On the landscape, however, the soils are natural phenomena, and they have the characteristic variability of all natural phenomena. Thus, the range of some observed properties may extend beyond the limits defined for a taxonomic class. Areas of soils of a single taxonomic class rarely, if ever, can be mapped without including areas of other taxonomic classes. Consequently, every map unit is made up of the soils or miscellaneous areas for which it is named and some minor components that belong to taxonomic classes other than those of the major soils.

Most minor soils have properties similar to those of the dominant soil or soils in the map unit, and thus they do not affect use and management. These are called noncontrasting, or similar, components. They may or may not be mentioned in a particular map unit description. Other minor components, however, have properties and behavioral characteristics divergent enough to affect use or to require different management. These are called contrasting, or dissimilar, components. They generally are in small areas and could not be mapped separately because of the scale used. Some small areas of strongly contrasting soils or miscellaneous areas are identified by a special symbol on the maps. If included in the database for a given area, the contrasting minor components are identified in the map unit descriptions along with some characteristics of each. A few areas of minor components may not have been observed, and consequently they are not mentioned in the descriptions, especially where the pattern was so complex that it was impractical to make enough observations to identify all the soils and miscellaneous areas on the landscape.

The presence of minor components in a map unit in no way diminishes the usefulness or accuracy of the data. The objective of mapping is not to delineate pure taxonomic classes but rather to separate the landscape into landforms or landform segments that have similar use and management requirements. The delineation of such segments on the map provides sufficient information for the development of resource plans. If intensive use of small areas is planned, however, onsite investigation is needed to define and locate the soils and miscellaneous areas.

Custom Soil Resource Report

An identifying symbol precedes the map unit name in the map unit descriptions. Each description includes general facts about the unit and gives important soil properties and qualities.

Soils that have profiles that are almost alike make up a *soil series*. Except for differences in texture of the surface layer, all the soils of a series have major horizons that are similar in composition, thickness, and arrangement.

Soils of one series can differ in texture of the surface layer, slope, stoniness, salinity, degree of erosion, and other characteristics that affect their use. On the basis of such differences, a soil series is divided into *soil phases*. Most of the areas shown on the detailed soil maps are phases of soil series. The name of a soil phase commonly indicates a feature that affects use or management. For example, Alpha silt loam, 0 to 2 percent slopes, is a phase of the Alpha series.

Some map units are made up of two or more major soils or miscellaneous areas. These map units are complexes, associations, or undifferentiated groups.

A *complex* consists of two or more soils or miscellaneous areas in such an intricate pattern or in such small areas that they cannot be shown separately on the maps. The pattern and proportion of the soils or miscellaneous areas are somewhat similar in all areas. Alpha-Beta complex, 0 to 6 percent slopes, is an example.

An *association* is made up of two or more geographically associated soils or miscellaneous areas that are shown as one unit on the maps. Because of present or anticipated uses of the map units in the survey area, it was not considered practical or necessary to map the soils or miscellaneous areas separately. The pattern and relative proportion of the soils or miscellaneous areas are somewhat similar. Alpha-Beta association, 0 to 2 percent slopes, is an example.

An *undifferentiated group* is made up of two or more soils or miscellaneous areas that could be mapped individually but are mapped as one unit because similar interpretations can be made for use and management. The pattern and proportion of the soils or miscellaneous areas in a mapped area are not uniform. An area can be made up of only one of the major soils or miscellaneous areas, or it can be made up of all of them. Alpha and Beta soils, 0 to 2 percent slopes, is an example.

Some surveys include *miscellaneous areas*. Such areas have little or no soil material and support little or no vegetation. Rock outcrop is an example.

El Paso County Area, Colorado

8—Blakeland loamy sand, 1 to 9 percent slopes

Map Unit Setting

National map unit symbol: 369v
Elevation: 4,600 to 5,800 feet
Mean annual precipitation: 14 to 16 inches
Mean annual air temperature: 46 to 48 degrees F
Frost-free period: 125 to 145 days
Farmland classification: Not prime farmland

Map Unit Composition

Blakeland and similar soils: 98 percent
Minor components: 2 percent
Estimates are based on observations, descriptions, and transects of the mapunit.

Description of Blakeland

Setting

Landform: Hills, flats
Landform position (three-dimensional): Side slope, talf
Down-slope shape: Linear
Across-slope shape: Linear
Parent material: Alluvium derived from sedimentary rock and/or eolian deposits derived from sedimentary rock

Typical profile

A - 0 to 11 inches: loamy sand
AC - 11 to 27 inches: loamy sand
C - 27 to 60 inches: sand

Properties and qualities

Slope: 1 to 9 percent
Depth to restrictive feature: More than 80 inches
Drainage class: Somewhat excessively drained
Runoff class: Low
Capacity of the most limiting layer to transmit water (Ksat): High to very high (5.95 to 19.98 in/hr)
Depth to water table: More than 80 inches
Frequency of flooding: None
Frequency of ponding: None
Calcium carbonate, maximum content: 5 percent
Available water supply, 0 to 60 inches: Low (about 4.5 inches)

Interpretive groups

Land capability classification (irrigated): 3e
Land capability classification (nonirrigated): 6e
Hydrologic Soil Group: A
Ecological site: R049XB210CO - Sandy Foothill
Hydric soil rating: No

Minor Components

Other soils

Percent of map unit: 1 percent

Custom Soil Resource Report

Hydric soil rating: No

Pleasant

Percent of map unit: 1 percent

Landform: Depressions

Hydric soil rating: Yes

References

- American Association of State Highway and Transportation Officials (AASHTO). 2004. Standard specifications for transportation materials and methods of sampling and testing. 24th edition.
- American Society for Testing and Materials (ASTM). 2005. Standard classification of soils for engineering purposes. ASTM Standard D2487-00.
- Cowardin, L.M., V. Carter, F.C. Golet, and E.T. LaRoe. 1979. Classification of wetlands and deep-water habitats of the United States. U.S. Fish and Wildlife Service FWS/OBS-79/31.
- Federal Register. July 13, 1994. Changes in hydric soils of the United States.
- Federal Register. September 18, 2002. Hydric soils of the United States.
- Hurt, G.W., and L.M. Vasilas, editors. Version 6.0, 2006. Field indicators of hydric soils in the United States.
- National Research Council. 1995. Wetlands: Characteristics and boundaries.
- Soil Survey Division Staff. 1993. Soil survey manual. Soil Conservation Service. U.S. Department of Agriculture Handbook 18. http://www.nrcs.usda.gov/wps/portal/nrcs/detail/national/soils/?cid=nrcs142p2_054262
- Soil Survey Staff. 1999. Soil taxonomy: A basic system of soil classification for making and interpreting soil surveys. 2nd edition. Natural Resources Conservation Service, U.S. Department of Agriculture Handbook 436. http://www.nrcs.usda.gov/wps/portal/nrcs/detail/national/soils/?cid=nrcs142p2_053577
- Soil Survey Staff. 2010. Keys to soil taxonomy. 11th edition. U.S. Department of Agriculture, Natural Resources Conservation Service. http://www.nrcs.usda.gov/wps/portal/nrcs/detail/national/soils/?cid=nrcs142p2_053580
- Tiner, R.W., Jr. 1985. Wetlands of Delaware. U.S. Fish and Wildlife Service and Delaware Department of Natural Resources and Environmental Control, Wetlands Section.
- United States Army Corps of Engineers, Environmental Laboratory. 1987. Corps of Engineers wetlands delineation manual. Waterways Experiment Station Technical Report Y-87-1.
- United States Department of Agriculture, Natural Resources Conservation Service. National forestry manual. http://www.nrcs.usda.gov/wps/portal/nrcs/detail/soils/home/?cid=nrcs142p2_053374
- United States Department of Agriculture, Natural Resources Conservation Service. National range and pasture handbook. <http://www.nrcs.usda.gov/wps/portal/nrcs/detail/national/landuse/rangepasture/?cid=stelprdb1043084>

Custom Soil Resource Report

United States Department of Agriculture, Natural Resources Conservation Service. National soil survey handbook, title 430-VI. http://www.nrcs.usda.gov/wps/portal/nrcs/detail/soils/scientists/?cid=nrcs142p2_054242

United States Department of Agriculture, Natural Resources Conservation Service. 2006. Land resource regions and major land resource areas of the United States, the Caribbean, and the Pacific Basin. U.S. Department of Agriculture Handbook 296. http://www.nrcs.usda.gov/wps/portal/nrcs/detail/national/soils/?cid=nrcs142p2_053624

United States Department of Agriculture, Soil Conservation Service. 1961. Land capability classification. U.S. Department of Agriculture Handbook 210. http://www.nrcs.usda.gov/Internet/FSE_DOCUMENTS/nrcs142p2_052290.pdf

National Flood Hazard Layer FIRMMette



104°45'2"W 38°46'5"N

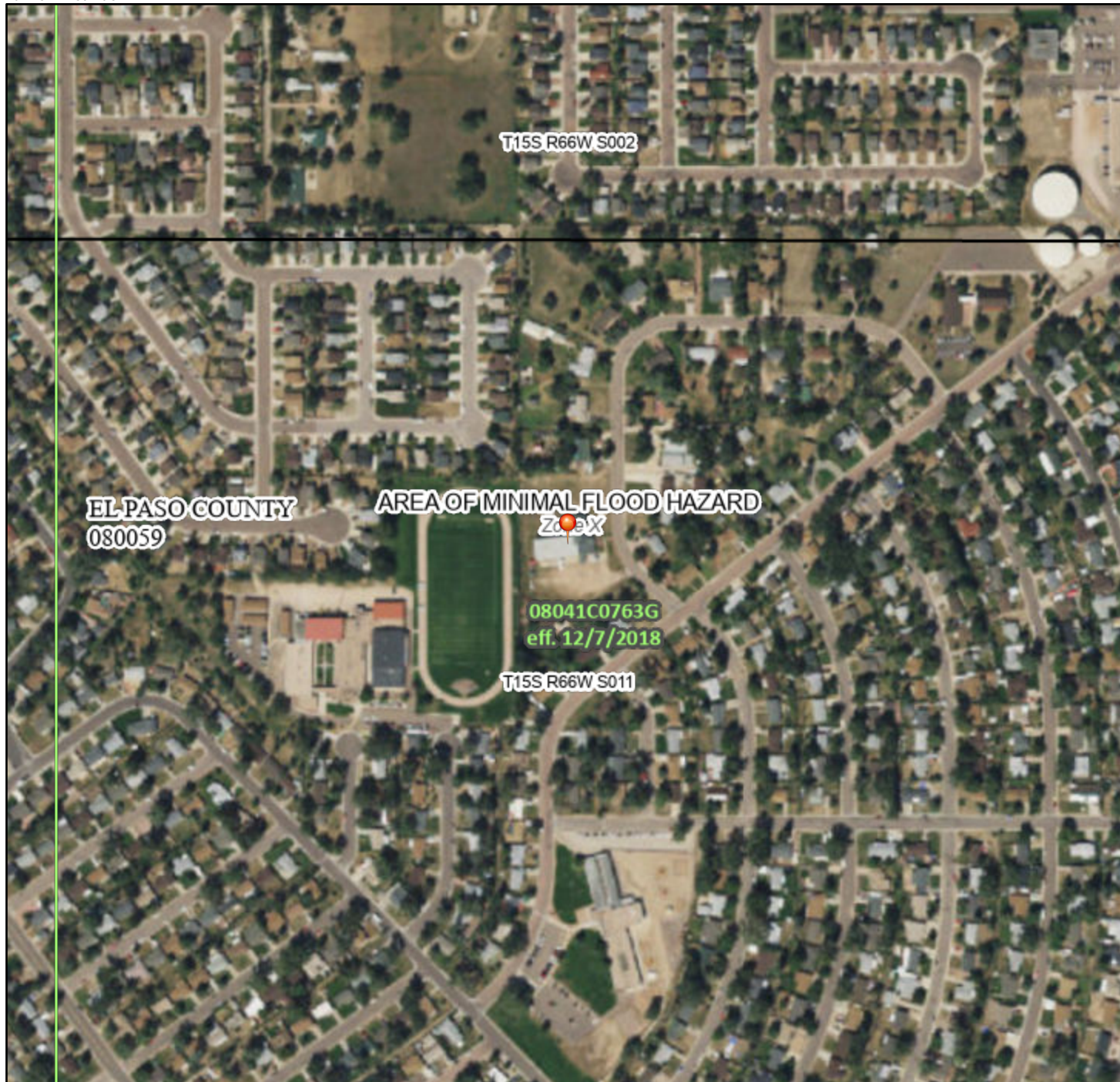

Legend

SEE FIS REPORT FOR DETAILED LEGEND AND INDEX MAP FOR FIRM PANEL LAYOUT

- | | | |
|------------------------------------|--|--|
| SPECIAL FLOOD HAZARD AREAS | | Without Base Flood Elevation (BFE)
<i>Zone A, V, A99</i> |
| | | With BFE or Depth <i>Zone AE, AO, AH, VE, AR</i> |
| | | Regulatory Floodway |
| OTHER AREAS OF FLOOD HAZARD | | 0.2% Annual Chance Flood Hazard, Areas of 1% annual chance flood with average depth less than one foot or with drainage areas of less than one square mile <i>Zone X</i> |
| | | Future Conditions 1% Annual Chance Flood Hazard <i>Zone X</i> |
| | | Area with Reduced Flood Risk due to Levee. See Notes. <i>Zone X</i> |
| | | Area with Flood Risk due to Levee <i>Zone D</i> |
| OTHER AREAS | | NO SCREEN Area of Minimal Flood Hazard <i>Zone X</i> |
| | | Effective LOMRs |
| GENERAL STRUCTURES | | Area of Undetermined Flood Hazard <i>Zone D</i> |
| | | Channel, Culvert, or Storm Sewer |
| | | Levee, Dike, or Floodwall |
| OTHER FEATURES | | 20.2 Cross Sections with 1% Annual Chance |
| | | 17.5 Water Surface Elevation |
| | | 8 Coastal Transect |
| | | Base Flood Elevation Line (BFE) |
| | | Limit of Study |
| MAP PANELS | | Jurisdiction Boundary |
| | | Coastal Transect Baseline |
| | | Profile Baseline |
| | | Hydrographic Feature |
| | | Digital Data Available |
| | | No Digital Data Available |
| | | Unmapped |
| | | The pin displayed on the map is an approximate point selected by the user and does not represent an authoritative property location. |



This map complies with FEMA's standards for the use of digital flood maps if it is not void as described below. The basemap shown complies with FEMA's basemap accuracy standards

The flood hazard information is derived directly from the authoritative NFHL web services provided by FEMA. This map was exported on **10/5/2021 at 4:37 PM** and does not reflect changes or amendments subsequent to this date and time. The NFHL and effective information may change or become superseded by new data over time.

This map image is void if the one or more of the following map elements do not appear: basemap imagery, flood zone labels, legend, scale bar, map creation date, community identifiers, FIRM panel number, and FIRM effective date. Map images for unmapped and unmodernized areas cannot be used for regulatory purposes.

NOTES TO USERS

This map is for use in administering the National Flood Insurance Program. It does not necessarily identify all areas subject to flooding, particularly from local drainage sources of small size. The community map repository should be consulted for possible updated or additional flood hazard information.

To obtain more detailed information in areas where **Base Flood Elevations (BFEs)** and/or **floodways** have been determined, users are encouraged to consult the Flood Profiles and Floodway Data and/or Summary of Stillwater Elevations tables contained within the Flood Insurance Study (FIS) report that accompanies this FIRM. Users should be aware that BFEs shown on the FIRM represent rounded whole-foot elevations. These BFEs are intended for flood insurance rating purposes only and should not be used as the sole source of flood elevation information. Accordingly, flood elevation data presented in the FIS report should be utilized in conjunction with the FIRM for purposes of construction and/or floodplain management.

Coastal Base Flood Elevations shown on this map apply only landward of 0.0' North American Vertical Datum of 1988 (NAVD88). Users of this FIRM should be aware that coastal flood elevations are also provided in the Summary of Stillwater Elevations table in the Flood Insurance Study report for this jurisdiction. Elevations shown in the Summary of Stillwater Elevations table should be used for construction and/or floodplain management purposes when they are higher than the elevations shown on this FIRM.

Boundaries of the **floodways** were computed at cross sections and interpolated between cross sections. The floodways were based on hydraulic considerations with regard to requirements of the National Flood Insurance Program. Floodway widths and other pertinent floodway data are provided in the Flood Insurance Study report for this jurisdiction.

Certain areas not in Special Flood Hazard Areas may be protected by **flood control structures**. Refer to section 2.4 "Flood Protection Measures" of the Flood Insurance Study report for information on flood control structures for this jurisdiction.

The **projection** used in the preparation of this map was Universal Transverse Mercator (UTM) zone 13. The **horizontal datum** was NAD83, GRS80 spheroid. Differences in datum, spheroid, projection or UTM zones zones used in the production of FIRMs for adjacent jurisdictions may result in slight positional differences in map features across jurisdiction boundaries. These differences do not affect the accuracy of this FIRM.

Flood elevations on this map are referenced to the **North American Vertical Datum of 1988 (NAVD88)**. These flood elevations must be compared to structure and ground elevations referenced to the same **vertical datum**. For information regarding conversion between the National Geodetic Vertical Datum of 1929 and the North American Vertical Datum of 1988, visit the National Geodetic Survey website at <http://www.ngs.noaa.gov/> or contact the National Geodetic Survey at the following address:

NGS Information Services
 NOAA, NINGS12
 National Geodetic Survey
 SSMC-3, #9202
 1315 East-West Highway
 Silver Spring, MD 20910-3282

To obtain current elevation, description, and/or location information for **bench marks** shown on this map, please contact the Information Services Branch of the National Geodetic Survey at (301) 713-3242 or visit its website at <http://www.ngs.noaa.gov/>.

Base Map information shown on this FIRM was provided in digital format by El Paso County, Colorado Springs Utilities, City of Fountain, Bureau of Land Management, National Oceanic and Atmospheric Administration, United States Geological Survey, and Anderson Consulting Engineers, Inc. These data are current as of 2006.

This map reflects more detailed and up-to-date **stream channel configurations and floodplain delineations** than those shown on the previous FIRM for this jurisdiction. The floodplains and floodways that were transferred from the previous FIRM may have been adjusted to conform to these new stream channel configurations. As a result, the Flood Profiles and Floodway Data tables in the Flood Insurance Study Report (which contains authoritative hydraulic data) may reflect stream channel distances that differ from what is shown on this map. The profile baselines depicted on this map represent the hydraulic modeling baselines that match the flood profiles and Floodway Data Tables if applicable, in the FIS report. As a result, the profile baselines may deviate significantly from the new base map channel representation and may appear outside of the floodplain.

Corporate limits shown on this map are based on the best data available at the time of publication. Because changes due to annexations or de-annexations may have occurred after this map was published, map users should contact appropriate community officials to verify current corporate limit locations.

Please refer to the separately printed **Map Index** for an overview map of the county showing the layout of map panels; community map repository addresses; and a Listing of Communities table containing National Flood Insurance Program dates for each community as well as a listing of the panels on which each community is located.

Contact **FEMA Map Service Center (MSC)** via the FEMA Map Information eXchange (FMIX) 1-877-336-2627 for information on available products associated with this FIRM. Available products may include previously issued Letters of Map Change, a Flood Insurance Study Report, and/or digital versions of this map. The MSC may also be reached by Fax at 1-800-358-9620 and its website at <http://www.msc.fema.gov/>.

If you have **questions about this map** or questions concerning the National Flood Insurance Program in general, please call 1-877-FEMA MAP (1-877-336-2627) or visit the FEMA website at <http://www.fema.gov/business/nfp>.

El Paso County Vertical Datum Offset Table

Flooding Source	Vertical Datum Offset (ft)
REFER TO SECTION 3.3 OF THE EL PASO COUNTY FLOOD INSURANCE STUDY FOR STREAM BY STREAM VERTICAL DATUM CONVERSION INFORMATION	

Panel Location Map

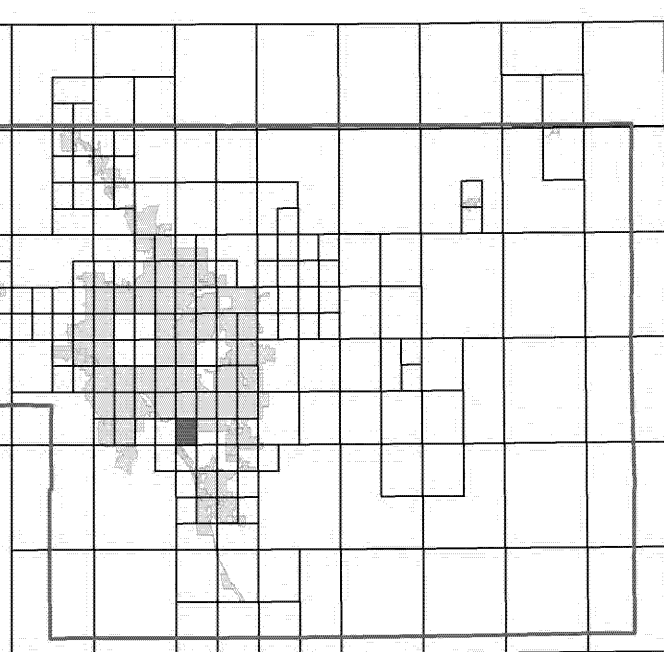

This Digital Flood Insurance Rate Map (DFIRM) was produced through a Cooperating Technical Partner (CTP) agreement between the State of Colorado Water Conservation Board (CWCB) and the Federal Emergency Management Agency (FEMA).



Additional Flood Hazard information and resources are available from local communities and the Colorado Water Conservation Board.

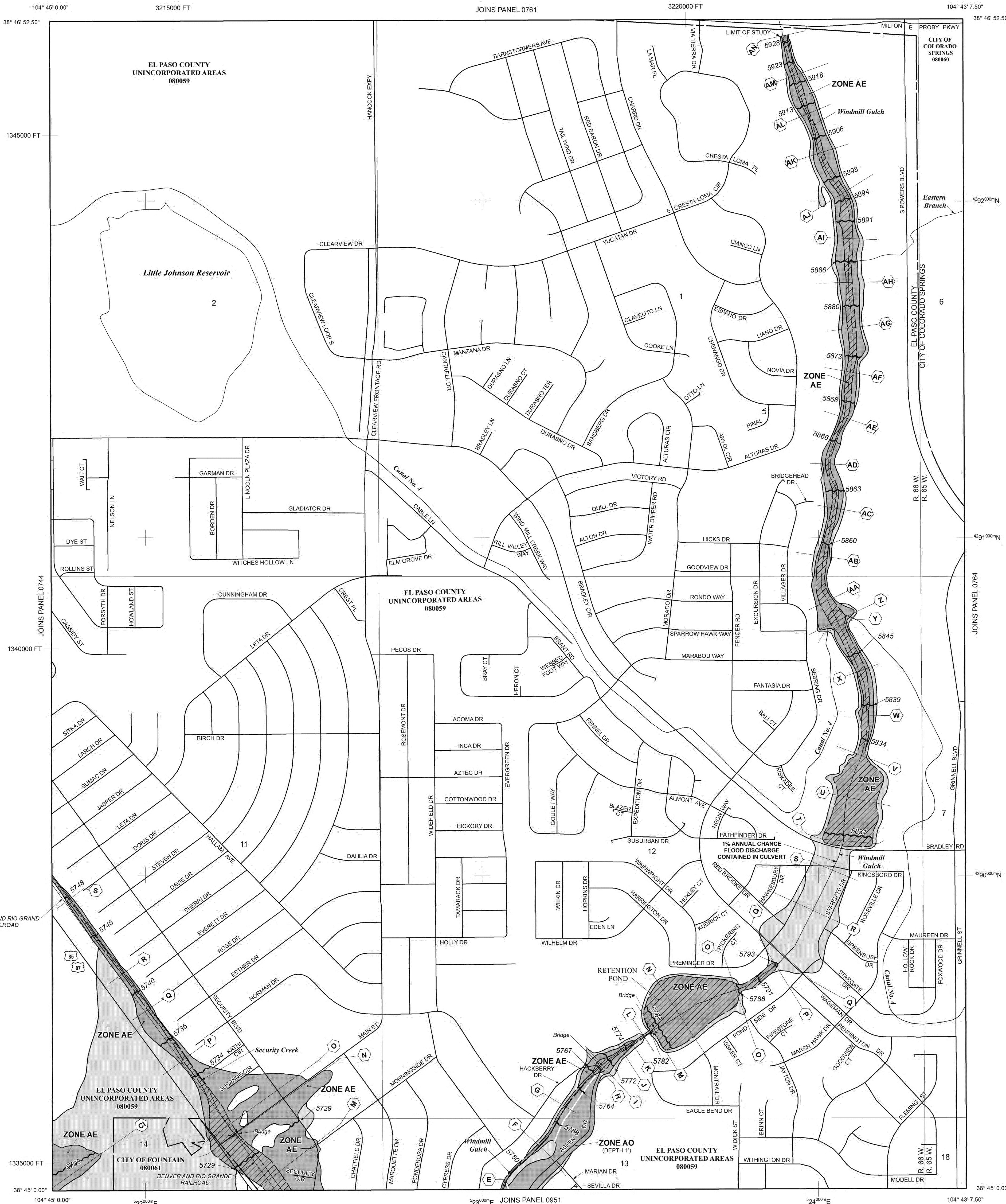

NOTE: MAP AREA SHOWN ON THIS PANEL IS LOCATED WITHIN TOWNSHIP 15 SOUTH, RANGE 65 WEST, AND TOWNSHIP 15 SOUTH, RANGE 66 WEST.

LEGEND

SPECIAL FLOOD HAZARD AREAS (SFHAS) SUBJECT TO INUNDATION BY THE 1% ANNUAL CHANCE FLOOD

The 1% annual chance flood (100-year flood), also known as the base flood, is the flood that has a 1% chance of being equalled or exceeded in any given year. The Special Flood Hazard Area is the area subject to flooding by the 1% annual chance flood. Areas of Special Flood Hazard include Zones A, AE, AH, AO, AR, AV, and VE. The Base Flood Elevation is the water-surface elevation of the 1% annual chance flood.

- ZONE A** No Base Flood Elevations determined.
- ZONE AE** Base Flood Elevations determined.
- ZONE AH** Flood depths of 1 to 3 feet (usually areas of ponding); Base Flood Elevations determined.
- ZONE AO** Flood depths of 1 to 3 feet (usually sheet flow on sloping terrain); average depths determined. For areas of alluvial fan flooding, velocities also determined.
- ZONE AR** Special Flood Hazard Area Formerly protected from the 1% annual chance flood by a flood control system that was subsequently dewatered. Zone AR indicates that the former flood control system is being restored to provide protection from the 1% annual chance or greater flood.
- ZONE AV** Area to be protected from 1% annual chance flood by a Federal flood protection system under construction; no Base Flood Elevations determined.
- ZONE VE** Coastal flood zone with velocity hazard (wave action); no Base Flood Elevations determined.

FLOODWAY AREAS IN ZONE AE
 The floodway is the channel of a stream plus any adjacent floodplain areas that must be kept free of encroachment so that the 1% annual chance flood can be carried without substantial increases in flood heights.

OTHER FLOOD AREAS

ZONE X Areas of 0.2% annual chance flood; areas of 1% annual chance flood with average depths of less than 1 foot, or with drainage areas less than 1 square mile, and areas protected by levees from 1% annual chance flood.

OTHER AREAS

ZONE X Areas determined to be outside the 0.2% annual chance floodplain.
ZONE D Areas in which flood hazards are undetermined, but possible.

COASTAL BARRIER RESOURCES SYSTEM (CBRS) AREAS

OTHERWISE PROTECTED AREAS (OPAs)

CBRS areas and OPAs are normally located within or adjacent to Special Flood Hazard Areas.

- Floodplain boundary
- Floodway boundary
- Zone D Boundary
- CBRS and OPA boundary
- Boundary dividing Special Flood Hazard Areas of different Base Flood Elevations, flood depths or flood velocities.

513 Base Flood Elevation line and value; elevation in feet* (EL 987)
 Base Flood Elevation value where uniform within zone; elevation in feet* (EL 987)

* Referenced to the North American Vertical Datum of 1988 (NAVD 88)

A-A Cross section line

23-23 Transsect line

97° 07' 30.00" 32° 22' 30.00" Geographic coordinates referenced to the North American Datum of 1983 (NAD 83)

4726500N 1000-meter Universal Transverse Mercator grid ticks, zone 13

6000000 FT 5000-foot grid ticks; Colorado State Plane coordinate system, central zone (FIPSZONE 0902), Lambert Conformal Conic Projection

DX5510 Bench mark (see explanation in Notes to Users section of this FIRM panel)

M1.5 River Mile

MAP REPOSITORIES Refer to Map Repository list on Map Index

EFFECTIVE DATE OF COUNTYWIDE FLOOD INSURANCE RATE MAP MARCH 17, 1997

EFFECTIVE DATE(S) OF REVISION(S) TO THIS PANEL DECEMBER 7, 2018 - to update corporate limits, to change Base Flood Elevations and Special Flood Hazard Areas, to update map format, to add roads and road names, and to incorporate previously issued Letters of Map Revision.

For community map revision history prior to countywide mapping, refer to the Community Map History Table located in the Flood Insurance Study report for this jurisdiction.

To determine if flood insurance is available in this community, contact your insurance agent or call the National Flood Insurance Program at 1-800-638-6620.

MAP SCALE 1" = 500'

250 0 500 1000 FEET

150 0 150 300 METERS

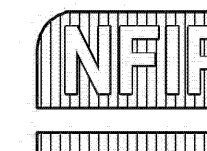

PANEL 0763G

FIRM
FLOOD INSURANCE RATE MAP
EL PASO COUNTY, COLORADO AND INCORPORATED AREAS

PANEL 763 OF 1300
 (SEE MAP INDEX FOR FIRM PANEL LAYOUT)

CONTAINS:

COMMUNITY	NUMBER	PANEL	SUFFIX
COLORADO SPRINGS, CITY OF	08060	0763	G
EL PASO COUNTY	08059	0763	G
FOUNTAIN, CITY OF	08081	0763	G

Notice to User: The Map Number shown below should be used when placing map orders. The Community Number shown above should be used on insurance applications for the subject community.

MAP NUMBER 08041C0763G

MAP REVISED DECEMBER 7, 2018

Federal Emergency Management Agency



**APPENDIX B- EXISTING ROUTING
CALCULATIONS AND DRAINAGE MAP**

SITE DEVELOPMENT PLAN 208 CUNNINGHAM DRIVE

LOCATED IN LOT 4, BLOCK 5, 1 REFILL SECURITY, COLORADO ADDITION 4 WITHIN A PORTION OF
THE NORTHEAST QUARTER OF SECTION 11, TOWNSHIP 15 SOUTH, RANGE 66 WEST OF THE SIXTH
P.M., COLORADO SPRINGS, EL PASO COUNTY, STATE OF COLORADO
LOCATED AT: 208 CUNNINGHAM DR, COLORADO SPRINGS, CO 80911



Know what's below.
Call before you dig.



- - - - - DRAINAGE BASIN BOUNDARY
- - - - - Tc FLOW PATH

Basin	Area (acres)	5-yr (cfs)	100-yr (cfs)
OS1	14.78	8.54	24.13
EX1	2.02	0.69	2.68
EX2	0.09	0.02	0.11
EX3	0.02	0.00	0.02

Design Point	Contributing Basins	Area (acres)	5-yr (cfs)	100-yr (cfs)
1	OS1	14.78	8.54	24.13
2	EX1, EX2	2.11	0.70	2.77
3	EX3	0.09	0.02	0.02

NO.	REVISION	BY	DATE
1	COUNTY COMMENTS	JLH	8/16/24

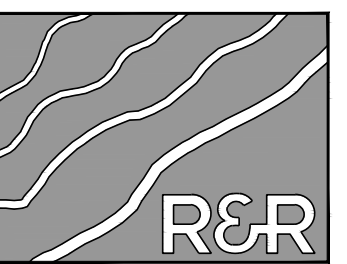

R&R ENGINEERS-SURVEYORS, INC.

1635 WEST 13TH AVENUE, SUITE 310
DENVER, COLORADO 80204
PHONE: 303-753-6730

WWW.RRENGINEERS.COM

FOUNTAIN VALLEY SALVATION ARMY
208 CUNNINGHAM DRIVE
COLORADO SPRINGS, CO 80911

PREPARED FOR:
FOUNTAIN VALLEY SALVATION ARMY
208 CUNNINGHAM DR
COLORADO SPRINGS, CO 80911

SITE DEVELOPMENT PLAN
JOB NO: FV21181
ORG. SUBM. DATE: 12/22/2023
DWN: JMP | CHK: RSD

PRE DEVELOPMENT DRAINAGE MAP

NO. **1**

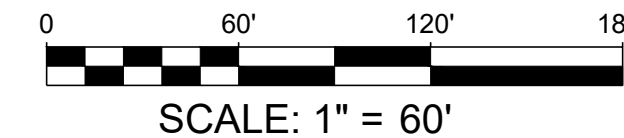

COUNTY FILE NO. CDR242

PATH: V:\21181_208_CUNNINGHAM_DR\ENGINEERING\DRAWINGS\PLAN\DRAINAGE\FV21181 - DRN - EX.DWG, PLOT DATE: 8/27/2024 4:08:23 PM, BY: JESSICA HEYR

EXISTING C VALUES

Designer: JMP
 Company: R&R Engineers-Surveyors
 Date: 8/27/2024
 Project: FOUNTAIN VALLEY SALVATION ARMY
 Location: EL PASO COUNTY



Global Parameters ¹	
Land Use	% Imp.
Open Space/Landscaping	2
Hardscape	100
Roof	90
Gravel	40

Summary	
Total Area (ac)	16.91
Composite Impervious	33.7%
Cells of this color are for required user-input	
Cells of this color are for optional user-input	

¹ From Table 6-3 in MHFD Volume 1
² From Table 6-4 in MHFD Volume 1

Basin Name	Area (ac)	NRCS Hydrologic Soil Group	Open Space/Landscaping		Hardscape		Roof		Gravel		% Check	Percent Imperviousness	Runoff Coefficient, C ²			
			Area (ac)	%	Area (ac)	%	Area (ac)	%	Area (ac)	%			2-yr	5-yr	10-yr	100-yr
OS1	14.78	A	9.72	65.8%	5.06	34.2%	0.00	0.0%	0.00	0.0%	100.00%	35.6%	0.22	0.23	0.24	0.39
EX1	2.02	A	1.37	67.8%	0.05	2.5%	0.22	10.8%	0.38	18.9%	100.00%	21.1%	0.11	0.12	0.13	0.27
EX2	0.09	A	0.08	88.9%	0.01	11.1%	0.00	0.0%	0.00	0.0%	100.00%	12.9%	0.06	0.06	0.07	0.21
EX3	0.02	A	0.02	100.0%	0.00	0.0%	0.00	0.0%	0.00	0.0%	100.00%	2.0%	0.01	0.01	0.01	0.13

TIME OF CONCENTRATION

Designer: JMP
 Company: R&R Engineers-Surveyors
 Date: 8/27/2024
 Project: FOUNTAIN VALLEY SALVATION ARMY
 Location: EL PASO COUNTY

$$t_i = \frac{0.395(1.1 - C_s)\sqrt{L_i}}{S_i^{0.33}}$$

$$\text{Computed } t_c = t_i + t_t$$

$$t_{\text{minimum}} = 5 \text{ (urban)}$$

$$t_{\text{minimum}} = 10 \text{ (non-urban)}$$

$$t_t = \frac{L_t}{60K\sqrt{S_t}} = \frac{L_t}{60V_t}$$

$$\text{Selected } t_c = \max\{t_{\text{minimum}}, \min(\text{Computed } t_c, \text{Regional } t_c)\}$$

$$\text{Regional } t_c = (26 - 17i) + \frac{L_t}{60(14i + 9)\sqrt{S_t}}$$

Cells of this color are for required user-input



**ENGINEERS
SURVEYORS** INC

Subbasin Data				Overland (Initial) Flow Time			Channelized (Travel) Flow Time					Time of Concentration			Remarks
Basin	Area	% Impervious	C5	Overland Flow Length L _i (ft)	Overland Flow Slope S _i (ft/ft)	Overland Flow Time t _i (min)	Channelized Flow Length L _t (ft)	Channelized Flow Slope S _t (ft/ft)	NRCS Conveyance Factor K	Channelized Flow Velocity V _t (ft/sec)	Channelized Flow Time t _t (min)	Computed t _c (min)	Regional t _c (min)	Selected t _c (min)	
OS1	14.78	35.6%	0.23	100.00	0.044	9.63	1388.77	0.037	7	1.35	17.19	26.82	28.57	26.82	
EX1	2.02	21.1%	0.12	100.00	0.043	10.95	594.55	0.020	7	0.99	10.01	20.96	28.28	20.96	
EX2	0.09	12.9%	0.06	100.00	0.030	13.03	39.00	0.030	7	1.21	0.54	13.57	24.16	13.57	
EX3	0.02	2.0%	0.01	6.92	0.014	4.65			7		0.00	4.65		5.00	

Rainfall Data
FOUNTAIN VALLEY SALVATION ARMY
EL PASO COUNTY

Recurrence Interval (yrs)	1-hr Rainfall Depth (in)
2	1.19
5	1.50
10	1.75
25	2.00
50	2.25
100	2.52

**APPENDIX C- PROPOSED ROUTING
CALCULATIONS AND DRAINAGE MAP**

SITE DEVELOPMENT PLAN 208 CUNNINGHAM DRIVE

LOCATED IN LOT 4, BLOCK 5, 1 REFILL SECURITY, COLORADO ADDITION 4 WITHIN A PORTION OF THE NORTHEAST QUARTER OF SECTION 11, TOWNSHIP 15 SOUTH, RANGE 66 WEST OF THE SIXTH P.M., COLORADO SPRINGS, EL PASO COUNTY, STATE OF COLORADO
LOCATED AT: 208 CUNNINGHAM DR, COLORADO SPRINGS, CO 80911



Know what's below.
Call before you dig.

--- DRAINAGE BASIN BOUNDARY
--- Tc FLOW PATH

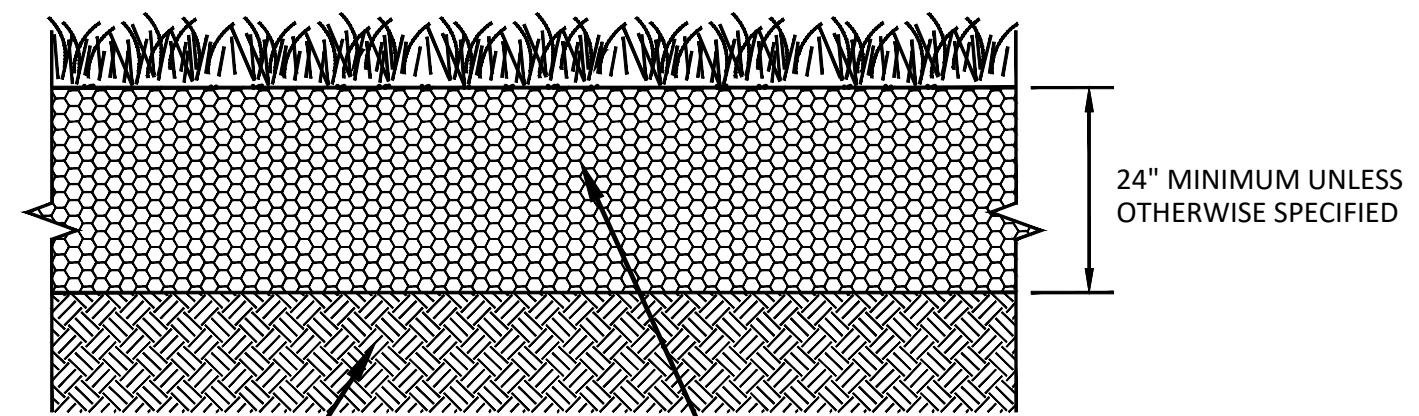

**BIORETENTION CROSS SECTION
SECTION
N.T.S.**

TABLE BR-3. BIORETENTION MEDIA PROPERTIES

SOIL PARAMETERS	TEST NAME	BIORETENTION MEDIA PROPERTIES
Texture/Gradation	ASTM D7928 Sedimentation (Hydrometer) Method	Particle Size Distribution: 70-80% Sand (0.05-2.0 mm diameter) 5-25% Silt (0.002-0.05 mm diameter) 5-15% Clay (<0.002 mm diameter) Notes: Sand, silt and clay percentages are by dry weight. Particle sizes are based on the USDA soil classification system. Distribution is measured after gravel > 2 mm is removed from sample. Media should have no more than 25% material > 2 mm. Equivalent sieve sizes for the upper and lower limit of sand are #10 and #240, respectively.
Organic Matter	ASTM D2974	1-5% by dry weight
pH	ASA/AASHTO	6.0 - 8.5
Salinity/Salts (EC) dS/m or mmhos/cm	Saturated Paste	<3
Nitrate Nitrogen (ppm)	ASA2 33-3	<30
Phosphorus (ppm)	Use Olsen when pH>6.2, otherwise use Mehlich-3	Olsen: <20 or Mehlich-3: <30

TABLE BR-4. NATIVE SEED MIX FOR BIORETENTION

COMMON NAME	SCIENTIFIC NAME	VARIETY	PURE LIVE SEED (PLS)	
			POUNDS/ACRE	OUNCES/ACRE
Sand bluestem	<i>Andropogon hallii</i>	Garden	3.5	
Sideoats grama	<i>Bouteloua curtipendula</i>	Butte	3	
Prairie sandreed	<i>Calamovilfa longifolia</i>	Goshen	3	
Indian ricegrass	<i>Oryzopsis hymenoides</i>	Paloma	3	
Switchgrass	<i>Panicum virgatum</i>	Blackwell	4	
Western wheatgrass	<i>Pascopyrum smithii</i>	Ariba	3	
Little bluestem	<i>Schizachyrium scoparium</i>	Patura	3	
Alkali sacaton	<i>Sporobolus airoides</i>		3	
Sand dropseed	<i>Sporobolus cryptandrus</i>		3	
Pasture sage ¹	<i>Artemisia frigida</i>			2
Blue aster ¹	<i>Aster laevis</i>			4
Blanket flower ¹	<i>Gaillardia aristata</i>			8
Prairie coneflower ¹	<i>Ratibida columnifera</i>			4
Purple Prairie Clover ¹	<i>Dalea (Petalostemum) purpurea</i>			4
Sub-Totals:			27.5	22
Total pounds/acre			28.9	

¹ Wildflower seed (optional) for a more diverse and natural look.

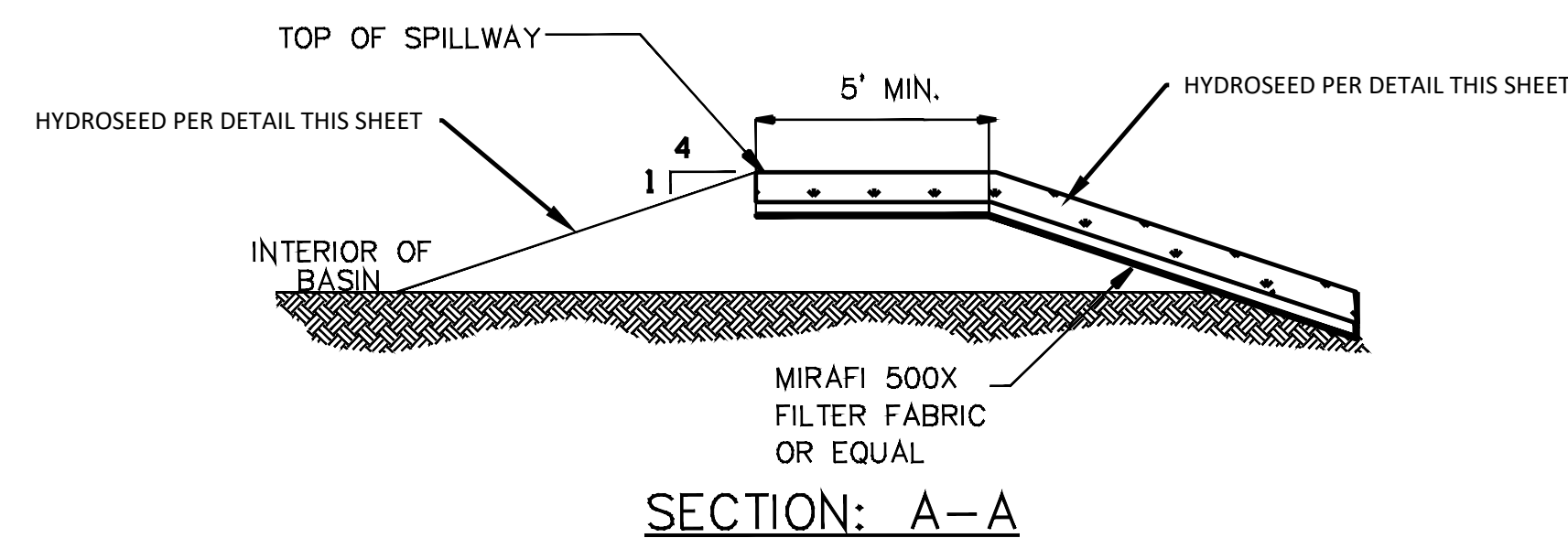

SECTION: A-A

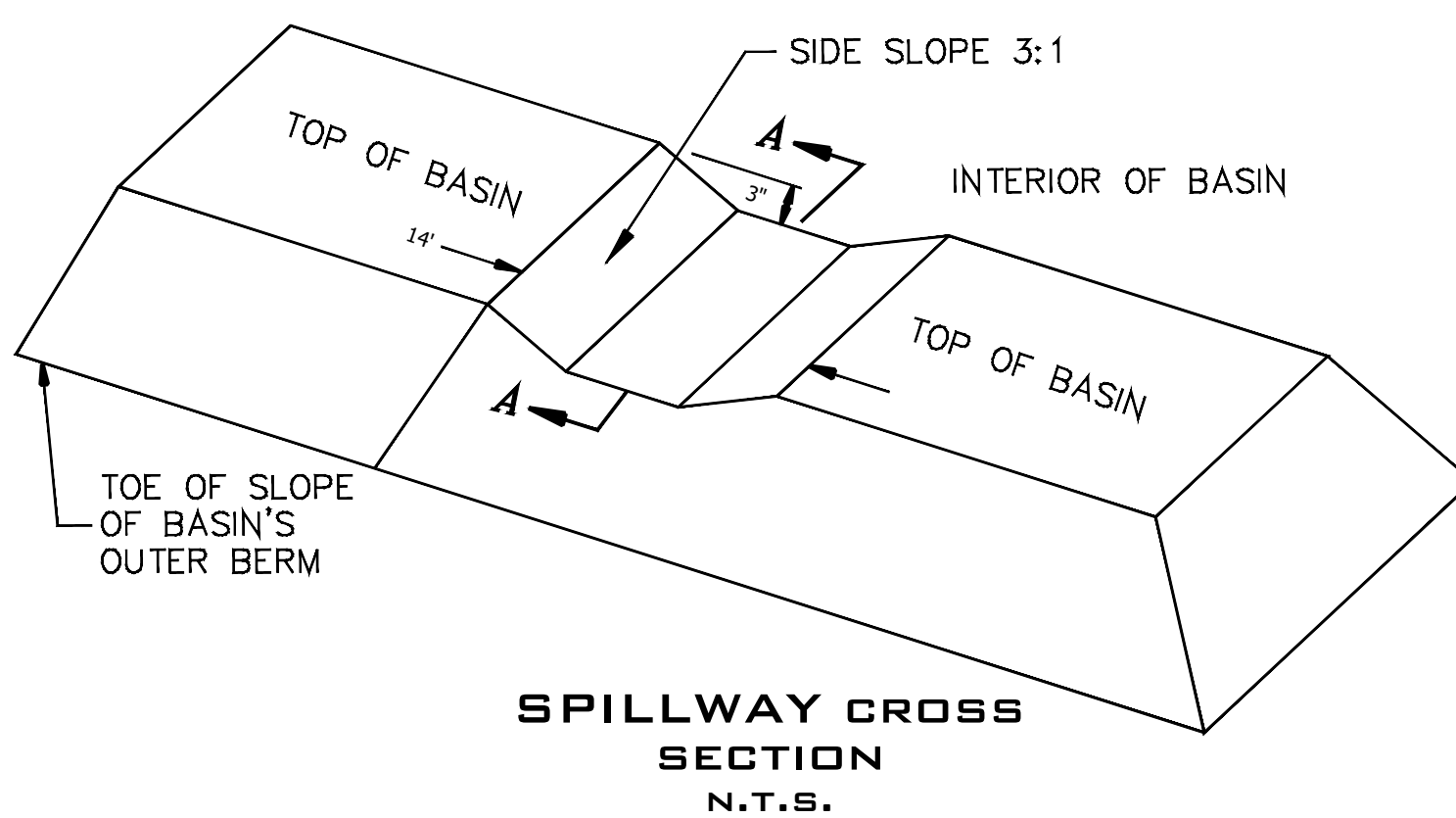

**SPILLWAY CROSS SECTION
SECTION
N.T.S.**

APN: 6511124023
OWNER: FOLSOM, DANIELLE D.
LOT 20, BLOCK 3,
BRADLEY RANCH FILING NO. 2 PHASE II
NOT A PART

APN: 6511101021
OWNER: ANDRADA, BENEDICTO V.
NOT A PART
LOT 7

APN: 6511126008
OWNER: WIDEFIELD SCHOOL DISTRICT NO. 3
NOT A PART

APN: 6511100002
OWNER: WIDEFIELD SCHOOL DISTRICT NO. 3
REC. NO. 113703
NOT A PART

APN: 6511101019
OWNER: COTTINGHAM, LENA M.
REC. NO. 2193197
NOT A PART

APN: 6511101017
OWNER: ARRAND, DAVID L.
REC. NO. 2220559
NOT A PART

APN: 6511101018
OWNER: GROFF, DAVID A.
REC. NO. 94117749
NOT A PART

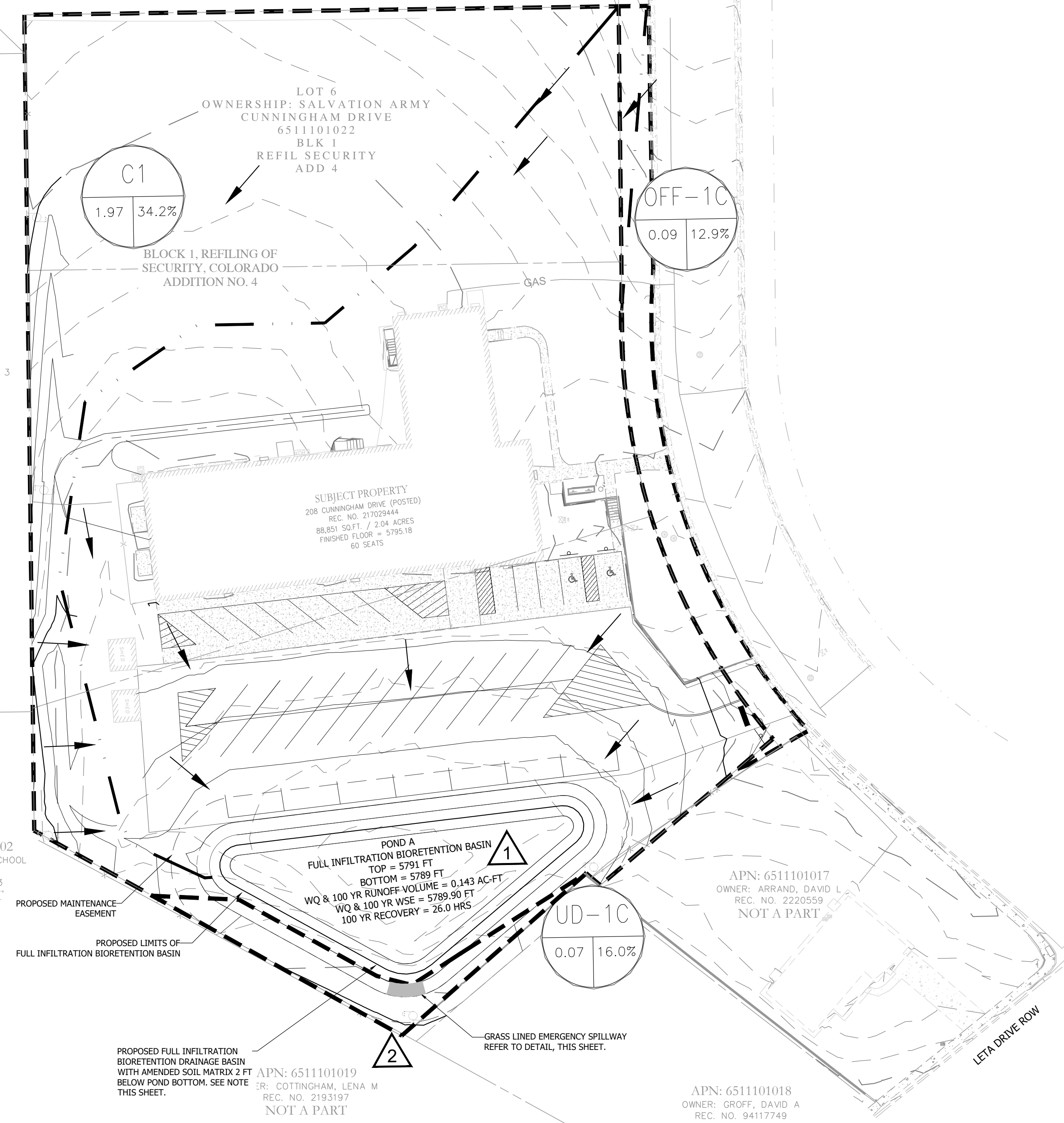

BASIN SUMMARY TABLE

Basin	Area (acres)	5-yr (cfs)	100-yr (cfs)
C1	1.97	1.32	3.80
OFF-1C	0.09	0.02	0.11
UD-1C	0.07	0.02	0.11

DESIGN POINT SUMMARY TABLE

Design Point	Contributing Basins	Area (acres)	5-yr (cfs)	100-yr (cfs)
1	C1, OFF-1C	2.06	1.33	3.90
2	UD-1C	0.07	0.02	0.11

SOIL MATRIX AMENDMENT
CONTRACTOR REQUIRED TO REMOVE 2 FT OF NATIVE SOIL FROM THE LIMITS OF THE POND AND REPLACE WITH WELL GRADED GRAVELY SANDS. CONTRACTOR REQUIRED TO PROVIDE A GRADATION OR SIEVE ANALYSIS AND PERMEABILITY RATES OF IMPORT SAND TO EOR FOR APPROVAL PRIOR TO PLACEMENT OF IMPORT SAND.

NOTE: POROUS LANDSCAPE DETENTION SHOULD NOT BE INSTALLED UNTIL FINAL STABILIZATION OF THE SITE.

NO.	REVISION	DATE
1	COUNTY COMMENTS	8/16/24
2	SIGNATURE SET	1/8/25

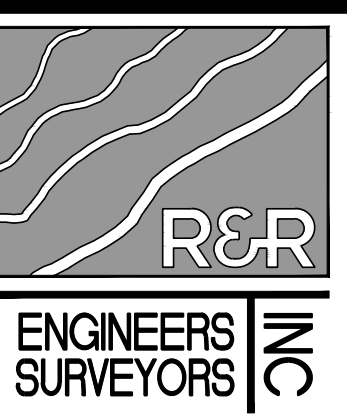

R&R ENGINEERS-SURVEYORS, INC.
1635 WEST 13TH AVENUE, SUITE 310
DENVER, COLORADO 80204
PHONE: 303-753-6730

WWW.RRENGINEERS.COM

FOUNTAIN VALLEY SALVATION ARMY
208 CUNNINGHAM DRIVE
COLORADO SPRINGS, CO 80911
PREPARED FOR: FOUNTAIN VALLEY SALVATION ARMY
208 CUNNINGHAM DR
COLORADO SPRINGS, CO 80911

SITE DEVELOPMENT PLAN

JOB NO.	FV21181
ORG. SUBM. DATE	12/22/2023
DWN.	JMP / CHD / RSD
NAME	

POST DEVELOPMENT DRAINAGE MAP

NO. **2**

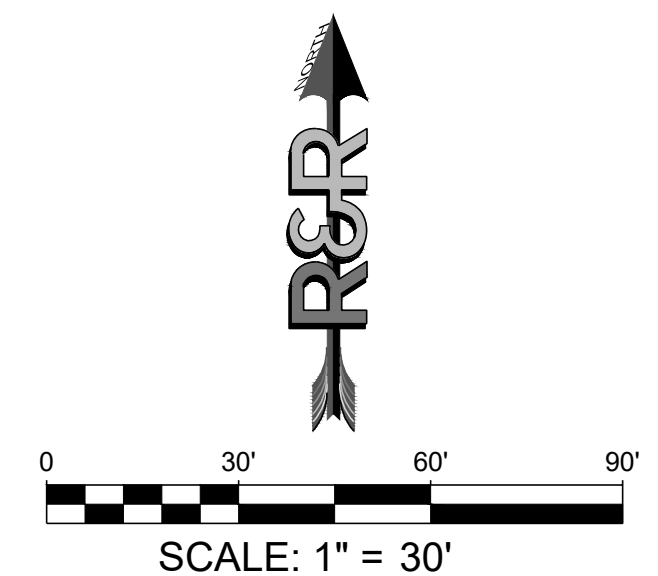

COUNTY FILE NO. CDR242

P:\21181_V21181_208_CUNNINGHAM_DR_ENGINEERS_VL_DRAINAGES_PANS_DRAINAGE_V21181 - DRN - PROP.DWG. PLOT DATE: 1/8/2025 10:54:39 AM BY: LENA PERDUE

Rainfall Data
FOUNTAIN VALLEY SALVATION ARMY
EL PASO COUNTY

Recurrence Interval (yrs)	1-hr Rainfall Depth (in)
2	1.19
5	1.50
10	1.75
25	2.00
50	2.25
100	2.52

APPENDIX D- HYDRAULIC CALCULATIONS

FV1181 – 208 CUNNINGHAM SWM/FULL INFILTRATION BIORETENTION BASIN SUMMARY

Proposed Conditions:

Basin C1 flows to the full infiltration rain garden. The insitu soils infiltration rate is not satisfactory for a full infiltration bioretention pond, therefore overexcavation and import of clean sands is required for full operation and recovery. The bioretention media must meet stringent specifications and the contractor is required to provide testing data from the supplier prior to delivery or to get the media tested after delivery and prior to placement. Specifications for the import sand matrix is identified on the grading plan for contractor's reference. In addition, the gradation Infiltration calculations are as follows:

- The attributes for the total contributing drainage basin area:
 - 1.97 acres
 - 100% Type A soils
 - 34.2% impervious
 - Watershed length is about 632', length to centroid is about 316', slope across this length is about 3.1%
- Results (per MHFD-Detention):
 - WQCV = 0.022 ac-ft
 - EURV = 0.122 ac-ft
 - **100-YR = 0.143 ac-ft = 6,229 CF**
 - **This is the maximum volume of post-development runoff that needs to recover in 72 hrs**

Infiltration Basin Design

- Design with existing soils: **(THESE CALCS DO NOT APPLY AS SOIL WILL BE IMPORTED)**

From Kumar & Associates, Inc., measured infiltration rate is 0.56 in/hr (0.047 ft/hr).
Area of infiltration basin bottom = 3,958 sf
 $3,958 \text{ sf} \times 0.047 \text{ ft/hr} = 186 \text{ cf/hr}$ release rate into existing soils
Approximate volume of proposed infiltration basin = 12,493 CF
 $12,493 \text{ cf} / 186 \text{ cf/hr} = 68 \text{ hours}$ (100 yr volume recovers within 72 hrs)

 - **Recovery is achieved within 72 hrs; no factor of safety**
- Design with 2 FT of over excavation of pond bottom and import clean sand (well graded gravely sand):

Import sand infiltration rate must be at least 1.5 in/hr (0.125 ft/hr).
Area of infiltration basin bottom = 3,958 sf
 $3,958 \text{ sf} \times 0.125 \text{ ft/hr} = 495 \text{ cf/hr}$ release rate into imported soils
Approximate volume of proposed infiltration basin = 12,493 CF
 $12,493 \text{ cf} / 495 \text{ cf/hr} = 26 \text{ hours}$ (100 yr volume recovers within 72 hrs)

 - **Recovery is achieved within 72 hrs**

NOTE: Please refer to the drainage report and the GEC plans for requirements of the contractor for soil amendment and details on the full infiltration bioretention pond.

Weir Report

Rain Garden Spillway

Trapezoidal Weir

Crest = Sharp
Bottom Length (ft) = 12.50
Total Depth (ft) = 0.25
Side Slope (z:1) = 3.00

Highlighted

Depth (ft) = 0.24
Q (cfs) = 3.900
Area (sqft) = 3.17
Velocity (ft/s) = 1.23
Top Width (ft) = 13.94

Calculations

Weir Coeff. Cw = 2.60
Compute by: Known Q
Known Q (cfs) = 3.90

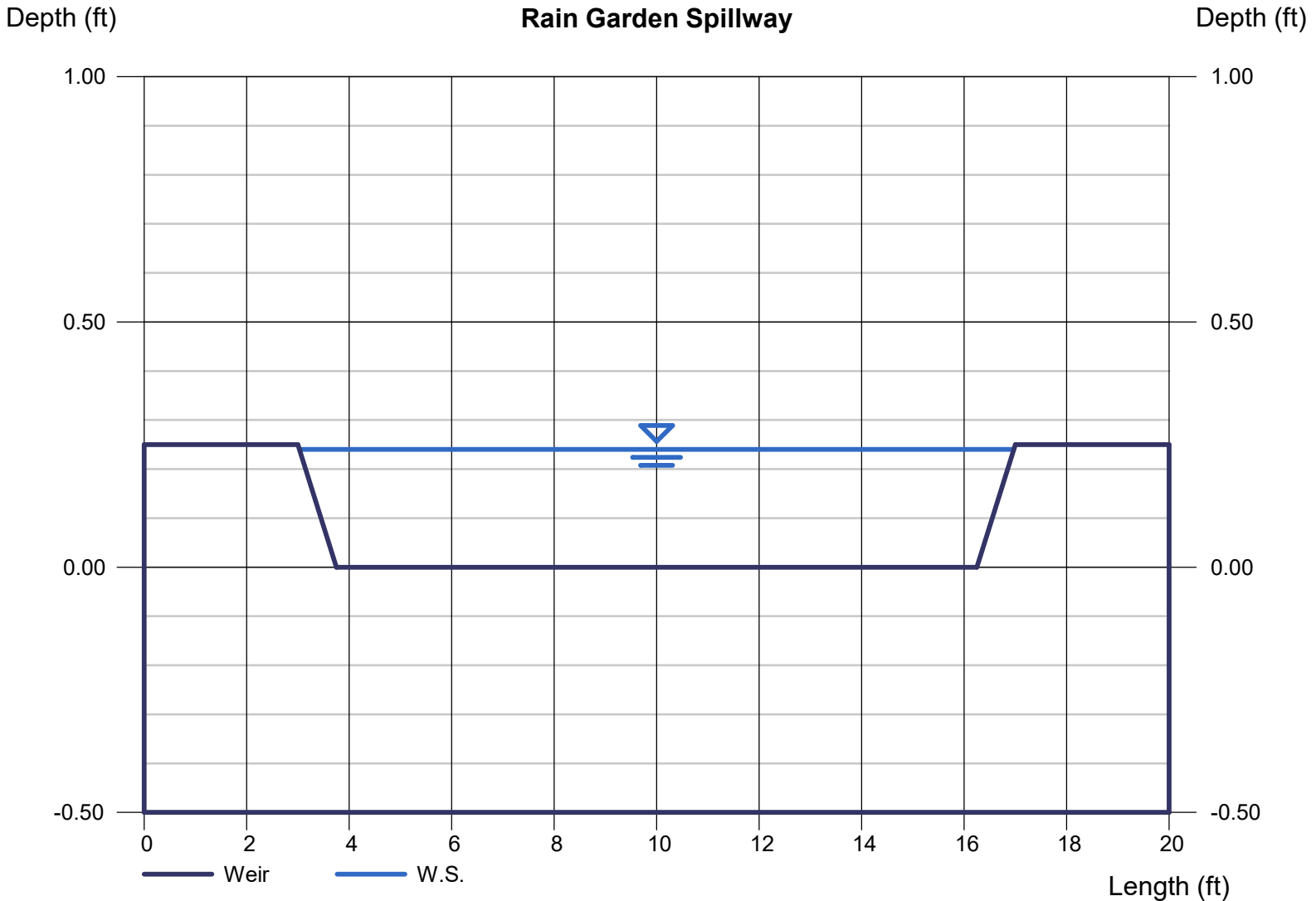

**DRAINAGE PUBLIC IMPROVEMENTS
(ENGINEER'S COST ESTIMATE)
Salvation Army**

Contributions					
I.	Cost Recovery Fees				
	Storm Sewer	LS	0.00	\$17,600.00	\$0
		LS	0.00	\$21,000.00	\$0
	Sub Total (I)				\$0
II.	Voluntary Contributions				
	Bridge Repairs	LS	0.00	\$17,600.00	\$0
	Downstream Channel Improvements	LS	0.00	\$21,000.00	\$0
	Sub Total (II)				\$0
Contributions Total					\$0
Summary					
	On-site Public Improvements				\$10,076
	Off-site Public Improvements				\$0
	Metropolitan District Improvements				\$0
	As-Built Certification (3% to 6%)		@ 3%		\$302
	Contributions				\$0
Grand Total					\$10,378

In providing opinions of probable construction cost, the client understands that the Engineer has no control over cost or price of labor, equipment or materials, or over the contractor's method of pricing, and that the opinions of probable construction costs provided herein are made on the basis of the Engineer's qualifications and experience. The Engineer makes no warranty, expressed or implied, to the accuracy of such opinions as compared to bid or actual costs.

Approved:



 RR Engineers & Surveyors, LLC
 Tim Stackhouse, PE

10/29/24

 Date

Approved:

 SEMSWA

 Date