



INNOVATIVE DESIGN. CLASSIC RESULTS.

PRELIMINARY/FINAL DRAINAGE REPORT

MIDTOWN COLLECTION AT HANNAH RIDGE
FILING No. 3
(A Replat of Tract CC, Hannah Ridge at
Feathergrass Subdivision Filing No. 1)
PUDSP-20-007

AUGUST 2020

Prepared for:
ELITE PROPERTIES OF AMERICA, INC.
2138 FLYING HORSE CLUB DRIVE
COLORADO SPRINGS, CO 80921

Prepared by:
CLASSIC CONSULTING ENGINEERS & SURVEYORS
619 CASCADE AVENUE, SUITE 200
COLORADO SPRINGS, CO 80903
(719) 785-0790

Job no. 1116.35



PRELIMINARY/FINAL DRAINAGE REPORT FOR MIDTOWN COLLECTION AT HANNAH RIDGE FILING NO. 3 (A Replat of Tract CC, Hannah Ridge at Feathergrass Subdivision Filing No. 1)

DRAINAGE REPORT STATEMENT

DESIGN ENGINEER'S STATEMENT:

The attached drainage plan and report were prepared under my direction and supervision and are correct to the best of my knowledge and belief. Said drainage report has been prepared according to the criteria established by the County for drainage reports and said report is in conformity with the applicable master plan of the drainage basin. I accept responsibility for any liability caused by any negligent acts, errors, or omissions on my part in preparing this report.

Kyle R. Campbell, Colorado P.E. #29794

Date

OWNERS/DEVELOPER'S STATEMENT:

I, the owner/developer, have read and will comply with all of the requirements specified in this drainage report and plan.

Business Name: Elite Properties of America, Inc.

Date

Title: _____

Address: 2138 Flying Horse Club Drive

Colorado Springs, CO 80921

EL PASO COUNTY:

Filed in accordance with the requirements of the Drainage Criteria Manual, Volumes 1 and 2, El Paso County Engineering Criteria Manual and Land Development Code, as amended.

Jennifer Irvine, P.E.
County Engineer / ECM Administrator

Date

Conditions:

TABLE OF CONTENTS:



PRELIMINARY/FINAL DRAINAGE REPORT FOR MIDTOWN COLLECTION AT HANNAH RIDGE FILING NO. 3 (A Replat of Tract CC, Hannah Ridge at Feathergrass Subdivision Filing No. 1)

PURPOSE	Page 4
GENERAL DESCRIPTION	Page 4
EXISTING DRAINAGE CONDITIONS	Page 5
DEVELOPED DRAINAGE CONDITIONS	Page 5
HYDROLOGIC CALCULATIONS	Page 8
FLOODPLAIN STATEMENT	Page 10
EROSION CONTROL PLAN	Page 10
DRAINAGE FACILITY COST OPINION	Page 10
DRAINAGE AND BRIDGE FEES	Page 11
SUMMARY	Page 12
REFERENCES	Page 13

APPENDICES

VICINITY MAP
SOILS MAP (S.C.S. SURVEY)
F.E.M.A. MAP
REFERENCE MATERIAL FROM ADJACENT STUDIES EXISTING CONDITIONS DRAINAGE MAP
HYDROLOGIC / HYDRAULIC CALCULATIONS
SWQ / FULL SPECTRUM DETENTION CALCULATIONS
DRAINAGE MAPS



PURPOSE

This document is the Preliminary and Final Drainage Report for Midtown Collection at Hannah Ridge Filing No. 3. The purpose of this report is to identify onsite and offsite drainage patterns, storm sewer, inlet locations, and areas tributary to the site, and to safely route developed storm water runoff to adequate detention and water quality facilities while releasing storm water at or below historic rates and in accordance with all applicable master drainage plans. This report will discuss the proposed storm system to be built with Filing 3 and discuss the construction details, and more specifically, the design details of the proposed sub-regional public detention/water quality facility located within Filing 3 that will handle the treatment for this site as well as Hannah Ridge at Feathergrass Filings No. 1 & 2. Design information for the Filing No. 3 detention/water quality facility is included in this report.

It is anticipated that an amendment to this report will be provided when the Final Plat and Construction Drawings details are processed for review.

GENERAL DESCRIPTION

The overall Hannah Ridge at Feathergrass development is a 121.2 acre residential and commercial district within the south half of Section 32, Township 13 South, Range 65 West of the 6th Principal Meridian in El Paso County, Colorado. The site is located on the west side of Akers Drive just north of Constitution Avenue. The existing abandoned Chicago Rock Island and Pacific Railroad sits directly north and west of the site, with Akers Drive bordering the east side and Constitution adjoining the south side of the site. The development includes a total of 345 single-family residences that will be developed in seven filings, as well as two small lot PUD single family developments and one commercial parcel, Tract CC. Tract CC is now proposed for a small lot PUD single family development which is prompting the PUD rezone and PUD site plan applications. Midtown Collection at Hannah Ridge Filing No. 3 (Tract CC) is 7.44 acres in size and contains 42 proposed small lot, single-family detached lots.

The average soil condition of the entire site and tributary area to the proposed ponds reflects Hydrologic Group "A" (Blakeland, loamy sand) as determined by the "Soil Survey of El Paso County Area," prepared by the National Cooperative Soil Survey (see map in Appendix).

EXISTING DRAINAGE CONDITIONS

The site is located within the Sand Creek Drainage Basin. More specifically, it is situated in the far southeast portion of the overall Hannah Ridge at Feathergrass development. This site was previously studied in the "Final Drainage Report for Hannah Ridge at Feathergrass Subdivision Filing No. 1", by MVE, Inc. dated January 2014 this proposed residential filing is located in Basin D9, D11 and G1 from the Filing No. 1 report as shown on the developed drainage map provided by MVE, Inc. (See Appendix). Existing Hannah Ridge Drive along the west edge of the development serves as the westerly basin boundary and Hunter Jumper Drive to the north as the northerly basin boundary. The construction of Hannah Ridge at Feathergrass Filing 1 and 2 improvements included the public storm under Hunter Jumper Drive and Hannah Ridge Drive out-falling into the existing drainageway that runs parallel to Constitution. The 84" RCP public storm from Hunter Jumper Drive to Hannah Ridge Drive was previously constructed. The on-site pre-development drainage patterns are generally sheet flowing towards Constitution Avenue where existing inlets intercept the flows and transfer them to an existing stormwater quality only facility located on the east side of Hannah Ridge Drive also constructed with Filing No. 1 and Filing No. 2. Filing No. 1 existing flows generally drain as street flow in a westerly direction towards the existing public drainage facilities within Hannah Ridge Drive. The prior report anticipated released of fully developed flows downstream into the dual cell box culverts under Constitution Avenue.

DEVELOPED DRAINAGE CONDITIONS

Based upon City/County Drainage Criteria, the drainage approach for this development now reflects current criteria for stormwater quality and Full Spectrum Detention requirements. The existing pond on the site will be redesigned as a Full Spectrum facility to accommodate the development of this site and all of northerly Hannah Ridge at Feathergrass Filing 1 and portions of Filing No. 2. This will include the design of concrete forebays, concrete trickle channels, concrete micro-pool and an outlet structure designed to release flows based on full spectrum criteria. The attached developed conditions drainage



map contains the design points related to proposed sump conditions. All public and private Type R inlets have been designed at these various locations to accept both the 5-yr. and 100-yr. developed flows.

All proposed storm facilities within the public Right-of-way will be public with ownership and maintenance by El Paso County. All other proposed storm facilities are either public or private (as labeled on map and described below) and are within easements or tracts. The proposed modified Pond 1 will be owned and maintained by the Hannah Ridge Midtown Collection HOA. All existing public storm facilities are located within existing easements as reflected on the drainage map.

Design Point 1 ($Q_5 = 1.9$ cfs and $Q_{100} = 4.1$ cfs) is comprised of 0.76 acres of proposed on-site developed flows from Basin A. These single-family lots and private street flows travel west to the proposed intersection at Equine Court. The flows are intercepted by a 6' cross pan and routed south into Basin B along the east side of proposed public Equine Court.

Do you mean DP 1? Flow from DP2 and DP4 do not get conveyed by the same pipe run.

Design Point 2 ($Q_5 = 4.3$ cfs and $Q_{100} = 10.5$ cfs) collect developed flows from Basin B-1 and C and the flows from Design Point 1. Basin B-1 and C flows are comprised of proposed single-family homes and public and private street flows. At this sump condition, a 10' public Type R sump inlet will be installed to completely collect both the 5-year and 100-year developed flows. These flows will have a maximum ponding depth of 6 inches and will then be conveyed via a 24" RCP public storm sewer in a northerly direction towards the Tract A Pond. The total flow within the pipe at this location is given by **Pipe Run 2** ($Q_5 = 5.0$ cfs and $Q_{100} = 12.0$ cfs) which includes flows from Design Point 4 ($Q_5 = 0.8$ cfs and $Q_{100} = 11.7$ cfs), a small 0.34-acre basin of a portion of 7 proposed lots and landscape area. The emergency overflow route at this location is in the southerly direction directly into the southerly drainage tract that will route the flows south towards Constitution Avenue.

Design Point 3 ($Q_5 = 3.1$ cfs and $Q_{100} = 6.2$ cfs) is developed flows from Basin D, proposed single family homes and public and private street flows. At this sump condition, a 10' private Type R private sump inlet, will be installed to completely collect both the 5-year and 100-year developed flows. These flows will have a maximum ponding depth of 6 inches and then be conveyed via an 18" PVC or ADS private

storm sewer towards the Tract A Pond. The total flow within the pipe at this location is given by **Pipe Run 3 ($Q_5 = 3.1$ cfs and $Q_{100} = 6.2$ cfs)**. The emergency overflow route at this location is south directly into the proposed expanded Pond. **Pipe Run 4 ($Q_5 = 33.4$ cfs and $Q_{100} = 69.5$ cfs)** represents the combined pipe flows from Design Points 3 and all northerly off-site developed flows. A 48" RCP public storm sewer will route these combined developed flows directly into the Pond.

Basin B-2 does not have a DP on the drainage map. Revise text/map as needed.

Design Point 4 ($Q_5 = 0.8$ cfs and $Q_{100} = 1.7$ cfs) collects developed flows from Basin B-2. At this sump condition, a private CDOT Type C sump grated inlet will be installed to completely collect both the 5-year and 100-year developed flows. These flows being collected have a maximum ponding depth of 6 inches and then be conveyed via a private 12" PVC or ADS storm sewer towards Design Point 2. The total flow within the pipe at this location is given by **Pipe Run 1 ($Q_5 = 0.8$ cfs and $Q_{100} = 1.7$ cfs)**. The emergency overflow route at this location is via Tract A directly into the proposed pond.

Add a discussion of this channel to the narrative: capacity, size, material, direction of flow, discharge point, etc.

Runoff from Basin F (1.23 Acres) and Basin G (1.87 Acres) flow directly into the proposed expanded pond or into the southerly drainage channel.

What about Basin E? Discussion not seen in this section of report text.

Basin H ($Q_5 = 0.2$ cfs and $Q_{100} = 1.4$ cfs) is a small 0.42-acre landscape parcel at the southeast corner of the site that street flows directly into Akers Drive and Constitution Avenue similar to existing conditions.

Explain how WQ is being addressed for this basin or applicable exclusions. Possible exclusions include I.7.1.B.7 (land disturbance to undeveloped land that will remain undeveloped) and/or I.7.1.C.1 (which allows for 20% not to exceed 1 acre of the applicable development site area to not be captured).

The total inflow into the expanded Pond is $Q_5 = 33.4$ cfs and $Q_{100} = 69.5$ cfs from both outfalls into the pond. The existing facility will be expanded with the proposed Filing 3 development. This facility will have two inflow points. Both inflow points will outfall into proposed concrete forebays. The west inflow will be from a proposed 48" RCP into a proposed concrete forebay with a required size of .010 ac-ft based on 3% of the WQCV from this inflow. The forebay is designed with 12" high walls, 7.4" notch and a 30" wide concrete trickle channel routing the flows towards the pond outlet. The east inflow will be from a proposed 24" RCP into a proposed concrete forebay with a required size of .010 ac-ft based on 3% of the WQCV from this inflow. The forebay is designed with 12" high walls, 3.3" notch and a 30" wide concrete trickle channel routing the flows toward the pond outlet. The outlet structure consists of a 6'x5' concrete box with an integral 100 Square Foot micro-pool allowing for 6"

initial surcharge depth. The micro-pool total depth of 3.0' provides the required 0.3% of the WQCV. The outlet box will have a height of 4.50' above the micro-pool water elevation. (see UD-BMP Spreadsheets in the Appendix). The orifice plate on the front of the outlet box consists of a series of 3 – 1 5/8" holes, 18" apart (see UD Detention Spreadsheets in Appendix) this facility will be owned and maintained by the Hannah Ridge Midtown Collection HOA.

Pond 1 has the following design parameters as a Full Spectrum Facility:

0.346 Ac.-ft. WQCV required

0.666 Ac.-ft. EURV required

1.861 Ac.-ft. 100-year storage required

Pond Design Release: $Q_5 = 0.363$ cfs, $Q_{100} = 33.2$ cfs

Pre-development Release: $Q_5 = 0.70$ cfs, $Q_{100} = 31.90$ cfs

An existing 24" HDPE storm pipe currently conveys the released flow and will continue to do so (Pipe Run Outfall). A 5' long by 3' wide rip-rap (Type VL) dissipator will be provided at the existing pipe outlet.

Hydrologic Soil Group B was used for FSD Calculations as use of Group A does not reflect the regrading and landscaping of the existing pond which is better reflected with the use of Group B Soil.

HYDROLOGIC CALCULATIONS

Hydrologic calculations were performed using the City of Colorado Springs/El Paso County Drainage Criteria Manual, as revised in November 1991 and 1994 with County adopted Chapter 6 and Section 3.2.1 of Chapter 13 of the City of Colorado Springs/El Paso County Drainage Criteria Manual as revised in May 2014. Individual on-site developed basin design used for inlet sizing and storm system routing was calculated using the Rational Method. Full-Spectrum detention pond modeling developed using UD-Detention spreadsheet ver. 3.07, Urban Drainage and Flood Control District.

The City of Colorado Springs/El Paso County DCM requires the Four Step Process for receiving water protection that focuses on reducing runoff volumes, treating the water quality capture volume (WQCV), stabilizing drainage ways, and implementing long-term source controls. The Four Step Process pertains to management of smaller, frequently occurring storm events, as opposed to larger storms for which drainage and flood control infrastructure are sized. Implementation of these four steps helps to achieve storm water permit requirements.

This site adheres to this **Four Step Process** as follows:

1. **Employ Runoff Reduction Practices:** Proposed impervious areas (roof tops, patios) will sheet flow across landscaped yards and through open space areas to slow runoff and increase time of concentration prior to being conveyed to the proposed public streets. This will minimize directly connected impervious areas within the project site.
2. **Stabilize Drainageways:** After developed flows utilize the runoff reduction practices through the yards, these flows will travel via curb and gutter within the public streets and eventually public storm systems. These collected flows are then routed directly to the full-spectrum detention facility on-site and ultimately released into a proposed stabilized drainage channel.
3. **Provide Water Quality Capture Volume (WQCV):** Runoff from this development will be treated through capture and slow release of the WQCV in the proposed full-spectrum permanent Extended Detention Basin (Pond 1) designed per current El Paso County drainage criteria.
4. **Consider need for Industrial and Commercial BMPs:** No industrial or commercial uses are proposed within this development. However, a site-specific storm water quality and erosion control plan and narrative has been submitted along with the grading and erosion control plan. Details such as site-specific source control construction BMP's as well as permanent BMP's were detailed in this plan and narrative to protect receiving waters. BMP's will be constructed and maintained as the development has been graded and erosion control methods employed.

FLOODPLAIN STATEMENT

No portion of this site is located within a FEMA floodplain as determined by the Flood Insurance Rate Maps (F.I.R.M.) Map Number 08041C0752G and 756G, with effective dates of December 7, 2018 (See Appendix).

EROSION CONTROL PLAN

The Drainage Criteria Manual specifies an Erosion Control Plan and associated cost estimate be submitted with the Final Drainage Report. We respectfully request that the Erosion Control Plan and cost estimate be submitted in conjunction with the Overlot Grading Plan and construction assurances posted prior to obtaining a grading permit. Early grading is not being requested with these applications.

Midtown Collection at Hannah Ridge Filing No. 3 Drainage Improvement Costs (Non-Reimbursable)

ITEM	DESCRIPTION	QUANTITY	UNIT COST	COST
1.	5' Type R Inlet	1 EACH	\$3,791/EA	\$ 3,791.00
2.	10' Type R Inlet	2 EACH	\$5,950/EA	\$ 11,900.00
3.	18" RCP Storm Drain	105 LF	\$69/LF	\$ 7,245.00
4.	24" RCP Storm Drain	380 LF	\$84/LF	\$ 31,920.00
5.	48" RCP Storm Drain	75 LF	\$122/LF	\$ 9,150.00
6.	Type I MH	1 EACH	\$8,592/EA	\$ 8,592.00
7.	Type II MH	4EACH	\$4,575/EA	\$ 18,300.00
8.	Pond 1 FSD	1 EACH	\$83,000/EA	\$ 83,000.00
SUB-TOTAL				\$ 173,898.00
10% ENGINEERING				\$ 17,389.80
5% CONTINGENCIES				\$ 8,694.90
GRAND-TOTAL				<u>\$ 199,982.70</u>

Classic Consulting Engineers & Surveyors cannot and does not guarantee that the construction cost will not vary from these opinions of probable construction costs. These opinions represent our best judgment as design professionals familiar with the construction industry and this development in particular.



DRAINAGE & BRIDGE FEES

This site lies within the Sand Creek Drainage Basin. The fees are calculated using the following impervious acreage method approved by El Paso County. Filing No. 3 is a re-plat of previously platted Tract CC within Filing 1. However, Tract CC was designated as future development and no fees were paid at time of original platting. Thus, the percent imperviousness for each Filing is calculated below based on the following acreage:

Filing 3: 7.44 ac.

The total development area is broken into different residential uses:

PUD zone (1/8 acre or less SF lots – 65% Impervious)

PUD zone Open space/drainage tracts (Greenbelts – 2% Impervious).

The following calculations are based on the 2020 drainage/bridge fees for the Sand Creek Basin:

FILING 3:

2158 SF avg. lots (1/8 acre or less)

(Per El Paso County Percent Impervious Chart for 1/8 acre or less SF lots: 65%)

7.44 Ac. x 65% = **4.84 Impervious Ac.**

Open Space Tracts

(Per El Paso County Percent Impervious Chart for greenbelts: 2%)

2.60 Ac. x 2% = **0.05 Impervious Ac.**

Total Impervious Acreage: 4.89 Imp. Ac.

FILING 3 FEE TOTALS:

Bridge Fees

\$ 8,057.00 x 4.89 Impervious Ac. = \$ 39,398.73

Drainage Fees

\$ 19,698.00 x 4.89 Impervious Ac. = \$ 96,323.22

These Drainage Fees will be paid by developer in the form of cash and/or credits.



SUMMARY

This proposed development remains consistent with the previously approved MDDP and Final Drainage Report for Hannah Ridge at Feathergrass Filing No. 1. The existing storm facilities continue to adequately handle both the 5-yr. and 100-yr. developed flows. The proposed detention facility meets current criteria and provides full spectrum design. The proposed development will not adversely impact surrounding developments.

A future Final Plat application will include Construction Drawings and amendment to this report to provide further Final Design details associated with the more detailed design.

PREPARED BY:
Classic Consulting

Kyle R. Campbell, P.E.
Division Manager

db/111635/REPORTS/PDRdoc



REFERENCES

1. City of Colorado Springs/County of El Paso Drainage Criteria Manual dated October 1991.*
2. "Sand Creek Drainage Basin Planning Study," Kiowa Engineering Corp, dated March 1996.
3. "Master Development Drainage Plan for Hannah Ridge", prepared by MVE, Inc. November 2007
4. "Final Drainage Report for Hannah Ridge at Feathergrass Subdivision Filing No. 1", by MVE, Inc. January 2014.
5. Drainage Criteria Manual (Volume 3) latest revision April 2008, Urban Drainage and Flood Criteria District.
6. "Final Drainage Report for Hannah Ridge at Feathergrass Filing No. 3", by MVE, Inc. October 2017.
7. "Final Drainage Report for Hannah Ridge at Feathergrass Filing No. 4", by MVE, Inc. October 2017.
8. El Paso County Engineering Criteria Manual, Resolution No. 20-222, June 23, 2020 (Supp. No.2).

*EPC Board Resolution NO. 15-042 (El Paso County adoption of Chapter 6 and Section 3.2.1 Chapter 13 of the City of Colorado Springs Drainage Criteria manual dated May 2014, hydrology and full-spectrum detention)

APPENDIX



VICINITY MAP



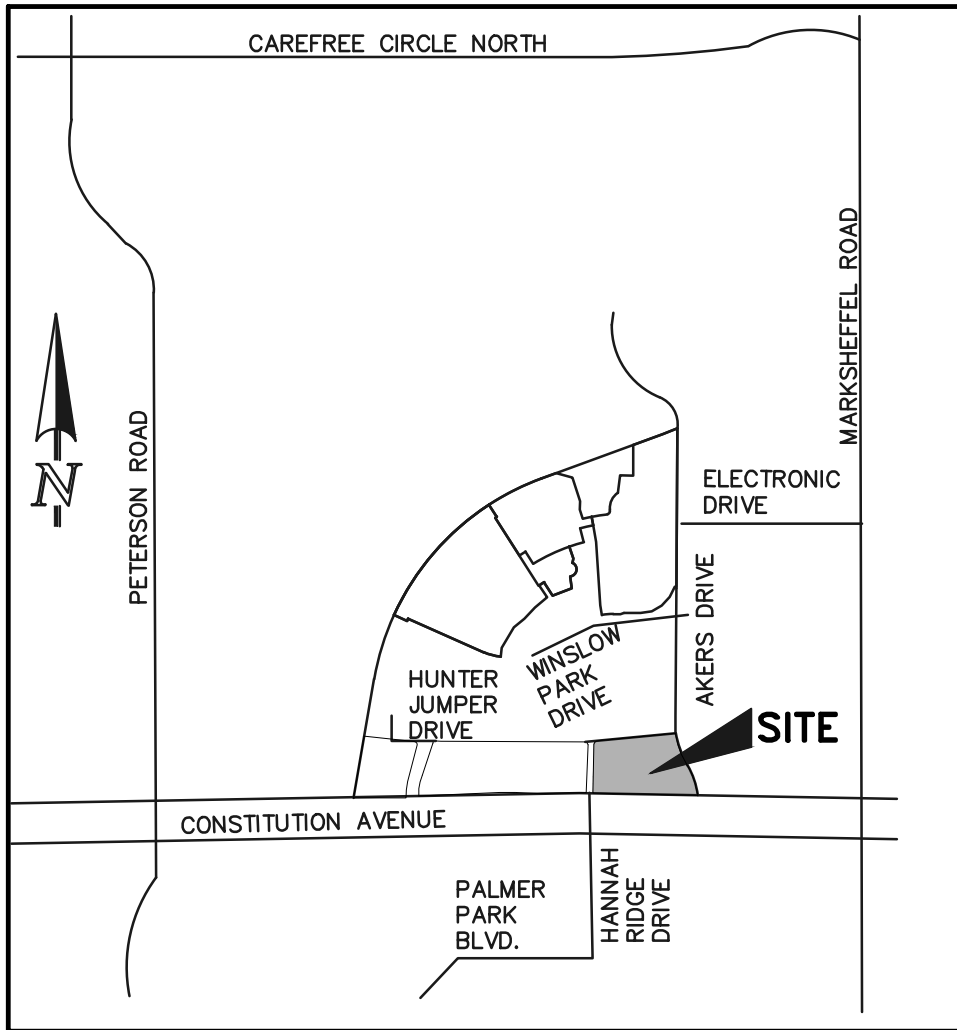

VICINITY MAP

N.T.S.

SOILS MAP (S.C.S SURVEY)





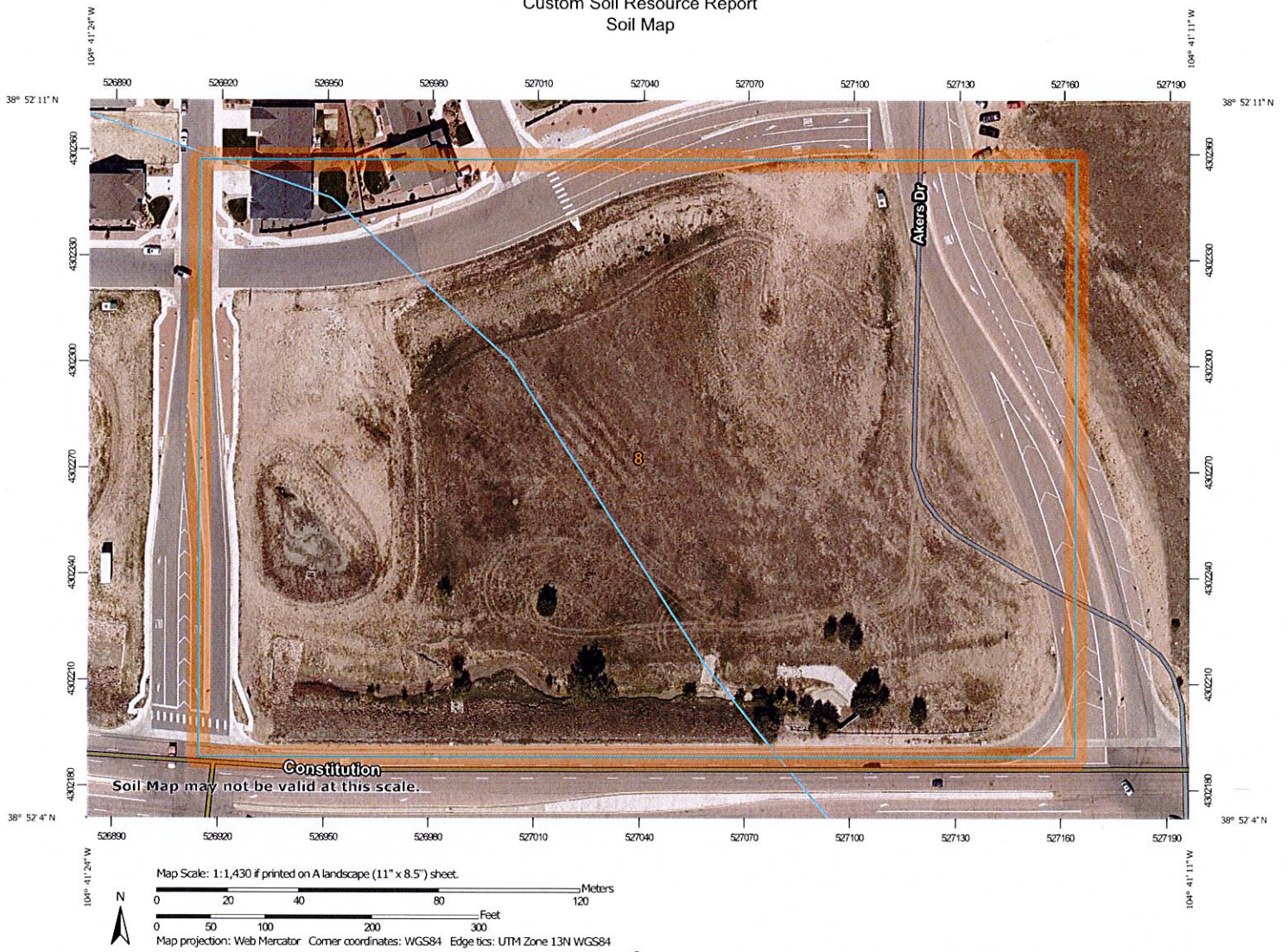

































Custom Soil Resource Report
Soil Map



Custom Soil Resource Report

MAP LEGEND

Area of Interest (AOI)		 Spoil Area
	Area of Interest (AOI)	 Stony Spot
Soils		 Very Stony Spot
	Soil Map Unit Polygons	 Wet Spot
	Soil Map Unit Lines	 Other
	Soil Map Unit Points	 Special Line Features
Special Point Features		Water Features
	Blowout	 Streams and Canals
	Borrow Pit	Transportation
	Clay Spot	 Rails
	Closed Depression	 Interstate Highways
	Gravel Pit	 US Routes
	Gravelly Spot	 Major Roads
	Landfill	 Local Roads
	Lava Flow	Background
	Marsh or swamp	 Aerial Photography
	Mine or Quarry	
	Miscellaneous Water	
	Perennial Water	
	Rock Outcrop	
	Saline Spot	
	Sandy Spot	
	Severely Eroded Spot	
	Sinkhole	
	Slide or Slip	
	Sodic Spot	

MAP INFORMATION

The soil surveys that comprise your AOI were mapped at 1:24,000.

Warning: Soil Map may not be valid at this scale.

Enlargement of maps beyond the scale of mapping can cause misunderstanding of the detail of mapping and accuracy of soil line placement. The maps do not show the small areas of contrasting soils that could have been shown at a more detailed scale.

Please rely on the bar scale on each map sheet for map measurements.

Source of Map: Natural Resources Conservation Service
 Web Soil Survey URL:
 Coordinate System: Web Mercator (EPSG:3857)

Maps from the Web Soil Survey are based on the Web Mercator projection, which preserves direction and shape but distorts distance and area. A projection that preserves area, such as the Albers equal-area conic projection, should be used if more accurate calculations of distance or area are required.

This product is generated from the USDA-NRCS certified data as of the version date(s) listed below.

Soil Survey Area: El Paso County Area, Colorado
 Survey Area Data: Version 18, Jun 5, 2020

Soil map units are labeled (as space allows) for map scales 1:50,000 or larger.

Date(s) aerial images were photographed: Aug 19, 2018—Sep 23, 2018

The orthophoto or other base map on which the soil lines were compiled and digitized probably differs from the background imagery displayed on these maps. As a result, some minor shifting of map unit boundaries may be evident.

Map Unit Legend

Map Unit Symbol	Map Unit Name	Acres in AOI	Percent of AOI
8	Blakeland loamy sand, 1 to 9 percent slopes	10.5	100.0%
Totals for Area of Interest		10.5	100.0%

Map Unit Descriptions

The map units delineated on the detailed soil maps in a soil survey represent the soils or miscellaneous areas in the survey area. The map unit descriptions, along with the maps, can be used to determine the composition and properties of a unit.

A map unit delineation on a soil map represents an area dominated by one or more major kinds of soil or miscellaneous areas. A map unit is identified and named according to the taxonomic classification of the dominant soils. Within a taxonomic class there are precisely defined limits for the properties of the soils. On the landscape, however, the soils are natural phenomena, and they have the characteristic variability of all natural phenomena. Thus, the range of some observed properties may extend beyond the limits defined for a taxonomic class. Areas of soils of a single taxonomic class rarely, if ever, can be mapped without including areas of other taxonomic classes. Consequently, every map unit is made up of the soils or miscellaneous areas for which it is named and some minor components that belong to taxonomic classes other than those of the major soils.

Most minor soils have properties similar to those of the dominant soil or soils in the map unit, and thus they do not affect use and management. These are called noncontrasting, or similar, components. They may or may not be mentioned in a particular map unit description. Other minor components, however, have properties and behavioral characteristics divergent enough to affect use or to require different management. These are called contrasting, or dissimilar, components. They generally are in small areas and could not be mapped separately because of the scale used. Some small areas of strongly contrasting soils or miscellaneous areas are identified by a special symbol on the maps. If included in the database for a given area, the contrasting minor components are identified in the map unit descriptions along with some characteristics of each. A few areas of minor components may not have been observed, and consequently they are not mentioned in the descriptions, especially where the pattern was so complex that it was impractical to make enough observations to identify all the soils and miscellaneous areas on the landscape.

The presence of minor components in a map unit in no way diminishes the usefulness or accuracy of the data. The objective of mapping is not to delineate pure taxonomic classes but rather to separate the landscape into landforms or landform segments that have similar use and management requirements. The delineation of such segments on the map provides sufficient information for the development of resource plans. If intensive use of small areas is planned, however, onsite investigation is needed to define and locate the soils and miscellaneous areas.

Custom Soil Resource Report

An identifying symbol precedes the map unit name in the map unit descriptions. Each description includes general facts about the unit and gives important soil properties and qualities.

Soils that have profiles that are almost alike make up a *soil series*. Except for differences in texture of the surface layer, all the soils of a series have major horizons that are similar in composition, thickness, and arrangement.

Soils of one series can differ in texture of the surface layer, slope, stoniness, salinity, degree of erosion, and other characteristics that affect their use. On the basis of such differences, a soil series is divided into *soil phases*. Most of the areas shown on the detailed soil maps are phases of soil series. The name of a soil phase commonly indicates a feature that affects use or management. For example, Alpha silt loam, 0 to 2 percent slopes, is a phase of the Alpha series.

Some map units are made up of two or more major soils or miscellaneous areas. These map units are complexes, associations, or undifferentiated groups.

A *complex* consists of two or more soils or miscellaneous areas in such an intricate pattern or in such small areas that they cannot be shown separately on the maps. The pattern and proportion of the soils or miscellaneous areas are somewhat similar in all areas. Alpha-Beta complex, 0 to 6 percent slopes, is an example.

An *association* is made up of two or more geographically associated soils or miscellaneous areas that are shown as one unit on the maps. Because of present or anticipated uses of the map units in the survey area, it was not considered practical or necessary to map the soils or miscellaneous areas separately. The pattern and relative proportion of the soils or miscellaneous areas are somewhat similar. Alpha-Beta association, 0 to 2 percent slopes, is an example.

An *undifferentiated group* is made up of two or more soils or miscellaneous areas that could be mapped individually but are mapped as one unit because similar interpretations can be made for use and management. The pattern and proportion of the soils or miscellaneous areas in a mapped area are not uniform. An area can be made up of only one of the major soils or miscellaneous areas, or it can be made up of all of them. Alpha and Beta soils, 0 to 2 percent slopes, is an example.

Some surveys include *miscellaneous areas*. Such areas have little or no soil material and support little or no vegetation. Rock outcrop is an example.

El Paso County Area, Colorado

8—Blakeland loamy sand, 1 to 9 percent slopes

Map Unit Setting

National map unit symbol: 369v
Elevation: 4,600 to 5,800 feet
Mean annual precipitation: 14 to 16 inches
Mean annual air temperature: 46 to 48 degrees F
Frost-free period: 125 to 145 days
Farmland classification: Not prime farmland

Map Unit Composition

Blakeland and similar soils: 98 percent
Minor components: 2 percent
Estimates are based on observations, descriptions, and transects of the mapunit.

Description of Blakeland

Setting

Landform: Hills, flats
Landform position (three-dimensional): Side slope, talf
Down-slope shape: Linear
Across-slope shape: Linear
Parent material: Alluvium derived from sedimentary rock and/or eolian deposits
derived from sedimentary rock

Typical profile

A - 0 to 11 inches: loamy sand
AC - 11 to 27 inches: loamy sand
C - 27 to 60 inches: sand

Properties and qualities

Slope: 1 to 9 percent
Depth to restrictive feature: More than 80 inches
Natural drainage class: Somewhat excessively drained
Runoff class: Low
Capacity of the most limiting layer to transmit water (Ksat): High to very high (5.95 to 19.98 in/hr)
Depth to water table: More than 80 inches
Frequency of flooding: None
Frequency of ponding: None
Calcium carbonate, maximum in profile: 5 percent
Available water storage in profile: Low (about 4.5 inches)

Interpretive groups

Land capability classification (irrigated): 3e
Land capability classification (nonirrigated): 6e
Hydrologic Soil Group: A
Ecological site: Sandy Foothill (R049XB210CO)
Hydric soil rating: No

Minor Components

Pleasant

Percent of map unit: 1 percent

Custom Soil Resource Report

Landform: Depressions
Hydric soil rating: Yes

Other soils

Percent of map unit: 1 percent
Hydric soil rating: No

F.E.M.A. MAP

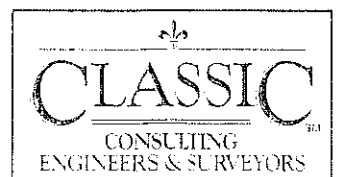

National Flood Hazard Layer FIRMette

104°41'36"W 38°52'22"N



USGS The National Map: Orthoimagery. Data refreshed April 2020. 104°40'59"W 38°51'54"N

Legend

SEE FIS REPORT FOR DETAILED LEGEND AND INDEX MAP FOR FIRM PANEL LAYOUT

SPECIAL FLOOD HAZARD AREAS

- Without Base Flood Elevation (BFE) Zone A, V, A99
- With BFE or Depth Zone AE, AO, AH, VE, AR
- Regulatory Floodway

OTHER AREAS OF FLOOD HAZARD

- 0.2% Annual Chance Flood Hazard, Area of 1% annual chance flood with average depth less than one foot or with drainage areas of less than one square mile (Zone X)
- Future Conditions 1% Annual Chance Flood Hazard (Zone X)
- Area with Reduced Flood Risk due to Levee. See Notes, Zone X
- Area with Flood Risk due to Levee (Zone D)

OTHER AREAS

- NO SCREEN
- Area of Minimal Flood Hazard (Zone X)
- Effective LOMRs
- Area of Undetermined Flood Hazard (Zone X)

GENERAL STRUCTURES

- Channel, Culvert, or Storm Sewer
- Levee, Dike, or Floodwall

OTHER FEATURES

- Cross Sections with 1% Annual Chance Water Surface Elevation
- Coastal Transect
- Base Flood Elevation Line (BFE)
- Limit of Study
- Jurisdiction Boundary
- Coastal Transect Baseline
- Profile Baseline
- Hydrographic Feature

MAP PANELS

- Digital Data Available
- No Digital Data Available
- Unmapped

The pin displayed on the map is an approximate point selected by the user and does not represent an authoritative property location.

This map complies with FEMA's standards for the use of digital flood maps if it is not void as described below. The basemap shown complies with FEMA's basemap accuracy standards

The flood hazard information is derived directly from the authoritative NFHL web services provided by FEMA. This map was exported on 7/3/2020 at 6:39 PM and does not reflect changes or amendments subsequent to this date and time. The NFHL and effective information may change or become superseded by new data over time.

This map image is void if the one or more of the following map elements do not appear: basemap imagery, flood zone labels, legend, scale bar, map creation date, community identifiers, FIRM panel number, and FIRM effective date. Map images for unmapped and unmodernized areas cannot be used for regulatory purposes.

REFERENCE MATERIAL FROM ADJACENT STUDIES
EXISTING CONDITIONS DRAINAGE MAP

LEGEND

- EXISTING INDEX CONTOUR
- EXISTING STORM DRAIN CURB INLET
- EXISTING STORM DRAIN LINE
- EXISTING PROPERTY LINE
- EXISTING ROAD
- DRAINAGE BASIN BOUNDARY
- DRAINAGE BASIN DESIGNATION
- DRAINAGE BASIN AREA
- FLOW DIRECTION AND QUANTITIES
- FLOW DIRECTION
- DESIGN POINT

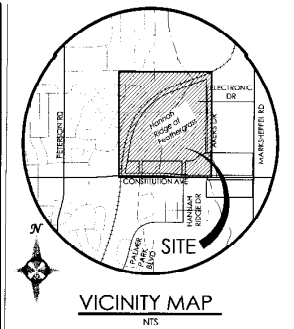
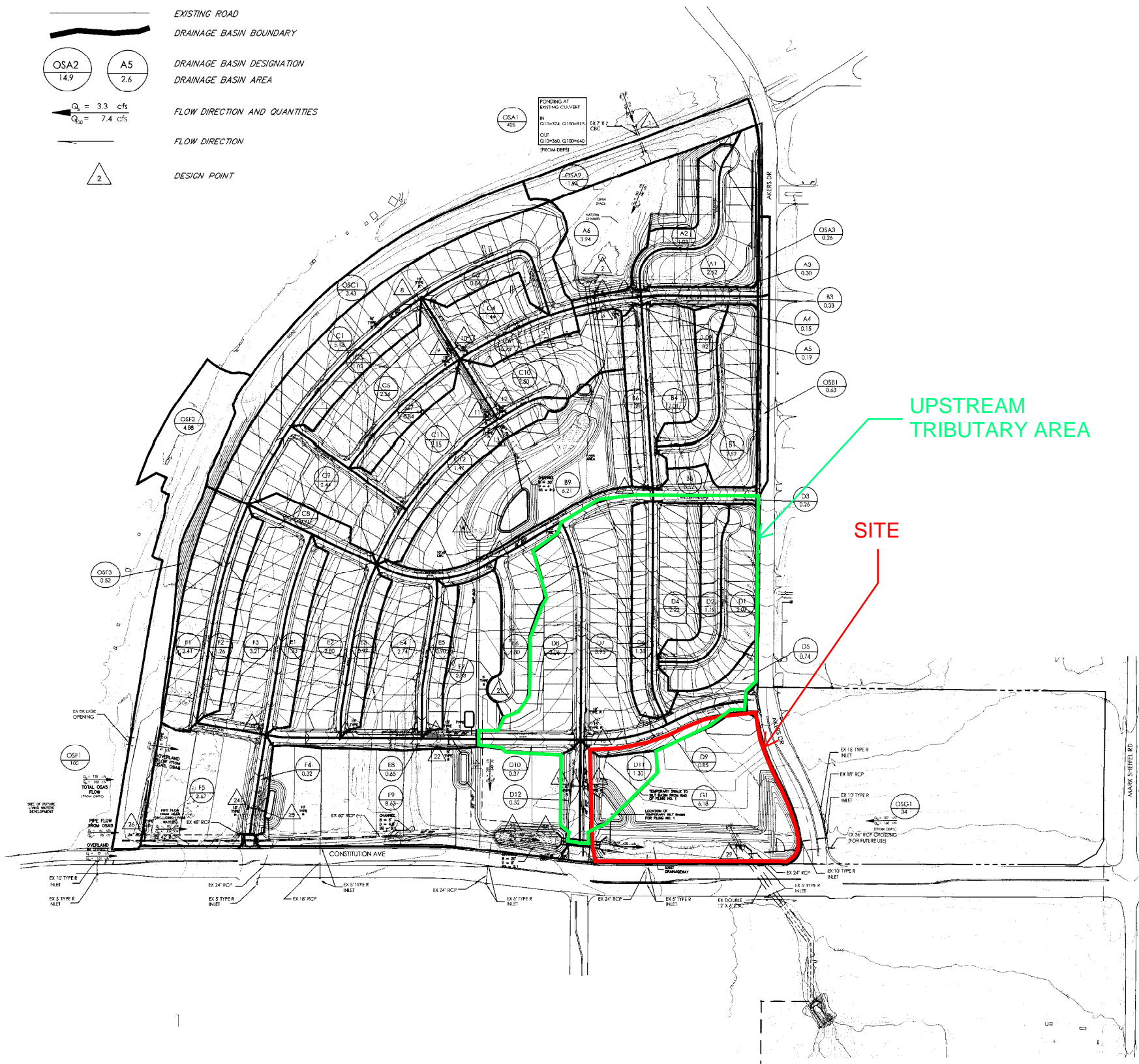

BENCHMARK
 THE BENCHMARK FOR THESE PLANS IS THE TOP OF #4 REBAR, PANEL POINT NO. 1, LOCATED ON THE SOUTH EDGE OF CONSTITUTION AVE AND THE WEST EDGE OF THE ROCK ISLAND TRAIL, 335 FEET WEST OF THE CENTERLINE OF SHAWNEE DR. ELEVATION = 6486.63. (EPIC DATUM ELEVATION = 6485.29).

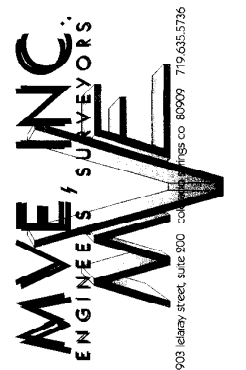
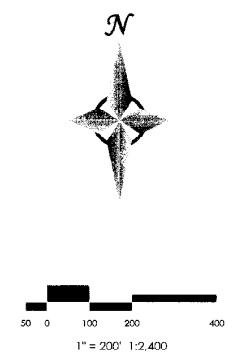

DEVELOPED SUMMARY RUNOFF TARIFF					
BASIN or DESIGN POINT	CONTRIBUTING BASINS	CONTRIBUTING AREA (AC)	5-YR (Q5) RUNOFF (CFS)*	100 YR (Q100) RUNOFF (CFS)	DESCRIPTION
OSA1 (IN)		425	374 *	915 (IN)	
1 [OUT]	OSA1	425	360 *	640 [OUT]	EX 7x7 CBC
2	OSA1, OSA2, A6	430.8	360 *	640 *	12'Wx6'H CBC
3	A1,A2,OSA3,A3	4.2	9.4	18.8	CROSS PAN
4	A1,A2,OSA3,A3,A4	4.4	9.7	19.2	10' TYPE R INLET (SUMP)
5	A5	0.2	0.7	1.3	5' TYPE R INLET (SUMP)
6	OSB1,B1,B2,B3,B4,B5,B6	8.2	19.5	38.5	CROSS PAN
7	OSB1,B1,B2,B3,B4,B5,B6,B7	8.9	20.4	40.1	15' TYPE R (SUMP), 15' TYPE R INLETS
8	OSC1,C1	8.6	15.0	31.1	10' TYPE R (SUMP), 10' TYPE R INLETS
9	C3,C5	3.6	8.9	17.8	15' TYPE R INLET (SUMP)
10	C2,C4	2.3	5.5	10.9	10' TYPE R INLET (SUMP)
11	C7,C8,C9,C11	6.1	13.4	26.6	15' TYPE R INLET (SUMP)
12	C6,C10	3.2	6.6	14.1	10' TYPE R INLET (SUMP)
13	C12	1.5	3.7	7.4	5' TYPE R INLET (SUMP)
14	OSA1-A6, OSB1-B9, OSC1-C12	476	360 *	640 *	10'Wx6'H CBC & 90' RCP
15	D1,D2,D3,D4,D5,D6	7.8	19.2	38.0	CROSS PAN
16	D1,D2,D3,D4,D5,D6,D7	11.7	26.6	52.8	10' TYPE R & 15' TYPE R INLETS
17	D1-D7,D9,D11	13.9	29.6	59.0	15' TYPE R INLET (SUMP)
18	D8,D10,D12	4.0	8.7	17.1	10' TYPE R INLET (SUMP)
19	E1,E2,E3	5.0	11.9	23.7	15' TYPE R INLET
20	E1,E2,E3,E4,E5,E7	11.0	23.4	48.4	15' TYPE R (SUMP), TYPE C INLETS
21	E6	1.0	4.5	9.0	5' TYPE R INLET (SUMP)
22	E8	0.7	1.8	3.6	5' TYPE R INLET (SUMP)
23	OSF1,F1,F2,F3	7.4	16.2	32.5	CROSS PAN
24	OSF1,F1,F2,F3,F5	11.0	23.4	48.4	15' TYPE R (SUMP), TYPE C INLETS
25	F4	0.3	0.9	1.9	5' TYPE R INLET (SUMP)
26	OSF2	4.9	4.2	9.6	TYPE D INLET (SUMP)
27	OSA1-A6, OSB1-B9, OSC1-C12, E1-E9, OSF1-OSF3, F1-F5	619	428 *	991 *	OPEN CHANNEL
28	OSA1-A6, OSB1-B9, OSC1-C12, E1-E9, OSF1-OSF3, F1-F5, D1-D12	647	428 *	991 *	DBL 10'Wx6'H CBC
29	OSA1-A6, OSB1-B9, OSC1-C12, E1-E9, OSF1-OSF3, F1-F5, D1-D12, G1	685	457 *	1076 *	EXISTING DBL 12'Wx6'H CBC

* NOTE: MAIN CHANNEL MINOR STORM FLOW RATES ARE 10-YEAR IN ACCORDANCE WITH DRAINAGE BASIN PLANNING STUDY

REVISIONS

DESIGNED BY DRG August 21, 2013
 DRAWN BY DRG August 21, 2013
 CHECKED BY
 AS-BUILTS BY
 CHECKED BY

**Hannah Ridge
 at Feathergrass**

**DEVELOPED
 Drainage Map**

MVE PROJECT 60970
 MVE DRAWING 60970110

**December 12, 2013
 SHEET 1 OF 1**

HYDROLOGIC / HYDRAULIC CALCULATIONS

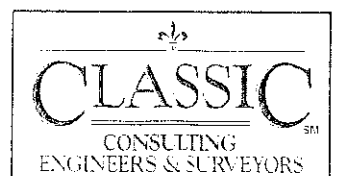

Table 6-6. Runoff Coefficients for Rational Method
(Source: UDFCD 2001)

Land Use or Surface Characteristics	Percent Impervious	Runoff Coefficients											
		2-year		5-year		10-year		25-year		50-year		100-year	
		HSG A&B	HSG C&D	HSG A&B	HSG C&D	HSG A&B	HSG C&D	HSG A&B	HSG C&D	HSG A&B	HSG C&D	HSG A&B	HSG C&D
Business													
Commercial Areas	95	0.79	0.80	0.81	0.82	0.83	0.84	0.85	0.87	0.87	0.88	0.88	0.89
Neighborhood Areas	70	0.45	0.49	0.49	0.53	0.53	0.57	0.58	0.62	0.60	0.65	0.62	0.68
Residential													
1/8 Acre or less	65	0.41	0.45	0.45	0.49	0.49	0.54	0.54	0.59	0.57	0.62	0.59	0.65
1/4 Acre	40	0.23	0.28	0.30	0.35	0.36	0.42	0.42	0.50	0.46	0.54	0.50	0.58
1/3 Acre	30	0.18	0.22	0.25	0.30	0.32	0.38	0.39	0.47	0.43	0.52	0.47	0.57
1/2 Acre	25	0.15	0.20	0.22	0.28	0.30	0.36	0.37	0.46	0.41	0.51	0.46	0.56
1 Acre	20	0.12	0.17	0.20	0.26	0.27	0.34	0.35	0.44	0.40	0.50	0.44	0.55
Industrial													
Light Areas	80	0.57	0.60	0.59	0.63	0.63	0.66	0.66	0.70	0.68	0.72	0.70	0.74
Heavy Areas	90	0.71	0.73	0.73	0.75	0.75	0.77	0.78	0.80	0.80	0.82	0.81	0.83
Parks and Cemeteries	7	0.05	0.09	0.12	0.19	0.20	0.29	0.30	0.40	0.34	0.46	0.39	0.52
Playgrounds	13	0.07	0.13	0.16	0.23	0.24	0.31	0.32	0.42	0.37	0.48	0.41	0.54
Railroad Yard Areas	40	0.23	0.28	0.30	0.35	0.36	0.42	0.42	0.50	0.46	0.54	0.50	0.58
Undeveloped Areas													
Historic Flow Analysis-- Greenbelts, Agriculture	2	0.03	0.05	0.09	0.16	0.17	0.26	0.26	0.38	0.31	0.45	0.36	0.51
Pasture/Meadow	0	0.02	0.04	0.08	0.15	0.15	0.25	0.25	0.37	0.30	0.44	0.35	0.50
Forest	0	0.02	0.04	0.08	0.15	0.15	0.25	0.25	0.37	0.30	0.44	0.35	0.50
Exposed Rock	100	0.89	0.89	0.90	0.90	0.92	0.92	0.94	0.94	0.95	0.95	0.96	0.96
Offsite Flow Analysis (when landuse is undefined)	45	0.26	0.31	0.32	0.37	0.38	0.44	0.44	0.51	0.48	0.55	0.51	0.59
Streets													
Paved	100	0.89	0.89	0.90	0.90	0.92	0.92	0.94	0.94	0.95	0.95	0.96	0.96
Gravel	80	0.57	0.60	0.59	0.63	0.63	0.66	0.66	0.70	0.68	0.72	0.70	0.74
Drive and Walks	100	0.89	0.89	0.90	0.90	0.92	0.92	0.94	0.94	0.95	0.95	0.96	0.96
Roofs	90	0.71	0.73	0.73	0.75	0.75	0.77	0.78	0.80	0.80	0.82	0.81	0.83
Lawns	0	0.02	0.04	0.08	0.15	0.15	0.25	0.25	0.37	0.30	0.44	0.35	0.50

3.2 Time of Concentration

One of the basic assumptions underlying the Rational Method is that runoff is a function of the average rainfall rate during the time required for water to flow from the hydraulically most remote part of the drainage area under consideration to the design point. However, in practice, the time of concentration can be an empirical value that results in reasonable and acceptable peak flow calculations.

For urban areas, the time of concentration (t_c) consists of an initial time or overland flow time (t_i) plus the travel time (t_t) in the storm sewer, paved gutter, roadside drainage ditch, or drainage channel. For non-urban areas, the time of concentration consists of an overland flow time (t_i) plus the time of travel in a concentrated form, such as a swale or drainageway. The travel portion (t_t) of the time of concentration can be estimated from the hydraulic properties of the storm sewer, gutter, swale, ditch, or drainageway. Initial time, on the other hand, will vary with surface slope, depression storage, surface cover, antecedent rainfall, and infiltration capacity of the soil, as well as distance of surface flow. The time of concentration is represented by Equation 6-7 for both urban and non-urban areas.

** OFF-SITE FLOW SUMMARY
FROM MVE FILING NO. 1 REPORT*

Basin Label	Channel Type or Basin	Cont. Area A _c (Ac)	5 Year Coef. C _s	100 yr. Coef. of Curve No. C ₁₀₀ or CN	Manning Rough. n	Length L (ft)	Elev Change (ft)	Average Slope S	Channel Flow* Q (cfs)	Flow Depth d (ft)	Flow Area A (ft ²)	Flow Velocity v (ft/s)	Time of Cont** T _c (min)	Total Time T _t (min)	5 Year Intensity I ₅ (in/hr)	100 Year Intensity I ₁₀₀ (in/hr)	5 Year Discharge Q ₅ (cfs)	100 Year Discharge Q ₁₀₀ (cfs)
D1+D2+D3+D4	3	5.7	0.61	0.71	0.016	0	0	0.250	31.76	0.33	2.39	13.31	0.0	10.0	4.09	7.00	14.3	28.3
D5	0	0.7	0.57	0.66	-	140	6	0.043	-	-	-	-	7.2	-	-	-	-	-
D5	3	0.7	0.57	0.66	0.016	310	13	0.040	-	-	-	-	10.0	-	-	-	-	-
D1+D2+D3+D4+D5	D1+D2+D3+D4	5.7	0.61	0.71	-	-	-	-	3.87	0.22	0.97	3.98	1.3	8.5	4.36	7.48	1.9	3.6
D1+D2+D3+D4+D5	3	6.5	0.60	0.70	0.016	0	0	0.250	35.58	0.34	2.60	13.69	0.0	10.0	4.09	7.00	16.0	31.7
D8	0	1.3	0.60	0.70	-	60	1	0.013	-	-	-	-	6.6	-	-	-	-	-
D8	3	1.3	0.60	0.70	0.016	535	22	0.040	7.52	0.27	1.60	4.69	1.9	-	-	-	-	-
D6	3	1.3	0.60	0.70	0.016	210	4	0.020	7.52	0.31	2.07	3.63	1.0	9.5	4.18	7.15	3.3	6.6
D1+D2+D3+D4+D5+D6	D1+D2+D3+D4+D5	6.5	0.60	0.70	-	-	-	-	-	-	-	-	10.0	-	-	-	-	-
D1+D2+D3+D4+D5+D6	3	7.8	0.60	0.70	0.016	35	1	0.040	42.78	0.51	5.94	7.20	0.1	10.0	4.08	6.97	19.2	38.0
D7	0	4.0	0.60	0.70	-	140	2	0.015	-	-	-	-	9.7	-	-	-	-	-
D7	3	4.0	0.60	0.70	0.016	475	19	0.040	19.58	0.38	3.32	5.90	1.3	-	-	-	-	-
D7	3	4.0	0.60	0.70	0.016	270	4	0.015	19.58	0.46	4.80	4.08	1.1	12.1	3.77	6.43	8.9	17.8
D1+D2+D3+D4+D5+D6+D7	D7	4.0	0.60	0.70	-	-	-	-	-	-	-	-	12.1	-	-	-	-	-
D1+D2+D3+D4+D5+D6+D7	3	11.7	0.60	0.70	0.016	0	0	0.250	58.18	0.41	3.76	15.47	0.0	12.1	3.77	6.43	26.6	52.8
D9	0	0.9	0.50	0.58	-	40	1	0.020	-	-	-	-	5.6	-	-	-	-	-
D9	3	0.9	0.50	0.58	0.016	585	20	0.034	4.28	0.23	1.12	3.83	2.5	8.2	4.42	7.58	1.9	3.8
D1+D2+D3+D4+D5+D6+D9	D1+D2+D3+D4+D5+D6	7.8	0.60	0.70	-	-	-	-	-	-	-	-	10.0	-	-	-	-	-
D1+D2+D3+D4+D5+D6+D9	3	8.6	0.59	0.69	0.016	300	11	0.036	46.67	0.53	6.60	7.07	0.7	10.7	3.97	6.78	20.3	40.3
D1+D2+D3+D4+D5+D6+D7+D9	D1+D2+D3+D4+D5+D6+D7	11.7	0.60	0.70	-	-	-	-	-	-	-	-	12.1	-	-	-	-	-
D1+D2+D3+D4+D5+D6+D7+D9	3	12.6	0.59	0.69	0.016	0	0	0.250	61.69	0.42	3.93	15.69	0.0	12.1	3.77	6.43	28.2	56.0
D8	0	3.1	0.60	0.70	-	120	1	0.010	-	-	-	-	10.2	-	-	-	-	-
D8	3	3.1	0.60	0.70	0.016	450	18	0.040	14.81	0.35	2.68	5.53	1.4	-	-	-	-	-
D8	3	3.1	0.60	0.70	0.016	270	4	0.015	14.81	0.41	3.89	3.81	1.2	12.8	3.68	6.28	6.8	13.4
D10	0	0.4	0.60	0.70	-	32	1	0.020	-	-	-	-	4.2	-	-	-	-	-
D10	3	0.4	0.60	0.70	0.016	330	7	0.020	2.33	0.21	0.87	2.68	2.1	6.2	4.85	8.35	1.1	2.2
D8+D10	D8	3.1	0.60	0.70	-	-	-	-	-	-	-	-	12.8	-	-	-	-	-
D8+D10	3	3.4	0.60	0.70	0.016	0	0	0.250	16.61	0.26	1.47	11.33	0.0	12.8	3.68	6.28	7.6	15.1
D11	0	1.3	0.38	0.47	-	210	4	0.019	-	-	-	-	15.9	-	-	-	-	-
D11	3	1.3	0.38	0.47	0.016	95	1	0.015	3.43	0.25	1.30	2.64	0.6	16.5	3.26	5.57	1.6	3.4
D1+D2+D3+D4+D5+D6+D9+D11	D1+D2+D3+D4+D5+D6+D9	8.6	0.59	0.69	-	-	-	-	-	-	-	-	10.7	-	-	-	-	-
D1+D2+D3+D4+D5+D6+D9+D11	3	9.9	0.56	0.66	0.016	130	2	0.015	51.42	0.64	9.77	5.27	0.4	11.2	3.90	6.87	21.9	43.7
* D1+D2+D3+D4+D5+D6+D7+D9+D11	D1+D2+D3+D4+D5+D6+D7+D9	12.6	0.59	0.69	-	-	-	-	-	-	-	-	12.1	-	-	-	-	-
D1+D2+D3+D4+D5+D6+D7+D9+D11	3	13.9	0.57	0.67	0.016	140	2	0.015	65.98	0.71	11.89	5.55	0.4	12.5	3.71	6.33	29.6	59.0
D12	0	0.5	0.65	0.72	-	85	3	0.035	-	-	-	-	5.1	-	-	-	-	-
D12	3	0.5	0.65	0.72	0.016	130	2	0.015	3.33	0.24	1.25	2.67	0.8	5.9	4.93	8.50	1.7	3.2
D8+D10+D12	D8+D10+D12	3.4	0.60	0.70	-	-	-	-	-	-	-	-	12.8	-	-	-	-	-
D8+D10+D12	3	4.0	0.61	0.70	0.016	130	2	0.015	19.19	0.45	4.66	4.12	0.5	13.3	3.61	6.16	8.7	17.1
E1	0	1.2	0.60	0.70	-	65	1	0.015	-	-	-	-	6.5	-	-	-	-	-
E1	3	1.2	0.60	0.70	0.016	615	11	0.018	7.08	0.31	2.08	3.40	3.0	9.6	4.16	7.12	3.1	6.1
E2	0	2.8	0.60	0.70	-	130	3	0.020	-	-	-	-	8.5	-	-	-	-	-
E2	3	2.8	0.60	0.70	0.016	580	11	0.020	14.63	0.39	3.47	4.22	2.3	10.8	3.96	6.77	6.7	13.3
E1+E2	E2	2.8	0.60	0.70	-	-	-	-	-	-	-	-	10.8	-	-	-	-	-
E1+E2	3	4.0	0.60	0.70	0.016	0	0	0.250	21.06	0.29	1.75	12.02	0.0	10.8	3.96	6.77	9.6	19.1
E3	0	1.0	0.60	0.70	-	60	1	0.015	-	-	-	-	6.3	-	-	-	-	-
E3	3	1.0	0.60	0.70	0.016	515	10	0.020	5.64	0.28	1.68	3.37	2.6	8.9	4.28	7.33	2.5	5.0
E1+E2+E3	E1+E2	4.0	0.60	0.70	-	-	-	-	-	-	-	-	10.8	-	-	-	-	-
E1+E2+E3	3	5.0	0.60	0.70	0.016	0	0	0.250	26.13	0.31	2.06	12.68	0.0	10.8	3.96	6.77	11.9	23.7
E4	0	2.7	0.60	0.70	-	125	3	0.020	-	-	-	-	8.3	-	-	-	-	-
E4	3	2.7	0.60	0.70	0.016	500	11	0.023	14.43	0.38	3.24	4.45	1.9	10.2	4.06	6.93	6.7	13.3
E1+E2+E3+E4	E1+E2+E3	5.0	0.60	0.70	-	-	-	-	-	-	-	-	10.8	-	-	-	-	-
E1+E2+E3+E4	3	7.0	0.60	0.70	0.016	295	8	0.025	40.45	0.54	6.75	5.99	0.8	11.6	3.84	6.56	17.8	35.5
E5	0	0.9	0.60	0.70	-	60	1	0.015	-	-	-	-	6.3	-	-	-	-	-
E5	3	0.9	0.60	0.70	0.016	460	11	0.023	5.24	0.27	1.50	3.50	2.2	8.5	4.35	7.45	2.3	4.7
E1+E2+E3+E4+E5	E1+E2+E3+E4	7.7	0.60	0.70	-	-	-	-	-	-	-	-	11.6	-	-	-	-	-
E1+E2+E3+E4+E5	3	8.6	0.60	0.70	0.016	0	0	0.250	45.16	0.37	3.11	14.52	0.0	11.6	3.84	6.56	18.9	39.7
E6	0	1.8	0.60	0.70	-	105	3	0.029	-	-	-	-	6.8	-	-	-	-	-
E6	3	1.8	0.60	0.70	0.016	575	8	0.015	10.23	0.36	2.96	3.45	2.8	9.5	4.16	7.12	4.5	9.0
E7	0	2.3	0.43	0.61	-	200	4	0.020	-	-	-	-	14.1	-	-	-	-	-
E7	3	2.3	0.43	0.61	0.016	365	7	0.019	8.58	0.33	2.34	3.66	1.7	15.8	3.33	5.69	3.3	8.1
E4+E5	E4	2.7	0.60	0.70	-	-	-	-	-	-	-	-	10.2	-	-	-	-	-
E4+E5	3	3.6	0.60	0.70	0.016	0	0	0.250	19.17	0.28	1.63	11.74	0.0	10.2	4.06	6.93	8.9	17.7
E4+E5+E7	E4+E5	3.6	0.60	0.70	-	-	-	-	-	-	-	-	10.2	-	-	-	-	-
E4+E5+E7	3	6.0	0.53	0.67	0.016	100	3	0.025	29.94	0.49	5.42	5.52	0.3	10.5	4.01	6.85	12.6	27.2
E1+E2+E3+E4+E5+E7	E1+E2+E3+E4+E5	8.6	0.60	0.70	-	-	-	-	-	-	-	-	11.6	-	-	-	-	-
E1+E2+E3+E4+E5+E7	3	11.0	0.58	0.68	0.016	100	1	0.010	55.85	0.72	12.21	4.57	0.4	12.0	3.79	6.47	23.4	48.4

JOB NAME: Midtown Collection at Hannah Ridge Filing No. 3
 JOB NUMBER: 1116.35
 DATE: 08/20/20
 CALCULATED BY: KRC

FINAL DRAINAGE REPORT ~ BASIN RUNOFF COEFFICIENT SUMMARY (PROPOSED CONDITIONS)

BASIN	TOTAL AREA (AC)	IMPERVIOUS AREA / STREETS							LANDSCAPE/UNDEVELOPED AREAS							WEIGHTED			WEIGHTED CA	
		AREA (AC)	C(2)	C(5)	C(10)	C(25)	C(50)	C(100)	AREA (AC)	C(2)	C(5)	C(10)	C(25)	C(50)	C(100)	C(2)	C(5)	C(100)	CA(5)	CA(100)
A	0.76	0.48	0.89	0.90	0.92	0.94	0.95	0.96	0.28	0.04	0.15	0.25	0.37	0.44	0.5	0.58	0.62	0.79	0.47	0.60
B-1	1.36	0.79	0.89	0.90	0.92	0.94	0.95	0.96	0.57	0.04	0.15	0.25	0.37	0.44	0.5	0.53	0.59	0.77	0.80	1.04
B-2	0.34	0.20	0.89	0.90	0.92	0.94	0.95	0.96	0.14	0.04	0.15	0.25	0.37	0.44	0.5	0.54	0.59	0.77	0.20	0.26
C	0.29	0.21	0.89	0.90	0.92	0.94	0.95	0.96	0.08	0.04	0.15	0.25	0.37	0.44	0.5	0.66	0.69	0.83	0.20	0.24
D	1.08	0.79	0.89	0.90	0.92	0.94	0.95	0.96	0.29	0.04	0.15	0.25	0.37	0.44	0.5	0.66	0.70	0.84	0.75	0.90
E	0.89	0.67	0.89	0.90	0.92	0.94	0.95	0.96	0.22	0.04	0.15	0.25	0.37	0.44	0.5	0.68	0.71	0.85	0.64	0.75
F	1.23	0.22	0.89	0.90	0.92	0.94	0.95	0.96	1.01	0.04	0.15	0.25	0.37	0.44	0.5	0.19	0.28	0.58	0.35	0.72
G	1.87	0.00	0.89	0.90	0.92	0.94	0.95	0.96	1.87	0.04	0.15	0.25	0.37	0.44	0.5	0.04	0.15	0.50	0.28	0.94
H	0.42	0.00	0.89	0.90	0.92	0.94	0.95	0.96	0.42	0.04	0.15	0.25	0.37	0.44	0.5	0.04	0.15	0.50	0.06	0.21

JOB NAME: *Midtown Collection at Hannah Ridge Filing No. 3*
 JOB NUMBER: *1116.35*
 DATE: *08/20/20*
 CALC'D BY: *KRC*

BASIN RUNOFF SUMMARY (PROPOSED CONDITIONS)

BASIN	WEIGHTED			OVERLAND				STREET / CHANNEL FLOW				Tc	INTENSITY		TOTAL FLOWS	
	CA(2)	CA(5)	CA(100)	C(5)	Length (ft)	Height (ft)	Tc (min)	Length (ft)	Slope (%)	Velocity (fps)	Tc (min)	TOTAL (min)	I(5) (in/hr)	I(100) (in/hr)	Q(5) (cfs)	Q(100) (cfs)
A	0.44	0.47	0.60	0.15	80	3	9.9	150	4.0%	7.0	0.4	10.3	4.09	6.86	1.9	4.1
B-1	0.73	0.80	1.04	0.15	200	6	16.9	90	4.0%	7.0	0.2	17.1	3.32	5.58	2.6	5.8
B-2	0.18	0.20	0.26	0.15	130	5	12.5	0	0.0%	0.0	0.0	12.5	3.79	6.36	0.8	1.7
C	0.19	0.20	0.24	0.15	45	0.9	9.2	80	4.0%	7.0	0.2	9.3	4.23	7.10	0.9	1.7
D	0.71	0.75	0.90	0.15	50	1	9.6	290	3.0%	6.1	0.8	10.4	4.06	6.82	3.1	6.2
E	0.61	0.64	0.75	0.15	240	8	17.9	0	0.0%	0.0	0.0	17.9	3.26	5.47	2.1	4.1
F	0.24	0.35	0.72	0.15	50	1	9.6	0	0.0%	0.0	0.0	9.6	4.18	7.02	1.5	5.0
G	0.07	0.28	0.94	0.15	50	1	9.6	0	0.0%	0.0	0.0	9.6	4.18	7.02	1.2	6.6
H	0.02	0.06	0.21	0.15	95	3	11.4	0	0.0%	0.0	0.0	11.4	3.93	6.59	0.2	1.4

JOB NAME: Midtown Collection at Hannah Ridge Filing No. 3
 JOB NUMBER: 1116.35
 DATE: 08/20/20
 CALC'D BY: KRC

SURFACE ROUTING SUMMARY (PROPOSED CONDITIONS)

Design Point(s)	Contributing Basins	Equivalent CA(5)	Equivalent CA(100)	Maximum Tc	Intensity		Flow		Inlet Size/Conveyance
					I(5)	I(100)	Q(5)	Q(100)	
1	BASIN A	0.47	0.60	10.3	4.08	6.86	1.9	4.1	Street flow south to DP #2
2	BASIN A, B-1 and C	1.31	1.89	17.1	3.32	5.58	4.3	10.5	Proposed 10' type R public inlet
3	BASIN D	0.75	0.90	10.4	4.06	6.82	3.1	6.2	Proposed 10' type R public inlet
4	BASIN B-2	0.20	0.26	12.5	3.79	6.36	0.8	1.7	Proposed 5' type R public inlet
5	DP 2, 3, 4 and Basin F	10.04	12.46	17.1	3.32	5.58	33.4	69.5	Outfall into pond
6	Pond Outlet								Pond Discharge

JOB NAME: Midtown Collection at Hannah Ridge Filing No. 3
 JOB NUMBER: 1116.35
 DATE: 08/20/20
 CALC'D BY: KRC

* PIPES ARE LISTED AT MAXIMUM SIZE REQUIRED TO ACCOMMODATE Q100 FLOWS AT MINIMUM GRADE.
 REFER TO INDIVIDUAL PIPE SHEETS FOR HYDRAULIC INFORMATION.

FINAL DRAINAGE REPORT ~ PIPE ROUTING SUMMARY

Pipe Run	Contributing Basins	Equivalent CA(5)	Equivalent CA(100)	Maximum Tc	Intensity		Flow		Pipe Size*
					I(5)	I(100)	Q(5)	Q(100)	
1	DP 4	0.20	0.26	12.5	3.79	6.36	0.8	1.7	12" Private PVC/ADS
2	DP 2 and DP 4	1.51	2.15	17.1	3.32	5.58	5.0	12.0	24" Public RCP
3	DP 3	0.75	0.90	10.4	4.06	6.82	3.1	6.2	18" Private PVC/ADS
4	DP 5	10.04	12.46	17.1	3.32	5.58	33.4	69.5	48" Public RCP

ALLOWABLE CAPACITY FOR ONE-HALF OF STREET (Minor & Major Storm)

(Based on Regulated Criteria for Maximum Allowable Flow Depth and Spread)

Project: Midtown Collection at Hannah Ridge Filing No. 3
 Inlet ID: DP #2

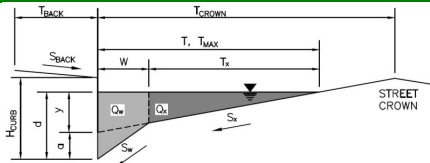

Gutter Geometry (Enter data in the blue cells)							
Maximum Allowable Width for Spread Behind Curb	$T_{BACK} = 10.0$ ft						
Side Slope Behind Curb (leave blank for no conveyance credit behind curb)	$S_{BACK} = 0.020$ ft/ft						
Manning's Roughness Behind Curb (typically between 0.012 and 0.020)	$n_{BACK} = 0.016$						
Height of Curb at Gutter Flow Line	$H_{CURB} = 6.00$ inches						
Distance from Curb Face to Street Crown	$T_{CROWN} = 36.0$ ft						
Gutter Width	$W = 1.00$ ft						
Street Transverse Slope	$S_x = 0.040$ ft/ft						
Gutter Cross Slope (typically 2 inches over 24 inches or 0.083 ft/ft)	$S_w = 0.083$ ft/ft						
Street Longitudinal Slope - Enter 0 for sump condition	$S_o = 0.000$ ft/ft						
Manning's Roughness for Street Section (typically between 0.012 and 0.020)	$n_{STREET} = 0.018$						
Max. Allowable Spread for Minor & Major Storm	<table border="1"> <tr> <th>Minor Storm</th> <th>Major Storm</th> <th>ft</th> </tr> <tr> <td>15.0</td> <td>36.0</td> <td></td> </tr> </table>	Minor Storm	Major Storm	ft	15.0	36.0	
Minor Storm	Major Storm	ft					
15.0	36.0						
Max. Allowable Depth at Gutter Flowline for Minor & Major Storm	<table border="1"> <tr> <th>Minor Storm</th> <th>Major Storm</th> <th>inches</th> </tr> <tr> <td>6.0</td> <td>7.7</td> <td></td> </tr> </table>	Minor Storm	Major Storm	inches	6.0	7.7	
Minor Storm	Major Storm	inches					
6.0	7.7						
Check boxes are not applicable in SUMP conditions	<input type="checkbox"/> <input type="checkbox"/>						
MINOR STORM Allowable Capacity is based on Depth Criterion							
MAJOR STORM Allowable Capacity is based on Depth Criterion							
Allowable Capacity	<table border="1"> <tr> <th>Minor Storm</th> <th>Major Storm</th> <th>cfs</th> </tr> <tr> <td>SUMP</td> <td>SUMP</td> <td></td> </tr> </table>	Minor Storm	Major Storm	cfs	SUMP	SUMP	
Minor Storm	Major Storm	cfs					
SUMP	SUMP						

INLET IN A SUMP OR SAG LOCATION

Version 4.05 Released March 2017

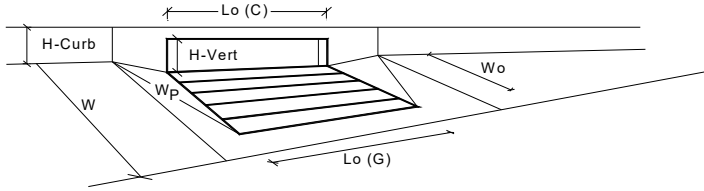

Design Information (Input)	MINOR	MAJOR	
Type of Inlet	CDOT Type R Curb Opening		
Local Depression (additional to continuous gutter depression 'a' from above)	3.00	3.00	inches
Number of Unit Inlets (Grate or Curb Opening)	1	1	
Water Depth at Flowline (outside of local depression)	6.0	7.7	inches
Grate Information	MINOR	MAJOR	<input type="checkbox"/> Override Depths
Length of a Unit Grate	N/A	N/A	feet
Width of a Unit Grate	N/A	N/A	feet
Area Opening Ratio for a Grate (typical values 0.15-0.90)	N/A	N/A	
Clogging Factor for a Single Grate (typical value 0.50 - 0.70)	N/A	N/A	
Grate Weir Coefficient (typical value 2.15 - 3.60)	N/A	N/A	
Grate Orifice Coefficient (typical value 0.60 - 0.80)	N/A	N/A	
Curb Opening Information	MINOR	MAJOR	
Length of a Unit Curb Opening	10.00	10.00	feet
Height of Vertical Curb Opening in Inches	6.00	6.00	inches
Height of Curb Orifice Throat in Inches	6.00	6.00	inches
Angle of Throat (see USDCM Figure ST-5)	63.40	63.40	degrees
Side Width for Depression Pan (typically the gutter width of 2 feet)	1.00	1.00	feet
Clogging Factor for a Single Curb Opening (typical value 0.10)	0.10	0.10	
Curb Opening Weir Coefficient (typical value 2.3-3.7)	3.60	3.60	
Curb Opening Orifice Coefficient (typical value 0.60 - 0.70)	0.67	0.67	
Low Head Performance Reduction (Calculated)	MINOR	MAJOR	
Depth for Grate Midwidth	N/A	N/A	ft
Depth for Curb Opening Weir Equation	0.42	0.56	ft
Combination Inlet Performance Reduction Factor for Long Inlets	0.57	0.73	
Curb Opening Performance Reduction Factor for Long Inlets	0.93	1.00	
Grated Inlet Performance Reduction Factor for Long Inlets	N/A	N/A	
Total Inlet Interception Capacity (assumes clogged condition)	MINOR	MAJOR	
Q_a	10.0	16.6	cfs
$Q_{PEAK\ REQUIRED}$	4.9	10.5	cfs

Inlet Capacity IS GOOD for Minor and Major Storms(>Q PEAK)

ALLOWABLE CAPACITY FOR ONE-HALF OF STREET (Minor & Major Storm)

(Based on Regulated Criteria for Maximum Allowable Flow Depth and Spread)

Project: Midtown Collection at Hannah Ridge Filing No. 3
 Inlet ID: DP #3

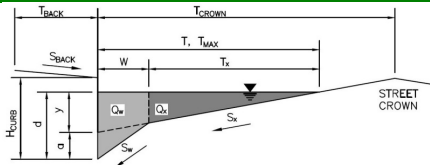

Gutter Geometry (Enter data in the blue cells)									
Maximum Allowable Width for Spread Behind Curb	$T_{BACK} = $ <input style="width: 50px;" type="text" value="0.0"/> ft								
Side Slope Behind Curb (leave blank for no conveyance credit behind curb)	$S_{BACK} = $ <input style="width: 50px;" type="text" value="0.020"/> ft/ft								
Manning's Roughness Behind Curb (typically between 0.012 and 0.020)	$n_{BACK} = $ <input style="width: 50px;" type="text" value="0.016"/>								
Height of Curb at Gutter Flow Line	$H_{CURB} = $ <input style="width: 50px;" type="text" value="6.00"/> inches								
Distance from Curb Face to Street Crown	$T_{CROWN} = $ <input style="width: 50px;" type="text" value="24.0"/> ft								
Gutter Width	$W = $ <input style="width: 50px;" type="text" value="1.00"/> ft								
Street Transverse Slope	$S_x = $ <input style="width: 50px;" type="text" value="0.020"/> ft/ft								
Gutter Cross Slope (typically 2 inches over 24 inches or 0.083 ft/ft)	$S_w = $ <input style="width: 50px;" type="text" value="0.083"/> ft/ft								
Street Longitudinal Slope - Enter 0 for sump condition	$S_o = $ <input style="width: 50px;" type="text" value="0.000"/> ft/ft								
Manning's Roughness for Street Section (typically between 0.012 and 0.020)	$n_{STREET} = $ <input style="width: 50px;" type="text" value="0.018"/>								
Max. Allowable Spread for Minor & Major Storm	<table style="width: 100%; border: none;"> <tr> <td style="text-align: center; border: none;">$T_{MAX} =$</td> <td style="text-align: center; border: none;">Minor Storm</td> <td style="text-align: center; border: none;">Major Storm</td> <td style="border: none;"></td> </tr> <tr> <td style="border: 1px solid black; width: 50px; text-align: center;">24.0</td> <td style="border: 1px solid black; width: 50px; text-align: center;">24.0</td> <td style="border: 1px solid black; width: 50px; text-align: center;">24.0</td> <td style="border: none; text-align: right;">ft</td> </tr> </table>	$T_{MAX} = $	Minor Storm	Major Storm		24.0	24.0	24.0	ft
$T_{MAX} = $	Minor Storm	Major Storm							
24.0	24.0	24.0	ft						
Max. Allowable Depth at Gutter Flowline for Minor & Major Storm	<table style="width: 100%; border: none;"> <tr> <td style="text-align: center; border: none;">$d_{MAX} =$</td> <td style="text-align: center; border: none;">Minor Storm</td> <td style="text-align: center; border: none;">Major Storm</td> <td style="border: none;"></td> </tr> <tr> <td style="border: 1px solid black; width: 50px; text-align: center;">6.0</td> <td style="border: 1px solid black; width: 50px; text-align: center;">6.0</td> <td style="border: 1px solid black; width: 50px; text-align: center;">6.0</td> <td style="border: none; text-align: right;">inches</td> </tr> </table>	$d_{MAX} = $	Minor Storm	Major Storm		6.0	6.0	6.0	inches
$d_{MAX} = $	Minor Storm	Major Storm							
6.0	6.0	6.0	inches						
Check boxes are not applicable in SUMP conditions	<input type="checkbox"/> <input type="checkbox"/>								
MINOR STORM Allowable Capacity is based on Depth Criterion									
MAJOR STORM Allowable Capacity is based on Depth Criterion									
Q _{allow} =	<table style="width: 100%; border: none;"> <tr> <td style="text-align: center; border: none;">Minor Storm</td> <td style="text-align: center; border: none;">Major Storm</td> <td style="border: none;"></td> </tr> <tr> <td style="border: 1px solid black; width: 50px; text-align: center;">SUMP</td> <td style="border: 1px solid black; width: 50px; text-align: center;">SUMP</td> <td style="border: none; text-align: right;">cfs</td> </tr> </table>	Minor Storm	Major Storm		SUMP	SUMP	cfs		
Minor Storm	Major Storm								
SUMP	SUMP	cfs							

INLET IN A SUMP OR SAG LOCATION

Version 4.05 Released March 2017

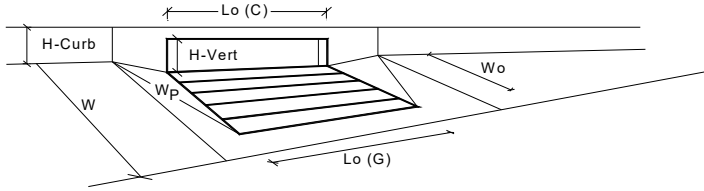

Design Information (Input)	MINOR	MAJOR	
Type of Inlet	CDOT Type R Curb Opening		
Local Depression (additional to continuous gutter depression 'a' from above)	3.00	3.00	inches
Number of Unit Inlets (Grate or Curb Opening)	1	1	
Water Depth at Flowline (outside of local depression)	6.0	6.0	inches
Grate Information	MINOR	MAJOR	<input type="checkbox"/> Override Depths
Length of a Unit Grate	N/A	N/A	feet
Width of a Unit Grate	N/A	N/A	feet
Area Opening Ratio for a Grate (typical values 0.15-0.90)	N/A	N/A	
Clogging Factor for a Single Grate (typical value 0.50 - 0.70)	N/A	N/A	
Grate Weir Coefficient (typical value 2.15 - 3.60)	N/A	N/A	
Grate Orifice Coefficient (typical value 0.60 - 0.80)	N/A	N/A	
Curb Opening Information	MINOR	MAJOR	
Length of a Unit Curb Opening	10.00	10.00	feet
Height of Vertical Curb Opening in Inches	6.00	6.00	inches
Height of Curb Orifice Throat in Inches	6.00	6.00	inches
Angle of Throat (see USDCM Figure ST-5)	63.40	63.40	degrees
Side Width for Depression Pan (typically the gutter width of 2 feet)	1.00	1.00	feet
Clogging Factor for a Single Curb Opening (typical value 0.10)	0.10	0.10	
Curb Opening Weir Coefficient (typical value 2.3-3.7)	3.60	3.60	
Curb Opening Orifice Coefficient (typical value 0.60 - 0.70)	0.67	0.67	
Low Head Performance Reduction (Calculated)	MINOR	MAJOR	
Depth for Grate Midwidth	N/A	N/A	ft
Depth for Curb Opening Weir Equation	0.42	0.42	ft
Combination Inlet Performance Reduction Factor for Long Inlets	0.57	0.57	
Curb Opening Performance Reduction Factor for Long Inlets	0.93	0.93	
Grated Inlet Performance Reduction Factor for Long Inlets	N/A	N/A	
Total Inlet Interception Capacity (assumes clogged condition)	MINOR	MAJOR	
Q_a	10.0	10.0	cfs
Q _{PEAK REQUIRED}	3.1	6.2	cfs

Inlet Capacity IS GOOD for Minor and Major Storms(>Q PEAK)

AREA INLET IN A SWALE

Midtown Collection at Hannah Ridge Filing No. 3

DP #4

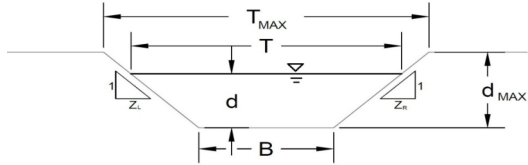

This worksheet uses the NRCS vegetative retardance method to determine Manning's n.
For more information see Section 7.2.3 of the USDCM.

Analysis of Trapezoidal Grass-Lined Channel Using SCS Method														
NRCS Vegetal Retardance (A, B, C, D, or E)	A, B, C, D or E													
Manning's n (Leave cell D16 blank to manually enter an n value)	n =	0.035												
Channel Invert Slope	S ₀ =	0.0300 ft/ft												
Bottom Width	B =	3.00 ft												
Left Side Slope	Z ₁ =	50.00 ft/ft												
Right Side Slope	Z ₂ =	50.00 ft/ft												
Check one of the following soil types:	Choose One:													
<table border="1" style="width: 100%; border-collapse: collapse;"> <thead> <tr> <th style="text-align: left;">Soil Type:</th> <th style="text-align: left;">Max. Velocity (V_{MAX})</th> <th style="text-align: left;">Max Froude No. (F_{MAX})</th> </tr> </thead> <tbody> <tr> <td>Non-Cohesive</td> <td>5.0 fps</td> <td>0.60</td> </tr> <tr> <td>Cohesive</td> <td>7.0 fps</td> <td>0.80</td> </tr> <tr> <td>Paved</td> <td>N/A</td> <td>N/A</td> </tr> </tbody> </table>	Soil Type:	Max. Velocity (V _{MAX})	Max Froude No. (F _{MAX})	Non-Cohesive	5.0 fps	0.60	Cohesive	7.0 fps	0.80	Paved	N/A	N/A	<input type="checkbox"/> Non-Cohesive <input checked="" type="checkbox"/> Cohesive <input type="checkbox"/> Paved	
Soil Type:	Max. Velocity (V _{MAX})	Max Froude No. (F _{MAX})												
Non-Cohesive	5.0 fps	0.60												
Cohesive	7.0 fps	0.80												
Paved	N/A	N/A												
Max. Allowable Top Width of Channel for Minor & Major Storm	T _{MAX} =	<table border="1" style="width: 100%; border-collapse: collapse;"> <thead> <tr> <th style="width: 50%;">Minor Storm</th> <th style="width: 50%;">Major Storm</th> </tr> </thead> <tbody> <tr> <td style="text-align: center;">20.00</td> <td style="text-align: center;">30.00</td> </tr> </tbody> </table> feet	Minor Storm	Major Storm	20.00	30.00								
Minor Storm	Major Storm													
20.00	30.00													
Max. Allowable Water Depth in Channel for Minor & Major Storm	d _{MAX} =	<table border="1" style="width: 100%; border-collapse: collapse;"> <thead> <tr> <th style="width: 50%;">Minor Storm</th> <th style="width: 50%;">Major Storm</th> </tr> </thead> <tbody> <tr> <td style="text-align: center;">0.40</td> <td style="text-align: center;">0.60</td> </tr> </tbody> </table> feet	Minor Storm	Major Storm	0.40	0.60								
Minor Storm	Major Storm													
0.40	0.60													
Allowable Channel Capacity Based On Channel Geometry														
MINOR STORM Allowable Capacity is based on Top Width Criterion	Q _{allow} =	<table border="1" style="width: 100%; border-collapse: collapse;"> <thead> <tr> <th style="width: 50%;">Minor Storm</th> <th style="width: 50%;">Major Storm</th> </tr> </thead> <tbody> <tr> <td style="text-align: center;">3.1</td> <td style="text-align: center;">9.2</td> </tr> </tbody> </table> cfs	Minor Storm	Major Storm	3.1	9.2								
Minor Storm	Major Storm													
3.1	9.2													
MAJOR STORM Allowable Capacity is based on Top Width Criterion	d _{allow} =	<table border="1" style="width: 100%; border-collapse: collapse;"> <thead> <tr> <th style="width: 50%;">Minor Storm</th> <th style="width: 50%;">Major Storm</th> </tr> </thead> <tbody> <tr> <td style="text-align: center;">0.17</td> <td style="text-align: center;">0.27</td> </tr> </tbody> </table> ft	Minor Storm	Major Storm	0.17	0.27								
Minor Storm	Major Storm													
0.17	0.27													
Water Depth in Channel Based On Design Peak Flow														
Design Peak Flow	Q _c =	<table border="1" style="width: 100%; border-collapse: collapse;"> <thead> <tr> <th style="width: 50%;">Minor Storm</th> <th style="width: 50%;">Major Storm</th> </tr> </thead> <tbody> <tr> <td style="text-align: center;">0.8</td> <td style="text-align: center;">1.7</td> </tr> </tbody> </table> cfs	Minor Storm	Major Storm	0.8	1.7								
Minor Storm	Major Storm													
0.8	1.7													
Water Depth	d =	<table border="1" style="width: 100%; border-collapse: collapse;"> <thead> <tr> <th style="width: 50%;">Minor Storm</th> <th style="width: 50%;">Major Storm</th> </tr> </thead> <tbody> <tr> <td style="text-align: center;">0.09</td> <td style="text-align: center;">0.13</td> </tr> </tbody> </table> feet	Minor Storm	Major Storm	0.09	0.13								
Minor Storm	Major Storm													
0.09	0.13													
<p style="color: red; font-size: small;">Minor storm max. allowable capacity GOOD - greater than the design flow given on sheet 'Inlet Management'</p> <p style="color: red; font-size: small;">Major storm max. allowable capacity GOOD - greater than the design flow given on sheet 'Inlet Management'</p>														

AREA INLET IN A SWALE

Midtown Collection at Hannah Ridge Filing No. 3

DP #4

Inlet Design Information (Input)

Type of Inlet: CDOT Type C (Depressed) Inlet Type = CDOT Type C (Depressed)

Angle of Inclined Grate (must be <= 30 degrees) $\theta =$ 0.00 degrees

Width of Grate $W =$ 3.00 feet

Length of Grate $L =$ 3.00 feet

Open Area Ratio $A_{RATIO} =$ 0.70

Height of Inclined Grate $H_B =$ 0.00 feet

Clogging Factor $C_f =$ 0.50

Grate Discharge Coefficient $C_d =$ 0.84

Orifice Coefficient $C_o =$ 0.56

Weir Coefficient $C_w =$ 1.81

	MINOR	MAJOR	
$d =$	1.09	1.13	
Total Inlet Interception Capacity (assumes clogged condition)			
$Q_a =$	14.9	15.1	cfs
Bypassed Flow, $Q_b =$	0.0	0.0	cfs
Capture Percentage = $Q_a/Q_o = C\%$	100	100	%

Warning 04: Froude No. exceeds USDCM Volume I recommendation.

PR 1

Project Description	
Friction Method	Manning Formula
Solve For	Normal Depth
Input Data	
Roughness Coefficient	0.010
Channel Slope	0.005 ft/ft
Diameter	12.0 in
Discharge	1.70 cfs
Results	
Normal Depth	6.1 in
Flow Area	0.4 ft ²
Wetted Perimeter	1.6 ft
Hydraulic Radius	3.0 in
Top Width	1.00 ft
Critical Depth	6.7 in
Percent Full	51.1 %
Critical Slope	0.004 ft/ft
Velocity	4.21 ft/s
Velocity Head	0.28 ft
Specific Energy	0.79 ft
Froude Number	1.168
Maximum Discharge	3.52 cfs
Discharge Full	3.27 cfs
Slope Full	0.001 ft/ft
Flow Type	Supercritical
GVF Input Data	
Downstream Depth	0.0 in
Length	0.0 ft
Number Of Steps	0
GVF Output Data	
Upstream Depth	0.0 in
Profile Description	N/A
Profile Headloss	0.00 ft
Average End Depth Over Rise	0.0 %
Normal Depth Over Rise	51.1 %
Downstream Velocity	Infinity ft/s
Upstream Velocity	Infinity ft/s
Normal Depth	6.1 in
Critical Depth	6.7 in
Channel Slope	0.005 ft/ft
Critical Slope	0.004 ft/ft

PR 2

Project Description	
Friction Method	Manning Formula
Solve For	Normal Depth

Input Data	
Roughness Coefficient	0.013
Channel Slope	0.005 ft/ft
Diameter	24.0 in
Discharge	12.00 cfs

Results	
Normal Depth	15.5 in
Flow Area	2.1 ft ²
Wetted Perimeter	3.7 ft
Hydraulic Radius	6.9 in
Top Width	1.91 ft
Critical Depth	14.9 in
Percent Full	64.6 %
Critical Slope	0.006 ft/ft
Velocity	5.59 ft/s
Velocity Head	0.49 ft
Specific Energy	1.78 ft
Froude Number	0.930
Maximum Discharge	17.21 cfs
Discharge Full	16.00 cfs
Slope Full	0.003 ft/ft
Flow Type	Subcritical

GVF Input Data	
Downstream Depth	0.0 in
Length	0.0 ft
Number Of Steps	0

GVF Output Data	
Upstream Depth	0.0 in
Profile Description	N/A
Profile Headloss	0.00 ft
Average End Depth Over Rise	0.0 %
Normal Depth Over Rise	54.5 %
Downstream Velocity	Infinity ft/s
Upstream Velocity	Infinity ft/s
Normal Depth	15.5 in
Critical Depth	14.9 in
Channel Slope	0.005 ft/ft
Critical Slope	0.006 ft/ft

PR 3

Project Description	
Friction Method	Manning Formula
Solve For	Normal Depth

Input Data	
Roughness Coefficient	0.013
Channel Slope	0.010 ft/ft
Diameter	18.0 in
Discharge	6.20 cfs

Results	
Normal Depth	9.9 in
Flow Area	1.0 ft ²
Wetted Perimeter	2.5 ft
Hydraulic Radius	4.8 in
Top Width	1.49 ft
Critical Depth	11.5 in
Percent Full	55.3 %
Critical Slope	0.006 ft/ft
Velocity	6.19 ft/s
Velocity Head	0.60 ft
Specific Energy	1.42 ft
Froude Number	1.332
Maximum Discharge	11.30 cfs
Discharge Full	10.50 cfs
Slope Full	0.003 ft/ft
Flow Type	Supercritical

GVF Input Data	
Downstream Depth	0.0 in
Length	0.0 ft
Number Of Steps	0

GVF Output Data	
Upstream Depth	0.0 in
Profile Description	N/A
Profile Headloss	0.00 ft
Average End Depth Over Rise	0.0 %
Normal Depth Over Rise	55.3 %
Downstream Velocity	Infinity ft/s
Upstream Velocity	Infinity ft/s
Normal Depth	9.9 in
Critical Depth	11.5 in
Channel Slope	0.010 ft/ft
Critical Slope	0.006 ft/ft

PR 5

Project Description	
Friction Method	Manning Formula
Solve For	Normal Depth

Input Data	
Roughness Coefficient	0.013
Channel Slope	0.005 ft/ft
Diameter	48.0 in
Discharge	69.50 cfs

Results	
Normal Depth	29.1 in
Flow Area	8.0 ft ²
Wetted Perimeter	7.1 ft
Hydraulic Radius	13.4 in
Top Width	3.91 ft
Critical Depth	30.2 in
Percent Full	60.7 %
Critical Slope	0.004 ft/ft
Velocity	8.70 ft/s
Velocity Head	1.18 ft
Specific Energy	3.61 ft
Froude Number	1.073
Maximum Discharge	109.25 cfs
Discharge Full	101.57 cfs
Slope Full	0.002 ft/ft
Flow Type	Supercritical

GVF Input Data	
Downstream Depth	0.0 in
Length	0.0 ft
Number Of Steps	0

GVF Output Data	
Upstream Depth	0.0 in
Profile Description	N/A
Profile Headloss	0.00 ft
Average End Depth Over Rise	0.0 %
Normal Depth Over Rise	60.7 %
Downstream Velocity	Infinity ft/s
Upstream Velocity	Infinity ft/s
Normal Depth	29.1 in
Critical Depth	30.2 in
Channel Slope	0.005 ft/ft
Critical Slope	0.004 ft/ft

PR- Outfall

Project Description	
Friction Method	Manning Formula
Solve For	Normal Depth
Input Data	
Roughness Coefficient	0.010
Channel Slope	0.012 ft/ft
Diameter	24.0 in
Discharge	33.20 cfs
Results	
Normal Depth	20.4 in
Flow Area	2.8 ft ²
Wetted Perimeter	4.7 ft
Hydraulic Radius	7.3 in
Top Width	1.43 ft
Critical Depth	22.8 in
Percent Full	85.0 %
Critical Slope	0.011 ft/ft
Velocity	11.66 ft/s
Velocity Head	2.11 ft
Specific Energy	3.81 ft
Froude Number	1.456
Maximum Discharge	34.65 cfs
Discharge Full	32.21 cfs
Slope Full	0.013 ft/ft
Flow Type	Supercritical
GVF Input Data	
Downstream Depth	0.0 in
Length	0.0 ft
Number Of Steps	0
GVF Output Data	
Upstream Depth	0.0 in
Profile Description	N/A
Profile Headloss	0.00 ft
Average End Depth Over Rise	0.0 %
Normal Depth Over Rise	85.0 %
Downstream Velocity	Infinity ft/s
Upstream Velocity	Infinity ft/s
Normal Depth	20.4 in
Critical Depth	22.8 in
Channel Slope	0.012 ft/ft
Critical Slope	0.011 ft/ft

Determination of Culvert Headwater and Outlet Protection

Project: **Midtown Collection at Hannah Ridge Fil. No. 3**

Basin ID: **FSD Outfall**

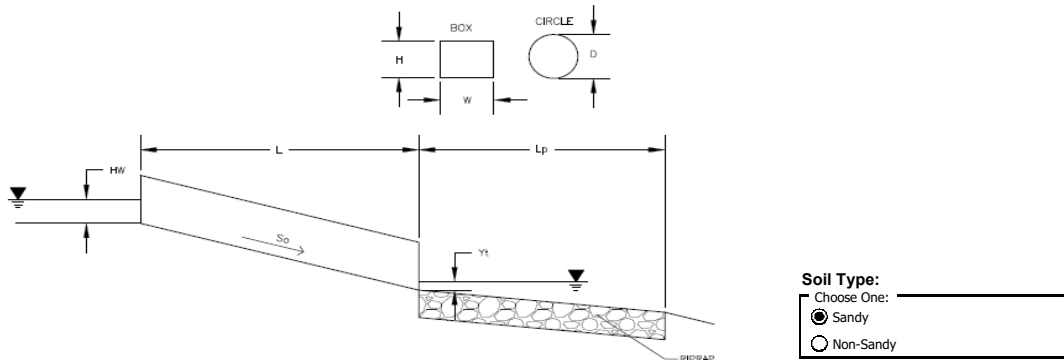

Supercritical Flow! Using D_a to calculate protection type.

Design Information (Input):	
Design Discharge	Q = <input style="width: 100px;" type="text" value="33.2"/> cfs
Circular Culvert:	
Barrel Diameter in Inches	D = <input style="width: 100px;" type="text" value="24"/> inches
Inlet Edge Type (Choose from pull-down list)	1.5 : 1 Beveled Edge <input type="button" value="OR"/>
Box Culvert:	
Barrel Height (Rise) in Feet	Height (Rise) = <input style="width: 100px;" type="text"/>
Barrel Width (Span) in Feet	Width (Span) = <input style="width: 100px;" type="text"/>
Inlet Edge Type (Choose from pull-down list)	<input type="button" value="OR"/>
Number of Barrels	No = <input style="width: 100px;" type="text" value="1"/>
Inlet Elevation	Elev IN = <input style="width: 100px;" type="text" value="100"/> ft
Outlet Elevation OR Slope	Elev OUT = <input style="width: 100px;" type="text" value="99.85"/> ft
Culvert Length	L = <input style="width: 100px;" type="text" value="100"/> ft
Manning's Roughness	n = <input style="width: 100px;" type="text" value="0.013"/>
Bend Loss Coefficient	k_b = <input style="width: 100px;" type="text" value="0"/>
Exit Loss Coefficient	k_x = <input style="width: 100px;" type="text" value="1"/>
Tailwater Surface Elevation	Elev Y_t = <input style="width: 100px;" type="text"/>
Max Allowable Channel Velocity	V = <input style="width: 100px;" type="text" value="5"/> ft/s
Required Protection (Output):	
Tailwater Surface Height	Y_t = <input style="width: 100px;" type="text" value="5.70"/> ft
Flow Area at Max Channel Velocity	A_t = <input style="width: 100px;" type="text" value="0.58"/> ft ²
Culvert Cross Sectional Area Available	A = <input style="width: 100px;" type="text" value="1.77"/> ft ²
Entrance Loss Coefficient	k_e = <input style="width: 100px;" type="text" value="0.20"/>
Friction Loss Coefficient	k_f = <input style="width: 100px;" type="text" value="0.97"/>
Sum of All Losses Coefficients	k_s = <input style="width: 100px;" type="text" value="2.17"/> ft
Culvert Normal Depth	Y_n = <input style="width: 100px;" type="text" value="0.64"/> ft
Culvert Critical Depth	Y_c = <input style="width: 100px;" type="text" value="0.65"/> ft
Tailwater Depth for Design	d = <input style="width: 100px;" type="text" value="1.07"/> ft
Adjusted Diameter OR Adjusted Rise	D_a = <input style="width: 100px;" type="text" value="1.07"/> ft
Expansion Factor	$1/(2*\tan(\theta))$ = <input style="width: 100px;" type="text" value="6.70"/>
Flow/Diameter ^{2.5} OR Flow/(Span * Rise ^{1.5})	$Q/D^{2.5}$ = <input style="width: 100px;" type="text" value="1.05"/> ft ^{0.5} /s
Froude Number	Fr = <input style="width: 100px;" type="text" value="1.01"/> Supercritical!
Tailwater/Adjusted Diameter OR Tailwater/Adjusted Rise	Y_t/D = <input style="width: 100px;" type="text" value="5.32"/>
Inlet Control Headwater	HW_i = <input style="width: 100px;" type="text" value="0.90"/> ft
Outlet Control Headwater	HW_o = <input style="width: 100px;" type="text" value="0.88"/> ft
Design Headwater Elevation	HW = <input style="width: 100px;" type="text" value="6,421.65"/> ft
Headwater/Diameter OR Headwater/Rise Ratio	HW/D = <input style="width: 100px;" type="text" value="0.60"/>
Minimum Theoretical Riprap Size	d_{50} = <input style="width: 100px;" type="text" value="0"/> in
Nominal Riprap Size	d_{50} = <input style="width: 100px;" type="text" value="6"/> in
UDFCD Riprap Type	Type = <input style="width: 100px;" type="text" value="VL"/>
Length of Protection	L_p = <input style="width: 100px;" type="text" value="5"/> ft
Width of Protection	T = <input style="width: 100px;" type="text" value="3"/> ft

**SWQ / FULL SPECTRUM
DETENTION CALCULATIONS**

DETENTION BASIN STAGE-STORAGE TABLE BUILDER

UD-Detention, Version 3.07 (February 2017)

Project: **MIDTOWN AT HANNAH RIDGE FILING NO. 3**
 Basin ID: **POND**

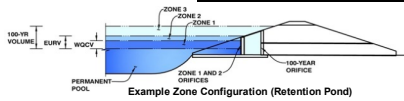

Example Zone Configuration (Retention Pond)

Required Volume Calculation

Selected BMP Type =	EDB	
Watershed Area =	21.08	acres
Watershed Length =	1,200	ft
Watershed Slope =	0.050	ft/ft
Watershed Imperviousness =	44.00%	percent
Percentage Hydrologic Soil Group A =	0.0%	percent
Percentage Hydrologic Soil Group B =	100.0%	percent
Percentage Hydrologic Soil Groups C/D =	0.0%	percent
Desired WQCV Drain Time =	40.0	hours
Location for 1-hr Rainfall Depths =	User Input	
Water Quality Capture Volume (WQCV) =	0.334	acre-feet
Excess Urban Runoff Volume (EURV) =	0.981	acre-feet
2-yr Runoff Volume (P1 = 1.19 in.) =	0.781	acre-feet
5-yr Runoff Volume (P1 = 1.5 in.) =	1.078	acre-feet
10-yr Runoff Volume (P1 = 1.75 in.) =	1.499	acre-feet
25-yr Runoff Volume (P1 = 2 in.) =	2.181	acre-feet
50-yr Runoff Volume (P1 = 2.25 in.) =	2.645	acre-feet
100-yr Runoff Volume (P1 = 2.52 in.) =	3.253	acre-feet
500-yr Runoff Volume (P1 = 2.75 in.) =	3.933	acre-feet
Approximate 2-yr Detention Volume =	0.731	acre-feet
Approximate 5-yr Detention Volume =	1.012	acre-feet
Approximate 10-yr Detention Volume =	1.370	acre-feet
Approximate 25-yr Detention Volume =	1.517	acre-feet
Approximate 50-yr Detention Volume =	1.589	acre-feet
Approximate 100-yr Detention Volume =	1.800	acre-feet

Optional User Override 1-hr Precipitation	1.19	inches
	1.50	inches
	1.75	inches
	2.00	inches
	2.25	inches
	2.52	inches
	2.75	inches

Stage-Storage Calculation

Zone 1 Volume (WQCV) =	0.334	acre-feet
Zone 2 Volume (EURV - Zone 1) =	0.647	acre-feet
Zone 3 Volume (100-year - Zones 1 & 2) =	0.819	acre-feet
Total Detention Basin Volume =	1.800	acre-feet
Initial Surcharge Volume (ISV) =	user	ft ³
Initial Surcharge Depth (ISD) =	user	ft
Total Available Detention Depth (H _{total}) =	user	ft
Depth of Trickle Channel (H _{TC}) =	user	ft
Slope of Trickle Channel (S _{TC}) =	user	ft/ft
Slopes of Main Basin Sides (S _{main}) =	user	H:V
Basin Length-to-Width Ratio (R _{L/W}) =	user	
Initial Surcharge Area (A _{ISV}) =	user	ft ²
Surcharge Volume Length (L _{ISV}) =	user	ft
Surcharge Volume Width (W _{ISV}) =	user	ft
Depth of Basin Floor (H _{floor}) =	user	ft
Length of Basin Floor (L _{floor}) =	user	ft
Width of Basin Floor (W _{floor}) =	user	ft
Area of Basin Floor (A _{floor}) =	user	ft ²
Volume of Basin Floor (V _{floor}) =	user	ft ³
Depth of Main Basin (H _{main}) =	user	ft
Length of Main Basin (L _{main}) =	user	ft
Width of Main Basin (W _{main}) =	user	ft
Area of Main Basin (A _{main}) =	user	ft ²
Volume of Main Basin (V _{main}) =	user	ft ³
Calculated Total Basin Volume (V _{total}) =	user	acre-feet

Depth Increment =	1	ft							
Stage - Storage Description	Stage (ft)	Optional Override Stage (ft)	Length (ft)	Width (ft)	Area (ft ²)	Optional Override Area (ft ²)	Area (acre)	Volume (ft ³)	Volume (ac-ft)
Top of Micropool	--	0.00	--	--	--	100	0.002	49	0.001
42.5	--	0.50	--	--	--	100	0.002	49	0.001
43	--	1.00	--	--	--	8,596	0.197	2,139	0.049
44	--	2.00	--	--	--	10,617	0.244	11,724	0.269
45	--	3.00	--	--	--	12,664	0.291	23,471	0.539
46	--	4.00	--	--	--	14,842	0.341	37,224	0.855
47	--	5.00	--	--	--	17,081	0.392	53,185	1.221
48	--	6.00	--	--	--	19,386	0.445	71,419	1.640
49	--	7.00	--	--	--	21,778	0.500	92,001	2.112
50	--	8.00	--	--	--	24,304	0.558	115,042	2.641

DETENTION BASIN STAGE-STORAGE TABLE BUILDER

UD-Detention, Version 3.07 (February 2017)

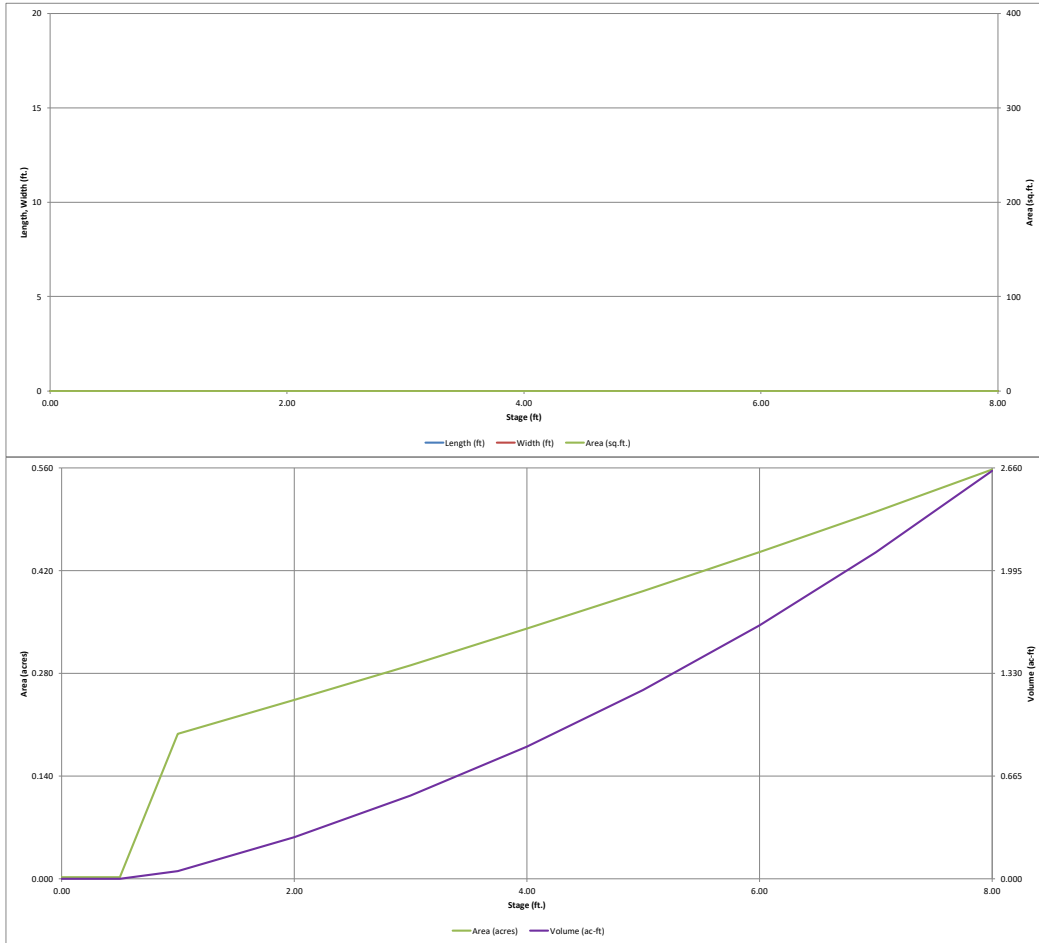

Detention Basin Outlet Structure Design

UD-Detention, Version 3.07 (February 2017)

Project: _____

Basin ID: _____

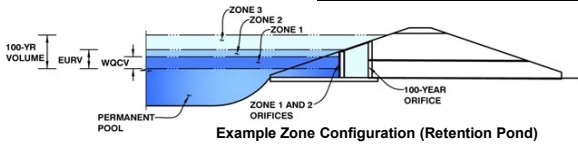

	Stage (ft)	Zone Volume (ac-ft)	Outlet Type
Zone 1 (WQCV)	2.26	0.334	Orifice Plate
Zone 2 (EURV)	4.37	0.647	Orifice Plate
Zone 3 (100-year)	6.36	0.819	Weir&Pipe (Restrict)
		1.800	Total

User Input: Orifice at Underdrain Outlet (typically used to drain WQCV in a Filtration BMP)

Underdrain Orifice Invert Depth = ft (distance below the filtration media surface)
 Underdrain Orifice Diameter = inches

Calculated Parameters for Underdrain

Underdrain Orifice Area = ft²
 Underdrain Orifice Centroid = feet

User Input: Orifice Plate with one or more orifices or Elliptical Slot Weir (typically used to drain WQCV and/or EURV in a sedimentation BMP)

Invert of Lowest Orifice = ft (relative to basin bottom at Stage = 0 ft)
 Depth at top of Zone using Orifice Plate = ft (relative to basin bottom at Stage = 0 ft)
 Orifice Plate: Orifice Vertical Spacing = inches
 Orifice Plate: Orifice Area per Row = sq. inches (diameter = 1-5/8 inches)

Calculated Parameters for Plate

WQ Orifice Area per Row = ft²
 Elliptical Half-Width = feet
 Elliptical Slot Centroid = feet
 Elliptical Slot Area = ft²

User Input: Stage and Total Area of Each Orifice Row (numbered from lowest to highest)

	Row 1 (required)	Row 2 (optional)	Row 3 (optional)	Row 4 (optional)	Row 5 (optional)	Row 6 (optional)	Row 7 (optional)	Row 8 (optional)
Stage of Orifice Centroid (ft)	0.00	1.50	3.00					
Orifice Area (sq. inches)	2.12	2.12	2.12					

	Row 9 (optional)	Row 10 (optional)	Row 11 (optional)	Row 12 (optional)	Row 13 (optional)	Row 14 (optional)	Row 15 (optional)	Row 16 (optional)
Stage of Orifice Centroid (ft)								
Orifice Area (sq. inches)								

User Input: Vertical Orifice (Circular or Rectangular)

	Not Selected	Not Selected	
Invert of Vertical Orifice =	<input type="text" value="N/A"/>	<input type="text" value="N/A"/>	ft (relative to basin bottom at Stage = 0 ft)
Depth at top of Zone using Vertical Orifice =	<input type="text" value="N/A"/>	<input type="text" value="N/A"/>	ft (relative to basin bottom at Stage = 0 ft)
Vertical Orifice Diameter =	<input type="text" value="N/A"/>	<input type="text" value="N/A"/>	inches

Calculated Parameters for Vertical Orifice

	Not Selected	Not Selected	
Vertical Orifice Area =	<input type="text" value="N/A"/>	<input type="text" value="N/A"/>	ft ²
Vertical Orifice Centroid =	<input type="text" value="N/A"/>	<input type="text" value="N/A"/>	feet

User Input: Overflow Weir (Dropbox) and Grate (Flat or Sloped)

	Zone 3 Weir	Not Selected	
Overflow Weir Front Edge Height, Ho =	<input type="text" value="4.50"/>	<input type="text" value="N/A"/>	ft (relative to basin bottom at Stage = 0 ft)
Overflow Weir Front Edge Length =	<input type="text" value="6.00"/>	<input type="text" value="N/A"/>	feet
Overflow Weir Slope =	<input type="text" value="3.00"/>	<input type="text" value="N/A"/>	H:V (enter zero for flat grate)
Horiz. Length of Weir Sides =	<input type="text" value="5.00"/>	<input type="text" value="N/A"/>	feet
Overflow Grate Open Area % =	<input type="text" value="55%"/>	<input type="text" value="N/A"/>	% grate open area/total area
Debris Clogging % =	<input type="text" value="50%"/>	<input type="text" value="N/A"/>	%

Calculated Parameters for Overflow Weir

	Zone 3 Weir	Not Selected	
Height of Grate Upper Edge, H ₁ =	<input type="text" value="6.17"/>	<input type="text" value="N/A"/>	feet
Over Flow Weir Slope Length =	<input type="text" value="5.27"/>	<input type="text" value="N/A"/>	feet
Grate Open Area / 100-yr Orifice Area =	<input type="text" value="5.54"/>	<input type="text" value="N/A"/>	should be ≥ 4
Overflow Grate Open Area w/o Debris =	<input type="text" value="17.39"/>	<input type="text" value="N/A"/>	ft ²
Overflow Grate Open Area w/ Debris =	<input type="text" value="8.70"/>	<input type="text" value="N/A"/>	ft ²

User Input: Outlet Pipe w/ Flow Restriction Plate (Circular Orifice, Restrictor Plate, or Rectangular Orifice)

	Zone 3 Restrictor	Not Selected	
Depth to Invert of Outlet Pipe =	<input type="text" value="2.50"/>	<input type="text" value="N/A"/>	ft (distance below basin bottom at Stage = 0 ft)
Outlet Pipe Diameter =	<input type="text" value="24.00"/>	<input type="text" value="N/A"/>	inches
Restrictor Plate Height Above Pipe Invert =	<input type="text" value="24.00"/>	<input type="text" value="N/A"/>	inches

Calculated Parameters for Outlet Pipe w/ Flow Restriction Plate

	Zone 3 Restrictor	Not Selected	
Outlet Orifice Area =	<input type="text" value="3.14"/>	<input type="text" value="N/A"/>	ft ²
Outlet Orifice Centroid =	<input type="text" value="1.00"/>	<input type="text" value="N/A"/>	feet
Half-Central Angle of Restrictor Plate on Pipe =	<input type="text" value="3.14"/>	<input type="text" value="N/A"/>	radians

User Input: Emergency Spillway (Rectangular or Trapezoidal)

Spillway Invert Stage = ft (relative to basin bottom at Stage = 0 ft)
 Spillway Crest Length = feet
 Spillway End Slopes = H:V
 Freeboard above Max Water Surface = feet

Calculated Parameters for Spillway

Spillway Design Flow Depth = feet
 Stage at Top of Freeboard = feet
 Basin Area at Top of Freeboard = acres

Routed Hydrograph Results

	WQCV	EURV	2 Year	5 Year	10 Year	25 Year	50 Year	100 Year	500 Year
Design Storm Return Period =									
One-Hour Rainfall Depth (in) =	0.53	1.07	1.19	1.50	1.75	2.00	2.25	2.52	2.75
Calculated Runoff Volume (acre-ft) =	0.334	0.981	0.781	1.078	1.499	2.181	2.645	3.253	3.933
OPTIONAL Override Runoff Volume (acre-ft) =									
Inflow Hydrograph Volume (acre-ft) =	0.334	0.981	0.781	1.077	1.498	2.179	2.643	3.251	3.930
Predevelopment Unit Peak Flow, q (cfs/acre) =	0.00	0.00	0.02	0.03	0.26	0.82	1.13	1.51	1.95
Predevelopment Peak Q (cfs) =	0.0	0.0	0.3	0.549	5.4	17.3	23.9	31.9	41.1
Peak Inflow Q (cfs) =	6.8	19.9	15.9	21.8	30.2	43.7	52.9	64.8	78.1
Peak Outflow Q (cfs) =	0.2	0.3	0.3	0.363	5.0	15.8	23.5	33.2	48.2
Ratio Peak Outflow to Predevelopment Q =	N/A	N/A	N/A	0.7	0.9	0.9	1.0	1.0	1.2
Structure Controlling Flow =	Plate	Plate	Plate	Overflow Grate 1	Overflow Grate 1	Overflow Grate 1	Overflow Grate 1	Overflow Grate 1	Spillway
Max Velocity through Grate 1 (fps) =	N/A	N/A	N/A	0.0	0.3	0.9	1.3	1.9	2.4
Max Velocity through Grate 2 (fps) =	N/A	N/A	N/A	N/A	N/A	N/A	N/A	N/A	N/A
Time to Drain 97% of Inflow Volume (hours) =	40	68	62	70	70	67	65	62	59
Time to Drain 99% of Inflow Volume (hours) =	41	72	65	75	76	74	74	73	71
Maximum Ponding Depth (ft) =	2.17	4.24	3.67	4.50	5.11	5.70	6.00	6.32	6.61
Area at Maximum Ponding Depth (acres) =	0.25	0.35	0.32	0.37	0.40	0.43	0.44	0.46	0.48
Maximum Volume Stored (acre-ft) =	0.314	0.938	0.745	1.031	1.260	1.508	1.635	1.785	1.916

Detention Basin Outlet Structure Design

UD-Detention, Version 3.07 (February 2017)

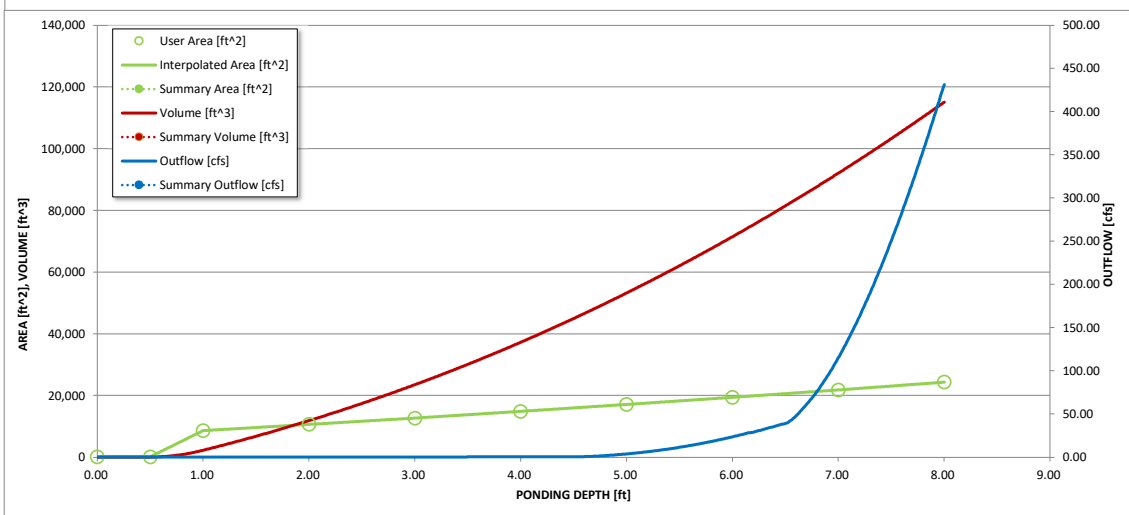
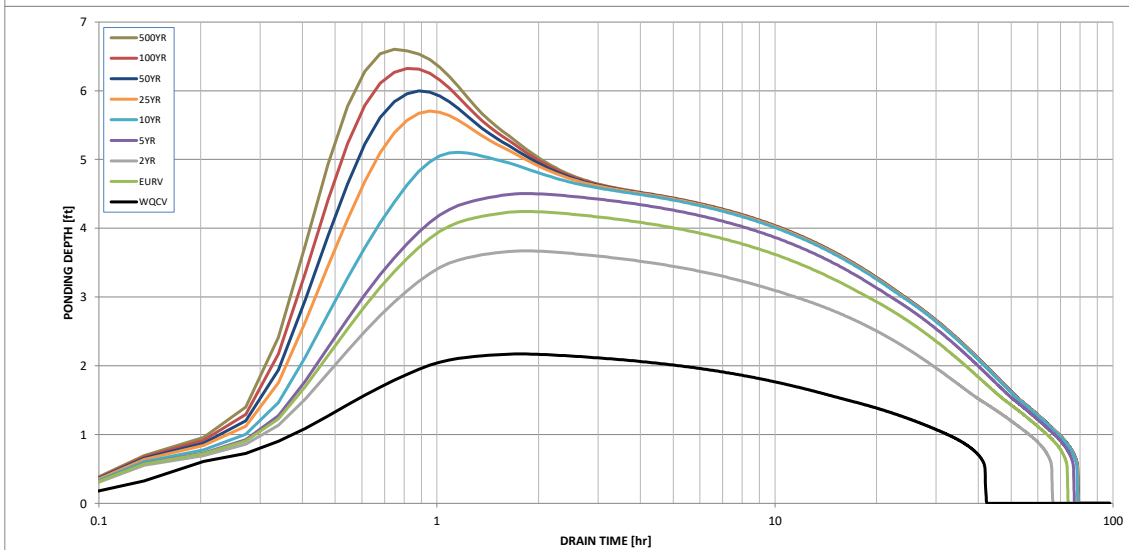
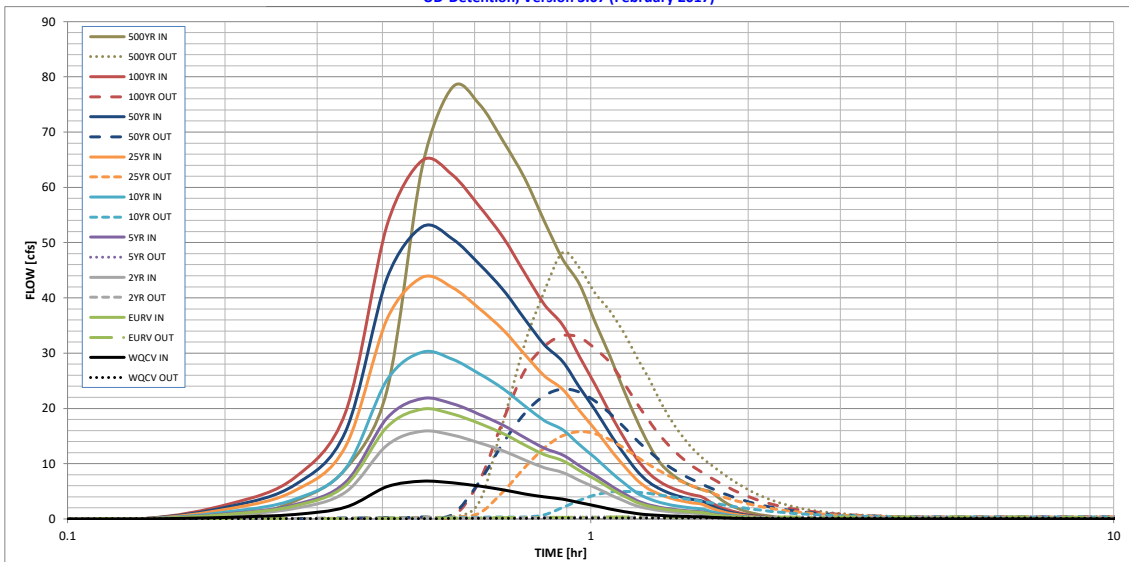

S-A-V-D Chart Axis Override	X-axis	Left Y-Axis	Right Y-Axis
minimum bound			
maximum bound			

Design Procedure Form: Extended Detention Basin (EDB)

UD-BMP (Version 3.06, November 2016)

Sheet 1 of 4

Designer: _____
Company: Classic Consulting Engineers
Date: October 18, 2021
Project: Midtown Collection at Hannah Ridge Filing No. 3
Location: EDB Forebay 1

<p>1. Basin Storage Volume</p> <p>A) Effective Imperviousness of Tributary Area, I_a</p> <p>B) Tributary Area's Imperviousness Ratio ($i = I_a / 100$)</p> <p>C) Contributing Watershed Area</p> <p>D) For Watersheds Outside of the Denver Region, Depth of Average Runoff Producing Storm</p> <p>E) Design Concept (Select EURV when also designing for flood control)</p> <p>F) Design Volume (WQCV) Based on 40-hour Drain Time ($V_{DESIGN} = (1.0 * (0.91 * I^3 - 1.19 * I^2 + 0.78 * I) / 12 * Area)$)</p> <p>G) For Watersheds Outside of the Denver Region, Water Quality Capture Volume (WQCV) Design Volume ($V_{WQCV\ OTHER} = (d_b * (V_{DESIGN} / 0.43))$)</p> <p>H) User Input of Water Quality Capture Volume (WQCV) Design Volume (Only if a different WQCV Design Volume is desired)</p> <p>I) Predominant Watershed NRCS Soil Group</p> <p>J) Excess Urban Runoff Volume (EURV) Design Volume For HSG A: $EURV_A = 1.68 * i^{1.28}$ For HSG B: $EURV_B = 1.36 * i^{1.08}$ For HSG C/D: $EURV_{C/D} = 1.20 * i^{1.08}$ </p>	<p>$I_a =$ <u>44.0</u> %</p> <p>$i =$ <u>0.440</u></p> <p>Area = <u>21.080</u> ac</p> <p>$d_b =$ <u>0.43</u> in</p> <div style="border: 1px solid black; padding: 5px; margin-bottom: 10px;"> Choose One <input type="radio"/> Water Quality Capture Volume (WQCV) <input checked="" type="radio"/> Excess Urban Runoff Volume (EURV) </div> <p>$V_{DESIGN} =$ <u>0.334</u> ac-ft</p> <p>$V_{DESIGN\ OTHER} =$ <u>0.334</u> ac-ft</p> <p>$V_{DESIGN\ USER} =$ _____ ac-ft</p> <div style="border: 1px solid black; padding: 5px; margin-bottom: 10px;"> Choose One <input type="radio"/> A <input checked="" type="radio"/> B <input type="radio"/> C / D </div> <p>EURV = <u>0.984</u> ac-ft</p>
<p>2. Basin Shape: Length to Width Ratio (A basin length to width ratio of at least 2:1 will improve TSS reduction.)</p>	<p>L : W = <u>2.0</u> : 1</p>
<p>3. Basin Side Slopes</p> <p>A) Basin Maximum Side Slopes (Horizontal distance per unit vertical, 4:1 or flatter preferred)</p>	<p>Z = <u>3.00</u> ft / ft DIFFICULT TO MAINTAIN, INCREASE WHERE POSSIBLE</p>
<p>4. Inlet</p> <p>A) Describe means of providing energy dissipation at concentrated inflow locations:</p>	<p>_____</p> <p>_____</p> <p>_____</p> <p>_____</p>

Design Procedure Form: Extended Detention Basin (EDB)

Designer: _____
Company: Classic Consulting Engineers
Date: October 18, 2021
Project: Midtown Collection at Hannah Ridge Filing No. 3
Location: EDB Forebay 1

<p>5. Forebay</p> <p>A) Minimum Forebay Volume ($V_{FMIN} = \underline{3\%}$ of the WQCV)</p> <p>B) Actual Forebay Volume</p> <p>C) Forebay Depth ($D_F = \underline{18}$ inch maximum)</p> <p>D) Forebay Discharge</p> <p style="padding-left: 40px;">i) Undetained 100-year Peak Discharge</p> <p style="padding-left: 40px;">ii) Forebay Discharge Design Flow ($Q_F = 0.02 * Q_{100}$)</p> <p>E) Forebay Discharge Design</p> <p>F) Discharge Pipe Size (minimum 8-inches)</p> <p>G) Rectangular Notch Width</p>	<p>$V_{FMIN} = \underline{0.010}$ ac-ft</p> <p>$V_F = \underline{0.012}$ ac-ft</p> <p>$D_F = \underline{12.0}$ in</p> <p>$Q_{100} = \underline{69.50}$ cfs</p> <p>$Q_F = \underline{1.39}$ cfs</p> <div style="border: 1px solid black; padding: 2px; display: inline-block; margin: 5px 0;"> Choose One <input type="radio"/> Berm With Pipe <input checked="" type="radio"/> Wall with Rect. Notch <input type="radio"/> Wall with V-Notch Weir </div> <p style="color: blue; font-size: small;">(flow too small for berm w/ pipe)</p> <p>Calculated $D_p = \underline{\hspace{1cm}}$ in</p> <p>Calculated $W_N = \underline{7.4}$ in</p>
<p>6. Trickle Channel</p> <p>A) Type of Trickle Channel</p> <p>F) Slope of Trickle Channel</p>	<div style="border: 1px solid black; padding: 2px; display: inline-block; margin: 5px 0;"> Choose One <input checked="" type="radio"/> Concrete <input type="radio"/> Soft Bottom </div> <p>$S = \underline{0.0100}$ ft / ft</p>
<p>7. Micropool and Outlet Structure</p> <p>A) Depth of Micropool (2.5-feet minimum)</p> <p>B) Surface Area of Micropool (10 ft² minimum)</p> <p>C) Outlet Type</p> <p>D) Smallest Dimension of Orifice Opening Based on Hydrograph Routing (Use UD-Detention)</p> <p>E) Total Outlet Area</p>	<p>$D_M = \underline{2.5}$ ft</p> <p>$A_M = \underline{100}$ sq ft</p> <div style="border: 1px solid black; padding: 2px; display: inline-block; margin: 5px 0;"> Choose One <input checked="" type="radio"/> Orifice Plate <input type="radio"/> Other (Describe): </div> <hr style="border: 0; border-top: 1px solid black; margin: 5px 0;"/> <hr style="border: 0; border-top: 1px solid black; margin: 5px 0;"/> <hr style="border: 0; border-top: 1px solid black; margin: 5px 0;"/> <p>$D_{orifice} = \underline{1.63}$ inches</p> <p>$A_{ot} = \underline{6.36}$ square inches</p>

Design Procedure Form: Extended Detention Basin (EDB)

Designer: _____
Company: Classic Consulting Engineers
Date: October 18, 2021
Project: Midtown Collection at Hannah Ridge Filing No. 3
Location: EDB Forebay 1

<p>8. Initial Surge Volume</p> <p>A) Depth of Initial Surge Volume (Minimum recommended depth is 4 inches)</p> <p>B) Minimum Initial Surge Volume (Minimum volume of 0.3% of the WQCV)</p> <p>C) Initial Surge Provided Above Micropool</p>	<p>$D_{IS} =$ <u>6</u> in</p> <p>$V_{IS} =$ <u>43.7</u> cu ft</p> <p>$V_s =$ <u>50.0</u> cu ft</p>
<p>9. Trash Rack</p> <p>A) Water Quality Screen Open Area: $A_t = A_{ot} * 38.5 * (e^{-0.095D})$</p> <p>B) Type of Screen (If specifying an alternative to the materials recommended in the USDCM, indicate "other" and enter the ratio of the total open are to the total screen are for the material specified.)</p> <p style="padding-left: 40px;">Other (Y/N): <u>N</u></p> <p>C) Ratio of Total Open Area to Total Area (only for type 'Other')</p> <p>D) Total Water Quality Screen Area (based on screen type)</p> <p>E) Depth of Design Volume (EURV or WQCV) (Based on design concept chosen under 1E)</p> <p>F) Height of Water Quality Screen (H_{TR})</p> <p>G) Width of Water Quality Screen Opening ($W_{opening}$) (Minimum of 12 inches is recommended)</p>	<p>$A_t =$ <u>210</u> square inches</p> <p><u>Aluminum Amico-Klemp SR Series with Cross Rods 2" O.C.</u></p> <hr/> <hr/> <p>User Ratio =</p> <p>$A_{total} =$ <u>296</u> sq. in.</p> <p>$H =$ <u>4.5</u> feet</p> <p>$H_{TR} =$ <u>82</u> inches</p> <p>$W_{opening} =$ <u>12.0</u> inches</p>

Design Procedure Form: Extended Detention Basin (EDB)

Designer: _____
Company: Classic Consulting Engineers
Date: October 18, 2021
Project: Midtown Collection at Hannah Ridge Filing No. 3
Location: EDB Forebay 1

<p>10. Overflow Embankment</p> <p>A) Describe embankment protection for 100-year and greater overtopping:</p> <p>B) Slope of Overflow Embankment (Horizontal distance per unit vertical, 4:1 or flatter preferred)</p>	<p>_____</p> <p>_____</p> <p>_____</p>
<p>11. Vegetation</p>	<p>Choose One</p> <p><input checked="" type="radio"/> Irrigated</p> <p><input type="radio"/> Not Irrigated</p> <p>AVOID PLACING IRRIGATION HEADS IN THE BOTTOM OF THE BASIN</p>
<p>12. Access</p> <p>A) Describe Sediment Removal Procedures</p>	<p>_____</p> <p>_____</p> <p>_____</p> <p>_____</p>
<p>Notes: _____</p> <p>_____</p> <p>_____</p>	

Design Procedure Form: Extended Detention Basin (EDB)

Designer: _____
Company: Classic Consulting Engineers
Date: October 18, 2021
Project: Midtown Collection at Hannah Ridge Filing No. 3
Location: EDB Forebay 2

<p>5. Forebay</p> <p>A) Minimum Forebay Volume ($V_{FMIN} =$ <u>3%</u> of the WQCV)</p> <p>B) Actual Forebay Volume</p> <p>C) Forebay Depth ($D_F =$ <u>18</u> inch maximum)</p> <p>D) Forebay Discharge</p> <p style="margin-left: 40px;">i) Undetained 100-year Peak Discharge</p> <p style="margin-left: 40px;">ii) Forebay Discharge Design Flow ($Q_F = 0.02 * Q_{100}$)</p> <p>E) Forebay Discharge Design</p> <p>F) Discharge Pipe Size (minimum 8-inches)</p> <p>G) Rectangular Notch Width</p>	<p>$V_{FMIN} =$ <u>0.010</u> ac-ft</p> <p>$V_F =$ <u>0.012</u> ac-ft</p> <p>$D_F =$ <u>12.0</u> in</p> <p>$Q_{100} =$ <u>12.00</u> cfs</p> <p>$Q_F =$ <u>0.24</u> cfs</p> <div style="border: 1px solid black; padding: 2px; margin: 5px 0;"> <p>Choose One</p> <p><input type="radio"/> Berm With Pipe</p> <p><input checked="" type="radio"/> Wall with Rect. Notch</p> <p><input type="radio"/> Wall with V-Notch Weir</p> </div> <p style="margin-left: 100px; color: blue;">(flow too small for berm w/ pipe)</p> <p>Calculated $D_p =$ <u> </u> in</p> <p>Calculated $W_N =$ <u>3.3</u> in</p>
<p>6. Trickle Channel</p> <p>A) Type of Trickle Channel</p> <p>F) Slope of Trickle Channel</p>	<div style="border: 1px solid black; padding: 2px; margin: 5px 0;"> <p>Choose One</p> <p><input checked="" type="radio"/> Concrete</p> <p><input type="radio"/> Soft Bottom</p> </div> <p>$S =$ <u>0.0100</u> ft / ft</p>
<p>7. Micropool and Outlet Structure</p> <p>A) Depth of Micropool (2.5-feet minimum)</p> <p>B) Surface Area of Micropool (10 ft² minimum)</p> <p>C) Outlet Type</p> <p>D) Smallest Dimension of Orifice Opening Based on Hydrograph Routing (Use UD-Detention)</p> <p>E) Total Outlet Area</p>	<p>$D_M =$ <u>2.5</u> ft</p> <p>$A_M =$ <u>100</u> sq ft</p> <div style="border: 1px solid black; padding: 2px; margin: 5px 0;"> <p>Choose One</p> <p><input checked="" type="radio"/> Orifice Plate</p> <p><input type="radio"/> Other (Describe):</p> </div> <hr style="border: 0; border-top: 1px solid black; margin: 5px 0;"/> <hr style="border: 0; border-top: 1px solid black; margin: 5px 0;"/> <hr style="border: 0; border-top: 1px solid black; margin: 5px 0;"/> <p>$D_{orifice} =$ <u>1.63</u> inches</p> <p>$A_{ot} =$ <u>6.36</u> square inches</p>

Site-Level Low Impact Development (LID) Design Effective Impervious Calculator

LID Credit by Impervious Reduction Factor (IRF) Method

UD-BMP (Version 3.06, November 2016)

User Input	
Calculated cells	
***Design Storm: 1-Hour Rain Depth	WQCV Event: 0.53 inches
***Minor Storm: 1-Hour Rain Depth	5-Year Event: 1.50 inches
***Major Storm: 1-Hour Rain Depth	100-Year Event: 2.52 inches
Optional User Defined Storm	CUHP
(CUHP) NOAA 1 Hour Rainfall Depth and Frequency for User Defined Storm	100-Year Event: 2.52
Max Intensity for Optional User Defined Storm	2.51496

Designer: dlg
Company: CLASSIC CONSULTING ENGINEERS
Date: October 18, 2021
Project: MIDTOWN AT HANNAH RIDGE FIL 3
Location: _____

Sub-basin Identifier	A	B-1	C	D	E	F	D8,D10	D1-D7	D12					
Receiving Pervious Area Soil Type	Loamy Sand	Loamy Sand	Loamy Sand	Loamy Sand	Loamy Sand	Loamy Sand	Loamy Sand	Loamy Sand	Loamy Sand					
Total Area (ac., Sum of DCIA, UIA, RPA, & SPA)	0.760	1.360	0.290	1.080	0.890	1.230	3.300	11.740	0.430					
Directly Connected Impervious Area (DCIA, acres)	0.220	0.430	0.070	0.480	0.360	0.000	0.870	2.710	0.430					
Unconnected Impervious Area (UIA, acres)	0.340	0.240	0.030	0.170	0.090	0.060	0.680	2.580	0.000					
Receiving Pervious Area (RPA, acres)	0.000	0.530	0.190	0.430	0.320	0.280	1.750	6.290	0.000					
Separate Pervious Area (SPA, acres)	0.200	0.160	0.000	0.000	0.120	0.890	0.000	0.160	0.000					
RPA Treatment Type: Conveyance (C), Volume (V), or Permeable Pavement (PP)	C	C	C	C	C	C	C	C	C					

CALCULATED RESULTS (OUTPUT)														
Total Calculated Area (ac, check against input)	0.760	1.360	0.290	1.080	0.890	1.230	3.300	11.740	0.430					
Directly Connected Impervious Area (DCIA, %)	28.9%	31.6%	24.1%	44.4%	40.4%	0.0%	26.4%	23.1%	100.0%					
Unconnected Impervious Area (UIA, %)	44.7%	17.6%	10.3%	15.7%	10.1%	4.9%	20.6%	22.0%	0.0%					
Receiving Pervious Area (RPA, %)	0.0%	39.0%	65.5%	39.8%	36.0%	22.8%	53.0%	53.6%	0.0%					
Separate Pervious Area (SPA, %)	26.3%	11.8%	0.0%	0.0%	13.5%	72.4%	0.0%	1.4%	0.0%					
A _p (RPA / UIA)	0.000	2.208	6.333	2.529	3.556	4.667	2.574	2.438	0.000					
I _s Check	1.000	0.310	0.140	0.280	0.220	0.180	0.280	0.290	1.000					
f / I for WQCV Event:	3.6	3.6	3.6	3.6	3.6	3.6	3.6	3.6	3.6					
f / I for 5-Year Event:	0.5	0.5	0.5	0.5	0.5	0.5	0.5	0.5	0.5					
f / I for 100-Year Event:	0.4	0.4	0.4	0.4	0.4	0.4	0.4	0.4	0.4					
f / I for Optional User Defined Storm CUHP:	0.39	0.39	0.39	0.39	0.39	0.39	0.39	0.39	0.39					
IRF for WQCV Event:	1.00	0.50	0.30	0.48	0.45	0.39	0.48	0.49	1.00					
IRF for 5-Year Event:	1.00	0.86	0.59	0.85	0.84	0.75	0.85	0.85	1.00					
IRF for 100-Year Event:	1.00	0.88	0.61	0.88	0.87	0.78	0.88	0.88	1.00					
IRF for Optional User Defined Storm CUHP:	1.00	0.88	0.61	0.88	0.87	0.78	0.88	0.88	1.00					
Total Site Imperviousness: I _{total}	73.7%	49.3%	34.5%	60.2%	50.6%	4.9%	47.0%	45.1%	100.0%					
Effective Imperviousness for WQCV Event:	73.7%	40.4%	27.3%	52.0%	45.0%	1.9%	36.3%	33.8%	100.0%					
Effective Imperviousness for 5-Year Event:	73.7%	46.7%	30.2%	57.9%	49.0%	3.7%	43.9%	41.8%	100.0%					
Effective Imperviousness for 100-Year Event:	73.7%	47.2%	30.4%	58.3%	49.2%	3.8%	44.5%	42.4%	100.0%					
Effective Imperviousness for Optional User Defined Storm CUHP:	73.7%	47.2%	30.4%	58.3%	49.2%	3.8%	44.5%	42.4%	100.0%					

LID / EFFECTIVE IMPERVIOUSNESS CREDITS														
WQCV Event CREDIT: Reduce Detention By:	0.0%	11.4%	13.4%	10.6%	7.2%	59.4%	14.3%	15.7%	0.0%	N/A	N/A	N/A	N/A	N/A
This line only for 10-Year Event	N/A	N/A	N/A	N/A	N/A	N/A	N/A	N/A	N/A	N/A	N/A	N/A	N/A	N/A
100-Year Event CREDIT**: Reduce Detention By:	0.0%	4.2%	12.4%	3.1%	2.6%	38.2%	5.3%	5.9%	0.1%	N/A	N/A	N/A	N/A	N/A
User Defined CUHP CREDIT: Reduce Detention By:	0.0%	3.8%	8.8%	3.5%	2.5%	10.1%	4.7%	5.0%	0.0%					

Total Site Imperviousness:	46.3%
Total Site Effective Imperviousness for WQCV Event:	36.8%
Total Site Effective Imperviousness for 5-Year Event:	43.6%
Total Site Effective Imperviousness for 100-Year Event:	44.0%
Total Site Effective Imperviousness for Optional User Defined Storm CUHP:	44.0%

Notes:
 * Use Green-Ampt average infiltration rate values from Table 3-3.
 ** Flood control detention volume credits based on empirical equations from Storage Chapter of USDCM.
 *** Method assumes that 1-hour rainfall depth is equivalent to 1-hour intensity for calculation purposed

DRAINAGE MAP

DESIGN POINT SUMMARY			
DESIGN POINT	Q5 (CFS)	Q100 (CFS)	INLET SIZE
1	1.9	4.1	STREET FLOW
2	4.3	10.5	10' TYPE R SUMP
3	3.1	6.2	10' TYPE R SUMP
4	0.8	1.7	5' TYPE R SUMP
5	33.4	69.5	OUTFALL TO POND
6	-	-	POND DISCHARGE

BASIN RUNOFF SUMMARY		
BASIN	Q5 (CFS)	Q100 (CFS)
A	1.9	4.1
B-1	2.6	5.8
B-2	0.8	1.7
C	0.9	1.7
D	3.1	6.2
E	2.1	4.1
F	1.5	5.0
G	1.2	6.6
H	0.2	1.4

PIPE ROUTING SUMMARY			
PIPE RUN	Q5 (CFS)	Q100 (CFS)	PIPE SIZE
1	0.8	1.7	12" PRIV PVC/ADS
2	5.0	12.0	24" PUB RCP
3	3.1	6.2	18" PRIV PVC/ADS
4	33.4	69.5	48" PUB RCP

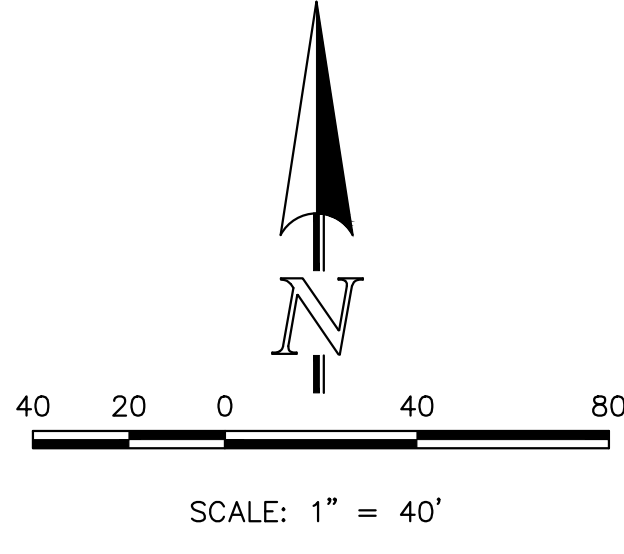

LEGEND

- (6770) EXISTING CONTOUR
- 6770 PROPOSED CONTOUR
- FILING LINE
- BOUNDARY/R.O.W. LINE
- EXISTING FLOW DIRECTION
- PROPOSED FLOW
- "A" A LOT
- "B" B LOT
- "W/O" WALKOUT LOT
- "T" TRANSITION LOT
- "G" GARDEN LOT
- PROPOSED INLET
- PROPOSED STORM SEWER PIPE
- HP PROPOSED HIGH POINT
- LP PROPOSED LOW POINT
- (D) BASIN IDENTIFIER
- (1.41) AREA IN ACRES
- △ PIPE RUN
- (1) DESIGN POINT

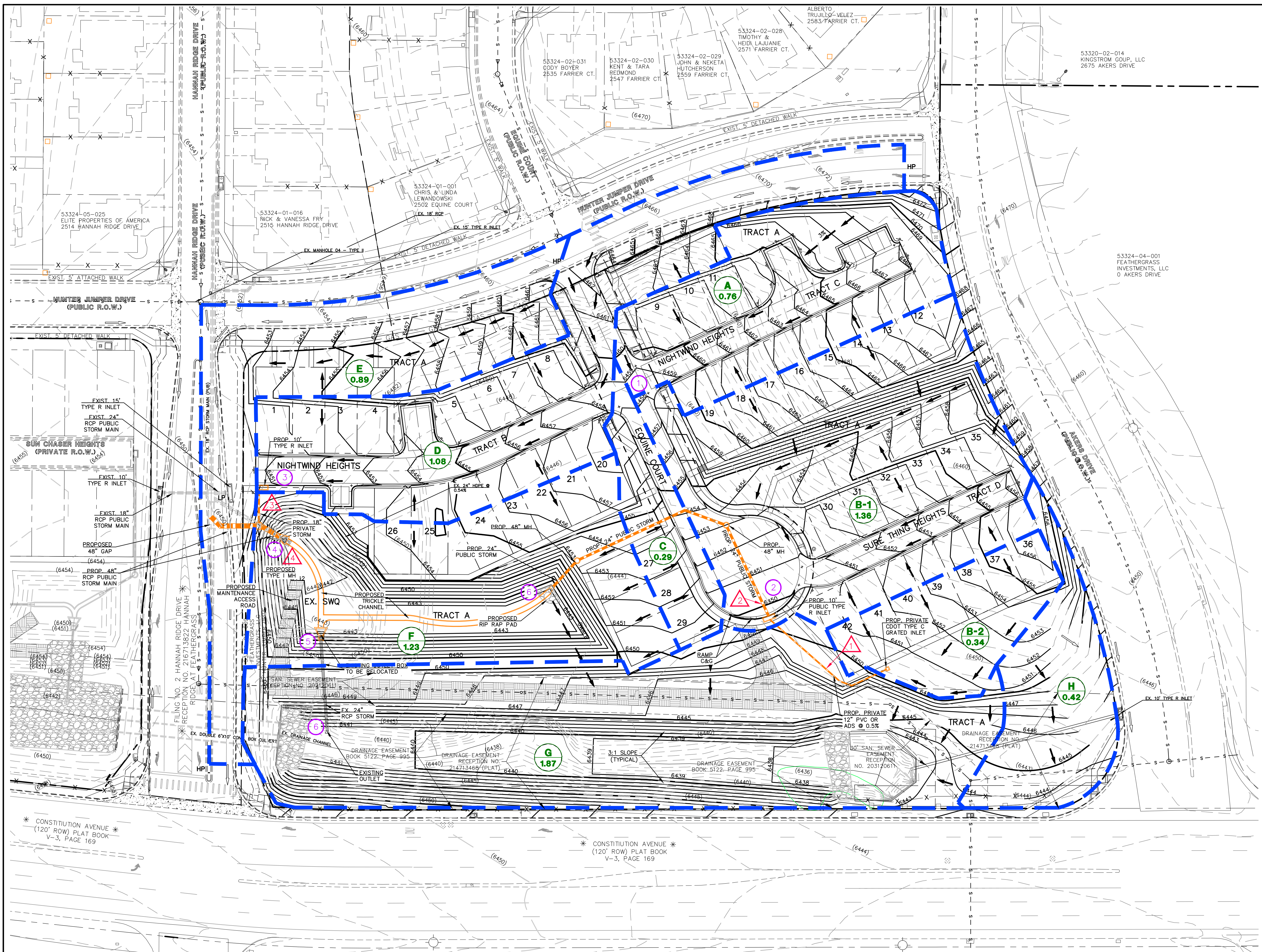

PUD SP-20-007

619 N. Cascade Avenue, Suite 200
Colorado Springs, Colorado 80903

(719) 785-0790
(719) 785-0799 (Fax)

MIDTOWN COLLECTION AT HANNAH RIDGE
FILING NO. 3
DEVELOPED CONDITIONS DRAINAGE MAP

DESIGNED BY: KRC SCALE: DATE: 10/15/21

DRAWN BY: KC (H) 1" = 40' SHEET 1 OF 1

CHECKED BY: KRC (V) 1" = N/A JOB NO.: 1116.35

N:\111635\DRAWINGS\DEVELOPMENT\111635-FDR-MAP-DEVELOPED.dwg, 10/15/2021 4:43:48 PM, 1:1