



LSC TRANSPORTATION CONSULTANTS, INC.
545 East Pikes Peak Avenue, Suite 210
Colorado Springs, CO 80903
(719) 633-2868
FAX (719) 633-5430
E-mail: lsc@lsctrans.com
Website: <http://www.lsctrans.com>

Refer to
comments on
TIS submitted
with PUD

Rollin' Ridge
Updated Traffic Impact Study
PCD File No. P181
(LSC #174470)
May 14, 2018

Traffic Engineer's Statement

This traffic report and supporting information were prepared under my responsible charge and they comport with the standard of care. So far as is consistent with the standard of care, said report was prepared in general conformance with the criteria established by the County for traffic reports.



Developer's Statement

I, the Developer, have read and will comply with all commitments made on my behalf within this report.

Cam Turner

5-15-18
Date



LSC TRANSPORTATION CONSULTANTS, INC.
545 East Pikes Peak Avenue, Suite 210
Colorado Springs, CO 80903
(719) 633-2868
FAX (719) 633-5430
E-mail: lsc@lsctrans.com
Website: <http://www.lsctrans.com>

May 14, 2018

TC & C, LLC
c/o Carl Turse
17572 Colonial Park Drive
Monument, CO 80132-2209

RE: Rollin' Ridge
El Paso County, CO
Updated Traffic Impact Study
LSC #174470

Dear Mr. Turse,

LSC Transportation Consultants, Inc. has prepared this updated traffic impact study for the proposed Rollin' Ridge development planned to be located southwest of the intersection of Hodgen Road/State Highway 83 in Colorado Springs, Colorado. One access to Hodgen Road, located approximately 900 feet west of State Highway (SH) 83 and across from Cherry Crossing Drive, is proposed for the site. No direct access to SH 83 is proposed. This report has been prepared for submittal to the Colorado Department of Transportation (CDOT) and El Paso County.

REPORT CONTENTS

The preparation of this report included the following:

- An inventory of existing road and traffic conditions near the intersections of Hodgen Road with SH 83 and Cherry Crossing Drive adjacent to the site, including functional classification, traffic control signs, posted speed limits, intersection and access spacing, roadway and intersection alignments, and any auxiliary turn lanes.
- Weekday morning and late afternoon peak-hour turning movement traffic counts at the following intersections:
 - SH 83/Hodgen Road
 - Hodgen Road/Cherry Crossing Drive
- CDOT annual average daily traffic volumes.
- Projections of 20-year background traffic volumes on SH 83 and adjacent to the proposed site access on Hodgen Road.
- Proposed site land use and access locations.

- Estimates of average weekday peak-hour trip generation for the proposed development, including the estimated directional distribution of site-generated vehicle-trips on SH 83 and adjacent to the intersection of Hodgen Road/site access/Cherry Crossing Drive near the site.
- Projected site-generated and resulting total traffic.
- Intersection level of service analysis.
- Auxiliary right-/left-turn lane needs analysis based on the projected volumes and criteria in the El Paso County *Engineering Criteria Manual* (ECM) and the *Colorado State Highway Access Code*.
- Findings and recommendations.
- A list of associated deviation requests being submitted concurrently with this TIS.

LAND USE AND ACCESS

Figure 1 shows the site location relative to the adjacent and nearby roadways. Rollin' Ridge is planned to contain 16 lots for **single-family homes** and a commercial site. The site plan is shown in Figure 2a and Figure 2b.

Rollin' Ridge's most recent commercial site plan identifies several buildings with a mix of land uses, as shown in Table 1.

Table 1: Land Uses for Proposed Rollin' Ridge Commercial Development

Lot #	ITE Code	ITE Land Use Description	Value	Units
17	946	Gasoline/Service Station w/ Convenience Market	5.000	KSF*
18	720	Medical-Dental Office Building	5.000	KSF
	820	Shopping Center	5.000	KSF
19	820	Shopping Center	5.000	KSF
	820	Shopping Center	5.000	KSF
	820	Shopping Center	5.000	KSF
	820	Shopping Center	5.000	KSF
* KSF = 1,000 square feet 12 vehicle fueling positions (VFPs) are planned				

Access to Hodgen Road is proposed via a full-movement access located approximately 900 feet west of SH 83 (centerline spacing) and across from Cherry Crossing Drive.

The centerline access spacing along the main access drive (Cherry Crossing Drive extended south of Hodgen) is 360 feet between Hodgen and the northernmost internal access point and 290 feet south to the southern commercial access point.

ROAD AND TRAFFIC CONDITIONS

Area Roads and Streets

Figure 1 shows the roads in the vicinity of the site. The major roads are identified below followed by a brief description of each:

State Highway (SH) 83 extends from Colorado Springs north to Parker and areas of southeast Denver. In the vicinity of the site, SH 83 is classified as a Regional Highway (R-A). At this location, SH 83 is a two-lane rural highway with two- to four-foot shoulders and a speed limit of 60 miles per hour (mph). The intersection with Hodgen Road is signalized. Per the El Paso County 2040 *Major Transportation Corridors Plan (MTCP)*, SH 83 is projected to be expanded from a two-lane highway to a four-lane highway by 2040. Additionally, the southbound approach is projected to have a dual left-turn lane and an exclusive right-turn lane by 2040. El Paso County's 2060 *MTCP* also shows State Highway 83 as a future six-lane Principal Arterial. This is a CDOT roadway and the requirement for right of way dedication will be determined by CDOT.

Hodgen Road is a two-lane paved Rural Principal Arterial that extends west from State Highway 83 to Roller Coaster Road, where it continues west as Baptist Road. Hodgen also extends east from the intersection of Roller Coaster Road/Baptist Road to Eastonville Road (as a Minor Arterial). The speed limit on Hodgen Road is 40 mph adjacent to the site. El Paso County's 2060 *MTCP* shows Hodgen Road as a four-lane Rural Principal Arterial (180 feet of right-of-way per the ECM).

Cherry Crossing Drive is a north/south, two-lane local road with a posted speed limit of 30 mph. Currently a T-intersection, the intersection of Cherry Crossing Drive/Hodgen Road would be converted to a full-movement, two-way stop sign-controlled intersection with this project.

Traffic Volumes

Turning movement traffic counts were conducted on Wednesday, June 21, 2017 from 6:30 to 8:30 a.m. and from 4:00 to 6:00 p.m. at the intersections of Hodgen Road with SH 83 and Cherry Crossing Drive, as shown in Figure 3. Raw count volume data is attached for reference. The figure also shows CDOT annual average daily traffic volumes.

Sight Distance

Field-measured sight distance to the west from the proposed site access along Hodgen Road is 695 feet, which meets the minimum required 360 feet of stopping sight distance on a 45-mph (design speed/40-mph posted speed) two-lane roadway prescribed in Table 2-17 of the *ECM*.

The required intersection sight distance for passenger vehicles is 500 feet. This distance is met. The required intersection sight distance for trucks is 775 feet; however, given the driver's eye for trucks is significantly higher than for passenger cars, this distance requirement is also met.

The sight distance to the east extends to the east side of the intersection of Hodgen and SH 83 – about 950 feet.

TRIP GENERATION

Estimates of the vehicle-trips projected to be generated by the proposed development have been made using the nationally published trip generation rates from *Trip Generation, 10th Edition, 2017* by the Institute of Transportation Engineers (ITE).

Pass-By and Diverted Trips

The total number of trips generated by the site has also been aggregated by trip type to account for pass-by and diverted trips. A pass-by trip is one made by a motorist who would already be on an adjacent road regardless of the proposed development, but who stops in at the site while passing by. That pass-by motorist would then continue on his or her way to a final destination in the original direction. Table 7 (attached) shows the percent of the trips generated that were assumed to be pass-by trips. Pass-by percentage has been based on data from the *Trip Generation Handbook - An ITE Proposed Recommended Practice, 3rd Edition, 2014* by ITE and adjustments by LSC for site-specific conditions.

Analysis also accounts for diverted trips from adjacent State Highway 83. These trips are technically considered non-pass-by trips. These trips would be added to Hodgen Road and would result in altered turning movements at the nearby major intersection of SH 83/Hodgen Road. New trips would also be added to the proposed site access intersection.

The ITE-average percent pass-by and percent diverted trips were modified due to this site-specific situation. There are high northbound and southbound through volumes on State Highway 83 at its intersection with Hodgen Road approximately 900 feet to the east of the site. LSC increased the proportion of diverted trips generated by the gas station to 45 percent (to consider the volume of vehicles traveling on SH 83) while decreasing the share of pass-by trips (trips only from Hodgen Road) from 56 percent (ITE average) to 40 percent. Similarly, the ITE average of 34 percent passby trips generated by shopping centers, while LSC reduced that proportion to 30 percent. No major modifications were made to the estimated primary trip percentage for either of the two aforementioned land uses.

The proposed site is projected to generate about 2,899 non-pass-by total vehicle-trips on the **average weekday** during a 24-hour period. This includes a significant percentage of diverted trips from the SH 83/Hodgen intersection.

Driveway Trips

Table 2, below, presents a summary of the estimated site trip generation. The detailed trip generation estimate for the development, including ITE rates for the proposed land use, is presented in Table 7 (attached).

During the morning peak hour, approximately 157 vehicles would enter and 116 vehicles would exit the site. During the evening peak hour, approximately 183 vehicles would enter and 183 vehicles would exit the site. The morning peak-hour trip generation may be conservative depending on this particular store's opening time.

Table 2: Estimated Peak-Hour Vehicle-Trip Generation

Analysis Period	Weekday		
	In	Out	Total
A.M. Peak Hour (Driveway Trips)	157	116	271
P.M. Peak Hour (Driveway Trips)	183	183	366

TRIP DISTRIBUTION AND ASSIGNMENT

Trip Directional Distribution

An estimate of the directional distribution of site-generated vehicle-trips to the study area roads and intersections is a necessary component in determining the site's traffic impacts. Figure 4 shows the directional distribution estimate for the site-generated trips. The figure shows the percentages of the site-generated vehicle-trips projected to be oriented to and from the site's major approaches.

Estimated percentages have been based on the following factors: the site's proposed land uses, the area roadway system, the anticipated service area, and the existing and projected peak-hour traffic volumes. Additionally, Figure 4 shows the separate estimated pass-by and diverted trip distributions.

Site-Generated Traffic

Site-generated traffic volumes at the proposed site access and the intersection of SH 83/Hodgen have been calculated by applying the directional distribution percentages estimated by LSC to the trip generation estimates (from Table 2). Figure 5 shows the projected site-generated traffic volumes for the weekday morning and evening peak hours.

FUTURE TRAFFIC VOLUMES

Existing Plus Site-Generated Traffic

Figure 6 shows the sum of the 2017 existing background traffic volumes (from Figure 3) and site-generated peak-hour traffic volumes (shown in Figure 5). These volumes represent the projected short-term total traffic following site buildout. Lane geometry and traffic control at the proposed Hodgen/site access and SH 83/Hodgen intersections are also shown in this figure.

Long-Term Background (2040)

Figure 7 shows the estimated background traffic volumes for the year 2040. These are estimates by LSC based on historical count data, CDOT factors, and other traffic studies completed in the area. Traffic from the site is not included in the 2040 background traffic volumes.

Long-Term Total Traffic (2040)

Figure 8 shows the sum of 2040 background traffic volumes (from Figure 7) plus the site-generated traffic volumes (from Figure 5). Figure 7 and Figure 8 also show the lane geometry and traffic control at the proposed site access intersection and the intersection of SH 83/Hodgen for the 2040 background and background plus site conditions, respectively.

LEVEL OF SERVICE ANALYSIS

Level of service (LOS) is a quantitative measure of the level of congestion or delay at an intersection and is indicated on a scale from "A" to "F." LOS A is indicative of little congestion or delay. LOS F indicates a high level of congestion or delay. Table 3 shows the level of service delay ranges for signalized and unsignalized intersections.

Table 3: Intersection Levels of Service Delay Ranges

Level of Service	Signalized Intersections		Unsignalized Intersections
	Average Control Delay (seconds/vehicle)	V/C ⁽¹⁾	Average Control Delay (seconds/vehicle) ⁽²⁾
A	≤ 10.0	< 0.60	≤ 10.0
B	10.1 – 20.0	0.60 – 0.69	10.1 – 15.0
C	20.1 – 35.0	0.70 – 0.79	15.1 – 25.0
D	35.1 – 55.0	0.80 – 0.89	25.1 – 35.0
E	55.1 – 80.0	0.90 – 0.99	35.1 – 50.0
F	≥ 80.1	≥ 1.00	≥ 50.1

(1) Source: *Transportation Research Circular 212*
 (2) For unsignalized intersections, if V/C is > 1.00, then LOS is LOS F regardless of the projected average control delay per vehicle.

The proposed access intersection on Hodgen Road and the SH 83/Hodgen intersection have been analyzed to determine the projected control delay and corresponding levels of service and for the key intersection approaches (or for specific individual turning movements as applicable). As the proposed site access (Cherry Crossing Drive) intersection with Hodgen Road is/will be two-way stop-sign controlled (TWSC), traffic on the northbound and southbound approaches incur delay given the stop-sign control. The major street left-turn movements also incur delay.

Morning Peak Hour

A summary of current and projected 2040 background traffic conditions—both with and without considering site-generated traffic—is shown in Table 4. LOS and control delays during the weekday morning peak hour are shown in this table. Detailed Synchro reports are attached. SimTraffic simulation results were used in place of the *Highway Capacity Manual* (HCM) results at the TWSC site access intersection with Hodgen Road, as the SimTraffic micro-simulation better accounts for westbound traffic gaps created by nearby Hodgen/SH 83 signalized intersection.

Table 4: Level of Service Comparison by Scenario (A.M. Peak)

Analysis Period	Cherry Crossing Drive/ Hodgen Road					State Highway 83/ Hodgen Road					Lap Wai Ct/ Site Access		
	Traffic Control	SB	NB L/T	NBR	WBL	Traffic Control	Overall	EBL	WBL	NBL	SBL	EB	WB
LOS													
2017 Existing	TWSC*	A	-	-	-	Signal	B	A	B	A	A	-	-
2017 Existing + Site		A	A	A	A		B	B	B	A	A	A	A
2040 Background		C	-	-	-		C	C	C	B	B	-	-
2040 Background + Site		C	C	A	A		C	C	C	B	B	A	A
Control Delay (Seconds)													
2017 Existing	TWSC*	4.2	-	-	-	Signal	10.3	9.5	15.4	9.3	9.8	-	-
2017 Existing + Site		7.4	8.9	3.2	3.9		10.2	10.3	15.6	9.9	9.5	6.1	3.2
2040 Background		19.7	-	-	-		23.0	23.2	31.5	16.9	16.1	-	-
2040 Background + Site		20.5	18.0	4.9	6.0		21.7	20.6	25.8	16.6	15.5	7.6	3.0

Cherry Crossing Drive/Hodgen Road

All turning movements at this intersection are projected to operate at LOS C or better for all short-term and long-term morning peak-hour traffic conditions, with or without development.

State Highway 83/Hodgen Road

All turning movements at this intersection are projected to operate at LOS C or better in the short and long term during the weekday morning peak hour.

Cherry Crossing Drive/Lap Wai Court/Proposed Site Access

All turning movements at the proposed site access off Cherry Crossing Drive are projected to operate at LOS A during all short-term and long-term morning peak-hour traffic conditions, with or without development.

Evening Peak Hour

A summary of current and projected 2040 background traffic conditions—both with and without considering site-generated traffic—is shown in Table 5. LOS and control delays during the weekday evening peak hour are shown in this table. Detailed Synchro reports are attached.

Table 5: Level of Service Comparison by Scenario (P.M. Peak)

Analysis Period	Cherry Crossing Drive/ Hodgen Road					State Highway 83/ Hodgen Road					Lap Wai Ct/ Site Access		
	Traffic Control	SB	NB L/T	NBR	WBL	Traffic Control	Overall	EBL	WBL	NBL	SBL	EB	WB
LOS													
2017 Existing	TWSC*	A	-	-	-	Signal	A	B	B	A	B	-	-
2017 Existing + Site		A	A	A	A		A	B	B	A	B	A	A
2040 Background		B	-	-	-		C	D	D	B	D	-	-
2040 Background + Site		C	D	A	A		C	D	C	B	D	A	A
Control Delay (Seconds)													
2017 Existing	TWSC*	6.7	-	-	-	Signal	9.4	12.7	16.5	7.3	13.2	-	-
2017 Existing + Site		8.4	9.9	3.9	4.6		9.0	12.8	15.4	8.3	10.5	8.4	3.4
2040 Background		14.5	-	-	-		32.9	49.9	52.6	12.2	43.6	-	-
2040 Background + Site		24.8	32.1	6.0	8.7		30.3	37.8	32.6	16.0	42.3	7.0	3.1
* TWSC = Two-Way Stop Sign Control													

Cherry Crossing Drive/Hodgen Road

All turning movements at the intersection of Hodgen Road/Cherry Crossing Drive currently operate and are projected to remain at LOS D or better for all short-term and long-term evening traffic conditions, with or without development.

State Highway 83/Hodgen Road

This intersection is projected to operate at LOS D or better in the short and long term during the weekday evening peak hour.

Cherry Crossing Drive/Lap Wai Court/Proposed Site Access

All turning movements at the proposed site access off Cherry Crossing Drive are projected to operate at LOS A during all short-term and long-term evening peak-hour traffic conditions, with or without development.

QUEUING ANALYSIS

Table 6 summarizes queueing analysis results assuming site buildout traffic is added to the projected long-term background traffic volumes at the intersection of Hodgen Road/Cherry Crossing Drive. Deviations from ECM-prescribed deceleration and taper distances are compared to the proposed lengths. Please refer to the attached striping plan exhibits for detailed proposed turn lane lengths. Also, please refer to the deviation request for the westbound left turn lane on Hodgen

Road at the proposed site access/Cherry Crossing Drive. The proposed left-turn lane will provide a reasonable length for the westbound left turn lane approaching Cherry Crossing Drive without shortening the existing eastbound left turn lane approaching SH 83.

For the westbound left turn lane on Hodgen Road at Cherry Crossing Drive, the ECM standard for a 45-mph design speed roadway is interpolated to be 200 feet of deceleration distance plus a 170-foot taper plus stacking needs. There appears to be a grade of just over three percent at the start of the left turn lane, then the grades become more level closer to the intersection. To be conservative, a grade-adjusted combined deceleration plus taper length is 444 feet - or 74 feet longer. The stacking length required from the analysis included in the TIS is 61 feet. Therefore, a full-width lane length of 335 feet (200'+74'+61') would be required (250' proposed as shown on the striping exhibit). The required taper is 170-feet and a 100-foot taper is proposed.

Assuming a separate northbound shared left/through lane and an exclusive northbound right-turn lane on northbound approach to Hodgen/Cherry Crossing Drive, the projected long-term queue is **not** projected to exceed the available stacking distance during either peak hour at the intersection of Hodgen Road/Cherry Crossing Drive. The proposed 90 feet of stacking distance with 75-foot taper for the southbound left-turn lane at the intersection of Cherry Crossing Drive/Lap Wai Court/commercial site access will accommodate all projected queues during both peak hours.

Table 6: Queuing Analysis Results (2040 Background Plus Site-Generated Traffic)

Queue Data	Hodgen Road/ Cherry Crossing Drive			Lap Wai Court/ Cherry Crossing Drive
	NB LT/TH	NBR	WBL	SBL
Taper Length				
ECM Standard (ft)	N/A	N/A**	170'	N/A**
Proposed Taper Length (ft)		75'	100'	75'
Difference from ECM (ft)		+75'	- 70'	+75'
Full-Width Lane (Stacking + Deceleration) Length				
ECM Standard (ft)	275*	N/A**	335'	N/A**
Proposed Distance (ft)		105'	250'	90'
Difference from ECM (ft)		+105'	- 85'	+90'
Queuing (AM Peak Hour)***				
Maximum Queue (ft)	44'	55'	57'	30'
Upstream Block Time (%)	0%	0%	0%	0%
Storage Block Time (%)	0%	0%	0%	0%
Queuing (PM Peak Hour)***				
Maximum Queue (ft)	64'	69'	61'	33'
Upstream Block Time (%)	0%	0%	0%	0%
Storage Block Time (%)	0%	0%	0%	0%
<p>* Represents the distance between the intersections. ** Not required for Local streets, however proposed for Modified Rural Local street classification to accommodate the projected traffic volumes. ***Maximum queues reported in SimTraffic analysis are shown. ECM Table 2-26 shows general values for bay taper lengths for 12' lanes by design speed.</p>				

CONCLUSIONS AND RECOMMENDATIONS

- The site is projected to generate about 2,899 new/non-pass-by vehicle-trips on the average weekday. A significant portion of these non-pass-by trips are projected to be diverted trips from the Highway 83/Hodgen Road intersection.
- Approximately 157 vehicles would enter the site during the weekday morning peak hour, while 116 vehicles are projected to exit. During the weekday evening peak hour of adjacent street traffic, 183 vehicles would enter the site while 183 vehicles would exit.
- All approaches at the site access intersection with Hodgen Road and at the intersection of SH 83/Hodgen will operate at LOS D or better during both the short and long term during the weekday morning peak hour and evening peak hour following the addition of this development. It is assumed that SH 83 will be expanded to a four-lane highway from

Hodgen Road south with dual southbound left-turn lanes in the long term (assumed for 2040).

- According to the El Paso County *Engineering Criteria Manual* (ECM), exclusive left-turn lanes shall be provided for any access on a Principal Arterial with a projected peak-hour ingress turning volume of 10 vehicles per hour (vph) or greater. Projected left-turn volumes at the site access point are expected to exceed the minimum left-turn volume thresholds outlined in the *ECM* upon site buildout. Thus, an exclusive westbound left-turn lane is prescribed by the ECM at the intersection of Hodgen Road/Cherry Crossing Drive/site access. LSC recommends the painted center median be restriped to provide for this left-turn lane. This turn lane would be back-to-back with the eastbound left-turn lane at the Hodgen/SH 83 intersection. Please refer to the Queuing Analysis section and the attached lane exhibit for details.
- As shown in Figure 6 and Figure 8, the projected future westbound left-turn volumes, including existing, future background, and site traffic, are approximately 115 and 129 vehicles during the short- and long-term morning peak hour and evening peak hour, respectively.
- Per ECM criteria, exclusive Arterial with a projected peak-hour ingress turning volume of 10 vehicles per hour or greater. As shown in Figure 6 and Figure 8, the projected future eastbound right-turn volume is approximately 63 vehicles during the evening peak hour, which exceeds the minimum right-turn volume ECM thresholds upon site buildout. Thus, an exclusive right-turn deceleration lane is prescribed by the ECM at the intersection of Hodgen Road/site access.
- The *Colorado State Highway Access Code* requires a right-turn deceleration lane for any "access" (Hodgen Road is considered an "access" to SH 83) with a projected peak-hour right ingress turning volume greater than 25 vph. Per code, a southbound right-turn deceleration lane is required at the intersection of SH 83/Hodgen Road based on existing traffic volumes.
- The *Colorado State Highway Access Code* requires a right-turn acceleration lane for any "access" (Hodgen Road is considered an "access" to SH 83) with a projected peak-hour right ingress turning volume greater than 50 vph. Per code, a southbound right-turn acceleration lane is required at the intersection of SH 83/Hodgen Road based on existing traffic volumes.
- The current northbound left-turn deceleration lane at the SH 83/Hodgen intersection will need to be lengthened to the south to meet Access Code criteria based on existing plus buildout site-generated traffic.

Is there sufficient length to meet the minimum requirements per the ECM? Identify the minimum requirement per the ECM and the amount that would be accommodated with the restriping.

- Proposed turn lane length designs, including deceleration (where applicable) storage and taper lengths, are projected to accommodate long-term queues at the intersections of Hodgen Road/Cherry Crossing Drive and the Lap Wai Court/site access. Deviations to ECM-prescribed turn lane design criteria are shown in Table 6. Please refer to the attached lane exhibits and deviation requests.
- Please refer to the attached lane exhibits for Hodgen Road and the main access drive (Cherry Crossing Drive).
- **Roadway Classification:** LSC recommends that Cherry Crossing Drive south of Hodgen Road be classified as a “modified” Rural Local roadway. The projected buildout ADT is 4,343 vehicles per day. Please refer to the attached lane exhibit. A deviation request for the modified standard roadway has been included with this submittal and would apply to the section of roadway from Hodgen Road south to the southernmost commercial site access.

The ECM-standard roadway design elements, per Table 2-5 of the ECM, would be modified to accommodate the accommodate the higher-than-Local-standard traffic volumes as follows:

- Right- and left-turn bays would be included, where needed in addition to the two 12-foot-wide through lanes, to accommodate the projected higher-than-Local-standard traffic volumes.
- Outside shoulder widths of 8 feet, including 4 feet of paved shoulder and 4 feet of gravel shoulder – also to accommodate the higher-than-Local-standard traffic volumes.
- No on-street parking and no individual lot access except south of the south commercial access.
- Seventy-foot right-of way north of the first commercial access, tapering/variable right-of-way between the two commercial access points, and Local standard 60 feet of right-of-way with two 5-foot public improvements easements south of the south commercial access.
- An intersection spacing of 290 feet between the two commercial access drives is requested where local street spacing is 330 feet – this is included in the deviation request.

All other streets would be classified as Rural Local.

- **Roadway Right-of-Way:** The site plan shows right-of-way dedication for a 90-foot half-right-of-way for both Hodgen Road and State Highway 83.



Was the right-of-way dedication on HWY 83 coordinated with CDOT? Any right-of-way dedication or preservation must be discussed with CDOT.

- **Deviation Requests:** Two deviation requests accompany this submittal. The first is for the projected ADT and modified Rural Local cross-section for Cherry Crossing Drive south of Hodgen. The second is for the westbound left turn lane dimensions along Hodgen Road at the Cherry Crossing Drive intersection.

- This project will be required to participate in the El Paso County Road Impact Fee program. Consideration for Fee Program credit may be given to intersection improvements completed at the State Highway 83/Hodgen Road intersection (applicable MTCP project reference numbers U9 and SH 6).

* * * * *

Please contact me if you have any questions regarding this report.

Sincerely,

LSC TRANSPORTATION CONSULTANTS, INC.

By

Jeffrey C. Hodsdon, P.E., PTOE
Principal

JCH:JAB:bjwb

Enclosures: Table 7
Figure 1 – Figure 8
Lane Exhibits: Hodgen Road and Site Access Drive (Cherry Crossing Drive)
Traffic Count Reports
Synchro Reports
SimTraffic Reports

Table 7: Detailed Trip Generation Estimate

ITE		Value	Units	Trip Generation Rates ⁽¹⁾				Driveway Trips Generated				% Diverted Trips	% Pass-by Trips	Non-Pass-by Trips Generated						
Code	Description			Avg Weekday Traffic	A.M.		P.M.		Avg Weekday Traffic	A.M.				P.M.		Avg Weekday Traffic	A.M.		P.M.	
				In	Out	In	Out		In	Out	In	Out				In	Out	In	Out	
210	Single-Family Detached Housing	16	DU ⁽²⁾	9.52	0.19	0.56	0.63	0.37	152	3	9	10	6	0%	0%	152	3	9	10	6
945	Gasoline/Service Station w/ Convenience Market	12	VFP ⁽³⁾	162.78	5.08	5.08	6.76	6.76	1,953	61	61	81	81	45%	40%	1172	37	37	49	49
720	Medical-Dental Office Building	5.000	KSF ⁽⁴⁾	36.13	1.89	0.50	1.00	2.57	181	9	3	5	13	0%	0%	181	9	3	5	13
820	Shopping Center	25.000	KSF	88.38	3.45	2.11	3.86	3.57	2,209	86	53	97	89	30%	30%	1547	60	37	68	62
									4,343	157	116	183	183			2,899	106	76	121	124

(1) Source: *Trip Generation, 9th Edition, 2012* by the Institute of Transportation Engineers (ITE)

(2) DU = dwelling units

(3) VFP = vehicle fueling positions

(4) KSF = 1,000 square feet

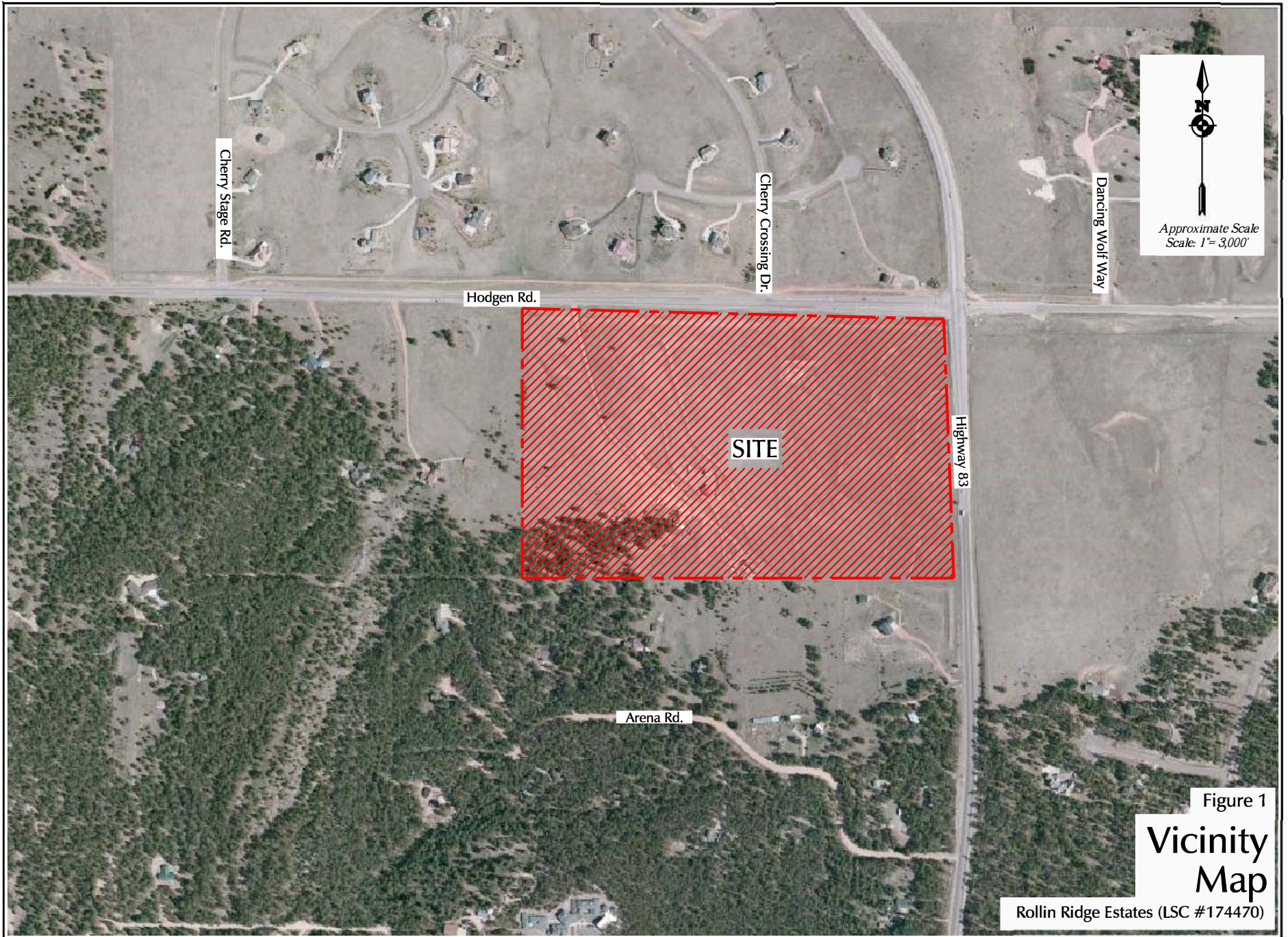
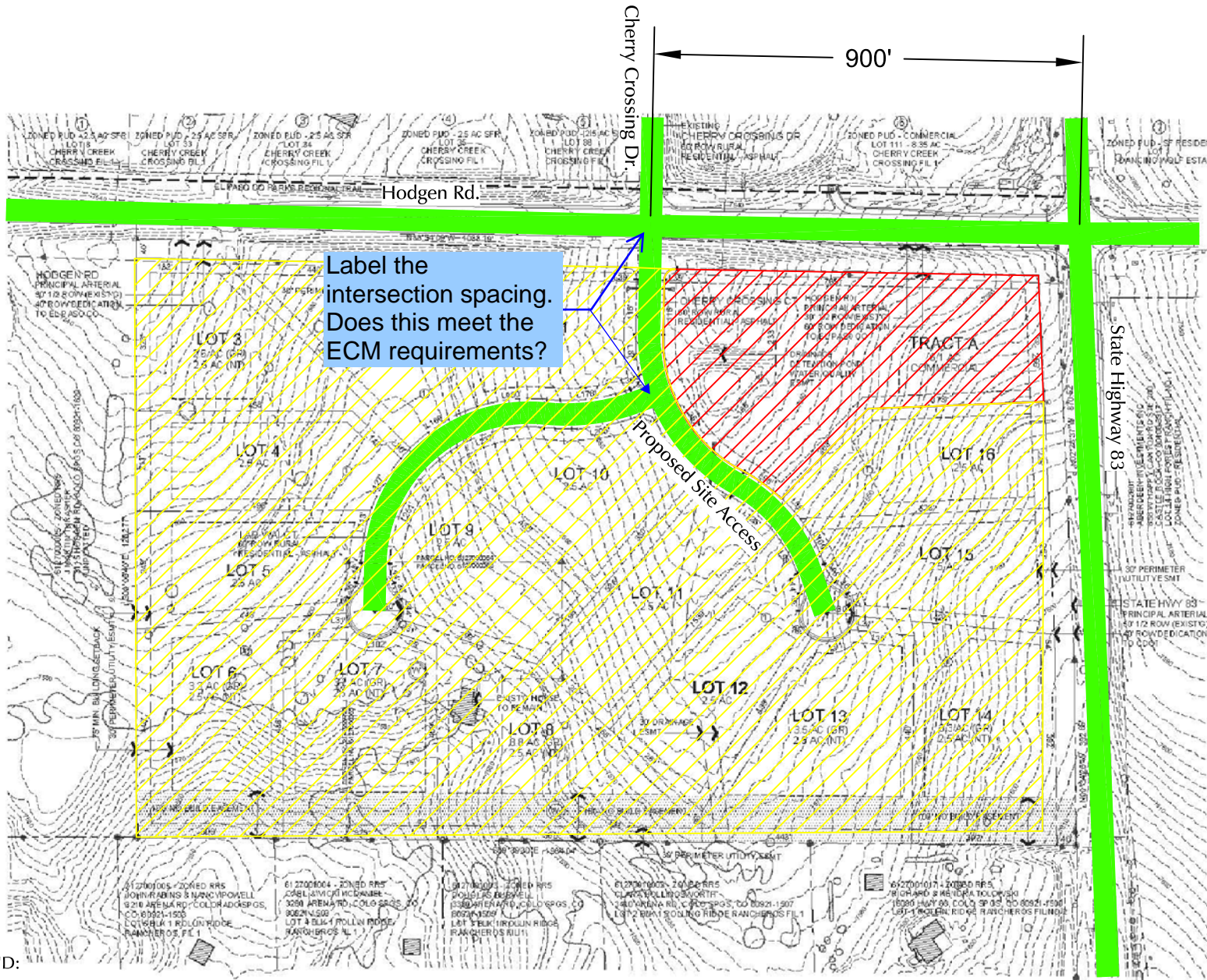

Figure 1
**Vicinity
Map**

Rollin Ridge Estates (LSC #174470)



Approximate Scale
Scale: 1" = 600'

LEGEND:

- = Commercial Development Site (See Figure 2b for Commercial Site Plan Detail)
- = Residential Development Site

Figure 2a
Site Plan

Rollin Ridge Estates (LSC #174470)

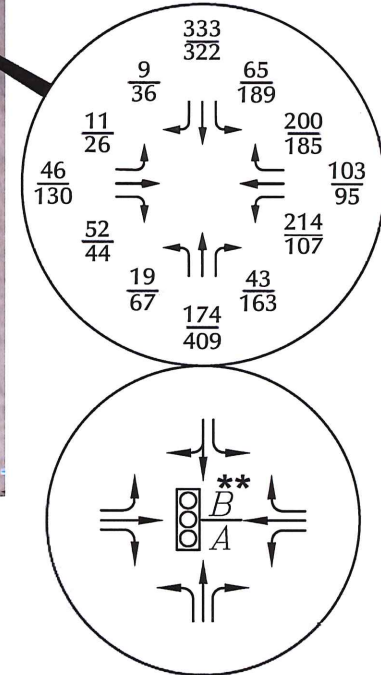
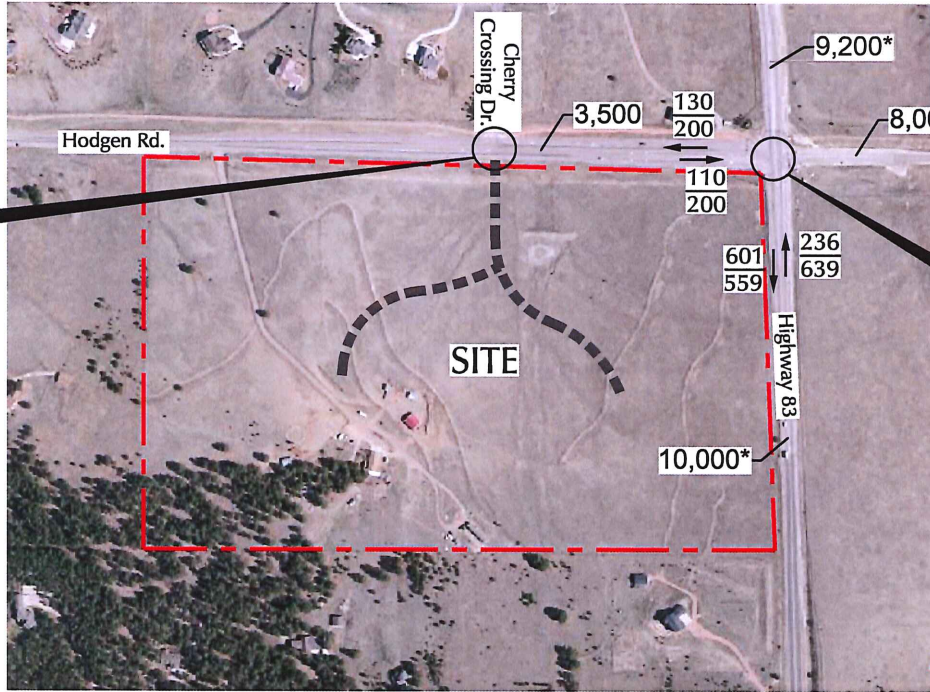
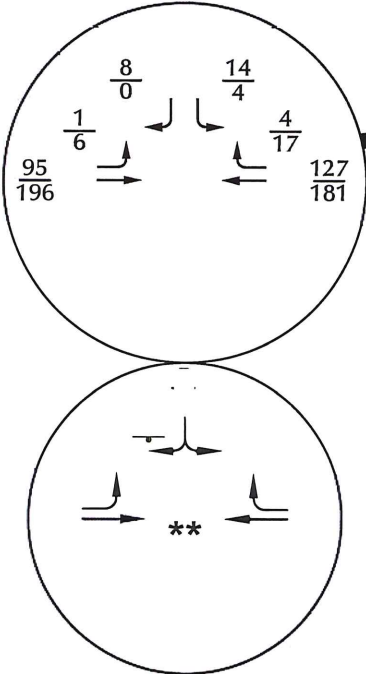
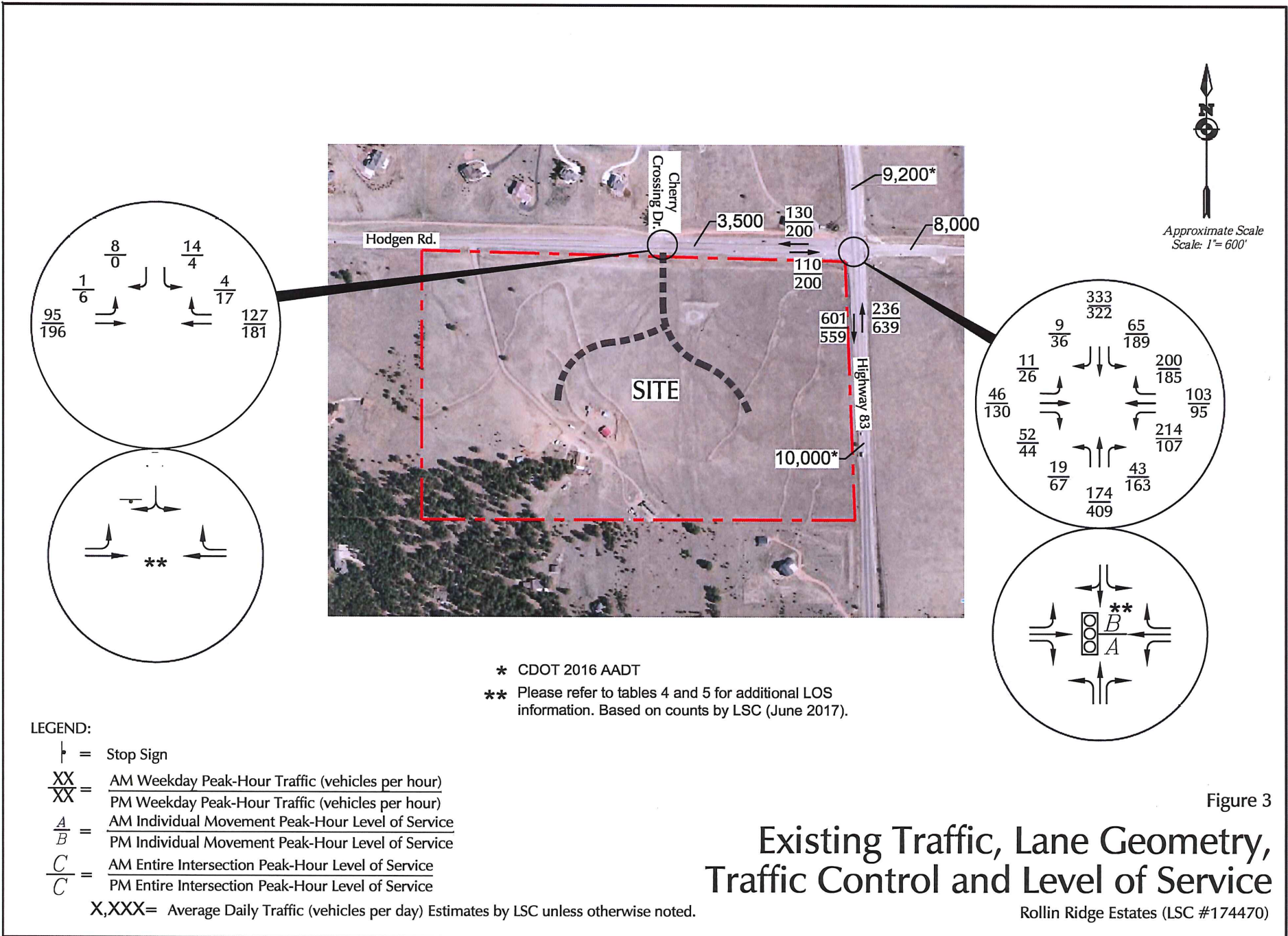

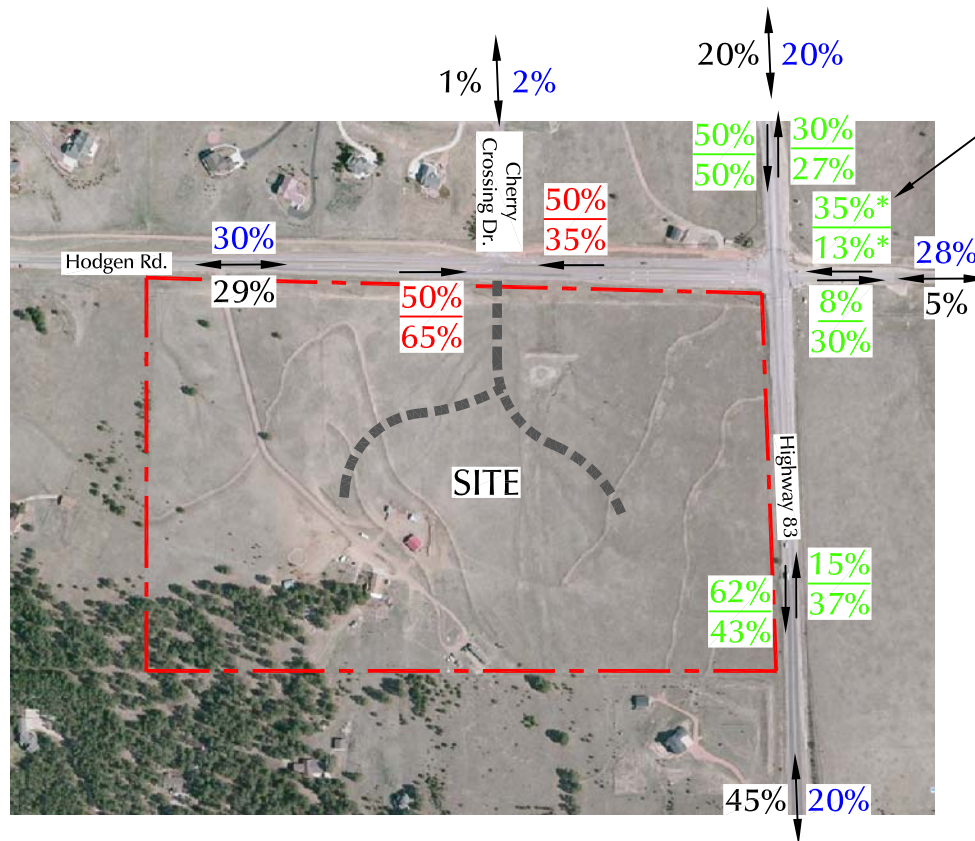

Note: WB diverted trips would otherwise turn left or right at SH 83.

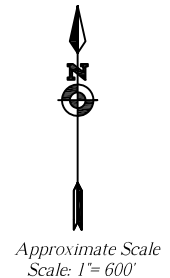

- LEGEND:
- XX% = Primary Percent Directional Distribution (Residential)
 - XX% = Primary Percent Directional Distribution (Commercial)
 - XX% = AM Passby Percent Directional Distribution (Commercial)
 - XX% = PM Passby Percent Directional Distribution (Commercial)
 - XX% = AM Diverted Percent Directional Distribution (Commercial)
 - XX% = PM Diverted Percent Directional Distribution (Commercial)

Figure 4
Directional Distribution of Site-Generated Traffic
 Rollin Ridge Estates (LSC #174470)

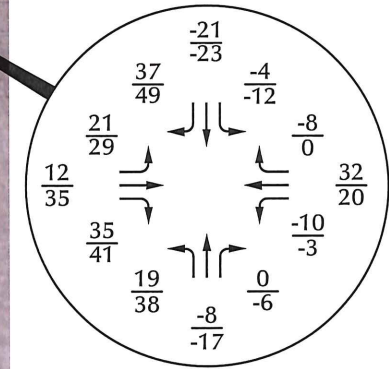
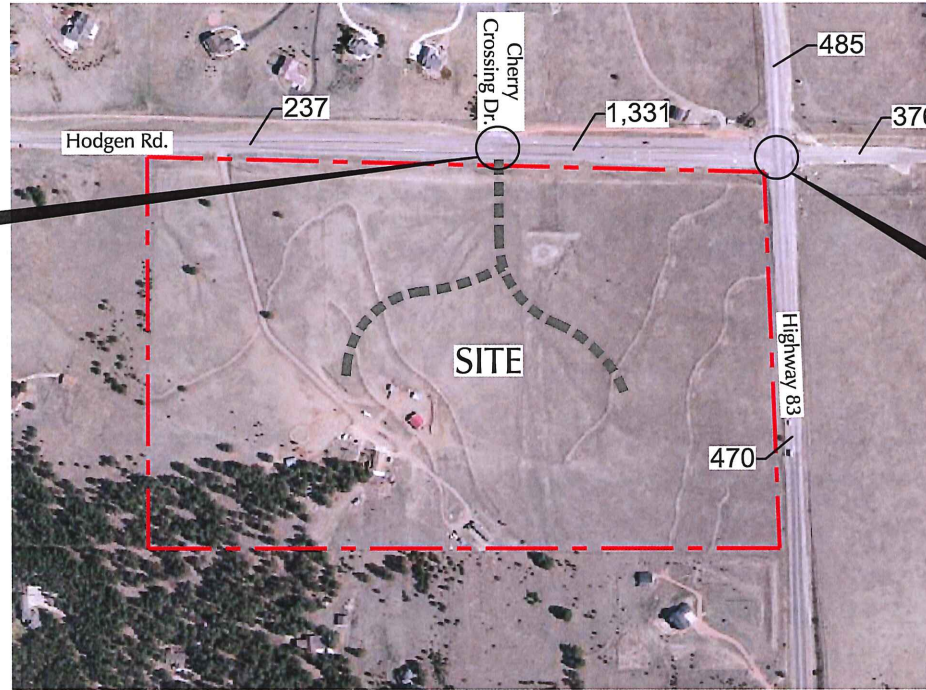
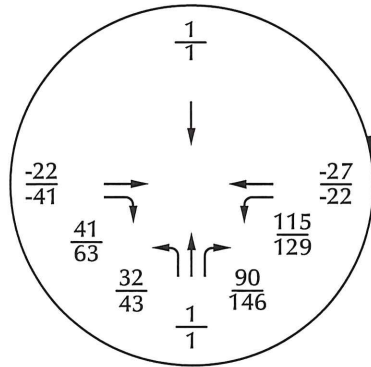

Approximate Scale
Scale: 1" = 600'

LEGEND:

$\frac{XX}{XX}$ = AM Weekday Peak-Hour Traffic (vehicles per hour)
 $\frac{XX}{XX}$ = PM Weekday Peak-Hour Traffic (vehicles per hour)

X,XXX= Average Daily Traffic (vehicles per day)

Figure 5
**Assignment of
 Site-Generated Traffic**
 Rollin Ridge Estates (LSC #174470)

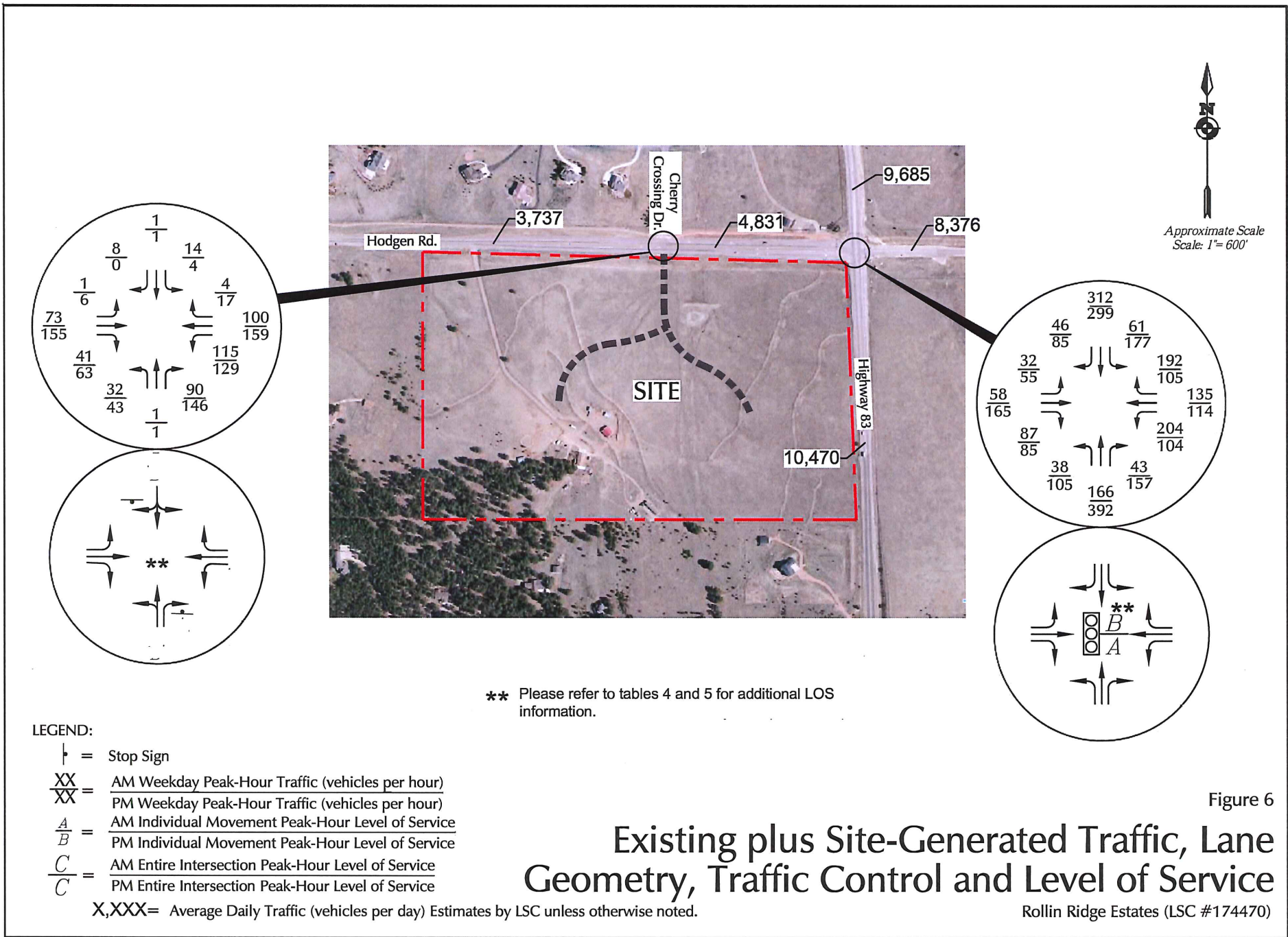

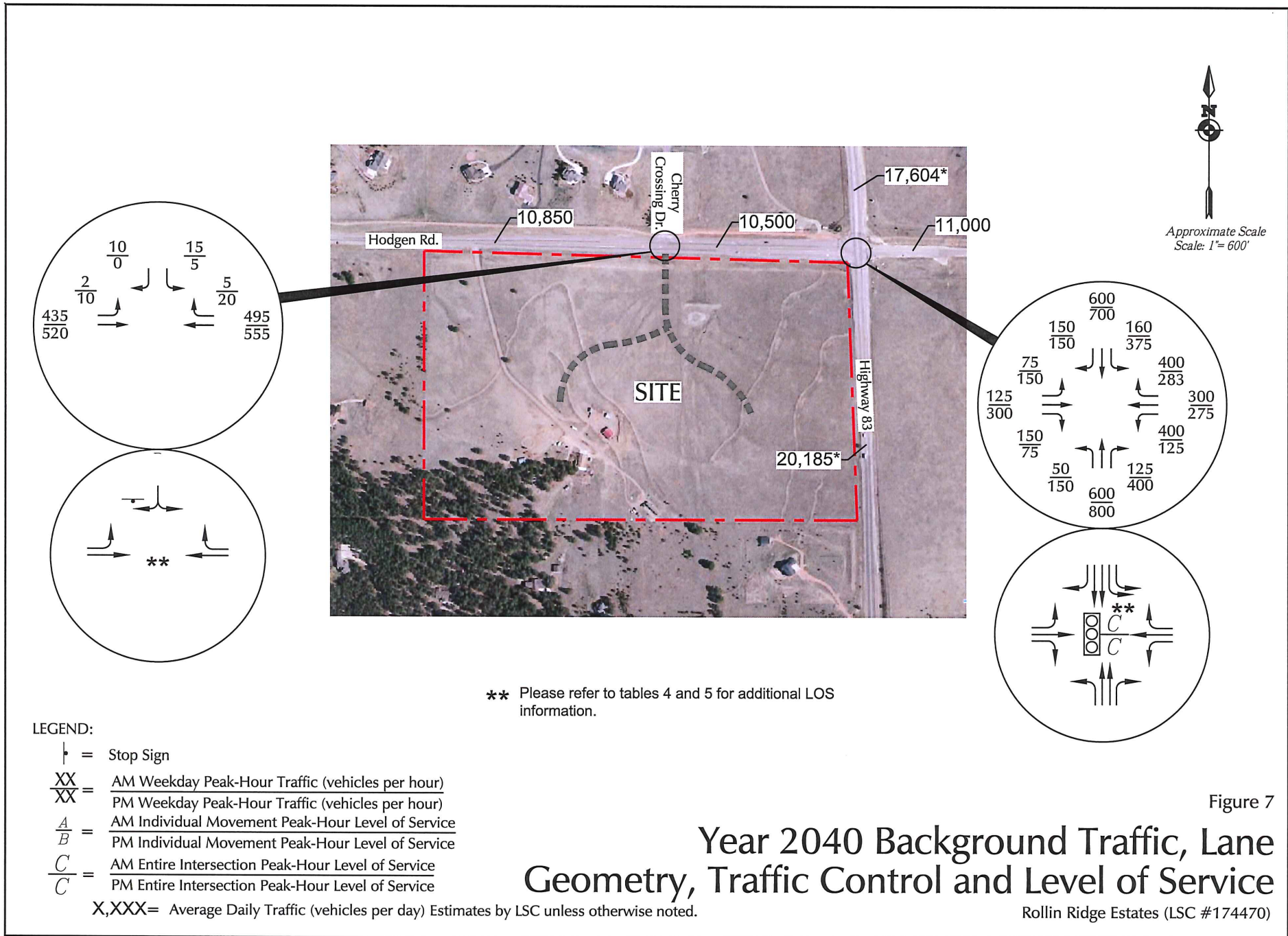

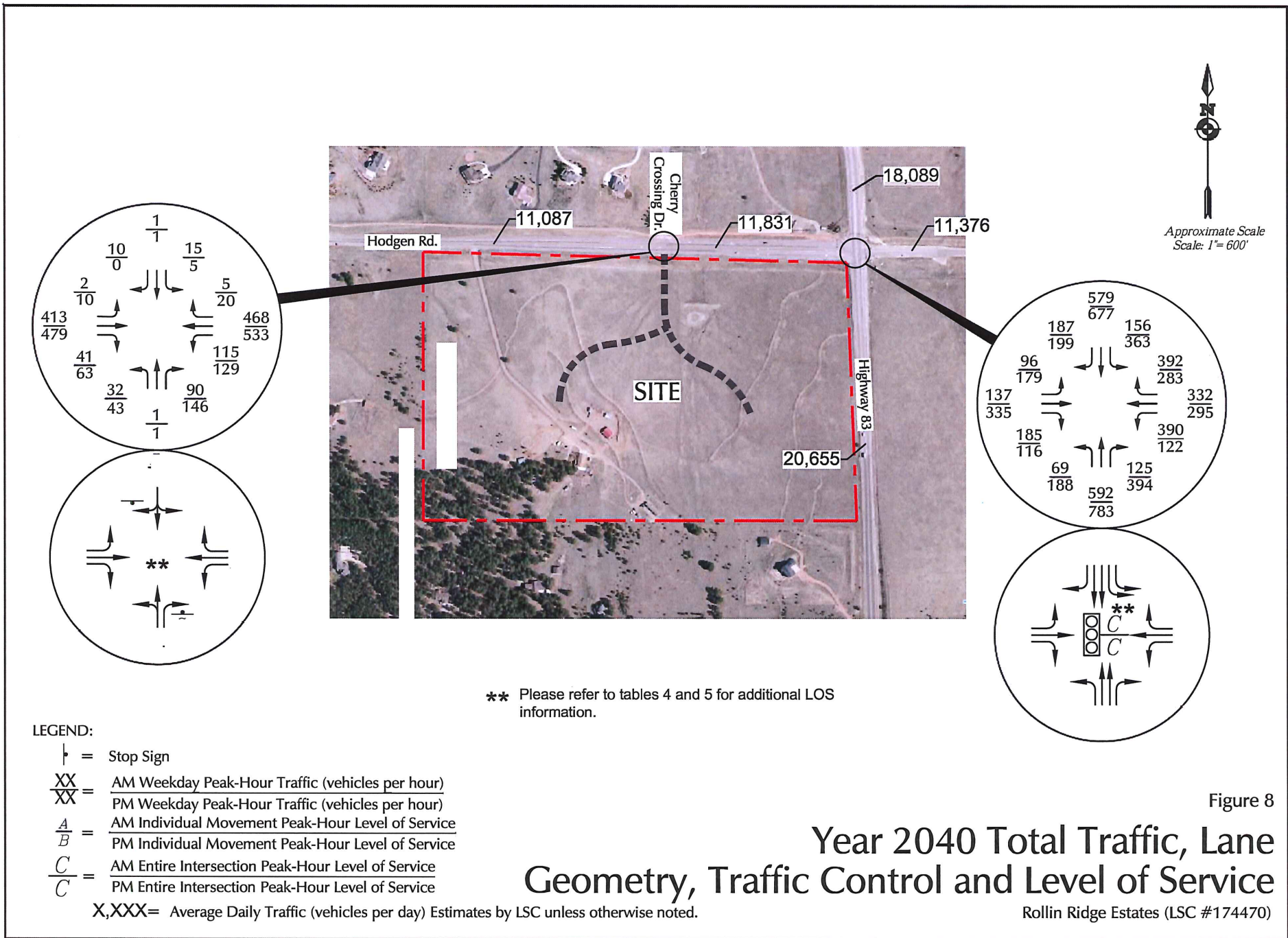

Figure 8

Year 2040 Total Traffic, Lane Geometry, Traffic Control and Level of Service

Rollin Ridge Estates (LSC #174470)

Eastbound Right Turn Deceleration Lane

Cherry Crossing Drive

Restripe for 250' Westbound Left Turn Lane

Restripe for Shared 100' Bay Taper

Existing 400' Eastbound Left Turn Lane

Existing Eastbound Right Turn Deceleration Lane

Hodgen Road

Site Access Drive

Hodgen Road Lane Exhibit

1" = 60'

Rollin' Ridge

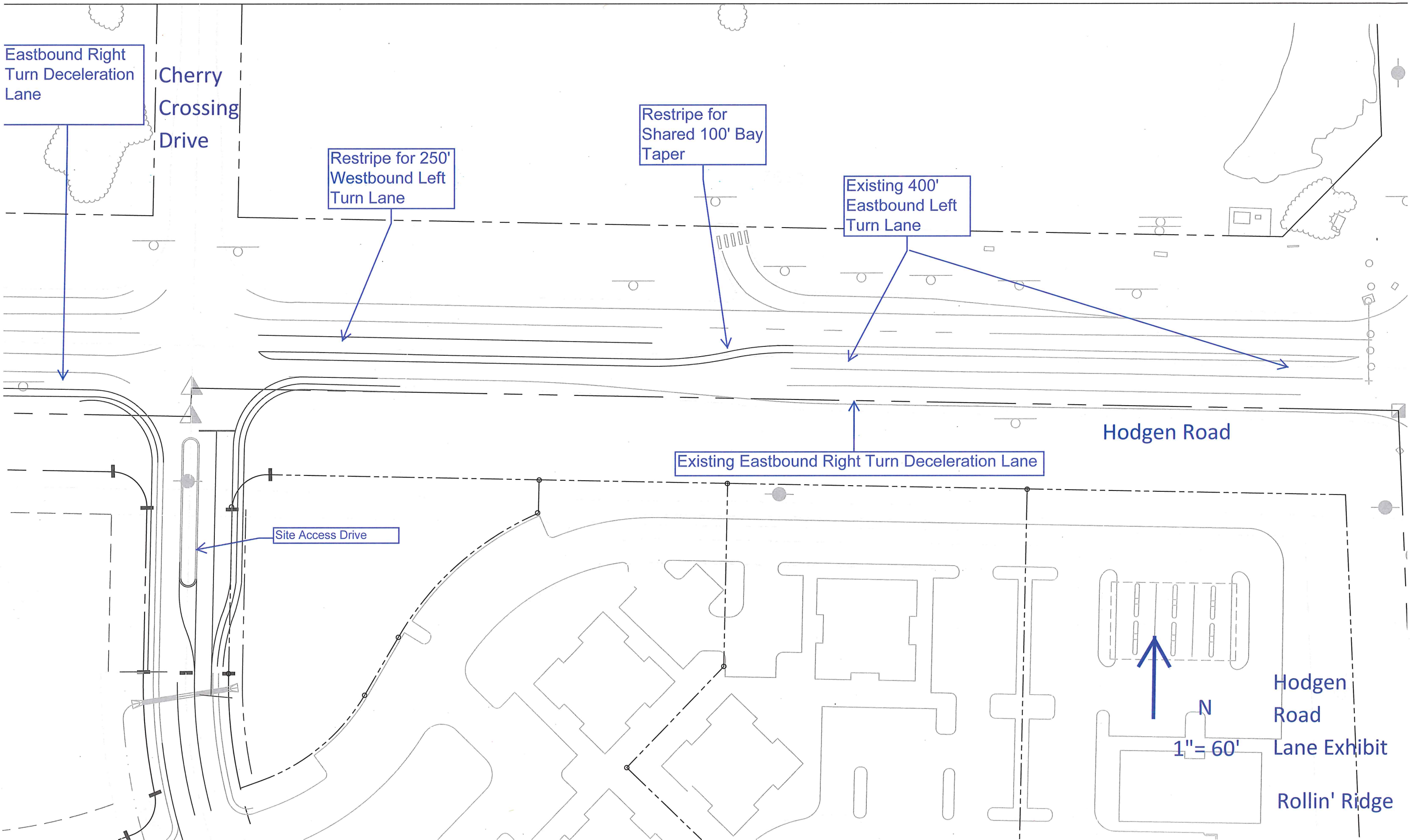

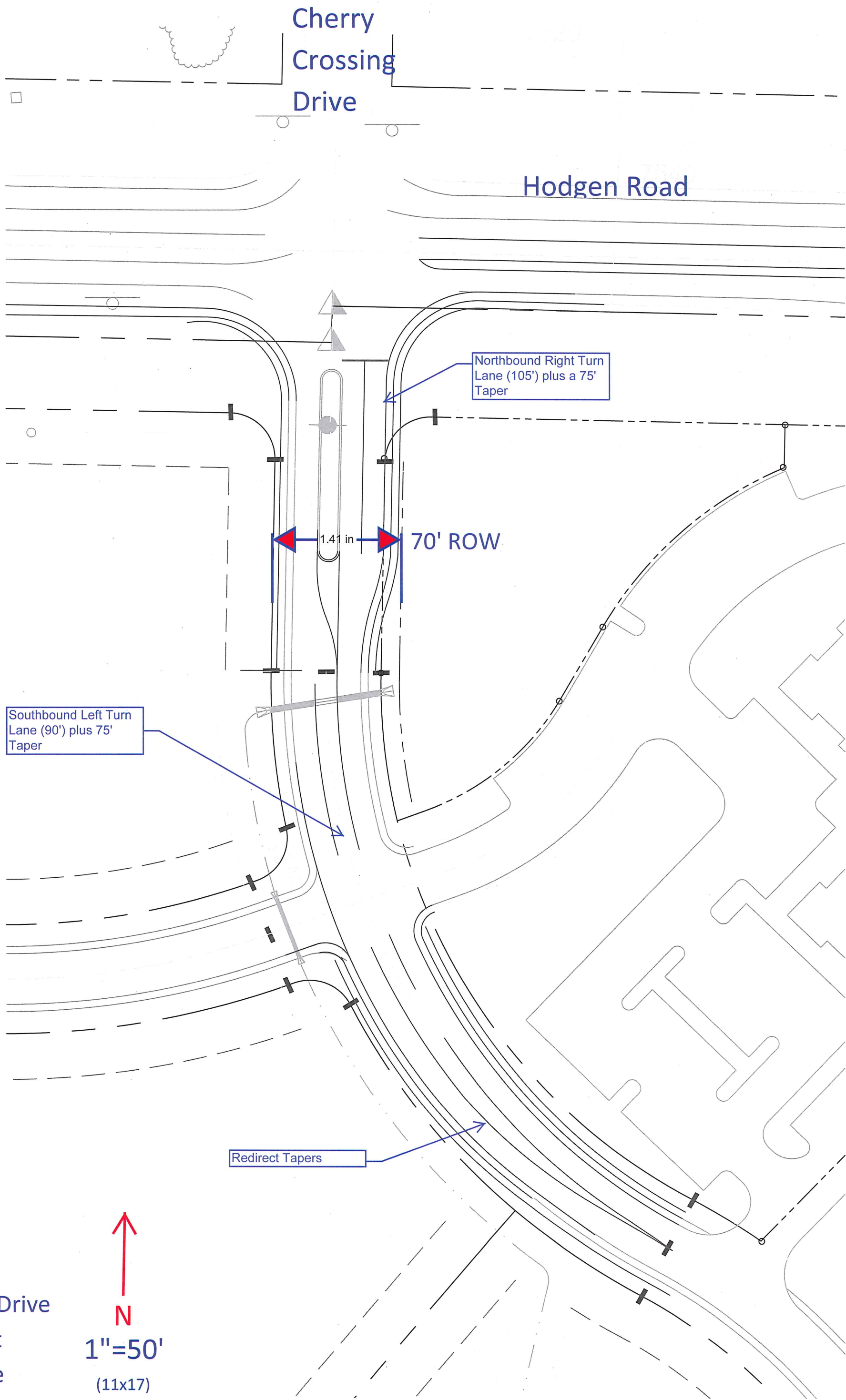

Site Access Drive
Lane Exhibit
Rollin' Ridge

↑
N
1"=50'
(11x17)

Counts by LSC

LSC Transportation Consultants, Inc.

File Name : Cherry Crossing Dr - Hodgen Rd AM
 Site Code : 00174470
 Start Date : 06/21/2017
 Page No : 1

Groups Printed- Bank 1

Start Time	Cherry Crossing Dr From North				Hodgen Rd From East				From South				Hodgen Rd From West				Int. Total
	Right	Thru	Left	Peds	Right	Thru	Left	Peds	Right	Thru	Left	Peds	Right	Thru	Left	Peds	
Factor	1.0	1.0	1.0	1.0	1.0	1.0	1.0	1.0	1.0	1.0	1.0	1.0	1.0	1.0	1.0	1.0	
06:30 AM	1	0	1	0	0	0	0	0	0	0	0	0	0	0	0	0	2
06:45 AM	1	0	1	0	0	0	0	0	0	0	0	0	0	0	0	0	2
Total	2	0	2	0	0	0	0	0	0	0	0	0	0	0	0	0	4
07:00 AM	0	0	1	0	0	0	0	0	0	0	0	0	0	0	0	0	1
07:15 AM	0	0	2	0	0	0	0	0	0	0	0	0	0	0	0	0	2
07:30 AM	1	0	6	0	1	0	0	0	0	0	0	0	0	0	0	0	8
07:45 AM	2	0	3	0	1	0	0	0	0	0	0	0	0	0	0	0	6
Total	3	0	12	0	2	0	0	0	0	0	0	0	0	0	0	0	17
08:00 AM	2	0	4	0	1	0	0	0	0	0	0	0	0	0	0	0	7
08:15 AM	3	0	1	0	1	0	0	0	0	0	0	0	0	0	1	0	6
Grand Total	10	0	19	0	4	0	0	0	0	0	0	0	0	0	1	0	34
Apprch %	34.5	0.0	65.5	0.0	100. 0	0.0	0.0	0.0	0.0	0.0	0.0	0.0	0.0	0.0	100. 0	0.0	
Total %	29.4	0.0	55.9	0.0	11.8	0.0	0.0	0.0	0.0	0.0	0.0	0.0	0.0	0.0	2.9	0.0	

Counts by LSC

File Name : Cherry Crossing Dr - Hodgen Rd AM
 Site Code : 00174470
 Start Date : 06/21/2017
 Page No : 2

Start Time	Cherry Crossing Dr From North					Hodgen Rd From East					From South					Hodgen Rd From West					Int. Total
	Rig ht	Thru	Lef t	Pe ds	App. Total	Rig ht	Thru	Lef t	Pe ds	App. Total	Rig ht	Thru	Lef t	Pe ds	App. Total	Rig ht	Thru	Lef t	Pe ds	App. Total	
Peak Hour From 06:30 AM to 08:15 AM - Peak 1 of 1																					
Intersection	07:30 AM																				
Volume	8	0	14	0	22	4	0	0	0	4	0	0	0	0	0	0	0	1	0	1	27
Percent	36.	0.0	63.	0.0		10	0.0	0.0	0.0		0.0	0.0	0.0	0.0		0.0	0.0	10	0.0		
	4		6			0.0												0.0			
07:30 Volume	1	0	6	0	7	1	0	0	0	1	0	0	0	0	0	0	0	0	0	0	8
Peak Factor																					
High Int.	07:30 AM					07:30 AM					6:15:00 AM					08:15 AM					
Volume	1	0	6	0	7	1	0	0	0	1	0	0	0	0	0	0	0	1	0	1	
Peak Factor	0.78					1.00										0.25					
	6					0										0					

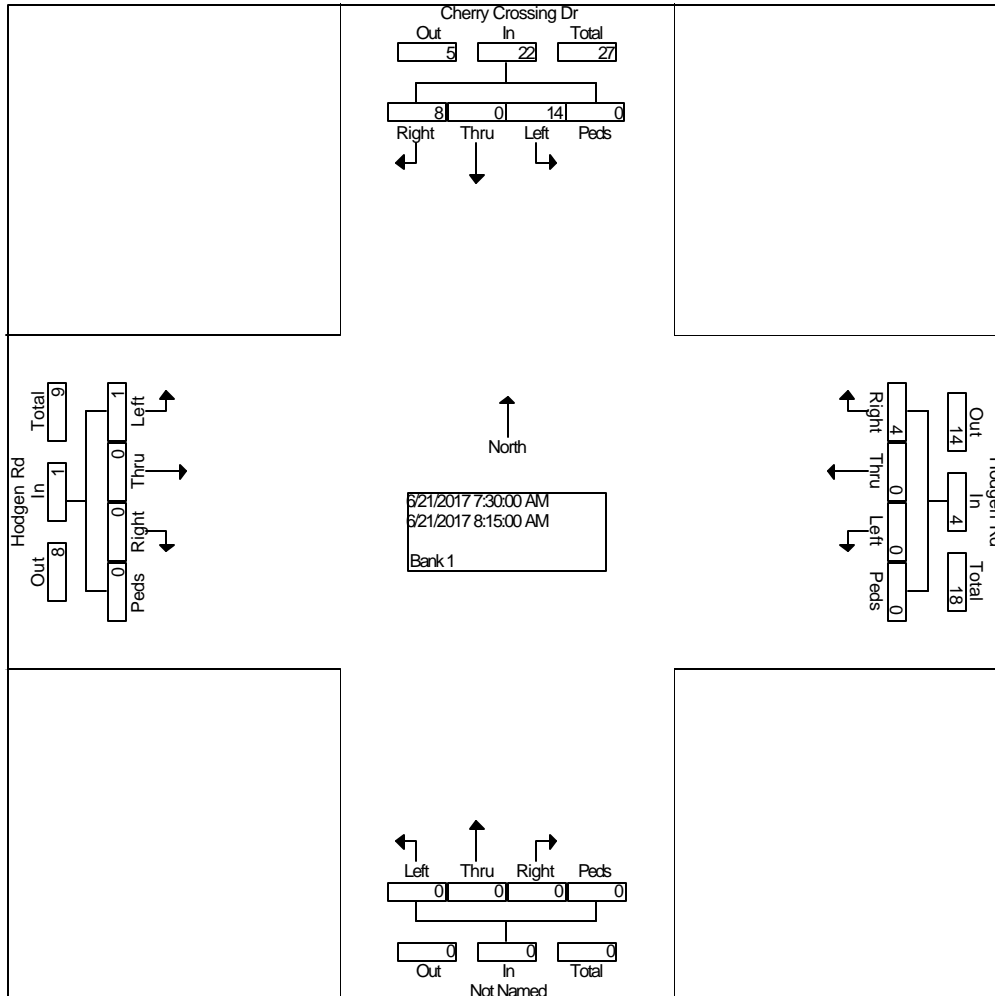

Counts by LSC

LSC Transportation Consultants, Inc.

File Name : Cherry Crossing Dr - Hodgen Rd PM
 Site Code : 00174470
 Start Date : 06/21/2017
 Page No : 1

Groups Printed- Bank 1

Start Time	Cherry Crossing Dr From North				Hodgen Rd From East				From South				Hodgen Rd From West				Int. Total
	Right	Thru	Left	Peds	Right	Thru	Left	Peds	Right	Thru	Left	Peds	Right	Thru	Left	Peds	
Factor	1.0	1.0	1.0	1.0	1.0	1.0	1.0	1.0	1.0	1.0	1.0	1.0	1.0	1.0	1.0	1.0	
04:00 PM	0	0	1	0	3	0	0	0	0	0	0	0	0	0	0	0	4
04:15 PM	0	0	2	0	3	0	0	0	0	0	0	0	0	0	1	0	6
04:30 PM	0	0	2	0	6	0	0	0	0	0	0	0	0	0	1	0	9
04:45 PM	0	0	0	0	5	0	0	0	0	0	0	0	0	0	0	0	5
Total	0	0	5	0	17	0	0	0	0	0	0	0	0	0	2	0	24
05:00 PM	0	0	1	0	2	0	0	0	0	0	0	0	0	0	2	0	5
05:15 PM	0	0	1	0	4	0	0	0	0	0	0	0	0	0	3	0	8
05:30 PM	1	0	2	0	3	0	0	0	0	0	0	0	0	0	0	0	6
05:45 PM	0	0	1	0	5	0	0	0	0	0	0	0	0	0	1	0	7
Total	1	0	5	0	14	0	0	0	0	0	0	0	0	0	6	0	26
Grand Total	1	0	10	0	31	0	0	0	0	0	0	0	0	0	8	0	50
Apprch %	9.1	0.0	90.9	0.0	100.	0.0	0.0	0.0	0.0	0.0	0.0	0.0	0.0	0.0	100.	0.0	
Total %	2.0	0.0	20.0	0.0	62.0	0.0	0.0	0.0	0.0	0.0	0.0	0.0	0.0	0.0	16.0	0.0	

Counts by LSC

File Name : Cherry Crossing Dr - Hodgen Rd PM
 Site Code : 00174470
 Start Date : 06/21/2017
 Page No : 2

Start Time	Cherry Crossing Dr From North					Hodgen Rd From East					From South					Hodgen Rd From West					Int. Total
	Rig ht	Thru	Lef t	Pe ds	App. Total	Rig ht	Thru	Lef t	Pe ds	App. Total	Rig ht	Thru	Lef t	Pe ds	App. Total	Rig ht	Thru	Lef t	Pe ds	App. Total	
Peak Hour From 04:00 PM to 05:45 PM - Peak 1 of 1																					
Intersection	04:30 PM																				
Volume	0	0	4	0	4	17	0	0	0	17	0	0	0	0	0	0	0	6	0	6	27
Percent	0.0	0.0	10	0.0		10	0.0	0.0	0.0		0.0	0.0	0.0	0.0		0.0	0.0	10	0.0		
			0.0			0.0												0.0			
04:30 Volume	0	0	2	0	2	6	0	0	0	6	0	0	0	0	0	0	0	1	0	1	9
Peak Factor																					
High Int.	04:30 PM					04:30 PM					3:45:00 PM					05:15 PM					
Volume	0	0	2	0	2	6	0	0	0	6	0	0	0	0	0	0	0	3	0	3	0.750
Peak Factor	0.50					0.70										0.50					
	0					8										0					

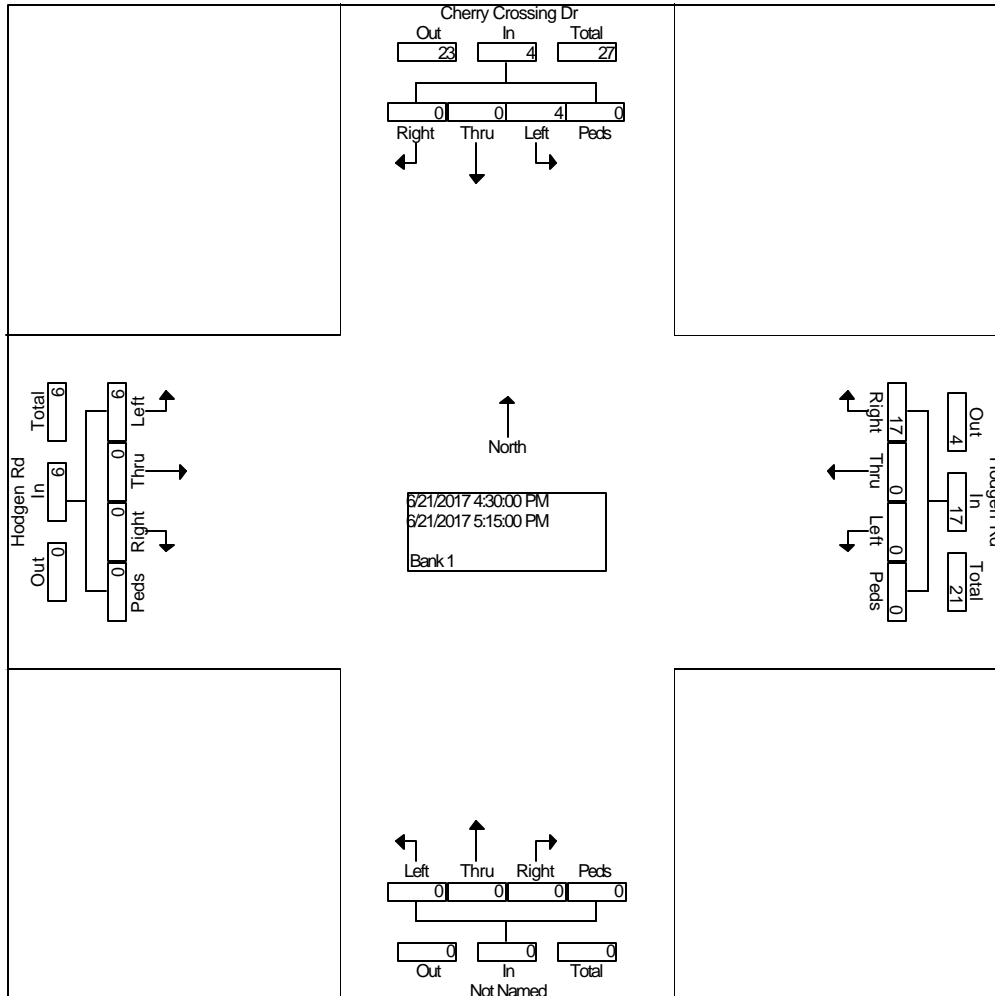

Counts by LSC

LSC Transportation Consultants, Inc.

File Name : Hwy 83 - Hodgen AM
 Site Code : 00174470
 Start Date : 06/21/2017
 Page No : 1

Groups Printed- Unshifted

Start Time	Hwy 83 From North				Hodgen Rd From East				Hwy 83 From South				Hodgen Rd From West				Int. Total
	Right	Thru	Left	Peds	Right	Thru	Left	Peds	Right	Thru	Left	Peds	Right	Thru	Left	Peds	
Factor	1.0	1.0	1.0	1.0	1.0	1.0	1.0	1.0	1.0	1.0	1.0	1.0	1.0	1.0	1.0	1.0	
06:30 AM	1	44	11	0	36	16	24	0	5	22	2	0	3	3	1	0	168
06:45 AM	3	60	17	0	39	24	41	0	8	50	4	0	6	10	3	0	265
Total	4	104	28	0	75	40	65	0	13	72	6	0	9	13	4	0	433
07:00 AM	1	86	11	0	44	22	50	0	10	41	5	0	13	7	1	0	291
07:15 AM	3	72	18	0	50	19	54	0	8	48	4	0	12	13	0	0	301
07:30 AM	1	105	16	0	57	30	60	0	10	46	4	0	13	18	5	0	365
07:45 AM	4	70	20	0	49	32	50	0	15	39	6	0	14	8	5	0	312
Total	9	333	65	0	200	103	214	0	43	174	19	0	52	46	11	0	1269
08:00 AM	4	62	14	0	34	23	44	0	14	52	6	0	7	6	4	0	270
08:15 AM	2	76	10	0	39	25	42	0	9	62	18	0	11	12	4	0	310
Grand Total	19	575	117	0	348	191	365	0	79	360	49	0	79	77	23	0	2282
Apprch %	2.7	80.9	16.5	0.0	38.5	21.1	40.4	0.0	16.2	73.8	10.0	0.0	44.1	43.0	12.8	0.0	
Total %	0.8	25.2	5.1	0.0	15.2	8.4	16.0	0.0	3.5	15.8	2.1	0.0	3.5	3.4	1.0	0.0	

Counts by LSC

File Name : Hwy 83 - Hodgen AM
 Site Code : 00174470
 Start Date : 06/21/2017
 Page No : 2

Start Time	Hwy 83 From North					Hodgen Rd From East					Hwy 83 From South					Hodgen Rd From West					Int. Total
	Rig ht	Thr u	Lef t	Pe ds	App. Total	Rig ht	Thr u	Lef t	Pe ds	App. Total	Rig ht	Thr u	Lef t	Pe ds	App. Total	Rig ht	Thr u	Lef t	Pe ds	App. Total	
Peak Hour From 06:30 AM to 08:15 AM - Peak 1 of 1																					
Intersection	07:00 AM																				
Volume	9	33	65	0	407	20	10	21	0	517	43	17	19	0	236	52	46	11	0	109	1269
Percent	2.2	81.8	16.0	0.0		38.7	19.9	41.4	0.0		18.2	7.3	8.1	0.0		47.7	42.2	10.1	0.0		
07:30 Volume	1	10	16	0	122	57	30	60	0	147	10	46	4	0	60	13	18	5	0	36	365
Peak Factor	0.869																				
High Int.	07:30 AM					07:30 AM					07:15 AM					07:30 AM					
Volume	1	10	16	0	122	57	30	60	0	147	8	48	4	0	60	13	18	5	0	36	
Peak Factor	0.834					0.879					0.983					0.757					

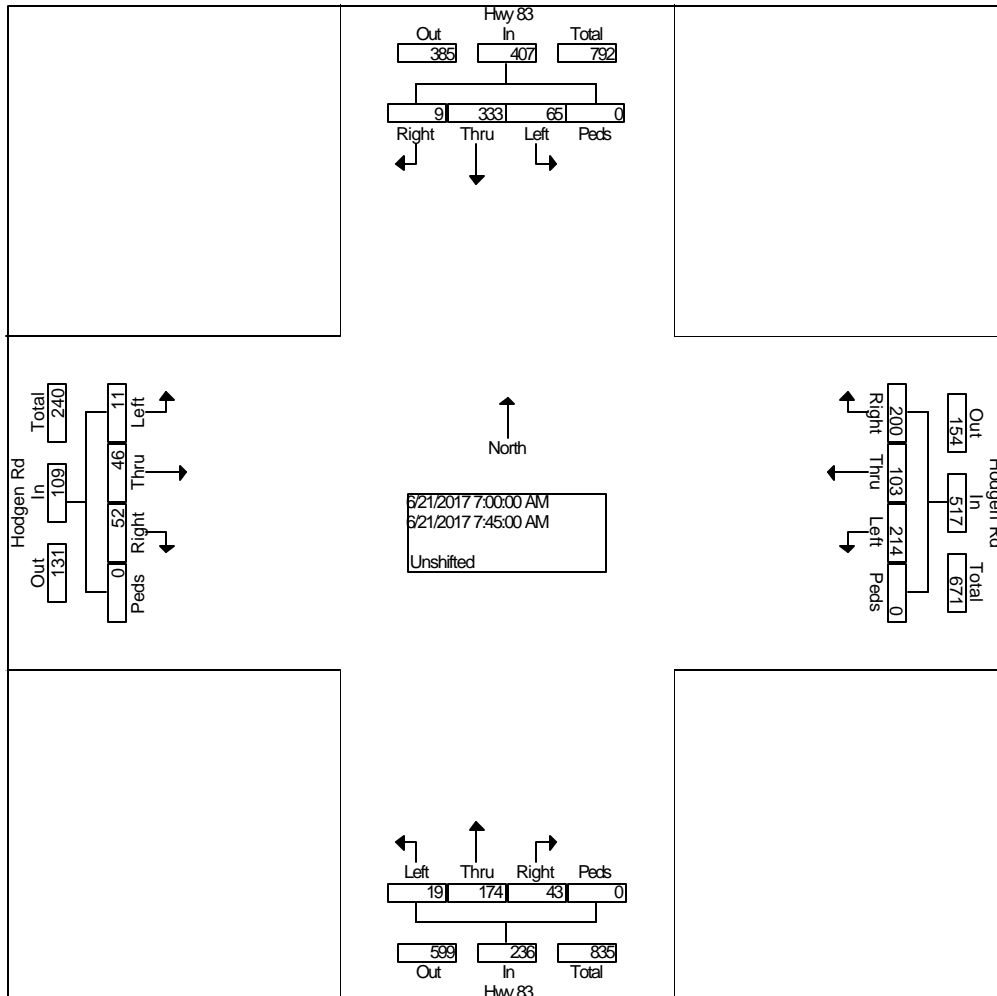

Counts by LSC

LSC Transportation Consultants, Inc.

File Name : Hwy 83 - Hodgen PM
 Site Code : 00174470
 Start Date : 06/21/2017
 Page No : 1

Groups Printed- Unshifted

Start Time	Hwy 83 From North				Hodgen Rd From East				Hwy 83 From South				Hodgen Rd From West				Int. Total
	Right	Thru	Left	Peds	Right	Thru	Left	Peds	Right	Thru	Left	Peds	Right	Thru	Left	Peds	
Factor	1.0	1.0	1.0	1.0	1.0	1.0	1.0	1.0	1.0	1.0	1.0	1.0	1.0	1.0	1.0	1.0	
04:00 PM	2	77	43	0	20	16	15	0	43	89	21	0	8	24	5	0	363
04:15 PM	7	68	53	0	30	22	25	0	32	72	14	0	13	32	3	0	371
04:30 PM	11	97	46	0	27	14	20	0	51	100	10	0	9	27	8	0	420
04:45 PM	8	90	52	0	32	23	28	0	33	95	19	0	9	32	5	0	426
Total	28	332	194	0	109	75	88	0	159	356	64	0	39	115	21	0	1580
05:00 PM	6	70	44	0	22	29	25	0	45	99	15	0	8	39	9	0	411
05:15 PM	10	77	42	0	28	20	25	0	44	102	16	0	18	26	3	0	411
05:30 PM	12	85	51	0	23	23	29	0	41	113	17	0	9	33	9	0	445
05:45 PM	7	84	38	0	25	16	19	0	45	106	13	0	13	37	8	0	411
Total	35	316	175	0	98	88	98	0	175	420	61	0	48	135	29	0	1678
Grand Total	63	648	369	0	207	163	186	0	334	776	125	0	87	250	50	0	3258
Apprch %	5.8	60.0	34.2	0.0	37.2	29.3	33.5	0.0	27.0	62.8	10.1	0.0	22.5	64.6	12.9	0.0	
Total %	1.9	19.9	11.3	0.0	6.4	5.0	5.7	0.0	10.3	23.8	3.8	0.0	2.7	7.7	1.5	0.0	

Counts by LSC





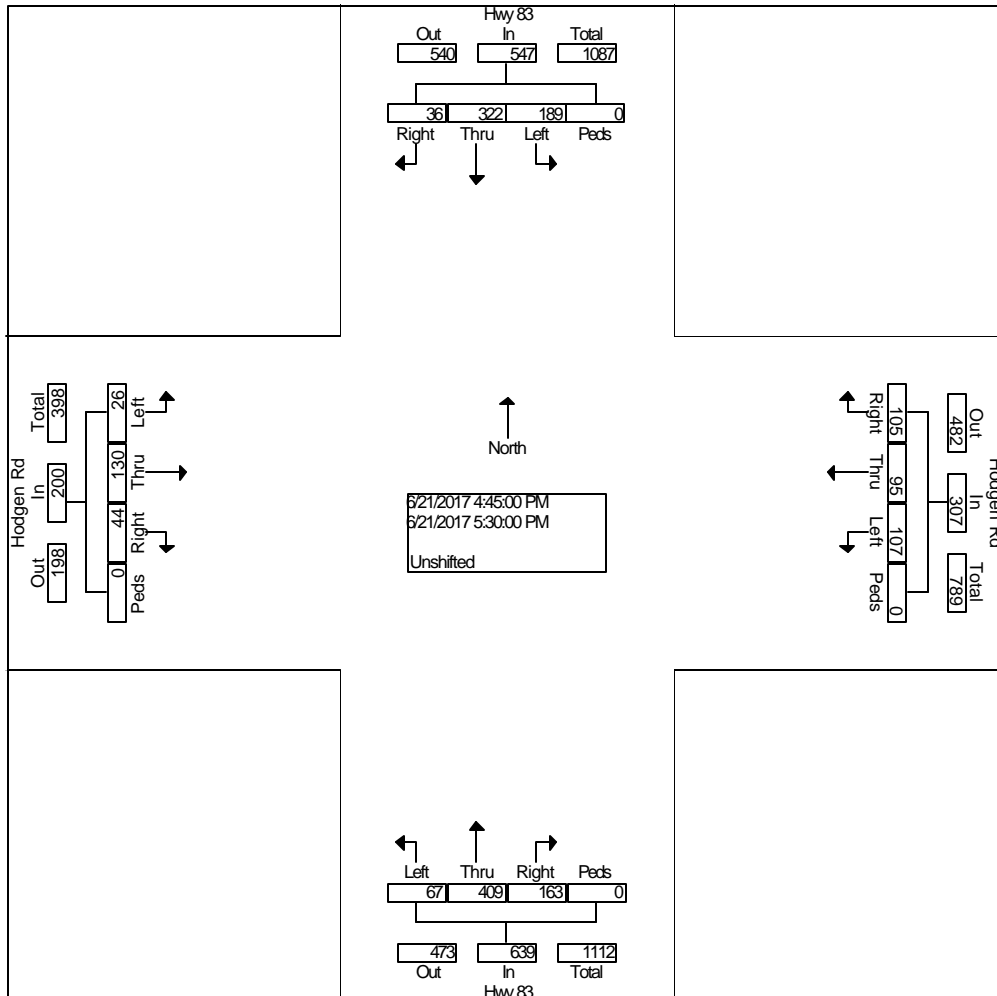



















File Name : Hwy 83 - Hodgen PM
 Site Code : 00174470
 Start Date : 06/21/2017
 Page No : 2

Start Time	Hwy 83 From North					Hodgen Rd From East					Hwy 83 From South					Hodgen Rd From West					Int. Total	
	Rig ht	Thr u	Lef t	Pe ds	App. Total	Rig ht	Thr u	Lef t	Pe ds	App. Total	Rig ht	Thr u	Lef t	Pe ds	App. Total	Rig ht	Thr u	Lef t	Pe ds	App. Total		
Peak Hour From 04:00 PM to 05:45 PM - Peak 1 of 1																						
Intersection	04:45 PM																					
Volume	36	32	18	0	547	10	95	10	0	307	16	40	67	0	639	44	13	26	0	200	1693	
Percent	6.6	58.9	34.6	0.0		34.2	30.9	34.9	0.0		25.5	64.0	10.5	0.0		22.0	65.0	13.0	0.0			
05:30 Volume	12	85	51	0	148	23	23	29	0	75	41	11	3	17	0	171	9	33	9	0	51	445
Peak Factor	0.951																					
High Int.	04:45 PM																					
Volume	8	90	52	0	150	32	23	28	0	83	41	11	3	17	0	171	8	39	9	0	56	
Peak Factor	0.912					0.925					0.934					0.893						



Lanes, Volumes, Timings
3: SH 83 & Hodgen Rd

2017 Existing
AM

												
Lane Group	EBL	EBT	EBR	WBL	WBT	WBR	NBL	NBT	NBR	SBL	SBT	SBR
Lane Configurations												
Traffic Volume (vph)	11	46	52	214	103	200	19	174	43	65	333	9
Future Volume (vph)	11	46	52	214	103	200	19	174	43	65	333	9
Ideal Flow (vphp)	1900	1900	1900	1900	1900	1900	1900	1900	1900	1900	1900	1900
Storage Length (ft)	450		450	400		400	200		900	650		0
Storage Lanes	1		1	1		1	1		1	1		0
Taper Length (ft)	100			100			100			100		
Lane Util. Factor	1.00	1.00	1.00	1.00	1.00	1.00	1.00	1.00	1.00	1.00	1.00	1.00
Frt			0.850			0.850			0.850		0.996	
Flt Protected	0.950			0.950			0.950			0.950		
Satd. Flow (prot)	1770	1863	1583	1770	1863	1583	1770	1863	1583	1770	1855	0
Flt Permitted	0.681			0.717			0.425			0.631		
Satd. Flow (perm)	1269	1863	1583	1336	1863	1583	792	1863	1583	1175	1855	0
Right Turn on Red			Yes			Yes			Yes			Yes
Satd. Flow (RTOR)			70			230			50			3
Link Speed (mph)		40			40			60			60	
Link Distance (ft)		843			1794			2113			2252	
Travel Time (s)		14.4			30.6			24.0			25.6	
Peak Hour Factor	0.74	0.74	0.74	0.87	0.87	0.87	0.86	0.86	0.86	0.79	0.79	0.79
Adj. Flow (vph)	15	62	70	246	118	230	22	202	50	82	422	11
Shared Lane Traffic (%)												
Lane Group Flow (vph)	15	62	70	246	118	230	22	202	50	82	433	0
Enter Blocked Intersection	No	No	No	No	No	No	No	No	No	No	No	No
Lane Alignment	Left	Left	Right	Left	Left	Right	Left	Left	Right	Left	Left	Right
Median Width(ft)		12			12			12			12	
Link Offset(ft)		0			0			0			0	
Crosswalk Width(ft)		16			16			16			16	
Two way Left Turn Lane												
Headway Factor	1.00	1.00	1.00	1.00	1.00	1.00	1.00	1.00	1.00	1.00	1.00	1.00
Turning Speed (mph)	15		9	15		9	15		9	15		9
Number of Detectors	1	2	1	1	2	1	1	2	1	1	2	
Detector Template	Left	Thru	Right	Left	Thru	Right	Left	Thru	Right	Left	Thru	
Leading Detector (ft)	20	100	20	20	100	20	20	100	20	20	100	
Trailing Detector (ft)	0	0	0	0	0	0	0	0	0	0	0	
Detector 1 Position(ft)	0	0	0	0	0	0	0	0	0	0	0	
Detector 1 Size(ft)	20	6	20	20	6	20	20	6	20	20	6	
Detector 1 Type	Cl+Ex	Cl+Ex	Cl+Ex	Cl+Ex	Cl+Ex	Cl+Ex	Cl+Ex	Cl+Ex	Cl+Ex	Cl+Ex	Cl+Ex	
Detector 1 Channel												
Detector 1 Extend (s)	0.0	0.0	0.0	0.0	0.0	0.0	0.0	0.0	0.0	0.0	0.0	
Detector 1 Queue (s)	0.0	0.0	0.0	0.0	0.0	0.0	0.0	0.0	0.0	0.0	0.0	
Detector 1 Delay (s)	0.0	0.0	0.0	0.0	0.0	0.0	0.0	0.0	0.0	0.0	0.0	
Detector 2 Position(ft)		94			94			94			94	
Detector 2 Size(ft)		6			6			6			6	
Detector 2 Type		Cl+Ex			Cl+Ex			Cl+Ex			Cl+Ex	
Detector 2 Channel												
Detector 2 Extend (s)		0.0			0.0			0.0			0.0	
Turn Type	Perm	NA	Perm	Perm	NA	Perm	Perm	NA	Perm	Perm	NA	
Protected Phases		4			8			2			6	
Permitted Phases	4		4	8		8	2		2	6		

Lanes, Volumes, Timings
3: SH 83 & Hodgen Rd

2017 Existing
AM



Lane Group	EBL	EBT	EBR	WBL	WBT	WBR	NBL	NBT	NBR	SBL	SBT	SBR
Detector Phase	4	4	4	8	8	8	2	2	2	6	6	
Switch Phase												
Minimum Initial (s)	5.0	5.0	5.0	5.0	5.0	5.0	5.0	5.0	5.0	5.0	5.0	5.0
Minimum Split (s)	22.5	22.5	22.5	22.5	22.5	22.5	22.5	22.5	22.5	22.5	22.5	22.5
Total Split (s)	28.0	28.0	28.0	28.0	28.0	28.0	32.0	32.0	32.0	32.0	32.0	32.0
Total Split (%)	46.7%	46.7%	46.7%	46.7%	46.7%	46.7%	53.3%	53.3%	53.3%	53.3%	53.3%	53.3%
Maximum Green (s)	23.5	23.5	23.5	23.5	23.5	23.5	27.5	27.5	27.5	27.5	27.5	27.5
Yellow Time (s)	3.5	3.5	3.5	3.5	3.5	3.5	3.5	3.5	3.5	3.5	3.5	3.5
All-Red Time (s)	1.0	1.0	1.0	1.0	1.0	1.0	1.0	1.0	1.0	1.0	1.0	1.0
Lost Time Adjust (s)	0.0	0.0	0.0	0.0	0.0	0.0	0.0	0.0	0.0	0.0	0.0	0.0
Total Lost Time (s)	4.5	4.5	4.5	4.5	4.5	4.5	4.5	4.5	4.5	4.5	4.5	4.5
Lead/Lag												
Lead-Lag Optimize?												
Vehicle Extension (s)	3.0	3.0	3.0	3.0	3.0	3.0	3.0	3.0	3.0	3.0	3.0	3.0
Recall Mode	None	None	None	None	None	None	Min	Min	Min	Min	Min	Min
Walk Time (s)	7.0	7.0	7.0	7.0	7.0	7.0	7.0	7.0	7.0	7.0	7.0	7.0
Flash Dont Walk (s)	11.0	11.0	11.0	11.0	11.0	11.0	11.0	11.0	11.0	11.0	11.0	11.0
Pedestrian Calls (#/hr)	0	0	0	0	0	0	0	0	0	0	0	0
Act Effect Green (s)	13.5	13.5	13.5	13.5	13.5	13.5	15.8	15.8	15.8	15.8	15.8	15.8
Actuated g/C Ratio	0.35	0.35	0.35	0.35	0.35	0.35	0.41	0.41	0.41	0.41	0.41	0.41
v/c Ratio	0.03	0.10	0.12	0.53	0.18	0.33	0.07	0.27	0.07	0.17	0.58	0.58
Control Delay	9.5	9.6	3.8	15.4	10.1	3.4	9.3	9.8	3.7	9.8	13.4	13.4
Queue Delay	0.0	0.0	0.0	0.0	0.0	0.0	0.0	0.0	0.0	0.0	0.0	0.0
Total Delay	9.5	9.6	3.8	15.4	10.1	3.4	9.3	9.8	3.7	9.8	13.4	13.4
LOS	A	A	A	B	B	A	A	A	A	A	A	B
Approach Delay		6.8			9.7			8.7				12.8
Approach LOS		A			A			A				B
Queue Length 50th (ft)	2	7	0	35	15	0	2	25	0	10	61	61
Queue Length 95th (ft)	10	25	12	107	50	30	14	75	14	34	146	146
Internal Link Dist (ft)		763			1714			2033				2172
Turn Bay Length (ft)	450		450	400		400	200		900	650		
Base Capacity (vph)	822	1208	1051	866	1208	1107	600	1413	1213	891	1408	1408
Starvation Cap Reductn	0	0	0	0	0	0	0	0	0	0	0	0
Spillback Cap Reductn	0	0	0	0	0	0	0	0	0	0	0	0
Storage Cap Reductn	0	0	0	0	0	0	0	0	0	0	0	0
Reduced v/c Ratio	0.02	0.05	0.07	0.28	0.10	0.21	0.04	0.14	0.04	0.09	0.31	0.31

Intersection Summary

Area Type:	Other
Cycle Length:	60
Actuated Cycle Length:	38.9
Natural Cycle:	45
Control Type:	Actuated-Uncoordinated
Maximum v/c Ratio:	0.58
Intersection Signal Delay:	10.3
Intersection LOS:	B
Intersection Capacity Utilization:	52.0%
ICU Level of Service:	A
Analysis Period (min):	15

Splits and Phases: 3: SH 83 & Hodgen Rd

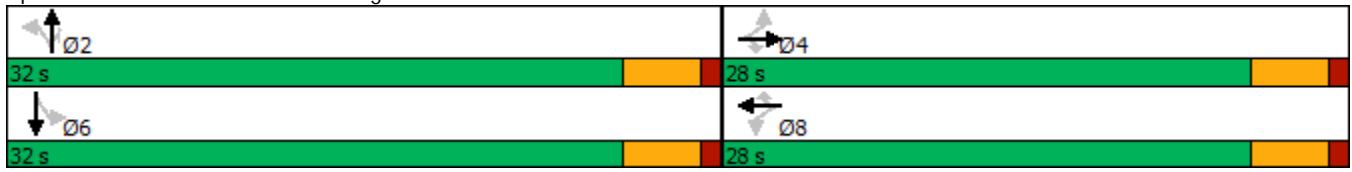

Lanes, Volumes, Timings
6: Hodgen Rd & Cherry Crossing Dr

2017 Existing
AM



Lane Group	EBL	EBT	WBT	WBR	SBL	SBR
Lane Configurations		↕	↑	↗	↘	
Traffic Volume (vph)	1	95	127	4	14	8
Future Volume (vph)	1	95	127	4	14	8
Ideal Flow (vphp)	1900	1900	1900	1900	1900	1900
Storage Length (ft)	0			0	0	0
Storage Lanes	0			1	1	0
Taper Length (ft)	100				100	
Lane Util. Factor	1.00	1.00	1.00	1.00	1.00	1.00
Frt				0.850	0.951	
Flt Protected					0.969	
Satd. Flow (prot)	0	1863	1863	1583	1717	0
Flt Permitted					0.969	
Satd. Flow (perm)	0	1863	1863	1583	1717	0
Link Speed (mph)		40	40		30	
Link Distance (ft)		1413	843		1348	
Travel Time (s)		24.1	14.4		30.6	
Peak Hour Factor	0.74	0.74	0.87	0.87	0.61	0.61
Adj. Flow (vph)	1	128	146	5	23	13
Shared Lane Traffic (%)						
Lane Group Flow (vph)	0	129	146	5	36	0
Enter Blocked Intersection	No	No	No	No	No	No
Lane Alignment	Left	Left	Left	Right	Left	Right
Median Width(ft)		12	12		12	
Link Offset(ft)		0	0		0	
Crosswalk Width(ft)		16	16		16	
Two way Left Turn Lane						
Headway Factor	1.00	1.00	1.00	1.00	1.00	1.00
Turning Speed (mph)	15			9	15	9
Sign Control		Free	Free		Stop	

Intersection Summary

Area Type: Other
Control Type: Unsignalized

6: Hodgen Rd & Cherry Crossing Dr Performance by movement Interval #1 7:00

Movement	EBT	WBT	WBR	SBL	SBR	All
Denied Del/Veh (s)	0.1	0.0	0.0	0.1	0.1	0.0
Total Del/Veh (s)	0.0	2.8	0.6	5.7	1.8	2.1

6: Hodgen Rd & Cherry Crossing Dr Performance by movement Interval #2 7:15

Movement	EBL	EBT	WBT	WBR	SBL	SBR	All
Denied Del/Veh (s)	0.1	0.1	0.0	0.0	0.1	0.1	0.1
Total Del/Veh (s)	0.8	0.2	1.9	3.2	4.1	2.1	1.4

6: Hodgen Rd & Cherry Crossing Dr Performance by movement Interval #3 7:30

Movement	EBT	WBT	WBR	SBL	SBR	All
Denied Del/Veh (s)	0.1	0.0	0.0	0.1	0.2	0.1
Total Del/Veh (s)	0.4	2.1	3.2	4.9	2.0	1.7

6: Hodgen Rd & Cherry Crossing Dr Performance by movement Interval #4 7:45

Movement	EBT	WBT	WBR	SBL	SBR	All
Denied Del/Veh (s)	0.2	0.0	0.0	0.1	0.1	0.1
Total Del/Veh (s)	0.3	2.2	0.6	4.3	2.4	1.6

6: Hodgen Rd & Cherry Crossing Dr Performance by movement Entire Run

Movement	EBL	EBT	WBT	WBR	SBL	SBR	All
Denied Del/Veh (s)	0.1	0.1	0.0	0.0	0.1	0.2	0.1
Total Del/Veh (s)	0.8	0.3	2.3	1.7	4.8	2.3	1.7

Lanes, Volumes, Timings
3: SH 83 & Hodgen Rd

2017 Existing
PM



Lane Group	EBL	EBT	EBR	WBL	WBT	WBR	NBL	NBT	NBR	SBL	SBT	SBR
Lane Configurations												
Traffic Volume (vph)	26	130	44	107	95	185	67	409	163	189	322	36
Future Volume (vph)	26	130	44	107	95	185	67	409	163	189	322	36
Ideal Flow (vphp)	1900	1900	1900	1900	1900	1900	1900	1900	1900	1900	1900	1900
Storage Length (ft)	450		450	400		400	200		900	650		0
Storage Lanes	1		1	1		1	1		1	1		0
Taper Length (ft)	100			100			100			100		
Lane Util. Factor	1.00	1.00	1.00	1.00	1.00	1.00	1.00	1.00	1.00	1.00	1.00	1.00
Frt			0.850			0.850			0.850		0.985	
Flt Protected	0.950			0.950			0.950			0.950		
Satd. Flow (prot)	1770	1863	1583	1770	1863	1583	1770	1863	1583	1770	1835	0
Flt Permitted	0.685			0.649			0.496			0.447		
Satd. Flow (perm)	1276	1863	1583	1209	1863	1583	924	1863	1583	833	1835	0
Right Turn on Red			Yes			Yes			Yes			Yes
Satd. Flow (RTOR)			58			218			181		12	
Link Speed (mph)		40			40			60			60	
Link Distance (ft)		843			1794			2113			2252	
Travel Time (s)		14.4			30.6			24.0			25.6	
Peak Hour Factor	0.76	0.76	0.76	0.85	0.85	0.85	0.90	0.90	0.90	0.89	0.89	0.89
Adj. Flow (vph)	34	171	58	126	112	218	74	454	181	212	362	40
Shared Lane Traffic (%)												
Lane Group Flow (vph)	34	171	58	126	112	218	74	454	181	212	402	0
Enter Blocked Intersection	No	No	No	No	No	No	No	No	No	No	No	No
Lane Alignment	Left	Left	Right	Left	Left	Right	Left	Left	Right	Left	Left	Right
Median Width(ft)		12			12			12			12	
Link Offset(ft)		0			0			0			0	
Crosswalk Width(ft)		16			16			16			16	
Two way Left Turn Lane												
Headway Factor	1.00	1.00	1.00	1.00	1.00	1.00	1.00	1.00	1.00	1.00	1.00	1.00
Turning Speed (mph)	15		9	15		9	15		9	15		9
Number of Detectors	1	2	1	1	2	1	1	2	1	1	2	
Detector Template	Left	Thru	Right	Left	Thru	Right	Left	Thru	Right	Left	Thru	
Leading Detector (ft)	20	100	20	20	100	20	20	100	20	20	100	
Trailing Detector (ft)	0	0	0	0	0	0	0	0	0	0	0	
Detector 1 Position(ft)	0	0	0	0	0	0	0	0	0	0	0	
Detector 1 Size(ft)	20	6	20	20	6	20	20	6	20	20	6	
Detector 1 Type	Cl+Ex	Cl+Ex	Cl+Ex	Cl+Ex	Cl+Ex	Cl+Ex	Cl+Ex	Cl+Ex	Cl+Ex	Cl+Ex	Cl+Ex	
Detector 1 Channel												
Detector 1 Extend (s)	0.0	0.0	0.0	0.0	0.0	0.0	0.0	0.0	0.0	0.0	0.0	
Detector 1 Queue (s)	0.0	0.0	0.0	0.0	0.0	0.0	0.0	0.0	0.0	0.0	0.0	
Detector 1 Delay (s)	0.0	0.0	0.0	0.0	0.0	0.0	0.0	0.0	0.0	0.0	0.0	
Detector 2 Position(ft)		94			94			94			94	
Detector 2 Size(ft)		6			6			6			6	
Detector 2 Type		Cl+Ex			Cl+Ex			Cl+Ex			Cl+Ex	
Detector 2 Channel												
Detector 2 Extend (s)		0.0			0.0			0.0			0.0	
Turn Type	Perm	NA	Perm	Perm	NA	Perm	Perm	NA	Perm	Perm	NA	
Protected Phases		4			8			2			6	
Permitted Phases	4		4	8		8	2		2	6		

Lanes, Volumes, Timings
3: SH 83 & Hodgen Rd

2017 Existing
PM



Lane Group	EBL	EBT	EBR	WBL	WBT	WBR	NBL	NBT	NBR	SBL	SBT	SBR
Detector Phase	4	4	4	8	8	8	2	2	2	6	6	
Switch Phase												
Minimum Initial (s)	5.0	5.0	5.0	5.0	5.0	5.0	5.0	5.0	5.0	5.0	5.0	5.0
Minimum Split (s)	22.5	22.5	22.5	22.5	22.5	22.5	22.5	22.5	22.5	22.5	22.5	22.5
Total Split (s)	28.0	28.0	28.0	28.0	28.0	28.0	32.0	32.0	32.0	32.0	32.0	32.0
Total Split (%)	46.7%	46.7%	46.7%	46.7%	46.7%	46.7%	53.3%	53.3%	53.3%	53.3%	53.3%	53.3%
Maximum Green (s)	23.5	23.5	23.5	23.5	23.5	23.5	27.5	27.5	27.5	27.5	27.5	27.5
Yellow Time (s)	3.5	3.5	3.5	3.5	3.5	3.5	3.5	3.5	3.5	3.5	3.5	3.5
All-Red Time (s)	1.0	1.0	1.0	1.0	1.0	1.0	1.0	1.0	1.0	1.0	1.0	1.0
Lost Time Adjust (s)	0.0	0.0	0.0	0.0	0.0	0.0	0.0	0.0	0.0	0.0	0.0	0.0
Total Lost Time (s)	4.5	4.5	4.5	4.5	4.5	4.5	4.5	4.5	4.5	4.5	4.5	4.5
Lead/Lag												
Lead-Lag Optimize?												
Vehicle Extension (s)	3.0	3.0	3.0	3.0	3.0	3.0	3.0	3.0	3.0	3.0	3.0	3.0
Recall Mode	None	None	None	None	None	None	Min	Min	Min	Min	Min	Min
Walk Time (s)	7.0	7.0	7.0	7.0	7.0	7.0	7.0	7.0	7.0	7.0	7.0	7.0
Flash Dont Walk (s)	11.0	11.0	11.0	11.0	11.0	11.0	11.0	11.0	11.0	11.0	11.0	11.0
Pedestrian Calls (#/hr)	0	0	0	0	0	0	0	0	0	0	0	0
Act Effect Green (s)	10.3	10.3	10.3	10.3	10.3	10.3	18.7	18.7	18.7	18.7	18.7	18.7
Actuated g/C Ratio	0.27	0.27	0.27	0.27	0.27	0.27	0.49	0.49	0.49	0.49	0.49	0.49
v/c Ratio	0.10	0.34	0.12	0.39	0.23	0.37	0.17	0.50	0.21	0.52	0.45	0.45
Control Delay	12.7	14.3	5.3	16.5	13.1	4.7	7.3	9.5	2.1	13.2	8.6	8.6
Queue Delay	0.0	0.0	0.0	0.0	0.0	0.0	0.0	0.0	0.0	0.0	0.0	0.0
Total Delay	12.7	14.3	5.3	16.5	13.1	4.7	7.3	9.5	2.1	13.2	8.6	8.6
LOS	B	B	A	B	B	A	A	A	A	B	A	A
Approach Delay		12.1			10.0			7.4			10.2	
Approach LOS		B			B			A			B	
Queue Length 50th (ft)	5	26	0	19	16	0	7	52	0	25	43	43
Queue Length 95th (ft)	20	65	14	62	52	32	29	145	22	89	120	120
Internal Link Dist (ft)		763			1714			2033			2172	
Turn Bay Length (ft)	450		450	400		400	200		900	650		
Base Capacity (vph)	823	1202	1042	780	1202	1098	697	1406	1239	629	1388	1388
Starvation Cap Reductn	0	0	0	0	0	0	0	0	0	0	0	0
Spillback Cap Reductn	0	0	0	0	0	0	0	0	0	0	0	0
Storage Cap Reductn	0	0	0	0	0	0	0	0	0	0	0	0
Reduced v/c Ratio	0.04	0.14	0.06	0.16	0.09	0.20	0.11	0.32	0.15	0.34	0.29	0.29

Intersection Summary

Area Type:	Other
Cycle Length:	60
Actuated Cycle Length:	38.5
Natural Cycle:	55
Control Type:	Actuated-Uncoordinated
Maximum v/c Ratio:	0.52
Intersection Signal Delay:	9.4
Intersection LOS:	A
Intersection Capacity Utilization:	59.8%
ICU Level of Service:	B
Analysis Period (min):	15

Splits and Phases: 3: SH 83 & Hodgen Rd

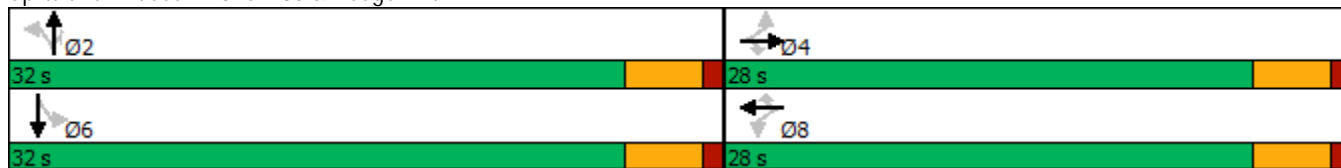

Lanes, Volumes, Timings
6: Hodgen Rd & Cherry Crossing Dr

2017 Existing
PM



Lane Group	EBL	EBT	WBT	WBR	SBL	SBR
Lane Configurations		↕	↑	↗	↘	
Traffic Volume (vph)	6	196	181	17	4	0
Future Volume (vph)	6	196	181	17	4	0
Ideal Flow (vphp)	1900	1900	1900	1900	1900	1900
Storage Length (ft)	0			0	0	0
Storage Lanes	0			1	1	0
Taper Length (ft)	100				100	
Lane Util. Factor	1.00	1.00	1.00	1.00	1.00	1.00
Frt				0.850		
Flt Protected		0.998			0.950	
Satd. Flow (prot)	0	1859	1863	1583	1770	0
Flt Permitted		0.998			0.950	
Satd. Flow (perm)	0	1859	1863	1583	1770	0
Link Speed (mph)		40	40		30	
Link Distance (ft)		1413	843		1348	
Travel Time (s)		24.1	14.4		30.6	
Peak Hour Factor	0.76	0.76	0.85	0.85	0.50	0.50
Adj. Flow (vph)	8	258	213	20	8	0
Shared Lane Traffic (%)						
Lane Group Flow (vph)	0	266	213	20	8	0
Enter Blocked Intersection	No	No	No	No	No	No
Lane Alignment	Left	Left	Left	Right	Left	Right
Median Width(ft)		12	12		12	
Link Offset(ft)		0	0		0	
Crosswalk Width(ft)		16	16		16	
Two way Left Turn Lane						
Headway Factor	1.00	1.00	1.00	1.00	1.00	1.00
Turning Speed (mph)	15			9	15	9
Sign Control		Free	Free		Stop	

Intersection Summary

Area Type: Other
Control Type: Unsignalized

6: Hodgen Rd & Cherry Crossing Dr Performance by movement Interval #1 7:00

Movement	EBL	EBT	WBT	WBR	SBL	All
Denied Del/Veh (s)	0.4	0.2	0.0	0.0		0.1
Total Del/Veh (s)	1.6	0.3	1.9	1.3		1.2

6: Hodgen Rd & Cherry Crossing Dr Performance by movement Interval #2 7:15

Movement	EBL	EBT	WBT	WBR	SBL	All
Denied Del/Veh (s)	0.5	0.2	0.0	0.0		0.1
Total Del/Veh (s)	2.2	0.4	1.9	1.3		1.2

6: Hodgen Rd & Cherry Crossing Dr Performance by movement Interval #3 7:30

Movement	EBL	EBT	WBT	WBR	SBL	All
Denied Del/Veh (s)	0.1	0.2	0.0	0.0	0.1	0.1
Total Del/Veh (s)	0.9	0.4	1.9	1.0	6.7	1.3

6: Hodgen Rd & Cherry Crossing Dr Performance by movement Interval #4 7:45

























Movement	EBL	EBT	WBT	WBR	SBL	All
Denied Del/Veh (s)	0.1	0.2	0.0	0.0	0.1	0.1
Total Del/Veh (s)	0.7	0.2	1.7	1.2	2.7	1.0

6: Hodgen Rd & Cherry Crossing Dr Performance by movement Entire Run

Movement	EBL	EBT	WBT	WBR	SBL	All
Denied Del/Veh (s)	0.2	0.2	0.0	0.0	0.1	0.1
Total Del/Veh (s)	1.3	0.4	1.9	1.3	7.0	1.2

Lanes, Volumes, Timings
3: SH 83 & Hodgen Rd

2017 Existing + Site
AM

												
Lane Group	EBL	EBT	EBR	WBL	WBT	WBR	NBL	NBT	NBR	SBL	SBT	SBR
Lane Configurations												
Traffic Volume (vph)	32	58	87	204	135	192	38	166	43	61	312	46
Future Volume (vph)	32	58	87	204	135	192	38	166	43	61	312	46
Ideal Flow (vphp)	1900	1900	1900	1900	1900	1900	1900	1900	1900	1900	1900	1900
Storage Length (ft)	450		450	400		400	200		900	650		0
Storage Lanes	1		1	1		1	1		1	1		0
Taper Length (ft)	100			100			100			100		
Lane Util. Factor	1.00	1.00	1.00	1.00	1.00	1.00	1.00	1.00	1.00	1.00	1.00	1.00
Frt			0.850			0.850			0.850		0.981	
Flt Protected	0.950			0.950			0.950			0.950		
Satd. Flow (prot)	1770	1863	1583	1770	1863	1583	1770	1863	1583	1770	1827	0
Flt Permitted	0.659			0.706			0.406			0.636		
Satd. Flow (perm)	1228	1863	1583	1315	1863	1583	756	1863	1583	1185	1827	0
Right Turn on Red			Yes			Yes			Yes			Yes
Satd. Flow (RTOR)			118			221			50		16	
Link Speed (mph)		40			40			60			60	
Link Distance (ft)		843			1794			2113			2252	
Travel Time (s)		14.4			30.6			24.0			25.6	
Peak Hour Factor	0.74	0.74	0.74	0.87	0.87	0.87	0.86	0.86	0.86	0.79	0.79	0.79
Adj. Flow (vph)	43	78	118	234	155	221	44	193	50	77	395	58
Shared Lane Traffic (%)												
Lane Group Flow (vph)	43	78	118	234	155	221	44	193	50	77	453	0
Enter Blocked Intersection	No	No	No	No	No	No	No	No	No	No	No	No
Lane Alignment	Left	Left	Right	Left	Left	Right	Left	Left	Right	Left	Left	Right
Median Width(ft)		12			12			12			12	
Link Offset(ft)		0			0			0			0	
Crosswalk Width(ft)		16			16			16			16	
Two way Left Turn Lane												
Headway Factor	1.00	1.00	1.00	1.00	1.00	1.00	1.00	1.00	1.00	1.00	1.00	1.00
Turning Speed (mph)	15		9	15		9	15		9	15		9
Number of Detectors	1	2	1	1	2	1	1	2	1	1	2	
Detector Template	Left	Thru	Right	Left	Thru	Right	Left	Thru	Right	Left	Thru	
Leading Detector (ft)	20	100	20	20	100	20	20	100	20	20	100	
Trailing Detector (ft)	0	0	0	0	0	0	0	0	0	0	0	
Detector 1 Position(ft)	0	0	0	0	0	0	0	0	0	0	0	
Detector 1 Size(ft)	20	6	20	20	6	20	20	6	20	20	6	
Detector 1 Type	Cl+Ex	Cl+Ex	Cl+Ex	Cl+Ex	Cl+Ex	Cl+Ex	Cl+Ex	Cl+Ex	Cl+Ex	Cl+Ex	Cl+Ex	
Detector 1 Channel												
Detector 1 Extend (s)	0.0	0.0	0.0	0.0	0.0	0.0	0.0	0.0	0.0	0.0	0.0	
Detector 1 Queue (s)	0.0	0.0	0.0	0.0	0.0	0.0	0.0	0.0	0.0	0.0	0.0	
Detector 1 Delay (s)	0.0	0.0	0.0	0.0	0.0	0.0	0.0	0.0	0.0	0.0	0.0	
Detector 2 Position(ft)		94			94			94			94	
Detector 2 Size(ft)		6			6			6			6	
Detector 2 Type		Cl+Ex			Cl+Ex			Cl+Ex			Cl+Ex	
Detector 2 Channel												
Detector 2 Extend (s)		0.0			0.0			0.0			0.0	
Turn Type	Perm	NA	Perm	Perm	NA	Perm	Perm	NA	Perm	Perm	NA	
Protected Phases		4			8			2			6	
Permitted Phases	4		4	8		8	2		2	6		

Lanes, Volumes, Timings
3: SH 83 & Hodgen Rd

2017 Existing + Site
AM



Lane Group	EBL	EBT	EBR	WBL	WBT	WBR	NBL	NBT	NBR	SBL	SBT	SBR
Detector Phase	4	4	4	8	8	8	2	2	2	6	6	
Switch Phase												
Minimum Initial (s)	5.0	5.0	5.0	5.0	5.0	5.0	5.0	5.0	5.0	5.0	5.0	5.0
Minimum Split (s)	22.5	22.5	22.5	22.5	22.5	22.5	22.5	22.5	22.5	22.5	22.5	22.5
Total Split (s)	28.0	28.0	28.0	28.0	28.0	28.0	32.0	32.0	32.0	32.0	32.0	32.0
Total Split (%)	46.7%	46.7%	46.7%	46.7%	46.7%	46.7%	53.3%	53.3%	53.3%	53.3%	53.3%	53.3%
Maximum Green (s)	23.5	23.5	23.5	23.5	23.5	23.5	27.5	27.5	27.5	27.5	27.5	27.5
Yellow Time (s)	3.5	3.5	3.5	3.5	3.5	3.5	3.5	3.5	3.5	3.5	3.5	3.5
All-Red Time (s)	1.0	1.0	1.0	1.0	1.0	1.0	1.0	1.0	1.0	1.0	1.0	1.0
Lost Time Adjust (s)	0.0	0.0	0.0	0.0	0.0	0.0	0.0	0.0	0.0	0.0	0.0	0.0
Total Lost Time (s)	4.5	4.5	4.5	4.5	4.5	4.5	4.5	4.5	4.5	4.5	4.5	4.5
Lead/Lag												
Lead-Lag Optimize?												
Vehicle Extension (s)	3.0	3.0	3.0	3.0	3.0	3.0	3.0	3.0	3.0	3.0	3.0	3.0
Recall Mode	None	None	None	None	None	None	Min	Min	Min	Min	Min	Min
Walk Time (s)	7.0	7.0	7.0	7.0	7.0	7.0	7.0	7.0	7.0	7.0	7.0	7.0
Flash Dont Walk (s)	11.0	11.0	11.0	11.0	11.0	11.0	11.0	11.0	11.0	11.0	11.0	11.0
Pedestrian Calls (#/hr)	0	0	0	0	0	0	0	0	0	0	0	0
Act Effect Green (s)	13.3	13.3	13.3	13.3	13.3	13.3	15.8	15.8	15.8	15.8	15.8	15.8
Actuated g/C Ratio	0.34	0.34	0.34	0.34	0.34	0.34	0.41	0.41	0.41	0.41	0.41	0.41
v/c Ratio	0.10	0.12	0.19	0.52	0.24	0.32	0.14	0.25	0.07	0.16	0.60	0.60
Control Delay	10.3	10.1	3.6	15.6	10.9	3.5	9.9	9.6	3.7	9.5	13.4	13.4
Queue Delay	0.0	0.0	0.0	0.0	0.0	0.0	0.0	0.0	0.0	0.0	0.0	0.0
Total Delay	10.3	10.1	3.6	15.6	10.9	3.5	9.9	9.6	3.7	9.5	13.4	13.4
LOS	B	B	A	B	B	A	A	A	A	A	A	B
Approach Delay		6.9			10.0			8.6				12.9
Approach LOS		A			B			A				B
Queue Length 50th (ft)	5	10	0	33	20	0	5	23	0	9	62	62
Queue Length 95th (ft)	21	31	15	106	65	30	24	71	14	32	150	150
Internal Link Dist (ft)		763			1714			2033				2172
Turn Bay Length (ft)	450		450	400		400	200		900	650		
Base Capacity (vph)	803	1219	1076	860	1219	1112	575	1418	1217	902	1395	1395
Starvation Cap Reductn	0	0	0	0	0	0	0	0	0	0	0	0
Spillback Cap Reductn	0	0	0	0	0	0	0	0	0	0	0	0
Storage Cap Reductn	0	0	0	0	0	0	0	0	0	0	0	0
Reduced v/c Ratio	0.05	0.06	0.11	0.27	0.13	0.20	0.08	0.14	0.04	0.09	0.32	0.32

Intersection Summary





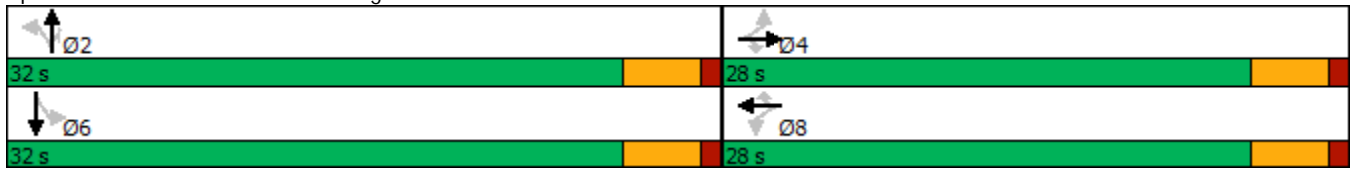













Area Type:	Other
Cycle Length:	60
Actuated Cycle Length:	38.9
Natural Cycle:	45
Control Type:	Actuated-Uncoordinated
Maximum v/c Ratio:	0.60
Intersection Signal Delay:	10.2
Intersection LOS:	B
Intersection Capacity Utilization:	53.8%
ICU Level of Service:	A
Analysis Period (min):	15

Splits and Phases: 3: SH 83 & Hodgen Rd























Lanes, Volumes, Timings
1: Cherry Crossing Dr & Lap Wai Ct/Retail Access

2017 Existing + Site
AM

												
Lane Group	EBL	EBT	EBR	WBL	WBT	WBR	NBL	NBT	NBR	SBL	SBT	SBR
Lane Configurations												
Traffic Volume (vph)	6	0	0	0	0	90	0	27	0	120	35	2
Future Volume (vph)	6	0	0	0	0	90	0	27	0	120	35	2
Ideal Flow (vphpl)	1900	1900	1900	1900	1900	1900	1900	1900	1900	1900	1900	1900
Storage Length (ft)	0		0	0		0	0		50	90		0
Storage Lanes	0		0	0		0	0		0	1		0
Taper Length (ft)	100			100			100			75		
Lane Util. Factor	1.00	1.00	1.00	1.00	1.00	1.00	1.00	1.00	1.00	1.00	1.00	1.00
Frt					0.865							0.992
Flt Protected		0.950								0.950		
Satd. Flow (prot)	0	1770	0	0	1611	0	0	1863	0	1770	1848	0
Flt Permitted		0.950								0.950		
Satd. Flow (perm)	0	1770	0	0	1611	0	0	1863	0	1770	1848	0
Link Speed (mph)		30			30			30			30	
Link Distance (ft)		409			623			534			331	
Travel Time (s)		9.3			14.2			12.1			7.5	
Peak Hour Factor	0.92	0.92	0.92	0.92	0.92	0.92	0.92	0.92	0.92	0.92	0.92	0.92
Adj. Flow (vph)	7	0	0	0	0	98	0	29	0	130	38	2
Shared Lane Traffic (%)												
Lane Group Flow (vph)	0	7	0	0	98	0	0	29	0	130	40	0
Enter Blocked Intersection	No	No	No	No	No	No	No	No	No	No	No	No
Lane Alignment	Left	Left	Right	Left	Left	Right	Left	Left	Right	Left	Left	Right
Median Width(ft)		0			0			12			12	
Link Offset(ft)		0			0			0			0	
Crosswalk Width(ft)		16			16			16			16	
Two way Left Turn Lane												
Headway Factor	1.00	1.00	1.00	1.00	1.00	1.00	1.00	1.00	1.00	1.00	1.00	1.00
Turning Speed (mph)	15		9	15		9	15		9	15		9
Sign Control		Stop			Stop			Free			Free	
Intersection Summary												
Area Type:	Other											
Control Type:	Unsignalized											

Lanes, Volumes, Timings
6: Cherry Crossing Dr & Hodgen Rd

2017 Existing + Site
AM

												
Lane Group	EBL	EBT	EBR	WBL	WBT	WBR	NBL	NBT	NBR	SBL	SBT	SBR
Lane Configurations												
Traffic Volume (vph)	1	73	41	115	100	4	32	1	90	14	1	8
Future Volume (vph)	1	73	41	115	100	4	32	1	90	14	1	8
Ideal Flow (vphpl)	1900	1900	1900	1900	1900	1900	1900	1900	1900	1900	1900	1900
Storage Length (ft)	0		150	150		0	0		105	0		0
Storage Lanes	0		1	1		1	0		1	0		0
Taper Length (ft)	100			100			100			100		
Lane Util. Factor	1.00	1.00	1.00	1.00	1.00	1.00	1.00	1.00	1.00	1.00	1.00	1.00
Frt			0.850			0.850			0.850		0.954	
Flt Protected				0.950				0.954			0.971	
Satd. Flow (prot)	0	1863	1583	1770	1863	1583	0	1777	1583	0	1726	0
Flt Permitted				0.950				0.954			0.971	
Satd. Flow (perm)	0	1863	1583	1770	1863	1583	0	1777	1583	0	1726	0
Link Speed (mph)		40		40				30			30	
Link Distance (ft)		1413		843				331			1348	
Travel Time (s)		24.1		14.4				7.5			30.6	
Peak Hour Factor	0.74	0.74	0.74	0.87	0.87	0.87	0.92	0.92	0.92	0.61	0.61	0.61
Adj. Flow (vph)	1	99	55	132	115	5	35	1	98	23	2	13
Shared Lane Traffic (%)												
Lane Group Flow (vph)	0	100	55	132	115	5	0	36	98	0	38	0
Enter Blocked Intersection	No	No	No	No	No	No	No	No	No	No	No	No
Lane Alignment	Left	Left	Right	Left	Left	Right	Left	Left	Right	Left	Left	Right
Median Width(ft)		12		12				12			12	
Link Offset(ft)		0		0				0			0	
Crosswalk Width(ft)		16		16				16			16	
Two way Left Turn Lane												
Headway Factor	1.00	1.00	1.00	1.00	1.00	1.00	1.00	1.00	1.00	1.00	1.00	1.00
Turning Speed (mph)	15		9	15		9	15		9	15		9
Sign Control		Free			Free			Stop			Stop	

Intersection Summary

Area Type: Other

Control Type: Unsignalized

1: Cherry Crossing Dr & Lap Wai Ct/Retail Access Performance by movement Interval #1 7:00

Movement	EBL	WBR	NBT	SBL	SBT	SBR	All
Denied Del/Veh (s)	0.1	0.2	0.1	0.1	0.0	0.0	0.1
Total Del/Veh (s)	6.1	3.0	0.2	1.8	0.3	0.3	1.9

1: Cherry Crossing Dr & Lap Wai Ct/Retail Access Performance by movement Interval #2 7:15

Movement	EBL	WBR	NBT	SBL	SBT	SBR	All
Denied Del/Veh (s)	0.1	0.1	0.1	0.1	0.0		0.1
Total Del/Veh (s)	5.3	2.9	0.1	1.9	0.2		2.0

1: Cherry Crossing Dr & Lap Wai Ct/Retail Access Performance by movement Interval #3 7:30

Movement	EBL	WBR	NBT	SBL	SBT	SBR	All
Denied Del/Veh (s)	0.1	0.2	0.2	0.0	0.0		0.1
Total Del/Veh (s)	3.9	3.2	0.2	1.8	0.2		1.9

1: Cherry Crossing Dr & Lap Wai Ct/Retail Access Performance by movement Interval #4 7:45

Movement	EBL	WBR	NBT	SBL	SBT	SBR	All
Denied Del/Veh (s)	0.1	0.1	0.1	0.3	0.0	0.0	0.2
Total Del/Veh (s)	4.6	2.7	0.2	1.7	0.2	0.2	1.7

1: Cherry Crossing Dr & Lap Wai Ct/Retail Access Performance by movement Entire Run

Movement	EBL	WBR	NBT	SBL	SBT	SBR	All
Denied Del/Veh (s)	0.1	0.2	0.1	0.1	0.0	0.0	0.1
Total Del/Veh (s)	4.8	3.0	0.2	1.8	0.2	0.3	1.9

6: Cherry Crossing Dr & Hodgen Rd Performance by movement Interval #1 7:00

Movement	EBL	EBT	EBR	WBL	WBT	WBR	NBL	NBT	NBR	SBL	SBT	SBR
Denied Del/Veh (s)		0.2	3.3	0.0	0.0	0.0	0.0	0.0	0.0	0.1		0.1
Total Del/Veh (s)		0.7	0.2	3.1	2.1	0.8	6.7	4.7	2.7	6.5		2.9

6: Cherry Crossing Dr & Hodgen Rd Performance by movement Interval #1 7:00

Movement	All
Denied Del/Veh (s)	0.3
Total Del/Veh (s)	2.8

6: Cherry Crossing Dr & Hodgen Rd Performance by movement Interval #2 7:15

Movement	EBT	EBR	WBL	WBT	WBR	NBL	NBT	NBR	SBL	SBT	SBR	All
Denied Del/Veh (s)	0.2	3.1	0.0	0.0	0.0	0.0		0.0	0.2		0.1	0.3
Total Del/Veh (s)	0.4	0.2	3.6	2.4	0.7	7.0		2.7	7.4		3.3	2.9

6: Cherry Crossing Dr & Hodgen Rd Performance by movement Interval #3 7:30

Movement	EBL	EBT	EBR	WBL	WBT	WBR	NBL	NBT	NBR	SBL	SBT	SBR
Denied Del/Veh (s)		0.2	3.2	0.0	0.0	0.0	0.0		0.0	0.1		0.2
Total Del/Veh (s)		0.6	0.4	3.9	2.0	1.1	8.8		3.2	6.5		3.6

6: Cherry Crossing Dr & Hodgen Rd Performance by movement Interval #3 7:30

Movement	All
Denied Del/Veh (s)	0.3
Total Del/Veh (s)	2.9

6: Cherry Crossing Dr & Hodgen Rd Performance by movement Interval #4 7:45

Movement	EBT	EBR	WBL	WBT	WBR	NBL	NBT	NBR	SBL	SBT	SBR	All
Denied Del/Veh (s)	0.2	2.7	0.1	0.0		0.0		0.0	0.1		0.1	0.3
Total Del/Veh (s)	0.6	0.2	2.8	1.9		6.1		2.9	7.1		2.9	2.5

6: Cherry Crossing Dr & Hodgen Rd Performance by movement Entire Run

Movement	EBL	EBT	EBR	WBL	WBT	WBR	NBL	NBT	NBR	SBL	SBT	SBR
Denied Del/Veh (s)	0.1	0.2	3.1	0.0	0.0	0.0	0.0	0.0	0.0	0.1	0.1	0.1
Total Del/Veh (s)	0.6	0.6	0.3	3.4	2.1	0.9	7.7	8.8	2.9	6.8	7.6	3.3

6: Cherry Crossing Dr & Hodgen Rd Performance by movement Entire Run

























Movement	All
Denied Del/Veh (s)	0.3
Total Del/Veh (s)	2.8

Total Zone Performance By Interval

Interval Start	7:00	7:15	7:30	7:45	All
Denied Del/Veh (s)		0.8	0.7	0.7	0.7
Total Del/Veh (s)		445.4	150.8	59.1	130.0

Lanes, Volumes, Timings
3: SH 83 & Hodgen Rd

2017 Existing + Site
PM

												
Lane Group	EBL	EBT	EBR	WBL	WBT	WBR	NBL	NBT	NBR	SBL	SBT	SBR
Lane Configurations												
Traffic Volume (vph)	55	165	85	104	114	105	105	392	157	177	299	85
Future Volume (vph)	55	165	85	104	114	105	105	392	157	177	299	85
Ideal Flow (vphp)	1900	1900	1900	1900	1900	1900	1900	1900	1900	1900	1900	1900
Storage Length (ft)	450		450	400		400	200		900	650		0
Storage Lanes	1		1	1		1	1		1	1		0
Taper Length (ft)	100			100			100			100		
Lane Util. Factor	1.00	1.00	1.00	1.00	1.00	1.00	1.00	1.00	1.00	1.00	1.00	1.00
Frt			0.850			0.850			0.850		0.967	
Flt Protected	0.950			0.950			0.950			0.950		
Satd. Flow (prot)	1770	1863	1583	1770	1863	1583	1770	1863	1583	1770	1801	0
Flt Permitted	0.671			0.622			0.482			0.478		
Satd. Flow (perm)	1250	1863	1583	1159	1863	1583	898	1863	1583	890	1801	0
Right Turn on Red			Yes			Yes			Yes			Yes
Satd. Flow (RTOR)			112			124			174		32	
Link Speed (mph)		40			40			60			60	
Link Distance (ft)		843			1794			2113			2252	
Travel Time (s)		14.4			30.6			24.0			25.6	
Peak Hour Factor	0.76	0.76	0.76	0.85	0.85	0.85	0.90	0.90	0.90	0.89	0.89	0.89
Adj. Flow (vph)	72	217	112	122	134	124	117	436	174	199	336	96
Shared Lane Traffic (%)												
Lane Group Flow (vph)	72	217	112	122	134	124	117	436	174	199	432	0
Enter Blocked Intersection	No	No	No	No	No	No	No	No	No	No	No	No
Lane Alignment	Left	Left	Right	Left	Left	Right	Left	Left	Right	Left	Left	Right
Median Width(ft)		12			12			12			12	
Link Offset(ft)		0			0			0			0	
Crosswalk Width(ft)		16			16			16			16	
Two way Left Turn Lane												
Headway Factor	1.00	1.00	1.00	1.00	1.00	1.00	1.00	1.00	1.00	1.00	1.00	1.00
Turning Speed (mph)	15		9	15		9	15		9	15		9
Number of Detectors	1	2	1	1	2	1	1	2	1	1	2	
Detector Template	Left	Thru	Right	Left	Thru	Right	Left	Thru	Right	Left	Thru	
Leading Detector (ft)	20	100	20	20	100	20	20	100	20	20	100	
Trailing Detector (ft)	0	0	0	0	0	0	0	0	0	0	0	
Detector 1 Position(ft)	0	0	0	0	0	0	0	0	0	0	0	
Detector 1 Size(ft)	20	6	20	20	6	20	20	6	20	20	6	
Detector 1 Type	Cl+Ex	Cl+Ex	Cl+Ex	Cl+Ex	Cl+Ex	Cl+Ex	Cl+Ex	Cl+Ex	Cl+Ex	Cl+Ex	Cl+Ex	
Detector 1 Channel												
Detector 1 Extend (s)	0.0	0.0	0.0	0.0	0.0	0.0	0.0	0.0	0.0	0.0	0.0	
Detector 1 Queue (s)	0.0	0.0	0.0	0.0	0.0	0.0	0.0	0.0	0.0	0.0	0.0	
Detector 1 Delay (s)	0.0	0.0	0.0	0.0	0.0	0.0	0.0	0.0	0.0	0.0	0.0	
Detector 2 Position(ft)		94			94			94			94	
Detector 2 Size(ft)		6			6			6			6	
Detector 2 Type		Cl+Ex			Cl+Ex			Cl+Ex			Cl+Ex	
Detector 2 Channel												
Detector 2 Extend (s)		0.0			0.0			0.0			0.0	
Turn Type	Perm	NA	Perm	Perm	NA	Perm	Perm	NA	Perm	Perm	NA	
Protected Phases		4			8			2			6	
Permitted Phases	4		4	8		8	2		2	6		

Lanes, Volumes, Timings
3: SH 83 & Hodgen Rd

2017 Existing + Site
PM



Lane Group	EBL	EBT	EBR	WBL	WBT	WBR	NBL	NBT	NBR	SBL	SBT	SBR
Detector Phase	4	4	4	8	8	8	2	2	2	6	6	
Switch Phase												
Minimum Initial (s)	5.0	5.0	5.0	5.0	5.0	5.0	5.0	5.0	5.0	5.0	5.0	5.0
Minimum Split (s)	22.5	22.5	22.5	22.5	22.5	22.5	22.5	22.5	22.5	22.5	22.5	22.5
Total Split (s)	28.0	28.0	28.0	28.0	28.0	28.0	32.0	32.0	32.0	32.0	32.0	32.0
Total Split (%)	46.7%	46.7%	46.7%	46.7%	46.7%	46.7%	53.3%	53.3%	53.3%	53.3%	53.3%	53.3%
Maximum Green (s)	23.5	23.5	23.5	23.5	23.5	23.5	27.5	27.5	27.5	27.5	27.5	27.5
Yellow Time (s)	3.5	3.5	3.5	3.5	3.5	3.5	3.5	3.5	3.5	3.5	3.5	3.5
All-Red Time (s)	1.0	1.0	1.0	1.0	1.0	1.0	1.0	1.0	1.0	1.0	1.0	1.0
Lost Time Adjust (s)	0.0	0.0	0.0	0.0	0.0	0.0	0.0	0.0	0.0	0.0	0.0	0.0
Total Lost Time (s)	4.5	4.5	4.5	4.5	4.5	4.5	4.5	4.5	4.5	4.5	4.5	4.5
Lead/Lag												
Lead-Lag Optimize?												
Vehicle Extension (s)	3.0	3.0	3.0	3.0	3.0	3.0	3.0	3.0	3.0	3.0	3.0	3.0
Recall Mode	None	None	None	None	None	None	Min	Min	Min	Min	Min	Min
Walk Time (s)	7.0	7.0	7.0	7.0	7.0	7.0	7.0	7.0	7.0	7.0	7.0	7.0
Flash Dont Walk (s)	11.0	11.0	11.0	11.0	11.0	11.0	11.0	11.0	11.0	11.0	11.0	11.0
Pedestrian Calls (#/hr)	0	0	0	0	0	0	0	0	0	0	0	0
Act Effect Green (s)	10.5	10.5	10.5	10.3	10.3	10.3	20.3	20.3	20.3	20.3	20.3	20.3
Actuated g/C Ratio	0.29	0.29	0.29	0.28	0.28	0.28	0.56	0.56	0.56	0.56	0.56	0.56
v/c Ratio	0.20	0.40	0.21	0.37	0.25	0.23	0.23	0.42	0.18	0.40	0.40	0.42
Control Delay	12.8	14.0	4.5	15.4	12.6	4.5	8.3	8.6	2.0	10.5	8.1	
Queue Delay	0.0	0.0	0.0	0.0	0.0	0.0	0.0	0.0	0.0	0.0	0.0	0.0
Total Delay	12.8	14.0	4.5	15.4	12.6	4.5	8.3	8.6	2.0	10.5	8.1	
LOS	B	B	A	B	B	A	A	A	A	B	A	
Approach Delay		11.2			10.9			7.0			8.9	
Approach LOS		B			B			A			A	
Queue Length 50th (ft)	9	30	0	17	18	0	12	50	0	22	45	
Queue Length 95th (ft)	34	81	18	61	60	25	45	137	22	79	127	
Internal Link Dist (ft)		763			1714			2033			2172	
Turn Bay Length (ft)	450		450	400		400	200		900	650		
Base Capacity (vph)	869	1295	1134	806	1295	1138	721	1496	1305	715	1453	
Starvation Cap Reductn	0	0	0	0	0	0	0	0	0	0	0	0
Spillback Cap Reductn	0	0	0	0	0	0	0	0	0	0	0	0
Storage Cap Reductn	0	0	0	0	0	0	0	0	0	0	0	0
Reduced v/c Ratio	0.08	0.17	0.10	0.15	0.10	0.11	0.16	0.29	0.13	0.28	0.30	

Intersection Summary





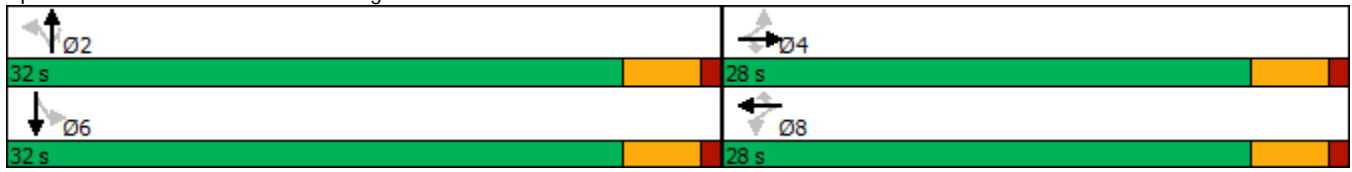













Area Type:	Other
Cycle Length:	60
Actuated Cycle Length:	36.2
Natural Cycle:	50
Control Type:	Actuated-Uncoordinated
Maximum v/c Ratio:	0.42
Intersection Signal Delay:	9.0
Intersection LOS:	A
Intersection Capacity Utilization:	59.9%
ICU Level of Service:	B
Analysis Period (min):	15

Splits and Phases: 3: SH 83 & Hodgen Rd



Lanes, Volumes, Timings
1: Cherry Crossing Dr & Lap Wai Ct/Retail Access

2017 Existing + Site
PM

												
Lane Group	EBL	EBT	EBR	WBL	WBT	WBR	NBL	NBT	NBR	SBL	SBT	SBR
Lane Configurations												
Traffic Volume (vph)	4	0	0	0	0	150	0	36	0	130	56	7
Future Volume (vph)	4	0	0	0	0	150	0	36	0	130	56	7
Ideal Flow (vphpl)	1900	1900	1900	1900	1900	1900	1900	1900	1900	1900	1900	1900
Storage Length (ft)	0		0	0		0	0		50	90		0
Storage Lanes	0		0	0		0	0		1	1		0
Taper Length (ft)	100			100			100			75		
Lane Util. Factor	1.00	1.00	1.00	1.00	1.00	1.00	1.00	1.00	1.00	1.00	1.00	1.00
Frt					0.865							0.983
Flt Protected		0.950								0.950		
Satd. Flow (prot)	0	1770	0	0	1611	0	0	1863	1863	1770	1831	0
Flt Permitted		0.950								0.950		
Satd. Flow (perm)	0	1770	0	0	1611	0	0	1863	1863	1770	1831	0
Link Speed (mph)		30			30			30			30	
Link Distance (ft)		409			623			534			331	
Travel Time (s)		9.3			14.2			12.1			7.5	
Peak Hour Factor	0.92	0.92	0.92	0.92	0.92	0.92	0.92	0.92	0.92	0.92	0.92	0.92
Adj. Flow (vph)	4	0	0	0	0	163	0	39	0	141	61	8
Shared Lane Traffic (%)												
Lane Group Flow (vph)	0	4	0	0	163	0	0	39	0	141	69	0
Enter Blocked Intersection	No	No	No	No	No	No	No	No	No	No	No	No
Lane Alignment	Left	Left	Right	Left	Left	Right	Left	Left	Right	Left	Left	Right
Median Width(ft)		0			0			12			12	
Link Offset(ft)		0			0			0			0	
Crosswalk Width(ft)		16			16			16			16	
Two way Left Turn Lane												
Headway Factor	1.00	1.00	1.00	1.00	1.00	1.00	1.00	1.00	1.00	1.00	1.00	1.00
Turning Speed (mph)	15		9	15		9	15		9	15		9
Sign Control		Stop			Stop			Free			Free	





















Intersection Summary

Area Type: Other

Control Type: Unsignalized

Lanes, Volumes, Timings
6: Cherry Crossing Dr & Hodgen Rd

2017 Existing + Site
PM

												
Lane Group	EBL	EBT	EBR	WBL	WBT	WBR	NBL	NBT	NBR	SBL	SBT	SBR
Lane Configurations												
Traffic Volume (vph)	6	155	63	129	159	17	43	1	146	4	1	0
Future Volume (vph)	6	155	63	129	159	17	43	1	146	4	1	0
Ideal Flow (vphpl)	1900	1900	1900	1900	1900	1900	1900	1900	1900	1900	1900	1900
Storage Length (ft)	0		150	150		0	0		105	0		0
Storage Lanes	0		1	1		1	0		1	0		0
Taper Length (ft)	100			100			100			100		
Lane Util. Factor	1.00	1.00	1.00	1.00	1.00	1.00	1.00	1.00	1.00	1.00	1.00	1.00
Frt			0.850			0.850			0.850			
Flt Protected		0.998		0.950				0.953			0.962	
Satd. Flow (prot)	0	1859	1583	1770	1863	1583	0	1775	1583	0	1792	0
Flt Permitted		0.998		0.950				0.953			0.962	
Satd. Flow (perm)	0	1859	1583	1770	1863	1583	0	1775	1583	0	1792	0
Link Speed (mph)		40		40				30			30	
Link Distance (ft)		1413		843				331			1348	
Travel Time (s)		24.1		14.4				7.5			30.6	
Peak Hour Factor	0.76	0.76	0.76	0.85	0.85	0.85	0.92	0.92	0.95	0.50	0.50	0.50
Adj. Flow (vph)	8	204	83	152	187	20	47	1	154	8	2	0
Shared Lane Traffic (%)												
Lane Group Flow (vph)	0	212	83	152	187	20	0	48	154	0	10	0
Enter Blocked Intersection	No	No	No	No	No	No	No	No	No	No	No	No
Lane Alignment	Left	Left	Right	Left	Left	Right	Left	Left	Right	Left	Left	Right
Median Width(ft)		12		12				12			12	
Link Offset(ft)		0		0				0			0	
Crosswalk Width(ft)		16		16				16			16	
Two way Left Turn Lane												
Headway Factor	1.00	1.00	1.00	1.00	1.00	1.00	1.00	1.00	1.00	1.00	1.00	1.00
Turning Speed (mph)	15		9	15		9	15		9	15		9
Sign Control		Free			Free			Stop			Stop	

Intersection Summary

Area Type: Other

Control Type: Unsignalized

1: Cherry Crossing Dr & Lap Wai Ct/Retail Access Performance by movement Interval #1 4:30

Movement	EBL	WBR	NBT	SBL	SBT	SBR	All
Denied Del/Veh (s)	0.1	0.2	0.1	0.2	0.0	0.0	0.1
Total Del/Veh (s)	4.0	3.0	0.3	1.8	0.2	0.1	1.9

1: Cherry Crossing Dr & Lap Wai Ct/Retail Access Performance by movement Interval #2 4:45

Movement	EBL	WBR	NBT	SBL	SBT	SBR	All
Denied Del/Veh (s)	0.1	0.2	0.1	0.2	0.0	0.0	0.2
Total Del/Veh (s)	8.4	2.7	0.2	1.8	0.3	0.0	1.8

1: Cherry Crossing Dr & Lap Wai Ct/Retail Access Performance by movement Interval #3 5:00

Movement	EBL	WBR	NBT	SBL	SBT	SBR	All
Denied Del/Veh (s)	0.1	0.2	0.1	0.0	0.0	0.0	0.1
Total Del/Veh (s)	7.7	3.4	0.3	2.0	0.4	0.2	2.0

1: Cherry Crossing Dr & Lap Wai Ct/Retail Access Performance by movement Interval #4 5:15

Movement	EBL	WBR	NBT	SBL	SBT	SBR	All
Denied Del/Veh (s)	0.1	0.2	0.1	0.2	0.0	0.0	0.1
Total Del/Veh (s)	4.7	3.0	0.3	1.8	0.3	0.1	2.0

1: Cherry Crossing Dr & Lap Wai Ct/Retail Access Performance by movement Entire Run

Movement	EBL	WBR	NBT	SBL	SBT	SBR	All
Denied Del/Veh (s)	0.1	0.2	0.1	0.1	0.0	0.0	0.1
Total Del/Veh (s)	5.9	3.1	0.3	1.9	0.3	0.1	1.9

6: Cherry Crossing Dr & Hodgen Rd Performance by movement Interval #1 4:30

Movement	EBL	EBT	EBR	WBL	WBT	WBR	NBL	NBT	NBR	SBL	SBT	All
Denied Del/Veh (s)	0.5	0.2	3.3	0.0	0.0	0.0	0.0		0.0	0.1		0.3
Total Del/Veh (s)	0.9	1.0	0.4	3.3	1.7	2.3	7.1		3.2	7.7		2.5

6: Cherry Crossing Dr & Hodgen Rd Performance by movement Interval #2 4:45

Movement	EBL	EBT	EBR	WBL	WBT	WBR	NBL	NBT	NBR	SBL	SBT	All
Denied Del/Veh (s)	0.3	0.3	3.0	0.0	0.0	0.0	0.0		0.1	0.1		0.3
Total Del/Veh (s)	1.5	0.8	0.3	3.8	1.9	1.4	8.4		3.2	8.4		2.5

6: Cherry Crossing Dr & Hodgen Rd Performance by movement Interval #3 5:00

Movement	EBL	EBT	EBR	WBL	WBT	WBR	NBL	NBT	NBR	SBL	SBT	All
Denied Del/Veh (s)	0.3	0.4	3.1	0.1	0.0	0.0	0.0	0.0	0.0	0.1	0.1	0.4
Total Del/Veh (s)	2.9	1.5	0.6	4.6	2.1	1.3	9.9	2.3	3.9	6.4	5.8	3.1

6: Cherry Crossing Dr & Hodgen Rd Performance by movement Interval #4 5:15

Movement	EBL	EBT	EBR	WBL	WBT	WBR	NBL	NBT	NBR	SBL	SBT	All
Denied Del/Veh (s)	0.3	0.3	3.1	0.0	0.0	0.0	0.0		0.0			0.3
Total Del/Veh (s)	1.4	1.0	0.4	3.2	1.9	0.8	7.9		3.4			2.6

6: Cherry Crossing Dr & Hodgen Rd Performance by movement Entire Run

























Movement	EBL	EBT	EBR	WBL	WBT	WBR	NBL	NBT	NBR	SBL	SBT	All
Denied Del/Veh (s)	0.4	0.3	3.2	0.0	0.0	0.0	0.0	0.0	0.0	0.1	0.1	0.3
Total Del/Veh (s)	2.3	1.1	0.5	3.9	1.9	1.4	8.6	8.6	3.5	8.3	6.3	2.8

Total Zone Performance By Interval

Interval Start	4:30	4:45	5:00	5:15	All
Denied Del/Veh (s)		0.7	0.7	0.8	0.7
Total Del/Veh (s)		78.3	73.3	71.4	127.5

Lanes, Volumes, Timings
3: SH 83 & Hodgen Rd

2040 Background
AM

												
Lane Group	EBL	EBT	EBR	WBL	WBT	WBR	NBL	NBT	NBR	SBL	SBT	SBR
Lane Configurations												
Traffic Volume (vph)	75	125	150	400	300	400	50	600	125	160	600	150
Future Volume (vph)	75	125	150	400	300	400	50	600	125	160	600	150
Ideal Flow (vphp)	1900	1900	1900	1900	1900	1900	1900	1900	1900	1900	1900	1900
Storage Length (ft)	450		450	400		400	200		900	650		400
Storage Lanes	1		1	1		1	1		1	2		1
Taper Length (ft)	100			100			100			100		
Lane Util. Factor	1.00	1.00	1.00	1.00	1.00	1.00	1.00	0.95	1.00	0.97	0.95	1.00
Frt			0.850			0.850			0.850			0.850
Flt Protected	0.950			0.950			0.950			0.950		
Satd. Flow (prot)	1770	1863	1583	1770	1863	1583	1770	3539	1583	3433	3539	1583
Flt Permitted	0.569			0.413			0.332			0.301		
Satd. Flow (perm)	1060	1863	1583	769	1863	1583	618	3539	1583	1088	3539	1583
Right Turn on Red			Yes			Yes			Yes			Yes
Satd. Flow (RTOR)			158			279			138			158
Link Speed (mph)		40			40			60			60	
Link Distance (ft)		843			1794			2113			2252	
Travel Time (s)		14.4			30.6			24.0			25.6	
Peak Hour Factor	0.95	0.95	0.95	0.95	0.95	0.95	0.95	0.95	0.95	0.95	0.95	0.95
Adj. Flow (vph)	79	132	158	421	316	421	53	632	132	168	632	158
Shared Lane Traffic (%)												
Lane Group Flow (vph)	79	132	158	421	316	421	53	632	132	168	632	158
Enter Blocked Intersection	No	No	No	No	No	No	No	No	No	No	No	No
Lane Alignment	Left	Left	Right	Left	Left	Right	Left	Left	Right	Left	Left	Right
Median Width(ft)		12			12			24			24	
Link Offset(ft)		0			0			0			0	
Crosswalk Width(ft)		16			16			16			16	
Two way Left Turn Lane												
Headway Factor	1.00	1.00	1.00	1.00	1.00	1.00	1.00	1.00	1.00	1.00	1.00	1.00
Turning Speed (mph)	15		9	15		9	15		9	15		9
Number of Detectors	1	2	1	1	2	1	1	2	1	1	2	1
Detector Template	Left	Thru	Right	Left	Thru	Right	Left	Thru	Right	Left	Thru	Right
Leading Detector (ft)	20	100	20	20	100	20	20	100	20	20	100	20
Trailing Detector (ft)	0	0	0	0	0	0	0	0	0	0	0	0
Detector 1 Position(ft)	0	0	0	0	0	0	0	0	0	0	0	0
Detector 1 Size(ft)	20	6	20	20	6	20	20	6	20	20	6	20
Detector 1 Type	Cl+Ex	Cl+Ex	Cl+Ex	Cl+Ex	Cl+Ex	Cl+Ex	Cl+Ex	Cl+Ex	Cl+Ex	Cl+Ex	Cl+Ex	Cl+Ex
Detector 1 Channel												
Detector 1 Extend (s)	0.0	0.0	0.0	0.0	0.0	0.0	0.0	0.0	0.0	0.0	0.0	0.0
Detector 1 Queue (s)	0.0	0.0	0.0	0.0	0.0	0.0	0.0	0.0	0.0	0.0	0.0	0.0
Detector 1 Delay (s)	0.0	0.0	0.0	0.0	0.0	0.0	0.0	0.0	0.0	0.0	0.0	0.0
Detector 2 Position(ft)		94			94			94			94	
Detector 2 Size(ft)		6			6			6			6	
Detector 2 Type		Cl+Ex			Cl+Ex			Cl+Ex			Cl+Ex	
Detector 2 Channel												
Detector 2 Extend (s)		0.0			0.0			0.0			0.0	
Turn Type	pm+pt	NA	Perm	pm+pt	NA	Perm	pm+pt	NA	Perm	pm+pt	NA	Perm
Protected Phases	7	4		3	8		5	2		1	6	
Permitted Phases	4		4	8		8	2		2	6		6

Lanes, Volumes, Timings
3: SH 83 & Hodgen Rd

2040 Background
AM



Lane Group	EBL	EBT	EBR	WBL	WBT	WBR	NBL	NBT	NBR	SBL	SBT	SBR
Detector Phase	7	4	4	3	8	8	5	2	2	1	6	6
Switch Phase												
Minimum Initial (s)	5.0	5.0	5.0	5.0	5.0	5.0	5.0	5.0	5.0	5.0	5.0	5.0
Minimum Split (s)	9.5	22.5	22.5	9.5	22.5	22.5	9.5	22.5	22.5	9.5	22.5	22.5
Total Split (s)	12.0	25.0	25.0	41.0	54.0	54.0	11.0	42.0	42.0	11.0	42.0	42.0
Total Split (%)	10.1%	21.0%	21.0%	34.5%	45.4%	45.4%	9.2%	35.3%	35.3%	9.2%	35.3%	35.3%
Maximum Green (s)	7.5	20.5	20.5	36.5	49.5	49.5	6.5	37.5	37.5	6.5	37.5	37.5
Yellow Time (s)	3.5	3.5	3.5	3.5	3.5	3.5	3.5	3.5	3.5	3.5	3.5	3.5
All-Red Time (s)	1.0	1.0	1.0	1.0	1.0	1.0	1.0	1.0	1.0	1.0	1.0	1.0
Lost Time Adjust (s)	0.0	0.0	0.0	0.0	0.0	0.0	0.0	0.0	0.0	0.0	0.0	0.0
Total Lost Time (s)	4.5	4.5	4.5	4.5	4.5	4.5	4.5	4.5	4.5	4.5	4.5	4.5
Lead/Lag	Lead	Lag	Lag	Lead	Lag	Lag	Lead	Lag	Lag	Lead	Lag	Lag
Lead-Lag Optimize?	Yes	Yes	Yes	Yes	Yes	Yes	Yes	Yes	Yes	Yes	Yes	Yes
Vehicle Extension (s)	3.0	3.0	3.0	3.0	3.0	3.0	3.0	3.0	3.0	3.0	3.0	3.0
Recall Mode	None	None	None	None	None	None	None	Max	Max	None	Max	Max
Walk Time (s)		7.0	7.0		7.0	7.0		7.0	7.0		7.0	7.0
Flash Dont Walk (s)		11.0	11.0		11.0	11.0		11.0	11.0		11.0	11.0
Pedestrian Calls (#/hr)		0	0		0	0		0	0		0	0
Act Effct Green (s)	19.4	12.3	12.3	40.3	30.9	30.9	44.1	37.8	37.8	45.4	40.3	40.3
Actuated g/C Ratio	0.20	0.13	0.13	0.41	0.31	0.31	0.45	0.38	0.38	0.46	0.41	0.41
v/c Ratio	0.30	0.57	0.47	0.76	0.54	0.61	0.15	0.46	0.19	0.26	0.43	0.21
Control Delay	23.2	51.5	11.6	31.5	31.8	13.5	16.9	25.5	4.8	16.1	24.5	4.9
Queue Delay	0.0	0.0	0.0	0.0	0.0	0.0	0.0	0.0	0.0	0.0	0.0	0.0
Total Delay	23.2	51.5	11.6	31.5	31.8	13.5	16.9	25.5	4.8	16.1	24.5	4.9
LOS	C	D	B	C	C	B	B	C	A	B	C	A
Approach Delay		28.4			25.1			21.6			19.8	
Approach LOS		C			C			C			B	
Queue Length 50th (ft)	30	78	0	198	168	70	16	152	0	27	152	0
Queue Length 95th (ft)	57	149	59	286	249	166	47	252	39	58	252	46
Internal Link Dist (ft)		763			1714			2033			2172	
Turn Bay Length (ft)	450		450	400		400	200		900	650		400
Base Capacity (vph)	268	392	458	708	947	941	356	1363	694	659	1453	743
Starvation Cap Reductn	0	0	0	0	0	0	0	0	0	0	0	0
Spillback Cap Reductn	0	0	0	0	0	0	0	0	0	0	0	0
Storage Cap Reductn	0	0	0	0	0	0	0	0	0	0	0	0
Reduced v/c Ratio	0.29	0.34	0.34	0.59	0.33	0.45	0.15	0.46	0.19	0.25	0.43	0.21

Intersection Summary

Area Type:	Other
Cycle Length:	119
Actuated Cycle Length:	98.2
Natural Cycle:	65
Control Type:	Semi Act-Uncoord
Maximum v/c Ratio:	0.76
Intersection Signal Delay:	23.0
Intersection LOS:	C
Intersection Capacity Utilization:	64.9%
ICU Level of Service:	C
Analysis Period (min):	15

Splits and Phases: 3: SH 83 & Hodgen Rd

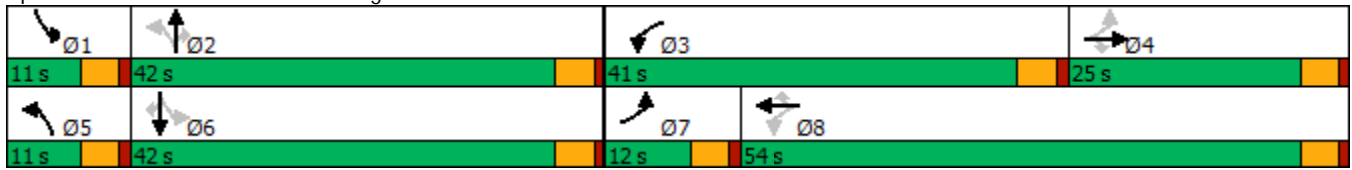

Lanes, Volumes, Timings
6: Hodgen Rd & Cherry Crossing Dr



Lane Group	EBL	EBT	WBT	WBR	SBL	SBR
Lane Configurations		↕	↑	↗	↘	
Traffic Volume (vph)	2	335	495	5	15	10
Future Volume (vph)	2	335	495	5	15	10
Ideal Flow (vphp)	1900	1900	1900	1900	1900	1900
Storage Length (ft)	0			0	0	0
Storage Lanes	0			1	1	0
Taper Length (ft)	100				100	
Lane Util. Factor	1.00	1.00	1.00	1.00	1.00	1.00
Frt				0.850	0.945	
Flt Protected					0.971	
Satd. Flow (prot)	0	1863	1863	1583	1709	0
Flt Permitted					0.971	
Satd. Flow (perm)	0	1863	1863	1583	1709	0
Link Speed (mph)		40	40		30	
Link Distance (ft)		1413	843		1348	
Travel Time (s)		24.1	14.4		30.6	
Peak Hour Factor	0.95	0.95	0.95	0.95	0.92	0.92
Adj. Flow (vph)	2	353	521	5	16	11
Shared Lane Traffic (%)						
Lane Group Flow (vph)	0	355	521	5	27	0
Enter Blocked Intersection	No	No	No	No	No	No
Lane Alignment	Left	Left	Left	Right	Left	Right
Median Width(ft)		12	12		12	
Link Offset(ft)		0	0		0	
Crosswalk Width(ft)		16	16		16	
Two way Left Turn Lane						
Headway Factor	1.00	1.00	1.00	1.00	1.00	1.00
Turning Speed (mph)	15			9	15	9
Sign Control		Free	Free		Stop	
Intersection Summary						
Area Type:	Other					
Control Type:	Unsignalized					

6: Hodgen Rd & Cherry Crossing Dr Performance by movement Interval #1 7:30

Movement	EBT	WBT	WBR	SBL	SBR	All
Denied Del/Veh (s)	0.4	0.0	0.0	0.1	0.1	0.2
Total Del/Veh (s)	0.9	2.9	3.2	16.0	1.8	2.3

6: Hodgen Rd & Cherry Crossing Dr Performance by movement Interval #2 7:45

Movement	EBT	WBT	SBL	SBR	All
Denied Del/Veh (s)	0.2	0.0	0.1	0.1	0.1
Total Del/Veh (s)	0.6	3.0	4.6	1.8	2.0

6: Hodgen Rd & Cherry Crossing Dr Performance by movement Interval #3 8:00

Movement	EBT	WBT	WBR	SBL	SBR	All
Denied Del/Veh (s)	0.3	0.0	0.0	0.1	0.1	0.1
Total Del/Veh (s)	0.9	3.0	2.2	16.1	6.3	2.4

6: Hodgen Rd & Cherry Crossing Dr Performance by movement Interval #4 8:15

























Movement	EBT	WBT	WBR	SBL	SBR	All
Denied Del/Veh (s)	0.2	0.0	0.0	0.1	0.1	0.1
Total Del/Veh (s)	0.8	3.4	1.3	6.1	19.7	2.6

6: Hodgen Rd & Cherry Crossing Dr Performance by movement Entire Run

Movement	EBT	WBT	WBR	SBL	SBR	All
Denied Del/Veh (s)	0.3	0.0	0.0	0.1	0.1	0.1
Total Del/Veh (s)	0.8	3.1	1.9	11.5	8.7	2.4

Lanes, Volumes, Timings
3: SH 83 & Hodgen Rd

2040 Background
PM

												
Lane Group	EBL	EBT	EBR	WBL	WBT	WBR	NBL	NBT	NBR	SBL	SBT	SBR
Lane Configurations												
Traffic Volume (vph)	150	300	75	125	275	283	150	800	400	375	700	150
Future Volume (vph)	150	300	75	125	275	283	150	800	400	375	700	150
Ideal Flow (vphp)	1900	1900	1900	1900	1900	1900	1900	1900	1900	1900	1900	1900
Storage Length (ft)	450		450	400		400	0		900	650		400
Storage Lanes	1		1	1		1	1		1	2		1
Taper Length (ft)	100			100			100			100		
Lane Util. Factor	1.00	1.00	1.00	1.00	1.00	1.00	1.00	0.95	1.00	0.97	0.95	1.00
Frt			0.850			0.850			0.850			0.850
Flt Protected	0.950			0.950			0.950			0.950		
Satd. Flow (prot)	1770	1863	1583	1770	1863	1583	1770	3539	1583	3433	3539	1583
Flt Permitted	0.327			0.364			0.274			0.165		
Satd. Flow (perm)	609	1863	1583	678	1863	1583	510	3539	1583	596	3539	1583
Right Turn on Red			Yes			Yes			Yes			Yes
Satd. Flow (RTOR)			169			298			304			158
Link Speed (mph)		40			40			60			60	
Link Distance (ft)		843			4808			4090			2881	
Travel Time (s)		14.4			82.0			46.5			32.7	
Peak Hour Factor	0.95	0.95	0.95	0.95	0.95	0.95	0.95	0.95	0.95	0.95	0.95	0.95
Adj. Flow (vph)	158	316	79	132	289	298	158	842	421	395	737	158
Shared Lane Traffic (%)												
Lane Group Flow (vph)	158	316	79	132	289	298	158	842	421	395	737	158
Enter Blocked Intersection	No	No	No	No	No	No	No	No	No	No	No	No
Lane Alignment	Left	Left	Right	Left	Left	Right	Left	Left	Right	Left	Left	Right
Median Width(ft)		12			12			24			24	
Link Offset(ft)		0			0			0			0	
Crosswalk Width(ft)		16			16			16			16	
Two way Left Turn Lane												
Headway Factor	1.00	1.00	1.00	1.00	1.00	1.00	1.00	1.00	1.00	1.00	1.00	1.00
Turning Speed (mph)	15		9	15		9	15		9	15		9
Number of Detectors	1	2	1	1	2	1	1	2	1	1	2	1
Detector Template	Left	Thru	Right	Left	Thru	Right	Left	Thru	Right	Left	Thru	Right
Leading Detector (ft)	20	100	20	20	100	20	20	100	20	20	100	20
Trailing Detector (ft)	0	0	0	0	0	0	0	0	0	0	0	0
Detector 1 Position(ft)	0	0	0	0	0	0	0	0	0	0	0	0
Detector 1 Size(ft)	20	6	20	20	6	20	20	6	20	20	6	20
Detector 1 Type	Cl+Ex	Cl+Ex	Cl+Ex	Cl+Ex	Cl+Ex	Cl+Ex	Cl+Ex	Cl+Ex	Cl+Ex	Cl+Ex	Cl+Ex	Cl+Ex
Detector 1 Channel												
Detector 1 Extend (s)	0.0	0.0	0.0	0.0	0.0	0.0	0.0	0.0	0.0	0.0	0.0	0.0
Detector 1 Queue (s)	0.0	0.0	0.0	0.0	0.0	0.0	0.0	0.0	0.0	0.0	0.0	0.0
Detector 1 Delay (s)	0.0	0.0	0.0	0.0	0.0	0.0	0.0	0.0	0.0	0.0	0.0	0.0
Detector 2 Position(ft)		94			94			94			94	
Detector 2 Size(ft)		6			6			6			6	
Detector 2 Type		Cl+Ex			Cl+Ex			Cl+Ex			Cl+Ex	
Detector 2 Channel												
Detector 2 Extend (s)		0.0			0.0			0.0			0.0	
Turn Type	pm+pt	NA	Perm	pm+pt	NA	Perm	pm+pt	NA	Perm	pm+pt	NA	Perm
Protected Phases	7	4		3	8		5	2		1	6	
Permitted Phases	4		4	8		8	2		2	6		6

Lanes, Volumes, Timings
3: SH 83 & Hodgen Rd

2040 Background
PM



Lane Group	EBL	EBT	EBR	WBL	WBT	WBR	NBL	NBT	NBR	SBL	SBT	SBR
Detector Phase	7	4	4	3	8	8	5	2	2	1	6	6
Switch Phase												
Minimum Initial (s)	5.0	5.0	5.0	5.0	5.0	5.0	5.0	5.0	5.0	5.0	5.0	5.0
Minimum Split (s)	9.5	23.5	23.5	9.5	23.5	23.5	11.5	24.5	24.5	9.5	24.5	24.5
Total Split (s)	12.0	29.6	29.6	10.2	27.8	27.8	16.2	35.0	35.0	25.2	44.0	44.0
Total Split (%)	12.0%	29.6%	29.6%	10.2%	27.8%	27.8%	16.2%	35.0%	35.0%	25.2%	44.0%	44.0%
Maximum Green (s)	8.0	24.1	24.1	6.2	22.3	22.3	12.2	28.5	28.5	21.2	37.5	37.5
Yellow Time (s)	3.0	4.5	4.5	3.0	4.5	4.5	3.0	5.5	5.5	3.0	5.5	5.5
All-Red Time (s)	1.0	1.0	1.0	1.0	1.0	1.0	1.0	1.0	1.0	1.0	1.0	1.0
Lost Time Adjust (s)	0.0	0.0	0.0	0.0	0.0	0.0	0.0	0.0	0.0	0.0	0.0	0.0
Total Lost Time (s)	4.0	5.5	5.5	4.0	5.5	5.5	4.0	6.5	6.5	4.0	6.5	6.5
Lead/Lag	Lead	Lag	Lag	Lead	Lag	Lag	Lead	Lag	Lag	Lead	Lag	Lag
Lead-Lag Optimize?	Yes	Yes	Yes	Yes	Yes	Yes	Yes	Yes	Yes	Yes	Yes	Yes
Vehicle Extension (s)	3.0	3.0	3.0	3.0	3.0	3.0	3.0	3.0	3.0	3.0	3.0	3.0
Recall Mode	None	None	None	None	None	None	None	Min	Min	None	Min	Min
Walk Time (s)		7.0	7.0		7.0	7.0		7.0	7.0		7.0	7.0
Flash Dont Walk (s)		11.0	11.0		11.0	11.0		11.0	11.0		11.0	11.0
Pedestrian Calls (#/hr)		0	0		0	0		0	0		0	0
Act Effect Green (s)	29.0	19.5	19.5	25.7	17.9	17.9	38.0	25.9	25.9	41.7	27.8	27.8
Actuated g/C Ratio	0.35	0.23	0.23	0.31	0.21	0.21	0.46	0.31	0.31	0.50	0.33	0.33
v/c Ratio	0.49	0.73	0.16	0.45	0.72	0.52	0.42	0.77	0.60	0.58	0.63	0.25
Control Delay	24.9	41.0	0.7	25.0	42.8	7.4	14.8	32.3	11.6	14.6	26.8	4.9
Queue Delay	0.0	0.0	0.0	0.0	0.0	0.0	0.0	0.0	0.0	0.0	0.0	0.0
Total Delay	24.9	41.0	0.7	25.0	42.8	7.4	14.8	32.3	11.6	14.6	26.8	4.9
LOS	C	D	A	C	D	A	B	C	B	B	C	A
Approach Delay		30.6			24.9			24.2			20.4	
Approach LOS		C			C			C			C	

Intersection Summary

Area Type:	Other
Cycle Length:	100
Actuated Cycle Length:	83.5
Natural Cycle:	70
Control Type:	Actuated-Uncoordinated
Maximum v/c Ratio:	0.77
Intersection Signal Delay:	24.0
Intersection LOS:	C
Intersection Capacity Utilization:	72.3%
ICU Level of Service:	C
Analysis Period (min):	15

Splits and Phases: 3: SH 83 & Hodgen Rd

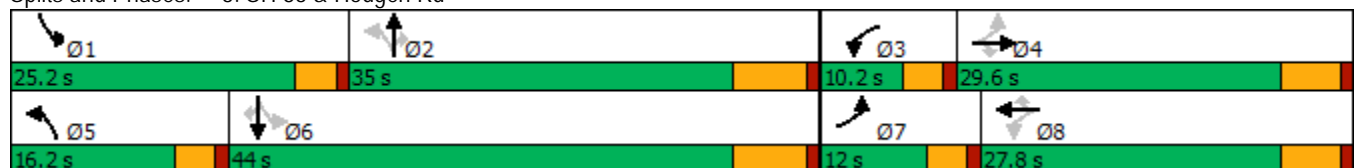

Lanes, Volumes, Timings
6: Hodgen Rd & Cherry Crossing Dr

2040 Background
PM



Lane Group	EBL	EBT	WBT	WBR	SBL	SBR
Lane Configurations						
Traffic Volume (vph)	10	520	555	20	5	0
Future Volume (vph)	10	520	555	20	5	0
Ideal Flow (vphp)	1900	1900	1900	1900	1900	1900
Storage Length (ft)	0			0	0	0
Storage Lanes	0			1	1	0
Taper Length (ft)	100				100	
Lane Util. Factor	1.00	1.00	1.00	1.00	1.00	1.00
Frt				0.850		
Flt Protected		0.999			0.950	
Satd. Flow (prot)	0	1861	1863	1583	1770	0
Flt Permitted		0.999			0.950	
Satd. Flow (perm)	0	1861	1863	1583	1770	0
Link Speed (mph)		40	40		30	
Link Distance (ft)		1413	843		1348	
Travel Time (s)		24.1	14.4		30.6	
Peak Hour Factor	0.95	0.95	0.95	0.95	0.95	0.95
Adj. Flow (vph)	11	547	584	21	5	0
Shared Lane Traffic (%)						
Lane Group Flow (vph)	0	558	584	21	5	0
Enter Blocked Intersection	No	No	No	No	No	No
Lane Alignment	Left	Left	Left	Right	Left	Right
Median Width(ft)		12	12		12	
Link Offset(ft)		0	0		0	
Crosswalk Width(ft)		16	16		16	
Two way Left Turn Lane						
Headway Factor	1.00	1.00	1.00	1.00	1.00	1.00
Turning Speed (mph)	15			9	15	9
Sign Control		Free	Free		Stop	

Intersection Summary

Area Type: Other
Control Type: Unsignalized

6: Hodgen Rd & Cherry Crossing Dr Performance by movement Interval #1 7:00

Movement	EBL	EBT	WBT	WBR	SBL	All
Denied Del/Veh (s)	0.6	0.4	0.0	0.0	0.1	0.2
Total Del/Veh (s)	5.3	1.3	3.6	1.6	10.7	2.5

6: Hodgen Rd & Cherry Crossing Dr Performance by movement Interval #2 7:15

Movement	EBL	EBT	WBT	WBR	SBL	All
Denied Del/Veh (s)	0.4	0.4	0.0	0.0	0.1	0.2
Total Del/Veh (s)	4.5	1.2	3.7	1.9	14.5	2.5

6: Hodgen Rd & Cherry Crossing Dr Performance by movement Interval #3 7:30

Movement	EBL	EBT	WBT	WBR	SBL	All
Denied Del/Veh (s)	0.1	0.4	0.0	0.0	0.1	0.2
Total Del/Veh (s)	2.3	1.0	3.7	1.7	8.5	2.4

6: Hodgen Rd & Cherry Crossing Dr Performance by movement Interval #4 7:45

























Movement	EBL	EBT	WBT	WBR	SBL	All
Denied Del/Veh (s)	0.2	0.4	0.0	0.0	0.1	0.2
Total Del/Veh (s)	4.5	1.2	3.5	1.9	12.6	2.5

6: Hodgen Rd & Cherry Crossing Dr Performance by movement Entire Run

Movement	EBL	EBT	WBT	WBR	SBL	All
Denied Del/Veh (s)	0.4	0.4	0.0	0.0	0.1	0.2
Total Del/Veh (s)	4.8	1.2	3.7	1.8	13.5	2.5

Lanes, Volumes, Timings
3: SH 83 & Hodgen Rd

2040 Background + Site
AM

												
Lane Group	EBL	EBT	EBR	WBL	WBT	WBR	NBL	NBT	NBR	SBL	SBT	SBR
Lane Configurations												
Traffic Volume (vph)	96	137	185	390	332	392	69	592	125	156	579	187
Future Volume (vph)	96	137	185	390	332	392	69	592	125	156	579	187
Ideal Flow (vphp)	1900	1900	1900	1900	1900	1900	1900	1900	1900	1900	1900	1900
Storage Length (ft)	450		450	400		400	200		900	650		400
Storage Lanes	1		1	1		1	1		1	2		1
Taper Length (ft)	100			100			100			100		
Lane Util. Factor	1.00	1.00	1.00	1.00	1.00	1.00	1.00	0.95	1.00	0.97	0.95	1.00
Frt			0.850			0.850			0.850			0.850
Flt Protected	0.950			0.950			0.950			0.950		
Satd. Flow (prot)	1770	1863	1583	1770	1863	1583	1770	3539	1583	3433	3539	1583
Flt Permitted	0.552			0.463			0.357			0.310		
Satd. Flow (perm)	1028	1863	1583	862	1863	1583	665	3539	1583	1120	3539	1583
Right Turn on Red			Yes			Yes			Yes			Yes
Satd. Flow (RTOR)			195			283			158			197
Link Speed (mph)		40			40			60			60	
Link Distance (ft)		843			1794			2113			2252	
Travel Time (s)		14.4			30.6			24.0			25.6	
Peak Hour Factor	0.95	0.95	0.95	0.95	0.95	0.95	0.95	0.95	0.95	0.95	0.95	0.95
Adj. Flow (vph)	101	144	195	411	349	413	73	623	132	164	609	197
Shared Lane Traffic (%)												
Lane Group Flow (vph)	101	144	195	411	349	413	73	623	132	164	609	197
Enter Blocked Intersection	No	No	No	No	No	No	No	No	No	No	No	No
Lane Alignment	Left	Left	Right	Left	Left	Right	Left	Left	Right	Left	Left	Right
Median Width(ft)		12			12			24			24	
Link Offset(ft)		0			0			0			0	
Crosswalk Width(ft)		16			16			16			16	
Two way Left Turn Lane												
Headway Factor	1.00	1.00	1.00	1.00	1.00	1.00	1.00	1.00	1.00	1.00	1.00	1.00
Turning Speed (mph)	15		9	15		9	15		9	15		9
Number of Detectors	1	2	1	1	2	1	1	2	1	1	2	1
Detector Template	Left	Thru	Right	Left	Thru	Right	Left	Thru	Right	Left	Thru	Right
Leading Detector (ft)	20	100	20	20	100	20	20	100	20	20	100	20
Trailing Detector (ft)	0	0	0	0	0	0	0	0	0	0	0	0
Detector 1 Position(ft)	0	0	0	0	0	0	0	0	0	0	0	0
Detector 1 Size(ft)	20	6	20	20	6	20	20	6	20	20	6	20
Detector 1 Type	Cl+Ex	Cl+Ex	Cl+Ex	Cl+Ex	Cl+Ex	Cl+Ex	Cl+Ex	Cl+Ex	Cl+Ex	Cl+Ex	Cl+Ex	Cl+Ex
Detector 1 Channel												
Detector 1 Extend (s)	0.0	0.0	0.0	0.0	0.0	0.0	0.0	0.0	0.0	0.0	0.0	0.0
Detector 1 Queue (s)	0.0	0.0	0.0	0.0	0.0	0.0	0.0	0.0	0.0	0.0	0.0	0.0
Detector 1 Delay (s)	0.0	0.0	0.0	0.0	0.0	0.0	0.0	0.0	0.0	0.0	0.0	0.0
Detector 2 Position(ft)		94			94			94			94	
Detector 2 Size(ft)		6			6			6			6	
Detector 2 Type		Cl+Ex			Cl+Ex			Cl+Ex			Cl+Ex	
Detector 2 Channel												
Detector 2 Extend (s)		0.0			0.0			0.0			0.0	
Turn Type	pm+pt	NA	Perm	pm+pt	NA	Perm	pm+pt	NA	Perm	pm+pt	NA	Perm
Protected Phases	7	4		3	8		5	2		1	6	
Permitted Phases	4		4	8		8	2		2	6		6

Lanes, Volumes, Timings
3: SH 83 & Hodgen Rd

2040 Background + Site
AM

Lane Group	EBL	EBT	EBR	WBL	WBT	WBR	NBL	NBT	NBR	SBL	SBT	SBR
Detector Phase	7	4	4	3	8	8	5	2	2	1	6	6
Switch Phase												
Minimum Initial (s)	5.0	5.0	5.0	5.0	5.0	5.0	5.0	5.0	5.0	5.0	5.0	5.0
Minimum Split (s)	9.5	23.5	23.5	9.5	23.5	23.5	9.5	24.5	24.5	9.5	24.5	24.5
Total Split (s)	10.4	24.0	24.0	30.0	43.6	43.6	10.0	36.0	36.0	10.0	36.0	36.0
Total Split (%)	10.4%	24.0%	24.0%	30.0%	43.6%	43.6%	10.0%	36.0%	36.0%	10.0%	36.0%	36.0%
Maximum Green (s)	6.4	18.5	18.5	26.0	38.1	38.1	6.0	29.5	29.5	6.0	29.5	29.5
Yellow Time (s)	3.0	4.5	4.5	3.0	4.5	4.5	3.0	5.5	5.5	3.0	5.5	5.5
All-Red Time (s)	1.0	1.0	1.0	1.0	1.0	1.0	1.0	1.0	1.0	1.0	1.0	1.0
Lost Time Adjust (s)	0.0	0.0	0.0	0.0	0.0	0.0	0.0	0.0	0.0	0.0	0.0	0.0
Total Lost Time (s)	4.0	5.5	5.5	4.0	5.5	5.5	4.0	6.5	6.5	4.0	6.5	6.5
Lead/Lag	Lead	Lag	Lag	Lead	Lag	Lag	Lead	Lag	Lag	Lead	Lag	Lag
Lead-Lag Optimize?	Yes	Yes	Yes	Yes	Yes	Yes	Yes	Yes	Yes	Yes	Yes	Yes
Vehicle Extension (s)	3.0	3.0	3.0	3.0	3.0	3.0	3.0	3.0	3.0	3.0	3.0	3.0
Recall Mode	None	None	None	None	None	None	None	Max	Max	None	Max	Max
Walk Time (s)		7.0	7.0		7.0	7.0		7.0	7.0		7.0	7.0
Flash Dont Walk (s)		11.0	11.0		11.0	11.0		11.0	11.0		11.0	11.0
Pedestrian Calls (#/hr)		0	0		0	0		0	0		0	0
Act Effect Green (s)	20.1	12.2	12.2	37.9	28.3	28.3	38.2	29.7	29.7	39.2	32.0	32.0
Actuated g/C Ratio	0.23	0.14	0.14	0.43	0.32	0.32	0.43	0.34	0.34	0.44	0.36	0.36
v/c Ratio	0.35	0.56	0.50	0.71	0.58	0.59	0.20	0.52	0.21	0.25	0.47	0.28
Control Delay	20.6	44.9	10.3	25.8	29.8	11.6	16.6	26.9	3.6	15.5	25.6	5.1
Queue Delay	0.0	0.0	0.0	0.0	0.0	0.0	0.0	0.0	0.0	0.0	0.0	0.0
Total Delay	20.6	44.9	10.3	25.8	29.8	11.6	16.6	26.9	3.6	15.5	25.6	5.1
LOS	C	D	B	C	C	B	B	C	A	B	C	A
Approach Delay		24.0			22.0			22.3			19.7	
Approach LOS		C			C			C			B	

Intersection Summary





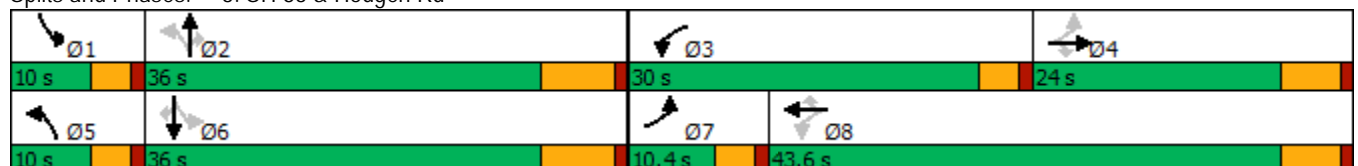













Area Type:	Other
Cycle Length:	100
Actuated Cycle Length:	88.3
Natural Cycle:	70
Control Type:	Semi Act-Uncoord
Maximum v/c Ratio:	0.71
Intersection Signal Delay:	21.7
Intersection LOS:	C
Intersection Capacity Utilization:	66.3%
ICU Level of Service:	C
Analysis Period (min):	15

Splits and Phases: 3: SH 83 & Hodgen Rd























Lanes, Volumes, Timings
1: Cherry Crossing Dr & Lap Wai Ct/Retail Access

2040 Background + Site
AM

												
Lane Group	EBL	EBT	EBR	WBL	WBT	WBR	NBL	NBT	NBR	SBL	SBT	SBR
Lane Configurations												
Traffic Volume (vph)	6	0	0	0	0	90	0	27	0	120	35	2
Future Volume (vph)	6	0	0	0	0	90	0	27	0	120	35	2
Ideal Flow (vphpl)	1900	1900	1900	1900	1900	1900	1900	1900	1900	1900	1900	1900
Storage Length (ft)	0		0	0		0	0		50	90		0
Storage Lanes	0		0	0		0	0		0	1		0
Taper Length (ft)	100			100			100			75		
Lane Util. Factor	1.00	1.00	1.00	1.00	1.00	1.00	1.00	1.00	1.00	1.00	1.00	1.00
Frt					0.865							0.992
Flt Protected		0.950								0.950		
Satd. Flow (prot)	0	1770	0	0	1611	0	0	1863	0	1770	1848	0
Flt Permitted		0.950								0.950		
Satd. Flow (perm)	0	1770	0	0	1611	0	0	1863	0	1770	1848	0
Link Speed (mph)		30			30			30			30	
Link Distance (ft)		409			623			534			331	
Travel Time (s)		9.3			14.2			12.1			7.5	
Peak Hour Factor	0.92	0.92	0.92	0.92	0.92	0.92	0.92	0.92	0.92	0.92	0.92	0.92
Adj. Flow (vph)	7	0	0	0	0	98	0	29	0	130	38	2
Shared Lane Traffic (%)												
Lane Group Flow (vph)	0	7	0	0	98	0	0	29	0	130	40	0
Enter Blocked Intersection	No	No	No	No	No	No	No	No	No	No	No	No
Lane Alignment	Left	Left	Right	Left	Left	Right	Left	Left	Right	Left	Left	Right
Median Width(ft)		0			0			12			12	
Link Offset(ft)		0			0			0			0	
Crosswalk Width(ft)		16			16			16			16	
Two way Left Turn Lane												
Headway Factor	1.00	1.00	1.00	1.00	1.00	1.00	1.00	1.00	1.00	1.00	1.00	1.00
Turning Speed (mph)	15		9	15		9	15		9	15		9
Sign Control		Stop			Stop			Free			Free	
Intersection Summary												
Area Type:	Other											
Control Type:	Unsignalized											

Lanes, Volumes, Timings
6: Cherry Crossing Dr & Hodgen Rd

2040 Background + Site
AM

												
Lane Group	EBL	EBT	EBR	WBL	WBT	WBR	NBL	NBT	NBR	SBL	SBT	SBR
Lane Configurations												
Traffic Volume (vph)	2	313	41	115	468	5	32	1	90	15	1	10
Future Volume (vph)	2	313	41	115	468	5	32	1	90	15	1	10
Ideal Flow (vphpl)	1900	1900	1900	1900	1900	1900	1900	1900	1900	1900	1900	1900
Storage Length (ft)	0		150	150		0	0		105	0		0
Storage Lanes	0		1	1		1	0		1	0		0
Taper Length (ft)	100			100			50			100		
Lane Util. Factor	1.00	1.00	1.00	1.00	1.00	1.00	1.00	1.00	1.00	1.00	1.00	1.00
Frt			0.850			0.850			0.850		0.947	
Flt Protected				0.950				0.954			0.972	
Satd. Flow (prot)	0	1863	1583	1770	1863	1583	0	1777	1583	0	1715	0
Flt Permitted				0.950				0.954			0.972	
Satd. Flow (perm)	0	1863	1583	1770	1863	1583	0	1777	1583	0	1715	0
Link Speed (mph)		40		40				30			30	
Link Distance (ft)		1413		843				331			1348	
Travel Time (s)		24.1		14.4				7.5			30.6	
Peak Hour Factor	0.95	0.95	0.95	0.95	0.95	0.95	0.92	0.92	0.92	0.95	0.95	0.95
Adj. Flow (vph)	2	329	43	121	493	5	35	1	98	16	1	11
Shared Lane Traffic (%)												
Lane Group Flow (vph)	0	331	43	121	493	5	0	36	98	0	28	0
Enter Blocked Intersection	No	No	No	No	No	No	No	No	No	No	No	No
Lane Alignment	Left	Left	Right	Left	Left	Right	Left	Left	Right	Left	Left	Right
Median Width(ft)		12		12				12			12	
Link Offset(ft)		0		0				0			0	
Crosswalk Width(ft)		16		16				16			16	
Two way Left Turn Lane												
Headway Factor	1.00	1.00	1.00	1.00	1.00	1.00	1.00	1.00	1.00	1.00	1.00	1.00
Turning Speed (mph)	15		9	15		9	15		9	15		9
Sign Control		Free			Free			Stop			Stop	
Intersection Summary												
Area Type:	Other											
Control Type:	Unsignalized											

1: Cherry Crossing Dr & Lap Wai Ct/Retail Access Performance by movement Interval #1 7:30

Movement	EBL	WBR	NBT	SBL	SBT	SBR	All
Denied Del/Veh (s)	0.1	0.1	0.1	0.0	0.0	0.0	0.1
Total Del/Veh (s)	7.6	3.0	0.2	2.0	0.4	0.4	2.0

1: Cherry Crossing Dr & Lap Wai Ct/Retail Access Performance by movement Interval #2 7:45

Movement	EBL	WBR	NBT	SBL	SBT	SBR	All
Denied Del/Veh (s)	0.1	0.1	0.1	0.0	0.0		0.1
Total Del/Veh (s)	6.2	2.8	0.2	2.0	0.4		1.9

1: Cherry Crossing Dr & Lap Wai Ct/Retail Access Performance by movement Interval #3 8:00

Movement	EBL	WBR	NBT	SBL	SBT	SBR	All
Denied Del/Veh (s)	0.1	0.2	0.1	0.2	0.0		0.1
Total Del/Veh (s)	4.4	3.0	0.2	1.9	0.4		2.0

1: Cherry Crossing Dr & Lap Wai Ct/Retail Access Performance by movement Interval #4 8:15

Movement	EBL	WBR	NBT	SBL	SBT	SBR	All
Denied Del/Veh (s)	0.1	0.2	0.1	0.0	0.0	0.0	0.1
Total Del/Veh (s)	3.8	2.8	0.2	2.0	0.6	0.3	1.9

1: Cherry Crossing Dr & Lap Wai Ct/Retail Access Performance by movement Entire Run

Movement	EBL	WBR	NBT	SBL	SBT	SBR	All
Denied Del/Veh (s)	0.1	0.1	0.1	0.0	0.0	0.0	0.1
Total Del/Veh (s)	5.1	2.9	0.2	2.0	0.5	0.4	2.0

6: Cherry Crossing Dr & Hodgen Rd Performance by movement Interval #1 7:30

Movement	EBL	EBT	EBR	WBL	WBT	WBR	NBL	NBT	NBR	SBL	SBT	SBR
Denied Del/Veh (s)		0.3	3.0	0.0	0.0	0.0	0.0		0.0	0.2		0.2
Total Del/Veh (s)		1.2	0.4	5.8	3.2	1.0	17.0		4.6	19.7		8.9

6: Cherry Crossing Dr & Hodgen Rd Performance by movement Interval #1 7:30

Movement	All
Denied Del/Veh (s)	0.2
Total Del/Veh (s)	3.7

6: Cherry Crossing Dr & Hodgen Rd Performance by movement Interval #2 7:45

Movement	EBL	EBT	EBR	WBL	WBT	WBR	NBL	NBT	NBR	SBL	SBT	SBR
Denied Del/Veh (s)		0.3	3.1	0.0	0.0	0.0	0.0		0.0	0.2		0.1
Total Del/Veh (s)		1.1	0.5	5.4	3.4	1.9	13.1		4.2	14.8		5.0

6: Cherry Crossing Dr & Hodgen Rd Performance by movement Interval #2 7:45

Movement	All
Denied Del/Veh (s)	0.2
Total Del/Veh (s)	3.4

6: Cherry Crossing Dr & Hodgen Rd Performance by movement Interval #3 8:00

Movement	EBL	EBT	EBR	WBL	WBT	WBR	NBL	NBT	NBR	SBL	SBT	SBR
Denied Del/Veh (s)		0.3	2.7	0.0	0.0	0.0	0.0		0.0	0.1		0.2
Total Del/Veh (s)		1.3	0.5	6.0	3.7	1.6	18.0		4.9	14.2		7.3

6: Cherry Crossing Dr & Hodgen Rd Performance by movement Interval #3 8:00

Movement	All
Denied Del/Veh (s)	0.2
Total Del/Veh (s)	3.7

6: Cherry Crossing Dr & Hodgen Rd Performance by movement Interval #4 8:15

Movement	EBL	EBT	EBR	WBL	WBT	WBR	NBL	NBT	NBR	SBL	SBT	SBR
Denied Del/Veh (s)		0.2	2.5	0.0	0.0	0.0	0.0		0.0	0.1		0.1
Total Del/Veh (s)		0.9	0.5	5.6	3.5	1.2	17.3		4.2	20.5		9.6

6: Cherry Crossing Dr & Hodgen Rd Performance by movement Interval #4 8:15

Movement	All
Denied Del/Veh (s)	0.1
Total Del/Veh (s)	3.8

6: Cherry Crossing Dr & Hodgen Rd Performance by movement Entire Run

Movement	EBL	EBT	EBR	WBL	WBT	WBR	NBL	NBT	NBR	SBL	SBT	SBR
Denied Del/Veh (s)	0.8	0.3	2.9	0.0	0.0	0.0	0.0	0.0	0.0	0.1	0.1	0.1
Total Del/Veh (s)	3.6	1.1	0.5	5.8	3.6	1.4	16.1	8.4	4.6	16.4	21.9	7.6

6: Cherry Crossing Dr & Hodgen Rd Performance by movement Entire Run

























Movement	All
Denied Del/Veh (s)	0.2
Total Del/Veh (s)	3.7

Total Zone Performance By Interval

Interval Start	7:30	7:45	8:00	8:15	All
Denied Del/Veh (s)	0.4	0.5	0.5	0.3	0.4
Total Del/Veh (s)	195.0	113.2	157.2	197.9	661.8

Lanes, Volumes, Timings
3: SH 83 & Hodgen Rd

2040 Background + Site
PM

												
Lane Group	EBL	EBT	EBR	WBL	WBT	WBR	NBL	NBT	NBR	SBL	SBT	SBR
Lane Configurations												
Traffic Volume (vph)	179	335	116	122	295	283	188	783	394	363	677	199
Future Volume (vph)	179	335	116	122	295	283	188	783	394	363	677	199
Ideal Flow (vphp)	1900	1900	1900	1900	1900	1900	1900	1900	1900	1900	1900	1900
Storage Length (ft)	450		450	400		400	0		900	650		400
Storage Lanes	1		1	1		1	1		1	2		1
Taper Length (ft)	100			100			100			100		
Lane Util. Factor	1.00	1.00	1.00	1.00	1.00	1.00	1.00	0.95	1.00	0.97	0.95	1.00
Frt			0.850			0.850			0.850			0.850
Flt Protected	0.950			0.950			0.950			0.950		
Satd. Flow (prot)	1770	1863	1583	1770	1863	1583	1770	3539	1583	3433	3539	1583
Flt Permitted	0.297			0.312			0.262			0.180		
Satd. Flow (perm)	553	1863	1583	581	1863	1583	488	3539	1583	650	3539	1583
Right Turn on Red			Yes			Yes			Yes			Yes
Satd. Flow (RTOR)			169			298			293			209
Link Speed (mph)		40			40			60			60	
Link Distance (ft)		843			4808			4090			2881	
Travel Time (s)		14.4			82.0			46.5			32.7	
Peak Hour Factor	0.95	0.95	0.95	0.95	0.95	0.95	0.95	0.95	0.95	0.95	0.95	0.95
Adj. Flow (vph)	188	353	122	128	311	298	198	824	415	382	713	209
Shared Lane Traffic (%)												
Lane Group Flow (vph)	188	353	122	128	311	298	198	824	415	382	713	209
Enter Blocked Intersection	No	No	No	No	No	No	No	No	No	No	No	No
Lane Alignment	Left	Left	Right	Left	Left	Right	Left	Left	Right	Left	Left	Right
Median Width(ft)		12			12			24			24	
Link Offset(ft)		0			0			0			0	
Crosswalk Width(ft)		16			16			16			16	
Two way Left Turn Lane												
Headway Factor	1.00	1.00	1.00	1.00	1.00	1.00	1.00	1.00	1.00	1.00	1.00	1.00
Turning Speed (mph)	15		9	15		9	15		9	15		9
Number of Detectors	1	2	1	1	2	1	1	2	1	1	2	1
Detector Template	Left	Thru	Right	Left	Thru	Right	Left	Thru	Right	Left	Thru	Right
Leading Detector (ft)	20	100	20	20	100	20	20	100	20	20	100	20
Trailing Detector (ft)	0	0	0	0	0	0	0	0	0	0	0	0
Detector 1 Position(ft)	0	0	0	0	0	0	0	0	0	0	0	0
Detector 1 Size(ft)	20	6	20	20	6	20	20	6	20	20	6	20
Detector 1 Type	Cl+Ex	Cl+Ex	Cl+Ex	Cl+Ex	Cl+Ex	Cl+Ex	Cl+Ex	Cl+Ex	Cl+Ex	Cl+Ex	Cl+Ex	Cl+Ex
Detector 1 Channel												
Detector 1 Extend (s)	0.0	0.0	0.0	0.0	0.0	0.0	0.0	0.0	0.0	0.0	0.0	0.0
Detector 1 Queue (s)	0.0	0.0	0.0	0.0	0.0	0.0	0.0	0.0	0.0	0.0	0.0	0.0
Detector 1 Delay (s)	0.0	0.0	0.0	0.0	0.0	0.0	0.0	0.0	0.0	0.0	0.0	0.0
Detector 2 Position(ft)		94			94			94			94	
Detector 2 Size(ft)		6			6			6			6	
Detector 2 Type		Cl+Ex			Cl+Ex			Cl+Ex			Cl+Ex	
Detector 2 Channel												
Detector 2 Extend (s)		0.0			0.0			0.0			0.0	
Turn Type	pm+pt	NA	Perm	pm+pt	NA	Perm	pm+pt	NA	Perm	pm+pt	NA	Perm
Protected Phases	7	4		3	8		5	2		1	6	
Permitted Phases	4		4	8		8	2		2	6		6

Lanes, Volumes, Timings
3: SH 83 & Hodgen Rd

2040 Background + Site
PM

Lane Group	EBL	EBT	EBR	WBL	WBT	WBR	NBL	NBT	NBR	SBL	SBT	SBR
Detector Phase	7	4	4	3	8	8	5	2	2	1	6	6
Switch Phase												
Minimum Initial (s)	5.0	5.0	5.0	5.0	5.0	5.0	5.0	5.0	5.0	5.0	5.0	5.0
Minimum Split (s)	9.5	23.5	23.5	9.5	23.5	23.5	11.5	24.5	24.5	9.5	24.5	24.5
Total Split (s)	12.0	29.6	29.6	10.2	27.8	27.8	16.2	35.0	35.0	25.2	44.0	44.0
Total Split (%)	12.0%	29.6%	29.6%	10.2%	27.8%	27.8%	16.2%	35.0%	35.0%	25.2%	44.0%	44.0%
Maximum Green (s)	8.0	24.1	24.1	6.2	22.3	22.3	12.2	28.5	28.5	21.2	37.5	37.5
Yellow Time (s)	3.0	4.5	4.5	3.0	4.5	4.5	3.0	5.5	5.5	3.0	5.5	5.5
All-Red Time (s)	1.0	1.0	1.0	1.0	1.0	1.0	1.0	1.0	1.0	1.0	1.0	1.0
Lost Time Adjust (s)	0.0	0.0	0.0	0.0	0.0	0.0	0.0	0.0	0.0	0.0	0.0	0.0
Total Lost Time (s)	4.0	5.5	5.5	4.0	5.5	5.5	4.0	6.5	6.5	4.0	6.5	6.5
Lead/Lag	Lead	Lag	Lag	Lead	Lag	Lag	Lead	Lag	Lag	Lead	Lag	Lag
Lead-Lag Optimize?	Yes	Yes	Yes	Yes	Yes	Yes	Yes	Yes	Yes	Yes	Yes	Yes
Vehicle Extension (s)	3.0	3.0	3.0	3.0	3.0	3.0	3.0	3.0	3.0	3.0	3.0	3.0
Recall Mode	None	None	None	None	None	None	None	Min	Min	None	Min	Min
Walk Time (s)		7.0	7.0		7.0	7.0		7.0	7.0		7.0	7.0
Flash Dont Walk (s)		11.0	11.0		11.0	11.0		11.0	11.0		11.0	11.0
Pedestrian Calls (#/hr)		0	0		0	0		0	0		0	0
Act Effect Green (s)	30.3	20.6	20.6	26.6	18.8	18.8	38.8	25.7	25.7	40.1	26.4	26.4
Actuated g/C Ratio	0.36	0.24	0.24	0.32	0.22	0.22	0.46	0.31	0.31	0.48	0.31	0.31
v/c Ratio	0.59	0.77	0.24	0.47	0.75	0.51	0.52	0.76	0.60	0.56	0.64	0.33
Control Delay	28.1	43.3	2.9	25.3	43.6	7.1	16.8	32.3	12.1	14.8	28.2	4.9
Queue Delay	0.0	0.0	0.0	0.0	0.0	0.0	0.0	0.0	0.0	0.0	0.0	0.0
Total Delay	28.1	43.3	2.9	25.3	43.6	7.1	16.8	32.3	12.1	14.8	28.2	4.9
LOS	C	D	A	C	D	A	B	C	B	B	C	A
Approach Delay		31.5			25.7			24.3			20.6	
Approach LOS		C			C			C			C	

Intersection Summary





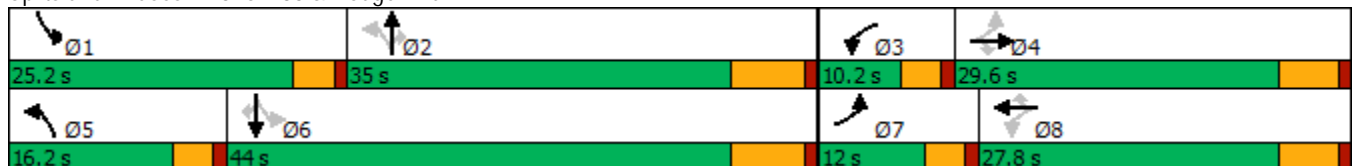













Area Type:	Other
Cycle Length:	100
Actuated Cycle Length:	84.1
Natural Cycle:	70
Control Type:	Actuated-Uncoordinated
Maximum v/c Ratio:	0.77
Intersection Signal Delay:	24.5
Intersection LOS:	C
Intersection Capacity Utilization:	74.1%
ICU Level of Service:	D
Analysis Period (min):	15

Splits and Phases: 3: SH 83 & Hodgen Rd























Lanes, Volumes, Timings
 1: Cherry Crossing Dr & Lap Wai Ct/Retail Access

2040 Background + Site
 PM (NB L/T + NBR)

												
Lane Group	EBL	EBT	EBR	WBL	WBT	WBR	NBL	NBT	NBR	SBL	SBT	SBR
Lane Configurations												
Traffic Volume (vph)	4	0	0	0	0	150	0	36	0	130	56	7
Future Volume (vph)	4	0	0	0	0	150	0	36	0	130	56	7
Ideal Flow (vphpl)	1900	1900	1900	1900	1900	1900	1900	1900	1900	1900	1900	1900
Storage Length (ft)	0		0	0		0	0		50	90		0
Storage Lanes	0		0	0		0	0		1	1		0
Taper Length (ft)	100			100			100			75		
Lane Util. Factor	1.00	1.00	1.00	1.00	1.00	1.00	1.00	1.00	1.00	1.00	1.00	1.00
Frt					0.865							0.983
Flt Protected		0.950								0.950		
Satd. Flow (prot)	0	1770	0	0	1611	0	0	1863	1863	1770	1831	0
Flt Permitted		0.950								0.950		
Satd. Flow (perm)	0	1770	0	0	1611	0	0	1863	1863	1770	1831	0
Link Speed (mph)		30			30			30			30	
Link Distance (ft)		409			623			534			331	
Travel Time (s)		9.3			14.2			12.1			7.5	
Peak Hour Factor	0.92	0.92	0.92	0.92	0.92	0.92	0.92	0.92	0.92	0.92	0.92	0.92
Adj. Flow (vph)	4	0	0	0	0	163	0	39	0	141	61	8
Shared Lane Traffic (%)												
Lane Group Flow (vph)	0	4	0	0	163	0	0	39	0	141	69	0
Enter Blocked Intersection	No	No	No	No	No	No	No	No	No	No	No	No
Lane Alignment	Left	Left	Right	Left	Left	Right	Left	Left	Right	Left	Left	Right
Median Width(ft)		0			0			12			12	
Link Offset(ft)		0			0			0			0	
Crosswalk Width(ft)		16			16			16			16	
Two way Left Turn Lane												
Headway Factor	1.00	1.00	1.00	1.00	1.00	1.00	1.00	1.00	1.00	1.00	1.00	1.00
Turning Speed (mph)	15		9	15		9	15		9	15		9
Sign Control		Stop			Stop			Free			Free	
Intersection Summary												
Area Type:	Other											
Control Type:	Unsignalized											

Lanes, Volumes, Timings
6: Cherry Crossing Dr & Hodgen Rd

2040 Background + Site
PM (NB L/T + NBR)

												
Lane Group	EBL	EBT	EBR	WBL	WBT	WBR	NBL	NBT	NBR	SBL	SBT	SBR
Lane Configurations												
Traffic Volume (vph)	10	479	63	129	533	20	43	1	146	5	1	0
Future Volume (vph)	10	479	63	129	533	20	43	1	146	5	1	0
Ideal Flow (vphpl)	1900	1900	1900	1900	1900	1900	1900	1900	1900	1900	1900	1900
Storage Length (ft)	0		150	150		0	0		105	0		0
Storage Lanes	0		1	1		1	0		1	0		0
Taper Length (ft)	100			100			50			100		
Lane Util. Factor	1.00	1.00	1.00	1.00	1.00	1.00	1.00	1.00	1.00	1.00	1.00	1.00
Frt			0.850			0.850			0.850			
Flt Protected		0.999		0.950				0.953			0.960	
Satd. Flow (prot)	0	1861	1583	1770	1863	1583	0	1775	1583	0	1788	0
Flt Permitted		0.999		0.950				0.953			0.960	
Satd. Flow (perm)	0	1861	1583	1770	1863	1583	0	1775	1583	0	1788	0
Link Speed (mph)		40			40			30			30	
Link Distance (ft)		1413			843			331			1348	
Travel Time (s)		24.1			14.4			7.5			30.6	
Peak Hour Factor	0.76	0.76	0.76	0.85	0.85	0.85	0.92	0.92	0.95	0.50	0.50	0.50
Adj. Flow (vph)	13	630	83	152	627	24	47	1	154	10	2	0
Shared Lane Traffic (%)												
Lane Group Flow (vph)	0	643	83	152	627	24	0	48	154	0	12	0
Enter Blocked Intersection	No	No	No	No	No	No	No	No	No	No	No	No
Lane Alignment	Left	Left	Right	Left	Left	Right	Left	Left	Right	Left	Left	Right
Median Width(ft)		12			12			12			12	
Link Offset(ft)		0			0			0			0	
Crosswalk Width(ft)		16			16			16			16	
Two way Left Turn Lane												
Headway Factor	1.00	1.00	1.00	1.00	1.00	1.00	1.00	1.00	1.00	1.00	1.00	1.00
Turning Speed (mph)	15		9	15		9	15		9	15		9
Sign Control		Free			Free			Stop			Stop	
Intersection Summary												
Area Type:	Other											
Control Type:	Unsignalized											

1: Cherry Crossing Dr & Lap Wai Ct/Retail Access Performance by movement Interval #1 4:30

Movement	EBL	WBR	NBT	SBL	SBT	SBR	All
Denied Del/Veh (s)	0.1	0.2	0.1	0.0	0.0	0.0	0.1
Total Del/Veh (s)	7.0	2.8	0.3	2.1	0.5	0.4	2.0

1: Cherry Crossing Dr & Lap Wai Ct/Retail Access Performance by movement Interval #2 4:45

Movement	EBL	WBR	NBT	SBL	SBT	SBR	All
Denied Del/Veh (s)	0.1	0.2	0.1	0.0	0.0	0.0	0.1
Total Del/Veh (s)	4.6	3.1	0.2	2.0	0.4	0.3	1.9

1: Cherry Crossing Dr & Lap Wai Ct/Retail Access Performance by movement Interval #3 5:00

Movement	EBL	WBR	NBT	SBL	SBT	SBR	All
Denied Del/Veh (s)	0.1	0.2	0.1	0.1	0.0	0.0	0.1
Total Del/Veh (s)	3.2	3.1	0.2	2.0	0.5	0.5	2.1

1: Cherry Crossing Dr & Lap Wai Ct/Retail Access Performance by movement Interval #4 5:15

Movement	EBL	WBR	NBT	SBL	SBT	SBR	All
Denied Del/Veh (s)	0.1	0.2	0.1	0.0	0.0	0.0	0.1
Total Del/Veh (s)	6.4	3.1	0.4	2.1	0.4	0.4	2.1

1: Cherry Crossing Dr & Lap Wai Ct/Retail Access Performance by movement Entire Run

Movement	EBL	WBR	NBT	SBL	SBT	SBR	All
Denied Del/Veh (s)	0.1	0.2	0.1	0.0	0.0	0.0	0.1
Total Del/Veh (s)	6.9	3.1	0.3	2.1	0.5	0.4	2.1

6: Cherry Crossing Dr & Hodgen Rd Performance by movement Interval #1 4:30

Movement	EBL	EBT	EBR	WBL	WBT	WBR	NBL	NBT	NBR	SBL	SBT	All
Denied Del/Veh (s)	0.2	0.5	2.8	0.0	0.0	0.0	0.0		0.1	0.1		0.3
Total Del/Veh (s)	4.6	1.6	0.7	7.3	3.5	1.7	26.6		5.7	20.2		3.9

6: Cherry Crossing Dr & Hodgen Rd Performance by movement Interval #2 4:45

Movement	EBL	EBT	EBR	WBL	WBT	WBR	NBL	NBT	NBR	SBL	SBT	All
Denied Del/Veh (s)	0.4	0.6	2.9	0.0	0.0	0.0	0.0		0.0	0.1		0.3
Total Del/Veh (s)	5.8	2.0	0.8	8.7	3.5	1.9	25.9		6.0	14.9		4.1

6: Cherry Crossing Dr & Hodgen Rd Performance by movement Interval #3 5:00

Movement	EBL	EBT	EBR	WBL	WBT	WBR	NBL	NBT	NBR	SBL	SBT	All
Denied Del/Veh (s)	0.6	0.5	2.9	0.0	0.0	0.0	0.0	0.0	0.0	0.1		0.3
Total Del/Veh (s)	5.2	1.9	0.7	7.3	3.6	1.5	32.1	2.1	6.0	6.4		4.2

6: Cherry Crossing Dr & Hodgen Rd Performance by movement Interval #4 5:15

Movement	EBL	EBT	EBR	WBL	WBT	WBR	NBL	NBR	SBL	SBT	All
Denied Del/Veh (s)	0.4	0.5	2.7	0.0	0.0	0.0	0.0	0.0	0.1		0.3
Total Del/Veh (s)	5.6	2.0	0.8	6.8	3.7	1.6	28.2	5.9	24.8		4.5

6: Cherry Crossing Dr & Hodgen Rd Performance by movement Entire Run

Movement	EBL	EBT	EBR	WBL	WBT	WBR	NBL	NBT	NBR	SBL	SBT	All
Denied Del/Veh (s)	0.4	0.5	2.8	0.0	0.0	0.0	0.0	0.0	0.0	0.1	0.1	0.3
Total Del/Veh (s)	5.3	1.9	0.8	7.6	3.6	1.6	29.9	7.9	6.0	16.6	27.0	4.3

Total Zone Performance By Interval

Interval Start	4:30	4:45	5:00	5:15	All
Denied Del/Veh (s)		0.6	0.7	0.7	0.6
Total Del/Veh (s)		131.6	189.4	128.2	152.1

Intersection: 1: Cherry Crossing Dr & Lap Wai Ct/Retail Access, Interval #1

Movement	EB	WB	SB
Directions Served	LTR	LTR	L
Maximum Queue (ft)	15	46	20
Average Queue (ft)	4	33	3
95th Queue (ft)	21	50	17
Link Distance (ft)	374	589	
Upstream Blk Time (%)			
Queuing Penalty (veh)			
Storage Bay Dist (ft)			90
Storage Blk Time (%)			
Queuing Penalty (veh)			

Intersection: 1: Cherry Crossing Dr & Lap Wai Ct/Retail Access, Interval #2

Movement	EB	WB	SB
Directions Served	LTR	LTR	L
Maximum Queue (ft)	25	38	15
Average Queue (ft)	4	29	3
95th Queue (ft)	19	44	17
Link Distance (ft)	374	589	
Upstream Blk Time (%)			
Queuing Penalty (veh)			
Storage Bay Dist (ft)			90
Storage Blk Time (%)			
Queuing Penalty (veh)			

Intersection: 1: Cherry Crossing Dr & Lap Wai Ct/Retail Access, Interval #3

Movement	EB	WB	SB
Directions Served	LTR	LTR	L
Maximum Queue (ft)	25	52	15
Average Queue (ft)	6	33	3
95th Queue (ft)	26	48	19
Link Distance (ft)	374	589	
Upstream Blk Time (%)			
Queuing Penalty (veh)			
Storage Bay Dist (ft)			90
Storage Blk Time (%)			
Queuing Penalty (veh)			

Intersection: 1: Cherry Crossing Dr & Lap Wai Ct/Retail Access, Interval #4

Movement	EB	WB	SB
Directions Served	LTR	LTR	L
Maximum Queue (ft)	20	43	20
Average Queue (ft)	5	31	5
95th Queue (ft)	23	46	22
Link Distance (ft)	374	589	
Upstream Blk Time (%)			
Queuing Penalty (veh)			
Storage Bay Dist (ft)			90
Storage Blk Time (%)			
Queuing Penalty (veh)			

Intersection: 1: Cherry Crossing Dr & Lap Wai Ct/Retail Access, All Intervals

Movement	EB	WB	SB
Directions Served	LTR	LTR	L
Maximum Queue (ft)	30	60	30
Average Queue (ft)	5	31	3
95th Queue (ft)	23	47	19
Link Distance (ft)	374	589	
Upstream Blk Time (%)			
Queuing Penalty (veh)			
Storage Bay Dist (ft)			90
Storage Blk Time (%)			
Queuing Penalty (veh)			

Intersection: 6: Cherry Crossing Dr & Hodgen Rd, Interval #1

Movement	EB	WB	NB	NB	SB
Directions Served	R	L	LT	R	LTR
Maximum Queue (ft)	4	57	40	49	36
Average Queue (ft)	1	25	21	30	18
95th Queue (ft)	6	56	47	55	39
Link Distance (ft)			256		1303
Upstream Blk Time (%)					
Queuing Penalty (veh)					
Storage Bay Dist (ft)	150	150		105	
Storage Blk Time (%)					
Queuing Penalty (veh)					

Intersection: 6: Cherry Crossing Dr & Hodgen Rd, Interval #2

Movement	EB	EB	WB	NB	NB	SB
Directions Served	LT	R	L	LT	R	LTR
Maximum Queue (ft)	4	6	49	36	46	28
Average Queue (ft)	0	1	22	16	24	17
95th Queue (ft)	0	9	49	39	38	38
Link Distance (ft)	1376			256		1303
Upstream Blk Time (%)						
Queuing Penalty (veh)						
Storage Bay Dist (ft)		150	150		105	
Storage Blk Time (%)						
Queuing Penalty (veh)						

Intersection: 6: Cherry Crossing Dr & Hodgen Rd, Interval #3

Movement	EB	WB	NB	NB	SB
Directions Served	R	L	LT	R	LTR
Maximum Queue (ft)	3	32	40	55	28
Average Queue (ft)	0	19	22	28	14
95th Queue (ft)	5	39	46	50	34
Link Distance (ft)			256		1303
Upstream Blk Time (%)					
Queuing Penalty (veh)					
Storage Bay Dist (ft)	150	150		105	
Storage Blk Time (%)					
Queuing Penalty (veh)					

Intersection: 6: Cherry Crossing Dr & Hodgen Rd, Interval #4

Movement	EB	WB	NB	NB	SB
Directions Served	R	L	LT	R	LTR
Maximum Queue (ft)	6	44	44	48	38
Average Queue (ft)	0	23	21	28	18
95th Queue (ft)	5	46	48	47	44
Link Distance (ft)			256		1303
Upstream Blk Time (%)					
Queuing Penalty (veh)					
Storage Bay Dist (ft)	150	150		105	
Storage Blk Time (%)					
Queuing Penalty (veh)					

Intersection: 6: Cherry Crossing Dr & Hodgen Rd, All Intervals

Movement	EB	EB	WB	NB	NB	SB
Directions Served	LT	R	L	LT	R	LTR
Maximum Queue (ft)	4	13	61	54	65	46
Average Queue (ft)	0	1	22	20	27	17
95th Queue (ft)	0	6	48	45	48	39
Link Distance (ft)	1376			256		1303
Upstream Blk Time (%)						
Queuing Penalty (veh)						
Storage Bay Dist (ft)		150	150		105	
Storage Blk Time (%)						
Queuing Penalty (veh)						

Zone Summary

Zone wide Queuing Penalty, Interval #1: 0
Zone wide Queuing Penalty, Interval #2: 0
Zone wide Queuing Penalty, Interval #3: 0
Zone wide Queuing Penalty, Interval #4: 0
Zone wide Queuing Penalty, All Intervals: 0

Intersection: 1: Cherry Crossing Dr & Lap Wai Ct/Retail Access, Interval #1

Movement	EB	WB	SB
Directions Served	LTR	LTR	L
Maximum Queue (ft)	25	48	13
Average Queue (ft)	2	29	3
95th Queue (ft)	15	50	19
Link Distance (ft)	374	575	
Upstream Blk Time (%)			
Queuing Penalty (veh)			
Storage Bay Dist (ft)			90
Storage Blk Time (%)			
Queuing Penalty (veh)			

Intersection: 1: Cherry Crossing Dr & Lap Wai Ct/Retail Access, Interval #2

Movement	EB	WB	SB
Directions Served	LTR	LTR	L
Maximum Queue (ft)	18	52	15
Average Queue (ft)	3	32	3
95th Queue (ft)	16	56	17
Link Distance (ft)	374	575	
Upstream Blk Time (%)			
Queuing Penalty (veh)			
Storage Bay Dist (ft)			90
Storage Blk Time (%)			
Queuing Penalty (veh)			

Intersection: 1: Cherry Crossing Dr & Lap Wai Ct/Retail Access, Interval #3

Movement	EB	WB	SB
Directions Served	LTR	LTR	L
Maximum Queue (ft)	20	45	15
Average Queue (ft)	4	29	3
95th Queue (ft)	20	46	17
Link Distance (ft)	374	575	
Upstream Blk Time (%)			
Queuing Penalty (veh)			
Storage Bay Dist (ft)			90
Storage Blk Time (%)			
Queuing Penalty (veh)			

Intersection: 1: Cherry Crossing Dr & Lap Wai Ct/Retail Access, Interval #4

Movement	EB	WB	SB
Directions Served	LTR	LTR	L
Maximum Queue (ft)	10	38	33
Average Queue (ft)	3	26	7
95th Queue (ft)	17	40	30
Link Distance (ft)	374	575	
Upstream Blk Time (%)			
Queuing Penalty (veh)			
Storage Bay Dist (ft)			90
Storage Blk Time (%)			
Queuing Penalty (veh)			

Intersection: 1: Cherry Crossing Dr & Lap Wai Ct/Retail Access, All Intervals

Movement	EB	WB	SB
Directions Served	LTR	LTR	L
Maximum Queue (ft)	30	55	36
Average Queue (ft)	3	29	4
95th Queue (ft)	17	48	21
Link Distance (ft)	374	575	
Upstream Blk Time (%)			
Queuing Penalty (veh)			
Storage Bay Dist (ft)			90
Storage Blk Time (%)			
Queuing Penalty (veh)			

Intersection: 6: Cherry Crossing Dr & Hodgen Rd, Interval #1

Movement	EB	EB	WB	NB	NB	SB
Directions Served	LT	R	L	LT	R	LTR
Maximum Queue (ft)	27	12	61	56	56	12
Average Queue (ft)	6	2	34	27	33	3
95th Queue (ft)	38	13	66	57	59	16
Link Distance (ft)	1376			256		1303
Upstream Blk Time (%)						
Queuing Penalty (veh)						
Storage Bay Dist (ft)		150	150		105	
Storage Blk Time (%)						
Queuing Penalty (veh)						

Intersection: 6: Cherry Crossing Dr & Hodgen Rd, Interval #2

Movement	EB	WB	NB	NB	SB
Directions Served	LT	L	LT	R	LTR
Maximum Queue (ft)	21	61	50	69	20
Average Queue (ft)	3	32	27	36	5
95th Queue (ft)	21	59	56	68	20
Link Distance (ft)	1376		256		1303
Upstream Blk Time (%)					
Queuing Penalty (veh)					
Storage Bay Dist (ft)		150		105	
Storage Blk Time (%)				0	
Queuing Penalty (veh)				0	

Intersection: 6: Cherry Crossing Dr & Hodgen Rd, Interval #3

Movement	EB	EB	WB	NB	NB	SB
Directions Served	LT	R	L	LT	R	LTR
Maximum Queue (ft)	52	11	59	64	52	20
Average Queue (ft)	12	2	30	31	35	6
95th Queue (ft)	51	15	56	67	57	23
Link Distance (ft)	1376			256		1303
Upstream Blk Time (%)						
Queuing Penalty (veh)						
Storage Bay Dist (ft)		150	150		105	
Storage Blk Time (%)				0		
Queuing Penalty (veh)				0		

Intersection: 6: Cherry Crossing Dr & Hodgen Rd, Interval #4

Movement	EB	EB	WB	NB	NB	SB
Directions Served	LT	R	L	LT	R	LTR
Maximum Queue (ft)	35	11	54	46	66	20
Average Queue (ft)	7	2	25	24	32	4
95th Queue (ft)	38	14	53	56	68	17
Link Distance (ft)	1376			256		1303
Upstream Blk Time (%)						
Queuing Penalty (veh)						
Storage Bay Dist (ft)		150	150		105	
Storage Blk Time (%)				0	0	
Queuing Penalty (veh)				0	0	

Intersection: 6: Cherry Crossing Dr & Hodgen Rd, All Intervals

Movement	EB	EB	WB	NB	NB	SB
Directions Served	LT	R	L	LT	R	LTR
Maximum Queue (ft)	68	24	75	74	93	24
Average Queue (ft)	7	1	30	27	34	5
95th Queue (ft)	39	12	59	59	64	19
Link Distance (ft)	1376			256		1303
Upstream Blk Time (%)						
Queuing Penalty (veh)						
Storage Bay Dist (ft)		150	150		105	
Storage Blk Time (%)				0	0	
Queuing Penalty (veh)				0	0	

Zone Summary

Zone wide Queuing Penalty, Interval #1: 0
Zone wide Queuing Penalty, Interval #2: 0
Zone wide Queuing Penalty, Interval #3: 0
Zone wide Queuing Penalty, Interval #4: 0
Zone wide Queuing Penalty, All Intervals: 0



LSC TRANSPORTATION CONSULTANTS, INC.
 545 East Pikes Peak Avenue, Suite 210
 Colorado Springs, CO 80903
 (719) 633-2868
 FAX (719) 633-5430
 E-mail: lsc@lsctrans.com
 Website: <http://www.lsctrans.com>

Rollin' Ridge
 Traffic Impact Study
 (LSC #174470)
 January 3, 2018

Add "PCD File No P181"

Traffic Engineer's Statement

The traffic report and supporting information were prepared under my responsible charge and they comport with the standard of care. So far as is consistent with the standard of care, said report was prepared in general conformance with the criteria established by the County for traffic reports.

 Jeffrey C. Hodsdon, P.E., #31684



1/4/18
 Date

Developer's Statement

The Developer, have read and will comply with all commitments made on my behalf within this report.



1-3-18
 Date

Summary of Comments on Microsoft Word - Rollin' Ridge -- report

Page: 1

☰ Number: 1 Author: dsdlaforce Subject: Text Box Date: 3/26/2018 7:09:20 AM

[Add "PCD File No P181"](#)

Status

jchodsdon Completed

5/10/2018 4:26:41 PM

- Estimates of average weekday peak-hour trip generation for the proposed development, including the estimated directional distribution of site-generated vehicle-trips on SH 83 and adjacent to the intersection of Hodgen Road/site access/Cherry Crossing Drive near the site.
- Projected site-generated and resulting total traffic.
- Intersection level of service analysis.
- Auxiliary right-/left-turn lane needs analysis based on the projected volumes and criteria in the El Paso County *Engineering Criteria Manual* (ECM) and the *Colorado State Highway Access Code*.
- Findings and recommendations.

LAND USE AND ACCESS

Figure 1 shows the site location relative to the adjacent and nearby roadways. Rollin' Ridge is planned to contain 16 lots for **single-family homes** and a commercial site. The site plan is shown in Figure 2a and Figure 2b.

Rollin' Ridge's most recent commercial site plan identifies several buildings with a mix of land uses, as shown in Table 1.

Table 1: Land Uses for Proposed Rollin' Ridge Commercial Development

Lot #	ITE Code	ITE Land Use Description	Value	Units
17	946	Gasoline/Service Station w/ Convenience Market	5.000	KSF*
18	720	Medical-Dental Office Building	5.000	KSF
	820	Shopping Center	5.000	KSF
19	820	Shopping Center	5.000	KSF
	820	Shopping Center	5.000	KSF
	820	Shopping Center	5.000	KSF
	820	Shopping Center	5.000	KSF

* KSF = 1,000 square feet
12 vehicle fueling positions (VFPs) are planned

Access to Hodgen Road is proposed via a full-movement access located approximately 900 feet west of SH 83 (centerline spacing) and across from Cherry Crossing Drive.

ROAD AND TRAFFIC CONDITIONS

Area Roads and Streets

State what the sight distance is at the site access to Hodgen and whether it can be met. If it cannot be met, state the required modifications so that it can be met. 1

Figure 1 shows the roads in the vicinity of the site. The major roads are identified below followed by a brief description of each:

State Highway (SH) 83 extends from Colorado Springs north to Parker and areas of southeast Denver. In the vicinity of the site, SH 83 is classified as a Regional Highway (R-A). At this location,

Number: 1 Author: dsdlaforce Subject: Callout Date: 3/26/2018 11:01:00 AM

State what the sight distance is at the site access to Hodgen and whether it can be met. If it cannot be met, state the required modifications so that it can be met.

Status

Jchodsdon Completed

5/10/2018 4:26:37 PM

SH 83 is a two-lane rural highway with two- to four-foot shoulders and a speed limit of 60 miles per hour (mph). The intersection with Hodgen Road is signalized. Per the El Paso County 2040 *Major Transportation Corridors Plan (MTCP)*, SH 83 is projected to be expanded from a two-lane highway to a four-lane highway by 2040. Additionally, the southbound approach is projected to have a dual left-turn lane and an exclusive right-turn lane by 2040. 1

Update to include the MTCP Corridor Preservation Plan.

Hodgen Road is a two-lane paved Rural Principal Arterial that extends west from State Highway 83 to Roller Coaster Road, where it continues west as Baptist Road. Hodgen also extends east from the intersection of Roller Coaster Road/Baptist Road to Eastonville Road (as a Minor Arterial). The speed limit on Hodgen Road is 40 mph adjacent to the site.

Cherry Crossing Drive is a north/south, two-lane paved Rural Principal Arterial that extends from State Highway 83 south to the site. The speed limit on Cherry Crossing Drive is 40 mph.

Elaborate. Does the intersection along Hodgen Rd b/w Cherry Crossing Dr and Hwy 83 meet County Criteria. If not may need to identify that a deviation request is required in the recommendation section and submit a deviation request.

Traffic Volumes

Turning movement traffic counts were collected from 8:30 a.m. and from 4:00 to 6:00 p.m. at the intersections of Hodgen Road with SH 83 and Cherry Crossing Drive, as shown in Figure 3. Raw data is provided in Appendix B. Figure 3 also shows CDOT annual average daily traffic (AADT) for SH 83 and Cherry Crossing Drive. 3

No site access intersection is proposed between Cherry Crossing Drive and SH 83. All access will be from the extension of Cherry Crossing Drive south of Hodgen.

TRIP GENERATION

Estimates of the vehicle-trips projected to be generated by the proposed development have been made using the nationally published trip generation rates from *Trip Generation, 10th Edition, 2017* by the Institute of Transportation Engineers (ITE).

Pass-By and Diverted Trips

The total number of trips generated by the site has also been aggregated by trip type to account for pass-by and diverted trips. A pass-by trip is one made by a motorist who would already be on an adjacent road regardless of the proposed development, but who stops in at the site while passing by. That pass-by motorist would then continue on his or her way to a final destination in the original direction. Table 6 (attached) shows the percent of the trips generated that were assumed to be pass-by trips. Pass-by percentage has been based on data from the *Trip Generation Handbook - An ITE Proposed Recommended Practice, 3rd Edition, 2014* by ITE and adjustments by LSC for site-specific conditions.

Analysis also accounts for diverted trips from adjacent State Highway 83. These trips are considered non-pass-by trips. These trips would be added to Hodgen Road and would result in altered turning movements at the nearby major intersection of SH 83/Hodgen Road. New trips would also be added to the proposed site access intersection.

Elaborate. Identify the ITE average and the adjustment proposed by LSC. Explain the site-specific condition that lead to the LSC value. 4

☰ Number: 1 Author: dsdlaforce Subject: Callout Date: 3/26/2018 9:25:31 AM

Update to include the MTCP Corridor Preservation Plan.

Status

jchodsdon Completed 5/10/2018 5:04:10 PM

☰ Number: 2 Author: dsdlaforce Subject: Callout Date: 3/26/2018 9:28:51 AM

Elaborate. Does the intersection along Hodgen Rd b/w Cherry Crossing Dr and Hwy 83 meet County Criteria. If not may need to identify that a deviation request is required in the recommendation section and submit a deviation request.

☰ Number: 3 Author: jchodsdon Subject: Text Box Date: 5/10/2018 5:04:00 PM

No site access intersection is proposed between Cherry Crossing Drive and SH 83. All access will be from the extension of Cherry Crossing Drive south of Hodgen.

☰ Number: 4 Author: dsdlaforce Subject: Callout Date: 3/26/2018 8:35:13 AM

Elaborate. Identify the ITE average and the adjustment proposed by LSC. Explain the site-specific condition that lead to the LSC value.

Status

jchodsdon None 5/10/2018 5:02:52 PM

Evening Peak Hour

A summary of current and projected 2040 background traffic conditions—both with and without considering site-generated traffic—is shown in Table 5. LOS and control delays during the weekday evening peak hour are shown in this table. Detailed Synchro reports are attached.

Table 5: Level of Service Comparison by Scenario (P.M. Peak)

Analysis Period	Site Access @ Hodgen					SH 83 @ Hodgen					
	Control	SB	NBL	NBR	WBL	Control	Overall	EBL	WBL	NBL	SBL
LOS											
2017 Existing	TWSC*	B	-	-	-	Signal	A	B	B	A	B
2017 Existing + Site		B	B	A	A		A	B	B	A	B
2040 Background		B	-	-	-		C	C	C	B	B
2040 Background + Site		C	C	A	A		C	C	C	B	B
Control Delay (Seconds)											
2017 Existing	TWSC	10.6	-	-	-	Signal	9.4	12.7	16.5	7.3	13.2
2017 Existing + Site		10.0	13.2	4.4	5.6		9.0	12.8	15.4	8.3	10.5
2040 Background		10.4	-	-	-		24.0	24.9	25.0	14.8	14.6
2040 Background + Site		27.1	26.0	6.0	9.9		24.5	28.1	25.3	16.8	14.8
* TWSC = Two-Way Stop Sign Control											

Site Access/Hodgen Road

All turning movements at the intersection of Hodgen Road/Cherry Crossing Drive/site access currently operate and are projected to remain at LOS C or better for all short-term and long-term evening traffic conditions, with or without development.

SH 83/Hodgen Road

This intersection is projected to operate at LOS D or weekday evening peak hour.

Update to include recommendations regarding ROW dedication and preservation. 1

CONCLUSIONS AND RECOMMENDATIONS

- The site is projected to generate about 2,899 new/non-passby vehicle-trips on the average weekday. A significant portion of these non-pass-by trips are projected to be diverted trips from the Highway 83/Hodgen Road intersection.
- Approximately 157 vehicles would enter the site during the weekday morning peak hour, while 116 vehicles are projected to exit. During the weekday evening peak hour of adjacent street traffic, 183 vehicles would enter the site while 183 vehicles would exit.

Number: 1 Author: dsdlaforce Subject: Callout Date: 3/26/2018 9:22:39 AM

[Update to include recommendations regarding ROW dedication and preservation.](#)

Status

jchodsdon Accepted 5/10/2018 4:27:57 PM

- All approaches at the site access intersection with Hodgen Road and at the intersection of SH 83/Hodgen will operate at LOS C or better during both the short and long term during the weekday morning peak hour and evening peak hour for this development. It is assumed that SH 83 will be expanded (Hodgen Road south with dual southbound left-turn lanes in 2040).
- According to the El Paso County *Engineering Criteria Manual* (ECM), exclusive left-turn lanes shall be provided for any access on a Principal Arterial with a projected peak-hour ingress turning volume of 10 vehicles per hour (vph) or greater. Projected left-turn volumes at the site access point are expected to exceed the minimum left-turn volume thresholds outlined in the *ECM* upon site buildout. Thus, an exclusive westbound left-turn lane is prescribed by the ECM at the intersection of Hodgen Road/Cherry Crossing Drive/site access. The painted center median could be restriped to provide for this left-turn lane. This turn lane would be back-to-back with the eastbound left-turn lane at the Hodgen/SH 83 intersection.
- As shown in Figure 6 and Figure 8, the projected future westbound left-turn volume, including existing, future background, and site traffic, is approximately 115 and 129 vehicles during the short- and long-term morning peak hour and evening peak hour, respectively.
- Per ECM criteria, exclusive right-turn lanes shall be provided for any access on a Principal Arterial with a projected peak-hour ingress turning volume of 25 vehicles per hour (vph) or greater. As shown in Figure 6 and Figure 8, the projected future eastbound right-turn volume is approximately 63 vehicles during the evening peak hour, which exceeds the minimum right-turn volume ECM thresholds upon site buildout. Thus, an exclusive right-turn deceleration lane is prescribed by the ECM at the intersection of Hodgen Road/site access.
- The *Colorado State Highway Access Code* requires a right-turn deceleration lane for any "access" (Hodgen Road is considered an "access" to SH 83) with a projected peak-hour right ingress turning volume greater than 25 vph. Per code, a southbound right-turn deceleration lane is required at the intersection of SH 83/Hodgen Road based on existing traffic volumes.
- The *Colorado State Highway Access Code* requires a right-turn acceleration lane for any "access" (Hodgen Road is considered an "access" to SH 83) with a projected peak-hour right ingress turning volume greater than 50 vph. Per code, a southbound right-turn acceleration lane is required at the intersection of SH 83/Hodgen Road based on existing traffic volumes.

1
Is there sufficient length to meet the minimum requirements per the ECM? Identify the minimum requirement per the ECM and the amount that would be accommodated with the restriping.

2
Provide an exhibit showing these proposed auxiliary lane improvements. Are there additional ROW dedication that will be required?

☰ Number: 1 Author: dsdlaforce Subject: Callout Date: 3/26/2018 10:48:40 AM

Is there sufficient length to meet the minimum requirements per the ECM? Identify the minimum requirement per the ECM and the amount that would be accommodated with the restriping.

Status

jchodsdon Completed 5/10/2018 4:28:20 PM

☰ Number: 2 Author: dsdlaforce Subject: Text Box Date: 3/26/2018 10:52:51 AM

Provide an exhibit showing these proposed auxiliary lane improvements. Are there additional ROW dedication that will be required?

Status

jchodsdon Completed 5/10/2018 4:28:37 PM

- The current northbound left-turn deceleration lane at the SH 83/Hodgen intersection will need to be lengthened to the south to meet Access Code criteria based on existing plus buildout site-generated traffic.
- This project will be required to participate in the El Paso County Road Impact Fee program. Consideration for Fee Program credit may be given to intersection improvements completed at the State Highway 83/Hodgen Road intersection (applicable MTCP project reference numbers U9 and SH 6).

* * * * *

Please contact me if you have any questions regarding this report.

Sincerely,

LSC TRANSPORTATION CONSULTANTS, INC.

By

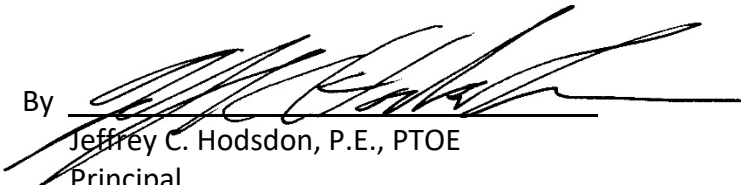
Jeffrey C. Hodsdon, P.E., PTOE
Principal

JCH:JAB:bjwb

Enclosures: Table 6
Figure 1 – Figure 8
Traffic Count Reports
Level of Service Reports

Include an exhibit identifying roadway classification for the proposed internal roads. ¹

List all deviations from the ECM that the applicant will be making. Submit signed/stamped deviation request forms for the deviations requested.

The recommended classification of the internal roads has been added to the report narrative. ²

The TIS report includes a list of deviations

☰ Number: 1 Author: dsdlaforce Subject: Text Box Date: 3/26/2018 11:02:52 AM

Include an exhibit identifying roadway classification for the proposed internal roads. List all deviations from the ECM that the applicant will be making. Submit signed/stamped deviation request forms for the deviations requested.

Status

jchodsdon Completed 5/10/2018 5:02:04 PM

☰ Number: 2 Author: jchodsdon Subject: Text Box Date: 5/10/2018 5:02:00 PM

The recommended classification of the internal roads has been added to the report narrative.

The TIS report includes a list of deviations

revise to 945

1

Table 6: Detailed Trip Generation Estimate

ITE		Value	Units	Trip Generation Rates ⁽¹⁾				Driveway Trips Generated				% Diverted Trips	% Pass-by Trips	Non-Pass-by Trips Generated						
Code	Description			Avg Weekday Traffic	A.M.		P.M.		Avg Weekday Traffic	A.M.				P.M.		Avg Weekday Traffic	A.M.		P.M.	
210	Single-Family Detached Housing	16	DU ⁽²⁾	9.52	0.19	0.56	0.63	0.37	152	3	9	10	6	0%	0%	152	3	9	10	6
945	Gasoline/Service Station w/ Convenience Market	12	VFP ⁽³⁾	162.78	5.08	5.08	6.76	6.76	1,953	61	61	81	81	45%	40%	1172	37	37	49	49
720	Medical-Dental Office Building	5,000	KSF ⁽⁴⁾	36.13	1.89	0.50	1.00	2.57	181	9	3	5	13	0%	0%	181	9	3	5	13
820	Shopping Center	25,000	KSF	88.38	3.45	2.11	3.86	3.57	2,209	86	53	97	89	30%	30%	1547	60	37	68	62
									4,343	157	116	183	183			2,899	106	76	121	124

(1) Source: *Trip Generation, 9th Edition, 2012* by the Institute of Transportation Engineers (ITE)

(2) DU = dwelling units

(3) VFP = vehicle fueling positions

(4) KSF = 1,000 square feet

Number: 1 Author: dsdlaforce Subject: Callout Date: 3/26/2018 8:23:42 AM

[revise to 945](#)

Status

jchodsdon Completed

5/10/2018 5:00:41 PM

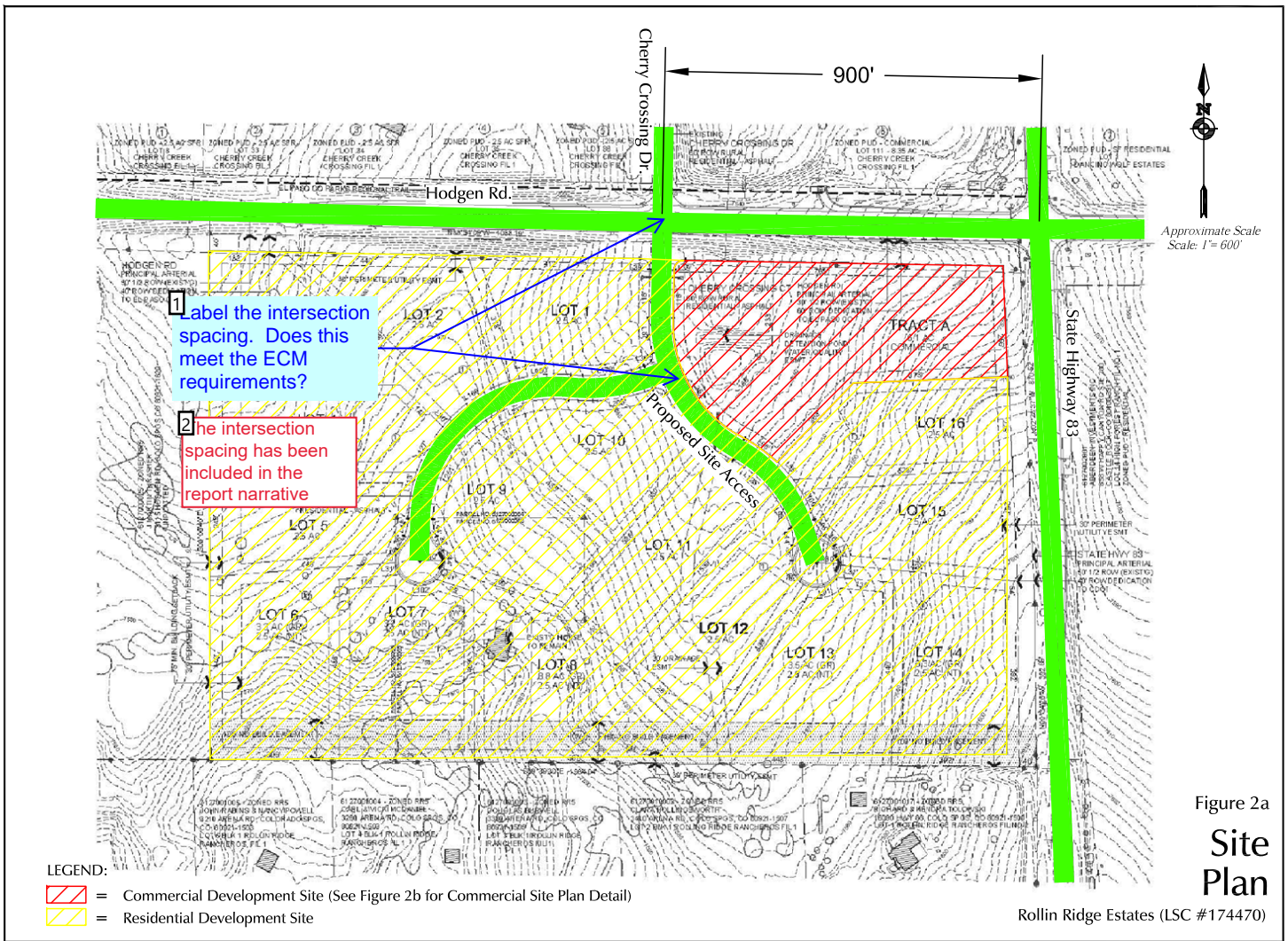

☰ Number: 1 Author: dsdlaforce Subject: Callout Date: 3/26/2018 8:10:06 AM

Label the intersection spacing. Does this meet the ECM requirements?

Status

jchodsdon Completed 5/10/2018 4:59:16 PM

☰ Number: 2 Author: jchodsdon Subject: Text Box Date: 5/10/2018 4:59:09 PM

The intersection spacing has been included in the report narrative

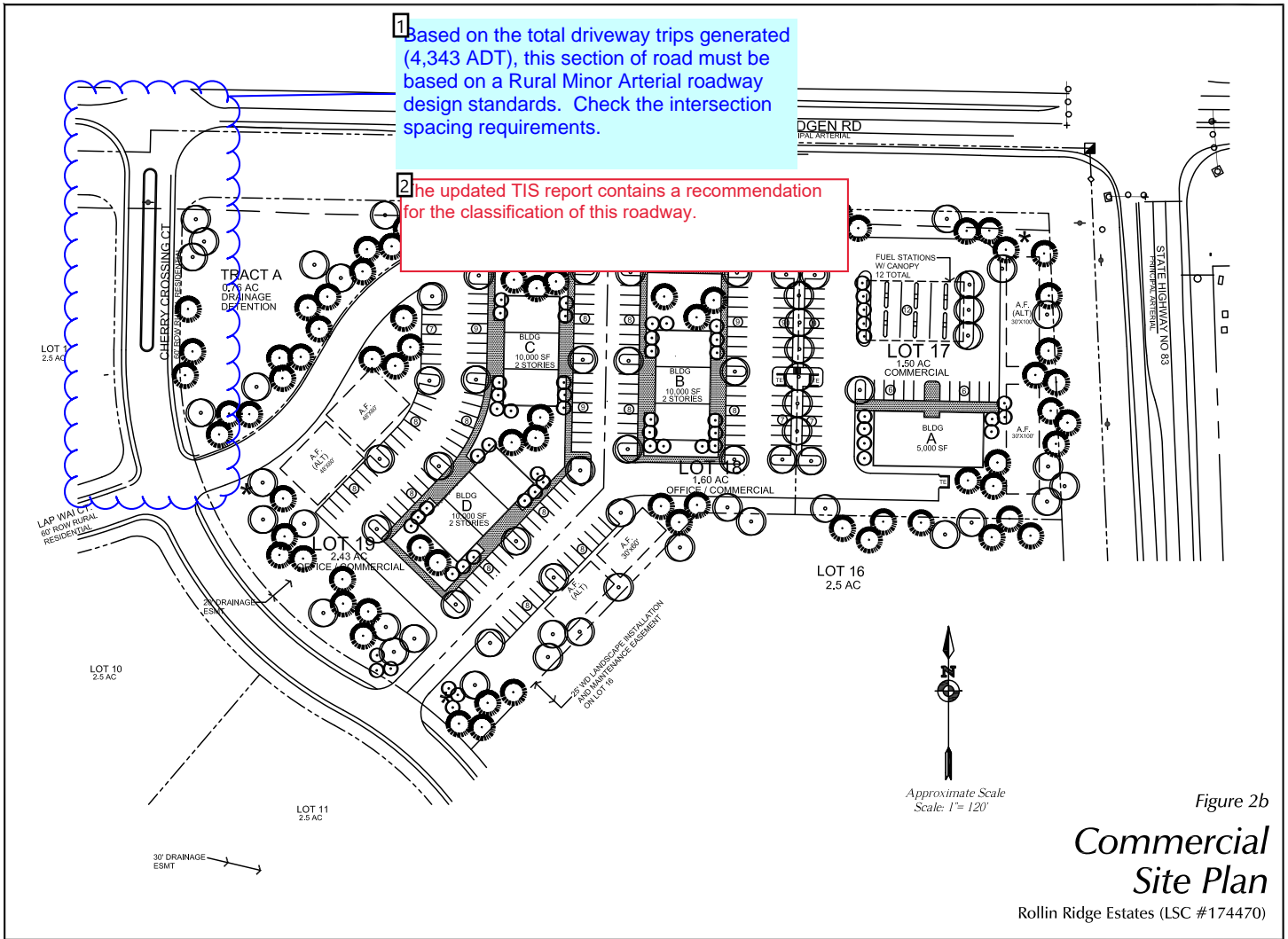

Figure 2b
Commercial Site Plan
 Rollin Ridge Estates (LSC #174470)

Number: 1 Author: dsdlaforce Subject: Cloud+ Date: 3/26/2018 10:39:00 AM

Based on the total driveway trips generated (4,343 ADT), this section of road must be based on a Rural Minor Arterial roadway design standards. Check the intersection spacing requirements.

Status

jchodsdon Completed 5/10/2018 5:00:12 PM

Number: 2 Author: jchodsdon Subject: Text Box Date: 5/10/2018 5:00:28 PM

The updated TIS report contains a recommendation for the classification of this roadway.

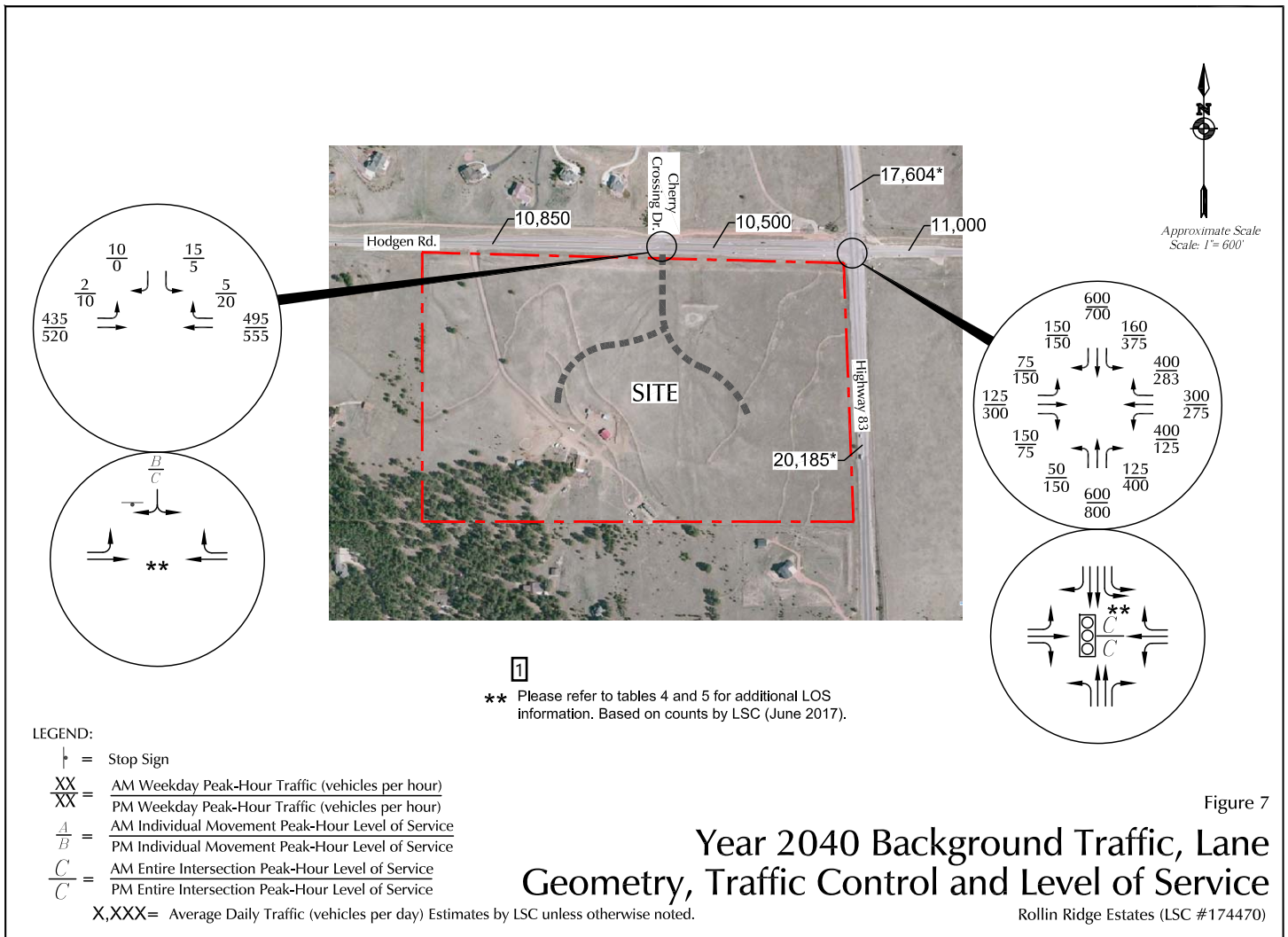

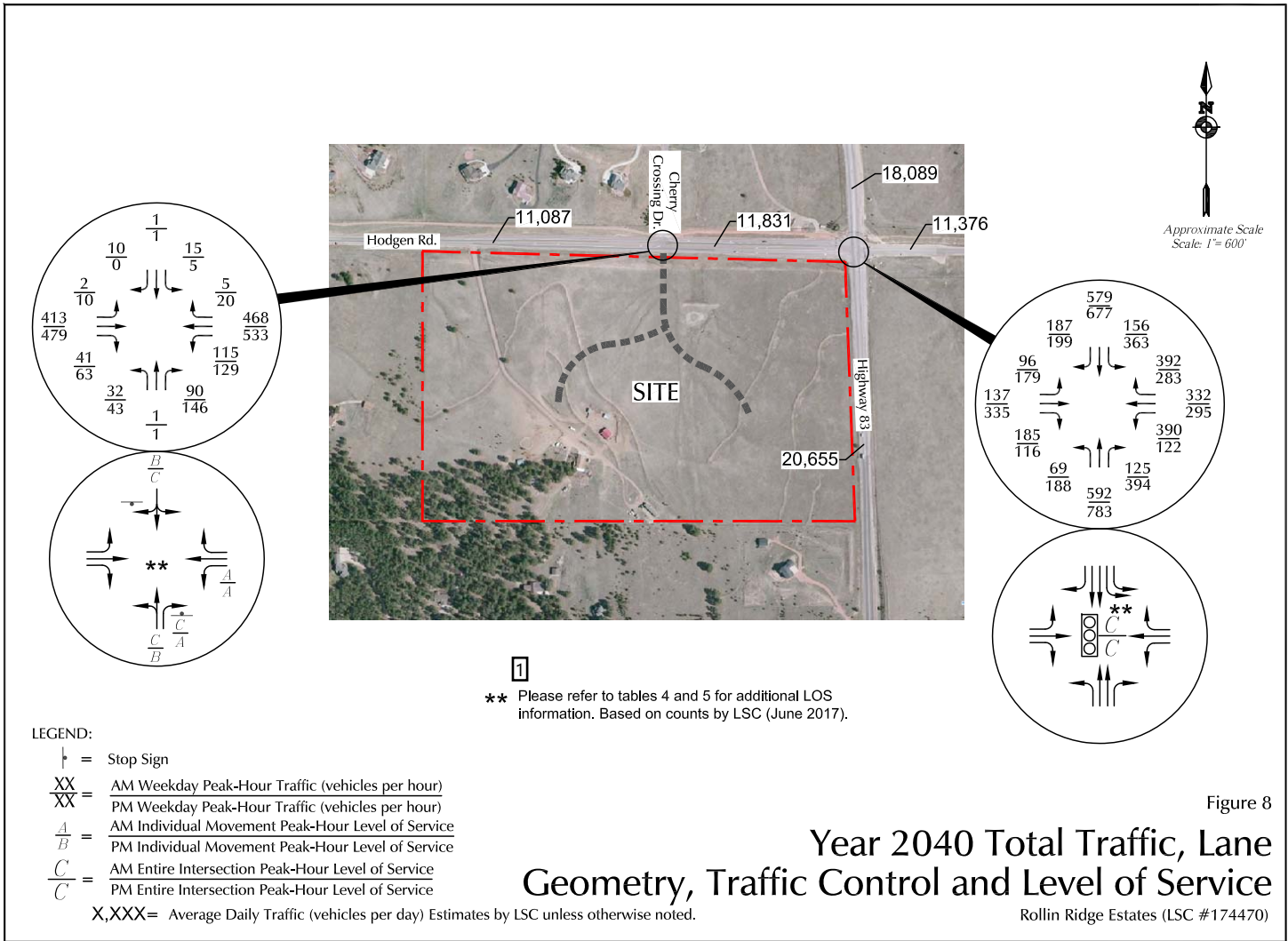

Figure 8



Development Services Department
2880 International Circle
Colorado Springs, Colorado 80910

Phone: 719.520.6300
 Fax: 719.520.6695
 Website www.elpasoco.com

**DEVIATION REVIEW
 AND DECISION FORM**

Procedure # R-FM-051-07
 Issue Date: 12/31/07
 Revision Issued: 00/00/00

DSD FILE NO.:

--	--	--	--	--	--	--	--

General Property Information:

Address of Subject Property (Street Number/Name): 16390 Highway 83

Tax Schedule ID(s) #:6127000064

Legal Description of Property:

THAT PT N2N2 SEC 27-11-66 DESC AS FOLS; COM AT NW COR SD SEC 27, TH S88<54'14"E ALG N LN OF SD SEC 1974.02 FT TO THE NW COR OF THE E2NE4NW4 SD SEC 27, TH S 00<06'40"E ALG W LN OF SD E2 50.04 FT & POB, TH S00<06'40"E 1262.73 FT, S89<30'26"E 443.60 FT, N00<00'00"W 585.28 FT, N90<00'00"E 454.78 FT, S00<00'00"E 247.11 FT, N90<00'00"W 127.15 FT, S00<00'00"E 340.99 FT, TH S90<30'26"E 1212.80 FT, N00<24'12"W 393.03 FT, N02<29'28"W 870.43 FT TO S LN OF THE N 30.0 FT SD SEC 27, TH N88<54'17"W 856.46, S01<05'43"W 20.0 FT, N88<54'17"W 430.09 FT TO W LN NW4NE4 & POB

Subdivision or Project Name: Rollin' Ridge Estates

Section of ECM from Which Deviation is Sought: 2.3.7.E.1, 2.3.7.E.2, and 2.3.7.E.3

Specific Criteria from Which a Deviation is Sought: Turn Lane Design, Taper Lengths, and Storage Lengths

Proposed Nature and Extent of Deviation: Allow an abbreviated westbound left-turn lane length on Hodgen Road at the Cherry Crossing Drive intersection given the constrained distance (about 950 feet - center to center) between the two intersections. The ECM prescribes deceleration plus vehicle storage distance plus transition taper for left-turn lanes on Principal Arterial roadways where turn lanes are required per section 2.3.7.D. The attached exhibit for Hodgen Road reflects 250 feet of total full-width plus an abbreviated 100-foot-long reverse curve taper for this lane and the eastbound left turn lane approaching the Hodgen/SH 83 intersection. The intent of this striping plan is to best allocate the available back-to-back left-turn decel/ stacking distance available between the Cherry Crossing Drive and SH 83 intersections.

Applicant Information:

Applicant: Carl Turse, TC&C, LLC

Email Address: carlturse@icloud.com

Applicant is: Owner Consultant Contractor

Mailing Address: 17572 Colonial Park Drive, Monument

State: CO

Postal Code: 80132

Telephone Number: 488-8600

Engineer Information:

Engineer: Jeffrey C. Hodsdon, P.E., PTOE

Email Address: jeff@LSCTrans.com

Company Name: LSC Transportation Consultants, Inc.

Mailing Address: 545 East Pikes Peak Ave. Suite 210 Colo Springs

State: CO

Postal Code: 80903

Registration Number: 31684

State of Registration: CO

Telephone Number: 719-633-2868

Fax Number: 719-633-5430

Explanation of Request (Attached diagrams, figures and other documentation to clarify request):

Section of ECM from Which Deviation is Sought: 2.3.7.E.1, 2.3.7.E.2, and 2.3.7.E.3

Specific Criteria from Which a Deviation is Sought: Turn Lane Design, Taper Lengths, and Storage Lengths

Proposed Nature and Extent of Deviation: Allow an abbreviated westbound left-turn lane length on Hodgen Road at the Cherry Crossing Drive intersection given the constrained distance (about 950 feet - center to center) between the two intersections. The ECM prescribes deceleration plus vehicle storage distance plus transition taper for left-turn lanes on Principal Arterial roadways where turn lanes are required per section 2.3.7.D. The attached exhibit for Hodgen Road reflects 250 feet of total full-width plus an abbreviated 100-foot-long reverse curve taper for this lane and the eastbound left turn lane approaching the Hodgen/SH 83 intersection. The intent of this striping plan is to best allocate the available back-to-back left-turn decel/ stacking distance available between the Cherry Crossing Drive and SH 83 intersections.

Reason for the Requested Deviation: The deviation is requested given the constrained distance for back-to-back left-turn lanes between the two intersections of Hodgen Road/SH 83 and Hodgen Road/Cherry Crossing Drive. No access is permitted to State Highway 83 and the standard access spacing along Hodgen is 1/2 mile. Aligning the access with Cherry Crossing Drive is proposed as this is an existing intersection. However, there is limited back-to-back stacking distance due to the existing spacing.

Comparison of Proposed Deviation to ECM Standard: The ECM standard for a 45-mph design speed is interpolated to be 200 feet of deceleration distance plus a 170-foot taper plus stacking needs. There appears to be a grade of just over three percent at the start of the left turn lane, then the grades become more level closer to the intersection. To be conservative, an adjusted combined deceleration plus taper length is 444 feet - or 74 feet longer. The stacking length required from the analysis included in the TIS is 61 feet. Therefore, a full-width lane length of 335 feet (200'+74'+61') would be required (250' proposed as shown on the striping exhibit). The required taper is 170-feet and a 100-foot taper is proposed.

Applicable Regional or National Standards used as Basis:

Application Consideration:

CHECK IF APPLICATION MEETS CRITERIA FOR CONSIDERATION

JUSTIFICATION

The ECM standard is inapplicable to a particular situation.

Topography, right-of-way, or other geographical conditions or impediments impose an undue hardship on the applicant, and an equivalent alternative that can accomplish the same design objective is available and does not compromise public safety or accessibility.

The deviation is requested given the constrained distance for back-to-back left- turn lanes between the two intersections of Hodgen Road/SH 83 and Hodgen Road/Cherry Crossing Drive. No access is permitted to State Highway 83 and the standard access spacing along Hodgen is 1/2 mile. Aligning the access with Cherry Crossing Drive is proposed as this is an existing intersection. However, there is limited back-to-back stacking distance due to the existing spacing.

A change to a standard is required to address a specific design or construction problem, and if not modified, the standard will impose an undue hardship on the applicant with little or no material benefit to the public.

If at least one of the criteria listed above is not met, this application for deviation cannot be considered.

Criteria for Approval:

PLEASE EXPLAIN HOW EACH OF THE FOLLOWING CRITERIA HAVE BEEN SATISFIED BY THIS REQUEST

The request for a deviation is not based exclusively on financial considerations.

The deviation is requested due to the limited back-to-back left turn lane distance along Hodgen Road.

The deviation will achieve the intended result with a comparable or superior design and quality of improvement.

The proposed left-turn lane will provide a reasonable length for the westbound left turn lane approaching Cherry Crossing Drive without shortening the existing eastbound left turn lane approaching SH 83. The proposed laneage is shown in the attached exhibit.

The deviation will not adversely affect safety or operations.

The 2040 queuing analysis contained in the TIS indicates no queue block time or spillback time during either peak hour for the westbound left-turn lane at the intersections of Hodgen Road/Cherry Crossing Drive. Please refer to the queuing analysis section of the updated TIS (May 2018). The grade adjustment included in this deviation is likely conservative as the grades over three percent are not for the entire length of the lane.

The deviation will not adversely affect maintenance and its associated cost.

This deviation will not change the maintenance cost.

The deviation will not adversely affect aesthetic appearance.

This deviation will not change the aesthetic appearance.

Owner, Applicant and Engineer Declaration:

To the best of my knowledge, the information on this application and all additional or supplemental documentation is true, factual and complete. I am fully aware that any misrepresentation of any information on this application may be grounds for denial. I have familiarized myself with the rules, regulations and procedures with respect to preparing and filing this application. I also understand that an incorrect submittal will be cause to have the project removed from the agenda of the Planning Commission, Board of County Commissioners and/or Board of Adjustment or delay review, and that any approval of this application is based on the representations made in the application and may be revoked on any breach of representation or condition(s) of approval.

Grant Turner

6-15-18

Signature of owner (or authorized representative)

Date

Signature of applicant (if different from owner)

Date

Signature of Engineer

Date

Engineer's Seal



Review and Recommendation:
APPROVED by the ECM Administrator

_____ Date _____
This request has been determined to have met the criteria for approval. A deviation from Section _____ of ECM is hereby granted based on the justification provided. Comments:

____ Additional comments or information are attached.

DENIED by the ECM Administrator

_____ Date _____
This request has been determined not to have met criteria for approval. A deviation from Section _____ of ECM is hereby denied. Comments:

____ Additional comments or information are attached.

Eastbound Right Turn Deceleration Lane

Cherry Crossing Drive

Restripe for 250' Westbound Left Turn Lane

Restripe for Shared 100' Bay Taper

Existing 400' Eastbound Left Turn Lane

Existing Eastbound Right Turn Deceleration Lane

Hodgen Road

Site Access Drive

Hodgen Road Lane Exhibit

Rollin' Ridge

1" = 60'

N

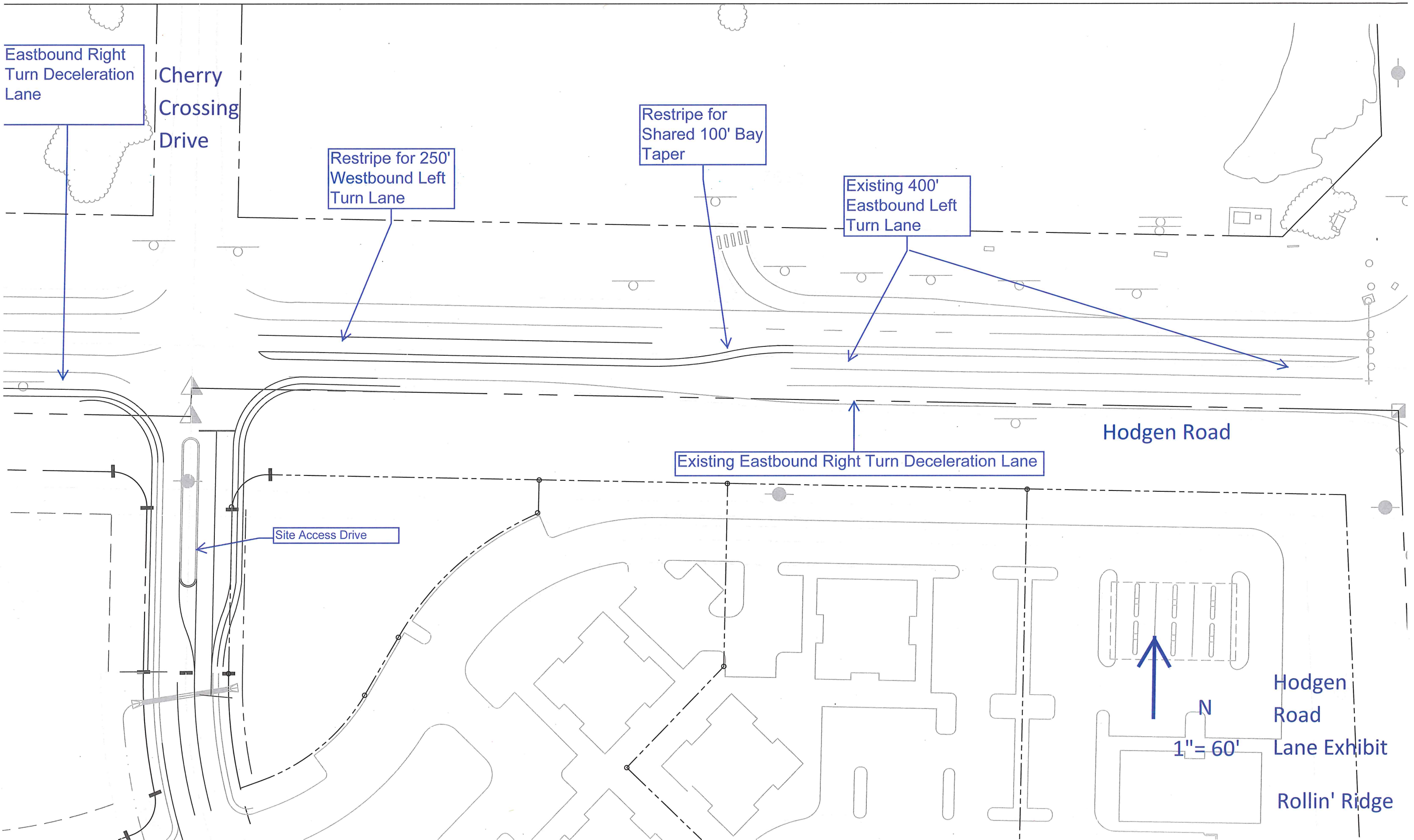



Development Services Department
2880 International Circle
Colorado Springs, Colorado 80910

Phone: 719.520.6300
 Fax: 719.520.6695
 Website www.elpasoco.com

**DEVIATION REVIEW
 AND DECISION FORM**

Procedure # R-FM-051-07
 Issue Date: 12/31/07
 Revision Issued: 00/00/00

DSD FILE NO.:

--	--	--	--	--	--	--	--

General Property Information:

Address of Subject Property (Street Number/Name): 16390 Highway 83

Tax Schedule ID(s) #6127000064:

Legal Description of Property: THAT PT N2N2 SEC 27-11-66 DESC AS FOLS; COM AT NW COR SD SEC 27, TH S88<54'14"E ALG N LN OF SD SEC 1974.02 FT TO THE NW COR OF THE E2NE4NW4 SD SEC 27, TH S 00<06'40"E ALG W LN OF SD E2 50.04 FT & POB, TH S00<06'40"E 1262.73 FT, S89<30'26"E 443.60 FT, N00<00'00"W 585.28 FT, N90<00'00"E 454.78 FT, S00<00'00"E 247.11 FT, N90<00'00"W 127.15 FT, S00<00'00"E 340.99 FT, TH S90<30'26"E 1212.80 FT, N00<24'12"W 393.03 FT, N02<29'28"W 870.43 FT TO S LN OF THE N 30.0 FT SD SEC 27, TH N88<54'17"W 856.46, S01<05'43"W 20.0 FT, N88<54'17"W 430.09 FT TO W LN NW4NE4 & POB

Subdivision or Project Name: Rollin' Ridge

Section of ECM from Which Deviation is Sought: 2.3.2 Design Standards by Functional Classification w/ Table 2-5 "Design ADT" for a Rural Local Roadway.

Specific Criteria from Which a Deviation is Sought: Table 2-5 prescribes a maximum Design ADT (Average Daily Traffic volume) of 750 vehicles per day on a Rural Local roadway.

Proposed Nature and Extent of Deviation: This deviation request is to allow an ADT of up to 5,000 vehicles per day for the proposed Cherry Crossing Drive south of Hodgen Road. The roadway is proposed as a "modified" Rural Local roadway. The deviation would apply to the section of roadway from Hodgen Road south to the southernmost commercial site access. The projected buildout ADT in the traffic report is 4,343 vehicles per day. Please refer to the attached lane exhibit.

The ECM-standard roadway design elements would be modified to accommodate the higher-than-Local-standard traffic volumes as follows:

- o Right- and left-turn bays where needed, in addition to the two 12-foot-wide through lanes, to accommodate the projected higher-than-Local-standard traffic volumes.
- o Outside shoulder widths of 8 feet, including 4 feet of paved shoulder and 4 feet of gravel shoulder – also to accommodate the higher-than-Local-standard traffic volumes.
- o No on-street parking and no individual lot access except south of the south commercial access.
- o Seventy-foot right-of way north of the first commercial access, tapering/variable right-of-way between the two commercial access points, and Local standard 60 feet of right-of-way with two 5-foot public improvements easements south of the south commercial access.
- o As part of this deviation, an intersection spacing of 290 feet between the two commercial access drives is requested where local street spacing is 330 feet.

Applicant Information:

Applicant: TC&C LLC (Carl Turse)

Email Address: carlturse@icloud.com

Applicant is: Owner Consultant Contractor

Mailing Address: 17572 Colonial Park Drive, Monument

State: CO

Postal Code: 80132

Telephone Number: (719) 488-8600

Fax Number: _____

Application Consideration:

CHECK IF APPLICATION MEETS CRITERIA FOR CONSIDERATION

JUSTIFICATION

The ECM standard is inapplicable to a particular situation.

Topography, right-of-way, or other geographical conditions or impediments impose an undue hardship on the applicant, and an equivalent alternative that can accomplish the same design objective is available and does not compromise public safety or accessibility.

This deviation request is to allow an ADT of up to 5,000 vehicles per day for the proposed Cherry Crossing Drive south of Hodgen Road. The roadway is proposed as a "modified" Rural Local roadway. The deviation would apply to the section of roadway from Hodgen Road south to the southernmost commercial site access. The projected buildout ADT in the traffic report is 4,343 vehicles per day. Please refer to the attached lane exhibit.

- The proposed commercial development is not allowed access to State Highway 83 or Hodgen Road -- the two existing adjacent roadways. Access would only be from the proposed internal road -- Cherry Crossing Drive.

- There would be a relatively small number of residential lots served by this roadway. Except for the lots south of the south commercial access, all lots would access the other local street proposed for the development.

- The roadway is not planned to extend to the south of this property.

- The proposed modified Rural Local classification and associated modifications to the standard roadway design elements would be more appropriate for this development than the Rural Minor Arterial classification (with a design ADT of up to 10,000 ADT). A Rural Minor Arterial would not be appropriate. This roadway will only serve a relatively small residential development and a small commercial center. The roadway will basically be an access drive with a length of 950 feet. Most traffic will turn left into and right out of the first commercial access point located 360 feet south of Hodgen Road (centerline spacing). Given the nature and low level of continuity of the roadway, a modified local roadway is more appropriate than a Minor Arterial. The modifications are to allow for higher traffic volumes, but not high-speed, through traffic volumes, rather low-speed, local access traffic turning to/from Hodgen Road and turning into and out of the commercial center and the residential subdivision streets.

A change to a standard is required to address a specific design or construction problem, and if not modified, the standard will impose an undue hardship on the applicant with little or no material benefit to the public.

If at least one of the criteria listed above is not met, this application for deviation cannot be considered.

Criteria for Approval:

PLEASE EXPLAIN HOW EACH OF THE FOLLOWING CRITERIA HAVE BEEN SATISFIED BY THIS REQUEST

The request for a deviation is not based exclusively on financial considerations.	See next paragraph.
The deviation will achieve the intended result with a comparable or superior design and quality of improvement.	The proposed modified Rural Local roadway can be designed to accommodate the projected commercial (and residential) traffic volumes. The proposed cross section shown in the attached lane exhibit includes the addition of auxiliary turn lanes and wider shoulders to accommodating the proposed daily commercial traffic volumes (and peak hour intersection turning movement volumes) that would need to use this section of street due to access restrictions on SH 83 and Hodgen Road.
The deviation will not adversely affect safety or operations.	<p>The proposed modified Rural Local classification and associated modifications to the standard roadway design elements would be more appropriate for this development than the Rural Minor Arterial classification (with a design ADT of up to 10,000 ADT). A Rural Minor Arterial would not be appropriate. This roadway will only serve a relatively small residential development and a small commercial center. The roadway will basically be an access drive with a length of 950 feet. Most traffic will turn left into and right out of the first commercial access point located 360 feet south of Hodgen Road (centerline spacing). Given the nature and low level of continuity of the roadway, a modified local roadway is more appropriate than a Minor Arterial. The modifications are to allow for higher traffic volumes, but not high-speed, through traffic volumes, rather low-speed, local access traffic turning to/from Hodgen Road and turning into and out of the commercial center and the residential subdivision streets.</p> <p>The queuing analysis included in the Traffic Impact Study (dated May 14, 2018) indicates that the projected queues can be accommodated by the proposed laneage shown in the attached exhibit. Intersection levels of service are shown to meet county standards.</p>
The deviation will not adversely affect maintenance and its associated cost.	The proposed cross section would be less costly to maintain than a higher classification roadway.
The deviation will not adversely affect aesthetic appearance.	The proposed right-of-way and cross section would be more aesthetically pleasing than with a right-of-way and cross section for a higher classification roadway. The roadway would not be excessively wide with unnecessary pavement width.

Owner, Applicant and Engineer Declaration:

To the best of my knowledge, the information on this application and all additional or supplemental documentation is true, factual and complete. I am fully aware that any misrepresentation of any information on this application may be grounds for denial. I have familiarized myself with the rules, regulations and procedures with respect to preparing and filing this application. I also understand that an incorrect submittal will be cause to have the project removed from the agenda of the Planning Commission, Board of County Commissioners and/or Board of Adjustment or delay review, and that any approval of this application is based on the representations made in the application and may be revoked on any breach of representation or condition(s) of approval.

Gene Turley _____ Date 5-15-18

Signature of applicant (if different from owner) _____ Date

Signature of Engineer _____ Date

Engineer's Seal

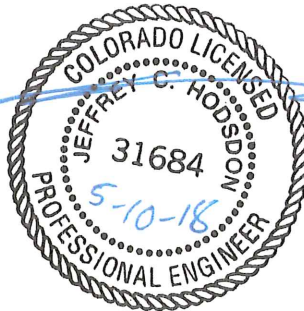

Review and Recommendation:

APPROVED by the ECM Administrator

Date _____
This request has been determined to have met the criteria for approval. A deviation from Section _____
of ECM is hereby granted based on the justification provided. Comments:

____ Additional comments or information are attached.

DENIED by the ECM Administrator

Date _____
This request has been determined not to have met criteria for approval. A deviation from Section _____
of ECM is hereby denied. Comments:

____ Additional comments or information are attached.

Cherry
Crossing
Drive

Hodgen Road

Northbound Right Turn
Lane (105') plus a 75'
Taper

Southbound Left Turn
Lane (90') plus 75'
Taper

1.41 in 70' ROW

Redirect Tapers

Site Access Drive
Lane Exhibit
Rollin' Ridge

↑
N
1"=50'
(11x17)

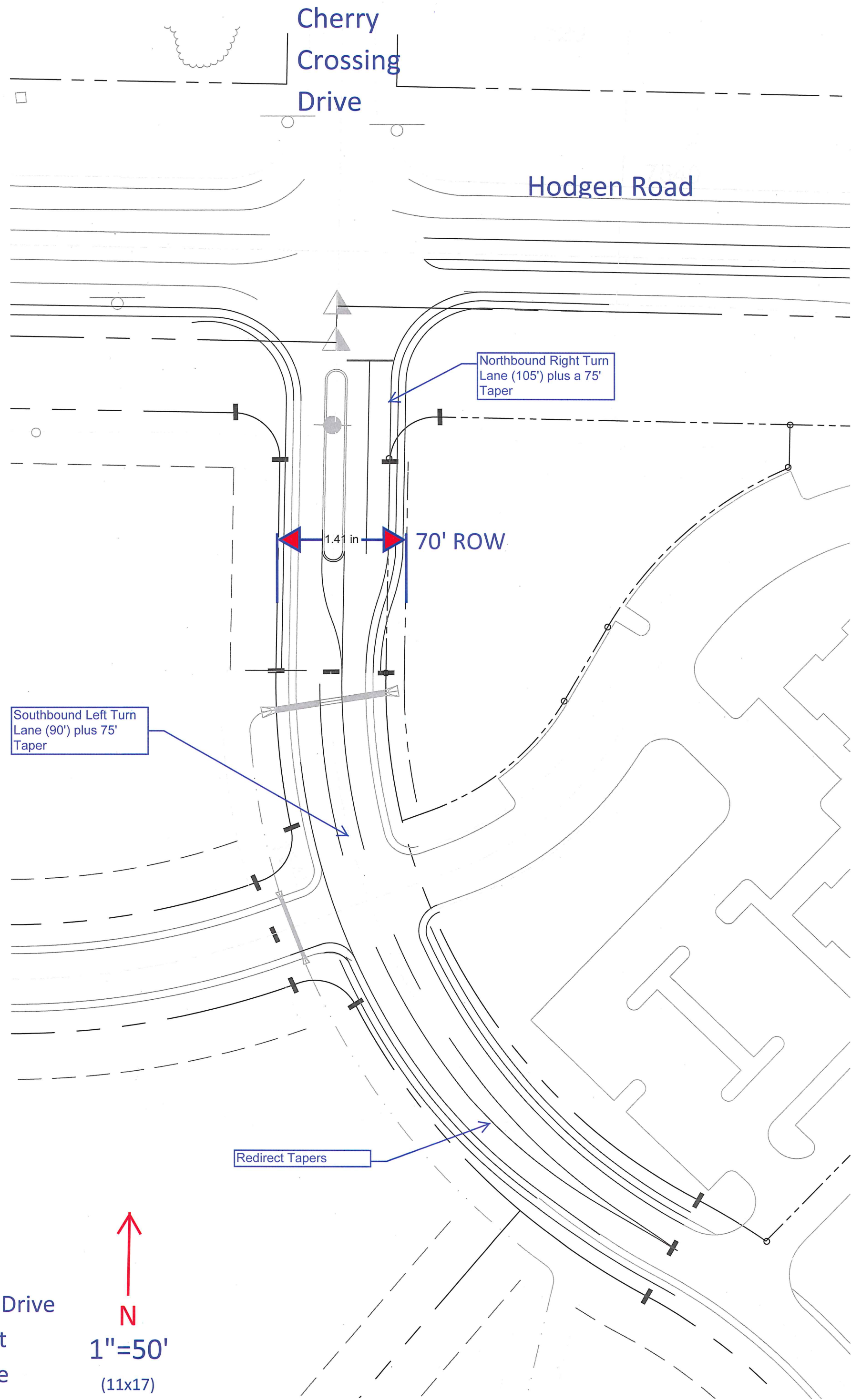

Markup Summary

dsdgrimm (5)

Refer to comments on TIS submitted with PUD

5/45 6/15/2018 1:15:01 PM

Subject: Engineer
Page Label: 1
Lock: Locked
Author: dsdgrimm
Date: 6/15/2018 1:15:01 PM
Color: ■

Refer to comments on TIS submitted with PUD

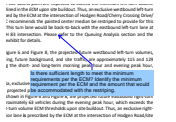

Subject: Engineer
Page Label: 13
Lock: Locked
Author: dsdgrimm
Date: 6/15/2018 1:15:02 PM
Color: ■

Is there sufficient length to meet the minimum requirements per the ECM? Identify the minimum requirement per the ECM and the amount that would be accommodated with the restriping.

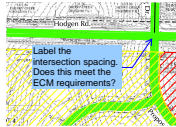

Subject: Engineer
Page Label: 18
Lock: Locked
Author: dsdgrimm
Date: 6/15/2018 1:15:04 PM
Color: ■

Label the intersection spacing. Does this meet the ECM requirements?

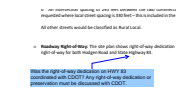

Subject: Engineer
Page Label: 14
Lock: Locked
Author: dsdgrimm
Date: 6/15/2018 1:15:04 PM
Color: ■

Was the right-of-way dedication on HWY 83 coordinated with CDOT? Any right-of-way dedication or preservation must be discussed with CDOT.

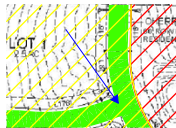

Subject: Arrow
Page Label: 18
Lock: Locked
Author: dsdgrimm
Date: 6/15/2018 1:15:05 PM
Color: ■