



## EXECUTIVE SUMMARY

This study addresses the traffic impacts associated with the proposed Dutch Bros Coffee development located in Colorado Springs, Colorado. The development is located at 5810 Omaha Boulevard.

The purpose of this traffic impact study is to analyze traffic operations at key intersections for existing (2024) and opening day (2025) conditions with and without the proposed project and to recommend mitigation measures as needed. The morning and evening peak hour level of service (LOS) results are shown in Table ES-1. Recommended storage lengths are shown in Table ES-2. A site plan of the project is provided in Appendix A.

**Table ES-1: Peak Hour Level of Service Results**

Intersection		Level of Service							
		Existing (2024)				Opening Day (2025)			
		Background		BG mit.		Background		Plus Project	
		AM	PM	AM	PM	AM	PM	AM	PM
1	Palmer Park Boulevard / Powers Boulevard	E	E	D	D	E	E	E	E
2	Access Road / Palmer Park Boulevard	A	B	A	B	A	B	A	B
3	Paonia Street / Palmer Park Boulevard	f	d	f	d	f	d	f	d
4	Access Road / Omaha Boulevard	b	b	b	b	b	b	b	c
5	Paonia Street / Omaha Boulevard	b	c	b	c	c	c	c	c

1. Intersection LOS values represent the overall intersection average for roundabout, signalized, and all-way stop-controlled (AWSC) intersections (uppercase letter) and the worst movement for all other unsignalized intersections (lowercase letter)

2. BG = Background, mit. = Mitigated

Source: Hales Engineering, April 2024

**Table ES-2: Recommended Storage Length**

Intersection		Recommended Storage Lengths (feet)															
		Northbound				Southbound				Eastbound				Westbound			
		LT		RT		LT		RT		LT		RT		LT		RT	
		E	P	E	P	E	P	E	P	E	P	E	P	E	P	E	P
1	Palmer Park Boulevard / Powers Boulevard	885	-	-	-	695	-	545	-	320	-	250	-	100	150	150	-

1. Storage lengths are based on 2025 95th percentile queue lengths and do not include required deceleration / taper distances

2. E = Existing storage length (approximate), if applicable; P = proposed storage length for new turn lanes or changes to existing turn lanes, if applicable

Source: Hales Engineering, April 2024

**SUMMARY OF KEY FINDINGS & RECOMMENDATIONS**

**Project Conditions**

- The development will consist of a 950 sq. ft. Dutch Bros coffee shop.
- The project is anticipated to generate approximately 670 weekday daily trips, including 134 trips in the morning peak hour, and 94 trips in the evening peak hour, including pass-by trips.

2024		Background	
<b>Findings</b>	<ul style="list-style-type: none"> <li>• Poor LOS at the Palmer Park Boulevard / Powers Boulevard and Paonia Street / Powers Boulevard intersections</li> </ul>		
<b>Mitigations</b>	<ul style="list-style-type: none"> <li>• <b>Palmer Park Boulevard / Powers Boulevard:</b> Implement signal timing adjustments</li> <li>• Vehicles will reroute from the Paonia Street / Palmer Park Boulevard intersection or utilize the center two-way left-turn lane (TWLTL) to create a two-stage gap when heavy delays are present. Peak hour MUTCD signal warrants are not met during the evening peak hour.</li> </ul>		
2025		Background	Plus Project
<b>Findings</b>	<ul style="list-style-type: none"> <li>• Poor LOS at the Palmer Park Boulevard / Powers Boulevard and Paonia Street / Powers Boulevard intersections</li> </ul>		<ul style="list-style-type: none"> <li>• Poor LOS at the Palmer Park Boulevard / Powers Boulevard and Paonia Street / Powers Boulevard intersections</li> </ul>
<b>Mitigations</b>	<ul style="list-style-type: none"> <li>• None, it is anticipated that future operational improvements and signal upgrades will be made at the Palmer Park Boulevard / Powers Boulevard intersection based on the El Paso County MTCP and the PPACG Long Range Transportation Plan.</li> </ul>		<ul style="list-style-type: none"> <li>• None</li> </ul>

**TABLE OF CONTENTS**

**EXECUTIVE SUMMARY ..... i**

SUMMARY OF KEY FINDINGS & RECOMMENDATIONS ..... ii

**TABLE OF CONTENTS ..... iii**

**LIST OF TABLES ..... iv**

**LIST OF FIGURES ..... iv**

**I. INTRODUCTION ..... 1**

A. Purpose ..... 1

B. Scope ..... 2

C. Analysis Methodology ..... 2

D. Level of Service Standards ..... 2

**II. EXISTING (2024) BACKGROUND CONDITIONS..... 4**

A. Purpose ..... 4

B. Roadway System ..... 4

C. Traffic Volumes ..... 4

D. Crash Summary ..... 5

E. Level of Service Analysis ..... 5

F. Queuing Analysis ..... 8

G. Mitigation Measures ..... 9

H. Mitigated Scenario ..... 9

**III. OPENING DAY (2025) BACKGROUND CONDITIONS ..... 10**

A. Purpose ..... 10

B. Roadway Network ..... 10

C. Traffic Volumes ..... 10

D. Level of Service Analysis ..... 10

E. Queuing Analysis ..... 10

F. Mitigation Measures ..... 11

**IV. PROJECT CONDITIONS ..... 14**

A. Purpose ..... 14

B. Project Description ..... 14

C. Trip Generation ..... 14

D. Trip Distribution and Assignment ..... 15

E. Access ..... 18

**V. OPENING DAY (2025) PLUS PROJECT CONDITIONS ..... 19**

A. Purpose ..... 19

B. Traffic Volumes ..... 19

C. Level of Service Analysis ..... 19

D. Queuing Analysis ..... 19

E. Mitigation Measures ..... 19

F. Recommended Storage Lengths ..... 22

- Appendix A: Project Site Plan**
- Appendix B: Turning Movement Counts**
- Appendix C: Synchro HCM 7<sup>th</sup> Edition Reports**



**LIST OF TABLES**

Table 1: Level of Service Description ..... 3  
Table 2: Crash Data Summary ..... 5  
Table 3: Existing (2024) Background Peak Hour LOS ..... 8  
Table 4: Mitigated Existing (2024) Background Peak Hour LOS ..... 9  
Table 5: Opening Day (2025) Background Peak Hour LOS ..... 11  
Table 6: Trip Generation ..... 15  
Table 7: New Trip Distribution..... 15  
Table 8: Opening Day (2025) Plus Project Peak Hour LOS ..... 22  
Table 9: Recommended Storage Lengths..... 23

**LIST OF FIGURES**

Figure 1: Vicinity map of project in Colorado Springs, Colorado..... 1  
Figure 2: Existing (2024) background peak hour traffic volumes ..... 6  
Figure 3: Opening Day (2025) background peak hour traffic volumes ..... 12  
Figure 4: Trip assignment for the peak hours..... 16  
Figure 5: Opening Day (2025) plus project peak hour traffic volumes ..... 20

## I. INTRODUCTION

### A. Purpose

This study addresses the traffic impacts associated with the proposed Dutch Bros Coffee development located in Colorado Springs, Colorado. The proposed project is located at 5810 Omaha Boulevard. Figure 1 shows a vicinity map of the proposed development.

The purpose of this traffic impact study is to analyze traffic operations at key intersections for existing (2024) and opening day (2025) conditions with and without the proposed project and to recommend mitigation measures as needed.



Figure 1: Vicinity map of project in Colorado Springs, Colorado

## **B. Scope**

The study area was defined based on conversations with the development team. This study was scoped to evaluate the traffic operational performance impacts of the project on the following intersections:

- Palmer Park Boulevard / Powers Boulevard
- Access Road / Palmer Park Boulevard
- Paonia Street / Palmer Park Boulevard
- Omaha Boulevard / Powers Boulevard
- Access Road / Palmer Park Boulevard
- Paonia Street / Omaha Boulevard

## **C. Analysis Methodology**

Level of service (LOS) is a term that describes the operating performance of an intersection or roadway. LOS is measured quantitatively and reported on a scale from A to F, with A representing the best performance and F the worst. Table 1 provides a brief description of each LOS letter designation and an accompanying average delay per vehicle for both signalized and unsignalized intersections.

The *Highway Capacity Manual (HCM)*, 7<sup>th</sup> Edition, 2022 methodology was used in this study to remain consistent with “state-of-the-practice” professional standards. This methodology has different quantitative evaluations for signalized and unsignalized intersections. For signalized, roundabout, and all-way stop-controlled (AWSC) intersections, the LOS is provided for the overall intersection (weighted average of all approach delays). For all other unsignalized intersections, LOS is reported based on the worst movement.







Using Synchro software, which follow the HCM methodology, the peak hour LOS was computed for each study intersection. The detailed HCM 7<sup>th</sup> Edition LOS reports and 95<sup>th</sup> percentile queuing are provided in Appendix C.

Many of the figures in this report are printouts of the Synchro model. These figures are not meant to be a design exhibit for exact lane striping and design, due to the limitations of the Synchro software. Instead, the purpose of these figures is to show assumed peak hour turning movement volumes and the conceptual travel lane configuration of the study roadway network.

## **D. Level of Service Standards**

For the purposes of this study, a minimum acceptable intersection performance for each of the study intersections was set at LOS D. If levels of service E or F conditions exist, an explanation and/or mitigation measures will be presented. A LOS D threshold is consistent with “state-of-the-practice” traffic engineering principles for urbanized areas.

**Table 1: Level of Service Description**

LOS	Description of Traffic Conditions	Average Delay (seconds/vehicle)	
		Signalized Intersections	Unsignalized Intersections
A	 Free Flow / Insignificant Delay	≤ 10	≤ 10
B	 Stable Operations / Minimum Delays	> 10 to 20	> 10 to 15
C	 Stable Operations / Acceptable Delays	> 20 to 35	> 15 to 25
D	 Approaching Unstable Flows / Tolerable Delays	> 35 to 55	> 25 to 35
E	 Unstable Operations / Significant Delays	> 55 to 80	> 35 to 50
F	 Forced Flows / Unpredictable Flows / Excessive Delays	> 80	> 50

Source: Hales Engineering Descriptions, based on the *Highway Capacity Manual (HCM)*, 7<sup>th</sup> Edition, 2022 Methodology (Transportation Research Board)

## II. EXISTING (2024) BACKGROUND CONDITIONS

### A. Purpose

The purpose of the background analysis is to study the intersections and roadways during the peak travel periods of the day with background traffic and geometric conditions. Through this analysis, background traffic operational deficiencies can be identified, and potential mitigation measures recommended. This analysis provides a baseline condition that may be compared to the build conditions to identify the impacts of the development.

### B. Roadway System

The primary roadways that will provide access to the project site are described below:

Palmer Park Boulevard – is a county-maintained roadway which is classified by the Pikes Peak Area Council of Governments (PPACG) Roadway Network Map as local road east of Powers Boulevard and an “other principal arterial” west of Powers Boulevard, where it is maintained by the City of Colorado Springs. The roadway has two travel lanes in each direction. The posted speed limit is 35 mph in the study area.

Omaha Boulevard – is a county-maintained roadway which is classified by the PPACG Roadway Network Map as a local road. The roadway has one travel lane in each direction. The posted speed limit is 40 mph in the study area.

### C. Traffic Volumes

Weekday morning (7:00 to 9:00 a.m.) and evening (4:00 to 6:00 p.m.) peak period traffic counts were performed at the following intersections:

- Palmer Park Boulevard / Powers Boulevard
- Access Road / Palmer Park Boulevard
- Paonia Street / Palmer Park Boulevard
- Omaha Boulevard / Powers Boulevard
- Access Road / Palmer Park Boulevard
- Paonia Street / Omaha Boulevard

The counts were performed on Wednesday, March 6, 2024. The morning peak hour was determined to be between 7:15 and 8:15 a.m., and the evening peak hour was determined to be between 4:00 and 5:00 p.m. The evening peak hour volumes were approximately 3% higher than the morning peak hour volumes. Both the morning and evening peak hour volumes were used in the analysis. Detailed count data are included in Appendix B.

Hales Engineering made seasonal adjustments to the observed traffic volumes. Monthly traffic volume data were obtained from a nearby CDOT automatic traffic recorder (ATR) on Powers Boulevard (Station #107556). In recent years, traffic volumes in March have been equal to



approximately 95% of average traffic volumes. The observed traffic volumes were increased accordingly by approximately 5.3% to determine average turning movement counts at the study intersections.

Additionally, daily traffic volumes were collected on Powers Boulevard, Palmer Park Boulevard, Omaha Boulevard, and Paonia Street. These can also be found in Appendix B of this document. Adjusted for seasonality and rounded to the nearest one hundred vehicles per day (vpd), the average annual daily traffic (AADT) volumes for each of these roadways adjacent to the project site are as follows:

- Powers Boulevard: 73,600 vpd
- Palmer Park Boulevard: 16,600 vpd
- Omaha Boulevard: 2,900 vpd
- Paonia Street: 3,100 vpd

Figure 2 shows the existing morning and evening peak hour volumes as well as intersection geometry at the study intersections.

**D. Crash Summary**

Crash data from the most recent 5-year period available were obtained from the Colorado Department of Transportation crash data website. A summary of the crashes experienced along Powers Boulevard within the influence areas of the Palmer Park Boulevard and Omaha Boulevard intersections is shown in Table 2. It should be noted that the crash data is confidential and may be protected under 23 USC 407. More detailed crash data can be made available upon formal request via the Colorado Open Records Act (CORA) website.

**Table 2: Crash Data Summary**

Crash Type	2018	2019	2020	2021	2022
Angle	7	3	9	4	1
Rear-End	24	24	13	12	19
Sideswipe	13	8	6	6	7
Pedestrian	0	1	1	1	3
Injury	11	7	15	14	25
Fatal	1	0	0	0	1
<b>Total</b>	<b>54</b>	<b>38</b>	<b>33</b>	<b>29</b>	<b>36</b>

**E. Level of Service Analysis**

Hales Engineering determined that the Palmer Park Boulevard / Powers Boulevard intersection operates at poor levels of service during the morning and evening peak hours, as shown in Table 3. Additionally, the Paonia Street / Palmer Park Boulevard intersection also operates poorly during the morning peak hour.







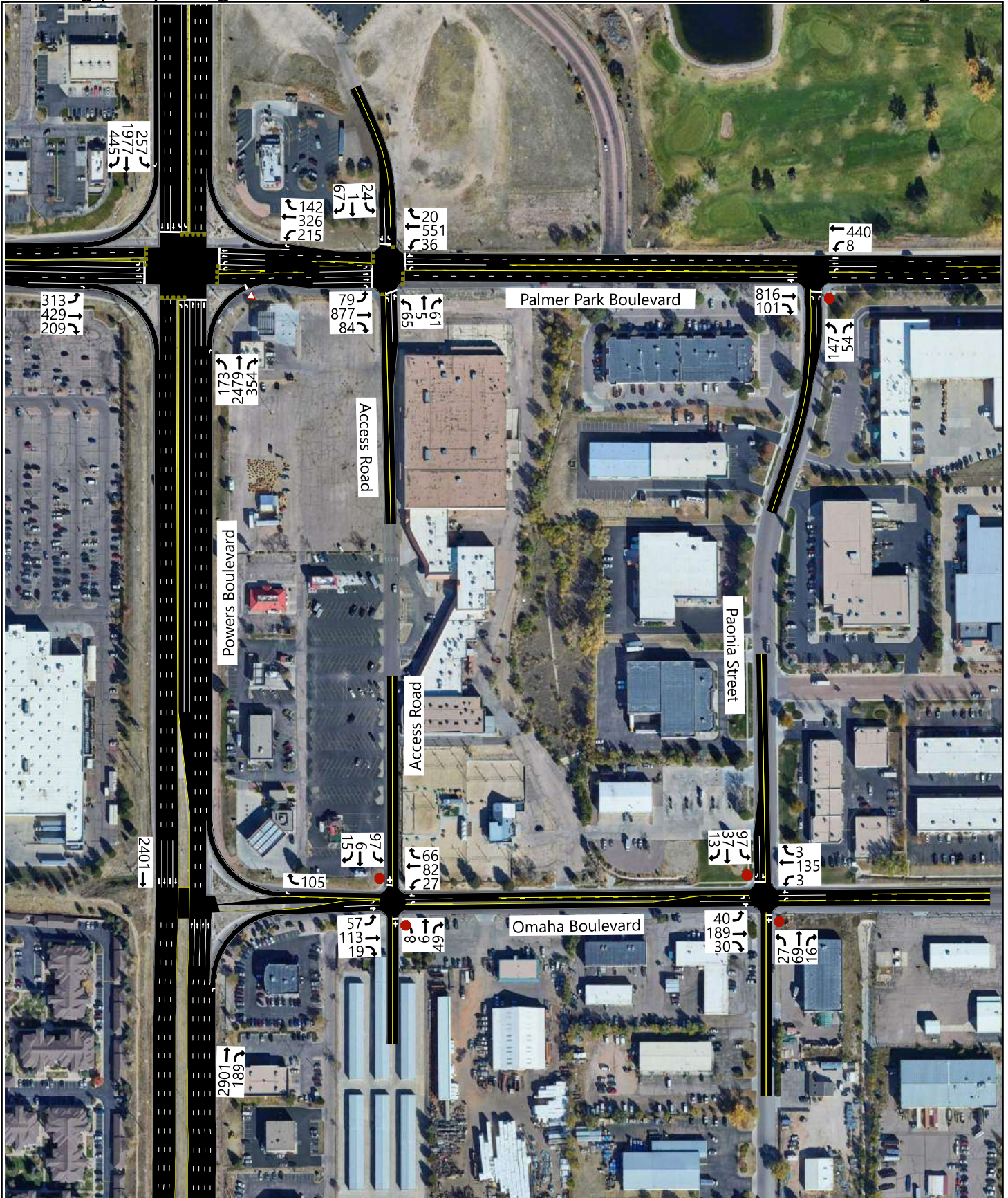

**Table 3: Existing (2024) Background Peak Hour LOS**

Intersection		LOS and Delay (s/veh) by Lane Group					
Description	Approach	Morning Peak Hour			Evening Peak Hour		
		LT	TH	RT	LT	TH	RT
Palmer Park Boulevard / Powers Boulevard	NB	E (70.5)	C (25.6)	-	E (74.9)	D (46.1)	-
	SB	F (95.5)	F (52.6)	-	F (100.3)	C (25.1)	-
	EB	E (79.0)	E (71.6)	-	F (80.4)	F (123.2)	-
	WB	E (76.7)	F (172.2)	-	E (77.8)	F (134.9)	-
	ALL	<b>E (55.4)</b>			<b>E (55.4)</b>		
Access Road / Palmer Park Boulevard	NB	E (69.1)	E (63.6)		E (68.9)	E (61.3)	
	SB	E (64.5)	E (63.6)		E (64.5)	E (61.3)	
	EB	A (3.7)	A (2.7)	A (2.4)	A (4.8)	A (4.0)	A (3.1)
	WB	A (3.5)	A (3.1)	A (3.1)	A (5.9)	A (3.7)	A (3.7)
	ALL	<b>A (9.1)</b>			<b>B (11.1)</b>		
Paonia Street / Palmer Park Boulevard	NB	<b>F (57.7)</b>	-	E (35.2)	<b>D (31.4)</b>	-	B (12.7)
	EB	-	-	-	-	-	-
	WB	C (19.1)	-	-	B (10.2)	-	-
Access Road / Omaha Boulevard	NB	A (9.5)			B (10.1)		
	SB	<b>B (11.3)</b>			<b>B (14.4)</b>		
	EB	A (7.7)	-		A (7.7)	-	
	WB	A (7.4)	-		A (7.6)	-	
Paonia Street / Omaha Boulevard	NB	B (12.4)			B (14.3)		
	SB	<b>B (14.5)</b>		A (9.4)	<b>C (17.5)</b>		A (9.1)
	EB	A (7.8)	-		A (7.6)	-	
	WB	A (7.4)	-		A (7.7)	-	

1. Bolded LOS and delay value is the controlling lane group LOS and delay for the intersection or the overall LOS for signals and roundabouts.  
Source: Hales Engineering, April 2024

**F. Queuing Analysis**

Hales Engineering calculated the 95<sup>th</sup> percentile queue lengths for each of the study intersections. Significant 95<sup>th</sup> percentile queue lengths during the morning and evening peak hour are summarized as follows:

- Powers Boulevard & Palmer Park Boulevard:
  - Northbound: >1,000 feet (PM)
  - Southbound: >1,000 feet (AM)
  - Eastbound: >200 feet (AM), >350 feet (PM)
  - Westbound: >300 feet (AM, PM)



### G. Mitigation Measures

Northbound and southbound traffic volumes on Powers Boulevard are approaching capacity for an at-grade intersection. According to the PPACG Long Range Transportation Plan, intersection improvements are planned for the Palmer Park Boulevard / Paonia Street intersection at a future date. In the interim, signal timing may be adjusted to allow for better levels of service at the intersection.

The Paonia Street / Palmer Park Boulevard intersection does not currently meet signal peak hour signal warrants. Drivers may reroute to avoid delays or utilize the center two-way left-turn lane to create a 2-stage gap while turning onto Palmer Park Boulevard.

### H. Mitigated Scenario

Intersection LOS with the recommended signal timing adjustments are shown in Table 4. These results serve as a baseline condition for the impact analysis of the proposed development during existing (2024) conditions.

**Table 4: Mitigated Existing (2024) Background Peak Hour LOS**

Intersection		LOS and Delay (s/veh) by Lane Group					
Description	Approach	Morning Peak Hour			Evening Peak Hour		
		LT	TH	RT	LT	TH	RT
Palmer Park Boulevard / Powers Boulevard	NB	E (70.5)	C (26.3)	-	E (72.6)	F (53.7)	-
	SB	E (76.2)	F (53.1)	-	F (100.3)	C (26.8)	-
	EB	E (71.7)	E (71.5)	-	E (78.4)	F (90.4)	-
	WB	E (70.3)	F (172.2)	-	E (68.8)	F (89.6)	-
	ALL	<b>D (54.7)</b>			<b>D (53.8)</b>		
Access Road / Palmer Park Boulevard	NB	E (69.1)	E (63.6)		E (68.9)	E (61.3)	
	SB	E (64.5)	E (63.6)		E (64.5)	E (61.3)	
	EB	A (3.7)	A (2.8)	A (2.4)	A (4.8)	A (4.0)	A (3.1)
	WB	A (3.5)	A (3.1)	A (3.1)	A (5.9)	A (3.7)	A (3.7)
	ALL	<b>A (9.1)</b>			<b>B (11.1)</b>		
Paonia Street / Palmer Park Boulevard	NB	<b>F (57.7)</b>	-	E (35.2)	<b>D (31.4)</b>	-	B (12.7)
	EB	-	-	-	-	-	-
	WB	C (19.1)	-	-	B (10.2)	-	-
Access Road / Omaha Boulevard	NB	A (9.5)			B (10.1)		
	SB	<b>B (11.3)</b>			<b>B (14.4)</b>		
	EB	A (7.7)	-		A (7.7)	-	
	WB	A (7.4)	-		A (7.6)	-	
Paonia Street / Omaha Boulevard	NB	B (12.4)			B (14.3)		
	SB	<b>B (14.5)</b>		A (9.4)	<b>C (17.5)</b>		A (9.1)
	EB	A (7.8)	-		A (7.6)	-	
	WB	A (7.4)	-		A (7.7)	-	

1. Bolded LOS and delay value is the controlling lane group LOS and delay for the intersection or the overall LOS for signals and roundabouts.

Source: Hales Engineering, April 2024

### III. OPENING DAY (2025) BACKGROUND CONDITIONS

#### A. Purpose

The purpose of the Opening Day (2025) background analysis is to study the intersections and roadways during the peak travel periods of the day for future background traffic and geometric conditions. Through this analysis, future background traffic operational deficiencies can be identified, and potential mitigation measures recommended.

#### B. Roadway Network

According to the El Paso County 2040 Major Transportation Corridors Plan (MTCP) and the PPACG Long Range Transportation Plan, there are no projects planned before 2025 in the study area. Therefore, no changes were made to the roadway network for the opening day (2025) analysis.

#### C. Traffic Volumes

Hales Engineering obtained future (2025) forecasted volumes from El Paso County 2040 MTCP. Peak period turning movement counts were estimated using National Cooperative Highway Research Program (NCHRP) 255 methodologies which utilize existing peak period turn volumes and future average weekday daily traffic (AWDT) volumes to project the future turn volumes at the major intersections. Opening Day (2025) morning and evening peak hour turning movement volumes are shown in Figure 3.

#### D. Level of Service Analysis

Hales Engineering determined that the Palmer Park Boulevard / Powers Boulevard intersection is anticipated to operate at a poor level of service during the morning and evening peak hours in Opening Day (2025) background conditions, as shown in Table 5. Additionally, the Paonia Street & Palmer Park Boulevard intersection is anticipated to continue to operate poorly during the morning peak hour. These results serve as a baseline condition for the impact analysis of the proposed development for Opening Day (2025) conditions.

#### E. Queuing Analysis

Hales Engineering calculated the 95<sup>th</sup> percentile queue lengths for each of the study intersections. Significant 95<sup>th</sup> percentile queue lengths during the morning and evening peak hour are summarized as follows:

- Powers Boulevard & Palmer Park Boulevard:
  - Northbound: >1,000 feet (PM)
  - Southbound: >1,000 feet (AM)
  - Eastbound: >200 feet (AM), >350 feet (PM)
  - Westbound: >300 feet (AM, PM)

**Table 5: Opening Day (2025) Background Peak Hour LOS**

Intersection		LOS and Delay (s/veh) by Lane Group					
Description	Approach	Morning Peak Hour			Evening Peak Hour		
		LT	TH	RT	LT	TH	RT
<b>Palmer Park Boulevard / Powers Boulevard</b>	NB	E (75.3)	C (24.2)	-	E (76.1)	F (53.6)	-
	SB	F (130.7)	F (56.5)	-	F (102.7)	C (26.2)	-
	EB	F (139.0)	F (84.2)	-	F (80.6)	F (126.6)	-
	WB	E (79.2)	F (145.3)	-	E (78.4)	F (138.8)	-
	ALL	<b>E (59.4)</b>			<b>E (59.0)</b>		
<b>Access Road / Palmer Park Boulevard</b>	NB	E (68.9)	E (63.4)		E (68.7)	E (60.6)	
	SB	E (64.6)	E (63.4)		E (64.2)	E (60.6)	
	EB	A (4.0)	A (2.9)	A (2.5)	A (5.2)	A (4.3)	A (3.3)
	WB	A (3.9)	A (3.4)	A (3.4)	A (6.5)	A (4.0)	A (4.0)
	ALL	<b>A (9.9)</b>			<b>B (11.8)</b>		
<b>Paonia Street / Palmer Park Boulevard</b>	NB	<b>F (62.1)</b>	-	E (36.6)	<b>D (33.0)</b>	-	B (12.9)
	EB	-	-	-	-	-	-
	WB	C (19.6)	-	-	B (10.3)	-	-
<b>Access Road / Omaha Boulevard</b>	NB	B (10.1)			B (10.3)		
	SB	<b>B (11.7)</b>			<b>B (14.9)</b>		
	EB	A (7.7)	-		A (7.7)	-	
	WB	A (7.5)	-		A (7.6)	-	
<b>Paonia Street / Omaha Boulevard</b>	NB	B (12.9)			B (14.9)		
	SB	<b>C (15.6)</b>		A (9.5)	<b>C (18.8)</b>		A (9.1)
	EB	A (7.8)	-		A (7.6)	-	
	WB	A (7.5)	-		A (7.7)	-	

1. Bolded LOS and delay value is the controlling lane group LOS and delay for the intersection or the overall LOS for signals and roundabouts.  
Source: Hales Engineering, April 2024

**F. Mitigation Measures**

No mitigation measures are recommended. It is anticipated that in future years, operational improvements will be made to Powers Boulevard and to the Palmer Park Boulevard / Powers Boulevard intersection based on the El Paso County MTCP and the PPACG Long Range Transportation Plan. Based on existing and projected (2025) volumes, a separate grade intersection may be warranted to provide adequate capacity.







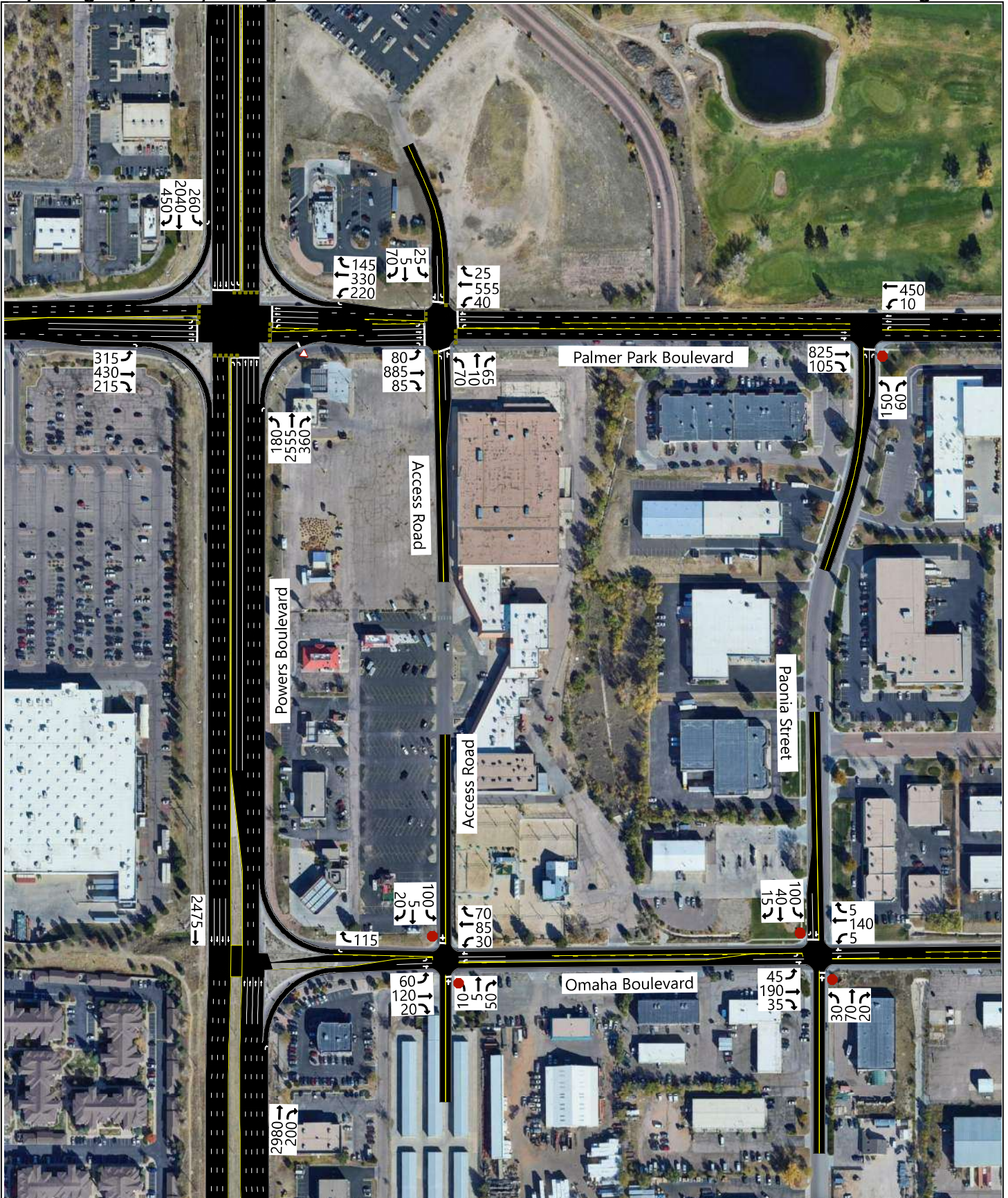



## **IV. PROJECT CONDITIONS**

### **A. Purpose**

The project conditions discussion explains the type and intensity of development. This provides the basis for trip generation, distribution, and assignment of project trips to the surrounding study intersections defined in Chapter I.

### **B. Project Description**

The proposed Dutch Bros Coffee development is located at 5810 Omaha Boulevard. The development will consist of a 950 sq. ft. Dutch Bros Coffee shop. A concept plan for the proposed development is provided in Appendix A.

### **C. Trip Generation**

Trip generation for the development was calculated using both data from similar Dutch Bros sites and trip generation rates published in the Institute of Transportation Engineers (ITE), *Trip Generation*, 11<sup>th</sup> Edition, 2021. Since no weekday daily trip data was available from similar Dutch Bros sites, Hales Engineering used a similar ratio from ITE rates to calculate weekday daily trips from morning peak hour rates. Hales Engineering used the average trip generation rate provided by ITE unless there were more than 20 data points and the equation fit the provided data for that land use more accurately. In this case, the average rate was used in all cases except for the ITE rates for the morning peak hour. Trip generation for the proposed project is included in Table 6.

The total trip generation for the development using Dutch Bros data is as follows:

- Daily Trips: 101 (+569 pass-by)
- Morning Peak Hour Trips: 20 (+114 pass-by)
- Evening Peak Hour Trips: 9 (+85 pass-by)

The total trip generation for the development using ITE trip generation rates is as follows:

- Daily Trips: 27 (+153 pass-by)
- Morning Peak Hour Trips: 5 (+31 pass-by)
- Evening Peak Hour Trips: 2 (+14 pass-by)

Based on this, Hales Engineering used the Dutch Bros data to remain conservative in this analysis. It is anticipated that there will be pass-by trips entering and exiting the proposed development. These are trips that are coming from existing vehicles already on the roadway. According to ITE data, the average pass-by percentage for a coffee shop with a Street-thru window and no indoor seating is 90% during the morning peak hour and 98% during the evening peak hour. To be conservative, Hales Engineering decreased the pass-by percentage to 85% during the morning peak hour and 90% during the evening peak hour. Based on this, 85% was also used for the weekday pass-by rate.

**Table 6: Trip Generation**

Trip Generation CO Montrose - Dutch Bros TIS												
Land Use <sup>1</sup>	# of Units	Unit Type	Average Rate or Equation	Trip Generation					Reductions	New Trips		
				Total	% In	% Out	In	Out	Pass-by	In	Out	Total
<b>Weekday Daily</b>												
Dutch Bros : Coffee Shop w/Drive-thru & No Indoor Seating (938)	95	KSF	705.00	670	50%	50%	335	335	85%	51	50	101
ITE : Coffee Shop w/Drive-thru & No Indoor Seating (938)	1	Drive-thru Lanes	179.00	180	50%	50%	90	90	85%	13	14	27
<b>AM Peak Hour</b>												
Dutch Bros : Coffee Shop w/Drive-thru & No Indoor Seating (938)	95	KSF	139.54	134	51%	49%	68	66	85%	10	10	20
ITE : Coffee Shop w/Drive-thru & No Indoor Seating (938)	1	Drive-thru Lanes	53.21*# - 17.43	36	50%	50%	18	18	85%	2	3	5
<b>PM Peak Hour</b>												
Dutch Bros : Coffee Shop w/Drive-thru & No Indoor Seating (938)	95	KSF	97.4	94	47%	53%	44	50	90%	4	5	9
ITE : Coffee Shop w/Drive-thru & No Indoor Seating (938)	1	Drive-thru Lanes	15.08	16	50%	50%	8	8	90%	1	1	2

1. Land Use Code from the Institute of Transportation Engineers (ITE) Trip Generation, 11th Edition, 2021.  
SOURCE: Hales Engineering, March 2024

**D. Trip Distribution and Assignment**

Project traffic is assigned to the roadway network based on the type of trip and the proximity of project access points to major streets, high population densities, and regional trip attractions. Existing travel patterns observed during data collection also provide helpful guidance to establish these distribution percentages, especially near the site. The resulting distribution of project generated trips during the morning and evening peak hour is shown in Table 7.

**Table 7: New Trip Distribution**

Direction	% To/From Project
North	30%
South	20%
East	30%
West	20%

Since the majority of trips to and from a Dutch Bros location are pass-by trips, pass-by trip distributions are anticipated to be comprised primarily of northbound vehicles on Powers Boulevard that will have easy access to the site, being able to enter and exit Omaha Boulevard using right-turn movements. Therefore, all of the pass-by trips for the development were assumed to be northbound trips on Powers Boulevard.

These trip distribution assumptions were used to assign the morning and evening peak hour trip generation at the study intersections to create trip assignment for the proposed development. Trip assignment for the development is shown in Figure 4.











## **E. Access**

The proposed access for the site will be gained at the following locations:

### Omaha Boulevard:

- The Access Drive / Omaha Boulevard intersection is located approximately 350 feet east of the Omaha Boulevard / Powers Boulevard intersection. It will access the project on the north side of Omaha Boulevard. It is anticipated that access will be stop-controlled. There is currently an eastbound-to-northbound left-turn pocket at this access intersection.

### Palmer Park Boulevard:

- The Access Drive / Palmer Park Boulevard intersection is located approximately 350 feet east of the Palmer Park Boulevard / Powers Boulevard intersection. It will access the project on the south side of Palmer Park Boulevard. The access is signal-controlled. There are currently eastbound-to-southbound and westbound-to-southbound right-turn and left-turn pockets at this intersection.

## V. OPENING DAY (2025) PLUS PROJECT CONDITIONS

### A. Purpose

The purpose of the existing (2025) plus project analysis is to study the intersections and roadways during the peak travel periods of the day for existing background traffic and geometric conditions plus the net trips generated by the proposed development. This scenario provides valuable insight into the potential impacts of the proposed project on background traffic conditions.

### B. Traffic Volumes

Hales Engineering added the project trips discussed in Chapter III to the existing (2025) background traffic volumes to predict turning movement volumes for Opening Day (2025) Plus Project conditions. Existing (2025) plus project morning and evening peak hour turning movement volumes are shown in Figure 5.

### C. Level of Service Analysis

Hales Engineering determined that the Palmer Park Boulevard / Powers Boulevard is anticipated to continue to operate at a poor level of service during the morning and evening peak hours with project traffic added, as shown in Table 8. Additionally, the Paonia Street & Palmer Park Boulevard intersection is anticipated to continue to operate poorly during the morning peak hour.

### D. Queuing Analysis

Hales Engineering calculated the 95<sup>th</sup> percentile queue lengths for each of the study intersections. Significant 95<sup>th</sup> percentile queue lengths during the morning and evening peak hour are summarized as follows:

- Powers Boulevard & Palmer Park Boulevard:
  - Northbound: >1,000 feet (PM)
  - Southbound: >1,000 feet (AM)
  - Eastbound: >250 feet (AM), >350 feet (PM)
  - Westbound: >300 feet (AM, PM)

### E. Mitigation Measures

No mitigation measures are recommended.



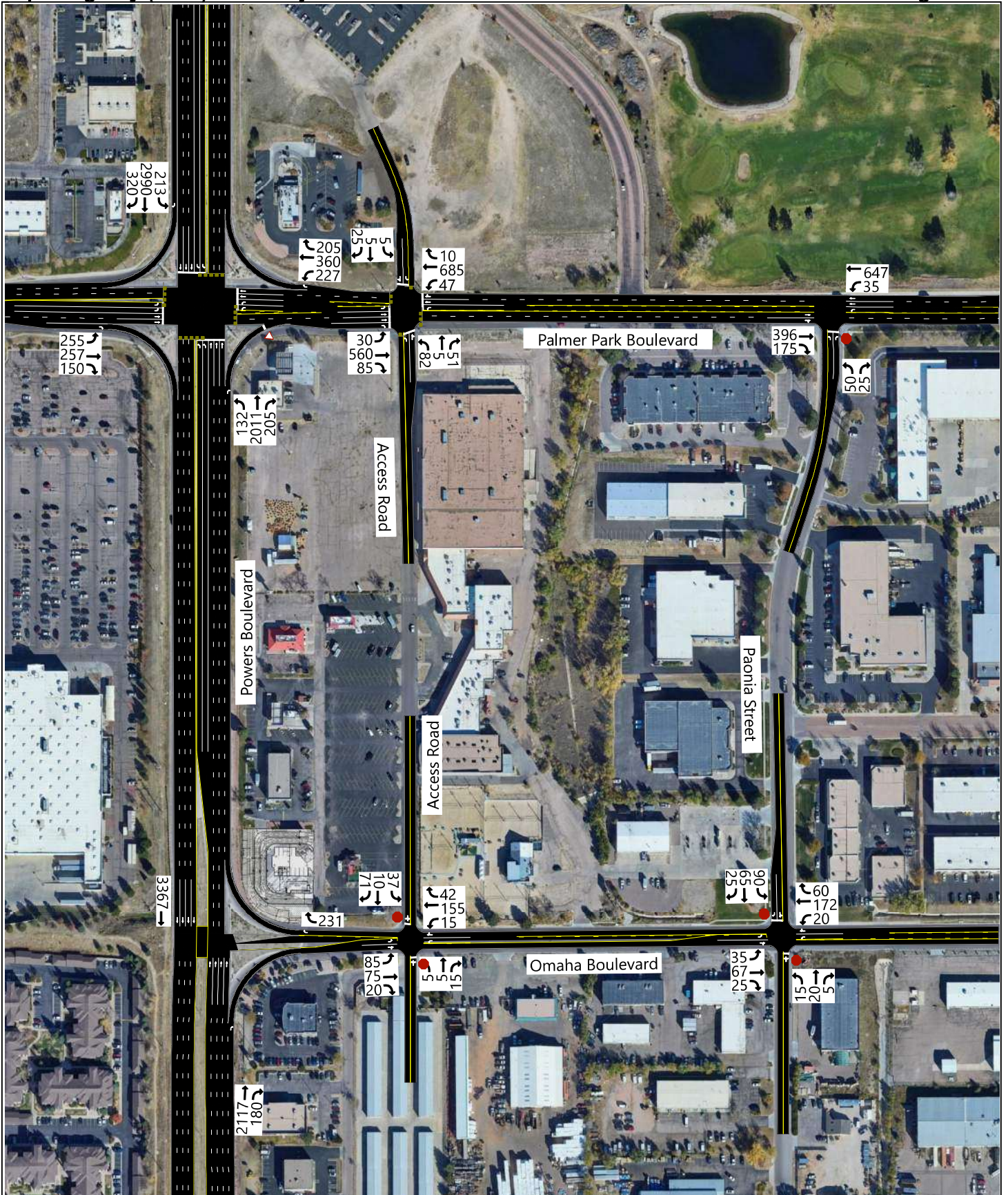



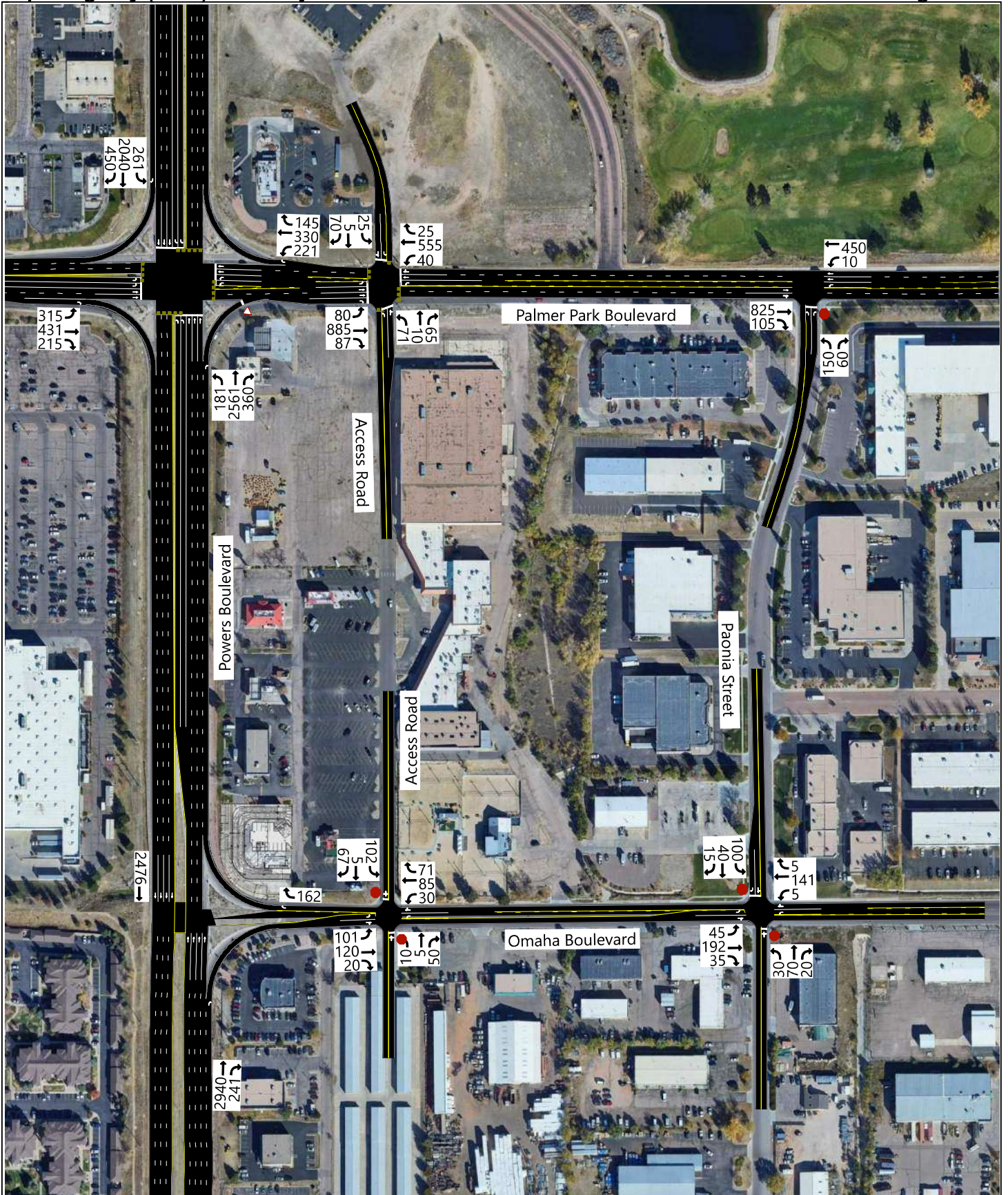

**Table 8: Opening Day (2025) Plus Project Peak Hour LOS**

Intersection		LOS and Delay (s/veh) by Lane Group					
Description	Approach	Morning Peak Hour			Evening Peak Hour		
		LT	TH	RT	LT	TH	RT
<b>Palmer Park Boulevard / Powers Boulevard</b>	NB	E (75.8)	C (24.2)	-	E (76.2)	F (54.3)	-
	SB	F (134.4)	F (56.9)	-	F (103.6)	C (26.2)	-
	EB	F (139.0)	F (86.7)	-	F (80.6)	F (128.2)	-
	WB	E (79.4)	F (145.3)	-	E (78.5)	F (138.8)	-
	ALL	<b>E (59.8)</b>			<b>E (59.5)</b>		
<b>Access Road / Palmer Park Boulevard</b>	NB	E (68.9)	E (63.2)		E (68.6)	E (60.5)	
	SB	E (64.4)	E (63.2)		E (64.0)	E (60.5)	
	EB	A (4.1)	A (3.0)	A (2.6)	A (5.2)	A (4.4)	A (3.3)
	WB	A (3.9)	A (3.4)	A (3.4)	A (6.6)	A (4.1)	A (4.0)
	ALL	<b>A (10.0)</b>			<b>B (11.8)</b>		
<b>Paonia Street / Palmer Park Boulevard</b>	NB	<b>F (62.3)</b>	-	E (36.7)	<b>D (33.0)</b>	-	B (12.9)
	EB	-	-	-	-	-	-
	WB	C (19.6)	-	-	B (10.3)	-	-
<b>Access Road / Omaha Boulevard</b>	NB	B (10.9)			B (10.8)		
	SB	<b>B (12.3)</b>			<b>C (16.4)</b>		
	EB	A (7.9)	-		A (7.8)	-	
	WB	A (7.5)	-		A (7.6)	-	
<b>Paonia Street / Omaha Boulevard</b>	NB	B (13.0)			B (14.9)		
	SB	<b>C (15.7)</b>		A (9.5)	<b>C (18.9)</b>		A (9.1)
	EB	A (7.8)	-		A (7.6)	-	
	WB	A (7.5)	-		A (7.8)	-	

1. Bolded LOS and delay value is the controlling lane group LOS and delay for the intersection or the overall LOS for signals and roundabouts.  
Source: Hales Engineering, April 2024

**F. Recommended Storage Lengths**

Hales Engineering determined recommended storage lengths based on the 95<sup>th</sup> percentile queue lengths given in the opening day (2025) plus project scenario. These storage lengths do not include the taper length. Recommended storage lengths for the study intersections are shown in Table 9. Intersections shown in Table 9 include new intersections and existing intersections that have recommended storage length changes.



**Table 9: Recommended Storage Lengths**

Intersection	Recommended Storage Lengths (feet)															
	Northbound				Southbound				Eastbound				Westbound			
	LT		RT		LT		RT		LT		RT		LT		RT	
	E	P	E	P	E	P	E	P	E	P	E	P	E	P	E	P
<b>1</b> Palmer Park Boulevard / Powers Boulevard	885	-	-	-	695	-	545	-	320	-	250	-	100	150	150	-
1. Storage lengths are based on 2025 95th percentile queue lengths and do not include required deceleration / taper distances 2. E = Existing storage length (approximate), if applicable; P = proposed storage length for new turn lanes or changes to existing turn lanes, if applicable Source: Hales Engineering, April 2024																



# APPENDIX A

## Site Plan

---

DUTCH BROS. COFFEE - CO0907, COLORADO SPRINGS, CO

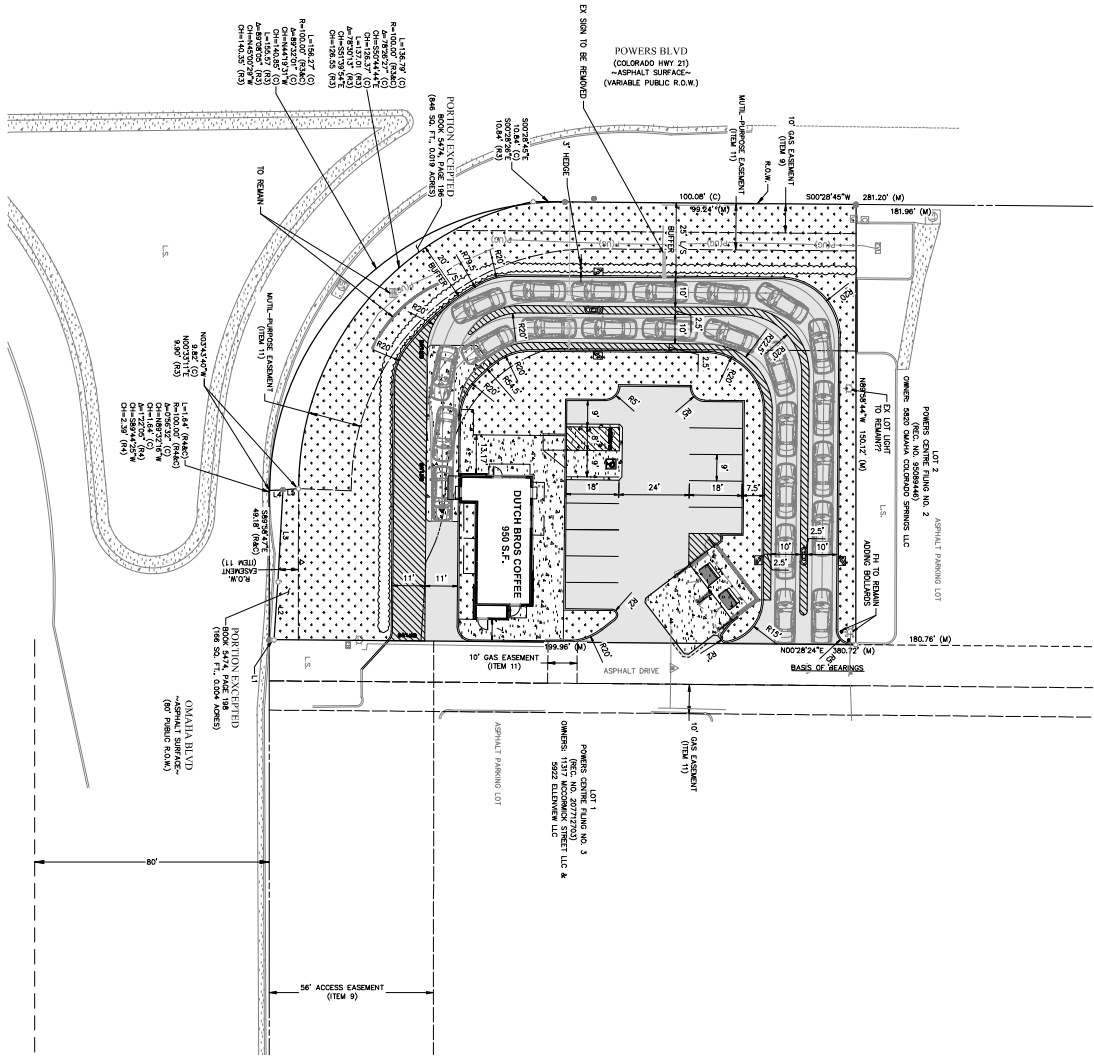
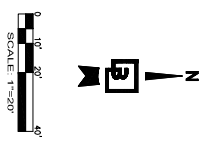

PRELIMINARY NOT FOR CONSTRUCTION

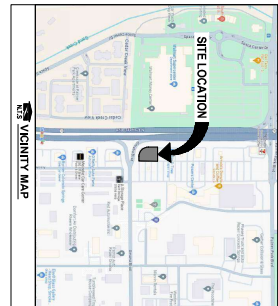

**PROJECT DATA**

DESIGN-42	= 24.17'
THRU ENCLOSURE	= 11
PROPOSED REPAIR PAVING	= 12
PROPOSED SITE PAVING	= 12
TOTAL PAVING	= 24
OPENING	= 28

**LEGEND**

CONNECT THE BE SIGNALS TO EXISTING UTILITIES

- DATE REVISION
- APPROVED: [Signature]
- NOT REVISION
- REVISION: [Signature]

**Dutch Bros**

- BUILDING LINE
- EXISTING CURB TO REMAIN
- PROPOSED CURB
- EXISTING LANDSCAPING
- PROPOSED ASPHALT
- PROPOSED CONCRETE

Job Number  
**23098**

Sheet  
**1 OF 1**

**Barghausen Consulting Engineers, Inc.**  
18215 72nd Avenue South  
Kirk, WA 98032  
425.251.6222 | [barghausen.com](http://barghausen.com)

Designed CT Scale: Horizontal  
 Drawn AL 1" = 20'  
 Checked JML Vertical  
 Approved JML  
 Date 1/19/24 N/A

For: **DUTCH BROS**

Title: **PRELIMINARY SITE PLAN  
5810 OMAHA BLVD  
COLORADO SPRINGS, CO**

# APPENDIX B

## Turning Movement Counts

---



Ridgeview Data  
Collection

Colorado Springs, CO  
CO Springs Powers Blvd Count  
AM Peak  
Powers Blvd and Palmer Park Blvd

File Name : Powers and Palmer AM  
Site Code : Hales  
Start Date : 3/6/2024  
Page No : 1

Groups Printed- Automobiles - Bicycle and Pedestrian

Start Time	Palmer Park Blvd Eastbound					Palmer Park Blvd Westbound					Powers Blvd Northbound					Powers Blvd Southbound					Int. Total
	Left	Thru	Right	Peds	App. Total	Left	Thru	Right	Peds	App. Total	Left	Thru	Right	Peds	App. Total	Left	Thru	Right	Peds	App. Total	
07:00 AM	47	51	32	0	130	50	66	50	0	166	15	405	67	0	487	44	681	54	0	779	1562
07:15 AM	52	37	38	0	127	53	83	43	0	179	28	455	51	0	534	43	710	79	0	832	1672
07:30 AM	57	62	35	0	154	50	84	39	0	173	24	501	58	0	583	57	747	70	0	874	1784
07:45 AM	73	75	35	0	183	56	81	47	0	184	34	479	45	0	558	49	682	77	0	808	1733
Total	229	225	140	0	594	209	314	179	0	702	101	1840	221	0	2162	193	2820	280	0	3293	6751
08:00 AM	60	67	29	0	156	47	91	57	0	195	35	415	39	0	489	44	616	76	0	736	1576
08:15 AM	50	38	38	0	126	40	68	43	1	152	35	424	25	0	484	45	594	72	1	712	1474
08:30 AM	52	39	31	0	122	46	45	41	1	133	29	441	29	0	499	54	585	62	0	701	1455
08:45 AM	47	36	42	0	125	34	48	40	0	122	29	392	24	1	446	42	498	81	0	621	1314
Total	209	180	140	0	529	167	252	181	2	602	128	1672	117	1	1918	185	2293	291	1	2770	5819
Grand Total	438	405	280	0	1123	376	566	360	2	1304	229	3512	338	1	4080	378	5113	571	1	6063	12570
Apprch %	39	36.1	24.9	0		28.8	43.4	27.6	0.2		5.6	86.1	8.3	0		6.2	84.3	9.4	0		
Total %	3.5	3.2	2.2	0	8.9	3	4.5	2.9	0	10.4	1.8	27.9	2.7	0	32.5	3	40.7	4.5	0	48.2	
Automobiles	438	405	280	0	1123	376	566	360	0	1302	229	3512	338	0	4079	378	5113	571	0	6062	12566
% Automobiles	100	100	100	0	100	100	100	100	0	99.8	100	100	100	0	100	100	100	100	0	100	100
Bicycle and Pedestrian	0	0	0	0	0	0	0	0	2	2	0	0	0	1	1	0	0	0	1	1	4
% Bicycle and Pedestrian	0	0	0	0	0	0	0	0	100	0.2	0	0	0	100	0	0	0	0	100	0	0



Ridgeview Data  
Collection

Colorado Springs, CO  
CO Springs Powers Blvd Count  
AM Peak  
Powers Blvd and Palmer Park Blvd

File Name : Powers and Palmer AM  
Site Code : Hales  
Start Date : 3/6/2024  
Page No : 2

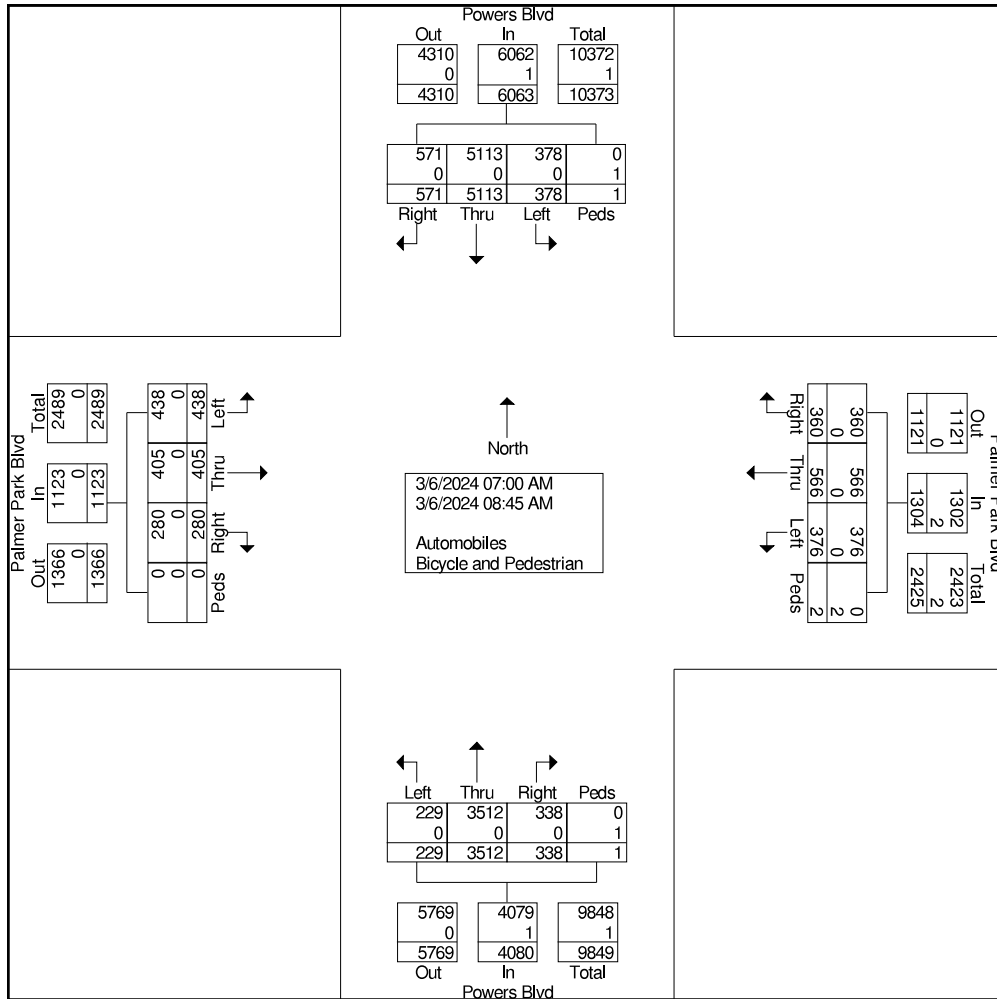





Colorado Springs, CO  
 CO Springs Powers Blvd Count  
 AM Peak  
 Powers Blvd and Palmer Park Blvd

File Name : Powers and Palmer AM  
 Site Code : Hales  
 Start Date : 3/6/2024  
 Page No : 3

Start Time	Palmer Park Blvd Eastbound					Palmer Park Blvd Westbound					Powers Blvd Northbound					Powers Blvd Southbound					Int. Total
	Left	Thru	Right	Peds	App. Total	Left	Thru	Right	Peds	App. Total	Left	Thru	Right	Peds	App. Total	Left	Thru	Right	Peds	App. Total	
Peak Hour Analysis From 07:00 AM to 08:45 AM - Peak 1 of 1																					
Peak Hour for Entire Intersection Begins at 07:15 AM																					
07:15 AM	52	37	38	0	127	53	83	43	0	179	28	455	51	0	534	43	710	79	0	832	1672
07:30 AM	57	62	35	0	154	50	84	39	0	173	24	501	58	0	583	57	747	70	0	874	1784
07:45 AM	73	75	35	0	183	56	81	47	0	184	34	479	45	0	558	49	682	77	0	808	1733
08:00 AM	60	67	29	0	156	47	91	57	0	195	35	415	39	0	489	44	616	76	0	736	1576
Total Volume	242	241	137	0	620	206	339	186	0	731	121	1850	193	0	2164	193	2755	302	0	3250	6765
% App. Total	39	38.9	22.1	0		28.2	46.4	25.4	0		5.6	85.5	8.9	0		5.9	84.8	9.3	0		
PHF	.829	.803	.901	.000	.847	.920	.931	.816	.000	.937	.864	.923	.832	.000	.928	.846	.922	.956	.000	.930	.948

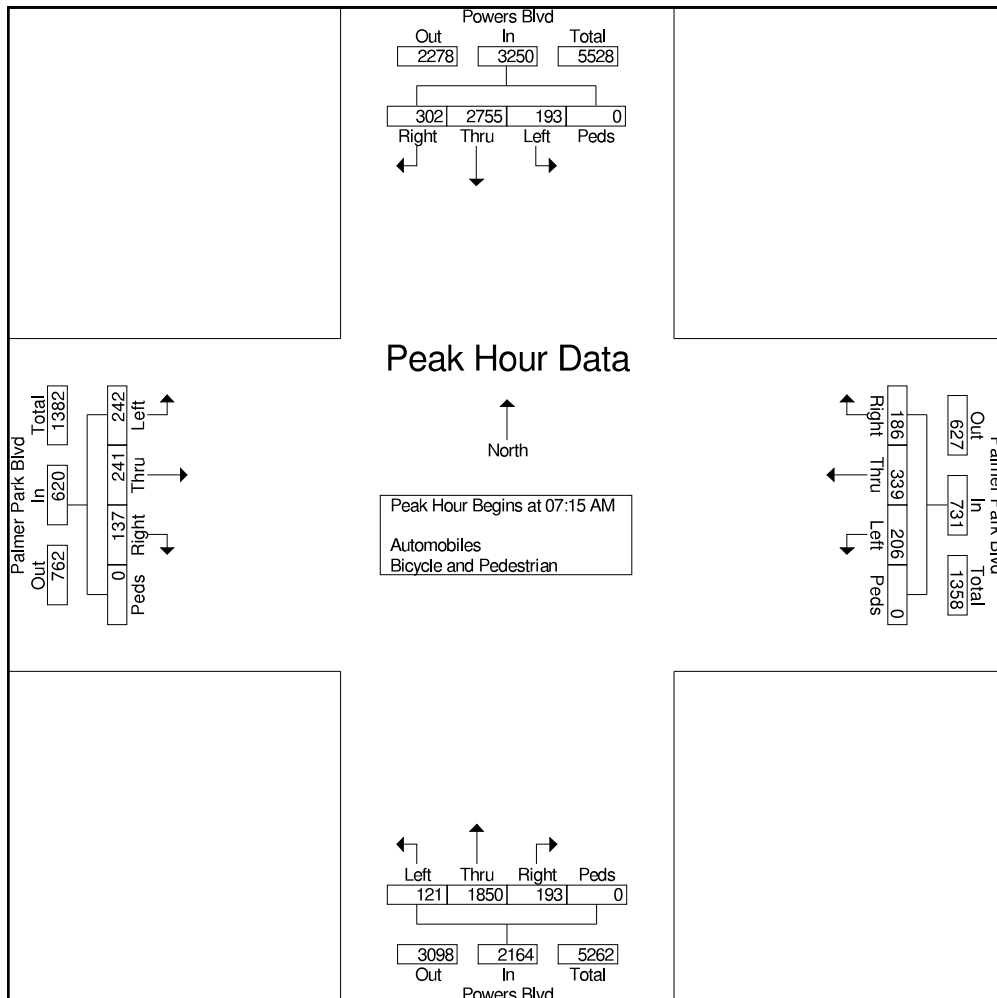



Ridgeview Data  
Collection

Colorado Springs, CO  
CO Springs Powers Blvd Count  
AM Peak  
Powers Blvd and Palmer Park Blvd

File Name : Powers and Palmer AM  
Site Code : Hales  
Start Date : 3/6/2024  
Page No : 4

Image 1

The number of pedestrians shown on this report is representative of the crossing on the approaching leg, i.e. pedestrians crossing the north side of the intersection are counted as pedestrians in the southbound crosswalk, as that is the approaching leg that they are crossing (see figure below). Diagonal crossings are counted on the two legs that will get the pedestrian to the same end point. Diagonals can be counted separately if discussed prior to count.

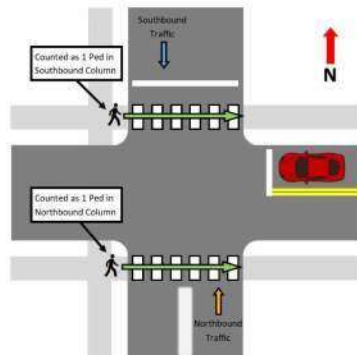



Colorado Springs, CO  
 CO Springs Powers Blvd Count  
 PM Peak  
 Powers Blvd and Palmer Park Blvd

File Name : Powers and Palmer PM  
 Site Code : Hales  
 Start Date : 3/6/2024  
 Page No : 1

Groups Printed- Automobiles - Bicycle and Pedestrian

Start Time	Palmer Park Blvd Eastbound					Palmer Park Blvd Westbound					Powers Blvd Northbound					Powers Blvd Southbound					Int. Total
	Left	Thru	Right	Peds	App. Total	Left	Thru	Right	Peds	App. Total	Left	Thru	Right	Peds	App. Total	Left	Thru	Right	Peds	App. Total	
04:00 PM	63	94	44	1	202	63	76	39	0	178	44	648	76	1	769	73	489	103	1	666	1815
04:15 PM	64	99	50	0	213	48	74	34	0	156	39	621	83	0	743	57	452	109	0	618	1730
04:30 PM	83	108	54	1	246	47	90	32	1	170	38	560	88	1	687	59	485	114	2	660	1763
04:45 PM	88	108	51	0	247	47	70	30	0	147	44	532	90	0	666	56	457	98	0	611	1671
Total	298	409	199	2	908	205	310	135	1	651	165	2361	337	2	2865	245	1883	424	3	2555	6979
05:00 PM	80	107	44	2	233	58	92	30	2	182	35	600	93	0	728	84	479	100	2	665	1808
05:15 PM	76	107	50	3	236	56	69	36	0	161	44	599	87	0	730	72	440	79	0	591	1718
05:30 PM	55	107	46	2	210	47	80	28	0	155	50	565	68	0	683	56	536	76	2	670	1718
05:45 PM	76	81	51	0	208	40	55	29	0	124	33	568	67	0	668	62	452	85	0	599	1599
Total	287	402	191	7	887	201	296	123	2	622	162	2332	315	0	2809	274	1907	340	4	2525	6843
Grand Total	585	811	390	9	1795	406	606	258	3	1273	327	4693	652	2	5674	519	3790	764	7	5080	13822
Apprch %	32.6	45.2	21.7	0.5		31.9	47.6	20.3	0.2		5.8	82.7	11.5	0		10.2	74.6	15	0.1		
Total %	4.2	5.9	2.8	0.1	13	2.9	4.4	1.9	0	9.2	2.4	34	4.7	0	41.1	3.8	27.4	5.5	0.1	36.8	
Automobiles	585	811	390	0	1786	406	606	258	0	1270	327	4693	652	0	5672	519	3790	764	0	5073	13801
% Automobiles	100	100	100	0	99.5	100	100	100	0	99.8	100	100	100	0	100	100	100	100	0	99.9	99.8
Bicycle and Pedestrian	0	0	0	9	9	0	0	0	3	3	0	0	0	2	2	0	0	0	7	7	21
% Bicycle and Pedestrian	0	0	0	100	0.5	0	0	0	100	0.2	0	0	0	100	0	0	0	0	100	0.1	0.2





Ridgeview Data  
Collection

Colorado Springs, CO  
CO Springs Powers Blvd Count  
PM Peak  
Powers Blvd and Palmer Park Blvd

File Name : Powers and Palmer PM  
Site Code : Hales  
Start Date : 3/6/2024  
Page No : 2

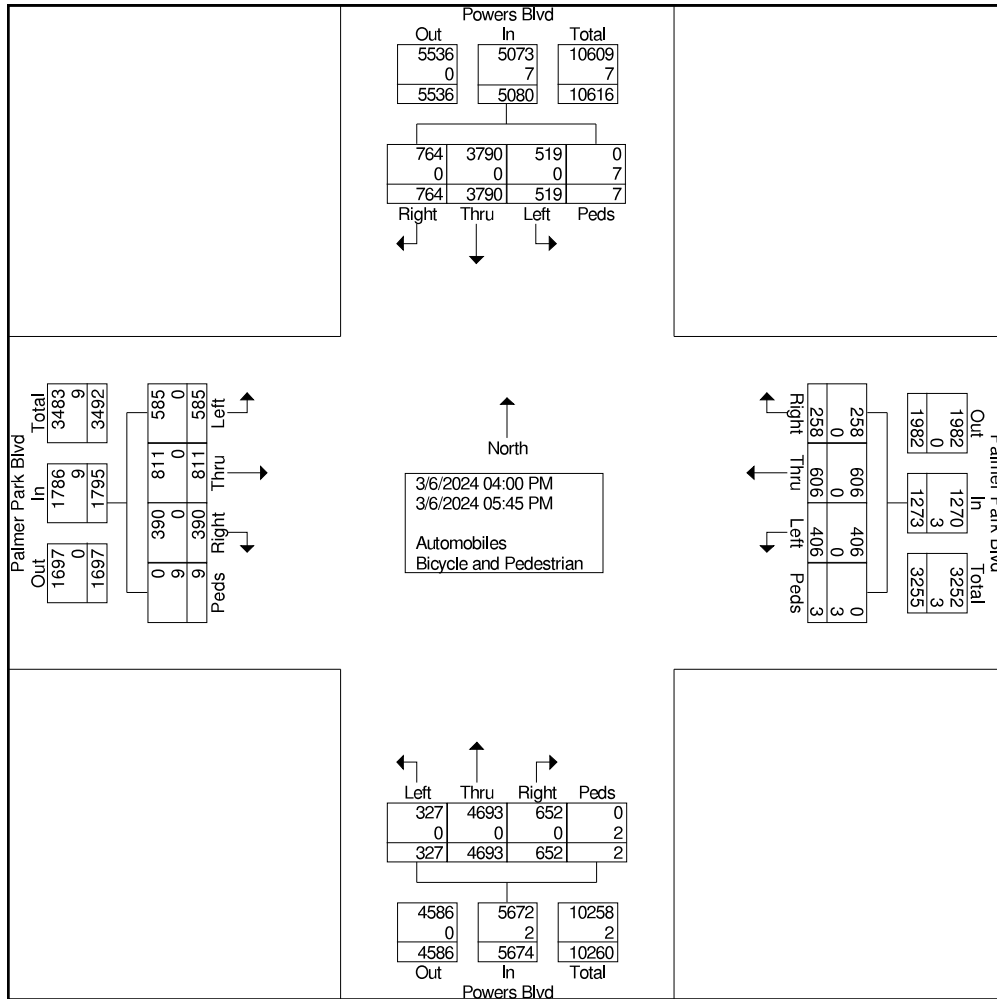



Ridgeview Data  
Collection

Colorado Springs, CO  
CO Springs Powers Blvd Count  
PM Peak  
Powers Blvd and Palmer Park Blvd

File Name : Powers and Palmer PM  
Site Code : Hales  
Start Date : 3/6/2024  
Page No : 3

Start Time	Palmer Park Blvd Eastbound					Palmer Park Blvd Westbound					Powers Blvd Northbound					Powers Blvd Southbound					Int. Total
	Left	Thru	Right	Peds	App. Total	Left	Thru	Right	Peds	App. Total	Left	Thru	Right	Peds	App. Total	Left	Thru	Right	Peds	App. Total	
Peak Hour Analysis From 04:00 PM to 05:45 PM - Peak 1 of 1																					
Peak Hour for Entire Intersection Begins at 04:00 PM																					
04:00 PM	63	94	44	1	202	63	76	39	0	178	44	648	76	1	769	73	489	103	1	666	1815
04:15 PM	64	99	50	0	213	48	74	34	0	156	39	621	83	0	743	57	452	109	0	618	1730
04:30 PM	83	108	54	1	246	47	90	32	1	170	38	560	88	1	687	59	485	114	2	660	1763
04:45 PM	88	108	51	0	247	47	70	30	0	147	44	532	90	0	666	56	457	98	0	611	1671
Total Volume	298	409	199	2	908	205	310	135	1	651	165	2361	337	2	2865	245	1883	424	3	2555	6979
% App. Total	32.8	45	21.9	0.2		31.5	47.6	20.7	0.2		5.8	82.4	11.8	0.1		9.6	73.7	16.6	0.1		
PHF	.847	.947	.921	.500	.919	.813	.861	.865	.250	.914	.938	.911	.936	.500	.931	.839	.963	.930	.375	.959	.961

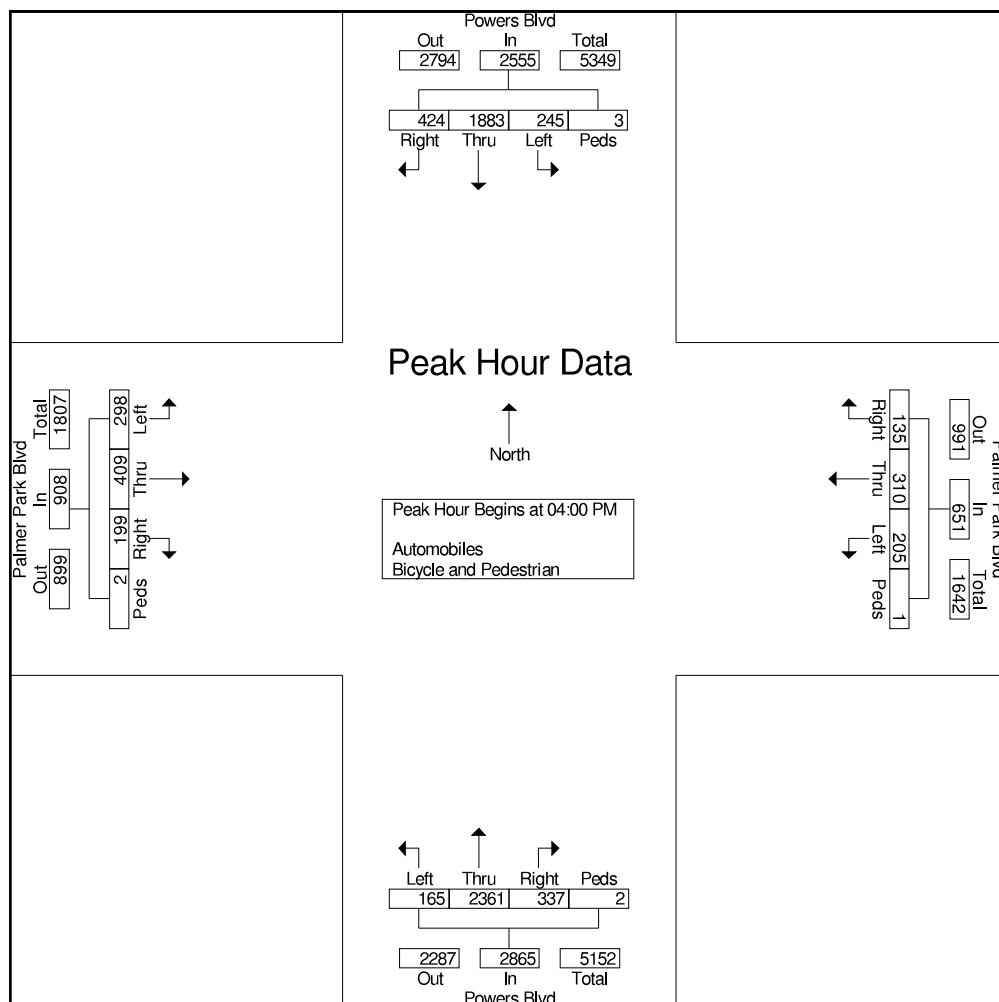



Ridgeview Data  
Collection

Colorado Springs, CO  
CO Springs Powers Blvd Count  
PM Peak  
Powers Blvd and Palmer Park Blvd

File Name : Powers and Palmer PM  
Site Code : Hales  
Start Date : 3/6/2024  
Page No : 4

Image 1

The number of pedestrians shown on this report is representative of the crossing on the approaching leg, i.e. pedestrians crossing the north side of the intersection are counted as pedestrians in the southbound crosswalk, as that is the approaching leg that they are crossing (see figure below). Diagonal crossings are counted on the two legs that will get the pedestrian to the same end point. Diagonals can be counted separately if discussed prior to count.

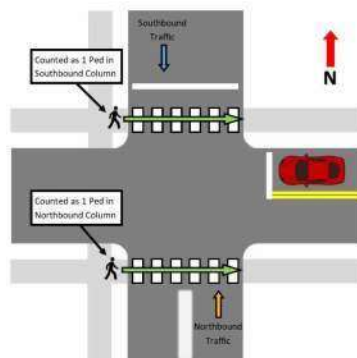







Ridgeview Data Collection

Colorado Springs, CO  
CO Springs Powers Blvd Count  
AM Peak  
Palmer Park Blvd Driveways

File Name : Palmer Park Driveways AM  
Site Code : Hales  
Start Date : 3/6/2024  
Page No : 2

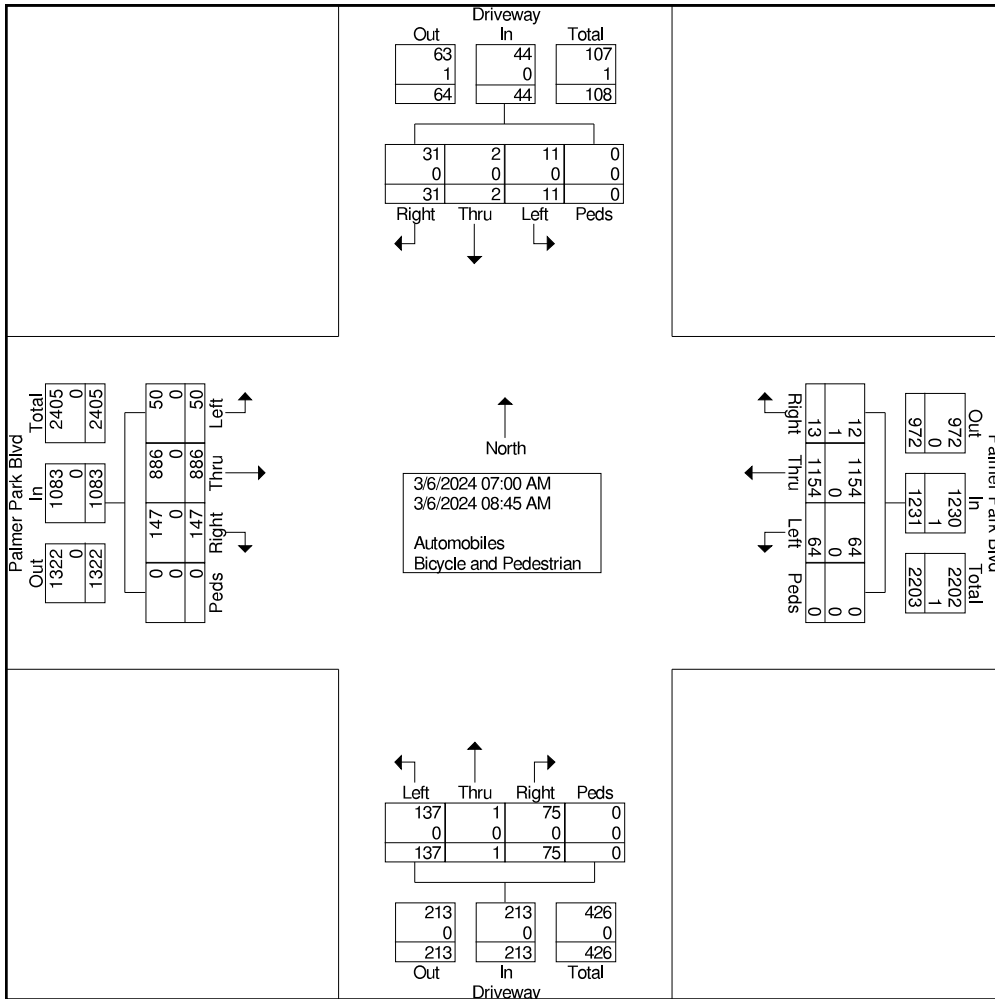



Ridgeview Data  
Collection

Colorado Springs, CO  
CO Springs Powers Blvd Count  
AM Peak  
Palmer Park Blvd Driveways

File Name : Palmer Park Driveways AM  
Site Code : Hales  
Start Date : 3/6/2024  
Page No : 3

Start Time	Palmer Park Blvd Eastbound					Palmer Park Blvd Westbound					Driveway Northbound					Driveway Southbound					Int. Total
	Left	Thru	Right	Peds	App. Total	Left	Thru	Right	Peds	App. Total	Left	Thru	Right	Peds	App. Total	Left	Thru	Right	Peds	App. Total	
Peak Hour Analysis From 07:00 AM to 08:45 AM - Peak 1 of 1																					
Peak Hour for Entire Intersection Begins at 07:15 AM																					
07:15 AM	8	104	20	0	132	5	167	3	0	175	17	0	7	0	24	2	0	4	0	6	337
07:30 AM	6	143	20	0	169	8	171	1	0	180	13	0	10	0	23	1	0	5	0	6	378
07:45 AM	7	135	16	0	158	13	156	0	0	169	16	0	15	0	31	0	1	3	0	4	362
08:00 AM	6	131	18	0	155	13	158	4	0	175	28	0	11	0	39	1	1	8	0	10	379
Total Volume	27	513	74	0	614	39	652	8	0	699	74	0	43	0	117	4	2	20	0	26	1456
% App. Total	4.4	83.6	12.1	0		5.6	93.3	1.1	0		63.2	0	36.8	0		15.4	7.7	76.9	0		
PHF	.844	.897	.925	.000	.908	.750	.953	.500	.000	.971	.661	.000	.717	.000	.750	.500	.500	.625	.000	.650	.960

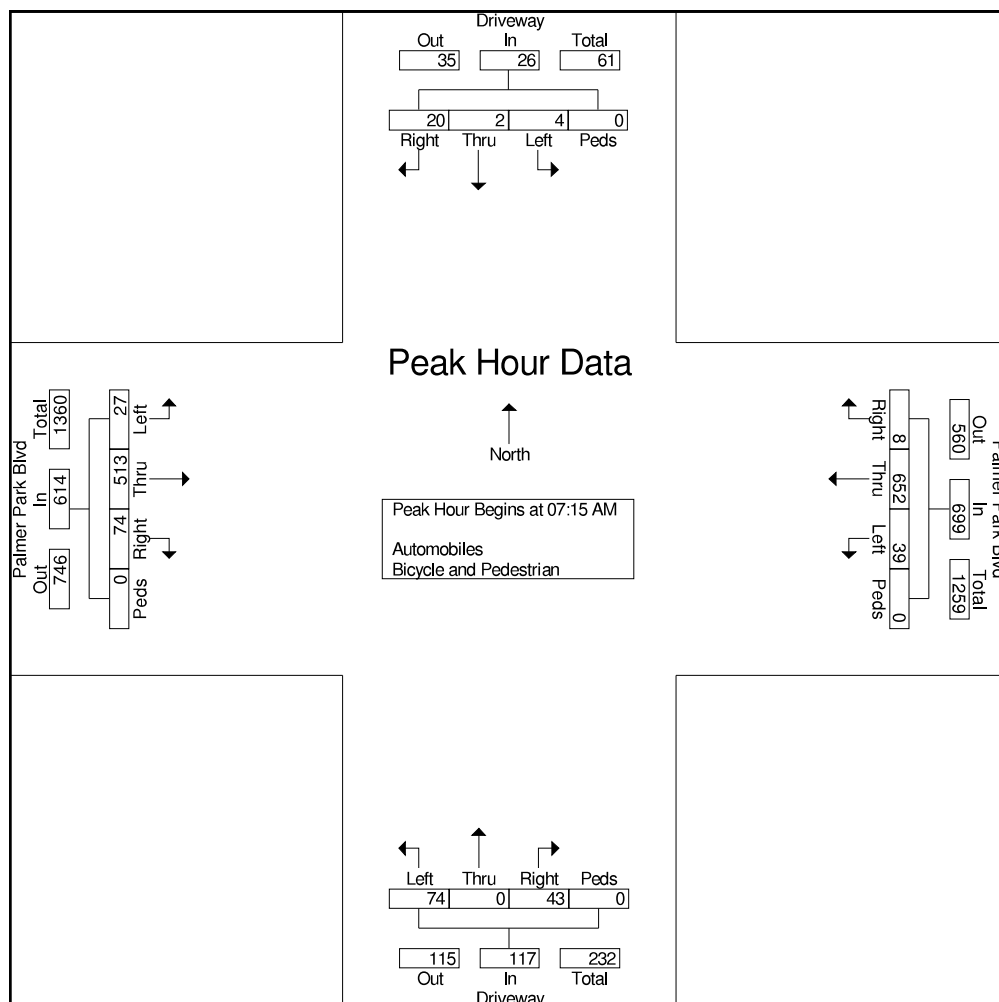





Ridgeview Data  
Collection

Colorado Springs, CO  
CO Springs Powers Blvd Count  
AM Peak  
Palmer Park Blvd Driveways

File Name : Palmer Park Driveways AM  
Site Code : Hales  
Start Date : 3/6/2024  
Page No : 4

Image 1

The number of pedestrians shown on this report is representative of the crossing on the approaching leg, i.e. pedestrians crossing the north side of the intersection are counted as pedestrians in the southbound crosswalk, as that is the approaching leg that they are crossing (see figure below). Diagonal crossings are counted on the two legs that will get the pedestrian to the same end point. Diagonals can be counted separately if discussed prior to count.

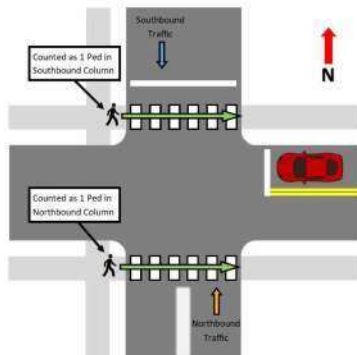



Ridgeview Data  
Collection

Colorado Springs, CO  
CO Springs Powers Blvd Count  
PM Peak  
Palmer Park Blvd Driveways

File Name : Palmer Park Driveways PM  
Site Code : Hales  
Start Date : 3/6/2024  
Page No : 1

Groups Printed- Automobiles - Bicycle and Pedestrian

Start Time	Palmer Park Blvd Eastbound					Palmer Park Blvd Westbound					Driveway Northbound					Driveway Southbound					Int. Total
	Left	Thru	Right	Peds	App. Total	Left	Thru	Right	Peds	App. Total	Left	Thru	Right	Peds	App. Total	Left	Thru	Right	Peds	App. Total	
04:00 PM	17	203	13	0	233	8	132	1	1	142	20	3	14	1	38	9	2	18	0	29	442
04:15 PM	16	215	8	0	239	9	131	3	0	143	12	0	15	0	27	4	2	17	0	23	432
04:30 PM	13	216	19	0	248	11	145	4	0	160	17	0	12	0	29	5	1	12	0	18	455
04:45 PM	21	214	19	0	254	3	108	2	0	113	16	1	15	2	34	5	0	15	0	20	421
Total	67	848	59	0	974	31	516	10	1	558	65	4	56	3	128	23	5	62	0	90	1750
05:00 PM	16	235	18	0	269	9	157	5	0	171	11	2	14	0	27	6	0	16	0	22	489
05:15 PM	25	229	24	0	278	11	118	8	0	137	18	2	17	0	37	7	0	18	2	27	479
05:30 PM	21	186	20	0	227	3	118	4	0	125	17	2	13	0	32	8	0	10	0	18	402
05:45 PM	31	167	10	0	208	2	98	3	0	103	15	2	3	0	20	6	0	17	0	23	354
Total	93	817	72	0	982	25	491	20	0	536	61	8	47	0	116	27	0	61	2	90	1724
Grand Total	160	1665	131	0	1956	56	1007	30	1	1094	126	12	103	3	244	50	5	123	2	180	3474
Apprch %	8.2	85.1	6.7	0		5.1	92	2.7	0.1		51.6	4.9	42.2	1.2		27.8	2.8	68.3	1.1		
Total %	4.6	47.9	3.8	0	56.3	1.6	29	0.9	0	31.5	3.6	0.3	3	0.1	7	1.4	0.1	3.5	0.1	5.2	
Automobiles	160	1665	131	0	1956	56	1007	30	0	1093	126	12	103	0	241	50	5	123	0	178	3468
% Automobiles	100	100	100	0	100	100	100	100	0	99.9	100	100	100	0	98.8	100	100	100	0	98.9	99.8
Bicycle and Pedestrian	0	0	0	0	0	0	0	0	1	1	0	0	0	3	3	0	0	0	2	2	6
% Bicycle and Pedestrian	0	0	0	0	0	0	0	0	100	0.1	0	0	0	100	1.2	0	0	0	100	1.1	0.2



Ridgeview Data  
Collection

Colorado Springs, CO  
CO Springs Powers Blvd Count  
PM Peak  
Palmer Park Blvd Driveways

File Name : Palmer Park Driveways PM  
Site Code : Hales  
Start Date : 3/6/2024  
Page No : 2

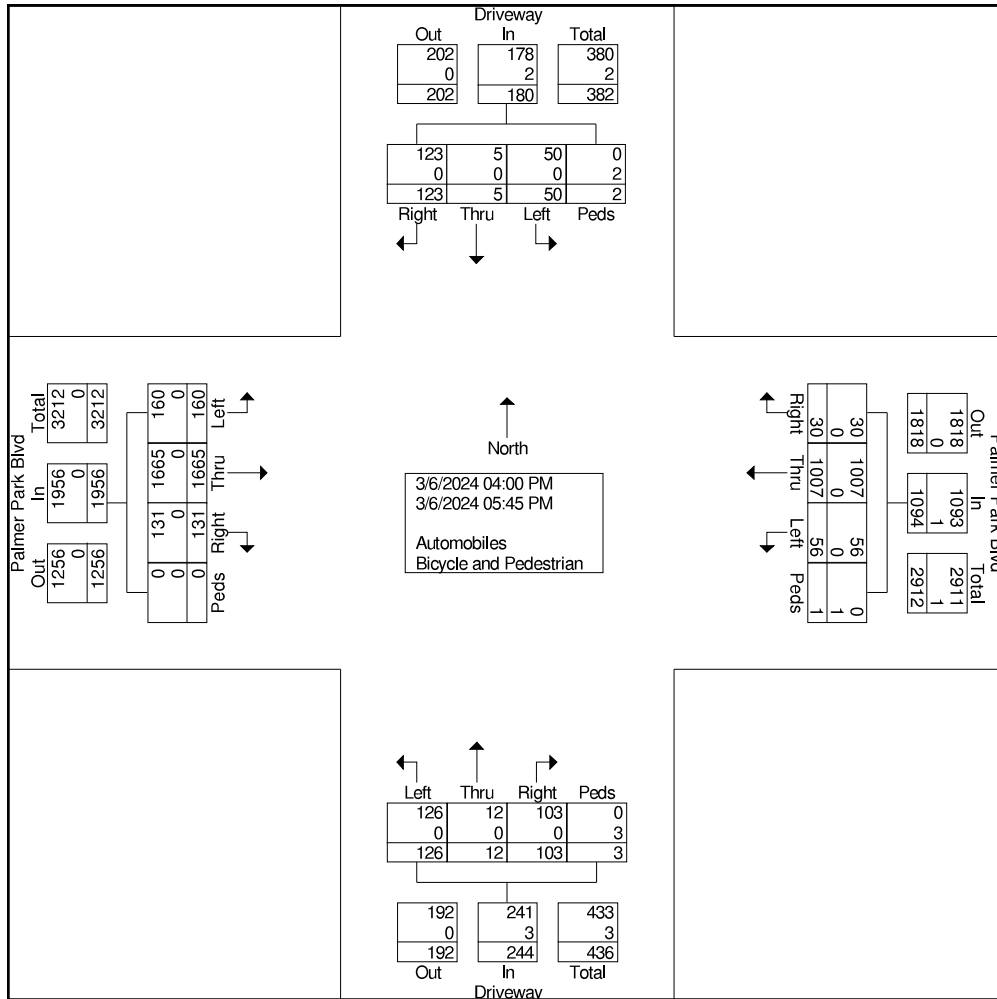





Colorado Springs, CO  
 CO Springs Powers Blvd Count  
 PM Peak  
 Palmer Park Blvd Driveways

File Name : Palmer Park Driveways PM  
 Site Code : Hales  
 Start Date : 3/6/2024  
 Page No : 3

Start Time	Palmer Park Blvd Eastbound					Palmer Park Blvd Westbound					Driveway Northbound					Driveway Southbound					Int. Total
	Left	Thru	Right	Peds	App. Total	Left	Thru	Right	Peds	App. Total	Left	Thru	Right	Peds	App. Total	Left	Thru	Right	Peds	App. Total	
Peak Hour Analysis From 04:00 PM to 05:45 PM - Peak 1 of 1																					
Peak Hour for Entire Intersection Begins at 04:30 PM																					
04:30 PM	13	216	19	0	248	11	145	4	0	160	17	0	12	0	29	5	1	12	0	18	455
04:45 PM	21	214	19	0	254	3	108	2	0	113	16	1	15	2	34	5	0	15	0	20	421
05:00 PM	16	<b>235</b>	18	0	269	9	<b>157</b>	5	0	<b>171</b>	11	2	14	0	27	6	0	16	0	22	<b>489</b>
05:15 PM	<b>25</b>	229	<b>24</b>	0	<b>278</b>	11	118	<b>8</b>	0	137	<b>18</b>	2	<b>17</b>	0	<b>37</b>	<b>7</b>	0	<b>18</b>	<b>2</b>	<b>27</b>	479
Total Volume	75	894	80	0	1049	34	528	19	0	581	62	5	58	2	127	23	1	61	2	87	1844
% App. Total	7.1	85.2	7.6	0		5.9	90.9	3.3	0		48.8	3.9	45.7	1.6		26.4	1.1	70.1	2.3		
PHF	.750	.951	.833	.000	.943	.773	.841	.594	.000	.849	.861	.625	.853	.250	.858	.821	.250	.847	.250	.806	.943

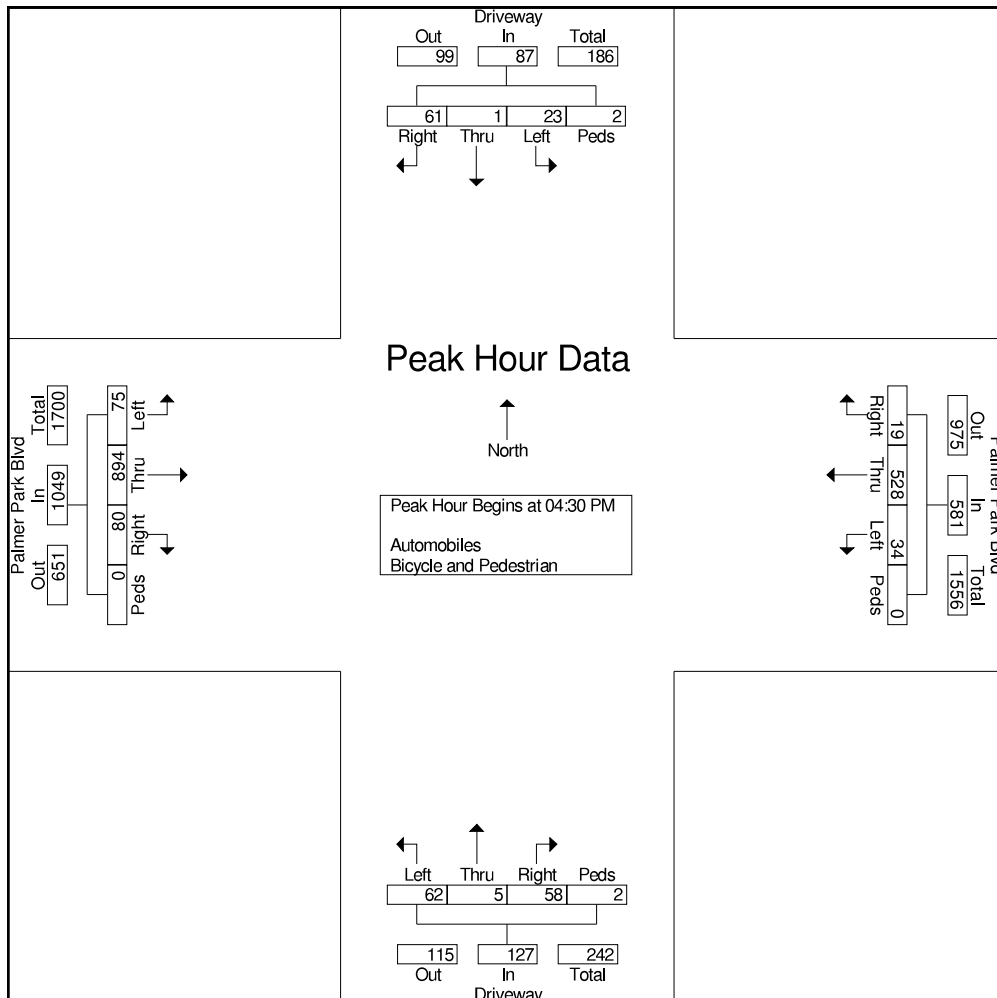



Ridgeview Data  
Collection

Colorado Springs, CO  
CO Springs Powers Blvd Count  
PM Peak  
Palmer Park Blvd Driveways

File Name : Palmer Park Driveways PM  
Site Code : Hales  
Start Date : 3/6/2024  
Page No : 4

Image 1

The number of pedestrians shown on this report is representative of the crossing on the approaching leg, i.e. pedestrians crossing the north side of the intersection are counted as pedestrians in the southbound crosswalk, as that is the approaching leg that they are crossing (see figure below). Diagonal crossings are counted on the two legs that will get the pedestrian to the same end point. Diagonals can be counted separately if discussed prior to count.

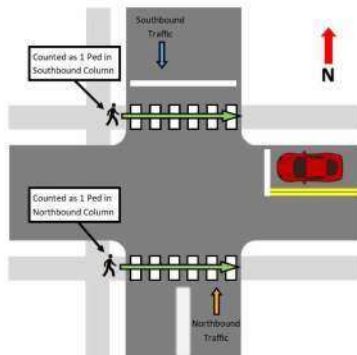



Ridgeview Data  
Collection

Colorado Springs, CO  
CO Springs Powers Blvd Count  
AM Peak  
Palmer Park Blvd and Paonia St

File Name : Palmer Park and Paonia AM  
Site Code : Hales  
Start Date : 3/6/2024  
Page No : 1

Groups Printed- Automobiles - Bicycle and Pedestrian

Start Time	Palmer Park Blvd Eastbound				Palmer Park Blvd Westbound				Paonia St Northbound				Int. Total
	Thru	Right	Peds	App. Total	Left	Thru	Peds	App. Total	Left	Right	Peds	App. Total	
07:00 AM	65	37	0	102	2	154	0	156	12	2	0	14	272
07:15 AM	69	30	0	99	6	152	0	158	10	4	1	15	272
07:30 AM	94	45	0	139	9	151	0	160	9	4	0	13	312
07:45 AM	92	51	0	143	7	147	0	154	10	8	0	18	315
Total	320	163	0	483	24	604	0	628	41	18	1	60	1171
08:00 AM	87	38	0	125	7	145	0	152	16	4	0	20	297
08:15 AM	50	37	0	87	8	112	0	120	9	10	0	19	226
08:30 AM	57	36	0	93	3	109	0	112	11	5	0	16	221
08:45 AM	48	31	0	79	5	94	0	99	22	1	0	23	201
Total	242	142	0	384	23	460	0	483	58	20	0	78	945
Grand Total	562	305	0	867	47	1064	0	1111	99	38	1	138	2116
Apprch %	64.8	35.2	0		4.2	95.8	0		71.7	27.5	0.7		
Total %	26.6	14.4	0	41	2.2	50.3	0	52.5	4.7	1.8	0	6.5	
Automobiles	562	305	0	867	47	1064	0	1111	99	38	0	137	2115
% Automobiles	100	100	0	100	100	100	0	100	100	100	0	99.3	100
Bicycle and Pedestrian	0	0	0	0	0	0	0	0	0	0	1	1	1
% Bicycle and Pedestrian	0	0	0	0	0	0	0	0	0	0	100	0.7	0





Ridgeview Data  
Collection

Colorado Springs, CO  
CO Springs Powers Blvd Count  
AM Peak  
Palmer Park Blvd and Paonia St

File Name : Palmer Park and Paonia AM  
Site Code : Hales  
Start Date : 3/6/2024  
Page No : 2

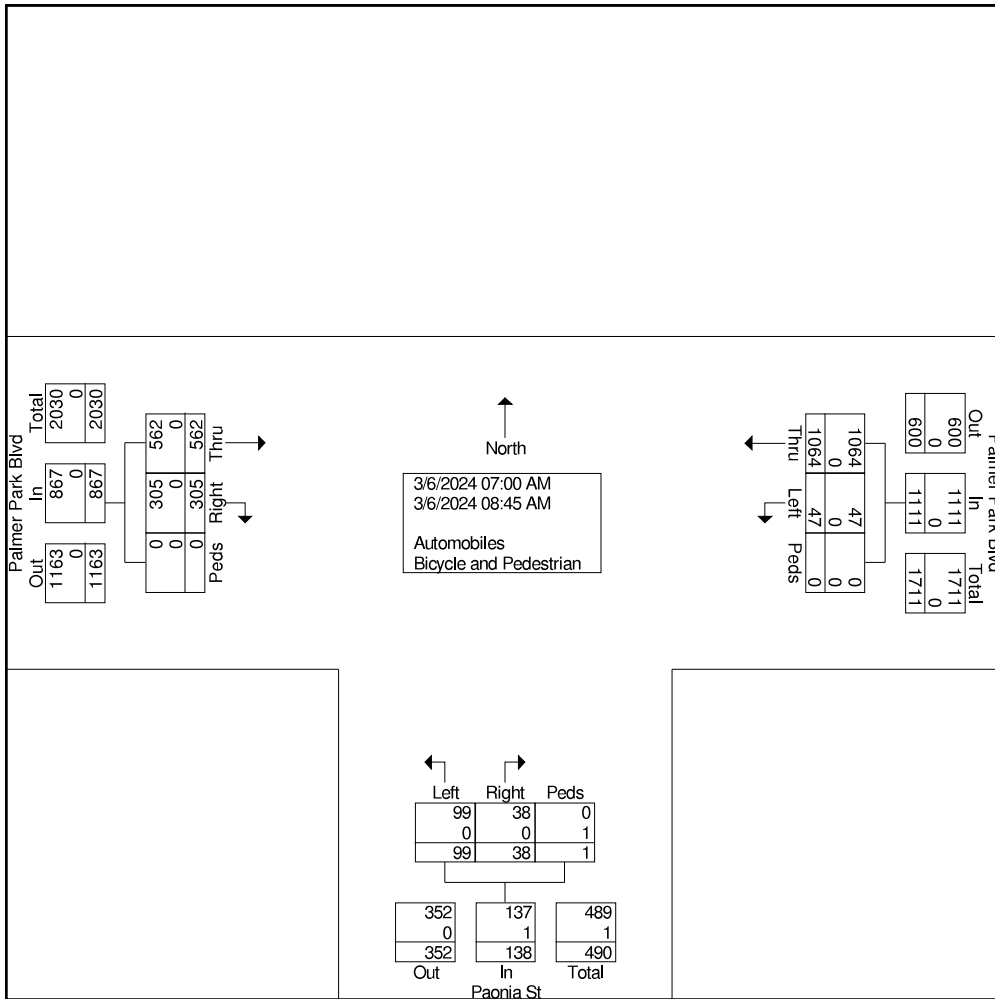



Ridgeview Data  
Collection

Colorado Springs, CO  
CO Springs Powers Blvd Count  
AM Peak  
Palmer Park Blvd and Paonia St

File Name : Palmer Park and Paonia AM  
Site Code : Hales  
Start Date : 3/6/2024  
Page No : 3

Start Time	Palmer Park Blvd Eastbound				Palmer Park Blvd Westbound				Paonia St Northbound				Int. Total
	Thru	Right	Peds	App. Total	Left	Thru	Peds	App. Total	Left	Right	Peds	App. Total	
Peak Hour Analysis From 07:00 AM to 08:45 AM - Peak 1 of 1													
Peak Hour for Entire Intersection Begins at 07:15 AM													
07:15 AM	69	30	0	99	6	152	0	158	10	4	1	15	272
07:30 AM	94	45	0	139	9	151	0	160	9	4	0	13	312
07:45 AM	92	51	0	143	7	147	0	154	10	8	0	18	315
08:00 AM	87	38	0	125	7	145	0	152	16	4	0	20	297
Total Volume	342	164	0	506	29	595	0	624	45	20	1	66	1196
% App. Total	67.6	32.4	0		4.6	95.4	0		68.2	30.3	1.5		
PHF	.910	.804	.000	.885	.806	.979	.000	.975	.703	.625	.250	.825	.949

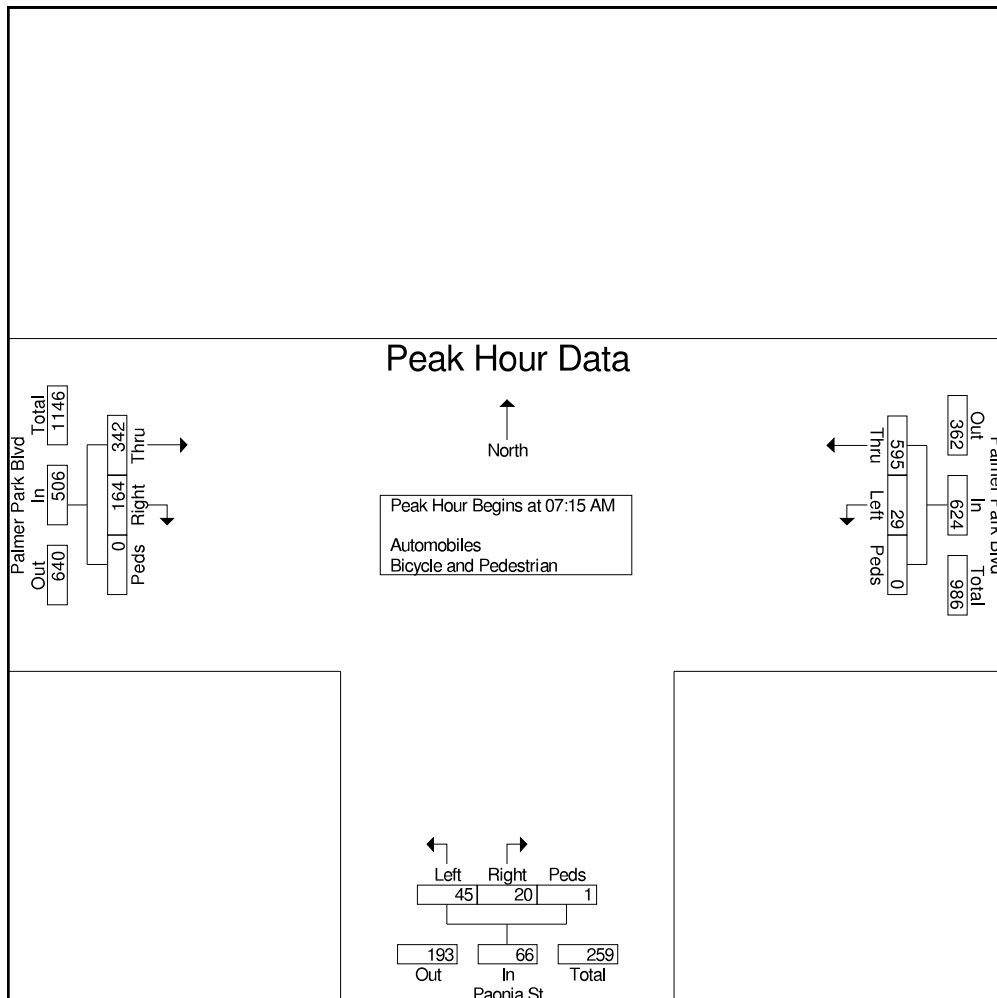



Ridgeview Data  
Collection

Colorado Springs, CO  
CO Springs Powers Blvd Count  
AM Peak  
Palmer Park Blvd and Paonia St

File Name : Palmer Park and Paonia AM  
Site Code : Hales  
Start Date : 3/6/2024  
Page No : 4

Image 1

The number of pedestrians shown on this report is representative of the crossing on the approaching leg, i.e. pedestrians crossing the north side of the intersection are counted as pedestrians in the southbound crosswalk, as that is the approaching leg that they are crossing (see figure below). Diagonal crossings are counted on the two legs that will get the pedestrian to the same end point. Diagonals can be counted separately if discussed prior to count.

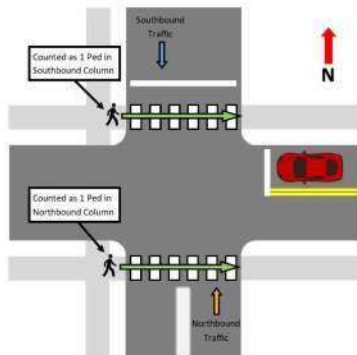





Ridgeview Data  
Collection

Colorado Springs, CO  
CO Springs Powers Blvd Count  
PM Peak  
Palmer Park Blvd and Paonia St

File Name : Palmer Park and Paonia PM  
Site Code : Hales  
Start Date : 3/6/2024  
Page No : 1

Groups Printed- Automobiles - Bicycle and Pedestrian

Start Time	Palmer Park Blvd Eastbound				Palmer Park Blvd Westbound				Paonia St Northbound				Int. Total
	Thru	Right	Peds	App. Total	Left	Thru	Peds	App. Total	Left	Right	Peds	App. Total	
04:00 PM	172	34	0	206	3	97	0	100	27	10	0	37	343
04:15 PM	171	38	0	209	3	91	0	94	34	11	0	45	348
04:30 PM	184	24	0	208	4	123	0	127	36	11	0	47	382
04:45 PM	179	21	0	200	3	82	0	85	24	15	0	39	324
Total	706	117	0	823	13	393	0	406	121	47	0	168	1397
05:00 PM	198	28	0	226	0	114	0	114	45	16	0	61	401
05:15 PM	211	23	0	234	1	100	0	101	35	9	2	46	381
05:30 PM	169	26	0	195	5	94	0	99	20	8	0	28	322
05:45 PM	149	24	0	173	1	84	0	85	7	5	0	12	270
Total	727	101	0	828	7	392	0	399	107	38	2	147	1374
Grand Total	1433	218	0	1651	20	785	0	805	228	85	2	315	2771
Apprch %	86.8	13.2	0		2.5	97.5	0		72.4	27	0.6		
Total %	51.7	7.9	0	59.6	0.7	28.3	0	29.1	8.2	3.1	0.1	11.4	
Automobiles	1433	218	0	1651	20	784	0	804	228	85	0	313	2768
% Automobiles	100	100	0	100	100	99.9	0	99.9	100	100	0	99.4	99.9
Bicycle and Pedestrian	0	0	0	0	0	1	0	1	0	0	2	2	3
% Bicycle and Pedestrian	0	0	0	0	0	0.1	0	0.1	0	0	100	0.6	0.1



Ridgeview Data Collection

Colorado Springs, CO  
CO Springs Powers Blvd Count  
PM Peak  
Palmer Park Blvd and Paonia St

File Name : Palmer Park and Paonia PM  
Site Code : Hales  
Start Date : 3/6/2024  
Page No : 2

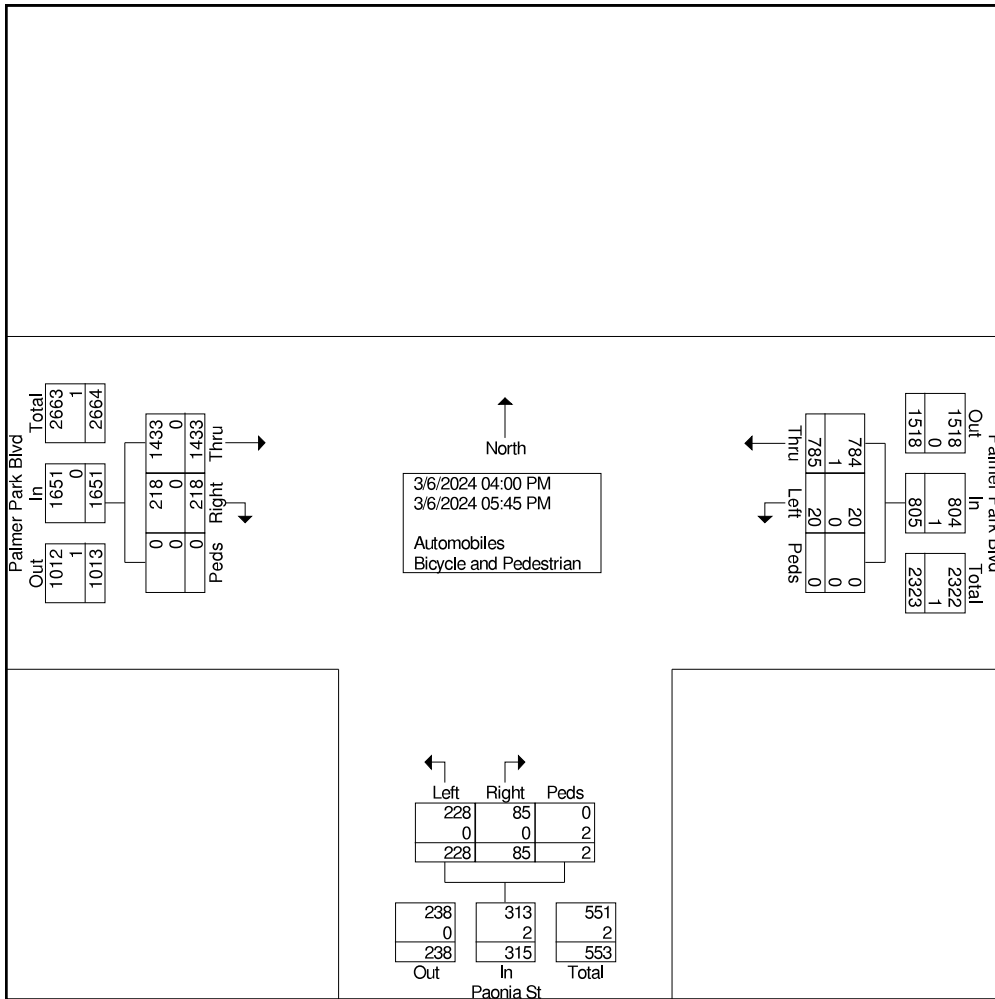



Ridgeview Data  
Collection

Colorado Springs, CO  
CO Springs Powers Blvd Count  
PM Peak  
Palmer Park Blvd and Paonia St

File Name : Palmer Park and Paonia PM  
Site Code : Hales  
Start Date : 3/6/2024  
Page No : 3

Start Time	Palmer Park Blvd Eastbound				Palmer Park Blvd Westbound				Paonia St Northbound				Int. Total
	Thru	Right	Peds	App. Total	Left	Thru	Peds	App. Total	Left	Right	Peds	App. Total	
Peak Hour Analysis From 04:00 PM to 05:45 PM - Peak 1 of 1													
Peak Hour for Entire Intersection Begins at 04:30 PM													
04:30 PM	184	24	0	208	4	123	0	127	36	11	0	47	382
04:45 PM	179	21	0	200	3	82	0	85	24	15	0	39	324
05:00 PM	198	28	0	226	0	114	0	114	45	16	0	61	401
05:15 PM	211	23	0	234	1	100	0	101	35	9	2	46	381
Total Volume	772	96	0	868	8	419	0	427	140	51	2	193	1488
% App. Total	88.9	11.1	0		1.9	98.1	0		72.5	26.4	1		
PHF	.915	.857	.000	.927	.500	.852	.000	.841	.778	.797	.250	.791	.928

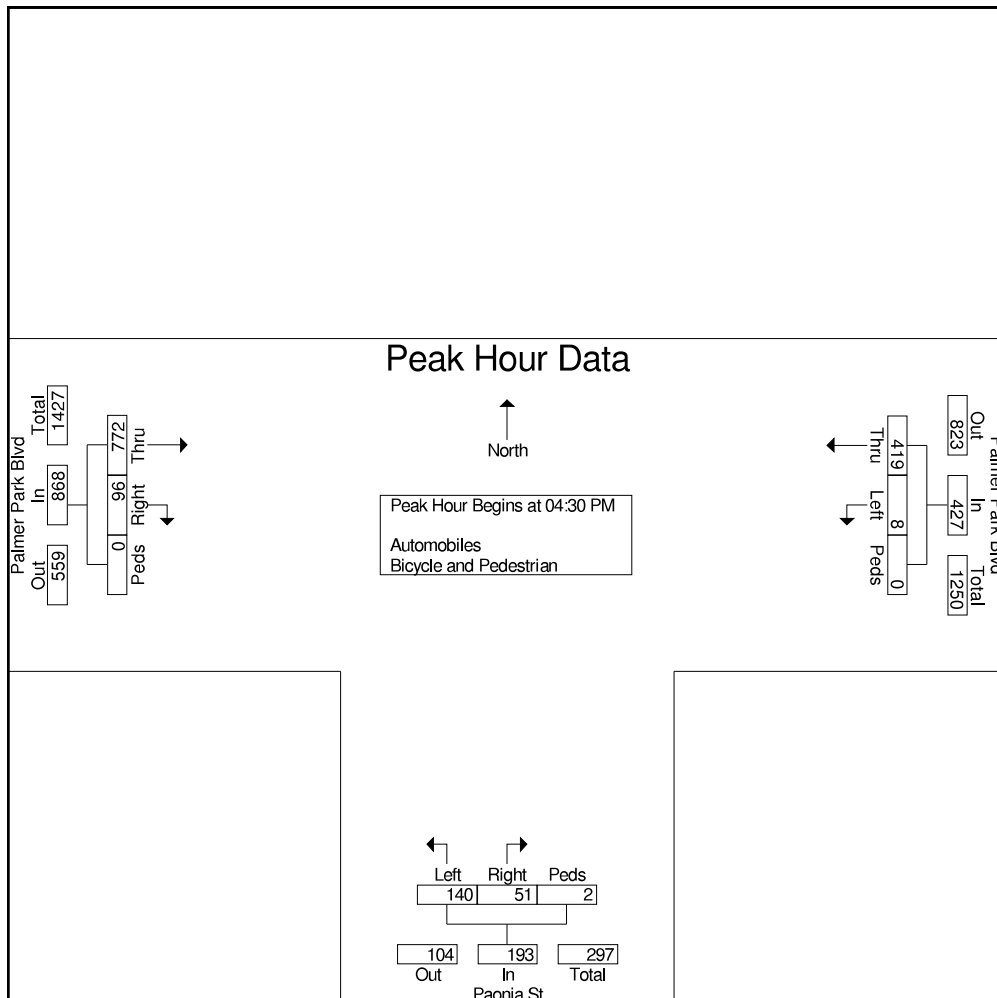



Ridgeview Data  
Collection

Colorado Springs, CO  
CO Springs Powers Blvd Count  
PM Peak  
Palmer Park Blvd and Paonia St

File Name : Palmer Park and Paonia PM  
Site Code : Hales  
Start Date : 3/6/2024  
Page No : 4

Image 1

The number of pedestrians shown on this report is representative of the crossing on the approaching leg, i.e. pedestrians crossing the north side of the intersection are counted as pedestrians in the southbound crosswalk, as that is the approaching leg that they are crossing (see figure below). Diagonal crossings are counted on the two legs that will get the pedestrian to the same end point. Diagonals can be counted separately if discussed prior to count.

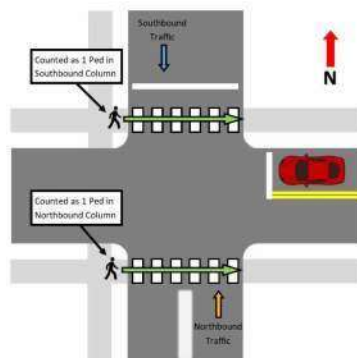





Ridgeview Data  
Collection

Colorado Springs, CO  
CO Springs Powers Blvd Count  
AM Peak  
Powers Blvd and Omaha Blvd

File Name : Powers and Omaha AM  
Site Code : Hales  
Start Date : 3/6/2024  
Page No : 1

Groups Printed- Automobiles - Bicycle and Pedestrian

Start Time	Omaha Blvd Westbound				Powers Blvd Northbound				Powers Blvd Southbound				Int. Total
	Left	Right	Peds	App. Total	Thru	Right	Peds	App. Total	Left	Thru	Peds	App. Total	
07:00 AM	0	13	0	13	481	25	0	506	0	775	1	776	1295
07:15 AM	0	36	0	36	496	15	0	511	0	819	0	819	1366
07:30 AM	0	44	0	44	569	21	0	590	0	842	0	842	1476
07:45 AM	0	38	0	38	564	22	0	586	0	778	0	778	1402
Total	0	131	0	131	2110	83	0	2193	0	3214	1	3215	5539
08:00 AM	0	32	0	32	460	18	0	478	0	711	0	711	1221
08:15 AM	0	34	0	34	451	25	0	476	0	685	0	685	1195
08:30 AM	0	30	0	30	464	18	0	482	0	679	0	679	1191
08:45 AM	0	31	0	31	427	35	0	462	0	581	0	581	1074
Total	0	127	0	127	1802	96	0	1898	0	2656	0	2656	4681
Grand Total	0	258	0	258	3912	179	0	4091	0	5870	1	5871	10220
Apprch %	0	100	0		95.6	4.4	0		0	100	0		
Total %	0	2.5	0	2.5	38.3	1.8	0	40	0	57.4	0	57.4	
Automobiles	0	258	0	258	3912	179	0	4091	0	5870	0	5870	10219
% Automobiles	0	100	0	100	100	100	0	100	0	100	0	100	100
Bicycle and Pedestrian	0	0	0	0	0	0	0	0	0	0	1	1	1
% Bicycle and Pedestrian	0	0	0	0	0	0	0	0	0	0	100	0	0



Ridgeview Data  
Collection

Colorado Springs, CO  
CO Springs Powers Blvd Count  
AM Peak  
Powers Blvd and Omaha Blvd

File Name : Powers and Omaha AM  
Site Code : Hales  
Start Date : 3/6/2024  
Page No : 2

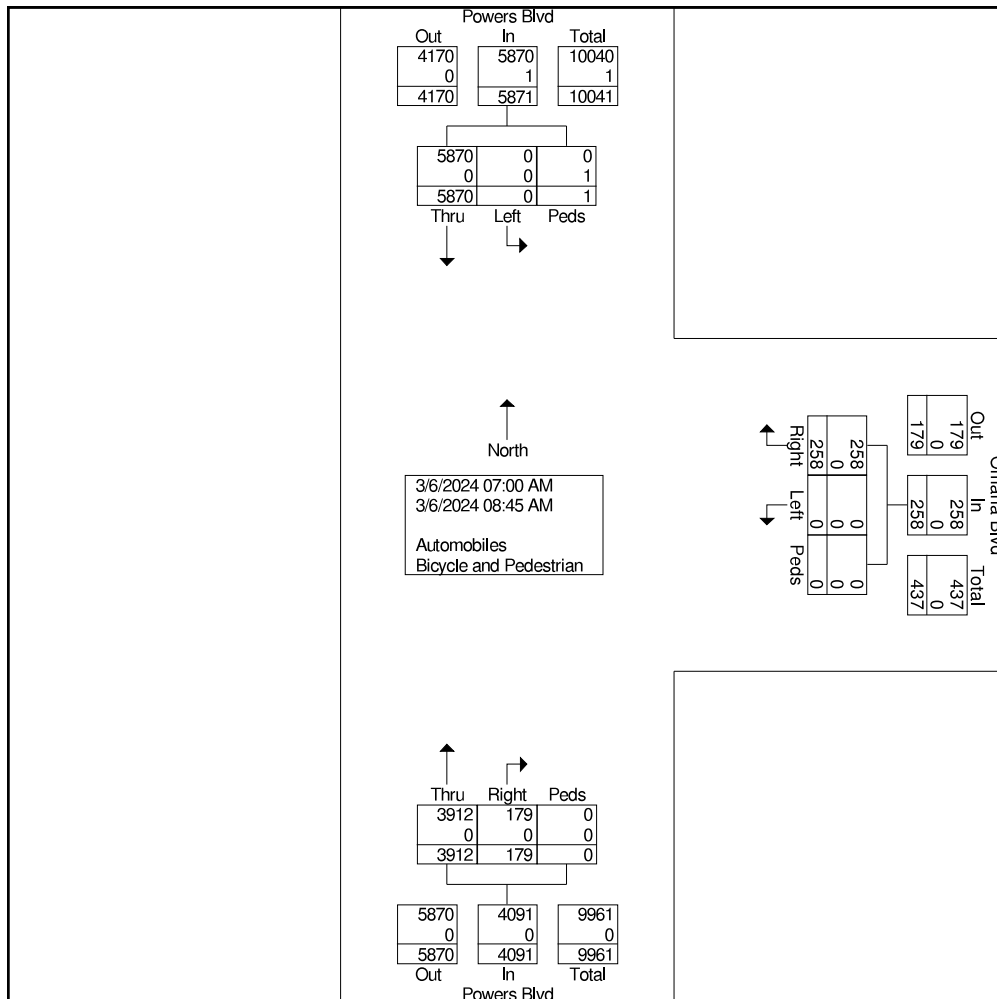



Ridgeview Data  
Collection

Colorado Springs, CO  
CO Springs Powers Blvd Count  
AM Peak  
Powers Blvd and Omaha Blvd

File Name : Powers and Omaha AM  
Site Code : Hales  
Start Date : 3/6/2024  
Page No : 3

Start Time	Omaha Blvd Westbound				Powers Blvd Northbound				Powers Blvd Southbound				Int. Total
	Left	Right	Peds	App. Total	Thru	Right	Peds	App. Total	Left	Thru	Peds	App. Total	
Peak Hour Analysis From 07:00 AM to 08:45 AM - Peak 1 of 1													
Peak Hour for Entire Intersection Begins at 07:00 AM													
07:00 AM	0	13	0	13	481	25	0	506	0	775	1	776	1295
07:15 AM	0	36	0	36	496	15	0	511	0	819	0	819	1366
07:30 AM	0	44	0	44	569	21	0	590	0	842	0	842	1476
07:45 AM	0	38	0	38	564	22	0	586	0	778	0	778	1402
Total Volume	0	131	0	131	2110	83	0	2193	0	3214	1	3215	5539
% App. Total	0	100	0		96.2	3.8	0		0	100	0		
PHF	.000	.744	.000	.744	.927	.830	.000	.929	.000	.954	.250	.955	.938

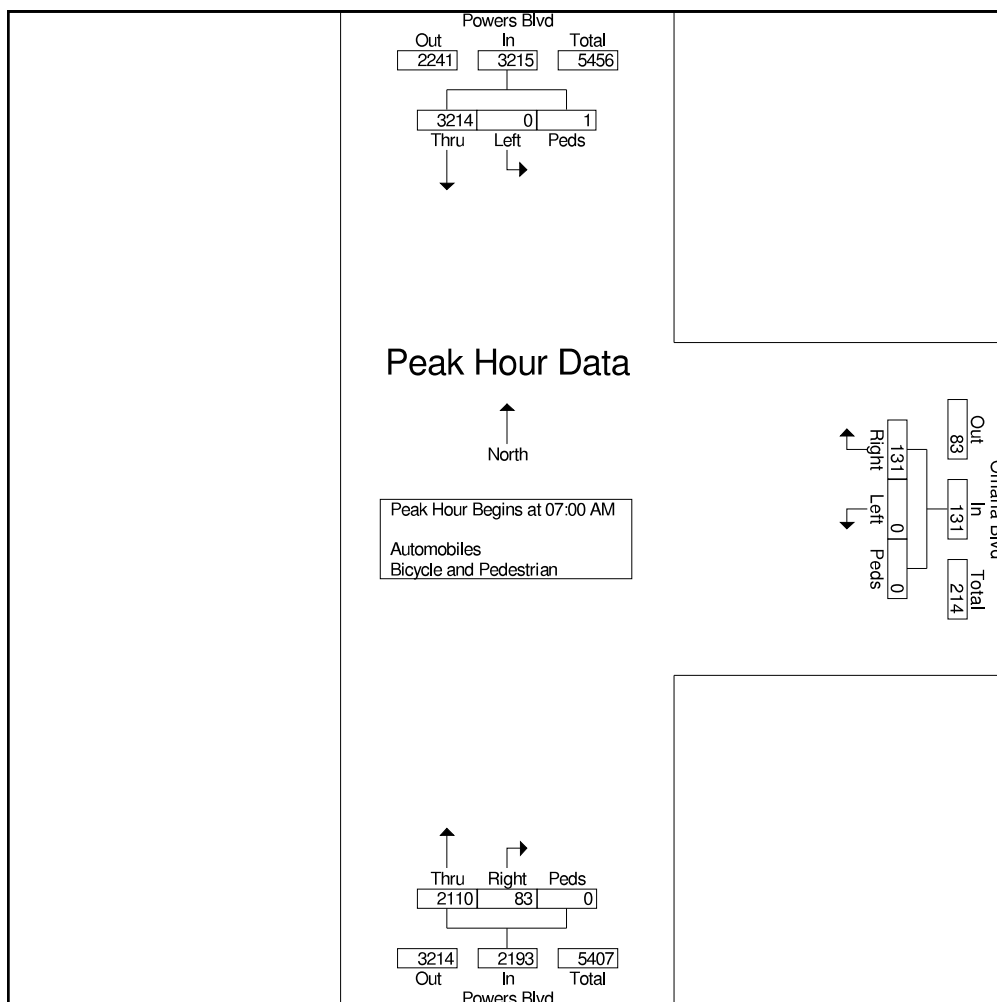



Ridgeview Data  
Collection

Colorado Springs, CO  
CO Springs Powers Blvd Count  
AM Peak  
Powers Blvd and Omaha Blvd

File Name : Powers and Omaha AM  
Site Code : Hales  
Start Date : 3/6/2024  
Page No : 4

Image 1

The number of pedestrians shown on this report is representative of the crossing on the approaching leg, i.e. pedestrians crossing the north side of the intersection are counted as pedestrians in the southbound crosswalk, as that is the approaching leg that they are crossing (see figure below). Diagonal crossings are counted on the two legs that will get the pedestrian to the same end point. Diagonals can be counted separately if discussed prior to count.

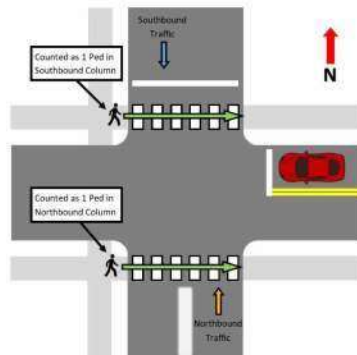







Ridgeview Data  
Collection

Colorado Springs, CO  
CO Springs Powers Blvd Count  
PM Peak  
Powers Blvd and Omaha Blvd

File Name : Powers and Omaha PM  
Site Code : Hales  
Start Date : 3/6/2024  
Page No : 2

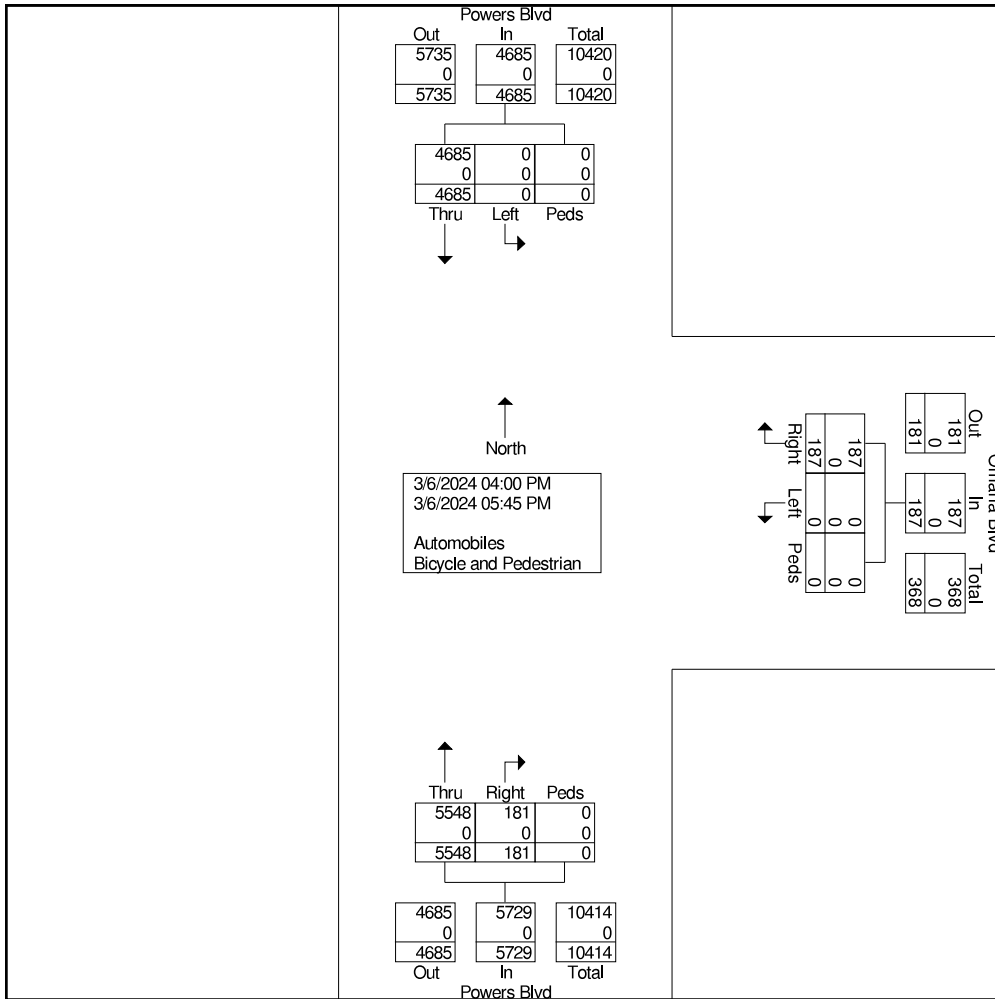



Ridgeview Data  
Collection

Colorado Springs, CO  
CO Springs Powers Blvd Count  
PM Peak  
Powers Blvd and Omaha Blvd

File Name : Powers and Omaha PM  
Site Code : Hales  
Start Date : 3/6/2024  
Page No : 3

Start Time	Omaha Blvd Westbound				Powers Blvd Northbound				Powers Blvd Southbound				Int. Total
	Left	Right	Peds	App. Total	Thru	Right	Peds	App. Total	Left	Thru	Peds	App. Total	
Peak Hour Analysis From 04:00 PM to 05:45 PM - Peak 1 of 1													
Peak Hour for Entire Intersection Begins at 05:00 PM													
05:00 PM	0	38	0	38	744	26	0	770	0	612	0	612	1420
05:15 PM	0	26	0	26	694	27	0	721	0	555	0	555	1302
05:30 PM	0	22	0	22	665	15	0	680	0	642	0	642	1344
05:45 PM	0	13	0	13	660	22	0	682	0	556	0	556	1251
Total Volume	0	99	0	99	2763	90	0	2853	0	2365	0	2365	5317
% App. Total	0	100	0		96.8	3.2	0		0	100	0		
PHF	.000	.651	.000	.651	.928	.833	.000	.926	.000	.921	.000	.921	.936

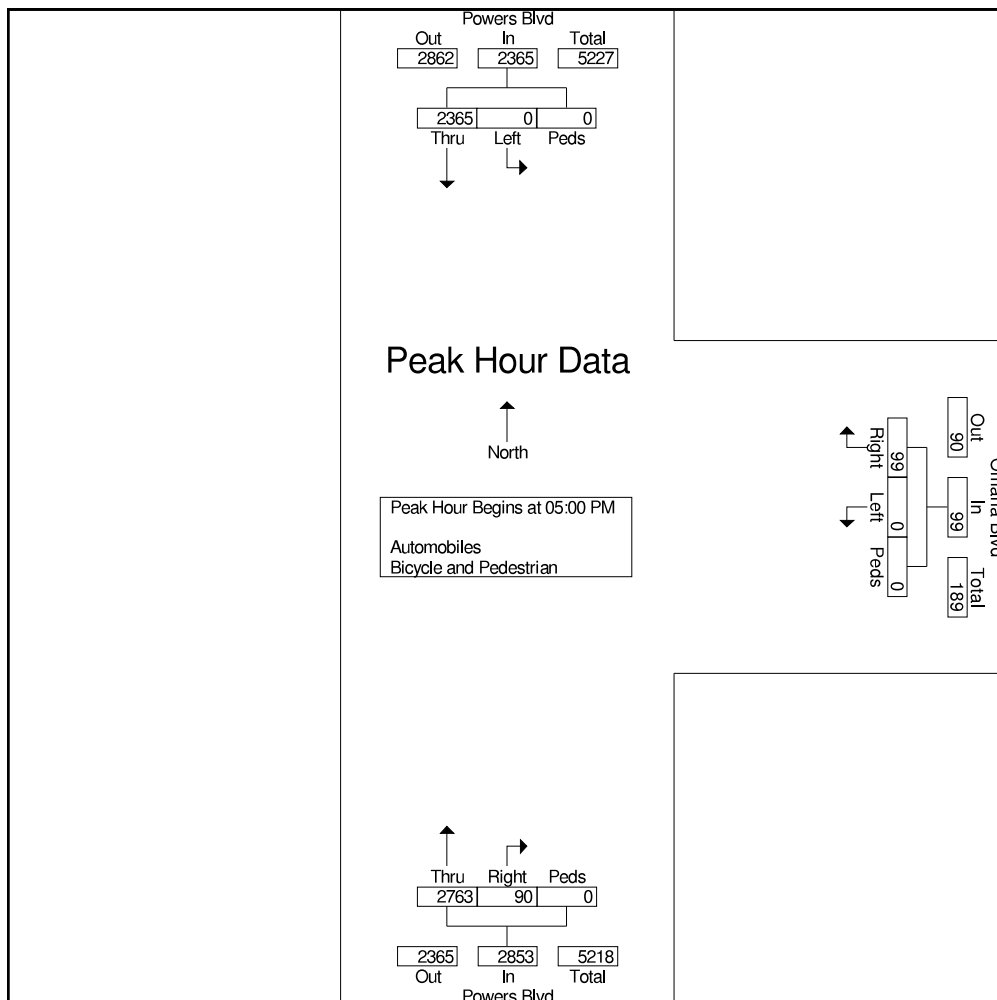



Ridgeview Data  
Collection

Colorado Springs, CO  
CO Springs Powers Blvd Count  
PM Peak  
Powers Blvd and Omaha Blvd

File Name : Powers and Omaha PM  
Site Code : Hales  
Start Date : 3/6/2024  
Page No : 4

Image 1

The number of pedestrians shown on this report is representative of the crossing on the approaching leg, i.e. pedestrians crossing the north side of the intersection are counted as pedestrians in the southbound crosswalk, as that is the approaching leg that they are crossing (see figure below). Diagonal crossings are counted on the two legs that will get the pedestrian to the same end point. Diagonals can be counted separately if discussed prior to count.

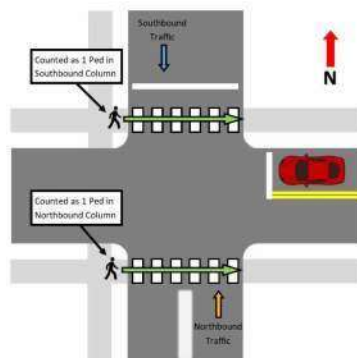





Colorado Springs, CO  
 CO Springs Powers Blvd Count  
 AM Peak  
 Omaha Blvd Driveways

File Name : Omaha Blvd Driveways AM  
 Site Code : Hales  
 Start Date : 3/6/2024  
 Page No : 1

Groups Printed- Automobiles - Bicycle and Pedestrian

Start Time	Omaha Blvd Eastbound					Omaha Blvd Westbound					Driveway Northbound					Driveway Southbound					Int. Total
	Left	Thru	Right	Peds	App. Total	Left	Thru	Right	Peds	App. Total	Left	Thru	Right	Peds	App. Total	Left	Thru	Right	Peds	App. Total	
07:00 AM	5	19	1	0	25	0	13	4	0	17	0	0	0	0	0	9	0	0	0	9	51
07:15 AM	1	14	0	0	15	0	37	4	0	41	0	0	1	0	1	10	2	0	0	12	69
07:30 AM	5	14	3	0	22	3	42	6	0	51	1	1	0	0	2	2	2	0	0	4	79
07:45 AM	3	16	3	0	22	2	34	9	0	45	2	1	4	0	7	7	1	2	0	10	84
Total	14	63	7	0	84	5	126	23	0	154	3	2	5	0	10	28	5	2	0	35	283
08:00 AM	6	9	2	0	17	5	29	11	0	45	0	1	2	0	3	6	1	3	0	10	75
08:15 AM	6	15	3	0	24	2	32	8	0	42	1	0	2	0	3	10	3	1	0	14	83
08:30 AM	3	12	4	1	20	3	28	11	1	43	1	1	4	1	7	4	1	1	0	6	76
08:45 AM	7	22	6	0	35	1	29	6	0	36	1	0	4	0	5	11	1	1	0	13	89
Total	22	58	15	1	96	11	118	36	1	166	3	2	12	1	18	31	6	6	0	43	323
Grand Total	36	121	22	1	180	16	244	59	1	320	6	4	17	1	28	59	11	8	0	78	606
Apprch %	20	67.2	12.2	0.6		5	76.2	18.4	0.3		21.4	14.3	60.7	3.6		75.6	14.1	10.3	0		
Total %	5.9	20	3.6	0.2	29.7	2.6	40.3	9.7	0.2	52.8	1	0.7	2.8	0.2	4.6	9.7	1.8	1.3	0	12.9	
Automobiles	36	121	22	0	179	16	244	59	0	319	6	4	17	0	27	59	11	8	0	78	603
% Automobiles	100	100	100	0	99.4	100	100	100	0	99.7	100	100	100	0	96.4	100	100	100	0	100	99.5
Bicycle and Pedestrian	0	0	0	1	1	0	0	0	1	1	0	0	0	1	1	0	0	0	0	0	3
% Bicycle and Pedestrian	0	0	0	100	0.6	0	0	0	100	0.3	0	0	0	100	3.6	0	0	0	0	0	0.5



Ridgeview Data Collection

Colorado Springs, CO  
CO Springs Powers Blvd Count  
AM Peak  
Omaha Blvd Driveways

File Name : Omaha Blvd Driveways AM  
Site Code : Hales  
Start Date : 3/6/2024  
Page No : 2

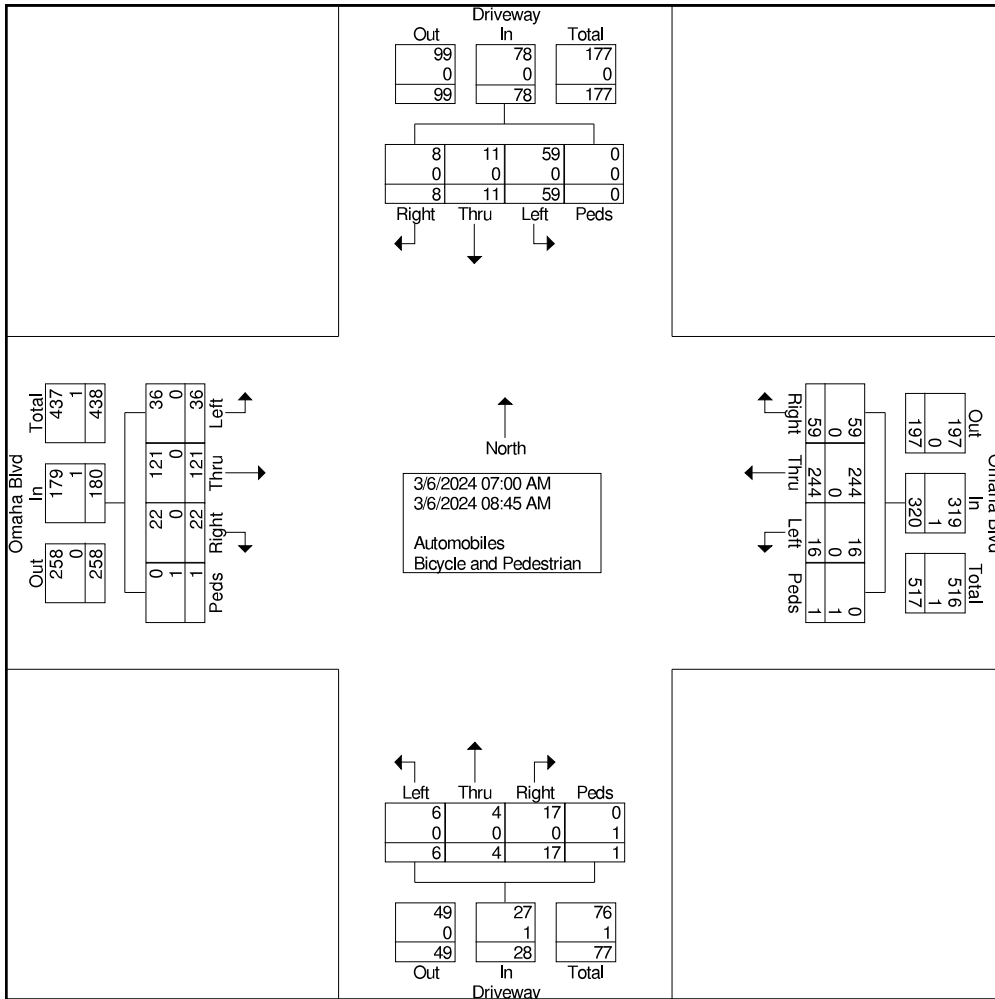



Ridgeview Data  
Collection

Colorado Springs, CO  
CO Springs Powers Blvd Count  
AM Peak  
Omaha Blvd Driveways

File Name : Omaha Blvd Driveways AM  
Site Code : Hales  
Start Date : 3/6/2024  
Page No : 3

Start Time	Omaha Blvd Eastbound					Omaha Blvd Westbound					Driveway Northbound					Driveway Southbound					Int. Total
	Left	Thru	Right	Peds	App. Total	Left	Thru	Right	Peds	App. Total	Left	Thru	Right	Peds	App. Total	Left	Thru	Right	Peds	App. Total	
Peak Hour Analysis From 07:00 AM to 08:45 AM - Peak 1 of 1																					
Peak Hour for Entire Intersection Begins at 08:00 AM																					
08:00 AM	6	9	2	0	17	5	29	11	0	45	0	1	2	0	3	6	1	3	0	10	75
08:15 AM	6	15	3	0	24	2	32	8	0	42	1	0	2	0	3	10	3	1	0	14	83
08:30 AM	3	12	4	1	20	3	28	11	1	43	1	1	4	1	7	4	1	1	0	6	76
08:45 AM	7	22	6	0	35	1	29	6	0	36	1	0	4	0	5	11	1	1	0	13	89
Total Volume	22	58	15	1	96	11	118	36	1	166	3	2	12	1	18	31	6	6	0	43	323
% App. Total	22.9	60.4	15.6	1		6.6	71.1	21.7	0.6		16.7	11.1	66.7	5.6		72.1	14	14	0		
PHF	.786	.659	.625	.250	.686	.550	.922	.818	.250	.922	.750	.500	.750	.250	.643	.705	.500	.500	.000	.768	.907

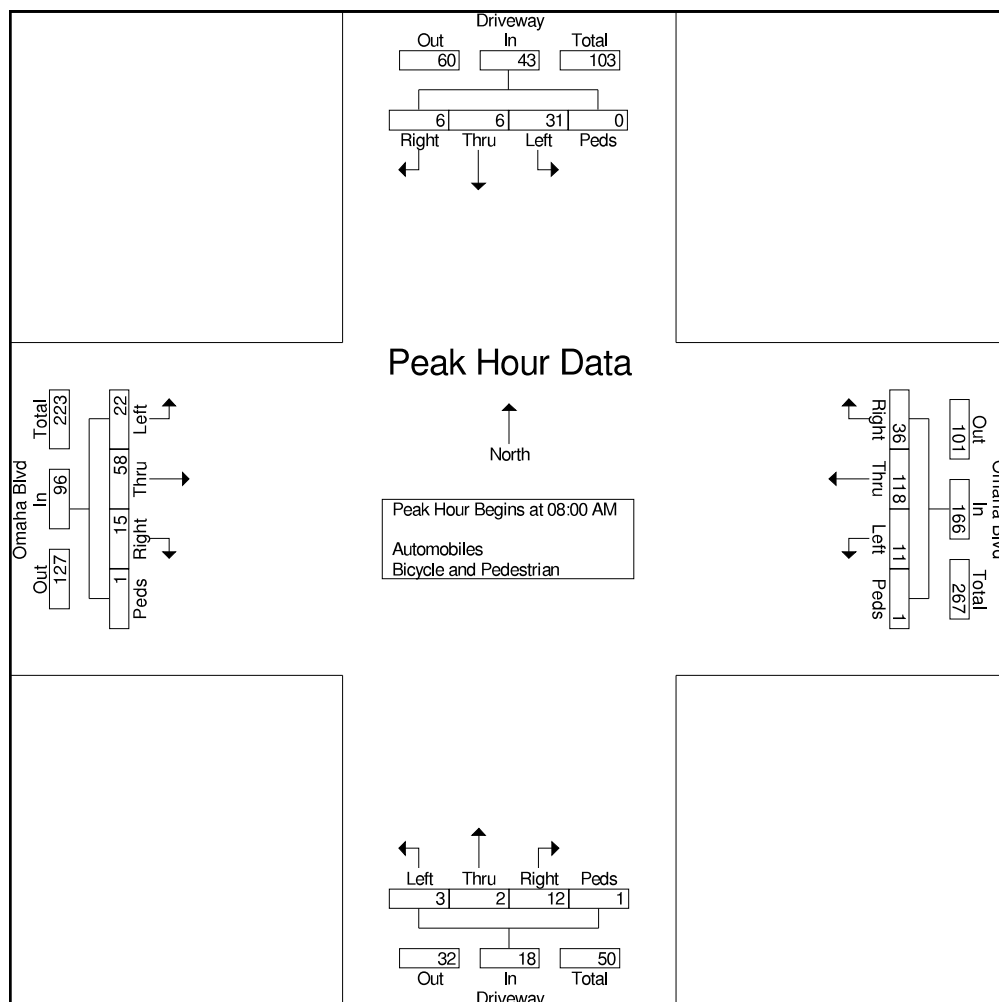



Ridgeview Data  
Collection

Colorado Springs, CO  
CO Springs Powers Blvd Count  
AM Peak  
Omaha Blvd Driveways

File Name : Omaha Blvd Driveways AM  
Site Code : Hales  
Start Date : 3/6/2024  
Page No : 4

Image 1

The number of pedestrians shown on this report is representative of the crossing on the approaching leg, i.e. pedestrians crossing the north side of the intersection are counted as pedestrians in the southbound crosswalk, as that is the approaching leg that they are crossing (see figure below). Diagonal crossings are counted on the two legs that will get the pedestrian to the same end point. Diagonals can be counted separately if discussed prior to count.

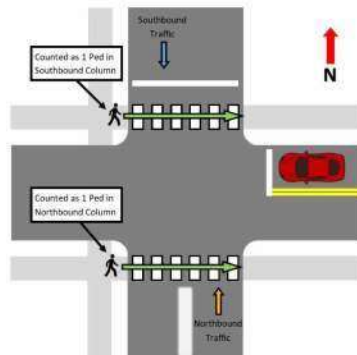







Ridgeview Data Collection

Colorado Springs, CO  
CO Springs Powers Blvd Count  
PM Peak  
Omaha Blvd Driveways

File Name : Omaha Blvd Driveways PM  
Site Code : Hales  
Start Date : 3/6/2024  
Page No : 2

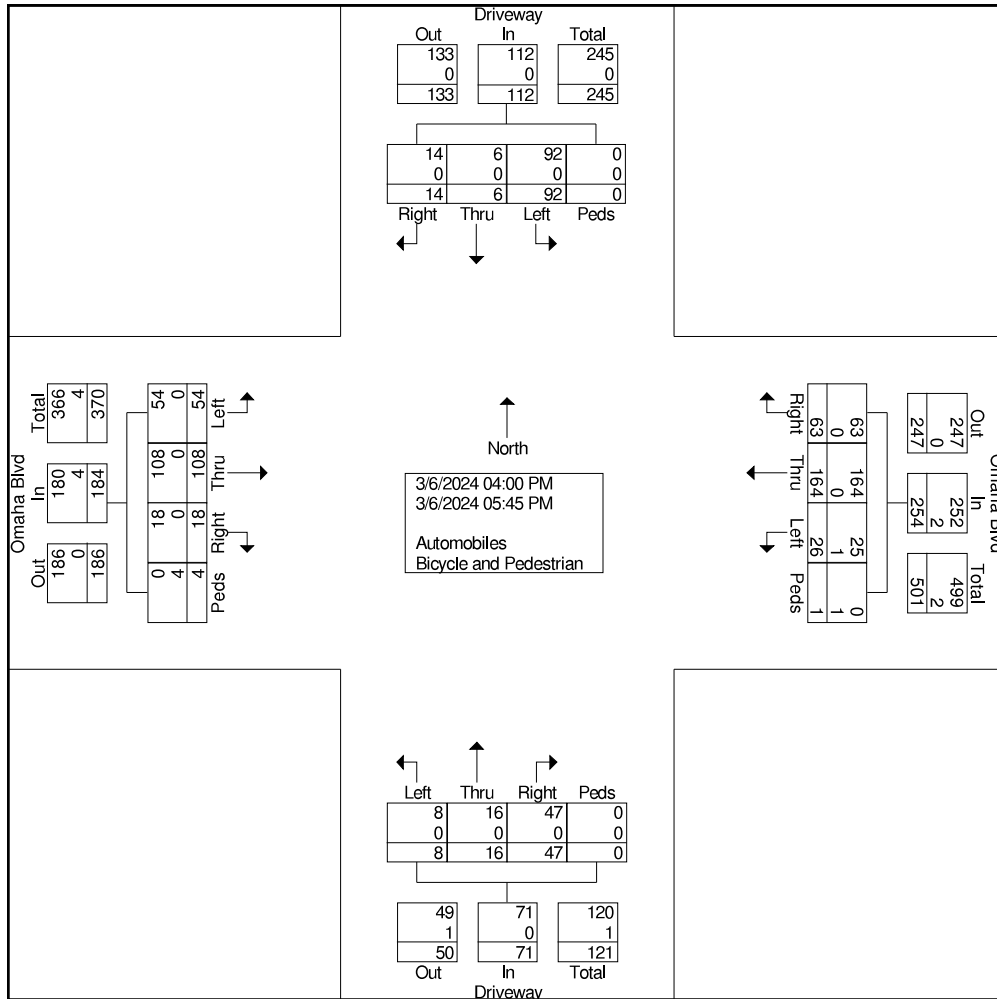



Ridgeview Data  
Collection

Colorado Springs, CO  
CO Springs Powers Blvd Count  
PM Peak  
Omaha Blvd Driveways

File Name : Omaha Blvd Driveways PM  
Site Code : Hales  
Start Date : 3/6/2024  
Page No : 3

Start Time	Omaha Blvd Eastbound					Omaha Blvd Westbound					Driveway Northbound					Driveway Southbound					Int. Total
	Left	Thru	Right	Peds	App. Total	Left	Thru	Right	Peds	App. Total	Left	Thru	Right	Peds	App. Total	Left	Thru	Right	Peds	App. Total	
Peak Hour Analysis From 04:00 PM to 05:45 PM - Peak 1 of 1																					
Peak Hour for Entire Intersection Begins at 04:30 PM																					
04:30 PM	9	18	3	2	32	2	22	6	0	30	1	2	6	0	9	13	1	0	0	14	85
04:45 PM	5	13	1	0	19	4	17	11	0	32	1	2	6	0	9	14	1	0	0	15	75
05:00 PM	10	16	0	0	26	5	32	8	0	45	3	2	5	0	10	7	2	3	0	12	93
05:15 PM	9	16	0	1	26	2	19	6	0	27	2	3	7	0	12	17	1	5	0	23	88
Total Volume	33	63	4	3	103	13	90	31	0	134	7	9	24	0	40	51	5	8	0	64	341
% App. Total	32	61.2	3.9	2.9		9.7	67.2	23.1	0		17.5	22.5	60	0		79.7	7.8	12.5	0		
PHF	.825	.875	.333	.375	.805	.650	.703	.705	.000	.744	.583	.750	.857	.000	.833	.750	.625	.400	.000	.696	.917

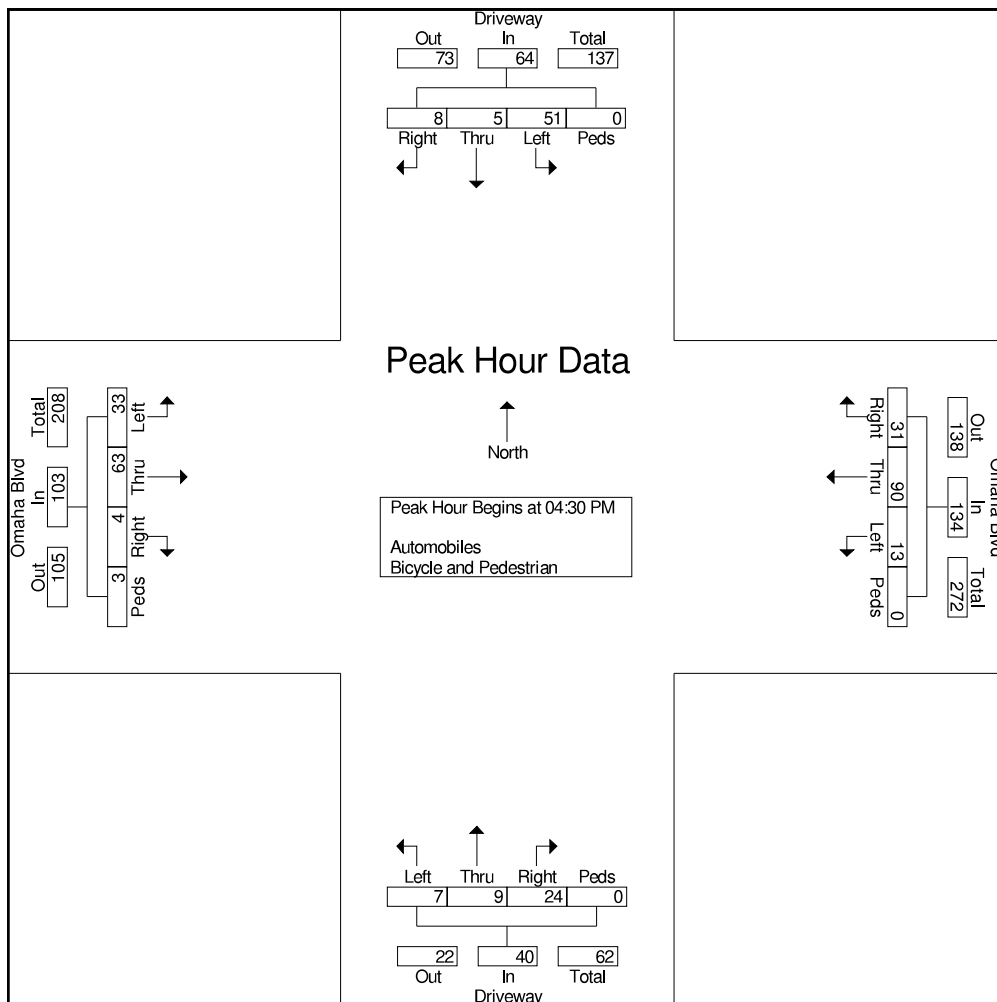



Ridgeview Data  
Collection

Colorado Springs, CO  
CO Springs Powers Blvd Count  
PM Peak  
Omaha Blvd Driveways

File Name : Omaha Blvd Driveways PM  
Site Code : Hales  
Start Date : 3/6/2024  
Page No : 4

Image 1

The number of pedestrians shown on this report is representative of the crossing on the approaching leg, i.e. pedestrians crossing the north side of the intersection are counted as pedestrians in the southbound crosswalk, as that is the approaching leg that they are crossing (see figure below). Diagonal crossings are counted on the two legs that will get the pedestrian to the same end point. Diagonals can be counted separately if discussed prior to count.

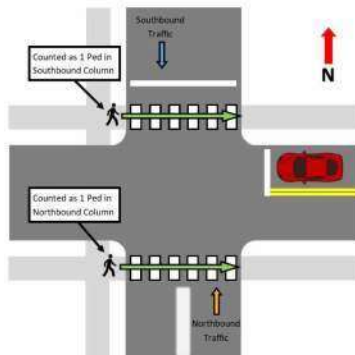





Ridgeview Data Collection

Colorado Springs, CO  
CO Springs Powers Blvd Count  
AM Peak  
Omaha Blvd and Paonia St

File Name : Omaha and Paonia AM  
Site Code : Hales  
Start Date : 3/6/2024  
Page No : 2

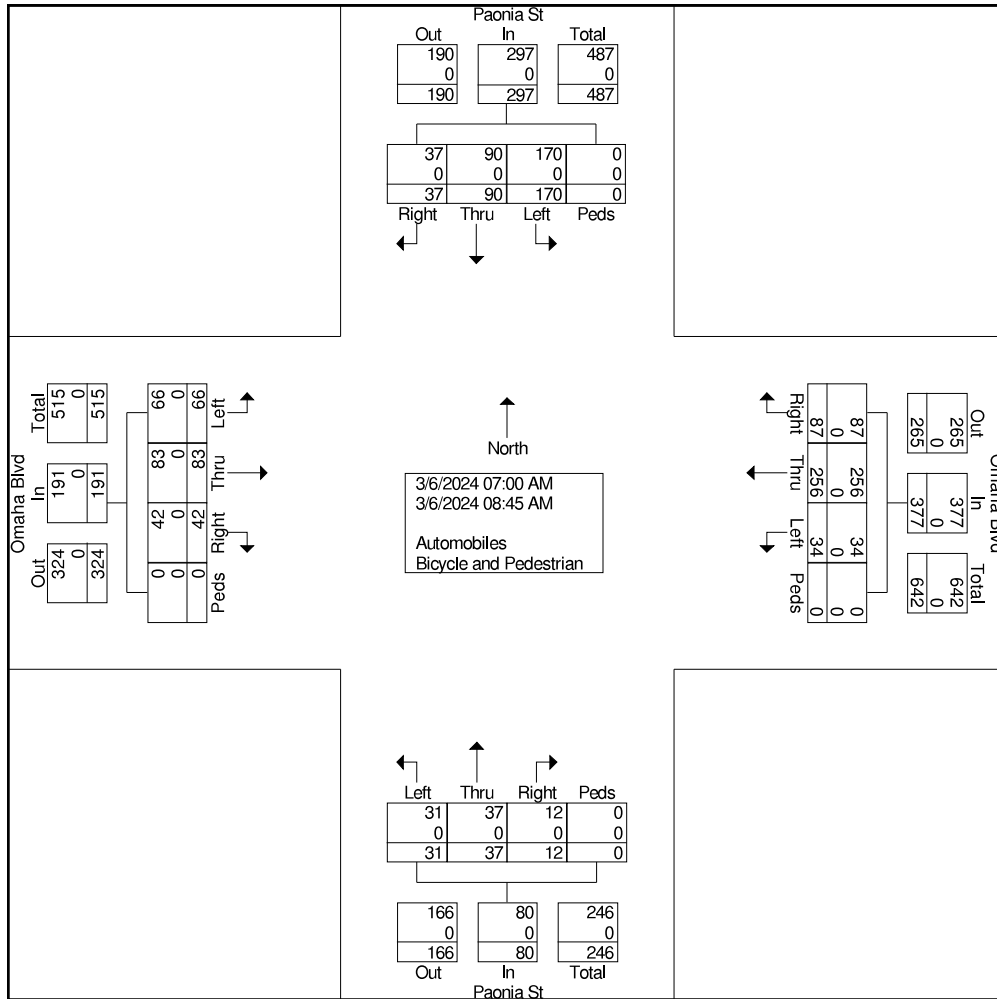





Ridgeview Data  
Collection

Colorado Springs, CO  
CO Springs Powers Blvd Count  
AM Peak  
Omaha Blvd and Paonia St

File Name : Omaha and Paonia AM  
Site Code : Hales  
Start Date : 3/6/2024  
Page No : 3

Start Time	Omaha Blvd Eastbound					Omaha Blvd Westbound					Paonia St Northbound					Paonia St Southbound					Int. Total
	Left	Thru	Right	Peds	App. Total	Left	Thru	Right	Peds	App. Total	Left	Thru	Right	Peds	App. Total	Left	Thru	Right	Peds	App. Total	
Peak Hour Analysis From 07:00 AM to 08:45 AM - Peak 1 of 1																					
Peak Hour for Entire Intersection Begins at 07:15 AM																					
07:15 AM	7	10	6	0	23	3	39	15	0	57	0	2	3	0	5	19	20	3	0	42	127
07:30 AM	9	6	3	0	18	5	37	16	0	58	5	3	0	0	8	25	16	7	0	48	132
07:45 AM	8	10	6	0	24	4	37	11	0	52	4	1	0	0	5	24	8	6	0	38	119
08:00 AM	7	6	5	0	18	2	33	10	0	45	4	11	0	0	15	17	14	7	0	38	116
Total Volume	31	32	20	0	83	14	146	52	0	212	13	17	3	0	33	85	58	23	0	166	494
% App. Total	37.3	38.6	24.1	0		6.6	68.9	24.5	0		39.4	51.5	9.1	0		51.2	34.9	13.9	0		
PHF	.861	.800	.833	.000	.865	.700	.936	.813	.000	.914	.650	.386	.250	.000	.550	.850	.725	.821	.000	.865	.936

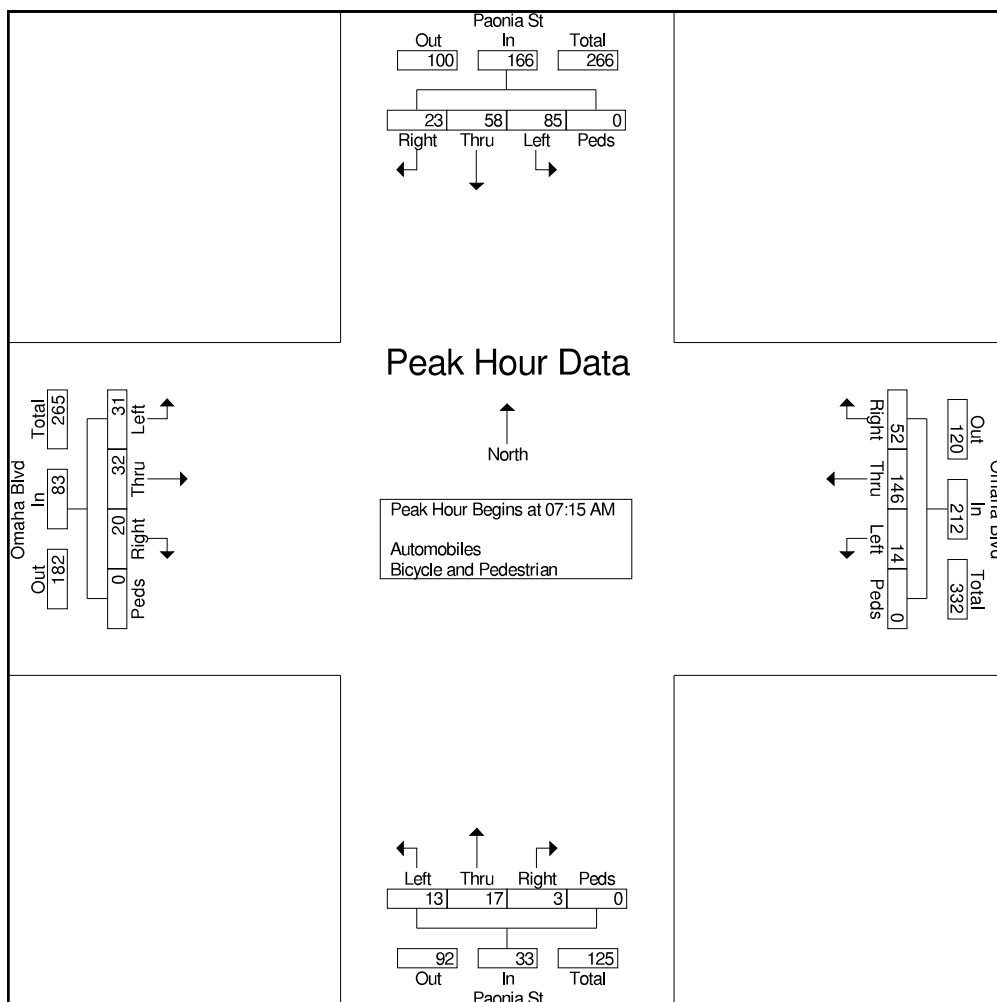



Ridgeview Data  
Collection

Colorado Springs, CO  
CO Springs Powers Blvd Count  
AM Peak  
Omaha Blvd and Paonia St

File Name : Omaha and Paonia AM  
Site Code : Hales  
Start Date : 3/6/2024  
Page No : 4

Image 1

The number of pedestrians shown on this report is representative of the crossing on the approaching leg, i.e. pedestrians crossing the north side of the intersection are counted as pedestrians in the southbound crosswalk, as that is the approaching leg that they are crossing (see figure below). Diagonal crossings are counted on the two legs that will get the pedestrian to the same end point. Diagonals can be counted separately if discussed prior to count.

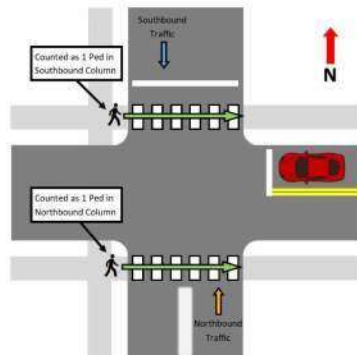



Ridgeview Data  
Collection

Colorado Springs, CO  
CO Springs Powers Blvd Count  
PM Peak  
Omaha Blvd and Paonia St

File Name : Omaha and Paonia PM  
Site Code : Hales  
Start Date : 3/6/2024  
Page No : 1

Groups Printed- Automobiles - Bicycle and Pedestrian

Start Time	Omaha Blvd Eastbound					Omaha Blvd Westbound					Paonia St Northbound					Paonia St Southbound					Int. Total
	Left	Thru	Right	Peds	App. Total	Left	Thru	Right	Peds	App. Total	Left	Thru	Right	Peds	App. Total	Left	Thru	Right	Peds	App. Total	
04:00 PM	4	18	10	0	32	2	20	2	0	24	4	6	1	0	11	27	14	2	0	43	110
04:15 PM	6	21	5	0	32	1	31	1	0	33	6	17	4	0	27	30	10	5	0	45	137
04:30 PM	4	21	11	0	36	0	28	0	0	28	0	12	3	0	15	17	14	3	0	34	113
04:45 PM	9	17	3	0	29	2	19	2	0	23	11	19	4	0	34	19	4	0	0	23	109
Total	23	77	29	0	129	5	98	5	0	108	21	54	12	0	87	93	42	10	0	145	469
05:00 PM	19	12	10	0	41	0	38	0	0	38	9	18	4	0	31	26	7	4	0	37	147
05:15 PM	8	29	9	0	46	2	23	2	0	27	2	9	3	0	14	28	8	0	0	36	123
05:30 PM	6	20	3	0	29	2	23	2	0	27	2	4	5	0	11	27	4	3	0	34	101
05:45 PM	1	21	4	0	26	1	19	1	0	21	1	3	2	0	6	22	3	1	0	26	79
Total	34	82	26	0	142	5	103	5	0	113	14	34	14	0	62	103	22	8	0	133	450
Grand Total	57	159	55	0	271	10	201	10	0	221	35	88	26	0	149	196	64	18	0	278	919
Apprch %	21	58.7	20.3	0		4.5	91	4.5	0		23.5	59.1	17.4	0		70.5	23	6.5	0		
Total %	6.2	17.3	6	0	29.5	1.1	21.9	1.1	0	24	3.8	9.6	2.8	0	16.2	21.3	7	2	0	30.3	
Automobiles	57	159	55	0	271	10	201	10	0	221	35	88	26	0	149	196	64	18	0	278	919
% Automobiles	100	100	100	0	100	100	100	100	0	100	100	100	100	0	100	100	100	100	0	100	100
Bicycle and Pedestrian	0	0	0	0	0	0	0	0	0	0	0	0	0	0	0	0	0	0	0	0	0
% Bicycle and Pedestrian	0	0	0	0	0	0	0	0	0	0	0	0	0	0	0	0	0	0	0	0	0



Ridgeview Data Collection

Colorado Springs, CO  
CO Springs Powers Blvd Count  
PM Peak  
Omaha Blvd and Paonia St

File Name : Omaha and Paonia PM  
Site Code : Hales  
Start Date : 3/6/2024  
Page No : 2

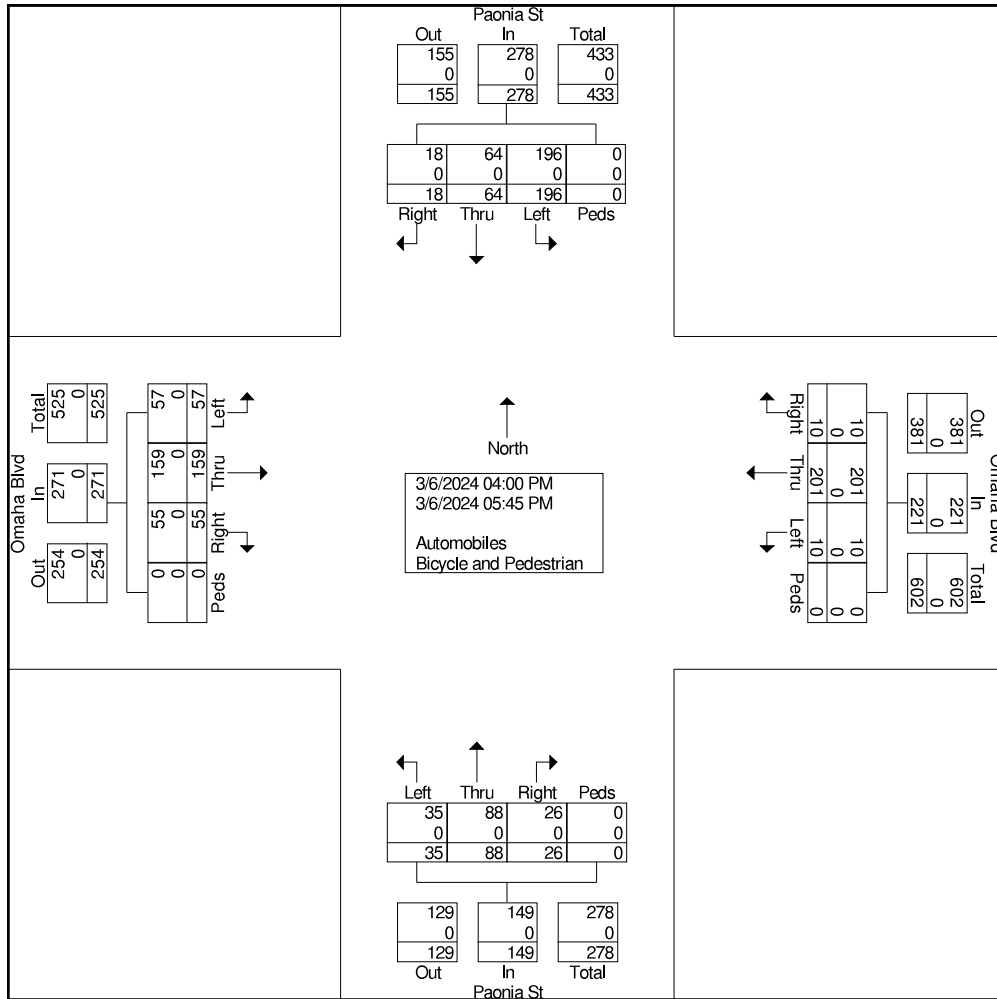



Ridgeview Data  
Collection

Colorado Springs, CO  
CO Springs Powers Blvd Count  
PM Peak  
Omaha Blvd and Paonia St

File Name : Omaha and Paonia PM  
Site Code : Hales  
Start Date : 3/6/2024  
Page No : 3

Start Time	Omaha Blvd Eastbound					Omaha Blvd Westbound					Paonia St Northbound					Paonia St Southbound					Int. Total
	Left	Thru	Right	Peds	App. Total	Left	Thru	Right	Peds	App. Total	Left	Thru	Right	Peds	App. Total	Left	Thru	Right	Peds	App. Total	
Peak Hour Analysis From 04:00 PM to 05:45 PM - Peak 1 of 1																					
Peak Hour for Entire Intersection Begins at 04:15 PM																					
04:15 PM	6	21	5	0	32	1	31	1	0	33	6	17	4	0	27	30	10	5	0	45	137
04:30 PM	4	21	11	0	36	0	28	0	0	28	0	12	3	0	15	17	14	3	0	34	113
04:45 PM	9	17	3	0	29	2	19	2	0	23	11	19	4	0	34	19	4	0	0	23	109
05:00 PM	19	12	10	0	41	0	38	0	0	38	9	18	4	0	31	26	7	4	0	37	147
Total Volume	38	71	29	0	138	3	116	3	0	122	26	66	15	0	107	92	35	12	0	139	506
% App. Total	27.5	51.4	21	0		2.5	95.1	2.5	0		24.3	61.7	14	0		66.2	25.2	8.6	0		
PHF	.500	.845	.659	.000	.841	.375	.763	.375	.000	.803	.591	.868	.938	.000	.787	.767	.625	.600	.000	.772	.861

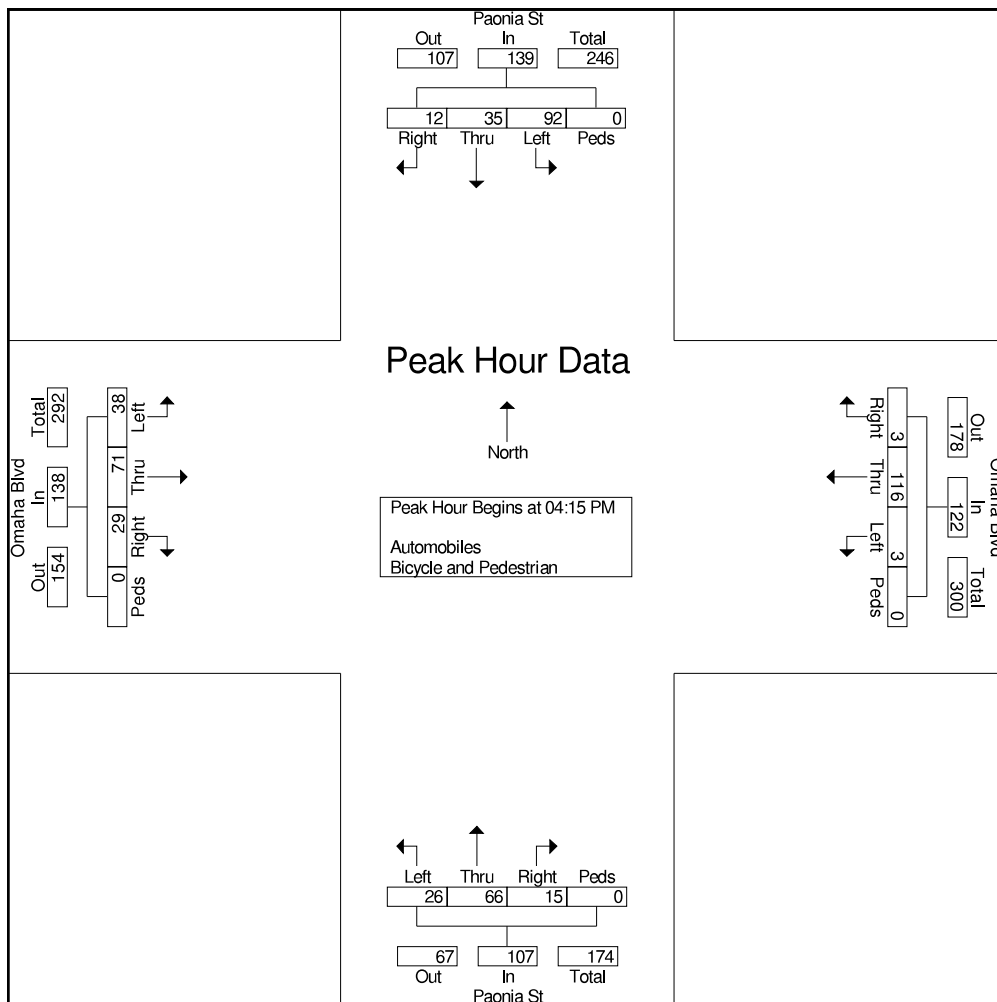





Ridgeview Data  
Collection

Colorado Springs, CO  
CO Springs Powers Blvd Count  
PM Peak  
Omaha Blvd and Paonia St

File Name : Omaha and Paonia PM  
Site Code : Hales  
Start Date : 3/6/2024  
Page No : 4

Image 1

The number of pedestrians shown on this report is representative of the crossing on the approaching leg, i.e. pedestrians crossing the north side of the intersection are counted as pedestrians in the southbound crosswalk, as that is the approaching leg that they are crossing (see figure below). Diagonal crossings are counted on the two legs that will get the pedestrian to the same end point. Diagonals can be counted separately if discussed prior to count.

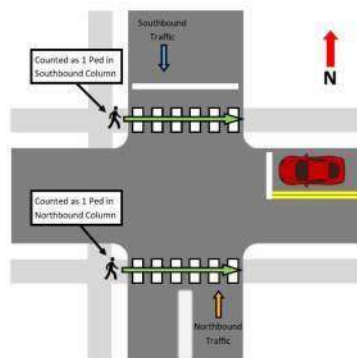



Ridgeview Data  
Collection

Colorado Springs, CO  
CO Springs Power Blvd Counts  
24 hour  
Powers Blvd btwn Palmer Pk & Omaha Blvd

File Name : Powers Blvd btwn Palmer and Omaha  
Site Code : Hales  
Start Date : 3/6/2024  
Page No : 1

Groups Printed- Light - Heavy

Start Time	Powers Blvd Northbound		Powers Blvd Southbound		Int. Total
	Thru	App. Total	Thru	App. Total	
12:00 AM	56	56	59	59	115
12:15 AM	51	51	43	43	94
12:30 AM	46	46	42	42	88
12:45 AM	21	21	33	33	54
Total	174	174	177	177	351
01:00 AM	31	31	38	38	69
01:15 AM	31	31	18	18	49
01:30 AM	27	27	32	32	59
01:45 AM	16	16	16	16	32
Total	105	105	104	104	209
02:00 AM	29	29	20	20	49
02:15 AM	28	28	13	13	41
02:30 AM	25	25	28	28	53
02:45 AM	18	18	25	25	43
Total	100	100	86	86	186
03:00 AM	14	14	50	50	64
03:15 AM	16	16	31	31	47
03:30 AM	34	34	58	58	92
03:45 AM	38	38	64	64	102
Total	102	102	203	203	305
04:00 AM	34	34	66	66	100
04:15 AM	60	60	113	113	173
04:30 AM	68	68	140	140	208
04:45 AM	92	92	178	178	270
Total	254	254	497	497	751



Ridgeview Data  
Collection

Colorado Springs, CO  
CO Springs Power Blvd Counts  
24 hour  
Powers Blvd btwn Palmer Pk & Omaha Blvd

File Name : Powers Blvd btwn Palmer and Omaha  
Site Code : Hales  
Start Date : 3/6/2024  
Page No : 2

Groups Printed- Light - Heavy

Start Time	Powers Blvd Northbound		Powers Blvd Southbound		Int. Total
	Thru	App. Total	Thru	App. Total	
05:00 AM	91	91	187	187	278
05:15 AM	105	105	248	248	353
05:30 AM	131	131	341	341	472
05:45 AM	210	210	378	378	588
Total	537	537	1154	1154	1691
06:00 AM	243	243	465	465	708
06:15 AM	331	331	541	541	872
06:30 AM	421	421	689	689	1110
06:45 AM	457	457	828	828	1285
Total	1452	1452	2523	2523	3975
07:00 AM	492	492	777	777	1269
07:15 AM	533	533	812	812	1345
07:30 AM	609	609	841	841	1450
07:45 AM	598	598	784	784	1382
Total	2232	2232	3214	3214	5446
08:00 AM	493	493	715	715	1208
08:15 AM	482	482	696	696	1178
08:30 AM	493	493	685	685	1178
08:45 AM	460	460	587	587	1047
Total	1928	1928	2683	2683	4611
09:00 AM	430	430	456	456	886
09:15 AM	414	414	487	487	901
09:30 AM	414	414	485	485	899
09:45 AM	459	459	470	470	929
Total	1717	1717	1898	1898	3615
10:00 AM	446	446	416	416	862
10:15 AM	452	452	456	456	908



Ridgeview Data  
Collection

Colorado Springs, CO  
CO Springs Power Blvd Counts  
24 hour  
Powers Blvd btwn Palmer Pk & Omaha Blvd

File Name : Powers Blvd btwn Palmer and Omaha  
Site Code : Hales  
Start Date : 3/6/2024  
Page No : 3

Groups Printed- Light - Heavy

Start Time	Powers Blvd Northbound		Powers Blvd Southbound		Int. Total
	Thru	App. Total	Thru	App. Total	
10:30 AM	464	464	457	457	921
10:45 AM	490	490	471	471	961
Total	1852	1852	1800	1800	3652
11:00 AM	477	477	416	416	893
11:15 AM	534	534	525	525	1059
11:30 AM	536	536	484	484	1020
11:45 AM	565	565	529	529	1094
Total	2112	2112	1954	1954	4066
12:00 PM	518	518	484	484	1002
12:15 PM	561	561	550	550	1111
12:30 PM	525	525	555	555	1080
12:45 PM	515	515	584	584	1099
Total	2119	2119	2173	2173	4292
01:00 PM	501	501	474	474	975
01:15 PM	452	452	552	552	1004
01:30 PM	537	537	489	489	1026
01:45 PM	531	531	481	481	1012
Total	2021	2021	1996	1996	4017
02:00 PM	568	568	497	497	1065
02:15 PM	552	552	545	545	1097
02:30 PM	640	640	491	491	1131
02:45 PM	605	605	572	572	1177
Total	2365	2365	2105	2105	4470
03:00 PM	739	739	572	572	1311
03:15 PM	691	691	591	591	1282
03:30 PM	730	730	607	607	1337
03:45 PM	759	759	620	620	1379
Total	2919	2919	2390	2390	5309



Ridgeview Data  
Collection

Colorado Springs, CO  
CO Springs Power Blvd Counts  
24 hour  
Powers Blvd btwn Palmer Pk & Omaha Blvd

File Name : Powers Blvd btwn Palmer and Omaha  
Site Code : Hales  
Start Date : 3/6/2024  
Page No : 4

Groups Printed- Light - Heavy

Start Time	Powers Blvd Northbound		Powers Blvd Southbound		Int. Total
	Thru	App. Total	Thru	App. Total	
04:00 PM	756	756	610	610	1366
04:15 PM	761	761	538	538	1299
04:30 PM	710	710	598	598	1308
04:45 PM	622	622	545	545	1167
Total	2849	2849	2291	2291	5140
05:00 PM	767	767	602	602	1369
05:15 PM	712	712	548	548	1260
05:30 PM	679	679	636	636	1315
05:45 PM	668	668	556	556	1224
Total	2826	2826	2342	2342	5168
06:00 PM	601	601	519	519	1120
06:15 PM	582	582	486	486	1068
06:30 PM	528	528	478	478	1006
06:45 PM	430	430	439	439	869
Total	2141	2141	1922	1922	4063
07:00 PM	382	382	407	407	789
07:15 PM	381	381	375	375	756
07:30 PM	331	331	354	354	685
07:45 PM	315	315	347	347	662
Total	1409	1409	1483	1483	2892
08:00 PM	271	271	335	335	606
08:15 PM	347	347	334	334	681
08:30 PM	285	285	344	344	629
08:45 PM	284	284	264	264	548
Total	1187	1187	1277	1277	2464
09:00 PM	204	204	247	247	451
09:15 PM	212	212	236	236	448





Ridgeview Data  
Collection

Colorado Springs, CO  
CO Springs Power Blvd Counts  
24 hour  
Powers Blvd btwn Palmer Pk & Omaha Blvd

File Name : Powers Blvd btwn Palmer and Omaha  
Site Code : Hales  
Start Date : 3/6/2024  
Page No : 5

Groups Printed- Light - Heavy

Start Time	Powers Blvd Northbound		Powers Blvd Southbound		Int. Total
	Thru	App. Total	Thru	App. Total	
09:30 PM	197	197	185	185	382
09:45 PM	148	148	187	187	335
Total	761	761	855	855	1616
10:00 PM	144	144	151	151	295
10:15 PM	167	167	149	149	316
10:30 PM	143	143	128	128	271
10:45 PM	85	85	85	85	170
Total	539	539	513	513	1052
11:00 PM	99	99	83	83	182
11:15 PM	48	48	74	74	122
11:30 PM	54	54	65	65	119
11:45 PM	66	66	49	49	115
Total	267	267	271	271	538
Grand Total	33968	33968	35911	35911	69879
Aprch %	100		100		
Total %	48.6	48.6	51.4	51.4	
Light	33343	33343	35243	35243	68586
% Light	98.2	98.2	98.1	98.1	98.1
Heavy	625	625	668	668	1293
% Heavy	1.8	1.8	1.9	1.9	1.9



Ridgeview Data  
Collection

Colorado Springs, CO  
CO Springs Power Blvd Counts  
24 hour  
Powers Blvd btwn Palmer Pk & Omaha Blvd

File Name : Powers Blvd btwn Palmer and Omaha  
Site Code : Hales  
Start Date : 3/6/2024  
Page No : 6

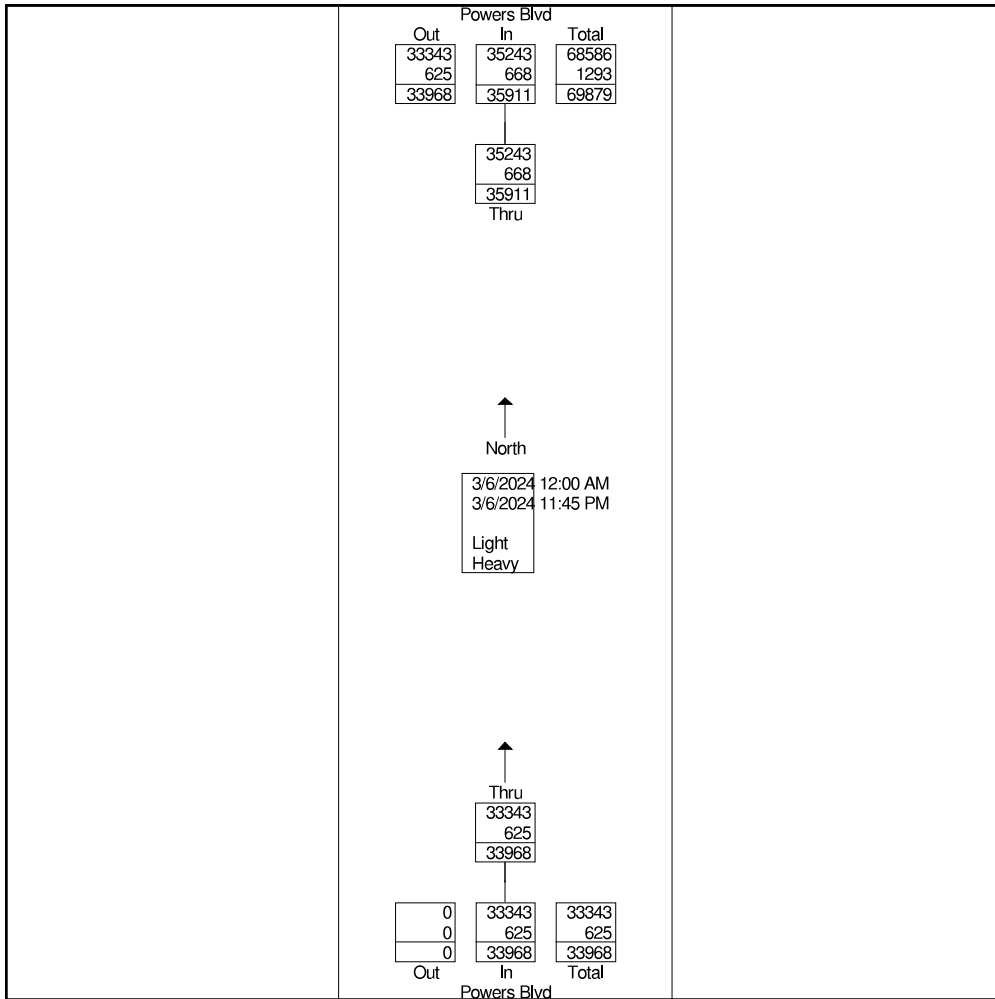



Ridgeview Data  
Collection

Colorado Springs, CO  
CO Springs Power Blvd Counts  
24 hour  
Powers Blvd btwn Palmer Pk & Omaha Blvd

File Name : Powers Blvd btwn Palmer and Omaha  
Site Code : Hales  
Start Date : 3/6/2024  
Page No : 7

Start Time	Powers Blvd Northbound		Powers Blvd Southbound		Int. Total
	Thru	App. Total	Thru	App. Total	
Peak Hour Analysis From 12:00 AM to 12:00 PM - Peak 1 of 1					
Peak Hour for Entire Intersection Begins at 07:00 AM					
07:00 AM	492	492	777	777	1269
07:15 AM	533	533	812	812	1345
07:30 AM	<b>609</b>	<b>609</b>	<b>841</b>	<b>841</b>	<b>1450</b>
07:45 AM	598	598	784	784	1382
Total Volume	2232	2232	3214	3214	5446
% App. Total	100		100		
PHF	.916	.916	.955	.955	.939

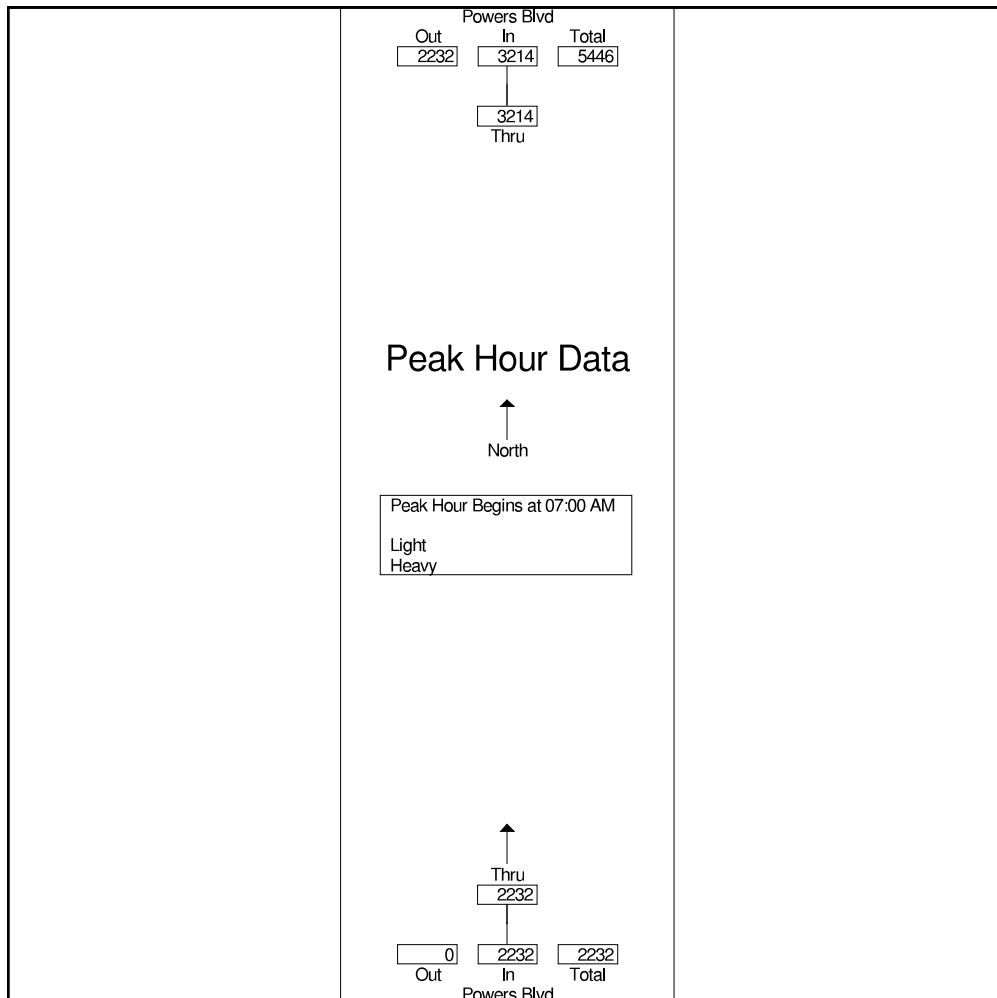



Ridgeview Data  
Collection

Colorado Springs, CO  
CO Springs Power Blvd Counts  
24 hour  
Powers Blvd btwn Palmer Pk & Omaha Blvd

File Name : Powers Blvd btwn Palmer and Omaha  
Site Code : Hales  
Start Date : 3/6/2024  
Page No : 8

Start Time	Powers Blvd Northbound		Powers Blvd Southbound		Int. Total
	Thru	App. Total	Thru	App. Total	
Peak Hour Analysis From 12:15 PM to 11:45 PM - Peak 1 of 1					
Peak Hour for Entire Intersection Begins at 03:30 PM					
03:30 PM	730	730	607	607	1337
03:45 PM	759	759	<b>620</b>	<b>620</b>	<b>1379</b>
04:00 PM	756	756	610	610	1366
04:15 PM	<b>761</b>	<b>761</b>	538	538	1299
Total Volume	3006	3006	2375	2375	5381
% App. Total	100		100		
PHF	.988	.988	.958	.958	.976

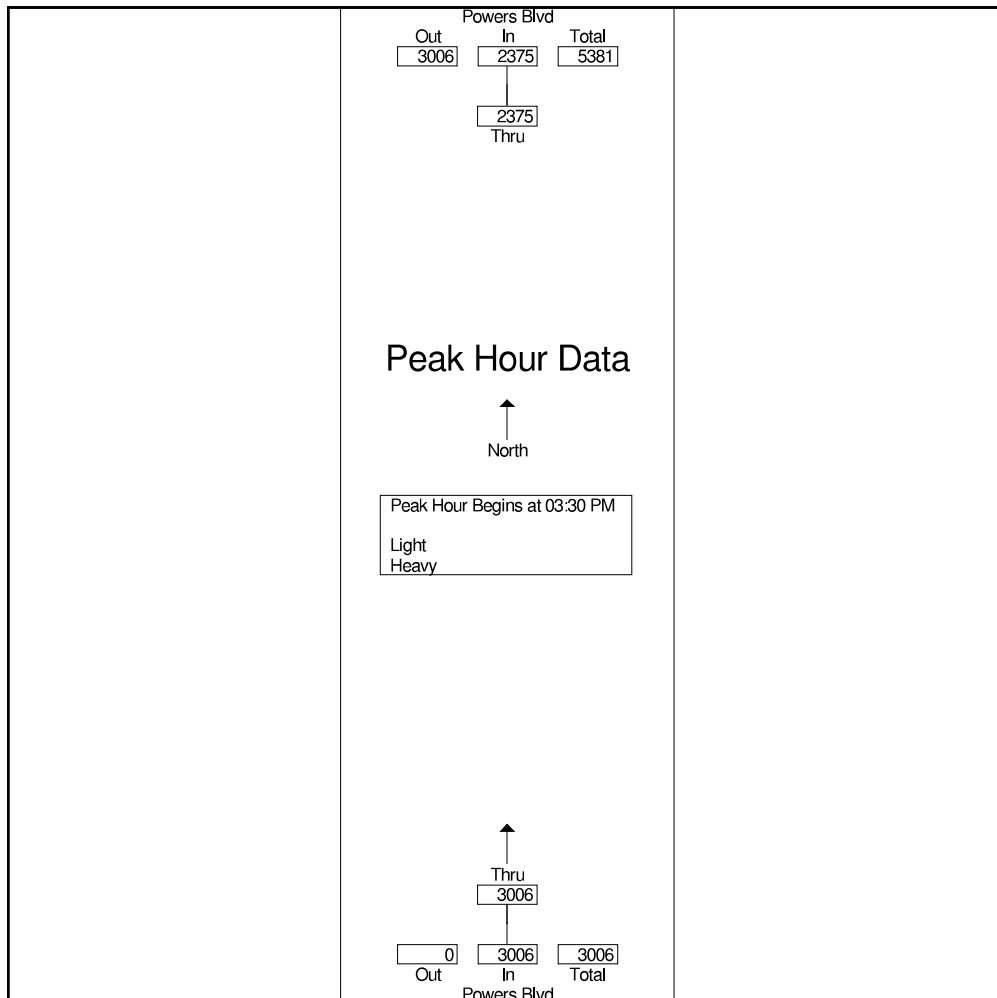



Ridgeview Data  
Collection

Colorado Springs, CO  
CO Springs Power Blvd Counts  
24 hour  
Palmer Park Blvd west of Waynoka Rd

File Name : Palmer Park Blvd west of Waynoka Rd  
Site Code : Hales  
Start Date : 3/6/2024  
Page No : 1

Groups Printed- Light - Heavy

Start Time	Palmer Park Blvd Eastbound		Palmer Park Blvd Westbound		Int. Total
	Thru	App. Total	Thru	App. Total	
12:00 AM	11	11	9	9	20
12:15 AM	7	7	3	3	10
12:30 AM	10	10	4	4	14
12:45 AM	4	4	2	2	6
Total	32	32	18	18	50
01:00 AM	9	9	11	11	20
01:15 AM	6	6	4	4	10
01:30 AM	4	4	4	4	8
01:45 AM	6	6	4	4	10
Total	25	25	23	23	48
02:00 AM	1	1	3	3	4
02:15 AM	3	3	1	1	4
02:30 AM	3	3	4	4	7
02:45 AM	5	5	2	2	7
Total	12	12	10	10	22
03:00 AM	5	5	4	4	9
03:15 AM	3	3	5	5	8
03:30 AM	3	3	9	9	12
03:45 AM	6	6	8	8	14
Total	17	17	26	26	43
04:00 AM	3	3	8	8	11
04:15 AM	9	9	14	14	23
04:30 AM	11	11	18	18	29
04:45 AM	16	16	23	23	39
Total	39	39	63	63	102





Ridgeview Data  
Collection

Colorado Springs, CO  
CO Springs Power Blvd Counts  
24 hour  
Palmer Park Blvd west of Waynoka Rd

File Name : Palmer Park Blvd west of Waynoka Rd  
Site Code : Hales  
Start Date : 3/6/2024  
Page No : 2

Groups Printed- Light - Heavy

Start Time	Palmer Park Blvd Eastbound		Palmer Park Blvd Westbound		Int. Total
	Thru	App. Total	Thru	App. Total	
05:00 AM	14	14	17	17	31
05:15 AM	22	22	29	29	51
05:30 AM	24	24	45	45	69
05:45 AM	51	51	61	61	112
Total	111	111	152	152	263
06:00 AM	44	44	59	59	103
06:15 AM	74	74	85	85	159
06:30 AM	92	92	121	121	213
06:45 AM	129	129	128	128	257
Total	339	339	393	393	732
07:00 AM	129	129	168	168	297
07:15 AM	117	117	188	188	305
07:30 AM	147	147	163	163	310
07:45 AM	157	157	174	174	331
Total	550	550	693	693	1243
08:00 AM	140	140	174	174	314
08:15 AM	95	95	124	124	219
08:30 AM	98	98	123	123	221
08:45 AM	85	85	118	118	203
Total	418	418	539	539	957
09:00 AM	81	81	103	103	184
09:15 AM	92	92	90	90	182
09:30 AM	88	88	111	111	199
09:45 AM	84	84	93	93	177
Total	345	345	397	397	742
10:00 AM	113	113	98	98	211
10:15 AM	101	101	94	94	195



Ridgeview Data  
Collection

Colorado Springs, CO  
CO Springs Power Blvd Counts  
24 hour  
Palmer Park Blvd west of Waynoka Rd

File Name : Palmer Park Blvd west of Waynoka Rd  
Site Code : Hales  
Start Date : 3/6/2024  
Page No : 3

Groups Printed- Light - Heavy

Start Time	Palmer Park Blvd Eastbound		Palmer Park Blvd Westbound		Int. Total
	Thru	App. Total	Thru	App. Total	
10:30 AM	91	91	95	95	186
10:45 AM	117	117	102	102	219
Total	422	422	389	389	811
11:00 AM	111	111	100	100	211
11:15 AM	107	107	112	112	219
11:30 AM	113	113	105	105	218
11:45 AM	146	146	98	98	244
Total	477	477	415	415	892
12:00 PM	121	121	112	112	233
12:15 PM	145	145	126	126	271
12:30 PM	134	134	112	112	246
12:45 PM	131	131	124	124	255
Total	531	531	474	474	1005
01:00 PM	140	140	112	112	252
01:15 PM	134	134	98	98	232
01:30 PM	128	128	117	117	245
01:45 PM	147	147	102	102	249
Total	549	549	429	429	978
02:00 PM	135	135	109	109	244
02:15 PM	128	128	111	111	239
02:30 PM	133	133	135	135	268
02:45 PM	173	173	113	113	286
Total	569	569	468	468	1037
03:00 PM	176	176	156	156	332
03:15 PM	197	197	176	176	373
03:30 PM	195	195	174	174	369
03:45 PM	218	218	166	166	384
Total	786	786	672	672	1458



Ridgeview Data  
Collection

Colorado Springs, CO  
CO Springs Power Blvd Counts  
24 hour  
Palmer Park Blvd west of Waynoka Rd

File Name : Palmer Park Blvd west of Waynoka Rd  
Site Code : Hales  
Start Date : 3/6/2024  
Page No : 4

Groups Printed- Light - Heavy

Start Time	Palmer Park Blvd Eastbound		Palmer Park Blvd Westbound		Int. Total
	Thru	App. Total	Thru	App. Total	
04:00 PM	227	227	137	137	364
04:15 PM	235	235	140	140	375
04:30 PM	234	234	163	163	397
04:45 PM	231	231	111	111	342
Total	927	927	551	551	1478
05:00 PM	254	254	174	174	428
05:15 PM	257	257	131	131	388
05:30 PM	207	207	126	126	333
05:45 PM	177	177	101	101	278
Total	895	895	532	532	1427
06:00 PM	160	160	103	103	263
06:15 PM	139	139	95	95	234
06:30 PM	127	127	80	80	207
06:45 PM	115	115	67	67	182
Total	541	541	345	345	886
07:00 PM	97	97	62	62	159
07:15 PM	91	91	63	63	154
07:30 PM	93	93	52	52	145
07:45 PM	79	79	49	49	128
Total	360	360	226	226	586
08:00 PM	73	73	45	45	118
08:15 PM	85	85	50	50	135
08:30 PM	78	78	36	36	114
08:45 PM	62	62	27	27	89
Total	298	298	158	158	456
09:00 PM	52	52	24	24	76
09:15 PM	50	50	20	20	70



Ridgeview Data  
Collection

Colorado Springs, CO  
CO Springs Power Blvd Counts  
24 hour  
Palmer Park Blvd west of Waynoka Rd

File Name : Palmer Park Blvd west of Waynoka Rd  
Site Code : Hales  
Start Date : 3/6/2024  
Page No : 5

Groups Printed- Light - Heavy

Start Time	Palmer Park Blvd Eastbound		Palmer Park Blvd Westbound		Int. Total
	Thru	App. Total	Thru	App. Total	
09:30 PM	60	60	27	27	87
09:45 PM	34	34	14	14	48
Total	196	196	85	85	281
10:00 PM	38	38	12	12	50
10:15 PM	35	35	18	18	53
10:30 PM	32	32	18	18	50
10:45 PM	16	16	11	11	27
Total	121	121	59	59	180
11:00 PM	23	23	13	13	36
11:15 PM	16	16	2	2	18
11:30 PM	9	9	9	9	18
11:45 PM	11	11	7	7	18
Total	59	59	31	31	90
Grand Total	8619	8619	7148	7148	15767
Aprch %	100		100		
Total %	54.7	54.7	45.3	45.3	
Light	8486	8486	7028	7028	15514
% Light	98.5	98.5	98.3	98.3	98.4
Heavy	133	133	120	120	253
% Heavy	1.5	1.5	1.7	1.7	1.6



Ridgeview Data  
Collection

Colorado Springs, CO  
CO Springs Power Blvd Counts  
24 hour  
Palmer Park Blvd west of Waynoka Rd

File Name : Palmer Park Blvd west of Waynoka Rd  
Site Code : Hales  
Start Date : 3/6/2024  
Page No : 6

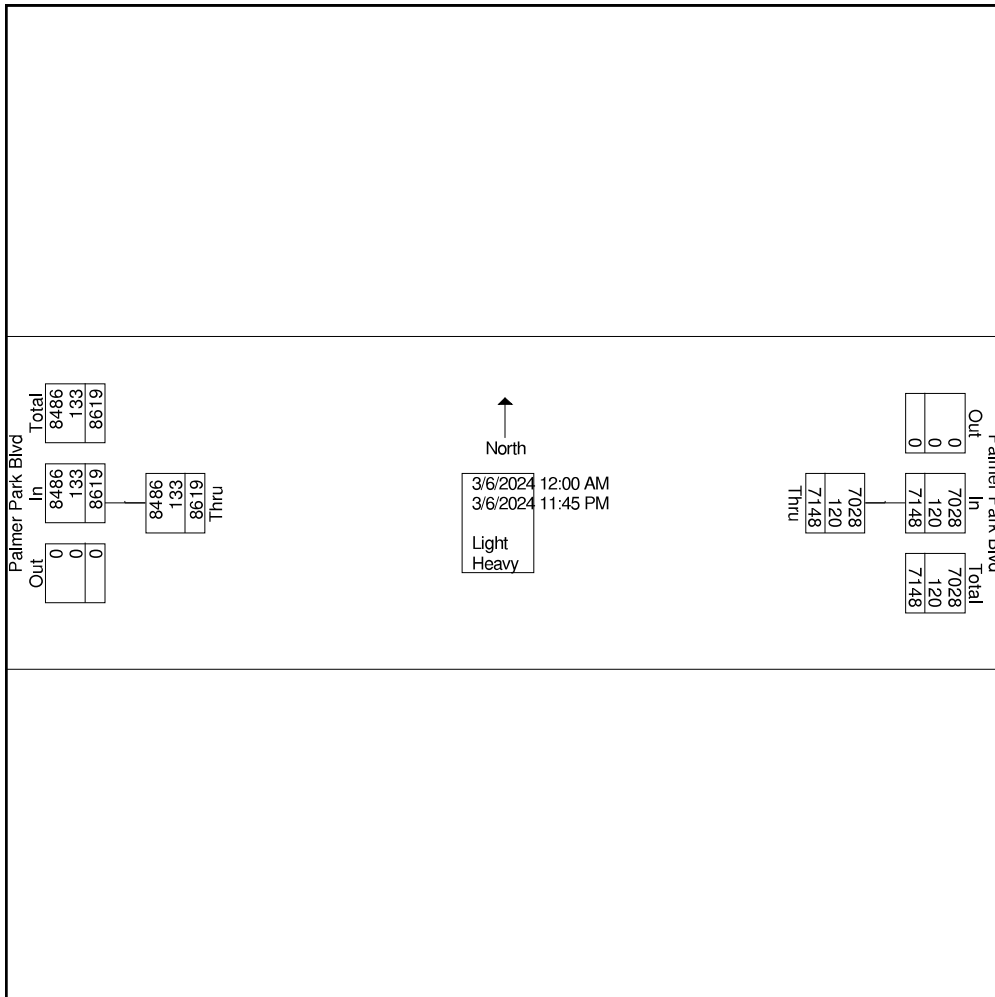



Ridgeview Data  
Collection

Colorado Springs, CO  
CO Springs Power Blvd Counts  
24 hour  
Palmer Park Blvd west of Waynoka Rd

File Name : Palmer Park Blvd west of Waynoka Rd  
Site Code : Hales  
Start Date : 3/6/2024  
Page No : 7

Start Time	Palmer Park Blvd Eastbound		Palmer Park Blvd Westbound		Int. Total
	Thru	App. Total	Thru	App. Total	
Peak Hour Analysis From 12:00 AM to 12:00 PM - Peak 1 of 1					
Peak Hour for Entire Intersection Begins at 07:15 AM					
07:15 AM	117	117	188	188	305
07:30 AM	147	147	163	163	310
07:45 AM	157	157	174	174	331
08:00 AM	140	140	174	174	314
Total Volume	561	561	699	699	1260
% App. Total	100		100		
PHF	.893	.893	.930	.930	.952

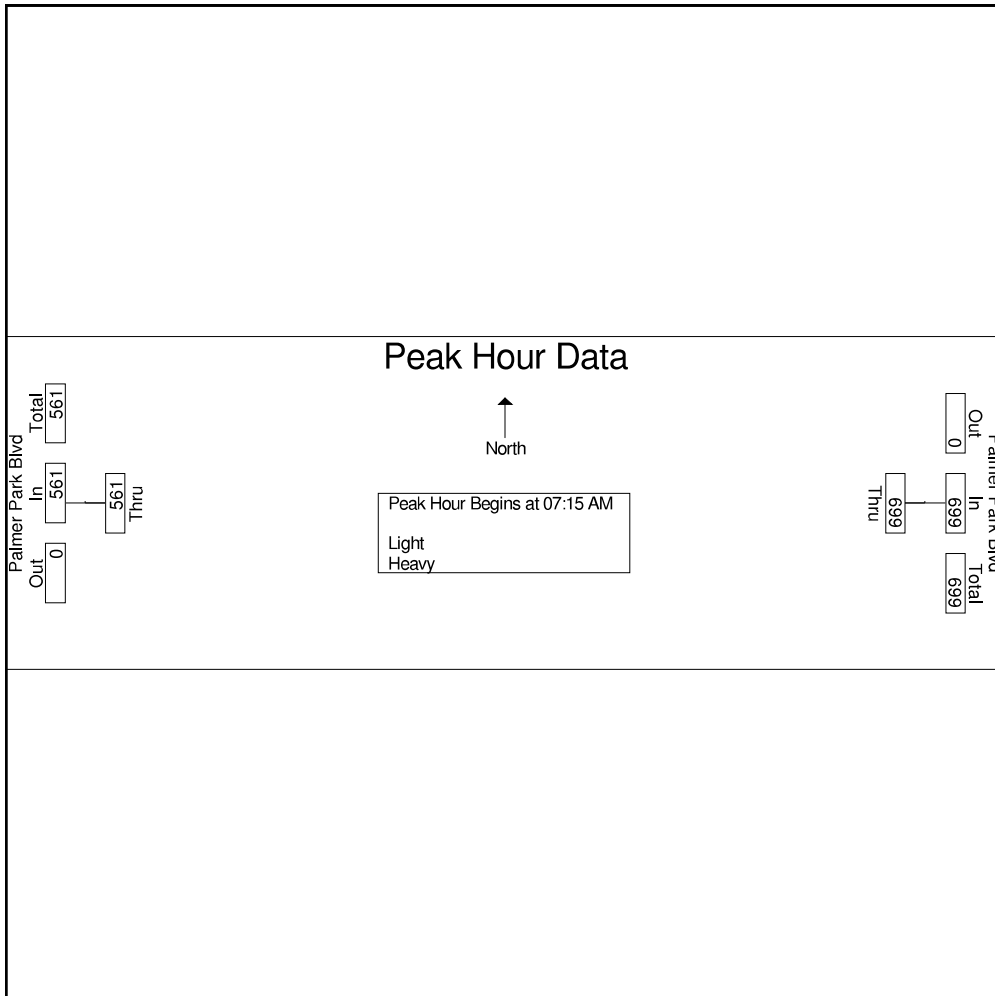





Ridgeview Data  
Collection

Colorado Springs, CO  
CO Springs Power Blvd Counts  
24 hour  
Palmer Park Blvd west of Waynoka Rd

File Name : Palmer Park Blvd west of Waynoka Rd  
Site Code : Hales  
Start Date : 3/6/2024  
Page No : 8

Start Time	Palmer Park Blvd Eastbound		Palmer Park Blvd Westbound		Int. Total
	Thru	App. Total	Thru	App. Total	
Peak Hour Analysis From 12:15 PM to 11:45 PM - Peak 1 of 1					
Peak Hour for Entire Intersection Begins at 04:30 PM					
04:30 PM	234	234	163	163	397
04:45 PM	231	231	111	111	342
05:00 PM	254	254	<b>174</b>	<b>174</b>	<b>428</b>
05:15 PM	<b>257</b>	<b>257</b>	131	131	388
Total Volume	976	976	579	579	1555
% App. Total	100		100		
PHF	.949	.949	.832	.832	.908

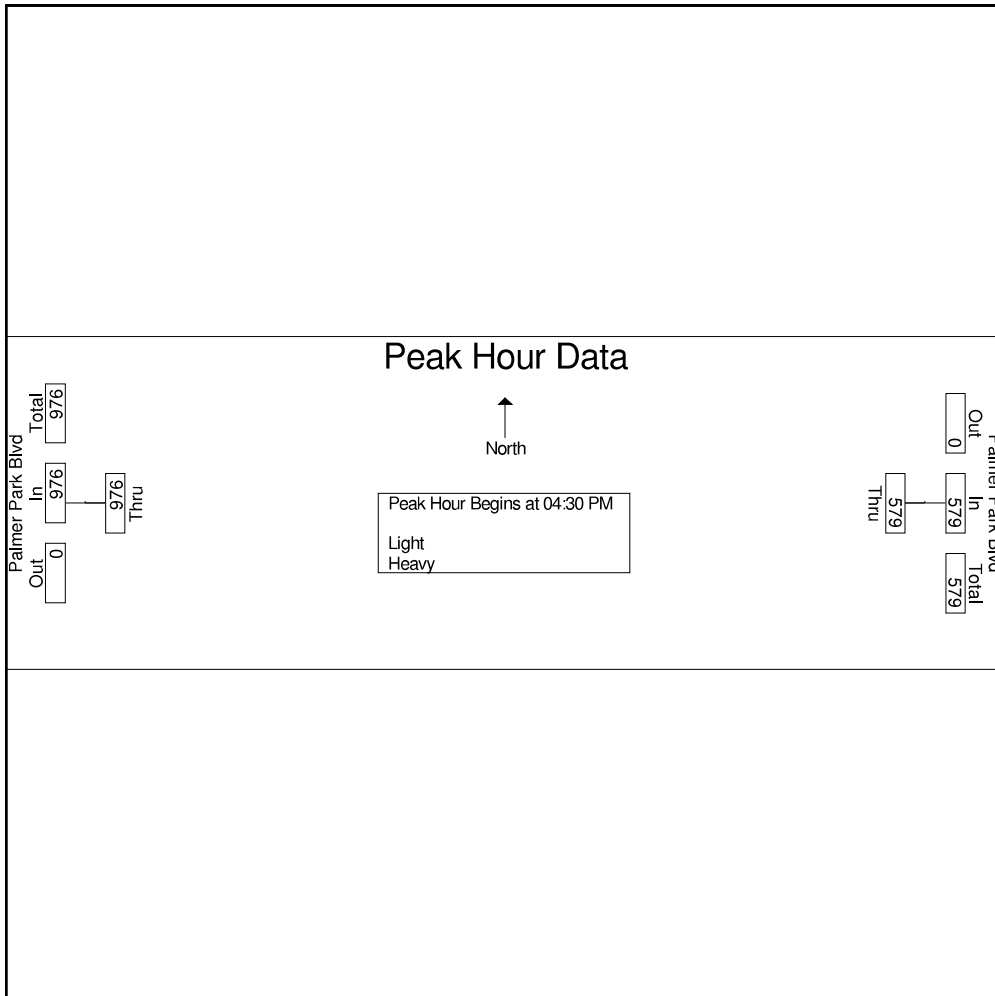



Ridgeview Data  
Collection

Colorado Springs, CO  
CO Springs Power Blvd Counts  
24 hour  
Omaha Blvd bwtm Powers Blvd & Paonia

File Name : Omaha Blvd btwn Powers Blvd and Paonia St  
Site Code : Hales  
Start Date : 3/7/2024  
Page No : 1

Groups Printed- Light - Heavy

Start Time	Omaha Blvd Eastbound		Omaha Blvd Westbound		Int. Total
	Thru	App. Total	Thru	App. Total	
12:00 AM	0	0	1	1	1
12:15 AM	0	0	1	1	1
12:30 AM	0	0	0	0	0
12:45 AM	1	1	1	1	2
Total	1	1	3	3	4
01:00 AM	0	0	1	1	1
01:15 AM	0	0	2	2	2
01:30 AM	0	0	1	1	1
01:45 AM	0	0	1	1	1
Total	0	0	5	5	5
02:00 AM	0	0	1	1	1
02:15 AM	0	0	3	3	3
02:30 AM	0	0	1	1	1
02:45 AM	0	0	0	0	0
Total	0	0	5	5	5
03:00 AM	0	0	1	1	1
03:15 AM	1	1	2	2	3
03:30 AM	0	0	1	1	1
03:45 AM	0	0	1	1	1
Total	1	1	5	5	6
04:00 AM	0	0	3	3	3
04:15 AM	1	1	0	0	1
04:30 AM	3	3	3	3	6
04:45 AM	5	5	6	6	11
Total	9	9	12	12	21



Ridgeview Data  
Collection

Colorado Springs, CO  
CO Springs Power Blvd Counts  
24 hour  
Omaha Blvd bwtm Powers Blvd & Paonia

File Name : Omaha Blvd btwn Powers Blvd and Paonia St  
Site Code : Hales  
Start Date : 3/7/2024  
Page No : 2

Groups Printed- Light - Heavy

Start Time	Omaha Blvd Eastbound		Omaha Blvd Westbound		Int. Total
	Thru	App. Total	Thru	App. Total	
05:00 AM	2	2	3	3	5
05:15 AM	8	8	8	8	16
05:30 AM	10	10	10	10	20
05:45 AM	11	11	5	5	16
Total	31	31	26	26	57
06:00 AM	9	9	15	15	24
06:15 AM	17	17	13	13	30
06:30 AM	16	16	19	19	35
06:45 AM	17	17	29	29	46
Total	59	59	76	76	135
07:00 AM	25	25	13	13	38
07:15 AM	15	15	37	37	52
07:30 AM	22	22	43	43	65
07:45 AM	22	22	38	38	60
Total	84	84	131	131	215
08:00 AM	17	17	32	32	49
08:15 AM	24	24	34	34	58
08:30 AM	19	19	30	30	49
08:45 AM	35	35	31	31	66
Total	95	95	127	127	222
09:00 AM	20	20	34	34	54
09:15 AM	23	23	17	17	40
09:30 AM	12	12	23	23	35
09:45 AM	16	16	22	22	38
Total	71	71	96	96	167
10:00 AM	24	24	29	29	53
10:15 AM	22	22	23	23	45



Ridgeview Data  
Collection

Colorado Springs, CO  
CO Springs Power Blvd Counts  
24 hour  
Omaha Blvd bwtm Powers Blvd & Paonia

File Name : Omaha Blvd btwn Powers Blvd and Paonia St  
Site Code : Hales  
Start Date : 3/7/2024  
Page No : 3

Groups Printed- Light - Heavy

Start Time	Omaha Blvd Eastbound		Omaha Blvd Westbound		Int. Total
	Thru	App. Total	Thru	App. Total	
10:30 AM	22	22	22	22	44
10:45 AM	15	15	25	25	40
Total	83	83	99	99	182
11:00 AM	28	28	21	21	49
11:15 AM	34	34	22	22	56
11:30 AM	18	18	24	24	42
11:45 AM	23	23	29	29	52
Total	103	103	96	96	199
12:00 PM	16	16	42	42	58
12:15 PM	29	29	36	36	65
12:30 PM	27	27	22	22	49
12:45 PM	25	25	27	27	52
Total	97	97	127	127	224
01:00 PM	19	19	26	26	45
01:15 PM	20	20	30	30	50
01:30 PM	18	18	28	28	46
01:45 PM	23	23	18	18	41
Total	80	80	102	102	182
02:00 PM	20	20	35	35	55
02:15 PM	20	20	35	35	55
02:30 PM	29	29	31	31	60
02:45 PM	16	16	34	34	50
Total	85	85	135	135	220
03:00 PM	25	25	32	32	57
03:15 PM	14	14	25	25	39
03:30 PM	21	21	29	29	50
03:45 PM	24	24	25	25	49
Total	84	84	111	111	195



Ridgeview Data  
Collection

Colorado Springs, CO  
CO Springs Power Blvd Counts  
24 hour  
Omaha Blvd bwtm Powers Blvd & Paonia

File Name : Omaha Blvd btwn Powers Blvd and Paonia St  
Site Code : Hales  
Start Date : 3/7/2024  
Page No : 4

Groups Printed- Light - Heavy

Start Time	Omaha Blvd Eastbound		Omaha Blvd Westbound		Int. Total
	Thru	App. Total	Thru	App. Total	
04:00 PM	19	19	18	18	37
04:15 PM	24	24	28	28	52
04:30 PM	30	30	23	23	53
04:45 PM	19	19	18	18	37
Total	92	92	87	87	179
05:00 PM	26	26	38	38	64
05:15 PM	25	25	26	26	51
05:30 PM	16	16	22	22	38
05:45 PM	21	21	13	13	34
Total	88	88	99	99	187
06:00 PM	17	17	21	21	38
06:15 PM	9	9	18	18	27
06:30 PM	14	14	12	12	26
06:45 PM	16	16	12	12	28
Total	56	56	63	63	119
07:00 PM	10	10	15	15	25
07:15 PM	9	9	22	22	31
07:30 PM	10	10	21	21	31
07:45 PM	7	7	10	10	17
Total	36	36	68	68	104
08:00 PM	7	7	10	10	17
08:15 PM	7	7	13	13	20
08:30 PM	6	6	9	9	15
08:45 PM	5	5	8	8	13
Total	25	25	40	40	65
09:00 PM	5	5	5	5	10
09:15 PM	5	5	3	3	8



Ridgeview Data  
Collection

Colorado Springs, CO  
CO Springs Power Blvd Counts  
24 hour  
Omaha Blvd bwtm Powers Blvd & Paonia

File Name : Omaha Blvd btwn Powers Blvd and Paonia St  
Site Code : Hales  
Start Date : 3/7/2024  
Page No : 5

Groups Printed- Light - Heavy

Start Time	Omaha Blvd Eastbound		Omaha Blvd Westbound		Int. Total
	Thru	App. Total	Thru	App. Total	
09:30 PM	5	5	6	6	11
09:45 PM	4	4	10	10	14
Total	19	19	24	24	43
10:00 PM	2	2	5	5	7
10:15 PM	3	3	11	11	14
10:30 PM	2	2	4	4	6
10:45 PM	3	3	5	5	8
Total	10	10	25	25	35
11:00 PM	2	2	4	4	6
11:15 PM	0	0	1	1	1
11:30 PM	1	1	3	3	4
11:45 PM	1	1	2	2	3
Total	4	4	10	10	14
Grand Total	1213	1213	1572	1572	2785
Aprch %	100		100		
Total %	43.6	43.6	56.4	56.4	
Light	1176	1176	1540	1540	2716
% Light	96.9	96.9	98	98	97.5
Heavy	37	37	32	32	69
% Heavy	3.1	3.1	2	2	2.5





Ridgeview Data Collection

Colorado Springs, CO  
CO Springs Power Blvd Counts  
24 hour  
Omaha Blvd bwtm Powers Blvd & Paonia

File Name : Omaha Blvd btwn Powers Blvd and Paonia St  
Site Code : Hales  
Start Date : 3/7/2024  
Page No : 6

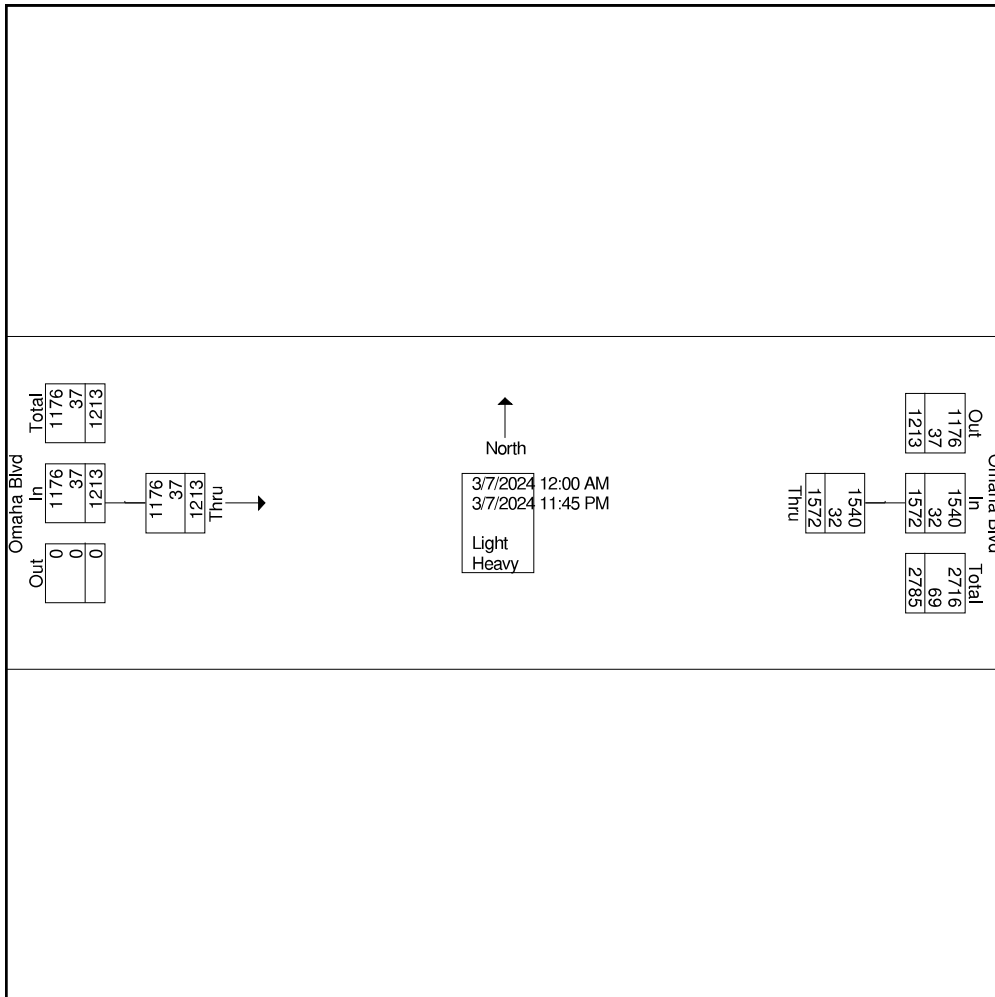



Ridgeview Data  
Collection

Colorado Springs, CO  
CO Springs Power Blvd Counts  
24 hour  
Omaha Blvd bwtm Powers Blvd & Paonia

File Name : Omaha Blvd btwn Powers Blvd and Paonia St  
Site Code : Hales  
Start Date : 3/7/2024  
Page No : 7

Start Time	Omaha Blvd Eastbound		Omaha Blvd Westbound		Int. Total
	Thru	App. Total	Thru	App. Total	
Peak Hour Analysis From 12:00 AM to 12:00 PM - Peak 1 of 1					
Peak Hour for Entire Intersection Begins at 07:30 AM					
07:30 AM	22	22	43	43	65
07:45 AM	22	22	38	38	60
08:00 AM	17	17	32	32	49
08:15 AM	24	24	34	34	58
Total Volume	85	85	147	147	232
% App. Total	100		100		
PHF	.885	.885	.855	.855	.892

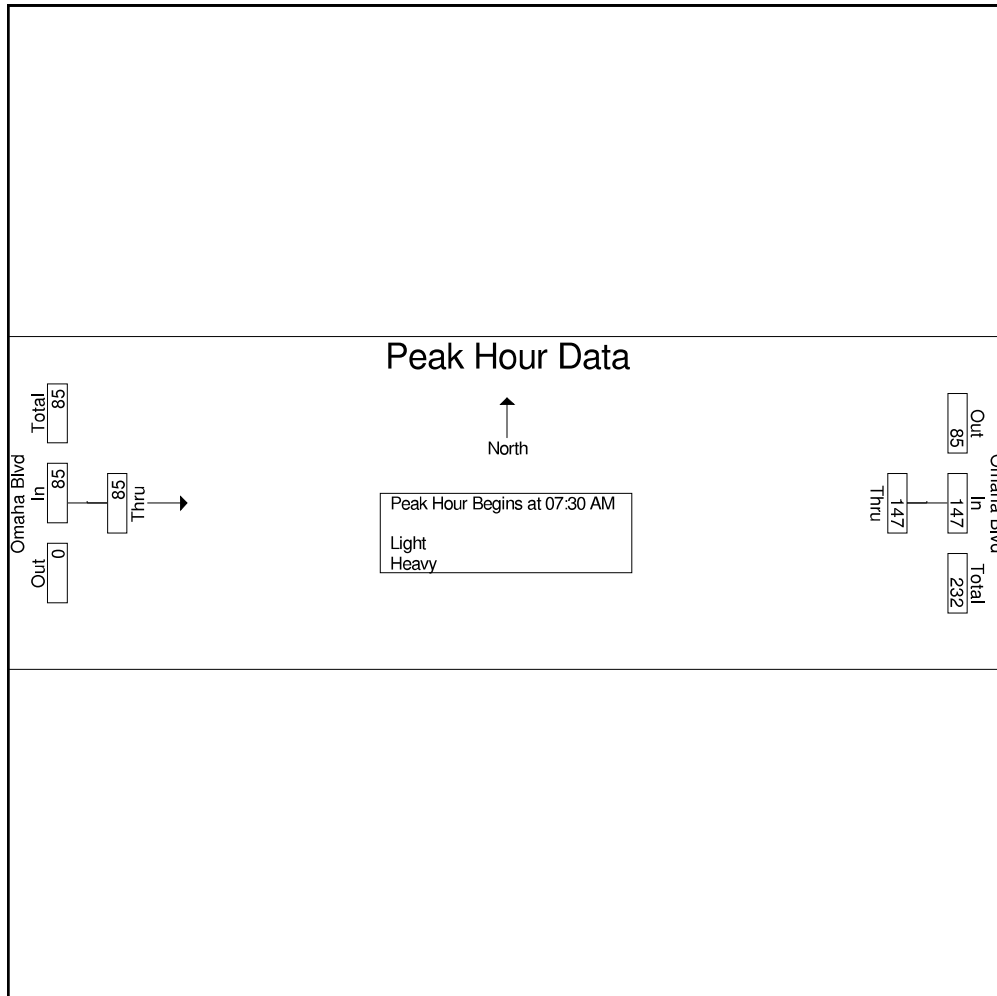



Ridgeview Data  
Collection

Colorado Springs, CO  
CO Springs Power Blvd Counts  
24 hour  
Omaha Blvd bwtm Powers Blvd & Paonia

File Name : Omaha Blvd btwn Powers Blvd and Paonia St  
Site Code : Hales  
Start Date : 3/7/2024  
Page No : 8

Start Time	Omaha Blvd Eastbound		Omaha Blvd Westbound		Int. Total
	Thru	App. Total	Thru	App. Total	
Peak Hour Analysis From 12:15 PM to 11:45 PM - Peak 1 of 1					
Peak Hour for Entire Intersection Begins at 02:15 PM					
02:15 PM	20	20	35	35	55
02:30 PM	29	29	31	31	60
02:45 PM	16	16	34	34	50
03:00 PM	25	25	32	32	57
Total Volume	90	90	132	132	222
% App. Total	100		100		
PHF	.776	.776	.943	.943	.925

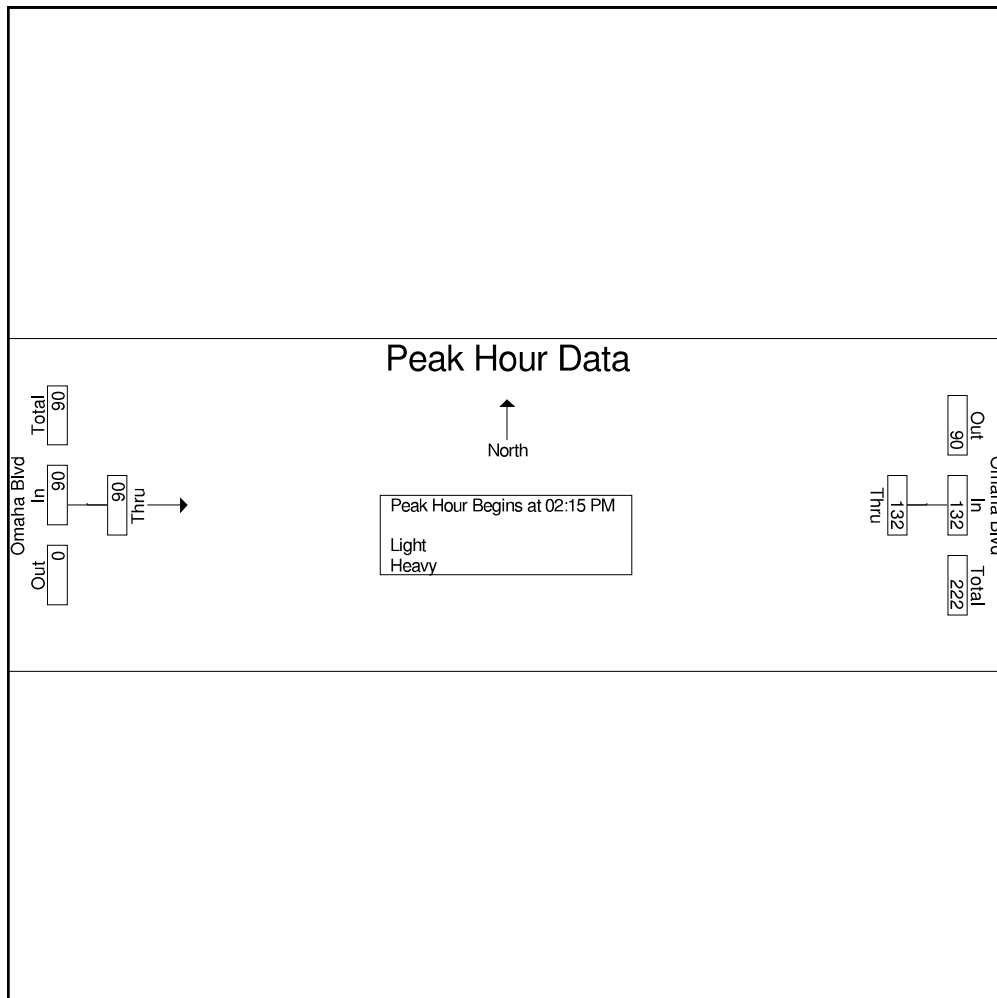

## Daily Vehicle Volume Report

Study Date: Wednesday, 03/06/2024

Unit ID: RDC 112

Location: Paonia St btwn Palmer Park and Tuskegee Pl

Comments: Colorado Springs, CO

	Northbound Volume	Southbound Volume	Total Volume
00:00 - 00:59	1	4	5
01:00 - 01:59	2	4	6
02:00 - 02:59	0	2	2
03:00 - 03:59	2	4	6
04:00 - 04:59	3	8	11
05:00 - 05:59	9	47	56
06:00 - 06:59	40	134	174
07:00 - 07:59	56	161	217
08:00 - 08:59	76	150	226
09:00 - 09:59	82	97	179
10:00 - 10:59	63	119	182
11:00 - 11:59	74	111	185
12:00 - 12:59	88	148	236
13:00 - 13:59	76	139	215
14:00 - 14:59	88	119	207
15:00 - 15:59	94	130	224
16:00 - 16:59	158	127	285
17:00 - 17:59	112	114	226
18:00 - 18:59	39	82	121
19:00 - 19:59	24	65	89
20:00 - 20:59	7	43	50
21:00 - 21:59	4	38	42
22:00 - 22:59	6	17	23
23:00 - 23:59	3	20	23
<b>Totals</b>	<b>1107</b>	<b>1883</b>	<b>2990</b>
<b>AM Peak Time</b>	<b>08:32 - 09:31</b>	<b>06:44 - 07:43</b>	<b>07:52 - 08:51</b>
<b>AM Peak Volume</b>	<b>93</b>	<b>186</b>	<b>249</b>
<b>PM Peak Time</b>	<b>16:07 - 17:06</b>	<b>12:08 - 13:07</b>	<b>16:06 - 17:05</b>
<b>PM Peak Volume</b>	<b>172</b>	<b>163</b>	<b>304</b>

## Daily Northbound Classes Report

Study Date: Wednesday, 03/06/2024  
 Unit ID: RDC 112  
 Location: Paonia St btwn Palmer Park and Tuskegee Pl  
 Comments: Colorado Springs, CO

	#1	#2	#3	#4	#5	#6	#7	#8	#9	#10	#11	#12	#13	Total
00:00 - 00:59	0	1	0	0	0	0	0	0	0	0	0	0	0	1
01:00 - 01:59	0	1	1	0	0	0	0	0	0	0	0	0	0	2
02:00 - 02:59	0	0	0	0	0	0	0	0	0	0	0	0	0	0
03:00 - 03:59	0	2	0	0	0	0	0	0	0	0	0	0	0	2
04:00 - 04:59	0	2	1	0	0	0	0	0	0	0	0	0	0	3
05:00 - 05:59	0	5	2	0	1	1	0	0	0	0	0	0	0	9
06:00 - 06:59	0	20	9	1	7	1	0	0	1	1	0	0	0	40
07:00 - 07:59	0	35	12	0	9	0	0	0	0	0	0	0	0	56
08:00 - 08:59	0	44	16	0	15	1	0	0	0	0	0	0	0	76
09:00 - 09:59	0	44	23	1	14	0	0	0	0	0	0	0	0	82
10:00 - 10:59	1	28	17	1	12	0	0	2	2	0	0	0	0	63
11:00 - 11:59	0	40	18	1	14	0	0	1	0	0	0	0	0	74
12:00 - 12:59	0	53	16	0	17	1	0	0	1	0	0	0	0	88
13:00 - 13:59	0	39	16	0	19	1	0	1	0	0	0	0	0	76
14:00 - 14:59	0	57	17	0	11	1	0	0	2	0	0	0	0	88
15:00 - 15:59	0	52	21	0	21	0	0	0	0	0	0	0	0	94
16:00 - 16:59	0	102	23	1	28	3	0	1	0	0	0	0	0	158
17:00 - 17:59	0	67	33	0	12	0	0	0	0	0	0	0	0	112
18:00 - 18:59	0	30	6	0	3	0	0	0	0	0	0	0	0	39
19:00 - 19:59	0	16	5	0	3	0	0	0	0	0	0	0	0	24
20:00 - 20:59	0	5	1	0	1	0	0	0	0	0	0	0	0	7
21:00 - 21:59	0	3	1	0	0	0	0	0	0	0	0	0	0	4
22:00 - 22:59	0	3	1	1	1	0	0	0	0	0	0	0	0	6
23:00 - 23:59	0	0	2	0	1	0	0	0	0	0	0	0	0	3
<b>Totals</b>	<b>1</b>	<b>649</b>	<b>241</b>	<b>6</b>	<b>189</b>	<b>9</b>	<b>0</b>	<b>5</b>	<b>6</b>	<b>1</b>	<b>0</b>	<b>0</b>	<b>0</b>	<b>1107</b>
<b>Percent of Total</b>	<b>0.1</b>	<b>58.6</b>	<b>21.8</b>	<b>0.5</b>	<b>17.1</b>	<b>0.8</b>	<b>0.0</b>	<b>0.5</b>	<b>0.5</b>	<b>0.1</b>	<b>0.0</b>	<b>0.0</b>	<b>0.0</b>	<b>100</b>
<b>Percent of AM</b>	<b>0.2</b>	<b>54.4</b>	<b>24.3</b>	<b>1.0</b>	<b>17.6</b>	<b>0.7</b>	<b>0.0</b>	<b>0.7</b>	<b>0.7</b>	<b>0.2</b>	<b>0.0</b>	<b>0.0</b>	<b>0.0</b>	<b>100</b>
<b>Percent of PM</b>	<b>0.0</b>	<b>61.1</b>	<b>20.3</b>	<b>0.3</b>	<b>16.7</b>	<b>0.9</b>	<b>0.0</b>	<b>0.3</b>	<b>0.4</b>	<b>0.0</b>	<b>0.0</b>	<b>0.0</b>	<b>0.0</b>	<b>100</b>

**Truck Summary:**

Total Trucks: 216                      % Trucks: 19.5                      AM % Trucks: 21.1                      PM % Trucks: 18.6

Classification Scheme: FHWA (ID: 1)

- |                                   |                                   |                                  |
|-----------------------------------|-----------------------------------|----------------------------------|
| #1 Motorcycles - 2 Axles          | #6 Single Unit Truck - 3 Axles    | #11 Multi-Unit - 5 Axles or Less |
| #2 Passenger Cars - 2 Axles       | #7 Single Unit - 4 Axles          | #12 Multi-Unit - 6 Axles         |
| #3 Pickup Trucks, Vans - 2 Axles  | #8 Single Unit - 4 Axles or Less  | #13 Multi-Unit - 7 Axles or More |
| #4 Buses                          | #9 Double Unit - 5 Axles          |                                  |
| #5 Single Unit - 2 Axles, 6 Tires | #10 Double Unit - 6 Axles or More |                                  |

## Daily Southbound Classes Report

Study Date: Wednesday, 03/06/2024  
 Unit ID: RDC 112  
 Location: Paonia St btwn Palmer Park and Tuskegee Pl  
 Comments: Colorado Springs, CO

	#1	#2	#3	#4	#5	#6	#7	#8	#9	#10	#11	#12	#13	Total
00:00 - 00:59	0	4	0	0	0	0	0	0	0	0	0	0	0	4
01:00 - 01:59	0	4	0	0	0	0	0	0	0	0	0	0	0	4
02:00 - 02:59	0	2	0	0	0	0	0	0	0	0	0	0	0	2
03:00 - 03:59	0	2	1	0	1	0	0	0	0	0	0	0	0	4
04:00 - 04:59	0	3	4	0	1	0	0	0	0	0	0	0	0	8
05:00 - 05:59	0	30	12	0	5	0	0	0	0	0	0	0	0	47
06:00 - 06:59	0	85	35	1	13	0	0	0	0	0	0	0	0	134
07:00 - 07:59	0	107	36	0	18	0	0	0	0	0	0	0	0	161
08:00 - 08:59	0	90	32	0	27	0	0	1	0	0	0	0	0	150
09:00 - 09:59	0	45	32	1	19	0	0	0	0	0	0	0	0	97
10:00 - 10:59	2	60	36	1	19	1	0	0	0	0	0	0	0	119
11:00 - 11:59	0	78	22	1	10	0	0	0	0	0	0	0	0	111
12:00 - 12:59	0	88	32	2	23	2	0	1	0	0	0	0	0	148
13:00 - 13:59	0	81	25	2	30	1	0	0	0	0	0	0	0	139
14:00 - 14:59	0	62	34	0	19	0	0	3	1	0	0	0	0	119
15:00 - 15:59	0	69	37	0	23	0	0	1	0	0	0	0	0	130
16:00 - 16:59	0	77	26	0	22	1	0	0	1	0	0	0	0	127
17:00 - 17:59	0	76	25	0	12	0	0	1	0	0	0	0	0	114
18:00 - 18:59	0	65	8	0	8	0	0	1	0	0	0	0	0	82
19:00 - 19:59	0	51	11	0	3	0	0	0	0	0	0	0	0	65
20:00 - 20:59	0	36	5	0	2	0	0	0	0	0	0	0	0	43
21:00 - 21:59	0	28	7	1	2	0	0	0	0	0	0	0	0	38
22:00 - 22:59	0	14	3	0	0	0	0	0	0	0	0	0	0	17
23:00 - 23:59	0	18	2	0	0	0	0	0	0	0	0	0	0	20
<b>Totals</b>	<b>2</b>	<b>1175</b>	<b>425</b>	<b>9</b>	<b>257</b>	<b>5</b>	<b>0</b>	<b>8</b>	<b>2</b>	<b>0</b>	<b>0</b>	<b>0</b>	<b>0</b>	<b>1883</b>
<b>Percent of Total</b>	<b>0.1</b>	<b>62.4</b>	<b>22.6</b>	<b>0.5</b>	<b>13.6</b>	<b>0.3</b>	<b>0.0</b>	<b>0.4</b>	<b>0.1</b>	<b>0.0</b>	<b>0.0</b>	<b>0.0</b>	<b>0.0</b>	<b>100</b>
<b>Percent of AM</b>	<b>0.2</b>	<b>60.6</b>	<b>25.0</b>	<b>0.5</b>	<b>13.4</b>	<b>0.1</b>	<b>0.0</b>	<b>0.1</b>	<b>0.0</b>	<b>0.0</b>	<b>0.0</b>	<b>0.0</b>	<b>0.0</b>	<b>100</b>
<b>Percent of PM</b>	<b>0.0</b>	<b>63.8</b>	<b>20.6</b>	<b>0.5</b>	<b>13.8</b>	<b>0.4</b>	<b>0.0</b>	<b>0.7</b>	<b>0.2</b>	<b>0.0</b>	<b>0.0</b>	<b>0.0</b>	<b>0.0</b>	<b>100</b>

**Truck Summary:**

Total Trucks: 281                      % Trucks: 14.9                      AM % Trucks: 14.1                      PM % Trucks: 15.5

Classification Scheme: FHWA (ID: 1)

- |                                   |                                   |                                  |
|-----------------------------------|-----------------------------------|----------------------------------|
| #1 Motorcycles - 2 Axles          | #6 Single Unit Truck - 3 Axles    | #11 Multi-Unit - 5 Axles or Less |
| #2 Passenger Cars - 2 Axles       | #7 Single Unit - 4 Axles          | #12 Multi-Unit - 6 Axles         |
| #3 Pickup Trucks, Vans - 2 Axles  | #8 Single Unit - 4 Axles or Less  | #13 Multi-Unit - 7 Axles or More |
| #4 Buses                          | #9 Double Unit - 5 Axles          |                                  |
| #5 Single Unit - 2 Axles, 6 Tires | #10 Double Unit - 6 Axles or More |                                  |



## Daily Total Classes Report

Study Date: Wednesday, 03/06/2024  
 Unit ID: RDC 112  
 Location: Paonia St btwn Palmer Park and Tuskegee Pl  
 Comments: Colorado Springs, CO

	#1	#2	#3	#4	#5	#6	#7	#8	#9	#10	#11	#12	#13	Total
00:00 - 00:59	0	5	0	0	0	0	0	0	0	0	0	0	0	5
01:00 - 01:59	0	5	1	0	0	0	0	0	0	0	0	0	0	6
02:00 - 02:59	0	2	0	0	0	0	0	0	0	0	0	0	0	2
03:00 - 03:59	0	4	1	0	1	0	0	0	0	0	0	0	0	6
04:00 - 04:59	0	5	5	0	1	0	0	0	0	0	0	0	0	11
05:00 - 05:59	0	35	14	0	6	1	0	0	0	0	0	0	0	56
06:00 - 06:59	0	105	44	2	20	1	0	0	1	1	0	0	0	174
07:00 - 07:59	0	142	48	0	27	0	0	0	0	0	0	0	0	217
08:00 - 08:59	0	134	48	0	42	1	0	1	0	0	0	0	0	226
09:00 - 09:59	0	89	55	2	33	0	0	0	0	0	0	0	0	179
10:00 - 10:59	3	88	53	2	31	1	0	2	2	0	0	0	0	182
11:00 - 11:59	0	118	40	2	24	0	0	1	0	0	0	0	0	185
12:00 - 12:59	0	141	48	2	40	3	0	1	1	0	0	0	0	236
13:00 - 13:59	0	120	41	2	49	2	0	1	0	0	0	0	0	215
14:00 - 14:59	0	119	51	0	30	1	0	3	3	0	0	0	0	207
15:00 - 15:59	0	121	58	0	44	0	0	1	0	0	0	0	0	224
16:00 - 16:59	0	179	49	1	50	4	0	1	1	0	0	0	0	285
17:00 - 17:59	0	143	58	0	24	0	0	1	0	0	0	0	0	226
18:00 - 18:59	0	95	14	0	11	0	0	1	0	0	0	0	0	121
19:00 - 19:59	0	67	16	0	6	0	0	0	0	0	0	0	0	89
20:00 - 20:59	0	41	6	0	3	0	0	0	0	0	0	0	0	50
21:00 - 21:59	0	31	8	1	2	0	0	0	0	0	0	0	0	42
22:00 - 22:59	0	17	4	1	1	0	0	0	0	0	0	0	0	23
23:00 - 23:59	0	18	4	0	1	0	0	0	0	0	0	0	0	23
<b>Totals</b>	<b>3</b>	<b>1824</b>	<b>666</b>	<b>15</b>	<b>446</b>	<b>14</b>	<b>0</b>	<b>13</b>	<b>8</b>	<b>1</b>	<b>0</b>	<b>0</b>	<b>0</b>	<b>2990</b>
<b>Percent of Total</b>	<b>0.1</b>	<b>61.0</b>	<b>22.3</b>	<b>0.5</b>	<b>14.9</b>	<b>0.5</b>	<b>0.0</b>	<b>0.4</b>	<b>0.3</b>	<b>0.0</b>	<b>0.0</b>	<b>0.0</b>	<b>0.0</b>	<b>100</b>
<b>Percent of AM</b>	<b>0.2</b>	<b>58.6</b>	<b>24.7</b>	<b>0.6</b>	<b>14.8</b>	<b>0.3</b>	<b>0.0</b>	<b>0.3</b>	<b>0.2</b>	<b>0.1</b>	<b>0.0</b>	<b>0.0</b>	<b>0.0</b>	<b>100</b>
<b>Percent of PM</b>	<b>0.0</b>	<b>62.7</b>	<b>20.5</b>	<b>0.4</b>	<b>15.0</b>	<b>0.6</b>	<b>0.0</b>	<b>0.5</b>	<b>0.3</b>	<b>0.0</b>	<b>0.0</b>	<b>0.0</b>	<b>0.0</b>	<b>100</b>

**Truck Summary:**

Total Trucks: 497                      % Trucks: 16.6                      AM % Trucks: 16.4                      PM % Trucks: 16.8

Classification Scheme: FHWA (ID: 1)

- |                                   |                                   |                                  |
|-----------------------------------|-----------------------------------|----------------------------------|
| #1 Motorcycles - 2 Axles          | #6 Single Unit Truck - 3 Axles    | #11 Multi-Unit - 5 Axles or Less |
| #2 Passenger Cars - 2 Axles       | #7 Single Unit - 4 Axles          | #12 Multi-Unit - 6 Axles         |
| #3 Pickup Trucks, Vans - 2 Axles  | #8 Single Unit - 4 Axles or Less  | #13 Multi-Unit - 7 Axles or More |
| #4 Buses                          | #9 Double Unit - 5 Axles          |                                  |
| #5 Single Unit - 2 Axles, 6 Tires | #10 Double Unit - 6 Axles or More |                                  |

# APPENDIX C

## Synchro HCM 7<sup>th</sup> Edition Reports

---

Queues  
1: Powers Boulevard & Palmer Park Bouevard

Existing (2024) Background  
Morning Peak Hour



Lane Group	EBL	EBT	EBR	WBL	WBT	WBR	NBL	NBT	NBR	SBL	SBT	SBR
Lane Group Flow (vph)	267	266	152	233	375	209	134	2053	214	214	3053	334
v/c Ratio	0.82	0.69	0.09	0.77	1.04	0.13	0.63	0.76	0.13	0.90	1.08	0.21
Control Delay (s/veh)	85.1	73.0	0.1	74.6	116.1	0.1	80.3	28.2	0.1	104.8	75.3	0.3
Queue Delay	0.0	0.0	0.0	0.0	0.0	0.0	0.0	0.0	0.0	0.0	0.0	0.0
Total Delay (s/veh)	85.1	73.0	0.1	74.6	116.1	0.1	80.3	28.2	0.1	104.8	75.3	0.3
Queue Length 50th (ft)	129	131	0	114	~215	0	65	540	0	106	~1189	0
Queue Length 95th (ft)	179	#207	0	127	#337	0	100	601	0	#182	#1295	0
Internal Link Dist (ft)		785			359			1286			1318	
Turn Bay Length (ft)	320		250	100		150	885			695		545
Base Capacity (vph)	365	382	1538	365	360	1538	274	2693	1538	239	2818	1538
Starvation Cap Reductn	0	0	0	0	0	0	0	0	0	0	0	0
Spillback Cap Reductn	0	0	0	0	0	0	0	0	0	0	0	0
Storage Cap Reductn	0	0	0	0	0	0	0	0	0	0	0	0
Reduced v/c Ratio	0.73	0.70	0.10	0.64	1.04	0.14	0.49	0.76	0.14	0.90	1.08	0.22

Intersection Summary

- ~ Volume exceeds capacity, queue is theoretically infinite.  
Queue shown is maximum after two cycles.
- # 95th percentile volume exceeds capacity, queue may be longer.  
Queue shown is maximum after two cycles.

HCM 7th Signalized Intersection Summary  
1: Powers Boulevard & Palmer Park Boulevard

Existing (2024) Background  
Morning Peak Hour



Movement	EBL	EBT	EBR	WBL	WBT	WBR	NBL	NBT	NBR	SBL	SBT	SBR
Lane Configurations	↖↗	↑↑	↖	↖↗	↑↑	↖	↖↗	↑↑↑	↖	↖↗	↑↑↑	↖
Traffic Volume (veh/h)	254	253	144	221	356	199	127	1950	203	203	2900	317
Future Volume (veh/h)	254	253	144	221	356	199	127	1950	203	203	2900	317
Initial Q (Qb), veh	0	0	0	0	0	0	0	0	0	0	0	0
Lane Width Adj.	1.00	1.00	1.00	1.00	1.00	1.00	1.00	1.00	1.00	1.00	1.00	1.00
Ped-Bike Adj(A_pbT)	1.00		1.00	1.00		1.00	1.00		1.00	1.00		1.00
Parking Bus, Adj	1.00	1.00	1.00	1.00	1.00	1.00	1.00	1.00	1.00	1.00	1.00	1.00
Work Zone On Approach		No			No			No			No	
Adj Sat Flow, veh/h/ln	1826	1826	1826	1826	1826	1826	1826	1826	1826	1826	1826	1826
Adj Flow Rate, veh/h	267	266	0	233	375	0	134	2053	0	214	3053	0
Peak Hour Factor	0.95	0.95	0.95	0.95	0.95	0.95	0.95	0.95	0.95	0.95	0.95	0.95
Percent Heavy Veh, %	5	5	5	5	5	5	5	5	5	5	5	5
Cap, veh/h	312	354		280	321		179	2799		243	2979	
Arrive On Green	0.09	0.10	0.00	0.06	0.06	0.00	0.05	0.56	0.00	0.07	0.60	0.00
Sat Flow, veh/h	3374	3469	1547	3374	3469	1547	3374	4985	1547	3374	4985	1547
Grp Volume(v), veh/h	267	266	0	233	375	0	134	2053	0	214	3053	0
Grp Sat Flow(s),veh/h/ln	1687	1735	1547	1687	1735	1547	1687	1662	1547	1687	1662	1547
Q Serve(g_s), s	11.4	10.9	0.0	10.0	13.5	0.0	5.7	44.8	0.0	9.2	87.2	0.0
Cycle Q Clear(g_c), s	11.4	10.9	0.0	10.0	13.5	0.0	5.7	44.8	0.0	9.2	87.2	0.0
Prop In Lane	1.00		1.00	1.00		1.00	1.00		1.00	1.00		1.00
Lane Grp Cap(c), veh/h	312	354		280	321		179	2799		243	2979	
V/C Ratio(X)	0.86	0.75		0.83	1.17		0.75	0.73		0.88	1.02	
Avail Cap(c_a), veh/h	370	354		370	321		277	2799		243	2979	
HCM Platoon Ratio	1.00	1.00	1.00	0.67	0.67	0.67	1.00	1.00	1.00	1.00	1.00	1.00
Upstream Filter(I)	1.00	1.00	0.00	0.97	0.97	0.00	1.00	1.00	0.00	1.00	1.00	0.00
Uniform Delay (d), s/veh	65.3	63.8	0.0	67.9	68.5	0.0	68.2	23.9	0.0	67.1	29.4	0.0
Incr Delay (d2), s/veh	13.7	7.9	0.0	8.8	103.7	0.0	2.4	1.7	0.0	28.3	23.2	0.0
Initial Q Delay(d3), s/veh	0.0	0.0	0.0	0.0	0.0	0.0	0.0	0.0	0.0	0.0	0.0	0.0
%ile BackOfQ(50%),veh/ln	5.5	5.2	0.0	4.7	10.8	0.0	2.5	16.5	0.0	4.8	36.8	0.0
Unsig. Movement Delay, s/veh												
LnGrp Delay(d), s/veh	79.0	71.6	0.0	76.7	172.2	0.0	70.5	25.6	0.0	95.5	52.6	0.0
LnGrp LOS	E	E		E	F		E	C		F	F	
Approach Vol, veh/h		533			608			2187			3267	
Approach Delay, s/veh		75.3			135.6			28.4			55.4	
Approach LOS		E			F			C			E	
Timer - Assigned Phs	1	2	3	4	5	6	7	8				
Phs Duration (G+Y+Rc), s	18.0	89.5	17.1	21.4	12.7	94.7	18.5	20.0				
Change Period (Y+Rc), s	7.5	7.5	5.0	6.5	5.0	7.5	5.0	6.5				
Max Green Setting (Gmax), s	10.5	79.5	16.0	13.5	12.0	80.5	16.0	13.5				
Max Q Clear Time (g_c+I1), s	11.2	46.8	12.0	12.9	7.7	89.2	13.4	15.5				
Green Ext Time (p_c), s	0.0	26.1	0.1	0.0	0.1	0.0	0.1	0.0				

Intersection Summary												
HCM 7th Control Delay, s/veh											55.4	
HCM 7th LOS											E	

Notes  
User approved pedestrian interval to be less than phase max green.  
Unsignalized Delay for [NBR, EBR, WBR, SBR] is excluded from calculations of the approach delay and intersection delay.

Queues

Existing (2024) Background

2: Access Road & Palmer Park Boulevard/Palmer Park Boulevard

Morning Peak Hour

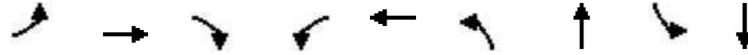

Lane Group	EBL	EBT	EBR	WBL	WBT	NBL	NBT	SBL	SBT
Lane Group Flow (vph)	29	582	82	43	721	82	47	4	24
v/c Ratio	0.05	0.20	0.06	0.06	0.25	0.57	0.09	0.02	0.12
Control Delay (s/veh)	1.3	1.1	0.0	4.1	4.0	75.8	0.4	53.5	22.0
Queue Delay	0.0	0.1	0.0	0.0	0.0	0.0	0.0	0.0	0.0
Total Delay (s/veh)	1.3	1.3	0.0	4.1	4.0	75.8	0.4	53.5	22.0
Queue Length 50th (ft)	1	14	0	6	67	76	0	4	2
Queue Length 95th (ft)	m3	m27	m0	22	135	123	0	14	29
Internal Link Dist (ft)		359			829		469		317
Turn Bay Length (ft)	110		125	175					
Base Capacity (vph)	547	2788	1262	635	2783	312	636	306	380
Starvation Cap Reductn	0	1341	0	0	0	0	0	0	0
Spillback Cap Reductn	0	0	0	0	0	0	0	0	0
Storage Cap Reductn	0	0	0	0	0	0	0	0	0
Reduced v/c Ratio	0.05	0.40	0.06	0.07	0.26	0.26	0.07	0.01	0.06

Intersection Summary

m Volume for 95th percentile queue is metered by upstream signal.

HCM 7th Signalized Intersection Summary  
 2: Access Road & Palmer Park Bouevard/Palmer Park Boulevard

Existing (2024) Background  
 Morning Peak Hour



Movement	EBL	EBT	EBR	WBL	WBT	WBR	NBL	NBT	NBR	SBL	SBT	SBR
Lane Configurations	↖	↑↑	↗	↖	↑↑		↖	↗		↖	↗	
Traffic Volume (veh/h)	28	553	78	41	677	8	78	0	45	4	2	21
Future Volume (veh/h)	28	553	78	41	677	8	78	0	45	4	2	21
Initial Q (Qb), veh	0	0	0	0	0	0	0	0	0	0	0	0
Lane Width Adj.	1.00	1.00	1.00	1.00	1.00	1.00	1.00	1.00	1.00	1.00	1.00	1.00
Ped-Bike Adj(A_pbT)	1.00		1.00	1.00		1.00	1.00		1.00	1.00		1.00
Parking Bus, Adj	1.00	1.00	1.00	1.00	1.00	1.00	1.00	1.00	1.00	1.00	1.00	1.00
Work Zone On Approach		No			No			No			No	
Adj Sat Flow, veh/h/ln	1826	1826	1826	1826	1826	1826	1826	1826	1826	1826	1826	1826
Adj Flow Rate, veh/h	29	582	82	43	713	8	82	0	47	4	2	22
Peak Hour Factor	0.95	0.95	0.95	0.95	0.95	0.95	0.95	0.95	0.95	0.95	0.95	0.95
Percent Heavy Veh, %	5	5	5	5	5	5	5	5	5	5	5	5
Cap, veh/h	609	2869	1280	646	2906	33	153	0	140	132	12	130
Arrive On Green	0.83	0.83	0.83	0.83	0.83	0.83	0.09	0.00	0.09	0.09	0.09	0.09
Sat Flow, veh/h	714	3469	1547	753	3514	39	1354	0	1547	1326	131	1437
Grp Volume(v), veh/h	29	582	82	43	352	369	82	0	47	4	0	24
Grp Sat Flow(s),veh/h/ln	714	1735	1547	753	1735	1819	1354	0	1547	1326	0	1567
Q Serve(g_s), s	1.3	5.1	1.4	1.8	6.4	6.4	8.7	0.0	4.2	0.4	0.0	2.1
Cycle Q Clear(g_c), s	7.8	5.1	1.4	6.9	6.4	6.4	10.8	0.0	4.2	4.6	0.0	2.1
Prop In Lane	1.00		1.00	1.00		0.02	1.00		1.00	1.00		0.92
Lane Grp Cap(c), veh/h	609	2869	1280	646	1435	1504	153	0	140	132	0	142
V/C Ratio(X)	0.05	0.20	0.06	0.07	0.25	0.25	0.54	0.00	0.33	0.03	0.00	0.17
Avail Cap(c_a), veh/h	609	2869	1280	646	1435	1504	346	0	360	320	0	365
HCM Platoon Ratio	1.00	1.00	1.00	1.00	1.00	1.00	1.00	1.00	1.00	1.00	1.00	1.00
Upstream Filter(I)	0.78	0.78	0.78	1.00	1.00	1.00	1.00	0.00	1.00	1.00	0.00	1.00
Uniform Delay (d), s/veh	3.6	2.6	2.3	3.3	2.7	2.7	66.3	0.0	62.2	64.4	0.0	61.3
Incr Delay (d2), s/veh	0.1	0.1	0.1	0.2	0.4	0.4	2.9	0.0	1.4	0.1	0.0	0.6
Initial Q Delay(d3), s/veh	0.0	0.0	0.0	0.0	0.0	0.0	0.0	0.0	0.0	0.0	0.0	0.0
%ile BackOfQ(50%),veh/ln	0.2	1.4	0.4	0.3	1.9	2.0	3.2	0.0	1.7	0.1	0.0	0.9
Unsig. Movement Delay, s/veh												
LnGrp Delay(d), s/veh	3.7	2.7	2.4	3.5	3.1	3.1	69.1	0.0	63.6	64.5	0.0	61.8
LnGrp LOS	A	A	A	A	A	A	E		E	E		E
Approach Vol, veh/h		693			764			129				28
Approach Delay, s/veh		2.7			3.2			67.1				62.2
Approach LOS		A			A			E				E
Timer - Assigned Phs		2		4		6		8				
Phs Duration (G+Y+Rc), s		126.7		19.3		126.7		19.3				
Change Period (Y+Rc), s		6.0		6.0		6.0		6.0				
Max Green Setting (Gmax), s		100.0		34.0		100.0		34.0				
Max Q Clear Time (g_c+I1), s		9.8		6.6		8.9		12.8				
Green Ext Time (p_c), s		7.0		0.1		10.0		0.5				
<b>Intersection Summary</b>												
HCM 7th Control Delay, s/veh				9.1								
HCM 7th LOS				A								



Intersection						
Int Delay, s/veh	3.1					
Movement	EBT	EBR	WBL	WBT	NBL	NBR
Lane Configurations	↑↑		↘	↑↑	↘	↗
Traffic Vol, veh/h	385	172	30	634	47	21
Future Vol, veh/h	385	172	30	634	47	21
Conflicting Peds, #/hr	0	0	595	0	0	1
Sign Control	Free	Free	Free	Free	Stop	Stop
RT Channelized	-	None	-	None	-	None
Storage Length	-	-	100	-	-	100
Veh in Median Storage, #	0	-	-	0	0	-
Grade, %	0	-	-	0	0	-
Peak Hour Factor	95	95	95	95	95	95
Heavy Vehicles, %	5	5	5	5	5	5
Mvmt Flow	405	181	32	667	49	22

Major/Minor	Major1	Major2	Minor1	Minor2	Minor3
Conflicting Flow All	0	0	1181	0	1488
Stage 1	-	-	-	-	1091
Stage 2	-	-	-	-	397
Critical Hdwy	-	-	4.2	-	6.9
Critical Hdwy Stg 1	-	-	-	-	5.9
Critical Hdwy Stg 2	-	-	-	-	5.9
Follow-up Hdwy	-	-	2.25	-	3.55
Pot Cap-1 Maneuver	-	-	570	-	112
Stage 1	-	-	-	-	277
Stage 2	-	-	-	-	639
Platoon blocked, %	-	-	-	-	-
Mov Cap-1 Maneuver	-	-	288	-	50
Mov Cap-2 Maneuver	-	-	-	-	115
Stage 1	-	-	-	-	140
Stage 2	-	-	-	-	569

Approach	EB	WB	NB
HCM Control Delay, s/v	0	0.86	50.77
HCM LOS			F

Minor Lane/Major Mvmt	NBLn1	NBLn2	EBT	EBR	WBL	WBT
Capacity (veh/h)	115	141	-	-	288	-
HCM Lane V/C Ratio	0.428	0.157	-	-	0.11	-
HCM Control Delay (s/veh)	57.7	35.2	-	-	19.1	-
HCM Lane LOS	F	E	-	-	C	-
HCM 95th %tile Q(veh)	1.8	0.5	-	-	0.4	-

Intersection												
Int Delay, s/veh	2.6											
Movement	EBL	EBT	EBR	WBL	WBT	WBR	NBL	NBT	NBR	SBL	SBT	SBR
Lane Configurations	↖	↗		↖	↗			↕			↕	
Traffic Vol, veh/h	23	61	16	12	149	38	3	2	13	33	6	6
Future Vol, veh/h	23	61	16	12	149	38	3	2	13	33	6	6
Conflicting Peds, #/hr	0	0	1	0	0	1	0	0	1	0	0	0
Sign Control	Free	Free	Free	Free	Free	Free	Stop	Stop	Stop	Stop	Stop	Stop
RT Channelized	-	-	None	-	-	None	-	-	None	-	-	None
Storage Length	75	-	-	100	-	-	-	-	-	-	-	-
Veh in Median Storage, #	-	0	-	-	0	-	-	0	-	-	0	-
Grade, %	-	0	-	-	0	-	-	0	-	-	0	-
Peak Hour Factor	95	95	95	95	95	95	95	95	95	95	95	95
Heavy Vehicles, %	5	5	5	5	5	5	5	5	5	5	5	5
Mvmt Flow	24	64	17	13	157	40	3	2	14	35	6	6

Major/Minor	Major1			Major2			Minor1			Minor2		
Conflicting Flow All	198	0	0	82	0	0	307	345	75	318	334	178
Stage 1	-	-	-	-	-	-	122	122	-	203	203	-
Stage 2	-	-	-	-	-	-	185	223	-	115	130	-
Critical Hdwy	4.15	-	-	4.15	-	-	7.15	6.55	6.25	7.15	6.55	6.25
Critical Hdwy Stg 1	-	-	-	-	-	-	6.15	5.55	-	6.15	5.55	-
Critical Hdwy Stg 2	-	-	-	-	-	-	6.15	5.55	-	6.15	5.55	-
Follow-up Hdwy	2.245	-	-	2.245	-	-	3.545	4.045	3.345	3.545	4.045	3.345
Pot Cap-1 Maneuver	1357	-	-	1496	-	-	639	573	979	629	582	857
Stage 1	-	-	-	-	-	-	875	789	-	792	728	-
Stage 2	-	-	-	-	-	-	810	713	-	883	782	-
Platoon blocked, %		-	-		-	-						
Mov Cap-1 Maneuver	1356	-	-	1495	-	-	611	557	977	601	565	857
Mov Cap-2 Maneuver	-	-	-	-	-	-	611	557	-	601	565	-
Stage 1	-	-	-	-	-	-	859	774	-	785	721	-
Stage 2	-	-	-	-	-	-	790	707	-	852	768	-

Approach	EB			WB			NB			SB		
HCM Control Delay, s/v	1.77			0.45			9.46			11.28		
HCM LOS							A			B		

Minor Lane/Major Mvmt	NBLn1	EBL	EBT	EBR	WBL	WBT	WBR	SBLn1
Capacity (veh/h)	825	1356	-	-	1495	-	-	620
HCM Lane V/C Ratio	0.023	0.018	-	-	0.008	-	-	0.076
HCM Control Delay (s/veh)	9.5	7.7	-	-	7.4	-	-	11.3
HCM Lane LOS	A	A	-	-	A	-	-	B
HCM 95th %tile Q(veh)	0.1	0.1	-	-	0	-	-	0.2

Intersection												
Int Delay, s/veh	5.8											
Movement	EBL	EBT	EBR	WBL	WBT	WBR	NBL	NBT	NBR	SBL	SBT	SBR
Lane Configurations	↶	↷		↶	↷			↷			↶	↷
Traffic Vol, veh/h	33	53	21	15	161	55	14	18	3	89	61	24
Future Vol, veh/h	33	53	21	15	161	55	14	18	3	89	61	24
Conflicting Peds, #/hr	0	0	0	0	0	0	0	0	0	0	0	0
Sign Control	Free	Free	Free	Free	Free	Free	Stop	Stop	Stop	Stop	Stop	Stop
RT Channelized	-	-	None	-	-	None	-	-	None	-	-	None
Storage Length	100	-	-	100	-	-	-	-	-	-	-	100
Veh in Median Storage, #	-	0	-	-	0	-	-	0	-	-	0	-
Grade, %	-	0	-	-	0	-	-	0	-	-	0	-
Peak Hour Factor	95	95	95	95	95	95	95	95	95	95	95	95
Heavy Vehicles, %	5	5	5	5	5	5	5	5	5	5	5	5
Mvmt Flow	35	56	22	16	169	58	15	19	3	94	64	25

Major/Minor	Major1			Major2			Minor1			Minor2		
Conflicting Flow All	227	0	0	78	0	0	369	395	67	365	377	198
Stage 1	-	-	-	-	-	-	136	136	-	230	230	-
Stage 2	-	-	-	-	-	-	233	259	-	135	147	-
Critical Hdwy	4.15	-	-	4.15	-	-	7.15	6.55	6.25	7.15	6.55	6.25
Critical Hdwy Stg 1	-	-	-	-	-	-	6.15	5.55	-	6.15	5.55	-
Critical Hdwy Stg 2	-	-	-	-	-	-	6.15	5.55	-	6.15	5.55	-
Follow-up Hdwy	2.245	-	-	2.245	-	-	3.545	4.045	3.345	3.545	4.045	3.345
Pot Cap-1 Maneuver	1323	-	-	1502	-	-	582	537	988	586	550	835
Stage 1	-	-	-	-	-	-	860	778	-	766	708	-
Stage 2	-	-	-	-	-	-	763	688	-	861	769	-
Platoon blocked, %	-	-	-	-	-	-	-	-	-	-	-	-
Mov Cap-1 Maneuver	1323	-	-	1502	-	-	480	517	988	543	530	835
Mov Cap-2 Maneuver	-	-	-	-	-	-	480	517	-	543	530	-
Stage 1	-	-	-	-	-	-	837	758	-	758	701	-
Stage 2	-	-	-	-	-	-	665	681	-	815	749	-

Approach	EB			WB			NB			SB		
HCM Control Delay, s/v	2.4			0.48			12.42			13.77		
HCM LOS							B			B		

Minor Lane/Major Mvmt	NBLn1	EBL	EBT	EBR	WBL	WBT	WBR	SBLn1	SBLn2
Capacity (veh/h)	522	1323	-	-	1502	-	-	537	835
HCM Lane V/C Ratio	0.071	0.026	-	-	0.011	-	-	0.294	0.03
HCM Control Delay (s/veh)	12.4	7.8	-	-	7.4	-	-	14.5	9.4
HCM Lane LOS	B	A	-	-	A	-	-	B	A
HCM 95th %tile Q(veh)	0.2	0.1	-	-	0	-	-	1.2	0.1

Queues  
1: Powers Boulevard & Palmer Park Bouevard

Existing (2024) Background  
Evening Peak Hour



Lane Group	EBL	EBT	EBR	WBL	WBT	WBR	NBL	NBT	NBR	SBL	SBT	SBR
Lane Group Flow (vph)	326	447	218	224	340	148	180	2582	369	268	2059	464
v/c Ratio	0.86	1.01	0.14	0.77	0.96	0.09	0.72	1.01	0.23	0.94	0.76	0.30
Control Delay (s/veh)	85.2	107.7	0.1	76.1	101.3	0.1	82.6	55.4	0.3	105.5	28.5	0.5
Queue Delay	0.0	0.0	0.0	0.0	0.0	0.0	0.0	0.0	0.0	0.0	0.0	0.0
Total Delay (s/veh)	85.2	107.7	0.1	76.1	101.3	0.1	82.6	55.4	0.3	105.5	28.5	0.5
Queue Length 50th (ft)	157	~240	0	110	~189	0	87	~908	0	132	546	0
Queue Length 95th (ft)	#224	#377	0	119	#295	0	128	#1026	0	#223	624	0
Internal Link Dist (ft)		785			359			1286			1318	
Turn Bay Length (ft)	320		250	100		150	885			695		545
Base Capacity (vph)	411	441	1519	342	351	1538	296	2554	1538	285	2693	1538
Starvation Cap Reductn	0	0	0	0	0	0	0	0	0	0	0	0
Spillback Cap Reductn	0	0	0	0	0	0	0	0	0	0	0	0
Storage Cap Reductn	0	0	0	0	0	0	0	0	0	0	0	0
Reduced v/c Ratio	0.79	1.01	0.14	0.65	0.97	0.10	0.61	1.01	0.24	0.94	0.76	0.30

Intersection Summary

- ~ Volume exceeds capacity, queue is theoretically infinite.  
Queue shown is maximum after two cycles.
- # 95th percentile volume exceeds capacity, queue may be longer.  
Queue shown is maximum after two cycles.

HCM 7th Signalized Intersection Summary  
 1: Powers Boulevard & Palmer Park Boulevard

Existing (2024) Background  
 Evening Peak Hour



Movement	EBL	EBT	EBR	WBL	WBT	WBR	NBL	NBT	NBR	SBL	SBT	SBR
Lane Configurations	↗↘	↑↑	↗	↗↘	↑↑	↗	↗↘	↑↑↑	↗	↗↘	↑↑↑	↗
Traffic Volume (veh/h)	313	429	209	215	326	142	173	2479	354	257	1977	445
Future Volume (veh/h)	313	429	209	215	326	142	173	2479	354	257	1977	445
Initial Q (Qb), veh	0	0	0	0	0	0	0	0	0	0	0	0
Lane Width Adj.	1.00	1.00	1.00	1.00	1.00	1.00	1.00	1.00	1.00	1.00	1.00	1.00
Ped-Bike Adj(A_pbT)	1.00		1.00	1.00		1.00	1.00		1.00	1.00		1.00
Parking Bus, Adj	1.00	1.00	1.00	1.00	1.00	1.00	1.00	1.00	1.00	1.00	1.00	1.00
Work Zone On Approach		No			No			No			No	
Adj Sat Flow, veh/h/ln	1826	1826	1826	1826	1826	1826	1826	1826	1826	1826	1826	1826
Adj Flow Rate, veh/h	326	447	0	224	340	0	180	2582	0	268	2059	0
Peak Hour Factor	0.96	0.96	0.96	0.96	0.96	0.96	0.96	0.96	0.96	0.96	0.96	0.96
Percent Heavy Veh, %	5	5	5	5	5	5	5	5	5	5	5	5
Cap, veh/h	371	423		271	321		225	2645		289	2824	
Arrive On Green	0.11	0.12	0.00	0.05	0.06	0.00	0.07	0.53	0.00	0.09	0.57	0.00
Sat Flow, veh/h	3374	3469	1547	3374	3469	1547	3374	4985	1547	3374	4985	1547
Grp Volume(v), veh/h	326	447	0	224	340	0	180	2582	0	268	2059	0
Grp Sat Flow(s),veh/h/ln	1687	1735	1547	1687	1735	1547	1687	1662	1547	1687	1662	1547
Q Serve(g_s), s	13.9	17.8	0.0	9.6	13.5	0.0	7.7	73.7	0.0	11.5	44.5	0.0
Cycle Q Clear(g_c), s	13.9	17.8	0.0	9.6	13.5	0.0	7.7	73.7	0.0	11.5	44.5	0.0
Prop In Lane	1.00		1.00	1.00		1.00	1.00		1.00	1.00		1.00
Lane Grp Cap(c), veh/h	371	423		271	321		225	2645		289	2824	
V/C Ratio(X)	0.88	1.06		0.83	1.06		0.80	0.98		0.93	0.73	
Avail Cap(c_a), veh/h	416	423		347	321		300	2645		289	2824	
HCM Platoon Ratio	1.00	1.00	1.00	0.67	0.67	0.67	1.00	1.00	1.00	1.00	1.00	1.00
Upstream Filter(I)	1.00	1.00	0.00	0.98	0.98	0.00	1.00	1.00	0.00	1.00	1.00	0.00
Uniform Delay (d), s/veh	64.0	64.1	0.0	68.1	68.5	0.0	67.2	33.4	0.0	66.3	23.4	0.0
Incr Delay (d2), s/veh	16.4	59.1	0.0	9.7	66.4	0.0	7.7	12.8	0.0	34.0	1.7	0.0
Initial Q Delay(d3), s/veh	0.0	0.0	0.0	0.0	0.0	0.0	0.0	0.0	0.0	0.0	0.0	0.0
%ile BackOfQ(50%),veh/ln	6.8	11.3	0.0	4.6	9.1	0.0	3.5	30.0	0.0	6.2	16.3	0.0
Unsig. Movement Delay, s/veh												
LnGrp Delay(d), s/veh	80.4	123.2	0.0	77.8	134.9	0.0	74.9	46.1	0.0	100.3	25.1	0.0
LnGrp LOS	F	F		E	F		E	D		F	C	
Approach Vol, veh/h		773			564			2762			2327	
Approach Delay, s/veh		105.2			112.2			48.0			33.7	
Approach LOS		F			F			D			C	
Timer - Assigned Phs	1	2	3	4	5	6	7	8				
Phs Duration (G+Y+Rc), s	20.0	85.0	16.7	24.3	14.7	90.2	21.0	20.0				
Change Period (Y+Rc), s	7.5	7.5	5.0	6.5	5.0	7.5	5.0	6.5				
Max Green Setting (Gmax), s	12.5	75.5	15.0	16.5	13.0	77.5	18.0	13.5				
Max Q Clear Time (g_c+I1), s	13.5	75.7	11.6	19.8	9.7	46.5	15.9	15.5				
Green Ext Time (p_c), s	0.0	0.0	0.1	0.0	0.1	25.1	0.1	0.0				

Intersection Summary												
HCM 7th Control Delay, s/veh											55.4	
HCM 7th LOS											E	

Notes  
 User approved pedestrian interval to be less than phase max green.  
 Unsignalized Delay for [NBR, EBR, WBR, SBR] is excluded from calculations of the approach delay and intersection delay.

Queues

Existing (2024) Background

2: Access Road & Palmer Park Boulevard/Palmer Park Boulevard

Evening Peak Hour

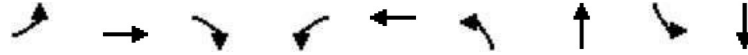

Lane Group	EBL	EBT	EBR	WBL	WBT	NBL	NBT	SBL	SBT
Lane Group Flow (vph)	82	914	88	38	595	68	69	25	71
v/c Ratio	0.12	0.32	0.06	0.08	0.21	0.52	0.32	0.19	0.32
Control Delay (s/veh)	1.4	1.6	0.0	4.3	3.6	74.7	18.0	60.0	15.7
Queue Delay	0.0	0.2	0.0	0.0	0.0	0.0	0.0	0.0	0.0
Total Delay (s/veh)	1.4	1.9	0.0	4.3	3.6	74.7	18.0	60.0	15.7
Queue Length 50th (ft)	4	23	0	5	50	63	4	22	1
Queue Length 95th (ft)	m8	m44	m0	21	107	106	48	49	46
Internal Link Dist (ft)		359			829		469		317
Turn Bay Length (ft)	110		125	175					
Base Capacity (vph)	631	2809	1272	446	2796	299	406	299	412
Starvation Cap Reductn	0	1120	0	0	0	0	0	0	0
Spillback Cap Reductn	0	0	0	0	0	0	0	0	0
Storage Cap Reductn	0	0	0	0	0	0	0	0	0
Reduced v/c Ratio	0.13	0.54	0.07	0.09	0.21	0.23	0.17	0.08	0.17

Intersection Summary

m Volume for 95th percentile queue is metered by upstream signal.

HCM 7th Signalized Intersection Summary  
 2: Access Road & Palmer Park Bouevard/Palmer Park Boulevard

Existing (2024) Background  
 Evening Peak Hour



Movement	EBL	EBT	EBR	WBL	WBT	WBR	NBL	NBT	NBR	SBL	SBT	SBR
Lane Configurations	↘	↑↑	↗	↘	↑↑		↘	↗		↘	↗	
Traffic Volume (veh/h)	79	877	84	36	551	20	65	5	61	24	1	67
Future Volume (veh/h)	79	877	84	36	551	20	65	5	61	24	1	67
Initial Q (Qb), veh	0	0	0	0	0	0	0	0	0	0	0	0
Lane Width Adj.	1.00	1.00	1.00	1.00	1.00	1.00	1.00	1.00	1.00	1.00	1.00	1.00
Ped-Bike Adj(A_pbT)	1.00		1.00	1.00		1.00	1.00		0.99	1.00		1.00
Parking Bus, Adj	1.00	1.00	1.00	1.00	1.00	1.00	1.00	1.00	1.00	1.00	1.00	1.00
Work Zone On Approach		No			No			No			No	
Adj Sat Flow, veh/h/ln	1826	1826	1826	1826	1826	1826	1826	1826	1826	1826	1826	1826
Adj Flow Rate, veh/h	82	914	88	38	574	21	68	5	64	25	1	70
Peak Hour Factor	0.96	0.96	0.96	0.96	0.96	0.96	0.96	0.96	0.96	0.96	0.96	0.96
Percent Heavy Veh, %	5	5	5	5	5	5	5	5	5	5	5	5
Cap, veh/h	663	2788	1243	452	2743	100	142	13	165	144	2	175
Arrive On Green	0.80	0.80	0.80	0.80	0.80	0.80	0.11	0.11	0.11	0.11	0.11	0.11
Sat Flow, veh/h	803	3469	1547	549	3413	125	1298	113	1444	1295	22	1529
Grp Volume(v), veh/h	82	914	88	38	291	304	68	0	69	25	0	71
Grp Sat Flow(s),veh/h/ln	803	1735	1547	549	1735	1803	1298	0	1557	1295	0	1551
Q Serve(g_s), s	3.9	10.3	1.7	2.9	5.8	5.8	7.5	0.0	6.0	2.7	0.0	6.2
Cycle Q Clear(g_c), s	9.7	10.3	1.7	13.2	5.8	5.8	13.7	0.0	6.0	8.7	0.0	6.2
Prop In Lane	1.00		1.00	1.00		0.07	1.00		0.93	1.00		0.99
Lane Grp Cap(c), veh/h	663	2788	1243	452	1394	1449	142	0	178	144	0	177
V/C Ratio(X)	0.12	0.33	0.07	0.08	0.21	0.21	0.48	0.00	0.39	0.17	0.00	0.40
Avail Cap(c_a), veh/h	663	2788	1243	452	1394	1449	296	0	363	298	0	361
HCM Platoon Ratio	1.00	1.00	1.00	1.00	1.00	1.00	1.00	1.00	1.00	1.00	1.00	1.00
Upstream Filter(I)	0.61	0.61	0.61	1.00	1.00	1.00	1.00	0.00	1.00	1.00	0.00	1.00
Uniform Delay (d), s/veh	4.5	3.8	3.0	5.6	3.4	3.4	66.4	0.0	59.9	63.9	0.0	60.0
Incr Delay (d2), s/veh	0.2	0.2	0.1	0.4	0.3	0.3	2.5	0.0	1.4	0.6	0.0	1.5
Initial Q Delay(d3), s/veh	0.0	0.0	0.0	0.0	0.0	0.0	0.0	0.0	0.0	0.0	0.0	0.0
%ile BackOfQ(50%),veh/ln	0.6	3.1	0.5	0.4	1.8	1.9	2.6	0.0	2.5	0.9	0.0	2.5
Unsig. Movement Delay, s/veh												
LnGrp Delay(d), s/veh	4.8	4.0	3.1	5.9	3.7	3.7	68.9	0.0	61.3	64.5	0.0	61.5
LnGrp LOS	A	A	A	A	A	A	E		E	E		E
Approach Vol, veh/h		1084			633			137				96
Approach Delay, s/veh		4.0			3.9			65.1				62.3
Approach LOS		A			A			E				E
Timer - Assigned Phs		2		4		6		8				
Phs Duration (G+Y+Rc), s		123.3		22.7		123.3		22.7				
Change Period (Y+Rc), s		6.0		6.0		6.0		6.0				
Max Green Setting (Gmax), s		100.0		34.0		100.0		34.0				
Max Q Clear Time (g_c+I1), s		12.3		10.7		15.2		15.7				
Green Ext Time (p_c), s		15.2		0.4		8.1		0.5				
<b>Intersection Summary</b>												
HCM 7th Control Delay, s/veh				11.1								
HCM 7th LOS				B								



Intersection						
Int Delay, s/veh	3.4					
Movement	EBT	EBR	WBL	WBT	NBL	NBR
Lane Configurations	↑↑		↘	↑↑	↘	↗
Traffic Vol, veh/h	816	101	8	440	147	54
Future Vol, veh/h	816	101	8	440	147	54
Conflicting Peds, #/hr	0	0	0	0	0	2
Sign Control	Free	Free	Free	Free	Stop	Stop
RT Channelized	-	None	-	None	-	None
Storage Length	-	-	100	-	-	100
Veh in Median Storage, #	0	-	-	0	0	-
Grade, %	0	-	-	0	0	-
Peak Hour Factor	96	96	96	96	96	96
Heavy Vehicles, %	5	5	5	5	5	5
Mvmt Flow	850	105	8	458	153	56

Major/Minor	Major1	Major2	Minor1	Minor2	Minor3
Conflicting Flow All	0	0	955	0	1148
Stage 1	-	-	-	-	903
Stage 2	-	-	-	-	246
Critical Hdwy	-	-	4.2	-	6.9
Critical Hdwy Stg 1	-	-	-	-	5.9
Critical Hdwy Stg 2	-	-	-	-	5.9
Follow-up Hdwy	-	-	2.25	-	3.55
Pot Cap-1 Maneuver	-	-	697	-	188
Stage 1	-	-	-	-	349
Stage 2	-	-	-	-	763
Platoon blocked, %	-	-	-	-	-
Mov Cap-1 Maneuver	-	-	697	-	185
Mov Cap-2 Maneuver	-	-	-	-	285
Stage 1	-	-	-	-	349
Stage 2	-	-	-	-	754

Approach	EB	WB	NB
HCM Control Delay, s/v	0	0.18	26.36
HCM LOS			D

Minor Lane/Major Mvmt	NBLn1	NBLn2	EBT	EBR	WBL	WBT
Capacity (veh/h)	285	523	-	-	697	-
HCM Lane V/C Ratio	0.537	0.107	-	-	0.012	-
HCM Control Delay (s/veh)	31.4	12.7	-	-	10.2	-
HCM Lane LOS	D	B	-	-	B	-
HCM 95th %tile Q(veh)	3	0.4	-	-	0	-

Intersection												
Int Delay, s/veh	5.5											
Movement	EBL	EBT	EBR	WBL	WBT	WBR	NBL	NBT	NBR	SBL	SBT	SBR
Lane Configurations	↖	↗		↖	↗			↕			↕	
Traffic Vol, veh/h	57	113	19	27	82	66	8	6	49	97	6	15
Future Vol, veh/h	57	113	19	27	82	66	8	6	49	97	6	15
Conflicting Peds, #/hr	0	0	1	0	0	1	0	0	1	0	0	0
Sign Control	Free	Free	Free	Free	Free	Free	Stop	Stop	Stop	Stop	Stop	Stop
RT Channelized	-	-	None	-	-	None	-	-	None	-	-	None
Storage Length	75	-	-	100	-	-	-	-	-	-	-	-
Veh in Median Storage, #	-	0	-	-	0	-	-	0	-	-	0	-
Grade, %	-	0	-	-	0	-	-	0	-	-	0	-
Peak Hour Factor	96	96	96	96	96	96	96	96	96	96	96	96
Heavy Vehicles, %	5	5	5	5	5	5	5	5	5	5	5	5
Mvmt Flow	59	118	20	28	85	69	8	6	51	101	6	16

Major/Minor	Major1		Major2		Minor1			Minor2				
Conflicting Flow All	155	0	0	139	0	0	392	459	130	418	434	121
Stage 1	-	-	-	-	-	-	247	247	-	177	177	-
Stage 2	-	-	-	-	-	-	145	211	-	241	257	-
Critical Hdwy	4.15	-	-	4.15	-	-	7.15	6.55	6.25	7.15	6.55	6.25
Critical Hdwy Stg 1	-	-	-	-	-	-	6.15	5.55	-	6.15	5.55	-
Critical Hdwy Stg 2	-	-	-	-	-	-	6.15	5.55	-	6.15	5.55	-
Follow-up Hdwy	2.245	-	-	2.245	-	-	3.545	4.045	3.345	3.545	4.045	3.345
Pot Cap-1 Maneuver	1407	-	-	1427	-	-	562	494	912	540	510	923
Stage 1	-	-	-	-	-	-	750	696	-	818	747	-
Stage 2	-	-	-	-	-	-	851	722	-	756	689	-
Platoon blocked, %		-	-		-	-						
Mov Cap-1 Maneuver	1406	-	-	1426	-	-	512	463	911	472	478	922
Mov Cap-2 Maneuver	-	-	-	-	-	-	512	463	-	472	478	-
Stage 1	-	-	-	-	-	-	718	666	-	801	732	-
Stage 2	-	-	-	-	-	-	813	707	-	677	660	-

Approach	EB		WB		NB		SB	
HCM Control Delay, s/v	2.31		1.17		10.15		14.44	
HCM LOS					B		B	

Minor Lane/Major Mvmt	NBLn1	EBL	EBT	EBR	WBL	WBT	WBR	SBLn1
Capacity (veh/h)	765	1406	-	-	1426	-	-	504
HCM Lane V/C Ratio	0.086	0.042	-	-	0.02	-	-	0.244
HCM Control Delay (s/veh)	10.1	7.7	-	-	7.6	-	-	14.4
HCM Lane LOS	B	A	-	-	A	-	-	B
HCM 95th %tile Q(veh)	0.3	0.1	-	-	0.1	-	-	0.9

Intersection												
Int Delay, s/veh	6.7											
Movement	EBL	EBT	EBR	WBL	WBT	WBR	NBL	NBT	NBR	SBL	SBT	SBR
Lane Configurations	↶	↷		↶	↷			↷			↶	↷
Traffic Vol, veh/h	40	189	30	3	135	3	27	69	16	97	37	13
Future Vol, veh/h	40	189	30	3	135	3	27	69	16	97	37	13
Conflicting Peds, #/hr	0	0	0	0	0	0	0	0	0	0	0	0
Sign Control	Free	Free	Free	Free	Free	Free	Stop	Stop	Stop	Stop	Stop	Stop
RT Channelized	-	-	None	-	-	None	-	-	None	-	-	None
Storage Length	100	-	-	100	-	-	-	-	-	-	-	100
Veh in Median Storage, #	-	0	-	-	0	-	-	0	-	-	0	-
Grade, %	-	0	-	-	0	-	-	0	-	-	0	-
Peak Hour Factor	96	96	96	96	96	96	96	96	96	96	96	96
Heavy Vehicles, %	5	5	5	5	5	5	5	5	5	5	5	5
Mvmt Flow	42	197	31	3	141	3	28	72	17	101	39	14

Major/Minor	Major1			Major2			Minor1			Minor2		
Conflicting Flow All	144	0	0	228	0	0	462	446	213	465	460	142
Stage 1	-	-	-	-	-	-	296	296	-	148	148	-
Stage 2	-	-	-	-	-	-	166	150	-	316	311	-
Critical Hdwy	4.15	-	-	4.15	-	-	7.15	6.55	6.25	7.15	6.55	6.25
Critical Hdwy Stg 1	-	-	-	-	-	-	6.15	5.55	-	6.15	5.55	-
Critical Hdwy Stg 2	-	-	-	-	-	-	6.15	5.55	-	6.15	5.55	-
Follow-up Hdwy	2.245	-	-	2.245	-	-	3.545	4.045	3.345	3.545	4.045	3.345
Pot Cap-1 Maneuver	1420	-	-	1323	-	-	505	503	820	503	494	898
Stage 1	-	-	-	-	-	-	706	663	-	847	769	-
Stage 2	-	-	-	-	-	-	829	767	-	689	653	-
Platoon blocked, %		-	-		-	-						
Mov Cap-1 Maneuver	1420	-	-	1323	-	-	444	487	820	409	478	898
Mov Cap-2 Maneuver	-	-	-	-	-	-	444	487	-	409	478	-
Stage 1	-	-	-	-	-	-	685	644	-	845	767	-
Stage 2	-	-	-	-	-	-	773	766	-	582	633	-

Approach	EB			WB			NB			SB		
HCM Control Delay, s/v	1.18			0.16			14.27			16.78		
HCM LOS							B			C		

Minor Lane/Major Mvmt	NBLn1	EBL	EBT	EBR	WBL	WBT	WBR	SBLn1	SBLn2
Capacity (veh/h)	504	1420	-	-	1323	-	-	426	898
HCM Lane V/C Ratio	0.231	0.029	-	-	0.002	-	-	0.328	0.015
HCM Control Delay (s/veh)	14.3	7.6	-	-	7.7	-	-	17.5	9.1
HCM Lane LOS	B	A	-	-	A	-	-	C	A
HCM 95th %tile Q(veh)	0.9	0.1	-	-	0	-	-	1.4	0

Queues  
1: Powers Boulevard & Palmer Park Bouevard

Mitigated Existing (2024) Background  
Morning Peak Hour

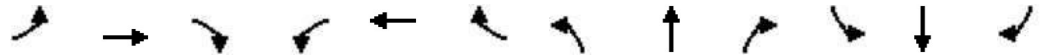

Lane Group	EBL	EBT	EBR	WBL	WBT	WBR	NBL	NBT	NBR	SBL	SBT	SBR
Lane Group Flow (vph)	267	266	152	233	375	209	134	2053	214	214	3053	334
v/c Ratio	0.77	0.56	0.09	0.75	0.86	0.13	0.63	0.82	0.13	0.76	1.13	0.21
Control Delay (s/veh)	78.9	65.1	0.1	73.5	77.8	0.1	79.7	34.5	0.1	82.9	99.9	0.3
Queue Delay	0.0	0.0	0.0	0.0	0.0	0.0	0.0	0.0	0.0	0.0	0.0	0.0
Total Delay (s/veh)	78.9	65.1	0.1	73.5	77.8	0.1	79.7	34.5	0.1	82.9	99.9	0.3
Queue Length 50th (ft)	129	126	0	114	188	0	65	597	0	104	~1238	0
Queue Length 95th (ft)	173	182	0	125	#332	0	100	680	0	147	#1350	0
Internal Link Dist (ft)		785			359			1286			1318	
Turn Bay Length (ft)	320		250	100		150	885			695		545
Base Capacity (vph)	456	468	1538	456	433	1538	296	2493	1538	331	2679	1538
Starvation Cap Reductn	0	0	0	0	0	0	0	0	0	0	0	0
Spillback Cap Reductn	0	0	0	0	0	0	0	0	0	0	0	0
Storage Cap Reductn	0	0	0	0	0	0	0	0	0	0	0	0
Reduced v/c Ratio	0.59	0.57	0.10	0.51	0.87	0.14	0.45	0.82	0.14	0.65	1.14	0.22

**Intersection Summary**

~ Volume exceeds capacity, queue is theoretically infinite.  
Queue shown is maximum after two cycles.

# 95th percentile volume exceeds capacity, queue may be longer.  
Queue shown is maximum after two cycles.

HCM 7th Signalized Intersection Summary  
 1: Powers Boulevard & Palmer Park Boulevard

Mitigated Existing (2024) Background  
 Morning Peak Hour



Movement	EBL	EBT	EBR	WBL	WBT	WBR	NBL	NBT	NBR	SBL	SBT	SBR
Lane Configurations	↔↔	↑↑	↗	↔↔	↑↑	↗	↔↔	↑↑↑	↗	↔↔	↑↑↑	↗
Traffic Volume (veh/h)	254	253	144	221	356	199	127	1950	203	203	2900	317
Future Volume (veh/h)	254	253	144	221	356	199	127	1950	203	203	2900	317
Initial Q (Qb), veh	0	0	0	0	0	0	0	0	0	0	0	0
Lane Width Adj.	1.00	1.00	1.00	1.00	1.00	1.00	1.00	1.00	1.00	1.00	1.00	1.00
Ped-Bike Adj(A_pbT)	1.00		1.00	1.00		1.00	1.00		1.00	1.00		1.00
Parking Bus, Adj	1.00	1.00	1.00	1.00	1.00	1.00	1.00	1.00	1.00	1.00	1.00	1.00
Work Zone On Approach		No			No			No			No	
Adj Sat Flow, veh/h/ln	1826	1826	1826	1826	1826	1826	1826	1826	1826	1826	1826	1826
Adj Flow Rate, veh/h	267	266	0	233	375	0	134	2053	0	214	3053	0
Peak Hour Factor	0.95	0.95	0.95	0.95	0.95	0.95	0.95	0.95	0.95	0.95	0.95	0.95
Percent Heavy Veh, %	5	5	5	5	5	5	5	5	5	5	5	5
Cap, veh/h	315	354		282	321		179	2771		259	2975	
Arrive On Green	0.09	0.10	0.00	0.06	0.06	0.00	0.05	0.56	0.00	0.08	0.60	0.00
Sat Flow, veh/h	3374	3469	1547	3374	3469	1547	3374	4985	1547	3374	4985	1547
Grp Volume(v), veh/h	267	266	0	233	375	0	134	2053	0	214	3053	0
Grp Sat Flow(s),veh/h/ln	1687	1735	1547	1687	1735	1547	1687	1662	1547	1687	1662	1547
Q Serve(g_s), s	11.4	10.9	0.0	10.0	13.5	0.0	5.7	45.4	0.0	9.1	87.1	0.0
Cycle Q Clear(g_c), s	11.4	10.9	0.0	10.0	13.5	0.0	5.7	45.4	0.0	9.1	87.1	0.0
Prop In Lane	1.00		1.00	1.00		1.00	1.00		1.00	1.00		1.00
Lane Grp Cap(c), veh/h	315	354		282	321		179	2771		259	2975	
V/C Ratio(X)	0.85	0.75		0.83	1.17		0.75	0.74		0.83	1.03	
Avail Cap(c_a), veh/h	462	354		462	321		300	2771		335	2975	
HCM Platoon Ratio	1.00	1.00	1.00	0.67	0.67	0.67	1.00	1.00	1.00	1.00	1.00	1.00
Upstream Filter(I)	1.00	1.00	0.00	0.97	0.97	0.00	1.00	1.00	0.00	1.00	1.00	0.00
Uniform Delay (d), s/veh	65.2	63.7	0.0	67.9	68.5	0.0	68.2	24.5	0.0	66.4	29.4	0.0
Incr Delay (d2), s/veh	6.5	7.7	0.0	2.5	103.7	0.0	2.3	1.8	0.0	9.8	23.7	0.0
Initial Q Delay(d3), s/veh	0.0	0.0	0.0	0.0	0.0	0.0	0.0	0.0	0.0	0.0	0.0	0.0
%ile BackOfQ(50%),veh/ln	5.2	5.2	0.0	4.5	10.8	0.0	2.5	16.8	0.0	4.2	36.9	0.0
Unsig. Movement Delay, s/veh												
LnGrp Delay(d), s/veh	71.7	71.5	0.0	70.3	172.2	0.0	70.5	26.3	0.0	76.2	53.1	0.0
LnGrp LOS	E	E		E	F		E	C		E	F	
Approach Vol, veh/h		533			608			2187			3267	
Approach Delay, s/veh		71.6			133.1			29.0			54.6	
Approach LOS		E			F			C			D	
Timer - Assigned Phs	1	2	3	4	5	6	7	8				
Phs Duration (G+Y+Rc), s	18.7	88.7	17.2	21.4	12.7	94.6	18.6	20.0				
Change Period (Y+Rc), s	7.5	7.5	5.0	6.5	5.0	7.5	5.0	6.5				
Max Green Setting (Gmax), s	14.5	71.5	20.0	13.5	13.0	75.5	20.0	13.5				
Max Q Clear Time (g_c+I1), s	11.1	47.4	12.0	12.9	7.7	89.1	13.4	15.5				
Green Ext Time (p_c), s	0.1	20.2	0.2	0.0	0.1	0.0	0.2	0.0				

Intersection Summary												
HCM 7th Control Delay, s/veh											54.7	
HCM 7th LOS											D	

Notes  
 User approved pedestrian interval to be less than phase max green.  
 Unsignalized Delay for [NBR, EBR, WBR, SBR] is excluded from calculations of the approach delay and intersection delay.

Queues

Mitigated Existing (2024) Background

2: Access Road & Palmer Park Boulevard/Palmer Park Boulevard

Morning Peak Hour

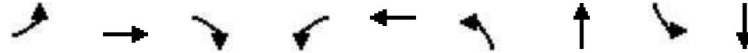

Lane Group	EBL	EBT	EBR	WBL	WBT	NBL	NBT	SBL	SBT
Lane Group Flow (vph)	29	582	82	43	721	82	47	4	24
v/c Ratio	0.05	0.20	0.06	0.06	0.25	0.57	0.09	0.02	0.12
Control Delay (s/veh)	1.3	1.1	0.0	4.1	4.0	75.8	0.4	53.5	22.0
Queue Delay	0.0	0.1	0.0	0.0	0.0	0.0	0.0	0.0	0.0
Total Delay (s/veh)	1.3	1.3	0.0	4.1	4.0	75.8	0.4	53.5	22.0
Queue Length 50th (ft)	1	14	0	6	67	76	0	4	2
Queue Length 95th (ft)	m4	27	m0	22	135	123	0	14	29
Internal Link Dist (ft)		359			829		469		317
Turn Bay Length (ft)	110		125	175					
Base Capacity (vph)	547	2788	1262	635	2783	312	636	306	380
Starvation Cap Reductn	0	1223	0	0	0	0	0	0	0
Spillback Cap Reductn	0	0	0	0	0	0	0	0	0
Storage Cap Reductn	0	0	0	0	0	0	0	0	0
Reduced v/c Ratio	0.05	0.37	0.06	0.07	0.26	0.26	0.07	0.01	0.06

Intersection Summary

m Volume for 95th percentile queue is metered by upstream signal.

HCM 7th Signalized Intersection Summary

Mitigated Existing (2024) Background

2: Access Road & Palmer Park Boulevard/Palmer Park Boulevard

Morning Peak Hour



Movement	EBL	EBT	EBR	WBL	WBT	WBR	NBL	NBT	NBR	SBL	SBT	SBR
Lane Configurations	↘	↑↑	↗	↘	↑↑		↘	↗		↘	↗	
Traffic Volume (veh/h)	28	553	78	41	677	8	78	0	45	4	2	21
Future Volume (veh/h)	28	553	78	41	677	8	78	0	45	4	2	21
Initial Q (Qb), veh	0	0	0	0	0	0	0	0	0	0	0	0
Lane Width Adj.	1.00	1.00	1.00	1.00	1.00	1.00	1.00	1.00	1.00	1.00	1.00	1.00
Ped-Bike Adj(A_pbT)	1.00		1.00	1.00		1.00	1.00		1.00	1.00		1.00
Parking Bus, Adj	1.00	1.00	1.00	1.00	1.00	1.00	1.00	1.00	1.00	1.00	1.00	1.00
Work Zone On Approach		No			No			No			No	
Adj Sat Flow, veh/h/ln	1826	1826	1826	1826	1826	1826	1826	1826	1826	1826	1826	1826
Adj Flow Rate, veh/h	29	582	82	43	713	8	82	0	47	4	2	22
Peak Hour Factor	0.95	0.95	0.95	0.95	0.95	0.95	0.95	0.95	0.95	0.95	0.95	0.95
Percent Heavy Veh, %	5	5	5	5	5	5	5	5	5	5	5	5
Cap, veh/h	609	2869	1280	646	2906	33	153	0	140	132	12	130
Arrive On Green	0.83	0.83	0.83	0.83	0.83	0.83	0.09	0.00	0.09	0.09	0.09	0.09
Sat Flow, veh/h	714	3469	1547	753	3514	39	1354	0	1547	1326	131	1437
Grp Volume(v), veh/h	29	582	82	43	352	369	82	0	47	4	0	24
Grp Sat Flow(s),veh/h/ln	714	1735	1547	753	1735	1819	1354	0	1547	1326	0	1567
Q Serve(g_s), s	1.3	5.1	1.4	1.8	6.4	6.4	8.7	0.0	4.2	0.4	0.0	2.1
Cycle Q Clear(g_c), s	7.8	5.1	1.4	6.9	6.4	6.4	10.8	0.0	4.2	4.6	0.0	2.1
Prop In Lane	1.00		1.00	1.00		0.02	1.00		1.00	1.00		0.92
Lane Grp Cap(c), veh/h	609	2869	1280	646	1435	1504	153	0	140	132	0	142
V/C Ratio(X)	0.05	0.20	0.06	0.07	0.25	0.25	0.54	0.00	0.33	0.03	0.00	0.17
Avail Cap(c_a), veh/h	609	2869	1280	646	1435	1504	346	0	360	320	0	365
HCM Platoon Ratio	1.00	1.00	1.00	1.00	1.00	1.00	1.00	1.00	1.00	1.00	1.00	1.00
Upstream Filter(I)	0.86	0.86	0.86	1.00	1.00	1.00	1.00	0.00	1.00	1.00	0.00	1.00
Uniform Delay (d), s/veh	3.6	2.6	2.3	3.3	2.7	2.7	66.3	0.0	62.2	64.4	0.0	61.3
Incr Delay (d2), s/veh	0.1	0.1	0.1	0.2	0.4	0.4	2.9	0.0	1.4	0.1	0.0	0.6
Initial Q Delay(d3), s/veh	0.0	0.0	0.0	0.0	0.0	0.0	0.0	0.0	0.0	0.0	0.0	0.0
%ile BackOfQ(50%),veh/ln	0.2	1.4	0.4	0.3	1.9	2.0	3.2	0.0	1.7	0.1	0.0	0.9
Unsig. Movement Delay, s/veh												
LnGrp Delay(d), s/veh	3.7	2.8	2.4	3.5	3.1	3.1	69.1	0.0	63.6	64.5	0.0	61.8
LnGrp LOS	A	A	A	A	A	A	E		E	E		E
Approach Vol, veh/h		693			764			129				28
Approach Delay, s/veh		2.8			3.2			67.1				62.2
Approach LOS		A			A			E				E
Timer - Assigned Phs		2		4		6		8				
Phs Duration (G+Y+Rc), s		126.7		19.3		126.7		19.3				
Change Period (Y+Rc), s		6.0		6.0		6.0		6.0				
Max Green Setting (Gmax), s		100.0		34.0		100.0		34.0				
Max Q Clear Time (g_c+I1), s		9.8		6.6		8.9		12.8				
Green Ext Time (p_c), s		7.0		0.1		10.0		0.5				
<b>Intersection Summary</b>												
HCM 7th Control Delay, s/veh				9.1								
HCM 7th LOS				A								



**Intersection**

Int Delay, s/veh 3.1

Movement	EBT	EBR	WBL	WBT	NBL	NBR
Lane Configurations	↑↑		↘	↑↑	↘	↗
Traffic Vol, veh/h	385	172	30	634	47	21
Future Vol, veh/h	385	172	30	634	47	21
Conflicting Peds, #/hr	0	0	595	0	0	1
Sign Control	Free	Free	Free	Free	Stop	Stop
RT Channelized	-	None	-	None	-	None
Storage Length	-	-	100	-	-	100
Veh in Median Storage, #	0	-	-	0	0	-
Grade, %	0	-	-	0	0	-
Peak Hour Factor	95	95	95	95	95	95
Heavy Vehicles, %	5	5	5	5	5	5
Mvmt Flow	405	181	32	667	49	22

Major/Minor	Major1	Major2	Minor1
Conflicting Flow All	0	0	1181
Stage 1	-	-	-
Stage 2	-	-	-
Critical Hdwy	-	-	4.2
Critical Hdwy Stg 1	-	-	-
Critical Hdwy Stg 2	-	-	-
Follow-up Hdwy	-	-	2.25
Pot Cap-1 Maneuver	-	-	570
Stage 1	-	-	-
Stage 2	-	-	-
Platoon blocked, %	-	-	-
Mov Cap-1 Maneuver	-	-	288
Mov Cap-2 Maneuver	-	-	-
Stage 1	-	-	-
Stage 2	-	-	-

Approach	EB	WB	NB
HCM Control Delay, s/v	0	0.86	50.77
HCM LOS			F

Minor Lane/Major Mvmt	NBLn1	NBLn2	EBT	EBR	WBL	WBT
Capacity (veh/h)	115	141	-	-	288	-
HCM Lane V/C Ratio	0.428	0.157	-	-	0.11	-
HCM Control Delay (s/veh)	57.7	35.2	-	-	19.1	-
HCM Lane LOS	F	E	-	-	C	-
HCM 95th %tile Q(veh)	1.8	0.5	-	-	0.4	-

HCM 7th TWSC  
5: Omaha Boulevard & Access Road

Mitigated Existing (2024) Background  
Morning Peak Hour

Intersection												
Int Delay, s/veh	2.6											
Movement	EBL	EBT	EBR	WBL	WBT	WBR	NBL	NBT	NBR	SBL	SBT	SBR
Lane Configurations	↖	↗		↖	↗			↕			↕	
Traffic Vol, veh/h	23	61	16	12	149	38	3	2	13	33	6	6
Future Vol, veh/h	23	61	16	12	149	38	3	2	13	33	6	6
Conflicting Peds, #/hr	0	0	1	0	0	1	0	0	1	0	0	0
Sign Control	Free	Free	Free	Free	Free	Free	Stop	Stop	Stop	Stop	Stop	Stop
RT Channelized	-	-	None	-	-	None	-	-	None	-	-	None
Storage Length	75	-	-	100	-	-	-	-	-	-	-	-
Veh in Median Storage, #	-	0	-	-	0	-	-	0	-	-	0	-
Grade, %	-	0	-	-	0	-	-	0	-	-	0	-
Peak Hour Factor	95	95	95	95	95	95	95	95	95	95	95	95
Heavy Vehicles, %	5	5	5	5	5	5	5	5	5	5	5	5
Mvmt Flow	24	64	17	13	157	40	3	2	14	35	6	6

Major/Minor	Major1		Major2		Minor1			Minor2				
Conflicting Flow All	198	0	0	82	0	0	307	345	75	318	334	178
Stage 1	-	-	-	-	-	-	122	122	-	203	203	-
Stage 2	-	-	-	-	-	-	185	223	-	115	130	-
Critical Hdwy	4.15	-	-	4.15	-	-	7.15	6.55	6.25	7.15	6.55	6.25
Critical Hdwy Stg 1	-	-	-	-	-	-	6.15	5.55	-	6.15	5.55	-
Critical Hdwy Stg 2	-	-	-	-	-	-	6.15	5.55	-	6.15	5.55	-
Follow-up Hdwy	2.245	-	-	2.245	-	-	3.545	4.045	3.345	3.545	4.045	3.345
Pot Cap-1 Maneuver	1357	-	-	1496	-	-	639	573	979	629	582	857
Stage 1	-	-	-	-	-	-	875	789	-	792	728	-
Stage 2	-	-	-	-	-	-	810	713	-	883	782	-
Platoon blocked, %		-	-		-	-						
Mov Cap-1 Maneuver	1356	-	-	1495	-	-	611	557	977	601	565	857
Mov Cap-2 Maneuver	-	-	-	-	-	-	611	557	-	601	565	-
Stage 1	-	-	-	-	-	-	859	774	-	785	721	-
Stage 2	-	-	-	-	-	-	790	707	-	852	768	-

Approach	EB		WB		NB		SB	
HCM Control Delay, s/v	1.77		0.45		9.46		11.28	
HCM LOS					A		B	

Minor Lane/Major Mvmt	NBLn1	EBL	EBT	EBR	WBL	WBT	WBR	SBLn1
Capacity (veh/h)	825	1356	-	-	1495	-	-	620
HCM Lane V/C Ratio	0.023	0.018	-	-	0.008	-	-	0.076
HCM Control Delay (s/veh)	9.5	7.7	-	-	7.4	-	-	11.3
HCM Lane LOS	A	A	-	-	A	-	-	B
HCM 95th %tile Q(veh)	0.1	0.1	-	-	0	-	-	0.2

Intersection												
Int Delay, s/veh	5.8											
Movement	EBL	EBT	EBR	WBL	WBT	WBR	NBL	NBT	NBR	SBL	SBT	SBR
Lane Configurations	↖	↗		↖	↗			↕			↖	↗
Traffic Vol, veh/h	33	53	21	15	161	55	14	18	3	89	61	24
Future Vol, veh/h	33	53	21	15	161	55	14	18	3	89	61	24
Conflicting Peds, #/hr	0	0	0	0	0	0	0	0	0	0	0	0
Sign Control	Free	Free	Free	Free	Free	Free	Stop	Stop	Stop	Stop	Stop	Stop
RT Channelized	-	-	None	-	-	None	-	-	None	-	-	None
Storage Length	100	-	-	100	-	-	-	-	-	-	-	100
Veh in Median Storage, #	-	0	-	-	0	-	-	0	-	-	0	-
Grade, %	-	0	-	-	0	-	-	0	-	-	0	-
Peak Hour Factor	95	95	95	95	95	95	95	95	95	95	95	95
Heavy Vehicles, %	5	5	5	5	5	5	5	5	5	5	5	5
Mvmt Flow	35	56	22	16	169	58	15	19	3	94	64	25

Major/Minor	Major1			Major2			Minor1			Minor2		
Conflicting Flow All	227	0	0	78	0	0	369	395	67	365	377	198
Stage 1	-	-	-	-	-	-	136	136	-	230	230	-
Stage 2	-	-	-	-	-	-	233	259	-	135	147	-
Critical Hdwy	4.15	-	-	4.15	-	-	7.15	6.55	6.25	7.15	6.55	6.25
Critical Hdwy Stg 1	-	-	-	-	-	-	6.15	5.55	-	6.15	5.55	-
Critical Hdwy Stg 2	-	-	-	-	-	-	6.15	5.55	-	6.15	5.55	-
Follow-up Hdwy	2.245	-	-	2.245	-	-	3.545	4.045	3.345	3.545	4.045	3.345
Pot Cap-1 Maneuver	1323	-	-	1502	-	-	582	537	988	586	550	835
Stage 1	-	-	-	-	-	-	860	778	-	766	708	-
Stage 2	-	-	-	-	-	-	763	688	-	861	769	-
Platoon blocked, %		-	-		-	-						
Mov Cap-1 Maneuver	1323	-	-	1502	-	-	480	517	988	543	530	835
Mov Cap-2 Maneuver	-	-	-	-	-	-	480	517	-	543	530	-
Stage 1	-	-	-	-	-	-	837	758	-	758	701	-
Stage 2	-	-	-	-	-	-	665	681	-	815	749	-

Approach	EB			WB			NB			SB		
HCM Control Delay, s/v	2.4			0.48			12.42			13.77		
HCM LOS							B			B		

Minor Lane/Major Mvmt	NBLn1	EBL	EBT	EBR	WBL	WBT	WBR	SBLn1	SBLn2
Capacity (veh/h)	522	1323	-	-	1502	-	-	537	835
HCM Lane V/C Ratio	0.071	0.026	-	-	0.011	-	-	0.294	0.03
HCM Control Delay (s/veh)	12.4	7.8	-	-	7.4	-	-	14.5	9.4
HCM Lane LOS	B	A	-	-	A	-	-	B	A
HCM 95th %tile Q(veh)	0.2	0.1	-	-	0	-	-	1.2	0.1

Queues  
1: Powers Boulevard & Palmer Park Bouevard

Mitigated Existing (2024) Background  
Evening Peak Hour

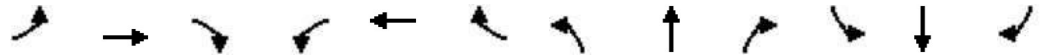

Lane Group	EBL	EBT	EBR	WBL	WBT	WBR	NBL	NBT	NBR	SBL	SBT	SBR
Lane Group Flow (vph)	326	447	218	224	340	148	180	2582	369	268	2059	464
v/c Ratio	0.84	0.89	0.14	0.74	0.81	0.09	0.71	1.05	0.23	0.94	0.79	0.30
Control Delay (s/veh)	83.4	81.4	0.1	74.1	74.7	0.1	81.1	69.8	0.3	105.5	31.7	0.5
Queue Delay	0.0	0.0	0.0	0.0	0.0	0.0	0.0	0.0	0.0	0.0	0.0	0.0
Total Delay (s/veh)	83.4	81.4	0.1	74.1	74.7	0.1	81.1	69.8	0.3	105.5	31.7	0.5
Queue Length 50th (ft)	158	223	0	110	171	0	87	~979	0	132	573	0
Queue Length 95th (ft)	211	#368	0	126	#270	0	127	#1062	0	#223	664	0
Internal Link Dist (ft)		785			359			1286			1318	
Turn Bay Length (ft)	320		250	100		150	885			695		545
Base Capacity (vph)	434	501	1519	411	416	1538	319	2453	1538	285	2585	1538
Starvation Cap Reductn	0	0	0	0	0	0	0	0	0	0	0	0
Spillback Cap Reductn	0	0	0	0	0	0	0	0	0	0	0	0
Storage Cap Reductn	0	0	0	0	0	0	0	0	0	0	0	0
Reduced v/c Ratio	0.75	0.89	0.14	0.55	0.82	0.10	0.56	1.05	0.24	0.94	0.80	0.30

Intersection Summary

- ~ Volume exceeds capacity, queue is theoretically infinite.  
Queue shown is maximum after two cycles.
- # 95th percentile volume exceeds capacity, queue may be longer.  
Queue shown is maximum after two cycles.

HCM 7th Signalized Intersection Summary  
1: Powers Boulevard & Palmer Park Bouevard

Mitigated Existing (2024) Background  
Evening Peak Hour



Movement	EBL	EBT	EBR	WBL	WBT	WBR	NBL	NBT	NBR	SBL	SBT	SBR
Lane Configurations	↖↗	↑↑	↖	↖↗	↑↑	↖	↖↗	↑↑↑	↖	↖↗	↑↑↑	↖
Traffic Volume (veh/h)	313	429	209	215	326	142	173	2479	354	257	1977	445
Future Volume (veh/h)	313	429	209	215	326	142	173	2479	354	257	1977	445
Initial Q (Qb), veh	0	0	0	0	0	0	0	0	0	0	0	0
Lane Width Adj.	1.00	1.00	1.00	1.00	1.00	1.00	1.00	1.00	1.00	1.00	1.00	1.00
Ped-Bike Adj(A_pbT)	1.00		1.00	1.00		1.00	1.00		1.00	1.00		1.00
Parking Bus, Adj	1.00	1.00	1.00	1.00	1.00	1.00	1.00	1.00	1.00	1.00	1.00	1.00
Work Zone On Approach		No			No			No			No	
Adj Sat Flow, veh/h/ln	1826	1826	1826	1826	1826	1826	1826	1826	1826	1826	1826	1826
Adj Flow Rate, veh/h	326	447	0	224	340	0	180	2582	0	268	2059	0
Peak Hour Factor	0.96	0.96	0.96	0.96	0.96	0.96	0.96	0.96	0.96	0.96	0.96	0.96
Percent Heavy Veh, %	5	5	5	5	5	5	5	5	5	5	5	5
Cap, veh/h	372	473		270	368		225	2575		289	2754	
Arrive On Green	0.11	0.14	0.00	0.11	0.14	0.00	0.07	0.52	0.00	0.09	0.55	0.00
Sat Flow, veh/h	3374	3469	1547	3374	3469	1547	3374	4985	1547	3374	4985	1547
Grp Volume(v), veh/h	326	447	0	224	340	0	180	2582	0	268	2059	0
Grp Sat Flow(s),veh/h/ln	1687	1735	1547	1687	1735	1547	1687	1662	1547	1687	1662	1547
Q Serve(g_s), s	13.9	18.7	0.0	9.5	14.1	0.0	7.7	75.4	0.0	11.5	46.0	0.0
Cycle Q Clear(g_c), s	13.9	18.7	0.0	9.5	14.1	0.0	7.7	75.4	0.0	11.5	46.0	0.0
Prop In Lane	1.00		1.00	1.00		1.00	1.00		1.00	1.00		1.00
Lane Grp Cap(c), veh/h	372	473		270	368		225	2575		289	2754	
V/C Ratio(X)	0.88	0.95		0.83	0.92		0.80	1.00		0.93	0.75	
Avail Cap(c_a), veh/h	439	473		416	368		323	2575		289	2754	
HCM Platoon Ratio	1.00	1.00	1.00	1.33	1.33	1.33	1.00	1.00	1.00	1.00	1.00	1.00
Upstream Filter(I)	1.00	1.00	0.00	0.98	0.98	0.00	1.00	1.00	0.00	1.00	1.00	0.00
Uniform Delay (d), s/veh	64.0	62.5	0.0	64.2	62.1	0.0	67.2	35.3	0.0	66.3	24.9	0.0
Incr Delay (d2), s/veh	14.4	27.8	0.0	4.5	27.5	0.0	5.5	18.4	0.0	34.0	1.9	0.0
Initial Q Delay(d3), s/veh	0.0	0.0	0.0	0.0	0.0	0.0	0.0	0.0	0.0	0.0	0.0	0.0
%ile BackOfQ(50%),veh/ln	6.7	10.0	0.0	4.1	7.4	0.0	3.4	32.1	0.0	6.2	17.0	0.0
Unsig. Movement Delay, s/veh												
LnGrp Delay(d), s/veh	78.4	90.4	0.0	68.8	89.6	0.0	72.6	53.7	0.0	100.3	26.8	0.0
LnGrp LOS	E	F		E	F		E	F		F	C	
Approach Vol, veh/h		773			564			2762			2327	
Approach Delay, s/veh		85.3			81.3			54.9			35.3	
Approach LOS		F			F			D			D	
Timer - Assigned Phs	1	2	3	4	5	6	7	8				
Phs Duration (G+Y+Rc), s	20.0	82.9	16.7	26.4	14.8	88.2	21.1	22.0				
Change Period (Y+Rc), s	7.5	7.5	5.0	6.5	5.0	7.5	5.0	6.5				
Max Green Setting (Gmax), s	12.5	72.5	18.0	16.5	14.0	73.5	19.0	15.5				
Max Q Clear Time (g_c+I1), s	13.5	77.4	11.5	20.7	9.7	48.0	15.9	16.1				
Green Ext Time (p_c), s	0.0	0.0	0.2	0.0	0.1	21.3	0.2	0.0				

Intersection Summary												
HCM 7th Control Delay, s/veh											53.8	
HCM 7th LOS											D	

Notes  
User approved pedestrian interval to be less than phase max green.  
Unsignalized Delay for [NBR, EBR, WBR, SBR] is excluded from calculations of the approach delay and intersection delay.

Queues

Mitigated Existing (2024) Background

2: Access Road & Palmer Park Boulevard/Palmer Park Boulevard

Evening Peak Hour

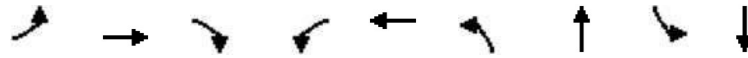

Lane Group	EBL	EBT	EBR	WBL	WBT	NBL	NBT	SBL	SBT
Lane Group Flow (vph)	82	914	88	38	595	68	69	25	71
v/c Ratio	0.12	0.32	0.06	0.08	0.21	0.52	0.32	0.19	0.32
Control Delay (s/veh)	1.4	1.5	0.0	4.3	3.6	74.7	18.0	60.0	15.7
Queue Delay	0.0	0.2	0.0	0.0	0.0	0.0	0.0	0.0	0.0
Total Delay (s/veh)	1.4	1.8	0.0	4.3	3.6	74.7	18.0	60.0	15.7
Queue Length 50th (ft)	4	23	0	5	50	63	4	22	1
Queue Length 95th (ft)	m9	m46	m0	21	107	106	48	49	46
Internal Link Dist (ft)		359			829		469		317
Turn Bay Length (ft)	110		125	175					
Base Capacity (vph)	631	2809	1272	446	2796	299	406	299	412
Starvation Cap Reductn	0	1077	0	0	0	0	0	0	0
Spillback Cap Reductn	0	0	0	0	0	0	0	0	0
Storage Cap Reductn	0	0	0	0	0	0	0	0	0
Reduced v/c Ratio	0.13	0.53	0.07	0.09	0.21	0.23	0.17	0.08	0.17

Intersection Summary

m Volume for 95th percentile queue is metered by upstream signal.

HCM 7th Signalized Intersection Summary

Mitigated Existing (2024) Background

2: Access Road & Palmer Park Bouevard/Palmer Park Boulevard

Evening Peak Hour



Movement	EBL	EBT	EBR	WBL	WBT	WBR	NBL	NBT	NBR	SBL	SBT	SBR
Lane Configurations	↘	↑↑	↗	↘	↑↑		↘	↗		↘	↗	
Traffic Volume (veh/h)	79	877	84	36	551	20	65	5	61	24	1	67
Future Volume (veh/h)	79	877	84	36	551	20	65	5	61	24	1	67
Initial Q (Qb), veh	0	0	0	0	0	0	0	0	0	0	0	0
Lane Width Adj.	1.00	1.00	1.00	1.00	1.00	1.00	1.00	1.00	1.00	1.00	1.00	1.00
Ped-Bike Adj(A_pbT)	1.00		1.00	1.00		1.00	1.00		0.99	0.99		1.00
Parking Bus, Adj	1.00	1.00	1.00	1.00	1.00	1.00	1.00	1.00	1.00	1.00	1.00	1.00
Work Zone On Approach		No			No			No			No	
Adj Sat Flow, veh/h/ln	1826	1826	1826	1826	1826	1826	1826	1826	1826	1826	1826	1826
Adj Flow Rate, veh/h	82	914	88	38	574	21	68	5	64	25	1	70
Peak Hour Factor	0.96	0.96	0.96	0.96	0.96	0.96	0.96	0.96	0.96	0.96	0.96	0.96
Percent Heavy Veh, %	5	5	5	5	5	5	5	5	5	5	5	5
Cap, veh/h	663	2788	1243	452	2743	100	142	13	164	144	2	175
Arrive On Green	0.80	0.80	0.80	0.80	0.80	0.80	0.11	0.11	0.11	0.11	0.11	0.11
Sat Flow, veh/h	803	3469	1547	549	3413	125	1298	112	1439	1292	22	1529
Grp Volume(v), veh/h	82	914	88	38	291	304	68	0	69	25	0	71
Grp Sat Flow(s),veh/h/ln	803	1735	1547	549	1735	1803	1298	0	1552	1292	0	1551
Q Serve(g_s), s	3.9	10.3	1.7	2.9	5.8	5.8	7.5	0.0	6.0	2.7	0.0	6.2
Cycle Q Clear(g_c), s	9.7	10.3	1.7	13.2	5.8	5.8	13.7	0.0	6.0	8.7	0.0	6.2
Prop In Lane	1.00		1.00	1.00		0.07	1.00		0.93	1.00		0.99
Lane Grp Cap(c), veh/h	663	2788	1243	452	1394	1449	142	0	177	144	0	177
V/C Ratio(X)	0.12	0.33	0.07	0.08	0.21	0.21	0.48	0.00	0.39	0.17	0.00	0.40
Avail Cap(c_a), veh/h	663	2788	1243	452	1394	1449	296	0	361	297	0	361
HCM Platoon Ratio	1.00	1.00	1.00	1.00	1.00	1.00	1.00	1.00	1.00	1.00	1.00	1.00
Upstream Filter(I)	0.67	0.67	0.67	1.00	1.00	1.00	1.00	0.00	1.00	1.00	0.00	1.00
Uniform Delay (d), s/veh	4.5	3.8	3.0	5.6	3.4	3.4	66.4	0.0	59.9	64.0	0.0	60.0
Incr Delay (d2), s/veh	0.3	0.2	0.1	0.4	0.3	0.3	2.5	0.0	1.4	0.6	0.0	1.5
Initial Q Delay(d3), s/veh	0.0	0.0	0.0	0.0	0.0	0.0	0.0	0.0	0.0	0.0	0.0	0.0
%ile BackOfQ(50%),veh/ln	0.6	3.1	0.5	0.4	1.8	1.9	2.6	0.0	2.5	0.9	0.0	2.5
Unsig. Movement Delay, s/veh												
LnGrp Delay(d), s/veh	4.8	4.0	3.1	5.9	3.7	3.7	68.9	0.0	61.3	64.5	0.0	61.5
LnGrp LOS	A	A	A	A	A	A	E		E	E		E
Approach Vol, veh/h		1084			633			137				96
Approach Delay, s/veh		4.0			3.9			65.1				62.3
Approach LOS		A			A			E				E
Timer - Assigned Phs		2		4		6		8				
Phs Duration (G+Y+Rc), s		123.3		22.7		123.3		22.7				
Change Period (Y+Rc), s		6.0		6.0		6.0		6.0				
Max Green Setting (Gmax), s		100.0		34.0		100.0		34.0				
Max Q Clear Time (g_c+I1), s		12.3		10.7		15.2		15.7				
Green Ext Time (p_c), s		15.2		0.4		8.1		0.5				
<b>Intersection Summary</b>												
HCM 7th Control Delay, s/veh				11.1								
HCM 7th LOS				B								



**Intersection**

Int Delay, s/veh 3.4

Movement	EBT	EBR	WBL	WBT	NBL	NBR
Lane Configurations	↑↑		↘	↑↑	↘	↗
Traffic Vol, veh/h	816	101	8	440	147	54
Future Vol, veh/h	816	101	8	440	147	54
Conflicting Peds, #/hr	0	0	0	0	0	2
Sign Control	Free	Free	Free	Free	Stop	Stop
RT Channelized	-	None	-	None	-	None
Storage Length	-	-	100	-	-	100
Veh in Median Storage, #	0	-	-	0	0	-
Grade, %	0	-	-	0	0	-
Peak Hour Factor	96	96	96	96	96	96
Heavy Vehicles, %	5	5	5	5	5	5
Mvmt Flow	850	105	8	458	153	56

**Major/Minor**

	Major1	Major2	Minor1		
Conflicting Flow All	0	0	955	0	1148 480
Stage 1	-	-	-	-	903 -
Stage 2	-	-	-	-	246 -
Critical Hdwy	-	-	4.2	-	6.9 7
Critical Hdwy Stg 1	-	-	-	-	5.9 -
Critical Hdwy Stg 2	-	-	-	-	5.9 -
Follow-up Hdwy	-	-	2.25	-	3.55 3.35
Pot Cap-1 Maneuver	-	-	697	-	188 524
Stage 1	-	-	-	-	349 -
Stage 2	-	-	-	-	763 -
Platoon blocked, %	-	-	-	-	-
Mov Cap-1 Maneuver	-	-	697	-	185 523
Mov Cap-2 Maneuver	-	-	-	-	285 -
Stage 1	-	-	-	-	349 -
Stage 2	-	-	-	-	754 -

**Approach**

	EB	WB	NB
HCM Control Delay, s/v	0	0.18	26.36
HCM LOS			D

**Minor Lane/Major Mvmt**

	NBLn1	NBLn2	EBT	EBR	WBL	WBT
Capacity (veh/h)	285	523	-	-	697	-
HCM Lane V/C Ratio	0.537	0.107	-	-	0.012	-
HCM Control Delay (s/veh)	31.4	12.7	-	-	10.2	-
HCM Lane LOS	D	B	-	-	B	-
HCM 95th %tile Q(veh)	3	0.4	-	-	0	-

Intersection												
Int Delay, s/veh	5.5											
Movement	EBL	EBT	EBR	WBL	WBT	WBR	NBL	NBT	NBR	SBL	SBT	SBR
Lane Configurations	↶	↷		↶	↷			↕			↕	
Traffic Vol, veh/h	57	113	19	27	82	66	8	6	49	97	6	15
Future Vol, veh/h	57	113	19	27	82	66	8	6	49	97	6	15
Conflicting Peds, #/hr	0	0	1	0	0	1	0	0	1	0	0	0
Sign Control	Free	Free	Free	Free	Free	Free	Stop	Stop	Stop	Stop	Stop	Stop
RT Channelized	-	-	None	-	-	None	-	-	None	-	-	None
Storage Length	75	-	-	100	-	-	-	-	-	-	-	-
Veh in Median Storage, #	-	0	-	-	0	-	-	0	-	-	0	-
Grade, %	-	0	-	-	0	-	-	0	-	-	0	-
Peak Hour Factor	96	96	96	96	96	96	96	96	96	96	96	96
Heavy Vehicles, %	5	5	5	5	5	5	5	5	5	5	5	5
Mvmt Flow	59	118	20	28	85	69	8	6	51	101	6	16

Major/Minor	Major1		Major2		Minor1			Minor2				
Conflicting Flow All	155	0	0	139	0	0	392	459	130	418	434	121
Stage 1	-	-	-	-	-	-	247	247	-	177	177	-
Stage 2	-	-	-	-	-	-	145	211	-	241	257	-
Critical Hdwy	4.15	-	-	4.15	-	-	7.15	6.55	6.25	7.15	6.55	6.25
Critical Hdwy Stg 1	-	-	-	-	-	-	6.15	5.55	-	6.15	5.55	-
Critical Hdwy Stg 2	-	-	-	-	-	-	6.15	5.55	-	6.15	5.55	-
Follow-up Hdwy	2.245	-	-	2.245	-	-	3.545	4.045	3.345	3.545	4.045	3.345
Pot Cap-1 Maneuver	1407	-	-	1427	-	-	562	494	912	540	510	923
Stage 1	-	-	-	-	-	-	750	696	-	818	747	-
Stage 2	-	-	-	-	-	-	851	722	-	756	689	-
Platoon blocked, %		-	-		-	-						
Mov Cap-1 Maneuver	1406	-	-	1426	-	-	512	463	911	472	478	922
Mov Cap-2 Maneuver	-	-	-	-	-	-	512	463	-	472	478	-
Stage 1	-	-	-	-	-	-	718	666	-	801	732	-
Stage 2	-	-	-	-	-	-	813	707	-	677	660	-

Approach	EB		WB		NB		SB	
HCM Control Delay, s/v	2.31		1.17		10.15		14.44	
HCM LOS					B		B	

Minor Lane/Major Mvmt	NBLn1	EBL	EBT	EBR	WBL	WBT	WBR	SBLn1
Capacity (veh/h)	765	1406	-	-	1426	-	-	504
HCM Lane V/C Ratio	0.086	0.042	-	-	0.02	-	-	0.244
HCM Control Delay (s/veh)	10.1	7.7	-	-	7.6	-	-	14.4
HCM Lane LOS	B	A	-	-	A	-	-	B
HCM 95th %tile Q(veh)	0.3	0.1	-	-	0.1	-	-	0.9

Intersection												
Int Delay, s/veh	6.7											
Movement	EBL	EBT	EBR	WBL	WBT	WBR	NBL	NBT	NBR	SBL	SBT	SBR
Lane Configurations	↖	↗		↖	↗			↔			↖	↗
Traffic Vol, veh/h	40	189	30	3	135	3	27	69	16	97	37	13
Future Vol, veh/h	40	189	30	3	135	3	27	69	16	97	37	13
Conflicting Peds, #/hr	0	0	0	0	0	0	0	0	0	0	0	0
Sign Control	Free	Free	Free	Free	Free	Free	Stop	Stop	Stop	Stop	Stop	Stop
RT Channelized	-	-	None	-	-	None	-	-	None	-	-	None
Storage Length	100	-	-	100	-	-	-	-	-	-	-	100
Veh in Median Storage, #	-	0	-	-	0	-	-	0	-	-	0	-
Grade, %	-	0	-	-	0	-	-	0	-	-	0	-
Peak Hour Factor	96	96	96	96	96	96	96	96	96	96	96	96
Heavy Vehicles, %	5	5	5	5	5	5	5	5	5	5	5	5
Mvmt Flow	42	197	31	3	141	3	28	72	17	101	39	14

Major/Minor	Major1			Major2			Minor1			Minor2		
Conflicting Flow All	144	0	0	228	0	0	462	446	213	465	460	142
Stage 1	-	-	-	-	-	-	296	296	-	148	148	-
Stage 2	-	-	-	-	-	-	166	150	-	316	311	-
Critical Hdwy	4.15	-	-	4.15	-	-	7.15	6.55	6.25	7.15	6.55	6.25
Critical Hdwy Stg 1	-	-	-	-	-	-	6.15	5.55	-	6.15	5.55	-
Critical Hdwy Stg 2	-	-	-	-	-	-	6.15	5.55	-	6.15	5.55	-
Follow-up Hdwy	2.245	-	-	2.245	-	-	3.545	4.045	3.345	3.545	4.045	3.345
Pot Cap-1 Maneuver	1420	-	-	1323	-	-	505	503	820	503	494	898
Stage 1	-	-	-	-	-	-	706	663	-	847	769	-
Stage 2	-	-	-	-	-	-	829	767	-	689	653	-
Platoon blocked, %		-	-		-	-						
Mov Cap-1 Maneuver	1420	-	-	1323	-	-	444	487	820	409	478	898
Mov Cap-2 Maneuver	-	-	-	-	-	-	444	487	-	409	478	-
Stage 1	-	-	-	-	-	-	685	644	-	845	767	-
Stage 2	-	-	-	-	-	-	773	766	-	582	633	-

Approach	EB			WB			NB			SB		
HCM Control Delay, s/v	1.18			0.16			14.27			16.78		
HCM LOS							B			C		

Minor Lane/Major Mvmt	NBLn1	EBL	EBT	EBR	WBL	WBT	WBR	SBLn1	SBLn2
Capacity (veh/h)	504	1420	-	-	1323	-	-	426	898
HCM Lane V/C Ratio	0.231	0.029	-	-	0.002	-	-	0.328	0.015
HCM Control Delay (s/veh)	14.3	7.6	-	-	7.7	-	-	17.5	9.1
HCM Lane LOS	B	A	-	-	A	-	-	C	A
HCM 95th %tile Q(veh)	0.9	0.1	-	-	0	-	-	1.4	0

Queues  
1: Powers Boulevard & Palmer Park Boulevard

Opening Day (2025) Background  
Morning Peak Hour



Lane Group	EBL	EBT	EBR	WBL	WBT	WBR	NBL	NBT	NBR	SBL	SBT	SBR
Lane Group Flow (vph)	268	268	158	237	379	216	137	2116	216	221	3147	337
v/c Ratio	1.06	0.91	0.10	0.79	1.11	0.14	0.68	0.74	0.14	1.01	1.05	0.21
Control Delay (s/veh)	137.7	100.0	0.1	77.6	136.6	0.1	85.0	24.6	0.1	131.5	64.1	0.3
Queue Delay	0.0	0.0	0.0	0.0	0.0	0.0	0.0	0.0	0.0	0.0	0.0	0.0
Total Delay (s/veh)	137.7	100.0	0.1	77.6	136.6	0.1	85.0	24.6	0.1	131.5	64.1	0.3
Queue Length 50th (ft)	~144	136	0	116	~217	0	67	523	0	~114	~1209	0
Queue Length 95th (ft)	#240	#247	0	155	#329	0	104	580	0	#203	#1287	0
Internal Link Dist (ft)		785			359			1286			1318	
Turn Bay Length (ft)	320		250	100		150	885			695		545
Base Capacity (vph)	251	292	1538	342	341	1538	228	2859	1538	217	2970	1538
Starvation Cap Reductn	0	0	0	0	0	0	0	0	0	0	0	0
Spillback Cap Reductn	0	0	0	0	0	0	0	0	0	0	0	0
Storage Cap Reductn	0	0	0	0	0	0	0	0	0	0	0	0
Reduced v/c Ratio	1.07	0.92	0.10	0.69	1.11	0.14	0.60	0.74	0.14	1.02	1.06	0.22

Intersection Summary

~ Volume exceeds capacity, queue is theoretically infinite.

Queue shown is maximum after two cycles.

# 95th percentile volume exceeds capacity, queue may be longer.

Queue shown is maximum after two cycles.

HCM 7th Signalized Intersection Summary  
 1: Powers Boulevard & Palmer Park Boulevard

Opening Day (2025) Background  
 Morning Peak Hour



Movement	EBL	EBT	EBR	WBL	WBT	WBR	NBL	NBT	NBR	SBL	SBT	SBR
Lane Configurations	↔↔	↑↑	↗	↔↔	↑↑	↗	↔↔	↑↑↑	↗	↔↔	↑↑↑	↗
Traffic Volume (veh/h)	255	255	150	225	360	205	130	2010	205	210	2990	320
Future Volume (veh/h)	255	255	150	225	360	205	130	2010	205	210	2990	320
Initial Q (Qb), veh	0	0	0	0	0	0	0	0	0	0	0	0
Lane Width Adj.	1.00	1.00	1.00	1.00	1.00	1.00	1.00	1.00	1.00	1.00	1.00	1.00
Ped-Bike Adj(A_pbT)	1.00		1.00	1.00		1.00	1.00		1.00	1.00		1.00
Parking Bus, Adj	1.00	1.00	1.00	1.00	1.00	1.00	1.00	1.00	1.00	1.00	1.00	1.00
Work Zone On Approach		No			No			No			No	
Adj Sat Flow, veh/h/ln	1826	1826	1826	1826	1826	1826	1826	1826	1826	1826	1826	1826
Adj Flow Rate, veh/h	268	268	0	237	379	0	137	2116	0	221	3147	0
Peak Hour Factor	0.95	0.95	0.95	0.95	0.95	0.95	0.95	0.95	0.95	0.95	0.95	0.95
Percent Heavy Veh, %	5	5	5	5	5	5	5	5	5	5	5	5
Cap, veh/h	254	314		284	345		181	2885		220	3027	
Arrive On Green	0.08	0.09	0.00	0.06	0.07	0.00	0.05	0.58	0.00	0.07	0.61	0.00
Sat Flow, veh/h	3374	3469	1547	3374	3469	1547	3374	4985	1547	3374	4985	1547
Grp Volume(v), veh/h	268	268	0	237	379	0	137	2116	0	221	3147	0
Grp Sat Flow(s),veh/h/ln	1687	1735	1547	1687	1735	1547	1687	1662	1547	1687	1662	1547
Q Serve(g_s), s	11.0	11.1	0.0	10.2	14.5	0.0	5.8	45.4	0.0	9.5	88.7	0.0
Cycle Q Clear(g_c), s	11.0	11.1	0.0	10.2	14.5	0.0	5.8	45.4	0.0	9.5	88.7	0.0
Prop In Lane	1.00		1.00	1.00		1.00	1.00		1.00	1.00		1.00
Lane Grp Cap(c), veh/h	254	314		284	345		181	2885		220	3027	
V/C Ratio(X)	1.05	0.85		0.84	1.10		0.76	0.73		1.01	1.04	
Avail Cap(c_a), veh/h	254	314		347	345		231	2885		220	3027	
HCM Platoon Ratio	1.00	1.00	1.00	0.67	0.67	0.67	1.00	1.00	1.00	1.00	1.00	1.00
Upstream Filter(I)	1.00	1.00	0.00	0.96	0.96	0.00	1.00	1.00	0.00	1.00	1.00	0.00
Uniform Delay (d), s/veh	67.5	65.4	0.0	67.9	68.1	0.0	68.1	22.5	0.0	68.3	28.7	0.0
Incr Delay (d2), s/veh	71.5	18.8	0.0	11.3	77.2	0.0	7.2	1.7	0.0	62.5	27.9	0.0
Initial Q Delay(d3), s/veh	0.0	0.0	0.0	0.0	0.0	0.0	0.0	0.0	0.0	0.0	0.0	0.0
%ile BackOfQ(50%),veh/ln	7.2	5.7	0.0	4.9	10.3	0.0	2.6	16.5	0.0	5.9	38.5	0.0
Unsig. Movement Delay, s/veh												
LnGrp Delay(d), s/veh	139.0	84.2	0.0	79.2	145.3	0.0	75.3	24.2	0.0	130.7	56.5	0.0
LnGrp LOS	F	F		E	F		E	C		F	F	
Approach Vol, veh/h		536			616			2253			3368	
Approach Delay, s/veh		111.6			119.9			27.3			61.4	
Approach LOS		F			F			C			E	
Timer - Assigned Phs	1	2	3	4	5	6	7	8				
Phs Duration (G+Y+Rc), s	17.0	92.0	17.3	19.7	12.8	96.2	16.0	21.0				
Change Period (Y+Rc), s	7.5	7.5	5.0	6.5	5.0	7.5	5.0	6.5				
Max Green Setting (Gmax), s	9.5	84.5	15.0	10.5	10.0	86.5	11.0	14.5				
Max Q Clear Time (g_c+I1), s	11.5	47.4	12.2	13.1	7.8	90.7	13.0	16.5				
Green Ext Time (p_c), s	0.0	29.7	0.1	0.0	0.0	0.0	0.0	0.0				

Intersection Summary												
HCM 7th Control Delay, s/veh											59.4	
HCM 7th LOS											E	

Notes  
 User approved pedestrian interval to be less than phase max green.  
 Unsignalized Delay for [NBR, EBR, WBR, SBR] is excluded from calculations of the approach delay and intersection delay.

Queues  
2: Access Road & Palmer Park Boulevard

Opening Day (2025) Background  
Morning Peak Hour

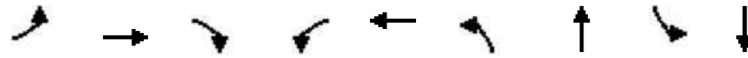

Lane Group	EBL	EBT	EBR	WBL	WBT	NBL	NBT	SBL	SBT
Lane Group Flow (vph)	32	589	84	47	732	84	58	5	31
v/c Ratio	0.05	0.21	0.06	0.07	0.26	0.58	0.26	0.03	0.16
Control Delay (s/veh)	1.3	1.3	0.0	4.1	4.1	76.5	18.2	53.6	23.3
Queue Delay	0.0	0.2	0.0	0.0	0.0	0.0	0.0	0.0	0.0
Total Delay (s/veh)	1.3	1.5	0.0	4.1	4.1	76.5	18.2	53.6	23.3
Queue Length 50th (ft)	1	14	0	7	69	78	4	4	4
Queue Length 95th (ft)	m3	m25	m0	24	137	126	45	17	34
Internal Link Dist (ft)		359			829		469		317
Turn Bay Length (ft)	110		125	175					
Base Capacity (vph)	540	2784	1261	630	2779	310	404	302	388
Starvation Cap Reductn	0	1431	0	0	0	0	0	0	0
Spillback Cap Reductn	0	0	0	0	0	0	0	0	0
Storage Cap Reductn	0	0	0	0	0	0	0	0	0
Reduced v/c Ratio	0.06	0.44	0.07	0.07	0.26	0.27	0.14	0.02	0.08

Intersection Summary

m Volume for 95th percentile queue is metered by upstream signal.

HCM 7th Signalized Intersection Summary  
2: Access Road & Palmer Park Boulevard

Opening Day (2025) Background  
Morning Peak Hour



Movement	EBL	EBT	EBR	WBL	WBT	WBR	NBL	NBT	NBR	SBL	SBT	SBR
Lane Configurations	↖	↗	↘	↖	↗		↖	↗		↖	↗	
Traffic Volume (veh/h)	30	560	80	45	685	10	80	5	50	5	5	25
Future Volume (veh/h)	30	560	80	45	685	10	80	5	50	5	5	25
Initial Q (Qb), veh	0	0	0	0	0	0	0	0	0	0	0	0
Lane Width Adj.	1.00	1.00	1.00	1.00	1.00	1.00	1.00	1.00	1.00	1.00	1.00	1.00
Ped-Bike Adj(A_pbT)	1.00		1.00	1.00		1.00	1.00		1.00	1.00		1.00
Parking Bus, Adj	1.00	1.00	1.00	1.00	1.00	1.00	1.00	1.00	1.00	1.00	1.00	1.00
Work Zone On Approach		No			No			No			No	
Adj Sat Flow, veh/h/ln	1826	1826	1826	1826	1826	1826	1826	1826	1826	1826	1826	1826
Adj Flow Rate, veh/h	32	589	84	47	721	11	84	5	53	5	5	26
Peak Hour Factor	0.95	0.95	0.95	0.95	0.95	0.95	0.95	0.95	0.95	0.95	0.95	0.95
Percent Heavy Veh, %	5	5	5	5	5	5	5	5	5	5	5	5
Cap, veh/h	597	2848	1270	635	2871	44	156	13	139	131	25	129
Arrive On Green	0.82	0.82	0.82	0.82	0.82	0.82	0.10	0.10	0.10	0.10	0.10	0.10
Sat Flow, veh/h	707	3469	1547	747	3498	53	1346	135	1433	1313	256	1331
Grp Volume(v), veh/h	32	589	84	47	358	374	84	0	58	5	0	31
Grp Sat Flow(s),veh/h/ln	707	1735	1547	747	1735	1816	1346	0	1568	1313	0	1586
Q Serve(g_s), s	1.6	5.3	1.5	2.1	6.8	6.8	9.0	0.0	5.1	0.5	0.0	2.6
Cycle Q Clear(g_c), s	8.4	5.3	1.5	7.5	6.8	6.8	11.6	0.0	5.1	5.6	0.0	2.6
Prop In Lane	1.00		1.00	1.00		0.03	1.00		0.91	1.00		0.84
Lane Grp Cap(c), veh/h	597	2848	1270	635	1424	1491	156	0	152	131	0	154
V/C Ratio(X)	0.05	0.21	0.07	0.07	0.25	0.25	0.54	0.00	0.38	0.04	0.00	0.20
Avail Cap(c_a), veh/h	597	2848	1270	635	1424	1491	338	0	365	310	0	369
HCM Platoon Ratio	1.00	1.00	1.00	1.00	1.00	1.00	1.00	1.00	1.00	1.00	1.00	1.00
Upstream Filter(I)	0.63	0.63	0.63	1.00	1.00	1.00	1.00	0.00	1.00	1.00	0.00	1.00
Uniform Delay (d), s/veh	3.9	2.8	2.5	3.6	3.0	3.0	66.1	0.0	61.8	64.4	0.0	60.7
Incr Delay (d2), s/veh	0.1	0.1	0.1	0.2	0.4	0.4	2.9	0.0	1.6	0.1	0.0	0.6
Initial Q Delay(d3), s/veh	0.0	0.0	0.0	0.0	0.0	0.0	0.0	0.0	0.0	0.0	0.0	0.0
%ile BackOfQ(50%),veh/ln	0.2	1.5	0.4	0.3	2.0	2.1	3.2	0.0	2.1	0.2	0.0	1.1
Unsig. Movement Delay, s/veh												
LnGrp Delay(d), s/veh	4.0	2.9	2.5	3.9	3.4	3.4	68.9	0.0	63.4	64.6	0.0	61.4
LnGrp LOS	A	A	A	A	A	A	E		E	E		E
Approach Vol, veh/h		705			779			142				36
Approach Delay, s/veh		2.9			3.4			66.7				61.8
Approach LOS		A			A			E				E
Timer - Assigned Phs		2		4		6		8				
Phs Duration (G+Y+Rc), s		125.8		20.2		125.8		20.2				
Change Period (Y+Rc), s		6.0		6.0		6.0		6.0				
Max Green Setting (Gmax), s		100.0		34.0		100.0		34.0				
Max Q Clear Time (g_c+I1), s		10.4		7.6		9.5		13.6				
Green Ext Time (p_c), s		7.2		0.1		10.4		0.6				
<b>Intersection Summary</b>												
HCM 7th Control Delay, s/veh				9.9								
HCM 7th LOS				A								



Intersection						
Int Delay, s/veh	3.6					
Movement	EBT	EBR	WBL	WBT	NBL	NBR
Lane Configurations	↑↑		↘	↑↑	↘	↘
Traffic Vol, veh/h	395	175	35	645	50	25
Future Vol, veh/h	395	175	35	645	50	25
Conflicting Peds, #/hr	0	0	595	0	0	1
Sign Control	Free	Free	Free	Free	Stop	Stop
RT Channelized	-	None	-	None	-	None
Storage Length	-	-	100	-	-	100
Veh in Median Storage, #	0	-	-	0	0	-
Grade, %	0	-	-	0	0	-
Peak Hour Factor	95	95	95	95	95	95
Heavy Vehicles, %	5	5	5	5	5	5
Mvmt Flow	416	184	37	679	53	26

Major/Minor	Major1	Major2	Minor1			
Conflicting Flow All	0	0	1195	0	1516	896
Stage 1	-	-	-	-	1103	-
Stage 2	-	-	-	-	413	-
Critical Hdwy	-	-	4.2	-	6.9	7
Critical Hdwy Stg 1	-	-	-	-	5.9	-
Critical Hdwy Stg 2	-	-	-	-	5.9	-
Follow-up Hdwy	-	-	2.25	-	3.55	3.35
Pot Cap-1 Maneuver	-	-	563	-	107	277
Stage 1	-	-	-	-	273	-
Stage 2	-	-	-	-	627	-
Platoon blocked, %	-	-	-	-	-	-
Mov Cap-1 Maneuver	-	-	284	-	~ 47	140
Mov Cap-2 Maneuver	-	-	-	-	113	-
Stage 1	-	-	-	-	138	-
Stage 2	-	-	-	-	546	-

Approach	EB	WB	NB
HCM Control Delay, s/v	0	1.01	53.62
HCM LOS			F

Minor Lane/Major Mvmt	NBLn1	NBLn2	EBT	EBR	WBL	WBT
Capacity (veh/h)	113	140	-	-	284	-
HCM Lane V/C Ratio	0.466	0.188	-	-	0.13	-
HCM Control Delay (s/veh)	62.1	36.6	-	-	19.6	-
HCM Lane LOS	F	E	-	-	C	-
HCM 95th %tile Q(veh)	2.1	0.7	-	-	0.4	-

Notes  
 ~: Volume exceeds capacity    \$: Delay exceeds 300s    +: Computation Not Defined    \*: All major volume in platoon

HCM 7th TWSC  
5: Omaha Boulevard & Access Road

Opening Day (2025) Background  
Morning Peak Hour

Intersection												
Int Delay, s/veh	2.9											
Movement	EBL	EBT	EBR	WBL	WBT	WBR	NBL	NBT	NBR	SBL	SBT	SBR
Lane Configurations	↶	↷		↶	↷			↕			↕	
Traffic Vol, veh/h	25	75	20	15	155	40	5	5	15	35	10	10
Future Vol, veh/h	25	75	20	15	155	40	5	5	15	35	10	10
Conflicting Peds, #/hr	0	0	1	0	0	1	0	0	1	0	0	0
Sign Control	Free	Free	Free	Free	Free	Free	Stop	Stop	Stop	Stop	Stop	Stop
RT Channelized	-	-	None	-	-	None	-	-	None	-	-	None
Storage Length	75	-	-	100	-	-	-	-	-	-	-	-
Veh in Median Storage, #	-	0	-	-	0	-	-	0	-	-	0	-
Grade, %	-	0	-	-	0	-	-	0	-	-	0	-
Peak Hour Factor	95	95	95	95	95	95	95	95	95	95	95	95
Heavy Vehicles, %	5	5	5	5	5	5	5	5	5	5	5	5
Mvmt Flow	26	79	21	16	163	42	5	5	16	37	11	11

Major/Minor	Major1			Major2			Minor1			Minor2		
Conflicting Flow All	206	0	0	101	0	0	343	381	91	352	370	185
Stage 1	-	-	-	-	-	-	143	143	-	217	217	-
Stage 2	-	-	-	-	-	-	200	238	-	135	154	-
Critical Hdwy	4.15	-	-	4.15	-	-	7.15	6.55	6.25	7.15	6.55	6.25
Critical Hdwy Stg 1	-	-	-	-	-	-	6.15	5.55	-	6.15	5.55	-
Critical Hdwy Stg 2	-	-	-	-	-	-	6.15	5.55	-	6.15	5.55	-
Follow-up Hdwy	2.245	-	-	2.245	-	-	3.545	4.045	3.345	3.545	4.045	3.345
Pot Cap-1 Maneuver	1347	-	-	1473	-	-	605	547	958	597	555	849
Stage 1	-	-	-	-	-	-	853	773	-	779	718	-
Stage 2	-	-	-	-	-	-	795	703	-	861	765	-
Platoon blocked, %		-	-		-	-						
Mov Cap-1 Maneuver	1346	-	-	1472	-	-	568	530	956	563	537	849
Mov Cap-2 Maneuver	-	-	-	-	-	-	568	530	-	563	537	-
Stage 1	-	-	-	-	-	-	835	757	-	770	710	-
Stage 2	-	-	-	-	-	-	765	695	-	824	749	-

Approach	EB			WB			NB			SB		
HCM Control Delay, s/v	1.61			0.53			10.07			11.71		
HCM LOS							B			B		

Minor Lane/Major Mvmt	NBLn1	EBL	EBT	EBR	WBL	WBT	WBR	SBLn1
Capacity (veh/h)	737	1346	-	-	1472	-	-	594
HCM Lane V/C Ratio	0.036	0.02	-	-	0.011	-	-	0.097
HCM Control Delay (s/veh)	10.1	7.7	-	-	7.5	-	-	11.7
HCM Lane LOS	B	A	-	-	A	-	-	B
HCM 95th %tile Q(veh)	0.1	0.1	-	-	0	-	-	0.3

HCM 7th TWSC  
6: Paonia Street & Omaha Boulevard

Opening Day (2025) Background  
Morning Peak Hour

Intersection												
Int Delay, s/veh	6.1											
Movement	EBL	EBT	EBR	WBL	WBT	WBR	NBL	NBT	NBR	SBL	SBT	SBR
Lane Configurations	↖	↗		↖	↗			↔			↖	↗
Traffic Vol, veh/h	35	65	25	20	170	60	15	20	5	90	65	25
Future Vol, veh/h	35	65	25	20	170	60	15	20	5	90	65	25
Conflicting Peds, #/hr	0	0	0	0	0	0	0	0	0	0	0	0
Sign Control	Free	Free	Free	Free	Free	Free	Stop	Stop	Stop	Stop	Stop	Stop
RT Channelized	-	-	None	-	-	None	-	-	None	-	-	None
Storage Length	100	-	-	100	-	-	-	-	-	-	-	100
Veh in Median Storage, #	-	0	-	-	0	-	-	0	-	-	0	-
Grade, %	-	0	-	-	0	-	-	0	-	-	0	-
Peak Hour Factor	95	95	95	95	95	95	95	95	95	95	95	95
Heavy Vehicles, %	5	5	5	5	5	5	5	5	5	5	5	5
Mvmt Flow	37	68	26	21	179	63	16	21	5	95	68	26

Major/Minor	Major1			Major2			Minor1			Minor2		
Conflicting Flow All	242	0	0	95	0	0	411	439	82	405	421	211
Stage 1	-	-	-	-	-	-	155	155	-	253	253	-
Stage 2	-	-	-	-	-	-	255	284	-	153	168	-
Critical Hdwy	4.15	-	-	4.15	-	-	7.15	6.55	6.25	7.15	6.55	6.25
Critical Hdwy Stg 1	-	-	-	-	-	-	6.15	5.55	-	6.15	5.55	-
Critical Hdwy Stg 2	-	-	-	-	-	-	6.15	5.55	-	6.15	5.55	-
Follow-up Hdwy	2.245	-	-	2.245	-	-	3.545	4.045	3.345	3.545	4.045	3.345
Pot Cap-1 Maneuver	1307	-	-	1481	-	-	546	507	970	551	519	822
Stage 1	-	-	-	-	-	-	840	763	-	745	693	-
Stage 2	-	-	-	-	-	-	743	671	-	843	753	-
Platoon blocked, %		-	-		-	-						
Mov Cap-1 Maneuver	1307	-	-	1481	-	-	439	486	970	503	497	822
Mov Cap-2 Maneuver	-	-	-	-	-	-	439	486	-	503	497	-
Stage 1	-	-	-	-	-	-	816	742	-	734	683	-
Stage 2	-	-	-	-	-	-	638	661	-	791	732	-

Approach	EB			WB			NB			SB		
HCM Control Delay, s/v	2.19			0.6			12.91			14.78		
HCM LOS							B			B		

Minor Lane/Major Mvmt	NBLn1	EBL	EBT	EBR	WBL	WBT	WBR	SBLn1	SBLn2
Capacity (veh/h)	497	1307	-	-	1481	-	-	501	822
HCM Lane V/C Ratio	0.085	0.028	-	-	0.014	-	-	0.326	0.032
HCM Control Delay (s/veh)	12.9	7.8	-	-	7.5	-	-	15.6	9.5
HCM Lane LOS	B	A	-	-	A	-	-	C	A
HCM 95th %tile Q(veh)	0.3	0.1	-	-	0	-	-	1.4	0.1

Queues  
1: Powers Boulevard & Palmer Park Boulevard

Opening Day (2025) Background  
Evening Peak Hour



Lane Group	EBL	EBT	EBR	WBL	WBT	WBR	NBL	NBT	NBR	SBL	SBT	SBR
Lane Group Flow (vph)	328	448	224	229	344	151	188	2661	375	271	2125	469
v/c Ratio	0.86	1.02	0.14	0.78	0.98	0.09	0.74	1.04	0.24	0.95	0.79	0.30
Control Delay (s/veh)	85.4	109.5	0.2	76.5	104.5	0.1	83.7	64.5	0.3	107.6	29.7	0.5
Queue Delay	0.0	0.0	0.0	0.0	0.0	0.0	0.0	0.0	0.0	0.0	0.0	0.0
Total Delay (s/veh)	85.4	109.5	0.2	76.5	104.5	0.1	83.7	64.5	0.3	107.6	29.7	0.5
Queue Length 50th (ft)	158	~243	0	112	~194	0	91	~1000	0	134	579	0
Queue Length 95th (ft)	#226	#378	0	123	#302	0	133	#1081	0	#225	657	0
Internal Link Dist (ft)		785			359			1286			1318	
Turn Bay Length (ft)	320		250	100		150	885			695		545
Base Capacity (vph)	411	439	1519	342	350	1538	296	2554	1538	285	2686	1538
Starvation Cap Reductn	0	0	0	0	0	0	0	0	0	0	0	0
Spillback Cap Reductn	0	0	0	0	0	0	0	0	0	0	0	0
Storage Cap Reductn	0	0	0	0	0	0	0	0	0	0	0	0
Reduced v/c Ratio	0.80	1.02	0.15	0.67	0.98	0.10	0.64	1.04	0.24	0.95	0.79	0.30

Intersection Summary

- ~ Volume exceeds capacity, queue is theoretically infinite.  
Queue shown is maximum after two cycles.
- # 95th percentile volume exceeds capacity, queue may be longer.  
Queue shown is maximum after two cycles.

HCM 7th Signalized Intersection Summary  
 1: Powers Boulevard & Palmer Park Boulevard

Opening Day (2025) Background  
 Evening Peak Hour



Movement	EBL	EBT	EBR	WBL	WBT	WBR	NBL	NBT	NBR	SBL	SBT	SBR
Lane Configurations	↖↗	↑↑	↖	↖↗	↑↑	↖	↖↗	↑↑↑	↖	↖↗	↑↑↑	↖
Traffic Volume (veh/h)	315	430	215	220	330	145	180	2555	360	260	2040	450
Future Volume (veh/h)	315	430	215	220	330	145	180	2555	360	260	2040	450
Initial Q (Qb), veh	0	0	0	0	0	0	0	0	0	0	0	0
Lane Width Adj.	1.00	1.00	1.00	1.00	1.00	1.00	1.00	1.00	1.00	1.00	1.00	1.00
Ped-Bike Adj(A_pbT)	1.00		1.00	1.00		1.00	1.00		1.00	1.00		1.00
Parking Bus, Adj	1.00	1.00	1.00	1.00	1.00	1.00	1.00	1.00	1.00	1.00	1.00	1.00
Work Zone On Approach		No			No			No			No	
Adj Sat Flow, veh/h/ln	1826	1826	1826	1826	1826	1826	1826	1826	1826	1826	1826	1826
Adj Flow Rate, veh/h	328	448	0	229	344	0	188	2661	0	271	2125	0
Peak Hour Factor	0.96	0.96	0.96	0.96	0.96	0.96	0.96	0.96	0.96	0.96	0.96	0.96
Percent Heavy Veh, %	5	5	5	5	5	5	5	5	5	5	5	5
Cap, veh/h	373	420		276	321		233	2642		289	2810	
Arrive On Green	0.11	0.12	0.00	0.05	0.06	0.00	0.07	0.53	0.00	0.09	0.56	0.00
Sat Flow, veh/h	3374	3469	1547	3374	3469	1547	3374	4985	1547	3374	4985	1547
Grp Volume(v), veh/h	328	448	0	229	344	0	188	2661	0	271	2125	0
Grp Sat Flow(s),veh/h/ln	1687	1735	1547	1687	1735	1547	1687	1662	1547	1687	1662	1547
Q Serve(g_s), s	14.0	17.7	0.0	9.8	13.5	0.0	8.0	77.4	0.0	11.7	47.3	0.0
Cycle Q Clear(g_c), s	14.0	17.7	0.0	9.8	13.5	0.0	8.0	77.4	0.0	11.7	47.3	0.0
Prop In Lane	1.00		1.00	1.00		1.00	1.00		1.00	1.00		1.00
Lane Grp Cap(c), veh/h	373	420		276	321		233	2642		289	2810	
V/C Ratio(X)	0.88	1.07		0.83	1.07		0.81	1.01		0.94	0.76	
Avail Cap(c_a), veh/h	416	420		347	321		300	2642		289	2810	
HCM Platoon Ratio	1.00	1.00	1.00	0.67	0.67	0.67	1.00	1.00	1.00	1.00	1.00	1.00
Upstream Filter(I)	1.00	1.00	0.00	0.98	0.98	0.00	1.00	1.00	0.00	1.00	1.00	0.00
Uniform Delay (d), s/veh	64.0	64.2	0.0	68.0	68.5	0.0	67.0	34.3	0.0	66.4	24.2	0.0
Incr Delay (d2), s/veh	16.6	62.5	0.0	10.4	70.3	0.0	9.1	19.3	0.0	36.4	2.0	0.0
Initial Q Delay(d3), s/veh	0.0	0.0	0.0	0.0	0.0	0.0	0.0	0.0	0.0	0.0	0.0	0.0
%ile BackOfQ(50%),veh/ln	6.8	11.4	0.0	4.7	9.3	0.0	3.7	33.0	0.0	6.3	17.4	0.0
Unsig. Movement Delay, s/veh												
LnGrp Delay(d), s/veh	80.6	126.6	0.0	78.4	138.8	0.0	76.1	53.6	0.0	102.7	26.2	0.0
LnGrp LOS	F	F		E	F		E	F		F	C	
Approach Vol, veh/h		776			573			2849			2396	
Approach Delay, s/veh		107.2			114.6			55.1			34.8	
Approach LOS		F			F			E			C	
Timer - Assigned Phs	1	2	3	4	5	6	7	8				
Phs Duration (G+Y+Rc), s	20.0	84.9	16.9	24.2	15.1	89.8	21.1	20.0				
Change Period (Y+Rc), s	7.5	7.5	5.0	6.5	5.0	7.5	5.0	6.5				
Max Green Setting (Gmax), s	12.5	75.5	15.0	16.5	13.0	77.5	18.0	13.5				
Max Q Clear Time (g_c+I1), s	13.7	79.4	11.8	19.7	10.0	49.3	16.0	15.5				
Green Ext Time (p_c), s	0.0	0.0	0.1	0.0	0.1	23.7	0.1	0.0				

Intersection Summary												
HCM 7th Control Delay, s/veh											59.0	
HCM 7th LOS											E	

Notes  
 User approved pedestrian interval to be less than phase max green.  
 Unsignalized Delay for [NBR, EBR, WBR, SBR] is excluded from calculations of the approach delay and intersection delay.

Queues  
2: Access Road & Palmer Park Boulevard

Opening Day (2025) Background  
Evening Peak Hour

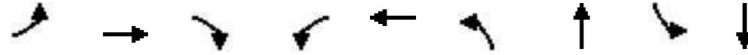

Lane Group	EBL	EBT	EBR	WBL	WBT	NBL	NBT	SBL	SBT
Lane Group Flow (vph)	83	922	89	42	604	73	78	26	78
v/c Ratio	0.13	0.32	0.07	0.09	0.21	0.55	0.35	0.19	0.34
Control Delay (s/veh)	1.4	1.7	0.0	4.4	3.7	75.8	19.4	59.7	17.0
Queue Delay	0.0	0.2	0.0	0.0	0.0	0.0	0.0	0.0	0.0
Total Delay (s/veh)	1.4	2.0	0.0	4.4	3.7	75.8	19.4	59.7	17.0
Queue Length 50th (ft)	4	25	0	6	52	68	9	23	4
Queue Length 95th (ft)	m8	m44	m0	23	110	113	55	50	51
Internal Link Dist (ft)		359			829		469		317
Turn Bay Length (ft)	110		125	175					
Base Capacity (vph)	622	2798	1268	440	2783	297	413	297	418
Starvation Cap Reductn	0	1109	0	0	0	0	0	0	0
Spillback Cap Reductn	0	0	0	0	0	0	0	0	0
Storage Cap Reductn	0	0	0	0	0	0	0	0	0
Reduced v/c Ratio	0.13	0.55	0.07	0.10	0.22	0.25	0.19	0.09	0.19

**Intersection Summary**  
m Volume for 95th percentile queue is metered by upstream signal.

HCM 7th Signalized Intersection Summary  
 2: Access Road & Palmer Park Boulevard

Opening Day (2025) Background  
 Evening Peak Hour



Movement	EBL	EBT	EBR	WBL	WBT	WBR	NBL	NBT	NBR	SBL	SBT	SBR
Lane Configurations	↘	↑↑	↗	↘	↑↑		↘	↗		↘	↗	
Traffic Volume (veh/h)	80	885	85	40	555	25	70	10	65	25	5	70
Future Volume (veh/h)	80	885	85	40	555	25	70	10	65	25	5	70
Initial Q (Qb), veh	0	0	0	0	0	0	0	0	0	0	0	0
Lane Width Adj.	1.00	1.00	1.00	1.00	1.00	1.00	1.00	1.00	1.00	1.00	1.00	1.00
Ped-Bike Adj(A_pbT)	1.00		1.00	1.00		1.00	1.00		0.99	0.99		1.00
Parking Bus, Adj	1.00	1.00	1.00	1.00	1.00	1.00	1.00	1.00	1.00	1.00	1.00	1.00
Work Zone On Approach		No			No			No			No	
Adj Sat Flow, veh/h/ln	1826	1826	1826	1826	1826	1826	1826	1826	1826	1826	1826	1826
Adj Flow Rate, veh/h	83	922	89	42	578	26	73	10	68	26	5	73
Peak Hour Factor	0.96	0.96	0.96	0.96	0.96	0.96	0.96	0.96	0.96	0.96	0.96	0.96
Percent Heavy Veh, %	5	5	5	5	5	5	5	5	5	5	5	5
Cap, veh/h	649	2761	1231	442	2691	121	147	25	167	147	12	178
Arrive On Green	0.80	0.80	0.80	0.80	0.80	0.80	0.12	0.12	0.12	0.12	0.12	0.12
Sat Flow, veh/h	796	3469	1547	544	3381	152	1290	201	1366	1282	100	1462
Grp Volume(v), veh/h	83	922	89	42	296	308	73	0	78	26	0	78
Grp Sat Flow(s),veh/h/ln	796	1735	1547	544	1735	1799	1290	0	1567	1282	0	1563
Q Serve(g_s), s	4.2	10.8	1.8	3.4	6.1	6.2	8.1	0.0	6.7	2.8	0.0	6.7
Cycle Q Clear(g_c), s	10.3	10.8	1.8	14.2	6.1	6.2	14.8	0.0	6.7	9.5	0.0	6.7
Prop In Lane	1.00		1.00	1.00		0.08	1.00		0.87	1.00		0.94
Lane Grp Cap(c), veh/h	649	2761	1231	442	1380	1431	147	0	191	147	0	191
V/C Ratio(X)	0.13	0.33	0.07	0.09	0.21	0.22	0.50	0.00	0.41	0.18	0.00	0.41
Avail Cap(c_a), veh/h	649	2761	1231	442	1380	1431	290	0	365	289	0	364
HCM Platoon Ratio	1.00	1.00	1.00	1.00	1.00	1.00	1.00	1.00	1.00	1.00	1.00	1.00
Upstream Filter(I)	0.60	0.60	0.60	1.00	1.00	1.00	1.00	0.00	1.00	1.00	0.00	1.00
Uniform Delay (d), s/veh	4.9	4.1	3.2	6.1	3.7	3.7	66.1	0.0	59.2	63.6	0.0	59.2
Incr Delay (d2), s/veh	0.2	0.2	0.1	0.4	0.4	0.3	2.6	0.0	1.4	0.6	0.0	1.4
Initial Q Delay(d3), s/veh	0.0	0.0	0.0	0.0	0.0	0.0	0.0	0.0	0.0	0.0	0.0	0.0
%ile BackOfQ(50%),veh/ln	0.7	3.3	0.5	0.4	2.0	2.1	2.8	0.0	2.8	0.9	0.0	2.8
Unsig. Movement Delay, s/veh												
LnGrp Delay(d), s/veh	5.2	4.3	3.3	6.5	4.0	4.0	68.7	0.0	60.6	64.2	0.0	60.6
LnGrp LOS	A	A	A	A	A	A	E		E	E		E
Approach Vol, veh/h		1094			646			151				104
Approach Delay, s/veh		4.3			4.2			64.5				61.5
Approach LOS		A			A			E				E
Timer - Assigned Phs		2		4		6		8				
Phs Duration (G+Y+Rc), s		122.2		23.8		122.2		23.8				
Change Period (Y+Rc), s		6.0		6.0		6.0		6.0				
Max Green Setting (Gmax), s		100.0		34.0		100.0		34.0				
Max Q Clear Time (g_c+I1), s		12.8		11.5		16.2		16.8				
Green Ext Time (p_c), s		15.4		0.4		8.4		0.6				
<b>Intersection Summary</b>												
HCM 7th Control Delay, s/veh				11.8								
HCM 7th LOS				B								



Intersection						
Int Delay, s/veh	3.6					
Movement	EBT	EBR	WBL	WBT	NBL	NBR
Lane Configurations	↑↑		↘	↑↑	↘	↘
Traffic Vol, veh/h	825	105	10	450	150	60
Future Vol, veh/h	825	105	10	450	150	60
Conflicting Peds, #/hr	0	0	0	0	0	2
Sign Control	Free	Free	Free	Free	Stop	Stop
RT Channelized	-	None	-	None	-	None
Storage Length	-	-	100	-	-	100
Veh in Median Storage, #	0	-	-	0	0	-
Grade, %	0	-	-	0	0	-
Peak Hour Factor	96	96	96	96	96	96
Heavy Vehicles, %	5	5	5	5	5	5
Mvmt Flow	859	109	10	469	156	63

Major/Minor	Major1	Major2	Minor1	Minor2	Minor3
Conflicting Flow All	0	0	969	0	1169
Stage 1	-	-	-	-	914
Stage 2	-	-	-	-	255
Critical Hdwy	-	-	4.2	-	6.9
Critical Hdwy Stg 1	-	-	-	-	5.9
Critical Hdwy Stg 2	-	-	-	-	5.9
Follow-up Hdwy	-	-	2.25	-	3.55
Pot Cap-1 Maneuver	-	-	689	-	182
Stage 1	-	-	-	-	344
Stage 2	-	-	-	-	755
Platoon blocked, %	-	-	-	-	-
Mov Cap-1 Maneuver	-	-	689	-	179
Mov Cap-2 Maneuver	-	-	-	-	280
Stage 1	-	-	-	-	344
Stage 2	-	-	-	-	744

Approach	EB	WB	NB
HCM Control Delay, s/v	0	0.22	27.23
HCM LOS			D

Minor Lane/Major Mvmt	NBLn1	NBLn2	EBT	EBR	WBL	WBT
Capacity (veh/h)	280	518	-	-	689	-
HCM Lane V/C Ratio	0.558	0.121	-	-	0.015	-
HCM Control Delay (s/veh)	33	12.9	-	-	10.3	-
HCM Lane LOS	D	B	-	-	B	-
HCM 95th %tile Q(veh)	3.1	0.4	-	-	0	-

HCM 7th TWSC  
5: Omaha Boulevard & Access Road

Opening Day (2025) Background  
Evening Peak Hour

Intersection												
Int Delay, s/veh	5.6											
Movement	EBL	EBT	EBR	WBL	WBT	WBR	NBL	NBT	NBR	SBL	SBT	SBR
Lane Configurations	↶	↷		↶	↷			↕			↕	
Traffic Vol, veh/h	60	120	20	30	85	70	10	5	50	100	5	20
Future Vol, veh/h	60	120	20	30	85	70	10	5	50	100	5	20
Conflicting Peds, #/hr	0	0	1	0	0	1	0	0	1	0	0	0
Sign Control	Free	Free	Free	Free	Free	Free	Stop	Stop	Stop	Stop	Stop	Stop
RT Channelized	-	-	None	-	-	None	-	-	None	-	-	None
Storage Length	75	-	-	100	-	-	-	-	-	-	-	-
Veh in Median Storage, #	-	0	-	-	0	-	-	0	-	-	0	-
Grade, %	-	0	-	-	0	-	-	0	-	-	0	-
Peak Hour Factor	96	96	96	96	96	96	96	96	96	96	96	96
Heavy Vehicles, %	5	5	5	5	5	5	5	5	5	5	5	5
Mvmt Flow	63	125	21	31	89	73	10	5	52	104	5	21

Major/Minor	Major1			Major2			Minor1			Minor2		
Conflicting Flow All	162	0	0	147	0	0	415	486	137	442	460	126
Stage 1	-	-	-	-	-	-	261	261	-	189	189	-
Stage 2	-	-	-	-	-	-	154	225	-	254	272	-
Critical Hdwy	4.15	-	-	4.15	-	-	7.15	6.55	6.25	7.15	6.55	6.25
Critical Hdwy Stg 1	-	-	-	-	-	-	6.15	5.55	-	6.15	5.55	-
Critical Hdwy Stg 2	-	-	-	-	-	-	6.15	5.55	-	6.15	5.55	-
Follow-up Hdwy	2.245	-	-	2.245	-	-	3.545	4.045	3.345	3.545	4.045	3.345
Pot Cap-1 Maneuver	1398	-	-	1417	-	-	543	477	903	521	493	916
Stage 1	-	-	-	-	-	-	737	686	-	806	739	-
Stage 2	-	-	-	-	-	-	842	712	-	744	679	-
Platoon blocked, %	-	-	-	-	-	-	-	-	-	-	-	-
Mov Cap-1 Maneuver	1397	-	-	1416	-	-	490	445	902	452	460	916
Mov Cap-2 Maneuver	-	-	-	-	-	-	490	445	-	452	460	-
Stage 1	-	-	-	-	-	-	703	655	-	788	722	-
Stage 2	-	-	-	-	-	-	799	696	-	664	648	-

Approach	EB			WB			NB			SB		
HCM Control Delay, s/v	2.31			1.23			10.31			14.91		
HCM LOS							B			B		

Minor Lane/Major Mvmt	NBLn1	EBL	EBT	EBR	WBL	WBT	WBR	SBLn1
Capacity (veh/h)	746	1397	-	-	1416	-	-	493
HCM Lane V/C Ratio	0.091	0.045	-	-	0.022	-	-	0.264
HCM Control Delay (s/veh)	10.3	7.7	-	-	7.6	-	-	14.9
HCM Lane LOS	B	A	-	-	A	-	-	B
HCM 95th %tile Q(veh)	0.3	0.1	-	-	0.1	-	-	1.1

**Intersection**

Int Delay, s/veh 7.1

Movement	EBL	EBT	EBR	WBL	WBT	WBR	NBL	NBT	NBR	SBL	SBT	SBR
Lane Configurations	↖	↗		↖	↗			↕			↖	↗
Traffic Vol, veh/h	45	190	35	5	140	5	30	70	20	100	40	15
Future Vol, veh/h	45	190	35	5	140	5	30	70	20	100	40	15
Conflicting Peds, #/hr	0	0	0	0	0	0	0	0	0	0	0	0
Sign Control	Free	Free	Free	Free	Free	Free	Stop	Stop	Stop	Stop	Stop	Stop
RT Channelized	-	-	None	-	-	None	-	-	None	-	-	None
Storage Length	100	-	-	100	-	-	-	-	-	-	-	100
Veh in Median Storage, #	-	0	-	-	0	-	-	0	-	-	0	-
Grade, %	-	0	-	-	0	-	-	0	-	-	0	-
Peak Hour Factor	96	96	96	96	96	96	96	96	96	96	96	96
Heavy Vehicles, %	5	5	5	5	5	5	5	5	5	5	5	5
Mvmt Flow	47	198	36	5	146	5	31	73	21	104	42	16

Major/Minor	Major1			Major2			Minor1			Minor2		
Conflicting Flow All	151	0	0	234	0	0	487	471	216	487	487	148
Stage 1	-	-	-	-	-	-	310	310	-	159	159	-
Stage 2	-	-	-	-	-	-	177	161	-	328	328	-
Critical Hdwy	4.15	-	-	4.15	-	-	7.15	6.55	6.25	7.15	6.55	6.25
Critical Hdwy Stg 1	-	-	-	-	-	-	6.15	5.55	-	6.15	5.55	-
Critical Hdwy Stg 2	-	-	-	-	-	-	6.15	5.55	-	6.15	5.55	-
Follow-up Hdwy	2.245	-	-	2.245	-	-	3.545	4.045	3.345	3.545	4.045	3.345
Pot Cap-1 Maneuver	1412	-	-	1316	-	-	486	486	816	486	476	890
Stage 1	-	-	-	-	-	-	694	654	-	836	761	-
Stage 2	-	-	-	-	-	-	818	759	-	678	642	-
Platoon blocked, %		-	-		-	-						
Mov Cap-1 Maneuver	1412	-	-	1316	-	-	419	468	816	387	459	890
Mov Cap-2 Maneuver	-	-	-	-	-	-	419	468	-	387	459	-
Stage 1	-	-	-	-	-	-	671	632	-	833	758	-
Stage 2	-	-	-	-	-	-	756	756	-	565	620	-

Approach	EB			WB			NB			SB		
HCM Control Delay, s/v	1.27			0.26			14.88			17.85		
HCM LOS							B			C		

Minor Lane/Major Mvmt	NBLn1	EBL	EBT	EBR	WBL	WBT	WBR	SBLn1	SBLn2
Capacity (veh/h)	489	1412	-	-	1316	-	-	405	890
HCM Lane V/C Ratio	0.256	0.033	-	-	0.004	-	-	0.36	0.018
HCM Control Delay (s/veh)	14.9	7.6	-	-	7.7	-	-	18.8	9.1
HCM Lane LOS	B	A	-	-	A	-	-	C	A
HCM 95th %tile Q(veh)	1	0.1	-	-	0	-	-	1.6	0.1

Queues  
1: Powers Boulevard & Palmer Park Boulevard

Opening Day (2025) Plus Project  
Morning Peak Hour



Lane Group	EBL	EBT	EBR	WBL	WBT	WBR	NBL	NBT	NBR	SBL	SBT	SBR
Lane Group Flow (vph)	268	271	158	239	379	216	139	2117	216	224	3147	337
v/c Ratio	1.06	0.92	0.10	0.79	1.11	0.14	0.69	0.74	0.14	1.03	1.06	0.21
Control Delay (s/veh)	137.7	102.4	0.1	77.9	136.6	0.1	85.4	24.6	0.1	134.4	64.3	0.3
Queue Delay	0.0	0.0	0.0	0.0	0.0	0.0	0.0	0.0	0.0	0.0	0.0	0.0
Total Delay (s/veh)	137.7	102.4	0.1	77.9	136.6	0.1	85.4	24.6	0.1	134.4	64.3	0.3
Queue Length 50th (ft)	~144	137	0	117	~217	0	67	523	0	~117	~1210	0
Queue Length 95th (ft)	#240	#250	0	156	#329	0	105	580	0	#206	#1287	0
Internal Link Dist (ft)		785			359			1286			1318	
Turn Bay Length (ft)	320		250	100		150	885			695		545
Base Capacity (vph)	251	292	1538	342	341	1538	228	2859	1538	217	2968	1538
Starvation Cap Reductn	0	0	0	0	0	0	0	0	0	0	0	0
Spillback Cap Reductn	0	0	0	0	0	0	0	0	0	0	0	0
Storage Cap Reductn	0	0	0	0	0	0	0	0	0	0	0	0
Reduced v/c Ratio	1.07	0.93	0.10	0.70	1.11	0.14	0.61	0.74	0.14	1.03	1.06	0.22

Intersection Summary

~ Volume exceeds capacity, queue is theoretically infinite.

Queue shown is maximum after two cycles.

# 95th percentile volume exceeds capacity, queue may be longer.

Queue shown is maximum after two cycles.

# HCM 7th Signalized Intersection Summary

## 1: Powers Boulevard & Palmer Park Boulevard

Opening Day (2025) Plus Project  
Morning Peak Hour



Movement	EBL	EBT	EBR	WBL	WBT	WBR	NBL	NBT	NBR	SBL	SBT	SBR
Lane Configurations	↔↔	↑↑	↗	↔↔	↑↑	↗	↔↔	↑↑↑	↗	↔↔	↑↑↑	↗
Traffic Volume (veh/h)	255	257	150	227	360	205	132	2011	205	213	2990	320
Future Volume (veh/h)	255	257	150	227	360	205	132	2011	205	213	2990	320
Initial Q (Qb), veh	0	0	0	0	0	0	0	0	0	0	0	0
Lane Width Adj.	1.00	1.00	1.00	1.00	1.00	1.00	1.00	1.00	1.00	1.00	1.00	1.00
Ped-Bike Adj(A_pbT)	1.00		1.00	1.00		1.00	1.00		1.00	1.00		1.00
Parking Bus, Adj	1.00	1.00	1.00	1.00	1.00	1.00	1.00	1.00	1.00	1.00	1.00	1.00
Work Zone On Approach		No			No			No			No	
Adj Sat Flow, veh/h/ln	1826	1826	1826	1826	1826	1826	1826	1826	1826	1826	1826	1826
Adj Flow Rate, veh/h	268	271	0	239	379	0	139	2117	0	224	3147	0
Peak Hour Factor	0.95	0.95	0.95	0.95	0.95	0.95	0.95	0.95	0.95	0.95	0.95	0.95
Percent Heavy Veh, %	5	5	5	5	5	5	5	5	5	5	5	5
Cap, veh/h	254	312		285	345		183	2885		220	3024	
Arrive On Green	0.08	0.09	0.00	0.06	0.07	0.00	0.05	0.58	0.00	0.07	0.61	0.00
Sat Flow, veh/h	3374	3469	1547	3374	3469	1547	3374	4985	1547	3374	4985	1547
Grp Volume(v), veh/h	268	271	0	239	379	0	139	2117	0	224	3147	0
Grp Sat Flow(s),veh/h/ln	1687	1735	1547	1687	1735	1547	1687	1662	1547	1687	1662	1547
Q Serve(g_s), s	11.0	11.3	0.0	10.2	14.5	0.0	5.9	45.4	0.0	9.5	88.6	0.0
Cycle Q Clear(g_c), s	11.0	11.3	0.0	10.2	14.5	0.0	5.9	45.4	0.0	9.5	88.6	0.0
Prop In Lane	1.00		1.00	1.00		1.00	1.00		1.00	1.00		1.00
Lane Grp Cap(c), veh/h	254	312		285	345		183	2885		220	3024	
V/C Ratio(X)	1.05	0.87		0.84	1.10		0.76	0.73		1.02	1.04	
Avail Cap(c_a), veh/h	254	312		347	345		231	2885		220	3024	
HCM Platoon Ratio	1.00	1.00	1.00	0.67	0.67	0.67	1.00	1.00	1.00	1.00	1.00	1.00
Upstream Filter(I)	1.00	1.00	0.00	0.96	0.96	0.00	1.00	1.00	0.00	1.00	1.00	0.00
Uniform Delay (d), s/veh	67.5	65.6	0.0	67.9	68.1	0.0	68.1	22.5	0.0	68.3	28.7	0.0
Incr Delay (d2), s/veh	71.5	21.1	0.0	11.5	77.2	0.0	7.7	1.7	0.0	66.1	28.2	0.0
Initial Q Delay(d3), s/veh	0.0	0.0	0.0	0.0	0.0	0.0	0.0	0.0	0.0	0.0	0.0	0.0
%ile BackOfQ(50%),veh/ln	7.2	5.9	0.0	5.0	10.3	0.0	2.7	16.5	0.0	6.0	38.5	0.0
Unsig. Movement Delay, s/veh												
LnGrp Delay(d), s/veh	139.0	86.7	0.0	79.4	145.3	0.0	75.8	24.2	0.0	134.4	56.9	0.0
LnGrp LOS	F	F		E	F		E	C		F	F	
Approach Vol, veh/h		539			618			2256			3371	
Approach Delay, s/veh		112.7			119.8			27.4			62.1	
Approach LOS		F			F			C			E	
Timer - Assigned Phs	1	2	3	4	5	6	7	8				
Phs Duration (G+Y+Rc), s	17.0	92.0	17.4	19.6	12.9	96.1	16.0	21.0				
Change Period (Y+Rc), s	7.5	7.5	5.0	6.5	5.0	7.5	5.0	6.5				
Max Green Setting (Gmax), s	9.5	84.5	15.0	10.5	10.0	86.5	11.0	14.5				
Max Q Clear Time (g_c+I1), s	11.5	47.4	12.2	13.3	7.9	90.6	13.0	16.5				
Green Ext Time (p_c), s	0.0	29.7	0.1	0.0	0.0	0.0	0.0	0.0				
<b>Intersection Summary</b>												
HCM 7th Control Delay, s/veh			59.8									
HCM 7th LOS			E									
<b>Notes</b>												
User approved pedestrian interval to be less than phase max green.												
Unsignalized Delay for [NBR, EBR, WBR, SBR] is excluded from calculations of the approach delay and intersection delay.												

Queues  
2: Access Road & Palmer Park Boulevard

Opening Day (2025) Plus Project  
Morning Peak Hour

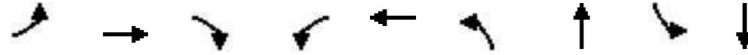

Lane Group	EBL	EBT	EBR	WBL	WBT	NBL	NBT	SBL	SBT
Lane Group Flow (vph)	32	589	89	49	732	86	59	5	31
v/c Ratio	0.05	0.21	0.07	0.07	0.26	0.59	0.27	0.03	0.15
Control Delay (s/veh)	1.3	1.3	0.0	4.2	4.1	76.6	18.1	53.6	23.3
Queue Delay	0.0	0.2	0.0	0.0	0.0	0.0	0.0	0.0	0.0
Total Delay (s/veh)	1.3	1.5	0.0	4.2	4.1	76.6	18.1	53.6	23.3
Queue Length 50th (ft)	1	14	0	8	70	80	4	4	4
Queue Length 95th (ft)	m3	m24	m0	25	137	129	46	17	34
Internal Link Dist (ft)		359			829		469		317
Turn Bay Length (ft)	110		125	175					
Base Capacity (vph)	538	2779	1260	629	2774	310	405	302	388
Starvation Cap Reductn	0	1430	0	0	0	0	0	0	0
Spillback Cap Reductn	0	0	0	0	0	0	0	0	0
Storage Cap Reductn	0	0	0	0	0	0	0	0	0
Reduced v/c Ratio	0.06	0.44	0.07	0.08	0.26	0.28	0.15	0.02	0.08

Intersection Summary

m Volume for 95th percentile queue is metered by upstream signal.

HCM 7th Signalized Intersection Summary  
2: Access Road & Palmer Park Boulevard

Opening Day (2025) Plus Project  
Morning Peak Hour



Movement	EBL	EBT	EBR	WBL	WBT	WBR	NBL	NBT	NBR	SBL	SBT	SBR
Lane Configurations	↖	↗	↘	↖	↗		↖	↗		↖	↗	
Traffic Volume (veh/h)	30	560	85	47	685	10	82	5	51	5	5	25
Future Volume (veh/h)	30	560	85	47	685	10	82	5	51	5	5	25
Initial Q (Qb), veh	0	0	0	0	0	0	0	0	0	0	0	0
Lane Width Adj.	1.00	1.00	1.00	1.00	1.00	1.00	1.00	1.00	1.00	1.00	1.00	1.00
Ped-Bike Adj(A_pbT)	1.00		1.00	1.00		1.00	1.00		1.00	1.00		1.00
Parking Bus, Adj	1.00	1.00	1.00	1.00	1.00	1.00	1.00	1.00	1.00	1.00	1.00	1.00
Work Zone On Approach		No			No			No			No	
Adj Sat Flow, veh/h/ln	1826	1826	1826	1826	1826	1826	1826	1826	1826	1826	1826	1826
Adj Flow Rate, veh/h	32	589	89	49	721	11	86	5	54	5	5	26
Peak Hour Factor	0.95	0.95	0.95	0.95	0.95	0.95	0.95	0.95	0.95	0.95	0.95	0.95
Percent Heavy Veh, %	5	5	5	5	5	5	5	5	5	5	5	5
Cap, veh/h	595	2843	1268	631	2866	44	158	13	141	132	25	131
Arrive On Green	0.82	0.82	0.82	0.82	0.82	0.82	0.10	0.10	0.10	0.10	0.10	0.10
Sat Flow, veh/h	707	3469	1547	743	3498	53	1346	133	1435	1312	256	1331
Grp Volume(v), veh/h	32	589	89	49	358	374	86	0	59	5	0	31
Grp Sat Flow(s),veh/h/ln	707	1735	1547	743	1735	1816	1346	0	1568	1312	0	1586
Q Serve(g_s), s	1.6	5.4	1.6	2.2	6.8	6.9	9.2	0.0	5.1	0.5	0.0	2.6
Cycle Q Clear(g_c), s	8.4	5.4	1.6	7.6	6.8	6.9	11.8	0.0	5.1	5.7	0.0	2.6
Prop In Lane	1.00		1.00	1.00		0.03	1.00		0.92	1.00		0.84
Lane Grp Cap(c), veh/h	595	2843	1268	631	1421	1488	158	0	154	132	0	156
V/C Ratio(X)	0.05	0.21	0.07	0.08	0.25	0.25	0.55	0.00	0.38	0.04	0.00	0.20
Avail Cap(c_a), veh/h	595	2843	1268	631	1421	1488	338	0	365	309	0	369
HCM Platoon Ratio	1.00	1.00	1.00	1.00	1.00	1.00	1.00	1.00	1.00	1.00	1.00	1.00
Upstream Filter(I)	0.62	0.62	0.62	1.00	1.00	1.00	1.00	0.00	1.00	1.00	0.00	1.00
Uniform Delay (d), s/veh	4.0	2.9	2.5	3.7	3.0	3.0	65.9	0.0	61.7	64.3	0.0	60.5
Incr Delay (d2), s/veh	0.1	0.1	0.1	0.2	0.4	0.4	2.9	0.0	1.6	0.1	0.0	0.6
Initial Q Delay(d3), s/veh	0.0	0.0	0.0	0.0	0.0	0.0	0.0	0.0	0.0	0.0	0.0	0.0
%ile BackOfQ(50%),veh/ln	0.2	1.5	0.4	0.3	2.1	2.2	3.3	0.0	2.1	0.2	0.0	1.1
Unsig. Movement Delay, s/veh												
LnGrp Delay(d), s/veh	4.1	3.0	2.6	3.9	3.4	3.4	68.9	0.0	63.2	64.4	0.0	61.1
LnGrp LOS	A	A	A	A	A	A	E		E	E		E
Approach Vol, veh/h		710			781			145				36
Approach Delay, s/veh		3.0			3.4			66.6				61.6
Approach LOS		A			A			E				E
Timer - Assigned Phs		2		4		6		8				
Phs Duration (G+Y+Rc), s		125.6		20.4		125.6		20.4				
Change Period (Y+Rc), s		6.0		6.0		6.0		6.0				
Max Green Setting (Gmax), s		100.0		34.0		100.0		34.0				
Max Q Clear Time (g_c+I1), s		10.4		7.7		9.6		13.8				
Green Ext Time (p_c), s		7.1		0.1		10.4		0.6				
<b>Intersection Summary</b>												
HCM 7th Control Delay, s/veh				10.0								
HCM 7th LOS				A								



Intersection						
Int Delay, s/veh	3.6					
Movement	EBT	EBR	WBL	WBT	NBL	NBR
Lane Configurations	↑↑		↖	↑↑	↖	↖
Traffic Vol, veh/h	396	175	35	647	50	25
Future Vol, veh/h	396	175	35	647	50	25
Conflicting Peds, #/hr	0	0	595	0	0	1
Sign Control	Free	Free	Free	Free	Stop	Stop
RT Channelized	-	None	-	None	-	None
Storage Length	-	-	100	-	-	100
Veh in Median Storage, #	0	-	-	0	0	-
Grade, %	0	-	-	0	0	-
Peak Hour Factor	95	95	95	95	95	95
Heavy Vehicles, %	5	5	5	5	5	5
Mvmt Flow	417	184	37	681	53	26

Major/Minor	Major1	Major2	Minor1			
Conflicting Flow All	0	0	1196	0	1518	897
Stage 1	-	-	-	-	1104	-
Stage 2	-	-	-	-	414	-
Critical Hdwy	-	-	4.2	-	6.9	7
Critical Hdwy Stg 1	-	-	-	-	5.9	-
Critical Hdwy Stg 2	-	-	-	-	5.9	-
Follow-up Hdwy	-	-	2.25	-	3.55	3.35
Pot Cap-1 Maneuver	-	-	563	-	107	277
Stage 1	-	-	-	-	273	-
Stage 2	-	-	-	-	627	-
Platoon blocked, %	-	-	-	-	-	-
Mov Cap-1 Maneuver	-	-	284	-	~ 47	140
Mov Cap-2 Maneuver	-	-	-	-	113	-
Stage 1	-	-	-	-	137	-
Stage 2	-	-	-	-	545	-

Approach	EB	WB	NB
HCM Control Delay, s/v	0	1	53.73
HCM LOS			F

Minor Lane/Major Mvmt	NBLn1	NBLn2	EBT	EBR	WBL	WBT
Capacity (veh/h)	113	140	-	-	284	-
HCM Lane V/C Ratio	0.467	0.188	-	-	0.13	-
HCM Control Delay (s/veh)	62.3	36.7	-	-	19.6	-
HCM Lane LOS	F	E	-	-	C	-
HCM 95th %tile Q(veh)	2.1	0.7	-	-	0.4	-

Notes  
 ~: Volume exceeds capacity    \$: Delay exceeds 300s    +: Computation Not Defined    \*: All major volume in platoon

**Intersection**

Int Delay, s/veh 4.7

Movement	EBL	EBT	EBR	WBL	WBT	WBR	NBL	NBT	NBR	SBL	SBT	SBR
Lane Configurations	↶	↷		↶	↷			↕			↕	
Traffic Vol, veh/h	85	75	20	15	155	42	5	5	15	37	10	71
Future Vol, veh/h	85	75	20	15	155	42	5	5	15	37	10	71
Conflicting Peds, #/hr	0	0	1	0	0	1	0	0	1	0	0	0
Sign Control	Free	Free	Free	Free	Free	Free	Stop	Stop	Stop	Stop	Stop	Stop
RT Channelized	-	-	None	-	-	None	-	-	None	-	-	None
Storage Length	75	-	-	100	-	-	-	-	-	-	-	-
Veh in Median Storage, #	-	0	-	-	0	-	-	0	-	-	0	-
Grade, %	-	0	-	-	0	-	-	0	-	-	0	-
Peak Hour Factor	95	95	95	95	95	95	95	95	95	95	95	95
Heavy Vehicles, %	5	5	5	5	5	5	5	5	5	5	5	5
Mvmt Flow	89	79	21	16	163	44	5	5	16	39	11	75

Major/Minor	Major1	Major2	Minor1	Minor2
Conflicting Flow All	208	0	0	101
Stage 1	-	-	-	-
Stage 2	-	-	-	-
Critical Hdwy	4.15	-	-	4.15
Critical Hdwy Stg 1	-	-	-	-
Critical Hdwy Stg 2	-	-	-	-
Follow-up Hdwy	2.245	-	-	2.245
Pot Cap-1 Maneuver	1345	-	-	1473
Stage 1	-	-	-	-
Stage 2	-	-	-	-
Platoon blocked, %		-	-	-
Mov Cap-1 Maneuver	1344	-	-	1472
Mov Cap-2 Maneuver	-	-	-	-
Stage 1	-	-	-	-
Stage 2	-	-	-	-

Approach	EB	WB	NB	SB
HCM Control Delay, s/v	3.72	0.53	10.95	12.28
HCM LOS			B	B

Minor Lane/Major Mvmt	NBLn1	EBL	EBT	EBR	WBL	WBT	WBR	SBLn1
Capacity (veh/h)	631	1344	-	-	1472	-	-	618
HCM Lane V/C Ratio	0.042	0.067	-	-	0.011	-	-	0.201
HCM Control Delay (s/veh)	10.9	7.9	-	-	7.5	-	-	12.3
HCM Lane LOS	B	A	-	-	A	-	-	B
HCM 95th %tile Q(veh)	0.1	0.2	-	-	0	-	-	0.7

Intersection												
Int Delay, s/veh	6											
Movement	EBL	EBT	EBR	WBL	WBT	WBR	NBL	NBT	NBR	SBL	SBT	SBR
Lane Configurations	↖	↗		↖	↗			↕			↖	↗
Traffic Vol, veh/h	35	67	25	20	172	60	15	20	5	90	65	25
Future Vol, veh/h	35	67	25	20	172	60	15	20	5	90	65	25
Conflicting Peds, #/hr	0	0	0	0	0	0	0	0	0	0	0	0
Sign Control	Free	Free	Free	Free	Free	Free	Stop	Stop	Stop	Stop	Stop	Stop
RT Channelized	-	-	None	-	-	None	-	-	None	-	-	None
Storage Length	100	-	-	100	-	-	-	-	-	-	-	100
Veh in Median Storage, #	-	0	-	-	0	-	-	0	-	-	0	-
Grade, %	-	0	-	-	0	-	-	0	-	-	0	-
Peak Hour Factor	95	95	95	95	95	95	95	95	95	95	95	95
Heavy Vehicles, %	5	5	5	5	5	5	5	5	5	5	5	5
Mvmt Flow	37	71	26	21	181	63	16	21	5	95	68	26

Major/Minor	Major1			Major2			Minor1			Minor2		
Conflicting Flow All	244	0	0	97	0	0	415	444	84	409	425	213
Stage 1	-	-	-	-	-	-	157	157	-	255	255	-
Stage 2	-	-	-	-	-	-	257	286	-	155	171	-
Critical Hdwy	4.15	-	-	4.15	-	-	7.15	6.55	6.25	7.15	6.55	6.25
Critical Hdwy Stg 1	-	-	-	-	-	-	6.15	5.55	-	6.15	5.55	-
Critical Hdwy Stg 2	-	-	-	-	-	-	6.15	5.55	-	6.15	5.55	-
Follow-up Hdwy	2.245	-	-	2.245	-	-	3.545	4.045	3.345	3.545	4.045	3.345
Pot Cap-1 Maneuver	1305	-	-	1478	-	-	543	504	967	547	516	820
Stage 1	-	-	-	-	-	-	838	762	-	743	691	-
Stage 2	-	-	-	-	-	-	741	669	-	841	752	-
Platoon blocked, %		-	-		-	-						
Mov Cap-1 Maneuver	1305	-	-	1478	-	-	436	483	967	499	495	820
Mov Cap-2 Maneuver	-	-	-	-	-	-	436	483	-	499	495	-
Stage 1	-	-	-	-	-	-	814	740	-	732	681	-
Stage 2	-	-	-	-	-	-	636	660	-	789	731	-

Approach	EB			WB			NB			SB		
HCM Control Delay, s/v	2.16			0.59			12.97			14.87		
HCM LOS							B			B		

Minor Lane/Major Mvmt	NBLn1	EBL	EBT	EBR	WBL	WBT	WBR	SBLn1	SBLn2
Capacity (veh/h)	494	1305	-	-	1478	-	-	497	820
HCM Lane V/C Ratio	0.085	0.028	-	-	0.014	-	-	0.328	0.032
HCM Control Delay (s/veh)	13	7.8	-	-	7.5	-	-	15.7	9.5
HCM Lane LOS	B	A	-	-	A	-	-	C	A
HCM 95th %tile Q(veh)	0.3	0.1	-	-	0	-	-	1.4	0.1

Queues  
1: Powers Boulevard & Palmer Park Boulevard

Opening Day (2025) Plus Project  
Evening Peak Hour



Lane Group	EBL	EBT	EBR	WBL	WBT	WBR	NBL	NBT	NBR	SBL	SBT	SBR
Lane Group Flow (vph)	328	449	224	230	344	151	189	2668	375	272	2125	469
v/c Ratio	0.86	1.02	0.14	0.78	0.98	0.09	0.74	1.04	0.24	0.95	0.79	0.30
Control Delay (s/veh)	85.4	110.3	0.2	76.6	104.5	0.1	83.8	65.4	0.3	108.3	29.7	0.5
Queue Delay	0.0	0.0	0.0	0.0	0.0	0.0	0.0	0.0	0.0	0.0	0.0	0.0
Total Delay (s/veh)	85.4	110.3	0.2	76.6	104.5	0.1	83.8	65.4	0.3	108.3	29.7	0.5
Queue Length 50th (ft)	158	~246	0	112	~194	0	91	~1005	0	135	580	0
Queue Length 95th (ft)	#226	#380	0	123	#302	0	134	#1086	0	#226	657	0
Internal Link Dist (ft)		785			359			1286			1318	
Turn Bay Length (ft)	320		250	100		150	885			695		545
Base Capacity (vph)	411	438	1519	342	350	1538	296	2554	1538	285	2686	1538
Starvation Cap Reductn	0	0	0	0	0	0	0	0	0	0	0	0
Spillback Cap Reductn	0	0	0	0	0	0	0	0	0	0	0	0
Storage Cap Reductn	0	0	0	0	0	0	0	0	0	0	0	0
Reduced v/c Ratio	0.80	1.03	0.15	0.67	0.98	0.10	0.64	1.04	0.24	0.95	0.79	0.30

Intersection Summary

~ Volume exceeds capacity, queue is theoretically infinite.

Queue shown is maximum after two cycles.

# 95th percentile volume exceeds capacity, queue may be longer.

Queue shown is maximum after two cycles.

HCM 7th Signalized Intersection Summary  
 1: Powers Boulevard & Palmer Park Boulevard

Opening Day (2025) Plus Project  
 Evening Peak Hour



Movement	EBL	EBT	EBR	WBL	WBT	WBR	NBL	NBT	NBR	SBL	SBT	SBR
Lane Configurations	↖↗	↑↑	↖	↖↗	↑↑	↖	↖↗	↑↑↑	↖	↖↗	↑↑↑	↖
Traffic Volume (veh/h)	315	431	215	221	330	145	181	2561	360	261	2040	450
Future Volume (veh/h)	315	431	215	221	330	145	181	2561	360	261	2040	450
Initial Q (Qb), veh	0	0	0	0	0	0	0	0	0	0	0	0
Lane Width Adj.	1.00	1.00	1.00	1.00	1.00	1.00	1.00	1.00	1.00	1.00	1.00	1.00
Ped-Bike Adj(A_pbT)	1.00		1.00	1.00		1.00	1.00		1.00	1.00		1.00
Parking Bus, Adj	1.00	1.00	1.00	1.00	1.00	1.00	1.00	1.00	1.00	1.00	1.00	1.00
Work Zone On Approach		No			No			No			No	
Adj Sat Flow, veh/h/ln	1826	1826	1826	1826	1826	1826	1826	1826	1826	1826	1826	1826
Adj Flow Rate, veh/h	328	449	0	230	344	0	189	2668	0	272	2125	0
Peak Hour Factor	0.96	0.96	0.96	0.96	0.96	0.96	0.96	0.96	0.96	0.96	0.96	0.96
Percent Heavy Veh, %	5	5	5	5	5	5	5	5	5	5	5	5
Cap, veh/h	373	419		277	321		234	2642		289	2808	
Arrive On Green	0.11	0.12	0.00	0.05	0.06	0.00	0.07	0.53	0.00	0.09	0.56	0.00
Sat Flow, veh/h	3374	3469	1547	3374	3469	1547	3374	4985	1547	3374	4985	1547
Grp Volume(v), veh/h	328	449	0	230	344	0	189	2668	0	272	2125	0
Grp Sat Flow(s),veh/h/ln	1687	1735	1547	1687	1735	1547	1687	1662	1547	1687	1662	1547
Q Serve(g_s), s	14.0	17.6	0.0	9.9	13.5	0.0	8.1	77.4	0.0	11.7	47.4	0.0
Cycle Q Clear(g_c), s	14.0	17.6	0.0	9.9	13.5	0.0	8.1	77.4	0.0	11.7	47.4	0.0
Prop In Lane	1.00		1.00	1.00		1.00	1.00		1.00	1.00		1.00
Lane Grp Cap(c), veh/h	373	419		277	321		234	2642		289	2808	
V/C Ratio(X)	0.88	1.07		0.83	1.07		0.81	1.01		0.94	0.76	
Avail Cap(c_a), veh/h	416	419		347	321		300	2642		289	2808	
HCM Platoon Ratio	1.00	1.00	1.00	0.67	0.67	0.67	1.00	1.00	1.00	1.00	1.00	1.00
Upstream Filter(I)	1.00	1.00	0.00	0.98	0.98	0.00	1.00	1.00	0.00	1.00	1.00	0.00
Uniform Delay (d), s/veh	64.0	64.2	0.0	68.0	68.5	0.0	67.0	34.3	0.0	66.4	24.3	0.0
Incr Delay (d2), s/veh	16.6	64.1	0.0	10.5	70.3	0.0	9.3	20.0	0.0	37.2	2.0	0.0
Initial Q Delay(d3), s/veh	0.0	0.0	0.0	0.0	0.0	0.0	0.0	0.0	0.0	0.0	0.0	0.0
%ile BackOfQ(50%),veh/ln	6.8	11.5	0.0	4.7	9.3	0.0	3.7	33.1	0.0	6.4	17.5	0.0
Unsig. Movement Delay, s/veh												
LnGrp Delay(d), s/veh	80.6	128.2	0.0	78.5	138.8	0.0	76.2	54.3	0.0	103.6	26.2	0.0
LnGrp LOS	F	F		E	F		E	F		F	C	
Approach Vol, veh/h		777			574			2857			2397	
Approach Delay, s/veh		108.1			114.6			55.7			35.0	
Approach LOS		F			F			E			C	
Timer - Assigned Phs	1	2	3	4	5	6	7	8				
Phs Duration (G+Y+Rc), s	20.0	84.9	17.0	24.1	15.1	89.8	21.1	20.0				
Change Period (Y+Rc), s	7.5	7.5	5.0	6.5	5.0	7.5	5.0	6.5				
Max Green Setting (Gmax), s	12.5	75.5	15.0	16.5	13.0	77.5	18.0	13.5				
Max Q Clear Time (g_c+I1), s	13.7	79.4	11.9	19.6	10.1	49.4	16.0	15.5				
Green Ext Time (p_c), s	0.0	0.0	0.1	0.0	0.1	23.6	0.1	0.0				

Intersection Summary												
HCM 7th Control Delay, s/veh											59.5	
HCM 7th LOS											E	

Notes  
 User approved pedestrian interval to be less than phase max green.  
 Unsignalized Delay for [NBR, EBR, WBR, SBR] is excluded from calculations of the approach delay and intersection delay.

Queues  
2: Access Road & Palmer Park Boulevard

Opening Day (2025) Plus Project  
Evening Peak Hour

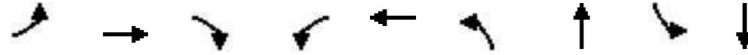

Lane Group	EBL	EBT	EBR	WBL	WBT	NBL	NBT	SBL	SBT
Lane Group Flow (vph)	83	922	91	42	604	74	78	26	78
v/c Ratio	0.13	0.32	0.07	0.09	0.21	0.56	0.35	0.19	0.34
Control Delay (s/veh)	1.4	1.7	0.0	4.4	3.7	76.1	19.4	59.6	16.9
Queue Delay	0.0	0.2	0.0	0.0	0.0	0.0	0.0	0.0	0.0
Total Delay (s/veh)	1.4	2.0	0.0	4.4	3.7	76.1	19.4	59.6	16.9
Queue Length 50th (ft)	4	25	0	6	52	69	9	23	4
Queue Length 95th (ft)	m8	m44	m0	23	110	114	55	50	51
Internal Link Dist (ft)		359			829		469		317
Turn Bay Length (ft)	110		125	175					
Base Capacity (vph)	622	2797	1267	440	2781	297	413	297	418
Starvation Cap Reductn	0	1110	0	0	0	0	0	0	0
Spillback Cap Reductn	0	0	0	0	0	0	0	0	0
Storage Cap Reductn	0	0	0	0	0	0	0	0	0
Reduced v/c Ratio	0.13	0.55	0.07	0.10	0.22	0.25	0.19	0.09	0.19

Intersection Summary

m Volume for 95th percentile queue is metered by upstream signal.

HCM 7th Signalized Intersection Summary  
 2: Access Road & Palmer Park Boulevard

Opening Day (2025) Plus Project  
 Evening Peak Hour



Movement	EBL	EBT	EBR	WBL	WBT	WBR	NBL	NBT	NBR	SBL	SBT	SBR
Lane Configurations	↖	↗↗	↖	↖	↗↗		↖	↗		↖	↗	
Traffic Volume (veh/h)	80	885	87	40	555	25	71	10	65	25	5	70
Future Volume (veh/h)	80	885	87	40	555	25	71	10	65	25	5	70
Initial Q (Qb), veh	0	0	0	0	0	0	0	0	0	0	0	0
Lane Width Adj.	1.00	1.00	1.00	1.00	1.00	1.00	1.00	1.00	1.00	1.00	1.00	1.00
Ped-Bike Adj(A_pbT)	1.00		1.00	1.00		1.00	1.00		1.00	1.00		1.00
Parking Bus, Adj	1.00	1.00	1.00	1.00	1.00	1.00	1.00	1.00	1.00	1.00	1.00	1.00
Work Zone On Approach		No			No			No			No	
Adj Sat Flow, veh/h/ln	1826	1826	1826	1826	1826	1826	1826	1826	1826	1826	1826	1826
Adj Flow Rate, veh/h	83	922	91	42	578	26	74	10	68	26	5	73
Peak Hour Factor	0.96	0.96	0.96	0.96	0.96	0.96	0.96	0.96	0.96	0.96	0.96	0.96
Percent Heavy Veh, %	5	5	5	5	5	5	5	5	5	5	5	5
Cap, veh/h	649	2758	1230	441	2688	121	148	25	168	148	12	179
Arrive On Green	0.80	0.80	0.80	0.80	0.80	0.80	0.12	0.12	0.12	0.12	0.12	0.12
Sat Flow, veh/h	796	3469	1547	543	3381	152	1290	201	1370	1285	100	1462
Grp Volume(v), veh/h	83	922	91	42	296	308	74	0	78	26	0	78
Grp Sat Flow(s),veh/h/ln	796	1735	1547	543	1735	1799	1290	0	1571	1285	0	1563
Q Serve(g_s), s	4.2	10.8	1.9	3.4	6.2	6.2	8.2	0.0	6.7	2.8	0.0	6.7
Cycle Q Clear(g_c), s	10.4	10.8	1.9	14.2	6.2	6.2	14.9	0.0	6.7	9.5	0.0	6.7
Prop In Lane	1.00		1.00	1.00		0.08	1.00		0.87	1.00		0.94
Lane Grp Cap(c), veh/h	649	2758	1230	441	1379	1430	148	0	193	148	0	192
V/C Ratio(X)	0.13	0.33	0.07	0.10	0.21	0.22	0.50	0.00	0.40	0.18	0.00	0.41
Avail Cap(c_a), veh/h	649	2758	1230	441	1379	1430	290	0	366	290	0	364
HCM Platoon Ratio	1.00	1.00	1.00	1.00	1.00	1.00	1.00	1.00	1.00	1.00	1.00	1.00
Upstream Filter(I)	0.59	0.59	0.59	1.00	1.00	1.00	1.00	0.00	1.00	1.00	0.00	1.00
Uniform Delay (d), s/veh	5.0	4.2	3.3	6.2	3.7	3.7	66.0	0.0	59.1	63.5	0.0	59.1
Incr Delay (d2), s/veh	0.2	0.2	0.1	0.4	0.4	0.3	2.6	0.0	1.4	0.6	0.0	1.4
Initial Q Delay(d3), s/veh	0.0	0.0	0.0	0.0	0.0	0.0	0.0	0.0	0.0	0.0	0.0	0.0
%ile BackOfQ(50%),veh/ln	0.7	3.4	0.5	0.4	2.0	2.1	2.8	0.0	2.8	0.9	0.0	2.8
Unsig. Movement Delay, s/veh												
LnGrp Delay(d), s/veh	5.2	4.4	3.3	6.6	4.1	4.0	68.6	0.0	60.5	64.0	0.0	60.5
LnGrp LOS	A	A	A	A	A	A	E		E	E		E
Approach Vol, veh/h		1096			646			152				104
Approach Delay, s/veh		4.3			4.2			64.4				61.4
Approach LOS		A			A			E				E
Timer - Assigned Phs		2		4		6		8				
Phs Duration (G+Y+Rc), s		122.1		23.9		122.1		23.9				
Change Period (Y+Rc), s		6.0		6.0		6.0		6.0				
Max Green Setting (Gmax), s		100.0		34.0		100.0		34.0				
Max Q Clear Time (g_c+I1), s		12.8		11.5		16.2		16.9				
Green Ext Time (p_c), s		15.4		0.4		8.4		0.6				
<b>Intersection Summary</b>												
HCM 7th Control Delay, s/veh				11.8								
HCM 7th LOS				B								



HCM 7th TWSC  
 3: Paonia Street & Palmer Park Boulevard

Opening Day (2025) Plus Project  
 Evening Peak Hour

Intersection						
Int Delay, s/veh	3.6					
Movement	EBT	EBR	WBL	WBT	NBL	NBR
Lane Configurations	↑↑		↘	↑↑	↘	↘
Traffic Vol, veh/h	825	105	10	450	150	60
Future Vol, veh/h	825	105	10	450	150	60
Conflicting Peds, #/hr	0	0	0	0	0	2
Sign Control	Free	Free	Free	Free	Stop	Stop
RT Channelized	-	None	-	None	-	None
Storage Length	-	-	100	-	-	100
Veh in Median Storage, #	0	-	-	0	0	-
Grade, %	0	-	-	0	0	-
Peak Hour Factor	96	96	96	96	96	96
Heavy Vehicles, %	5	5	5	5	5	5
Mvmt Flow	859	109	10	469	156	63

Major/Minor	Major1	Major2	Minor1			
Conflicting Flow All	0	0	969	0	1169	486
Stage 1	-	-	-	-	914	-
Stage 2	-	-	-	-	255	-
Critical Hdwy	-	-	4.2	-	6.9	7
Critical Hdwy Stg 1	-	-	-	-	5.9	-
Critical Hdwy Stg 2	-	-	-	-	5.9	-
Follow-up Hdwy	-	-	2.25	-	3.55	3.35
Pot Cap-1 Maneuver	-	-	689	-	182	519
Stage 1	-	-	-	-	344	-
Stage 2	-	-	-	-	755	-
Platoon blocked, %	-	-	-	-	-	-
Mov Cap-1 Maneuver	-	-	689	-	179	518
Mov Cap-2 Maneuver	-	-	-	-	280	-
Stage 1	-	-	-	-	344	-
Stage 2	-	-	-	-	744	-

Approach	EB	WB	NB
HCM Control Delay, s/v	0	0.22	27.23
HCM LOS			D

Minor Lane/Major Mvmt	NBLn1	NBLn2	EBT	EBR	WBL	WBT
Capacity (veh/h)	280	518	-	-	689	-
HCM Lane V/C Ratio	0.558	0.121	-	-	0.015	-
HCM Control Delay (s/veh)	33	12.9	-	-	10.3	-
HCM Lane LOS	D	B	-	-	B	-
HCM 95th %tile Q(veh)	3.1	0.4	-	-	0	-

HCM 7th TWSC  
5: Omaha Boulevard & Access Road

Opening Day (2025) Plus Project  
Evening Peak Hour

Intersection												
Int Delay, s/veh	6.9											
Movement	EBL	EBT	EBR	WBL	WBT	WBR	NBL	NBT	NBR	SBL	SBT	SBR
Lane Configurations	↶	↷		↶	↷			↕			↕	
Traffic Vol, veh/h	101	120	20	30	85	71	10	5	50	102	5	67
Future Vol, veh/h	101	120	20	30	85	71	10	5	50	102	5	67
Conflicting Peds, #/hr	0	0	1	0	0	1	0	0	1	0	0	0
Sign Control	Free	Free	Free	Free	Free	Free	Stop	Stop	Stop	Stop	Stop	Stop
RT Channelized	-	-	None	-	-	None	-	-	None	-	-	None
Storage Length	75	-	-	100	-	-	-	-	-	-	-	-
Veh in Median Storage, #	-	0	-	-	0	-	-	0	-	-	0	-
Grade, %	-	0	-	-	0	-	-	0	-	-	0	-
Peak Hour Factor	96	96	96	96	96	96	96	96	96	96	96	96
Heavy Vehicles, %	5	5	5	5	5	5	5	5	5	5	5	5
Mvmt Flow	105	125	21	31	89	74	10	5	52	106	5	70

Major/Minor	Major1			Major2			Minor1			Minor2		
Conflicting Flow All	164	0	0	147	0	0	500	573	137	528	546	127
Stage 1	-	-	-	-	-	-	347	347	-	189	189	-
Stage 2	-	-	-	-	-	-	154	226	-	339	357	-
Critical Hdwy	4.15	-	-	4.15	-	-	7.15	6.55	6.25	7.15	6.55	6.25
Critical Hdwy Stg 1	-	-	-	-	-	-	6.15	5.55	-	6.15	5.55	-
Critical Hdwy Stg 2	-	-	-	-	-	-	6.15	5.55	-	6.15	5.55	-
Follow-up Hdwy	2.245	-	-	2.245	-	-	3.545	4.045	3.345	3.545	4.045	3.345
Pot Cap-1 Maneuver	1397	-	-	1417	-	-	476	426	903	456	441	916
Stage 1	-	-	-	-	-	-	663	630	-	806	738	-
Stage 2	-	-	-	-	-	-	842	711	-	669	623	-
Platoon blocked, %	-	-	-	-	-	-	-	-	-	-	-	-
Mov Cap-1 Maneuver	1396	-	-	1416	-	-	393	384	902	383	398	915
Mov Cap-2 Maneuver	-	-	-	-	-	-	393	384	-	383	398	-
Stage 1	-	-	-	-	-	-	612	582	-	787	721	-
Stage 2	-	-	-	-	-	-	755	695	-	577	576	-

Approach	EB			WB			NB			SB		
HCM Control Delay, s/v	3.26			1.23			10.77			16.43		
HCM LOS							B			C		

Minor Lane/Major Mvmt	NBLn1	EBL	EBT	EBR	WBL	WBT	WBR	SBLn1
Capacity (veh/h)	692	1396	-	-	1416	-	-	495
HCM Lane V/C Ratio	0.098	0.075	-	-	0.022	-	-	0.367
HCM Control Delay (s/veh)	10.8	7.8	-	-	7.6	-	-	16.4
HCM Lane LOS	B	A	-	-	A	-	-	C
HCM 95th %tile Q(veh)	0.3	0.2	-	-	0.1	-	-	1.7

Intersection												
Int Delay, s/veh	7.1											
Movement	EBL	EBT	EBR	WBL	WBT	WBR	NBL	NBT	NBR	SBL	SBT	SBR
Lane Configurations	↶	↷		↶	↷			↷			↶	↷
Traffic Vol, veh/h	45	192	35	5	141	5	30	70	20	100	40	15
Future Vol, veh/h	45	192	35	5	141	5	30	70	20	100	40	15
Conflicting Peds, #/hr	0	0	0	0	0	0	0	0	0	0	0	0
Sign Control	Free	Free	Free	Free	Free	Free	Stop	Stop	Stop	Stop	Stop	Stop
RT Channelized	-	-	None	-	-	None	-	-	None	-	-	None
Storage Length	100	-	-	100	-	-	-	-	-	-	-	100
Veh in Median Storage, #	-	0	-	-	0	-	-	0	-	-	0	-
Grade, %	-	0	-	-	0	-	-	0	-	-	0	-
Peak Hour Factor	96	96	96	96	96	96	96	96	96	96	96	96
Heavy Vehicles, %	5	5	5	5	5	5	5	5	5	5	5	5
Mvmt Flow	47	200	36	5	147	5	31	73	21	104	42	16

Major/Minor	Major1		Major2		Minor1			Minor2				
Conflicting Flow All	152	0	0	236	0	0	490	474	218	490	490	149
Stage 1	-	-	-	-	-	-	312	312	-	160	160	-
Stage 2	-	-	-	-	-	-	178	163	-	330	330	-
Critical Hdwy	4.15	-	-	4.15	-	-	7.15	6.55	6.25	7.15	6.55	6.25
Critical Hdwy Stg 1	-	-	-	-	-	-	6.15	5.55	-	6.15	5.55	-
Critical Hdwy Stg 2	-	-	-	-	-	-	6.15	5.55	-	6.15	5.55	-
Follow-up Hdwy	2.245	-	-	2.245	-	-	3.545	4.045	3.345	3.545	4.045	3.345
Pot Cap-1 Maneuver	1411	-	-	1313	-	-	484	484	814	484	474	889
Stage 1	-	-	-	-	-	-	692	652	-	835	760	-
Stage 2	-	-	-	-	-	-	817	758	-	677	640	-
Platoon blocked, %		-	-	-	-	-						
Mov Cap-1 Maneuver	1411	-	-	1313	-	-	417	466	814	385	457	889
Mov Cap-2 Maneuver	-	-	-	-	-	-	417	466	-	385	457	-
Stage 1	-	-	-	-	-	-	669	631	-	832	757	-
Stage 2	-	-	-	-	-	-	755	755	-	564	619	-

Approach	EB		WB		NB		SB	
HCM Control Delay, s/v	1.26		0.26		14.93		17.96	
HCM LOS					B		C	

Minor Lane/Major Mvmt	NBLn1	EBL	EBT	EBR	WBL	WBT	WBR	SBLn1	SBLn2
Capacity (veh/h)	487	1411	-	-	1313	-	-	403	889
HCM Lane V/C Ratio	0.257	0.033	-	-	0.004	-	-	0.362	0.018
HCM Control Delay (s/veh)	14.9	7.6	-	-	7.8	-	-	18.9	9.1
HCM Lane LOS	B	A	-	-	A	-	-	C	A
HCM 95th %tile Q(veh)	1	0.1	-	-	0	-	-	1.6	0.1