

**LOTS 3, 4, AND 5 NORTHCREST CENTER FILING NO 2
PHASE 1 SUBDIVISION
REFERRED TO AS: “NORTHCREST CENTER”
FINAL DRAINAGE REPORT**

2510 & 2522 CANADA DRIVE
COLORADO SPRINGS, COLORADO
80922

PREPARED FOR: LEISURE CONSTRUCTION
3443 TAMPA ROAD, SUITE B
PALM HARBOR, FL 34684
(727) 242-5121

PCD FILE NO. PPR-21-036

November 11, 2022

Prepared by
David Walker, P.E.
Rocky Mountain Group
2910 Austin Bluffs Blvd. | Colorado Springs, CO 80918 | 719-434-5638



SIGNATURE PAGE

**LOTS 3, 4, AND 5 NORTHCREST CENTER FILING NO 2 PHASE 1
SUBDIVISION**

ENGINEER'S STATEMENT

The attached drainage plan and report were prepared under my direction and supervision and are correct to the best of my knowledge and belief. Said drainage report has been prepared according to the criteria established by the County for drainage reports and said report is in conformity with the applicable master plan of the drainage basin. I accept responsibility for any liability caused by negligent acts, errors or omissions on my part in preparing this report.

SIGNATURE (Affix Seal):



David Wilker, P.E., No. 51909

11/14/22
Date:

DEVELOPER'S STATEMENT

I, the owner/developer have read and will comply with all of the requirements specified in this drainage report and plan.

K&S Development, LLC
Name of Developer

SL Edwards, MM 11-14-22
Authorized Signature Date

Sean L. Edwards
Printed Name

Managing Member
Title

3442 Tampa Rd., Suite B, Palm Harbor, FL 34684
Address

EL PASO COUNTY:

Filed in accordance with the requirements of the Drainage Criteria Manual, Volumes 1 and 2, El Paso County Engineering Criteria Manual and Land Development Code as amended.

Joshua Palmer, P.E. Date
County Engineer / ECM Administrator

Conditions:

TABLE OF CONTENTS

I.	PURPOSE.....	5
II.	GENERAL LOCATION AND DESCRIPTION.....	5
A.	LOCATION.....	5
B.	DESCRIPTION OF PROPERTY – EXISTING CONDITIONS.....	6
C.	EXISTING SOILS.....	6
D.	EXISTING DRAINAGE.....	7
E.	DESCRIPTION OF PROPERTY – PROPOSED CONDITIONS.....	7
III.	DRAINAGE BASINS AND SUB-BASINS.....	8
A.	EXISTING MAJOR DRAINAGE BASIN AND SUB-BASINS.....	8
B.	DEVELOPED MAJOR DRAINAGE BASIN AND SUB-BASINS.....	8
IV.	DRAINAGE DESIGN CRITERIA.....	12
A.	REGULATIONS.....	12
B.	DEVELOPMENT CRITERIA REFERENCE AND CONSTRAINTS.....	12
C.	HYDROLOGICAL CRITERIA.....	12
D.	FOUR-STEP PROCESS.....	12
V.	DRAINAGE INFRASTRUCTURE COSTS AND FEES.....	13
A.	DRAINAGE AND BRIDGE FEES.....	13
B.	STORM DRAIN SYSTEM QUANTITIES AND COSTS ESTIMATE.....	14
VI.	CONCLUSIONS.....	14
A.	COMPLIANCE WITH STANDARDS.....	14
VII.	REFERENCES.....	15
VIII.	Appendices.....	16

APPENDICES

A – Vicinity Map

B – Hydrologic and Hydraulic Computations

C – FEMA Floodplain Map

D – USGS Soils Survey Map

E – Drainage Plans

I. PURPOSE

This report is a Final Drainage Report for Lots 3, 4 & 5 Northcrest Center Subdivision, a currently unaddressed set of lots, for the development for a multi-unit commercial development, Northcrest Center.

The purpose of this report is to identify on-site and off-site drainage patterns, assess stormwater conditions per delineated basin and sub-basins, demonstrate adequate design standards for storm water flow and release into the existing storm water system or right-of-way, and provide a narrative for any other drainage considerations related to the development of this parcel.

II. GENERAL LOCATION AND DESCRIPTION

A. LOCATION

The proposed development of thirteen 2,280 square foot commercial buildings, is located at the address of Northcrest Center (formerly Lots 3, 4, & 5) in the City of Colorado Springs, Colorado in El Paso County within the Northcrest Center Subdivision. The parcel schedule numbers are 5332309004, 5332309006, and 5332309005 and the legal descriptions are Lot 3 Northcrest Center, A Vacation & Replat Of Tract B Northcrest Fil No 2 Phase 1, Lot 5 Northcrest Center, A Vacation & Replat Of Tract B Northcrest Fil No 2 Phase 1, and Lot 4 Northcrest Center, A Vacation & Replat Of Tract B Northcrest Fil No 2 Phase 1. The parcel is located to the north of Constitution Avenue, west of Canada Drive, east of Peterson Road, and south of Bismark Road.

The surrounding parcels are as follows:

North of Lots 3, 4 & 5 Northcrest Center, A Vacation & Replat of Tract B Northcrest Fil No 2 Phase 1 (Northcrest Center (formerly Lots 3, 4, & 5)) from west to east:

2508 Weyburn Way, Schedule No. 5332308031, Zoning RS-6000 CAD-O, Plat No. 10281, Lot 15 Constitution Hills Fil No 8

2507 Weyburn Way, Schedule No. 5332308032, Zoning RS-6000 CAD-O, Plat No. 10281, Lot 14 Constitution Hills Fil No 8

2630 Tibburn Way, Schedule No. 5332308040, Zoning RS-6000 CAD-O, Plat No. 10281, Lot 6 Constitution Hills Fil No 8

2610 Tibburn Way, Schedule No. 5332308041, Zoning RS-6000 CAD-O, Plat No. 10281, Lot 5 Constitution Hills Fil No 8

2605 Tibburn Way, Schedule No. 5332308042, Zoning RS-6000 CAD-O, Plat No. 10281, Lot 4 Constitution Hills Fil No 8

2624 Tibburn Way, Schedule No. 5332308043, Zoning RS-6000 CAD-O, Plat No. 10281, Lot 3 Constitution Hills Fil No 8

East of Lots 3, 4 & 5 Northcrest Center, A Vacation & Replat of Tract B Northcrest Fil No 2 Phase 1 (Northcrest Center (formerly Lots 3, 4, & 5)) from north to south:

2535 Canada Drive, Schedule No. 5332310002, Zoning RS-6000 CAD-O, Plat No. 8956, Lot 1 Living Waters Sub

2525 Canada Drive, Schedule No. 5332310003, Zoning PUD CAD-O, Plat No. 8956, Lot 2 Living Waters Sub

2455 Canada Drive, Schedule No. 5405207050, Zoning RM-30 CAD-O, Plat No. 7588, Lot 2 Northcrest Fil No 4

South of Lots 3, 4 & 5 Northcrest Center, A Vacation & Replat of Tract B Northcrest Fil No 2 Phase 1 (Northcrest Center (formerly Lots 3, 4, & 5)) from west to east:

6855 Constitution Avenue, Schedule No. 5405218002, Zoning CC CAD-O, Plat No. 9808, Lot 1 Eight Line Sub

West of Lots 3, 4 & 5 Northcrest Center, A Vacation & Replat of Tract B Northcrest Fil No 2 Phase 1 (Northcrest Center (formerly Lots 3, 4, & 5)) from north to south:

6805 Bismark Road, Schedule No. 5332309007, Zoning CC CAD-O, Plat No. 7776, Lots 1 & 2 Northcrest Center, A Vacation & Replat of Tract B Northcrest Fil No 2 Phase 1

B. DESCRIPTION OF PROPERTY – EXISTING CONDITIONS

Lots 3, 4, and 5 (Northcrest Center (formerly Lots 3, 4, & 5)) is approximately 144,776 square feet combined (3.32 acres) and is located on the north side of Constitution Avenue, east side of Peterson Road, West of Canada Drive, and south of Bismark Road. The parcels fall within the SW 1/4 of Section 32, Township 13 South, Range 65 West of the 6th P.M. of Colorado Springs, El Paso County, Colorado.

The property currently consists of undeveloped natural vegetation. There is existing curb and gutter along Bismark Drive, Canada Drive, and Constitution Avenue.

The existing percent imperviousness is approximately 1.5 percent on Lots 3, 4, and 5.

The existing topography consists of grades between 5.3 and 19.17 percent. Drainage patterns sheet flow across the parcel southeasterly to the corner of Canada Drive and Constitution Avenue.

C. EXISTING SOILS

The soils indicative to the site are classified as Truckton sandy loam by the USDA Soil Conservation Service and are listed as NRCS (National Resources Conservation Service) Hydrologic Soil Group A. A USDA Soil Map is provided in the Appendix.

A subsurface soils investigation was conducted for Commercial Development Site Constitution and Peterson, with a letter entitled *Geotechnical Report* by RMG – Rocky Mountain Group dated

February 23, 2021. The investigation “revealed similar substance subsurface soil conditions across the site, being primarily silty sand extending from the ground surface to the extent of the test borings. Neither expansive clay soil nor bedrock were encountered in the borings.”

“Test Borings for structures and storage yards were advanced with a power-driven, continuous-flight auger drill rig to depths of 15 and 20-feet below the existing ground surface. Pavement Borings were advanced to 5 and 10-foot depths.”

The study found that “groundwater was not encountered in the test borings during field exploration.”

D. EXISTING DRAINAGE

The existing topography consists of grades between 5.3 and 19.17 percent within the entire parcel that ultimately flows southeast. The existing imperviousness of the lot is approximately 1.5 percent. The existing vegetation consists of native grasses and has been identified via site visits and aerial photography as well as survey data and pictures.

The existing drainage pattern from storm runoff is generally characterized as overland flow to the southeast of the parcel across pervious landscaped yard. The runoff from this parcel and the surrounding neighborhood flows via curb and gutter in the public right of way of Bismark Road, Constitution Avenue, and Canada Drive. The runoff flows south on Canada Drive into the existing Public 15' CDOT Type R Curb Inlet located at the northwest corner of the intersection of Canada Drive and Constitution Avenue. This Public Storm Inlet is a branch of the Public 24" RCP Storm Main that flows west to east along the north side of Constitution Avenue and ultimately outfalls into Jimmy Camp Creek.

Lots 3, 4, and 5 do not lie within a designated floodplain according to information published in the Federal Emergency Management Agency Floodplain Map No. 08041C0752G, dated December 7, 2018. The FEMA Floodplain map is provided in Appendix C showing it lies within Zone X, a minimal flood hazard area.

There are no known non-stormwater discharges that contribute to the storm water systems on site and downstream, both private and public.

E. DESCRIPTION OF PROPERTY – PROPOSED CONDITIONS

The proposed development consists of thirteen 2,280 square foot commercial units and approximately 69,000 square feet of concrete and asphalt pavement for drive accesses, sidewalks, and curb and gutter. Other on-site features includes approximately 29,000 square feet of landscaping, 760 linear feet of retaining wall, and 2,800 square feet for a full spectrum detention pond.

There is no existing access point to the property. Two new curb cuts are proposed along Canada Drive.

III. DRAINAGE BASINS AND SUB-BASINS

A. EXISTING MAJOR DRAINAGE BASIN AND SUB-BASINS

The parcel is delineated into sub-basins according to the existing and proposed grading for existing and developed conditions.

Basin E is the entirety of the parcel representing existing conditions and consists of one on-site sub-basin. There are no off-site flows that enter the property due to the slope of the existing drive aisle between this lot and the neighboring lot.

Sub-basin E-1 (3.24 ac.; $Q_{10} = 2.15$ cfs, $Q_{100} = 6.86$ cfs) is the entirety of Lots 3, 4, and 5 to be replatted via vacation into a single lot which contains natural vegetation that flows to the right of ways of Bismark Road, Canada Drive, and Constitution Ave. Those right of ways have curb and gutter directly adjacent to the lot that flow to a Public 15' CDOT Type R Curb Inlet. This public stormwater system is connected to a Public 24" RCP Storm Main that runs west to east along the south side of the lot within Constitution Avenue. The Public 15' & 5' CDOT Type R Curb Inlets located at the northwest and northeast corners, respectively, of the intersection of Canada Drive and Constitutions Avenue are branches that connect to the public stormwater main within Constitution Avenue. The public stormwater system ultimately flows to the East Fork Sand Creek.

EP1 is the existing conditions design point representing the Public 15' CDOT Type R Curb Inlet at the northwest corner at the intersection of Canada Drive and Constitution Avenue where sub-basin E-1 flows over the pervious lot containing native grasses and vegetation to the public roadways. The emergency flow route of this public storm inlet is due east along the north side of Constitution Avenue.

B. DEVELOPED MAJOR DRAINAGE BASIN AND SUB-BASINS

Basin D is the entirety of the developed parcel representing developed conditions and consists of nine sub-basins. Some off-site flows will enter the proposed site from the western paved drive access currently serving the existing school.

Sub-basin D-1 (0.29 ac. ; $Q_{10} = 1.14$ cfs, $Q_{100} = 1.80$ cfs) is the northwestern area of the development consisting of an asphalt drive access off of the common drive access for this property and the neighboring lot from Bismark Road as well as enclosed storage and large vehicle parking area that consists of compacted gravel. The sub-basin is sloped southeast and overland flow is directed to a concrete drainage pan within the drive aisle and channeled to a Private 3'x3' CDOT Type C Depressed Inlet with Grate.

DP1 is the Design Point representing the Private 3'x3' CDOT Type C Depressed Inlet with Grate for Sub-basin D-1. The Private Storm Inlet flows downstream to subsequent Design Point 6 before entering the Full Spectrum Extended Detention Basin via the Private Storm Sewer system. The total peak runoff flowing into DP1 is 1.14 cfs for the 10-year peak flow and 1.80 cfs for the 100-year peak flow. The emergency flow route for DP1 is an overflow condition of the Private Storm Inlet that would cause storm water pooling within the northern drive aisle and

would flow due east into Canada Drive and ultimately to the Public 15' CDOT Type R Curb Inlet at the northwest corner of the intersection of Canada Drive and Constitution Avenue.

Sub-basin D-2 (0.45 ac. ; $Q_{10} = 1.86$ cfs, $Q_{100} = 2.90$ cfs) is the middle-north area of the development consisting of an asphalt drive access off of the common drive access for this property as well as enclosed storage and large vehicle parking area that consists of compacted gravel. The sub-basin is sloped southeast and overland flow is directed to the concrete drain pan within the drive aisle and channeled to a Private 3'x3' CDOT Type C Depressed Inlet with Grate, the second in a series of storm inlets in the northern area.

DP2 is the Design Point representing the Private 3'x3' CDOT Type C Depressed Inlet with Grate for Sub-basin D-2. The Private Storm Inlet flows downstream to subsequent Design Points 1 and 6 before entering the Full Spectrum Extended Detention Basin via the Private Storm Sewer system. The total peak runoff flowing into DP2 is 1.86 cfs for the 10-year peak flow and 2.90 cfs for the 100-year peak flow. The emergency flow route for DP2 is an overflow condition of the Private Storm Inlet that would cause storm water pooling within the northern drive aisle and would flow due east into Canada Drive and ultimately to the Public 15' CDOT Type R Curb Inlet at the northwest corner of the intersection of Canada Drive and Constitution Avenue.

Sub-basin D-3 (0.37 ac. ; $Q_{10} = 1.70$ cfs, $Q_{100} = 2.63$ cfs) is the northeast area of the development consisting of an asphalt drive access off of the common drive access for this property as well as enclosed storage and large vehicle parking area that consists of compacted gravel. The sub-basin is sloped southeast and overland flow is directed to the concrete drain pan within the drive aisle and channeled to a Private 3'x3' CDOT Type C Depressed Inlet with Grate, the third in a series of storm inlets in the northern area.

DP3 is the Design Point representing the Private 3'x3' CDOT Type C Depressed Inlet with Grate for Sub-basin D-3. The Private Storm Inlet flows downstream to subsequent Design Points 2, 1, and 6 before entering the Full Spectrum Extended Detention Basin via the Private Storm Sewer system. The total peak runoff flowing into DP3 is 1.70 cfs for the 10-year peak flow and 2.63 cfs for the 100-year peak flow. The emergency flow route for DP3 is an overflow condition of the Private Storm Inlet that would cause storm water pooling within the northern drive aisle and would flow due east into Canada Drive and ultimately to the Public 15' CDOT Type R Curb Inlet at the northwest corner of the intersection of Canada Drive and Constitution Avenue.

Sub-basin D-4 (0.73 ac. ; $Q_{10} = 3.29$ cfs, $Q_{100} = 5.12$ cfs) is the roof of the proposed building within the center of the lot. This sub-basin captures stormwater runoff from the roof and distributes it to roof drains along the northern edge of the building. Roof drains will be connected to the underground storm drain line under the concrete drainage pan within the north drive aisle. Runoff from this sub-basin is only included in the detention basin design point DP4.

DP4 is the Design Point representing the proposed roof runoff. The total peak runoff flowing into DP4 is 3.29 cfs for the 10-year peak flow and 5.12 cfs for the 100-year peak flow.

Sub-basin D-5 (0.50 ac. ; $Q_{10} = 2.69$ cfs, $Q_{100} = 4.07$ cfs) is the southern area of the development consisting of the south frontage parking lot. The sub-basin is generally sloped southeast within the parking lot with storm water conveyances via overland flow and curb and

gutter. The sub-basin flows to a proposed Private 10' CDOT Type R Curb Inlet and conveys it to the Full Spectrum Extended Detention Basin via the Private Storm Sewer system.

DP5 is the Design Point representing the Private 10' CDOT Type R Curb Inlet for Sub-basin D-5. The Private Storm Inlet flows downstream to the Full Spectrum Extended Detention Basin via the Private Storm Sewer system. The total peak runoff flowing into DP5 is 2.69 cfs for the 10-year peak flow and 4.07 cfs for the 100-year peak flow. The emergency flow route for DP5 is to the east following proposed curb and gutter into Canada Drive and ultimately to the Public 15' CDOT Type R Curb Inlet at the northwest corner of the intersection of Canada Drive and Constitution Avenue.

Sub-basin D-6 (0.31 ac. ; $Q_{10} = 1.58$ cfs, $Q_{100} = 2.42$ cfs) is the tributary area within the property boundary that consists of the common drive access off of Bismark Road to be extended to the south parking lot frontage of the development. This sub-basin previously flowed southeast to the public storm system and is proposed to flow southeast to the proposed curb inlet within the south parking lot, DP-6. The existing drainage pattern along the western property line will be preserved to accomplish this.

DP6 is the Design Point representing the Private 10' CDOT Type R Curb Inlet for Sub-basin D-6. The Private Storm Inlet flows downstream to the Full Spectrum Extended Detention Basin via the Private Storm Sewer system. The total peak runoff flowing into DP6 is 1.58 cfs for the 10-year peak flow and 2.42 cfs for the 100-year peak flow. The emergency flow route for DP6 is to the east following proposed curb and gutter into Canada Drive and ultimately to the Public 15' CDOT Type R Curb Inlet at the northwest corner of the intersection of Canada Drive and Constitution Avenue.

Sub-basin D-7 (0.14 ac. ; $Q_{10} = 0.26$ cfs, $Q_{100} = 0.56$ cfs) accounts for the tributary area of the development that consists of the Full Spectrum Extended Detention Basin footprint. Runoff in this area is directly collected by the basin.

DP7 is the Design Point representing the Full Spectrum Extended Detention Basin that is designed to detain a major storm event for the developed lot and provide Water Quality. The EDB is proposed to consist of 5.5-foot high structural walls with a detention volume of 24,000 cubic feet. The EDB consists of two forebays, concrete trickle channel, micropool, and outlet structure with an engineered orifice plate to comply with release rates for Water Quality Capture Volume, Excess Urban Runoff Volume, and the 100-Year Major Storm Event. The emergency spillway of the detention basin is via a 6' wide wall notch in the westerly wall that discharges into a riprap lined slope flowing due south to Constitution Avenue, ultimately flowing into the existing Public 15' CDOT Type R Curb Inlet at the northwest corner of the intersection of Canada Drive and Constitution Avenue.

Sub-basin D-8 (0.21 ac. ; $Q_{10} = 0.17$ cfs, $Q_{100} = 0.66$ cfs) is the southwest area of the development consisting of landscaping. The sub-basin flow is directed to the grass swale within the landscape area and channeled to a Private 3'x3' CDOT Type C Depressed Inlet with Grate.

DP8 is the Design Point representing the Private 3'x3' CDOT Type C Depressed Inlet with Grate for Sub-basin D-8. The Private Storm Inlet flows downstream to subsequent Design Points

via the Private Storm Sewer system. The total peak runoff flowing into DP8 is 0.17 cfs for the 10-year peak flow and 0.58 cfs for the 100-year peak flow. The emergency flow route for DP8 is to the east into Canada Drive and ultimately to the Public 15' CDOT Type R Curb Inlet at the northwest corner of the intersection of Canada Drive and Constitution Avenue.

Sub-basin D-9 (0.63 ac. ; $Q_{10} = 1.20$ cfs, $Q_{100} = 2.54$ cfs) is the tributary area within the property boundary that flows toward the adjacent right of ways of Bismark Road, Canada Drive, and Constitution Avenue. The sub-basin consists mostly of proposed landscaped areas, public concrete sidewalk, and ingress/egress curb cuts. The sub-basin flows to Design Point 9 via the adjacent roadways' curb and gutter, ultimately to the Public 15' CDOT Type R Curb Inlet at the northwest corner of the intersection of Canada Drive and Constitution Avenue.

DP9 is the Design Point representing the Public 15' CDOT Type R Curb Inlet at the northwest corner of the intersection of Canada Drive and Constitution Avenue. This Public Storm Inlet is a branch line of the Public Storm Main that runs west to east within Constitution Avenue and is the ultimate recipient of storm water flow from the developed lot as it is proposed to connect to the outlet structure of the EDB (DP7). The emergency flow route of this public storm inlet is due east along the north side of Constitution Avenue.

There is an existing Water Quality Capture Volume BMP/control measure constructed for the neighboring lot (Northcrest Center Fil No 2 Lots 1 & 2). This feature will not see additional runoff due to the proposed development, and was not evaluated for its current conditions.

The difference between Basin E and Basin D results in an overall increase of the 100-year storm Water volume of 14.71 cfs overall due to increased impervious surfaces.

2.65 acres (83.9% imperviousness) of on-site flows, and 0.31 acres of off-site flows drain to the Full Spectrum Detention Basin, with a total runoff of 20.19 cfs (100-yr storm) being captured.

A Full Spectrum Extended Detention Basin is proposed for the site to provide water quality and detention prior to attenuated storm water release to the public storm system. The vertical concrete walls on all four sides of the Extended Detention Basin are due to site constraints including an existing electric vault and existing easement where the pond is being constructed. The Full Spectrum Extended Detention Basin does include a 10' wide concrete maintenance access ramp with a grass bottom that slopes to the trickle channel.

It is anticipated that there will be no negative impact to downstream developments or infrastructure as a result of this development.

IV. DRAINAGE DESIGN CRITERIA

A. REGULATIONS

The hydrological and hydraulic calculations and design of the site conform to the City of Colorado Springs Drainage Criteria Manuals I and II (latest revision, May 2014) as well as the Mile High Flood District Drainage Criteria manuals revised August 2018.

B. DEVELOPMENT CRITERIA REFERENCE AND CONSTRAINTS

The parcel falls within the Sand Creek major drainage basin (East Fork Sand Creek) designated by the City of Colorado Springs Water Resources Engineering Department with the ultimate receiving waters of Arkansas River. The drainage on this parcel will have no effect on downstream infrastructure or facilities, streets, utilities, transit, or further development of adjacent lots. Relevant criteria for the calculations shown further include equations and design criteria for the rational method, volumes and runoff of various storm events.

C. HYDROLOGICAL CRITERIA

The rational method was used to calculate the peak runoff of the delineated sub-basins using the manuals referenced prior with the C, I, and P1 values from the Design Criteria Manual Volume I, Chapter 6 as well as the Colorado Springs designated IDF curve values. Specific calculations and tables are provided further with inputs including design rainfall, sub-basin acreage and percent imperviousness, runoff coefficients, one-hour rainfall depths, rainfall intensities, time of concentration, and peak discharge of various storm events. The default rainfall intensities and volumes use runoff coefficients based on soil types. Weighted runoff coefficients were calculated for each basin and sub-basin due to the mix of impervious surfaces, shown in the Appendix exhibits.

D. FOUR-STEP PROCESS

The selection of appropriate control measures is based on the characteristics of the site and potential pollutants. The Four-Step Process provides a method of going through the selection process. The following applies the four-step process to the Development Plan for the Northcrest Center.

Step 1: Employ Runoff Reduction Practices

The Development Plan including the Landscape Plan utilizes landscaping areas for plantings and grass or mulch wherever possible without obstructing utilities or drainageways. Given the proposed land use, the majority of the site is to be paved for vehicular use. Within the mostly-impervious site, the storm water runoff is kept to the site limits where possible by use of grading, a private storm system and all other areas are to be landscaped, including the right of way landscape buffer areas.

Step 2: Provide Water Quality Capture Volume

The Development Plan and Final Drainage Report indicate the use of a storm water detention pond as a control measure for capturing storm water runoff and properly treating the storm water prior to release either via percolation into the soil or attenuated to the public storm system. The detention pond is to be installed and the configuration is sized for capture of the WQCV as well as the EURV and full-spectrum detention, and 100-year detention.

Step 3: Stabilize Drainageways

The drainage within the site is stabilized by way of pavement with features such as drainage pans, curb and gutter, and sloped pavement to direct storm water to the private storm system. There are no unpaved or unstabilized drainageways on this site.

Step 4: Implement Site Specific and Other Source Control BMPs

No control measures beyond the Full Spectrum Extended Detention Basin are proposed as there are no unusual land uses that would result in the need for other source control BMPs.

V. DRAINAGE INFRASTRUCTURE COSTS AND FEES

A. DRAINAGE AND BRIDGE FEES

The development falls within the Sand Creek drainage basin (FOFO4000) which has a drainage basin fee of \$20,387 per impervious acre and a bridge fee of \$8,339 per impervious acre according to the 2021 El Paso County Drainage Basin Fees document. The development has a total impervious acreage of 2.72 acres (3.24 acres * 83.9% imperviousness).

Drainage Basin Fee: $\$20,387/\text{impervious acre} * 2.72 \text{ impervious acres} = \$55,452.64$

Bridge Fee: $\$8,339/\text{impervious acre} * 2.72 \text{ impervious acres} = \$22,682.08$

Since the site is already platted, drainage fees are assumed to have already been paid. Since this development is increasing imperviousness, the County shall review their records and make a decision on fee requirements.

Any outstanding fees must be paid prior to plat recordation.

B. STORM DRAIN SYSTEM QUANTITIES AND COSTS ESTIMATE

The following summarizes the Engineer's Opinion of Probable Cost for the proposed storm facilities for the development (installation plus materials).

Private System

Description	Quantity	Unit	Unit Price	Cost
Earthwork for cut of Pond (Less than 1,000)	612	CY	\$ 8	\$ 4,896
12" RCP	230	LF	\$ 55	\$ 12,650
18" RCP	226	LF	\$ 65	\$ 14,690
24" RCP	74	LF	\$ 78	\$ 5,772
Curb Inlet (Type R) L=10' 5' ≤ Depth < 10'	2	EA	\$ 8,136	\$ 16,272
Pond Outlet Structure	1	EA	\$ 10,000	\$ 10,000
Grated Inlet (Type C) Depth < 5'	4	EA	\$ 4,802	\$ 19,208
Storm Sewer Manhole, Box Base	2	EA	\$ 12,034	\$ 24,068
Concrete Basin Walls and Safety Railing	1	EA	\$20,000	\$20,000

Total Cost \$127,556.00
Engineering

Contingency (10%) \$ 12,755.60

**Grand Total (w/
Contingency)**
Non-Reimbursable \$140,311.60

VI. CONCLUSIONS

A. COMPLIANCE WITH STANDARDS

The criteria used to design the storm water runoff volumes are formulas and figures within the City of Colorado Springs Drainage Manuals as well as the Mile High Flood District Drainage Criteria manual. Grading practices for optimal drainage shall comply with the geotechnical investigative report and City standards. The development of Lots 3-5 is within compliance and standards and meets the requirements for the Northcrest Center.

The proposed grading and drainage is within substantial conformance for the master drainage plan for the Subdivision and Drainage Basin. There is no impact on major drainageway planning studies within the larger drainage basin. This development will not adversely affect downstream development.

VII. REFERENCES

Colorado Springs Drainage Manual Volumes I & II (May 2014)

Colorado Urban Drainage and Flood Control District Drainage Criteria Manual, Volume I (August 2018)

Colorado Urban Drainage and Flood Control District Drainage Criteria Manual, Volume III (April 2018)

Urban Storm Drainage Criteria Manual, Volume III (November, 2015)

FEMA Flood Map Service Center

United States Department of Agriculture National Resources Conservation Service

Subsurface Soil Investigation prepared by RMG-Rocky Mountain Group Engineers dated February 23, 2021

VIII. Appendices

APPENDIX A – VICINITY MAP

VICINITY MAP
NORTHCREST CENTER
TBD BISMARK ROAD
COLORADO SPRINGS, COLORADO 80922
EL PASO COUNTY

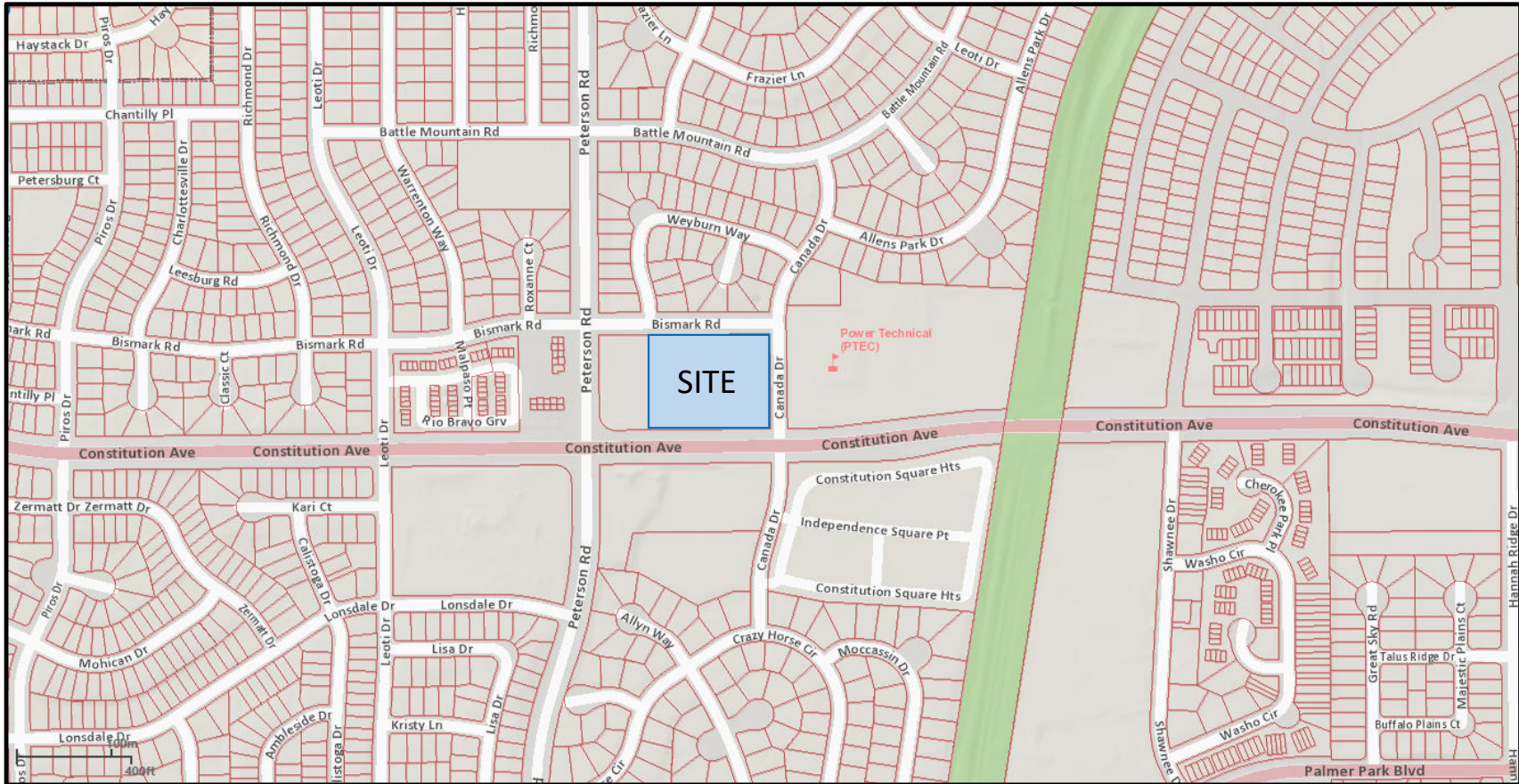

APPENDIX B – HYDROLOGIC AND HYDRAULIC COMPUTATIONS

Project: Northcrest Center PEMBs Development - EXISTING CONDITIONS
 Engineer: David Walker, PE
 Date: 11/11/2022
 Address: 2510 & 2521 Canada Dr

Sub-Basin:	E-1 (DF Curve Equations from Figure 6-5 of the DCM Volume 1)					
T _d Duration:	15.15					
	I ₂	I ₅	I ₁₀	I ₂₅	I ₅₀	I ₁₀₀
	2.800816441	3.506298035	4.0908477	4.6753974	5.2599471	5.8861407

Hydrologic Soil Type: **A**

Coefficient (Table 6-6)																						
Land Use or Surface Characteristic	Square Feet	Acres	Coefficient ₁	Coefficient ₂	Coefficient ₃	Coefficient ₄	Coefficient ₅	Coefficient ₆	Coefficient ₇	2 Yr. C * A	5 Yr. C * A	10 Yr. C * A	25 Yr. C * A	50 Yr. C * A	100 Yr. C * A	2 Yr. C ₁	5 Yr. C ₁	10 Yr. C ₁	25 Yr. C ₁	50 Yr. C ₁	100 Yr. C ₁	
Roof	0	0.000	0.71	0.73	0.75	0.78	0.80	0.81	0.000	0.000	0.000	0.000	0.000	0.000	0.000	0.033	0.099	0.162	0.261	0.310	0.359	
Pavement	2155	0.049	0.89	0.90	0.92	0.94	0.95	0.96	0.044	0.045	0.046	0.047	0.047	0.047	0.047							
Lawn	139193	3.195	0.02	0.08	0.15	0.25	0.30	0.35	0.064	0.256	0.479	0.799	0.959	1.118								
A:	141348.11	3.245																				

Q Peak Flow (cfs)					
2 Year Q	5 Year Q	10 Year Q	25 Year Q	50 Year Q	100 Year Q
0.30	1.05	2.15	3.95	5.29	6.86

Design Points		
Design Point	Q ₁₀	Q ₁₀₀
EX DP1	2.15	6.86
TOTAL SITE	2.15	6.86

Time of Concentration

$$t_c = t_i + t_t$$

3.2.1 - Overland (Initial) Flow Time

$$t_i = \frac{0.395(1.1 - C_s)\sqrt{L}}{S^{0.33}} \quad (\text{Eq. 6-8})$$

Where:

t_i = overland (initial) flow time (min)

C_s = runoff coefficient for 5-year frequency (see Table 6-6)

L = length of overland flow (300 ft maximum for non-urban land uses, 100 ft maximum for urban land uses)

S = average basin slope (ft/ft)

Note that in some urban watersheds, the overland flow time may be very small because flows quickly concentrate and channelize.

Sub-Basin or DP:	E-1	
C_{10} :	0.16	[Table 6-6. Runoff Coefficients for Rational Method]
L:	100	ft
S:	0.045	ft/ft

Composite Runoff Coefficient Calculation:

$$C_c = (C_1 A_1 + C_2 A_2 + C_3 A_3 + \dots + C_i A_i) / A_t$$

Land Use or Surface Characteristic	Square Feet	Acreage	C_{10}
Roof	0	0.00	0.75
Pavement	2155	0.05	0.92
Lawn	139193	3.20	0.15
A_t :	141348	3.24	

$$C_c = (0.92 * 0.05 + 0.15 * 3.20) / 3.24 = \quad \mathbf{0.16}$$

$$t_i = (0.395 * (1.1 - C_{10}) * \sqrt{L}) / (S^{0.33})$$

$$t_i = (0.395 * (1.1 - 0.09) * \sqrt{550}) / (0.045^{0.33}) = \quad \mathbf{10.31} \text{ mins}$$

3.2.2 Travel Time

For catchments with overland and channelized flow, the time of concentration needs to be considered in combination with the travel time, t_t , which is calculated using the hydraulic properties of the swale, ditch, or channel. For preliminary work, the overland travel time, t_t , can be estimated with the help of Figure 6-25 or Equation 6-9 (Guo 1999).

$$V = C_v S_w^{0.5} \quad (\text{Eq. 6-9})$$

Where:

V = velocity (ft/s)

C_v = conveyance coefficient (from Table 6-7)

S_w = watercourse slope (ft/ft)

$$V = C_v S_w^{0.5}$$

$$V = (20)(0.006)^{0.5} = \quad \mathbf{1.55} \text{ ft/s}$$

$$\text{Flow Distance:} \quad \mathbf{450.00} \text{ ft}$$

$$t_t = L/V = \quad \mathbf{290.47} \text{ sec.}$$

$$\mathbf{4.84} \text{ min.}$$

Table 6-7. Conveyance Coefficient, C_v

Type of Land Surface	C_v
Heavy meadow	2.5
Tillage/field	5
Riprap (not buried)	6.5
Short pasture and lawns	7
Nearly bare ground	10
Grassed waterway	15
Paved areas and shallow paved swales	20

For buried riprap, select C_v value based on type of vegetative cover.

$$t_c = t_i + t_t = \quad \mathbf{15.15} \text{ min.}$$

3.2.4 Minimum Time of Concentration

If the calculations result in a t_c of less than 10 minutes for undeveloped conditions, it is recommended that a minimum value of 10 minutes be used. The minimum t_c for urbanized areas is 5 minutes.

$$\text{Final } t_c: \quad \mathbf{15.15} \text{ min.}$$

Project: Northeast Center PEMs Commercial Development - DEVELOPED CONDITIONS
 Engineer: David Walker, PE
 Date: 11/6/2022
 Address: 2510 & 2522 Canada Dr

Sub-Basin:	D-1		[DF Curve Equations from Figure 6-5 of the DCM Volume 1]				
T ₁ Duration:	5.91						
	I ₁	I ₂	I ₃₀	I ₂₅	I ₁₀	I ₁₀₀	
	3.919923358	9.916937006	5.7365932	6.5562493	7.3759055	8.2360142	

Hydrologic Soil Type: A

Coefficient (Table 6-6)														
Land Use or Surface Characteristic	Square Feet	Area	Coefficient	Coefficient	Coefficient	Coefficient	Coefficient	Coefficient	2 Yr. C * A	5 Yr. C * A	10 Yr. C * A	25 Yr. C * A	50 Yr. C * A	100 Yr. C * A
Roof	0	0.000	0.71	0.73	0.75	0.78	0.80	0.81	0.000	0.000	0.000	0.000	0.000	0.000
Pavement	4720	0.108	0.89	0.90	0.92	0.94	0.95	0.96	0.098	0.100	0.102	0.103	0.104	
Lawn	2117	0.028	0.02	0.08	0.15	0.25	0.30	0.35	0.001	0.004	0.007	0.008	0.010	
Gravel	6027	0.149	0.57	0.59	0.63	0.66	0.68	0.70	0.085	0.088	0.094	0.099	0.102	
A _c	12444	0.29												

Q Peak Flow (cfs)						
2 Year Q	5 Year Q	10 Year Q	25 Year Q	50 Year Q	100 Year Q	
0.71	0.92	1.14	1.36	1.57	1.80	

Sub-Basin:	D-2		[DF Curve Equations from Figure 6-5 of the DCM Volume 1]				
T ₁ Duration:	5.89						
	I ₁	I ₂	I ₃₀	I ₂₅	I ₁₀	I ₁₀₀	
	3.925794857	9.524938181	5.7452279	6.5661176	7.3870073	8.2684481	

Hydrologic Soil Type: A

Coefficient (Table 6-6)														
Land Use or Surface Characteristic	Square Feet	Area	Coefficient	Coefficient	Coefficient	Coefficient	Coefficient	Coefficient	2 Yr. C * A	5 Yr. C * A	10 Yr. C * A	25 Yr. C * A	50 Yr. C * A	100 Yr. C * A
Roof	0	0.000	0.71	0.73	0.75	0.78	0.80	0.81	0.000	0.000	0.000	0.000	0.000	0.000
Pavement	6189	0.142	0.89	0.90	0.92	0.94	0.95	0.96	0.128	0.131	0.133	0.135	0.136	
Lawn	0	0.000	0.02	0.08	0.15	0.25	0.30	0.35	0.000	0.000	0.000	0.000	0.000	
Gravel	13359	0.307	0.57	0.59	0.63	0.66	0.68	0.70	0.175	0.181	0.189	0.202	0.209	
A _c	19542	0.45												

Q Peak Flow (cfs)						
2 Year Q	5 Year Q	10 Year Q	25 Year Q	50 Year Q	100 Year Q	
1.18	1.52	1.86	2.21	2.54	2.90	

Sub-Basin:	D-3		[DF Curve Equations from Figure 6-5 of the DCM Volume 1]				
T ₁ Duration:	5.00						
	I ₁	I ₂	I ₃₀	I ₂₅	I ₁₀	I ₁₀₀	
	4.119768884	9.168843111	6.0204837	6.8921242	7.7537647	8.6792165	

Hydrologic Soil Type: A

Coefficient (Table 6-6)														
Land Use or Surface Characteristic	Square Feet	Area	Coefficient	Coefficient	Coefficient	Coefficient	Coefficient	Coefficient	2 Yr. C * A	5 Yr. C * A	10 Yr. C * A	25 Yr. C * A	50 Yr. C * A	100 Yr. C * A
Roof	0	0.000	0.71	0.73	0.75	0.78	0.80	0.81	0.000	0.000	0.000	0.000	0.000	0.000
Pavement	7141	0.164	0.89	0.90	0.92	0.94	0.95	0.96	0.148	0.151	0.154	0.156	0.157	
Lawn	0	0.000	0.02	0.08	0.15	0.25	0.30	0.35	0.000	0.000	0.000	0.000	0.000	
Gravel	9590	0.208	0.57	0.59	0.63	0.66	0.68	0.70	0.118	0.123	0.131	0.137	0.141	
A _c	16191	0.37												

Q Peak Flow (cfs)						
2 Year Q	5 Year Q	10 Year Q	25 Year Q	50 Year Q	100 Year Q	
2.09	1.40	1.70	2.08	2.30	2.65	

Sub-Basin:	D-4		[DF Curve Equations from Figure 6-5 of the DCM Volume 1]				
T ₁ Duration:	5.00						
	I ₁	I ₂	I ₃₀	I ₂₅	I ₁₀	I ₁₀₀	
	4.119768884	9.168843111	6.0204837	6.8921242	7.7537647	8.6792165	

Hydrologic Soil Type: A

Coefficient (Table 6-6)														
Land Use or Surface Characteristic	Square Feet	Area	Coefficient	Coefficient	Coefficient	Coefficient	Coefficient	Coefficient	2 Yr. C * A	5 Yr. C * A	10 Yr. C * A	25 Yr. C * A	50 Yr. C * A	100 Yr. C * A
Roof	31733	0.718	0.71	0.73	0.75	0.78	0.80	0.81	0.517	0.532	0.546	0.568	0.583	
Pavement	0	0.000	0.89	0.90	0.92	0.94	0.95	0.96	0.000	0.000	0.000	0.000	0.000	
Lawn	0	0.000	0.02	0.08	0.15	0.25	0.30	0.35	0.000	0.000	0.000	0.000	0.000	
A _c	31733	0.73												

Q Peak Flow (cfs)						
2 Year Q	5 Year Q	10 Year Q	25 Year Q	50 Year Q	100 Year Q	
3.13	2.75	3.19	3.92	4.52	5.12	

Sub-Basin:	D-5		[DF Curve Equations from Figure 6-5 of the DCM Volume 1]				
T ₁ Duration:	5.00						
	I ₁	I ₂	I ₃₀	I ₂₅	I ₁₀	I ₁₀₀	
	4.119768884	9.168843111	6.0204837	6.8921242	7.7537647	8.6792165	

Hydrologic Soil Type: A

Coefficient (Table 6-6)														
Land Use or Surface Characteristic	Square Feet	Area	Coefficient	Coefficient	Coefficient	Coefficient	Coefficient	Coefficient	2 Yr. C * A	5 Yr. C * A	10 Yr. C * A	25 Yr. C * A	50 Yr. C * A	100 Yr. C * A
Roof	0	0.000	0.71	0.73	0.75	0.78	0.80	0.81	0.000	0.000	0.000	0.000	0.000	0.000
Pavement	20994	0.482	0.89	0.90	0.92	0.94	0.95	0.96	0.429	0.434	0.443	0.453	0.458	
Lawn	784	0.018	0.02	0.08	0.15	0.25	0.30	0.35	0.000	0.001	0.003	0.004	0.005	
A _c	21778	0.50												

Q Peak Flow (cfs)						
2 Year Q	5 Year Q	10 Year Q	25 Year Q	50 Year Q	100 Year Q	
1.77	2.25	2.69	3.15	3.59	4.07	

Sub-Basin:	D-6		[DF Curve Equations from Figure 6-5 of the DCM				
t _r Duration:	5.00		Volume 1]				
	I ₁	I ₂	I ₃₀	I ₂₅	I ₁₀	I ₁₀₀	
	4.13976884	5.16484311	6.0304837	6.89211242	7.7937647	8.6790165	

Hydrologic Soil Type: A

Coefficient (Table 6-6)														
Land Use or Surface Characteristic	Square Feet	Average	Coefficient ₁	Coefficient ₂	Coefficient ₃	Coefficient ₄	Coefficient ₅	Coefficient ₆	2 Yr. C * A	5 Yr. C * A	10 Yr. C * A	25 Yr. C * A	50 Yr. C * A	100 Yr. C * A
Roof	0	0.000	0.71	0.73	0.75	0.78	0.80	0.81	0.000	0.000	0.000	0.000	0.000	0.000
Pavement	12249	0.281	0.89	0.90	0.92	0.94	0.95	0.96	0.250	0.253	0.259	0.264	0.267	0.270
Lawn	1104	0.029	0.02	0.08	0.15	0.25	0.30	0.35	0.001	0.002	0.004	0.006	0.008	0.009
A _T	13353	0.31												

Q Peak Flow (cfs)					
2 Year Q	5 Year Q	10 Year Q	25 Year Q	50 Year Q	100 Year Q
1.09	1.32	1.58	1.87	2.13	2.42

Sub-Basin:	D-7		[DF Curve Equations from Figure 6-5 of the DCM				
t _r Duration:	5.49		Volume 1]				
	I ₁	I ₂	I ₃₀	I ₂₅	I ₁₀	I ₁₀₀	
	4.00864233	5.028669204	5.8589474	6.7052235	7.5435938	8.4437243	

Hydrologic Soil Type: A

Coefficient (Table 6-6)														
Land Use or Surface Characteristic	Square Feet	Average	Coefficient ₁	Coefficient ₂	Coefficient ₃	Coefficient ₄	Coefficient ₅	Coefficient ₆	2 Yr. C * A	5 Yr. C * A	10 Yr. C * A	25 Yr. C * A	50 Yr. C * A	100 Yr. C * A
Roof	0	0.000	0.71	0.73	0.75	0.78	0.80	0.81	0.000	0.000	0.000	0.000	0.000	0.000
Pavement	1385	0.046	0.89	0.90	0.92	0.94	0.95	0.96	0.041	0.041	0.042	0.043	0.043	0.044
Lawn	4290	0.058	0.02	0.08	0.15	0.25	0.30	0.35	0.002	0.008	0.015	0.025	0.030	0.034
A _T	6275	0.14												

Q Peak Flow (cfs)					
2 Year Q	5 Year Q	10 Year Q	25 Year Q	50 Year Q	100 Year Q
0.17	0.25	0.33	0.45	0.55	0.66

Sub-Basin:	D-8		[DF Curve Equations from Figure 6-5 of the DCM				
t _r Duration:	6.45		Volume 1]				
	I ₁	I ₂	I ₃₀	I ₂₅	I ₁₀	I ₁₀₀	
	3.82628983	4.79891124	5.5988964	6.3988817	7.1988669	8.0377300	

Hydrologic Soil Type: A

Coefficient (Table 6-6)														
Land Use or Surface Characteristic	Square Feet	Average	Coefficient ₁	Coefficient ₂	Coefficient ₃	Coefficient ₄	Coefficient ₅	Coefficient ₆	2 Yr. C * A	5 Yr. C * A	10 Yr. C * A	25 Yr. C * A	50 Yr. C * A	100 Yr. C * A
Roof	0	0.000	0.71	0.73	0.75	0.78	0.80	0.81	0.000	0.000	0.000	0.000	0.000	0.000
Pavement	0	0.000	0.89	0.90	0.92	0.94	0.95	0.96	0.000	0.000	0.000	0.000	0.000	0.000
Lawn	8969	0.208	0.02	0.08	0.15	0.25	0.30	0.35	0.004	0.016	0.031	0.051	0.062	0.072
A _T	8969	0.21												

Q Peak Flow (cfs)					
2 Year Q	5 Year Q	10 Year Q	25 Year Q	50 Year Q	100 Year Q
0.02	0.08	0.17	0.33	0.44	0.58

Sub-Basin:	D-9		[DF Curve Equations from Figure 6-5 of the DCM				
t _r Duration:	11.17		Volume 1]				
	I ₁	I ₂	I ₃₀	I ₂₅	I ₁₀	I ₁₀₀	
	3.16309954	3.96295741	4.623617	5.2842765	5.9449361	6.6533285	

Hydrologic Soil Type: A

Coefficient (Table 6-6)														
Land Use or Surface Characteristic	Square Feet	Average	Coefficient ₁	Coefficient ₂	Coefficient ₃	Coefficient ₄	Coefficient ₅	Coefficient ₆	2 Yr. C * A	5 Yr. C * A	10 Yr. C * A	25 Yr. C * A	50 Yr. C * A	100 Yr. C * A
Roof	0	0.000	0.71	0.73	0.75	0.78	0.80	0.81	0.000	0.000	0.000	0.000	0.000	0.000
Pavement	6715	0.154	0.89	0.90	0.92	0.94	0.95	0.96	0.137	0.139	0.142	0.145	0.146	0.148
Lawn	2083	0.478	0.02	0.08	0.15	0.25	0.30	0.35	0.010	0.038	0.072	0.119	0.143	0.167
A _T	27527	0.63												

Q Peak Flow (cfs)					
2 Year Q	5 Year Q	10 Year Q	25 Year Q	50 Year Q	100 Year Q
0.56	0.85	1.20	1.69	2.09	2.54

Design Points		
Design Points	Q ₁₀	Q ₁₀₀
DP1	1.14	1.80
DP2	1.86	2.90
DP3	1.70	2.63
DP4	3.29	5.10
DP5	2.69	4.00
DP6	1.58	2.42
DP7	0.33	0.66
DP8	0.17	0.58
TOTAL ON-SITE	12.77	20.10
DP9	1.20	2.34
TOTAL OFF-SITE	1.20	2.34

Time of Concentration

$$t_c = t_i + t_t$$

3.2.1 - Overland (Initial) Flow Time

$$t_i = \frac{0.395(1.1 - C_s)\sqrt{L}}{S^{0.33}} \quad (\text{Eq. 6-8})$$

Where:

t_i = overland (initial) flow time (min)

C_s = runoff coefficient for 5-year frequency (see Table 6-6)

L = length of overland flow (300 ft maximum for non-urban land uses, 100 ft maximum for urban land uses)

S = average basin slope (ft/ft)

Note that in some urban watersheds, the overland flow time may be very small because flows quickly concentrate and channelize.

Sub-Basin or DP:	D-1	
C_{10} :	0.69	[Table 6-6. Runoff Coefficients for Rational Method]
L :	100	ft
S :	0.025	ft/ft

Composite Runoff Coefficient Calculation:

$$C_c = (C_1 A_1 + C_2 A_2 + C_3 A_3 + \dots + C_i A_i) / A_t$$

Land Use or Surface Characteristic	Square Feet	Acreage	C_{10}
Roof	0	0.00	0.75
Pavement	4720	0.11	0.92
Lawn	1217	0.03	0.15
Gravel	6507	0.15	0.63
A_t :	12444	0.29	

$$C_c = (0.92*0.11 + 0.15*0.03 + 0.63*0.15) / 0.29 = \mathbf{0.69}$$

$$t_i = (0.395*(1.1 - C_{10}) * \sqrt{L}) / (S^{0.33})$$

$$t_i = (0.395*(1.1 - 0.48) * \sqrt{145}) / (0.055^{0.33}) = \mathbf{5.47} \text{ mins}$$

3.2.2 Travel Time

For catchments with overland and channelized flow, the time of concentration needs to be considered in combination with the travel time, t_t , which is calculated using the hydraulic properties of the swale, ditch, or channel. For preliminary work, the overland travel time, t_t , can be estimated with the help of Figure 6-25 or Equation 6-9 (Guo 1999).

$$V = C_v S_w^{0.5} \quad (\text{Eq. 6-9})$$

Where:

V = velocity (ft/s)

C_v = conveyance coefficient (from Table 6-7)

S_w = watercourse slope (ft/ft)

$$V = C_v S_w^{0.5}$$

$$V = (20)(0.025)^{0.5} = \mathbf{3.16} \text{ ft/s}$$

$$\text{Flow Distance: } \mathbf{85.00} \text{ ft}$$

$$t_t = L/V = \mathbf{26.88} \text{ sec.}$$

$$\mathbf{0.45} \text{ min.}$$

Table 6-7. Conveyance Coefficient, C_v

Type of Land Surface	C_v
Heavy meadow	2.5
Tillage/field	5
Riprap (not buried)	6.5
Short pasture and lawns	7
Nearly bare ground	10
Grassed waterway	15
Paved areas and shallow paved swales	20

For buried riprap, select C_v value based on type of vegetative cover.

$$t_c = t_i + t_t = \mathbf{5.91} \text{ min.}$$

3.2.4 Minimum Time of Concentration

If the calculations result in a t_c of less than 10 minutes for undeveloped conditions, it is recommended that a minimum value of 10 minutes be used. The minimum t_c for urbanized areas is 5 minutes.

$$\text{Final } t_c: \mathbf{5.91} \text{ min.}$$

Time of Concentration

$$t_c = t_i + t_t$$

3.2.1 - Overland (Initial) Flow Time

$$t_i = \frac{0.395(1.1 - C_s)\sqrt{L}}{S^{0.33}} \quad (\text{Eq. 6-8})$$

Where:

t_i = overland (initial) flow time (min)

C_s = runoff coefficient for 5-year frequency (see Table 6-6)

L = length of overland flow (300 ft maximum for non-urban land uses, 100 ft maximum for urban land uses)

S = average basin slope (ft/ft)

Note that in some urban watersheds, the overland flow time may be very small because flows quickly concentrate and channelize.

Sub-Basin or DP:	D-2
C_{10} :	0.72
L :	100 ft
S :	0.025 ft/ft

[Table 6-6. Runoff Coefficients for Rational Method]

Composite Runoff Coefficient Calculation:

$$C_c = (C_1 A_1 + C_2 A_2 + C_3 A_3 + \dots C_i A_i) / A_t$$

Land Use or Surface Characteristic	Square Feet	Acreage	C_{10}
Roof	0	0.00	0.75
Pavement	6183	0.14	0.92
Lawn	0	0.00	0.15
Gravel	13359	0.31	0.63
A_t :	19542	0.45	

$$C_c = (0.92 * 0.14 + 0.63 * 0.31) / 0.45 =$$

0.72

$$t_i = (0.395 * (1.1 - C_{10}) * \sqrt{L}) / (S^{0.33})$$

$$t_i = (0.395 * (1.1 - 0.39) * \sqrt{124}) / (0.03^{0.33}) =$$

5.05

mins

3.2.2 Travel Time

For catchments with overland and channelized flow, the time of concentration needs to be considered in combination with the travel time, t_t , which is calculated using the hydraulic properties of the swale, ditch, or channel. For preliminary work, the overland travel time, t_t , can be estimated with the help of Figure 6-25 or Equation 6-9 (Guo 1999).

$$V = C_v S_w^{0.5} \quad (\text{Eq. 6-9})$$

Where:

V = velocity (ft/s)

C_v = conveyance coefficient (from Table 6-7)

S_w = watercourse slope (ft/ft)

$$V = C_v S_w^{0.5}$$

$$V = (20)(0.025)^{0.5} =$$

3.16

ft/s

$$\text{Flow Distance:}$$

159.00

ft

$$t_t = L/V =$$

50.28

sec.

0.84

min.

Table 6-7. Conveyance Coefficient, C_v

Type of Land Surface	C_v
Heavy meadow	2.5
Tillage/field	5
Riprap (not buried)	6.5
Short pasture and lawns	7
Nearly bare ground	10
Grassed waterway	15
Paved areas and shallow paved swales	20

For buried riprap, select C_v value based on type of vegetative cover.

$$t_c = t_i + t_t =$$

5.89

min.

3.2.4 Minimum Time of Concentration

If the calculations result in a t_c of less than 10 minutes for undeveloped conditions, it is recommended that a minimum value of 10 minutes be used. The minimum t_c for urbanized areas is 5 minutes.

Final t_c :

5.89

min.

Time of Concentration

$$t_c = t_i + t_t$$

3.2.1 - Overland (Initial) Flow Time

$$t_i = \frac{0.395(1.1 - C_s)\sqrt{L}}{S^{0.33}} \quad (\text{Eq. 6-8})$$

Where:

t_i = overland (initial) flow time (min)

C_s = runoff coefficient for 5-year frequency (see Table 6-6)

L = length of overland flow (300 ft maximum for non-urban land uses, 100 ft maximum for urban land uses)

S = average basin slope (ft/ft)

Note that in some urban watersheds, the overland flow time may be very small because flows quickly concentrate and channelize.

Sub-Basin or DP:	D-3
C_{10} :	0.76
L :	100 ft
S :	0.025 ft/ft

[Table 6-6. Runoff Coefficients for Rational Method]

Composite Runoff Coefficient Calculation:

$$C_c = (C_1 A_1 + C_2 A_2 + C_3 A_3 + \dots + C_i A_i) / A_t$$

Land Use or Surface Characteristic	Square Feet	Acreage	C_{10}
Roof	0	0.00	0.75
Pavement	7141	0.16	0.92
Lawn	0	0.00	0.15
Gravel	9050	0.21	0.63
A_t :	16191	0.37	

$$C_c = (0.92 * 0.16 + 0.63 * 0.21) / 0.37 =$$

0.76

$$t_i = (0.395 * (1.1 - C_{10}) * \sqrt{L}) / (S^{0.33})$$

$$t_i = (0.395 * (1.1 - 0.90) * \sqrt{124}) / (0.03^{0.33}) =$$

4.56

mins

3.2.2 Travel Time

For catchments with overland and channelized flow, the time of concentration needs to be considered in combination with the travel time, t_t , which is calculated using the hydraulic properties of the swale, ditch, or channel. For preliminary work, the overland travel time, t_t , can be estimated with the help of Figure 6-25 or Equation 6-9 (Guo 1999).

$$V = C_v S_w^{0.5} \quad (\text{Eq. 6-9})$$

Where:

V = velocity (ft/s)

C_v = conveyance coefficient (from Table 6-7)

S_w = watercourse slope (ft/ft)

$$V = C_v S_w^{0.5}$$

$$V = (20)(0.025)^{0.5} =$$

3.16

ft/s

$$\text{Flow Distance:}$$

82.00

ft

$$t_t = L/V =$$

25.93

sec.

0.43

min.

Table 6-7. Conveyance Coefficient, C_v

Type of Land Surface	C_v
Heavy meadow	2.5
Tillage/field	5
Riprap (not buried)	6.5
Short pasture and lawns	7
Nearly bare ground	10
Grassed waterway	15
Paved areas and shallow paved swales	20

For buried riprap, select C_v value based on type of vegetative cover.

$$t_c = t_i + t_t =$$

5.00

min.

3.2.4 Minimum Time of Concentration

If the calculations result in a t_c of less than 10 minutes for undeveloped conditions, it is recommended that a minimum value of 10 minutes be used. The minimum t_c for urbanized areas is 5 minutes.

$$\text{Final } t_c: \quad 5.00 \text{ min.}$$

Time of Concentration

$$t_c = t_i + t_t$$

3.2.1 - Overland (Initial) Flow Time

$$t_i = \frac{0.395(1.1 - C_s)\sqrt{L}}{S^{0.33}} \quad (\text{Eq. 6-8})$$

Where:

t_i = overland (initial) flow time (min)

C_s = runoff coefficient for 5-year frequency (see Table 6-6)

L = length of overland flow (300 ft maximum for non-urban land uses, 100 ft maximum for urban land uses)

S = average basin slope (ft/ft)

Note that in some urban watersheds, the overland flow time may be very small because flows quickly concentrate and channelize.

Sub-Basin or DP:	D-4	
C_{10} :	0.75	[Table 6-6. Runoff Coefficients for Rational Method]
L:	95	ft
S:	0.083	ft/ft

Composite Runoff Coefficient Calculation:

$$C_c = (C_1 A_1 + C_2 A_2 + C_3 A_3 + \dots + C_i A_i) / A_t$$

Land Use or Surface Characteristic	Square Feet	Acreage	C_{10}
Roof	31714	0.73	0.75
Pavement	0	0.00	0.92
Lawn	0	0.000	0.15
A_t :	31714	0.73	

$$C_c = (0.75 * 0.73) / 0.73 =$$

0.75

$$t_i = (0.395 * (1.1 - C_{10}) * \sqrt{L}) / (S^{0.33})$$

$$t_i = (0.395 * (1.1 - 0.87) * \sqrt{90}) / (0.035^{0.33}) =$$

3.06 mins

3.2.2 Travel Time

For catchments with overland and channelized flow, the time of concentration needs to be considered in combination with the travel time, t_t , which is calculated using the hydraulic properties of the swale, ditch, or channel. For preliminary work, the overland travel time, t_t , can be estimated with the help of Figure 6-25 or Equation 6-9 (Guo 1999).

$$V = C_v S_w^{0.5} \quad (\text{Eq. 6-9})$$

Where:

V = velocity (ft/s)

C_v = conveyance coefficient (from Table 6-7)

S_w = watercourse slope (ft/ft)

$$V = C_v S_w^{0.5}$$

$$V = (20)(0.042)^{0.5} =$$

0.00 ft/s

Flow Distance:

0.00 ft

$$t_t = L/V =$$

0.00 sec.

0.00 min.

Table 6-7. Conveyance Coefficient, C_v

Type of Land Surface	C_v
Heavy meadow	2.5
Tillage/field	5
Riprap (not buried)*	6.5
Short pasture and lawns	7
Nearly bare ground	10
Grassed waterway	15
Paved areas and shallow paved swales	20

*For buried riprap, select C_v value based on type of vegetative cover.

$$t_c = t_i + t_t =$$

3.06 min.

3.2.4 Minimum Time of Concentration

If the calculations result in a t_c of less than 10 minutes for undeveloped conditions, it is recommended that a minimum value of 10 minutes be used. The minimum t_c for urbanized areas is 5 minutes.

Final t_c :

5.00 min.

Time of Concentration

$$t_c = t_i + t_t$$

3.2.1 - Overland (Initial) Flow Time

$$t_i = \frac{0.395(1.1 - C_s)\sqrt{L}}{S^{0.33}} \quad (\text{Eq. 6-8})$$

Where:

t_i = overland (initial) flow time (min)

C_s = runoff coefficient for 5-year frequency (see Table 6-6)

L = length of overland flow (300 ft maximum for non-urban land uses, 100 ft maximum for urban land uses)

S = average basin slope (ft/ft)

Note that in some urban watersheds, the overland flow time may be very small because flows quickly concentrate and channelize.

Sub-Basin or DP:	D-5	
C_{10} :	0.89	[Table 6-6. Runoff Coefficients for Rational Method]
L:	100	ft
S:	0.035	ft/ft

Composite Runoff Coefficient Calculation:

$$C_c = (C_1 A_1 + C_2 A_2 + C_3 A_3 + \dots + C_i A_i) / A_t$$

Land Use or Surface Characteristic	Square Feet	Acreage	C_{10}
Roof	0	0.00	0.75
Pavement	21716	0.50	0.92
Lawn	784	0.018	0.15
A_t :	22500	0.517	

$$C_c = (0.92 * 0.50 + 0.15 * 0.018) / 0.515 = \mathbf{0.89}$$

$$t_i = (0.395 * (1.1 - C_{10}) * \sqrt{L}) / (S^{0.33})$$

$$t_i = (0.395 * (1.1 - 0.88) * \sqrt{125}) / (0.035^{0.33}) = \mathbf{2.47} \text{ mins}$$

3.2.2 Travel Time

For catchments with overland and channelized flow, the time of concentration needs to be considered in combination with the travel time, t_t , which is calculated using the hydraulic properties of the swale, ditch, or channel. For preliminary work, the overland travel time, t_t , can be estimated with the help of Figure 6-25 or Equation 6-9 (Guo 1999).

$$V = C_v S_w^{0.5} \quad (\text{Eq. 6-9})$$

Where:

V = velocity (ft/s)

C_v = conveyance coefficient (from Table 6-7)

S_w = watercourse slope (ft/ft)

$$V = C_v S_w^{0.5}$$

$$V = (20) / (0.035)^{0.5} = \mathbf{3.74} \text{ ft/s}$$

$$\text{Flow Distance: } \mathbf{166.00} \text{ ft}$$

$$t_t = L/V = \mathbf{44.37} \text{ sec.}$$

$$\mathbf{0.74} \text{ min.}$$

Table 6-7. Conveyance Coefficient, C_v

Type of Land Surface	C_v
Heavy meadow	2.5
Tillage/field	5
Riprap (not buried)*	6.5
Short pasture and lawns	7
Nearly bare ground	10
Grassed waterway	15
Paved areas and shallow paved swales	20

*For buried riprap, select C_v value based on type of vegetative cover.

$$t_c = t_i + t_t = \mathbf{3.21} \text{ min.}$$

3.2.4 Minimum Time of Concentration

If the calculations result in a t_c of less than 10 minutes for undeveloped conditions, it is recommended that a minimum value of 10 minutes be used. The minimum t_c for urbanized areas is 5 minutes.

$$\text{Final } t_c: \mathbf{5.00} \text{ min.}$$

Time of Concentration

$$t_c = t_i + t_t$$

3.2.1 - Overland (Initial) Flow Time

$$t_i = \frac{0.395(1.1 - C_s)\sqrt{L}}{S^{0.33}} \quad (\text{Eq. 6-8})$$

Where:

t_i = overland (initial) flow time (min)

C_s = runoff coefficient for 5-year frequency (see Table 6-6)

L = length of overland flow (300 ft maximum for non-urban land uses, 100 ft maximum for urban land uses)

S = average basin slope (ft/ft)

Note that in some urban watersheds, the overland flow time may be very small because flows quickly concentrate and channelize.

Sub-Basin or DP:	D-6	
C_{10} :	0.86	[Table 6-6. Runoff Coefficients for Rational Method]
L:	100	ft
S:	0.07	ft/ft

Composite Runoff Coefficient Calculation:

$$C_c = (C_1 A_1 + C_2 A_2 + C_3 A_3 + \dots + C_i A_i) / A_t$$

Land Use or Surface Characteristic	Square Feet	Acreage	C_{10}
Roof	0	0.00	0.75
Pavement	12249	0.28	0.92
Lawn	1104	0.03	0.15
A_t :	13353	0.31	

$$C_c = (0.92 * 0.28 + 0.15 * 0.03) / 0.31 = \mathbf{0.86}$$

$$t_i = (0.395 * (1.1 - C_{10}) * \sqrt{L}) / (S^{0.33})$$

$$t_i = (0.395 * (1.1 - 0.86) * \sqrt{100}) / (0.07^{0.33}) = \mathbf{2.31} \text{ mins}$$

3.2.2 Travel Time

For catchments with overland and channelized flow, the time of concentration needs to be considered in combination with the travel time, t_t , which is calculated using the hydraulic properties of the swale, ditch, or channel. For preliminary work, the overland travel time, t_t , can be estimated with the help of Figure 6-25 or Equation 6-9 (Guo 1999).

$$V = C_v S_w^{0.5} \quad (\text{Eq. 6-9})$$

Where:

V = velocity (ft/s)

C_v = conveyance coefficient (from Table 6-7)

S_w = watercourse slope (ft/ft)

$$V = C_v S_w^{0.5}$$

$$V = (20 / 0.053)^{0.5} = \mathbf{4.60} \text{ ft/s}$$

$$\text{Flow Distance: } \mathbf{188.00} \text{ ft}$$

$$t_t = L/V = \mathbf{40.83} \text{ sec.}$$

$$\mathbf{0.68} \text{ min.}$$

Table 6-7. Conveyance Coefficient, C_v

Type of Land Surface	C_v
Heavy meadow	2.5
Tillage/field	5
Riprap (not buried)*	6.5
Short pasture and lawns	7
Nearly bare ground	10
Grassed waterway	15
Paved areas and shallow paved swales	20

*For buried riprap, select C_v value based on type of vegetative cover.

$$t_c = t_i + t_t = \mathbf{3.00} \text{ min.}$$

3.2.4 Minimum Time of Concentration

If the calculations result in a t_c of less than 10 minutes for undeveloped conditions, it is recommended that a minimum value of 10 minutes be used. The minimum t_c for urbanized areas is 5 minutes.

$$\text{Final } t_c: \mathbf{5.00} \text{ min.}$$

Time of Concentration

$$t_c = t_i + t_t$$

3.2.1 - Overland (Initial) Flow Time

$$t_i = \frac{0.395(1.1 - C_s)\sqrt{L}}{S^{0.33}} \quad (\text{Eq. 6-8})$$

Where:

t_i = overland (initial) flow time (min)

C_s = runoff coefficient for 5-year frequency (see Table 6-6)

L = length of overland flow (300 ft maximum for non-urban land uses, 100 ft maximum for urban land uses)

S = average basin slope (ft/ft)

Note that in some urban watersheds, the overland flow time may be very small because flows quickly concentrate and channelize.

Sub-Basin or DP:	D-7	
C_{10} :	0.40	[Table 6-6. Runoff Coefficients for Rational Method]
L:	15	ft
S:	0.01	ft/ft

Composite Runoff Coefficient Calculation:

$$C_c = (C_1 A_1 + C_2 A_2 + C_3 A_3 + \dots + C_i A_i) / A_t$$

Land Use or Surface Characteristic	Square Feet	Acreage	C_{10}
Roof	0	0.00	0.75
Pavement	1985	0.05	0.92
Lawn	4119	0.09	0.15
A_t :	6104	0.14	

$$C_c = (0.75 * 0.0 + 0.92 * 0.10 + 0.15 * 0.07) / 0.08 = \mathbf{0.40}$$

$$t_i = (0.395 * (1.1 - C_{10}) * \sqrt{L}) / (S^{0.33})$$

$$t_i = (0.395 * (1.1 - 0.20) * \sqrt{15}) / (0.01^{0.33}) = \mathbf{4.89} \text{ mins}$$

3.2.2 Travel Time

For catchments with overland and channelized flow, the time of concentration needs to be considered in combination with the travel time, t_t , which is calculated using the hydraulic properties of the swale, ditch, or channel. For preliminary work, the overland travel time, t_t , can be estimated with the help of Figure 6-25 or Equation 6-9 (Guo 1999).

$$V = C_v S_w^{0.5} \quad (\text{Eq. 6-9})$$

Where:

V = velocity (ft/s)

C_v = conveyance coefficient (from Table 6-7)

S_w = watercourse slope (ft/ft)

$$V = C_v S_w^{0.5}$$

$$V = (20)(0.01)^{0.5} = \mathbf{2.00} \text{ ft/s}$$

$$\text{Flow Distance: } \mathbf{66.00} \text{ ft}$$

$$t_t = L/V = \mathbf{33.00} \text{ sec.}$$

$$\mathbf{0.55} \text{ min.}$$

Table 6-7. Conveyance Coefficient, C_v

Type of Land Surface	C_v
Heavy meadow	2.5
Tillage/field	5
Riprap (not buried)*	6.5
Short pasture and lawns	7
Nearly bare ground	10
Grassed waterway	15
Paved areas and shallow paved swales	20

*For buried riprap, select C_v value based on type of vegetative cover.

$$t_c = t_i + t_t = \mathbf{5.44} \text{ min.}$$

3.2.4 Minimum Time of Concentration

If the calculations result in a t_c of less than 10 minutes for undeveloped conditions, it is recommended that a minimum value of 10 minutes be used. The minimum t_c for urbanized areas is 5 minutes.

$$\text{Final } t_c: \mathbf{5.44} \text{ min.}$$

Time of Concentration

$$t_c = t_i + t_t$$

3.2.1 - Overland (Initial) Flow Time

$$t_i = \frac{0.395(1.1 - C_s)\sqrt{L}}{S^{0.33}} \quad (\text{Eq. 6-8})$$

Where:

t_i = overland (initial) flow time (min)

C_s = runoff coefficient for 5-year frequency (see Table 6-6)

L = length of overland flow (300 ft maximum for non-urban land uses, 100 ft maximum for urban land uses)

S = average basin slope (ft/ft)

Note that in some urban watersheds, the overland flow time may be very small because flows quickly concentrate and channelize.

Sub-Basin or DP:	D-8	
C_{10} :	0.15	[Table 6-6. Runoff Coefficients for Rational Method]
L:	25	ft
S:	0.04	ft/ft

Composite Runoff Coefficient Calculation:

$$C_c = (C_1 A_1 + C_2 A_2 + C_3 A_3 + \dots + C_i A_i) / A_t$$

Land Use or Surface Characteristic	Square Feet	Acreage	C_{10}
Roof	0	0.00	0.75
Pavement	0	0.00	0.92
Lawn	8402	0.19	0.15
A_t :	8402	0.19	

$$C_c = (0.15 * 0.25) / 0.25 =$$

0.15

$$t_i = (0.395 * (1.1 - C_{10}) * \text{sqrt}(L)) / (S^{0.33})$$

$$t_i = (0.395 * (1.1 - 0.15) * \text{sqrt}(46)) / (0.25^{0.33}) =$$

5.43

mins

3.2.2 Travel Time

For catchments with overland and channelized flow, the time of concentration needs to be considered in combination with the travel time, t_t , which is calculated using the hydraulic properties of the swale, ditch, or channel. For preliminary work, the overland travel time, t_t , can be estimated with the help of Figure 6-25 or Equation 6-9 (Guo 1999).

$$V = C_v S_w^{0.5} \quad (\text{Eq. 6-9})$$

Where:

V = velocity (ft/s)

C_v = conveyance coefficient (from Table 6-7)

S_w = watercourse slope (ft/ft)

$$V = C_v S_w^{0.5}$$

$$V = (20)(0.04)^{0.5} =$$

4.00

ft/s

Flow Distance:

233.00

ft

$$t_t = L/V =$$

58.25

sec.

0.97

min.

Table 6-7. Conveyance Coefficient, C_v

Type of Land Surface	C_v
Heavy meadow	2.5
Tillage/field	5
Riprap (not buried)*	6.5
Short pasture and lawns	7
Nearly bare ground	10
Grassed waterway	15
Paved areas and shallow paved swales	20

*For buried riprap, select C_v value based on type of vegetative cover.

$$t_c = t_i + t_t =$$

6.40

min.

3.2.4 Minimum Time of Concentration

If the calculations result in a t_c of less than 10 minutes for undeveloped conditions, it is recommended that a minimum value of 10 minutes be used. The minimum t_c for urbanized areas is 5 minutes.

Final t_c :

6.40

min.

Time of Concentration

$$t_c = t_i + t_t$$

3.2.1 - Overland (Initial) Flow Time

$$t_i = \frac{0.395(1.1 - C_s)\sqrt{L}}{S^{0.33}} \quad (\text{Eq. 6-8})$$

Where:

t_i = overland (initial) flow time (min)

C_s = runoff coefficient for 5-year frequency (see Table 6-6)

L = length of overland flow (300 ft maximum for non-urban land uses, 100 ft maximum for urban land uses)

S = average basin slope (ft/ft)

Note that in some urban watersheds, the overland flow time may be very small because flows quickly concentrate and channelize.

Sub-Basin or DP:	D-9	
C_{10} :	0.34	[Table 6-6. Runoff Coefficients for Rational Method]
L:	100	ft
S:	0.04	ft/ft

Composite Runoff Coefficient Calculation:

$$C_c = (C_1 A_1 + C_2 A_2 + C_3 A_3 + \dots + C_i A_i) / A_t$$

Land Use or Surface Characteristic	Square Feet	Acreage	C_{10}
Roof	0	0.00	0.75
Pavement	6715	0.15	0.92
Lawn	20727	0.48	0.15
A_t :	27442	0.63	

$$C_c = (0.15 * 0.39 + 0.92 * 0.10) / 0.50 =$$

0.34

$$t_i = (0.395 * (1.1 - C_{10}) * \text{sqrt}(L)) / (S^{0.33})$$

$$t_i = (0.395 * (1.1 - 0.35) * \text{sqrt}(46)) / (0.25^{0.33}) =$$

8.70 mins

3.2.2 Travel Time

For catchments with overland and channelized flow, the time of concentration needs to be considered in combination with the travel time, t_t , which is calculated using the hydraulic properties of the swale, ditch, or channel. For preliminary work, the overland travel time, t_t , can be estimated with the help of Figure 6-25 or Equation 6-9 (Guo 1999).

$$V = C_v S_w^{0.5} \quad (\text{Eq. 6-9})$$

Where:

V = velocity (ft/s)

C_v = conveyance coefficient (from Table 6-7)

S_w = watercourse slope (ft/ft)

$$V = C_v S_w^{0.5}$$

$$V = (20)(0.04)^{0.5} =$$

4.00 ft/s

$$\text{Flow Distance:}$$

591.00 ft

$$t_t = L/V =$$

147.75 sec.

2.46 min.

Table 6-7. Conveyance Coefficient, C_v

Type of Land Surface	C_v
Heavy meadow	2.5
Tillage/field	5
Riprap (not buried)*	6.5
Short pasture and lawns	7
Nearly bare ground	10
Grassed waterway	15
Paved areas and shallow paved swales	20

*For buried riprap, select C_v value based on type of vegetative cover.

$$t_c = t_i + t_t =$$

11.16 min.

3.2.4 Minimum Time of Concentration

If the calculations result in a t_c of less than 10 minutes for undeveloped conditions, it is recommended that a minimum value of 10 minutes be used. The minimum t_c for urbanized areas is 5 minutes.

Final t_c : 11.16 min.

DETENTION BASIN STAGE-STORAGE TABLE BUILDER

MHFD-Detention, Version 4.06 (July 2022)

Project: **Northcrest Center**

Basin ID: **EDB, Full Spectrum Extended Detention Basin**

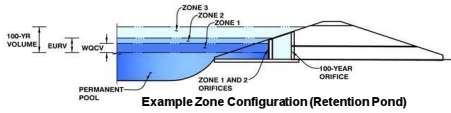

Example Zone Configuration (Retention Pond)

Watershed Information

Selected BMP Type =	EDB
Watershed Area =	3.02 acres
Watershed Length =	400 ft
Watershed Length to Centroid =	175 ft
Watershed Slope =	0.050 ft/ft
Watershed Imperviousness =	86.46% percent
Percentage Hydrologic Soil Group A =	100.0% percent
Percentage Hydrologic Soil Group B =	0.0% percent
Percentage Hydrologic Soil Groups C/D =	0.0% percent
Target WQC Drain Time =	40.0 hours
Location for 1-hr Rainfall Depths =	User Input

After providing required inputs above including 1-hour rainfall depths, click "Run CURP" to generate runoff hydrographs using the embedded Colorado Urban Hydrograph Procedure.

Optional User Overrides

Water Quality Capture Volume (WQCV) =	0.094 acre-feet	
Excess Urban Runoff Volume (EURV) =	0.351 acre-feet	
2-yr Runoff Volume (P1 = 1.5 in.) =	0.219 acre-feet	1.19 inches
5-yr Runoff Volume (P1 = 1.5 in.) =	0.283 acre-feet	1.50 inches
10-yr Runoff Volume (P1 = 1.75 in.) =	0.334 acre-feet	1.75 inches
25-yr Runoff Volume (P1 = 2 in.) =	0.391 acre-feet	2.00 inches
50-yr Runoff Volume (P1 = 2.25 in.) =	0.447 acre-feet	2.25 inches
100-yr Runoff Volume (P1 = 2.52 in.) =	0.511 acre-feet	2.52 inches
500-yr Runoff Volume (P1 = 3.48 in.) =	0.731 acre-feet	3.48 inches
Approximate 2-yr Detention Volume =	0.231 acre-feet	
Approximate 5-yr Detention Volume =	0.300 acre-feet	
Approximate 10-yr Detention Volume =	0.357 acre-feet	
Approximate 25-yr Detention Volume =	0.422 acre-feet	
Approximate 50-yr Detention Volume =	0.460 acre-feet	
Approximate 100-yr Detention Volume =	0.493 acre-feet	

Define Zones and Basin Geometry

Zone 1 Volume (WQCV) =	0.094 acre-feet
Zone 2 Volume (EURV - Zone 1) =	0.257 acre-feet
Zone 3 Volume (100-year - Zones 1 & 2) =	0.142 acre-feet
Total Detention Basin Volume =	0.493 acre-feet
Initial Surcharge Volume (ISV) =	user ft ²
Initial Surcharge Depth (ISD) =	user ft
Total Available Detention Depth (H _{TOT}) =	user ft
Depth of Trickle Channel (H _T) =	user ft
Slope of Trickle Channel (S _T) =	user ft/ft
Slopes of Main Basin Sides (S _{MAIN}) =	user H:V
Basin Length-to-Width Ratio (R _{L/W}) =	user
Initial Surcharge Area (A _{ISV}) =	user ft ²
Surcharge Volume Length (L _{ISV}) =	user ft
Surcharge Volume Width (W _{ISV}) =	user ft
Depth of Basin Floor (H _{FLOOR}) =	user ft
Length of Basin Floor (L _{FLOOR}) =	user ft
Width of Basin Floor (W _{FLOOR}) =	user ft
Area of Basin Floor (A _{FLOOR}) =	user ft ²
Volume of Basin Floor (V _{FLOOR}) =	user ft ³
Depth of Main Basin (H _{MAIN}) =	user ft
Length of Main Basin (L _{MAIN}) =	user ft
Width of Main Basin (W _{MAIN}) =	user ft
Area of Main Basin (A _{MAIN}) =	user ft ²
Volume of Main Basin (V _{MAIN}) =	user ft ³
Calculated Total Basin Volume (V _{TOT}) =	user acre-feet

Stage - Storage Description	Stage (ft)	Optional Override Stage (ft)	Length (ft)	Width (ft)	Area (ft ²)	Optional Override Area (ft ²)	Area (acre)	Volume (ft ³)	Volume (ac-ft)
Top of Micropool	--	0.00	--	--	--	100	0.002		
	--	0.20	--	--	--	907	0.021	101	0.002
	--	0.40	--	--	--	2,357	0.054	427	0.010
	--	0.60	--	--	--	3,257	0.075	988	0.023
	--	0.80	--	--	--	3,873	0.089	1,701	0.039
	--	1.00	--	--	--	4,400	0.101	2,529	0.058
	--	1.20	--	--	--	4,846	0.111	3,453	0.079
	--	1.40	--	--	--	4,876	0.112	4,426	0.102
	--	1.60	--	--	--	4,905	0.113	5,404	0.124
	--	1.80	--	--	--	4,935	0.113	6,388	0.147
	--	2.00	--	--	--	4,964	0.114	7,378	0.169
	--	2.20	--	--	--	4,994	0.115	8,373	0.192
	--	2.40	--	--	--	5,024	0.115	9,375	0.215
	--	2.60	--	--	--	5,053	0.116	10,383	0.238
	--	2.80	--	--	--	5,083	0.117	11,396	0.262
	--	3.00	--	--	--	5,113	0.117	12,416	0.285
	--	3.20	--	--	--	5,142	0.118	13,442	0.309
	--	3.40	--	--	--	5,172	0.119	14,473	0.332
	--	3.60	--	--	--	5,202	0.119	15,510	0.356
	--	3.80	--	--	--	5,232	0.120	16,554	0.380
	--	4.00	--	--	--	5,267	0.121	17,604	0.404
	--	4.20	--	--	--	5,297	0.122	18,660	0.428
	--	4.40	--	--	--	5,327	0.122	19,722	0.453
	--	4.60	--	--	--	5,358	0.123	20,791	0.477
	--	4.80	--	--	--	5,388	0.124	21,866	0.502
	--	5.00	--	--	--	5,419	0.124	22,946	0.527
	--	5.20	--	--	--	5,451	0.125	24,033	0.552
	--	5.40	--	--	--	5,480	0.126	25,126	0.577
	--	5.60	--	--	--	5,513	0.127	26,226	0.602

DETENTION BASIN STAGE-STORAGE TABLE BUILDER

MHFD-Detention, Version 4.06 (July 2022)

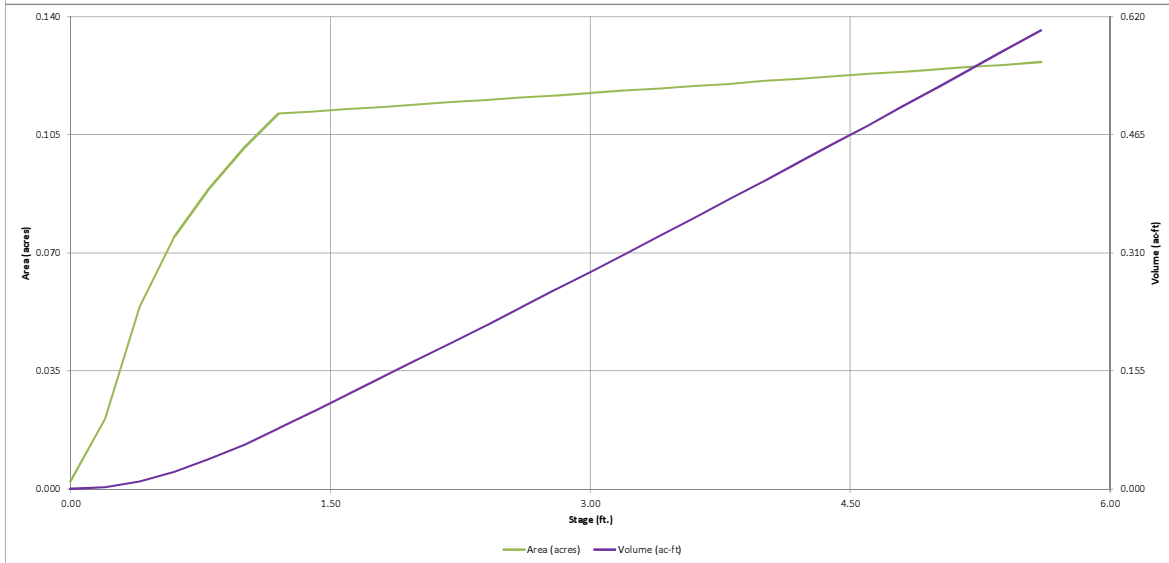
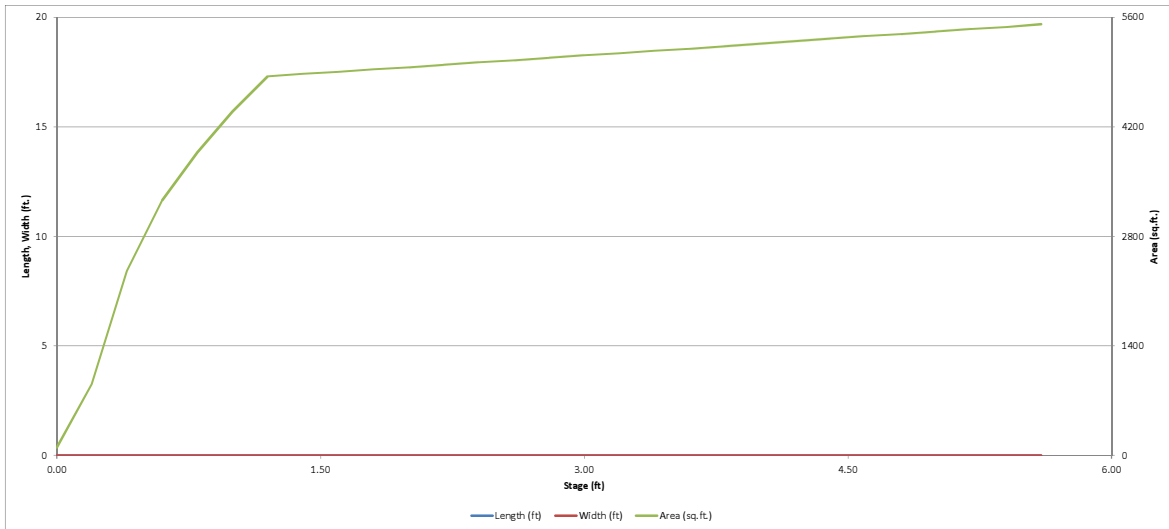

DETENTION BASIN OUTLET STRUCTURE DESIGN

MHFD-*Detention*, Version 4.06 (July 2022)

Project: Northcrest Center
Basin ID: EDB, Full Spectrum Extended Detention Basin

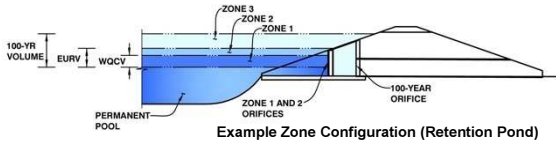

	Estimated Stage (ft)	Estimated Volume (ac-ft)	Outlet Type
Zone 1 (WQCV)	1.34	0.094	Orifice Plate
Zone 2 (EURV)	3.56	0.257	Orifice Plate
Zone 3 (100-year)	4.73	0.142	Weir&Pipe (Restrict)
Total (all zones)		0.493	

User Input: Orifice at Underdrain Outlet (typically used to drain WQCV in a Filtration BMP)

Underdrain Orifice Invert Depth = ft (distance below the filtration media surface)
 Underdrain Orifice Diameter = inches

Calculated Parameters for Underdrain
 Underdrain Orifice Area = ft²
 Underdrain Orifice Centroid = feet

User Input: Orifice Plate with one or more orifices or Elliptical Slot Weir (typically used to drain WQCV and/or EURV in a sedimentation BMP)

Centroid of Lowest Orifice = ft (relative to basin bottom at Stage = 0 ft)
 Depth at top of Zone using Orifice Plate = ft (relative to basin bottom at Stage = 0 ft)
 Orifice Plate: Orifice Vertical Spacing = inches
 Orifice Plate: Orifice Area per Row = sq. inches

Calculated Parameters for Plate
 WQ Orifice Area per Row = ft²
 Elliptical Half-Width = feet
 Elliptical Slot Centroid = feet
 Elliptical Slot Area = ft²

User Input: Stage and Total Area of Each Orifice Row (numbered from lowest to highest)

	Row 1 (required)	Row 2 (optional)	Row 3 (optional)	Row 4 (optional)	Row 5 (optional)	Row 6 (optional)	Row 7 (optional)	Row 8 (optional)
Stage of Orifice Centroid (ft)	0.00	0.89	1.78	2.67				
Orifice Area (sq. inches)	0.79	0.79	0.44	0.44				

	Row 9 (optional)	Row 10 (optional)	Row 11 (optional)	Row 12 (optional)	Row 13 (optional)	Row 14 (optional)	Row 15 (optional)	Row 16 (optional)
Stage of Orifice Centroid (ft)								
Orifice Area (sq. inches)								

User Input: Vertical Orifice (Circular or Rectangular)

Invert of Vertical Orifice = ft (relative to basin bottom at Stage = 0 ft)
 Depth at top of Zone using Vertical Orifice = ft (relative to basin bottom at Stage = 0 ft)
 Vertical Orifice Diameter = inches

Calculated Parameters for Vertical Orifice
 Vertical Orifice Area = ft²
 Vertical Orifice Centroid = feet

User Input: Overflow Weir (Dropbox with Flat or Sloped Grate and Outlet Pipe OR Rectangular/Trapezoidal Weir and No Outlet Pipe)

Overflow Weir Front Edge Height, H_o = ft (relative to basin bottom at Stage = 0 ft)
 Overflow Weir Front Edge Length = feet
 Overflow Weir Grate Slope = H:V
 Horiz. Length of Weir Sides = feet
 Overflow Grate Type =
 Debris Clogging % = %

Calculated Parameters for Overflow Weir
 Height of Grate Upper Edge, H_g = feet
 Overflow Weir Slope Length = feet
 Grate Open Area / 100-yr Orifice Area =
 Overflow Grate Open Area w/o Debris = ft²
 Overflow Grate Open Area w/ Debris = ft²

User Input: Outlet Pipe w/ Flow Restriction Plate (Circular Orifice, Restrictor Plate, or Rectangular Orifice)

Depth to Invert of Outlet Pipe = ft (distance below basin bottom at Stage = 0 ft)
 Outlet Pipe Diameter = inches
 Restrictor Plate Height Above Pipe Invert = inches

Calculated Parameters for Outlet Pipe w/ Flow Restriction Plate
 Outlet Orifice Area = ft²
 Outlet Orifice Centroid = feet
 Half-Central Angle of Restrictor Plate on Pipe = radians

User Input: Emergency Spillway (Rectangular or Trapezoidal)

Spillway Invert Stage = ft (relative to basin bottom at Stage = 0 ft)
 Spillway Crest Length = feet
 Spillway End Slopes = H:V
 Freeboard above Max Water Surface = feet

Calculated Parameters for Spillway
 Spillway Design Flow Depth = feet
 Stage at Top of Freeboard = feet
 Basin Area at Top of Freeboard = acres
 Basin Volume at Top of Freeboard = acre-ft

Routed Hydrograph Results

The user can override the default CUHP hydrographs and runoff volumes by entering new values in the Inflow Hydrographs table (Columns W through AF).

	WQCV	EURV	2 Year	5 Year	10 Year	25 Year	50 Year	100 Year	500 Year
Design Storm Return Period	N/A	N/A	1.19	1.50	1.75	2.00	2.25	2.52	3.48
One-Hour Rainfall Depth (in)	N/A	N/A	0.219	0.283	0.334	0.391	0.447	0.511	0.731
CUHP Runoff Volume (acre-ft)	0.094	0.351	0.219	0.283	0.334	0.391	0.447	0.511	0.731
Inflow Hydrograph Volume (acre-ft)	N/A	N/A	0.219	0.283	0.334	0.391	0.447	0.511	0.731
CUHP Predevelopment Peak Q (cfs)	N/A	N/A	0.0	0.1	0.1	0.9	1.7	2.8	6.2
OPTIONAL Override Predevelopment Peak Q (cfs)	N/A	N/A	0.3	1.1	2.2	4.0	5.3	6.9	8.0
Predevelopment Unit Peak Flow, q (cfs/acre)	N/A	N/A	0.10	0.35	0.71	1.31	1.75	2.27	2.65
Peak Inflow Q (cfs)	N/A	N/A	5.4	6.9	8.2	9.8	11.2	12.5	17.9
Peak Outflow Q (cfs)	0.0	0.1	0.1	0.1	0.1	0.7	1.5	3.0	7.4
Ratio Peak Outflow to Predevelopment Q	N/A	N/A	N/A	0.1	0.1	0.2	0.3	0.4	0.9
Structure Controlling Flow	Plate	Overflow Weir 1	Plate	Plate	Plate	Overflow Weir 1	Overflow Weir 1	Overflow Weir 1	Spillway
Max Velocity through Gate 1 (fps)	N/A	N/A	N/A	N/A	N/A	0.1	0.1	0.3	0.4
Max Velocity through Gate 2 (fps)	N/A	N/A	N/A	N/A	N/A	N/A	N/A	N/A	N/A
Time to Drain 97% of Inflow Volume (hours)	42	74	62	69	73	75	74	73	69
Time to Drain 99% of Inflow Volume (hours)	44	79	66	74	79	81	81	80	79
Maximum Ponding Depth (ft)	1.34	3.56	2.34	2.87	3.28	3.61	3.65	3.71	4.03
Area at Maximum Ponding Depth (acres)	0.11	0.12	0.12	0.12	0.12	0.12	0.12	0.12	0.12
Maximum Volume Stored (acre-ft)	0.095	0.351	0.207	0.269	0.318	0.356	0.361	0.368	0.407

DETENTION BASIN OUTLET STRUCTURE DESIGN

MHFD-Detention, Version 4.06 (July 2022)

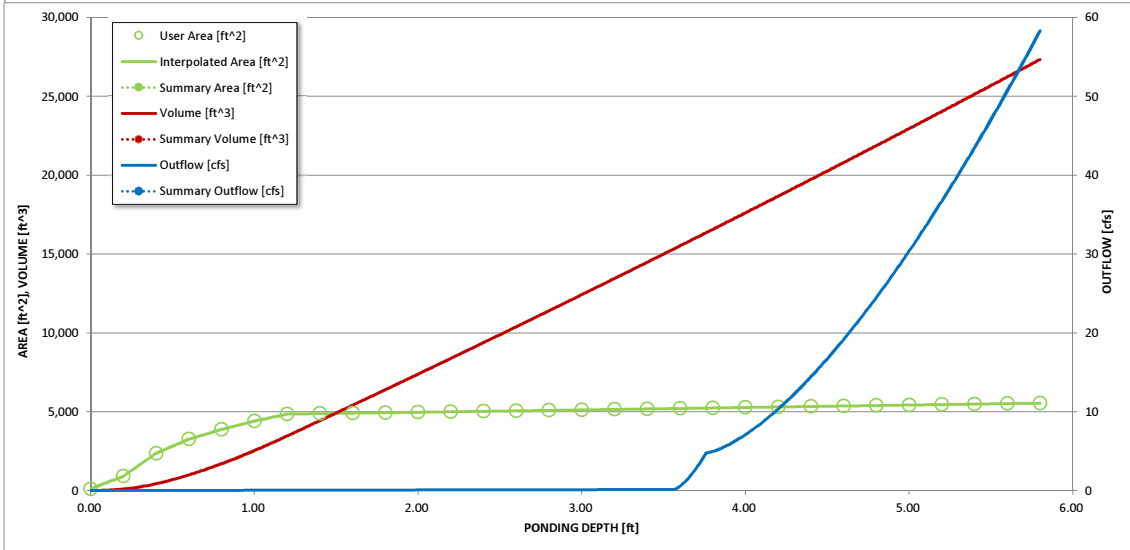
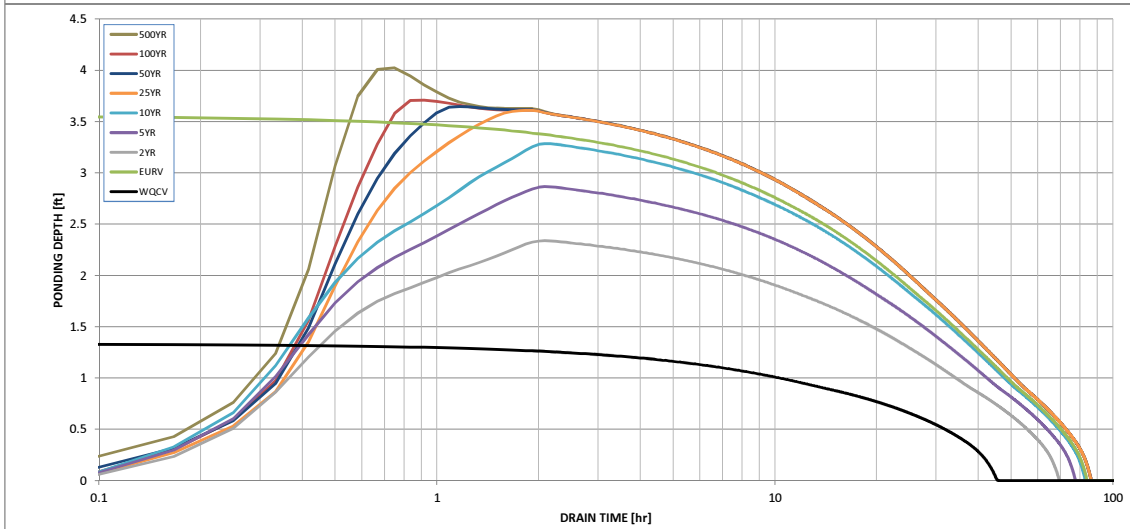
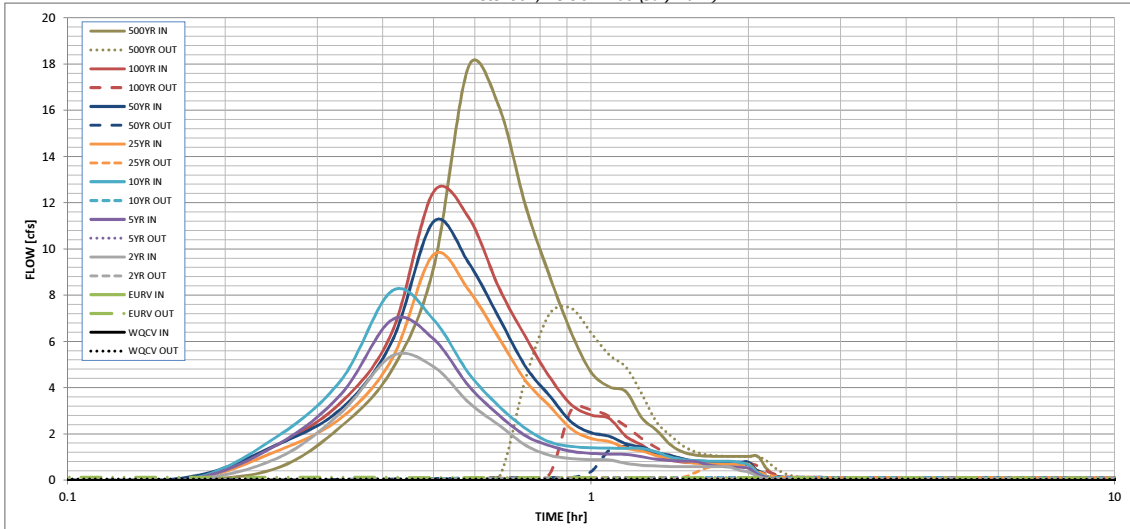

S-A-V-D Chart Axis Override	X-axis	Left Y-Axis	Right Y-Axis
minimum bound			
maximum bound			

DETENTION BASIN OUTLET STRUCTURE DESIGN

Outflow Hydrograph Workbook Filename: _____

Inflow Hydrographs

The user can override the calculated inflow hydrographs from this workbook with inflow hydrographs developed in a separate program.

Time Interval	SOURCE	CUHP	CUHP	CUHP	CUHP	CUHP	CUHP	CUHP	CUHP	CUHP
	TIME	WQCV [cfs]	EURV [cfs]	2 Year [cfs]	5 Year [cfs]	10 Year [cfs]	25 Year [cfs]	50 Year [cfs]	100 Year [cfs]	500 Year [cfs]
5.00 min	0:00:00	0.00	0.00	0.00	0.00	0.00	0.00	0.00	0.00	0.00
	0:05:00	0.00	0.00	0.00	0.00	0.00	0.00	0.00	0.00	0.00
	0:10:00	0.00	0.00	0.00	0.00	0.00	0.00	0.10	0.01	0.51
	0:15:00	0.00	0.00	0.93	1.51	1.86	1.25	1.52	1.51	2.34
	0:20:00	0.00	0.00	2.94	3.74	4.35	2.71	3.10	3.38	4.79
	0:25:00	0.00	0.00	5.38	6.95	8.20	5.25	6.02	6.41	9.17
	0:30:00	0.00	0.00	4.92	6.11	6.95	9.75	11.18	12.47	17.90
	0:35:00	0.00	0.00	3.37	4.09	4.63	8.24	9.41	11.37	16.17
	0:40:00	0.00	0.00	2.39	2.82	3.20	6.15	7.03	8.33	11.86
	0:45:00	0.00	0.00	1.51	1.92	2.24	4.30	4.90	6.19	8.83
	0:50:00	0.00	0.00	1.08	1.49	1.65	3.21	3.65	4.46	6.38
	0:55:00	0.00	0.00	0.94	1.25	1.47	2.22	2.52	3.27	4.68
	1:00:00	0.00	0.00	0.89	1.16	1.41	1.81	2.06	2.82	4.04
	1:05:00	0.00	0.00	0.88	1.13	1.39	1.67	1.90	2.67	3.83
	1:10:00	0.00	0.00	0.73	1.12	1.38	1.39	1.57	1.89	2.70
	1:15:00	0.00	0.00	0.65	1.01	1.38	1.27	1.43	1.52	2.16
	1:20:00	0.00	0.00	0.61	0.91	1.22	1.06	1.20	1.10	1.54
	1:25:00	0.00	0.00	0.59	0.85	1.01	0.96	1.08	0.87	1.21
	1:30:00	0.00	0.00	0.59	0.83	0.90	0.81	0.91	0.79	1.09
	1:35:00	0.00	0.00	0.59	0.82	0.85	0.74	0.83	0.75	1.04
	1:40:00	0.00	0.00	0.59	0.68	0.83	0.71	0.80	0.75	1.03
	1:45:00	0.00	0.00	0.59	0.61	0.82	0.69	0.78	0.75	1.03
	1:50:00	0.00	0.00	0.59	0.58	0.82	0.69	0.78	0.75	1.03
	1:55:00	0.00	0.00	0.43	0.56	0.78	0.69	0.78	0.75	1.03
	2:00:00	0.00	0.00	0.36	0.52	0.66	0.69	0.78	0.75	1.03
	2:05:00	0.00	0.00	0.16	0.24	0.31	0.33	0.37	0.35	0.49
	2:10:00	0.00	0.00	0.07	0.11	0.13	0.14	0.16	0.16	0.21
	2:15:00	0.00	0.00	0.03	0.04	0.05	0.06	0.07	0.06	0.09
	2:20:00	0.00	0.00	0.01	0.01	0.01	0.01	0.01	0.01	0.02
	2:25:00	0.00	0.00	0.00	0.00	0.00	0.00	0.00	0.00	0.00
	2:30:00	0.00	0.00	0.00	0.00	0.00	0.00	0.00	0.00	0.00
	2:35:00	0.00	0.00	0.00	0.00	0.00	0.00	0.00	0.00	0.00
	2:40:00	0.00	0.00	0.00	0.00	0.00	0.00	0.00	0.00	0.00
	2:45:00	0.00	0.00	0.00	0.00	0.00	0.00	0.00	0.00	0.00
	2:50:00	0.00	0.00	0.00	0.00	0.00	0.00	0.00	0.00	0.00
	2:55:00	0.00	0.00	0.00	0.00	0.00	0.00	0.00	0.00	0.00
	3:00:00	0.00	0.00	0.00	0.00	0.00	0.00	0.00	0.00	0.00
	3:05:00	0.00	0.00	0.00	0.00	0.00	0.00	0.00	0.00	0.00
	3:10:00	0.00	0.00	0.00	0.00	0.00	0.00	0.00	0.00	0.00
	3:15:00	0.00	0.00	0.00	0.00	0.00	0.00	0.00	0.00	0.00
	3:20:00	0.00	0.00	0.00	0.00	0.00	0.00	0.00	0.00	0.00
	3:25:00	0.00	0.00	0.00	0.00	0.00	0.00	0.00	0.00	0.00
	3:30:00	0.00	0.00	0.00	0.00	0.00	0.00	0.00	0.00	0.00
	3:35:00	0.00	0.00	0.00	0.00	0.00	0.00	0.00	0.00	0.00
	3:40:00	0.00	0.00	0.00	0.00	0.00	0.00	0.00	0.00	0.00
	3:45:00	0.00	0.00	0.00	0.00	0.00	0.00	0.00	0.00	0.00
	3:50:00	0.00	0.00	0.00	0.00	0.00	0.00	0.00	0.00	0.00
	3:55:00	0.00	0.00	0.00	0.00	0.00	0.00	0.00	0.00	0.00
	4:00:00	0.00	0.00	0.00	0.00	0.00	0.00	0.00	0.00	0.00
	4:05:00	0.00	0.00	0.00	0.00	0.00	0.00	0.00	0.00	0.00
	4:10:00	0.00	0.00	0.00	0.00	0.00	0.00	0.00	0.00	0.00
	4:15:00	0.00	0.00	0.00	0.00	0.00	0.00	0.00	0.00	0.00
	4:20:00	0.00	0.00	0.00	0.00	0.00	0.00	0.00	0.00	0.00
	4:25:00	0.00	0.00	0.00	0.00	0.00	0.00	0.00	0.00	0.00
	4:30:00	0.00	0.00	0.00	0.00	0.00	0.00	0.00	0.00	0.00
	4:35:00	0.00	0.00	0.00	0.00	0.00	0.00	0.00	0.00	0.00
	4:40:00	0.00	0.00	0.00	0.00	0.00	0.00	0.00	0.00	0.00
	4:45:00	0.00	0.00	0.00	0.00	0.00	0.00	0.00	0.00	0.00
	4:50:00	0.00	0.00	0.00	0.00	0.00	0.00	0.00	0.00	0.00
	4:55:00	0.00	0.00	0.00	0.00	0.00	0.00	0.00	0.00	0.00
	5:00:00	0.00	0.00	0.00	0.00	0.00	0.00	0.00	0.00	0.00
	5:05:00	0.00	0.00	0.00	0.00	0.00	0.00	0.00	0.00	0.00
	5:10:00	0.00	0.00	0.00	0.00	0.00	0.00	0.00	0.00	0.00
	5:15:00	0.00	0.00	0.00	0.00	0.00	0.00	0.00	0.00	0.00
	5:20:00	0.00	0.00	0.00	0.00	0.00	0.00	0.00	0.00	0.00
	5:25:00	0.00	0.00	0.00	0.00	0.00	0.00	0.00	0.00	0.00
	5:30:00	0.00	0.00	0.00	0.00	0.00	0.00	0.00	0.00	0.00
	5:35:00	0.00	0.00	0.00	0.00	0.00	0.00	0.00	0.00	0.00
	5:40:00	0.00	0.00	0.00	0.00	0.00	0.00	0.00	0.00	0.00
	5:45:00	0.00	0.00	0.00	0.00	0.00	0.00	0.00	0.00	0.00
	5:50:00	0.00	0.00	0.00	0.00	0.00	0.00	0.00	0.00	0.00
	5:55:00	0.00	0.00	0.00	0.00	0.00	0.00	0.00	0.00	0.00
	6:00:00	0.00	0.00	0.00	0.00	0.00	0.00	0.00	0.00	0.00

INLET MANAGEMENT

Worksheet Protected

INLET NAME	DP1	DP2	DP6	DP6	DP3	DP6
Site Type (Urban or Rural)						
Inlet Application (Street or Area)	AREA	AREA	STREET	STREET	AREA	AREA
Hydraulic Condition	Swale	Swale	On Grade	On Grade	Swale	Swale
Inlet Type	CDOT Type C (Depressed)	CDOT Type C (Depressed)	CDOT Type R Curb Opening	CDOT Type R Curb Opening	CDOT Type C (Depressed)	CDOT Type C (Depressed)

USER-DEFINED INPUT

User-Defined Design Flows						
Minor Q_{design} (cfs)	0.4	1.0	1.4	2.3	1.7	0.1
Major Q_{design} (cfs)	1.0	2.4	2.4	4.1	2.6	0.4
Bypass (Carry-Over) Flow from Upstream						
Receive Bypass Flow from:	No Bypass Flow Received	No Bypass Flow Received	No Bypass Flow Received	No Bypass Flow Received	No Bypass Flow Received	No Bypass Flow Received
Minor Bypass Flow Received, Q_b (cfs)	0.0	0.0	0.0	0.0	0.0	0.0
Major Bypass Flow Received, Q_b (cfs)	0.0	0.0	0.0	0.0	0.0	0.0
Watershed Characteristics						
Subcatchment Area (acres)						
Percent Impervious						
NRCS Soil Type						
Watershed Profile						
Overland Slope (ft/ft)						
Overland Length (ft)						
Channel Slope (ft/ft)						
Channel Length (ft)						
Minor Storm Rainfall Input						
Design Storm Return Period, T, (years)						
One-Hour Precipitation, P, (inches)						
Major Storm Rainfall Input						
Design Storm Return Period, T, (years)						
One-Hour Precipitation, P, (inches)						

CALCULATED OUTPUT

Minor Total Design Peak Flow, Q (cfs)	0.4	1.0	1.4	2.3	1.7	0.1
Major Total Design Peak Flow, Q (cfs)	1.0	2.4	2.4	4.1	2.6	0.4
Minor Flow Bypassed Downstream, Q_b (cfs)	0.0	0.0	0.0	0.0	0.0	0.0
Major Flow Bypassed Downstream, Q_b (cfs)	0.0	0.0	0.0	0.0	0.0	0.0

AREA INLET IN A SWALE

NORTHCREST CENTER PEMBS - EL PASO COUNTY
DP1

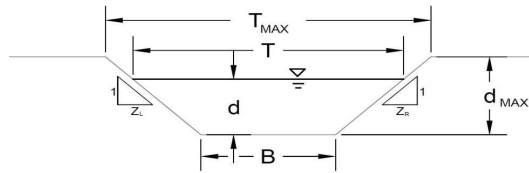

This worksheet uses the NRCS vegetat retardance method to determine Manning's n.
 For more information see Section 7.2.3 of the USDCM.

Analysis of Trapezoidal Grass-Lined Channel Using SCS Method

NRCS Vegetal Retardance (A, B, C, D, or E) A, B, C, D, or E =

Manning's n (Leave cell D16 blank to manually enter an n value) n = 0.012

Channel Invert Slope S₀ = 0.0300 ft/ft

Bottom Width B = 4.00 ft

Left Side Slope Z₁ = 0.02 ft/ft

Right Side Slope Z₂ = 0.02 ft/ft

Check one of the following soil types:

Soil Type:	Max. Velocity (V _{MAX})	Max Froude No. (F _{MAX})
Non-Cohesive	5.0 fps	0.60
Cohesive	7.0 fps	0.80
Paved	N/A	N/A

Choose One:

Non-Cohesive

Cohesive

Paved

	Minor Storm	Major Storm	
Maximum Allowable Top Width of Channel for Minor & Major Storm	T_{MAX} = 30.00	30.00	ft
Maximum Allowable Water Depth in Channel for Minor & Major Storm	d_{MAX} = 0.50	0.50	ft

Allowable Channel Capacity Based On Channel Geometry

MINOR STORM Allowable Capacity is based on Depth Criterion

MAJOR STORM Allowable Capacity is based on Depth Criterion

	Minor Storm	Major Storm	
Q _{allow}	23.4	23.4	cfs
d _{allow}	0.50	0.50	ft

Water Depth in Channel Based On Design Peak Flow

Design Peak Flow

Water Depth

	Minor Storm	Major Storm	
Q _o	0.4	1.0	cfs
d	0.04	0.07	ft

Minor storm max. allowable capacity GOOD - greater than the design flow given on sheet 'Inlet Management'
Major storm max. allowable capacity GOOD - greater than the design flow given on sheet 'Inlet Management'

Warning 01
Warning 01

AREA INLET IN A SWALE

NORTHCREST CENTER PEMBS - EL PASO COUNTY
DP1

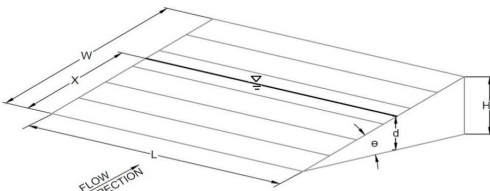
Inlet Design Information (Input)																												
Type of Inlet CDOT Type C (Depressed)	Inlet Type = CDOT Type C (Depressed)																											
Angle of Inclined Gate (must be ≤ 30 degrees) Width of Gate Length of Gate Open Area Ratio Height of Inclined Gate Clogging Factor Grate Discharge Coefficient Orifice Coefficient Weir Coefficient	<table style="width: 100%; border-collapse: collapse;"> <tr><td style="width: 150px;">θ =</td><td style="text-align: center;">1.19</td><td style="text-align: right;">degrees</td></tr> <tr><td>W =</td><td style="text-align: center;">3.00</td><td style="text-align: right;">ft</td></tr> <tr><td>L =</td><td style="text-align: center;">3.00</td><td style="text-align: right;">ft</td></tr> <tr><td>A_{RATIO} =</td><td style="text-align: center;">0.70</td><td></td></tr> <tr><td>H_B =</td><td style="text-align: center;">0.06</td><td style="text-align: right;">ft</td></tr> <tr><td>C_f =</td><td style="text-align: center;">0.50</td><td></td></tr> <tr><td>C_d =</td><td style="text-align: center;">0.79</td><td></td></tr> <tr><td>C_o =</td><td style="text-align: center;">0.52</td><td></td></tr> <tr><td>C_w =</td><td style="text-align: center;">1.68</td><td></td></tr> </table>	θ =	1.19	degrees	W =	3.00	ft	L =	3.00	ft	A_{RATIO} =	0.70		H_B =	0.06	ft	C_f =	0.50		C_d =	0.79		C_o =	0.52		C_w =	1.68	
θ =	1.19	degrees																										
W =	3.00	ft																										
L =	3.00	ft																										
A_{RATIO} =	0.70																											
H_B =	0.06	ft																										
C_f =	0.50																											
C_d =	0.79																											
C_o =	0.52																											
C_w =	1.68																											
	<table style="width: 100%; border-collapse: collapse;"> <thead> <tr> <th></th> <th style="text-align: center;">MINOR</th> <th style="text-align: center;">MAJOR</th> <th></th> </tr> </thead> <tbody> <tr> <td>d =</td> <td style="text-align: center;">1.04</td> <td style="text-align: center;">1.07</td> <td></td> </tr> <tr> <td>Q_a =</td> <td style="text-align: center;">15.6</td> <td style="text-align: center;">16.3</td> <td style="text-align: right;">cfs</td> </tr> <tr> <td>Q_b =</td> <td style="text-align: center;">0.0</td> <td style="text-align: center;">0.0</td> <td style="text-align: right;">cfs</td> </tr> <tr> <td>$C\%$ =</td> <td style="text-align: center;">100</td> <td style="text-align: center;">100</td> <td style="text-align: right;">%</td> </tr> </tbody> </table>		MINOR	MAJOR		d =	1.04	1.07		Q_a =	15.6	16.3	cfs	Q_b =	0.0	0.0	cfs	$C\%$ =	100	100	%							
	MINOR	MAJOR																										
d =	1.04	1.07																										
Q_a =	15.6	16.3	cfs																									
Q_b =	0.0	0.0	cfs																									
$C\%$ =	100	100	%																									
Water Depth at Inlet (for depressed inlets, 1 foot is added for depression) Total Inlet Interception Capacity (assumes clogged condition) Bypassed Flow Capture Percentage = Q_a/Q_o																												

Warning 01: Sideslope steepness exceeds USDCM Volume I recommendation.
Warning 02: Depth (d) exceeds USDCM Volume I recommendation.

AREA INLET IN A SWALE

NORTHCREST CENTER PEMBS - EL PASO COUNTY
DP2

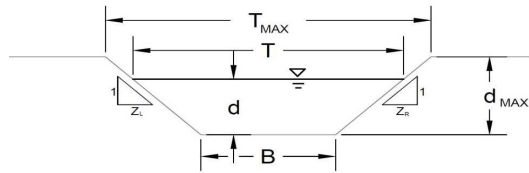

This worksheet uses the NRCS vegetative retardance method to determine Manning's n.
 For more information see Section 7.2.3 of the USDCM.

Warning 01
Warning 01

Analysis of Trapezoidal Grass-Lined Channel Using SCS Method

NRCS Vegetal Retardance (A, B, C, D, or E) A, B, C, D, or E =

Manning's n (Leave cell D16 blank to manually enter an n value) n = 0.012

Channel Invert Slope S₀ = 0.0300 ft/ft

Bottom Width B = 4.00 ft

Left Side Slope Z₁ = 0.02 ft/ft

Right Side Slope Z₂ = 0.02 ft/ft

Check one of the following soil types:

Soil Type:	Max. Velocity (V _{MAX})	Max Froude No. (F _{MAX})
Non-Cohesive	5.0 fps	0.60
Cohesive	7.0 fps	0.80
Paved	N/A	N/A

Choose One:

Non-Cohesive

Cohesive

Paved

	Minor Storm	Major Storm	
Maximum Allowable Top Width of Channel for Minor & Major Storm	T_{MAX} = 30.00	30.00	ft
Maximum Allowable Water Depth in Channel for Minor & Major Storm	d_{MAX} = 0.50	0.50	ft

Allowable Channel Capacity Based On Channel Geometry

MINOR STORM Allowable Capacity is based on Depth Criterion

MAJOR STORM Allowable Capacity is based on Depth Criterion

	Minor Storm	Major Storm	
Q _{allow} =	23.4	23.4	cfs
d _{allow} =	0.50	0.50	ft

Water Depth in Channel Based On Design Peak Flow

Design Peak Flow

Water Depth

	Minor Storm	Major Storm	
Q _o =	1.0	2.4	cfs
d =	0.07	0.12	ft

Minor storm max. allowable capacity GOOD - greater than the design flow given on sheet 'Inlet Management'
Major storm max. allowable capacity GOOD - greater than the design flow given on sheet 'Inlet Management'

MHFD-Inlet, Version 5.01 (April 2021)
AREA INLET IN A SWALE

NORTHCREST CENTER PEMBS - EL PASO COUNTY
DP2

Inlet Design Information (Input)

Type of Inlet: Inlet Type =

Angle of Inclined Gate (must be ≤ 30 degrees) $\theta = 1.19$ degrees

Width of Gate $W = 3.00$ ft

Length of Gate $L = 3.00$ ft

Open Area Ratio $A_{RATIO} = 0.70$

Height of Inclined Gate $H_B = 0.06$ ft

Clogging Factor $C_f = 0.50$

Grate Discharge Coefficient $C_d = 0.79$

Orifice Coefficient $C_o = 0.52$

Weir Coefficient $C_w = 1.68$

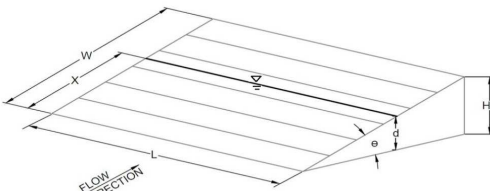

Water Depth at Inlet (for depressed inlets, 1 foot is added for depression)

	MINOR	MAJOR	
$d =$	1.07	1.12	
$Q_a =$	16.4	17.4	cfs
$Q_b =$	0.0	0.0	cfs
$C\% =$	100	100	%

Total Inlet Interception Capacity (assumes clogged condition)

Bypassed Flow

Capture Percentage = Q_a/Q_o

Warning 01: Sideslope steepness exceeds USDCM Volume I recommendation.
Warning 02: Depth (d) exceeds USDCM Volume I recommendation.

AREA INLET IN A SWALE

NORTHCREST CENTER PEMBS - EL PASO COUNTY
DP3

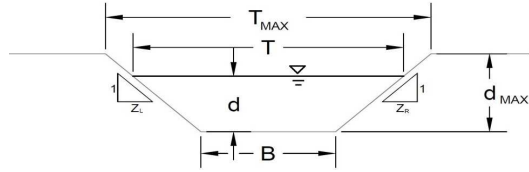

This worksheet uses the NRCS vegetative retardance method to determine Manning's n.
 For more information see Section 7.2.3 of the USDCM.

Warning 01
Warning 01

Analysis of Trapezoidal Grass-Lined Channel Using SCS Method

NRCS Vegetal Retardance (A, B, C, D, or E) A, B, C, D, or E =

Manning's n (Leave cell D16 blank to manually enter an n value) n = 0.012

Channel Invert Slope S₀ = 0.0300 ft/ft

Bottom Width B = 4.00 ft

Left Side Slope Z₁ = 0.02 ft/ft

Right Side Slope Z₂ = 0.02 ft/ft

Check one of the following soil types:

Soil Type:	Max. Velocity (V _{MAX})	Max Froude No. (F _{MAX})
Non-Cohesive	5.0 fps	0.60
Cohesive	7.0 fps	0.80
Paved	N/A	N/A

Choose One:

Non-Cohesive

Cohesive

Paved

	Minor Storm	Major Storm	
Maximum Allowable Top Width of Channel for Minor & Major Storm	T_{MAX} = 30.00	30.00	ft
Maximum Allowable Water Depth in Channel for Minor & Major Storm	d_{MAX} = 0.50	0.50	ft

Allowable Channel Capacity Based On Channel Geometry

MINOR STORM Allowable Capacity is based on Depth Criterion

MAJOR STORM Allowable Capacity is based on Depth Criterion

	Minor Storm	Major Storm	
Allowable Capacity	Q_{allow} = 23.4	23.4	cfs
Water Depth	d_{allow} = 0.50	0.50	ft

Water Depth in Channel Based On Design Peak Flow

Design Peak Flow Q_o = 1.7 cfs

Water Depth d = 0.10 ft

Minor storm max. allowable capacity GOOD - greater than the design flow given on sheet 'Inlet Management'
 Major storm max. allowable capacity GOOD - greater than the design flow given on sheet 'Inlet Management'

MHFD-Inlet, Version 5.01 (April 2021)
AREA INLET IN A SWALE

NORTHCREST CENTER PEMBS - EL PASO COUNTY
DP3

Inlet Design Information (Input)

Type of Inlet: Inlet Type =

Angle of Inclined Gate (must be ≤ 30 degrees) $\theta = 1.20$ degrees

Width of Gate $W = 3.00$ ft

Length of Gate $L = 3.00$ ft

Open Area Ratio $A_{RATIO} = 0.70$

Height of Inclined Gate $H_B = 0.06$ ft

Clogging Factor $C_f = 0.50$

Grate Discharge Coefficient $C_d = 0.78$

Orifice Coefficient $C_o = 0.52$

Weir Coefficient $C_w = 1.68$

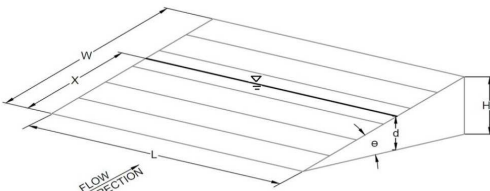

	MINOR	MAJOR	
$d =$	1.10	1.13	
$Q_a =$	16.9	17.6	cfs
$Q_b =$	0.0	0.0	cfs
$C\% =$	100	100	%

Water Depth at Inlet (for depressed inlets, 1 foot is added for depression)

Total Inlet Interception Capacity (assumes clogged condition)

Bypassed Flow

Capture Percentage = Q_a/Q_o

Warning 01: Sideslope steepness exceeds USDCM Volume I recommendation.
Warning 02: Depth (d) exceeds USDCM Volume I recommendation.

ALLOWABLE CAPACITY FOR ONE-HALF OF STREET (Minor & Major Storm)

(Based on Regulated Criteria for Maximum Allowable Flow Depth and Spread)

Project: NORTHCREST CENTER PEMBS - EL PASO COUNTY
Inlet ID: DP5

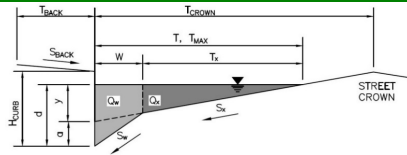

Gutter Geometry:

Maximum Allowable Width for Spread Behind Curb
 Side Slope Behind Curb (leave blank for no conveyance credit behind curb)
 Manning's Roughness Behind Curb (typically between 0.012 and 0.020)
 Height of Curb at Gutter Flow Line
 Distance from Curb Face to Street Crown
 Gutter Width
 Street Transverse Slope
 Gutter Cross Slope (typically 2 inches over 24 inches or 0.083 ft/ft)
 Street Longitudinal Slope - Enter 0 for sump condition
 Manning's Roughness for Street Section (typically between 0.012 and 0.020)

T_{BACK} =	0.0	ft
S_{BACK} =		ft/ft
n_{BACK} =		
H_{CURB} =	6.00	inches
T_{CROWN} =	60.0	ft
W =	2.00	ft
S_x =	0.040	ft/ft
S_w =	0.083	ft/ft
S_0 =	0.035	ft/ft
n_{STREET} =	0.016	

Max. Allowable Spread for Minor & Major Storm
 Max. Allowable Depth at Gutter Flowline for Minor & Major Storm
 Allow Flow Depth at Street Crown (check box for yes, leave blank for no)

	Minor Storm	Major Storm	
T_{MAX} =	5.0	6.0	ft
d_{MAX} =	6.0	6.0	inches
	<input type="checkbox"/>	<input type="checkbox"/>	

MINOR STORM Allowable Capacity is based on Spread Criterion
 MAJOR STORM Allowable Capacity is based on Spread Criterion

	Minor Storm	Major Storm	
Q_{allow} =	3.1	4.6	cfs

Minor storm max. allowable capacity GOOD - greater than the design flow given on sheet 'Inlet Management'
Major storm max. allowable capacity GOOD - greater than the design flow given on sheet 'Inlet Management'

INLET ON A CONTINUOUS GRADE

MHFD-Inlet, Version 5.01 (April 2021)

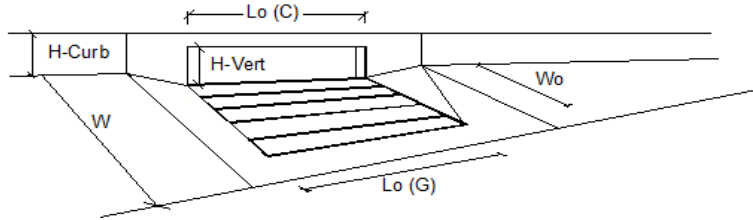

Design Information (Input)	MINOR		MAJOR	
Type of Inlet	CDOT Type R Curb Opening			
Local Depression (additional to continuous gutter depression 'a')	Type =	CDOT Type R Curb Opening		
Total Number of Units in the Inlet (Grate or Curb Opening)	a _{LOCAL} =	3.0	3.0	inches
Length of a Single Unit Inlet (Grate or Curb Opening)	No =	2	2	
Width of a Unit Grate (cannot be greater than W, Gutter Width)	L _o =	5.00	5.00	ft
Clogging Factor for a Single Unit Grate (typical min. value = 0.5)	W _o =	N/A	N/A	ft
Clogging Factor for a Single Unit Curb Opening (typical min. value = 0.1)	C _{r-G} =	N/A	N/A	
	C _{r-C} =	0.10	0.10	
Street Hydraulics: OK - Q < Allowable Street Capacity				
Total Inlet Interception Capacity	MINOR		MAJOR	
Total Inlet Carry-Over Flow (flow bypassing inlet)	Q =	2.3	4.1	cfs
Capture Percentage = Q _i /Q _s =	Q _s =	0.0	0.0	cfs
	C% =	100	100	%

ALLOWABLE CAPACITY FOR ONE-HALF OF STREET (Minor & Major Storm)

(Based on Regulated Criteria for Maximum Allowable Flow Depth and Spread)

Project: NORTHCREST CENTER PEMBS - EL PASO COUNTY
Inlet ID: DP6

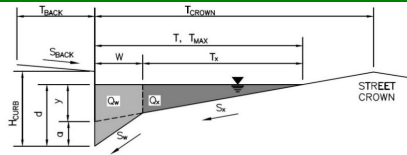

Gutter Geometry:

Maximum Allowable Width for Spread Behind Curb
 Side Slope Behind Curb (leave blank for no conveyance credit behind curb)
 Manning's Roughness Behind Curb (typically between 0.012 and 0.020)
 Height of Curb at Gutter Flow Line
 Distance from Curb Face to Street Crown
 Gutter Width
 Street Transverse Slope
 Gutter Cross Slope (typically 2 inches over 24 inches or 0.083 ft/ft)
 Street Longitudinal Slope - Enter 0 for sump condition
 Manning's Roughness for Street Section (typically between 0.012 and 0.020)

$T_{BACK} =$ ft
 $S_{BACK} =$ ft/ft
 $n_{BACK} =$
 $H_{CURB} =$ inches
 $T_{CROWN} =$ ft
 $W =$ ft
 $S_x =$ ft/ft
 $S_w =$ ft/ft
 $S_0 =$ ft/ft
 $n_{STREET} =$

Max. Allowable Spread for Minor & Major Storm
 Max. Allowable Depth at Gutter Flowline for Minor & Major Storm
 Allow Flow Depth at Street Crown (check box for yes, leave blank for no)

	Minor Storm	Major Storm	
$T_{MAX} =$	<input type="text" value="4.0"/>	<input type="text" value="5.0"/>	ft
$d_{MAX} =$	<input type="text" value="6.0"/>	<input type="text" value="6.0"/>	inches
	<input type="checkbox"/>	<input type="checkbox"/>	

MINOR STORM Allowable Capacity is based on Spread Criterion
 MAJOR STORM Allowable Capacity is based on Spread Criterion

$Q_{allow} =$

Minor Storm	Major Storm
<input type="text" value="2.2"/>	<input type="text" value="3.4"/>

 cfs

Minor storm max. allowable capacity GOOD - greater than the design flow given on sheet 'Inlet Management'
Major storm max. allowable capacity GOOD - greater than the design flow given on sheet 'Inlet Management'

INLET ON A CONTINUOUS GRADE

MHFD-Inlet, Version 5.01 (April 2021)

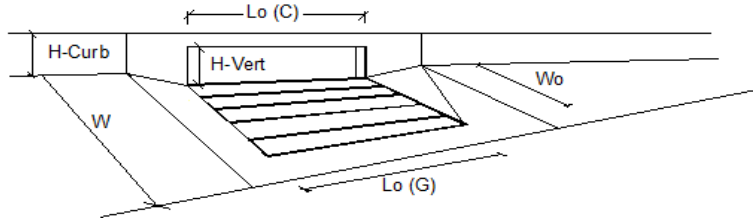

Design Information (Input)	MINOR	MAJOR	
Type of Inlet	CDOT Type R Curb Opening		
Local Depression (additional to continuous gutter depression 'a')	3.0	3.0	inches
Total Number of Units in the Inlet (Grate or Curb Opening)	2	2	
Length of a Single Unit Inlet (Grate or Curb Opening)	5.00	5.00	ft
Width of a Unit Grate (cannot be greater than W, Gutter Width)	N/A	N/A	ft
Clogging Factor for a Single Unit Grate (typical min. value = 0.5)	N/A	N/A	
Clogging Factor for a Single Unit Curb Opening (typical min. value = 0.1)	0.10	0.10	
Street Hydraulics: OK - Q < Allowable Street Capacity			
Total Inlet Interception Capacity	1.3	2.4	cfs
Total Inlet Carry-Over Flow (flow bypassing inlet)	0.0	0.0	cfs
Capture Percentage = Q_i/Q_o =	100	100	%

AREA INLET IN A SWALE

NORTHCREST CENTER PEMBS - EL PASO COUNTY
DP8

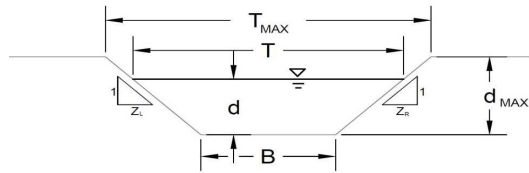

This worksheet uses the NRCS vegetative retardance method to determine Manning's n.
 For more information see Section 7.2.3 of the USDCM.

Warning 01
Warning 01

Analysis of Trapezoidal Grass-Lined Channel Using SCS Method

NRCS Vegetal Retardance (A, B, C, D, or E) A, B, C, D, or E =

Manning's n (Leave cell D16 blank to manually enter an n value) n = 0.012

Channel Invert Slope S₀ = 0.0300 ft/ft

Bottom Width B = 4.00 ft

Left Side Slope Z₁ = 0.02 ft/ft

Right Side Slope Z₂ = 0.02 ft/ft

Check one of the following soil types:

Soil Type:	Max. Velocity (V _{MAX})	Max Froude No. (F _{MAX})
Non-Cohesive	5.0 fps	0.60
Cohesive	7.0 fps	0.80
Paved	N/A	N/A

Choose One:

Non-Cohesive

Cohesive

Paved

	Minor Storm	Major Storm	
Maximum Allowable Top Width of Channel for Minor & Major Storm	T_{MAX} = 30.00	30.00	ft
Maximum Allowable Water Depth in Channel for Minor & Major Storm	d_{MAX} = 0.50	0.50	ft

Allowable Channel Capacity Based On Channel Geometry

MINOR STORM Allowable Capacity is based on Depth Criterion Minor Storm

MAJOR STORM Allowable Capacity is based on Depth Criterion Major Storm

	Minor Storm	Major Storm	
Allowable Capacity (Q _{allow})	23.4	23.4	cfs
Allowable Water Depth (d _{allow})	0.50	0.50	ft

Water Depth in Channel Based On Design Peak Flow

Design Peak Flow Q_o =

Water Depth d =

	Minor Storm	Major Storm	
Design Peak Flow	0.1	0.4	cfs
Water Depth	0.02	0.04	ft

Minor storm max. allowable capacity GOOD - greater than the design flow given on sheet 'Inlet Management'
 Major storm max. allowable capacity GOOD - greater than the design flow given on sheet 'Inlet Management'

MHFD-Inlet, Version 5.01 (April 2021)
AREA INLET IN A SWALE

NORTHCREST CENTER PEMBS - EL PASO COUNTY
DP8

Inlet Design Information (Input)

Type of Inlet: Inlet Type =

Angle of Inclined Gate (must be ≤ 30 degrees) $\theta = 0.50$ degrees

Width of Gate $W = 3.00$ ft

Length of Gate $L = 3.00$ ft

Open Area Ratio $A_{RATIO} = 0.70$

Height of Inclined Gate $H_B = 0.03$ ft

Clogging Factor $C_f = 0.50$

Grate Discharge Coefficient $C_d = 0.82$

Orifice Coefficient $C_o = 0.55$

Weir Coefficient $C_w = 1.75$

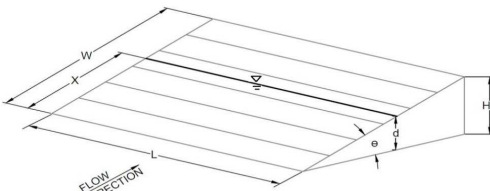

Water Depth at Inlet (for depressed inlets, 1 foot is added for depression)

	MINOR	MAJOR	
$d =$	1.02	1.04	
$Q_a =$	16.1	16.6	cfs
$Q_b =$	0.0	0.0	cfs
$C\% =$	100	100	%

Total Inlet Interception Capacity (assumes clogged condition)

Bypassed Flow

Capture Percentage = Q_a/Q_o

Warning 01: Sideslope steepness exceeds USDCM Volume I recommendation.
Warning 02: Depth (d) exceeds USDCM Volume I recommendation.

Warning 04: Froude No. exceeds USDCM Volume I recommendation.

-Using MHFD EDB T-5, Table EDB-4

Using "EDBs with up to 5 impervious acres":

Minimum Forebay Volume = 2.0% of WQCV

Maximum Forebay Depth = 18in

Forebay Release and Configuration = Release 2% of the undetainted 100yr peaf runoff via wall/notch

Total Runoff:

100yr Runoff Entering Forebay (F-1)=	10.33	cfs
100yr Runoff Entering Forebay (F-2)=	4.07	cfs

Forebay Required Release Rate:

2% of 100yr (F-1)=	0.21	cfs
2% of 100yr (F-2)=	0.08	cfs

Forebay Required Volume:

WQCV Entering Forebay (F-1)=	0.014	acre-feet
Forebay (F-1) Volume (2% of WQCV)	11.9	cubic feet
WQCV Entering Forebay (F-2)=	0.005	acre-feet
Forebay (F-2) Volume (2% of WQCV)	4.7	cubic feet

Forebay Dimensions:

Forebay (F-1) Depth =	8	in
=	0.67	ft
Min. Forebay Area =	17.8	sf (min)
Forebay (F-2) Depth =	8	in
=	0.67	ft
Min. Forebay Area =	7.0	sf (min)

Forebay Notch Dimensions:

Forebay (F-1) Notch:	4.00	in Wide
	3.0	in High
Forebay (F-2) Notch:	3.00	in Wide
	3.0	in High

FOREBAY F-1



online_rectangular_weir: Calculation of discharge through a rectangular weir

Formula:

$$Q = C_e (L + k_b) (H + 0.003)^{3/2} \quad [\text{in U.S. Units}]$$

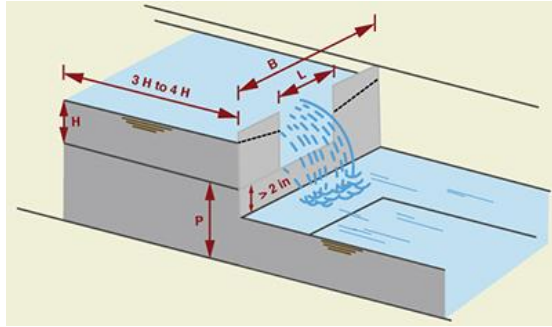

Head H on the weir, in m [or ft]
Length L of the weir, in m [or ft]
Width B of the channel, in m [or ft]
Height P to the weir crest, in m [or ft]
 C_e is a function of H/P and L/B
 k_b is a function of L/B

Discharge Q in L/s [or cfs]

See USBR Manual for general methodology

INPUT DATA:

[Description]

Select Units:

Head H : ft

[$H > 0$]

Length L : ft

[$L > 0$]

Width B : ft

[$B > 0$]

Height P : ft

[$P > 0$]

OUTPUT:

Discharge Q : 0.2228 cfs

Your request was processed at 01:17:23 pm on November 11th, 2022 [221111 13:17:23].

Thank you for running online_rectangular_weir Please call again. [131030 13:30]

FOREBAY F-2



online_rectangular_weir: Calculation of discharge through a rectangular weir

Formula:

$$Q = C_e (L + k_b) (H + 0.003)^{3/2} \quad [\text{in U.S. Units}]$$

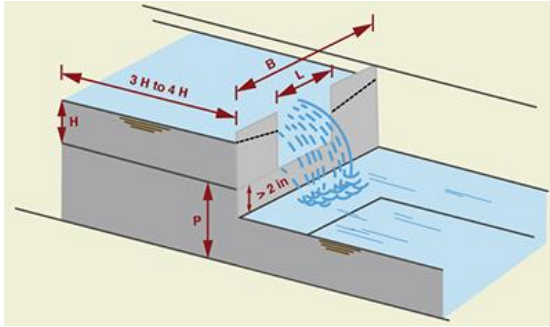

Head H on the weir, in m [or ft]
Length L of the weir, in m [or ft]
Width B of the channel, in m [or ft]
Height P to the weir crest, in m [or ft]
 C_e is a function of H/P and L/B
 k_b is a function of L/B

Discharge Q in L/s [or cfs]

See USBR Manual for general methodology

INPUT DATA: [Description]

Select Units:

Head H : ft

[$H > 0$]

Length L : ft

[$L > 0$]

Width B : ft

[$B > 0$]

Height P : ft

[$P > 0$]

OUTPUT:

Discharge Q : 0.1289 cfs

Your request was processed at 01:13:54 pm on November 11th, 2022 [221111 13:13:54].

Thank you for running online_rectangular_weir Please call again. [131030 13:30]

DETERMINATION OF CULVERT HEADWATER AND OUTLET PROTECTION

MHFD-Culvert, Version 4.00 (May 2020)

Project: Northcrest Center
ID: Emergency Spillway Riprap

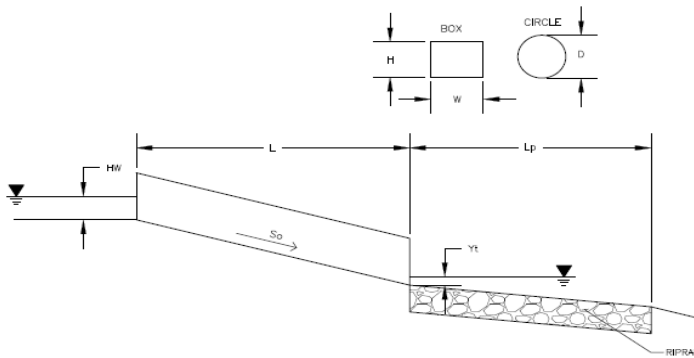

Soil Type:
 Choose One:
 Sandy
 Non-Sandy

Supercritical Flow! Using Adjusted Rise to calculate protection type.

Design Information:	
Design Discharge	Q = <input type="text" value="1.2"/> cfs
Circular Culvert:	
Barrel Diameter in Inches	D = <input type="text"/> inches
Inlet Edge Type (Choose from pull-down list)	
OR:	
Box Culvert:	
Barrel Height (Rise) in Feet	H (Rise) = <input type="text" value="2"/> ft
Barrel Width (Span) in Feet	W (Span) = <input type="text" value="6"/> ft
Inlet Edge Type (Choose from pull-down list)	Square Edge w/ 90 deg. Headwall
Number of Barrels	# Barrels = <input type="text" value="1"/>
Inlet Elevation	Elev IN = <input type="text" value="6513.25"/> ft
Outlet Elevation OR Slope	So = <input type="text" value="0.01"/> ft/ft
Culvert Length	L = <input type="text" value="2"/> ft
Manning's Roughness	n = <input type="text" value="0.012"/>
Bend Loss Coefficient	k _b = <input type="text" value="0"/>
Exit Loss Coefficient	k _x = <input type="text" value="1"/>
Tailwater Surface Elevation	Y _t Elevation = <input type="text"/> ft
Max Allowable Channel Velocity	V = <input type="text" value="7"/> ft/s
Calculated Results:	
Culvert Cross Sectional Area Available	A = <input type="text" value="12.00"/> ft ²
Culvert Normal Depth	Y _n = <input type="text" value="0.09"/> ft
Culvert Critical Depth	Y _c = <input type="text" value="0.11"/> ft
Froude Number	Fr = <input type="text" value="1.42"/> Supercritical!
Entrance Loss Coefficient	k _e = <input type="text" value="0.20"/>
Friction Loss Coefficient	k _f = <input type="text" value="0.01"/>
Sum of All Loss Coefficients	k _s = <input type="text" value="1.21"/> ft
Headwater:	
Inlet Control Headwater	HW _i = <input type="text" value="0.18"/> ft
Outlet Control Headwater	HW _o = <input type="text" value="N/A"/> ft
Design Headwater Elevation	HW = <input type="text" value="N/A"/> ft
Headwater/Diameter OR Headwater/Rise Ratio	HW/H = <input type="text" value="N/A"/>
Outlet Control Headwater Approximation Method Inaccurate for Low Flow - Backwater Calculations Required	
Outlet Protection:	
Flow/(Span * Rise ^{1.5})	Q/WH ^{1.5} = <input type="text" value="0.07"/> ft ^{0.5} /s
Tailwater Surface Height	Y _t = <input type="text" value="0.80"/> ft
Tailwater/Rise	Y _t /H = <input type="text" value="0.40"/>
Expansion Factor	1/(2*tan(Θ)) = <input type="text" value="6.65"/>
Flow Area at Max Channel Velocity	A _t = <input type="text" value="0.17"/> ft ²
Width of Equivalent Conduit for Multiple Barrels	W _{eq} = <input type="text" value="-"/> ft
Length of Riprap Protection	L_p = <input type="text" value="6"/> ft
Width of Riprap Protection at Downstream End	T = <input type="text" value="7"/> ft
Adjusted Rise for Supercritical Flow	Ha = <input type="text" value="1.04"/> ft
Minimum Theoretical Riprap Size	d ₅₀ min = <input type="text" value="0"/> in
Nominal Riprap Size	d ₅₀ nominal = <input type="text" value="6"/> in
MHFD Riprap Type	Type = <input type="text" value="VL"/>

APPENDIX C – FEMA FLOODPLAIN MAP

National Flood Hazard Layer FIRMMette



104°42'18"W 38°52'21"N

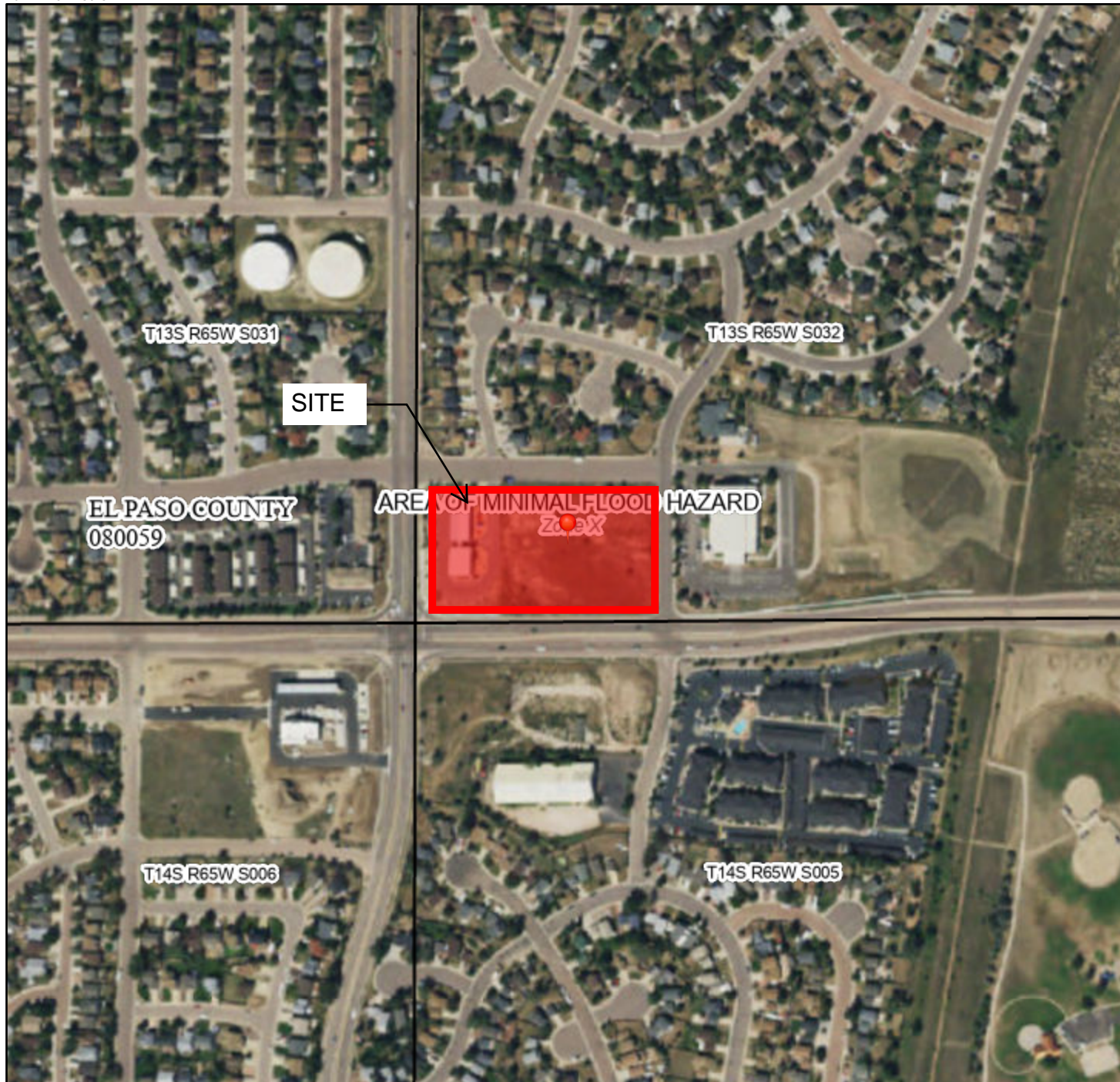

Legend

SEE FIS REPORT FOR DETAILED LEGEND AND INDEX MAP FOR FIRM PANEL LAYOUT

- | | | |
|------------------------------------|--|--|
| SPECIAL FLOOD HAZARD AREAS | | Without Base Flood Elevation (BFE)
<i>Zone A, V, A99</i> |
| | | With BFE or Depth <i>Zone AE, AO, AH, VE, AR</i> |
| | | Regulatory Floodway |
| OTHER AREAS OF FLOOD HAZARD | | 0.2% Annual Chance Flood Hazard, Areas of 1% annual chance flood with average depth less than one foot or with drainage areas of less than one square mile <i>Zone X</i> |
| | | Future Conditions 1% Annual Chance Flood Hazard <i>Zone X</i> |
| | | Area with Reduced Flood Risk due to Levee. See Notes. <i>Zone X</i> |
| | | Area with Flood Risk due to Levee <i>Zone D</i> |
| OTHER AREAS | | NO SCREEN Area of Minimal Flood Hazard <i>Zone X</i> |
| | | Effective LOMRs |
| GENERAL STRUCTURES | | Area of Undetermined Flood Hazard <i>Zone D</i> |
| | | Channel, Culvert, or Storm Sewer |
| | | Levee, Dike, or Floodwall |
| OTHER FEATURES | | 20.2 Cross Sections with 1% Annual Chance |
| | | 17.5 Water Surface Elevation |
| | | Coastal Transect |
| | | Base Flood Elevation Line (BFE) |
| | | Limit of Study |
| MAP PANELS | | Jurisdiction Boundary |
| | | Coastal Transect Baseline |
| | | Profile Baseline |
| | | Hydrographic Feature |
| | | Digital Data Available |
| | | No Digital Data Available |
| | | Unmapped |
| | | The pin displayed on the map is an approximate point selected by the user and does not represent an authoritative property location. |



This map complies with FEMA's standards for the use of digital flood maps if it is not void as described below. The basemap shown complies with FEMA's basemap accuracy standards.

The flood hazard information is derived directly from the authoritative NFHL web services provided by FEMA. This map was exported on **3/17/2021 at 3:21 PM** and does not reflect changes or amendments subsequent to this date and time. The NFHL and effective information may change or become superseded by new data over time.

This map image is void if the one or more of the following map elements do not appear: basemap imagery, flood zone labels, legend, scale bar, map creation date, community identifiers, FIRM panel number, and FIRM effective date. Map images for unmapped and unmodernized areas cannot be used for regulatory purposes.

APPENDIX D – USGS SOILS SURVEY MAP

Hydrologic Soil Group—El Paso County Area, Colorado

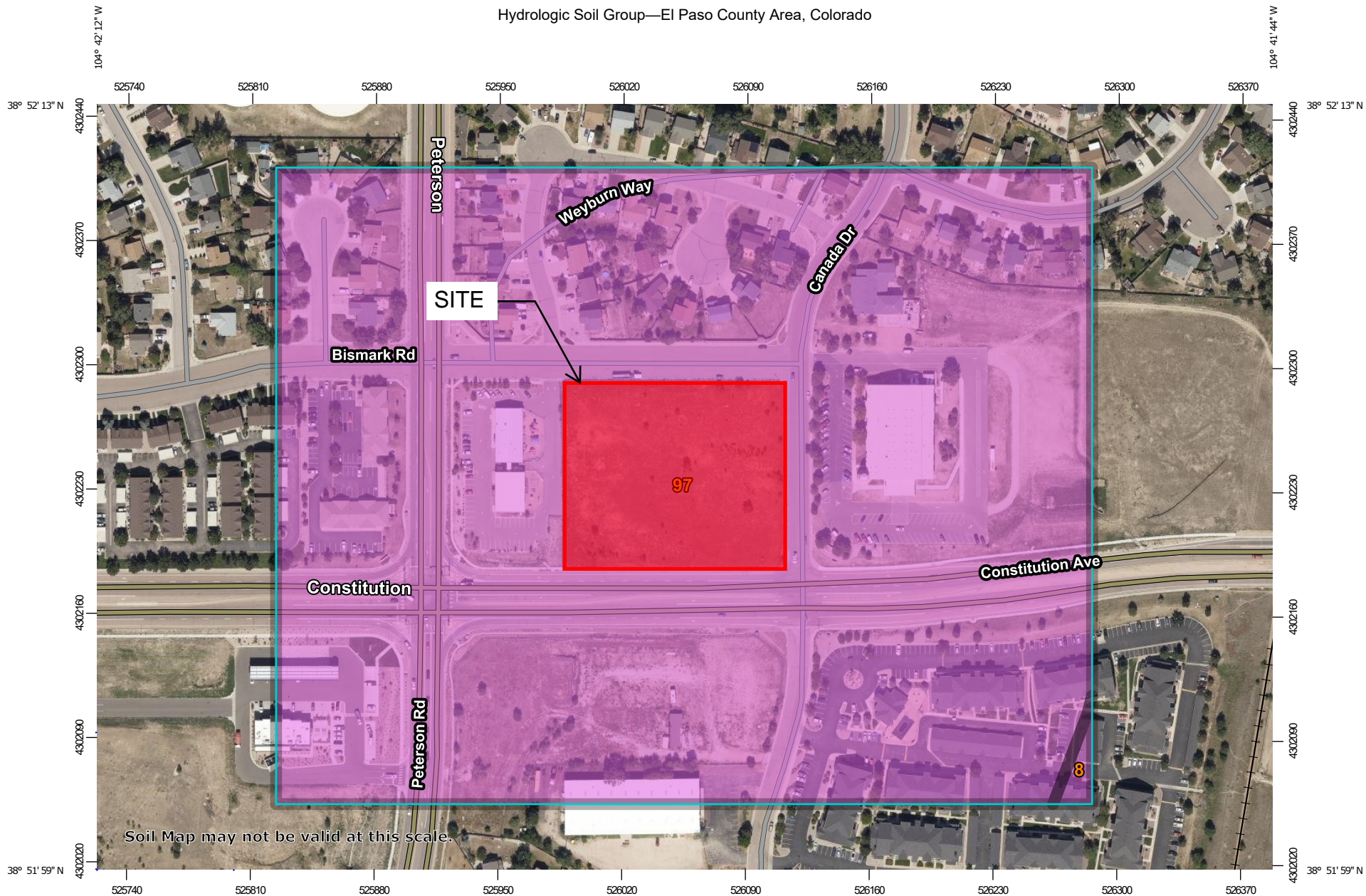





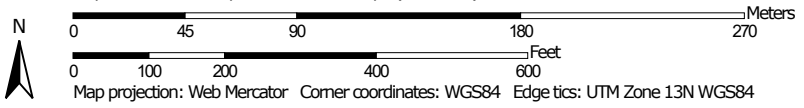



























Soil Map may not be valid at this scale.

Map Scale: 1:3,040 if printed on A landscape (11" x 8.5") sheet.



MAP LEGEND

- Area of Interest (AOI)**
 -  Area of Interest (AOI)
- Soils**
 - Soil Rating Polygons**
 -  A
 -  A/D
 -  B
 -  B/D
 -  C
 -  C/D
 -  D
 -  Not rated or not available
 - Soil Rating Lines**
 -  A
 -  A/D
 -  B
 -  B/D
 -  C
 -  C/D
 -  D
 -  Not rated or not available
 - Soil Rating Points**
 -  A
 -  A/D
 -  B
 -  B/D
- Water Features**
 -  Streams and Canals
- Transportation**
 -  Rails
 -  Interstate Highways
 -  US Routes
 -  Major Roads
 -  Local Roads
- Background**
 -  Aerial Photography
- Other**
 -  C
 -  C/D
 -  D
 -  Not rated or not available

MAP INFORMATION

The soil surveys that comprise your AOI were mapped at 1:24,000.

Warning: Soil Map may not be valid at this scale.
 Enlargement of maps beyond the scale of mapping can cause misunderstanding of the detail of mapping and accuracy of soil line placement. The maps do not show the small areas of contrasting soils that could have been shown at a more detailed scale.

Please rely on the bar scale on each map sheet for map measurements.

Source of Map: Natural Resources Conservation Service
 Web Soil Survey URL:
 Coordinate System: Web Mercator (EPSG:3857)

Maps from the Web Soil Survey are based on the Web Mercator projection, which preserves direction and shape but distorts distance and area. A projection that preserves area, such as the Albers equal-area conic projection, should be used if more accurate calculations of distance or area are required.

This product is generated from the USDA-NRCS certified data as of the version date(s) listed below.

Soil Survey Area: El Paso County Area, Colorado
 Survey Area Data: Version 18, Jun 5, 2020

Soil map units are labeled (as space allows) for map scales 1:50,000 or larger.

Date(s) aerial images were photographed: Aug 19, 2018—Sep 23, 2018

The orthophoto or other base map on which the soil lines were compiled and digitized probably differs from the background imagery displayed on these maps. As a result, some minor shifting of map unit boundaries may be evident.

Hydrologic Soil Group

Map unit symbol	Map unit name	Rating	Acres in AOI	Percent of AOI
8	Blakeland loamy sand, 1 to 9 percent slopes	A	0.2	0.4%
97	Truckton sandy loam, 3 to 9 percent slopes	A	40.9	99.6%
Totals for Area of Interest			41.1	100.0%

Description

Hydrologic soil groups are based on estimates of runoff potential. Soils are assigned to one of four groups according to the rate of water infiltration when the soils are not protected by vegetation, are thoroughly wet, and receive precipitation from long-duration storms.

The soils in the United States are assigned to four groups (A, B, C, and D) and three dual classes (A/D, B/D, and C/D). The groups are defined as follows:

Group A. Soils having a high infiltration rate (low runoff potential) when thoroughly wet. These consist mainly of deep, well drained to excessively drained sands or gravelly sands. These soils have a high rate of water transmission.

Group B. Soils having a moderate infiltration rate when thoroughly wet. These consist chiefly of moderately deep or deep, moderately well drained or well drained soils that have moderately fine texture to moderately coarse texture. These soils have a moderate rate of water transmission.

Group C. Soils having a slow infiltration rate when thoroughly wet. These consist chiefly of soils having a layer that impedes the downward movement of water or soils of moderately fine texture or fine texture. These soils have a slow rate of water transmission.

Group D. Soils having a very slow infiltration rate (high runoff potential) when thoroughly wet. These consist chiefly of clays that have a high shrink-swell potential, soils that have a high water table, soils that have a claypan or clay layer at or near the surface, and soils that are shallow over nearly impervious material. These soils have a very slow rate of water transmission.

If a soil is assigned to a dual hydrologic group (A/D, B/D, or C/D), the first letter is for drained areas and the second is for undrained areas. Only the soils that in their natural condition are in group D are assigned to dual classes.

Rating Options

Aggregation Method: Dominant Condition

Component Percent Cutoff: None Specified

Tie-break Rule: Higher

APPENDIX E – DRAINAGE PLANS

LEGEND

DESCRIPTION	SYMBOL
EX. CONTOUR	- - - - -
DRAINAGE SUB-BASIN BOUNDARY	- - - - -
TIME OF CONCENTRATION PATH	- - - - -
DESCRIPTION	SYMBOL
BASIN IDENTIFIER	→ (E-1)
AREA IN ACRES	→ (X.XX AC)
DESIGN POINT ID	→ (DP1)
FLOW ARROW	→
PROPERTY LINE	—

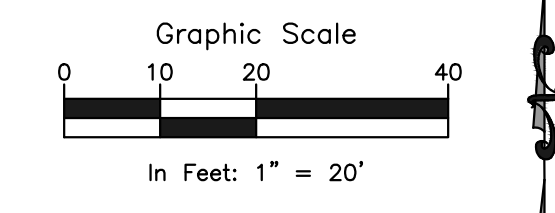

DESIGN POINT	FLOW (CFS)
1	Q ₁₀ = 2.15 Q ₁₀₀ = 6.86

BASIN SUMMARY			
BASIN	Q(10)-CFS	Q(100)-CFS	ACRES(AC)
E-1	2.15	6.86	3.24

ROCKY MOUNTAIN GROUP
 ARCHITECTS
 ENGINEERS
 Geotechnical
 Materials Testing
 Civil Planning
 Architectural
 Structural
 Forensics

RMG
 ENGINEERS

SOUTHERN COLORADO
 2910 AUSTIN BLUFFS PARKWAY, COLORADO SPRINGS, CO 80918
 (719) 586-6600 WWW.ROCKYMOUNTAINENGINEERS.COM
 SURVEYING, ENGINEERING, ARCHITECTURE, PLANNING, ENVIRONMENTAL

NOT FOR CONSTRUCTION
 FOR CIVIL ONLY

NORTHEAST PEMB DEVELOPMENT
 2510 & 2522 CANADA DRIVE
 COLORADO SPRINGS, COLORADO
 LEISURE CONSTRUCTION

These plans are copyrighted 2020 by Geotechnical Engineers Inc. dba RMG - Rocky Mountain Group all rights reserved. Any sale, reproduction, creation of derivative works based on these plans, or use of these plans for any purpose without proper compensation to and the express written consent of RMG, is strictly prohibited.

SHEET NAME	PROJECT STATUS
EXISTING CONDITIONS SUB-BASIN HYDROLOGY	DESIGN DEVELOPMENT

ENG.	DWG.
DRAWN: TPT	
CHECKED: DWG	
DATE	11/11/2022

#	REVISION	DATE

JOB NO.	SHEET NO.
180649	DR-01

LAST SAVED: 11/11/2022 10:38:54 AM PATH: \\local-mc-epc\p\proj\180649\CDM\Drawings\From RMG\Sheet Sub-Basin Analysis\180649-CDM\Drawings\From RMG\Sheet Sub-Basin Analysis.dwg

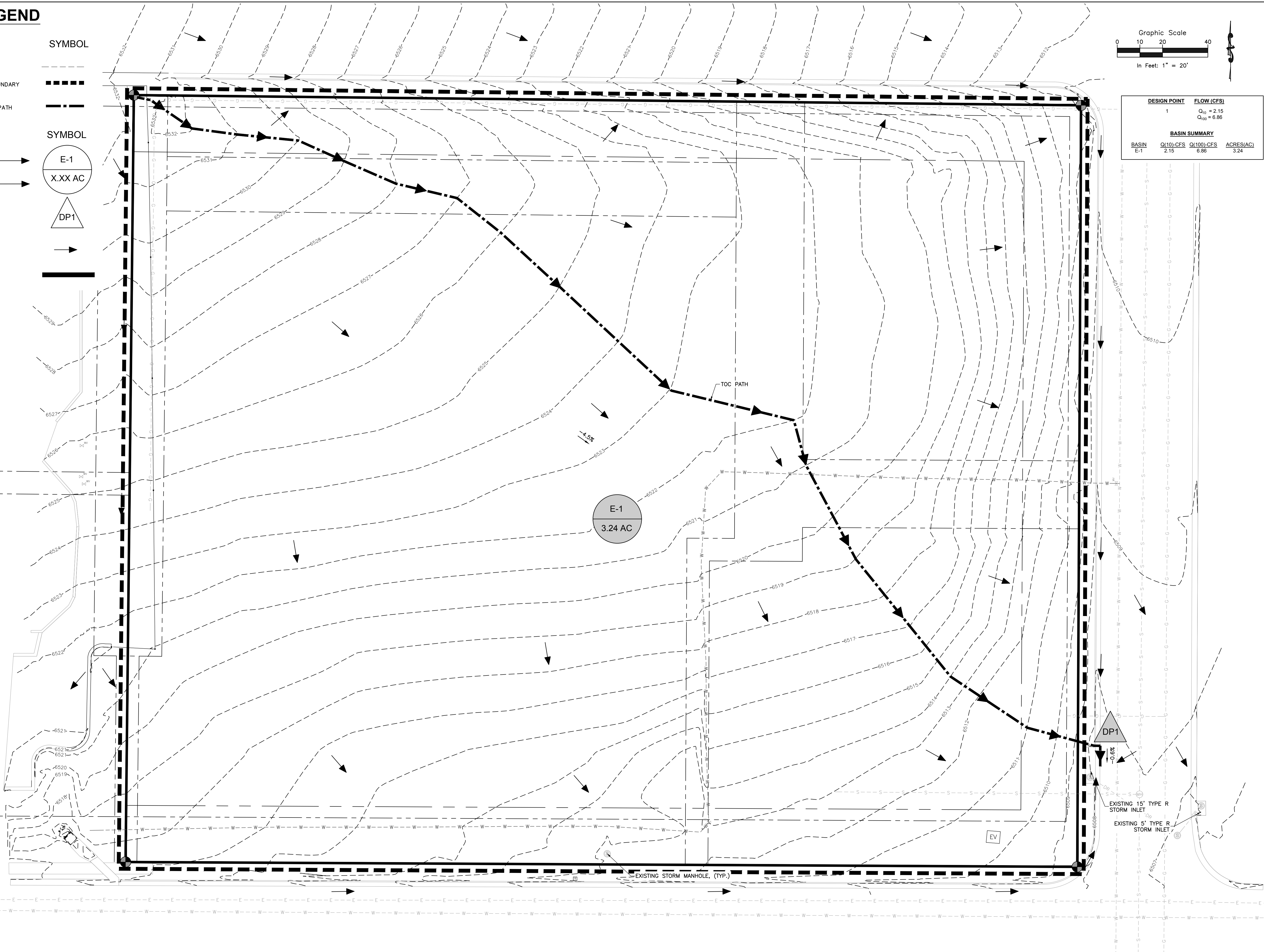

LEGEND

DESCRIPTION	SYMBOL
PROP. STRUCTURE/BUILDING	
TIME OF CONCENTRATION PATH	
EX. CONTOUR	
PROP. CONTOUR	
DRAINAGE SUB-BASIN BOUNDARY	

DESCRIPTION	SYMBOL
BASIN IDENTIFIER	
AREA IN ACRES	
DESIGN POINT ID	
FLOW ARROW	
PROPERTY LINE	

DESIGN POINT	FLOW (CFS)
DP-1	Q ₁₀ = 1.14 Q ₁₀₀ = 1.80
DP-2	Q ₁₀ = 1.86 Q ₁₀₀ = 2.90
DP-3	Q ₁₀ = 1.70 Q ₁₀₀ = 2.63
DP-4	Q ₁₀ = 3.29 Q ₁₀₀ = 5.12
DP-5	Q ₁₀ = 2.69 Q ₁₀₀ = 4.07
DP-6	Q ₁₀ = 1.58 Q ₁₀₀ = 2.42
DP-7	Q ₁₀ = 0.33 Q ₁₀₀ = 0.66
DP-8	Q ₁₀ = 0.17 Q ₁₀₀ = 0.58
DP-9	Q ₁₀ = 1.20 Q ₁₀₀ = 2.54

BASIN SUMMARY			
BASIN	Q(10)-CFS	Q(100)-CFS	ACRES(AC)
D-1	1.14	1.80	0.29
D-2	1.86	2.90	0.45
D-3	1.70	2.63	0.37
D-4	3.29	5.12	0.73
D-5	2.69	4.07	0.50
D-6	1.58	2.42	0.31
D-7	0.33	0.66	0.14
D-8	0.17	0.58	0.21
D-9	1.20	2.54	0.63

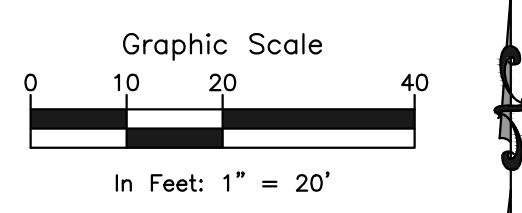
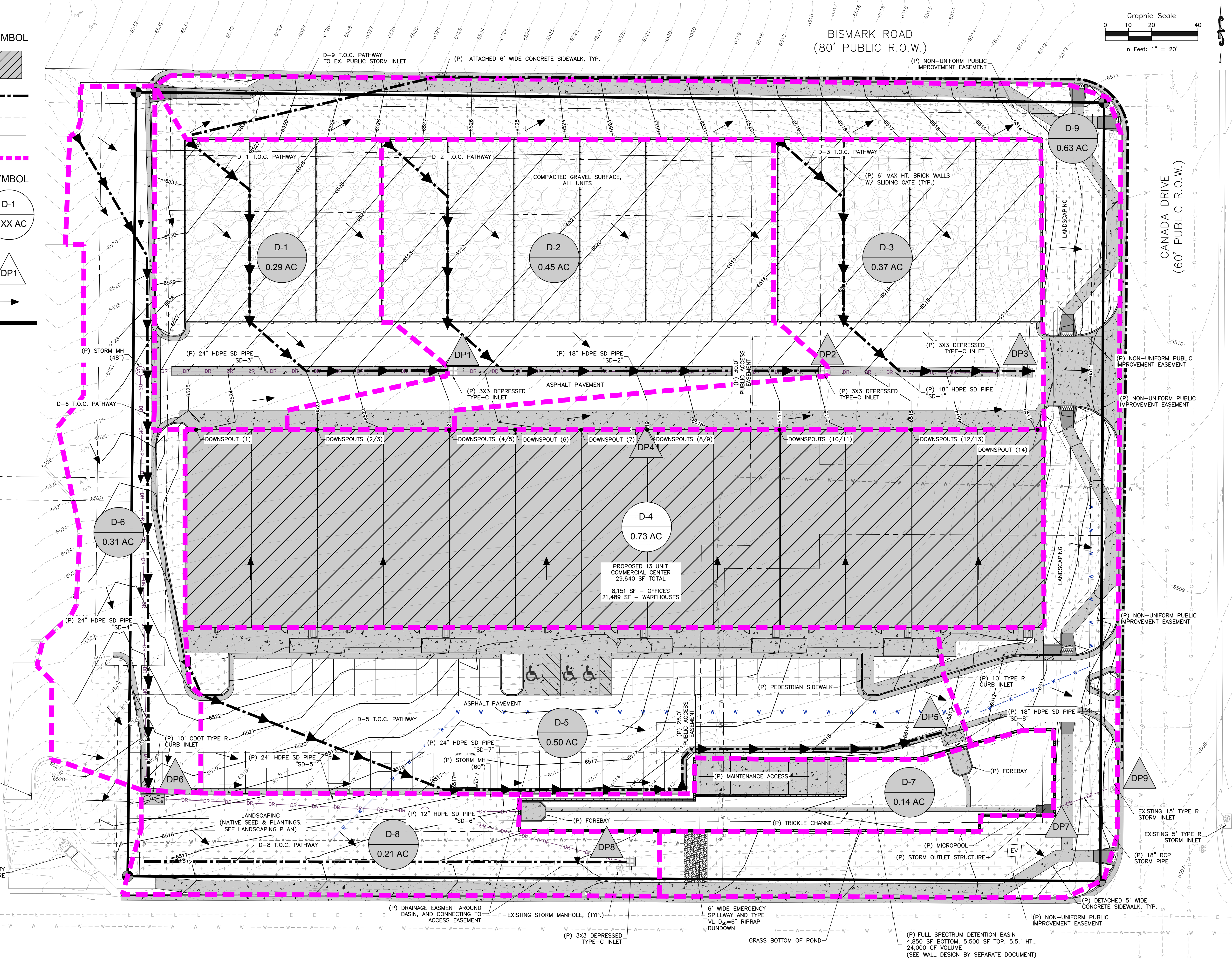

ROCKY MOUNTAIN GROUP
Architectural Structural Forestry
RMG ENGINEERS
SOUTHERN COLORADO
2910 ALBERT BLUFFS PARKWAY, COLORADO SPRINGS, CO 80918
719.536.6600 WWW.ROCKYMOUNTAINENGINEERS.COM
Sustainable Infrastructure. Diverse Applications. Proven Expertise.

NORTHWEST PEMB DEVELOPMENT
2510 & 2522 CANADA DRIVE
COLORADO SPRINGS, COLORADO
LEISURE CONSTRUCTION

DEVELOPED CONDITIONS
SUB-BASINS HYDROLOGY
DESIGN DEVELOPMENT

ENG:	DOV	
DRAWN:	TPT	
CHECKED:	DGW	
DATE:	11/11/2022	
#	REVISION	DATE
JOB NO.:	180649	
SHEET NO.:	DR-02	

LAST SAVED: 11/11/2022 1:18:59 PM PATH: \\local\imp\employees\m\m\m\Projects\2022\180649\Drawings\180649-Sub-Basins\180649-Sub-Basins\Analysis.dwg