

Village at Lorson Ranch Traffic Impact Study

PCD file No.
CS242

Thank you for reviewing our TIS. The PCD file No. has been added to the report.

Prepared for:
El Paso County, CO

Prepared by:



2435 Research Parkway, Suite 300
Colorado Springs, CO 80920

Contact: Scott Barnhart, PE, PTOE

On Behalf of:

The Landhuis Company
212 N. Wahsatch Avenue, Suite 301
Colorado Springs, CO 80903

April 8, 2024

VILLAGE AT LORSON RANCH

TRAFFIC IMPACT STUDY

Prepared for:

El Paso County, CO

Prepared by:



2435 Research Parkway, Suite 300
Colorado Springs, CO 80920

Contact: Scott Barnhart, PE, PTOE
719.575.0100

On Behalf of:

The Landhuis Company
212 N. Wahsatch Avenue Suite 301
Colorado Springs, CO 80903

Traffic Engineer's Statement

The attached traffic report and supporting information were prepared under my responsible charge and they comply with the standard of care. So far as is consistent with the standard of care, said report was prepared in general performance with the criteria established by the County for traffic reports.

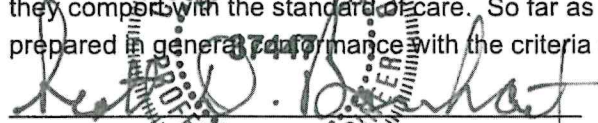

Scott D. Barnhart, P.E. #37447

4/10/2024

Date

Developer's Statement

I, the Developer, have read and will comply with all commitments made on my behalf within this report.

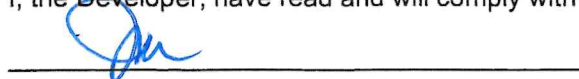

Jeff Mark, President

4/10/24

Date

Table of Contents

Introduction	1
Area Conditions	2
Proposed Development.....	3
Crash History.....	10
Projected Development Traffic.....	12
Trip Generation	12
Trip Distribution	13
Traffic Analysis	18
Buildout (2030) Background Conditions.....	18
Buildout (2030) Total Conditions.....	29
Horizon (2045) Background Conditions.....	35
Horizon (2045) Total Conditions.....	40
Conclusions and Recommendations.....	47

Appendices

- Appendix A – Traffic Counts
- Appendix B – Existing Conditions Analyses
- Appendix C – Trip Generation
- Appendix D – Buildout Year (2030) Conditions Analyses
- Appendix E – Horizon Year (2045) Conditions Analyses
- Appendix F – Supporting Documents

List of Figures

Figure 1.	Vicinity Map	3
Figure 2.	Village at Lorson Ranch Site Plan	4
Figure 3.	Existing Conditions Traffic Volumes (AM Peak Hour)	5
Figure 4.	Existing Conditions Traffic Volumes (PM Peak Hour)	6
Figure 5.	Existing Conditions Daily Traffic Volumes	7
Figure 6.	Existing Conditions Intersection Configurations and LOS.....	8
Figure 7.	Fatality Crash Map	11
Figure 8.	Serious Injury Crash Map	11
Figure 9.	Trip Distribution.....	13
Figure 10.	Roadway Classification	14
Figure 11.	Village at Lorson Ranch Site Trips (AM Peak Hour)	15
Figure 12.	Village at Lorson Ranch Site Trips (PM Peak Hour).....	16
Figure 13.	Village at Lorson Ranch Daily Site Trips	17
Figure 14.	Buildout (2030) Background Traffic Volumes (AM Peak Hour)	19
Figure 15.	Buildout (2030) Background Traffic Volumes (PM Peak Hour)	20
Figure 16.	Buildout (2030) Background Daily Traffic Volumes and Roadway Classification	21
Figure 17.	Buildout (2030) Background Intersection Configuration and LOS	22
Figure 18.	Mitigated - Buildout (2030) Background Traffic Volumes (AM Peak Hour)	24
Figure 19.	Mitigated - Buildout (2030) Background Traffic Volumes (PM Peak Hour)	25
Figure 20.	Mitigated - Buildout (2030) Background Intersection Configuration and LOS	26
Figure 21.	Buildout (2030) Total Traffic Volumes (AM Peak Hour)	29
Figure 22.	Buildout (2030) Total Traffic Volumes (PM Peak Hour)	30
Figure 23.	Buildout (2030) Total Traffic Volumes and Roadway Classification.....	31
Figure 24.	Buildout (2030) Total Intersection Configuration and LOS	32
Figure 25.	Horizon (2045) Background Traffic Volumes (AM Peak Hour)	35
Figure 26.	Horizon (2045) Background Traffic Volumes (PM Peak Hour).....	36
Figure 27.	Horizon (2045) Background Daily Volume and Roadway Classification	37
Figure 28.	Horizon (2045) Background Intersection Configuration and LOS	38
Figure 29.	Horizon (2045) Total Traffic Volumes (AM Peak Hour)	41
Figure 30.	Horizon (2045) Total Traffic Volumes (PM Peak Hour)	42
Figure 31.	Horizon (2045) Total Daily Volume and Roadway Classification	43
Figure 32.	Horizon (2045) Total Intersection Configuration and LOS	44

List of Tables

Table 1.	Existing Conditions Intersection Operations (AM Peak Hour)	9
Table 2.	Existing Conditions Intersection Operations (PM Peak Hour).....	9
Table 3.	Existing Conditions Turn Lane Evaluations	10
Table 4.	Village at Lorson Ranch Trip Generation	12
Table 5.	Buildout (2030) Background Intersection Operations (AM Peak Hour)	23
Table 6.	Buildout (2030) Background Intersection Operations (PM Peak Hour).....	23
Table 7.	Mitigated - Buildout (2030) Background Intersection Operations (AM Peak Hour)	27
Table 8.	Mitigated - Buildout (2030) Background Intersection Operations (PM Peak Hour).....	27
Table 9.	Buildout (2030) Background Turn Lane Evaluations	28
Table 10.	Buildout (2030) Total Intersection Operations (AM Peak Hour)	33
Table 11.	Buildout (2030) Total Intersection Operations (PM Peak Hour)	33
Table 12.	Buildout (2030) Total Turn Lane Evaluations	34
Table 13.	Horizon (2045) Background Intersection Operations (AM Peak Hour)	39
Table 14.	Horizon (2045) Background Intersection Operations (PM Peak Hour).....	39
Table 15.	Horizon (2045) Background Turn Lane Evaluations	40
Table 16.	Horizon (2045) Total Intersection Operations (AM Peak Hour)	45
Table 17.	Horizon (2045) Total Intersection Operations (PM Peak Hour).....	45
Table 18.	Horizon (2045) Total Turn Lane Evaluations	46
Table 19.	Village at Lorson Ranch Fair Share Calculations	48
Table 20.	Road Impact Fee Schedule	49
Table 21.	Summary of Required Improvements.....	50

Introduction

The Village at Lorson Ranch project (project) is an 9.725 -acre development located at the northeast corner of Marksheffel Road/Fontaine Boulevard in El Paso County. The project consists of a gas station/convenience store, three fast food restaurants, a daycare facility, and a storage facility.

The project is bounded on the east by Carriage Meadows Drive, on the west by Marksheffel Road, and on the south by Fontaine Boulevard. Three access points are designated for the project. One full movement access point located on Carriage Meadows Drive, a Right-IN (RI) only access on Fontaine Boulevard and a Right-In-Right-Out (RIRO) access on Marksheffel Road.

The purpose of this traffic impact study is to assess the effects this proposed development will have on the surrounding transportation system.

The report is organized as follows:

- **Introduction** – Describes the purpose and intent of this study.
- **Area Conditions** – Describes the study area land uses as well as the existing and future roadway network.
- **Proposed Development** – Describes the proposed development and the location.
- **Projected Traffic** – Identifies the expected number of daily trips that will be generated by the Village at Lorson Ranch development. The expected external trip distribution is also shown.
- **Traffic Analysis** – Analyzes the existing conditions in the study area as well as buildout year (2030) and horizon year (2045) conditions both with and without the project.
- **Findings and Conclusions** – Identifies any deficiencies in the study area roadway network with or without the project and mitigation measures that will alleviate any identified deficiencies.
- **Recommendations** – Provides a summary of the study findings.

Please include a discussion of the deviation request that has been made with the County as part of SF248.

A discussion has been added to the report explaining the requested deviation.

Area Conditions

This section describes the existing conditions and the planned level of improvements adjacent to the Village at Lorson Ranch development.

Site Accessibility

The existing roadway system consists of the following transportation facilities:

Marksheffel Road is a north-south transportation facility and is a three-lane facility. This roadway is classified as a 4-lane Expressway in the El Paso County 2040 Major Transportation Corridor Plan (MTCP). The daily traffic capacity is 48,000 ADT. Marksheffel Road provides a paved shoulder to accommodate cyclists. The City of Colorado Springs Major Throughfare Plan classifies this road as a principal arterial with a daily traffic capacity of up to 25,000 ADT for a 4-lane Principal Arterial or 60,000 ADT for a 6-lane Principal Arterial. The City of Colorado Springs has recently taken over the ownership and maintenance of this roadway.

Fontaine Boulevard is an east-west facility classified as a 4-lane Principal Arterial in the 2040 MTCP. The daily traffic capacity is 40,000 ADT. Fontaine Boulevard is currently providing 2 lanes in each direction and a paved shoulder to accommodate cyclists. The City of Colorado Springs also classified this road as a principal arterial.

Carriage Meadows Drive is a north-south local street. This facility provides one lane in each direction. Sidewalk, curb, and gutter are provided on both sides of the road. The posted speed limit is 25 mph and ADT threshold capacity is 3,000 vehicles. As a local road, it does not appear on the County's 2040 MTCP or 2060 Corridor Preservation Plan.

The study area is rapidly growing, and multiple large-scale developments are planning to be built in the future in the vicinity of the project. Specifically, Rolling Meadows/Bull Hill, Bradley Heights, Hillside at Lorson Ranch, and Corvallis. In this memo, Matrix used the *Hillside at Lorson Ranch TIS* (June 30, 2022) for the future background volumes except for the through volumes on Marksheffel Road in the buildout year. For this purpose, collected counts and an appropriate growth factor was used to represent a realistic future condition. Traffic counts were collected on March 12, 2024, to analyze the existing and future conditions. Existing counts can be found in Appendix A – Existing Conditions Analysis. Excerpts of the *Hillside at Lorson Ranch TIS* can be found in Appendix F – Supporting Documents.

Intersection analysis for the existing conditions were confined to the intersections listed below

- Marksheffel Road/Fontaine Boulevard
- Marksheffel Road/Lorson Boulevard
- Fontaine Boulevard/Carriage Meadows Drive

The vicinity map is shown in Figure 1. Site plan is shown in Figure 2. The AM and PM peak hour volumes at the studied intersections are shown in Figure 3 and Figure 4 and the daily traffic volumes in the existing conditions are shown in Figure 5

Please include a discussion of any impacts on neighborhood schools

Discussion added.

Figure 1. Vicinity Map

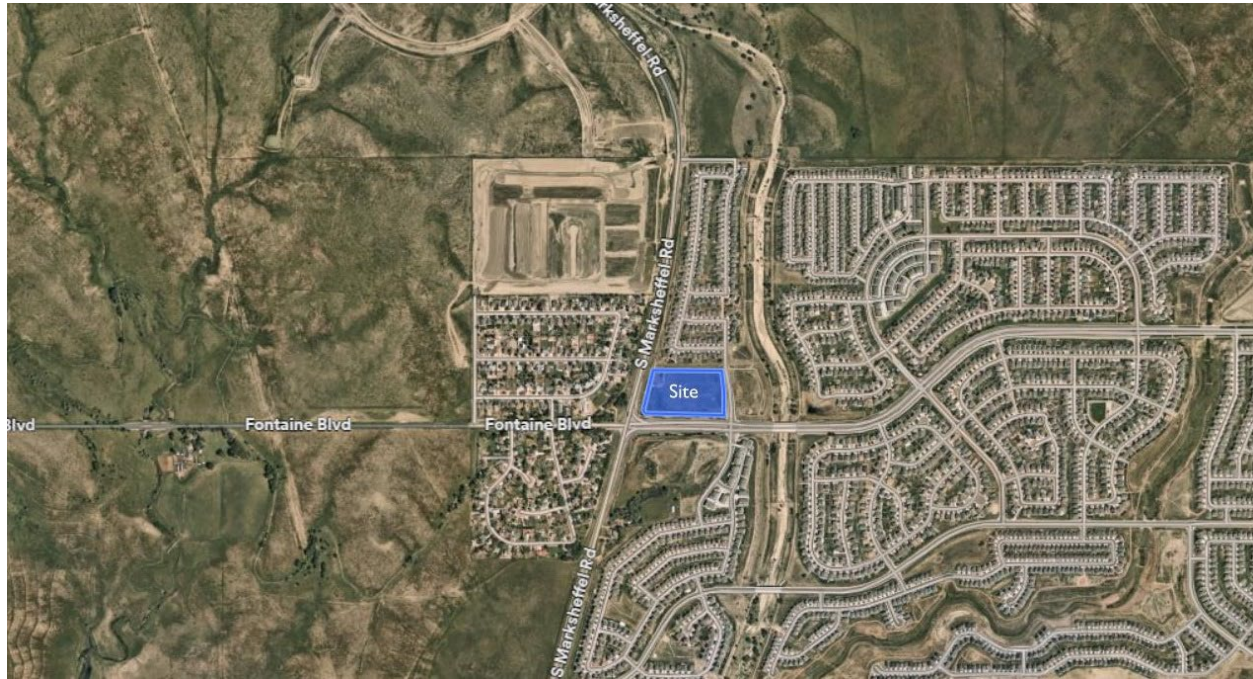

Proposed Development

The Project will consist of a gas station/convenience store, three fast food restaurants, a day care and a storage facility. Figure 2 illustrates the Project site plan.

Figure 2. Village at Lorson Ranch Site Plan

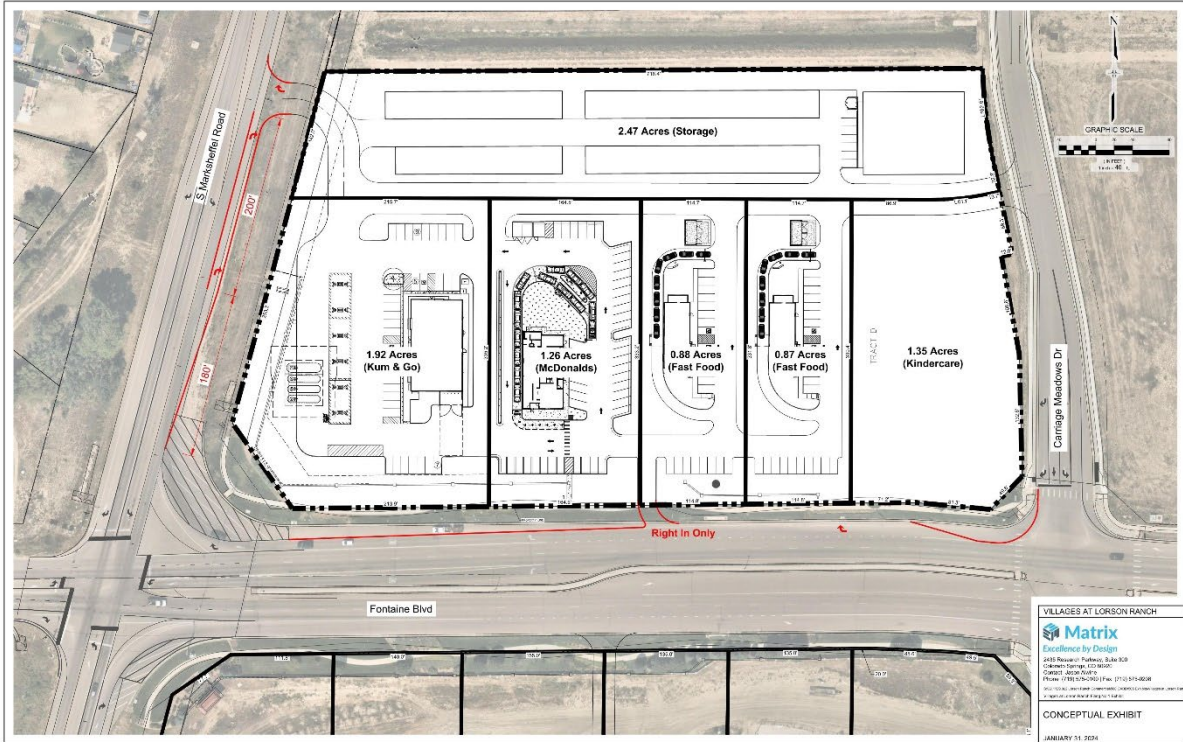

Figure 3. Existing Conditions Traffic Volumes (AM Peak Hour)

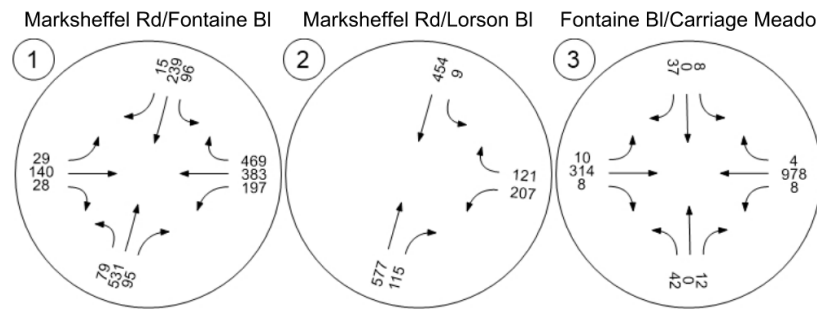
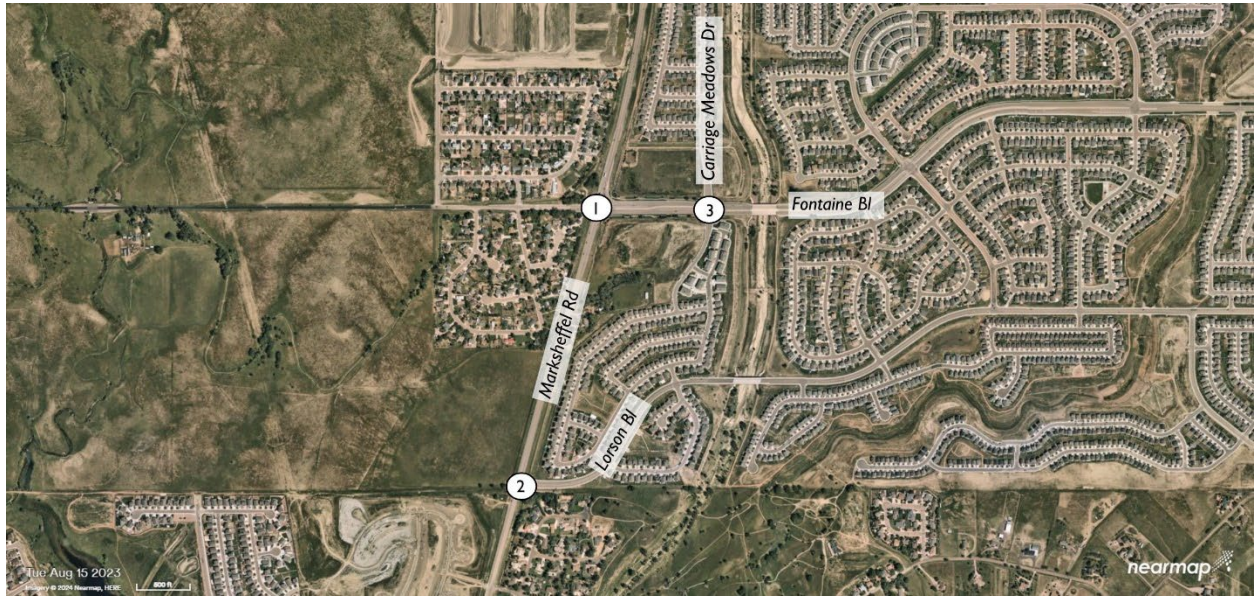
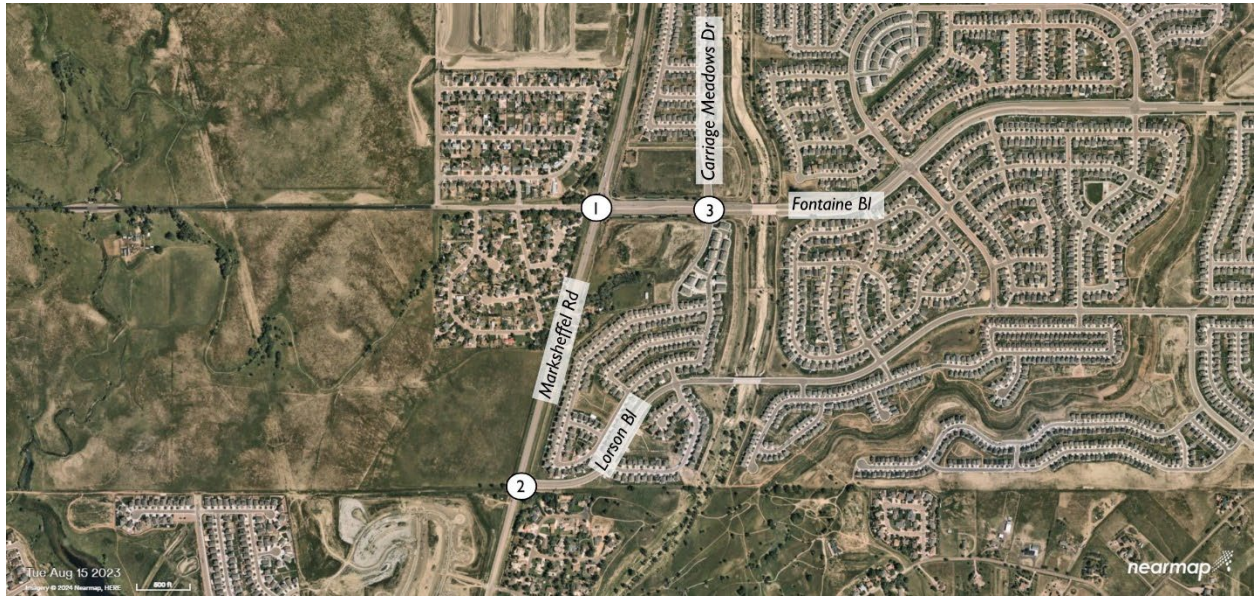
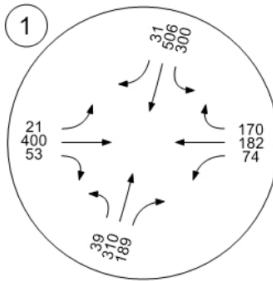

Figure 4. Existing Conditions Traffic Volumes (PM Peak Hour)



Marksheffel Rd/Fontaine Bl



Marksheffel Rd/Lorson Bl

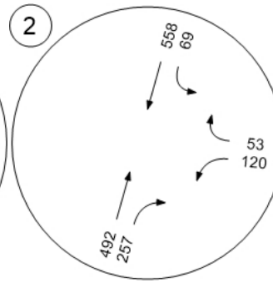

Fontaine Bl/Carriage Meado

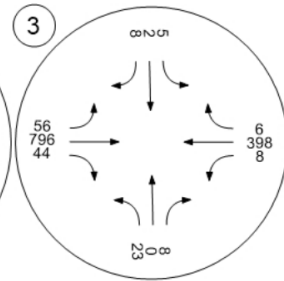
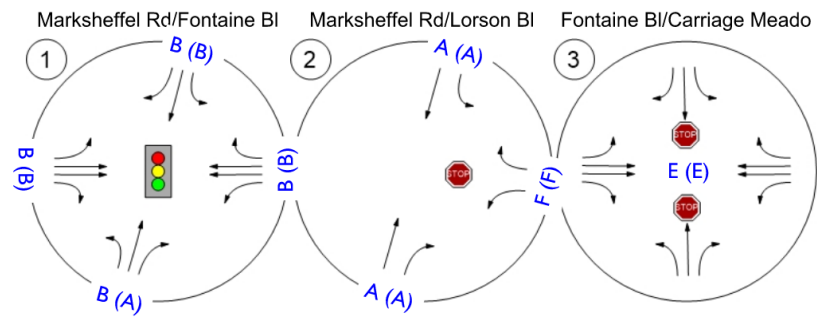
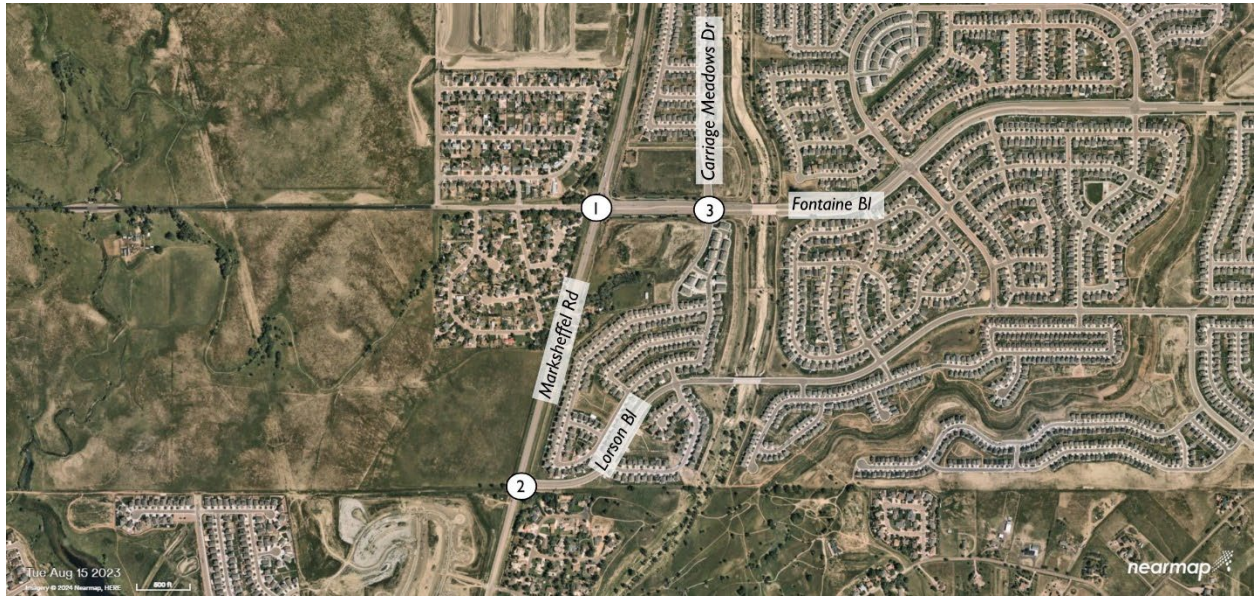

Figure 5. Existing Conditions Daily Traffic Volumes



The existing intersection configurations are shown in Figure 6.

Figure 6. Existing Conditions Intersection Configurations and LOS



Intersection LOS analysis was performed for the study area intersections and the results are shown in Table 1 and Table 2. The intersections along Marksheffel Road were studied based on the City of Colorado Springs Traffic Criteria Manual (TCM), and the remaining intersection was studied based on the El Paso County Engineering Criteria Manual (ECM).

Table 1. Existing Conditions Intersection Operations (AM Peak Hour)

Intersection Analysis Summary							
ID	Intersection Name	Control Type	Method	Worst Mvmt	V/C	Delay (s/veh)	LOS
1	Marksheffel Rd/Fontaine Bl	Signalized	HCM 7th Edition	WB Left	0.521	14.4	B
2	Marksheffel Rd/Lorson Bl	Two-way stop	HCM 7th Edition	WB Left	1.247	195.0	F
3	Fontaine Bl/Carriage Meadows Dr	Two-way stop	HCM 7th Edition	SB Left	0.095	42.7	E

V/C, Delay, LOS: For two-way stop, these values are taken from the movement with the worst (highest) delay value. For all other control types, they are taken for the whole intersection.

Table 2. Existing Conditions Intersection Operations (PM Peak Hour)

Intersection Analysis Summary							
ID	Intersection Name	Control Type	Method	Worst Mvmt	V/C	Delay (s/veh)	LOS
1	Marksheffel Rd/Fontaine Bl	Signalized	HCM 7th Edition	WB Left	0.458	13.1	B
2	Marksheffel Rd/Lorson Bl	Two-way stop	HCM 7th Edition	WB Left	0.859	92.7	F
3	Fontaine Bl/Carriage Meadows Dr	Two-way stop	HCM 7th Edition	NB Left	0.239	46.7	E

V/C, Delay, LOS: For two-way stop, these values are taken from the movement with the worst (highest) delay value. For all other control types, they are taken for the whole intersection.

Table 1 and Table 2 indicate two intersections operate below the acceptable LOS. Acceptable operations per the El Paso County ECM are defined as any intersection that operates at LOS D or better. The City of Colorado Springs TCM requires all intersection approaches operate at LOS D or better.

The intersection of Marksheffel Road/Lorson Boulevard (#2) operates at LOS F during both AM and PM peak hours. The City of Colorado Springs currently plans to install a traffic signal at this intersection. By changing the traffic control type, this intersection will operate at LOS B in both AM and PM peak. All approaches will also operate at LOS B. The intersection operations after changing the control type to signalized is labeled as “Mitigated” in Appendix B – Existing Conditions Analyses.

In addition, Fontaine Boulevard/Carriage Meadows (#3) operates at LOS E in both peak hours. This is due to the deficient southbound left-turn movement in AM peak, and the deficient northbound left-turn movement in the PM peak hour. Both movements’ LOS are at LOS E in the existing conditions. However,

the 95-percentile queue length is less than 1.42 vehicles at any time. As a result, Matrix does not recommend any mitigations for this intersection in the existing conditions.

Turn lane evaluations were done based on the City of Colorado Springs (CCS) TCM and El Paso County (EPC) ECM and results are summarized in Table 3, below.

Table 3. Existing Conditions Turn Lane Evaluations

ID	Intersection	Control Type	Movement	Speed (mph)	Turning Volume	Queue (ft)	Agency	Deceleration (ft)	Taper (ft)	Storage (ft)	Total (ft)	Provided (ft)	Improvement (ft)
1	Marksheffel Rd/Fontaine Bl	Signalized	NBL	55	79	27	CCS	263	220		485	740	
			NBR	55	189	0		263	220		485	740	
			SBL	55	300	126		263	220		485	665	
			SBR	55	31	2		263	220		485	665	
			EBL	35	29	18		120	140		260	330	
			EBR	35	53	11		120	140		260	50	210
			WBL	45	197	121		200	180		380	545	
			WBR	45	469	122		200	180		380	Continuous	
2	Marksheffel Rd/Lorson Bl	Signalized	NBR	55	257	80	CCS	263	220		485	565	
			SBL	55	69	41		263	220		485	Continuous	
			WBLT	35	207	128		120	140		260	485	
			WBRT	35	121	69		120	140		260	Continuous	
3	Fontaine Bl/Carriage Meadows Dr	Stop-Controlled	NBL	25	23	35	EPC	Not Required			190		
			NBR	25	8	2		Not Required			180		
			SBL	25	5	8		Not Required			100		
			SBR	25	8	8		Not Required			100		
			EBL	45	56	5		235	200	50	485	500	
			EBR	45	44	0		235	200		435	Continuous	
			WBL	45	8	1		Not Required			510		
			WBR	45	6	0		Not Required			330		

Marksheffel Road/Fontaine Boulevard (#1)

- A 210-ft extension of eastbound right-turn.

Marksheffel Road/Lorson Boulevard (#2)

- A traffic signal.

Crash History

The El Paso County Road Safety Plan website was used to obtain the number of fatal and severe crashes in the vicinity of the project. Crash data from the year 2015 to 2019 were collected and shown as a density map on the website. As shown in Figure 7 and Figure 8, two fatal crashes occurred near the project at two locations, while one serious injury crash was reported. The project will help to improve safety by contributing to installation of a traffic signal and reducing the probability of conflicting movements at the intersection of Carriage Meadows/Fontaine Boulevard.

Figure 7. Fatality Crash Map

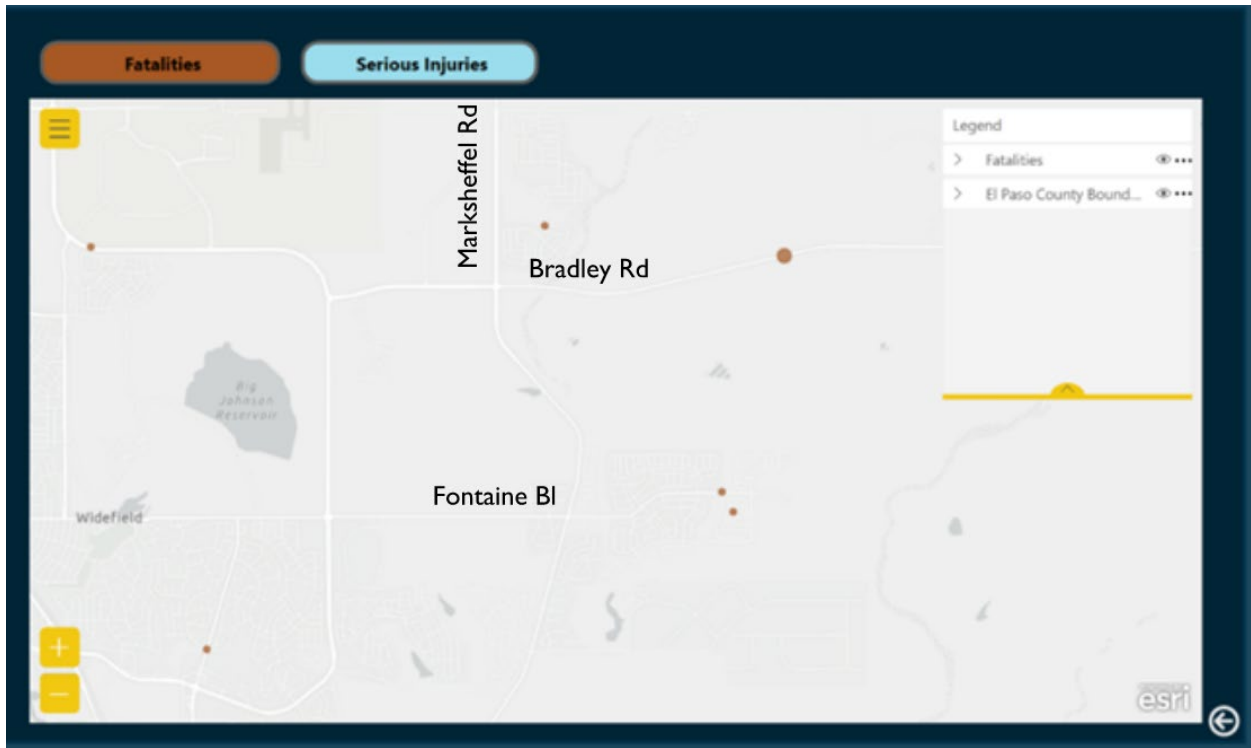
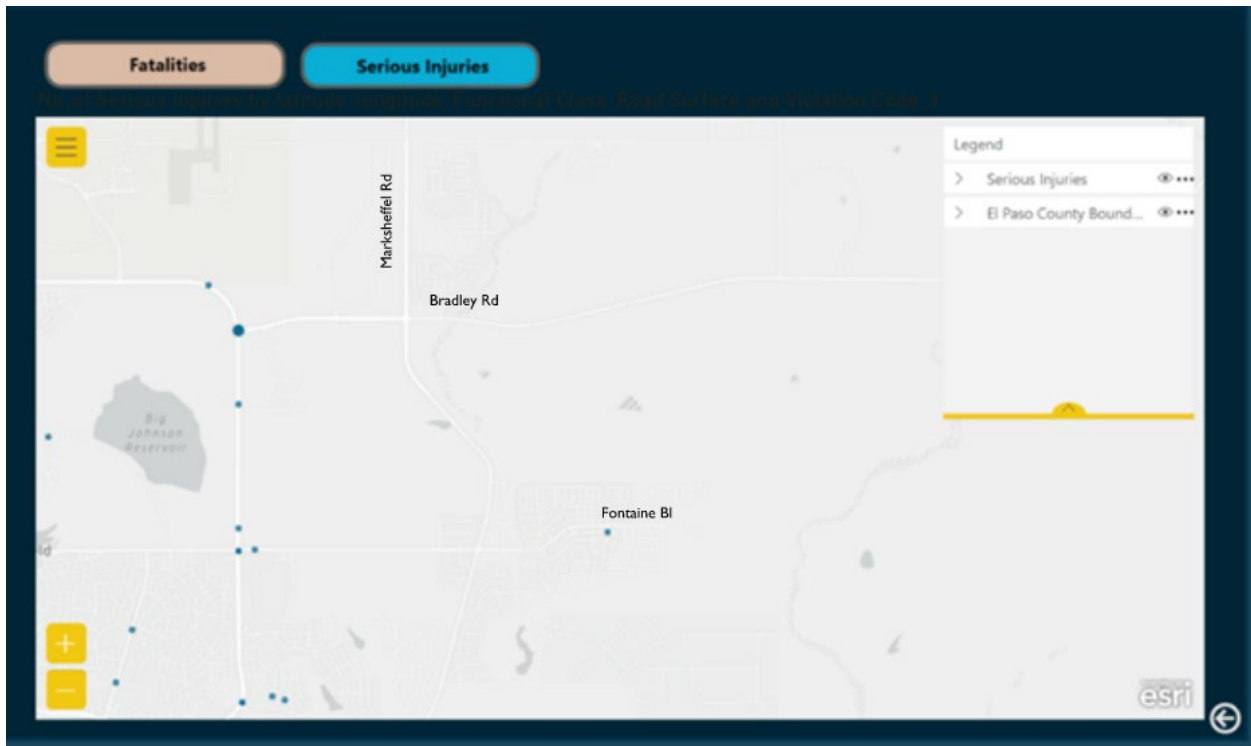

Figure 8. Serious Injury Crash Map



Projected Development Traffic

This section documents how much traffic the project development is expected to generate and how the external site trips will be distributed on the adjacent roadway network.

Trip Generation

The vehicle trips associated with the project were calculated using the Institute of Transportation Engineers (ITE) *Trip Generation Manual, 11th Edition*. This methodology consists of choosing an independent variable for the land use for a particular time of day. The independent variable correlates to the variation in trip ends and is related to the land use. The value of the independent variable is either multiplied by a weighted average or used in a regression equation to calculate the trips generated by the land use. The *ITE Trip Generation Manual* provides guidance on when to use the weighted average versus the regression equation.

Table 4 shows the trips that are expected to be generated by Village at Lorson Ranch at buildout. It was assumed that 100% of trips will be made by personal vehicles and no public transit use was assumed for this development as there is no transit service in the area.

In addition to the report, Mead will be the bu Also, it corner develo and th – Site Suppo

The average trip rates have been added to the report. Please note that trip reduction was performed for the AM and PM peak hour (only for the north area). Please see Appendix C - Trip Generation for more information.

...ch, trips from two future adjacent developments were included in this land located at the northeast corner of Fontaine Boulevard/Carriage at 50 dwelling units of single family attached housings (townhomes) 0 (buildout year) at this location. The townhomes traffic is included in

Ranch Commercial South (LRCS) will be constructed at the southeast ne Boulevard by the year 2045 (horizon year). The traffic from this zon background scenario was assumed that the LRCS will be retail io (FAR) that is planned for the Village at Lorson Ranch (see Figure 2 the LRCS. A land use plan for the LRCS can be found in Appendix F –

Please include the trip generation rate from the ITE in the table

Table 4. Village at Lorson Ranch Trip Generation

ITE - Code and Land Use	Size	Units	Weekday			AM Peak Hour			PM Peak Hour		
			Total	Entering	Exiting	Total	Entering	Exiting	Total	Entering	Exiting
The Project : Village at Lorson Ranch											
934 - Fast Food Restaurant With Drive Through Window	8.17	KSF	3820	1910	1910	186	95	91	135	70	65
945 - Convenience Store/Gas Station VFP (9-15)	5.68	KSF	3734	1867	1867	120	60	60	106	53	53
565 - Day Care Center	12	KSF	572	286	286	132	70	62	134	63	71
151 - Mini Warehouse	36.5	KSF	52	26	26	3	2	1	6	3	3
Total			8178	4089	4089	441	227	214	381	189	192
Townhomes (Included in Buildout 2030 Scenarios)											
215 - Single Family Attached Housing	50	DU	331	165	166	20	5	15	26	15	11
Lorson Ranch Commercial South (Included in 2045 Scenarios)											
821 - Shopping Plaza (40-150 K)	81.54	KSF	5506	2753	2753	141	87	54	423	207	216

Trip Distribution

Figure 9 illustrates the expected external distribution of travel for the site-generated trips. This distribution was determined by reviewing current traffic volumes and trip distributions of surrounding developments.

Figure 9. Trip Distribution

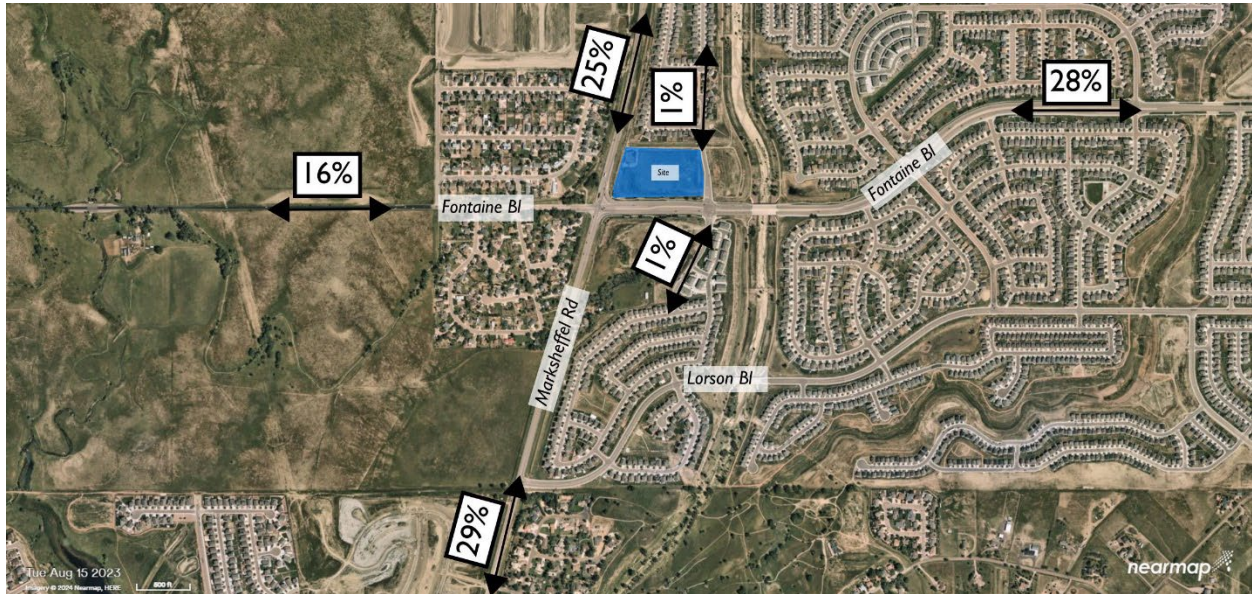

Roadways adjacent to the new development were classified based on the 2040 Major Transportation Corridor Plan (EPC), or the City of Colorado Springs Major Throughfare Plan (CCS) for the existing conditions and are shown in Figure 10. For the future conditions, Matrix classified the transportation network based on the estimated ADT.

Figure 10. Roadway Classification

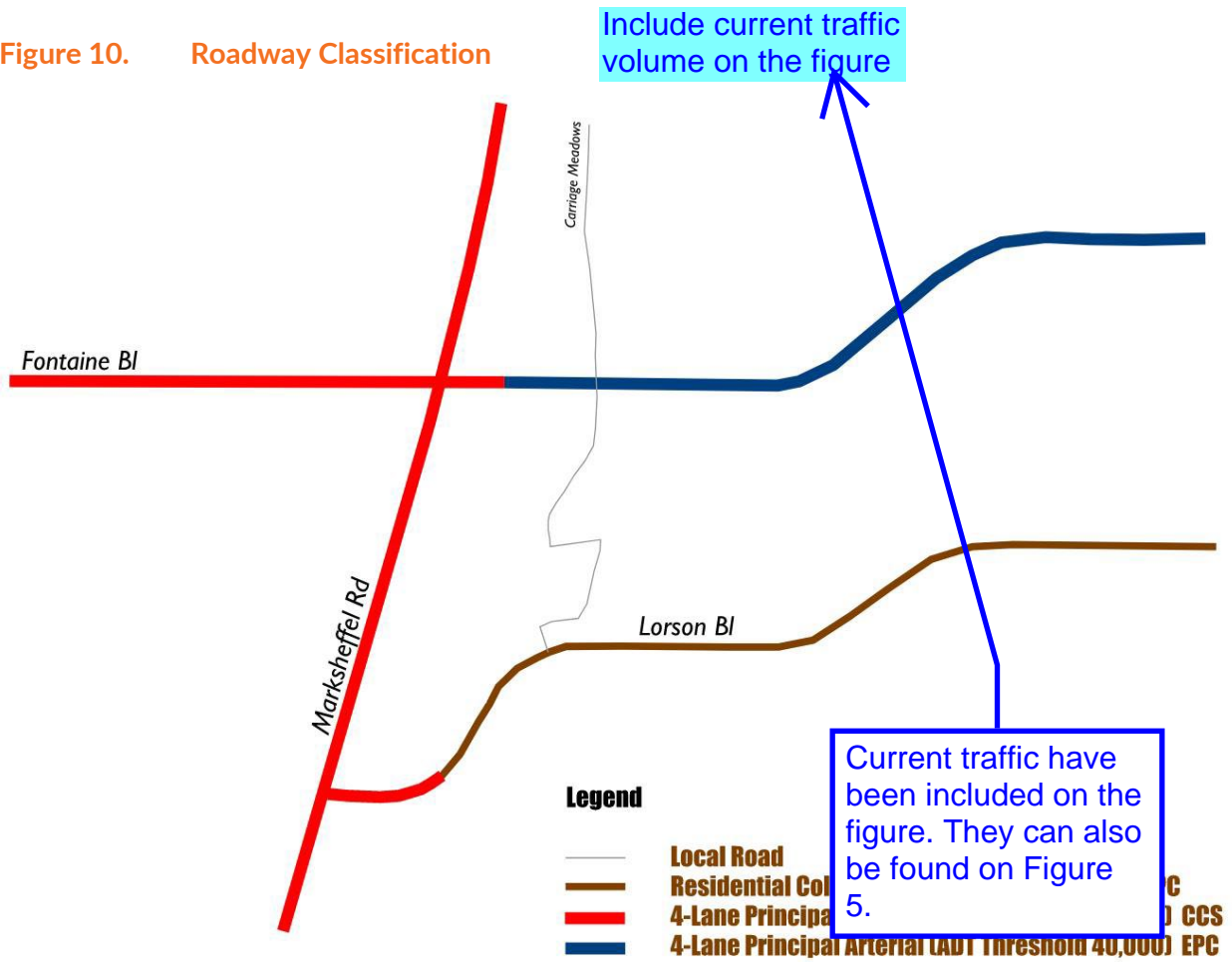

The project trips in AM and PM peak hours are shown in Figure 11 and Figure 12 . The daily site trips are shown in Figure 13.

Figure 11. Village at Lorson Ranch Site Trips (AM Peak Hour)

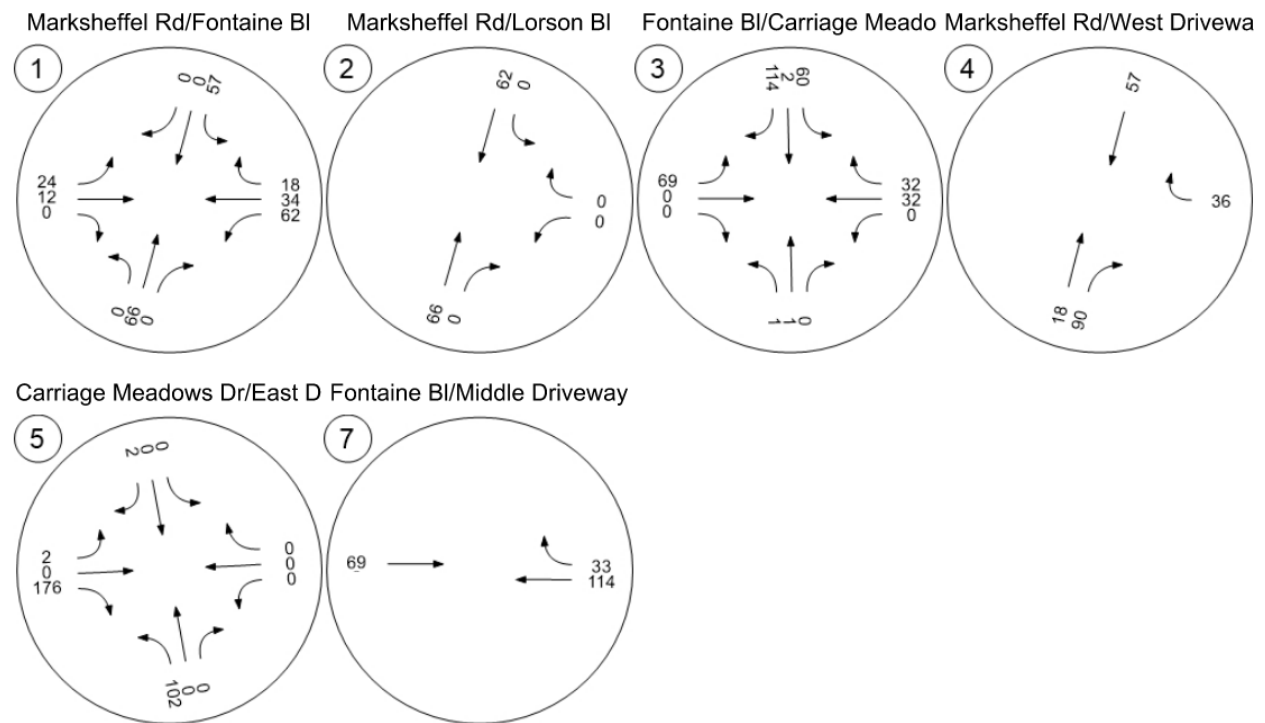
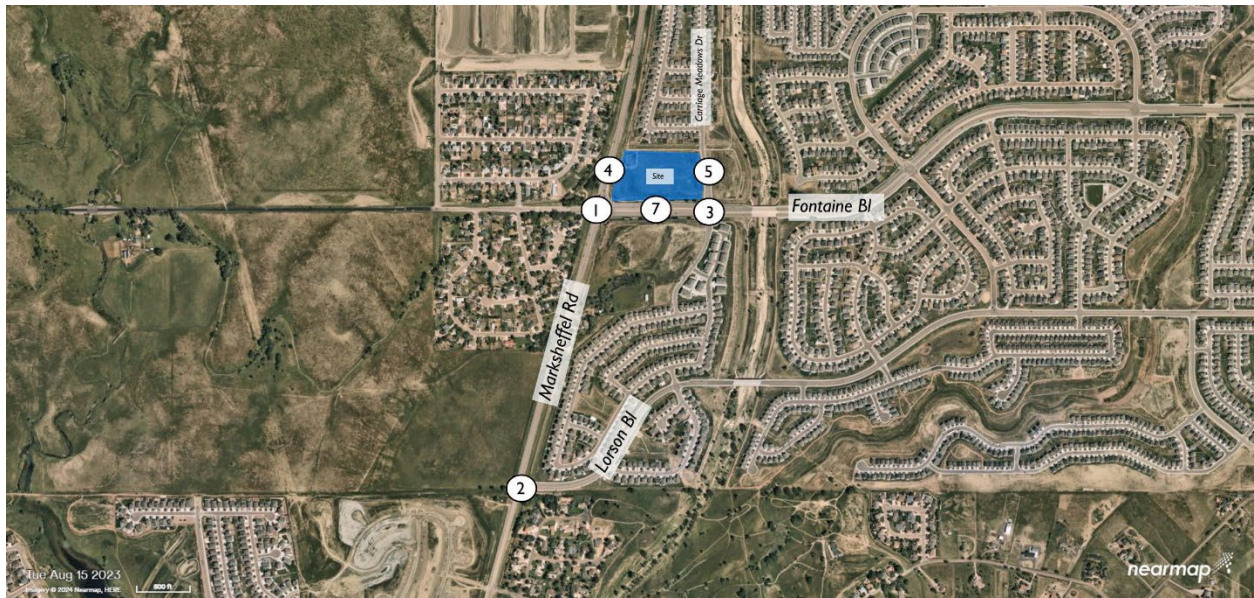
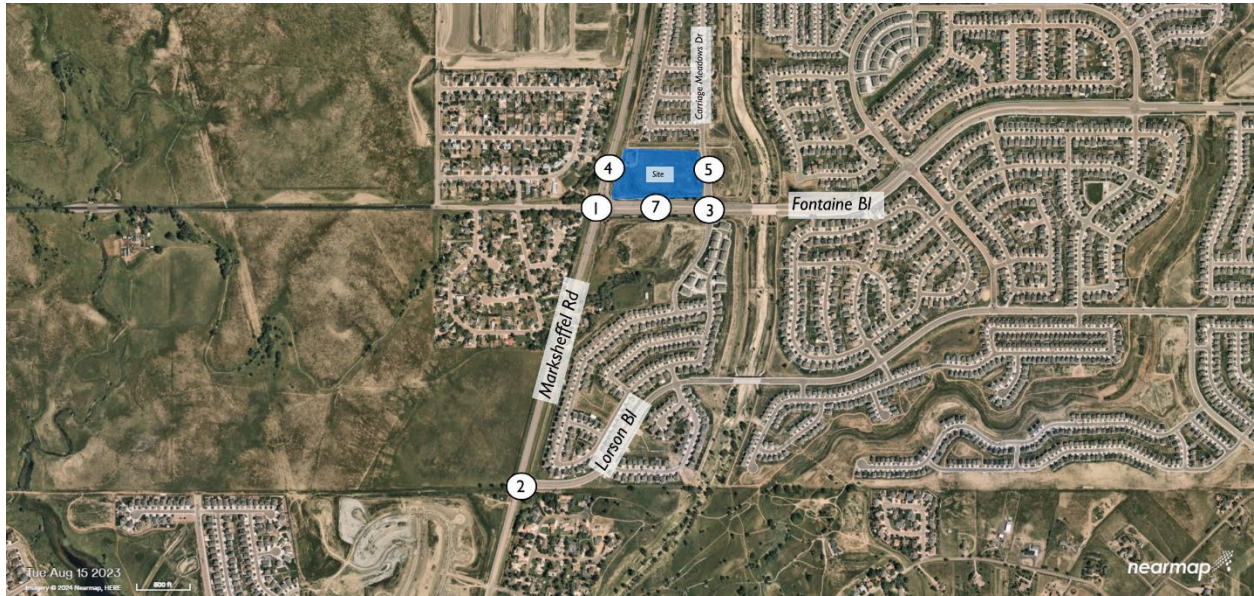
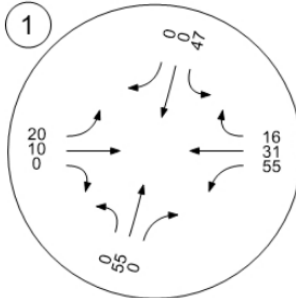

Figure 12. Village at Lorson Ranch Site Trips (PM Peak Hour)



Marksheffel Rd/Fontaine Bl



Marksheffel Rd/Lorson Bl

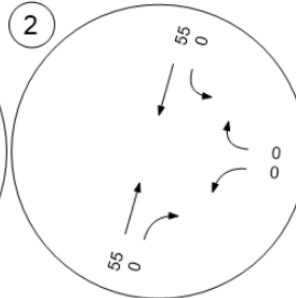

Fontaine Bl/Carriage Meado

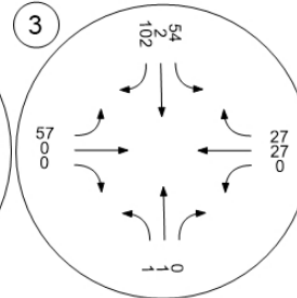

Marksheffel Rd/West Drivewa

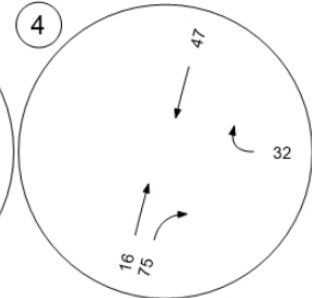

Carriage Meadows Dr/East D Fontaine Bl/Middle Driveway

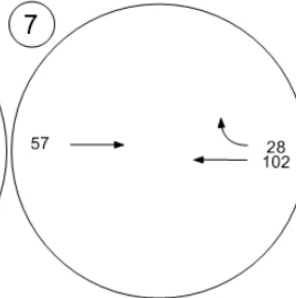
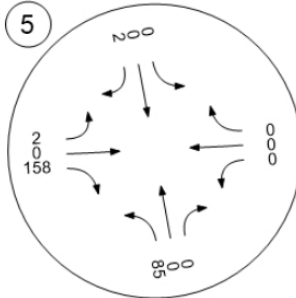
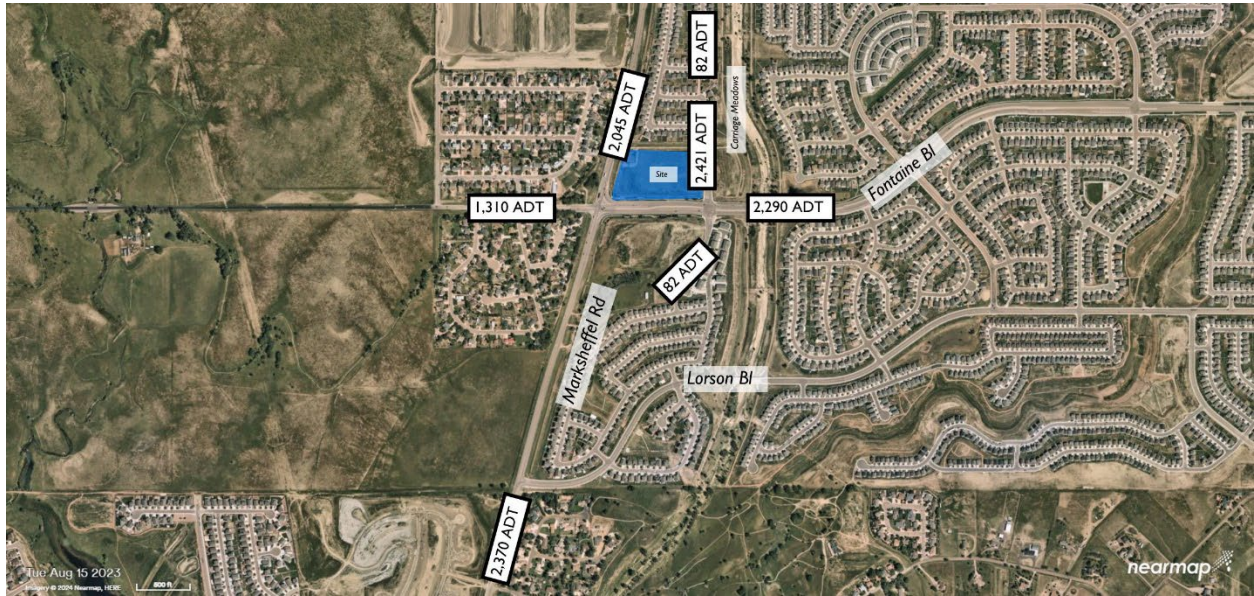

Figure 13. Village at Lorson Ranch Daily Site Trips



Traffic Analysis

Traffic conditions without the project for the buildout year (2030) and horizon year (2045) conditions were studied in this report and the results are documented as follows.

Buildout (2030) Background Conditions

The buildout year traffic volumes without the project are shown in Figure 14, and Figure 15 for the AM and PM peak hours, respectively. The daily traffic volumes and roadway classifications are shown in Figure 16.

The background traffic was derived from the *Hillside at Lorson Ranch* TIS (2022) with one exception. The through traffic on Marksheffel Road seemed underestimated in the TIS. As a result, we compared two collected counts, one collected in 2021 and one collected in 2024 at Marksheffel Road south of Fontaine Boulevard to obtain the annual growth rate at this segment. This segment experiences a 2.59% annual growth according to our collected counts. Therefore, the growth factor for the year 2030 and the year 2045 were equal to 1.166 and 1.712, respectively. The previous (2021) data collection on Marksheffel Road can be found in Appendix F – Supporting Documents.

Finally, the traffic from the townhomes at the northeast corner of Fontaine Boulevard/Carriage Meadows were added to the 2030 background conditions.

Figure 14. Buildout (2030) Background Traffic Volumes (AM Peak Hour)

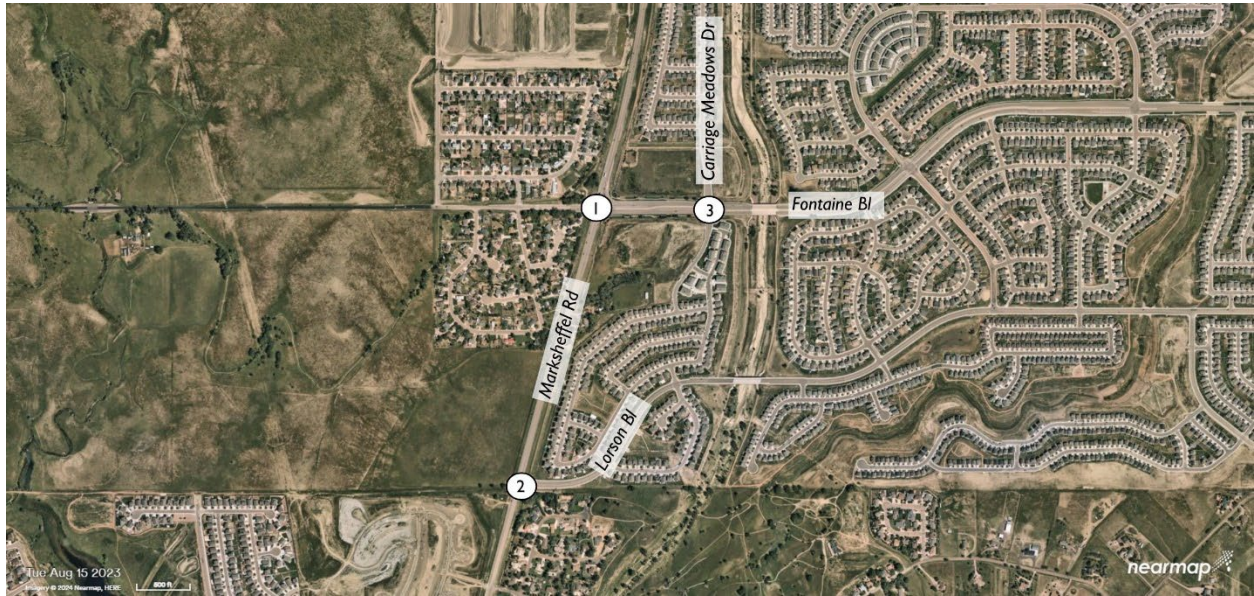

Marksheffel Rd/Fontaine Bl

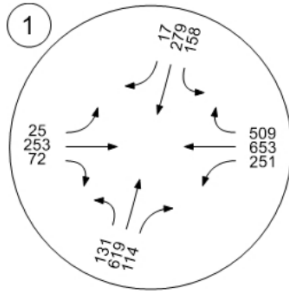

Marksheffel Rd/Lorson Bl

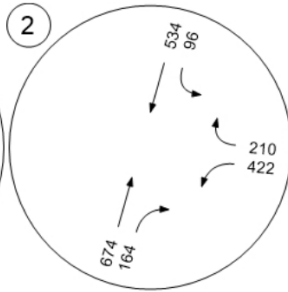

Fontaine Bl/Carriage Meado

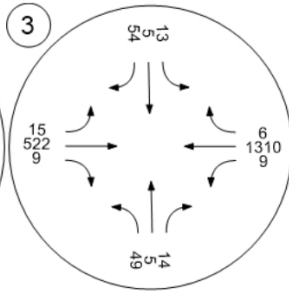
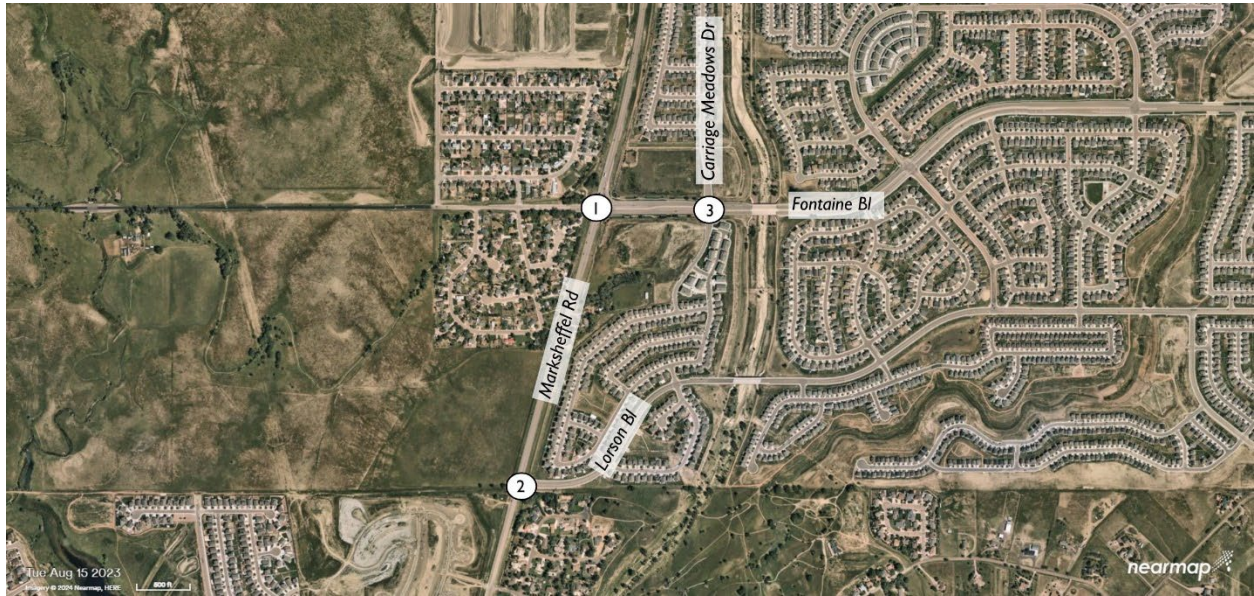

Figure 15. Buildout (2030) Background Traffic Volumes (PM Peak Hour)



Marksheffel Rd/Fontaine Bl

Marksheffel Rd/Lorson Bl

Fontaine Bl/Carriage Meado

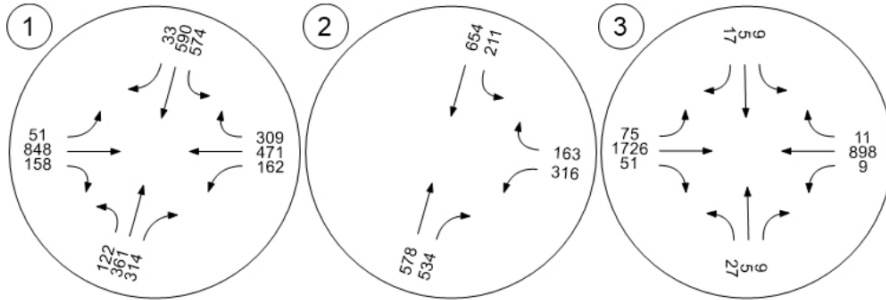
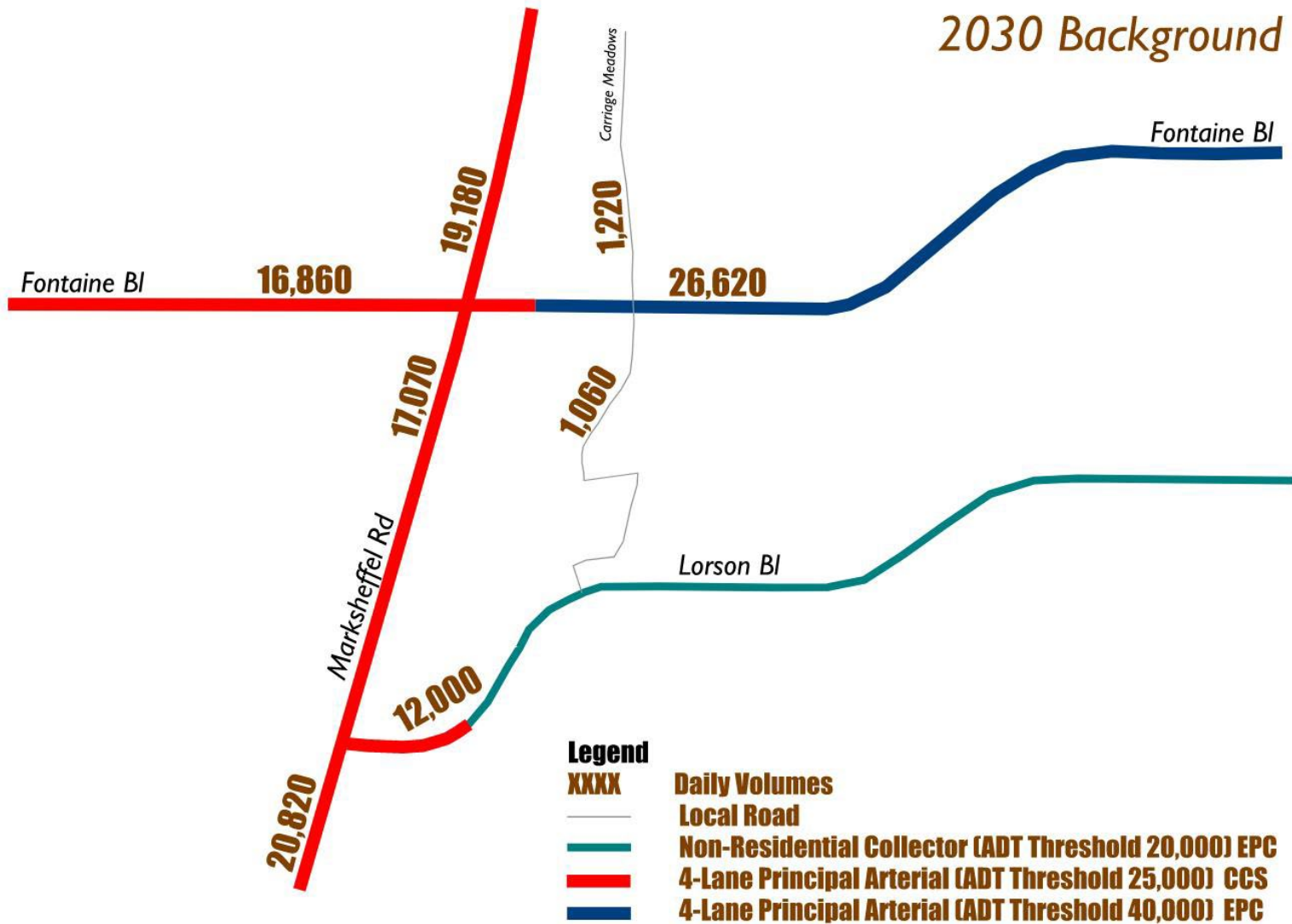
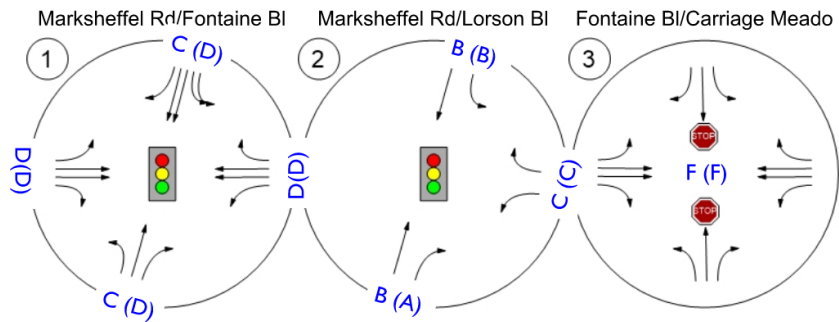
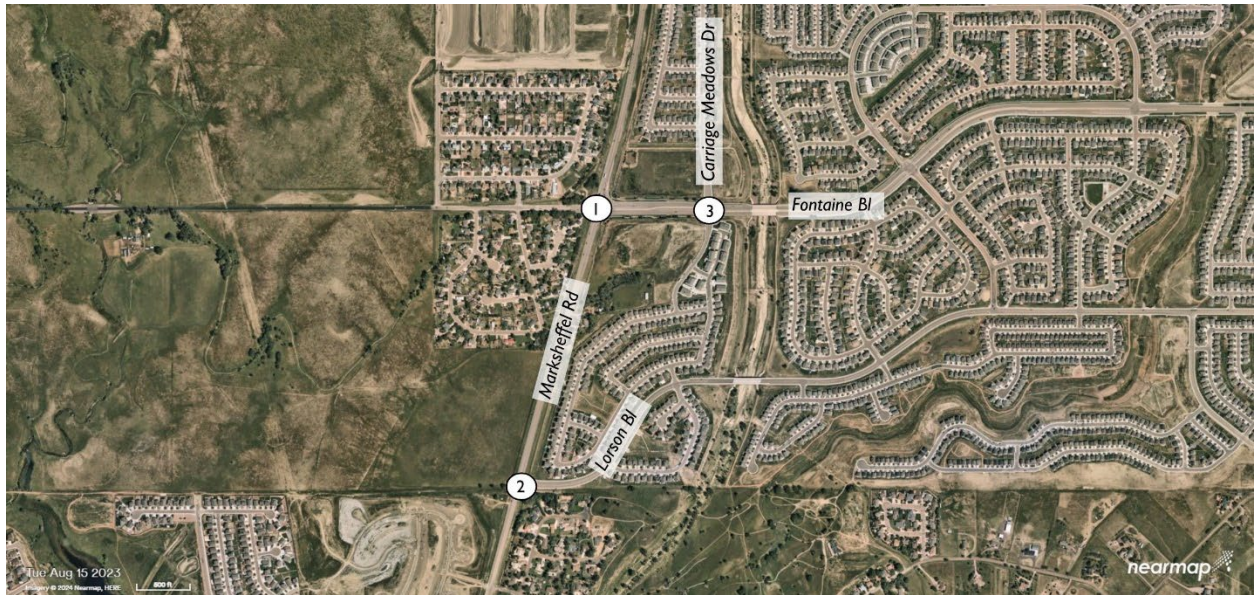

Figure 16. Buildout (2030) Background Daily Traffic Volumes and Roadway Classification



The intersection configuration and level of service are shown in Figure 17.

Figure 17. Buildout (2030) Background Intersection Configuration and LOS



The intersection operations in the AM and PM peak hours are shown in Table 5 and Table 6, respectively.

Table 5. Buildout (2030) Background Intersection Operations (AM Peak Hour)

Intersection Analysis Summary

ID	Intersection Name	Control Type	Method	Worst Mvmt	V/C	Delay (s/veh)	LOS
1	Marksheffel Rd/Fontaine Bl	Signalized	HCM 7th Edition	WB Left	0.692	36.7	D
2	Marksheffel Rd/Lorson Bl	Signalized	HCM 7th Edition	SB Left	0.703	17.1	B
3	Fontaine Bl/Carriage Meadows Dr	Two-way stop	HCM 7th Edition	NB Left	0.949	211.3	F

V/C, Delay, LOS: For two-way stop, these values are taken from the movement with the worst (highest) delay value. For all other control types, they are taken for the whole intersection.

Table 6. Buildout (2030) Background Intersection Operations (PM Peak Hour)

Intersection Analysis Summary

ID	Intersection Name	Control Type	Method	Worst Mvmt	V/C	Delay (s/veh)	LOS
1	Marksheffel Rd/Fontaine Bl	Signalized	HCM 7th Edition	EB Left	0.810	45.1	D
2	Marksheffel Rd/Lorson Bl	Signalized	HCM 7th Edition	SB Left	0.647	14.9	B
3	Fontaine Bl/Carriage Meadows Dr	Two-way stop	HCM 7th Edition	NB Left	47.294	10,000.0	F

V/C, Delay, LOS: For two-way stop, these values are taken from the movement with the worst (highest) delay value. For all other control types, they are taken for the whole intersection.

Please explain this value

As shown in Table 5 and Table 6, all intersections operate at an acceptable LOS, except for Fontaine Boulevard/Carriage Meadows Drive intersection which operates at LOS F during both AM and PM peak hour. The queue length for northbound left-turn movement in PM peak hour is approximately 6 vehicles. Since a traffic signal is not warranted in the background conditions, Matrix recommends prohibiting northbound left-turn and southbound left-turn at this intersection. The intersection will still operate at LOS F (due to deficient northbound through and southbound through movements), however, the queue length will be no more than 1.47 vehicles. Figure 18, and Figure 19, show the traffic volumes in the mitigated scenarios. These prohibited left-turn volumes are now right-turns at adjacent intersections. These volumes are included as U-turns at Fontaine Boulevard/Carriage Meadows Drive intersection. All intersections operate at an acceptable LOS in the buildout year without the project. All approaches also operate at acceptable LOS for the intersections along Marksheffel Road that are owned and maintained by the City of Colorado Springs.

An explanation has been added.

Understood. Discussion removed.

This condition of prohibiting the left turns will not be allowed. Please revise the figures accordingly.

Figure 18. Mitigated - Buildout (2030) Background Traffic Volumes (AM Peak Hour)

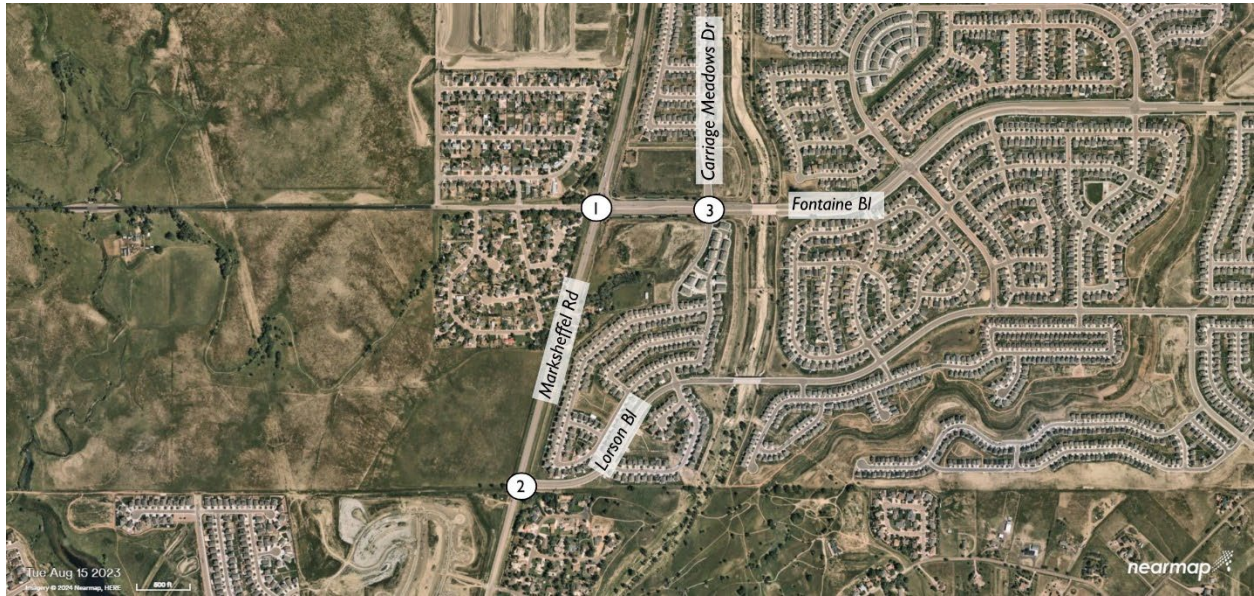

Marksheffel Rd/Fontaine Bl

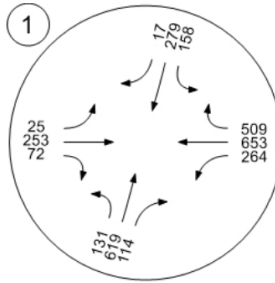

Marksheffel Rd/Lorson Bl

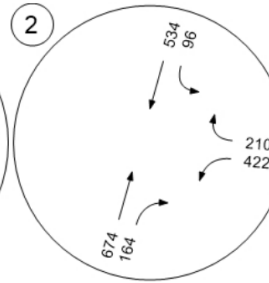

Fontaine Bl/Carriage Meado

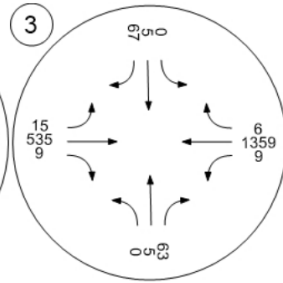
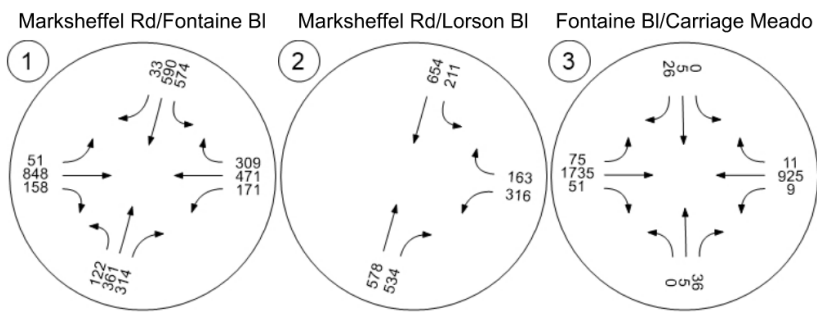
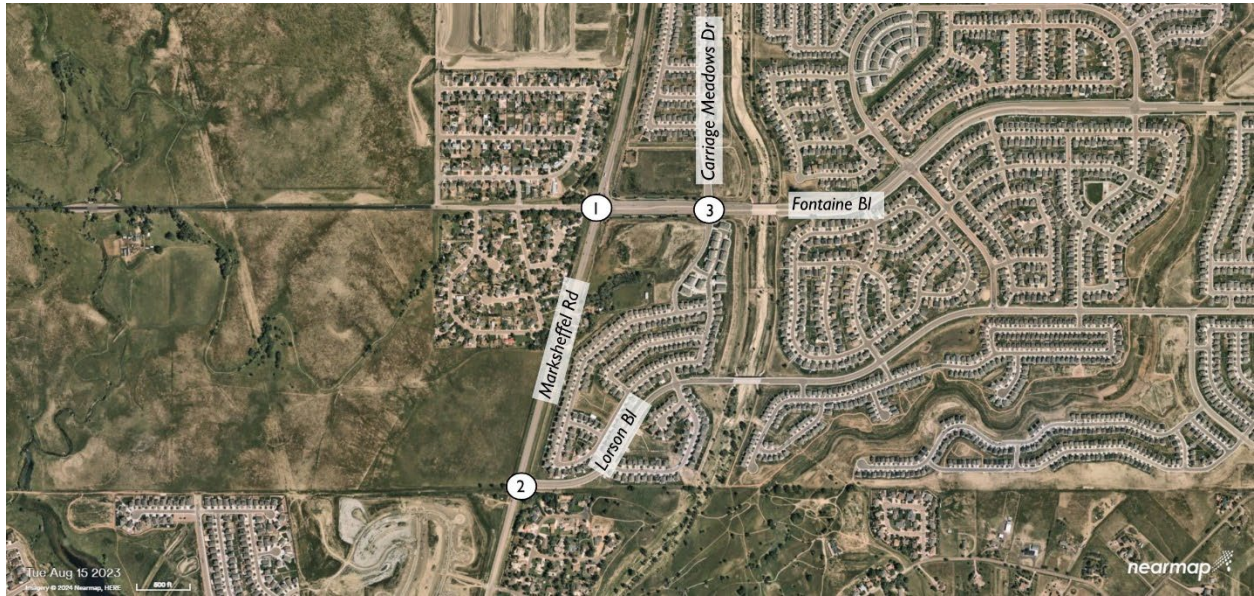
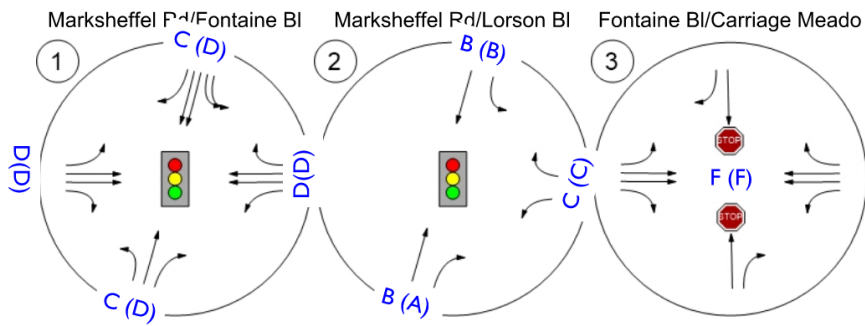
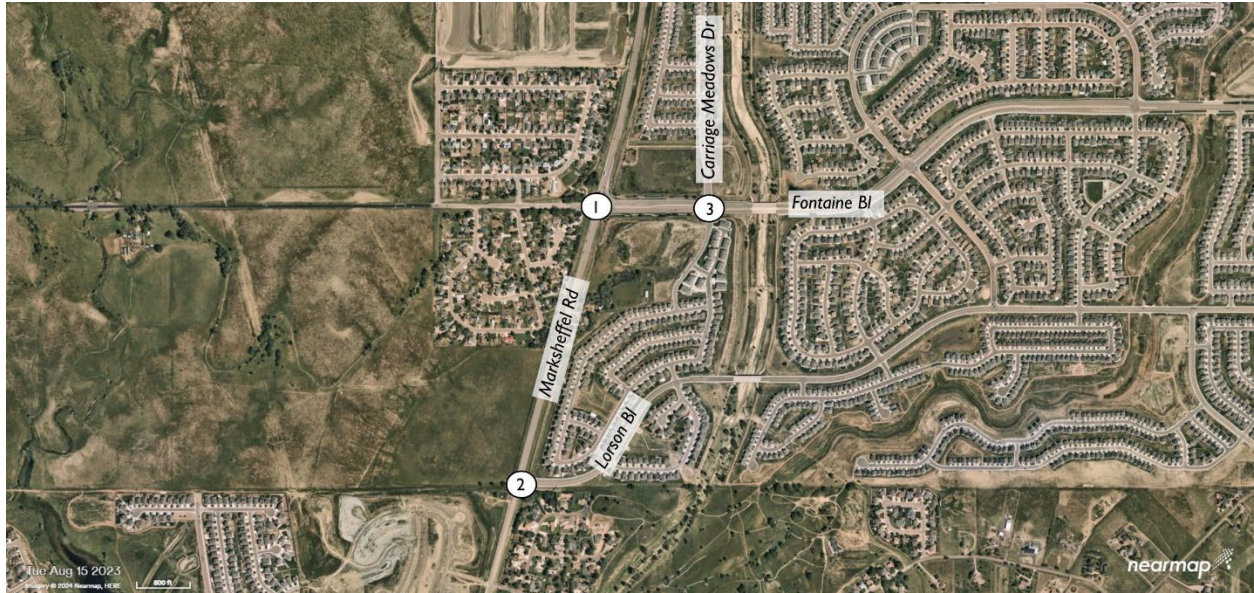

Figure 19. Mitigated - Buildout (2030) Background Traffic Volumes (PM Peak Hour)



The intersection configurations and LOS for the mitigated scenario is shown in Figure 20.

Figure 20. Mitigated - Buildout (2030) Background Intersection Configuration and LOS



The intersection operations for the mitigated scenarios in the AM and PM peak hours are shown in Table 7 and Table 8, Respectively.

Table 7. Mitigated - Buildout (2030) Background Intersection Operations (AM Peak Hour)

Intersection Analysis Summary

ID	Intersection Name	Control Type	Method	Worst Mvmt	V/C	Delay (s/veh)	LOS
1	Marksheffel Rd/Fontaine Bl	Signalized	HCM 7th Edition	WB Left	0.701	37.7	D
2	Marksheffel Rd/Lorson Bl	Signalized	HCM 7th Edition	SB Left	0.703	17.1	B
3	Fontaine Bl/Carriage Meadows Dr	Two-way stop	HCM 7th Edition	SB Thru	0.166	123.3	F

V/C, Delay, LOS: For two-way stop, these values are taken from the movement with the worst (highest) delay value. For all other control types, they are taken for the whole intersection.

Table 8. Mitigated - Buildout (2030) Background Intersection Operations (PM Peak Hour)

Intersection Analysis Summary

ID	Intersection Name	Control Type	Method	Worst Mvmt	V/C	Delay (s/veh)	LOS
1	Marksheffel Rd/Fontaine Bl	Signalized	HCM 7th Edition	EB Left	0.810	45.1	D
2	Marksheffel Rd/Lorson Bl	Signalized	HCM 7th Edition	SB Left	0.647	14.9	B
3	Fontaine Bl/Carriage Meadows Dr	Two-way stop	HCM 7th Edition	NB Left	47.294	10,000.0	F

V/C, Delay, LOS: For two-way stop, these values are taken from the movement with the worst (highest) delay value. For all other control types, they are taken for the whole intersection.

The turn lane evaluations are shown in Table 9.

Table 9. Buildout (2030) Background Turn Lane Evaluations

ID	Intersection	Control Type	Speed (mph)	Turning Volume (vph)	Queue (ft)	Agency	Deceleration (ft)	Taper (ft)	Storage (ft)	Total (ft)	Provided (ft)	Improvement (ft)		
1	Marksheffel Rd/Fontaine Bl	Signalized	NBL	55	131	203	CCS	263	220		485	740	-	
			NBR	55	314	0		263	220		485	740	-	
			SBL	55	574	401		263	220		485	665	-	
			SBR	55	33	16		263	220		485	665	-	
			EBL	35	51	93		120	140		260	330	-	
			EBR	35	158	91		120	140		260	50	-	
			WBL	45	251	271		200	180		380	545	-	
			WBR	45	509	243		200	180		380	Continuous	-	
2	Marksheffel Rd/Lorson Bl	Signalized	NBR	55	534	51	CCS	263	220		485	565	-	
			SBL	55	211	196		263	220		485	Continuous	-	
			WBL	35	422	270		120	140		260	485	-	
			WBR	35	210	54		120	140		260	Continuous	-	
3	Fontaine Bl/Carriage Meadows Dr	Stop-Controlled	NBL				EPC				100			
			NBR	25	63	16		115	120		235	180	55	
			SBL											
			SBR	25	67	23		115	120		235	100	135	
			EBL	45	75	12		235	200	75	510	500	10	
			EBR	45	51	4		235	200		435	Continuous	-	
			WBL	45	9	3		Not Required			510	-		
			WBR	45	11	1		Not Required			330	-		

Fontaine Boulevard/Carriage Meadows Drive (#3)

- Prohibit northbound left-turn and southbound left-turn
- A 55-ft extension of northbound right-turn.
- A 135-ft extension of southbound right-turn.
- A 10-ft extension of eastbound left-turn.

Buildout (2030) Total Conditions

Buildout total traffic volumes are shown in Figure 21 and Figure 22 for the AM and PM peak hours, respectively. Daily volumes and roadway classification are shown in Figure 23.

Figure 21. Buildout (2030) Total Traffic Volumes (AM Peak Hour)

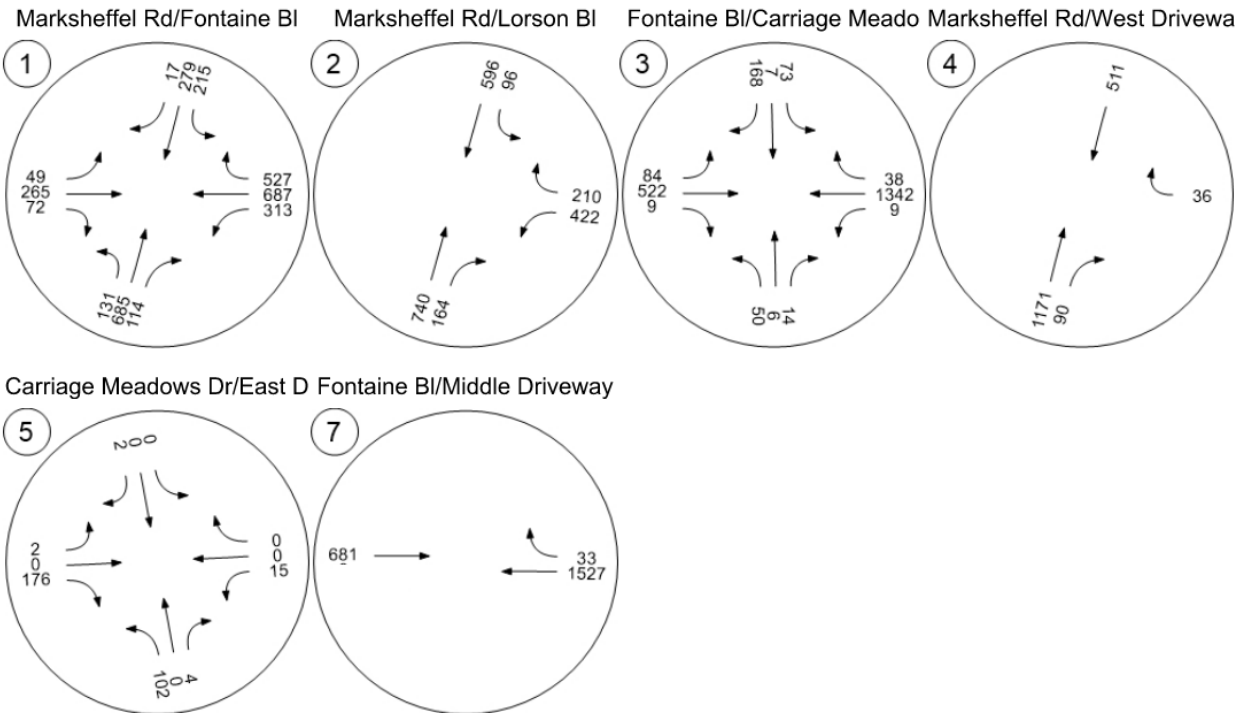
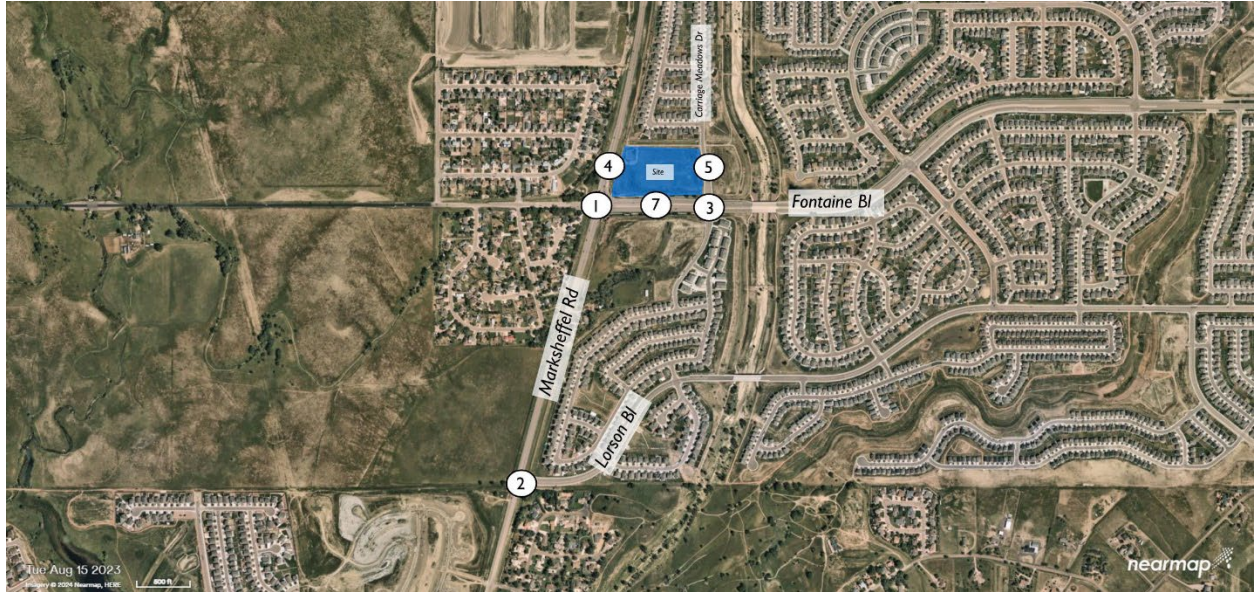
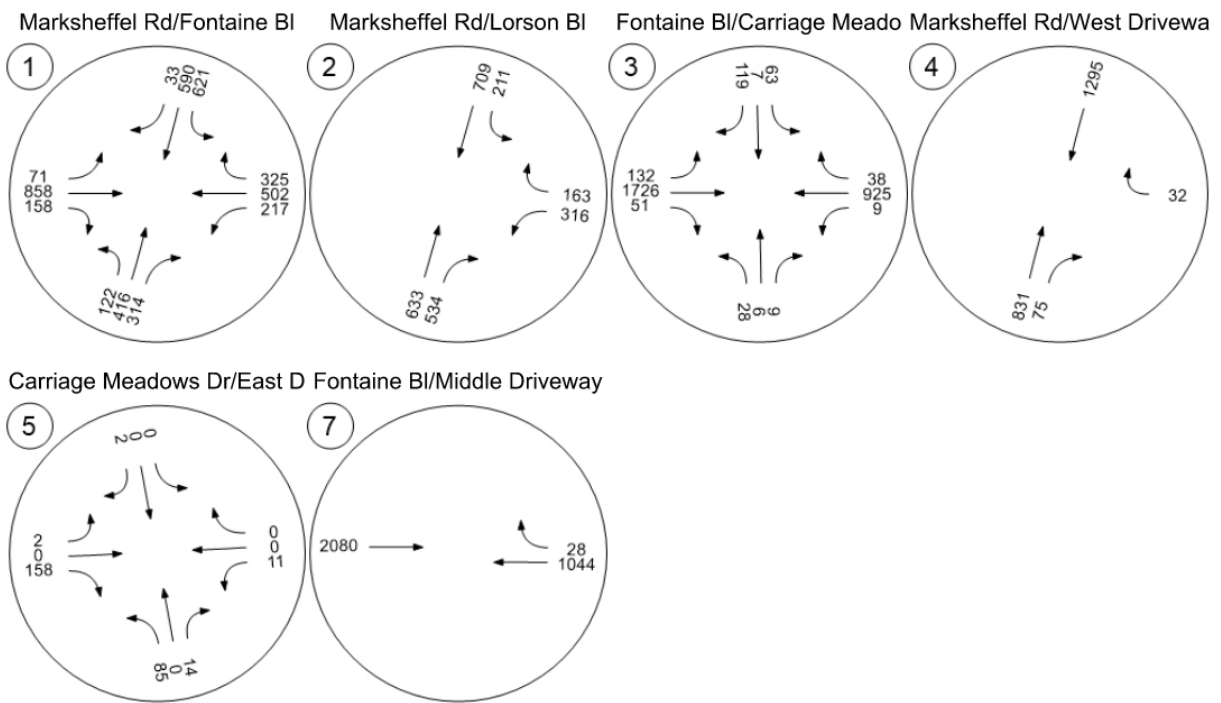
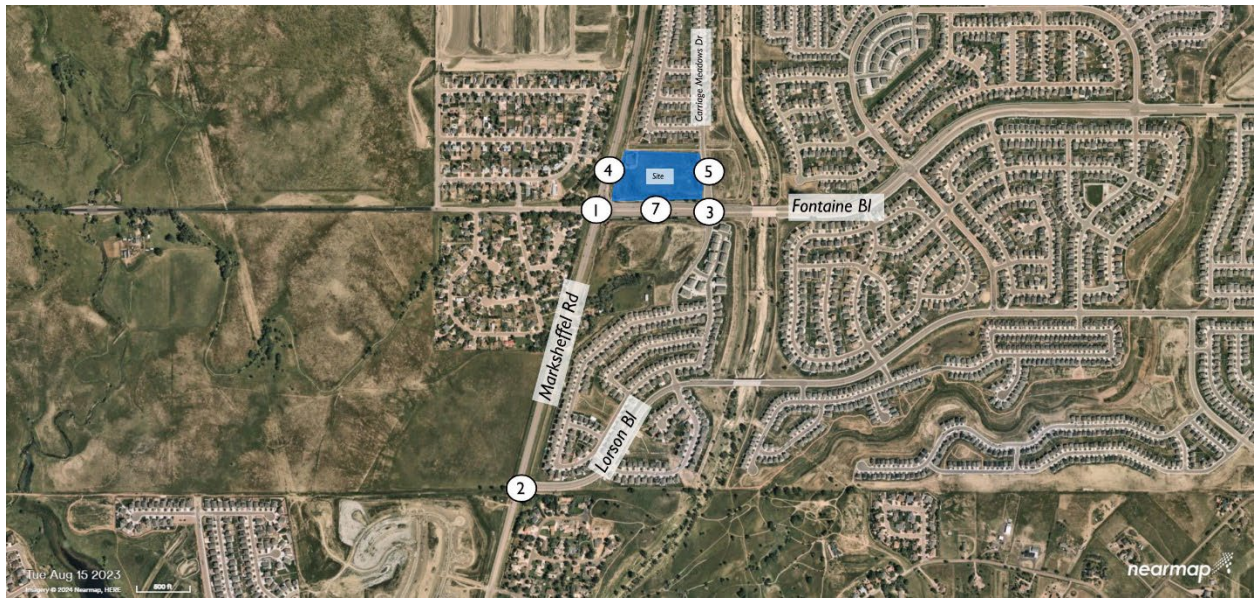
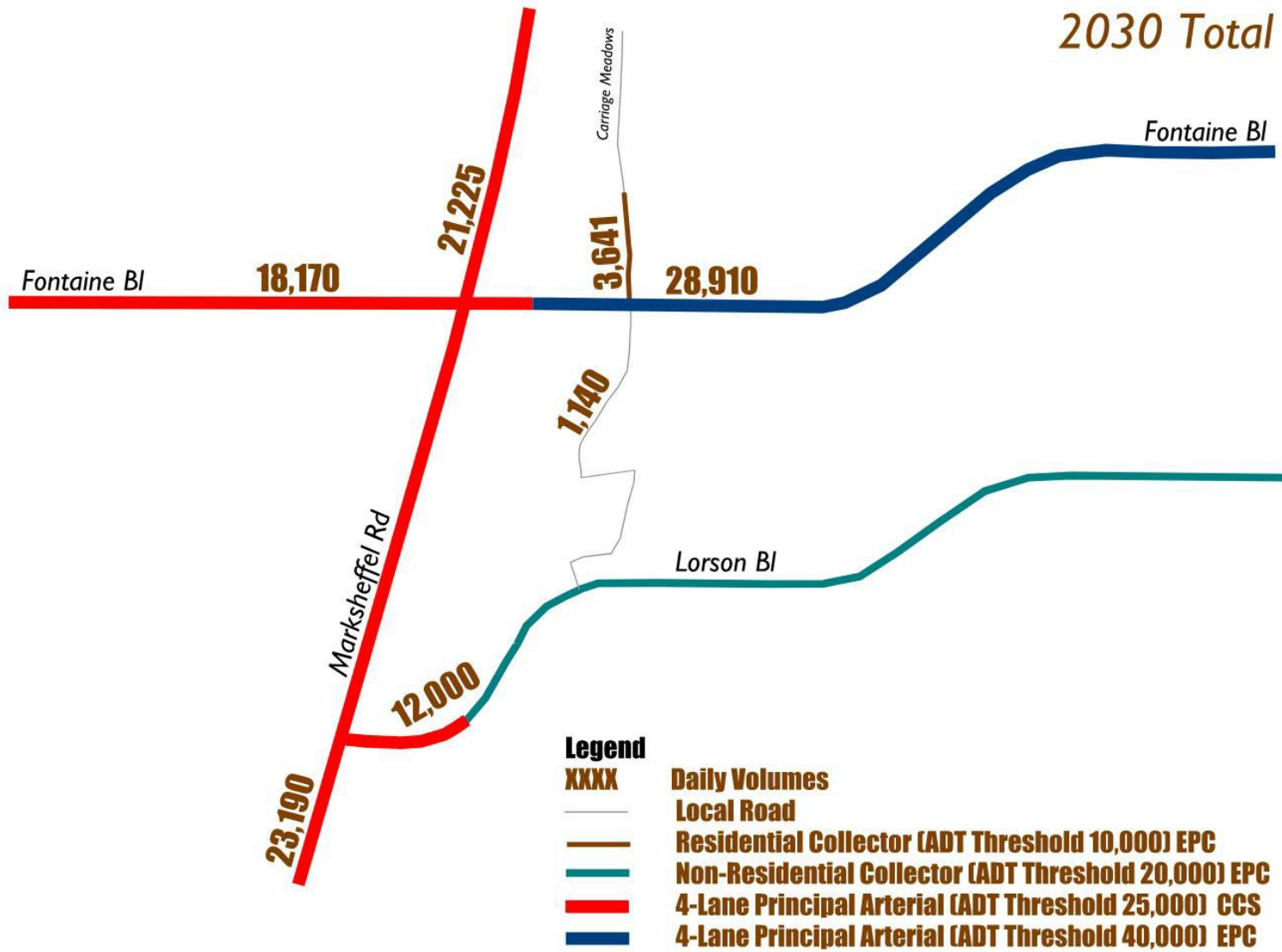

Figure 22. Buildout (2030) Total Traffic Volumes (PM Peak Hour)



Buildout traffic daily volumes with the project traffic added are shown in Figure 23.

Figure 23. Buildout (2030) Total Traffic Volumes and Roadway Classification



The intersection configuration and level of service are shown in Figure 24.

Figure 24. Buildout (2030) Total Intersection Configuration and LOS

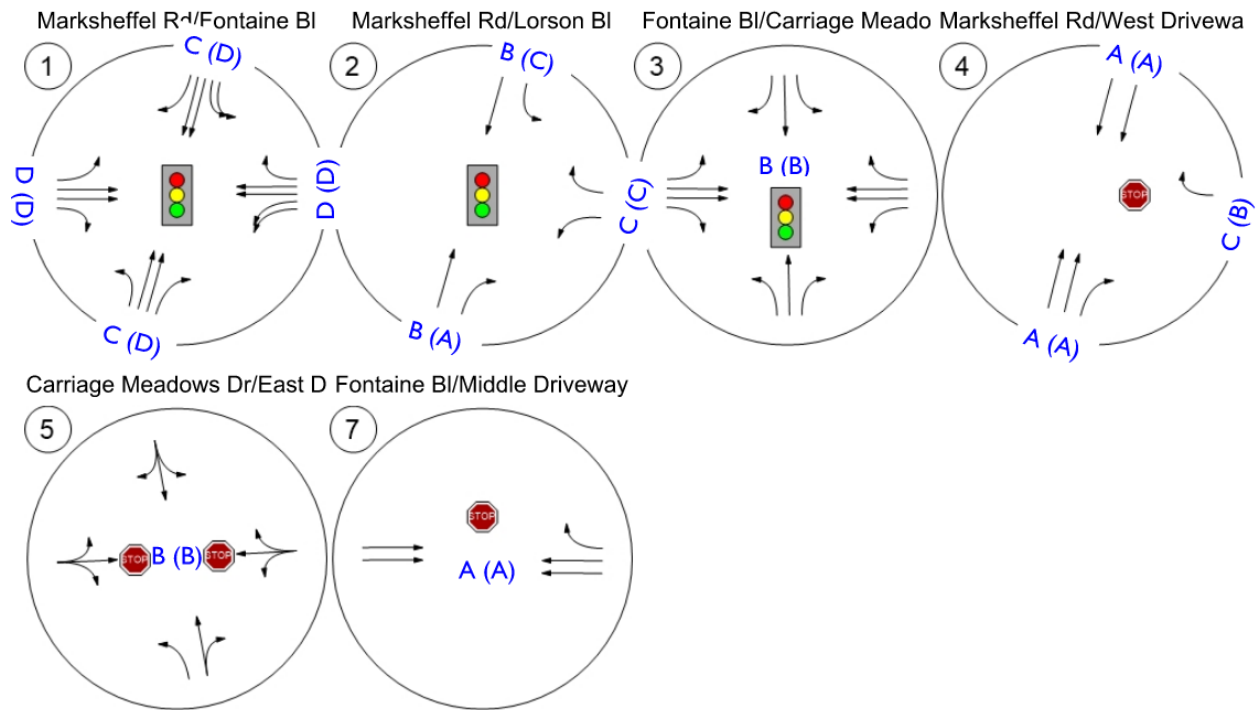
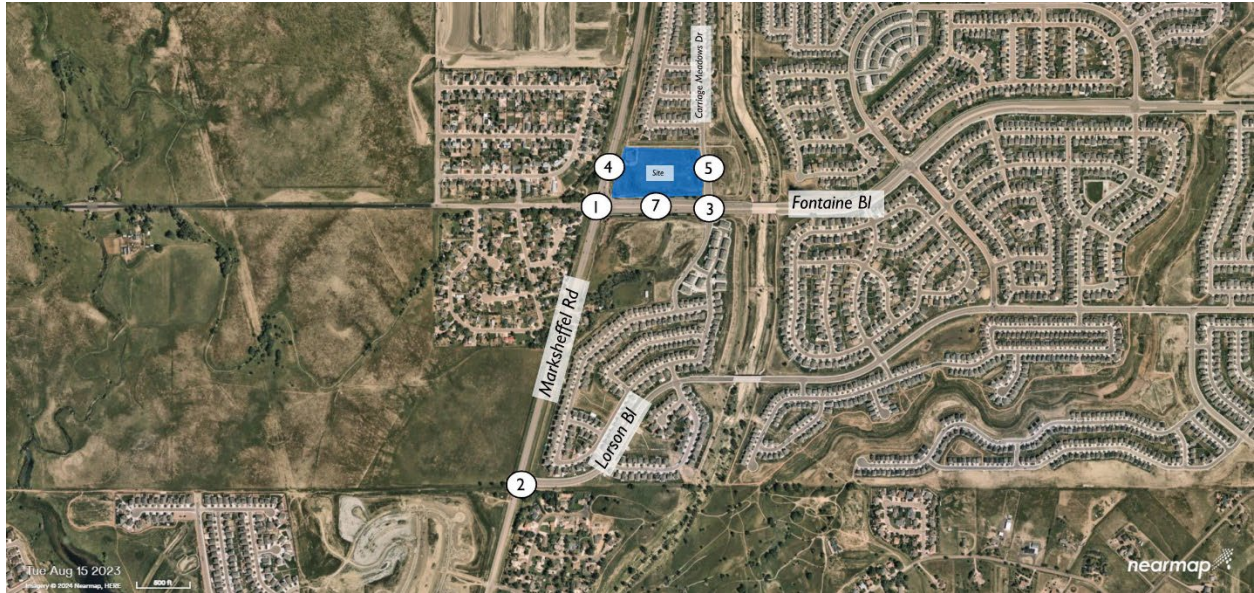

The intersection operations in the AM and PM peak hours are shown in Table 10 and Table 11, respectively.

Table 10. Buildout (2030) Total Intersection Operations (AM Peak Hour)

Intersection Analysis Summary

ID	Intersection Name	Control Type	Method	Worst Mvmt	V/C	Delay (s/veh)	LOS
1	Marksheffel Rd/Fontaine Bl	Signalized	HCM 7th Edition	EB Left	0.559	32.3	C
2	Marksheffel Rd/Lorson Bl	Signalized	HCM 7th Edition	SB Left	0.744	20.5	C
3	Fontaine Bl/Carriage Meadows Dr	Signalized	HCM 7th Edition	EB Left	0.561	12.2	B
4	Marksheffel Rd/West Driveway	Two-way stop	HCM 7th Edition	WB Right	0.039	8.5	A
5	Carriage Meadows Dr/East Driveway	Two-way stop	HCM 7th Edition	WB Left	0.040	13.2	B
7	Fontaine Bl/Middle Driveway	Two-way stop	HCM 7th Edition	WB Thru	0.018	0.0	A

V/C, Delay, LOS: For two-way stop, these values are taken from the movement with the worst (highest) delay value. For all other control types, they are taken for the whole intersection.

Table 11. Buildout (2030) Total Intersection Operations (PM Peak Hour)

Intersection Analysis Summary

ID	Intersection Name	Control Type	Method	Worst Mvmt	V/C	Delay (s/veh)	LOS
1	Marksheffel Rd/Fontaine Bl	Signalized	HCM 7th Edition	EB Left	0.706	42.3	D
2	Marksheffel Rd/Lorson Bl	Signalized	HCM 7th Edition	SB Left	0.674	16.4	B
3	Fontaine Bl/Carriage Meadows Dr	Signalized	HCM 7th Edition	EB Left	0.623	10.3	B
4	Marksheffel Rd/West Driveway	Two-way stop	HCM 7th Edition	WB Right	0.036	8.5	A
5	Carriage Meadows Dr/East Driveway	Two-way stop	HCM 7th Edition	WB Left	0.026	12.3	B
7	Fontaine Bl/Middle Driveway	Two-way stop	HCM 7th Edition	EB Thru	0.024	0.0	A

V/C, Delay, LOS: For two-way stop, these values are taken from the movement with the worst (highest) delay value. For all other control types, they are taken for the whole intersection.

As shown in Table 10, Table 11, and Figure 24 all intersections operate at an acceptable LOS. All approaches operate at acceptable LOS at Marksheffel Road/Fontaine Boulevard, Marksheffel Road/Lorson Boulevard, and the west driveway. The turn lane evaluations are shown in Table 12.

Table 12. Buildout (2030) Total Turn Lane Evaluations

ID	Intersection	Control Type	Movement	Speed (mph)	Turning Volume	Queue (ft)	Agency	Deceleration (ft)	Taper (ft)	Storage (ft)	Total (ft)	Provided (ft)	Improvement (ft)		
1	Marksheffel Rd/Fontaine Bl	Signalized	NBL	55	131	200	CCS	263	220		485	740	-		
			NBR	55	314	0		263	220		485	740	-		
			SBL	55	621	423		263	220		485	665	-		
			SBR	55	33	12		263	220		485	665	-		
			EBL	35	71	125		120	140		260	330	-		
			EBR	35	158	69		120	140		260	50	-		
			WBL	45	313	183		200	180		380	545	-		
			WBR	45	527	249		200	180		380	Continuous	-		
2	Marksheffel Rd/Lorson Bl	Signalized	NBR	55	534	51	CCS	263	220		485	565	-		
			SBL	55	211	224		263	220		485	Continuous	-		
			WBL	35	422	324		120	140		260	485	-		
			WBR	35	210	55		120	140		260	Continuous	-		
3	Fontaine Bl/Carriage Meadows Dr	Signalized	NBL	25	50	50	EPC	115	120	50	285	190	95		
			NBR	25	14	6		Not Required			180	-			
			SBL	25	73	74		115	120	74	310	100	210		
			SBR	25	168	85		115	120	85	320	100	85		
			EBL	45	132	162		235	200	162	597	500	90		
			EBR	45	51	2		235	200	2	437	Continuous	-		
			WBL	45	9	8		Not Required			510	-			
			WBR	45	38	8		Not Required			330	-			
4	Marksheffel Rd/West Driveway	Stop-Controlled	NBR	55	90	0	CCS	263	220		485		485		
5	Carruage Meadows Dr/East Driveway	Stop-Controlled	NBL	25	102	6	EPC	115	120	100	335		335		
			EBR	25	158	0		115	120				235		
7	Fontaine Bl/Middle Driveway	Stop-Controlled	WBR	45	33	0	EPC	235	200		435		435		

Fontaine Boulevard/Carriage Meadows Drive (#3)

- A Traffic Signal.
- A 95-extension of northbound left-turn.
- A 210-ft extension of southbound left-turn lane.
- A 90-ft extension of eastbound left-turn lane.
- An 85-ft extension of southbound right-turn lane. This intersection also requires an extension of the northwest curb return to protect the westbound deceleration lane into the project driveway along Fontaine Boulevard.

Marksheffel Road/West Driveway (#4)

- A 485-ft northbound right-turn lane. Included a 265-ft of deceleration lane, and a 220-ft taper lane.

Carriage Meadows/East Driveway (#5)

- A 335-ft northbound left-turn. Included a 115-ft deceleration lane, 120-ft taper lane, and a 100-ft storage lane.
- A 235-ft eastbound right-turn lane. Included a 115-ft deceleration lane, and a 120-ft taper lane.

Fontaine Boulevard/Middle Driveway (#7)

- A 435-ft westbound right-turn. Matrix recommends an extension of the northwest corner of the Fontaine/Carriage Meadows intersection to define the deceleration lane into the driveway along Fontaine Boulevard according to the Figure 2. A higher quality of this exhibit is provided in Appendix F – Supporting Documents.

Horizon (2045) Background Conditions

The horizon year traffic volumes without the Village at Lorson Ranch project in AM and PM peak hours are shown in Figure 25, and Figure 26, respectively. The daily volumes and roadway classification are shown in Figure 27. The background volumes were obtained from *The Hillside at Lorson Ranch* (2022) TIS. The traffic from the LRCS is also added to the horizon background conditions.

Figure 25. Horizon (2045) Background Traffic Volumes (AM Peak Hour)

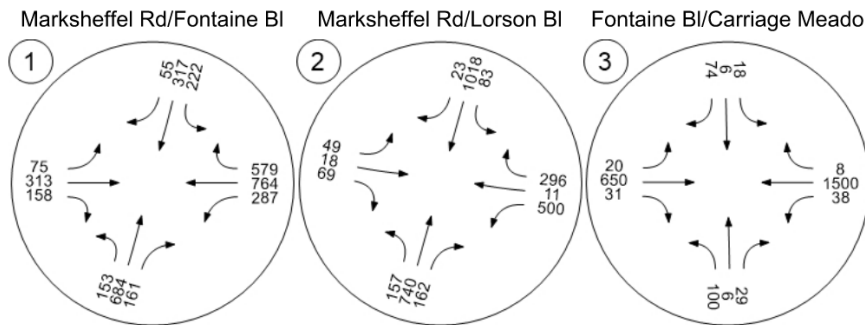
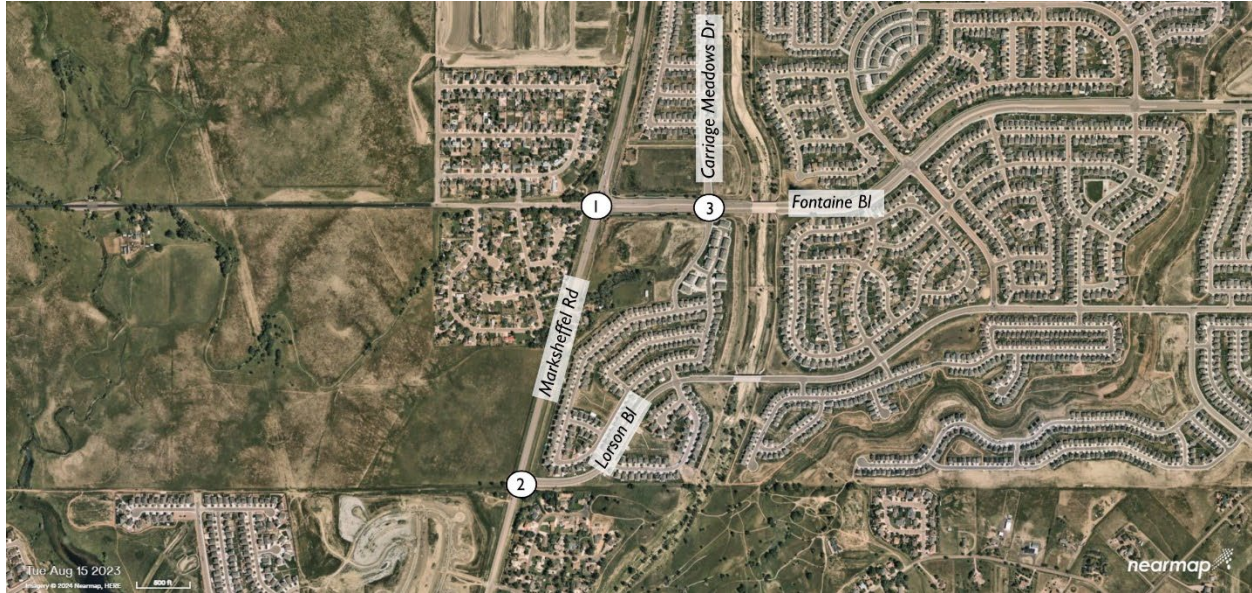
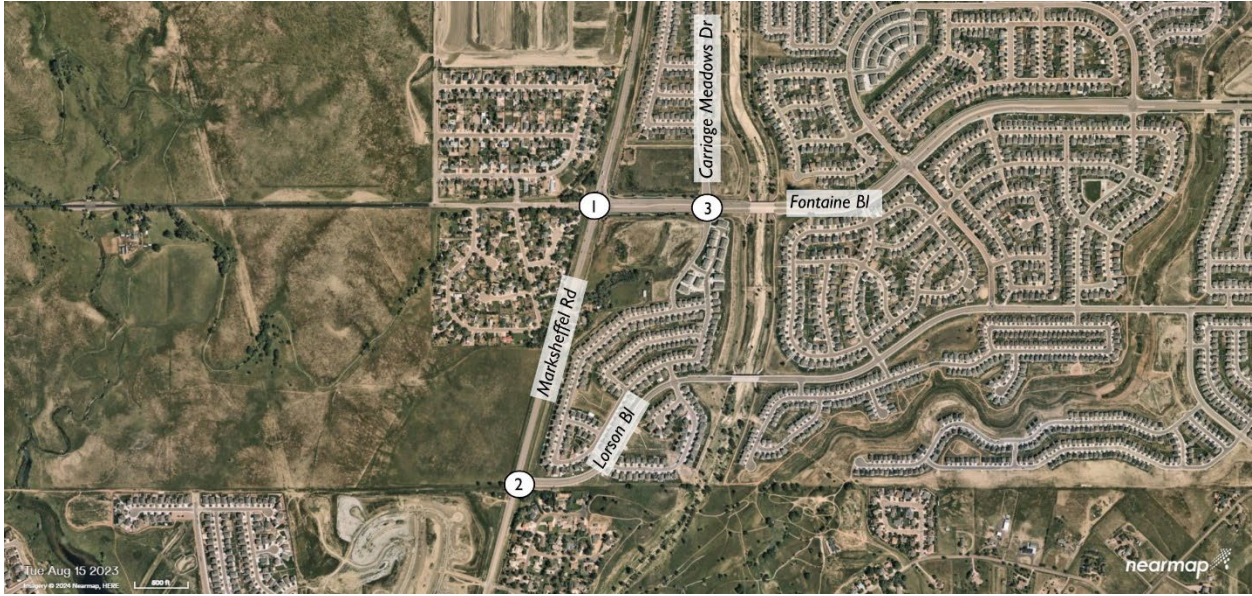

Figure 26. Horizon (2045) Background Traffic Volumes (PM Peak Hour)



1 Marksheffel Rd/Fontaine Bl 2 Marksheffel Rd/Lorson Bl 3 Fontaine Bl/Carriage Meado

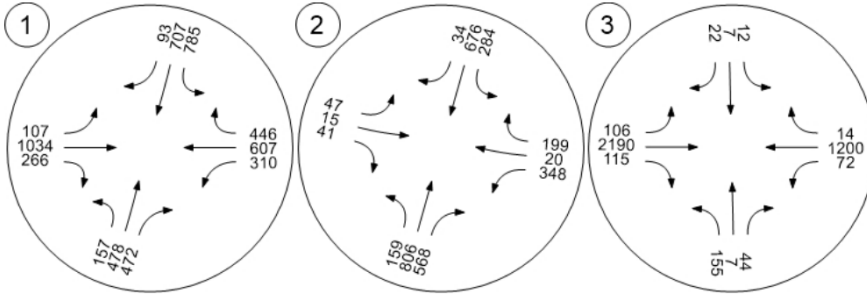
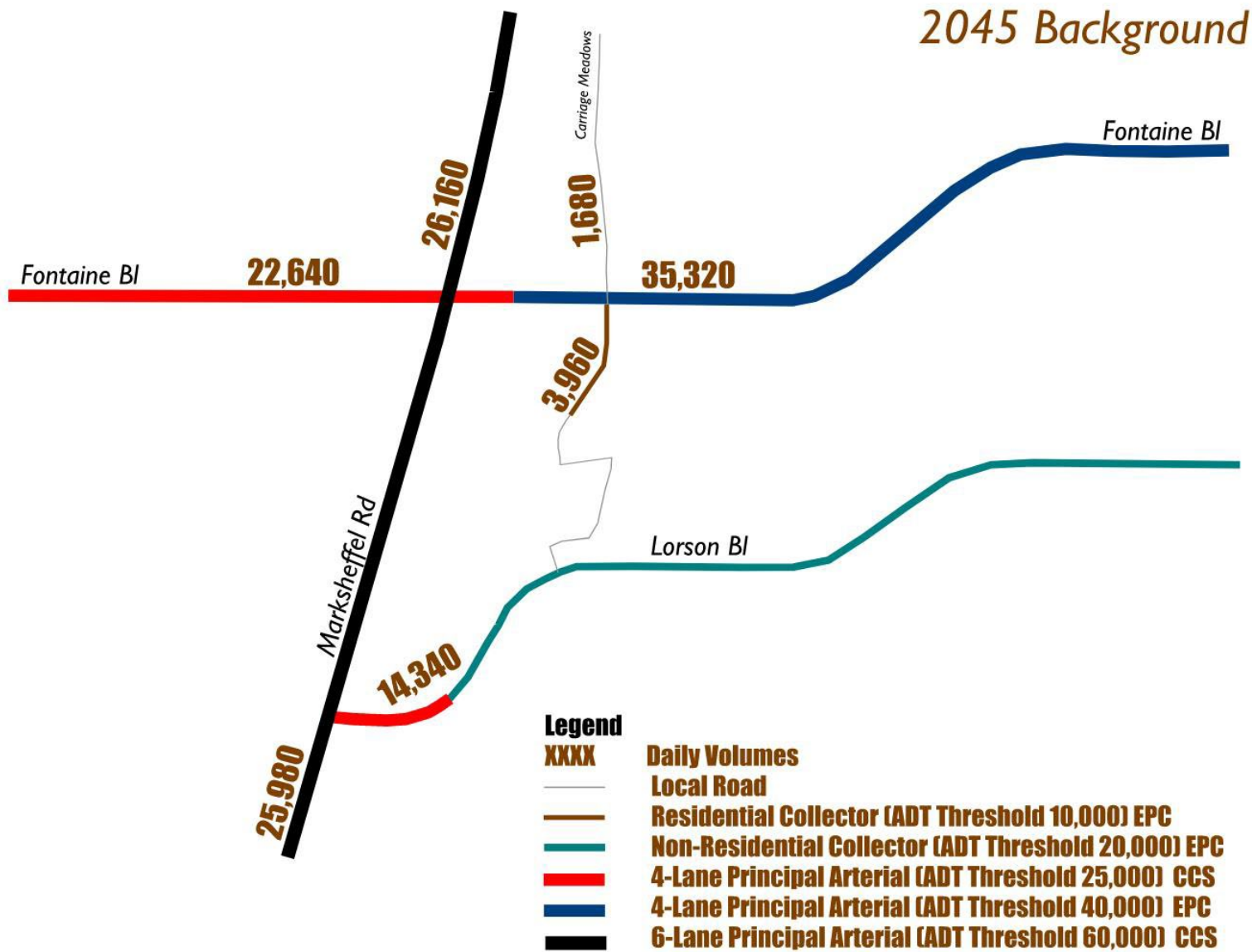
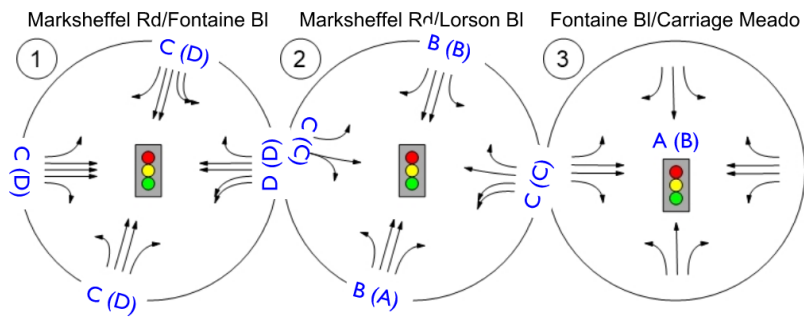
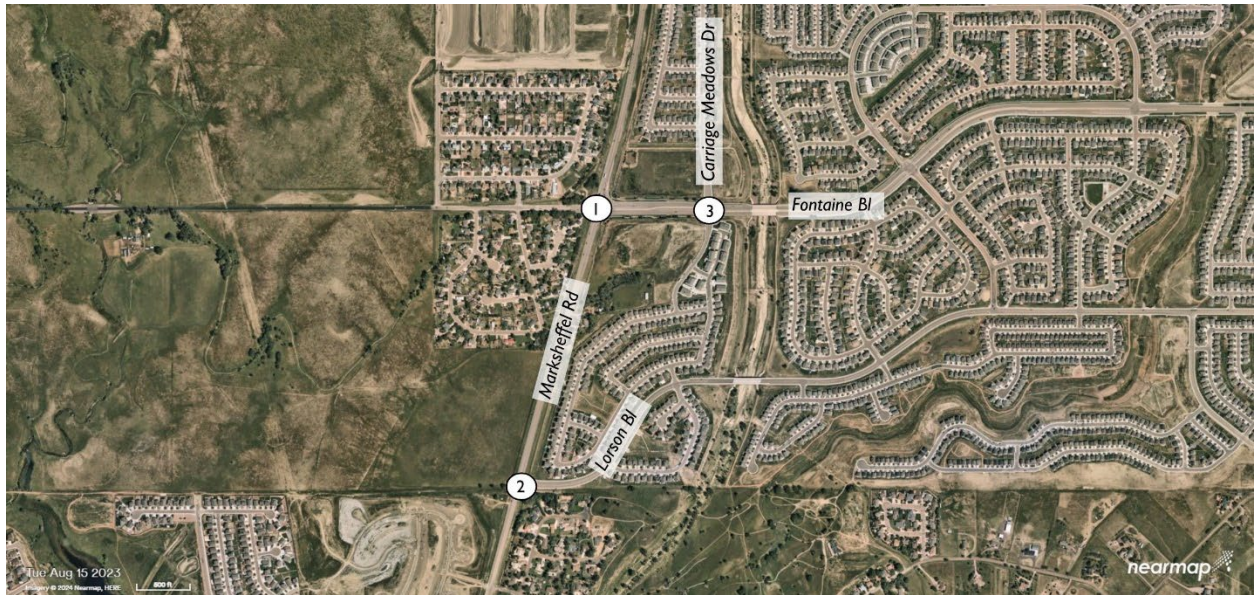

Figure 27. Horizon (2045) Background Daily Volume and Roadway Classification



The intersection configurations and level of service are shown in Figure 28.

Figure 28. Horizon (2045) Background Intersection Configuration and LOS



The intersection operations in the AM and PM peak hours are shown in Table 10 and Table 11, respectively.

Table 13. Horizon (2045) Background Intersection Operations (AM Peak Hour)

Intersection Analysis Summary

ID	Intersection Name	Control Type	Method	Worst Mvmt	V/C	Delay (s/veh)	LOS
1	Marksheffel Rd/Fontaine Bl	Signalized	HCM 7th Edition	NB Left	0.558	31.6	C
2	Marksheffel Rd/Lorson Bl	Signalized	HCM 7th Edition	WB Left	0.525	19.0	B
3	Fontaine Bl/Carriage Meadows Dr	Signalized	HCM 7th Edition	EB Left	0.553	9.6	A

Table 14. Horizon (2045) Background Intersection Operations (PM Peak Hour)

Intersection Analysis Summary

ID	Intersection Name	Control Type	Method	Worst Mvmt	V/C	Delay (s/veh)	LOS
1	Marksheffel Rd/Fontaine Bl	Signalized	HCM 7th Edition	EB Left	0.726	45.3	D
2	Marksheffel Rd/Lorson Bl	Signalized	HCM 7th Edition	SB Left	0.798	15.1	B
3	Fontaine Bl/Carriage Meadows Dr	Signalized	HCM 7th Edition	WB Left	0.789	17.1	B

As shown in Table 13, Table 14, and Figure 28 all intersections operate at an acceptable LOS. All approaches at the intersections along Marksheffel Road also operate at an acceptable LOS. The turn lane evaluations are shown in Table 15.

Table 15. Horizon (2045) Background Turn Lane Evaluations

ID	Intersection	Control Type	Movement	Speed (mph)	Turning Volume (vph)	Queue (ft)	Agency	Deceleration (ft)	Taper (ft)	Storage (ft)	Total (ft)	Provided (ft)	Improvement (ft)
1	Marksheffel Rd/Fontaine Bl	Signalized	NBL	55	157	229	CCS	263	220		485	740	-
			NBR	55	472	284		263	220		485	740	-
			SBL	55	785	485		263	220		485	665	-
			SBR	55	93	39		263	220		485	665	-
			EBL	35	107	170		120	140		260	330	-
			EBR	35	266	160		120	140		260	50	-
			WBL	45	310	222		200	180		380	545	-
			WBR	45	579	253		200	180		380	Continuous	-
2	Marksheffel Rd/Lorson Bl	Signalized	NBL	55	159	147	CCS	263	220		485		-
			NBR	55	568	60		263	220		485	565	-
			SBL	55	284	301		263	220		485	Continuous	-
			SBR	55	34	7		263	220		485		-
			EBL	35	49	41		120	140		260		-
			EBR	35	69	73		120	140		260		-
			WBL	35	500	233		120	140		260	485	-
			WBR	35	296	98		120	140		260	Continuous	-
3	Fontaine Bl/Carriage Meadows Dr	Signalized	NBL	25	155	190	EPC	115	120	190	425	190	325
			NBR	25	44	25		Not Required			180		
			SBL	25	18	16		Not Required			100		
			SBR	25	74	66		115	120	66	300	100	65
			EBL	45	106	190		235	200	190	625	500	115
			EBR	45	115	9		235	200	9	445	Continuous	
			WBL	45	72	164		235	200	164	600	510	90
			WBR	45	14	2		Not Required			330		

Fontaine Boulevard/Carriage Meadows Drive (#3)

- A 325-ft extension of northbound left-turn.
- A 115-ft extension of eastbound left-turn.
- A 65-ft extension of southbound right-turn.
- A 90-ft extension of westbound left-turn.

Note that the signal is warranted at this intersection in horizon background conditions due to the LRCS development. If the Village at Lorson Ranch is not going to be built, the signal would still be warranted.

Horizon (2045) Total Conditions

With the project traffic added to the 2045 background traffic, the resulting total traffic volumes in the AM and PM peak hours are shown in Figure 29 and Figure 30. The daily volumes and roadway classification in the horizon year total conditions are shown in Figure 31.

please include a discussion of the included right in right out being added for the southern commercial area.

The RIRO access on the eastbound has been removed. The traffic is redirected to Carriage Meadows Dr/Fontaine Bl intersection. Please see the new submittal.

Figure 29. Horizon (2045) Total Traffic Volumes (AM Peak Hour)

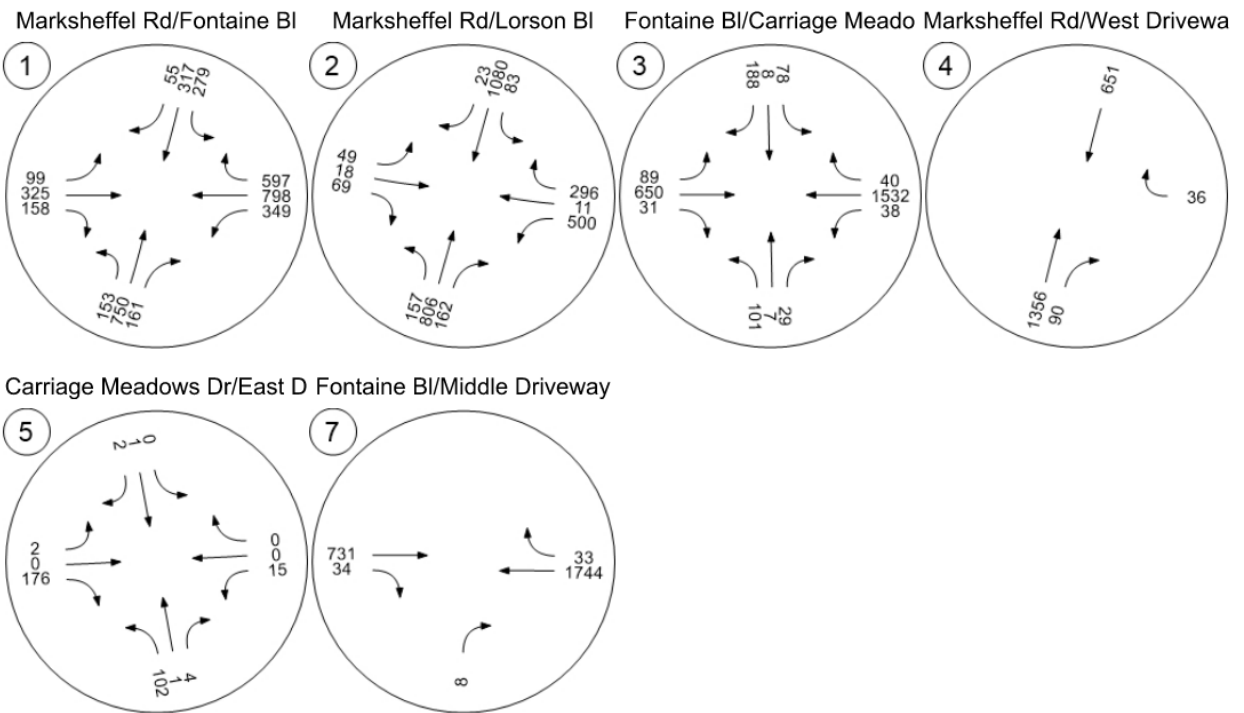
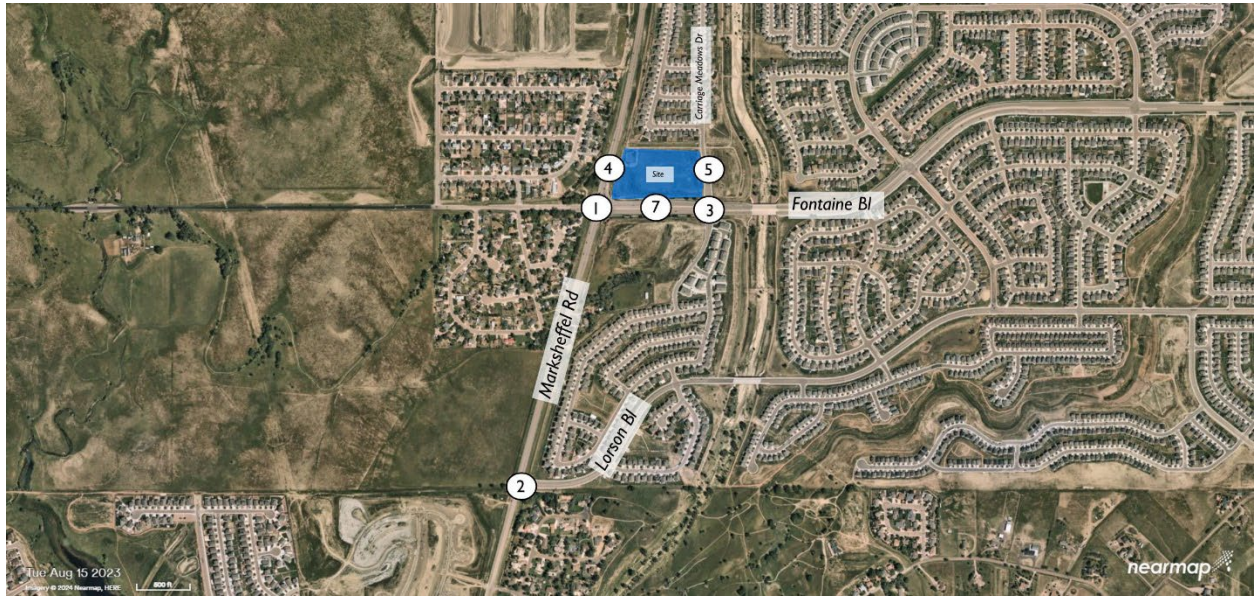

Figure 30. Horizon (2045) Total Traffic Volumes (PM Peak Hour)

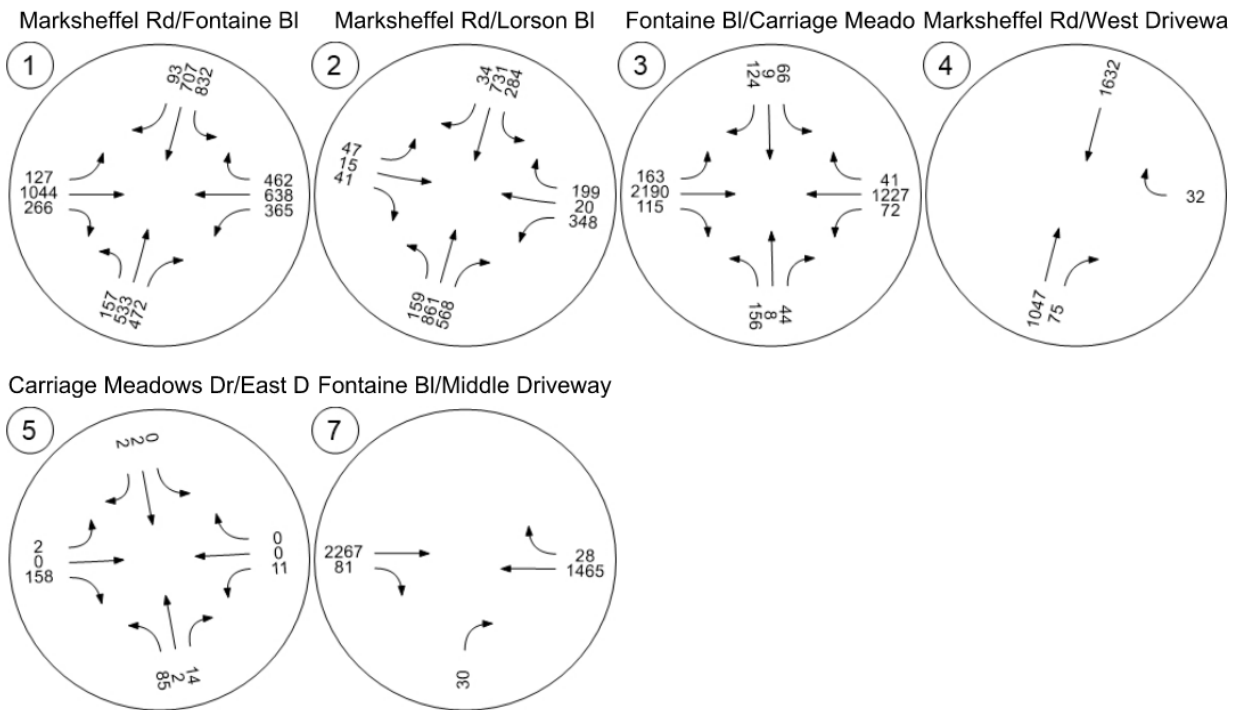
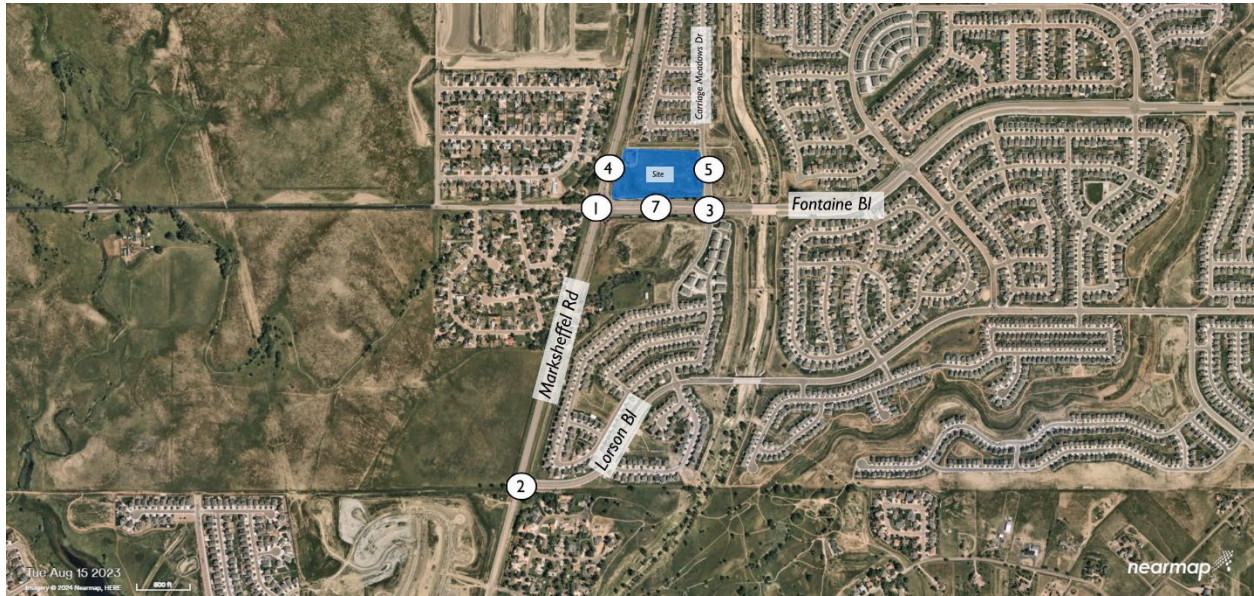
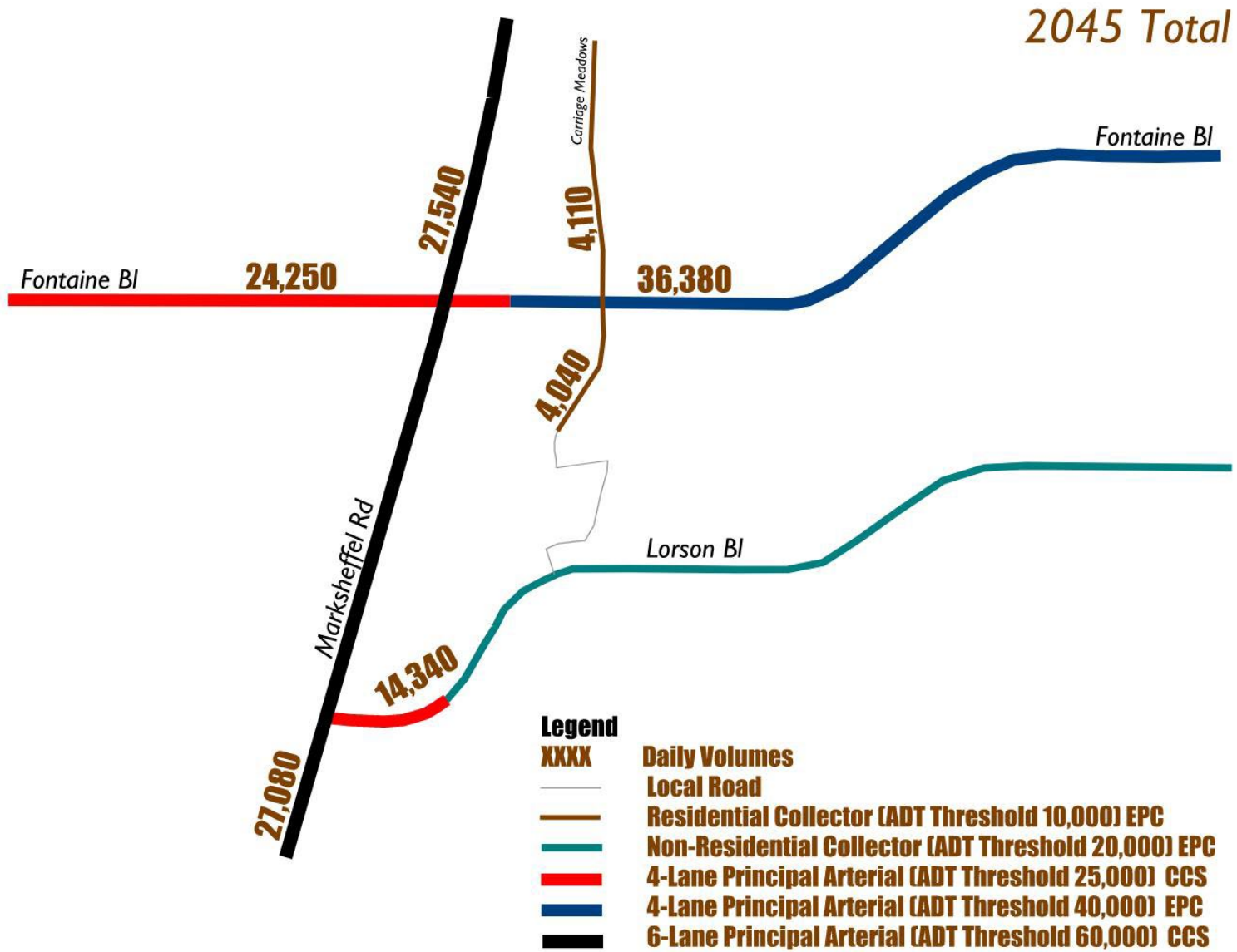
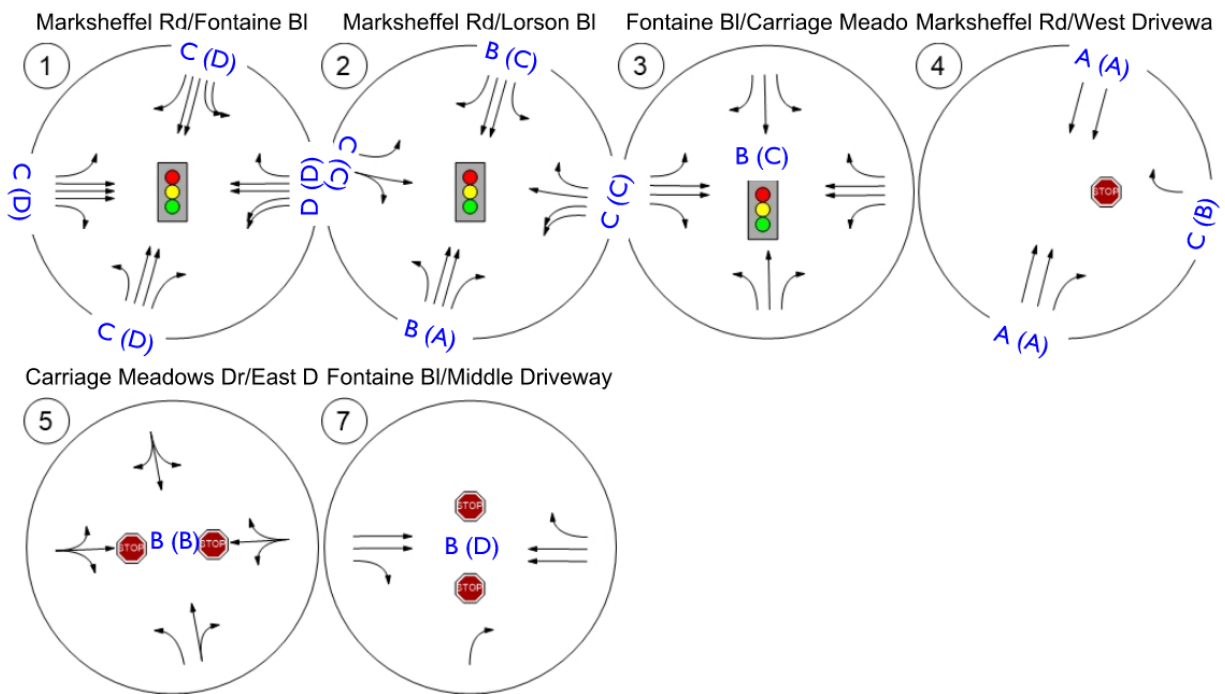
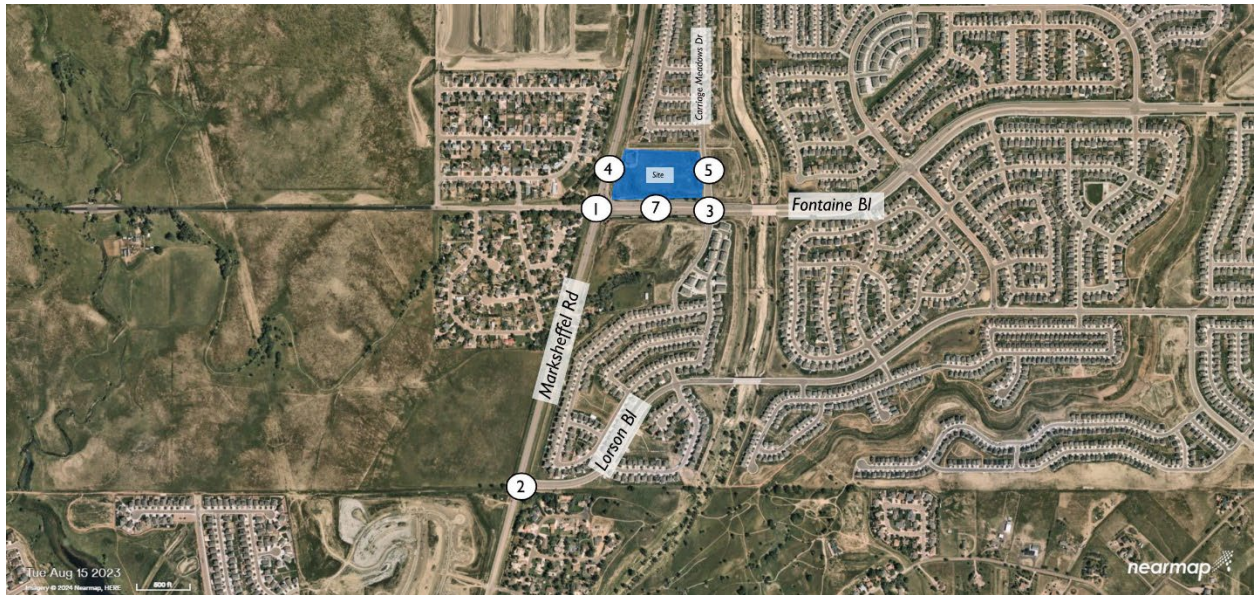

Figure 31. Horizon (2045) Total Daily Volume and Roadway Classification



The intersection configuration and level of service are shown in Figure 32.

Figure 32. Horizon (2045) Total Intersection Configuration and LOS



The intersection operations in the AM and PM peak hours are shown in Table 16 and Table 17, respectively.

Table 16. Horizon (2045) Total Intersection Operations (AM Peak Hour)

Intersection Analysis Summary

ID	Intersection Name	Control Type	Method	Worst Mvmt	V/C	Delay (s/veh)	LOS
1	Marksheffel Rd/Fontaine Bl	Signalized	HCM 7th Edition	EB Left	0.621	33.4	C
2	Marksheffel Rd/Lorson Bl	Signalized	HCM 7th Edition	NB Left	0.546	19.3	B
3	Fontaine Bl/Carriage Meadows Dr	Signalized	HCM 7th Edition	EB Left	0.608	13.1	B
4	Marksheffel Rd/West Driveway	Two-way stop	HCM 7th Edition	WB Right	0.037	8.5	A
5	Carriage Meadows Dr/East Driveway	Two-way stop	HCM 7th Edition	WB Left	0.033	12.7	B
7	Fontaine Bl/Middle Driveway	Two-way stop	HCM 7th Edition	NB Right	0.015	11.1	B

V/C, Delay, LOS: For two-way stop, these values are taken from the movement with the worst (highest) delay value. For all other control types, they are taken for the whole intersection.

Table 17. Horizon (2045) Total Intersection Operations (PM Peak Hour)

Intersection Analysis Summary

ID	Intersection Name	Control Type	Method	Worst Mvmt	V/C	Delay (s/veh)	LOS
1	Marksheffel Rd/Fontaine Bl	Signalized	HCM 7th Edition	EB Left	0.762	49.0	D
2	Marksheffel Rd/Lorson Bl	Signalized	HCM 7th Edition	SB Left	0.836	16.0	B
3	Fontaine Bl/Carriage Meadows Dr	Signalized	HCM 7th Edition	WB Left	0.797	20.0	C
4	Marksheffel Rd/West Driveway	Two-way stop	HCM 7th Edition	WB Right	0.034	8.6	A
5	Carriage Meadows Dr/East Driveway	Two-way stop	HCM 7th Edition	WB Left	0.023	11.9	B
7	Fontaine Bl/Middle Driveway	Two-way stop	HCM 7th Edition	NB Right	0.196	31.4	D

V/C, Delay, LOS: For two-way stop, these values are taken from the movement with the worst (highest) delay value. For all other control types, they are taken for the whole intersection.

As shown in Table 16, Table 17, and Figure 32 all intersections operate at an acceptable LOS. All approaches at the intersections along Marksheffel Road also operate at an acceptable LOS.

Turn lane evaluations are shown in Table 18.

Table 18. Horizon (2045) Total Turn Lane Evaluations

ID	Intersection	Control Type	Movement	Speed (mph)	Turning Volume (vph)	Queue (ft)	Agency	Deceleration (ft)	Taper (ft)	Storage (ft)	Total (ft)	Provided (ft)	Improvement (ft)				
1	Marksheffel Rd/Fontaine Bl	Signalized	NBL	55	157	229	CCS	263	220		485	740	-				
			NBR	55	472	288		263	220		485	740	-				
			SBL	55	832	530		263	220		485	665	-				
			SBR	55	55	39		263	220		485	665	-				
			EBL	35	127	198		120	140		260	330	-				
			EBR	35	266	163		120	140		260	50	-				
			WBL	45	365	259		200	180		380	545	-				
			WBR	45	597	267		200	180		380	Continuous	-				
2	Marksheffel Rd/Lorson Bl	Signalized	NBL	55	159		CCS	263	220		485						
			NBR	55	568	51		263	220		485	565	-				
			SBL	55	284	224		263	220		485	Continuous	-				
			SBR	55	34			263	220		485						
			EBL	35	49			120	140		260						
			EBR	35	69			120	140		260						
			WBL	35	500	324		120	140		260	485	-				
			WBR	35	296	55		120	140		260	Continuous	-				
3	Fontaine Bl/Carriage Meadows Dr	Signalized	NBL	25	156	171	EPC	115	120	171	405	190					
			NBR	25	44	21		Not Required			180	-					
			SBL	25	73	73		115	120	73	310	100	-				
			SBR	25	188	86		115	120	86	320	100	-				
			EBL	45	163	265		235	200	265	700	500	75				
			EBR	45	115	9		235	200	9	444	Continuous	-				
			WBL	45	72	159		235	200	159	594	510	-				
			WBR	45	41	7		Not Required			330	-					
			4	Marksheffel Rd/West Driveway	Stop-Controlled	NBR		55	90	0	CCS	263	220		485		-
			5	Carriage Meadows Dr Rd/East Driveway	Stop-Controlled	NBL		25	102	6	EPC	115	120	100	335		-
EBR	25	158				0	115	120		235			-				
7	Fontaine Bl/Middle Driveway	Stop-Controlled	WBR	45	33	0	EPC	235	200		435		-				

Fontaine Boulevard/Carriage Meadows Drive (#3)

- A 75-ft extension of eastbound left-turn

Conclusions and Recommendations

In this report, the traffic impact of Village at Lorson Ranch on the adjacent roadways was studied. The *Hillside at Lorson Ranch (2022)* study was used to derive the background volumes in the future conditions. Two adjacent developments, namely townhomes at the northeast corner of Fontaine Boulevard/Carriage Meadows Drive and Lorson Ranch Commercial South traffic were also added to the background traffic. Summary of the required improvements are as follow:

Existing Conditions:

Marksheffel Road/Fontaine Boulevard (#1)

- A 210-ft extension of eastbound right-turn.

Marksheffel Road/Lorson Boulevard (#2)

- A Traffic Signal.

Buildout (2030) Background:

Fontaine Boulevard/Carriage Meadows Drive (#3)

- Prohibit northbound left-turn and southbound left-turn. A 55-ft extension of northbound right-turn.
- A 135-ft extension of southbound right-turn.
- A 10-ft extension of eastbound left-turn.

EPC will not approve this solution

Removed.

Buildout (2030) Total:

Fontaine Boulevard/Carriage Meadows Drive (#3)

- A traffic signal.
- A 95-ft extension of northbound left-turn.
- A 210-ft extension of southbound left-turn lane.
- A 90-ft extension of eastbound left-turn lane.
- An 85-ft extension of southbound right-turn lane. Upon the buildout year the southbound right-turn needs to be a continuous lane from the east driveway (#5)

Marksheffel Road/West Driveway (#4)

- A 485-ft northbound right-turn lane. Included a 265-ft deceleration lane, and a 220-ft taper lane. The project is fully responsible for this improvement.

Carriage Meadows Drive/East Driveway (#5)

- A 335-ft northbound left-turn. Included a 115-ft deceleration lane, 120-ft taper lane, and a 100-ft storage lane. The project is fully responsible for this improvement.

- A 235-ft shared eastbound right-turn lane. Included a 115-ft deceleration lane, and a 120-ft taper lane. The project is fully responsible for this improvement.

Fontaine Boulevard/Middle Driveway (#7)

- A 435-ft westbound right-turn. Matrix recommends an extension of the northwest corner of the Fontaine/Carriage Meadows intersection to define the deceleration lane into the driveway along Fontaine Boulevard according to the Figure 2. A higher quality of this exhibit is provided in Appendix F – Supporting Documents. The project is fully responsible for this improvement.

Horizon (2045) Background:

Fontaine Boulevard/Carriage Meadows Drive (#3)

- A 325-ft extension of northbound left-turn.
- A 65-ft extension of southbound right-turn.
- A 115-ft extension of eastbound left-turn.
- A 90-ft extension of westbound left-turn.

Horizon (2045) Total:

Fontaine Boulevard/Carriage Meadows Drive (#3)

- A 75-ft extension of eastbound left-turn

The project fair share is summarized in Table 19.

Table 19. Village at Lorson Ranch Fair Share Calculations

ID	Intersection	2030 Total AM	2030 Total PM	2045 Total AM	2045 Total PM	Site AM	Site PM	Existing AM	Existing PM	Fairshare 2030 AM	Fairshare 2030 PM	Fairshare 2030 (Weighted Average)	Fairshare 2045 AM	Fairshare 2045 PM	Fairshare 2045 (Weighted Average)
1	Marksheffel Road/Fontaine Boulevard	3354	4227	4041	5696	273	234	2301	2275	25.93%	11.99%	18.15%	15.69%	6.84%	10.51%
3	Fontaine Boulevard/Carriage Meadows Drive	2322	3113	2791	4215	311	271	1421	1354	34.52%	15.41%	23.57%	22.70%	9.47%	14.74%

Finally, the applicant is required to pay road impact fees to El Paso County. The County allows for the applicant to pay three different upfront fee amounts. The applicant can either pay the full fee amount, a smaller upfront fee to the 5 mill Public Improvement District (PID), or an even smaller upfront fee amount to the 10 mill PID. The different fee amounts are shown in Table 20. The applicant will choose which fee method to follow at a later date. If the applicant chooses one of the PIDs, the PID will collect taxes over time. Table 20 summarizes the road impact fees.

Table 20. Road Impact Fee Schedule

Land Use		Unit	Size	Full Fee	5 Mill PID	10 Mill PID
Day Care	General Commercial	ksf	12	\$59,496	\$46,212	\$32,940
Fast Food	Conveninece Comm.	ksf	8.17	\$71,896	\$43,064	\$14,289
Gas Station	Conveninece Comm.	ksf	5.68	\$49,984	\$29,939	\$9,934
Mini Warehouse	Mini Warehouse	ksf	36.5	\$26,463	\$8,870	N/A

The summary of required improvements is also listed in Table 21.

Day care may be classified under Public / Institutional

This table has been revised to show Day Care under Public/Institutional

Table 21. Summary of Required Improvements

ID	Intersection	Improvement	Year	Responsibility
1	Marksheffel Road/Fontaine Boulevard	A 210-ft extension of eastbound right turn	Existing	The Project has no responsibility for this improvement.
2	Marksheffel Road/Lorson Boulevard	Traffic Signal	Existing	The Project has no responsibility for this improvement.
3	Fontaine Boulevard/Carriage Meadows Drive	Prohibit northbound left-turn and southbound left-turn. A 55-ft extension of northbound right-turn. A 135-ft extension of southbound right-turn. A 10-ft extension of eastbound left-turn.	Buildout (2030) Background	The Project has no responsibility for these improvements.
3	Fontaine Boulevard/Carriage Meadows Drive	A traffic signal. A 95-ft extension of northbound left-turn. A 210-ft extension of southbound left-turn lane. A 90-ft extension of eastbound left-turn lane. An 85-ft extension of southbound right-turn lane. Upon the buildout year the southbound right-turn needs to be a continuous lane from the east driveway (#5)	Buildout (2030) Total	The Project fairshare is shown in Table 20.
4	Marksheffel Road/West Driveway	A 485-ft northbound right-turn lane. Included a 265-ft deceleration lane, and a 220-ft taper lane	Buildout (2030) Total	The project is fully responsible for this improvement.
5	Carriage Meadows Drive/East Driveway	A 335-ft northbound left-turn. Included a 115-ft deceleration lane, 120-ft taper lane, and a 100-ft storage lane. A 235-ft eastbound right-turn lane. Included a 115-ft deceleration lane, and a 120-ft taper lane.	Buildout (2030) Total	The project is fully responsible for this improvement.
7	Fontaine Boulevard/Middle Driveway (#7)	A 435-ft westbound right-turn	Buildout (2030) Total	The project is fully responsible for this improvement.
3	Fontaine Boulevard/Carriage Meadows Drive	A 325-ft extension of northbound left-turn. A 65-ft extension of southbound right-turn. A 115-ft extension of eastbound left-turn. A 90-ft extension of westbound left-turn.	Horizon (2045) Background	The Project has no responsibility for these improvements.
3	Fontaine Boulevard/Carriage Meadows Drive	A 75-ft extension of eastbound left-turn	Horizon (2045) Total	The Project fairshare is shown in Table 20.

Appendix A – Traffic Counts

All Traffic Data Services
 9660 W 44th Ave
 Wheat Ridge, CO 80033

Site Code: 4
 Station ID: 4
 MARKSHEFFEL RD N.O. FONTAINE BLVD

Start Time	12-Mar-24 Tue	NB	SB	Total						
12:00 AM		20	39	59						
01:00		12	18	30						
02:00		9	10	19						
03:00		26	18	44						
04:00		75	34	109						
05:00		244	89	333						
06:00		718	188	906						
07:00		1029	350	1379						
08:00		491	324	815						
09:00		336	218	554						
10:00		319	220	539						
11:00		283	280	563						
12:00 PM		333	329	662						
01:00		282	334	616						
02:00		347	402	749						
03:00		497	617	1114						
04:00		501	837	1338						
05:00		503	744	1247						
06:00		287	479	766						
07:00		153	287	440						
08:00		108	265	373						
09:00		51	150	201						
10:00		40	106	146						
11:00		38	50	88						
Total		6702	6388	13090						
Percent		51.2%	48.8%							
AM Peak	-	07:00	07:00	-	-	-	-	-	-	07:00
Vol.	-	1029	350	-	-	-	-	-	-	1379
PM Peak	-	17:00	16:00	-	-	-	-	-	-	16:00
Vol.	-	503	837	-	-	-	-	-	-	1338
Grand Total		6702	6388							13090
Percent		51.2%	48.8%							
ADT		ADT 13,090	AADT 13,090							

All Traffic Data Services
 9660 W 44th Ave
 Wheat Ridge, CO 80033

Site Code: 5
 Station ID: 5
 FONTAINE BLVD W.O. MARKSHEFFEL RD

Start Time	12-Mar-24 Tue	EB	WB							Total
12:00 AM		26	10							36
01:00		10	11							21
02:00		7	6							13
03:00		6	16							22
04:00		5	60							65
05:00		40	188							228
06:00		101	311							412
07:00		197	477							674
08:00		175	299							474
09:00		133	228							361
10:00		125	206							331
11:00		193	199							392
12:00 PM		173	220							393
01:00		195	230							425
02:00		254	227							481
03:00		363	305							668
04:00		474	252							726
05:00		409	308							717
06:00		354	214							568
07:00		271	155							426
08:00		186	125							311
09:00		106	78							184
10:00		85	51							136
11:00		58	23							81
Total		3946	4199							8145
Percent		48.4%	51.6%							
AM Peak	-	07:00	07:00	-	-	-	-	-	-	07:00
Vol.	-	197	477	-	-	-	-	-	-	674
PM Peak	-	16:00	17:00	-	-	-	-	-	-	16:00
Vol.	-	474	308	-	-	-	-	-	-	726
Grand Total		3946	4199							8145
Percent		48.4%	51.6%							
ADT		ADT 8,145	AADT 8,145							

All Traffic Data Services
 9660 W 44th Ave
 Wheat Ridge, CO 80033

Site Code: 6
 Station ID: 6
 FONTAINE BLVD E.O. CARRIAGE MEADOWS DR

Start Time	12-Mar-24 Tue	EB	WB							Total
12:00 AM		48	17							65
01:00		20	14							34
02:00		11	13							24
03:00		15	39							54
04:00		21	91							112
05:00		43	360							403
06:00		142	627							769
07:00		336	990							1326
08:00		300	567							867
09:00		228	371							599
10:00		223	331							554
11:00		325	319							644
12:00 PM		334	338							672
01:00		325	320							645
02:00		481	369							850
03:00		603	500							1103
04:00		811	412							1223
05:00		765	460							1225
06:00		642	329							971
07:00		469	217							686
08:00		350	158							508
09:00		216	92							308
10:00		158	67							225
11:00		79	39							118
Total		6945	7040							13985
Percent		49.7%	50.3%							
AM Peak	-	07:00	07:00	-	-	-	-	-	-	07:00
Vol.	-	336	990	-	-	-	-	-	-	1326
PM Peak	-	16:00	15:00	-	-	-	-	-	-	17:00
Vol.	-	811	500	-	-	-	-	-	-	1225
Grand Total		6945	7040							13985
Percent		49.7%	50.3%							
ADT		ADT 13,985	AADT 13,985							

All Traffic Data Services

9660 W 44th Ave
Wheat Ridge, CO 80033

Site Code: 7
Station ID: 7
MARKSHEFFEL RD S.O. LORSON BLVD

Start Time	12-Mar-24 Tue	NB	SB							Total
12:00 AM		28	24							52
01:00		15	10							25
02:00		7	9							16
03:00		9	26							35
04:00		50	55							105
05:00		154	369							523
06:00		469	471							940
07:00		692	661							1353
08:00		466	598							1064
09:00		312	339							651
10:00		321	299							620
11:00		363	325							688
12:00 PM		345	325							670
01:00		385	361							746
02:00		484	398							882
03:00		697	607							1304
04:00		749	678							1427
05:00		793	598							1391
06:00		511	391							902
07:00		352	264							616
08:00		249	182							431
09:00		169	114							283
10:00		92	72							164
11:00		65	45							110
Total		7777	7221							14998
Percent		51.9%	48.1%							
AM Peak	-	07:00	07:00	-	-	-	-	-	-	07:00
Vol.	-	692	661	-	-	-	-	-	-	1353
PM Peak	-	17:00	16:00	-	-	-	-	-	-	16:00
Vol.	-	793	678	-	-	-	-	-	-	1427
Grand Total		7777	7221							14998
Percent		51.9%	48.1%							
ADT		ADT 14,998	AADT 14,998							

Location: 1 MARKSHEFFEL RD & FONTAINE BLVD AM

Date: Tuesday, March 12, 2024

Peak Hour: 07:00 AM - 08:00 AM

Peak 15-Minutes: 07:15 AM - 07:30 AM

Peak Hour - Motorized Vehicles

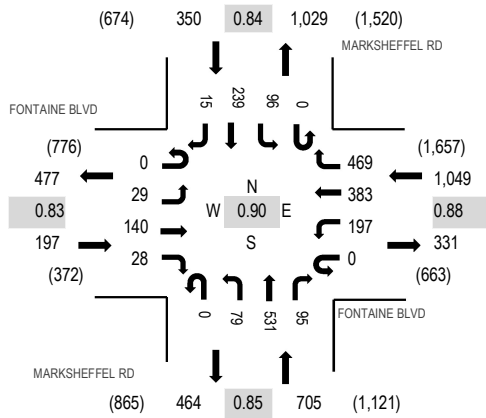

Peak Hour - Bicycles

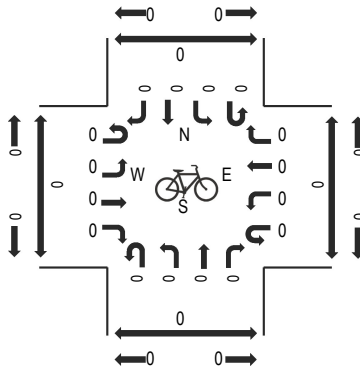

Peak Hour - Pedestrians

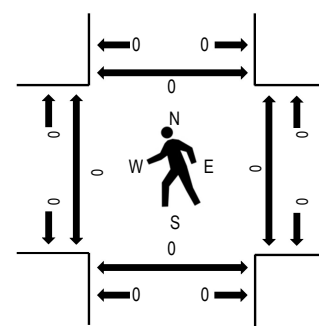

Note: Total study counts contained in parentheses.

Traffic Counts - Motorized Vehicles

Interval Start Time	FONTAINE BLVD Eastbound				FONTAINE BLVD Westbound				MARKSHEFFEL RD Northbound				MARKSHEFFEL RD Southbound				Total	Rolling Hour	Pedestrian Crossings			
	U-Turn	Left	Thru	Right	U-Turn	Left	Thru	Right	U-Turn	Left	Thru	Right	U-Turn	Left	Thru	Right			West	East	South	North
7:00 AM	0	8	41	4	0	51	117	102	0	12	133	25	0	17	71	1	582	2,301	0	0	0	0
7:15 AM	0	8	43	8	0	47	96	149	0	18	158	30	0	28	49	2	636	2,148	0	0	0	0
7:30 AM	0	10	31	9	0	58	106	135	0	31	160	16	0	22	47	5	630	1,919	0	0	0	0
7:45 AM	0	3	25	7	0	41	64	83	0	18	80	24	0	29	72	7	453	1,675	0	0	0	0
8:00 AM	0	2	24	21	0	56	68	67	0	10	71	21	0	27	56	6	429	1,523	0	0	0	0
8:15 AM	0	5	33	14	0	40	58	45	0	14	80	25	0	32	61	0	407		0	0	0	0
8:30 AM	0	2	28	9	0	42	73	49	0	15	75	22	0	27	43	1	386		0	0	0	0
8:45 AM	0	2	31	4	0	26	43	41	0	8	52	23	0	39	29	3	301		0	0	0	0
Count Total	0	40	256	76	0	361	625	671	0	126	809	186	0	221	428	25	3,824		0	0	0	0
Peak Hour	0	29	140	28	0	197	383	469	0	79	531	95	0	96	239	15	2,301		0	0	0	0

Location: 2 MARKSHEFFEL RD & LORSON BLVD AM

Date: Tuesday, March 12, 2024

Peak Hour: 07:00 AM - 08:00 AM

Peak 15-Minutes: 07:15 AM - 07:30 AM

Peak Hour - Motorized Vehicles

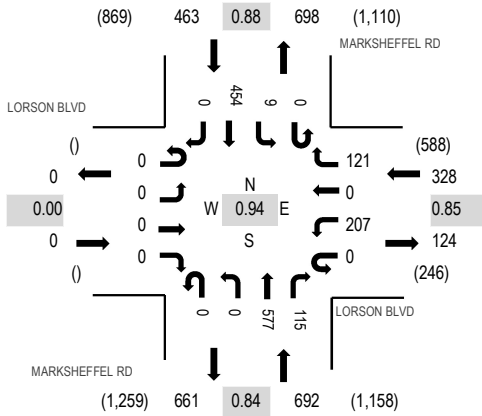

Peak Hour - Bicycles

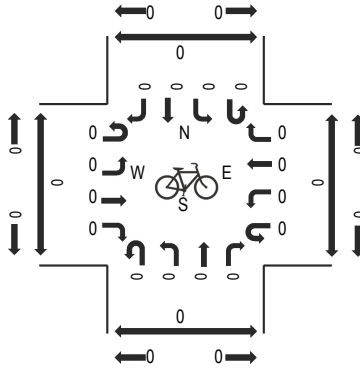

Peak Hour - Pedestrians

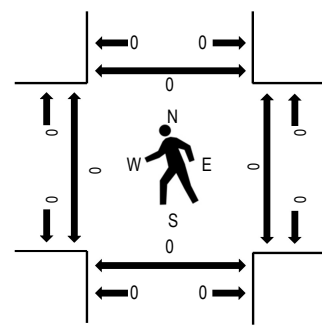

Note: Total study counts contained in parentheses.

Traffic Counts - Motorized Vehicles

Interval Start Time	LORSON BLVD Eastbound				LORSON BLVD Westbound				MARKSHEFFEL RD Northbound				MARKSHEFFEL RD Southbound				Total	Rolling Hour	Pedestrian Crossings			
	U-Turn	Left	Thru	Right	U-Turn	Left	Thru	Right	U-Turn	Left	Thru	Right	U-Turn	Left	Thru	Right			West	East	South	North
7:00 AM	0	0	0	0	0	56	0	24	0	0	152	23	0	6	121	0	382	1,483	0	0	0	0
7:15 AM	0	0	0	0	0	45	0	37	0	0	176	30	0	3	103	0	394	1,418	0	0	0	0
7:30 AM	0	0	0	0	0	60	0	36	0	0	154	29	0	0	112	0	391	1,364	0	0	0	0
7:45 AM	0	0	0	0	0	46	0	24	0	0	95	33	0	0	118	0	316	1,252	0	0	0	0
8:00 AM	0	0	0	0	0	47	0	12	0	0	94	27	0	7	130	0	317	1,132	0	0	0	0
8:15 AM	0	0	0	0	0	79	0	17	0	0	99	31	0	9	105	0	340		0	0	0	0
8:30 AM	0	0	0	0	0	48	0	12	0	0	96	25	0	4	94	0	279		0	0	0	0
8:45 AM	0	0	0	0	0	38	0	7	0	0	75	19	0	0	57	0	196		0	0	0	0
Count Total	0	0	0	0	0	419	0	169	0	0	941	217	0	29	840	0	2,615		0	0	0	0
Peak Hour	0	0	0	0	0	207	0	121	0	0	577	115	0	9	454	0	1,483		0	0	0	0

Location: 3 CARRIAGE MEADOWS DR & FONTAINE BLVD AM

Date: Tuesday, March 12, 2024

Peak Hour: 07:00 AM - 08:00 AM

Peak 15-Minutes: 07:15 AM - 07:30 AM

Peak Hour - Motorized Vehicles

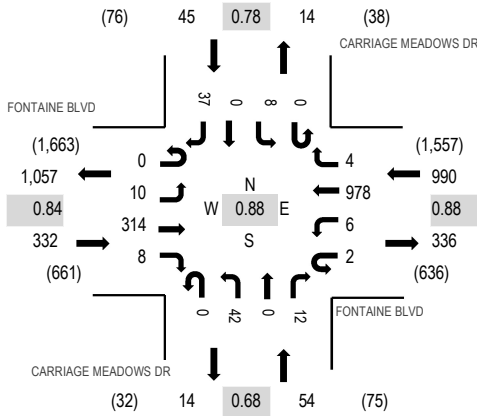

Peak Hour - Bicycles

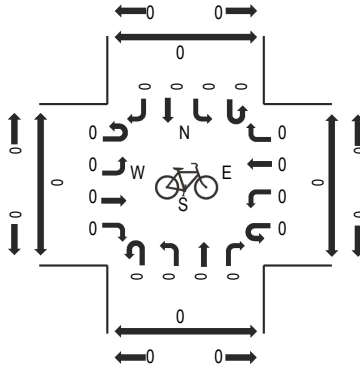

Peak Hour - Pedestrians

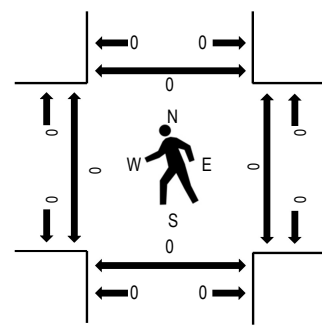

Note: Total study counts contained in parentheses.

Traffic Counts - Motorized Vehicles

Interval Start Time	FONTAINE BLVD Eastbound				FONTAINE BLVD Westbound				CARRIAGE MEADOWS DR Northbound				CARRIAGE MEADOWS DR Southbound				Total	Rolling Hour	Pedestrian Crossings			
	U-Turn	Left	Thru	Right	U-Turn	Left	Thru	Right	U-Turn	Left	Thru	Right	U-Turn	Left	Thru	Right			West	East	South	North
	7:00 AM	0	1	84	0	0	2	251	0	0	12	0	1	0	1	0			8	360	1,421	0
7:15 AM	0	7	88	4	0	0	281	1	0	8	0	2	0	4	0	11	406	1,328	0	0	0	0
7:30 AM	0	1	68	2	0	2	270	3	0	12	0	8	0	2	0	11	379	1,153	0	0	0	0
7:45 AM	0	1	74	2	2	2	176	0	0	10	0	1	0	1	0	7	276	1,016	0	0	0	0
8:00 AM	0	6	65	1	1	2	173	1	0	7	0	0	0	0	0	11	267	948	0	0	0	0
8:15 AM	1	4	76	7	0	0	126	0	0	5	0	2	0	2	0	8	231		0	0	0	0
8:30 AM	0	7	64	3	1	2	154	1	0	2	0	0	0	0	0	8	242		0	0	0	0
8:45 AM	0	4	88	3	0	0	105	1	0	4	0	1	0	0	0	2	208		0	0	0	0
Count Total	1	31	607	22	4	10	1,536	7	0	60	0	15	0	10	0	66	2,369		0	0	0	0
Peak Hour	0	10	314	8	2	6	978	4	0	42	0	12	0	8	0	37	1,421		0	0	0	0

Location: 1 MARKSHEFFEL RD & FONTAINE BLVD PM

Date: Tuesday, March 12, 2024

Peak Hour: 04:00 PM - 05:00 PM

Peak 15-Minutes: 04:30 PM - 04:45 PM

Peak Hour - Motorized Vehicles

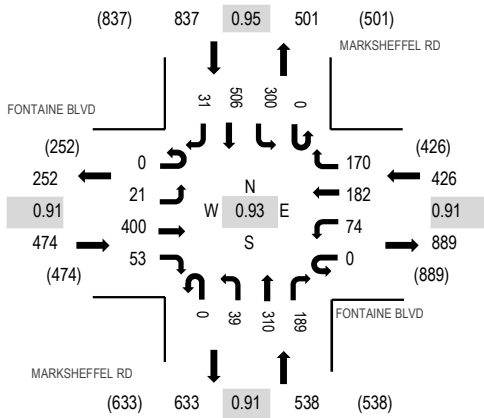

Peak Hour - Bicycles

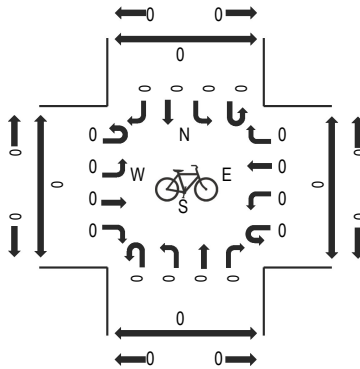

Peak Hour - Pedestrians

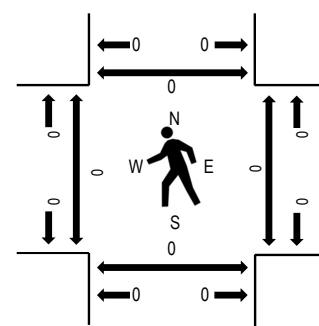

Note: Total study counts contained in parentheses.

Traffic Counts - Motorized Vehicles

Interval Start Time	FONTAINE BLVD Eastbound				FONTAINE BLVD Westbound				MARKSHEFFEL RD Northbound				MARKSHEFFEL RD Southbound				Total	Rolling Hour	Pedestrian Crossings			
	U-Turn	Left	Thru	Right	U-Turn	Left	Thru	Right	U-Turn	Left	Thru	Right	U-Turn	Left	Thru	Right			West	East	South	North
4:00 PM	0	6	101	13	0	15	45	47	0	13	80	43	0	77	122	9	571	2,275	0	0	0	0
4:15 PM	0	6	87	17	0	13	35	39	0	10	79	52	0	75	120	9	542		0	0	0	0
4:30 PM	0	7	115	8	0	21	55	39	0	9	85	54	0	80	134	7	614		0	0	0	0
4:45 PM	0	2	97	15	0	25	47	45	0	7	66	40	0	68	130	6	548		0	0	0	0
Count Total	0	21	400	53	0	74	182	170	0	39	310	189	0	300	506	31	2,275		0	0	0	0
Peak Hour	0	21	400	53	0	74	182	170	0	39	310	189	0	300	506	31	2,275		0	0	0	0

Location: 2 MARKSHEFFEL RD & LORSON BLVD PM

Date: Tuesday, March 12, 2024

Peak Hour: 04:00 PM - 05:00 PM

Peak 15-Minutes: 04:30 PM - 04:45 PM

Peak Hour - Motorized Vehicles

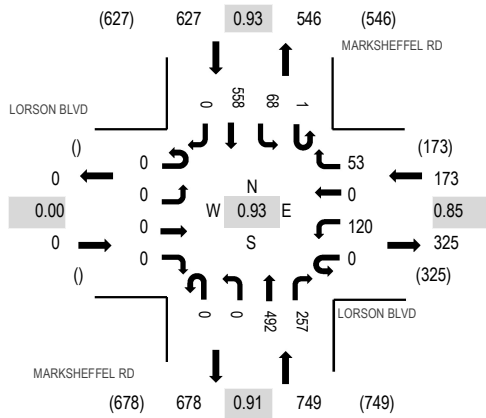

Peak Hour - Bicycles

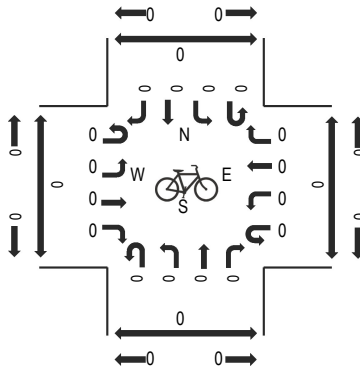

Peak Hour - Pedestrians

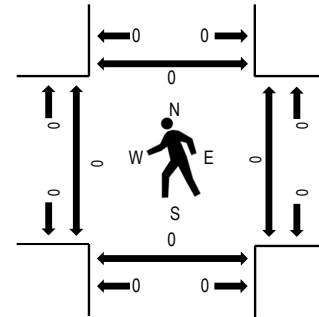

Note: Total study counts contained in parentheses.

Traffic Counts - Motorized Vehicles

Interval Start Time	LORSON BLVD Eastbound				LORSON BLVD Westbound				MARKSHEFFEL RD Northbound				MARKSHEFFEL RD Southbound				Total	Rolling Hour	Pedestrian Crossings			
	U-Turn	Left	Thru	Right	U-Turn	Left	Thru	Right	U-Turn	Left	Thru	Right	U-Turn	Left	Thru	Right			West	East	South	North
4:00 PM	0	0	0	0	0	33	0	18	0	0	120	59	0	11	140	0	381	1,549	0	0	0	0
4:15 PM	0	0	0	0	0	26	0	11	0	0	132	66	0	17	126	0	378		0	0	0	0
4:30 PM	0	0	0	0	0	32	0	13	0	0	135	70	0	18	147	0	415		0	0	0	0
4:45 PM	0	0	0	0	0	29	0	11	0	0	105	62	1	22	145	0	375		0	0	0	0
Count Total	0	0	0	0	0	120	0	53	0	0	492	257	1	68	558	0	1,549		0	0	0	0
Peak Hour	0	0	0	0	0	120	0	53	0	0	492	257	1	68	558	0	1,549		0	0	0	0

Location: 3 CARRIAGE MEADOWS DR & FONTAINE BLVD PM

Date: Tuesday, March 12, 2024

Peak Hour: 04:00 PM - 05:00 PM

Peak 15-Minutes: 04:30 PM - 04:45 PM

Peak Hour - Motorized Vehicles

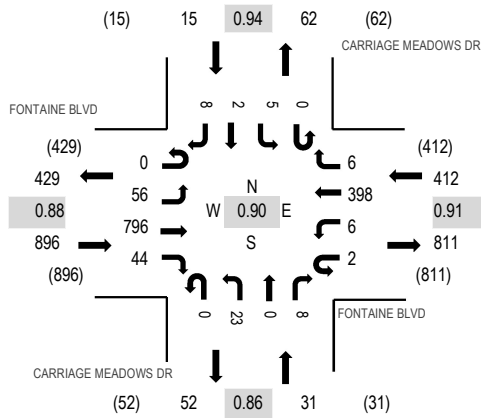

Peak Hour - Bicycles

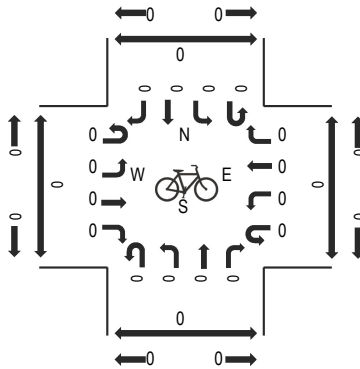

Peak Hour - Pedestrians

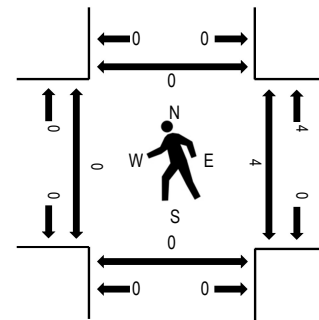

Note: Total study counts contained in parentheses.

Traffic Counts - Motorized Vehicles

Interval Start Time	FONTAINE BLVD Eastbound				FONTAINE BLVD Westbound				CARRIAGE MEADOWS DR Northbound				CARRIAGE MEADOWS DR Southbound				Total	Rolling Hour	Pedestrian Crossings			
	U-Turn	Left	Thru	Right	U-Turn	Left	Thru	Right	U-Turn	Left	Thru	Right	U-Turn	Left	Thru	Right			West	East	South	North
	4:00 PM	0	11	196	15	0	0	101	2	0	7	0	1	0	1	1			2	337	1,354	0
4:15 PM	0	20	184	8	0	3	80	1	0	5	0	4	0	2	0	1	308		0	0	0	0
4:30 PM	0	10	233	11	1	0	109	3	0	5	0	1	0	1	0	3	377		0	4	0	0
4:45 PM	0	15	183	10	1	3	108	0	0	6	0	2	0	1	1	2	332		0	0	0	0
Count Total	0	56	796	44	2	6	398	6	0	23	0	8	0	5	2	8	1,354		0	4	0	0
Peak Hour	0	56	796	44	2	6	398	6	0	23	0	8	0	5	2	8	1,354		0	4	0	0

Appendix B – Existing Conditions Analyses





Table of Contents

Intersection Level Of Service Report	2
Intersection 1: Marksheffel Rd/Fontaine Bl	2
Intersection 2: Marksheffel Rd/Lorson Bl	7
Intersection 3: Fontaine Bl/Carriage Meadows Dr	9
Signal Warrants Report	11
Intersection 2: Marksheffel Rd/Lorson Bl	11
Intersection 3: Fontaine Bl/Carriage Meadows Dr	13

Intersection Level Of Service Report
Intersection 1: Marksheffel Rd/Fontaine Bl

Control Type:	Signalized	Delay (sec / veh):	14.4
Analysis Method:	HCM 7th Edition	Level Of Service:	B
Analysis Period:	15 minutes	Volume to Capacity (v/c):	0.521

Intersection Setup

Name	Marksheffel Rd			Marksheffel Rd			Fontaine Bl			Fontaine Bl		
Approach	Northbound			Southbound			Eastbound			Westbound		
Lane Configuration												
Turning Movement	Left	Thru	Right	Left	Thru	Right	Left	Thru	Right	Left	Thru	Right
Lane Width [ft]	12.00	12.00	12.00	12.00	12.00	12.00	12.00	12.00	12.00	12.00	12.00	12.00
No. of Lanes in Entry Pocket	1	0	1	1	0	1	1	0	1	1	0	0
Entry Pocket Length [ft]	680.00	100.00	680.00	750.00	100.00	500.00	360.00	100.00	200.00	535.00	100.00	100.00
No. of Lanes in Exit Pocket	0	0	0	0	0	0	0	0	0	0	0	0
Exit Pocket Length [ft]	0.00	0.00	0.00	0.00	0.00	0.00	0.00	0.00	0.00	0.00	0.00	0.00
Speed [mph]	55.00			55.00			45.00			45.00		
Grade [%]	0.00			0.00			0.00			0.00		
Curb Present	No			No			No			No		
Crosswalk	Yes			Yes			Yes			Yes		

Volumes

Name	Marksheffel Rd			Marksheffel Rd			Fontaine Bl			Fontaine Bl		
Base Volume Input [veh/h]	79	531	95	96	239	15	29	140	28	197	383	469
Base Volume Adjustment Factor	1.0000	1.0000	1.0000	1.0000	1.0000	1.0000	1.0000	1.0000	1.0000	1.0000	1.0000	1.0000
Heavy Vehicles Percentage [%]	2.00	2.00	2.00	2.00	2.00	2.00	2.00	2.00	2.00	2.00	2.00	2.00
Proportion of CAVs [%]	0.00											
Growth Factor	1.0000	1.0000	1.0000	1.0000	1.0000	1.0000	1.0000	1.0000	1.0000	1.0000	1.0000	1.0000
In-Process Volume [veh/h]	0	0	0	0	0	0	0	0	0	0	0	0
Site-Generated Trips [veh/h]	0	0	0	0	0	0	0	0	0	0	0	0
Diverted Trips [veh/h]	0	0	0	0	0	0	0	0	0	0	0	0
Pass-by Trips [veh/h]	0	0	0	0	0	0	0	0	0	0	0	0
Existing Site Adjustment Volume [veh/h]	0	0	0	0	0	0	0	0	0	0	0	0
Other Volume [veh/h]	0	0	0	0	0	0	0	0	0	0	0	0
Right Turn on Red Volume [veh/h]	0	0	48	0	0	8	0	0	14	0	0	235
Total Hourly Volume [veh/h]	79	531	47	96	239	7	29	140	14	197	383	234
Peak Hour Factor	0.8500	0.8500	0.8500	0.8400	0.8400	0.8400	0.8300	0.8300	0.8300	0.8800	0.8800	0.8800
Other Adjustment Factor	1.0000	1.0000	1.0000	1.0000	1.0000	1.0000	1.0000	1.0000	1.0000	1.0000	1.0000	1.0000
Total 15-Minute Volume [veh/h]	23	156	14	29	71	2	9	42	4	56	109	66
Total Analysis Volume [veh/h]	93	625	55	114	285	8	35	169	17	224	435	266
Presence of On-Street Parking	No		No	No		No	No		No	No		No
On-Street Parking Maneuver Rate [/h]	0	0	0	0	0	0	0	0	0	0	0	0
Local Bus Stopping Rate [/h]	0	0	0	0	0	0	0	0	0	0	0	0
v_do, Outbound Pedestrian Volume crossing	0			0			0			0		
v_di, Inbound Pedestrian Volume crossing m	0			0			0			0		
v_co, Outbound Pedestrian Volume crossing	0			0			0			0		
v_ci, Inbound Pedestrian Volume crossing mi	0			0			0			0		
v_ab, Corner Pedestrian Volume [ped/h]	0			0			0			0		
Bicycle Volume [bicycles/h]	0			0			0			0		

Intersection Settings

Located in CBD	No
Signal Coordination Group	-
Cycle Length [s]	60
Active Pattern	Pattern 1
Coordination Type	Time of Day Pattern Coordinated
Actuation Type	Fully actuated
Offset [s]	0.0
Offset Reference	Lead Green - Beginning of First Green
Permissive Mode	SingleBand
Lost time [s]	0.00

Phasing & Timing

Control Type	Permiss	Permiss	Permiss	Permiss	Permiss	Permiss	Permiss	Permiss	Permiss	Permiss	Permiss	Permiss
Signal Group	0	6	0	0	2	0	0	8	0	0	4	0
Auxiliary Signal Groups												
Lead / Lag	-	-	-	-	-	-	-	-	-	-	-	-
Minimum Green [s]	0	10	0	0	10	0	0	10	0	0	10	0
Maximum Green [s]	0	103	0	0	103	0	0	109	0	0	109	0
Amber [s]	0.0	3.0	0.0	0.0	3.0	0.0	0.0	3.0	0.0	0.0	3.0	0.0
All red [s]	0.0	1.0	0.0	0.0	1.0	0.0	0.0	1.0	0.0	0.0	1.0	0.0
Split [s]	0	35	0	0	35	0	0	25	0	0	25	0
Vehicle Extension [s]	0.0	3.0	0.0	0.0	3.0	0.0	0.0	3.0	0.0	0.0	3.0	0.0
Walk [s]	0	7	0	0	7	0	0	7	0	0	7	0
Pedestrian Clearance [s]	0	24	0	0	21	0	0	14	0	0	14	0
Delayed Vehicle Green [s]	0.0	0.0	0.0	0.0	0.0	0.0	0.0	0.0	0.0	0.0	0.0	0.0
Rest In Walk		No			No			No			No	
I1, Start-Up Lost Time [s]	0.0	2.0	0.0	0.0	2.0	0.0	0.0	2.0	0.0	0.0	2.0	0.0
I2, Clearance Lost Time [s]	0.0	2.0	0.0	0.0	2.0	0.0	0.0	2.0	0.0	0.0	2.0	0.0
Minimum Recall		No			No			No			No	
Maximum Recall		No			No			No			No	
Pedestrian Recall		No			No			No			No	
Detector Location [ft]	0.0	0.0	0.0	0.0	0.0	0.0	0.0	0.0	0.0	0.0	0.0	0.0
Detector Length [ft]	0.0	0.0	0.0	0.0	0.0	0.0	0.0	0.0	0.0	0.0	0.0	0.0
I, Upstream Filtering Factor	1.00	1.00	1.00	1.00	1.00	1.00	1.00	1.00	1.00	1.00	1.00	1.00

Exclusive Pedestrian Phase

Pedestrian Signal Group	0
Pedestrian Walk [s]	0
Pedestrian Clearance [s]	0

Lane Group Calculations

Lane Group	L	C	R	L	C	R	L	C	R	L	C	R
C, Cycle Length [s]	60	60	60	60	60	60	60	60	60	60	60	60
L, Total Lost Time per Cycle [s]	4.00	4.00	4.00	4.00	4.00	4.00	4.00	4.00	4.00	4.00	4.00	4.00
l1_p, Permitted Start-Up Lost Time [s]	2.00	0.00	0.00	2.00	0.00	0.00	2.00	0.00	0.00	2.00	0.00	0.00
l2, Clearance Lost Time [s]	2.00	2.00	2.00	2.00	2.00	2.00	2.00	2.00	2.00	2.00	2.00	2.00
g_i, Effective Green Time [s]	34	34	34	34	34	34	18	18	18	18	18	18
g / C, Green / Cycle	0.56	0.56	0.56	0.56	0.56	0.56	0.30	0.30	0.30	0.30	0.30	0.30
(v / s)_i Volume / Saturation Flow Rate	0.09	0.33	0.03	0.15	0.15	0.01	0.05	0.05	0.01	0.19	0.12	0.17
s, saturation flow rate [veh/h]	1086	1870	1589	760	1870	1589	745	3560	1589	1197	3560	1589
c, Capacity [veh/h]	621	1056	898	366	1056	898	244	1075	480	395	1075	480
d1, Uniform Delay [s]	9.53	8.54	5.89	16.17	6.71	5.72	21.90	15.35	14.78	21.92	16.66	17.56
k, delay calibration	0.50	0.50	0.50	0.50	0.50	0.50	0.11	0.11	0.11	0.11	0.11	0.11
l, Upstream Filtering Factor	1.00	1.00	1.00	1.00	1.00	1.00	1.00	1.00	1.00	1.00	1.00	1.00
d2, Incremental Delay [s]	0.51	2.44	0.13	2.21	0.63	0.02	0.27	0.07	0.03	1.28	0.25	1.00
d3, Initial Queue Delay [s]	0.00	0.00	0.00	0.00	0.00	0.00	0.00	0.00	0.00	0.00	0.00	0.00
Rp, platoon ratio	1.00	1.00	1.00	1.00	1.00	1.00	1.00	1.00	1.00	1.00	1.00	1.00
PF, progression factor	1.00	1.00	1.00	1.00	1.00	1.00	1.00	1.00	1.00	1.00	1.00	1.00

Lane Group Results

X, volume / capacity	0.15	0.59	0.06	0.31	0.27	0.01	0.14	0.16	0.04	0.57	0.40	0.55
d, Delay for Lane Group [s/veh]	10.04	10.98	6.02	18.38	7.34	5.73	22.17	15.42	14.81	23.21	16.90	18.56
Lane Group LOS	B	B	A	B	A	A	C	B	B	C	B	B
Critical Lane Group	No	Yes	No	No	No	No	No	No	No	Yes	No	No
50th-Percentile Queue Length [veh/ln]	0.59	3.76	0.22	1.20	1.27	0.03	0.40	0.73	0.14	2.70	2.04	2.71
50th-Percentile Queue Length [ft/ln]	14.82	93.91	5.43	29.98	31.84	0.76	9.94	18.15	3.57	67.44	50.90	67.78
95th-Percentile Queue Length [veh/ln]	1.07	6.76	0.39	2.16	2.29	0.05	0.72	1.31	0.26	4.86	3.66	4.88
95th-Percentile Queue Length [ft/ln]	26.68	169.04	9.77	53.96	57.31	1.37	17.90	32.67	6.42	121.39	91.62	122.01

Movement, Approach, & Intersection Results

d_M, Delay for Movement [s/veh]	10.04	10.98	6.02	18.38	7.34	5.73	22.17	15.42	14.81	23.21	16.90	18.56
Movement LOS	B	B	A	B	A	A	C	B	B	C	B	B
d_A, Approach Delay [s/veh]	10.52			10.40			16.44			18.91		
Approach LOS	B			B			B			B		
d_I, Intersection Delay [s/veh]	14.40											
Intersection LOS	B											
Intersection V/C	0.521											

Other Modes

g_Walk,mi, Effective Walk Time [s]	11.0			11.0			11.0			11.0		
M_corner, Corner Circulation Area [ft ² /ped]	0.00			0.00			0.00			0.00		
M_CW, Crosswalk Circulation Area [ft ² /ped]	0.00			0.00			0.00			0.00		
d_p, Pedestrian Delay [s]	20.02			20.02			20.02			20.02		
I_p,int, Pedestrian LOS Score for Intersectio	3.104			2.874			2.772			3.436		
Crosswalk LOS	C			C			C			C		
s_b, Saturation Flow Rate of the bicycle lane	2000			2000			2000			2000		
c_b, Capacity of the bicycle lane [bicycles/h]	1033			1033			700			700		
d_b, Bicycle Delay [s]	7.02			7.02			12.68			12.68		
I_b,int, Bicycle LOS Score for Intersection	2.914			2.244			1.753			2.517		
Bicycle LOS	C			B			A			B		

Sequence

Ring 1	-	2	-	4	-	-	-	-	-	-	-	-	-	-	-	-	-
Ring 2	-	6	-	8	-	-	-	-	-	-	-	-	-	-	-	-	-
Ring 3	-	-	-	-	-	-	-	-	-	-	-	-	-	-	-	-	-
Ring 4	-	-	-	-	-	-	-	-	-	-	-	-	-	-	-	-	-



Intersection Level Of Service Report
Intersection 2: Marksheffel Rd/Lorson Bl

Control Type:	Two-way stop	Delay (sec / veh):	195.0
Analysis Method:	HCM 7th Edition	Level Of Service:	F
Analysis Period:	15 minutes	Volume to Capacity (v/c):	1.247

Intersection Setup

Name	Marksheffel Rd		Marksheffel Rd		Lorson Bl	
Approach	Northbound		Southbound		Westbound	
Lane Configuration	↕↗		↖↕		↖↗	
Turning Movement	Thru	Right	Left	Thru	Left	Right
Lane Width [ft]	12.00	12.00	12.00	12.00	12.00	12.00
No. of Lanes in Entry Pocket	0	1	1	0	1	0
Entry Pocket Length [ft]	100.00	500.00	580.00	100.00	510.00	100.00
No. of Lanes in Exit Pocket	0	0	0	0	0	0
Exit Pocket Length [ft]	0.00	0.00	0.00	0.00	0.00	0.00
Speed [mph]	55.00		55.00		25.00	
Grade [%]	0.00		0.00		0.00	
Crosswalk	Yes		Yes		Yes	

Volumes

Name	Marksheffel Rd		Marksheffel Rd		Lorson Bl	
Base Volume Input [veh/h]	577	115	9	454	207	121
Base Volume Adjustment Factor	1.0000	1.0000	1.0000	1.0000	1.0000	1.0000
Heavy Vehicles Percentage [%]	2.00	2.00	2.00	2.00	2.00	2.00
Growth Factor	1.0000	1.0000	1.0000	1.0000	1.0000	1.0000
In-Process Volume [veh/h]	0	0	0	0	0	0
Site-Generated Trips [veh/h]	0	0	0	0	0	0
Diverted Trips [veh/h]	0	0	0	0	0	0
Pass-by Trips [veh/h]	0	0	0	0	0	0
Existing Site Adjustment Volume [veh/h]	0	0	0	0	0	0
Other Volume [veh/h]	0	0	0	0	0	0
Total Hourly Volume [veh/h]	577	115	9	454	207	121
Peak Hour Factor	0.8400	0.8400	0.8800	0.8800	0.8500	0.8500
Other Adjustment Factor	1.0000	1.0000	1.0000	1.0000	1.0000	1.0000
Total 15-Minute Volume [veh/h]	172	34	3	129	61	36
Total Analysis Volume [veh/h]	687	137	10	516	244	142
Pedestrian Volume [ped/h]	0		0		0	

Intersection Settings

Priority Scheme	Free	Free	Stop
Flared Lane			
Storage Area [veh]	0	0	0
Two-Stage Gap Acceptance			No
Number of Storage Spaces in Median	0	0	0

Movement, Approach, & Intersection Results

V/C, Movement V/C Ratio	0.01	0.00	0.01	0.01	1.25	0.32
d_M, Delay for Movement [s/veh]	0.00	0.00	9.52	0.00	194.99	16.76
Movement LOS	A	A	A	A	F	C
95th-Percentile Queue Length [veh/ln]	0.00	0.00	0.04	0.00	13.06	1.35
95th-Percentile Queue Length [ft/ln]	0.00	0.00	0.94	0.00	326.45	33.74
d_A, Approach Delay [s/veh]	0.00		0.18		129.42	
Approach LOS	A		A		F	
d_I, Intersection Delay [s/veh]	28.83					
Intersection LOS	F					

Intersection Level Of Service Report
Intersection 3: Fontaine Bl/Carriage Meadows Dr

Control Type:	Two-way stop	Delay (sec / veh):	42.7
Analysis Method:	HCM 7th Edition	Level Of Service:	E
Analysis Period:	15 minutes	Volume to Capacity (v/c):	0.095

Intersection Setup

Name	Carriage Meadows Dr			Carriage Meadows Dr			Fontaine Bl			Fontaine Bl		
Approach	Northbound			Southbound			Eastbound			Westbound		
Lane Configuration	↔↔↔			↔↔↔			↔↔↔			↔↔↔		
Turning Movement	Left	Thru	Right	Left	Thru	Right	Left	Thru	Right	Left	Thru	Right
Lane Width [ft]	12.00	12.00	12.00	12.00	12.00	12.00	12.00	12.00	12.00	12.00	12.00	12.00
No. of Lanes in Entry Pocket	1	0	1	1	0	1	1	0	0	1	0	1
Entry Pocket Length [ft]	100.00	100.00	100.00	100.00	100.00	100.00	510.00	100.00	100.00	330.00	100.00	330.00
No. of Lanes in Exit Pocket	0	0	0	0	0	0	0	0	0	0	0	0
Exit Pocket Length [ft]	0.00	0.00	0.00	0.00	0.00	0.00	0.00	0.00	0.00	0.00	0.00	0.00
Speed [mph]	25.00			25.00			45.00			45.00		
Grade [%]	0.00			0.00			0.00			0.00		
Crosswalk	Yes			Yes			Yes			Yes		

Volumes

Name	Carriage Meadows Dr			Carriage Meadows Dr			Fontaine Bl			Fontaine Bl		
Base Volume Input [veh/h]	42	0	12	8	0	37	10	314	8	8	978	4
Base Volume Adjustment Factor	1.0000	1.0000	1.0000	1.0000	1.0000	1.0000	1.0000	1.0000	1.0000	1.0000	1.0000	1.0000
Heavy Vehicles Percentage [%]	2.00	2.00	2.00	2.00	2.00	2.00	2.00	2.00	2.00	2.00	2.00	2.00
Growth Factor	1.0000	1.0000	1.0000	1.0000	1.0000	1.0000	1.0000	1.0000	1.0000	1.0000	1.0000	1.0000
In-Process Volume [veh/h]	0	0	0	0	0	0	0	0	0	0	0	0
Site-Generated Trips [veh/h]	0	0	0	0	0	0	0	0	0	0	0	0
Diverted Trips [veh/h]	0	0	0	0	0	0	0	0	0	0	0	0
Pass-by Trips [veh/h]	0	0	0	0	0	0	0	0	0	0	0	0
Existing Site Adjustment Volume [veh/h]	0	0	0	0	0	0	0	0	0	0	0	0
Other Volume [veh/h]	0	0	0	0	0	0	0	0	0	0	0	0
Total Hourly Volume [veh/h]	42	0	12	8	0	37	10	314	8	8	978	4
Peak Hour Factor	0.6800	0.6800	0.6800	0.7800	0.7800	0.7800	0.8400	0.8400	0.8400	0.8800	0.8800	0.8800
Other Adjustment Factor	1.0000	1.0000	1.0000	1.0000	1.0000	1.0000	1.0000	1.0000	1.0000	1.0000	1.0000	1.0000
Total 15-Minute Volume [veh/h]	15	0	4	3	0	12	3	93	2	2	278	1
Total Analysis Volume [veh/h]	62	0	18	10	0	47	12	374	10	9	1111	5
Pedestrian Volume [ped/h]	0			0			0			0		

Intersection Settings

Priority Scheme	Stop	Stop	Free	Free
Flared Lane				
Storage Area [veh]	0	0	0	0
Two-Stage Gap Acceptance	No	No		
Number of Storage Spaces in Median	0	0	0	0

Movement, Approach, & Intersection Results

V/C, Movement V/C Ratio	0.34	0.00	0.02	0.09	0.00	0.10	0.02	0.00	0.00	0.01	0.01	0.00
d_M, Delay for Movement [s/veh]	34.77	36.99	9.47	42.66	37.21	13.41	10.91	0.00	0.00	8.10	0.00	0.00
Movement LOS	D	E	A	E	E	B	B	A	A	A	A	A
95th-Percentile Queue Length [veh/ln]	1.42	0.00	0.07	0.31	0.00	0.33	0.06	0.00	0.00	0.02	0.00	0.00
95th-Percentile Queue Length [ft/ln]	35.51	0.00	1.68	7.66	0.00	8.19	1.48	0.00	0.00	0.58	0.00	0.00
d_A, Approach Delay [s/veh]	29.08			18.54			0.33			0.06		
Approach LOS	D			C			A			A		
d_I, Intersection Delay [s/veh]	2.16											
Intersection LOS	E											

Signal Warrants Report For Intersection 2: Marksheffel Rd/Lorson Bl

Warrants Summary

Warrant	Name	Met?
#1	Eight Hour Vehicular Volume	Yes
#2	Four Hour Vehicular Volume	Yes
#3	Peak Hour	Yes

Intersection Warrants Parameters

Major Approaches	N, S
Minor Approaches	E
Speed > 40mph	Yes
Population < 10,000	No
Warrant Factor	70%

Warrant Analysis Traffic Volumes

Hour	Major Streets		Minor Streets
	N	S	E
1	463	692	328
2	449	671	318
3	440	657	312
4	412	616	292
5	366	547	259
6	361	540	256
7	357	533	253
8	324	484	230
9	319	477	226
10	315	471	223
11	273	408	194
12	255	381	180
13	250	374	177
14	185	277	131
15	185	277	131
16	130	194	92
17	74	111	52
18	74	111	52
19	42	62	30
20	23	35	16
21	14	21	10
22	5	7	3
23	5	7	3
24	5	7	3

Warrant Analysis by Hour

Hour	Major Streets		Minor Street		Warrant 1 Condition A				Warrant 1 Condition B				Warrant 2	Warrant 3 Condition B
	Number	Volume	Number	Volume	100%	80%	70%	56%	100%	80%	70%	56%		
1	2	1155	2	328	Yes	Yes	Yes	Yes	Yes	Yes	Yes	Yes	Yes	Yes
2	2	1120	2	318	Yes	Yes	Yes	Yes	Yes	Yes	Yes	Yes	Yes	Yes
3	2	1097	2	312	Yes	Yes	Yes	Yes	Yes	Yes	Yes	Yes	Yes	Yes
4	2	1028	2	292	Yes	Yes	Yes	Yes	Yes	Yes	Yes	Yes	Yes	Yes
5	2	913	2	259	Yes	Yes	Yes	Yes	Yes	Yes	Yes	Yes	Yes	Yes
6	2	901	2	256	Yes	Yes	Yes	Yes	Yes	Yes	Yes	Yes	Yes	Yes
7	2	890	2	253	Yes	Yes	Yes	Yes	No	Yes	Yes	Yes	Yes	Yes
8	2	808	2	230	Yes	Yes	Yes	Yes	No	Yes	Yes	Yes	Yes	Yes
9	2	796	2	226	Yes	Yes	Yes	Yes	No	Yes	Yes	Yes	Yes	Yes
10	2	786	2	223	Yes	Yes	Yes	Yes	No	Yes	Yes	Yes	Yes	Yes
11	2	681	2	194	No	Yes	Yes	Yes	No	No	Yes	Yes	Yes	No
12	2	636	2	180	No	Yes	Yes	Yes	No	No	Yes	Yes	Yes	No
13	2	624	2	177	No	Yes	Yes	Yes	No	No	No	Yes	Yes	No
14	2	462	2	131	No	No	No	Yes	No	No	No	No	No	No
15	2	462	2	131	No	No	No	Yes	No	No	No	No	No	No
16	2	324	2	92	No	No	No	No	No	No	No	No	No	No
17	2	185	2	52	No	No	No	No	No	No	No	No	No	No
18	2	185	2	52	No	No	No	No	No	No	No	No	No	No
19	2	104	2	30	No	No	No	No	No	No	No	No	No	No
20	2	58	2	16	No	No	No	No	No	No	No	No	No	No
21	2	35	2	10	No	No	No	No	No	No	No	No	No	No
22	2	12	2	3	No	No	No	No	No	No	No	No	No	No
23	2	12	2	3	No	No	No	No	No	No	No	No	No	No
24	2	12	2	3	No	No	No	No	No	No	No	No	No	No
Hours Met					10	13	13	15	6	10	12	13	13	10

Warrant 3 Condition A

Orientation	E
Total Stopped Delay Per Vehicle on Minor Approach (s)	129.4
Number of Lanes on Minor Street Approach	2
VehicleHours of Stopped Delay on Minor Approach (h:mm)	11:47
Delay Condition Met	Yes
Volume on Minor Street Approach During Same Hour	328
High Minor Volume Condition Met	Yes
Total Entering Volume on All Approaches During Same Hour	1483
Number of Approaches on Intersection	3
Total Volume Condition Met	Yes
Warrant Met for Approach	Yes
Warrant Met for Intersection	Yes

Signal Warrants Report For Intersection 3: Fontaine Bl/Carriage Meadows Dr

Warrants Summary

Warrant	Name	Met?
#1	Eight Hour Vehicular Volume	No
#2	Four Hour Vehicular Volume	No
#3	Peak Hour	No

Intersection Warrants Parameters

Major Approaches	E, W
Minor Approaches	S, N
Speed > 40mph	Yes
Population < 10,000	No
Warrant Factor	70%

Warrant Analysis Traffic Volumes

Hour	Major Streets		Minor Streets	
	E	W	S	N
1	990	332	54	45
2	960	322	52	44
3	941	315	51	43
4	881	295	48	40
5	782	262	43	36
6	772	259	42	35
7	762	256	42	35
8	693	232	38	31
9	683	229	37	31
10	673	226	37	31
11	584	196	32	27
12	545	183	30	25
13	535	179	29	24
14	396	133	22	18
15	396	133	22	18
16	277	93	15	13
17	158	53	9	7
18	158	53	9	7
19	89	30	5	4
20	50	17	3	2
21	30	10	2	1
22	10	3	1	0
23	10	3	1	0
24	10	3	1	0

Warrant Analysis by Hour

Hour	Major Streets		Minor Street		Warrant 1 Condition A				Warrant 1 Condition B				Warrant 2	Warrant 3 Condition B
	Number	Volume	Number	Volume	100%	80%	70%	56%	100%	80%	70%	56%		
1	4	1322	3	54	No	No	No	No	No	No	No	No	No	No
2	4	1282	3	52	No	No	No	No	No	No	No	No	No	No
3	4	1256	3	51	No	No	No	No	No	No	No	No	No	No
4	4	1176	3	48	No	No	No	No	No	No	No	No	No	No
5	4	1044	3	43	No	No	No	No	No	No	No	No	No	No
6	4	1031	3	42	No	No	No	No	No	No	No	No	No	No
7	4	1018	3	42	No	No	No	No	No	No	No	No	No	No
8	4	925	3	38	No	No	No	No	No	No	No	No	No	No
9	4	912	3	37	No	No	No	No	No	No	No	No	No	No
10	4	899	3	37	No	No	No	No	No	No	No	No	No	No
11	4	780	3	32	No	No	No	No	No	No	No	No	No	No
12	4	728	3	30	No	No	No	No	No	No	No	No	No	No
13	4	714	3	29	No	No	No	No	No	No	No	No	No	No
14	4	529	3	22	No	No	No	No	No	No	No	No	No	No
15	4	529	3	22	No	No	No	No	No	No	No	No	No	No
16	4	370	3	15	No	No	No	No	No	No	No	No	No	No
17	4	211	3	9	No	No	No	No	No	No	No	No	No	No
18	4	211	3	9	No	No	No	No	No	No	No	No	No	No
19	4	119	3	5	No	No	No	No	No	No	No	No	No	No
20	4	67	3	3	No	No	No	No	No	No	No	No	No	No
21	4	40	3	2	No	No	No	No	No	No	No	No	No	No
22	4	13	3	1	No	No	No	No	No	No	No	No	No	No
23	4	13	3	1	No	No	No	No	No	No	No	No	No	No
24	4	13	3	1	No	No	No	No	No	No	No	No	No	No
Hours Met					0	0	0	0	0	0	0	0	0	0

Warrant 3 Condition A

Orientation	S	N
Total Stopped Delay Per Vehicle on Minor Approach (s)	29.1	18.5
Number of Lanes on Minor Street Approach	3	3
VehicleHours of Stopped Delay on Minor Approach (h:mm)	0:26	0:13
Delay Condition Met	No	No
Volume on Minor Street Approach During Same Hour	54	45
High Minor Volume Condition Met	No	No
Total Entering Volume on All Approaches During Same Hour	1421	1421
Number of Approaches on Intersection	4	4
Total Volume Condition Met	Yes	Yes
Warrant Met for Approach	No	No
Warrant Met for Intersection	No	





Table of Contents

Intersection Level Of Service Report	2
Intersection 1: Marksheffel Rd/Fontaine Bl	2
Intersection 2: Marksheffel Rd/Lorson Bl	7
Intersection 3: Fontaine Bl/Carriage Meadows Dr	9
Signal Warrants Report	11
Intersection 2: Marksheffel Rd/Lorson Bl	11
Intersection 3: Fontaine Bl/Carriage Meadows Dr	13

Intersection Level Of Service Report
Intersection 1: Marksheffel Rd/Fontaine Bl

Control Type:	Signalized	Delay (sec / veh):	13.1
Analysis Method:	HCM 7th Edition	Level Of Service:	B
Analysis Period:	15 minutes	Volume to Capacity (v/c):	0.458

Intersection Setup

Name	Marksheffel Rd			Marksheffel Rd			Fontaine Bl			Fontaine Bl		
Approach	Northbound			Southbound			Eastbound			Westbound		
Lane Configuration												
Turning Movement	Left	Thru	Right	Left	Thru	Right	Left	Thru	Right	Left	Thru	Right
Lane Width [ft]	12.00	12.00	12.00	12.00	12.00	12.00	12.00	12.00	12.00	12.00	12.00	12.00
No. of Lanes in Entry Pocket	1	0	1	1	0	1	1	0	1	1	0	0
Entry Pocket Length [ft]	680.00	100.00	680.00	750.00	100.00	500.00	360.00	100.00	200.00	535.00	100.00	100.00
No. of Lanes in Exit Pocket	0	0	0	0	0	0	0	0	0	0	0	0
Exit Pocket Length [ft]	0.00	0.00	0.00	0.00	0.00	0.00	0.00	0.00	0.00	0.00	0.00	0.00
Speed [mph]	55.00			55.00			45.00			45.00		
Grade [%]	0.00			0.00			0.00			0.00		
Curb Present	No			No			No			No		
Crosswalk	Yes			Yes			Yes			Yes		

Volumes

Name	Marksheffel Rd			Marksheffel Rd			Fontaine Bl			Fontaine Bl		
Base Volume Input [veh/h]	39	310	189	300	506	31	21	400	53	74	182	170
Base Volume Adjustment Factor	1.0000	1.0000	1.0000	1.0000	1.0000	1.0000	1.0000	1.0000	1.0000	1.0000	1.0000	1.0000
Heavy Vehicles Percentage [%]	2.00	2.00	2.00	2.00	2.00	2.00	2.00	2.00	2.00	2.00	2.00	2.00
Proportion of CAVs [%]	0.00											
Growth Factor	1.0000	1.0000	1.0000	1.0000	1.0000	1.0000	1.0000	1.0000	1.0000	1.0000	1.0000	1.0000
In-Process Volume [veh/h]	0	0	0	0	0	0	0	0	0	0	0	0
Site-Generated Trips [veh/h]	0	0	0	0	0	0	0	0	0	0	0	0
Diverted Trips [veh/h]	0	0	0	0	0	0	0	0	0	0	0	0
Pass-by Trips [veh/h]	0	0	0	0	0	0	0	0	0	0	0	0
Existing Site Adjustment Volume [veh/h]	0	0	0	0	0	0	0	0	0	0	0	0
Other Volume [veh/h]	0	0	0	0	0	0	0	0	0	0	0	0
Right Turn on Red Volume [veh/h]	0	0	95	0	0	16	0	0	27	0	0	85
Total Hourly Volume [veh/h]	39	310	94	300	506	15	21	400	26	74	182	85
Peak Hour Factor	0.9100	0.9100	0.9100	0.9500	0.9500	0.9500	0.9100	0.9100	0.9100	0.9100	0.9100	0.9100
Other Adjustment Factor	1.0000	1.0000	1.0000	1.0000	1.0000	1.0000	1.0000	1.0000	1.0000	1.0000	1.0000	1.0000
Total 15-Minute Volume [veh/h]	11	85	26	79	133	4	6	110	7	20	50	23
Total Analysis Volume [veh/h]	43	341	103	316	533	16	23	440	29	81	200	93
Presence of On-Street Parking	No		No	No		No	No		No	No		No
On-Street Parking Maneuver Rate [/h]	0	0	0	0	0	0	0	0	0	0	0	0
Local Bus Stopping Rate [/h]	0	0	0	0	0	0	0	0	0	0	0	0
v_do, Outbound Pedestrian Volume crossing	0			0			0			0		
v_di, Inbound Pedestrian Volume crossing m	0			0			0			0		
v_co, Outbound Pedestrian Volume crossing	0			0			0			0		
v_ci, Inbound Pedestrian Volume crossing mi	0			0			0			0		
v_ab, Corner Pedestrian Volume [ped/h]	0			0			0			0		
Bicycle Volume [bicycles/h]	0			0			0			0		

Intersection Settings

Located in CBD	No
Signal Coordination Group	-
Cycle Length [s]	60
Active Pattern	Pattern 1
Coordination Type	Time of Day Pattern Coordinated
Actuation Type	Fully actuated
Offset [s]	0.0
Offset Reference	Lead Green - Beginning of First Green
Permissive Mode	SingleBand
Lost time [s]	0.00

Phasing & Timing

Control Type	Permiss	Permiss	Permiss	Permiss	Permiss	Permiss	Permiss	Permiss	Permiss	Permiss	Permiss	Permiss
Signal Group	0	6	0	0	2	0	0	8	0	0	4	0
Auxiliary Signal Groups												
Lead / Lag	-	-	-	-	-	-	-	-	-	-	-	-
Minimum Green [s]	0	10	0	0	10	0	0	10	0	0	10	0
Maximum Green [s]	0	103	0	0	103	0	0	109	0	0	109	0
Amber [s]	0.0	3.0	0.0	0.0	3.0	0.0	0.0	3.0	0.0	0.0	3.0	0.0
All red [s]	0.0	1.0	0.0	0.0	1.0	0.0	0.0	1.0	0.0	0.0	1.0	0.0
Split [s]	0	35	0	0	35	0	0	25	0	0	25	0
Vehicle Extension [s]	0.0	3.0	0.0	0.0	3.0	0.0	0.0	3.0	0.0	0.0	3.0	0.0
Walk [s]	0	7	0	0	7	0	0	7	0	0	7	0
Pedestrian Clearance [s]	0	24	0	0	21	0	0	14	0	0	14	0
Delayed Vehicle Green [s]	0.0	0.0	0.0	0.0	0.0	0.0	0.0	0.0	0.0	0.0	0.0	0.0
Rest In Walk		No			No			No			No	
I1, Start-Up Lost Time [s]	0.0	2.0	0.0	0.0	2.0	0.0	0.0	2.0	0.0	0.0	2.0	0.0
I2, Clearance Lost Time [s]	0.0	2.0	0.0	0.0	2.0	0.0	0.0	2.0	0.0	0.0	2.0	0.0
Minimum Recall		No			No			No			No	
Maximum Recall		No			No			No			No	
Pedestrian Recall		No			No			No			No	
Detector Location [ft]	0.0	0.0	0.0	0.0	0.0	0.0	0.0	0.0	0.0	0.0	0.0	0.0
Detector Length [ft]	0.0	0.0	0.0	0.0	0.0	0.0	0.0	0.0	0.0	0.0	0.0	0.0
I, Upstream Filtering Factor	1.00	1.00	1.00	1.00	1.00	1.00	1.00	1.00	1.00	1.00	1.00	1.00

Exclusive Pedestrian Phase

Pedestrian Signal Group	0
Pedestrian Walk [s]	0
Pedestrian Clearance [s]	0

Lane Group Calculations

Lane Group	L	C	R	L	C	R	L	C	R	L	C	R
C, Cycle Length [s]	60	60	60	60	60	60	60	60	60	60	60	60
L, Total Lost Time per Cycle [s]	4.00	4.00	4.00	4.00	4.00	4.00	4.00	4.00	4.00	4.00	4.00	4.00
l1_p, Permitted Start-Up Lost Time [s]	2.00	0.00	0.00	2.00	0.00	0.00	2.00	0.00	0.00	2.00	0.00	0.00
l2, Clearance Lost Time [s]	2.00	2.00	2.00	2.00	2.00	2.00	2.00	2.00	2.00	2.00	2.00	2.00
g_i, Effective Green Time [s]	36	36	36	36	36	36	16	16	16	16	16	16
g / C, Green / Cycle	0.61	0.61	0.61	0.61	0.61	0.61	0.26	0.26	0.26	0.26	0.26	0.26
(v / s)_i Volume / Saturation Flow Rate	0.05	0.18	0.06	0.33	0.29	0.01	0.02	0.12	0.02	0.09	0.06	0.06
s, saturation flow rate [veh/h]	858	1870	1589	945	1870	1589	1086	3560	1589	924	3560	1589
c, Capacity [veh/h]	472	1130	961	574	1130	961	323	934	417	238	934	417
d1, Uniform Delay [s]	10.99	5.74	5.02	12.17	6.57	4.74	20.25	18.63	16.63	25.04	17.30	17.34
k, delay calibration	0.50	0.50	0.50	0.50	0.50	0.50	0.11	0.11	0.11	0.11	0.11	0.11
l, Upstream Filtering Factor	1.00	1.00	1.00	1.00	1.00	1.00	1.00	1.00	1.00	1.00	1.00	1.00
d2, Incremental Delay [s]	0.38	0.69	0.22	3.77	1.41	0.03	0.09	0.37	0.07	0.84	0.11	0.27
d3, Initial Queue Delay [s]	0.00	0.00	0.00	0.00	0.00	0.00	0.00	0.00	0.00	0.00	0.00	0.00
Rp, platoon ratio	1.00	1.00	1.00	1.00	1.00	1.00	1.00	1.00	1.00	1.00	1.00	1.00
PF, progression factor	1.00	1.00	1.00	1.00	1.00	1.00	1.00	1.00	1.00	1.00	1.00	1.00

Lane Group Results

X, volume / capacity	0.09	0.30	0.11	0.55	0.47	0.02	0.07	0.47	0.07	0.34	0.21	0.22
d, Delay for Lane Group [s/veh]	11.37	6.43	5.25	15.94	7.98	4.77	20.34	19.00	16.70	25.88	17.41	17.61
Lane Group LOS	B	A	A	B	A	A	C	B	B	C	B	B
Critical Lane Group	No	No	No	Yes	No	No	No	Yes	No	No	No	No
50th-Percentile Queue Length [veh/ln]	0.31	1.28	0.34	2.80	2.35	0.05	0.24	2.24	0.27	1.03	0.94	0.89
50th-Percentile Queue Length [ft/ln]	7.81	32.06	8.54	69.93	58.76	1.25	6.08	56.08	6.66	25.79	23.53	22.37
95th-Percentile Queue Length [veh/ln]	0.56	2.31	0.62	5.03	4.23	0.09	0.44	4.04	0.48	1.86	1.69	1.61
95th-Percentile Queue Length [ft/ln]	14.06	57.71	15.38	125.87	105.77	2.24	10.94	100.95	11.99	46.43	42.36	40.27

Movement, Approach, & Intersection Results

d_M, Delay for Movement [s/veh]	11.37	6.43	5.25	15.94	7.98	4.77	20.34	19.00	16.70	25.88	17.41	17.61
Movement LOS	B	A	A	B	A	A	C	B	B	C	B	B
d_A, Approach Delay [s/veh]	6.62			10.83			18.93			19.30		
Approach LOS	A			B			B			B		
d_I, Intersection Delay [s/veh]	13.13											
Intersection LOS	B											
Intersection V/C	0.458											

Other Modes

g_Walk,mi, Effective Walk Time [s]	11.0			11.0			11.0			11.0		
M_corner, Corner Circulation Area [ft ² /ped]	0.00			0.00			0.00			0.00		
M_CW, Crosswalk Circulation Area [ft ² /ped]	0.00			0.00			0.00			0.00		
d_p, Pedestrian Delay [s]	20.01			20.01			20.01			20.01		
I_p,int, Pedestrian LOS Score for Intersectio	2.918			2.800			2.723			3.495		
Crosswalk LOS	C			C			B			C		
s_b, Saturation Flow Rate of the bicycle lane	2000			2000			2000			2000		
c_b, Capacity of the bicycle lane [bicycles/h]	1033			1033			700			700		
d_b, Bicycle Delay [s]	7.01			7.01			12.68			12.68		
I_b,int, Bicycle LOS Score for Intersection	2.520			3.013			1.988			1.938		
Bicycle LOS	B			C			A			A		

Sequence

Ring 1	-	2	-	4	-	-	-	-	-	-	-	-	-	-	-	-	-
Ring 2	-	6	-	8	-	-	-	-	-	-	-	-	-	-	-	-	-
Ring 3	-	-	-	-	-	-	-	-	-	-	-	-	-	-	-	-	-
Ring 4	-	-	-	-	-	-	-	-	-	-	-	-	-	-	-	-	-



Intersection Level Of Service Report
Intersection 2: Marksheffel Rd/Lorson Bl

Control Type:	Two-way stop	Delay (sec / veh):	92.7
Analysis Method:	HCM 7th Edition	Level Of Service:	F
Analysis Period:	15 minutes	Volume to Capacity (v/c):	0.859

Intersection Setup

Name	Marksheffel Rd		Marksheffel Rd		Lorson Bl	
Approach	Northbound		Southbound		Westbound	
Lane Configuration	↕↗		↖↕		↖↗	
Turning Movement	Thru	Right	Left	Thru	Left	Right
Lane Width [ft]	12.00	12.00	12.00	12.00	12.00	12.00
No. of Lanes in Entry Pocket	0	1	1	0	1	0
Entry Pocket Length [ft]	100.00	500.00	580.00	100.00	510.00	100.00
No. of Lanes in Exit Pocket	0	0	0	0	0	0
Exit Pocket Length [ft]	0.00	0.00	0.00	0.00	0.00	0.00
Speed [mph]	55.00		55.00		25.00	
Grade [%]	0.00		0.00		0.00	
Crosswalk	Yes		Yes		Yes	

Volumes

Name	Marksheffel Rd		Marksheffel Rd		Lorson Bl	
Base Volume Input [veh/h]	492	257	69	558	120	53
Base Volume Adjustment Factor	1.0000	1.0000	1.0000	1.0000	1.0000	1.0000
Heavy Vehicles Percentage [%]	2.00	2.00	2.00	2.00	2.00	2.00
Growth Factor	1.0000	1.0000	1.0000	1.0000	1.0000	1.0000
In-Process Volume [veh/h]	0	0	0	0	0	0
Site-Generated Trips [veh/h]	0	0	0	0	0	0
Diverted Trips [veh/h]	0	0	0	0	0	0
Pass-by Trips [veh/h]	0	0	0	0	0	0
Existing Site Adjustment Volume [veh/h]	0	0	0	0	0	0
Other Volume [veh/h]	0	0	0	0	0	0
Total Hourly Volume [veh/h]	492	257	69	558	120	53
Peak Hour Factor	0.9100	0.9100	0.9300	0.9300	0.8500	0.8500
Other Adjustment Factor	1.0000	1.0000	1.0000	1.0000	1.0000	1.0000
Total 15-Minute Volume [veh/h]	135	71	19	150	35	16
Total Analysis Volume [veh/h]	541	282	74	600	141	62
Pedestrian Volume [ped/h]	0		0		0	

Intersection Settings

Priority Scheme	Free	Free	Stop
Flared Lane			
Storage Area [veh]	0	0	0
Two-Stage Gap Acceptance			No
Number of Storage Spaces in Median	0	0	0

Movement, Approach, & Intersection Results

V/C, Movement V/C Ratio	0.01	0.00	0.09	0.01	0.86	0.11
d_M, Delay for Movement [s/veh]	0.00	0.00	9.91	0.00	92.67	12.51
Movement LOS	A	A	A	A	F	B
95th-Percentile Queue Length [veh/ln]	0.00	0.00	0.30	0.00	5.97	0.39
95th-Percentile Queue Length [ft/ln]	0.00	0.00	7.55	0.00	149.25	9.64
d_A, Approach Delay [s/veh]	0.00		1.09		68.19	
Approach LOS	A		A		F	
d_I, Intersection Delay [s/veh]	8.57					
Intersection LOS	F					

Intersection Level Of Service Report
Intersection 3: Fontaine Bl/Carriage Meadows Dr

Control Type:	Two-way stop	Delay (sec / veh):	46.7
Analysis Method:	HCM 7th Edition	Level Of Service:	E
Analysis Period:	15 minutes	Volume to Capacity (v/c):	0.239

Intersection Setup

Name	Carriage Meadows Dr			Carriage Meadows Dr			Fontaine Bl			Fontaine Bl		
Approach	Northbound			Southbound			Eastbound			Westbound		
Lane Configuration	↵↵↵			↵↵↵			↵↵↵			↵↵↵		
Turning Movement	Left	Thru	Right	Left	Thru	Right	Left	Thru	Right	Left	Thru	Right
Lane Width [ft]	12.00	12.00	12.00	12.00	12.00	12.00	12.00	12.00	12.00	12.00	12.00	12.00
No. of Lanes in Entry Pocket	1	0	1	1	0	1	1	0	0	1	0	1
Entry Pocket Length [ft]	100.00	100.00	100.00	100.00	100.00	100.00	510.00	100.00	100.00	330.00	100.00	330.00
No. of Lanes in Exit Pocket	0	0	0	0	0	0	0	0	0	0	0	0
Exit Pocket Length [ft]	0.00	0.00	0.00	0.00	0.00	0.00	0.00	0.00	0.00	0.00	0.00	0.00
Speed [mph]	25.00			25.00			45.00			45.00		
Grade [%]	0.00			0.00			0.00			0.00		
Crosswalk	Yes			Yes			Yes			Yes		

Volumes

Name	Carriage Meadows Dr			Carriage Meadows Dr			Fontaine Bl			Fontaine Bl		
Base Volume Input [veh/h]	23	0	8	5	2	8	56	796	44	8	398	6
Base Volume Adjustment Factor	1.0000	1.0000	1.0000	1.0000	1.0000	1.0000	1.0000	1.0000	1.0000	1.0000	1.0000	1.0000
Heavy Vehicles Percentage [%]	2.00	2.00	2.00	2.00	2.00	2.00	2.00	2.00	2.00	2.00	2.00	2.00
Growth Factor	1.0000	1.0000	1.0000	1.0000	1.0000	1.0000	1.0000	1.0000	1.0000	1.0000	1.0000	1.0000
In-Process Volume [veh/h]	0	0	0	0	0	0	0	0	0	0	0	0
Site-Generated Trips [veh/h]	0	0	0	0	0	0	0	0	0	0	0	0
Diverted Trips [veh/h]	0	0	0	0	0	0	0	0	0	0	0	0
Pass-by Trips [veh/h]	0	0	0	0	0	0	0	0	0	0	0	0
Existing Site Adjustment Volume [veh/h]	0	0	0	0	0	0	0	0	0	0	0	0
Other Volume [veh/h]	0	0	0	0	0	0	0	0	0	0	0	0
Total Hourly Volume [veh/h]	23	0	8	5	2	8	56	796	44	8	398	6
Peak Hour Factor	0.8600	0.8600	0.8600	0.9400	0.9400	0.9400	0.8800	0.8800	0.8800	0.9100	0.9100	0.9100
Other Adjustment Factor	1.0000	1.0000	1.0000	1.0000	1.0000	1.0000	1.0000	1.0000	1.0000	1.0000	1.0000	1.0000
Total 15-Minute Volume [veh/h]	7	0	2	1	1	2	16	226	13	2	109	2
Total Analysis Volume [veh/h]	27	0	9	5	2	9	64	905	50	9	437	7
Pedestrian Volume [ped/h]	0			0			0			0		

Intersection Settings

Priority Scheme	Stop	Stop	Free	Free
Flared Lane				
Storage Area [veh]	0	0	0	0
Two-Stage Gap Acceptance	No	No		
Number of Storage Spaces in Median	0	0	0	0

Movement, Approach, & Intersection Results

V/C, Movement V/C Ratio	0.24	0.00	0.02	0.03	0.02	0.01	0.06	0.01	0.00	0.01	0.00	0.00
d_M, Delay for Movement [s/veh]	46.67	36.75	11.60	26.79	39.38	9.64	8.43	0.00	0.00	10.10	0.00	0.00
Movement LOS	E	E	B	D	E	A	A	A	A	B	A	A
95th-Percentile Queue Length [veh/ln]	0.87	0.00	0.05	0.09	0.06	0.03	0.18	0.00	0.00	0.04	0.00	0.00
95th-Percentile Queue Length [ft/ln]	21.82	0.00	1.24	2.26	1.43	0.87	4.57	0.00	0.00	0.96	0.00	0.00
d_A, Approach Delay [s/veh]	37.90			18.71			0.53			0.20		
Approach LOS	E			C			A			A		
d_I, Intersection Delay [s/veh]	1.51											
Intersection LOS	E											

Signal Warrants Report For Intersection 2: Marksheffel Rd/Lorson BI

Warrants Summary

Warrant	Name	Met?
#1	Eight Hour Vehicular Volume	Yes
#2	Four Hour Vehicular Volume	Yes
#3	Peak Hour	Yes

Intersection Warrants Parameters

Major Approaches	N, S
Minor Approaches	E
Speed > 40mph	Yes
Population < 10,000	No
Warrant Factor	70%

Warrant Analysis Traffic Volumes

Hour	Major Streets		Minor Streets
	N	S	E
1	627	749	173
2	608	727	168
3	596	712	164
4	558	667	154
5	495	592	137
6	489	584	135
7	483	577	133
8	439	524	121
9	433	517	119
10	426	509	118
11	370	442	102
12	345	412	95
13	339	404	93
14	251	300	69
15	251	300	69
16	176	210	48
17	100	120	28
18	100	120	28
19	56	67	16
20	31	37	9
21	19	22	5
22	6	7	2
23	6	7	2
24	6	7	2

Warrant Analysis by Hour

Hour	Major Streets		Minor Street		Warrant 1 Condition A				Warrant 1 Condition B				Warrant 2	Warrant 3 Condition B
	Number	Volume	Number	Volume	100%	80%	70%	56%	100%	80%	70%	56%		
1	2	1376	2	173	No	Yes	Yes	Yes	Yes	Yes	Yes	Yes	Yes	Yes
2	2	1335	2	168	No	Yes	Yes	Yes	Yes	Yes	Yes	Yes	Yes	Yes
3	2	1308	2	164	No	Yes	Yes	Yes	Yes	Yes	Yes	Yes	Yes	Yes
4	2	1225	2	154	No	No	Yes	Yes	Yes	Yes	Yes	Yes	Yes	Yes
5	2	1087	2	137	No	No	No	Yes	Yes	Yes	Yes	Yes	Yes	Yes
6	2	1073	2	135	No	No	No	Yes	Yes	Yes	Yes	Yes	Yes	Yes
7	2	1060	2	133	No	No	No	Yes	Yes	Yes	Yes	Yes	Yes	Yes
8	2	963	2	121	No	No	No	Yes	Yes	Yes	Yes	Yes	Yes	No
9	2	950	2	119	No	No	No	Yes	Yes	Yes	Yes	Yes	Yes	No
10	2	935	2	118	No	No	No	Yes	Yes	Yes	Yes	Yes	Yes	No
11	2	812	2	102	No	No	No	No	No	Yes	Yes	Yes	No	No
12	2	757	2	95	No	No	No	No	No	Yes	Yes	Yes	No	No
13	2	743	2	93	No	No	No	No	No	Yes	Yes	Yes	No	No
14	2	551	2	69	No	No	No	No	No	No	No	Yes	No	No
15	2	551	2	69	No	No	No	No	No	No	No	Yes	No	No
16	2	386	2	48	No	No	No	No	No	No	No	No	No	No
17	2	220	2	28	No	No	No	No	No	No	No	No	No	No
18	2	220	2	28	No	No	No	No	No	No	No	No	No	No
19	2	123	2	16	No	No	No	No	No	No	No	No	No	No
20	2	68	2	9	No	No	No	No	No	No	No	No	No	No
21	2	41	2	5	No	No	No	No	No	No	No	No	No	No
22	2	13	2	2	No	No	No	No	No	No	No	No	No	No
23	2	13	2	2	No	No	No	No	No	No	No	No	No	No
24	2	13	2	2	No	No	No	No	No	No	No	No	No	No
Hours Met					0	3	4	10	10	13	13	15	10	7

Warrant 3 Condition A

Orientation	E
Total Stopped Delay Per Vehicle on Minor Approach (s)	68.2
Number of Lanes on Minor Street Approach	2
VehicleHours of Stopped Delay on Minor Approach (h:mm)	3:16
Delay Condition Met	No
Volume on Minor Street Approach During Same Hour	173
High Minor Volume Condition Met	Yes
Total Entering Volume on All Approaches During Same Hour	1549
Number of Approaches on Intersection	3
Total Volume Condition Met	Yes
Warrant Met for Approach	No
Warrant Met for Intersection	No

Signal Warrants Report For Intersection 3: Fontaine Bl/Carriage Meadows Dr

Warrants Summary

Warrant	Name	Met?
#1	Eight Hour Vehicular Volume	No
#2	Four Hour Vehicular Volume	No
#3	Peak Hour	No

Intersection Warrants Parameters

Major Approaches	E, W
Minor Approaches	S, N
Speed > 40mph	Yes
Population < 10,000	No
Warrant Factor	70%

Warrant Analysis Traffic Volumes

Hour	Major Streets		Minor Streets	
	E	W	S	N
1	412	896	31	15
2	400	869	30	15
3	391	851	29	14
4	367	797	28	13
5	325	708	24	12
6	321	699	24	12
7	317	690	24	12
8	288	627	22	11
9	284	618	21	10
10	280	609	21	10
11	243	529	18	9
12	227	493	17	8
13	222	484	17	8
14	165	358	12	6
15	165	358	12	6
16	115	251	9	4
17	66	143	5	2
18	66	143	5	2
19	37	81	3	1
20	21	45	2	1
21	12	27	1	0
22	4	9	0	0
23	4	9	0	0
24	4	9	0	0

Warrant Analysis by Hour

Hour	Major Streets		Minor Street		Warrant 1 Condition A				Warrant 1 Condition B				Warrant 2	Warrant 3 Condition B
	Number	Volume	Number	Volume	100%	80%	70%	56%	100%	80%	70%	56%		
1	4	1308	3	31	No	No	No	No	No	No	No	No	No	No
2	4	1269	3	30	No	No	No	No	No	No	No	No	No	No
3	4	1242	3	29	No	No	No	No	No	No	No	No	No	No
4	4	1164	3	28	No	No	No	No	No	No	No	No	No	No
5	4	1033	3	24	No	No	No	No	No	No	No	No	No	No
6	4	1020	3	24	No	No	No	No	No	No	No	No	No	No
7	4	1007	3	24	No	No	No	No	No	No	No	No	No	No
8	4	915	3	22	No	No	No	No	No	No	No	No	No	No
9	4	902	3	21	No	No	No	No	No	No	No	No	No	No
10	4	889	3	21	No	No	No	No	No	No	No	No	No	No
11	4	772	3	18	No	No	No	No	No	No	No	No	No	No
12	4	720	3	17	No	No	No	No	No	No	No	No	No	No
13	4	706	3	17	No	No	No	No	No	No	No	No	No	No
14	4	523	3	12	No	No	No	No	No	No	No	No	No	No
15	4	523	3	12	No	No	No	No	No	No	No	No	No	No
16	4	366	3	9	No	No	No	No	No	No	No	No	No	No
17	4	209	3	5	No	No	No	No	No	No	No	No	No	No
18	4	209	3	5	No	No	No	No	No	No	No	No	No	No
19	4	118	3	3	No	No	No	No	No	No	No	No	No	No
20	4	66	3	2	No	No	No	No	No	No	No	No	No	No
21	4	39	3	1	No	No	No	No	No	No	No	No	No	No
22	4	13	3	0	No	No	No	No	No	No	No	No	No	No
23	4	13	3	0	No	No	No	No	No	No	No	No	No	No
24	4	13	3	0	No	No	No	No	No	No	No	No	No	No
Hours Met					0	0	0	0	0	0	0	0	0	0

Warrant 3 Condition A

Orientation	S	N
Total Stopped Delay Per Vehicle on Minor Approach (s)	37.9	18.7
Number of Lanes on Minor Street Approach	3	3
VehicleHours of Stopped Delay on Minor Approach (h:mm)	0:19	0:04
Delay Condition Met	No	No
Volume on Minor Street Approach During Same Hour	31	15
High Minor Volume Condition Met	No	No
Total Entering Volume on All Approaches During Same Hour	1354	1354
Number of Approaches on Intersection	4	4
Total Volume Condition Met	Yes	Yes
Warrant Met for Approach	No	No
Warrant Met for Intersection	No	

Option 1: Signalized Marksheffel Rd/Lorson BI

Number	2					
Intersection	Marksheffel Rd/Lorson BI					
Control Type	Signalized					
Analysis Method	HCM 7th Edition					
Name	Marksheffel Rd		Marksheffel Rd		Lorson BI	
Approach	Northbound		Southbound		Westbound	
Lane Configuration	↑↔		↔↑		↔↔	
Turning Movement	Thru	Right	Left	Thru	Left	Right
Base Volume Input [veh/h]	577	115	9	454	207	121
Total Analysis Volume [veh/h]	687	137	10	516	244	142

Intersection Settings

Cycle Length [s]	60					
Active Pattern	Pattern 1					
Coordination Type	Time of Day Pattern Coordinated					
Actuation Type	Fixed time					
Lost time [s]	0.00					
Control Type	Permissive	Permissive	Permissive	Permissive	Permissive	Permissive
Signal Group	6	0	2	7	0	
Auxiliary Signal Groups						
Lead / Lag	-	-	-	Lead	-	
Minimum Green [s]	10	5	10	10	5	0
Maximum Green [s]	32	0	0	32	20	0
Amber [s]	3.0	0.0	0.0	3.0	3.0	0.0
All red [s]	1.0	0.0	0.0	1.0	1.0	0.0
Split [s]	36	0	0	36	24	0
Walk [s]	7	0	0	7	7	0
Pedestrian Clearance [s]		0	0	10	13	0
Delayed Vehicle Green [s]	0.0	0.0	0.0	0.0	0.0	0.0
l1, Start-Up Lost Time [s]	0	0.0	0.0	2.0	2.0	0.0
Minimum Recall	No			No	No	
Maximum Recall	No			No	No	
Pedestrian Recall	No			No	No	
Pedestrian Signal Group	0					
Pedestrian Walk [s]	0					
Pedestrian Clearance [s]	0					

Lane Group Calculations

g / C, Green / Cycle	0.53	0.53	0.53	0.53	0.33	0.33
(v / s)_i Volume / Saturation Flow Rate	0.41	0.10	0.02	0.31	0.15	0.10
so, Base Saturation Flow per Lane [pc/h/ln]	1900	1900	1900	1900	1900	1900
Arrival type	3		3		3	
s, saturation flow rate [veh/h]	1683	1431	598	1683	1603	1431
c, Capacity [veh/h]	898	763	227	898	534	477
X, volume / capacity	0.77	0.18	0.04	0.57	0.46	0.30
d, Delay for Lane Group [s/veh]	17.22	7.74	20.98	12.10	18.53	16.40

Lane Group LOS	B	A	C	B	B	B
Critical Lane Group	Yes	No	No	No	Yes	No
50th-Percentile Queue Length [veh/ln]	5.90	0.68	0.12	3.46	2.85	1.54
50th-Percentile Queue Length [ft/ln]	147.56	16.96	3.04	86.57	71.21	38.59
95th-Percentile Queue Length [veh/ln]	9.89	1.22	0.22	6.23	5.13	2.78
95th-Percentile Queue Length [ft/ln]	247.17	30.53	5.47	155.82	128.18	69.46

Movement, Approach, & Intersection Results

d_M, Delay for Movement [s/veh]	17.22	7.74	20.98	12.10	18.53	16.40
Movement LOS	B	A	C	B	B	B
Critical Movement	No	No	Yes	No	No	No
d_A, Approach Delay [s/veh]	15.64		12.27		17.74	
Approach LOS	B		B		B	
d_I, Intersection Delay [s/veh]	15.09					
Intersection LOS	B					
Intersection V/C	0.560					

Mitigated

Option 1: Signalized Marksheffel Rd/Lorson BI

Number	2					
Intersection	Marksheffel Rd/Lorson BI					
Control Type	Signalized					
Analysis Method	HCM 7th Edition					
Name	Marksheffel Rd		Marksheffel Rd		Lorson BI	
Approach	Northbound		Southbound		Westbound	
Lane Configuration	↑↔		↔↑		↔↔	
Turning Movement	Thru	Right	Left	Thru	Left	Right
Base Volume Input [veh/h]	492	257	69	558	120	53
Total Analysis Volume [veh/h]	541	282	74	600	141	62

Intersection Settings

Cycle Length [s]	70					
Active Pattern	Pattern 1					
Coordination Type	Time of Day Pattern Coordinated					
Actuation Type	Fixed time					
Lost time [s]	0.00					
Control Type	Permissive	Permissive	Permissive	Permissive	Permissive	Permissive
Signal Group	6	0	2	7	0	
Auxiliary Signal Groups						
Lead / Lag	-	-	-	Lead	-	
Minimum Green [s]	10	0	10	5	0	
Maximum Green [s]	40	0	40	22	0	
Amber [s]	3.0	0.0	3.0	3.0	0.0	
All red [s]	1.0	0.0	1.0	1.0	0.0	
Split [s]	44	0	44	26	0	
Walk [s]	7	0	7	7	0	
Pedestrian Clearance [s]		0	10	13	0	
Delayed Vehicle Green [s]	0.0	0.0	0.0	0.0	0.0	0.0
l1, Start-Up Lost Time [s]	0	0.0	0.0	2.0	2.0	0.0
Minimum Recall	No		No	No		
Maximum Recall	No		No	No		
Pedestrian Recall	No		No	No		
Pedestrian Signal Group	0					
Pedestrian Walk [s]	0					
Pedestrian Clearance [s]	0					

Lane Group Calculations

g / C, Green / Cycle	0.57	0.57	0.57	0.57	0.31	0.31
(v / s)_i Volume / Saturation Flow Rate	0.32	0.20	0.12	0.36	0.09	0.04
so, Base Saturation Flow per Lane [pc/h/ln]	1900	1900	1900	1900	1900	1900
Arrival type	3		3		3	
s, saturation flow rate [veh/h]	1683	1431	599	1683	1603	1431
c, Capacity [veh/h]	962	817	306	962	504	450
X, volume / capacity	0.56	0.34	0.24	0.62	0.28	0.14
d, Delay for Lane Group [s/veh]	11.85	9.16	19.27	13.04	19.43	17.84

Lane Group LOS	B	A	B	B	B	B
Critical Lane Group	No	No	No	Yes	Yes	No
50th-Percentile Queue Length [veh/ln]	4.07	1.78	0.90	4.84	1.84	0.77
50th-Percentile Queue Length [ft/ln]	101.84	44.43	22.57	120.90	46.10	19.29
95th-Percentile Queue Length [veh/ln]	7.33	3.20	1.63	8.44	3.32	1.39
95th-Percentile Queue Length [ft/ln]	183.31	79.97	40.63	211.06	82.98	34.73

Movement, Approach, & Intersection Results

d_M, Delay for Movement [s/veh]	11.85	9.16	19.27	13.04	19.43	17.84
Movement LOS	B	A	B	B	B	B
Critical Movement	No	No	No	No	Yes	No
d_A, Approach Delay [s/veh]	10.93		13.72		18.94	
Approach LOS	B		B		B	
d_I, Intersection Delay [s/veh]	12.99					
Intersection LOS	B					
Intersection V/C	0.444					

Mitigated

Appendix C – Trip Generation

PROJECT DETAILS

Project Name:	Lorson Ranch Commercial North	Type of Project:	
Project No:		City:	
Country:		Built-up Area(Sq.ft):	
Analyst Name:	Scott Barnhart	Clients Name:	
Date:	3/22/2024	ZIP/Postal Code:	
State/Province:		No. of Scenarios:	3
Analysis Region:			

SCENARIO SUMMARY

Scenarios	Name	No. of Land Uses	Phases of Development	No. of Years to Project Traffic	User Group	Estimated New Vehicle Trips		
						Entry	Exit	Total
Scenario - 1	Weekday	4	1	0		4089	4089	8178
Scenario - 2	AM Peak Hour	4	1	0		227	214	441
Scenario - 3	PM Peak Hour	4	1	0		189	192	381

Scenario - 1

Scenario Name: Weekday

User Group:

Dev. phase: 1

No. of Years to Project 0

Traffic :

Analyst Note:

Warning:

VEHICLE TRIPS BEFORE REDUCTION

Land Use & Data Source	Location	IV	Size	Time Period	Method	Entry	Exit	Total
					Rate/Equation	Split%	Split%	
934 - Fast-Food Restaurant with Drive-Through Data Source: Trip Generation Manual, 11th Ed	General Urban/Suburban	1000 Sq. Ft. GFA	8.17	Weekday	Average 467.48	1910 50%	1910 50%	3820
565 - Day Care Center Data Source: Trip Generation Manual, 11th Ed	General Urban/Suburban	1000 Sq. Ft. GFA	12	Weekday	Average 47.62	286 50%	286 50%	572
151 - Mini-Warehouse Data Source: Trip Generation Manual, 11th Ed	General Urban/Suburban	1000 Sq. Ft. GFA	36.5	Weekday	Average 1.45	26 50%	26 50%	52
945 - Convenience Store/Gas Station - VFP (9-15) Data Source: Trip Generation Manual, 11th Ed	General Urban/Suburban	1000 Sq. Ft. GFA	5.68	Weekday	Best Fit (LIN) T = 560.88(X) + 548.79	1867 50%	1867 50%	3734

VEHICLE TO PERSON TRIP CONVERSION

BASELINE SITE VEHICLE CHARACTERISTICS:

Land Use	Baseline Site Vehicle Mode Share		Baseline Site Vehicle Occupancy		Baseline Site Vehicle Directional Split	
	Entry (%)	Exit (%)	Entry	Exit	Entry (%)	Exit (%)
934 - Fast-Food Restaurant with Drive-Through Window	100	100	1	1	50	50
565 - Day Care Center	100	100	1	1	50	50
151 - Mini-Warehouse	100	100	1.6	1.6	50	50
945 - Convenience Store/Gas Station - VFP (9-15)	100	100	1	1	50	50

ESTIMATED BASELINE SITE PERSON TRIPS:

Land Use	Person Trips by Vehicle		Person Trips by Other Modes		Total Baseline Site Person Trips	
	Entry	Exit	Entry	Exit	Entry	Exit
934 - Fast-Food Restaurant with Drive-Through Window	1910	1910	0	0	1910	1910
	3820		0		3820	
565 - Day Care Center	286	286	0	0	286	286
	572		0		572	
151 - Mini-Warehouse	42	42	0	0	42	42
	84		0		84	
945 - Convenience Store/Gas Station - VFP (9-15)	1867	1867	0	0	1867	1867
	3734		0		3734	

INTERNAL VEHICLE TRIP REDUCTION

LAND USE GROUP ASSIGNMENT:

Land Use	Land Use Group
934 - Fast-Food Restaurant with Drive-Through Window	Resturant
565 - Day Care Center	Others
151 - Mini-Warehouse	Others
945 - Convenience Store/Gas Station - VFP (9-15)	Resturant

BALANCED PERSON TRIPS:

934 - Fast-Food Restaurant with Drive-Through Window					565 - Day Care Center				
Persons Exit	PAF	UIPTC	Unconstrained Demand	====>> BALANCED <<====	Unconstrained Demand	UIPTC	PAF	Persons Entry	
1910	0	0	0	0	0	0	0	286	
Persons Entry	PAF	UIPTC	Unconstrained Demand	<<<==== BALANCED <<<====	Unconstrained Demand	UIPTC	PAF	Persons Exit	
1910	0	0	0	0	0	0	0	286	
934 - Fast-Food Restaurant with Drive-Through Window					151 - Mini-Warehouse				
Persons Exit	PAF	UIPTC	Unconstrained Demand	====>> BALANCED <<====	Unconstrained Demand	UIPTC	PAF	Persons Entry	
1910	0	0	0	0	0	0	0	42	
Persons Entry	PAF	UIPTC	Unconstrained Demand	<<<==== BALANCED <<<====	Unconstrained Demand	UIPTC	PAF	Persons Exit	
1910	0	0	0	0	0	0	0	42	
934 - Fast-Food Restaurant with Drive-Through Window					945 - Convenience Store/Gas Station-VFP (9-15)				
Persons Exit	PAF	UIPTC	Unconstrained Demand	====>> BALANCED <<====	Unconstrained Demand	UIPTC	PAF	Persons Entry	
1910	0	0	0	0	0	0	0	1867	
Persons Entry	PAF	UIPTC	Unconstrained Demand	<<<==== BALANCED <<<====	Unconstrained Demand	UIPTC	PAF	Persons Exit	
1910	0	0	0	0	0	0	0	1867	
565 - Day Care Center					151 - Mini-Warehouse				
Persons Exit	PAF	UIPTC	Unconstrained Demand	====>> BALANCED <<====	Unconstrained Demand	UIPTC	PAF	Persons Entry	
286	0	0	0	0	0	0	0	42	
Persons Entry	PAF	UIPTC	Unconstrained Demand	<<<==== BALANCED <<<====	Unconstrained Demand	UIPTC	PAF	Persons Exit	
286	0	0	0	0	0	0	0	42	
565 - Day Care Center					945 - Convenience Store/Gas Station-VFP (9-15)				
Persons Exit	PAF	UIPTC	Unconstrained Demand	====>> BALANCED <<====	Unconstrained Demand	UIPTC	PAF	Persons Entry	
286	0	0	0	0	0	0	0	1867	
Persons Entry	PAF	UIPTC	Unconstrained Demand	<<<==== BALANCED <<<====	Unconstrained Demand	UIPTC	PAF	Persons Exit	
286	0	0	0	0	0	0	0	1867	
151 - Mini-Warehouse					945 - Convenience Store/Gas Station-VFP (9-15)				
Persons Exit	PAF	UIPTC	Unconstrained Demand	====>> BALANCED <<====	Unconstrained Demand	UIPTC	PAF	Persons Entry	
42	0	0	0	0	0	0	0	1867	
Persons Entry	PAF	UIPTC	Unconstrained Demand	<<<==== BALANCED <<<====	Unconstrained Demand	UIPTC	PAF	Persons Exit	
42	0	0	0	0	0	0	0	1867	

INTERNAL PERSON TRIPS:

934 - Fast-Food Restaurant with Drive-Through Window

Internal Person Trips From	Entry	Exit	Total
Total Internal Person Trips	0	0	0

565 - Day Care Center

Internal Person Trips From	Entry	Exit	Total
Total Internal Person Trips	0	0	0

151 - Mini-Warehouse

Internal Person Trips From	Entry	Exit	Total
Total Internal Person Trips	0	0	0

945 - Convenience Store/Gas Station-VFP (9-15)

Internal Person Trips From	Entry	Exit	Total
Total Internal Person Trips	0	0	0

INTERNAL VEHICLE TRIPS AND CAPTURE:

934 - Fast-Food Restaurant with Drive-Through Window

Total Internal Person Trips	0	0	0
Vehicle Mode Share	100%	100%	-
Vehicle Occupancy	1.00	1.00	-
Total Vehicle Internal Trips	0	0	0
Total External Vehicle Trips	1910	1910	3820
Internal Vehicle Trip Capture	0%	0%	0%

565 - Day Care Center

Total Internal Person Trips	0	0	0
Vehicle Mode Share	100%	100%	-
Vehicle Occupancy	1.00	1.00	-
Total Vehicle Internal Trips	0	0	0
Total External Vehicle Trips	286	286	572
Internal Vehicle Trip Capture	0%	0%	0%

151 - Mini-Warehouse

Total Internal Person Trips	0	0	0
Vehicle Mode Share	100%	100%	-
Vehicle Occupancy	1.00	1.00	-
Total Vehicle Internal Trips	0	0	0
Total External Vehicle Trips	26	26	52
Internal Vehicle Trip Capture	0%	0%	0%

945 - Convenience Store/Gas Station-VFP (9-15)

Total Internal Person Trips	0	0	0
Vehicle Mode Share	100%	100%	-
Vehicle Occupancy	1.00	1.00	-
Total Vehicle Internal Trips	0	0	0
Total External Vehicle Trips	1867	1867	3734
Internal Vehicle Trip Capture	0%	0%	0%

PASS-BY VEHICLE TRIP REDUCTION

Land Use	External Vehicle Trips		Pass-by Vehicle Trip %		Pass-by Vehicle Trips	
	Entry	Exit	Entry (%)	Exit (%)	Entry	Exit

934 - Fast-Food Restaurant with Drive-Through Window	1910	1910	0.00%	0.00%	0	0
565 - Day Care Center	286	286	0.00%	0.00%	0	0
151 - Mini-Warehouse	26	26	0.00%	0.00%	0	0
945 - Convenience Store/Gas Station - VFP (9-15)	1867	1867	0.00%	0.00%	0	0

DIVERTED VEHICLE TRIP REDUCTION

Land Use	External Vehicle Trips		Diverted Vehicle Trip %		Diverted Vehicle Trips	
	Entry	Exit	Entry (%)	Exit (%)	Entry	Exit
934 - Fast-Food Restaurant with Drive-Through Window	1910	1910	0.00%	0.00%	0	0
565 - Day Care Center	286	286	0.00%	0.00%	0	0
151 - Mini-Warehouse	26	26	0.00%	0.00%	0	0
945 - Convenience Store/Gas Station - VFP (9-15)	1867	1867	0.00%	0.00%	0	0

EXTRA VEHICLE TRIP REDUCTION

Land Use	(External - (Pass-by + Diverted)) Vehicle Trips		Extra Vehicle Trip Reduction %		Extra Reduced Vehicle Trips	
	Entry	Exit	Entry (%)	Exit (%)	Entry	Exit
934 - Fast-Food Restaurant with Drive-Through Window	1910	1910	0.00%	0.00%	0	0
565 - Day Care Center	286	286	0.00%	0.00%	0	0
151 - Mini-Warehouse	26	26	0.00%	0.00%	0	0
945 - Convenience Store/Gas Station - VFP (9-15)	1867	1867	0.00%	0.00%	0	0

NEW VEHICLE TRIPS

Land Use	New Vehicle Trips		
	Entry	Exit	Total
934 - Fast-Food Restaurant with Drive-Through Window	1910	1910	3820
565 - Day Care Center	286	286	572
151 - Mini-Warehouse	26	26	52
945 - Convenience Store/Gas Station - VFP (9-15)	1867	1867	3734

RESULTS

Site Totals	Entry	Exit	Total
Vehicle Trips Before Reduction	4089	4089	8178
Internal Vehicle Trips	0	0	0
External Vehicle Trips	4089	4089	8178
Internal Vehicle Trip Capture	0%	0%	0%
Pass-by Vehicle Trips	0	0	0
Diverted Vehicle Trips	0	0	0
Extra Reduced Vehicle Trips	0	0	0
New Vehicle Trips	4089	4089	8178

Scenario - 2

Scenario Name: AM Peak Hour

User Group:

Dev. phase: 1

No. of Years to Project 0

Traffic :

Analyst Note:

Warning:

VEHICLE TRIPS BEFORE REDUCTION

Land Use & Data Source	Location	IV	Size	Time Period	Method	Entry	Exit	Total
					Rate/Equation	Split%	Split%	
934 - Fast-Food Restaurant with Drive-Through Data Source: Trip Generation Manual, 11th Ed	General Urban/Suburban	1000 Sq. Ft. GFA	8.17	Weekday, Peak Hour of Adjacent Street Traffic,	Average 44.61	186 51%	179 49%	365
945 - Convenience Store/Gas Station - VFP (9-15) Data Source: Trip Generation Manual, 11th Ed	General Urban/Suburban	1000 Sq. Ft. GFA	5.68	Weekday, Peak Hour of Adjacent Street Traffic,	Average 56.52	161 50%	161 50%	322
565 - Day Care Center Data Source: Trip Generation Manual, 11th Ed	General Urban/Suburban	1000 Sq. Ft. GFA	12	Weekday, Peak Hour of Adjacent Street Traffic,	Average 11.00	70 53%	62 47%	132
151 - Mini-Warehouse Data Source: Trip Generation Manual, 11th Ed	General Urban/Suburban	1000 Sq. Ft. GFA	36.5	Weekday, Peak Hour of Adjacent Street Traffic,	Average 0.09	2 59%	1 41%	3

VEHICLE TO PERSON TRIP CONVERSION

BASELINE SITE VEHICLE CHARACTERISTICS:

Land Use	Baseline Site Vehicle Mode Share		Baseline Site Vehicle Occupancy		Baseline Site Vehicle Directional Split	
	Entry (%)	Exit (%)	Entry	Exit	Entry (%)	Exit (%)
934 - Fast-Food Restaurant with Drive-Through Window	100	100	1	1	51	49
945 - Convenience Store/Gas Station - VFP (9-15)	100	100	1	1	50	50
565 - Day Care Center	100	100	1	1	53	47
151 - Mini-Warehouse	100	100	1	1	59	41

ESTIMATED BASELINE SITE PERSON TRIPS:

Land Use	Person Trips by Vehicle		Person Trips by Other Modes		Total Baseline Site Person Trips	
	Entry	Exit	Entry	Exit	Entry	Exit
934 - Fast-Food Restaurant with Drive-Through Window	186	179	0	0	186	179
	365		0		365	
945 - Convenience Store/Gas Station - VFP (9-15)	161	161	0	0	161	161
	322		0		322	
565 - Day Care Center	70	62	0	0	70	62
	132		0		132	
151 - Mini-Warehouse	2	1	0	0	2	1
	3		0		3	

INTERNAL VEHICLE TRIP REDUCTION

LAND USE GROUP ASSIGNMENT:

Land Use	Land Use Group
934 - Fast-Food Restaurant with Drive-Through Window	Resturant
945 - Convenience Store/Gas Station - VFP (9-15)	Resturant
565 - Day Care Center	Others
151 - Mini-Warehouse	Others

BALANCED PERSON TRIPS:

934 - Fast-Food Restaurant with Drive-Through Window					945 - Convenience Store/Gas Station-VFP (9-15)				
Persons Exit	PAF	UIPTC	Unconstrained Demand	====>> BALANCED <<====	Unconstrained Demand	UIPTC	PAF	Persons Entry	
179	1	0	0	0	0	0	1	161	
Persons Entry	PAF	UIPTC	Unconstrained Demand	<<<==== BALANCED <<<====	Unconstrained Demand	UIPTC	PAF	Persons Exit	
186	1	0	0	0	0	0	1	161	
934 - Fast-Food Restaurant with Drive-Through Window					565 - Day Care Center				
Persons Exit	PAF	UIPTC	Unconstrained Demand	====>> BALANCED <<====	Unconstrained Demand	UIPTC	PAF	Persons Entry	
179	1	0	0	0	0	0	1	70	
Persons Entry	PAF	UIPTC	Unconstrained Demand	<<<==== BALANCED <<<====	Unconstrained Demand	UIPTC	PAF	Persons Exit	
186	1	0	0	0	0	0	1	62	
934 - Fast-Food Restaurant with Drive-Through Window					151 - Mini-Warehouse				
Persons Exit	PAF	UIPTC	Unconstrained Demand	====>> BALANCED <<====	Unconstrained Demand	UIPTC	PAF	Persons Entry	
179	1	0	0	0	0	0	1	2	
Persons Entry	PAF	UIPTC	Unconstrained Demand	<<<==== BALANCED <<<====	Unconstrained Demand	UIPTC	PAF	Persons Exit	
186	1	0	0	0	0	0	1	1	
945 - Convenience Store/Gas Station-VFP (9-15)					565 - Day Care Center				
Persons Exit	PAF	UIPTC	Unconstrained Demand	====>> BALANCED <<====	Unconstrained Demand	UIPTC	PAF	Persons Entry	
161	1	0	0	0	0	0	1	70	
Persons Entry	PAF	UIPTC	Unconstrained Demand	<<<==== BALANCED <<<====	Unconstrained Demand	UIPTC	PAF	Persons Exit	
161	1	0	0	0	0	0	1	62	
945 - Convenience Store/Gas Station-VFP (9-15)					151 - Mini-Warehouse				
Persons Exit	PAF	UIPTC	Unconstrained Demand	====>> BALANCED <<====	Unconstrained Demand	UIPTC	PAF	Persons Entry	
161	1	0	0	0	0	0	1	2	
Persons Entry	PAF	UIPTC	Unconstrained Demand	<<<==== BALANCED <<<====	Unconstrained Demand	UIPTC	PAF	Persons Exit	
161	1	0	0	0	0	0	1	1	
565 - Day Care Center					151 - Mini-Warehouse				
Persons Exit	PAF	UIPTC	Unconstrained Demand	====>> BALANCED <<====	Unconstrained Demand	UIPTC	PAF	Persons Entry	
62	1	0	0	0	0	0	1	2	
Persons Entry	PAF	UIPTC	Unconstrained Demand	<<<==== BALANCED <<<====	Unconstrained Demand	UIPTC	PAF	Persons Exit	
70	1	0	0	0	0	0	1	1	

INTERNAL PERSON TRIPS:

934 - Fast-Food Restaurant with Drive-Through Window

Internal Person Trips From	Entry	Exit	Total
945 - Convenience Store/Gas Station-VFP (9-15)	0	0	0

565 - Day Care Center	0	0	0
151 - Mini-Warehouse	0	0	0
Total Internal Person Trips	0	0	0

945 - Convenience Store/Gas Station-VFP (9-15)

Internal Person Trips From	Entry	Exit	Total
934 - Fast-Food Restaurant with Drive-Through Window	0	0	0
565 - Day Care Center	0	0	0
151 - Mini-Warehouse	0	0	0
Total Internal Person Trips	0	0	0

565 - Day Care Center

Internal Person Trips From	Entry	Exit	Total
934 - Fast-Food Restaurant with Drive-Through Window	0	0	0
945 - Convenience Store/Gas Station-VFP (9-15)	0	0	0
151 - Mini-Warehouse	0	0	0
Total Internal Person Trips	0	0	0

151 - Mini-Warehouse

Internal Person Trips From	Entry	Exit	Total
934 - Fast-Food Restaurant with Drive-Through Window	0	0	0
945 - Convenience Store/Gas Station-VFP (9-15)	0	0	0
565 - Day Care Center	0	0	0
Total Internal Person Trips	0	0	0

INTERNAL VEHICLE TRIPS AND CAPTURE:

934 - Fast-Food Restaurant with Drive-Through Window

Total Internal Person Trips	0	0	0
Vehicle Mode Share	100%	100%	-
Vehicle Occupancy	1.00	1.00	-
Total Vehicle Internal Trips	0	0	0
Total External Vehicle Trips	186	179	365
Internal Vehicle Trip Capture	0%	0%	0%

945 - Convenience Store/Gas Station-VFP (9-15)

Total Internal Person Trips	0	0	0
Vehicle Mode Share	100%	100%	-
Vehicle Occupancy	1.00	1.00	-
Total Vehicle Internal Trips	0	0	0
Total External Vehicle Trips	161	161	322
Internal Vehicle Trip Capture	0%	0%	0%

565 - Day Care Center

Total Internal Person Trips	0	0	0
Vehicle Mode Share	100%	100%	-
Vehicle Occupancy	1.00	1.00	-
Total Vehicle Internal Trips	0	0	0
Total External Vehicle Trips	70	62	132
Internal Vehicle Trip Capture	0%	0%	0%

151 - Mini-Warehouse

Total Internal Person Trips	0	0	0
Vehicle Mode Share	100%	100%	-
Vehicle Occupancy	1.00	1.00	-
Total Vehicle Internal Trips	0	0	0
Total External Vehicle Trips	2	1	3
Internal Vehicle Trip Capture	0%	0%	0%

PASS-BY VEHICLE TRIP REDUCTION

Land Use	External Vehicle Trips		Pass-by Vehicle Trip %		Pass-by Vehicle Trips	
	Entry	Exit	Entry (%)	Exit (%)	Entry	Exit
934 - Fast-Food Restaurant with Drive-Through Window	186	179	49.00%	49.00%	91	88
945 - Convenience Store/Gas Station - VFP (9-15)	161	161	63.00%	63.00%	101	101
565 - Day Care Center	70	62	0.00%	0.00%	0	0
151 - Mini-Warehouse	2	1	0.00%	0.00%	0	0

DIVERTED VEHICLE TRIP REDUCTION

Land Use	External Vehicle Trips		Diverted Vehicle Trip %		Diverted Vehicle Trips	
	Entry	Exit	Entry (%)	Exit (%)	Entry	Exit
934 - Fast-Food Restaurant with Drive-Through Window	186	179	0.00%	0.00%	0	0
945 - Convenience Store/Gas Station - VFP (9-15)	161	161	0.00%	0.00%	0	0
565 - Day Care Center	70	62	0.00%	0.00%	0	0
151 - Mini-Warehouse	2	1	0.00%	0.00%	0	0

EXTRA VEHICLE TRIP REDUCTION

Land Use	(External - (Pass-by + Diverted)) Vehicle Trips		Extra Vehicle Trip Reduction %		Extra Reduced Vehicle Trips	
	Entry	Exit	Entry (%)	Exit (%)	Entry	Exit
934 - Fast-Food Restaurant with Drive-Through Window	95	91	0.00%	0.00%	0	0
945 - Convenience Store/Gas Station - VFP (9-15)	60	60	0.00%	0.00%	0	0
565 - Day Care Center	70	62	0.00%	0.00%	0	0
151 - Mini-Warehouse	2	1	0.00%	0.00%	0	0

NEW VEHICLE TRIPS

Land Use	New Vehicle Trips		
	Entry	Exit	Total
934 - Fast-Food Restaurant with Drive-Through Window	95	91	186
945 - Convenience Store/Gas Station - VFP (9-15)	60	60	120
565 - Day Care Center	70	62	132
151 - Mini-Warehouse	2	1	3

RESULTS

Site Totals	Entry	Exit	Total
Vehicle Trips Before Reduction	419	403	822
Internal Vehicle Trips	0	0	0
External Vehicle Trips	419	403	822
Internal Vehicle Trip Capture	0%	0%	0%
Pass-by Vehicle Trips	192	189	381
Diverted Vehicle Trips	0	0	0

Extra Reduced Vehicle Trips	0	0	0
New Vehicle Trips	227	214	441

Scenario - 3

Scenario Name: PM Peak Hour

User Group:

Dev. phase: 1

No. of Years to Project 0

Traffic :

Analyst Note:

Warning:

VEHICLE TRIPS BEFORE REDUCTION

Land Use & Data Source	Location	IV	Size	Time Period	Method	Entry	Exit	Total
					Rate/Equation	Split%	Split%	
934 - Fast-Food Restaurant with Drive-Through Data Source: Trip Generation Manual, 11th Ed	General Urban/Suburban	1000 Sq. Ft. GFA	8.17	Weekday, Peak Hour of Adjacent Street Traffic,	Average 33.03	140 52%	130 48%	270
945 - Convenience Store/Gas Station - VFP (9-15) Data Source: Trip Generation Manual, 11th Ed	General Urban/Suburban	1000 Sq. Ft. GFA	5.68	Weekday, Peak Hour of Adjacent Street Traffic,	Average 54.52	155 50%	155 50%	310
565 - Day Care Center Data Source: Trip Generation Manual, 11th Ed	General Urban/Suburban	1000 Sq. Ft. GFA	12	Weekday, Peak Hour of Adjacent Street Traffic,	Average 11.12	63 47%	71 53%	134
151 - Mini-Warehouse Data Source: Trip Generation Manual, 11th Ed	General Urban/Suburban	1000 Sq. Ft. GFA	36.5	Weekday, Peak Hour of Adjacent Street Traffic,	Average 0.15	3 47%	3 53%	6

VEHICLE TO PERSON TRIP CONVERSION

BASELINE SITE VEHICLE CHARACTERISTICS:

Land Use	Baseline Site Vehicle Mode Share		Baseline Site Vehicle Occupancy		Baseline Site Vehicle Directional Split	
	Entry (%)	Exit (%)	Entry	Exit	Entry (%)	Exit (%)
934 - Fast-Food Restaurant with Drive-Through Window	100	100	1	1	52	48
945 - Convenience Store/Gas Station - VFP (9-15)	100	100	1	1	50	50
565 - Day Care Center	100	100	1	1	47	53
151 - Mini-Warehouse	100	100	1	1	47	53

ESTIMATED BASELINE SITE PERSON TRIPS:

Land Use	Person Trips by Vehicle		Person Trips by Other Modes		Total Baseline Site Person Trips	
	Entry	Exit	Entry	Exit	Entry	Exit
934 - Fast-Food Restaurant with Drive-Through Window	140	130	0	0	140	130
	270		0		270	
945 - Convenience Store/Gas Station - VFP (9-15)	155	155	0	0	155	155
	310		0		310	
565 - Day Care Center	63	71	0	0	63	71
	134		0		134	
151 - Mini-Warehouse	3	3	0	0	3	3
	6		0		6	

INTERNAL VEHICLE TRIP REDUCTION

LAND USE GROUP ASSIGNMENT:

Land Use	Land Use Group
934 - Fast-Food Restaurant with Drive-Through Window	Resturant
945 - Convenience Store/Gas Station - VFP (9-15)	Resturant
565 - Day Care Center	Others
151 - Mini-Warehouse	Others

BALANCED PERSON TRIPS:

934 - Fast-Food Restaurant with Drive-Through Window						945 - Convenience Store/Gas Station-VFP (9-15)				
Persons Exit	PAF	UIPTC	Unconstrained Demand	====>> BALANCED >>>==	Unconstrained Demand	UIPTC	PAF	Persons Entry		
130	1	0	0	0	0	0	1	155		
Persons Entry	PAF	UIPTC	Unconstrained Demand	<<<== BALANCED <<<==	Unconstrained Demand	UIPTC	PAF	Persons Exit		
140	1	0	0	0	0	0	1	155		
934 - Fast-Food Restaurant with Drive-Through Window						565 - Day Care Center				
Persons Exit	PAF	UIPTC	Unconstrained Demand	====>> BALANCED >>>==	Unconstrained Demand	UIPTC	PAF	Persons Entry		
130	1	0	0	0	0	0	1	63		
Persons Entry	PAF	UIPTC	Unconstrained Demand	<<<== BALANCED <<<==	Unconstrained Demand	UIPTC	PAF	Persons Exit		
140	1	0	0	0	0	0	1	71		
934 - Fast-Food Restaurant with Drive-Through Window						151 - Mini-Warehouse				
Persons Exit	PAF	UIPTC	Unconstrained Demand	====>> BALANCED >>>==	Unconstrained Demand	UIPTC	PAF	Persons Entry		
130	1	0	0	0	0	0	1	3		
Persons Entry	PAF	UIPTC	Unconstrained Demand	<<<== BALANCED <<<==	Unconstrained Demand	UIPTC	PAF	Persons Exit		
140	1	0	0	0	0	0	1	3		
945 - Convenience Store/Gas Station-VFP (9-15)						565 - Day Care Center				
Persons Exit	PAF	UIPTC	Unconstrained Demand	====>> BALANCED >>>==	Unconstrained Demand	UIPTC	PAF	Persons Entry		
155	1	0	0	0	0	0	1	63		
Persons Entry	PAF	UIPTC	Unconstrained Demand	<<<== BALANCED <<<==	Unconstrained Demand	UIPTC	PAF	Persons Exit		
155	1	0	0	0	0	0	1	71		
945 - Convenience Store/Gas Station-VFP (9-15)						151 - Mini-Warehouse				
Persons Exit	PAF	UIPTC	Unconstrained Demand	====>> BALANCED >>>==	Unconstrained Demand	UIPTC	PAF	Persons Entry		
155	1	0	0	0	0	0	1	3		
Persons Entry	PAF	UIPTC	Unconstrained Demand	<<<== BALANCED <<<==	Unconstrained Demand	UIPTC	PAF	Persons Exit		
155	1	0	0	0	0	0	1	3		
565 - Day Care Center						151 - Mini-Warehouse				
Persons Exit	PAF	UIPTC	Unconstrained Demand	====>> BALANCED >>>==	Unconstrained Demand	UIPTC	PAF	Persons Entry		
71	1	0	0	0	0	0	1	3		
Persons Entry	PAF	UIPTC	Unconstrained Demand	<<<== BALANCED <<<==	Unconstrained Demand	UIPTC	PAF	Persons Exit		
63	1	0	0	0	0	0	1	3		

INTERNAL PERSON TRIPS:

934 - Fast-Food Restaurant with Drive-Through Window

Internal Person Trips From	Entry	Exit	Total
945 - Convenience Store/Gas Station-VFP (9-15)	0	0	0

565 - Day Care Center	0	0	0
151 - Mini-Warehouse	0	0	0
Total Internal Person Trips	0	0	0

945 - Convenience Store/Gas Station-VFP (9-15)

Internal Person Trips From	Entry	Exit	Total
934 - Fast-Food Restaurant with Drive-Through Window	0	0	0
565 - Day Care Center	0	0	0
151 - Mini-Warehouse	0	0	0
Total Internal Person Trips	0	0	0

565 - Day Care Center

Internal Person Trips From	Entry	Exit	Total
934 - Fast-Food Restaurant with Drive-Through Window	0	0	0
945 - Convenience Store/Gas Station-VFP (9-15)	0	0	0
151 - Mini-Warehouse	0	0	0
Total Internal Person Trips	0	0	0

151 - Mini-Warehouse

Internal Person Trips From	Entry	Exit	Total
934 - Fast-Food Restaurant with Drive-Through Window	0	0	0
945 - Convenience Store/Gas Station-VFP (9-15)	0	0	0
565 - Day Care Center	0	0	0
Total Internal Person Trips	0	0	0

INTERNAL VEHICLE TRIPS AND CAPTURE:

934 - Fast-Food Restaurant with Drive-Through Window

Total Internal Person Trips	0	0	0
Vehicle Mode Share	100%	100%	-
Vehicle Occupancy	1.00	1.00	-
Total Vehicle Internal Trips	0	0	0
Total External Vehicle Trips	140	130	270
Internal Vehicle Trip Capture	0%	0%	0%

945 - Convenience Store/Gas Station-VFP (9-15)

Total Internal Person Trips	0	0	0
Vehicle Mode Share	100%	100%	-
Vehicle Occupancy	1.00	1.00	-
Total Vehicle Internal Trips	0	0	0
Total External Vehicle Trips	155	155	310
Internal Vehicle Trip Capture	0%	0%	0%

565 - Day Care Center

Total Internal Person Trips	0	0	0
Vehicle Mode Share	100%	100%	-
Vehicle Occupancy	1.00	1.00	-
Total Vehicle Internal Trips	0	0	0
Total External Vehicle Trips	63	71	134
Internal Vehicle Trip Capture	0%	0%	0%

151 - Mini-Warehouse

Total Internal Person Trips	0	0	0
Vehicle Mode Share	100%	100%	-
Vehicle Occupancy	1.00	1.00	-
Total Vehicle Internal Trips	0	0	0
Total External Vehicle Trips	3	3	6
Internal Vehicle Trip Capture	0%	0%	0%

PASS-BY VEHICLE TRIP REDUCTION

Land Use	External Vehicle Trips		Pass-by Vehicle Trip %		Pass-by Vehicle Trips	
	Entry	Exit	Entry (%)	Exit (%)	Entry	Exit
934 - Fast-Food Restaurant with Drive-Through Window	140	130	49.90%	49.90%	70	65
945 - Convenience Store/Gas Station - VFP (9-15)	155	155	66.00%	66.00%	102	102
565 - Day Care Center	63	71	0.00%	0.00%	0	0
151 - Mini-Warehouse	3	3	0.00%	0.00%	0	0

DIVERTED VEHICLE TRIP REDUCTION

Land Use	External Vehicle Trips		Diverted Vehicle Trip %		Diverted Vehicle Trips	
	Entry	Exit	Entry (%)	Exit (%)	Entry	Exit
934 - Fast-Food Restaurant with Drive-Through Window	140	130	0.00%	0.00%	0	0
945 - Convenience Store/Gas Station - VFP (9-15)	155	155	0.00%	0.00%	0	0
565 - Day Care Center	63	71	0.00%	0.00%	0	0
151 - Mini-Warehouse	3	3	0.00%	0.00%	0	0

EXTRA VEHICLE TRIP REDUCTION

Land Use	(External - (Pass-by + Diverted)) Vehicle Trips		Extra Vehicle Trip Reduction %		Extra Reduced Vehicle Trips	
	Entry	Exit	Entry (%)	Exit (%)	Entry	Exit
934 - Fast-Food Restaurant with Drive-Through Window	70	65	0.00%	0.00%	0	0
945 - Convenience Store/Gas Station - VFP (9-15)	53	53	0.00%	0.00%	0	0
565 - Day Care Center	63	71	0.00%	0.00%	0	0
151 - Mini-Warehouse	3	3	0.00%	0.00%	0	0

NEW VEHICLE TRIPS

Land Use	New Vehicle Trips		
	Entry	Exit	Total
934 - Fast-Food Restaurant with Drive-Through Window	70	65	135
945 - Convenience Store/Gas Station - VFP (9-15)	53	53	106
565 - Day Care Center	63	71	134
151 - Mini-Warehouse	3	3	6

RESULTS

Site Totals	Entry	Exit	Total
Vehicle Trips Before Reduction	361	359	720
Internal Vehicle Trips	0	0	0
External Vehicle Trips	361	359	720
Internal Vehicle Trip Capture	0%	0%	0%
Pass-by Vehicle Trips	172	167	339
Diverted Vehicle Trips	0	0	0

Extra Reduced Vehicle Trips	0	0	0
New Vehicle Trips	189	192	381

Appendix D – Buildout Year (2030) Conditions Analyses

Table of Contents

Intersection Level Of Service Report	2
Intersection 1: Marksheffel Rd/Fontaine Bl	2
Intersection 2: Marksheffel Rd/Lorson Bl	7
Intersection 3: Fontaine Bl/Carriage Meadows Dr	12
Signal Warrants Report	14
Intersection 3: Fontaine Bl/Carriage Meadows Dr	14

Intersection Level Of Service Report
Intersection 1: Marksheffel Rd/Fontaine BI

Control Type:	Signalized	Delay (sec / veh):	37.7
Analysis Method:	HCM 7th Edition	Level Of Service:	D
Analysis Period:	15 minutes	Volume to Capacity (v/c):	0.701

Intersection Setup

Name	Marksheffel Rd			Marksheffel Rd			Fontaine BI			Fontaine BI		
Approach	Northbound			Southbound			Eastbound			Westbound		
Lane Configuration												
Turning Movement	Left	Thru	Right	Left	Thru	Right	Left	Thru	Right	Left	Thru	Right
Lane Width [ft]	12.00	12.00	12.00	12.00	12.00	12.00	12.00	12.00	12.00	12.00	12.00	12.00
No. of Lanes in Entry Pocket	1	0	1	1	0	1	1	0	1	1	0	0
Entry Pocket Length [ft]	680.00	100.00	680.00	750.00	100.00	500.00	360.00	100.00	200.00	535.00	100.00	100.00
No. of Lanes in Exit Pocket	0	0	1	0	0	0	0	0	0	0	0	0
Exit Pocket Length [ft]	0.00	0.00	100.00	0.00	0.00	0.00	0.00	0.00	0.00	0.00	0.00	0.00
Speed [mph]	55.00			55.00			45.00			45.00		
Grade [%]	0.00			0.00			0.00			0.00		
Curb Present	No			No			No			No		
Crosswalk	Yes			Yes			Yes			Yes		

Volumes

Name	Marksheffel Rd			Marksheffel Rd			Fontaine Bl			Fontaine Bl		
Base Volume Input [veh/h]	131	531	113	157	239	17	25	252	72	246	651	505
Base Volume Adjustment Factor	1.0000	1.0000	1.0000	1.0000	1.0000	1.0000	1.0000	1.0000	1.0000	1.0000	1.0000	1.0000
Heavy Vehicles Percentage [%]	2.00	2.00	2.00	2.00	2.00	2.00	2.00	2.00	2.00	2.00	2.00	2.00
Proportion of CAVs [%]	0.00											
Growth Factor	1.0000	1.1660	1.0000	1.0000	1.1660	1.0000	1.0000	1.0000	1.0000	1.0000	1.0000	1.0000
In-Process Volume [veh/h]	0	0	0	0	0	0	0	0	0	0	0	0
Site-Generated Trips [veh/h]	0	0	1	1	0	0	0	1	0	5	2	4
Diverted Trips [veh/h]	0	0	0	0	0	0	0	0	0	13	0	0
Pass-by Trips [veh/h]	0	0	0	0	0	0	0	0	0	0	0	0
Existing Site Adjustment Volume [veh/h]	0	0	0	0	0	0	0	0	0	0	0	0
Other Volume [veh/h]	0	0	0	0	0	0	0	0	0	0	0	0
Right Turn on Red Volume [veh/h]	0	0	57	0	0	9	0	0	36	0	0	255
Total Hourly Volume [veh/h]	131	619	57	158	279	8	25	253	36	264	653	254
Peak Hour Factor	0.8500	0.8500	0.8500	0.8500	0.8500	0.8500	0.8500	0.8500	0.8500	0.8500	0.8500	0.8500
Other Adjustment Factor	1.0000	1.0000	1.0000	1.0000	1.0000	1.0000	1.0000	1.0000	1.0000	1.0000	1.0000	1.0000
Total 15-Minute Volume [veh/h]	39	182	17	46	82	2	7	74	11	78	192	75
Total Analysis Volume [veh/h]	154	728	67	186	328	9	29	298	42	311	768	299
Presence of On-Street Parking	No		No	No		No	No		No	No		No
On-Street Parking Maneuver Rate [/h]	0	0	0	0	0	0	0	0	0	0	0	0
Local Bus Stopping Rate [/h]	0	0	0	0	0	0	0	0	0	0	0	0
v_do, Outbound Pedestrian Volume crossing	0			0			0			0		
v_di, Inbound Pedestrian Volume crossing m	0			0			0			0		
v_co, Outbound Pedestrian Volume crossing	0			0			0			0		
v_ci, Inbound Pedestrian Volume crossing mi	0			0			0			0		
v_ab, Corner Pedestrian Volume [ped/h]	0			0			0			0		
Bicycle Volume [bicycles/h]	0			0			0			0		

Intersection Settings

Located in CBD	No
Signal Coordination Group	-
Cycle Length [s]	100
Active Pattern	Pattern 1
Coordination Type	Time of Day Pattern Coordinated
Actuation Type	Fully actuated
Offset [s]	0.0
Offset Reference	Lead Green - Beginning of First Green
Permissive Mode	SingleBand
Lost time [s]	0.00

Phasing & Timing

Control Type	Protecte	Permiss	Unsigna	Protecte	Permiss	Permiss	Protecte	Permiss	Permiss	Protecte	Permiss	Permiss
Signal Group	1	6	0	5	2	0	3	8	0	7	4	0
Auxiliary Signal Groups												
Lead / Lag	Lead	-	-	Lead	-	-	Lead	-	-	Lead	-	-
Minimum Green [s]	5	10	0	5	10	0	5	10	0	5	10	0
Maximum Green [s]	5	103	0	5	103	0	5	109	0	5	109	0
Amber [s]	3.0	3.0	0.0	3.0	3.0	0.0	3.0	3.0	0.0	3.0	3.0	0.0
All red [s]	1.0	1.0	0.0	1.0	1.0	0.0	1.0	1.0	0.0	1.0	1.0	0.0
Split [s]	17	38	0	11	32	0	9	25	0	26	42	0
Vehicle Extension [s]	3.0	3.0	0.0	3.0	3.0	0.0	3.0	3.0	0.0	3.0	3.0	0.0
Walk [s]	0	7	0	0	7	0	0	7	0	0	7	0
Pedestrian Clearance [s]	0	24	0	0	21	0	0	14	0	0	14	0
Delayed Vehicle Green [s]	0.0	0.0	0.0	0.0	0.0	0.0	0.0	0.0	0.0	0.0	0.0	0.0
Rest In Walk		No			No			No			No	
I1, Start-Up Lost Time [s]	2.0	2.0	0.0	2.0	2.0	0.0	2.0	2.0	0.0	2.0	2.0	0.0
I2, Clearance Lost Time [s]	2.0	2.0	0.0	2.0	2.0	0.0	2.0	2.0	0.0	2.0	2.0	0.0
Minimum Recall	No	No		No	No		No	No		No	No	
Maximum Recall	No	No		No	No		No	No		No	No	
Pedestrian Recall	No	No		No	No		No	No		No	No	
Detector Location [ft]	0.0	0.0	0.0	0.0	0.0	0.0	0.0	0.0	0.0	0.0	0.0	0.0
Detector Length [ft]	0.0	0.0	0.0	0.0	0.0	0.0	0.0	0.0	0.0	0.0	0.0	0.0
I, Upstream Filtering Factor	1.00	1.00	1.00	1.00	1.00	1.00	1.00	1.00	1.00	1.00	1.00	1.00

Exclusive Pedestrian Phase

Pedestrian Signal Group	0
Pedestrian Walk [s]	0
Pedestrian Clearance [s]	0

Lane Group Calculations

Lane Group	L	C	L	C	R	L	C	R	L	C	R
C, Cycle Length [s]	100	100	100	100	100	100	100	100	100	100	100
L, Total Lost Time per Cycle [s]	4.00	4.00	4.00	4.00	4.00	4.00	4.00	4.00	4.00	4.00	4.00
l1_p, Permitted Start-Up Lost Time [s]	0.00	0.00	0.00	0.00	0.00	0.00	0.00	0.00	0.00	0.00	0.00
l2, Clearance Lost Time [s]	2.00	2.00	2.00	2.00	2.00	2.00	2.00	2.00	2.00	2.00	2.00
g_i, Effective Green Time [s]	10	47	7	43	43	3	11	11	19	27	27
g / C, Green / Cycle	0.10	0.47	0.07	0.43	0.43	0.03	0.11	0.11	0.19	0.27	0.27
(v / s)_i Volume / Saturation Flow Rate	0.09	0.39	0.05	0.09	0.01	0.02	0.08	0.03	0.17	0.22	0.19
s, saturation flow rate [veh/h]	1781	1870	3459	3560	1589	1781	3560	1589	1781	3560	1589
c, Capacity [veh/h]	186	876	242	1544	689	50	387	173	344	976	436
d1, Uniform Delay [s]	43.95	23.17	45.78	17.68	16.14	48.10	43.40	40.85	39.49	33.64	32.50
k, delay calibration	0.17	0.50	0.11	0.50	0.50	0.11	0.11	0.11	0.29	0.11	0.11
l, Upstream Filtering Factor	1.00	1.00	1.00	1.00	1.00	1.00	1.00	1.00	1.00	1.00	1.00
d2, Incremental Delay [s]	13.31	9.04	5.12	0.31	0.03	10.46	3.25	0.72	19.52	1.45	1.93
d3, Initial Queue Delay [s]	0.00	0.00	0.00	0.00	0.00	0.00	0.00	0.00	0.00	0.00	0.00
Rp, platoon ratio	1.00	1.00	1.00	1.00	1.00	1.00	1.00	1.00	1.00	1.00	1.00
PF, progression factor	1.00	1.00	1.00	1.00	1.00	1.00	1.00	1.00	1.00	1.00	1.00

Lane Group Results

X, volume / capacity	0.83	0.83	0.77	0.21	0.01	0.58	0.77	0.24	0.90	0.79	0.69
d, Delay for Lane Group [s/veh]	57.26	32.20	50.90	18.00	16.18	58.56	46.65	41.57	59.01	35.09	34.43
Lane Group LOS	E	C	D	B	B	E	D	D	E	D	C
Critical Lane Group	No	Yes	Yes	No	No	No	Yes	No	Yes	No	No
50th-Percentile Queue Length [veh/ln]	4.21	15.00	2.32	2.18	0.11	0.84	3.63	0.95	8.97	8.34	6.36
50th-Percentile Queue Length [ft/ln]	105.19	375.11	57.94	54.51	2.81	20.89	90.67	23.76	224.31	208.46	158.93
95th-Percentile Queue Length [veh/ln]	7.57	21.36	4.17	3.92	0.20	1.50	6.53	1.71	13.88	13.07	10.49
95th-Percentile Queue Length [ft/ln]	189.29	533.92	104.29	98.12	5.06	37.60	163.20	42.76	347.12	326.85	262.31

Movement, Approach, & Intersection Results

d_M, Delay for Movement [s/veh]	57.26	32.20	0.00	50.90	18.00	16.18	58.56	46.65	41.57	59.01	35.09	34.43
Movement LOS	E	C		D	B	B	E	D	D	E	D	C
d_A, Approach Delay [s/veh]	34.36			29.66			47.01			40.35		
Approach LOS	C			C			D			D		
d_I, Intersection Delay [s/veh]	37.68											
Intersection LOS	D											
Intersection V/C	0.701											

Other Modes

g_Walk,mi, Effective Walk Time [s]	11.0			11.0			11.0			11.0		
M_corner, Corner Circulation Area [ft ² /ped]	0.00			0.00			0.00			0.00		
M_CW, Crosswalk Circulation Area [ft ² /ped]	0.00			0.00			0.00			0.00		
d_p, Pedestrian Delay [s]	39.64			39.64			39.64			39.64		
I_p,int, Pedestrian LOS Score for Intersectio	2.876			3.020			2.837			3.394		
Crosswalk LOS	C			C			C			C		
s_b, Saturation Flow Rate of the bicycle lane	2000			2000			2000			2000		
c_b, Capacity of the bicycle lane [bicycles/h]	680			560			420			759		
d_b, Bicycle Delay [s]	21.81			25.95			31.24			19.25		
I_b,int, Bicycle LOS Score for Intersection	3.015			1.999			1.894			2.907		
Bicycle LOS	C			A			A			C		

Sequence

Ring 1	1	2	3	4	-	-	-	-	-	-	-	-	-	-	-	-
Ring 2	5	6	7	8	-	-	-	-	-	-	-	-	-	-	-	-
Ring 3	-	-	-	-	-	-	-	-	-	-	-	-	-	-	-	-
Ring 4	-	-	-	-	-	-	-	-	-	-	-	-	-	-	-	-



Intersection Level Of Service Report
Intersection 2: Marksheffel Rd/Lorson Bl

Control Type:	Signalized	Delay (sec / veh):	17.1
Analysis Method:	HCM 7th Edition	Level Of Service:	B
Analysis Period:	15 minutes	Volume to Capacity (v/c):	0.703

Intersection Setup

Name	Marksheffel Rd		Marksheffel Rd		Lorson Bl	
Approach	Northbound		Southbound		Westbound	
Lane Configuration	↑↗		↖↑		↖↗	
Turning Movement	Thru	Right	Left	Thru	Left	Right
Lane Width [ft]	12.00	12.00	12.00	12.00	12.00	12.00
No. of Lanes in Entry Pocket	0	1	1	0	1	0
Entry Pocket Length [ft]	100.00	500.00	580.00	100.00	510.00	100.00
No. of Lanes in Exit Pocket	0	0	0	0	0	0
Exit Pocket Length [ft]	0.00	0.00	0.00	0.00	0.00	0.00
Speed [mph]	55.00		55.00		25.00	
Grade [%]	0.00		0.00		0.00	
Curb Present	No		No		No	
Crosswalk	Yes		Yes		Yes	

Volumes

Name	Marksheffel Rd		Marksheffel Rd		Lorson Bl	
Base Volume Input [veh/h]	577	164	96	454	422	210
Base Volume Adjustment Factor	1.0000	1.0000	1.0000	1.0000	1.0000	1.0000
Heavy Vehicles Percentage [%]	2.00	2.00	2.00	2.00	2.00	2.00
Proportion of CAVs [%]	0.00					
Growth Factor	1.1660	1.0000	1.0000	1.1660	1.0000	1.0000
In-Process Volume [veh/h]	0	0	0	0	0	0
Site-Generated Trips [veh/h]	1	0	0	5	0	0
Diverted Trips [veh/h]	0	0	0	0	0	0
Pass-by Trips [veh/h]	0	0	0	0	0	0
Existing Site Adjustment Volume [veh/h]	0	0	0	0	0	0
Other Volume [veh/h]	0	0	0	0	0	0
Right Turn on Red Volume [veh/h]	0	82	0	0	0	105
Total Hourly Volume [veh/h]	674	82	96	534	422	105
Peak Hour Factor	0.8500	0.8500	0.8500	0.8500	0.8500	0.8500
Other Adjustment Factor	1.0000	1.0000	1.0000	1.0000	1.0000	1.0000
Total 15-Minute Volume [veh/h]	198	24	28	157	124	31
Total Analysis Volume [veh/h]	793	96	113	628	496	124
Presence of On-Street Parking	No	No	No	No	No	No
On-Street Parking Maneuver Rate [/h]	0	0	0	0	0	0
Local Bus Stopping Rate [/h]	0	0	0	0	0	0
v_do, Outbound Pedestrian Volume crossing	0		0		0	
v_di, Inbound Pedestrian Volume crossing m	0		0		0	
v_co, Outbound Pedestrian Volume crossing	0		0		0	
v_ci, Inbound Pedestrian Volume crossing mi	0		0		0	
v_ab, Corner Pedestrian Volume [ped/h]	0		0		0	
Bicycle Volume [bicycles/h]	0		0		0	

Intersection Settings

Located in CBD	No
Signal Coordination Group	-
Cycle Length [s]	60
Active Pattern	Pattern 1
Coordination Type	Time of Day Pattern Coordinated
Actuation Type	Fully actuated
Offset [s]	0.0
Offset Reference	Lead Green - Beginning of First Green
Permissive Mode	SingleBand
Lost time [s]	0.00

Phasing & Timing

Control Type	Permissive	Permissive	Permissive	Permissive	Permissive	Permissive
Signal Group	6	0	0	2	7	0
Auxiliary Signal Groups						
Lead / Lag	-	-	-	-	Lead	-
Minimum Green [s]	10	0	0	10	5	0
Maximum Green [s]	43	0	0	41	19	0
Amber [s]	3.0	0.0	0.0	3.0	3.0	0.0
All red [s]	1.0	0.0	0.0	1.0	1.0	0.0
Split [s]	21	0	0	21	39	0
Vehicle Extension [s]	3.0	0.0	0.0	3.0	3.0	0.0
Walk [s]	7	0	0	7	7	0
Pedestrian Clearance [s]	10	0	0	10	13	0
Delayed Vehicle Green [s]	0.0	0.0	0.0	0.0	0.0	0.0
Rest In Walk	No			No	No	
I1, Start-Up Lost Time [s]	2.0	0.0	0.0	2.0	2.0	0.0
I2, Clearance Lost Time [s]	2.0	0.0	0.0	2.0	2.0	0.0
Minimum Recall	No			No	No	
Maximum Recall	No			No	No	
Pedestrian Recall	No			No	No	
Detector Location [ft]	0.0	0.0	0.0	0.0	0.0	0.0
Detector Length [ft]	0.0	0.0	0.0	0.0	0.0	0.0
I, Upstream Filtering Factor	1.00	1.00	1.00	1.00	1.00	1.00

Exclusive Pedestrian Phase

Pedestrian Signal Group	0
Pedestrian Walk [s]	0
Pedestrian Clearance [s]	0

Lane Group Calculations

Lane Group	C	R	L	C	L	R
C, Cycle Length [s]	60	60	60	60	60	60
L, Total Lost Time per Cycle [s]	4.00	4.00	4.00	4.00	4.00	4.00
l1_p, Permitted Start-Up Lost Time [s]	0.00	0.00	2.00	0.00	0.00	0.00
l2, Clearance Lost Time [s]	2.00	2.00	2.00	2.00	2.00	2.00
g_i, Effective Green Time [s]	33	33	33	33	19	19
g / C, Green / Cycle	0.54	0.54	0.54	0.54	0.32	0.32
(v / s)_i Volume / Saturation Flow Rate	0.42	0.06	0.18	0.34	0.28	0.08
s, saturation flow rate [veh/h]	1870	1589	625	1870	1781	1589
c, Capacity [veh/h]	1018	865	237	1018	575	513
d1, Uniform Delay [s]	10.86	6.66	24.24	9.42	19.17	15.00
k, delay calibration	0.50	0.50	0.50	0.50	0.11	0.11
l, Upstream Filtering Factor	1.00	1.00	1.00	1.00	1.00	1.00
d2, Incremental Delay [s]	5.88	0.26	6.71	2.80	3.99	0.24
d3, Initial Queue Delay [s]	0.00	0.00	0.00	0.00	0.00	0.00
Rp, platoon ratio	1.00	1.00	1.00	1.00	1.00	1.00
PF, progression factor	1.00	1.00	1.00	1.00	1.00	1.00

Lane Group Results

X, volume / capacity	0.78	0.11	0.48	0.62	0.86	0.24
d, Delay for Lane Group [s/veh]	16.74	6.92	30.95	12.22	23.16	15.24
Lane Group LOS	B	A	C	B	C	B
Critical Lane Group	Yes	No	No	No	Yes	No
50th-Percentile Queue Length [veh/ln]	6.60	0.43	1.76	4.19	6.59	1.20
50th-Percentile Queue Length [ft/ln]	165.11	10.73	44.00	104.64	164.84	29.99
95th-Percentile Queue Length [veh/ln]	10.82	0.77	3.17	7.53	10.80	2.16
95th-Percentile Queue Length [ft/ln]	270.47	19.31	79.19	188.35	270.12	53.98

Movement, Approach, & Intersection Results

d_M, Delay for Movement [s/veh]	16.74	6.92	30.95	12.22	23.16	15.24
Movement LOS	B	A	C	B	C	B
d_A, Approach Delay [s/veh]	15.68		15.08		21.57	
Approach LOS	B		B		C	
d_I, Intersection Delay [s/veh]	17.10					
Intersection LOS	B					
Intersection V/C	0.703					

Other Modes

g_Walk,mi, Effective Walk Time [s]	11.0	11.0	11.0
M_corner, Corner Circulation Area [ft ² /ped]	0.00	0.00	0.00
M_CW, Crosswalk Circulation Area [ft ² /ped]	0.00	0.00	0.00
d_p, Pedestrian Delay [s]	20.08	20.08	20.08
I_p,int, Pedestrian LOS Score for Intersectio	3.283	2.968	2.503
Crosswalk LOS	C	C	B
s_b, Saturation Flow Rate of the bicycle lane	2000	2000	2000
c_b, Capacity of the bicycle lane [bicycles/h]	565	565	1164
d_b, Bicycle Delay [s]	15.48	15.48	5.26
I_b,int, Bicycle LOS Score for Intersection	3.162	2.782	1.560
Bicycle LOS	C	C	A

Sequence

Ring 1	-	2	-	-	-	-	-	-	-	-	-	-	-	-	-	-	-
Ring 2	-	6	7	-	-	-	-	-	-	-	-	-	-	-	-	-	-
Ring 3	-	-	-	-	-	-	-	-	-	-	-	-	-	-	-	-	-
Ring 4	-	-	-	-	-	-	-	-	-	-	-	-	-	-	-	-	-

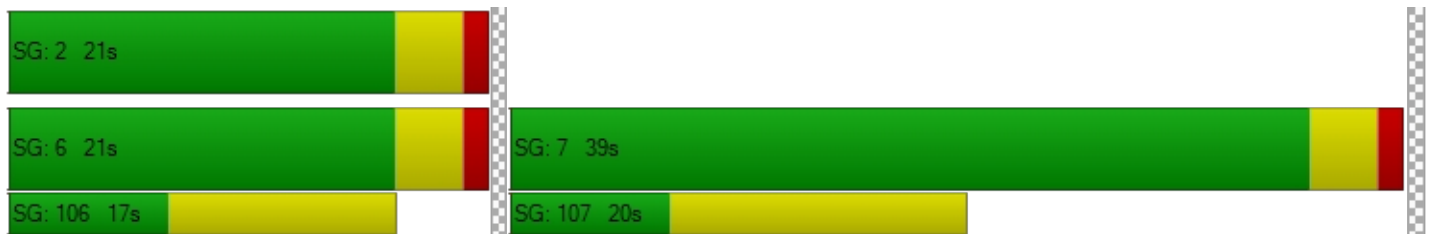

Intersection Level Of Service Report
Intersection 3: Fontaine Bl/Carriage Meadows Dr

Control Type:	Two-way stop	Delay (sec / veh):	123.3
Analysis Method:	HCM 7th Edition	Level Of Service:	F
Analysis Period:	15 minutes	Volume to Capacity (v/c):	0.166

Intersection Setup

Name	Carriage Meadows Dr			Carriage Meadows Dr			Fontaine Bl			Fontaine Bl		
Approach	Northbound			Southbound			Eastbound			Westbound		
Lane Configuration	↵↵↵			↵↵↵			↵↵↵			↵↵↵		
Turning Movement	Left	Thru	Right	Left	Thru	Right	Left	Thru	Right	Left	Thru	Right
Lane Width [ft]	12.00	12.00	12.00	12.00	12.00	12.00	12.00	12.00	12.00	12.00	12.00	12.00
No. of Lanes in Entry Pocket	1	0	1	1	0	1	1	0	0	1	0	1
Entry Pocket Length [ft]	100.00	100.00	100.00	100.00	100.00	100.00	510.00	100.00	100.00	330.00	100.00	330.00
No. of Lanes in Exit Pocket	0	0	0	0	0	0	0	0	0	0	0	0
Exit Pocket Length [ft]	0.00	0.00	0.00	0.00	0.00	0.00	0.00	0.00	0.00	0.00	0.00	0.00
Speed [mph]	25.00			25.00			45.00			45.00		
Grade [%]	0.00			0.00			0.00			0.00		
Crosswalk	Yes			Yes			Yes			Yes		

Volumes

Name	Carriage Meadows Dr			Carriage Meadows Dr			Fontaine Bl			Fontaine Bl		
Base Volume Input [veh/h]	42	5	12	8	5	37	10	522	8	8	1310	4
Base Volume Adjustment Factor	1.0000	1.0000	1.0000	1.0000	1.0000	1.0000	1.0000	1.0000	1.0000	1.0000	1.0000	1.0000
Heavy Vehicles Percentage [%]	2.00	2.00	2.00	2.00	2.00	2.00	2.00	2.00	2.00	2.00	2.00	2.00
Growth Factor	1.1660	1.0000	1.1660	1.1660	1.0000	1.1660	1.1660	1.0000	1.1660	1.1660	1.0000	1.1660
In-Process Volume [veh/h]	0	0	0	0	0	0	0	0	0	0	0	0
Site-Generated Trips [veh/h]	0	0	0	4	0	11	3	0	0	0	0	1
Diverted Trips [veh/h]	-49	0	49	-13	0	13	0	13	0	0	49	0
Pass-by Trips [veh/h]	0	0	0	0	0	0	0	0	0	0	0	0
Existing Site Adjustment Volume [veh/h]	0	0	0	0	0	0	0	0	0	0	0	0
Other Volume [veh/h]	0	0	0	0	0	0	0	0	0	0	0	0
Total Hourly Volume [veh/h]	0	5	63	0	5	67	15	535	9	9	1359	6
Peak Hour Factor	0.8500	0.8500	0.8500	0.8500	0.8500	0.8500	0.8500	0.8500	0.8500	0.8500	0.8500	0.8500
Other Adjustment Factor	1.0000	1.0000	1.0000	1.0000	1.0000	1.0000	1.0000	1.0000	1.0000	1.0000	1.0000	1.0000
Total 15-Minute Volume [veh/h]	0	1	19	0	1	20	4	157	3	3	400	2
Total Analysis Volume [veh/h]	0	6	74	0	6	79	18	629	11	11	1599	7
Pedestrian Volume [ped/h]	0			0			0			0		

Intersection Settings

Priority Scheme	Stop	Stop	Free	Free
Flared Lane				
Storage Area [veh]	0	0	0	0
Two-Stage Gap Acceptance	No	No		
Number of Storage Spaces in Median	0	0	0	0

Movement, Approach, & Intersection Results

V/C, Movement V/C Ratio	0.00	0.16	0.11	0.00	0.17	0.24	0.04	0.01	0.00	0.01	0.02	0.00
d_M, Delay for Movement [s/veh]	74.52	122.45	10.93	142.36	123.26	19.41	14.35	0.00	0.00	8.87	0.00	0.00
Movement LOS	F	F	B	F	F	C	B	A	A	A	A	A
95th-Percentile Queue Length [veh/ln]	0.00	0.52	0.36	0.00	0.52	0.92	0.14	0.00	0.00	0.04	0.00	0.00
95th-Percentile Queue Length [ft/ln]	0.00	13.01	9.10	0.00	13.09	23.09	3.50	0.00	0.00	0.89	0.00	0.00
d_A, Approach Delay [s/veh]	19.29			26.74			0.39			0.06		
Approach LOS	C			D			A			A		
d_I, Intersection Delay [s/veh]	1.71											
Intersection LOS	F											

Signal Warrants Report For Intersection 3: Fontaine Bl/Carriage Meadows Dr

Warrants Summary

Warrant	Name	Met?
#1	Eight Hour Vehicular Volume	No
#2	Four Hour Vehicular Volume	No
#3	Peak Hour	No

Intersection Warrants Parameters

Major Approaches	E, W
Minor Approaches	S, N
Speed > 40mph	Yes
Population < 10,000	No
Warrant Factor	70%

Warrant Analysis Traffic Volumes

Hour	Major Streets		Minor Streets	
	E	W	S	N
1	1374	559	68	72
2	1333	542	66	70
3	1305	531	65	68
4	1223	498	61	64
5	1085	442	54	57
6	1072	436	53	56
7	1058	430	52	55
8	962	391	48	50
9	948	386	47	50
10	934	380	46	49
11	811	330	40	42
12	756	307	37	40
13	742	302	37	39
14	550	224	27	29
15	550	224	27	29
16	385	157	19	20
17	220	89	11	12
18	220	89	11	12
19	124	50	6	6
20	69	28	3	4
21	41	17	2	2
22	14	6	1	1
23	14	6	1	1
24	14	6	1	1

Warrant Analysis by Hour

Hour	Major Streets		Minor Street		Warrant 1 Condition A				Warrant 1 Condition B				Warrant 2	Warrant 3 Condition B	
	Number	Volume	Number	Volume	100%	80%	70%	56%	100%	80%	70%	56%			
1	4	1933	3	72	No	No	No	No	No	No	Yes	Yes	No	No	
2	4	1875	3	70	No	No	No	No	No	No	Yes	Yes	No	No	
3	4	1836	3	68	No	No	No	No	No	No	No	Yes	No	No	
4	4	1721	3	64	No	No	No	No	No	No	No	Yes	No	No	
5	4	1527	3	57	No	No	No	No	No	No	No	Yes	No	No	
6	4	1508	3	56	No	No	No	No	No	No	No	Yes	No	No	
7	4	1488	3	55	No	No	No	No	No	No	No	No	No	No	
8	4	1353	3	50	No	No	No	No	No	No	No	No	No	No	
9	4	1334	3	50	No	No	No	No	No	No	No	No	No	No	
10	4	1314	3	49	No	No	No	No	No	No	No	No	No	No	
11	4	1141	3	42	No	No	No	No	No	No	No	No	No	No	
12	4	1063	3	40	No	No	No	No	No	No	No	No	No	No	
13	4	1044	3	39	No	No	No	No	No	No	No	No	No	No	
14	4	774	3	29	No	No	No	No	No	No	No	No	No	No	
15	4	774	3	29	No	No	No	No	No	No	No	No	No	No	
16	4	542	3	20	No	No	No	No	No	No	No	No	No	No	
17	4	309	3	12	No	No	No	No	No	No	No	No	No	No	
18	4	309	3	12	No	No	No	No	No	No	No	No	No	No	
19	4	174	3	6	No	No	No	No	No	No	No	No	No	No	
20	4	97	3	4	No	No	No	No	No	No	No	No	No	No	
21	4	58	3	2	No	No	No	No	No	No	No	No	No	No	
22	4	20	3	1	No	No	No	No	No	No	No	No	No	No	
23	4	20	3	1	No	No	No	No	No	No	No	No	No	No	
24	4	20	3	1	No	No	No	No	No	No	No	No	No	No	
Hours Met					0	0	0	0	0	0	0	2	6	0	0

Warrant 3 Condition A

Orientation	S	N
Total Stopped Delay Per Vehicle on Minor Approach (s)	19.3	26.7
Number of Lanes on Minor Street Approach	3	3
VehicleHours of Stopped Delay on Minor Approach (h:mm)	0:21	0:32
Delay Condition Met	No	No
Volume on Minor Street Approach During Same Hour	68	72
High Minor Volume Condition Met	No	No
Total Entering Volume on All Approaches During Same Hour	2073	2073
Number of Approaches on Intersection	4	4
Total Volume Condition Met	Yes	Yes
Warrant Met for Approach	No	No
Warrant Met for Intersection	No	

Table of Contents

Intersection Level Of Service Report	2
Intersection 1: Marksheffel Rd/Fontaine Bl	2
Intersection 2: Marksheffel Rd/Lorson Bl	7
Intersection 3: Fontaine Bl/Carriage Meadows Dr	12
Signal Warrants Report	14
Intersection 3: Fontaine Bl/Carriage Meadows Dr	14

Intersection Level Of Service Report
Intersection 1: Marksheffel Rd/Fontaine BI

Control Type:	Signalized	Delay (sec / veh):	46.9
Analysis Method:	HCM 7th Edition	Level Of Service:	D
Analysis Period:	15 minutes	Volume to Capacity (v/c):	0.816

Intersection Setup

Name	Marksheffel Rd			Marksheffel Rd			Fontaine BI			Fontaine BI		
Approach	Northbound			Southbound			Eastbound			Westbound		
Lane Configuration												
Turning Movement	Left	Thru	Right	Left	Thru	Right	Left	Thru	Right	Left	Thru	Right
Lane Width [ft]	12.00	12.00	12.00	12.00	12.00	12.00	12.00	12.00	12.00	12.00	12.00	12.00
No. of Lanes in Entry Pocket	1	0	1	1	0	1	1	0	1	1	0	0
Entry Pocket Length [ft]	680.00	100.00	680.00	750.00	100.00	500.00	360.00	100.00	200.00	535.00	100.00	100.00
No. of Lanes in Exit Pocket	0	0	1	0	0	0	0	0	0	0	0	0
Exit Pocket Length [ft]	0.00	0.00	100.00	0.00	0.00	0.00	0.00	0.00	0.00	0.00	0.00	0.00
Speed [mph]	55.00			55.00			45.00			45.00		
Grade [%]	0.00			0.00			0.00			0.00		
Curb Present	No			No			No			No		
Crosswalk	Yes			Yes			Yes			Yes		

Volumes

Name	Marksheffel Rd			Marksheffel Rd			Fontaine Bl			Fontaine Bl		
Base Volume Input [veh/h]	122	310	310	570	506	33	51	846	158	159	469	306
Base Volume Adjustment Factor	1.0000	1.0000	1.0000	1.0000	1.0000	1.0000	1.0000	1.0000	1.0000	1.0000	1.0000	1.0000
Heavy Vehicles Percentage [%]	2.00	2.00	2.00	2.00	2.00	2.00	2.00	2.00	2.00	2.00	2.00	2.00
Proportion of CAVs [%]	0.00											
Growth Factor	1.0000	1.1660	1.0000	1.0000	1.1660	1.0000	1.0000	1.0000	1.0000	1.0000	1.0000	1.0000
In-Process Volume [veh/h]	0	0	0	0	0	0	0	0	0	0	0	0
Site-Generated Trips [veh/h]	0	0	4	4	0	0	0	2	0	3	2	3
Diverted Trips [veh/h]	0	0	0	0	0	0	0	0	0	9	0	0
Pass-by Trips [veh/h]	0	0	0	0	0	0	0	0	0	0	0	0
Existing Site Adjustment Volume [veh/h]	0	0	0	0	0	0	0	0	0	0	0	0
Other Volume [veh/h]	0	0	0	0	0	0	0	0	0	0	0	0
Right Turn on Red Volume [veh/h]	0	0	157	0	0	17	0	0	79	0	0	155
Total Hourly Volume [veh/h]	122	361	157	574	590	16	51	848	79	171	471	154
Peak Hour Factor	0.8500	0.8500	0.8500	0.8500	0.8500	0.8500	0.8500	0.8500	0.8500	0.8500	0.8500	0.8500
Other Adjustment Factor	1.0000	1.0000	1.0000	1.0000	1.0000	1.0000	1.0000	1.0000	1.0000	1.0000	1.0000	1.0000
Total 15-Minute Volume [veh/h]	36	106	46	169	174	5	15	249	23	50	139	45
Total Analysis Volume [veh/h]	144	425	185	675	694	19	60	998	93	201	554	181
Presence of On-Street Parking	No		No	No		No	No		No	No		No
On-Street Parking Maneuver Rate [/h]	0	0	0	0	0	0	0	0	0	0	0	0
Local Bus Stopping Rate [/h]	0	0	0	0	0	0	0	0	0	0	0	0
v_do, Outbound Pedestrian Volume crossing	0			0			0			0		
v_di, Inbound Pedestrian Volume crossing m	0			0			0			0		
v_co, Outbound Pedestrian Volume crossing	0			0			0			0		
v_ci, Inbound Pedestrian Volume crossing mi	0			0			0			0		
v_ab, Corner Pedestrian Volume [ped/h]	0			0			0			0		
Bicycle Volume [bicycles/h]	0			0			0			0		

Intersection Settings

Located in CBD	No
Signal Coordination Group	-
Cycle Length [s]	120
Active Pattern	Pattern 1
Coordination Type	Time of Day Pattern Coordinated
Actuation Type	Fully actuated
Offset [s]	0.0
Offset Reference	Lead Green - Beginning of First Green
Permissive Mode	SingleBand
Lost time [s]	0.00

Phasing & Timing

Control Type	Protecte	Permiss	Unsigna	Protecte	Permiss	Permiss	Protecte	Permiss	Permiss	Protecte	Permiss	Permiss
Signal Group	1	6	0	5	2	0	3	8	0	7	4	0
Auxiliary Signal Groups												
Lead / Lag	Lead	-	-	Lead	-	-	Lead	-	-	Lead	-	-
Minimum Green [s]	5	10	0	5	10	0	5	10	0	5	10	0
Maximum Green [s]	5	103	0	5	103	0	5	109	0	5	109	0
Amber [s]	3.0	3.0	0.0	3.0	3.0	0.0	3.0	3.0	0.0	3.0	3.0	0.0
All red [s]	1.0	1.0	0.0	1.0	1.0	0.0	1.0	1.0	0.0	1.0	1.0	0.0
Split [s]	28	35	0	28	35	0	32	34	0	23	25	0
Vehicle Extension [s]	3.0	3.0	0.0	3.0	3.0	0.0	3.0	3.0	0.0	3.0	3.0	0.0
Walk [s]	0	7	0	0	7	0	0	7	0	0	7	0
Pedestrian Clearance [s]	0	24	0	0	21	0	0	14	0	0	14	0
Delayed Vehicle Green [s]	0.0	0.0	0.0	0.0	0.0	0.0	0.0	0.0	0.0	0.0	0.0	0.0
Rest In Walk		No			No			No			No	
I1, Start-Up Lost Time [s]	2.0	2.0	0.0	2.0	2.0	0.0	2.0	2.0	0.0	2.0	2.0	0.0
I2, Clearance Lost Time [s]	2.0	2.0	0.0	2.0	2.0	0.0	2.0	2.0	0.0	2.0	2.0	0.0
Minimum Recall	No	No		No	No		No	No		No	No	
Maximum Recall	No	No		No	No		No	No		No	No	
Pedestrian Recall	No	No		No	No		No	No		No	No	
Detector Location [ft]	0.0	0.0	0.0	0.0	0.0	0.0	0.0	0.0	0.0	0.0	0.0	0.0
Detector Length [ft]	0.0	0.0	0.0	0.0	0.0	0.0	0.0	0.0	0.0	0.0	0.0	0.0
I, Upstream Filtering Factor	1.00	1.00	1.00	1.00	1.00	1.00	1.00	1.00	1.00	1.00	1.00	1.00

Exclusive Pedestrian Phase

Pedestrian Signal Group	0
Pedestrian Walk [s]	0
Pedestrian Clearance [s]	0

Lane Group Calculations

Lane Group	L	C	L	C	R	L	C	R	L	C	R
C, Cycle Length [s]	120	120	120	120	120	120	120	120	120	120	120
L, Total Lost Time per Cycle [s]	4.00	4.00	4.00	4.00	4.00	4.00	4.00	4.00	4.00	4.00	4.00
l1_p, Permitted Start-Up Lost Time [s]	0.00	0.00	0.00	0.00	0.00	0.00	0.00	0.00	0.00	0.00	0.00
l2, Clearance Lost Time [s]	2.00	2.00	2.00	2.00	2.00	2.00	2.00	2.00	2.00	2.00	2.00
g_i, Effective Green Time [s]	12	31	24	43	43	5	34	34	15	44	44
g / C, Green / Cycle	0.10	0.26	0.20	0.36	0.36	0.04	0.28	0.28	0.13	0.36	0.36
(v / s)_i Volume / Saturation Flow Rate	0.08	0.23	0.20	0.19	0.01	0.03	0.28	0.06	0.11	0.16	0.11
s, saturation flow rate [veh/h]	1781	1870	3459	3560	1589	1781	3560	1589	1781	3560	1589
c, Capacity [veh/h]	173	484	687	1281	572	79	1000	446	229	1301	581
d1, Uniform Delay [s]	53.24	42.72	47.93	30.57	24.91	56.79	43.16	33.00	51.38	28.64	27.29
k, delay calibration	0.11	0.50	0.11	0.50	0.50	0.11	0.11	0.11	0.22	0.11	0.11
l, Upstream Filtering Factor	1.00	1.00	1.00	1.00	1.00	1.00	1.00	1.00	1.00	1.00	1.00
d2, Incremental Delay [s]	9.76	19.79	12.43	1.65	0.11	14.09	12.84	0.23	18.52	0.22	0.30
d3, Initial Queue Delay [s]	0.00	0.00	0.00	0.00	0.00	0.00	0.00	0.00	0.00	0.00	0.00
Rp, platoon ratio	1.00	1.00	1.00	1.00	1.00	1.00	1.00	1.00	1.00	1.00	1.00
PF, progression factor	1.00	1.00	1.00	1.00	1.00	1.00	1.00	1.00	1.00	1.00	1.00

Lane Group Results

X, volume / capacity	0.83	0.88	0.98	0.54	0.03	0.76	1.00	0.21	0.88	0.43	0.31
d, Delay for Lane Group [s/veh]	63.00	62.51	60.36	32.22	25.02	70.87	56.00	33.23	69.90	28.86	27.59
Lane Group LOS	E	E	E	C	C	E	E	C	E	C	C
Critical Lane Group	No	Yes	Yes	No	No	No	Yes	No	Yes	No	No
50th-Percentile Queue Length [veh/ln]	4.56	14.05	10.70	7.75	0.35	2.07	15.96	2.05	6.96	5.82	3.65
50th-Percentile Queue Length [ft/ln]	113.92	351.16	267.44	193.75	8.75	51.65	398.91	51.19	173.89	145.49	91.19
95th-Percentile Queue Length [veh/ln]	8.06	20.19	16.06	12.32	0.63	3.72	22.51	3.69	11.28	9.78	6.57
95th-Percentile Queue Length [ft/ln]	201.44	504.82	401.54	307.88	15.74	92.96	562.69	92.15	282.02	244.39	164.14

Movement, Approach, & Intersection Results

d_M, Delay for Movement [s/veh]	63.00	62.51	0.00	60.36	32.22	25.02	70.87	56.00	33.23	69.90	28.86	27.59
Movement LOS	E	E		E	C	C	E	E	C	E	C	C
d_A, Approach Delay [s/veh]	49.09			45.80			54.94			37.43		
Approach LOS	D			D			D			D		
d_I, Intersection Delay [s/veh]	46.93											
Intersection LOS	D											
Intersection V/C	0.816											

Other Modes

g_Walk,mi, Effective Walk Time [s]	11.0	11.0	11.0	11.0
M_corner, Corner Circulation Area [ft ² /ped]	0.00	0.00	0.00	0.00
M_CW, Crosswalk Circulation Area [ft ² /ped]	0.00	0.00	0.00	0.00
d_p, Pedestrian Delay [s]	49.53	49.53	49.53	49.53
I_p,int, Pedestrian LOS Score for Intersectio	2.899	3.154	3.058	3.334
Crosswalk LOS	C	C	C	C
s_b, Saturation Flow Rate of the bicycle lane	2000	2000	2000	2000
c_b, Capacity of the bicycle lane [bicycles/h]	516	516	500	350
d_b, Bicycle Delay [s]	33.03	33.03	33.78	40.87
I_b,int, Bicycle LOS Score for Intersection	2.498	2.719	2.574	2.460
Bicycle LOS	B	B	B	B

Sequence

Ring 1	1	2	3	4	-	-	-	-	-	-	-	-	-	-	-	-
Ring 2	5	6	7	8	-	-	-	-	-	-	-	-	-	-	-	-
Ring 3	-	-	-	-	-	-	-	-	-	-	-	-	-	-	-	-
Ring 4	-	-	-	-	-	-	-	-	-	-	-	-	-	-	-	-

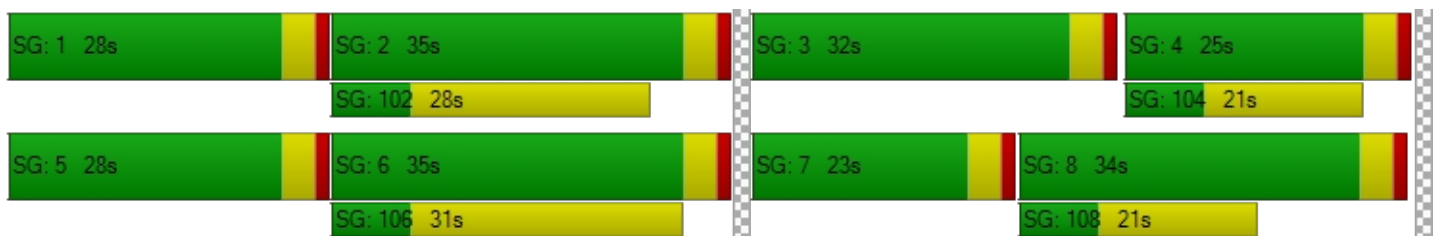

Intersection Level Of Service Report
Intersection 2: Marksheffel Rd/Lorson Bl

Control Type:	Signalized	Delay (sec / veh):	14.9
Analysis Method:	HCM 7th Edition	Level Of Service:	B
Analysis Period:	15 minutes	Volume to Capacity (v/c):	0.647

Intersection Setup

Name	Marksheffel Rd		Marksheffel Rd		Lorson Bl	
Approach	Northbound		Southbound		Westbound	
Lane Configuration	↑↗		↖↑		↖↗	
Turning Movement	Thru	Right	Left	Thru	Left	Right
Lane Width [ft]	12.00	12.00	12.00	12.00	12.00	12.00
No. of Lanes in Entry Pocket	0	1	1	0	1	0
Entry Pocket Length [ft]	100.00	500.00	580.00	100.00	510.00	100.00
No. of Lanes in Exit Pocket	0	0	0	0	0	0
Exit Pocket Length [ft]	0.00	0.00	0.00	0.00	0.00	0.00
Speed [mph]	55.00		55.00		25.00	
Grade [%]	0.00		0.00		0.00	
Curb Present	No		No		No	
Crosswalk	Yes		Yes		Yes	

Volumes

Name	Marksheffel Rd		Marksheffel Rd		Lorson Bl	
Base Volume Input [veh/h]	492	534	211	558	316	163
Base Volume Adjustment Factor	1.0000	1.0000	1.0000	1.0000	1.0000	1.0000
Heavy Vehicles Percentage [%]	2.00	2.00	2.00	2.00	2.00	2.00
Proportion of CAVs [%]	0.00					
Growth Factor	1.1660	1.0000	1.0000	1.1660	1.0000	1.0000
In-Process Volume [veh/h]	0	0	0	0	0	0
Site-Generated Trips [veh/h]	4	0	0	3	0	0
Diverted Trips [veh/h]	0	0	0	0	0	0
Pass-by Trips [veh/h]	0	0	0	0	0	0
Existing Site Adjustment Volume [veh/h]	0	0	0	0	0	0
Other Volume [veh/h]	0	0	0	0	0	0
Right Turn on Red Volume [veh/h]	0	267	0	0	0	82
Total Hourly Volume [veh/h]	578	267	211	654	316	81
Peak Hour Factor	0.8500	0.8500	0.8500	0.8500	0.8500	0.8500
Other Adjustment Factor	1.0000	1.0000	1.0000	1.0000	1.0000	1.0000
Total 15-Minute Volume [veh/h]	170	79	62	192	93	24
Total Analysis Volume [veh/h]	680	314	248	769	372	95
Presence of On-Street Parking	No	No	No	No	No	No
On-Street Parking Maneuver Rate [/h]	0	0	0	0	0	0
Local Bus Stopping Rate [/h]	0	0	0	0	0	0
v_do, Outbound Pedestrian Volume crossing	0		0		0	
v_di, Inbound Pedestrian Volume crossing m	0		0		0	
v_co, Outbound Pedestrian Volume crossing	0		0		0	
v_ci, Inbound Pedestrian Volume crossing mi	0		0		0	
v_ab, Corner Pedestrian Volume [ped/h]	0		0		0	
Bicycle Volume [bicycles/h]	0		0		0	

Intersection Settings

Located in CBD	No
Signal Coordination Group	-
Cycle Length [s]	60
Active Pattern	Pattern 1
Coordination Type	Time of Day Pattern Coordinated
Actuation Type	Fully actuated
Offset [s]	0.0
Offset Reference	Lead Green - Beginning of First Green
Permissive Mode	SingleBand
Lost time [s]	0.00

Phasing & Timing

Control Type	Permissive	Permissive	Permissive	Permissive	Permissive	Permissive
Signal Group	6	0	0	2	7	0
Auxiliary Signal Groups						
Lead / Lag	-	-	-	-	Lead	-
Minimum Green [s]	10	0	0	10	5	0
Maximum Green [s]	20	0	0	20	32	0
Amber [s]	3.0	0.0	0.0	3.0	3.0	0.0
All red [s]	1.0	0.0	0.0	1.0	1.0	0.0
Split [s]	36	0	0	36	24	0
Vehicle Extension [s]	3.0	0.0	0.0	3.0	3.0	0.0
Walk [s]	7	0	0	7	7	0
Pedestrian Clearance [s]	10	0	0	10	13	0
Delayed Vehicle Green [s]	0.0	0.0	0.0	0.0	0.0	0.0
Rest In Walk	No			No	No	
I1, Start-Up Lost Time [s]	2.0	0.0	0.0	2.0	2.0	0.0
I2, Clearance Lost Time [s]	2.0	0.0	0.0	2.0	2.0	0.0
Minimum Recall	No			No	No	
Maximum Recall	No			No	No	
Pedestrian Recall	No			No	No	
Detector Location [ft]	0.0	0.0	0.0	0.0	0.0	0.0
Detector Length [ft]	0.0	0.0	0.0	0.0	0.0	0.0
I, Upstream Filtering Factor	1.00	1.00	1.00	1.00	1.00	1.00

Exclusive Pedestrian Phase

Pedestrian Signal Group	0
Pedestrian Walk [s]	0
Pedestrian Clearance [s]	0

Lane Group Calculations

Lane Group	C	R	L	C	L	R
C, Cycle Length [s]	60	60	60	60	60	60
L, Total Lost Time per Cycle [s]	4.00	4.00	4.00	4.00	4.00	4.00
l1_p, Permitted Start-Up Lost Time [s]	0.00	0.00	2.00	0.00	0.00	0.00
l2, Clearance Lost Time [s]	2.00	2.00	2.00	2.00	2.00	2.00
g_i, Effective Green Time [s]	37	37	37	37	15	15
g / C, Green / Cycle	0.62	0.62	0.62	0.62	0.24	0.24
(v / s)_i Volume / Saturation Flow Rate	0.36	0.20	0.44	0.41	0.21	0.06
s, saturation flow rate [veh/h]	1870	1589	566	1870	1781	1589
c, Capacity [veh/h]	1162	987	322	1162	437	390
d1, Uniform Delay [s]	6.76	5.36	21.33	7.31	21.59	18.17
k, delay calibration	0.50	0.50	0.50	0.50	0.11	0.11
l, Upstream Filtering Factor	1.00	1.00	1.00	1.00	1.00	1.00
d2, Incremental Delay [s]	2.16	0.85	16.30	2.98	4.74	0.32
d3, Initial Queue Delay [s]	0.00	0.00	0.00	0.00	0.00	0.00
Rp, platoon ratio	1.00	1.00	1.00	1.00	1.00	1.00
PF, progression factor	1.00	1.00	1.00	1.00	1.00	1.00

Lane Group Results

X, volume / capacity	0.59	0.32	0.77	0.66	0.85	0.24
d, Delay for Lane Group [s/veh]	8.93	6.21	37.63	10.29	26.33	18.49
Lane Group LOS	A	A	D	B	C	B
Critical Lane Group	No	No	Yes	No	Yes	No
50th-Percentile Queue Length [veh/ln]	3.14	1.13	4.41	3.94	5.24	1.04
50th-Percentile Queue Length [ft/ln]	78.41	28.14	110.35	98.53	131.10	25.95
95th-Percentile Queue Length [veh/ln]	5.65	2.03	7.86	7.09	9.00	1.87
95th-Percentile Queue Length [ft/ln]	141.14	50.65	196.49	177.35	225.00	46.70

Movement, Approach, & Intersection Results

d_M, Delay for Movement [s/veh]	8.93	6.21	37.63	10.29	26.33	18.49
Movement LOS	A	A	D	B	C	B
d_A, Approach Delay [s/veh]	8.07		16.96		24.74	
Approach LOS	A		B		C	
d_I, Intersection Delay [s/veh]	14.86					
Intersection LOS	B					
Intersection V/C	0.647					

Other Modes

g_Walk,mi, Effective Walk Time [s]	11.0	11.0	11.0
M_corner, Corner Circulation Area [ft ² /ped]	0.00	0.00	0.00
M_CW, Crosswalk Circulation Area [ft ² /ped]	0.00	0.00	0.00
d_p, Pedestrian Delay [s]	20.01	20.01	20.01
I_p,int, Pedestrian LOS Score for Intersectio	3.729	3.034	2.760
Crosswalk LOS	D	C	C
s_b, Saturation Flow Rate of the bicycle lane	2000	2000	2000
c_b, Capacity of the bicycle lane [bicycles/h]	1067	1067	667
d_b, Bicycle Delay [s]	6.53	6.53	13.33
I_b,int, Bicycle LOS Score for Intersection	3.640	3.238	1.560
Bicycle LOS	D	C	A

Sequence

Ring 1	-	2	-	-	-	-	-	-	-	-	-	-	-	-	-	-
Ring 2	-	6	7	-	-	-	-	-	-	-	-	-	-	-	-	-
Ring 3	-	-	-	-	-	-	-	-	-	-	-	-	-	-	-	-
Ring 4	-	-	-	-	-	-	-	-	-	-	-	-	-	-	-	-



Intersection Level Of Service Report
Intersection 3: Fontaine Bl/Carriage Meadows Dr

Control Type:	Two-way stop	Delay (sec / veh):	1,108.7
Analysis Method:	HCM 7th Edition	Level Of Service:	F
Analysis Period:	15 minutes	Volume to Capacity (v/c):	0.988

Intersection Setup

Name	Carriage Meadows Dr			Carriage Meadows Dr			Fontaine Bl			Fontaine Bl		
Approach	Northbound			Southbound			Eastbound			Westbound		
Lane Configuration	↵↵↵			↵↵↵			↵↵↵			↵↵↵		
Turning Movement	Left	Thru	Right	Left	Thru	Right	Left	Thru	Right	Left	Thru	Right
Lane Width [ft]	12.00	12.00	12.00	12.00	12.00	12.00	12.00	12.00	12.00	12.00	12.00	12.00
No. of Lanes in Entry Pocket	1	0	1	1	0	1	1	0	0	1	0	1
Entry Pocket Length [ft]	100.00	100.00	100.00	100.00	100.00	100.00	510.00	100.00	100.00	330.00	100.00	330.00
No. of Lanes in Exit Pocket	0	0	0	0	0	0	0	0	0	0	0	0
Exit Pocket Length [ft]	0.00	0.00	0.00	0.00	0.00	0.00	0.00	0.00	0.00	0.00	0.00	0.00
Speed [mph]	25.00			25.00			45.00			45.00		
Grade [%]	0.00			0.00			0.00			0.00		
Crosswalk	Yes			Yes			Yes			Yes		

Volumes

Name	Carriage Meadows Dr			Carriage Meadows Dr			Fontaine Bl			Fontaine Bl		
Base Volume Input [veh/h]	23	5	8	5	5	8	56	1726	44	8	898	6
Base Volume Adjustment Factor	1.0000	1.0000	1.0000	1.0000	1.0000	1.0000	1.0000	1.0000	1.0000	1.0000	1.0000	1.0000
Heavy Vehicles Percentage [%]	2.00	2.00	2.00	2.00	2.00	2.00	2.00	2.00	2.00	2.00	2.00	2.00
Growth Factor	1.1660	1.0000	1.1660	1.1660	1.0000	1.1660	1.1660	1.0000	1.1660	1.1660	1.0000	1.1660
In-Process Volume [veh/h]	0	0	0	0	0	0	0	0	0	0	0	0
Site-Generated Trips [veh/h]	0	0	0	3	0	8	10	0	0	0	0	4
Diverted Trips [veh/h]	-27	0	27	-9	0	9	0	9	0	0	27	0
Pass-by Trips [veh/h]	0	0	0	0	0	0	0	0	0	0	0	0
Existing Site Adjustment Volume [veh/h]	0	0	0	0	0	0	0	0	0	0	0	0
Other Volume [veh/h]	0	0	0	0	0	0	0	0	0	0	0	0
Total Hourly Volume [veh/h]	0	5	36	0	5	26	75	1735	51	9	925	11
Peak Hour Factor	0.8500	0.8500	0.8500	0.8500	0.8500	0.8500	0.8500	0.8500	0.8500	0.8500	0.8500	0.8500
Other Adjustment Factor	1.0000	1.0000	1.0000	1.0000	1.0000	1.0000	1.0000	1.0000	1.0000	1.0000	1.0000	1.0000
Total 15-Minute Volume [veh/h]	0	1	11	0	1	8	22	510	15	3	272	3
Total Analysis Volume [veh/h]	0	6	42	0	6	31	88	2041	60	11	1088	13
Pedestrian Volume [ped/h]	0			0			0			0		

Intersection Settings

Priority Scheme	Stop	Stop	Free	Free
Flared Lane				
Storage Area [veh]	0	0	0	0
Two-Stage Gap Acceptance	No	No		
Number of Storage Spaces in Median	0	0	0	0

Movement, Approach, & Intersection Results

V/C, Movement V/C Ratio	0.00	0.92	0.18	0.00	0.99	0.06	0.14	0.02	0.00	0.04	0.01	0.00
d_M, Delay for Movement [s/veh]	10000.0	1015.95	23.72	2696.91	1108.74	12.96	11.64	0.00	0.00	19.56	0.00	0.00
Movement LOS	F	F	C	F	F	B	B	A	A	C	A	A
95th-Percentile Queue Length [veh/ln]	0.00	1.47	0.64	0.00	1.50	0.20	0.48	0.00	0.00	0.13	0.00	0.00
95th-Percentile Queue Length [ft/ln]	0.00	36.68	15.98	0.00	37.39	5.12	12.10	0.00	0.00	3.32	0.00	0.00
d_A, Approach Delay [s/veh]	147.75			190.65			0.47			0.19		
Approach LOS	F			F			A			A		
d_I, Intersection Delay [s/veh]	4.54											
Intersection LOS	F											

Signal Warrants Report For Intersection 3: Fontaine Bl/Carriage Meadows Dr

Warrants Summary

Warrant	Name	Met?
#1	Eight Hour Vehicular Volume	No
#2	Four Hour Vehicular Volume	No
#3	Peak Hour	No

Intersection Warrants Parameters

Major Approaches	E, W
Minor Approaches	S, N
Speed > 40mph	Yes
Population < 10,000	No
Warrant Factor	70%

Warrant Analysis Traffic Volumes

Hour	Major Streets		Minor Streets	
	E	W	S	N
1	945	1861	41	31
2	917	1805	40	30
3	898	1768	39	29
4	841	1656	36	28
5	747	1470	32	24
6	737	1452	32	24
7	728	1433	32	24
8	662	1303	29	22
9	652	1284	28	21
10	643	1265	28	21
11	558	1098	24	18
12	520	1024	23	17
13	510	1005	22	17
14	378	744	16	12
15	378	744	16	12
16	265	521	11	9
17	151	298	7	5
18	151	298	7	5
19	85	167	4	3
20	47	93	2	2
21	28	56	1	1
22	9	19	0	0
23	9	19	0	0
24	9	19	0	0

Warrant Analysis by Hour

Hour	Major Streets		Minor Street		Warrant 1 Condition A				Warrant 1 Condition B				Warrant 2	Warrant 3 Condition B
	Number	Volume	Number	Volume	100%	80%	70%	56%	100%	80%	70%	56%		
1	4	2806	3	41	No	No	No	No	No	No	No	No	No	No
2	4	2722	3	40	No	No	No	No	No	No	No	No	No	No
3	4	2666	3	39	No	No	No	No	No	No	No	No	No	No
4	4	2497	3	36	No	No	No	No	No	No	No	No	No	No
5	4	2217	3	32	No	No	No	No	No	No	No	No	No	No
6	4	2189	3	32	No	No	No	No	No	No	No	No	No	No
7	4	2161	3	32	No	No	No	No	No	No	No	No	No	No
8	4	1965	3	29	No	No	No	No	No	No	No	No	No	No
9	4	1936	3	28	No	No	No	No	No	No	No	No	No	No
10	4	1908	3	28	No	No	No	No	No	No	No	No	No	No
11	4	1656	3	24	No	No	No	No	No	No	No	No	No	No
12	4	1544	3	23	No	No	No	No	No	No	No	No	No	No
13	4	1515	3	22	No	No	No	No	No	No	No	No	No	No
14	4	1122	3	16	No	No	No	No	No	No	No	No	No	No
15	4	1122	3	16	No	No	No	No	No	No	No	No	No	No
16	4	786	3	11	No	No	No	No	No	No	No	No	No	No
17	4	449	3	7	No	No	No	No	No	No	No	No	No	No
18	4	449	3	7	No	No	No	No	No	No	No	No	No	No
19	4	252	3	4	No	No	No	No	No	No	No	No	No	No
20	4	140	3	2	No	No	No	No	No	No	No	No	No	No
21	4	84	3	1	No	No	No	No	No	No	No	No	No	No
22	4	28	3	0	No	No	No	No	No	No	No	No	No	No
23	4	28	3	0	No	No	No	No	No	No	No	No	No	No
24	4	28	3	0	No	No	No	No	No	No	No	No	No	No
Hours Met					0	0	0	0	0	0	0	0	0	0

Warrant 3 Condition A

Orientation	S	N
Total Stopped Delay Per Vehicle on Minor Approach (s)	147.7	190.7
Number of Lanes on Minor Street Approach	3	3
VehicleHours of Stopped Delay on Minor Approach (h:mm)	1:40	1:38
Delay Condition Met	No	No
Volume on Minor Street Approach During Same Hour	41	31
High Minor Volume Condition Met	No	No
Total Entering Volume on All Approaches During Same Hour	2878	2878
Number of Approaches on Intersection	4	4
Total Volume Condition Met	Yes	Yes
Warrant Met for Approach	No	No
Warrant Met for Intersection	No	

Table of Contents

Intersection Level Of Service Report	2
Intersection 1: Marksheffel Rd/Fontaine Bl	2
Intersection 2: Marksheffel Rd/Lorson Bl	7
Intersection 3: Fontaine Bl/Carriage Meadows Dr	12
Intersection 4: Marksheffel Rd/West Driveway	17
Intersection 5: Carriage Meadows Dr/East Driveway	19
Intersection 7: Fontaine Bl/Middle Driveway	21
Signal Warrants Report	23
Intersection 4: Marksheffel Rd/West Driveway	23
Intersection 5: Carriage Meadows Dr/East Driveway	25
Intersection 7: Fontaine Bl/Middle Driveway	27

Intersection Level Of Service Report
Intersection 1: Marksheffel Rd/Fontaine Bl

Control Type:	Signalized	Delay (sec / veh):	32.3
Analysis Method:	HCM 7th Edition	Level Of Service:	C
Analysis Period:	15 minutes	Volume to Capacity (v/c):	0.559

Intersection Setup

Name	Marksheffel Rd			Marksheffel Rd			Fontaine Bl			Fontaine Bl		
Approach	Northbound			Southbound			Eastbound			Westbound		
Lane Configuration	[Diagram]			[Diagram]			[Diagram]			[Diagram]		
Turning Movement	Left	Thru	Right	Left	Thru	Right	Left	Thru	Right	Left	Thru	Right
Lane Width [ft]	12.00	12.00	12.00	12.00	12.00	12.00	12.00	12.00	12.00	12.00	12.00	12.00
No. of Lanes in Entry Pocket	1	0	1	1	0	1	1	0	1	1	0	0
Entry Pocket Length [ft]	680.00	100.00	680.00	750.00	100.00	500.00	360.00	100.00	200.00	535.00	100.00	100.00
No. of Lanes in Exit Pocket	0	0	0	0	0	0	0	0	0	0	0	0
Exit Pocket Length [ft]	0.00	0.00	0.00	0.00	0.00	0.00	0.00	0.00	0.00	0.00	0.00	0.00
Speed [mph]	55.00			55.00			45.00			45.00		
Grade [%]	0.00			0.00			0.00			0.00		
Curb Present	No			No			No			No		
Crosswalk	Yes			Yes			Yes			Yes		

Volumes

Name	Marksheffel Rd			Marksheffel Rd			Fontaine Bl			Fontaine Bl		
Base Volume Input [veh/h]	131	531	113	157	239	17	25	252	72	246	651	505
Base Volume Adjustment Factor	1.0000	1.0000	1.0000	1.0000	1.0000	1.0000	1.0000	1.0000	1.0000	1.0000	1.0000	1.0000
Heavy Vehicles Percentage [%]	2.00	2.00	2.00	2.00	2.00	2.00	2.00	2.00	2.00	2.00	2.00	2.00
Proportion of CAVs [%]	0.00											
Growth Factor	1.0000	1.1660	1.0000	1.0000	1.1660	1.0000	1.0000	1.0000	1.0000	1.0000	1.0000	1.0000
In-Process Volume [veh/h]	0	0	0	0	0	0	0	0	0	0	0	0
Site-Generated Trips [veh/h]	0	66	1	58	0	0	24	13	0	67	36	22
Diverted Trips [veh/h]	0	0	0	0	0	0	0	0	0	0	0	0
Pass-by Trips [veh/h]	0	0	0	0	0	0	0	0	0	0	0	0
Existing Site Adjustment Volume [veh/h]	0	0	0	0	0	0	0	0	0	0	0	0
Other Volume [veh/h]	0	0	0	0	0	0	0	0	0	0	0	0
Right Turn on Red Volume [veh/h]	0	0	57	0	0	9	0	0	36	0	0	264
Total Hourly Volume [veh/h]	131	685	57	215	279	8	49	265	36	313	687	263
Peak Hour Factor	0.8500	0.8500	0.8500	0.8500	0.8500	0.8500	0.8500	0.8500	0.8500	0.8500	0.8500	0.8500
Other Adjustment Factor	1.0000	1.0000	1.0000	1.0000	1.0000	1.0000	1.0000	1.0000	1.0000	1.0000	1.0000	1.0000
Total 15-Minute Volume [veh/h]	39	201	17	63	82	2	14	78	11	92	202	77
Total Analysis Volume [veh/h]	154	806	67	253	328	9	58	312	42	368	808	309
Presence of On-Street Parking	No		No	No		No	No		No	No		No
On-Street Parking Maneuver Rate [/h]	0	0	0	0	0	0	0	0	0	0	0	0
Local Bus Stopping Rate [/h]	0	0	0	0	0	0	0	0	0	0	0	0
v_do, Outbound Pedestrian Volume crossing	0			0			0			0		
v_di, Inbound Pedestrian Volume crossing m	0			0			0			0		
v_co, Outbound Pedestrian Volume crossing	0			0			0			0		
v_ci, Inbound Pedestrian Volume crossing mi	0			0			0			0		
v_ab, Corner Pedestrian Volume [ped/h]	0			0			0			0		
Bicycle Volume [bicycles/h]	0			0			0			0		

Intersection Settings

Located in CBD	No
Signal Coordination Group	-
Cycle Length [s]	90
Active Pattern	Pattern 1
Coordination Type	Time of Day Pattern Coordinated
Actuation Type	Fully actuated
Offset [s]	0.0
Offset Reference	Lead Green - Beginning of First Green
Permissive Mode	SingleBand
Lost time [s]	0.00

Phasing & Timing

Control Type	Protecte	Permiss	Unsigna	Protecte	Permiss	Permiss	Protecte	Permiss	Permiss	Protecte	Permiss	Permiss
Signal Group	1	6	0	5	2	0	3	8	0	7	4	0
Auxiliary Signal Groups												
Lead / Lag	Lead	-	-	Lead	-	-	Lead	-	-	Lead	-	-
Minimum Green [s]	5	10	0	5	10	0	5	10	0	5	10	0
Maximum Green [s]	5	103	0	5	103	0	5	109	0	5	109	0
Amber [s]	3.0	3.0	0.0	3.0	3.0	0.0	3.0	3.0	0.0	3.0	3.0	0.0
All red [s]	1.0	1.0	0.0	1.0	1.0	0.0	1.0	1.0	0.0	1.0	1.0	0.0
Split [s]	14	35	0	11	32	0	19	25	0	19	25	0
Vehicle Extension [s]	3.0	3.0	0.0	3.0	3.0	0.0	3.0	3.0	0.0	3.0	3.0	0.0
Walk [s]	0	7	0	0	7	0	0	7	0	0	7	0
Pedestrian Clearance [s]	0	24	0	0	21	0	0	14	0	0	14	0
Delayed Vehicle Green [s]	0.0	0.0	0.0	0.0	0.0	0.0	0.0	0.0	0.0	0.0	0.0	0.0
Rest In Walk		No			No			No			No	
I1, Start-Up Lost Time [s]	2.0	2.0	0.0	2.0	2.0	0.0	2.0	2.0	0.0	2.0	2.0	0.0
I2, Clearance Lost Time [s]	2.0	2.0	0.0	2.0	2.0	0.0	2.0	2.0	0.0	2.0	2.0	0.0
Minimum Recall	No	No		No	No		No	No		No	No	
Maximum Recall	No	No		No	No		No	No		No	No	
Pedestrian Recall	No	No		No	No		No	No		No	No	
Detector Location [ft]	0.0	0.0	0.0	0.0	0.0	0.0	0.0	0.0	0.0	0.0	0.0	0.0
Detector Length [ft]	0.0	0.0	0.0	0.0	0.0	0.0	0.0	0.0	0.0	0.0	0.0	0.0
I, Upstream Filtering Factor	1.00	1.00	1.00	1.00	1.00	1.00	1.00	1.00	1.00	1.00	1.00	1.00

Exclusive Pedestrian Phase

Pedestrian Signal Group	0
Pedestrian Walk [s]	0
Pedestrian Clearance [s]	0

Lane Group Calculations

Lane Group	L	C	L	C	R	L	C	R	L	C	R
C, Cycle Length [s]	90	90	90	90	90	90	90	90	90	90	90
L, Total Lost Time per Cycle [s]	4.00	4.00	4.00	4.00	4.00	4.00	4.00	4.00	4.00	4.00	4.00
l1_p, Permitted Start-Up Lost Time [s]	0.00	0.00	0.00	0.00	0.00	0.00	0.00	0.00	0.00	0.00	0.00
l2, Clearance Lost Time [s]	2.00	2.00	2.00	2.00	2.00	2.00	2.00	2.00	2.00	2.00	2.00
g_i, Effective Green Time [s]	9	39	7	37	37	4	16	16	12	24	24
g / C, Green / Cycle	0.11	0.44	0.08	0.41	0.41	0.04	0.18	0.18	0.13	0.27	0.27
(v / s)_i Volume / Saturation Flow Rate	0.09	0.23	0.07	0.09	0.01	0.03	0.09	0.03	0.11	0.23	0.19
s, saturation flow rate [veh/h]	1781	3560	3459	3560	1589	1781	3560	1589	3459	3560	1589
c, Capacity [veh/h]	188	1550	268	1451	648	76	637	284	453	950	424
d1, Uniform Delay [s]	39.49	18.58	41.37	17.43	15.91	42.68	33.32	31.22	38.10	31.35	30.08
k, delay calibration	0.23	0.50	0.11	0.50	0.50	0.11	0.11	0.11	0.11	0.11	0.11
l, Upstream Filtering Factor	1.00	1.00	1.00	1.00	1.00	1.00	1.00	1.00	1.00	1.00	1.00
d2, Incremental Delay [s]	16.43	1.25	14.99	0.36	0.04	14.21	0.59	0.24	3.59	2.26	2.42
d3, Initial Queue Delay [s]	0.00	0.00	0.00	0.00	0.00	0.00	0.00	0.00	0.00	0.00	0.00
Rp, platoon ratio	1.00	1.00	1.00	1.00	1.00	1.00	1.00	1.00	1.00	1.00	1.00
PF, progression factor	1.00	1.00	1.00	1.00	1.00	1.00	1.00	1.00	1.00	1.00	1.00

Lane Group Results

X, volume / capacity	0.82	0.52	0.94	0.23	0.01	0.76	0.49	0.15	0.81	0.85	0.73
d, Delay for Lane Group [s/veh]	55.92	19.83	56.37	17.79	15.95	56.89	33.90	31.46	41.69	33.60	32.50
Lane Group LOS	E	B	E	B	B	E	C	C	D	C	C
Critical Lane Group	No	Yes	Yes	No	No	Yes	No	No	No	Yes	No
50th-Percentile Queue Length [veh/ln]	3.95	5.53	3.16	2.02	0.10	1.52	2.96	0.75	3.97	8.03	5.96
50th-Percentile Queue Length [ft/ln]	98.82	138.24	79.00	50.53	2.62	38.09	73.93	18.79	99.26	200.72	148.97
95th-Percentile Queue Length [veh/ln]	7.12	9.39	5.69	3.64	0.19	2.74	5.32	1.35	7.15	12.68	9.96
95th-Percentile Queue Length [ft/ln]	177.88	234.66	142.19	90.95	4.71	68.56	133.07	33.83	178.67	316.90	249.06

Movement, Approach, & Intersection Results

d_M, Delay for Movement [s/veh]	55.92	19.83	0.00	56.37	17.79	15.95	56.89	33.90	31.46	41.69	33.60	32.50
Movement LOS	E	B		E	B	B	E	C	C	D	C	C
d_A, Approach Delay [s/veh]	24.19			34.30			36.89			35.38		
Approach LOS	C			C			D			D		
d_I, Intersection Delay [s/veh]	32.26											
Intersection LOS	C											
Intersection V/C	0.559											

Other Modes

g_Walk,mi, Effective Walk Time [s]	11.0		11.0		11.0		11.0	
M_corner, Corner Circulation Area [ft ² /ped]	0.00		0.00		0.00		0.00	
M_CW, Crosswalk Circulation Area [ft ² /ped]	0.00		0.00		0.00		0.00	
d_p, Pedestrian Delay [s]	34.71		34.71		34.71		34.71	
I_p,int, Pedestrian LOS Score for Intersectio	2.969		3.126		2.852		3.523	
Crosswalk LOS	C		C		C		D	
s_b, Saturation Flow Rate of the bicycle lane	2000		2000		2000		2000	
c_b, Capacity of the bicycle lane [bicycles/h]	688		622		466		466	
d_b, Bicycle Delay [s]	19.37		21.39		26.48		26.48	
I_b,int, Bicycle LOS Score for Intersection	2.352		2.054		1.929		3.003	
Bicycle LOS	B		B		A		C	

Sequence

Ring 1	1	2	3	4	-	-	-	-	-	-	-	-	-	-	-	-
Ring 2	5	6	7	8	-	-	-	-	-	-	-	-	-	-	-	-
Ring 3	-	-	-	-	-	-	-	-	-	-	-	-	-	-	-	-
Ring 4	-	-	-	-	-	-	-	-	-	-	-	-	-	-	-	-

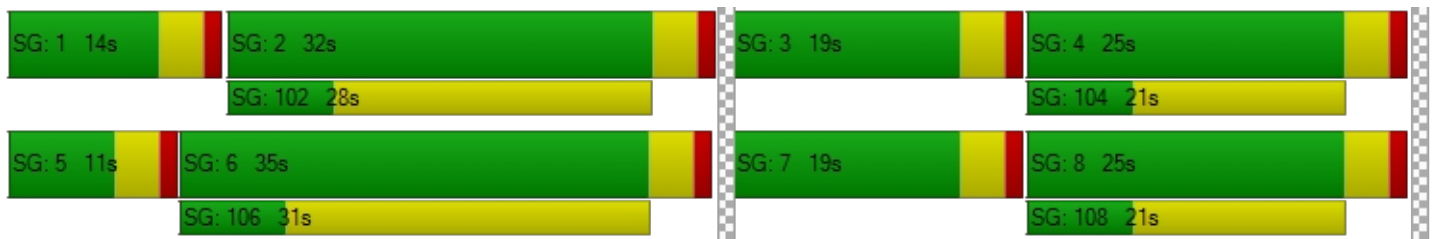

Intersection Level Of Service Report
Intersection 2: Marksheffel Rd/Lorson Bl

Control Type:	Signalized	Delay (sec / veh):	20.5
Analysis Method:	HCM 7th Edition	Level Of Service:	C
Analysis Period:	15 minutes	Volume to Capacity (v/c):	0.744

Intersection Setup

Name	Marksheffel Rd		Marksheffel Rd		Lorson Bl	
Approach	Northbound		Southbound		Westbound	
Lane Configuration	↑↗		↖↑		↖↗	
Turning Movement	Thru	Right	Left	Thru	Left	Right
Lane Width [ft]	12.00	12.00	12.00	12.00	12.00	12.00
No. of Lanes in Entry Pocket	0	1	1	0	1	0
Entry Pocket Length [ft]	100.00	500.00	580.00	100.00	510.00	100.00
No. of Lanes in Exit Pocket	0	0	0	0	0	0
Exit Pocket Length [ft]	0.00	0.00	0.00	0.00	0.00	0.00
Speed [mph]	55.00		55.00		25.00	
Grade [%]	0.00		0.00		0.00	
Curb Present	No		No		No	
Crosswalk	Yes		Yes		Yes	

Volumes

Name	Marksheffel Rd		Marksheffel Rd		Lorson Bl	
Base Volume Input [veh/h]	577	164	96	454	422	210
Base Volume Adjustment Factor	1.0000	1.0000	1.0000	1.0000	1.0000	1.0000
Heavy Vehicles Percentage [%]	2.00	2.00	2.00	2.00	2.00	2.00
Proportion of CAVs [%]	0.00					
Growth Factor	1.1660	1.0000	1.0000	1.1660	1.0000	1.0000
In-Process Volume [veh/h]	0	0	0	0	0	0
Site-Generated Trips [veh/h]	67	0	0	67	0	0
Diverted Trips [veh/h]	0	0	0	0	0	0
Pass-by Trips [veh/h]	0	0	0	0	0	0
Existing Site Adjustment Volume [veh/h]	0	0	0	0	0	0
Other Volume [veh/h]	0	0	0	0	0	0
Right Turn on Red Volume [veh/h]	0	82	0	0	0	105
Total Hourly Volume [veh/h]	740	82	96	596	422	105
Peak Hour Factor	0.8500	0.8500	0.8500	0.8500	0.8500	0.8500
Other Adjustment Factor	1.0000	1.0000	1.0000	1.0000	1.0000	1.0000
Total 15-Minute Volume [veh/h]	218	24	28	175	124	31
Total Analysis Volume [veh/h]	871	96	113	701	496	124
Presence of On-Street Parking	No	No	No	No	No	No
On-Street Parking Maneuver Rate [/h]	0	0	0	0	0	0
Local Bus Stopping Rate [/h]	0	0	0	0	0	0
v_do, Outbound Pedestrian Volume crossing	0		0		0	
v_di, Inbound Pedestrian Volume crossing m	0		0		0	
v_co, Outbound Pedestrian Volume crossing	0		0		0	
v_ci, Inbound Pedestrian Volume crossing mi	0		0		0	
v_ab, Corner Pedestrian Volume [ped/h]	0		0		0	
Bicycle Volume [bicycles/h]	0		0		0	

Intersection Settings

Located in CBD	No
Signal Coordination Group	-
Cycle Length [s]	60
Active Pattern	Pattern 1
Coordination Type	Time of Day Pattern Coordinated
Actuation Type	Fully actuated
Offset [s]	0.0
Offset Reference	Lead Green - Beginning of First Green
Permissive Mode	SingleBand
Lost time [s]	0.00

Phasing & Timing

Control Type	Permissive	Permissive	Permissive	Permissive	Permissive	Permissive
Signal Group	6	0	0	2	7	0
Auxiliary Signal Groups						
Lead / Lag	-	-	-	-	Lead	-
Minimum Green [s]	10	0	0	10	5	0
Maximum Green [s]	43	0	0	41	19	0
Amber [s]	3.0	0.0	0.0	3.0	3.0	0.0
All red [s]	1.0	0.0	0.0	1.0	1.0	0.0
Split [s]	36	0	0	36	24	0
Vehicle Extension [s]	3.0	0.0	0.0	3.0	3.0	0.0
Walk [s]	7	0	0	7	7	0
Pedestrian Clearance [s]	10	0	0	10	13	0
Delayed Vehicle Green [s]	0.0	0.0	0.0	0.0	0.0	0.0
Rest In Walk	No			No	No	
I1, Start-Up Lost Time [s]	2.0	0.0	0.0	2.0	2.0	0.0
I2, Clearance Lost Time [s]	2.0	0.0	0.0	2.0	2.0	0.0
Minimum Recall	No			No	No	
Maximum Recall	No			No	No	
Pedestrian Recall	No			No	No	
Detector Location [ft]	0.0	0.0	0.0	0.0	0.0	0.0
Detector Length [ft]	0.0	0.0	0.0	0.0	0.0	0.0
I, Upstream Filtering Factor	1.00	1.00	1.00	1.00	1.00	1.00

Exclusive Pedestrian Phase

Pedestrian Signal Group	0
Pedestrian Walk [s]	0
Pedestrian Clearance [s]	0

Lane Group Calculations

Lane Group	C	R	L	C	L	R
C, Cycle Length [s]	60	60	60	60	60	60
L, Total Lost Time per Cycle [s]	4.00	4.00	4.00	4.00	4.00	4.00
l1_p, Permitted Start-Up Lost Time [s]	0.00	0.00	2.00	0.00	0.00	0.00
l2, Clearance Lost Time [s]	2.00	2.00	2.00	2.00	2.00	2.00
g_i, Effective Green Time [s]	34	34	34	34	19	19
g / C, Green / Cycle	0.56	0.56	0.56	0.56	0.31	0.31
(v / s)_i Volume / Saturation Flow Rate	0.47	0.06	0.19	0.37	0.28	0.08
s, saturation flow rate [veh/h]	1870	1589	581	1870	1781	1589
c, Capacity [veh/h]	1043	887	200	1043	551	491
d1, Uniform Delay [s]	11.01	6.26	27.13	9.41	19.90	15.57
k, delay calibration	0.50	0.50	0.50	0.50	0.31	0.11
l, Upstream Filtering Factor	1.00	1.00	1.00	1.00	1.00	1.00
d2, Incremental Delay [s]	7.89	0.25	11.08	3.45	14.12	0.27
d3, Initial Queue Delay [s]	0.00	0.00	0.00	0.00	0.00	0.00
Rp, platoon ratio	1.00	1.00	1.00	1.00	1.00	1.00
PF, progression factor	1.00	1.00	1.00	1.00	1.00	1.00

Lane Group Results

X, volume / capacity	0.83	0.11	0.57	0.67	0.90	0.25
d, Delay for Lane Group [s/veh]	18.90	6.50	38.21	12.86	34.02	15.84
Lane Group LOS	B	A	D	B	C	B
Critical Lane Group	Yes	No	No	No	Yes	No
50th-Percentile Queue Length [veh/ln]	7.75	0.40	2.05	4.76	8.27	1.23
50th-Percentile Queue Length [ft/ln]	193.73	10.07	51.16	118.95	206.63	30.77
95th-Percentile Queue Length [veh/ln]	12.31	0.73	3.68	8.34	12.98	2.22
95th-Percentile Queue Length [ft/ln]	307.87	18.13	92.10	208.38	324.51	55.39

Movement, Approach, & Intersection Results

d_M, Delay for Movement [s/veh]	18.90	6.50	38.21	12.86	34.02	15.84
Movement LOS	B	A	D	B	C	B
d_A, Approach Delay [s/veh]	17.67		16.38		30.38	
Approach LOS	B		B		C	
d_I, Intersection Delay [s/veh]	20.51					
Intersection LOS	C					
Intersection V/C	0.744					

Other Modes

g_Walk,mi, Effective Walk Time [s]	11.0	11.0	11.0
M_corner, Corner Circulation Area [ft ² /ped]	0.00	0.00	0.00
M_CW, Crosswalk Circulation Area [ft ² /ped]	0.00	0.00	0.00
d_p, Pedestrian Delay [s]	20.05	20.05	20.05
I_p,int, Pedestrian LOS Score for Intersectio	3.373	3.058	2.503
Crosswalk LOS	C	C	B
s_b, Saturation Flow Rate of the bicycle lane	2000	2000	2000
c_b, Capacity of the bicycle lane [bicycles/h]	1065	1065	666
d_b, Bicycle Delay [s]	6.56	6.56	13.37
I_b,int, Bicycle LOS Score for Intersection	3.290	2.903	1.560
Bicycle LOS	C	C	A

Sequence

Ring 1	-	2	-	-	-	-	-	-	-	-	-	-	-	-	-	-
Ring 2	-	6	7	-	-	-	-	-	-	-	-	-	-	-	-	-
Ring 3	-	-	-	-	-	-	-	-	-	-	-	-	-	-	-	-
Ring 4	-	-	-	-	-	-	-	-	-	-	-	-	-	-	-	-



Intersection Level Of Service Report
Intersection 3: Fontaine Bl/Carriage Meadows Dr

Control Type:	Signalized	Delay (sec / veh):	12.2
Analysis Method:	HCM 7th Edition	Level Of Service:	B
Analysis Period:	15 minutes	Volume to Capacity (v/c):	0.561

Intersection Setup

Name	Carriage Meadows Dr			Carriage Meadows Dr			Fontaine Bl			Fontaine Bl		
Approach	Northbound			Southbound			Eastbound			Westbound		
Lane Configuration												
Turning Movement	Left	Thru	Right	Left	Thru	Right	Left	Thru	Right	Left	Thru	Right
Lane Width [ft]	12.00	12.00	12.00	12.00	12.00	12.00	12.00	12.00	12.00	12.00	12.00	12.00
No. of Lanes in Entry Pocket	1	0	1	1	0	1	1	0	0	1	0	1
Entry Pocket Length [ft]	100.00	100.00	100.00	100.00	100.00	100.00	510.00	100.00	100.00	330.00	100.00	330.00
No. of Lanes in Exit Pocket	0	0	0	0	0	0	0	0	0	0	0	0
Exit Pocket Length [ft]	0.00	0.00	0.00	0.00	0.00	0.00	0.00	0.00	0.00	0.00	0.00	0.00
Speed [mph]	25.00			25.00			45.00			45.00		
Grade [%]	0.00			0.00			0.00			0.00		
Curb Present	No			No			No			No		
Crosswalk	Yes			Yes			Yes			Yes		

Volumes

Name	Carriage Meadows Dr			Carriage Meadows Dr			Fontaine Bl			Fontaine Bl		
Base Volume Input [veh/h]	42	5	12	8	5	37	10	522	8	8	1310	4
Base Volume Adjustment Factor	1.0000	1.0000	1.0000	1.0000	1.0000	1.0000	1.0000	1.0000	1.0000	1.0000	1.0000	1.0000
Heavy Vehicles Percentage [%]	2.00	2.00	2.00	2.00	2.00	2.00	2.00	2.00	2.00	2.00	2.00	2.00
Proportion of CAVs [%]	0.00											
Growth Factor	1.1660	1.0000	1.1660	1.1660	1.0000	1.1660	1.1660	1.0000	1.1660	1.1660	1.0000	1.1660
In-Process Volume [veh/h]	0	0	0	0	0	0	0	0	0	0	0	0
Site-Generated Trips [veh/h]	1	1	0	64	2	125	72	0	0	0	32	33
Diverted Trips [veh/h]	0	0	0	0	0	0	0	0	0	0	0	0
Pass-by Trips [veh/h]	0	0	0	0	0	0	0	0	0	0	0	0
Existing Site Adjustment Volume [veh/h]	0	0	0	0	0	0	0	0	0	0	0	0
Other Volume [veh/h]	0	0	0	0	0	0	0	0	0	0	0	0
Right Turn on Red Volume [veh/h]	0	0	7	0	0	84	0	0	5	0	0	19
Total Hourly Volume [veh/h]	50	6	7	73	7	84	84	522	4	9	1342	19
Peak Hour Factor	0.8500	0.8500	0.8500	0.8500	0.8500	0.8500	0.8500	0.8500	0.8500	0.8500	0.8500	0.8500
Other Adjustment Factor	1.0000	1.0000	1.0000	1.0000	1.0000	1.0000	1.0000	1.0000	1.0000	1.0000	1.0000	1.0000
Total 15-Minute Volume [veh/h]	15	2	2	21	2	25	25	154	1	3	395	6
Total Analysis Volume [veh/h]	59	7	8	86	8	99	99	614	5	11	1579	22
Presence of On-Street Parking	No		No	No		No	No		No	No		No
On-Street Parking Maneuver Rate [/h]	0	0	0	0	0	0	0	0	0	0	0	0
Local Bus Stopping Rate [/h]	0	0	0	0	0	0	0	0	0	0	0	0
v_do, Outbound Pedestrian Volume crossing	0			0			0			0		
v_di, Inbound Pedestrian Volume crossing m	0			0			0			0		
v_co, Outbound Pedestrian Volume crossing	0			0			0			0		
v_ci, Inbound Pedestrian Volume crossing mi	0			0			0			0		
v_ab, Corner Pedestrian Volume [ped/h]	0			0			0			0		
Bicycle Volume [bicycles/h]	0			0			0			0		

Intersection Settings

Located in CBD	No
Signal Coordination Group	-
Cycle Length [s]	80
Active Pattern	Pattern 1
Coordination Type	Time of Day Pattern Coordinated
Actuation Type	Semi-actuated
Offset [s]	0.0
Offset Reference	Lead Green - Beginning of First Green
Permissive Mode	SingleBand
Lost time [s]	0.00

Phasing & Timing

Control Type	Permiss	Permiss	Permiss	Permiss	Permiss	Permiss	Protecte	Permiss	Permiss	Permiss	Permiss	Permiss
Signal Group	0	8	0	0	4	0	5	2	0	0	6	0
Auxiliary Signal Groups												
Lead / Lag	-	-	-	-	-	-	Lead	-	-	-	-	-
Minimum Green [s]	0	10	0	0	10	0	5	10	0	0	10	0
Maximum Green [s]	0	34	0	0	34	0	5	98	0	0	98	0
Amber [s]	0.0	3.0	0.0	0.0	3.0	0.0	3.0	3.0	0.0	0.0	3.0	0.0
All red [s]	0.0	1.0	0.0	0.0	1.0	0.0	1.0	1.0	0.0	0.0	1.0	0.0
Split [s]	0	38	0	0	38	0	17	42	0	0	25	0
Vehicle Extension [s]	0.0	3.0	0.0	0.0	3.0	0.0	3.0	3.0	0.0	0.0	3.0	0.0
Walk [s]	0	7	0	0	7	0	0	7	0	0	7	0
Pedestrian Clearance [s]	0	23	0	0	27	0	0	7	0	0	14	0
Delayed Vehicle Green [s]	0.0	0.0	0.0	0.0	0.0	0.0	0.0	0.0	0.0	0.0	0.0	0.0
Rest In Walk		No			No			No			No	
I1, Start-Up Lost Time [s]	0.0	2.0	0.0	0.0	2.0	0.0	2.0	2.0	0.0	0.0	2.0	0.0
I2, Clearance Lost Time [s]	0.0	2.0	0.0	0.0	2.0	0.0	2.0	2.0	0.0	0.0	2.0	0.0
Minimum Recall		No			No		No	No			No	
Maximum Recall		No			No		No	No			No	
Pedestrian Recall		No			No		No	No			No	
Detector Location [ft]	0.0	0.0	0.0	0.0	0.0	0.0	0.0	0.0	0.0	0.0	0.0	0.0
Detector Length [ft]	0.0	0.0	0.0	0.0	0.0	0.0	0.0	0.0	0.0	0.0	0.0	0.0
I, Upstream Filtering Factor	1.00	1.00	1.00	1.00	1.00	1.00	1.00	1.00	1.00	1.00	1.00	1.00

Exclusive Pedestrian Phase

Pedestrian Signal Group	0
Pedestrian Walk [s]	0
Pedestrian Clearance [s]	0

Lane Group Calculations

Lane Group	L	C	R	L	C	R	L	C	R	L	C	R
C, Cycle Length [s]	80	80	80	80	80	80	80	80	80	80	80	80
L, Total Lost Time per Cycle [s]	4.00	4.00	4.00	4.00	4.00	4.00	4.00	4.00	4.00	4.00	4.00	4.00
l1_p, Permitted Start-Up Lost Time [s]	2.00	0.00	0.00	2.00	0.00	0.00	0.00	0.00	0.00	2.00	0.00	0.00
l2, Clearance Lost Time [s]	2.00	2.00	2.00	2.00	2.00	2.00	2.00	2.00	2.00	2.00	2.00	2.00
g_i, Effective Green Time [s]	10	10	10	10	10	10	6	62	62	52	52	52
g / C, Green / Cycle	0.12	0.12	0.12	0.12	0.12	0.12	0.07	0.78	0.78	0.65	0.65	0.65
(v / s)_i Volume / Saturation Flow Rate	0.05	0.00	0.01	0.06	0.00	0.06	0.06	0.17	0.00	0.01	0.44	0.01
s, saturation flow rate [veh/h]	1286	1870	1589	1398	1870	1589	1781	3560	1589	804	3560	1589
c, Capacity [veh/h]	218	233	198	230	233	198	128	2761	1233	552	2327	1039
d1, Uniform Delay [s]	33.99	30.78	30.82	34.52	30.79	32.70	36.48	2.44	2.02	7.36	8.63	4.87
k, delay calibration	0.11	0.11	0.11	0.11	0.11	0.11	0.11	0.50	0.50	0.50	0.50	0.50
l, Upstream Filtering Factor	1.00	1.00	1.00	1.00	1.00	1.00	1.00	1.00	1.00	1.00	1.00	1.00
d2, Incremental Delay [s]	0.66	0.05	0.08	1.01	0.06	1.95	9.44	0.19	0.01	0.07	1.61	0.04
d3, Initial Queue Delay [s]	0.00	0.00	0.00	0.00	0.00	0.00	0.00	0.00	0.00	0.00	0.00	0.00
Rp, platoon ratio	1.00	1.00	1.00	1.00	1.00	1.00	1.00	1.00	1.00	1.00	1.00	1.00
PF, progression factor	1.00	1.00	1.00	1.00	1.00	1.00	1.00	1.00	1.00	1.00	1.00	1.00

Lane Group Results

X, volume / capacity	0.27	0.03	0.04	0.37	0.03	0.50	0.77	0.22	0.00	0.02	0.68	0.02
d, Delay for Lane Group [s/veh]	34.65	30.83	30.90	35.53	30.85	34.65	45.91	2.62	2.03	7.43	10.24	4.91
Lane Group LOS	C	C	C	D	C	C	D	A	A	A	B	A
Critical Lane Group	No	No	No	No	No	Yes	Yes	No	No	No	Yes	No
50th-Percentile Queue Length [veh/ln]	1.11	0.12	0.14	1.65	0.14	1.88	2.12	0.59	0.01	0.08	6.36	0.10
50th-Percentile Queue Length [ft/ln]	27.84	3.04	3.49	41.37	3.47	47.05	53.11	14.86	0.23	1.90	159.07	2.57
95th-Percentile Queue Length [veh/ln]	2.00	0.22	0.25	2.98	0.25	3.39	3.82	1.07	0.02	0.14	10.50	0.18
95th-Percentile Queue Length [ft/ln]	50.12	5.47	6.29	74.46	6.25	84.70	95.60	26.75	0.41	3.41	262.50	4.62

Movement, Approach, & Intersection Results

d_M, Delay for Movement [s/veh]	34.65	30.83	30.90	35.53	30.85	34.65	45.91	2.62	2.03	7.43	10.24	4.91
Movement LOS	C	C	C	D	C	C	D	A	A	A	B	A
d_A, Approach Delay [s/veh]	33.88			34.89			8.59			10.15		
Approach LOS	C			C			A			B		
d_I, Intersection Delay [s/veh]	12.23											
Intersection LOS	B											
Intersection V/C	0.561											

Other Modes

g_Walk,mi, Effective Walk Time [s]	11.0	11.0	11.0	11.0
M_corner, Corner Circulation Area [ft ² /ped]	0.00	0.00	0.00	0.00
M_CW, Crosswalk Circulation Area [ft ² /ped]	0.00	0.00	0.00	0.00
d_p, Pedestrian Delay [s]	29.76	29.76	29.76	29.76
I_p,int, Pedestrian LOS Score for Intersectio	2.172	2.330	3.210	3.167
Crosswalk LOS	B	B	C	C
s_b, Saturation Flow Rate of the bicycle lane	2000	2000	2000	2000
c_b, Capacity of the bicycle lane [bicycles/h]	850	850	950	525
d_b, Bicycle Delay [s]	13.23	13.23	11.03	21.76
I_b,int, Bicycle LOS Score for Intersection	1.693	2.017	2.156	2.905
Bicycle LOS	A	B	B	C

Sequence

Ring 1	-	2	-	4	-	-	-	-	-	-	-	-	-	-	-	-
Ring 2	5	6	-	8	-	-	-	-	-	-	-	-	-	-	-	-
Ring 3	-	-	-	-	-	-	-	-	-	-	-	-	-	-	-	-
Ring 4	-	-	-	-	-	-	-	-	-	-	-	-	-	-	-	-



Intersection Level Of Service Report
Intersection 4: Marksheffel Rd/West Driveway

Control Type:	Two-way stop	Delay (sec / veh):	15.4
Analysis Method:	HCM 7th Edition	Level Of Service:	C
Analysis Period:	15 minutes	Volume to Capacity (v/c):	0.108

Intersection Setup

Name	Marksheffel Rd		Marksheffel Rd		West Driveway	
Approach	Northbound		Southbound		Westbound	
Lane Configuration	↔				↔	
Turning Movement	Thru	Right	Left	Thru	Left	Right
Lane Width [ft]	12.00	12.00	12.00	12.00	12.00	12.00
No. of Lanes in Entry Pocket	0	1	0	0	0	0
Entry Pocket Length [ft]	100.00	100.00	100.00	100.00	100.00	100.00
No. of Lanes in Exit Pocket	0	0	0	1	0	0
Exit Pocket Length [ft]	0.00	0.00	0.00	590.00	0.00	0.00
Speed [mph]	55.00		55.00		25.00	
Grade [%]	0.00		0.00		0.00	
Crosswalk	No		No		Yes	

Volumes

Name	Marksheffel Rd		Marksheffel Rd		West Driveway	
Base Volume Input [veh/h]	1149	0	0	453	0	0
Base Volume Adjustment Factor	1.0000	1.0000	1.0000	1.0000	1.0000	1.0000
Heavy Vehicles Percentage [%]	2.00	2.00	2.00	2.00	2.00	2.00
Growth Factor	1.0000	1.1660	1.1660	1.0000	1.1660	1.1660
In-Process Volume [veh/h]	0	0	0	0	0	0
Site-Generated Trips [veh/h]	22	90	0	58	0	36
Diverted Trips [veh/h]	0	0	0	0	0	0
Pass-by Trips [veh/h]	0	0	0	0	0	0
Existing Site Adjustment Volume [veh/h]	0	0	0	0	0	0
Other Volume [veh/h]	0	0	0	0	0	0
Total Hourly Volume [veh/h]	1171	90	0	511	0	36
Peak Hour Factor	0.8500	0.8500	0.8500	0.8500	0.8500	0.8500
Other Adjustment Factor	1.0000	1.0000	1.0000	1.0000	1.0000	1.0000
Total 15-Minute Volume [veh/h]	344	26	0	150	0	11
Total Analysis Volume [veh/h]	1378	106	0	601	0	42
Pedestrian Volume [ped/h]	0		0		0	

Intersection Settings

Priority Scheme	Free	Free	Stop
Flared Lane			
Storage Area [veh]	0	0	0
Two-Stage Gap Acceptance			No
Number of Storage Spaces in Median	0	0	0

Movement, Approach, & Intersection Results

V/C, Movement V/C Ratio	0.01	0.00	0.00	0.01	0.00	0.11
d_M, Delay for Movement [s/veh]	0.00	0.00	0.00	0.00	0.00	15.40
Movement LOS	A	A		A		C
95th-Percentile Queue Length [veh/ln]	0.00	0.00	0.00	0.00	0.00	0.36
95th-Percentile Queue Length [ft/ln]	0.00	0.00	0.00	0.00	0.00	9.02
d_A, Approach Delay [s/veh]	0.00		0.00		15.40	
Approach LOS	A		A		C	
d_I, Intersection Delay [s/veh]	0.30					
Intersection LOS	C					

Intersection Level Of Service Report
Intersection 5: Carriage Meadows Dr/East Driveway

Control Type:	Two-way stop	Delay (sec / veh):	13.2
Analysis Method:	HCM 7th Edition	Level Of Service:	B
Analysis Period:	15 minutes	Volume to Capacity (v/c):	0.040

Intersection Setup

Name	Carriage Meadows Dr			Carriage Meadows Dr			East Driveway			Westbound		
Approach	Northbound			Southbound			Eastbound			Westbound		
Lane Configuration												
Turning Movement	Left	Thru	Right	Left	Thru	Right	Left	Thru	Right	Left	Thru	Right
Lane Width [ft]	12.00	12.00	12.00	12.00	12.00	12.00	12.00	12.00	12.00	12.00	12.00	12.00
No. of Lanes in Entry Pocket	1	0	0	0	0	0	1	0	0	0	0	0
Entry Pocket Length [ft]	100.00	100.00	100.00	100.00	100.00	100.00	100.00	100.00	100.00	100.00	100.00	100.00
No. of Lanes in Exit Pocket	0	0	0	0	0	0	0	0	0	0	0	0
Exit Pocket Length [ft]	0.00	0.00	0.00	0.00	0.00	0.00	0.00	0.00	0.00	0.00	0.00	0.00
Speed [mph]	25.00			25.00			25.00			30.00		
Grade [%]	0.00			0.00			0.00			0.00		
Crosswalk	No			No			Yes			Yes		

Volumes

Name	Carriage Meadows Dr			Carriage Meadows Dr			East Driveway			Westbound		
Base Volume Input [veh/h]	0	0	0	0	0	0	0	0	0	0	0	0
Base Volume Adjustment Factor	1.0000	1.0000	1.0000	1.0000	1.0000	1.0000	1.0000	1.0000	1.0000	1.0000	1.0000	1.0000
Heavy Vehicles Percentage [%]	2.00	2.00	2.00	2.00	2.00	2.00	2.00	2.00	2.00	2.00	2.00	2.00
Growth Factor	1.1660	1.1660	1.1660	1.1660	1.1660	1.1660	1.1660	1.1660	1.1660	1.1660	1.1660	1.1660
In-Process Volume [veh/h]	0	0	0	0	0	0	0	0	0	0	0	0
Site-Generated Trips [veh/h]	102	0	4	0	0	2	2	0	176	15	0	0
Diverted Trips [veh/h]	0	0	0	0	0	0	0	0	0	0	0	0
Pass-by Trips [veh/h]	0	0	0	0	0	0	0	0	0	0	0	0
Existing Site Adjustment Volume [veh/h]	0	0	0	0	0	0	0	0	0	0	0	0
Other Volume [veh/h]	0	0	0	0	0	0	0	0	0	0	0	0
Total Hourly Volume [veh/h]	102	0	4	0	0	2	2	0	176	15	0	0
Peak Hour Factor	0.8500	0.8500	0.8500	0.8500	0.8500	0.8500	0.8500	0.8500	0.8500	0.8500	0.8500	0.8500
Other Adjustment Factor	1.0000	1.0000	1.0000	1.0000	1.0000	1.0000	1.0000	1.0000	1.0000	1.0000	1.0000	1.0000
Total 15-Minute Volume [veh/h]	30	0	1	0	0	1	1	0	52	4	0	0
Total Analysis Volume [veh/h]	120	0	5	0	0	2	2	0	207	18	0	0
Pedestrian Volume [ped/h]	0			0			0			0		

Intersection Settings

Priority Scheme	Free	Free	Stop	Stop
Flared Lane			No	No
Storage Area [veh]	0	0	0	0
Two-Stage Gap Acceptance			No	No
Number of Storage Spaces in Median	0	0	0	0

Movement, Approach, & Intersection Results

V/C, Movement V/C Ratio	0.07	0.00	0.00	0.00	0.00	0.00	0.00	0.00	0.19	0.04	0.00	0.00
d_M, Delay for Movement [s/veh]	7.40	0.00	0.00	7.23	0.00	0.00	10.49	11.71	9.11	13.24	11.24	8.65
Movement LOS	A	A	A	A	A	A	B	B	A	B	B	A
95th-Percentile Queue Length [veh/ln]	0.24	0.00	0.00	0.00	0.00	0.00	0.01	0.70	0.70	0.12	0.12	0.12
95th-Percentile Queue Length [ft/ln]	5.99	0.00	0.00	0.00	0.00	0.00	0.23	17.60	17.60	3.08	3.08	3.08
d_A, Approach Delay [s/veh]	7.10			0.00			9.12			13.24		
Approach LOS	A			A			A			B		
d_I, Intersection Delay [s/veh]	8.56											
Intersection LOS	B											

Intersection Level Of Service Report
Intersection 7: Fontaine BI/Middle Driveway

Control Type:	Two-way stop	Delay (sec / veh):	0.0
Analysis Method:	HCM 7th Edition	Level Of Service:	A
Analysis Period:	15 minutes	Volume to Capacity (v/c):	0.018

Intersection Setup

Name	LRCS			Middle Driveway			Fontaine BI			Fontaine BI		
Approach	Northbound			Southbound			Eastbound			Westbound		
Lane Configuration	↻						↻			↻		
Turning Movement	Left	Thru	Right	Left	Thru	Right	Left	Thru	Right	Left	Thru	Right
Lane Width [ft]	12.00	12.00	12.00	12.00	12.00	12.00	12.00	12.00	12.00	12.00	12.00	12.00
No. of Lanes in Entry Pocket	0	0	0	0	0	0	0	0	0	0	0	0
Entry Pocket Length [ft]	100.00	100.00	100.00	100.00	100.00	100.00	100.00	100.00	100.00	100.00	100.00	100.00
No. of Lanes in Exit Pocket	0	0	0	0	0	0	0	0	0	0	0	0
Exit Pocket Length [ft]	0.00	0.00	0.00	0.00	0.00	0.00	0.00	0.00	0.00	0.00	0.00	0.00
Speed [mph]	25.00			25.00			45.00			45.00		
Grade [%]	0.00			0.00			0.00			0.00		
Crosswalk	Yes			Yes			No			No		

Volumes

Name	LRCS			Middle Driveway			Fontaine BI			Fontaine BI		
Base Volume Input [veh/h]	0	0	0	0	0	0	0	522	0	0	1402	0
Base Volume Adjustment Factor	1.0000	1.0000	1.0000	1.0000	1.0000	1.0000	1.0000	1.0000	1.0000	1.0000	1.0000	1.0000
Heavy Vehicles Percentage [%]	2.00	2.00	2.00	2.00	2.00	2.00	2.00	2.00	2.00	2.00	2.00	2.00
Growth Factor	1.1660	1.1660	1.1660	1.1660	1.1660	1.1660	1.1660	1.1660	1.1660	1.1660	1.0000	1.1660
In-Process Volume [veh/h]	0	0	0	0	0	0	0	0	0	0	0	0
Site-Generated Trips [veh/h]	0	0	0	0	0	0	0	72	0	0	125	33
Diverted Trips [veh/h]	0	0	0	0	0	0	0	0	0	0	0	0
Pass-by Trips [veh/h]	0	0	0	0	0	0	0	0	0	0	0	0
Existing Site Adjustment Volume [veh/h]	0	0	0	0	0	0	0	0	0	0	0	0
Other Volume [veh/h]	0	0	0	0	0	0	0	0	0	0	0	0
Total Hourly Volume [veh/h]	0	0	0	0	0	0	0	681	0	0	1527	33
Peak Hour Factor	0.8500	0.8500	0.8500	0.8500	0.8500	0.8500	0.8500	0.8500	0.8500	0.8500	0.8500	0.8500
Other Adjustment Factor	1.0000	1.0000	1.0000	1.0000	1.0000	1.0000	1.0000	1.0000	1.0000	1.0000	1.0000	1.0000
Total 15-Minute Volume [veh/h]	0	0	0	0	0	0	0	200	0	0	449	10
Total Analysis Volume [veh/h]	0	0	0	0	0	0	0	801	0	0	1796	39
Pedestrian Volume [ped/h]	0			0			0			0		

Intersection Settings

Priority Scheme	Stop	Stop	Free	Free
Flared Lane				
Storage Area [veh]	0	0	0	0
Two-Stage Gap Acceptance	No			
Number of Storage Spaces in Median	0	0	0	0

Movement, Approach, & Intersection Results

V/C, Movement V/C Ratio	0.00	0.00	0.00	0.00	0.00	0.00	0.00	0.01	0.00	0.00	0.02	0.00
d_M, Delay for Movement [s/veh]	0.00	0.00	11.01	0.00	0.00	0.00	0.00	0.00	0.00	0.00	0.00	0.00
Movement LOS			B					A	A		A	A
95th-Percentile Queue Length [veh/ln]	0.00	0.00	0.00	0.00	0.00	0.00	0.00	0.00	0.00	0.00	0.00	0.00
95th-Percentile Queue Length [ft/ln]	0.00	0.00	0.00	0.00	0.00	0.00	0.00	0.00	0.00	0.00	0.00	0.00
d_A, Approach Delay [s/veh]	11.01		0.00		0.00		0.00		0.00			
Approach LOS	B		A		A		A		A			
d_I, Intersection Delay [s/veh]	0.00											
Intersection LOS	A											

Signal Warrants Report For Intersection 4: Marksheffel Rd/West Driveway

Warrants Summary

Warrant	Name	Met?
#1	Eight Hour Vehicular Volume	No
#2	Four Hour Vehicular Volume	No
#3	Peak Hour	No

Intersection Warrants Parameters

Major Approaches	N, S
Minor Approaches	E
Speed > 40mph	Yes
Population < 10,000	No
Warrant Factor	70%

Warrant Analysis Traffic Volumes

Hour	Major Streets		Minor Streets
	N	S	E
1	511	1261	36
2	496	1223	35
3	485	1198	34
4	455	1122	32
5	404	996	28
6	399	984	28
7	393	971	28
8	358	883	25
9	353	870	25
10	347	857	24
11	301	744	21
12	281	694	20
13	276	681	19
14	204	504	14
15	204	504	14
16	143	353	10
17	82	202	6
18	82	202	6
19	46	113	3
20	26	63	2
21	15	38	1
22	5	13	0
23	5	13	0
24	5	13	0

Warrant Analysis by Hour

Hour	Major Streets		Minor Street		Warrant 1 Condition A				Warrant 1 Condition B				Warrant 2	Warrant 3 Condition B
	Number	Volume	Number	Volume	100%	80%	70%	56%	100%	80%	70%	56%		
1	3	1772	1	36	No	No	No	No	No	No	No	No	No	No
2	3	1719	1	35	No	No	No	No	No	No	No	No	No	No
3	3	1683	1	34	No	No	No	No	No	No	No	No	No	No
4	3	1577	1	32	No	No	No	No	No	No	No	No	No	No
5	3	1400	1	28	No	No	No	No	No	No	No	No	No	No
6	3	1383	1	28	No	No	No	No	No	No	No	No	No	No
7	3	1364	1	28	No	No	No	No	No	No	No	No	No	No
8	3	1241	1	25	No	No	No	No	No	No	No	No	No	No
9	3	1223	1	25	No	No	No	No	No	No	No	No	No	No
10	3	1204	1	24	No	No	No	No	No	No	No	No	No	No
11	3	1045	1	21	No	No	No	No	No	No	No	No	No	No
12	3	975	1	20	No	No	No	No	No	No	No	No	No	No
13	3	957	1	19	No	No	No	No	No	No	No	No	No	No
14	3	708	1	14	No	No	No	No	No	No	No	No	No	No
15	3	708	1	14	No	No	No	No	No	No	No	No	No	No
16	3	496	1	10	No	No	No	No	No	No	No	No	No	No
17	3	284	1	6	No	No	No	No	No	No	No	No	No	No
18	3	284	1	6	No	No	No	No	No	No	No	No	No	No
19	3	159	1	3	No	No	No	No	No	No	No	No	No	No
20	3	89	1	2	No	No	No	No	No	No	No	No	No	No
21	3	53	1	1	No	No	No	No	No	No	No	No	No	No
22	3	18	1	0	No	No	No	No	No	No	No	No	No	No
23	3	18	1	0	No	No	No	No	No	No	No	No	No	No
24	3	18	1	0	No	No	No	No	No	No	No	No	No	No
Hours Met					0	0	0	0	0	0	0	0	0	0

Warrant 3 Condition A

Orientation	E
Total Stopped Delay Per Vehicle on Minor Approach (s)	15.4
Number of Lanes on Minor Street Approach	1
VehicleHours of Stopped Delay on Minor Approach (h:mm)	0:09
Delay Condition Met	No
Volume on Minor Street Approach During Same Hour	36
High Minor Volume Condition Met	No
Total Entering Volume on All Approaches During Same Hour	1808
Number of Approaches on Intersection	3
Total Volume Condition Met	Yes
Warrant Met for Approach	No
Warrant Met for Intersection	No

Signal Warrants Report For Intersection 5: Carriage Meadows Dr/East Driveway

Warrants Summary

Warrant	Name	Met?
#1	Eight Hour Vehicular Volume	No
#2	Four Hour Vehicular Volume	No
#3	Peak Hour	No

Intersection Warrants Parameters

Major Approaches	S, N
Minor Approaches	E, W
Speed > 40mph	No
Population < 10,000	No
Warrant Factor	100%

Warrant Analysis Traffic Volumes

Hour	Major Streets		Minor Streets	
	S	N	E	W
1	106	2	15	178
2	103	2	15	173
3	101	2	14	169
4	94	2	13	158
5	84	2	12	141
6	83	2	12	139
7	82	2	12	137
8	74	1	11	125
9	73	1	10	123
10	72	1	10	121
11	63	1	9	105
12	58	1	8	98
13	57	1	8	96
14	42	1	6	71
15	42	1	6	71
16	30	1	4	50
17	17	0	2	28
18	17	0	2	28
19	10	0	1	16
20	5	0	1	9
21	3	0	0	5
22	1	0	0	2
23	1	0	0	2
24	1	0	0	2

Warrant Analysis by Hour

Hour	Major Streets		Minor Street		Warrant 1 Condition A				Warrant 1 Condition B				Warrant 2	Warrant 3 Condition B
	Number	Volume	Number	Volume	100%	80%	70%	56%	100%	80%	70%	56%		
1	2	108	2	178	No	No	No	No	No	No	No	No	No	No
2	2	105	2	173	No	No	No	No	No	No	No	No	No	No
3	2	103	2	169	No	No	No	No	No	No	No	No	No	No
4	2	96	2	158	No	No	No	No	No	No	No	No	No	No
5	2	86	2	141	No	No	No	No	No	No	No	No	No	No
6	2	85	2	139	No	No	No	No	No	No	No	No	No	No
7	2	84	2	137	No	No	No	No	No	No	No	No	No	No
8	2	75	2	125	No	No	No	No	No	No	No	No	No	No
9	2	74	2	123	No	No	No	No	No	No	No	No	No	No
10	2	73	2	121	No	No	No	No	No	No	No	No	No	No
11	2	64	2	105	No	No	No	No	No	No	No	No	No	No
12	2	59	2	98	No	No	No	No	No	No	No	No	No	No
13	2	58	2	96	No	No	No	No	No	No	No	No	No	No
14	2	43	2	71	No	No	No	No	No	No	No	No	No	No
15	2	43	2	71	No	No	No	No	No	No	No	No	No	No
16	2	31	2	50	No	No	No	No	No	No	No	No	No	No
17	2	17	2	28	No	No	No	No	No	No	No	No	No	No
18	2	17	2	28	No	No	No	No	No	No	No	No	No	No
19	2	10	2	16	No	No	No	No	No	No	No	No	No	No
20	2	5	2	9	No	No	No	No	No	No	No	No	No	No
21	2	3	2	5	No	No	No	No	No	No	No	No	No	No
22	2	1	2	2	No	No	No	No	No	No	No	No	No	No
23	2	1	2	2	No	No	No	No	No	No	No	No	No	No
24	2	1	2	2	No	No	No	No	No	No	No	No	No	No
Hours Met					0	0	0	0	0	0	0	0	0	0

Warrant 3 Condition A

Orientation	E	W
Total Stopped Delay Per Vehicle on Minor Approach (s)	13.2	9.1
Number of Lanes on Minor Street Approach	1	2
VehicleHours of Stopped Delay on Minor Approach (h:mm)	0:03	0:27
Delay Condition Met	No	No
Volume on Minor Street Approach During Same Hour	15	178
High Minor Volume Condition Met	No	Yes
Total Entering Volume on All Approaches During Same Hour	301	301
Number of Approaches on Intersection	4	4
Total Volume Condition Met	No	No
Warrant Met for Approach	No	No
Warrant Met for Intersection	No	

Signal Warrants Report For Intersection 7: Fontaine Bl/Middle Driveway

Warrants Summary

Warrant	Name	Met?
#1	Eight Hour Vehicular Volume	No
#2	Four Hour Vehicular Volume	No
#3	Peak Hour	No

Intersection Warrants Parameters

Major Approaches	E, W
Minor Approaches	S
Speed > 40mph	Yes
Population < 10,000	No
Warrant Factor	70%

Warrant Analysis Traffic Volumes

Hour	Major Streets		Minor Streets
	E	W	S
1	1560	681	0
2	1513	661	0
3	1482	647	0
4	1388	606	0
5	1232	538	0
6	1217	531	0
7	1201	524	0
8	1092	477	0
9	1076	470	0
10	1061	463	0
11	920	402	0
12	858	375	0
13	842	368	0
14	624	272	0
15	624	272	0
16	437	191	0
17	250	109	0
18	250	109	0
19	140	61	0
20	78	34	0
21	47	20	0
22	16	7	0
23	16	7	0
24	16	7	0

Warrant Analysis by Hour

Hour	Major Streets		Minor Street		Warrant 1 Condition A				Warrant 1 Condition B				Warrant 2	Warrant 3 Condition B
	Number	Volume	Number	Volume	100%	80%	70%	56%	100%	80%	70%	56%		
1	3	2241	1	0	No	No	No	No	No	No	No	No	No	No
2	3	2174	1	0	No	No	No	No	No	No	No	No	No	No
3	3	2129	1	0	No	No	No	No	No	No	No	No	No	No
4	3	1994	1	0	No	No	No	No	No	No	No	No	No	No
5	3	1770	1	0	No	No	No	No	No	No	No	No	No	No
6	3	1748	1	0	No	No	No	No	No	No	No	No	No	No
7	3	1725	1	0	No	No	No	No	No	No	No	No	No	No
8	3	1569	1	0	No	No	No	No	No	No	No	No	No	No
9	3	1546	1	0	No	No	No	No	No	No	No	No	No	No
10	3	1524	1	0	No	No	No	No	No	No	No	No	No	No
11	3	1322	1	0	No	No	No	No	No	No	No	No	No	No
12	3	1233	1	0	No	No	No	No	No	No	No	No	No	No
13	3	1210	1	0	No	No	No	No	No	No	No	No	No	No
14	3	896	1	0	No	No	No	No	No	No	No	No	No	No
15	3	896	1	0	No	No	No	No	No	No	No	No	No	No
16	3	628	1	0	No	No	No	No	No	No	No	No	No	No
17	3	359	1	0	No	No	No	No	No	No	No	No	No	No
18	3	359	1	0	No	No	No	No	No	No	No	No	No	No
19	3	201	1	0	No	No	No	No	No	No	No	No	No	No
20	3	112	1	0	No	No	No	No	No	No	No	No	No	No
21	3	67	1	0	No	No	No	No	No	No	No	No	No	No
22	3	23	1	0	No	No	No	No	No	No	No	No	No	No
23	3	23	1	0	No	No	No	No	No	No	No	No	No	No
24	3	23	1	0	No	No	No	No	No	No	No	No	No	No
Hours Met					0	0	0	0	0	0	0	0	0	0

Warrant 3 Condition A

Orientation	S
Total Stopped Delay Per Vehicle on Minor Approach (s)	11
Number of Lanes on Minor Street Approach	1
VehicleHours of Stopped Delay on Minor Approach (h:mm)	0:00
Delay Condition Met	No
Volume on Minor Street Approach During Same Hour	0
High Minor Volume Condition Met	No
Total Entering Volume on All Approaches During Same Hour	2241
Number of Approaches on Intersection	3
Total Volume Condition Met	Yes
Warrant Met for Approach	No
Warrant Met for Intersection	No

Table of Contents

Intersection Level Of Service Report	2
Intersection 1: Marksheffel Rd/Fontaine Bl	2
Intersection 2: Marksheffel Rd/Lorson Bl	7
Intersection 3: Fontaine Bl/Carriage Meadows Dr	12
Intersection 4: Marksheffel Rd/West Driveway	17
Intersection 5: Carriage Meadows Dr/East Driveway	19
Intersection 7: Fontaine Bl/Middle Driveway	21
Signal Warrants Report	23
Intersection 4: Marksheffel Rd/West Driveway	23
Intersection 5: Carriage Meadows Dr/East Driveway	25
Intersection 7: Fontaine Bl/Middle Driveway	27

Intersection Level Of Service Report
Intersection 1: Marksheffel Rd/Fontaine Bl

Control Type:	Signalized	Delay (sec / veh):	42.3
Analysis Method:	HCM 7th Edition	Level Of Service:	D
Analysis Period:	15 minutes	Volume to Capacity (v/c):	0.706

Intersection Setup

Name	Marksheffel Rd			Marksheffel Rd			Fontaine Bl			Fontaine Bl		
Approach	Northbound			Southbound			Eastbound			Westbound		
Lane Configuration	[Diagram]			[Diagram]			[Diagram]			[Diagram]		
Turning Movement	Left	Thru	Right	Left	Thru	Right	Left	Thru	Right	Left	Thru	Right
Lane Width [ft]	12.00	12.00	12.00	12.00	12.00	12.00	12.00	12.00	12.00	12.00	12.00	12.00
No. of Lanes in Entry Pocket	1	0	1	1	0	1	1	0	1	1	0	0
Entry Pocket Length [ft]	680.00	100.00	680.00	750.00	100.00	500.00	360.00	100.00	200.00	535.00	100.00	100.00
No. of Lanes in Exit Pocket	0	0	0	0	0	0	0	0	0	0	0	0
Exit Pocket Length [ft]	0.00	0.00	0.00	0.00	0.00	0.00	0.00	0.00	0.00	0.00	0.00	0.00
Speed [mph]	55.00			55.00			45.00			45.00		
Grade [%]	0.00			0.00			0.00			0.00		
Curb Present	No			No			No			No		
Crosswalk	Yes			Yes			Yes			Yes		

Volumes

Name	Marksheffel Rd			Marksheffel Rd			Fontaine Bl			Fontaine Bl		
Base Volume Input [veh/h]	122	310	310	570	506	33	51	846	158	159	469	306
Base Volume Adjustment Factor	1.0000	1.0000	1.0000	1.0000	1.0000	1.0000	1.0000	1.0000	1.0000	1.0000	1.0000	1.0000
Heavy Vehicles Percentage [%]	2.00	2.00	2.00	2.00	2.00	2.00	2.00	2.00	2.00	2.00	2.00	2.00
Proportion of CAVs [%]	0.00											
Growth Factor	1.0000	1.1660	1.0000	1.0000	1.1660	1.0000	1.0000	1.0000	1.0000	1.0000	1.0000	1.0000
In-Process Volume [veh/h]	0	0	0	0	0	0	0	0	0	0	0	0
Site-Generated Trips [veh/h]	0	55	4	51	0	0	20	12	0	58	33	19
Diverted Trips [veh/h]	0	0	0	0	0	0	0	0	0	0	0	0
Pass-by Trips [veh/h]	0	0	0	0	0	0	0	0	0	0	0	0
Existing Site Adjustment Volume [veh/h]	0	0	0	0	0	0	0	0	0	0	0	0
Other Volume [veh/h]	0	0	0	0	0	0	0	0	0	0	0	0
Right Turn on Red Volume [veh/h]	0	0	157	0	0	17	0	0	79	0	0	163
Total Hourly Volume [veh/h]	122	416	157	621	590	16	71	858	79	217	502	162
Peak Hour Factor	0.8500	0.8500	0.8500	0.8500	0.8500	0.8500	0.8500	0.8500	0.8500	0.8500	0.8500	0.8500
Other Adjustment Factor	1.0000	1.0000	1.0000	1.0000	1.0000	1.0000	1.0000	1.0000	1.0000	1.0000	1.0000	1.0000
Total 15-Minute Volume [veh/h]	36	122	46	183	174	5	21	252	23	64	148	48
Total Analysis Volume [veh/h]	144	489	185	731	694	19	84	1009	93	255	591	191
Presence of On-Street Parking	No		No	No		No	No		No	No		No
On-Street Parking Maneuver Rate [/h]	0	0	0	0	0	0	0	0	0	0	0	0
Local Bus Stopping Rate [/h]	0	0	0	0	0	0	0	0	0	0	0	0
v_do, Outbound Pedestrian Volume crossing	0			0			0			0		
v_di, Inbound Pedestrian Volume crossing m	0			0			0			0		
v_co, Outbound Pedestrian Volume crossing	0			0			0			0		
v_ci, Inbound Pedestrian Volume crossing mi	0			0			0			0		
v_ab, Corner Pedestrian Volume [ped/h]	0			0			0			0		
Bicycle Volume [bicycles/h]	0			0			0			0		

Intersection Settings

Located in CBD	No
Signal Coordination Group	-
Cycle Length [s]	120
Active Pattern	Pattern 1
Coordination Type	Time of Day Pattern Coordinated
Actuation Type	Fully actuated
Offset [s]	0.0
Offset Reference	Lead Green - Beginning of First Green
Permissive Mode	SingleBand
Lost time [s]	0.00

Phasing & Timing

Control Type	Protecte	Permiss	Unsigna	Protecte	Permiss	Overlap	Protecte	Permiss	Overlap	Protecte	Permiss	Permiss
Signal Group	1	6	0	5	2	3	3	8	1	7	4	0
Auxiliary Signal Groups						2,3			1,8			
Lead / Lag	Lead	-	-	Lead	-	-	Lead	-	-	Lead	-	-
Minimum Green [s]	5	10	0	5	10	5	5	10	5	5	10	0
Maximum Green [s]	5	103	0	5	103	5	5	109	5	5	109	0
Amber [s]	3.0	3.0	0.0	3.0	3.0	3.0	3.0	3.0	3.0	3.0	3.0	0.0
All red [s]	1.0	1.0	0.0	1.0	1.0	1.0	1.0	1.0	1.0	1.0	1.0	0.0
Split [s]	33	35	0	30	32	30	30	41	33	14	25	0
Vehicle Extension [s]	3.0	3.0	0.0	3.0	3.0	3.0	3.0	3.0	3.0	3.0	3.0	0.0
Walk [s]	0	7	0	0	7	0	0	7	0	0	7	0
Pedestrian Clearance [s]	0	24	0	0	21	0	0	14	0	0	14	0
Delayed Vehicle Green [s]	0.0	0.0	0.0	0.0	0.0	0.0	0.0	0.0	0.0	0.0	0.0	0.0
Rest In Walk		No			No			No			No	
I1, Start-Up Lost Time [s]	2.0	2.0	0.0	2.0	2.0	2.0	2.0	2.0	2.0	2.0	2.0	0.0
I2, Clearance Lost Time [s]	2.0	2.0	0.0	2.0	2.0	2.0	2.0	2.0	2.0	2.0	2.0	0.0
Minimum Recall	No	No		No	No	No	No	No	No	No	No	
Maximum Recall	No	No		No	No	No	No	No	No	No	No	
Pedestrian Recall	No	No		No	No	No	No	No	No	No	No	
Detector Location [ft]	0.0	0.0	0.0	0.0	0.0	0.0	0.0	0.0	0.0	0.0	0.0	0.0
Detector Length [ft]	0.0	0.0	0.0	0.0	0.0	0.0	0.0	0.0	0.0	0.0	0.0	0.0
I, Upstream Filtering Factor	1.00	1.00	1.00	1.00	1.00	1.00	1.00	1.00	1.00	1.00	1.00	1.00

Exclusive Pedestrian Phase

Pedestrian Signal Group	0
Pedestrian Walk [s]	0
Pedestrian Clearance [s]	0

Lane Group Calculations

Lane Group	L	C	L	C	R	L	C	R	L	C	R
C, Cycle Length [s]	120	120	120	120	120	120	120	120	120	120	120
L, Total Lost Time per Cycle [s]	4.00	4.00	4.00	4.00	4.00	4.00	4.00	4.00	4.00	4.00	4.00
l1_p, Permitted Start-Up Lost Time [s]	0.00	0.00	0.00	0.00	0.00	0.00	0.00	0.00	0.00	0.00	0.00
l2, Clearance Lost Time [s]	2.00	2.00	2.00	2.00	0.00	2.00	2.00	0.00	2.00	2.00	2.00
g_i, Effective Green Time [s]	12	32	26	46	57	7	36	52	10	39	39
g / C, Green / Cycle	0.10	0.27	0.22	0.38	0.48	0.06	0.30	0.43	0.08	0.32	0.32
(v / s)_i Volume / Saturation Flow Rate	0.08	0.14	0.21	0.19	0.01	0.05	0.28	0.06	0.07	0.17	0.12
s, saturation flow rate [veh/h]	1781	3560	3459	3560	1589	1781	3560	1589	3459	3560	1589
c, Capacity [veh/h]	177	952	746	1367	760	108	1069	688	288	1149	513
d1, Uniform Delay [s]	52.99	37.35	46.82	28.31	16.55	55.57	41.01	20.50	54.46	33.01	31.29
k, delay calibration	0.11	0.50	0.11	0.50	0.50	0.11	0.11	0.11	0.11	0.11	0.11
l, Upstream Filtering Factor	1.00	1.00	1.00	1.00	1.00	1.00	1.00	1.00	1.00	1.00	1.00
d2, Incremental Delay [s]	8.74	1.98	11.26	1.35	0.06	11.16	5.08	0.09	8.90	0.36	0.45
d3, Initial Queue Delay [s]	0.00	0.00	0.00	0.00	0.00	0.00	0.00	0.00	0.00	0.00	0.00
Rp, platoon ratio	1.00	1.00	1.00	1.00	1.00	1.00	1.00	1.00	1.00	1.00	1.00
PF, progression factor	1.00	1.00	1.00	1.00	1.00	1.00	1.00	1.00	1.00	1.00	1.00

Lane Group Results

X, volume / capacity	0.81	0.51	0.98	0.51	0.03	0.78	0.94	0.14	0.89	0.51	0.37
d, Delay for Lane Group [s/veh]	61.73	39.32	58.08	29.66	16.61	66.73	46.08	20.59	63.36	33.37	31.74
Lane Group LOS	E	D	E	C	B	E	D	C	E	C	C
Critical Lane Group	No	Yes	Yes	No	No	No	Yes	No	Yes	No	No
50th-Percentile Queue Length [veh/ln]	4.50	6.05	11.42	7.37	0.27	2.78	14.67	1.53	4.07	6.80	4.19
50th-Percentile Queue Length [ft/ln]	112.62	151.21	285.38	184.37	6.75	69.56	366.79	38.33	101.81	169.88	104.81
95th-Percentile Queue Length [veh/ln]	7.99	10.08	16.96	11.83	0.49	5.01	20.95	2.76	7.33	11.07	7.55
95th-Percentile Queue Length [ft/ln]	199.64	252.04	423.90	295.71	12.15	125.21	523.83	68.99	183.26	276.76	188.66

Movement, Approach, & Intersection Results

d_M, Delay for Movement [s/veh]	61.73	39.32	0.00	58.08	29.66	16.61	66.73	46.08	20.59	63.36	33.37	31.74
Movement LOS	E	D		E	C	B	E	D	C	E	C	C
d_A, Approach Delay [s/veh]	35.59			43.87			45.55			40.45		
Approach LOS	D			D			D			D		
d_I, Intersection Delay [s/veh]	42.29											
Intersection LOS	D											
Intersection V/C	0.706											

Other Modes

g_Walk,mi, Effective Walk Time [s]	11.0	11.0	11.0	11.0
M_corner, Corner Circulation Area [ft ² /ped]	0.00	0.00	0.00	0.00
M_CW, Crosswalk Circulation Area [ft ² /ped]	0.00	0.00	0.00	0.00
d_p, Pedestrian Delay [s]	49.52	49.52	49.52	49.52
I_p,int, Pedestrian LOS Score for Intersectio	2.989	3.242	3.075	3.455
Crosswalk LOS	C	C	C	C
s_b, Saturation Flow Rate of the bicycle lane	2000	2000	2000	2000
c_b, Capacity of the bicycle lane [bicycles/h]	517	467	617	350
d_b, Bicycle Delay [s]	33.02	35.28	28.72	40.85
I_b,int, Bicycle LOS Score for Intersection	2.082	2.765	2.603	2.550
Bicycle LOS	B	C	B	B

Sequence

Ring 1	1	2	3	4	-	-	-	-	-	-	-	-	-	-	-	-
Ring 2	5	6	7	8	-	-	-	-	-	-	-	-	-	-	-	-
Ring 3	-	-	-	-	-	-	-	-	-	-	-	-	-	-	-	-
Ring 4	-	-	-	-	-	-	-	-	-	-	-	-	-	-	-	-

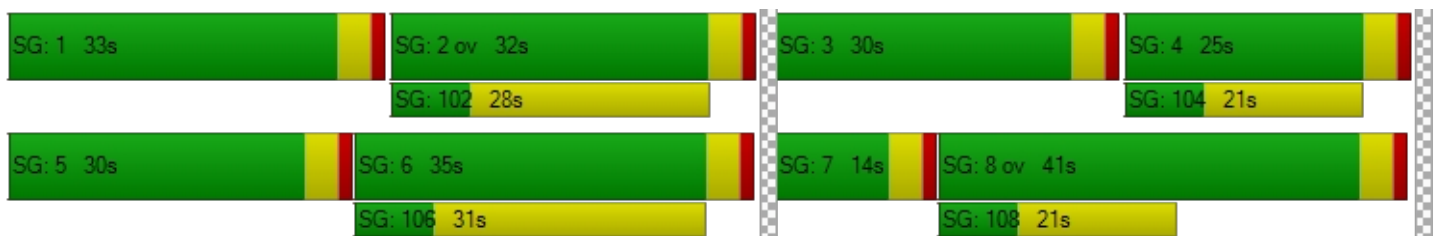

Intersection Level Of Service Report
Intersection 2: Marksheffel Rd/Lorson Bl

Control Type:	Signalized	Delay (sec / veh):	16.4
Analysis Method:	HCM 7th Edition	Level Of Service:	B
Analysis Period:	15 minutes	Volume to Capacity (v/c):	0.674

Intersection Setup

Name	Marksheffel Rd		Marksheffel Rd		Lorson Bl	
Approach	Northbound		Southbound		Westbound	
Lane Configuration	↑↔		↔↓		↔↔	
Turning Movement	Thru	Right	Left	Thru	Left	Right
Lane Width [ft]	12.00	12.00	12.00	12.00	12.00	12.00
No. of Lanes in Entry Pocket	0	1	1	0	1	0
Entry Pocket Length [ft]	100.00	500.00	580.00	100.00	510.00	100.00
No. of Lanes in Exit Pocket	0	0	0	0	0	0
Exit Pocket Length [ft]	0.00	0.00	0.00	0.00	0.00	0.00
Speed [mph]	55.00		55.00		25.00	
Grade [%]	0.00		0.00		0.00	
Curb Present	No		No		No	
Crosswalk	Yes		Yes		Yes	

Volumes

Name	Marksheffel Rd		Marksheffel Rd		Lorson Bl	
Base Volume Input [veh/h]	492	534	211	558	316	163
Base Volume Adjustment Factor	1.0000	1.0000	1.0000	1.0000	1.0000	1.0000
Heavy Vehicles Percentage [%]	2.00	2.00	2.00	2.00	2.00	2.00
Proportion of CAVs [%]	0.00					
Growth Factor	1.1660	1.0000	1.0000	1.1660	1.0000	1.0000
In-Process Volume [veh/h]	0	0	0	0	0	0
Site-Generated Trips [veh/h]	59	0	0	58	0	0
Diverted Trips [veh/h]	0	0	0	0	0	0
Pass-by Trips [veh/h]	0	0	0	0	0	0
Existing Site Adjustment Volume [veh/h]	0	0	0	0	0	0
Other Volume [veh/h]	0	0	0	0	0	0
Right Turn on Red Volume [veh/h]	0	267	0	0	0	82
Total Hourly Volume [veh/h]	633	267	211	709	316	81
Peak Hour Factor	0.8500	0.8500	0.8500	0.8500	0.8500	0.8500
Other Adjustment Factor	1.0000	1.0000	1.0000	1.0000	1.0000	1.0000
Total 15-Minute Volume [veh/h]	186	79	62	209	93	24
Total Analysis Volume [veh/h]	745	314	248	834	372	95
Presence of On-Street Parking	No	No	No	No	No	No
On-Street Parking Maneuver Rate [/h]	0	0	0	0	0	0
Local Bus Stopping Rate [/h]	0	0	0	0	0	0
v_do, Outbound Pedestrian Volume crossing	0		0		0	
v_di, Inbound Pedestrian Volume crossing m	0		0		0	
v_co, Outbound Pedestrian Volume crossing	0		0		0	
v_ci, Inbound Pedestrian Volume crossing mi	0		0		0	
v_ab, Corner Pedestrian Volume [ped/h]	0		0		0	
Bicycle Volume [bicycles/h]	0		0		0	

Intersection Settings

Located in CBD	No
Signal Coordination Group	-
Cycle Length [s]	60
Active Pattern	Pattern 1
Coordination Type	Time of Day Pattern Coordinated
Actuation Type	Fully actuated
Offset [s]	0.0
Offset Reference	Lead Green - Beginning of First Green
Permissive Mode	SingleBand
Lost time [s]	0.00

Phasing & Timing

Control Type	Permissive	Permissive	Permissive	Permissive	Permissive	Permissive
Signal Group	6	0	0	2	7	0
Auxiliary Signal Groups						
Lead / Lag	-	-	-	-	Lead	-
Minimum Green [s]	10	0	0	10	5	0
Maximum Green [s]	20	0	0	20	32	0
Amber [s]	3.0	0.0	0.0	3.0	3.0	0.0
All red [s]	1.0	0.0	0.0	1.0	1.0	0.0
Split [s]	36	0	0	36	24	0
Vehicle Extension [s]	3.0	0.0	0.0	3.0	3.0	0.0
Walk [s]	7	0	0	7	7	0
Pedestrian Clearance [s]	10	0	0	10	13	0
Delayed Vehicle Green [s]	0.0	0.0	0.0	0.0	0.0	0.0
Rest In Walk	No			No	No	
I1, Start-Up Lost Time [s]	2.0	0.0	0.0	2.0	2.0	0.0
I2, Clearance Lost Time [s]	2.0	0.0	0.0	2.0	2.0	0.0
Minimum Recall	No			No	No	
Maximum Recall	No			No	No	
Pedestrian Recall	No			No	No	
Detector Location [ft]	0.0	0.0	0.0	0.0	0.0	0.0
Detector Length [ft]	0.0	0.0	0.0	0.0	0.0	0.0
I, Upstream Filtering Factor	1.00	1.00	1.00	1.00	1.00	1.00

Exclusive Pedestrian Phase

Pedestrian Signal Group	0
Pedestrian Walk [s]	0
Pedestrian Clearance [s]	0

Lane Group Calculations

Lane Group	C	R	L	C	L	R
C, Cycle Length [s]	60	60	60	60	60	60
L, Total Lost Time per Cycle [s]	4.00	4.00	4.00	4.00	4.00	4.00
l1_p, Permitted Start-Up Lost Time [s]	0.00	0.00	2.00	0.00	0.00	0.00
l2, Clearance Lost Time [s]	2.00	2.00	2.00	2.00	2.00	2.00
g_i, Effective Green Time [s]	37	37	37	37	15	15
g / C, Green / Cycle	0.62	0.62	0.62	0.62	0.24	0.24
(v / s)_i Volume / Saturation Flow Rate	0.40	0.20	0.47	0.45	0.21	0.06
s, saturation flow rate [veh/h]	1870	1589	533	1870	1781	1589
c, Capacity [veh/h]	1162	987	291	1162	437	390
d1, Uniform Delay [s]	7.16	5.36	23.40	7.77	21.59	18.17
k, delay calibration	0.50	0.50	0.50	0.50	0.11	0.11
l, Upstream Filtering Factor	1.00	1.00	1.00	1.00	1.00	1.00
d2, Incremental Delay [s]	2.72	0.85	25.94	3.83	4.74	0.32
d3, Initial Queue Delay [s]	0.00	0.00	0.00	0.00	0.00	0.00
Rp, platoon ratio	1.00	1.00	1.00	1.00	1.00	1.00
PF, progression factor	1.00	1.00	1.00	1.00	1.00	1.00

Lane Group Results

X, volume / capacity	0.64	0.32	0.85	0.72	0.85	0.24
d, Delay for Lane Group [s/veh]	9.88	6.21	49.33	11.60	26.33	18.49
Lane Group LOS	A	A	D	B	C	B
Critical Lane Group	No	No	Yes	No	Yes	No
50th-Percentile Queue Length [veh/ln]	3.71	1.13	5.23	4.67	5.24	1.04
50th-Percentile Queue Length [ft/ln]	92.63	28.14	130.73	116.78	131.10	25.95
95th-Percentile Queue Length [veh/ln]	6.67	2.03	8.98	8.22	9.00	1.87
95th-Percentile Queue Length [ft/ln]	166.74	50.65	224.48	205.39	225.00	46.70

Movement, Approach, & Intersection Results

d_M, Delay for Movement [s/veh]	9.88	6.21	49.33	11.60	26.33	18.49
Movement LOS	A	A	D	B	C	B
d_A, Approach Delay [s/veh]	8.79		20.25		24.74	
Approach LOS	A		C		C	
d_I, Intersection Delay [s/veh]	16.40					
Intersection LOS	B					
Intersection V/C	0.674					

Other Modes

g_Walk,mi, Effective Walk Time [s]	11.0	11.0	11.0
M_corner, Corner Circulation Area [ft ² /ped]	0.00	0.00	0.00
M_CW, Crosswalk Circulation Area [ft ² /ped]	0.00	0.00	0.00
d_p, Pedestrian Delay [s]	20.01	20.01	20.01
I_p,int, Pedestrian LOS Score for Intersectio	3.806	3.112	2.760
Crosswalk LOS	D	C	C
s_b, Saturation Flow Rate of the bicycle lane	2000	2000	2000
c_b, Capacity of the bicycle lane [bicycles/h]	1067	1067	667
d_b, Bicycle Delay [s]	6.53	6.53	13.33
I_b,int, Bicycle LOS Score for Intersection	3.748	3.345	1.560
Bicycle LOS	D	C	A

Sequence





Ring 1	-	2	-	-	-	-	-	-	-	-	-	-	-	-	-	-	-
Ring 2	-	6	7	-	-	-	-	-	-	-	-	-	-	-	-	-	-
Ring 3	-	-	-	-	-	-	-	-	-	-	-	-	-	-	-	-	-
Ring 4	-	-	-	-	-	-	-	-	-	-	-	-	-	-	-	-	-



Intersection Level Of Service Report
Intersection 3: Fontaine Bl/Carriage Meadows Dr

Control Type:	Signalized	Delay (sec / veh):	10.3
Analysis Method:	HCM 7th Edition	Level Of Service:	B
Analysis Period:	15 minutes	Volume to Capacity (v/c):	0.623

Intersection Setup

Name	Carriage Meadows Dr			Carriage Meadows Dr			Fontaine Bl			Fontaine Bl		
Approach	Northbound			Southbound			Eastbound			Westbound		
Lane Configuration												
Turning Movement	Left	Thru	Right	Left	Thru	Right	Left	Thru	Right	Left	Thru	Right
Lane Width [ft]	12.00	12.00	12.00	12.00	12.00	12.00	12.00	12.00	12.00	12.00	12.00	12.00
No. of Lanes in Entry Pocket	1	0	1	1	0	1	1	0	0	1	0	1
Entry Pocket Length [ft]	100.00	100.00	100.00	100.00	100.00	100.00	510.00	100.00	100.00	330.00	100.00	330.00
No. of Lanes in Exit Pocket	0	0	0	0	0	0	0	0	0	0	0	0
Exit Pocket Length [ft]	0.00	0.00	0.00	0.00	0.00	0.00	0.00	0.00	0.00	0.00	0.00	0.00
Speed [mph]	25.00			25.00			45.00			45.00		
Grade [%]	0.00			0.00			0.00			0.00		
Curb Present	No			No			No			No		
Crosswalk	Yes			Yes			Yes			Yes		

Volumes

Name	Carriage Meadows Dr			Carriage Meadows Dr			Fontaine Bl			Fontaine Bl		
Base Volume Input [veh/h]	23	5	8	5	5	8	56	1726	44	8	898	6
Base Volume Adjustment Factor	1.0000	1.0000	1.0000	1.0000	1.0000	1.0000	1.0000	1.0000	1.0000	1.0000	1.0000	1.0000
Heavy Vehicles Percentage [%]	2.00	2.00	2.00	2.00	2.00	2.00	2.00	2.00	2.00	2.00	2.00	2.00
Proportion of CAVs [%]	0.00											
Growth Factor	1.1660	1.0000	1.1660	1.1660	1.0000	1.1660	1.1660	1.0000	1.1660	1.1660	1.0000	1.1660
In-Process Volume [veh/h]	0	0	0	0	0	0	0	0	0	0	0	0
Site-Generated Trips [veh/h]	1	1	0	57	2	110	67	0	0	0	27	31
Diverted Trips [veh/h]	0	0	0	0	0	0	0	0	0	0	0	0
Pass-by Trips [veh/h]	0	0	0	0	0	0	0	0	0	0	0	0
Existing Site Adjustment Volume [veh/h]	0	0	0	0	0	0	0	0	0	0	0	0
Other Volume [veh/h]	0	0	0	0	0	0	0	0	0	0	0	0
Right Turn on Red Volume [veh/h]	0	0	5	0	0	60	0	0	26	0	0	19
Total Hourly Volume [veh/h]	28	6	4	63	7	59	132	1726	25	9	925	19
Peak Hour Factor	0.8500	0.8500	0.8500	0.8500	0.8500	0.8500	0.8500	0.8500	0.8500	0.8500	0.8500	0.8500
Other Adjustment Factor	1.0000	1.0000	1.0000	1.0000	1.0000	1.0000	1.0000	1.0000	1.0000	1.0000	1.0000	1.0000
Total 15-Minute Volume [veh/h]	8	2	1	19	2	17	39	508	7	3	272	6
Total Analysis Volume [veh/h]	33	7	5	74	8	69	155	2031	29	11	1088	22
Presence of On-Street Parking	No		No	No		No	No		No	No		No
On-Street Parking Maneuver Rate [/h]	0	0	0	0	0	0	0	0	0	0	0	0
Local Bus Stopping Rate [/h]	0	0	0	0	0	0	0	0	0	0	0	0
v_do, Outbound Pedestrian Volume crossing	0			0			0			0		
v_di, Inbound Pedestrian Volume crossing m	0			0			0			0		
v_co, Outbound Pedestrian Volume crossing	0			0			0			0		
v_ci, Inbound Pedestrian Volume crossing mi	0			0			0			0		
v_ab, Corner Pedestrian Volume [ped/h]	0			0			0			0		
Bicycle Volume [bicycles/h]	0			0			0			0		

Intersection Settings

Located in CBD	No
Signal Coordination Group	-
Cycle Length [s]	90
Active Pattern	Pattern 1
Coordination Type	Time of Day Pattern Coordinated
Actuation Type	Semi-actuated
Offset [s]	0.0
Offset Reference	Lead Green - Beginning of First Green
Permissive Mode	SingleBand
Lost time [s]	0.00

Phasing & Timing

Control Type	Permiss	Permiss	Permiss	Permiss	Permiss	Permiss	Protecte	Permiss	Permiss	Permiss	Permiss	Permiss
Signal Group	0	8	0	0	4	0	5	2	0	0	6	0
Auxiliary Signal Groups												
Lead / Lag	-	-	-	-	-	-	Lead	-	-	-	-	-
Minimum Green [s]	0	10	0	0	10	0	5	10	0	0	10	0
Maximum Green [s]	0	34	0	0	34	0	5	108	0	0	108	0
Amber [s]	0.0	3.0	0.0	0.0	3.0	0.0	3.0	3.0	0.0	0.0	3.0	0.0
All red [s]	0.0	1.0	0.0	0.0	1.0	0.0	1.0	1.0	0.0	0.0	1.0	0.0
Split [s]	0	38	0	0	38	0	27	52	0	0	25	0
Vehicle Extension [s]	0.0	3.0	0.0	0.0	3.0	0.0	3.0	3.0	0.0	0.0	3.0	0.0
Walk [s]	0	7	0	0	7	0	0	7	0	0	7	0
Pedestrian Clearance [s]	0	23	0	0	27	0	0	7	0	0	14	0
Delayed Vehicle Green [s]	0.0	0.0	0.0	0.0	0.0	0.0	0.0	0.0	0.0	0.0	0.0	0.0
Rest In Walk		No			No			No			No	
I1, Start-Up Lost Time [s]	0.0	2.0	0.0	0.0	2.0	0.0	2.0	2.0	0.0	0.0	2.0	0.0
I2, Clearance Lost Time [s]	0.0	2.0	0.0	0.0	2.0	0.0	2.0	2.0	0.0	0.0	2.0	0.0
Minimum Recall		No			No		No	No			No	
Maximum Recall		No			No		No	No			No	
Pedestrian Recall		No			No		No	No			No	
Detector Location [ft]	0.0	0.0	0.0	0.0	0.0	0.0	0.0	0.0	0.0	0.0	0.0	0.0
Detector Length [ft]	0.0	0.0	0.0	0.0	0.0	0.0	0.0	0.0	0.0	0.0	0.0	0.0
I, Upstream Filtering Factor	1.00	1.00	1.00	1.00	1.00	1.00	1.00	1.00	1.00	1.00	1.00	1.00

Exclusive Pedestrian Phase

Pedestrian Signal Group	0
Pedestrian Walk [s]	0
Pedestrian Clearance [s]	0

Lane Group Calculations

Lane Group	L	C	R	L	C	R	L	C	R	L	C	R
C, Cycle Length [s]	90	90	90	90	90	90	90	90	90	90	90	90
L, Total Lost Time per Cycle [s]	4.00	4.00	4.00	4.00	4.00	4.00	4.00	4.00	4.00	4.00	4.00	4.00
l1_p, Permitted Start-Up Lost Time [s]	2.00	0.00	0.00	2.00	0.00	0.00	0.00	0.00	0.00	2.00	0.00	0.00
l2, Clearance Lost Time [s]	2.00	2.00	2.00	2.00	2.00	2.00	2.00	2.00	2.00	2.00	2.00	2.00
g_i, Effective Green Time [s]	10	10	10	10	10	10	10	72	72	58	58	58
g / C, Green / Cycle	0.11	0.11	0.11	0.11	0.11	0.11	0.11	0.80	0.80	0.65	0.65	0.65
(v / s)_i Volume / Saturation Flow Rate	0.02	0.00	0.00	0.05	0.00	0.04	0.09	0.57	0.02	0.05	0.31	0.01
s, saturation flow rate [veh/h]	1322	1870	1589	1402	1870	1589	1781	3560	1589	203	3560	1589
c, Capacity [veh/h]	195	205	174	203	205	174	192	2854	1274	151	2311	1032
d1, Uniform Delay [s]	38.47	35.81	35.79	39.56	35.83	37.29	39.22	4.13	1.81	20.20	7.98	5.62
k, delay calibration	0.11	0.11	0.11	0.11	0.11	0.11	0.11	0.50	0.50	0.50	0.50	0.50
l, Upstream Filtering Factor	1.00	1.00	1.00	1.00	1.00	1.00	1.00	1.00	1.00	1.00	1.00	1.00
d2, Incremental Delay [s]	0.41	0.07	0.07	1.10	0.08	1.46	7.71	1.54	0.03	0.94	0.69	0.04
d3, Initial Queue Delay [s]	0.00	0.00	0.00	0.00	0.00	0.00	0.00	0.00	0.00	0.00	0.00	0.00
Rp, platoon ratio	1.00	1.00	1.00	1.00	1.00	1.00	1.00	1.00	1.00	1.00	1.00	1.00
PF, progression factor	1.00	1.00	1.00	1.00	1.00	1.00	1.00	1.00	1.00	1.00	1.00	1.00

Lane Group Results

X, volume / capacity	0.17	0.03	0.03	0.37	0.04	0.40	0.81	0.71	0.02	0.07	0.47	0.02
d, Delay for Lane Group [s/veh]	38.87	35.88	35.85	40.66	35.91	38.75	46.93	5.67	1.84	21.14	8.67	5.66
Lane Group LOS	D	D	D	D	D	D	D	A	A	C	A	A
Critical Lane Group	No	No	No	Yes	No	No	No	Yes	No	No	No	No
50th-Percentile Queue Length [veh/ln]	0.70	0.14	0.10	1.64	0.16	1.49	3.59	3.88	0.05	0.19	4.29	0.13
50th-Percentile Queue Length [ft/ln]	17.62	3.54	2.54	40.94	4.05	37.13	89.84	97.06	1.31	4.68	107.22	3.17
95th-Percentile Queue Length [veh/ln]	1.27	0.25	0.18	2.95	0.29	2.67	6.47	6.99	0.09	0.34	7.69	0.23
95th-Percentile Queue Length [ft/ln]	31.72	6.37	4.57	73.69	7.29	66.84	161.71	174.72	2.36	8.42	192.13	5.70

Movement, Approach, & Intersection Results

d_M, Delay for Movement [s/veh]	38.87	35.88	35.85	40.66	35.91	38.75	46.93	5.67	1.84	21.14	8.67	5.66
Movement LOS	D	D	D	D	D	D	D	A	A	C	A	A
d_A, Approach Delay [s/veh]	38.07			39.53			8.50			8.74		
Approach LOS	D			D			A			A		
d_I, Intersection Delay [s/veh]	10.28											
Intersection LOS	B											
Intersection V/C	0.623											

Other Modes

g_Walk,mi, Effective Walk Time [s]	11.0	11.0	11.0	11.0
M_corner, Corner Circulation Area [ft ² /ped]	0.00	0.00	0.00	0.00
M_CW, Crosswalk Circulation Area [ft ² /ped]	0.00	0.00	0.00	0.00
d_p, Pedestrian Delay [s]	34.67	34.67	34.67	34.67
I_p,int, Pedestrian LOS Score for Intersectio	2.179	2.300	3.407	3.378
Crosswalk LOS	B	B	C	C
s_b, Saturation Flow Rate of the bicycle lane	2000	2000	2000	2000
c_b, Capacity of the bicycle lane [bicycles/h]	756	756	1067	467
d_b, Bicycle Delay [s]	17.42	17.42	9.80	26.45
I_b,int, Bicycle LOS Score for Intersection	1.642	1.908	3.408	2.500
Bicycle LOS	A	A	C	B

Sequence

Ring 1	-	2	-	4	-	-	-	-	-	-	-	-	-	-	-	-
Ring 2	5	6	-	8	-	-	-	-	-	-	-	-	-	-	-	-
Ring 3	-	-	-	-	-	-	-	-	-	-	-	-	-	-	-	-
Ring 4	-	-	-	-	-	-	-	-	-	-	-	-	-	-	-	-



Intersection Level Of Service Report
Intersection 4: Marksheffel Rd/West Driveway

Control Type:	Two-way stop	Delay (sec / veh):	12.4
Analysis Method:	HCM 7th Edition	Level Of Service:	B
Analysis Period:	15 minutes	Volume to Capacity (v/c):	0.072

Intersection Setup

Name	Marksheffel Rd		Marksheffel Rd		West Driveway	
Approach	Northbound		Southbound		Westbound	
Lane Configuration	↔				↔	
Turning Movement	Thru	Right	Left	Thru	Left	Right
Lane Width [ft]	12.00	12.00	12.00	12.00	12.00	12.00
No. of Lanes in Entry Pocket	0	1	1	0	0	0
Entry Pocket Length [ft]	100.00	100.00	100.00	100.00	100.00	100.00
No. of Lanes in Exit Pocket	0	0	0	1	0	0
Exit Pocket Length [ft]	0.00	0.00	0.00	590.00	0.00	0.00
Speed [mph]	55.00		55.00		25.00	
Grade [%]	0.00		0.00		0.00	
Crosswalk	No		No		Yes	

Volumes

Name	Marksheffel Rd		Marksheffel Rd		West Driveway	
Base Volume Input [veh/h]	812	0	0	1244	0	0
Base Volume Adjustment Factor	1.0000	1.0000	1.0000	1.0000	1.0000	1.0000
Heavy Vehicles Percentage [%]	2.00	2.00	2.00	2.00	2.00	2.00
Growth Factor	1.0000	1.1660	1.1660	1.0000	1.1660	1.1660
In-Process Volume [veh/h]	0	0	0	0	0	0
Site-Generated Trips [veh/h]	19	75	0	51	0	32
Diverted Trips [veh/h]	0	0	0	0	0	0
Pass-by Trips [veh/h]	0	0	0	0	0	0
Existing Site Adjustment Volume [veh/h]	0	0	0	0	0	0
Other Volume [veh/h]	0	0	0	0	0	0
Total Hourly Volume [veh/h]	831	75	0	1295	0	32
Peak Hour Factor	0.8500	0.8500	0.8500	0.8500	0.8500	0.8500
Other Adjustment Factor	1.0000	1.0000	1.0000	1.0000	1.0000	1.0000
Total 15-Minute Volume [veh/h]	244	22	0	381	0	9
Total Analysis Volume [veh/h]	978	88	0	1524	0	38
Pedestrian Volume [ped/h]	0		0		0	

Intersection Settings

Priority Scheme	Free	Free	Stop
Flared Lane			
Storage Area [veh]	0	0	0
Two-Stage Gap Acceptance			No
Number of Storage Spaces in Median	0	0	0

Movement, Approach, & Intersection Results

V/C, Movement V/C Ratio	0.01	0.00	0.00	0.02	0.00	0.07
d_M, Delay for Movement [s/veh]	0.00	0.00	0.00	0.00	0.00	12.39
Movement LOS	A	A		A		B
95th-Percentile Queue Length [veh/ln]	0.00	0.00	0.00	0.00	0.00	0.23
95th-Percentile Queue Length [ft/ln]	0.00	0.00	0.00	0.00	0.00	5.83
d_A, Approach Delay [s/veh]	0.00		0.00		12.39	
Approach LOS	A		A		B	
d_I, Intersection Delay [s/veh]	0.18					
Intersection LOS	B					

Intersection Level Of Service Report
Intersection 5: Carriage Meadows Dr/East Driveway

Control Type:	Two-way stop	Delay (sec / veh):	12.3
Analysis Method:	HCM 7th Edition	Level Of Service:	B
Analysis Period:	15 minutes	Volume to Capacity (v/c):	0.026

Intersection Setup

Name	Carriage Meadows Dr			Carriage Meadows Dr			East Driveway			Westbound		
Approach	Northbound			Southbound			Eastbound			Westbound		
Lane Configuration												
Turning Movement	Left	Thru	Right	Left	Thru	Right	Left	Thru	Right	Left	Thru	Right
Lane Width [ft]	12.00	12.00	12.00	12.00	12.00	12.00	12.00	12.00	12.00	12.00	12.00	12.00
No. of Lanes in Entry Pocket	1	0	0	0	0	0	1	0	0	0	0	0
Entry Pocket Length [ft]	100.00	100.00	100.00	100.00	100.00	100.00	100.00	100.00	100.00	100.00	100.00	100.00
No. of Lanes in Exit Pocket	0	0	0	0	0	0	0	0	0	0	0	0
Exit Pocket Length [ft]	0.00	0.00	0.00	0.00	0.00	0.00	0.00	0.00	0.00	0.00	0.00	0.00
Speed [mph]	25.00			25.00			25.00			30.00		
Grade [%]	0.00			0.00			0.00			0.00		
Crosswalk	No			No			Yes			Yes		

Volumes

Name	Carriage Meadows Dr			Carriage Meadows Dr			East Driveway			Westbound		
Base Volume Input [veh/h]	0	0	0	0	0	0	0	0	0	0	0	0
Base Volume Adjustment Factor	1.0000	1.0000	1.0000	1.0000	1.0000	1.0000	1.0000	1.0000	1.0000	1.0000	1.0000	1.0000
Heavy Vehicles Percentage [%]	2.00	2.00	2.00	2.00	2.00	2.00	2.00	2.00	2.00	2.00	2.00	2.00
Growth Factor	1.1660	1.1660	1.1660	1.1660	1.1660	1.1660	1.1660	1.1660	1.1660	1.1660	1.1660	1.1660
In-Process Volume [veh/h]	0	0	0	0	0	0	0	0	0	0	0	0
Site-Generated Trips [veh/h]	85	0	14	0	0	2	2	0	158	11	0	0
Diverted Trips [veh/h]	0	0	0	0	0	0	0	0	0	0	0	0
Pass-by Trips [veh/h]	0	0	0	0	0	0	0	0	0	0	0	0
Existing Site Adjustment Volume [veh/h]	0	0	0	0	0	0	0	0	0	0	0	0
Other Volume [veh/h]	0	0	0	0	0	0	0	0	0	0	0	0
Total Hourly Volume [veh/h]	85	0	14	0	0	2	2	0	158	11	0	0
Peak Hour Factor	0.8500	0.8500	0.8500	0.8500	0.8500	0.8500	0.8500	0.8500	0.8500	0.8500	0.8500	0.8500
Other Adjustment Factor	1.0000	1.0000	1.0000	1.0000	1.0000	1.0000	1.0000	1.0000	1.0000	1.0000	1.0000	1.0000
Total 15-Minute Volume [veh/h]	25	0	4	0	0	1	1	0	46	3	0	0
Total Analysis Volume [veh/h]	100	0	16	0	0	2	2	0	186	13	0	0
Pedestrian Volume [ped/h]	0			0			0			0		

Intersection Settings

Priority Scheme	Free	Free	Stop	Stop
Flared Lane			No	No
Storage Area [veh]	0	0	0	0
Two-Stage Gap Acceptance			No	No
Number of Storage Spaces in Median	0	0	0	0

Movement, Approach, & Intersection Results

V/C, Movement V/C Ratio	0.06	0.00	0.00	0.00	0.00	0.00	0.00	0.00	0.17	0.03	0.00	0.00
d_M, Delay for Movement [s/veh]	7.37	0.00	0.00	7.25	0.00	0.00	10.14	11.32	9.01	12.31	10.77	8.54
Movement LOS	A	A	A	A	A	A	B	B	A	B	B	A
95th-Percentile Queue Length [veh/ln]	0.20	0.00	0.00	0.00	0.00	0.00	0.01	0.62	0.62	0.08	0.08	0.08
95th-Percentile Queue Length [ft/ln]	4.93	0.00	0.00	0.00	0.00	0.00	0.21	15.46	15.46	1.98	1.98	1.98
d_A, Approach Delay [s/veh]	6.35			0.00			9.02			12.31		
Approach LOS	A			A			A			B		
d_I, Intersection Delay [s/veh]	8.13											
Intersection LOS	B											

Intersection Level Of Service Report
Intersection 7: Fontaine BI/Middle Driveway

Control Type:	Two-way stop	Delay (sec / veh):	0.0
Analysis Method:	HCM 7th Edition	Level Of Service:	A
Analysis Period:	15 minutes	Volume to Capacity (v/c):	0.024

Intersection Setup

Name	LRCS			Middle Driveway			Fontaine BI			Fontaine BI		
Approach	Northbound			Southbound			Eastbound			Westbound		
Lane Configuration	↶						↶			↶		
Turning Movement	Left	Thru	Right	Left	Thru	Right	Left	Thru	Right	Left	Thru	Right
Lane Width [ft]	12.00	12.00	12.00	12.00	12.00	12.00	12.00	12.00	12.00	12.00	12.00	12.00
No. of Lanes in Entry Pocket	0	0	0	0	0	0	0	0	0	0	0	0
Entry Pocket Length [ft]	100.00	100.00	100.00	100.00	100.00	100.00	100.00	100.00	100.00	100.00	100.00	100.00
No. of Lanes in Exit Pocket	0	0	0	0	0	0	0	0	0	0	0	0
Exit Pocket Length [ft]	0.00	0.00	0.00	0.00	0.00	0.00	0.00	0.00	0.00	0.00	0.00	0.00
Speed [mph]	25.00			25.00			45.00			45.00		
Grade [%]	0.00			0.00			0.00			0.00		
Crosswalk	Yes			Yes			No			No		

Volumes

Name	LRCS			Middle Driveway			Fontaine BI			Fontaine BI		
Base Volume Input [veh/h]	0	0	0	0	0	0	0	1726	0	0	934	0
Base Volume Adjustment Factor	1.0000	1.0000	1.0000	1.0000	1.0000	1.0000	1.0000	1.0000	1.0000	1.0000	1.0000	1.0000
Heavy Vehicles Percentage [%]	2.00	2.00	2.00	2.00	2.00	2.00	2.00	2.00	2.00	2.00	2.00	2.00
Growth Factor	1.1660	1.1660	1.1660	1.1660	1.1660	1.1660	1.1660	1.1660	1.1660	1.1660	1.0000	1.1660
In-Process Volume [veh/h]	0	0	0	0	0	0	0	0	0	0	0	0
Site-Generated Trips [veh/h]	0	0	0	0	0	0	0	67	0	0	110	28
Diverted Trips [veh/h]	0	0	0	0	0	0	0	0	0	0	0	0
Pass-by Trips [veh/h]	0	0	0	0	0	0	0	0	0	0	0	0
Existing Site Adjustment Volume [veh/h]	0	0	0	0	0	0	0	0	0	0	0	0
Other Volume [veh/h]	0	0	0	0	0	0	0	0	0	0	0	0
Total Hourly Volume [veh/h]	0	0	0	0	0	0	0	2080	0	0	1044	28
Peak Hour Factor	0.8500	0.8500	0.8500	0.8500	0.8500	0.8500	0.8500	0.8500	0.8500	0.8500	0.8500	0.8500
Other Adjustment Factor	1.0000	1.0000	1.0000	1.0000	1.0000	1.0000	1.0000	1.0000	1.0000	1.0000	1.0000	1.0000
Total 15-Minute Volume [veh/h]	0	0	0	0	0	0	0	612	0	0	307	8
Total Analysis Volume [veh/h]	0	0	0	0	0	0	0	2447	0	0	1228	33
Pedestrian Volume [ped/h]	0			0			0			0		

Intersection Settings

Priority Scheme	Stop	Stop	Free	Free
Flared Lane				
Storage Area [veh]	0	0	0	0
Two-Stage Gap Acceptance	No			
Number of Storage Spaces in Median	0	0	0	0

Movement, Approach, & Intersection Results

V/C, Movement V/C Ratio	0.00	0.00	0.00	0.00	0.00	0.00	0.00	0.02	0.00	0.00	0.01	0.00
d_M, Delay for Movement [s/veh]	0.00	0.00	26.05	0.00	0.00	0.00	0.00	0.00	0.00	0.00	0.00	0.00
Movement LOS			D					A	A		A	A
95th-Percentile Queue Length [veh/ln]	0.00	0.00	0.00	0.00	0.00	0.00	0.00	0.00	0.00	0.00	0.00	0.00
95th-Percentile Queue Length [ft/ln]	0.00	0.00	0.00	0.00	0.00	0.00	0.00	0.00	0.00	0.00	0.00	0.00
d_A, Approach Delay [s/veh]	26.05		0.00		0.00		0.00		0.00			
Approach LOS	D		A		A		A		A			
d_I, Intersection Delay [s/veh]	0.00											
Intersection LOS	A											

Signal Warrants Report For Intersection 4: Marksheffel Rd/West Driveway

Warrants Summary

Warrant	Name	Met?
#1	Eight Hour Vehicular Volume	No
#2	Four Hour Vehicular Volume	No
#3	Peak Hour	No

Intersection Warrants Parameters

Major Approaches	N, S
Minor Approaches	E
Speed > 40mph	Yes
Population < 10,000	No
Warrant Factor	70%

Warrant Analysis Traffic Volumes

Hour	Major Streets		Minor Streets
	N	S	E
1	1295	906	32
2	1256	879	31
3	1230	861	30
4	1153	806	28
5	1023	716	25
6	1010	707	25
7	997	698	25
8	906	634	22
9	894	625	22
10	881	616	22
11	764	535	19
12	712	498	18
13	699	489	17
14	518	362	13
15	518	362	13
16	363	254	9
17	207	145	5
18	207	145	5
19	117	82	3
20	65	45	2
21	39	27	1
22	13	9	0
23	13	9	0
24	13	9	0

Warrant Analysis by Hour

Hour	Major Streets		Minor Street		Warrant 1 Condition A				Warrant 1 Condition B				Warrant 2	Warrant 3 Condition B
	Number	Volume	Number	Volume	100%	80%	70%	56%	100%	80%	70%	56%		
1	3	2201	1	32	No	No	No	No	No	No	No	No	No	No
2	3	2135	1	31	No	No	No	No	No	No	No	No	No	No
3	3	2091	1	30	No	No	No	No	No	No	No	No	No	No
4	3	1959	1	28	No	No	No	No	No	No	No	No	No	No
5	3	1739	1	25	No	No	No	No	No	No	No	No	No	No
6	3	1717	1	25	No	No	No	No	No	No	No	No	No	No
7	3	1695	1	25	No	No	No	No	No	No	No	No	No	No
8	3	1540	1	22	No	No	No	No	No	No	No	No	No	No
9	3	1519	1	22	No	No	No	No	No	No	No	No	No	No
10	3	1497	1	22	No	No	No	No	No	No	No	No	No	No
11	3	1299	1	19	No	No	No	No	No	No	No	No	No	No
12	3	1210	1	18	No	No	No	No	No	No	No	No	No	No
13	3	1188	1	17	No	No	No	No	No	No	No	No	No	No
14	3	880	1	13	No	No	No	No	No	No	No	No	No	No
15	3	880	1	13	No	No	No	No	No	No	No	No	No	No
16	3	617	1	9	No	No	No	No	No	No	No	No	No	No
17	3	352	1	5	No	No	No	No	No	No	No	No	No	No
18	3	352	1	5	No	No	No	No	No	No	No	No	No	No
19	3	199	1	3	No	No	No	No	No	No	No	No	No	No
20	3	110	1	2	No	No	No	No	No	No	No	No	No	No
21	3	66	1	1	No	No	No	No	No	No	No	No	No	No
22	3	22	1	0	No	No	No	No	No	No	No	No	No	No
23	3	22	1	0	No	No	No	No	No	No	No	No	No	No
24	3	22	1	0	No	No	No	No	No	No	No	No	No	No
Hours Met					0	0	0	0	0	0	0	0	0	0

Warrant 3 Condition A

Orientation	E
Total Stopped Delay Per Vehicle on Minor Approach (s)	12.4
Number of Lanes on Minor Street Approach	1
VehicleHours of Stopped Delay on Minor Approach (h:mm)	0:06
Delay Condition Met	No
Volume on Minor Street Approach During Same Hour	32
High Minor Volume Condition Met	No
Total Entering Volume on All Approaches During Same Hour	2233
Number of Approaches on Intersection	3
Total Volume Condition Met	Yes
Warrant Met for Approach	No
Warrant Met for Intersection	No

Signal Warrants Report For Intersection 5: Carriage Meadows Dr/East Driveway

Warrants Summary

Warrant	Name	Met?
#1	Eight Hour Vehicular Volume	No
#2	Four Hour Vehicular Volume	No
#3	Peak Hour	No

Intersection Warrants Parameters

Major Approaches	S, N
Minor Approaches	E, W
Speed > 40mph	No
Population < 10,000	No
Warrant Factor	100%

Warrant Analysis Traffic Volumes

Hour	Major Streets		Minor Streets	
	S	N	E	W
1	99	2	11	160
2	96	2	11	155
3	94	2	10	152
4	88	2	10	142
5	78	2	9	126
6	77	2	9	125
7	76	2	8	123
8	69	1	8	112
9	68	1	8	110
10	67	1	7	109
11	58	1	6	94
12	54	1	6	88
13	53	1	6	86
14	40	1	4	64
15	40	1	4	64
16	28	1	3	45
17	16	0	2	26
18	16	0	2	26
19	9	0	1	14
20	5	0	1	8
21	3	0	0	5
22	1	0	0	2
23	1	0	0	2
24	1	0	0	2

Warrant Analysis by Hour

Hour	Major Streets		Minor Street		Warrant 1 Condition A				Warrant 1 Condition B				Warrant 2	Warrant 3 Condition B
	Number	Volume	Number	Volume	100%	80%	70%	56%	100%	80%	70%	56%		
1	2	101	2	160	No	No	No	No	No	No	No	No	No	No
2	2	98	2	155	No	No	No	No	No	No	No	No	No	No
3	2	96	2	152	No	No	No	No	No	No	No	No	No	No
4	2	90	2	142	No	No	No	No	No	No	No	No	No	No
5	2	80	2	126	No	No	No	No	No	No	No	No	No	No
6	2	79	2	125	No	No	No	No	No	No	No	No	No	No
7	2	78	2	123	No	No	No	No	No	No	No	No	No	No
8	2	70	2	112	No	No	No	No	No	No	No	No	No	No
9	2	69	2	110	No	No	No	No	No	No	No	No	No	No
10	2	68	2	109	No	No	No	No	No	No	No	No	No	No
11	2	59	2	94	No	No	No	No	No	No	No	No	No	No
12	2	55	2	88	No	No	No	No	No	No	No	No	No	No
13	2	54	2	86	No	No	No	No	No	No	No	No	No	No
14	2	41	2	64	No	No	No	No	No	No	No	No	No	No
15	2	41	2	64	No	No	No	No	No	No	No	No	No	No
16	2	29	2	45	No	No	No	No	No	No	No	No	No	No
17	2	16	2	26	No	No	No	No	No	No	No	No	No	No
18	2	16	2	26	No	No	No	No	No	No	No	No	No	No
19	2	9	2	14	No	No	No	No	No	No	No	No	No	No
20	2	5	2	8	No	No	No	No	No	No	No	No	No	No
21	2	3	2	5	No	No	No	No	No	No	No	No	No	No
22	2	1	2	2	No	No	No	No	No	No	No	No	No	No
23	2	1	2	2	No	No	No	No	No	No	No	No	No	No
24	2	1	2	2	No	No	No	No	No	No	No	No	No	No
Hours Met					0	0	0	0	0	0	0	0	0	0

Warrant 3 Condition A

Orientation	E	W
Total Stopped Delay Per Vehicle on Minor Approach (s)	12.3	9
Number of Lanes on Minor Street Approach	1	2
VehicleHours of Stopped Delay on Minor Approach (h:mm)	0:02	0:24
Delay Condition Met	No	No
Volume on Minor Street Approach During Same Hour	11	160
High Minor Volume Condition Met	No	Yes
Total Entering Volume on All Approaches During Same Hour	272	272
Number of Approaches on Intersection	4	4
Total Volume Condition Met	No	No
Warrant Met for Approach	No	No
Warrant Met for Intersection	No	

Signal Warrants Report For Intersection 7: Fontaine Bl/Middle Driveway

Warrants Summary

Warrant	Name	Met?
#1	Eight Hour Vehicular Volume	No
#2	Four Hour Vehicular Volume	No
#3	Peak Hour	No

Intersection Warrants Parameters

Major Approaches	E, W
Minor Approaches	S
Speed > 40mph	Yes
Population < 10,000	No
Warrant Factor	70%

Warrant Analysis Traffic Volumes

Hour	Major Streets		Minor Streets
	E	W	S
1	1072	2080	0
2	1040	2018	0
3	1018	1976	0
4	954	1851	0
5	847	1643	0
6	836	1622	0
7	825	1602	0
8	750	1456	0
9	740	1435	0
10	729	1414	0
11	632	1227	0
12	590	1144	0
13	579	1123	0
14	429	832	0
15	429	832	0
16	300	582	0
17	172	333	0
18	172	333	0
19	96	187	0
20	54	104	0
21	32	62	0
22	11	21	0
23	11	21	0
24	11	21	0

Warrant Analysis by Hour

Hour	Major Streets		Minor Street		Warrant 1 Condition A				Warrant 1 Condition B				Warrant 2	Warrant 3 Condition B
	Number	Volume	Number	Volume	100%	80%	70%	56%	100%	80%	70%	56%		
1	3	3152	1	0	No	No	No	No	No	No	No	No	No	No
2	3	3058	1	0	No	No	No	No	No	No	No	No	No	No
3	3	2994	1	0	No	No	No	No	No	No	No	No	No	No
4	3	2805	1	0	No	No	No	No	No	No	No	No	No	No
5	3	2490	1	0	No	No	No	No	No	No	No	No	No	No
6	3	2458	1	0	No	No	No	No	No	No	No	No	No	No
7	3	2427	1	0	No	No	No	No	No	No	No	No	No	No
8	3	2206	1	0	No	No	No	No	No	No	No	No	No	No
9	3	2175	1	0	No	No	No	No	No	No	No	No	No	No
10	3	2143	1	0	No	No	No	No	No	No	No	No	No	No
11	3	1859	1	0	No	No	No	No	No	No	No	No	No	No
12	3	1734	1	0	No	No	No	No	No	No	No	No	No	No
13	3	1702	1	0	No	No	No	No	No	No	No	No	No	No
14	3	1261	1	0	No	No	No	No	No	No	No	No	No	No
15	3	1261	1	0	No	No	No	No	No	No	No	No	No	No
16	3	882	1	0	No	No	No	No	No	No	No	No	No	No
17	3	505	1	0	No	No	No	No	No	No	No	No	No	No
18	3	505	1	0	No	No	No	No	No	No	No	No	No	No
19	3	283	1	0	No	No	No	No	No	No	No	No	No	No
20	3	158	1	0	No	No	No	No	No	No	No	No	No	No
21	3	94	1	0	No	No	No	No	No	No	No	No	No	No
22	3	32	1	0	No	No	No	No	No	No	No	No	No	No
23	3	32	1	0	No	No	No	No	No	No	No	No	No	No
24	3	32	1	0	No	No	No	No	No	No	No	No	No	No
Hours Met					0	0	0	0	0	0	0	0	0	0

Warrant 3 Condition A

Orientation	S
Total Stopped Delay Per Vehicle on Minor Approach (s)	26.1
Number of Lanes on Minor Street Approach	1
VehicleHours of Stopped Delay on Minor Approach (h:mm)	0:00
Delay Condition Met	No
Volume on Minor Street Approach During Same Hour	0
High Minor Volume Condition Met	No
Total Entering Volume on All Approaches During Same Hour	3152
Number of Approaches on Intersection	3
Total Volume Condition Met	Yes
Warrant Met for Approach	No
Warrant Met for Intersection	No

Signal Warrants Report For Intersection 3: Fontaine Bl/Carriage Meadows Dr

Warrants Summary

Warrant	Name	Met?
#1	Eight Hour Vehicular Volume	Yes
#2	Four Hour Vehicular Volume	Yes
#3	Peak Hour	Yes

Intersection Warrants Parameters

Major Approaches	E, W
Minor Approaches	S, N
Speed > 40mph	Yes
Population < 10,000	No
Warrant Factor	70%

Warrant Analysis Traffic Volumes

Hour	Major Streets		Minor Streets	
	E	W	S	N
1	972	1909	43	189
2	943	1852	42	183
3	923	1814	41	180
4	865	1699	38	168
5	768	1508	34	149
6	758	1489	34	147
7	748	1470	33	146
8	680	1336	30	132
9	671	1317	30	130
10	661	1298	29	129
11	573	1126	25	112
12	535	1050	24	104
13	525	1031	23	102
14	389	764	17	76
15	389	764	17	76
16	272	535	12	53
17	156	305	7	30
18	156	305	7	30
19	87	172	4	17
20	49	95	2	9
21	29	57	1	6
22	10	19	0	2
23	10	19	0	2
24	10	19	0	2

Warrant Analysis by Hour

Hour	Major Streets		Minor Street		Warrant 1 Condition A				Warrant 1 Condition B				Warrant 2	Warrant 3 Condition B
	Number	Volume	Number	Volume	100%	80%	70%	56%	100%	80%	70%	56%		
1	4	2881	3	189	No	Yes	Yes	Yes	Yes	Yes	Yes	Yes	Yes	Yes
2	4	2795	3	183	No	Yes	Yes	Yes	Yes	Yes	Yes	Yes	Yes	Yes
3	4	2737	3	180	No	Yes	Yes	Yes	Yes	Yes	Yes	Yes	Yes	Yes
4	4	2564	3	168	No	Yes	Yes	Yes	Yes	Yes	Yes	Yes	Yes	Yes
5	4	2276	3	149	No	No	Yes	Yes	Yes	Yes	Yes	Yes	Yes	Yes
6	4	2247	3	147	No	No	Yes	Yes	Yes	Yes	Yes	Yes	Yes	Yes
7	4	2218	3	146	No	No	Yes	Yes	Yes	Yes	Yes	Yes	Yes	Yes
8	4	2016	3	132	No	No	No	Yes	Yes	Yes	Yes	Yes	Yes	Yes
9	4	1988	3	130	No	No	No	Yes	Yes	Yes	Yes	Yes	Yes	Yes
10	4	1959	3	129	No	No	No	Yes	Yes	Yes	Yes	Yes	Yes	Yes
11	4	1699	3	112	No	No	No	Yes	Yes	Yes	Yes	Yes	Yes	Yes
12	4	1585	3	104	No	No	No	No	Yes	Yes	Yes	Yes	Yes	Yes
13	4	1556	3	102	No	No	No	No	Yes	Yes	Yes	Yes	Yes	Yes
14	4	1153	3	76	No	No	No	No	No	No	Yes	Yes	No	No
15	4	1153	3	76	No	No	No	No	No	No	Yes	Yes	No	No
16	4	807	3	53	No	No	No	No	No	No	No	No	No	No
17	4	461	3	30	No	No	No	No	No	No	No	No	No	No
18	4	461	3	30	No	No	No	No	No	No	No	No	No	No
19	4	259	3	17	No	No	No	No	No	No	No	No	No	No
20	4	144	3	9	No	No	No	No	No	No	No	No	No	No
21	4	86	3	6	No	No	No	No	No	No	No	No	No	No
22	4	29	3	2	No	No	No	No	No	No	No	No	No	No
23	4	29	3	2	No	No	No	No	No	No	No	No	No	No
24	4	29	3	2	No	No	No	No	No	No	No	No	No	No
Hours Met					0	4	7	11	13	13	15	15	13	13

Warrant 3 Condition A

Orientation	S	N
Total Stopped Delay Per Vehicle on Minor Approach (s)	1122.9	292.9
Number of Lanes on Minor Street Approach	3	3
VehicleHours of Stopped Delay on Minor Approach (h:mm)	13:24	15:22
Delay Condition Met	Yes	Yes
Volume on Minor Street Approach During Same Hour	43	189
High Minor Volume Condition Met	No	Yes
Total Entering Volume on All Approaches During Same Hour	3113	3113
Number of Approaches on Intersection	4	4
Total Volume Condition Met	Yes	Yes
Warrant Met for Approach	No	Yes
Warrant Met for Intersection	Yes	

Appendix E – Horizon Year (2045) Conditions Analyses

Table of Contents

Intersection Level Of Service Report	2
Intersection 1: Marksheffel Rd/Fontaine Bl	2
Intersection 2: Marksheffel Rd/Lorson Bl	7
Intersection 3: Fontaine Bl/Carriage Meadows Dr	12

Intersection Level Of Service Report
Intersection 1: Marksheffel Rd/Fontaine BI

Control Type:	Signalized	Delay (sec / veh):	31.6
Analysis Method:	HCM 7th Edition	Level Of Service:	C
Analysis Period:	15 minutes	Volume to Capacity (v/c):	0.558

Intersection Setup

Name	Marksheffel Rd			Marksheffel Rd			Fontaine BI			Fontaine BI		
Approach	Northbound			Southbound			Eastbound			Westbound		
Lane Configuration	[Diagram]			[Diagram]			[Diagram]			[Diagram]		
Turning Movement	Left	Thru	Right	Left	Thru	Right	Left	Thru	Right	Left	Thru	Right
Lane Width [ft]	12.00	12.00	12.00	12.00	12.00	12.00	12.00	12.00	12.00	12.00	12.00	12.00
No. of Lanes in Entry Pocket	1	0	1	1	0	1	1	0	1	1	0	0
Entry Pocket Length [ft]	680.00	100.00	680.00	750.00	100.00	500.00	360.00	100.00	200.00	535.00	100.00	100.00
No. of Lanes in Exit Pocket	0	0	1	0	0	1	0	0	0	0	0	0
Exit Pocket Length [ft]	0.00	0.00	100.00	0.00	0.00	100.00	0.00	0.00	0.00	0.00	0.00	0.00
Speed [mph]	55.00			55.00			45.00			45.00		
Grade [%]	0.00			0.00			0.00			0.00		
Curb Present	No			No			No			No		
Crosswalk	Yes			Yes			Yes			Yes		

Volumes

Name	Marksheffel Rd			Marksheffel Rd			Fontaine Bl			Fontaine Bl		
Base Volume Input [veh/h]	153	675	145	199	317	55	75	298	158	268	753	570
Base Volume Adjustment Factor	1.0000	1.0000	1.0000	1.0000	1.0000	1.0000	1.0000	1.0000	1.0000	1.0000	1.0000	1.0000
Heavy Vehicles Percentage [%]	2.00	2.00	2.00	2.00	2.00	2.00	2.00	2.00	2.00	2.00	2.00	2.00
Proportion of CAVs [%]	0.00											
Growth Factor	1.0000	1.0000	1.0000	1.0000	1.0000	1.0000	1.0000	1.0000	1.0000	1.0000	1.0000	1.0000
In-Process Volume [veh/h]	0	0	0	0	0	0	0	0	0	0	0	0
Site-Generated Trips [veh/h]	0	9	16	23	0	0	0	15	0	19	11	9
Diverted Trips [veh/h]	0	0	0	0	0	0	0	0	0	0	0	0
Pass-by Trips [veh/h]	0	0	0	0	0	0	0	0	0	0	0	0
Existing Site Adjustment Volume [veh/h]	0	0	0	0	0	0	0	0	0	0	0	0
Other Volume [veh/h]	0	0	0	0	0	0	0	0	0	0	0	0
Right Turn on Red Volume [veh/h]	0	0	81	0	0	28	0	0	79	0	0	290
Total Hourly Volume [veh/h]	153	684	80	222	317	27	75	313	79	287	764	289
Peak Hour Factor	0.9200	0.9200	0.9200	0.9200	0.9200	0.9200	0.9200	0.9200	0.9200	0.9200	0.9200	0.9200
Other Adjustment Factor	1.0000	1.0000	1.0000	1.0000	1.0000	1.0000	1.0000	1.0000	1.0000	1.0000	1.0000	1.0000
Total 15-Minute Volume [veh/h]	42	186	22	60	86	7	20	85	21	78	208	79
Total Analysis Volume [veh/h]	166	743	87	241	345	29	82	340	86	312	830	314
Presence of On-Street Parking	No		No	No		No	No		No	No		No
On-Street Parking Maneuver Rate [/h]	0	0	0	0	0	0	0	0	0	0	0	0
Local Bus Stopping Rate [/h]	0	0	0	0	0	0	0	0	0	0	0	0
v_do, Outbound Pedestrian Volume crossing	0			0			0			0		
v_di, Inbound Pedestrian Volume crossing m	0			0			0			0		
v_co, Outbound Pedestrian Volume crossing	0			0			0			0		
v_ci, Inbound Pedestrian Volume crossing mi	0			0			0			0		
v_ab, Corner Pedestrian Volume [ped/h]	0			0			0			0		
Bicycle Volume [bicycles/h]	0			0			0			0		

Intersection Settings

Located in CBD	No
Signal Coordination Group	-
Cycle Length [s]	90
Active Pattern	Pattern 1
Coordination Type	Time of Day Pattern Coordinated
Actuation Type	Fully actuated
Offset [s]	0.0
Offset Reference	Lead Green - Beginning of First Green
Permissive Mode	SingleBand
Lost time [s]	0.00

Phasing & Timing

Control Type	Protecte	Permiss	Permiss	Protecte	Permiss	Permiss	Protecte	Permiss	Permiss	Protecte	Permiss	Permiss
Signal Group	1	6	0	5	2	0	3	8	0	7	4	0
Auxiliary Signal Groups												
Lead / Lag	Lead	-	-	Lead	-	-	Lead	-	-	Lead	-	-
Minimum Green [s]	5	10	0	5	10	0	5	10	0	5	10	0
Maximum Green [s]	5	103	0	5	103	0	5	109	0	5	109	0
Amber [s]	3.0	3.0	0.0	3.0	3.0	0.0	3.0	3.0	0.0	3.0	3.0	0.0
All red [s]	1.0	1.0	0.0	1.0	1.0	0.0	1.0	1.0	0.0	1.0	1.0	0.0
Split [s]	16	35	0	13	32	0	17	25	0	17	25	0
Vehicle Extension [s]	3.0	3.0	0.0	3.0	3.0	0.0	3.0	3.0	0.0	3.0	3.0	0.0
Walk [s]	0	7	0	0	7	0	0	7	0	0	7	0
Pedestrian Clearance [s]	0	24	0	0	21	0	0	14	0	0	14	0
Delayed Vehicle Green [s]	0.0	0.0	0.0	0.0	0.0	0.0	0.0	0.0	0.0	0.0	0.0	0.0
Rest In Walk		No			No			No			No	
I1, Start-Up Lost Time [s]	2.0	2.0	0.0	2.0	2.0	0.0	2.0	2.0	0.0	2.0	2.0	0.0
I2, Clearance Lost Time [s]	2.0	2.0	0.0	2.0	2.0	0.0	2.0	2.0	0.0	2.0	2.0	0.0
Minimum Recall	No	No		No	No		No	No		No	No	
Maximum Recall	No	No		No	No		No	No		No	No	
Pedestrian Recall	No	No		No	No		No	No		No	No	
Detector Location [ft]	0.0	0.0	0.0	0.0	0.0	0.0	0.0	0.0	0.0	0.0	0.0	0.0
Detector Length [ft]	0.0	0.0	0.0	0.0	0.0	0.0	0.0	0.0	0.0	0.0	0.0	0.0
I, Upstream Filtering Factor	1.00	1.00	1.00	1.00	1.00	1.00	1.00	1.00	1.00	1.00	1.00	1.00

Exclusive Pedestrian Phase

Pedestrian Signal Group	0
Pedestrian Walk [s]	0
Pedestrian Clearance [s]	0

Lane Group Calculations

Lane Group	L	C	R	L	C	R	L	C	R	L	C	R
C, Cycle Length [s]	90	90	90	90	90	90	90	90	90	90	90	90
L, Total Lost Time per Cycle [s]	4.00	4.00	4.00	4.00	4.00	4.00	4.00	4.00	4.00	4.00	4.00	4.00
l1_p, Permitted Start-Up Lost Time [s]	0.00	0.00	0.00	0.00	0.00	0.00	0.00	0.00	0.00	0.00	0.00	0.00
l2, Clearance Lost Time [s]	2.00	2.00	2.00	2.00	2.00	2.00	2.00	2.00	2.00	2.00	2.00	2.00
g_i, Effective Green Time [s]	10	36	36	8	34	34	5	19	19	10	24	24
g / C, Green / Cycle	0.11	0.40	0.40	0.09	0.38	0.38	0.06	0.21	0.21	0.11	0.27	0.27
(v / s)_i Volume / Saturation Flow Rate	0.09	0.21	0.05	0.07	0.10	0.02	0.05	0.07	0.05	0.09	0.23	0.20
s, saturation flow rate [veh/h]	1781	3560	1589	3459	3560	1589	1781	5094	1589	3459	3560	1589
c, Capacity [veh/h]	201	1434	640	316	1357	606	107	1094	341	394	956	427
d1, Uniform Delay [s]	39.11	20.32	17.01	40.01	19.12	17.59	41.74	29.79	29.39	38.91	31.46	30.07
k, delay calibration	0.19	0.50	0.50	0.11	0.50	0.50	0.11	0.11	0.11	0.11	0.11	0.11
l, Upstream Filtering Factor	1.00	1.00	1.00	1.00	1.00	1.00	1.00	1.00	1.00	1.00	1.00	1.00
d2, Incremental Delay [s]	13.45	1.34	0.44	3.84	0.45	0.15	10.79	0.16	0.38	3.64	2.58	2.49
d3, Initial Queue Delay [s]	0.00	0.00	0.00	0.00	0.00	0.00	0.00	0.00	0.00	0.00	0.00	0.00
Rp, platoon ratio	1.00	1.00	1.00	1.00	1.00	1.00	1.00	1.00	1.00	1.00	1.00	1.00
PF, progression factor	1.00	1.00	1.00	1.00	1.00	1.00	1.00	1.00	1.00	1.00	1.00	1.00

Lane Group Results

X, volume / capacity	0.83	0.52	0.14	0.76	0.25	0.05	0.77	0.31	0.25	0.79	0.87	0.74
d, Delay for Lane Group [s/veh]	52.56	21.66	17.45	43.85	19.57	17.74	52.53	29.95	29.77	42.54	34.04	32.56
Lane Group LOS	D	C	B	D	B	B	D	C	C	D	C	C
Critical Lane Group	No	Yes	No	Yes	No	No	Yes	No	No	No	Yes	No
50th-Percentile Queue Length [veh/ln]	4.08	5.39	1.08	2.59	2.27	0.36	2.04	1.97	1.50	3.39	8.32	6.07
50th-Percentile Queue Length [ft/ln]	102.00	134.65	27.05	64.83	56.78	9.08	50.91	49.27	37.49	84.76	208.11	151.68
95th-Percentile Queue Length [veh/ln]	7.34	9.19	1.95	4.67	4.09	0.65	3.67	3.55	2.70	6.10	13.06	10.11
95th-Percentile Queue Length [ft/ln]	183.59	229.81	48.69	116.69	102.20	16.34	91.64	88.68	67.48	152.57	326.41	252.67

Movement, Approach, & Intersection Results

d_M, Delay for Movement [s/veh]	52.56	21.66	17.45	43.85	19.57	17.74	52.53	29.95	29.77	42.54	34.04	32.56
Movement LOS	D	C	B	D	B	B	D	C	C	D	C	C
d_A, Approach Delay [s/veh]	26.44			29.00			33.56			35.54		
Approach LOS	C			C			C			D		
d_I, Intersection Delay [s/veh]	31.60											
Intersection LOS	C											
Intersection V/C	0.558											

Other Modes

g_Walk,mi, Effective Walk Time [s]	11.0	11.0	11.0	11.0
M_corner, Corner Circulation Area [ft ² /ped]	0.00	0.00	0.00	0.00
M_CW, Crosswalk Circulation Area [ft ² /ped]	0.00	0.00	0.00	0.00
d_p, Pedestrian Delay [s]	34.71	34.71	34.71	34.71
I_p,int, Pedestrian LOS Score for Intersectio	3.133	3.162	3.048	3.578
Crosswalk LOS	C	C	C	D
s_b, Saturation Flow Rate of the bicycle lane	2000	2000	2000	2000
c_b, Capacity of the bicycle lane [bicycles/h]	688	622	466	466
d_b, Bicycle Delay [s]	19.37	21.39	26.48	26.48
I_b,int, Bicycle LOS Score for Intersection	2.448	2.090	1.882	3.000
Bicycle LOS	B	B	A	C

Sequence



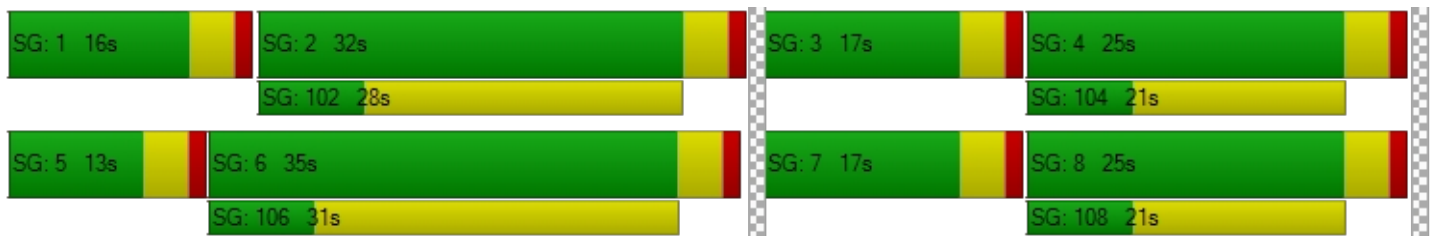

Ring 1	1	2	3	4	-	-	-	-	-	-	-	-	-	-	-	-
Ring 2	5	6	7	8	-	-	-	-	-	-	-	-	-	-	-	-
Ring 3	-	-	-	-	-	-	-	-	-	-	-	-	-	-	-	-
Ring 4	-	-	-	-	-	-	-	-	-	-	-	-	-	-	-	-



Intersection Level Of Service Report
Intersection 2: Marksheffel Rd/Lorson Bl

Control Type:	Signalized	Delay (sec / veh):	19.0
Analysis Method:	HCM 7th Edition	Level Of Service:	B
Analysis Period:	15 minutes	Volume to Capacity (v/c):	0.525

Intersection Setup

Name	Marksheffel Rd			Marksheffel Rd			Eastbound			Lorson Bl		
Approach	Northbound			Southbound			Eastbound			Westbound		
Lane Configuration												
Turning Movement	Left	Thru	Right	Left	Thru	Right	Left	Thru	Right	Left	Thru	Right
Lane Width [ft]	12.00	12.00	12.00	12.00	12.00	12.00	12.00	12.00	12.00	12.00	12.00	12.00
No. of Lanes in Entry Pocket	1	0	1	1	0	1	1	0	0	1	0	0
Entry Pocket Length [ft]	100.00	100.00	500.00	580.00	100.00	100.00	100.00	100.00	100.00	510.00	100.00	100.00
No. of Lanes in Exit Pocket	0	0	0	0	0	1	0	0	0	0	0	0
Exit Pocket Length [ft]	0.00	0.00	0.00	0.00	0.00	100.00	0.00	0.00	0.00	0.00	0.00	0.00
Speed [mph]	55.00			55.00			30.00			25.00		
Grade [%]	0.00			0.00			0.00			0.00		
Curb Present	No			No			No			No		
Crosswalk	Yes			Yes			Yes			Yes		

Volumes

Name	Marksheffel Rd			Marksheffel Rd						Lorson Bl		
Base Volume Input [veh/h]	157	714	162	83	999	23	49	18	69	500	11	296
Base Volume Adjustment Factor	1.0000	1.0000	1.0000	1.0000	1.0000	1.0000	1.0000	1.0000	1.0000	1.0000	1.0000	1.0000
Heavy Vehicles Percentage [%]	2.00	2.00	2.00	2.00	2.00	2.00	2.00	2.00	2.00	2.00	2.00	2.00
Proportion of CAVs [%]	0.00											
Growth Factor	1.0000	1.0000	1.0000	1.0000	1.0000	1.0000	1.0000	1.0000	1.0000	1.0000	1.0000	1.0000
In-Process Volume [veh/h]	0	0	0	0	0	0	0	0	0	0	0	0
Site-Generated Trips [veh/h]	0	26	0	0	19	0	0	0	0	0	0	0
Diverted Trips [veh/h]	0	0	0	0	0	0	0	0	0	0	0	0
Pass-by Trips [veh/h]	0	0	0	0	0	0	0	0	0	0	0	0
Existing Site Adjustment Volume [veh/h]	0	0	0	0	0	0	0	0	0	0	0	0
Other Volume [veh/h]	0	0	0	0	0	0	0	0	0	0	0	0
Right Turn on Red Volume [veh/h]	0	0	81	0	0	0	0	0	0	0	0	148
Total Hourly Volume [veh/h]	157	740	81	83	1018	23	49	18	69	500	11	148
Peak Hour Factor	1.0000	0.9200	0.9200	0.9200	0.9200	1.0000	1.0000	1.0000	1.0000	0.9200	1.0000	0.9200
Other Adjustment Factor	1.0000	1.0000	1.0000	1.0000	1.0000	1.0000	1.0000	1.0000	1.0000	1.0000	1.0000	1.0000
Total 15-Minute Volume [veh/h]	39	201	22	23	277	6	12	5	17	136	3	40
Total Analysis Volume [veh/h]	157	804	88	90	1107	23	49	18	69	543	11	161
Presence of On-Street Parking	No		No	No		No	No		No	No		No
On-Street Parking Maneuver Rate [/h]	0	0	0	0	0	0	0	0	0	0	0	0
Local Bus Stopping Rate [/h]	0	0	0	0	0	0	0	0	0	0	0	0
v_do, Outbound Pedestrian Volume crossing	0			0			0			0		
v_di, Inbound Pedestrian Volume crossing m	0			0			0			0		
v_co, Outbound Pedestrian Volume crossing	0			0			0			0		
v_ci, Inbound Pedestrian Volume crossing mi	0			0			0			0		
v_ab, Corner Pedestrian Volume [ped/h]	0			0			0			0		
Bicycle Volume [bicycles/h]	0			0			0			0		

Intersection Settings

Located in CBD	No
Signal Coordination Group	-
Cycle Length [s]	80
Active Pattern	Pattern 1
Coordination Type	Time of Day Pattern Coordinated
Actuation Type	Fully actuated
Offset [s]	0.0
Offset Reference	Lead Green - Beginning of First Green
Permissive Mode	SingleBand
Lost time [s]	0.00

Phasing & Timing

Control Type	Permiss	Permiss	Permiss	Permiss	Permiss	Permiss	Permiss	Permiss	Permiss	Protecte	Permiss	Permiss
Signal Group	0	6	0	0	2	0	0	8	0	7	4	0
Auxiliary Signal Groups												
Lead / Lag	-	-	-	-	-	-	-	-	-	Lead	-	-
Minimum Green [s]	0	10	0	0	10	0	0	10	0	5	10	0
Maximum Green [s]	0	10	0	0	10	0	0	10	0	5	10	0
Amber [s]	0.0	3.0	0.0	0.0	3.0	0.0	0.0	3.0	0.0	3.0	3.0	0.0
All red [s]	0.0	1.0	0.0	0.0	1.0	0.0	0.0	1.0	0.0	1.0	1.0	0.0
Split [s]	0	28	0	0	28	0	0	34	0	18	52	0
Vehicle Extension [s]	0.0	3.0	0.0	0.0	3.0	0.0	0.0	3.0	0.0	3.0	3.0	0.0
Walk [s]	0	7	0	0	7	0	0	7	0	0	7	0
Pedestrian Clearance [s]	0	17	0	0	10	0	0	23	0	0	21	0
Delayed Vehicle Green [s]	0.0	0.0	0.0	0.0	0.0	0.0	0.0	0.0	0.0	0.0	0.0	0.0
Rest In Walk		No			No			No			No	
I1, Start-Up Lost Time [s]	0.0	2.0	0.0	0.0	2.0	0.0	0.0	2.0	0.0	2.0	2.0	0.0
I2, Clearance Lost Time [s]	0.0	2.0	0.0	0.0	2.0	0.0	0.0	2.0	0.0	2.0	2.0	0.0
Minimum Recall		No			No			No		No	No	
Maximum Recall		No			No			No		No	No	
Pedestrian Recall		No			No			No		No	No	
Detector Location [ft]	0.0	0.0	0.0	0.0	0.0	0.0	0.0	0.0	0.0	0.0	0.0	0.0
Detector Length [ft]	0.0	0.0	0.0	0.0	0.0	0.0	0.0	0.0	0.0	0.0	0.0	0.0
I, Upstream Filtering Factor	1.00	1.00	1.00	1.00	1.00	1.00	1.00	1.00	1.00	1.00	1.00	1.00

Exclusive Pedestrian Phase

Pedestrian Signal Group	0
Pedestrian Walk [s]	0
Pedestrian Clearance [s]	0

Lane Group Calculations

Lane Group	L	C	R	L	C	R	L	C	L	C	R
C, Cycle Length [s]	80	80	80	80	80	80	80	80	80	80	80
L, Total Lost Time per Cycle [s]	4.00	4.00	4.00	4.00	4.00	4.00	4.00	4.00	4.00	4.00	4.00
l1_p, Permitted Start-Up Lost Time [s]	2.00	0.00	0.00	2.00	0.00	0.00	2.00	0.00	0.00	0.00	0.00
l2, Clearance Lost Time [s]	2.00	2.00	2.00	2.00	2.00	2.00	2.00	2.00	2.00	2.00	2.00
g_i, Effective Green Time [s]	44	44	44	44	44	44	10	10	14	27	27
g / C, Green / Cycle	0.56	0.56	0.56	0.56	0.56	0.56	0.12	0.12	0.17	0.34	0.34
(v / s)_i Volume / Saturation Flow Rate	0.32	0.23	0.06	0.14	0.31	0.01	0.04	0.05	0.16	0.01	0.10
s, saturation flow rate [veh/h]	498	3560	1589	623	3560	1589	1213	1640	3459	1870	1589
c, Capacity [veh/h]	254	1981	884	339	1981	884	199	195	603	642	546
d1, Uniform Delay [s]	26.29	10.15	8.31	16.88	11.40	7.97	34.45	32.73	32.27	17.31	19.15
k, delay calibration	0.50	0.50	0.50	0.50	0.50	0.50	0.11	0.11	0.11	0.11	0.11
l, Upstream Filtering Factor	1.00	1.00	1.00	1.00	1.00	1.00	1.00	1.00	1.00	1.00	1.00
d2, Incremental Delay [s]	10.83	0.62	0.22	1.91	1.14	0.05	0.64	1.60	5.21	0.01	0.30
d3, Initial Queue Delay [s]	0.00	0.00	0.00	0.00	0.00	0.00	0.00	0.00	0.00	0.00	0.00
Rp, platoon ratio	1.00	1.00	1.00	1.00	1.00	1.00	1.00	1.00	1.00	1.00	1.00
PF, progression factor	1.00	1.00	1.00	1.00	1.00	1.00	1.00	1.00	1.00	1.00	1.00

Lane Group Results

X, volume / capacity	0.62	0.41	0.10	0.27	0.56	0.03	0.25	0.45	0.90	0.02	0.29
d, Delay for Lane Group [s/veh]	37.12	10.76	8.54	18.80	12.54	8.02	35.09	34.32	37.49	17.32	19.45
Lane Group LOS	D	B	A	B	B	A	D	C	D	B	B
Critical Lane Group	Yes	No	No	No	No	No	No	Yes	Yes	No	No
50th-Percentile Queue Length [veh/ln]	3.26	3.20	0.60	1.16	5.00	0.15	0.92	1.62	5.48	0.13	2.18
50th-Percentile Queue Length [ft/ln]	81.47	79.94	14.96	29.04	124.94	3.73	22.99	40.46	137.03	3.34	54.48
95th-Percentile Queue Length [veh/ln]	5.87	5.76	1.08	2.09	8.66	0.27	1.66	2.91	9.32	0.24	3.92
95th-Percentile Queue Length [ft/ln]	146.65	143.88	26.92	52.28	216.59	6.72	41.38	72.83	233.01	6.02	98.07

Movement, Approach, & Intersection Results

d_M, Delay for Movement [s/veh]	37.12	10.76	8.54	18.80	12.54	8.02	35.09	34.32	34.32	37.49	17.32	19.45
Movement LOS	D	B	A	B	B	A	D	C	C	D	B	B
d_A, Approach Delay [s/veh]	14.52			12.92			34.60			33.12		
Approach LOS	B			B			C			C		
d_I, Intersection Delay [s/veh]	19.03											
Intersection LOS	B											
Intersection V/C	0.525											

Other Modes

g_Walk,mi, Effective Walk Time [s]	11.0	11.0	11.0	11.0
M_corner, Corner Circulation Area [ft ² /ped]	0.00	0.00	0.00	0.00
M_CW, Crosswalk Circulation Area [ft ² /ped]	0.00	0.00	0.00	0.00
d_p, Pedestrian Delay [s]	29.72	29.72	29.72	29.72
I_p,int, Pedestrian LOS Score for Intersectio	3.410	3.226	2.263	2.817
Crosswalk LOS	C	C	B	C
s_b, Saturation Flow Rate of the bicycle lane	2000	2000	2000	2000
c_b, Capacity of the bicycle lane [bicycles/h]	601	601	751	1201
d_b, Bicycle Delay [s]	19.56	19.56	15.59	6.37
I_b,int, Bicycle LOS Score for Intersection	2.492	2.566	1.784	2.984
Bicycle LOS	B	B	A	C

Sequence



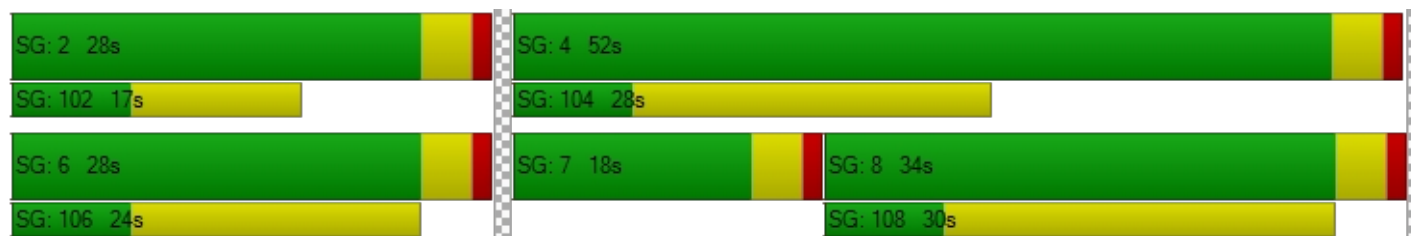

Ring 1	-	2	-	4	-	-	-	-	-	-	-	-	-	-	-	-
Ring 2	-	6	7	8	-	-	-	-	-	-	-	-	-	-	-	-
Ring 3	-	-	-	-	-	-	-	-	-	-	-	-	-	-	-	-
Ring 4	-	-	-	-	-	-	-	-	-	-	-	-	-	-	-	-



Intersection Level Of Service Report
Intersection 3: Fontaine Bl/Carriage Meadows Dr

Control Type:	Signalized	Delay (sec / veh):	9.6
Analysis Method:	HCM 7th Edition	Level Of Service:	A
Analysis Period:	15 minutes	Volume to Capacity (v/c):	0.553

Intersection Setup

Name	Carriage Meadows Dr			Carriage Meadows Dr			Fontaine Bl			Fontaine Bl		
Approach	Northbound			Southbound			Eastbound			Westbound		
Lane Configuration												
Turning Movement	Left	Thru	Right	Left	Thru	Right	Left	Thru	Right	Left	Thru	Right
Lane Width [ft]	12.00	12.00	12.00	12.00	12.00	12.00	12.00	12.00	12.00	12.00	12.00	12.00
No. of Lanes in Entry Pocket	1	0	1	1	0	1	1	0	0	1	0	1
Entry Pocket Length [ft]	100.00	100.00	100.00	100.00	100.00	100.00	510.00	100.00	100.00	330.00	100.00	330.00
No. of Lanes in Exit Pocket	0	0	0	0	0	0	0	0	0	0	0	0
Exit Pocket Length [ft]	0.00	0.00	0.00	0.00	0.00	0.00	0.00	0.00	0.00	0.00	0.00	0.00
Speed [mph]	25.00			25.00			45.00			45.00		
Grade [%]	0.00			0.00			0.00			0.00		
Curb Present	No			No			No			No		
Crosswalk	Yes			Yes			Yes			Yes		

Volumes

Name	Carriage Meadows Dr			Carriage Meadows Dr			Fontaine Bl			Fontaine Bl		
Base Volume Input [veh/h]	42	5	12	8	5	37	10	642	8	8	1500	4
Base Volume Adjustment Factor	1.0000	1.0000	1.0000	1.0000	1.0000	1.0000	1.0000	1.0000	1.0000	1.0000	1.0000	1.0000
Heavy Vehicles Percentage [%]	2.00	2.00	2.00	2.00	2.00	2.00	2.00	2.00	2.00	2.00	2.00	2.00
Proportion of CAVs [%]	0.00											
Growth Factor	1.7120	1.0000	1.7120	1.7120	1.0000	1.7120	1.7120	1.0000	1.7120	1.7120	1.0000	1.7120
In-Process Volume [veh/h]	0	0	0	0	0	0	0	0	0	0	0	0
Site-Generated Trips [veh/h]	28	1	8	4	1	11	3	8	17	24	0	1
Diverted Trips [veh/h]	0	0	0	0	0	0	0	0	0	0	0	0
Pass-by Trips [veh/h]	0	0	0	0	0	0	0	0	0	0	0	0
Existing Site Adjustment Volume [veh/h]	0	0	0	0	0	0	0	0	0	0	0	0
Other Volume [veh/h]	0	0	0	0	0	0	0	0	0	0	0	0
Right Turn on Red Volume [veh/h]	0	0	0	0	0	0	0	0	0	0	0	0
Total Hourly Volume [veh/h]	100	6	29	18	6	74	20	650	31	38	1500	8
Peak Hour Factor	0.9200	0.9200	0.9200	0.9200	0.9200	0.9200	0.9200	0.9200	0.9200	0.9200	0.9200	0.9200
Other Adjustment Factor	1.0000	1.0000	1.0000	1.0000	1.0000	1.0000	1.0000	1.0000	1.0000	1.0000	1.0000	1.0000
Total 15-Minute Volume [veh/h]	27	2	8	5	2	20	5	177	8	10	408	2
Total Analysis Volume [veh/h]	109	7	32	20	7	80	22	707	34	41	1630	9
Presence of On-Street Parking	No		No	No		No	No		No	No		No
On-Street Parking Maneuver Rate [/h]	0	0	0	0	0	0	0	0	0	0	0	0
Local Bus Stopping Rate [/h]	0	0	0	0	0	0	0	0	0	0	0	0
v_do, Outbound Pedestrian Volume crossing	0			0			0			0		
v_di, Inbound Pedestrian Volume crossing m	0			0			0			0		
v_co, Outbound Pedestrian Volume crossing	0			0			0			0		
v_ci, Inbound Pedestrian Volume crossing mi	0			0			0			0		
v_ab, Corner Pedestrian Volume [ped/h]	0			0			0			0		
Bicycle Volume [bicycles/h]	0			0			0			0		

Intersection Settings

Located in CBD	No
Signal Coordination Group	-
Cycle Length [s]	80
Active Pattern	Pattern 1
Coordination Type	Time of Day Pattern Coordinated
Actuation Type	Semi-actuated
Offset [s]	0.0
Offset Reference	Lead Green - Beginning of First Green
Permissive Mode	SingleBand
Lost time [s]	0.00

Phasing & Timing

Control Type	Permiss	Permiss	Permiss	Permiss	Permiss	Permiss	Protecte	Permiss	Permiss	Permiss	Permiss	Permiss
Signal Group	0	8	0	0	4	0	5	2	0	0	6	0
Auxiliary Signal Groups												
Lead / Lag	-	-	-	-	-	-	Lead	-	-	-	-	-
Minimum Green [s]	0	10	0	0	10	0	5	10	0	0	10	0
Maximum Green [s]	0	34	0	0	34	0	5	78	0	0	78	0
Amber [s]	0.0	3.0	0.0	0.0	3.0	0.0	3.0	3.0	0.0	0.0	3.0	0.0
All red [s]	0.0	1.0	0.0	0.0	1.0	0.0	1.0	1.0	0.0	0.0	1.0	0.0
Split [s]	0	38	0	0	38	0	17	42	0	0	25	0
Vehicle Extension [s]	0.0	3.0	0.0	0.0	3.0	0.0	3.0	3.0	0.0	0.0	3.0	0.0
Walk [s]	0	7	0	0	7	0	0	7	0	0	7	0
Pedestrian Clearance [s]	0	23	0	0	27	0	0	7	0	0	14	0
Delayed Vehicle Green [s]	0.0	0.0	0.0	0.0	0.0	0.0	0.0	0.0	0.0	0.0	0.0	0.0
Rest In Walk		No			No			No			No	
I1, Start-Up Lost Time [s]	0.0	2.0	0.0	0.0	2.0	0.0	2.0	2.0	0.0	0.0	2.0	0.0
I2, Clearance Lost Time [s]	0.0	2.0	0.0	0.0	2.0	0.0	2.0	2.0	0.0	0.0	2.0	0.0
Minimum Recall		No			No		No	No			No	
Maximum Recall		No			No		No	No			No	
Pedestrian Recall		No			No		No	No			No	
Detector Location [ft]	0.0	0.0	0.0	0.0	0.0	0.0	0.0	0.0	0.0	0.0	0.0	0.0
Detector Length [ft]	0.0	0.0	0.0	0.0	0.0	0.0	0.0	0.0	0.0	0.0	0.0	0.0
I, Upstream Filtering Factor	1.00	1.00	1.00	1.00	1.00	1.00	1.00	1.00	1.00	1.00	1.00	1.00

Exclusive Pedestrian Phase

Pedestrian Signal Group	0
Pedestrian Walk [s]	0
Pedestrian Clearance [s]	0

Lane Group Calculations

Lane Group	L	C	R	L	C	R	L	C	R	L	C	R
C, Cycle Length [s]	80	80	80	80	80	80	80	80	80	80	80	80
L, Total Lost Time per Cycle [s]	4.00	4.00	4.00	4.00	4.00	4.00	4.00	4.00	4.00	4.00	4.00	4.00
l1_p, Permitted Start-Up Lost Time [s]	2.00	0.00	0.00	2.00	0.00	0.00	0.00	0.00	0.00	2.00	0.00	0.00
l2, Clearance Lost Time [s]	2.00	2.00	2.00	2.00	2.00	2.00	2.00	2.00	2.00	2.00	2.00	2.00
g_i, Effective Green Time [s]	11	11	11	11	11	11	2	61	61	55	55	55
g / C, Green / Cycle	0.13	0.13	0.13	0.13	0.13	0.13	0.02	0.77	0.77	0.69	0.69	0.69
(v / s)_i Volume / Saturation Flow Rate	0.08	0.00	0.02	0.01	0.00	0.05	0.01	0.20	0.02	0.06	0.46	0.01
s, saturation flow rate [veh/h]	1310	1870	1589	1368	1870	1589	1781	3560	1589	718	3560	1589
c, Capacity [veh/h]	226	250	212	232	250	212	43	2729	1218	529	2465	1100
d1, Uniform Delay [s]	35.06	30.14	30.65	32.62	30.14	31.62	38.56	2.72	2.23	6.41	6.99	3.81
k, delay calibration	0.11	0.11	0.11	0.11	0.11	0.11	0.11	0.50	0.50	0.50	0.50	0.50
l, Upstream Filtering Factor	1.00	1.00	1.00	1.00	1.00	1.00	1.00	1.00	1.00	1.00	1.00	1.00
d2, Incremental Delay [s]	1.60	0.04	0.33	0.16	0.04	1.10	9.00	0.23	0.04	0.29	1.41	0.01
d3, Initial Queue Delay [s]	0.00	0.00	0.00	0.00	0.00	0.00	0.00	0.00	0.00	0.00	0.00	0.00
Rp, platoon ratio	1.00	1.00	1.00	1.00	1.00	1.00	1.00	1.00	1.00	1.00	1.00	1.00
PF, progression factor	1.00	1.00	1.00	1.00	1.00	1.00	1.00	1.00	1.00	1.00	1.00	1.00

Lane Group Results

X, volume / capacity	0.48	0.03	0.15	0.09	0.03	0.38	0.51	0.26	0.03	0.08	0.66	0.01
d, Delay for Lane Group [s/veh]	36.66	30.19	30.97	32.78	30.19	32.73	47.56	2.95	2.27	6.69	8.40	3.82
Lane Group LOS	D	C	C	C	C	C	D	A	A	A	A	A
Critical Lane Group	Yes	No	No	No	No	No	Yes	No	No	No	Yes	No
50th-Percentile Queue Length [veh/ln]	2.15	0.12	0.56	0.36	0.12	1.46	0.51	0.81	0.07	0.26	5.43	0.03
50th-Percentile Queue Length [ft/ln]	53.76	2.99	14.01	9.00	2.99	36.54	12.79	20.30	1.79	6.58	135.80	0.85
95th-Percentile Queue Length [veh/ln]	3.87	0.22	1.01	0.65	0.22	2.63	0.92	1.46	0.13	0.47	9.25	0.06
95th-Percentile Queue Length [ft/ln]	96.77	5.38	25.23	16.21	5.38	65.77	23.02	36.54	3.21	11.85	231.36	1.53

Movement, Approach, & Intersection Results

d_M, Delay for Movement [s/veh]	36.66	30.19	30.97	32.78	30.19	32.73	47.56	2.95	2.27	6.69	8.40	3.82
Movement LOS	D	C	C	C	C	C	D	A	A	A	A	A
d_A, Approach Delay [s/veh]	35.12			32.57			4.21		8.33			
Approach LOS	D			C			A		A			
d_I, Intersection Delay [s/veh]	9.60											
Intersection LOS	A											
Intersection V/C	0.553											

Other Modes

g_Walk,mi, Effective Walk Time [s]	11.0		11.0		11.0		11.0	
M_corner, Corner Circulation Area [ft ² /ped]	0.00		0.00		0.00		0.00	
M_CW, Crosswalk Circulation Area [ft ² /ped]	0.00		0.00		0.00		0.00	
d_p, Pedestrian Delay [s]	29.76		29.76		29.76		29.76	
I_p,int, Pedestrian LOS Score for Intersectio	2.229		2.154		3.282		3.069	
Crosswalk LOS	B		B		C		C	
s_b, Saturation Flow Rate of the bicycle lane	2000		2000		2000		2000	
c_b, Capacity of the bicycle lane [bicycles/h]	850		850		950		525	
d_b, Bicycle Delay [s]	13.23		13.23		11.03		21.76	
I_b,int, Bicycle LOS Score for Intersection	1.804		1.736		2.189		2.946	
Bicycle LOS	A		A		B		C	

Sequence

Ring 1	-	2	-	4	-	-	-	-	-	-	-	-	-	-	-	-	-
Ring 2	5	6	-	8	-	-	-	-	-	-	-	-	-	-	-	-	-
Ring 3	-	-	-	-	-	-	-	-	-	-	-	-	-	-	-	-	-
Ring 4	-	-	-	-	-	-	-	-	-	-	-	-	-	-	-	-	-



Table of Contents

Intersection Level Of Service Report	2
Intersection 1: Marksheffel Rd/Fontaine Bl	2
Intersection 2: Marksheffel Rd/Lorson Bl	7
Intersection 3: Fontaine Bl/Carriage Meadows Dr	12

Intersection Level Of Service Report
Intersection 1: Marksheffel Rd/Fontaine BI

Control Type:	Signalized	Delay (sec / veh):	45.3
Analysis Method:	HCM 7th Edition	Level Of Service:	D
Analysis Period:	15 minutes	Volume to Capacity (v/c):	0.726

Intersection Setup

Name	Marksheffel Rd			Marksheffel Rd			Fontaine BI			Fontaine BI		
Approach	Northbound			Southbound			Eastbound			Westbound		
Lane Configuration	[Diagram]			[Diagram]			[Diagram]			[Diagram]		
Turning Movement	Left	Thru	Right	Left	Thru	Right	Left	Thru	Right	Left	Thru	Right
Lane Width [ft]	12.00	12.00	12.00	12.00	12.00	12.00	12.00	12.00	12.00	12.00	12.00	12.00
No. of Lanes in Entry Pocket	1	0	1	1	0	1	1	0	1	1	0	0
Entry Pocket Length [ft]	680.00	100.00	680.00	750.00	100.00	500.00	360.00	100.00	200.00	535.00	100.00	100.00
No. of Lanes in Exit Pocket	0	0	1	0	0	1	0	0	0	0	0	0
Exit Pocket Length [ft]	0.00	0.00	100.00	0.00	0.00	100.00	0.00	0.00	0.00	0.00	0.00	0.00
Speed [mph]	55.00			55.00			45.00			45.00		
Grade [%]	0.00			0.00			0.00			0.00		
Curb Present	No			No			No			No		
Crosswalk	Yes			Yes			Yes			Yes		

Volumes

Name	Marksheffel Rd			Marksheffel Rd			Fontaine Bl			Fontaine Bl		
Base Volume Input [veh/h]	157	442	432	729	707	93	107	999	266	244	570	425
Base Volume Adjustment Factor	1.0000	1.0000	1.0000	1.0000	1.0000	1.0000	1.0000	1.0000	1.0000	1.0000	1.0000	1.0000
Heavy Vehicles Percentage [%]	2.00	2.00	2.00	2.00	2.00	2.00	2.00	2.00	2.00	2.00	2.00	2.00
Proportion of CAVs [%]	0.00											
Growth Factor	1.0000	1.0000	1.0000	1.0000	1.0000	1.0000	1.0000	1.0000	1.0000	1.0000	1.0000	1.0000
In-Process Volume [veh/h]	0	0	0	0	0	0	0	0	0	0	0	0
Site-Generated Trips [veh/h]	0	36	40	56	0	0	0	35	0	66	37	21
Diverted Trips [veh/h]	0	0	0	0	0	0	0	0	0	0	0	0
Pass-by Trips [veh/h]	0	0	0	0	0	0	0	0	0	0	0	0
Existing Site Adjustment Volume [veh/h]	0	0	0	0	0	0	0	0	0	0	0	0
Other Volume [veh/h]	0	0	0	0	0	0	0	0	0	0	0	0
Right Turn on Red Volume [veh/h]	0	0	236	0	0	47	0	0	133	0	0	223
Total Hourly Volume [veh/h]	157	478	236	785	707	46	107	1034	133	310	607	223
Peak Hour Factor	0.9200	0.9200	0.9200	0.9200	0.9200	0.9200	0.9200	0.9200	0.9200	0.9200	0.9200	0.9200
Other Adjustment Factor	1.0000	1.0000	1.0000	1.0000	1.0000	1.0000	1.0000	1.0000	1.0000	1.0000	1.0000	1.0000
Total 15-Minute Volume [veh/h]	43	130	64	213	192	13	29	281	36	84	165	61
Total Analysis Volume [veh/h]	171	520	257	853	768	50	116	1124	145	337	660	242
Presence of On-Street Parking	No		No	No		No	No		No	No		No
On-Street Parking Maneuver Rate [/h]	0	0	0	0	0	0	0	0	0	0	0	0
Local Bus Stopping Rate [/h]	0	0	0	0	0	0	0	0	0	0	0	0
v_do, Outbound Pedestrian Volume crossing	0			0			0			0		
v_di, Inbound Pedestrian Volume crossing m	0			0			0			0		
v_co, Outbound Pedestrian Volume crossing	0			0			0			0		
v_ci, Inbound Pedestrian Volume crossing mi	0			0			0			0		
v_ab, Corner Pedestrian Volume [ped/h]	0			0			0			0		
Bicycle Volume [bicycles/h]	0			0			0			0		

Intersection Settings

Located in CBD	No
Signal Coordination Group	-
Cycle Length [s]	120
Active Pattern	Pattern 1
Coordination Type	Time of Day Pattern Coordinated
Actuation Type	Fully actuated
Offset [s]	0.0
Offset Reference	Lead Green - Beginning of First Green
Permissive Mode	SingleBand
Lost time [s]	0.00

Phasing & Timing

Control Type	Protecte	Permiss	Permiss	Protecte	Permiss	Permiss	Protecte	Permiss	Permiss	Protecte	Permiss	Permiss
Signal Group	1	6	0	5	2	0	3	8	0	7	4	0
Auxiliary Signal Groups												
Lead / Lag	Lead	-	-	Lead	-	-	Lead	-	-	Lead	-	-
Minimum Green [s]	5	10	0	5	10	0	5	10	0	5	10	0
Maximum Green [s]	5	103	0	5	103	0	5	109	0	5	109	0
Amber [s]	3.0	3.0	0.0	3.0	3.0	0.0	3.0	3.0	0.0	3.0	3.0	0.0
All red [s]	1.0	1.0	0.0	1.0	1.0	0.0	1.0	1.0	0.0	1.0	1.0	0.0
Split [s]	36	35	0	34	33	0	26	33	0	18	25	0
Vehicle Extension [s]	3.0	3.0	0.0	3.0	3.0	0.0	3.0	3.0	0.0	3.0	3.0	0.0
Walk [s]	0	7	0	0	7	0	0	7	0	0	7	0
Pedestrian Clearance [s]	0	24	0	0	21	0	0	14	0	0	14	0
Delayed Vehicle Green [s]	0.0	0.0	0.0	0.0	0.0	0.0	0.0	0.0	0.0	0.0	0.0	0.0
Rest In Walk		No			No			No			No	
I1, Start-Up Lost Time [s]	2.0	2.0	0.0	2.0	2.0	0.0	2.0	2.0	0.0	2.0	2.0	0.0
I2, Clearance Lost Time [s]	2.0	2.0	0.0	2.0	2.0	0.0	2.0	2.0	0.0	2.0	2.0	0.0
Minimum Recall	No	No		No	No		No	No		No	No	
Maximum Recall	No	No		No	No		No	No		No	No	
Pedestrian Recall	No	No		No	No		No	No		No	No	
Detector Location [ft]	0.0	0.0	0.0	0.0	0.0	0.0	0.0	0.0	0.0	0.0	0.0	0.0
Detector Length [ft]	0.0	0.0	0.0	0.0	0.0	0.0	0.0	0.0	0.0	0.0	0.0	0.0
I, Upstream Filtering Factor	1.00	1.00	1.00	1.00	1.00	1.00	1.00	1.00	1.00	1.00	1.00	1.00

Exclusive Pedestrian Phase

Pedestrian Signal Group	0
Pedestrian Walk [s]	0
Pedestrian Clearance [s]	0

Lane Group Calculations

Lane Group	L	C	R	L	C	R	L	C	R	L	C	R
C, Cycle Length [s]	120	120	120	120	120	120	120	120	120	120	120	120
L, Total Lost Time per Cycle [s]	4.00	4.00	4.00	4.00	4.00	4.00	4.00	4.00	4.00	4.00	4.00	4.00
l1_p, Permitted Start-Up Lost Time [s]	0.00	0.00	0.00	0.00	0.00	0.00	0.00	0.00	0.00	0.00	0.00	0.00
l2, Clearance Lost Time [s]	2.00	2.00	2.00	2.00	2.00	2.00	2.00	2.00	2.00	2.00	2.00	2.00
g_i, Effective Green Time [s]	14	32	32	30	48	48	10	29	29	14	33	33
g / C, Green / Cycle	0.11	0.27	0.27	0.25	0.40	0.40	0.08	0.24	0.24	0.11	0.27	0.27
(v / s)_i Volume / Saturation Flow Rate	0.10	0.15	0.16	0.25	0.22	0.03	0.07	0.22	0.09	0.10	0.19	0.15
s, saturation flow rate [veh/h]	1781	3560	1589	3459	3560	1589	1781	5094	1589	3459	3560	1589
c, Capacity [veh/h]	202	946	422	860	1428	637	143	1219	380	391	968	432
d1, Uniform Delay [s]	52.21	37.91	38.62	44.98	27.46	22.24	54.29	44.56	38.22	52.32	39.06	37.54
k, delay calibration	0.11	0.50	0.50	0.11	0.50	0.50	0.11	0.11	0.11	0.11	0.11	0.11
l, Upstream Filtering Factor	1.00	1.00	1.00	1.00	1.00	1.00	1.00	1.00	1.00	1.00	1.00	1.00
d2, Incremental Delay [s]	9.44	2.30	6.40	12.52	1.46	0.24	10.26	3.43	0.63	5.68	0.86	1.14
d3, Initial Queue Delay [s]	0.00	0.00	0.00	0.00	0.00	0.00	0.00	0.00	0.00	0.00	0.00	0.00
Rp, platoon ratio	1.00	1.00	1.00	1.00	1.00	1.00	1.00	1.00	1.00	1.00	1.00	1.00
PF, progression factor	1.00	1.00	1.00	1.00	1.00	1.00	1.00	1.00	1.00	1.00	1.00	1.00

Lane Group Results

X, volume / capacity	0.85	0.55	0.61	0.99	0.54	0.08	0.81	0.92	0.38	0.86	0.68	0.56
d, Delay for Lane Group [s/veh]	61.65	40.21	45.01	57.50	28.92	22.48	64.54	47.99	38.84	58.00	39.92	38.67
Lane Group LOS	E	D	D	E	C	C	E	D	D	E	D	D
Critical Lane Group	No	No	Yes	Yes	No	No	No	Yes	No	Yes	No	No
50th-Percentile Queue Length [veh/ln]	5.36	6.54	7.03	13.39	8.09	0.87	3.77	10.87	3.54	5.16	8.51	6.05
50th-Percentile Queue Length [ft/ln]	134.03	163.44	175.73	334.70	202.37	21.64	94.26	271.67	88.61	129.10	212.65	151.24
95th-Percentile Queue Length [veh/ln]	9.16	10.73	11.38	19.39	12.76	1.56	6.79	16.27	6.38	8.89	13.29	10.08
95th-Percentile Queue Length [ft/ln]	228.96	268.27	284.43	484.72	319.02	38.95	169.67	406.83	159.51	222.27	332.22	252.08

Movement, Approach, & Intersection Results

d_M, Delay for Movement [s/veh]	61.65	40.21	45.01	57.50	28.92	22.48	64.54	47.99	38.84	58.00	39.92	38.67
Movement LOS	E	D	D	E	C	C	E	D	D	E	D	D
d_A, Approach Delay [s/veh]	45.38			43.32			48.42			44.59		
Approach LOS	D			D			D			D		
d_I, Intersection Delay [s/veh]	45.34											
Intersection LOS	D											
Intersection V/C	0.726											

Other Modes

g_Walk,mi, Effective Walk Time [s]	11.0	11.0	11.0	11.0
M_corner, Corner Circulation Area [ft ² /ped]	0.00	0.00	0.00	0.00
M_CW, Crosswalk Circulation Area [ft ² /ped]	0.00	0.00	0.00	0.00
d_p, Pedestrian Delay [s]	49.52	49.52	49.52	49.52
I_p,int, Pedestrian LOS Score for Intersectio	3.567	3.394	3.308	3.638
Crosswalk LOS	D	C	C	D
s_b, Saturation Flow Rate of the bicycle lane	2000	2000	2000	2000
c_b, Capacity of the bicycle lane [bicycles/h]	517	483	483	350
d_b, Bicycle Delay [s]	33.02	34.52	34.52	40.85
I_b,int, Bicycle LOS Score for Intersection	2.536	2.977	2.395	2.766
Bicycle LOS	B	C	B	C

Sequence



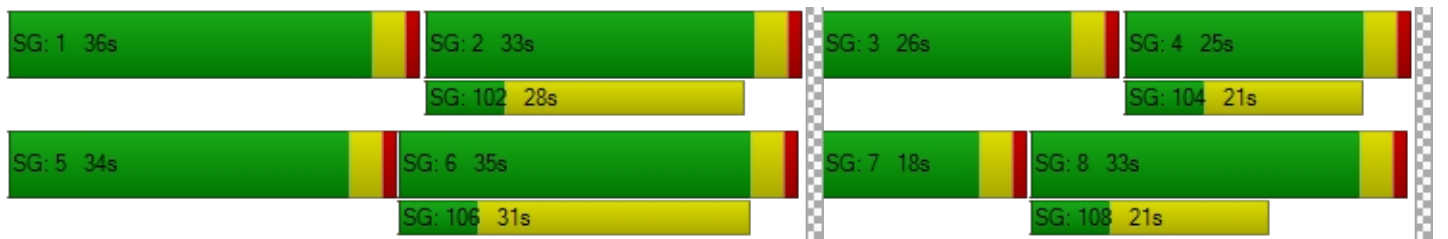

Ring 1	1	2	3	4	-	-	-	-	-	-	-	-	-	-	-	-
Ring 2	5	6	7	8	-	-	-	-	-	-	-	-	-	-	-	-
Ring 3	-	-	-	-	-	-	-	-	-	-	-	-	-	-	-	-
Ring 4	-	-	-	-	-	-	-	-	-	-	-	-	-	-	-	-



Intersection Level Of Service Report
Intersection 2: Marksheffel Rd/Lorson Bl

Control Type:	Signalized	Delay (sec / veh):	15.1
Analysis Method:	HCM 7th Edition	Level Of Service:	B
Analysis Period:	15 minutes	Volume to Capacity (v/c):	0.798

Intersection Setup

Name	Marksheffel Rd			Marksheffel Rd			Eastbound			Lorson Bl		
Approach	Northbound			Southbound			Eastbound			Westbound		
Lane Configuration												
Turning Movement	Left	Thru	Right	Left	Thru	Right	Left	Thru	Right	Left	Thru	Right
Lane Width [ft]	12.00	12.00	12.00	12.00	12.00	12.00	12.00	12.00	12.00	12.00	12.00	12.00
No. of Lanes in Entry Pocket	1	0	1	1	0	1	1	0	0	1	0	0
Entry Pocket Length [ft]	100.00	100.00	500.00	580.00	100.00	100.00	100.00	100.00	100.00	510.00	100.00	100.00
No. of Lanes in Exit Pocket	0	0	0	0	0	1	0	0	0	0	0	0
Exit Pocket Length [ft]	0.00	0.00	0.00	0.00	0.00	100.00	0.00	0.00	0.00	0.00	0.00	0.00
Speed [mph]	55.00			55.00			30.00			25.00		
Grade [%]	0.00			0.00			0.00			0.00		
Curb Present	No			No			No			No		
Crosswalk	Yes			Yes			Yes			Yes		

Volumes

Name	Marksheffel Rd			Marksheffel Rd						Lorson Bl		
Base Volume Input [veh/h]	159	742	568	284	610	34	47	15	41	348	20	199
Base Volume Adjustment Factor	1.0000	1.0000	1.0000	1.0000	1.0000	1.0000	1.0000	1.0000	1.0000	1.0000	1.0000	1.0000
Heavy Vehicles Percentage [%]	2.00	2.00	2.00	2.00	2.00	2.00	2.00	2.00	2.00	2.00	2.00	2.00
Proportion of CAVs [%]	0.00											
Growth Factor	1.0000	1.0000	1.0000	1.0000	1.0000	1.0000	1.0000	1.0000	1.0000	1.0000	1.0000	1.0000
In-Process Volume [veh/h]	0	0	0	0	0	0	0	0	0	0	0	0
Site-Generated Trips [veh/h]	0	64	0	0	66	0	0	0	0	0	0	0
Diverted Trips [veh/h]	0	0	0	0	0	0	0	0	0	0	0	0
Pass-by Trips [veh/h]	0	0	0	0	0	0	0	0	0	0	0	0
Existing Site Adjustment Volume [veh/h]	0	0	0	0	0	0	0	0	0	0	0	0
Other Volume [veh/h]	0	0	0	0	0	0	0	0	0	0	0	0
Right Turn on Red Volume [veh/h]	0	0	284	0	0	0	0	0	0	0	0	100
Total Hourly Volume [veh/h]	159	806	284	284	676	34	47	15	41	348	20	99
Peak Hour Factor	1.0000	0.9200	0.9200	0.9200	0.9200	1.0000	1.0000	1.0000	1.0000	0.9200	1.0000	0.9200
Other Adjustment Factor	1.0000	1.0000	1.0000	1.0000	1.0000	1.0000	1.0000	1.0000	1.0000	1.0000	1.0000	1.0000
Total 15-Minute Volume [veh/h]	40	219	77	77	184	9	12	4	10	95	5	27
Total Analysis Volume [veh/h]	159	876	309	309	735	34	47	15	41	378	20	108
Presence of On-Street Parking	No		No	No		No	No		No	No		No
On-Street Parking Maneuver Rate [/h]	0	0	0	0	0	0	0	0	0	0	0	0
Local Bus Stopping Rate [/h]	0	0	0	0	0	0	0	0	0	0	0	0
v_do, Outbound Pedestrian Volume crossing	0			0			0			0		
v_di, Inbound Pedestrian Volume crossing m	0			0			0			0		
v_co, Outbound Pedestrian Volume crossing	0			0			0			0		
v_ci, Inbound Pedestrian Volume crossing mi	0			0			0			0		
v_ab, Corner Pedestrian Volume [ped/h]	0			0			0			0		
Bicycle Volume [bicycles/h]	0			0			0			0		

Intersection Settings

Located in CBD	No
Signal Coordination Group	-
Cycle Length [s]	70
Active Pattern	Pattern 1
Coordination Type	Time of Day Pattern Coordinated
Actuation Type	Fully actuated
Offset [s]	0.0
Offset Reference	Lead Green - Beginning of First Green
Permissive Mode	SingleBand
Lost time [s]	0.00

Phasing & Timing

Control Type	Permiss	Permiss	Permiss	Permiss	Permiss	Permiss	Permiss	Permiss	Permiss	Permiss	Permiss	Permiss
Signal Group	0	6	0	0	2	0	0	8	0	0	4	0
Auxiliary Signal Groups												
Lead / Lag	-	-	-	-	-	-	-	-	-	-	-	-
Minimum Green [s]	0	10	0	0	10	0	0	10	0	0	10	0
Maximum Green [s]	0	10	0	0	10	0	0	10	0	0	10	0
Amber [s]	0.0	3.0	0.0	0.0	3.0	0.0	0.0	3.0	0.0	0.0	3.0	0.0
All red [s]	0.0	1.0	0.0	0.0	1.0	0.0	0.0	1.0	0.0	0.0	1.0	0.0
Split [s]	0	36	0	0	36	0	0	34	0	0	34	0
Vehicle Extension [s]	0.0	3.0	0.0	0.0	3.0	0.0	0.0	3.0	0.0	0.0	3.0	0.0
Walk [s]	0	7	0	0	7	0	0	7	0	0	7	0
Pedestrian Clearance [s]	0	17	0	0	10	0	0	23	0	0	21	0
Delayed Vehicle Green [s]	0.0	0.0	0.0	0.0	0.0	0.0	0.0	0.0	0.0	0.0	0.0	0.0
Rest In Walk		No			No			No			No	
I1, Start-Up Lost Time [s]	0.0	2.0	0.0	0.0	2.0	0.0	0.0	2.0	0.0	0.0	2.0	0.0
I2, Clearance Lost Time [s]	0.0	2.0	0.0	0.0	2.0	0.0	0.0	2.0	0.0	0.0	2.0	0.0
Minimum Recall		No			No			No			No	
Maximum Recall		No			No			No			No	
Pedestrian Recall		No			No			No			No	
Detector Location [ft]	0.0	0.0	0.0	0.0	0.0	0.0	0.0	0.0	0.0	0.0	0.0	0.0
Detector Length [ft]	0.0	0.0	0.0	0.0	0.0	0.0	0.0	0.0	0.0	0.0	0.0	0.0
I, Upstream Filtering Factor	1.00	1.00	1.00	1.00	1.00	1.00	1.00	1.00	1.00	1.00	1.00	1.00

Exclusive Pedestrian Phase

Pedestrian Signal Group	0
Pedestrian Walk [s]	0
Pedestrian Clearance [s]	0

Lane Group Calculations

Lane Group	L	C	R	L	C	R	L	C	L	C	R
C, Cycle Length [s]	70	70	70	70	70	70	70	70	70	70	70
L, Total Lost Time per Cycle [s]	4.00	4.00	4.00	4.00	4.00	4.00	4.00	4.00	4.00	4.00	4.00
l1_p, Permitted Start-Up Lost Time [s]	2.00	0.00	0.00	2.00	0.00	0.00	2.00	0.00	2.00	0.00	0.00
l2, Clearance Lost Time [s]	2.00	2.00	2.00	2.00	2.00	2.00	2.00	2.00	2.00	2.00	2.00
g_i, Effective Green Time [s]	45	45	45	45	45	45	17	17	17	17	17
g / C, Green / Cycle	0.64	0.64	0.64	0.64	0.64	0.64	0.24	0.24	0.24	0.24	0.24
(v / s)_i Volume / Saturation Flow Rate	0.23	0.25	0.19	0.65	0.21	0.02	0.04	0.03	0.14	0.01	0.07
s, saturation flow rate [veh/h]	700	3560	1589	473	3560	1589	1262	1656	2616	1870	1589
c, Capacity [veh/h]	473	2287	1021	342	2287	1021	350	402	568	454	386
d1, Uniform Delay [s]	10.06	5.92	5.54	21.26	5.62	4.56	23.45	20.71	27.60	20.23	21.47
k, delay calibration	0.50	0.50	0.50	0.50	0.50	0.50	0.11	0.11	0.11	0.11	0.11
l, Upstream Filtering Factor	1.00	1.00	1.00	1.00	1.00	1.00	1.00	1.00	1.00	1.00	1.00
d2, Incremental Delay [s]	1.92	0.49	0.76	29.31	0.37	0.06	0.17	0.16	1.35	0.04	0.39
d3, Initial Queue Delay [s]	0.00	0.00	0.00	0.00	0.00	0.00	0.00	0.00	0.00	0.00	0.00
Rp, platoon ratio	1.00	1.00	1.00	1.00	1.00	1.00	1.00	1.00	1.00	1.00	1.00
PF, progression factor	1.00	1.00	1.00	1.00	1.00	1.00	1.00	1.00	1.00	1.00	1.00

Lane Group Results

X, volume / capacity	0.34	0.38	0.30	0.90	0.32	0.03	0.13	0.14	0.67	0.04	0.28
d, Delay for Lane Group [s/veh]	11.98	6.41	6.30	50.56	6.00	4.62	23.62	20.87	28.96	20.27	21.86
Lane Group LOS	B	A	A	D	A	A	C	C	C	C	C
Critical Lane Group	No	No	No	Yes	No	No	No	No	Yes	No	No
50th-Percentile Queue Length [veh/ln]	1.31	1.85	1.33	7.54	1.47	0.12	0.64	0.70	3.05	0.25	1.44
50th-Percentile Queue Length [ft/ln]	32.69	46.16	33.33	188.61	36.67	2.96	15.97	17.57	76.24	6.22	35.96
95th-Percentile Queue Length [veh/ln]	2.35	3.32	2.40	12.05	2.64	0.21	1.15	1.27	5.49	0.45	2.59
95th-Percentile Queue Length [ft/ln]	58.84	83.09	60.00	301.23	66.00	5.33	28.74	31.63	137.23	11.19	64.73

Movement, Approach, & Intersection Results

d_M, Delay for Movement [s/veh]	11.98	6.41	6.30	50.56	6.00	4.62	23.62	20.87	20.87	28.96	20.27	21.86
Movement LOS	B	A	A	D	A	A	C	C	C	C	C	C
d_A, Approach Delay [s/veh]	7.04			18.73			22.12			27.10		
Approach LOS	A			B			C			C		
d_I, Intersection Delay [s/veh]	15.06											
Intersection LOS	B											
Intersection V/C	0.798											

Other Modes

g_Walk,mi, Effective Walk Time [s]	11.0			11.0			11.0			11.0		
M_corner, Corner Circulation Area [ft ² /ped]	0.00			0.00			0.00			0.00		
M_CW, Crosswalk Circulation Area [ft ² /ped]	0.00			0.00			0.00			0.00		
d_p, Pedestrian Delay [s]	24.82			24.82			24.82			24.82		
I_p,int, Pedestrian LOS Score for Intersectio	4.209			3.164			2.255			3.115		
Crosswalk LOS	D			C			B			C		
s_b, Saturation Flow Rate of the bicycle lane	2000			2000			2000			2000		
c_b, Capacity of the bicycle lane [bicycles/h]	915			915			858			858		
d_b, Bicycle Delay [s]	10.28			10.28			11.40			11.40		
I_b,int, Bicycle LOS Score for Intersection	2.903			2.449			1.730			2.560		
Bicycle LOS	C			B			A			B		

Sequence



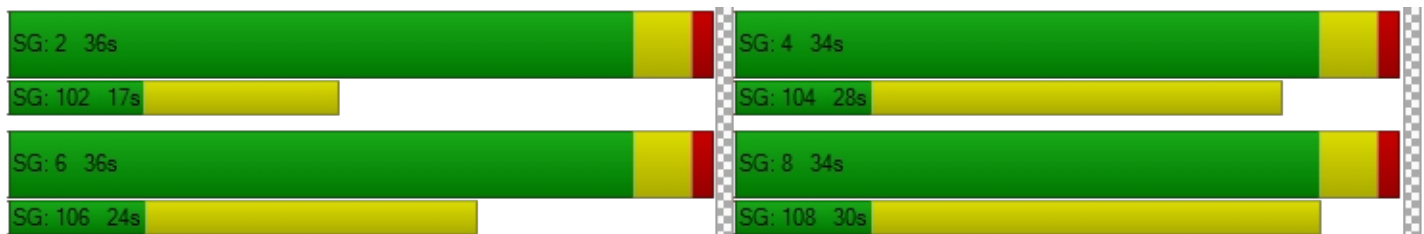

Ring 1	-	2	-	4	-	-	-	-	-	-	-	-	-	-	-	-	-
Ring 2	-	6	-	8	-	-	-	-	-	-	-	-	-	-	-	-	-
Ring 3	-	-	-	-	-	-	-	-	-	-	-	-	-	-	-	-	-
Ring 4	-	-	-	-	-	-	-	-	-	-	-	-	-	-	-	-	-



Intersection Level Of Service Report
Intersection 3: Fontaine Bl/Carriage Meadows Dr

Control Type:	Signalized	Delay (sec / veh):	17.1
Analysis Method:	HCM 7th Edition	Level Of Service:	B
Analysis Period:	15 minutes	Volume to Capacity (v/c):	0.789

Intersection Setup

Name	Carriage Meadows Dr			Carriage Meadows Dr			Fontaine Bl			Fontaine Bl		
Approach	Northbound			Southbound			Eastbound			Westbound		
Lane Configuration												
Turning Movement	Left	Thru	Right	Left	Thru	Right	Left	Thru	Right	Left	Thru	Right
Lane Width [ft]	12.00	12.00	12.00	12.00	12.00	12.00	12.00	12.00	12.00	12.00	12.00	12.00
No. of Lanes in Entry Pocket	1	0	1	1	0	1	1	0	0	1	0	1
Entry Pocket Length [ft]	100.00	100.00	100.00	100.00	100.00	100.00	510.00	100.00	100.00	330.00	100.00	330.00
No. of Lanes in Exit Pocket	0	0	0	0	0	0	0	0	0	0	0	0
Exit Pocket Length [ft]	0.00	0.00	0.00	0.00	0.00	0.00	0.00	0.00	0.00	0.00	0.00	0.00
Speed [mph]	25.00			25.00			45.00			45.00		
Grade [%]	0.00			0.00			0.00			0.00		
Curb Present	No			No			No			No		
Crosswalk	Yes			Yes			Yes			Yes		

Volumes

Name	Carriage Meadows Dr			Carriage Meadows Dr			Fontaine BI			Fontaine BI		
Base Volume Input [veh/h]	23	5	8	5	5	8	56	2160	44	8	1200	6
Base Volume Adjustment Factor	1.0000	1.0000	1.0000	1.0000	1.0000	1.0000	1.0000	1.0000	1.0000	1.0000	1.0000	1.0000
Heavy Vehicles Percentage [%]	2.00	2.00	2.00	2.00	2.00	2.00	2.00	2.00	2.00	2.00	2.00	2.00
Proportion of CAVs [%]	0.00											
Growth Factor	1.7120	1.0000	1.7120	1.7120	1.0000	1.7120	1.7120	1.0000	1.7120	1.7120	1.0000	1.7120
In-Process Volume [veh/h]	0	0	0	0	0	0	0	0	0	0	0	0
Site-Generated Trips [veh/h]	116	2	30	3	2	8	10	30	40	58	0	4
Diverted Trips [veh/h]	0	0	0	0	0	0	0	0	0	0	0	0
Pass-by Trips [veh/h]	0	0	0	0	0	0	0	0	0	0	0	0
Existing Site Adjustment Volume [veh/h]	0	0	0	0	0	0	0	0	0	0	0	0
Other Volume [veh/h]	0	0	0	0	0	0	0	0	0	0	0	0
Right Turn on Red Volume [veh/h]	0	0	22	0	0	11	0	0	58	0	0	7
Total Hourly Volume [veh/h]	155	7	22	12	7	11	106	2190	57	72	1200	7
Peak Hour Factor	0.9200	0.9200	0.9200	0.9200	0.9200	0.9200	0.9200	0.9200	0.9200	0.9200	0.9200	0.9200
Other Adjustment Factor	1.0000	1.0000	1.0000	1.0000	1.0000	1.0000	1.0000	1.0000	1.0000	1.0000	1.0000	1.0000
Total 15-Minute Volume [veh/h]	42	2	6	3	2	3	29	595	15	20	326	2
Total Analysis Volume [veh/h]	168	8	24	13	8	12	115	2380	62	78	1304	8
Presence of On-Street Parking	No		No	No		No	No		No	No		No
On-Street Parking Maneuver Rate [/h]	0	0	0	0	0	0	0	0	0	0	0	0
Local Bus Stopping Rate [/h]	0	0	0	0	0	0	0	0	0	0	0	0
v_do, Outbound Pedestrian Volume crossing	0			0			0			0		
v_di, Inbound Pedestrian Volume crossing m	0			0			0			0		
v_co, Outbound Pedestrian Volume crossing	0			0			0			0		
v_ci, Inbound Pedestrian Volume crossing mi	0			0			0			0		
v_ab, Corner Pedestrian Volume [ped/h]	0			0			0			0		
Bicycle Volume [bicycles/h]	0			0			0			0		

Intersection Settings

Located in CBD	No
Signal Coordination Group	-
Cycle Length [s]	100
Active Pattern	Pattern 1
Coordination Type	Time of Day Pattern Coordinated
Actuation Type	Semi-actuated
Offset [s]	0.0
Offset Reference	Lead Green - Beginning of First Green
Permissive Mode	SingleBand
Lost time [s]	0.00

Phasing & Timing

Control Type	Permiss	Permiss	Permiss	Permiss	Permiss	Permiss	Protecte	Permiss	Permiss	Permiss	Permiss	Permiss
Signal Group	0	8	0	0	4	0	5	2	0	0	6	0
Auxiliary Signal Groups												
Lead / Lag	-	-	-	-	-	-	Lead	-	-	-	-	-
Minimum Green [s]	0	10	0	0	10	0	5	10	0	0	10	0
Maximum Green [s]	0	34	0	0	34	0	5	168	0	0	168	0
Amber [s]	0.0	3.0	0.0	0.0	3.0	0.0	3.0	3.0	0.0	0.0	3.0	0.0
All red [s]	0.0	1.0	0.0	0.0	1.0	0.0	1.0	1.0	0.0	0.0	1.0	0.0
Split [s]	0	38	0	0	38	0	11	62	0	0	51	0
Vehicle Extension [s]	0.0	3.0	0.0	0.0	3.0	0.0	3.0	3.0	0.0	0.0	3.0	0.0
Walk [s]	0	7	0	0	7	0	0	7	0	0	7	0
Pedestrian Clearance [s]	0	23	0	0	27	0	0	7	0	0	14	0
Delayed Vehicle Green [s]	0.0	0.0	0.0	0.0	0.0	0.0	0.0	0.0	0.0	0.0	0.0	0.0
Rest In Walk		No			No			No			No	
I1, Start-Up Lost Time [s]	0.0	2.0	0.0	0.0	2.0	0.0	2.0	2.0	0.0	0.0	2.0	0.0
I2, Clearance Lost Time [s]	0.0	2.0	0.0	0.0	2.0	0.0	2.0	2.0	0.0	0.0	2.0	0.0
Minimum Recall		No			No		No	No			No	
Maximum Recall		No			No		No	No			No	
Pedestrian Recall		No			No		No	No			No	
Detector Location [ft]	0.0	0.0	0.0	0.0	0.0	0.0	0.0	0.0	0.0	0.0	0.0	0.0
Detector Length [ft]	0.0	0.0	0.0	0.0	0.0	0.0	0.0	0.0	0.0	0.0	0.0	0.0
I, Upstream Filtering Factor	1.00	1.00	1.00	1.00	1.00	1.00	1.00	1.00	1.00	1.00	1.00	1.00

Exclusive Pedestrian Phase

Pedestrian Signal Group	0
Pedestrian Walk [s]	0
Pedestrian Clearance [s]	0

Lane Group Calculations

Lane Group	L	C	R	L	C	R	L	C	R	L	C	R
C, Cycle Length [s]	100	100	100	100	100	100	100	100	100	100	100	100
L, Total Lost Time per Cycle [s]	4.00	4.00	4.00	4.00	4.00	4.00	4.00	4.00	4.00	4.00	4.00	4.00
l1_p, Permitted Start-Up Lost Time [s]	2.00	0.00	0.00	2.00	0.00	0.00	0.00	0.00	0.00	2.00	0.00	0.00
l2, Clearance Lost Time [s]	2.00	2.00	2.00	2.00	2.00	2.00	2.00	2.00	2.00	2.00	2.00	2.00
g_i, Effective Green Time [s]	15	15	15	15	15	15	7	77	77	66	66	66
g / C, Green / Cycle	0.15	0.15	0.15	0.15	0.15	0.15	0.07	0.77	0.77	0.66	0.66	0.66
(v / s)_i Volume / Saturation Flow Rate	0.12	0.00	0.02	0.01	0.00	0.01	0.06	0.67	0.04	0.56	0.37	0.01
s, saturation flow rate [veh/h]	1392	1870	1589	1377	1870	1589	1781	3560	1589	139	3560	1589
c, Capacity [veh/h]	271	279	238	269	279	238	125	2744	1225	86	2352	1050
d1, Uniform Delay [s]	41.78	36.33	36.73	37.09	36.33	36.45	46.23	7.94	2.74	49.06	9.09	5.79
k, delay calibration	0.11	0.11	0.11	0.11	0.11	0.11	0.28	0.50	0.50	0.50	0.50	0.50
l, Upstream Filtering Factor	1.00	1.00	1.00	1.00	1.00	1.00	1.00	1.00	1.00	1.00	1.00	1.00
d2, Incremental Delay [s]	2.31	0.04	0.18	0.07	0.04	0.09	42.91	4.02	0.08	72.96	0.95	0.01
d3, Initial Queue Delay [s]	0.00	0.00	0.00	0.00	0.00	0.00	0.00	0.00	0.00	0.00	0.00	0.00
Rp, platoon ratio	1.00	1.00	1.00	1.00	1.00	1.00	1.00	1.00	1.00	1.00	1.00	1.00
PF, progression factor	1.00	1.00	1.00	1.00	1.00	1.00	1.00	1.00	1.00	1.00	1.00	1.00

Lane Group Results

X, volume / capacity	0.62	0.03	0.10	0.05	0.03	0.05	0.92	0.87	0.05	0.90	0.55	0.01
d, Delay for Lane Group [s/veh]	44.09	36.37	36.91	37.16	36.37	36.54	89.14	11.96	2.82	122.02	10.04	5.80
Lane Group LOS	D	D	D	D	D	D	F	B	A	F	B	A
Critical Lane Group	Yes	No	No	No	No	No	No	Yes	No	No	No	No
50th-Percentile Queue Length [veh/ln]	4.22	0.17	0.52	0.28	0.17	0.26	4.22	11.53	0.21	3.64	6.32	0.05
50th-Percentile Queue Length [ft/ln]	105.49	4.30	13.09	7.08	4.30	6.49	105.59	288.26	5.16	90.94	157.97	1.27
95th-Percentile Queue Length [veh/ln]	7.59	0.31	0.94	0.51	0.31	0.47	7.59	17.10	0.37	6.55	10.44	0.09
95th-Percentile Queue Length [ft/ln]	189.71	7.73	23.56	12.75	7.73	11.68	189.85	427.48	9.29	163.70	261.03	2.29

Movement, Approach, & Intersection Results

d_M, Delay for Movement [s/veh]	44.09	36.37	36.91	37.16	36.37	36.54	89.14	11.96	2.82	122.02	10.04	5.80
Movement LOS	D	D	D	D	D	D	F	B	A	F	B	A
d_A, Approach Delay [s/veh]	42.92			36.74			15.21			16.30		
Approach LOS	D			D			B			B		
d_I, Intersection Delay [s/veh]	17.07											
Intersection LOS	B											
Intersection V/C	0.789											

Other Modes

g_Walk,mi, Effective Walk Time [s]	11.0	11.0	11.0	11.0
M_corner, Corner Circulation Area [ft ² /ped]	0.00	0.00	0.00	0.00
M_CW, Crosswalk Circulation Area [ft ² /ped]	0.00	0.00	0.00	0.00
d_p, Pedestrian Delay [s]	39.61	39.61	39.61	39.61
I_p,int, Pedestrian LOS Score for Intersectio	2.365	2.189	3.779	3.421
Crosswalk LOS	B	B	D	C
s_b, Saturation Flow Rate of the bicycle lane	2000	2000	2000	2000
c_b, Capacity of the bicycle lane [bicycles/h]	680	680	1160	940
d_b, Bicycle Delay [s]	21.78	21.78	8.82	14.05
I_b,int, Bicycle LOS Score for Intersection	1.926	1.632	3.717	2.712
Bicycle LOS	A	A	D	B

Sequence

Ring 1	-	2	-	4	-	-	-	-	-	-	-	-	-	-	-	-
Ring 2	5	6	-	8	-	-	-	-	-	-	-	-	-	-	-	-
Ring 3	-	-	-	-	-	-	-	-	-	-	-	-	-	-	-	-
Ring 4	-	-	-	-	-	-	-	-	-	-	-	-	-	-	-	-

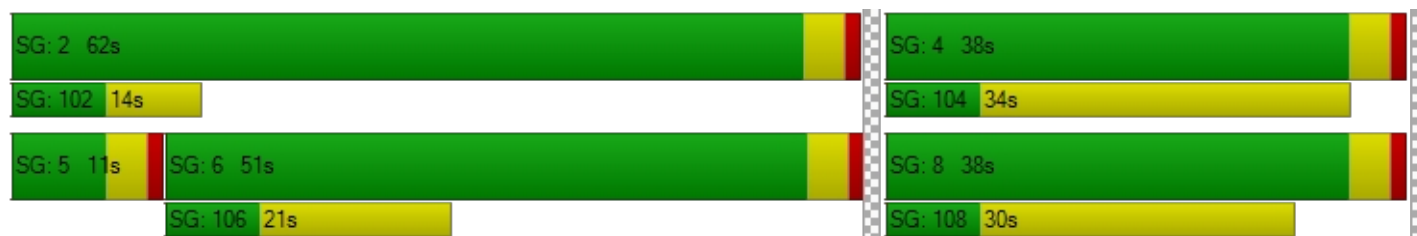

Signal Warrants Report For Intersection 3: Fontaine Bl/Carriage Meadows Dr

Warrants Summary

Warrant	Name	Met?
#1	Eight Hour Vehicular Volume	Yes
#2	Four Hour Vehicular Volume	Yes
#3	Peak Hour	Yes

Intersection Warrants Parameters

Major Approaches	E, W
Minor Approaches	S, N
Speed > 40mph	Yes
Population < 10,000	No
Warrant Factor	70%

Warrant Analysis Traffic Volumes

Hour	Major Streets		Minor Streets	
	E	W	S	N
1	1286	2411	206	41
2	1247	2339	200	40
3	1222	2290	196	39
4	1145	2146	183	36
5	1016	1905	163	32
6	1003	1881	161	32
7	990	1856	159	32
8	900	1688	144	29
9	887	1664	142	28
10	874	1639	140	28
11	759	1422	122	24
12	707	1326	113	23
13	694	1302	111	22
14	514	964	82	16
15	514	964	82	16
16	360	675	58	11
17	206	386	33	7
18	206	386	33	7
19	116	217	19	4
20	64	121	10	2
21	39	72	6	1
22	13	24	2	0
23	13	24	2	0
24	13	24	2	0

Warrant Analysis by Hour

Hour	Major Streets		Minor Street		Warrant 1 Condition A				Warrant 1 Condition B				Warrant 2	Warrant 3 Condition B
	Number	Volume	Number	Volume	100%	80%	70%	56%	100%	80%	70%	56%		
1	4	3697	3	206	Yes	Yes	Yes	Yes	Yes	Yes	Yes	Yes	Yes	Yes
2	4	3586	3	200	Yes	Yes	Yes	Yes	Yes	Yes	Yes	Yes	Yes	Yes
3	4	3512	3	196	No	Yes	Yes	Yes	Yes	Yes	Yes	Yes	Yes	Yes
4	4	3291	3	183	No	Yes	Yes	Yes	Yes	Yes	Yes	Yes	Yes	Yes
5	4	2921	3	163	No	Yes	Yes	Yes	Yes	Yes	Yes	Yes	Yes	Yes
6	4	2884	3	161	No	Yes	Yes	Yes	Yes	Yes	Yes	Yes	Yes	Yes
7	4	2846	3	159	No	No	Yes	Yes	Yes	Yes	Yes	Yes	Yes	Yes
8	4	2588	3	144	No	No	Yes	Yes	Yes	Yes	Yes	Yes	Yes	Yes
9	4	2551	3	142	No	No	Yes	Yes	Yes	Yes	Yes	Yes	Yes	Yes
10	4	2513	3	140	No	No	Yes	Yes	Yes	Yes	Yes	Yes	Yes	Yes
11	4	2181	3	122	No	No	No	Yes	Yes	Yes	Yes	Yes	Yes	Yes
12	4	2033	3	113	No	No	No	Yes	Yes	Yes	Yes	Yes	Yes	Yes
13	4	1996	3	111	No	No	No	No	Yes	Yes	Yes	Yes	Yes	Yes
14	4	1478	3	82	No	No	No	No	No	Yes	Yes	Yes	Yes	No
15	4	1478	3	82	No	No	No	No	No	Yes	Yes	Yes	Yes	No
16	4	1035	3	58	No	No	No	No	No	No	No	Yes	No	No
17	4	592	3	33	No	No	No	No	No	No	No	No	No	No
18	4	592	3	33	No	No	No	No	No	No	No	No	No	No
19	4	333	3	19	No	No	No	No	No	No	No	No	No	No
20	4	185	3	10	No	No	No	No	No	No	No	No	No	No
21	4	111	3	6	No	No	No	No	No	No	No	No	No	No
22	4	37	3	2	No	No	No	No	No	No	No	No	No	No
23	4	37	3	2	No	No	No	No	No	No	No	No	No	No
24	4	37	3	2	No	No	No	No	No	No	No	No	No	No
Hours Met					2	6	10	12	13	15	15	16	15	13

Warrant 3 Condition A

Orientation	S	N
Total Stopped Delay Per Vehicle on Minor Approach (s)	7806.2	2517.2
Number of Lanes on Minor Street Approach	3	3
VehicleHours of Stopped Delay on Minor Approach (h:mm)	446:41	28:40
Delay Condition Met	Yes	Yes
Volume on Minor Street Approach During Same Hour	206	41
High Minor Volume Condition Met	Yes	No
Total Entering Volume on All Approaches During Same Hour	3944	3944
Number of Approaches on Intersection	4	4
Total Volume Condition Met	Yes	Yes
Warrant Met for Approach	Yes	No
Warrant Met for Intersection	Yes	

Table of Contents

Intersection Level Of Service Report	2
Intersection 1: Marksheffel Rd/Fontaine Bl	2
Intersection 2: Marksheffel Rd/Lorson Bl	7
Intersection 3: Fontaine Bl/Carriage Meadows Dr	12
Intersection 4: Marksheffel Rd/West Driveway	17
Intersection 5: Carriage Meadows Dr/East Driveway	19
Intersection 7: Fontaine Bl/Middle Driveway	21
Signal Warrants Report	23
Intersection 4: Marksheffel Rd/West Driveway	23
Intersection 5: Carriage Meadows Dr/East Driveway	25
Intersection 7: Fontaine Bl/Middle Driveway	27

Intersection Level Of Service Report
Intersection 1: Marksheffel Rd/Fontaine Bl

Control Type:	Signalized	Delay (sec / veh):	33.4
Analysis Method:	HCM 7th Edition	Level Of Service:	C
Analysis Period:	15 minutes	Volume to Capacity (v/c):	0.621

Intersection Setup

Name	Marksheffel Rd			Marksheffel Rd			Fontaine Bl			Fontaine Bl		
Approach	Northbound			Southbound			Eastbound			Westbound		
Lane Configuration	[Diagram]			[Diagram]			[Diagram]			[Diagram]		
Turning Movement	Left	Thru	Right	Left	Thru	Right	Left	Thru	Right	Left	Thru	Right
Lane Width [ft]	12.00	12.00	12.00	12.00	12.00	12.00	12.00	12.00	12.00	12.00	12.00	12.00
No. of Lanes in Entry Pocket	1	0	1	1	0	1	1	0	1	1	0	0
Entry Pocket Length [ft]	680.00	100.00	680.00	750.00	100.00	500.00	360.00	100.00	200.00	535.00	100.00	100.00
No. of Lanes in Exit Pocket	0	0	1	0	0	1	0	0	0	0	0	0
Exit Pocket Length [ft]	0.00	0.00	100.00	0.00	0.00	100.00	0.00	0.00	0.00	0.00	0.00	0.00
Speed [mph]	55.00			55.00			45.00			45.00		
Grade [%]	0.00			0.00			0.00			0.00		
Curb Present	No			No			No			No		
Crosswalk	Yes			Yes			Yes			Yes		

Volumes

Name	Marksheffel Rd			Marksheffel Rd			Fontaine Bl			Fontaine Bl		
Base Volume Input [veh/h]	153	675	145	199	317	55	75	298	158	268	753	570
Base Volume Adjustment Factor	1.0000	1.0000	1.0000	1.0000	1.0000	1.0000	1.0000	1.0000	1.0000	1.0000	1.0000	1.0000
Heavy Vehicles Percentage [%]	2.00	2.00	2.00	2.00	2.00	2.00	2.00	2.00	2.00	2.00	2.00	2.00
Proportion of CAVs [%]	0.00											
Growth Factor	1.0000	1.0000	1.0000	1.0000	1.0000	1.0000	1.0000	1.0000	1.0000	1.0000	1.0000	1.0000
In-Process Volume [veh/h]	0	0	0	0	0	0	0	0	0	0	0	0
Site-Generated Trips [veh/h]	0	75	16	80	0	0	24	27	0	81	45	27
Diverted Trips [veh/h]	0	0	0	0	0	0	0	0	0	0	0	0
Pass-by Trips [veh/h]	0	0	0	0	0	0	0	0	0	0	0	0
Existing Site Adjustment Volume [veh/h]	0	0	0	0	0	0	0	0	0	0	0	0
Other Volume [veh/h]	0	0	0	0	0	0	0	0	0	0	0	0
Right Turn on Red Volume [veh/h]	0	0	81	0	0	28	0	0	79	0	0	299
Total Hourly Volume [veh/h]	153	750	80	279	317	27	99	325	79	349	798	298
Peak Hour Factor	0.9200	0.9200	0.9200	0.9200	0.9200	0.9200	0.9200	0.9200	0.9200	0.9200	0.9200	0.9200
Other Adjustment Factor	1.0000	1.0000	1.0000	1.0000	1.0000	1.0000	1.0000	1.0000	1.0000	1.0000	1.0000	1.0000
Total 15-Minute Volume [veh/h]	42	204	22	76	86	7	27	88	21	95	217	81
Total Analysis Volume [veh/h]	166	815	87	303	345	29	108	353	86	379	867	324
Presence of On-Street Parking	No		No	No		No	No		No	No		No
On-Street Parking Maneuver Rate [/h]	0	0	0	0	0	0	0	0	0	0	0	0
Local Bus Stopping Rate [/h]	0	0	0	0	0	0	0	0	0	0	0	0
v_do, Outbound Pedestrian Volume crossing	0			0			0			0		
v_di, Inbound Pedestrian Volume crossing m	0			0			0			0		
v_co, Outbound Pedestrian Volume crossing	0			0			0			0		
v_ci, Inbound Pedestrian Volume crossing mi	0			0			0			0		
v_ab, Corner Pedestrian Volume [ped/h]	0			0			0			0		
Bicycle Volume [bicycles/h]	0			0			0			0		

Intersection Settings

Located in CBD	No
Signal Coordination Group	-
Cycle Length [s]	90
Active Pattern	Pattern 1
Coordination Type	Time of Day Pattern Coordinated
Actuation Type	Fully actuated
Offset [s]	0.0
Offset Reference	Lead Green - Beginning of First Green
Permissive Mode	SingleBand
Lost time [s]	0.00

Phasing & Timing

Control Type	Protecte	Permiss	Permiss	Protecte	Permiss	Permiss	Protecte	Permiss	Permiss	Protecte	Permiss	Permiss
Signal Group	1	6	0	5	2	0	3	8	0	7	4	0
Auxiliary Signal Groups												
Lead / Lag	Lead	-	-	Lead	-	-	Lead	-	-	Lead	-	-
Minimum Green [s]	5	10	0	5	10	0	5	10	0	5	10	0
Maximum Green [s]	5	103	0	5	103	0	5	109	0	5	109	0
Amber [s]	3.0	3.0	0.0	3.0	3.0	0.0	3.0	3.0	0.0	3.0	3.0	0.0
All red [s]	1.0	1.0	0.0	1.0	1.0	0.0	1.0	1.0	0.0	1.0	1.0	0.0
Split [s]	18	35	0	15	32	0	13	25	0	15	27	0
Vehicle Extension [s]	3.0	3.0	0.0	3.0	3.0	0.0	3.0	3.0	0.0	3.0	3.0	0.0
Walk [s]	0	7	0	0	7	0	0	7	0	0	7	0
Pedestrian Clearance [s]	0	24	0	0	21	0	0	14	0	0	14	0
Delayed Vehicle Green [s]	0.0	0.0	0.0	0.0	0.0	0.0	0.0	0.0	0.0	0.0	0.0	0.0
Rest In Walk		No			No			No			No	
I1, Start-Up Lost Time [s]	2.0	2.0	0.0	2.0	2.0	0.0	2.0	2.0	0.0	2.0	2.0	0.0
I2, Clearance Lost Time [s]	2.0	2.0	0.0	2.0	2.0	0.0	2.0	2.0	0.0	2.0	2.0	0.0
Minimum Recall	No	No		No	No		No	No		No	No	
Maximum Recall	No	No		No	No		No	No		No	No	
Pedestrian Recall	No	No		No	No		No	No		No	No	
Detector Location [ft]	0.0	0.0	0.0	0.0	0.0	0.0	0.0	0.0	0.0	0.0	0.0	0.0
Detector Length [ft]	0.0	0.0	0.0	0.0	0.0	0.0	0.0	0.0	0.0	0.0	0.0	0.0
I, Upstream Filtering Factor	1.00	1.00	1.00	1.00	1.00	1.00	1.00	1.00	1.00	1.00	1.00	1.00

Exclusive Pedestrian Phase

Pedestrian Signal Group	0
Pedestrian Walk [s]	0
Pedestrian Clearance [s]	0

Lane Group Calculations

Lane Group	L	C	R	L	C	R	L	C	R	L	C	R
C, Cycle Length [s]	90	90	90	90	90	90	90	90	90	90	90	90
L, Total Lost Time per Cycle [s]	4.00	4.00	4.00	4.00	4.00	4.00	4.00	4.00	4.00	4.00	4.00	4.00
l1_p, Permitted Start-Up Lost Time [s]	0.00	0.00	0.00	0.00	0.00	0.00	0.00	0.00	0.00	0.00	0.00	0.00
l2, Clearance Lost Time [s]	2.00	2.00	2.00	2.00	2.00	2.00	2.00	2.00	2.00	2.00	2.00	2.00
g_i, Effective Green Time [s]	10	33	33	10	33	33	7	20	20	11	24	24
g / C, Green / Cycle	0.11	0.37	0.37	0.11	0.36	0.36	0.08	0.22	0.22	0.12	0.27	0.27
(v / s)_i Volume / Saturation Flow Rate	0.09	0.23	0.05	0.09	0.10	0.02	0.06	0.07	0.05	0.11	0.24	0.20
s, saturation flow rate [veh/h]	1781	3560	1589	3459	3560	1589	1781	5094	1589	3459	3560	1589
c, Capacity [veh/h]	202	1310	585	379	1297	579	138	1136	354	422	953	425
d1, Uniform Delay [s]	39.06	23.35	19.05	39.16	20.18	18.56	40.86	29.24	28.77	39.03	31.96	30.37
k, delay calibration	0.13	0.50	0.50	0.11	0.50	0.50	0.11	0.11	0.11	0.11	0.11	0.11
l, Upstream Filtering Factor	1.00	1.00	1.00	1.00	1.00	1.00	1.00	1.00	1.00	1.00	1.00	1.00
d2, Incremental Delay [s]	9.36	2.23	0.54	3.91	0.50	0.16	9.41	0.15	0.35	7.08	3.77	2.85
d3, Initial Queue Delay [s]	0.00	0.00	0.00	0.00	0.00	0.00	0.00	0.00	0.00	0.00	0.00	0.00
Rp, platoon ratio	1.00	1.00	1.00	1.00	1.00	1.00	1.00	1.00	1.00	1.00	1.00	1.00
PF, progression factor	1.00	1.00	1.00	1.00	1.00	1.00	1.00	1.00	1.00	1.00	1.00	1.00

Lane Group Results

X, volume / capacity	0.82	0.62	0.15	0.80	0.27	0.05	0.79	0.31	0.24	0.90	0.91	0.76
d, Delay for Lane Group [s/veh]	48.42	25.58	19.58	43.07	20.68	18.73	50.27	29.40	29.13	46.10	35.73	33.21
Lane Group LOS	D	C	B	D	C	B	D	C	C	D	D	C
Critical Lane Group	No	Yes	No	Yes	No	No	Yes	No	No	No	Yes	No
50th-Percentile Queue Length [veh/ln]	3.85	6.63	1.17	3.24	2.36	0.38	2.61	2.03	1.48	4.33	8.96	6.34
50th-Percentile Queue Length [ft/ln]	96.28	165.76	29.28	80.95	58.96	9.43	65.13	50.64	36.99	108.26	223.98	158.61
95th-Percentile Queue Length [veh/ln]	6.93	10.85	2.11	5.83	4.25	0.68	4.69	3.65	2.66	7.74	13.87	10.48
95th-Percentile Queue Length [ft/ln]	173.31	271.33	52.71	145.72	106.13	16.97	117.23	91.15	66.58	193.59	346.70	261.88

Movement, Approach, & Intersection Results

d_M, Delay for Movement [s/veh]	48.42	25.58	19.58	43.07	20.68	18.73	50.27	29.40	29.13	46.10	35.73	33.21
Movement LOS	D	C	B	D	C	B	D	C	C	D	D	C
d_A, Approach Delay [s/veh]	28.64			30.62			33.48			37.71		
Approach LOS	C			C			C			D		
d_I, Intersection Delay [s/veh]	33.36											
Intersection LOS	C											
Intersection V/C	0.621											

Other Modes

g_Walk,mi, Effective Walk Time [s]	11.0	11.0	11.0	11.0
M_corner, Corner Circulation Area [ft ² /ped]	0.00	0.00	0.00	0.00
M_CW, Crosswalk Circulation Area [ft ² /ped]	0.00	0.00	0.00	0.00
d_p, Pedestrian Delay [s]	34.71	34.71	34.71	34.71
I_p,int, Pedestrian LOS Score for Intersectio	3.175	3.268	3.064	3.610
Crosswalk LOS	C	C	C	D
s_b, Saturation Flow Rate of the bicycle lane	2000	2000	2000	2000
c_b, Capacity of the bicycle lane [bicycles/h]	688	622	466	511
d_b, Bicycle Delay [s]	19.37	21.39	26.48	24.97
I_b,int, Bicycle LOS Score for Intersection	2.508	2.141	1.904	3.102
Bicycle LOS	B	B	A	C

Sequence



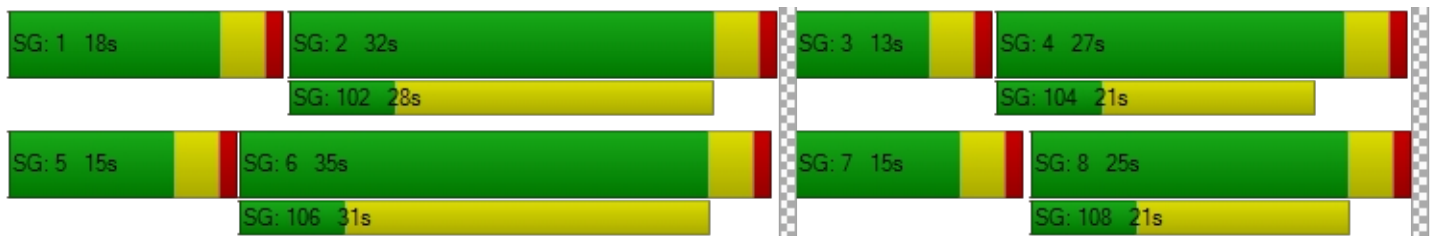

Ring 1	1	2	3	4	-	-	-	-	-	-	-	-	-	-	-	-
Ring 2	5	6	7	8	-	-	-	-	-	-	-	-	-	-	-	-
Ring 3	-	-	-	-	-	-	-	-	-	-	-	-	-	-	-	-
Ring 4	-	-	-	-	-	-	-	-	-	-	-	-	-	-	-	-



Intersection Level Of Service Report
Intersection 2: Marksheffel Rd/Lorson Bl

Control Type:	Signalized	Delay (sec / veh):	19.3
Analysis Method:	HCM 7th Edition	Level Of Service:	B
Analysis Period:	15 minutes	Volume to Capacity (v/c):	0.546

Intersection Setup

Name	Marksheffel Rd			Marksheffel Rd			Eastbound			Lorson Bl		
Approach	Northbound			Southbound			Eastbound			Westbound		
Lane Configuration												
Turning Movement	Left	Thru	Right	Left	Thru	Right	Left	Thru	Right	Left	Thru	Right
Lane Width [ft]	12.00	12.00	12.00	12.00	12.00	12.00	12.00	12.00	12.00	12.00	12.00	12.00
No. of Lanes in Entry Pocket	1	0	1	1	0	1	1	0	0	1	0	0
Entry Pocket Length [ft]	100.00	100.00	500.00	580.00	100.00	100.00	100.00	100.00	100.00	510.00	100.00	100.00
No. of Lanes in Exit Pocket	0	0	0	0	0	1	0	0	0	0	0	0
Exit Pocket Length [ft]	0.00	0.00	0.00	0.00	0.00	100.00	0.00	0.00	0.00	0.00	0.00	0.00
Speed [mph]	55.00			55.00			30.00			25.00		
Grade [%]	0.00			0.00			0.00			0.00		
Curb Present	No			No			No			No		
Crosswalk	Yes			Yes			Yes			Yes		

Volumes

Name	Marksheffel Rd			Marksheffel Rd						Lorson Bl		
Base Volume Input [veh/h]	157	714	162	83	999	23	49	18	69	500	11	296
Base Volume Adjustment Factor	1.0000	1.0000	1.0000	1.0000	1.0000	1.0000	1.0000	1.0000	1.0000	1.0000	1.0000	1.0000
Heavy Vehicles Percentage [%]	2.00	2.00	2.00	2.00	2.00	2.00	2.00	2.00	2.00	2.00	2.00	2.00
Proportion of CAVs [%]	0.00											
Growth Factor	1.0000	1.0000	1.0000	1.0000	1.0000	1.0000	1.0000	1.0000	1.0000	1.0000	1.0000	1.0000
In-Process Volume [veh/h]	0	0	0	0	0	0	0	0	0	0	0	0
Site-Generated Trips [veh/h]	0	92	0	0	81	0	0	0	0	0	0	0
Diverted Trips [veh/h]	0	0	0	0	0	0	0	0	0	0	0	0
Pass-by Trips [veh/h]	0	0	0	0	0	0	0	0	0	0	0	0
Existing Site Adjustment Volume [veh/h]	0	0	0	0	0	0	0	0	0	0	0	0
Other Volume [veh/h]	0	0	0	0	0	0	0	0	0	0	0	0
Right Turn on Red Volume [veh/h]	0	0	81	0	0	0	0	0	0	0	0	148
Total Hourly Volume [veh/h]	157	806	81	83	1080	23	49	18	69	500	11	148
Peak Hour Factor	1.0000	0.9200	0.9200	0.9200	0.9200	1.0000	1.0000	1.0000	1.0000	0.9200	1.0000	0.9200
Other Adjustment Factor	1.0000	1.0000	1.0000	1.0000	1.0000	1.0000	1.0000	1.0000	1.0000	1.0000	1.0000	1.0000
Total 15-Minute Volume [veh/h]	39	219	22	23	293	6	12	5	17	136	3	40
Total Analysis Volume [veh/h]	157	876	88	90	1174	23	49	18	69	543	11	161
Presence of On-Street Parking	No		No	No		No	No		No	No		No
On-Street Parking Maneuver Rate [/h]	0	0	0	0	0	0	0	0	0	0	0	0
Local Bus Stopping Rate [/h]	0	0	0	0	0	0	0	0	0	0	0	0
v_do, Outbound Pedestrian Volume crossing	0			0			0			0		
v_di, Inbound Pedestrian Volume crossing m	0			0			0			0		
v_co, Outbound Pedestrian Volume crossing	0			0			0			0		
v_ci, Inbound Pedestrian Volume crossing mi	0			0			0			0		
v_ab, Corner Pedestrian Volume [ped/h]	0			0			0			0		
Bicycle Volume [bicycles/h]	0			0			0			0		

Intersection Settings

Located in CBD	No
Signal Coordination Group	-
Cycle Length [s]	80
Active Pattern	Pattern 1
Coordination Type	Time of Day Pattern Coordinated
Actuation Type	Fully actuated
Offset [s]	0.0
Offset Reference	Lead Green - Beginning of First Green
Permissive Mode	SingleBand
Lost time [s]	0.00

Phasing & Timing

Control Type	Permiss	Permiss	Permiss	Permiss	Permiss	Permiss	Permiss	Permiss	Permiss	Protecte	Permiss	Permiss
Signal Group	0	6	0	0	2	0	0	8	0	7	4	0
Auxiliary Signal Groups												
Lead / Lag	-	-	-	-	-	-	-	-	-	Lead	-	-
Minimum Green [s]	0	10	0	0	10	0	0	10	0	5	10	0
Maximum Green [s]	0	10	0	0	10	0	0	10	0	5	10	0
Amber [s]	0.0	3.0	0.0	0.0	3.0	0.0	0.0	3.0	0.0	3.0	3.0	0.0
All red [s]	0.0	1.0	0.0	0.0	1.0	0.0	0.0	1.0	0.0	1.0	1.0	0.0
Split [s]	0	28	0	0	28	0	0	34	0	18	52	0
Vehicle Extension [s]	0.0	3.0	0.0	0.0	3.0	0.0	0.0	3.0	0.0	3.0	3.0	0.0
Walk [s]	0	7	0	0	7	0	0	7	0	0	7	0
Pedestrian Clearance [s]	0	17	0	0	10	0	0	23	0	0	21	0
Delayed Vehicle Green [s]	0.0	0.0	0.0	0.0	0.0	0.0	0.0	0.0	0.0	0.0	0.0	0.0
Rest In Walk		No			No			No			No	
I1, Start-Up Lost Time [s]	0.0	2.0	0.0	0.0	2.0	0.0	0.0	2.0	0.0	2.0	2.0	0.0
I2, Clearance Lost Time [s]	0.0	2.0	0.0	0.0	2.0	0.0	0.0	2.0	0.0	2.0	2.0	0.0
Minimum Recall		No			No			No		No	No	
Maximum Recall		No			No			No		No	No	
Pedestrian Recall		No			No			No		No	No	
Detector Location [ft]	0.0	0.0	0.0	0.0	0.0	0.0	0.0	0.0	0.0	0.0	0.0	0.0
Detector Length [ft]	0.0	0.0	0.0	0.0	0.0	0.0	0.0	0.0	0.0	0.0	0.0	0.0
I, Upstream Filtering Factor	1.00	1.00	1.00	1.00	1.00	1.00	1.00	1.00	1.00	1.00	1.00	1.00

Exclusive Pedestrian Phase

Pedestrian Signal Group	0
Pedestrian Walk [s]	0
Pedestrian Clearance [s]	0

Lane Group Calculations

Lane Group	L	C	R	L	C	R	L	C	L	C	R
C, Cycle Length [s]	80	80	80	80	80	80	80	80	80	80	80
L, Total Lost Time per Cycle [s]	4.00	4.00	4.00	4.00	4.00	4.00	4.00	4.00	4.00	4.00	4.00
l1_p, Permitted Start-Up Lost Time [s]	2.00	0.00	0.00	2.00	0.00	0.00	2.00	0.00	0.00	0.00	0.00
l2, Clearance Lost Time [s]	2.00	2.00	2.00	2.00	2.00	2.00	2.00	2.00	2.00	2.00	2.00
g_i, Effective Green Time [s]	44	44	44	44	44	44	10	10	14	27	27
g / C, Green / Cycle	0.56	0.56	0.56	0.56	0.56	0.56	0.12	0.12	0.17	0.34	0.34
(v / s)_i Volume / Saturation Flow Rate	0.34	0.25	0.06	0.15	0.33	0.01	0.04	0.05	0.16	0.01	0.10
s, saturation flow rate [veh/h]	467	3560	1589	583	3560	1589	1213	1640	3459	1870	1589
c, Capacity [veh/h]	235	1981	884	313	1981	884	199	195	603	642	546
d1, Uniform Delay [s]	28.45	10.42	8.31	17.96	11.72	7.97	34.45	32.73	32.27	17.31	19.15
k, delay calibration	0.50	0.50	0.50	0.50	0.50	0.50	0.11	0.11	0.11	0.11	0.11
l, Upstream Filtering Factor	1.00	1.00	1.00	1.00	1.00	1.00	1.00	1.00	1.00	1.00	1.00
d2, Incremental Delay [s]	14.00	0.72	0.22	2.30	1.31	0.05	0.64	1.60	5.21	0.01	0.30
d3, Initial Queue Delay [s]	0.00	0.00	0.00	0.00	0.00	0.00	0.00	0.00	0.00	0.00	0.00
Rp, platoon ratio	1.00	1.00	1.00	1.00	1.00	1.00	1.00	1.00	1.00	1.00	1.00
PF, progression factor	1.00	1.00	1.00	1.00	1.00	1.00	1.00	1.00	1.00	1.00	1.00

Lane Group Results

X, volume / capacity	0.67	0.44	0.10	0.29	0.59	0.03	0.25	0.45	0.90	0.02	0.29
d, Delay for Lane Group [s/veh]	42.45	11.14	8.54	20.26	13.03	8.02	35.09	34.32	37.49	17.32	19.45
Lane Group LOS	D	B	A	C	B	A	D	C	D	B	B
Critical Lane Group	Yes	No	No	No	No	No	No	Yes	Yes	No	No
50th-Percentile Queue Length [veh/ln]	3.58	3.58	0.60	1.23	5.47	0.15	0.92	1.62	5.48	0.13	2.18
50th-Percentile Queue Length [ft/ln]	89.55	89.61	14.96	30.73	136.66	3.73	22.99	40.46	137.03	3.34	54.48
95th-Percentile Queue Length [veh/ln]	6.45	6.45	1.08	2.21	9.30	0.27	1.66	2.91	9.32	0.24	3.92
95th-Percentile Queue Length [ft/ln]	161.19	161.29	26.92	55.32	232.52	6.72	41.38	72.83	233.01	6.02	98.07

Movement, Approach, & Intersection Results

d_M, Delay for Movement [s/veh]	42.45	11.14	8.54	20.26	13.03	8.02	35.09	34.32	34.32	37.49	17.32	19.45
Movement LOS	D	B	A	C	B	A	D	C	C	D	B	B
d_A, Approach Delay [s/veh]	15.32			13.45			34.60			33.12		
Approach LOS	B			B			C			C		
d_I, Intersection Delay [s/veh]	19.29											
Intersection LOS	B											
Intersection V/C	0.546											

Other Modes

g_Walk,mi, Effective Walk Time [s]	11.0			11.0			11.0			11.0		
M_corner, Corner Circulation Area [ft ² /ped]	0.00			0.00			0.00			0.00		
M_CW, Crosswalk Circulation Area [ft ² /ped]	0.00			0.00			0.00			0.00		
d_p, Pedestrian Delay [s]	29.72			29.72			29.72			29.72		
I_p,int, Pedestrian LOS Score for Intersectio	3.452			3.267			2.263			2.817		
Crosswalk LOS	C			C			B			C		
s_b, Saturation Flow Rate of the bicycle lane	2000			2000			2000			2000		
c_b, Capacity of the bicycle lane [bicycles/h]	601			601			751			1201		
d_b, Bicycle Delay [s]	19.56			19.56			15.59			6.37		
I_b,int, Bicycle LOS Score for Intersection	2.551			2.621			1.784			2.984		
Bicycle LOS	B			B			A			C		

Sequence

Ring 1	-	2	-	4	-	-	-	-	-	-	-	-	-	-	-	-
Ring 2	-	6	7	8	-	-	-	-	-	-	-	-	-	-	-	-
Ring 3	-	-	-	-	-	-	-	-	-	-	-	-	-	-	-	-
Ring 4	-	-	-	-	-	-	-	-	-	-	-	-	-	-	-	-

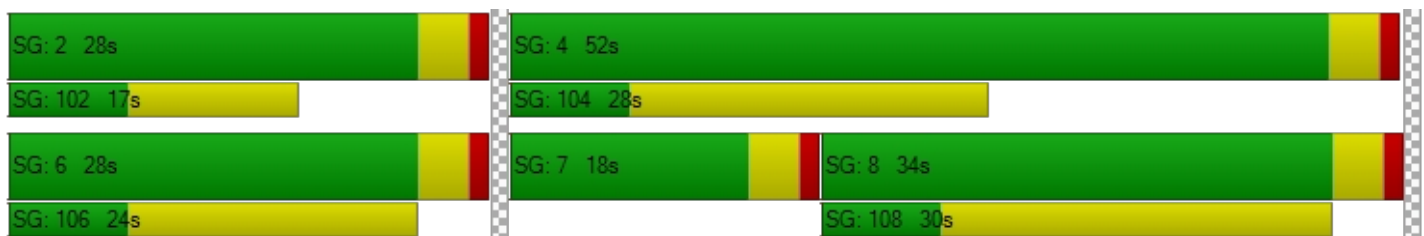

Intersection Level Of Service Report
Intersection 3: Fontaine Bl/Carriage Meadows Dr

Control Type:	Signalized	Delay (sec / veh):	13.1
Analysis Method:	HCM 7th Edition	Level Of Service:	B
Analysis Period:	15 minutes	Volume to Capacity (v/c):	0.608

Intersection Setup

Name	Carriage Meadows Dr			Carriage Meadows Dr			Fontaine Bl			Fontaine Bl		
Approach	Northbound			Southbound			Eastbound			Westbound		
Lane Configuration												
Turning Movement	Left	Thru	Right	Left	Thru	Right	Left	Thru	Right	Left	Thru	Right
Lane Width [ft]	12.00	12.00	12.00	12.00	12.00	12.00	12.00	12.00	12.00	12.00	12.00	12.00
No. of Lanes in Entry Pocket	1	0	1	1	0	1	1	0	0	1	0	1
Entry Pocket Length [ft]	100.00	100.00	100.00	100.00	100.00	100.00	510.00	100.00	100.00	330.00	100.00	330.00
No. of Lanes in Exit Pocket	0	0	0	0	0	0	0	0	0	0	0	0
Exit Pocket Length [ft]	0.00	0.00	0.00	0.00	0.00	0.00	0.00	0.00	0.00	0.00	0.00	0.00
Speed [mph]	25.00			25.00			45.00			45.00		
Grade [%]	0.00			0.00			0.00			0.00		
Curb Present	No			No			No			No		
Crosswalk	Yes			Yes			Yes			Yes		

Volumes

Name	Carriage Meadows Dr			Carriage Meadows Dr			Fontaine Bl			Fontaine Bl		
Base Volume Input [veh/h]	42	5	12	8	5	37	10	642	8	8	1500	4
Base Volume Adjustment Factor	1.0000	1.0000	1.0000	1.0000	1.0000	1.0000	1.0000	1.0000	1.0000	1.0000	1.0000	1.0000
Heavy Vehicles Percentage [%]	2.00	2.00	2.00	2.00	2.00	2.00	2.00	2.00	2.00	2.00	2.00	2.00
Proportion of CAVs [%]	0.00											
Growth Factor	1.7120	1.0000	1.7120	1.7120	1.0000	1.7120	1.7120	1.0000	1.7120	1.7120	1.0000	1.7120
In-Process Volume [veh/h]	0	0	0	0	0	0	0	0	0	0	0	0
Site-Generated Trips [veh/h]	29	2	8	64	3	125	72	8	17	24	32	33
Diverted Trips [veh/h]	0	0	0	0	0	0	0	0	0	0	0	0
Pass-by Trips [veh/h]	0	0	0	0	0	0	0	0	0	0	0	0
Existing Site Adjustment Volume [veh/h]	0	0	0	0	0	0	0	0	0	0	0	0
Other Volume [veh/h]	0	0	0	0	0	0	0	0	0	0	0	0
Right Turn on Red Volume [veh/h]	0	0	15	0	0	94	0	0	16	0	0	20
Total Hourly Volume [veh/h]	101	7	14	78	8	94	89	650	15	38	1532	20
Peak Hour Factor	0.9200	0.9200	0.9200	0.9200	0.9200	0.9200	0.9200	0.9200	0.9200	0.9200	0.9200	0.9200
Other Adjustment Factor	1.0000	1.0000	1.0000	1.0000	1.0000	1.0000	1.0000	1.0000	1.0000	1.0000	1.0000	1.0000
Total 15-Minute Volume [veh/h]	27	2	4	21	2	26	24	177	4	10	416	5
Total Analysis Volume [veh/h]	110	8	15	85	9	102	97	707	16	41	1665	22
Presence of On-Street Parking	No		No	No		No	No		No	No		No
On-Street Parking Maneuver Rate [/h]	0	0	0	0	0	0	0	0	0	0	0	0
Local Bus Stopping Rate [/h]	0	0	0	0	0	0	0	0	0	0	0	0
v_do, Outbound Pedestrian Volume crossing	0			0			0			0		
v_di, Inbound Pedestrian Volume crossing m	0			0			0			0		
v_co, Outbound Pedestrian Volume crossing	0			0			0			0		
v_ci, Inbound Pedestrian Volume crossing mi	0			0			0			0		
v_ab, Corner Pedestrian Volume [ped/h]	0			0			0			0		
Bicycle Volume [bicycles/h]	0			0			0			0		

Intersection Settings

Located in CBD	No
Signal Coordination Group	-
Cycle Length [s]	80
Active Pattern	Pattern 1
Coordination Type	Time of Day Pattern Coordinated
Actuation Type	Semi-actuated
Offset [s]	0.0
Offset Reference	Lead Green - Beginning of First Green
Permissive Mode	SingleBand
Lost time [s]	0.00

Phasing & Timing

Control Type	Permiss	Permiss	Permiss	Permiss	Permiss	Permiss	Protecte	Permiss	Permiss	Permiss	Permiss	Permiss
Signal Group	0	8	0	0	4	0	5	2	0	0	6	0
Auxiliary Signal Groups												
Lead / Lag	-	-	-	-	-	-	Lead	-	-	-	-	-
Minimum Green [s]	0	10	0	0	10	0	5	10	0	0	10	0
Maximum Green [s]	0	34	0	0	34	0	5	78	0	0	78	0
Amber [s]	0.0	3.0	0.0	0.0	3.0	0.0	3.0	3.0	0.0	0.0	3.0	0.0
All red [s]	0.0	1.0	0.0	0.0	1.0	0.0	1.0	1.0	0.0	0.0	1.0	0.0
Split [s]	0	38	0	0	38	0	17	42	0	0	25	0
Vehicle Extension [s]	0.0	3.0	0.0	0.0	3.0	0.0	3.0	3.0	0.0	0.0	3.0	0.0
Walk [s]	0	7	0	0	7	0	0	7	0	0	7	0
Pedestrian Clearance [s]	0	23	0	0	27	0	0	7	0	0	14	0
Delayed Vehicle Green [s]	0.0	0.0	0.0	0.0	0.0	0.0	0.0	0.0	0.0	0.0	0.0	0.0
Rest In Walk		No			No			No			No	
I1, Start-Up Lost Time [s]	0.0	2.0	0.0	0.0	2.0	0.0	2.0	2.0	0.0	0.0	2.0	0.0
I2, Clearance Lost Time [s]	0.0	2.0	0.0	0.0	2.0	0.0	2.0	2.0	0.0	0.0	2.0	0.0
Minimum Recall		No			No		No	No			No	
Maximum Recall		No			No		No	No			No	
Pedestrian Recall		No			No		No	No			No	
Detector Location [ft]	0.0	0.0	0.0	0.0	0.0	0.0	0.0	0.0	0.0	0.0	0.0	0.0
Detector Length [ft]	0.0	0.0	0.0	0.0	0.0	0.0	0.0	0.0	0.0	0.0	0.0	0.0
I, Upstream Filtering Factor	1.00	1.00	1.00	1.00	1.00	1.00	1.00	1.00	1.00	1.00	1.00	1.00

Exclusive Pedestrian Phase

Pedestrian Signal Group	0
Pedestrian Walk [s]	0
Pedestrian Clearance [s]	0

Lane Group Calculations

Lane Group	L	C	R	L	C	R	L	C	R	L	C	R
C, Cycle Length [s]	80	80	80	80	80	80	80	80	80	80	80	80
L, Total Lost Time per Cycle [s]	4.00	4.00	4.00	4.00	4.00	4.00	4.00	4.00	4.00	4.00	4.00	4.00
l1_p, Permitted Start-Up Lost Time [s]	2.00	0.00	0.00	2.00	0.00	0.00	0.00	0.00	0.00	2.00	0.00	0.00
l2, Clearance Lost Time [s]	2.00	2.00	2.00	2.00	2.00	2.00	2.00	2.00	2.00	2.00	2.00	2.00
g_i, Effective Green Time [s]	11	11	11	11	11	11	6	61	61	52	52	52
g / C, Green / Cycle	0.14	0.14	0.14	0.14	0.14	0.14	0.07	0.76	0.76	0.64	0.64	0.64
(v / s)_i Volume / Saturation Flow Rate	0.09	0.00	0.01	0.06	0.00	0.06	0.05	0.20	0.01	0.06	0.47	0.01
s, saturation flow rate [veh/h]	1282	1870	1589	1388	1870	1589	1781	3560	1589	730	3560	1589
c, Capacity [veh/h]	223	251	213	234	251	213	125	2726	1217	502	2298	1026
d1, Uniform Delay [s]	35.16	30.11	30.27	34.21	30.13	32.04	36.56	2.74	2.22	8.05	9.45	5.10
k, delay calibration	0.11	0.11	0.11	0.11	0.11	0.11	0.11	0.50	0.50	0.50	0.50	0.50
l, Upstream Filtering Factor	1.00	1.00	1.00	1.00	1.00	1.00	1.00	1.00	1.00	1.00	1.00	1.00
d2, Incremental Delay [s]	1.69	0.05	0.14	0.94	0.06	1.66	9.71	0.23	0.02	0.32	2.03	0.04
d3, Initial Queue Delay [s]	0.00	0.00	0.00	0.00	0.00	0.00	0.00	0.00	0.00	0.00	0.00	0.00
Rp, platoon ratio	1.00	1.00	1.00	1.00	1.00	1.00	1.00	1.00	1.00	1.00	1.00	1.00
PF, progression factor	1.00	1.00	1.00	1.00	1.00	1.00	1.00	1.00	1.00	1.00	1.00	1.00

Lane Group Results

X, volume / capacity	0.49	0.03	0.07	0.36	0.04	0.48	0.77	0.26	0.01	0.08	0.72	0.02
d, Delay for Lane Group [s/veh]	36.86	30.16	30.40	35.15	30.18	33.69	46.27	2.97	2.24	8.36	11.48	5.14
Lane Group LOS	D	C	C	D	C	C	D	A	A	A	B	A
Critical Lane Group	Yes	No	No	No	No	No	Yes	No	No	No	Yes	No
50th-Percentile Queue Length [veh/ln]	2.18	0.14	0.26	1.62	0.15	1.90	2.09	0.82	0.03	0.31	7.43	0.11
50th-Percentile Queue Length [ft/ln]	54.49	3.42	6.47	40.54	3.84	47.58	52.29	20.51	0.84	7.78	185.68	2.69
95th-Percentile Queue Length [veh/ln]	3.92	0.25	0.47	2.92	0.28	3.43	3.76	1.48	0.06	0.56	11.90	0.19
95th-Percentile Queue Length [ft/ln]	98.07	6.15	11.65	72.97	6.92	85.64	94.12	36.91	1.51	14.00	297.42	4.85

Movement, Approach, & Intersection Results

d_M, Delay for Movement [s/veh]	36.86	30.16	30.40	35.15	30.18	33.69	46.27	2.97	2.24	8.36	11.48	5.14
Movement LOS	D	C	C	D	C	C	D	A	A	A	B	A
d_A, Approach Delay [s/veh]	35.73			34.16			8.08			11.32		
Approach LOS	D			C			A			B		
d_I, Intersection Delay [s/veh]	13.08											
Intersection LOS	B											
Intersection V/C	0.608											

Other Modes

g_Walk,mi, Effective Walk Time [s]	11.0	11.0	11.0	11.0
M_corner, Corner Circulation Area [ft ² /ped]	0.00	0.00	0.00	0.00
M_CW, Crosswalk Circulation Area [ft ² /ped]	0.00	0.00	0.00	0.00
d_p, Pedestrian Delay [s]	29.76	29.76	29.76	29.76
I_p,int, Pedestrian LOS Score for Intersectio	2.251	2.347	3.353	3.222
Crosswalk LOS	B	B	C	C
s_b, Saturation Flow Rate of the bicycle lane	2000	2000	2000	2000
c_b, Capacity of the bicycle lane [bicycles/h]	850	850	950	525
d_b, Bicycle Delay [s]	13.23	13.23	11.03	21.76
I_b,int, Bicycle LOS Score for Intersection	1.804	2.038	2.249	3.002
Bicycle LOS	A	B	B	C

Sequence

Ring 1	-	2	-	4	-	-	-	-	-	-	-	-	-	-	-	-
Ring 2	5	6	-	8	-	-	-	-	-	-	-	-	-	-	-	-
Ring 3	-	-	-	-	-	-	-	-	-	-	-	-	-	-	-	-
Ring 4	-	-	-	-	-	-	-	-	-	-	-	-	-	-	-	-



Intersection Level Of Service Report
Intersection 4: Marksheffel Rd/West Driveway

Control Type:	Two-way stop	Delay (sec / veh):	16.2
Analysis Method:	HCM 7th Edition	Level Of Service:	C
Analysis Period:	15 minutes	Volume to Capacity (v/c):	0.108

Intersection Setup

Name	Marksheffel Rd		Marksheffel Rd		West Driveway	
Approach	Northbound		Southbound		Westbound	
Lane Configuration	↔				↔	
Turning Movement	Thru	Right	Left	Thru	Left	Right
Lane Width [ft]	12.00	12.00	12.00	12.00	12.00	12.00
No. of Lanes in Entry Pocket	0	1	1	0	0	0
Entry Pocket Length [ft]	100.00	100.00	100.00	100.00	100.00	100.00
No. of Lanes in Exit Pocket	0	0	0	1	0	0
Exit Pocket Length [ft]	0.00	0.00	0.00	590.00	0.00	0.00
Speed [mph]	55.00		55.00		25.00	
Grade [%]	0.00		0.00		0.00	
Crosswalk	No		No		Yes	

Volumes

Name	Marksheffel Rd		Marksheffel Rd		West Driveway	
Base Volume Input [veh/h]	1320	0	0	571	0	0
Base Volume Adjustment Factor	1.0000	1.0000	1.0000	1.0000	1.0000	1.0000
Heavy Vehicles Percentage [%]	2.00	2.00	2.00	2.00	2.00	2.00
Growth Factor	1.0000	1.0000	1.0000	1.0000	1.0000	1.0000
In-Process Volume [veh/h]	0	0	0	0	0	0
Site-Generated Trips [veh/h]	36	90	0	80	0	36
Diverted Trips [veh/h]	0	0	0	0	0	0
Pass-by Trips [veh/h]	0	0	0	0	0	0
Existing Site Adjustment Volume [veh/h]	0	0	0	0	0	0
Other Volume [veh/h]	0	0	0	0	0	0
Total Hourly Volume [veh/h]	1356	90	0	651	0	36
Peak Hour Factor	0.9200	0.9200	0.9200	0.9200	0.9200	0.9200
Other Adjustment Factor	1.0000	1.0000	1.0000	1.0000	1.0000	1.0000
Total 15-Minute Volume [veh/h]	368	24	0	177	0	10
Total Analysis Volume [veh/h]	1474	98	0	708	0	39
Pedestrian Volume [ped/h]	0		0		0	

Intersection Settings

Priority Scheme	Free	Free	Stop
Flared Lane			
Storage Area [veh]	0	0	0
Two-Stage Gap Acceptance			No
Number of Storage Spaces in Median	0	0	0

Movement, Approach, & Intersection Results

V/C, Movement V/C Ratio	0.01	0.00	0.00	0.01	0.00	0.11
d_M, Delay for Movement [s/veh]	0.00	0.00	0.00	0.00	0.00	16.18
Movement LOS	A	A		A		C
95th-Percentile Queue Length [veh/ln]	0.00	0.00	0.00	0.00	0.00	0.36
95th-Percentile Queue Length [ft/ln]	0.00	0.00	0.00	0.00	0.00	9.01
d_A, Approach Delay [s/veh]	0.00		0.00		16.18	
Approach LOS	A		A		C	
d_I, Intersection Delay [s/veh]	0.27					
Intersection LOS	C					

Intersection Level Of Service Report
Intersection 5: Carriage Meadows Dr/East Driveway

Control Type:	Two-way stop	Delay (sec / veh):	12.7
Analysis Method:	HCM 7th Edition	Level Of Service:	B
Analysis Period:	15 minutes	Volume to Capacity (v/c):	0.033

Intersection Setup

Name	Carriage Meadows Dr			Carriage Meadows Dr			East Driveway			Westbound		
Approach	Northbound			Southbound			Eastbound			Westbound		
Lane Configuration												
Turning Movement	Left	Thru	Right	Left	Thru	Right	Left	Thru	Right	Left	Thru	Right
Lane Width [ft]	12.00	12.00	12.00	12.00	12.00	12.00	12.00	12.00	12.00	12.00	12.00	12.00
No. of Lanes in Entry Pocket	1	0	0	0	0	0	0	0	0	0	0	0
Entry Pocket Length [ft]	100.00	100.00	100.00	100.00	100.00	100.00	100.00	100.00	100.00	100.00	100.00	100.00
No. of Lanes in Exit Pocket	0	0	0	0	0	0	0	0	0	0	0	0
Exit Pocket Length [ft]	0.00	0.00	0.00	0.00	0.00	0.00	0.00	0.00	0.00	0.00	0.00	0.00
Speed [mph]	25.00			25.00			25.00			30.00		
Grade [%]	0.00			0.00			0.00			0.00		
Crosswalk	No			No			Yes			Yes		

Volumes

Name	Carriage Meadows Dr			Carriage Meadows Dr			East Driveway			Westbound		
Base Volume Input [veh/h]	0	0	0	0	0	0	0	0	0	0	0	0
Base Volume Adjustment Factor	1.0000	1.0000	1.0000	1.0000	1.0000	1.0000	1.0000	1.0000	1.0000	1.0000	1.0000	1.0000
Heavy Vehicles Percentage [%]	2.00	2.00	2.00	2.00	2.00	2.00	2.00	2.00	2.00	2.00	2.00	2.00
Growth Factor	1.0000	1.0000	1.0000	1.0000	1.0000	1.0000	1.0000	1.0000	1.0000	1.0000	1.0000	1.0000
In-Process Volume [veh/h]	0	0	0	0	0	0	0	0	0	0	0	0
Site-Generated Trips [veh/h]	102	1	4	0	1	2	2	0	176	15	0	0
Diverted Trips [veh/h]	0	0	0	0	0	0	0	0	0	0	0	0
Pass-by Trips [veh/h]	0	0	0	0	0	0	0	0	0	0	0	0
Existing Site Adjustment Volume [veh/h]	0	0	0	0	0	0	0	0	0	0	0	0
Other Volume [veh/h]	0	0	0	0	0	0	0	0	0	0	0	0
Total Hourly Volume [veh/h]	102	1	4	0	1	2	2	0	176	15	0	0
Peak Hour Factor	0.9200	0.9200	0.9200	0.9200	0.9200	0.9200	0.9200	0.9200	0.9200	0.9200	0.9200	0.9200
Other Adjustment Factor	1.0000	1.0000	1.0000	1.0000	1.0000	1.0000	1.0000	1.0000	1.0000	1.0000	1.0000	1.0000
Total 15-Minute Volume [veh/h]	28	0	1	0	0	1	1	0	48	4	0	0
Total Analysis Volume [veh/h]	111	1	4	0	1	2	2	0	191	16	0	0
Pedestrian Volume [ped/h]	0			0			0			0		

Intersection Settings

Priority Scheme	Free	Free	Stop	Stop
Flared Lane			No	No
Storage Area [veh]	0	0	0	0
Two-Stage Gap Acceptance			No	No
Number of Storage Spaces in Median	0	0	0	0

Movement, Approach, & Intersection Results

V/C, Movement V/C Ratio	0.07	0.00	0.00	0.00	0.00	0.00	0.00	0.00	0.18	0.03	0.00	0.00
d_M, Delay for Movement [s/veh]	7.39	0.00	0.00	7.23	0.00	0.00	11.04	11.49	9.06	12.70	11.01	8.59
Movement LOS	A	A	A	A	A	A	B	B	A	B	B	A
95th-Percentile Queue Length [veh/ln]	0.22	0.00	0.00	0.00	0.00	0.00	0.65	0.65	0.65	0.10	0.10	0.10
95th-Percentile Queue Length [ft/ln]	5.51	0.00	0.00	0.00	0.00	0.00	16.30	16.30	16.30	2.56	2.56	2.56
d_A, Approach Delay [s/veh]	7.07			0.00			9.08			12.70		
Approach LOS	A			A			A			B		
d_I, Intersection Delay [s/veh]	8.46											
Intersection LOS	B											

Intersection Level Of Service Report
Intersection 7: Fontaine BI/Middle Driveway

Control Type:	Two-way stop	Delay (sec / veh):	11.1
Analysis Method:	HCM 7th Edition	Level Of Service:	B
Analysis Period:	15 minutes	Volume to Capacity (v/c):	0.015

Intersection Setup

Name	LRCS			Middle Driveway			Fontaine BI			Fontaine BI		
Approach	Northbound			Southbound			Eastbound			Westbound		
Lane Configuration	↶						↶			↶		
Turning Movement	Left	Thru	Right	Left	Thru	Right	Left	Thru	Right	Left	Thru	Right
Lane Width [ft]	12.00	12.00	12.00	12.00	12.00	12.00	12.00	12.00	12.00	12.00	12.00	12.00
No. of Lanes in Entry Pocket	0	0	0	0	0	0	0	0	0	0	0	0
Entry Pocket Length [ft]	100.00	100.00	100.00	100.00	100.00	100.00	100.00	100.00	100.00	100.00	100.00	100.00
No. of Lanes in Exit Pocket	0	0	0	0	0	0	0	0	0	0	0	0
Exit Pocket Length [ft]	0.00	0.00	0.00	0.00	0.00	0.00	0.00	0.00	0.00	0.00	0.00	0.00
Speed [mph]	25.00			25.00			45.00			45.00		
Grade [%]	0.00			0.00			0.00			0.00		
Crosswalk	Yes			Yes			No			No		

Volumes

Name	LRCS			Middle Driveway			Fontaine BI			Fontaine BI		
Base Volume Input [veh/h]	0	0	0	0	0	0	0	642	0	0	1591	0
Base Volume Adjustment Factor	1.0000	1.0000	1.0000	1.0000	1.0000	1.0000	1.0000	1.0000	1.0000	1.0000	1.0000	1.0000
Heavy Vehicles Percentage [%]	2.00	2.00	2.00	2.00	2.00	2.00	2.00	2.00	2.00	2.00	2.00	2.00
Growth Factor	1.0000	1.0000	1.0000	1.0000	1.0000	1.0000	1.0000	1.0000	1.0000	1.0000	1.0000	1.0000
In-Process Volume [veh/h]	0	0	0	0	0	0	0	0	0	0	0	0
Site-Generated Trips [veh/h]	0	0	8	0	0	0	0	89	34	0	153	33
Diverted Trips [veh/h]	0	0	0	0	0	0	0	0	0	0	0	0
Pass-by Trips [veh/h]	0	0	0	0	0	0	0	0	0	0	0	0
Existing Site Adjustment Volume [veh/h]	0	0	0	0	0	0	0	0	0	0	0	0
Other Volume [veh/h]	0	0	0	0	0	0	0	0	0	0	0	0
Total Hourly Volume [veh/h]	0	0	8	0	0	0	0	731	34	0	1744	33
Peak Hour Factor	0.9200	0.9200	0.9200	0.9200	0.9200	0.9200	0.9200	0.9200	0.9200	0.9200	0.9200	0.9200
Other Adjustment Factor	1.0000	1.0000	1.0000	1.0000	1.0000	1.0000	1.0000	1.0000	1.0000	1.0000	1.0000	1.0000
Total 15-Minute Volume [veh/h]	0	0	2	0	0	0	0	199	9	0	474	9
Total Analysis Volume [veh/h]	0	0	9	0	0	0	0	795	37	0	1896	36
Pedestrian Volume [ped/h]	0			0			0			0		

Intersection Settings

Priority Scheme	Stop	Stop	Free	Free
Flared Lane				
Storage Area [veh]	0	0	0	0
Two-Stage Gap Acceptance	No			
Number of Storage Spaces in Median	0	0	0	0

Movement, Approach, & Intersection Results

V/C, Movement V/C Ratio	0.00	0.00	0.01	0.00	0.00	0.00	0.00	0.01	0.00	0.00	0.02	0.00
d_M, Delay for Movement [s/veh]	0.00	0.00	11.07	0.00	0.00	0.00	0.00	0.00	0.00	0.00	0.00	0.00
Movement LOS			B					A	A		A	A
95th-Percentile Queue Length [veh/ln]	0.00	0.00	0.05	0.00	0.00	0.00	0.00	0.00	0.00	0.00	0.00	0.00
95th-Percentile Queue Length [ft/ln]	0.00	0.00	1.14	0.00	0.00	0.00	0.00	0.00	0.00	0.00	0.00	0.00
d_A, Approach Delay [s/veh]	11.07		0.00		0.00		0.00		0.00			
Approach LOS	B		A		A		A		A			
d_I, Intersection Delay [s/veh]	0.04											
Intersection LOS	B											

Signal Warrants Report For Intersection 4: Marksheffel Rd/West Driveway

Warrants Summary

Warrant	Name	Met?
#1	Eight Hour Vehicular Volume	No
#2	Four Hour Vehicular Volume	No
#3	Peak Hour	No

Intersection Warrants Parameters

Major Approaches	N, S
Minor Approaches	E
Speed > 40mph	Yes
Population < 10,000	No
Warrant Factor	70%

Warrant Analysis Traffic Volumes

Hour	Major Streets		Minor Streets
	N	S	E
1	651	1446	36
2	631	1403	35
3	618	1374	34
4	579	1287	32
5	514	1142	28
6	508	1128	28
7	501	1113	28
8	456	1012	25
9	449	998	25
10	443	983	24
11	384	853	21
12	358	795	20
13	352	781	19
14	260	578	14
15	260	578	14
16	182	405	10
17	104	231	6
18	104	231	6
19	59	130	3
20	33	72	2
21	20	43	1
22	7	14	0
23	7	14	0
24	7	14	0

Warrant Analysis by Hour

Hour	Major Streets		Minor Street		Warrant 1 Condition A				Warrant 1 Condition B				Warrant 2	Warrant 3 Condition B
	Number	Volume	Number	Volume	100%	80%	70%	56%	100%	80%	70%	56%		
1	3	2097	1	36	No	No	No	No	No	No	No	No	No	No
2	3	2034	1	35	No	No	No	No	No	No	No	No	No	No
3	3	1992	1	34	No	No	No	No	No	No	No	No	No	No
4	3	1866	1	32	No	No	No	No	No	No	No	No	No	No
5	3	1656	1	28	No	No	No	No	No	No	No	No	No	No
6	3	1636	1	28	No	No	No	No	No	No	No	No	No	No
7	3	1614	1	28	No	No	No	No	No	No	No	No	No	No
8	3	1468	1	25	No	No	No	No	No	No	No	No	No	No
9	3	1447	1	25	No	No	No	No	No	No	No	No	No	No
10	3	1426	1	24	No	No	No	No	No	No	No	No	No	No
11	3	1237	1	21	No	No	No	No	No	No	No	No	No	No
12	3	1153	1	20	No	No	No	No	No	No	No	No	No	No
13	3	1133	1	19	No	No	No	No	No	No	No	No	No	No
14	3	838	1	14	No	No	No	No	No	No	No	No	No	No
15	3	838	1	14	No	No	No	No	No	No	No	No	No	No
16	3	587	1	10	No	No	No	No	No	No	No	No	No	No
17	3	335	1	6	No	No	No	No	No	No	No	No	No	No
18	3	335	1	6	No	No	No	No	No	No	No	No	No	No
19	3	189	1	3	No	No	No	No	No	No	No	No	No	No
20	3	105	1	2	No	No	No	No	No	No	No	No	No	No
21	3	63	1	1	No	No	No	No	No	No	No	No	No	No
22	3	21	1	0	No	No	No	No	No	No	No	No	No	No
23	3	21	1	0	No	No	No	No	No	No	No	No	No	No
24	3	21	1	0	No	No	No	No	No	No	No	No	No	No
Hours Met					0	0	0	0	0	0	0	0	0	0

Warrant 3 Condition A

Orientation	E
Total Stopped Delay Per Vehicle on Minor Approach (s)	16.2
Number of Lanes on Minor Street Approach	1
VehicleHours of Stopped Delay on Minor Approach (h:mm)	0:09
Delay Condition Met	No
Volume on Minor Street Approach During Same Hour	36
High Minor Volume Condition Met	No
Total Entering Volume on All Approaches During Same Hour	2133
Number of Approaches on Intersection	3
Total Volume Condition Met	Yes
Warrant Met for Approach	No
Warrant Met for Intersection	No

Signal Warrants Report For Intersection 5: Carriage Meadows Dr/East Driveway

Warrants Summary

Warrant	Name	Met?
#1	Eight Hour Vehicular Volume	No
#2	Four Hour Vehicular Volume	No
#3	Peak Hour	No

Intersection Warrants Parameters

Major Approaches	S, N
Minor Approaches	E, W
Speed > 40mph	No
Population < 10,000	No
Warrant Factor	100%

Warrant Analysis Traffic Volumes

Hour	Major Streets		Minor Streets	
	S	N	E	W
1	107	3	15	178
2	104	3	15	173
3	102	3	14	169
4	95	3	13	158
5	85	2	12	141
6	83	2	12	139
7	82	2	12	137
8	75	2	11	125
9	74	2	10	123
10	73	2	10	121
11	63	2	9	105
12	59	2	8	98
13	58	2	8	96
14	43	1	6	71
15	43	1	6	71
16	30	1	4	50
17	17	0	2	28
18	17	0	2	28
19	10	0	1	16
20	5	0	1	9
21	3	0	0	5
22	1	0	0	2
23	1	0	0	2
24	1	0	0	2

Warrant Analysis by Hour

Hour	Major Streets		Minor Street		Warrant 1 Condition A				Warrant 1 Condition B				Warrant 2	Warrant 3 Condition B
	Number	Volume	Number	Volume	100%	80%	70%	56%	100%	80%	70%	56%		
1	2	110	1	178	No	No	No	No	No	No	No	No	No	No
2	2	107	1	173	No	No	No	No	No	No	No	No	No	No
3	2	105	1	169	No	No	No	No	No	No	No	No	No	No
4	2	98	1	158	No	No	No	No	No	No	No	No	No	No
5	2	87	1	141	No	No	No	No	No	No	No	No	No	No
6	2	85	1	139	No	No	No	No	No	No	No	No	No	No
7	2	84	1	137	No	No	No	No	No	No	No	No	No	No
8	2	77	1	125	No	No	No	No	No	No	No	No	No	No
9	2	76	1	123	No	No	No	No	No	No	No	No	No	No
10	2	75	1	121	No	No	No	No	No	No	No	No	No	No
11	2	65	1	105	No	No	No	No	No	No	No	No	No	No
12	2	61	1	98	No	No	No	No	No	No	No	No	No	No
13	2	60	1	96	No	No	No	No	No	No	No	No	No	No
14	2	44	1	71	No	No	No	No	No	No	No	No	No	No
15	2	44	1	71	No	No	No	No	No	No	No	No	No	No
16	2	31	1	50	No	No	No	No	No	No	No	No	No	No
17	2	17	1	28	No	No	No	No	No	No	No	No	No	No
18	2	17	1	28	No	No	No	No	No	No	No	No	No	No
19	2	10	1	16	No	No	No	No	No	No	No	No	No	No
20	2	5	1	9	No	No	No	No	No	No	No	No	No	No
21	2	3	1	5	No	No	No	No	No	No	No	No	No	No
22	2	1	1	2	No	No	No	No	No	No	No	No	No	No
23	2	1	1	2	No	No	No	No	No	No	No	No	No	No
24	2	1	1	2	No	No	No	No	No	No	No	No	No	No
Hours Met					0	0	0	0	0	0	0	0	0	0

Warrant 3 Condition A

Orientation	E	W
Total Stopped Delay Per Vehicle on Minor Approach (s)	12.7	9.1
Number of Lanes on Minor Street Approach	1	1
VehicleHours of Stopped Delay on Minor Approach (h:mm)	0:03	0:26
Delay Condition Met	No	No
Volume on Minor Street Approach During Same Hour	15	178
High Minor Volume Condition Met	No	Yes
Total Entering Volume on All Approaches During Same Hour	303	303
Number of Approaches on Intersection	4	4
Total Volume Condition Met	No	No
Warrant Met for Approach	No	No
Warrant Met for Intersection	No	

Signal Warrants Report For Intersection 7: Fontaine Bl/Middle Driveway

Warrants Summary

Warrant	Name	Met?
#1	Eight Hour Vehicular Volume	No
#2	Four Hour Vehicular Volume	No
#3	Peak Hour	No

Intersection Warrants Parameters

Major Approaches	E, W
Minor Approaches	S
Speed > 40mph	Yes
Population < 10,000	No
Warrant Factor	70%

Warrant Analysis Traffic Volumes

Hour	Major Streets		Minor Streets
	E	W	S
1	1777	765	8
2	1724	742	8
3	1688	727	8
4	1582	681	7
5	1404	604	6
6	1386	597	6
7	1368	589	6
8	1244	536	6
9	1226	528	6
10	1208	520	5
11	1048	451	5
12	977	421	4
13	960	413	4
14	711	306	3
15	711	306	3
16	498	214	2
17	284	122	1
18	284	122	1
19	160	69	1
20	89	38	0
21	53	23	0
22	18	8	0
23	18	8	0
24	18	8	0

Warrant Analysis by Hour

Hour	Major Streets		Minor Street		Warrant 1 Condition A				Warrant 1 Condition B				Warrant 2	Warrant 3 Condition B
	Number	Volume	Number	Volume	100%	80%	70%	56%	100%	80%	70%	56%		
1	3	2542	1	8	No	No	No	No	No	No	No	No	No	No
2	3	2466	1	8	No	No	No	No	No	No	No	No	No	No
3	3	2415	1	8	No	No	No	No	No	No	No	No	No	No
4	3	2263	1	7	No	No	No	No	No	No	No	No	No	No
5	3	2008	1	6	No	No	No	No	No	No	No	No	No	No
6	3	1983	1	6	No	No	No	No	No	No	No	No	No	No
7	3	1957	1	6	No	No	No	No	No	No	No	No	No	No
8	3	1780	1	6	No	No	No	No	No	No	No	No	No	No
9	3	1754	1	6	No	No	No	No	No	No	No	No	No	No
10	3	1728	1	5	No	No	No	No	No	No	No	No	No	No
11	3	1499	1	5	No	No	No	No	No	No	No	No	No	No
12	3	1398	1	4	No	No	No	No	No	No	No	No	No	No
13	3	1373	1	4	No	No	No	No	No	No	No	No	No	No
14	3	1017	1	3	No	No	No	No	No	No	No	No	No	No
15	3	1017	1	3	No	No	No	No	No	No	No	No	No	No
16	3	712	1	2	No	No	No	No	No	No	No	No	No	No
17	3	406	1	1	No	No	No	No	No	No	No	No	No	No
18	3	406	1	1	No	No	No	No	No	No	No	No	No	No
19	3	229	1	1	No	No	No	No	No	No	No	No	No	No
20	3	127	1	0	No	No	No	No	No	No	No	No	No	No
21	3	76	1	0	No	No	No	No	No	No	No	No	No	No
22	3	26	1	0	No	No	No	No	No	No	No	No	No	No
23	3	26	1	0	No	No	No	No	No	No	No	No	No	No
24	3	26	1	0	No	No	No	No	No	No	No	No	No	No
Hours Met					0	0	0	0	0	0	0	0	0	0

Warrant 3 Condition A

Orientation	S
Total Stopped Delay Per Vehicle on Minor Approach (s)	11.1
Number of Lanes on Minor Street Approach	1
VehicleHours of Stopped Delay on Minor Approach (h:mm)	0:01
Delay Condition Met	No
Volume on Minor Street Approach During Same Hour	8
High Minor Volume Condition Met	No
Total Entering Volume on All Approaches During Same Hour	2550
Number of Approaches on Intersection	3
Total Volume Condition Met	Yes
Warrant Met for Approach	No
Warrant Met for Intersection	No

Table of Contents

Intersection Level Of Service Report	2
Intersection 1: Marksheffel Rd/Fontaine Bl	2
Intersection 2: Marksheffel Rd/Lorson Bl	7
Intersection 3: Fontaine Bl/Carriage Meadows Dr	12
Intersection 4: Marksheffel Rd/West Driveway	17
Intersection 5: Carriage Meadows Dr/East Driveway	19
Intersection 7: Fontaine Bl/Middle Driveway	21
Signal Warrants Report	23
Intersection 4: Marksheffel Rd/West Driveway	23
Intersection 5: Carriage Meadows Dr/East Driveway	25
Intersection 7: Fontaine Bl/Middle Driveway	27

Intersection Level Of Service Report
Intersection 1: Marksheffel Rd/Fontaine Bl

Control Type:	Signalized	Delay (sec / veh):	49.0
Analysis Method:	HCM 7th Edition	Level Of Service:	D
Analysis Period:	15 minutes	Volume to Capacity (v/c):	0.762

Intersection Setup

Name	Marksheffel Rd			Marksheffel Rd			Fontaine Bl			Fontaine Bl		
Approach	Northbound			Southbound			Eastbound			Westbound		
Lane Configuration	[Diagram]			[Diagram]			[Diagram]			[Diagram]		
Turning Movement	Left	Thru	Right	Left	Thru	Right	Left	Thru	Right	Left	Thru	Right
Lane Width [ft]	12.00	12.00	12.00	12.00	12.00	12.00	12.00	12.00	12.00	12.00	12.00	12.00
No. of Lanes in Entry Pocket	1	0	1	1	0	1	1	0	1	1	0	0
Entry Pocket Length [ft]	680.00	100.00	680.00	750.00	100.00	500.00	360.00	100.00	200.00	535.00	100.00	100.00
No. of Lanes in Exit Pocket	0	0	1	0	0	0	0	0	0	0	0	0
Exit Pocket Length [ft]	0.00	0.00	100.00	0.00	0.00	0.00	0.00	0.00	0.00	0.00	0.00	0.00
Speed [mph]	55.00			55.00			45.00			45.00		
Grade [%]	0.00			0.00			0.00			0.00		
Curb Present	No			No			No			No		
Crosswalk	Yes			Yes			Yes			Yes		

Volumes

Name	Marksheffel Rd			Marksheffel Rd			Fontaine Bl			Fontaine Bl		
Base Volume Input [veh/h]	157	442	432	729	707	93	107	999	266	244	570	425
Base Volume Adjustment Factor	1.0000	1.0000	1.0000	1.0000	1.0000	1.0000	1.0000	1.0000	1.0000	1.0000	1.0000	1.0000
Heavy Vehicles Percentage [%]	2.00	2.00	2.00	2.00	2.00	2.00	2.00	2.00	2.00	2.00	2.00	2.00
Proportion of CAVs [%]	0.00											
Growth Factor	1.0000	1.0000	1.0000	1.0000	1.0000	1.0000	1.0000	1.0000	1.0000	1.0000	1.0000	1.0000
In-Process Volume [veh/h]	0	0	0	0	0	0	0	0	0	0	0	0
Site-Generated Trips [veh/h]	0	91	40	103	0	0	20	45	0	121	68	37
Diverted Trips [veh/h]	0	0	0	0	0	0	0	0	0	0	0	0
Pass-by Trips [veh/h]	0	0	0	0	0	0	0	0	0	0	0	0
Existing Site Adjustment Volume [veh/h]	0	0	0	0	0	0	0	0	0	0	0	0
Other Volume [veh/h]	0	0	0	0	0	0	0	0	0	0	0	0
Right Turn on Red Volume [veh/h]	0	0	236	0	0	47	0	0	133	0	0	231
Total Hourly Volume [veh/h]	157	533	236	832	707	46	127	1044	133	365	638	231
Peak Hour Factor	0.9200	0.9200	0.9200	0.9200	0.9200	0.9200	0.9200	0.9200	0.9200	0.9200	0.9200	0.9200
Other Adjustment Factor	1.0000	1.0000	1.0000	1.0000	1.0000	1.0000	1.0000	1.0000	1.0000	1.0000	1.0000	1.0000
Total 15-Minute Volume [veh/h]	43	145	64	226	192	13	35	284	36	99	173	63
Total Analysis Volume [veh/h]	171	579	257	904	768	50	138	1135	145	397	693	251
Presence of On-Street Parking	No		No	No		No	No		No	No		No
On-Street Parking Maneuver Rate [/h]	0	0	0	0	0	0	0	0	0	0	0	0
Local Bus Stopping Rate [/h]	0	0	0	0	0	0	0	0	0	0	0	0
v_do, Outbound Pedestrian Volume crossing	0			0			0			0		
v_di, Inbound Pedestrian Volume crossing m	0			0			0			0		
v_co, Outbound Pedestrian Volume crossing	0			0			0			0		
v_ci, Inbound Pedestrian Volume crossing mi	0			0			0			0		
v_ab, Corner Pedestrian Volume [ped/h]	0			0			0			0		
Bicycle Volume [bicycles/h]	0			0			0			0		

Intersection Settings

Located in CBD	No
Signal Coordination Group	-
Cycle Length [s]	120
Active Pattern	Pattern 1
Coordination Type	Time of Day Pattern Coordinated
Actuation Type	Fully actuated
Offset [s]	0.0
Offset Reference	Lead Green - Beginning of First Green
Permissive Mode	SingleBand
Lost time [s]	0.00

Phasing & Timing

Control Type	Protecte	Permiss	Permiss	Protecte	Permiss	Permiss	Protecte	Permiss	Permiss	Protecte	Permiss	Permiss
Signal Group	1	6	0	5	2	0	3	8	0	7	4	0
Auxiliary Signal Groups												
Lead / Lag	Lead	-	-	Lead	-	-	Lead	-	-	Lead	-	-
Minimum Green [s]	5	10	0	5	10	0	5	10	0	5	10	0
Maximum Green [s]	5	103	0	5	103	0	5	109	0	5	109	0
Amber [s]	3.0	3.0	0.0	3.0	3.0	0.0	3.0	3.0	0.0	3.0	3.0	0.0
All red [s]	1.0	1.0	0.0	1.0	1.0	0.0	1.0	1.0	0.0	1.0	1.0	0.0
Split [s]	38	35	0	35	32	0	21	31	0	19	29	0
Vehicle Extension [s]	3.0	3.0	0.0	3.0	3.0	0.0	3.0	3.0	0.0	3.0	3.0	0.0
Walk [s]	0	7	0	0	7	0	0	7	0	0	7	0
Pedestrian Clearance [s]	0	24	0	0	21	0	0	14	0	0	14	0
Delayed Vehicle Green [s]	0.0	0.0	0.0	0.0	0.0	0.0	0.0	0.0	0.0	0.0	0.0	0.0
Rest In Walk		No			No			No			No	
I1, Start-Up Lost Time [s]	2.0	2.0	0.0	2.0	2.0	0.0	2.0	2.0	0.0	2.0	2.0	0.0
I2, Clearance Lost Time [s]	2.0	2.0	0.0	2.0	2.0	0.0	2.0	2.0	0.0	2.0	2.0	0.0
Minimum Recall	No	No		No	No		No	No		No	No	
Maximum Recall	No	No		No	No		No	No		No	No	
Pedestrian Recall	No	No		No	No		No	No		No	No	
Detector Location [ft]	0.0	0.0	0.0	0.0	0.0	0.0	0.0	0.0	0.0	0.0	0.0	0.0
Detector Length [ft]	0.0	0.0	0.0	0.0	0.0	0.0	0.0	0.0	0.0	0.0	0.0	0.0
I, Upstream Filtering Factor	1.00	1.00	1.00	1.00	1.00	1.00	1.00	1.00	1.00	1.00	1.00	1.00

Exclusive Pedestrian Phase

Pedestrian Signal Group	0
Pedestrian Walk [s]	0
Pedestrian Clearance [s]	0

Lane Group Calculations

Lane Group	L	C	R	L	C	R	L	C	R	L	C	R
C, Cycle Length [s]	120	120	120	120	120	120	120	120	120	120	120	120
L, Total Lost Time per Cycle [s]	4.00	4.00	4.00	4.00	4.00	4.00	4.00	4.00	4.00	4.00	4.00	4.00
l1_p, Permitted Start-Up Lost Time [s]	0.00	0.00	0.00	0.00	0.00	0.00	0.00	0.00	0.00	0.00	0.00	0.00
l2, Clearance Lost Time [s]	2.00	2.00	2.00	2.00	2.00	2.00	2.00	2.00	2.00	2.00	2.00	2.00
g_i, Effective Green Time [s]	14	31	31	31	48	48	11	27	27	15	31	31
g / C, Green / Cycle	0.11	0.26	0.26	0.26	0.40	0.40	0.09	0.23	0.23	0.12	0.26	0.26
(v / s)_i Volume / Saturation Flow Rate	0.10	0.16	0.16	0.26	0.22	0.03	0.08	0.22	0.09	0.11	0.19	0.16
s, saturation flow rate [veh/h]	1781	3560	1589	3459	3560	1589	1781	5094	1589	3459	3560	1589
c, Capacity [veh/h]	202	922	411	889	1433	640	166	1152	359	432	918	410
d1, Uniform Delay [s]	52.21	39.38	39.34	44.61	27.33	22.13	53.52	46.25	39.56	51.94	41.05	39.26
k, delay calibration	0.11	0.50	0.50	0.11	0.50	0.50	0.11	0.11	0.11	0.11	0.11	0.11
l, Upstream Filtering Factor	1.00	1.00	1.00	1.00	1.00	1.00	1.00	1.00	1.00	1.00	1.00	1.00
d2, Incremental Delay [s]	9.40	3.24	6.99	18.61	1.44	0.24	10.24	9.35	0.73	8.36	1.29	1.49
d3, Initial Queue Delay [s]	0.00	0.00	0.00	0.00	0.00	0.00	0.00	0.00	0.00	0.00	0.00	0.00
Rp, platoon ratio	1.00	1.00	1.00	1.00	1.00	1.00	1.00	1.00	1.00	1.00	1.00	1.00
PF, progression factor	1.00	1.00	1.00	1.00	1.00	1.00	1.00	1.00	1.00	1.00	1.00	1.00

Lane Group Results

X, volume / capacity	0.85	0.63	0.62	1.02	0.54	0.08	0.83	0.99	0.40	0.92	0.75	0.61
d, Delay for Lane Group [s/veh]	61.60	42.62	46.33	63.22	28.78	22.37	63.76	55.61	40.28	60.30	42.34	40.75
Lane Group LOS	E	D	D	F	C	C	E	E	D	E	D	D
Critical Lane Group	No	Yes	No	Yes	No	No	No	Yes	No	Yes	No	No
50th-Percentile Queue Length [veh/ln]	5.36	7.57	7.15	14.69	8.07	0.86	4.46	11.83	3.62	6.24	9.28	6.49
50th-Percentile Queue Length [ft/ln]	133.97	189.28	178.63	367.26	201.65	21.57	111.55	295.77	90.59	156.11	232.03	162.13
95th-Percentile Queue Length [veh/ln]	9.16	12.08	11.53	21.19	12.72	1.55	7.93	17.47	6.52	10.34	14.28	10.66
95th-Percentile Queue Length [ft/ln]	228.88	302.10	288.23	529.84	318.10	38.82	198.16	436.79	163.06	258.57	356.94	266.55

Movement, Approach, & Intersection Results

d_M, Delay for Movement [s/veh]	61.60	42.62	46.33	63.22	28.78	22.37	63.76	55.61	40.28	60.30	42.34	40.75
Movement LOS	E	D	D	F	C	C	E	E	D	E	D	D
d_A, Approach Delay [s/veh]	46.79			46.67			54.83			47.36		
Approach LOS	D			D			D			D		
d_I, Intersection Delay [s/veh]	48.97											
Intersection LOS	D											
Intersection V/C	0.762											

Other Modes

g_Walk,mi, Effective Walk Time [s]	11.0	11.0	11.0	11.0
M_corner, Corner Circulation Area [ft ² /ped]	0.00	0.00	0.00	0.00
M_CW, Crosswalk Circulation Area [ft ² /ped]	0.00	0.00	0.00	0.00
d_p, Pedestrian Delay [s]	49.52	49.52	49.52	49.52
I_p,int, Pedestrian LOS Score for Intersectio	3.603	3.432	3.322	3.666
Crosswalk LOS	D	C	C	D
s_b, Saturation Flow Rate of the bicycle lane	2000	2000	2000	2000
c_b, Capacity of the bicycle lane [bicycles/h]	517	467	450	417
d_b, Bicycle Delay [s]	33.02	35.28	36.05	37.62
I_b,int, Bicycle LOS Score for Intersection	2.585	3.019	2.413	2.857
Bicycle LOS	B	C	B	C

Sequence



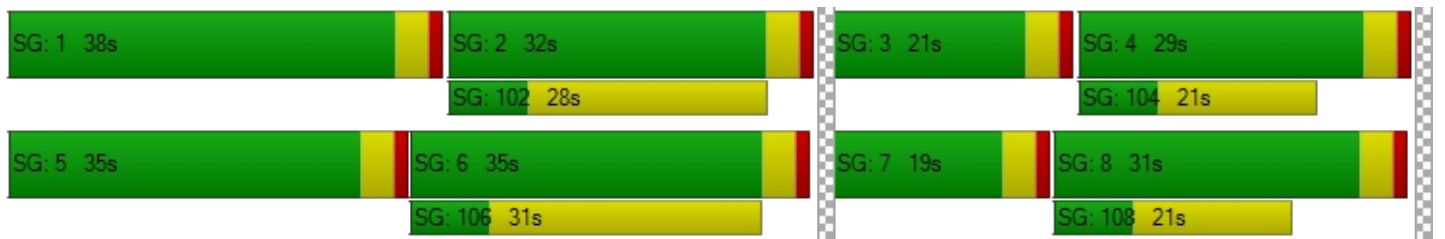

Ring 1	1	2	3	4	-	-	-	-	-	-	-	-	-	-	-	-
Ring 2	5	6	7	8	-	-	-	-	-	-	-	-	-	-	-	-
Ring 3	-	-	-	-	-	-	-	-	-	-	-	-	-	-	-	-
Ring 4	-	-	-	-	-	-	-	-	-	-	-	-	-	-	-	-



Intersection Level Of Service Report
Intersection 2: Marksheffel Rd/Lorson Bl

Control Type:	Signalized	Delay (sec / veh):	16.0
Analysis Method:	HCM 7th Edition	Level Of Service:	B
Analysis Period:	15 minutes	Volume to Capacity (v/c):	0.836

Intersection Setup

Name	Marksheffel Rd			Marksheffel Rd			Eastbound			Lorson Bl		
Approach	Northbound			Southbound			Eastbound			Westbound		
Lane Configuration												
Turning Movement	Left	Thru	Right	Left	Thru	Right	Left	Thru	Right	Left	Thru	Right
Lane Width [ft]	12.00	12.00	12.00	12.00	12.00	12.00	12.00	12.00	12.00	12.00	12.00	12.00
No. of Lanes in Entry Pocket	1	0	1	1	0	1	1	0	0	1	0	0
Entry Pocket Length [ft]	100.00	100.00	500.00	580.00	100.00	100.00	100.00	100.00	100.00	510.00	100.00	100.00
No. of Lanes in Exit Pocket	0	0	0	0	0	1	0	0	0	0	0	0
Exit Pocket Length [ft]	0.00	0.00	0.00	0.00	0.00	100.00	0.00	0.00	0.00	0.00	0.00	0.00
Speed [mph]	55.00			55.00			30.00			25.00		
Grade [%]	0.00			0.00			0.00			0.00		
Curb Present	No			No			No			No		
Crosswalk	Yes			Yes			Yes			Yes		

Volumes

Name	Marksheffel Rd			Marksheffel Rd						Lorson Bl		
Base Volume Input [veh/h]	159	742	568	284	610	34	47	15	41	348	20	199
Base Volume Adjustment Factor	1.0000	1.0000	1.0000	1.0000	1.0000	1.0000	1.0000	1.0000	1.0000	1.0000	1.0000	1.0000
Heavy Vehicles Percentage [%]	2.00	2.00	2.00	2.00	2.00	2.00	2.00	2.00	2.00	2.00	2.00	2.00
Proportion of CAVs [%]	0.00											
Growth Factor	1.0000	1.0000	1.0000	1.0000	1.0000	1.0000	1.0000	1.0000	1.0000	1.0000	1.0000	1.0000
In-Process Volume [veh/h]	0	0	0	0	0	0	0	0	0	0	0	0
Site-Generated Trips [veh/h]	0	119	0	0	121	0	0	0	0	0	0	0
Diverted Trips [veh/h]	0	0	0	0	0	0	0	0	0	0	0	0
Pass-by Trips [veh/h]	0	0	0	0	0	0	0	0	0	0	0	0
Existing Site Adjustment Volume [veh/h]	0	0	0	0	0	0	0	0	0	0	0	0
Other Volume [veh/h]	0	0	0	0	0	0	0	0	0	0	0	0
Right Turn on Red Volume [veh/h]	0	0	284	0	0	0	0	0	0	0	0	100
Total Hourly Volume [veh/h]	159	861	284	284	731	34	47	15	41	348	20	99
Peak Hour Factor	1.0000	0.9200	0.9200	0.9200	0.9200	1.0000	1.0000	1.0000	1.0000	0.9200	1.0000	0.9200
Other Adjustment Factor	1.0000	1.0000	1.0000	1.0000	1.0000	1.0000	1.0000	1.0000	1.0000	1.0000	1.0000	1.0000
Total 15-Minute Volume [veh/h]	40	234	77	77	199	9	12	4	10	95	5	27
Total Analysis Volume [veh/h]	159	936	309	309	795	34	47	15	41	378	20	108
Presence of On-Street Parking	No		No	No		No	No		No	No		No
On-Street Parking Maneuver Rate [/h]	0	0	0	0	0	0	0	0	0	0	0	0
Local Bus Stopping Rate [/h]	0	0	0	0	0	0	0	0	0	0	0	0
v_do, Outbound Pedestrian Volume crossing	0			0			0			0		
v_di, Inbound Pedestrian Volume crossing m	0			0			0			0		
v_co, Outbound Pedestrian Volume crossing	0			0			0			0		
v_ci, Inbound Pedestrian Volume crossing mi	0			0			0			0		
v_ab, Corner Pedestrian Volume [ped/h]	0			0			0			0		
Bicycle Volume [bicycles/h]	0			0			0			0		

Intersection Settings

Located in CBD	No
Signal Coordination Group	-
Cycle Length [s]	70
Active Pattern	Pattern 1
Coordination Type	Time of Day Pattern Coordinated
Actuation Type	Fully actuated
Offset [s]	0.0
Offset Reference	Lead Green - Beginning of First Green
Permissive Mode	SingleBand
Lost time [s]	0.00

Phasing & Timing

Control Type	Permiss	Permiss	Permiss	Permiss	Permiss	Permiss	Permiss	Permiss	Permiss	Permiss	Permiss	Permiss
Signal Group	0	6	0	0	2	0	0	8	0	0	4	0
Auxiliary Signal Groups												
Lead / Lag	-	-	-	-	-	-	-	-	-	-	-	-
Minimum Green [s]	0	10	0	0	10	0	0	10	0	0	10	0
Maximum Green [s]	0	10	0	0	10	0	0	10	0	0	10	0
Amber [s]	0.0	3.0	0.0	0.0	3.0	0.0	0.0	3.0	0.0	0.0	3.0	0.0
All red [s]	0.0	1.0	0.0	0.0	1.0	0.0	0.0	1.0	0.0	0.0	1.0	0.0
Split [s]	0	36	0	0	36	0	0	34	0	0	34	0
Vehicle Extension [s]	0.0	3.0	0.0	0.0	3.0	0.0	0.0	3.0	0.0	0.0	3.0	0.0
Walk [s]	0	7	0	0	7	0	0	7	0	0	7	0
Pedestrian Clearance [s]	0	17	0	0	10	0	0	23	0	0	21	0
Delayed Vehicle Green [s]	0.0	0.0	0.0	0.0	0.0	0.0	0.0	0.0	0.0	0.0	0.0	0.0
Rest In Walk		No			No			No			No	
I1, Start-Up Lost Time [s]	0.0	2.0	0.0	0.0	2.0	0.0	0.0	2.0	0.0	0.0	2.0	0.0
I2, Clearance Lost Time [s]	0.0	2.0	0.0	0.0	2.0	0.0	0.0	2.0	0.0	0.0	2.0	0.0
Minimum Recall		No			No			No			No	
Maximum Recall		No			No			No			No	
Pedestrian Recall		No			No			No			No	
Detector Location [ft]	0.0	0.0	0.0	0.0	0.0	0.0	0.0	0.0	0.0	0.0	0.0	0.0
Detector Length [ft]	0.0	0.0	0.0	0.0	0.0	0.0	0.0	0.0	0.0	0.0	0.0	0.0
I, Upstream Filtering Factor	1.00	1.00	1.00	1.00	1.00	1.00	1.00	1.00	1.00	1.00	1.00	1.00

Exclusive Pedestrian Phase

Pedestrian Signal Group	0
Pedestrian Walk [s]	0
Pedestrian Clearance [s]	0

Lane Group Calculations

Lane Group	L	C	R	L	C	R	L	C	L	C	R
C, Cycle Length [s]	70	70	70	70	70	70	70	70	70	70	70
L, Total Lost Time per Cycle [s]	4.00	4.00	4.00	4.00	4.00	4.00	4.00	4.00	4.00	4.00	4.00
l1_p, Permitted Start-Up Lost Time [s]	2.00	0.00	0.00	2.00	0.00	0.00	2.00	0.00	2.00	0.00	0.00
l2, Clearance Lost Time [s]	2.00	2.00	2.00	2.00	2.00	2.00	2.00	2.00	2.00	2.00	2.00
g_i, Effective Green Time [s]	45	45	45	45	45	45	17	17	17	17	17
g / C, Green / Cycle	0.64	0.64	0.64	0.64	0.64	0.64	0.24	0.24	0.24	0.24	0.24
(v / s)_i Volume / Saturation Flow Rate	0.24	0.26	0.19	0.69	0.22	0.02	0.04	0.03	0.14	0.01	0.07
s, saturation flow rate [veh/h]	661	3560	1589	447	3560	1589	1262	1656	2616	1870	1589
c, Capacity [veh/h]	446	2287	1021	324	2287	1021	350	402	568	454	386
d1, Uniform Delay [s]	10.64	6.06	5.54	22.53	5.75	4.56	23.45	20.71	27.60	20.23	21.47
k, delay calibration	0.50	0.50	0.50	0.50	0.50	0.50	0.11	0.11	0.11	0.11	0.11
l, Upstream Filtering Factor	1.00	1.00	1.00	1.00	1.00	1.00	1.00	1.00	1.00	1.00	1.00
d2, Incremental Delay [s]	2.22	0.54	0.76	39.29	0.42	0.06	0.17	0.16	1.35	0.04	0.39
d3, Initial Queue Delay [s]	0.00	0.00	0.00	0.00	0.00	0.00	0.00	0.00	0.00	0.00	0.00
Rp, platoon ratio	1.00	1.00	1.00	1.00	1.00	1.00	1.00	1.00	1.00	1.00	1.00
PF, progression factor	1.00	1.00	1.00	1.00	1.00	1.00	1.00	1.00	1.00	1.00	1.00

Lane Group Results

X, volume / capacity	0.36	0.41	0.30	0.95	0.35	0.03	0.13	0.14	0.67	0.04	0.28
d, Delay for Lane Group [s/veh]	12.86	6.60	6.30	61.82	6.17	4.62	23.62	20.87	28.96	20.27	21.86
Lane Group LOS	B	A	A	E	A	A	C	C	C	C	C
Critical Lane Group	No	No	No	Yes	No	No	No	No	Yes	No	No
50th-Percentile Queue Length [veh/ln]	1.39	2.02	1.33	8.30	1.62	0.12	0.64	0.70	3.05	0.25	1.44
50th-Percentile Queue Length [ft/ln]	34.65	50.54	33.33	207.46	40.58	2.96	15.97	17.57	76.24	6.22	35.96
95th-Percentile Queue Length [veh/ln]	2.50	3.64	2.40	13.02	2.92	0.21	1.15	1.27	5.49	0.45	2.59
95th-Percentile Queue Length [ft/ln]	62.38	90.97	60.00	325.57	73.04	5.33	28.74	31.63	137.23	11.19	64.73

Movement, Approach, & Intersection Results

d_M, Delay for Movement [s/veh]	12.86	6.60	6.30	61.82	6.17	4.62	23.62	20.87	20.87	28.96	20.27	21.86
Movement LOS	B	A	A	E	A	A	C	C	C	C	C	C
d_A, Approach Delay [s/veh]	7.24			21.23			22.12			27.10		
Approach LOS	A			C			C			C		
d_I, Intersection Delay [s/veh]	15.97											
Intersection LOS	B											
Intersection V/C	0.836											

Other Modes

g_Walk,mi, Effective Walk Time [s]	11.0			11.0			11.0			11.0		
M_corner, Corner Circulation Area [ft ² /ped]	0.00			0.00			0.00			0.00		
M_CW, Crosswalk Circulation Area [ft ² /ped]	0.00			0.00			0.00			0.00		
d_p, Pedestrian Delay [s]	24.82			24.82			24.82			24.82		
I_p,int, Pedestrian LOS Score for Intersectio	4.245			3.200			2.255			3.115		
Crosswalk LOS	D			C			B			C		
s_b, Saturation Flow Rate of the bicycle lane	2000			2000			2000			2000		
c_b, Capacity of the bicycle lane [bicycles/h]	915			915			858			858		
d_b, Bicycle Delay [s]	10.28			10.28			11.40			11.40		
I_b,int, Bicycle LOS Score for Intersection	2.952			2.498			1.730			2.560		
Bicycle LOS	C			B			A			B		

Sequence



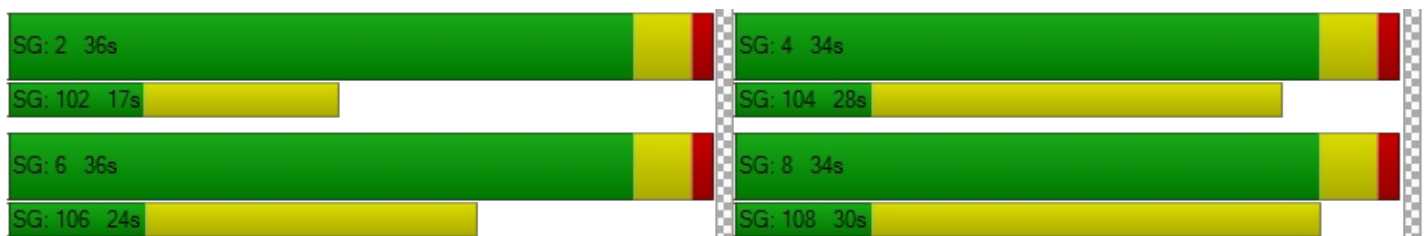

Ring 1	-	2	-	4	-	-	-	-	-	-	-	-	-	-	-	-	-
Ring 2	-	6	-	8	-	-	-	-	-	-	-	-	-	-	-	-	-
Ring 3	-	-	-	-	-	-	-	-	-	-	-	-	-	-	-	-	-
Ring 4	-	-	-	-	-	-	-	-	-	-	-	-	-	-	-	-	-



Intersection Level Of Service Report
Intersection 3: Fontaine Bl/Carriage Meadows Dr

Control Type:	Signalized	Delay (sec / veh):	20.0
Analysis Method:	HCM 7th Edition	Level Of Service:	C
Analysis Period:	15 minutes	Volume to Capacity (v/c):	0.797

Intersection Setup

Name	Carriage Meadows Dr			Carriage Meadows Dr			Fontaine Bl			Fontaine Bl		
Approach	Northbound			Southbound			Eastbound			Westbound		
Lane Configuration												
Turning Movement	Left	Thru	Right	Left	Thru	Right	Left	Thru	Right	Left	Thru	Right
Lane Width [ft]	12.00	12.00	12.00	12.00	12.00	12.00	12.00	12.00	12.00	12.00	12.00	12.00
No. of Lanes in Entry Pocket	1	0	1	1	0	1	1	0	0	1	0	1
Entry Pocket Length [ft]	100.00	100.00	100.00	100.00	100.00	100.00	510.00	100.00	100.00	330.00	100.00	330.00
No. of Lanes in Exit Pocket	0	0	0	0	0	0	0	0	0	0	0	0
Exit Pocket Length [ft]	0.00	0.00	0.00	0.00	0.00	0.00	0.00	0.00	0.00	0.00	0.00	0.00
Speed [mph]	25.00			25.00			45.00			45.00		
Grade [%]	0.00			0.00			0.00			0.00		
Curb Present	No			No			No			No		
Crosswalk	Yes			Yes			Yes			Yes		

Volumes

Name	Carriage Meadows Dr			Carriage Meadows Dr			Fontaine BI			Fontaine BI		
Base Volume Input [veh/h]	23	5	8	5	5	8	56	2160	44	8	1200	6
Base Volume Adjustment Factor	1.0000	1.0000	1.0000	1.0000	1.0000	1.0000	1.0000	1.0000	1.0000	1.0000	1.0000	1.0000
Heavy Vehicles Percentage [%]	2.00	2.00	2.00	2.00	2.00	2.00	2.00	2.00	2.00	2.00	2.00	2.00
Proportion of CAVs [%]	0.00											
Growth Factor	1.7120	1.0000	1.7120	1.7120	1.0000	1.7120	1.7120	1.0000	1.7120	1.7120	1.0000	1.7120
In-Process Volume [veh/h]	0	0	0	0	0	0	0	0	0	0	0	0
Site-Generated Trips [veh/h]	117	3	30	57	4	110	67	30	40	58	27	31
Diverted Trips [veh/h]	0	0	0	0	0	0	0	0	0	0	0	0
Pass-by Trips [veh/h]	0	0	0	0	0	0	0	0	0	0	0	0
Existing Site Adjustment Volume [veh/h]	0	0	0	0	0	0	0	0	0	0	0	0
Other Volume [veh/h]	0	0	0	0	0	0	0	0	0	0	0	0
Right Turn on Red Volume [veh/h]	0	0	22	0	0	62	0	0	58	0	0	21
Total Hourly Volume [veh/h]	156	8	22	66	9	62	163	2190	57	72	1227	20
Peak Hour Factor	0.9200	0.9200	0.9200	0.9200	0.9200	0.9200	0.9200	0.9200	0.9200	0.9200	0.9200	0.9200
Other Adjustment Factor	1.0000	1.0000	1.0000	1.0000	1.0000	1.0000	1.0000	1.0000	1.0000	1.0000	1.0000	1.0000
Total 15-Minute Volume [veh/h]	42	2	6	18	2	17	44	595	15	20	333	5
Total Analysis Volume [veh/h]	170	9	24	72	10	67	177	2380	62	78	1334	22
Presence of On-Street Parking	No		No	No		No	No		No	No		No
On-Street Parking Maneuver Rate [/h]	0	0	0	0	0	0	0	0	0	0	0	0
Local Bus Stopping Rate [/h]	0	0	0	0	0	0	0	0	0	0	0	0
v_do, Outbound Pedestrian Volume crossing	0			0			0			0		
v_di, Inbound Pedestrian Volume crossing m	0			0			0			0		
v_co, Outbound Pedestrian Volume crossing	0			0			0			0		
v_ci, Inbound Pedestrian Volume crossing mi	0			0			0			0		
v_ab, Corner Pedestrian Volume [ped/h]	0			0			0			0		
Bicycle Volume [bicycles/h]	0			0			0			0		

Intersection Settings

Located in CBD	No
Signal Coordination Group	-
Cycle Length [s]	90
Active Pattern	Pattern 1
Coordination Type	Time of Day Pattern Coordinated
Actuation Type	Semi-actuated
Offset [s]	0.0
Offset Reference	Lead Green - Beginning of First Green
Permissive Mode	SingleBand
Lost time [s]	0.00

Phasing & Timing

Control Type	Permiss	Permiss	Permiss	Permiss	Permiss	Permiss	Protecte	Permiss	Permiss	Permiss	Permiss	Permiss
Signal Group	0	8	0	0	4	0	5	2	0	0	6	0
Auxiliary Signal Groups												
Lead / Lag	-	-	-	-	-	-	Lead	-	-	-	-	-
Minimum Green [s]	0	10	0	0	10	0	5	10	0	0	10	0
Maximum Green [s]	0	34	0	0	34	0	5	168	0	0	168	0
Amber [s]	0.0	3.0	0.0	0.0	3.0	0.0	3.0	3.0	0.0	0.0	3.0	0.0
All red [s]	0.0	1.0	0.0	0.0	1.0	0.0	1.0	1.0	0.0	0.0	1.0	0.0
Split [s]	0	38	0	0	38	0	13	52	0	0	39	0
Vehicle Extension [s]	0.0	3.0	0.0	0.0	3.0	0.0	3.0	3.0	0.0	0.0	3.0	0.0
Walk [s]	0	7	0	0	7	0	0	7	0	0	7	0
Pedestrian Clearance [s]	0	23	0	0	27	0	0	7	0	0	14	0
Delayed Vehicle Green [s]	0.0	0.0	0.0	0.0	0.0	0.0	0.0	0.0	0.0	0.0	0.0	0.0
Rest In Walk		No			No			No			No	
I1, Start-Up Lost Time [s]	0.0	2.0	0.0	0.0	2.0	0.0	2.0	2.0	0.0	0.0	2.0	0.0
I2, Clearance Lost Time [s]	0.0	2.0	0.0	0.0	2.0	0.0	2.0	2.0	0.0	0.0	2.0	0.0
Minimum Recall		No			No		No	No			No	
Maximum Recall		No			No		No	No			No	
Pedestrian Recall		No			No		No	No			No	
Detector Location [ft]	0.0	0.0	0.0	0.0	0.0	0.0	0.0	0.0	0.0	0.0	0.0	0.0
Detector Length [ft]	0.0	0.0	0.0	0.0	0.0	0.0	0.0	0.0	0.0	0.0	0.0	0.0
I, Upstream Filtering Factor	1.00	1.00	1.00	1.00	1.00	1.00	1.00	1.00	1.00	1.00	1.00	1.00

Exclusive Pedestrian Phase

Pedestrian Signal Group	0
Pedestrian Walk [s]	0
Pedestrian Clearance [s]	0

Lane Group Calculations

Lane Group	L	C	R	L	C	R	L	C	R	L	C	R
C, Cycle Length [s]	90	90	90	90	90	90	90	90	90	90	90	90
L, Total Lost Time per Cycle [s]	4.00	4.00	4.00	4.00	4.00	4.00	4.00	4.00	4.00	4.00	4.00	4.00
l1_p, Permitted Start-Up Lost Time [s]	2.00	0.00	0.00	2.00	0.00	0.00	0.00	0.00	0.00	2.00	0.00	0.00
l2, Clearance Lost Time [s]	2.00	2.00	2.00	2.00	2.00	2.00	2.00	2.00	2.00	2.00	2.00	2.00
g_i, Effective Green Time [s]	14	14	14	14	14	14	9	68	68	55	55	55
g / C, Green / Cycle	0.16	0.16	0.16	0.16	0.16	0.16	0.10	0.75	0.75	0.61	0.61	0.61
(v / s)_i Volume / Saturation Flow Rate	0.13	0.00	0.02	0.05	0.01	0.04	0.10	0.67	0.04	0.56	0.37	0.01
s, saturation flow rate [veh/h]	1322	1870	1589	1376	1870	1589	1781	3560	1589	139	3560	1589
c, Capacity [veh/h]	282	300	255	290	300	255	178	2673	1193	84	2159	964
d1, Uniform Delay [s]	37.07	31.89	32.22	34.07	31.90	33.13	40.47	8.42	2.91	44.93	11.15	7.07
k, delay calibration	0.11	0.11	0.11	0.11	0.11	0.11	0.35	0.50	0.50	0.50	0.50	0.50
l, Upstream Filtering Factor	1.00	1.00	1.00	1.00	1.00	1.00	1.00	1.00	1.00	1.00	1.00	1.00
d2, Incremental Delay [s]	2.07	0.04	0.16	0.44	0.04	0.54	55.17	4.96	0.08	79.70	1.34	0.04
d3, Initial Queue Delay [s]	0.00	0.00	0.00	0.00	0.00	0.00	0.00	0.00	0.00	0.00	0.00	0.00
Rp, platoon ratio	1.00	1.00	1.00	1.00	1.00	1.00	1.00	1.00	1.00	1.00	1.00	1.00
PF, progression factor	1.00	1.00	1.00	1.00	1.00	1.00	1.00	1.00	1.00	1.00	1.00	1.00

Lane Group Results

X, volume / capacity	0.60	0.03	0.09	0.25	0.03	0.26	0.99	0.89	0.05	0.93	0.62	0.02
d, Delay for Lane Group [s/veh]	39.14	31.93	32.38	34.51	31.95	33.67	95.64	13.39	2.99	124.64	12.49	7.11
Lane Group LOS	D	C	C	C	C	C	F	B	A	F	B	A
Critical Lane Group	Yes	No	No	No	No	No	No	Yes	No	No	No	No
50th-Percentile Queue Length [veh/ln]	3.78	0.17	0.46	1.44	0.19	1.32	6.45	11.34	0.20	3.53	7.08	0.15
50th-Percentile Queue Length [ft/ln]	94.49	4.23	11.46	36.10	4.71	33.06	161.26	283.52	4.95	88.33	176.88	3.78
95th-Percentile Queue Length [veh/ln]	6.80	0.30	0.83	2.60	0.34	2.38	10.62	16.86	0.36	6.36	11.44	0.27
95th-Percentile Queue Length [ft/ln]	170.07	7.62	20.63	64.97	8.47	59.50	265.40	421.59	8.92	158.99	285.94	6.81

Movement, Approach, & Intersection Results

d_M, Delay for Movement [s/veh]	39.14	31.93	32.38	34.51	31.95	33.67	95.64	13.39	2.99	124.64	12.49	7.11
Movement LOS	D	C	C	C	C	C	F	B	A	F	B	A
d_A, Approach Delay [s/veh]	38.02			33.96			18.70			18.50		
Approach LOS	D			C			B			B		
d_I, Intersection Delay [s/veh]	20.04											
Intersection LOS	C											
Intersection V/C	0.797											

Other Modes

g_Walk,mi, Effective Walk Time [s]	11.0			11.0			11.0			11.0		
M_corner, Corner Circulation Area [ft ² /ped]	0.00			0.00			0.00			0.00		
M_CW, Crosswalk Circulation Area [ft ² /ped]	0.00			0.00			0.00			0.00		
d_p, Pedestrian Delay [s]	34.67			34.67			34.67			34.67		
I_p,int, Pedestrian LOS Score for Intersectio	2.361			2.308			3.818			3.548		
Crosswalk LOS	B			B			D			D		
s_b, Saturation Flow Rate of the bicycle lane	2000			2000			2000			2000		
c_b, Capacity of the bicycle lane [bicycles/h]	756			756			1067			778		
d_b, Bicycle Delay [s]	17.42			17.42			9.80			16.81		
I_b,int, Bicycle LOS Score for Intersection	1.931			1.908			3.768			2.760		
Bicycle LOS	A			A			D			C		

Sequence

Ring 1	-	2	-	4	-	-	-	-	-	-	-	-	-	-	-	-	-
Ring 2	5	6	-	8	-	-	-	-	-	-	-	-	-	-	-	-	-
Ring 3	-	-	-	-	-	-	-	-	-	-	-	-	-	-	-	-	-
Ring 4	-	-	-	-	-	-	-	-	-	-	-	-	-	-	-	-	-



Intersection Level Of Service Report
Intersection 4: Marksheffel Rd/West Driveway

Control Type:	Two-way stop	Delay (sec / veh):	13.4
Analysis Method:	HCM 7th Edition	Level Of Service:	B
Analysis Period:	15 minutes	Volume to Capacity (v/c):	0.075

Intersection Setup

Name	Marksheffel Rd		Marksheffel Rd		West Driveway	
Approach	Northbound		Southbound		Westbound	
Lane Configuration	↔				↔	
Turning Movement	Thru	Right	Left	Thru	Left	Right
Lane Width [ft]	12.00	12.00	12.00	12.00	12.00	12.00
No. of Lanes in Entry Pocket	0	1	1	0	0	0
Entry Pocket Length [ft]	100.00	100.00	100.00	100.00	100.00	100.00
No. of Lanes in Exit Pocket	0	0	0	1	0	0
Exit Pocket Length [ft]	0.00	0.00	0.00	590.00	0.00	0.00
Speed [mph]	55.00		55.00		25.00	
Grade [%]	0.00		0.00		0.00	
Crosswalk	No		No		Yes	

Volumes

Name	Marksheffel Rd		Marksheffel Rd		West Driveway	
Base Volume Input [veh/h]	974	0	0	1529	0	0
Base Volume Adjustment Factor	1.0000	1.0000	1.0000	1.0000	1.0000	1.0000
Heavy Vehicles Percentage [%]	2.00	2.00	2.00	2.00	2.00	2.00
Growth Factor	1.0000	1.0000	1.0000	1.0000	1.0000	1.0000
In-Process Volume [veh/h]	0	0	0	0	0	0
Site-Generated Trips [veh/h]	73	75	0	103	0	32
Diverted Trips [veh/h]	0	0	0	0	0	0
Pass-by Trips [veh/h]	0	0	0	0	0	0
Existing Site Adjustment Volume [veh/h]	0	0	0	0	0	0
Other Volume [veh/h]	0	0	0	0	0	0
Total Hourly Volume [veh/h]	1047	75	0	1632	0	32
Peak Hour Factor	0.9200	0.9200	0.9200	0.9200	0.9200	0.9200
Other Adjustment Factor	1.0000	1.0000	1.0000	1.0000	1.0000	1.0000
Total 15-Minute Volume [veh/h]	285	20	0	443	0	9
Total Analysis Volume [veh/h]	1138	82	0	1774	0	35
Pedestrian Volume [ped/h]	0		0		0	

Intersection Settings

Priority Scheme	Free	Free	Stop
Flared Lane			
Storage Area [veh]	0	0	0
Two-Stage Gap Acceptance			No
Number of Storage Spaces in Median	0	0	0

Movement, Approach, & Intersection Results

V/C, Movement V/C Ratio	0.01	0.00	0.00	0.02	0.00	0.08
d_M, Delay for Movement [s/veh]	0.00	0.00	0.00	0.00	0.00	13.36
Movement LOS	A	A		A		B
95th-Percentile Queue Length [veh/ln]	0.00	0.00	0.00	0.00	0.00	0.24
95th-Percentile Queue Length [ft/ln]	0.00	0.00	0.00	0.00	0.00	6.07
d_A, Approach Delay [s/veh]	0.00		0.00		13.36	
Approach LOS	A		A		B	
d_I, Intersection Delay [s/veh]	0.15					
Intersection LOS	B					

Intersection Level Of Service Report
Intersection 5: Carriage Meadows Dr/East Driveway

Control Type:	Two-way stop	Delay (sec / veh):	11.9
Analysis Method:	HCM 7th Edition	Level Of Service:	B
Analysis Period:	15 minutes	Volume to Capacity (v/c):	0.023

Intersection Setup

Name	Carriage Meadows Dr			Carriage Meadows Dr			East Driveway			Westbound		
Approach	Northbound			Southbound			Eastbound			Westbound		
Lane Configuration												
Turning Movement	Left	Thru	Right	Left	Thru	Right	Left	Thru	Right	Left	Thru	Right
Lane Width [ft]	12.00	12.00	12.00	12.00	12.00	12.00	12.00	12.00	12.00	12.00	12.00	12.00
No. of Lanes in Entry Pocket	1	0	0	0	0	0	0	0	0	0	0	0
Entry Pocket Length [ft]	100.00	100.00	100.00	100.00	100.00	100.00	100.00	100.00	100.00	100.00	100.00	100.00
No. of Lanes in Exit Pocket	0	0	0	0	0	0	0	0	0	0	0	0
Exit Pocket Length [ft]	0.00	0.00	0.00	0.00	0.00	0.00	0.00	0.00	0.00	0.00	0.00	0.00
Speed [mph]	25.00			25.00			25.00			30.00		
Grade [%]	0.00			0.00			0.00			0.00		
Crosswalk	No			No			Yes			Yes		

Volumes

Name	Carriage Meadows Dr			Carriage Meadows Dr			East Driveway			Westbound		
Base Volume Input [veh/h]	0	0	0	0	0	0	0	0	0	0	0	0
Base Volume Adjustment Factor	1.0000	1.0000	1.0000	1.0000	1.0000	1.0000	1.0000	1.0000	1.0000	1.0000	1.0000	1.0000
Heavy Vehicles Percentage [%]	2.00	2.00	2.00	2.00	2.00	2.00	2.00	2.00	2.00	2.00	2.00	2.00
Growth Factor	1.0000	1.0000	1.0000	1.0000	1.0000	1.0000	1.0000	1.0000	1.0000	1.0000	1.0000	1.0000
In-Process Volume [veh/h]	0	0	0	0	0	0	0	0	0	0	0	0
Site-Generated Trips [veh/h]	85	2	14	0	2	2	2	0	158	11	0	0
Diverted Trips [veh/h]	0	0	0	0	0	0	0	0	0	0	0	0
Pass-by Trips [veh/h]	0	0	0	0	0	0	0	0	0	0	0	0
Existing Site Adjustment Volume [veh/h]	0	0	0	0	0	0	0	0	0	0	0	0
Other Volume [veh/h]	0	0	0	0	0	0	0	0	0	0	0	0
Total Hourly Volume [veh/h]	85	2	14	0	2	2	2	0	158	11	0	0
Peak Hour Factor	0.9200	0.9200	0.9200	0.9200	0.9200	0.9200	0.9200	0.9200	0.9200	0.9200	0.9200	0.9200
Other Adjustment Factor	1.0000	1.0000	1.0000	1.0000	1.0000	1.0000	1.0000	1.0000	1.0000	1.0000	1.0000	1.0000
Total 15-Minute Volume [veh/h]	23	1	4	0	1	1	1	0	43	3	0	0
Total Analysis Volume [veh/h]	92	2	15	0	2	2	2	0	172	12	0	0
Pedestrian Volume [ped/h]	0			0			0			0		

Intersection Settings

Priority Scheme	Free	Free	Stop	Stop
Flared Lane			No	No
Storage Area [veh]	0	0	0	0
Two-Stage Gap Acceptance			No	No
Number of Storage Spaces in Median	0	0	0	0

Movement, Approach, & Intersection Results

V/C, Movement V/C Ratio	0.06	0.00	0.00	0.00	0.00	0.00	0.00	0.00	0.16	0.02	0.00	0.00
d_M, Delay for Movement [s/veh]	7.36	0.00	0.00	7.25	0.00	0.00	10.65	11.16	8.98	11.93	10.62	8.51
Movement LOS	A	A	A	A	A	A	B	B	A	B	B	A
95th-Percentile Queue Length [veh/ln]	0.18	0.00	0.00	0.00	0.00	0.00	0.58	0.58	0.58	0.07	0.07	0.07
95th-Percentile Queue Length [ft/ln]	4.52	0.00	0.00	0.00	0.00	0.00	14.42	14.42	14.42	1.73	1.73	1.73
d_A, Approach Delay [s/veh]	6.21			0.00			9.00			11.93		
Approach LOS	A			A			A			B		
d_I, Intersection Delay [s/veh]	7.98											
Intersection LOS	B											

Intersection Level Of Service Report
Intersection 7: Fontaine BI/Middle Driveway

Control Type:	Two-way stop	Delay (sec / veh):	31.4
Analysis Method:	HCM 7th Edition	Level Of Service:	D
Analysis Period:	15 minutes	Volume to Capacity (v/c):	0.196

Intersection Setup

Name	LRCS			Middle Driveway			Fontaine BI			Fontaine BI		
Approach	Northbound			Southbound			Eastbound			Westbound		
Lane Configuration	↶						↶			↶		
Turning Movement	Left	Thru	Right	Left	Thru	Right	Left	Thru	Right	Left	Thru	Right
Lane Width [ft]	12.00	12.00	12.00	12.00	12.00	12.00	12.00	12.00	12.00	12.00	12.00	12.00
No. of Lanes in Entry Pocket	0	0	0	0	0	0	0	0	0	0	0	0
Entry Pocket Length [ft]	100.00	100.00	100.00	100.00	100.00	100.00	100.00	100.00	100.00	100.00	100.00	100.00
No. of Lanes in Exit Pocket	0	0	0	0	0	0	0	0	0	0	0	0
Exit Pocket Length [ft]	0.00	0.00	0.00	0.00	0.00	0.00	0.00	0.00	0.00	0.00	0.00	0.00
Speed [mph]	25.00			25.00			45.00			45.00		
Grade [%]	0.00			0.00			0.00			0.00		
Crosswalk	Yes			Yes			No			No		

Volumes

Name	LRCS			Middle Driveway			Fontaine BI			Fontaine BI		
Base Volume Input [veh/h]	0	0	0	0	0	0	0	2160	0	0	1239	0
Base Volume Adjustment Factor	1.0000	1.0000	1.0000	1.0000	1.0000	1.0000	1.0000	1.0000	1.0000	1.0000	1.0000	1.0000
Heavy Vehicles Percentage [%]	2.00	2.00	2.00	2.00	2.00	2.00	2.00	2.00	2.00	2.00	2.00	2.00
Growth Factor	1.0000	1.0000	1.0000	1.0000	1.0000	1.0000	1.0000	1.0000	1.0000	1.0000	1.0000	1.0000
In-Process Volume [veh/h]	0	0	0	0	0	0	0	0	0	0	0	0
Site-Generated Trips [veh/h]	0	0	30	0	0	0	0	107	81	0	226	28
Diverted Trips [veh/h]	0	0	0	0	0	0	0	0	0	0	0	0
Pass-by Trips [veh/h]	0	0	0	0	0	0	0	0	0	0	0	0
Existing Site Adjustment Volume [veh/h]	0	0	0	0	0	0	0	0	0	0	0	0
Other Volume [veh/h]	0	0	0	0	0	0	0	0	0	0	0	0
Total Hourly Volume [veh/h]	0	0	30	0	0	0	0	2267	81	0	1465	28
Peak Hour Factor	0.9200	0.9200	0.9200	0.9200	0.9200	0.9200	0.9200	0.9200	0.9200	0.9200	0.9200	0.9200
Other Adjustment Factor	1.0000	1.0000	1.0000	1.0000	1.0000	1.0000	1.0000	1.0000	1.0000	1.0000	1.0000	1.0000
Total 15-Minute Volume [veh/h]	0	0	8	0	0	0	0	616	22	0	398	8
Total Analysis Volume [veh/h]	0	0	33	0	0	0	0	2464	88	0	1592	30
Pedestrian Volume [ped/h]	0			0			0			0		

Intersection Settings

Priority Scheme	Stop	Stop	Free	Free
Flared Lane				
Storage Area [veh]	0	0	0	0
Two-Stage Gap Acceptance	No			
Number of Storage Spaces in Median	0	0	0	0

Movement, Approach, & Intersection Results

V/C, Movement V/C Ratio	0.00	0.00	0.20	0.00	0.00	0.00	0.00	0.02	0.00	0.00	0.02	0.00
d_M, Delay for Movement [s/veh]	0.00	0.00	31.44	0.00	0.00	0.00	0.00	0.00	0.00	0.00	0.00	0.00
Movement LOS			D					A	A		A	A
95th-Percentile Queue Length [veh/ln]	0.00	0.00	0.70	0.00	0.00	0.00	0.00	0.00	0.00	0.00	0.00	0.00
95th-Percentile Queue Length [ft/ln]	0.00	0.00	17.51	0.00	0.00	0.00	0.00	0.00	0.00	0.00	0.00	0.00
d_A, Approach Delay [s/veh]	31.44			0.00			0.00			0.00		
Approach LOS	D			A			A			A		
d_I, Intersection Delay [s/veh]	0.25											
Intersection LOS	D											

Signal Warrants Report For Intersection 4: Marksheffel Rd/West Driveway

Warrants Summary

Warrant	Name	Met?
#1	Eight Hour Vehicular Volume	No
#2	Four Hour Vehicular Volume	No
#3	Peak Hour	No

Intersection Warrants Parameters

Major Approaches	N, S
Minor Approaches	E
Speed > 40mph	Yes
Population < 10,000	No
Warrant Factor	70%

Warrant Analysis Traffic Volumes

Hour	Major Streets		Minor Streets
	N	S	E
1	1632	1122	32
2	1583	1088	31
3	1550	1066	30
4	1452	999	28
5	1289	886	25
6	1273	875	25
7	1257	864	25
8	1142	785	22
9	1126	774	22
10	1110	763	22
11	963	662	19
12	898	617	18
13	881	606	17
14	653	449	13
15	653	449	13
16	457	314	9
17	261	180	5
18	261	180	5
19	147	101	3
20	82	56	2
21	49	34	1
22	16	11	0
23	16	11	0
24	16	11	0

Warrant Analysis by Hour

Hour	Major Streets		Minor Street		Warrant 1 Condition A				Warrant 1 Condition B				Warrant 2	Warrant 3 Condition B
	Number	Volume	Number	Volume	100%	80%	70%	56%	100%	80%	70%	56%		
1	3	2754	1	32	No	No	No	No	No	No	No	No	No	No
2	3	2671	1	31	No	No	No	No	No	No	No	No	No	No
3	3	2616	1	30	No	No	No	No	No	No	No	No	No	No
4	3	2451	1	28	No	No	No	No	No	No	No	No	No	No
5	3	2175	1	25	No	No	No	No	No	No	No	No	No	No
6	3	2148	1	25	No	No	No	No	No	No	No	No	No	No
7	3	2121	1	25	No	No	No	No	No	No	No	No	No	No
8	3	1927	1	22	No	No	No	No	No	No	No	No	No	No
9	3	1900	1	22	No	No	No	No	No	No	No	No	No	No
10	3	1873	1	22	No	No	No	No	No	No	No	No	No	No
11	3	1625	1	19	No	No	No	No	No	No	No	No	No	No
12	3	1515	1	18	No	No	No	No	No	No	No	No	No	No
13	3	1487	1	17	No	No	No	No	No	No	No	No	No	No
14	3	1102	1	13	No	No	No	No	No	No	No	No	No	No
15	3	1102	1	13	No	No	No	No	No	No	No	No	No	No
16	3	771	1	9	No	No	No	No	No	No	No	No	No	No
17	3	441	1	5	No	No	No	No	No	No	No	No	No	No
18	3	441	1	5	No	No	No	No	No	No	No	No	No	No
19	3	248	1	3	No	No	No	No	No	No	No	No	No	No
20	3	138	1	2	No	No	No	No	No	No	No	No	No	No
21	3	83	1	1	No	No	No	No	No	No	No	No	No	No
22	3	27	1	0	No	No	No	No	No	No	No	No	No	No
23	3	27	1	0	No	No	No	No	No	No	No	No	No	No
24	3	27	1	0	No	No	No	No	No	No	No	No	No	No
Hours Met					0	0	0	0	0	0	0	0	0	0

Warrant 3 Condition A

Orientation	E
Total Stopped Delay Per Vehicle on Minor Approach (s)	13.4
Number of Lanes on Minor Street Approach	1
VehicleHours of Stopped Delay on Minor Approach (h:mm)	0:07
Delay Condition Met	No
Volume on Minor Street Approach During Same Hour	32
High Minor Volume Condition Met	No
Total Entering Volume on All Approaches During Same Hour	2786
Number of Approaches on Intersection	3
Total Volume Condition Met	Yes
Warrant Met for Approach	No
Warrant Met for Intersection	No

Signal Warrants Report For Intersection 5: Carriage Meadows Dr/East Driveway

Warrants Summary

Warrant	Name	Met?
#1	Eight Hour Vehicular Volume	No
#2	Four Hour Vehicular Volume	No
#3	Peak Hour	No

Intersection Warrants Parameters

Major Approaches	S, N
Minor Approaches	E, W
Speed > 40mph	No
Population < 10,000	No
Warrant Factor	100%

Warrant Analysis Traffic Volumes

Hour	Major Streets		Minor Streets	
	S	N	E	W
1	101	4	11	160
2	98	4	11	155
3	96	4	10	152
4	90	4	10	142
5	80	3	9	126
6	79	3	9	125
7	78	3	8	123
8	71	3	8	112
9	70	3	8	110
10	69	3	7	109
11	60	2	6	94
12	56	2	6	88
13	55	2	6	86
14	40	2	4	64
15	40	2	4	64
16	28	1	3	45
17	16	1	2	26
18	16	1	2	26
19	9	0	1	14
20	5	0	1	8
21	3	0	0	5
22	1	0	0	2
23	1	0	0	2
24	1	0	0	2

Warrant Analysis by Hour

Hour	Major Streets		Minor Street		Warrant 1 Condition A				Warrant 1 Condition B				Warrant 2	Warrant 3 Condition B
	Number	Volume	Number	Volume	100%	80%	70%	56%	100%	80%	70%	56%		
1	2	105	1	160	No	No	No	No	No	No	No	No	No	No
2	2	102	1	155	No	No	No	No	No	No	No	No	No	No
3	2	100	1	152	No	No	No	No	No	No	No	No	No	No
4	2	94	1	142	No	No	No	No	No	No	No	No	No	No
5	2	83	1	126	No	No	No	No	No	No	No	No	No	No
6	2	82	1	125	No	No	No	No	No	No	No	No	No	No
7	2	81	1	123	No	No	No	No	No	No	No	No	No	No
8	2	74	1	112	No	No	No	No	No	No	No	No	No	No
9	2	73	1	110	No	No	No	No	No	No	No	No	No	No
10	2	72	1	109	No	No	No	No	No	No	No	No	No	No
11	2	62	1	94	No	No	No	No	No	No	No	No	No	No
12	2	58	1	88	No	No	No	No	No	No	No	No	No	No
13	2	57	1	86	No	No	No	No	No	No	No	No	No	No
14	2	42	1	64	No	No	No	No	No	No	No	No	No	No
15	2	42	1	64	No	No	No	No	No	No	No	No	No	No
16	2	29	1	45	No	No	No	No	No	No	No	No	No	No
17	2	17	1	26	No	No	No	No	No	No	No	No	No	No
18	2	17	1	26	No	No	No	No	No	No	No	No	No	No
19	2	9	1	14	No	No	No	No	No	No	No	No	No	No
20	2	5	1	8	No	No	No	No	No	No	No	No	No	No
21	2	3	1	5	No	No	No	No	No	No	No	No	No	No
22	2	1	1	2	No	No	No	No	No	No	No	No	No	No
23	2	1	1	2	No	No	No	No	No	No	No	No	No	No
24	2	1	1	2	No	No	No	No	No	No	No	No	No	No
Hours Met					0	0	0	0	0	0	0	0	0	0

Warrant 3 Condition A

Orientation	E	W
Total Stopped Delay Per Vehicle on Minor Approach (s)	11.9	9
Number of Lanes on Minor Street Approach	1	1
VehicleHours of Stopped Delay on Minor Approach (h:mm)	0:02	0:23
Delay Condition Met	No	No
Volume on Minor Street Approach During Same Hour	11	160
High Minor Volume Condition Met	No	Yes
Total Entering Volume on All Approaches During Same Hour	276	276
Number of Approaches on Intersection	4	4
Total Volume Condition Met	No	No
Warrant Met for Approach	No	No
Warrant Met for Intersection	No	

Signal Warrants Report For Intersection 7: Fontaine Bl/Middle Driveway

Warrants Summary

Warrant	Name	Met?
#1	Eight Hour Vehicular Volume	No
#2	Four Hour Vehicular Volume	No
#3	Peak Hour	No

Intersection Warrants Parameters

Major Approaches	E, W
Minor Approaches	S
Speed > 40mph	Yes
Population < 10,000	No
Warrant Factor	70%

Warrant Analysis Traffic Volumes

Hour	Major Streets		Minor Streets
	E	W	S
1	1493	2348	30
2	1448	2278	29
3	1418	2231	29
4	1329	2090	27
5	1179	1855	24
6	1165	1831	23
7	1150	1808	23
8	1045	1644	21
9	1030	1620	21
10	1015	1597	20
11	881	1385	18
12	821	1291	17
13	806	1268	16
14	597	939	12
15	597	939	12
16	418	657	8
17	239	376	5
18	239	376	5
19	134	211	3
20	75	117	2
21	45	70	1
22	15	23	0
23	15	23	0
24	15	23	0

Warrant Analysis by Hour

Hour	Major Streets		Minor Street		Warrant 1 Condition A				Warrant 1 Condition B				Warrant 2	Warrant 3 Condition B
	Number	Volume	Number	Volume	100%	80%	70%	56%	100%	80%	70%	56%		
1	3	3841	1	30	No	No	No	No	No	No	No	No	No	No
2	3	3726	1	29	No	No	No	No	No	No	No	No	No	No
3	3	3649	1	29	No	No	No	No	No	No	No	No	No	No
4	3	3419	1	27	No	No	No	No	No	No	No	No	No	No
5	3	3034	1	24	No	No	No	No	No	No	No	No	No	No
6	3	2996	1	23	No	No	No	No	No	No	No	No	No	No
7	3	2958	1	23	No	No	No	No	No	No	No	No	No	No
8	3	2689	1	21	No	No	No	No	No	No	No	No	No	No
9	3	2650	1	21	No	No	No	No	No	No	No	No	No	No
10	3	2612	1	20	No	No	No	No	No	No	No	No	No	No
11	3	2266	1	18	No	No	No	No	No	No	No	No	No	No
12	3	2112	1	17	No	No	No	No	No	No	No	No	No	No
13	3	2074	1	16	No	No	No	No	No	No	No	No	No	No
14	3	1536	1	12	No	No	No	No	No	No	No	No	No	No
15	3	1536	1	12	No	No	No	No	No	No	No	No	No	No
16	3	1075	1	8	No	No	No	No	No	No	No	No	No	No
17	3	615	1	5	No	No	No	No	No	No	No	No	No	No
18	3	615	1	5	No	No	No	No	No	No	No	No	No	No
19	3	345	1	3	No	No	No	No	No	No	No	No	No	No
20	3	192	1	2	No	No	No	No	No	No	No	No	No	No
21	3	115	1	1	No	No	No	No	No	No	No	No	No	No
22	3	38	1	0	No	No	No	No	No	No	No	No	No	No
23	3	38	1	0	No	No	No	No	No	No	No	No	No	No
24	3	38	1	0	No	No	No	No	No	No	No	No	No	No
Hours Met					0	0	0	0	0	0	0	0	0	0

Warrant 3 Condition A

Orientation	S
Total Stopped Delay Per Vehicle on Minor Approach (s)	31.4
Number of Lanes on Minor Street Approach	1
VehicleHours of Stopped Delay on Minor Approach (h:mm)	0:15
Delay Condition Met	No
Volume on Minor Street Approach During Same Hour	30
High Minor Volume Condition Met	No
Total Entering Volume on All Approaches During Same Hour	3871
Number of Approaches on Intersection	3
Total Volume Condition Met	Yes
Warrant Met for Approach	No
Warrant Met for Intersection	No

Appendix F – Supporting Documents

Figure 15. Build Out Total Traffic Volumes (AM Peak Hour)

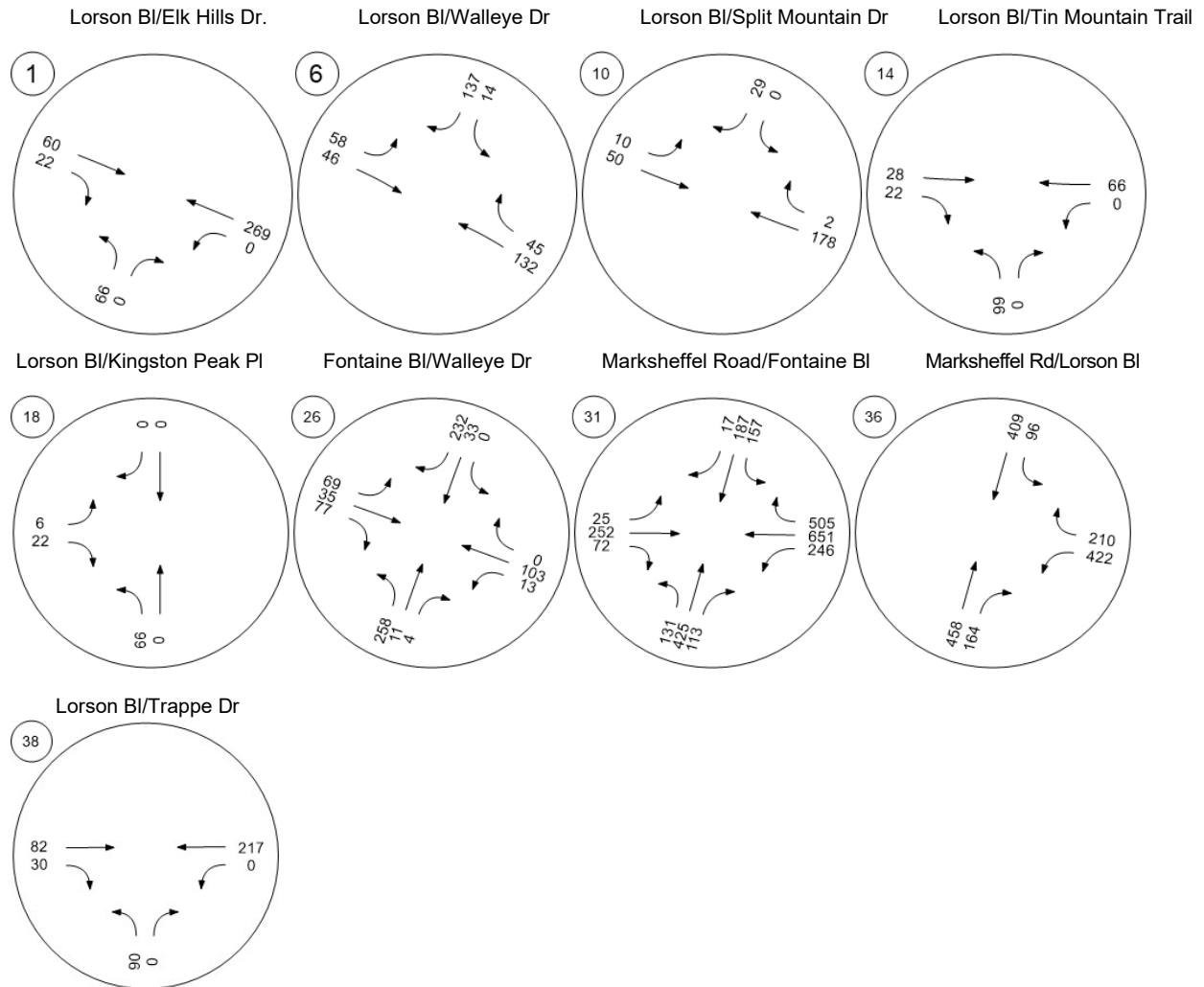

Figure 16. Build Out Total Traffic Volumes (PM Peak Hour)

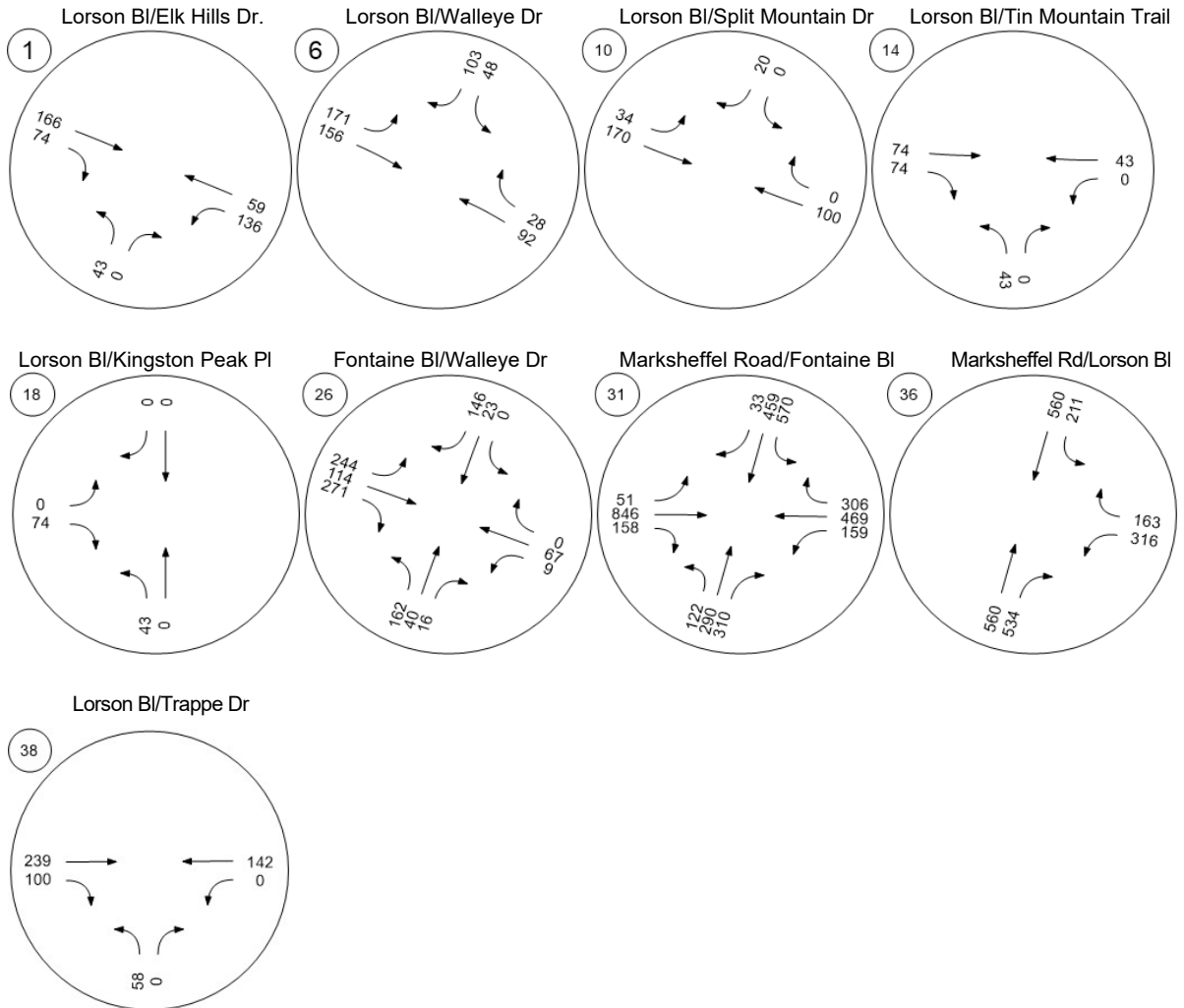

Figure 18. Build Out Total Project Specific Intersection Configurations

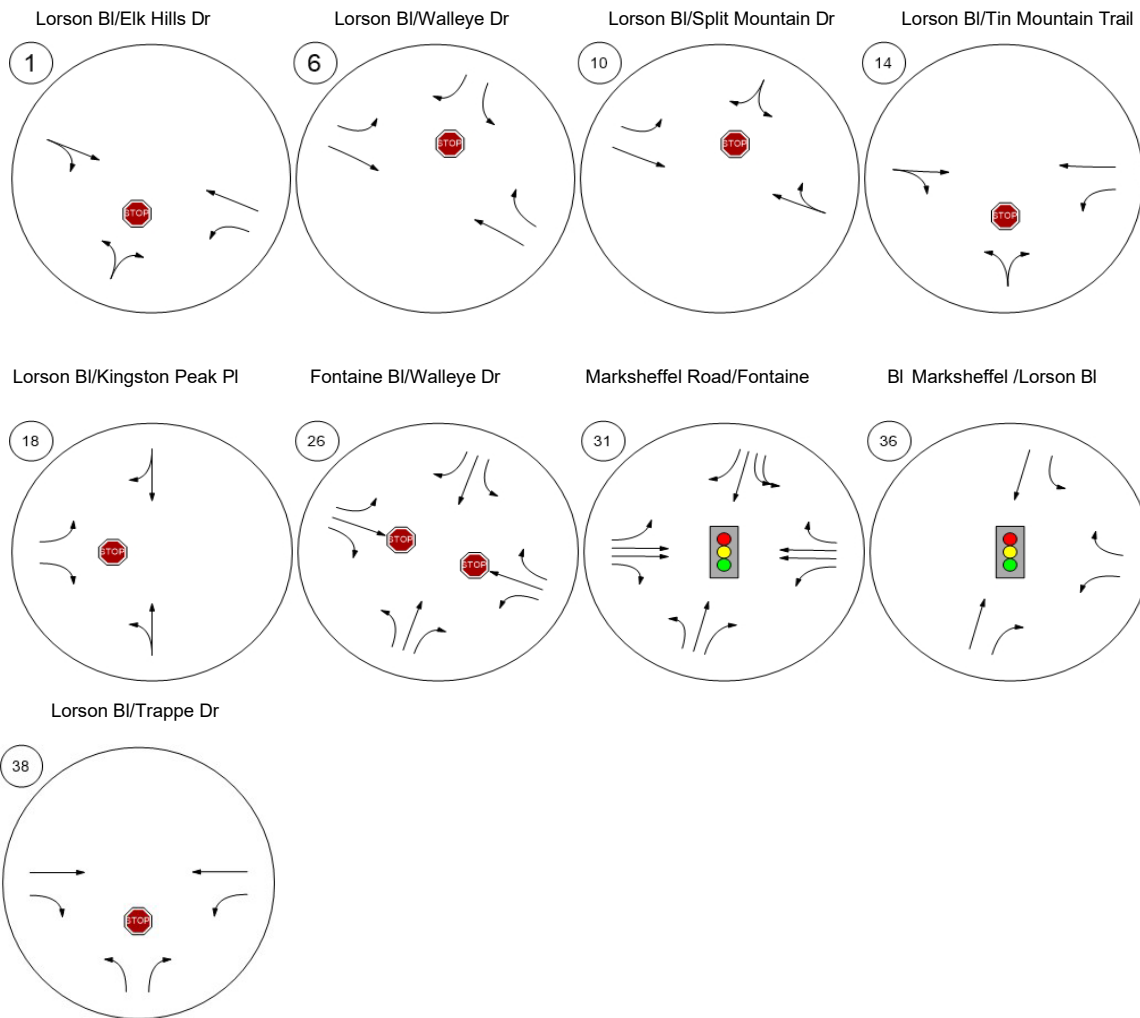

Figure 23. Horizon Total Traffic Volumes (AM Peak Hour)

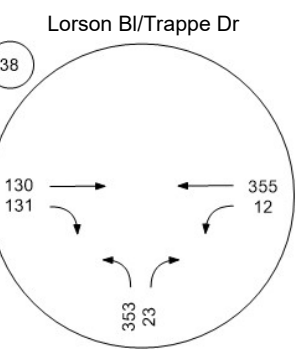
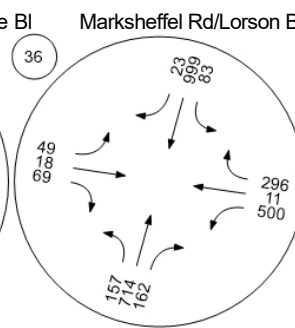
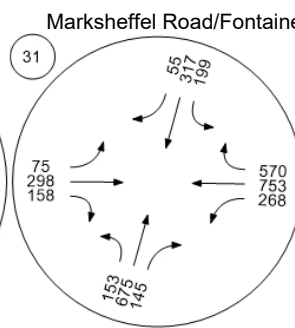
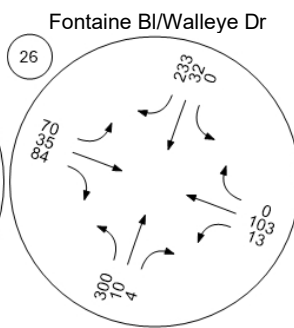
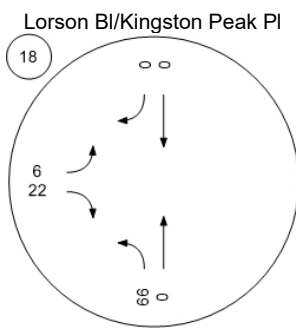
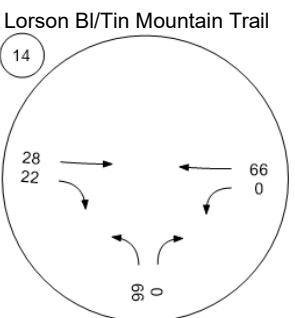
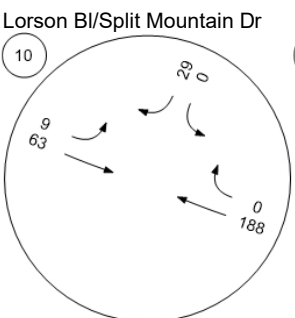
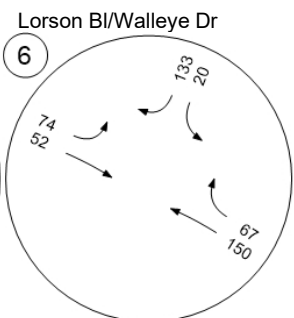
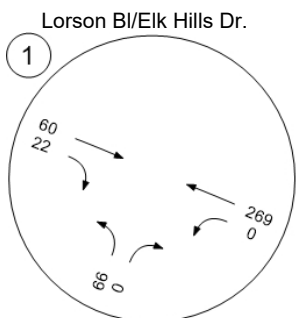
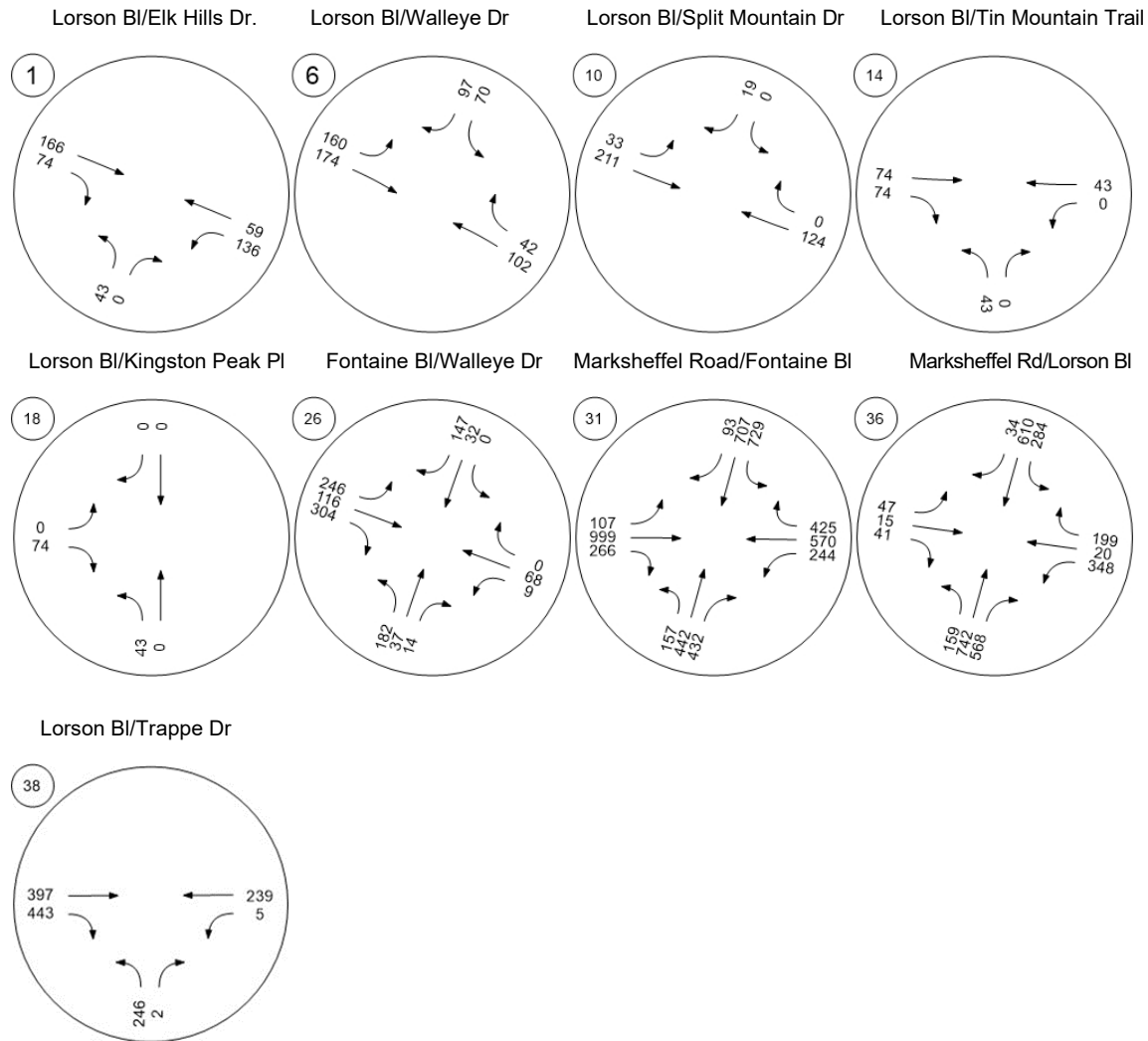

Figure 24. Horizon Total Traffic Volumes (PM Peak Hour)



Intersection Level Of Service Report
Intersection 31: Marksheffel Road/Fontaine Blvd

Control Type:	Signalized	Delay (sec / veh):	46.7
Analysis Method:	HCM 6th Edition	Level Of Service:	D
Analysis Period:	15 minutes	Volume to Capacity (v/c):	0.800

Intersection Setup

Name	Marksheffel Rd			Marksheffel Rd			Fontaine Bl			Fontaine Bl		
Approach	Northbound			Southbound			Eastbound			Westbound		
Lane Configuration	[Diagram]			[Diagram]			[Diagram]			[Diagram]		
Turning Movement	Left	Thru	Right	Left	Thru	Right	Left	Thru	Right	Left	Thru	Right
Lane Width [ft]	12.00	12.00	12.00	12.00	12.00	12.00	12.00	12.00	12.00	12.00	12.00	12.00
No. of Lanes in Entry Pocket	1	0	1	1	0	1	1	0	1	1	0	1
Entry Pocket Length [ft]	460.00	100.00	460.00	390.00	100.00	390.00	260.00	100.00	40.00	430.00	100.00	430.00
No. of Lanes in Exit Pocket	0	0	0	0	0	0	0	0	0	0	0	2
Exit Pocket Length [ft]	0.00	0.00	0.00	0.00	0.00	0.00	0.00	0.00	0.00	0.00	0.00	300.00
Speed [mph]	30.00			30.00			30.00			30.00		
Grade [%]	0.00			0.00			0.00			0.00		
Curb Present	No			No			No			No		
Crosswalk	Yes			Yes			Yes			Yes		

**Intersection Level Of Service Report
Intersection 36: Marksheffel Rd/Lorson Bl**

Control Type:	Signalized	Delay (sec / veh):	25.0
Analysis Method:	HCM 6th Edition	Level Of Service:	C
Analysis Period:	15 minutes	Volume to Capacity (v/c):	0.900

Intersection Setup

Name	Marksheffel Rd			Marksheffel Rd			Eastbound			Lorson Bl		
Approach	Northbound			Southbound			Eastbound			Westbound		
Lane Configuration	⇐ ⇐ ⇐			⇐ ⇐ ⇐			⇐ ⇐			⇐ ⇐ ⇐		
Turning Movement	Left	Thru	Right	Left	Thru	Right	Left	Thru	Right	Left	Thru	Right
Lane Width [ft]	12.00	12.00	12.00	12.00	12.00	12.00	12.00	12.00	12.00	12.00	12.00	12.00
No. of Lanes in Entry Pocket	1	0	1	1	0	1	1	0	0	1	0	0
Entry Pocket Length [ft]	100.00	100.00	250.00	400.00	100.00	100.00	100.00	100.00	100.00	250.00	100.00	100.00
No. of Lanes in Exit Pocket	0	0	0	0	0	1	0	0	0	0	0	0
Exit Pocket Length [ft]	0.00	0.00	0.00	0.00	0.00	100.00	0.00	0.00	0.00	0.00	0.00	0.00
Speed [mph]	30.00			30.00			30.00			30.00		
Grade [%]	0.00			0.00			0.00			0.00		
Curb Present	No			No			No			No		
Crosswalk	Yes			Yes			Yes			Yes		

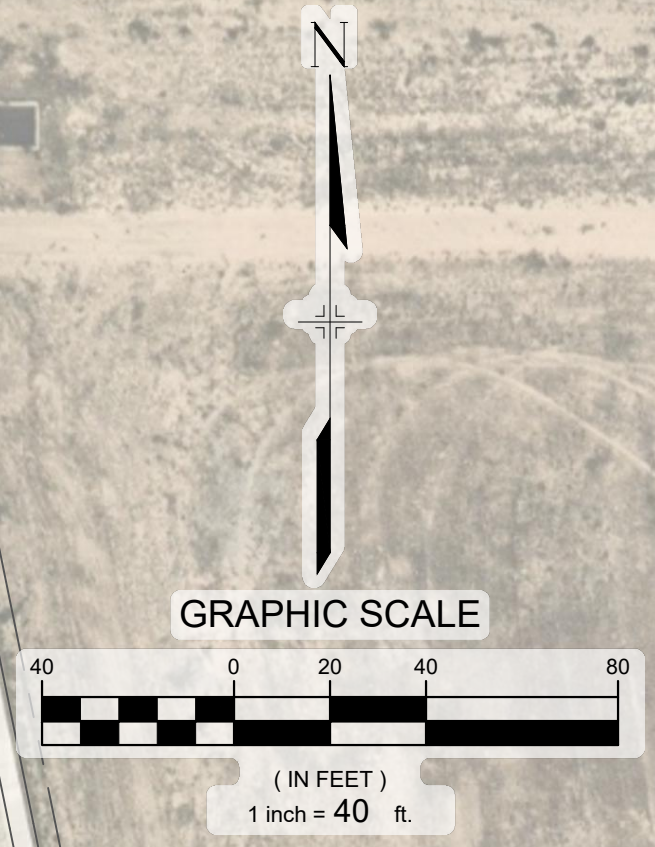
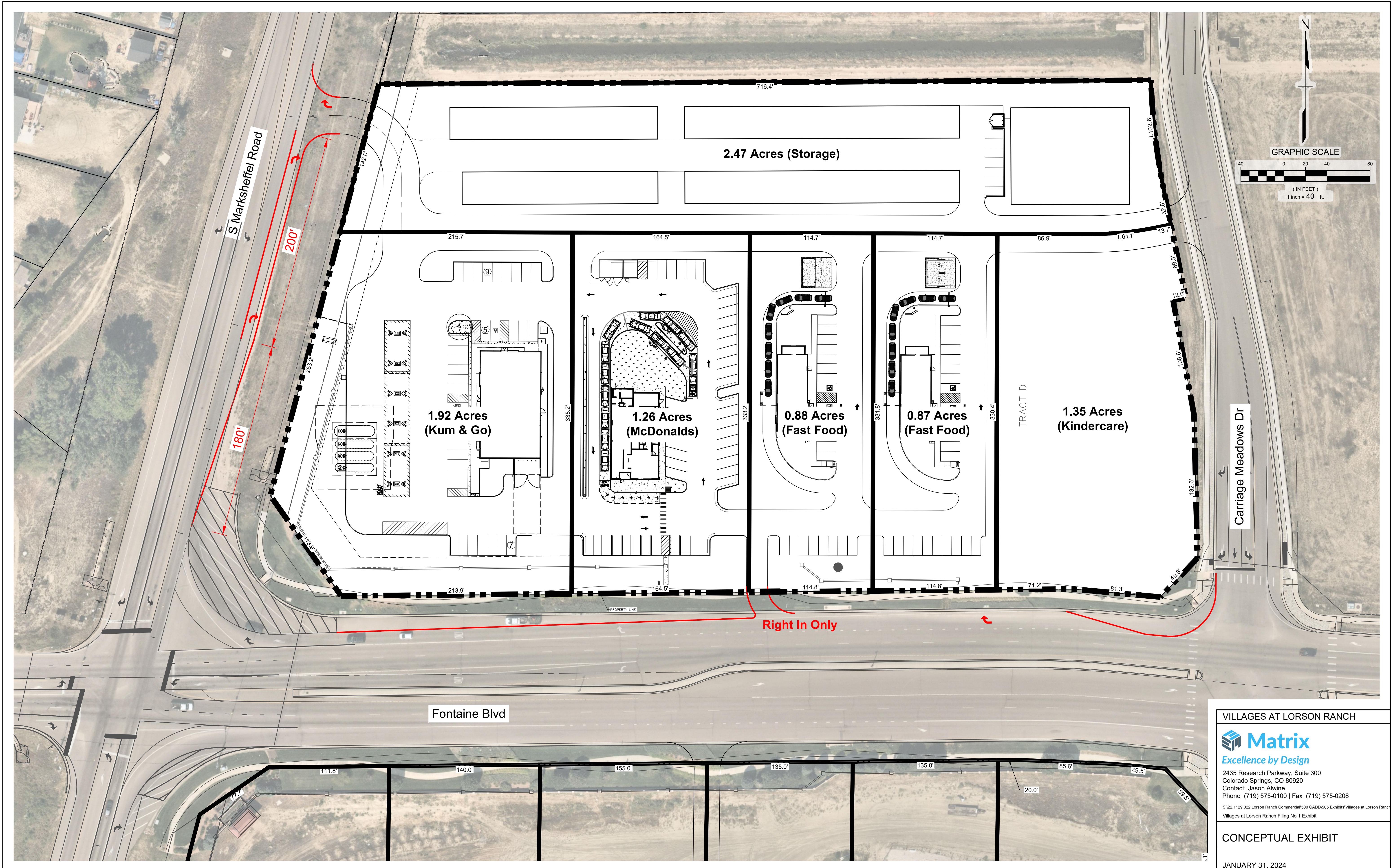

2.47 Acres (Storage)

1.92 Acres (Kum & Go)

1.26 Acres (McDonalds)

0.88 Acres (Fast Food)

0.87 Acres (Fast Food)

1.35 Acres (Kindercare)

S Marksheffel Road

Fontaine Blvd

Carriage Meadows Dr

Right In Only

VILLAGES AT LORSON RANCH

2435 Research Parkway, Suite 300
 Colorado Springs, CO 80920
 Contact: Jason Alwine
 Phone (719) 575-0100 | Fax (719) 575-0208

S:\22.1129.022 Lorson Ranch Commercial\500 CADD\505 Exhibits\Villages at Lorson Ranch
 Villages at Lorson Ranch Filing No 1 Exhibit

CONCEPTUAL EXHIBIT

JANUARY 31, 2024

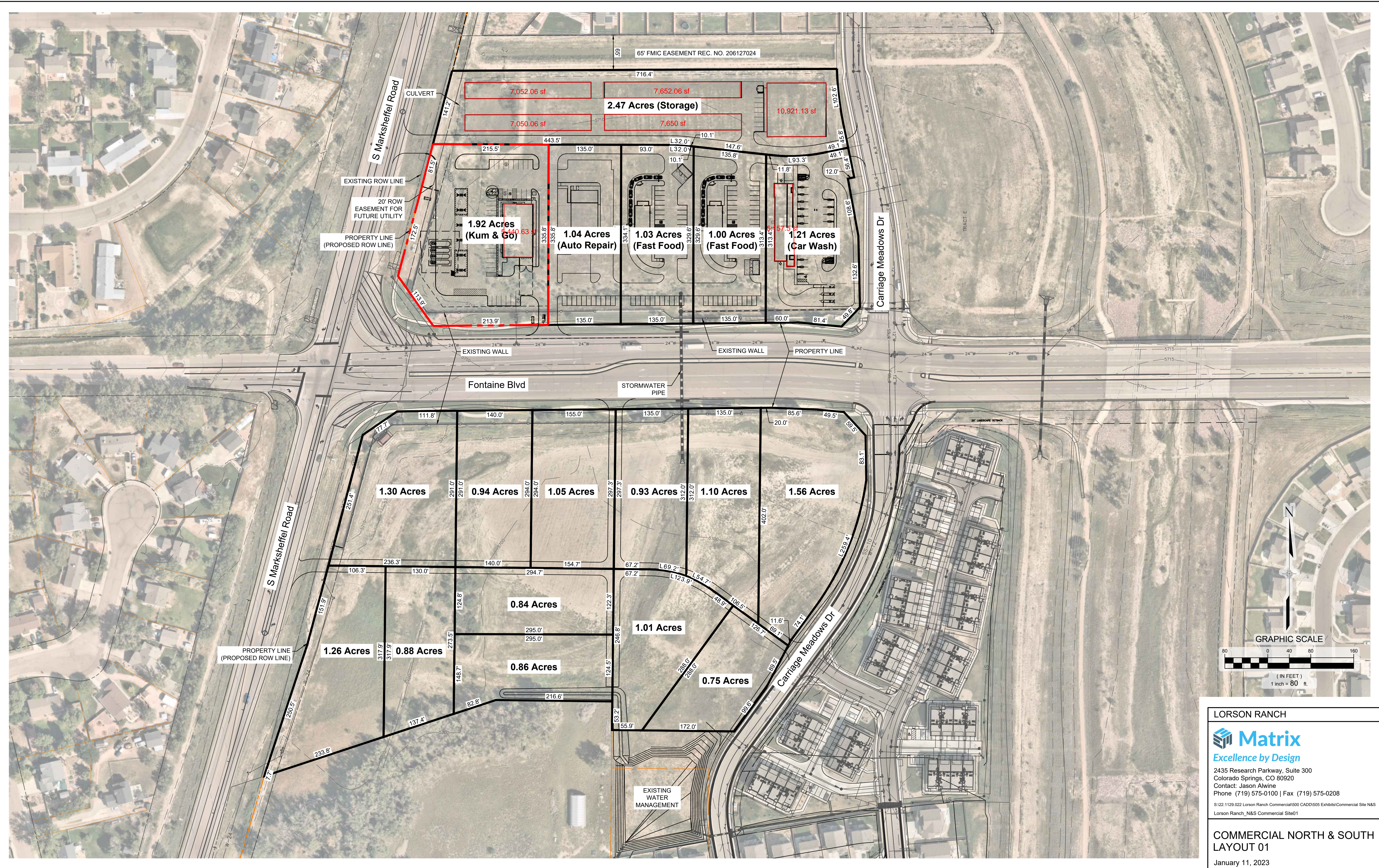

65' FMIC EASEMENT REC. NO. 206127024

7,052.06 sf 7,652.06 sf 10,921.13 sf

7,050.06 sf 7,650 sf

2.47 Acres (Storage)

EXISTING ROW LINE

20' ROW EASEMENT FOR FUTURE UTILITY

PROPERTY LINE (PROPOSED ROW LINE)

1.92 Acres (Kum & Go)

1.40 Acres

1.04 Acres (Auto Repair)

1.03 Acres (Fast Food)

1.00 Acres (Fast Food)

1.21 Acres (Car Wash)

Fontaine Blvd

STORMWATER PIPE

EXISTING WALL

EXISTING WALL

PROPERTY LINE

Carriage Meadows Dr

1.30 Acres

0.94 Acres

1.05 Acres

0.93 Acres

1.10 Acres

1.56 Acres

0.84 Acres

1.01 Acres

0.86 Acres

0.75 Acres

1.26 Acres

0.88 Acres

EXISTING WATER MANAGEMENT

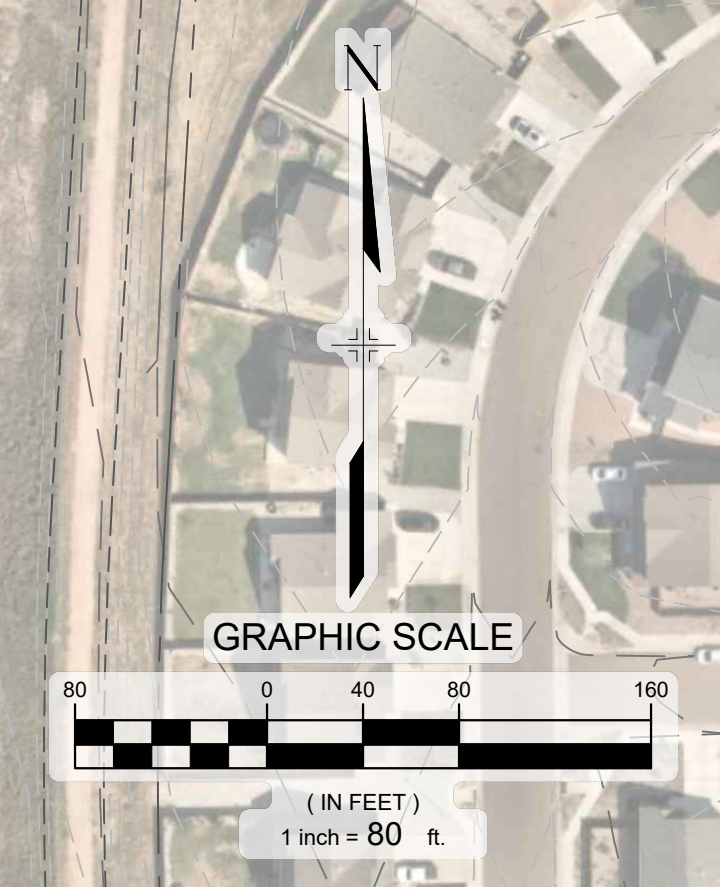

LORSON RANCH

Matrix
Excellence by Design

2435 Research Parkway, Suite 300
Colorado Springs, CO 80920
Contact: Jason Alwine
Phone (719) 575-0100 | Fax (719) 575-0208

S:\22\1129\022 Lorson Ranch Commercial\500 CADD\505 Exhibits\Commercial Site N&S
Lorson Ranch_N&S Commercial Site01

COMMERCIAL NORTH & SOUTH LAYOUT 01

January 11, 2023

All Traffic Data Services
www.alltrafficdata.net

Date Start: 15-Jun-21
Site Code: 19
Station ID: 19
MARKSHEFFEL RD S.O. FONTAINE BLVD

Start Time	15-Jun-21 Tue	NB	SB	Total						
12:00 AM		18	17	35						
01:00		8	7	15						
02:00		10	6	16						
03:00		11	9	20						
04:00		42	30	72						
05:00		157	205	362						
06:00		439	243	682						
07:00		670	276	946						
08:00		499	271	770						
09:00		286	204	490						
10:00		263	213	476						
11:00		302	257	559						
12:00 PM		328	283	611						
01:00		278	261	539						
02:00		276	283	559						
03:00		331	388	719						
04:00		345	708	1053						
05:00		402	661	1063						
06:00		329	293	622						
07:00		225	244	469						
08:00		173	172	345						
09:00		120	119	239						
10:00		62	57	119						
11:00		34	29	63						
Total		5608	5236	10844						
Percent		51.7%	48.3%							
AM Peak	-	07:00	07:00	-	-	-	-	-	-	07:00
Vol.	-	670	276	-	-	-	-	-	-	946
PM Peak	-	17:00	16:00	-	-	-	-	-	-	17:00
Vol.	-	402	708	-	-	-	-	-	-	1063
Grand Total		5608	5236							10844
Percent		51.7%	48.3%							
ADT		ADT 10,844	AADT 10,844							