

Traffic Impact Study

To: Bill Guman, William Guman and Associates, LTD
From: Eli Farney, PE, PTOE
Date: December 16, 2024

Esteban Rodriguez Site

El Paso County, Colorado

PCD File No. SP245

Prepared By:



Unresolved Review 1 Comment:

Add PCD File No. CC241, P2412, P2411

In order to not slow down the rezone project, this TIS should be strictly for the rezone. Please address the minor comments provided that have not been addressed from review 1.

Alternatively, the Master TIS can be used for this rezone project.

Eli Farney, PE, PTOE

efarney@jrengineering.com

JR Engineering

7200 South Alton Way, Suite C400

Centennial, CO 80112



Please provide correct County signature block. See image below.

ENGINEER'S STATEMENT:

Traffic Engineer's Statement

The attached traffic report and supporting information were prepared under my responsible charge and they comport with the standard of care. So far as is consistent with the standard of care, said report was prepared in general conformance with the criteria established by the County for traffic reports.

_____ Date _____
[Name, P.E. # _____]

Developer's Statement

I, the Developer, have read and will comply with all commitments made on my behalf within this report.

_____ Date _____
[Name, Title]
[Business Name]
[Address]

EL PASO COUNTY:

County report review is provided only for general conformance with County standards and design criteria. The County is not responsible for the accuracy and adequacy of the data, analysis, or conclusions. The County through the approval of this document assumes not responsibility for completeness and/or accuracy of this document.

Joshua Palmer, P.E. Date _____
County Engineer/ ECM Administrator

Conditions:

Please remove county portion of the signature block.

Table of Contents

Executive Summary.....	4
Introduction	5
Existing Conditions.....	8
Traffic Volumes and Distribution	9
Traffic Operations Analysis	17
Conclusion.....	21

List of Figures

Figure 1: Vicinity Map	7
Figure 2: 2024 Existing Traffic Volumes and Lane Geometry.....	10
Figure 3: Site Generated Traffic Volumes and Distribution.....	11
Figure 4: 2029 Proposed Lane Geometry	12
Figure 5: 2029 Opening Day Background Traffic Volumes	13
Figure 6: 2029 Opening Day Total Traffic Volumes	14
Figure 7: 2045 Future Year Background Traffic Volumes	15
Figure 8: 2045 Future Year Total Traffic Volumes	16

List of Tables

Table 1: 2024 Existing Levels of Service.....	17
Table 2: 2029 Opening Day Levels of Service	17
Table 3: 2045 Future Year Levels of Service	18
Table 4: 2024 Existing 95 th Percentile Queue Lengths	19
Table 5: 2029 Opening Day 95 th Percentile Queue Lengths.....	19
Table 6: 2045 Future Year 95 th Percentile Queue Lengths.....	20

List of Appendices

- Appendix A: Site Plan
- Appendix B: Traffic Counts
- Appendix C: Trip Generation Report
- Appendix D: Synchro Reports

Executive Summary

JR Engineering (JR) has completed a review of the traffic impacts resulting from the proposed development of the Esteban Rodriguez Site (Project) in El Paso County, Colorado (County). A master traffic impact study was completed by LSC Transportation Consultants, dated August 15, 2023.

The objectives of this Traffic Impact Study (TIS, Study) are:

- Collect Year 2024 existing traffic count data at nearby intersections.
- Estimate site-generated traffic and route trips onto adjacent streets.
- Perform traffic operations analysis for Year 2029 Opening Day and Year 2045 Future scenarios.
- Make recommendations for roadway improvements to accommodate new traffic.

The methodology, content, and findings of this TIS are consistent with the following documents:

- *El Paso County Engineering Criteria Manual*, Appendix B: Transportation Impact Study Guidelines
- *Esteban Rodriguez Subdivision Master TIS* by LSC Transportation Consultants, dated August 15, 2023

Key Findings of this TIS

- **Levels of Service:** 2024 Existing condition levels of service are LOS B or better. In the 2029 Opening Day condition, all movements are expected to operate at LOS C or better with total traffic volumes. In the 2045 Future Year condition, all movements are expected to operate at LOS C or better with total traffic.
- **Queue Lengths:** Queuing is expected to be minimal at both intersections in the Existing, Opening Day, and Future Year conditions. No operational issues with queuing are anticipated.
- **Recommendations:** JR recommends adding both left and right turn lanes at each of the Study intersections to accommodate turning traffic by 2029 Opening Day. These turn lanes are not triggered solely by the Esteban Rodriguez site, but along with the surrounding background developments.

Introduction

JR has completed a review of the existing and forecasted traffic operations in the vicinity of the Esteban Rodriguez Site. A vicinity map is included in **Figure 1**.

Proposed Land Use

The majority of the development is anticipated to contain low-density residential land use. Additionally, warehousing and retail land uses are expected along Judge Orr Road on the north side of the site. For the purpose of estimating site-generated traffic volumes using ITE *Trip Generation Manual*, 11th Edition, the following land uses were assumed:

- Warehousing (ITE 150) – 190,000 square feet
- Single-Family Detached Housing (ITE 210) – 144 dwelling units
- Strip Retail Plaza (<40k SF) (ITE 822) – 10,000 square feet

A site plan is included in **Appendix A**.

Study Intersections

The Study analyzes two intersections:

- Judge Orr Road & Elbert Road (E1)
- Judge Orr Road & Northeast Site Access (A1)

Proposed Roadway Improvements

The following improvements are proposed in order to accommodate forecasted traffic volumes:

- Add left and right turn lanes at the Study intersections
 - Based on El Paso County criteria for required turn lanes

Proposed lane geometry and intersection control are shown in **Figure 4**.

Judge Orr Road Classification

Judge Orr Road is classified as a Rural Minor Arterial roadway in the El Paso County *Major Transportation Corridors Plan* (MTCP), adopted July 18, 2024. It is proposed to have 2 lanes in the year 2045. Judge Orr Road was modeled accordingly in this Study.

Review 1 comment: please also reference the roadway improvements table identified in the Master TIS.

Further detail of the required improvements listed in the master TIS shall be provided with the TIS at the subdivision stage as identified in table 7 of the master TIS

Review 2 comment: Unresolved. Please address. The master TIS discusses roadway improvements starting on page 15 and in table 7, as mentioned in the previous comment.

Phase 1 Traffic Analysis

In addition to analyzing the entire Esteban Rodriguez development, JR analyzed an interim condition in which only Phase 1 of the Project is complete.

Phase 1 includes 15 single-family detached homes, which would generate the following trips:

- Average Daily Trips: 176
- AM Peak Entering Site: 3
- AM Peak Exiting Site: 10
- PM Peak Entering Site: 11
- PM Peak Exiting Site: 6

Traffic volumes generated by Phase 1 only are small compared to traffic generated by the entire Project. Therefore, JR does not anticipate any operational issues to result from Phase 1 traffic.

US 24 & Stapleton Road Future Signal

The US 24 & Stapleton Road intersection is planned to be signalized in the future. CDOT has indicated that nearby projects will be required to escrow a fair share amount toward this traffic signal. Cost estimates and escrow amounts for the Esteban Rodriguez development should be determined at the final plat stage.



Figure 1 - Vicinity Map



2500 1250 0 2500



ORIGINAL SCALE: 1" = 2500'

7200 South Alton Way, Suite C400, Centennial, CO 80112
 303-740-9393 Fax: 303-721-9019 www.jrengineering.com



JR ENGINEERING

Existing Conditions

Existing Land Use

The Project site is currently vacant. The site does not generate trips in the existing condition.

Existing Traffic Volumes

Existing traffic volumes were obtained on Wednesday, February 21, 2024 by All Traffic Data Services at the intersection of Judge Orr Road & Elbert Road. Existing traffic volumes and lane geometry are shown in **Figure 2**. Traffic counts are included in **Appendix B**.



Traffic Volumes and Dis

Review 1 Comment: This is not consistent with the master TIS. The master TIS identified a 3% initial growth rate (first 6 years). Revise accordingly.
Review 2 comment: Unresolved. Please address.

Background Traffic Growth Rate

To determine background traffic volumes, JR considered traffic studies from the Project site. The site-generated trips from these nearby studies were considered as background traffic in year 2029:

- *Saddlehorn Ranch Filing No. 2 TIS* by LSC Transportation Consultants, dated April 11, 2023
- *Davis Ranch Subdivision Master TIS* by LSC Transportation Consultants, dated July 7, 2023
- *BOCES Campus TIS* by JR Engineering

Additionally, JR applied a 1% annual growth rate to existing traffic volumes to account for other future regional development. Future background traffic volumes are shown in **Figure 5** (2029) and **Figure 7** (2045).

Site-Generated Traffic Volumes

Site-generated traffic volumes for the 2029 build-out condition were estimated using ITE *Trip Generation Manual*, 11th Edition. The residential and commercial development is expected to produce the following trips:

- Average Daily Trips: 2,292
- AM Peak Entering Site: 76
- AM Peak Exiting Site: 98
- PM Peak Entering Site: 141
- PM Peak Exiting Site: 126

Site-generated traffic volumes are shown in **Figure 3**. A trip generation report is included in **Appendix C**.

Distribution of Site-Generated Traffic

Site-generated traffic was routed onto adjacent streets according to a distribution based on existing traffic counts. The distribution is shown in **Figure 3**.

Total Traffic

Total traffic is the sum of background and site-generated traffic. JR forecasted total traffic volumes at the Study intersections in the years 2029 (Opening Day) and 2045 (Future Year). Total traffic volumes are shown in **Figure 6** (2029) and **Figure 8** (2045).



Figure 2 - 2024 Existing Traffic Volumes and Lane Geometry

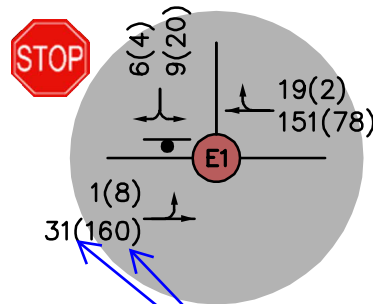

Unresolved review comment 1:

identify the ADT on all figures per ECM B.8

Review comment 2: Unresolved. Please address.

Review comment 1: Identify which of these is AM and PM peak hour traffic. Provide a legend, typical on all figures
 Review comment 2: Unresolved. Please address.



600 300 0 600



ORIGINAL SCALE: 1" = 600'



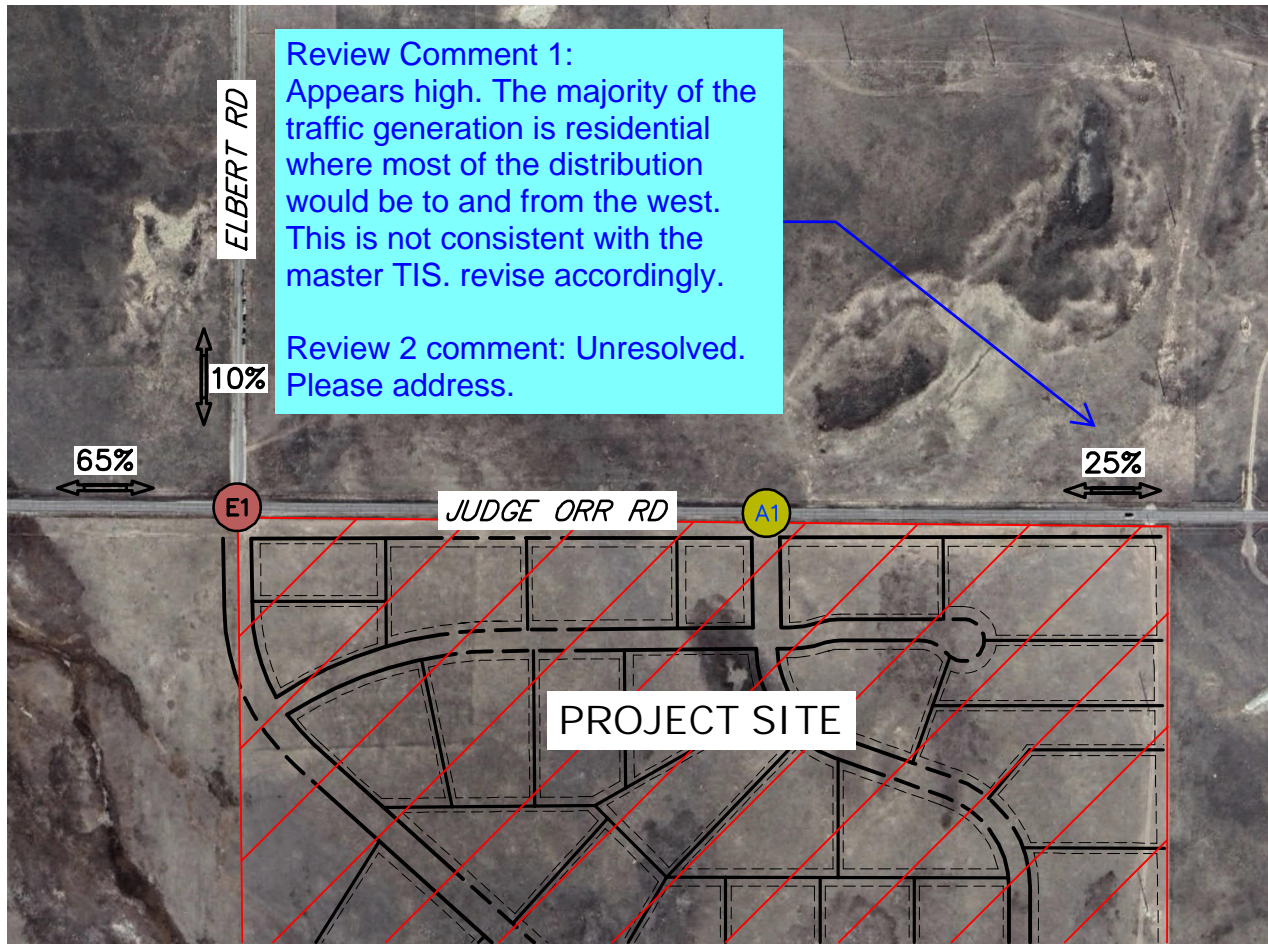
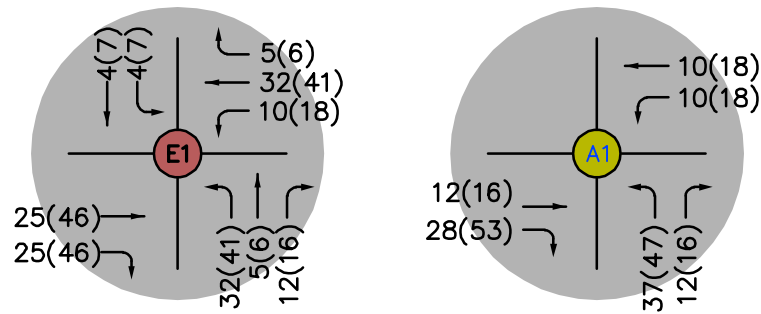

Figure 3 - Site Generated Traffic Volumes and Distribution



600 300 0 600



ORIGINAL SCALE: 1" = 600'



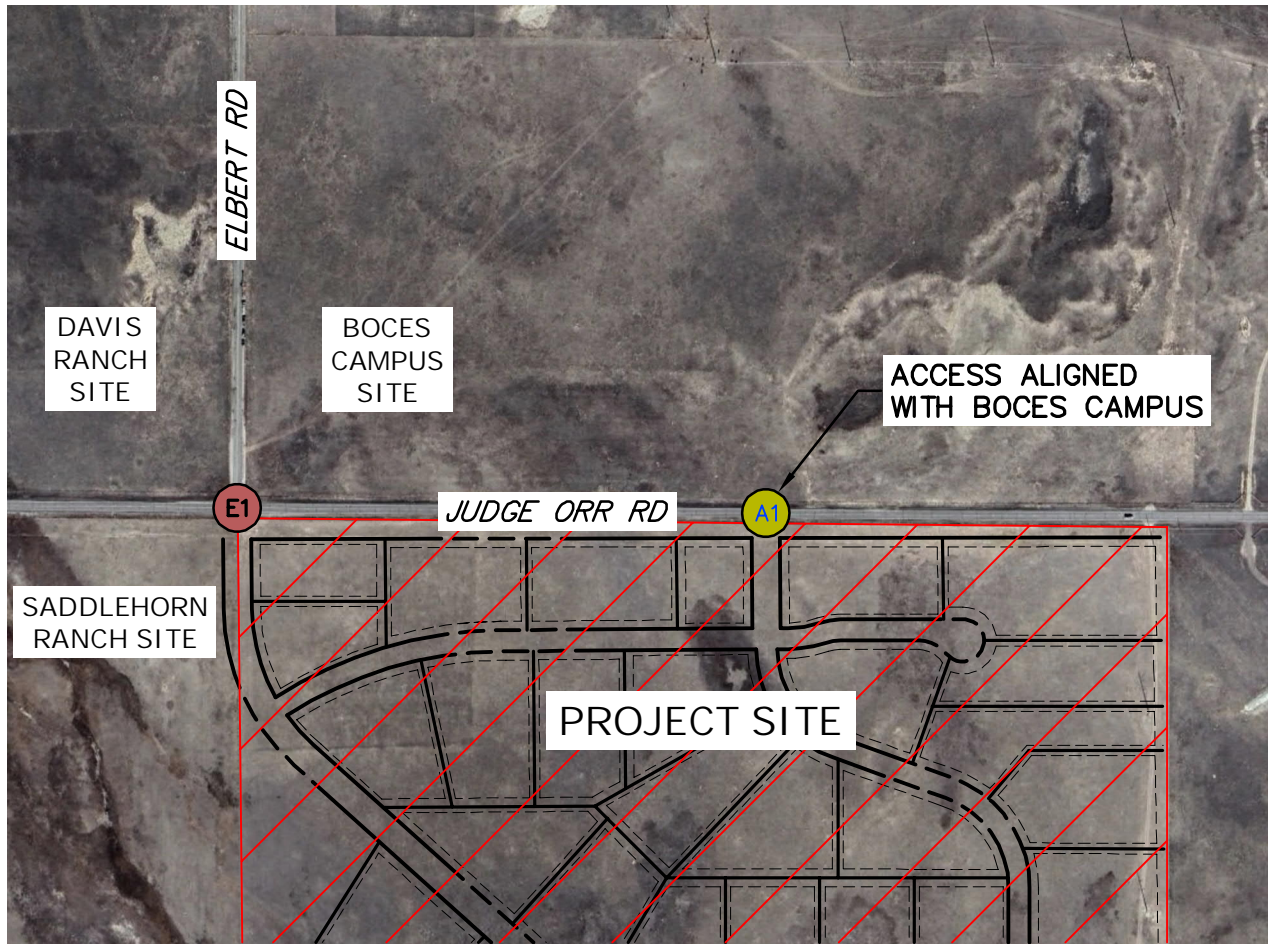
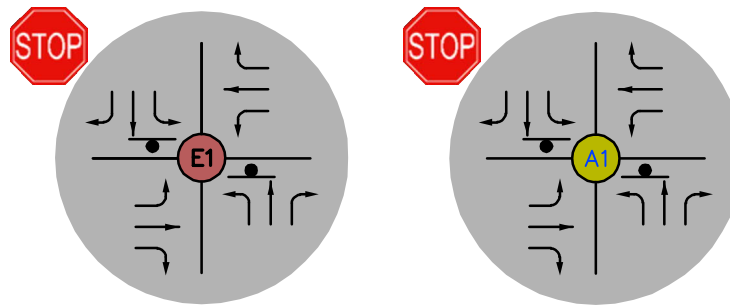

Figure 4 - Proposed Lane Geometry



600 300 0 600

ORIGINAL SCALE: 1" = 600'



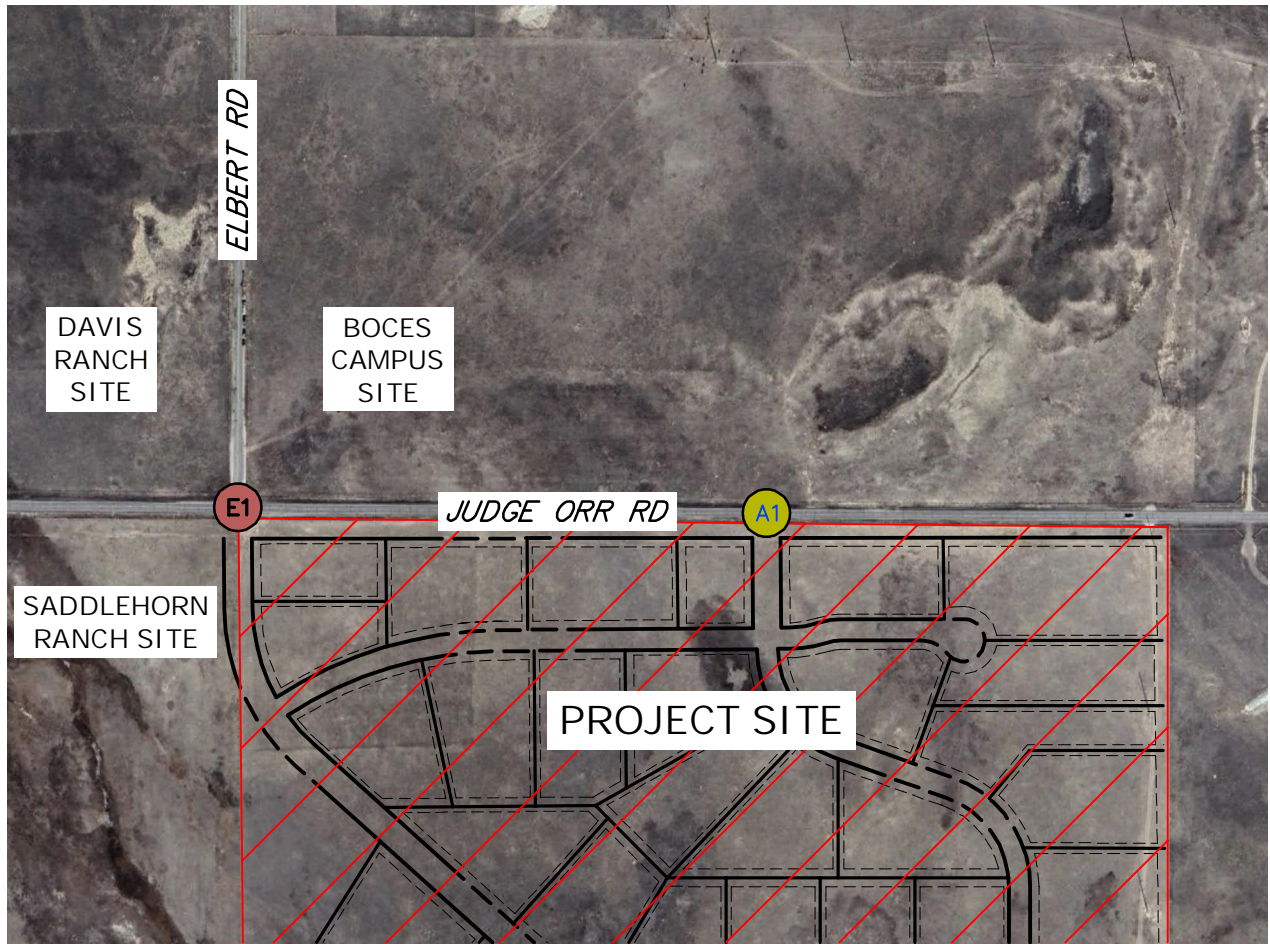
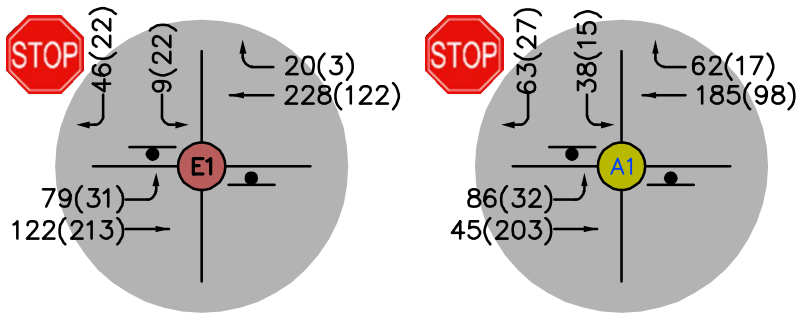

Figure 5 - 2029 Opening Day Background Traffic Volumes



600 300 0 600



ORIGINAL SCALE: 1" = 600'



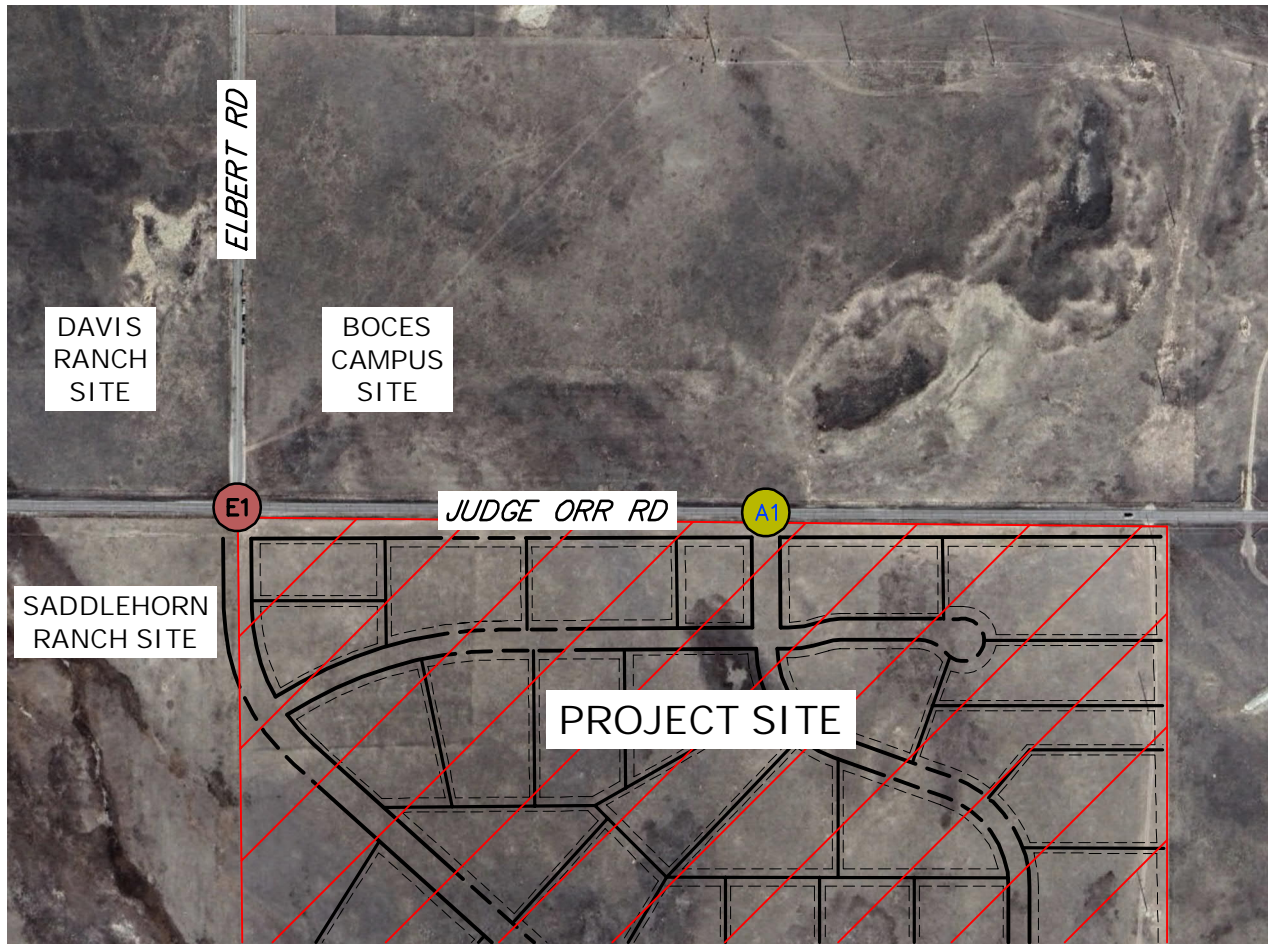
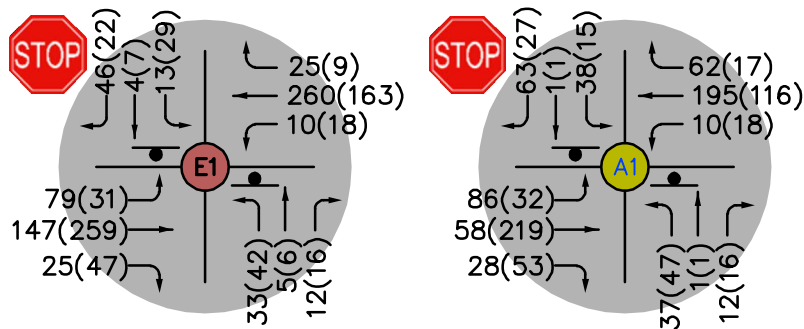

Figure 6 - 2029 Opening Day Total Traffic Volumes



600 300 0 600

ORIGINAL SCALE: 1" = 600'



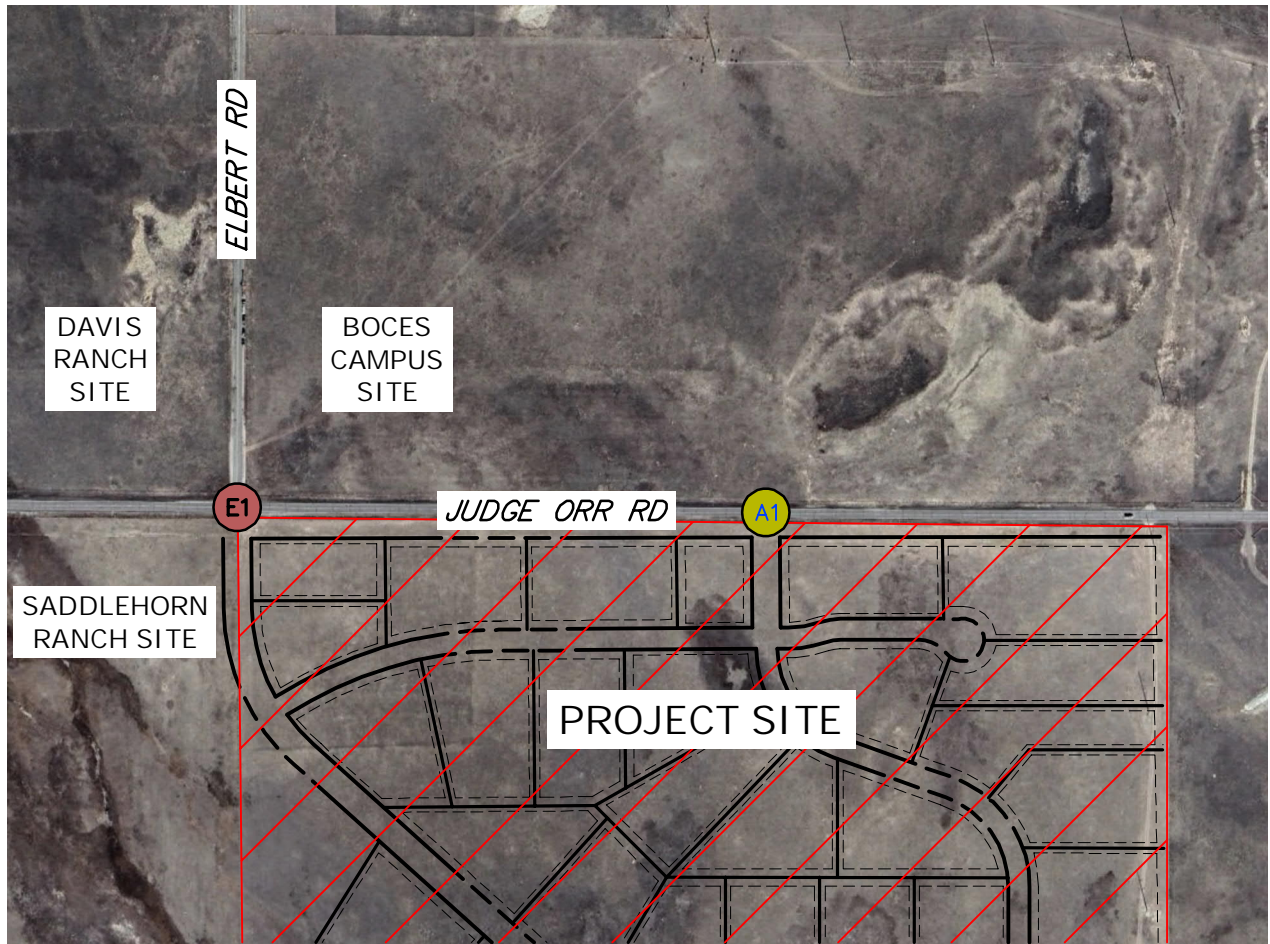
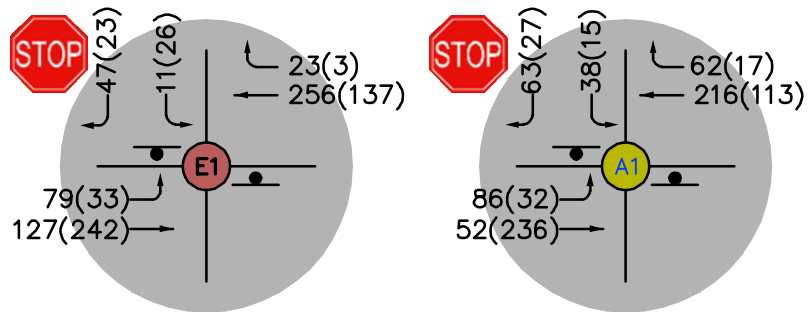

Figure 7 - 2045 Future Year Background Traffic Volumes



600 300 0 600



ORIGINAL SCALE: 1" = 600'



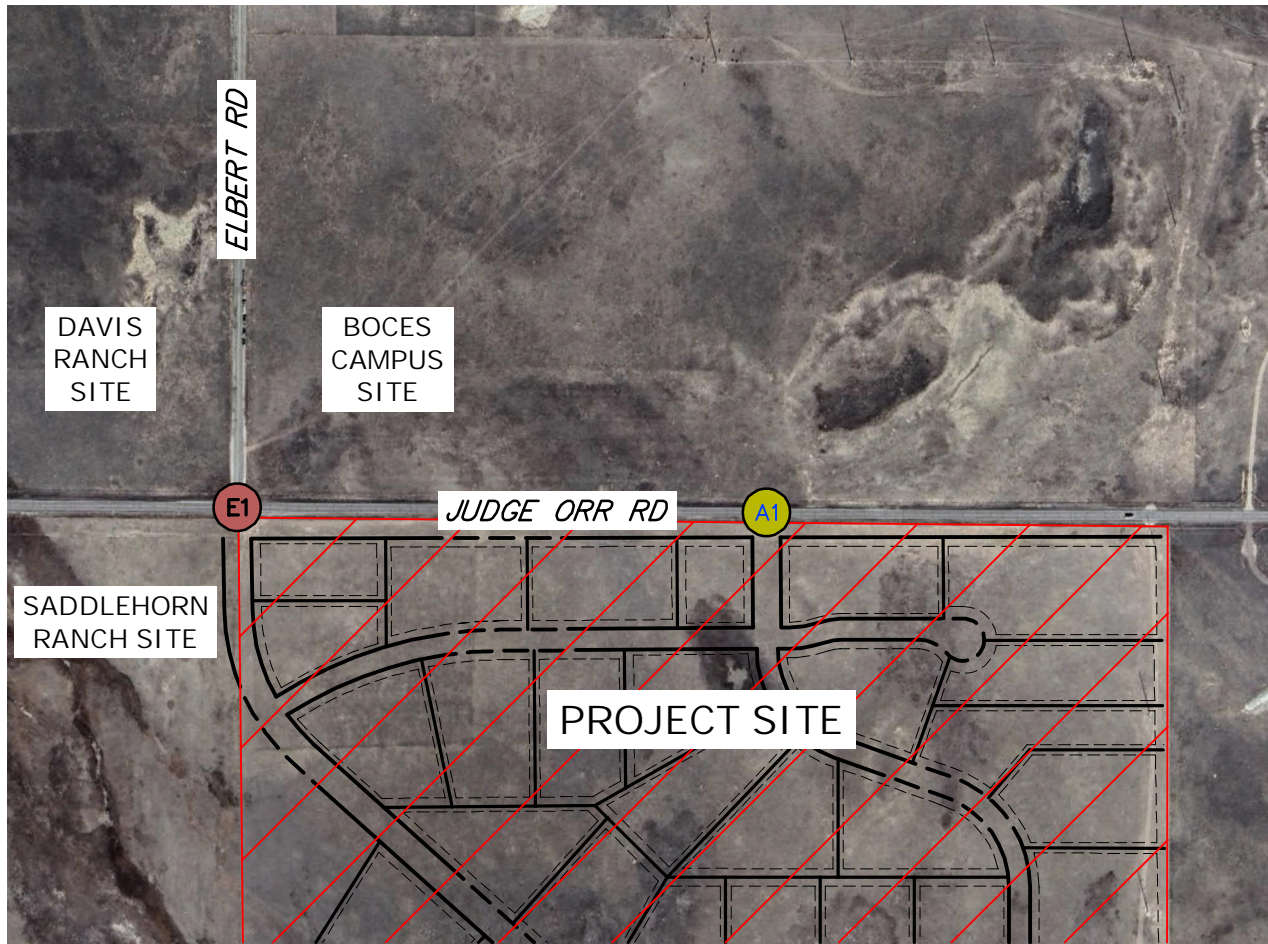
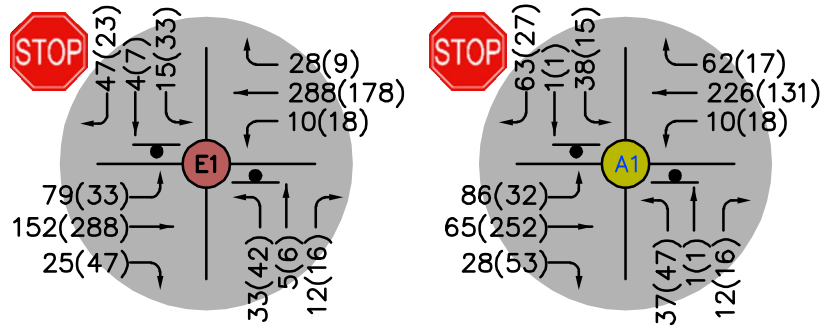

Figure 8 - 2045 Future Year Total Traffic Volumes



600 300 0 600

ORIGINAL SCALE: 1" = 600'



Traffic Operations Analysis

Traffic operations were analyzed using *Highway Capacity Manual*, 7th Edition methodology. Synchro reports are included in **Appendix D**.

Levels of Service



JR analyzed each of the Study intersections for peak hour level of service (LOS). **Table 1** includes the LOS for each movement in the existing condition (year 2024). **Table 2** includes the forecasted LOS for background traffic and total traffic in the year 2029. **Table 3** includes the forecasted LOS for background traffic and total traffic in the year 2045.

Table 1: 2024 Existing Levels of Service





Intersection	Movement	AM Peak LOS	PM Peak LOS
E1: Judge Orr Rd & Elbert Rd	EB Left/Through	A	A
	WB Through/Right	N/A	N/A
	SB Left/Right	A	B

Table 2: 2029 Opening Day Levels of Service

Intersection	Movement	AM Peak LOS		PM Peak LOS	
		Background Traffic	Total Traffic	Background Traffic	Total Traffic
E1: Judge Orr Rd & Elbert Rd	EB Left	A	A	A	A
	WB Left	N/A	A	N/A	A
	NB Left	N/A	C	N/A	C
	NB Through	N/A	C	N/A	B
	NB Right	N/A	A	N/A	A
	SB Left	B	C	B	C
	SB Through	N/A	C	N/A	C
	SB Right	B	B	A	A
A1: NE Access & Judge Orr Rd	EB Left	A	A	A	A
	WB Left	N/A	A	N/A	A
	NB Left	N/A	C	N/A	B
	NB Through	N/A	B	N/A	B
	NB Right	N/A	A	N/A	A
	SB Left	B	C	B	B
	SB Through	N/A	B	N/A	B
	SB Right	A	A	A	A

Table 3: 2045 Future Year Levels of Service

Intersection	Movement	AM Peak LOS		PM Peak LOS	
		Background Traffic	Total Traffic	Background Traffic	Total Traffic
 E1: Judge Orr Rd & Elbert Rd	EB Left	A	A	A	A
	WB Left	N/A	A	N/A	A
	NB Left	N/A	C	N/A	C
	NB Through	N/A	C	N/A	C
	NB Right	N/A	A	N/A	B
	SB Left	C	C	B	C
	SB Through	N/A	C	N/A	C
	SB Right	B	B	A	A
 A1: NE Access & Judge Orr Rd	EB Left	A	A	A	A
	WB Left	N/A	A	N/A	A
	NB Left	N/A	C	N/A	C
	NB Through	N/A	C	N/A	B
	NB Right	N/A	A	N/A	A
	SB Left	B	C	B	B
	SB Through	N/A	B	N/A	B
	SB Right	B	B	A	A

Discussion on Levels of Service

In the 2024 Existing condition, movements at the Judge Orr & Elbert intersection operate at LOS B or better.

In the 2029 Opening Day condition, all movements are expected to operate at LOS B or better with only background traffic. With total traffic volumes, some movements are expected to degrade, but do not become worse than LOS C.

In the 2045 Future Year condition, all movements are expected to operate at LOS C or better with total traffic volumes.

Queue Lengths



JR analyzed each of the Study intersections for 95th percentile queue lengths. **Table 4** includes the queue lengths for the year 2024 with existing traffic. **Table 5** includes the queue lengths for the year 2029 with total traffic. **Table 6** includes the queue lengths for the year 2045 with total traffic.

Table 4: 2024 Existing 95th Percentile Queue Lengths





Intersection	Movement	AM Peak Queue (ft)	PM Peak Queue (ft)
E1: Judge Orr Rd & Elbert Rd	EB Left/Through	<25	<25
	WB Through/Right	N/A	N/A
	SB Left/Right	<25	<25

Table 5: 2029 Opening Day 95th Percentile Queue Lengths

Intersection	Movement	AM Peak Queue (ft)	PM Peak Queue (ft)
E1: Judge Orr Rd & Elbert Rd	EB Left	<25	<25
	WB Left	<25	<25
	NB Left	<25	<25
	NB Through	<25	<25
	NB Right	<25	<25
	SB Left	<25	<25
	SB Through	<25	<25
	SB Right	<25	<25
A1: NE Access & Judge Orr Rd	EB Left	<25	<25
	WB Left	<25	<25
	NB Left	<25	<25
	NB Through	<25	<25
	NB Right	<25	<25
	SB Left	<25	<25
	SB Through	<25	<25
	SB Right	<25	<25

Table 6: 2045 Future Year 95th Percentile Queue Lengths

	Intersection	Movement	AM Peak Queue (ft)	PM Peak Queue (ft)
	E1: Judge Orr Rd & Elbert Rd	EB Left	<25	<25
		WB Left	<25	<25
		NB Left	<25	<25
		NB Through	<25	<25
		NB Right	<25	<25
		SB Left	<25	<25
		SB Through	<25	<25
	A1: NE Access & Judge Orr Rd	EB Left	<25	<25
		WB Left	<25	<25
		NB Left	<25	<25
		NB Through	<25	<25
		NB Right	<25	<25
		SB Left	<25	<25
		SB Through	<25	<25
		SB Right	<25	<25

Discussion on Queue Lengths

Queue lengths are expected to be minimal at each intersection in the Existing, Opening Day, and Future Year conditions. This is a result of low traffic volumes in the vicinity of the Project. No operational issues with queuing are anticipated.

Conclusion

Below is a summary of the conclusions and findings of this TIS.

Levels of Service

2024 Existing condition levels of service are LOS B or better. In the 2029 Opening Day condition, all movements are expected to operate at LOS C or better with total traffic volumes. In the 2045 Future Year condition, all movements are expected to operate at LOS C or better with total traffic.

Queue Lengths

Queue lengths are expected to be minimal at both intersections in the Existing, Opening Day, and Future Year conditions. No operational issues with queuing are anticipated.

Recommendations

JR recommends adding both left and right turn lanes at each of the Study intersections to accommodate turning traffic by 2029 Opening Day. These turn lanes are not triggered solely by the Esteban Rodriguez site, but along with the surrounding background developments.

Review 1 comment: Identify that the development is subject to the road impact fee program. If it is not known what option will be selected for payment you may state that it will be determined at the subdivision stage.
Review 2 comment: Unresolved. Please address.

Appendix A: Site Plan

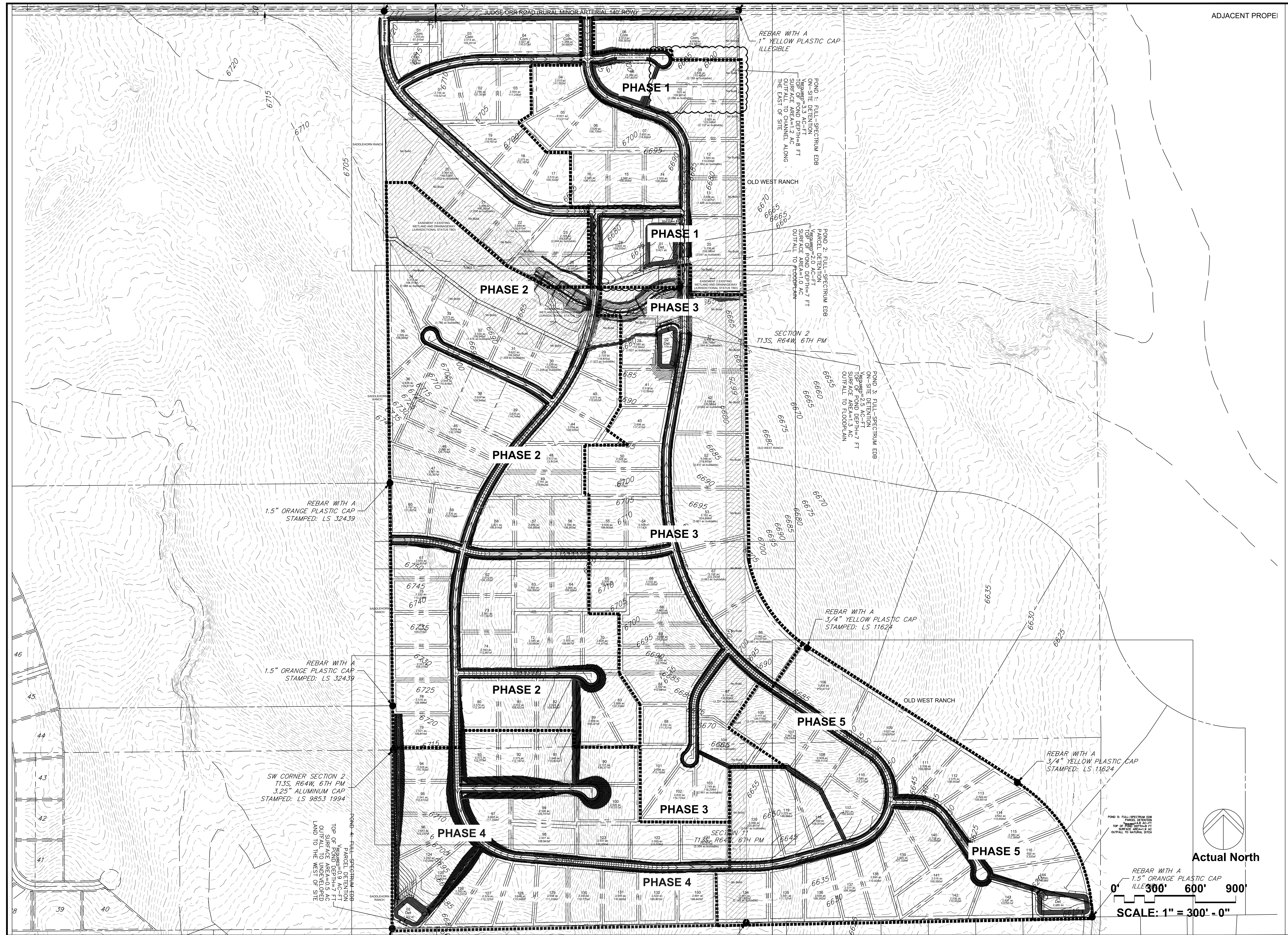

ADJACENT PROPE

William Guman & Associates, Ltd.
 URBAN PLANNING | SURVEYING | DESIGN | I
 LANDSCAPE ARCHITECTURE
 731 North Weber Street
 Colorado Springs, CO 80903
 (719) 633-9700
 www.gumanltd.com
 bill@gumanltd.com

THIS DRAWING IS AN INSTRUMENT OF SERVICE AND AS SUCH REMAINS THE EXCLUSIVE PROPERTY OF WILLIAM GUMAN & ASSOCIATES, LTD. ANY REPRODUCTION OR UNAUTHORIZED USE OF THIS DRAWING WITHOUT THE WRITTEN CONSENT OF WILLIAM GUMAN & ASSOCIATES, LTD. IS STRICTLY PROHIBITED.

THIS DRAWING IS DIAGNOSTIC IN THE EVENT OF A CONFLICT, ALL QUANTITIES THAT CAN BE DETERMINED FROM THIS DRAWING SHALL PREVAIL OVER ANY SCHEDULED STATEMENTS OF WORK OR ANY OTHER DOCUMENTS. ANY CHANGES TO THE DRAWING SHALL BE MADE BY THE DESIGNER AND APPROVED BY THE CLIENT. ANY CHANGES MADE WITHOUT THE WRITTEN APPROVAL OF THE DESIGNER SHALL BE AT THE CLIENT'S RISK AND WITHOUT LIABILITY TO THE DESIGNER.

ONLY DRAWINGS BEARING THE OFFICIAL STAMP OF THE LICENSED LANDSCAPE ARCHITECT IN THE STATE OF COLORADO ARE VALID FOR CONSTRUCTION PURPOSES.

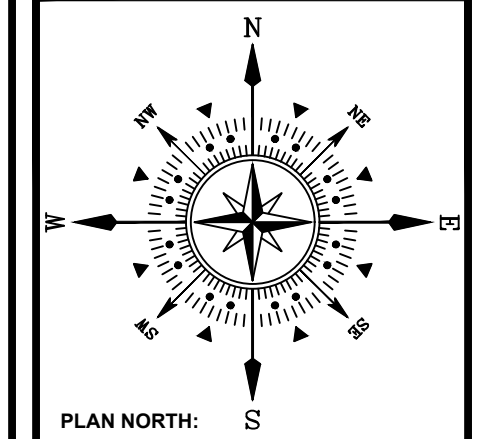

ESTEBAN RODRIGUEZ
JUDGE ORR ROAD
PEYTON, CO 80831
 PROJECT NAME:
 PROJECT ADDRESS:
 PROJECT DESCRIPTION: 496.25 ACRE PHASING PLAN

DATE: 07/19/2024
 DESIGNED: WFG
 CHECKED: GEM

REVISIONS:	DATE:	BY:	DESCRIPTION:
08/19/24	WFG	WFG	PHASING LIMITS MODIFICATIONS
08/27/24	WFG	WFG	LOT MODIFICATIONS
08/29/24	WFG	WFG	CC MODIFICATIONS
10/30/24	WFG	WFG	DETENTION POND MODIFICATIONS

NOTES:

PLAN SCALE: 1" = 300' (OR AS NOTED ON PLAN)

SHEET TITLE:
PHASING PLAN

SHEET NO.
PLP1.6

7 of 8 SHEETS

FILE NO.
 XXXXX

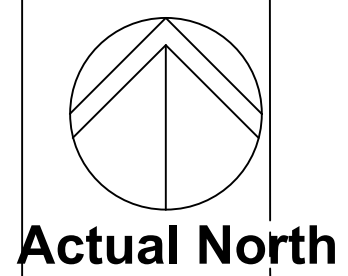
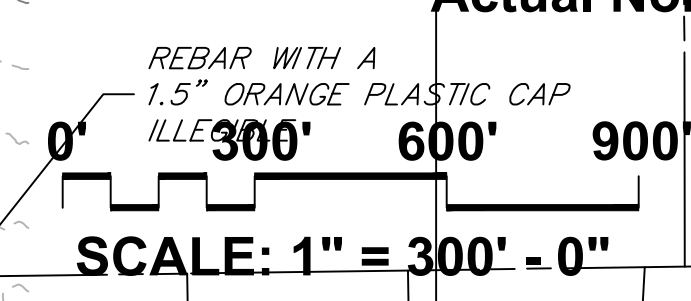

Appendix B: Traffic Counts

Location: 1 ELBERT RD & JUDGE ORR RD AM

Date: Wednesday, February 21, 2024

Peak Hour: 07:00 AM - 08:00 AM

Peak 15-Minutes: 07:15 AM - 07:30 AM

Peak Hour - Motorized Vehicles

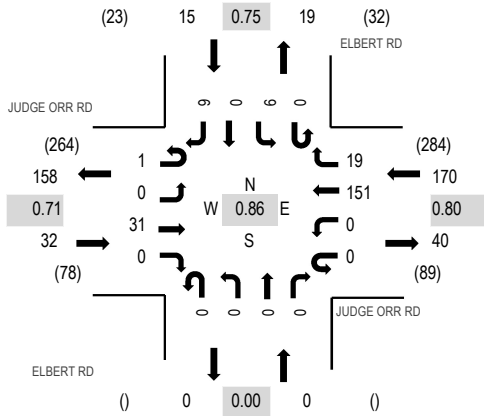

Peak Hour - Bicycles

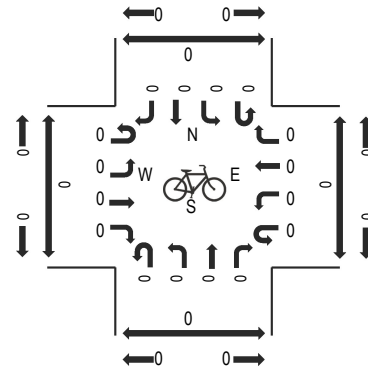

Peak Hour - Pedestrians

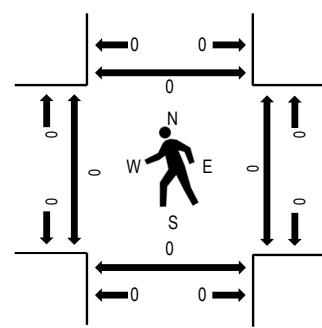

Note: Total study counts contained in parentheses.

Traffic Counts - Motorized Vehicles

Interval Start Time	JUDGE ORR RD Eastbound				JUDGE ORR RD Westbound				ELBERT RD Northbound				ELBERT RD Southbound				Total	Rolling Hour	Pedestrian Crossings			
	U-Turn	Left	Thru	Right	U-Turn	Left	Thru	Right	U-Turn	Left	Thru	Right	U-Turn	Left	Thru	Right			West	East	South	North
7:00 AM	0	0	1	0	0	0	47	6	0	0	0	0	0	2	0	3	59	217	0	0	0	0
7:15 AM	0	0	11	0	0	0	41	7	0	0	0	0	0	3	0	1	63	201	0	0	0	0
7:30 AM	0	0	10	0	0	0	38	4	0	0	0	0	0	1	0	1	54	183	0	0	0	0
7:45 AM	1	0	9	0	0	0	25	2	0	0	0	0	0	3	0	1	41	166	0	0	0	0
8:00 AM	0	1	16	0	0	0	20	5	0	0	0	0	0	0	0	1	43	168	0	0	0	0
8:15 AM	0	0	10	0	0	0	31	2	0	0	0	0	0	2	0	0	45		0	0	0	0
8:30 AM	0	0	9	0	0	0	25	1	0	0	0	0	0	1	0	1	37		0	0	0	0
8:45 AM	0	0	10	0	0	0	26	4	0	0	0	0	0	1	0	2	43		0	0	0	0
Count Total	1	1	76	0	0	0	253	31	0	0	0	0	0	13	0	10	385		0	0	0	0
Peak Hour	1	0	31	0	0	0	151	19	0	0	0	0	0	9	0	6	217		0	0	0	0

Location: 1 ELBERT RD & JUDGE ORR RD PM

Date: Wednesday, February 21, 2024

Peak Hour: 04:00 PM - 05:00 PM

Peak 15-Minutes: 04:30 PM - 04:45 PM

Peak Hour - Motorized Vehicles

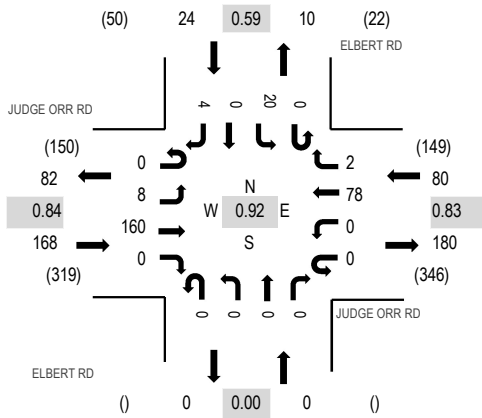

Peak Hour - Bicycles

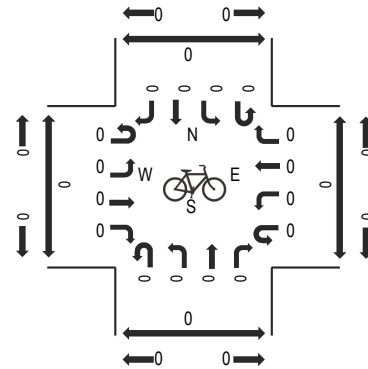

Peak Hour - Pedestrians

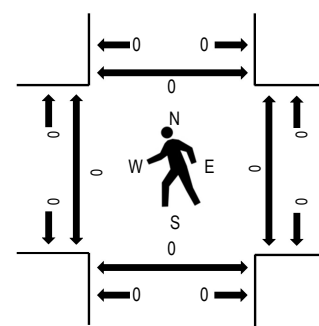

Note: Total study counts contained in parentheses.

Traffic Counts - Motorized Vehicles

Interval Start Time	JUDGE ORR RD Eastbound				JUDGE ORR RD Westbound				ELBERT RD Northbound				ELBERT RD Southbound				Total	Rolling Hour	Pedestrian Crossings				
	U-Turn	Left	Thru	Right	U-Turn	Left	Thru	Right	U-Turn	Left	Thru	Right	U-Turn	Left	Thru	Right			West	East	South	North	
4:00 PM	0	2	48	0	0	0	12	1	0	0	0	0	0	0	6	0	2	71	272	0	0	0	0
4:15 PM	0	2	35	0	0	0	23	1	0	0	0	0	0	5	0	1	67	261	0	0	0	0	
4:30 PM	0	1	40	0	0	0	26	0	0	0	0	0	0	6	0	1	74	242	0	0	0	0	
4:45 PM	0	3	37	0	0	0	17	0	0	0	0	0	0	3	0	0	60	238	0	0	0	0	
5:00 PM	0	5	32	0	0	0	18	1	0	0	0	0	0	4	0	0	60	246	0	0	0	0	
5:15 PM	0	1	33	0	0	0	10	2	0	0	0	0	0	1	0	1	48		0	0	0	0	
5:30 PM	0	0	46	0	0	0	15	0	0	0	0	0	0	8	0	1	70		0	0	0	0	
5:45 PM	0	2	32	0	0	0	22	1	0	0	0	0	0	10	0	1	68		0	0	0	0	
Count Total	0	16	303	0	0	0	143	6	0	0	0	0	0	43	0	7	518		0	0	0	0	
Peak Hour	0	8	160	0	0	0	78	2	0	0	0	0	0	20	0	4	272		0	0	0	0	

Appendix C: Trip Generation Report

Project: Esteban Rodriguez Site

ITE Code	Description	Size	Units	Weekday Average Daily Trips			Weekday AM Peak Hour Trips			Weekday PM Peak Hour Trips		
				Enter	Exit	Total	Enter	Exit	Total	Enter	Exit	Total
150	Warehousing	190	1000 Square Ft.	169	169	338	36	10	46	14	35	49
210	Single-Family Detached Housing	144	Dwelling Units	705	705	1410	26	78	104	88	52	140
822	Strip Retail Plaza (<40k)	10	1000 Square Ft.	272	272	544	14	10	24	39	39	78
Unadjusted Volume				1146	1146	2292	76	98	174	141	126	267
Internal Capture				0%	0%	0%	0%	0%	0%	0%	0%	0%
Pass-By Trips				0%	0%	0%	0%	0%	0%	0%	0%	0%
Volume Added to Adjacent Streets				1146	1146	2292	76	98	174	141	126	267

Source: Institute of Transportation Engineers, *Trip Generation Manual*, 11th Edition

Appendix D: Synchro Reports

Lanes, Volumes, Timings
 1: Judge Orr Road & Elbert Road



Lane Group	EBL	EBT	WBT	WBR	SBL	SBR
Lane Configurations		↖	↗		↘	↙
Traffic Volume (vph)	1	31	151	19	9	6
Future Volume (vph)	1	31	151	19	9	6
Ideal Flow (vphpl)	1900	1900	1900	1900	1900	1900
Lane Util. Factor	1.00	1.00	1.00	1.00	1.00	1.00
Frt			0.984		0.946	
Flt Protected		0.999			0.971	
Satd. Flow (prot)	0	1861	1833	0	1711	0
Flt Permitted		0.999			0.971	
Satd. Flow (perm)	0	1861	1833	0	1711	0
Link Speed (mph)		55	55		40	
Link Distance (ft)		624	2250		531	
Travel Time (s)		14.2	51.1		12.1	
Peak Hour Factor	0.78	0.78	0.85	0.78	0.78	0.78
Adj. Flow (vph)	1	40	178	24	12	8
Shared Lane Traffic (%)						
Lane Group Flow (vph)	0	41	202	0	20	0
Enter Blocked Intersection	No	No	No	No	No	No
Lane Alignment	Left	Left	Left	Right	Left	Right
Median Width(ft)		0	0		12	
Link Offset(ft)		0	0		0	
Crosswalk Width(ft)		16	16		16	
Two way Left Turn Lane						
Headway Factor	1.00	1.00	1.00	1.00	1.00	1.00
Turning Speed (mph)	15			9	15	9
Sign Control		Free	Free		Stop	

Intersection Summary

Area Type:	Other
Control Type:	Unsignalized
Intersection Capacity Utilization	19.1%
Analysis Period (min)	15
	ICU Level of Service A

Intersection						
Int Delay, s/veh	0.7					
Movement	EBL	EBT	WBT	WBR	SBL	SBR
Lane Configurations		↶	↷		↶	
Traffic Vol, veh/h	1	31	151	19	9	6
Future Vol, veh/h	1	31	151	19	9	6
Conflicting Peds, #/hr	0	0	0	0	0	0
Sign Control	Free	Free	Free	Free	Stop	Stop
RT Channelized	-	None	-	None	-	None
Storage Length	-	-	-	-	0	-
Veh in Median Storage, #	-	0	0	-	0	-
Grade, %	-	0	0	-	0	-
Peak Hour Factor	78	78	85	78	78	78
Heavy Vehicles, %	2	2	2	2	2	2
Mvmt Flow	1	40	178	24	12	8

Major/Minor	Major1	Major2	Minor2		
Conflicting Flow All	202	0	-	0	232 190
Stage 1	-	-	-	-	190 -
Stage 2	-	-	-	-	42 -
Critical Hdwy	4.12	-	-	-	6.42 6.22
Critical Hdwy Stg 1	-	-	-	-	5.42 -
Critical Hdwy Stg 2	-	-	-	-	5.42 -
Follow-up Hdwy	2.218	-	-	-	3.518 3.318
Pot Cap-1 Maneuver	1370	-	-	-	756 852
Stage 1	-	-	-	-	842 -
Stage 2	-	-	-	-	980 -
Platoon blocked, %		-	-	-	
Mov Cap-1 Maneuver	1370	-	-	-	755 852
Mov Cap-2 Maneuver	-	-	-	-	755 -
Stage 1	-	-	-	-	842 -
Stage 2	-	-	-	-	980 -

Approach	EB	WB	SB
HCM Control Delay, s/v	0.24	0	9.66
HCM LOS			A

Minor Lane/Major Mvmt	EBL	EBT	WBT	WBR	SBLn1
Capacity (veh/h)	56	-	-	-	791
HCM Lane V/C Ratio	0.001	-	-	-	0.024
HCM Control Delay (s/veh)	7.6	0	-	-	9.7
HCM Lane LOS	A	A	-	-	A
HCM 95th %tile Q(veh)	0	-	-	-	0.1

Lanes, Volumes, Timings
 1: Judge Orr Road & Elbert Road

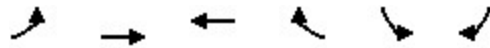

Lane Group	EBL	EBT	WBT	WBR	SBL	SBR
Lane Configurations						
Traffic Volume (vph)	8	160	78	2	20	4
Future Volume (vph)	8	160	78	2	20	4
Ideal Flow (vphpl)	1900	1900	1900	1900	1900	1900
Lane Util. Factor	1.00	1.00	1.00	1.00	1.00	1.00
Frt			0.996		0.978	
Flt Protected		0.997			0.960	
Satd. Flow (prot)	0	1857	1855	0	1749	0
Flt Permitted		0.997			0.960	
Satd. Flow (perm)	0	1857	1855	0	1749	0
Link Speed (mph)		55	55		40	
Link Distance (ft)		624	2250		531	
Travel Time (s)		14.2	51.1		12.1	
Peak Hour Factor	0.78	0.85	0.81	0.78	0.78	0.78
Adj. Flow (vph)	10	188	96	3	26	5
Shared Lane Traffic (%)						
Lane Group Flow (vph)	0	198	99	0	31	0
Enter Blocked Intersection	No	No	No	No	No	No
Lane Alignment	Left	Left	Left	Right	Left	Right
Median Width(ft)		0	0		12	
Link Offset(ft)		0	0		0	
Crosswalk Width(ft)		16	16		16	
Two way Left Turn Lane						
Headway Factor	1.00	1.00	1.00	1.00	1.00	1.00
Turning Speed (mph)	15			9	15	9
Sign Control		Free	Free		Stop	

Intersection Summary

Area Type:	Other
Control Type:	Unsignalized
Intersection Capacity Utilization	24.9%
Analysis Period (min)	15
	ICU Level of Service A

























Intersection						
Int Delay, s/veh	1.2					
Movement	EBL	EBT	WBT	WBR	SBL	SBR
Lane Configurations		↶	↷		↶	↷
Traffic Vol, veh/h	8	160	78	2	20	4
Future Vol, veh/h	8	160	78	2	20	4
Conflicting Peds, #/hr	0	0	0	0	0	0
Sign Control	Free	Free	Free	Free	Stop	Stop
RT Channelized	-	None	-	None	-	None
Storage Length	-	-	-	-	0	-
Veh in Median Storage, #	-	0	0	-	0	-
Grade, %	-	0	0	-	0	-
Peak Hour Factor	78	85	81	78	78	78
Heavy Vehicles, %	2	2	2	2	2	2
Mvmt Flow	10	188	96	3	26	5

Major/Minor	Major1	Major2	Minor2		
Conflicting Flow All	99	0	-	0	306 98
Stage 1	-	-	-	-	98 -
Stage 2	-	-	-	-	209 -
Critical Hdwy	4.12	-	-	-	6.42 6.22
Critical Hdwy Stg 1	-	-	-	-	5.42 -
Critical Hdwy Stg 2	-	-	-	-	5.42 -
Follow-up Hdwy	2.218	-	-	-	3.518 3.318
Pot Cap-1 Maneuver	1494	-	-	-	686 958
Stage 1	-	-	-	-	926 -
Stage 2	-	-	-	-	826 -
Platoon blocked, %		-	-	-	
Mov Cap-1 Maneuver	1494	-	-	-	680 958
Mov Cap-2 Maneuver	-	-	-	-	680 -
Stage 1	-	-	-	-	919 -
Stage 2	-	-	-	-	826 -

Approach	EB	WB	SB
HCM Control Delay, s/v	0.38	0	10.26
HCM LOS			B

Minor Lane/Major Mvmt	EBL	EBT	WBT	WBR	SBLn1
Capacity (veh/h)	93	-	-	-	715
HCM Lane V/C Ratio	0.007	-	-	-	0.043
HCM Control Delay (s/veh)	7.4	0	-	-	10.3
HCM Lane LOS	A	A	-	-	B
HCM 95th %tile Q(veh)	0	-	-	-	0.1

Lanes, Volumes, Timings
1: Elbert Road & Judge Orr Road

												
Lane Group	EBL	EBT	EBR	WBL	WBT	WBR	NBL	NBT	NBR	SBL	SBT	SBR
Lane Configurations												
Traffic Volume (vph)	79	122	0	0	228	20	1	0	0	9	0	46
Future Volume (vph)	79	122	0	0	228	20	1	0	0	9	0	46
Ideal Flow (vphp)	1900	1900	1900	1900	1900	1900	1900	1900	1900	1900	1900	1900
Storage Length (ft)	150		150	150		150	150		150	150		150
Storage Lanes	1		1	1		1	1		1	1		1
Taper Length (ft)	25			25			25			25		
Lane Util. Factor	1.00	1.00	1.00	1.00	1.00	1.00	1.00	1.00	1.00	1.00	1.00	1.00
Frt						0.850						0.850
Flt Protected	0.950						0.950			0.950		
Satd. Flow (prot)	1770	1863	1863	1863	1863	1583	1770	1863	1863	1770	1863	1583
Flt Permitted	0.950						0.950			0.950		
Satd. Flow (perm)	1770	1863	1863	1863	1863	1583	1770	1863	1863	1770	1863	1583
Link Speed (mph)		55			55			40			40	
Link Distance (ft)		624			2250			428			531	
Travel Time (s)		7.7			27.9			7.3			9.1	
Peak Hour Factor	0.81	0.84	0.78	0.78	0.87	0.78	0.78	0.78	0.78	0.78	0.78	0.78
Adj. Flow (vph)	98	145	0	0	262	26	1	0	0	12	0	59
Shared Lane Traffic (%)												
Lane Group Flow (vph)	98	145	0	0	262	26	1	0	0	12	0	59
Enter Blocked Intersection	No	No	No	No	No	No	No	No	No	No	No	No
Lane Alignment	Left	Left	Right	Left	Left	Right	Left	Left	Right	Left	Left	Right
Median Width(ft)		12			12			12			12	
Link Offset(ft)		0			0			0			0	
Crosswalk Width(ft)		16			16			16			16	
Two way Left Turn Lane												
Headway Factor	1.00	1.00	1.00	1.00	1.00	1.00	1.00	1.00	1.00	1.00	1.00	1.00
Turning Speed (mph)	15		9	15		9	15		9	15		9
Sign Control		Free			Free			Stop			Stop	

Intersection Summary

Area Type:	Other
Control Type:	Unsignalized
Intersection Capacity Utilization	33.5%
ICU Level of Service	A
Analysis Period (min)	15

























Intersection												
Int Delay, s/veh	2.6											
Movement	EBL	EBT	EBR	WBL	WBT	WBR	NBL	NBT	NBR	SBL	SBT	SBR
Lane Configurations	↘	↗	↗	↘	↗	↗	↘	↗	↗	↘	↗	↗
Traffic Vol, veh/h	79	122	0	0	228	20	1	0	0	9	0	46
Future Vol, veh/h	79	122	0	0	228	20	1	0	0	9	0	46
Conflicting Peds, #/hr	0	0	0	0	0	0	0	0	0	0	0	0
Sign Control	Free	Free	Free	Free	Free	Free	Stop	Stop	Stop	Stop	Stop	Stop
RT Channelized	-	-	None	-	-	None	-	-	None	-	-	None
Storage Length	150	-	150	150	-	150	150	-	150	150	-	150
Veh in Median Storage, #	-	0	-	-	0	-	-	0	-	-	0	-
Grade, %	-	0	-	-	0	-	-	0	-	-	0	-
Peak Hour Factor	81	84	78	78	87	78	78	78	78	78	78	78
Heavy Vehicles, %	2	2	2	2	2	2	2	2	2	2	2	2
Mvmt Flow	98	145	0	0	262	26	1	0	0	12	0	59

Major/Minor	Major1			Major2			Minor1			Minor2		
Conflicting Flow All	288	0	0	145	0	0	602	628	145	602	602	262
Stage 1	-	-	-	-	-	-	340	340	-	262	262	-
Stage 2	-	-	-	-	-	-	262	288	-	340	340	-
Critical Hdwy	4.12	-	-	4.12	-	-	7.12	6.52	6.22	7.12	6.52	6.22
Critical Hdwy Stg 1	-	-	-	-	-	-	6.12	5.52	-	6.12	5.52	-
Critical Hdwy Stg 2	-	-	-	-	-	-	6.12	5.52	-	6.12	5.52	-
Follow-up Hdwy	2.218	-	-	2.218	-	-	3.518	4.018	3.318	3.518	4.018	3.318
Pot Cap-1 Maneuver	1274	-	-	1437	-	-	411	400	902	411	413	777
Stage 1	-	-	-	-	-	-	674	639	-	743	691	-
Stage 2	-	-	-	-	-	-	743	674	-	674	639	-
Platoon blocked, %	-	-	-	-	-	-	-	-	-	-	-	-
Mov Cap-1 Maneuver	1274	-	-	1437	-	-	351	369	902	380	382	777
Mov Cap-2 Maneuver	-	-	-	-	-	-	351	369	-	380	382	-
Stage 1	-	-	-	-	-	-	623	590	-	743	691	-
Stage 2	-	-	-	-	-	-	687	674	-	623	590	-

Approach	EB	WB	NB	SB
HCM Control Delay, s/v	3.24	0	15.29	10.8
HCM LOS			C	B

Minor Lane/Major Mvmt	NBLn1	NBLn2	NBLn3	EBL	EBT	EBR	WBL	WBT	WBR	SBLn1	SBLn2	SBLn3
Capacity (veh/h)	351	-	-	1274	-	-	1437	-	-	380	-	777
HCM Lane V/C Ratio	0.004	-	-	0.077	-	-	-	-	-	0.03	-	0.076
HCM Control Delay (s/veh)	15.3	0	0	8.1	-	-	0	-	-	14.8	0	10
HCM Lane LOS	C	A	A	A	-	-	A	-	-	B	A	B
HCM 95th %tile Q(veh)	0	-	-	0.2	-	-	0	-	-	0.1	-	0.2

Lanes, Volumes, Timings
2: Northeast Access & Judge Orr Road

												
Lane Group	EBL	EBT	EBR	WBL	WBT	WBR	NBL	NBT	NBR	SBL	SBT	SBR
Lane Configurations												
Traffic Volume (vph)	86	45	0	0	185	62	0	0	0	38	0	63
Future Volume (vph)	86	45	0	0	185	62	0	0	0	38	0	63
Ideal Flow (vphpl)	1900	1900	1900	1900	1900	1900	1900	1900	1900	1900	1900	1900
Storage Length (ft)	150		150	150		150	150		150	150		150
Storage Lanes	1		1	1		1	1		1	1		1
Taper Length (ft)	25			25			25			25		
Lane Util. Factor	1.00	1.00	1.00	1.00	1.00	1.00	1.00	1.00	1.00	1.00	1.00	1.00
Frt						0.850						0.850
Flt Protected	0.950									0.950		
Satd. Flow (prot)	1770	1863	1863	1863	1863	1583	1863	1863	1863	1770	1863	1583
Flt Permitted	0.950									0.950		
Satd. Flow (perm)	1770	1863	1863	1863	1863	1583	1863	1863	1863	1770	1863	1583
Link Speed (mph)		55			55			30				30
Link Distance (ft)		2250			375			584				460
Travel Time (s)		27.9			4.6			13.3				10.5
Peak Hour Factor	0.82	0.78	0.78	0.78	0.86	0.79	0.78	0.78	0.78	0.78	0.78	0.79
Adj. Flow (vph)	105	58	0	0	215	78	0	0	0	49	0	80
Shared Lane Traffic (%)												
Lane Group Flow (vph)	105	58	0	0	215	78	0	0	0	49	0	80
Enter Blocked Intersection	No	No	No	No	No	No	No	No	No	No	No	No
Lane Alignment	Left	Left	Right	Left	Left	Right	Left	Left	Right	Left	Left	Right
Median Width(ft)		12			12			12				12
Link Offset(ft)		0			0			0				0
Crosswalk Width(ft)		16			16			16				16
Two way Left Turn Lane												
Headway Factor	1.00	1.00	1.00	1.00	1.00	1.00	1.00	1.00	1.00	1.00	1.00	1.00
Turning Speed (mph)	15		9	15		9	15		9	15		9
Sign Control		Free			Free			Stop				Stop

Intersection Summary

Area Type:	Other
Control Type:	Unsignalized
Intersection Capacity Utilization	27.8%
ICU Level of Service	A
Analysis Period (min)	15

Intersection												
Int Delay, s/veh	4											
Movement	EBL	EBT	EBR	WBL	WBT	WBR	NBL	NBT	NBR	SBL	SBT	SBR
Lane Configurations	↘	↑	↗	↘	↑	↗	↘	↑	↗	↘	↑	↗
Traffic Vol, veh/h	86	45	0	0	185	62	0	0	0	38	0	63
Future Vol, veh/h	86	45	0	0	185	62	0	0	0	38	0	63
Conflicting Peds, #/hr	0	0	0	0	0	0	0	0	0	0	0	0
Sign Control	Free	Free	Free	Free	Free	Free	Stop	Stop	Stop	Stop	Stop	Stop
RT Channelized	-	-	None	-	-	None	-	-	None	-	-	None
Storage Length	150	-	150	150	-	150	150	-	150	150	-	150
Veh in Median Storage, #	-	0	-	-	0	-	-	0	-	-	0	-
Grade, %	-	0	-	-	0	-	-	0	-	-	0	-
Peak Hour Factor	82	78	78	78	86	79	78	78	78	78	78	79
Heavy Vehicles, %	2	2	2	2	2	2	2	2	2	2	2	2
Mvmt Flow	105	58	0	0	215	78	0	0	0	49	0	80

Major/Minor	Major1			Major2			Minor1			Minor2		
Conflicting Flow All	294	0	0	58	0	0	483	561	58	483	483	215
Stage 1	-	-	-	-	-	-	267	267	-	215	215	-
Stage 2	-	-	-	-	-	-	215	294	-	267	267	-
Critical Hdwy	4.12	-	-	4.12	-	-	7.12	6.52	6.22	7.12	6.52	6.22
Critical Hdwy Stg 1	-	-	-	-	-	-	6.12	5.52	-	6.12	5.52	-
Critical Hdwy Stg 2	-	-	-	-	-	-	6.12	5.52	-	6.12	5.52	-
Follow-up Hdwy	2.218	-	-	2.218	-	-	3.518	4.018	3.318	3.518	4.018	3.318
Pot Cap-1 Maneuver	1268	-	-	1547	-	-	494	436	1008	494	484	825
Stage 1	-	-	-	-	-	-	738	688	-	787	725	-
Stage 2	-	-	-	-	-	-	787	670	-	738	688	-
Platoon blocked, %	-	-	-	-	-	-	-	-	-	-	-	-
Mov Cap-1 Maneuver	1268	-	-	1547	-	-	409	400	1008	453	444	825
Mov Cap-2 Maneuver	-	-	-	-	-	-	409	400	-	453	444	-
Stage 1	-	-	-	-	-	-	677	631	-	787	725	-
Stage 2	-	-	-	-	-	-	711	670	-	677	631	-

Approach	EB	WB	NB	SB
HCM Control Delay, s/v	5.22	0	0	11.37
HCM LOS			A	B

Minor Lane/Major Mvmt	NBLn1	NBLn2	NBLn3	EBL	EBT	EBR	WBL	WBT	WBR	SBLn1	SBLn2	SBLn3
Capacity (veh/h)	-	-	-	1268	-	-	1547	-	-	453	-	825
HCM Lane V/C Ratio	-	-	-	0.083	-	-	-	-	-	0.107	-	0.097
HCM Control Delay (s/veh)	0	0	0	8.1	-	-	0	-	-	13.9	0	9.8
HCM Lane LOS	A	A	A	A	-	-	A	-	-	B	A	A
HCM 95th %tile Q(veh)	-	-	-	0.3	-	-	0	-	-	0.4	-	0.3

Lanes, Volumes, Timings
1: Elbert Road & Judge Orr Road

JR Engineering
07/23/2024

Lane Group	EBL	EBT	EBR	WBL	WBT	WBR	NBL	NBT	NBR	SBL	SBT	SBR
Lane Configurations												
Traffic Volume (vph)	31	213	1	0	122	3	1	0	0	22	0	22
Future Volume (vph)	31	213	1	0	122	3	1	0	0	22	0	22
Ideal Flow (vphpl)	1900	1900	1900	1900	1900	1900	1900	1900	1900	1900	1900	1900
Storage Length (ft)	150		150	150		150	150		150	150		150
Storage Lanes	1		1	1		1	1		1	1		1
Taper Length (ft)	25			25			25			25		
Lane Util. Factor	1.00	1.00	1.00	1.00	1.00	1.00	1.00	1.00	1.00	1.00	1.00	1.00
Frt			0.850			0.850						0.850
Flt Protected	0.950						0.950			0.950		
Satd. Flow (prot)	1770	1863	1583	1863	1863	1583	1770	1863	1863	1770	1863	1583
Flt Permitted	0.950						0.950			0.950		
Satd. Flow (perm)	1770	1863	1583	1863	1863	1583	1770	1863	1863	1770	1863	1583
Link Speed (mph)		55			55			40			40	
Link Distance (ft)		624			2250			428			531	
Travel Time (s)		7.7			27.9			7.3			9.1	
Peak Hour Factor	0.78	0.87	0.78	0.78	0.84	0.78	0.78	0.78	0.78	0.78	0.78	0.78
Adj. Flow (vph)	40	245	1	0	145	4	1	0	0	28	0	28
Shared Lane Traffic (%)												
Lane Group Flow (vph)	40	245	1	0	145	4	1	0	0	28	0	28
Enter Blocked Intersection	No	No	No	No	No	No	No	No	No	No	No	No
Lane Alignment	Left	Left	Right	Left	Left	Right	Left	Left	Right	Left	Left	Right
Median Width(ft)		12			12			12			12	
Link Offset(ft)		0			0			0			0	
Crosswalk Width(ft)		16			16			16			16	
Two way Left Turn Lane												
Headway Factor	1.00	1.00	1.00	1.00	1.00	1.00	1.00	1.00	1.00	1.00	1.00	1.00
Turning Speed (mph)	15		9	15		9	15		9	15		9
Sign Control		Free			Free			Stop			Stop	

Intersection Summary

Area Type:	Other
Control Type:	Unsignalized
Intersection Capacity Utilization	32.4%
ICU Level of Service	A
Analysis Period (min)	15

Intersection												
Int Delay, s/veh	1.9											
Movement	EBL	EBT	EBR	WBL	WBT	WBR	NBL	NBT	NBR	SBL	SBT	SBR
Lane Configurations	↖	↗	↖	↖	↗	↖	↖	↗	↖	↖	↗	↖
Traffic Vol, veh/h	31	213	1	0	122	3	1	0	0	22	0	22
Future Vol, veh/h	31	213	1	0	122	3	1	0	0	22	0	22
Conflicting Peds, #/hr	0	0	0	0	0	0	0	0	0	0	0	0
Sign Control	Free	Free	Free	Free	Free	Free	Stop	Stop	Stop	Stop	Stop	Stop
RT Channelized	-	-	None	-	-	None	-	-	None	-	-	None
Storage Length	150	-	150	150	-	150	150	-	150	150	-	150
Veh in Median Storage, #	-	0	-	-	0	-	-	0	-	-	0	-
Grade, %	-	0	-	-	0	-	-	0	-	-	0	-
Peak Hour Factor	78	87	78	78	84	78	78	78	78	78	78	78
Heavy Vehicles, %	2	2	2	2	2	2	2	2	2	2	2	2
Mvmt Flow	40	245	1	0	145	4	1	0	0	28	0	28

























Major/Minor	Major1			Major2			Minor1			Minor2		
Conflicting Flow All	149	0	0	246	0	0	470	473	245	470	471	145
Stage 1	-	-	-	-	-	-	324	324	-	145	145	-
Stage 2	-	-	-	-	-	-	145	149	-	324	326	-
Critical Hdwy	4.12	-	-	4.12	-	-	7.12	6.52	6.22	7.12	6.52	6.22
Critical Hdwy Stg 1	-	-	-	-	-	-	6.12	5.52	-	6.12	5.52	-
Critical Hdwy Stg 2	-	-	-	-	-	-	6.12	5.52	-	6.12	5.52	-
Follow-up Hdwy	2.218	-	-	2.218	-	-	3.518	4.018	3.318	3.518	4.018	3.318
Pot Cap-1 Maneuver	1432	-	-	1320	-	-	504	489	794	504	491	902
Stage 1	-	-	-	-	-	-	688	649	-	857	777	-
Stage 2	-	-	-	-	-	-	857	774	-	688	649	-
Platoon blocked, %	-	-	-	-	-	-	-	-	-	-	-	-
Mov Cap-1 Maneuver	1432	-	-	1320	-	-	475	476	794	490	477	902
Mov Cap-2 Maneuver	-	-	-	-	-	-	475	476	-	490	477	-
Stage 1	-	-	-	-	-	-	669	631	-	857	777	-
Stage 2	-	-	-	-	-	-	831	774	-	669	631	-

Approach	EB	WB	NB	SB
HCM Control Delay, s/v	1.05	0	12.6	10.96
HCM LOS			B	B

Minor Lane/Major Mvmt	NBLn1	NBLn2	NBLn3	EBL	EBT	EBR	WBL	WBT	WBR	SBLn1	SBLn2	SBLn3
Capacity (veh/h)	475	-	-	1432	-	-	1320	-	-	490	-	902
HCM Lane V/C Ratio	0.003	-	-	0.028	-	-	-	-	-	0.058	-	0.031
HCM Control Delay (s/veh)	12.6	0	0	7.6	-	-	0	-	-	12.8	0	9.1
HCM Lane LOS	B	A	A	A	-	-	A	-	-	B	A	A
HCM 95th %tile Q(veh)	0	-	-	0.1	-	-	0	-	-	0.2	-	0.1

Lanes, Volumes, Timings
2: Northeast Access & Judge Orr Road

JR Engineering
07/23/2024

												
Lane Group	EBL	EBT	EBR	WBL	WBT	WBR	NBL	NBT	NBR	SBL	SBT	SBR
Lane Configurations												
Traffic Volume (vph)	32	203	0	0	98	17	0	0	0	15	0	27
Future Volume (vph)	32	203	0	0	98	17	0	0	0	15	0	27
Ideal Flow (vphpl)	1900	1900	1900	1900	1900	1900	1900	1900	1900	1900	1900	1900
Storage Length (ft)	150		150	150		150	150		150	150		150
Storage Lanes	1		1	1		1	1		1	1		1
Taper Length (ft)	25			25			25			25		
Lane Util. Factor	1.00	1.00	1.00	1.00	1.00	1.00	1.00	1.00	1.00	1.00	1.00	1.00
Frt						0.850						0.850
Flt Protected	0.950									0.950		
Satd. Flow (prot)	1770	1863	1863	1863	1863	1583	1863	1863	1863	1770	1863	1583
Flt Permitted	0.950									0.950		
Satd. Flow (perm)	1770	1863	1863	1863	1863	1583	1863	1863	1863	1770	1863	1583
Link Speed (mph)		55			55			30				30
Link Distance (ft)		2250			375			584				464
Travel Time (s)		27.9			4.6			13.3				10.5
Peak Hour Factor	0.78	0.87	0.78	0.78	0.83	0.78	0.78	0.78	0.78	0.78	0.78	0.78
Adj. Flow (vph)	41	233	0	0	118	22	0	0	0	19	0	35
Shared Lane Traffic (%)												
Lane Group Flow (vph)	41	233	0	0	118	22	0	0	0	19	0	35
Enter Blocked Intersection	No	No	No	No	No	No	No	No	No	No	No	No
Lane Alignment	Left	Left	Right	Left	Left	Right	Left	Left	Right	Left	Left	Right
Median Width(ft)		12			12			12				12
Link Offset(ft)		0			0			0				0
Crosswalk Width(ft)		16			16			16				16
Two way Left Turn Lane												
Headway Factor	1.00	1.00	1.00	1.00	1.00	1.00	1.00	1.00	1.00	1.00	1.00	1.00
Turning Speed (mph)	15		9	15		9	15		9	15		9
Sign Control		Free			Free			Stop				Stop

Intersection Summary

Area Type:	Other
Control Type:	Unsignalized
Intersection Capacity Utilization	20.7%
ICU Level of Service	A
Analysis Period (min)	15

Intersection												
Int Delay, s/veh	1.8											
Movement	EBL	EBT	EBR	WBL	WBT	WBR	NBL	NBT	NBR	SBL	SBT	SBR
Lane Configurations	↘	↑	↗	↘	↑	↗	↘	↑	↗	↘	↑	↗
Traffic Vol, veh/h	32	203	0	0	98	17	0	0	0	15	0	27
Future Vol, veh/h	32	203	0	0	98	17	0	0	0	15	0	27
Conflicting Peds, #/hr	0	0	0	0	0	0	0	0	0	0	0	0
Sign Control	Free	Free	Free	Free	Free	Free	Stop	Stop	Stop	Stop	Stop	Stop
RT Channelized	-	-	None	-	-	None	-	-	None	-	-	None
Storage Length	150	-	150	150	-	150	150	-	150	150	-	150
Veh in Median Storage, #	-	0	-	-	0	-	-	0	-	-	0	-
Grade, %	-	0	-	-	0	-	-	0	-	-	0	-
Peak Hour Factor	78	87	78	78	83	78	78	78	78	78	78	78
Heavy Vehicles, %	2	2	2	2	2	2	2	2	2	2	2	2
Mvmt Flow	41	233	0	0	118	22	0	0	0	19	0	35

























Major/Minor	Major1			Major2			Minor1			Minor2		
Conflicting Flow All	140	0	0	233	0	0	433	455	233	433	433	118
Stage 1	-	-	-	-	-	-	315	315	-	118	118	-
Stage 2	-	-	-	-	-	-	118	140	-	315	315	-
Critical Hdwy	4.12	-	-	4.12	-	-	7.12	6.52	6.22	7.12	6.52	6.22
Critical Hdwy Stg 1	-	-	-	-	-	-	6.12	5.52	-	6.12	5.52	-
Critical Hdwy Stg 2	-	-	-	-	-	-	6.12	5.52	-	6.12	5.52	-
Follow-up Hdwy	2.218	-	-	2.218	-	-	3.518	4.018	3.318	3.518	4.018	3.318
Pot Cap-1 Maneuver	1443	-	-	1334	-	-	533	501	806	533	515	934
Stage 1	-	-	-	-	-	-	696	655	-	886	798	-
Stage 2	-	-	-	-	-	-	886	781	-	696	655	-
Platoon blocked, %	-	-	-	-	-	-	-	-	-	-	-	-
Mov Cap-1 Maneuver	1443	-	-	1334	-	-	498	487	806	517	501	934
Mov Cap-2 Maneuver	-	-	-	-	-	-	498	487	-	517	501	-
Stage 1	-	-	-	-	-	-	676	637	-	886	798	-
Stage 2	-	-	-	-	-	-	854	781	-	676	637	-

Approach	EB	WB	NB	SB
HCM Control Delay, s/v	1.13	0	0	10.15
HCM LOS			A	B

Minor Lane/Major Mvmt	NBLn1	NBLn2	NBLn3	EBL	EBT	EBR	WBL	WBT	WBR	SBLn1	SBLn2	SBLn3
Capacity (veh/h)	-	-	-	1443	-	-	1334	-	-	517	-	934
HCM Lane V/C Ratio	-	-	-	0.028	-	-	-	-	-	0.037	-	0.037
HCM Control Delay (s/veh)	0	0	0	7.6	-	-	0	-	-	12.2	0	9
HCM Lane LOS	A	A	A	A	-	-	A	-	-	B	A	A
HCM 95th %tile Q(veh)	-	-	-	0.1	-	-	0	-	-	0.1	-	0.1

Lanes, Volumes, Timings
1: Elbert Road & Judge Orr Road

JR Engineering
07/29/2024

												
Lane Group	EBL	EBT	EBR	WBL	WBT	WBR	NBL	NBT	NBR	SBL	SBT	SBR
Lane Configurations												
Traffic Volume (vph)	79	147	25	10	260	25	33	5	12	13	4	46
Future Volume (vph)	79	147	25	10	260	25	33	5	12	13	4	46
Ideal Flow (vphp)	1900	1900	1900	1900	1900	1900	1900	1900	1900	1900	1900	1900
Storage Length (ft)	150		150	150		150	150		150	150		150
Storage Lanes	1		1	1		1	1		1	1		1
Taper Length (ft)	25			25			25			25		
Lane Util. Factor	1.00	1.00	1.00	1.00	1.00	1.00	1.00	1.00	1.00	1.00	1.00	1.00
Frt			0.850			0.850			0.850			0.850
Flt Protected	0.950			0.950			0.950			0.950		
Satd. Flow (prot)	1770	1863	1583	1770	1863	1583	1770	1863	1583	1770	1863	1583
Flt Permitted	0.950			0.950			0.950			0.950		
Satd. Flow (perm)	1770	1863	1583	1770	1863	1583	1770	1863	1583	1770	1863	1583
Link Speed (mph)		55			55			40			40	
Link Distance (ft)		624			2250			428			531	
Travel Time (s)		7.7			27.9			7.3			9.1	
Peak Hour Factor	0.81	0.85	0.78	0.78	0.88	0.78	0.78	0.78	0.78	0.78	0.78	0.78
Adj. Flow (vph)	98	173	32	13	295	32	42	6	15	17	5	59
Shared Lane Traffic (%)												
Lane Group Flow (vph)	98	173	32	13	295	32	42	6	15	17	5	59
Enter Blocked Intersection	No	No	No	No	No	No	No	No	No	No	No	No
Lane Alignment	Left	Left	Right	Left	Left	Right	Left	Left	Right	Left	Left	Right
Median Width(ft)		12			12			12			12	
Link Offset(ft)		0			0			0			0	
Crosswalk Width(ft)		16			16			16			16	
Two way Left Turn Lane												
Headway Factor	1.00	1.00	1.00	1.00	1.00	1.00	1.00	1.00	1.00	1.00	1.00	1.00
Turning Speed (mph)	15		9	15		9	15		9	15		9
Sign Control		Free			Free			Stop			Stop	

Intersection Summary

Area Type:	Other
Control Type:	Unsignalized
Intersection Capacity Utilization	36.6%
ICU Level of Service	A
Analysis Period (min)	15

























Intersection												
Int Delay, s/veh	3.7											
Movement	EBL	EBT	EBR	WBL	WBT	WBR	NBL	NBT	NBR	SBL	SBT	SBR
Lane Configurations	↘	↑	↗	↘	↑	↗	↘	↑	↗	↘	↑	↗
Traffic Vol, veh/h	79	147	25	10	260	25	33	5	12	13	4	46
Future Vol, veh/h	79	147	25	10	260	25	33	5	12	13	4	46
Conflicting Peds, #/hr	0	0	0	0	0	0	0	0	0	0	0	0
Sign Control	Free	Free	Free	Free	Free	Free	Stop	Stop	Stop	Stop	Stop	Stop
RT Channelized	-	-	None	-	-	None	-	-	None	-	-	None
Storage Length	150	-	150	150	-	150	150	-	150	150	-	150
Veh in Median Storage, #	-	0	-	-	0	-	-	0	-	-	0	-
Grade, %	-	0	-	-	0	-	-	0	-	-	0	-
Peak Hour Factor	81	85	78	78	88	78	78	78	78	78	78	78
Heavy Vehicles, %	2	2	2	2	2	2	2	2	2	2	2	2
Mvmt Flow	98	173	32	13	295	32	42	6	15	17	5	59

Major/Minor	Major1			Major2			Minor1			Minor2		
Conflicting Flow All	328	0	0	205	0	0	692	721	173	692	721	295
Stage 1	-	-	-	-	-	-	368	368	-	321	321	-
Stage 2	-	-	-	-	-	-	324	353	-	371	400	-
Critical Hdwy	4.12	-	-	4.12	-	-	7.12	6.52	6.22	7.12	6.52	6.22
Critical Hdwy Stg 1	-	-	-	-	-	-	6.12	5.52	-	6.12	5.52	-
Critical Hdwy Stg 2	-	-	-	-	-	-	6.12	5.52	-	6.12	5.52	-
Follow-up Hdwy	2.218	-	-	2.218	-	-	3.518	4.018	3.318	3.518	4.018	3.318
Pot Cap-1 Maneuver	1232	-	-	1366	-	-	358	353	871	358	353	744
Stage 1	-	-	-	-	-	-	652	621	-	691	652	-
Stage 2	-	-	-	-	-	-	689	631	-	649	602	-
Platoon blocked, %	-	-	-	-	-	-	-	-	-	-	-	-
Mov Cap-1 Maneuver	1232	-	-	1366	-	-	297	322	871	315	322	744
Mov Cap-2 Maneuver	-	-	-	-	-	-	297	322	-	315	322	-
Stage 1	-	-	-	-	-	-	600	572	-	684	645	-
Stage 2	-	-	-	-	-	-	623	625	-	581	554	-

Approach	EB			WB			NB			SB		
HCM Control Delay, s/v	2.63			0.29			16.48			12.05		
HCM LOS							C			B		

Minor Lane/Major Mvmt	NBLn1	NBLn2	NBLn3	EBL	EBT	EBR	WBL	WBT	WBR	SBLn1	SBLn2	SBLn3
Capacity (veh/h)	297	322	871	1232	-	-	1366	-	-	315	322	744
HCM Lane V/C Ratio	0.143	0.02	0.018	0.079	-	-	0.009	-	-	0.053	0.016	0.079
HCM Control Delay (s/veh)	19.1	16.4	9.2	8.2	-	-	7.7	-	-	17.1	16.3	10.3
HCM Lane LOS	C	C	A	A	-	-	A	-	-	C	C	B
HCM 95th %tile Q(veh)	0.5	0.1	0.1	0.3	-	-	0	-	-	0.2	0	0.3

Lanes, Volumes, Timings
2: Northeast Access & Judge Orr Road

												
Lane Group	EBL	EBT	EBR	WBL	WBT	WBR	NBL	NBT	NBR	SBL	SBT	SBR
Lane Configurations												
Traffic Volume (vph)	86	58	28	10	195	62	37	1	12	38	1	63
Future Volume (vph)	86	58	28	10	195	62	37	1	12	38	1	63
Ideal Flow (vphp)	1900	1900	1900	1900	1900	1900	1900	1900	1900	1900	1900	1900
Storage Length (ft)	150		150	150		150	150		150	150		150
Storage Lanes	1		1	1		1	1		1	1		1
Taper Length (ft)	25			25			25			25		
Lane Util. Factor	1.00	1.00	1.00	1.00	1.00	1.00	1.00	1.00	1.00	1.00	1.00	1.00
Frt			0.850			0.850			0.850			0.850
Flt Protected	0.950			0.950			0.950			0.950		
Satd. Flow (prot)	1770	1863	1583	1770	1863	1583	1770	1863	1583	1770	1863	1583
Flt Permitted	0.950			0.950			0.950			0.950		
Satd. Flow (perm)	1770	1863	1583	1770	1863	1583	1770	1863	1583	1770	1863	1583
Link Speed (mph)		55			55			30			30	
Link Distance (ft)		2250			375			584			426	
Travel Time (s)		27.9			4.6			13.3			9.7	
Peak Hour Factor	0.82	0.79	0.78	0.78	0.87	0.79	0.78	0.78	0.78	0.78	0.78	0.79
Adj. Flow (vph)	105	73	36	13	224	78	47	1	15	49	1	80
Shared Lane Traffic (%)												
Lane Group Flow (vph)	105	73	36	13	224	78	47	1	15	49	1	80
Enter Blocked Intersection	No	No	No	No	No	No	No	No	No	No	No	No
Lane Alignment	Left	Left	Right	Left	Left	Right	Left	Left	Right	Left	Left	Right
Median Width(ft)		12			12			12			12	
Link Offset(ft)		0			0			0			0	
Crosswalk Width(ft)		16			16			16			16	
Two way Left Turn Lane												
Headway Factor	1.00	1.00	1.00	1.00	1.00	1.00	1.00	1.00	1.00	1.00	1.00	1.00
Turning Speed (mph)	15		9	15		9	15		9	15		9
Sign Control		Free			Free			Stop			Stop	

Intersection Summary

Area Type:	Other
Control Type:	Unsignalized
Intersection Capacity Utilization	33.8%
ICU Level of Service	A
Analysis Period (min)	15

























Intersection												
Int Delay, s/veh	4.7											
Movement	EBL	EBT	EBR	WBL	WBT	WBR	NBL	NBT	NBR	SBL	SBT	SBR
Lane Configurations	↘	↗	↗	↘	↗	↗	↘	↗	↗	↘	↗	↗
Traffic Vol, veh/h	86	58	28	10	195	62	37	1	12	38	1	63
Future Vol, veh/h	86	58	28	10	195	62	37	1	12	38	1	63
Conflicting Peds, #/hr	0	0	0	0	0	0	0	0	0	0	0	0
Sign Control	Free	Free	Free	Free	Free	Free	Stop	Stop	Stop	Stop	Stop	Stop
RT Channelized	-	-	None	-	-	None	-	-	None	-	-	None
Storage Length	150	-	150	150	-	150	150	-	150	150	-	150
Veh in Median Storage, #	-	0	-	-	0	-	-	0	-	-	0	-
Grade, %	-	0	-	-	0	-	-	0	-	-	0	-
Peak Hour Factor	82	79	78	78	87	79	78	78	78	78	78	79
Heavy Vehicles, %	2	2	2	2	2	2	2	2	2	2	2	2
Mvmt Flow	105	73	36	13	224	78	47	1	15	49	1	80

Major/Minor	Major1			Major2			Minor1			Minor2		
Conflicting Flow All	303	0	0	109	0	0	534	611	73	534	569	224
Stage 1	-	-	-	-	-	-	283	283	-	250	250	-
Stage 2	-	-	-	-	-	-	250	328	-	284	319	-
Critical Hdwy	4.12	-	-	4.12	-	-	7.12	6.52	6.22	7.12	6.52	6.22
Critical Hdwy Stg 1	-	-	-	-	-	-	6.12	5.52	-	6.12	5.52	-
Critical Hdwy Stg 2	-	-	-	-	-	-	6.12	5.52	-	6.12	5.52	-
Follow-up Hdwy	2.218	-	-	2.218	-	-	3.518	4.018	3.318	3.518	4.018	3.318
Pot Cap-1 Maneuver	1258	-	-	1481	-	-	457	408	988	457	432	815
Stage 1	-	-	-	-	-	-	724	677	-	754	700	-
Stage 2	-	-	-	-	-	-	754	647	-	723	653	-
Platoon blocked, %	-	-	-	-	-	-	-	-	-	-	-	-
Mov Cap-1 Maneuver	1258	-	-	1481	-	-	374	371	988	408	393	815
Mov Cap-2 Maneuver	-	-	-	-	-	-	374	371	-	408	393	-
Stage 1	-	-	-	-	-	-	664	621	-	748	694	-
Stage 2	-	-	-	-	-	-	673	641	-	651	598	-

Approach	EB			WB			NB			SB		
HCM Control Delay, s/v	3.98			0.3			14.25			11.86		
HCM LOS							B			B		

Minor Lane/Major Mvmt	NBLn1	NBLn2	NBLn3	EBL	EBT	EBR	WBL	WBT	WBR	SBLn1	SBLn2	SBLn3
Capacity (veh/h)	374	371	988	1258	-	-	1481	-	-	408	393	815
HCM Lane V/C Ratio	0.127	0.003	0.016	0.083	-	-	0.009	-	-	0.12	0.003	0.098
HCM Control Delay (s/veh)	16	14.7	8.7	8.1	-	-	7.5	-	-	15	14.2	9.9
HCM Lane LOS	C	B	A	A	-	-	A	-	-	C	B	A
HCM 95th %tile Q(veh)	0.4	0	0	0.3	-	-	0	-	-	0.4	0	0.3

Lanes, Volumes, Timings
1: Elbert Road & Judge Orr Road

												
Lane Group	EBL	EBT	EBR	WBL	WBT	WBR	NBL	NBT	NBR	SBL	SBT	SBR
Lane Configurations												
Traffic Volume (vph)	31	259	47	18	163	9	42	6	16	29	7	22
Future Volume (vph)	31	259	47	18	163	9	42	6	16	29	7	22
Ideal Flow (vphp)	1900	1900	1900	1900	1900	1900	1900	1900	1900	1900	1900	1900
Storage Length (ft)	150		150	150		150	150		150	150		150
Storage Lanes	1		1	1		1	1		1	1		1
Taper Length (ft)	25			25			25			25		
Lane Util. Factor	1.00	1.00	1.00	1.00	1.00	1.00	1.00	1.00	1.00	1.00	1.00	1.00
Frt			0.850			0.850			0.850			0.850
Flt Protected	0.950			0.950			0.950			0.950		
Satd. Flow (prot)	1770	1863	1583	1770	1863	1583	1770	1863	1583	1770	1863	1583
Flt Permitted	0.950			0.950			0.950			0.950		
Satd. Flow (perm)	1770	1863	1583	1770	1863	1583	1770	1863	1583	1770	1863	1583
Link Speed (mph)		55			55			40			40	
Link Distance (ft)		624			2250			428			531	
Travel Time (s)		7.7			27.9			7.3			9.1	
Peak Hour Factor	0.78	0.88	0.78	0.78	0.85	0.78	0.78	0.78	0.78	0.78	0.78	0.78
Adj. Flow (vph)	40	294	60	23	192	12	54	8	21	37	9	28
Shared Lane Traffic (%)												
Lane Group Flow (vph)	40	294	60	23	192	12	54	8	21	37	9	28
Enter Blocked Intersection	No	No	No	No	No	No	No	No	No	No	No	No
Lane Alignment	Left	Left	Right	Left	Left	Right	Left	Left	Right	Left	Left	Right
Median Width(ft)		12			12			12			12	
Link Offset(ft)		0			0			0			0	
Crosswalk Width(ft)		16			16			16			16	
Two way Left Turn Lane												
Headway Factor	1.00	1.00	1.00	1.00	1.00	1.00	1.00	1.00	1.00	1.00	1.00	1.00
Turning Speed (mph)	15		9	15		9	15		9	15		9
Sign Control		Free			Free			Stop			Stop	

Intersection Summary

Area Type:	Other
Control Type:	Unsignalized
Intersection Capacity Utilization	36.0%
Analysis Period (min)	15
	ICU Level of Service A

Intersection												
Int Delay, s/veh	3.5											
Movement	EBL	EBT	EBR	WBL	WBT	WBR	NBL	NBT	NBR	SBL	SBT	SBR
Lane Configurations	↘	↗	↗	↘	↗	↗	↘	↗	↗	↘	↗	↗
Traffic Vol, veh/h	31	259	47	18	163	9	42	6	16	29	7	22
Future Vol, veh/h	31	259	47	18	163	9	42	6	16	29	7	22
Conflicting Peds, #/hr	0	0	0	0	0	0	0	0	0	0	0	0
Sign Control	Free	Free	Free	Free	Free	Free	Stop	Stop	Stop	Stop	Stop	Stop
RT Channelized	-	-	None	-	-	None	-	-	None	-	-	None
Storage Length	150	-	150	150	-	150	150	-	150	150	-	150
Veh in Median Storage, #	-	0	-	-	0	-	-	0	-	-	0	-
Grade, %	-	0	-	-	0	-	-	0	-	-	0	-
Peak Hour Factor	78	88	78	78	85	78	78	78	78	78	78	78
Heavy Vehicles, %	2	2	2	2	2	2	2	2	2	2	2	2
Mvmt Flow	40	294	60	23	192	12	54	8	21	37	9	28

Major/Minor	Major1			Major2			Minor1			Minor2		
Conflicting Flow All	203	0	0	355	0	0	616	623	294	616	672	192
Stage 1	-	-	-	-	-	-	374	374	-	238	238	-
Stage 2	-	-	-	-	-	-	242	249	-	378	434	-
Critical Hdwy	4.12	-	-	4.12	-	-	7.12	6.52	6.22	7.12	6.52	6.22
Critical Hdwy Stg 1	-	-	-	-	-	-	6.12	5.52	-	6.12	5.52	-
Critical Hdwy Stg 2	-	-	-	-	-	-	6.12	5.52	-	6.12	5.52	-
Follow-up Hdwy	2.218	-	-	2.218	-	-	3.518	4.018	3.318	3.518	4.018	3.318
Pot Cap-1 Maneuver	1368	-	-	1204	-	-	403	402	745	403	377	850
Stage 1	-	-	-	-	-	-	647	618	-	765	708	-
Stage 2	-	-	-	-	-	-	761	700	-	644	581	-
Platoon blocked, %	-	-	-	-	-	-	-	-	-	-	-	-
Mov Cap-1 Maneuver	1368	-	-	1204	-	-	362	383	745	366	359	850
Mov Cap-2 Maneuver	-	-	-	-	-	-	362	383	-	366	359	-
Stage 1	-	-	-	-	-	-	628	600	-	751	695	-
Stage 2	-	-	-	-	-	-	712	687	-	600	564	-

Approach	EB			WB			NB			SB		
HCM Control Delay, s/v	0.78			0.82			14.81			13.37		
HCM LOS							B			B		

Minor Lane/Major Mvmt	NBLn1	NBLn2	NBLn3	EBL	EBT	EBR	WBL	WBT	WBR	SBLn1	SBLn2	SBLn3
Capacity (veh/h)	362	383	745	1368	-	-	1204	-	-	366	359	850
HCM Lane V/C Ratio	0.149	0.02	0.028	0.029	-	-	0.019	-	-	0.102	0.025	0.033
HCM Control Delay (s/veh)	16.7	14.6	10	7.7	-	-	8	-	-	15.9	15.3	9.4
HCM Lane LOS	C	B	A	A	-	-	A	-	-	C	C	A
HCM 95th %tile Q(veh)	0.5	0.1	0.1	0.1	-	-	0.1	-	-	0.3	0.1	0.1

Lanes, Volumes, Timings
2: Northeast Access & Judge Orr Road

JR Engineering
07/29/2024

Lane Group	EBL	EBT	EBR	WBL	WBT	WBR	NBL	NBT	NBR	SBL	SBT	SBR
Lane Configurations												
Traffic Volume (vph)	32	219	53	18	116	17	47	1	16	15	1	27
Future Volume (vph)	32	219	53	18	116	17	47	1	16	15	1	27
Ideal Flow (vphp)	1900	1900	1900	1900	1900	1900	1900	1900	1900	1900	1900	1900
Storage Length (ft)	150		150	150		150	150		150	150		150
Storage Lanes	1		1	1		1	1		1	1		1
Taper Length (ft)	25			25			25			25		
Lane Util. Factor	1.00	1.00	1.00	1.00	1.00	1.00	1.00	1.00	1.00	1.00	1.00	1.00
Frt			0.850			0.850			0.850			0.850
Flt Protected	0.950			0.950			0.950			0.950		
Satd. Flow (prot)	1770	1863	1583	1770	1863	1583	1770	1863	1583	1770	1863	1583
Flt Permitted	0.950			0.950			0.950			0.950		
Satd. Flow (perm)	1770	1863	1583	1770	1863	1583	1770	1863	1583	1770	1863	1583
Link Speed (mph)		55			55			30			30	
Link Distance (ft)		2250			375			584			422	
Travel Time (s)		27.9			4.6			13.3			9.6	
Peak Hour Factor	0.78	0.87	0.79	0.78	0.84	0.78	0.78	0.78	0.78	0.78	0.78	0.78
Adj. Flow (vph)	41	252	67	23	138	22	60	1	21	19	1	35
Shared Lane Traffic (%)												
Lane Group Flow (vph)	41	252	67	23	138	22	60	1	21	19	1	35
Enter Blocked Intersection	No	No	No	No	No	No	No	No	No	No	No	No
Lane Alignment	Left	Left	Right	Left	Left	Right	Left	Left	Right	Left	Left	Right
Median Width(ft)		12			12			12			12	
Link Offset(ft)		0			0			0			0	
Crosswalk Width(ft)		16			16			16			16	
Two way Left Turn Lane												
Headway Factor	1.00	1.00	1.00	1.00	1.00	1.00	1.00	1.00	1.00	1.00	1.00	1.00
Turning Speed (mph)	15		9	15		9	15		9	15		9
Sign Control		Free			Free			Stop			Stop	

Intersection Summary

Area Type:	Other
Control Type:	Unsignalized
Intersection Capacity Utilization	30.9%
ICU Level of Service	A
Analysis Period (min)	15

Intersection												
Int Delay, s/veh	3.2											
Movement	EBL	EBT	EBR	WBL	WBT	WBR	NBL	NBT	NBR	SBL	SBT	SBR
Lane Configurations	↘	↑	↗	↘	↑	↗	↘	↑	↗	↘	↑	↗
Traffic Vol, veh/h	32	219	53	18	116	17	47	1	16	15	1	27
Future Vol, veh/h	32	219	53	18	116	17	47	1	16	15	1	27
Conflicting Peds, #/hr	0	0	0	0	0	0	0	0	0	0	0	0
Sign Control	Free	Free	Free	Free	Free	Free	Stop	Stop	Stop	Stop	Stop	Stop
RT Channelized	-	-	None	-	-	None	-	-	None	-	-	None
Storage Length	150	-	150	150	-	150	150	-	150	150	-	150
Veh in Median Storage, #	-	0	-	-	0	-	-	0	-	-	0	-
Grade, %	-	0	-	-	0	-	-	0	-	-	0	-
Peak Hour Factor	78	87	79	78	84	78	78	78	78	78	78	78
Heavy Vehicles, %	2	2	2	2	2	2	2	2	2	2	2	2
Mvmt Flow	41	252	67	23	138	22	60	1	21	19	1	35

























Major/Minor	Major1			Major2			Minor1			Minor2		
Conflicting Flow All	160	0	0	319	0	0	519	540	252	519	585	138
Stage 1	-	-	-	-	-	-	334	334	-	184	184	-
Stage 2	-	-	-	-	-	-	185	206	-	334	401	-
Critical Hdwy	4.12	-	-	4.12	-	-	7.12	6.52	6.22	7.12	6.52	6.22
Critical Hdwy Stg 1	-	-	-	-	-	-	6.12	5.52	-	6.12	5.52	-
Critical Hdwy Stg 2	-	-	-	-	-	-	6.12	5.52	-	6.12	5.52	-
Follow-up Hdwy	2.218	-	-	2.218	-	-	3.518	4.018	3.318	3.518	4.018	3.318
Pot Cap-1 Maneuver	1419	-	-	1241	-	-	468	449	787	468	423	910
Stage 1	-	-	-	-	-	-	680	643	-	817	747	-
Stage 2	-	-	-	-	-	-	817	731	-	679	601	-
Platoon blocked, %	-	-	-	-	-	-	-	-	-	-	-	-
Mov Cap-1 Maneuver	1419	-	-	1241	-	-	427	428	787	433	403	910
Mov Cap-2 Maneuver	-	-	-	-	-	-	427	428	-	433	403	-
Stage 1	-	-	-	-	-	-	660	625	-	802	733	-
Stage 2	-	-	-	-	-	-	770	718	-	641	584	-

Approach	EB	WB	NB	SB
HCM Control Delay, s/v	0.87	1	13.5	10.83
HCM LOS			B	B

Minor Lane/Major Mvmt	NBLn1	NBLn2	NBLn3	EBL	EBT	EBR	WBL	WBT	WBR	SBLn1	SBLn2	SBLn3
Capacity (veh/h)	427	428	787	1419	-	-	1241	-	-	433	403	910
HCM Lane V/C Ratio	0.141	0.003	0.026	0.029	-	-	0.019	-	-	0.044	0.003	0.038
HCM Control Delay (s/veh)	14.8	13.4	9.7	7.6	-	-	8	-	-	13.7	14	9.1
HCM Lane LOS	B	B	A	A	-	-	A	-	-	B	B	A
HCM 95th %tile Q(veh)	0.5	0	0.1	0.1	-	-	0.1	-	-	0.1	0	0.1

Lanes, Volumes, Timings
1: Elbert Road & Judge Orr Road

JR Engineering
07/23/2024

												
Lane Group	EBL	EBT	EBR	WBL	WBT	WBR	NBL	NBT	NBR	SBL	SBT	SBR
Lane Configurations												
Traffic Volume (vph)	79	127	0	0	256	23	1	0	0	11	0	47
Future Volume (vph)	79	127	0	0	256	23	1	0	0	11	0	47
Ideal Flow (vphpl)	1900	1900	1900	1900	1900	1900	1900	1900	1900	1900	1900	1900
Storage Length (ft)	150		150	150		150	150		150	150		150
Storage Lanes	1		1	1		1	1		1	1		1
Taper Length (ft)	25			25			25			25		
Lane Util. Factor	1.00	1.00	1.00	1.00	1.00	1.00	1.00	1.00	1.00	1.00	1.00	1.00
Frt						0.850						0.850
Flt Protected	0.950						0.950			0.950		
Satd. Flow (prot)	1770	1863	1863	1863	1863	1583	1770	1863	1863	1770	1863	1583
Flt Permitted	0.950						0.950			0.950		
Satd. Flow (perm)	1770	1863	1863	1863	1863	1583	1770	1863	1863	1770	1863	1583
Link Speed (mph)		55			55			40			40	
Link Distance (ft)		624			2250			428			531	
Travel Time (s)		7.7			27.9			7.3			9.1	
Peak Hour Factor	0.81	0.84	0.78	0.78	0.88	0.78	0.78	0.78	0.78	0.78	0.78	0.78
Adj. Flow (vph)	98	151	0	0	291	29	1	0	0	14	0	60
Shared Lane Traffic (%)												
Lane Group Flow (vph)	98	151	0	0	291	29	1	0	0	14	0	60
Enter Blocked Intersection	No	No	No	No	No	No	No	No	No	No	No	No
Lane Alignment	Left	Left	Right	Left	Left	Right	Left	Left	Right	Left	Left	Right
Median Width(ft)		12			12			12			12	
Link Offset(ft)		0			0			0			0	
Crosswalk Width(ft)		16			16			16			16	
Two way Left Turn Lane												
Headway Factor	1.00	1.00	1.00	1.00	1.00	1.00	1.00	1.00	1.00	1.00	1.00	1.00
Turning Speed (mph)	15		9	15		9	15		9	15		9
Sign Control		Free			Free			Stop			Stop	

Intersection Summary

Area Type:	Other
Control Type:	Unsignalized
Intersection Capacity Utilization	35.1%
Analysis Period (min)	15
	ICU Level of Service A

Intersection												
Int Delay, s/veh	2.6											
Movement	EBL	EBT	EBR	WBL	WBT	WBR	NBL	NBT	NBR	SBL	SBT	SBR
Lane Configurations	↘	↗	↗	↘	↗	↗	↘	↗	↗	↘	↗	↗
Traffic Vol, veh/h	79	127	0	0	256	23	1	0	0	11	0	47
Future Vol, veh/h	79	127	0	0	256	23	1	0	0	11	0	47
Conflicting Peds, #/hr	0	0	0	0	0	0	0	0	0	0	0	0
Sign Control	Free	Free	Free	Free	Free	Free	Stop	Stop	Stop	Stop	Stop	Stop
RT Channelized	-	-	None	-	-	None	-	-	None	-	-	None
Storage Length	150	-	150	150	-	150	150	-	150	150	-	150
Veh in Median Storage, #	-	0	-	-	0	-	-	0	-	-	0	-
Grade, %	-	0	-	-	0	-	-	0	-	-	0	-
Peak Hour Factor	81	84	78	78	88	78	78	78	78	78	78	78
Heavy Vehicles, %	2	2	2	2	2	2	2	2	2	2	2	2
Mvmt Flow	98	151	0	0	291	29	1	0	0	14	0	60

























Major/Minor	Major1			Major2			Minor1			Minor2		
Conflicting Flow All	320	0	0	151	0	0	637	667	151	637	637	291
Stage 1	-	-	-	-	-	-	346	346	-	291	291	-
Stage 2	-	-	-	-	-	-	291	320	-	346	346	-
Critical Hdwy	4.12	-	-	4.12	-	-	7.12	6.52	6.22	7.12	6.52	6.22
Critical Hdwy Stg 1	-	-	-	-	-	-	6.12	5.52	-	6.12	5.52	-
Critical Hdwy Stg 2	-	-	-	-	-	-	6.12	5.52	-	6.12	5.52	-
Follow-up Hdwy	2.218	-	-	2.218	-	-	3.518	4.018	3.318	3.518	4.018	3.318
Pot Cap-1 Maneuver	1240	-	-	1430	-	-	390	380	895	390	395	748
Stage 1	-	-	-	-	-	-	670	635	-	717	672	-
Stage 2	-	-	-	-	-	-	717	652	-	670	635	-
Platoon blocked, %	-	-	-	-	-	-	-	-	-	-	-	-
Mov Cap-1 Maneuver	1240	-	-	1430	-	-	330	350	895	359	364	748
Mov Cap-2 Maneuver	-	-	-	-	-	-	330	350	-	359	364	-
Stage 1	-	-	-	-	-	-	617	585	-	717	672	-
Stage 2	-	-	-	-	-	-	659	652	-	617	585	-

Approach	EB			WB			NB			SB		
HCM Control Delay, s/v	3.2			0			15.94			11.22		
HCM LOS							C			B		

Minor Lane/Major Mvmt	NBLn1	NBLn2	NBLn3	EBL	EBT	EBR	WBL	WBT	WBR	SBLn1	SBLn2	SBLn3
Capacity (veh/h)	330	-	-	1240	-	-	1430	-	-	359	-	748
HCM Lane V/C Ratio	0.004	-	-	0.079	-	-	-	-	-	0.039	-	0.081
HCM Control Delay (s/veh)	15.9	0	0	8.2	-	-	0	-	-	15.4	0	10.2
HCM Lane LOS	C	A	A	A	-	-	A	-	-	C	A	B
HCM 95th %tile Q(veh)	0	-	-	0.3	-	-	0	-	-	0.1	-	0.3

Lanes, Volumes, Timings
2: Northeast Access & Judge Orr Road

JR Engineering
07/23/2024

												
Lane Group	EBL	EBT	EBR	WBL	WBT	WBR	NBL	NBT	NBR	SBL	SBT	SBR
Lane Configurations												
Traffic Volume (vph)	86	52	0	0	216	62	0	0	0	38	0	63
Future Volume (vph)	86	52	0	0	216	62	0	0	0	38	0	63
Ideal Flow (vphpl)	1900	1900	1900	1900	1900	1900	1900	1900	1900	1900	1900	1900
Storage Length (ft)	150		150	150		150	150		150	150		150
Storage Lanes	1		1	1		1	1		1	1		1
Taper Length (ft)	25			25			25			25		
Lane Util. Factor	1.00	1.00	1.00	1.00	1.00	1.00	1.00	1.00	1.00	1.00	1.00	1.00
Frt						0.850						0.850
Flt Protected	0.950									0.950		
Satd. Flow (prot)	1770	1863	1863	1863	1863	1583	1863	1863	1863	1770	1863	1583
Flt Permitted	0.950									0.950		
Satd. Flow (perm)	1770	1863	1863	1863	1863	1583	1863	1863	1863	1770	1863	1583
Link Speed (mph)		55			55			30				30
Link Distance (ft)		2250			375			584				419
Travel Time (s)		27.9			4.6			13.3				9.5
Peak Hour Factor	0.82	0.78	0.78	0.78	0.87	0.79	0.78	0.78	0.78	0.78	0.78	0.79
Adj. Flow (vph)	105	67	0	0	248	78	0	0	0	49	0	80
Shared Lane Traffic (%)												
Lane Group Flow (vph)	105	67	0	0	248	78	0	0	0	49	0	80
Enter Blocked Intersection	No	No	No	No	No	No	No	No	No	No	No	No
Lane Alignment	Left	Left	Right	Left	Left	Right	Left	Left	Right	Left	Left	Right
Median Width(ft)		12			12			12				12
Link Offset(ft)		0			0			0				0
Crosswalk Width(ft)		16			16			16				16
Two way Left Turn Lane												
Headway Factor	1.00	1.00	1.00	1.00	1.00	1.00	1.00	1.00	1.00	1.00	1.00	1.00
Turning Speed (mph)	15		9	15		9	15		9	15		9
Sign Control		Free			Free			Stop				Stop

Intersection Summary

Area Type:	Other
Control Type:	Unsignalized
Intersection Capacity Utilization	29.5%
ICU Level of Service	A
Analysis Period (min)	15

Intersection												
Int Delay, s/veh	3.8											
Movement	EBL	EBT	EBR	WBL	WBT	WBR	NBL	NBT	NBR	SBL	SBT	SBR
Lane Configurations	↘	↗	↗	↘	↗	↗	↘	↗	↗	↘	↗	↗
Traffic Vol, veh/h	86	52	0	0	216	62	0	0	0	38	0	63
Future Vol, veh/h	86	52	0	0	216	62	0	0	0	38	0	63
Conflicting Peds, #/hr	0	0	0	0	0	0	0	0	0	0	0	0
Sign Control	Free	Free	Free	Free	Free	Free	Stop	Stop	Stop	Stop	Stop	Stop
RT Channelized	-	-	None	-	-	None	-	-	None	-	-	None
Storage Length	150	-	150	150	-	150	150	-	150	150	-	150
Veh in Median Storage, #	-	0	-	-	0	-	-	0	-	-	0	-
Grade, %	-	0	-	-	0	-	-	0	-	-	0	-
Peak Hour Factor	82	78	78	78	87	79	78	78	78	78	78	79
Heavy Vehicles, %	2	2	2	2	2	2	2	2	2	2	2	2
Mvmt Flow	105	67	0	0	248	78	0	0	0	49	0	80

























Major/Minor	Major1			Major2			Minor1			Minor2		
Conflicting Flow All	327	0	0	67	0	0	525	603	67	525	525	248
Stage 1	-	-	-	-	-	-	276	276	-	248	248	-
Stage 2	-	-	-	-	-	-	248	327	-	276	276	-
Critical Hdwy	4.12	-	-	4.12	-	-	7.12	6.52	6.22	7.12	6.52	6.22
Critical Hdwy Stg 1	-	-	-	-	-	-	6.12	5.52	-	6.12	5.52	-
Critical Hdwy Stg 2	-	-	-	-	-	-	6.12	5.52	-	6.12	5.52	-
Follow-up Hdwy	2.218	-	-	2.218	-	-	3.518	4.018	3.318	3.518	4.018	3.318
Pot Cap-1 Maneuver	1233	-	-	1535	-	-	463	413	997	463	458	790
Stage 1	-	-	-	-	-	-	730	682	-	756	701	-
Stage 2	-	-	-	-	-	-	756	648	-	730	682	-
Platoon blocked, %	-	-	-	-	-	-	-	-	-	-	-	-
Mov Cap-1 Maneuver	1233	-	-	1535	-	-	381	378	997	424	419	790
Mov Cap-2 Maneuver	-	-	-	-	-	-	381	378	-	424	419	-
Stage 1	-	-	-	-	-	-	668	624	-	756	701	-
Stage 2	-	-	-	-	-	-	679	648	-	668	624	-

Approach	EB	WB	NB	SB
HCM Control Delay, s/v	5.01	0	0	11.78
HCM LOS			A	B

Minor Lane/Major Mvmt	NBLn1	NBLn2	NBLn3	EBL	EBT	EBR	WBL	WBT	WBR	SBLn1	SBLn2	SBLn3
Capacity (veh/h)	-	-	-	1233	-	-	1535	-	-	424	-	790
HCM Lane V/C Ratio	-	-	-	0.085	-	-	-	-	-	0.115	-	0.101
HCM Control Delay (s/veh)	0	0	0	8.2	-	-	0	-	-	14.6	0	10.1
HCM Lane LOS	A	A	A	A	-	-	A	-	-	B	A	B
HCM 95th %tile Q(veh)	-	-	-	0.3	-	-	0	-	-	0.4	-	0.3

Lanes, Volumes, Timings
1: Elbert Road & Judge Orr Road

JR Engineering
07/23/2024

												
Lane Group	EBL	EBT	EBR	WBL	WBT	WBR	NBL	NBT	NBR	SBL	SBT	SBR
Lane Configurations												
Traffic Volume (vph)	33	242	1	0	137	3	1	0	0	26	0	23
Future Volume (vph)	33	242	1	0	137	3	1	0	0	26	0	23
Ideal Flow (vphpl)	1900	1900	1900	1900	1900	1900	1900	1900	1900	1900	1900	1900
Storage Length (ft)	150		150	150		150	150		150	150		150
Storage Lanes	1		1	1		1	1		1	1		1
Taper Length (ft)	25			25			25			25		
Lane Util. Factor	1.00	1.00	1.00	1.00	1.00	1.00	1.00	1.00	1.00	1.00	1.00	1.00
Frt			0.850			0.850						0.850
Flt Protected	0.950						0.950			0.950		
Satd. Flow (prot)	1770	1863	1583	1863	1863	1583	1770	1863	1863	1770	1863	1583
Flt Permitted	0.950						0.950			0.950		
Satd. Flow (perm)	1770	1863	1583	1863	1863	1583	1770	1863	1863	1770	1863	1583
Link Speed (mph)		55			55			40			40	
Link Distance (ft)		624			2250			428			531	
Travel Time (s)		7.7			27.9			7.3			9.1	
Peak Hour Factor	0.78	0.88	0.78	0.78	0.85	0.78	0.78	0.78	0.78	0.78	0.78	0.78
Adj. Flow (vph)	42	275	1	0	161	4	1	0	0	33	0	29
Shared Lane Traffic (%)												
Lane Group Flow (vph)	42	275	1	0	161	4	1	0	0	33	0	29
Enter Blocked Intersection	No	No	No	No	No	No	No	No	No	No	No	No
Lane Alignment	Left	Left	Right	Left	Left	Right	Left	Left	Right	Left	Left	Right
Median Width(ft)		12			12			12			12	
Link Offset(ft)		0			0			0			0	
Crosswalk Width(ft)		16			16			16			16	
Two way Left Turn Lane												
Headway Factor	1.00	1.00	1.00	1.00	1.00	1.00	1.00	1.00	1.00	1.00	1.00	1.00
Turning Speed (mph)	15		9	15		9	15		9	15		9
Sign Control		Free			Free			Stop			Stop	

Intersection Summary

Area Type:	Other
Control Type:	Unsignalized
Intersection Capacity Utilization	34.2%
Analysis Period (min)	15
	ICU Level of Service A

























Intersection												
Int Delay, s/veh	1.9											
Movement	EBL	EBT	EBR	WBL	WBT	WBR	NBL	NBT	NBR	SBL	SBT	SBR
Lane Configurations	↘	↑	↗	↘	↑	↗	↘	↑	↗	↘	↑	↗
Traffic Vol, veh/h	33	242	1	0	137	3	1	0	0	26	0	23
Future Vol, veh/h	33	242	1	0	137	3	1	0	0	26	0	23
Conflicting Peds, #/hr	0	0	0	0	0	0	0	0	0	0	0	0
Sign Control	Free	Free	Free	Free	Free	Free	Stop	Stop	Stop	Stop	Stop	Stop
RT Channelized	-	-	None	-	-	None	-	-	None	-	-	None
Storage Length	150	-	150	150	-	150	150	-	150	150	-	150
Veh in Median Storage, #	-	0	-	-	0	-	-	0	-	-	0	-
Grade, %	-	0	-	-	0	-	-	0	-	-	0	-
Peak Hour Factor	78	88	78	78	85	78	78	78	78	78	78	78
Heavy Vehicles, %	2	2	2	2	2	2	2	2	2	2	2	2
Mvmt Flow	42	275	1	0	161	4	1	0	0	33	0	29

Major/Minor	Major1			Major2			Minor1			Minor2		
Conflicting Flow All	165	0	0	276	0	0	521	525	275	521	522	161
Stage 1	-	-	-	-	-	-	360	360	-	161	161	-
Stage 2	-	-	-	-	-	-	161	165	-	360	361	-
Critical Hdwy	4.12	-	-	4.12	-	-	7.12	6.52	6.22	7.12	6.52	6.22
Critical Hdwy Stg 1	-	-	-	-	-	-	6.12	5.52	-	6.12	5.52	-
Critical Hdwy Stg 2	-	-	-	-	-	-	6.12	5.52	-	6.12	5.52	-
Follow-up Hdwy	2.218	-	-	2.218	-	-	3.518	4.018	3.318	3.518	4.018	3.318
Pot Cap-1 Maneuver	1413	-	-	1287	-	-	466	458	764	466	459	884
Stage 1	-	-	-	-	-	-	659	627	-	841	765	-
Stage 2	-	-	-	-	-	-	841	762	-	659	626	-
Platoon blocked, %	-	-	-	-	-	-	-	-	-	-	-	-
Mov Cap-1 Maneuver	1413	-	-	1287	-	-	437	444	764	452	446	884
Mov Cap-2 Maneuver	-	-	-	-	-	-	437	444	-	452	446	-
Stage 1	-	-	-	-	-	-	639	608	-	841	765	-
Stage 2	-	-	-	-	-	-	813	762	-	639	607	-

Approach	EB			WB			NB			SB		
HCM Control Delay, s/v	1.01			0			13.26			11.54		
HCM LOS							B			B		

Minor Lane/Major Mvmt	NBLn1	NBLn2	NBLn3	EBL	EBT	EBR	WBL	WBT	WBR	SBLn1	SBLn2	SBLn3
Capacity (veh/h)	437	-	-	1413	-	-	1287	-	-	452	-	884
HCM Lane V/C Ratio	0.003	-	-	0.03	-	-	-	-	-	0.074	-	0.033
HCM Control Delay (s/veh)	13.3	0	0	7.6	-	-	0	-	-	13.6	0	9.2
HCM Lane LOS	B	A	A	A	-	-	A	-	-	B	A	A
HCM 95th %tile Q(veh)	0	-	-	0.1	-	-	0	-	-	0.2	-	0.1

Lanes, Volumes, Timings
 2: Northeast Access & Judge Orr Road

												
Lane Group	EBL	EBT	EBR	WBL	WBT	WBR	NBL	NBT	NBR	SBL	SBT	SBR
Lane Configurations												
Traffic Volume (vph)	32	236	0	0	113	17	0	0	0	15	0	27
Future Volume (vph)	32	236	0	0	113	17	0	0	0	15	0	27
Ideal Flow (vphp)	1900	1900	1900	1900	1900	1900	1900	1900	1900	1900	1900	1900
Storage Length (ft)	150		150	150		150	150		150	150		150
Storage Lanes	1		1	1		1	1		1	1		1
Taper Length (ft)	25			25			25			25		
Lane Util. Factor	1.00	1.00	1.00	1.00	1.00	1.00	1.00	1.00	1.00	1.00	1.00	1.00
Frt						0.850						0.850
Flt Protected	0.950									0.950		
Satd. Flow (prot)	1770	1863	1863	1863	1863	1583	1863	1863	1863	1770	1863	1583
Flt Permitted	0.950									0.950		
Satd. Flow (perm)	1770	1863	1863	1863	1863	1583	1863	1863	1863	1770	1863	1583
Link Speed (mph)		55			55			30				30
Link Distance (ft)		2250			375			584				430
Travel Time (s)		27.9			4.6			13.3				9.8
Peak Hour Factor	0.78	0.88	0.78	0.78	0.84	0.78	0.78	0.78	0.78	0.78	0.78	0.78
Adj. Flow (vph)	41	268	0	0	135	22	0	0	0	19	0	35
Shared Lane Traffic (%)												
Lane Group Flow (vph)	41	268	0	0	135	22	0	0	0	19	0	35
Enter Blocked Intersection	No	No	No	No	No	No	No	No	No	No	No	No
Lane Alignment	Left	Left	Right	Left	Left	Right	Left	Left	Right	Left	Left	Right
Median Width(ft)		12			12			12				12
Link Offset(ft)		0			0			0				0
Crosswalk Width(ft)		16			16			16				16
Two way Left Turn Lane												
Headway Factor	1.00	1.00	1.00	1.00	1.00	1.00	1.00	1.00	1.00	1.00	1.00	1.00
Turning Speed (mph)	15		9	15		9	15		9	15		9
Sign Control		Free			Free			Stop				Stop

Intersection Summary	
Area Type:	Other
Control Type:	Unsignalized
Intersection Capacity Utilization	22.4%
	ICU Level of Service A
Analysis Period (min)	15

Intersection												
Int Delay, s/veh	1.7											
Movement	EBL	EBT	EBR	WBL	WBT	WBR	NBL	NBT	NBR	SBL	SBT	SBR
Lane Configurations	↘	↑	↗	↘	↑	↗	↘	↑	↗	↘	↑	↗
Traffic Vol, veh/h	32	236	0	0	113	17	0	0	0	15	0	27
Future Vol, veh/h	32	236	0	0	113	17	0	0	0	15	0	27
Conflicting Peds, #/hr	0	0	0	0	0	0	0	0	0	0	0	0
Sign Control	Free	Free	Free	Free	Free	Free	Stop	Stop	Stop	Stop	Stop	Stop
RT Channelized	-	-	None	-	-	None	-	-	None	-	-	None
Storage Length	150	-	150	150	-	150	150	-	150	150	-	150
Veh in Median Storage, #	-	0	-	-	0	-	-	0	-	-	0	-
Grade, %	-	0	-	-	0	-	-	0	-	-	0	-
Peak Hour Factor	78	88	78	78	84	78	78	78	78	78	78	78
Heavy Vehicles, %	2	2	2	2	2	2	2	2	2	2	2	2
Mvmt Flow	41	268	0	0	135	22	0	0	0	19	0	35

Major/Minor	Major1			Major2			Minor1			Minor2		
Conflicting Flow All	156	0	0	268	0	0	485	507	268	485	485	135
Stage 1	-	-	-	-	-	-	350	350	-	135	135	-
Stage 2	-	-	-	-	-	-	135	156	-	350	350	-
Critical Hdwy	4.12	-	-	4.12	-	-	7.12	6.52	6.22	7.12	6.52	6.22
Critical Hdwy Stg 1	-	-	-	-	-	-	6.12	5.52	-	6.12	5.52	-
Critical Hdwy Stg 2	-	-	-	-	-	-	6.12	5.52	-	6.12	5.52	-
Follow-up Hdwy	2.218	-	-	2.218	-	-	3.518	4.018	3.318	3.518	4.018	3.318
Pot Cap-1 Maneuver	1424	-	-	1295	-	-	493	469	770	493	482	914
Stage 1	-	-	-	-	-	-	666	633	-	869	785	-
Stage 2	-	-	-	-	-	-	869	768	-	666	633	-
Platoon blocked, %	-	-	-	-	-	-	-	-	-	-	-	-
Mov Cap-1 Maneuver	1424	-	-	1295	-	-	460	455	770	478	468	914
Mov Cap-2 Maneuver	-	-	-	-	-	-	460	455	-	478	468	-
Stage 1	-	-	-	-	-	-	647	614	-	869	785	-
Stage 2	-	-	-	-	-	-	836	768	-	647	614	-

Approach	EB	WB	NB	SB
HCM Control Delay, s/v	1.01	0	0	10.43
HCM LOS			A	B

Minor Lane/Major Mvmt	NBLn1	NBLn2	NBLn3	EBL	EBT	EBR	WBL	WBT	WBR	SBLn1	SBLn2	SBLn3
Capacity (veh/h)	-	-	-	1424	-	-	1295	-	-	478	-	914
HCM Lane V/C Ratio	-	-	-	0.029	-	-	-	-	-	0.04	-	0.038
HCM Control Delay (s/veh)	0	0	0	7.6	-	-	0	-	-	12.8	0	9.1
HCM Lane LOS	A	A	A	A	-	-	A	-	-	B	A	A
HCM 95th %tile Q(veh)	-	-	-	0.1	-	-	0	-	-	0.1	-	0.1

Lanes, Volumes, Timings
1: Elbert Road & Judge Orr Road

Lane Group	EBL	EBT	EBR	WBL	WBT	WBR	NBL	NBT	NBR	SBL	SBT	SBR
Lane Configurations												
Traffic Volume (vph)	79	152	25	10	288	28	33	5	12	15	4	47
Future Volume (vph)	79	152	25	10	288	28	33	5	12	15	4	47
Ideal Flow (vphpl)	1900	1900	1900	1900	1900	1900	1900	1900	1900	1900	1900	1900
Storage Length (ft)	150		150	150		150	150		150	150		150
Storage Lanes	1		1	1		1	1		1	1		1
Taper Length (ft)	25			25			25			25		
Lane Util. Factor	1.00	1.00	1.00	1.00	1.00	1.00	1.00	1.00	1.00	1.00	1.00	1.00
Frt			0.850			0.850			0.850			0.850
Flt Protected	0.950			0.950			0.950			0.950		
Satd. Flow (prot)	1770	1863	1583	1770	1863	1583	1770	1863	1583	1770	1863	1583
Flt Permitted	0.950			0.950			0.950			0.950		
Satd. Flow (perm)	1770	1863	1583	1770	1863	1583	1770	1863	1583	1770	1863	1583
Link Speed (mph)		55			55			40			40	
Link Distance (ft)		624			2250			428			531	
Travel Time (s)		7.7			27.9			7.3			9.1	
Peak Hour Factor	0.81	0.85	0.78	0.78	0.88	0.78	0.78	0.78	0.78	0.78	0.78	0.78
Adj. Flow (vph)	98	179	32	13	327	36	42	6	15	19	5	60
Shared Lane Traffic (%)												
Lane Group Flow (vph)	98	179	32	13	327	36	42	6	15	19	5	60
Enter Blocked Intersection	No	No	No	No	No	No	No	No	No	No	No	No
Lane Alignment	Left	Left	Right	Left	Left	Right	Left	Left	Right	Left	Left	Right
Median Width(ft)		12			12			12			12	
Link Offset(ft)		0			0			0			0	
Crosswalk Width(ft)		16			16			16			16	
Two way Left Turn Lane												
Headway Factor	1.00	1.00	1.00	1.00	1.00	1.00	1.00	1.00	1.00	1.00	1.00	1.00
Turning Speed (mph)	15		9	15		9	15		9	15		9
Sign Control		Free			Free			Stop			Stop	

Intersection Summary

Area Type:	Other
Control Type:	Unsignalized
Intersection Capacity Utilization	38.0%
ICU Level of Service	A
Analysis Period (min)	15

























Intersection												
Int Delay, s/veh	3.7											
Movement	EBL	EBT	EBR	WBL	WBT	WBR	NBL	NBT	NBR	SBL	SBT	SBR
Lane Configurations	↘	↗	↗	↘	↗	↗	↘	↗	↗	↘	↗	↗
Traffic Vol, veh/h	79	152	25	10	288	28	33	5	12	15	4	47
Future Vol, veh/h	79	152	25	10	288	28	33	5	12	15	4	47
Conflicting Peds, #/hr	0	0	0	0	0	0	0	0	0	0	0	0
Sign Control	Free	Free	Free	Free	Free	Free	Stop	Stop	Stop	Stop	Stop	Stop
RT Channelized	-	-	None	-	-	None	-	-	None	-	-	None
Storage Length	150	-	150	150	-	150	150	-	150	150	-	150
Veh in Median Storage, #	-	0	-	-	0	-	-	0	-	-	0	-
Grade, %	-	0	-	-	0	-	-	0	-	-	0	-
Peak Hour Factor	81	85	78	78	88	78	78	78	78	78	78	78
Heavy Vehicles, %	2	2	2	2	2	2	2	2	2	2	2	2
Mvmt Flow	98	179	32	13	327	36	42	6	15	19	5	60

Major/Minor	Major1			Major2			Minor1			Minor2		
Conflicting Flow All	363	0	0	211	0	0	729	763	179	730	759	327
Stage 1	-	-	-	-	-	-	374	374	-	353	353	-
Stage 2	-	-	-	-	-	-	355	389	-	377	406	-
Critical Hdwy	4.12	-	-	4.12	-	-	7.12	6.52	6.22	7.12	6.52	6.22
Critical Hdwy Stg 1	-	-	-	-	-	-	6.12	5.52	-	6.12	5.52	-
Critical Hdwy Stg 2	-	-	-	-	-	-	6.12	5.52	-	6.12	5.52	-
Follow-up Hdwy	2.218	-	-	2.218	-	-	3.518	4.018	3.318	3.518	4.018	3.318
Pot Cap-1 Maneuver	1195	-	-	1360	-	-	338	334	864	338	336	714
Stage 1	-	-	-	-	-	-	647	618	-	664	631	-
Stage 2	-	-	-	-	-	-	662	608	-	644	598	-
Platoon blocked, %	-	-	-	-	-	-	-	-	-	-	-	-
Mov Cap-1 Maneuver	1195	-	-	1360	-	-	277	304	864	296	306	714
Mov Cap-2 Maneuver	-	-	-	-	-	-	277	304	-	296	306	-
Stage 1	-	-	-	-	-	-	594	567	-	658	625	-
Stage 2	-	-	-	-	-	-	595	603	-	575	549	-

Approach	EB			WB			NB			SB		
HCM Control Delay, s/v	2.62			0.26			17.32			12.6		
HCM LOS							C			B		

Minor Lane/Major Mvmt	NBLn1	NBLn2	NBLn3	EBL	EBT	EBR	WBL	WBT	WBR	SBLn1	SBLn2	SBLn3
Capacity (veh/h)	277	304	864	1195	-	-	1360	-	-	296	306	714
HCM Lane V/C Ratio	0.153	0.021	0.018	0.082	-	-	0.009	-	-	0.065	0.017	0.084
HCM Control Delay (s/veh)	20.3	17.1	9.2	8.3	-	-	7.7	-	-	18	17	10.5
HCM Lane LOS	C	C	A	A	-	-	A	-	-	C	C	B
HCM 95th %tile Q(veh)	0.5	0.1	0.1	0.3	-	-	0	-	-	0.2	0.1	0.3

Lanes, Volumes, Timings
 2: Northeast Access & Judge Orr Road

												
Lane Group	EBL	EBT	EBR	WBL	WBT	WBR	NBL	NBT	NBR	SBL	SBT	SBR
Lane Configurations												
Traffic Volume (vph)	86	65	28	10	226	62	37	1	12	38	1	63
Future Volume (vph)	86	65	28	10	226	62	37	1	12	38	1	63
Ideal Flow (vphp)	1900	1900	1900	1900	1900	1900	1900	1900	1900	1900	1900	1900
Storage Length (ft)	150		150	150		150	150		150	150		150
Storage Lanes	1		1	1		1	1		1	1		1
Taper Length (ft)	25			25			25			25		
Lane Util. Factor	1.00	1.00	1.00	1.00	1.00	1.00	1.00	1.00	1.00	1.00	1.00	1.00
Frt			0.850			0.850			0.850			0.850
Flt Protected	0.950			0.950			0.950			0.950		
Satd. Flow (prot)	1770	1863	1583	1770	1863	1583	1770	1863	1583	1770	1863	1583
Flt Permitted	0.950			0.950			0.950			0.950		
Satd. Flow (perm)	1770	1863	1583	1770	1863	1583	1770	1863	1583	1770	1863	1583
Link Speed (mph)		55			55			30			30	
Link Distance (ft)		2250			375			584			400	
Travel Time (s)		27.9			4.6			13.3			9.1	
Peak Hour Factor	0.82	0.80	0.78	0.78	0.87	0.79	0.78	0.78	0.78	0.78	0.78	0.79
Adj. Flow (vph)	105	81	36	13	260	78	47	1	15	49	1	80
Shared Lane Traffic (%)												
Lane Group Flow (vph)	105	81	36	13	260	78	47	1	15	49	1	80
Enter Blocked Intersection	No	No	No	No	No	No	No	No	No	No	No	No
Lane Alignment	Left	Left	Right	Left	Left	Right	Left	Left	Right	Left	Left	Right
Median Width(ft)		12			12			12			12	
Link Offset(ft)		0			0			0			0	
Crosswalk Width(ft)		16			16			16			16	
Two way Left Turn Lane												
Headway Factor	1.00	1.00	1.00	1.00	1.00	1.00	1.00	1.00	1.00	1.00	1.00	1.00
Turning Speed (mph)	15		9	15		9	15		9	15		9
Sign Control		Free			Free			Stop			Stop	

Intersection Summary	
Area Type:	Other
Control Type:	Unsignalized
Intersection Capacity Utilization	35.4%
ICU Level of Service	A
Analysis Period (min)	15

























Intersection												
Int Delay, s/veh	4.6											
Movement	EBL	EBT	EBR	WBL	WBT	WBR	NBL	NBT	NBR	SBL	SBT	SBR
Lane Configurations	↖	↗	↖	↖	↗	↖	↖	↗	↖	↖	↗	↖
Traffic Vol, veh/h	86	65	28	10	226	62	37	1	12	38	1	63
Future Vol, veh/h	86	65	28	10	226	62	37	1	12	38	1	63
Conflicting Peds, #/hr	0	0	0	0	0	0	0	0	0	0	0	0
Sign Control	Free	Free	Free	Free	Free	Free	Stop	Stop	Stop	Stop	Stop	Stop
RT Channelized	-	-	None	-	-	None	-	-	None	-	-	None
Storage Length	150	-	150	150	-	150	150	-	150	150	-	150
Veh in Median Storage, #	-	0	-	-	0	-	-	0	-	-	0	-
Grade, %	-	0	-	-	0	-	-	0	-	-	0	-
Peak Hour Factor	82	80	78	78	87	79	78	78	78	78	78	79
Heavy Vehicles, %	2	2	2	2	2	2	2	2	2	2	2	2
Mvmt Flow	105	81	36	13	260	78	47	1	15	49	1	80

Major/Minor	Major1			Major2			Minor1			Minor2		
Conflicting Flow All	338	0	0	117	0	0	577	655	81	577	612	260
Stage 1	-	-	-	-	-	-	291	291	-	285	285	-
Stage 2	-	-	-	-	-	-	286	364	-	292	327	-
Critical Hdwy	4.12	-	-	4.12	-	-	7.12	6.52	6.22	7.12	6.52	6.22
Critical Hdwy Stg 1	-	-	-	-	-	-	6.12	5.52	-	6.12	5.52	-
Critical Hdwy Stg 2	-	-	-	-	-	-	6.12	5.52	-	6.12	5.52	-
Follow-up Hdwy	2.218	-	-	2.218	-	-	3.518	4.018	3.318	3.518	4.018	3.318
Pot Cap-1 Maneuver	1221	-	-	1471	-	-	428	386	979	428	408	779
Stage 1	-	-	-	-	-	-	717	672	-	722	675	-
Stage 2	-	-	-	-	-	-	721	624	-	716	648	-
Platoon blocked, %	-	-	-	-	-	-	-	-	-	-	-	-
Mov Cap-1 Maneuver	1221	-	-	1471	-	-	347	350	979	380	370	779
Mov Cap-2 Maneuver	-	-	-	-	-	-	347	350	-	380	370	-
Stage 1	-	-	-	-	-	-	655	614	-	716	670	-
Stage 2	-	-	-	-	-	-	641	619	-	643	592	-

Approach	EB			WB			NB			SB		
HCM Control Delay, s/v	3.89			0.27			15			12.34		
HCM LOS							B			B		

Minor Lane/Major Mvmt	NBLn1	NBLn2	NBLn3	EBL	EBT	EBR	WBL	WBT	WBR	SBLn1	SBLn2	SBLn3
Capacity (veh/h)	347	350	979	1221	-	-	1471	-	-	380	370	779
HCM Lane V/C Ratio	0.137	0.004	0.016	0.086	-	-	0.009	-	-	0.128	0.003	0.102
HCM Control Delay (s/veh)	17	15.3	8.7	8.2	-	-	7.5	-	-	15.9	14.8	10.1
HCM Lane LOS	C	C	A	A	-	-	A	-	-	C	B	B
HCM 95th %tile Q(veh)	0.5	0	0	0.3	-	-	0	-	-	0.4	0	0.3

Lanes, Volumes, Timings
1: Elbert Road & Judge Orr Road

												
Lane Group	EBL	EBT	EBR	WBL	WBT	WBR	NBL	NBT	NBR	SBL	SBT	SBR
Lane Configurations												
Traffic Volume (vph)	33	288	47	18	178	9	42	6	16	33	7	23
Future Volume (vph)	33	288	47	18	178	9	42	6	16	33	7	23
Ideal Flow (vphp)	1900	1900	1900	1900	1900	1900	1900	1900	1900	1900	1900	1900
Storage Length (ft)	150		150	150		150	150		150	150		150
Storage Lanes	1		1	1		1	1		1	1		1
Taper Length (ft)	25			25			25			25		
Lane Util. Factor	1.00	1.00	1.00	1.00	1.00	1.00	1.00	1.00	1.00	1.00	1.00	1.00
Frt			0.850			0.850			0.850			0.850
Flt Protected	0.950			0.950			0.950			0.950		
Satd. Flow (prot)	1770	1863	1583	1770	1863	1583	1770	1863	1583	1770	1863	1583
Flt Permitted	0.950			0.950			0.950			0.950		
Satd. Flow (perm)	1770	1863	1583	1770	1863	1583	1770	1863	1583	1770	1863	1583
Link Speed (mph)		55			55			40			40	
Link Distance (ft)		624			2250			428			531	
Travel Time (s)		7.7			27.9			7.3			9.1	
Peak Hour Factor	0.78	0.89	0.78	0.78	0.86	0.78	0.78	0.78	0.78	0.78	0.78	0.78
Adj. Flow (vph)	42	324	60	23	207	12	54	8	21	42	9	29
Shared Lane Traffic (%)												
Lane Group Flow (vph)	42	324	60	23	207	12	54	8	21	42	9	29
Enter Blocked Intersection	No	No	No	No	No	No	No	No	No	No	No	No
Lane Alignment	Left	Left	Right	Left	Left	Right	Left	Left	Right	Left	Left	Right
Median Width(ft)		12			12			12			12	
Link Offset(ft)		0			0			0			0	
Crosswalk Width(ft)		16			16			16			16	
Two way Left Turn Lane												
Headway Factor	1.00	1.00	1.00	1.00	1.00	1.00	1.00	1.00	1.00	1.00	1.00	1.00
Turning Speed (mph)	15		9	15		9	15		9	15		9
Sign Control		Free			Free			Stop			Stop	

Intersection Summary

Area Type:	Other
Control Type:	Unsignalized
Intersection Capacity Utilization	37.5%
Analysis Period (min)	15
	ICU Level of Service A

























Intersection												
Int Delay, s/veh	3.6											
Movement	EBL	EBT	EBR	WBL	WBT	WBR	NBL	NBT	NBR	SBL	SBT	SBR
Lane Configurations	↘	↑	↗	↘	↑	↗	↘	↑	↗	↘	↑	↗
Traffic Vol, veh/h	33	288	47	18	178	9	42	6	16	33	7	23
Future Vol, veh/h	33	288	47	18	178	9	42	6	16	33	7	23
Conflicting Peds, #/hr	0	0	0	0	0	0	0	0	0	0	0	0
Sign Control	Free	Free	Free	Free	Free	Free	Stop	Stop	Stop	Stop	Stop	Stop
RT Channelized	-	-	None	-	-	None	-	-	None	-	-	None
Storage Length	150	-	150	150	-	150	150	-	150	150	-	150
Veh in Median Storage, #	-	0	-	-	0	-	-	0	-	-	0	-
Grade, %	-	0	-	-	0	-	-	0	-	-	0	-
Peak Hour Factor	78	89	78	78	86	78	78	78	78	78	78	78
Heavy Vehicles, %	2	2	2	2	2	2	2	2	2	2	2	2
Mvmt Flow	42	324	60	23	207	12	54	8	21	42	9	29

Major/Minor	Major1			Major2			Minor1			Minor2		
Conflicting Flow All	219	0	0	384	0	0	666	673	324	665	722	207
Stage 1	-	-	-	-	-	-	408	408	-	253	253	-
Stage 2	-	-	-	-	-	-	258	265	-	412	468	-
Critical Hdwy	4.12	-	-	4.12	-	-	7.12	6.52	6.22	7.12	6.52	6.22
Critical Hdwy Stg 1	-	-	-	-	-	-	6.12	5.52	-	6.12	5.52	-
Critical Hdwy Stg 2	-	-	-	-	-	-	6.12	5.52	-	6.12	5.52	-
Follow-up Hdwy	2.218	-	-	2.218	-	-	3.518	4.018	3.318	3.518	4.018	3.318
Pot Cap-1 Maneuver	1351	-	-	1175	-	-	373	377	717	373	353	833
Stage 1	-	-	-	-	-	-	620	597	-	751	698	-
Stage 2	-	-	-	-	-	-	747	690	-	617	561	-
Platoon blocked, %	-	-	-	-	-	-	-	-	-	-	-	-
Mov Cap-1 Maneuver	1351	-	-	1175	-	-	333	358	717	337	335	833
Mov Cap-2 Maneuver	-	-	-	-	-	-	333	358	-	337	335	-
Stage 1	-	-	-	-	-	-	601	578	-	736	684	-
Stage 2	-	-	-	-	-	-	697	676	-	573	543	-

Approach	EB			WB			NB			SB		
HCM Control Delay, s/v	0.77			0.78			15.71			14.25		
HCM LOS							C			B		

Minor Lane/Major Mvmt	NBLn1	NBLn2	NBLn3	EBL	EBT	EBR	WBL	WBT	WBR	SBLn1	SBLn2	SBLn3
Capacity (veh/h)	333	358	717	1351	-	-	1175	-	-	337	335	833
HCM Lane V/C Ratio	0.162	0.022	0.029	0.031	-	-	0.02	-	-	0.125	0.027	0.035
HCM Control Delay (s/veh)	17.9	15.3	10.2	7.8	-	-	8.1	-	-	17.2	16	9.5
HCM Lane LOS	C	C	B	A	-	-	A	-	-	C	C	A
HCM 95th %tile Q(veh)	0.6	0.1	0.1	0.1	-	-	0.1	-	-	0.4	0.1	0.1

Lanes, Volumes, Timings
2: Northeast Access & Judge Orr Road

												
Lane Group	EBL	EBT	EBR	WBL	WBT	WBR	NBL	NBT	NBR	SBL	SBT	SBR
Lane Configurations												
Traffic Volume (vph)	32	252	53	18	131	17	47	1	16	15	1	27
Future Volume (vph)	32	252	53	18	131	17	47	1	16	15	1	27
Ideal Flow (vphp)	1900	1900	1900	1900	1900	1900	1900	1900	1900	1900	1900	1900
Storage Length (ft)	150		150	150		150	150		150	150		150
Storage Lanes	1		1	1		1	1		1	1		1
Taper Length (ft)	25			25			25			25		
Lane Util. Factor	1.00	1.00	1.00	1.00	1.00	1.00	1.00	1.00	1.00	1.00	1.00	1.00
Frt			0.850			0.850			0.850			0.850
Flt Protected	0.950			0.950			0.950			0.950		
Satd. Flow (prot)	1770	1863	1583	1770	1863	1583	1770	1863	1583	1770	1863	1583
Flt Permitted	0.950			0.950			0.950			0.950		
Satd. Flow (perm)	1770	1863	1583	1770	1863	1583	1770	1863	1583	1770	1863	1583
Link Speed (mph)		55			55			30			30	
Link Distance (ft)		2250			375			584			445	
Travel Time (s)		27.9			4.6			13.3			10.1	
Peak Hour Factor	0.78	0.89	0.88	0.82	0.87	0.78	0.88	0.78	0.82	0.78	0.78	0.78
Adj. Flow (vph)	41	283	60	22	151	22	53	1	20	19	1	35
Shared Lane Traffic (%)												
Lane Group Flow (vph)	41	283	60	22	151	22	53	1	20	19	1	35
Enter Blocked Intersection	No	No	No	No	No	No	No	No	No	No	No	No
Lane Alignment	Left	Left	Right	Left	Left	Right	Left	Left	Right	Left	Left	Right
Median Width(ft)		12			12			12			12	
Link Offset(ft)		0			0			0			0	
Crosswalk Width(ft)		16			16			16			16	
Two way Left Turn Lane												
Headway Factor	1.00	1.00	1.00	1.00	1.00	1.00	1.00	1.00	1.00	1.00	1.00	1.00
Turning Speed (mph)	15		9	15		9	15		9	15		9
Sign Control		Free			Free			Stop			Stop	

Intersection Summary

Area Type:	Other
Control Type:	Unsignalized
Intersection Capacity Utilization	35.9%
ICU Level of Service	A
Analysis Period (min)	15

Intersection												
Int Delay, s/veh	3											
Movement	EBL	EBT	EBR	WBL	WBT	WBR	NBL	NBT	NBR	SBL	SBT	SBR
Lane Configurations	↘	↑	↗	↘	↑	↗	↘	↑	↗	↘	↑	↗
Traffic Vol, veh/h	32	252	53	18	131	17	47	1	16	15	1	27
Future Vol, veh/h	32	252	53	18	131	17	47	1	16	15	1	27
Conflicting Peds, #/hr	0	0	0	0	0	0	0	0	0	0	0	0
Sign Control	Free	Free	Free	Free	Free	Free	Stop	Stop	Stop	Stop	Stop	Stop
RT Channelized	-	-	None	-	-	None	-	-	None	-	-	None
Storage Length	150	-	150	150	-	150	150	-	150	150	-	150
Veh in Median Storage, #	-	0	-	-	0	-	-	0	-	-	0	-
Grade, %	-	0	-	-	0	-	-	0	-	-	0	-
Peak Hour Factor	78	89	88	82	87	78	88	78	82	78	78	78
Heavy Vehicles, %	2	2	2	2	2	2	2	2	2	2	2	2
Mvmt Flow	41	283	60	22	151	22	53	1	20	19	1	35

Major/Minor	Major1			Major2			Minor1			Minor2		
Conflicting Flow All	172	0	0	343	0	0	560	581	283	560	620	151
Stage 1	-	-	-	-	-	-	365	365	-	194	194	-
Stage 2	-	-	-	-	-	-	195	216	-	366	425	-
Critical Hdwy	4.12	-	-	4.12	-	-	7.12	6.52	6.22	7.12	6.52	6.22
Critical Hdwy Stg 1	-	-	-	-	-	-	6.12	5.52	-	6.12	5.52	-
Critical Hdwy Stg 2	-	-	-	-	-	-	6.12	5.52	-	6.12	5.52	-
Follow-up Hdwy	2.218	-	-	2.218	-	-	3.518	4.018	3.318	3.518	4.018	3.318
Pot Cap-1 Maneuver	1405	-	-	1216	-	-	439	425	756	439	404	896
Stage 1	-	-	-	-	-	-	654	623	-	807	740	-
Stage 2	-	-	-	-	-	-	807	724	-	653	586	-
Platoon blocked, %	-	-	-	-	-	-	-	-	-	-	-	-
Mov Cap-1 Maneuver	1405	-	-	1216	-	-	401	405	756	406	385	896
Mov Cap-2 Maneuver	-	-	-	-	-	-	401	405	-	406	385	-
Stage 1	-	-	-	-	-	-	635	605	-	793	726	-
Stage 2	-	-	-	-	-	-	760	711	-	617	569	-

Approach	EB			WB			NB			SB		
HCM Control Delay, s/v	0.82			0.91			13.9			11.09		
HCM LOS							B			B		

Minor Lane/Major Mvmt	NBLn1	NBLn2	NBLn3	EBL	EBT	EBR	WBL	WBT	WBR	SBLn1	SBLn2	SBLn3
Capacity (veh/h)	401	405	756	1405	-	-	1216	-	-	406	385	896
HCM Lane V/C Ratio	0.133	0.003	0.026	0.029	-	-	0.018	-	-	0.047	0.003	0.039
HCM Control Delay (s/veh)	15.4	13.9	9.9	7.6	-	-	8	-	-	14.3	14.4	9.2
HCM Lane LOS	C	B	A	A	-	-	A	-	-	B	B	A
HCM 95th %tile Q(veh)	0.5	0	0.1	0.1	-	-	0.1	-	-	0.1	0	0.1