



MVE, INC.
ENGINEERS SURVEYORS

1903 Icklaray street, suite 200
colorado springs, co 80909
719.635.5736

Final Drainage Report

**Eagle Rising
Filing No. 1**

Project No. 61145

May 21, 2024

PCD File No. SF2225

Final Drainage Report

For

Eagle Rising Filing No. 1

Project No. 61145

May 21, 2024

Prepared for

MyPad, Inc., and Casas Limited Partnership #4

5390 N. Academy Boulevard, Suite 300

Colorado Springs, CO 80918

Prepared by

M.V.E., Inc.

1903 Lelaray Street, Suite 200

Colorado Springs, CO 80909

(719) 635-5736

Statements and Acknowledgments

Engineer's Statement

The attached drainage plan and report were prepared under my direction and supervision and are correct to the best of my knowledge and belief. Said drainage report has been prepared according to the criteria established by the County for drainage reports and said report is in conformity with the applicable master plan of the drainage basin. I accept responsibility for any liability caused by any negligent acts, errors, or omissions on my part in preparing this report.



Charles C. Crum, P.E. Colorado No. 13348
For and on Behalf of M.V.E., Inc.

5/22/2024

Date

Owner's Statement

I, the owner, has read and will comply with all of the requirements specified in this drainage report and plan.

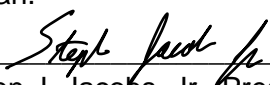

Stephen J. Jacobs, Jr., President
MyPad, Inc., General Partner of Casas Limited Partnership #4
5390 N. Academy Boulevard, Suite 300
Colorado Springs, CO 80918

5/21/2024

Date

Developer's Statement

I, the developer, has read and will comply with all of the requirements specified in this drainage report and plan.

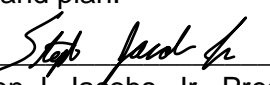

Stephen J. Jacobs, Jr., President
MyPad, Inc.
5390 N. Academy Boulevard, Suite 300
Colorado Springs, CO 80918

5/21/2024

Date

El Paso County

Filed in accordance with the requirements of the Drainage Criteria Manual, Volumes 1 and 2, El Paso County Engineering Criteria Manual and Land Development Code as amended.

Joshua Palmer, P.E.
County Engineer / ECM Administrator

Date

Conditions:

Contents

1. General Location and Description	2
1.1. Location	2
1.2. Description of Property	2
2. Drainage Basins and Sub-Basins.....	4
2.1. Major Basin Description	4
2.2. Other Drainage Reports	4
2.3. Sub-Basin Description	4
3. Drainage Design Criteria.....	5
3.1. Development Criteria Reference.....	5
3.2. Hydrologic Criteria	5
4. Drainage Facility Design	5
4.1. General Concept	5
4.2. Hydrologic Conditions	6
4.2.1. Existing Hydrologic Conditions	6
4.2.2. Developed Hydrologic Conditions.....	9
5. Erosion Control.....	14
6. Water Quality Enhancement Best Management Practices.....	14
7. Drainage Facilities	16
8. Drainage and Bridge Fees	18
9. Conclusion	18
References.....	19
Appendices.....	21
10. General Maps and Supporting Data.....	
11. Hydrologic Calculations.....	
12. Hydraulic Calculations.....	
13. Report Maps.....	

Final Drainage Report

The purpose of this Final Drainage Report is to identify drainage patterns and quantities within and affecting the proposed Eagle Rising Filing No. 1 subdivision. The development project is a residential subdivision with ten (10) 2.5± to 7.1± acre lots, and two (2) tracts. The report will identify specific solutions to problems on-site and off-site resulting from the proposed project. The report and included maps present results of hydrologic and drainage facilities analyses. The report will discuss the recommended drainage improvements to the site and identify drainage requirements relative to the proposed project. This report has been prepared and submitted in accordance with the requirements of the El Paso County development approval process. An Appendix is included with this report with pertinent calculations and graphs used in the drainage analyses and design.

1. General Location and Description

1.1. Location

The proposed Eagle Rising Filing No. 1 is located within the east one-half of Section 29, Township 12 South, Range 65 west of the 6th principal meridian in El Paso County, Colorado. The Eagle Rising Filing No.1 site is situated northeast of Black Forest Road and Briargate Parkway. The site contains two existing single-family residences, a large barn, and several ancillary buildings. The El Paso County Assessor's Schedule Number for the site is 5229000034. The proposed site has never been platted. A Vicinity Map is included in the Appendix.

The south edge of the site is adjacent to Highland Park Subdivision Filing No. 2 zoned RR-2.5 (Rural Residential (2.5 acres). Lots 8, 10 & 11 Eagle Wing Estates zoned RR-2.5 each containing a single-family residence are located adjacent to the west side of the site. Also adjacent to the west side of the site is an unplatted parcel containing a single-family residence zoned RR-5. Lots 135, 136, 137, 141 & 142, Highland Park Filing No. 3, Lots 135 & 136 are vacant, all lots are zoned RR-2.5 and adjacent to the east side of the site. Lot 1, Poco Subdivision, containing a single-family residence zoned RR-5, is also adjacent to the east side of the site. Also, adjacent to the east side of the site are lots 8 & 9 block 19 Park Forest Estates Filing No 2 zoned RR-5, containing a single-family residence. Lot 14 block 18, and lot 5 block 19, Park Forest Estates Filing No. 2, each containing a single-family residence and zoned RR-5, are adjacent to the north of the site. The site is located in El Paso County's Cottonwood Creek Drainage Basin.

1.2. Description of Property

Eagle Rising Filing No. 1 contains 35.282 acres and is zoned RR-2.5 (Residential Rural -2.5 Acres). The property is the location of two (2) single-family residences, a large barn,

several ancillary buildings with two existing gravel driveways. There are two in-line ponds along the main stem of Cottonwood Creek to the east of said Filing No. 1 which were believed to be constructed around the 1950's. The purpose for their construction is unknown due to lack of history but is speculated to be for livestock use. The ponds are not to be utilized to satisfy water quality requirements, which will be accomplished through other means. The existing ponds provide innate detention function and value but are not considered detention ponds. The proposed large lot single-family residential subdivision is shown to not require detention in this report.

The site is covered with native grass and weeds (i.e., diverse, mature wetland fauna, upland shrubs, and riparian overstory – see ERO Natural Resources Assessment) in good condition, and coniferous trees. The existing site topography slopes toward Cottonwood Creek with grades that range from 1% to 12%. Cottonwood Creek flows north to southeast of Eagle Rising Filing No. 1 subdivision with all storm runoff from said Eagle Rising Filing No. 1 subdivision flowing into Cottonwood Creek. The site is in the Cottonwood Creek Drainage Basin. The flows from Cottonwood Creek are tributary to Monument Creek.

According to the National Resource Conservation Service, there are two (2) soil types in the Eagle Rising site. Kettle gravelly loamy sand (map unit 40) makes up a portion of the soil in the northern end of the site. The soil is deep and somewhat excessively drained. Permeability is moderately rapid, surface runoff is slow, and the hazard of erosion is slight to moderate. Kettle gravelly loamy sand is classified as being part of Hydrologic Soil Group B.

The other soil type is Pring Coarse Sandy Loam (map unit 71) which makes up the rest of the site. The soil is deep and well drained. Permeability is moderately rapid, surface runoff is slow, and the hazard of erosion is slight to moderate. Pring Coarse Sandy Loam is classified as being part of Hydrologic Soil Group B.

A portion of the Soil Map and data tables from the National Cooperative Soil Survey and relevant Official Soil Series Descriptions (OSD) are included in the **Appendix**.^{1 2}

Cottonwood Creek, a major drainage way and flows north to south to the east of the Eagle Rising Filing No. 1 subdivision. The 100-year water surface elevation for the drainage-way was determined by hydraulic analysis utilizing HEC-RAS as prepared by M.V.E., Inc. which is included and accepted in this report. No build areas are shown on the Final Plat for Eagle Rising Filing No. 1. No build areas include the 100-year inundated area determined in the hydraulic analyses as well as Construction/Disturbance Limits from the Wetland Determination Mapping for the project. The two existing ponds, which are to remain, are present in the drainageway.

¹ WSS

² OSD

The current Flood Insurance Study of the region includes Flood Insurance Rate Maps (FIRM), effective on December 7, 2018.³ The proposed subdivision is included in the Community Panels Numbered 08041C0527 G and 08041C0535 G of the Flood Insurance Rate Maps for the El Paso County. No area in Eagle Rising Filing No. 1 is shown to be included in a 100-year flood hazard area as determined by FEMA. A portion of the current FEMA Flood Insurance Rate Maps with the site delineated is included in the **Appendix**.

2. Drainage Basins and Sub-Basins

2.1. Major Basin Description

Eagle Rising Filing No. 1 subdivision is in the Cottonwood Creek Drainage Basin (FOMO2200) of the Fountain Creek Major Drainage Basin. The Cottonwood Creek Drainage Basin Covers an area of approximately 19 square miles and drains to Monument Creek. The Cottonwood Creek Drainage Basin Planning Study Final Report⁴ (DBPS), July 2019, prepared by Matrix Design Group provides development recommendations and requirements for drainage development in the Cottonwood Creek Drainage Basin. The Cottonwood Creek Drainage Basin encompasses a part of the northeast portion of the City of Colorado Springs and extends to the north and east. The drainage basin and Cottonwood Creek drain southwest into Monument Creek. The Eagle Rising site is located north of Cottonwood Creek as it flows offsite towards Monument Creek. The site is in portions of sub-basins UC100, UC120, and UC130 upstream of Design Point UUC126 and downstream of Design Point JUC 82 of the DBPS. No improvements are recommended on or near the Eagle Rising Filing No. 1 subdivision.

2.2. Other Drainage Reports

The “Master Development Drainage Plan / Preliminary Drainage Report” for Eagle Rising prepared by MVE, Inc. dated March 7, 2024 was reviewed in preparation of this Final Drainage Plan for Eagle Rising Filing No. 1. Calculations in said “Master Development Drainage Plan/Preliminary Drainage Report” was found to be in compliance with the current Drainage Design and used for the preparation of this report.

2.3. Sub-Basin Description

The existing drainage patterns of the Eagle Rising development project are described by various sub-basins making up Existing Design Points and Developed Design Points. All existing sub-basin delineations and data are depicted on the attached **Eagle Rising Filing No. 1 Existing (On-Site) Drainage Map..**

³ FIRM

⁴ DBPS

3. Drainage Design Criteria

3.1. Development Criteria Reference

This Final Drainage Report for Eagle Rising has been prepared according to the report guidelines presented in the latest edition of El Paso County Drainage Criteria Manual (DCM)⁵. The County has also adopted portions of the City of Colorado Springs Drainage Criteria Manual Volumes 1 and 2, especially concerning the calculation of rainfall runoff flow rates.^{6 7} The hydrologic analysis is based on a collection of data from the DCM, the NRCS Web Soil Survey⁸, and existing topographic data by Land Resource Associates.

3.2. Hydrologic Criteria

This Final Drainage Report, the Rational Method as described in the Drainage Criteria Manual has been used for all Storm Runoff calculations, as the development and all sub-basins are less than 130 acres in area. “Colorado Springs Rainfall Intensity Duration Frequency” curves, Figure 6-5 in the DCM, were used to obtain the design rainfall values; a copy is included in the **Appendix**. The “Overland (Initial) Flow Equation” (Eq. 6-8) in the DCM, and Manning's equation with estimated depths were used in time of concentration calculations. “Runoff Coefficients for Rational Method”, Table 6-6 in the DCM, was utilized as a guide in estimating runoff coefficient and Percent Impervious values; a copy is included in the **Appendix**. Peak runoff discharges were calculated for each drainage sub-basin for both the 5-year storm event and the 100-year storm event with the Rational Method formula, (Eq. 6-5) in the DCM.⁹

4. Drainage Facility Design

4.1. General Concept

The intent of the drainage concept presented in Final Drainage Report is to allow for the development Eagle Rising Filing No. 1 which consists of ten (10) 2.5± to 7.1± acre lots, and two (2) tracts while maintaining the existing drainage patterns on the site. The site will follow the County's Stormwater Management regulations. Major and minor storm flows will continue to be safely conveyed through the site and downstream.

No additional drainage conveyance, stabilizing or protective facilities are required for the development of Eagle Rising Filing No. 1. The proposed land use of 2.5+ acre rural residential lots does not lead to the necessity of onsite drainage facilities, other than the existing culverts that convey the existing and proposed flows under the existing private roadway and driveways. Areas within the proposed 2.5+ acre lots are exempt from water

⁵ DCM Section 4.3 and Section 4.4

⁶ CS DCM Vol 1

⁷ CS DCM Vol 2

⁸ WSS

⁹ DCM

quality treatment requirements, but the existing and proposed roadways will have water quality PBMP/PCM's as discussed in the Step 3 section of the Four Step Process in this report.

The existing and proposed drainage hydrologic conditions are described in more detail below. Input data and results for all calculations are included in the **Appendix**. Drainage maps for the hydrologic analysis are also included in the **Appendix**.

4.2. Hydrologic Conditions

4.2.1. Existing Hydrologic Conditions

The Eagle Rising Filing No. 1 subdivision development is approximately 35.3+/- acres in size. The site primarily consists of grass land with slopes ranging from 4% to 12% and greater adjacent to Cottonwood Creek. The Cottonwood Creek main stem and several tributary branches are located to the east of the Eagle Rising Filing No. 1 subdivision eastern boundary. There are two existing single – family residences, a large barn, and several ancillary buildings present. Existing gravel roadway provides access. There is no evidence of severe erosion or degradation of the existing channel.

Wetland areas are defined in the Natural Resources Assessment Eagle Rising Subdivision¹⁰, prepared by ERO Resources Corporation, Denver, CO and dated June 23, 2022, denotes most of the on-site Cottonwood Creek natural drainageway as wetlands. Any future proposed construction of grade control structures within the wetlands would require approval by the Corps of Engineers a Section 404 permit. Note that damage to the natural wetlands compared to the benefit of any grade control structures would be more detrimental than beneficial to Cottonwood Creek.

A brief description of each existing drainage basin adjacent to and affecting the proposed Eagle Rising Filing No. 1 subdivision including runoff rates, and drainage patterns is provided for in this section of the report. A summary of existing runoff for the basins and designated design points are depicted on the EXISTING (ON-SITE) DRAINAGE MAP in the **Appendix**. The off-site drainage area impacting Eagle Rising Filing No. 1 subdivision and more particularly on-site drainage areas have been divided into existing drainage basins described as follows:

The included Eagle Rising Hydrology Maps (Existing On-Site) depict the existing topographic mapping, drainage basin delineations, drainage patterns, existing drives, drainage facilities, and runoff quantities with a data table including drainage areas and flow rates. The existing hydraulic calculations for this 'Eagle Rising Filing No. 1 - Final Drainage Report' are included in the **Appendix**.

¹⁰ NRA

COTTONWOOD CREEK 2019 CHANNEL DESIGN POINTS

The Master Development Drainage Plan/Preliminary Report for Eagle Rising established the 100-year water surface elevations in the Cottonwood Creek Channel. These 100-year water surface elevations were used to establish the 'No Build Areas' at a minimum of 2' above said 100-year water surface elevations on the Eagle Rising Filing No. 1 Subdivision Plat. Analysis of the creek and supporting calculations can be found in the Master Development Drainage Plan/Preliminary Report for Eagle Rising.

OFF-SITE DESIGN POINTS

Design Point 4 (DP 4) storm water flows (Q5=9.2 cfs, Q100=52.2 cfs) are generated from off-site basin OS-B1A consisting of 24.9 acres. This sub-basin has been created to determine the storm water flow at the northern and western site boundary line. This basin consists of 2.5 Acre Rural Residential, Woods (Fair Condition), Natural Open Space (Fair Condition), and Civic uses.

Design Point 5 (DP 5) storm water flows (Q5=11.9 cfs, Q100=76.7 cfs) are generated from off-site basin OS-B1B consisting of 41.0 acres. This sub-basin has been created to determine the storm water flow at the western site boundary line. to the basin line. This basin consists of 2.5 Acre Rural Residential, Woods (Fair Condition), and Natural Open Space (Fair Condition).

Design Point E7 (DP E7) storm water flows (Q5=0.6 cfs, Q100=4.0 cfs) are generated from off-site basin OS-B1C consisting of 1.8 acres. Off-site basin OS-B1C consists of Natural Open Space (Fair Condition).

Design Point E8 (DP E8) storm water flows (Q5=1.6 cfs, Q100=11.8 cfs) are generated from off-site basin OS-B1D consisting of 6.0 acres. Off-site basin OS-B1C consists of Natural Open Space (Fair Condition).

Design Point E10 (DP E10) storm water flows (Q5=3.1 cfs, Q100=20.5 cfs) are generated from off-site basin OS-B1E consisting of 10.1 acres. Off-site basin OS-B1C consists of 2.5 Acre Rural Residential, and Natural Open Space (Fair Condition).

Design Point E11 (DP E11) storm water flows (Q5=3.8 cfs, Q100=21.3 cfs) are generated from off-site basin OS-B3A consisting of 9.1 acres. Off-site basin OS-B3A consists of 2.5 Acre Rural Residential, and Natural Open Space (Fair Condition).

Design Point E13 (DP E13) storm water flows (Q5=1.1 cfs, Q100=6.2 cfs) are generated from off-site basin OS-B3B consisting of 2.5 acres. Off-site basin OS-B3B consists of 2.5 Acre Rural Residential, and Natural Open Space (Fair Condition). Storm water flows exit said basin via a 15” CS pipe.

Design Point E15 (DP E15) storm water flows (Q5=2.5cfs, Q100=13.9cfs) are generated from off-site basin OS-B3C consisting of 5.95 acres. Off-site basin OS-B3C has been created to determine the flow at the western site boundary and does not mix with on-site flow. This basin consists of 2.5 Acre Rural Residential, and Natural Open Space (Fair Condition) adjacent to the western boundary of the Eagle Wing proposed preliminary plan.

ON-SITE DESIGN POINTS

Design Point 6 (DP 6) storm water flows (Q5=22.0 cfs, Q100=134.1 cfs) are generated from off-site **DP 4** and **DP 5**, and on-site basins EX-B and EX-C consisting totally of 71.87 acres. The summation of these flows at **DP 6** are combined in an existing small local depression area. The depression appears to be man-made, possibly for livestock watering. The current condition of the depression appears to hold some water at certain times of year but not continually. The downstream end of the depression area is a small bank to trap the water in the existing natural swale. The depression area is proposed to be left intact and not disturbed.

Design Point 6A (DP 6A) storm water flows (Q5=3.6 cfs, Q100=12.6 cfs) are generated from off-site **DP E7** and on-site basin EX-E1 consisting totally of 5.25 acres. The summation of these flows at **DP 6A** will combine with **DP 6B** and enter Cottonwood Creek.

Design Point 6B (DP 6B) storm water flows (Q5=23.5 cfs, Q100=141.5 cfs) are generated from on-site **DP 6** and on-site basin EX-D consisting totally of 78.97 acres. The summation of these flows at **DP 6B** will combine with **DP 6A** and enter Cottonwood Creek.

Design Point 6C (DP 6C) storm water flows (Q5=26.6 cfs, Q100=152.3 cfs) are generated from on-site **DP 6A** and **DP 6B** consisting totally of 84.22 acres. The summation of these flows at **DP 6C** enter Cottonwood Creek. Also, on-site Basins EX-A1 storm water flows (Q5=1.5 cfs, Q100=10.7 cfs) consisting of 4.95 acres and EX-A2 storm water flows of (Q5=0.5 cfs, Q100=3.9 cfs) consisting of 1.74 acres enter Cottonwood Creek. These storm water flows are included in the Cottonwood Creek channel storm water flows.

Design Point 7 (DP 7) storm water flows (Q5=9.7 cfs, Q100=30.2 cfs) are generated from off-site **DP E8** and on-site basin EX-F1 consisting totally of 12.48 acres. On-site basin EX-F1 consists of a single-family residence, a portion of a barn, a portion of a gravel road, and Natural Open Space (Fair Condition).

Design Point 8 (DP 8) storm water flows (Q5=4.7 cfs, Q100=18.6 cfs) are generated from on-site basin EX-E2 consisting of 7.77 acres. On-site basin EX-E2 consists of a portion of a storage barn, a garage, and a small hot house, and Natural Open Space (Fair Condition). These storm water flows enter Cottonwood Creek and are included in the Cottonwood Creek channel storm water flows.

Design Point 8A (DP 8A) storm water flows (Q5=9.2 cfs, Q100=50.8 cfs) are generated from off-site **DP E10** and **DP E11** and on-site basins EX-H and EX-I consist totally of 24.92 acres. On-site basin EX-F1 consists of a portion of a gravel road, and Natural Open Space (Fair Condition). Storm water flows exit basin at the existing 2 - 24" R.C. Pipes under said gravel road.

Design Point 9 (DP 9) storm water flows (Q5=9.7 cfs, Q100=32.0 cfs) are generated from off-site **DP E8** and **DP E11** and on-site basins EX-F2 consisting totally of 14.50 acres. On-site basin EX-F2 consists of a portion of a gravel road, and Natural Open Space (Fair Condition). Storm water flows exit basin and enter Cottonwood Creek and are included in the Cottonwood Creek channel storm water flows.

Design Point 10 (DP 10) storm water flows (Q5=1.0 cfs, Q100=6.5 cfs) are generated from on-site basin EX-G consisting of 2.98 acres. On-site basin EX-G consists of Natural Open Space (Fair Condition).

Design Point 11 (DP 11) storm water flows (Q5=2.3cfs, Q100=13.5 cfs) are generated from off-site **DP E13** and on-site basin EX-M consisting totally of 6.60 acres. On-site basin EX-M consists of Natural Open Space (Fair Condition). These storm water flows enter Cottonwood Creek and are included in the Cottonwood Creek channel storm water flows.

Design Point 12 (DP 12) storm water flows (Q5=9.8 cfs, Q100=53.6 cfs) are generated from off-site **DP E10, DP E11, DP 8A**, and on-site basins EX-J consisting totally of 27.34 acres. On-site basin EX-J consists of Natural Open Space (Fair Condition). These storm water flows enter Cottonwood Creek and are included in the Cottonwood Creek channel storm water flows.

Design Point 13 (DP 13) storm water flows (Q5=2.9 cfs, Q100=17.4 cfs) are generated from off-site E 15 on-site basin EX-L consisting totally of 8.09 acres. On-site basin EX-L consists of Natural Open Space (Fair Condition) and storm water flows exit the site along the southern boundary line.

4.2.2. Developed Hydrologic Conditions

No additional drainage conveyance, stabilizing or protective facilities are required for the development of Eagle Rising Filing No. 1. The private road improvements are existing but are considered in the hydrologic analysis in this report. Existing drainage facilities on-site have been analyzed and are discussed below and calculations included in the

Appendix. A new hydraulic analysis of Cottonwood Creek was performed for the reach within the new Preliminary Plan for Eagle Rising. These hydraulic calculations were performed with the new & current El Paso Drainage Criteria and provided in the Master Development Drainage Plan/Preliminary Drainage Report. The proposed use of the land being 2.5± to 7.1± acre lots does not lead to the necessity of onsite drainage facilities, other than existing culverts to convey the existing and proposed flows under the existing roadway and driveways. The existing channel is currently witnessing close to the ultimate flows from the existing upstream developed property. The channel will be left in a natural condition for its aesthetic value, better water quality conditions, for both engineering and economic considerations. The 100-year storm water flow level has been established by said Master Development Drainage Plan/Preliminary Drainage Report and has been used to provide the no build easements above said 100-year levels for the Lots that are impacted in this Eagle Rising Filing No. 1 subdivision.

The impact to the proposed Lots was found to be only the increase in water surface elevation up to the said 100-year storm water flow level. The No-Build easements are placed at a minimum of 2' above said 100-year studied elevation. No geologic hazards or soil hazards were found to impact these areas.

A brief description of each developed drainage basin including developed runoff rates, drainage patterns and any drainage facilities for each basin is provided in this section of the report. A summary of peak developed runoff for the basins and designated design points are depicted on the Proposed Hydrologic Map (on-site) in the **Appendix**. The site has been divided into twenty-two developed drainage basins described as follows:

Design Point 6 (DP 6) storm water flows (Q5=22.5 cfs, Q100=134.7 cfs) are generated from off-site **DP 4** and **DP 5**, and on-site developed basins B and C consisting totally of 71.87 acres. The summation of these flows at **DP 6** are combined in an existing small local depression area. The depression appears to be man-made, possibly for livestock watering. The current condition of the depression appears to hold some water at certain times of year but not continually. The downstream end of the depression area is a small bank to trap the water in the existing natural swale. No documentation exists for this historic condition and no action is necessary. The depression area is proposed to be left intact, non-disturbed, and is within a drainage easement. Developed storm water flow increases from existing hydraulic conditions at this **DP 6** by 0.5 cfs for Q5 and by 0.6 cfs for Q100. These are negligible increases for the developed condition and are very close to the existing conditions. Regarding surface water rights, this existing depression is allowed and included in the March 15, 2013 Findings Of Fact, Conclusions of Law, Ruling of the Referee, Judgment and Decree which is included in the approved MDDP / Preliminary Drainage Report where it is referred to as Eagle Rising Pond No. 3 aka Stock Pond.

A drainage easement is proposed for the existing swale between **DP 4** and through basin B with storm water flows of Q5=11.6 cfs, Q100=63.3 cfs. The slope of the existing swale is approximately 2.7% for the Reach. The velocities are 1.8 fps and 3.4 fps, depths of 0.2'

and 0.5' during the 5yr and 100yr storms respectively for the Reach. The velocity values are within the permissible velocities denoted in the Soil, Geology, Geologic Hazard Study for Eagle Rising Filing No. 1 prepared by Entech Engineering, Inc. and dated June 29, 2022 (Revised December 13, 2022) for this project the velocity values are between 4 to 7 fps with 7 fps being used for established vegetation. The Reach is therefore considered non-erosive in nature. Therefore, no improvements are proposed for this Reach.

A drainage easement is proposed for the existing swale between **DP 5** and through basin C with storm water flows of $Q_5=12.6$ cfs, $Q_{100}=80.7$ cfs. The slope of the existing swale is approximately 1.6% for the Reach. The velocities are 2.1 fps and 3.5 fps, depths of 0.4' and 1.0' during the 5yr and 100yr storms respectively for the Reach. This velocity values are within the permissible velocities denoted in the Soil, Geology, Geologic Hazard Study for Eagle Rising Filing No. 1 prepared by Entech Engineering, Inc. and dated June 29, 2022 (Revised December 13, 2022) for this project the velocity values are between 4 to 7 fps with 7 fps being used for established vegetation. The Reach is therefore considered non-erosive in nature. Therefore, no improvements are proposed for this Reach.

Design Point 6A (DP 6A) storm water flows ($Q_5=3.6$ cfs, $Q_{100}=12.6$ cfs) are generated from off-site **DP E7** and on-site basin E1 consisting totally of 5.25 acres. Developed storm water flow at this **DP 6A** remains the same as the existing. The summation of these flows at **DP 6A** will combine with **DP 6B** and enter Cottonwood Creek. The combined minimal increase of flows and minimal velocities do not create a need for improvements to the existing drainage swale.

Design Point 6B (DP 6B) storm water flows ($Q_5=24.4$ cfs, $Q_{100}=142.6$ cfs) are generated from on-site **DP 6** and on-site basin D consisting totally of 78.97 acres. Developed storm water flow therefore increases at this **DP 6B** by 0.9 cfs for Q_5 and by 1.1 cfs for Q_{100} . These are negligible increases for the developed condition and are very close to the existing conditions. The summation of these flows at **DP 6B** will combine with **DP 6A** and enter Cottonwood Creek.

Design Point 6C (DP 6C) storm water flows ($Q_5=27.5$ cfs, $Q_{100}=153.4$ cfs) are generated from on-site **DP 6A** and **DP 6B** consisting totally of 84.22 acres. Developed storm water flow therefore increases at this **DP 6C** by 0.9 cfs for Q_5 and by 1.1 cfs for Q_{100} . These are negligible increases for the developed condition and are very close to the existing conditions. No detention of storm waters is required for this insignificant increase in the Developed Peak Runoff Rates. The summation of these flows at **DP 6A and DP 6B** will combine and enter Cottonwood Creek. At the downstream end of the drainage-way, flows reach Cottonwood Creek. Since the drainage-way outfall is immediately adjacent to the creek, short in nature, well vegetated, no required improvements are recommended these Reaches.

Also, on-site Basins EX-A1 storm water flows ($Q_5=1.5$ cfs, $Q_{100}=10.7$ cfs) consisting of 4.95 acres and EX-A2 storm water flows of ($Q_5=0.5$ cfs, $Q_{100}=3.9$ cfs) consisting of 1.74 acres enter Cottonwood Creek. There is no increase or decrease to these storm water

flows as there is no change in the existing condition. These storm water flows were included in the Cottonwood Creek channel **Design Points**.

Design Point 7 (DP 7) storm water flows (Q5=10.1 cfs, Q100=30.6 cfs) are generated from off-site **DP E8** and on-site basin F1 consisting totally of 12.48 acres. The purpose of **DP 7** is to understand the proposed flows at the two flag lot drive crossings and to size the driveway culvert to provide access Lots 3,4,5, & 6 and Lots 6, 7, 8 & 9. At this time the exact location of the driveway culverts is unknown. However, a 30" RCP or equivalent should be installed under each driveway to adequately convey the flows. When the lots are developed, a portion (128,000+/- SF) of the existing gravel area will be re-vegetated increasing the pervious area. Developed storm water flow decreases at this **DP 7** by 0.4 cfs for Q5 and by 0.4 cfs for Q100. These are decreases for the developed condition and are less than the existing conditions.

Design Point 8 (DP 8) storm water flows (Q5=5.3cfs, Q100=19.2 cfs) are generated from on-site basin E2 consisting totally of 7.77 acres. These storm water flows for the developed condition increases at this **DP 8** by 0.6 cfs for Q5 and by 0.6 cfs for Q100. These are increases for the developed condition and are close to the existing conditions. The storm water flows leave basin E2 generally uniformly along basin line which joins Cottonwood Creek. A small, localized point of concentrated flow enters Cottonwood Creek that is currently lined with type VL riprap. The existing riprap rundown is stable and shows no signs of erosion. Calculations for this riprap and rundown are included in the **Appendix**. No detention of storm waters is required for this insignificant increase in the Developed Peak Runoff Rates which are close to the existing conditions. No detention of storm waters is required for this insignificant increase in the Developed Peak Runoff Rates.

Design Point 9 (DP 9) storm water flows (Q5=10.4 cfs, Q100=32.9 cfs) are generated from off-site **DP E7** and on-site **DP 7 & 8** and on-site basin F2 consisting totally of 14.50 acres. Developed storm water flow increases at this **DP 9** by 0.7 cfs for Q5 and by 0.9 cfs for Q100. These are increases for the developed condition and are close to the existing conditions. No detention of storm waters is required for this insignificant increase in the Developed Peak Runoff Rates. The summation of these flows at **DP 9** will enter Cottonwood Creek. A drainage easement is proposed for the existing swale which will convey the flows into the Cottonwood Creek Channel. The slope of the existing swale is approximately 3.8% for Reach 1 and 5.7% for Reach 2. At the steepest and most defined point along Reach 2 the velocities are 2.8 fps and 4.0 fps, depths of 0.5' and 0.8' during the 5yr and 100yr storms respectively. These velocity values are within the permissible velocities denoted in the Soil, Geology, Geologic Hazard Study for Eagle Rising Filing No. 1 prepared by Entech Engineering, Inc. and dated June 29, 2022 (Revised December 13, 2022). For this project the velocity values are between 4 to 7 fps with 7 fps being used for established vegetation. Reach 1 & 2 are therefore considered non-erosive in nature. Therefore, no improvements are proposed. At the downstream end of the drainage-way, flows reach Cottonwood Creek at an existing type VL riprap rundown. The existing riprap rundown is stable and shows no signs of erosion. Calculations for this riprap and rundown

are included in the **Appendix**. Since the drainage-way outfall is immediately adjacent to the creek, short in nature, well vegetated and riprap lined, no required additional improvements are recommended these Reaches.

Design Point 8A (DP 8A) storm water flows (Q5=10.0 cfs, Q100=51.8 cfs) are generated from off-site **DP E10** and **DP E11** and on-site basins H and I consisting totally of 24.92 acres. Storm water flows exit basin at the existing 2 - 24" R.C. Pipes under the existing gravel road with existing rip rap outfall aprons. Developed storm water flow increases at this **DP 8A** by 0.8 cfs for Q5 and by 1.0 cfs for Q100. These are negligible increases for the developed condition and are very close to the existing conditions. The ponding area upstream was determined by the headwater of the culverts and a drainage easement is proposed along an elevation 2' higher than said ponding elevation. No additional storm drainage improvements are required at **DP 8A**.

Design Point 10 (DP 10) storm water flows (Q5=1.5 cfs, Q100=7.2 cfs) are generated from on-site basin G consisting totally of 2.98 acres. Developed storm water flow therefore decreases at **DP 10** by 1.2 cfs for Q5 and by 1.5 cfs for Q100. These are negligible decreases for the developed condition and are close to the existing conditions. No detention of storm waters is required for this insignificant increase in the Developed Peak Runoff Rates. The summation of these flows at **DP 10** will enter Cottonwood Creek.

Design Point 12 (DP 12) storm water flows (Q5=11.0 cfs, Q100=55.1 cfs) are generated from on-site **DP 8A** and on-site basin J consisting totally of 27.34 acres. Developed storm water flow increases at this **DP 12** by 1.2 cfs for Q5 and by 1.5 cfs for Q100. These are negligible decreases for the developed condition and are close to the existing conditions. No detention of storm waters is required for this insignificant increase in the Developed Peak Runoff Rates. The summation of these flows at **DP 12** will enter Cottonwood Creek. A drainage easement is proposed for the existing swale between **DP 8A** and **DP 12** with storm water flows of Q5=11.0 cfs, Q100=55.1 cfs. The slope of the existing swale is approximately 4.8% for the Reach. The velocities are 3.6 fps and 5.5 fps, depths of 0.6' and 1.1' during the 5yr and 100yr storms respectively for the Reach. These velocity values are within the permissible velocities denoted in the Soil, Geology, Geologic Hazard Study for Eagle Rising Filing No. 1 prepared by Entech Engineering, Inc. and dated June 29, 2022 (Revised December 13, 2022). For this project the values are between 4 to 7 fps with 7 fps being used for established vegetation. The Reach is therefore considered non-erosive in nature. Therefore, no improvements are required for this Reach. At the downstream end of the drainage-way, flows reach Cottonwood Creek. Since the drainage-way outfall is immediately adjacent to the creek, short in nature, well vegetated, no proposed improvements are recommended to these Reaches.

Design Point 11 (DP 11) storm water flows (Q5=2.7 cfs, Q100=14.1 cfs) are generated from off-site **DP E13** and on-site basin M consisting totally of 6.60 acres. Developed storm water flow therefore increases at this **DP 11** by 0.4 cfs for Q5 and by 0.6 cfs for Q100. These are negligible increases for the developed condition and are close to the existing conditions. No detention of storm waters is required for this insignificant increase in the

Developed Peak Runoff Rates. The summation of these flows at **DP 13** flow overland across the Eagle Rising southern boundary and eventually will enter Cottonwood Creek.

Design Point 13 (DP 13) storm water flows (Q5=3.4 cfs, Q100=18.0 cfs) are generated from off-site **DP E15** and on-site basin L consisting totally of 8.09 acres. Developed storm water flow therefore increases at this **DP 13** by 0.5 cfs for Q5 and by 0.6 cfs for Q100. These are negligible increases for the developed condition and are close to the existing conditions. No detention of storm waters is required for this insignificant increase in the Developed Peak Runoff Rates. The summation of these flows at **DP 13** flow overland across the Eagle Rising southern boundary and eventually will enter Cottonwood Creek.

5. Erosion Control

The only public infrastructure construction to be associated with this subdivision is the Eagle Wing Drive turnaround and will require construction control measures (CCM's). Private infrastructure consisting of a short extension of the right-of-way transitioning to the existing gravel drive to remain. The CCM's for the Eagle Wing Drive turn around are shown on the Grading & Erosion Control Plan for Eagle Rising Filing No.1. The total disturbed for the construction of the Eagle Wing Drive turnaround will be 0.82 acres. Any required construction control measures (CCM's) for the individual lot home construction will be handled on the BESQCP for each lot at time of building permit.

It shall be the responsibility of the home builder and subsequently the homeowner to ensure flows from stormwater are appropriately routed around said structures to prevent flooding and damage to property. This can be accomplished using broad swales as opposed to ditches which tend to concentrate flows and are therefore more susceptible to erosion. Swales shall be protected from erosion until such time that vegetation is established. A civil engineer can aid in determination of swale placement and erosion control measures to be used.

6. Water Quality Enhancement Best Management Practices

The El Paso County Engineering Criteria Manual (Appendix I, Section I.7.2) and Drainage Criteria Manual (Section 4.1) requires the consideration of a "Four Step Process for receiving water protection that focuses on employing Runoff Reduction practices, stabilizing drainage ways, treating the water quality capture volume (WQCV), and considering the need for industrial and commercial CM's. The proposed limits of disturbance is only 0.82 ± acres and is not subject to water quality or detention mitigation as the overall disturbance of this project is less than 1 acre.

The Four Step Process is incorporated in this project and the elements are discussed below.

1. Runoff Reduction Practices are employed in this project. Impervious surfaces have been reduced as much as practically possible. There is only minimal

concrete or other hard surfaces proposed. Minimized Directly Connected Impervious Areas (MDCIA) is employed on the project because runoff passes through a private roadside ditch and an open space meadow area before leaving the site.

2. All minor drainage paths on the site have been previously stabilized with riprap protection. Calculations are included in this report showing riprap design sizing is adequate as installed. The Cottonwood Creek drainageway is located primarily offsite of the Eagle Rising Filing No. 1 subdivision on a property having different ownership than the currently proposed subdivision. Portions of the 100 year water surface cross several lots in this Filing. Drainage easements encompass these areas. Stabilization measures within Cottonwood Creek that are required as referenced in the MDDP / Preliminary Drainage Report will be undertaken with the future plat filings associated with the approved Preliminary Plan.
3. The runoff generated from the impervious areas of the private gravel road contained in Tract A will be treated for water quality by utilizing the Runoff Reduction standard in accordance with Section I.7.1.C.3 of the El Paso County Engineering Criteria Manual. Stormwater from the existing roadway runs off onto the vegetated side slopes and roadside ditches and then infiltrates into the ground, evaporates, or evapotranspires a quantity of water equal to at least 60% of what the calculated WQCV would be if all impervious area for the applicable development site discharged without infiltration. The WQCV Reduction was calculated using MHFD's UD-BMP (Version 3.07) with a Depth of Average Runoff Producing Storm of 0.42 inches. That value was chosen based this projects location on Figure 3-1 of the City of Colorado Springs Drainage Criteria Manual, Volume 2, Chapter 3. Figure 3-1, Runoff Reduction calculations, and the Basin Area ID Map are included in the appendix. The Grading and Erosion Control Plan identify those areas requiring uniform turf grass vegetation at a minimum of 80% ground cover. The areas to be vegetated shall be properly prepared in accordance with Detail EC-2, Urban Drainage and Flood Control District Urban Storm Drainage Criteria Manual Volume 3 included in the Storm Water Management Plan (SWMP). Irrigation is required (temporary or permanent) to ensure the establishment of sufficient vegetation and not weeds.

While water quality treatment of the residential Lots 1 – 10 are exempt from the use of WQCV CMs by ECM I.7.1.B.5 by virtue of the large-lot rural residential designation having areas 2.5 acres or larger and having percent imperviousness values of less than 10%. The percent imperviousness value cited for the Drainage Fee calculation in this report includes the roadway surface in Tract A in addition to the individual lot percent imperviousness and is also in accordance with the value cited in Drainage Criteria Manual Appendix L.3.7.3a, Table 3.1.

4. This project contains no industrial or commercial uses that would pose a potential hazard to water quality. The rural residential development is not anticipated to contain storage of potentially harmful substances or use of potentially harmful substances. No site specific industrial or commercial CM's for source controls are required.

7. Drainage Facilities

Drainage facilities for Eagle Rising Filing No. 1 include the installation of two Horizontal Elliptical RC Pipe culverts (HE-RCP) at the Lot 7 flag stem access. These culverts will be placed by the future lot owner at the time of residential building permit and driveway construction. Culvert sizing and outlet protection calculations are included in the Appendix of this report.

Cottonwood Creek is located primarily to the east of Eagle Rising Filing No. 1 in a parcel offsite to the proposed subdivision. Access to the Cottonwood Creek streambed and banks along with the ponds and pond embankments through the subdivision is provided along the lot line drainage and utility easements which are included on the Final Plat. An exhibit indicating the routes available is included in the **Appendix** of this report.

The Cottonwood Creek channel, offsite of Eagle Rising Filing No. 1, but located within the area designated as the Preliminary Plan for Eagle Rising contains two constructed ponds with stabilized embankments that have created wetland conditions within the creek that provides natural aesthetic qualities, wildlife habitat, erosion control, and pollutant removal. The two ponds constitute stabilizing features and provide the added benefits of supporting wetland vegetation and controlling flow rates in the creek under most conditions. The existing pond spillway at DP 104 will require riprap installation in a future plat filing as noted on the Drainage Plan to protect the spillway during storm water overflows from the pond to the downstream creek drainageway. The Spillway at DP 126 has existing riprap in place and no further installation is required. The ponds have withstood repeated significantly sized rainfall events throughout decades of existence.

Analysis of the Cottonwood Creek channel and detailed discussion of the existing vegetation are included in the Master Development Drainage Plan / Preliminary Drainage Report.

A deviation was approved for the existing channel vegetation and is included in the Appendix.

7.1.1. Maintenance and Maintenance Access for Cottonwood Creek

Natural, well-established creeks typically do not require maintenance. The creek bed and banks within the subdivision are well-established with dense vegetation as detailed above. However, access for any needed maintenance within Cottonwood Creek is provided within the Public Utility, Drainage and Maintenance Access Easements which are located along each side front, side and rear lot line. Said Easements will be 10' wide on all side lot lines, 15' wide on all front lines and 10' wide on all rear lot lines. A Creek Access Exhibit is included in the appendix of this report to illustrate potential access routes within the easements where terrain is amenable for this use. Maintenance of the access easements is vested with the individual property owner. The property owners will preserve and manage the creek bed and vegetation as required by the OA

individually and in accordance with a channel sustainability and management agreement and/or basin drainage maintenance agreement to be negotiated with El Paso County.

It is questionable that ECM Section 3.3.3.K which requires construction of 15' wide access roads, was intended to be applicable to natural drainages in a rural residential setting. Even so, Section 3.3.3.K.2 provides that 15' wide access roads on both sides of the channel can be omitted: *“Exclusion of Access Road. When the lack of an access road is not considered detrimental to the maintenance and integrity of the channel, the access road can be omitted under the following conditions:*

- *Where suitable exit-entry ramps are provided to intermediate channels with a minimum bottom width of 8 feet at roadway crossings and at other approved, needed locations to facilitate travel or maintenance of emergency vehicles in the channel bottom. At a minimum, one access ramp must be provided at each end of a channel.”*

- *Where vehicular access to the channel on a maximum spacing of 1,000 feet and at other approved, needed locations is provided to small channels with a bottom width of less than 8 feet.”*

In the case of Eagle Rising the lack of constructed access roads is not detrimental to maintenance or integrity of the channel since access will be provided through easements along lot lines. Access to the creek bed is practically attainable at several locations throughout the reach utilizing the easements and not constructed roadways.

8. Drainage and Bridge Fees

The site is located within the Cottonwood Creek Drainage Basin of Fountain Creek, El Paso Basin Number FOMO2200, which was last studied in 1994. 2022 fees associated with this basin are Drainage Fees of \$21,134 per impervious acre and Bridge Fees of \$1,156 per impervious acre. The percent Imperviousness of the entire 2.5-acre Rural Residential subdivision, for purposes of drainage fee calculation including the roadway and residential lots, is 11% in accordance with El Paso County Engineering Criteria Manual Appendix L Table 3-1. Also, reduction in the per acre Drainage Fee are allowed pursuant to El Paso County Resolution 99-383 in the amount of 25% for lots 2.5 acres or larger will be utilized for this project. The Eagle Rising Filing No. 1 subdivision contains 35.282 acres. Drainage and Bridge Fees for the site are calculated below. Fees will be paid at the time of Final Plat recording.

FEE CALCULATION (Cottonwood Creek 2022 Drainage and Bridge Fees)

Drainage Fee =	35.282 Ac. x \$21,134/Imp. Ac. x 0.11 Imp.	=	\$82,021.48
Less 25% Drainage Fee Reduction per Resolution 99-383		=	(20,505.37)
Bridge Fee =	35.282 Ac. x \$1,156/Imp. Ac. x 0.11 Imp.	=	<u>4,486.46</u>
	Grand Total Drainage and Bridge Fees	=	<u>\$66,002.57</u>

In addition to the Drainage Fees stated above, the owner has constructed improvements to the two Cottonwood Creek ponds that serve to mitigate flow rates downstream of the ponds and provide stabilization within the reach. The owner reserves the opportunity to seek reimbursement or drainage credits for these improvements from the City/County Drainage Board in accordance with the procedures outlined in DCM Section 3.3 pursuant to an updated or amended DBPS.

9. Conclusion

This Final Drainage Report presents existing and proposed drainage conditions for the proposed Eagle Rising Filing No. 1 project. The development contains 35.3 acres with ten (10) 2.5-acre to 7.1-acre single family residential lots, and associated roadway which will have negligible and inconsequential effects on the existing site drainage and drainage conditions downstream. The proposed project will not, with respect to stormwater runoff, negatively impact the adjacent properties and downstream properties. Applicable agency permitting requirements will be observed and adhered to in the development of the subdivision.

References

NRCS Web Soil Survey. United States Department of Agriculture, Natural Resources Conservation Service ("<http://websoilsurvey.nrcs.usda.gov/app/WebSoilSurvey.aspx>", accessed March, 2018).

NRCS Official Soil Series Descriptions. United States Department of Agriculture, Natural Resources Conservation Service ("<http://soils.usda.gov/technical/classification/osd/index.html>", accessed March, 2018).

Flood Insurance Rate Map. Federal Emergency Management Agency, National Flood Insurance Program (Washington D.C.: FEMA, December 7, 2018).

Cottonwood Creek Drainage Basin Planning Study, City of Colorado Springs and El Paso County. URS Consultants (Colorado Springs, Colorado: . June, 1994)

Cottonwood Creek Drainage Basin Planning Study. Matrix Design Group (Colorado Springs: El Paso County, July, 2019). (Not Adopted by El Paso County)

Eagle Rising Master Development Drainage Plan / Preliminary Drainage Report, MVE, Inc. (Colorado Springs, Colorado: , March, 2024).

NCSS Web Soil Survey. United States Department of Agriculture, Natural Resources Conservation Service ("<http://websoilsurvey.nrcs.usda.gov/app/WebSoilSurvey.aspx>", accessed May, 2017).

El Paso County Engineering Criteria Manual. El Paso County, Colorado. (El Paso County, Colorado October 14, 2020.)

Drainage Criteria Manual Volume 2, Stormwater Quality Policies, Procedures and Best Management Practices (BMPs). City of Colorado Spring Engineering Division (Colorado Springs: , May 2014).

City of Colorado Springs Drainage Criteria Manual, Volume 1. City of Colorado Springs Engineering Division Staff, Matrix Design Group/Wright Water Engineers (Colorado Springs: , May 2014).

City of Colorado Springs/El Paso County Drainage Criteria Manual. City of Colorado Springs, Department of Public Works, Engineering Division; HDR Infrastructure, Inc.; El Paso County, Department of Public Works, Engineering Division (Colorado Springs: City of Colorado Springs, Revised November 1991).

City of Colorado Springs Drainage Criteria Manual Volume 1. City of Colorado Springs Engineering Division with Matrix Design Group and Wright Water Engineers (Colorado Springs, Colorado: , May 2014).

Soil, Geology, Geologic Hazard Study - Eagle Rising. Entech Engineering, Inc (Colorado Springs, Colorado: , December 13, 2022).

Water Resource Assessment for Eagle Rising Subdivision. ERO Resources Corporation (El Paso County, Colorado: , September 14, 2012).

Design Procedure Form: Runoff Reduction Spreadsheet. Mile High Flood District ("https://mhfd.org/wp-content/uploads/2020/03/UD-BMP_v3.07.xlsm", accessed August, 2022).

ERO Resources Corporation. 2023." Natural Resources Assessment, Eagle Rising Subdivision, El Paso County, Colorado."

ERO Resources Corporation. 2012. "Wetland Delineation Report, Eagles Rising Subdivision, El Paso County, Colorado."

U.S. Army Corps of Engineers. 2020. "National Wetland Plant List."

U.S. Department of Agriculture, Natural Resources Conservation Service. 2022a. "PLANTS Database." PLANTS Database. 2022. <https://plants.sc.egov.usda.gov/home>.

U.S. Geological Survey. 2016. "National Land Cover Database." 2016. <https://www.usgs.gov/node/279743>.

Appendices

10. General Maps and Supporting Data

Vicinity Map

Portions of Flood Insurance Rate Map

NRCS Soil Map and Tables

SCS Soil Type Descriptions

Hydrologic Soil Group Map and Tables

Site Photographs

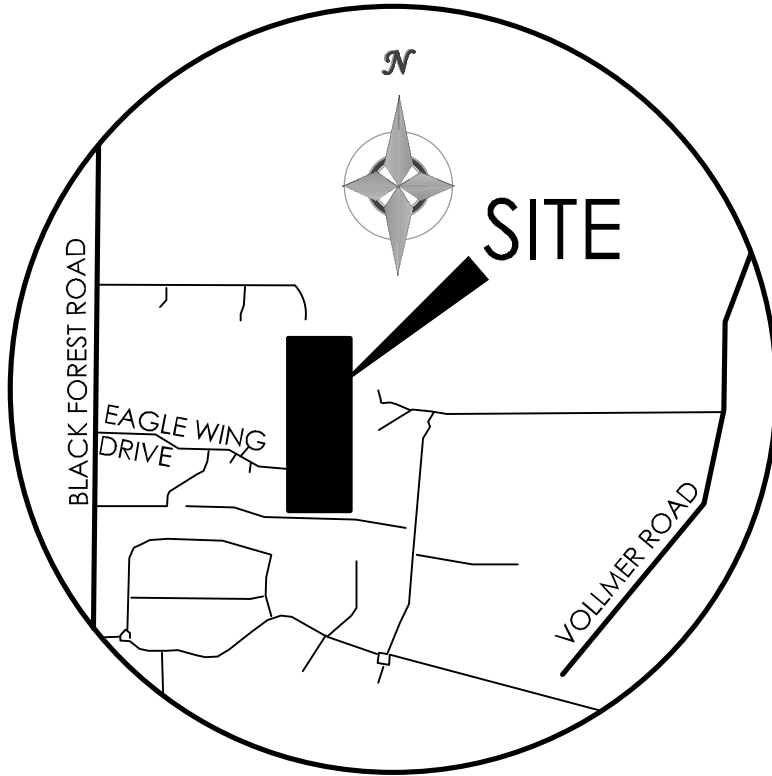

VICINITY MAP

NOT TO SCALE

National Flood Hazard Layer FIRMMette



104°41'41"W 38°58'59"N



Legend

SEE FIS REPORT FOR DETAILED LEGEND AND INDEX MAP FOR FIRM PANEL LAYOUT

SPECIAL FLOOD HAZARD AREAS		Without Base Flood Elevation (BFE) Zone A, V, A99
		With BFE or Depth Zone AE, AO, AH, VE, AR
		Regulatory Floodway
OTHER AREAS OF FLOOD HAZARD		0.2% Annual Chance Flood Hazard, Areas of 1% annual chance flood with average depth less than one foot or with drainage areas of less than one square mile Zone X
		Future Conditions 1% Annual Chance Flood Hazard Zone X
		Area with Reduced Flood Risk due to Levee. See Notes. Zone X
		Area with Flood Risk due to Levee Zone D
OTHER AREAS		NO SCREEN Area of Minimal Flood Hazard Zone X
		Effective LOMRs
GENERAL STRUCTURES		Area of Undetermined Flood Hazard Zone D
		Channel, Culvert, or Storm Sewer
OTHER FEATURES		Levee, Dike, or Floodwall
		20.2 Cross Sections with 1% Annual Chance Water Surface Elevation
MAP PANELS		17.5 Coastal Transect
		Base Flood Elevation Line (BFE)
		Limit of Study
		Jurisdiction Boundary
		Coastal Transect Baseline
		Profile Baseline
		Hydrographic Feature
		Digital Data Available
		No Digital Data Available
		Unmapped

The pin displayed on the map is an approximate point selected by the user and does not represent an authoritative property location.

This map complies with FEMA's standards for the use of digital flood maps if it is not void as described below. The basemap shown complies with FEMA's basemap accuracy standards

The flood hazard information is derived directly from the authoritative NFHL web services provided by FEMA. This map was exported on **11/15/2021 at 6:32 PM** and does not reflect changes or amendments subsequent to this date and time. The NFHL and effective information may change or become superseded by new data over time.

This map image is void if the one or more of the following map elements do not appear: basemap imagery, flood zone labels, legend, scale bar, map creation date, community identifiers, FIRM panel number, and FIRM effective date. Map images for unmapped and unmodernized areas cannot be used for regulatory purposes.

0 250 500 1,000 1,500 2,000 Feet 1:6,000

Basemap: USGS National Map: Orthoimagery: Data refreshed October, 2020

104°41'3"W 38°58'31"N

National Flood Hazard Layer FIRMMette



104°41'41"W 38°58'36"N

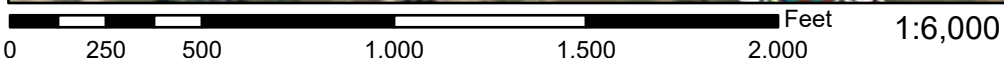
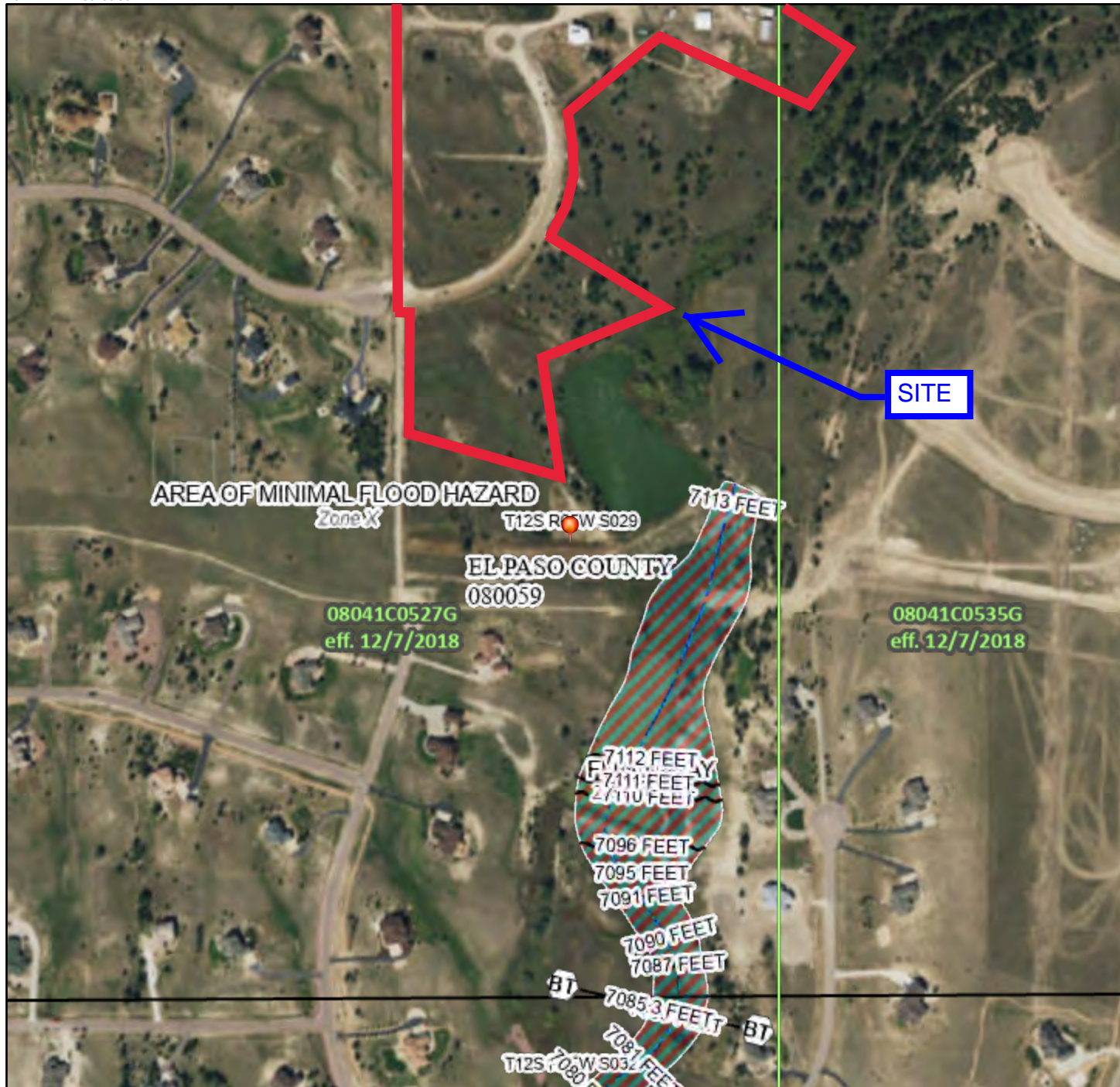

Basemap: USGS National Map: Orthoimagery: Data refreshed October, 2020

Legend

SEE FIS REPORT FOR DETAILED LEGEND AND INDEX MAP FOR FIRM PANEL LAYOUT

SPECIAL FLOOD HAZARD AREAS		Without Base Flood Elevation (BFE) Zone A, V, A99
		With BFE or Depth Zone AE, AO, AH, VE, AR
		Regulatory Floodway
OTHER AREAS OF FLOOD HAZARD		0.2% Annual Chance Flood Hazard, Areas of 1% annual chance flood with average depth less than one foot or with drainage areas of less than one square mile Zone X
		Future Conditions 1% Annual Chance Flood Hazard Zone X
		Area with Reduced Flood Risk due to Levee. See Notes. Zone X
		Area with Flood Risk due to Levee Zone D
OTHER AREAS		NO SCREEN Area of Minimal Flood Hazard Zone X
		Effective LOMRs
GENERAL STRUCTURES		Area of Undetermined Flood Hazard Zone D
		Channel, Culvert, or Storm Sewer
OTHER FEATURES		Levee, Dike, or Floodwall
		20.2 Cross Sections with 1% Annual Chance
MAP PANELS		17.5 Water Surface Elevation
		8 Coastal Transect
		Base Flood Elevation Line (BFE)
		Limit of Study
		Jurisdiction Boundary
		Coastal Transect Baseline
		Profile Baseline
		Hydrographic Feature
		Digital Data Available
		No Digital Data Available
		Unmapped



The pin displayed on the map is an approximate point selected by the user and does not represent an authoritative property location.

This map complies with FEMA's standards for the use of digital flood maps if it is not void as described below. The basemap shown complies with FEMA's basemap accuracy standards.

The flood hazard information is derived directly from the authoritative NFHL web services provided by FEMA. This map was exported on **11/15/2021 at 6:36 PM** and does not reflect changes or amendments subsequent to this date and time. The NFHL and effective information may change or become superseded by new data over time.

This map image is void if the one or more of the following map elements do not appear: basemap imagery, flood zone labels, legend, scale bar, map creation date, community identifiers, FIRM panel number, and FIRM effective date. Map images for unmapped and unmodernized areas cannot be used for regulatory purposes.

Custom Soil Resource Report for El Paso County Area, Colorado



Preface

Soil surveys contain information that affects land use planning in survey areas. They highlight soil limitations that affect various land uses and provide information about the properties of the soils in the survey areas. Soil surveys are designed for many different users, including farmers, ranchers, foresters, agronomists, urban planners, community officials, engineers, developers, builders, and home buyers. Also, conservationists, teachers, students, and specialists in recreation, waste disposal, and pollution control can use the surveys to help them understand, protect, or enhance the environment.

Various land use regulations of Federal, State, and local governments may impose special restrictions on land use or land treatment. Soil surveys identify soil properties that are used in making various land use or land treatment decisions. The information is intended to help the land users identify and reduce the effects of soil limitations on various land uses. The landowner or user is responsible for identifying and complying with existing laws and regulations.

Although soil survey information can be used for general farm, local, and wider area planning, onsite investigation is needed to supplement this information in some cases. Examples include soil quality assessments (<http://www.nrcs.usda.gov/wps/portal/nrcs/main/soils/health/>) and certain conservation and engineering applications. For more detailed information, contact your local USDA Service Center (<https://offices.sc.egov.usda.gov/locator/app?agency=nrcs>) or your NRCS State Soil Scientist (http://www.nrcs.usda.gov/wps/portal/nrcs/detail/soils/contactus/?cid=nrcs142p2_053951).

Great differences in soil properties can occur within short distances. Some soils are seasonally wet or subject to flooding. Some are too unstable to be used as a foundation for buildings or roads. Clayey or wet soils are poorly suited to use as septic tank absorption fields. A high water table makes a soil poorly suited to basements or underground installations.

The National Cooperative Soil Survey is a joint effort of the United States Department of Agriculture and other Federal agencies, State agencies including the Agricultural Experiment Stations, and local agencies. The Natural Resources Conservation Service (NRCS) has leadership for the Federal part of the National Cooperative Soil Survey.

Information about soils is updated periodically. Updated information is available through the NRCS Web Soil Survey, the site for official soil survey information.

The U.S. Department of Agriculture (USDA) prohibits discrimination in all its programs and activities on the basis of race, color, national origin, age, disability, and where applicable, sex, marital status, familial status, parental status, religion, sexual orientation, genetic information, political beliefs, reprisal, or because all or a part of an individual's income is derived from any public assistance program. (Not all prohibited bases apply to all programs.) Persons with disabilities who require

alternative means for communication of program information (Braille, large print, audiotape, etc.) should contact USDA's TARGET Center at (202) 720-2600 (voice and TDD). To file a complaint of discrimination, write to USDA, Director, Office of Civil Rights, 1400 Independence Avenue, S.W., Washington, D.C. 20250-9410 or call (800) 795-3272 (voice) or (202) 720-6382 (TDD). USDA is an equal opportunity provider and employer.

Contents

Preface	2
Soil Map	5
Soil Map.....	6
Legend.....	7
Map Unit Legend.....	8
Map Unit Descriptions.....	8
El Paso County Area, Colorado.....	10
40—Kettle gravelly loamy sand, 3 to 8 percent slopes.....	10
71—Pring coarse sandy loam, 3 to 8 percent slopes.....	11

Soil Map

The soil map section includes the soil map for the defined area of interest, a list of soil map units on the map and extent of each map unit, and cartographic symbols displayed on the map. Also presented are various metadata about data used to produce the map, and a description of each soil map unit.

Custom Soil Resource Report Soil Map

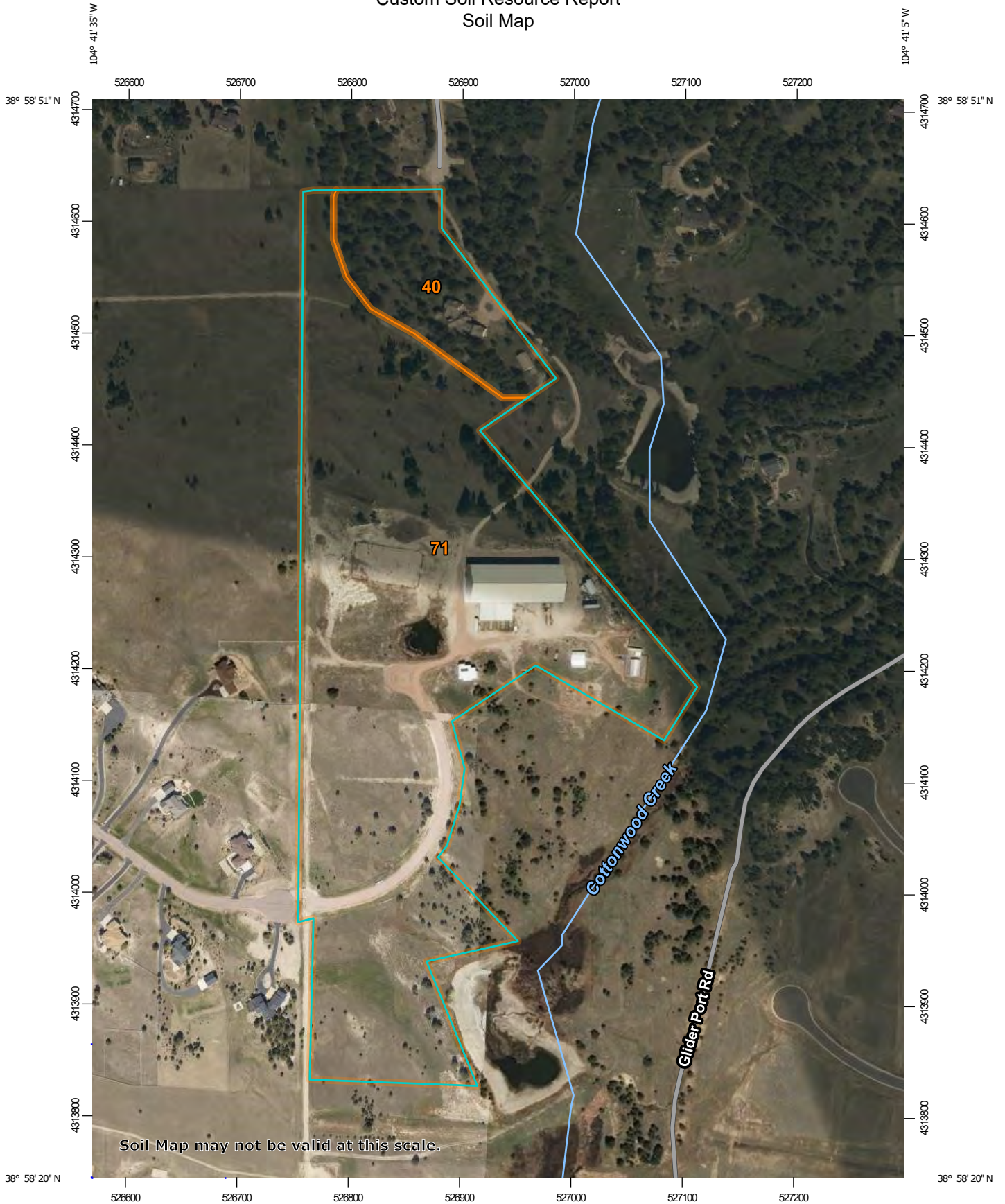

Map Scale: 1:4,700 if printed on A portrait (8.5" x 11") sheet.

0 50 100 200 300 Meters

0 200 400 800 1200 Feet

Map projection: Web Mercator Corner coordinates: WGS84 Edge tics: UTM Zone 13N WGS84

MAP LEGEND

Area of Interest (AOI)

 Area of Interest (AOI)



















Soils

 Soil Map Unit Polygons

 Soil Map Unit Lines

 Soil Map Unit Points

Special Point Features

-  Blowout
-  Borrow Pit
-  Clay Spot
-  Closed Depression
-  Gravel Pit
-  Gravelly Spot
-  Landfill
-  Lava Flow
-  Marsh or swamp
-  Mine or Quarry
-  Miscellaneous Water
-  Perennial Water
-  Rock Outcrop
-  Saline Spot
-  Sandy Spot
-  Severely Eroded Spot
-  Sinkhole
-  Slide or Slip
-  Sodic Spot

-  Spoil Area
-  Stony Spot
-  Very Stony Spot
-  Wet Spot
-  Other
-  Special Line Features

Water Features

 Streams and Canals

Transportation

-  Rails
-  Interstate Highways
-  US Routes
-  Major Roads
-  Local Roads

Background

 Aerial Photography

MAP INFORMATION

The soil surveys that comprise your AOI were mapped at 1:24,000.

Warning: Soil Map may not be valid at this scale.

Enlargement of maps beyond the scale of mapping can cause misunderstanding of the detail of mapping and accuracy of soil line placement. The maps do not show the small areas of contrasting soils that could have been shown at a more detailed scale.

Please rely on the bar scale on each map sheet for map measurements.

Source of Map: Natural Resources Conservation Service
 Web Soil Survey URL:
 Coordinate System: Web Mercator (EPSG:3857)

Maps from the Web Soil Survey are based on the Web Mercator projection, which preserves direction and shape but distorts distance and area. A projection that preserves area, such as the Albers equal-area conic projection, should be used if more accurate calculations of distance or area are required.

This product is generated from the USDA-NRCS certified data as of the version date(s) listed below.

Soil Survey Area: El Paso County Area, Colorado
 Survey Area Data: Version 20, Sep 2, 2022

Soil map units are labeled (as space allows) for map scales 1:50,000 or larger.

Date(s) aerial images were photographed: Aug 19, 2018—May 26, 2019

The orthophoto or other base map on which the soil lines were compiled and digitized probably differs from the background imagery displayed on these maps. As a result, some minor shifting of map unit boundaries may be evident.

Map Unit Legend

Map Unit Symbol	Map Unit Name	Acres in AOI	Percent of AOI
40	Kettle gravelly loamy sand, 3 to 8 percent slopes	4.5	12.2%
71	Pring coarse sandy loam, 3 to 8 percent slopes	32.4	87.8%
Totals for Area of Interest		36.9	100.0%

Map Unit Descriptions

The map units delineated on the detailed soil maps in a soil survey represent the soils or miscellaneous areas in the survey area. The map unit descriptions, along with the maps, can be used to determine the composition and properties of a unit.

A map unit delineation on a soil map represents an area dominated by one or more major kinds of soil or miscellaneous areas. A map unit is identified and named according to the taxonomic classification of the dominant soils. Within a taxonomic class there are precisely defined limits for the properties of the soils. On the landscape, however, the soils are natural phenomena, and they have the characteristic variability of all natural phenomena. Thus, the range of some observed properties may extend beyond the limits defined for a taxonomic class. Areas of soils of a single taxonomic class rarely, if ever, can be mapped without including areas of other taxonomic classes. Consequently, every map unit is made up of the soils or miscellaneous areas for which it is named and some minor components that belong to taxonomic classes other than those of the major soils.

Most minor soils have properties similar to those of the dominant soil or soils in the map unit, and thus they do not affect use and management. These are called noncontrasting, or similar, components. They may or may not be mentioned in a particular map unit description. Other minor components, however, have properties and behavioral characteristics divergent enough to affect use or to require different management. These are called contrasting, or dissimilar, components. They generally are in small areas and could not be mapped separately because of the scale used. Some small areas of strongly contrasting soils or miscellaneous areas are identified by a special symbol on the maps. If included in the database for a given area, the contrasting minor components are identified in the map unit descriptions along with some characteristics of each. A few areas of minor components may not have been observed, and consequently they are not mentioned in the descriptions, especially where the pattern was so complex that it was impractical to make enough observations to identify all the soils and miscellaneous areas on the landscape.

The presence of minor components in a map unit in no way diminishes the usefulness or accuracy of the data. The objective of mapping is not to delineate pure taxonomic classes but rather to separate the landscape into landforms or landform segments that have similar use and management requirements. The delineation of such segments on the map provides sufficient information for the development of resource plans. If intensive use of small areas is planned, however,

Custom Soil Resource Report

onsite investigation is needed to define and locate the soils and miscellaneous areas.

An identifying symbol precedes the map unit name in the map unit descriptions. Each description includes general facts about the unit and gives important soil properties and qualities.

Soils that have profiles that are almost alike make up a *soil series*. Except for differences in texture of the surface layer, all the soils of a series have major horizons that are similar in composition, thickness, and arrangement.

Soils of one series can differ in texture of the surface layer, slope, stoniness, salinity, degree of erosion, and other characteristics that affect their use. On the basis of such differences, a soil series is divided into *soil phases*. Most of the areas shown on the detailed soil maps are phases of soil series. The name of a soil phase commonly indicates a feature that affects use or management. For example, Alpha silt loam, 0 to 2 percent slopes, is a phase of the Alpha series.

Some map units are made up of two or more major soils or miscellaneous areas. These map units are complexes, associations, or undifferentiated groups.

A *complex* consists of two or more soils or miscellaneous areas in such an intricate pattern or in such small areas that they cannot be shown separately on the maps. The pattern and proportion of the soils or miscellaneous areas are somewhat similar in all areas. Alpha-Beta complex, 0 to 6 percent slopes, is an example.

An *association* is made up of two or more geographically associated soils or miscellaneous areas that are shown as one unit on the maps. Because of present or anticipated uses of the map units in the survey area, it was not considered practical or necessary to map the soils or miscellaneous areas separately. The pattern and relative proportion of the soils or miscellaneous areas are somewhat similar. Alpha-Beta association, 0 to 2 percent slopes, is an example.

An *undifferentiated group* is made up of two or more soils or miscellaneous areas that could be mapped individually but are mapped as one unit because similar interpretations can be made for use and management. The pattern and proportion of the soils or miscellaneous areas in a mapped area are not uniform. An area can be made up of only one of the major soils or miscellaneous areas, or it can be made up of all of them. Alpha and Beta soils, 0 to 2 percent slopes, is an example.

Some surveys include *miscellaneous areas*. Such areas have little or no soil material and support little or no vegetation. Rock outcrop is an example.

El Paso County Area, Colorado

40—Kettle gravelly loamy sand, 3 to 8 percent slopes

Map Unit Setting

National map unit symbol: 368g
Elevation: 7,000 to 7,700 feet
Farmland classification: Not prime farmland

Map Unit Composition

Kettle and similar soils: 85 percent
Estimates are based on observations, descriptions, and transects of the mapunit.

Description of Kettle

Setting

Landform: Hills
Landform position (three-dimensional): Side slope
Down-slope shape: Linear
Across-slope shape: Linear
Parent material: Sandy alluvium derived from arkose

Typical profile

E - 0 to 16 inches: gravelly loamy sand
Bt - 16 to 40 inches: gravelly sandy loam
C - 40 to 60 inches: extremely gravelly loamy sand

Properties and qualities

Slope: 3 to 8 percent
Depth to restrictive feature: More than 80 inches
Drainage class: Somewhat excessively drained
Runoff class: Low
Capacity of the most limiting layer to transmit water (Ksat): High (2.00 to 6.00 in/hr)
Depth to water table: More than 80 inches
Frequency of flooding: None
Frequency of ponding: None
Available water supply, 0 to 60 inches: Low (about 3.4 inches)

Interpretive groups

Land capability classification (irrigated): None specified
Land capability classification (nonirrigated): 4e
Hydrologic Soil Group: B
Ecological site: F048AY908CO - Mixed Conifer
Hydric soil rating: No

Minor Components

Other soils

Percent of map unit:
Hydric soil rating: No

Pleasant

Percent of map unit:
Landform: Depressions
Hydric soil rating: Yes

71—Pring coarse sandy loam, 3 to 8 percent slopes

Map Unit Setting

National map unit symbol: 369k
Elevation: 6,800 to 7,600 feet
Farmland classification: Not prime farmland

Map Unit Composition

Pring and similar soils: 85 percent
Estimates are based on observations, descriptions, and transects of the mapunit.

Description of Pring

Setting

Landform: Hills
Landform position (three-dimensional): Side slope
Down-slope shape: Linear
Across-slope shape: Linear
Parent material: Arkosic alluvium derived from sedimentary rock

Typical profile

A - 0 to 14 inches: coarse sandy loam
C - 14 to 60 inches: gravelly sandy loam

Properties and qualities

Slope: 3 to 8 percent
Depth to restrictive feature: More than 80 inches
Drainage class: Well drained
Runoff class: Low
Capacity of the most limiting layer to transmit water (Ksat): High (2.00 to 6.00 in/hr)
Depth to water table: More than 80 inches
Frequency of flooding: None
Frequency of ponding: None
Available water supply, 0 to 60 inches: Low (about 6.0 inches)

Interpretive groups

Land capability classification (irrigated): None specified
Land capability classification (nonirrigated): 3e
Hydrologic Soil Group: B
Ecological site: R048AY222CO - Loamy Park
Hydric soil rating: No

Minor Components

Pleasant

Percent of map unit:
Landform: Depressions
Hydric soil rating: Yes

Custom Soil Resource Report

Other soils

Percent of map unit:

Hydric soil rating: No

pricklypear occur. Ample amounts of litter and forage should be left on the soil because of the high hazard of soil blowing.

Windbreaks and environmental plantings are generally well suited to this soil. Summer fallow a year prior to planting and continued cultivation for weed control are needed to insure establishment and survival of plantings. Trees that are best suited and have good survival are Rocky Mountain juniper, eastern redcedar, ponderosa pine, Siberian elm, Russian-olive, and hackberry. Shrubs that are best suited are skunkbush sumac, lilac, Siberian peashrub, and American plum.

Depending on land use, this soil can produce habitat that is suitable for either rangeland wildlife, such as antelope, or for openland wildlife, such as pheasant, cottontail, and mourning dove. Availability of irrigation water largely determines the land use. Where no irrigation water is available, this soil is mainly used as rangeland, a use that favors rangeland wildlife. If this soil is used as rangeland, fences, livestock water developments, and proper livestock grazing use are practices that enhance habitat for rangeland wildlife. Production of crops such as wheat, corn, and alfalfa provides suitable habitat for openland wildlife, especially pheasant. Among the practices that increase openland wildlife populations are planting trees and shrubs and providing undisturbed nesting cover.

The main limitation of this soil for urban use is shrink-swell potential. Buildings and roads need to be designed to overcome this limitation. Roads need to be designed to minimize frost-heave damage. Capability subclasses IVE, nonirrigated, and IIe, irrigated.

40—Kettle gravelly loamy sand, 3 to 8 percent slopes. This deep, well drained soil formed in sandy arkosic deposits on uplands. Elevation ranges from 7,000 to 7,700 feet. The average annual precipitation is about 18 inches, the average annual air temperature is about 43 degrees F, and the average frost-free period is about 120 days.

Typically, the surface layer is gray gravelly loamy sand about 3 inches thick. The subsurface layer is light gray gravelly loamy sand about 13 inches thick. The subsoil is very pale brown gravelly sandy loam about 24 inches thick. It consists of a matrix of loamy coarse sand that has thin bands of coarse sandy loam or sandy clay loam. The substratum to a depth of 60 inches or more is light yellowish brown extremely gravelly loamy sand.

Included with this soil in mapping are small areas of Alamosa loam, 1 to 3 percent slopes; Elbeth sandy loam, 3 to 8 percent slopes; Pring coarse sandy loam, 3 to 8 percent slopes; Tomah-Crowfoot loamy sands, 3 to 8 percent slopes; and a few rock outcrops.

Permeability of this Kettle soil is rapid. Effective rooting depth is 60 inches or more. Available water capacity is low to moderate. Surface runoff is slow, and the hazard of erosion is slight to moderate. A few gullies have formed in drainageways.

This soil is used for woodland, livestock grazing, wildlife habitat, recreation, and homesites.

This soil is suited to the production of ponderosa pine. It is capable of producing about 2,240 cubic feet or 4,900 board feet (International rule), of merchantable timber per acre from a fully stocked, even-aged stand of 80-year-old trees. The main limitation for the production or harvesting of timber is the low available water capacity. The low available water capacity also influences seedling survival, especially in areas where understory plants are plentiful. Erosion must be kept to a minimum when harvesting timber.

This soil has good potential for mule deer, tree squirrels, cottontail rabbit, and wild turkey. These animals obtain their food and shelter from pine trees, shrubs, and ground cover, which provide browse, forbs, fruit, and seeds. The presence of ponderosa pine and Gambel oak should encourage wild turkey populations; however, where water is not naturally present, wildlife watering facilities must be provided to attract and maintain wild turkey and other wildlife species. Livestock grazing management is vital on this soil if wildlife populations are to be maintained.

This soil has good potential for use as homesites. Plans for homesite development on this soil should provide for the preservation of as many trees as possible in order to maintain the esthetic value of the sites. During seasons of low precipitation, fire may become a hazard to homesites. This hazard can be minimized by installing firebreaks and reducing the amount of litter on the forest floor. Capability subclass VIe.

41—Kettle gravelly loamy sand, 8 to 40 percent slopes. This deep, well drained soil formed in sandy arkosic deposits on uplands. Elevation ranges from 7,000 to 7,700 feet. The average annual precipitation is about 18 inches, the average annual air temperature is about 43 degrees F, and the average frost-free period is about 120 days.

Typically, the surface layer is gray gravelly loamy sand about 3 inches thick. The subsurface layer is light gray gravelly loamy sand about 13 inches thick. The subsoil is very pale brown gravelly sandy loam about 24 inches thick. It consists of a matrix of loamy coarse sand that has thin bands of coarse sandy loam or sandy clay loam. The substratum to a depth of 60 inches or more is light yellowish brown extremely gravelly loamy sand.

Included with this soil in mapping are small areas of Elbeth sandy loam, 8 to 15 percent slopes; Pring coarse sandy loam, 8 to 15 percent slopes; Tomah-Crowfoot loamy sands, 8 to 15 percent slopes; and a few rock outcrops.

Permeability of this Kettle soil is rapid. Effective rooting depth is 60 inches or more. Available water capacity is low to moderate. Surface runoff is medium, and the hazard of erosion is moderate. Some gullies have formed in drainageways.

The soil is used for woodland, livestock grazing, wildlife habitat, recreation, and homesites.

This soil is suited to the production of ponderosa pine. It is capable of producing 2,240 cubic feet, or 4,900 board

survival are Rocky Mountain juniper, eastern redcedar, ponderosa pine, Siberian elm, Russian-olive, and hackberry. Shrubs that are best suited are skunkbush sumac, lilac, and Siberian peashrub.

These soils are suited to habitat for openland and rangeland wildlife. Rangeland wildlife, such as pronghorn antelope, can be encouraged by developing livestock watering facilities, properly managing livestock grazing, and reseeding range where needed.

These soils have a good potential for homesites. The main limitations, especially on the Peyton soil, are low bearing strength and frost-action potential. Buildings and roads can be designed to overcome these limitations. Access roads should have adequate cut-slope grade and be provided with drains to control surface runoff and keep soil losses to a minimum. Capability subclass VIe.

69—Peyton-Pring complex, 8 to 15 percent slopes. These gently to moderately sloping soils are on valley side slopes and on uplands. Elevation ranges from 6,800 to 7,600 feet. The average annual precipitation is about 17 inches, the average annual air temperature is about 43 degrees F, and the average frost-free period is about 120 days.

The Peyton soil makes up about 40 percent of the complex, the Pring soil about 30 percent, and other soils about 30 percent.

Included with these soils in mapping are areas of Holderness loam, 8 to 15 percent slopes; Tomah-Crowfoot loamy sands, 8 to 15 percent slopes; Kettle gravelly loamy sand, 8 to 40 percent slopes; and a few areas of Rock outcrop.

The Peyton soil is commonly on the less sloping part of the landscape. It is deep, noncalcareous, and well drained. It formed in alluvium and residuum derived from weathered, arkosic, sedimentary rock. Typically, the surface layer is grayish brown sandy loam about 12 inches thick. The subsoil, about 23 inches thick, is pale brown sandy clay loam in the upper 13 inches and pale brown sandy loam in the lower 10 inches. The substratum is pale brown sandy loam to a depth of 60 inches or more.

Permeability of the Peyton soil is moderate. Effective rooting depth is 60 inches or more. Available water capacity is high. Surface runoff is medium to rapid, and the hazard of erosion is moderate to high. Some gullies have developed along drainageways and livestock trails.

The Pring soil is deep, noncalcareous, and well drained. It formed in sandy sediment derived from weathered, arkosic, sedimentary rock. Typically, the surface layer is dark grayish brown coarse sandy loam about 4 inches thick. The substratum is dark grayish brown coarse sandy loam about 10 inches thick over pale brown gravelly sandy loam that extends to a depth of 60 inches or more.

Permeability of the Pring soil is rapid. Effective rooting depth is 60 inches or more. Available water capacity is moderate. Surface runoff is medium to rapid, and the hazard of erosion is moderate to high. Some gullies have developed along drainageways and livestock trails.

The soils in this complex are used as rangeland, for wildlife habitat, and for homesites.

These soils are well suited to the production of native vegetation suitable for grazing. The dominant native species are mountain muhly, bluestem grasses, needle-andthread, and blue grama. These soils are subject to invasion of Kentucky bluegrass and Gambel oak. Common forbs are hairy goldenrod, geranium, milkvetch, low larkspur, fringed sage, and buckwheat.

Properly locating livestock watering facilities helps to control grazing. Timely deferment of grazing is needed to protect the plant cover.

Windbreaks and environmental plantings generally are suited to these soils. Soil blowing is the main limitation to the establishment of trees and shrubs. This limitation can be overcome by cultivating only in the tree rows and leaving a strip of vegetation between the rows. Supplemental irrigation may be needed when planting and during dry periods. Trees that are best suited and have good survival are Rocky Mountain juniper, eastern redcedar, ponderosa pine, Siberian elm, Russian-olive, and hackberry. Shrubs that are best suited are skunkbush sumac, lilac, and Siberian peashrub.

These soils are well suited to wildlife habitat. They are best suited to habitat for openland and rangeland wildlife. Rangeland wildlife, such as pronghorn antelope, can be encouraged by developing livestock watering facilities, properly managing livestock grazing, and reseeding range where needed.

These soils have good potential for use as homesites. The main limitations are steepness of slope, limited ability to support a load, and frost-action potential. Buildings and roads can be designed to overcome these limitations. These soils also require special site or building designs because of the slope. Access roads should have adequate cut-slope grade, and drains should be provided to control surface runoff and keep soil losses to a minimum. Capability subclass VIe.

70—Pits, gravel. Gravel pits are in nearly level to rolling areas. They are open excavations several feet deep and commonly 5 acres or less in size.

Gravel pits are very low in natural fertility and are highly susceptible to soil blowing. A cover of weeds or straw helps to control erosion.

Windbreaks and environmental plantings generally are not suited to these areas. Onsite investigation is needed to determine if plantings are feasible. Capability subclass VIIIs.

71—Pring coarse sandy loam, 3 to 8 percent slopes. This deep, noncalcareous, well drained soil formed in sandy sediment derived from arkosic sedimentary rock on valley side slopes and on uplands. Elevation ranges from 6,800 to 7,600 feet. The average annual precipitation is about 17 inches, the average annual air temperature is about 43 degrees F, and the average frost-free period is about 120 days.

Typically, the surface layer is dark grayish brown coarse sandy loam about 4 inches thick. The substratum is dark grayish brown coarse sandy loam about 10 inches thick over pale brown gravelly sandy loam that extends to a depth of 60 inches or more.

Included with this soil in mapping are small areas of Alamosa loam, 1 to 3 percent slopes, along drainageways; Cruckton sandy loam, 1 to 9 percent slopes; Peyton sandy loam, 1 to 5 percent slopes; Peyton sandy loam, 5 to 9 percent slopes; and Tomah-Crowfoot loamy sands, 3 to 8 percent slopes. In some places arkose beds of sandstone and shale are at a depth of 0 to 40 inches.

Permeability of this Pring soil is rapid. Effective rooting depth is 60 inches or more. Available water capacity is moderate. Surface runoff is medium, and the hazard of erosion is moderate.

Almost all areas of this soil are used as rangeland. Some areas previously cultivated have been reseeded to grass. This soil is also used for wildlife habitat and homesites.

This soil is well suited to the production of native vegetation suitable for grazing by cattle and sheep. Rangeland vegetation is mainly mountain muhly, little bluestem, needleandthread, Parry oatgrass, and junegrass.

Deferment of grazing in spring helps to maintain vigor and production of the cool-season bunchgrasses. Fencing and properly locating livestock watering facilities help to control grazing.

Windbreaks and environmental plantings generally are suited to this soil. The hazard of soil blowing is the main limitation to the establishment of trees and shrubs. This limitation can be overcome by cultivating only in the tree rows and leaving a strip of vegetation between the rows. Supplemental irrigation may be needed when planting and during dry periods. Trees that are best suited and have good survival are Rocky Mountain juniper, eastern redcedar, ponderosa pine, Siberian elm, Russian-olive, and hackberry. Shrubs that are best suited are skunkbush sumac, lilac, and Siberian peashrub.

This soil is suited to habitat for openland and rangeland wildlife. Rangeland wildlife, such as pronghorn antelope, can be encouraged by developing livestock watering facilities, properly managing livestock grazing, and reseeding range where needed.

This soil is well suited for use as homesites. Erosion control practices are needed to control soil blowing and water erosion on construction sites where the ground cover has been removed. Capability subclass IVe.

72—Pring coarse sandy loam, 8 to 15 percent slopes. This deep, noncalcareous, well drained soil formed in sandy sediment derived from arkosic sedimentary rock on valley side slopes and on uplands. Elevation ranges from 6,800 to 7,600 feet. The average annual precipitation is about 17 inches, the average annual air temperature is about 43 degrees F, and the average frost-free period is about 120 days.

Typically, the surface layer is dark grayish brown coarse sandy loam about 4 inches thick. The substratum is dark grayish brown coarse sandy loam about 10 inches thick over pale brown gravelly sandy loam that extends to a depth of 60 inches or more.

Included with this soil in mapping are small areas of Cruckton sandy loam, 1 to 9 percent slopes; Peyton sandy

loam, 5 to 9 percent slopes; and Tomah-Crowfoot loamy sands, 8 to 15 percent slopes. Arkose beds of sandstone and shale are at a depth of 0 to 40 inches in some places.

Permeability of this Pring soil is rapid. Effective rooting depth is 60 inches or more. Available water capacity is moderate. Surface runoff is medium, and the hazard of erosion is moderate. Some gullies have developed along drainageways.

Almost all areas of this soil are used as rangeland. Some areas previously cultivated have been reseeded to grass. This soil is also used for wildlife habitat and as homesites.

This soil is well suited to the production of native vegetation suitable for grazing by cattle and sheep. The native vegetation is mainly mountain muhly, little bluestem, needleandthread, Parry oatgrass, and junegrass.

Deferment of grazing in spring helps to maintain the vigor and production of the cool-season bunchgrasses. Fencing and properly locating livestock watering facilities help to control grazing.

Windbreaks and environmental plantings generally are suited to this soil. The hazard of soil blowing is the main limitation to the establishment of trees and shrubs. This limitation can be overcome by cultivating only in the tree rows and leaving a strip of vegetation between the rows. Supplemental irrigation may be needed when planting and during dry periods. Trees that are best suited and have good survival are Rocky Mountain juniper, eastern redcedar, ponderosa pine, Siberian elm, Russian-olive, and hackberry. Shrubs that are best suited are skunkbush sumac, lilac, and Siberian peashrub.

This soil is suited to habitat for openland and rangeland wildlife habitat. Rangeland wildlife, such as pronghorn antelope, can be encouraged by developing livestock watering facilities, properly managing livestock grazing, and reseeding range where needed.

This soil has good potential for urban uses. The main limitation is slope. Special site or building designs are needed because of the slope. Access roads must have adequate cut-slope grade and be provided with drains to control surface runoff. Capability subclass VIe.

73—Razor clay loam, 3 to 9 percent slopes. This moderately deep, well drained, clayey soil formed in residuum derived from calcareous shale on uplands. Elevation ranges from 5,300 to 6,100 feet. The average annual precipitation is about 13 inches, the average annual air temperature is about 49 degrees F, and the average frost-free period is about 145 days.

Typically, the surface layer is light brownish gray clay loam about 3 inches thick. The subsoil is grayish brown heavy clay loam or clay about 15 inches thick. The substratum is grayish brown clay that grades to calcareous shale at a depth of about 31 inches. Visible lime is in the lower part of the subsoil and in the substratum.

Included with this soil in mapping are small areas of Midway clay loam, 3 to 25 percent slopes; Heldt clay loam, 0 to 3 percent slopes; and Stoneham sandy loam, 3 to 8 percent slopes.

11. Hydrologic Calculations

Runoff Coefficients and Percent Imperviousness Table 6-6

Colorado Springs Rainfall Intensity Duration Frequency Table 6-5

Hydrologic Calculations Summary Form SF-1 for Existing & Developed Conditions

Hydrologic Calculations Summary 5-yr Form SF-2 for Existing & Developed Conditions

Hydrologic Calculations Summary 100-yr Form SF-2 for Existing & Developed Conditions

Runoff Reduction Calculations

Runoff Reduction Map

Figure 6-5. Colorado Springs Rainfall Intensity Duration Frequency

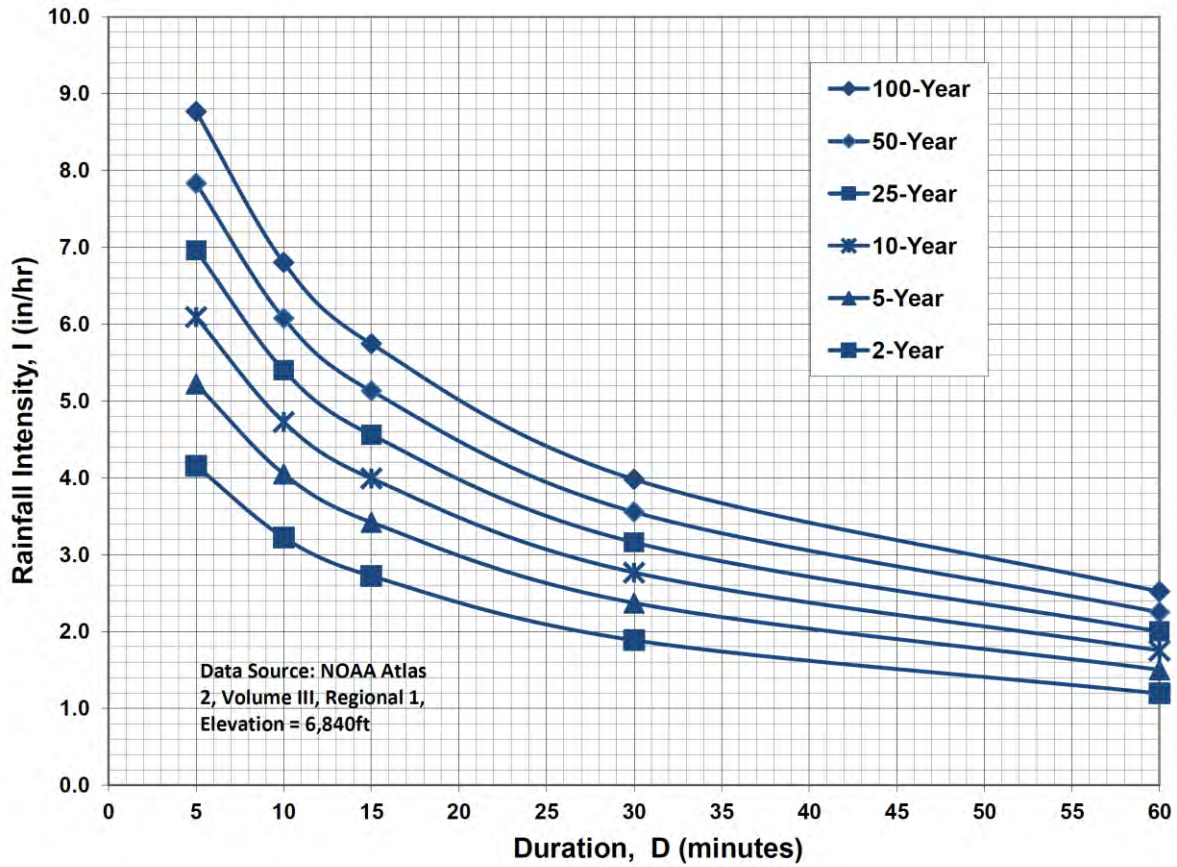

IDF Equations

$$I_{100} = -2.52 \ln(D) + 12.735$$

$$I_{50} = -2.25 \ln(D) + 11.375$$

$$I_{25} = -2.00 \ln(D) + 10.111$$

$$I_{10} = -1.75 \ln(D) + 8.847$$

$$I_5 = -1.50 \ln(D) + 7.583$$

$$I_2 = -1.19 \ln(D) + 6.035$$

Note: Values calculated by equations may not precisely duplicate values read from figure.

Table 6-6. Runoff Coefficients for Rational Method
(Source: UDFCD 2001)

Land Use or Surface Characteristics	Percent Impervious	Runoff Coefficients											
		2-year		5-year		10-year		25-year		50-year		100-year	
		HSG A&B	HSG C&D	HSG A&B	HSG C&D	HSG A&B	HSG C&D	HSG A&B	HSG C&D	HSG A&B	HSG C&D	HSG A&B	HSG C&D
Business													
Commercial Areas	95	0.79	0.80	0.81	0.82	0.83	0.84	0.85	0.87	0.87	0.88	0.88	0.89
Neighborhood Areas	70	0.45	0.49	0.49	0.53	0.53	0.57	0.58	0.62	0.60	0.65	0.62	0.68
Residential													
1/8 Acre or less	65	0.41	0.45	0.45	0.49	0.49	0.54	0.54	0.59	0.57	0.62	0.59	0.65
1/4 Acre	40	0.23	0.28	0.30	0.35	0.36	0.42	0.42	0.50	0.46	0.54	0.50	0.58
1/3 Acre	30	0.18	0.22	0.25	0.30	0.32	0.38	0.39	0.47	0.43	0.52	0.47	0.57
1/2 Acre	25	0.15	0.20	0.22	0.28	0.30	0.36	0.37	0.46	0.41	0.51	0.46	0.56
1 Acre	20	0.12	0.17	0.20	0.26	0.27	0.34	0.35	0.44	0.40	0.50	0.44	0.55
Industrial													
Light Areas	80	0.57	0.60	0.59	0.63	0.63	0.66	0.66	0.70	0.68	0.72	0.70	0.74
Heavy Areas	90	0.71	0.73	0.73	0.75	0.75	0.77	0.78	0.80	0.80	0.82	0.81	0.83
Parks and Cemeteries	7	0.05	0.09	0.12	0.19	0.20	0.29	0.30	0.40	0.34	0.46	0.39	0.52
Playgrounds	13	0.07	0.13	0.16	0.23	0.24	0.31	0.32	0.42	0.37	0.48	0.41	0.54
Railroad Yard Areas	40	0.23	0.28	0.30	0.35	0.36	0.42	0.42	0.50	0.46	0.54	0.50	0.58
Undeveloped Areas													
Historic Flow Analysis-- Greenbelts, Agriculture	2	0.03	0.05	0.09	0.16	0.17	0.26	0.26	0.38	0.31	0.45	0.36	0.51
Pasture/Meadow	0	0.02	0.04	0.08	0.15	0.15	0.25	0.25	0.37	0.30	0.44	0.35	0.50
Forest	0	0.02	0.04	0.08	0.15	0.15	0.25	0.25	0.37	0.30	0.44	0.35	0.50
Exposed Rock	100	0.89	0.89	0.90	0.90	0.92	0.92	0.94	0.94	0.95	0.95	0.96	0.96
Offsite Flow Analysis (when landuse is undefined)	45	0.26	0.31	0.32	0.37	0.38	0.44	0.44	0.51	0.48	0.55	0.51	0.59
Streets													
Paved	100	0.89	0.89	0.90	0.90	0.92	0.92	0.94	0.94	0.95	0.95	0.96	0.96
Gravel	80	0.57	0.60	0.59	0.63	0.63	0.66	0.66	0.70	0.68	0.72	0.70	0.74
Drive and Walks	100	0.89	0.89	0.90	0.90	0.92	0.92	0.94	0.94	0.95	0.95	0.96	0.96
Roofs	90	0.71	0.73	0.73	0.75	0.75	0.77	0.78	0.80	0.80	0.82	0.81	0.83
Lawns	0	0.02	0.04	0.08	0.15	0.15	0.25	0.25	0.37	0.30	0.44	0.35	0.50

Job No.: **61145**
 Project: **Eagle Rising - Preliminary/Final (Existing)**

Date: **11/14/2023 8:46**
 Calcs By: **O. Ali**
 Checked By: _____

Time of Concentration (Modified from Standard Form SF-1)

Sub-Basin	Sub-Basin Data				Overland			Shallow Channel				Channelized				t _c Check		
	Area (Acres)	C ₅	C ₁₀₀ /CN	% Imp.	L ₀ (ft)	S ₀ (%)	t _i (min)	L _{0t} (ft)	S _{0t} (ft/ft)	v _{0sc} (ft/s)	t _t (min)	L _{0c} (ft)	S _{0c} (ft/ft)	v _{0c} (ft/s)	t _c (min)	L (min)	t _{c,alt} (min)	t _c (min)
EX-A1	4.95	0.08	0.35	0%	299	11%	14.6	337	0.059	1.7	3.3	0	0.000	0.0	0.0	636	13.5	13.5
EX-A2	1.74	0.08	0.35	0%	154	13%	9.8	238	0.059	1.7	2.3	0	0.000	0.0	0.0	392	12.2	12.1
EX-B	4.35	0.12	0.38	5%	100	8%	9.1	176	0.031	1.2	2.4	240	0.023	3.2	1.2	516	12.9	12.7
EX-C	1.66	0.08	0.35	0%	100	5%	10.8	238	0.050	1.6	2.5	0	0.000	0.0	0.0	338	11.9	11.9
EX-D	7.10	0.12	0.38	6%	100	7%	9.3	160	0.088	2.1	1.3	621	0.034	4.2	2.5	881	14.9	13.1
EX-E1	3.41	0.28	0.49	30%	100	7%	7.8	0	0.000	0.0	0.0	865	0.016	2.7	5.3	965	15.4	13.1
EX-E2	7.77	0.18	0.42	15%	299	3%	19.3	222	0.054	1.6	2.3	618	0.024	3.8	2.7	1139	16.3	16.3
EX-F1	6.45	0.42	0.58	51%	100	2%	9.8	343	0.012	0.8	7.6	239	0.056	4.9	0.8	682	13.8	13.8
EX-F2	2.02	0.08	0.35	1%	84	4%	11.0	306	0.046	1.5	3.4	241	0.050	3.5	1.1	631	13.5	13.5
EX-G	2.98	0.10	0.36	2%	126	10%	9.7	186	0.032	1.3	2.5	427	0.042	3.6	2.0	739	14.1	14.1
EX-H	4.10	0.14	0.40	8%	100	4%	10.9	382	0.050	1.6	4.1	208	0.058	4.2	0.8	690	13.8	13.8
EX-I	1.64	0.17	0.42	11%	100	9%	8.1	166	0.030	1.2	2.3	147	0.020	1.2	2.0	413	12.3	12.3
EX-J	2.42	0.14	0.39	7%	100	7%	9.1	144	0.076	1.9	1.2	274	0.036	3.4	1.3	518	12.9	11.7
EX-K	2.65	0.08	0.35	0%	150	9%	11.1	0	0.000	0.0	0.0	0	0.000	0.0	0.0	150	10.8	10.8
EX-L	2.14	0.08	0.35	0%	206	5%	15.2	224	0.020	1.0	3.8	0	0.000	0.0	0.0	430	12.4	12.4
EX-M	4.10	0.10	0.36	2%	108	4%	12.2	453	0.022	1.0	7.3	312	0.032	1.5	3.5	873	14.9	14.9
OS-B1A	24.88	0.12	0.40	10%	300	6%	17.0	1000	0.047	1.5	11.0	344	0.020	3.1	1.9	1644	19.1	19.1
OS-B1B	40.97	0.10	0.37	5%	300	5%	18.5	1000	0.055	1.6	10.2	711	0.020	3.0	3.9	2011	21.2	21.2
OS-B1C	1.84	0.08	0.35	0%	300	2%	24.1	228	0.039	1.4	2.7	0	0.000	0.0	0.0	528	12.9	12.9
OS-B1D	6.03	0.08	0.35	0%	300	3%	22.2	942	0.034	1.3	12.2	0	0.000	0.0	0.0	1242	16.9	16.9
OS-B1E	10.12	0.10	0.37	4%	300	7%	16.8	1000	0.035	1.3	12.7	104	0.058	4.5	0.4	1404	17.8	17.8
OS-B3A	9.06	0.12	0.40	11%	300	4%	19.4	638	0.052	1.6	6.7	0	0.000	0.0	0.0	938	15.2	15.2
OS-B3B	2.50	0.12	0.40	11%	300	4%	20.0	336	0.054	1.6	3.5	0	0.000	0.0	0.0	636	13.5	13.5
OS-B3C	5.95	0.12	0.40	11%	300	3%	20.6	694	0.040	1.4	8.2	0	0.000	0.0	0.0	994	15.5	15.5

Job No.: **61145**
 Project: **Eagle Rising - Preliminary/Final (Developed)**

Date: **11/14/2023 8:46**
 Calcs By: **O. Ali**
 Checked By: _____

Time of Concentration (Modified from Standard Form SF-1)

Sub-Basin	Sub-Basin Data				Overland			Shallow Channel				Channelized				t _c Check		t _c (min)
	Area (Acres)	C ₅	C ₁₀₀ /CN	% Imp.	L ₀ (ft)	S ₀ (%)	t _i (min)	L _{0t} (ft)	S _{0t} (ft/ft)	v _{0sc} (ft/s)	t _t (min)	L _{0c} (ft)	S _{0c} (ft/ft)	v _{0c} (ft/s)	t _c (min)	L (min)	t _{c,alt} (min)	
A1	4.95	0.12	0.38	6%	299	11%	13.9	337	0.059	1.7	3.3	0	0.000	0.0	0.0	636	13.5	13.5
A2	1.74	0.08	0.35	0%	154	13%	9.8	238	0.059	1.7	2.3	0	0.000	0.0	0.0	392	12.2	12.1
B	4.35	0.15	0.40	9%	100	8%	8.8	176	0.031	1.2	2.4	240	0.023	3.2	1.2	516	12.9	12.5
C	1.66	0.11	0.37	3%	100	5%	10.6	238	0.050	1.6	2.5	0	0.000	0.0	0.0	338	11.9	11.9
D	7.10	0.14	0.40	9%	100	7%	9.1	160	0.088	2.1	1.3	621	0.034	4.2	2.5	881	14.9	12.8
E1	3.41	0.28	0.49	30%	100	7%	7.8	0	0.000	0.0	0.0	865	0.016	2.7	5.3	965	15.4	13.1
E2	7.77	0.20	0.43	17%	299	3%	18.8	222	0.054	1.6	2.3	618	0.024	3.8	2.7	1139	16.3	16.3
F1	6.45	0.44	0.60	54%	100	2%	9.5	343	0.012	0.8	7.6	239	0.056	4.9	0.8	682	13.8	13.8
F2	2.02	0.15	0.40	9%	84	4%	10.3	306	0.046	1.5	3.4	241	0.050	3.5	1.1	631	13.5	13.5
G	2.98	0.14	0.39	8%	126	10%	9.3	186	0.032	1.3	2.5	427	0.042	3.6	2.0	739	14.1	13.7
H	4.10	0.20	0.44	15%	100	4%	10.3	382	0.050	1.6	4.1	208	0.058	4.2	0.8	690	13.8	13.8
I	1.64	0.21	0.45	17%	100	9%	7.8	166	0.030	1.2	2.3	147	0.020	1.2	2.0	413	12.3	12.0
J	2.42	0.19	0.43	14%	100	7%	8.7	144	0.076	1.9	1.2	274	0.036	3.4	1.3	518	12.9	11.2
K	2.65	0.08	0.35	0%	150	9%	11.1	0	0.000	0.0	0.0	0	0.000	0.0	0.0	150	10.8	10.8
L	2.14	0.14	0.39	8%	206	5%	14.3	224	0.022	1.0	3.6	0	0.000	0.0	0.0	430	12.4	12.4
M	4.10	0.13	0.39	6%	108	4%	11.8	453	0.022	1.0	7.3	312	0.032	1.5	3.5	873	14.9	14.9
OS-B1A	24.88	0.12	0.40	10%	300	6%	17.0	1000	0.047	1.5	11.0	344	0.020	3.1	1.9	1644	19.1	19.1
OS-B1B	40.97	0.10	0.37	5%	300	5%	18.5	1000	0.055	1.6	10.2	711	0.020	3.0	3.9	2011	21.2	21.2
OS-B1C	1.84	0.08	0.35	0%	300	2%	24.1	228	0.039	1.4	2.7	0	0.000	0.0	0.0	528	12.9	12.9
OS-B1D	6.03	0.08	0.35	0%	300	3%	22.2	942	0.034	1.3	12.2	0	0.000	0.0	0.0	1242	16.9	16.9
OS-B1E	10.12	0.10	0.37	4%	300	7%	16.8	1000	0.035	1.3	12.7	104	0.058	4.5	0.4	1404	17.8	17.8
OS-B3A	9.06	0.12	0.40	11%	300	4%	19.4	638	0.052	1.6	6.7	0	0.000	0.0	0.0	938	15.2	15.2
OS-B3B	2.50	0.12	0.40	11%	300	4%	20.0	336	0.054	1.6	3.5	0	0.000	0.0	0.0	636	13.5	13.5
OS-B3C	5.95	0.12	0.40	11%	300	3%	20.6	694	0.040	1.4	8.2	0	0.000	0.0	0.0	994	15.5	15.5

Job No.: **61145**
 Project: **Eagle Rising - Preliminary/Final (Existing)**
 Design Storm: **5-Year Storm (20% Probability)**
 Jurisdiction: **DCM**

Date: **11/14/2023 8:46**
 Calcs By: **O. Ali**
 Checked By: _____

Sub-Basin and Combined Flows (Modified from Standard Form SF-2)

DP	Sub-Basin	Area (Acres)	C5	Direct Runoff				Combined Runoff				Streetflow			Pipe Flow				Travel Time			
				t _c	CA	I5	Q5	t _c	CA	I5	Q5	Slope	Length	Q	Q	Slope	Mnngs	Length	D _{pipe}	Length	V _{osc}	t _t
				(min)	(Acres)	(in/hr)	(cfs)	(min)	(Acres)	(in/hr)	(cfs)	(%)	(ft)	(cfs)	(cfs)	(%)	n	(ft)	(in)	(ft)	(ft/s)	(min)
	EX-A1	4.95	0.08	13.5	0.40	3.68	1.46															
	EX-A2	1.74	0.08	12.1	0.14	3.84	0.53															
	EX-B	4.35	0.12	12.7	0.51	3.77	1.92															
	EX-C	1.66	0.08	11.9	0.13	3.87	0.52															
	EX-D	7.10	0.12	13.1	0.87	3.73	3.26															
	EX-E1	3.41	0.28	13.1	0.95	3.72	3.53															
EX-DP8	EX-E2	7.77	0.18	16.3	1.40	3.39	4.74															
	EX-F1	6.45	0.42	13.8	2.68	3.65	9.78															
	EX-F2	2.02	0.08	13.5	0.17	3.68	0.63															
EX-DP10	EX-G	2.98	0.10	14.1	0.29	3.61	1.03															
	EX-H	4.10	0.14	13.8	0.59	3.64	2.16															
	EX-I	1.64	0.17	12.3	0.29	3.82	1.09															
	EX-J	2.42	0.14	11.7	0.34	3.89	1.32															
	EX-K	2.65	0.08	10.8	0.21	4.01	0.85															
	EX-L	2.14	0.08	12.4	0.17	3.81	0.65															
	EX-M	4.10	0.10	14.9	0.40	3.54	1.42															
EX-DP6		71.87	0.10					22.3	7.50	2.93	22.0											
EX-DP6A		5.25	0.21					17.9	1.10	3.25	3.6											
EX-DP6B		78.97	0.11					24.1	8.37	2.81	23.5											
EX-DP6C		84.22	0.11					24.1	9.47	2.81	26.6											
EX-DP7		12.48	0.25					20.4	3.16	3.06	9.7											
EX-DP8A		24.92	0.12					19.5	2.93	3.12	9.2											
EX-DP9		14.50	0.23					22.8	3.33	2.89	9.7											
EX-DP11		6.60	0.11					18.1	0.70	3.24	2.3											
EX-DP12		27.34	0.12					21.2	3.27	3.00	9.8											
EX-DP13		8.09	0.11					17.2	0.89	3.32	2.9											
	OS-B1A	24.88	0.12	19.1	2.90	3.16	9.16															
	OS-B1B	40.97	0.10	21.2	3.95	3.00	11.87															
	OS-B1C	1.84	0.08	12.9	0.15	3.74	0.55															
	OS-B1D	6.03	0.08	16.9	0.48	3.34	1.61															
	OS-B1E	10.12	0.10	17.8	0.96	3.26	3.15															
	OS-B3A	9.06	0.12	15.2	1.09	3.50	3.81															
	OS-B3B	2.50	0.12	13.5	0.30	3.68	1.10															
	OS-B3C	5.95	0.12	15.5	0.71	3.47	2.48															

DCM: $I = C1 * \ln(tc) + C2$
 C1: 1.5
 C2: 7.583

Job No.: **61145**
 Project: **Eagle Rising - Preliminary/Final** (Developed)
 Design Storm: **5-Year Storm** (20% Probability)
 Jurisdiction: **DCM**

Date: **11/14/2023 8:46**
 Calcs By: **O. Ali**
 Checked By: _____

Sub-Basin and Combined Flows (Modified from Standard Form SF-2)

DP	Sub-Basin	Area (Acres)	C5	Direct Runoff				Combined Runoff				Streetflow			Pipe Flow					Travel Time									
				t _c	CA	I5	Q5	t _c	CA	I5	Q5	Slope	Length	Q	Q	Slope	Mnngs	Length	D _{Pipe}	Length	V _{disc}	t _t							
				(min)	(Acres)	(in/hr)	(cfs)	(min)	(Acres)	(in/hr)	(cfs)	(%)	(ft)	(cfs)	(cfs)	(%)	n	(ft)	(in)	(ft)	(ft/s)	(min)							
DP8	A1	4.95	0.12	13.5	0.61	3.68	2.25																						
	A2	1.74	0.08	12.1	0.14	3.84	0.53																						
	B	4.35	0.15	12.5	0.64	3.80	2.43																						
	C	1.66	0.11	11.9	0.18	3.87	0.68																						
	D	7.10	0.14	12.8	1.03	3.75	3.85																						
	E1	3.41	0.28	13.1	0.95	3.72	3.53																						
	E2	7.77	0.20	16.3	1.56	3.39	5.29																						
	F1	6.45	0.44	13.8	2.81	3.65	10.25																						
	F2	2.02	0.15	13.5	0.30	3.68	1.10																						
	DP10	G	2.98	0.14	13.7	0.42	3.66	1.52																					
		H	4.10	0.20	13.8	0.81	3.64	2.93																					
		I	1.64	0.21	12.0	0.35	3.86	1.34																					
		J	2.42	0.19	11.2	0.45	3.95	1.79																					
K		2.65	0.08	10.8	0.21	4.01	0.85																						
L		2.14	0.14	12.4	0.30	3.81	1.15																						
M		4.10	0.13	14.9	0.53	3.54	1.89																						
DP6		71.87	0.11					22.3	7.67	2.93	22.5																		
DP6A		5.25	0.21					17.9	1.10	3.25	3.6																		
DP6B		78.97	0.11					24.1	8.70	2.81	24.4																		
DP6C		84.22	0.12					24.1	9.79	2.81	27.5																		
DP7		12.48	0.26					20.4	3.29	3.06	10.1																		
DP8A		24.92	0.13					19.5	3.21	3.12	10.0																		
DP9		14.50	0.25					22.8	3.59	2.89	10.4																		
DP11		6.60	0.13					18.1	0.83	3.24	2.7																		
DP12		27.34	0.13					21.2	3.66	3.00	11.0																		
DP13		8.09	0.13					17.2	1.02	3.32	3.4																		
	OS-B1A	24.88	0.12	19.1	2.90	3.16	9.16																						
	OS-B1B	40.97	0.10	21.2	3.95	3.00	11.87																						
	OS-B1C	1.84	0.08	12.9	0.15	3.74	0.55																						
	OS-B1D	6.03	0.08	16.9	0.48	3.34	1.61																						
	OS-B1E	10.12	0.10	17.8	0.96	3.26	3.15																						
	OS-B3A	9.06	0.12	15.2	1.09	3.50	3.81																						
	OS-B3B	2.50	0.12	13.5	0.30	3.68	1.10																						
OS-B3C	5.95	0.12	15.5	0.71	3.47	2.48																							

DCM: $I = C1 * \ln(tc) + C2$
 C1: 1.5
 C2: 7.583

Job No.: **61145**
 Project: **Eagle Rising - Preliminary/Final (Existing)**
 Design Storm: **100-Year Storm (1% Probability)**
 Jurisdiction: **DCM**

Date: **11/14/2023 8:46**
 Calcs By: **O. Ali**
 Checked By: _____

Sub-Basin and Combined Flows (Modified from Standard Form SF-2)

DP	Sub-Basin	Area (Acres)	C100	Direct Runoff				Combined Runoff				Streetflow			Pipe Flow					Travel Time		
				t _c (min)	CA (Acres)	I100 (in/hr)	Q100 (cfs)	t _c (min)	CA (Acres)	I100 (in/hr)	Q100 (cfs)	Slope (%)	Length (ft)	Q (cfs)	Q (cfs)	Slope (%)	Mnngs n	Length (ft)	D _{Pipe} (in)	Length (ft)	V _{isc} (ft/s)	t _t (min)
	EX-A1	4.95	0.35	13.5	1.73	6.17	10.69															
	EX-A2	1.74	0.35	12.1	0.61	6.44	3.93															
	EX-B	4.35	0.38	12.7	1.64	6.32	10.38															
	EX-C	1.66	0.35	11.9	0.58	6.50	3.79															
	EX-D	7.10	0.38	13.1	2.70	6.26	16.94															
	EX-E1	3.41	0.49	13.1	1.66	6.25	10.38															
	EX-E2	7.77	0.42	16.3	3.26	5.70	18.55															
	EX-F1	6.45	0.58	13.8	3.76	6.12	23.00															
	EX-F2	2.02	0.35	13.5	0.71	6.18	4.41															
	EX-G	2.98	0.36	14.1	1.08	6.07	6.54															
	EX-H	4.10	0.40	13.8	1.63	6.11	9.99															
	EX-I	1.64	0.42	12.3	0.69	6.41	4.41															
	EX-J	2.42	0.39	11.7	0.96	6.54	6.25															
	EX-K	2.65	0.35	10.8	0.93	6.73	6.25															
	EX-L	2.14	0.35	12.4	0.75	6.39	4.79															
	EX-M	4.10	0.36	14.9	1.49	5.94	8.85															
	EX-DP6	71.87	0.38					22.3	27.30	4.91	134.1											
	EX-DP6A	5.25	0.44					17.9	2.31	5.46	12.6											
	EX-DP6B	78.97	0.38					24.1	30.00	4.71	141.5											
	EX-DP6C	84.22	0.38					24.1	32.31	4.71	152.3											
	EX-DP7	12.48	0.47					20.4	5.87	5.14	30.2											
	EX-DP8A	24.92	0.39					19.5	9.68	5.25	50.8											
	EX-DP9	14.50	0.45					22.8	6.58	4.86	32.0											
	EX-DP11	6.60	0.38					18.1	2.49	5.44	13.5											
	EX-DP12	27.34	0.39					21.2	10.64	5.04	53.6											
	EX-DP13	8.09	0.39					17.2	3.13	5.57	17.4											
	OS-B1A	24.88	0.40	19.1	9.86	5.30	52.23															
	OS-B1B	40.97	0.37	21.2	15.21	5.04	76.72															
	OS-B1C	1.84	0.35	12.9	0.64	6.28	4.04															
	OS-B1D	6.03	0.35	16.9	2.11	5.61	11.84															
	OS-B1E	10.12	0.37	17.8	3.73	5.48	20.46															
	OS-B3A	9.06	0.40	15.2	3.63	5.88	21.30															
	OS-B3B	2.50	0.40	13.5	1.00	6.17	6.18															
	OS-B3C	5.95	0.40	15.5	2.38	5.82	13.87															

DCM: $I = C1 * \ln(tc) + C2$
 C1: 2.52
 C1: 12.735

Job No.: **61145**
 Project: **Eagle Rising - Preliminary/Final** (Developed)
 Design Storm: **100-Year Storm** (1% Probability)
 Jurisdiction: **DCM**

Date: **11/14/2023 8:46**
 Calcs By: **O. Ali**
 Checked By: _____

Sub-Basin and Combined Flows (Modified from Standard Form SF-2)

DP	Sub-Basin	Area (Acres)	C100	Direct Runoff				Combined Runoff				Streetflow			Pipe Flow					Travel Time							
				t _c	CA	I100	Q100	t _c	CA	I100	Q100	Slope	Length	Q	Q	Slope	Mnngs	Length	D _{Pipe}	Length	V _{disc}	t _t					
				(min)	(Acres)	(in/hr)	(cfs)	(min)	(Acres)	(in/hr)	(cfs)	(%)	(ft)	(cfs)	(cfs)	(%)	n	(ft)	(in)	(ft)	(ft/s)	(min)					
	A1	4.95	0.38	13.5	1.89	6.17	11.66																				
	A2	1.74	0.35	12.1	0.61	6.44	3.93																				
	B	4.35	0.40	12.5	1.74	6.38	11.07																				
	C	1.66	0.37	11.9	0.61	6.50	3.99																				
	D	7.10	0.40	12.8	2.81	6.30	17.74																				
	E1	3.41	0.49	13.1	1.66	6.25	10.38																				
DP8	E2	7.77	0.43	16.3	3.38	5.70	19.25																				
	F1	6.45	0.60	13.8	3.85	6.12	23.57																				
	F2	2.02	0.40	13.5	0.81	6.18	4.98																				
DP10	G	2.98	0.39	13.7	1.17	6.14	7.21																				
	H	4.10	0.44	13.8	1.79	6.11	10.93																				
	I	1.64	0.45	12.0	0.73	6.47	4.74																				
	J	2.42	0.43	11.2	1.04	6.64	6.89																				
	K	2.65	0.35	10.8	0.93	6.73	6.25																				
	L	2.14	0.39	12.4	0.84	6.39	5.39																				
	M	4.10	0.39	14.9	1.58	5.94	9.41																				
DP6		71.87	0.38					22.3	27.42	4.91	134.7																
DP6A		5.25	0.44					17.9	2.31	5.46	12.6																
DP6B		78.97	0.38					24.1	30.24	4.71	142.6																
DP6C		84.22	0.39					24.1	32.55	4.71	153.4																
DP7		12.48	0.48					20.4	5.96	5.14	30.6																
DP8A		24.92	0.40					19.5	9.88	5.25	51.8																
DP9		14.50	0.47					22.8	6.77	4.86	32.9																
DP11		6.60	0.39					18.1	2.59	5.44	14.1																
DP12		27.34	0.40					21.2	10.92	5.04	55.1																
DP13		8.09	0.40					17.2	3.22	5.57	18.0																
	OS-B1A	24.88	0.40	19.1	9.86	5.30	52.23																				
	OS-B1B	40.97	0.37	21.2	15.21	5.04	76.72																				
	OS-B1C	1.84	0.35	12.9	0.64	6.28	4.04																				
	OS-B1D	6.03	0.35	16.9	2.11	5.61	11.84																				
	OS-B1E	10.12	0.37	17.8	3.73	5.48	20.46																				
	OS-B3A	9.06	0.40	15.2	3.63	5.88	21.30																				
	OS-B3B	2.50	0.40	13.5	1.00	6.17	6.18																				
	OS-B3C	5.95	0.40	15.5	2.38	5.82	13.87																				

DCM: $I = C1 * \ln(tc) + C2$
 C1: 2.52
 C1: 12.735

Sub-Basin OS-B1A (DP4) Runoff Calculations

Job No.: 61145
 Project: Eagle Rising - Preliminary/Final
 Jurisdiction: DCM
 Runoff Coefficient: Surface Type

Date: 11/14/2023 8:46
 Calcs by: O. Ali
 Checked by: _____
 Soil Type: B
 Urbanization: Urban

Basin Land Use Characteristics

Surface	Area		Runoff Coefficient						% Imperv.
	(SF)	(Acres)	C2	C5	C10	C25	C50	C100	
2-1/2 Acre	942,816	21.64	0.08	0.12	0.22	0.31	0.36	0.4	11%
5 Acre	99,743	2.29	0.06	0.1	0.2	0.29	0.34	0.38	7%
Pasture/Meadow	41,339	0.95	0.02	0.08	0.15	0.25	0.3	0.35	0%
Combined	1,083,898	24.88	0.08	0.12	0.22	0.31	0.36	0.40	10.2%

Basin Travel Time

	Shallow Channel	Ground Cover	Short Pasture/Lawns				
	$L_{max,Overland}$	300 ft		C_v	7		
	L (ft)	ΔZ_0 (ft)	S_0 (ft/ft)	v (ft/s)	t (min)	t_{Alt} (min)	
Total	1,644	72	-	-	-	-	
Initial Time	300	18	0.060	-	17.0	19.1	DCM Eq. 6-8
Shallow Channel	1,000	47	0.047	1.5	11.0	-	DCM Eq. 6-9
Channelized	344	7	0.020	3.1	1.9	-	V-Ditch
				t_c	19.1 min.		

Rainfall Intensity & Runoff

	2-Yr	5-Yr	10-Yr	25-Yr	50-Yr	100-Yr
Intensity (in/hr)	2.52	3.16	3.68	4.21	4.73	5.30
Runoff (cfs)	4.8	9.2	19.7	32.0	41.9	52.2
Release Rates (cfs/ac)	-	-	-	-	-	-
Allowed Release (cfs)	4.8	9.2	19.7	32.0	41.9	52.2

DCM: $I = C1 * \ln(tc) + C2$

C1	1.19	1.5	1.75	2	2.25	2.52
C2	6.035	7.583	8.847	10.111	11.375	12.735

Notes

Sub-Basin OS-B1B (DP5) Runoff Calculations

Job No.: 61145
 Project: Eagle Rising - Preliminary/Final
 Jurisdiction: DCM
 Runoff Coefficient: Surface Type

Date: 11/14/2023 8:46
 Calcs by: O. Ali
 Checked by: _____
 Soil Type: B
 Urbanization: Urban

Basin Land Use Characteristics

Surface	Area		Runoff Coefficient						% Imperv.
	(SF)	(Acres)	C2	C5	C10	C25	C50	C100	
2-1/2 Acre	601,016	13.80	0.08	0.12	0.22	0.31	0.36	0.4	11%
5 Acre	267,802	6.15	0.06	0.1	0.2	0.29	0.34	0.38	7%
Pasture/Meadow	915,935	21.03	0.02	0.08	0.15	0.25	0.3	0.35	0%
Combined	1,784,753	40.97	0.05	0.10	0.18	0.28	0.33	0.37	4.8%

Basin Travel Time

	Shallow Channel	Ground Cover	Short Pasture/Lawns				
	$L_{max,Overland}$	300 ft		C_v	7		
	L (ft)	ΔZ_0 (ft)	S_0 (ft/ft)	v (ft/s)	t (min)	t_{Alt} (min)	
Total	2,011	84	-	-	-	-	
Initial Time	300	15	0.050	-	18.5	21.2 DCM Eq. 6-8	
Shallow Channel	1,000	55	0.055	1.6	10.2	- DCM Eq. 6-9	
Channelized	711	14	0.020	3.0	3.9	- V-Ditch	
				t_c	21.2 min.		

Rainfall Intensity & Runoff

	2-Yr	5-Yr	10-Yr	25-Yr	50-Yr	100-Yr
Intensity (in/hr)	2.40	3.00	3.50	4.01	4.51	5.04
Runoff (cfs)	4.5	11.9	26.0	45.3	60.2	76.7
Release Rates (cfs/ac)	-	-	-	-	-	-
Allowed Release (cfs)	4.5	11.9	26.0	45.3	60.2	76.7

DCM: $I = C1 * \ln(tc) + C2$

C1	1.19	1.5	1.75	2	2.25	2.52
C2	6.035	7.583	8.847	10.111	11.375	12.735

Notes

Sub-Basin OS-B1C (DP-E7) Runoff Calculations

Job No.: 61145
 Project: Eagle Rising - Preliminary/Final
 Jurisdiction: DCM
 Runoff Coefficient: Surface Type

Date: 11/14/2023 8:46
 Calcs by: O. Ali
 Checked by: _____
 Soil Type: B
 Urbanization: Urban

Basin Land Use Characteristics

Surface	Area		Runoff Coefficient						% Imperv.
	(SF)	(Acres)	C2	C5	C10	C25	C50	C100	
Pasture/Meadow	80,078	1.84	0.02	0.08	0.15	0.25	0.3	0.35	0%
Combined	80,078	1.84	0.02	0.08	0.15	0.25	0.30	0.35	0.0%

Basin Travel Time

	Shallow Channel Ground Cover		Short Pasture/Lawns			
	$L_{max,Overland}$	300 ft	S_0 (ft/ft)	v (ft/s)	t (min)	t_{Alt} (min)
Total	528	16	-	-	-	-
Initial Time	300	7	0.023	-	24.1	12.9 DCM Eq. 6-8
Shallow Channel	228	9	0.039	1.4	2.7	- DCM Eq. 6-9
Channelized			0.000	0.0	0.0	- V-Ditch
				t_c	12.9 min.	

Rainfall Intensity & Runoff

	2-Yr	5-Yr	10-Yr	25-Yr	50-Yr	100-Yr
Intensity (in/hr)	2.99	3.74	4.37	4.99	5.62	6.28
Runoff (cfs)	0.1	0.6	1.2	2.3	3.1	4.0
Release Rates (cfs/ac)	-	-	-	-	-	-
Allowed Release (cfs)	0.1	0.6	1.2	2.3	3.1	4.0

DCM: $I = C1 * \ln(tc) + C2$

C1	1.19	1.5	1.75	2	2.25	2.52
C2	6.035	7.583	8.847	10.111	11.375	12.735

Notes

Sub-Basin OS-B1D (DP-E8) Runoff Calculations

Job No.: 61145
 Project: Eagle Rising - Preliminary/Final
 Jurisdiction: DCM
 Runoff Coefficient: Surface Type

Date: 11/14/2023 8:46
 Calcs by: O. Ali
 Checked by: _____
 Soil Type: B
 Urbanization: Urban

Basin Land Use Characteristics

Surface	Area		Runoff Coefficient						% Imperv.
	(SF)	(Acres)	C2	C5	C10	C25	C50	C100	
Pasture/Meadow	262,653	6.03	0.02	0.08	0.15	0.25	0.3	0.35	0%
Combined	262,653	6.03	0.02	0.08	0.15	0.25	0.30	0.35	0.0%

Basin Travel Time

	Shallow Channel Ground Cover		Short Pasture/Lawns					
	$L_{max,Overland}$	300 ft	S_0 (ft/ft)	v (ft/s)	t (min)	t_{Alt} (min)	C_v	7
Total	1,242	41	-	-	-	-	-	-
Initial Time	300	9	0.030	-	22.2	16.9	DCM Eq. 6-8	
Shallow Channel	942	32	0.034	1.3	12.2	-	DCM Eq. 6-9	
Channelized			0.000	0.0	0.0	-	V-Ditch	
				t_c	16.9 min.			

Rainfall Intensity & Runoff

	2-Yr	5-Yr	10-Yr	25-Yr	50-Yr	100-Yr
Intensity (in/hr)	2.67	3.34	3.90	4.46	5.01	5.61
Runoff (cfs)	0.3	1.6	3.5	6.7	9.1	11.8
Release Rates (cfs/ac)	-	-	-	-	-	-
Allowed Release (cfs)	0.3	1.6	3.5	6.7	9.1	11.8

DCM: $I = C1 * \ln(tc) + C2$

C1	1.19	1.5	1.75	2	2.25	2.52
C2	6.035	7.583	8.847	10.111	11.375	12.735

Notes

Sub-Basin OS-B1E (DP-E10) Runoff Calculations

Job No.: 61145
 Project: Eagle Rising - Preliminary/Final
 Jurisdiction: DCM
 Runoff Coefficient: Surface Type

Date: 11/14/2023 8:46
 Calcs by: O. Ali
 Checked by: _____
 Soil Type: B
 Urbanization: Urban

Basin Land Use Characteristics

Surface	Area		Runoff Coefficient						% Imperv.
	(SF)	(Acres)	C2	C5	C10	C25	C50	C100	
2-1/2 Acre Pasture/Meadow	168,070	3.86	0.08	0.12	0.22	0.31	0.36	0.4	11%
	272,638	6.26	0.02	0.08	0.15	0.25	0.3	0.35	0%
Combined	440,708	10.12	0.04	0.10	0.18	0.27	0.32	0.37	4.2%

Basin Travel Time

	Shallow Channel	Ground Cover	Short Pasture/Lawns				
	$L_{max,Overland}$	300 ft	C_v	7			
	L (ft)	ΔZ_o (ft)	S_o (ft/ft)	v (ft/s)	t (min)	t_{Alt} (min)	
Total	1,404	61	-	-	-	-	
Initial Time	300	20	0.067	-	16.8	17.8	DCM Eq. 6-8
Shallow Channel	1,000	35	0.035	1.3	12.7	-	DCM Eq. 6-9
Channelized	104	6	0.058	4.5	0.4	-	V-Ditch
				t_c	17.8 min.		

Rainfall Intensity & Runoff

	2-Yr	5-Yr	10-Yr	25-Yr	50-Yr	100-Yr
Intensity (in/hr)	2.61	3.26	3.81	4.35	4.90	5.48
Runoff (cfs)	1.1	3.1	6.8	12.0	16.0	20.5
Release Rates (cfs/ac)	-	-	-	-	-	-
Allowed Release (cfs)	1.1	3.1	6.8	12.0	16.0	20.5

DCM: $I = C1 * \ln(tc) + C2$

C1	1.19	1.5	1.75	2	2.25	2.52
C2	6.035	7.583	8.847	10.111	11.375	12.735

Notes

Sub-Basin OS-B3A (DP-E11) Runoff Calculations

Job No.: 61145
 Project: Eagle Rising - Preliminary/Final
 Jurisdiction: DCM
 Runoff Coefficient: Surface Type

Date: 11/14/2023 8:46
 Calcs by: O. Ali
 Checked by: _____
 Soil Type: B
 Urbanization: Urban

Basin Land Use Characteristics

Surface	Area		Runoff Coefficient						% Imperv.
	(SF)	(Acres)	C2	C5	C10	C25	C50	C100	
2-1/2 Acre	394,804	9.06	0.08	0.12	0.22	0.31	0.36	0.4	11%
Combined	394,804	9.06	0.08	0.12	0.22	0.31	0.36	0.40	11.0%

Basin Travel Time

	Shallow Channel Ground Cover		Short Pasture/Lawns				
	$L_{max,Overland}$	300 ft			C_v	7	
	L (ft)	ΔZ_0 (ft)	S_0 (ft/ft)	v (ft/s)	t (min)	t_{Alt} (min)	
Total	938	45	-	-	-	-	
Initial Time	300	12	0.040	-	19.4	15.2	DCM Eq. 6-8
Shallow Channel	638	33	0.052	1.6	6.7	-	DCM Eq. 6-9
Channelized			0.000	0.0	0.0	-	V-Ditch
				t_c	15.2 min.		

Rainfall Intensity & Runoff

	2-Yr	5-Yr	10-Yr	25-Yr	50-Yr	100-Yr
Intensity (in/hr)	2.80	3.50	4.08	4.67	5.25	5.88
Runoff (cfs)	2.0	3.8	8.1	13.1	17.1	21.3
Release Rates (cfs/ac)	-	-	-	-	-	-
Allowed Release (cfs)	2.0	3.8	8.1	13.1	17.1	21.3

DCM: $I = C1 * \ln(tc) + C2$

C1	1.19	1.5	1.75	2	2.25	2.52
C2	6.035	7.583	8.847	10.111	11.375	12.735

Notes

Sub-Basin OS-B3B (DP-E13) Runoff Calculations

Job No.: 61145
 Project: Eagle Rising - Preliminary/Final
 Jurisdiction: DCM
 Runoff Coefficient: Surface Type

Date: 11/14/2023 8:46
 Calcs by: O. Ali
 Checked by: _____
 Soil Type: B
 Urbanization: Urban

Basin Land Use Characteristics

Surface	Area		Runoff Coefficient						% Imperv.
	(SF)	(Acres)	C2	C5	C10	C25	C50	C100	
2-1/2 Acre	109,046	2.50	0.08	0.12	0.22	0.31	0.36	0.4	11%
Combined	109,046	2.50	0.08	0.12	0.22	0.31	0.36	0.40	11.0%

Basin Travel Time

	Shallow Channel	Ground Cover	Short Pasture/Lawns			
	$L_{max,Overland}$	300 ft			C_v	7
	L (ft)	ΔZ_0 (ft)	S_0 (ft/ft)	v (ft/s)	t (min)	t_{Alt} (min)
Total	636	29	-	-	-	-
Initial Time	300	11	0.037	-	20.0	13.5 DCM Eq. 6-8
Shallow Channel	336	18	0.054	1.6	3.5	- DCM Eq. 6-9
Channelized			0.000	0.0	0.0	- V-Ditch
				t_c	13.5 min.	

Rainfall Intensity & Runoff

	2-Yr	5-Yr	10-Yr	25-Yr	50-Yr	100-Yr
Intensity (in/hr)	2.93	3.68	4.29	4.90	5.51	6.17
Runoff (cfs)	0.6	1.1	2.4	3.8	5.0	6.2
Release Rates (cfs/ac)	-	-	-	-	-	-
Allowed Release (cfs)	0.6	1.1	2.4	3.8	5.0	6.2

DCM: $I = C1 * \ln(tc) + C2$

C1	1.19	1.5	1.75	2	2.25	2.52
C2	6.035	7.583	8.847	10.111	11.375	12.735

Notes

Sub-Basin OS-B3C (DP-E15) Runoff Calculations

Job No.: 61145
 Project: Eagle Rising - Preliminary/Final
 Jurisdiction: DCM
 Runoff Coefficient: Surface Type

Date: 11/14/2023 8:46
 Calcs by: O. Ali
 Checked by: _____
 Soil Type: B
 Urbanization: Urban

Basin Land Use Characteristics

Surface	Area		Runoff Coefficient						% Imperv.
	(SF)	(Acres)	C2	C5	C10	C25	C50	C100	
2-1/2 Acre	259,332	5.95	0.08	0.12	0.22	0.31	0.36	0.4	11%
Combined	259,332	5.95	0.08	0.12	0.22	0.31	0.36	0.40	11.0%

Basin Travel Time

	Shallow Channel Ground Cover		Short Pasture/Lawns			
	$L_{max,Overland}$	300 ft	S_0 (ft/ft)	v (ft/s)	t (min)	t_{Alt} (min)
Total	994	38	-	-	-	-
Initial Time	300	10	0.033	-	20.6	15.5 DCM Eq. 6-8
Shallow Channel	694	28	0.040	1.4	8.2	- DCM Eq. 6-9
Channelized			0.000	0.0	0.0	- V-Ditch
				t_c	15.5 min.	

Rainfall Intensity & Runoff

	2-Yr	5-Yr	10-Yr	25-Yr	50-Yr	100-Yr
Intensity (in/hr)	2.77	3.47	4.05	4.63	5.20	5.82
Runoff (cfs)	1.3	2.5	5.3	8.5	11.2	13.9
Release Rates (cfs/ac)	-	-	-	-	-	-
Allowed Release (cfs)	1.3	2.5	5.3	8.5	11.2	13.9

DCM: $I = C1 * \ln(tc) + C2$

C1	1.19	1.5	1.75	2	2.25	2.52
C2	6.035	7.583	8.847	10.111	11.375	12.735

Notes

Sub-Basin EX-A1 Runoff Calculations

Job No.: 61145
 Project: Eagle Rising - Preliminary/Final
 Jurisdiction: DCM
 Runoff Coefficient: Surface Type

Date: 11/14/2023 8:46
 Calcs by: O. Ali
 Checked by: _____
 Soil Type: B
 Urbanization: Urban

Basin Land Use Characteristics

Surface	Area		Runoff Coefficient						% Imperv.
	(SF)	(Acres)	C2	C5	C10	C25	C50	C100	
Pasture/Meadow	215,572	4.95	0.02	0.08	0.15	0.25	0.3	0.35	0%
Combined	215,572	4.95	0.02	0.08	0.15	0.25	0.30	0.35	0.0%

215572

Basin Travel Time

	Shallow Channel	Ground Cover	Short Pasture/Lawns				
	$L_{max,Overland}$	300 ft	C_v	7			
	L (ft)	ΔZ_o (ft)	S_o (ft/ft)	v (ft/s)	t (min)	t_{Alt} (min)	
Total	636	52	-	-	-	-	
Initial Time	299	32	0.107	-	14.6	13.5	DCM Eq. 6-8
Shallow Channel	337	20	0.059	1.7	3.3	-	DCM Eq. 6-9
Channelized			0.000	0.0	0.0	-	V-Ditch
				t_c	13.5 min.		

Rainfall Intensity & Runoff

	2-Yr	5-Yr	10-Yr	25-Yr	50-Yr	100-Yr
Intensity (in/hr)	2.93	3.68	4.29	4.90	5.51	6.17
Runoff (cfs)	0.3	1.5	3.2	6.1	8.2	10.7
Release Rates (cfs/ac)	-	-	-	-	-	-
Allowed Release (cfs)	0.3	1.5	3.2	6.1	8.2	10.7

DCM: $I = C1 * \ln(tc) + C2$

C1	1.19	1.5	1.75	2	2.25	2.52
C2	6.035	7.583	8.847	10.111	11.375	12.735

Notes

Sub-Basin EX-A2 Runoff Calculations

Job No.: 61145
 Project: Eagle Rising - Preliminary/Final
 Jurisdiction: DCM
 Runoff Coefficient: Surface Type

Date: 11/14/2023 8:46
 Calcs by: O. Ali
 Checked by: _____
 Soil Type: B
 Urbanization: Urban

Basin Land Use Characteristics

Surface	Area		Runoff Coefficient						% Imperv.
	(SF)	(Acres)	C2	C5	C10	C25	C50	C100	
Pasture/Meadow	75,899	1.74	0.02	0.08	0.15	0.25	0.3	0.35	0%
Combined	75,899	1.74	0.02	0.08	0.15	0.25	0.30	0.35	0.0%

75899

Basin Travel Time

	Shallow Channel Ground Cover		Short Pasture/Lawns			
	$L_{max,Overland}$	300 ft	S_0 (ft/ft)	v (ft/s)	t (min)	t_{Alt} (min)
Total	392	34	-	-	-	-
Initial Time	154	20	0.130	-	9.8	12.2 DCM Eq. 6-8
Shallow Channel	238	14	0.059	1.7	2.3	- DCM Eq. 6-9
Channelized			0.000	0.0	0.0	- V-Ditch
				t_c	12.1 min.	

Rainfall Intensity & Runoff

	2-Yr	5-Yr	10-Yr	25-Yr	50-Yr	100-Yr
Intensity (in/hr)	3.06	3.84	4.48	5.12	5.76	6.44
Runoff (cfs)	0.1	0.5	1.2	2.2	3.0	3.9
Release Rates (cfs/ac)	-	-	-	-	-	-
Allowed Release (cfs)	0.1	0.5	1.2	2.2	3.0	3.9

DCM: $I = C1 * \ln(tc) + C2$

C1	1.19	1.5	1.75	2	2.25	2.52
C2	6.035	7.583	8.847	10.111	11.375	12.735

Notes

Sub-Basin EX-B Runoff Calculations

Job No.: 61145
 Project: Eagle Rising - Preliminary/Final
 Jurisdiction: DCM
 Runoff Coefficient: Surface Type

Date: 11/14/2023 8:46
 Calcs by: O. Ali
 Checked by: _____
 Soil Type: B
 Urbanization: Urban

Basin Land Use Characteristics

Surface	Area		Runoff Coefficient						% Imperv.
	(SF)	(Acres)	C2	C5	C10	C25	C50	C100	
Roofs	1,676	0.04	0.71	0.73	0.75	0.78	0.8	0.81	90%
Paved	7,329	0.17	0.89	0.9	0.92	0.94	0.95	0.96	100%
Pasture/Meadow	180,315	4.14	0.02	0.08	0.15	0.25	0.3	0.35	0%
Combined	189,320	4.35	0.06	0.12	0.19	0.28	0.33	0.38	4.7%

189320

Basin Travel Time

	Shallow Channel	Ground Cover	Short Pasture/Lawns				
	$L_{max,Overland}$	300 ft	C_v	7			
	L (ft)	ΔZ_o (ft)	S_o (ft/ft)	v (ft/s)	t (min)	t_{Alt} (min)	
Total	516	19	-	-	-	-	
Initial Time	100	8	0.075	-	9.1	12.9	DCM Eq. 6-8
Shallow Channel	176	6	0.031	1.2	2.4	-	DCM Eq. 6-9
Channelized	240	6	0.023	3.2	1.2	-	V-Ditch
				t_c	12.7 min.		

Rainfall Intensity & Runoff

	2-Yr	5-Yr	10-Yr	25-Yr	50-Yr	100-Yr
Intensity (in/hr)	3.01	3.77	4.39	5.02	5.65	6.32
Runoff (cfs)	0.8	1.9	3.5	6.1	8.1	10.4
Release Rates (cfs/ac)	-	-	-	-	-	-
Allowed Release (cfs)	0.8	1.9	3.5	6.1	8.1	10.4

DCM: $I = C1 * \ln(tc) + C2$

C1	1.19	1.5	1.75	2	2.25	2.52
C2	6.035	7.583	8.847	10.111	11.375	12.735

Notes

Sub-Basin EX-C Runoff Calculations

Job No.: 61145
 Project: Eagle Rising - Preliminary/Final
 Jurisdiction: DCM
 Runoff Coefficient: Surface Type

Date: 11/14/2023 8:46
 Calcs by: O. Ali
 Checked by: _____
 Soil Type: B
 Urbanization: Urban

Basin Land Use Characteristics

Surface	Area		Runoff Coefficient						% Imperv.
	(SF)	(Acres)	C2	C5	C10	C25	C50	C100	
Pasture/Meadow	72,522	1.66	0.02	0.08	0.15	0.25	0.3	0.35	0%
Combined	72,522	1.66	0.02	0.08	0.15	0.25	0.30	0.35	0.0%

72522

Basin Travel Time

	Shallow Channel	Ground Cover	Short Pasture/Lawns				
	$L_{max,Overland}$	300 ft	C_v	7			
	L (ft)	ΔZ_o (ft)	S_o (ft/ft)	v (ft/s)	t (min)	t_{Alt} (min)	
Total	338	17	-	-	-	-	
Initial Time	100	5	0.050	-	10.8	11.9	DCM Eq. 6-8
Shallow Channel	238	12	0.050	1.6	2.5	-	DCM Eq. 6-9
Channelized			0.000	0.0	0.0	-	V-Ditch
				t_c	11.9 min.		

Rainfall Intensity & Runoff

	2-Yr	5-Yr	10-Yr	25-Yr	50-Yr	100-Yr
Intensity (in/hr)	3.09	3.87	4.52	5.16	5.81	6.50
Runoff (cfs)	0.1	0.5	1.1	2.1	2.9	3.8
Release Rates (cfs/ac)	-	-	-	-	-	-
Allowed Release (cfs)	0.1	0.5	1.1	2.1	2.9	3.8

DCM: $I = C1 * \ln(tc) + C2$

C1	1.19	1.5	1.75	2	2.25	2.52
C2	6.035	7.583	8.847	10.111	11.375	12.735

Notes

Sub-Basin EX-D Runoff Calculations

Job No.: 61145
 Project: Eagle Rising - Preliminary/Final
 Jurisdiction: DCM
 Runoff Coefficient: Surface Type

Date: 11/14/2023 8:46
 Calcs by: O. Ali
 Checked by: _____
 Soil Type: B
 Urbanization: Urban

Basin Land Use Characteristics

Surface	Area		Runoff Coefficient						% Imperv.
	(SF)	(Acres)	C2	C5	C10	C25	C50	C100	
Roofs	5,302	0.12	0.71	0.73	0.75	0.78	0.8	0.81	90%
Paved	6,215	0.14	0.89	0.9	0.92	0.94	0.95	0.96	100%
Pasture/Meadow	288,588	6.63	0.02	0.08	0.15	0.25	0.3	0.35	0%
Gravel	9,370	0.22	0.57	0.59	0.63	0.66	0.68	0.7	80%
Combined	309,475	7.10	0.07	0.12	0.19	0.29	0.33	0.38	6.0%

309475

Basin Travel Time

	Shallow Channel Ground Cover		Short Pasture/Lawns			
	L _{max,Overland} (ft)	ΔZ ₀ (ft)	S ₀ (ft/ft)	v (ft/s)	t (min)	t _{Alt} (min)
Total	881	42	-	-	-	-
Initial Time	100	7	0.070	-	9.3	14.9 DCM Eq. 6-8
Shallow Channel	160	14	0.088	2.1	1.3	- DCM Eq. 6-9
Channelized	621	21	0.034	4.2	2.5	- V-Ditch
t_c					13.1 min.	

Rainfall Intensity & Runoff

	2-Yr	5-Yr	10-Yr	25-Yr	50-Yr	100-Yr
Intensity (in/hr)	2.98	3.73	4.35	4.97	5.59	6.26
Runoff (cfs)	1.4	3.3	5.9	10.1	13.2	16.9
Release Rates (cfs/ac)	-	-	-	-	-	-
Allowed Release (cfs)	1.4	3.3	5.9	10.1	13.2	16.9

DCM: $I = C1 * \ln(tc) + C2$

C1	1.19	1.5	1.75	2	2.25	2.52
C2	6.035	7.583	8.847	10.111	11.375	12.735

Notes

Sub-Basin EX-E1 Runoff Calculations

Job No.: 61145
 Project: Eagle Rising - Preliminary/Final
 Jurisdiction: DCM
 Runoff Coefficient: Surface Type

Date: 11/14/2023 8:46
 Calcs by: O. Ali
 Checked by: _____
 Soil Type: B
 Urbanization: Urban

Basin Land Use Characteristics

Surface	Area		Runoff Coefficient						% Imperv.
	(SF)	(Acres)	C2	C5	C10	C25	C50	C100	
Roofs	15,215	0.35	0.71	0.73	0.75	0.78	0.8	0.81	90%
Gravel	38,377	0.88	0.57	0.59	0.63	0.66	0.68	0.7	80%
Pasture/Meadow	94,964	2.18	0.02	0.08	0.15	0.25	0.3	0.35	0%
Combined	148,556	3.41	0.23	0.28	0.34	0.41	0.45	0.49	29.9%

148556

Basin Travel Time

	Shallow Channel Ground Cover		Short Pasture/Lawns			
	$L_{max,Overland}$	300 ft	S_0 (ft/ft)	v (ft/s)	t (min)	t_{Alt} (min)
Total	965	21	-	-	-	-
Initial Time	100	7	0.070	-	7.8	15.4 DCM Eq. 6-8
Shallow Channel			0.000	0.0	0.0	- DCM Eq. 6-9
Channelized	865	14	0.016	2.7	5.3	- V-Ditch
			t_c 13.1 min.			

Rainfall Intensity & Runoff

	2-Yr	5-Yr	10-Yr	25-Yr	50-Yr	100-Yr
Intensity (in/hr)	2.97	3.72	4.34	4.96	5.58	6.25
Runoff (cfs)	2.4	3.5	5.0	6.9	8.6	10.4
Release Rates (cfs/ac)	-	-	-	-	-	-
Allowed Release (cfs)	2.4	3.5	5.0	6.9	8.6	10.4

DCM: $I = C1 * \ln(tc) + C2$

C1	1.19	1.5	1.75	2	2.25	2.52
C2	6.035	7.583	8.847	10.111	11.375	12.735

Notes

Sub-Basin EX-E2 (EX-DP8) Runoff Calculations

Job No.: 61145 Date: 11/14/2023 8:46
 Project: Eagle Rising - Preliminary/Final Calcs by: O. Ali
 Checked by: _____
 Jurisdiction: DCM Soil Type: B
 Runoff Coefficient: Surface Type Urbanization: Urban

Basin Land Use Characteristics

Surface	Area		Runoff Coefficient						% Imperv.
	(SF)	(Acres)	C2	C5	C10	C25	C50	C100	
Roofs	12,616	0.29	0.71	0.73	0.75	0.78	0.8	0.81	90%
Gravel	50,194	1.15	0.57	0.59	0.63	0.66	0.68	0.7	80%
Pasture/Meadow	275,673	6.33	0.02	0.08	0.15	0.25	0.3	0.35	0%
Combined	338,483	7.77	0.13	0.18	0.24	0.33	0.37	0.42	15.2%

338483

Basin Travel Time

	Shallow Channel	Ground Cover	Short Pasture/Lawns				
	$L_{max,Overland}$	300 ft	C_v	7			
	L (ft)	ΔZ_o (ft)	S_o (ft/ft)	v (ft/s)	t (min)	t_{Alt} (min)	
Total	1,139	37	-	-	-	-	
Initial Time	299	10	0.033	-	19.3	16.3	DCM Eq. 6-8
Shallow Channel	222	12	0.054	1.6	2.3	-	DCM Eq. 6-9
Channelized	618	15	0.024	3.8	2.7	-	V-Ditch
				t_c	16.3 min.		

Rainfall Intensity & Runoff

	2-Yr	5-Yr	10-Yr	25-Yr	50-Yr	100-Yr
Intensity (in/hr)	2.71	3.39	3.96	4.53	5.09	5.70
Runoff (cfs)	2.7	4.7	7.5	11.6	14.8	18.6
Release Rates (cfs/ac)	-	-	-	-	-	-
Allowed Release (cfs)	2.7	4.7	7.5	11.6	14.8	18.6

DCM: $I = C1 * \ln(tc) + C2$

C1	1.19	1.5	1.75	2	2.25	2.52
C2	6.035	7.583	8.847	10.111	11.375	12.735

Notes

Sub-Basin EX-F1 Runoff Calculations

Job No.: 61145 Date: 11/14/2023 8:46
 Project: Eagle Rising - Preliminary/Final Calcs by: O. Ali
 Checked by: _____
 Jurisdiction: DCM Soil Type: B
 Runoff Coefficient: Surface Type Urbanization: Urban

Basin Land Use Characteristics

Surface	Area		Runoff Coefficient						% Imperv.
	(SF)	(Acres)	C2	C5	C10	C25	C50	C100	
Roofs	9,594	0.22	0.71	0.73	0.75	0.78	0.8	0.81	90%
Paved	7,538	0.17	0.89	0.9	0.92	0.94	0.95	0.96	100%
Pasture/Meadow	103,459	2.38	0.02	0.08	0.15	0.25	0.3	0.35	0%
Gravel	160,546	3.69	0.57	0.59	0.63	0.66	0.68	0.7	80%
Combined	281,137	6.45	0.38	0.42	0.47	0.52	0.55	0.58	51.4%

281137

Basin Travel Time

	Shallow Channel	Ground Cover	Short Pasture/Lawns				
	$L_{max,Overland}$	300 ft	C_v	7			
	L (ft)	ΔZ_0 (ft)	S_0 (ft/ft)	v (ft/s)	t (min)	t_{Alt} (min)	
Total	682	20	-	-	-	-	
Initial Time	100	2	0.020	-	9.8	13.8	DCM Eq. 6-8
Shallow Channel	343	4	0.012	0.8	7.6	-	DCM Eq. 6-9
Channelized	239	14	0.056	4.9	0.8	-	V-Ditch
				t_c	13.8 min.		

Rainfall Intensity & Runoff

	2-Yr	5-Yr	10-Yr	25-Yr	50-Yr	100-Yr
Intensity (in/hr)	2.91	3.65	4.26	4.86	5.47	6.12
Runoff (cfs)	7.2	9.8	12.8	16.3	19.5	23.0
Release Rates (cfs/ac)	-	-	-	-	-	-
Allowed Release (cfs)	7.2	9.8	12.8	16.3	19.5	23.0

DCM: $I = C1 * \ln(tc) + C2$

C1	1.19	1.5	1.75	2	2.25	2.52
C2	6.035	7.583	8.847	10.111	11.375	12.735

Notes

Sub-Basin EX-F2 Runoff Calculations

Job No.: 61145
 Project: Eagle Rising - Preliminary/Final
 Jurisdiction: DCM
 Runoff Coefficient: Surface Type

Date: 11/14/2023 8:46
 Calcs by: O. Ali
 Checked by: _____
 Soil Type: B
 Urbanization: Urban

Basin Land Use Characteristics

Surface	Area		Runoff Coefficient						% Imperv.
	(SF)	(Acres)	C2	C5	C10	C25	C50	C100	
Pasture/Meadow	87,492	2.01	0.02	0.08	0.15	0.25	0.3	0.35	0%
Paved	476	0.01	0.89	0.9	0.92	0.94	0.95	0.96	100%
Combined	87,968	2.02	0.02	0.08	0.15	0.25	0.30	0.35	0.5%

87968

Basin Travel Time

	Shallow Channel Ground Cover		Short Pasture/Lawns			
	$L_{max,Overland}$ (ft)	ΔZ_0 (ft)	S_0 (ft/ft)	v (ft/s)	t (min)	t_{Alt} (min)
Total	631	29	-	-	-	-
Initial Time	84	3	0.036	-	11.0	13.5 DCM Eq. 6-8
Shallow Channel	306	14	0.046	1.5	3.4	- DCM Eq. 6-9
Channelized	241	12	0.050	3.5	1.1	- V-Ditch
t_c					13.5 min.	

Rainfall Intensity & Runoff

	2-Yr	5-Yr	10-Yr	25-Yr	50-Yr	100-Yr
Intensity (in/hr)	2.94	3.68	4.29	4.90	5.52	6.18
Runoff (cfs)	0.1	0.6	1.3	2.5	3.4	4.4
Release Rates (cfs/ac)	-	-	-	-	-	-
Allowed Release (cfs)	0.1	0.6	1.3	2.5	3.4	4.4

DCM: $I = C1 * \ln(tc) + C2$

C1	1.19	1.5	1.75	2	2.25	2.52
C2	6.035	7.583	8.847	10.111	11.375	12.735

Notes

Sub-Basin EX-G (EX-DP10) Runoff Calculations

Job No.: 61145
 Project: Eagle Rising - Preliminary/Final
 Jurisdiction: DCM
 Runoff Coefficient: Surface Type

Date: 11/14/2023 8:46
 Calcs by: O. Ali
 Checked by: _____
 Soil Type: B
 Urbanization: Urban

Basin Land Use Characteristics

Surface	Area		Runoff Coefficient						% Imperv.
	(SF)	(Acres)	C2	C5	C10	C25	C50	C100	
Pasture/Meadow	127,367	2.92	0.02	0.08	0.15	0.25	0.3	0.35	0%
Paved	2,498	0.06	0.89	0.9	0.92	0.94	0.95	0.96	100%
Combined	129,865	2.98	0.04	0.10	0.16	0.26	0.31	0.36	1.9%

129865

Basin Travel Time

	Shallow Channel	Ground Cover	Short Pasture/Lawns				
	$L_{max,Overland}$	300 ft	C_v	7			
	L (ft)	ΔZ_o (ft)	S_o (ft/ft)	v (ft/s)	t (min)	t_{Alt} (min)	
Total	739	36	-	-	-	-	
Initial Time	126	12	0.095	-	9.7	14.1	DCM Eq. 6-8
Shallow Channel	186	6	0.032	1.3	2.5	-	DCM Eq. 6-9
Channelized	427	18	0.042	3.6	2.0	-	V-Ditch
				t_c	14.1 min.		

Rainfall Intensity & Runoff

	2-Yr	5-Yr	10-Yr	25-Yr	50-Yr	100-Yr
Intensity (in/hr)	2.89	3.61	4.22	4.82	5.42	6.07
Runoff (cfs)	0.3	1.0	2.1	3.8	5.1	6.5
Release Rates (cfs/ac)	-	-	-	-	-	-
Allowed Release (cfs)	0.3	1.0	2.1	3.8	5.1	6.5

DCM: $I = C1 * \ln(tc) + C2$

C1	1.19	1.5	1.75	2	2.25	2.52
C2	6.035	7.583	8.847	10.111	11.375	12.735

Notes

Sub-Basin EX-H Runoff Calculations

Job No.: 61145
 Project: Eagle Rising - Preliminary/Final
 Jurisdiction: DCM
 Runoff Coefficient: Surface Type

Date: 11/14/2023 8:46
 Calcs by: O. Ali
 Checked by: _____
 Soil Type: B
 Urbanization: Urban

Basin Land Use Characteristics

Surface	Area		Runoff Coefficient						% Imperv.
	(SF)	(Acres)	C2	C5	C10	C25	C50	C100	
Pasture/Meadow	164,577	3.78	0.02	0.08	0.15	0.25	0.3	0.35	0%
Paved	14,101	0.32	0.89	0.9	0.92	0.94	0.95	0.96	100%
Combined	178,678	4.10	0.09	0.14	0.21	0.30	0.35	0.40	7.9%

178678

Basin Travel Time

	Shallow Channel Ground Cover		Short Pasture/Lawns			
	$L_{max,Overland}$	300 ft	S_0 (ft/ft)	v (ft/s)	t (min)	t_{Alt} (min)
Total	690	35	-	-	-	-
Initial Time	100	4	0.040	-	10.9	13.8 DCM Eq. 6-8
Shallow Channel	382	19	0.050	1.6	4.1	- DCM Eq. 6-9
Channelized	208	12	0.058	4.2	0.8	- V-Ditch
				t_c	13.8 min.	

Rainfall Intensity & Runoff

	2-Yr	5-Yr	10-Yr	25-Yr	50-Yr	100-Yr
Intensity (in/hr)	2.91	3.64	4.25	4.86	5.46	6.11
Runoff (cfs)	1.1	2.2	3.7	6.1	7.9	10.0
Release Rates (cfs/ac)	-	-	-	-	-	-
Allowed Release (cfs)	1.1	2.2	3.7	6.1	7.9	10.0

DCM: $I = C1 * \ln(tc) + C2$

C1	1.19	1.5	1.75	2	2.25	2.52
C2	6.035	7.583	8.847	10.111	11.375	12.735

Notes

Sub-Basin EX-I Runoff Calculations

Job No.: 61145
 Project: Eagle Rising - Preliminary/Final
 Jurisdiction: DCM
 Runoff Coefficient: Surface Type

Date: 11/14/2023 8:46
 Calcs by: O. Ali
 Checked by: _____
 Soil Type: B
 Urbanization: Urban

Basin Land Use Characteristics

Surface	Area		Runoff Coefficient						% Imperv.
	(SF)	(Acres)	C2	C5	C10	C25	C50	C100	
Pasture/Meadow	63,090	1.45	0.02	0.08	0.15	0.25	0.3	0.35	0%
Paved	8,194	0.19	0.89	0.9	0.92	0.94	0.95	0.96	100%
Combined	71,284	1.64	0.12	0.17	0.24	0.33	0.37	0.42	11.5%

71284

Basin Travel Time

	Shallow Channel	Ground Cover	Short Pasture/Lawns				
	$L_{max,Overland}$	300 ft	C_v	7			
	L (ft)	ΔZ_o (ft)	S_o (ft/ft)	v (ft/s)	t (min)	t_{Alt} (min)	
Total	413	17	-	-	-	-	
Initial Time	100	9	0.090	-	8.1	12.3	DCM Eq. 6-8
Shallow Channel	166	5	0.030	1.2	2.3	-	DCM Eq. 6-9
Channelized	147	3	0.020	1.2	2.0	-	V-Ditch
				t_c	12.3 min.		

Rainfall Intensity & Runoff

	2-Yr	5-Yr	10-Yr	25-Yr	50-Yr	100-Yr
Intensity (in/hr)	3.05	3.82	4.46	5.09	5.73	6.41
Runoff (cfs)	0.6	1.1	1.7	2.7	3.5	4.4
Release Rates (cfs/ac)	-	-	-	-	-	-
Allowed Release (cfs)	0.6	1.1	1.7	2.7	3.5	4.4

DCM: $I = C1 * \ln(tc) + C2$

C1	1.19	1.5	1.75	2	2.25	2.52
C2	6.035	7.583	8.847	10.111	11.375	12.735

Notes

Sub-Basin EX-J Runoff Calculations

Job No.: 61145
 Project: Eagle Rising - Preliminary/Final
 Jurisdiction: DCM
 Runoff Coefficient: Surface Type

Date: 11/14/2023 8:46
 Calcs by: O. Ali
 Checked by: _____
 Soil Type: B
 Urbanization: Urban

Basin Land Use Characteristics

Surface	Area		Runoff Coefficient						% Imperv.
	(SF)	(Acres)	C2	C5	C10	C25	C50	C100	
Pasture/Meadow	97,872	2.25	0.02	0.08	0.15	0.25	0.3	0.35	0%
Paved	7,699	0.18	0.89	0.9	0.92	0.94	0.95	0.96	100%
Combined	105,571	2.42	0.08	0.14	0.21	0.30	0.35	0.39	7.3%

105571

Basin Travel Time

	Shallow Channel Ground Cover		Short Pasture/Lawns			
	$L_{max,Overland}$	300 ft	S_0 (ft/ft)	v (ft/s)	t (min)	t_{Alt} (min)
Total	518	28	-	-	-	-
Initial Time	100	7	0.070	-	9.1	12.9 DCM Eq. 6-8
Shallow Channel	144	11	0.076	1.9	1.2	- DCM Eq. 6-9
Channelized	274	10	0.036	3.4	1.3	- V-Ditch
			t_c 11.7 min.			

Rainfall Intensity & Runoff

	2-Yr	5-Yr	10-Yr	25-Yr	50-Yr	100-Yr
Intensity (in/hr)	3.11	3.89	4.54	5.19	5.84	6.54
Runoff (cfs)	0.6	1.3	2.3	3.8	4.9	6.3
Release Rates (cfs/ac)	-	-	-	-	-	-
Allowed Release (cfs)	0.6	1.3	2.3	3.8	4.9	6.3

DCM: $I = C1 * \ln(tc) + C2$

C1	1.19	1.5	1.75	2	2.25	2.52
C2	6.035	7.583	8.847	10.111	11.375	12.735

Notes

Sub-Basin EX-K Runoff Calculations

Job No.: 61145
 Project: Eagle Rising - Preliminary/Final
 Jurisdiction: DCM
 Runoff Coefficient: Surface Type

Date: 11/14/2023 8:46
 Calcs by: O. Ali
 Checked by: _____
 Soil Type: B
 Urbanization: Urban

Basin Land Use Characteristics

Surface	Area		Runoff Coefficient						% Imperv.
	(SF)	(Acres)	C2	C5	C10	C25	C50	C100	
Pasture/Meadow	115,609	2.65	0.02	0.08	0.15	0.25	0.3	0.35	0%
Combined	115,609	2.65	0.02	0.08	0.15	0.25	0.30	0.35	0.0%

115609

Basin Travel Time

	Shallow Channel Ground Cover		Short Pasture/Lawns			
	$L_{max,Overland}$	300 ft			C_v	7
	L (ft)	ΔZ_0 (ft)	S_0 (ft/ft)	v (ft/s)	t (min)	t_{Alt} (min)
Total	150	13	-	-	-	-
Initial Time	150	13	0.087	-	11.1	10.8 DCM Eq. 6-8
Shallow Channel			0.000	0.0	0.0	- DCM Eq. 6-9
Channelized			0.000	0.0	0.0	- V-Ditch
				t_c	10.8 min.	

Rainfall Intensity & Runoff

	2-Yr	5-Yr	10-Yr	25-Yr	50-Yr	100-Yr
Intensity (in/hr)	3.20	4.01	4.68	5.35	6.01	6.73
Runoff (cfs)	0.2	0.9	1.9	3.5	4.8	6.3
Release Rates (cfs/ac)	-	-	-	-	-	-
Allowed Release (cfs)	0.2	0.9	1.9	3.5	4.8	6.3

DCM: $I = C1 * \ln(tc) + C2$

C1	1.19	1.5	1.75	2	2.25	2.52
C2	6.035	7.583	8.847	10.111	11.375	12.735

Notes

Sub-Basin EX-L Runoff Calculations

Job No.: 61145
 Project: Eagle Rising - Preliminary/Final
 Jurisdiction: DCM
 Runoff Coefficient: Surface Type

Date: 11/14/2023 8:46
 Calcs by: O. Ali
 Checked by: _____
 Soil Type: B
 Urbanization: Urban

Basin Land Use Characteristics

Surface	Area		Runoff Coefficient						% Imperv.
	(SF)	(Acres)	C2	C5	C10	C25	C50	C100	
Pasture/Meadow	93,208	2.14	0.02	0.08	0.15	0.25	0.3	0.35	0%
Combined	93,208	2.14	0.02	0.08	0.15	0.25	0.30	0.35	0.0%

93208

Basin Travel Time

	Shallow Channel Ground Cover		Short Pasture/Lawns			
	$L_{max,Overland}$	300 ft	S_0 (ft/ft)	v (ft/s)	t (min)	t_{Alt} (min)
Total	430	16	-	-	-	-
Initial Time	206	11	0.053	-	15.2	12.4 DCM Eq. 6-8
Shallow Channel	224	5	0.020	1.0	3.8	- DCM Eq. 6-9
Channelized			0.000	0.0	0.0	- V-Ditch
				t_c	12.4 min.	

Rainfall Intensity & Runoff

	2-Yr	5-Yr	10-Yr	25-Yr	50-Yr	100-Yr
Intensity (in/hr)	3.04	3.81	4.44	5.08	5.71	6.39
Runoff (cfs)	0.1	0.7	1.4	2.7	3.7	4.8
Release Rates (cfs/ac)	-	-	-	-	-	-
Allowed Release (cfs)	0.1	0.7	1.4	2.7	3.7	4.8

DCM: $I = C1 * \ln(tc) + C2$

C1	1.19	1.5	1.75	2	2.25	2.52
C2	6.035	7.583	8.847	10.111	11.375	12.735

Notes

Sub-Basin EX-M Runoff Calculations

Job No.: 61145
 Project: Eagle Rising - Preliminary/Final
 Jurisdiction: DCM
 Runoff Coefficient: Surface Type

Date: 11/14/2023 8:46
 Calcs by: O. Ali
 Checked by: _____
 Soil Type: B
 Urbanization: Urban

Basin Land Use Characteristics

Surface	Area		Runoff Coefficient						% Imperv.
	(SF)	(Acres)	C2	C5	C10	C25	C50	C100	
Paved	3,980	0.09	0.89	0.9	0.92	0.94	0.95	0.96	100%
Pasture/Meadow	174,550	4.01	0.02	0.08	0.15	0.25	0.3	0.35	0%
Combined	178,530	4.10	0.04	0.10	0.17	0.27	0.31	0.36	2.2%

178530

Basin Travel Time

	Shallow Channel Ground Cover		Short Pasture/Lawns					
	$L_{max,Overland}$	300 ft	S_0 (ft/ft)	v (ft/s)	t (min)	t_{Alt} (min)	C_v	7
Total	873	24	-	-	-	-	-	-
Initial Time	108	4	0.037	-	12.2	14.9	-	DCM Eq. 6-8
Shallow Channel	453	10	0.022	1.0	7.3	-	-	DCM Eq. 6-9
Channelized	312	10	0.032	1.5	3.5	-	-	V-Ditch
				t_c	14.9 min.			

Rainfall Intensity & Runoff

	2-Yr	5-Yr	10-Yr	25-Yr	50-Yr	100-Yr
Intensity (in/hr)	2.82	3.54	4.13	4.72	5.30	5.94
Runoff (cfs)	0.5	1.4	2.8	5.1	6.8	8.8
Release Rates (cfs/ac)	-	-	-	-	-	-
Allowed Release (cfs)	0.5	1.4	2.8	5.1	6.8	8.8

DCM: $I = C1 * \ln(tc) + C2$

C1	1.19	1.5	1.75	2	2.25	2.52
C2	6.035	7.583	8.847	10.111	11.375	12.735

Notes

Combined Sub-Basin Runoff Calculations - DP6 Existing

Includes Basins OS-B1A OS-B1B EX-B EX-C

Job No.:	61145	Date:	11/14/2023 8:46
Project:	Eagle Rising - Preliminary/Final	Calcs by:	O. Ali
Jurisdiction	DCM	Checked by:	
Runoff Coefficient	Surface Type	Soil Type	B
		Urbanization	Urban

Basin Land Use Characteristics

Surface	Area		Runoff Coefficient						% Imperv.
	(SF)	(Acres)	C2	C5	C10	C25	C50	C100	
Pasture/Meadow	1,210,111	27.78	0.02	0.08	0.15	0.25	0.3	0.35	0%
2-1/2 Acre	1,543,832	35.44	0.08	0.12	0.22	0.31	0.36	0.4	11%
5 Acre	367,545	8.44	0.06	0.1	0.2	0.29	0.34	0.38	7%
Roofs	1,676	0.04	0.71	0.73	0.75	0.78	0.8	0.81	90%
Paved	7,329	0.17	0.89	0.9	0.92	0.94	0.95	0.96	100%
Gravel	-	0.00	0.57	0.59	0.63	0.66	0.68	0.7	80%
Combined	3,130,493	71.87	0.06	0.10	0.19	0.29	0.34	0.38	6.5%

Basin Travel Time

	Sub-basin or Channel Type	Material Type	L (ft)	Elev. ΔZ ₀ (ft)	Q _i (cfs)	Base or Dia (ft)	Sides z:1 (ft/ft)	v (ft/s)	t (min)
Furthest Reach	OS-B1B	-	2,011	84	-	-	-	-	21.2
Channelized-1	V-Ditch	2	378	9	77	0	2	5.7	1.1
Channelized-2									
Channelized-3									
Total			2,389	93					

2 = Natural, Winding, minimal vegetation/shallow grass

t_c (min) 22.3

Storage Volume

		40 -hr release time							
EURV	0.00 (in)	a =	1						Detention is NOT required
WQCV	0.00 (in)								Water Quality is NOT required
i (return period)	5-year	10-year	100-year						
K _i (ft)	0.0000	0.0000	0						
V _i (acre-ft)	0.000	0.000	0		EURV	0%	0	0	0
V _i (ft ³)	0	0	0		WQCV	0%	0	0	0

Contributing Offsite Flows (Added to Runoff and Allowed Release, below.)

Contributing Basins/Areas

Q_{Minor} (cfs) - 5-year Storm

Q_{Major} (cfs) - 100-year Storm

Rainfall Intensity & Runoff

	2-Yr	5-Yr	10-Yr	25-Yr	50-Yr	100-Yr
Intensity (in/hr)	2.34	2.93	3.42	3.90	4.39	4.91
Site Runoff (cfs)	9.54	21.95	47.25	80.28	106.06	134.13
OffSite Runoff (cfs)	-	0.00	-	-	-	0.00
Release Rates (cfs/ac)	-	-	-	-	-	-
Allowed Release (cfs)	-	22.0	-	-	-	134.1

DCM: $I = C1 * \ln(tc) + C2$

C1	1.19	1.5	1.75	2	2.25	2.52
C2	6.035	7.583	8.847	10.111	11.375	12.735

Notes

Runoff from Offsite basins have been assumed constant, despite additional times of concentration.

Combined Sub-Basin Runoff Calculations- DP6A Existing

Includes Basins OS-B1C EX-E1

Job No.:	61145	Date:	11/14/2023 8:46
Project:	Eagle Rising - Preliminary/Final	Calcs by:	O. Ali
Jurisdiction	DCM	Checked by:	
Runoff Coefficient	Surface Type	Soil Type	B
		Urbanization	Urban

Basin Land Use Characteristics

Surface	Area		Runoff Coefficient						% Imperv.
	(SF)	(Acres)	C2	C5	C10	C25	C50	C100	
2-1/2 Acre	-	0.00	0.08	0.12	0.22	0.31	0.36	0.4	11%
5 Acre	-	0.00	0.06	0.1	0.2	0.29	0.34	0.38	7%
Gravel	38,377	0.88	0.57	0.59	0.63	0.66	0.68	0.7	80%
Paved	-	0.00	0.89	0.9	0.92	0.94	0.95	0.96	100%
Pasture/Meadow	175,042	4.02	0.02	0.08	0.15	0.25	0.3	0.35	0%
Roofs	15,215	0.35	0.71	0.73	0.75	0.78	0.8	0.81	90%
Combined	228,634	5.25	0.16	0.21	0.27	0.35	0.40	0.44	19.4%

Basin Travel Time

	Sub-basin or Channel Type	Material Type	L (ft)	Elev. ΔZ ₀ (ft)	Q _i (cfs)	Base or Dia (ft)	Sides z:1 (ft/ft)	v (ft/s)	t (min)
Furthest Reach	OS-B1C	-	528	16	-	-	-	-	12.9
Channelized-1	V-Ditch	2	963	36	4	0	2	3.2	5.0
Channelized-2									
Channelized-3									
Total			1,491	52					

2 = Natural, Winding, minimal vegetation/shallow grass

t_c (min) 17.9

Storage Volume

		40 -hr release time							
EURV	0.00 (in)	a =	1						Detention is NOT required
WQCV	0.00 (in)								Water Quality is NOT required
i (return period)	5-year	10-year	100-year						
K _i (ft)	0.0000	0.0000	0						
V _i (acre-ft)	0.000	0.000	0		EURV	0%		0	0
V _i (ft ³)	0	0	0		WQCV	0%	0	0	0

Contributing Offsite Flows (Added to Runoff and Allowed Release, below.)

Contributing Basins/Areas

Q_{Minor} (cfs) - 5-year Storm

Q_{Major} (cfs) - 100-year Storm

Rainfall Intensity & Runoff

	2-Yr	5-Yr	10-Yr	25-Yr	50-Yr	100-Yr
Intensity (in/hr)	2.60	3.25	3.80	4.34	4.88	5.46
Site Runoff (cfs)	2.16	3.57	5.39	8.06	10.17	12.59
OffSite Runoff (cfs)	-	0.00	-	-	-	0.00
Release Rates (cfs/ac)	-	-	-	-	-	-
Allowed Release (cfs)	-	3.6	-	-	-	12.6

DCM: $I = C1 * \ln(tc) + C2$

C1	1.19	1.5	1.75	2	2.25	2.52
C2	6.035	7.583	8.847	10.111	11.375	12.735

Notes

Runoff from Offsite basins have been assumed constant, despite additional times of concentration.

Combined Sub-Basin Runoff Calculations- DP6B Existing

Includes Basins OS-B1A OS-B1B EX-B EX-C EX-D

Job No.:	61145	Date:	11/14/2023 8:46
Project:	Eagle Rising - Preliminary/Final	Calcs by:	O. Ali
Jurisdiction	DCM	Checked by:	
Runoff Coefficient	Surface Type	Soil Type	B
		Urbanization	Urban

Basin Land Use Characteristics

Surface	Area		Runoff Coefficient							% Imperv.
	(SF)	(Acres)	C2	C5	C10	C25	C50	C100		
2-1/2 Acre	1,543,832	35.44	0.08	0.12	0.22	0.31	0.36	0.4	11%	
5 Acre	367,545	8.44	0.06	0.1	0.2	0.29	0.34	0.38	7%	
Gravel	9,370	0.22	0.57	0.59	0.63	0.66	0.68	0.7	80%	
Paved	13,544	0.31	0.89	0.9	0.92	0.94	0.95	0.96	100%	
Pasture/Meadow	1,498,699	34.41	0.02	0.08	0.15	0.25	0.3	0.35	0%	
Roofs	6,978	0.16	0.71	0.73	0.75	0.78	0.8	0.81	90%	
Combined	3,439,968	78.97	0.06	0.11	0.19	0.29	0.34	0.38	6.5%	

Basin Travel Time

	Sub-basin or Channel Type	Material Type	L (ft)	Elev. ΔZ ₀ (ft)	Q _i (cfs)	Base or Dia (ft)	Sides z:1 (ft/ft)	v (ft/s)	t (min)
Furthest Reach	OS-B1B	-	2,011	84	-	-	-	-	21.2
Channelized-1	V-Ditch	2	1,083	32	77	0	2	6.1	2.9
Channelized-2									
Channelized-3									
Total			3,094	116					

2 = Natural, Winding, minimal vegetation/shallow grass

t_c (min) 24.1

Storage Volume

		40 -hr release time							
EURV	0.00 (in)	a =	1						Detention is NOT required
WQCV	0.00 (in)								Water Quality is NOT required
i (return period)	5-year	10-year	100-year						
K _i (ft)	0.0000	0.0000	0						
V _i (acre-ft)	0.000	0.000	0		EURV	0%		0	0
V _i (ft ³)	0	0	0		WQCV	0%	0	0	0

Contributing Offsite Flows (Added to Runoff and Allowed Release, below.)

Contributing Basins/Areas

Q_{Minor} (cfs) - 5-year Storm

Q_{Major} (cfs) - 100-year Storm

Rainfall Intensity & Runoff

	2-Yr	5-Yr	10-Yr	25-Yr	50-Yr	100-Yr
Intensity (in/hr)	2.25	2.81	3.28	3.75	4.21	4.71
Site Runoff (cfs)	10.21	23.52	49.78	84.64	111.76	141.47
OffSite Runoff (cfs)	-	0.00	-	-	-	0.00
Release Rates (cfs/ac)	-	-	-	-	-	-
Allowed Release (cfs)	-	23.5	-	-	-	141.5

DCM: $I = C1 * \ln(tc) + C2$

C1	1.19	1.5	1.75	2	2.25	2.52
C2	6.035	7.583	8.847	10.111	11.375	12.735

Notes

Runoff from Offsite basins have been assumed constant, despite additional times of concentration.

Combined Sub-Basin Runoff Calculations- DP6C Existing

Includes Basins OS-B1A OS-B1B EX-B EX-C EX-D OS-B1C EX-E1

Job No.:	61145	Date:	11/14/2023 8:46
Project:	Eagle Rising - Preliminary/Final	Calcs by:	O. Ali
Jurisdiction	DCM	Checked by:	
Runoff Coefficient	Surface Type	Soil Type	B
		Urbanization	Urban

Basin Land Use Characteristics

Surface	Area		Runoff Coefficient						% Imperv.
	(SF)	(Acres)	C2	C5	C10	C25	C50	C100	
2-1/2 Acre	1,543,832	35.44	0.08	0.12	0.22	0.31	0.36	0.4	11%
5 Acre	367,545	8.44	0.06	0.1	0.2	0.29	0.34	0.38	7%
Gravel	47,747	1.10	0.57	0.59	0.63	0.66	0.68	0.7	80%
Paved	13,544	0.31	0.89	0.9	0.92	0.94	0.95	0.96	100%
Pasture/Meadow	1,673,741	38.42	0.02	0.08	0.15	0.25	0.3	0.35	0%
Roofs	22,193	0.51	0.71	0.73	0.75	0.78	0.8	0.81	90%
Combined	3,668,602	84.22	0.06	0.11	0.20	0.29	0.34	0.38	7.3%

Basin Travel Time

	Sub-basin or Channel Type	Material Type	L (ft)	Elev. ΔZ ₀ (ft)	Q _i (cfs)	Base or Dia (ft)	Sides z:1 (ft/ft)	v (ft/s)	t (min)
Furthest Reach	OS-B1B	-	2,011	84	-	-	-	-	21.2
Channelized-1	V-Ditch	2	1,083	32	77	0	2	6.1	2.9
Channelized-2									
Channelized-3									
Total			3,094	116					

2 = Natural, Winding, minimal vegetation/shallow grass

t_c (min) 24.1

Storage Volume

		40 -hr release time							
EURV	0.00 (in)	a =	1						Detention is NOT required
WQCV	0.00 (in)								Water Quality is NOT required
i (return period)	5-year	10-year	100-year						
K _i (ft)	0.0000	0.0000	0						
V _i (acre-ft)	0.000	0.000	0		EURV	0%		0	0
V _i (ft ³)	0	0	0		WQCV	0%	0	0	0

Contributing Offsite Flows (Added to Runoff and Allowed Release, below.)

Contributing Basins/Areas

Q_{Minor} (cfs) - 5-year Storm

Q_{Major} (cfs) - 100-year Storm

Rainfall Intensity & Runoff

	2-Yr	5-Yr	10-Yr	25-Yr	50-Yr	100-Yr
Intensity (in/hr)	2.25	2.81	3.28	3.75	4.21	4.71
Site Runoff (cfs)	12.08	26.60	54.43	91.60	120.54	152.34
OffSite Runoff (cfs)	-	0.00	-	-	-	0.00
Release Rates (cfs/ac)	-	-	-	-	-	-
Allowed Release (cfs)	-	26.6	-	-	-	152.3

DCM: $I = C1 * \ln(tc) + C2$

C1	1.19	1.5	1.75	2	2.25	2.52
C2	6.035	7.583	8.847	10.111	11.375	12.735

Notes

Runoff from Offsite basins have been assumed constant, despite additional times of concentration.

Combined Sub-Basin Runoff Calculations - DP7 Existing

Includes Basins OS-B1D EX-F1

Job No.:	61145	Date:	11/14/2023 8:46
Project:	Eagle Rising - Preliminary/Final	Calcs by:	O. Ali
Jurisdiction	DCM	Checked by:	
Runoff Coefficient	Surface Type	Soil Type	B
		Urbanization	Urban

Basin Land Use Characteristics

Surface	Area		Runoff Coefficient						% Imperv.
	(SF)	(Acres)	C2	C5	C10	C25	C50	C100	
Pasture/Meadow	366,112	8.40	0.02	0.08	0.15	0.25	0.3	0.35	0%
2-1/2 Acre	-	0.00	0.08	0.12	0.22	0.31	0.36	0.4	11%
5 Acre	-	0.00	0.06	0.1	0.2	0.29	0.34	0.38	7%
Roofs	9,594	0.22	0.71	0.73	0.75	0.78	0.8	0.81	90%
Paved	7,538	0.17	0.89	0.9	0.92	0.94	0.95	0.96	100%
Gravel	160,546	3.69	0.57	0.59	0.63	0.66	0.68	0.7	80%
Combined	543,790	12.48	0.21	0.25	0.31	0.39	0.43	0.47	26.6%

Basin Travel Time

	Sub-basin or Channel Type	Material Type	L (ft)	Elev. ΔZ ₀ (ft)	Q _i (cfs)	Base or Dia (ft)	Sides z:1 (ft/ft)	v (ft/s)	t (min)
Furthest Reach	OS-B1D	-	1,242	41	-	-	-	-	16.9
Channelized-1	V-Ditch	2	869	32	12	0	2	4.2	3.5
Channelized-2									
Channelized-3									
Total			2,111	73					

2 = Natural, Winding, minimal vegetation/shallow grass

t_c (min) 20.4

Storage Volume

		40 -hr release time							
EURV	0.00 (in)	a =	1						Detention is NOT required
WQCV	0.00 (in)								Water Quality is NOT required
i (return period)	5-year	10-year	100-year						
K _i (ft)	0.0000	0.0000	0						
V _i (acre-ft)	0.000	0.000	0		EURV	0%		0	0
V _i (ft ³)	0	0	0		WQCV	0%	0	0	0

Contributing Offsite Flows (Added to Runoff and Allowed Release, below.)

Contributing Basins/Areas

Q_{Minor} (cfs) - 5-year Storm

Q_{Major} (cfs) - 100-year Storm

Rainfall Intensity & Runoff

	2-Yr	5-Yr	10-Yr	25-Yr	50-Yr	100-Yr
Intensity (in/hr)	2.45	3.06	3.57	4.08	4.59	5.14
Site Runoff (cfs)	6.32	9.69	13.96	19.88	24.66	30.15
OffSite Runoff (cfs)	-	0.00	-	-	-	0.00
Release Rates (cfs/ac)	-	-	-	-	-	-
Allowed Release (cfs)	-	9.7	-	-	-	30.2

DCM: $I = C1 * \ln(tc) + C2$

C1	1.19	1.5	1.75	2	2.25	2.52
C2	6.035	7.583	8.847	10.111	11.375	12.735

Notes

Runoff from Offsite basins have been assumed constant, despite additional times of concentration.

Combined Sub-Basin Runoff Calculations - DP8A Existing

Includes Basins OS-B1E OS-B3A EX-H EX-I

Job No.:	61145	Date:	11/14/2023 8:46
Project:	Eagle Rising - Preliminary/Final	Calcs by:	O. Ali
Jurisdiction	DCM	Checked by:	
Runoff Coefficient	Surface Type	Soil Type	B
		Urbanization	Urban

Basin Land Use Characteristics

Surface	Area		Runoff Coefficient						% Imperv.
	(SF)	(Acres)	C2	C5	C10	C25	C50	C100	
Pasture/Meadow	500,305	11.49	0.02	0.08	0.15	0.25	0.3	0.35	0%
2-1/2 Acre	562,874	12.92	0.08	0.12	0.22	0.31	0.36	0.4	11%
5 Acre	-	0.00	0.06	0.1	0.2	0.29	0.34	0.38	7%
Roofs	-	0.00	0.71	0.73	0.75	0.78	0.8	0.81	90%
Paved	22,295	0.51	0.89	0.9	0.92	0.94	0.95	0.96	100%
Gravel	-	0.00	0.57	0.59	0.63	0.66	0.68	0.7	80%
Combined	1,085,474	24.92	0.07	0.12	0.20	0.30	0.34	0.39	7.8%

Basin Travel Time

	Sub-basin or Channel Type	Material Type	L (ft)	Elev. ΔZ ₀ (ft)	Q _i (cfs)	Base or Dia (ft)	Sides z:1 (ft/ft)	v (ft/s)	t (min)
Furthest Reach	OS-B1E	-	1,404	61	-	-	-	-	17.8
Channelized-1	V-Ditch	2	524	22	20	0	2	5.0	1.7
Channelized-2									
Channelized-3									
Total			1,928	83					

2 = Natural, Winding, minimal vegetation/shallow grass

t_c (min) 19.5

Storage Volume

		40 -hr release time		Detention is NOT required
EURV	0.00 (in)	a =	1	Water Quality is NOT required
WQCV	0.00 (in)			
i (return period)	5-year	10-year	100-year	Design Volume (ft³)
K _i (ft)	0.0000	0.0000	0	% Storage
V _i (acre-ft)	0.000	0.000	0	100-year
V _i (ft ³)	0	0	0	WQCV
				Total
				0
				0

Contributing Offsite Flows (Added to Runoff and Allowed Release, below.)

Contributing Basins/Areas OS-B4B

Q_{Minor} (cfs) - 5-year Storm

Q_{Major} (cfs) - 100-year Storm

Rainfall Intensity & Runoff

	2-Yr	5-Yr	10-Yr	25-Yr	50-Yr	100-Yr
Intensity (in/hr)	2.50	3.12	3.65	4.17	4.69	5.25
Site Runoff (cfs)	4.29	9.16	18.36	30.66	40.24	50.77
OffSite Runoff (cfs)	-	0.00	-	-	-	0.00
Release Rates (cfs/ac)	-	-	-	-	-	-
Allowed Release (cfs)	-	9.2	-	-	-	50.8

DCM: $I = C1 * \ln(tc) + C2$

C1	1.19	1.5	1.75	2	2.25	2.52
C2	6.035	7.583	8.847	10.111	11.375	12.735

Notes

Runoff from Offsite basins have been assumed constant, despite additional times of concentration.

Combined Sub-Basin Runoff Calculations - DP9 Existing

Includes Basins OS-B1D EX-F1 EX-F2

Job No.:	61145	Date:	11/14/2023 8:46
Project:	Eagle Rising - Preliminary/Final	Calcs by:	O. Ali
Jurisdiction	DCM	Checked by:	
Runoff Coefficient	Surface Type	Soil Type	B
		Urbanization	Urban

Basin Land Use Characteristics

Surface	Area		Runoff Coefficient						% Imperv.
	(SF)	(Acres)	C2	C5	C10	C25	C50	C100	
Pasture/Meadow	453,604	10.41	0.02	0.08	0.15	0.25	0.3	0.35	0%
2-1/2 Acre	-	0.00	0.08	0.12	0.22	0.31	0.36	0.4	11%
5 Acre	-	0.00	0.06	0.1	0.2	0.29	0.34	0.38	7%
Roofs	9,594	0.22	0.71	0.73	0.75	0.78	0.8	0.81	90%
Paved	8,014	0.18	0.89	0.9	0.92	0.94	0.95	0.96	100%
Gravel	160,546	3.69	0.57	0.59	0.63	0.66	0.68	0.7	80%
Combined	631,758	14.50	0.18	0.23	0.29	0.37	0.41	0.45	23.0%

Basin Travel Time

	Sub-basin or Channel Type	Material Type	L (ft)	Elev. ΔZ ₀ (ft)	Q _i (cfs)	Base or Dia (ft)	Sides z:1 (ft/ft)	v (ft/s)	t (min)
Furthest Reach	OS-B1D	-	1,242	41	-	-	-	-	16.9
Channelized-1	V-Ditch	2	1,500	58	12	0	2	4.3	5.9
Channelized-2									
Channelized-3									
Total			2,742	99					

2 = Natural, Winding, minimal vegetation/shallow grass

t_c (min) 22.8

Storage Volume

		40 -hr release time		Detention is NOT required
EURV	0.00 (in)	a =	1	Water Quality is NOT required
WQCV	0.00 (in)			
i (return period)	5-year	10-year	100-year	Design Volume (ft³)
K _i (ft)	0.0000	0.0000	0	% Storage
V _i (acre-ft)	0.000	0.000	0	100-year WQCV
V _i (ft ³)	0	0	0	Total
				EURV 0% 0 0
				WQCV 0% 0 0

Contributing Offsite Flows (Added to Runoff and Allowed Release, below.)

Contributing Basins/Areas OS-B4B

Q_{Minor} (cfs) - 5-year Storm

Q_{Major} (cfs) - 100-year Storm

Rainfall Intensity & Runoff

	2-Yr	5-Yr	10-Yr	25-Yr	50-Yr	100-Yr
Intensity (in/hr)	2.32	2.89	3.38	3.86	4.34	4.86
Site Runoff (cfs)	6.09	9.65	14.25	20.77	25.98	31.97
OffSite Runoff (cfs)	-	0.00	-	-	-	0.00
Release Rates (cfs/ac)	-	-	-	-	-	-
Allowed Release (cfs)	-	9.7	-	-	-	32.0

DCM: $I = C1 * \ln(tc) + C2$

C1	1.19	1.5	1.75	2	2.25	2.52
C2	6.035	7.583	8.847	10.111	11.375	12.735

Notes

Runoff from Offsite basins have been assumed constant, despite additional times of concentration.

Combined Sub-Basin Runoff Calculations (OS-B3A+I) Existing

Includes Basins OS-B3A EX-I

Job No.:	61145	Date:	11/14/2023 8:46
Project:	Eagle Rising - Preliminary/Final	Calcs by:	O. Ali
Jurisdiction	DCM	Checked by:	
Runoff Coefficient	Surface Type	Soil Type	B
		Urbanization	Urban

Basin Land Use Characteristics

Surface	Area		Runoff Coefficient						% Imperv.
	(SF)	(Acres)	C2	C5	C10	C25	C50	C100	
2-1/2 Acre	394,804	9.06	0.08	0.12	0.22	0.31	0.36	0.4	11%
5 Acre	-	0.00	0.06	0.1	0.2	0.29	0.34	0.38	7%
Roofs	-	0.00	0.71	0.73	0.75	0.78	0.8	0.81	90%
Pasture/Meadow	63,090	1.45	0.02	0.08	0.15	0.25	0.3	0.35	0%
Paved	8,194	0.19	0.89	0.9	0.92	0.94	0.95	0.96	100%
Combined	466,088	10.70	0.09	0.13	0.22	0.31	0.36	0.40	11.1%

Basin Travel Time

	Sub-basin or Channel Type	Material Type	L (ft)	Elev. ΔZ ₀ (ft)	Q _i (cfs)	Base or Dia (ft)	Sides z:1 (ft/ft)	v (ft/s)	t (min)
Furthest Reach	OS-B3A	-	938	45	-	-	-	-	15.2
Channelized-1	V-Ditch	2	339	17	21	0	2	5.4	1.0
Channelized-2									
Channelized-3									
Total			1,277	62					

2 = Natural, Winding, minimal vegetation/shallow grass

t_c (min) 16.2

Contributing Offsite Flows (Added to Runoff and Allowed Release, below.)

Contributing Basins/Areas: [Redacted]

Q_{Minor}: [Redacted] (cfs) - 5-year Storm

Q_{Major}: [Redacted] (cfs) - 100-year Storm

Rainfall Intensity & Runoff

	2-Yr	5-Yr	10-Yr	25-Yr	50-Yr	100-Yr
Intensity (in/hr)	2.72	3.40	3.97	4.53	5.10	5.71
Site Runoff (cfs)	2.50	4.67	9.46	15.19	19.78	24.62
OffSite Runoff (cfs)	-	0.00	-	-	-	0.00
Release Rates (cfs/ac)	-	-	-	-	-	-
Allowed Release (cfs)	-	4.7	-	-	-	24.6

DCM: $I = C1 * \ln(tc) + C2$

C1	1.19	1.5	1.75	2	2.25	2.52
C2	6.035	7.583	8.847	10.111	11.375	12.735

Notes

Runoff from Offsite basins have been assumed constant, despite additional times of concentration.

Combined Sub-Basin Runoff Calculations - DP11 Existing

Includes Basins OS-B3B EX-M

Job No.:	61145	Date:	11/14/2023 8:46
Project:	Eagle Rising - Preliminary/Final	Calcs by:	O. Ali
Jurisdiction	DCM	Checked by:	
Runoff Coefficient	Surface Type	Soil Type	B
		Urbanization	Urban

Basin Land Use Characteristics

Surface	Area		Runoff Coefficient						% Imperv.
	(SF)	(Acres)	C2	C5	C10	C25	C50	C100	
Pasture/Meadow	174,550	4.01	0.02	0.08	0.15	0.25	0.3	0.35	0%
2-1/2 Acre	109,046	2.50	0.08	0.12	0.22	0.31	0.36	0.4	11%
5 Acre	-	0.00	0.06	0.1	0.2	0.29	0.34	0.38	7%
Roofs	-	0.00	0.71	0.73	0.75	0.78	0.8	0.81	90%
Paved	3,980	0.09	0.89	0.9	0.92	0.94	0.95	0.96	100%
Gravel	-	0.00	0.57	0.59	0.63	0.66	0.68	0.7	80%
Combined	287,576	6.60	0.05	0.11	0.19	0.28	0.33	0.38	5.6%

Basin Travel Time

	Sub-basin or Channel Type	Material Type	L (ft)	Elev. ΔZ ₀ (ft)	Q _i (cfs)	Base or Dia (ft)	Sides z:1 (ft/ft)	v (ft/s)	t (min)
Furthest Reach	OS-B3B	-	636	29	-	-	-	-	13.5
Channelized-1	V-Ditch	2	873	24	6	0	2	3.2	4.6
Channelized-2									
Channelized-3									
Total			1,509	53					

2 = Natural, Winding, minimal vegetation/shallow grass

t_c (min) 18.1

Storage Volume

		40 -hr release time							
EURV	0.00 (in)	a =	1						Detention is NOT required
WQCV	0.00 (in)								Water Quality is NOT required
i (return period)	5-year	10-year	100-year						
K _i (ft)	0.0000	0.0000	0						
V _i (acre-ft)	0.000	0.000	0		EURV	0%		0	0
V _i (ft ³)	0	0	0		WQCV	0%	0	0	0

Contributing Offsite Flows (Added to Runoff and Allowed Release, below.)

Contributing Basins/Areas **OS-B4B**

Q_{Minor} (cfs) - 5-year Storm

Q_{Major} (cfs) - 100-year Storm

Rainfall Intensity & Runoff

	2-Yr	5-Yr	10-Yr	25-Yr	50-Yr	100-Yr
Intensity (in/hr)	2.59	3.24	3.78	4.32	4.86	5.44
Site Runoff (cfs)	0.94	2.28	4.67	8.05	10.64	13.55
OffSite Runoff (cfs)	-	0.00	-	-	-	0.00
Release Rates (cfs/ac)	-	-	-	-	-	-
Allowed Release (cfs)	-	2.3	-	-	-	13.5

DCM: $I = C1 * \ln(tc) + C2$

C1	1.19	1.5	1.75	2	2.25	2.52
C2	6.035	7.583	8.847	10.111	11.375	12.735

Notes

Runoff from Offsite basins have been assumed constant, despite additional times of concentration.

Combined Sub-Basin Runoff Calculations - DP12 Existing

Includes Basins OS-B1E OS-B3A EX-H EX-I EX-J

Job No.:	61145	Date:	11/14/2023 8:46
Project:	Eagle Rising - Preliminary/Final	Calcs by:	O. Ali
Jurisdiction	DCM	Checked by:	
Runoff Coefficient	Surface Type	Soil Type	B
		Urbanization	Urban

Basin Land Use Characteristics

Surface	Area		Runoff Coefficient						% Imperv.
	(SF)	(Acres)	C2	C5	C10	C25	C50	C100	
Pasture/Meadow	598,177	13.73	0.02	0.08	0.15	0.25	0.3	0.35	0%
2-1/2 Acre	562,874	12.92	0.08	0.12	0.22	0.31	0.36	0.4	11%
5 Acre	-	0.00	0.06	0.1	0.2	0.29	0.34	0.38	7%
Roofs	-	0.00	0.71	0.73	0.75	0.78	0.8	0.81	90%
Paved	29,994	0.69	0.89	0.9	0.92	0.94	0.95	0.96	100%
Gravel	-	0.00	0.57	0.59	0.63	0.66	0.68	0.7	80%
Combined	1,191,045	27.34	0.07	0.12	0.20	0.30	0.34	0.39	7.7%

Basin Travel Time

	Sub-basin or Channel Type	Material Type	L (ft)	Elev. ΔZ ₀ (ft)	Q _i (cfs)	Base or Dia (ft)	Sides z:1 (ft/ft)	v (ft/s)	t (min)
Furthest Reach	OS-B1E	-	1,404	61	-	-	-	-	17.8
Channelized-1	V-Ditch	2	955	34	20	0	2	4.7	3.4
Channelized-2									
Channelized-3									
Total			2,359	95					

2 = Natural, Winding, minimal vegetation/shallow grass

t_c (min) 21.2

Storage Volume

		40 -hr release time							
EURV	0.00 (in)	a =	1						Detention is NOT required
WQCV	0.00 (in)								Water Quality is NOT required
i (return period)	5-year	10-year	100-year						
K _i (ft)	0.0000	0.0000	0						
V _i (acre-ft)	0.000	0.000	0		EURV	0%	0	0	0
V _i (ft ³)	0	0	0		WQCV	0%	0	0	0

Contributing Offsite Flows (Added to Runoff and Allowed Release, below.)

Contributing Basins/Areas OS-B4B

Q_{Minor} (cfs) - 5-year Storm

Q_{Major} (cfs) - 100-year Storm

Rainfall Intensity & Runoff

	2-Yr	5-Yr	10-Yr	25-Yr	50-Yr	100-Yr
Intensity (in/hr)	2.40	3.00	3.51	4.01	4.51	5.04
Site Runoff (cfs)	4.62	9.82	19.41	32.40	42.49	53.64
OffSite Runoff (cfs)	-	0.00	-	-	-	0.00
Release Rates (cfs/ac)	-	-	-	-	-	-
Allowed Release (cfs)	-	9.8	-	-	-	53.6

DCM: $I = C1 * \ln(tc) + C2$

C1	1.19	1.5	1.75	2	2.25	2.52
C2	6.035	7.583	8.847	10.111	11.375	12.735

Notes

Runoff from Offsite basins have been assumed constant, despite additional times of concentration.

Combined Sub-Basin Runoff Calculations - DP13 Existing

Includes Basins OS-B3C EX-L

Job No.:	61145	Date:	11/14/2023 8:46
Project:	Eagle Rising - Preliminary/Final	Calcs by:	O. Ali
Jurisdiction	DCM	Soil Type	B
Runoff Coefficient	Surface Type	Urbanization	Urban

Basin Land Use Characteristics

Surface	Area		Runoff Coefficient						% Imperv.
	(SF)	(Acres)	C2	C5	C10	C25	C50	C100	
Pasture/Meadow	93,208	2.14	0.02	0.08	0.15	0.25	0.3	0.35	0%
2-1/2 Acre	259,332	5.95	0.08	0.12	0.22	0.31	0.36	0.4	11%
5 Acre	-	0.00	0.06	0.1	0.2	0.29	0.34	0.38	7%
Roofs	-	0.00	0.71	0.73	0.75	0.78	0.8	0.81	90%
Paved	-	0.00	0.89	0.9	0.92	0.94	0.95	0.96	100%
Gravel	-	0.00	0.57	0.59	0.63	0.66	0.68	0.7	80%
Combined	352,540	8.09	0.06	0.11	0.20	0.29	0.34	0.39	8.1%

Basin Travel Time

	Sub-basin or Channel Type	Material Type	L (ft)	Elev. ΔZ ₀ (ft)	Q _i (cfs)	Base or Dia (ft)	Sides z:1 (ft/ft)	v (ft/s)	t (min)
Furthest Reach	OS-B3C	-	994	38	-	-	-	-	15.5
Channelized-1	V-Ditch	2	430	16	14	0	2	4.4	1.6
Channelized-2									
Channelized-3									
Total			1,424	54					

2 = Natural, Winding, minimal vegetation/shallow grass

t_c (min) 17.2

Storage Volume

		40 -hr release time							
EURV	0.00 (in)	a =	1						Detention is NOT required
WQCV	0.00 (in)								Water Quality is NOT required
i (return period)	5-year	10-year	100-year						
K _i (ft)	0.0000	0.0000	0						
V _i (acre-ft)	0.000	0.000	0		EURV	0%	0	0	0
V _i (ft ³)	0	0	0		WQCV	0%	0	0	0

Contributing Offsite Flows (Added to Runoff and Allowed Release, below.)

Contributing Basins/Areas OS-B4B

Q_{Minor} (cfs) - 5-year Storm

Q_{Major} (cfs) - 100-year Storm

Rainfall Intensity & Runoff

	2-Yr	5-Yr	10-Yr	25-Yr	50-Yr	100-Yr
Intensity (in/hr)	2.65	3.32	3.87	4.43	4.98	5.57
Site Runoff (cfs)	1.38	2.94	6.31	10.54	13.87	17.44
OffSite Runoff (cfs)	-	0.00	-	-	-	0.00
Release Rates (cfs/ac)	-	-	-	-	-	-
Allowed Release (cfs)	-	2.9	-	-	-	17.4

DCM: $I = C1 * \ln(tc) + C2$

C1	1.19	1.5	1.75	2	2.25	2.52
C2	6.035	7.583	8.847	10.111	11.375	12.735

Notes

Runoff from Offsite basins have been assumed constant, despite additional times of concentration.

Sub-Basin A1 Runoff Calculations

Job No.: 61145
 Project: Eagle Rising - Preliminary/Final
 Jurisdiction: DCM
 Runoff Coefficient: Surface Type

Date: 11/14/2023 8:46
 Calcs by: O. Ali
 Checked by: _____
 Soil Type: B
 Urbanization: Urban

Basin Land Use Characteristics

Surface	Area		Runoff Coefficient						% Imperv.
	(SF)	(Acres)	C2	C5	C10	C25	C50	C100	
Pasture/Meadow	202,272	4.64	0.02	0.08	0.15	0.25	0.3	0.35	0%
Roofs	8,500	0.20	0.71	0.73	0.75	0.78	0.8	0.81	90%
Paved	4,800	0.11	0.89	0.9	0.92	0.94	0.95	0.96	100%
Combined	215,572	4.95	0.07	0.12	0.19	0.29	0.33	0.38	5.8%

215572

Basin Travel Time

	Shallow Channel Ground Cover		Short Pasture/Lawns			
	$L_{max,Overland}$ (ft)	ΔZ_0 (ft)	S_0 (ft/ft)	v (ft/s)	t (min)	t_{Alt} (min)
Total	636	52	-	-	-	-
Initial Time	299	32	0.107	-	13.9	13.5 DCM Eq. 6-8
Shallow Channel	337	20	0.059	1.7	3.3	- DCM Eq. 6-9
Channelized			0.000	0.0	0.0	- V-Ditch
				t_c	13.5 min.	

Rainfall Intensity & Runoff

	2-Yr	5-Yr	10-Yr	25-Yr	50-Yr	100-Yr
Intensity (in/hr)	2.93	3.68	4.29	4.90	5.51	6.17
Runoff (cfs)	1.0	2.3	4.0	6.9	9.1	11.7
Release Rates (cfs/ac)	-	-	-	-	-	-
Allowed Release (cfs)	1.0	2.3	4.0	6.9	9.1	11.7

DCM: $I = C1 * \ln(tc) + C2$

C1	1.19	1.5	1.75	2	2.25	2.52
C2	6.035	7.583	8.847	10.111	11.375	12.735

Notes

Sub-Basin A2 Runoff Calculations

Job No.: 61145
 Project: Eagle Rising - Preliminary/Final
 Jurisdiction: DCM
 Runoff Coefficient: Surface Type

Date: 11/14/2023 8:46
 Calcs by: O. Ali
 Checked by: _____
 Soil Type: B
 Urbanization: Urban

Basin Land Use Characteristics

Surface	Area		Runoff Coefficient						% Imperv.
	(SF)	(Acres)	C2	C5	C10	C25	C50	C100	
Pasture/Meadow	75,899	1.74	0.02	0.08	0.15	0.25	0.3	0.35	0%
Combined	75,899	1.74	0.02	0.08	0.15	0.25	0.30	0.35	0.0%

75899

Basin Travel Time

	Shallow Channel Ground Cover		Short Pasture/Lawns			
	$L_{max,Overland}$ (ft)	ΔZ_0 (ft)	S_0 (ft/ft)	v (ft/s)	t (min)	t_{Alt} (min)
Total	392	34	-	-	-	-
Initial Time	154	20	0.130	-	9.8	12.2 DCM Eq. 6-8
Shallow Channel	238	14	0.059	1.7	2.3	- DCM Eq. 6-9
Channelized			0.000	0.0	0.0	- V-Ditch
				t_c	12.1 min.	

Rainfall Intensity & Runoff

	2-Yr	5-Yr	10-Yr	25-Yr	50-Yr	100-Yr
Intensity (in/hr)	3.06	3.84	4.48	5.12	5.76	6.44
Runoff (cfs)	0.1	0.5	1.2	2.2	3.0	3.9
Release Rates (cfs/ac)	-	-	-	-	-	-
Allowed Release (cfs)	0.1	0.5	1.2	2.2	3.0	3.9

DCM: $I = C1 * \ln(tc) + C2$

C1	1.19	1.5	1.75	2	2.25	2.52
C2	6.035	7.583	8.847	10.111	11.375	12.735

Notes

Sub-Basin B Runoff Calculations

Job No.: 61145 Date: 11/14/2023 8:46
 Project: Eagle Rising - Preliminary/Final Calcs by: O. Ali
 Checked by: _____
 Jurisdiction: DCM Soil Type: B
 Runoff Coefficient: Surface Type Urbanization: Urban

Basin Land Use Characteristics

Surface	Area		Runoff Coefficient						% Imperv.
	(SF)	(Acres)	C2	C5	C10	C25	C50	C100	
Roofs	6,776	0.16	0.71	0.73	0.75	0.78	0.8	0.81	90%
Paved	10,209	0.23	0.89	0.9	0.92	0.94	0.95	0.96	100%
Pasture/Meadow	172,335	3.96	0.02	0.08	0.15	0.25	0.3	0.35	0%
Combined	189,320	4.35	0.09	0.15	0.21	0.31	0.35	0.40	8.6%

189320

Basin Travel Time

	Shallow Channel	Ground Cover	Short Pasture/Lawns				
	$L_{max,Overland}$	300 ft	C_v	7			
	L (ft)	ΔZ_o (ft)	S_o (ft/ft)	v (ft/s)	t (min)	t_{Alt} (min)	
Total	516	19	-	-	-	-	
Initial Time	100	8	0.075	-	8.8	12.9	DCM Eq. 6-8
Shallow Channel	176	6	0.031	1.2	2.4	-	DCM Eq. 6-9
Channelized	240	6	0.023	3.2	1.2	-	V-Ditch
				t_c	12.5 min.		

Rainfall Intensity & Runoff

	2-Yr	5-Yr	10-Yr	25-Yr	50-Yr	100-Yr
Intensity (in/hr)	3.03	3.80	4.43	5.07	5.70	6.38
Runoff (cfs)	1.2	2.4	4.1	6.7	8.7	11.1
Release Rates (cfs/ac)	-	-	-	-	-	-
Allowed Release (cfs)	1.2	2.4	4.1	6.7	8.7	11.1

DCM: $I = C1 * \ln(tc) + C2$

C1	1.19	1.5	1.75	2	2.25	2.52
C2	6.035	7.583	8.847	10.111	11.375	12.735

Notes

Sub-Basin C Runoff Calculations

Job No.: 61145 Date: 11/14/2023 8:46
 Project: Eagle Rising - Preliminary/Final Calcs by: O. Ali
 Checked by: _____
 Jurisdiction: DCM Soil Type: B
 Runoff Coefficient: Surface Type Urbanization: Urban

Basin Land Use Characteristics

Surface	Area		Runoff Coefficient						% Imperv.
	(SF)	(Acres)	C2	C5	C10	C25	C50	C100	
Roofs	1,698	0.04	0.71	0.73	0.75	0.78	0.8	0.81	90%
Paved	959	0.02	0.89	0.9	0.92	0.94	0.95	0.96	100%
Pasture/Meadow	69,865	1.60	0.02	0.08	0.15	0.25	0.3	0.35	0%
Combined	72,522	1.66	0.05	0.11	0.17	0.27	0.32	0.37	3.4%

72522

Basin Travel Time

	Shallow Channel	Ground Cover	Short Pasture/Lawns				
	$L_{max,Overland}$	300 ft	C_v	7			
	L (ft)	ΔZ_o (ft)	S_o (ft/ft)	v (ft/s)	t (min)	t_{Alt} (min)	
Total	338	17	-	-	-	-	
Initial Time	100	5	0.050	-	10.6	11.9	DCM Eq. 6-8
Shallow Channel	238	12	0.050	1.6	2.5	-	DCM Eq. 6-9
Channelized			0.000	0.0	0.0	-	V-Ditch
				t_c	11.9 min.		

Rainfall Intensity & Runoff

	2-Yr	5-Yr	10-Yr	25-Yr	50-Yr	100-Yr
Intensity (in/hr)	3.09	3.87	4.52	5.16	5.81	6.50
Runoff (cfs)	0.2	0.7	1.3	2.3	3.1	4.0
Release Rates (cfs/ac)	-	-	-	-	-	-
Allowed Release (cfs)	0.2	0.7	1.3	2.3	3.1	4.0

DCM: $I = C1 * \ln(tc) + C2$

C1	1.19	1.5	1.75	2	2.25	2.52
C2	6.035	7.583	8.847	10.111	11.375	12.735

Notes

Sub-Basin D Runoff Calculations

Job No.: 61145 Date: 11/14/2023 8:46
 Project: Eagle Rising - Preliminary/Final Calcs by: O. Ali
 Checked by: _____
 Jurisdiction: DCM Soil Type: B
 Runoff Coefficient: Surface Type Urbanization: Urban

Basin Land Use Characteristics

Surface	Area		Runoff Coefficient						% Imperv.
	(SF)	(Acres)	C2	C5	C10	C25	C50	C100	
Roofs	11,254	0.26	0.71	0.73	0.75	0.78	0.8	0.81	90%
Paved	9,576	0.22	0.89	0.9	0.92	0.94	0.95	0.96	100%
Pasture/Meadow	279,275	6.41	0.02	0.08	0.15	0.25	0.3	0.35	0%
Gravel	9,370	0.22	0.57	0.59	0.63	0.66	0.68	0.7	80%
Combined	309,475	7.10	0.09	0.14	0.21	0.30	0.35	0.40	8.8%

309475

Basin Travel Time

	Shallow Channel Ground Cover		Short Pasture/Lawns			
	$L_{max,Overland}$	300 ft			C_v	7
	L (ft)	ΔZ_0 (ft)	S_0 (ft/ft)	v (ft/s)	t (min)	t_{Alt} (min)
Total	881	42	-	-	-	-
Initial Time	100	7	0.070	-	9.1	14.9 DCM Eq. 6-8
Shallow Channel	160	14	0.088	2.1	1.3	- DCM Eq. 6-9
Channelized	621	21	0.034	4.2	2.5	- V-Ditch
				t_c	12.8 min.	

Rainfall Intensity & Runoff

	2-Yr	5-Yr	10-Yr	25-Yr	50-Yr	100-Yr
Intensity (in/hr)	3.00	3.75	4.38	5.00	5.63	6.30
Runoff (cfs)	1.9	3.9	6.5	10.8	14.0	17.7
Release Rates (cfs/ac)	-	-	-	-	-	-
Allowed Release (cfs)	1.9	3.9	6.5	10.8	14.0	17.7

DCM: $I = C1 * \ln(tc) + C2$

C1	1.19	1.5	1.75	2	2.25	2.52
C2	6.035	7.583	8.847	10.111	11.375	12.735

Notes

Sub-Basin E1 Runoff Calculations

Job No.: 61145
 Project: Eagle Rising - Preliminary/Final
 Jurisdiction: DCM
 Runoff Coefficient: Surface Type

Date: 11/14/2023 8:46
 Calcs by: O. Ali
 Checked by: _____
 Soil Type: B
 Urbanization: Urban

Basin Land Use Characteristics

Surface	Area		Runoff Coefficient						% Imperv.
	(SF)	(Acres)	C2	C5	C10	C25	C50	C100	
Roofs	15,215	0.35	0.71	0.73	0.75	0.78	0.8	0.81	90%
Gravel	38,377	0.88	0.57	0.59	0.63	0.66	0.68	0.7	80%
Pasture/Meadow	94,964	2.18	0.02	0.08	0.15	0.25	0.3	0.35	0%
Combined	148,556	3.41	0.23	0.28	0.34	0.41	0.45	0.49	29.9%

148556

Basin Travel Time

	Shallow Channel Ground Cover		Short Pasture/Lawns			
	$L_{max,Overland}$	300 ft	S_0 (ft/ft)	v (ft/s)	t (min)	t_{Alt} (min)
Total	965	21	-	-	-	-
Initial Time	100	7	0.070	-	7.8	15.4 DCM Eq. 6-8
Shallow Channel			0.000	0.0	0.0	- DCM Eq. 6-9
Channelized	865	14	0.016	2.7	5.3	- V-Ditch
			t_c 13.1 min.			

Rainfall Intensity & Runoff

	2-Yr	5-Yr	10-Yr	25-Yr	50-Yr	100-Yr
Intensity (in/hr)	2.97	3.72	4.34	4.96	5.58	6.25
Runoff (cfs)	2.4	3.5	5.0	6.9	8.6	10.4
Release Rates (cfs/ac)	-	-	-	-	-	-
Allowed Release (cfs)	2.4	3.5	5.0	6.9	8.6	10.4

DCM: $I = C1 * \ln(tc) + C2$

C1	1.19	1.5	1.75	2	2.25	2.52
C2	6.035	7.583	8.847	10.111	11.375	12.735

Notes

Sub-Basin E2 (DP8) Runoff Calculations

Job No.: 61145 Date: 11/14/2023 8:46
 Project: Eagle Rising - Preliminary/Final Calcs by: O. Ali
 Checked by: _____
 Jurisdiction: DCM Soil Type: B
 Runoff Coefficient: Surface Type Urbanization: Urban

Basin Land Use Characteristics

Surface	Area		Runoff Coefficient						% Imperv.
	(SF)	(Acres)	C2	C5	C10	C25	C50	C100	
Roofs	26,889	0.62	0.71	0.73	0.75	0.78	0.8	0.81	90%
Paved	5,760	0.13	0.89	0.9	0.92	0.94	0.95	0.96	100%
Pasture/Meadow	269,259	6.18	0.02	0.08	0.15	0.25	0.3	0.35	0%
Gravel	36,575	0.84	0.57	0.59	0.63	0.66	0.68	0.7	80%
Combined	338,483	7.77	0.15	0.20	0.26	0.35	0.39	0.43	17.5%

338483

Basin Travel Time

	Shallow Channel	Ground Cover	Short Pasture/Lawns				
	$L_{max,Overland}$	300 ft	C_v	7			
	L (ft)	ΔZ_o (ft)	S_o (ft/ft)	v (ft/s)	t (min)	t_{Alt} (min)	
Total	1,139	37	-	-	-	-	
Initial Time	299	10	0.033	-	18.8	16.3	DCM Eq. 6-8
Shallow Channel	222	12	0.054	1.6	2.3	-	DCM Eq. 6-9
Channelized	618	15	0.024	3.8	2.7	-	V-Ditch
				t_c	16.3 min.		

Rainfall Intensity & Runoff

	2-Yr	5-Yr	10-Yr	25-Yr	50-Yr	100-Yr
Intensity (in/hr)	2.71	3.39	3.96	4.53	5.09	5.70
Runoff (cfs)	3.1	5.3	8.1	12.2	15.5	19.2
Release Rates (cfs/ac)	-	-	-	-	-	-
Allowed Release (cfs)	3.1	5.3	8.1	12.2	15.5	19.2

DCM: $I = C1 * \ln(tc) + C2$

C1	1.19	1.5	1.75	2	2.25	2.52
C2	6.035	7.583	8.847	10.111	11.375	12.735

Notes

Sub-Basin F1 Runoff Calculations

Job No.: 61145 Date: 11/14/2023 8:46
 Project: Eagle Rising - Preliminary/Final Calcs by: O. Ali
 Checked by: _____
 Jurisdiction: DCM Soil Type: B
 Runoff Coefficient: Surface Type Urbanization: Urban

Basin Land Use Characteristics

Surface	Area		Runoff Coefficient						% Imperv.
	(SF)	(Acres)	C2	C5	C10	C25	C50	C100	
Roofs	14,674	0.34	0.71	0.73	0.75	0.78	0.8	0.81	90%
Paved	10,418	0.24	0.89	0.9	0.92	0.94	0.95	0.96	100%
Pasture/Meadow	95,499	2.19	0.02	0.08	0.15	0.25	0.3	0.35	0%
Gravel	160,546	3.69	0.57	0.59	0.63	0.66	0.68	0.7	80%
Combined	281,137	6.45	0.40	0.44	0.48	0.54	0.57	0.60	54.1%

281137

Basin Travel Time

	Shallow Channel Ground Cover		Short Pasture/Lawns				
	$L_{max,Overland}$	300 ft			C_v	7	
	L (ft)	ΔZ_o (ft)	S_o (ft/ft)	v (ft/s)	t (min)	t_{Alt} (min)	
Total	682	20	-	-	-	-	
Initial Time	100	2	0.020	-	9.5	13.8	DCM Eq. 6-8
Shallow Channel	343	4	0.012	0.8	7.6	-	DCM Eq. 6-9
Channelized	239	14	0.056	4.9	0.8	-	V-Ditch
				t_c	13.8 min.		

Rainfall Intensity & Runoff

	2-Yr	5-Yr	10-Yr	25-Yr	50-Yr	100-Yr
Intensity (in/hr)	2.91	3.65	4.26	4.86	5.47	6.12
Runoff (cfs)	7.6	10.3	13.3	16.9	20.0	23.6
Release Rates (cfs/ac)	-	-	-	-	-	-
Allowed Release (cfs)	7.6	10.3	13.3	16.9	20.0	23.6

DCM: $I = C1 * \ln(tc) + C2$

C1	1.19	1.5	1.75	2	2.25	2.52
C2	6.035	7.583	8.847	10.111	11.375	12.735

Notes

Sub-Basin F2 Runoff Calculations

Job No.: 61145 Date: 11/14/2023 8:46
 Project: Eagle Rising - Preliminary/Final Calcs by: O. Ali
 Checked by: _____
 Jurisdiction: DCM Soil Type: B
 Runoff Coefficient: Surface Type Urbanization: Urban

Basin Land Use Characteristics

Surface	Area		Runoff Coefficient						% Imperv.
	(SF)	(Acres)	C2	C5	C10	C25	C50	C100	
Roofs	5,100	0.12	0.71	0.73	0.75	0.78	0.8	0.81	90%
Paved	3,253	0.07	0.89	0.9	0.92	0.94	0.95	0.96	100%
Pasture/Meadow	79,615	1.83	0.02	0.08	0.15	0.25	0.3	0.35	0%
Combined	87,968	2.02	0.09	0.15	0.21	0.31	0.35	0.40	8.9%

87968

Basin Travel Time

	Shallow Channel Ground Cover		Short Pasture/Lawns			
	$L_{max,Overland}$	300 ft			C_v	7
	L (ft)	ΔZ_0 (ft)	S_0 (ft/ft)	v (ft/s)	t (min)	t_{Alt} (min)
Total	631	29	-	-	-	-
Initial Time	84	3	0.036	-	10.3	13.5 DCM Eq. 6-8
Shallow Channel	306	14	0.046	1.5	3.4	- DCM Eq. 6-9
Channelized	241	12	0.050	3.5	1.1	- V-Ditch
				t_c	13.5 min.	

Rainfall Intensity & Runoff

	2-Yr	5-Yr	10-Yr	25-Yr	50-Yr	100-Yr
Intensity (in/hr)	2.94	3.68	4.29	4.90	5.52	6.18
Runoff (cfs)	0.5	1.1	1.8	3.0	3.9	5.0
Release Rates (cfs/ac)	-	-	-	-	-	-
Allowed Release (cfs)	0.5	1.1	1.8	3.0	3.9	5.0

DCM: $I = C1 * \ln(tc) + C2$

C1	1.19	1.5	1.75	2	2.25	2.52
C2	6.035	7.583	8.847	10.111	11.375	12.735

Notes

Sub-Basin G (DP10) Runoff Calculations

Job No.: 61145 Date: 11/14/2023 8:46
 Project: Eagle Rising - Preliminary/Final Calcs by: O. Ali
 Checked by: _____
 Jurisdiction: DCM Soil Type: B
 Runoff Coefficient: Surface Type Urbanization: Urban

Basin Land Use Characteristics

Surface	Area		Runoff Coefficient						% Imperv.
	(SF)	(Acres)	C2	C5	C10	C25	C50	C100	
Roofs	5,100	0.12	0.71	0.73	0.75	0.78	0.8	0.81	90%
Paved	5,394	0.12	0.89	0.9	0.92	0.94	0.95	0.96	100%
Pasture/Meadow	119,371	2.74	0.02	0.08	0.15	0.25	0.3	0.35	0%
Combined	129,865	2.98	0.08	0.14	0.21	0.30	0.35	0.39	7.7%

129865

Basin Travel Time

	Shallow Channel	Ground Cover	Short Pasture/Lawns				
$L_{max,Overland}$	300	ft	C_v	7			
L (ft)	ΔZ_0 (ft)	S_0 (ft/ft)	v (ft/s)	t (min)	t_{Alt} (min)		
Total	739	36	-	-	-		
Initial Time	126	12	0.095	-	9.3	14.1	DCM Eq. 6-8
Shallow Channel	186	6	0.032	1.3	2.5	-	DCM Eq. 6-9
Channelized	427	18	0.042	3.6	2.0	-	V-Ditch
				t_c	13.7 min.		

Rainfall Intensity & Runoff

	2-Yr	5-Yr	10-Yr	25-Yr	50-Yr	100-Yr
Intensity (in/hr)	2.92	3.66	4.27	4.88	5.49	6.14
Runoff (cfs)	0.7	1.5	2.6	4.4	5.7	7.2
Release Rates (cfs/ac)	-	-	-	-	-	-
Allowed Release (cfs)	0.7	1.5	2.6	4.4	5.7	7.2

DCM: $I = C1 * \ln(tc) + C2$

C1	1.19	1.5	1.75	2	2.25	2.52
C2	6.035	7.583	8.847	10.111	11.375	12.735

Notes

Sub-Basin H Runoff Calculations

Job No.: 61145 Date: 11/14/2023 8:46
 Project: Eagle Rising - Preliminary/Final Calcs by: O. Ali
 Checked by: _____
 Jurisdiction: DCM Soil Type: B
 Runoff Coefficient: Surface Type Urbanization: Urban

Basin Land Use Characteristics

Surface	Area		Runoff Coefficient						% Imperv.
	(SF)	(Acres)	C2	C5	C10	C25	C50	C100	
Roofs	7,650	0.18	0.71	0.73	0.75	0.78	0.8	0.81	90%
Paved	19,307	0.44	0.89	0.9	0.92	0.94	0.95	0.96	100%
Pasture/Meadow	151,721	3.48	0.02	0.08	0.15	0.25	0.3	0.35	0%
Combined	178,678	4.10	0.14	0.20	0.26	0.35	0.39	0.44	14.7%

178678

Basin Travel Time

	Shallow Channel Ground Cover		Short Pasture/Lawns			
	$L_{max,Overland}$	300 ft			C_v	7
	L (ft)	ΔZ_0 (ft)	S_0 (ft/ft)	v (ft/s)	t (min)	t_{Alt} (min)
Total	690	35	-	-	-	-
Initial Time	100	4	0.040	-	10.3	13.8 DCM Eq. 6-8
Shallow Channel	382	19	0.050	1.6	4.1	- DCM Eq. 6-9
Channelized	208	12	0.058	4.2	0.8	- V-Ditch
				t_c	13.8 min.	

Rainfall Intensity & Runoff

	2-Yr	5-Yr	10-Yr	25-Yr	50-Yr	100-Yr
Intensity (in/hr)	2.91	3.64	4.25	4.86	5.46	6.11
Runoff (cfs)	1.7	2.9	4.5	6.9	8.8	10.9
Release Rates (cfs/ac)	-	-	-	-	-	-
Allowed Release (cfs)	1.7	2.9	4.5	6.9	8.8	10.9

DCM: $I = C1 * \ln(tc) + C2$

C1	1.19	1.5	1.75	2	2.25	2.52
C2	6.035	7.583	8.847	10.111	11.375	12.735

Notes

Sub-Basin I Runoff Calculations

Job No.: 61145
 Project: Eagle Rising - Preliminary/Final
 Jurisdiction: DCM
 Runoff Coefficient: Surface Type

Date: 11/14/2023 8:46
 Calcs by: O. Ali
 Checked by: _____
 Soil Type: B
 Urbanization: Urban

Basin Land Use Characteristics

Surface	Area		Runoff Coefficient						% Imperv.
	(SF)	(Acres)	C2	C5	C10	C25	C50	C100	
Roofs	2,550	0.06	0.71	0.73	0.75	0.78	0.8	0.81	90%
Paved	9,527	0.22	0.89	0.9	0.92	0.94	0.95	0.96	100%
Pasture/Meadow	59,207	1.36	0.02	0.08	0.15	0.25	0.3	0.35	0%
Combined	71,284	1.64	0.16	0.21	0.27	0.36	0.40	0.45	16.6%

71284

Basin Travel Time

	Shallow Channel Ground Cover		Short Pasture/Lawns			
	$L_{max,Overland}$ (ft)	ΔZ_0 (ft)	S_0 (ft/ft)	v (ft/s)	t (min)	t_{Alt} (min)
Total	413	17	-	-	-	-
Initial Time	100	9	0.090	-	7.8	12.3 DCM Eq. 6-8
Shallow Channel	166	5	0.030	1.2	2.3	- DCM Eq. 6-9
Channelized	147	3	0.020	1.2	2.0	- V-Ditch
t_c					12.0 min.	

Rainfall Intensity & Runoff

	2-Yr	5-Yr	10-Yr	25-Yr	50-Yr	100-Yr
Intensity (in/hr)	3.08	3.86	4.50	5.14	5.78	6.47
Runoff (cfs)	0.8	1.3	2.0	3.0	3.8	4.7
Release Rates (cfs/ac)	-	-	-	-	-	-
Allowed Release (cfs)	0.8	1.3	2.0	3.0	3.8	4.7

DCM: $I = C1 * \ln(tc) + C2$

C1	1.19	1.5	1.75	2	2.25	2.52
C2	6.035	7.583	8.847	10.111	11.375	12.735

Notes

Sub-Basin J Runoff Calculations

Job No.: 61145 Date: 11/14/2023 8:46
 Project: Eagle Rising - Preliminary/Final Calcs by: O. Ali
 Checked by: _____
 Jurisdiction: DCM Soil Type: B
 Runoff Coefficient: Surface Type Urbanization: Urban

Basin Land Use Characteristics

Surface	Area		Runoff Coefficient						% Imperv.
	(SF)	(Acres)	C2	C5	C10	C25	C50	C100	
Roofs	5,100	0.12	0.71	0.73	0.75	0.78	0.8	0.81	90%
Paved	9,725	0.22	0.89	0.9	0.92	0.94	0.95	0.96	100%
Pasture/Meadow	90,746	2.08	0.02	0.08	0.15	0.25	0.3	0.35	0%
Combined	105,571	2.42	0.13	0.19	0.25	0.34	0.38	0.43	13.6%

105571

Basin Travel Time

	Shallow Channel Ground Cover		Short Pasture/Lawns			
	$L_{max,Overland}$	300 ft			C_v	7
	L (ft)	ΔZ_0 (ft)	S_0 (ft/ft)	v (ft/s)	t (min)	t_{Alt} (min)
Total	518	28	-	-	-	-
Initial Time	100	7	0.070	-	8.7	12.9 DCM Eq. 6-8
Shallow Channel	144	11	0.076	1.9	1.2	- DCM Eq. 6-9
Channelized	274	10	0.036	3.4	1.3	- V-Ditch
				t_c	11.2 min.	

Rainfall Intensity & Runoff

	2-Yr	5-Yr	10-Yr	25-Yr	50-Yr	100-Yr
Intensity (in/hr)	3.15	3.95	4.61	5.27	5.93	6.64
Runoff (cfs)	1.0	1.8	2.8	4.3	5.5	6.9
Release Rates (cfs/ac)	-	-	-	-	-	-
Allowed Release (cfs)	1.0	1.8	2.8	4.3	5.5	6.9

DCM: $I = C1 * \ln(tc) + C2$

C1	1.19	1.5	1.75	2	2.25	2.52
C2	6.035	7.583	8.847	10.111	11.375	12.735

Notes

Sub-Basin K Runoff Calculations

Job No.: 61145
 Project: Eagle Rising - Preliminary/Final
 Jurisdiction: DCM
 Runoff Coefficient: Surface Type

Date: 11/14/2023 8:46
 Calcs by: O. Ali
 Checked by: _____
 Soil Type: B
 Urbanization: Urban

Basin Land Use Characteristics

Surface	Area		Runoff Coefficient						% Imperv.
	(SF)	(Acres)	C2	C5	C10	C25	C50	C100	
Pasture/Meadow	115,609	2.65	0.02	0.08	0.15	0.25	0.3	0.35	0%
Combined	115,609	2.65	0.02	0.08	0.15	0.25	0.30	0.35	0.0%

115609

Basin Travel Time

	Shallow Channel	Ground Cover	Short Pasture/Lawns			
	$L_{max,Overland}$	300 ft			C_v	7
	L (ft)	ΔZ_0 (ft)	S_0 (ft/ft)	v (ft/s)	t (min)	t_{Alt} (min)
Total	150	13	-	-	-	-
Initial Time	150	13	0.087	-	11.1	10.8 DCM Eq. 6-8
Shallow Channel			0.000	0.0	0.0	- DCM Eq. 6-9
Channelized			0.000	0.0	0.0	- V-Ditch
				t_c	10.8 min.	

Rainfall Intensity & Runoff

	2-Yr	5-Yr	10-Yr	25-Yr	50-Yr	100-Yr
Intensity (in/hr)	3.20	4.01	4.68	5.35	6.01	6.73
Runoff (cfs)	0.2	0.9	1.9	3.5	4.8	6.3
Release Rates (cfs/ac)	-	-	-	-	-	-
Allowed Release (cfs)	0.2	0.9	1.9	3.5	4.8	6.3

DCM: $I = C1 * \ln(tc) + C2$

C1	1.19	1.5	1.75	2	2.25	2.52
C2	6.035	7.583	8.847	10.111	11.375	12.735

Notes

Sub-Basin L Runoff Calculations

Job No.: 61145 Date: 11/14/2023 8:46
 Project: Eagle Rising - Preliminary/Final Calcs by: O. Ali
 Checked by: _____
 Jurisdiction: DCM Soil Type: B
 Runoff Coefficient: Surface Type Urbanization: Urban

Basin Land Use Characteristics

Surface	Area		Runoff Coefficient						% Imperv.
	(SF)	(Acres)	C2	C5	C10	C25	C50	C100	
Roofs	5,100	0.12	0.71	0.73	0.75	0.78	0.8	0.81	90%
Paved	2,880	0.07	0.89	0.9	0.92	0.94	0.95	0.96	100%
Pasture/Meadow	85,228	1.96	0.02	0.08	0.15	0.25	0.3	0.35	0%
Combined	93,208	2.14	0.08	0.14	0.21	0.30	0.35	0.39	8.0%

93208

Basin Travel Time

	Shallow Channel Ground Cover		Short Pasture/Lawns			
	$L_{max,Overland}$ (ft)	300	S_0 (ft/ft)	v (ft/s)	t (min)	t_{Alt} (min)
Total	430	16	-	-	-	-
Initial Time	206	11	0.053	-	14.3	12.4 DCM Eq. 6-8
Shallow Channel	224	5	0.022	1.0	3.6	- DCM Eq. 6-9
Channelized			0.000	0.0	0.0	- V-Ditch
				t_c	12.4 min.	

Rainfall Intensity & Runoff

	2-Yr	5-Yr	10-Yr	25-Yr	50-Yr	100-Yr
Intensity (in/hr)	3.04	3.81	4.44	5.08	5.71	6.39
Runoff (cfs)	0.6	1.1	2.0	3.3	4.2	5.4
Release Rates (cfs/ac)	-	-	-	-	-	-
Allowed Release (cfs)	0.6	1.1	2.0	3.3	4.2	5.4

DCM: $I = C1 * \ln(tc) + C2$

C1	1.19	1.5	1.75	2	2.25	2.52
C2	6.035	7.583	8.847	10.111	11.375	12.735

Notes

Sub-Basin M Runoff Calculations

Job No.: 61145 Date: 11/14/2023 8:46
 Project: Eagle Rising - Preliminary/Final Calcs by: O. Ali
 Checked by: _____
 Jurisdiction: DCM Soil Type: B
 Runoff Coefficient: Surface Type Urbanization: Urban

Basin Land Use Characteristics

Surface	Area		Runoff Coefficient						% Imperv.
	(SF)	(Acres)	C2	C5	C10	C25	C50	C100	
Roofs	5,100	0.12	0.71	0.73	0.75	0.78	0.8	0.81	90%
Paved	6,860	0.16	0.89	0.9	0.92	0.94	0.95	0.96	100%
Pasture/Meadow	166,570	3.82	0.02	0.08	0.15	0.25	0.3	0.35	0%
Combined	178,530	4.10	0.07	0.13	0.20	0.29	0.34	0.39	6.4%

178530

Basin Travel Time

	Shallow Channel Ground Cover		Short Pasture/Lawns				
	$L_{max,Overland}$	300 ft			C_v	7	
	L (ft)	ΔZ_0 (ft)	S_0 (ft/ft)	v (ft/s)	t (min)	t_{Alt} (min)	
Total	873	24	-	-	-	-	
Initial Time	108	4	0.037	-	11.8	14.9	DCM Eq. 6-8
Shallow Channel	453	10	0.022	1.0	7.3	-	DCM Eq. 6-9
Channelized	312	10	0.032	1.5	3.5	-	V-Ditch
				t_c	14.9 min.		

Rainfall Intensity & Runoff

	2-Yr	5-Yr	10-Yr	25-Yr	50-Yr	100-Yr
Intensity (in/hr)	2.82	3.54	4.13	4.72	5.30	5.94
Runoff (cfs)	0.8	1.9	3.3	5.6	7.4	9.4
Release Rates (cfs/ac)	-	-	-	-	-	-
Allowed Release (cfs)	0.8	1.9	3.3	5.6	7.4	9.4

DCM: $I = C1 * \ln(tc) + C2$

C1	1.19	1.5	1.75	2	2.25	2.52
C2	6.035	7.583	8.847	10.111	11.375	12.735

Notes

Combined Sub-Basin Runoff Calculations - DP6 Developed

Includes Basins OS-B1A OS-B1B B C

Job No.:	61145	Date:	11/14/2023 8:46
Project:	Eagle Rising - Preliminary/Final	Calcs by:	O. Ali
Jurisdiction	DCM	Checked by:	
Runoff Coefficient	Surface Type	Soil Type	B
		Urbanization	Urban

Basin Land Use Characteristics

Surface	Area		Runoff Coefficient						% Imperv.
	(SF)	(Acres)	C2	C5	C10	C25	C50	C100	
Pasture/Meadow	1,199,474	27.54	0.02	0.08	0.15	0.25	0.3	0.35	0%
2-1/2 Acre	1,543,832	35.44	0.08	0.12	0.22	0.31	0.36	0.4	11%
5 Acre	367,545	8.44	0.06	0.1	0.2	0.29	0.34	0.38	7%
Roofs	8,474	0.19	0.71	0.73	0.75	0.78	0.8	0.81	90%
Paved	11,168	0.26	0.89	0.9	0.92	0.94	0.95	0.96	100%
Gravel	-	0.00	0.57	0.59	0.63	0.66	0.68	0.7	80%
Combined	3,130,493	71.87	0.06	0.11	0.19	0.29	0.34	0.38	6.8%

Basin Travel Time

	Sub-basin or Channel Type	Material Type	L (ft)	Elev. ΔZ ₀ (ft)	Q _i (cfs)	Base or Dia (ft)	Sides z:1 (ft/ft)	v (ft/s)	t (min)
Furthest Reach	OS-B1B	-	2,011	84	-	-	-	-	21.2
Channelized-1	V-Ditch	2	378	9	77	0	2	5.7	1.1
Channelized-2									
Channelized-3									
Total			2,389	93					

2 = Natural, Winding, minimal vegetation/shallow grass

t_c (min) 22.3

Storage Volume

		40 -hr release time							
EURV	0.00 (in)	a =	1						Detention is NOT required
WQCV	0.00 (in)								Water Quality is NOT required
i (return period)	5-year	10-year	100-year						
K _i (ft)	0.0000	0.0000	0						
V _i (acre-ft)	0.000	0.000	0		EURV	0%	0	0	0
V _i (ft ³)	0	0	0		WQCV	0%	0	0	0

Contributing Offsite Flows (Added to Runoff and Allowed Release, below.)

Contributing Basins/Areas

Q_{Minor} (cfs) - 5-year Storm

Q_{Major} (cfs) - 100-year Storm

Rainfall Intensity & Runoff

	2-Yr	5-Yr	10-Yr	25-Yr	50-Yr	100-Yr
Intensity (in/hr)	2.34	2.93	3.42	3.90	4.39	4.91
Site Runoff (cfs)	9.97	22.46	47.80	80.84	106.66	134.74
OffSite Runoff (cfs)	-	0.00	-	-	-	0.00
Release Rates (cfs/ac)	-	-	-	-	-	-
Allowed Release (cfs)	-	22.5	-	-	-	134.7

DCM: $I = C1 * \ln(tc) + C2$

C1	1.19	1.5	1.75	2	2.25	2.52
C2	6.035	7.583	8.847	10.111	11.375	12.735

Notes

Runoff from Offsite basins have been assumed constant, despite additional times of concentration.

Combined Sub-Basin Runoff Calculations- DP6A Developed

Includes Basins OS-B1C E1

Job No.:	61145	Date:	11/14/2023 8:46
Project:	Eagle Rising - Preliminary/Final	Calcs by:	O. Ali
Jurisdiction	DCM	Checked by:	
Runoff Coefficient	Surface Type	Soil Type	B
		Urbanization	Urban

Basin Land Use Characteristics

Surface	Area		Runoff Coefficient						% Imperv.
	(SF)	(Acres)	C2	C5	C10	C25	C50	C100	
2-1/2 Acre	-	0.00	0.08	0.12	0.22	0.31	0.36	0.4	11%
5 Acre	-	0.00	0.06	0.1	0.2	0.29	0.34	0.38	7%
Gravel	38,377	0.88	0.57	0.59	0.63	0.66	0.68	0.7	80%
Paved	-	0.00	0.89	0.9	0.92	0.94	0.95	0.96	100%
Pasture/Meadow	175,042	4.02	0.02	0.08	0.15	0.25	0.3	0.35	0%
Roofs	15,215	0.35	0.71	0.73	0.75	0.78	0.8	0.81	90%
Combined	228,634	5.25	0.16	0.21	0.27	0.35	0.40	0.44	19.4%

Basin Travel Time

	Sub-basin or Channel Type	Material Type	L (ft)	Elev. ΔZ ₀ (ft)	Q _i (cfs)	Base or Dia (ft)	Sides z:1 (ft/ft)	v (ft/s)	t (min)
Furthest Reach	OS-B1C	-	528	16	-	-	-	-	12.9
Channelized-1	V-Ditch	2	963	36	4	0	2	3.2	5.0
Channelized-2									
Channelized-3									
Total			1,491	52					

2 = Natural, Winding, minimal vegetation/shallow grass

t_c (min) 17.9

Storage Volume

		40 -hr release time							
EURV	0.00 (in)	a =	1						Detention is NOT required
WQCV	0.00 (in)								Water Quality is NOT required
i (return period)	5-year	10-year	100-year						
K _i (ft)	0.0000	0.0000	0						
V _i (acre-ft)	0.000	0.000	0		EURV	0%		0	0
V _i (ft ³)	0	0	0		WQCV	0%	0	0	0

Contributing Offsite Flows (Added to Runoff and Allowed Release, below.)

Contributing Basins/Areas

Q_{Minor} (cfs) - 5-year Storm

Q_{Major} (cfs) - 100-year Storm

Rainfall Intensity & Runoff

	2-Yr	5-Yr	10-Yr	25-Yr	50-Yr	100-Yr
Intensity (in/hr)	2.60	3.25	3.80	4.34	4.88	5.46
Site Runoff (cfs)	2.16	3.57	5.39	8.06	10.17	12.59
OffSite Runoff (cfs)	-	0.00	-	-	-	0.00
Release Rates (cfs/ac)	-	-	-	-	-	-
Allowed Release (cfs)	-	3.6	-	-	-	12.6

DCM: $I = C1 * \ln(tc) + C2$

C1	1.19	1.5	1.75	2	2.25	2.52
C2	6.035	7.583	8.847	10.111	11.375	12.735

Notes

Runoff from Offsite basins have been assumed constant, despite additional times of concentration.

Combined Sub-Basin Runoff Calculations- DP6B Developed

Includes Basins OS-B1A OS-B1B B C D

Job No.:	61145	Date:	11/14/2023 8:46
Project:	Eagle Rising - Preliminary/Final	Calcs by:	O. Ali
Jurisdiction	DCM	Checked by:	
Runoff Coefficient	Surface Type	Soil Type	B
		Urbanization	Urban

Basin Land Use Characteristics

Surface	Area		Runoff Coefficient						% Imperv.
	(SF)	(Acres)	C2	C5	C10	C25	C50	C100	
2-1/2 Acre	1,543,832	35.44	0.08	0.12	0.22	0.31	0.36	0.4	11%
5 Acre	367,545	8.44	0.06	0.1	0.2	0.29	0.34	0.38	7%
Gravel	9,370	0.22	0.57	0.59	0.63	0.66	0.68	0.7	80%
Paved	20,744	0.48	0.89	0.9	0.92	0.94	0.95	0.96	100%
Pasture/Meadow	1,478,749	33.95	0.02	0.08	0.15	0.25	0.3	0.35	0%
Roofs	19,728	0.45	0.71	0.73	0.75	0.78	0.8	0.81	90%
Combined	3,439,968	78.97	0.06	0.11	0.20	0.29	0.34	0.38	7.0%

Basin Travel Time

	Sub-basin or Channel Type	Material Type	L (ft)	Elev. ΔZ ₀ (ft)	Q _i (cfs)	Base or Dia (ft)	Sides z:1 (ft/ft)	v (ft/s)	t (min)
Furthest Reach	OS-B1B	-	2,011	84	-	-	-	-	21.2
Channelized-1	V-Ditch	2	1,083	32	77	0	2	6.1	2.9
Channelized-2									
Channelized-3									
Total			3,094	116					

2 = Natural, Winding, minimal vegetation/shallow grass

t_c (min) 24.1

Storage Volume

		40 -hr release time							
EURV	0.00 (in)	a =	1						Detention is NOT required
WQCV	0.00 (in)								Water Quality is NOT required
i (return period)	5-year	10-year	100-year						
K _i (ft)	0.0000	0.0000	0						
V _i (acre-ft)	0.000	0.000	0		EURV	0%		0	0
V _i (ft ³)	0	0	0		WQCV	0%	0	0	0

Contributing Offsite Flows (Added to Runoff and Allowed Release, below.)

Contributing Basins/Areas

Q_{Minor} (cfs) - 5-year Storm

Q_{Major} (cfs) - 100-year Storm

Rainfall Intensity & Runoff

	2-Yr	5-Yr	10-Yr	25-Yr	50-Yr	100-Yr
Intensity (in/hr)	2.25	2.81	3.28	3.75	4.21	4.71
Site Runoff (cfs)	10.99	24.44	50.77	85.64	112.83	142.58
OffSite Runoff (cfs)	-	0.00	-	-	-	0.00
Release Rates (cfs/ac)	-	-	-	-	-	-
Allowed Release (cfs)	-	24.4	-	-	-	142.6

DCM: $I = C1 * \ln(tc) + C2$

C1	1.19	1.5	1.75	2	2.25	2.52
C2	6.035	7.583	8.847	10.111	11.375	12.735

Notes

Runoff from Offsite basins have been assumed constant, despite additional times of concentration.

Combined Sub-Basin Runoff Calculations- DP6C Developed

Includes Basins OS-B1A OS-B1B B C D OS-B1C E1

Job No.:	61145	Date:	11/14/2023 8:46
Project:	Eagle Rising - Preliminary/Final	Calcs by:	O. Ali
Jurisdiction	DCM	Checked by:	
Runoff Coefficient	Surface Type	Soil Type	B
		Urbanization	Urban

Basin Land Use Characteristics

Surface	Area		Runoff Coefficient							% Imperv.
	(SF)	(Acres)	C2	C5	C10	C25	C50	C100		
2-1/2 Acre	1,543,832	35.44	0.08	0.12	0.22	0.31	0.36	0.4	11%	
5 Acre	367,545	8.44	0.06	0.1	0.2	0.29	0.34	0.38	7%	
Gravel	47,747	1.10	0.57	0.59	0.63	0.66	0.68	0.7	80%	
Paved	20,744	0.48	0.89	0.9	0.92	0.94	0.95	0.96	100%	
Pasture/Meadow	1,653,791	37.97	0.02	0.08	0.15	0.25	0.3	0.35	0%	
Roofs	34,943	0.80	0.71	0.73	0.75	0.78	0.8	0.81	90%	
Combined	3,668,602	84.22	0.07	0.12	0.20	0.29	0.34	0.39	7.8%	

Basin Travel Time

	Sub-basin or Channel Type	Material Type	L (ft)	Elev. ΔZ ₀ (ft)	Q _i (cfs)	Base or Dia (ft)	Sides z:1 (ft/ft)	v (ft/s)	t (min)
Furthest Reach	OS-B1B	-	2,011	84	-	-	-	-	21.2
Channelized-1	V-Ditch	2	1,083	32	77	0	2	6.1	2.9
Channelized-2									
Channelized-3									
Total			3,094	116					

2 = Natural, Winding, minimal vegetation/shallow grass

t_c (min) 24.1

Storage Volume

		40 -hr release time				Detention is NOT required		
EURV	0.00 (in)	a = 1				Water Quality is NOT required		
WQCV	0.00 (in)							
i (return period)	5-year	10-year	100-year	Design Volume (ft³)				
K _i (ft)	0.0000	0.0000	0	% Storage	100-year	WQCV	Total	
V _i (acre-ft)	0.000	0.000	0	EURV	0%	0	0	0
V _i (ft ³)	0	0	0	WQCV	0%	0	0	0

Contributing Offsite Flows (Added to Runoff and Allowed Release, below.)

Contributing Basins/Areas

Q_{Minor} (cfs) - 5-year Storm

Q_{Major} (cfs) - 100-year Storm

Rainfall Intensity & Runoff

	2-Yr	5-Yr	10-Yr	25-Yr	50-Yr	100-Yr
Intensity (in/hr)	2.25	2.81	3.28	3.75	4.21	4.71
Site Runoff (cfs)	12.86	27.52	55.42	92.61	121.61	153.45
OffSite Runoff (cfs)	-	0.00	-	-	-	0.00
Release Rates (cfs/ac)	-	-	-	-	-	-
Allowed Release (cfs)	-	27.5	-	-	-	153.4

DCM: $I = C1 * \ln(tc) + C2$

C1	1.19	1.5	1.75	2	2.25	2.52
C2	6.035	7.583	8.847	10.111	11.375	12.735

Notes

Runoff from Offsite basins have been assumed constant, despite additional times of concentration.

Combined Sub-Basin Runoff Calculations - DP7 Developed

Includes Basins OS-B1D F1

Job No.:	61145	Date:	11/14/2023 8:46
Project:	Eagle Rising - Preliminary/Final	Calcs by:	O. Ali
Jurisdiction	DCM	Soil Type	B
Runoff Coefficient	Surface Type	Urbanization	Urban

Basin Land Use Characteristics

Surface	Area		Runoff Coefficient						% Imperv.
	(SF)	(Acres)	C2	C5	C10	C25	C50	C100	
Pasture/Meadow	358,152	8.22	0.02	0.08	0.15	0.25	0.3	0.35	0%
2-1/2 Acre	-	0.00	0.08	0.12	0.22	0.31	0.36	0.4	11%
5 Acre	-	0.00	0.06	0.1	0.2	0.29	0.34	0.38	7%
Roofs	14,674	0.34	0.71	0.73	0.75	0.78	0.8	0.81	90%
Paved	10,418	0.24	0.89	0.9	0.92	0.94	0.95	0.96	100%
Gravel	160,546	3.69	0.57	0.59	0.63	0.66	0.68	0.7	80%
Combined	543,790	12.48	0.22	0.26	0.32	0.40	0.44	0.48	28.0%

Basin Travel Time

	Sub-basin or Channel Type	Material Type	L (ft)	Elev. ΔZ ₀ (ft)	Q _i (cfs)	Base or Dia (ft)	Sides z:1 (ft/ft)	v (ft/s)	t (min)
Furthest Reach	OS-B1D	-	1,242	41	-	-	-	-	16.9
Channelized-1	V-Ditch	2	869	32	12	0	2	4.2	3.5
Channelized-2									
Channelized-3									
Total			2,111	73					

2 = Natural, Winding, minimal vegetation/shallow grass

t_c (min) 20.4

Storage Volume

		40 -hr release time			Detention is NOT required			
EURV	0.00 (in)	a = 1			Water Quality is NOT required			
WQCV	0.00 (in)							
i (return period)	5-year	10-year	100-year	Design Volume (ft³)				
K _i (ft)	0.0000	0.0000	0	% Storage	100-year	WQCV	Total	
V _i (acre-ft)	0.000	0.000	0	EURV	0%	0	0	0
V _i (ft ³)	0	0	0	WQCV	0%	0	0	0

Contributing Offsite Flows (Added to Runoff and Allowed Release, below.)

Contributing Basins/Areas

Q_{Minor} (cfs) - 5-year Storm

Q_{Major} (cfs) - 100-year Storm

Rainfall Intensity & Runoff

	2-Yr	5-Yr	10-Yr	25-Yr	50-Yr	100-Yr
Intensity (in/hr)	2.45	3.06	3.57	4.08	4.59	5.14
Site Runoff (cfs)	6.65	10.09	14.39	20.32	25.13	30.64
OffSite Runoff (cfs)	-	0.00	-	-	-	0.00
Release Rates (cfs/ac)	-	-	-	-	-	-
Allowed Release (cfs)	-	10.1	-	-	-	30.6

DCM: $I = C1 * \ln(tc) + C2$

C1	1.19	1.5	1.75	2	2.25	2.52
C2	6.035	7.583	8.847	10.111	11.375	12.735

Notes

Runoff from Offsite basins have been assumed constant, despite additional times of concentration.

Combined Sub-Basin Runoff Calculations - DP8A Developed

Includes Basins OS-B1E OS-B3A H I

Job No.:	61145	Date:	11/14/2023 8:46
Project:	Eagle Rising - Preliminary/Final	Calcs by:	O. Ali
Jurisdiction	DCM	Checked by:	
Runoff Coefficient	Surface Type	Soil Type	B
		Urbanization	Urban

Basin Land Use Characteristics

Surface	Area		Runoff Coefficient						% Imperv.
	(SF)	(Acres)	C2	C5	C10	C25	C50	C100	
Pasture/Meadow	483,566	11.10	0.02	0.08	0.15	0.25	0.3	0.35	0%
2-1/2 Acre	562,874	12.92	0.08	0.12	0.22	0.31	0.36	0.4	11%
5 Acre	-	0.00	0.06	0.1	0.2	0.29	0.34	0.38	7%
Roofs	10,200	0.23	0.71	0.73	0.75	0.78	0.8	0.81	90%
Paved	28,834	0.66	0.89	0.9	0.92	0.94	0.95	0.96	100%
Gravel	-	0.00	0.57	0.59	0.63	0.66	0.68	0.7	80%
Combined	1,085,474	24.92	0.08	0.13	0.21	0.30	0.35	0.40	9.2%

Basin Travel Time

	Sub-basin or Channel Type	Material Type	L (ft)	Elev. ΔZ ₀ (ft)	Q _i (cfs)	Base or Dia (ft)	Sides z:1 (ft/ft)	v (ft/s)	t (min)
Furthest Reach	OS-B1E	-	1,404	61	-	-	-	-	17.8
Channelized-1	V-Ditch	2	524	22	20	0	2	5.0	1.7
Channelized-2									
Channelized-3									
Total			1,928	83					

2 = Natural, Winding, minimal vegetation/shallow grass

t_c (min) 19.5

Storage Volume

		40 -hr release time				Detention is NOT required		
EURV	0.00 (in)	a =	1			Water Quality is NOT required		
WQCV	0.00 (in)							
i (return period)	5-year	10-year	100-year		Design Volume (ft³)			
K _i (ft)	0.0000	0.0000	0		% Storage	100-year	WQCV	Total
V _i (acre-ft)	0.000	0.000	0	EURV	0%	0	0	0
V _i (ft ³)	0	0	0	WQCV	0%	0	0	0

Contributing Offsite Flows (Added to Runoff and Allowed Release, below.)

Contributing Basins/Areas OS-B4B

Q_{Minor} (cfs) - 5-year Storm

Q_{Major} (cfs) - 100-year Storm

Rainfall Intensity & Runoff

	2-Yr	5-Yr	10-Yr	25-Yr	50-Yr	100-Yr
Intensity (in/hr)	2.50	3.12	3.65	4.17	4.69	5.25
Site Runoff (cfs)	5.02	10.02	19.30	31.61	41.24	51.82
OffSite Runoff (cfs)	-	0.00	-	-	-	0.00
Release Rates (cfs/ac)	-	-	-	-	-	-
Allowed Release (cfs)	-	10.0	-	-	-	51.8

DCM: $I = C1 * \ln(tc) + C2$

C1	1.19	1.5	1.75	2	2.25	2.52
C2	6.035	7.583	8.847	10.111	11.375	12.735

Notes

Runoff from Offsite basins have been assumed constant, despite additional times of concentration.

Combined Sub-Basin Runoff Calculations - DP9 Developed

Includes Basins OS-B1D F1 F2

Job No.:	61145	Date:	11/14/2023 8:46
Project:	Eagle Rising - Preliminary/Final	Calcs by:	O. Ali
Jurisdiction	DCM	Checked by:	
Runoff Coefficient	Surface Type	Soil Type	B
		Urbanization	Urban

Basin Land Use Characteristics

Surface	Area		Runoff Coefficient						% Imperv.
	(SF)	(Acres)	C2	C5	C10	C25	C50	C100	
Pasture/Meadow	437,767	10.05	0.02	0.08	0.15	0.25	0.3	0.35	0%
2-1/2 Acre	-	0.00	0.08	0.12	0.22	0.31	0.36	0.4	11%
5 Acre	-	0.00	0.06	0.1	0.2	0.29	0.34	0.38	7%
Roofs	19,774	0.45	0.71	0.73	0.75	0.78	0.8	0.81	90%
Paved	13,671	0.31	0.89	0.9	0.92	0.94	0.95	0.96	100%
Gravel	160,546	3.69	0.57	0.59	0.63	0.66	0.68	0.7	80%
Combined	631,758	14.50	0.20	0.25	0.31	0.39	0.43	0.47	25.3%

Basin Travel Time

	Sub-basin or Channel Type	Material Type	L (ft)	Elev. ΔZ ₀ (ft)	Q _i (cfs)	Base or Dia (ft)	Sides z:1 (ft/ft)	v (ft/s)	t (min)
Furthest Reach	OS-B1D	-	1,242	41	-	-	-	-	16.9
Channelized-1	V-Ditch	2	1,500	58	12	0	2	4.3	5.9
Channelized-2									
Channelized-3									
Total			2,742	99					

2 = Natural, Winding, minimal vegetation/shallow grass

t_c (min) 22.8

Storage Volume

		40 -hr release time			Detention is NOT required			
EURV	0.00 (in)	a = 1			Water Quality is NOT required			
WQCV	0.00 (in)							
i (return period)	5-year	10-year	100-year	Design Volume (ft³)				
K _i (ft)	0.0000	0.0000	0	% Storage	100-year	WQCV	Total	
V _i (acre-ft)	0.000	0.000	0	EURV	0%	0	0	0
V _i (ft ³)	0	0	0	WQCV	0%	0	0	0

Contributing Offsite Flows (Added to Runoff and Allowed Release, below.)

Contributing Basins/Areas OS-B4B

Q_{Minor} (cfs) - 5-year Storm

Q_{Major} (cfs) - 100-year Storm

Rainfall Intensity & Runoff

	2-Yr	5-Yr	10-Yr	25-Yr	50-Yr	100-Yr
Intensity (in/hr)	2.32	2.89	3.38	3.86	4.34	4.86
Site Runoff (cfs)	6.72	10.40	15.06	21.59	26.85	32.88
OffSite Runoff (cfs)	-	0.00	-	-	-	0.00
Release Rates (cfs/ac)	-	-	-	-	-	-
Allowed Release (cfs)	-	10.4	-	-	-	32.9

DCM: $I = C1 * \ln(tc) + C2$

C1	1.19	1.5	1.75	2	2.25	2.52
C2	6.035	7.583	8.847	10.111	11.375	12.735

Notes

Runoff from Offsite basins have been assumed constant, despite additional times of concentration.

Combined Sub-Basin Runoff Calculations (OS-B3A+I) Developed

Includes Basins OS-B3A I

Job No.:	61145	Date:	11/14/2023 8:46
Project:	Eagle Rising - Preliminary/Final	Calcs by:	O. Ali
Jurisdiction	DCM	Checked by:	
Runoff Coefficient	Surface Type	Soil Type	B
		Urbanization	Urban

Basin Land Use Characteristics

Surface	Area		Runoff Coefficient						% Imperv.
	(SF)	(Acres)	C2	C5	C10	C25	C50	C100	
2-1/2 Acre	394,804	9.06	0.08	0.12	0.22	0.31	0.36	0.4	11%
5 Acre	-	0.00	0.06	0.1	0.2	0.29	0.34	0.38	7%
Roofs	2,550	0.06	0.71	0.73	0.75	0.78	0.8	0.81	90%
Pasture/Meadow	59,207	1.36	0.02	0.08	0.15	0.25	0.3	0.35	0%
Paved	9,527	0.22	0.89	0.9	0.92	0.94	0.95	0.96	100%
Combined	466,088	10.70	0.09	0.13	0.23	0.32	0.37	0.41	11.9%

Basin Travel Time

	Sub-basin or Channel Type	Material Type	L (ft)	Elev. ΔZ ₀ (ft)	Q _i (cfs)	Base or Dia (ft)	Sides z:1 (ft/ft)	v (ft/s)	t (min)
Furthest Reach	OS-B3A	-	938	45	-	-	-	-	15.2
Channelized-1	V-Ditch	2	339	17	21	0	2	5.4	1.0
Channelized-2									
Channelized-3									
Total			1,277	62					

2 = Natural, Winding, minimal vegetation/shallow grass

t_c (min) 16.2

Contributing Offsite Flows (Added to Runoff and Allowed Release, below.)

Contributing Basins/Areas: [Redacted]

Q_{Minor}: [Redacted] (cfs) - 5-year Storm

Q_{Major}: [Redacted] (cfs) - 100-year Storm

Rainfall Intensity & Runoff

	2-Yr	5-Yr	10-Yr	25-Yr	50-Yr	100-Yr
Intensity (in/hr)	2.72	3.40	3.97	4.53	5.10	5.71
Site Runoff (cfs)	2.69	4.88	9.69	15.42	20.03	24.88
OffSite Runoff (cfs)	-	0.00	-	-	-	0.00
Release Rates (cfs/ac)	-	-	-	-	-	-
Allowed Release (cfs)	-	4.9	-	-	-	24.9

DCM: $I = C1 * \ln(tc) + C2$

C1	1.19	1.5	1.75	2	2.25	2.52
C2	6.035	7.583	8.847	10.111	11.375	12.735

Notes

Runoff from Offsite basins have been assumed constant, despite additional times of concentration.

Combined Sub-Basin Runoff Calculations - DP11 Developed

Includes Basins OS-B3B M

Job No.:	61145	Date:	11/14/2023 8:46
Project:	Eagle Rising - Preliminary/Final	Calcs by:	O. Ali
Jurisdiction	DCM	Checked by:	
Runoff Coefficient	Surface Type	Soil Type	B
		Urbanization	Urban

Basin Land Use Characteristics

Surface	Area		Runoff Coefficient						% Imperv.
	(SF)	(Acres)	C2	C5	C10	C25	C50	C100	
Pasture/Meadow	166,570	3.82	0.02	0.08	0.15	0.25	0.3	0.35	0%
2-1/2 Acre	109,046	2.50	0.08	0.12	0.22	0.31	0.36	0.4	11%
5 Acre	-	0.00	0.06	0.1	0.2	0.29	0.34	0.38	7%
Roofs	5,100	0.12	0.71	0.73	0.75	0.78	0.8	0.81	90%
Paved	6,860	0.16	0.89	0.9	0.92	0.94	0.95	0.96	100%
Gravel	-	0.00	0.57	0.59	0.63	0.66	0.68	0.7	80%
Combined	287,576	6.60	0.08	0.13	0.21	0.30	0.35	0.39	8.2%

Basin Travel Time

	Sub-basin or Channel Type	Material Type	L (ft)	Elev. ΔZ ₀ (ft)	Q _i (cfs)	Base or Dia (ft)	Sides z:1 (ft/ft)	v (ft/s)	t (min)
Furthest Reach	OS-B3B	-	636	29	-	-	-	-	13.5
Channelized-1	V-Ditch	2	873	24	6	0	2	3.2	4.6
Channelized-2									
Channelized-3									
Total			1,509	53					

2 = Natural, Winding, minimal vegetation/shallow grass

t_c (min) 18.1

Storage Volume

		40 -hr release time			Detention is NOT required			
EURV	0.00 (in)	a = 1			Water Quality is NOT required			
WQCV	0.00 (in)							
i (return period)	5-year	10-year	100-year	Design Volume (ft³)				
K _i (ft)	0.0000	0.0000	0	% Storage	100-year	WQCV	Total	
V _i (acre-ft)	0.000	0.000	0	EURV	0%	0	0	0
V _i (ft ³)	0	0	0	WQCV	0%	0	0	0

Contributing Offsite Flows (Added to Runoff and Allowed Release, below.)

Contributing Basins/Areas OS-B4B

Q_{Minor} (cfs) - 5-year Storm

Q_{Major} (cfs) - 100-year Storm

Rainfall Intensity & Runoff

	2-Yr	5-Yr	10-Yr	25-Yr	50-Yr	100-Yr
Intensity (in/hr)	2.59	3.24	3.78	4.32	4.86	5.44
Site Runoff (cfs)	1.29	2.70	5.13	8.51	11.14	14.06
OffSite Runoff (cfs)	-	0.00	-	-	-	0.00
Release Rates (cfs/ac)	-	-	-	-	-	-
Allowed Release (cfs)	-	2.7	-	-	-	14.1

DCM: $I = C1 * \ln(tc) + C2$

C1	1.19	1.5	1.75	2	2.25	2.52
C2	6.035	7.583	8.847	10.111	11.375	12.735

Notes

Runoff from Offsite basins have been assumed constant, despite additional times of concentration.

Combined Sub-Basin Runoff Calculations - DP12 Developed

Includes Basins OS-B1E OS-B3A H I J

Job No.:	61145	Date:	11/14/2023 8:46
Project:	Eagle Rising - Preliminary/Final	Calcs by:	O. Ali
Jurisdiction	DCM	Soil Type	B
Runoff Coefficient	Surface Type	Urbanization	Urban

Basin Land Use Characteristics

Surface	Area		Runoff Coefficient						% Imperv.
	(SF)	(Acres)	C2	C5	C10	C25	C50	C100	
Pasture/Meadow	574,312	13.18	0.02	0.08	0.15	0.25	0.3	0.35	0%
2-1/2 Acre	562,874	12.92	0.08	0.12	0.22	0.31	0.36	0.4	11%
5 Acre	-	0.00	0.06	0.1	0.2	0.29	0.34	0.38	7%
Roofs	15,300	0.35	0.71	0.73	0.75	0.78	0.8	0.81	90%
Paved	38,559	0.89	0.89	0.9	0.92	0.94	0.95	0.96	100%
Gravel	-	0.00	0.57	0.59	0.63	0.66	0.68	0.7	80%
Combined	1,191,045	27.34	0.09	0.13	0.22	0.31	0.36	0.40	9.6%

Basin Travel Time

	Sub-basin or Channel Type	Material Type	L (ft)	Elev. ΔZ ₀ (ft)	Q _i (cfs)	Base or Dia (ft)	Sides z:1 (ft/ft)	v (ft/s)	t (min)
Furthest Reach	OS-B1E	-	1,404	61	-	-	-	-	17.8
Channelized-1	V-Ditch	2	955	34	20	0	2	4.7	3.4
Channelized-2									
Channelized-3									
Total			2,359	95					

2 = Natural, Winding, minimal vegetation/shallow grass

t_c (min) 21.2

Storage Volume

		40 -hr release time		Detention is NOT required
EURV	0.00 (in)	a =	1	Water Quality is NOT required
WQCV	0.00 (in)			
i (return period)	5-year	10-year	100-year	Design Volume (ft³)
K _i (ft)	0.0000	0.0000	0	% Storage
V _i (acre-ft)	0.000	0.000	0	100-year
V _i (ft ³)	0	0	0	WQCV
				Total
				0
				0

Contributing Offsite Flows (Added to Runoff and Allowed Release, below.)

Contributing Basins/Areas OS-B4B

Q_{Minor} (cfs) - 5-year Storm

Q_{Major} (cfs) - 100-year Storm

Rainfall Intensity & Runoff

	2-Yr	5-Yr	10-Yr	25-Yr	50-Yr	100-Yr
Intensity (in/hr)	2.40	3.00	3.51	4.01	4.51	5.04
Site Runoff (cfs)	5.61	10.99	20.68	33.69	43.86	55.06
OffSite Runoff (cfs)	-	0.00	-	-	-	0.00
Release Rates (cfs/ac)	-	-	-	-	-	-
Allowed Release (cfs)	-	11.0	-	-	-	55.1

DCM: $I = C1 * \ln(tc) + C2$

C1	1.19	1.5	1.75	2	2.25	2.52
C2	6.035	7.583	8.847	10.111	11.375	12.735

Notes

Runoff from Offsite basins have been assumed constant, despite additional times of concentration.

Combined Sub-Basin Runoff Calculations - DP13 Developed

Includes Basins OS-B3C L

Job No.:	61145	Date:	11/14/2023 8:46
Project:	Eagle Rising - Preliminary/Final	Calcs by:	O. Ali
Jurisdiction	DCM	Checked by:	
Runoff Coefficient	Surface Type	Soil Type	B
		Urbanization	Urban

Basin Land Use Characteristics

Surface	Area		Runoff Coefficient						% Imperv.
	(SF)	(Acres)	C2	C5	C10	C25	C50	C100	
Pasture/Meadow	85,228	1.96	0.02	0.08	0.15	0.25	0.3	0.35	0%
2-1/2 Acre	259,332	5.95	0.08	0.12	0.22	0.31	0.36	0.4	11%
5 Acre	-	0.00	0.06	0.1	0.2	0.29	0.34	0.38	7%
Roofs	5,100	0.12	0.71	0.73	0.75	0.78	0.8	0.81	90%
Paved	2,880	0.07	0.89	0.9	0.92	0.94	0.95	0.96	100%
Gravel	-	0.00	0.57	0.59	0.63	0.66	0.68	0.7	80%
Combined	352,540	8.09	0.08	0.13	0.22	0.31	0.36	0.40	10.2%

Basin Travel Time

	Sub-basin or Channel Type	Material Type	L (ft)	Elev. ΔZ ₀ (ft)	Q _i (cfs)	Base or Dia (ft)	Sides z:1 (ft/ft)	v (ft/s)	t (min)
Furthest Reach	OS-B3C	-	994	38	-	-	-	-	15.5
Channelized-1	V-Ditch	2	430	16	14	0	2	4.4	1.6
Channelized-2									
Channelized-3									
Total			1,424	54					

2 = Natural, Winding, minimal vegetation/shallow grass

t_c (min) 17.2

Storage Volume

		40 -hr release time							
EURV	0.00 (in)	a =	1						Detention is NOT required
WQCV	0.00 (in)								Water Quality is NOT required
i (return period)	5-year	10-year	100-year						
K _i (ft)	0.0000	0.0000	0						
V _i (acre-ft)	0.000	0.000	0		EURV	0%		0	0
V _i (ft ³)	0	0	0		WQCV	0%	0	0	0

Contributing Offsite Flows (Added to Runoff and Allowed Release, below.)

Contributing Basins/Areas OS-B4B

Q_{Minor} (cfs) - 5-year Storm

Q_{Major} (cfs) - 100-year Storm

Rainfall Intensity & Runoff

	2-Yr	5-Yr	10-Yr	25-Yr	50-Yr	100-Yr
Intensity (in/hr)	2.65	3.32	3.87	4.43	4.98	5.57
Site Runoff (cfs)	1.74	3.37	6.78	11.01	14.37	17.96
OffSite Runoff (cfs)	-	0.00	-	-	-	0.00
Release Rates (cfs/ac)	-	-	-	-	-	-
Allowed Release (cfs)	-	3.4	-	-	-	18.0

DCM: $I = C1 * \ln(tc) + C2$

C1	1.19	1.5	1.75	2	2.25	2.52
C2	6.035	7.583	8.847	10.111	11.375	12.735

Notes

Runoff from Offsite basins have been assumed constant, despite additional times of concentration.

Table 3-1. Number of Rainfall Events in the Denver Area
(Adapted from Urbonas et al. 1989)

Total Rainfall Depth (inches)	Average Annual Number of Storm Events	Percent of Total Storm Events	Percentile of Runoff-producing Storms
0.0 to 0.1	46	61.07%	0.00%
0.1 to 0.5	22	29.21%	75.04%
≤ 0.6	69	91.61%	80.00%
0.5 to 1.0	4.7	6.24%	91.07%
1.0 to 1.5	1.5	1.99%	96.19%
1.5 to 2.0	0.6	0.80%	98.23%
2.0 to 3.0	0.3	0.40%	99.26%
3.0 to 4.0	0.19	0.25%	99.90%
4.0 to 5.0	0.028	0.04%	100.00%
> 5.0	0	0.00%	100.00%
TOTAL:	75	100%	100%

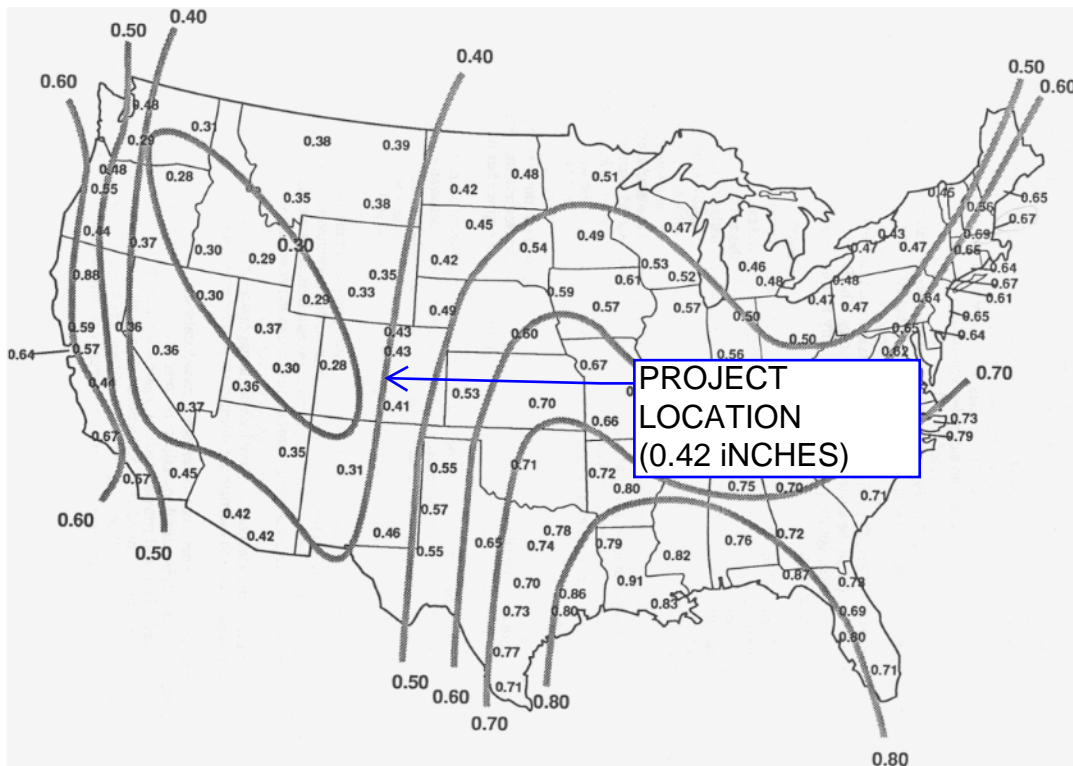

Figure 3-1. Map of the Average Runoff Producing Storm's Precipitation Depth in the United States In Inches
(Source: Driscoll et al., 1989)

Design Procedure Form: Runoff Reduction

UD-BMP (Version 3.07, March 2018)

Sheet 1 of 1

Designer: O. Ali
Company: M.V.E., Inc.
Date: May 22, 2024
Project: Eagle Rising
Location: Eagle Wing Drive

SITE INFORMATION (User Input in Blue Cells)

WQCV Rainfall Depth = 0.60 inches
 Depth of Average Runoff Producing Storm, d_6 = 0.42 inches (for Watersheds Outside of the Denver Region, Figure 3-1 in USDCM Vol. 3)

Area Type	UIA:RPA	UIA:RPA	UIA:RPA	UIA:RPA						
Area ID	1	2	3	4						
Downstream Design Point ID	1	2	3	4						
Downstream BMP Type	None	None	None	None						
DCIA (ft ²)	--	--	--	--						
UIA (ft ²)	24,531	5,595	6,599	4,030						
RPA (ft ²)	10,741	2,009	1,788	899						
SPA (ft ²)	--	--	--	--						
HSG A (%)	0%	0%	0%	0%						
HSG B (%)	100%	100%	100%	100%						
HSG C/D (%)	0%	0%	0%	0%						
Average Slope of RPA (ft/ft)	0.167	0.167	0.167	0.017						
UIA:RPA Interface Width (ft)	770.00	204.00	204.00	66.00						

CALCULATED RUNOFF RESULTS

Area ID	1	2	3	4						
UIA:RPA Area (ft ²)	35,272	7,604	8,387	4,929						
L / W Ratio	0.06	0.18	0.20	1.13						
UIA / Area	0.6955	0.7358	0.7868	0.8176						
Runoff (in)	0.04	0.10	0.17	0.20						
Runoff (ft ³)	105	60	116	83						
Runoff Reduction (ft ³)	917	173	159	84						

CALCULATED WQCV RESULTS

Area ID	1	2	3	4						
WQCV (ft ³)	998	228	269	164						
WQCV Reduction (ft ³)	894	167	153	81						
WQCV Reduction (%)	89%	74%	57%	49%						
Untreated WQCV (ft ³)	105	60	116	83						

CALCULATED DESIGN POINT RESULTS (sums results from all columns with the same Downstream Design Point ID)

Downstream Design Point ID	1	2	3	4						
DCIA (ft ²)	0	0	0	0						
UIA (ft ²)	24,531	5,595	6,599	4,030						
RPA (ft ²)	10,741	2,009	1,788	899						
SPA (ft ²)	0	0	0	0						
Total Area (ft ²)	35,272	7,604	8,387	4,929						
Total Impervious Area (ft ²)	24,531	5,595	6,599	4,030						
WQCV (ft ³)	998	228	269	164						
WQCV Reduction (ft ³)	894	167	153	81						
WQCV Reduction (%)	89%	74%	57%	49%						
Untreated WQCV (ft ³)	105	60	116	83						

CALCULATED SITE RESULTS (sums results from all columns in worksheet)

Total Area (ft ²)	56,192
Total Impervious Area (ft ²)	40,755
WQCV (ft ³)	1,659
WQCV Reduction (ft ³)	1,294
WQCV Reduction (%)	78%
Untreated WQCV (ft ³)	365

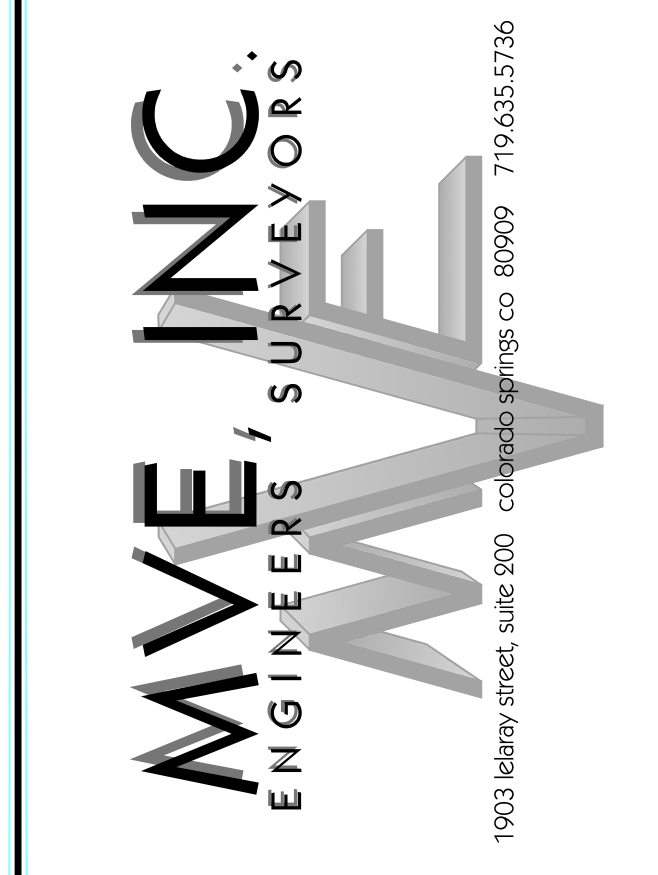
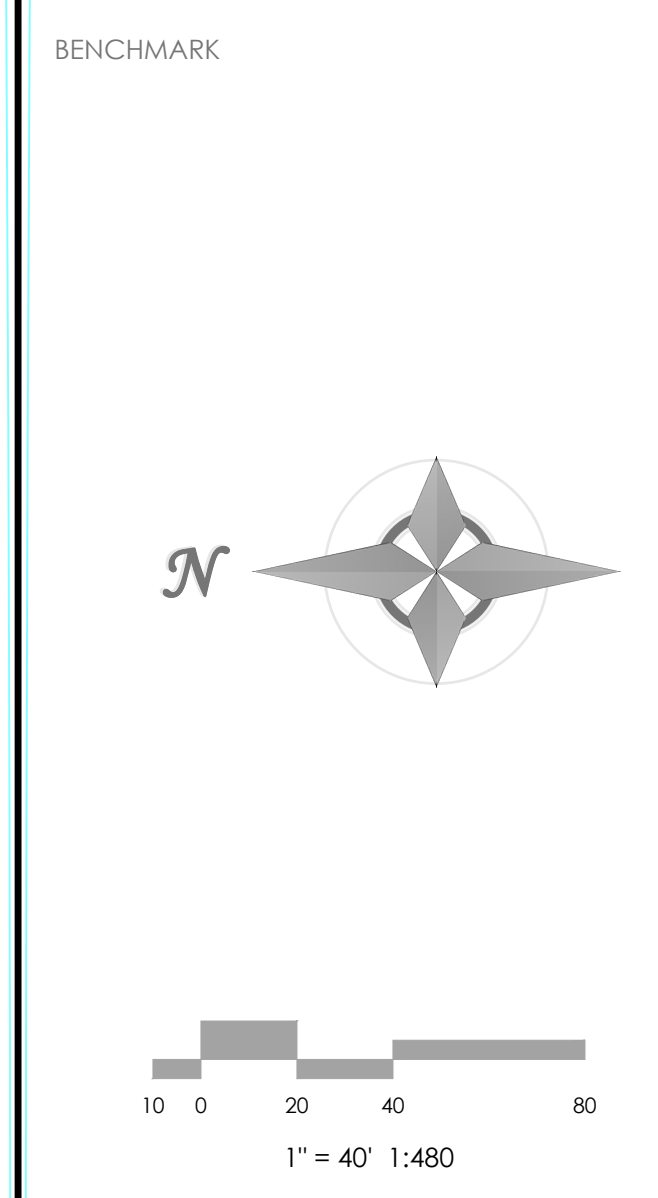
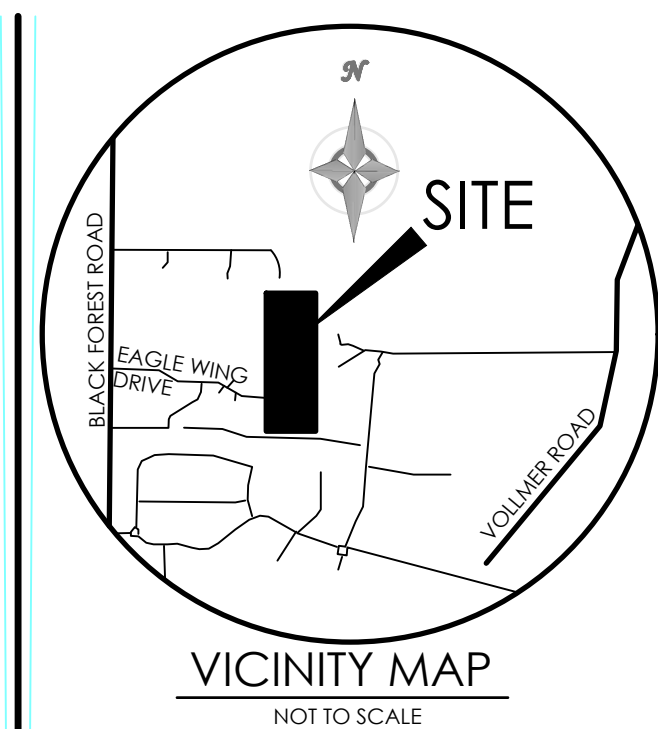
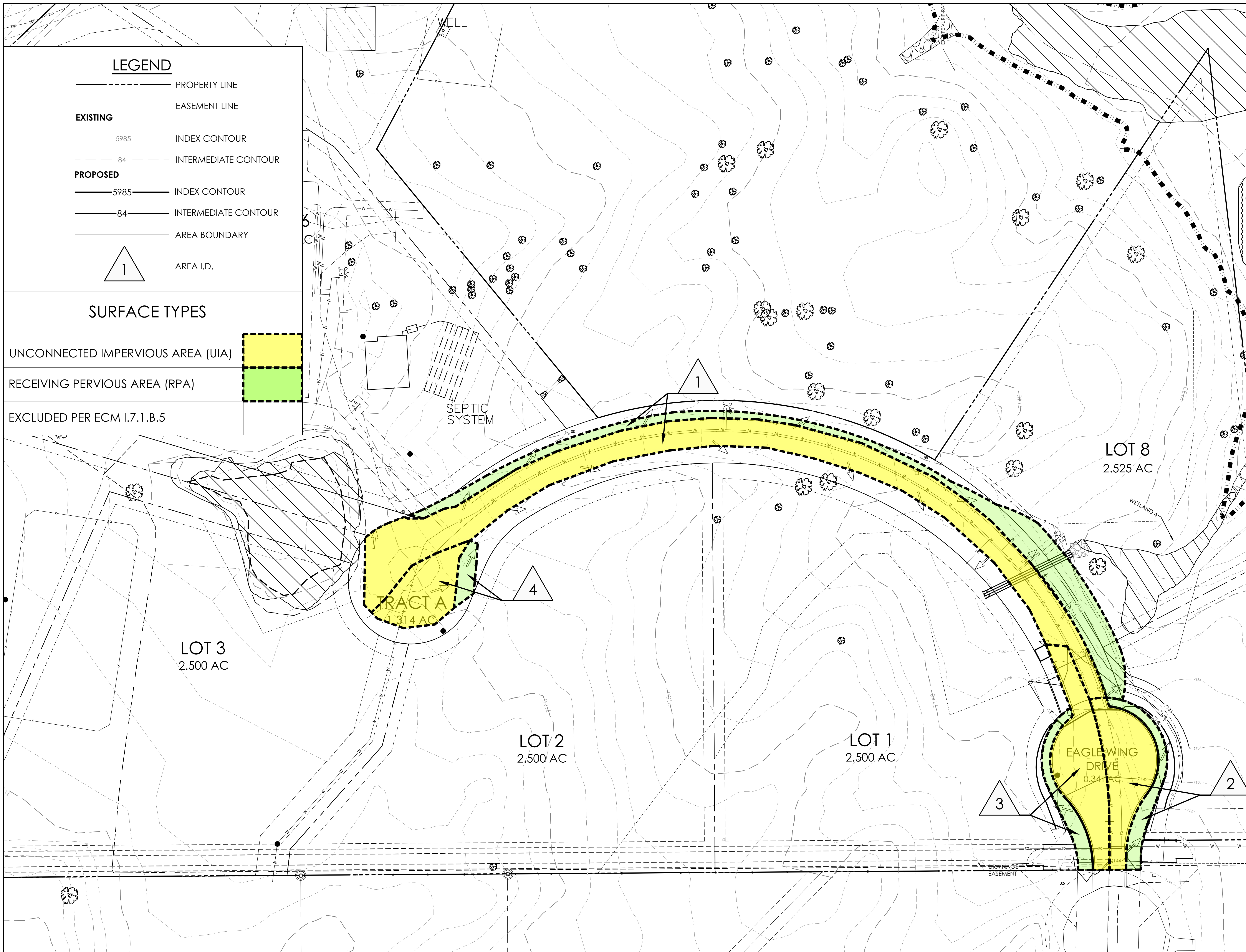

REVISIONS

NO.	DESCRIPTION	DATE
	DESIGNED BY	
	DRAWN BY	
	CHECKED BY	
	AS-BUILTS BY	
	CHECKED BY	

EAGLE RISING

BMP AREA ID
MAP

MVE PROJECT 61145
MVE DRAWING BMP-Area

MAY 22, 2024
SHEET 1 OF 1

12. Hydraulic Calculations

Culvert Calculations

Ditch Flow Calculations

Culvert Report

61145 - Eagle Rising DP-E13 Exist 15in RCP Culvert

Invert Elev Dn (ft)	= 7136.00
Pipe Length (ft)	= 30.00
Slope (%)	= 2.00
Invert Elev Up (ft)	= 7136.60
Rise (in)	= 15.0
Shape	= Circular
Span (in)	= 15.0
No. Barrels	= 1
n-Value	= 0.013
Culvert Type	= Circular Concrete
Culvert Entrance	= Groove end projecting (C)
Coeff. K,M,c,Y,k	= 0.0045, 2, 0.0317, 0.69, 0.2

Embankment	
Top Elevation (ft)	= 7139.00
Top Width (ft)	= 20.00
Crest Width (ft)	= 100.00

Calculations	
Qmin (cfs)	= 1.10
Qmax (cfs)	= 6.20
Tailwater Elev (ft)	= Normal

Highlighted	
Qtotal (cfs)	= 1.10
Qpipe (cfs)	= 1.10
Qovertop (cfs)	= 0.00
Veloc Dn (ft/s)	= 4.97
Veloc Up (ft/s)	= 3.11
HGL Dn (ft)	= 7136.30
HGL Up (ft)	= 7137.01
Hw Elev (ft)	= 7137.15
Hw/D (ft)	= 0.44
Flow Regime	= Inlet Control

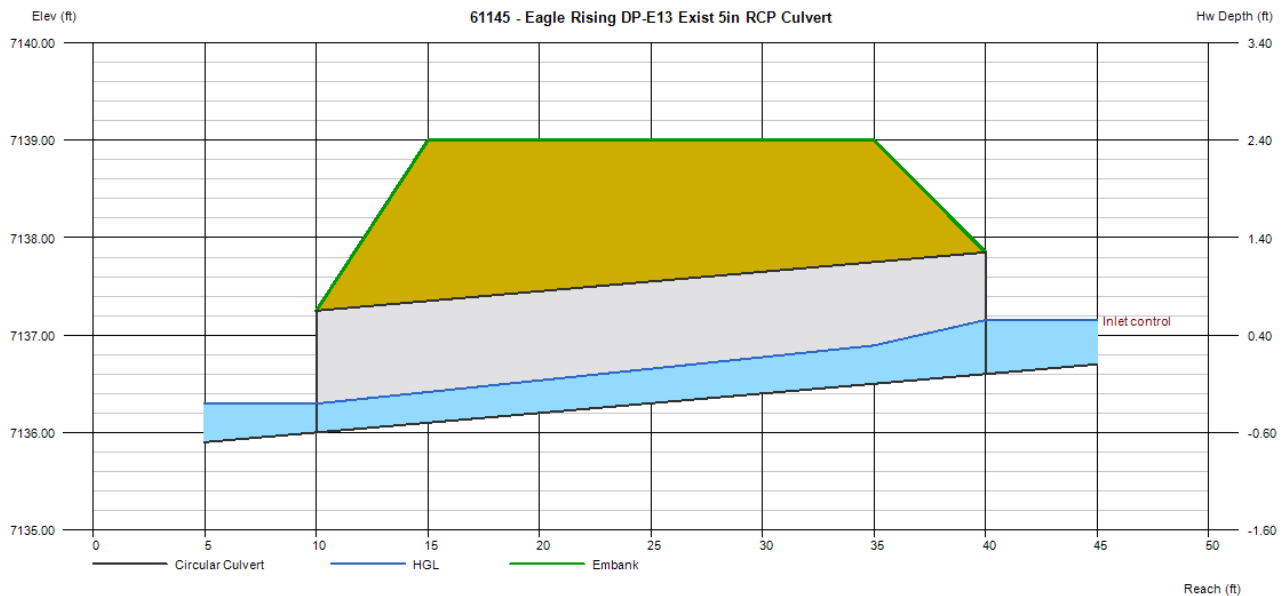

Determination of Culvert Headwater and Outlet Protection

Project: **61145 - Eagle Rising**
 Basin ID: **DP E13 24in RCP Driveway Culvert**

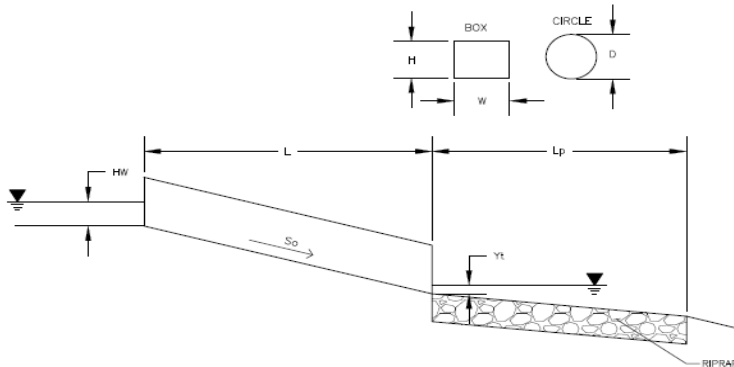

Soil Type:

Choose One:

- Sandy
 Non-Sandy

Design Information (Input):

Design Discharge	Q =	<input type="text" value="6.1"/>	cfs
Circular Culvert:			
Barrel Diameter in Inches	D =	<input type="text" value="24"/>	inches
Inlet Edge Type (Choose from pull-down list)		<input type="text" value="Grooved End Projection"/>	
Box Culvert:			
Barrel Height (Rise) in Feet	Height (Rise) =	<input type="text" value=""/>	ft
Barrel Width (Span) in Feet	Width (Span) =	<input type="text" value=""/>	ft
Inlet Edge Type (Choose from pull-down list)		<input type="text" value=""/>	
Number of Barrels	No =	<input type="text" value="1"/>	
Inlet Elevation	Elev IN =	<input type="text" value="7136.6"/>	ft
Outlet Elevation OR Slope	Elev OUT =	<input type="text" value="7136"/>	ft
Culvert Length	L =	<input type="text" value="30"/>	ft
Manning's Roughness	n =	<input type="text" value="0.013"/>	
Bend Loss Coefficient	k _b =	<input type="text" value="0"/>	
Exit Loss Coefficient	k _x =	<input type="text" value="1"/>	
Tailwater Surface Elevation	Elev Y _t =	<input type="text" value=""/>	ft
Max Allowable Channel Velocity	V =	<input type="text" value="7"/>	ft/s

Required Protection (Output):

Tailwater Surface Height	Y _t =	<input type="text" value="0.80"/>	ft
Flow Area at Max Channel Velocity	A _t =	<input type="text" value="3.69"/>	ft ²
Culvert Cross Sectional Area Available	A =	<input type="text" value="3.14"/>	ft ²
Entrance Loss Coefficient	k _e =	<input type="text" value="0.20"/>	
Friction Loss Coefficient	k _f =	<input type="text" value="0.62"/>	
Sum of All Losses Coefficients	k _s =	<input type="text" value="1.82"/>	
Culvert Normal Depth	Y _n =	<input type="text" value="1.46"/>	ft
Culvert Critical Depth	Y _c =	<input type="text" value="1.78"/>	ft
Tailwater Depth for Design	d =	<input type="text" value="1.89"/>	ft
Adjusted Diameter OR Adjusted Rise	D _a =	<input type="text" value="-"/>	ft
Expansion Factor	1/(2*tan(θ)) =	<input type="text" value="2.88"/>	
Flow/Diameter ^{2.5} OR Flow/(Span * Rise ^{1.5})	Q/D ^{2.5} =	<input type="text" value="4.56"/>	ft ^{0.5} /s
Froude Number	Fr =	<input type="text" value="-"/>	Pressure flow!
Tailwater/Adjusted Diameter OR Tailwater/Adjusted Rise	Y _t /D =	<input type="text" value="0.40"/>	
Inlet Control Headwater	HW _i =	<input type="text" value="3.50"/>	ft
Outlet Control Headwater	HW _o =	<input type="text" value="3.29"/>	ft
Design Headwater Elevation	HW =	<input type="text" value="7,150.00"/>	ft
Headwater/Diameter OR Headwater/Rise Ratio	HW/D =	<input type="text" value="1.75"/>	HW/D > 1.5!
Minimum Theoretical Riprap Size	d ₅₀ =	<input type="text" value="8"/>	in
Nominal Riprap Size	d ₅₀ =	<input type="text" value="9"/>	in
UDFCD Riprap Type	Type =	<input type="text" value="L"/>	
Length of Protection	L _p =	<input type="text" value="8"/>	ft
Width of Protection	T =	<input type="text" value="5"/>	ft

Culvert Report

61145 - Eagle Rising DP7 23x14 HE-RCP Driveway Culvert Lot 7 flag

Invert Elev Dn (ft)	= 7146.00
Pipe Length (ft)	= 50.00
Slope (%)	= 1.00
Invert Elev Up (ft)	= 7146.50
Rise (in)	= 14.0
Shape	= Elliptical
Span (in)	= 23.0
No. Barrels	= 2
n-Value	= 0.013
Culvert Type	= Horizontal Ellipse Concrete
Culvert Entrance	= Groove end projecting (H)
Coeff. K,M,c,Y,k	= 0.0045, 2, 0.0317, 0.69, 0.2

Embankment	
Top Elevation (ft)	= 7150.00
Top Width (ft)	= 20.00
Crest Width (ft)	= 115.00

Calculations	
Qmin (cfs)	= 30.60
Qmax (cfs)	= 30.60
Tailwater Elev (ft)	= (dc+D)/2

Highlighted	
Qtotal (cfs)	= 30.60
Qpipe (cfs)	= 30.60
Qovertop (cfs)	= 0.00
Veloc Dn (ft/s)	= 8.71
Veloc Up (ft/s)	= 8.71
HGL Dn (ft)	= 7147.12
HGL Up (ft)	= 7148.24
Hw Elev (ft)	= 7149.71
Hw/D (ft)	= 2.75
Flow Regime	= Inlet Control

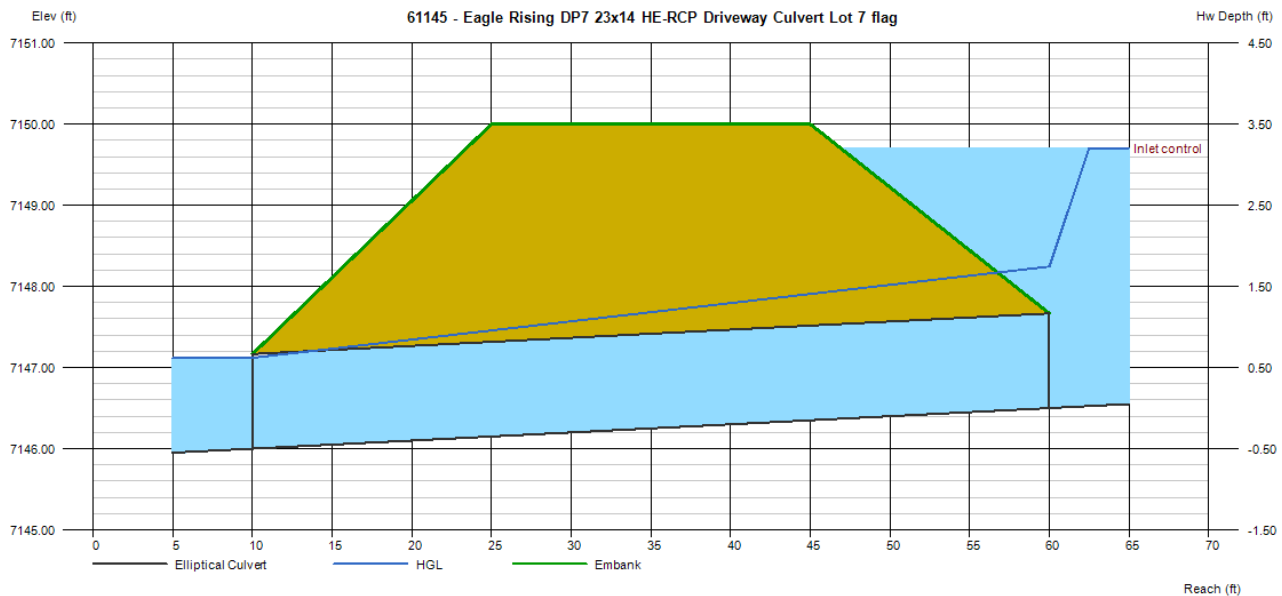

Determination of Culvert Headwater and Outlet Protection

Project: **61145 - Eagle Rising**
 Basin ID: **DP7 30in RCP Driveway Culvert**

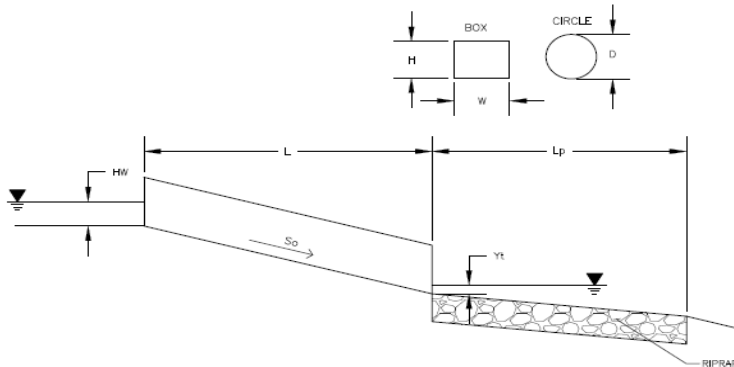

Soil Type:
 Choose One:
 Sandy
 Non-Sandy

Design Information (Input):

Design Discharge	Q = <input type="text" value="25.8"/> cfs
Circular Culvert:	
Barrel Diameter in Inches	D = <input type="text" value="24"/> inches
Inlet Edge Type (Choose from pull-down list)	Grooved End Projection
Box Culvert:	OR
Barrel Height (Rise) in Feet	Height (Rise) = <input type="text"/> ft
Barrel Width (Span) in Feet	Width (Span) = <input type="text"/> ft
Inlet Edge Type (Choose from pull-down list)	
Number of Barrels	No = <input type="text" value="1"/>
Inlet Elevation	Elev IN = <input type="text" value="7146.5"/> ft
Outlet Elevation OR Slope	Elev OUT = <input type="text" value="7146"/> ft
Culvert Length	L = <input type="text" value="50"/> ft
Manning's Roughness	n = <input type="text" value="0.013"/>
Bend Loss Coefficient	k _b = <input type="text" value="0"/>
Exit Loss Coefficient	k _x = <input type="text" value="1"/>
Tailwater Surface Elevation	Elev Y _t = <input type="text"/> ft
Max Allowable Channel Velocity	V = <input type="text" value="7"/> ft/s

Required Protection (Output):

Tailwater Surface Height	Y _t = <input type="text" value="0.80"/> ft
Flow Area at Max Channel Velocity	A _t = <input type="text" value="3.69"/> ft ²
Culvert Cross Sectional Area Available	A = <input type="text" value="3.14"/> ft ²
Entrance Loss Coefficient	k _e = <input type="text" value="0.20"/>
Friction Loss Coefficient	k _f = <input type="text" value="0.62"/>
Sum of All Losses Coefficients	k _s = <input type="text" value="1.82"/> ft
Culvert Normal Depth	Y _n = <input type="text" value="1.46"/> ft
Culvert Critical Depth	Y _c = <input type="text" value="1.78"/> ft
Tailwater Depth for Design	d = <input type="text" value="1.89"/> ft
Adjusted Diameter OR Adjusted Rise	D _a = <input type="text" value="-"/> ft
Expansion Factor	1/(2*tan(θ)) = <input type="text" value="2.88"/>
Flow/Diameter ^{2.5} OR Flow/(Span * Rise ^{1.5})	Q/D ^{2.5} = <input type="text" value="4.56"/> ft ^{0.5} /s
Froude Number	Fr = <input type="text" value="-"/> Pressure flow!
Tailwater/Adjusted Diameter OR Tailwater/Adjusted Rise	Y _t /D = <input type="text" value="0.40"/>
Inlet Control Headwater	HW _i = <input type="text" value="3.50"/> ft
Outlet Control Headwater	HW _o = <input type="text" value="3.29"/> ft
Design Headwater Elevation	HW = <input type="text" value="7,150.00"/> ft
Headwater/Diameter OR Headwater/Rise Ratio	HW/D = <input type="text" value="1.75"/> HW/D > 1.5!
Minimum Theoretical Riprap Size	d ₅₀ = <input type="text" value="8"/> in
Nominal Riprap Size	d ₅₀ = <input type="text" value="9"/> in
UDFCD Riprap Type	Type = <input type="text" value="L"/>
Length of Protection	L_p = <input type="text" value="8"/> ft
Width of Protection	T = <input type="text" value="5"/> ft

Culvert Report

61145 - Eagle Rising DP8A 24in RCP Culvert

Invert Elev Dn (ft)	= 7129.68
Pipe Length (ft)	= 89.80
Slope (%)	= 3.73
Invert Elev Up (ft)	= 7133.03
Rise (in)	= 24.0
Shape	= Circular
Span (in)	= 24.0
No. Barrels	= 2
n-Value	= 0.013
Culvert Type	= Circular Concrete
Culvert Entrance	= Groove end projecting (C)
Coeff. K,M,c,Y,k	= 0.0045, 2, 0.0317, 0.69, 0.2

Embankment

Top Elevation (ft)	= 7136.71
Top Width (ft)	= 28.00
Crest Width (ft)	= 205.00

Calculations

Qmin (cfs)	= 0.00
Qmax (cfs)	= 51.80
Tailwater Elev (ft)	= (dc+D)/2

Highlighted

Qtotal (cfs)	= 51.80
Qpipe (cfs)	= 51.80
Qovertop (cfs)	= 0.00
Veloc Dn (ft/s)	= 8.42
Veloc Up (ft/s)	= 8.76
HGL Dn (ft)	= 7131.57
HGL Up (ft)	= 7134.81
Hw Elev (ft)	= 7136.53
Hw/D (ft)	= 1.75
Flow Regime	= Inlet Control

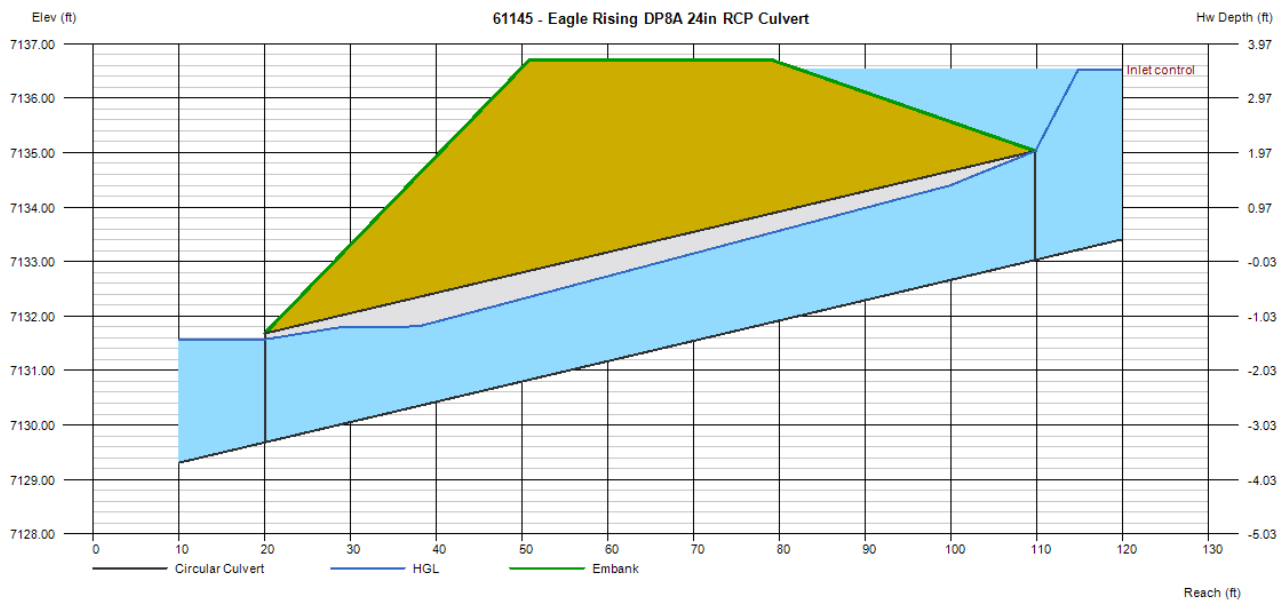

Determination of Culvert Headwater and Outlet Protection

Project: **61145 - Eagle Rising**
 Basin ID: **DP8A Double 24in RCP**

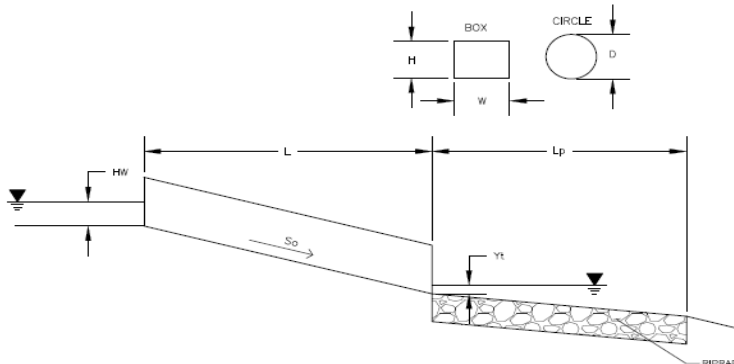

Soil Type:

Choose One:

- Sandy
 Non-Sandy

Supercritical Flow! Using D_a to calculate protection type.

Design Information (Input):

Design Discharge	Q = <input style="border: 1px solid blue;" type="text" value="51.8"/> cfs
Circular Culvert:	
Barrel Diameter in Inches	D = <input style="border: 1px solid blue;" type="text" value="24"/> inches
Inlet Edge Type (Choose from pull-down list)	<input style="border: 1px solid blue;" type="text" value="1.5 : 1 Beveled Edge"/> ▼
Box Culvert:	OR
Barrel Height (Rise) in Feet	Height (Rise) = <input style="border: 1px solid blue;" type="text"/>
Barrel Width (Span) in Feet	Width (Span) = <input style="border: 1px solid blue;" type="text"/>
Inlet Edge Type (Choose from pull-down list)	<input style="border: 1px solid blue;" type="text"/> ▼
Number of Barrels	No = <input style="border: 1px solid blue;" type="text" value="2"/>
Inlet Elevation	Elev IN = <input style="border: 1px solid blue;" type="text" value="7133.03"/> ft
Outlet Elevation OR Slope	Elev OUT = <input style="border: 1px solid blue;" type="text" value="7129.68"/> ft
Culvert Length	L = <input style="border: 1px solid blue;" type="text" value="89.8"/> ft
Manning's Roughness	n = <input style="border: 1px solid blue;" type="text" value="0.013"/>
Bend Loss Coefficient	k_b = <input style="border: 1px solid blue;" type="text" value="0"/>
Exit Loss Coefficient	k_x = <input style="border: 1px solid blue;" type="text" value="1"/>
Tailwater Surface Elevation	Elev Y_t = <input style="border: 1px solid blue;" type="text"/>
Max Allowable Channel Velocity	V = <input style="border: 1px solid blue;" type="text" value="7"/> ft/s

Required Protection (Output):

Tailwater Surface Height	Y_t = <input style="border: 1px solid green;" type="text" value="0.80"/> ft
Flow Area at Max Channel Velocity	A_t = <input style="border: 1px solid green;" type="text" value="3.70"/> ft ²
Culvert Cross Sectional Area Available	A = <input style="border: 1px solid green;" type="text" value="3.14"/> ft ²
Entrance Loss Coefficient	k_e = <input style="border: 1px solid green;" type="text" value="0.20"/>
Friction Loss Coefficient	k_f = <input style="border: 1px solid green;" type="text" value="1.11"/>
Sum of All Losses Coefficients	k_s = <input style="border: 1px solid green;" type="text" value="2.31"/> ft
Culvert Normal Depth	Y_n = <input style="border: 1px solid green;" type="text" value="1.11"/> ft
Culvert Critical Depth	Y_c = <input style="border: 1px solid green;" type="text" value="1.78"/> ft
Tailwater Depth for Design	d = <input style="border: 1px solid green;" type="text" value="1.89"/> ft
Adjusted Diameter OR Adjusted Rise	D_a = <input style="border: 1px solid green;" type="text" value="1.55"/> ft
Expansion Factor	$1/(2*\tan(\theta))$ = <input style="border: 1px solid green;" type="text" value="4.22"/>
Flow/Diameter ^{2.5} OR Flow/(Span * Rise ^{1.5})	$Q/D^{2.5}$ = <input style="border: 1px solid green;" type="text" value="4.58"/> ft ^{0.5} /s
Froude Number	Fr = <input style="border: 1px solid green;" type="text" value="2.70"/> Supercritical!
Tailwater/Adjusted Diameter OR Tailwater/Adjusted Rise	Y_t/D = <input style="border: 1px solid green;" type="text" value="0.52"/>
Inlet Control Headwater	HW_i = <input style="border: 1px solid green;" type="text" value="3.32"/> ft
Outlet Control Headwater	HW_o = <input style="border: 1px solid green;" type="text" value="0.98"/> ft
Design Headwater Elevation	HW = <input style="border: 1px solid green;" type="text" value="7,136.35"/> ft
Headwater/Diameter OR Headwater/Rise Ratio	HW/D = <input style="border: 1px solid green;" type="text" value="1.66"/> HW/D > 1.5!
Minimum Theoretical Riprap Size	d_{50} = <input style="border: 1px solid green;" type="text" value="8"/> in
Nominal Riprap Size	d_{50} = <input style="border: 1px solid green;" type="text" value="9"/> in
UDFCD Riprap Type	Type = <input style="border: 1px solid green;" type="text" value="L"/>
Length of Protection	L_p = <input style="border: 1px solid green;" type="text" value="12"/> ft
Width of Protection	T = <input style="border: 1px solid green;" type="text" value="5"/> ft

Channel Report

Design Point E11 (Lot 1) - Redirect Culvert (21.3 cfs 100 Year)

Circular

Diameter (ft) = 2.00

Invert Elev (ft) = 100.00

Slope (%) = 1.00

N-Value = 0.013

Calculations

Compute by: Known Q

Known Q (cfs) = 21.30

Highlighted

Depth (ft) = 1.55

Q (cfs) = 21.30

Area (sqft) = 2.62

Velocity (ft/s) = 8.15

Wetted Perim (ft) = 4.31

Crit Depth, Y_c (ft) = 1.66

Top Width (ft) = 1.67

EGL (ft) = 2.58

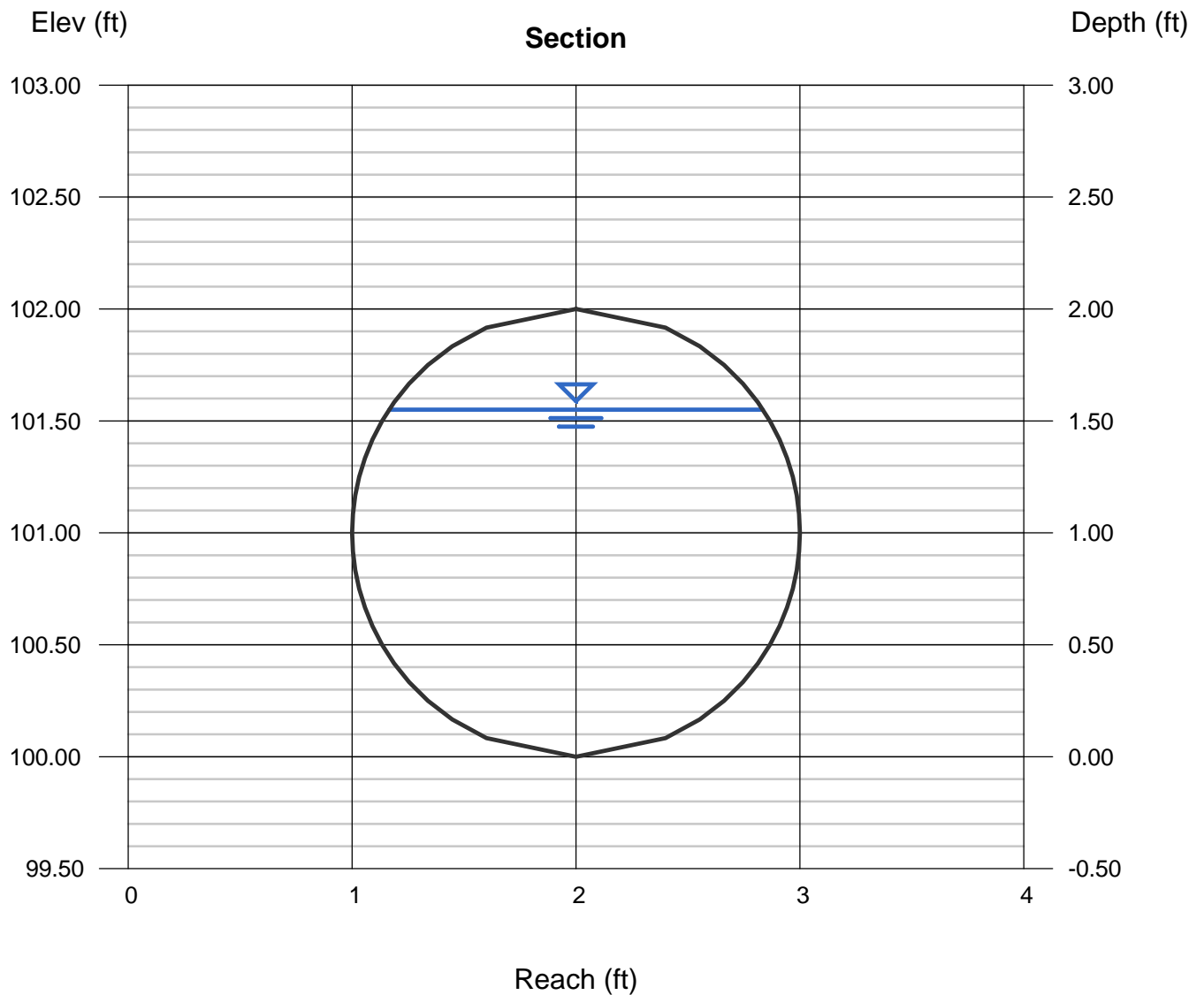

Channel Report

Basin B - Swale Calculation - Reach (Q5)

Trapezoidal

Bottom Width (ft) = 33.00
Side Slopes (z:1) = 10.00, 10.00
Total Depth (ft) = 2.00
Invert Elev (ft) = 7180.00
Slope (%) = 2.70
N-Value = 0.040

Highlighted

Depth (ft) = 0.18
Q (cfs) = 11.60
Area (sqft) = 6.26
Velocity (ft/s) = 1.85
Wetted Perim (ft) = 36.62
Crit Depth, Yc (ft) = 0.16
Top Width (ft) = 36.60
EGL (ft) = 0.23

Calculations

Compute by: Known Q
Known Q (cfs) = 11.60

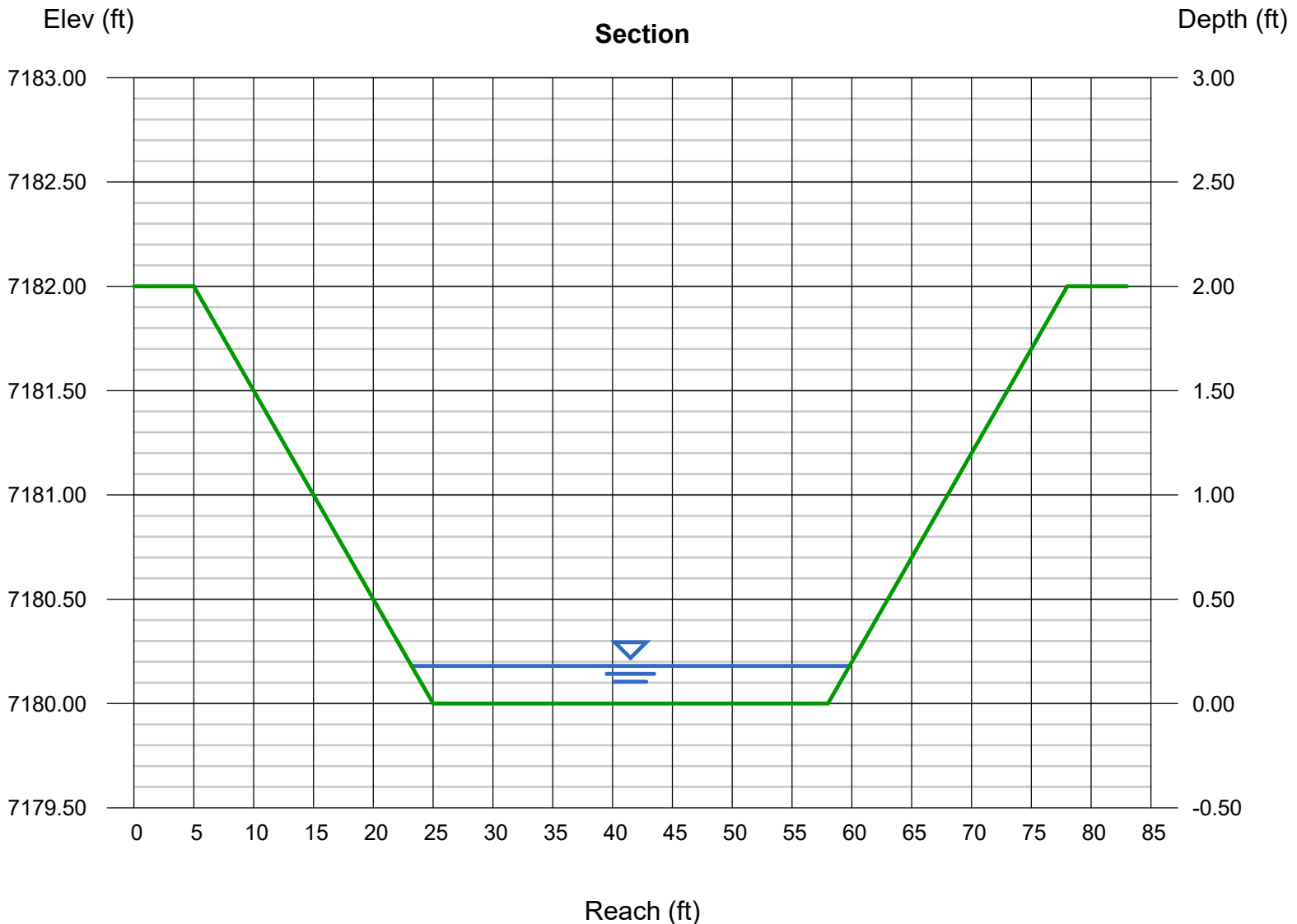

Channel Report

Basin B - Swale Calculation - Reach (Q100)

Trapezoidal

Bottom Width (ft) = 33.00
Side Slopes (z:1) = 10.00, 10.00
Total Depth (ft) = 2.00
Invert Elev (ft) = 7180.00
Slope (%) = 2.70
N-Value = 0.040

Highlighted

Depth (ft) = 0.49
Q (cfs) = 63.30
Area (sqft) = 18.57
Velocity (ft/s) = 3.41
Wetted Perim (ft) = 42.85
Crit Depth, Yc (ft) = 0.47
Top Width (ft) = 42.80
EGL (ft) = 0.67

Calculations

Compute by: Known Q
Known Q (cfs) = 63.30

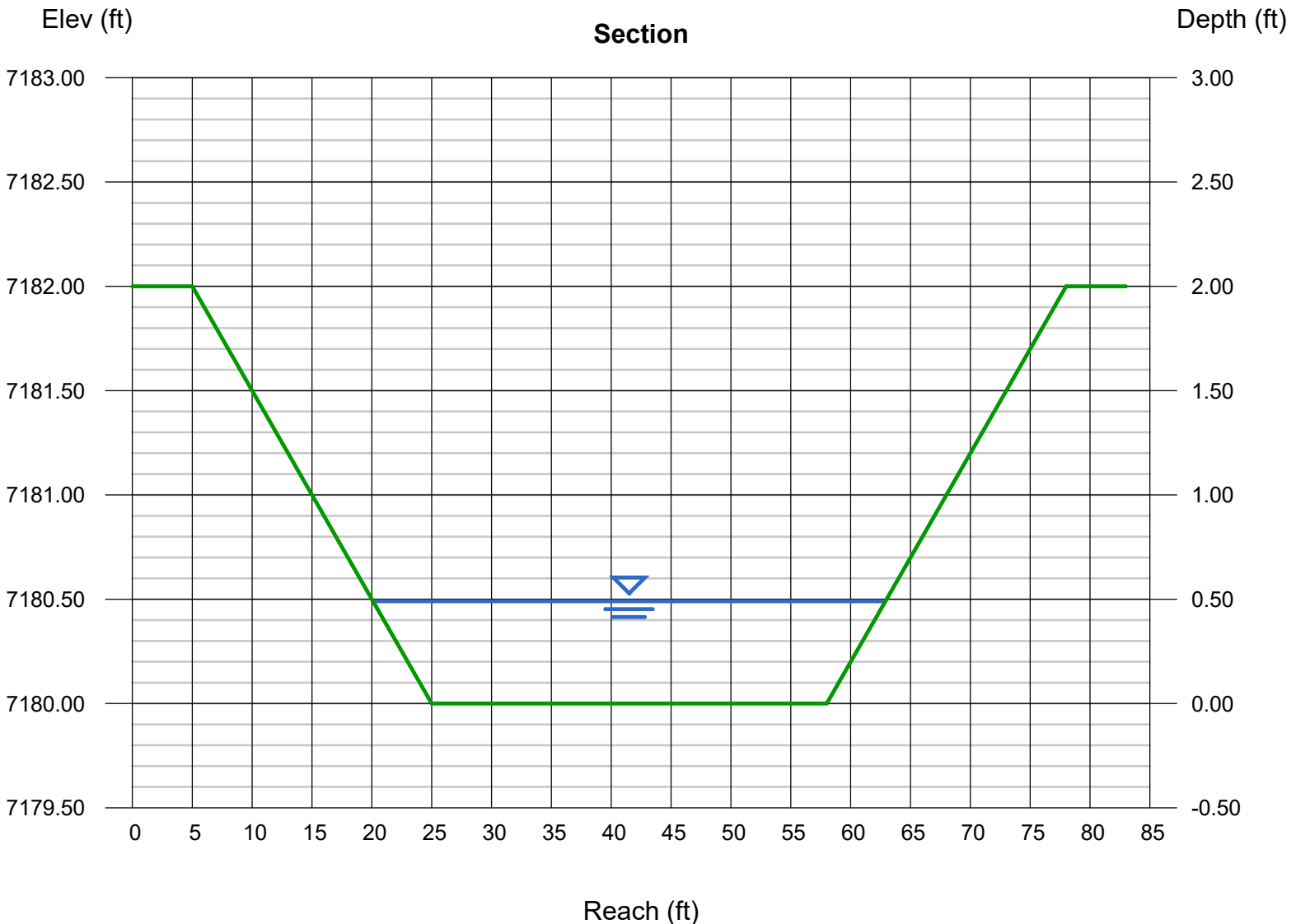

Channel Report

Basin C - Swale Calculation - Reach (Q5)

Trapezoidal

Bottom Width (ft) = 10.00
Side Slopes (z:1) = 9.00, 16.00
Total Depth (ft) = 2.00
Invert Elev (ft) = 7176.00
Slope (%) = 1.60
N-Value = 0.040

Highlighted

Depth (ft) = 0.40
Q (cfs) = 12.60
Area (sqft) = 6.00
Velocity (ft/s) = 2.10
Wetted Perim (ft) = 20.03
Crit Depth, Yc (ft) = 0.32
Top Width (ft) = 20.00
EGL (ft) = 0.47

Calculations

Compute by: Known Q
Known Q (cfs) = 12.60

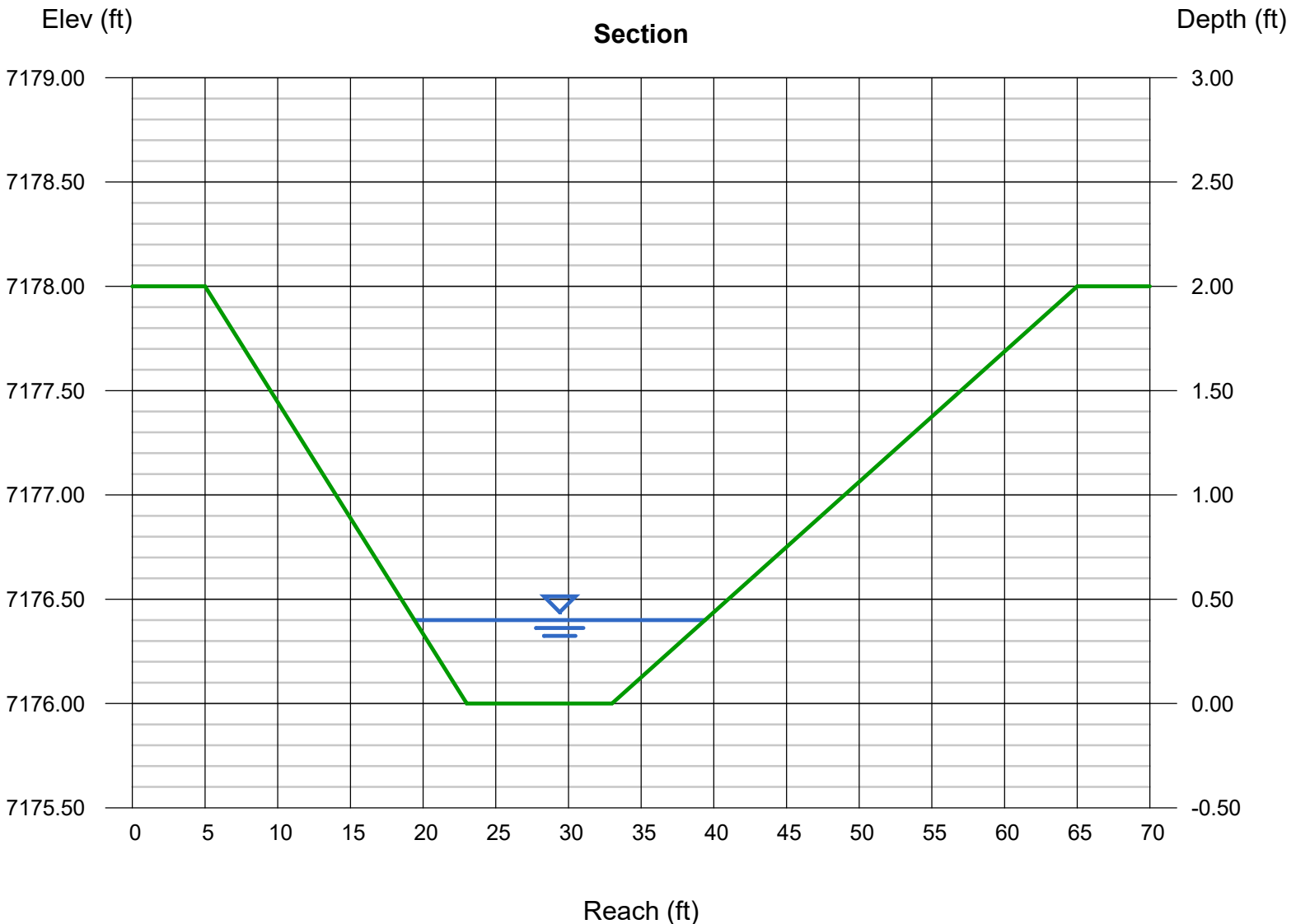

Channel Report

Basin C - Swale Calculation - Reach (Q100)

Trapezoidal

Bottom Width (ft) = 10.00
Side Slopes (z:1) = 9.00, 16.00
Total Depth (ft) = 2.00
Invert Elev (ft) = 7176.00
Slope (%) = 1.60
N-Value = 0.040

Highlighted

Depth (ft) = 1.02
Q (cfs) = 80.70
Area (sqft) = 23.20
Velocity (ft/s) = 3.48
Wetted Perim (ft) = 35.59
Crit Depth, Y_c (ft) = 0.89
Top Width (ft) = 35.50
EGL (ft) = 1.21

Calculations

Compute by: Known Q
Known Q (cfs) = 80.70

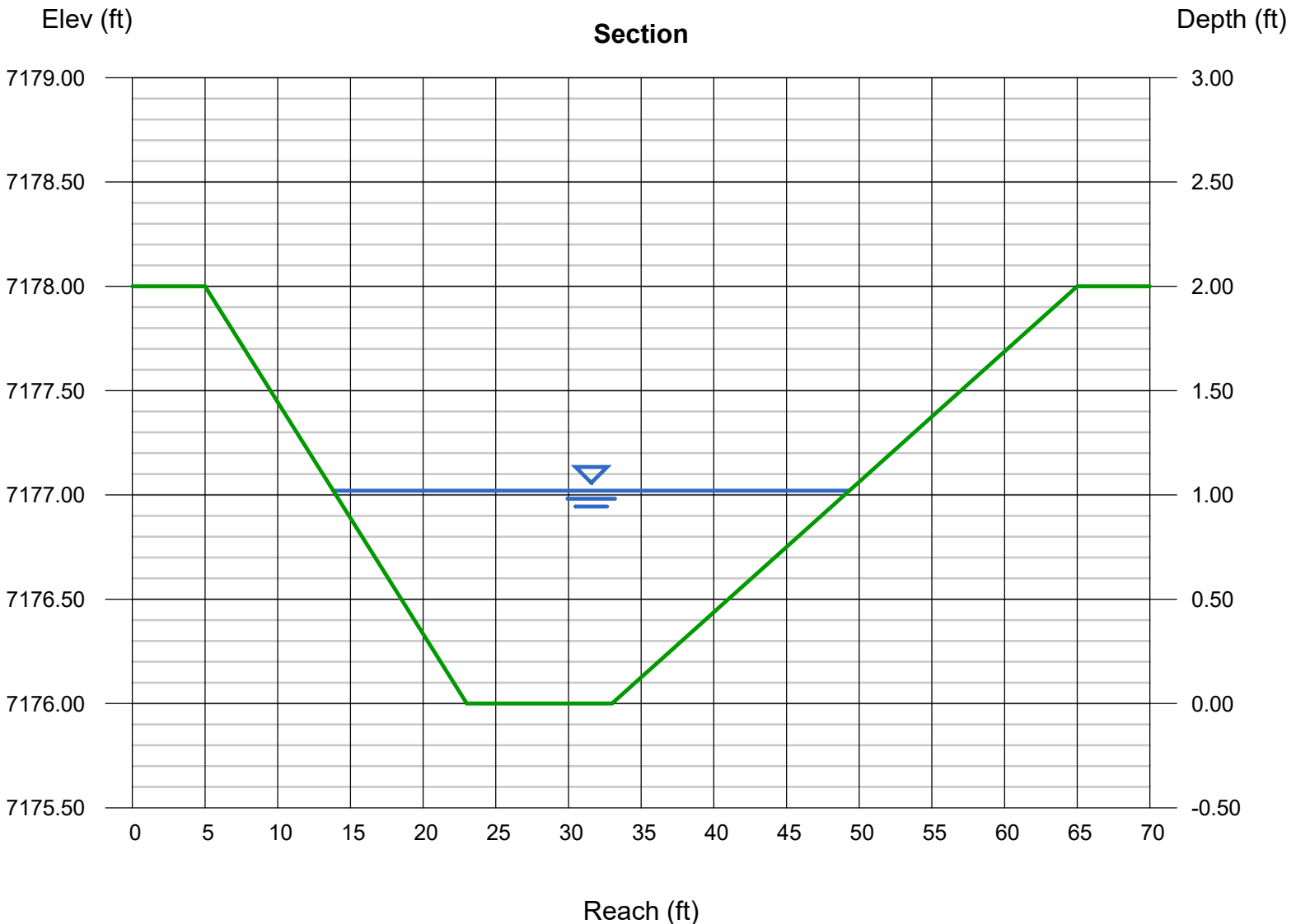

Channel Report

Basin D - Swale Calculation - Reach (Q5)

Trapezoidal

Bottom Width (ft) = 20.00
Side Slopes (z:1) = 5.00, 10.00
Total Depth (ft) = 2.00
Invert Elev (ft) = 7170.00
Slope (%) = 3.70
N-Value = 0.040

Highlighted

Depth (ft) = 0.34
Q (cfs) = 24.40
Area (sqft) = 7.67
Velocity (ft/s) = 3.18
Wetted Perim (ft) = 25.15
Crit Depth, Yc (ft) = 0.35
Top Width (ft) = 25.10
EGL (ft) = 0.50

Calculations

Compute by: Known Q
Known Q (cfs) = 24.40

EXISTING SWALE LINED WITH
TYPE VL RIPRAP

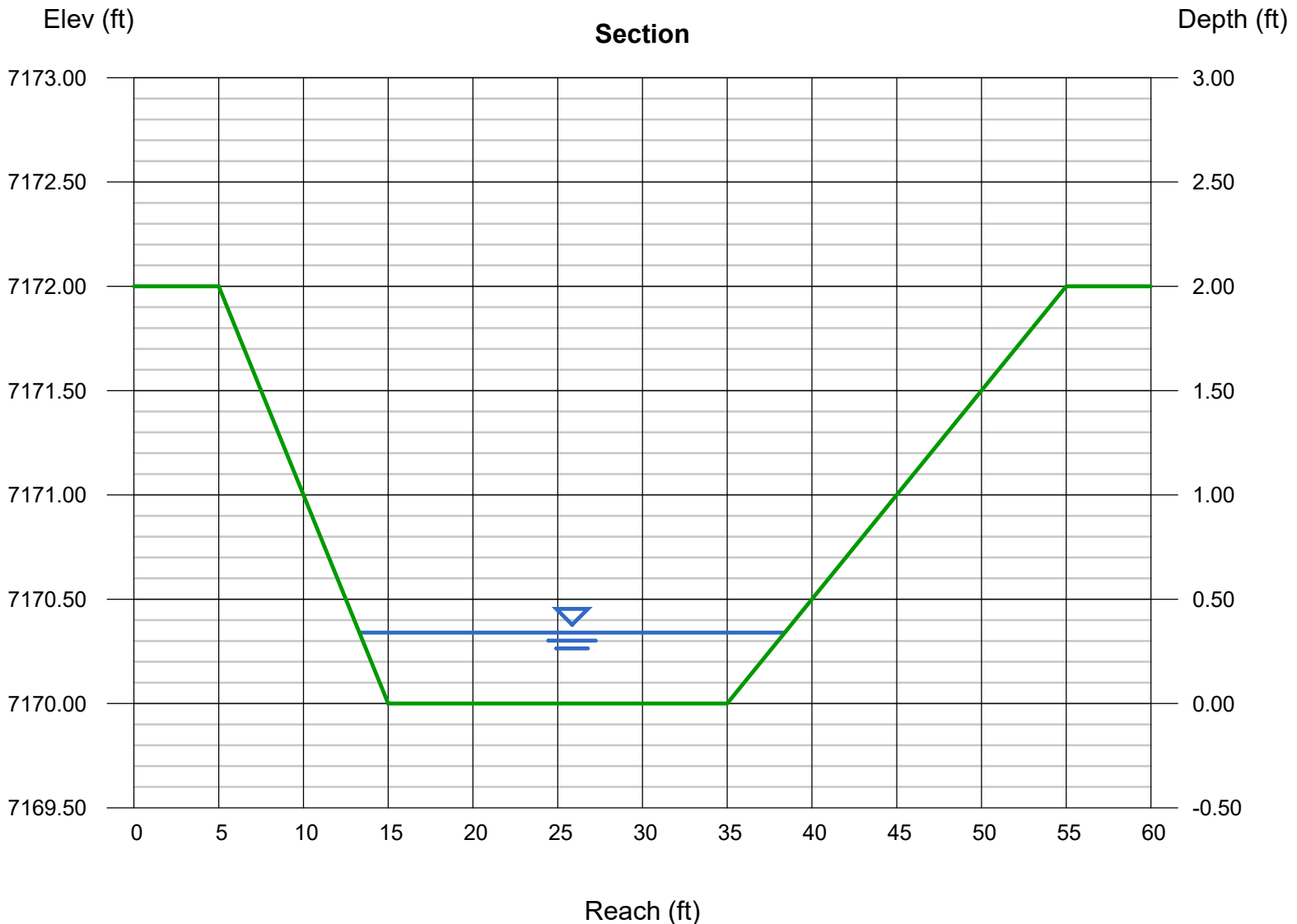

Channel Report

Basin D - Swale Calculation - Reach (Q100)

Trapezoidal

Bottom Width (ft)	= 20.00
Side Slopes (z:1)	= 5.00, 10.00
Total Depth (ft)	= 2.00
Invert Elev (ft)	= 7170.00
Slope (%)	= 3.70
N-Value	= 0.040

Highlighted

Depth (ft)	= 0.92
Q (cfs)	= 142.60
Area (sqft)	= 24.75
Velocity (ft/s)	= 5.76
Wetted Perim (ft)	= 33.94
Crit Depth, Yc (ft)	= 1.02
Top Width (ft)	= 33.80
EGL (ft)	= 1.44

Calculations

Compute by:	Known Q
Known Q (cfs)	= 142.60

EXISTING SWALE LINED WITH
TYPE VL RIPRAP

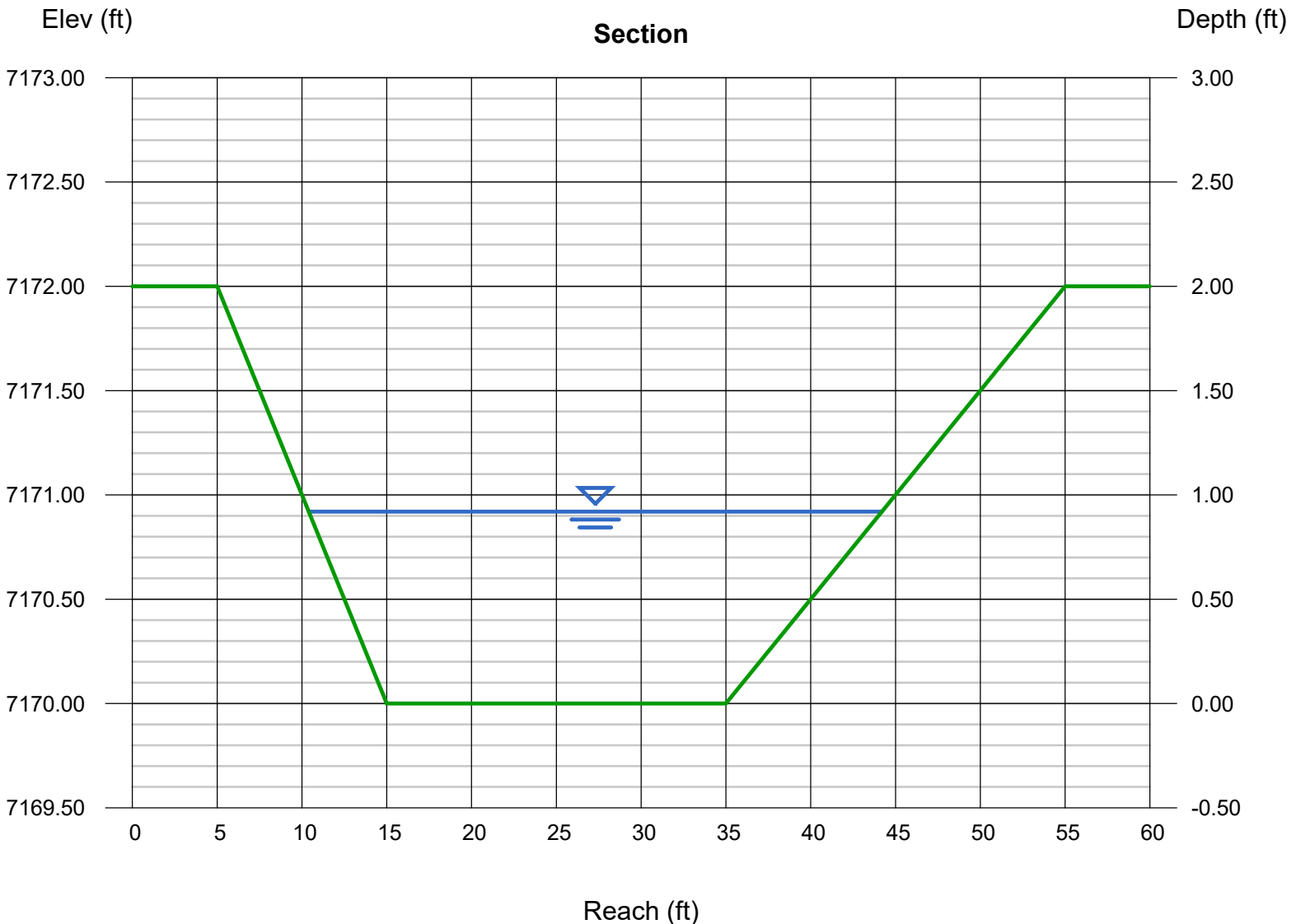

Channel Report

Basin F2 Swale Calculation - Reach 1 (Q5)

Triangular

Side Slopes (z:1) = 10.00, 10.00
Total Depth (ft) = 2.00

Invert Elev (ft) = 7146.00
Slope (%) = 3.80
N-Value = 0.040

Calculations

Compute by: Known Q
Known Q (cfs) = 6.40

Highlighted

Depth (ft) = 0.48
Q (cfs) = 6.400
Area (sqft) = 2.30
Velocity (ft/s) = 2.78
Wetted Perim (ft) = 9.65
Crit Depth, Yc (ft) = 0.48
Top Width (ft) = 9.60
EGL (ft) = 0.60

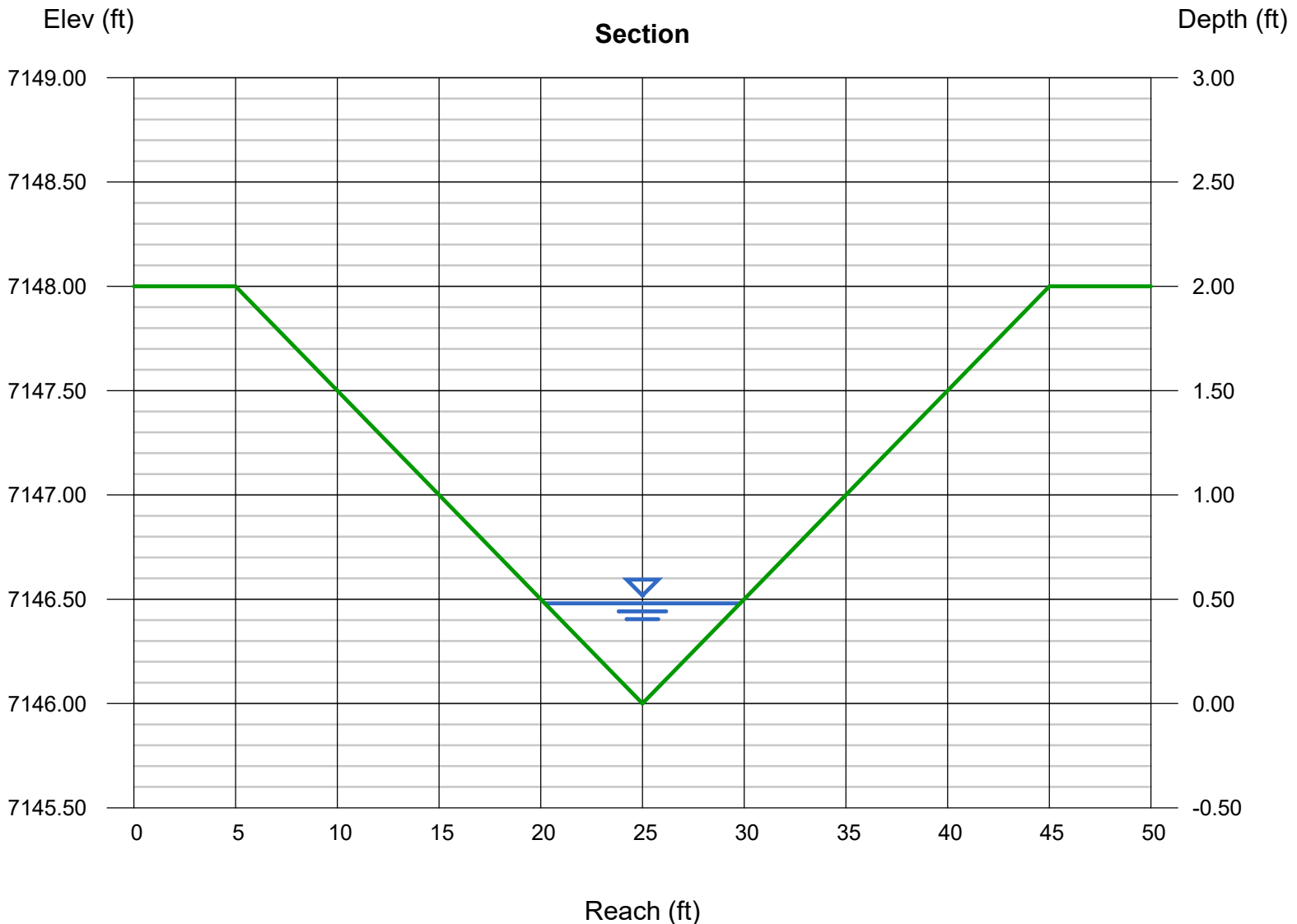

Channel Report

Basin F2 Swale Calculation - Reach 1 (Q100)

Triangular

Side Slopes (z:1) = 10.00, 10.00
Total Depth (ft) = 2.00

Invert Elev (ft) = 7146.00
Slope (%) = 3.80
N-Value = 0.040

Calculations

Compute by: Known Q
Known Q (cfs) = 28.30

Highlighted

Depth (ft) = 0.84
Q (cfs) = 28.30
Area (sqft) = 7.06
Velocity (ft/s) = 4.01
Wetted Perim (ft) = 16.88
Crit Depth, Yc (ft) = 0.87
Top Width (ft) = 16.80
EGL (ft) = 1.09

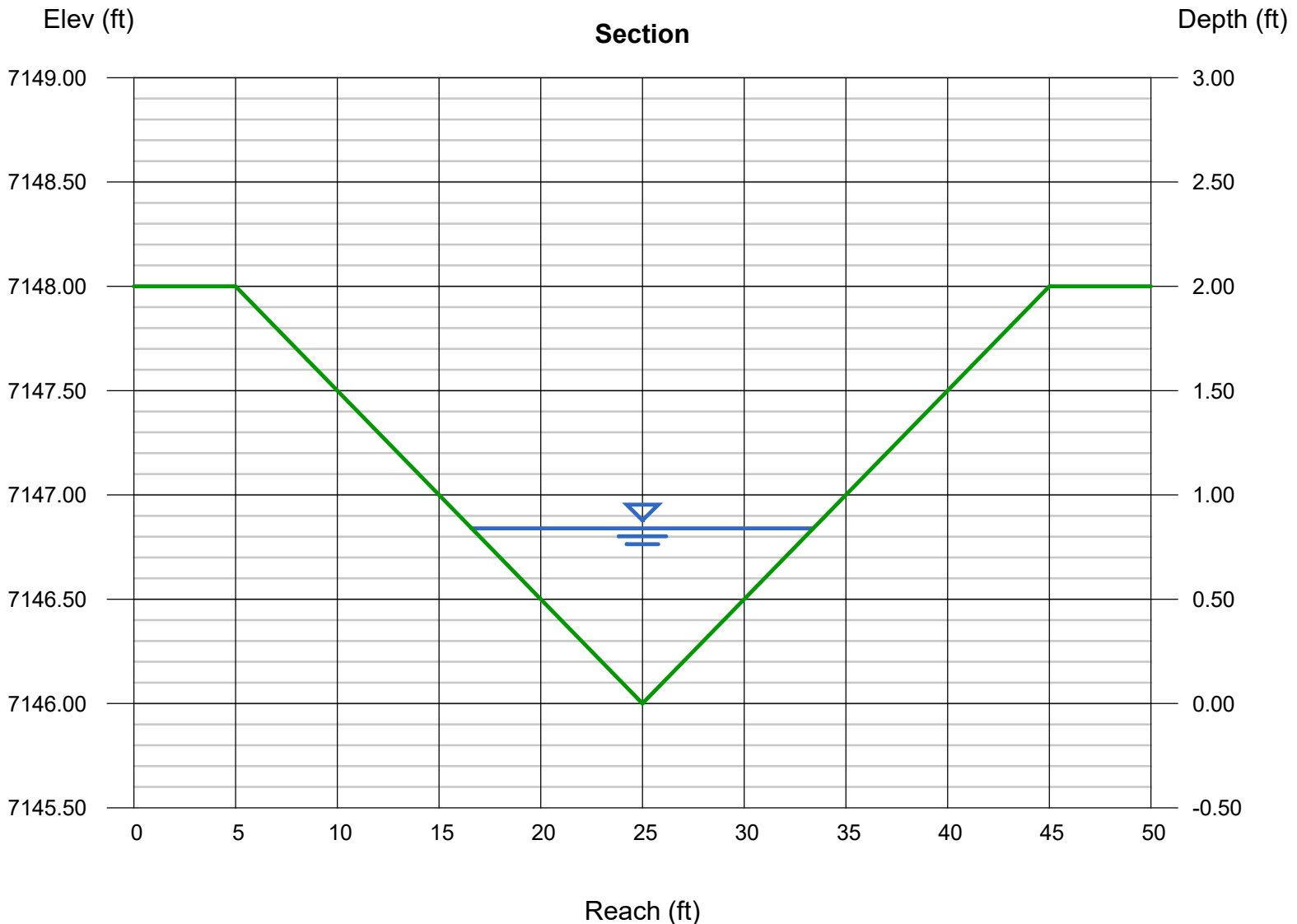

Channel Report

Basin F2 Swale Calculation - Reach 2 (Q5)

Triangular

Side Slopes (z:1) = 6.00, 6.00

Total Depth (ft) = 2.00

Invert Elev (ft) = 7132.00

Slope (%) = 5.70

N-Value = 0.040

Calculations

Compute by: Known Q

Known Q (cfs) = 6.40

Highlighted

Depth (ft) = 0.54

Q (cfs) = 6.400

Area (sqft) = 1.75

Velocity (ft/s) = 3.66

Wetted Perim (ft) = 6.57

Crit Depth, Yc (ft) = 0.59

Top Width (ft) = 6.48

EGL (ft) = 0.75

EXISTING SWALE LINED WITH
TYPE VL RIPRAP

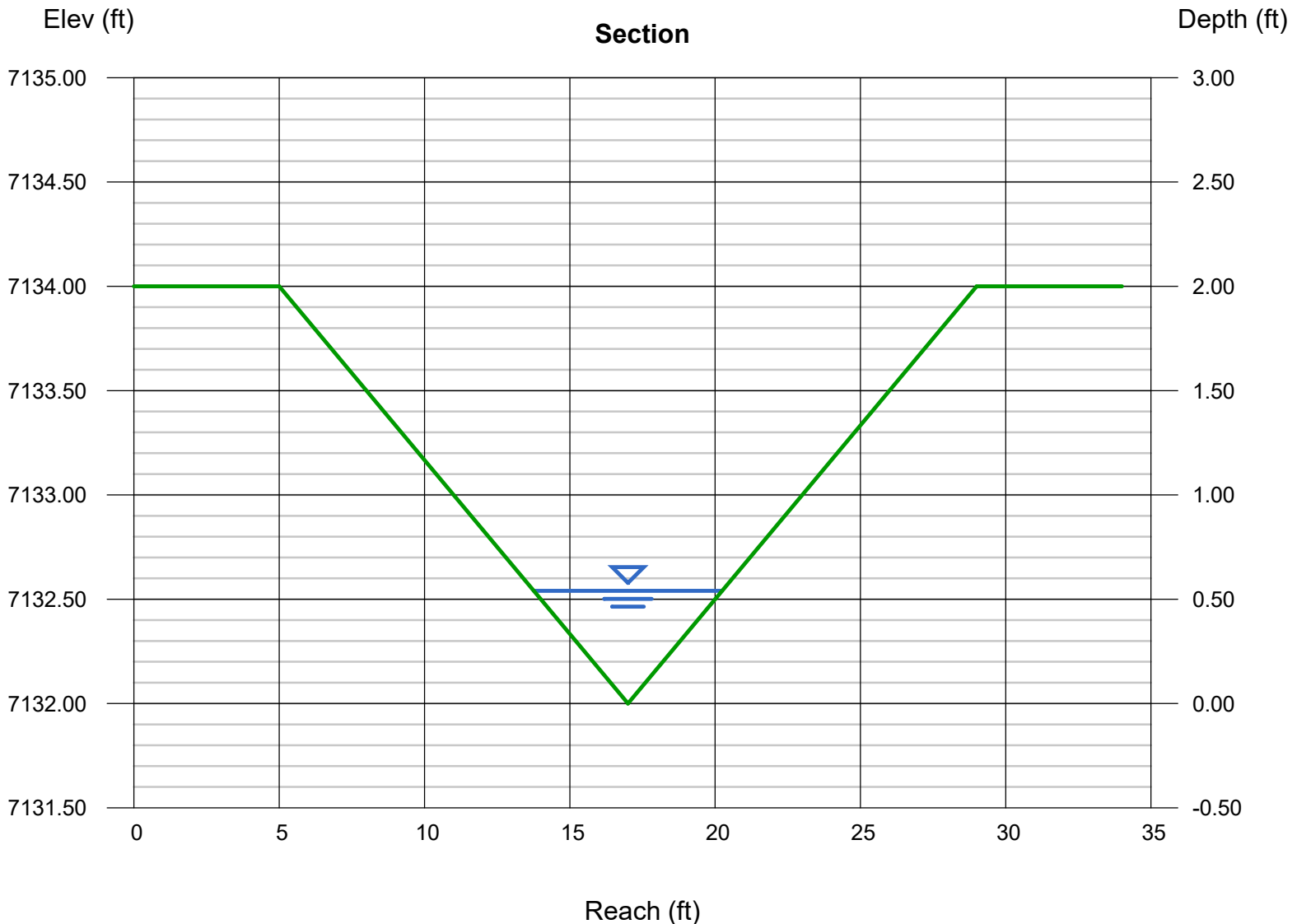

Channel Report

Basin F2 Swale Calculation - Reach 2 (Q100)

Triangular

Side Slopes (z:1) = 6.00, 6.00

Total Depth (ft) = 2.00

Invert Elev (ft) = 7132.00

Slope (%) = 5.70

N-Value = 0.040

Calculations

Compute by: Known Q

Known Q (cfs) = 28.30

Highlighted

Depth (ft) = 0.95

Q (cfs) = 28.30

Area (sqft) = 5.41

Velocity (ft/s) = 5.23

Wetted Perim (ft) = 11.56

Crit Depth, Yc (ft) = 1.07

Top Width (ft) = 11.40

EGL (ft) = 1.37

EXISTING SWALE LINED WITH
TYPE VL RIPRAP

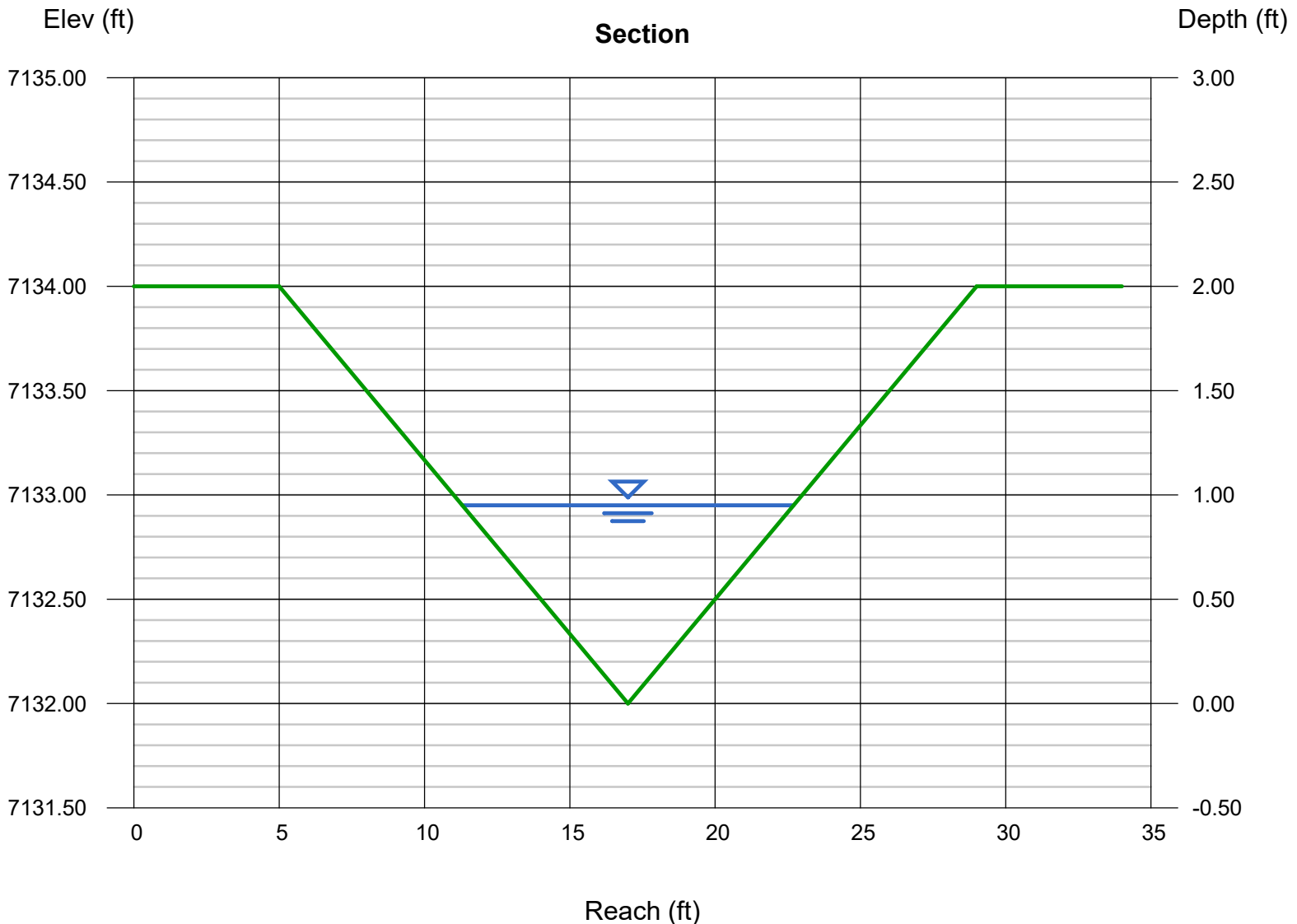

Channel Report

Basin J - Swale Calculation - Reach (Q5)

Triangular

Side Slopes (z:1) = 8.00, 8.00
Total Depth (ft) = 2.00

Invert Elev (ft) = 7132.00
Slope (%) = 4.80
N-Value = 0.040

Calculations

Compute by: Known Q
Known Q (cfs) = 11.00

Highlighted

Depth (ft) = 0.62
Q (cfs) = 11.00
Area (sqft) = 3.08
Velocity (ft/s) = 3.58
Wetted Perim (ft) = 10.00
Crit Depth, Yc (ft) = 0.66
Top Width (ft) = 9.92
EGL (ft) = 0.82

EXISTING SWALE LINED WITH
TYPE VL RIPRAP

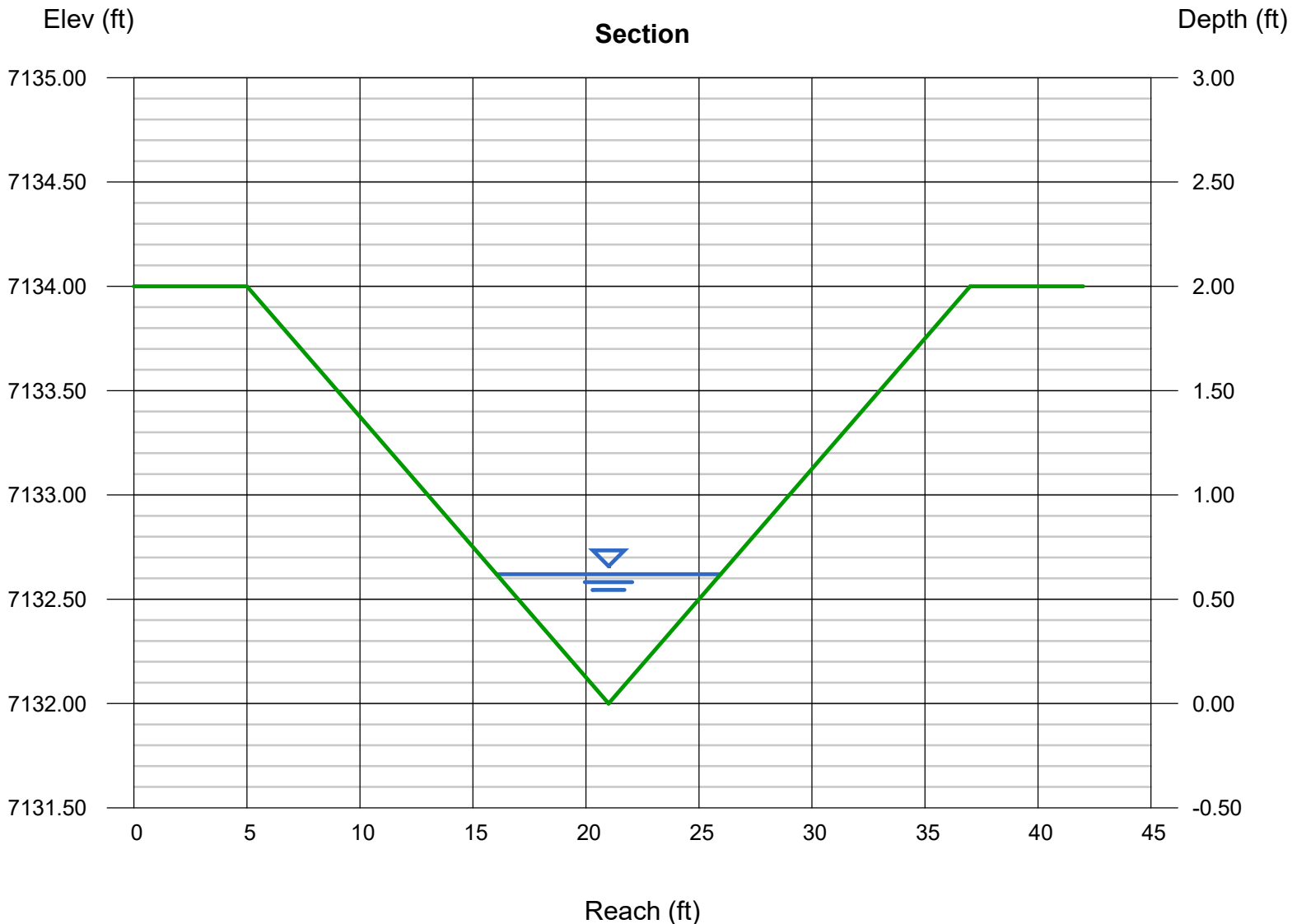

Channel Report

Basin J - Swale Calculation - Reach (Q100)

Triangular

Side Slopes (z:1) = 8.00, 8.00
Total Depth (ft) = 2.00

Invert Elev (ft) = 7132.00
Slope (%) = 4.80
N-Value = 0.040

Calculations

Compute by: Known Q
Known Q (cfs) = 55.10

Highlighted

Depth (ft) = 1.12
Q (cfs) = 55.10
Area (sqft) = 10.04
Velocity (ft/s) = 5.49
Wetted Perim (ft) = 18.06
Crit Depth, Yc (ft) = 1.25
Top Width (ft) = 17.92
EGL (ft) = 1.59

EXISTING SWALE LINED WITH
TYPE VL RIPRAP

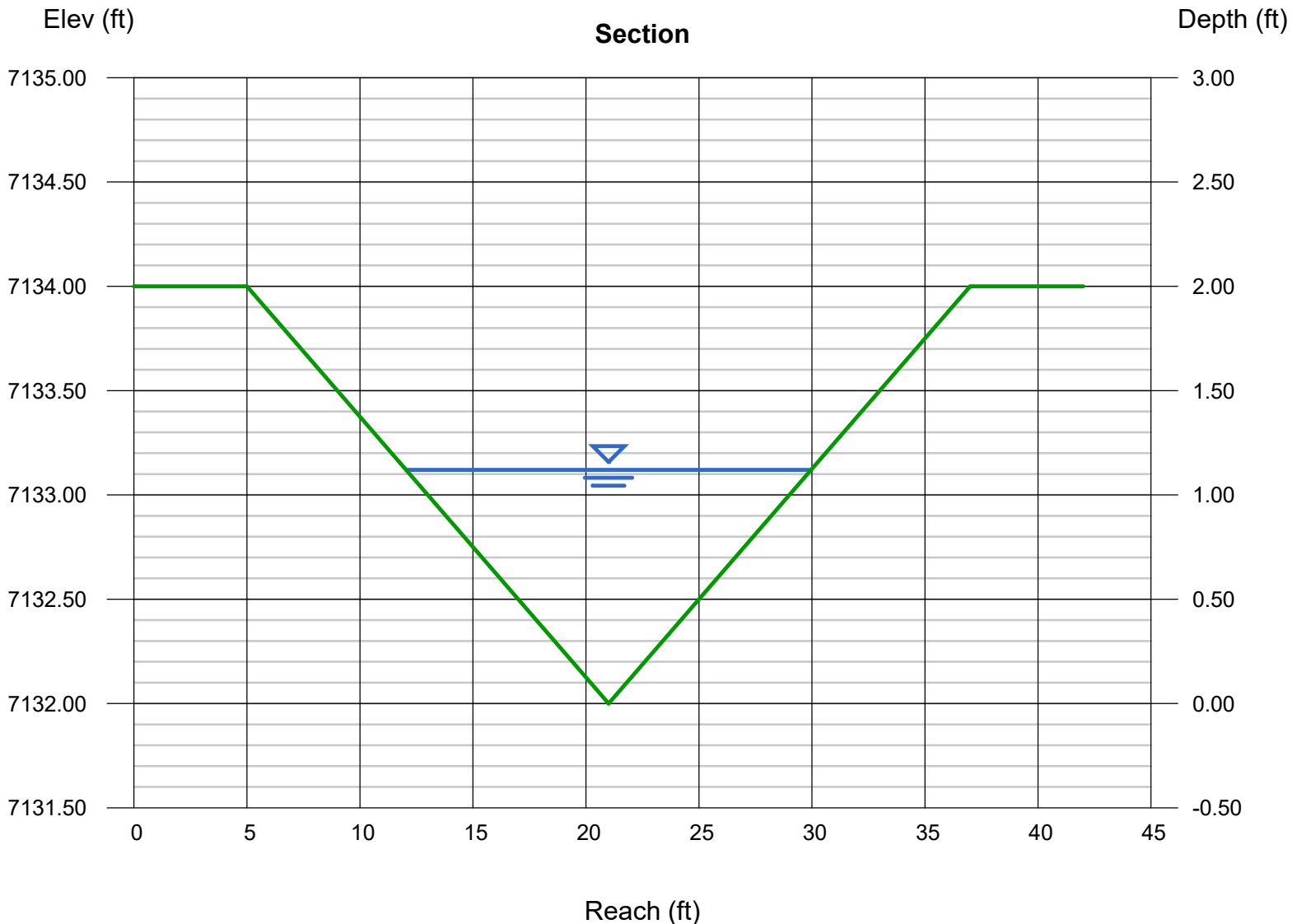

Channel Report

Design Point DP6A Channel

Triangular

Side Slopes (z:1) = 8.00, 8.00
Total Depth (ft) = 2.00

Invert Elev (ft) = 7154.00
Slope (%) = 12.00
N-Value = 0.034

Calculations

Compute by: Known Q
Known Q (cfs) = 12.00

Highlighted

Depth (ft) = 0.51
Q (cfs) = 12.00
Area (sqft) = 2.08
Velocity (ft/s) = 5.77
Wetted Perim (ft) = 8.22
Crit Depth, Yc (ft) = 0.68
Top Width (ft) = 8.16
EGL (ft) = 1.03

EXISTING SWALE LINED WITH
TYPE VL RIPRAP

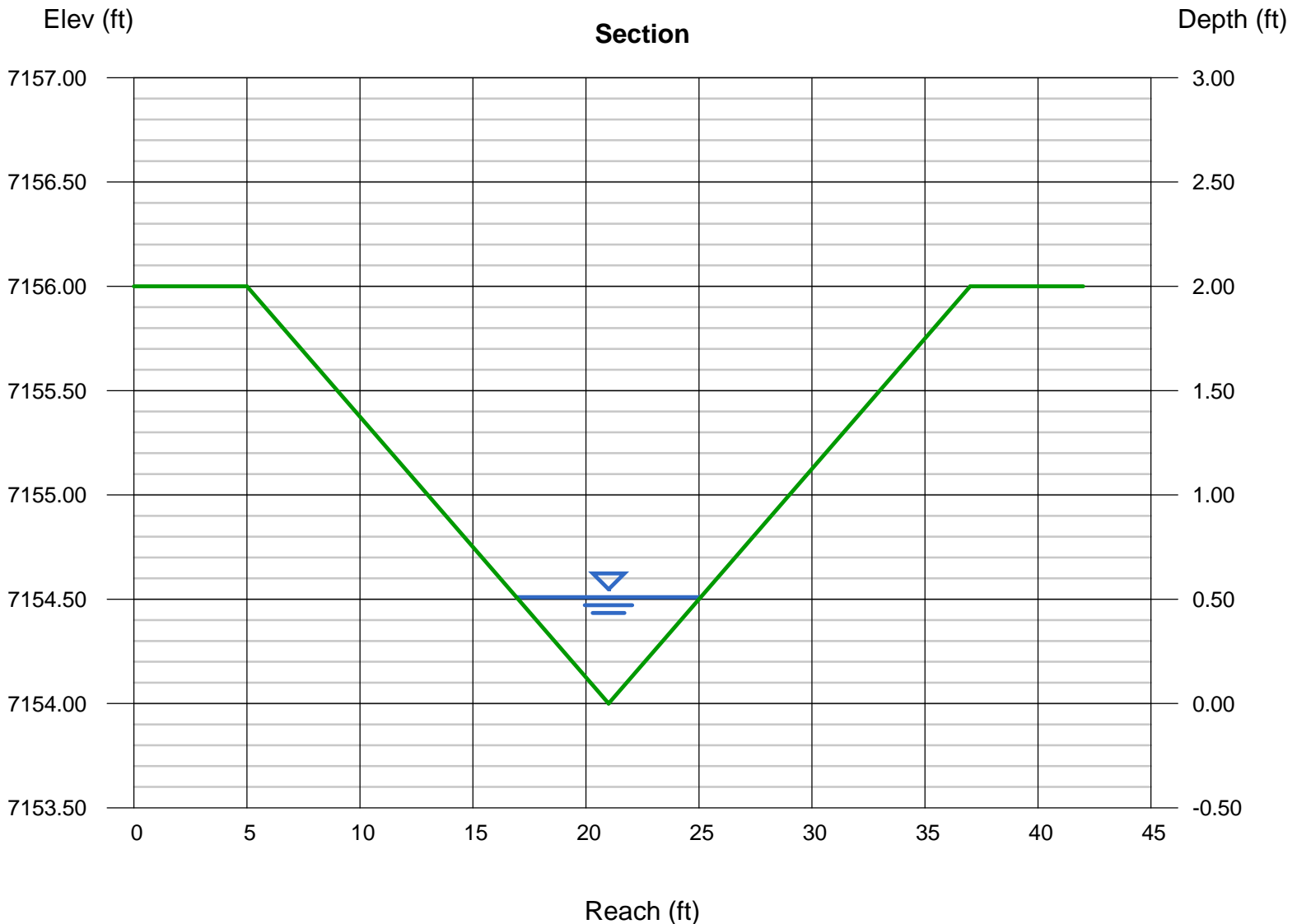

Channel Report

Roadside Ditch Calc Sub-Basin H (0.7 ac - 2.2 cfs = 20% of Sub-Basin 100 yr)

Triangular

Side Slopes (z:1) = 4.00, 4.00
Total Depth (ft) = 1.50

Invert Elev (ft) = 100.00
Slope (%) = 4.00
N-Value = 0.035

Calculations

Compute by: Known Q
Known Q (cfs) = 2.20

Highlighted

Depth (ft) = 0.43
Q (cfs) = 2.200
Area (sqft) = 0.74
Velocity (ft/s) = 2.97
Wetted Perim (ft) = 3.55
Crit Depth, Yc (ft) = 0.46
Top Width (ft) = 3.44
EGL (ft) = 0.57

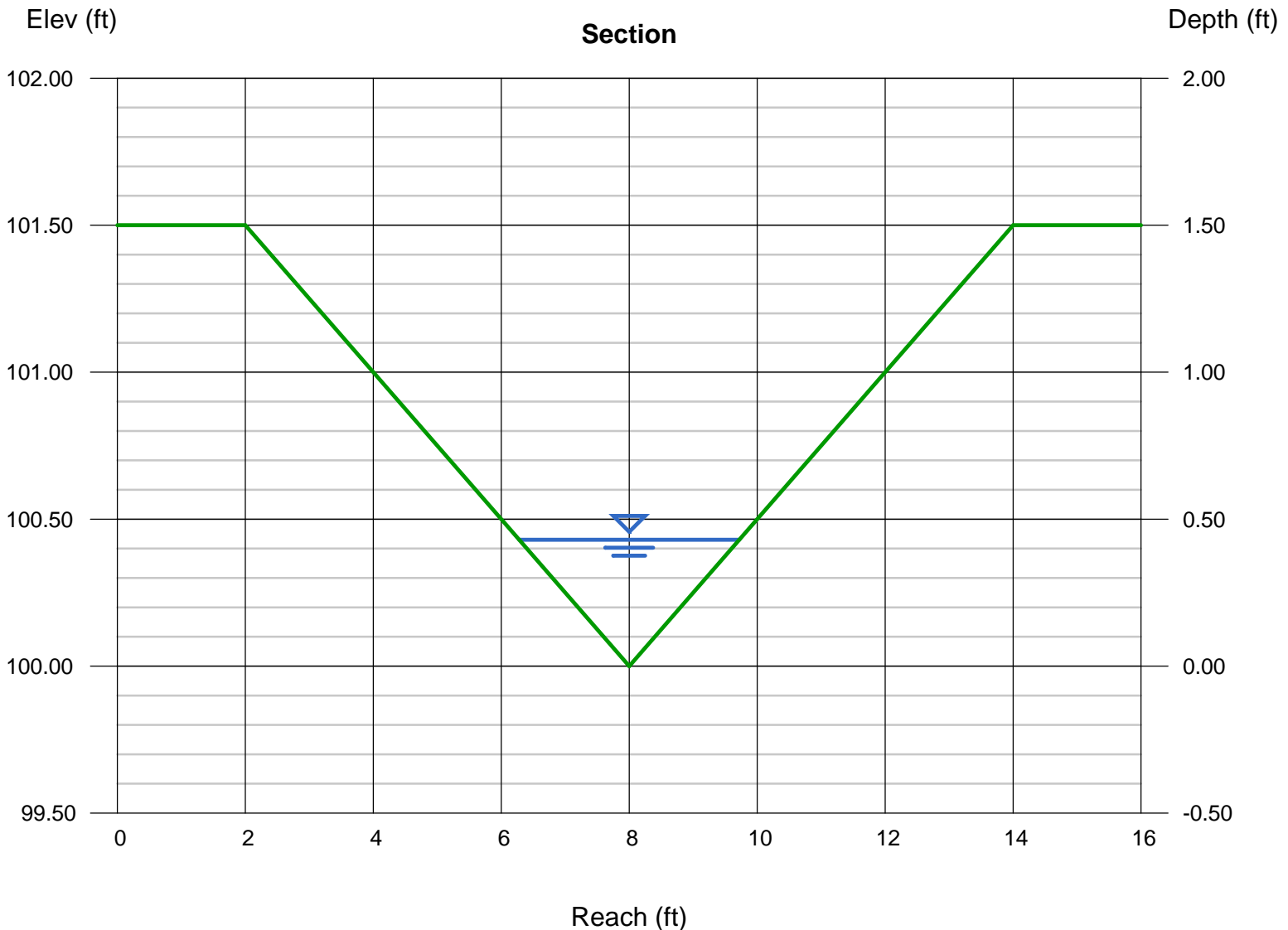

Rip Rap Sizing Calculations (Mild Slope)

MHFC Eq 8-11

$$d50 = (V * S^{0.17} / (4.5 * (G_s - 1)^{0.66}))^2$$

Channel Designation	Q100 (cfs)	V (ft/sec)	S (ft/ft)	G _s	d50 (ft)	d50 (in)	Note
Swale DP6A	12	5.77	0.12	2.6	0.43	5.2	Existing Type VL
Lot 9/10	28.3	5.23	0.25	2.6	0.45	5.4	Existing Type VL
Lot 11	55.1	5.49	0.06	2.6	0.31	3.7	Existing Type VL

Manning's n calculation for riprap

MHFC Eq 8-9

$$n = 0.0395 * D50^{1/6}$$

Channel Designation	D (ft)	n
Typical	0.43 Existing Type VL	0.034

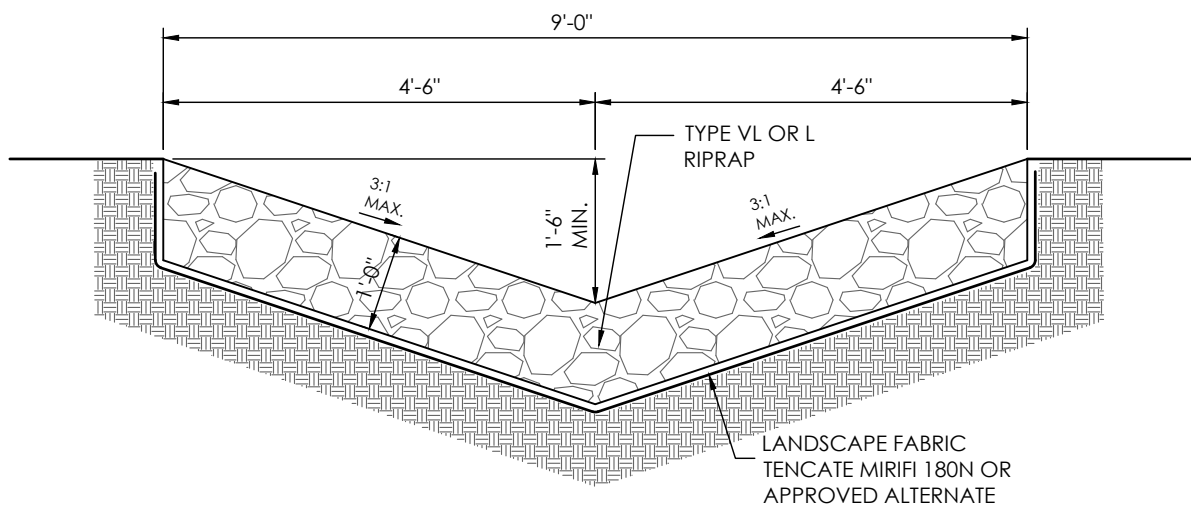

TYPICAL SWALE (TYPE "VL" OR "L")

SCALE 1" = 1.0'

ACCESS NOTES:

ACCESS FOR ANY NEEDED MAINTENANCE WITHIN COTTONWOOD CREEK IS PROVIDED WITHIN THE PUBLIC UTILITY, DRAINAGE AND MAINTENANCE ACCESS EASEMENTS WHICH ARE LOCATED ALONG EACH SIDE FRONT, SIDE AND REAR LOT LINE. SAID EASEMENTS WILL BE 10' WIDE ON ALL SIDE LOT LINES, 15' WIDE ON ALL FRONT LINES AND 10' WIDE ON ALL REAR LOT LINES.

LOT OWNERS SHALL NOT CONSTRUCT FENCES, PLACE TREES OR OTHERWISE IMPEDE ACCESS THROUGH SAID EASEMENTS.

LEGEND	
	PROPERTY LINE
	EASEMENT LINE
	NO BUILD LIMIT LINE
	LOT LINE
	EXISTING
	INDEX CONTOUR
	INTERMEDIATE CONTOUR
	PROPOSED
	INDEX CONTOUR
	INTERMEDIATE CONTOUR
	100 YEAR STORM WATER FLOOD LEVEL
	POSSIBLE ACCESS PATH

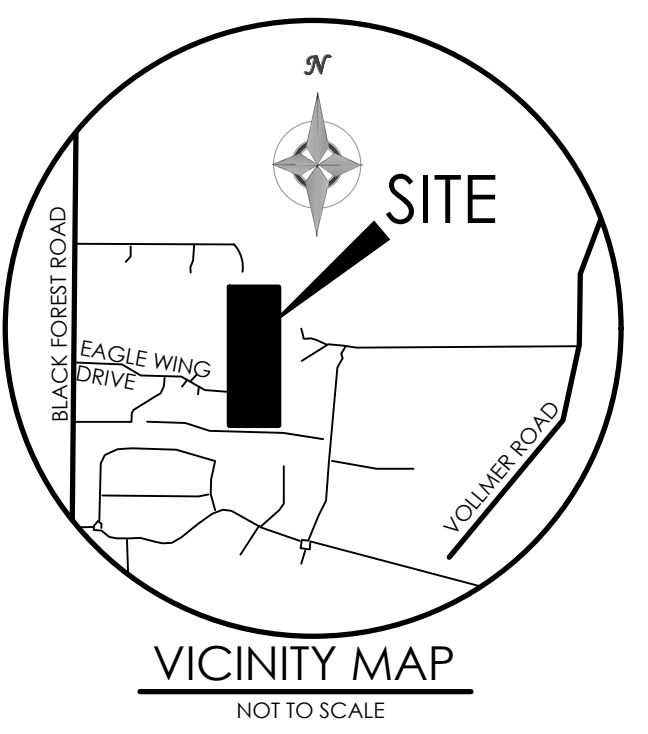

BENCHMARK

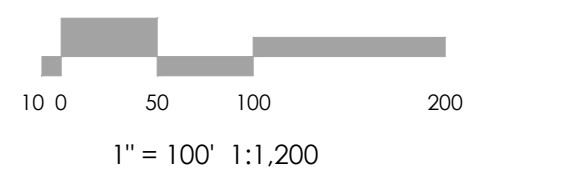
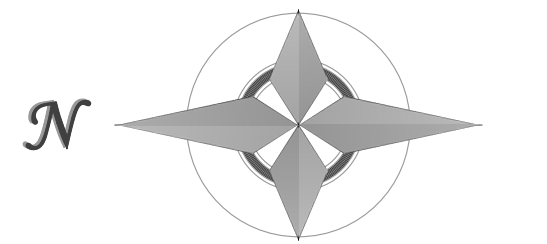

REVISIONS

DESIGNED BY _____
 DRAWN BY _____
 CHECKED BY _____
 AS-BUILTS BY _____
 CHECKED BY _____

**EAGLE RISING
 FILING NO. 1**

CREEK ACCESS

EXHIBIT

MVE PROJECT 61145

MVE DRAWING DRN-MAP-ACCESS

MAY 3, 2024

SHEET 1 OF 1

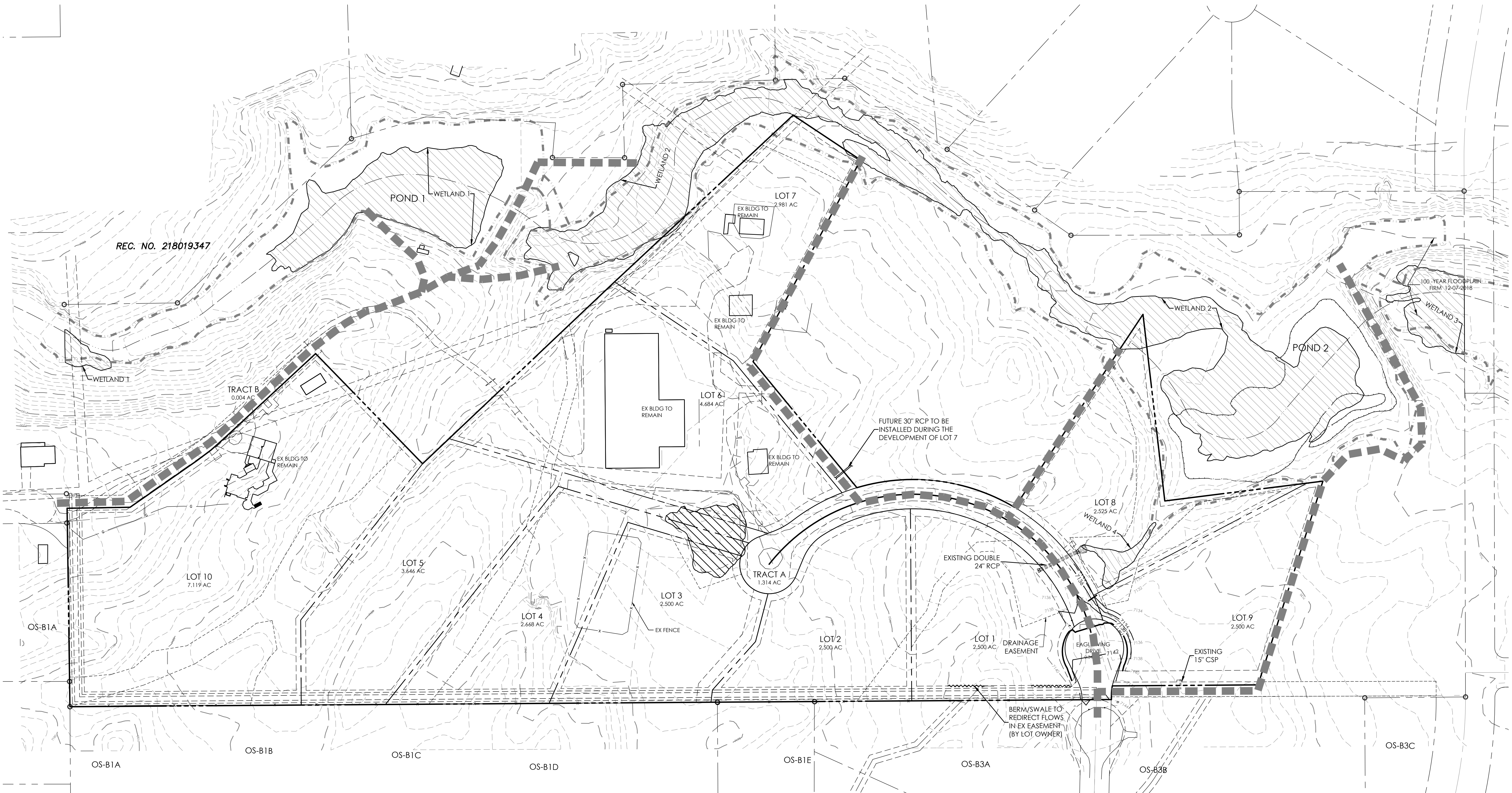



**Planning and Community
Development Department**
2880 International Circle
Colorado Springs, Colorado 80910
Phone: 719.520.6300
Fax: 719.520.6695
Website www.elpasoco.com

**DEVIATION REQUEST
AND DECISION FORM**

Updated: 6/26/2019

PROJECT INFORMATION

Project Name : Eagle Rising PCD File No. SP205 & SF2225
 Schedule No.(s) : 52290-00-034 & 52290-00-035
 Legal Description : See Attached

APPLICANT INFORMATION

Company : Casas Limited Partnership #4, MyPad, Inc., General Partner, Stephen J. Jacobs Jr., President; and
 Name : IQ Investors, LLC, Managed by SESMAR Corp., Stephen J. Jacobs, MD., President
 Owner Consultant Contractor
 Mailing Address : P.O. Box 2076
 Colorado Springs, CO 80901
 Phone Number : (719) 359-1473
 FAX Number :
 Email Address : stripejacobs@gmail.com

ENGINEER INFORMATION

Company : M.V.E., Inc.
 Name : David Gorman Colorado P.E. Number : 31672
 Mailing Address : 1903 Lelaray St, Ste 200
 Phone Number : (719) 635-5736
 FAX Number :
 Email Address : daveg@mvecivil.com

OWNER, APPLICANT, AND ENGINEER DECLARATION

To the best of my knowledge, the information on this application and all additional or supplemental documentation is true, factual and complete. I am fully aware that any misrepresentation of any information on this application may be grounds for denial. I have familiarized myself with the rules, regulations and procedures with respect to preparing and filing this application. I also understand that an incorrect submittal will be cause to have the project removed from the agenda of the Planning Commission, Board of County Commissioners and/or Board of Adjustment or delay review until corrections are made, and that any approval of this application is based on the representations made in the application and may be revoked on any breach of representation or condition(s) of approval.

Steph Jacobs Jr Signature of owner (or authorized representative) 4/5/24 Date

Engineer's Seal, Signature
And Date of Signature

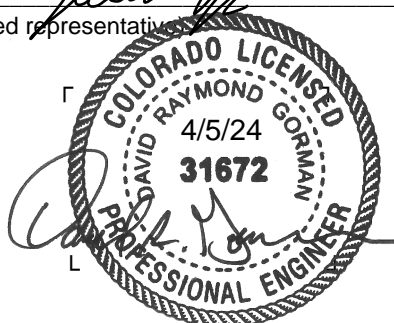

DEVIATION REQUEST (Attach diagrams, figures, and other documentation to clarify request)

A deviation from the standards of or in Section(s) **ECM 3.3.3 B and C** of the Engineering Criteria Manual (ECM) is requested.

Identify the specific ECM standard which a deviation is requested:

ECM 3.3.3.B: Conformance with DCM Volume 1 Sections 6.5.2, Table 10-4 Channel Velocity.

Concrete, riprap, or soil cement linings as approved by the City/County shall be used where channel bottom velocities exceed 6.0 ft/sec. Grass lined channels shall not be used where velocity exceeds permissible velocities in Table 10-4, or the Froude number is greater than 0.9 for the 100-year storm.

DCM Volume 1 Sections 10.2.1 Soft Lined Channels

Grass lined channels are the preferred means of conveying storm water runoff because of their desirability from the standpoint of erosion protection, maintainability, accessibility, and aesthetics.

Grasses typically used for channel lining are Bermudagrass, Kentucky bluegrass, orchardgrass, redtop, Stalian ryegrass, and buffalograss.

ECM 3.3.3.C Channel Types

1. Soft-Lined Channels
2. Hard-Lined Channels

State the reason for the requested deviation:

Table 10-4 and DCM Volume 1 Section 10.2.1 do not include provisions or standards for the type of willow, sedge, rush and reed vegetation present in Cottonwood Creek within the project reach. Excellent stream stabilization exists within the subject reach of Cottonwood Creek consisting of mature dense vegetation (grasses, sedges, rushes, reeds, 6 species of willows, numerous shrubs and trees), pond embankments which support wetland vegetation and provide stormwater storage, and large boulder grade check and pond bank lining. For more than a decade, the owners, Entech Engineering, Inc. and ERO Resources Corporation consultants have observed and reported on the natural conditions of stream and riparian corridor within the site. All referenced parties support the preservation of the creek in its existing stabilized and well-vegetated state. See reports uploaded in Applicants submittal EPC Project Numbers SP205, SF2225, SP126 and SF1829.

“Natural Channel” is not listed as a channel type in ECM 3.3.3.C

Other sections of the DCM refer to “natural channels” however it is not included as a channel type in the ECM standard.

In the DCM Open Channels and Structures 10.1 General Statement “Generally speaking, a stabilized natural channel, or the man-made channel which most nearly conforms to the character of a stabilized natural channel, is the most efficient and the most desirable.”

DCM 2.2.1 Channelization “A stable natural channel reaches “equilibrium” over many years.”

Explain the proposed alternative and compare to the ECM standards (May provide applicable regional or national standards used as basis):

Utilize the stabilizing value of the existing established pond embankments, existing willow vegetation and existing boulder placements as fully adequate stabilization and not require additional stabilization where hydraulic analysis indicates channel velocities are less than 6 fps, Froude Number values are lower than 1.0 in accordance with the criteria of DCM Section 6.5.2.

The Cottonwood Creek channel within the Eagle Rising Preliminary Plan contains two existing constructed ponds with stabilized embankments, existing boulder thalweg and pond stabilization, along with established dense willow growth that supports established wetlands. The entire wetlands provide natural aesthetic qualities, wildlife habitat, erosion control, and pollutant removal. The aforementioned boulders and pond stabilization were installed over 40 years ago and consist of rocks ranging in size between 4'x4'x2' and 7'x4.5'x5' that are imbedded and integrated with the surrounding soils. Boulder thalweg protection is located just upstream of the northerly pond while the boulder pond protection is located along the east bank of the northerly pond. The two ponds themselves are stabilizing features within the creek that provide the added benefits of controlling flow rates in the creek. Also, an important engineering consideration is that the slope of the creek for the project reach is mild at 1% to 2% with an average of 1.2% as compared to other offsite creek locations in the immediate vicinity. The existing pond spillway at DP 104 will require additional riprap installation at time of final plat as noted on the Drainage Plan. This will further protect the spillway during severe storm water overflows from the pond to the downstream creek drainageway. The Spillway at DP 126 has adequate existing riprap in place. If Pond 2 fills to capacity, the overflows will overtop the embankment at the southeast corner and inundate an open area at the southeast corner of the site. Overflows will then be released at the existing riprap spillway under weir flow conditions. Pondered water in the inundated area is not released at locations other than the riprap protected spillway. The ponds and creek bed have withstood repeated significantly sized rainfall events throughout decades of existence including owner observations of the large rainfall events of 2015 and 2023.

The creek bed, wetland areas and riparian overstory of Cottonwood Creek throughout the site are well vegetated native grasses, shrubs and trees as illustrated by the photos contained in the appendix of this report. The Natural Resources Assessment by ERO

Explain the proposed alternative and compare to the ECM standards (May provide applicable regional or national standards used as basis):

Resources Corporation lists with botanic specificity the various plants found. The ERO report also contains photographic documentation of the plants and site conditions. Wetland areas feature native grasses such as Nebraska Sedge, Baltic Rush, Redtop and Broadleaf Cattail. The wetlands also contain mature, dense and well-established willows which serve to anchor the soil of the creek bed throughout the site. Specific willow species include Sandbar Willow, Greenleaf Willow, Peachleaf Willow, Strapleaf Willow, Park Willow and Shining Willow. The riparian overstory is described as containing Peachleaf Willow and Plains Cottonwood trees. Shrubs present in the riparian corridor through the site include Snowberry, Wood's Rose, Golden Current, and Chokecherry. All these species act together to preserve the existing creek alignment and grades that are observed at the site and documented by photographic evidence as attached.

Supplemental information concerning permissible velocities and permissible shear stresses for channel lining materials is included in the appendix. The information includes suggested permissible values for the native grasses, willows and trees that grow in the project reach. Live willow stakes are included and listed to have permissible velocities of 3 to 10 f/sec with permissible shear stress of 2.10 to 3.10 lbs/sf. However, the supplemental information assumes that the vegetation is newly planted, as in Reed Plantings, Hardwood Tree Plantings and Live Willow Stakes. In this case, the vegetative cover throughout the site is not plantings or stakes, but well established, robust, and dense cover that has served to stabilize the creek bed and banks for decades. The upper end (and beyond) of the permissible value range applies in this project reach.

The results of the hydraulic analysis contained in this report indicate four cross-sections at two locations that exhibit channel flow velocities that approach or exceed 6 fps and/or have Froude Number values that equal or exceed 1.0. Two cross sections are located at the north pond overflow spillway and the two cross sections are located at the south pond overflow spillway are protected with riprap indicated on the Drainage Map contained in the MDDP Drainage Report. The presence of dense vegetation throughout the project reach serves to provide additional stabilization. The existing boulder structure and thalweg protection, located upstream of the pond at DP 104 provides stabilization. Portions of the banks inside the DP 104 pond are lined with large boulders. The boulders have been in place for approximately 40 years and are well embedded and incorporated into the creek terrain. They appear to range in size from 3'x3'x2.5' to 7'x4.5'x5'. Based on site observation and riprap sizing calculations that show Type VL (D50 = 6") is more than adequate to remain in place at this location, it is M.V.E., Inc.'s opinion and engineering judgement, that the existing boulders adequately fulfill stabilization function and will remain in place during the 100-year rainfall event. No further improvements are needed in the creek assuming the existing vegetation is preserved. The vegetation is naturally occurring and has been in place for many years. During this time, it has survived various meteorologic cycles. Additionally, with the present level of development in the upstream watershed, the amount of runoff in this section of Cottonwood Creek is not likely to be altered in the future. Considering all these factors, the exiting vegetation is persistent and not in danger of failing. The owners will preserve and sustain the vegetation.

The allowances in Section 6.5.2 and Table 10-4 do not account for the types and condition of the vegetation present in the creek channel and are not applicable to this case. The type and quality of the existing vegetation, which consists of mature dense grasses, sedges, rushes, reeds, six species of willows, numerous shrubs and trees, are not anticipated in the allowed flow velocities as found in DCM Section 6.5.2 and Table 10-4. Furthermore, hydraulic analysis results for the channel reach comply with the provision of Section 6.5.2 except at the two pond overflow spillways, is expected and addressed with riprap protection at each spillway.

Alternative Information is provided in the form of attached Table 2 containing Permissible Velocity and Shear Stress values for Long Native Grasses, Hardwood Tree Plantings and Live Willow Stakes complete with a list of sources including documentation from U.S. Army Engineer Research and Development Center, U.S. Dept. of Transportation, Federal Highway Administration, and others.

The DCM provides that concrete, riprap, or soil cement linings as approved by the City/County shall be used where channel bottom velocities exceed 6.0 ft/sec. Grass lined channels shall not be used where velocity exceeds permissible velocities in Table 10-4 or the Froude number is greater than 0.9 for the 100-year storm. Table 10-4 does not account for the type of vegetation present in the creek throughout the project reach as stated above. Alternatively, M.V.E., Inc. recommends the allowance of velocities associated with willow vegetation and native grasses as shown in the Table 2 that is attached in the Appendix of this request. In the referenced Table 2, Long Native Grasses have permissible velocities of 4 fps to 6 fps, while Live Willow Stakes have permissible velocities of up to 10 fps. Allowable Shear stresses are also noted in the cited sources of up to 3.10 lbs. per sf. Shear Stresses at HEC-RAS model section 3700, 3500, 2703, 2669, 2101, 1900, 1700, 1500, 1400, 1200, 409 and 374 exceed 3.10 lbs. per sf. However, all these locations also have velocities and Froude Number that comply with the DCM. Furthermore, the actual vegetation on the site is well established and exhibits dense growth. The existing plants possess stabilizing characteristics far beyond those of recent plant stakings. Although the hydraulic analysis of the creek reach indicates acceptable velocities in accordance with the DCM, except at pond spillways, a Deviation Request is submitted in support of the higher allowable velocities for the specific type of creek vegetation found at the site. Existing conditions at section 3500 exhibit dense willow growth and native grass vegetation that is well established. There is no evidence of erosion present at this location. Sections 2703 and 2669 is the location of the Pond 1 emergency spillway which will have riprap protection added in developed conditions. Existing conditions at sections 2101, 1900, 1700, 1500, 1400 and 1200 exhibit dense willow growth and native grass vegetation that is well established. There is no evidence of erosion present at these locations. Sections 409 and 374 is the location of the Pond 2 emergency spillway which has existing riprap protection installed. The property owners will preserve and manage the creek bed and vegetation as required through the Owner's Association (OA) or individually in accordance with a drainage maintenance agreement with El Paso County.

Natural well-established creeks typically don't require maintenance. The creek bed and banks within this subdivision are very well established with dense vegetation as detailed above. The owners **elect ECM 3.3.3.K.2.**, which provides that "When the lack of an access road is not considered detrimental to the maintenance and integrity of the channel, the access road can be omitted under

Explain the proposed alternative and compare to the ECM standards (May provide applicable regional or national standards used as basis):

the following conditions: • Where suitable exit-entry ramps are provided to intermediate channels with a minimum bottom width of 8 feet at roadway crossings and at other approved, needed locations to facilitate travel or maintenance of emergency vehicles in the channel bottom. At a minimum, one access ramp must be provided at each end of a channel. • Where vehicular access to the channel on a maximum spacing of 1,000 feet and at other approved, needed locations is provided to small channels with a bottom width of less than 8 feet.” The proposed easements will include restrictions on the placement of new trees, fencing, or other new improvements that would prevent effective access over the easement. This access alternative allows lot line easements to serve as access pathways and omits construction of 15’ wide access roads which would unnecessarily deface and destabilize the creekside and interfere with the use and enjoyment of the private residential lots. The 15’ access road may be omitted in recognition that the available corridors through the lot line easements are adequate with regard to available travel width and the traversable terrain. See the attached Creek Access Exhibit. These access conditions meet the criteria and intent of ECM 3.3.3.K.2.

LIMITS OF CONSIDERATION

(At least one of the conditions listed below must be met for this deviation request to be considered.)

- The ECM standard is inapplicable to the particular situation.
- Topography, right-of-way, or other geographical conditions or impediments impose an undue hardship and an equivalent alternative that can accomplish the same design objective is available and does not compromise public safety or accessibility.
A change to a standard is required to address a specific design or construction problem, and if not modified, the standard will impose an undue hardship on the applicant with little or no material benefit to the public.

Provide justification:

The allowances in Section 6.5.2 and Table 10-4 do not account for the types and condition of the vegetation present in the creek channel and the types of vegetation listed in 10-4 are not present at this site. The existing creek on this site, and potentially others in El Paso County, contains established, mature and dense stands of tall native grasses, sedges, rushes, reeds, six species of willows along with numerous shrubs and trees. The supplemental information provided with this deviation request (Table 2 in the Appendix) suggests allowable flow velocities and shear stresses that are more closely applicable to the type of vegetation found within the subject creek reach and site. The results of hydraulic analysis using this appropriate supplemental engineering data show that all sections of the creek channel comply with the provision of Section 6.5.2.

The two overflow spillways at the two ponds do not contain vegetation, but instead are protected by riprap lining.

Furthermore the U.S. Army Core of Engineers has, after staff viewing the site, verbally recommended that the existing wetlands and natural channel and features not be disturbed, seeing no beneficial outcomes to further structural stabilization.

The application of the requested data to this project will preserve the existing stabilizing vegetation and natural terrain for the benefit of the site, natural aesthetics, wildlife, and future lot owners.

CRITERIA FOR APPROVAL

Per ECM section 5.8.7 the request for a deviation may be considered if the request is **not based exclusively on financial considerations**. The deviation must not be detrimental to public safety or surrounding property. The applicant must include supporting information demonstrating compliance with **all of the following criteria**:

The deviation will achieve the intended result with a comparable or superior design and quality of improvement.

"Generally speaking, a stabilized natural channel, or the man-made channel which most nearly conforms to the character of a stabilized natural channel, is the most efficient and the most desirable." DCM 10.1

Allowance of the deviation is superior to the level of stabilization available from other stabilization options because it does not involve the alteration of the current natural terrain and natural features of the site. The property owners will preserve the creek bed and vegetation as required through the OA or individually as provided in the CCR's to be recorded with the Final Plat and in accordance with the drainage maintenance agreement.

The existing established mature willow growth along with the existing sedges, reeds, rushes, brush, trees and native grasses currently prevent erosion of the creek to a sufficient degree as demonstrated with the photographs contained in the Appendix of this request. Other existing features of the site, consisting of the two ponds and boulder placements which were installed prior to the time of current ownership, act together with the vegetation to promote stability of the creek reach. This deviation allows continuance

The deviation will achieve the intended result with a comparable or superior design and quality of improvement.

of the existing terrain and vegetation, which provides comparable stabilizing effects as other more invasive methods, but without disturbance of the current natural environment. It is desirable that the natural features of the existing riparian creek, wetlands and wildlife habitat be preserved and protected. Therefore, the owners do not wish to see the creek destabilized or the existing terrain, plantings, and natural beauty of the creek harmed or destroyed by the mechanized interventions required to install unnecessary, functionally inferior and maintenance intensive hard drainage structures.

The deviation will not adversely affect safety or operations.

The existing vegetation already fulfills all stabilization requirements for the creek. The allowance of the deviation will not adversely affect safety or operations. The presence of the existing natural terrain and vegetation poses no additional safety risks to people or the environment. Safe and adequate access to the creek is provided within the proposed lot line easements as discussed, which allows performance of potential maintenance. These easements on the site allow physical access to the pond embankments and operation of the pond outlet works.

The deviation will not adversely affect maintenance and its associated cost.

All observation, preservation and management of the creek and riparian corridor within the Drainage Easement will be undertaken by the owners and the Owners Association in accordance with CCR's which are to be recorded at the time of Final Plat recording and in accordance with the drainage maintenance agreement. The deviation will not adversely affect maintenance or maintenance costs.

It is understood that "Grass lined channels" are dependent upon continuous growth of "grass." As noted above, the native willow and other dense vegetation in place is significantly superior to grass and is already very well established. It is naturally occurring and has been in place for many decades. During this time, it has survived various meteorologic cycles from drought to overly wet seasons. Additionally, with the present level of development in the upstream watershed, the amount of runoff in this section of Cottonwood Creek is not likely to be altered in the future. Considering all these factors, the existing vegetation is vigorously persistent and not in danger of failing. The owners agree to continue to observe the waterway and to take appropriate steps to preserve the vegetation if its survival is threatened. No maintenance is anticipated at this time and is to be provided in the drainage maintenance agreement with El Paso County.

The deviation will not adversely affect aesthetic appearance.

"Generally speaking, a stabilized natural channel, or the man-made channel which most nearly conforms to the character of a stabilized natural channel, is the most efficient and the most desirable." DCM 10.1

Preserving the natural aesthetic appearance of the site is exactly the intent of this deviation request. Granting this deviation will continue the beauty and tranquility inherent to the site with its functioning ecosystem. This includes the existing flora and fauna which remain intact and in place. Conversely, the introduction of constructed stabilization irreparably alter the natural features of the site and harm the site's biodynamic stability and aesthetic appearance. It would be a shame if the naturally stabilizing features of the site were to be removed for the sake of installing an artificial means of accomplishing the same level of stabilization that already exists.

The deviation meets the design intent and purpose of the ECM standards.

The supporting documentation provided in this deviation request and the MDDP/Preliminary Drainage Report shows that the existing vegetation has served and will serve as the required stabilization within the creek. The purpose of the ECM standard is met.

The deviation meets the control measure requirements of Part I.E.3 and Part I.E.4 of the County's MS4 permit, as applicable.

- The proposed deviation request meets the control measure requirements specified by the County's MS4 Permit.
- The allowance of this deviation will avoid and prevent disturbance of the creek bed and banks and therefore prevent erosion and sedimentation within the creek.
- Stormwater quality treatment for the development site will be provided as required.
- Appropriate stormwater control measures will be implemented for any land disturbance as required in accordance with an approved Grading and Erosion Control Plan.

1.1. PURPOSE

The purpose of this resource is to provide a form for documenting the findings and decision by the ECM Administrator concerning a deviation request. The form is used to document the review and decision concerning a requested deviation. The request and decision concerning each deviation from a specific section of the ECM shall be recorded on a separate form.

1.2. BACKGROUND

A deviation is a critical aspect of the review process and needs to be documented to ensure that the deviations granted are applied to a specific development application in conformance with the criteria for approval and that the action is documented as such requests can point to potential needed revisions to the ECM.

1.3. APPLICABLE STATUTES AND REGULATIONS

Section 5.8 of the ECM establishes a mechanism whereby an engineering design standard can be modified when if strictly adhered to, would cause unnecessary hardship or unsafe design because of topographical or other conditions particular to the site, and that a departure may be made without destroying the intent of such provision.

1.4. APPLICABILITY

All provisions of the ECM are subject to deviation by the ECM Administrator provided that one of the following conditions is met:

- The ECM standard is inapplicable to a particular situation.
- Topography, right-of-way, or other geographical conditions or impediments impose an undue hardship on the applicant, and an equivalent alternative that can accomplish the same design objective is available and does not compromise public safety or accessibility.
- A change to a standard is required to address a specific design or construction problem, and if not modified, the standard will impose an undue hardship on the applicant with little or no material benefit to the public.

1.5. TECHNICAL GUIDANCE

The review shall ensure all criteria for approval are adequately considered and that justification for the deviation is properly documented.

1.6. LIMITS OF APPROVAL

Whether a request for deviation is approved as proposed or with conditions, the approval is for project-specific use and shall not constitute a precedent or general deviation from these Standards.

1.7. REVIEW FEES

A Deviation Review Fee shall be paid in full at the time of submission of a request for deviation. The fee for Deviation Review shall be as determined by resolution of the BoCC.

NORTH PORTION – (10195 KURIE ROAD)

LEGAL DESCRIPTION:

THAT PORTION OF SECTION 29, TOWNSHIP 12 SOUTH, RANGE 65 WEST OF THE 6TH P.M., EL PASO COUNTY, COLORADO DESCRIBED AS FOLLOWS:

COMMENCING AT THE SOUTHEAST CORNER OF THE NORTHEAST ONE-QUARTER OF THE NORTHWEST ONE-QUARTER OF SAID SECTION 29, SAID POINT BEING ON THE SOUTHERLY BOUNDARY OF PARK FOREST ESTATES FILING NO 2 (PLAT BOOK B-2 AT PAGE 52); THENCE S 00° 13'40"E ON THE WEST LINE OF THE EAST HALF OF SAID SECTION 29, A DISTANCE OF 1413.98 FEET TO THE TRUE POINT OF BEGINNING; THENCE N 00° 13'40"W, 1413.98 FEET; THENCE N89° 14' 16"E, ON THE SOUTHERLY BOUNDARY OF SAID PARK FOREST ESTATES, A DISTANCE OF 375.32 FEET TO THE SOUTHEAST CORNER OF LOT 14, BLOCK 18 OF SAID PARK FOREST ESTATES; THENCE N89° 13'46"E ALONG SAID SOUTHERLY BOUNDARY, A DISTANCE OF 60.00 FEET TO THE EAST LINE OF KURIE ROAD; THENCE N89°33' 17"E ALONG SAID SOUTHERLY BOUNDARY, A DISTANCE OF 237.50 FEET; THENCE N89°20'43"E ALONG SAID SOUTHERLY BOUNDARY, A DISTANCE OF 149.96 FEET; THENCE S00°39'26"E, DEPARTING SAID SOUTHERLY BOUNDARY OF PARK FOREST ESTATES, A DISTANCE OF 231.57 FEET; THENCE S43°12'03"E, A DISTANCE OF 433.08 FEET; THENCE S43°12'03"E, A DISTANCE OF 56.61 FEET; THENCE N88°33' 24"E, A DISTANCE OF 0.10 FEET TO THE NORTHWEST CORNER OF LOT 1 POCO SUBDIVISION ACCORDING TO THE TO THE OFFICIAL MAP THEREOF FILED IN THE OFFICE OF THE COUNTY RECORDER OF EL PASO COUNTY, COLORADO, AS RECEPTION NO. 2406425; THENCE SOUTHERLY ALONG THE WESTERLY LINE OF SAID LOT 1 THE FOLLOWING SIX (6) COURSES:

S16°04'20"E, 158.01 FEET;

S02°43'41"W, 265.73 FEET:

N84°46'48"W, 71.67 FEET;

S00°11'34"W, 147.46 FEET;

N88°32'26"E, 150.00 FEET;

S01°27'34"E, 275.63 FEET;

THENCE S89°45'28"W DEPARTING SAID WESTERLY LINE OF SAID LOT 1, A DISTANCE OF 766.08 FEET; THENCE N00°14'32"W, 100.00 FEET; THENCE S89°45'28"W, 152.00 FEET; THENCE S00°14'32"E, 200.00 FEET; THENCE S89°45'28"W, 152.00 FEET; THENCE N00°14'32"W, 100.00 FEET; THENCE S89°45'28"W, 201.18 FEET TO A POINT ON SAID WEST LINE OF THE EAST HALF OF SAID SECTION 29, SAID POINT BEING THE TRUE POINT OF BEGINNING.

DESCRIPTION PREPARED BY:

M & S CIVIL CONSULTANTS, INC.
102 EAST PIKES PEAK AVE. STE.306
COLORADO SPRINGS, COLORADO

SOUTH PORTION –(10115 KURIE ROAD)

LEGAL DESCRIPTION:

THAT PORTION OF SECTION 29, TOWNSHIP 12 SOUTH, RANGE 65 WEST OF THE 6TH P.M., EL PASO COUNTY, COLORADO, MORE PARTICULARLY DESCRIBED AS FOLLOWS:

COMMENCING AT THE SOUTHEAST CORNER OF THE NORTHEAST ONE-QUARTER OF THE NORTHWEST ONE-QUARTER OF SAID SECTION 29, SAID POINT BEING ON THE SOUTHERLY BOUNDARY OF PARK FOREST ESTATES FILING NO. 2 (PLAT BOOK B-2 AT PAGE 52), THENCE N89°14'16"E, ON THE SOUTHERLY BOUNDARY OF SAID PARK FOREST ESTATES, A DISTANCE OF 375.32 FEET TO THE SOUTHEAST CORNER OF LOT 14, BLOCK 18 OF SAID PARK FOREST ESTATES; THENCE N89°13'46"E ALONG SAID SOUTHERLY BOUNDARY, A DISTANCE OF 60.00 FEET TO THE EAST LINE OF KURIE ROAD; THENCE N89°33'17"E ALONG SAID SOUTHERLY BOUNDARY, A DISTANCE OF 237.50 FEET; THENCE N89°20'43"E ALONG SAID SOUTHERLY BOUNDARY, A DISTANCE OF 149.96 FEET; THENCE S00°39'26"E, DEPARTING SAID SOUTHERLY BOUNDARY OF PARK FOREST ESTATES, A DISTANCE OF 231.57 FEET; THENCE S43°12'03"E, A DISTANCE OF 433.08 FEET; THENCE S43°12'03"E, A DISTANCE OF 56.61 FEET; THENCE N88°33'24"E, A DISTANCE OF 0.10 FEET TO THE NORTHWEST CORNER OF LOT 1 POCO SUBDIVISION ACCORDING TO THE TO THE OFFICIAL MAP THEREOF FILED IN THE OFFICE OF THE COUNTY RECORDER OF EL PASO COUNTY, COLORADO, AS RECEPTION NO. 2406425; THENCE SOUTHERLY ALONG THE WESTERLY LINE OF SAID LOT 1 THE FOLLOWING SIX (6) COURSES:

S16°04'20"E, 158.01 FEET;

S02°43'41"W, 265.73 FEET;

N84°46'48"W, 71.67 FEET;

S00°11'34"W, 147.46 FEET;

N88°32'26"E, 150.00 FEET;

S01°27'34"E, A DISTANCE OF 275.63 FEET TO THE TRUE POINT OF BEGINNING; THENCE S01°27'34"E, A DISTANCE OF 178.87 FEET; THENCE S34°54'56"W, A DISTANCE OF 563.22 FEET; THENCE S00°00'00"E, A DISTANCE OF 344.55 FEET; THENCE N90°00'00"E, A DISTANCE OF 87.56 FEET; THENCE S00°00'00"E, A DISTANCE OF 459.65 FEET; THENCE S89°59'26"W, A DISTANCE OF 1035.05 FEET TO A POINT ON THE WEST LINE OF THE EAST HALF OF SAID SECTION 29; THENCE N00°13'40"W, ALONG SAID WEST LINE, A DISTANCE OF 1439.98 FEET TO A POINT WHICH IS DRAWN S 89° 45'28" W FROM THE POINT OF BEGINNING; THENCE N 89°45'28"E, A DISTANCE OF 201.18 FEET; THENCE S00°14'32"E, 100.00FEET; THENCE N89°45'28"E, 152.00 FEET; THENCE N00°14'32"W, 200.00 FEET; THENCE N89°45'28"E, 152.00 FEET; THENCE S00°14'32"E, 100.00 FEET; THENCE N89°45'28"E, 766.08 FEET, MORE OR LESS TO THE TRUE POINT OF BEGINNING.

DESCRIPTION PREPARED BY:

M & S CIVIL CONSULTANTS, INC.

102 EAST PIKES PEAK AVE. STE 306

COLORADO SPRINGS, COLORADO

80903

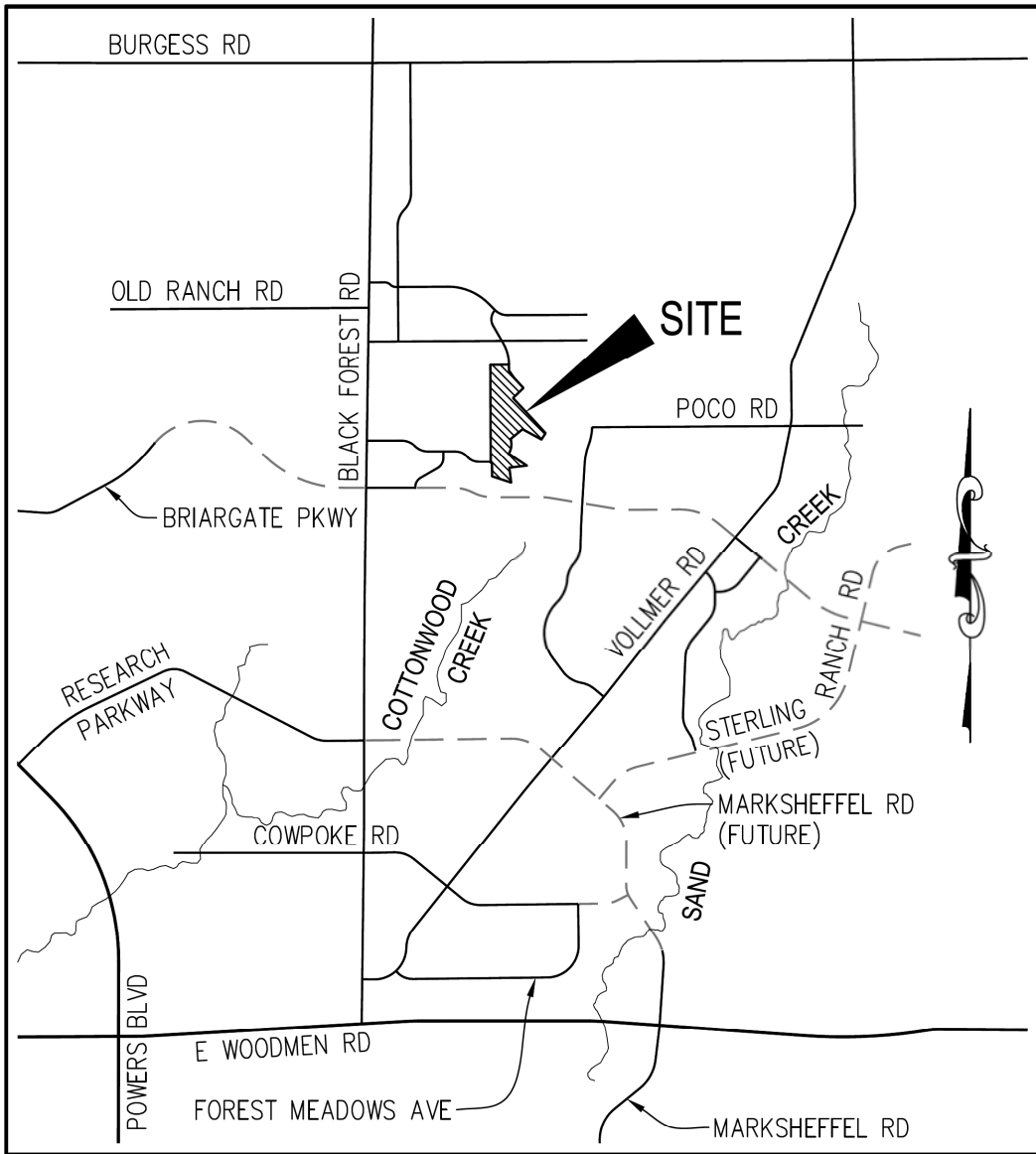

VICINITY MAP

N.T.S.

Table 2. Permissible Shear and Velocity for Selected Lining Materials¹

Boundary Category	Boundary Type	Permissible Shear Stress (lb/sq ft)	Permissible Velocity (ft/sec)	Citation(s)
<u>Soils</u>	Fine colloidal sand	0.02 - 0.03	1.5	A
	Sandy loam (noncolloidal)	0.03 - 0.04	1.75	A
	Alluvial silt (noncolloidal)	0.045 - 0.05	2	A
	Silty loam (noncolloidal)	0.045 - 0.05	1.75 – 2.25	A
	Firm loam	0.075	2.5	A
	Fine gravels	0.075	2.5	A
	Stiff clay	0.26	3 – 4.5	A, F
	Alluvial silt (colloidal)	0.26	3.75	A
	Graded loam to cobbles	0.38	3.75	A
	Graded silts to cobbles	0.43	4	A
	Shales and hardpan	0.67	6	A
<u>Gravel/Cobble</u>	1-in.	0.33	2.5 – 5	A
	2-in.	0.67	3 – 6	A
	6-in.	2.0	4 – 7.5	A
	12-in.	4.0	5.5 – 12	A
<u>Vegetation</u>	Class A turf	3.7	6 – 8	E, N
	Class B turf	2.1	4 - 7	E, N
	Class C turf	1.0	3.5	E, N
	Long native grasses	1.2 – 1.7	4 – 6	G, H, L, N
	Short native and bunch grass	0.7 - 0.95	3 – 4	G, H, L, N
	Reed plantings	0.1-0.6	N/A	F, N
	Hardwood tree plantings	0.41-2.5	N/A	E, N
<u>Temporary Degradable RECPs</u>	Jute net	0.45	1 – 2.5	E, H, M
	Straw with net	1.5 – 1.65	1 – 3	E, H, M
	Coconut fiber with net	2.25	3 – 4	E, M
	Fiberglass roving	2.00	2.5 – 7	E, H, M
<u>Non-Degradable RECPs</u>	Unvegetated	3.00	5 – 7	E, G, M
	Partially established	4.0-6.0	7.5 – 15	E, G, M
	Fully vegetated	8.00	8 – 21	F, L, M
<u>Riprap</u>	6 – in. d ₅₀	2.5	5 – 10	H
	9 – in. d ₅₀	3.8	7 – 11	H
	12 – in. d ₅₀	5.1	10 – 13	H
	18 – in. d ₅₀	7.6	12 – 16	H
	24 – in. d ₅₀	10.1	14 – 18	E
<u>Soil Bioengineering</u>	Wattles	0.2 – 1.0	3	C, I, J, N
	Reed fascine	0.6-1.25	5	E
	Coir roll	3 - 5	8	E, M, N
	Vegetated coir mat	4 - 8	9.5	E, M, N
	Live brush mattress (initial)	0.4 – 4.1	4	B, E, I
	Live brush mattress (grown)	3.90-8.2	12	B, C, E, I, N
	Brush layering (initial/grown)	0.4 – 6.25	12	E, I, N
	Live fascine	1.25-3.10	6 – 8	C, E, I, J
	Live willow stakes	2.10-3.10	3 – 10	E, N, O
<u>Hard Surfacing</u>	Gabions	10	14 – 19	D
	Concrete	12.5	>18	H

¹ Ranges of values generally reflect multiple sources of data or different testing conditions.

A. Chang, H.H. (1988).

B. Florineth. (1982)

C. Gerstgraser, C. (1998).

D. Goff, K. (1999).

E. Gray, D.H., and Sotir, R.B. (1996).

F. Julien, P.Y. (1995).

G. Kouwen, N.; Li, R. M.; and Simons, D.B., (1980).

H. Norman, J. N. (1975).

I. Schiechl, H. M. and R. Stern. (1996).

J. Schoklisch, A. (1937).

K. Sprague, C.J. (1999).

L. Temple, D.M. (1980).

M. TXDOT (1999)

N. Data from Author (2001)

O. USACE (1997).

Fischenich, C. (2001). "Stability Thresholds for Stream Restoration Materials," EMRRP Technical Notes Collection (ERDC TN-EMRRP-SR-29), U.S. Army Engineer Research and Development Center, Vicksburg, MS.
www.wes.army.mil/el/emrrp

REFERENCES

Chang, H.H. (1988). *Fluvial Processes in River Engineering*, John Wiley and Sons, New York and other cities, citing Fortier, S., and Scobey, F.C. (1926). "Permissible canal velocities," *Transactions of the ASCE*, 89:940-984.

Fischenich and Allen (2000). "Stream management," Water Operations Technical Support Program Special Report ERDC/EL SR-W-00-1, Vicksburg, MS.

Florineth, F., (1982). Begrünungen von Erosionszonen im Bereich über der Waldgrenze. *Zeitschrift für Vegetationstechnik* 5, S. 20-24 (In German).

Gerstgraser, C. (1998). "Bioengineering methods of bank stabilization," *GARTEN & LANDSCHAFT*, Vol. 9, September 1998, 35-37.

Goff, K. (1999). "Designer linings," *Erosion Control*, Vol. 6, No. 5.

Gray, D.H., and Sotir, R.B. (1996). *Biotechnical and soil bioengineering: a practical guide for erosion control*. John Wiley and Sons, New York.

Julien, P.Y. (1995). *Erosion and sedimentation*. Cambridge University Press, New York.

Kouwen, N.; Li, R.-M.; and Simons, D.B. (1980). "A stability criteria for vegetated Waterways." *Proceedings, International Symposium on Urban Storm Runoff*. University of Kentucky, Lexington, KY, 28-31 July 1980, 203-210.

Norman, J. N. (1975). "Design of stable channels with flexible linings," Hydraulic Engineering Circular 15, U.S. Dept. of Transportation, Federal Highway Adm., Washington, DC.

Schiechtl, H. M., and Stern, R. (1996). *Water Bioengineering Techniques for Watercourse Bank and Shoreline Protection*. Blackwell Science, Inc. 224 pp.

Schoklitsch, A. (1937). *Hydraulic structures; a text and handbook*. Translated by Samuel Shulits. The American Society of Mechanical Engineers, New York.

Shields, A. (1936). "Anwendung der ähnlichkeits-mechanik und der turbulenz-forschung auf die geschiebebewegung," *Mitt. Preuss. Versuchsanst. Wasser. Schiffsbau*, 26, 1-26 (in German).

Sprague, C.J. (1999). "Green engineering: Design principles and applications using rolled erosion control products," *CE News Online*, downloaded from <http://www.cenews.com/edecp0399.html>.

Temple, D.M. (1980). "Tractive force design of vegetated channels," *Transactions of the ASAE*, 23:884-890.

TXDOT (1999). "Field Performance Testing of Selected Erosion Control Products," TXDOT / TTI Hydraulics and Erosion Control Laboratory, Bryan, TX.

USACE TR EL 97-8

Eagle Rising Hydraulic Analysis Results

Velocity, Froude Number & Shear Stress at Selected Channel Sections

Hydraulic Data from HEC-RAS Analysis, M.V.E., Inc.

Shear Stress $\tau = \gamma RS$

τ = Shear Stress (lbs/sf)

γ = Weight Density of Water (lb/cf) = 62.4

R = Hydraulic Radius = Area/Wetted Perimeter (ft)

S = Energy Grade Slope (ft/ft)

Froude No. $Fr = \frac{V}{\sqrt{gD}}$

V = Channel Velocity (ft/sec)

D = Hydr Depth = Flow Area / Top Width

g = Acceleration of gravity = 32.2 ft/sec²

Channel Section	Q100 (cfs)	S Energy Slope (ft/ft)	Max Channel Depth (ft)	D Hydraulic (Ave) Depth (ft)	P Wetted Perimeter (ft)	R Hydraulic Radius (ft)	A Flow Area (sf)	W Top Width (ft)	V Channel Velocity (ft/sec)	Fr Froude No.	τ Shear Stress (lbs/sf)	Notes:
3800	410	0.013	3.3	2.5	72	2.5	180	71	2.3	0.25	1.98	dense vegetation existing
3700	410	0.026	3.5	2.5	49	2.4	119	48	3.3	0.37	3.98	dense vegetation existing
3600	410	0.007	4.1	3.1	73	3.1	222	72	1.9	0.19	1.26	dense vegetation existing
3500	470	0.079	3.0	2.2	71	2.1	152	70	3.1	0.38	10.52	dense vegetation existing Shear Greater than 3.10 - See Report
3400	470	0.010	3.3	2.5	88	2.5	223	88	2.1	0.23	1.58	dense vegetation existing
3300	470	0.011	2.5	1.9	95	1.9	184	94	2.6	0.32	1.34	dense vegetation existing
3200	470	0.008	2.1	1.5	115	1.5	175	115	2.7	0.39	0.79	boulder check existing
3100	470	0.001	3.5	2.2	210	2.2	464	210	1.0	0.12	0.10	native grasses and pond existing
3000	560	0.001	3.7	2.9	188	2.9	536	187	1.1	0.11	0.10	native grasses and pond existing
2900	560	0.000	5.4	3.7	223	3.6	814	223	0.7	0.06	0.04	native grasses and pond existing
2801	560	0.000	6.9	5.0	278	4.9	1372	277	0.4	0.03	0.01	native grasses and pond existing
2745	700	0.005	2.1	1.2	303	1.2	354	303	2.2	0.36	0.37	native grasses and pond existing
2722	700	0.018	1.7	1.4	139	1.4	190	139	3.7	0.56	1.56	native grasses and pond existing
2703	700	0.057	1.8	1.0	122	1.0	123	122	6.1	1.06	3.62	spillway riprap proposed Shear Greater than 3.10 - Riprap Spillway
2669	700	0.036	3.0	1.6	65	1.6	106	64	7.9	1.09	3.66	spillway riprap proposed Shear Greater than 3.10 - Riprap Spillway
2451	700	0.015	3.7	2.4	125	2.4	295	124	2.4	0.27	2.25	dense vegetation existing
2200	700	0.013	3.2	2.7	115	2.7	311	114	2.3	0.24	2.23	dense vegetation existing
2101	750	0.024	3.4	2.9	84	2.8	238	83	3.2	0.33	4.22	dense vegetation existing Shear Greater than 3.10 - See Report
2000	750	0.011	3.9	2.2	144	2.2	318	144	2.2	0.27	1.48	dense vegetation existing
1900	820	0.020	3.4	2.5	117	2.5	291	116	2.8	0.31	3.19	dense vegetation existing Shear Greater than 3.10 - See Report
1800	820	0.012	3.9	3.2	107	3.2	340	106	2.4	0.24	2.33	dense vegetation existing
1700	820	0.018	3.4	3.0	100	3.0	298	99	2.8	0.28	3.26	dense vegetation existing Shear Greater than 3.10 - See Report
1600	820	0.010	5.1	3.7	85	3.6	309	84	2.7	0.25	2.33	dense vegetation existing
1500	820	0.026	4.6	3.1	80	3.1	244	79	3.4	0.34	5.01	dense vegetation existing Shear Greater than 3.10 - See Report
1400	820	0.035	4.6	2.5	129	2.4	315	128	2.6	0.30	5.34	dense vegetation existing
1299	820	0.005	4.4	3.5	105	3.5	369	104	2.2	0.21	1.19	dense vegetation existing
1200	820	0.036	3.1	1.6	113	1.6	183	113	4.5	0.62	3.64	dense vegetation existing Shear Greater than 3.10 - See Report
1099	820	0.005	1.9	1.5	243	1.5	375	243	2.3	0.32	0.51	native grass existing
1000	820	0.000	4.9	3.3	293	3.3	963	293	1.0	0.10	0.06	native grasses and pond existing
791	820	0.000	6.9	5.3	393	5.3	2092	392	0.4	0.03	0.01	native grasses and pond existing
598	820	0.000	9.0	6.4	321	6.4	2045	320	0.5	0.03	0.01	native grasses and pond existing
449	820	0.000	4.9	4.0	409	4.0	1626	409	0.5	0.05	0.02	native grasses and pond existing
409	820	0.059	2.9	1.8	62	1.7	108	62	7.6	1.01	6.42	spillway riprap Shear Greater than 3.10 - Riprap Spillway
374	820	0.062	1.8	1.5	77	1.5	116	77	7.0	1.01	5.82	spillway riprap Shear Greater than 3.10 - Riprap Spillway
300	820	0.003	3.7	2.7	121	2.7	326	121	2.6	0.28	0.55	dense vegetation existing
200	820	0.008	3.3	2.5	157	2.5	391	156	1.8	0.20	1.19	dense vegetation existing
100	820	0.050	1.6	1.5	184	1.5	282	183	2.9	0.42	4.77	dense vegetation existing Shear Greater than 3.10 - See Report

*** NOTE:**

SHEAR STRESSES AT HEC-RAS MODEL SECTION 3700, 3500, 2703, 2669, 2101, 1900, 1700, 1500, 1400, 1200, 409 AND 374 EXCEED 3.10 LBS. PER SF. HOWEVER, ALL THESE LOCATIONS ALSO HAVE VELOCITIES AND FROUDE NUMBER THAT COMPLIES WITH THE DCM. FURTHERMORE, THE ACTUAL VEGETATION ON THE SITE IS WELL ESTABLISHED AND EXHIBITS DENSE GROWTH. THE EXISTING PLANTS POSSESS STABILIZING CHARACTERISTICS FAR BEYOND THOSE OF RECENT PLANT STAKINGS. THERE IS NO EVIDENCE OF EXISTING EROSION CONDITIONS AT THESE LOCATIONS.

LEGEND

- PROPERTY LINE
- - - EASEMENT LINE
- LOT LINE
- EXISTING**
- - - 5985 INDEX CONTOUR
- - - 84 INTERMEDIATE CONTOUR
- PROPOSED**
- - - 5985 INDEX CONTOUR
- - - 84 INTERMEDIATE CONTOUR

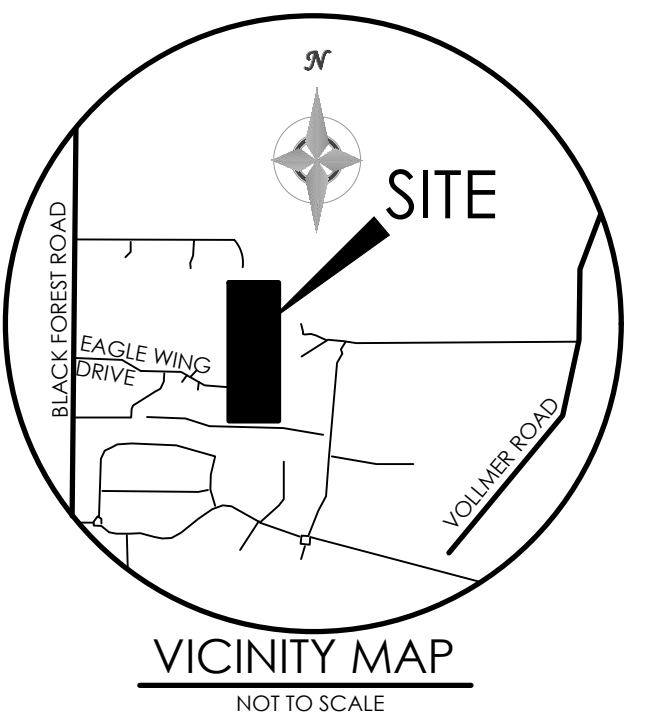

BENCHMARK

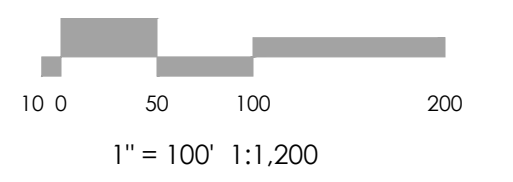
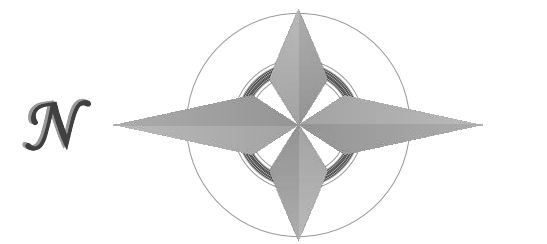

REVISIONS

DESIGNED BY _____
 DRAWN BY _____
 CHECKED BY _____
 AS-BUILTS BY _____
 CHECKED BY _____

EAGLE RISING
 FILING NO.1

PROPOSED
 DRAINAGE MAP
 HECRAS SECTIONS

MVE PROJECT 61145
 MVE DRAWING DRN-MAP-HECRAS

MARCH 7, 2024
 SHEET 1 OF 1

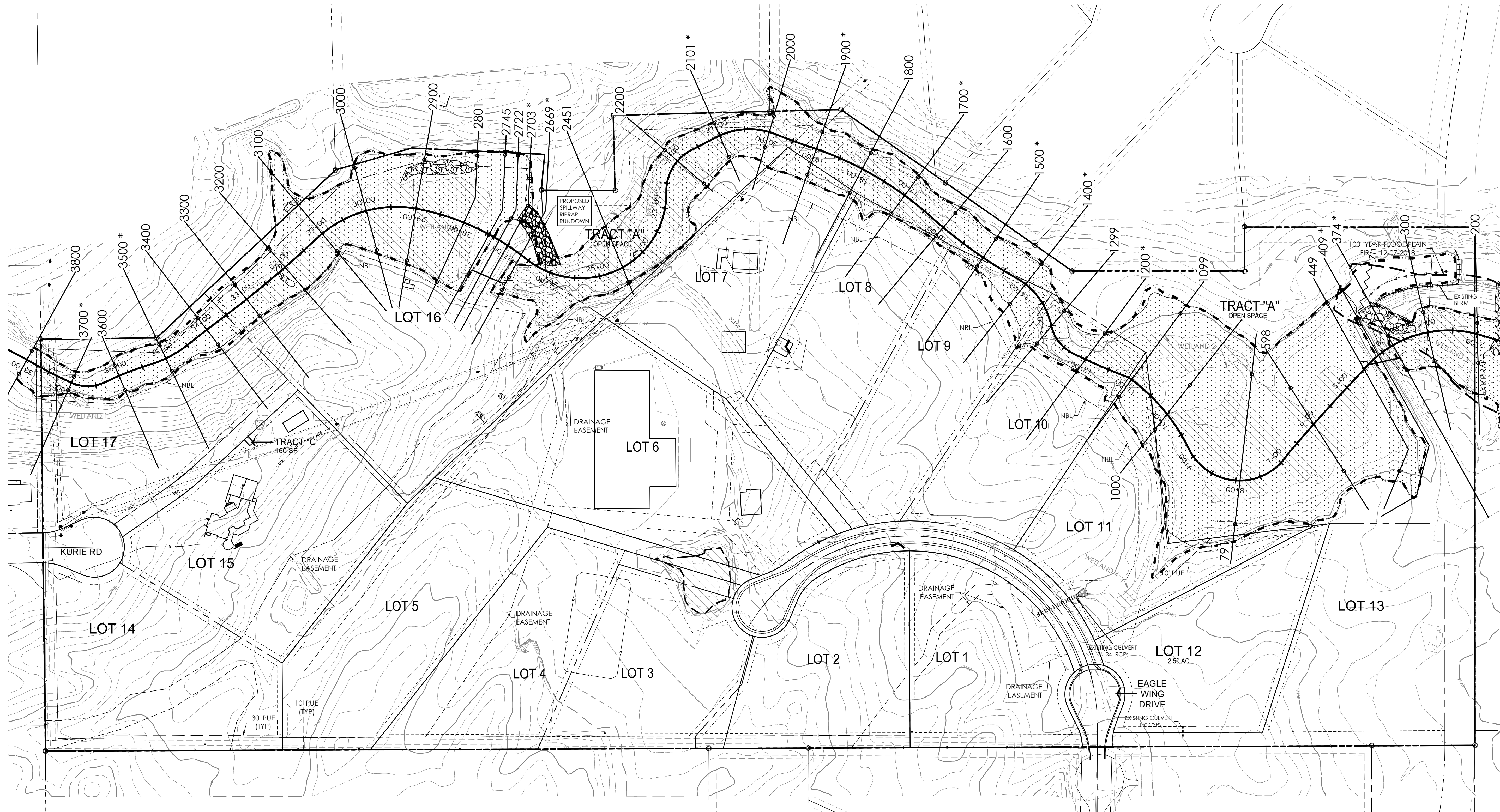

HEC-RAS Cross Section Location and Photo Key Map

LEGEND

- PROPERTY LINE
- EASEMENT LINE
- LOT LINE

EXISTING

- INDEX CONTOUR
- INTERMEDIATE CONTOUR
- DBPS DESIGN POINT (104)
- LOCAL DESIGN POINT (6C)
- DRAINAGE REPORT PHOTO NUMBER / DIRECTION (14)

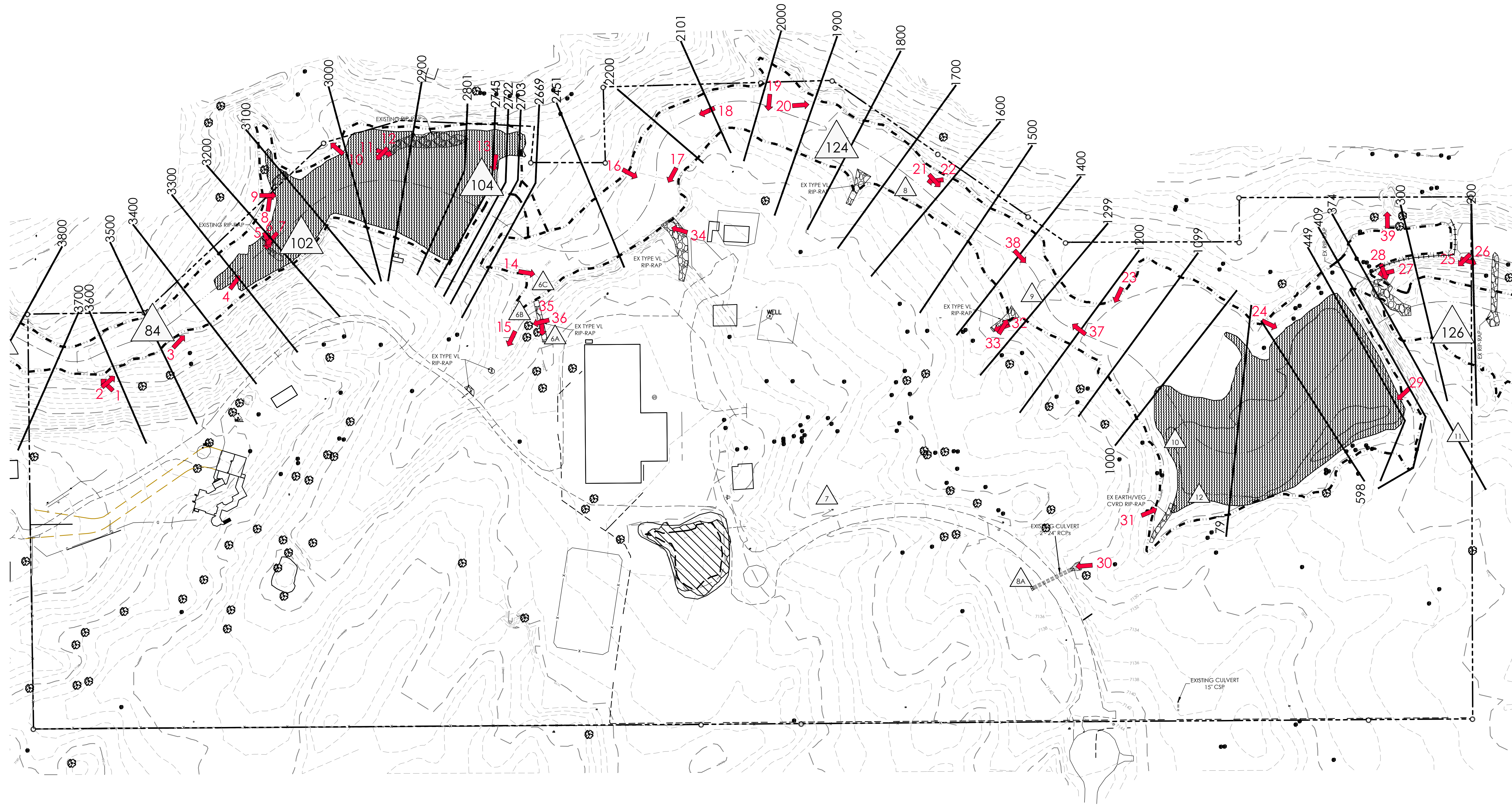
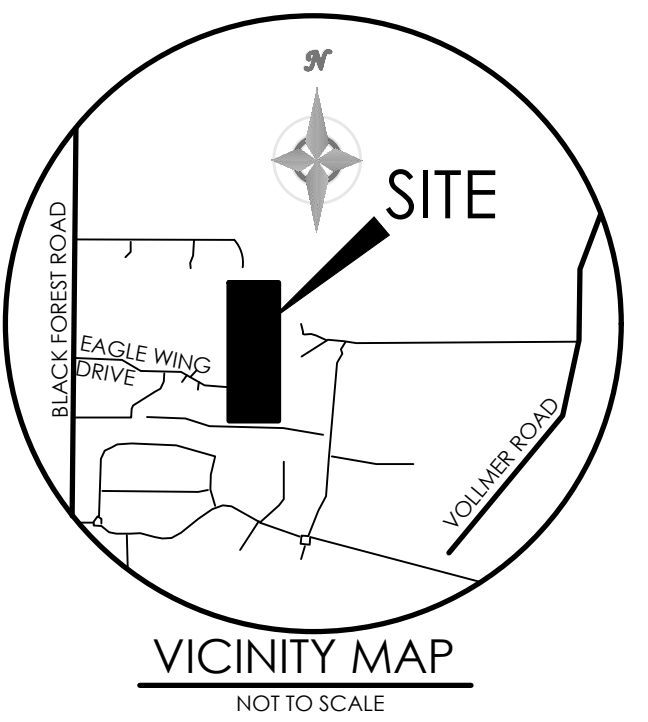

BENCHMARK

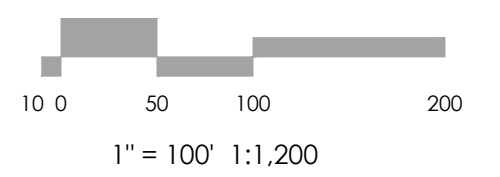
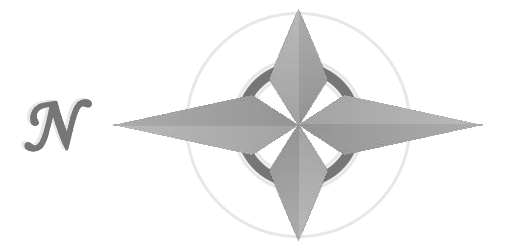

MVE, INC.
ENGINEERS / SURVEYORS

1903 Library Street, Suite 200 Colorado Springs, CO 80909 719.635.5736

REVISIONS

DESIGNED BY
DRAWN BY
CHECKED BY
AS-BUILT BY
CHECKED BY

EAGLE RISING
FILING NO. 1

STREAM VEGETATION
PHOTO LOCATIONS

MVE PROJECT 61145
MVE DRAWING DRN-MAP-HECRAS

MARCH 7, 2024
SHEET 1 OF 1

LEGEND

- PROPERTY LINE
- - - EASEMENT LINE
- - - LOT LINE
- EXISTING
- - - INDEX CONTOUR
- - - INTERMEDIATE CONTOUR
- ▲ 104 DBPS DESIGN POINT
- ▲ 6C LOCAL DESIGN POINT
- 14 → DRAINAGE REPORT PHOTO NUMBER / DIRECTION

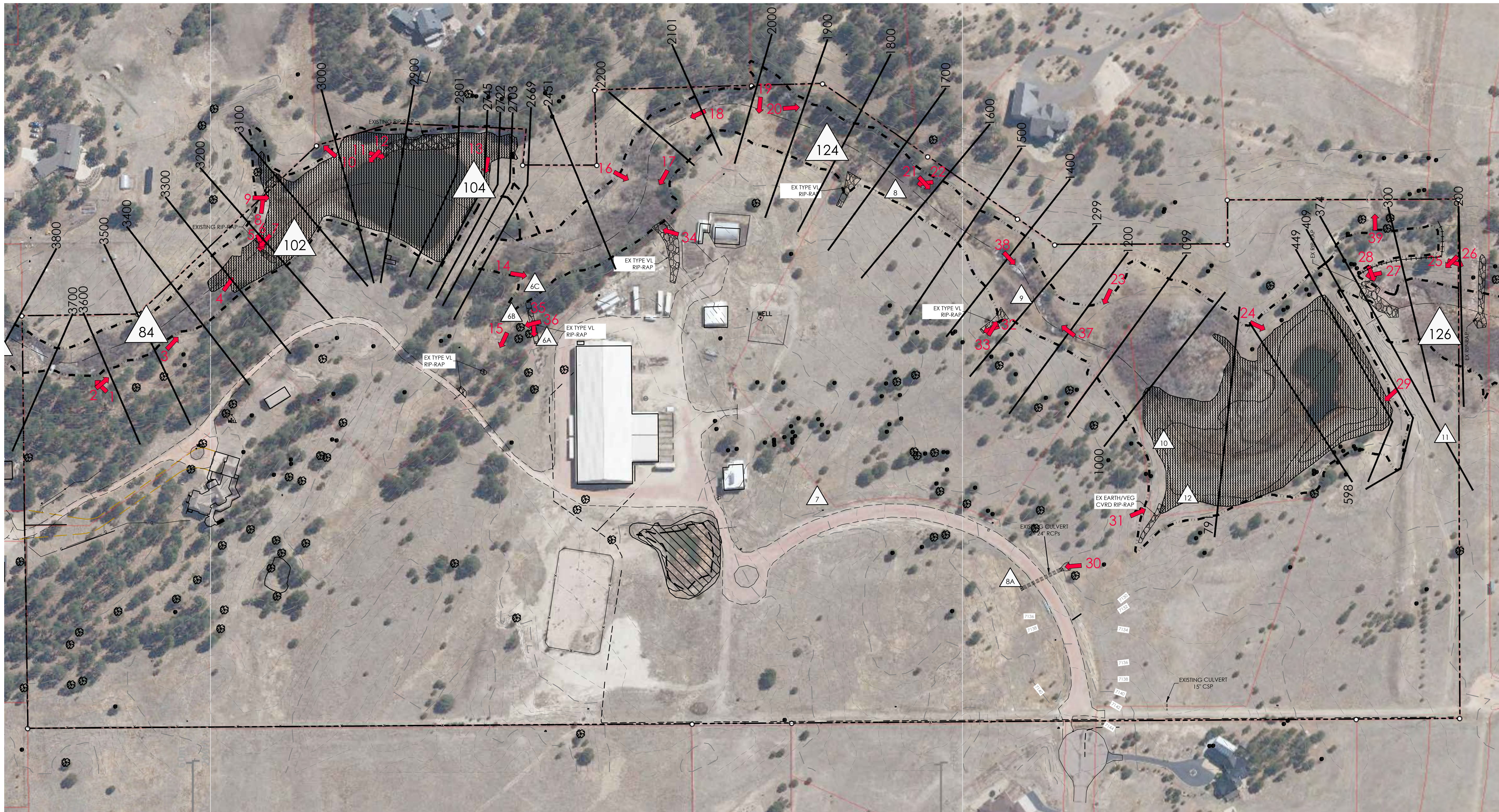
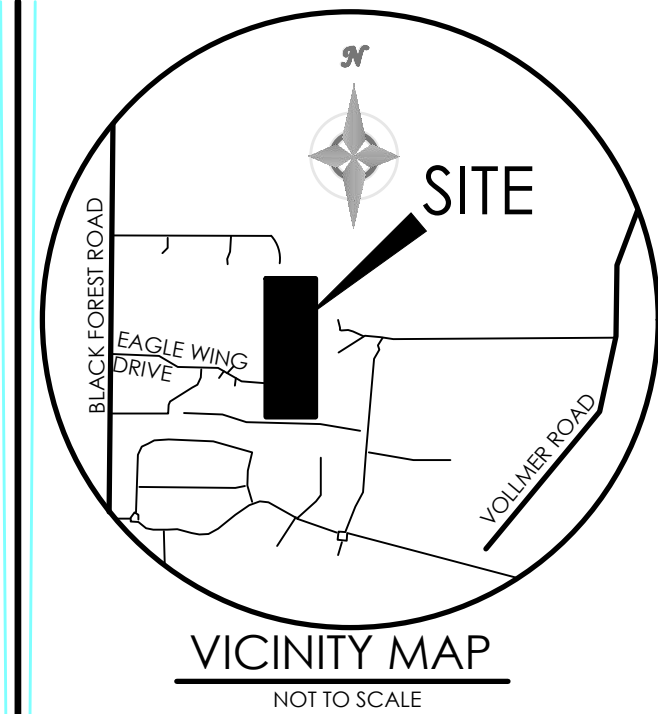

BENCHMARK

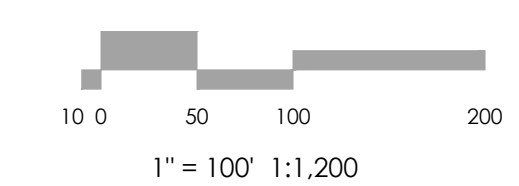
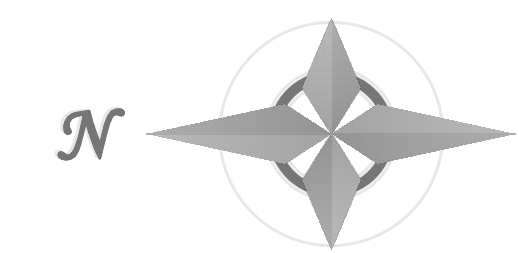

MVE, INC.
ENGINEERS & SURVEYORS

1903 Library Street, Suite 200 Colorado Springs, CO 80909 719.635.5736

REVISIONS

DESIGNED BY _____
 DRAWN BY _____
 CHECKED BY _____
 AS-BUILT BY _____
 CHECKED BY _____

EAGLE RISING
 FILING NO.1

STREAM VEGETATION
 PHOTO LOCATIONS

MVE PROJECT 61145
 MVE DRAWING DRN-MAP-HECRAS

MARCH 7, 2024
 SHEET 1 OF 1



1

Looking downstream,
from 250 feet
downstream of
Cottonwood Creek
DBPS Design Point
82.

September 27, 2022



2

Looking upstream,
from 250 feet
downstream of
Cottonwood Creek
DBPS Design Point
82.

September 27, 2022



3

Looking
downstream, from
Cottonwood Creek
DBPS Design Point
84.

September 27, 2022



4

Looking downstream,
from 200 feet
downstream of
Cottonwood Creek
DBPS Design Point
84.

September 27, 2022

see additional March 1,
2024 photos



4

Looking downstream, from
200 feet downstream of
Cottonwood Creek DBPS
Design Point 84.

March 1, 2024



4

Looking downstream, from
200 feet downstream of
Cottonwood Creek DBPS
Design Point 84.

March 1, 2024



5

Looking upstream,
from Cottonwood
Creek DBPS Design
Point 102.

September 27, 2022



6

Looking upstream,
from Cottonwood
Creek DBPS Design
Point 102.

September 27, 2022



7

Looking upstream,
from Cottonwood
Creek DBPS Design
Point 102.

September 27, 2022



8

Looking upstream
tributary stream, from
Cottonwood Creek
DBPS Design Point
102.

September 27, 2022



9

Looking downstream,
from Cottonwood
Creek DBPS Design
Point 102.

September 27, 2022



10

Looking northeast,
from 100 feet
downstream of
Cottonwood Creek
DBPS Design Point
102.

September 27, 2022



11

Looking downstream,
from 200 feet
downstream of
Cottonwood Creek
DBPS Design Point
102. Emergency
spillway on left
corner of pond.

September 27, 2022



12

Looking upstream,
from 200 feet
downstream of
Cottonwood Creek
DBPS Design Point
102.

September 27, 2022



13

Buried and partially buried riprap at emergency overflow, from Cottonwood Creek DBPS Design Point 104.

September 27, 2022



14

Looking at heavy vegetation downstream, from Design Point 6C.

September 27, 2022



15

Looking at riprap
upstream tributary
flow, from Design
Point 6B.

September 27, 2022



16

Looking southwest
across stream, from
450 feet downstream
of Cottonwood Creek
DBPS Design Point
104.

September 27, 2022



17

Looking up stream,
from 450 feet
downstream of
Cottonwood Creek
DBPS Design Point
104.

September 27, 2022



18

Looking upstream,
from 300 feet
upstream of
Cottonwood Creek
DBPS Design Point
124.

September 27, 2022



19

Looking west across channel, from 100 feet upstream of Cottonwood Creek DBPS Design Point 124.

September 27, 2022



20

Looking downstream at the upper banks, from 100 feet upstream of Cottonwood Creek DBPS Design Point 124.

September 27, 2022



21

Looking upstream,
from Design Point 8.

September 27, 2022



22

Looking downstream,
from Design Point 8.

September 27, 2022



23

On the east side of the creek looking west, from 200 feet downstream of Design Point 9.

September 27, 2022



24

Looking southwest towards pond embankment, from 400 feet downstream of Design Point 10.

September 27, 2022



25

Looking downstream towards offsite pond and riprap, from Cottonwood Creek DBPS Design Point 126.

September 27, 2022

Location is off-site, south of property



26

Looking upstream, from Cottonwood Creek DBPS Design Point 126.

September 27, 2022



27

Looking upstream towards riprap of emergency spillway, from east bank 550 feet downstream of Design Point 10.

September 27, 2022
see additional March 1, 2024 photos



28

Riprap of emergency spillway, from east bank 550 feet downstream of Design Point 10.

September 27, 2022
see additional March 1, 2024 photo



Pond 2 Emergency
Spillway Looking
downstream
(southwest)

March 1, 2024



Pond 2 Emergency
Spillway Looking
upstream
(northeast)

March 1, 2024



29

Looking upstream,
from the west bank
500 feet downstream
of Design Point 10.

September 27, 2022



30

Looking north at
culverts, on the east
side of the road from
100 feet south of
Design Point 8A.

September 27, 2022



31

Riprap lining
downstream from
DP8A, from 100 feet
north of Design Point
12.

September 27, 2022



32

Looking northwest up
tributary stream, from
100 feet northwest of
Design Point 9.

September 27, 2022



33

Looking east, on west bank of creek, from 100 feet northwest of Design Point 9.

September 27, 2022



34

Riprap lined swale from barn area to creek, 450 feet downstream of DBPS Design Point 104.

September 27, 2022

Riprap added

See additional March 1, 2024 photo



35

Looking west,
existing riprap lined
swale in need of
additional riprap from
Design Point 6A.

September 27, 2022



36

Looking at riprap on
tributary flow
upstream of DP6B,
from Design Point
6A.

September 27, 2022



37

Looking northeast
from the centerline of
the creek at
HECRAS Station
1200.

December 11, 2023



38

Looking southwest
from the centerline of
the creek at
HECRAS Station
1400.

December 11, 2023



39

Looking east at east
property line at
approximately
HECRAS station
300.

December 11, 2023

Supplimental Photos and Key Map

February 2024

SP205 + SF2225: DRAWING EXTRACTED FROM THE DEVIATION REQUEST SUBMITTED FOR EMC 3.3.3 B & C TO SHOW LOCATIONS OF THE ATTACHED ADDED PHOTOS JEFF RICE REQUESTED JANUARY 29, 2024

HEC-RAS Cross Section Location and Photo Key Map

LEGEND

- PROPERTY LINE
- EASEMENT LINE
- LOT LINE
- EXISTING INDEX CONTOUR
- INTERMEDIATE CONTOUR
- DBPS DESIGN POINT
- LOCAL DESIGN POINT
- 14 → DRAINAGE REPORT PHOTO NUMBER / DIRECTION

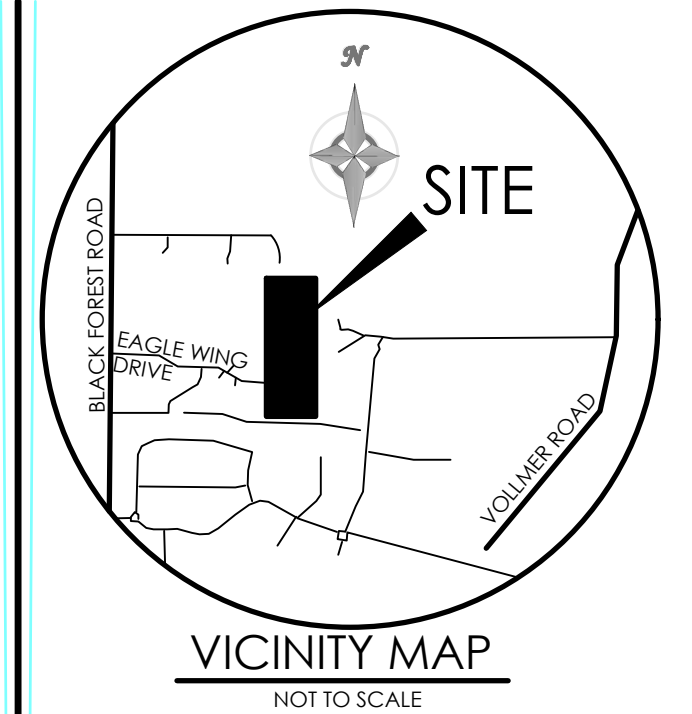

ADDS TO LEGEND FEBRUARY 2024
FEBRUARY 2024 PHOTOS
NUMBER & VIEWING DIRECTION
APPLICANT ANSWERS & COMMENTS
TO REVIEW QUESTIONS

YES SEE PHOTOS
0084 SE & 0085 S. Stormwater
from the east flows north then
SE if elevation is reached for
flow at overflow Rip-Rap

BENCHMARK



NOT ON PROPERTY

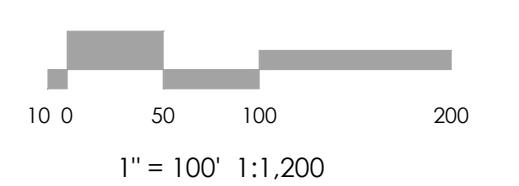

MVE, INC.
ENGINEERS / SURVEYORS
 1903 Leary Street, Suite 200 Colorado Springs, CO 80909 719.635.5736

REVISIONS

DESIGNED BY
 DRAWN BY
 CHECKED BY
 AS-BUILT BY
 CHECKED BY

EAGLE RISING
 FILING NO. 1
FEBRUARY 28, 2024 WMT
 Revised March 5, 2024

STREAM VEGETATION
 PHOTO LOCATIONS

MVE PROJECT 61145
 MVE DRAWING DRN-MAP-HECRAS

OCTOBER 31, 2023
 SHEET 1 OF 1

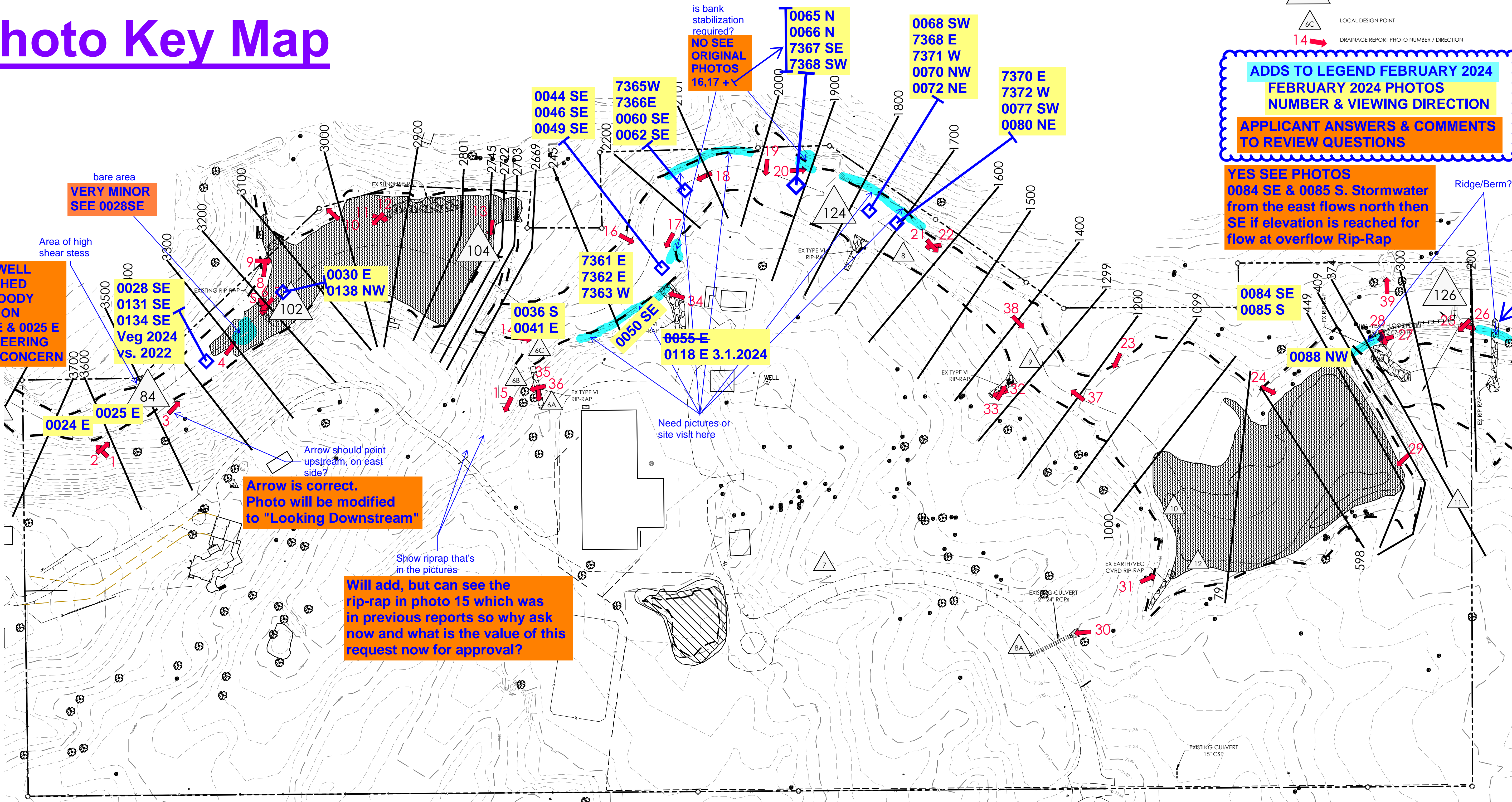

MATURE WELL ESTABLISHED DENSE WOODY VEGETATION
 SEE 0024E & 0025 E
NO ENGINEERING EROSION CONCERN

bare area VERY MINOR
 SEE 0028SE

Area of high shear stress

0028 SE
0131 SE
0134 SE
 Veg 2024 vs. 2022

0024 E
0025 E

Arrow is correct.
Photo will be modified to "Looking Downstream"

Will add, but can see the rip-rap in photo 15 which was in previous reports so why ask now and what is the value of this request now for approval?

Need pictures or site visit here

is bank stabilization required?
NO SEE ORIGINAL PHOTOS 16,17 + v

0065 N
0066 N
7367 SE
7368 SW

0068 SW
7368 E
7371 W
0072 NE

7370 E
7372 W
0077 SW
0080 NE

0044 SE
0046 SE
0049 SE

7365W
7366E
0060 SE
0062 SE

7361 E
7362 E
7363 W

0036 S
0041 E

0050 SE
0055 E
0118 E 3.1.2024

0084 SE
0085 S

0088 NW

NOTE:
TYPICAL RESIDENTIAL 2.5 ACRE LOT DEVELOPMENTS RESULT IN LESS THAN 5% IMPERVIOUS CONDITIONS. STORM DRAINAGE FROM THIS RESIDENTIAL DEVELOPMENT EVEN IF 10% WILL NOT MATERIALLY DRAIN TO OR AFFECT COTTONWOOD CREEK.

Eagle Rising SP205 & SF2225

**Added photos requested by Jeff Rice in the EDARP 1.29.2024 Review Comments
To the Deviation Request submitted for EMC 3.3.3 B & C**



0024 E



0025 E



0028 SE Veg Growth vs. 2022



0030 E Boulder dam in place & stable for 40+ years

Commercial Real Estate, Development and Construction Management

735 Lancers Court West, Suite 100, Monument, CO 80132

Telephone: 719-886-6535 Cell: 719-351-8629

www.NLdevelopment.com wtimura@NLdevelopment.com



0138 NW Vegetation Growth vs. 2022 3.1.2024



0134 SE Vegetation Growth vs. 2022 3.1.2024



0131 SE Vegetation Growth vs. 2022 3.1.2024



0036 S



0041 E



7361 E



7362 E



7363W



0044 SE



0046 SE



0049 SE



0050 SE



0118 E 3.1.2024



7365W



7366E



0060 SE



0062 SE



0065 N



0066 N



7367SE



7368SW



0068 SW



7368 E



7371 W



0070 NW



0072 NE



7370 E



7372 W



0077 SW



0080 NE



0084 SE



0085 S



0088 NW

LEGEND	
	PROPERTY LINE
	EASEMENT LINE
	NO BUILD LIMIT LINE
	LOT LINE
	EXISTING
	INDEX CONTOUR
	INTERMEDIATE CONTOUR
	PROPOSED
	INDEX CONTOUR
	INTERMEDIATE CONTOUR
	100 YEAR STORM WATER FLOOD LEVEL
	POSSIBLE ACCESS PATH

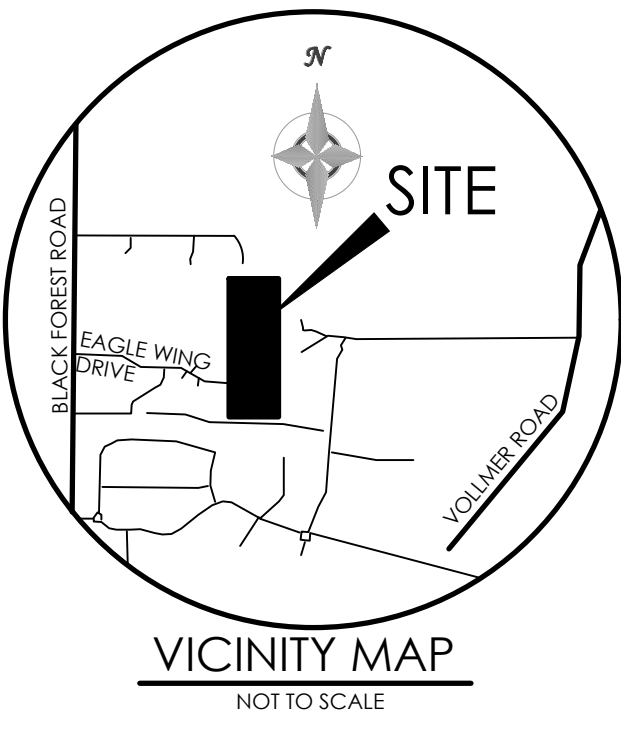

BENCHMARK

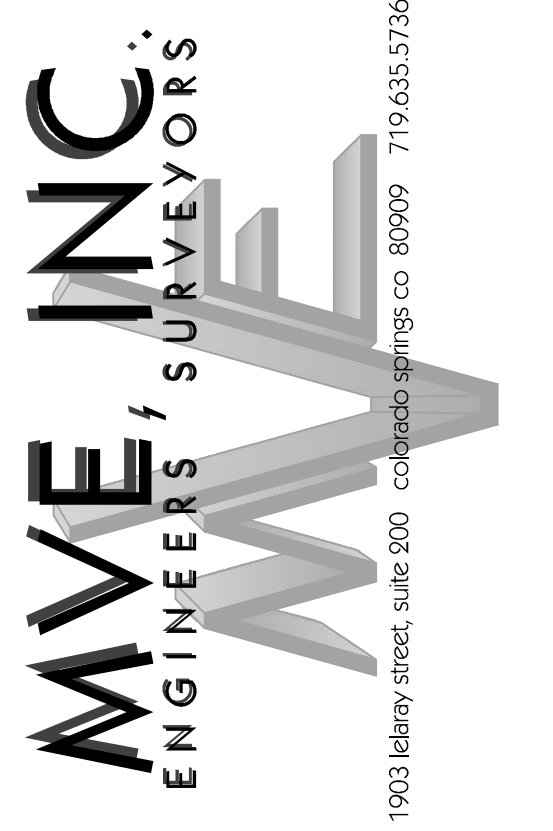
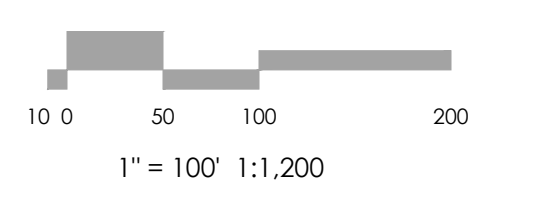
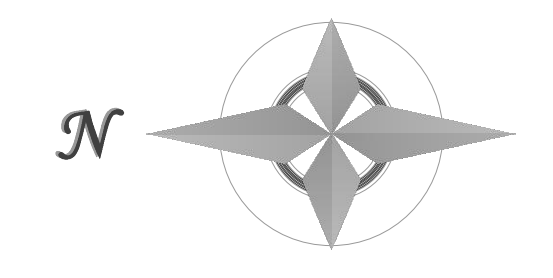

REVISIONS

DESIGNED BY _____
 DRAWN BY _____
 CHECKED BY _____
 AS-BUILTS BY _____
 CHECKED BY _____

**EAGLE RISING
 PRELIMINARY PLAN**

CREEK ACCESS

EXHIBIT

MVE PROJECT 61145
 MVE DRAWING DRN-MAP-DEV

MARCH 7, 2024
 SHEET 1 OF 1

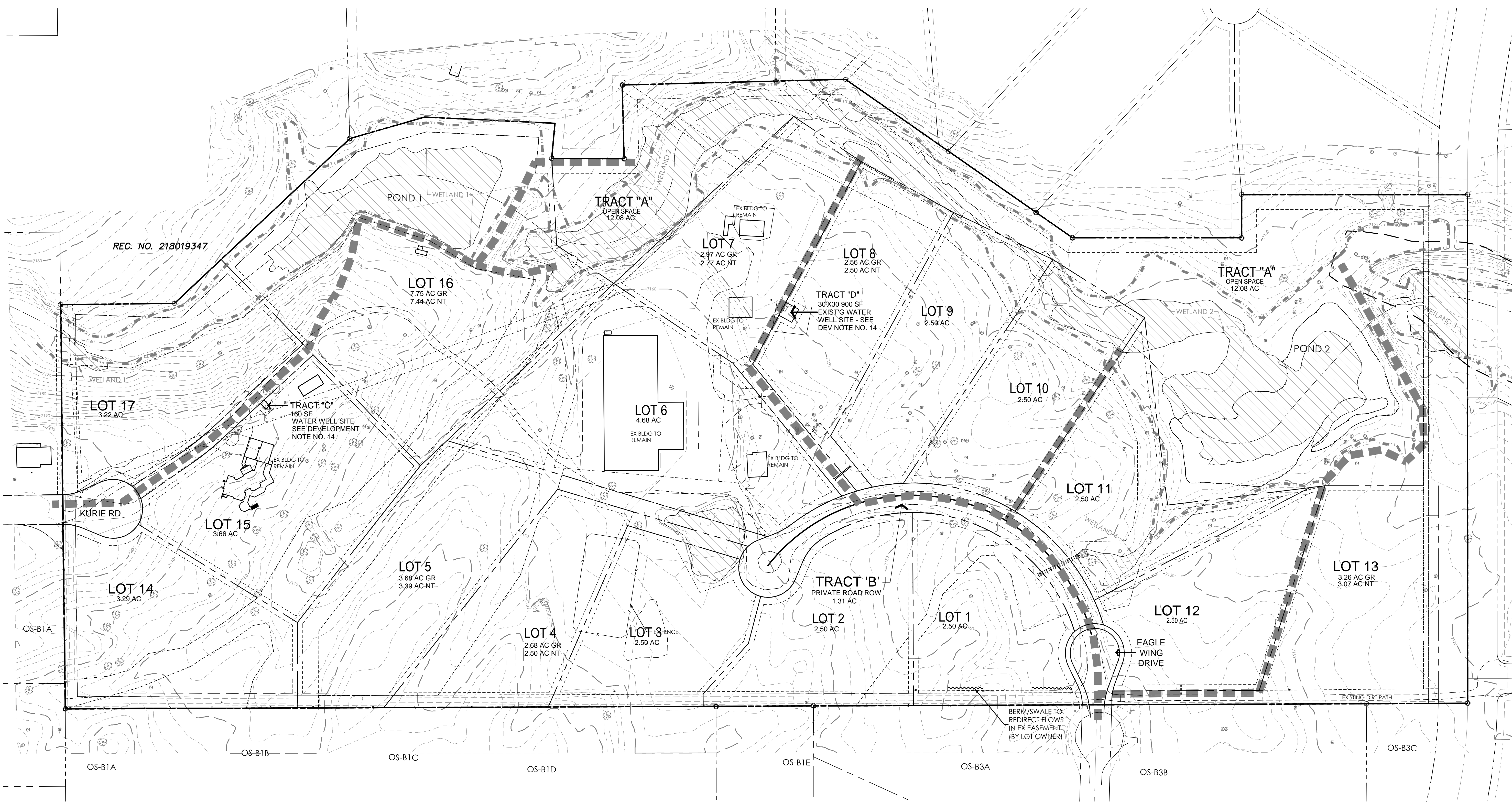

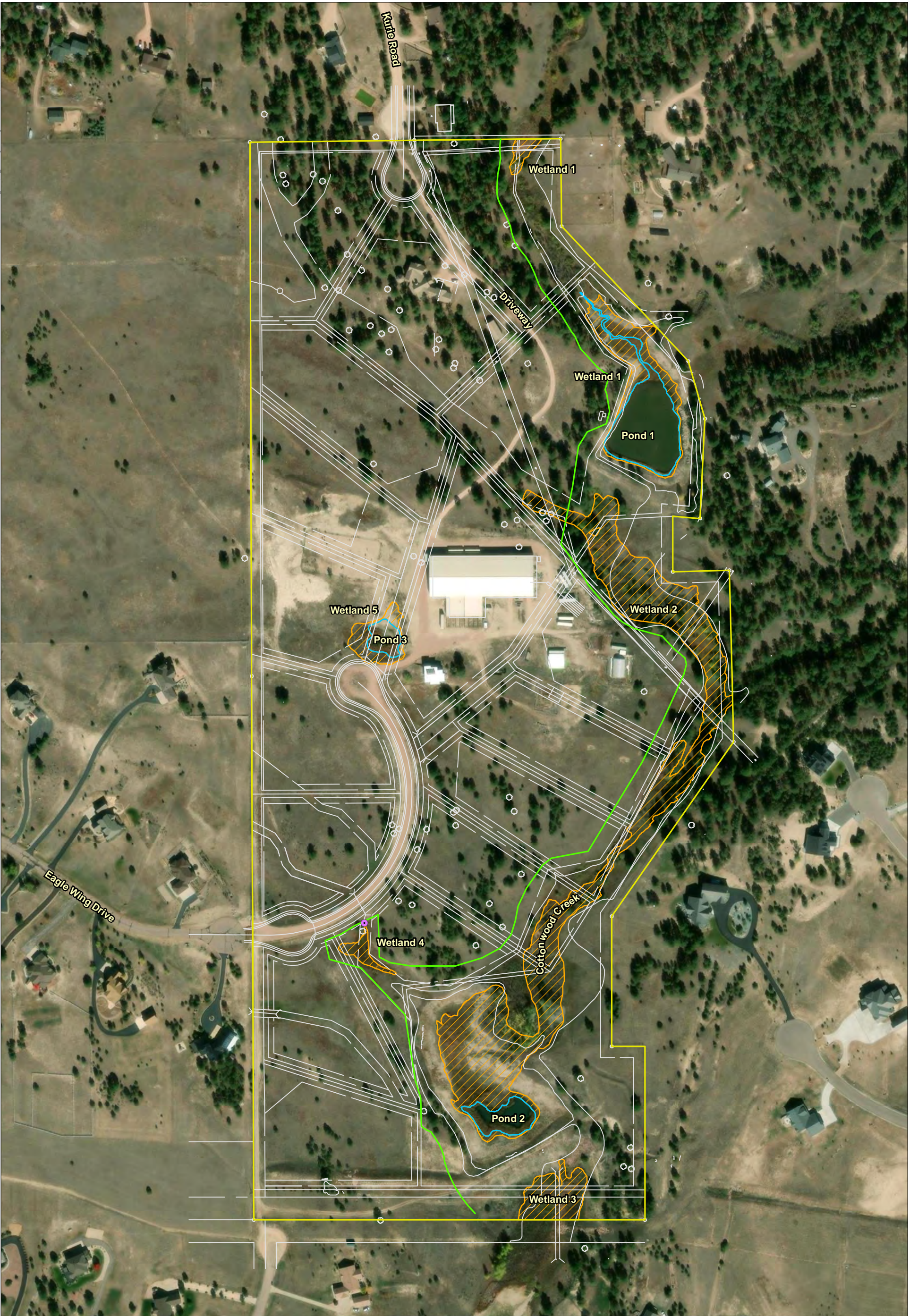

Eagle Rising 2022 Natural Resources Assessment





-  Culvert
-  Construction/Disturbance Limit
-  Open Water
-  Project Area Boundary
-  Wetland

Image Source: Maxar Technologies©, October 14, 2022

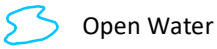
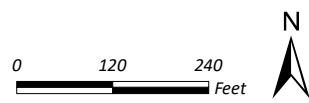

Figure 3
Proposed Subdivision

Prepared for: Steve Jacobs
File: 22_113 Figure 3.mxd (GS)
August 25, 2023



be impacted by development of the project area and to identify any significant changes in natural resources since the assessment conducted in 2012.

The project area has been continually influenced by human activities for more than 100 years. Timber was a major industry in the Black Forest in the late 1800's with numerous lumber mills scattered through the area. Grazing and agriculture dominated the land use in the early 1900's, eventually giving way to summer homes, and full-time residences (El Paso County Land Use Department 1987).

Methods

During the 2022 site visits, ERO conducted an updated natural resources assessment of the project area. In addition to the information gathered during the 2022 site visits, natural resource information was obtained from existing databases and sources such as aerial photography, the Colorado Natural Diversity Information Source (NDIS), U.S. Fish and Wildlife Service (Service) National Wetlands Inventory database, U.S. Geological Survey (USGS) National Hydrography Dataset (NHD), and other sources ("Google, Inc." 2022; Natural Diversity Information Source 2021; U.S. Fish and Wildlife Service, n.d.; U.S. Geological Survey 2022). Based on the information gathered from existing sources and the initial site visit, ERO verified existing vegetation communities and identified important wildlife attributes of the project area.

Project Area Description

The National Land Cover Database maps five land cover types in the project area (U.S. Geological Survey 2016). Grassland/Herbaceous is the most dominant and occurs throughout the majority of the western portion of the project area. The other land cover types in the project area include evergreen forest, scrub/shrub, open water, and barren land.

The project area is on the southern edge of the Black Forest, northeast of Colorado Springs (Figure 1). Vegetation in the project area consists of upland grasslands, patches of ponderosa pine (*Pinus ponderosa*) and upland shrubs, and wetland/riparian vegetation along drainages. Three tributaries to Cottonwood Creek converge at the eastern project area boundary. In the project area, Cottonwood Creek generally flows from north to south and primarily consists of wetlands throughout the channel (Figure 2; Photos 5a through 7a, 5b, 6b). Two ponds (Ponds 1 and 2) occur along Cottonwood Creek in the project area that are contained behind earthen dams (Photos 1a through 4a). As a result of water rights negotiations and drought, the wetlands along Cottonwood Creek and the two ponds were drier in 2022 than what was observed in 2012 (Photos 1b through 4b). A third pond (Pond 3), that was excavated in uplands occurs in the west, central portion of the project area (Figure 2; Photos 6a and 6b)). Wetlands occur in the channel and on benches and terraces along Cottonwood Creek and as small fringes along the ponds. A depressional area and swale consisting of wetland vegetation (Wetland 4) occurs downstream of a culvert in the project area northwest of Pond 2 (Figure 2). Wetlands in the project area are dominated by Nebraska sedge (*Carex nebrascensis*), Baltic rush (*Juncus balticus*), redtop (*Agrostis gigantea*), broadleaf cattail (*Typha angustifolia*), sandbar willow (*Salix exigua*), strapleaf willow

(*Salix ligulifolia*), park willow (*Salix monticola*), and shining willow (*Salix lucida* subsp. *caudata*). The riparian overstory along Cottonwood Creek is dominated by peachleaf willow (*Salix amygdaloides*) and plains cottonwood (*Populus deltoides* subsp. *monilifera*) trees. Upland shrubs in the riparian corridor include snowberry (*Symphoricarpos occidentalis*), Woods' rose (*Rosa woodsii*), golden currant (*Ribes aureum*), and chokecherry (*Padus virginiana*) (Photo 10). The soils in the project area primarily consist of Pring coarse sandy loam, 3 to 8 percent slopes (Natural Resources Conservation Service 2022).

The project area is one of the last remaining nonresidential tracts of land along Cottonwood Creek. Rural residential development (2- to 5-acre lots) surrounds the entire project area. Two existing homes are located in the northwest corner of the project area and a large barn, corral, and disturbed area occurs in the north-central portion of the project area (Photo 8a). The uplands in the project area are a mixture of native grassland and disturbed areas (Photos 9a and 9b). The project area has historically been used for cattle grazing, and some limited grazing continues in the southeast corner of the project area. The native upland areas are dominated by blue grama (*Bouteloua gracilis*), sand dropseed (*Sporobolus cryptandrus*), threeawn (*Aristida* sp.), soapweed yucca (*Yucca glauca*), Canada wildrye (*Elymus canadensis*), intermediate wheatgrass (*Thinopyrum intermedium*), sideoats grama (*Bouteloua curtipendula*), muhly (*Muhlenbergia* sp.), and ponderosa pine (Photos 9a and 9b). The disturbed uplands are dominated by smooth brome (*Bromus inermis*), diffuse knapweed (*Centaurea diffusa*), Canada thistle (*Cirsium arvensis*), musk thistle (*Carduus nutans*), common mullein (*Verbascum thapsus*), common teasel (*Dipsacus fullonum*), and kochia (*Bassia scopara*).

Conclusions

On behalf of the project proponent, ERO is requesting an approved JD for the old stock pond and upland vegetated swale in the northeastern portion of the project area, Pond 3 and associated Wetland 5, and Wetland 4. Based on the information in this report, if the Corps determines that the wetlands and waters are not jurisdictional, ERO would appreciate a written determination of this request confirming that no further consultation under Section 404 is required.

If you have any questions or need additional information, please do not hesitate to contact me at 303-830-1188 or by email at cmarne@eroresources.com. I look forward to hearing from you.

Sincerely,



Courtney Marne
Biologist/Associate

cc: David Jones - Land Resource Associates
Stephen Jacobs - MyPad, Inc.

Attachments: Figures 1 and 2; Photo Log; Routine Wetland Determination Forms; JD Form

References

- Environmental Laboratory. 1987. "Corps of Engineers Wetlands Delineation Manual." Wetlands Research Program Technical Report Y-87-1. Vicksburg, Mississippi: U.S. Army Engineer Waterways Experiment Station.
<https://www.lrh.usace.army.mil/Portals/38/docs/USACE%2087%20Wetland%20Delineation%20Manual.pdf>.
- ERO Resources Corporation. 2012. "Wetland Delineation Report, Eagles Rising Subdivision, El Paso County, Colorado."
- U.S. Army Corps of Engineers. 2010. "Regional Supplement to the Corps of Engineers Wetland Delineation Manual: Western Mountains, Valleys, and Coast Region (Version 2.0)." Vicksburg, Mississippi. <https://usace.contentdm.oclc.org/utis/getfile/collection/p266001coll1/id/7646>.
- U.S. Army Corps of Engineers. 2020. "National Wetland Plant List."
- U.S. Department of Agriculture, Natural Resources Conservation Service. 2022a. "PLANTS Database." PLANTS Database. 2022. <https://plants.sc.egov.usda.gov/home>.
- U.S. Department of Agriculture, Natural Resources Conservation Service. 2022b. "Web Soil Survey." 2022. <https://websoilsurvey.sc.egov.usda.gov/App/HomePage.htm>.
- U.S. Geological Survey. 2016. "National Land Cover Database." 2016. <https://www.usgs.gov/node/279743>.

U.S. Geological Survey. 2022. "National Hydrography Dataset." U.S. Department of the Interior, U.S. Geological Survey. <https://apps.nationalmap.gov/viewer/>.

Weber, William A., Ronald C. Wittmann, and Linna Weber Müller-Wille. 2012. *Colorado Flora: Eastern Slope, Fourth Edition. A Field Guide to the Vascular Plants*. University Press of Colorado.

EAGLE RISING SUBDIVISION
PHOTO LOG
MARCH 19, 2012 AND APRIL 27, 2022



Photo 1a - Cottonwood Creek at the southern boundary of the project area. View is to the south.



Photo 1b - Cottonwood Creek at the southern boundary of the project area. View is to the south.



Photo 2a - Wetlands along Cottonwood Creek in the project area. View is to the south.



Photo 2b - Wetlands along Cottonwood Creek in the project area. View is to the south.



Photo 3a - Pond 1 in the project area. View is to the east.



Photo 3b - Immediately upstream of Pond 1 in the project area. View is to the east.

EAGLE RISING SUBDIVISION
PHOTO LOG
MARCH 19, 2012 AND APRIL 27, 2022



Photo 4a - Pond 2 in the project area.
View is to the northwest.



Photo 4b - Pond 2 in the project area.
View is to the northwest.



Photo 5a - Vegetated swale upstream of Cottonwood Creek
in the project area. View is to the northwest.



Photo 5b - Vegetated swale upstream of Cottonwood Creek
in the project area. View is to the northwest.



Photo 6a - Pond 3 in the project area.
View is to the northwest.



Photo 6b - Pond 3 and associate Wetland 5 in the project area.
View is to the northwest.

EAGLE RISING SUBDIVISION
PHOTO LOG
MARCH 19, 2012 AND APRIL 27, 2022



Photo 7a - Wetland 9 in the project area.
View is to the southeast.



Photo 7b - Wetland 9 in the project area.
View is to the southeast.



Photo 8a - Disturbed uplands and barn in the project area.
View is to the northeast.



Photo 8b - Disturbed uplands and barn in the project area.
View is to the northeast.



Photo 9a - Native uplands in the project area.
View is to the northeast.



Photo 9b - Native uplands in the project area.
View is to the northeast.

EAGLE RISING SUBDIVISION
PHOTO LOG
MARCH 19, 2012 AND APRIL 27, 2022



Photo 10a - Riparian corridor in the project area.
View is to the southeast.



Photo 10b - Riparian corridor in the project area.
View is to the southeast.

Publication indicating the utilization of willow for stream stabilization



COLORADO STATE PARKS STEWARDSHIP PRESCRIPTION



Date Created: April 10, 2002

Revised: April 1, 2005

Author: Mindy Wheeler

Parks Affected: Most

Cottonwood and Willow Management ^{Stewardship} Rx

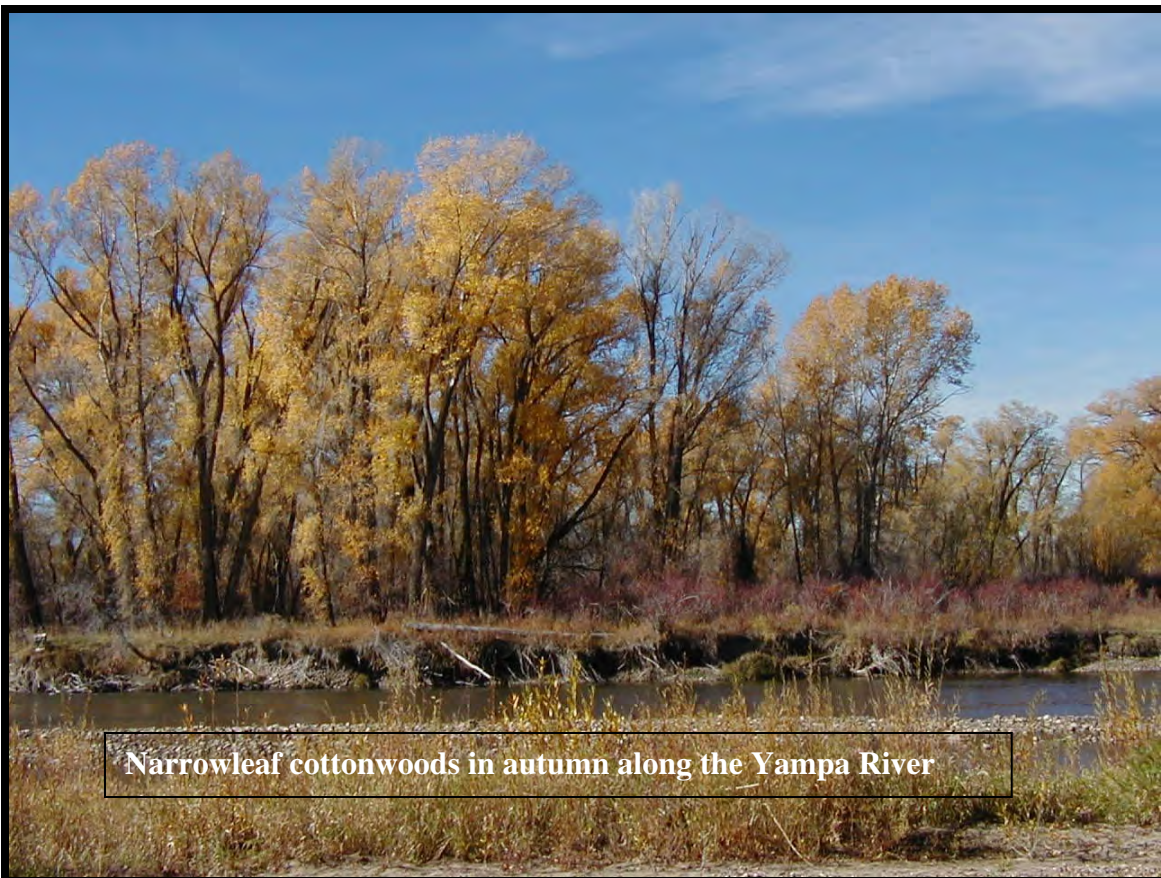

Narrowleaf cottonwoods in autumn along the Yampa River



RESTORING STREAM BANKS WITH WILLOWS



Willows along a stream serve many important functions. They provide shade and cover for stream life and improve water quality by absorbing and storing chemicals. Their ability to withstand flooding, to stabilize soils, and to grow quickly in saturated areas make them ideal for revegetating stream banks.

Establishing willow cuttings, stakes, and/or wattles on a stream bank will benefit you and the stream. The most appropriate material and method to use will depend upon stream size and planting location.

Willows growing in a nearby area, with similar soil and moisture conditions as your problem area, should be used as planting stock to help increase tree survival.

If plants are purchased from a nursery, you should buy cuttings and not rooted seedlings. Also, select a native species to enhance survival and decrease competition with other plants.

Recommended species include black willow (*Salix nigra*), sand bar willow (*S. interior*), meadow willow (*S. petiolaris*), heart-leaved willow (*S. rigida*) and Ward's willow (*S. caroliniana*).



Collect and plant the willows during the dormant season. Willows planted in the spring before the buds swell seem to do the best. When storing or transporting plants, keep them cool and slightly moist.

Willow Cuttings

Cuttings are used on small streams where flooding and erosion is minimal. This material is easy to obtain, requires few tools and little labor to plant.

- (1) Cut ½ - to 1-inch diameter plants or stems and remove all lateral branches.
- (2) Cut the stems with a knife or pruning shears into 12- to 24-inch lengths.
- (3) Make a horizontal cut on the end which will remain exposed and a 45° angle cut on the end to be planted. This will prevent you from planting them upside down. Note: Buds on plant should face up.

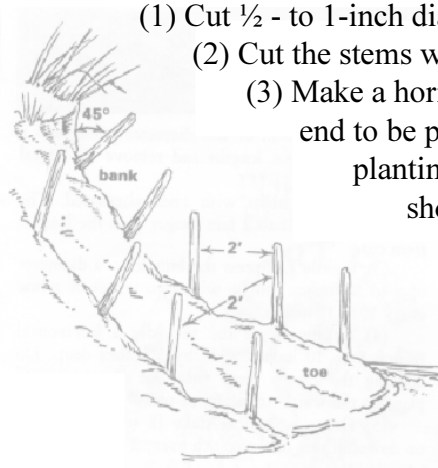

- (4) Push cutting directly into soil or produce a pilot hole by pounding a piece of metal rebar into the soil and then push the cutting into the hole. A planting (dibble) bar may also be used. Plant so that only a few inches remain exposed.



Willow Stakes



Use stakes where materials need to be driven deeper to improve moisture supply to the stakes.

(1) Cut 1- to 3-inch diameter stems into 18- to 36-inch lengths with a hand saw or chainsaw and remove all lateral stems. (Note: Using an axe or knife to cut the stems may damage the plant.)

(2) Use dibble bar or drive stake with mallet until approximately 3 to 6 inches remain exposed or to refusal. **Do not force and split stake.**

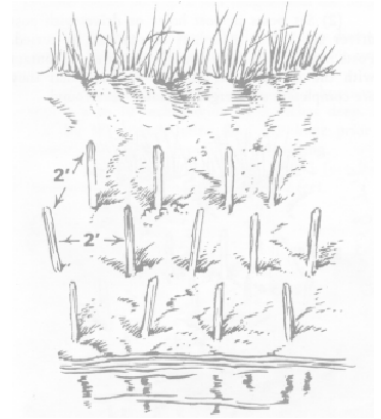

Willow Posts

Posts can also be used to revegetate stream banks. They are most appropriate in situations where a stable moisture supply is deep in the soil and willow materials need to be driven deeper to reach it. This is a very labor intensive method, but posts can withstand relatively high flows.

(1) Cut 3- to 6-inch diameter trees into 6- to 8-foot lengths with a chainsaw and remove all lateral branches. Sharpen bottom end to ease planting and score 12 to 14 inches.

(2) Set posts in post holes or drive with post driver so that at least half of the post is buried. Posts must be set deep enough to maintain contact with the water table, but not so deep that they are completely submerged in water year-round.

(3) The damaged top few inches of each post should be cut after planting if posts were driven.

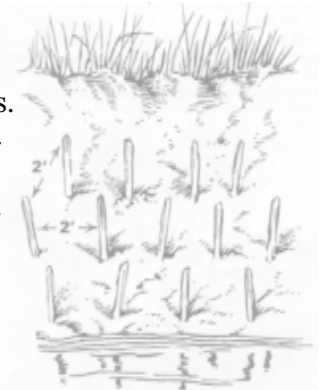

Wattles

Use wattles in slow-moving water areas to trap sediments and revegetate banks. This method is more labor intensive than planting cuttings or stakes.

- (1) Cut 1 1/2-inch or less diameter stems into a minimum of 3-foot lengths and remove all lateral branches.
- (2) Bundle stems with ends alternated. The bundle should be 1 to 2 feet longer than the longest stem cut.
- (3) Tightly compress bundle to a diameter of 8 to 10 inches and tie with two wraps of twine every 10 - 15 inches.
- (4) Beginning at the toe, dig a horizontal trench 8 to 10 inches wide by 5 inches deep. Do not dig the trench more than one hour prior to planting the wattle to minimize soil drying.
- (5) Drive a vertical stake (2 to 3 feet long) on done-hill side of trench every 2 feet.
- (6) Place wattles in trench and drive 2- to 3-foot long stakes through the bundle every 3 feet.
- (7) Cover with soil and tamp wattle so that no more than 20 percent of the wattle is exposed.

A combination of these methods may be needed based on the characteristics of the stream and its banks.



Proper maintenance will be needed to attain long-term success. Protect young, growing willows from livestock. Also, avoid herbicide treatment on planted areas.

Planting willows along and on stream banks provides a number of benefits to the fragile stream environment and the surrounding land. However, this technique does not replace the need for responsible stream corridor management such as maintaining a permanent corridor of trees along streams. It is merely a tool to help mend problem areas. If you have further questions,

please contact your local Missouri Department of Conservation Regional Office.

**Wetland / Riparian Plant Finder 6:
Riparian – Foothills and Canyons**

(dominant species in bold type)

TREES AND SHRUBS (continued)

<i>Rubacer parviflorum</i>	thimbleberry
<i>Salix amygdaloides</i>	peachleaf willow
<i>Salix bebbiana</i>	Bebb willow
<i>Salix drummondiana</i>	Drummond's willow
<i>Salix geyeriana</i>	Geyer's willow
<i>Salix irrorata</i>	bluestem willow
<i>Salix lucida</i>	shining willow
<i>Salix monticola</i>	mountain willow
<i>Swida sericea</i>	red-osier dogwood

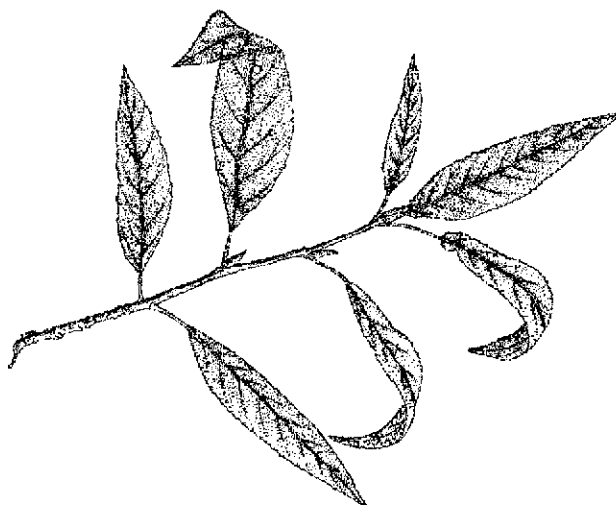

Populus angustifolia

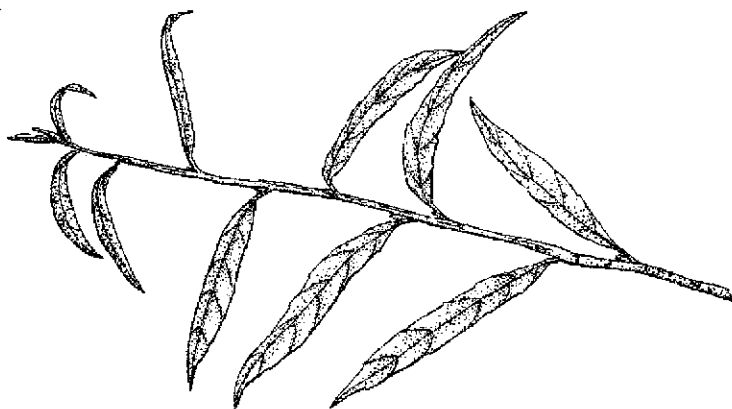

Salix exigua

Publication on restoration of Colorado streams and rivers utilizing new willow plantings



**Restoration Plan and
Environmental Assessment for the
Upper Arkansas River Watershed**

April 14, 2010

PREPARED FOR

U.S. Department of the Interior
U.S. Fish and Wildlife Service
U.S. Bureau of Land Management
U.S. Bureau of Reclamation

State of Colorado
Department of Natural Resources
Department of Public Health and Environment
Department of Law

PREPARED BY

Stratus Consulting Inc.
PO Box 4059
Boulder, CO 80306-4059
303-381-8000
Contact: Diana R. Lane, PhD
or Allison Ebbets, MS

(See original submittal for complete report)

13. Report Maps

Existing (ON-SITE) Drainage Map
Developed (ON-SITE) Drainage Map

OFF-SITE DRAINAGE BASIN SUMMARY TABLE					
DESIGN POINT	INCLUDED BASINS	AREA (AC)	Tc (MIN)	RUNOFF	
				Q5	Q100
4	OS-B1A	24.9	19.1	9.2	52.2
5	OS-B1B	41.0	21.2	11.9	76.7
E7	OS-B1C	1.8	12.9	0.6	4.0
E8	OS-B1D	6.0	16.9	1.6	11.8
E10	OS-B1E	10.1	17.8	3.1	20.5
E11	OS-B3A	9.1	15.2	3.8	21.3
E13	OS-B3B	2.5	13.5	1.1	6.2
E15	OS-B3C	5.95	15.5	2.5	13.9

ON-SITE DRAINAGE BASIN SUMMARY TABLE					
DESIGN POINT	INCLUDED BASINS	AREA (AC)	Tc (MIN)	RUNOFF	
				Q5	Q100
EX-A1		4.95	13.5	1.5	10.7
EX-A2		1.74	12.1	0.5	3.9
EX-B		4.35	12.7	1.9	10.4
EX-C		1.66	11.9	0.5	3.8
EX-D		7.10	13.1	3.3	16.9
EX-E1		3.41	13.1	3.5	10.4
EX-E2		7.77	16.3	4.7	18.6
EX-F1		6.45	13.8	9.8	23.0
EX-F2		2.02	13.5	0.6	4.4
EX-G		2.98	14.1	1.0	6.5
EX-H		4.10	13.8	2.2	10.0
EX-I		1.64	12.3	1.1	4.4
EX-J		2.42	11.7	1.3	6.3
EX-K		2.65	10.8	0.9	6.3
EX-L		2.14	12.4	0.7	4.8
EX-M		4.10	14.9	1.4	8.8

ON-SITE DESIGN POINTS					
DESIGN POINT	INCLUDED BASINS	AREA (AC)	Tc (MIN)	RUNOFF	
				Q5	Q100
DP6	OS-B1A, OS-B1B, EX-B, EX-C	71.87	22.3	22.0	134.1
DP6A	OS-B1C, EX-E1	5.25	17.9	3.6	12.6
DP6B	DP6, EX-D	78.97	19.1	23.5	141.5
DP6C	DP6A, DP6B	84.22	19.1	26.6	152.3
DP7	OS-B1D, EX-F1	12.48	20.4	9.7	30.2
DP8	EX-E2	7.77	16.3	4.7	18.6
DP8A	OS-B1E, OS-B3A, EX-H, EX-I	24.92	19.5	9.2	50.8
DP9	OS-B1D, EX-F1, EX-F2	14.50	22.8	9.7	32.0
DP10	EX-G	2.98	14.1	1.0	6.5
DP11	OS-B3B, EX-M	6.60	18.1	2.3	13.5
DP12	OS-B1E, OS-B3A, EX-H, EX-I, EX-J	27.34	21.2	9.8	53.6
DP13	OS-B3C, EX-L	8.09	17.2	2.9	17.4

LEGEND

- PROPERTY LINE
- EASEMENT LINE
- LOT LINE
- EXISTING INDEX CONTOUR
- INTERMEDIATE CONTOUR
- BASIN BOUNDARY
- 100 YEAR STORM WATER FLOOD LEVEL
- GENERAL FLOW/DIRECTION
- SLOPE DIRECTION AND GRADE
- BASIN LABEL AREA IN ACRES PERCENT IMPERVIOUS
- DESIGN POINT
- COTTONWOOD CREEK DBPS DESIGN POINT
- M&S DESIGN POINT

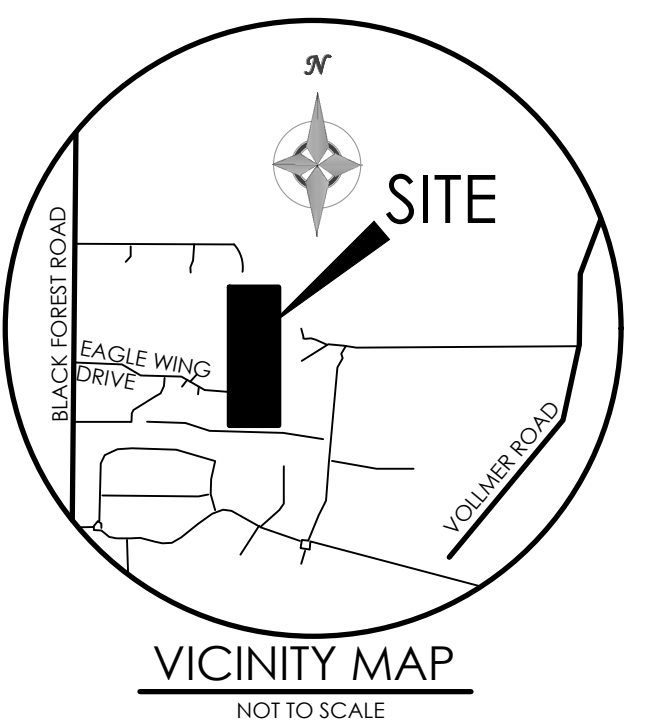

BENCHMARK

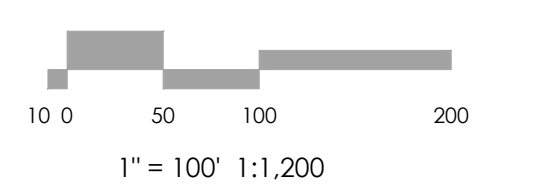
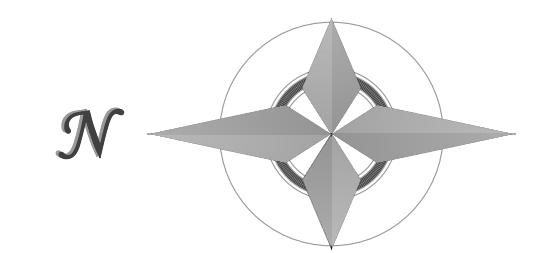

MVE, INC.
ENGINEERS & SURVEYORS

1903 Leary Street, Suite 200 Colorado Springs, CO 80909 719.635.5736

REVISIONS

DESIGNED BY
DRAWN BY
CHECKED BY
AS-BUILTS BY
CHECKED BY

EAGLE RISING
FILING NO. 1

EXISTING
(ON - SITE)
DRAINAGE MAP

MVE PROJECT 61145
MVE DRAWING DRN-MAP-EX

MAY 1, 2024
SHEET 1 OF 1



OFF-SITE DRAINAGE BASIN SUMMARY TABLE					
DESIGN POINT	INCLUDED BASINS	AREA (AC)	Tc (MIN)	RUNOFF	
				Q5	Q100
4	OS-B1A	24.9	19.1	9.2	52.2
5	OS-B1B	41.0	21.2	11.9	76.7
E7	OS-B1C	1.8	12.9	0.6	4.0
E8	OS-B1D	6.0	16.9	1.6	11.8
E10	OS-B1E	10.1	17.8	3.1	20.5
E11	OS-B3A	9.1	15.2	3.8	21.3
E13	OS-B3B	2.5	13.5	1.1	6.2
E15	OS-B3C	5.95	15.5	2.5	13.9

ON-SITE BASINS					
DESIGN POINT	INCLUDED BASINS	AREA (AC)	Tc (MIN)	RUNOFF	
				Q5	Q100
A1		4.95	13.5	2.3	11.7
A2		1.74	12.1	0.5	3.9
B		4.35	12.5	2.4	11.1
C		1.66	11.9	0.7	4.0
D		7.10	12.8	3.9	17.7
E1		3.41	13.1	3.5	10.4
E2		7.77	16.3	5.3	19.2
F1		6.45	13.8	10.3	23.6
F2		2.02	13.5	1.1	5.0
G		2.98	13.7	1.5	7.2
H		4.10	13.8	2.9	10.9
I		1.64	12.0	1.3	4.7
J		2.42	11.2	1.8	6.9
K		2.65	10.8	0.9	6.3
L		2.14	12.4	1.1	5.4
M		4.10	14.9	1.9	9.4

ON-SITE DESIGN POINTS					
DESIGN POINT	INCLUDED BASINS	AREA (AC)	Tc (MIN)	RUNOFF	
				Q5	Q100
DP6	OS-B1A, OS-B1B, B, C	71.87	22.3	22.5	134.7
DP6A	OS-B1C, E1	5.25	17.9	3.6	12.6
DP6B	DP6, D	78.97	19.1	24.4	142.6
DP6C	DP6A, DP6B	84.22	19.1	27.5	153.4
DP7	OS-B1D, F1	12.48	20.4	10.1	30.6
DP8	E2	7.77	16.3	5.3	19.2
DP8A	OS-B1E, OS-B3A, H, I	24.92	19.5	10.0	51.8
DP9	OS-B1D, F1, F2	14.50	22.8	6.4	28.3
DP10	G	2.98	13.7	1.5	7.2
DP11	OS-B3B, M	6.60	18.1	2.7	14.1
DP12	OS-B1E, OS-B3A, H, I, J	27.34	21.2	11.0	55.1
DP13	OS-B3C, L	8.09	17.2	3.4	18.0

LEGEND

- PROPERTY LINE
- EASEMENT LINE
- NBL NO BUILD LIMIT LINE
- LOT LINE
- EXISTING INDEX CONTOUR
- PROPOSED INDEX CONTOUR
- EXISTING INTERMEDIATE CONTOUR
- PROPOSED INTERMEDIATE CONTOUR
- BASIN BOUNDARY
- 100 YEAR STORM WATER FLOOD LEVEL
- GENERAL FLOW/DIRECTION
- SLOPE DIRECTION AND GRADE
- BASIN LABEL AREA IN ACRES PERCENT IMPERVIOUS
- DESIGN POINT
- COTTONWOOD CREEK DBPS DESIGN POINT
- M&S DESIGN POINT

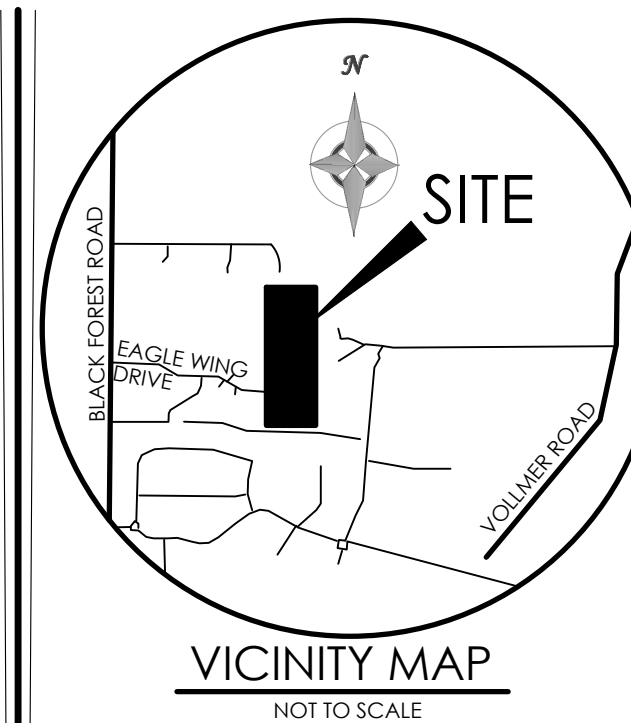

BENCHMARK

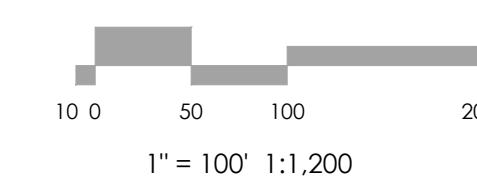
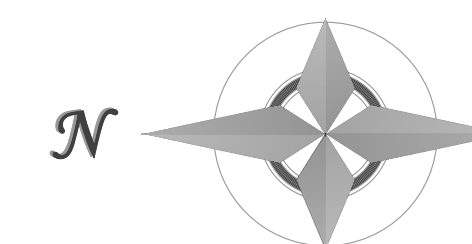

MVE, INC.
ENGINEERS & SURVEYORS

1903 Leary Street, Suite 200 Colorado Springs, CO 80909 719.635.5736

REVISIONS

DESIGNED BY
DRAWN BY
CHECKED BY
AS-BUILTS BY
CHECKED BY

EAGLE RISING
FILING NO. 1

DEVELOPED
(ON-SITE)
DRAINAGE MAP

MVE PROJECT 61145
MVE DRAWING DRN-MAP-DEV

MAY 1, 2024
SHEET 1 OF 1

