

# **Guntzelman Porcelain Pines Subdivision Final Drainage Report**

**Colorado Springs, El Paso County, Colorado**

**January 2024**

**Completed By:**

**Brett Louk, P.E.**

**PCD No. MS234**



620 North Tejon, Suite 201  
Colorado Springs, Colorado 80903  
719-465-2145  
blouk@smhconsultants.com

# TABLE OF CONTENTS

- TABLE OF CONTENTS ..... 1
- STATEMENT SHEET ..... 2
- 1. INTRODUCTION ..... 3
- 2. DRAINAGE BASINS AND SUB-BASINS ..... 4
- 3. DRAINAGE DESIGN CRITERIA..... 6
- 4. DRAINAGE FACILITY DESIGN ..... 7
- 5. FOUR STEP PROCESS ..... 8
- 6. FLOODPLAIN STATEMENT ..... 9
- 7. DRAINAGE BASIN FEES ..... 9
- 8. SUMMARY..... 9

# STATEMENT SHEET

## **Engineer's Statement:**

The attached drainage plan and report were prepared under my direction and supervision and are correct to the best of my knowledge and belief. Said drainage report has been prepared according to the criteria established by the County for drainage reports and said report is in conformity with the master plan of the drainage basin. I accept responsibility for any liability caused by any negligent acts, errors or omissions on my part in preparing this report.

\_\_\_\_\_  
Brett Louk, P.E. # \_\_\_\_\_

\_\_\_\_\_  
Date

## **Developer's Statement:**

I, the developer have read and will comply with all of the requirements specified in this drainage report and plan.

Owner: \_\_\_\_\_

\_\_\_\_\_  
Date

Address: 5381 Sugar Camp Road

Milford, OH 45150

## **El Paso County:**

Filed in accordance with the requirements of the Drainage Criteria Manual, Volumes 1 and 2, El Paso County Engineering Criteria Manual and Land Development Code as amended

\_\_\_\_\_  
Joshua Palmer, P.E.  
ECM Administrator/County Engineer

\_\_\_\_\_  
Date

Conditions:

# 1. INTRODUCTION

The owner of parcel number 8322200018 (TBD Nampa Rd.) has asked SMH Consultants, P.A. (SMH) to conduct a stormwater drainage analysis for the proposed Guntzelman Porcelain Pines Subdivision to satisfy the El Paso County drainage criteria manual requirements. This analysis will determine potential impacts resulting from subdividing a 35.06-acre parcel into three single-family residential lots.

## a. Development Location

The property is located in the NW  $\frac{1}{4}$  of Section 22, Township 13 South, Range 68 West of the Sixth Principal Meridian in Cascade, El Paso County, Colorado. Major streets adjacent to the subdivision include Kulsa Road, Mountain Road, Ute Road, Nampa Road, and Pikes Peak Highway. There are no major drainage ways or existing facilities on the property, however, there are two natural drainage corridors that run through the property. Runoff from the site generally flows into Fountain Creek to the northeast. The site is generally bordered by the Ute Pass Summer Colorado Subdivision #1 to the north, the Pikes Peak Mountain Estates & Azco Properties LLC to the east, and Pike National Forest to the south and west. A vicinity map has been provided in the appendix of this report. The subject property is to be platted into three single-family lots.

## b. Description of Property

The 35.06-acre site is to be divided into three residential lots. The site is located within the Upper Fountain Drainage Basin. The site is heavily forested and has slopes that vary from 20% to 50%.

Based on a Custom Soil Resource Report, obtained from the USDA NRCS Web Soil Survey (accessed February 7, 2023) for the site, the primary soils on the site include Legault-Rock outcrop complex and Tecolote very gravely sandy loam. The Legault-Rock outcrop complex is classified as Hydrologic Soils Group D and range in slope from 15%-65%. Group D soils include soils that have a very slow infiltration rate (high runoff potential) when thoroughly wet, consist of mainly clays that have a high shrink-swell potential and have a slow rate of water transmission. Tecolote soils are classified as Hydrologic Soils Group B and range in slope from 15%-40%. Group B soils include soils that have a moderate infiltration rate (medium to low runoff potential) when thoroughly wet, consist mainly of moderately deep or deep, moderately well drained or well drained soils and have a moderate rate of water transmission. The Custom Soil Report has been included in the appendix of this report.

The nearest major drainageway is Fountain Creek. Fountain Creek flows southeast eventually flowing into the Arkansas River. There are no irrigation facilities on the site. There are currently no existing utilities on the site, however, water and electric services are located on Kulsa Road.



## **2. DRAINAGE BASINS AND SUB-BASINS**

### **a. Major Basin Descriptions**

The subject site is located entirely in the Upper Fountain Drainage Basin. The site can be split into 8 smaller sub-basin drainage areas based on where flows leave the site. The Drainage Maps have been included in the appendix of this report. The entirety of the site flows to the east/northeast into Fountain Creek.

### **b. Sub-Basin Descriptions**

#### **Existing Conditions**

Offsite Drainage Area OS-1 is approximately 2.48 acres and is located south of the site on Pike National Forest property. Stormwater runoff flows northeast at slopes ranging from 50-70 percent and flows along existing terrain patterns through drainage area EX-1 and leaves the site at Design Point 1. This drainage area is heavily forested. Offsite Drainage Area OS-1 has existing runoff values of 1.42 cfs and 7.96 cfs, respectively for the 5-year and 100-year events.

Offsite Drainage Area OS-2 is approximately 2.10 acres and is located south of the site on Pike National Forest Property. Stormwater runoff flows northeast at slopes ranging from 60-90 percent and flows along existing terrain patterns through drainage area EX-2 and leaves the site at Design Point 2. This drainage area is heavily forested. Offsite Drainage Area OS-2 has existing runoff values of 1.09 cfs and 6.10 cfs, respectively for the 5-year and 100-year events.

Offsite Drainage Area OS-3 is approximately 11.34 acres and is located south/southwest of the site on Pike National Forest property. Stormwater runoff flows northeast at slopes ranging from 70-80 percent and flows along existing terrain patterns through drainage area EX-3 and leaves the site at Design Point 3. This drainage area is heavily forested. Offsite Drainage Area OS-3 has existing runoff values of 6.07 cfs and 33.98 cfs, respectively for the 5-year and 100-year events.

Offsite Drainage Area OS-4 is approximately 4.04 acres and is located southwest of the site on Pike National Forest property. Stormwater runoff flows northeast at slopes ranging from 70-90 percent and flows along existing terrain patterns through drainage area EX-4 and leaves the site at Design Point 4. This drainage area is heavily forested. Offsite Drainage Area OS-4 has existing runoff values of 2.28 cfs and 12.75 cfs, respectively for the 5-year and 100-year events.

Offsite Drainage Area OS-5 is approximately 4.82 acres and is located west of the site on Pike National Forest property. Stormwater runoff flows northeast at slopes ranging from 70-80 percent and flows along existing terrain patterns through drainage area EX-6 and leaves the site at Design Point 6. This drainage area is heavily forested. Offsite Drainage Area OS-5

has existing runoff values of 2.60 cfs and 14.56 cfs, respectively for the 5-year and 100-year events.

Offsite Drainage Area OS-6 is approximately 19.17 acres and is located west of the site on Pike National Forest property. Stormwater runoff flows northeast at slopes ranging from 60-80 percent and flows along existing terrain patterns through drainage area EX-8 and leaves the site at Design Point 8. This drainage area is heavily forested. Offsite Drainage Area OS-6 has existing runoff values of 8.88 cfs and 49.68 cfs, respectively for the 5-year and 100-year events.

Offsite Drainage Area OS-7 is approximately 6.26 acres and is located north/northwest of the site on Pike National Forest property, an adjacent unplatted single-family residential lot, and lots 114-116 of Ute Pass Summer Homes Colorado Subdivision No. 1. Stormwater runoff flows north/northeast/southeast at slopes ranging from 25-35 percent and flows along existing terrain patterns through drainage area EX-8 and leaves the site at Design Point 8. This drainage area is heavily forested, contains three single-family residences, gravel drives/parking, and asphalt drives. Offsite Drainage Area OS-7 has existing runoff values of 3.26 cfs and 16.42 cfs, respectively for the 5-year and 100-year events.

Drainage Area EX-1 is approximately 0.39 acres and is located in the southeast corner of the property. Stormwater runoff flows northeast, at slopes ranging from 30-40 percent, onto Pikes Peak Highway at Design Point 1. This drainage area is heavily forested. Drainage Area EX-1 has existing runoff values of 0.30 cfs and 1.66 cfs, respectively for the 5-year and 100-year events.

Drainage Area EX-2 is approximately 1.68 acres and is located in the southeast corner of the property. Stormwater runoff flows northeast, at slopes ranging from 35-40 percent, onto Pikes Peak Highway at Design Point 2. This drainage area is heavily forested. Drainage Area EX-2 has existing runoff values of 1.06 cfs and 5.91 cfs, respectively for the 5-year and 100-year events.

Drainage Area EX-3 is approximately 2.55 acres and is located in the southeast corner of the property. Stormwater runoff flows northeast, at slopes ranging from 35-50 percent, onto Pikes Peak Highway at Design Point 3. This drainage area is heavily forested. Drainage Area EX-3 has existing runoff values of 1.45 cfs and 8.11 cfs, respectively for the 5-year and 100-year events.

Drainage Area EX-4 is approximately 6.14 acres and is located on the south end of the property. Stormwater runoff flows northeast, at slopes ranging from 40-55 percent, onto Pikes Peak Highway at Design Point 4. This drainage area is heavily forested. Drainage Area EX-4 has existing runoff values of 3.43 cfs and 19.17 cfs, respectively for the 5-year and 100-year events.

Drainage Area EX-5 is approximately 3.58 acres and is located in the southern half of the property. Stormwater runoff flows northeast, at slopes ranging from 45-60 percent, onto Pikes Peak Highway at Design Point 5. This drainage area is heavily forested and receives no

offsite runoff. Drainage Area EX-5 has existing runoff values of 2.06 cfs and 11.52 cfs, respectively for the 5-year and 100-year events.

Drainage Area EX-6 is approximately 7.24 acres and is located in the center of the property. Stormwater runoff flows northeast, at slopes ranging from 30-50 percent, onto Pikes Peak Highway at Design Point 6. This drainage area is heavily forested. Drainage Area EX-6 has existing runoff values of 3.86 cfs and 21.61 cfs, respectively for the 5-year and 100-year events.

Drainage Area EX-7 is approximately 3.73 acres and is located in the northeast corner of the property. Stormwater runoff flows northeast, at slopes ranging from 20-25 percent, and leaves the site at Design Point 7 via one of the existing drainage corridors on the property. Flow from Design Point 7 eventually enters Fountain Creek east of the property. This drainage area is heavily forested. Drainage Area EX-7 has existing runoff values of 1.62 cfs and 9.09 cfs, respectively for the 5-year and 100-year events.

Drainage Area EX-8 is approximately 9.74 acres and is located in the north half of the property. Stormwater runoff flows northeast, at slopes ranging from 20-30 percent, and leaves the site at Design Point 8 via one of the existing drainage corridors on the property. Flow from Design Point 8 eventually enters Fountain Creek east of the property. This drainage area is heavily forested. Drainage Area EX-8 has existing runoff values of 3.95 cfs and 22.07 cfs, respectively for the 5-year and 100-year events.

### **3. DRAINAGE DESIGN CRITERIA**

#### **a. Development Criteria Reference**

Pre- and post-development drainage characteristics were reviewed, studied, and analyzed using the *El Paso County Drainage Criteria Manual*, Federal Emergency Management Agency's Flood Insurance Rate Map and USDA NRCS Web Soil Survey.

#### **b. Hydrologic Criteria**

Hydrology calculations in this report were performed following the methodologies outlined in the El Paso County Engineering Criteria Manual and the El Paso County Drainage Criteria Manual (DCM) Volumes 1 and 2. Drainage characteristics were delineated based on existing topographic information from topographic survey, Lidar and USGS topographical maps. The existing drainage map has been included in the appendix of this report.

Since the watershed area encompassing the development site is less than 100 acres, the Rational Method was used to determine peak flows for the 5-year and 100-year storm events. Weighted C values were determined for each drainage area within the proposed site based on the amount of impervious and pervious areas. A runoff coefficient (C) was chosen from Table 6-6 of the *El Paso County Drainage Criteria Manual, Volume 1 Update*. As mentioned earlier, the site consists of Hydrological Soil Groups D and B. To be conservative, all

calculations were performed using values for Hydrologic Soils Group D. The Weighted C values are shown in the Appendix of this report.

The time of concentration was calculated for each drainage area based off methods found in Chapter 6, Section 3.2 of the *El Paso County Drainage Criteria Manual, Volume 1 update*. The first 300 feet of unconcentrated overland flow time was calculated and added to the subsequent channelized flow times. Channelized flow times were calculated using channel flow time equation. All time of concentration calculations can be seen in the appendix of this report.

## **4. DRAINAGE FACILITY DESIGN**

### **a. General Concept**

The site will be subdivided into three single-family residential lots. This development does not include any lot grading, however, it does include grading and construction of a private drive to serve the lots and installation of a storm sewer culvert under the private drive. In lieu of this, the developed drainage basins and design points are the same as pre-developed. The C values for the site will change minimally due to the addition of the single-family residences. The 5-year and 100-year runoff calculations can be seen in the appendix of this report.

Drainage Area P-1 is approximately 0.39 acres and is located in the southeast corner of the property. Stormwater runoff flows northeast, at slopes ranging from 30-40 percent, onto Pikes Peak Highway at Design Point 1. This drainage area is heavily forested and will remain unchanged from existing conditions. Drainage Area P-1 has runoff values of 0.30 cfs and 1.66 cfs, respectively for the 5-year and 100-year events.

Drainage Area P-2 is approximately 1.68 acres and is located in the southeast corner of the property. Stormwater runoff flows northeast, at slopes ranging from 35-40 percent, onto Pikes Peak Highway at Design Point 2. This drainage area is heavily forested and will remain unchanged from existing conditions. Drainage Area P-2 has runoff values of 1.06 cfs and 5.91 cfs, respectively for the 5-year and 100-year events.

Drainage Area P-3 is approximately 2.55 acres and is located in the southeast corner of the property. Stormwater runoff flows northeast, at slopes ranging from 35-50 percent, onto Pikes Peak Highway at Design Point 3. This drainage area is heavily forested and will remain unchanged from existing conditions. Drainage Area P-3 has runoff values of 1.45 cfs and 8.11 cfs, respectively for the 5-year and 100-year events.

Drainage Area P-4 is approximately 6.14 acres and is located on the south end of the property. Stormwater runoff flows northeast, at slopes ranging from 40-55 percent, onto Pikes Peak Highway at Design Point 4. This drainage area is heavily forested and will remain unchanged from existing conditions. Drainage Area P-4 has runoff values of 3.43 cfs and 19.17 cfs, respectively for the 5-year and 100-year events.

Drainage Area P-5 is approximately 3.58 acres and is located in the southern half of the property. Stormwater runoff flows northeast, at slopes ranging from 45-60 percent, onto Pikes Peak Highway at Design Point 5. This drainage area is heavily forested, receives no offsite runoff, and will remain unchanged from existing conditions. Drainage Area P-5 has existing runoff values of 2.06 cfs and 11.52 cfs, respectively for the 5-year and 100-year events.

Drainage Area P-6 is approximately 7.24 acres and is located in the center of the property. Stormwater runoff flows northeast, at slopes ranging from 30-50 percent, onto Pikes Peak Highway at Design Point 6. This drainage area consists of heavily forested areas, a future single-family residence, and a drive to serve the residence. Drainage Area P-6 has proposed runoff values of 4.86 cfs and 22.81 cfs, respectively for the 5-year and 100-year events.

Drainage Area P-7 is approximately 3.73 acres and is located in the northeast corner of the property. Stormwater runoff flows northeast, at slopes ranging from 20-25 percent, and leaves the site at Design Point 7 via one of the existing drainage corridors on the property. Flow from Design Point 7 eventually enters Fountain Creek east of the property. This drainage area consists of heavily forested areas, a future single-family residence, and a drive to serve the residence. Drainage Area P-7 has proposed runoff values of 2.04 cfs and 9.59 cfs, respectively for the 5-year and 100-year events.

Drainage Area P-8 is approximately 9.74 acres and is located in the north half of the property. Stormwater runoff flows northeast, at slopes ranging from 20-30 percent, and leaves the site at Design Point 8 via one of the existing drainage corridors on the property. Flow from Design Point 8 eventually enters Fountain Creek east of the property. This drainage area consists of heavily forested areas, two future single-family residences, and drives to serve the residences. This drainage area will also include dual 30" culverts under the private drive serving the individual lots. Drainage Area P-8 has existing runoff values of 4.96 cfs and 23.27 cfs, respectively for the 5-year and 100-year events.

Please revise as drainage map shows a 24" dual culvert.

## 5. FOUR STEP PROCESS

El Paso County requires a four step process for stormwater quality management: reducing runoff volumes, treating the water quality capture volume, stabilizing streams, and implementing long-term source controls. These steps are further outlined in Volumes 1 and 2 of the County's Drainage Criteria Manual.

Step 1: Employ Runoff Reduction Practices. The site has been designed so that all runoff runs through native vegetation before leaving the site and entering downstream receiving waters. The new driveway will be constructed of gravel, which has a greater infiltration rate than that of typical pavement. This will minimize directly connected impervious areas within the site.

Step 2: Implement BMPs that Provide Water Quality Capture Volume (WQCV) with Slow Release. Per the Phase II Stormwater Regulations in Volume II of the Drainage Criteria Manual, this site is not required to provide permanent stormwater quality facilities. The total

area to be disturbed for the private drive will be less than 1 acre. Per the County's Post Construction Stormwater Management Applicability (PBMP) Evaluation Form, permanent BMPs are not required as the project is considered a Large Lot Single-Family site with greater than 2.5 acres per dwelling and less than 10% impervious area for each lot.

Step 3: Stabilize Drainageways. The existing natural channels will remain in place and undisturbed. Leaving the existing native vegetation will provide established vegetation to help prevent erosion. Once runoff leaves the site, it will travel approximately 1,199 feet, through native vegetation, before it enters Fountain Creek. The increase in runoff from the proposed site is also minimal. Because of the path the runoff from the subject site takes, before it enters the first receiving waters, no downstream improvements are needed.

Step 4: Implement Site Specific and Other Source Control BMPs. Soil erosion control measures will be implemented during construction of the private drive serving the individual lots, and in the future when the single-family residences are constructed on each individual lot. Some of the measures to be implemented during construction include: silt fence, temporary construction entrance, permanent/temporary seeding, slope tracking/stabilization, erosion control blanket, etc. The erosion control measures to be utilized during construction will be further outlined at the time of building permit application.

## **6. FLOODPLAIN STATEMENT**

The site is located in Zone X (areas of minimal flood hazard) and Zone D (areas which flood hazards are undetermined, but possible) as determined by the Flood Insurance Rate Map (FIRM) number 08041C0486G effective date December 7, 2018 (see appendix).

## **7. DRAINAGE BASIN FEES**

The site is located entirely within the Upper Fountain Drainage Basin. The Upper Fountain Drainage Basin is not studied within El Paso County, therefore no fees are due.

## **8. SUMMARY**

A drainage analysis was conducted for a 35.06-acre residential site to be subdivided into three single-family residential lots and will be known as Guntzelman Porcelain Pines Subdivision. The site is located in the Upper Fountain drainage basin. Based on the analysis, the 5-year & 100-year post-development stormwater peak flow rates will be slightly higher than the pre-developed stormwater peak flow rates. Subdividing the site and developing the residential lots should not adversely impact surrounding or downstream properties.

Please state the difference in pre and post-development flows.

## References

El Paso County Assessor (2020). *El Paso County Assessor's Real Property Search*. Retrieved from <https://www.elpasoco.com/search-el-paso-county/>

El Paso County Clerk and Recorder (2001-2020). *El Paso County Clerk and Recorder Web Access*. Retrieved from [publicrecordsearch.elpasoco.com/](http://publicrecordsearch.elpasoco.com/)

United States Department of Agriculture Natural Resources Conservation Service (2091, July 31). *Web Soil Survey*. Retrieved from <https://websoilsurvey.sc.egov.usda.gov/App/WebSoilSurvey.aspx>

Federal Emergency Management Agency (2020). *FEMA Flood Map Service Center*. Retrieved from <https://msc.fema.gov/portal/home>

El Paso County, Colorado (2018). *Drainage Criteria Manual Volume 1*. Retrieved from: [https://library.municode.com/co/el\\_paso\\_county/codes/drainage\\_criteria\\_manual?nodeId=DRCRMAVO1ELPACO](https://library.municode.com/co/el_paso_county/codes/drainage_criteria_manual?nodeId=DRCRMAVO1ELPACO)

El Paso County, Colorado (2018). *Drainage Criteria Manual Volume 2*. Retrieved from: [https://library.municode.com/co/el\\_paso\\_county/codes/drainage\\_criteria\\_manual?nodeId=DRCRMAVO2STQUPOPRBEMAPRBM](https://library.municode.com/co/el_paso_county/codes/drainage_criteria_manual?nodeId=DRCRMAVO2STQUPOPRBEMAPRBM)

# APPENDIX

---



# VICINITY MAP

---



REVISION DATE	REVISION DESCRIPTION (DESCRIPTION)
00/00/00	

VICINITY MAP

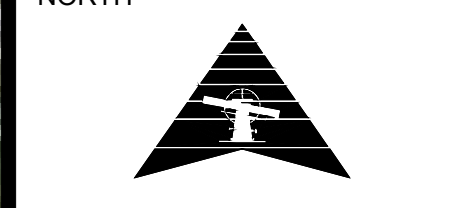

SCALE: 1" = 150'

PROJECT #: 2107-0307  
CHECKED BY: BML  
DRAWN BY: JMT

DATE: 07/08/2022

SHEET # **FIG. 1**

TOTAL SHEETS

# SOILS REPORT

---





A product of the National Cooperative Soil Survey, a joint effort of the United States Department of Agriculture and other Federal agencies, State agencies including the Agricultural Experiment Stations, and local participants

# Custom Soil Resource Report for Pike National Forest, Eastern Part, Colorado, Parts of Douglas, El Paso, Jefferson, and Teller Counties



# Preface

---

Soil surveys contain information that affects land use planning in survey areas. They highlight soil limitations that affect various land uses and provide information about the properties of the soils in the survey areas. Soil surveys are designed for many different users, including farmers, ranchers, foresters, agronomists, urban planners, community officials, engineers, developers, builders, and home buyers. Also, conservationists, teachers, students, and specialists in recreation, waste disposal, and pollution control can use the surveys to help them understand, protect, or enhance the environment.

Various land use regulations of Federal, State, and local governments may impose special restrictions on land use or land treatment. Soil surveys identify soil properties that are used in making various land use or land treatment decisions. The information is intended to help the land users identify and reduce the effects of soil limitations on various land uses. The landowner or user is responsible for identifying and complying with existing laws and regulations.

Although soil survey information can be used for general farm, local, and wider area planning, onsite investigation is needed to supplement this information in some cases. Examples include soil quality assessments (<http://www.nrcs.usda.gov/wps/portal/nrcs/main/soils/health/>) and certain conservation and engineering applications. For more detailed information, contact your local USDA Service Center (<https://offices.sc.egov.usda.gov/locator/app?agency=nrcs>) or your NRCS State Soil Scientist ([http://www.nrcs.usda.gov/wps/portal/nrcs/detail/soils/contactus/?cid=nrcs142p2\\_053951](http://www.nrcs.usda.gov/wps/portal/nrcs/detail/soils/contactus/?cid=nrcs142p2_053951)).

Great differences in soil properties can occur within short distances. Some soils are seasonally wet or subject to flooding. Some are too unstable to be used as a foundation for buildings or roads. Clayey or wet soils are poorly suited to use as septic tank absorption fields. A high water table makes a soil poorly suited to basements or underground installations.

The National Cooperative Soil Survey is a joint effort of the United States Department of Agriculture and other Federal agencies, State agencies including the Agricultural Experiment Stations, and local agencies. The Natural Resources Conservation Service (NRCS) has leadership for the Federal part of the National Cooperative Soil Survey.

Information about soils is updated periodically. Updated information is available through the NRCS Web Soil Survey, the site for official soil survey information.

The U.S. Department of Agriculture (USDA) prohibits discrimination in all its programs and activities on the basis of race, color, national origin, age, disability, and where applicable, sex, marital status, familial status, parental status, religion, sexual orientation, genetic information, political beliefs, reprisal, or because all or a part of an individual's income is derived from any public assistance program. (Not all prohibited bases apply to all programs.) Persons with disabilities who require

alternative means for communication of program information (Braille, large print, audiotape, etc.) should contact USDA's TARGET Center at (202) 720-2600 (voice and TDD). To file a complaint of discrimination, write to USDA, Director, Office of Civil Rights, 1400 Independence Avenue, S.W., Washington, D.C. 20250-9410 or call (800) 795-3272 (voice) or (202) 720-6382 (TDD). USDA is an equal opportunity provider and employer.

# Contents

---

<b>Preface</b> .....	2
<b>How Soil Surveys Are Made</b> .....	5
<b>Soil Map</b> .....	8
Soil Map.....	9
Legend.....	10
Map Unit Legend.....	12
Map Unit Descriptions.....	12
Pike National Forest, Eastern Part, Colorado, Parts of Douglas, El Paso, Jefferson, and Teller Counties.....	14
26—Legault-Rock outcrop complex, 15 to 65 percent slopes.....	14
48—Tecolote very gravelly sandy loam, 15 to 40 percent slopes, very stony.....	16
<b>References</b> .....	18

# How Soil Surveys Are Made

---

Soil surveys are made to provide information about the soils and miscellaneous areas in a specific area. They include a description of the soils and miscellaneous areas and their location on the landscape and tables that show soil properties and limitations affecting various uses. Soil scientists observed the steepness, length, and shape of the slopes; the general pattern of drainage; the kinds of crops and native plants; and the kinds of bedrock. They observed and described many soil profiles. A soil profile is the sequence of natural layers, or horizons, in a soil. The profile extends from the surface down into the unconsolidated material in which the soil formed or from the surface down to bedrock. The unconsolidated material is devoid of roots and other living organisms and has not been changed by other biological activity.

Currently, soils are mapped according to the boundaries of major land resource areas (MLRAs). MLRAs are geographically associated land resource units that share common characteristics related to physiography, geology, climate, water resources, soils, biological resources, and land uses (USDA, 2006). Soil survey areas typically consist of parts of one or more MLRA.

The soils and miscellaneous areas in a survey area occur in an orderly pattern that is related to the geology, landforms, relief, climate, and natural vegetation of the area. Each kind of soil and miscellaneous area is associated with a particular kind of landform or with a segment of the landform. By observing the soils and miscellaneous areas in the survey area and relating their position to specific segments of the landform, a soil scientist develops a concept, or model, of how they were formed. Thus, during mapping, this model enables the soil scientist to predict with a considerable degree of accuracy the kind of soil or miscellaneous area at a specific location on the landscape.

Commonly, individual soils on the landscape merge into one another as their characteristics gradually change. To construct an accurate soil map, however, soil scientists must determine the boundaries between the soils. They can observe only a limited number of soil profiles. Nevertheless, these observations, supplemented by an understanding of the soil-vegetation-landscape relationship, are sufficient to verify predictions of the kinds of soil in an area and to determine the boundaries.

Soil scientists recorded the characteristics of the soil profiles that they studied. They noted soil color, texture, size and shape of soil aggregates, kind and amount of rock fragments, distribution of plant roots, reaction, and other features that enable them to identify soils. After describing the soils in the survey area and determining their properties, the soil scientists assigned the soils to taxonomic classes (units). Taxonomic classes are concepts. Each taxonomic class has a set of soil characteristics with precisely defined limits. The classes are used as a basis for comparison to classify soils systematically. Soil taxonomy, the system of taxonomic classification used in the United States, is based mainly on the kind and character of soil properties and the arrangement of horizons within the profile. After the soil



## Custom Soil Resource Report

scientists classified and named the soils in the survey area, they compared the individual soils with similar soils in the same taxonomic class in other areas so that they could confirm data and assemble additional data based on experience and research.

The objective of soil mapping is not to delineate pure map unit components; the objective is to separate the landscape into landforms or landform segments that have similar use and management requirements. Each map unit is defined by a unique combination of soil components and/or miscellaneous areas in predictable proportions. Some components may be highly contrasting to the other components of the map unit. The presence of minor components in a map unit in no way diminishes the usefulness or accuracy of the data. The delineation of such landforms and landform segments on the map provides sufficient information for the development of resource plans. If intensive use of small areas is planned, onsite investigation is needed to define and locate the soils and miscellaneous areas.

Soil scientists make many field observations in the process of producing a soil map. The frequency of observation is dependent upon several factors, including scale of mapping, intensity of mapping, design of map units, complexity of the landscape, and experience of the soil scientist. Observations are made to test and refine the soil-landscape model and predictions and to verify the classification of the soils at specific locations. Once the soil-landscape model is refined, a significantly smaller number of measurements of individual soil properties are made and recorded. These measurements may include field measurements, such as those for color, depth to bedrock, and texture, and laboratory measurements, such as those for content of sand, silt, clay, salt, and other components. Properties of each soil typically vary from one point to another across the landscape.

Observations for map unit components are aggregated to develop ranges of characteristics for the components. The aggregated values are presented. Direct measurements do not exist for every property presented for every map unit component. Values for some properties are estimated from combinations of other properties.

While a soil survey is in progress, samples of some of the soils in the area generally are collected for laboratory analyses and for engineering tests. Soil scientists interpret the data from these analyses and tests as well as the field-observed characteristics and the soil properties to determine the expected behavior of the soils under different uses. Interpretations for all of the soils are field tested through observation of the soils in different uses and under different levels of management. Some interpretations are modified to fit local conditions, and some new interpretations are developed to meet local needs. Data are assembled from other sources, such as research information, production records, and field experience of specialists. For example, data on crop yields under defined levels of management are assembled from farm records and from field or plot experiments on the same kinds of soil.

Predictions about soil behavior are based not only on soil properties but also on such variables as climate and biological activity. Soil conditions are predictable over long periods of time, but they are not predictable from year to year. For example, soil scientists can predict with a fairly high degree of accuracy that a given soil will have a high water table within certain depths in most years, but they cannot predict that a high water table will always be at a specific level in the soil on a specific date.

After soil scientists located and identified the significant natural bodies of soil in the survey area, they drew the boundaries of these bodies on aerial photographs and

## Custom Soil Resource Report

identified each as a specific map unit. Aerial photographs show trees, buildings, fields, roads, and rivers, all of which help in locating boundaries accurately.

# Soil Map

---

The soil map section includes the soil map for the defined area of interest, a list of soil map units on the map and extent of each map unit, and cartographic symbols displayed on the map. Also presented are various metadata about data used to produce the map, and a description of each soil map unit.

# Custom Soil Resource Report Soil Map

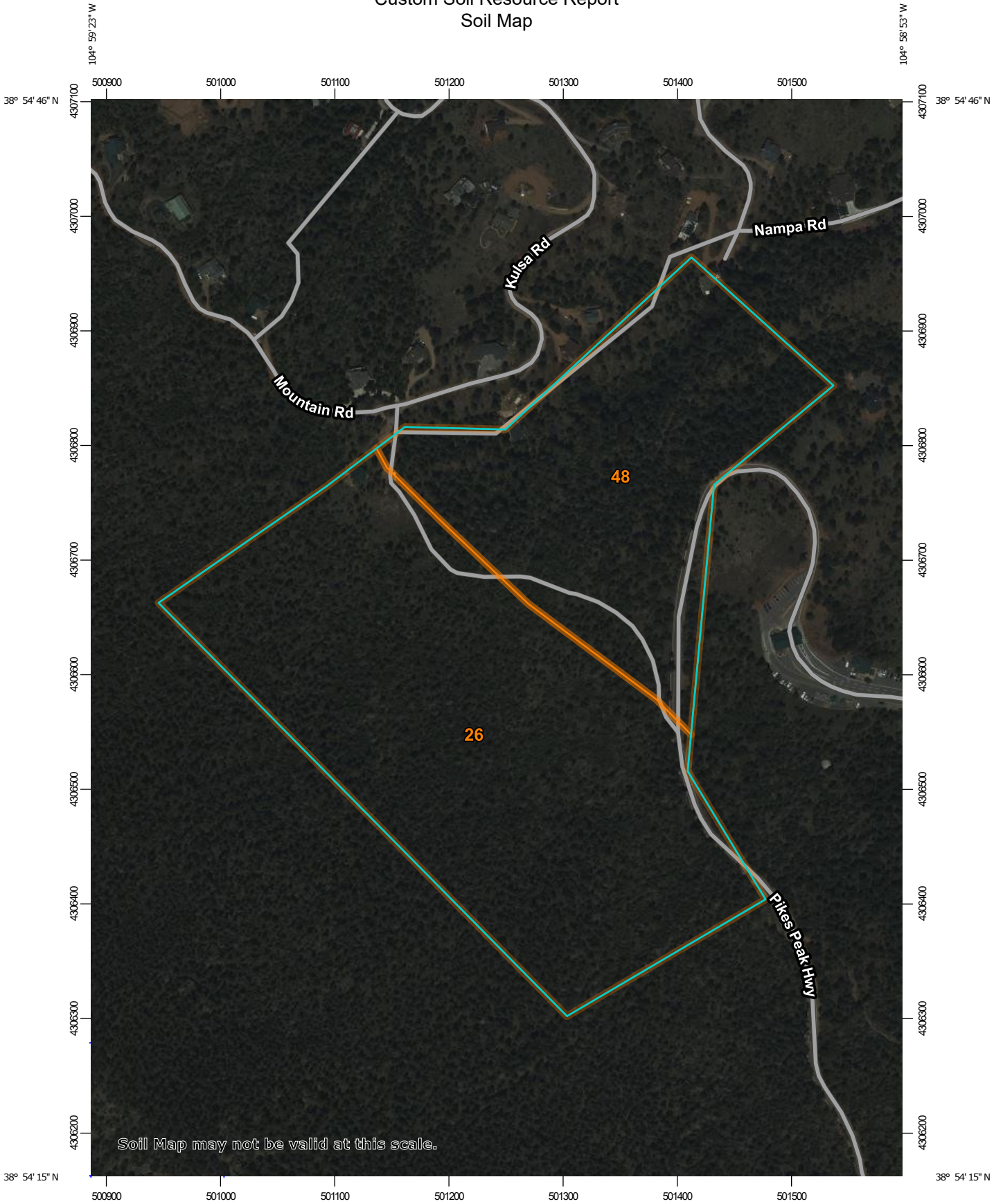

Map Scale: 1:4,580 if printed on A portrait (8.5" x 11") sheet.

0 50 100 200 300 Meters

0 200 400 800 1200 Feet

Map projection: Web Mercator Corner coordinates: WGS84 Edge tics: UTM Zone 13N WGS84



### MAP LEGEND

**Area of Interest (AOI)**

 Area of Interest (AOI)



















**Soils**

 Soil Map Unit Polygons

 Soil Map Unit Lines

 Soil Map Unit Points

**Special Point Features**





-  Blowout
-  Borrow Pit
-  Clay Spot
-  Closed Depression
-  Gravel Pit
-  Gravelly Spot
-  Landfill
-  Lava Flow
-  Marsh or swamp
-  Mine or Quarry
-  Miscellaneous Water
-  Perennial Water
-  Rock Outcrop
-  Saline Spot
-  Sandy Spot
-  Severely Eroded Spot
-  Sinkhole
-  Slide or Slip
-  Sodic Spot

-  Spoil Area
-  Stony Spot
-  Very Stony Spot
-  Wet Spot
-  Other
-  Special Line Features

**Water Features**

 Streams and Canals

**Transportation**

-  Rails
-  Interstate Highways
-  US Routes
-  Major Roads
-  Local Roads

**Background**

 Aerial Photography

### MAP INFORMATION

The soil surveys that comprise your AOI were mapped at 1:24,000.

Warning: Soil Map may not be valid at this scale.

Enlargement of maps beyond the scale of mapping can cause misunderstanding of the detail of mapping and accuracy of soil line placement. The maps do not show the small areas of contrasting soils that could have been shown at a more detailed scale.

Please rely on the bar scale on each map sheet for map measurements.

Source of Map: Natural Resources Conservation Service  
 Web Soil Survey URL:  
 Coordinate System: Web Mercator (EPSG:3857)

Maps from the Web Soil Survey are based on the Web Mercator projection, which preserves direction and shape but distorts distance and area. A projection that preserves area, such as the Albers equal-area conic projection, should be used if more accurate calculations of distance or area are required.

This product is generated from the USDA-NRCS certified data as of the version date(s) listed below.

Soil Survey Area: Pike National Forest, Eastern Part, Colorado, Parts of Douglas, El Paso, Jefferson, and Teller Counties  
 Survey Area Data: Version 9, Sep 7, 2022

Soil map units are labeled (as space allows) for map scales 1:50,000 or larger.

Date(s) aerial images were photographed: May 18, 2020—May 21, 2020

The orthophoto or other base map on which the soil lines were compiled and digitized probably differs from the background

**MAP LEGEND**

**MAP INFORMATION**

imagery displayed on these maps. As a result, some minor shifting of map unit boundaries may be evident.

## Map Unit Legend

Map Unit Symbol	Map Unit Name	Acres in AOI	Percent of AOI
26	Legault-Rock outcrop complex, 15 to 65 percent slopes	29.3	63.2%
48	Tecolote very gravelly sandy loam, 15 to 40 percent slopes, very stony	17.0	36.8%
<b>Totals for Area of Interest</b>		<b>46.3</b>	<b>100.0%</b>

## Map Unit Descriptions

The map units delineated on the detailed soil maps in a soil survey represent the soils or miscellaneous areas in the survey area. The map unit descriptions, along with the maps, can be used to determine the composition and properties of a unit.

A map unit delineation on a soil map represents an area dominated by one or more major kinds of soil or miscellaneous areas. A map unit is identified and named according to the taxonomic classification of the dominant soils. Within a taxonomic class there are precisely defined limits for the properties of the soils. On the landscape, however, the soils are natural phenomena, and they have the characteristic variability of all natural phenomena. Thus, the range of some observed properties may extend beyond the limits defined for a taxonomic class. Areas of soils of a single taxonomic class rarely, if ever, can be mapped without including areas of other taxonomic classes. Consequently, every map unit is made up of the soils or miscellaneous areas for which it is named and some minor components that belong to taxonomic classes other than those of the major soils.

Most minor soils have properties similar to those of the dominant soil or soils in the map unit, and thus they do not affect use and management. These are called noncontrasting, or similar, components. They may or may not be mentioned in a particular map unit description. Other minor components, however, have properties and behavioral characteristics divergent enough to affect use or to require different management. These are called contrasting, or dissimilar, components. They generally are in small areas and could not be mapped separately because of the scale used. Some small areas of strongly contrasting soils or miscellaneous areas are identified by a special symbol on the maps. If included in the database for a given area, the contrasting minor components are identified in the map unit descriptions along with some characteristics of each. A few areas of minor components may not have been observed, and consequently they are not mentioned in the descriptions, especially where the pattern was so complex that it was impractical to make enough observations to identify all the soils and miscellaneous areas on the landscape.

The presence of minor components in a map unit in no way diminishes the usefulness or accuracy of the data. The objective of mapping is not to delineate pure taxonomic classes but rather to separate the landscape into landforms or landform segments that have similar use and management requirements. The delineation of such segments on the map provides sufficient information for the

## Custom Soil Resource Report

development of resource plans. If intensive use of small areas is planned, however, onsite investigation is needed to define and locate the soils and miscellaneous areas.

An identifying symbol precedes the map unit name in the map unit descriptions. Each description includes general facts about the unit and gives important soil properties and qualities.

Soils that have profiles that are almost alike make up a *soil series*. Except for differences in texture of the surface layer, all the soils of a series have major horizons that are similar in composition, thickness, and arrangement.

Soils of one series can differ in texture of the surface layer, slope, stoniness, salinity, degree of erosion, and other characteristics that affect their use. On the basis of such differences, a soil series is divided into *soil phases*. Most of the areas shown on the detailed soil maps are phases of soil series. The name of a soil phase commonly indicates a feature that affects use or management. For example, Alpha silt loam, 0 to 2 percent slopes, is a phase of the Alpha series.

Some map units are made up of two or more major soils or miscellaneous areas. These map units are complexes, associations, or undifferentiated groups.

A *complex* consists of two or more soils or miscellaneous areas in such an intricate pattern or in such small areas that they cannot be shown separately on the maps. The pattern and proportion of the soils or miscellaneous areas are somewhat similar in all areas. Alpha-Beta complex, 0 to 6 percent slopes, is an example.

An *association* is made up of two or more geographically associated soils or miscellaneous areas that are shown as one unit on the maps. Because of present or anticipated uses of the map units in the survey area, it was not considered practical or necessary to map the soils or miscellaneous areas separately. The pattern and relative proportion of the soils or miscellaneous areas are somewhat similar. Alpha-Beta association, 0 to 2 percent slopes, is an example.

An *undifferentiated group* is made up of two or more soils or miscellaneous areas that could be mapped individually but are mapped as one unit because similar interpretations can be made for use and management. The pattern and proportion of the soils or miscellaneous areas in a mapped area are not uniform. An area can be made up of only one of the major soils or miscellaneous areas, or it can be made up of all of them. Alpha and Beta soils, 0 to 2 percent slopes, is an example.

Some surveys include *miscellaneous areas*. Such areas have little or no soil material and support little or no vegetation. Rock outcrop is an example.



## Pike National Forest, Eastern Part, Colorado, Parts of Douglas, El Paso, Jefferson, and Teller Counties

### 26—Legault-Rock outcrop complex, 15 to 65 percent slopes

#### Map Unit Setting

*National map unit symbol:* jpj7  
*Elevation:* 6,500 to 12,000 feet  
*Mean annual precipitation:* 17 to 25 inches  
*Mean annual air temperature:* 32 to 46 degrees F  
*Frost-free period:* 20 to 100 days  
*Farmland classification:* Not prime farmland

#### Map Unit Composition

*Legault and similar soils:* 50 percent  
*Rock outcrop:* 30 percent  
*Minor components:* 20 percent  
*Estimates are based on observations, descriptions, and transects of the mapunit.*

#### Description of Legault

##### Setting

*Landform:* Mountain slopes  
*Landform position (three-dimensional):* Mountainflank  
*Down-slope shape:* Convex, linear  
*Across-slope shape:* Convex, linear  
*Parent material:* Weathered from granite

##### Typical profile

*O<sub>i</sub> - 0 to 1 inches:* slightly decomposed plant material  
*A - 1 to 3 inches:* very gravelly coarse sandy loam  
*E - 3 to 9 inches:* very gravelly coarse sandy loam  
*C - 9 to 18 inches:* very gravelly loamy coarse sand  
*Cr - 18 to 61 inches:* bedrock

##### Properties and qualities

*Slope:* 15 to 65 percent  
*Depth to restrictive feature:* 10 to 20 inches to paralithic bedrock  
*Drainage class:* Well drained  
*Runoff class:* Very high  
*Capacity of the most limiting layer to transmit water (K<sub>sat</sub>):* Very low to moderately low (0.00 to 0.06 in/hr)  
*Depth to water table:* More than 80 inches  
*Frequency of flooding:* None  
*Frequency of ponding:* None  
*Maximum salinity:* Nonsaline to very slightly saline (0.0 to 2.0 mmhos/cm)  
*Available water supply, 0 to 60 inches:* Very low (about 1.2 inches)

##### Interpretive groups

*Land capability classification (irrigated):* None specified  
*Land capability classification (nonirrigated):* 7e  
*Hydrologic Soil Group:* D  
*Ecological site:* F048AY908CO - Mixed Conifer  
*Other vegetative classification:* Douglas-fir/kinnikinnick-common juniper (PSME/ARUV-JUCO6) (C1219)

## Custom Soil Resource Report

*Hydric soil rating:* No

### Description of Rock Outcrop

#### Setting

*Landform:* Mountain slopes

*Landform position (three-dimensional):* Mountainflank

*Down-slope shape:* Convex, linear

*Across-slope shape:* Convex, linear

#### Typical profile

*- 0 to 4 inches:* bedrock

#### Properties and qualities

*Slope:* 15 to 65 percent

*Depth to restrictive feature:* 0 inches to lithic bedrock

*Runoff class:* Very high

*Capacity of the most limiting layer to transmit water (Ksat):* Very low to moderately low (0.00 to 0.06 in/hr)

#### Interpretive groups

*Land capability classification (irrigated):* None specified

*Land capability classification (nonirrigated):* 8s

*Hydrologic Soil Group:* D

*Hydric soil rating:* No

### Minor Components

#### Tecolote

*Percent of map unit:* 10 percent

*Landform:* Mountain slopes

*Landform position (three-dimensional):* Mountainbase, lower third of mountainflank

*Down-slope shape:* Convex, linear

*Across-slope shape:* Convex, linear

*Other vegetative classification:* Douglas-fir/Gambel oak (PSME/QUGA) (C1214)

*Hydric soil rating:* No

#### Sphinx

*Percent of map unit:* 5 percent

*Landform:* Mountain slopes

*Landform position (three-dimensional):* Mountaintop, mountainflank

*Down-slope shape:* Convex, linear

*Across-slope shape:* Convex, linear

*Other vegetative classification:* Ponderosa pine/kinnikinnick (PIPO/ARUV) (C1140)

*Hydric soil rating:* No

#### Herbman

*Percent of map unit:* 5 percent

*Landform:* Mountain slopes

*Landform position (three-dimensional):* Mountaintop, mountainflank

*Down-slope shape:* Convex, linear

*Across-slope shape:* Convex, linear

*Other vegetative classification:* Engelmann spruce/moss (PIEN/moss) (C0406)

*Hydric soil rating:* No

## **48—Tecolote very gravelly sandy loam, 15 to 40 percent slopes, very stony**

### **Map Unit Setting**

*National map unit symbol:* jpk0  
*Elevation:* 7,500 to 9,000 feet  
*Mean annual precipitation:* 20 to 25 inches  
*Mean annual air temperature:* 43 to 46 degrees F  
*Frost-free period:* 65 to 75 days  
*Farmland classification:* Not prime farmland

### **Map Unit Composition**

*Tecolote, very stony, and similar soils:* 85 percent  
*Minor components:* 15 percent  
*Estimates are based on observations, descriptions, and transects of the mapunit.*

### **Description of Tecolote, Very Stony**

#### **Setting**

*Landform:* Mountain slopes  
*Landform position (three-dimensional):* Mountainbase, lower third of mountainflank  
*Down-slope shape:* Convex, linear  
*Across-slope shape:* Convex, linear  
*Parent material:* Cobbly or stony colluvium over weathered granite

#### **Typical profile**

*O<sub>i</sub> - 0 to 1 inches:* slightly decomposed plant material  
*A - 1 to 3 inches:* very gravelly sandy loam  
*E - 3 to 21 inches:* very cobbly sandy loam  
*B/E - 21 to 31 inches:* very cobbly sandy clay loam  
*Bt - 31 to 46 inches:* very cobbly sandy clay loam  
*Cr - 46 to 61 inches:* bedrock

#### **Properties and qualities**

*Slope:* 15 to 40 percent  
*Surface area covered with cobbles, stones or boulders:* 3.0 percent  
*Depth to restrictive feature:* 40 to 60 inches to paralithic bedrock  
*Drainage class:* Well drained  
*Runoff class:* Medium  
*Capacity of the most limiting layer to transmit water (Ksat):* Very low to moderately low (0.00 to 0.06 in/hr)  
*Depth to water table:* More than 80 inches  
*Frequency of flooding:* None  
*Frequency of ponding:* None  
*Maximum salinity:* Nonsaline to very slightly saline (0.0 to 2.0 mmhos/cm)  
*Available water supply, 0 to 60 inches:* Low (about 3.6 inches)

## Custom Soil Resource Report

### Interpretive groups

*Land capability classification (irrigated):* None specified

*Land capability classification (nonirrigated):* 7e

*Hydrologic Soil Group:* B

*Ecological site:* F048AY924CO - Douglas Fir/Gambel Oak

*Other vegetative classification:* Douglas-fir/Gambel oak (PSME/QUGA) (C1214)

*Hydric soil rating:* No

### Minor Components

#### Tecolote, non-skeletal

*Percent of map unit:* 5 percent

*Landform:* Mountain slopes

*Landform position (three-dimensional):* Mountainbase, lower third of mountainflank

*Down-slope shape:* Convex, linear

*Across-slope shape:* Convex, linear

*Other vegetative classification:* Douglas-fir/Gambel oak (PSME/QUGA) (C1214)

*Hydric soil rating:* No

#### Tecolote, mollic

*Percent of map unit:* 5 percent

*Landform:* Mountain slopes

*Landform position (three-dimensional):* Mountainbase, lower third of mountainflank

*Down-slope shape:* Convex, linear

*Across-slope shape:* Convex, linear

*Other vegetative classification:* Douglas-fir/Gambel oak (PSME/QUGA) (C1214)

*Hydric soil rating:* No

#### Tecolote, very deep

*Percent of map unit:* 5 percent

*Landform:* Mountain slopes

*Landform position (three-dimensional):* Mountainbase, lower third of mountainflank

*Down-slope shape:* Convex, linear

*Across-slope shape:* Convex, linear

*Other vegetative classification:* Douglas-fir/Gambel oak (PSME/QUGA) (C1214)

*Hydric soil rating:* No

# References

---

- American Association of State Highway and Transportation Officials (AASHTO). 2004. Standard specifications for transportation materials and methods of sampling and testing. 24th edition.
- American Society for Testing and Materials (ASTM). 2005. Standard classification of soils for engineering purposes. ASTM Standard D2487-00.
- Cowardin, L.M., V. Carter, F.C. Golet, and E.T. LaRoe. 1979. Classification of wetlands and deep-water habitats of the United States. U.S. Fish and Wildlife Service FWS/OBS-79/31.
- Federal Register. July 13, 1994. Changes in hydric soils of the United States.
- Federal Register. September 18, 2002. Hydric soils of the United States.
- Hurt, G.W., and L.M. Vasilas, editors. Version 6.0, 2006. Field indicators of hydric soils in the United States.
- National Research Council. 1995. Wetlands: Characteristics and boundaries.
- Soil Survey Division Staff. 1993. Soil survey manual. Soil Conservation Service. U.S. Department of Agriculture Handbook 18. [http://www.nrcs.usda.gov/wps/portal/nrcs/detail/national/soils/?cid=nrcs142p2\\_054262](http://www.nrcs.usda.gov/wps/portal/nrcs/detail/national/soils/?cid=nrcs142p2_054262)
- Soil Survey Staff. 1999. Soil taxonomy: A basic system of soil classification for making and interpreting soil surveys. 2nd edition. Natural Resources Conservation Service, U.S. Department of Agriculture Handbook 436. [http://www.nrcs.usda.gov/wps/portal/nrcs/detail/national/soils/?cid=nrcs142p2\\_053577](http://www.nrcs.usda.gov/wps/portal/nrcs/detail/national/soils/?cid=nrcs142p2_053577)
- Soil Survey Staff. 2010. Keys to soil taxonomy. 11th edition. U.S. Department of Agriculture, Natural Resources Conservation Service. [http://www.nrcs.usda.gov/wps/portal/nrcs/detail/national/soils/?cid=nrcs142p2\\_053580](http://www.nrcs.usda.gov/wps/portal/nrcs/detail/national/soils/?cid=nrcs142p2_053580)
- Tiner, R.W., Jr. 1985. Wetlands of Delaware. U.S. Fish and Wildlife Service and Delaware Department of Natural Resources and Environmental Control, Wetlands Section.
- United States Army Corps of Engineers, Environmental Laboratory. 1987. Corps of Engineers wetlands delineation manual. Waterways Experiment Station Technical Report Y-87-1.
- United States Department of Agriculture, Natural Resources Conservation Service. National forestry manual. [http://www.nrcs.usda.gov/wps/portal/nrcs/detail/soils/home/?cid=nrcs142p2\\_053374](http://www.nrcs.usda.gov/wps/portal/nrcs/detail/soils/home/?cid=nrcs142p2_053374)
- United States Department of Agriculture, Natural Resources Conservation Service. National range and pasture handbook. <http://www.nrcs.usda.gov/wps/portal/nrcs/detail/national/landuse/rangepasture/?cid=stelprdb1043084>

## Custom Soil Resource Report

United States Department of Agriculture, Natural Resources Conservation Service. National soil survey handbook, title 430-VI. [http://www.nrcs.usda.gov/wps/portal/nrcs/detail/soils/scientists/?cid=nrcs142p2\\_054242](http://www.nrcs.usda.gov/wps/portal/nrcs/detail/soils/scientists/?cid=nrcs142p2_054242)

United States Department of Agriculture, Natural Resources Conservation Service. 2006. Land resource regions and major land resource areas of the United States, the Caribbean, and the Pacific Basin. U.S. Department of Agriculture Handbook 296. [http://www.nrcs.usda.gov/wps/portal/nrcs/detail/national/soils/?cid=nrcs142p2\\_053624](http://www.nrcs.usda.gov/wps/portal/nrcs/detail/national/soils/?cid=nrcs142p2_053624)

United States Department of Agriculture, Soil Conservation Service. 1961. Land capability classification. U.S. Department of Agriculture Handbook 210. [http://www.nrcs.usda.gov/Internet/FSE\\_DOCUMENTS/nrcs142p2\\_052290.pdf](http://www.nrcs.usda.gov/Internet/FSE_DOCUMENTS/nrcs142p2_052290.pdf)

# FEMA FLOOD PLAIN MAP

---



**NOTES TO USERS**

This map is for use in administering the National Flood Insurance Program. It does not necessarily identify all areas subject to flooding, particularly from local drainage sources of small size. The community map repository should be consulted for possible updated or additional flood hazard information.

To obtain more detailed information in areas where **Base Flood Elevations (BFEs)** and/or **floodways** have been determined, users are encouraged to consult the Flood Profiles and Floodway Data and/or Summary of Stillwater Elevations tables contained within the Flood Insurance Study (FIS) report that accompanies this FIRM. Users should be aware that BFEs shown on the FIRM represent rounded whole-foot elevations. These BFEs are intended for flood insurance rating purposes only and should not be used as the sole source of flood elevation information. Accordingly, flood elevation data presented in the FIS report should be utilized in conjunction with the FIRM for purposes of construction and/or floodplain management.

**Coastal Base Flood Elevations** shown on this map apply only landward of 0.0' North American Vertical Datum of 1988 (NAVD88). Users of this FIRM should be aware that coastal flood elevations are also provided in the Summary of Stillwater Elevations table in the Flood Insurance Study report for this jurisdiction. Elevations shown in the Summary of Stillwater Elevations table should be used for construction and/or floodplain management purposes when they are higher than the elevations shown on this FIRM.

Boundaries of the **floodways** were computed at cross sections and interpolated between cross sections. The floodways were based on hydraulic considerations with regard to requirements of the National Flood Insurance Program. Floodway widths and other pertinent floodway data are provided in the Flood Insurance Study report for this jurisdiction.

Certain areas not in Special Flood Hazard Areas may be protected by **flood control structures**. Refer to section 2.4 "Flood Protection Measures" of the Flood Insurance Study report for information on flood control structures for this jurisdiction.

The **projection** used in the preparation of this map was Universal Transverse Mercator (UTM) zone 13. The **horizontal datum** was NAD83, GRS80 spheroid. Differences in datum, spheroid, projection or UTM zones zones used in the production of FIRMs for adjacent jurisdictions may result in slight positional differences in map features across jurisdiction boundaries. These differences do not affect the accuracy of this FIRM.

Flood elevations on this map are referenced to the **North American Vertical Datum of 1988 (NAVD88)**. These flood elevations must be compared to structure and ground elevations referenced to the same **vertical datum**. For information regarding conversion between the National Geodetic Vertical Datum of 1929 and the North American Vertical Datum of 1988, visit the National Geodetic Survey website at <http://www.ngs.noaa.gov/> or contact the National Geodetic Survey at the following address:

NGS Information Services  
NOAA, NINGS12  
National Geodetic Survey  
SSMC-3, #9202  
1315 East-West Highway  
Silver Spring, MD 20910-3282

To obtain current elevation, description, and/or location information for **bench marks** shown on this map, please contact the Information Services Branch of the National Geodetic Survey at (301) 713-3242 or visit its website at <http://www.ngs.noaa.gov/>.

**Base Map** information shown on this FIRM was provided in digital format by El Paso County, Colorado Springs Utilities, City of Fountain, Bureau of Land Management, National Oceanic and Atmospheric Administration, United States Geological Survey, and Anderson Consulting Engineers, Inc. These data are current as of 2006.

This map reflects more detailed and up-to-date **stream channel configurations and floodplain delineations** than those shown on the previous FIRM for this jurisdiction. The floodplains and floodways that were transferred from the previous FIRM may have been adjusted to conform to these new stream channel configurations. As a result, the Flood Profiles and Floodway Data tables in the Flood Insurance Study Report (which contains authoritative hydraulic data) may reflect stream channel distances that differ from what is shown on this map. The profile baselines depicted on this map represent the hydraulic modeling baselines that match the flood profiles and Floodway Data Tables if applicable, in the FIS report. As a result, the profile baselines may deviate significantly from the new base map channel representation and may appear outside of the floodplain.

**Corporate limits** shown on this map are based on the best data available at the time of publication. Because changes due to annexations or de-annexations may have occurred after this map was published, map users should contact appropriate community officials to verify current corporate limit locations.

Please refer to the separately printed **Map Index** for an overview map of the county showing the layout of map panels; community map repository addresses; and a Listing of Communities table containing National Flood Insurance Program dates for each community as well as a listing of the panels on which each community is located.

Contact **FEMA Map Service Center (MSC)** via the FEMA Map Information eXchange (FMIX) 1-877-336-2627 for information on available products associated with this FIRM. Available products may include previously issued Letters of Map Change, a Flood Insurance Study Report, and/or digital versions of this map. The MSC may also be reached by Fax at 1-800-358-9620 and its website at <http://www.msc.fema.gov/>.

If you have **questions about this map** or questions concerning the National Flood Insurance Program in general, please call 1-877-FEMA MAP (1-877-336-2627) or visit the FEMA website at <http://www.fema.gov/business/nfp/>.

**El Paso County Vertical Datum Offset Table**

Flooding Source	Vertical Datum Offset (ft)
REFER TO SECTION 3.3 OF THE EL PASO COUNTY FLOOD INSURANCE STUDY FOR STREAM BY STREAM VERTICAL DATUM CONVERSION INFORMATION	

**Panel Location Map**

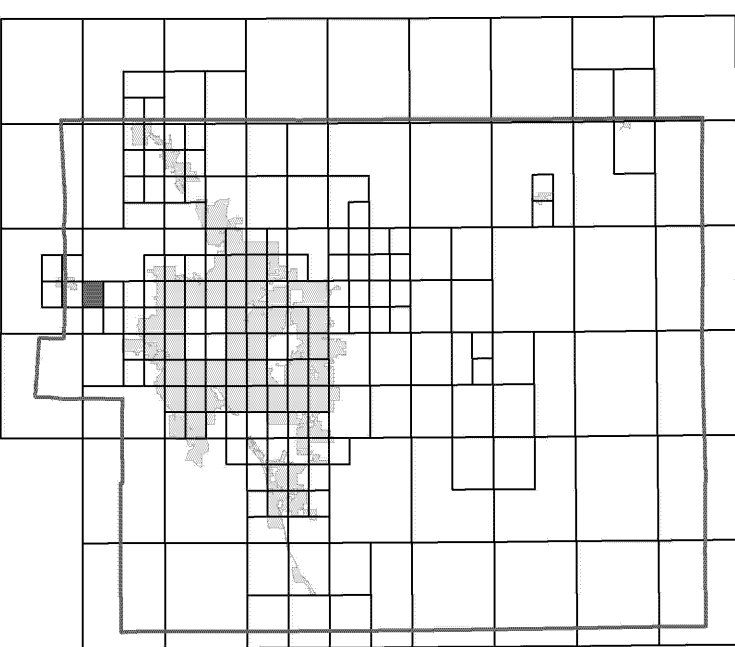

This Digital Flood Insurance Rate Map (DFIRM) was produced through a Cooperating Technical Partner (CTP) agreement between the State of Colorado Water Conservation Board (CWCB) and the Federal Emergency Management Agency (FEMA).



Additional Flood Hazard information and resources are available from local communities and the Colorado Water Conservation Board.

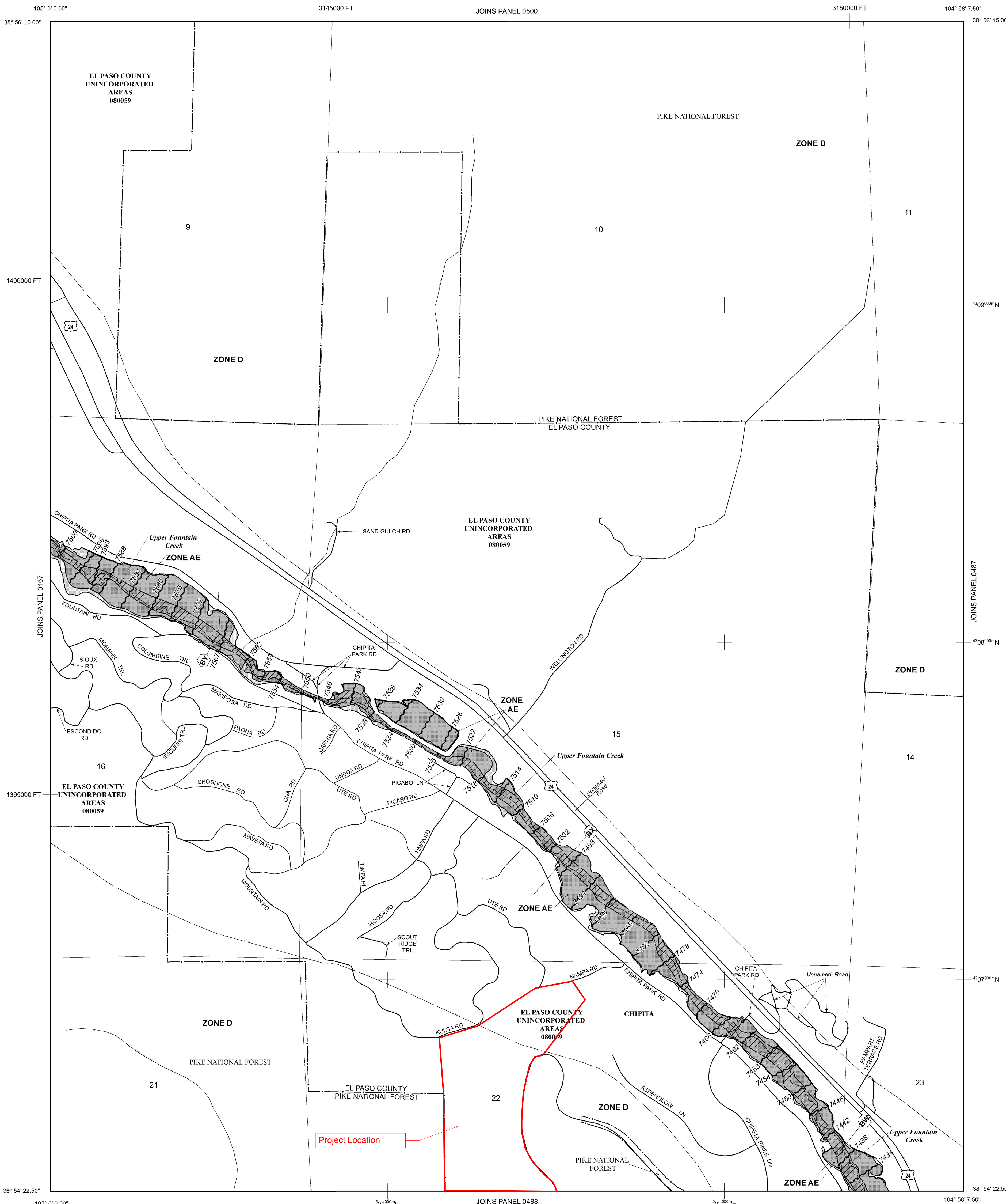

NOTE: MAP AREA SHOWN ON THIS PANEL IS LOCATED WITHIN TOWNSHIP 13 SOUTH, RANGE 68 WEST.

**LEGEND**

- SPECIAL FLOOD HAZARD AREAS (SFHAs) SUBJECT TO INUNDATION BY THE 1% ANNUAL CHANCE FLOOD
- The 1% annual chance flood (100-year flood), also known as the base flood, is the flood that has a 1% chance of being equaled or exceeded in any given year. The Special Flood Hazard Area is the area subject to flooding by the 1% annual chance flood. Areas of Special Flood Hazard include Zones A, AE, AH, AO, AR, A99, V, and VE. The Base Flood Elevation is the water-surface elevation of the 1% annual chance flood.
- ZONE A** No Base Flood Elevations determined.
- ZONE AE** Base Flood Elevations determined.
- ZONE AH** Flood depths of 1 to 3 feet (usually areas of ponding); Base Flood Elevations determined.
- ZONE AO** Flood depths of 1 to 3 feet (usually sheet flow on sloping terrain); average depths determined. For areas of alluvial fan flooding, velocities also determined.
- ZONE AR** Special Flood Hazard Area Formerly protected from the 1% annual chance flood by a flood control system that was subsequently decertified. Zone AR indicates that the former flood control system is being restored to provide protection from the 1% annual chance or greater flood.
- ZONE A99** Area to be protected from 1% annual chance flood by a Federal flood protection system under construction; no Base Flood Elevations determined.
- ZONE V** Coastal flood zone with velocity hazard (wave action); no Base Flood Elevations determined.
- ZONE VE** Coastal flood zone with velocity hazard (wave action); Base Flood Elevations determined.
- FLOODWAY AREAS IN ZONE AE
- The floodway is the channel of a stream plus any adjacent floodplain areas that must be kept free of encroachment so that the 1% annual chance flood can be carried without substantial increases in flood heights.
- OTHER FLOOD AREAS**
- ZONE X** Areas of 0.2% annual chance flood; areas of 1% annual chance flood with average depths of less than 1 foot or with drainage areas less than 1 square mile; and areas protected by levees from 1% annual chance flood.
- OTHER AREAS**
- ZONE X** Areas determined to be outside the 0.2% annual chance floodplain.
- ZONE D** Areas in which flood hazards are undetermined, but possible.
- COASTAL BARRIER RESOURCES SYSTEM (CBRS) AREAS
- OTHERWISE PROTECTED AREAS (OPAs)

- CBRS areas and OPAs are normally located within or adjacent to Special Flood Hazard Areas.
- Floodplain boundary
- Floodway boundary
- Zone D Boundary
- CBRS and OPA boundary

- Boundary dividing Special Flood Hazard Areas of different Base Flood Elevations, flood depths or flood velocities.
- Base Flood Elevation line and value; elevation in feet\* (EL 987)

\* Referenced to the North American Vertical Datum of 1988 (NAVD 88)

- Cross section line
- Transsect line
- Geographic coordinates referenced to the North American Datum of 1983 (NAD 83)
- 1000-meter Universal Transverse Mercator grid ticks, zone 13
- 5000-foot grid ticks: Colorado State Plane coordinate system, central zone (FIPSZONE 0502), Lambert Conformal Conic Projection
- Bench mark (see explanation in Notes to Users section of this FIRM panel)
- River Mile

- MAP REPOSITORIES**  
Refer to Map Repositories list on Map Index
- EFFECTIVE DATE OF COUNTYWIDE FLOOD INSURANCE RATE MAP**  
MARCH 17, 1997
- EFFECTIVE DATE(S) OF REVISION(S) TO THIS PANEL**  
DECEMBER 7, 2018 - to update corporate limits, to change Base Flood Elevations and Special Flood Hazard Areas, to update map format, to add roads and road names, and to incorporate previously issued Letters of Map Revision.

For community map revision history prior to countywide mapping, refer to the Community Map History Table located in the Flood Insurance Study report for this jurisdiction. To determine if flood insurance is available in this community, contact your insurance agent or call the National Flood Insurance Program at 1-800-638-6620.

MAP SCALE 1" = 500'

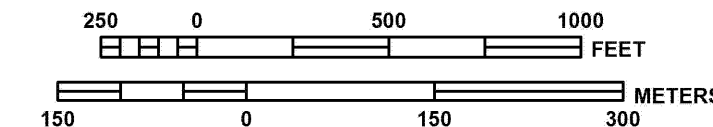

**PANEL 0486G**

**FIRM**  
**FLOOD INSURANCE RATE MAP**  
**EL PASO COUNTY,**  
**COLORADO**  
**AND INCORPORATED AREAS**

**PANEL 486 OF 1300**  
(SEE MAP INDEX FOR FIRM PANEL LAYOUT)

CONTAINS:	COMMUNITY	NUMBER	PANEL	SUFFIX
	EL PASO COUNTY	08009	0486	G

Notice to User: The Map Number shown below should be used when placing map orders. The Community Number shown above should be used on insurance applications for the subject community.

**MAP NUMBER**  
**08041C0486G**

**MAP REVISED**  
**DECEMBER 7, 2018**  
Federal Emergency Management Agency



# HYDROLOGIC CALCULATIONS

---

Table 1 - Pre-Development Weighted C Calculations				
Drainage Area	Cover Type	C <sub>s</sub> Value	Area (AC)	CxA
EX-1	Forest	0.15	0.39	0.06
Weighted C: (CxA) <sub>tot</sub> /A <sub>tot</sub>				0.15
Drainage Area	Cover Type	C <sub>s</sub> Value	Area (AC)	CxA
EX-2	Forest	0.15	1.68	0.25
Weighted C: (CxA) <sub>tot</sub> /A <sub>tot</sub>				0.15
Drainage Area	Cover Type	C <sub>s</sub> Value	Area (AC)	CxA
EX-3	Forest	0.15	2.55	0.38
Weighted C: (CxA) <sub>tot</sub> /A <sub>tot</sub>				0.15
Drainage Area	Cover Type	C <sub>s</sub> Value	Area (AC)	CxA
EX-4	Forest	0.15	6.14	0.92
Weighted C: (CxA) <sub>tot</sub> /A <sub>tot</sub>				0.15
Drainage Area	Cover Type	C <sub>s</sub> Value	Area (AC)	CxA
EX-5	Forest	0.15	3.58	0.54
Weighted C: (CxA) <sub>tot</sub> /A <sub>tot</sub>				0.15
Drainage Area	Cover Type	C <sub>s</sub> Value	Area (AC)	CxA
EX-6	Forest	0.15	7.24	1.09
Weighted C: (CxA) <sub>tot</sub> /A <sub>tot</sub>				0.15
Drainage Area	Cover Type	C <sub>s</sub> Value	Area (AC)	CxA
EX-7	Forest	0.15	3.73	0.56
Weighted C: (CxA) <sub>tot</sub> /A <sub>tot</sub>				0.15
Drainage Area	Cover Type	C <sub>s</sub> Value	Area (AC)	CxA
EX-8	Forest	0.15	9.74	1.46
Weighted C: (CxA) <sub>tot</sub> /A <sub>tot</sub>				0.15
Drainage Area	Cover Type	C <sub>s</sub> Value	Area (AC)	CxA
OS-1	Forest	0.15	2.48	0.37
Weighted C: (CxA) <sub>tot</sub> /A <sub>tot</sub>				0.15
Drainage Area	Cover Type	C <sub>s</sub> Value	Area (AC)	CxA
OS-2	Forest	0.15	2.10	0.31
Weighted C: (CxA) <sub>tot</sub> /A <sub>tot</sub>				0.15
Drainage Area	Cover Type	C <sub>s</sub> Value	Area (AC)	CxA
OS-3	Forest	0.15	11.34	1.70
Weighted C: (CxA) <sub>tot</sub> /A <sub>tot</sub>				0.15
Drainage Area	Cover Type	C <sub>s</sub> Value	Area (AC)	CxA
OS-4	Forest	0.15	4.04	0.61
Weighted C: (CxA) <sub>tot</sub> /A <sub>tot</sub>				0.15
Drainage Area	Cover Type	C <sub>s</sub> Value	Area (AC)	CxA
OS-5	Forest	0.15	4.82	0.72
Weighted C: (CxA) <sub>tot</sub> /A <sub>tot</sub>				0.15
Drainage Area	Cover Type	C <sub>s</sub> Value	Area (AC)	CxA
OS-6	Forest	0.15	19.17	2.88
Weighted C: (CxA) <sub>tot</sub> /A <sub>tot</sub>				0.15
Drainage Area	Cover Type	C <sub>s</sub> Value	Area (AC)	CxA
OS-7	Forest	0.15	6.04	0.91
	Roof	0.75	0.08	0.06
	Pavement	0.90	0.05	0.05
	Gravel	0.63	0.09	0.06
Weighted C: (CxA) <sub>tot</sub> /A <sub>tot</sub>				0.17

Table 2 - Pre-Development Weighted C Calculations				
Drainage Area	Cover Type	C <sub>10</sub> Value	Area (AC)	CxA
EX-1	Forest	0.25	0.39	0.10
Weighted C: (CxA) <sub>tot</sub> /A <sub>tot</sub>				0.25
Drainage Area	Cover Type	C <sub>10</sub> Value	Area (AC)	CxA
EX-2	Forest	0.25	1.68	0.42
Weighted C: (CxA) <sub>tot</sub> /A <sub>tot</sub>				0.25
Drainage Area	Cover Type	C <sub>10</sub> Value	Area (AC)	CxA
EX-3	Forest	0.25	2.55	0.64
Weighted C: (CxA) <sub>tot</sub> /A <sub>tot</sub>				0.25
Drainage Area	Cover Type	C <sub>10</sub> Value	Area (AC)	CxA
EX-4	Forest	0.25	6.14	1.53
Weighted C: (CxA) <sub>tot</sub> /A <sub>tot</sub>				0.25
Drainage Area	Cover Type	C <sub>10</sub> Value	Area (AC)	CxA
EX-5	Forest	0.25	3.58	0.90
Weighted C: (CxA) <sub>tot</sub> /A <sub>tot</sub>				0.25
Drainage Area	Cover Type	C <sub>10</sub> Value	Area (AC)	CxA
EX-6	Forest	0.25	7.24	1.81
Weighted C: (CxA) <sub>tot</sub> /A <sub>tot</sub>				0.25
Drainage Area	Cover Type	C <sub>10</sub> Value	Area (AC)	CxA
EX-7	Forest	0.25	3.73	0.93
Weighted C: (CxA) <sub>tot</sub> /A <sub>tot</sub>				0.25
Drainage Area	Cover Type	C <sub>10</sub> Value	Area (AC)	CxA
EX-8	Forest	0.25	9.74	2.43
Weighted C: (CxA) <sub>tot</sub> /A <sub>tot</sub>				0.25
Drainage Area	Cover Type	C <sub>10</sub> Value	Area (AC)	CxA
OS-1	Forest	0.25	2.48	0.62
Weighted C: (CxA) <sub>tot</sub> /A <sub>tot</sub>				0.25
Drainage Area	Cover Type	C <sub>s</sub> Value	Area (AC)	CxA
OS-2	Forest	0.25	2.10	0.52
Weighted C: (CxA) <sub>tot</sub> /A <sub>tot</sub>				0.25
Drainage Area	Cover Type	C <sub>s</sub> Value	Area (AC)	CxA
OS-3	Forest	0.25	11.34	2.83
Weighted C: (CxA) <sub>tot</sub> /A <sub>tot</sub>				0.25
Drainage Area	Cover Type	C <sub>s</sub> Value	Area (AC)	CxA
OS-4	Forest	0.25	4.04	1.01
Weighted C: (CxA) <sub>tot</sub> /A <sub>tot</sub>				0.25
Drainage Area	Cover Type	C <sub>s</sub> Value	Area (AC)	CxA
OS-5	Forest	0.25	4.82	1.21
Weighted C: (CxA) <sub>tot</sub> /A <sub>tot</sub>				0.25
Drainage Area	Cover Type	C <sub>10</sub> Value	Area (AC)	CxA
OS-6	Forest	0.25	19.17	4.79
Weighted C: (CxA) <sub>tot</sub> /A <sub>tot</sub>				0.25
Drainage Area	Cover Type	C <sub>10</sub> Value	Area (AC)	CxA
OS-7	Forest	0.25	6.04	1.51
	Roof	0.77	0.08	0.06
	Pavement	0.92	0.05	0.05
	Gravel	0.66	0.09	0.06
Weighted C: (CxA) <sub>tot</sub> /A <sub>tot</sub>				0.27

Table 3 - Pre-Development Weighted C Calculations				
Drainage Area	Cover Type	C <sub>100</sub> Value	Area (AC)	CxA
EX-1	Forest	0.50	0.39	0.20
Weighted C: (CxA) <sub>tot</sub> /A <sub>tot</sub>				0.50
Drainage Area	Cover Type	C <sub>100</sub> Value	Area (AC)	CxA
EX-2	Forest	0.50	1.68	0.84
Weighted C: (CxA) <sub>tot</sub> /A <sub>tot</sub>				0.50
Drainage Area	Cover Type	C <sub>100</sub> Value	Area (AC)	CxA
EX-3	Forest	0.50	2.55	1.28
Weighted C: (CxA) <sub>tot</sub> /A <sub>tot</sub>				0.50
Drainage Area	Cover Type	C <sub>100</sub> Value	Area (AC)	CxA
EX-4	Forest	0.50	6.14	3.07
Weighted C: (CxA) <sub>tot</sub> /A <sub>tot</sub>				0.50
Drainage Area	Cover Type	C <sub>100</sub> Value	Area (AC)	CxA
EX-5	Forest	0.50	3.58	1.79
Weighted C: (CxA) <sub>tot</sub> /A <sub>tot</sub>				0.50
Drainage Area	Cover Type	C <sub>100</sub> Value	Area (AC)	CxA
EX-6	Forest	0.50	7.24	3.62
Weighted C: (CxA) <sub>tot</sub> /A <sub>tot</sub>				0.50
Drainage Area	Cover Type	C <sub>100</sub> Value	Area (AC)	CxA
EX-7	Forest	0.50	3.73	1.86
Weighted C: (CxA) <sub>tot</sub> /A <sub>tot</sub>				0.50
Drainage Area	Cover Type	C <sub>100</sub> Value	Area (AC)	CxA
EX-8	Forest	0.50	9.74	4.87
Weighted C: (CxA) <sub>tot</sub> /A <sub>tot</sub>				0.50
Drainage Area	Cover Type	C <sub>100</sub> Value	Area (AC)	CxA
OS-1	Forest	0.50	2.48	1.24
Weighted C: (CxA) <sub>tot</sub> /A <sub>tot</sub>				0.50
Drainage Area	Cover Type	C <sub>s</sub> Value	Area (AC)	CxA
OS-2	Forest	0.50	2.10	1.05
Weighted C: (CxA) <sub>tot</sub> /A <sub>tot</sub>				0.50
Drainage Area	Cover Type	C <sub>s</sub> Value	Area (AC)	CxA
OS-3	Forest	0.50	11.34	5.67
Weighted C: (CxA) <sub>tot</sub> /A <sub>tot</sub>				0.50
Drainage Area	Cover Type	C <sub>s</sub> Value	Area (AC)	CxA
OS-4	Forest	0.50	4.04	2.02
Weighted C: (CxA) <sub>tot</sub> /A <sub>tot</sub>				0.50
Drainage Area	Cover Type	C <sub>s</sub> Value	Area (AC)	CxA
OS-5	Forest	0.50	4.82	2.41
Weighted C: (CxA) <sub>tot</sub> /A <sub>tot</sub>				0.50
Drainage Area	Cover Type	C <sub>100</sub> Value	Area (AC)	CxA
OS-6	Forest	0.50	19.17	9.59
Weighted C: (CxA) <sub>tot</sub> /A <sub>tot</sub>				0.50
Drainage Area	Cover Type	C <sub>100</sub> Value	Area (AC)	CxA
OS-7	Forest	0.50	6.04	3.02
	Roof	0.83	0.08	0.07
	Pavement	0.96	0.05	0.05
	Gravel	0.74	0.09	0.07
Weighted C: (CxA) <sub>tot</sub> /A <sub>tot</sub>				0.51

Table 4 - Post-Development Weighted C Calculations				
Drainage Area	Cover Type	C <sub>10</sub> Value	Area (AC)	CxA
P-1	Forest	0.15	0.39	0.06
	Weighted C: (CxA) <sub>tot</sub> /A <sub>tot</sub>			
P-2	Forest	0.15	1.68	0.25
	Weighted C: (CxA) <sub>tot</sub> /A <sub>tot</sub>			
P-3	Forest	0.15	2.55	0.38
	Weighted C: (CxA) <sub>tot</sub> /A <sub>tot</sub>			
P-4	Forest	0.15	6.14	0.92
	Weighted C: (CxA) <sub>tot</sub> /A <sub>tot</sub>			
P-5	Forest	0.15	3.58	0.54
	Weighted C: (CxA) <sub>tot</sub> /A <sub>tot</sub>			
P-6	Forest	0.15	6.878	1.03
	Impervious	0.89	0.362	0.32
	Weighted C: (CxA) <sub>tot</sub> /A <sub>tot</sub>			
P-7	Forest	0.15	3.544	0.53
	Impervious	0.89	0.187	0.17
	Weighted C: (CxA) <sub>tot</sub> /A <sub>tot</sub>			
P-8	Forest	0.15	9.253	1.39
	Impervious	0.89	0.487	0.43
	Weighted C: (CxA) <sub>tot</sub> /A <sub>tot</sub>			
OS-1	Forest	0.15	2.48	0.37
	Weighted C: (CxA) <sub>tot</sub> /A <sub>tot</sub>			
OS-2	Forest	0.15	2.10	0.31
	Weighted C: (CxA) <sub>tot</sub> /A <sub>tot</sub>			
OS-3	Forest	0.15	11.34	1.70
	Weighted C: (CxA) <sub>tot</sub> /A <sub>tot</sub>			
OS-4	Forest	0.15	4.04	0.61
	Weighted C: (CxA) <sub>tot</sub> /A <sub>tot</sub>			
OS-5	Forest	0.15	4.82	0.72
	Weighted C: (CxA) <sub>tot</sub> /A <sub>tot</sub>			
OS-6	Forest	0.15	19.17	2.88
	Weighted C: (CxA) <sub>tot</sub> /A <sub>tot</sub>			
OS-7	Forest	0.15	6.04	0.91
	Roof	0.75	0.08	0.06
	Pavement	0.90	0.05	0.05
	Gravel	0.63	0.09	0.06
	Weighted C: (CxA) <sub>tot</sub> /A <sub>tot</sub>			

Table 5 - Post-Development Weighted C Calculations				
Drainage Area	Cover Type	C <sub>10</sub> Value	Area (AC)	CxA
P-1	Forest	0.25	0.39	0.10
	Weighted C: (CxA) <sub>tot</sub> /A <sub>tot</sub>			
P-2	Forest	0.25	1.68	0.42
	Weighted C: (CxA) <sub>tot</sub> /A <sub>tot</sub>			
P-3	Forest	0.25	2.55	0.64
	Weighted C: (CxA) <sub>tot</sub> /A <sub>tot</sub>			
P-4	Forest	0.25	6.14	1.53
	Weighted C: (CxA) <sub>tot</sub> /A <sub>tot</sub>			
P-5	Forest	0.25	3.58	0.90
	Weighted C: (CxA) <sub>tot</sub> /A <sub>tot</sub>			
P-6	Forest	0.25	6.878	1.72
	Impervious	0.90	0.362	0.33
	Weighted C: (CxA) <sub>tot</sub> /A <sub>tot</sub>			
P-7	Forest	0.25	3.544	0.89
	Impervious	0.90	0.187	0.17
	Weighted C: (CxA) <sub>tot</sub> /A <sub>tot</sub>			
P-8	Forest	0.28	9.253	2.59
	Impervious	0.90	0.487	0.44
	Weighted C: (CxA) <sub>tot</sub> /A <sub>tot</sub>			
OS-1	Forest	0.25	2.48	0.62
	Weighted C: (CxA) <sub>tot</sub> /A <sub>tot</sub>			
OS-2	Forest	0.25	2.10	0.52
	Weighted C: (CxA) <sub>tot</sub> /A <sub>tot</sub>			
OS-3	Forest	0.25	11.34	2.83
	Weighted C: (CxA) <sub>tot</sub> /A <sub>tot</sub>			
OS-4	Forest	0.25	4.04	1.01
	Weighted C: (CxA) <sub>tot</sub> /A <sub>tot</sub>			
OS-5	Forest	0.25	4.82	1.21
	Weighted C: (CxA) <sub>tot</sub> /A <sub>tot</sub>			
OS-6	Forest	0.25	19.17	4.79
	Weighted C: (CxA) <sub>tot</sub> /A <sub>tot</sub>			
OS-7	Forest	0.25	6.04	1.51
	Roof	0.77	0.08	0.06
	Pavement	0.92	0.05	0.05
	Gravel	0.66	0.09	0.06
	Weighted C: (CxA) <sub>tot</sub> /A <sub>tot</sub>			

Table 6 - Post-Development Weighted C Calculations				
Drainage Area	Cover Type	C <sub>100</sub> Value	Area (AC)	CxA
P-1	Forest	0.50	0.39	0.20
	Weighted C: (CxA) <sub>tot</sub> /A <sub>tot</sub>			
P-2	Forest	0.50	1.68	0.84
	Weighted C: (CxA) <sub>tot</sub> /A <sub>tot</sub>			
P-3	Forest	0.50	2.55	1.28
	Weighted C: (CxA) <sub>tot</sub> /A <sub>tot</sub>			
P-4	Forest	0.50	6.14	3.07
	Weighted C: (CxA) <sub>tot</sub> /A <sub>tot</sub>			
P-5	Forest	0.50	3.58	1.79
	Weighted C: (CxA) <sub>tot</sub> /A <sub>tot</sub>			
P-6	Forest	0.50	6.878	3.44
	Impervious	0.96	0.362	0.35
	Weighted C: (CxA) <sub>tot</sub> /A <sub>tot</sub>			
P-7	Forest	0.50	3.544	1.77
	Impervious	0.96	0.187	0.18
	Weighted C: (CxA) <sub>tot</sub> /A <sub>tot</sub>			
P-8	Forest	0.50	9.253	4.63
	Impervious	0.96	0.487	0.47
	Weighted C: (CxA) <sub>tot</sub> /A <sub>tot</sub>			
OS-1	Forest	0.50	2.48	1.24
	Weighted C: (CxA) <sub>tot</sub> /A <sub>tot</sub>			
OS-2	Forest	0.50	2.10	1.05
	Weighted C: (CxA) <sub>tot</sub> /A <sub>tot</sub>			
OS-3	Forest	0.50	11.34	5.67
	Weighted C: (CxA) <sub>tot</sub> /A <sub>tot</sub>			
OS-4	Forest	0.50	4.04	2.02
	Weighted C: (CxA) <sub>tot</sub> /A <sub>tot</sub>			
OS-5	Forest	0.50	4.82	2.41
	Weighted C: (CxA) <sub>tot</sub> /A <sub>tot</sub>			
OS-6	Forest	0.50	19.17	9.59
	Weighted C: (CxA) <sub>tot</sub> /A <sub>tot</sub>			
OS-7	Forest	0.50	6.04	3.02
	Roof	0.83	0.08	0.07
	Pavement	0.96	0.05	0.05
	Gravel	0.74	0.09	0.07
	Weighted C: (CxA) <sub>tot</sub> /A <sub>tot</sub>			

Pre-Development Time of Concentration Calculations																		
Sub-Basin			Time of Concentration Estimate															
Drainage Area	Area (AC)	C <sub>s</sub>	Initial/Overland Time (t <sub>i</sub> )			Travel Time (t <sub>t</sub> )											Combined t <sub>c</sub>	
			Length (ft)	Slope (ft/ft)	t <sub>i</sub> (min)	Length (ft)	Slope (ft/ft)	Land Type	C <sub>v</sub>	Velocity (ft/sec)	t <sub>t</sub> (min)	Length (ft)	Slope (ft/ft)	Land Type	C <sub>v</sub>	Velocity (ft/sec)		t <sub>t</sub> (min)
EX-1	0.39	0.15	109	0.37	5.46													5.46
EX-2	1.68	0.15	300	0.39	8.89	65	0.35	HM	2.5	1.48	0.73							9.63
EX-3	2.55	0.15	300	0.50	8.19	391	0.35	HM	2.5	1.48	4.41							12.59
EX-4	6.14	0.15	300	0.54	7.98	500	0.42	HM	2.5	1.62	5.14							13.12
EX-5	3.58	0.15	300	0.61	7.66	475	0.49	HM	2.5	1.75	4.52							12.19
EX-6	7.24	0.15	300	0.53	8.03	573	0.33	HM	2.5	1.44	6.65							14.68
EX-7	3.73	0.15	300	0.25	10.31	884	0.23	HM	2.5	1.20	12.29							22.60
EX-8	9.74	0.15	300	0.32	9.50	1101	0.20	HM	2.5	1.12	16.41							25.91
OS-1	2.48	0.15	300	0.67	7.43	524	0.53	HM	2.5	1.82	4.80							12.23
OS-2	2.10	0.15	300	0.90	6.73	1064	0.64	HM	2.5	2.00	8.87							15.60
OS-3	11.34	0.15	300	0.77	7.09	931	0.70	HM	2.5	2.09	7.42							14.51
OS-4	4.04	0.15	300	0.86	6.83	762	0.72	HM	2.5	2.12	5.99							12.82
OS-5	4.82	0.15	300	0.77	7.09	912	0.72	HM	2.5	2.12	7.17							14.26
OS-6	19.17	0.15	300	0.78	7.06	1519	0.61	HM	2.5	1.95	12.97							20.03
OS-7	6.26	0.17	300	0.33	9.20	843	0.25	HM	2.5	1.25	11.24							20.44

Post-Development Time of Concentration Calculations																		
Sub-Basin			Time of Concentration Estimate															
Drainage Area	Area (AC)	C <sub>s</sub>	Initial/Overland Time (t <sub>i</sub> )			Travel Time (t <sub>t</sub> )											Combined t <sub>c</sub>	
			Length (ft)	Slope (ft/ft)	t <sub>i</sub> (min)	Length (ft)	Slope (ft/ft)	Land Type	C <sub>v</sub>	Velocity (ft/sec)	t <sub>t</sub> (min)	Length (ft)	Slope (ft/ft)	Land Type	C <sub>v</sub>	Velocity (ft/sec)		t <sub>t</sub> (min)
P-1	0.39	0.15	109	0.37	5.46													5.46
P-2	1.68	0.15	300	0.39	8.89	65	0.35	HM	2.5	1.48	0.73							9.63
P-3	2.55	0.15	300	0.50	8.19	391	0.35	HM	2.5	1.48	4.41							12.59
P-4	6.14	0.15	300	0.54	7.98	500	0.42	HM	2.5	1.62	5.14							13.12
P-5	3.58	0.15	300	0.61	7.66	475	0.49	HM	2.5	1.75	4.52							12.19
P-6	7.24	0.19	300	0.53	7.72	573	0.33	HM	2.5	1.44	6.65							14.37
P-7	3.73	0.19	300	0.25	9.91	884	0.23	HM	2.5	1.20	12.29							22.20
P-8	9.74	0.19	300	0.32	9.13	1101	0.20	HM	2.5	1.12	16.41							25.54
OS-1	2.48	0.15	300	0.67	7.43	524	0.53	HM	2.5	1.82	4.80							12.23
OS-2	2.10	0.15	300	0.90	6.73	1064	0.64	HM	2.5	2.00	8.87							15.60
OS-3	11.34	0.15	300	0.77	7.09	931	0.70	HM	2.5	2.09	7.42							14.51
OS-4	4.04	0.15	300	0.86	6.83	762	0.72	HM	2.5	2.12	5.99							12.82
OS-5	4.82	0.15	300	0.77	7.09	912	0.72	HM	2.5	2.12	7.17							14.26
OS-6	19.17	0.15	300	0.78	7.06	1519	0.61	HM	2.5	1.95	12.97							20.03
OS-7	6.26	0.17	300	0.33	9.20	843	0.25	HM	2.5	1.25	11.24							20.44

**Equations:**

$t_i$  (overland) =  $0.395(1.1-C_s)L^{0.5}S^{-0.333}$

C = Runoff Coefficient

L = Length of overland flow (Max 300 ft)

S = Slope

Travel Time:  $V = C_s S^{0.5}$

V = Velocity (ft/s)

C<sub>v</sub> = Conveyance Coefficient

S = Slope

t<sub>c</sub> Check = (L/180)+10 (developed condition only)

L = Overall Length

Conveyance Coefficient C <sub>v</sub>		
Type of Land Surface	Land Type	C <sub>v</sub>
Heavy Meadow	HM	2.5
Tillage/Fields	TF	5
Riprap (Not Buried)	RR	6.5
Short Pasture/Lawns	SP	7
Nearly Bare Ground	NBG	10
Grassed Waterway	GW	15
Paved Areas & Shallow Paved Swales	PV	20

HSG: D

Pre-Development Design Point Time of Concentration Calculations																			
Sub-Basin			Time of Concentration Estimate																
Drainage Area	Area (AC)	C <sub>s</sub>	Initial/Overland Time (t <sub>i</sub> )			Travel Time (t <sub>t</sub> )											Combined		
			Length (ft)	Slope (ft/ft)	t <sub>i</sub> (min)	Length (ft)	Slope (ft/ft)	Land Type	C <sub>v</sub>	Velocity (ft/sec)	t <sub>t</sub> (min)	Length (ft)	Slope (ft/ft)	Land Type	C <sub>v</sub>	Velocity (ft/sec)		t <sub>t</sub> (min)	t <sub>c</sub>
DP-1	2.87	0.15	300	0.67	7.43	633	0.50	HM	2.5	1.77	5.97								13.39
DP-2	3.78	0.15	300	0.90	6.73	1429	0.58	HM	2.5	1.90	12.51								19.24
DP-3	13.89	0.15	300	0.77	7.09	1622	0.58	HM	2.5	1.90	14.20								21.29
DP-4	10.18	0.15	300	0.89	6.76	1562	0.59	HM	2.5	1.92	13.56								20.31
DP-5	3.58	0.15	300	0.61	7.66	475	0.49	HM	2.5	1.75	4.52								12.19
DP-6	12.08	0.15	300	0.77	7.09	1785	0.56	HM	2.5	1.87	15.90								22.99
DP-7	3.73	0.15	300	0.25	10.31	884	0.23	HM	2.5	1.20	12.29								22.60
DP-8	35.17	0.15	300	0.78	7.06	2920	0.42	HM	2.5	1.62	30.04								37.10

Post-Development Design Point Time of Concentration Calculations																			
Sub-Basin			Time of Concentration Estimate																
Drainage Area	Area (AC)	C <sub>s</sub>	Initial/Overland Time (t <sub>i</sub> )			Travel Time (t <sub>t</sub> )											Combined		
			Length (ft)	Slope (ft/ft)	t <sub>i</sub> (min)	Length (ft)	Slope (ft/ft)	Land Type	C <sub>v</sub>	Velocity (ft/sec)	t <sub>t</sub> (min)	Length (ft)	Slope (ft/ft)	Land Type	C <sub>v</sub>	Velocity (ft/sec)		t <sub>t</sub> (min)	t <sub>c</sub> (min)
DP-1	2.87	0.15	300	0.67	7.43	633	0.50	HM	2.5	1.77	5.97								13.39
DP-2	3.78	0.15	300	0.90	6.73	1429	0.58	HM	2.5	1.90	12.51								19.24
DP-3	13.89	0.15	300	0.77	7.09	1622	0.58	HM	2.5	1.90	14.20								21.29
DP-4	10.18	0.15	300	0.89	6.76	1562	0.59	HM	2.5	1.92	13.56								20.31
DP-5	3.58	0.15	300	0.61	7.66	475	0.49	HM	2.5	1.75	4.52								12.19
DP-6	12.08	0.17	300	0.77	6.91	1785	0.56	HM	2.5	1.87	15.90								22.81
DP-7	3.73	0.19	300	0.25	9.88	884	0.23	HM	2.5	1.20	12.29								22.17
DP-8	35.17	0.17	300	0.78	6.95	2920	0.42	HM	2.5	1.62	30.04								36.99

**Equations:**

$t_i$  (overland) =  $0.395(1.1-C_s)L^{0.5}S^{-0.333}$

C = Runoff Coefficient

L = Length of overland flow (Max 300 ft)

S = Slope

Travel Time:  $V = C_s S^{0.5}$

V = Velocity (ft/s)

C<sub>v</sub> = Conveyance Coefficient

S = Slope

t<sub>c</sub> Check = (L/180)+10 (developed condition only)

L = Overall Length

Conveyance Coefficient C <sub>v</sub>		
Type of Land Surface	Land Type	C <sub>v</sub>
Heavy Meadow	HM	2.5
Tillage/Fields	TF	5
Riprap (Not Buried)	RR	6.5
Short Pasture/Lawns	SP	7
Nearly Bare Ground	NBG	10
Grassed Waterway	GW	15
Paved Areas & Shallow Paved Swales	PV	20

HSG: D

Pre-Development Runoff Calculations										
Drainage Basin	C <sub>5</sub>	C <sub>100</sub>	t <sub>c</sub> (min)	i <sub>5</sub> (in./hr.)	i <sub>100</sub> (in./hr.)	Area (AC)	Q <sub>5</sub> (cfs)	Q <sub>100</sub> (cfs)		
EX-1	0.15	0.50	5.46	5.04	8.46	0.39	0.30	1.66		
EX-2	0.15	0.50	9.63	4.19	7.03	1.68	1.06	5.91		
EX-3	0.15	0.50	12.59	3.78	6.35	2.55	1.45	8.11		
EX-4	0.15	0.50	13.12	3.72	6.25	6.14	3.43	19.17		
EX-5	0.15	0.50	12.19	3.83	6.43	3.58	2.06	11.52		
EX-6	0.15	0.50	14.68	3.55	5.97	7.24	3.86	21.61		
EX-7	0.15	0.50	22.60	2.91	4.88	3.73	1.62	9.09		
EX-8	0.15	0.50	25.91	2.70	4.53	9.74	3.95	22.07		
OS-1	0.15	0.50	12.23	3.83	6.43	2.48	1.42	7.96		
OS-2	0.15	0.50	15.60	3.46	5.81	2.10	1.09	6.10		
OS-3	0.15	0.50	14.51	3.57	5.99	11.34	6.07	33.98		
OS-4	0.15	0.50	12.82	3.76	6.31	4.04	2.28	12.75		
OS-5	0.15	0.50	14.26	3.60	6.04	4.82	2.60	14.56		
OS-6	0.15	0.50	20.03	3.09	5.18	19.17	8.88	49.68		
OS-7	0.17	0.51	20.44	3.06	5.13	6.26	3.26	16.42		

Post-Development Runoff Calculations										
Drainage Basin	C <sub>5</sub>	C <sub>100</sub>	t <sub>c</sub> (min)	i <sub>5</sub> (in./hr.)	i <sub>100</sub> (in./hr.)	Area (AC)	Q <sub>5</sub> (cfs)	Q <sub>100</sub> (cfs)		
P-1	0.15	0.50	5.46	5.04	8.46	0.39	0.30	1.66		
P-2	0.15	0.50	9.63	4.19	7.03	1.68	1.06	5.91		
P-3	0.15	0.50	12.59	3.78	6.35	2.55	1.45	8.11		
P-4	0.15	0.50	13.12	3.72	6.25	6.14	3.43	19.17		
P-5	0.15	0.50	12.19	3.83	6.43	3.58	2.06	11.52		
P-6	0.19	0.52	14.37	3.59	6.02	7.24	4.86	22.81		
P-7	0.19	0.52	22.20	2.93	4.92	3.73	2.04	9.59		
P-8	0.19	0.52	25.54	2.72	4.57	9.74	4.96	23.27		
OS-1	0.15	0.50	12.23	3.83	6.43	2.48	1.42	7.96		
OS-2	0.15	0.50	15.60	3.46	5.81	2.10	1.09	6.10		
OS-3	0.15	0.50	14.51	3.57	5.99	11.34	6.07	33.98		
OS-4	0.15	0.50	12.82	3.76	6.31	4.04	2.28	12.75		
OS-5	0.15	0.50	14.26	3.60	6.04	4.82	2.60	14.56		
OS-6	0.15	0.50	20.03	3.09	5.18	19.17	8.88	49.68		
OS-7	0.17	0.51	20.44	3.06	5.13	6.26	3.26	16.42		

Equations:

$$Q = CiA$$

$$Q = \text{runoff (cfs)}$$

$$C = \text{Rational Coefficient}$$

$$I = \text{Rainfall intensity (in/hr)}$$

$$A = \text{Triburary Area (AC)}$$

$$i_5 = -1.50\ln(D)+7.583$$

$$D = \text{Duration (min)} = t_c$$

$$i_{100} = -2.52\ln(D)+12.735$$

$$D = \text{Duration (min)} = t_c$$

Pre-Development Design Point Runoff Calculations									
Drainage Basin	C <sub>5</sub>	C <sub>100</sub>	t <sub>c</sub> (min)	i <sub>5</sub> (in./hr.)	i <sub>100</sub> (in./hr.)	Area (AC)	Q <sub>5</sub> (cfs)	Q <sub>100</sub> (cfs)	
DP-1	0.15	0.50	13.39	3.69	6.20	2.87	1.59	8.89	
DP-2	0.15	0.50	19.24	3.15	5.28	3.78	1.78	9.99	
DP-3	0.15	0.50	21.29	3.00	5.03	13.89	6.24	34.92	
DP-4	0.15	0.50	20.31	3.07	5.15	10.18	4.68	26.20	
DP-5	0.15	0.50	12.19	3.83	6.43	3.58	2.06	11.52	
DP-6	0.15	0.50	22.99	2.88	4.83	12.08	5.22	29.20	
DP-7	0.15	0.50	22.60	2.91	4.88	3.73	1.63	9.10	
DP-8	0.15	0.50	37.10	2.16	3.63	35.17	11.41	63.81	

Post-Development Design Point Runoff Calculations									
Drainage Basin	C <sub>5</sub>	C <sub>100</sub>	t <sub>c</sub> (min)	i <sub>5</sub> (in./hr.)	i <sub>100</sub> (in./hr.)	Area (AC)	Q <sub>5</sub> (cfs)	Q <sub>100</sub> (cfs)	
DP-1	0.15	0.50	13.39	3.69	6.20	2.87	1.59	8.89	
DP-2	0.15	0.50	19.24	3.15	5.28	3.78	1.78	9.99	
DP-3	0.15	0.50	21.29	3.00	5.03	13.89	6.24	34.92	
DP-4	0.15	0.50	20.31	3.07	5.15	10.18	4.68	26.20	
DP-5	0.15	0.50	12.19	3.83	6.43	3.58	2.06	11.52	
DP-6	0.17	0.52	22.81	2.89	4.85	12.08	6.08	30.49	
DP-7	0.19	0.53	22.17	2.94	4.93	3.73	2.08	9.74	
DP-8	0.17	0.51	36.99	2.17	3.64	35.17	12.58	65.23	

Equations:

$$Q = CiA$$

Q = runoff (cfs)

C = Rational Coefficient

I = Rainfall intensity (in/hr)

A = Tributary Area (AC)

$$i_5 = -1.50\ln(D)+7.583$$

D = Duration (min) = t<sub>c</sub>

$$i_{100} = -2.52\ln(D)+12.735$$

D = Duration (min) = t<sub>c</sub>

# HYDRAULIC CALCULATIONS

---



# DETERMINATION OF CULVERT HEADWATER AND OUTLET PROTECTION

MHFD-Culvert, Version 4.00 (May 2020)

**Project:** \_\_\_\_\_  
**ID:** \_\_\_\_\_

Please fill out information and ID for culvert.

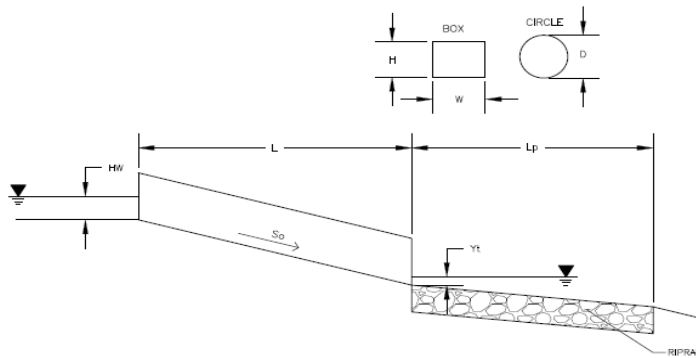

**Soil Type:**

Choose One:

- Sandy  
 Non-Sandy

Supercritical Flow! Using Adjusted Diameter to calculate protection type.

<b>Design Information:</b>	
Design Discharge	Q = <input type="text" value="46.46"/> cfs
<b>Circular Culvert:</b>	
Barrel Diameter in Inches	D = <input type="text" value="24"/> inches
Inlet Edge Type (Choose from pull-down list)	Grooved Edge Projecting
<b>OR:</b>	
<b>Box Culvert:</b>	
Barrel Height (Rise) in Feet	H (Rise) = <input type="text"/> ft
Barrel Width (Span) in Feet	W (Span) = <input type="text"/> ft
Inlet Edge Type (Choose from pull-down list)	
Number of Barrels	# Barrels = <input type="text" value="2"/>
Inlet Elevation	Elev IN = <input type="text" value="7875"/> ft
Outlet Elevation <b>OR</b> Slope	Elev OUT = <input type="text" value="7873.4"/> ft
Culvert Length	L = <input type="text" value="38"/> ft
Manning's Roughness	n = <input type="text" value="0.013"/>
Bend Loss Coefficient	k <sub>b</sub> = <input type="text" value="0"/>
Exit Loss Coefficient	k <sub>x</sub> = <input type="text" value="1"/>
Tailwater Surface Elevation	Y <sub>t</sub> , Elevation = <input type="text"/> ft
Max Allowable Channel Velocity	V = <input type="text" value="7"/> ft/s
<b>Calculated Results:</b>	
Culvert Cross Sectional Area Available	A = <input type="text" value="3.14"/> ft <sup>2</sup>
Culvert Normal Depth	Y <sub>n</sub> = <input type="text" value="1.00"/> ft
Culvert Critical Depth	Y <sub>c</sub> = <input type="text" value="1.71"/> ft
Froude Number	Fr = <input type="text" value="2.95"/> <span style="color: red; font-weight: bold;">Supercritical!</span>
Entrance Loss Coefficient	k <sub>e</sub> = <input type="text" value="0.20"/>
Friction Loss Coefficient	k <sub>f</sub> = <input type="text" value="0.47"/>
Sum of All Loss Coefficients	k <sub>s</sub> = <input type="text" value="1.67"/> ft
<b>Headwater:</b>	
Inlet Control Headwater	HW <sub>I</sub> = <input type="text" value="3.06"/> ft
Outlet Control Headwater	HW <sub>O</sub> = <input type="text" value="1.67"/> ft
<b>Design Headwater Elevation</b>	<b>HW = <input type="text" value="7878.06"/> ft</b>
<b>Headwater/Diameter <u>OR</u> Headwater/Rise Ratio</b>	<b>HW/D = <input type="text" value="1.53"/> <span style="color: red; font-weight: bold;">HW/D &gt; 1.5!</span></b>
<b>Outlet Protection:</b>	
Flow/(Diameter <sup>2.5</sup> )	Q/D <sup>2.5</sup> = <input type="text" value="4.11"/> ft <sup>0.5</sup> /s
Tailwater Surface Height	Y <sub>t</sub> = <input type="text" value="0.80"/> ft
Tailwater/Diameter	Y <sub>t</sub> /D = <input type="text" value="0.40"/>
Expansion Factor	1/(2*tan(θ)) = <input type="text" value="3.39"/>
Flow Area at Max Channel Velocity	A <sub>t</sub> = <input type="text" value="6.64"/> ft <sup>2</sup>
Width of Equivalent Conduit for Multiple Barrels	W <sub>eq</sub> = <input type="text" value="4.00"/> ft
<b>Length of Riprap Protection</b>	<b>L<sub>p</sub> = <input type="text" value="15"/> ft</b>
<b>Width of Riprap Protection at Downstream End</b>	<b>T = <input type="text" value="9"/> ft</b>
Adjusted Diameter for Supercritical Flow	Da = <input type="text" value="1.50"/> ft
Minimum Theoretical Riprap Size	d <sub>50</sub> min = <input type="text" value="7"/> in
Nominal Riprap Size	d <sub>50</sub> nominal = <input type="text" value="9"/> in
<b>MHFD Riprap Type</b>	<b>Type = <input type="text" value="L"/></b>

Please revise design to meet criteria regarding supercritical flow and froude number less than 1. Or provide inlet protection calculations/design for the culvert.

Please include missing culvert calculations.

Unresolved from Submittal 1 - Address culvert calculations with comments addressed.

## CGS DRAINAGE MEMO

---



## Technical Memorandum

To: El Paso County Planning and Community Development  
From: SMH Consultants, Brett Louk  
Date: 12/11/2023  
Subject: Guntzelman Porcelain Pines Subdivision Additional Hydraulic/Hydrologic Analysis  
PCD No. MS234

### INTRODUCTION

SMH Consultants, P.A. (SMH) has prepared this memorandum to describe additional hydrologic and hydraulic analyses performed for the Guntzelman Porcelain Pines Subdivision. These analyses were performed to address concerns from Colorado Geologic Survey (CGS) regarding possible debris flows and/or hyperconcentrated flows. These conditions could be created by runoff rates in excess of the typical design flow rates that could have a greater chance of occurrence than the 100-year event. However, these higher runoff rates are not recommended for design, but rather for hydraulic impacts to the development from these higher flow rates. The hydrologic and hydraulic design of the proposed facilities have been sized to handle the 100-year event as required by El Paso County drainage criteria. The analysis in this memorandum shows that the higher potential flow rates can be conveyed by existing natural channels with little impact to the development.

### OFFSITE HYDROLOGY/HYDRAULICS

CGS' concerns with the development are related to higher (bulked) flows, leading to debris flow and/or hyperconcentrated flow, and the impact of these to the proposed development. The concerns are primarily related to two (2) offsite drainage basins, previously identified as OS-2 and OS-3. These offsite basins are now identified as OS-6 and OS-7 as part of the final drainage report prepared by SMH. It should also be noted that the Manning residence, parcel no. 8322200017, is no longer part of this proposed subdivision. Thus, OS-6 is the only offsite basin that has been further analyzed in terms of hazardous debris flows and hyperconcentrated flows.

### SUPPLEMENTAL HYDROLOGIC/HYDRAULIC ANALYSIS

CGS raised concerns regarding the potential for offsite flows to transport sediment and debris. Otherwise known as debris flow and/or hyperconcentrated flows. CGS commented that they agree with the findings of RMG's Soil and Geology Report, dated March 2022, and stating "The gradients and source materials on the subject property are,

in general, not conducive for generation of debris flows". However, CGS identified offsite drainage basins where the potential hyperconcentrated flood and debris flow hazards exist for the upstream area now identified as basin OS-6. This basin includes steep slopes and material available for transport, such as, fallen trees, boulders, and weathered granite. Due to this observation, CGS recommends that flows for this offsite basin be bulked for high sediment and debris flow yields. The table below shows the industry standard bulking factors to predict runoff volume for this basin.

Bulking Factor							
0	1.11	1.25	1.43	1.67	2.00	2.5	>3.33
Sediment Concentration by Weight (100% by WT = 1 x 10 <sup>6</sup> ppm)							
0	23	40	52	63	72	80	87 to 100
Sediment Concentration by Volume (specific gravity = 2.65)							
0	10	20	30	40	50	60	70 to 100
Normal Streamflow	Hyperconcentrated Flow		Debris Flow/ Mud Flow		Landslide		

**Table 1. Flow Classification by Sediment Concentration (adapt. From Bradley, 1986)**

Per the aforementioned table, and input from CGS, the recommended bulking factors for OS-6 are 1.25 to 1.67. For the purposes of this memorandum, 1.67 was chosen as the bulking factor. Table 2, below, shows the unbulked and bulked runoff rates for basin OS-6.

Tributary Area	Q100 - Unbulked (cfs)	Q100 - Bulked (cfs)
South Channel - OS-6	49.68	82.97

**Table 2. Unbulked and Bulked Flows**

The potential for large debris flow, from basin OS-6, for events up to the 100-year event are believed to be minimal. However, the potential for large debris flow was estimated to determine the impacts on existing natural drainageways within the development. The bulked flow rates shown in the preceding table were used for evaluating potential impacts on existing natural drainageways within the proposed development and are not recommended for design.

## PROPOSED DEVELOPMENT HYDRAULICS

Flow from basin OS-6 enters the site via a natural channel and flows from southwest to northeast through property. Dual 24-inch reinforced concrete pipe (RCP) culverts are proposed under the new shared driveway serving the three lots within the proposed subdivision. Design flow rates for the dual RCP culverts are based on the 100-year flow rates. There are no proposed improvements to the existing natural channel. The following table shows the drainage facilities and hydraulic analysis within the proposed development.

	Size	Capacity (cfs)	Design Flow Rate (cfs)	Max Flow Rate (cfs)
Channel	8'W X 7.5'D (Average)	~2000	65.23	82.97
Dual Culverts	24" (2)	49.68	49.68	82.97

**Table 3. Hydraulic Structure Capacity**

The existing drainage channel has an average bottom width of 8-feet, an average depth of 7.5-feet, an average top width of 35-feet, and average side slopes of 1.8H:1V. The average running slope for the channel is 16.5 percent. Based on these characteristics, the existing channel has an estimated capacity of 2,000 cfs. The dual 24-inch RCP culverts have an estimated capacity of 49.68 cfs. Flows exceeding the capacity for the culvert system will flow over the drive embankment and continue down the existing drainage channel. The existing drainage channel has the available capacity to handle the bulked flows from basin OS-6.

## **SUMMARY AND CONCLUSIONS**

These analyses were performed to address concerns from Colorado Geologic Survey (CGS) regarding possible debris flows and/or hyperconcentrated flows. These conditions could be created by runoff rates in excess of the typical design flow rates that could have a greater chance of occurrence than the 100-year event. However, these higher runoff rates are not recommended for design, but rather for hydraulic impacts to the development from these higher flow rates. The hydrologic and hydraulic design of the proposed facilities have been sized to handle the 100-year event as required by El Paso County drainage criteria. The higher flow rates were estimated by applying a bulking factor of 1.67 to the 100-year runoff rates. Based on the analysis presented in this memo, the existing natural channel has sufficient capacity to handle the bulked flows. There are no anticipated detrimental impacts to the proposed development from the higher bulked flows.

# DRAINAGE MAPS

---





**LEGEND**

- FLOW PATH
- PROPERTY BOUNDARY
- - - DRAINAGE AREAS
- ⊕ DRAINAGE AREA #
- △ # DESIGN POINT

**PRE-DEVELOPMENT SUMMARY TABLE**

DRAINAGE AREA	AREA (ACRE)	C5	C100	TIME OF CONCENTRATION (TC)	Q5 (CFS)	Q100 (CFS)
EX-1	0.39	0.15	0.50	5.46	0.30	1.66
EX-2	1.68	0.15	0.50	9.63	1.06	5.91
EX-3	2.55	0.15	0.50	12.59	1.45	8.11
EX-4	6.14	0.15	0.50	13.12	3.43	19.17
EX-5	3.58	0.15	0.50	12.19	2.06	11.52
EX-6	7.24	0.15	0.50	14.68	3.86	21.61
EX-7	3.73	0.15	0.50	22.60	1.62	9.09
EX-8	9.74	0.15	0.50	25.91	3.95	22.07
OS-1	2.48	0.15	0.50	12.23	1.42	7.96
OS-2	2.10	0.15	0.50	15.60	1.09	6.10
OS-3	11.34	0.15	0.50	14.51	6.07	33.98
OS-4	4.04	0.15	0.50	12.82	2.28	12.75
OS-5	4.82	0.15	0.50	14.26	2.60	14.56
OS-6	19.17	0.15	0.50	20.03	8.88	49.68
OS-7	6.26	0.17	0.51	20.44	3.26	16.42

**PRE-DEVELOPMENT DESIGN POINT SUMMARY TABLE**

DRAINAGE AREA	CONTRIBUTING BASIN	AREA (ACRE)	C5	C100	TIME OF CONCENTRATION (TC)	Q5 (CFS)	Q100 (CFS)
DP-1	OS-1,EX-1	2.87	0.15	0.50	13.39	1.59	8.89
DP-2	OS-2,EX-2	3.78	0.15	0.50	19.24	1.78	9.99
DP-3	OS-3,EX-3	13.89	0.15	0.50	21.29	6.24	34.92
DP-4	OS-4,EX-4	10.18	0.15	0.50	20.31	4.68	26.20
DP-5	EX-5	3.58	0.15	0.50	12.19	2.06	11.52
DP-6	OS-5,EX-6	12.08	0.15	0.50	22.99	5.22	29.20
DP-7	EX-7	3.73	0.15	0.50	22.60	1.63	9.10
DP-8	OS-6,OS-7,EX-8	35.17	0.15	0.50	37.10	11.41	63.81

**SMH CONSULTANTS**  
 www.smhconsultants.com  
 Civil Engineering • Land Surveying  
 Landscape Architecture  
 Manhattan, KS - HQ  
 (785) 776-0541  
 Dodge City, KS  
 (620) 255-1952  
 Overland Park, KS  
 (913) 444-9615  
 Colorado Springs, CO  
 (719) 465-2145

**GUNTZELMAN PORCELAIN PINES SUBDIVISION**  
 DRAINAGE STUDY  
 EL PASO COUNTY, COLORADO

**PRE-DEVELOPMENT DRAINAGE MAP**

REVISION DATE	00/00/00	REVISION DESCRIPTION	(DESCRIPTION)	
REVISION DATE		REVISION DESCRIPTION		
NORTH				
PROJECT #: 2107-0307 CHECKED BY: BML DRAWN BY: JMT				<b>FIG. 2</b>
DATE: 07/08/2022 SHEET #				
TOTAL SHEETS				







# V2\_Drainage Report - Final\_Comments.pdf Markup Summary

## Callout (3)

existing drainage corridors on the property, maintain Creek east of the property. This includes two future single-family residences, and the map will also include dual 30" culverts under drainage Area P-8 has existing runoff values of 100-year events.

Please revise the drainage map to show a 24" dual culvert.

For stormwater quality management: reducing runoff volume, stabilizing streams, and other steps are further outlined in Volumes 1 and 2

**Subject:** Callout  
**Page Label:** 9  
**Author:** Carlos  
**Date:** 1/10/2024 5:11:21 PM  
**Status:**  
**Color:** ■  
**Layer:**  
**Space:**

Please revise as drainage map shows a 24" dual culvert.

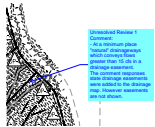

**Subject:** Callout  
**Page Label:** [1] Proposed  
**Author:** Carlos  
**Date:** 1/10/2024 5:17:36 PM  
**Status:**  
**Color:** ■  
**Layer:**  
**Space:**

Unresolved Review 1 Comment:  
- At a minimum place "natural" drainageways which conveys flows greater than 15 cfs in a drainage easement.  
The comment responses state drainage easements were added to the drainage map. However easements are not shown.

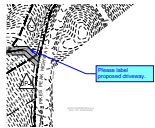

**Subject:** Callout  
**Page Label:** [1] Proposed  
**Author:** Carlos  
**Date:** 1/10/2024 5:17:55 PM  
**Status:**  
**Color:** ■  
**Layer:**  
**Space:**

Please label proposed driveway.

## Highlight (4)

drainage corridors on the property east of the property. This includes two future single-family residences, and the map includes dual 30" culverts under drainage Area P-8 has existing runoff values of 100-year events.

**Subject:** Highlight  
**Page Label:** 9  
**Author:** Carlos  
**Date:** 1/10/2024 5:10:58 PM  
**Status:**  
**Color:** ■  
**Layer:**  
**Space:**

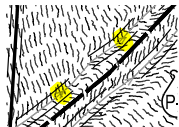

**Subject:** Highlight  
**Page Label:** [1] Proposed  
**Author:** Carlos  
**Date:** 1/10/2024 5:18:20 PM  
**Status:**  
**Color:** ■  
**Layer:**  
**Space:**

>  
>

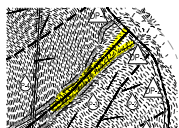

**Subject:** Highlight  
**Page Label:** [1] Proposed  
**Author:** Carlos  
**Date:** 1/10/2024 5:18:38 PM  
**Status:**  
**Color:** ■  
**Layer:**  
**Space:**



**Subject:** Highlight  
**Page Label:** [1] Proposed  
**Author:** Carlos  
**Date:** 1/10/2024 5:18:53 PM  
**Status:**  
**Color:** ■  
**Layer:**  
**Space:**

---

SW - Textbox with Arrow (1)

---

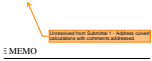

**Subject:** SW - Textbox with Arrow  
**Page Label:** 46  
**Author:** Mikayla Hartford  
**Date:** 1/17/2024 5:02:08 PM  
**Status:**  
**Color:** ■  
**Layer:**  
**Space:**

Unresolved from Submittal 1 - Address culvert calculations with comments addressed.

---

Text Box (5)

---



**Subject:** Text Box  
**Page Label:** 45  
**Author:** Carlos  
**Date:** 1/10/2024 4:50:57 PM  
**Status:**  
**Color:** ■  
**Layer:**  
**Space:**

Please fill out information and ID for culvert.

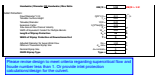

**Subject:** Text Box  
**Page Label:** 45  
**Author:** Carlos  
**Date:** 1/10/2024 5:08:01 PM  
**Status:**  
**Color:** ■  
**Layer:**  
**Space:**

Please revise design to meet criteria regarding supercritical flow and froude number less than 1. Or provide inlet protection calculations/design for the culvert.



**Subject:** Text Box  
**Page Label:** 46  
**Author:** Carlos  
**Date:** 1/10/2024 5:08:19 PM  
**Status:**  
**Color:** ■  
**Layer:**  
**Space:**

Please include missing culvert calculations.



**Subject:** Text Box  
**Page Label:** 10  
**Author:** Carlos  
**Date:** 1/10/2024 5:12:16 PM  
**Status:**  
**Color:** ■  
**Layer:**  
**Space:**

Please state the difference in pre and post-development flows.



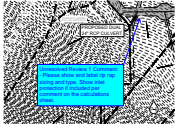

---

**Subject:** Text Box  
**Page Label:** [1] Proposed  
**Author:** Carlos  
**Date:** 1/10/2024 5:14:53 PM  
**Status:**  
**Color:** ■  
**Layer:**  
**Space:**

Unresolved Review 1 Comment:  
- Please show and label rip rap sizing and type.  
Show inlet protection if included per comment on  
the calculations sheet.