

Item Numbers refer to SWMP Checklist

## STORMWATER MANAGEMENT PLAN (SWMP)

Public High School: **Palmer Ridge High School, 19255 Frontage Road, Monument, CO 80132**

*Prepared for:*

**El Paso County Public Works**  
3275 Akers Dr  
Colorado Springs, CO 80922-1503

**Colorado Department of Public Health and Environment**  
Water Quality Control Division-Stormwater Program  
WQCD-Permits-B2  
4300 Cherry Creek Drive South  
Denver, CO 80246-1530

*On Behalf of:*

Lewis-Palmer School District 38  
Monument, Colorado

*Prepared by:*



4465 Northpark Dr., Suite 400A  
Colorado Springs, CO 80907  
(719) 291-2744

Item 1. Add Qualified Stormwater Manager and Contractor Information to cover/title sheet. If unknown, add a placeholder to be updated prior to the pre-construction meeting:

### QUALIFIED STORMWATER MANAGER

Name: \_\_\_\_\_  
Company: \_\_\_\_\_  
Address: \_\_\_\_\_

### CONTRACTOR

Name: \_\_\_\_\_  
Company: \_\_\_\_\_  
Address: \_\_\_\_\_



## **APPLICANT INFORMATION**

### **APPLICANT:**

Lewis Palmer School District 38  
Palmer Ridge High School  
19255 Frontage Rd  
Monument, CO 80132

### **DESIGN ENGINEER CONTACT INFORMATION:**

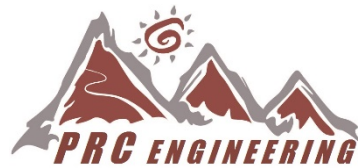

Mr. Ray Perez, P.E.  
PRC Engineering  
4465 Northpark Dr., Suite 400A  
Colorado Springs, CO 80907  
(719) 291-2744

"This *Grading, Erosion and Sediment Control (GESC)* document has been placed in the project file for this project and appears to fulfill the latest version of the *Grading, Erosion and Sediment Control Manual*. Additional grading, erosion and sediment Control Measures may be required of the owner or his/her agents, due to unforeseen erosion problems or if the submitted plan does not function as intended. The requirements of this GESC document shall run with the land and be the obligation of the landowner, or his/her designated representative(s) until such time as the plan is properly completed, modified or voided."

**ENGINEERS CERTIFICATE**

Engineer of Record:

The Stormwater Management Plan was prepared under my direction and supervision and is correct to the best of my knowledge and belief. Said Plan has been prepared according to the criteria established by the County and State for Stormwater Management Plans.



Engineer of record signature: \_\_\_\_\_ Date: July 19, 2021

State of Colorado No. 37173

Affix Seal

Date: July 19, 2021

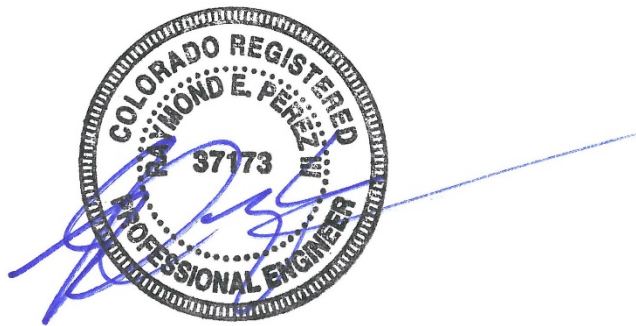

**LANDOWNER/AUTHORIZED AGENT ACKNOWLEDGEMENT CERTIFICATION STATEMENT:**

"I hereby certify that the Grading, Erosion, and Sediment Control Measures for the GSHP Remedial Renovation at Palmer Ridge High School shall be constructed according to the design presented in this document. I understand that additional erosion control, sediment control and water quality enhancing measures may be required of the owner and his or her agents due to unforeseen pollutant discharges or if the submitted plan does not function as intended. The requirements of the plan shall be the obligation of the landowner and/or his successors or heirs; until such time as the plan is properly completed, modified or voided."

Owner or Authorized Agent \_\_\_\_\_

Authorized Signature \_\_\_\_\_

**TABLE OF CONTENTS**

**A. SITE AND PROJECT DESCRIPTION ..... 1**

1. Project Description..... 1

2. Construction Activity..... 1

3. Progression of Significant Activities ..... 1

4. Area of Site and Area to be impacted ..... 2

5. Soil Erosion potential ..... 2

6. Existing Site Conditions ..... 2

7. Identified, Potential Pollutant Sources..... 2

    Potential Construction Site Stormwater Pollutants ..... 4

    Locations of Potential Sources of Stormwater Contamination..... 5

**B. MATERIALS HANDLING AND SPILL PREVENTION ..... 5**

1. Spill Containment Methods ..... 6

2. Spill Countermeasures ..... 6

**C. WATER DISCHARGE INFORMATION ..... 7**

1. Non-Stormwater Discharge..... 7

2. Receiving Waters ..... 7

3. Stream Crossings..... 7

**D. STORMWATER MANAGEMENT CONTROLS ..... 7**

**E. CONTROL MEASURES FOR STORMWATER POLLUTION PREVENTION..... 8**

1. Control Measures Overview..... 8

2. Phasing of Control Measures ..... 8

**F. PROJECT SITE CONTROL MEASURES INSPECTIONS, MAINTENANCE AND RECORD KEEPING ..... 13**

1. Site Inspections ..... 13

2. Control Measures Maintenance Procedures ..... 14

3. Record Keeping Procedures ..... 14

Appendix..... 19

**Appendix:**

- Stormwater Management Plan Inspection and Maintenance Log
- NRCS Soils Survey
- El Paso County Stormwater Management Plan Checklist
- GESC Drawings

**A. SITE AND PROJECT DESCRIPTION**

**1. Project Description**

The project is located in the Woodmoor neighborhood, east of I-25 and south of Misty Acres Blvd.

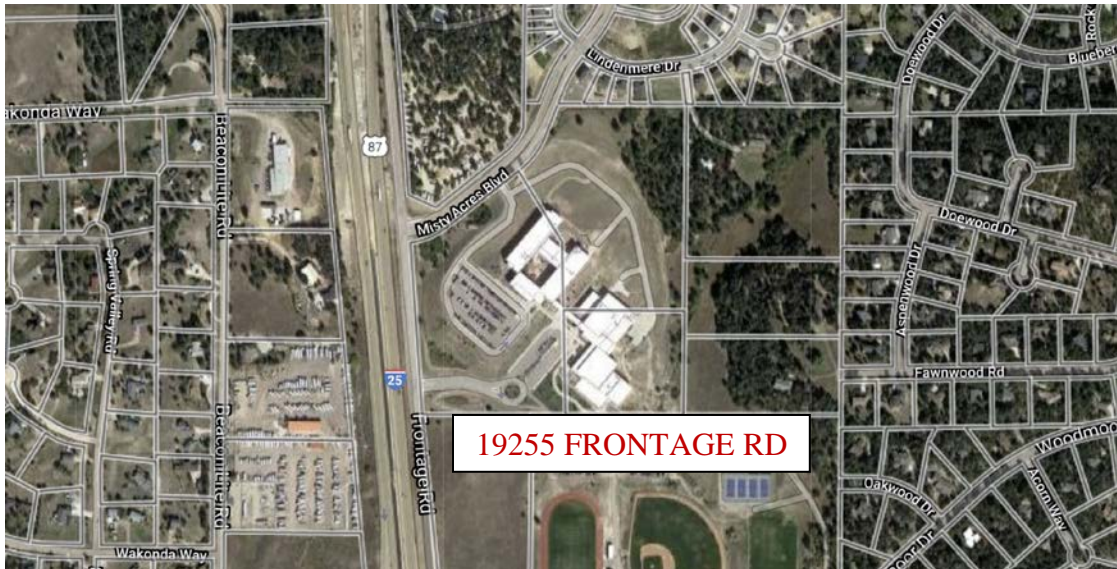

**Figure 1 – Vicinity Map**

The property consists of a high school campus, concrete drives, parking lots, ballfields, sidewalks, and vegetation. Contractor is expected to repair any damage to existing facilities in the area of disturbance.

No impact to downstream ponds or infrastructure on the drainage way is expected.

**2. Construction Activity**

Construction activities will include land disturbance up to the existing building structure, pavement areas, and the replacement of GSHP pipes. The entire site encompasses 15.10 acres. The anticipated area of disturbance is 2.58 acres. Both the existing and proposed land uses associated with this Project are typical of a public education facility.

**3. Progression of Significant Activities**

Once best management practices (Control Measures) are in place, construction will commence utilizing phasing to minimize stormwater and erosion impact.

Please see “Construction Schedule/Sequencing” for further description of the sequence of events.

**4. Area of Site and Area to be impacted**

The area of the project site is 15.10 acres. The total area proposed to be disturbed is approximately 2.58 acres.

**5. Soil Erosion potential**

According to the Natural Resources Conservation Service (NRCS), the soils in this area consist of Kettle Gravelly Loamy Sand, Pring Course Sandy Loam, and Tomah-Crowfoot Loamy Sands, all of which can be classified as Hydrologic Soil Group (HSG) Type B. HSG Type B soils have a moderate infiltration rate, and a moderate rate of water transmission. Kettle Gravelly Loamy Sand areas feature 8 to 40 percent slopes, while the other two soil groups feature 3 to 8 percent slopes. A copy of the NRCS report is provided in the Appendix.

**Table 1 - NRCS Soil Survey for El Paso County Area, Colorado**

Soil ID No.	Soil Type	Hydrologic Classification
41	Kettle Gravelly Loamy Sand	B
71	Pring Course Sandy Loam	B
92	Tomah-Crowfoot Loamy Sands	B

**6. Existing Site Conditions**

The existing site consists of a high school campus, concrete drives, parking lots, ballfields, sidewalks, and vegetation. **Item 9. Discuss existing vegetation, percent ground cover, and the method used to determine ground cover (i.e., visual, aerial inspection)**

**7. Identified, Potential Pollutant Sources**

Construction activities produce many kinds of pollutants which may cause stormwater contamination. Grading and excavation activities remove ground cover, rocks, vegetation, and other erodible surfaces, resulting in the exposure of underlying soil (a pollutant) to the elements. These construction activities leave the soil surface unprotected. Soil or sand particles are more easily picked up by wind and washed away by rain or other water sources. Additional materials and activities at the project site that may have an impact on stormwater include the following:

- excavation
- exposed soil sediment
- trash & debris
- sanitary waste
- portable toilet facilities
- hauling of materials
- heavy equipment

- concrete waste
- asphalt paving

The on-site construction equipment, their vehicular traffic, fueling, and maintenance operations also present the potential for spills and leaks. These potential pollutants include hydraulic oil, engine grease, diesel fuel, gasoline, and anti-freeze (ethylene glycol).

Pollutants that result from clearing, grading, and excavation materials and have the potential to be present in stormwater runoff are listed in the table below. Potential sources of stormwater contamination are listed as well.

**Potential Construction Site Stormwater Pollutants**

Trade Name or Material	Chemical/Physical Description	Stormwater Pollutants
Pesticides (insecticides, fungicides, herbicides, rodenticides)	Various colored to colorless liquid, powder, pellets, or grains	Chlorinated hydrocarbons, organophosphates, carbamates, arsenic
Fertilizer	Liquid or solid grains	Nitrogen, phosphorous
Cleaning solvents	Colorless, blue, or yellow-green liquid	Perchloroethylene, methylene chloride, trichloroethylene, petroleum distillates
Concrete	White solid	Limestone, sand
Paints	Various colored liquid	Metal oxides, stoddard solvent, talc, calcium carbonate, arsenic
Wastewater from construction equipment washing	Water	Soil, oil & grease, solids
Wood preservatives	Clear amber or dark brown liquid	Stoddard solvent, petroleum distillates, arsenic, copper, chromium
Hydraulic oil/fluids	Brown oily petroleum hydrocarbon	Mineral oil
Gasoline	Colorless, pale brown or pink petroleum hydrocarbon	Benzene, ethyl benzene, toluene, xylene, MTBE
Diesel Fuel	Clear, blue-green to yellow liquid	Petroleum distillate, oil & grease, naphthalene, xylenes
Kerosene	Pale yellow liquid petroleum hydrocarbon	Coal oil, petroleum distillates
Antifreeze/coolant	Clear green/yellow liquid	Ethylene glycol, propylene glycol, heavy metals (copper, lead, zinc)
Erosion	Solid Particles	Soil, Sediment



**Locations of Potential Sources of Stormwater Contamination**

Potential Stormwater Contamination	Potential Pollutants	Potential Problem
Construction site entrance	Soils/sediment,	Sediment load increased at storm sewer outfall and tracking of soil into the road through the construction site.
Cleared and Graded Areas	Hydraulic oil, gasoline, antifreeze, soil erosion, fertilizer	Leaking hydraulic oil and antifreeze from clearing and grading construction equipment. Gasoline and diesel fuel spills while fueling construction equipment, and erosion of exposed and stockpiled soils. Asphalt chemicals can be released to stormwater if a rain event occurs before curing is complete.
Any undisturbed areas; Staging Areas	Hydraulic oil, gasoline, antifreeze, soil erosion, fertilizer, pesticides	Leaking hydraulic oil and antifreeze from clearing and grading construction equipment. Gasoline and diesel fuel spills while fueling construction equipment, and erosion of exposed and stockpiled soils. Asphalt chemicals can be released to stormwater if a rain event occurs before curing is complete. Tracking of soil into the road through the construction site entrance.

Item 12. Note that this project does not anticipate utilizing batch plants in the SWMP text

All waste materials will be collected and stored in a metal dumpster. All trash and construction debris from the site will be deposited in the dumpster. The contractor will be responsible for the handling of all waste materials on site. No construction materials will be buried on-site. Good housekeeping and spill control practices should be followed during construction to minimize stormwater contamination from petroleum products, fertilizers, paints, and concrete.

**B. MATERIALS HANDLING AND SPILL PREVENTION**

To minimize potential for procedures or significant materials to contribute pollutants to runoff the project site superintendent will act as the point of contact for any spill that occurs. They will be responsible for implementing prevention practices, spill containment and cleanup, worker training, reporting, and completing documentation and updating the SWMP if a spill occurs. The storage and handling of any construction materials will be managed according to company mandated procedures and policies and as detailed in the SWMP. These policies will be communicated to all contractors, subcontractors, and vendors for proper adherence. The potential for spill pollution occurs where materials



are stored, from equipment leaks, maintenance, or fueling procedures, from waste materials, or other chemicals.

**1. Spill Containment Methods**

Should a spill occur from equipment in the form of fuel, grease, hydraulic oil, etc. the hazardous material will be contained within a secondary spill containment cell (drip/drain pan) and disposed of properly in an approved receptacle. Any undetected leak from equipment will be cleaned immediately upon detection. The contaminated soil from such a leak will be removed with hand shovels and placed in an approved receptacle (fuel/oil waste disposal drum). A leak or spill that occurs on impervious surface (asphalt, concrete, rock, etc.) will be contained using fuel absorbent pads or absorbent litter and once allowed to absorb the spill will be removed to an approved fuel/oil waste disposal receptacle. These used spill materials and contaminated soils will be disposed of offsite at an approved hazardous waste facility. The material storage trailer will have a spill kit to be used for containment.

**2. Spill Countermeasures**

Should a hazardous spill occur which may endanger health or the environment, cause pollution of the waters of the state, or may cause and exceedance of a water quality standard, the following procedures will take place:

- Stop the spill, unless it is too hazardous to do so or the spill involves any biohazards.
- Notify the Owner and/or the Owner’s representative (Operator, Project Site Superintendent). The Owner or the Owner’s representative will be onsite during the construction activities and will be able to respond immediately. Once the responsible parties have been notified, a determination will be made by the Owner or the Owner’s representative whether the nature of the spill warrants the notification of additional authorities. As required by the Stormwater Discharges Associated with Construction Activity permit (Appendix I) the Colorado Department of Health and Environment will be notified by the following procedures for spills meeting the above criteria in 3.3.2.
- For non-hazardous materials: Contact CDPHE Environmental Emergency Spill Reporting Line (1-877-518-5608) within 24 hours of the spill event. A written notification to CDPHE is also required within 5 days.
- For hazardous materials: Contact local emergency response team by calling 911. Then Contact the CDPHE Environmental Emergency Spill Reporting Line (1-877-518-5608) within 24 hours of the spill event. A written notification to CDPHE is also required within 5 days.

Advance preparations will be initiated by the permittee to ensure a prompt and effective response to any spills. These preparations include an action plan to stop/control further

leakage, containment of the spill with absorbent materials, or an earthen berm, and clean up and removal of residual pollutants and contaminated materials.

### **C. WATER DISCHARGE INFORMATION**

#### **1. Non-Stormwater Discharge**

There are no non-stormwater discharge sources that have been observed or are anticipated at this project site other than the allowable non-stormwater discharges covered in this section. No concrete waste will remain or be dumped onsite, in any drainage way, or storm sewer. Should groundwater or other discharge be encountered the proper permits will be obtained, stormwater management measures will be taken, and the SWMP will be revised and updated.

#### **2. Receiving Waters**

Stormwater runoff from this Project will flow into Monument Creek and ultimately discharge into the South Platte River. According to the Federal Emergency Management Agency (FEMA) Flood Insurance Rate Map (FIRM) number 08041C0276G dated December 6, 2018 this project is located within an area of minimal flood hazard, zone x.

#### **3. Stream Crossings**

No Streams cross the project area.

#### **Site Map**

A site map is included in the form of engineered plans identifying the following:

- Construction site boundaries
- All areas of ground surface disturbance
- Areas used for storage
- Areas used for equipment
- Areas used for soil or waste
- Locations of all structural Control Measures
- Locations of non-structural Control Measures as applicable
- Locations of springs, streams, wetlands, and other surface waters.
- Site Map (GESC Drawings) is located in the appendix of this report.

### **D. STORMWATER MANAGEMENT CONTROLS**

Temporary and permanent erosion and sediment controls used during construction activities will provide soil stabilization for disturbed areas and structural controls to divert runoff and remove sediment.

#### **1. Qualified Stormwater Manager**

The Qualified Stormwater Manager for the Project site will be determined by the general contractor. The General Contractor will update this document with appropriate contact

information for the Qualified Stormwater Manager. The Qualified Stormwater Manager's duties include the following:

- Implement the SWMP;
- Oversee installation and maintenance of Control Measures as identified in the SWMP;
- Implement and oversee employee training;
- Conduct or provide for inspection and monitoring activities;
- Identify potential pollutant sources and make sure they are added to the plan;
- Identify any deficiencies in the SWMP and make sure they are corrected; and
- Ensure that any changes in construction plans, phasing, or use of Control Measures are addressed in the SWMP.

Specific Control Measures to be used on the Project site are identified in this SWMP. The Qualified Stormwater Manager will be responsible for documenting Control Measures (including phasing of Control Measures implementation).

## **E. CONTROL MEASURES FOR STORMWATER POLLUTION PREVENTION**

### **1. Control Measures Overview**

Control Measures encompass a wide range of erosion and sediment control practices, both structural and non-structural in nature, that are intended to reduce or eliminate any possible water quality impacts from stormwater leaving a construction site. The individual Control Measures appropriate for a construction site are largely dependent on the types of potential pollutant sources present, the nature of the construction activity, and specific-site conditions.

The Control Measures referenced herein are widely used in the construction industry. They generally involve a simple and low-cost approach, and can be very effective when properly installed and maintained.

### **2. Phasing of Control Measures**

Installations of structural and non-structural Control Measures will be used for erosion control and stormwater management prior to commencement and during construction activities. The Operator/Permittee is committed to installing the Control Measures as listed, maintaining them as needed, and revising or adding to this plan as construction phasing or plans evolve.

#### **i. Project Schedule/Sequencing:**

- Estimated Construction Start Date – August 1, 2021
- Estimated Construction Completion Date – December 31, 2021
- Sediment (mud and dirt) transported onto a public road, regardless of the size of the site, shall be cleaned/removed at the end each day.
- Soil erosion Control Measures for all slopes, channels, ditches, or any disturbed land area shall be completed immediately after grading or earth

disturbance has occurred. All temporary soil erosion Control Measures and Control Measures shall be maintained until site reaches final stabilization and permanent soil erosion Control Measures are implemented.

- Once the road is cleaned and the surrounding disturbed areas are 70% established with vegetation, the silt fences around the Project site can be removed.
- Topsoil stockpiles will be stabilized with temporary seed and mulch no later than fourteen days from the last construction activities in that area.

ii. Control Measures Prior to Construction Commencement:

Control measures will be applied prior to initial construction.

Stabilized staging areas will be constructed prior to any commencement. This is an area that is designated for construction equipment and vehicles, stockpiles, waste bins, and other construction related materials. Stabilized construction site entrance will be constructed before clearing and grading begins. Clearing and grading will not occur in an area until it is necessary for construction to proceed.

Vehicle tracking control, silt fence, and construction fence will be addressed and applied prior to active construction and should be removed upon completion of construction activities.

Inlet protection will be installed prior to any ground disturbing activities, remain in place and maintained during excavation, utility installation, backfill, and paving and removed once the construction phase is completed in that area and the potential pollutant has been eliminated. These Control Measures will require regular maintenance including sediment and debris removal when build-up is visible. To prevent any stormwater pollution due to curb flow conveyance all storm drain inlets will need inlet protection.

iii. Control Measures During Construction:

Control Measures will be applied and maintained during the construction phase of the project.

Inlet protection will be installed as soon as drains have been installed, remain in place and maintained during excavation, utility installation, backfill, and paving and removed once the construction phase is completed in that area and the potential pollutant has been eliminated. These Control Measures will require regular maintenance including sediment and debris removal when build-up is visible. To prevent any stormwater pollution due to curb flow conveyance all storm drain inlets will need inlet protection.

Dust control with water, waste management, concrete waste management, spill measures, good housekeeping, and soil stabilization will be addressed or applied

during active construction. Maintenance of the Control Measures will be needed as previously stated. Restoration activities will be completed throughout the project. Exposed slopes greater than 4:1 will be covered by an erosion control blanket with mulching.

iv. Control Measures for Final Stabilization, Re-Vegetation, and Long-Term Stormwater Management:

Final Stabilization measures, upon completion of construction activities, where potential pollutants have been minimized, and once surfaces have been replaced to asphalt or concrete, will be initiated. Temporary Control Measures will be removed including stabilized staging area, vehicle tracing, silt fence, construction fence, and inlet protection. The site will be stabilized by permanent surfaces (mainly concrete, asphalt, seed/mulch and rip-rap bank stabilization), and good-housekeeping measures will be used to ensure a clean and complete project site. There are no new long-term Control Measures constructed for this project. The Control Measures will remain in the area of ground disturbance until 70% revegetation is achieved or a similar equivalent. Once construction activity ceases permanently in an area, the area will be stabilized with permanent seed and mulch.

**Control Measures Maintenance**

Visual inspections of all cleared and graded areas of the construction site will be performed on a minimum occurrence of once per week and/or within 24 hours of the end of any precipitation or snowmelt event that causes surface erosion. The first inspection shall occur within 7 days of construction commencement. The inspection will be the responsibility of the Qualified Stormwater Manager. An inspection report form has been provided in the Appendix. The inspection will verify that the structural Control Measures described in Section B of this SWMP are functioning properly, in good condition, up to date and minimize erosion. The inspection will also verify that the procedures used to prevent stormwater contamination from construction materials and petroleum products are effective. The following inspection and maintenance practices will be used to maintain erosion and sediment controls:

- Concrete Washout Area (CWA):
  - A sign shall be placed at each washout area to clearly indicate the location of the CWA/GWA to operators of concrete trucks and pump rigs.
  - Excavated material may be utilized in perimeter berm construction.
  - If there is a potential for high ground water, the CWA/GWA must have an impervious liner.
  - The CWA/GWA shall be repaired, enlarged, and/ or cleaned out as necessary to maintain capacity for wasted concrete.

- As needed during construction and at the end of construction, all concrete or grout waste shall be removed from the site and disposed of at an approved waste site.
- The GESC Manager shall inspect washout areas and maintain in good operating condition.
- Construction Fence (CF):
  - CM consisting of painted or flagged lath at approximately 100-foot spacing may be used to delineate the Limits of Construction, if approved by SEMSWA.
  - Steel tee posts shall be utilized for support of construction fence as appropriate to site conditions.
  - The GESC Manager shall inspect CF/CM and maintain in good operating condition.
- Erosion Control Blanket (ECB):
  - All ECB shall be double-sided netting and be made of 100% natural and biodegradable material; no plastic or other synthetic material, even if photodegradable, shall be allowed.
  - Unless otherwise approved by SEMSWA, in areas where ECB is shown on the plans, the GESC Manager shall place topsoil and perform final grading, surface preparation, and seeding below the blanket in accordance with the GESC Plan - Standard Notes and Details, Seeding and Mulching. Subgrade shall be smooth and moist prior to ECB installation and the ECB shall be in full contact with the subgrade; no gaps or voids shall exist under the ECB. Sufficient stakes will be used to keep blanket in contact with the soil to facilitate vegetation growth.
  - Staking spacing dimensions on center shall be based on expected shear velocities.
  - Perimeter anchor trench shall be used at the outside perimeter of all ECB areas.
  - Follow all manufacture installation specifications.
  - Depending on location, 2 x 4 wedge stakes may be required to be removed prior to Final Close-out.
  - The GESC Manager shall inspect ECB and maintain in good operating condition.
- Inlet Protection (IP):
  - Interim configuration of IP in streets (before paving) shall be installed immediately after pouring of the inlet and the concrete has taken initial set.
  - IP (after paving) shall be installed immediately after paving is placed.
  - Wire mesh shall be twisted into a mesh with a maximum opening of 1.0-inch (commonly termed "Chicken Wire").
  - Wire mesh shall be secured with wire ties at approximately 6-inch centers along all joints and at approximately 2-inch centers on ends of berm.
  - Crushed rock shall be fractured face (all sides) and shall comply with gradation shown on the GESC Plan - Standard Notes and Details (1-1/2" minus). Recycled concrete may not be used.
  - The top of reinforced rock berm shall allow for overtopping into the inlet.
  - No gaps shall exist between sections of reinforced rock berms or cinder block frames.
  - Tubular markers shall be placed on each end of IP located on streets where public access can occur.

- Reinforced rock berm or cinder block ends shall be placed tightly against curb face.
- IP is to remain in place until the upstream disturbed area is stabilized and grass cover approved, unless SEMSWA approves earlier removal of IP.
- Maintain IP when there is evidence of significant sediment buildup.
- Replace IP if removed for public/vehicle safety during a significant storm event, as approved by SEMSWA.
- The GESC Manager shall inspect IP and ensure it is maintained in good operating condition. More frequent inspections and repairs may be necessary during winter plowing conditions.
- Seeding & Mulching (SM):
  - All areas to be seeded and mulched shall have native topsoil or appropriately conditioned soil spread to a depth of at least 6-inches (loose depth).
  - All disturbed areas shall be loosened (tilled) to a depth of 6-inches prior to spreading topsoil.
  - The top 6-inches of the seed bed shall be generally free of rocks, woody debris and soil clods.
  - Stockpiles/areas that are being temporarily seeded do not require topsoil prior to seeding and mulching.
  - Seed shall be applied using a mechanical drill to a depth of not less than 1/4-inch and not more than 3/4- inch. Row spacing shall be no more than 6-inches. Material used for mulch shall consist of long-stemmed straw. At least 50-percent of the straw, by weight, shall be as long in length as possible. Mulch shall be applied and mechanically anchored to a depth of at least 3-inches at a rate of 4,000-pounds of straw/acre.
  - Copies of seed tickets shall be provided to the SEMSWA Inspector, upon request.
  - Temporary Irrigation is highly encouraged to assist with growth of vegetation.
  - Seeded and mulched areas shall be inspected for required coverage monthly, until the site reaches final acceptance. Repairs and re-seeding and mulching shall be undertaken for any areas failing to meet the required coverage until final acceptance. Required coverage is defined as 70% of the existing/ preconstruction condition, free of eroded areas, and free from infestation of noxious weeds.
  - Tackifier shall be utilized to help with straw displacement.
- Silt Fence (SF):
  - The bottom portion of the SF shall be trenched in and compacted per the GESC Plan - Standard Notes and Detail. SF installation machines that use trenching or slicing may be utilized to install SF.
  - Sediment accumulated upstream of SF shall be removed when the upstream sediment reaches 25%.
  - SF near the roadway is the responsibility of the Permittee/Contractor to maintain, even if damaged from public snow removal operations.
  - The GESC Manager shall inspect SF and ensure it is maintained in good operating condition.
- Stabilized Staging Area (SSA):



- SSA shall be large enough to contain equipment, parking, storage, and unloading and loading operations.
- SSA shall consist of a minimum thickness of 3 inches of angular granular material.
- The GESC Manager shall inspect the SSA and ensure it is maintained in good operating condition.
- Vehicle Tracking Control (VTC):
  - VTC shall be installed at every access point from the construction site.
  - VTC shall consist of hard, dense, durable stone, angular in shape and resistant to weathering. Rounded stone or boulders will not be acceptable. The stones shall not be smaller than 3-inches in size.
  - Curb ramps of any type are not allowed in the curb section.
  - VTC must be maintained whenever tracking is evident, or at the discretion of the SEMSWA Inspector.
  - Construction Fence (CF) will be required along each side of the VTC.
  - The GESC Manager shall inspect the VTC and ensure it is maintained in good operating condition.

The maintenance inspection report will be made after each inspection. A copy of the report form to be completed by the Qualified Stormwater Manager is provided in the Appendix. Completed forms will be maintained on-site during the entire construction project. Following construction and the expiration or inactivation of the permit, the completed forms will be retained at the general contractor's office, for a minimum of 3 years.

If construction activities or design modifications are made to the site plan which could impact stormwater, this SWMP will be amended appropriately. The amended SWMP will have a description of the new activities that contribute to the increased pollutant loading and the planned source control activities.

## **F. PROJECT SITE CONTROL MEASURES INSPECTIONS, MAINTENANCE AND RECORD KEEPING**

### **1. Site Inspections**

Inspections of the project site will be conducted as required by the Colorado Department of Public Health and Environment (CDPHE) - Water Quality Control Division permit, Stormwater Discharges Associated with Construction Activity. This permit will be the guiding document for field and administrative requirements during the life of the permit for this project. Therefore, the permittee or the permittee's representative will execute the required inspections of site conditions and installed Control Measures for impact and/or required maintenance. The SWMP is a living document and will be updated and revised, when necessary, including documentation of inspections. Inspections will occur at least every 7 calendar days and within 24 hours of a significant storm event and conducted as follows:

- All disturbed areas will be inspected for any existing or potential for erosion or transportation of sediment across or off the project site. All access points will be inspected for off-site tracking.
- All physical Control Measures will be inspected to ensure they are installed as detailed in the SWMP and effective in their quantity, size, and location. They will additionally be inspected to determine whether maintenance, repairs, cleaning, replacement, or modifications are needed.
- All site inlets and outlets and/or discharge points will be inspected for evidence of blockages, sediment buildup, and contaminating pollutants.
- All materials handling, storage, waste areas, and equipment will be inspected for evidence of leaks, spills, containment or procedure adherence, and/or contamination.
- Updating and revising of this SWMP will be assessed and applied collaborating with changing site conditions and construction phases.
- A written report will be generated documenting the inspection, findings, and necessary actions.

**2. Control Measures Maintenance Procedures**

In addition to regularly scheduled inspections, required maintenance, replacement, modifications, or cleaning of physical Control Measures will be completed proactively before stormwater pollution occurs. Any contaminants or pollutants that are cleaned and/or removed from installed Control Measures features will be disposed of properly.

**3. Record Keeping Procedures**

This Stormwater Management Plan is a living document and will be developed, implemented, maintained, and revised as construction progresses at this project site from Pre-construction to Final Stabilization. An on-site log in this SWMP will be maintained with records of inspections, maintenance activities, spills leaks or illicit discharges, training and any other known documents affecting stormwater management or erosion control for this project site.

Item 26. Add a note stating that this project does not rely on control measures owned or operated by another entity.

## **Appendix**

# **Stormwater Management Plan Inspection and Maintenance Log**



# **NRCS Soils Survey**



United States  
Department of  
Agriculture

**NRCS**

Natural  
Resources  
Conservation  
Service

A product of the National  
Cooperative Soil Survey,  
a joint effort of the United  
States Department of  
Agriculture and other  
Federal agencies, State  
agencies including the  
Agricultural Experiment  
Stations, and local  
participants

# Custom Soil Resource Report for El Paso County Area, Colorado

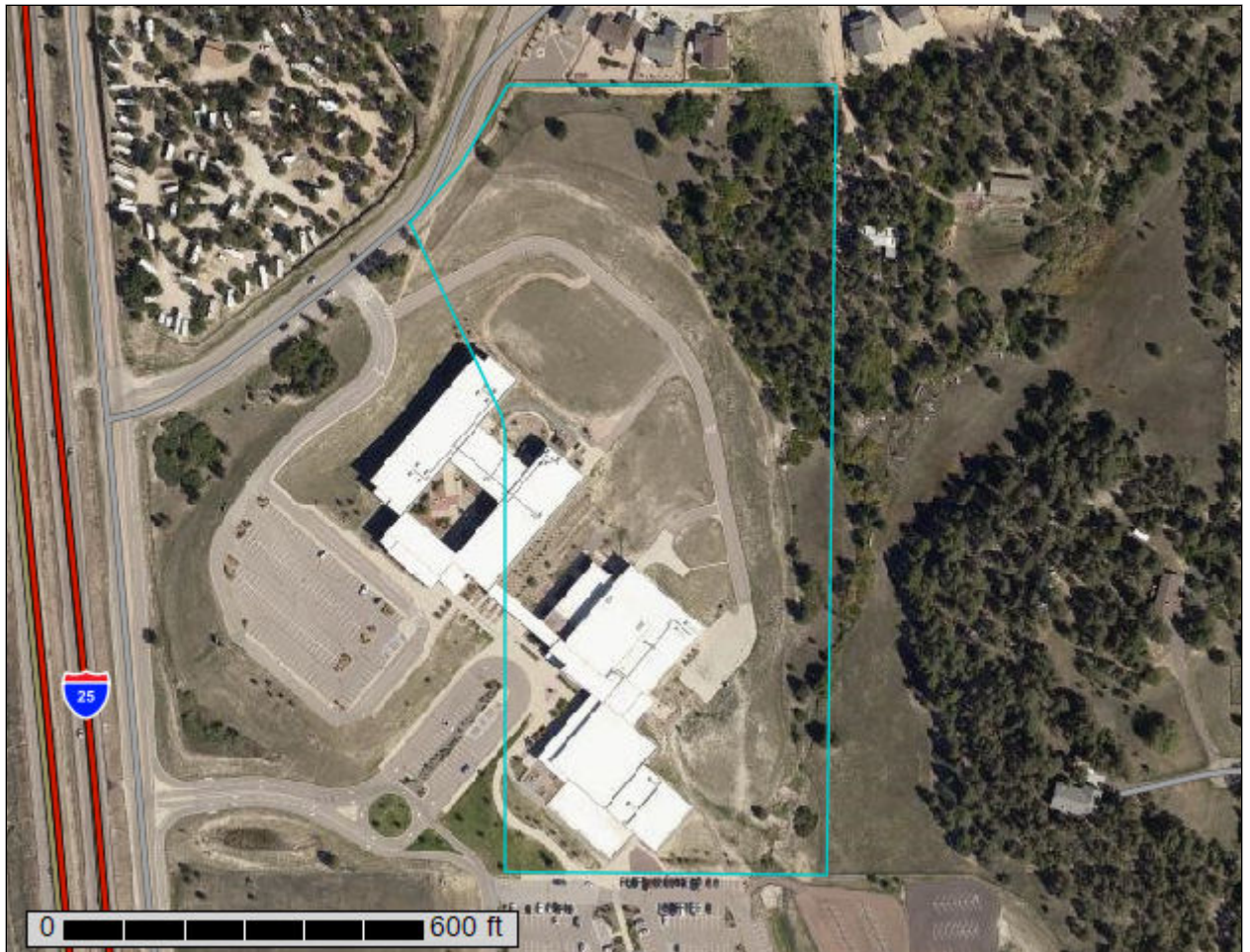

# Preface

---

Soil surveys contain information that affects land use planning in survey areas. They highlight soil limitations that affect various land uses and provide information about the properties of the soils in the survey areas. Soil surveys are designed for many different users, including farmers, ranchers, foresters, agronomists, urban planners, community officials, engineers, developers, builders, and home buyers. Also, conservationists, teachers, students, and specialists in recreation, waste disposal, and pollution control can use the surveys to help them understand, protect, or enhance the environment.

Various land use regulations of Federal, State, and local governments may impose special restrictions on land use or land treatment. Soil surveys identify soil properties that are used in making various land use or land treatment decisions. The information is intended to help the land users identify and reduce the effects of soil limitations on various land uses. The landowner or user is responsible for identifying and complying with existing laws and regulations.

Although soil survey information can be used for general farm, local, and wider area planning, onsite investigation is needed to supplement this information in some cases. Examples include soil quality assessments (<http://www.nrcs.usda.gov/wps/portal/nrcs/main/soils/health/>) and certain conservation and engineering applications. For more detailed information, contact your local USDA Service Center (<https://offices.sc.egov.usda.gov/locator/app?agency=nrcs>) or your NRCS State Soil Scientist ([http://www.nrcs.usda.gov/wps/portal/nrcs/detail/soils/contactus/?cid=nrcs142p2\\_053951](http://www.nrcs.usda.gov/wps/portal/nrcs/detail/soils/contactus/?cid=nrcs142p2_053951)).

Great differences in soil properties can occur within short distances. Some soils are seasonally wet or subject to flooding. Some are too unstable to be used as a foundation for buildings or roads. Clayey or wet soils are poorly suited to use as septic tank absorption fields. A high water table makes a soil poorly suited to basements or underground installations.

The National Cooperative Soil Survey is a joint effort of the United States Department of Agriculture and other Federal agencies, State agencies including the Agricultural Experiment Stations, and local agencies. The Natural Resources Conservation Service (NRCS) has leadership for the Federal part of the National Cooperative Soil Survey.

Information about soils is updated periodically. Updated information is available through the NRCS Web Soil Survey, the site for official soil survey information.

The U.S. Department of Agriculture (USDA) prohibits discrimination in all its programs and activities on the basis of race, color, national origin, age, disability, and where applicable, sex, marital status, familial status, parental status, religion, sexual orientation, genetic information, political beliefs, reprisal, or because all or a part of an individual's income is derived from any public assistance program. (Not all prohibited bases apply to all programs.) Persons with disabilities who require

alternative means for communication of program information (Braille, large print, audiotape, etc.) should contact USDA's TARGET Center at (202) 720-2600 (voice and TDD). To file a complaint of discrimination, write to USDA, Director, Office of Civil Rights, 1400 Independence Avenue, S.W., Washington, D.C. 20250-9410 or call (800) 795-3272 (voice) or (202) 720-6382 (TDD). USDA is an equal opportunity provider and employer.



# Contents

---

<b>Preface</b> .....	2
<b>How Soil Surveys Are Made</b> .....	5
<b>Soil Map</b> .....	8
Soil Map.....	9
Legend.....	10
Map Unit Legend.....	11
Map Unit Descriptions.....	11
El Paso County Area, Colorado.....	13
41—Kettle gravelly loamy sand, 8 to 40 percent slopes.....	13
71—Pring coarse sandy loam, 3 to 8 percent slopes.....	14
92—Tomah-Crowfoot loamy sands, 3 to 8 percent slopes.....	15
<b>References</b> .....	17

# How Soil Surveys Are Made

---

Soil surveys are made to provide information about the soils and miscellaneous areas in a specific area. They include a description of the soils and miscellaneous areas and their location on the landscape and tables that show soil properties and limitations affecting various uses. Soil scientists observed the steepness, length, and shape of the slopes; the general pattern of drainage; the kinds of crops and native plants; and the kinds of bedrock. They observed and described many soil profiles. A soil profile is the sequence of natural layers, or horizons, in a soil. The profile extends from the surface down into the unconsolidated material in which the soil formed or from the surface down to bedrock. The unconsolidated material is devoid of roots and other living organisms and has not been changed by other biological activity.

Currently, soils are mapped according to the boundaries of major land resource areas (MLRAs). MLRAs are geographically associated land resource units that share common characteristics related to physiography, geology, climate, water resources, soils, biological resources, and land uses (USDA, 2006). Soil survey areas typically consist of parts of one or more MLRA.

The soils and miscellaneous areas in a survey area occur in an orderly pattern that is related to the geology, landforms, relief, climate, and natural vegetation of the area. Each kind of soil and miscellaneous area is associated with a particular kind of landform or with a segment of the landform. By observing the soils and miscellaneous areas in the survey area and relating their position to specific segments of the landform, a soil scientist develops a concept, or model, of how they were formed. Thus, during mapping, this model enables the soil scientist to predict with a considerable degree of accuracy the kind of soil or miscellaneous area at a specific location on the landscape.

Commonly, individual soils on the landscape merge into one another as their characteristics gradually change. To construct an accurate soil map, however, soil scientists must determine the boundaries between the soils. They can observe only a limited number of soil profiles. Nevertheless, these observations, supplemented by an understanding of the soil-vegetation-landscape relationship, are sufficient to verify predictions of the kinds of soil in an area and to determine the boundaries.

Soil scientists recorded the characteristics of the soil profiles that they studied. They noted soil color, texture, size and shape of soil aggregates, kind and amount of rock fragments, distribution of plant roots, reaction, and other features that enable them to identify soils. After describing the soils in the survey area and determining their properties, the soil scientists assigned the soils to taxonomic classes (units). Taxonomic classes are concepts. Each taxonomic class has a set of soil characteristics with precisely defined limits. The classes are used as a basis for comparison to classify soils systematically. Soil taxonomy, the system of taxonomic classification used in the United States, is based mainly on the kind and character of soil properties and the arrangement of horizons within the profile. After the soil

## Custom Soil Resource Report

scientists classified and named the soils in the survey area, they compared the individual soils with similar soils in the same taxonomic class in other areas so that they could confirm data and assemble additional data based on experience and research.

The objective of soil mapping is not to delineate pure map unit components; the objective is to separate the landscape into landforms or landform segments that have similar use and management requirements. Each map unit is defined by a unique combination of soil components and/or miscellaneous areas in predictable proportions. Some components may be highly contrasting to the other components of the map unit. The presence of minor components in a map unit in no way diminishes the usefulness or accuracy of the data. The delineation of such landforms and landform segments on the map provides sufficient information for the development of resource plans. If intensive use of small areas is planned, onsite investigation is needed to define and locate the soils and miscellaneous areas.

Soil scientists make many field observations in the process of producing a soil map. The frequency of observation is dependent upon several factors, including scale of mapping, intensity of mapping, design of map units, complexity of the landscape, and experience of the soil scientist. Observations are made to test and refine the soil-landscape model and predictions and to verify the classification of the soils at specific locations. Once the soil-landscape model is refined, a significantly smaller number of measurements of individual soil properties are made and recorded. These measurements may include field measurements, such as those for color, depth to bedrock, and texture, and laboratory measurements, such as those for content of sand, silt, clay, salt, and other components. Properties of each soil typically vary from one point to another across the landscape.

Observations for map unit components are aggregated to develop ranges of characteristics for the components. The aggregated values are presented. Direct measurements do not exist for every property presented for every map unit component. Values for some properties are estimated from combinations of other properties.

While a soil survey is in progress, samples of some of the soils in the area generally are collected for laboratory analyses and for engineering tests. Soil scientists interpret the data from these analyses and tests as well as the field-observed characteristics and the soil properties to determine the expected behavior of the soils under different uses. Interpretations for all of the soils are field tested through observation of the soils in different uses and under different levels of management. Some interpretations are modified to fit local conditions, and some new interpretations are developed to meet local needs. Data are assembled from other sources, such as research information, production records, and field experience of specialists. For example, data on crop yields under defined levels of management are assembled from farm records and from field or plot experiments on the same kinds of soil.

Predictions about soil behavior are based not only on soil properties but also on such variables as climate and biological activity. Soil conditions are predictable over long periods of time, but they are not predictable from year to year. For example, soil scientists can predict with a fairly high degree of accuracy that a given soil will have a high water table within certain depths in most years, but they cannot predict that a high water table will always be at a specific level in the soil on a specific date.

After soil scientists located and identified the significant natural bodies of soil in the survey area, they drew the boundaries of these bodies on aerial photographs and

## Custom Soil Resource Report

identified each as a specific map unit. Aerial photographs show trees, buildings, fields, roads, and rivers, all of which help in locating boundaries accurately.

# Soil Map

---

The soil map section includes the soil map for the defined area of interest, a list of soil map units on the map and extent of each map unit, and cartographic symbols displayed on the map. Also presented are various metadata about data used to produce the map, and a description of each soil map unit.

# Custom Soil Resource Report Soil Map



Soil Map may not be valid at this scale.

Map Scale: 1:2,340 if printed on A portrait (8.5" x 11") sheet.

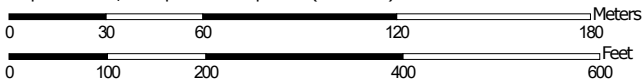

Map projection: Web Mercator Corner coordinates: WGS84 Edge tics: UTM Zone 13N WGS84

### MAP LEGEND

**Area of Interest (AOI)**

 Area of Interest (AOI)

**Soils**

 Soil Map Unit Polygons

 Soil Map Unit Lines

 Soil Map Unit Points

**Special Point Features**

-  Blowout
-  Borrow Pit
-  Clay Spot
-  Closed Depression
-  Gravel Pit
-  Gravelly Spot
-  Landfill
-  Lava Flow
-  Marsh or swamp
-  Mine or Quarry
-  Miscellaneous Water
-  Perennial Water
-  Rock Outcrop
-  Saline Spot
-  Sandy Spot
-  Severely Eroded Spot
-  Sinkhole
-  Slide or Slip
-  Sodic Spot

-  Spoil Area
-  Stony Spot
-  Very Stony Spot
-  Wet Spot
-  Other
-  Special Line Features

**Water Features**

 Streams and Canals

**Transportation**

-  Rails
-  Interstate Highways
-  US Routes
-  Major Roads
-  Local Roads

**Background**

 Aerial Photography

### MAP INFORMATION

The soil surveys that comprise your AOI were mapped at 1:24,000.

Warning: Soil Map may not be valid at this scale.

Enlargement of maps beyond the scale of mapping can cause misunderstanding of the detail of mapping and accuracy of soil line placement. The maps do not show the small areas of contrasting soils that could have been shown at a more detailed scale.

Please rely on the bar scale on each map sheet for map measurements.

Source of Map: Natural Resources Conservation Service  
 Web Soil Survey URL:  
 Coordinate System: Web Mercator (EPSG:3857)

Maps from the Web Soil Survey are based on the Web Mercator projection, which preserves direction and shape but distorts distance and area. A projection that preserves area, such as the Albers equal-area conic projection, should be used if more accurate calculations of distance or area are required.

This product is generated from the USDA-NRCS certified data as of the version date(s) listed below.

Soil Survey Area: El Paso County Area, Colorado  
 Survey Area Data: Version 18, Jun 5, 2020

Soil map units are labeled (as space allows) for map scales 1:50,000 or larger.

Date(s) aerial images were photographed: Aug 19, 2018—Sep 23, 2018

The orthophoto or other base map on which the soil lines were compiled and digitized probably differs from the background imagery displayed on these maps. As a result, some minor shifting of map unit boundaries may be evident.

## Map Unit Legend

Map Unit Symbol	Map Unit Name	Acres in AOI	Percent of AOI
41	Kettle gravelly loamy sand, 8 to 40 percent slopes	0.4	2.2%
71	Pring coarse sandy loam, 3 to 8 percent slopes	1.7	10.1%
92	Tomah-Crowfoot loamy sands, 3 to 8 percent slopes	15.2	87.8%
<b>Totals for Area of Interest</b>		<b>17.4</b>	<b>100.0%</b>

## Map Unit Descriptions

The map units delineated on the detailed soil maps in a soil survey represent the soils or miscellaneous areas in the survey area. The map unit descriptions, along with the maps, can be used to determine the composition and properties of a unit.

A map unit delineation on a soil map represents an area dominated by one or more major kinds of soil or miscellaneous areas. A map unit is identified and named according to the taxonomic classification of the dominant soils. Within a taxonomic class there are precisely defined limits for the properties of the soils. On the landscape, however, the soils are natural phenomena, and they have the characteristic variability of all natural phenomena. Thus, the range of some observed properties may extend beyond the limits defined for a taxonomic class. Areas of soils of a single taxonomic class rarely, if ever, can be mapped without including areas of other taxonomic classes. Consequently, every map unit is made up of the soils or miscellaneous areas for which it is named and some minor components that belong to taxonomic classes other than those of the major soils.

Most minor soils have properties similar to those of the dominant soil or soils in the map unit, and thus they do not affect use and management. These are called noncontrasting, or similar, components. They may or may not be mentioned in a particular map unit description. Other minor components, however, have properties and behavioral characteristics divergent enough to affect use or to require different management. These are called contrasting, or dissimilar, components. They generally are in small areas and could not be mapped separately because of the scale used. Some small areas of strongly contrasting soils or miscellaneous areas are identified by a special symbol on the maps. If included in the database for a given area, the contrasting minor components are identified in the map unit descriptions along with some characteristics of each. A few areas of minor components may not have been observed, and consequently they are not mentioned in the descriptions, especially where the pattern was so complex that it was impractical to make enough observations to identify all the soils and miscellaneous areas on the landscape.

The presence of minor components in a map unit in no way diminishes the usefulness or accuracy of the data. The objective of mapping is not to delineate pure taxonomic classes but rather to separate the landscape into landforms or



## Custom Soil Resource Report

landform segments that have similar use and management requirements. The delineation of such segments on the map provides sufficient information for the development of resource plans. If intensive use of small areas is planned, however, onsite investigation is needed to define and locate the soils and miscellaneous areas.

An identifying symbol precedes the map unit name in the map unit descriptions. Each description includes general facts about the unit and gives important soil properties and qualities.

Soils that have profiles that are almost alike make up a *soil series*. Except for differences in texture of the surface layer, all the soils of a series have major horizons that are similar in composition, thickness, and arrangement.

Soils of one series can differ in texture of the surface layer, slope, stoniness, salinity, degree of erosion, and other characteristics that affect their use. On the basis of such differences, a soil series is divided into *soil phases*. Most of the areas shown on the detailed soil maps are phases of soil series. The name of a soil phase commonly indicates a feature that affects use or management. For example, Alpha silt loam, 0 to 2 percent slopes, is a phase of the Alpha series.

Some map units are made up of two or more major soils or miscellaneous areas. These map units are complexes, associations, or undifferentiated groups.

A *complex* consists of two or more soils or miscellaneous areas in such an intricate pattern or in such small areas that they cannot be shown separately on the maps. The pattern and proportion of the soils or miscellaneous areas are somewhat similar in all areas. Alpha-Beta complex, 0 to 6 percent slopes, is an example.

An *association* is made up of two or more geographically associated soils or miscellaneous areas that are shown as one unit on the maps. Because of present or anticipated uses of the map units in the survey area, it was not considered practical or necessary to map the soils or miscellaneous areas separately. The pattern and relative proportion of the soils or miscellaneous areas are somewhat similar. Alpha-Beta association, 0 to 2 percent slopes, is an example.

An *undifferentiated group* is made up of two or more soils or miscellaneous areas that could be mapped individually but are mapped as one unit because similar interpretations can be made for use and management. The pattern and proportion of the soils or miscellaneous areas in a mapped area are not uniform. An area can be made up of only one of the major soils or miscellaneous areas, or it can be made up of all of them. Alpha and Beta soils, 0 to 2 percent slopes, is an example.

Some surveys include *miscellaneous areas*. Such areas have little or no soil material and support little or no vegetation. Rock outcrop is an example.

## El Paso County Area, Colorado

### 41—Kettle gravelly loamy sand, 8 to 40 percent slopes

#### Map Unit Setting

*National map unit symbol:* 368h  
*Elevation:* 7,000 to 7,700 feet  
*Farmland classification:* Not prime farmland

#### Map Unit Composition

*Kettle and similar soils:* 85 percent  
*Estimates are based on observations, descriptions, and transects of the mapunit.*

#### Description of Kettle

##### Setting

*Landform:* Hills  
*Landform position (three-dimensional):* Side slope  
*Down-slope shape:* Linear  
*Across-slope shape:* Linear  
*Parent material:* Sandy alluvium derived from arkose

##### Typical profile

*E - 0 to 16 inches:* gravelly loamy sand  
*Bt - 16 to 40 inches:* gravelly sandy loam  
*C - 40 to 60 inches:* extremely gravelly loamy sand

##### Properties and qualities

*Slope:* 8 to 40 percent  
*Depth to restrictive feature:* More than 80 inches  
*Drainage class:* Somewhat excessively drained  
*Runoff class:* Medium  
*Capacity of the most limiting layer to transmit water (Ksat):* High (2.00 to 6.00 in/hr)  
*Depth to water table:* More than 80 inches  
*Frequency of flooding:* None  
*Frequency of ponding:* None  
*Available water capacity:* Low (about 3.4 inches)

##### Interpretive groups

*Land capability classification (irrigated):* None specified  
*Land capability classification (nonirrigated):* 7e  
*Hydrologic Soil Group:* B  
*Hydric soil rating:* No

#### Minor Components

##### Pleasant

*Percent of map unit:*  
*Landform:* Depressions  
*Hydric soil rating:* Yes

##### Other soils

*Percent of map unit:*  
*Hydric soil rating:* No

## 71—Pring coarse sandy loam, 3 to 8 percent slopes

### Map Unit Setting

*National map unit symbol:* 369k  
*Elevation:* 6,800 to 7,600 feet  
*Farmland classification:* Not prime farmland

### Map Unit Composition

*Pring and similar soils:* 85 percent  
*Estimates are based on observations, descriptions, and transects of the mapunit.*

### Description of Pring

#### Setting

*Landform:* Hills  
*Landform position (three-dimensional):* Side slope  
*Down-slope shape:* Linear  
*Across-slope shape:* Linear  
*Parent material:* Arkosic alluvium derived from sedimentary rock

#### Typical profile

*A - 0 to 14 inches:* coarse sandy loam  
*C - 14 to 60 inches:* gravelly sandy loam

#### Properties and qualities

*Slope:* 3 to 8 percent  
*Depth to restrictive feature:* More than 80 inches  
*Drainage class:* Well drained  
*Runoff class:* Low  
*Capacity of the most limiting layer to transmit water (Ksat):* High (2.00 to 6.00 in/hr)  
*Depth to water table:* More than 80 inches  
*Frequency of flooding:* None  
*Frequency of ponding:* None  
*Available water capacity:* Low (about 6.0 inches)

#### Interpretive groups

*Land capability classification (irrigated):* None specified  
*Land capability classification (nonirrigated):* 3e  
*Hydrologic Soil Group:* B  
*Ecological site:* R048AY222CO  
*Hydric soil rating:* No

### Minor Components

#### Pleasant

*Percent of map unit:*  
*Landform:* Depressions  
*Hydric soil rating:* Yes

**Other soils**

*Percent of map unit:*  
*Hydric soil rating:* No

**92—Tomah-Crowfoot loamy sands, 3 to 8 percent slopes**

**Map Unit Setting**

*National map unit symbol:* 36b9  
*Elevation:* 7,300 to 7,600 feet  
*Farmland classification:* Not prime farmland

**Map Unit Composition**

*Tomah and similar soils:* 50 percent  
*Crowfoot and similar soils:* 30 percent  
*Estimates are based on observations, descriptions, and transects of the mapunit.*

**Description of Tomah**

**Setting**

*Landform:* Hills, alluvial fans  
*Landform position (three-dimensional):* Side slope, crest  
*Down-slope shape:* Linear  
*Across-slope shape:* Linear  
*Parent material:* Alluvium derived from arkose and/or residuum weathered from arkose

**Typical profile**

*A - 0 to 10 inches:* loamy sand  
*E - 10 to 22 inches:* coarse sand  
*C - 48 to 60 inches:* coarse sand

**Properties and qualities**

*Slope:* 3 to 8 percent  
*Depth to restrictive feature:* More than 80 inches  
*Drainage class:* Well drained  
*Runoff class:* Medium  
*Capacity of the most limiting layer to transmit water (Ksat):* Moderately high to high  
(0.60 to 2.00 in/hr)  
*Depth to water table:* More than 80 inches  
*Frequency of flooding:* None  
*Frequency of ponding:* None  
*Available water capacity:* Very low (about 2.0 inches)

**Interpretive groups**

*Land capability classification (irrigated):* None specified  
*Land capability classification (nonirrigated):* 4e  
*Hydrologic Soil Group:* B  
*Ecological site:* R049XB216CO - Sandy Divide  
*Hydric soil rating:* No

**Description of Crowfoot**

**Setting**

*Landform:* Alluvial fans, hills  
*Landform position (three-dimensional):* Side slope, crest  
*Down-slope shape:* Linear  
*Across-slope shape:* Linear  
*Parent material:* Alluvium

**Typical profile**

*A - 0 to 12 inches:* loamy sand  
*E - 12 to 23 inches:* sand  
*Bt - 23 to 36 inches:* sandy clay loam  
*C - 36 to 60 inches:* coarse sand

**Properties and qualities**

*Slope:* 3 to 8 percent  
*Depth to restrictive feature:* More than 80 inches  
*Drainage class:* Well drained  
*Runoff class:* Medium  
*Capacity of the most limiting layer to transmit water (Ksat):* Moderately high to high  
(0.60 to 2.00 in/hr)  
*Depth to water table:* More than 80 inches  
*Frequency of flooding:* None  
*Frequency of ponding:* None  
*Available water capacity:* Low (about 4.7 inches)

**Interpretive groups**

*Land capability classification (irrigated):* None specified  
*Land capability classification (nonirrigated):* 4e  
*Hydrologic Soil Group:* B  
*Ecological site:* R049XB216CO - Sandy Divide  
*Hydric soil rating:* No

**Minor Components**

**Other soils**

*Percent of map unit:*  
*Hydric soil rating:* No

**Pleasant**

*Percent of map unit:*  
*Landform:* Depressions  
*Hydric soil rating:* Yes

# References

---

- American Association of State Highway and Transportation Officials (AASHTO). 2004. Standard specifications for transportation materials and methods of sampling and testing. 24th edition.
- American Society for Testing and Materials (ASTM). 2005. Standard classification of soils for engineering purposes. ASTM Standard D2487-00.
- Cowardin, L.M., V. Carter, F.C. Golet, and E.T. LaRoe. 1979. Classification of wetlands and deep-water habitats of the United States. U.S. Fish and Wildlife Service FWS/OBS-79/31.
- Federal Register. July 13, 1994. Changes in hydric soils of the United States.
- Federal Register. September 18, 2002. Hydric soils of the United States.
- Hurt, G.W., and L.M. Vasilas, editors. Version 6.0, 2006. Field indicators of hydric soils in the United States.
- National Research Council. 1995. Wetlands: Characteristics and boundaries.
- Soil Survey Division Staff. 1993. Soil survey manual. Soil Conservation Service. U.S. Department of Agriculture Handbook 18. [http://www.nrcs.usda.gov/wps/portal/nrcs/detail/national/soils/?cid=nrcs142p2\\_054262](http://www.nrcs.usda.gov/wps/portal/nrcs/detail/national/soils/?cid=nrcs142p2_054262)
- Soil Survey Staff. 1999. Soil taxonomy: A basic system of soil classification for making and interpreting soil surveys. 2nd edition. Natural Resources Conservation Service, U.S. Department of Agriculture Handbook 436. [http://www.nrcs.usda.gov/wps/portal/nrcs/detail/national/soils/?cid=nrcs142p2\\_053577](http://www.nrcs.usda.gov/wps/portal/nrcs/detail/national/soils/?cid=nrcs142p2_053577)
- Soil Survey Staff. 2010. Keys to soil taxonomy. 11th edition. U.S. Department of Agriculture, Natural Resources Conservation Service. [http://www.nrcs.usda.gov/wps/portal/nrcs/detail/national/soils/?cid=nrcs142p2\\_053580](http://www.nrcs.usda.gov/wps/portal/nrcs/detail/national/soils/?cid=nrcs142p2_053580)
- Tiner, R.W., Jr. 1985. Wetlands of Delaware. U.S. Fish and Wildlife Service and Delaware Department of Natural Resources and Environmental Control, Wetlands Section.
- United States Army Corps of Engineers, Environmental Laboratory. 1987. Corps of Engineers wetlands delineation manual. Waterways Experiment Station Technical Report Y-87-1.
- United States Department of Agriculture, Natural Resources Conservation Service. National forestry manual. [http://www.nrcs.usda.gov/wps/portal/nrcs/detail/soils/home/?cid=nrcs142p2\\_053374](http://www.nrcs.usda.gov/wps/portal/nrcs/detail/soils/home/?cid=nrcs142p2_053374)
- United States Department of Agriculture, Natural Resources Conservation Service. National range and pasture handbook. <http://www.nrcs.usda.gov/wps/portal/nrcs/detail/national/landuse/rangepasture/?cid=stelprdb1043084>

## Custom Soil Resource Report

United States Department of Agriculture, Natural Resources Conservation Service. National soil survey handbook, title 430-VI. [http://www.nrcs.usda.gov/wps/portal/nrcs/detail/soils/scientists/?cid=nrcs142p2\\_054242](http://www.nrcs.usda.gov/wps/portal/nrcs/detail/soils/scientists/?cid=nrcs142p2_054242)

United States Department of Agriculture, Natural Resources Conservation Service. 2006. Land resource regions and major land resource areas of the United States, the Caribbean, and the Pacific Basin. U.S. Department of Agriculture Handbook 296. [http://www.nrcs.usda.gov/wps/portal/nrcs/detail/national/soils/?cid=nrcs142p2\\_053624](http://www.nrcs.usda.gov/wps/portal/nrcs/detail/national/soils/?cid=nrcs142p2_053624)

United States Department of Agriculture, Soil Conservation Service. 1961. Land capability classification. U.S. Department of Agriculture Handbook 210. [http://www.nrcs.usda.gov/Internet/FSE\\_DOCUMENTS/nrcs142p2\\_052290.pdf](http://www.nrcs.usda.gov/Internet/FSE_DOCUMENTS/nrcs142p2_052290.pdf)

## **GESC Plan and Report Checklist**





3275 Akers Drive  
 Colorado Springs, CO 80922  
 Phone 719-520-6460  
 Fax 719-520-6879  
 www.elpasoco.com

## EL PASO COUNTY STORMWATER MANAGEMENT PLAN CHECKLIST

EPC Project Number:

Revised: July 2019

		Applicant	EPC
<b>1. STORMWATER MANAGEMENT PLAN</b>			
1	Applicant (owner/designated operator), SWMP Preparer, Qualified Stormwater Manager, and Contractor Information. (On cover/title sheet)		
2	Table of Contents		
3	Site description and location to include: vicinity map with nearest street/crossroads description		
4	Narrative description of construction activities proposed (e.g., may include clearing and grubbing, temporary stabilization, road grading, utility / storm installation, final grading, final stabilization, and removal of temporary control measures)		
5	Phasing plan – may require separate drawings indicating initial, interim, and final site phases for larger projects. Provide “living maps” that can be revised in the field as conditions dictate		
6	Proposed sequence for major activities: Provide a construction schedule of anticipated starting and completion dates for each stage of land-disturbing activity depicting conservation measures anticipated, including the expected date on which the final stabilization will be completed		
7	Estimates of the total site area and area to undergo disturbance; current area of disturbance must be updated on the SWMP as changes occur		
8	Soil erosion potential and impacts on discharge that includes a summary of the data used to determine soil erosion potential		
9	A description of existing vegetation at the site and percent ground cover and method used to determine ground cover		
10	Location and description of all potential pollution sources including but not limited to: disturbed and stored soils; vehicle tracking; management of contaminated soils; loading and unloading operations; outdoor storage of materials; vehicle and equipment maintenance and fueling; significant dust generating process; routine maintenance activities involving fertilizers, pesticides, herbicides, detergents, fuels, solvents, oils, etc.; on-site waste management; concrete truck/equipment washing; dedicated asphalt, concrete batch plants and masonry mixing stations; non-industrial waste such as trash and portable toilets		
11	Material handling to include spill prevention and response plan and procedures		
12	Spill prevention and pollution controls for dedicated batch plants		
13	Other SW pollutant control measures to include waste disposal and off-site soil tracking		
14	Location and description of any anticipated allowable non-stormwater discharge (ground water, springs, irrigation, discharge covered by CDPHE Low Risk Guidance, etc.)		
15	Name(s) of ultimate receiving waters; size, type and location of stormwater outfall or storm sewer system discharge		
16	Description of all stream crossings located within the project area or statement that no streams cross the project area		



3275 Akers Drive  
 Colorado Springs, CO 80922  
 Phone 719-520-6460  
 Fax 719-520-6879  
 www.elpasoco.com

## EL PASO COUNTY STORMWATER MANAGEMENT PLAN CHECKLIST

EPC Project Number:

Revised: July 2019

		Applicant	EPC
17	SWMP Map to include:		
17a	construction site boundaries		
17b	flow arrows to depict stormwater flow directions		
17c	all areas of disturbance		
17d	areas of cut and fill		
17e	areas used for storage of building materials, soils (stockpiles) or wastes		
17f	location of any dedicated asphalt / concrete batch plants		
17g	location of all structural control measures		
17h	location of all non-structural control measures		
17i	springs, streams, wetlands and other surface waters, including areas that require maintenance of pre-existing vegetation within 50 feet of a receiving water		
18	Narrative description of all structural control measures to be used. Modifications to EPC standard control measures must meet or exceed County-approved details		
19	Description of all non-structural control measures to be used including seeding, mulching, protection of existing vegetation, site watering, sod placement, etc.		
20	Technical drawing details for all control measure installation and maintenance; custom or other jurisdiction's details used must meet or exceed EPC standards		
21	Procedure describing how the SWMP is to be revised		
22	Description of Final Stabilization and Long-term Stormwater Quality (describe nonstructural and structural measures to control SW pollutants after construction operations have been completed, including detention, water quality control measure etc.)		
23	Specification that final vegetative cover density is to be 70% of pre-disturbed levels		
24	Outline of permit holder inspection procedures to install, maintain, and effectively operate control measures to manage erosion and sediment		
25	Record keeping procedures identified to include signature on inspection logs and location of SWMP records on-site		
26	If this project relies on control measures owned or operated by another entity, a documented agreement must be included in the SWMP that identifies location, installation and design specifications, and maintenance requirements and responsibility of the control measure(s)		
<b>Please note: all items above must be addressed. If not applicable, explain why, simply identifying "not applicable" will not satisfy CDPHE requirement of explanation.</b>			
<b>2. ADDITIONAL REPORTS/PERMITS/DOCUMENTS</b>			
a	Grading and Erosion Control Plan (signed)		
b	Erosion and Stormwater Quality Control Permit (ESQCP) (signed)		



3275 Akers Drive  
 Colorado Springs, CO 80922  
 Phone 719-520-6460  
 Fax 719-520-6879  
 www.elpasoco.com

## EL PASO COUNTY STORMWATER MANAGEMENT PLAN CHECKLIST

EPC Project Number:

Revised: July 2019

Applicant	EPC
-----------	-----

**3. APPLICANT COMMENTS**

a			
b			
c			

**4. CHECKLIST REVIEW CERTIFICATIONS**

a	<p>Engineer of Record:          The Stormwater Management Plan was prepared under my direction and supervision and is correct to the best of my knowledge and belief. Said Plan has been prepared according to the criteria established by the County and State for Stormwater Management Plans.</p> <div style="display: flex; justify-content: space-between; align-items: flex-end; margin-top: 20px;"> <div style="text-align: center;"> <p>_____ Engineer of Record Signature</p> </div> <div style="text-align: center;"> <p>07-19-21</p> <p>_____ Date</p> </div> <div style="text-align: center;"> </div> </div>		
b	<p>Review Engineer:          The Stormwater Management Plan was reviewed and found to meet the checklist requirements except where otherwise noted or allowed by an approved deviation request.</p> <div style="display: flex; justify-content: space-between; align-items: flex-end; margin-top: 20px;"> <div style="text-align: center;"> <p>_____ Review Engineer</p> </div> <div style="text-align: center;"> <p>_____ Date</p> </div> </div>		

## **GESC Drawings**

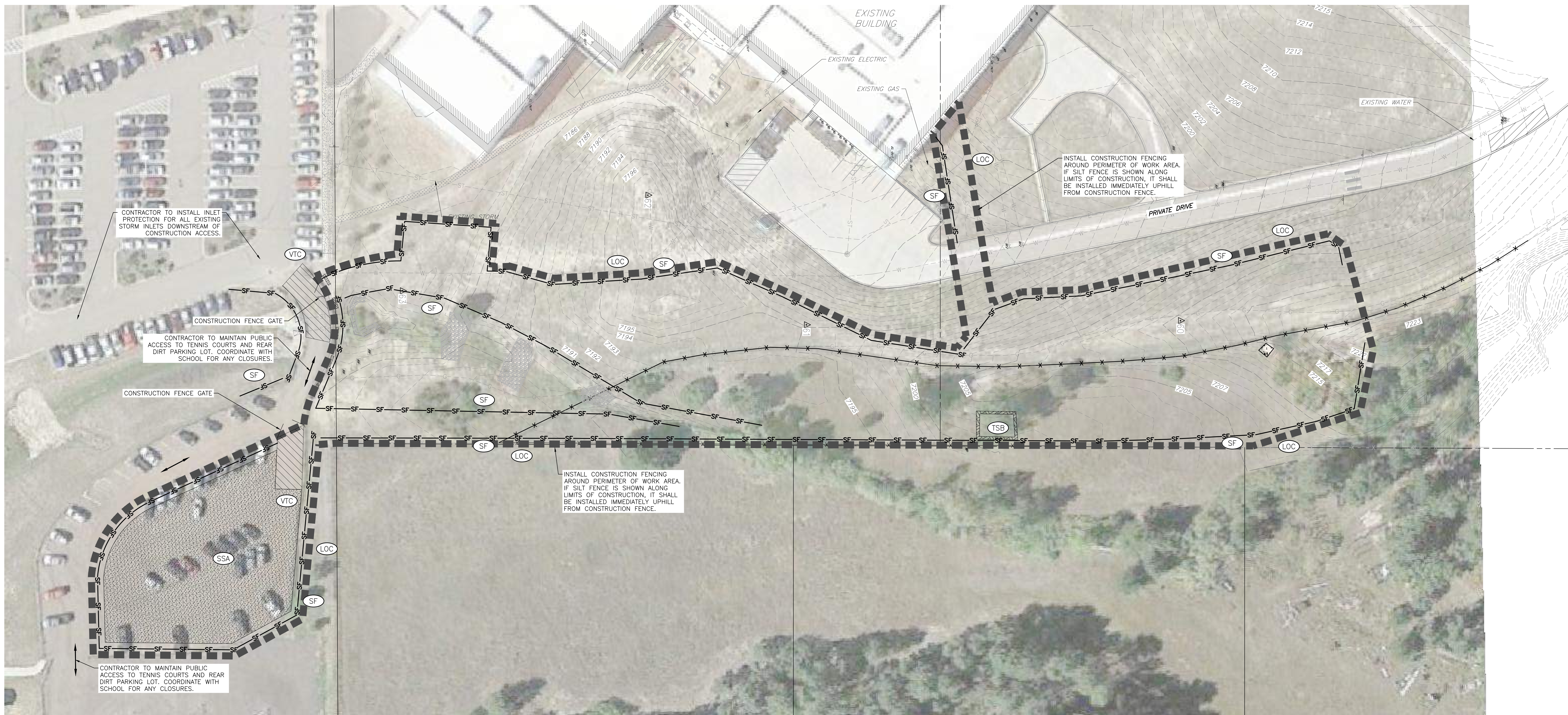

**STANDARD NOTES FOR EL PASO COUNTY GRADING AND EROSION CONTROL PLANS**

- REVISED JULY 2019
- STORMWATER DISCHARGES FROM CONSTRUCTION SITES SHALL NOT CAUSE OR THREATEN TO CAUSE POLLUTION, CONTAMINATION, OR DEGRADATION OF STATE WATERS. ALL WORK AND EARTH DISTURBANCE SHALL BE DONE IN A MANNER THAT MINIMIZES POLLUTION OF ANY ON-SITE OR OFF-SITE WATERS, INCLUDING WETLANDS.
  - NOTWITHSTANDING ANYTHING DEPICTED IN THESE PLANS IN WORDS OR GRAPHIC REPRESENTATION, ALL DESIGN AND CONSTRUCTION RELATED TO ROADS, STORM DRAINAGE AND EROSION CONTROL SHALL CONFORM TO THE STANDARDS AND REQUIREMENTS OF THE MOST RECENT VERSION OF THE RELEVANT ADOPTED EL PASO COUNTY STANDARDS, INCLUDING THE LAND DEVELOPMENT CODE, THE ENGINEERING CRITERIA MANUAL, THE DRAINAGE CRITERIA MANUAL, AND THE DRAINAGE CRITERIA MANUAL VOLUME 2. ANY DEVIATIONS TO REGULATIONS AND STANDARDS MUST BE REQUESTED, AND APPROVED, IN WRITING.
  - A SEPARATE STORMWATER MANAGEMENT PLAN (SWMP) FOR THIS PROJECT SHALL BE COMPLETED AND AN EROSION AND STORMWATER QUALITY CONTROL PERMIT (ESQCP) ISSUED PRIOR TO COMMENCING CONSTRUCTION. DURING CONSTRUCTION THE SWMP IS THE RESPONSIBILITY OF THE DESIGNATED QUALIFIED STORMWATER MANAGER OR CERTIFIED EROSION CONTROL INSPECTOR AND SHALL BE LOCATED ON SITE AT ALL TIMES DURING CONSTRUCTION AND SHALL BE KEPT UP TO DATE WITH WORK PROGRESS AND CHANGES IN THE FIELD.
  - ONCE THE ESQCP IS APPROVED AND A "NOTICE TO PROCEED" HAS BEEN ISSUED, THE CONTRACTOR MAY INSTALL THE INITIAL STAGE EROSION AND SEDIMENT CONTROL MEASURES AS INDICATED ON THE APPROVED GEC. A PRECONSTRUCTION MEETING BETWEEN THE CONTRACTOR, ENGINEER, AND EL PASO COUNTY WILL BE HELD PRIOR TO ANY CONSTRUCTION. IT IS THE RESPONSIBILITY OF THE APPLICANT TO COORDINATE THE MEETING TIME AND PLACE WITH COUNTY STAFF.
  - CONTROL MEASURES MUST BE INSTALLED PRIOR TO COMMENCEMENT OF ACTIVITIES THAT MAY CONTRIBUTE POLLUTANTS TO STORMWATER. TEMPORARY SEDIMENT AND EROSION CONTROL MEASURES FOR ALL SLOPES, CHANNELS, DITCHES, OR ANY DISTURBED LAND AREA SHALL BE COMPLETED IMMEDIATELY UPON COMPLETION OF THE DISTURBANCE.
  - ALL TEMPORARY SEDIMENT AND EROSION CONTROL MEASURES SHALL BE MAINTAINED AND REMAIN IN EFFECTIVE OPERATING CONDITION UNTIL PERMANENT SOIL EROSION CONTROL MEASURES ARE IMPLEMENTED AND FINAL STABILIZATION IS ESTABLISHED. ALL PERSONS ENGAGED IN LAND DISTURBANCE ACTIVITIES SHALL ASSESS THE ADEQUACY OF CONTROL MEASURES AT THE SITE AND IDENTIFY IF CHANGES TO THOSE CONTROL MEASURES IS NEEDED TO ENSURE THE CONTINUED EFFECTIVE PERFORMANCE OF THE CONTROL MEASURES. ALL CHANGES TO TEMPORARY SEDIMENT AND EROSION CONTROL MEASURES MUST BE INCORPORATED INTO THE STORMWATER MANAGEMENT PLAN PRIOR TO IMPLEMENTATION.
  - TEMPORARY STABILIZATION SHALL BE IMPLEMENTED ON DISTURBED AREAS AND STOCKPILES WHERE GROUND DISTURBING CONSTRUCTION ACTIVITY HAS PERMANENTLY CEASED OR TEMPORARILY CEASED FOR LONGER THAN 14 DAYS. AN AREA THAT IS GOING TO REMAIN IN AN INTERIM STATE FOR MORE THAN 60 DAYS SHALL ALSO BE STABILIZED.
  - FINAL STABILIZATION MUST BE IMPLEMENTED AT ALL APPLICABLE CONSTRUCTION SITES. FINAL STABILIZATION IS ACHIEVED WHEN ALL GROUND DISTURBING ACTIVITIES ARE COMPLETE AND ALL DISTURBED AREAS EITHER HAVE A UNIFORM VEGETATIVE COVER WITH INDIVIDUAL PLANT DENSITY OF 70 PERCENT OF PRE-DISTURBANCE LEVELS ESTABLISHED OR EQUIVALENT PERMANENT ALTERNATIVE STABILIZATION METHOD IS IMPLEMENTED. ALL TEMPORARY SEDIMENT AND EROSION CONTROL MEASURES SHALL BE REMOVED UPON FINAL STABILIZATION AND BEFORE PERMIT CLOSURE.
  - ALL PERMANENT STORMWATER MANAGEMENT FACILITIES SHALL BE INSTALLED AS DEFINED IN THE APPROVED PLANS. ANY PROPOSED CHANGES THAT AFFECT THE HYDROLOGY OR HYDRAULICS OF A PERMANENT STORMWATER MANAGEMENT STRUCTURES MUST BE APPROVED BY THE ECM ADMINISTRATOR PRIOR TO IMPLEMENTATION.
  - ANY EARTH DISTURBANCE SHALL BE CONDUCTED IN SUCH A MANNER SO AS TO EFFECTIVELY MINIMIZE ACCELERATED SOIL EROSION AND RESULTING SEDIMENTATION. ALL DISTURBANCES SHALL BE DESIGNED, CONSTRUCTED, AND COMPLETED SO THAT THE EXPOSED AREA OF ANY DISTURBED LAND SHALL BE LIMITED TO THE SHORTEST PRACTICAL PERIOD OF TIME. PRE-EXISTING VEGETATION SHALL BE PROTECTED AND MAINTAINED WITHIN 50 HORIZONTAL FEET OF A WATERS OF THE STATE, UNLESS INFEASIBLE.

- COMPACTION OF SOIL MUST BE PREVENTED IN AREAS DESIGNATED FOR INFILTRATION CONTROL MEASURES OR WHERE FINAL STABILIZATION WILL BE ACHIEVED BY VEGETATIVE COVER. AREAS DESIGNATED FOR INFILTRATION CONTROL SHALL ALSO BE PROTECTED FROM SEDIMENTATION DURING CONSTRUCTION UNTIL FINAL STABILIZATION IS ACHIEVED.
- ANY TEMPORARY OR PERMANENT FACILITY DESIGNED AND CONSTRUCTED FOR THE CONVEYANCE OF STORMWATER AROUND, THROUGH, OR FROM THE EARTH DISTURBANCE AREA SHALL BE A STABILIZED CONVEYANCE DESIGNED TO MINIMIZE EROSION AND THE DISCHARGE OF SEDIMENT OFF SITE.
- CONCRETE WASH WATER SHALL BE CONTAINED AND DISPOSED OF IN ACCORDANCE WITH THE SWMP. NO WASH WATER SHALL BE DISCHARGED TO OR ALLOWED TO RUNOFF TO STATE WATERS, INCLUDING ANY SURFACE OR SUBSURFACE STORM DRAINAGE SYSTEM OR FACILITIES. CONCRETE WASHOUT SHALL NOT BE LOCATED IN AN AREA WHERE SHALLOW GROUNDWATER MAY BE PRESENT, OR WITHIN 50 FEET OF A SURFACE WATER BODY.
- DEWATERING OPERATIONS: UNCONTAMINATED GROUND WATER MAY BE DISCHARGED ON SITE, BUT MAY NOT LEAVE THE SITE IN THE FORM OF SURFACE RUNOFF.
- EROSION CONTROL BLANKETING IS TO BE USED ON SLOPES STEEPER THAN 3:1.
- BUILDING, CONSTRUCTION, EXCAVATION, OR OTHER WASTE MATERIALS SHALL NOT BE TEMPORARILY PLACED OR STORED IN THE STREET, ALLEY, OR OTHER PUBLIC WAY, UNLESS IN ACCORDANCE WITH AN APPROVED TRAFFIC CONTROL PLAN. BMP'S MAY BE REQUIRED BY EL PASO COUNTY ENGINEERING IF DEEMED NECESSARY, BASED ON SPECIFIC CONDITIONS AND CIRCUMSTANCES.
- VEHICLE TRACKING OF SOILS AND CONSTRUCTION DEBRIS OFF-SITE SHALL BE MINIMIZED. MATERIALS TRACKED OFFSITE SHALL BE CLEANED UP AND PROPERLY DISPOSED OF IMMEDIATELY.
- CONTRACTOR SHALL BE RESPONSIBLE FOR THE REMOVAL OF ALL WASTES FROM THE CONSTRUCTION SITE FOR DISPOSAL IN ACCORDANCE WITH LOCAL AND STATE REGULATORY REQUIREMENTS. NO CONSTRUCTION DEBRIS, TREE SLASH, BUILDING MATERIAL WASTES OR UNUSED BUILDING MATERIALS SHALL BE BURIED, DUMPED, OR DISCHARGED AT THE SITE.
- THE OWNER, SITE DEVELOPER, CONTRACTOR, AND/OR THEIR AUTHORIZED AGENTS SHALL BE RESPONSIBLE FOR THE REMOVAL OF ALL CONSTRUCTION DEBRIS, DIRT, TRASH, ROCK, SEDIMENT, AND SAND THAT MAY ACCUMULATE IN THE STORM SEWER OR OTHER DRAINAGE CONVEYANCE SYSTEM AND STORMWATER APPURTENANCES AS A RESULT OF SITE DEVELOPMENT.
- THE QUANTITY OF MATERIALS STORED ON THE PROJECT SITE SHALL BE LIMITED, AS MUCH AS PRACTICAL, TO THAT QUANTITY REQUIRED TO PERFORM THE WORK IN AN ORDERLY SEQUENCE. ALL MATERIALS STORED ON-SITE SHALL BE STORED IN A NEAT, ORDERLY MANNER, IN THEIR ORIGINAL CONTAINERS, WITH ORIGINAL MANUFACTURER'S LABELS.
- NO CHEMICALS ARE TO BE USED BY THE CONTRACTOR, WHICH HAVE THE POTENTIAL TO BE RELEASED IN STORMWATER UNLESS PERMISSION FOR THE USE OF A SPECIFIC CHEMICAL IS GRANTED IN WRITING BY THE ECM ADMINISTRATOR. IN GRANTING THE USE OF SUCH CHEMICALS, SPECIAL CONDITIONS AND MONITORING MAY BE REQUIRED.
- BULK STORAGE OF PETROLEUM PRODUCTS OR OTHER LIQUID CHEMICALS IN EXCESS OF 55 GALLONS SHALL HAVE ADEQUATE SECONDARY CONTAINMENT PROTECTION TO CONTAIN ALL SPILLS AND PREVENT ANY SPILLED MATERIAL FROM ENTERING STATE WATERS, INCLUDING ANY SURFACE OR SUBSURFACE STORM DRAINAGE SYSTEM OR FACILITIES.
- NO PERSON SHALL CAUSE THE IMPEDIMENT OF STORMWATER FLOW IN THE FLOW LINE OF THE CURB AND GUTTER OR IN THE DITCH FLOW LINE.
- INDIVIDUALS SHALL COMPLY WITH THE "COLORADO WATER QUALITY CONTROL ACT" (TITLE 25, ARTICLE 8, CRS), AND THE "CLEAN WATER ACT" (33 USC 1344), IN ADDITION TO THE REQUIREMENTS INCLUDED IN THE DCM VOLUME II AND THE ECM APPENDIX I. ALL APPROPRIATE PERMITS MUST BE OBTAINED BY THE CONTRACTOR PRIOR TO CONSTRUCTION (NPDES, FLOODPLAIN, ADA, FUGITIVE DUST, ETC.). IN THE EVENT OF CONFLICTS BETWEEN THESE REQUIREMENTS AND LAWS, RULES, OR REGULATIONS OF OTHER FEDERAL, STATE, OR COUNTY AGENCIES, THE MORE RESTRICTIVE LAWS, RULES, OR REGULATIONS SHALL APPLY.
- ALL CONSTRUCTION TRAFFIC MUST ENTER/EXIT THE SITE AT APPROVED CONSTRUCTION ACCESS POINTS.

- PRIOR TO ACTUAL CONSTRUCTION THE PERMITEE SHALL VERIFY THE LOCATION OF EXISTING UTILITIES.
- A WATER SOURCE SHALL BE AVAILABLE ON SITE DURING EARTHWORK OPERATIONS AND UTILIZED AS REQUIRED TO MINIMIZE DUST FROM EARTHWORK EQUIPMENT AND WIND.
- THE SOILS REPORT FOR THIS SITE HAS BEEN PREPARED BY TERRACON CONSULTANTS, INC. AND SHALL BE CONSIDERED A PART OF THESE PLANS.
- AT LEAST TEN (10) DAYS PRIOR TO THE ANTICIPATED START OF CONSTRUCTION, FOR PROJECTS THAT WILL DISTURB 1 ACRE OR MORE, THE OWNER OR OPERATOR OF CONSTRUCTION ACTIVITY SHALL SUBMIT A PERMIT APPLICATION FOR STORMWATER DISCHARGE TO THE COLORADO DEPARTMENT OF PUBLIC HEALTH AND ENVIRONMENT, WATER QUALITY DIVISION. THE APPLICATION CONTAINS CERTIFICATION OF COMPLETION OF A STORMWATER MANAGEMENT PLAN (SWMP), OF WHICH THIS GRADING AND EROSION CONTROL PLAN MAY BE A PART. FOR INFORMATION OR APPLICATION MATERIALS CONTACT:  
COLORADO DEPARTMENT OF PUBLIC HEALTH AND ENVIRONMENT  
WATER QUALITY CONTROL DIVISION  
WOOD - PERMITS  
4300 CHERRY CREEK DRIVE SOUTH  
DENVER, CO 80246-1530  
ATTN: PERMITS UNIT

ENGINEER'S STATEMENT:  
THIS GRADING AND EROSION CONTROL PLAN WAS PREPARED UNDER MY DIRECTION AND SUPERVISION AND IS CORRECT TO THE BEST OF MY KNOWLEDGE AND BELIEF. SAID PLAN HAS BEEN PREPARED ACCORDING TO THE CRITERIA ESTABLISHED BY THE COUNTY FOR GRADING AND EROSION CONTROL PLANS. I ACCEPT RESPONSIBILITY FOR ANY LIABILITY CAUSED BY ANY NEGLIGENT ACTS, ERRORS OR OMISSIONS ON MY PART IN PREPARING THIS REPORT.

ENGINEER OF RECORD SIGNATURE \_\_\_\_\_ DATE \_\_\_\_\_

OWNER'S STATEMENT:  
THE OWNER WILL COMPLY WITH THE REQUIREMENTS OF THE GRADING AND EROSION CONTROL PLAN.

OWNER SIGNATURE \_\_\_\_\_ DATE \_\_\_\_\_

EL PASO COUNTY:  
COUNTY PLAN REVIEW IS PROVIDED ONLY FOR GENERAL CONFORMANCE WITH COUNTY DESIGN CRITERIA. THE COUNTY IS NOT RESPONSIBLE FOR THE ACCURACY AND ADEQUACY OF THE DESIGN, DIMENSIONS, AND/OR ELEVATIONS WHICH SHALL BE CONFIRMED AT THE JOB SITE. THE COUNTY THROUGH THE APPROVAL OF THIS DOCUMENT ASSUMES NO RESPONSIBILITY FOR COMPLETENESS AND/OR ACCURACY OF THIS DOCUMENT.

FILED IN ACCORDANCE WITH THE REQUIREMENTS OF THE EL PASO COUNTY LAND DEVELOPMENT CODE, DRAINAGE CRITERIA, AND ENGINEERING CRITERIA MANUAL AS AMENDED.

COUNTY PROJECT ENGINEER SIGNATURE \_\_\_\_\_ DATE \_\_\_\_\_

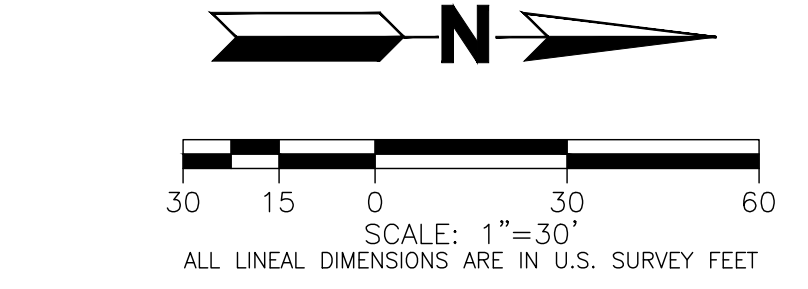
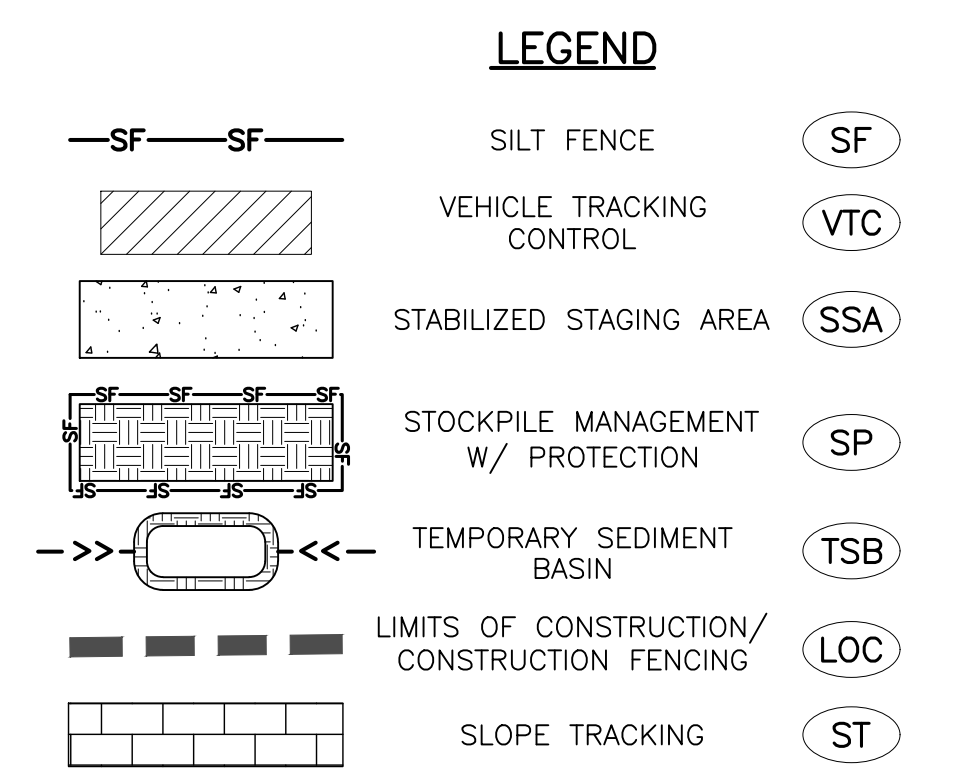

CALL 811 2-BUSINESS DAYS IN ADVANCE BEFORE YOU DIG, GRADE OR EXCAVATE FOR MARKING OF UNDERGROUND MEMBER UTILITIES

MARTIN/MARTIN ASSUMES NO RESPONSIBILITY FOR UTILITY LOCATIONS. UNLESS OTHERWISE NOTED, THE UTILITIES SHOWN ON THIS DRAWING ARE BASED ON INFORMATION PROVIDED BY OTHERS AND DEPICTED AS ASCE (38) QUALITY LEVEL D. IN ACCORDANCE WITH THE PROVISIONS OF COLORADO REVISED STATUTE, TITLE 9, IT IS THE CONTRACTOR'S RESPONSIBILITY TO CALL COLORADO 811 UTILITY LOCATE SERVICE FOR UTILITY LOCATES BEFORE DIGGING, AND FIELD VERIFY THE SIZE, MATERIAL, HORIZONTAL AND VERTICAL LOCATION OF ALL EXISTING UTILITIES (DEPICTED OR NOT DEPICTED) PRIOR TO THE COMMENCEMENT OF ANY CONSTRUCTION.

04-27-21  
PERMIT SET  
MARTIN/MARTIN  
CIVIL ENGINEERING ARCHITECTURE  
303 EAST GLOVER AVENUE, DENVER, COLORADO 80215  
303.831.6500 MARTINMARTIN.COM

Palmer Ridge High School, Lewis Palmer SD-38  
19255 Frontage (Monument Hill) Road  
Monument, CO 80132  
GSP Remedial Renovation

Ownership of Instruments of Service  
All reports, plans, specifications, computer files, field data, notes and other documents and instruments prepared by the Engineer as instruments of service shall remain the property of the Engineer. The Engineer shall retain all common-law, statutory and other reserved rights, including the copyright thereto.

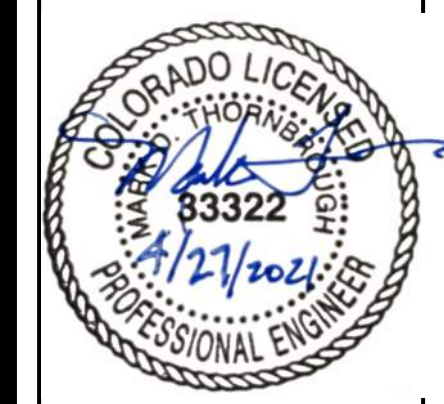

Phase 1  
GHX / Ctrl Plant  
INITIAL EROSION CONTROL PLAN

Phase 1  
C-200

PLOT DATE: Tuesday, Aug 27, 2021, 4:40 PM. LAST SAVED BY: CONTINUOUS  
 DRAWING LOCATION: C:\Users\martin\OneDrive\Desktop\EROSION\_CONTROL\_PLAN.rvt

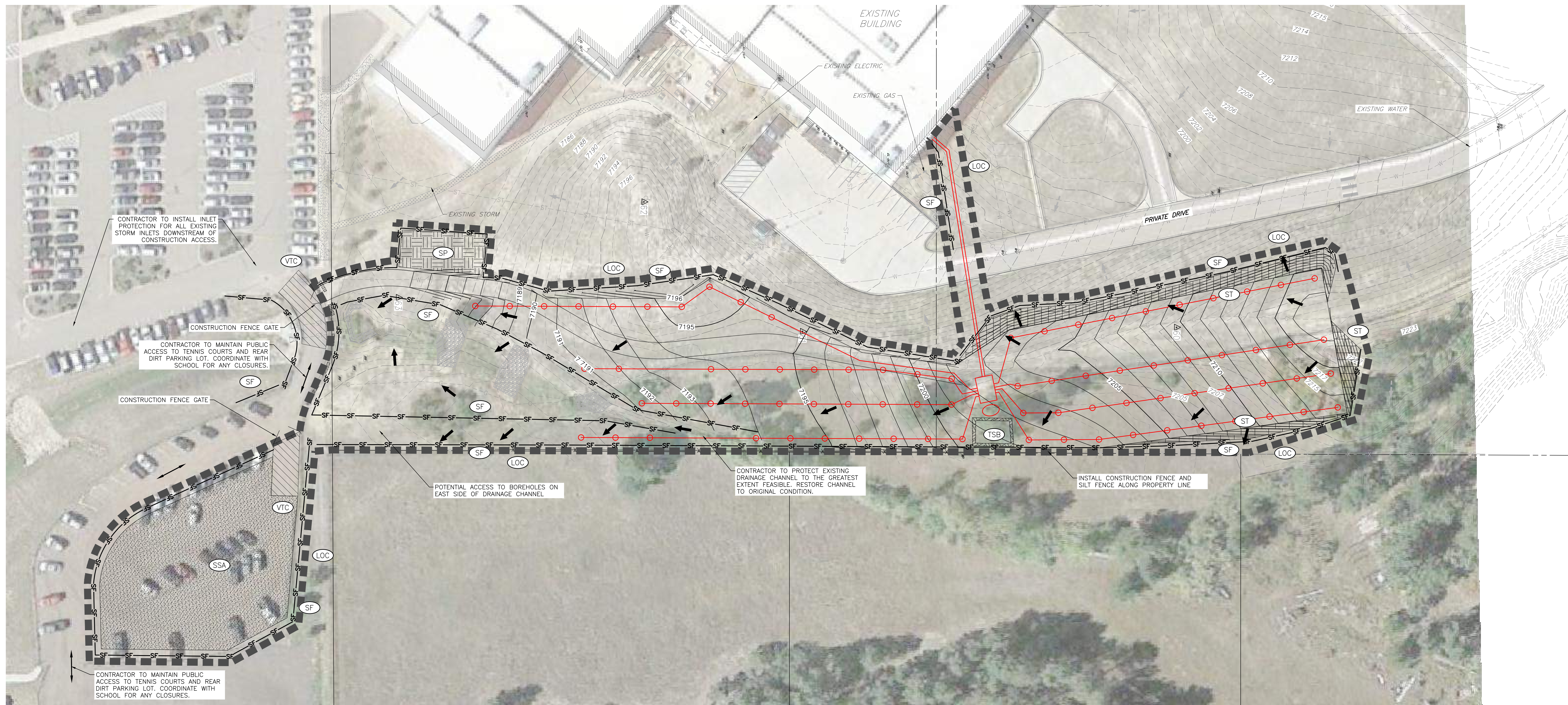

**STANDARD NOTES FOR EL PASO COUNTY GRADING AND EROSION CONTROL PLANS**

- REVISED JULY 2019
- STORMWATER DISCHARGES FROM CONSTRUCTION SITES SHALL NOT CAUSE OR THREATEN TO CAUSE POLLUTION, CONTAMINATION, OR DEGRADATION OF STATE WATERS. ALL WORK AND EARTH DISTURBANCE SHALL BE DONE IN A MANNER THAT MINIMIZES POLLUTION OF ANY ON-SITE OR OFF-SITE WATERS, INCLUDING WETLANDS.
  - NOTWITHSTANDING ANYTHING DEPICTED IN THESE PLANS IN WORDS OR GRAPHIC REPRESENTATION, ALL DESIGN AND CONSTRUCTION RELATED TO ROADS, STORM DRAINAGE AND EROSION CONTROL SHALL CONFORM TO THE STANDARDS AND REQUIREMENTS OF THE MOST RECENT VERSION OF THE RELEVANT ADOPTED EL PASO COUNTY STANDARDS, INCLUDING THE LAND DEVELOPMENT CODE, THE ENGINEERING CRITERIA MANUAL, THE DRAINAGE CRITERIA MANUAL, AND THE DRAINAGE CRITERIA MANUAL VOLUME 2. ANY DEVIATIONS TO REGULATIONS AND STANDARDS MUST BE REQUESTED, AND APPROVED, IN WRITING.
  - A SEPARATE STORMWATER MANAGEMENT PLAN (SWMP) FOR THIS PROJECT SHALL BE COMPLETED AND AN EROSION AND STORMWATER QUALITY CONTROL PERMIT (ESQCP) ISSUED PRIOR TO COMMENCING CONSTRUCTION. DURING CONSTRUCTION THE SWMP IS THE RESPONSIBILITY OF THE DESIGNATED QUALIFIED STORMWATER MANAGER OR CERTIFIED EROSION CONTROL INSPECTOR AND SHALL BE LOCATED ON SITE AT ALL TIMES DURING CONSTRUCTION AND SHALL BE KEPT UP TO DATE WITH WORK PROGRESS AND CHANGES IN THE FIELD.
  - ONCE THE ESQCP IS APPROVED AND A "NOTICE TO PROCEED" HAS BEEN ISSUED, THE CONTRACTOR MAY INSTALL THE INITIAL STAGE EROSION AND SEDIMENT CONTROL MEASURES AS INDICATED ON THE APPROVED GEC. A PRECONSTRUCTION MEETING BETWEEN THE CONTRACTOR, ENGINEER, AND EL PASO COUNTY WILL BE HELD PRIOR TO ANY CONSTRUCTION. IT IS THE RESPONSIBILITY OF THE APPLICANT TO COORDINATE THE MEETING TIME AND PLACE WITH COUNTY STAFF.
  - CONTROL MEASURES MUST BE INSTALLED PRIOR TO COMMENCEMENT OF ACTIVITIES THAT MAY CONTRIBUTE POLLUTANTS TO STORMWATER. TEMPORARY SEDIMENT AND EROSION CONTROL MEASURES FOR ALL SLOPES, CHANNELS, DITCHES, OR ANY DISTURBED LAND AREA SHALL BE COMPLETED IMMEDIATELY UPON COMPLETION OF THE DISTURBANCE.
  - ALL TEMPORARY SEDIMENT AND EROSION CONTROL MEASURES SHALL BE MAINTAINED AND REMAIN IN EFFECTIVE OPERATING CONDITION UNTIL PERMANENT SOIL EROSION CONTROL MEASURES ARE IMPLEMENTED AND FINAL STABILIZATION IS ESTABLISHED. ALL PERSONS ENGAGED IN LAND DISTURBANCE ACTIVITIES SHALL ASSESS THE ADEQUACY OF CONTROL MEASURES AT THE SITE AND IDENTIFY IF CHANGES TO THOSE CONTROL MEASURES IS NEEDED TO ENSURE THE CONTINUED EFFECTIVE PERFORMANCE OF THE CONTROL MEASURES. ALL CHANGES TO TEMPORARY SEDIMENT AND EROSION CONTROL MEASURES MUST BE INCORPORATED INTO THE STORMWATER MANAGEMENT PLAN PRIOR TO IMPLEMENTATION.
  - TEMPORARY STABILIZATION SHALL BE IMPLEMENTED ON DISTURBED AREAS AND STOCKPILES WHERE GROUND DISTURBING CONSTRUCTION ACTIVITY HAS PERMANENTLY CEASED OR TEMPORARILY CEASED FOR LONGER THAN 14 DAYS. AN AREA THAT IS GOING TO REMAIN IN AN INTERIM STATE FOR MORE THAN 60 DAYS SHALL ALSO BE STABILIZED.
  - FINAL STABILIZATION MUST BE IMPLEMENTED AT ALL APPLICABLE CONSTRUCTION SITES. FINAL STABILIZATION IS ACHIEVED WHEN ALL GROUND DISTURBING ACTIVITIES ARE COMPLETE AND ALL DISTURBED AREAS EITHER HAVE A UNIFORM VEGETATIVE COVER WITH INDIVIDUAL PLAN DENSITY OF 70 PERCENT OF PRE-DISTURBANCE LEVELS ESTABLISHED OR EQUIVALENT PERMANENT ALTERNATIVE STABILIZATION METHOD IS IMPLEMENTED. ALL TEMPORARY SEDIMENT AND EROSION CONTROL MEASURES SHALL BE REMOVED UPON FINAL STABILIZATION AND BEFORE PERMIT CLOSURE.
  - ALL PERMANENT STORMWATER MANAGEMENT FACILITIES SHALL BE INSTALLED AS DEFINED IN THE APPROVED PLANS. ANY PROPOSED CHANGES THAT EFFECT THE HYDROLOGY OR HYDRAULICS OF A PERMANENT STORMWATER MANAGEMENT STRUCTURES MUST BE APPROVED BY THE ECM ADMINISTRATOR PRIOR TO IMPLEMENTATION.
  - ANY EARTH DISTURBANCE SHALL BE CONDUCTED IN SUCH A MANNER SO AS TO EFFECTIVELY MINIMIZE ACCELERATED SOIL EROSION AND RESULTING SEDIMENTATION. ALL DISTURBANCES SHALL BE DESIGNED, CONSTRUCTED, AND COMPLETED SO THAT THE EXPOSED AREA OF ANY DISTURBED LAND SHALL BE LIMITED TO THE SHORTEST PRACTICAL PERIOD OF TIME. PRE-EXISTING VEGETATION SHALL BE PROTECTED AND MAINTAINED WITHIN 50 HORIZONTAL FEET OF A WATERS OF THE STATE, UNLESS INFEASIBLE.

- COMPACTION OF SOIL MUST BE PREVENTED IN AREAS DESIGNATED FOR INFILTRATION CONTROL MEASURES OR WHERE FINAL STABILIZATION WILL BE ACHIEVED BY VEGETATIVE COVER. AREAS DESIGNATED FOR INFILTRATION CONTROL SHALL ALSO BE PROTECTED FROM SEDIMENTATION DURING CONSTRUCTION UNTIL FINAL STABILIZATION IS ACHIEVED.
- ANY TEMPORARY OR PERMANENT FACILITY DESIGNED AND CONSTRUCTED FOR THE CONVEYANCE OF STORMWATER AROUND, THROUGH, OR FROM THE EARTH DISTURBANCE AREA SHALL BE A STABILIZED CONVEYANCE DESIGNED TO MINIMIZE EROSION AND THE DISCHARGE OF SEDIMENT OFF SITE.
- CONCRETE WASH WATER SHALL BE CONTAINED AND DISPOSED OF IN ACCORDANCE WITH THE SWMP. NO WASH WATER SHALL BE DISCHARGED TO OR ALLOWED TO RUNOFF TO STATE WATERS, INCLUDING ANY SURFACE OR SUBSURFACE STORM DRAINAGE SYSTEM OR FACILITIES. CONCRETE WASHOUT SHALL NOT BE LOCATED IN AN AREA WHERE SHALLOW GROUNDWATER MAY BE PRESENT, OR WITHIN 50 FEET OF A SURFACE WATER BODY.
- DEWATERING OPERATIONS: UNCONTAMINATED GROUND WATER MAY BE DISCHARGED ON SITE, BUT MAY NOT LEAVE THE SITE IN THE FORM OF SURFACE RUNOFF.
- EROSION CONTROL BLANKETING IS TO BE USED ON SLOPES STEEPER THAN 3:1.
- BUILDING, CONSTRUCTION, EXCAVATION, OR OTHER WASTE MATERIALS SHALL NOT BE TEMPORARILY PLACED OR STORED IN THE STREET, ALLEY, OR OTHER PUBLIC WAY, UNLESS IN ACCORDANCE WITH AN APPROVED TRAFFIC CONTROL PLAN. BMP'S MAY BE REQUIRED BY EL PASO COUNTY ENGINEERING IF DEEMED NECESSARY, BASED ON SPECIFIC CONDITIONS AND CIRCUMSTANCES.
- VEHICLE TRACKING OF SOILS AND CONSTRUCTION DEBRIS OFF-SITE SHALL BE MINIMIZED. MATERIALS TRACKED OFFSITE SHALL BE CLEANED UP AND PROPERLY DISPOSED OF IMMEDIATELY.
- CONTRACTOR SHALL BE RESPONSIBLE FOR THE REMOVAL OF ALL WASTES FROM THE CONSTRUCTION SITE FOR DISPOSAL IN ACCORDANCE WITH LOCAL AND STATE REGULATORY REQUIREMENTS. NO CONSTRUCTION DEBRIS, TREE SLASH, BUILDING MATERIAL WASTES OR UNUSED BUILDING MATERIALS SHALL BE BURIED, DUMPED, OR DISCHARGED AT THE SITE.
- THE OWNER, SITE DEVELOPER, CONTRACTOR, AND/OR THEIR AUTHORIZED AGENTS SHALL BE RESPONSIBLE FOR THE REMOVAL OF ALL CONSTRUCTION DEBRIS, DIRT, TRASH, ROCK, SEDIMENT, AND SAND THAT MAY ACCUMULATE IN THE STORM SEWER OR OTHER DRAINAGE CONVEYANCE SYSTEM AND STORMWATER APPURTENANCES AS A RESULT OF SITE DEVELOPMENT.
- THE QUANTITY OF MATERIALS STORED ON THE PROJECT SITE SHALL BE LIMITED, AS MUCH AS PRACTICAL, TO THAT QUANTITY REQUIRED TO PERFORM THE WORK IN AN ORDERLY SEQUENCE. ALL MATERIALS STORED ON-SITE SHALL BE STORED IN A NEAT, ORDERLY MANNER, IN THEIR ORIGINAL CONTAINERS, WITH ORIGINAL MANUFACTURER'S LABELS.
- NO CHEMICALS ARE TO BE USED BY THE CONTRACTOR, WHICH HAVE THE POTENTIAL TO BE RELEASED IN STORMWATER UNLESS PERMISSION FOR THE USE OF A SPECIFIC CHEMICAL IS GRANTED IN WRITING BY THE ECM ADMINISTRATOR. IN GRANTING THE USE OF SUCH CHEMICALS, SPECIAL CONDITIONS AND MONITORING MAY BE REQUIRED.
- BULK STORAGE OF PETROLEUM PRODUCTS OR OTHER LIQUID CHEMICALS IN EXCESS OF 55 GALLONS SHALL HAVE ADEQUATE SECONDARY CONTAINMENT PROTECTION TO CONTAIN ALL SPILLS AND PREVENT ANY SPILLED MATERIAL FROM ENTERING STATE WATERS, INCLUDING ANY SURFACE OR SUBSURFACE STORM DRAINAGE SYSTEM OR FACILITIES.
- NO PERSON SHALL CAUSE THE IMPEDIMENT OF STORMWATER FLOW IN THE FLOW LINE OF THE CURB AND GUTTER OR IN THE DITCH FLOW LINE.
- INDIVIDUALS SHALL COMPLY WITH THE "COLORADO WATER QUALITY CONTROL ACT" (TITLE 25, ARTICLE 8, CRS), AND THE "CLEAN WATER ACT" (33 USC 1344), IN ADDITION TO THE REQUIREMENTS INCLUDED IN THE DCM VOLUME II AND THE ECM APPENDIX I. ALL APPROPRIATE PERMITS MUST BE OBTAINED BY THE CONTRACTOR PRIOR TO CONSTRUCTION (NPDES, FLOODPLAIN, 404, FUGITIVE DUST, ETC.). IN THE EVENT OF CONFLICTS BETWEEN THESE REQUIREMENTS AND LAWS, RULES, OR REGULATIONS OF OTHER FEDERAL, STATE, OR COUNTY AGENCIES, THE MORE RESTRICTIVE LAWS, RULES, OR REGULATIONS SHALL APPLY.
- ALL CONSTRUCTION TRAFFIC MUST ENTER/EXIT THE SITE AT APPROVED CONSTRUCTION ACCESS POINTS.

- PRIOR TO ACTUAL CONSTRUCTION THE PERMITEE SHALL VERIFY THE LOCATION OF EXISTING UTILITIES.
- A WATER SOURCE SHALL BE AVAILABLE ON SITE DURING EARTHWORK OPERATIONS AND UTILIZED AS REQUIRED TO MINIMIZE DUST FROM EARTHWORK EQUIPMENT AND WIND.
- THE SOILS REPORT FOR THIS SITE HAS BEEN PREPARED BY TERRACON CONSULTANTS, INC. AND SHALL BE CONSIDERED A PART OF THESE PLANS.
- AT LEAST TEN (10) DAYS PRIOR TO THE ANTICIPATED START OF CONSTRUCTION, FOR PROJECTS THAT WILL DISTURB 1 ACRE OR MORE, THE OWNER OR OPERATOR OF CONSTRUCTION ACTIVITY SHALL SUBMIT A PERMIT APPLICATION FOR STORMWATER DISCHARGE TO THE COLORADO DEPARTMENT OF PUBLIC HEALTH AND ENVIRONMENT, WATER QUALITY DIVISION. THE APPLICATION CONTAINS CERTIFICATION OF COMPLETION OF A STORMWATER MANAGEMENT PLAN (SWMP), OF WHICH THIS GRADING AND EROSION CONTROL PLAN MAY BE A PART. FOR INFORMATION OR APPLICATION MATERIALS CONTACT:  
COLORADO DEPARTMENT OF PUBLIC HEALTH AND ENVIRONMENT  
WATER QUALITY CONTROL DIVISION  
WQCD - PERMITS  
4300 CHERRY CREEK DRIVE SOUTH  
DENVER, CO 80246-1530  
ATTN: PERMITS UNIT

ENGINEER'S STATEMENT:  
THIS GRADING AND EROSION CONTROL PLAN WAS PREPARED UNDER MY DIRECTION AND SUPERVISION AND IS CORRECT TO THE BEST OF MY KNOWLEDGE AND BELIEF. SAID PLAN HAS BEEN PREPARED ACCORDING TO THE CRITERIA ESTABLISHED BY THE COUNTY FOR GRADING AND EROSION CONTROL PLANS. I ACCEPT RESPONSIBILITY FOR ANY LIABILITY CAUSED BY ANY NEGLIGENT ACTS, ERRORS OR OMISSIONS ON MY PART IN PREPARING THIS REPORT.

ENGINEER OF RECORD SIGNATURE \_\_\_\_\_ DATE \_\_\_\_\_

OWNER'S STATEMENT:  
THE OWNER WILL COMPLY WITH THE REQUIREMENTS OF THE GRADING AND EROSION CONTROL PLAN.

OWNER SIGNATURE \_\_\_\_\_ DATE \_\_\_\_\_

EL PASO COUNTY:  
COUNTY PLAN REVIEW IS PROVIDED ONLY FOR GENERAL CONFORMANCE WITH COUNTY DESIGN CRITERIA. THE COUNTY IS NOT RESPONSIBLE FOR THE ACCURACY AND ADEQUACY OF THE DESIGN, DIMENSIONS, AND/OR ELEVATIONS WHICH SHALL BE CONFIRMED AT THE JOB SITE. THE COUNTY THROUGH THE APPROVAL OF THIS DOCUMENT ASSUMES NO RESPONSIBILITY FOR COMPLETENESS AND/OR ACCURACY OF THIS DOCUMENT.

FILED IN ACCORDANCE WITH THE REQUIREMENTS OF THE EL PASO COUNTY LAND DEVELOPMENT CODE, DRAINAGE CRITERIA, AND ENGINEERING CRITERIA MANUAL AS AMENDED.

COUNTY PROJECT ENGINEER SIGNATURE \_\_\_\_\_ DATE \_\_\_\_\_

**LEGEND**

	SILT FENCE	
	VEHICLE TRACKING CONTROL	
	STABILIZED STAGING AREA	
	STOCKPILE MANAGEMENT W/ PROTECTION	
	TEMPORARY SEDIMENT BASIN	
	LIMITS OF CONSTRUCTION/ CONSTRUCTION FENCING	
	SLOPE TRACKING	
	DRAINAGE FLOW ARROWS	
	GROUND HEAT EXCHANGER (GHX)	

30 15 0 SCALE: 1"=30'  
ALL LINEAL DIMENSIONS ARE IN U.S. SURVEY FEET

**COLORADO 811**  
KNOW WHAT'S BELOW. CALL BEFORE YOU DIG.

CALL 811 2-BUSINESS DAYS IN ADVANCE BEFORE YOU DIG, GRADE OR EXCAVATE FOR MARKING OF UNDERGROUND MEMBER UTILITIES

MARTIN/MARTIN ASSUMES NO RESPONSIBILITY FOR UTILITY LOCATIONS. UNLESS OTHERWISE NOTED, THE UTILITIES SHOWN ON THIS DRAWING ARE BASED ON INFORMATION PROVIDED BY OTHERS AND DEPICTED AS ASCE (38) QUALITY LEVEL D. IN ACCORDANCE WITH THE PROVISIONS OF COLORADO REVISED STATUTE, TITLE 9, IT IS THE CONTRACTOR'S RESPONSIBILITY TO CALL COLORADO 811 UTILITY LOCATE SERVICE FOR UTILITY LOCATES BEFORE DIGGING, AND FIELD VERIFY THE SIZE, MATERIAL, HORIZONTAL AND VERTICAL LOCATION OF ALL EXISTING UTILITIES (DEPICTED OR NOT DEPICTED) PRIOR TO THE COMMENCEMENT OF ANY CONSTRUCTION.

04-27-21  
PERMIT SET  
MARTIN/MARTIN  
303.831.6500  
MARTINMARTIN.COM

Palmer Ridge High School, Lewis Palmer SD-38  
19255 Frontage (Monument Hill) Road  
Monument, CO 80132  
GSHP Remedial Renovation

Ownership of Instruments of Service  
All reports, plans, specifications, computer files, field data, notes and other documents and instruments prepared by the Engineer as instruments of service shall remain the property of the Engineer. The Engineer shall retain all common, law, statutory and other reserved rights, including the copyright thereto.



Phase 1  
GHX / Ctrl Plant  
INTERIM  
EROSION  
CONTROL  
PLAN

Phase 1  
C-201

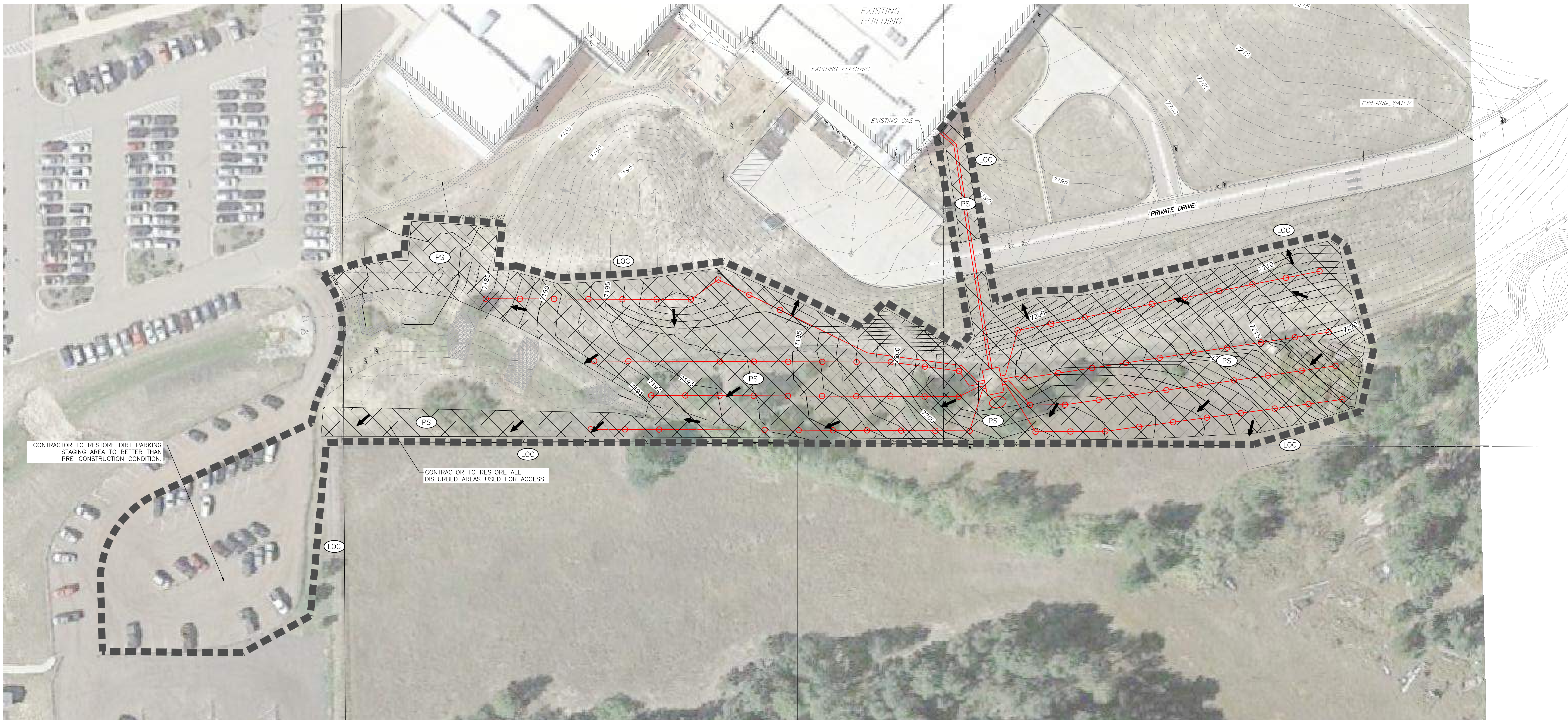

**STANDARD NOTES FOR EL PASO COUNTY GRADING AND EROSION CONTROL PLANS**

- REVISED JULY 2019
- STORMWATER DISCHARGES FROM CONSTRUCTION SITES SHALL NOT CAUSE OR THREATEN TO CAUSE POLLUTION, CONTAMINATION, OR DEGRADATION OF STATE WATERS. ALL WORK AND EARTH DISTURBANCE SHALL BE DONE IN A MANNER THAT MINIMIZES POLLUTION OF ANY ON-SITE OR OFF-SITE WATERS, INCLUDING WETLANDS.
  - NOTWITHSTANDING ANYTHING DEPICTED IN THESE PLANS IN WORDS OR GRAPHIC REPRESENTATION, ALL DESIGN AND CONSTRUCTION RELATED TO ROADS, STORM DRAINAGE AND EROSION CONTROL SHALL CONFORM TO THE STANDARDS AND REQUIREMENTS OF THE MOST RECENT VERSION OF THE RELEVANT ADOPTED EL PASO COUNTY STANDARDS, INCLUDING THE LAND DEVELOPMENT CODE, THE ENGINEERING CRITERIA MANUAL, THE DRAINAGE CRITERIA MANUAL, AND THE DRAINAGE CRITERIA MANUAL VOLUME 2. ANY DEVIATIONS TO REGULATIONS AND STANDARDS MUST BE REQUESTED, AND APPROVED, IN WRITING.
  - A SEPARATE STORMWATER MANAGEMENT PLAN (SWMP) FOR THIS PROJECT SHALL BE COMPLETED AND AN EROSION AND STORMWATER QUALITY CONTROL PERMIT (ESQCP) ISSUED PRIOR TO COMMENCING CONSTRUCTION. DURING CONSTRUCTION THE SWMP IS THE RESPONSIBILITY OF THE DESIGNATED QUALIFIED STORMWATER MANAGER OR CERTIFIED EROSION CONTROL INSPECTOR AND SHALL BE LOCATED ON SITE AT ALL TIMES DURING CONSTRUCTION AND SHALL BE KEPT UP TO DATE WITH WORK PROGRESS AND CHANGES IN THE FIELD.
  - ONCE THE ESQCP IS APPROVED AND A "NOTICE TO PROCEED" HAS BEEN ISSUED, THE CONTRACTOR MAY INSTALL THE INITIAL STAGE EROSION AND SEDIMENT CONTROL MEASURES AS INDICATED ON THE APPROVED GEC. A PRECONSTRUCTION MEETING BETWEEN THE CONTRACTOR, ENGINEER, AND EL PASO COUNTY WILL BE HELD PRIOR TO ANY CONSTRUCTION. IT IS THE RESPONSIBILITY OF THE APPLICANT TO COORDINATE THE MEETING TIME AND PLACE WITH COUNTY STAFF.
  - CONTROL MEASURES MUST BE INSTALLED PRIOR TO COMMENCEMENT OF ACTIVITIES THAT MAY CONTRIBUTE POLLUTANTS TO STORMWATER. TEMPORARY SEDIMENT AND EROSION CONTROL MEASURES FOR ALL SLOPES, CHANNELS, DITCHES, OR ANY DISTURBED LAND AREA SHALL BE COMPLETED IMMEDIATELY UPON COMPLETION OF THE DISTURBANCE.
  - ALL TEMPORARY SEDIMENT AND EROSION CONTROL MEASURES SHALL BE MAINTAINED AND REMAIN IN EFFECTIVE OPERATING CONDITION UNTIL PERMANENT SOIL EROSION CONTROL MEASURES ARE IMPLEMENTED AND FINAL STABILIZATION IS ESTABLISHED. ALL PERSONS ENGAGED IN LAND DISTURBANCE ACTIVITIES SHALL ASSESS THE ADEQUACY OF CONTROL MEASURES AT THE SITE AND IDENTIFY IF CHANGES TO THOSE CONTROL MEASURES IS NEEDED TO ENSURE THE CONTINUED EFFECTIVE PERFORMANCE OF THE CONTROL MEASURES. ALL CHANGES TO TEMPORARY SEDIMENT AND EROSION CONTROL MEASURES MUST BE INCORPORATED INTO THE STORMWATER MANAGEMENT PLAN PRIOR TO IMPLEMENTATION.
  - TEMPORARY STABILIZATION SHALL BE IMPLEMENTED ON DISTURBED AREAS AND STOCKPILES WHERE GROUND DISTURBING CONSTRUCTION ACTIVITY HAS PERMANENTLY CEASED OR TEMPORARILY CEASED FOR LONGER THAN 14 DAYS. AN AREA THAT IS GOING TO REMAIN IN AN INTERIM STATE FOR MORE THAN 60 DAYS SHALL ALSO BE STABILIZED.
  - FINAL STABILIZATION MUST BE IMPLEMENTED AT ALL APPLICABLE CONSTRUCTION SITES. FINAL STABILIZATION IS ACHIEVED WHEN ALL GROUND DISTURBING ACTIVITIES ARE COMPLETE AND ALL DISTURBED AREAS EITHER HAVE A UNIFORM VEGETATIVE COVER WITH INDIVIDUAL PLAN DENSITY OF 70 PERCENT OF PRE-DISTURBANCE LEVELS ESTABLISHED OR EQUIVALENT PERMANENT ALTERNATIVE STABILIZATION METHOD IS IMPLEMENTED. ALL TEMPORARY SEDIMENT AND EROSION CONTROL MEASURES SHALL BE REMOVED UPON FINAL STABILIZATION AND BEFORE PERMIT CLOSURE.
  - ALL PERMANENT STORMWATER MANAGEMENT FACILITIES SHALL BE INSTALLED AS DEFINED IN THE APPROVED PLANS. ANY PROPOSED CHANGES THAT EFFECT THE HYDROLOGY OR HYDRAULICS OF A PERMANENT STORMWATER MANAGEMENT STRUCTURES MUST BE APPROVED BY THE ECM ADMINISTRATOR PRIOR TO IMPLEMENTATION.
  - ANY EARTH DISTURBANCE SHALL BE CONDUCTED IN SUCH A MANNER SO AS TO EFFECTIVELY MINIMIZE ACCELERATED SOIL EROSION AND RESULTING SEDIMENTATION. ALL DISTURBANCES SHALL BE DESIGNED, CONSTRUCTED, AND COMPLETED SO THAT THE EXPOSED AREA OF ANY DISTURBED LAND SHALL BE LIMITED TO THE SHORTEST PRACTICAL PERIOD OF TIME. PRE-EXISTING VEGETATION SHALL BE PROTECTED AND MAINTAINED WITHIN 50 HORIZONTAL FEET OF A WATERS OF THE STATE, UNLESS INFEASIBLE.

- COMPACTION OF SOIL MUST BE PREVENTED IN AREAS DESIGNATED FOR INFILTRATION CONTROL MEASURES OR WHERE FINAL STABILIZATION WILL BE ACHIEVED BY VEGETATIVE COVER. AREAS DESIGNATED FOR INFILTRATION CONTROL SHALL ALSO BE PROTECTED FROM SEDIMENTATION DURING CONSTRUCTION UNTIL FINAL STABILIZATION IS ACHIEVED.
- ANY TEMPORARY OR PERMANENT FACILITY DESIGNED AND CONSTRUCTED FOR THE CONVEYANCE OF STORMWATER AROUND, THROUGH, OR FROM THE EARTH DISTURBANCE AREA SHALL BE A STABILIZED CONVEYANCE DESIGNED TO MINIMIZE EROSION AND THE DISCHARGE OF SEDIMENT OFF SITE.
- CONCRETE WASH WATER SHALL BE CONTAINED AND DISPOSED OF IN ACCORDANCE WITH THE SWMP. NO WASH WATER SHALL BE DISCHARGED TO OR ALLOWED TO RUNOFF TO STATE WATERS, INCLUDING ANY SURFACE OR SUBSURFACE STORM DRAINAGE SYSTEM OR FACILITIES. CONCRETE WASHOUT SHALL NOT BE LOCATED IN AN AREA WHERE SHALLOW GROUNDWATER MAY BE PRESENT, OR WITHIN 50 FEET OF A SURFACE WATER BODY.
- DEWATERING OPERATIONS: UNCONTAMINATED GROUND WATER MAY BE DISCHARGED ON SITE, BUT MAY NOT LEAVE THE SITE IN THE FORM OF SURFACE RUNOFF.
- EROSION CONTROL BLANKETING IS TO BE USED ON SLOPES STEEPER THAN 3:1.
- BUILDING, CONSTRUCTION, EXCAVATION, OR OTHER WASTE MATERIALS SHALL NOT BE TEMPORARILY PLACED OR STORED IN THE STREET, ALLEY, OR OTHER PUBLIC WAY, UNLESS IN ACCORDANCE WITH AN APPROVED TRAFFIC CONTROL PLAN. BMP'S MAY BE REQUIRED BY EL PASO COUNTY ENGINEERING IF DEEMED NECESSARY, BASED ON SPECIFIC CONDITIONS AND CIRCUMSTANCES.
- VEHICLE TRACKING OF SOILS AND CONSTRUCTION DEBRIS OFF-SITE SHALL BE MINIMIZED. MATERIALS TRACKED OFFSITE SHALL BE CLEANED UP AND PROPERLY DISPOSED OF IMMEDIATELY.
- CONTRACTOR SHALL BE RESPONSIBLE FOR THE REMOVAL OF ALL WASTES FROM THE CONSTRUCTION SITE FOR DISPOSAL IN ACCORDANCE WITH LOCAL AND STATE REGULATORY REQUIREMENTS. NO CONSTRUCTION DEBRIS, TREE SLASH, BUILDING MATERIAL WASTES OR UNUSED BUILDING MATERIALS SHALL BE BURIED, DUMPED, OR DISCHARGED AT THE SITE.
- THE OWNER, SITE DEVELOPER, CONTRACTOR, AND/OR THEIR AUTHORIZED AGENTS SHALL BE RESPONSIBLE FOR THE REMOVAL OF ALL CONSTRUCTION DEBRIS, DIRT, TRASH, ROCK, SEDIMENT, AND SAND THAT MAY ACCUMULATE IN THE STORM SEWER OR OTHER DRAINAGE CONVEYANCE SYSTEM AND STORMWATER APPURTENANCES AS A RESULT OF SITE DEVELOPMENT.
- THE QUANTITY OF MATERIALS STORED ON THE PROJECT SITE SHALL BE LIMITED, AS MUCH AS PRACTICAL, TO THAT QUANTITY REQUIRED TO PERFORM THE WORK IN AN ORDERLY SEQUENCE. ALL MATERIALS STORED ON-SITE SHALL BE STORED IN A NEAT, ORDERLY MANNER, IN THEIR ORIGINAL CONTAINERS, WITH ORIGINAL MANUFACTURER'S LABELS.
- NO CHEMICALS ARE TO BE USED BY THE CONTRACTOR, WHICH HAVE THE POTENTIAL TO BE RELEASED IN STORMWATER UNLESS PERMISSION FOR THE USE OF A SPECIFIC CHEMICAL IS GRANTED IN WRITING BY THE ECM ADMINISTRATOR. IN GRANTING THE USE OF SUCH CHEMICALS, SPECIAL CONDITIONS AND MONITORING MAY BE REQUIRED.
- BULK STORAGE OF PETROLEUM PRODUCTS OR OTHER LIQUID CHEMICALS IN EXCESS OF 55 GALLONS SHALL HAVE ADEQUATE SECONDARY CONTAINMENT PROTECTION TO CONTAIN ALL SPILLS AND PREVENT ANY SPILLED MATERIAL FROM ENTERING STATE WATERS, INCLUDING ANY SURFACE OR SUBSURFACE STORM DRAINAGE SYSTEM OR FACILITIES.
- NO PERSON SHALL CAUSE THE IMPEDIMENT OF STORMWATER FLOW IN THE FLOW LINE OF THE CURB AND GUTTER OR IN THE DITCH FLOW LINE.
- INDIVIDUALS SHALL COMPLY WITH THE "COLORADO WATER QUALITY CONTROL ACT" (TITLE 25, ARTICLE 8, CRS), AND THE "CLEAN WATER ACT" (33 USC 1344), IN ADDITION TO THE REQUIREMENTS INCLUDED IN THE DCM VOLUME II AND THE ECM APPENDIX I. ALL APPROPRIATE PERMITS MUST BE OBTAINED BY THE CONTRACTOR PRIOR TO CONSTRUCTION (NPDES, FLOODPLAIN, 404, FUGITIVE DUST, ETC.). IN THE EVENT OF CONFLICTS BETWEEN THESE REQUIREMENTS AND LAWS, RULES, OR REGULATIONS OF OTHER FEDERAL, STATE, OR COUNTY AGENCIES, THE MORE RESTRICTIVE LAWS, RULES, OR REGULATIONS SHALL APPLY.
- ALL CONSTRUCTION TRAFFIC MUST ENTER/EXIT THE SITE AT APPROVED CONSTRUCTION ACCESS POINTS.

- PRIOR TO ACTUAL CONSTRUCTION THE PERMITEE SHALL VERIFY THE LOCATION OF EXISTING UTILITIES.
  - A WATER SOURCE SHALL BE AVAILABLE ON SITE DURING EARTHWORK OPERATIONS AND UTILIZED AS REQUIRED TO MINIMIZE DUST FROM EARTHWORK EQUIPMENT AND WIND.
  - THE SOILS REPORT FOR THIS SITE HAS BEEN PREPARED BY TERRACON CONSULTANTS, INC. AND SHALL BE CONSIDERED A PART OF THESE PLANS.
  - AT LEAST TEN (10) DAYS PRIOR TO THE ANTICIPATED START OF CONSTRUCTION, FOR PROJECTS THAT WILL DISTURB 1 ACRE OR MORE, THE OWNER OR OPERATOR OF CONSTRUCTION ACTIVITY SHALL SUBMIT A PERMIT APPLICATION FOR STORMWATER DISCHARGE TO THE COLORADO DEPARTMENT OF PUBLIC HEALTH AND ENVIRONMENT, WATER QUALITY DIVISION. THE APPLICATION CONTAINS CERTIFICATION OF COMPLETION OF A STORMWATER MANAGEMENT PLAN (SWMP), OF WHICH THIS GRADING AND EROSION CONTROL PLAN MAY BE A PART. FOR INFORMATION OR APPLICATION MATERIALS CONTACT:  
  
COLORADO DEPARTMENT OF PUBLIC HEALTH AND ENVIRONMENT  
WATER QUALITY CONTROL DIVISION  
WOOD - PERMITS  
4300 CHERRY CREEK DRIVE SOUTH  
DENVER, CO 80246-1530  
ATTN: PERMITS UNIT
- ENGINEER'S STATEMENT:  
THIS GRADING AND EROSION CONTROL PLAN WAS PREPARED UNDER MY DIRECTION AND SUPERVISION AND IS CORRECT TO THE BEST OF MY KNOWLEDGE AND BELIEF. SAID PLAN HAS BEEN PREPARED ACCORDING TO THE CRITERIA ESTABLISHED BY THE COUNTY FOR GRADING AND EROSION CONTROL PLANS. I ACCEPT RESPONSIBILITY FOR ANY LIABILITY CAUSED BY ANY NEGLIGENT ACTS, ERRORS OR OMISSIONS ON MY PART IN PREPARING THIS REPORT.
- ENGINEER OF RECORD SIGNATURE \_\_\_\_\_ DATE \_\_\_\_\_  
OWNER'S STATEMENT:  
THE OWNER WILL COMPLY WITH THE REQUIREMENTS OF THE GRADING AND EROSION CONTROL PLAN.  
OWNER SIGNATURE \_\_\_\_\_ DATE \_\_\_\_\_  
EL PASO COUNTY:  
COUNTY PLAN REVIEW IS PROVIDED ONLY FOR GENERAL CONFORMANCE WITH COUNTY DESIGN CRITERIA. THE COUNTY IS NOT RESPONSIBLE FOR THE ACCURACY AND ADEQUACY OF THE DESIGN, DIMENSIONS, AND/OR ELEVATIONS WHICH SHALL BE CONFIRMED AT THE JOB SITE. THE COUNTY THROUGH THE APPROVAL OF THIS DOCUMENT ASSUMES NO RESPONSIBILITY FOR COMPLETENESS AND/OR ACCURACY OF THIS DOCUMENT.  
FILED IN ACCORDANCE WITH THE REQUIREMENTS OF THE EL PASO COUNTY LAND DEVELOPMENT CODE, DRAINAGE CRITERIA, AND ENGINEERING CRITERIA MANUAL AS AMENDED.  
COUNTY PROJECT ENGINEER SIGNATURE \_\_\_\_\_ DATE \_\_\_\_\_

**LEGEND**

-SF-SF-	SILT FENCE	(SF)
[Hatched Box]	VEHICLE TRACKING CONTROL	(VTC)
[Dotted Box]	STABILIZED STAGING AREA	(SSA)
-CF-CF-	CONSTRUCTION FENCE	(CF)
-SCL-SCL-	SEDIMENT CONTROL LOG	(SCL)
[Cross-hatched Box]	PERMANENT SEEDING	(PS)
[Diagonal-hatched Box]	EROSION CONTROL BLANKET	(ECB)
- - - -	LIMITS OF CONSTRUCTION	(LOC)
→	DRAINAGE FLOW ARROWS	
○-○	GROUND HEAT EXCHANGER (GHX)	

30 15 0 30 60  
SCALE: 1"=30'  
ALL LINEAL DIMENSIONS ARE IN U.S. SURVEY FEET

04-27-21  
PERMIT SET  
MARTIN/MARTIN  
303.851.6500  
MARTINMARTIN.COM

Palmer Ridge High School, Lewis Palmer SD-38  
19255 Frontage (Monument Hill) Road  
Monument, CO 80132  
GSHP Remedial Renovation

Ownership of Instruments of Service  
All reports, plans, specifications, computer files, field data, notes and other documents and instruments prepared by the Engineer as instruments of service shall remain the property of the Engineer. The Engineer shall retain all common, law, statutory and other reserved rights, including the copyright thereto.



Phase 1  
GHX / Ctrl Plant  
FINAL EROSION CONTROL PLAN

Phase 1  
C-202

**COLORADO 811**  
KNOW WHAT'S BELOW. CALL BEFORE YOU DIG.

CALL 811 2-BUSINESS DAYS IN ADVANCE BEFORE YOU DIG, GRADE OR EXCAVATE FOR MARKING OF UNDERGROUND MEMBER UTILITIES

MARTIN/MARTIN ASSUMES NO RESPONSIBILITY FOR UTILITY LOCATIONS. UNLESS OTHERWISE NOTED, THE UTILITIES SHOWN ON THIS DRAWING ARE BASED ON INFORMATION PROVIDED BY OTHERS AND DEPICTED AS ASCE (38) QUALITY LEVEL D. IN ACCORDANCE WITH THE PROVISIONS OF COLORADO REVISED STATUTE, TITLE 9, IT IS THE CONTRACTOR'S RESPONSIBILITY TO CALL COLORADO 811 UTILITY LOCATE SERVICE FOR UTILITY LOCATES BEFORE DIGGING, AND FIELD VERIFY THE SIZE, MATERIAL, HORIZONTAL AND VERTICAL LOCATION OF ALL EXISTING UTILITIES (DEPICTED OR NOT DEPICTED) PRIOR TO THE COMMENCEMENT OF ANY CONSTRUCTION.

P:\03 DATE: Tuesday, Aug 27, 2021 4:41 PM LAST SAVED BY: CONTINUERE  
 DRAWING LOCATION: C:\Users\cmh321\OneDrive - El Paso County\Documents\El Paso County\Projects\Palmer Ridge High School\Construction\811\Final Erosion Control Plans.dwg

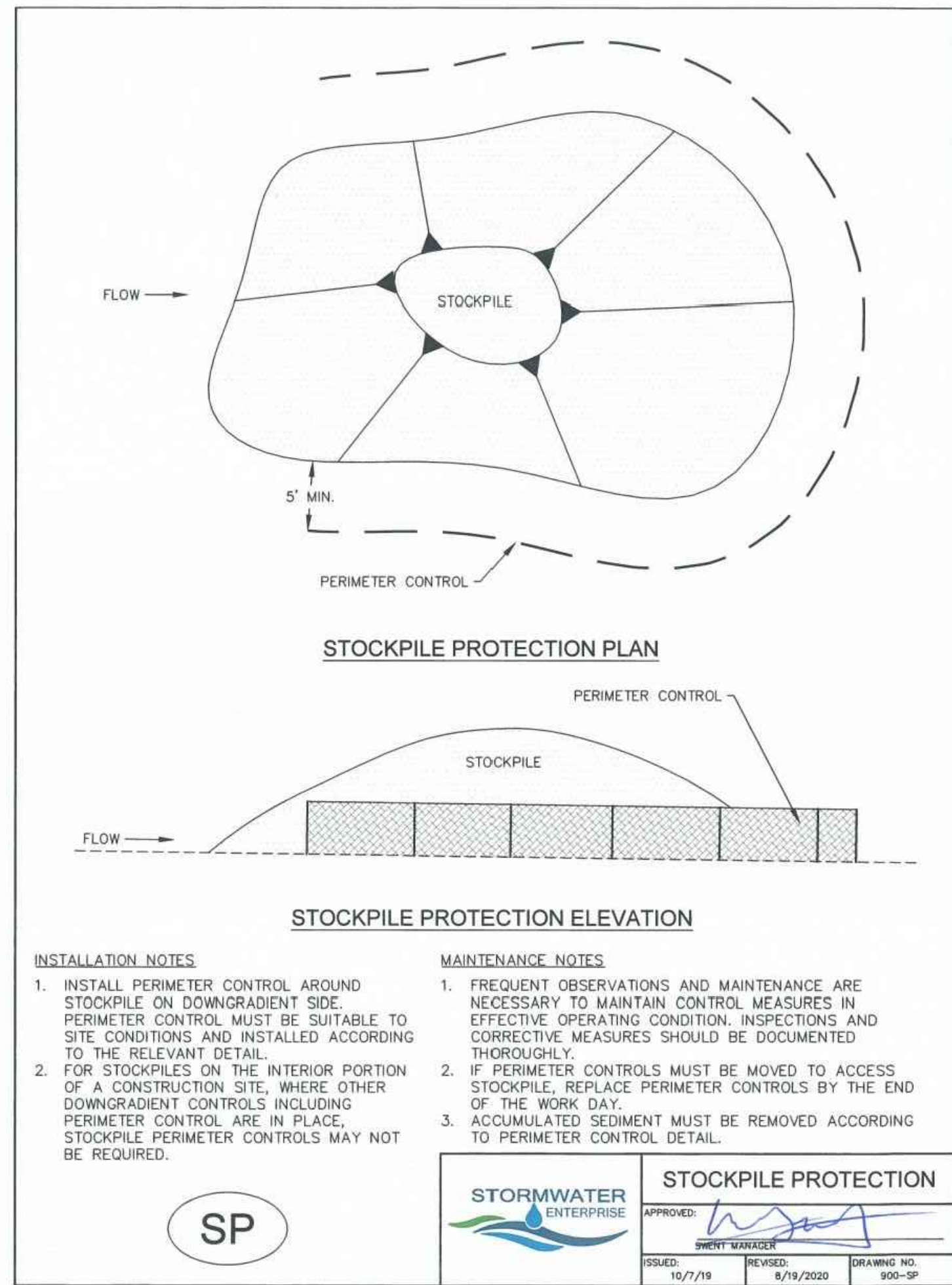
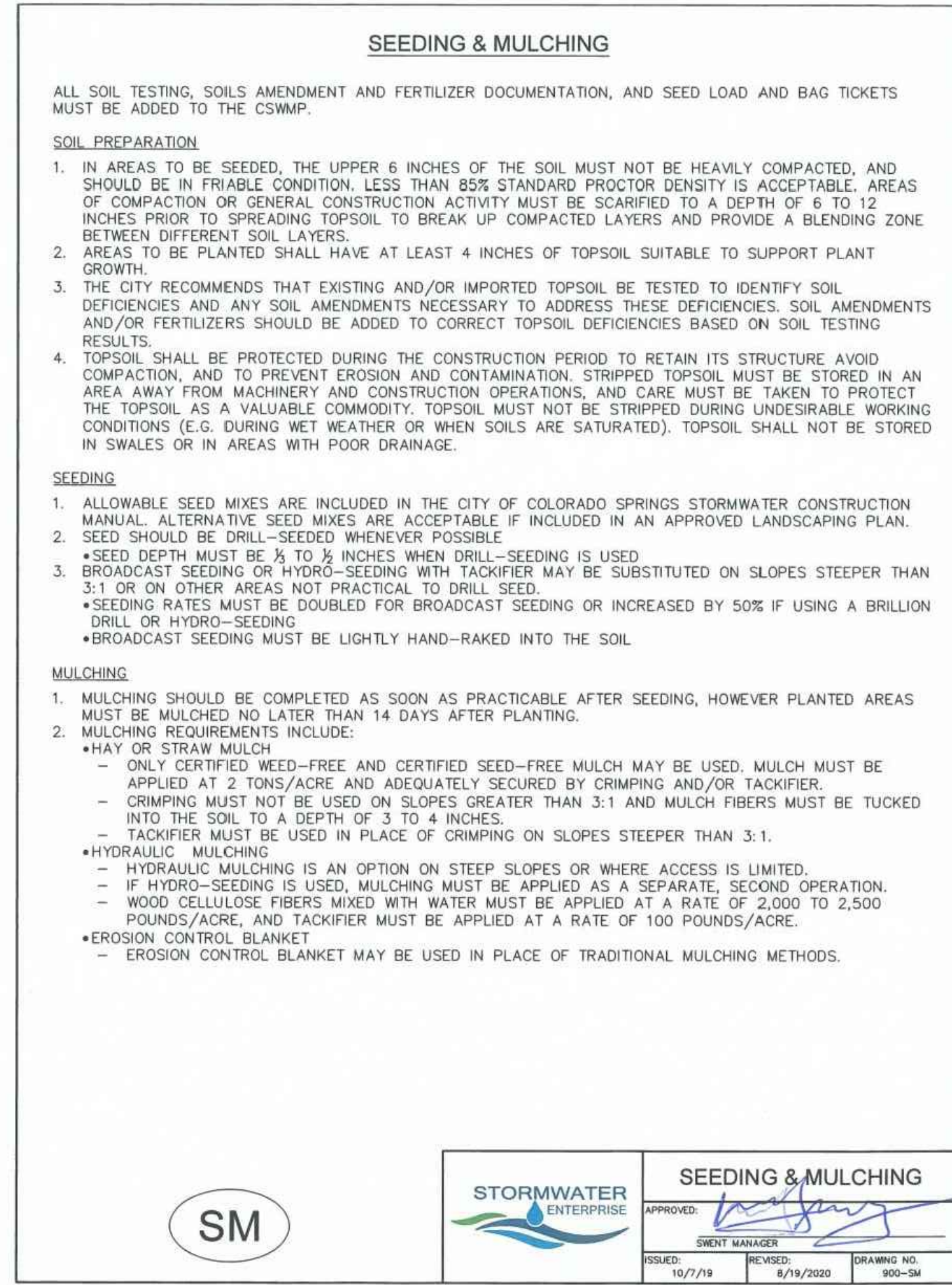
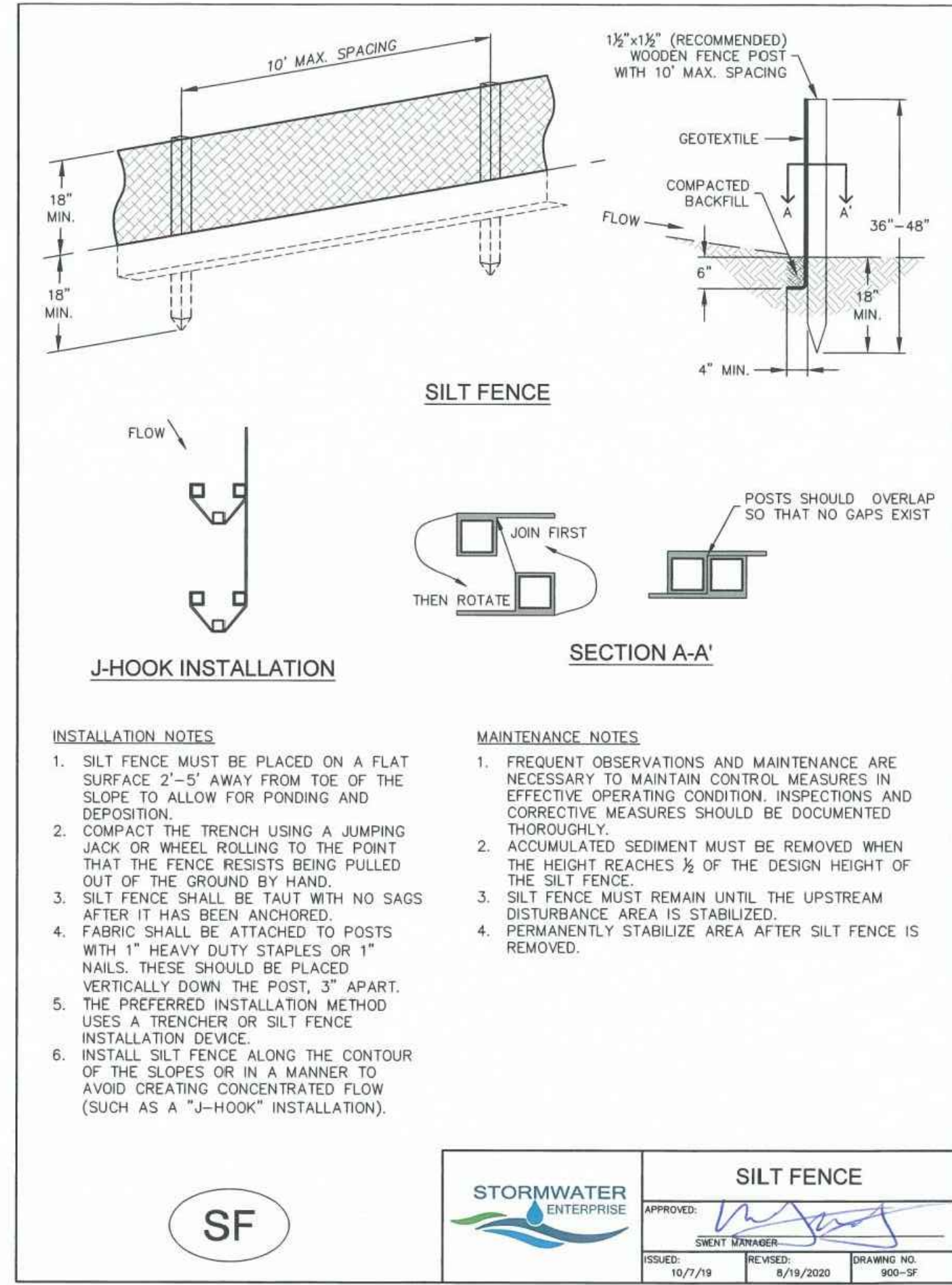
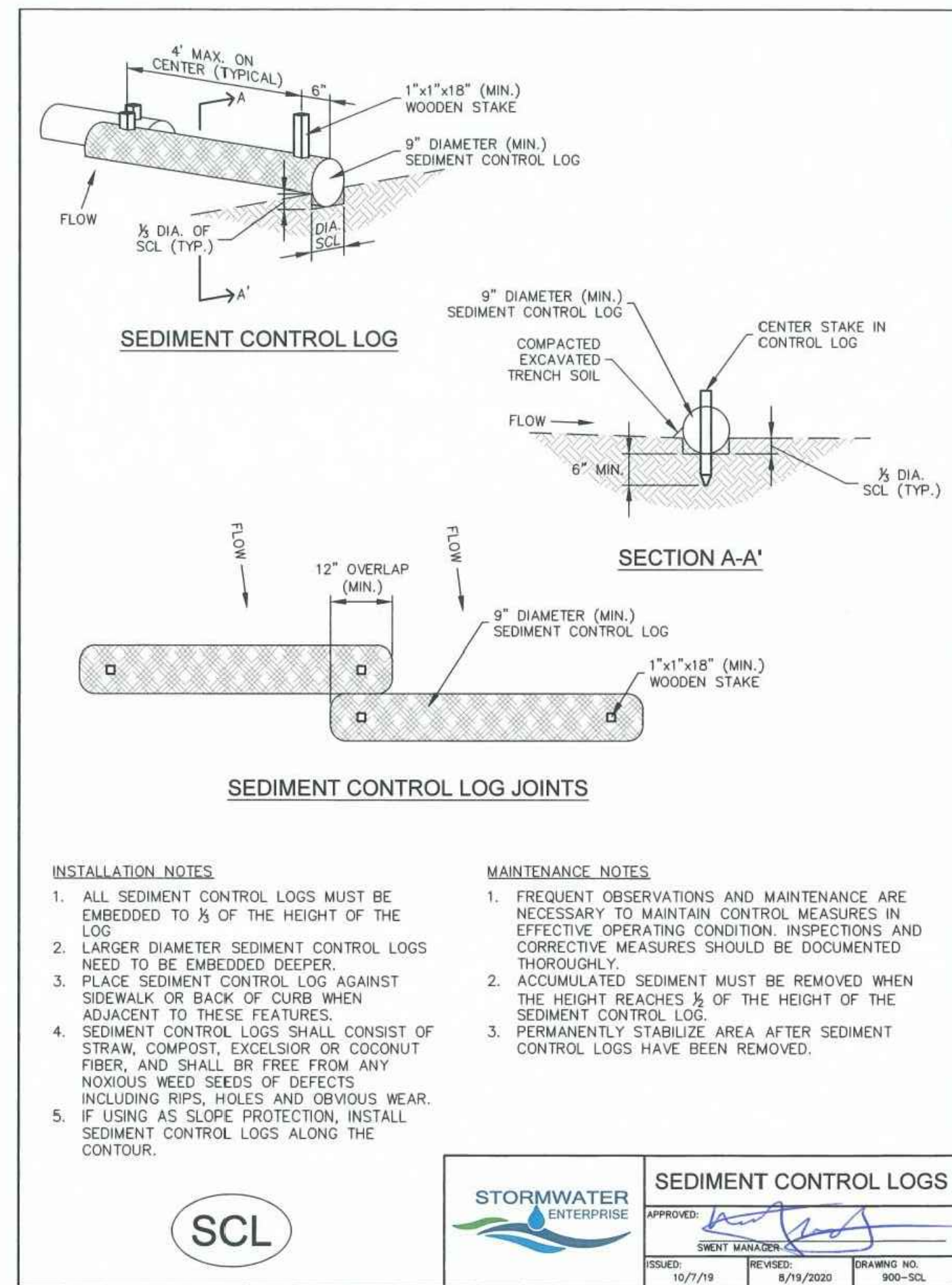
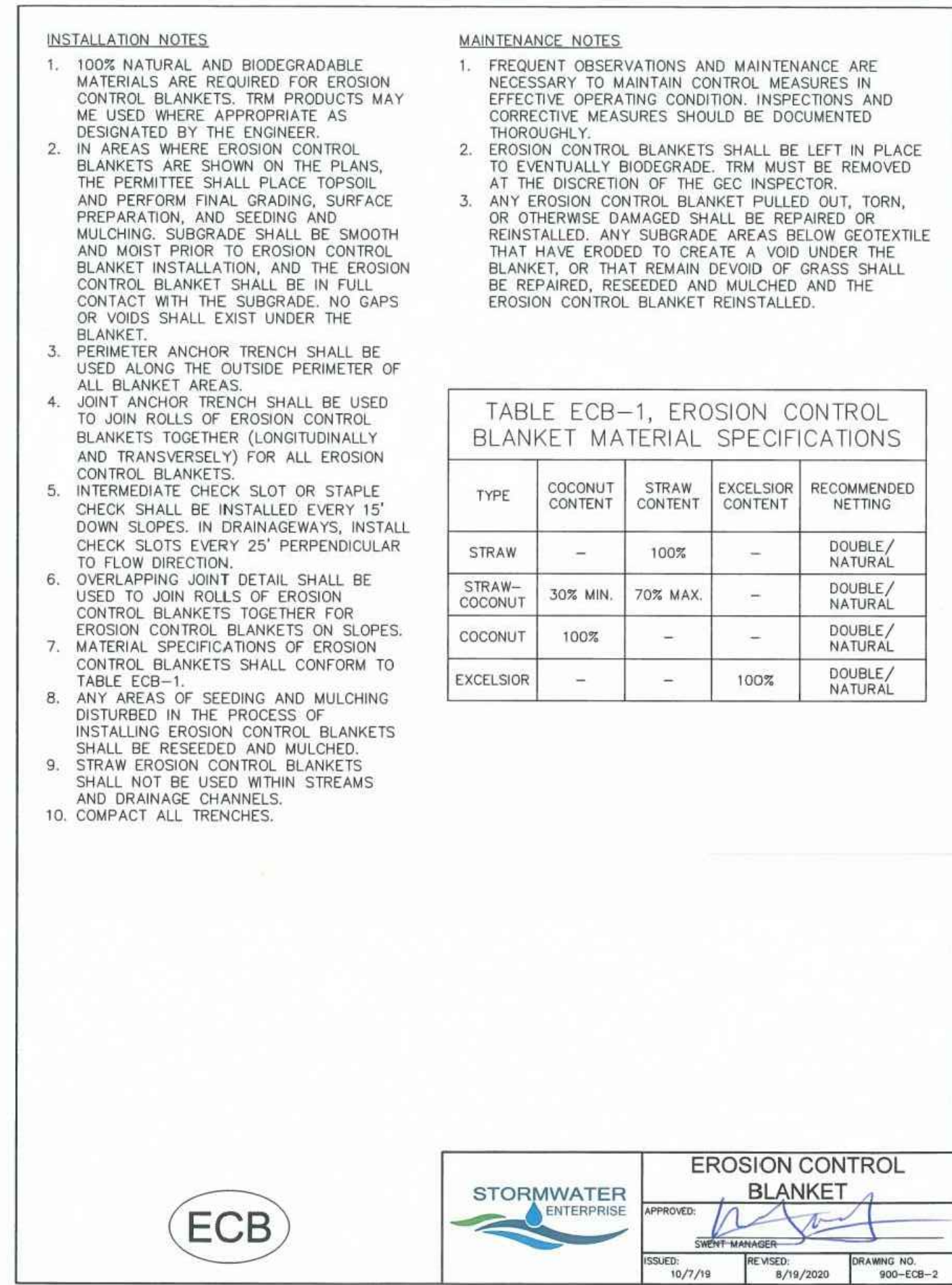
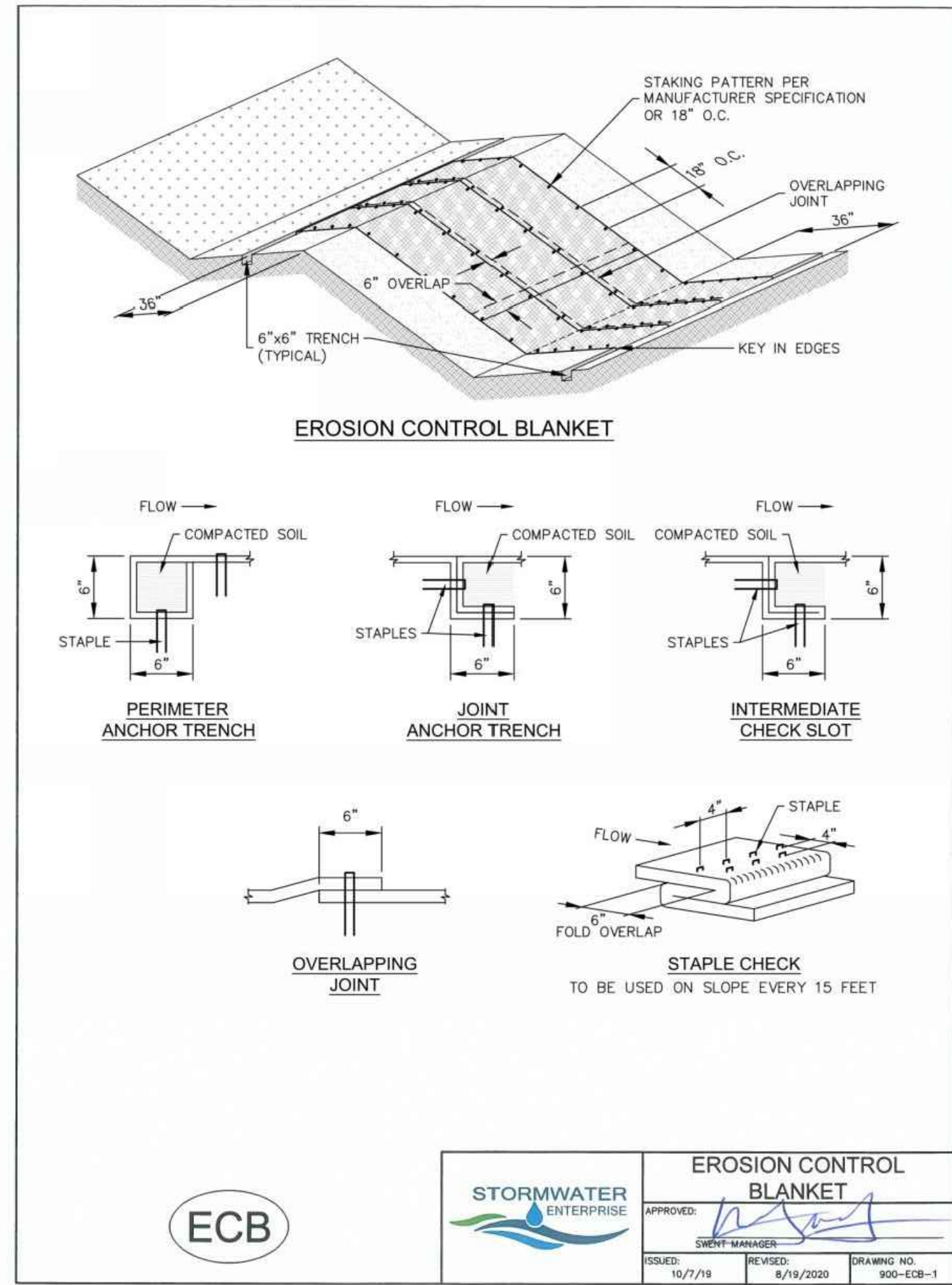
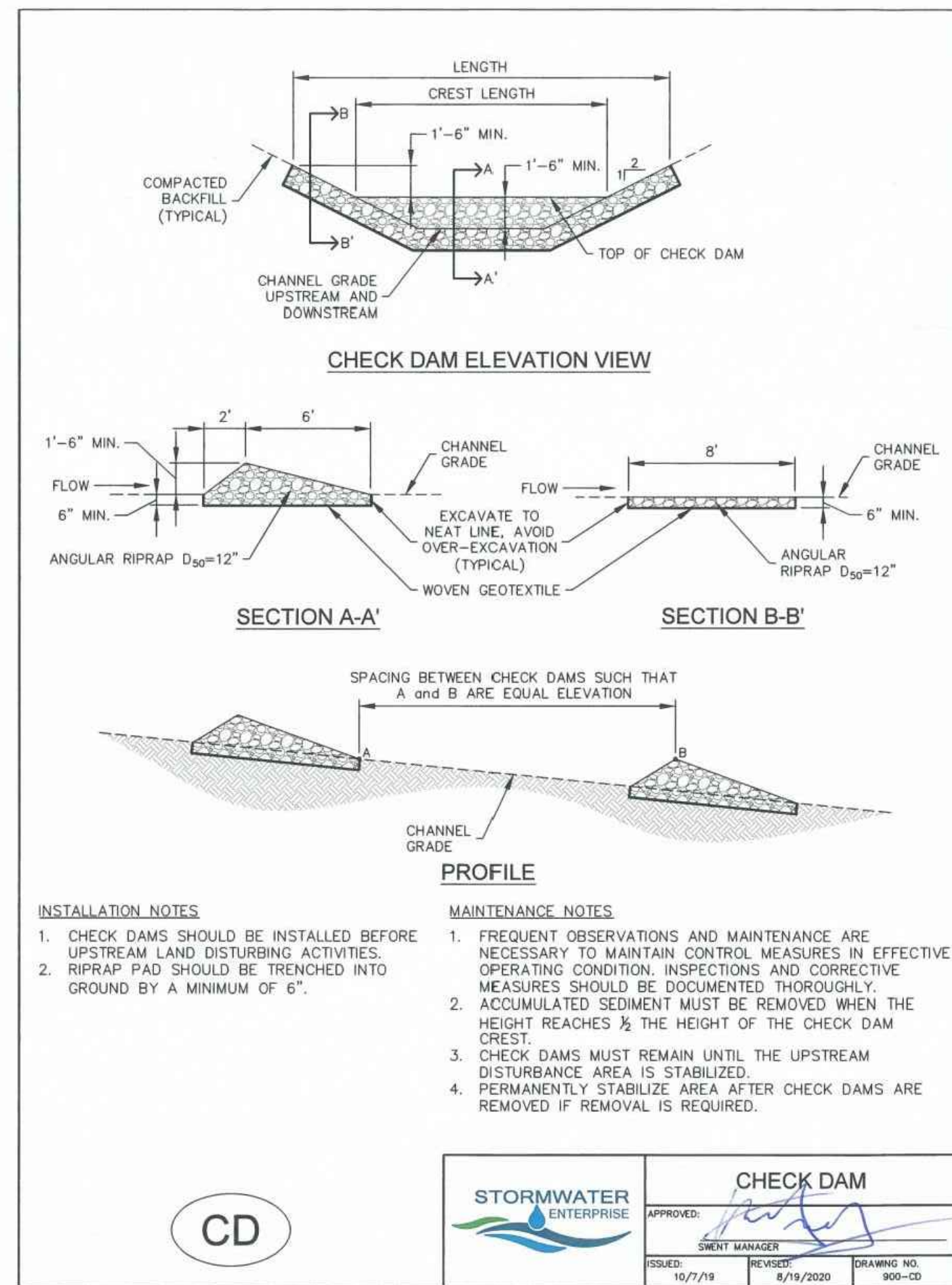

Palmer Ridge High School, Lewis Palmer SD-38  
 19255 Frontage (Monument Hill) Road  
 Monument, CO 80132  
 GSHP Remedial Renovation

Phase 1  
 GHX / Ctrl Plant  
 EROSION CONTROL DETAILS

Phase 1  
 C-210

PERMIT SET  
 04-27-21  
 MARTIN/MARTIN  
 CONSULTING ENGINEERS  
 303 EAST 10TH AVENUE, ANCHORAGE, ALASKA 99501  
 303.261.6500 MARTINMARTIN.COM



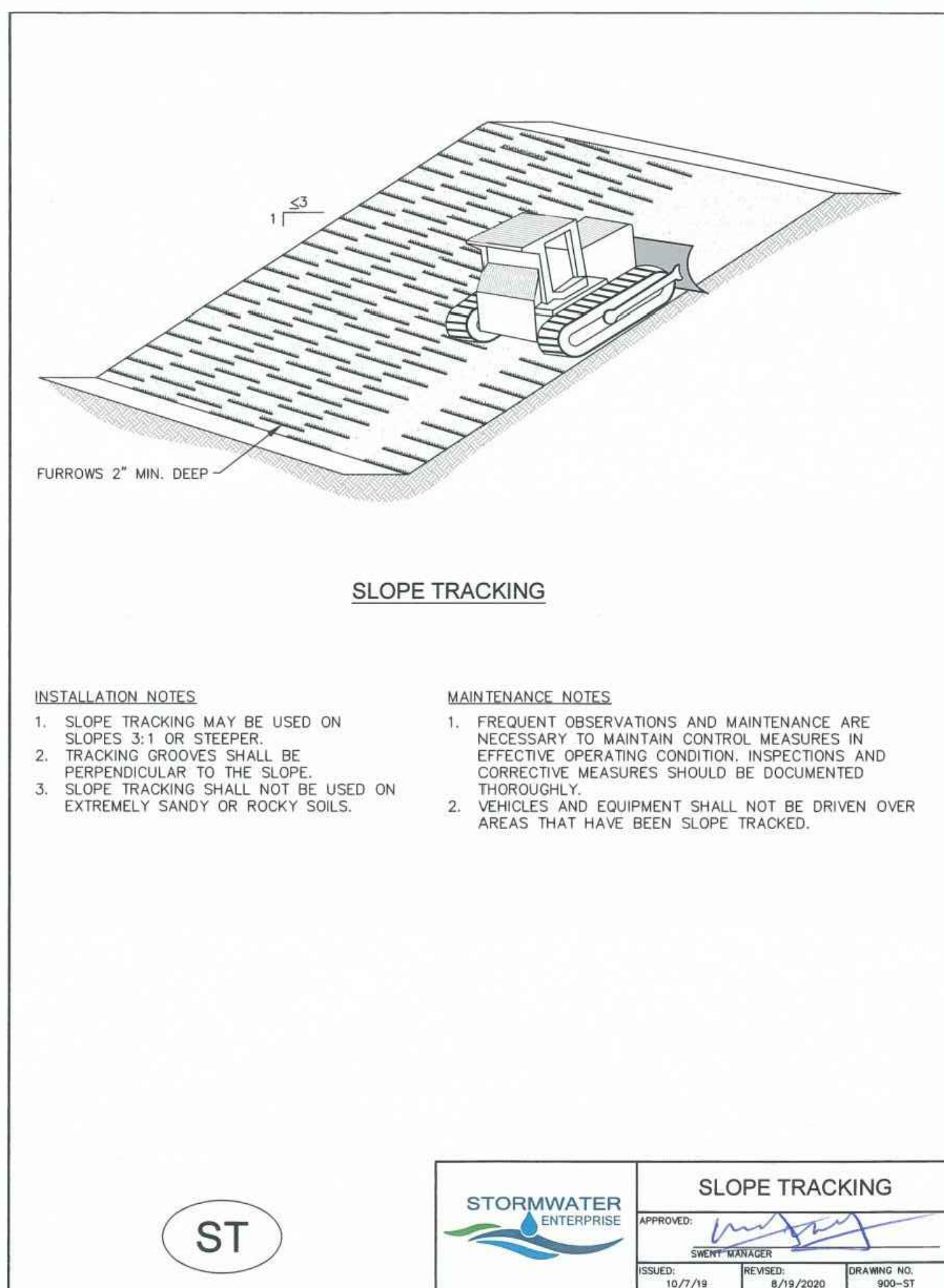

STORMWATER ENTERPRISE		
SLOPE TRACKING		
APPROVED:	CREATED:	DRAWING NO. 900-ST
10/7/19	6/19/2020	

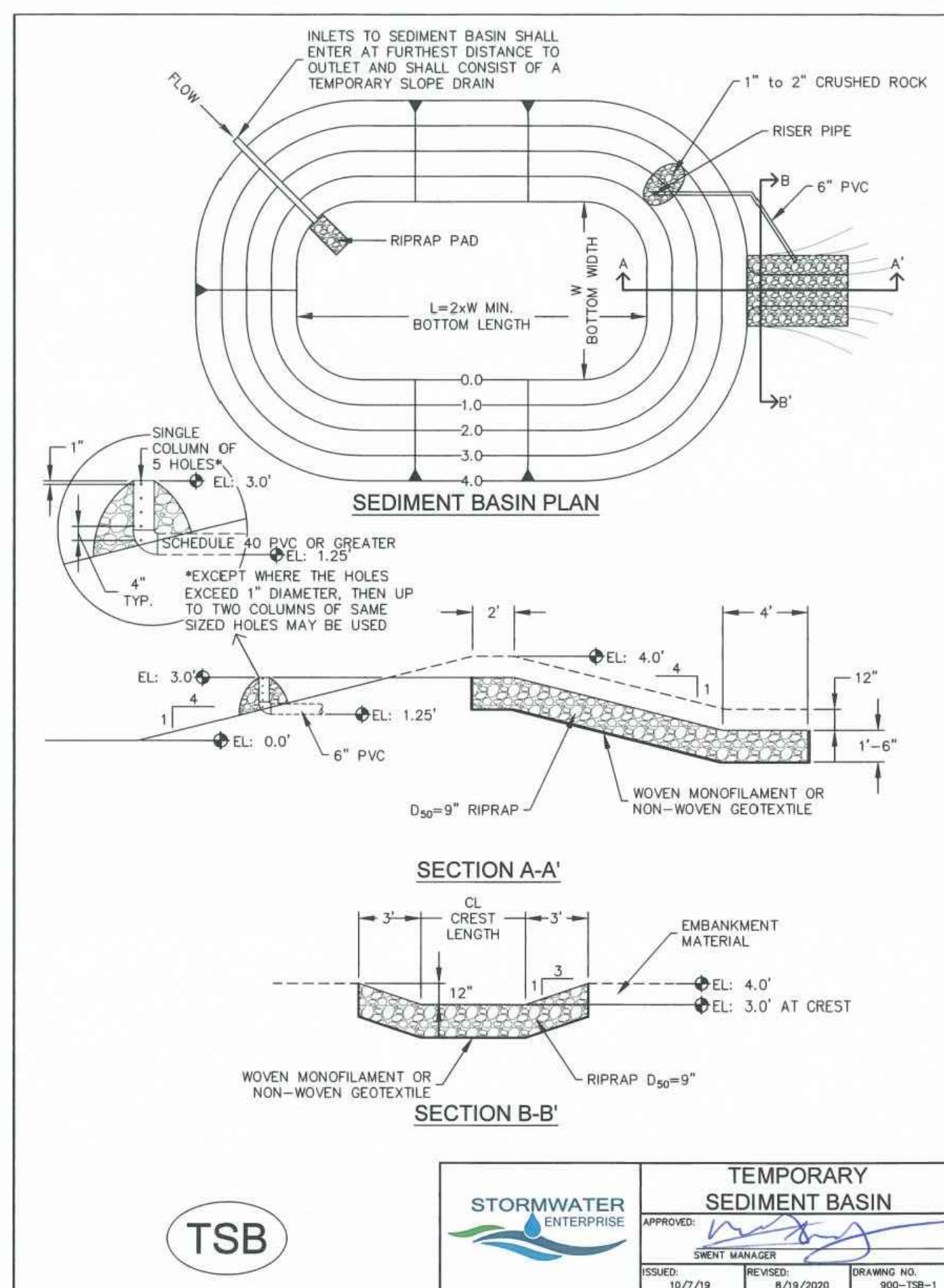

STORMWATER ENTERPRISE		
TEMPORARY SEDIMENT BASIN		
APPROVED:	CREATED:	DRAWING NO. 900-TSB-1
10/7/19	6/19/2020	

**TABLE SB-1, SIZING INFORMATION FOR STANDARD SEDIMENT BASIN**

UPSTREAM DRAINAGE AREA (ROUNDED TO NEAREST ACRE), (AC)	BASIN BOTTOM WIDTH (W), (FT)	SPILLWAY CREST LENGTH (CL), (FT)	HOLE DIAMETER (HD), (IN)
1	129	2	3/8
2	21	3	1/2
3	28	5	5/8
4	33 1/2	6	3/4
5	38 1/2	8	7/8
6	43	9	2 1/2
7	47 1/2	11	2 1/2
8	51	12	2 3/4
9	55	13	3
10	58 1/2	15	3 1/4
11	61	16	3 1/2
12	64	18	4
13	67 1/2	19	4 1/4
14	70 1/2	21	4 1/2
15	73 1/2	22	4 3/4

**INSTALLATION NOTES**

- FOR STANDARD BASIN, BOTTOM DIMENSION MAY BE MODIFIED AS LONG AS BOTTOM AREA IS NOT REDUCED.
- EMBANKMENT MATERIAL SHALL CONSIST OF SOIL FREE OF DEBRIS, ORGANIC MATERIAL, AND ROCKS OR CONCRETE GREATER THAN 3 INCHES, AND SHALL HAVE A MINIMUM OF 15 PERCENT BY WEIGHT PASSING THE No. 200 SIEVE. EMBANKMENT MATERIAL SHALL BE COMPACTED TO AT LEAST 95 PERCENT OF MAXIMUM DENSITY IN ACCORDANCE WITH ASTM D-698. PIPE SCHEDULE 40 OR GREATER SHALL BE USED.
- THE DETAILS SHOWN ON THESE SHEETS PERTAIN TO STANDARD SEDIMENT BASIN(S) FOR DRAINAGE AREAS LESS THAN 15 ACRES. SEE CONSTRUCTION DRAWINGS FOR EMBANKMENT, STORAGE VOLUME, SPILLWAY, OUTLET, AND OUTLET PROTECTION DETAILS FOR ANY SEDIMENT BASIN(S) THAT HAVE BEEN INDIVIDUALLY DESIGNED FOR DRAINAGE AREAS LARGER THAN 15 ACRES. DESIGN CALCULATIONS MUST BE APPROVED PRIOR TO IMPLEMENTATION.

**MAINTENANCE NOTES**

- FREQUENT OBSERVATIONS AND MAINTENANCE ARE NECESSARY TO MAINTAIN CONTROL MEASURES IN EFFECTIVE OPERATING CONDITION. INSPECTIONS AND CORRECTIVE MEASURES SHOULD BE DOCUMENTED THOROUGHLY.
- SEDIMENT ACCUMULATED IN BASIN SHALL BE REMOVED AS NEEDED TO MAINTAIN CONTROL MEASURE EFFECTIVENESS, TYPICALLY WHEN SEDIMENT DEPTH REACHES ONE FOOT (I.E. TWO FEET BELOW SPILLWAY CREST).
- SEDIMENT BASINS ARE TO REMAIN IN PLACE UNTIL THE UPSTREAM DISTURBED AREA IS PERMANENTLY STABILIZED.
- PERMANENTLY STABILIZE AREA AFTER SEDIMENT BASIN REMOVAL.

TSB

STORMWATER ENTERPRISE		
TEMPORARY SEDIMENT BASIN		
APPROVED:	CREATED:	DRAWING NO. 900-TSB-2
10/7/19	6/19/2020	

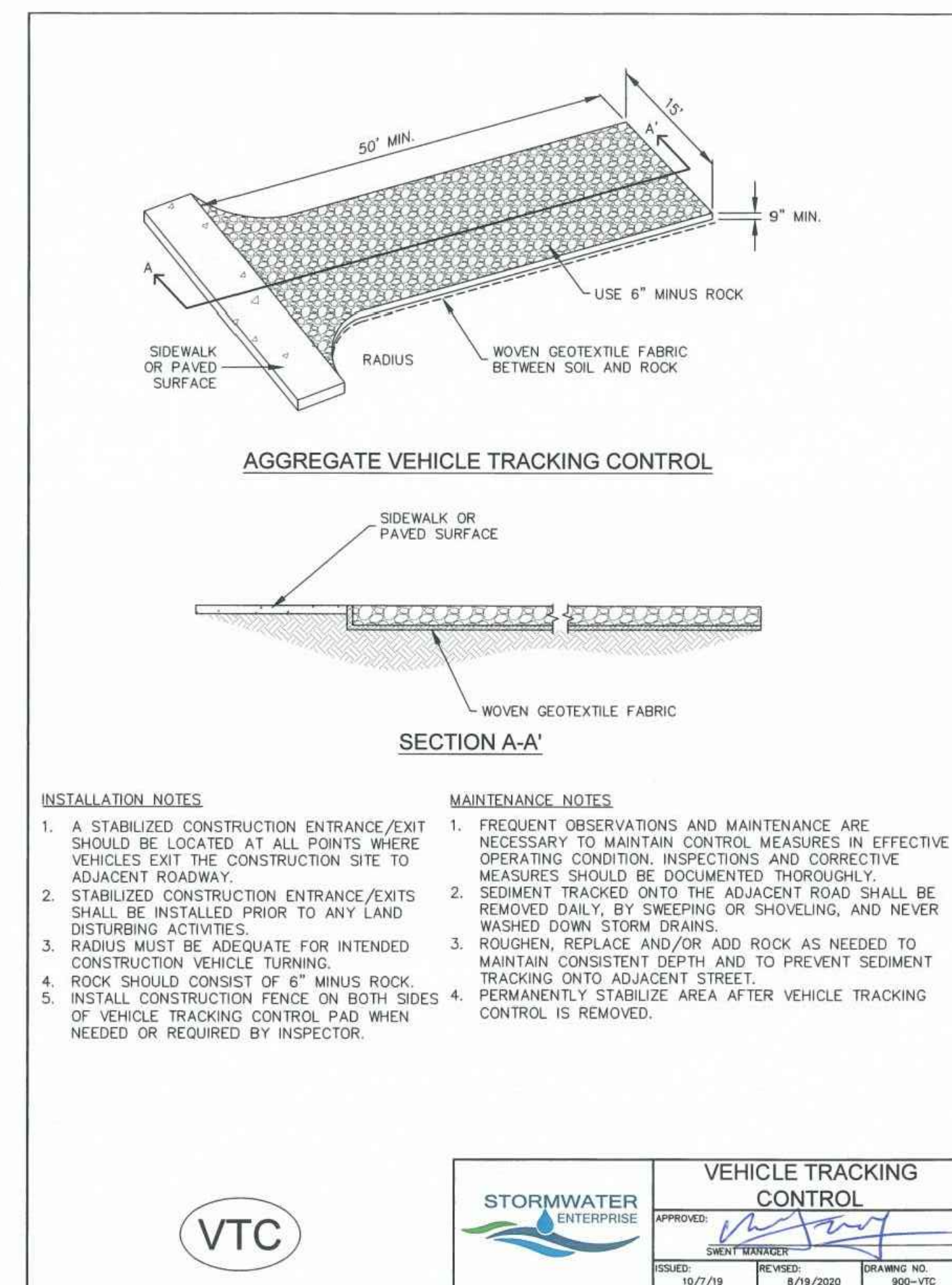

STORMWATER ENTERPRISE		
VEHICLE TRACKING CONTROL		
APPROVED:	CREATED:	DRAWING NO. 900-VTC
10/7/19	6/19/2020	

PLOT DATE: Tuesday, Aug 27, 2020, 4:41 PM. LAST SAVED BY: CONSUMERS. DRAWING LOCATION: C:\Users\consumers\OneDrive\Documents\Palmer Ridge Remedial Renovation - CONTROL DETAILS.dwg