



LSC TRANSPORTATION CONSULTANTS, INC.
2504 East Pikes Peak Avenue, Suite 304
Colorado Springs, CO 80909
(719) 633-2868
FAX (719) 633-5430
E-mail: lsc@lsctrans.com
Website: <http://www.lsctrans.com>

Settlers Ranch, Filing 3 Transportation Memorandum (LSC #S234130) March 22, 2024

Traffic Engineer's Statement

This traffic report and supporting information were prepared under my responsible charge and they comport with the standard of care. So far as is consistent with the standard of care, said report was prepared in general conformance with the criteria established by the County for traffic reports.

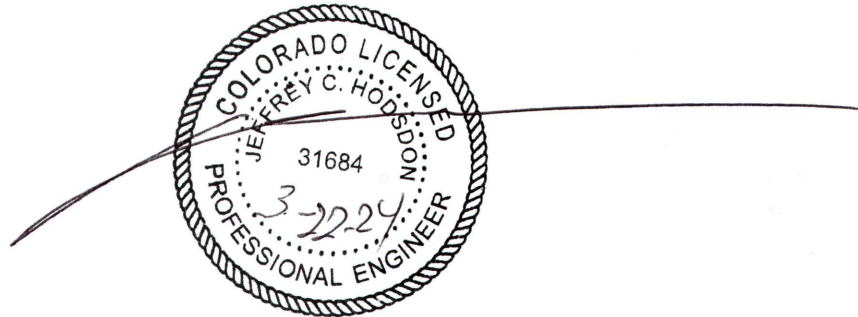

Developer's Statement

I, the Developer, have read and will comply with all commitments made on my behalf within this report.

Date

Settlers Ranch, Filing 3

Transportation Memorandum

Prepared for:
Mark Davis
<via email>

MARCH 22, 2024

LSC Transportation Consultants
Prepared by: Jeffrey C. Hodsdon, P.E.

LSC # S234130



CONTENTS

REPORT CONTENTS 1

PRIOR AREA TRAFFIC REPORTS 2

LAND USE AND ACCESS..... 2

 Adjacent Subdivisions – Existing and Proposed..... 3

 Settlers Ranch Filing Nos. 1 and 2..... 3

 Abert Ranch 3

 Settlers View 3

 Grandview..... 3

SIGHT DISTANCE..... 3

 Steppler Road/Settlers Ranch Road (Proposed w/ Completion of Settlers Ranch Road) 3

 Intersection Sight Distance (ECM 2.3.6.G)..... 4

 Stopping Sight Distance (Approaching an Intersection)..... 4

 Settlers Ranch Road/Timber Meadow Drive (Existing Intersection) 5

ROAD AND TRAFFIC CONDITIONS..... 5

 Area Roadways..... 5

 Existing Traffic Volumes..... 6

TRIP GENERATION..... 6

TRIP DISTRIBUTION AND ASSIGNMENT 7

 Trip Directional Distribution 7

 Site-Generated Traffic..... 7

 Short-Term Baseline Traffic Volumes 7

 Short-Term Total Traffic Volumes..... 7

 Estimated Future 2043 Background Traffic Volumes 7

 Future 2043 Total Traffic Volumes 8

LEVEL OF SERVICE ANALYSIS..... 8

 Hodgen/Timber Meadow 9

 Long Term with Current Laneage 9

 Long Term with Modified Laneage (Two Southbound Lanes)..... 9

 Timber Meadow/Settlers Ranch Road..... 9

 Steppler Road/Settlers Ranch Road..... 10

 Hodgen Road/Steppler Road 10

AUXILIARY TURN-LANE NEEDS ANALYSIS 10

Hodgen/Timber Meadow	10
Eastbound-Left-Turn Lane	10
Westbound-Right-Turn Lane.....	10
Hodgen/Steppler Road	10
Eastbound-Left-Turn Lane	10
Westbound-Right-Turn Lane.....	11
STEPPLER ROAD	11
MTCP Analysis.....	11
Steppler Road Paving	11
Short Term	11
Long Term	11
STREET CLASSIFICATIONS.....	11
MULTI-MODAL AND PEDESTRIAN/BIKE TRANSPORTATION.....	11
DEVIATIONS	12
ROADWAY IMPROVEMENT FEE PROGRAM.....	12
Anticipated Fees and PID Option	12
POTENTIALLY REIMBURSABLE IMPROVEMENTS UNDER THE MTCP FEE PROGRAM.....	12
FINDINGS & CONCLUSIONS	12
Enclosures:	13

Table 3

Figure 1 - Figure 11

Traffic Count Reports

Synchro LOS Reports



LSC TRANSPORTATION CONSULTANTS, INC.
2504 East Pikes Peak Avenue, Suite 304
Colorado Springs, CO 80909
(719) 633-2868
FAX (719) 633-5430
E-mail: lsc@lsctrans.com
Website: <http://www.lsctrans.com>

March 22, 2024

Mark Davis
<via email>

RE: Settlers Ranch, Filing 3
Transportation Memorandum
El Paso County, CO
LSC # S234130

Dear Mr. Davis,

LSC Transportation Consultants, Inc. has prepared this traffic impact study for Filing 3 of the Settlers Ranch residential development in El Paso County, Colorado. The site is located generally northwest of the intersection of Hodgen Road/Steppler Road. Filing 3 is proposed to include 24 lots for single-family homes.

Access is proposed to Settlers Ranch Road. The completion of Settlers Ranch Road to Steppler Road is proposed as part of this subdivision plat. This report has been prepared for submittal to El Paso County.

REPORT CONTENTS

The preparation of this report included the following:

- Inventory of existing adjacent and nearby area street system. This included surface conditions, functional classifications, roadway widths, lane configurations, traffic control, posted speed limits, pavement markings, intersection and access spacing, roadway and intersection alignments, auxiliary left- and right-turn lanes, intersection sight distances, etc.;
- Summary of morning and late-afternoon peak-hour turning-movement traffic counts at the study-area intersections of Hodgen Road/Timber Meadow Drive, Timber Meadow Drive/Settlers Ranch Road, and Hodgen Road/Steppler Road;
- Estimates of average weekday and peak-hour trip generation for the proposed development;
- Estimation of directional distribution of site-generated vehicle trips on the area street system, at the study-area intersections;
- Projections of site-generated turning-movement traffic volumes at the study-area intersections;

- Estimates of short- and long-term background traffic volumes at the study-area intersections;
- Total traffic (site traffic-plus-background traffic) projections at these intersections for the short term and long term;
- Level of service (LOS) analysis at the study-area intersections;
- Evaluation of existing, short-term, and long-term projected intersection volumes to determine the potential need for any new auxiliary right-/left-turn lanes based on the criteria in El Paso County's *Engineering Criteria Manual (ECM)*;
- Comparison of pedestrian and multi-modal facilities and conformance with the County's *Major Transportation Corridors Plan (MTCP)*;
- Other recommended improvements and modifications to the study-area streets and intersections; and
- Summary of compiled data, analysis, findings, and recommendations.

PRIOR AREA TRAFFIC REPORTS

LSC utilized the following previous traffic reports (completed within the past five years) to assist in the production of this report:

- Settlers View Subdivision, Final Plat – dated December 18, 2018
- Walden Preserve 2, Filing 5 – dated March 1, 2022

LAND USE AND ACCESS

Figure 1 shows the site location relative to the adjacent and nearby streets. The proposed Settlers Ranch Filing No. 3 residential subdivision, shown in Figure 2, would consist of 24 lots for single-family residential dwelling units. The site is located generally northwest of the intersection of Hodgen Road/Steppler Road in El Paso County, Colorado.

Access is proposed to the existing portion of Settlers Ranch Road west of Timber Meadow Drive, as well as to the currently proposed extension of Settlers Ranch Road and connection to Steppler Road. This report has been prepared for submittal to El Paso County. A copy of the subdivision plat is attached, for reference.

The extension of Abert Ranch Drive south to the new section of Settlers Ranch Road is assumed in this report. Trips generated by the Abert Ranch and Settlers View subdivisions have been included in the background traffic.

Adjacent Subdivisions – Existing and Proposed

Settlers Ranch Filing Nos. 1 and 2

These subdivisions have been completed, with about five vacant lots for single-family homes remaining. The portion of Settlers Ranch Road that has been constructed northeast of Timber Meadow Drive provides access to these subdivisions.

Abert Ranch

Abert Ranch is a single-family residential subdivision consisting of 10 lots, each a minimum of 2.5 acres. Site access to Stepler Road is currently through the Settlers View subdivision and the extension of Silver Nell Drive. A second access will become available via the extension of Abert Ranch Drive to the proposed extension of Settlers Ranch Road (with this Settlers Ranch Filing No. 3 subdivision) once constructed by the applicant.

Settlers View

Settlers View is an existing single-family residential subdivision consisting of 14 lots, each a minimum of 2.5 acres. Located generally north of the site, Settlers View has been developed. A second access will become available through the Abert Ranch subdivision via the extension of Abert Ranch Drive to the proposed extension of Settlers Ranch Road (with this Settlers Ranch Filing No. 3 subdivision) once constructed by the applicant.

Grandview

Grandview is located to the north of the Settlers View and Abert Ranch sites. It is developed, and Silver Nell Drive through Grandview exists and connects to Stepler Road. Silver Nell Drive has provided the initial access to both the Settlers View and Abert Ranch subdivisions.

SIGHT DISTANCE

Stepler Road/Settlers Ranch Road (Proposed w/ Completion of Settlers Ranch Road)

The proposed access point to Stepler Road, which is a planned public street connection, must meet *Engineering Criteria Manual (ECM)* standards for sight distance. LSC has field-measured and evaluated the proposed Settlers Ranch Road connection to Stepler Road for sight distance.

Note: site improvements, such as landscaping, buildings, fencing, parking areas, etc., must not impede the lines of sight required for *ECM*-prescribed entering or stopping sight distance.

LSC did not see any speed limit signs (MUTCD R2-1) on Stepler Road in the field. The 2019 EPC Road Inventory identifies Stepler as a “local service” roadway with 24 feet of pavement. Based

on *ECM* Rural Local criteria, the posted speed and design speeds are 30 mph. Note: the section north of the Silver Nell intersection is gravel. Note: The 2016 *MTCP* 2040 plan calls out Stepler as a Collector classification but indicates that an “unimproved paved roadway” would be adequate. It appears that half of an 80-foot ROW for a Rural Minor Collector has been dedicated along the project frontage

Intersection Sight Distance (ECM 2.3.6.G)

Sight distance field measurements utilized a height of 3.5 feet for driver’s eye height on the proposed Settlers Ranch Road approach to Stepler Road at the proposed Stepler Road/Settlers Ranch Road connection **and** a height of 3.5 feet for vehicles approaching from the north or south on Stepler Road. Roadway gradients adjacent to the proposed intersection location are between 0 and 2 percent approaching from each direction. Note: north of the north property line, the grades are between 6 and 8 percent approaching from the north.

These measurements were conducted in the field by LSC. The measurements were taken from a driver’s eye height of 3.5 feet to an approaching vehicle height of 3.5 feet.

Field measurements recorded about 434 feet of sight distance looking to the north and 730 feet looking to the south from the proposed Stepler Road/Settlers Ranch Road intersection, as shown in Figure 3.

Based on a 30-mph design speed, the minimum required intersection sight distance at the proposed Stepler Road/Settlers Ranch Road intersection is 335 feet for passenger vehicles (per Table 2-21 of the County’s *Engineering Criteria Manual*). Sight distances to the south would exceed 335.

Please refer to the attached sight-distance exhibits for details. The line of sight for the access-point intersection will need to be kept clear of any sight-distance obstructions. This includes landscaping, signage, etc. proposed for the residential development.

Stopping Sight Distance (Approaching an Intersection)

Stopping sight distance along Stepler Road approaching the proposed Settlers Ranch Road intersection location have been evaluated for stopping sight-distance requirements in *ECM* Table 2-17. The following are the existing sight-distance measurements. These measurements were conducted in the field by LSC. The measurements were taken from the driver’s eye height (3.5 feet) of an approaching vehicle to a height of 3.5 feet at the center of the intersection.

- 415 feet south to the proposed Stepler Road/Settlers Ranch Road intersection, from a southbound motorist on Stepler Road approaching the intersection from the north.
- 730 feet north to the proposed Stepler Road/Settlers Ranch Road intersection, from a northbound motorist on Stepler Road approaching the intersection from the south.

Assuming a 30-mph design speed, the minimum required stopping sight distance for motorists on Stepler Road approaching the proposed Stepler Road/Settlers Ranch Road intersection is 200 feet for passenger vehicles (per Table 2-17 of the County's *Engineering Criteria Manual*). Stopping sight distances approaching from the north or south exceed the 200-foot requirement.

Settlers Ranch Road/Timber Meadow Drive (Existing Intersection)

Sight distance exceeds 750 feet to the north on Timber Meadow Drive, and there is a clear line of sight south to the intersection of Hodgen Road/Timber Meadow Drive (about 600 feet). These sight distances exceed the *ECM*-prescribed values for intersection sight distance and stopping sight distance (approaching an Intersection).

ROAD AND TRAFFIC CONDITIONS

Area Roadways

Figure 1 shows the streets adjacent to and in the vicinity of the site. Adjacent streets serving the site are identified below followed by a brief description of each:

State Highway (SH) 83 extends from Colorado Springs north to Parker and areas of southeast Denver. In the vicinity of the site, SH 83 is classified as a Regional Highway (R-A). At this location, SH 83 is a two-lane rural highway with two-to-four-foot shoulders and a speed limit of 60 mph. Its intersection with Hodgen Road is signalized.

Hodgen Road is a two-lane paved Rural Minor Arterial that extends east from the intersection of Roller Coaster Road/Baptist Road to Eastonville Road. The speed limit on Hodgen Road is generally 55 mph east of SH 83. Auxiliary left-turn and right-turn lanes currently exist on both the eastbound and westbound approaches on Hodgen Road at Timber Meadow Drive.

Timber Meadow Drive is a Rural Minor Collector roadway that extends south from the intersection of Walden Way/Pond View Place to just south of Hodgen Road. The posted speed limit is 30 mph.

Stepler Road extends north from Hodgen Road to Walker Road. Stepler is an unimproved, two-lane, paved roadway between Hodgen Road and Silver Nell Drive. North of Silver Nell Drive, the roadway surface is gravel. LSC did not see any speed limit signs (MUTCD R2-1) on Stepler Road in the field. The 2019 EPC Road Inventory identifies Stepler as a "local service" roadway with 24 feet of pavement. Note: The design speed for an *ECM*-standard Rural Local roadway is 30 mph. The 2016 *MTCP* 2040 plan calls out Stepler as a Collector. It appears that half of an 80-foot ROW for a Rural Minor Collector has been dedicated along the project frontage. An eastbound-left-turn lane currently exists on Hodgen Road approaching Stepler Road. type on Stepler Road is paved south of Silver Nell Road and north of Silver Nell Road.

Existing Traffic Volumes

Vehicular turning-movement counts were conducted at the following intersections, dates, and times:

- Hodgen Road/Timber Meadow Drive
 - Tuesday, September 12, 2023 from 6:30 – 8:30 a.m.
 - Tuesday, September 12, 2023 from 4:00 – 6:00 p.m.
- Timber Meadow Drive/Settlers Ranch Road
 - Tuesday, September 12, 2023 from 6:30 – 8:30 a.m.
 - Tuesday, September 12, 2023 from 4:00 – 6:00 p.m.
- Hodgen Road/Steppler Road
 - Tuesday, March 7, 2023 from 6:30 – 8:30 a.m.
 - Tuesday, March 7, 2023 from 4:00 – 6:00 p.m.

Figure 4 shows these turning-movement volumes, as well as the estimated current average weekday traffic volumes on the study-area streets. Raw count data is attached.

TRIP GENERATION

Estimates of the vehicle trips to be generated by Filing No. 3 have been made using the following nationally-published trip-generation rates for land use code “210 – Single-Family (Detached) Housing” in *Trip Generation, 11th Edition, 2021* by the Institute of Transportation Engineers (ITE).

Table 1 below presents a summary of the estimated site trip generation for Filing No. 3. A detailed trip-generation estimate for the development, including ITE rates for the proposed 24 dwelling units within Filing 3, is presented in Table 3 (attached).

Table 1: Estimated Site Vehicle-Trip Generation – Filing 3 Only

Analysis Period	Weekday		
	In	Out	Total
Morning Peak Hour	5	15	20
Evening Peak Hour	16	10	26
Daily/24-hour	136	136	271

Based on the ITE estimate for the proposed **Filing No. 3** residential development, the site could generate about 271 external vehicle trips on the average weekday. During the weekday morning peak hour, approximately 5 vehicles would enter and 15 vehicles would exit the site. Approximately 16 entering vehicles and 10 exiting vehicles are projected for the weekday afternoon peak hour.

TRIP DISTRIBUTION AND ASSIGNMENT

Trip Directional Distribution

Estimating the directional distribution of site-generated vehicle trips to the study-area roads and intersections is a necessary component in determining the site's traffic impacts. Figure 6 shows the percentages of the site-generated vehicle trips projected to be oriented to and from the site's major approaches. Estimates have been based on the following factors: the proposed new land use, the area street and road system serving the site, and the site's geographic location relative to the balance of the El Paso County and the Pikes Peak region.

Site-Generated Traffic

Figure 7 shows the projected site-generated traffic volumes for the weekday morning and evening peak hours. Site-generated traffic volumes at the study-area intersections have been calculated by applying the directional-distribution percentages estimated by LSC (from Figure 6), combined localized trip routing estimates by LSC, to the trip-generation estimates (from Table 2).

Short-Term Baseline Traffic Volumes

Figure 5 shows estimated short-term baseline traffic volumes at the study-area intersections. This scenario incorporates the following adjustments to existing traffic volumes (Figure 4):

- Assumes that the proposed Settlers Ranch Road connection to Stepler Road completed.
- Minor shifts to existing traffic volumes on Settlers Ranch Road for trips currently being generated by Filing Nos. 1 and 2.
- Shifts in traffic from the Abert Ranch and Settlers View residential developments with the connection of Abert Ranch Drive to Settlers Ranch Road.
- Trips from five additional homes to be developed on currently platted but vacant lots within existing Filing Nos. 1 and 2.

Short-Term Total Traffic Volumes

Figure 8 shows the sum of the short-term baseline traffic volumes (from Figure 5) and Filing No. 3 site-generated peak-hour traffic volumes (shown in Figure 7). These volumes represent the estimated short-term total traffic following completion and buildout of the Filing No. 3 development.

Estimated Future 2043 Background Traffic Volumes

Figure 9 shows the projected 20-year background traffic volumes for the year 2043. Projected 20-year background traffic volumes do **not** include projected traffic to be generated by the proposed residential development. LSC used projected long-term volumes from nearby traffic studies, including *Settlers View Subdivision Final Plat* and *Walden Preserve 2 Filing 5*. Annual

growth rates of 2.75-3.0 percent were applied to eastbound-through and westbound-through traffic volumes on Hodgen Road during both long-term peak hours. Long-term background traffic growth on minor streets at the study-area intersections reflects increases in traffic from currently-undeveloped residential lots nearby.

Future 2043 Total Traffic Volumes

Figure 10 shows the projected 2043 total traffic volumes, which are the sum of 2043 background traffic volumes (Figure 9) plus the site-generated traffic volumes (from Figure 7).

LEVEL OF SERVICE ANALYSIS

The following intersections have been analyzed to determine the projected intersection levels of service for short- and long-term traffic scenarios for the AM and PM peak-hour time periods:

- Hodgen Road/Timber Meadow Drive
- Timber Meadow Drive/Settlers Ranch Road
- Stepler Road/Settlers Ranch Road
- Hodgen Road/Stepler Road

Level of service (LOS) is a quantitative measure of the level of congestion or delay at an intersection and is indicated on a scale from “A” to “F.” LOS A is indicative of little congestion or delay. LOS F indicates a high level of congestion or delay. Table 2 shows the level of service delay ranges for signalized and unsignalized intersections.

Table 2: Intersection Levels of Service Delay Ranges

Level of Service	Signalized Intersections	Unsignalized Intersections
	Average Control Delay (seconds per vehicle)	Average Control Delay (seconds per vehicle) ¹
A	10.0 sec or less	10.0 sec or less
B	10.1-20.0 sec	10.1-15.0 sec
C	20.1-35.0 sec	15.1-25.0 sec
D	35.1-55.0 sec	25.1-35.0 sec
E	55.1-80.0 sec	35.1-50.0 sec
F	80.1 sec or more	50.1 sec or more

¹ For unsignalized intersections, if V/C ratio is greater than 1.0 the level of service is LOS F, regardless of the projected average control delay per vehicle.

Detailed Synchro reports are attached. A summary of LOS during the weekday morning and evening peak hours for the following unsignalized intersections is shown in the following figures:

- Figure 4: 2023 Existing Traffic, Lane Geometry, Traffic Control, and LOS
- Figure 5: Short-Term Baseline Traffic, Lane Geometry, Traffic Control, and LOS
- Figure 8: 2023 Existing + Site Traffic, Lane Geometry, Traffic Control, and LOS
- Figure 9: 2043 Background Traffic, Lane Geometry, Traffic Control, and LOS
- Figure 10: 2043 Background + Site Traffic, Lane Geometry, Traffic Control, and LOS

Hodgen/Timber Meadow

All movements at the stop-sign-controlled intersection of Timber Meadows Drive/Hodgen Road are projected to continue to operate at LOS D or better during both short-term peak hours, based on the projected short-term total traffic volumes.

Long Term with Current Laneage

By 2043, the northbound approach is projected to operate at LOS F during both peak hours. The southbound approach is projected to operate at LOS F during the long-term AM peak hour and LOS D during the long-term PM peak hour, with or without the addition of Filing No. 3 site-generated traffic. However, both the northbound and southbound approaches would have a volume-to-capacity (v/c) ratio below 0.74 during all long-term peak hours and would benefit from gaps in traffic at the nearby signalized intersection of SH 83/Hodgen Road. It is unlikely that a traffic-signal warrant would be met at this intersection,, based on the northbound and southbound through and left turn volumes.

Long Term with Modified Laneage (Two Southbound Lanes)

If the southbound approach were to be reconstructed for a right-only and shared-left/through turn lanes, the higher-volume southbound-right lane would operate at LOS D or better during all 2043 peak periods. The southbound shared-left/through lane would operate at LOS E during the AM peak and LOS F during the PM peak, with or without the addition of site-generated traffic. All minor-street individual turning movements would have a v/c ratio below 0.52 during all 2043 scenarios with two southbound turn lanes. It is unlikely that a traffic-signal warrant would be met at this intersection based on the northbound and southbound through and left-turn volumes.

Timber Meadow/Settlers Ranch Road

All approaches and individual turning movements at the intersection of Timber Meadow/Settlers Ranch Road currently operate at and are projected to remain at LOS B or better through 2043 during both peak hours.

Steppler Road/Settlers Ranch Road

All approaches and individual turning movements at the proposed Settlers Ranch Road connection to Steppler Road are projected to operate at LOS A through 2043 during both peak hours.

Hodgen Road/Steppler Road

All approaches and individual turning movements at the intersection of Hodgen Road/Steppler Road currently operate at and are projected to remain at LOS C or better through 2043 during both peak hours.

AUXILIARY TURN-LANE NEEDS ANALYSIS

Hodgen/Timber Meadow

Eastbound-Left-Turn Lane

An eastbound-left-turn deceleration lane current exists on Hodgen Road approaching Timber Meadow Drive. Currently, the eastbound-left-turn lane is 680 feet total, consisting of 290 feet of deceleration length, a 240-foot taper, and 150 feet of additional storage (for stop-sign-controlled intersections). No modifications to this existing left-turn lane on Hodgen Road approaching Timber Meadow Drive would be required, as it meets the *ECM*-required 680-foot total length.

Westbound-Right-Turn Lane

A westbound-right-turn deceleration lane currently exists on Hodgen Road approaching Timber Meadow Drive. Currently, the eastbound-left-turn lane is 760 feet total, consisting of 520 feet of deceleration length plus a 240-foot taper. No modifications to this existing right-turn lane on Hodgen Road approaching Timber Meadow Drive would be required, as it meets the *ECM*-required 530-foot total length.

Hodgen/Steppler Road

Eastbound-Left-Turn Lane

An eastbound-left-turn deceleration lane currently exists on Hodgen Road approaching Steppler Road. Currently, the eastbound-left-turn lane is 655 feet total, consisting of 290 feet of deceleration length, a 240-foot taper, and 125 feet of additional storage length. No modifications to this existing left-turn lane on Hodgen Road approaching Timber Meadow Drive would be required, as it meets the *ECM*-required 605-foot total length (290 feet of deceleration length, a 240-foot taper, and 50-75 feet of additional storage length).

Westbound-Right-Turn Lane

Per *ECM* criteria, exclusive right-turn lanes shall be provided for any access on a Minor Arterial with a projected peak-hour ingress turning volume of 50 vehicles per hour (vph) or greater. The projected westbound-left-turn volume on Hodgen Road approaching Stepler Road is **not** expected to exceed the *ECM*-minimum right-turn volume thresholds prescribing a turn lane upon Filing 3 site buildout.

STEPPLER ROAD

MTCP Analysis

Steppler Road is shown to have classification of Collector on the 2016 *MTCP* 2040 Roadway Plan. The roadway is currently an unimproved paved roadway in the vicinity of the site (between Silver Nell and Hodgen Road). The 2040 *MTCP* plan shows Steppler Road as a current paved, unimproved roadway, although the north segment is gravel. The *MTCP* Unimproved Roadway Analysis shows the roadway as “adequate” as a paved, unimproved roadway.

Steppler Road Paving (North Segment)

Please refer to the Escrow Agreement narrative submitted with the application. This document proposes/requests relief from obligation to participate in paving based on past contributions to Steppler Road (paving of the segment south of Silver Nell). The projected net site-generated ADT on Steppler Road north of Silver Nell Drive is projected to be 42 vehicles per day.

Long Term

In the long term, Settlers Ranch Filing No. 3 traffic would constitute about 7 percent of the total long-term daily traffic on Steppler Road north of Silver Nell Drive. (42 vpd site traffic divided by 600 vpd total traffic [x100 for percent]).

STREET CLASSIFICATIONS

Streets internal to Filing No. 3 will be **Rural Local**.

MULTI-MODAL AND PEDESTRIAN/BIKE TRANSPORTATION

Pedestrian facilities do not currently exist on Hodgen or Timber Meadow adjacent to the site. No multi-modal improvement projects are shown adjacent to the site on “Map 15: Bicycle and Pedestrian Network and Improvements” on El Paso County’s *Major Transportation Corridors Plan (MTCP)*. Sidewalks would not be required on Settlers Ranch Road adjacent to the site, as the subdivision is classified as Rural.

DEVIATIONS

No deviations are requested as part of this application.

ROADWAY IMPROVEMENT FEE PROGRAM

Anticipated Fees and PID Option

This project will be required to participate in the El Paso County Road Improvement Fee Program. The applicant will opt-out of the PID options. The 2019 “full fee” building permit fee associated with the opt-out option is \$3,850 per dwelling unit for single-family residential. Based on 24 dwelling units, the total “full fee” payable at building permit would be \$92,400. Note: program fees are subject to change.

POTENTIALLY REIMBURSABLE IMPROVEMENTS UNDER THE MTCP FEE PROGRAM

Nearby improvement projects *which are potentially reimbursable* under the Fee Program are (from Map 13 on the *MTCP*) include:

- U9 – Hodgen from SH 83 to Roller Coaster Road (\$3,518,000)
- Upgrade from a 2-lane Rural Unimproved Roadway to a 2-lane Rural Minor Arterial [completed]

FINDINGS & CONCLUSIONS

- The site is projected to generate about 271 vehicle trips on the average weekday during Filing 3.
- During the weekday morning peak hour for Filing 3, approximately 5 vehicles would enter and 15 vehicles would exit the site.
- During the weekday evening peak hour of adjacent street traffic for Filing 3, 16 vehicles would enter the site while 10 vehicles would exit.
- Please refer to the “Level of Service” section above for detailed LOS analysis results for individual turning movements and approaches at all studied intersections, during both peak hours through the 2043 horizon year.
- Please refer to the “Auxiliary Turn-Lane Analysis” section for details regarding the auxiliary turn-lane needs evaluation at the study-area intersections.

* * * * *

Please contact me if you have any questions regarding this report.

Respectfully Submitted,

LSC TRANSPORTATION CONSULTANTS, INC.

By: Jeffrey C. Hodsdon, P.E.
Principal

JCH/JAB:jas

Enclosures: Table 3
Figure 1 - Figure 11
Traffic Count Reports
Synchro LOS Reports

Tables



Table 3: Trip Generation Estimate

ITE				Trip Generation Rates ²				Total External Trips Generated					
Code	Description	Value	Units ¹	Average	A.M.		P.M.		Average	A.M.		P.M.	
				Weekday	In	Out	In	Out	Weekday	In	Out	In	Out
Filing 3 Only													
210	Single-Family (Detached) Housing	24	DU	11.31	0.22	0.63	0.68	0.40	271	5	15	16	10

¹ DU = dwelling units

² Source: *Trip Generation, 11th Edition (2021)* by the Institute of Transportation Engineers (ITE)

Figures





Not to scale



Figure 1
Vicinity Map
Settlers Ranch Filing No. 3 (LSC#S234130)

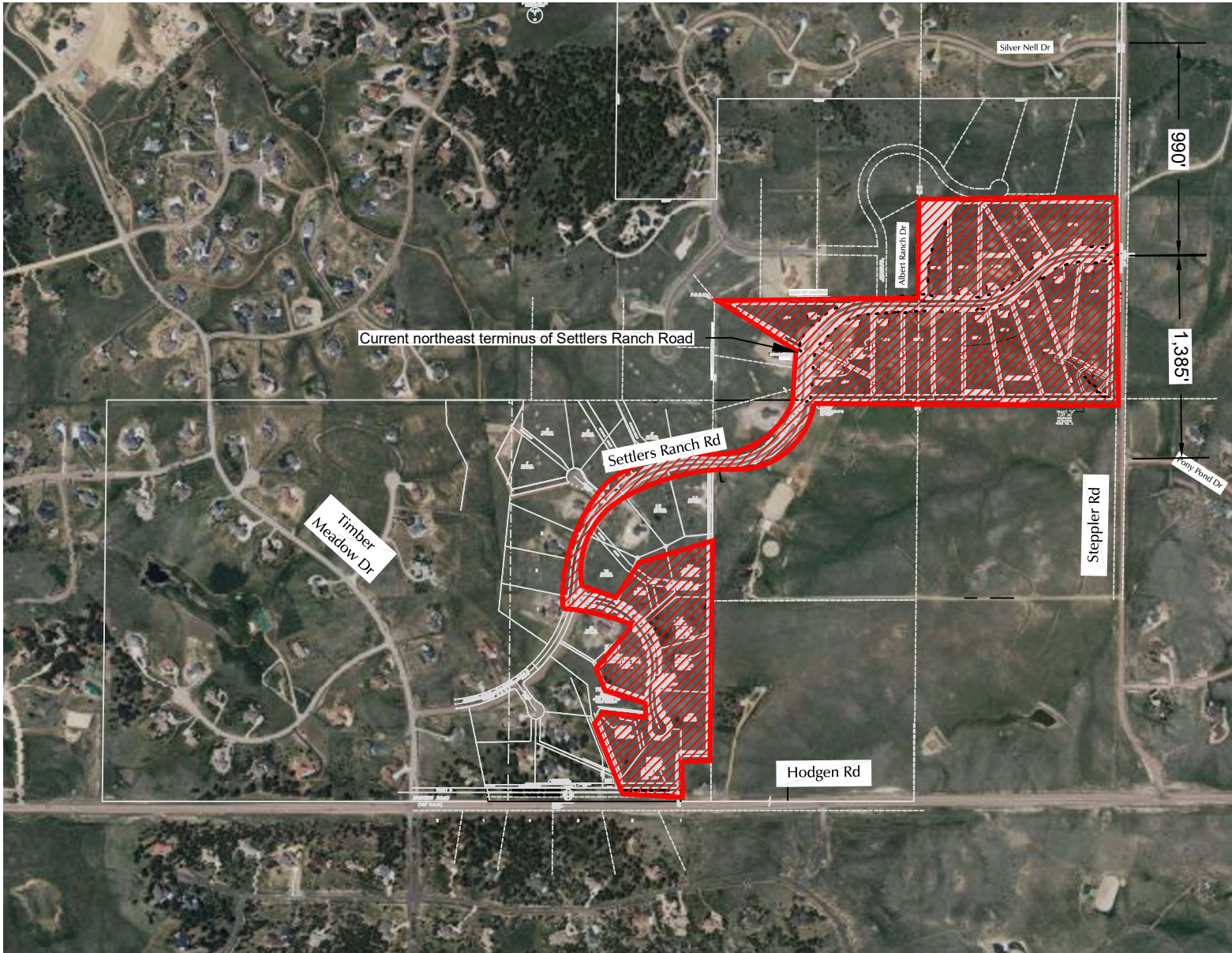

Approximate
Scale
1" = 1,000'

Figure 2
Site Plan

Settlers Ranch Filing No. 3 (LSC#S234130)

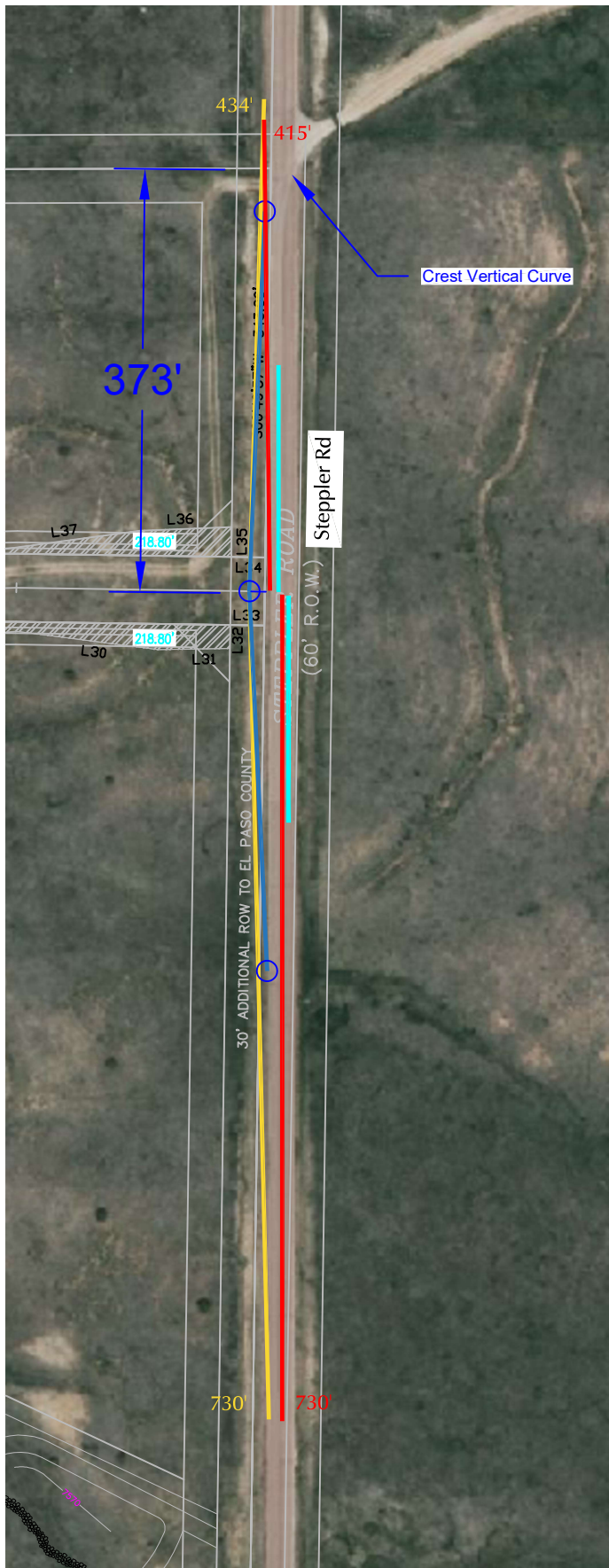

Approximate
Scale
1" = 150'

- Required intersection sight distance (ECM Table 2-21) 335' (30 mph design speed)
- Field-measured intersection sight distance
- Field-measured stopping sight distance
- Required stopping sight distance (ECM Table 2-17) 200'

Figure 3

Sight Distance

Settlers Ranch Filing No. 3 (LSC#S234130)

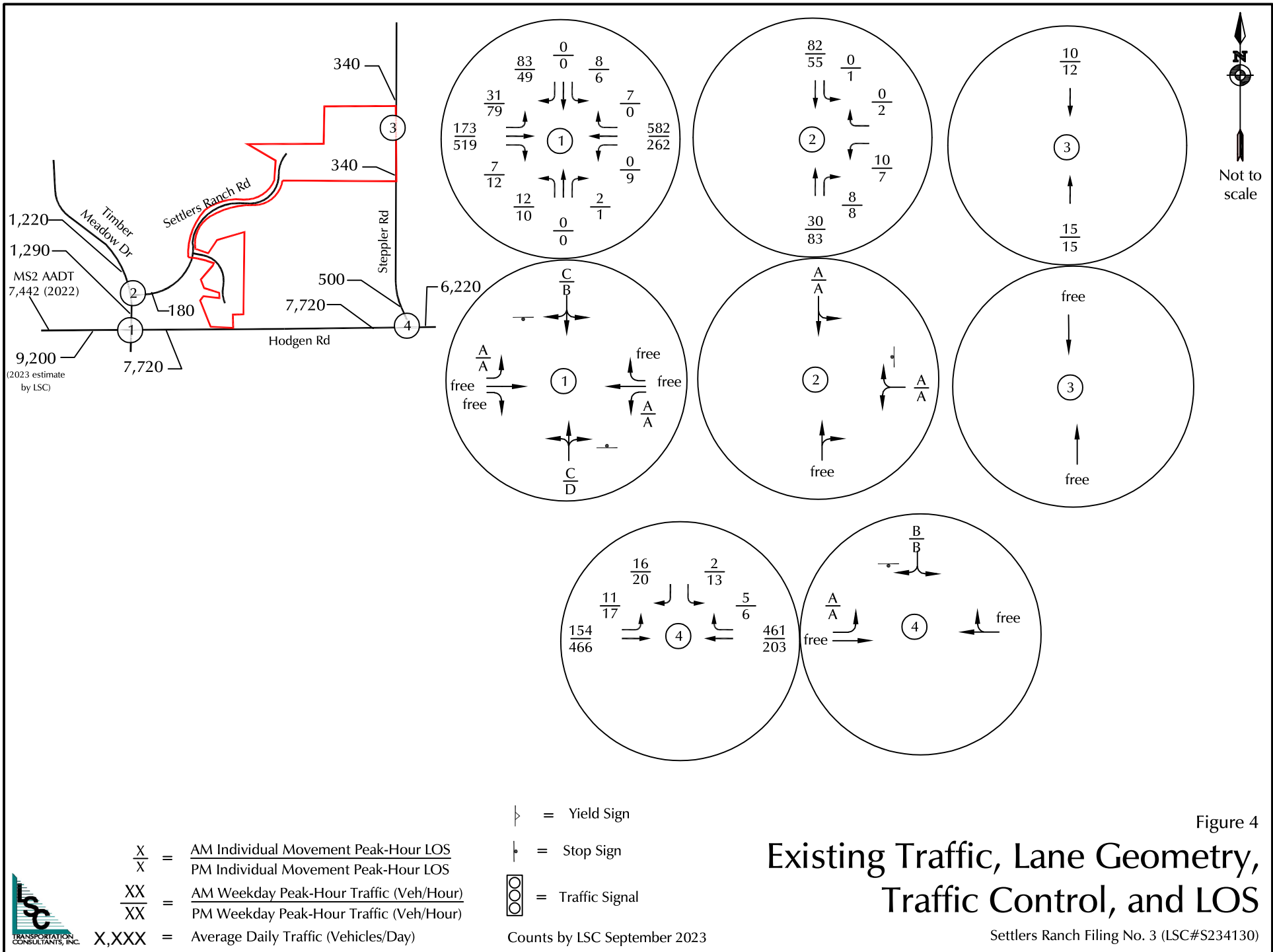
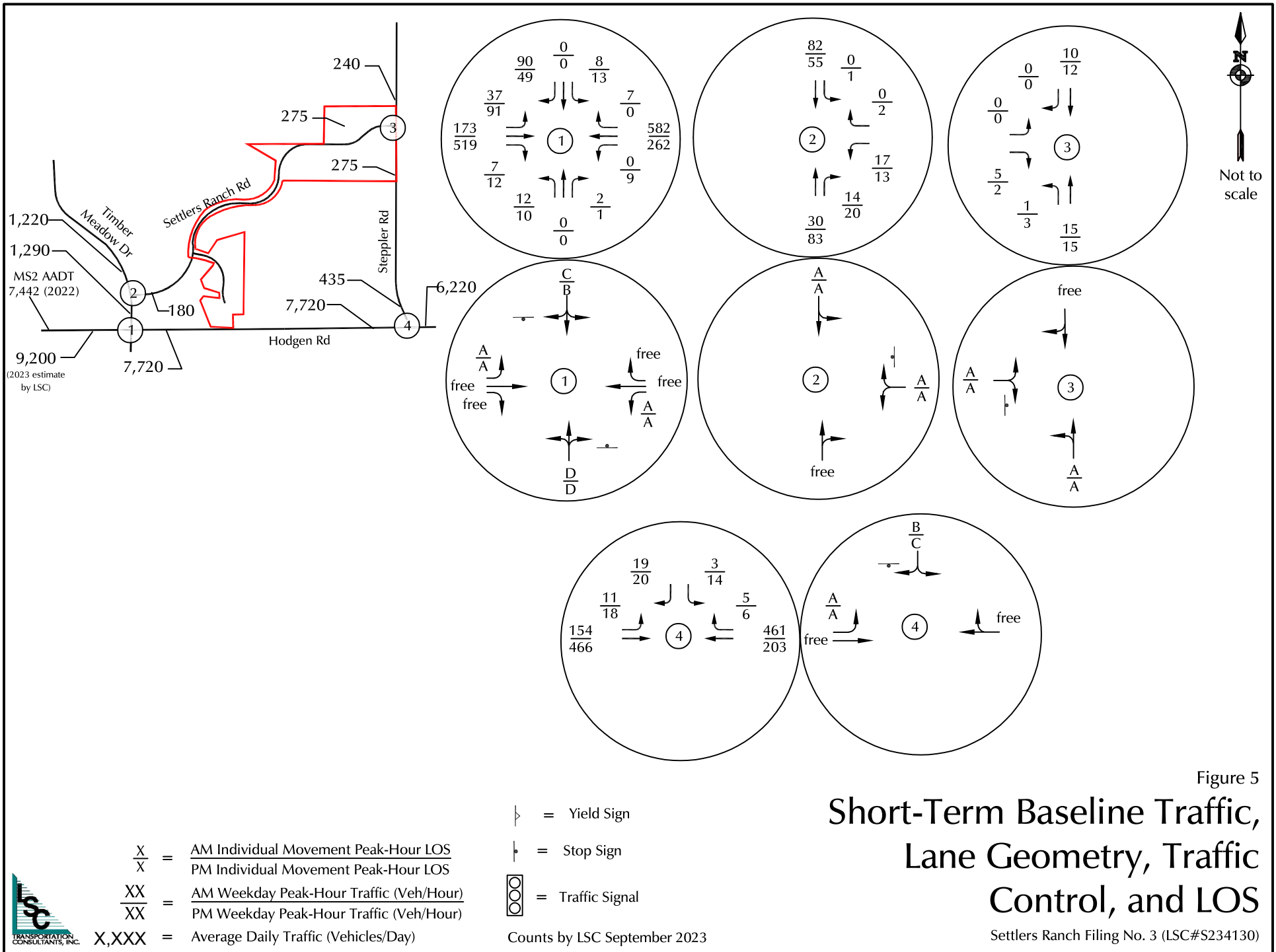

Figure 4
**Existing Traffic, Lane Geometry,
 Traffic Control, and LOS**

Settlers Ranch Filing No. 3 (LSC#S234130)





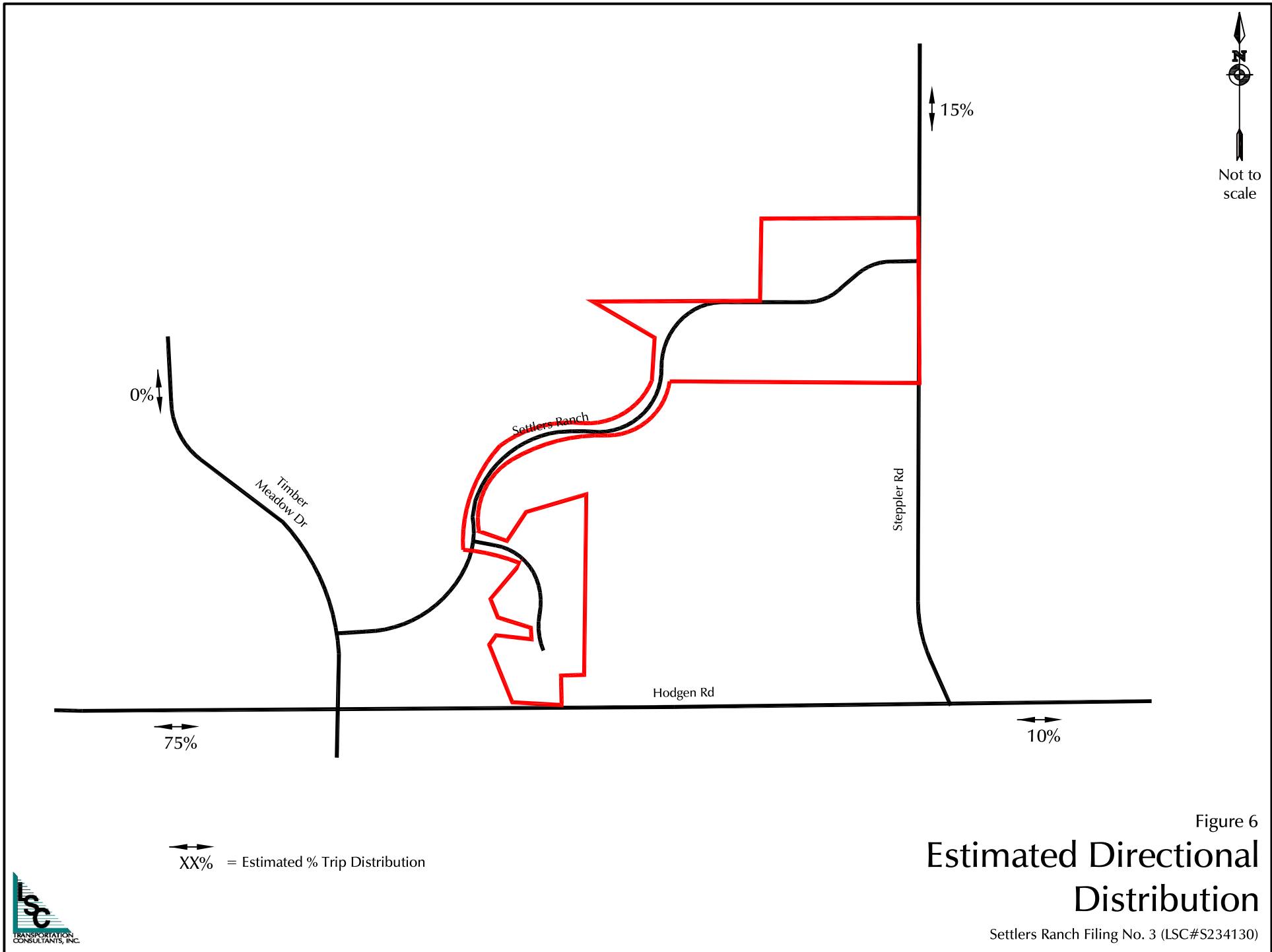
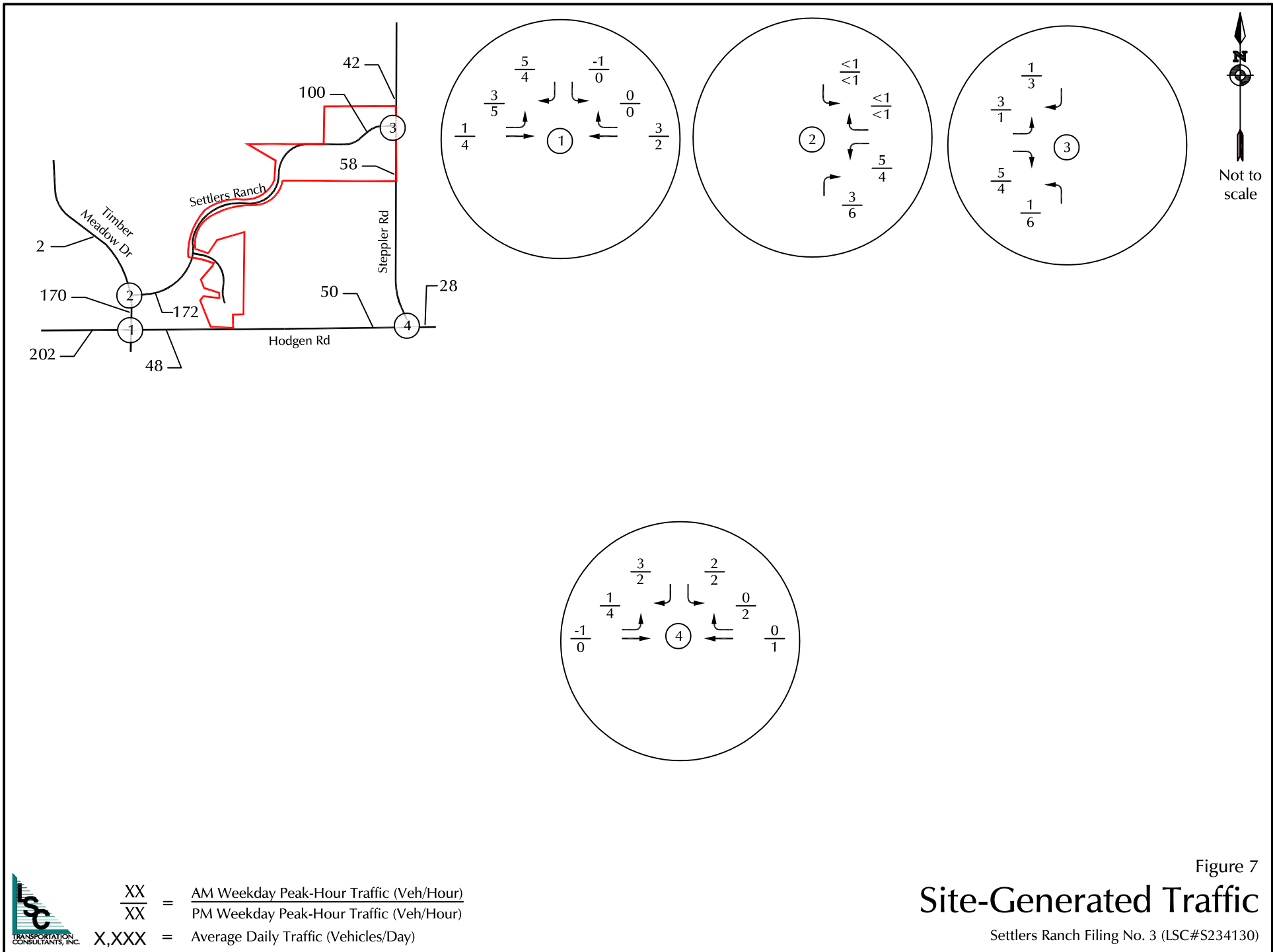
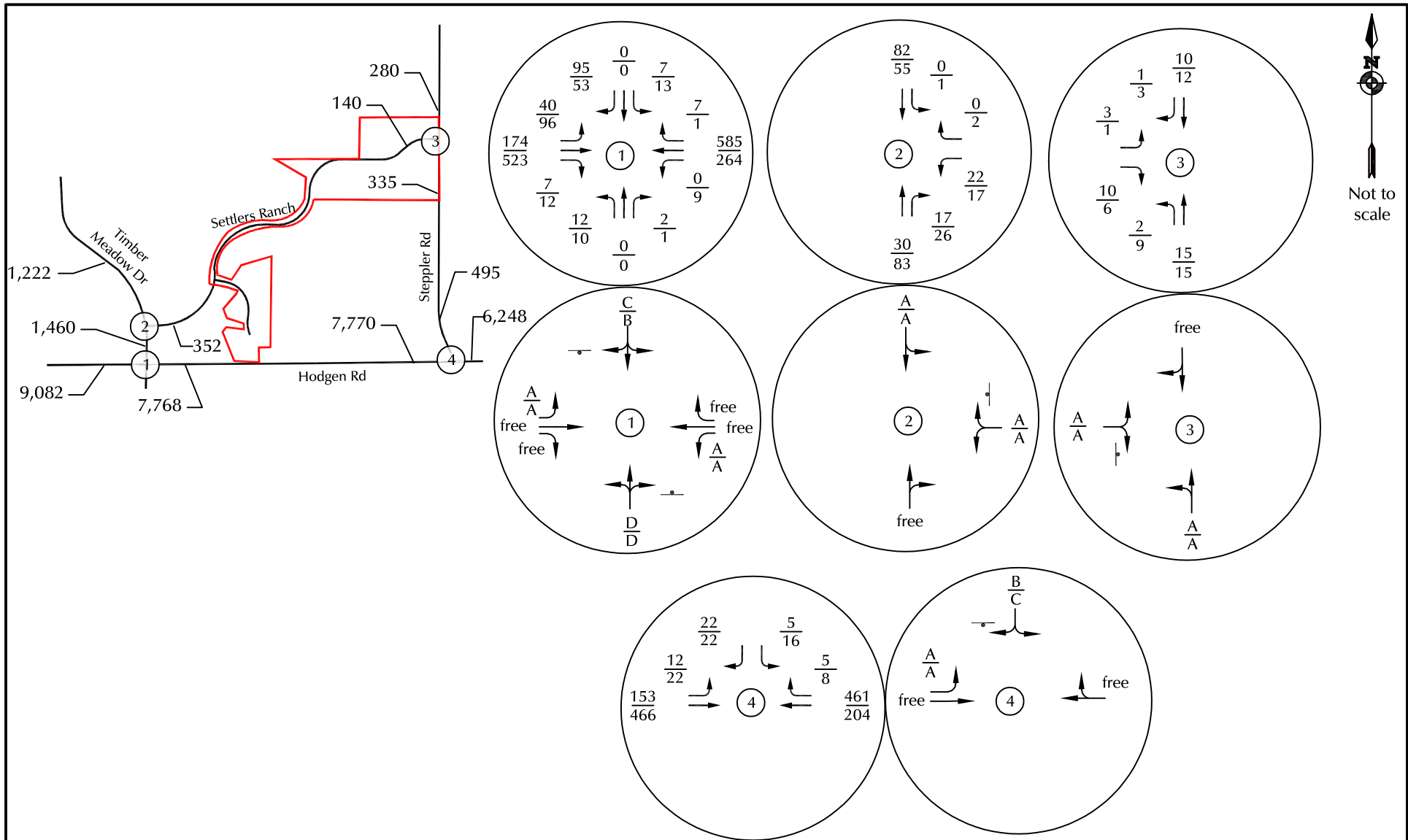

Figure 6
**Estimated Directional
 Distribution**

Settlers Ranch Filing No. 3 (LSC#S234130)





$\frac{X}{X}$ = AM Individual Movement Peak-Hour LOS
 $\frac{X}{X}$ = PM Individual Movement Peak-Hour LOS
 $\frac{XX}{XX}$ = AM Weekday Peak-Hour Traffic (Veh/Hour)
 $\frac{XX}{XX}$ = PM Weekday Peak-Hour Traffic (Veh/Hour)
 X,XXX = Average Daily Traffic (Vehicles/Day)

= Yield Sign
 = Stop Sign
 = Traffic Signal

Figure 8 Short-Term Baseline plus Site-Generated Traffic, Lane Geometry, Traffic Control, and LOS

Settlers Ranch Filing No. 3 (LSC#S234130)

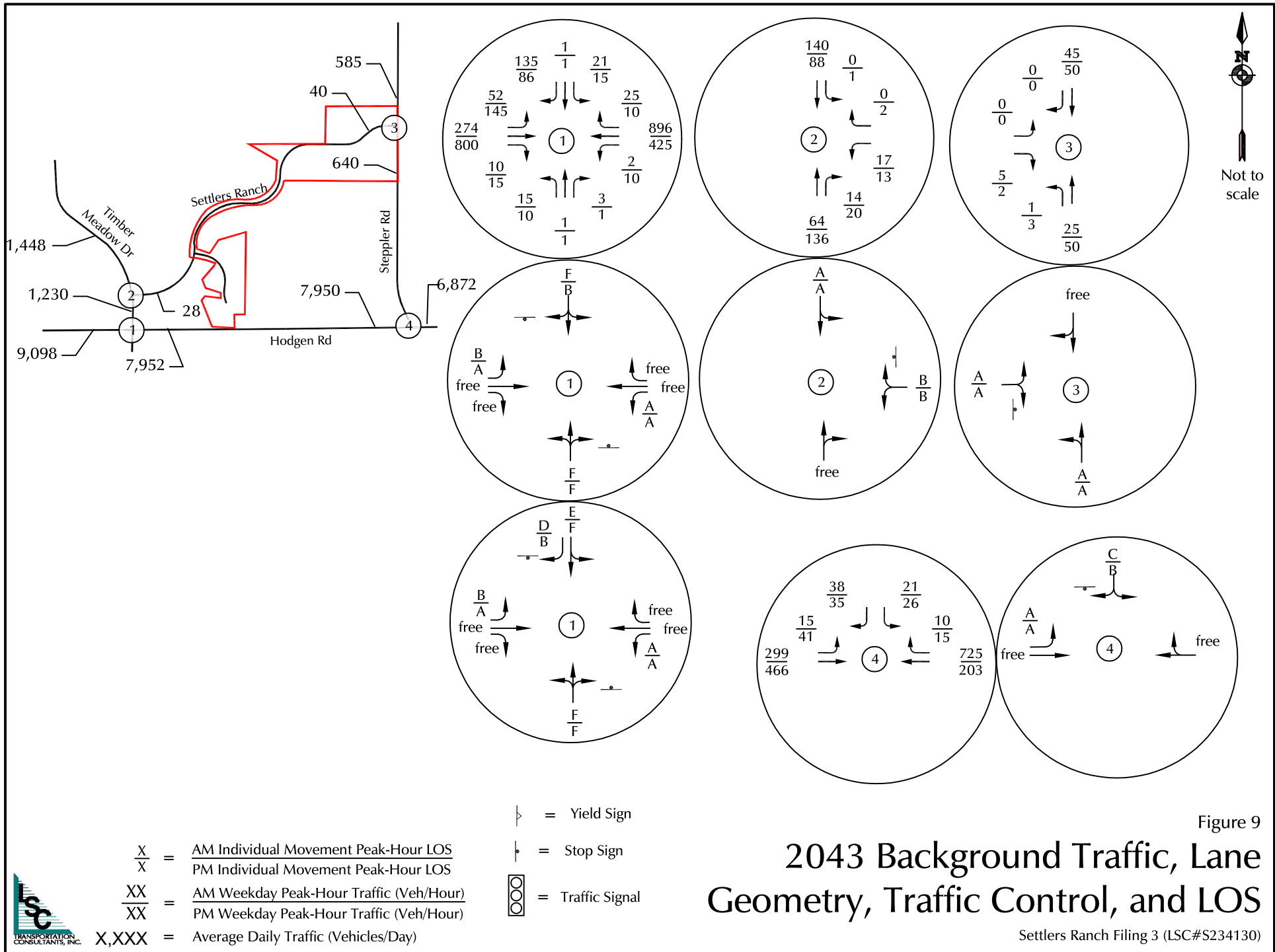

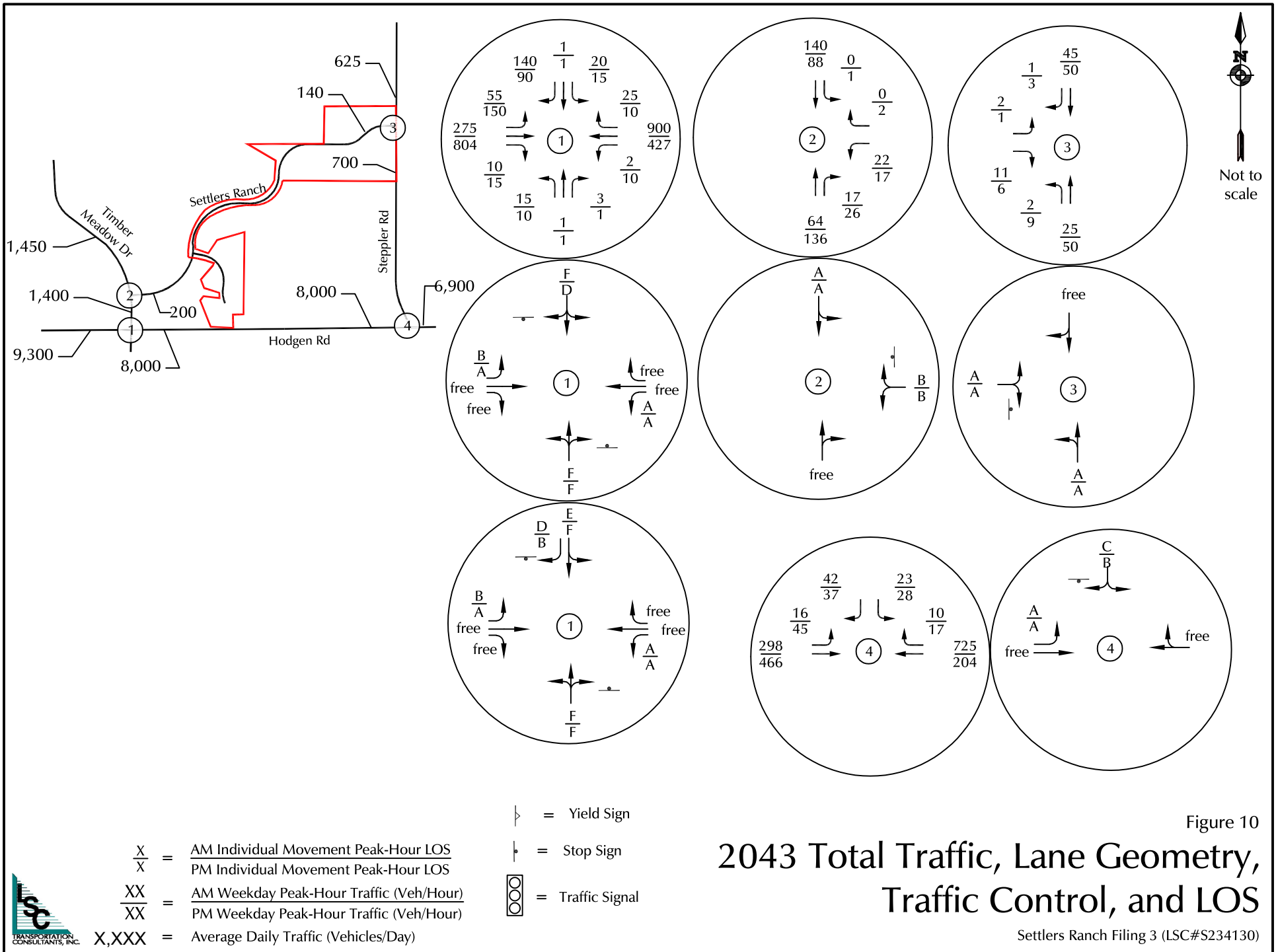

Traffic Counts



LSC Transportation Consultants, Inc.

2504 E. Pikes Peak Ave, Suite 304
 Colorado Springs, CO 80909
 719-633-2868

File Name : Steppler Rd - Hodgen Rd AM

Site Code : S234130

Start Date : 3/7/2023

Page No : 1

Groups Printed- Unshifted

Start Time	Steppler Rd Southbound					Hodgen Rd Westbound					Northbound					Hodgen Rd Eastbound					Int. Total
	Right	Thru	Left	Peds	App. Total	Right	Thru	Left	Peds	App. Total	Right	Thru	Left	Peds	App. Total	Right	Thru	Left	Peds	App. Total	
06:30	2	0	0	0	2	0	25	0	0	25	0	0	0	0	0	0	11	1	0	12	39
06:35	3	0	0	0	3	0	25	0	0	25	0	0	0	0	0	0	6	0	0	6	34
06:40	2	0	1	0	3	0	30	0	0	30	0	0	0	0	0	0	5	0	0	5	38
06:45	2	0	1	0	3	0	33	0	0	33	0	0	0	0	0	0	9	3	0	12	48
06:50	2	0	1	0	3	1	30	0	0	31	0	0	0	0	0	0	17	0	0	17	51
06:55	1	0	0	0	1	0	33	0	0	33	0	0	0	0	0	0	5	0	0	5	39
Total	12	0	3	0	15	1	176	0	0	177	0	0	0	0	0	0	53	4	0	57	249
07:00	3	0	0	0	3	2	21	0	0	23	0	0	0	0	0	0	8	0	0	8	34
07:05	1	0	0	0	1	0	27	0	0	27	0	0	0	0	0	0	6	1	0	7	35
07:10	0	0	0	0	0	0	41	0	0	41	0	0	0	0	0	0	14	0	0	14	55
07:15	2	0	1	0	3	0	39	0	0	39	0	0	0	0	0	0	11	2	0	13	55
07:20	3	0	0	0	3	1	40	0	0	41	0	0	0	0	0	0	5	1	0	6	50
07:25	1	0	0	0	1	0	41	0	0	41	0	0	0	0	0	0	18	2	0	20	62
07:30	4	0	0	0	4	1	65	0	0	66	0	0	0	0	0	0	9	1	0	10	80
07:35	0	0	0	0	0	0	37	0	0	37	0	0	0	0	0	0	16	0	0	16	53
07:40	0	0	0	0	0	0	43	0	0	43	0	0	0	0	0	0	10	0	0	10	53
07:45	1	0	0	0	1	1	47	0	0	48	0	0	0	0	0	0	15	1	0	16	65
07:50	3	0	1	0	4	1	32	0	0	33	0	0	0	0	0	0	15	2	0	17	54
07:55	1	0	0	0	1	1	25	0	0	26	0	0	0	0	0	0	15	0	0	15	42
Total	19	0	2	0	21	7	458	0	0	465	0	0	0	0	0	0	142	10	0	152	638
08:00	0	0	0	0	0	0	24	0	0	24	0	0	0	0	0	0	20	1	0	21	45
08:05	1	0	0	0	1	0	26	0	0	26	0	0	0	0	0	0	7	1	0	8	35
08:10	1	0	0	0	1	0	22	0	0	22	0	0	0	0	0	0	19	1	0	20	43
08:15	0	0	0	0	0	3	35	0	0	38	0	0	0	0	0	0	15	2	0	17	55
08:20	1	0	0	0	1	0	33	0	0	33	0	0	0	0	0	0	8	3	0	11	45
08:25	1	0	0	0	1	0	26	0	0	26	0	0	0	0	0	0	6	1	0	7	34
Grand Total	35	0	5	0	40	11	800	0	0	811	0	0	0	0	0	0	270	23	0	293	1144
Apprch %	87.5	0	12.5	0		1.4	98.6	0	0		0	0	0	0		0	92.2	7.8	0		
Total %	3.1	0	0.4	0	3.5	1	69.9	0	0	70.9	0	0	0	0	0	0	23.6	2	0	25.6	

LSC Transportation Consultants, Inc.

2504 E. Pikes Peak Ave, Suite 304
 Colorado Springs, CO 80909
 719-633-2868

File Name : Steppler Rd - Hodgen Rd AM
 Site Code : S234130
 Start Date : 3/7/2023
 Page No : 2

Start Time	Steppler Rd Southbound					Hodgen Rd Westbound					Northbound					Hodgen Rd Eastbound					Int. Total
	Right	Thru	Left	Peds	App. Total	Right	Thru	Left	Peds	App. Total	Right	Thru	Left	Peds	App. Total	Right	Thru	Left	Peds	App. Total	
Peak Hour Analysis From 06:30 to 08:25 - Peak 1 of 1																					
Peak Hour for Entire Intersection Begins at 07:05																					
07:05	1	0	0	0	1	0	27	0	0	27	0	0	0	0	0	0	6	1	0	7	35
07:10	0	0	0	0	0	0	41	0	0	41	0	0	0	0	0	0	14	0	0	14	55
07:15	2	0	1	0	3	0	39	0	0	39	0	0	0	0	0	0	11	2	0	13	55
07:20	3	0	0	0	3	1	40	0	0	41	0	0	0	0	0	0	5	1	0	6	50
07:25	1	0	0	0	1	0	41	0	0	41	0	0	0	0	0	0	18	2	0	20	62
07:30	4	0	0	0	4	1	65	0	0	66	0	0	0	0	0	0	9	1	0	10	80
07:35	0	0	0	0	0	0	37	0	0	37	0	0	0	0	0	0	16	0	0	16	53
07:40	0	0	0	0	0	0	43	0	0	43	0	0	0	0	0	0	10	0	0	10	53
07:45	1	0	0	0	1	1	47	0	0	48	0	0	0	0	0	0	15	1	0	16	65
07:50	3	0	1	0	4	1	32	0	0	33	0	0	0	0	0	0	15	2	0	17	54
07:55	1	0	0	0	1	1	25	0	0	26	0	0	0	0	0	0	15	0	0	15	42
08:00	0	0	0	0	0	0	24	0	0	24	0	0	0	0	0	0	20	1	0	21	45
Total Volume	16	0	2	0	18	5	461	0	0	466	0	0	0	0	0	0	154	11	0	165	649
% App. Total	88.9	0	11.1	0		1.1	98.9	0	0		0	0	0	0		0	93.3	6.7	0		
PHF	.333	.000	.167	.000	.375	.417	.591	.000	.000	.588	.000	.000	.000	.000	.000	.000	.642	.458	.000	.655	.676

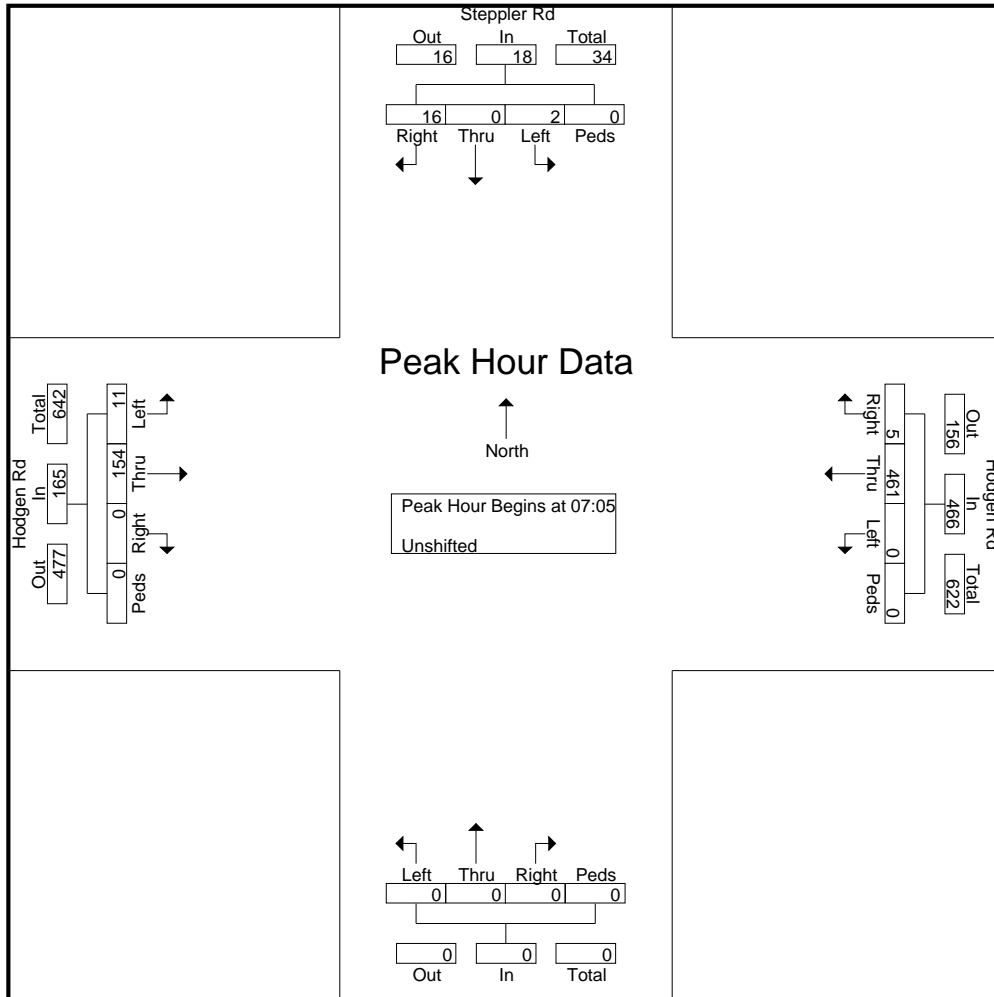

LSC Transportation Consultants, Inc.

2504 E. Pikes Peak Ave, Suite 304
 Colorado Springs, CO 80909
 719-633-2868

File Name : Stepler Rd - Hodgen Rd AM
 Site Code : S234130
 Start Date : 3/7/2023
 Page No : 3

Start Time	Stepler Rd Southbound					Hodgen Rd Westbound					Northbound					Hodgen Rd Eastbound					Int. Total
	Right	Thru	Left	Peds	App. Total	Right	Thru	Left	Peds	App. Total	Right	Thru	Left	Peds	App. Total	Right	Thru	Left	Peds	App. Total	

Peak Hour Analysis From 06:30 to 08:25 - Peak 1 of 1
 Peak Hour for Each Approach Begins at:

	06:35					06:55					06:30					07:25				
+0 mins.	3	0	0	0	3	0	33	0	0	33	0	0	0	0	0	0	18	2	0	20
+5 mins.	2	0	1	0	3	2	21	0	0	23	0	0	0	0	0	0	9	1	0	10
+10 mins.	2	0	1	0	3	0	27	0	0	27	0	0	0	0	0	0	16	0	0	16
+15 mins.	2	0	1	0	3	0	41	0	0	41	0	0	0	0	0	0	10	0	0	10
+20 mins.	1	0	0	0	1	0	39	0	0	39	0	0	0	0	0	0	15	1	0	16
+25 mins.	3	0	0	0	3	1	40	0	0	41	0	0	0	0	0	0	15	2	0	17
+30 mins.	1	0	0	0	1	0	41	0	0	41	0	0	0	0	0	0	15	0	0	15
+35 mins.	0	0	0	0	0	1	65	0	0	66	0	0	0	0	0	0	20	1	0	21
+40 mins.	2	0	1	0	3	0	37	0	0	37	0	0	0	0	0	0	7	1	0	8
+45 mins.	3	0	0	0	3	0	43	0	0	43	0	0	0	0	0	0	19	1	0	20
+50 mins.	1	0	0	0	1	1	47	0	0	48	0	0	0	0	0	0	15	2	0	17
+55 mins.	4	0	0	0	4	1	32	0	0	33	0	0	0	0	0	0	8	3	0	11
Total Volume	24	0	4	0	28	6	466	0	0	472	0	0	0	0	0	0	167	14	0	181
% App. Total	85.7	0	14.3	0		1.3	98.7	0	0		0	0	0	0		0	92.3	7.7	0	
PHF	.500	.000	.333	.000	.583	.250	.597	.000	.000	.596	.000	.000	.000	.000	.000	.000	.696	.389	.000	.718

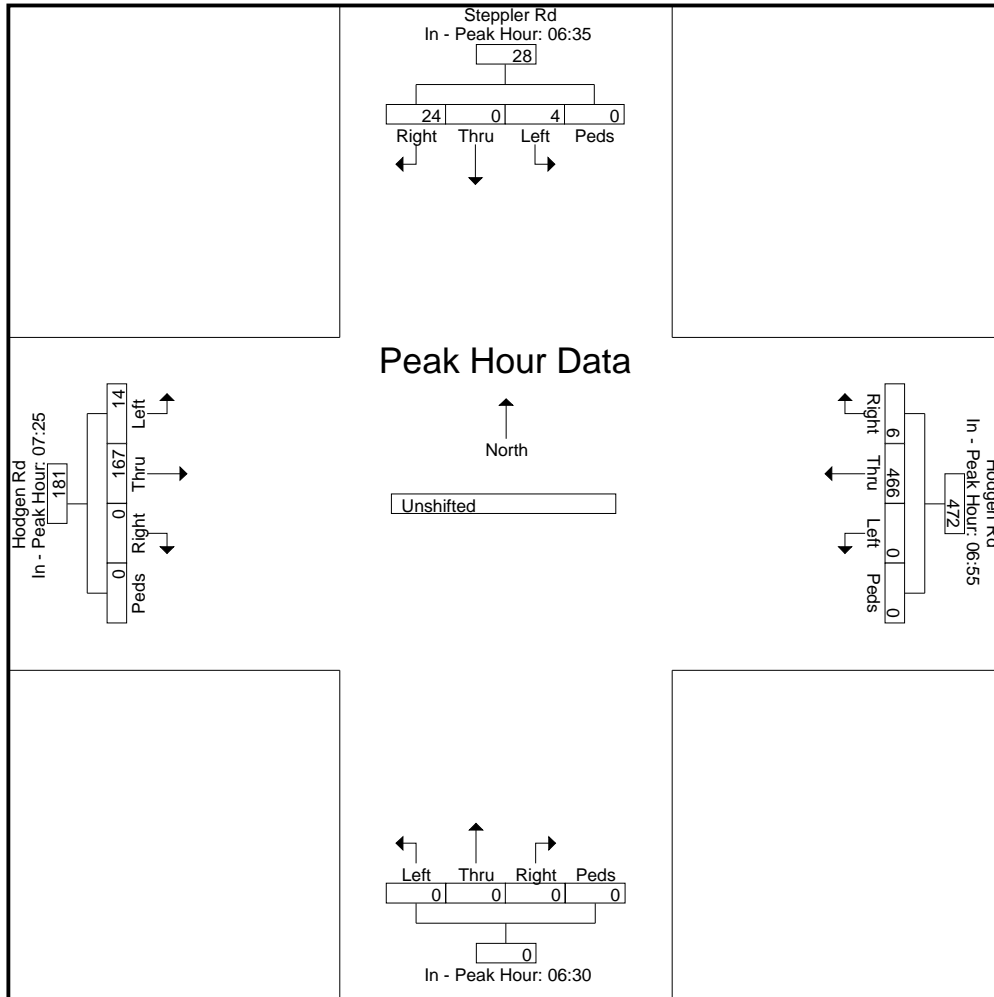

LSC Transportation Consultants, Inc.

2504 E. Pikes Peak Ave, Suite 304
 Colorado Springs, CO 80909
 719-633-2868

File Name : Stepler Rd - Hodgen Rd PM

Site Code : S234130

Start Date : 3/7/2023

Page No : 1

Groups Printed- Unshifted

Start Time	Stepler Rd Southbound					Hodgen Rd Westbound					Northbound					Hodgen Rd Eastbound					Int. Total
	Right	Thru	Left	Peds	App. Total	Right	Thru	Left	Peds	App. Total	Right	Thru	Left	Peds	App. Total	Right	Thru	Left	Peds	App. Total	
16:00	1	0	0	0	1	0	18	0	0	18	0	0	0	0	0	0	22	0	0	22	41
16:05	0	0	1	0	1	0	21	0	0	21	0	0	0	0	0	0	25	1	0	26	48
16:10	2	0	1	0	3	1	20	0	0	21	0	0	0	0	0	0	19	1	0	20	44
16:15	0	0	1	0	1	1	21	0	0	22	0	0	0	0	0	0	38	0	0	38	61
16:20	0	0	0	0	0	0	19	0	0	19	0	0	0	0	0	0	28	2	0	30	49
16:25	1	0	0	0	1	0	21	0	0	21	0	0	0	0	0	0	35	5	0	40	62
16:30	1	0	0	0	1	0	21	0	0	21	0	0	0	0	0	0	45	2	0	47	69
16:35	2	0	1	0	3	1	17	0	0	18	0	0	0	0	0	0	43	1	0	44	65
16:40	3	0	4	0	7	0	17	0	0	17	0	0	0	0	0	0	34	1	0	35	59
16:45	3	0	1	0	4	1	27	0	0	28	0	0	0	0	0	0	33	2	0	35	67
16:50	1	0	1	0	2	2	13	0	0	15	0	0	0	0	0	0	32	0	0	32	49
16:55	2	0	1	0	3	0	17	0	0	17	0	0	0	0	0	0	29	2	0	31	51
Total	16	0	11	0	27	6	232	0	0	238	0	0	0	0	0	0	383	17	0	400	665
17:00	0	0	0	0	0	0	14	0	0	14	0	0	0	0	0	0	40	1	0	41	55
17:05	1	0	0	0	1	0	21	0	0	21	0	0	0	0	0	0	41	1	0	42	64
17:10	3	0	2	0	5	0	15	0	0	15	0	0	0	0	0	0	37	1	0	38	58
17:15	1	0	0	0	1	0	12	0	0	12	0	0	0	0	0	0	39	1	0	40	53
17:20	2	0	0	0	2	1	15	0	0	16	0	0	0	0	0	0	41	2	0	43	61
17:25	1	0	3	0	4	1	14	0	0	15	0	0	0	0	0	0	52	3	0	55	74
17:30	1	0	0	0	1	0	7	0	0	7	0	0	0	0	0	0	17	1	0	18	26
17:35	0	0	0	0	0	0	13	0	0	13	0	0	0	0	0	0	37	0	0	37	50
17:40	0	0	0	0	0	0	13	0	0	13	0	0	0	0	0	0	31	5	0	36	49
17:45	0	0	1	0	1	1	11	0	0	12	0	0	0	0	0	0	22	3	0	25	38
17:50	1	0	0	0	1	0	17	0	0	17	0	0	0	0	0	0	25	2	0	27	45
17:55	0	0	1	0	1	0	17	0	0	17	0	0	0	0	0	0	41	1	0	42	60
Total	10	0	7	0	17	3	169	0	0	172	0	0	0	0	0	0	423	21	0	444	633
Grand Total	26	0	18	0	44	9	401	0	0	410	0	0	0	0	0	0	806	38	0	844	1298
Apprch %	59.1	0	40.9	0		2.2	97.8	0	0		0	0	0	0		0	95.5	4.5	0		
Total %	2	0	1.4	0	3.4	0.7	30.9	0	0	31.6	0	0	0	0	0	0	62.1	2.9	0	65	

LSC Transportation Consultants, Inc.

2504 E. Pikes Peak Ave, Suite 304
 Colorado Springs, CO 80909
 719-633-2868

File Name : Steppler Rd - Hodgen Rd PM
 Site Code : S234130
 Start Date : 3/7/2023
 Page No : 2

Start Time	Steppler Rd Southbound					Hodgen Rd Westbound					Northbound					Hodgen Rd Eastbound					Int. Total
	Right	Thru	Left	Peds	App. Total	Right	Thru	Left	Peds	App. Total	Right	Thru	Left	Peds	App. Total	Right	Thru	Left	Peds	App. Total	
Peak Hour Analysis From 16:00 to 17:55 - Peak 1 of 1																					
Peak Hour for Entire Intersection Begins at 16:30																					
16:30	1	0	0	0	1	0	21	0	0	21	0	0	0	0	0	0	45	2	0	47	69
16:35	2	0	1	0	3	1	17	0	0	18	0	0	0	0	0	0	43	1	0	44	65
16:40	3	0	4	0	7	0	17	0	0	17	0	0	0	0	0	0	34	1	0	35	59
16:45	3	0	1	0	4	1	27	0	0	28	0	0	0	0	0	0	33	2	0	35	67
16:50	1	0	1	0	2	2	13	0	0	15	0	0	0	0	0	0	32	0	0	32	49
16:55	2	0	1	0	3	0	17	0	0	17	0	0	0	0	0	0	29	2	0	31	51
17:00	0	0	0	0	0	0	14	0	0	14	0	0	0	0	0	0	40	1	0	41	55
17:05	1	0	0	0	1	0	21	0	0	21	0	0	0	0	0	0	41	1	0	42	64
17:10	3	0	2	0	5	0	15	0	0	15	0	0	0	0	0	0	37	1	0	38	58
17:15	1	0	0	0	1	0	12	0	0	12	0	0	0	0	0	0	39	1	0	40	53
17:20	2	0	0	0	2	1	15	0	0	16	0	0	0	0	0	0	41	2	0	43	61
17:25	1	0	3	0	4	1	14	0	0	15	0	0	0	0	0	0	52	3	0	55	74
Total Volume	20	0	13	0	33	6	203	0	0	209	0	0	0	0	0	0	466	17	0	483	725
% App. Total	60.6	0	39.4	0		2.9	97.1	0	0		0	0	0	0		0	96.5	3.5	0		
PHF	.556	.000	.271	.000	.393	.250	.627	.000	.000	.622	.000	.000	.000	.000	.000	.000	.747	.472	.000	.732	.816

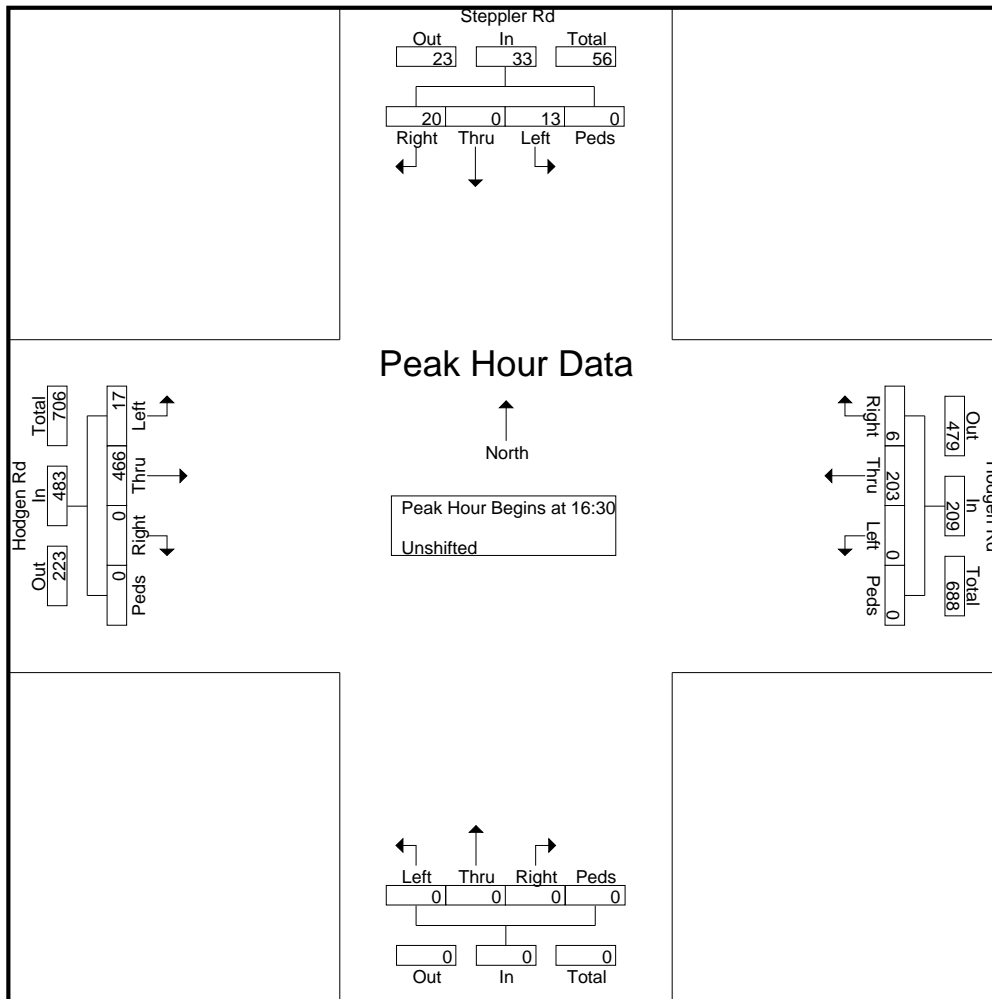

LSC Transportation Consultants, Inc.

2504 E. Pikes Peak Ave, Suite 304
 Colorado Springs, CO 80909
 719-633-2868

File Name : Steppler Rd - Hodgen Rd PM
 Site Code : S234130
 Start Date : 3/7/2023
 Page No : 3

Start Time	Steppler Rd Southbound					Hodgen Rd Westbound					Northbound					Hodgen Rd Eastbound					Int. Total
	Right	Thru	Left	Peds	App. Total	Right	Thru	Left	Peds	App. Total	Right	Thru	Left	Peds	App. Total	Right	Thru	Left	Peds	App. Total	
Peak Hour Analysis From 16:00 to 17:55 - Peak 1 of 1																					
Peak Hour for Each Approach Begins at:																					
	16:30					16:00					16:00					16:30					
+0 mins.	1	0	0	0	1	0	18	0	0	18	0	0	0	0	0	0	45	2	0	47	
+5 mins.	2	0	1	0	3	0	21	0	0	21	0	0	0	0	0	0	43	1	0	44	
+10 mins.	3	0	4	0	7	1	20	0	0	21	0	0	0	0	0	0	34	1	0	35	
+15 mins.	3	0	1	0	4	1	21	0	0	22	0	0	0	0	0	0	33	2	0	35	
+20 mins.	1	0	1	0	2	0	19	0	0	19	0	0	0	0	0	0	32	0	0	32	
+25 mins.	2	0	1	0	3	0	21	0	0	21	0	0	0	0	0	0	29	2	0	31	
+30 mins.	0	0	0	0	0	0	21	0	0	21	0	0	0	0	0	0	40	1	0	41	
+35 mins.	1	0	0	0	1	1	17	0	0	18	0	0	0	0	0	0	41	1	0	42	
+40 mins.	3	0	2	0	5	0	17	0	0	17	0	0	0	0	0	0	37	1	0	38	
+45 mins.	1	0	0	0	1	1	27	0	0	28	0	0	0	0	0	0	39	1	0	40	
+50 mins.	2	0	0	0	2	2	13	0	0	15	0	0	0	0	0	0	41	2	0	43	
+55 mins.	1	0	3	0	4	0	17	0	0	17	0	0	0	0	0	0	52	3	0	55	
Total Volume	20	0	13	0	33	6	232	0	0	238	0	0	0	0	0	0	466	17	0	483	
% App. Total	60.6	0	39.4	0		2.5	97.5	0	0		0	0	0	0		0	96.5	3.5	0		
PHF	.556	.000	.271	.000	.393	.250	.716	.000	.000	.708	.000	.000	.000	.000	.000	.000	.747	.472	.000	.732	

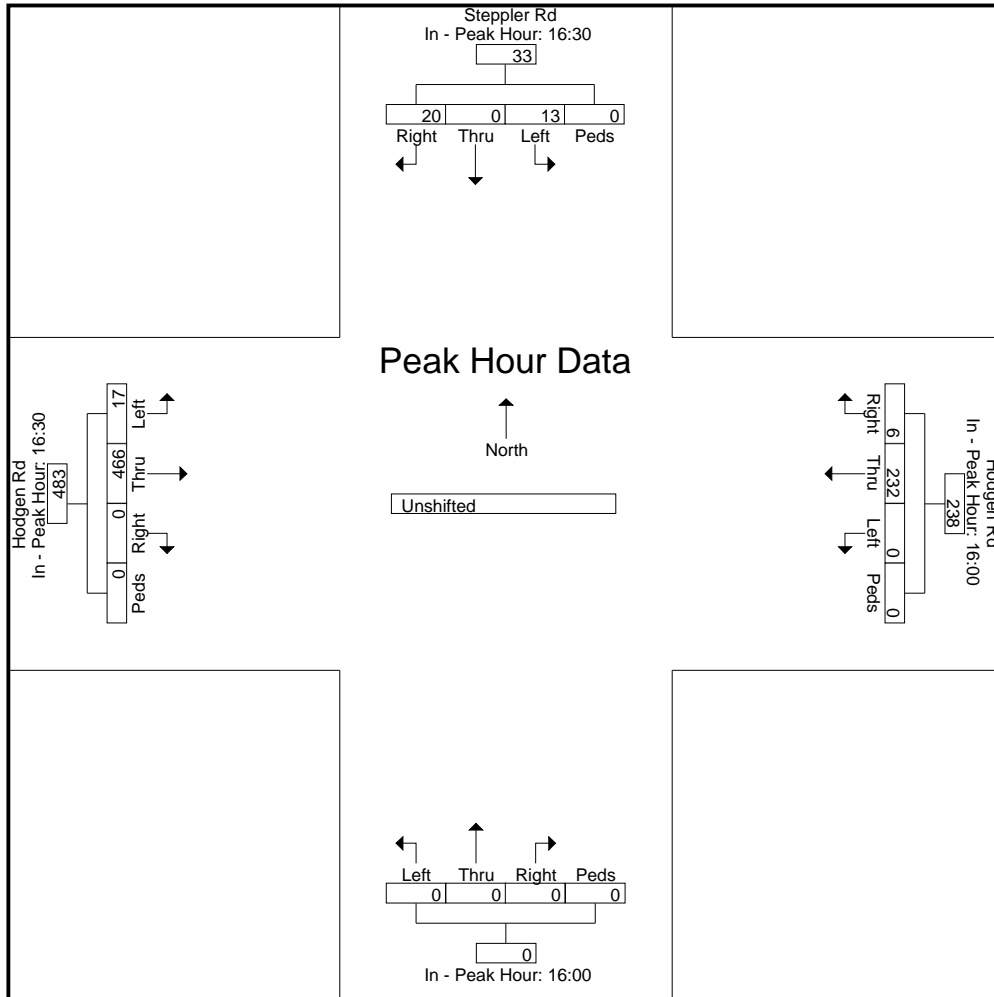

LSC Transportation Consultants, Inc.

2504 E. Pikes Peak Ave, Suite 304
 Colorado Springs, CO 80909
 719-633-2868

File Name : Timber Meadow Dr - Hodgen Rd AM 9-23

Site Code : S234130

Start Date : 9/12/2023

Page No : 1

Groups Printed- Unshifted

Start Time	Timber Meadow Dr Southbound					Hodgen Rd Westbound					Timber Meadow Dr Northbound					Hodgen Rd Eastbound					Int. Total
	Right	Thru	Left	Peds	App. Total	Right	Thru	Left	Peds	App. Total	Right	Thru	Left	Peds	App. Total	Right	Thru	Left	Peds	App. Total	
06:30	2	0	0	0	2	0	24	0	0	24	1	0	0	0	1	0	6	2	0	8	35
06:35	7	1	1	0	9	1	28	0	0	29	0	0	0	0	0	0	13	0	0	13	51
06:40	1	0	0	0	1	0	28	0	0	28	0	0	1	0	1	0	8	2	0	10	40
06:45	3	0	0	0	3	0	41	0	0	41	0	0	2	0	2	0	9	0	0	9	55
06:50	6	0	0	0	6	0	31	0	0	31	0	0	0	0	0	0	8	0	0	8	45
06:55	6	0	0	0	6	0	39	0	0	39	0	0	1	0	1	0	9	0	0	9	55
Total	25	1	1	0	27	1	191	0	0	192	1	0	4	0	5	0	53	4	0	57	281
07:00	3	0	1	0	4	1	39	0	0	40	1	0	1	0	2	1	10	1	0	12	58
07:05	9	0	1	0	10	0	45	0	0	45	0	0	0	0	0	0	13	0	0	13	68
07:10	13	0	3	0	16	0	51	0	0	51	0	0	1	0	1	0	9	2	0	11	79
07:15	5	0	0	0	5	0	65	0	0	65	0	0	0	0	0	0	10	4	0	14	84
07:20	8	0	1	0	9	0	56	0	0	56	0	0	1	0	1	0	10	1	0	11	77
07:25	6	0	0	0	6	1	53	0	0	54	0	0	1	0	1	1	12	3	0	16	77
07:30	6	0	0	0	6	0	38	0	0	38	0	0	4	0	4	1	13	3	0	17	65
07:35	11	0	0	0	11	3	55	0	0	58	0	0	1	0	1	1	23	5	0	29	99
07:40	11	0	0	0	11	2	49	0	0	51	0	0	0	0	0	1	20	4	0	25	87
07:45	4	0	0	0	4	0	43	0	0	43	0	0	1	0	1	1	22	4	0	27	75
07:50	4	0	1	0	5	0	48	0	0	48	0	0	1	0	1	0	21	1	0	22	76
07:55	3	0	1	0	4	0	40	0	0	40	1	0	1	0	2	1	10	3	0	14	60
Total	83	0	8	0	91	7	582	0	0	589	2	0	12	0	14	7	173	31	0	211	905
08:00	4	0	1	0	5	0	29	0	0	29	0	0	1	0	1	0	17	1	0	18	53
08:05	6	1	0	0	7	0	30	0	0	30	0	0	3	0	3	3	19	2	0	24	64
08:10	6	0	0	0	6	0	31	0	0	31	0	0	0	0	0	0	13	6	0	19	56
08:15	7	0	1	0	8	0	31	0	0	31	0	0	1	0	1	0	10	2	0	12	52
08:20	7	0	2	0	9	0	33	0	0	33	0	0	0	0	0	0	20	4	0	24	66
08:25	3	0	0	0	3	1	31	1	0	33	0	0	2	0	2	0	14	4	0	18	56
Grand Total	141	2	13	0	156	9	958	1	0	968	3	0	23	0	26	10	319	54	0	383	1533
Apprch %	90.4	1.3	8.3	0		0.9	99	0.1	0		11.5	0	88.5	0		2.6	83.3	14.1	0		
Total %	9.2	0.1	0.8	0	10.2	0.6	62.5	0.1	0	63.1	0.2	0	1.5	0	1.7	0.7	20.8	3.5	0	25	

LSC Transportation Consultants, Inc.

2504 E. Pikes Peak Ave, Suite 304
 Colorado Springs, CO 80909
 719-633-2868

File Name : Timber Meadow Dr - Hodgen Rd AM 9-23
 Site Code : S234130
 Start Date : 9/12/2023
 Page No : 2

Start Time	Timber Meadow Dr Southbound					Hodgen Rd Westbound					Timber Meadow Dr Northbound					Hodgen Rd Eastbound					Int. Total
	Right	Thru	Left	Peds	App. Total	Right	Thru	Left	Peds	App. Total	Right	Thru	Left	Peds	App. Total	Right	Thru	Left	Peds	App. Total	
Peak Hour Analysis From 06:30 to 08:25 - Peak 1 of 1																					
Peak Hour for Entire Intersection Begins at 07:00																					
07:00	3	0	1	0	4	1	39	0	0	40	1	0	1	0	2	1	10	1	0	12	58
07:05	9	0	1	0	10	0	45	0	0	45	0	0	0	0	0	0	13	0	0	13	68
07:10	13	0	3	0	16	0	51	0	0	51	0	0	1	0	1	0	9	2	0	11	79
07:15	5	0	0	0	5	0	65	0	0	65	0	0	0	0	0	0	10	4	0	14	84
07:20	8	0	1	0	9	0	56	0	0	56	0	0	1	0	1	0	10	1	0	11	77
07:25	6	0	0	0	6	1	53	0	0	54	0	0	1	0	1	1	12	3	0	16	77
07:30	6	0	0	0	6	0	38	0	0	38	0	0	4	0	4	1	13	3	0	17	65
07:35	11	0	0	0	11	3	55	0	0	58	0	0	1	0	1	1	23	5	0	29	99
07:40	11	0	0	0	11	2	49	0	0	51	0	0	0	0	0	1	20	4	0	25	87
07:45	4	0	0	0	4	0	43	0	0	43	0	0	1	0	1	1	22	4	0	27	75
07:50	4	0	1	0	5	0	48	0	0	48	0	0	1	0	1	0	21	1	0	22	76
07:55	3	0	1	0	4	0	40	0	0	40	1	0	1	0	2	1	10	3	0	14	60
Total Volume	83	0	8	0	91	7	582	0	0	589	2	0	12	0	14	7	173	31	0	211	905
% App. Total	91.2	0	8.8	0		1.2	98.8	0	0		14.3	0	85.7	0		3.3	82	14.7	0		
PHF	.532	.000	.222	.000	.474	.194	.746	.000	.000	.755	.167	.000	.250	.000	.292	.583	.627	.517	.000	.606	.762

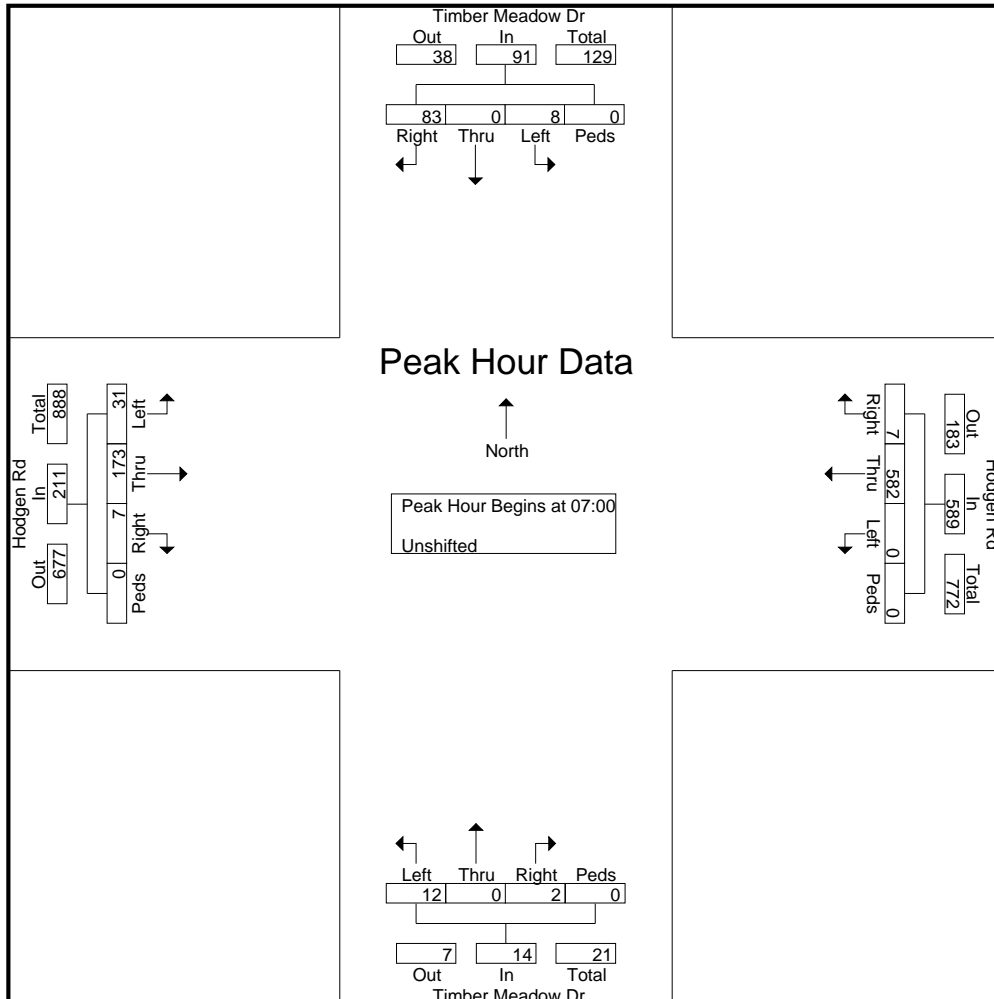

LSC Transportation Consultants, Inc.

2504 E. Pikes Peak Ave, Suite 304
 Colorado Springs, CO 80909
 719-633-2868

File Name : Timber Meadow Dr - Hodgen Rd AM 9-23
 Site Code : S234130
 Start Date : 9/12/2023
 Page No : 3

Start Time	Timber Meadow Dr Southbound					Hodgen Rd Westbound					Timber Meadow Dr Northbound					Hodgen Rd Eastbound					Int. Total
	Right	Thru	Left	Peds	App. Total	Right	Thru	Left	Peds	App. Total	Right	Thru	Left	Peds	App. Total	Right	Thru	Left	Peds	App. Total	
Peak Hour Analysis From 06:30 to 08:25 - Peak 1 of 1																					
Peak Hour for Each Approach Begins at:																					
	06:50					07:00					07:10					07:30					
+0 mins.	6	0	0	0	6	1	39	0	0	40	0	0	1	0	1	1	13	3	0	17	
+5 mins.	6	0	0	0	6	0	45	0	0	45	0	0	0	0	0	1	23	5	0	29	
+10 mins.	3	0	1	0	4	0	51	0	0	51	0	0	1	0	1	1	20	4	0	25	
+15 mins.	9	0	1	0	10	0	65	0	0	65	0	0	1	0	1	1	22	4	0	27	
+20 mins.	13	0	3	0	16	0	56	0	0	56	0	0	4	0	4	0	21	1	0	22	
+25 mins.	5	0	0	0	5	1	53	0	0	54	0	0	1	0	1	1	10	3	0	14	
+30 mins.	8	0	1	0	9	0	38	0	0	38	0	0	0	0	0	0	17	1	0	18	
+35 mins.	6	0	0	0	6	3	55	0	0	58	0	0	1	0	1	3	19	2	0	24	
+40 mins.	6	0	0	0	6	2	49	0	0	51	0	0	1	0	1	0	13	6	0	19	
+45 mins.	11	0	0	0	11	0	43	0	0	43	1	0	1	0	2	0	10	2	0	12	
+50 mins.	11	0	0	0	11	0	48	0	0	48	0	0	1	0	1	0	20	4	0	24	
+55 mins.	4	0	0	0	4	0	40	0	0	40	0	0	3	0	3	0	14	4	0	18	
Total Volume	88	0	6	0	94	7	582	0	0	589	1	0	15	0	16	8	202	39	0	249	
% App. Total	93.6	0	6.4	0		1.2	98.8	0	0		6.2	0	93.8	0		3.2	81.1	15.7	0		
PHF	.564	.000	.167	.000	.490	.194	.746	.000	.000	.755	.083	.000	.313	.000	.333	.222	.732	.542	.000	.716	

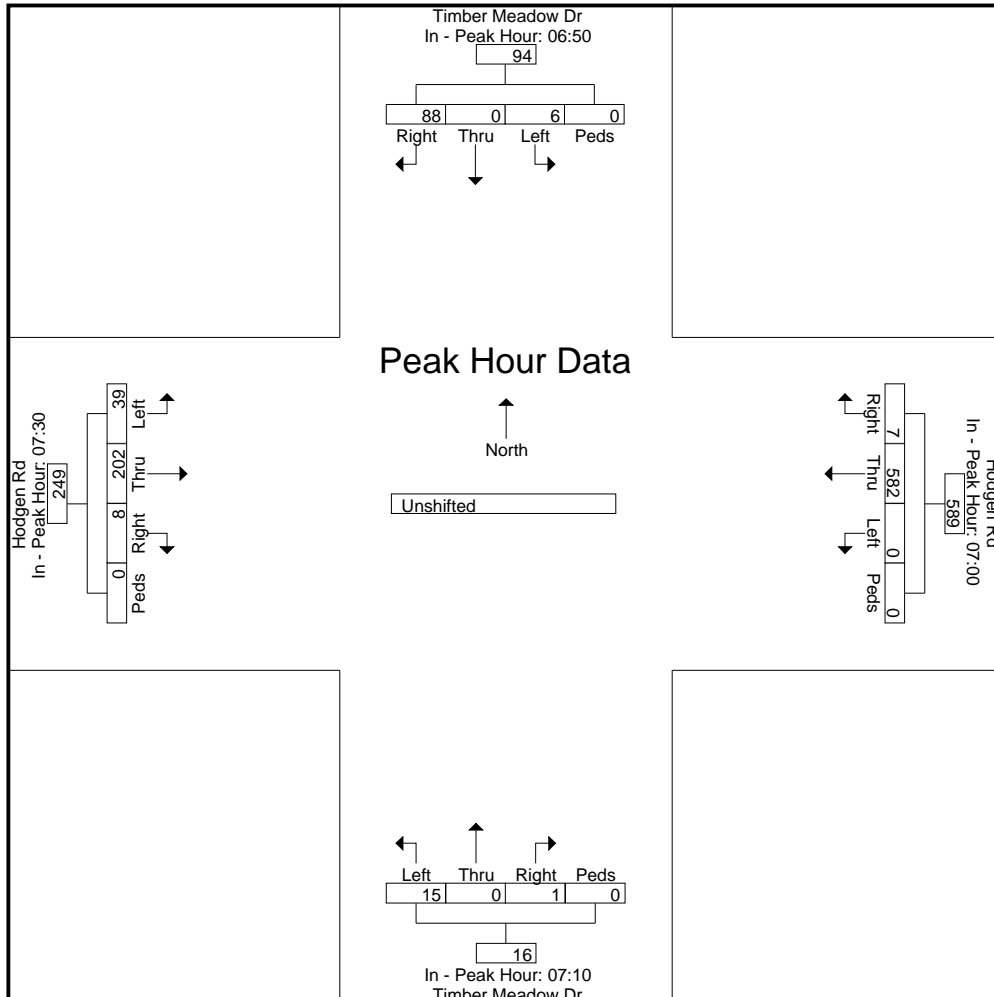

LSC Transportation Consultants, Inc.

2504 E. Pikes Peak Ave, Suite 304
 Colorado Springs, CO 80909
 719-633-2868

File Name : Timber Meadow Dr - Hodgen Rd PM 9-23

Site Code : S234130

Start Date : 9/12/2023

Page No : 1

Groups Printed- Unshifted

Start Time	Timber Meadow Dr Southbound					Hodgen Rd Westbound					Timber Meadow Dr Northbound					Hodgen Rd Eastbound					Int. Total
	Right	Thru	Left	Peds	App. Total	Right	Thru	Left	Peds	App. Total	Right	Thru	Left	Peds	App. Total	Right	Thru	Left	Peds	App. Total	
16:00	5	1	0	0	6	0	24	0	0	24	0	0	4	0	4	1	41	5	0	47	81
16:05	8	2	2	0	12	1	23	0	0	24	0	0	0	0	0	1	36	8	0	45	81
16:10	5	2	0	0	7	0	24	0	0	24	0	1	0	0	1	1	26	8	0	35	67
16:15	6	0	2	0	8	0	20	1	0	21	0	0	1	0	1	1	42	2	0	45	75
16:20	5	0	0	0	5	0	26	0	0	26	0	0	1	0	1	1	29	4	0	34	66
16:25	6	0	0	0	6	0	40	0	0	40	0	0	0	0	0	0	35	5	0	40	86
16:30	4	0	1	0	5	1	19	0	0	20	0	0	0	0	0	1	30	4	0	35	60
16:35	5	0	0	0	5	0	29	0	0	29	0	0	2	0	2	0	42	5	0	47	83
16:40	5	0	0	0	5	0	20	0	0	20	1	0	0	0	1	0	38	8	0	46	72
16:45	6	0	1	0	7	0	22	0	0	22	0	0	0	0	0	0	41	5	0	46	75
16:50	5	0	0	0	5	0	21	0	0	21	0	0	2	0	2	1	29	8	0	38	66
16:55	1	0	1	0	2	2	12	0	0	14	0	0	0	0	0	0	57	3	0	60	76
Total	61	5	7	0	73	4	280	1	0	285	1	1	10	0	12	7	446	65	0	518	888
17:00	5	0	0	0	5	0	18	0	0	18	0	0	0	0	0	1	44	5	0	50	73
17:05	8	0	0	0	8	2	19	0	0	21	0	0	2	0	2	0	44	7	0	51	82
17:10	3	0	1	0	4	1	32	0	0	33	1	0	0	0	1	1	41	8	0	50	88
17:15	3	0	2	0	5	2	27	0	0	29	0	0	1	0	1	1	48	7	0	56	91
17:20	5	0	0	0	5	0	18	0	0	18	0	0	0	0	0	3	46	9	0	58	81
17:25	5	0	1	0	6	0	26	0	0	26	0	0	1	0	1	1	46	5	0	52	85
17:30	4	0	0	0	4	0	15	0	0	15	0	0	0	0	0	1	44	8	0	53	72
17:35	3	0	0	0	3	1	35	0	0	36	0	0	0	0	0	1	31	10	0	42	81
17:40	4	0	1	0	5	1	20	0	0	21	0	0	2	0	2	1	43	3	0	47	75
17:45	3	0	0	0	3	0	19	0	0	19	0	0	2	0	2	1	46	6	0	53	77
17:50	6	0	0	0	6	1	26	0	0	27	1	0	0	0	1	1	16	7	0	24	58
17:55	3	0	0	0	3	0	13	0	0	13	0	0	0	0	0	0	30	5	0	35	51
Total	52	0	5	0	57	8	268	0	0	276	2	0	8	0	10	12	479	80	0	571	914
Grand Total	113	5	12	0	130	12	548	1	0	561	3	1	18	0	22	19	925	145	0	1089	1802
Apprch %	86.9	3.8	9.2	0		2.1	97.7	0.2	0		13.6	4.5	81.8	0		1.7	84.9	13.3	0		
Total %	6.3	0.3	0.7	0	7.2	0.7	30.4	0.1	0	31.1	0.2	0.1	1	0	1.2	1.1	51.3	8	0	60.4	

LSC Transportation Consultants, Inc.

2504 E. Pikes Peak Ave, Suite 304
 Colorado Springs, CO 80909
 719-633-2868

File Name : Timber Meadow Dr - Hodgen Rd PM 9-23

Site Code : S234130

Start Date : 9/12/2023

Page No : 2

Start Time	Timber Meadow Dr Southbound					Hodgen Rd Westbound					Timber Meadow Dr Northbound					Hodgen Rd Eastbound					Int. Total
	Right	Thru	Left	Peds	App. Total	Right	Thru	Left	Peds	App. Total	Right	Thru	Left	Peds	App. Total	Right	Thru	Left	Peds	App. Total	
Peak Hour Analysis From 16:00 to 17:55 - Peak 1 of 1																					
Peak Hour for Entire Intersection Begins at 16:50																					
16:50	5	0	0	0	5	0	21	0	0	21	0	0	2	0	2	1	29	8	0	38	66
16:55	1	0	1	0	2	2	12	0	0	14	0	0	0	0	0	0	57	3	0	60	76
17:00	5	0	0	0	5	0	18	0	0	18	0	0	0	0	0	1	44	5	0	50	73
17:05	8	0	0	0	8	2	19	0	0	21	0	0	2	0	2	0	44	7	0	51	82
17:10	3	0	1	0	4	1	32	0	0	33	1	0	0	0	1	1	41	8	0	50	88
17:15	3	0	2	0	5	2	27	0	0	29	0	0	1	0	1	1	48	7	0	56	91
17:20	5	0	0	0	5	0	18	0	0	18	0	0	0	0	0	3	46	9	0	58	81
17:25	5	0	1	0	6	0	26	0	0	26	0	0	1	0	1	1	46	5	0	52	85
17:30	4	0	0	0	4	0	15	0	0	15	0	0	0	0	0	1	44	8	0	53	72
17:35	3	0	0	0	3	1	35	0	0	36	0	0	0	0	0	1	31	10	0	42	81
17:40	4	0	1	0	5	1	20	0	0	21	0	0	2	0	2	1	43	3	0	47	75
17:45	3	0	0	0	3	0	19	0	0	19	0	0	2	0	2	1	46	6	0	53	77
Total Volume	49	0	6	0	55	9	262	0	0	271	1	0	10	0	11	12	519	79	0	610	947
% App. Total	89.1	0	10.9	0		3.3	96.7	0	0		9.1	0	90.9	0		2	85.1	13	0		
PHF	.510	.000	.250	.000	.573	.375	.624	.000	.000	.627	.083	.000	.417	.000	.458	.333	.759	.658	.000	.847	.867

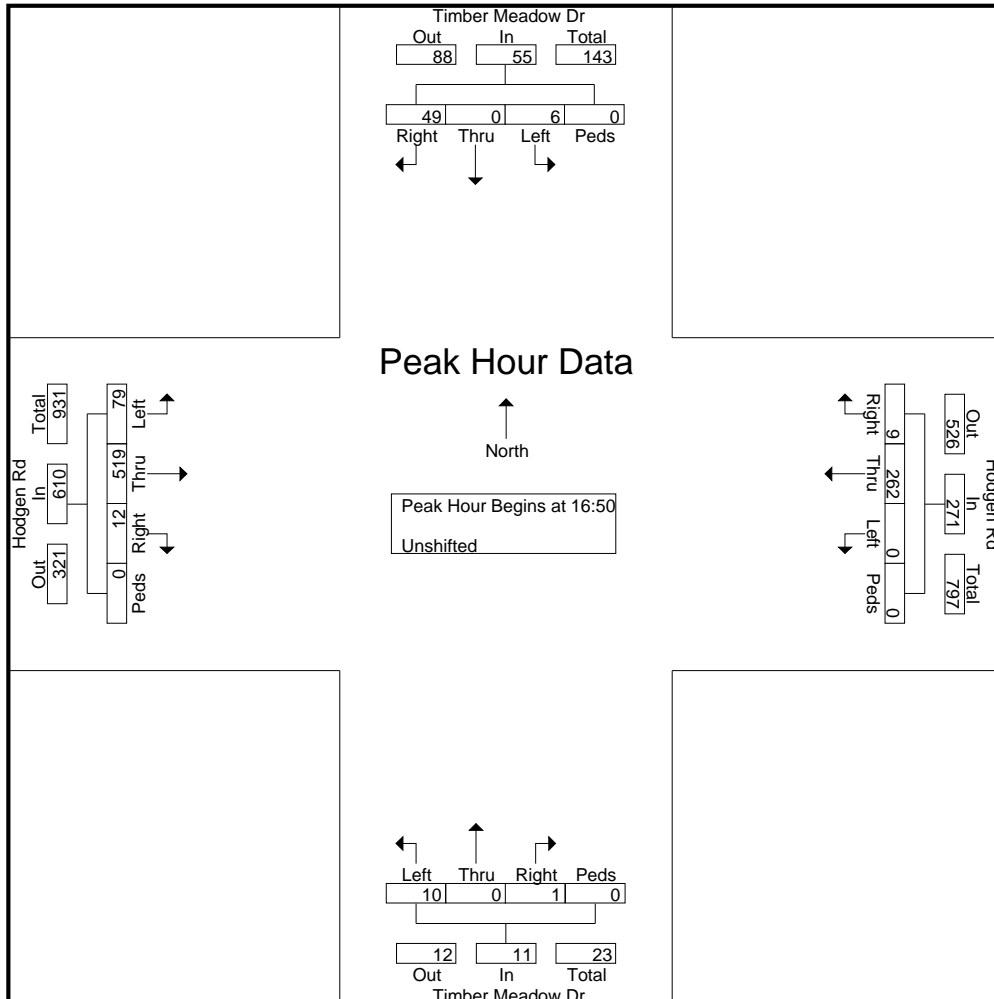

LSC Transportation Consultants, Inc.

2504 E. Pikes Peak Ave, Suite 304
 Colorado Springs, CO 80909
 719-633-2868

File Name : Timber Meadow Dr - Hodgen Rd PM 9-23

Site Code : S234130

Start Date : 9/12/2023

Page No : 3

Start Time	Timber Meadow Dr Southbound					Hodgen Rd Westbound					Timber Meadow Dr Northbound					Hodgen Rd Eastbound					Int. Total
	Right	Thru	Left	Peds	App. Total	Right	Thru	Left	Peds	App. Total	Right	Thru	Left	Peds	App. Total	Right	Thru	Left	Peds	App. Total	

Peak Hour Analysis From 16:00 to 17:55 - Peak 1 of 1

Peak Hour for Each Approach Begins at:

	16:00					16:20					16:00					16:50				
+0 mins.	5	1	0	0	6	0	26	0	0	26	0	0	4	0	4	1	29	8	0	38
+5 mins.	8	2	2	0	12	0	40	0	0	40	0	0	0	0	0	0	57	3	0	60
+10 mins.	5	2	0	0	7	1	19	0	0	20	0	1	0	0	1	1	44	5	0	50
+15 mins.	6	0	2	0	8	0	29	0	0	29	0	0	1	0	1	0	44	7	0	51
+20 mins.	5	0	0	0	5	0	20	0	0	20	0	0	1	0	1	1	41	8	0	50
+25 mins.	6	0	0	0	6	0	22	0	0	22	0	0	0	0	0	1	48	7	0	56
+30 mins.	4	0	1	0	5	0	21	0	0	21	0	0	0	0	0	3	46	9	0	58
+35 mins.	5	0	0	0	5	2	12	0	0	14	0	0	2	0	2	1	46	5	0	52
+40 mins.	5	0	0	0	5	0	18	0	0	18	1	0	0	0	1	1	44	8	0	53
+45 mins.	6	0	1	0	7	2	19	0	0	21	0	0	0	0	0	1	31	10	0	42
+50 mins.	5	0	0	0	5	1	32	0	0	33	0	0	2	0	2	1	43	3	0	47
+55 mins.	1	0	1	0	2	2	27	0	0	29	0	0	0	0	0	1	46	6	0	53
Total Volume	61	5	7	0	73	8	285	0	0	293	1	1	10	0	12	12	519	79	0	610
% App. Total	83.6	6.8	9.6	0		2.7	97.3	0	0		8.3	8.3	83.3	0		2	85.1	13	0	
PHF	.635	.208	.292	.000	.507	.333	.594	.000	.000	.610	.083	.083	.208	.000	.250	.333	.759	.658	.000	.847

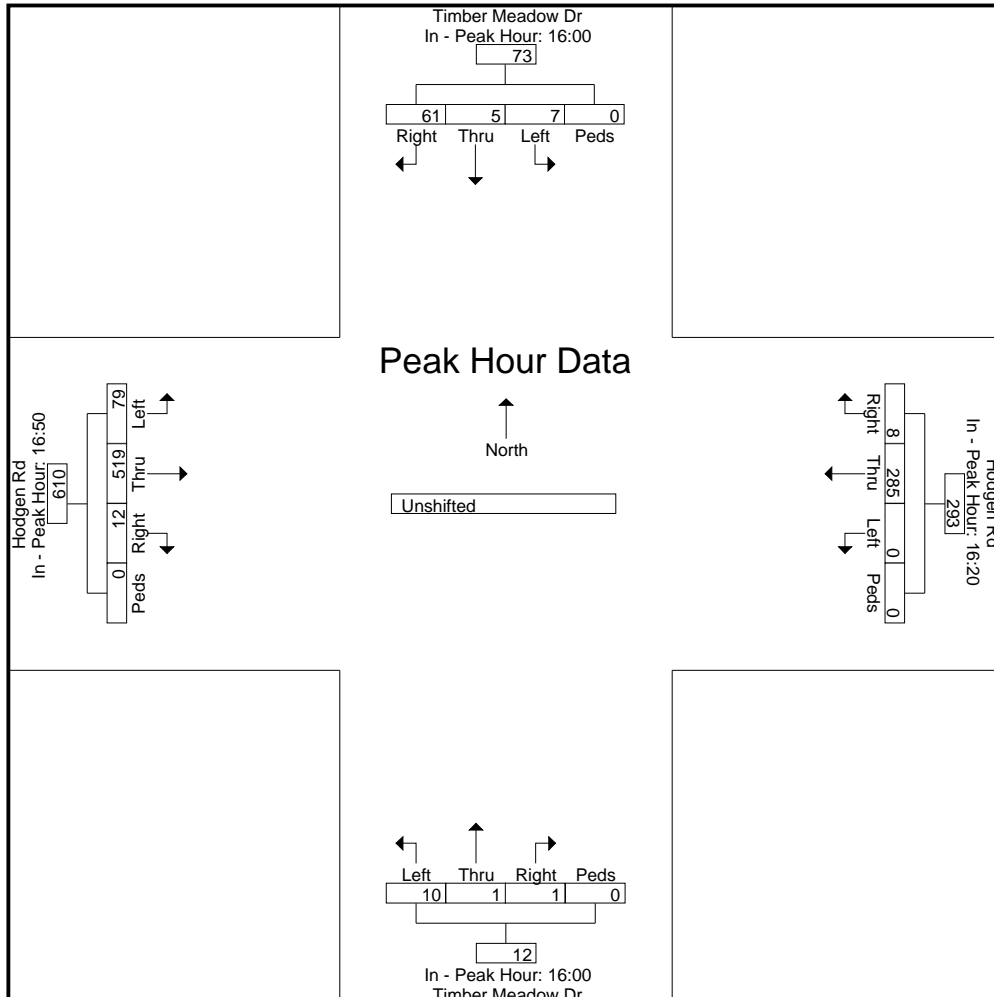

LSC Transportation Consultants, Inc.

2504 E. Pikes Peak Ave, Suite 304
 Colorado Springs, CO 80909
 719-633-2868

File Name : Timber Meadow Dr - Settlers Ranch Rd AM
 Site Code : S234130
 Start Date : 9/12/2023
 Page No : 1

Groups Printed- Bank 1

Start Time	Timber Meadow Dr Southbound					Settlers Ranch Rd Westbound					Timber Meadow Dr Northbound					Eastbound					Int. Total	
	Right	Thru	Left	Peds	App. Total	Right	Thru	Left	Peds	App. Total	Right	Thru	Left	Peds	App. Total	Right	Thru	Left	Peds	App. Total		
06:30	0	3	0	0	3	0	0	0	0	0	0	2	0	0	2	0	0	0	0	0	0	5
06:35	0	7	0	0	7	0	0	0	0	0	0	1	0	0	1	0	0	0	0	0	0	8
06:40	0	1	0	0	1	0	0	0	0	0	1	1	0	0	2	0	0	0	0	0	0	3
06:45	0	3	0	0	3	0	0	0	0	0	0	0	0	0	0	0	0	0	0	0	0	3
06:50	0	6	0	0	6	0	0	1	0	1	0	0	0	0	0	0	0	0	0	0	0	7
06:55	0	5	0	0	5	0	0	0	0	0	0	0	0	0	0	0	0	0	0	0	0	5
Total	0	25	0	0	25	0	0	1	0	1	1	4	0	0	5	0	0	0	0	0	0	31
07:00	0	4	0	0	4	0	0	1	0	1	0	2	0	0	2	0	0	0	0	0	0	7
07:05	0	12	0	0	12	0	0	0	0	0	0	0	0	0	0	0	0	0	0	0	0	12
07:10	0	14	0	0	14	0	0	1	0	1	0	2	0	0	2	0	0	0	0	0	0	17
07:15	0	4	0	0	4	0	0	0	0	0	1	3	0	0	4	0	0	0	0	0	0	8
07:20	0	7	0	0	7	0	0	2	0	2	0	1	0	0	1	0	0	0	0	0	0	10
07:25	0	5	0	0	5	0	0	1	0	1	0	4	0	0	4	0	0	0	0	0	0	10
07:30	0	6	0	0	6	0	0	1	0	1	1	2	0	0	3	0	0	0	0	0	0	10
07:35	0	9	0	0	9	0	0	1	0	1	2	6	0	0	8	0	0	0	0	0	0	18
07:40	0	9	0	0	9	0	0	2	0	2	1	4	0	0	5	0	0	0	0	0	0	16
07:45	0	4	0	0	4	0	0	0	0	0	0	5	0	0	5	0	0	0	0	0	0	9
07:50	0	5	0	0	5	0	0	0	0	0	1	0	0	0	1	0	0	0	0	0	0	6
07:55	0	3	0	0	3	0	0	1	0	1	2	1	0	0	3	0	0	0	0	0	0	7
Total	0	82	0	0	82	0	0	10	0	10	8	30	0	0	38	0	0	0	0	0	0	130
08:00	0	6	0	0	6	0	0	0	0	0	0	1	0	0	1	0	0	0	0	0	0	7
08:05	0	5	1	0	6	0	0	1	0	1	0	2	0	0	2	0	0	0	0	0	0	9
08:10	0	8	0	0	8	0	0	0	0	0	0	6	0	0	6	0	0	0	0	0	0	14
08:15	0	7	0	0	7	0	0	0	0	0	0	1	0	0	1	0	0	0	0	0	0	8
08:20	0	7	0	0	7	0	0	1	0	1	0	4	0	0	4	0	0	0	0	0	0	12
08:25	0	3	0	0	3	0	0	0	0	0	0	5	0	0	5	0	0	0	0	0	0	8
Grand Total	0	143	1	0	144	0	0	13	0	13	9	53	0	0	62	0	0	0	0	0	0	219
Apprch %	0	99.3	0.7	0		0	0	100	0		14.5	85.5	0	0		0	0	0	0	0	0	
Total %	0	65.3	0.5	0	65.8	0	0	5.9	0	5.9	4.1	24.2	0	0	28.3	0	0	0	0	0	0	

LSC Transportation Consultants, Inc.

2504 E. Pikes Peak Ave, Suite 304
 Colorado Springs, CO 80909
 719-633-2868

File Name : Timber Meadow Dr - Settlers Ranch Rd AM
 Site Code : S234130
 Start Date : 9/12/2023
 Page No : 2

Start Time	Timber Meadow Dr Southbound					Settlers Ranch Rd Westbound					Timber Meadow Dr Northbound					Eastbound					Int. Total
	Right	Thru	Left	Peds	App. Total	Right	Thru	Left	Peds	App. Total	Right	Thru	Left	Peds	App. Total	Right	Thru	Left	Peds	App. Total	
Peak Hour Analysis From 06:30 to 08:25 - Peak 1 of 1																					
Peak Hour for Entire Intersection Begins at 07:00																					
07:00	0	4	0	0	4	0	0	1	0	1	0	2	0	0	2	0	0	0	0	0	7
07:05	0	12	0	0	12	0	0	0	0	0	0	0	0	0	0	0	0	0	0	0	12
07:10	0	14	0	0	14	0	0	1	0	1	0	2	0	0	2	0	0	0	0	0	17
07:15	0	4	0	0	4	0	0	0	0	0	1	3	0	0	4	0	0	0	0	0	8
07:20	0	7	0	0	7	0	0	2	0	2	0	1	0	0	1	0	0	0	0	0	10
07:25	0	5	0	0	5	0	0	1	0	1	0	4	0	0	4	0	0	0	0	0	10
07:30	0	6	0	0	6	0	0	1	0	1	1	2	0	0	3	0	0	0	0	0	10
07:35	0	9	0	0	9	0	0	1	0	1	2	6	0	0	8	0	0	0	0	0	18
07:40	0	9	0	0	9	0	0	2	0	2	1	4	0	0	5	0	0	0	0	0	16
07:45	0	4	0	0	4	0	0	0	0	0	0	5	0	0	5	0	0	0	0	0	9
07:50	0	5	0	0	5	0	0	0	0	0	1	0	0	0	1	0	0	0	0	0	6
07:55	0	3	0	0	3	0	0	1	0	1	2	1	0	0	3	0	0	0	0	0	7
Total Volume	0	82	0	0	82	0	0	10	0	10	8	30	0	0	38	0	0	0	0	0	130
% App. Total	0	100	0	0		0	0	100	0		21.1	78.9	0	0		0	0	0	0		
PHF	.000	.488	.000	.000	.488	.000	.000	.417	.000	.417	.333	.417	.000	.000	.396	.000	.000	.000	.000	.000	.602

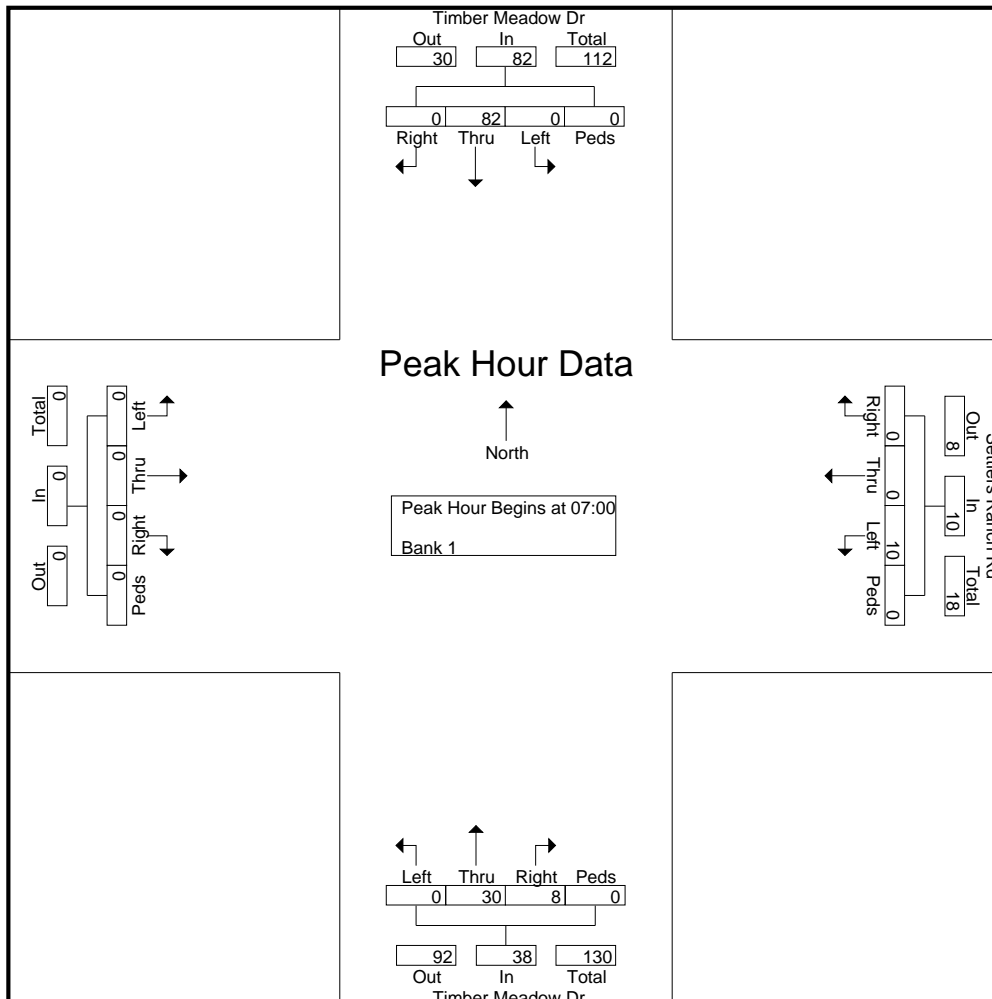

LSC Transportation Consultants, Inc.

2504 E. Pikes Peak Ave, Suite 304
 Colorado Springs, CO 80909
 719-633-2868

File Name : Timber Meadow Dr - Settlers Ranch Rd AM
 Site Code : S234130
 Start Date : 9/12/2023
 Page No : 3

Start Time	Timber Meadow Dr Southbound					Settlers Ranch Rd Westbound					Timber Meadow Dr Northbound					Eastbound					Int. Total
	Right	Thru	Left	Peds	App. Total	Right	Thru	Left	Peds	App. Total	Right	Thru	Left	Peds	App. Total	Right	Thru	Left	Peds	App. Total	

Peak Hour Analysis From 06:30 to 08:25 - Peak 1 of 1
 Peak Hour for Each Approach Begins at:

	06:50					06:45					07:30					06:30				
+0 mins.	0	6	0	0	6	0	0	0	0	0	1	2	0	0	3	0	0	0	0	0
+5 mins.	0	5	0	0	5	0	0	1	0	1	2	6	0	0	8	0	0	0	0	0
+10 mins.	0	4	0	0	4	0	0	0	0	0	1	4	0	0	5	0	0	0	0	0
+15 mins.	0	12	0	0	12	0	0	1	0	1	0	5	0	0	5	0	0	0	0	0
+20 mins.	0	14	0	0	14	0	0	0	0	0	1	0	0	0	1	0	0	0	0	0
+25 mins.	0	4	0	0	4	0	0	1	0	1	2	1	0	0	3	0	0	0	0	0
+30 mins.	0	7	0	0	7	0	0	0	0	0	0	1	0	0	1	0	0	0	0	0
+35 mins.	0	5	0	0	5	0	0	2	0	2	0	2	0	0	2	0	0	0	0	0
+40 mins.	0	6	0	0	6	0	0	1	0	1	0	6	0	0	6	0	0	0	0	0
+45 mins.	0	9	0	0	9	0	0	1	0	1	0	1	0	0	1	0	0	0	0	0
+50 mins.	0	9	0	0	9	0	0	1	0	1	0	4	0	0	4	0	0	0	0	0
+55 mins.	0	4	0	0	4	0	0	2	0	2	0	5	0	0	5	0	0	0	0	0
Total Volume	0	85	0	0	85	0	0	10	0	10	7	37	0	0	44	0	0	0	0	0
% App. Total	0	100	0	0		0	0	100	0		15.9	84.1	0	0		0	0	0	0	
PHF	.000	.506	.000	.000	.506	.000	.000	.417	.000	.417	.292	.514	.000	.000	.458	.000	.000	.000	.000	.000

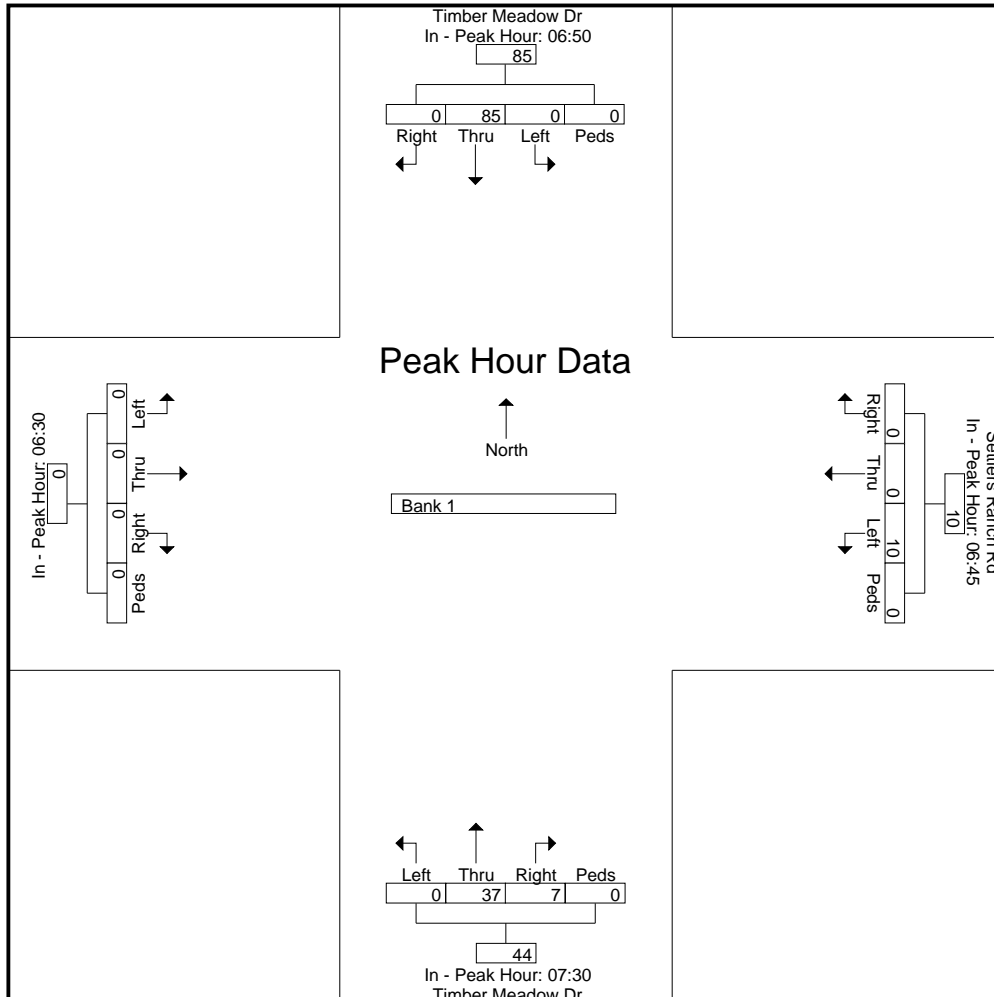

LSC Transportation Consultants, Inc.

2504 E. Pikes Peak Ave, Suite 304
 Colorado Springs, CO 80909
 719-633-2868

File Name : Timber Meadow Dr - Settlers Ranch Rd PM
 Site Code : S234130
 Start Date : 9/12/2023
 Page No : 1

Groups Printed- Bank 1

Start Time	Timber Meadow Dr Southbound					Settlers Ranch Rd Westbound					Timber Meadow Dr Northbound					Eastbound					Int. Total
	Right	Thru	Left	Peds	App. Total	Right	Thru	Left	Peds	App. Total	Right	Thru	Left	Peds	App. Total	Right	Thru	Left	Peds	App. Total	
16:00	0	5	0	0	5	0	0	0	0	0	0	4	0	0	4	0	0	0	0	0	9
16:05	0	11	1	0	12	1	0	1	0	2	0	10	0	0	10	0	0	0	0	0	24
16:10	0	7	1	0	8	0	0	0	0	0	1	6	0	0	7	0	0	0	0	0	15
16:15	0	8	0	0	8	0	0	0	0	0	0	3	0	0	3	0	0	0	0	0	11
16:20	0	5	0	0	5	0	0	0	0	0	0	4	0	0	4	0	0	0	0	0	9
16:25	0	7	0	0	7	0	0	0	0	0	0	5	0	0	5	0	0	0	0	0	12
16:30	0	3	0	0	3	0	0	0	0	0	1	3	0	0	4	0	0	0	0	0	7
16:35	0	5	0	0	5	0	0	0	0	0	1	4	0	0	5	0	0	0	0	0	10
16:40	0	5	0	0	5	1	0	1	0	2	2	5	0	0	7	0	0	0	0	0	14
16:45	0	6	0	0	6	0	0	0	0	0	0	7	0	0	7	0	0	0	0	0	13
16:50	0	6	0	0	6	0	0	0	0	0	1	7	0	0	8	0	0	0	0	0	14
16:55	0	2	1	0	3	0	0	1	0	1	0	5	0	0	5	0	0	0	0	0	9
Total	0	70	3	0	73	2	0	3	0	5	6	63	0	0	69	0	0	0	0	0	147
17:00	0	5	0	0	5	0	0	0	0	0	0	5	0	0	5	0	0	0	0	0	10
17:05	0	6	0	0	6	0	0	3	0	3	0	10	0	0	10	0	0	0	0	0	19
17:10	0	3	0	0	3	0	0	2	0	2	2	6	0	0	8	0	0	0	0	0	13
17:15	0	5	0	0	5	0	0	0	0	0	1	9	0	0	10	0	0	0	0	0	15
17:20	0	4	0	0	4	0	0	0	0	0	0	9	0	0	9	0	0	0	0	0	13
17:25	0	6	0	0	6	0	0	0	0	0	1	4	0	0	5	0	0	0	0	0	11
17:30	0	4	0	0	4	1	0	0	0	1	1	6	0	0	7	0	0	0	0	0	12
17:35	0	3	0	0	3	0	0	0	0	0	0	10	0	0	10	0	0	0	0	0	13
17:40	0	3	0	0	3	0	0	3	0	3	0	5	0	0	5	0	0	0	0	0	11
17:45	0	2	0	0	2	0	0	1	0	1	0	6	0	0	6	0	0	0	0	0	9
17:50	0	7	0	0	7	0	0	0	0	0	2	6	0	0	8	0	0	0	0	0	15
17:55	0	2	0	0	2	0	0	0	0	0	1	4	0	0	5	0	0	0	0	0	7
Total	0	50	0	0	50	1	0	9	0	10	8	80	0	0	88	0	0	0	0	0	148
Grand Total	0	120	3	0	123	3	0	12	0	15	14	143	0	0	157	0	0	0	0	0	295
Apprch %	0	97.6	2.4	0		20	0	80	0		8.9	91.1	0	0		0	0	0	0		
Total %	0	40.7	1	0	41.7	1	0	4.1	0	5.1	4.7	48.5	0	0	53.2	0	0	0	0	0	

LSC Transportation Consultants, Inc.

2504 E. Pikes Peak Ave, Suite 304
 Colorado Springs, CO 80909
 719-633-2868

File Name : Timber Meadow Dr - Settlers Ranch Rd PM

Site Code : S234130

Start Date : 9/12/2023

Page No : 2

Start Time	Timber Meadow Dr Southbound					Settlers Ranch Rd Westbound					Timber Meadow Dr Northbound					Eastbound					Int. Total
	Right	Thru	Left	Peds	App. Total	Right	Thru	Left	Peds	App. Total	Right	Thru	Left	Peds	App. Total	Right	Thru	Left	Peds	App. Total	
Peak Hour Analysis From 16:00 to 17:55 - Peak 1 of 1																					
Peak Hour for Entire Intersection Begins at 16:40																					
16:40	0	5	0	0	5	1	0	1	0	2	2	5	0	0	7	0	0	0	0	0	14
16:45	0	6	0	0	6	0	0	0	0	0	0	7	0	0	7	0	0	0	0	0	13
16:50	0	6	0	0	6	0	0	0	0	0	1	7	0	0	8	0	0	0	0	0	14
16:55	0	2	1	0	3	0	0	1	0	1	0	5	0	0	5	0	0	0	0	0	9
17:00	0	5	0	0	5	0	0	0	0	0	0	5	0	0	5	0	0	0	0	0	10
17:05	0	6	0	0	6	0	0	3	0	3	0	10	0	0	10	0	0	0	0	0	19
17:10	0	3	0	0	3	0	0	2	0	2	2	6	0	0	8	0	0	0	0	0	13
17:15	0	5	0	0	5	0	0	0	0	0	1	9	0	0	10	0	0	0	0	0	15
17:20	0	4	0	0	4	0	0	0	0	0	0	9	0	0	9	0	0	0	0	0	13
17:25	0	6	0	0	6	0	0	0	0	0	1	4	0	0	5	0	0	0	0	0	11
17:30	0	4	0	0	4	1	0	0	0	1	1	6	0	0	7	0	0	0	0	0	12
17:35	0	3	0	0	3	0	0	0	0	0	0	10	0	0	10	0	0	0	0	0	13
Total Volume	0	55	1	0	56	2	0	7	0	9	8	83	0	0	91	0	0	0	0	0	156
% App. Total	0	98.2	1.8	0		22.2	0	77.8	0		8.8	91.2	0	0		0	0	0	0		
PHF	.000	.764	.083	.000	.778	.167	.000	.194	.000	.250	.333	.692	.000	.000	.758	.000	.000	.000	.000	.000	.684

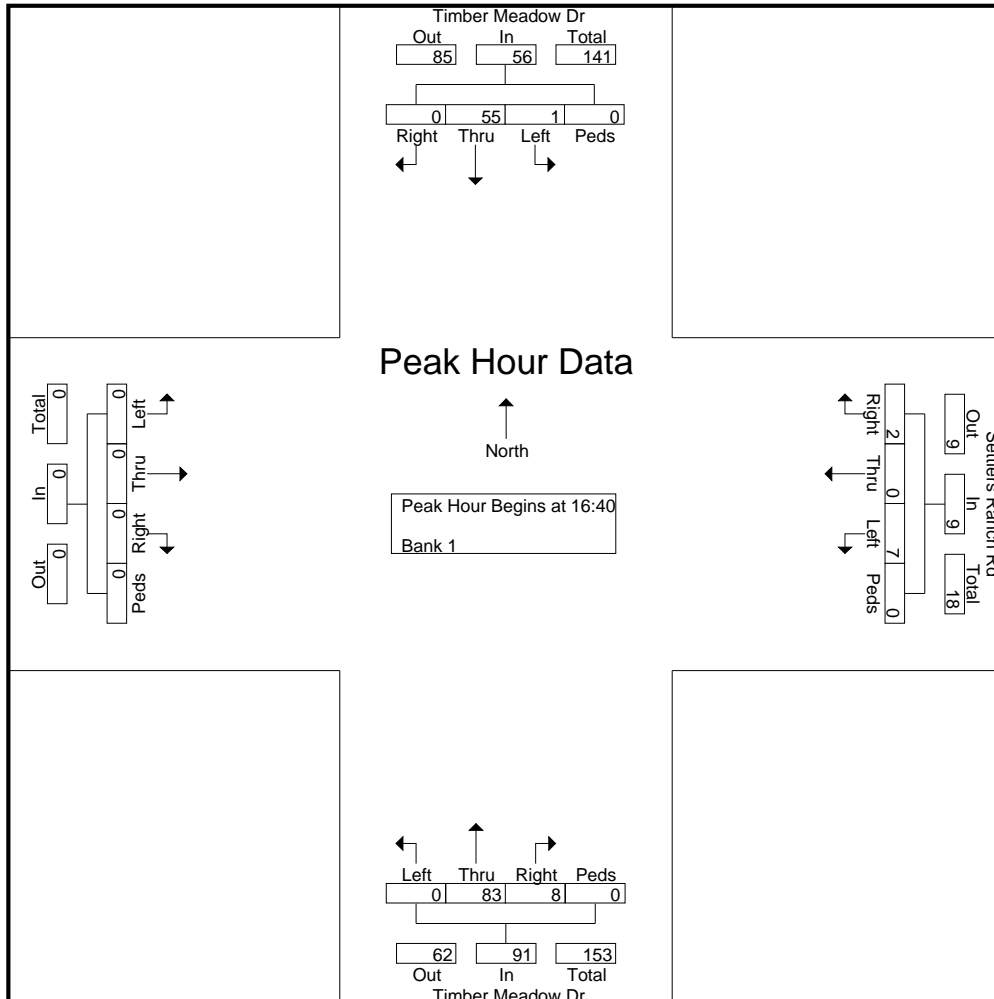

LSC Transportation Consultants, Inc.

2504 E. Pikes Peak Ave, Suite 304
 Colorado Springs, CO 80909
 719-633-2868

File Name : Timber Meadow Dr - Settlers Ranch Rd PM
 Site Code : S234130
 Start Date : 9/12/2023
 Page No : 3

	Timber Meadow Dr Southbound					Settlers Ranch Rd Westbound					Timber Meadow Dr Northbound					Eastbound					
Start Time	Right	Thru	Left	Peds	App. Total	Right	Thru	Left	Peds	App. Total	Right	Thru	Left	Peds	App. Total	Right	Thru	Left	Peds	App. Total	Int. Total

Peak Hour Analysis From 16:00 to 17:55 - Peak 1 of 1
 Peak Hour for Each Approach Begins at:

	16:00					16:50					16:40					16:00				
+0 mins.	0	5	0	0	5	0	0	0	0	0	2	5	0	0	7	0	0	0	0	0
+5 mins.	0	11	1	0	12	0	0	1	0	1	0	7	0	0	7	0	0	0	0	0
+10 mins.	0	7	1	0	8	0	0	0	0	0	1	7	0	0	8	0	0	0	0	0
+15 mins.	0	8	0	0	8	0	0	3	0	3	0	5	0	0	5	0	0	0	0	0
+20 mins.	0	5	0	0	5	0	0	2	0	2	0	5	0	0	5	0	0	0	0	0
+25 mins.	0	7	0	0	7	0	0	0	0	0	0	10	0	0	10	0	0	0	0	0
+30 mins.	0	3	0	0	3	0	0	0	0	0	2	6	0	0	8	0	0	0	0	0
+35 mins.	0	5	0	0	5	0	0	0	0	0	1	9	0	0	10	0	0	0	0	0
+40 mins.	0	5	0	0	5	1	0	0	0	1	0	9	0	0	9	0	0	0	0	0
+45 mins.	0	6	0	0	6	0	0	0	0	0	1	4	0	0	5	0	0	0	0	0
+50 mins.	0	6	0	0	6	0	0	3	0	3	1	6	0	0	7	0	0	0	0	0
+55 mins.	0	2	1	0	3	0	0	1	0	1	0	10	0	0	10	0	0	0	0	0
Total Volume	0	70	3	0	73	1	0	10	0	11	8	83	0	0	91	0	0	0	0	0
% App. Total	0	95.9	4.1	0		9.1	0	90.9	0		8.8	91.2	0	0		0	0	0	0	
PHF	.000	.530	.250	.000	.507	.083	.000	.278	.000	.306	.333	.692	.000	.000	.758	.000	.000	.000	.000	.000

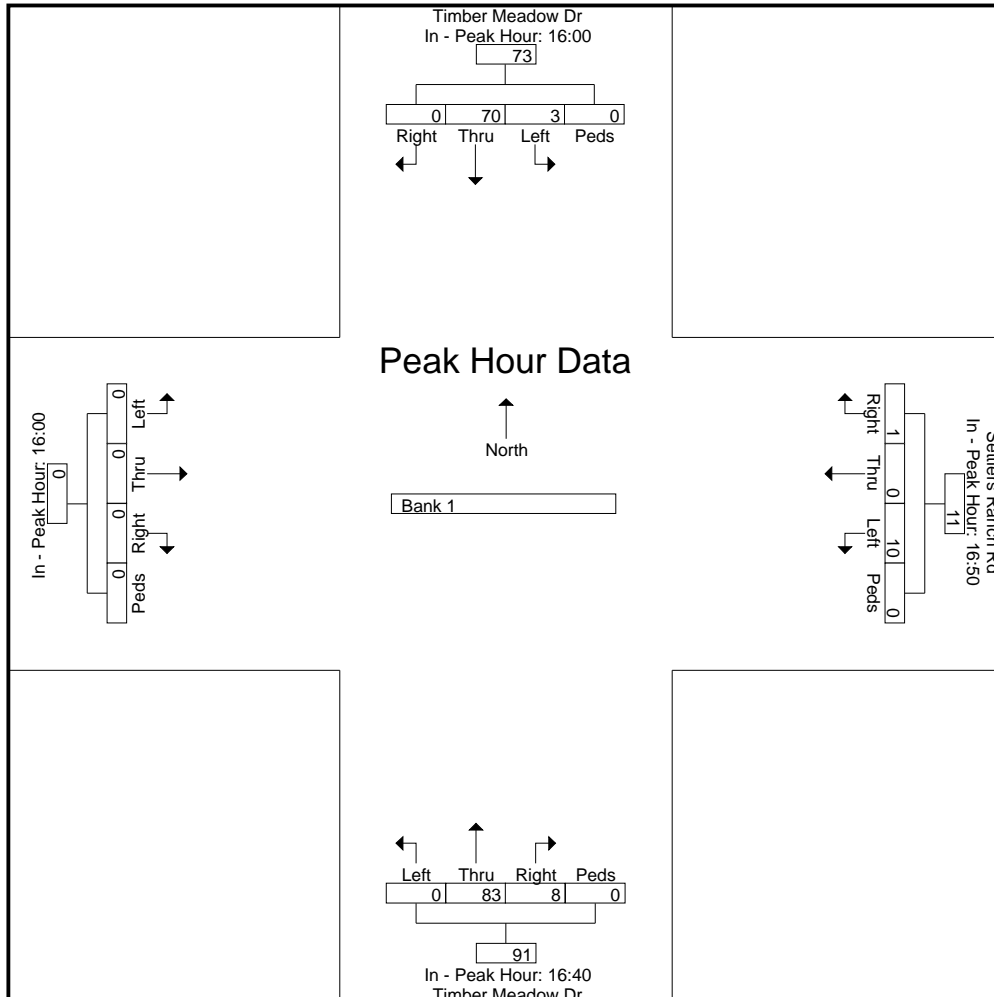

Level of Service Reports



Intersection												
Int Delay, s/veh	2.5											
Movement	EBL	EBT	EBR	WBL	WBT	WBR	NBL	NBT	NBR	SBL	SBT	SBR
Lane Configurations	↖	↑	↗	↖	↑	↗		↕			↕	
Traffic Vol, veh/h	31	173	7	0	582	7	12	0	2	8	0	83
Future Vol, veh/h	31	173	7	0	582	7	12	0	2	8	0	83
Conflicting Peds, #/hr	0	0	0	0	0	0	0	0	0	0	0	0
Sign Control	Free	Free	Free	Free	Free	Free	Stop	Stop	Stop	Stop	Stop	Stop
RT Channelized	-	-	None	-	-	None	-	-	None	-	-	None
Storage Length	460	-	410	520	-	520	-	-	-	-	-	-
Veh in Median Storage, #	-	0	-	-	0	-	-	0	-	-	0	-
Grade, %	-	0	-	-	0	-	-	0	-	-	0	-
Peak Hour Factor	87	87	87	93	93	93	78	78	78	83	83	83
Heavy Vehicles, %	2	2	2	2	2	2	2	2	2	2	2	2
Mvmt Flow	36	199	8	0	626	8	15	0	3	10	0	100

Major/Minor	Major1			Major2			Minor1			Minor2		
Conflicting Flow All	634	0	0	207	0	0	951	905	199	903	905	626
Stage 1	-	-	-	-	-	-	271	271	-	626	626	-
Stage 2	-	-	-	-	-	-	680	634	-	277	279	-
Critical Hdwy	4.12	-	-	4.12	-	-	7.12	6.52	6.22	7.12	6.52	6.22
Critical Hdwy Stg 1	-	-	-	-	-	-	6.12	5.52	-	6.12	5.52	-
Critical Hdwy Stg 2	-	-	-	-	-	-	6.12	5.52	-	6.12	5.52	-
Follow-up Hdwy	2.218	-	-	2.218	-	-	3.518	4.018	3.318	3.518	4.018	3.318
Pot Cap-1 Maneuver	949	-	-	1364	-	-	240	276	842	258	276	484
Stage 1	-	-	-	-	-	-	735	685	-	472	477	-
Stage 2	-	-	-	-	-	-	441	473	-	729	680	-
Platoon blocked, %	-	-	-	-	-	-	-	-	-	-	-	-
Mov Cap-1 Maneuver	949	-	-	1364	-	-	185	266	842	250	266	484
Mov Cap-2 Maneuver	-	-	-	-	-	-	185	266	-	250	266	-
Stage 1	-	-	-	-	-	-	707	659	-	454	477	-
Stage 2	-	-	-	-	-	-	350	473	-	699	654	-

Approach	EB	WB	NB	SB
HCM Control Delay, s	1.3	0	23.9	15.7
HCM LOS			C	C

Minor Lane/Major Mvmt	NBLn1	EBL	EBT	EBR	WBL	WBT	WBR	SBLn1
Capacity (veh/h)	208	949	-	-	1364	-	-	447
HCM Lane V/C Ratio	0.086	0.038	-	-	-	-	-	0.245
HCM Control Delay (s)	23.9	8.9	-	-	0	-	-	15.7
HCM Lane LOS	C	A	-	-	A	-	-	C
HCM 95th %tile Q(veh)	0.3	0.1	-	-	0	-	-	1

Intersection						
Int Delay, s/veh	0.7					
Movement	WBL	WBR	NBT	NBR	SBL	SBT
Lane Configurations						
Traffic Vol, veh/h	10	0	30	8	0	82
Future Vol, veh/h	10	0	30	8	0	82
Conflicting Peds, #/hr	0	0	0	0	0	0
Sign Control	Stop	Stop	Free	Free	Free	Free
RT Channelized	-	None	-	None	-	None
Storage Length	0	-	-	-	-	-
Veh in Median Storage, #	0	-	0	-	-	0
Grade, %	0	-	0	-	-	0
Peak Hour Factor	78	78	78	78	83	83
Heavy Vehicles, %	2	2	2	2	2	2
Mvmt Flow	13	0	38	10	0	99

Major/Minor	Minor1	Major1	Major2		
Conflicting Flow All	142	43	0	0	48
Stage 1	43	-	-	-	-
Stage 2	99	-	-	-	-
Critical Hdwy	6.42	6.22	-	-	4.12
Critical Hdwy Stg 1	5.42	-	-	-	-
Critical Hdwy Stg 2	5.42	-	-	-	-
Follow-up Hdwy	3.518	3.318	-	-	2.218
Pot Cap-1 Maneuver	851	1027	-	-	1559
Stage 1	979	-	-	-	-
Stage 2	925	-	-	-	-
Platoon blocked, %			-	-	-
Mov Cap-1 Maneuver	851	1027	-	-	1559
Mov Cap-2 Maneuver	851	-	-	-	-
Stage 1	979	-	-	-	-
Stage 2	925	-	-	-	-

Approach	WB	NB	SB
HCM Control Delay, s	9.3	0	0
HCM LOS	A		

Minor Lane/Major Mvmt	NBT	NBRWBLn1	SBL	SBT
Capacity (veh/h)	-	-	851	1559
HCM Lane V/C Ratio	-	-	0.015	-
HCM Control Delay (s)	-	-	9.3	0
HCM Lane LOS	-	-	A	A
HCM 95th %tile Q(veh)	-	-	0	0

Intersection						
Int Delay, s/veh	0					
Movement	EBL	EBR	NBL	NBT	SBT	SBR
Lane Configurations	T			T		
Traffic Vol, veh/h	0	0	0	15	10	0
Future Vol, veh/h	0	0	0	15	10	0
Conflicting Peds, #/hr	0	0	0	0	0	0
Sign Control	Stop	Stop	Free	Free	Free	Free
RT Channelized	-	None	-	None	-	None
Storage Length	0	-	-	-	-	-
Veh in Median Storage, #	0	-	-	0	0	-
Grade, %	0	-	-	0	0	-
Peak Hour Factor	78	78	78	78	78	78
Heavy Vehicles, %	2	2	2	2	2	2
Mvmt Flow	0	0	0	19	13	0

Major/Minor	Minor2	Major1		Major2	
Conflicting Flow All	32	13	13	0	0
Stage 1	13	-	-	-	-
Stage 2	19	-	-	-	-
Critical Hdwy	6.42	6.22	4.12	-	-
Critical Hdwy Stg 1	5.42	-	-	-	-
Critical Hdwy Stg 2	5.42	-	-	-	-
Follow-up Hdwy	3.518	3.318	2.218	-	-
Pot Cap-1 Maneuver	982	1067	1606	-	-
Stage 1	1010	-	-	-	-
Stage 2	1004	-	-	-	-
Platoon blocked, %				-	-
Mov Cap-1 Maneuver	982	1067	1606	-	-
Mov Cap-2 Maneuver	982	-	-	-	-
Stage 1	1010	-	-	-	-
Stage 2	1004	-	-	-	-

Approach	EB	NB	SB
HCM Control Delay, s	0	0	0
HCM LOS	A		

Minor Lane/Major Mvmt	NBL	NBT	EBLn1	SBT	SBR
Capacity (veh/h)	1606	-	-	-	-
HCM Lane V/C Ratio	-	-	-	-	-
HCM Control Delay (s)	0	-	0	-	-
HCM Lane LOS	A	-	A	-	-
HCM 95th %tile Q(veh)	0	-	-	-	-

Intersection						
Int Delay, s/veh	0.5					
Movement	EBL	EBT	WBT	WBR	SBL	SBR
Lane Configurations						
Traffic Vol, veh/h	11	154	461	5	2	16
Future Vol, veh/h	11	154	461	5	2	16
Conflicting Peds, #/hr	0	0	0	0	0	0
Sign Control	Free	Free	Free	Free	Stop	Stop
RT Channelized	-	None	-	None	-	None
Storage Length	415	-	-	-	0	-
Veh in Median Storage, #	-	0	0	-	0	-
Grade, %	-	0	0	-	0	-
Peak Hour Factor	87	87	92	92	78	78
Heavy Vehicles, %	2	2	2	2	2	2
Mvmt Flow	13	177	501	5	3	21

Major/Minor	Major1	Major2	Minor2		
Conflicting Flow All	506	0	-	0	707 504
Stage 1	-	-	-	-	504 -
Stage 2	-	-	-	-	203 -
Critical Hdwy	4.12	-	-	-	6.42 6.22
Critical Hdwy Stg 1	-	-	-	-	5.42 -
Critical Hdwy Stg 2	-	-	-	-	5.42 -
Follow-up Hdwy	2.218	-	-	-	3.518 3.318
Pot Cap-1 Maneuver	1059	-	-	-	402 568
Stage 1	-	-	-	-	607 -
Stage 2	-	-	-	-	831 -
Platoon blocked, %		-	-	-	
Mov Cap-1 Maneuver	1059	-	-	-	397 568
Mov Cap-2 Maneuver	-	-	-	-	397 -
Stage 1	-	-	-	-	600 -
Stage 2	-	-	-	-	831 -

Approach	EB	WB	SB
HCM Control Delay, s	0.6	0	11.9
HCM LOS			B

Minor Lane/Major Mvmt	EBL	EBT	WBT	WBR	SBLn1
Capacity (veh/h)	1059	-	-	-	542
HCM Lane V/C Ratio	0.012	-	-	-	0.043
HCM Control Delay (s)	8.4	-	-	-	11.9
HCM Lane LOS	A	-	-	-	B
HCM 95th %tile Q(veh)	0	-	-	-	0.1

Intersection												
Int Delay, s/veh	1.9											
Movement	EBL	EBT	EBR	WBL	WBT	WBR	NBL	NBT	NBR	SBL	SBT	SBR
Lane Configurations	↖	↗	↖	↖	↗	↖		↕			↕	
Traffic Vol, veh/h	79	519	12	9	262	0	10	0	1	6	0	49
Future Vol, veh/h	79	519	12	9	262	0	10	0	1	6	0	49
Conflicting Peds, #/hr	0	0	0	0	0	0	0	0	0	0	0	0
Sign Control	Free	Free	Free	Free	Free	Free	Stop	Stop	Stop	Stop	Stop	Stop
RT Channelized	-	-	None	-	-	None	-	-	None	-	-	None
Storage Length	460	-	410	520	-	520	-	-	-	-	-	-
Veh in Median Storage, #	-	0	-	-	0	-	-	0	-	-	0	-
Grade, %	-	0	-	-	0	-	-	0	-	-	0	-
Peak Hour Factor	93	93	93	92	92	92	78	78	78	83	83	83
Heavy Vehicles, %	2	2	2	2	2	2	2	2	2	2	2	2
Mvmt Flow	85	558	13	10	285	0	13	0	1	7	0	59

Major/Minor	Major1			Major2			Minor1			Minor2		
Conflicting Flow All	285	0	0	571	0	0	1063	1033	558	1040	1046	285
Stage 1	-	-	-	-	-	-	728	728	-	305	305	-
Stage 2	-	-	-	-	-	-	335	305	-	735	741	-
Critical Hdwy	4.12	-	-	4.12	-	-	7.12	6.52	6.22	7.12	6.52	6.22
Critical Hdwy Stg 1	-	-	-	-	-	-	6.12	5.52	-	6.12	5.52	-
Critical Hdwy Stg 2	-	-	-	-	-	-	6.12	5.52	-	6.12	5.52	-
Follow-up Hdwy	2.218	-	-	2.218	-	-	3.518	4.018	3.318	3.518	4.018	3.318
Pot Cap-1 Maneuver	1277	-	-	1002	-	-	201	232	529	208	228	754
Stage 1	-	-	-	-	-	-	415	429	-	705	662	-
Stage 2	-	-	-	-	-	-	679	662	-	411	423	-
Platoon blocked, %	-	-	-	-	-	-	-	-	-	-	-	-
Mov Cap-1 Maneuver	1277	-	-	1002	-	-	174	214	529	196	211	754
Mov Cap-2 Maneuver	-	-	-	-	-	-	174	214	-	196	211	-
Stage 1	-	-	-	-	-	-	387	400	-	658	655	-
Stage 2	-	-	-	-	-	-	620	655	-	383	395	-

Approach	EB			WB			NB			SB		
HCM Control Delay, s	1			0.3			26.1			12.1		
HCM LOS							D			B		

Minor Lane/Major Mvmt	NBLn1	EBL	EBT	EBR	WBL	WBT	WBR	SBLn1
Capacity (veh/h)	185	1277	-	-	1002	-	-	575
HCM Lane V/C Ratio	0.076	0.067	-	-	0.01	-	-	0.115
HCM Control Delay (s)	26.1	8	-	-	8.6	-	-	12.1
HCM Lane LOS	D	A	-	-	A	-	-	B
HCM 95th %tile Q(veh)	0.2	0.2	-	-	0	-	-	0.4

Intersection						
Int Delay, s/veh	0.6					
Movement	WBL	WBR	NBT	NBR	SBL	SBT
Lane Configurations						
Traffic Vol, veh/h	7	2	83	8	1	55
Future Vol, veh/h	7	2	83	8	1	55
Conflicting Peds, #/hr	0	0	0	0	0	0
Sign Control	Stop	Stop	Free	Free	Free	Free
RT Channelized	-	None	-	None	-	None
Storage Length	0	-	-	-	-	-
Veh in Median Storage, #	0	-	0	-	-	0
Grade, %	0	-	0	-	-	0
Peak Hour Factor	78	78	83	83	83	83
Heavy Vehicles, %	2	2	2	2	2	2
Mvmt Flow	9	3	100	10	1	66

Major/Minor	Minor1	Major1	Major2		
Conflicting Flow All	173	105	0	0	110
Stage 1	105	-	-	-	-
Stage 2	68	-	-	-	-
Critical Hdwy	6.42	6.22	-	-	4.12
Critical Hdwy Stg 1	5.42	-	-	-	-
Critical Hdwy Stg 2	5.42	-	-	-	-
Follow-up Hdwy	3.518	3.318	-	-	2.218
Pot Cap-1 Maneuver	817	949	-	-	1480
Stage 1	919	-	-	-	-
Stage 2	955	-	-	-	-
Platoon blocked, %			-	-	-
Mov Cap-1 Maneuver	816	949	-	-	1480
Mov Cap-2 Maneuver	816	-	-	-	-
Stage 1	919	-	-	-	-
Stage 2	954	-	-	-	-

Approach	WB	NB	SB
HCM Control Delay, s	9.3	0	0.1
HCM LOS	A		

Minor Lane/Major Mvmt	NBT	NBRWBLn1	SBL	SBT
Capacity (veh/h)	-	-	842	1480
HCM Lane V/C Ratio	-	-	0.014	0.001
HCM Control Delay (s)	-	-	9.3	7.4
HCM Lane LOS	-	-	A	A
HCM 95th %tile Q(veh)	-	-	0	0

Intersection						
Int Delay, s/veh	0					
Movement	EBL	EBR	NBL	NBT	SBT	SBR
Lane Configurations						
Traffic Vol, veh/h	0	0	0	15	12	0
Future Vol, veh/h	0	0	0	15	12	0
Conflicting Peds, #/hr	0	0	0	0	0	0
Sign Control	Stop	Stop	Free	Free	Free	Free
RT Channelized	-	None	-	None	-	None
Storage Length	0	-	-	-	-	-
Veh in Median Storage, #	0	-	-	0	0	-
Grade, %	0	-	-	0	0	-
Peak Hour Factor	78	78	78	78	78	78
Heavy Vehicles, %	2	2	2	2	2	2
Mvmt Flow	0	0	0	19	15	0

Major/Minor	Minor2	Major1		Major2	
Conflicting Flow All	34	15	15	0	0
Stage 1	15	-	-	-	-
Stage 2	19	-	-	-	-
Critical Hdwy	6.42	6.22	4.12	-	-
Critical Hdwy Stg 1	5.42	-	-	-	-
Critical Hdwy Stg 2	5.42	-	-	-	-
Follow-up Hdwy	3.518	3.318	2.218	-	-
Pot Cap-1 Maneuver	979	1065	1603	-	-
Stage 1	1008	-	-	-	-
Stage 2	1004	-	-	-	-
Platoon blocked, %				-	-
Mov Cap-1 Maneuver	979	1065	1603	-	-
Mov Cap-2 Maneuver	979	-	-	-	-
Stage 1	1008	-	-	-	-
Stage 2	1004	-	-	-	-

Approach	EB	NB	SB
HCM Control Delay, s	0	0	0
HCM LOS	A		

Minor Lane/Major Mvmt	NBL	NBT	EBLn1	SBT	SBR
Capacity (veh/h)	1603	-	-	-	-
HCM Lane V/C Ratio	-	-	-	-	-
HCM Control Delay (s)	0	-	0	-	-
HCM Lane LOS	A	-	A	-	-
HCM 95th %tile Q(veh)	0	-	-	-	-

Intersection						
Int Delay, s/veh	0.8					
Movement	EBL	EBT	WBT	WBR	SBL	SBR
Lane Configurations						
Traffic Vol, veh/h	17	466	203	6	13	20
Future Vol, veh/h	17	466	203	6	13	20
Conflicting Peds, #/hr	0	0	0	0	0	0
Sign Control	Free	Free	Free	Free	Stop	Stop
RT Channelized	-	None	-	None	-	None
Storage Length	415	-	-	-	0	-
Veh in Median Storage, #	-	0	0	-	0	-
Grade, %	-	0	0	-	0	-
Peak Hour Factor	92	92	87	87	78	78
Heavy Vehicles, %	2	2	2	2	2	2
Mvmt Flow	18	507	233	7	17	26

Major/Minor	Major1	Major2	Minor2		
Conflicting Flow All	240	0	-	0	780 237
Stage 1	-	-	-	-	237 -
Stage 2	-	-	-	-	543 -
Critical Hdwy	4.12	-	-	-	6.42 6.22
Critical Hdwy Stg 1	-	-	-	-	5.42 -
Critical Hdwy Stg 2	-	-	-	-	5.42 -
Follow-up Hdwy	2.218	-	-	-	3.518 3.318
Pot Cap-1 Maneuver	1327	-	-	-	364 802
Stage 1	-	-	-	-	802 -
Stage 2	-	-	-	-	582 -
Platoon blocked, %		-	-	-	
Mov Cap-1 Maneuver	1327	-	-	-	359 802
Mov Cap-2 Maneuver	-	-	-	-	359 -
Stage 1	-	-	-	-	791 -
Stage 2	-	-	-	-	582 -

Approach	EB	WB	SB
HCM Control Delay, s	0.3	0	12.2
HCM LOS			B

Minor Lane/Major Mvmt	EBL	EBT	WBT	WBR	SBLn1
Capacity (veh/h)	1327	-	-	-	540
HCM Lane V/C Ratio	0.014	-	-	-	0.078
HCM Control Delay (s)	7.8	-	-	-	12.2
HCM Lane LOS	A	-	-	-	B
HCM 95th %tile Q(veh)	0	-	-	-	0.3

Intersection												
Int Delay, s/veh	2.7											
Movement	EBL	EBT	EBR	WBL	WBT	WBR	NBL	NBT	NBR	SBL	SBT	SBR
Lane Configurations												
Traffic Vol, veh/h	37	173	7	0	582	7	12	0	2	8	0	90
Future Vol, veh/h	37	173	7	0	582	7	12	0	2	8	0	90
Conflicting Peds, #/hr	0	0	0	0	0	0	0	0	0	0	0	0
Sign Control	Free	Free	Free	Free	Free	Free	Stop	Stop	Stop	Stop	Stop	Stop
RT Channelized	-	-	None	-	-	None	-	-	None	-	-	None
Storage Length	460	-	410	520	-	520	-	-	-	-	-	-
Veh in Median Storage, #	-	0	-	-	0	-	-	0	-	-	0	-
Grade, %	-	0	-	-	0	-	-	0	-	-	0	-
Peak Hour Factor	87	87	87	93	93	93	78	78	78	83	83	83
Heavy Vehicles, %	2	2	2	2	2	2	2	2	2	2	2	2
Mvmt Flow	43	199	8	0	626	8	15	0	3	10	0	108

Major/Minor	Major1			Major2			Minor1			Minor2		
Conflicting Flow All	634	0	0	207	0	0	969	919	199	917	919	626
Stage 1	-	-	-	-	-	-	285	285	-	626	626	-
Stage 2	-	-	-	-	-	-	684	634	-	291	293	-
Critical Hdwy	4.12	-	-	4.12	-	-	7.12	6.52	6.22	7.12	6.52	6.22
Critical Hdwy Stg 1	-	-	-	-	-	-	6.12	5.52	-	6.12	5.52	-
Critical Hdwy Stg 2	-	-	-	-	-	-	6.12	5.52	-	6.12	5.52	-
Follow-up Hdwy	2.218	-	-	2.218	-	-	3.518	4.018	3.318	3.518	4.018	3.318
Pot Cap-1 Maneuver	949	-	-	1364	-	-	233	271	842	253	271	484
Stage 1	-	-	-	-	-	-	722	676	-	472	477	-
Stage 2	-	-	-	-	-	-	439	473	-	717	670	-
Platoon blocked, %	-	-	-	-	-	-	-	-	-	-	-	-
Mov Cap-1 Maneuver	949	-	-	1364	-	-	175	259	842	243	259	484
Mov Cap-2 Maneuver	-	-	-	-	-	-	175	259	-	243	259	-
Stage 1	-	-	-	-	-	-	690	646	-	451	477	-
Stage 2	-	-	-	-	-	-	341	473	-	682	640	-

Approach	EB	WB	NB	SB
HCM Control Delay, s	1.5	0	25.1	15.9
HCM LOS			D	C

Minor Lane/Major Mvmt	NBLn1	EBL	EBT	EBR	WBL	WBT	WBR	SBLn1
Capacity (veh/h)	197	949	-	-	1364	-	-	448
HCM Lane V/C Ratio	0.091	0.045	-	-	-	-	-	0.264
HCM Control Delay (s)	25.1	9	-	-	0	-	-	15.9
HCM Lane LOS	D	A	-	-	A	-	-	C
HCM 95th %tile Q(veh)	0.3	0.1	-	-	0	-	-	1

Intersection						
Int Delay, s/veh	1.2					
Movement	WBL	WBR	NBT	NBR	SBL	SBT
Lane Configurations	W		T			T
Traffic Vol, veh/h	17	0	30	14	0	82
Future Vol, veh/h	17	0	30	14	0	82
Conflicting Peds, #/hr	0	0	0	0	0	0
Sign Control	Stop	Stop	Free	Free	Free	Free
RT Channelized	-	None	-	None	-	None
Storage Length	0	-	-	-	-	-
Veh in Median Storage, #	0	-	0	-	-	0
Grade, %	0	-	0	-	-	0
Peak Hour Factor	78	78	78	78	83	83
Heavy Vehicles, %	2	2	2	2	2	2
Mvmt Flow	22	0	38	18	0	99

Major/Minor	Minor1	Major1	Major2		
Conflicting Flow All	146	47	0	0	56
Stage 1	47	-	-	-	-
Stage 2	99	-	-	-	-
Critical Hdwy	6.42	6.22	-	-	4.12
Critical Hdwy Stg 1	5.42	-	-	-	-
Critical Hdwy Stg 2	5.42	-	-	-	-
Follow-up Hdwy	3.518	3.318	-	-	2.218
Pot Cap-1 Maneuver	846	1022	-	-	1549
Stage 1	975	-	-	-	-
Stage 2	925	-	-	-	-
Platoon blocked, %					
Mov Cap-1 Maneuver	846	1022	-	-	1549
Mov Cap-2 Maneuver	846	-	-	-	-
Stage 1	975	-	-	-	-
Stage 2	925	-	-	-	-

Approach	WB	NB	SB
HCM Control Delay, s	9.4	0	0
HCM LOS	A		

Minor Lane/Major Mvmt	NBT	NBRWBLn1	SBL	SBT
Capacity (veh/h)	-	-	846	1549
HCM Lane V/C Ratio	-	-	0.026	-
HCM Control Delay (s)	-	-	9.4	0
HCM Lane LOS	-	-	A	A
HCM 95th %tile Q(veh)	-	-	0.1	0

Intersection						
Int Delay, s/veh	1.6					
Movement	EBL	EBR	NBL	NBT	SBT	SBR
Lane Configurations						
Traffic Vol, veh/h	0	5	1	15	10	0
Future Vol, veh/h	0	5	1	15	10	0
Conflicting Peds, #/hr	0	0	0	0	0	0
Sign Control	Stop	Stop	Free	Free	Free	Free
RT Channelized	-	None	-	None	-	None
Storage Length	0	-	-	-	-	-
Veh in Median Storage, #	0	-	-	0	0	-
Grade, %	0	-	-	0	0	-
Peak Hour Factor	78	78	78	78	78	78
Heavy Vehicles, %	2	2	2	2	2	2
Mvmt Flow	0	6	1	19	13	0

Major/Minor	Minor2	Major1		Major2	
Conflicting Flow All	34	13	13	0	0
Stage 1	13	-	-	-	-
Stage 2	21	-	-	-	-
Critical Hdwy	6.42	6.22	4.12	-	-
Critical Hdwy Stg 1	5.42	-	-	-	-
Critical Hdwy Stg 2	5.42	-	-	-	-
Follow-up Hdwy	3.518	3.318	2.218	-	-
Pot Cap-1 Maneuver	979	1067	1606	-	-
Stage 1	1010	-	-	-	-
Stage 2	1002	-	-	-	-
Platoon blocked, %				-	-
Mov Cap-1 Maneuver	978	1067	1606	-	-
Mov Cap-2 Maneuver	978	-	-	-	-
Stage 1	1009	-	-	-	-
Stage 2	1002	-	-	-	-

Approach	EB	NB	SB
HCM Control Delay, s	8.4	0.5	0
HCM LOS	A		

Minor Lane/Major Mvmt	NBL	NBT	EBLn1	SBT	SBR
Capacity (veh/h)	1606	-	1067	-	-
HCM Lane V/C Ratio	0.001	-	0.006	-	-
HCM Control Delay (s)	7.2	0	8.4	-	-
HCM Lane LOS	A	A	A	-	-
HCM 95th %tile Q(veh)	0	-	0	-	-

Intersection						
Int Delay, s/veh	0.6					
Movement	EBL	EBT	WBT	WBR	SBL	SBR
Lane Configurations						
Traffic Vol, veh/h	11	154	461	5	3	19
Future Vol, veh/h	11	154	461	5	3	19
Conflicting Peds, #/hr	0	0	0	0	0	0
Sign Control	Free	Free	Free	Free	Stop	Stop
RT Channelized	-	None	-	None	-	None
Storage Length	415	-	-	-	0	-
Veh in Median Storage, #	-	0	0	-	0	-
Grade, %	-	0	0	-	0	-
Peak Hour Factor	87	87	92	92	78	78
Heavy Vehicles, %	2	2	2	2	2	2
Mvmt Flow	13	177	501	5	4	24

Major/Minor	Major1	Major2	Minor2		
Conflicting Flow All	506	0	-	0	707
Stage 1	-	-	-	-	504
Stage 2	-	-	-	-	203
Critical Hdwy	4.12	-	-	-	6.42
Critical Hdwy Stg 1	-	-	-	-	5.42
Critical Hdwy Stg 2	-	-	-	-	5.42
Follow-up Hdwy	2.218	-	-	-	3.518
Pot Cap-1 Maneuver	1059	-	-	-	402
Stage 1	-	-	-	-	607
Stage 2	-	-	-	-	831
Platoon blocked, %		-	-	-	
Mov Cap-1 Maneuver	1059	-	-	-	397
Mov Cap-2 Maneuver	-	-	-	-	397
Stage 1	-	-	-	-	600
Stage 2	-	-	-	-	831

Approach	EB	WB	SB
HCM Control Delay, s	0.6	0	12.1
HCM LOS			B

Minor Lane/Major Mvmt	EBL	EBT	WBT	WBR	SBLn1
Capacity (veh/h)	1059	-	-	-	536
HCM Lane V/C Ratio	0.012	-	-	-	0.053
HCM Control Delay (s)	8.4	-	-	-	12.1
HCM Lane LOS	A	-	-	-	B
HCM 95th %tile Q(veh)	0	-	-	-	0.2

Intersection												
Int Delay, s/veh	2.2											
Movement	EBL	EBT	EBR	WBL	WBT	WBR	NBL	NBT	NBR	SBL	SBT	SBR
Lane Configurations	↖	↗	↖	↖	↗	↖		↔			↔	
Traffic Vol, veh/h	91	519	12	9	262	0	10	0	1	13	0	49
Future Vol, veh/h	91	519	12	9	262	0	10	0	1	13	0	49
Conflicting Peds, #/hr	0	0	0	0	0	0	0	0	0	0	0	0
Sign Control	Free	Free	Free	Free	Free	Free	Stop	Stop	Stop	Stop	Stop	Stop
RT Channelized	-	-	None	-	-	None	-	-	None	-	-	None
Storage Length	460	-	410	520	-	520	-	-	-	-	-	-
Veh in Median Storage, #	-	0	-	-	0	-	-	0	-	-	0	-
Grade, %	-	0	-	-	0	-	-	0	-	-	0	-
Peak Hour Factor	93	93	93	92	92	92	78	78	78	83	83	83
Heavy Vehicles, %	2	2	2	2	2	2	2	2	2	2	2	2
Mvmt Flow	98	558	13	10	285	0	13	0	1	16	0	59

Major/Minor	Major1			Major2			Minor1			Minor2		
Conflicting Flow All	285	0	0	571	0	0	1089	1059	558	1066	1072	285
Stage 1	-	-	-	-	-	-	754	754	-	305	305	-
Stage 2	-	-	-	-	-	-	335	305	-	761	767	-
Critical Hdwy	4.12	-	-	4.12	-	-	7.12	6.52	6.22	7.12	6.52	6.22
Critical Hdwy Stg 1	-	-	-	-	-	-	6.12	5.52	-	6.12	5.52	-
Critical Hdwy Stg 2	-	-	-	-	-	-	6.12	5.52	-	6.12	5.52	-
Follow-up Hdwy	2.218	-	-	2.218	-	-	3.518	4.018	3.318	3.518	4.018	3.318
Pot Cap-1 Maneuver	1277	-	-	1002	-	-	193	224	529	200	220	754
Stage 1	-	-	-	-	-	-	401	417	-	705	662	-
Stage 2	-	-	-	-	-	-	679	662	-	398	411	-
Platoon blocked, %	-	-	-	-	-	-	-	-	-	-	-	-
Mov Cap-1 Maneuver	1277	-	-	1002	-	-	166	205	529	186	201	754
Mov Cap-2 Maneuver	-	-	-	-	-	-	166	205	-	186	201	-
Stage 1	-	-	-	-	-	-	370	385	-	651	655	-
Stage 2	-	-	-	-	-	-	620	655	-	367	379	-

Approach	EB			WB			NB			SB		
HCM Control Delay, s	1.2			0.3			27.1			14.3		
HCM LOS							D			B		

Minor Lane/Major Mvmt	NBLn1	EBL	EBT	EBR	WBL	WBT	WBR	SBLn1
Capacity (veh/h)	177	1277	-	-	1002	-	-	460
HCM Lane V/C Ratio	0.08	0.077	-	-	0.01	-	-	0.162
HCM Control Delay (s)	27.1	8.1	-	-	8.6	-	-	14.3
HCM Lane LOS		D	A	-	-	A	-	B
HCM 95th %tile Q(veh)	0.3	0.2	-	-	0	-	-	0.6

Intersection						
Int Delay, s/veh	0.9					
Movement	WBL	WBR	NBT	NBR	SBL	SBT
Lane Configurations						
Traffic Vol, veh/h	13	2	83	20	1	55
Future Vol, veh/h	13	2	83	20	1	55
Conflicting Peds, #/hr	0	0	0	0	0	0
Sign Control	Stop	Stop	Free	Free	Free	Free
RT Channelized	-	None	-	None	-	None
Storage Length	0	-	-	-	-	-
Veh in Median Storage, #	0	-	0	-	-	0
Grade, %	0	-	0	-	-	0
Peak Hour Factor	78	78	83	83	83	83
Heavy Vehicles, %	2	2	2	2	2	2
Mvmt Flow	17	3	100	24	1	66

Major/Minor	Minor1	Major1	Major2		
Conflicting Flow All	180	112	0	0	124
Stage 1	112	-	-	-	-
Stage 2	68	-	-	-	-
Critical Hdwy	6.42	6.22	-	-	4.12
Critical Hdwy Stg 1	5.42	-	-	-	-
Critical Hdwy Stg 2	5.42	-	-	-	-
Follow-up Hdwy	3.518	3.318	-	-	2.218
Pot Cap-1 Maneuver	810	941	-	-	1463
Stage 1	913	-	-	-	-
Stage 2	955	-	-	-	-
Platoon blocked, %			-	-	-
Mov Cap-1 Maneuver	809	941	-	-	1463
Mov Cap-2 Maneuver	809	-	-	-	-
Stage 1	913	-	-	-	-
Stage 2	954	-	-	-	-

Approach	WB	NB	SB
HCM Control Delay, s	9.5	0	0.1
HCM LOS	A		

Minor Lane/Major Mvmt	NBT	NBRWBLn1	SBL	SBT
Capacity (veh/h)	-	-	824	1463
HCM Lane V/C Ratio	-	-	0.023	0.001
HCM Control Delay (s)	-	-	9.5	7.5
HCM Lane LOS	-	-	A	A
HCM 95th %tile Q(veh)	-	-	0.1	0

Intersection						
Int Delay, s/veh	1.2					
Movement	EBL	EBR	NBL	NBT	SBT	SBR
Lane Configurations						
Traffic Vol, veh/h	0	2	3	15	12	0
Future Vol, veh/h	0	2	3	15	12	0
Conflicting Peds, #/hr	0	0	0	0	0	0
Sign Control	Stop	Stop	Free	Free	Free	Free
RT Channelized	-	None	-	None	-	None
Storage Length	0	-	-	-	-	-
Veh in Median Storage, #	0	-	-	0	0	-
Grade, %	0	-	-	0	0	-
Peak Hour Factor	78	78	78	78	78	78
Heavy Vehicles, %	2	2	2	2	2	2
Mvmt Flow	0	3	4	19	15	0

Major/Minor	Minor2	Major1		Major2	
Conflicting Flow All	42	15	15	0	0
Stage 1	15	-	-	-	-
Stage 2	27	-	-	-	-
Critical Hdwy	6.42	6.22	4.12	-	-
Critical Hdwy Stg 1	5.42	-	-	-	-
Critical Hdwy Stg 2	5.42	-	-	-	-
Follow-up Hdwy	3.518	3.318	2.218	-	-
Pot Cap-1 Maneuver	969	1065	1603	-	-
Stage 1	1008	-	-	-	-
Stage 2	996	-	-	-	-
Platoon blocked, %				-	-
Mov Cap-1 Maneuver	966	1065	1603	-	-
Mov Cap-2 Maneuver	966	-	-	-	-
Stage 1	1005	-	-	-	-
Stage 2	996	-	-	-	-

Approach	EB	NB	SB
HCM Control Delay, s	8.4	1.2	0
HCM LOS	A		

Minor Lane/Major Mvmt	NBL	NBT	EBLn1	SBT	SBR
Capacity (veh/h)	1603	-	1065	-	-
HCM Lane V/C Ratio	0.002	-	0.002	-	-
HCM Control Delay (s)	7.3	0	8.4	-	-
HCM Lane LOS	A	A	A	-	-
HCM 95th %tile Q(veh)	0	-	0	-	-

Intersection						
Int Delay, s/veh	7.2					
Movement	EBL	EBT	WBT	WBR	SBL	SBR
Lane Configurations						
Traffic Vol, veh/h	466	18	203	6	14	20
Future Vol, veh/h	466	18	203	6	14	20
Conflicting Peds, #/hr	0	0	0	0	0	0
Sign Control	Free	Free	Free	Free	Stop	Stop
RT Channelized	-	None	-	None	-	None
Storage Length	415	-	-	-	0	-
Veh in Median Storage, #	-	0	0	-	0	-
Grade, %	-	0	0	-	0	-
Peak Hour Factor	92	92	87	87	78	78
Heavy Vehicles, %	2	2	2	2	2	2
Mvmt Flow	507	20	233	7	18	26

Major/Minor	Major1	Major2	Minor2		
Conflicting Flow All	240	0	-	0	1271 237
Stage 1	-	-	-	-	237 -
Stage 2	-	-	-	-	1034 -
Critical Hdwy	4.12	-	-	-	6.42 6.22
Critical Hdwy Stg 1	-	-	-	-	5.42 -
Critical Hdwy Stg 2	-	-	-	-	5.42 -
Follow-up Hdwy	2.218	-	-	-	3.518 3.318
Pot Cap-1 Maneuver	1327	-	-	-	185 802
Stage 1	-	-	-	-	802 -
Stage 2	-	-	-	-	343 -
Platoon blocked, %		-	-	-	
Mov Cap-1 Maneuver	1327	-	-	-	114 802
Mov Cap-2 Maneuver	-	-	-	-	114 -
Stage 1	-	-	-	-	496 -
Stage 2	-	-	-	-	343 -

Approach	EB	WB	SB
HCM Control Delay, s	9	0	24.3
HCM LOS			C

Minor Lane/Major Mvmt	EBL	EBT	WBT	WBR	SBLn1
Capacity (veh/h)	1327	-	-	-	230
HCM Lane V/C Ratio	0.382	-	-	-	0.19
HCM Control Delay (s)	9.4	-	-	-	24.3
HCM Lane LOS	A	-	-	-	C
HCM 95th %tile Q(veh)	1.8	-	-	-	0.7

Intersection												
Int Delay, s/veh	2.7											
Movement	EBL	EBT	EBR	WBL	WBT	WBR	NBL	NBT	NBR	SBL	SBT	SBR
Lane Configurations	↖	↗	↖	↖	↗	↖		↔			↔	
Traffic Vol, veh/h	40	174	7	0	585	7	12	0	2	7	0	95
Future Vol, veh/h	40	174	7	0	585	7	12	0	2	7	0	95
Conflicting Peds, #/hr	0	0	0	0	0	0	0	0	0	0	0	0
Sign Control	Free	Free	Free	Free	Free	Free	Stop	Stop	Stop	Stop	Stop	Stop
RT Channelized	-	-	None	-	-	None	-	-	None	-	-	None
Storage Length	460	-	410	520	-	520	-	-	-	-	-	-
Veh in Median Storage, #	-	0	-	-	0	-	-	0	-	-	0	-
Grade, %	-	0	-	-	0	-	-	0	-	-	0	-
Peak Hour Factor	87	87	87	93	93	93	78	78	78	83	83	83
Heavy Vehicles, %	2	2	2	2	2	2	2	2	2	2	2	2
Mvmt Flow	46	200	8	0	629	8	15	0	3	8	0	114

Major/Minor	Major1			Major2			Minor1			Minor2		
Conflicting Flow All	637	0	0	208	0	0	982	929	200	927	929	629
Stage 1	-	-	-	-	-	-	292	292	-	629	629	-
Stage 2	-	-	-	-	-	-	690	637	-	298	300	-
Critical Hdwy	4.12	-	-	4.12	-	-	7.12	6.52	6.22	7.12	6.52	6.22
Critical Hdwy Stg 1	-	-	-	-	-	-	6.12	5.52	-	6.12	5.52	-
Critical Hdwy Stg 2	-	-	-	-	-	-	6.12	5.52	-	6.12	5.52	-
Follow-up Hdwy	2.218	-	-	2.218	-	-	3.518	4.018	3.318	3.518	4.018	3.318
Pot Cap-1 Maneuver	947	-	-	1363	-	-	228	268	841	249	268	482
Stage 1	-	-	-	-	-	-	716	671	-	470	475	-
Stage 2	-	-	-	-	-	-	435	471	-	711	666	-
Platoon blocked, %	-	-	-	-	-	-	-	-	-	-	-	-
Mov Cap-1 Maneuver	947	-	-	1363	-	-	167	255	841	239	255	482
Mov Cap-2 Maneuver	-	-	-	-	-	-	167	255	-	239	255	-
Stage 1	-	-	-	-	-	-	681	638	-	447	475	-
Stage 2	-	-	-	-	-	-	332	471	-	674	633	-

Approach	EB	WB	NB	SB
HCM Control Delay, s	1.6	0	26	15.9
HCM LOS			D	C

Minor Lane/Major Mvmt	NBLn1	EBL	EBT	EBR	WBL	WBT	WBR	SBLn1
Capacity (veh/h)	189	947	-	-	1363	-	-	451
HCM Lane V/C Ratio	0.095	0.049	-	-	-	-	-	0.272
HCM Control Delay (s)	26	9	-	-	0	-	-	15.9
HCM Lane LOS	D	A	-	-	A	-	-	C
HCM 95th %tile Q(veh)	0.3	0.2	-	-	0	-	-	1.1

Intersection						
Int Delay, s/veh	1.4					
Movement	WBL	WBR	NBT	NBR	SBL	SBT
Lane Configurations						
Traffic Vol, veh/h	22	0	30	17	0	82
Future Vol, veh/h	22	0	30	17	0	82
Conflicting Peds, #/hr	0	0	0	0	0	0
Sign Control	Stop	Stop	Free	Free	Free	Free
RT Channelized	-	None	-	None	-	None
Storage Length	0	-	-	-	-	-
Veh in Median Storage, #	0	-	0	-	-	0
Grade, %	0	-	0	-	-	0
Peak Hour Factor	78	78	78	78	83	83
Heavy Vehicles, %	2	2	2	2	2	2
Mvmt Flow	28	0	38	22	0	99

Major/Minor	Minor1	Major1	Major2		
Conflicting Flow All	148	49	0	0	60
Stage 1	49	-	-	-	-
Stage 2	99	-	-	-	-
Critical Hdwy	6.42	6.22	-	-	4.12
Critical Hdwy Stg 1	5.42	-	-	-	-
Critical Hdwy Stg 2	5.42	-	-	-	-
Follow-up Hdwy	3.518	3.318	-	-	2.218
Pot Cap-1 Maneuver	844	1020	-	-	1544
Stage 1	973	-	-	-	-
Stage 2	925	-	-	-	-
Platoon blocked, %			-	-	-
Mov Cap-1 Maneuver	844	1020	-	-	1544
Mov Cap-2 Maneuver	844	-	-	-	-
Stage 1	973	-	-	-	-
Stage 2	925	-	-	-	-

Approach	WB	NB	SB
HCM Control Delay, s	9.4	0	0
HCM LOS	A		

Minor Lane/Major Mvmt	NBT	NBRWBLn1	SBL	SBT
Capacity (veh/h)	-	-	844	1544
HCM Lane V/C Ratio	-	-	0.033	-
HCM Control Delay (s)	-	-	9.4	0
HCM Lane LOS	-	-	A	A
HCM 95th %tile Q(veh)	-	-	0.1	0

Intersection						
Int Delay, s/veh	3.1					
Movement	EBL	EBR	NBL	NBT	SBT	SBR
Lane Configurations	T			T		
Traffic Vol, veh/h	3	10	2	15	10	1
Future Vol, veh/h	3	10	2	15	10	1
Conflicting Peds, #/hr	0	0	0	0	0	0
Sign Control	Stop	Stop	Free	Free	Free	Free
RT Channelized	-	None	-	None	-	None
Storage Length	0	-	-	-	-	-
Veh in Median Storage, #	0	-	-	0	0	-
Grade, %	0	-	-	0	0	-
Peak Hour Factor	78	78	78	78	78	78
Heavy Vehicles, %	2	2	2	2	2	2
Mvmt Flow	4	13	3	19	13	1

Major/Minor	Minor2	Major1		Major2	
Conflicting Flow All	39	14	14	0	0
Stage 1	14	-	-	-	-
Stage 2	25	-	-	-	-
Critical Hdwy	6.42	6.22	4.12	-	-
Critical Hdwy Stg 1	5.42	-	-	-	-
Critical Hdwy Stg 2	5.42	-	-	-	-
Follow-up Hdwy	3.518	3.318	2.218	-	-
Pot Cap-1 Maneuver	973	1066	1604	-	-
Stage 1	1009	-	-	-	-
Stage 2	998	-	-	-	-
Platoon blocked, %				-	-
Mov Cap-1 Maneuver	971	1066	1604	-	-
Mov Cap-2 Maneuver	971	-	-	-	-
Stage 1	1007	-	-	-	-
Stage 2	998	-	-	-	-

Approach	EB	NB	SB
HCM Control Delay, s	8.5	0.9	0
HCM LOS	A		

Minor Lane/Major Mvmt	NBL	NBT	EBLn1	SBT	SBR
Capacity (veh/h)	1604	-	1042	-	-
HCM Lane V/C Ratio	0.002	-	0.016	-	-
HCM Control Delay (s)	7.2	0	8.5	-	-
HCM Lane LOS	A	A	A	-	-
HCM 95th %tile Q(veh)	0	-	0	-	-

Intersection						
Int Delay, s/veh	0.7					
Movement	EBL	EBT	WBT	WBR	SBL	SBR
Lane Configurations						
Traffic Vol, veh/h	12	153	461	5	5	22
Future Vol, veh/h	12	153	461	5	5	22
Conflicting Peds, #/hr	0	0	0	0	0	0
Sign Control	Free	Free	Free	Free	Stop	Stop
RT Channelized	-	None	-	None	-	None
Storage Length	415	-	-	-	0	-
Veh in Median Storage, #	-	0	0	-	0	-
Grade, %	-	0	0	-	0	-
Peak Hour Factor	87	87	92	92	78	78
Heavy Vehicles, %	2	2	2	2	2	2
Mvmt Flow	14	176	501	5	6	28

Major/Minor	Major1	Major2	Minor2		
Conflicting Flow All	506	0	-	0	708 504
Stage 1	-	-	-	-	504 -
Stage 2	-	-	-	-	204 -
Critical Hdwy	4.12	-	-	-	6.42 6.22
Critical Hdwy Stg 1	-	-	-	-	5.42 -
Critical Hdwy Stg 2	-	-	-	-	5.42 -
Follow-up Hdwy	2.218	-	-	-	3.518 3.318
Pot Cap-1 Maneuver	1059	-	-	-	401 568
Stage 1	-	-	-	-	607 -
Stage 2	-	-	-	-	830 -
Platoon blocked, %		-	-	-	
Mov Cap-1 Maneuver	1059	-	-	-	396 568
Mov Cap-2 Maneuver	-	-	-	-	396 -
Stage 1	-	-	-	-	599 -
Stage 2	-	-	-	-	830 -

Approach	EB	WB	SB
HCM Control Delay, s	0.6	0	12.3
HCM LOS			B

Minor Lane/Major Mvmt	EBL	EBT	WBT	WBR	SBLn1
Capacity (veh/h)	1059	-	-	-	526
HCM Lane V/C Ratio	0.013	-	-	-	0.066
HCM Control Delay (s)	8.4	-	-	-	12.3
HCM Lane LOS	A	-	-	-	B
HCM 95th %tile Q(veh)	0	-	-	-	0.2

Intersection												
Int Delay, s/veh	2.3											
Movement	EBL	EBT	EBR	WBL	WBT	WBR	NBL	NBT	NBR	SBL	SBT	SBR
Lane Configurations												
Traffic Vol, veh/h	96	523	12	9	264	0	10	0	1	13	0	53
Future Vol, veh/h	96	523	12	9	264	0	10	0	1	13	0	53
Conflicting Peds, #/hr	0	0	0	0	0	0	0	0	0	0	0	0
Sign Control	Free	Free	Free	Free	Free	Free	Stop	Stop	Stop	Stop	Stop	Stop
RT Channelized	-	-	None	-	-	None	-	-	None	-	-	None
Storage Length	460	-	410	520	-	520	-	-	-	-	-	-
Veh in Median Storage, #	-	0	-	-	0	-	-	0	-	-	0	-
Grade, %	-	0	-	-	0	-	-	0	-	-	0	-
Peak Hour Factor	93	93	93	92	92	92	78	78	78	83	83	83
Heavy Vehicles, %	2	2	2	2	2	2	2	2	2	2	2	2
Mvmt Flow	103	562	13	10	287	0	13	0	1	16	0	64

Major/Minor	Major1			Major2			Minor1			Minor2		
Conflicting Flow All	287	0	0	575	0	0	1107	1075	562	1082	1088	287
Stage 1	-	-	-	-	-	-	768	768	-	307	307	-
Stage 2	-	-	-	-	-	-	339	307	-	775	781	-
Critical Hdwy	4.12	-	-	4.12	-	-	7.12	6.52	6.22	7.12	6.52	6.22
Critical Hdwy Stg 1	-	-	-	-	-	-	6.12	5.52	-	6.12	5.52	-
Critical Hdwy Stg 2	-	-	-	-	-	-	6.12	5.52	-	6.12	5.52	-
Follow-up Hdwy	2.218	-	-	2.218	-	-	3.518	4.018	3.318	3.518	4.018	3.318
Pot Cap-1 Maneuver	1275	-	-	998	-	-	188	220	526	195	216	752
Stage 1	-	-	-	-	-	-	394	411	-	703	661	-
Stage 2	-	-	-	-	-	-	676	661	-	391	405	-
Platoon blocked, %		-	-		-	-						
Mov Cap-1 Maneuver	1275	-	-	998	-	-	160	200	526	181	197	752
Mov Cap-2 Maneuver	-	-	-	-	-	-	160	200	-	181	197	-
Stage 1	-	-	-	-	-	-	362	378	-	646	654	-
Stage 2	-	-	-	-	-	-	612	654	-	359	372	-

Approach	EB			WB			NB			SB		
HCM Control Delay, s	1.2			0.3			27.9			14.4		
HCM LOS							D			B		

Minor Lane/Major Mvmt	NBLn1	EBL	EBT	EBR	WBL	WBT	WBR	SBLn1
Capacity (veh/h)	171	1275	-	-	998	-	-	464
HCM Lane V/C Ratio	0.082	0.081	-	-	0.01	-	-	0.171
HCM Control Delay (s)	27.9	8.1	-	-	8.6	-	-	14.4
HCM Lane LOS	D	A	-	-	A	-	-	B
HCM 95th %tile Q(veh)	0.3	0.3	-	-	0	-	-	0.6

Intersection						
Int Delay, s/veh	1.1					
Movement	WBL	WBR	NBT	NBR	SBL	SBT
Lane Configurations						
Traffic Vol, veh/h	17	2	83	26	1	55
Future Vol, veh/h	17	2	83	26	1	55
Conflicting Peds, #/hr	0	0	0	0	0	0
Sign Control	Stop	Stop	Free	Free	Free	Free
RT Channelized	-	None	-	None	-	None
Storage Length	0	-	-	-	-	-
Veh in Median Storage, #	0	-	0	-	-	0
Grade, %	0	-	0	-	-	0
Peak Hour Factor	78	78	83	83	83	83
Heavy Vehicles, %	2	2	2	2	2	2
Mvmt Flow	22	3	100	31	1	66

Major/Minor	Minor1	Major1	Major2		
Conflicting Flow All	184	116	0	0	131
Stage 1	116	-	-	-	-
Stage 2	68	-	-	-	-
Critical Hdwy	6.42	6.22	-	-	4.12
Critical Hdwy Stg 1	5.42	-	-	-	-
Critical Hdwy Stg 2	5.42	-	-	-	-
Follow-up Hdwy	3.518	3.318	-	-	2.218
Pot Cap-1 Maneuver	805	936	-	-	1454
Stage 1	909	-	-	-	-
Stage 2	955	-	-	-	-
Platoon blocked, %			-	-	-
Mov Cap-1 Maneuver	804	936	-	-	1454
Mov Cap-2 Maneuver	804	-	-	-	-
Stage 1	909	-	-	-	-
Stage 2	954	-	-	-	-

Approach	WB	NB	SB
HCM Control Delay, s	9.5	0	0.1
HCM LOS	A		

Minor Lane/Major Mvmt	NBT	NBRWBLn1	SBL	SBT
Capacity (veh/h)	-	-	816	1454
HCM Lane V/C Ratio	-	-	0.03	0.001
HCM Control Delay (s)	-	-	9.5	7.5
HCM Lane LOS	-	-	A	A
HCM 95th %tile Q(veh)	-	-	0.1	0

Intersection						
Int Delay, s/veh	2.7					
Movement	EBL	EBR	NBL	NBT	SBT	SBR
Lane Configurations	T		T		T	
Traffic Vol, veh/h	1	6	9	15	12	3
Future Vol, veh/h	1	6	9	15	12	3
Conflicting Peds, #/hr	0	0	0	0	0	0
Sign Control	Stop	Stop	Free	Free	Free	Free
RT Channelized	-	None	-	None	-	None
Storage Length	0	-	-	-	-	-
Veh in Median Storage, #	0	-	-	0	0	-
Grade, %	0	-	-	0	0	-
Peak Hour Factor	78	78	78	78	78	78
Heavy Vehicles, %	2	2	2	2	2	2
Mvmt Flow	1	8	12	19	15	4

Major/Minor	Minor2	Major1		Major2	
Conflicting Flow All	60	17	19	0	0
Stage 1	17	-	-	-	-
Stage 2	43	-	-	-	-
Critical Hdwy	6.42	6.22	4.12	-	-
Critical Hdwy Stg 1	5.42	-	-	-	-
Critical Hdwy Stg 2	5.42	-	-	-	-
Follow-up Hdwy	3.518	3.318	2.218	-	-
Pot Cap-1 Maneuver	947	1062	1597	-	-
Stage 1	1006	-	-	-	-
Stage 2	979	-	-	-	-
Platoon blocked, %				-	-
Mov Cap-1 Maneuver	939	1062	1597	-	-
Mov Cap-2 Maneuver	939	-	-	-	-
Stage 1	998	-	-	-	-
Stage 2	979	-	-	-	-

Approach	EB	NB	SB
HCM Control Delay, s	8.5	2.7	0
HCM LOS	A		

Minor Lane/Major Mvmt	NBL	NBT	EBLn1	SBT	SBR
Capacity (veh/h)	1597	-	1042	-	-
HCM Lane V/C Ratio	0.007	-	0.009	-	-
HCM Control Delay (s)	7.3	0	8.5	-	-
HCM Lane LOS	A	A	A	-	-
HCM 95th %tile Q(veh)	0	-	0	-	-

Intersection						
Int Delay, s/veh	1					
Movement	EBL	EBT	WBT	WBR	SBL	SBR
Lane Configurations						
Traffic Vol, veh/h	22	466	204	8	16	22
Future Vol, veh/h	22	466	204	8	16	22
Conflicting Peds, #/hr	0	0	0	0	0	0
Sign Control	Free	Free	Free	Free	Stop	Stop
RT Channelized	-	None	-	None	-	None
Storage Length	415	-	-	-	0	-
Veh in Median Storage, #	-	0	0	-	0	-
Grade, %	-	0	0	-	0	-
Peak Hour Factor	92	92	87	87	78	78
Heavy Vehicles, %	2	2	2	2	2	2
Mvmt Flow	24	507	234	9	21	28

Major/Minor	Major1	Major2	Minor2		
Conflicting Flow All	243	0	-	0	794 239
Stage 1	-	-	-	-	239 -
Stage 2	-	-	-	-	555 -
Critical Hdwy	4.12	-	-	-	6.42 6.22
Critical Hdwy Stg 1	-	-	-	-	5.42 -
Critical Hdwy Stg 2	-	-	-	-	5.42 -
Follow-up Hdwy	2.218	-	-	-	3.518 3.318
Pot Cap-1 Maneuver	1323	-	-	-	357 800
Stage 1	-	-	-	-	801 -
Stage 2	-	-	-	-	575 -
Platoon blocked, %		-	-	-	
Mov Cap-1 Maneuver	1323	-	-	-	351 800
Mov Cap-2 Maneuver	-	-	-	-	351 -
Stage 1	-	-	-	-	787 -
Stage 2	-	-	-	-	575 -

Approach	EB	WB	SB
HCM Control Delay, s	0.4	0	12.6
HCM LOS			B

Minor Lane/Major Mvmt	EBL	EBT	WBT	WBR	SBLn1
Capacity (veh/h)	1323	-	-	-	520
HCM Lane V/C Ratio	0.018	-	-	-	0.094
HCM Control Delay (s)	7.8	-	-	-	12.6
HCM Lane LOS	A	-	-	-	B
HCM 95th %tile Q(veh)	0.1	-	-	-	0.3

Intersection												
Int Delay, s/veh	7.8											
Movement	EBL	EBT	EBR	WBL	WBT	WBR	NBL	NBT	NBR	SBL	SBT	SBR
Lane Configurations	↖	↗	↖	↖	↗	↖		↕			↕	
Traffic Vol, veh/h	52	274	10	2	896	25	15	1	3	21	1	135
Future Vol, veh/h	52	274	10	2	896	25	15	1	3	21	1	135
Conflicting Peds, #/hr	0	0	0	0	0	0	0	0	0	0	0	0
Sign Control	Free	Free	Free	Free	Free	Free	Stop	Stop	Stop	Stop	Stop	Stop
RT Channelized	-	-	None	-	-	None	-	-	None	-	-	None
Storage Length	460	-	410	520	-	520	-	-	-	-	-	-
Veh in Median Storage, #	-	0	-	-	0	-	-	0	-	-	0	-
Grade, %	-	0	-	-	0	-	-	0	-	-	0	-
Peak Hour Factor	92	92	92	93	93	93	78	78	78	87	87	87
Heavy Vehicles, %	2	2	2	2	2	2	2	2	2	2	2	2
Mvmt Flow	57	298	11	2	963	27	19	1	4	24	1	155

Major/Minor	Major1			Major2			Minor1			Minor2		
Conflicting Flow All	990	0	0	309	0	0	1471	1406	298	1387	1390	963
Stage 1	-	-	-	-	-	-	412	412	-	967	967	-
Stage 2	-	-	-	-	-	-	1059	994	-	420	423	-
Critical Hdwy	4.12	-	-	4.12	-	-	7.12	6.52	6.22	7.12	6.52	6.22
Critical Hdwy Stg 1	-	-	-	-	-	-	6.12	5.52	-	6.12	5.52	-
Critical Hdwy Stg 2	-	-	-	-	-	-	6.12	5.52	-	6.12	5.52	-
Follow-up Hdwy	2.218	-	-	2.218	-	-	3.518	4.018	3.318	3.518	4.018	3.318
Pot Cap-1 Maneuver	698	-	-	1252	-	-	105	139	741	120	142	310
Stage 1	-	-	-	-	-	-	617	594	-	306	333	-
Stage 2	-	-	-	-	-	-	271	323	-	611	588	-
Platoon blocked, %	-	-	-	-	-	-	-	-	-	-	-	-
Mov Cap-1 Maneuver	698	-	-	1252	-	-	49	127	741	111	130	310
Mov Cap-2 Maneuver	-	-	-	-	-	-	49	127	-	111	130	-
Stage 1	-	-	-	-	-	-	566	545	-	281	332	-
Stage 2	-	-	-	-	-	-	135	322	-	557	540	-

Approach	EB	WB	NB	SB
HCM Control Delay, s	1.6	0	101.1	50.5
HCM LOS			F	F

Minor Lane/Major Mvmt	NBLn1	EBL	EBT	EBR	WBL	WBT	WBR	SBLn1
Capacity (veh/h)	60	698	-	-	1252	-	-	248
HCM Lane V/C Ratio	0.406	0.081	-	-	0.002	-	-	0.728
HCM Control Delay (s)	101.1	10.6	-	-	7.9	-	-	50.5
HCM Lane LOS	F	B	-	-	A	-	-	F
HCM 95th %tile Q(veh)	1.5	0.3	-	-	0	-	-	5

Intersection						
Int Delay, s/veh	0.8					
Movement	WBL	WBR	NBT	NBR	SBL	SBT
Lane Configurations						
Traffic Vol, veh/h	17	0	64	14	0	140
Future Vol, veh/h	17	0	64	14	0	140
Conflicting Peds, #/hr	0	0	0	0	0	0
Sign Control	Stop	Stop	Free	Free	Free	Free
RT Channelized	-	None	-	None	-	None
Storage Length	0	-	-	-	-	-
Veh in Median Storage, #	0	-	0	-	-	0
Grade, %	0	-	0	-	-	0
Peak Hour Factor	78	78	83	83	83	83
Heavy Vehicles, %	2	2	2	2	2	2
Mvmt Flow	22	0	77	17	0	169

Major/Minor	Minor1	Major1	Major2		
Conflicting Flow All	255	86	0	0	94
Stage 1	86	-	-	-	-
Stage 2	169	-	-	-	-
Critical Hdwy	6.42	6.22	-	-	4.12
Critical Hdwy Stg 1	5.42	-	-	-	-
Critical Hdwy Stg 2	5.42	-	-	-	-
Follow-up Hdwy	3.518	3.318	-	-	2.218
Pot Cap-1 Maneuver	734	973	-	-	1500
Stage 1	937	-	-	-	-
Stage 2	861	-	-	-	-
Platoon blocked, %			-	-	-
Mov Cap-1 Maneuver	734	973	-	-	1500
Mov Cap-2 Maneuver	734	-	-	-	-
Stage 1	937	-	-	-	-
Stage 2	861	-	-	-	-

Approach	WB	NB	SB
HCM Control Delay, s	10.1	0	0
HCM LOS	B		

Minor Lane/Major Mvmt	NBT	NBRWBLn1	SBL	SBT
Capacity (veh/h)	-	-	734	1500
HCM Lane V/C Ratio	-	-	0.03	-
HCM Control Delay (s)	-	-	10.1	0
HCM Lane LOS	-	-	B	A
HCM 95th %tile Q(veh)	-	-	0.1	0

Intersection						
Int Delay, s/veh	0.7					
Movement	EBL	EBR	NBL	NBT	SBT	SBR
Lane Configurations	T			T		
Traffic Vol, veh/h	0	5	1	25	45	0
Future Vol, veh/h	0	5	1	25	45	0
Conflicting Peds, #/hr	0	0	0	0	0	0
Sign Control	Stop	Stop	Free	Free	Free	Free
RT Channelized	-	None	-	None	-	None
Storage Length	0	-	-	-	-	-
Veh in Median Storage, #	0	-	-	0	0	-
Grade, %	0	-	-	0	0	-
Peak Hour Factor	78	78	78	78	78	78
Heavy Vehicles, %	2	2	2	2	2	2
Mvmt Flow	0	6	1	32	58	0

Major/Minor	Minor2	Major1	Major2			
Conflicting Flow All	92	58	58	0	-	0
Stage 1	58	-	-	-	-	-
Stage 2	34	-	-	-	-	-
Critical Hdwy	6.42	6.22	4.12	-	-	-
Critical Hdwy Stg 1	5.42	-	-	-	-	-
Critical Hdwy Stg 2	5.42	-	-	-	-	-
Follow-up Hdwy	3.518	3.318	2.218	-	-	-
Pot Cap-1 Maneuver	908	1008	1546	-	-	-
Stage 1	965	-	-	-	-	-
Stage 2	988	-	-	-	-	-
Platoon blocked, %				-	-	-
Mov Cap-1 Maneuver	907	1008	1546	-	-	-
Mov Cap-2 Maneuver	907	-	-	-	-	-
Stage 1	964	-	-	-	-	-
Stage 2	988	-	-	-	-	-

Approach	EB	NB	SB
HCM Control Delay, s	8.6	0.3	0
HCM LOS	A		

Minor Lane/Major Mvmt	NBL	NBT	EBLn1	SBT	SBR
Capacity (veh/h)	1546	-	1008	-	-
HCM Lane V/C Ratio	0.001	-	0.006	-	-
HCM Control Delay (s)	7.3	0	8.6	-	-
HCM Lane LOS	A	A	A	-	-
HCM 95th %tile Q(veh)	0	-	0	-	-

Intersection						
Int Delay, s/veh	1.3					
Movement	EBL	EBT	WBT	WBR	SBL	SBR
Lane Configurations						
Traffic Vol, veh/h	15	299	725	10	21	38
Future Vol, veh/h	15	299	725	10	21	38
Conflicting Peds, #/hr	0	0	0	0	0	0
Sign Control	Free	Free	Free	Free	Stop	Stop
RT Channelized	-	None	-	None	-	None
Storage Length	415	-	-	-	0	-
Veh in Median Storage, #	-	0	0	-	0	-
Grade, %	-	0	0	-	0	-
Peak Hour Factor	92	92	93	93	83	83
Heavy Vehicles, %	2	2	2	2	2	2
Mvmt Flow	16	325	780	11	25	46

Major/Minor	Major1	Major2	Minor2		
Conflicting Flow All	791	0	-	0	1143 786
Stage 1	-	-	-	-	786 -
Stage 2	-	-	-	-	357 -
Critical Hdwy	4.12	-	-	-	6.42 6.22
Critical Hdwy Stg 1	-	-	-	-	5.42 -
Critical Hdwy Stg 2	-	-	-	-	5.42 -
Follow-up Hdwy	2.218	-	-	-	3.518 3.318
Pot Cap-1 Maneuver	829	-	-	-	221 392
Stage 1	-	-	-	-	449 -
Stage 2	-	-	-	-	708 -
Platoon blocked, %		-	-	-	
Mov Cap-1 Maneuver	829	-	-	-	217 392
Mov Cap-2 Maneuver	-	-	-	-	217 -
Stage 1	-	-	-	-	440 -
Stage 2	-	-	-	-	708 -

Approach	EB	WB	SB
HCM Control Delay, s	0.5	0	20.4
HCM LOS			C

Minor Lane/Major Mvmt	EBL	EBT	WBT	WBR	SBLn1
Capacity (veh/h)	829	-	-	-	305
HCM Lane V/C Ratio	0.02	-	-	-	0.233
HCM Control Delay (s)	9.4	-	-	-	20.4
HCM Lane LOS	A	-	-	-	C
HCM 95th %tile Q(veh)	0.1	-	-	-	0.9

Intersection												
Int Delay, s/veh	3.9											
Movement	EBL	EBT	EBR	WBL	WBT	WBR	NBL	NBT	NBR	SBL	SBT	SBR
Lane Configurations												
Traffic Vol, veh/h	145	800	15	10	425	10	10	1	1	15	1	86
Future Vol, veh/h	145	800	15	10	425	10	10	1	1	15	1	86
Conflicting Peds, #/hr	0	0	0	0	0	0	0	0	0	0	0	0
Sign Control	Free	Free	Free	Free	Free	Free	Stop	Stop	Stop	Stop	Stop	Stop
RT Channelized	-	-	None	-	-	None	-	-	None	-	-	None
Storage Length	460	-	410	520	-	520	-	-	-	-	-	-
Veh in Median Storage, #	-	0	-	-	0	-	-	0	-	-	0	-
Grade, %	-	0	-	-	0	-	-	0	-	-	0	-
Peak Hour Factor	93	93	93	92	92	92	78	78	78	83	83	83
Heavy Vehicles, %	2	2	2	2	2	2	2	2	2	2	2	2
Mvmt Flow	156	860	16	11	462	11	13	1	1	18	1	104

Major/Minor	Major1			Major2			Minor1			Minor2		
Conflicting Flow All	473	0	0	876	0	0	1714	1667	860	1665	1672	462
Stage 1	-	-	-	-	-	-	1172	1172	-	484	484	-
Stage 2	-	-	-	-	-	-	542	495	-	1181	1188	-
Critical Hdwy	4.12	-	-	4.12	-	-	7.12	6.52	6.22	7.12	6.52	6.22
Critical Hdwy Stg 1	-	-	-	-	-	-	6.12	5.52	-	6.12	5.52	-
Critical Hdwy Stg 2	-	-	-	-	-	-	6.12	5.52	-	6.12	5.52	-
Follow-up Hdwy	2.218	-	-	2.218	-	-	3.518	4.018	3.318	3.518	4.018	3.318
Pot Cap-1 Maneuver	1089	-	-	771	-	-	71	96	356	77	96	600
Stage 1	-	-	-	-	-	-	234	266	-	564	552	-
Stage 2	-	-	-	-	-	-	525	546	-	232	262	-
Platoon blocked, %	-	-	-	-	-	-	-	-	-	-	-	-
Mov Cap-1 Maneuver	1089	-	-	771	-	-	51	81	356	67	81	600
Mov Cap-2 Maneuver	-	-	-	-	-	-	51	81	-	67	81	-
Stage 1	-	-	-	-	-	-	201	228	-	483	544	-
Stage 2	-	-	-	-	-	-	427	538	-	197	225	-

Approach	EB			WB			NB			SB		
HCM Control Delay, s	1.3			0.2			90			29.2		
HCM LOS							F			D		

Minor Lane/Major Mvmt	NBLn1	EBL	EBT	EBR	WBL	WBT	WBR	SBLn1
Capacity (veh/h)	57	1089	-	-	771	-	-	269
HCM Lane V/C Ratio	0.27	0.143	-	-	0.014	-	-	0.457
HCM Control Delay (s)	90	8.9	-	-	9.7	-	-	29.2
HCM Lane LOS	F	A	-	-	A	-	-	D
HCM 95th %tile Q(veh)	0.9	0.5	-	-	0	-	-	2.2

Intersection						
Int Delay, s/veh	0.7					
Movement	WBL	WBR	NBT	NBR	SBL	SBT
Lane Configurations	W		T			T
Traffic Vol, veh/h	13	2	136	20	1	88
Future Vol, veh/h	13	2	136	20	1	88
Conflicting Peds, #/hr	0	0	0	0	0	0
Sign Control	Stop	Stop	Free	Free	Free	Free
RT Channelized	-	None	-	None	-	None
Storage Length	0	-	-	-	-	-
Veh in Median Storage, #	0	-	0	-	-	0
Grade, %	0	-	0	-	-	0
Peak Hour Factor	78	78	87	87	83	83
Heavy Vehicles, %	2	2	2	2	2	2
Mvmt Flow	17	3	156	23	1	106

Major/Minor	Minor1	Major1	Major2		
Conflicting Flow All	276	168	0	0	179
Stage 1	168	-	-	-	-
Stage 2	108	-	-	-	-
Critical Hdwy	6.42	6.22	-	-	4.12
Critical Hdwy Stg 1	5.42	-	-	-	-
Critical Hdwy Stg 2	5.42	-	-	-	-
Follow-up Hdwy	3.518	3.318	-	-	2.218
Pot Cap-1 Maneuver	714	876	-	-	1397
Stage 1	862	-	-	-	-
Stage 2	916	-	-	-	-
Platoon blocked, %			-	-	-
Mov Cap-1 Maneuver	713	876	-	-	1397
Mov Cap-2 Maneuver	713	-	-	-	-
Stage 1	862	-	-	-	-
Stage 2	915	-	-	-	-

Approach	WB	NB	SB
HCM Control Delay, s	10.1	0	0.1
HCM LOS	B		

Minor Lane/Major Mvmt	NBT	NBRWBLn1	SBL	SBT
Capacity (veh/h)	-	-	731	1397
HCM Lane V/C Ratio	-	-	0.026	0.001
HCM Control Delay (s)	-	-	10.1	7.6
HCM Lane LOS	-	-	B	A
HCM 95th %tile Q(veh)	-	-	0.1	0

Intersection						
Int Delay, s/veh	0.4					
Movement	EBL	EBR	NBL	NBT	SBT	SBR
Lane Configurations	T			T		
Traffic Vol, veh/h	0	2	3	50	50	0
Future Vol, veh/h	0	2	3	50	50	0
Conflicting Peds, #/hr	0	0	0	0	0	0
Sign Control	Stop	Stop	Free	Free	Free	Free
RT Channelized	-	None	-	None	-	None
Storage Length	0	-	-	-	-	-
Veh in Median Storage, #	0	-	-	0	0	-
Grade, %	0	-	-	0	0	-
Peak Hour Factor	78	78	83	83	83	83
Heavy Vehicles, %	2	2	2	2	2	2
Mvmt Flow	0	3	4	60	60	0

Major/Minor	Minor2	Major1		Major2	
Conflicting Flow All	128	60	60	0	-
Stage 1	60	-	-	-	-
Stage 2	68	-	-	-	-
Critical Hdwy	6.42	6.22	4.12	-	-
Critical Hdwy Stg 1	5.42	-	-	-	-
Critical Hdwy Stg 2	5.42	-	-	-	-
Follow-up Hdwy	3.518	3.318	2.218	-	-
Pot Cap-1 Maneuver	866	1005	1544	-	-
Stage 1	963	-	-	-	-
Stage 2	955	-	-	-	-
Platoon blocked, %				-	-
Mov Cap-1 Maneuver	863	1005	1544	-	-
Mov Cap-2 Maneuver	863	-	-	-	-
Stage 1	960	-	-	-	-
Stage 2	955	-	-	-	-

Approach	EB	NB	SB
HCM Control Delay, s	8.6	0.4	0
HCM LOS	A		

Minor Lane/Major Mvmt	NBL	NBT	EBLn1	SBT	SBR
Capacity (veh/h)	1544	-	1005	-	-
HCM Lane V/C Ratio	0.002	-	0.003	-	-
HCM Control Delay (s)	7.3	0	8.6	-	-
HCM Lane LOS	A	A	A	-	-
HCM 95th %tile Q(veh)	0	-	0	-	-

Intersection						
Int Delay, s/veh	1.5					
Movement	EBL	EBT	WBT	WBR	SBL	SBR
Lane Configurations						
Traffic Vol, veh/h	41	466	203	15	26	35
Future Vol, veh/h	41	466	203	15	26	35
Conflicting Peds, #/hr	0	0	0	0	0	0
Sign Control	Free	Free	Free	Free	Stop	Stop
RT Channelized	-	None	-	None	-	None
Storage Length	415	-	-	-	0	-
Veh in Median Storage, #	-	0	0	-	0	-
Grade, %	-	0	0	-	0	-
Peak Hour Factor	92	92	87	87	83	83
Heavy Vehicles, %	2	2	2	2	2	2
Mvmt Flow	45	507	233	17	31	42

Major/Minor	Major1	Major2	Minor2		
Conflicting Flow All	250	0	-	0	839 242
Stage 1	-	-	-	-	242 -
Stage 2	-	-	-	-	597 -
Critical Hdwy	4.12	-	-	-	6.42 6.22
Critical Hdwy Stg 1	-	-	-	-	5.42 -
Critical Hdwy Stg 2	-	-	-	-	5.42 -
Follow-up Hdwy	2.218	-	-	-	3.518 3.318
Pot Cap-1 Maneuver	1316	-	-	-	336 797
Stage 1	-	-	-	-	798 -
Stage 2	-	-	-	-	550 -
Platoon blocked, %		-	-	-	
Mov Cap-1 Maneuver	1316	-	-	-	325 797
Mov Cap-2 Maneuver	-	-	-	-	325 -
Stage 1	-	-	-	-	771 -
Stage 2	-	-	-	-	550 -

Approach	EB	WB	SB
HCM Control Delay, s	0.6	0	13.6
HCM LOS			B

Minor Lane/Major Mvmt	EBL	EBT	WBT	WBR	SBLn1
Capacity (veh/h)	1316	-	-	-	492
HCM Lane V/C Ratio	0.034	-	-	-	0.149
HCM Control Delay (s)	7.8	-	-	-	13.6
HCM Lane LOS	A	-	-	-	B
HCM 95th %tile Q(veh)	0.1	-	-	-	0.5

Intersection												
Int Delay, s/veh	8.2											
Movement	EBL	EBT	EBR	WBL	WBT	WBR	NBL	NBT	NBR	SBL	SBT	SBR
Lane Configurations												
Traffic Vol, veh/h	55	275	10	2	900	25	15	1	3	20	1	140
Future Vol, veh/h	55	275	10	2	900	25	15	1	3	20	1	140
Conflicting Peds, #/hr	0	0	0	0	0	0	0	0	0	0	0	0
Sign Control	Free	Free	Free	Free	Free	Free	Stop	Stop	Stop	Stop	Stop	Stop
RT Channelized	-	-	None	-	-	None	-	-	None	-	-	None
Storage Length	460	-	410	520	-	520	-	-	-	-	-	-
Veh in Median Storage, #	-	0	-	-	0	-	-	0	-	-	0	-
Grade, %	-	0	-	-	0	-	-	0	-	-	0	-
Peak Hour Factor	92	92	92	93	93	93	78	78	78	87	87	87
Heavy Vehicles, %	2	2	2	2	2	2	2	2	2	2	2	2
Mvmt Flow	60	299	11	2	968	27	19	1	4	23	1	161

Major/Minor	Major1			Major2			Minor1			Minor2		
Conflicting Flow All	995	0	0	310	0	0	1486	1418	299	1399	1402	968
Stage 1	-	-	-	-	-	-	419	419	-	972	972	-
Stage 2	-	-	-	-	-	-	1067	999	-	427	430	-
Critical Hdwy	4.12	-	-	4.12	-	-	7.12	6.52	6.22	7.12	6.52	6.22
Critical Hdwy Stg 1	-	-	-	-	-	-	6.12	5.52	-	6.12	5.52	-
Critical Hdwy Stg 2	-	-	-	-	-	-	6.12	5.52	-	6.12	5.52	-
Follow-up Hdwy	2.218	-	-	2.218	-	-	3.518	4.018	3.318	3.518	4.018	3.318
Pot Cap-1 Maneuver	695	-	-	1250	-	-	103	137	741	118	140	308
Stage 1	-	-	-	-	-	-	612	590	-	304	331	-
Stage 2	-	-	-	-	-	-	269	321	-	606	583	-
Platoon blocked, %	-	-	-	-	-	-	-	-	-	-	-	-
Mov Cap-1 Maneuver	695	-	-	1250	-	-	46	125	741	109	128	308
Mov Cap-2 Maneuver	-	-	-	-	-	-	46	125	-	109	128	-
Stage 1	-	-	-	-	-	-	559	539	-	278	330	-
Stage 2	-	-	-	-	-	-	128	320	-	549	533	-

Approach	EB	WB	NB	SB
HCM Control Delay, s	1.7	0	111.7	52.1
HCM LOS			F	F

Minor Lane/Major Mvmt	NBLn1	EBL	EBT	EBR	WBL	WBT	WBR	SBLn1
Capacity (veh/h)	56	695	-	-	1250	-	-	249
HCM Lane V/C Ratio	0.435	0.086	-	-	0.002	-	-	0.743
HCM Control Delay (s)	111.7	10.7	-	-	7.9	-	-	52.1
HCM Lane LOS	F	B	-	-	A	-	-	F
HCM 95th %tile Q(veh)	1.6	0.3	-	-	0	-	-	5.2

Intersection						
Int Delay, s/veh	1					
Movement	WBL	WBR	NBT	NBR	SBL	SBT
Lane Configurations						
Traffic Vol, veh/h	22	0	64	17	0	140
Future Vol, veh/h	22	0	64	17	0	140
Conflicting Peds, #/hr	0	0	0	0	0	0
Sign Control	Stop	Stop	Free	Free	Free	Free
RT Channelized	-	None	-	None	-	None
Storage Length	0	-	-	-	-	-
Veh in Median Storage, #	0	-	0	-	-	0
Grade, %	0	-	0	-	-	0
Peak Hour Factor	78	78	83	83	83	83
Heavy Vehicles, %	2	2	2	2	2	2
Mvmt Flow	28	0	77	20	0	169

Major/Minor	Minor1	Major1	Major2		
Conflicting Flow All	256	87	0	0	97
Stage 1	87	-	-	-	-
Stage 2	169	-	-	-	-
Critical Hdwy	6.42	6.22	-	-	4.12
Critical Hdwy Stg 1	5.42	-	-	-	-
Critical Hdwy Stg 2	5.42	-	-	-	-
Follow-up Hdwy	3.518	3.318	-	-	2.218
Pot Cap-1 Maneuver	733	971	-	-	1496
Stage 1	936	-	-	-	-
Stage 2	861	-	-	-	-
Platoon blocked, %			-	-	-
Mov Cap-1 Maneuver	733	971	-	-	1496
Mov Cap-2 Maneuver	733	-	-	-	-
Stage 1	936	-	-	-	-
Stage 2	861	-	-	-	-

Approach	WB	NB	SB
HCM Control Delay, s	10.1	0	0
HCM LOS	B		

Minor Lane/Major Mvmt	NBT	NBRWBLn1	SBL	SBT
Capacity (veh/h)	-	-	733	1496
HCM Lane V/C Ratio	-	-	0.038	-
HCM Control Delay (s)	-	-	10.1	0
HCM Lane LOS	-	-	B	A
HCM 95th %tile Q(veh)	-	-	0.1	0

Intersection						
Int Delay, s/veh	1.5					
Movement	EBL	EBR	NBL	NBT	SBT	SBR
Lane Configurations						
Traffic Vol, veh/h	2	11	2	25	45	1
Future Vol, veh/h	2	11	2	25	45	1
Conflicting Peds, #/hr	0	0	0	0	0	0
Sign Control	Stop	Stop	Free	Free	Free	Free
RT Channelized	-	None	-	None	-	None
Storage Length	0	-	-	-	-	-
Veh in Median Storage, #	0	-	-	0	0	-
Grade, %	0	-	-	0	0	-
Peak Hour Factor	78	78	78	78	78	78
Heavy Vehicles, %	2	2	2	2	2	2
Mvmt Flow	3	14	3	32	58	1

Major/Minor	Minor2	Major1	Major2			
Conflicting Flow All	97	59	59	0	-	0
Stage 1	59	-	-	-	-	-
Stage 2	38	-	-	-	-	-
Critical Hdwy	6.42	6.22	4.12	-	-	-
Critical Hdwy Stg 1	5.42	-	-	-	-	-
Critical Hdwy Stg 2	5.42	-	-	-	-	-
Follow-up Hdwy	3.518	3.318	2.218	-	-	-
Pot Cap-1 Maneuver	902	1007	1545	-	-	-
Stage 1	964	-	-	-	-	-
Stage 2	984	-	-	-	-	-
Platoon blocked, %				-	-	-
Mov Cap-1 Maneuver	900	1007	1545	-	-	-
Mov Cap-2 Maneuver	900	-	-	-	-	-
Stage 1	962	-	-	-	-	-
Stage 2	984	-	-	-	-	-

Approach	EB	NB	SB
HCM Control Delay, s	8.7	0.5	0
HCM LOS	A		

Minor Lane/Major Mvmt	NBL	NBT	EBLn1	SBT	SBR
Capacity (veh/h)	1545	-	989	-	-
HCM Lane V/C Ratio	0.002	-	0.017	-	-
HCM Control Delay (s)	7.3	0	8.7	-	-
HCM Lane LOS	A	A	A	-	-
HCM 95th %tile Q(veh)	0	-	0.1	-	-

Intersection						
Int Delay, s/veh	1.5					
Movement	EBL	EBT	WBT	WBR	SBL	SBR
Lane Configurations						
Traffic Vol, veh/h	16	298	725	10	23	42
Future Vol, veh/h	16	298	725	10	23	42
Conflicting Peds, #/hr	0	0	0	0	0	0
Sign Control	Free	Free	Free	Free	Stop	Stop
RT Channelized	-	None	-	None	-	None
Storage Length	415	-	-	-	0	-
Veh in Median Storage, #	-	0	0	-	0	-
Grade, %	-	0	0	-	0	-
Peak Hour Factor	92	92	93	93	83	83
Heavy Vehicles, %	2	2	2	2	2	2
Mvmt Flow	17	324	780	11	28	51

Major/Minor	Major1	Major2	Minor2		
Conflicting Flow All	791	0	-	0	1144 786
Stage 1	-	-	-	-	786 -
Stage 2	-	-	-	-	358 -
Critical Hdwy	4.12	-	-	-	6.42 6.22
Critical Hdwy Stg 1	-	-	-	-	5.42 -
Critical Hdwy Stg 2	-	-	-	-	5.42 -
Follow-up Hdwy	2.218	-	-	-	3.518 3.318
Pot Cap-1 Maneuver	829	-	-	-	221 392
Stage 1	-	-	-	-	449 -
Stage 2	-	-	-	-	707 -
Platoon blocked, %		-	-	-	
Mov Cap-1 Maneuver	829	-	-	-	216 392
Mov Cap-2 Maneuver	-	-	-	-	216 -
Stage 1	-	-	-	-	440 -
Stage 2	-	-	-	-	707 -

Approach	EB	WB	SB
HCM Control Delay, s	0.5	0	20.9
HCM LOS			C

Minor Lane/Major Mvmt	EBL	EBT	WBT	WBR	SBLn1
Capacity (veh/h)	829	-	-	-	304
HCM Lane V/C Ratio	0.021	-	-	-	0.258
HCM Control Delay (s)	9.4	-	-	-	20.9
HCM Lane LOS	A	-	-	-	C
HCM 95th %tile Q(veh)	0.1	-	-	-	1

Intersection												
Int Delay, s/veh	4.1											
Movement	EBL	EBT	EBR	WBL	WBT	WBR	NBL	NBT	NBR	SBL	SBT	SBR
Lane Configurations												
Traffic Vol, veh/h	150	804	15	10	427	10	10	1	1	15	1	90
Future Vol, veh/h	150	804	15	10	427	10	10	1	1	15	1	90
Conflicting Peds, #/hr	0	0	0	0	0	0	0	0	0	0	0	0
Sign Control	Free	Free	Free	Free	Free	Free	Stop	Stop	Stop	Stop	Stop	Stop
RT Channelized	-	-	None	-	-	None	-	-	None	-	-	None
Storage Length	460	-	410	520	-	520	-	-	-	-	-	-
Veh in Median Storage, #	-	0	-	-	0	-	-	0	-	-	0	-
Grade, %	-	0	-	-	0	-	-	0	-	-	0	-
Peak Hour Factor	93	93	93	92	92	92	78	78	78	83	83	83
Heavy Vehicles, %	2	2	2	2	2	2	2	2	2	2	2	2
Mvmt Flow	161	865	16	11	464	11	13	1	1	18	1	108

Major/Minor	Major1			Major2			Minor1			Minor2		
Conflicting Flow All	475	0	0	881	0	0	1733	1684	865	1682	1689	464
Stage 1	-	-	-	-	-	-	1187	1187	-	486	486	-
Stage 2	-	-	-	-	-	-	546	497	-	1196	1203	-
Critical Hdwy	4.12	-	-	4.12	-	-	7.12	6.52	6.22	7.12	6.52	6.22
Critical Hdwy Stg 1	-	-	-	-	-	-	6.12	5.52	-	6.12	5.52	-
Critical Hdwy Stg 2	-	-	-	-	-	-	6.12	5.52	-	6.12	5.52	-
Follow-up Hdwy	2.218	-	-	2.218	-	-	3.518	4.018	3.318	3.518	4.018	3.318
Pot Cap-1 Maneuver	1087	-	-	767	-	-	69	94	353	75	93	598
Stage 1	-	-	-	-	-	-	230	262	-	563	551	-
Stage 2	-	-	-	-	-	-	522	545	-	227	257	-
Platoon blocked, %		-	-		-	-						
Mov Cap-1 Maneuver	1087	-	-	767	-	-	49	79	353	65	78	598
Mov Cap-2 Maneuver	-	-	-	-	-	-	49	79	-	65	78	-
Stage 1	-	-	-	-	-	-	196	223	-	480	543	-
Stage 2	-	-	-	-	-	-	420	537	-	192	219	-

Approach	EB			WB			NB			SB		
HCM Control Delay, s	1.4			0.2			94.1			29.9		
HCM LOS							F			D		

Minor Lane/Major Mvmt	NBLn1	EBL	EBT	EBR	WBL	WBT	WBR	SBLn1
Capacity (veh/h)	55	1087	-	-	767	-	-	269
HCM Lane V/C Ratio	0.28	0.148	-	-	0.014	-	-	0.475
HCM Control Delay (s)	94.1	8.9	-	-	9.8	-	-	29.9
HCM Lane LOS	F	A	-	-	A	-	-	D
HCM 95th %tile Q(veh)	1	0.5	-	-	0	-	-	2.4

Intersection						
Int Delay, s/veh	0.8					
Movement	WBL	WBR	NBT	NBR	SBL	SBT
Lane Configurations						
Traffic Vol, veh/h	17	2	136	26	1	88
Future Vol, veh/h	17	2	136	26	1	88
Conflicting Peds, #/hr	0	0	0	0	0	0
Sign Control	Stop	Stop	Free	Free	Free	Free
RT Channelized	-	None	-	None	-	None
Storage Length	0	-	-	-	-	-
Veh in Median Storage, #	0	-	0	-	-	0
Grade, %	0	-	0	-	-	0
Peak Hour Factor	78	78	87	87	83	83
Heavy Vehicles, %	2	2	2	2	2	2
Mvmt Flow	22	3	156	30	1	106

Major/Minor	Minor1	Major1	Major2		
Conflicting Flow All	279	171	0	0	186
Stage 1	171	-	-	-	-
Stage 2	108	-	-	-	-
Critical Hdwy	6.42	6.22	-	-	4.12
Critical Hdwy Stg 1	5.42	-	-	-	-
Critical Hdwy Stg 2	5.42	-	-	-	-
Follow-up Hdwy	3.518	3.318	-	-	2.218
Pot Cap-1 Maneuver	711	873	-	-	1388
Stage 1	859	-	-	-	-
Stage 2	916	-	-	-	-
Platoon blocked, %			-	-	-
Mov Cap-1 Maneuver	710	873	-	-	1388
Mov Cap-2 Maneuver	710	-	-	-	-
Stage 1	859	-	-	-	-
Stage 2	915	-	-	-	-

Approach	WB	NB	SB
HCM Control Delay, s	10.1	0	0.1
HCM LOS	B		

Minor Lane/Major Mvmt	NBT	NBRWBLn1	SBL	SBT
Capacity (veh/h)	-	-	724	1388
HCM Lane V/C Ratio	-	-	0.034	0.001
HCM Control Delay (s)	-	-	10.1	7.6
HCM Lane LOS	-	-	B	A
HCM 95th %tile Q(veh)	-	-	0.1	0

Intersection						
Int Delay, s/veh	1.1					
Movement	EBL	EBR	NBL	NBT	SBT	SBR
Lane Configurations						
Traffic Vol, veh/h	1	6	9	50	50	3
Future Vol, veh/h	1	6	9	50	50	3
Conflicting Peds, #/hr	0	0	0	0	0	0
Sign Control	Stop	Stop	Free	Free	Free	Free
RT Channelized	-	None	-	None	-	None
Storage Length	0	-	-	-	-	-
Veh in Median Storage, #	0	-	-	0	0	-
Grade, %	0	-	-	0	0	-
Peak Hour Factor	78	78	83	83	83	83
Heavy Vehicles, %	2	2	2	2	2	2
Mvmt Flow	1	8	11	60	60	4

Major/Minor	Minor2	Major1		Major2	
Conflicting Flow All	144	62	64	0	0
Stage 1	62	-	-	-	-
Stage 2	82	-	-	-	-
Critical Hdwy	6.42	6.22	4.12	-	-
Critical Hdwy Stg 1	5.42	-	-	-	-
Critical Hdwy Stg 2	5.42	-	-	-	-
Follow-up Hdwy	3.518	3.318	2.218	-	-
Pot Cap-1 Maneuver	849	1003	1538	-	-
Stage 1	961	-	-	-	-
Stage 2	941	-	-	-	-
Platoon blocked, %				-	-
Mov Cap-1 Maneuver	843	1003	1538	-	-
Mov Cap-2 Maneuver	843	-	-	-	-
Stage 1	954	-	-	-	-
Stage 2	941	-	-	-	-

Approach	EB	NB	SB
HCM Control Delay, s	8.7	1.1	0
HCM LOS	A		

Minor Lane/Major Mvmt	NBL	NBT	EBLn1	SBT	SBR
Capacity (veh/h)	1538	-	977	-	-
HCM Lane V/C Ratio	0.007	-	0.009	-	-
HCM Control Delay (s)	7.4	0	8.7	-	-
HCM Lane LOS	A	A	A	-	-
HCM 95th %tile Q(veh)	0	-	0	-	-

Intersection						
Int Delay, s/veh	1.7					
Movement	EBL	EBT	WBT	WBR	SBL	SBR
Lane Configurations						
Traffic Vol, veh/h	45	466	204	17	28	37
Future Vol, veh/h	45	466	204	17	28	37
Conflicting Peds, #/hr	0	0	0	0	0	0
Sign Control	Free	Free	Free	Free	Stop	Stop
RT Channelized	-	None	-	None	-	None
Storage Length	415	-	-	-	0	-
Veh in Median Storage, #	-	0	0	-	0	-
Grade, %	-	0	0	-	0	-
Peak Hour Factor	92	92	87	87	83	83
Heavy Vehicles, %	2	2	2	2	2	2
Mvmt Flow	49	507	234	20	34	45

Major/Minor	Major1	Major2	Minor2		
Conflicting Flow All	254	0	-	0	849 244
Stage 1	-	-	-	-	244 -
Stage 2	-	-	-	-	605 -
Critical Hdwy	4.12	-	-	-	6.42 6.22
Critical Hdwy Stg 1	-	-	-	-	5.42 -
Critical Hdwy Stg 2	-	-	-	-	5.42 -
Follow-up Hdwy	2.218	-	-	-	3.518 3.318
Pot Cap-1 Maneuver	1311	-	-	-	331 795
Stage 1	-	-	-	-	797 -
Stage 2	-	-	-	-	545 -
Platoon blocked, %		-	-	-	
Mov Cap-1 Maneuver	1311	-	-	-	319 795
Mov Cap-2 Maneuver	-	-	-	-	319 -
Stage 1	-	-	-	-	768 -
Stage 2	-	-	-	-	545 -

Approach	EB	WB	SB
HCM Control Delay, s	0.7	0	13.9
HCM LOS			B

Minor Lane/Major Mvmt	EBL	EBT	WBT	WBR	SBLn1
Capacity (veh/h)	1311	-	-	-	484
HCM Lane V/C Ratio	0.037	-	-	-	0.162
HCM Control Delay (s)	7.9	-	-	-	13.9
HCM Lane LOS	A	-	-	-	B
HCM 95th %tile Q(veh)	0.1	-	-	-	0.6

Intersection												
Int Delay, s/veh	3.4											
Movement	EBL	EBT	EBR	WBL	WBT	WBR	NBL	NBT	NBR	SBL	SBT	SBR
Lane Configurations												
Traffic Vol, veh/h	145	800	15	10	425	10	10	1	1	15	1	86
Future Vol, veh/h	145	800	15	10	425	10	10	1	1	15	1	86
Conflicting Peds, #/hr	0	0	0	0	0	0	0	0	0	0	0	0
Sign Control	Free	Free	Free	Free	Free	Free	Stop	Stop	Stop	Stop	Stop	Stop
RT Channelized	-	-	None	-	-	None	-	-	None	-	-	None
Storage Length	460	-	410	520	-	520	-	-	-	-	-	100
Veh in Median Storage, #	-	0	-	-	0	-	-	0	-	-	0	-
Grade, %	-	0	-	-	0	-	-	0	-	-	0	-
Peak Hour Factor	93	93	93	92	92	92	78	78	78	83	83	83
Heavy Vehicles, %	2	2	2	2	2	2	2	2	2	2	2	2
Mvmt Flow	156	860	16	11	462	11	13	1	1	18	1	104

Major/Minor	Major1			Major2			Minor1			Minor2		
Conflicting Flow All	473	0	0	876	0	0	1714	1667	860	1665	1672	462
Stage 1	-	-	-	-	-	-	1172	1172	-	484	484	-
Stage 2	-	-	-	-	-	-	542	495	-	1181	1188	-
Critical Hdwy	4.12	-	-	4.12	-	-	7.12	6.52	6.22	7.12	6.52	6.22
Critical Hdwy Stg 1	-	-	-	-	-	-	6.12	5.52	-	6.12	5.52	-
Critical Hdwy Stg 2	-	-	-	-	-	-	6.12	5.52	-	6.12	5.52	-
Follow-up Hdwy	2.218	-	-	2.218	-	-	3.518	4.018	3.318	3.518	4.018	3.318
Pot Cap-1 Maneuver	1089	-	-	771	-	-	71	96	356	77	96	600
Stage 1	-	-	-	-	-	-	234	266	-	564	552	-
Stage 2	-	-	-	-	-	-	525	546	-	232	262	-
Platoon blocked, %	-	-	-	-	-	-	-	-	-	-	-	-
Mov Cap-1 Maneuver	1089	-	-	771	-	-	51	81	356	67	81	600
Mov Cap-2 Maneuver	-	-	-	-	-	-	51	81	-	67	81	-
Stage 1	-	-	-	-	-	-	201	228	-	483	544	-
Stage 2	-	-	-	-	-	-	427	538	-	197	225	-

Approach	EB			WB			NB			SB		
HCM Control Delay, s	1.3			0.2			90			22.5		
HCM LOS							F			C		

Minor Lane/Major Mvmt	NBLn1	EBL	EBT	EBR	WBL	WBT	WBR	SBLn1	SBLn2
Capacity (veh/h)	57	1089	-	-	771	-	-	68	600
HCM Lane V/C Ratio	0.27	0.143	-	-	0.014	-	-	0.283	0.173
HCM Control Delay (s)	90	8.9	-	-	9.7	-	-	77.7	12.2
HCM Lane LOS	F	A	-	-	A	-	-	F	B
HCM 95th %tile Q(veh)	0.9	0.5	-	-	0	-	-	1	0.6

Intersection												
Int Delay, s/veh	5.4											
Movement	EBL	EBT	EBR	WBL	WBT	WBR	NBL	NBT	NBR	SBL	SBT	SBR
Lane Configurations												
Traffic Vol, veh/h	52	274	10	2	896	25	15	1	3	21	1	135
Future Vol, veh/h	52	274	10	2	896	25	15	1	3	21	1	135
Conflicting Peds, #/hr	0	0	0	0	0	0	0	0	0	0	0	0
Sign Control	Free	Free	Free	Free	Free	Free	Stop	Stop	Stop	Stop	Stop	Stop
RT Channelized	-	-	None	-	-	None	-	-	None	-	-	None
Storage Length	460	-	410	520	-	520	-	-	-	-	-	100
Veh in Median Storage, #	-	0	-	-	0	-	-	0	-	-	0	-
Grade, %	-	0	-	-	0	-	-	0	-	-	0	-
Peak Hour Factor	92	92	92	93	93	93	78	78	78	87	87	87
Heavy Vehicles, %	2	2	2	2	2	2	2	2	2	2	2	2
Mvmt Flow	57	298	11	2	963	27	19	1	4	24	1	155

Major/Minor	Major1			Major2			Minor1			Minor2		
Conflicting Flow All	990	0	0	309	0	0	1471	1406	298	1387	1390	963
Stage 1	-	-	-	-	-	-	412	412	-	967	967	-
Stage 2	-	-	-	-	-	-	1059	994	-	420	423	-
Critical Hdwy	4.12	-	-	4.12	-	-	7.12	6.52	6.22	7.12	6.52	6.22
Critical Hdwy Stg 1	-	-	-	-	-	-	6.12	5.52	-	6.12	5.52	-
Critical Hdwy Stg 2	-	-	-	-	-	-	6.12	5.52	-	6.12	5.52	-
Follow-up Hdwy	2.218	-	-	2.218	-	-	3.518	4.018	3.318	3.518	4.018	3.318
Pot Cap-1 Maneuver	698	-	-	1252	-	-	105	139	741	120	142	310
Stage 1	-	-	-	-	-	-	617	594	-	306	333	-
Stage 2	-	-	-	-	-	-	271	323	-	611	588	-
Platoon blocked, %	-	-	-	-	-	-	-	-	-	-	-	-
Mov Cap-1 Maneuver	698	-	-	1252	-	-	49	127	741	111	130	310
Mov Cap-2 Maneuver	-	-	-	-	-	-	49	127	-	111	130	-
Stage 1	-	-	-	-	-	-	566	545	-	281	332	-
Stage 2	-	-	-	-	-	-	135	322	-	557	540	-

Approach	EB	WB	NB	SB
HCM Control Delay, s	1.6	0	101.1	30.3
HCM LOS			F	D

Minor Lane/Major Mvmt	NBLn1	EBL	EBT	EBR	WBL	WBT	WBR	SBLn1	SBLn2
Capacity (veh/h)	60	698	-	-	1252	-	-	112	310
HCM Lane V/C Ratio	0.406	0.081	-	-	0.002	-	-	0.226	0.501
HCM Control Delay (s)	101.1	10.6	-	-	7.9	-	-	46.3	27.7
HCM Lane LOS	F	B	-	-	A	-	-	E	D
HCM 95th %tile Q(veh)	1.5	0.3	-	-	0	-	-	0.8	2.6

Intersection												
Int Delay, s/veh	5.8											
Movement	EBL	EBT	EBR	WBL	WBT	WBR	NBL	NBT	NBR	SBL	SBT	SBR
Lane Configurations												
Traffic Vol, veh/h	55	275	10	2	900	25	15	1	3	20	1	140
Future Vol, veh/h	55	275	10	2	900	25	15	1	3	20	1	140
Conflicting Peds, #/hr	0	0	0	0	0	0	0	0	0	0	0	0
Sign Control	Free	Free	Free	Free	Free	Free	Stop	Stop	Stop	Stop	Stop	Stop
RT Channelized	-	-	None	-	-	None	-	-	None	-	-	None
Storage Length	460	-	410	520	-	520	-	-	-	-	-	100
Veh in Median Storage, #	-	0	-	-	0	-	-	0	-	-	0	-
Grade, %	-	0	-	-	0	-	-	0	-	-	0	-
Peak Hour Factor	92	92	92	93	93	93	78	78	78	87	87	87
Heavy Vehicles, %	2	2	2	2	2	2	2	2	2	2	2	2
Mvmt Flow	60	299	11	2	968	27	19	1	4	23	1	161

Major/Minor	Major1			Major2			Minor1			Minor2		
Conflicting Flow All	995	0	0	310	0	0	1486	1418	299	1399	1402	968
Stage 1	-	-	-	-	-	-	419	419	-	972	972	-
Stage 2	-	-	-	-	-	-	1067	999	-	427	430	-
Critical Hdwy	4.12	-	-	4.12	-	-	7.12	6.52	6.22	7.12	6.52	6.22
Critical Hdwy Stg 1	-	-	-	-	-	-	6.12	5.52	-	6.12	5.52	-
Critical Hdwy Stg 2	-	-	-	-	-	-	6.12	5.52	-	6.12	5.52	-
Follow-up Hdwy	2.218	-	-	2.218	-	-	3.518	4.018	3.318	3.518	4.018	3.318
Pot Cap-1 Maneuver	695	-	-	1250	-	-	103	137	741	118	140	308
Stage 1	-	-	-	-	-	-	612	590	-	304	331	-
Stage 2	-	-	-	-	-	-	269	321	-	606	583	-
Platoon blocked, %	-	-	-	-	-	-	-	-	-	-	-	-
Mov Cap-1 Maneuver	695	-	-	1250	-	-	46	125	741	109	128	308
Mov Cap-2 Maneuver	-	-	-	-	-	-	46	125	-	109	128	-
Stage 1	-	-	-	-	-	-	559	539	-	278	330	-
Stage 2	-	-	-	-	-	-	128	320	-	549	533	-

Approach	EB	WB	NB	SB
HCM Control Delay, s	1.7	0	111.7	31.1
HCM LOS			F	D

Minor Lane/Major Mvmt	NBLn1	EBL	EBT	EBR	WBL	WBT	WBR	SBLn1	SBLn2
Capacity (veh/h)	56	695	-	-	1250	-	-	110	308
HCM Lane V/C Ratio	0.435	0.086	-	-	0.002	-	-	0.219	0.522
HCM Control Delay (s)	111.7	10.7	-	-	7.9	-	-	46.7	28.8
HCM Lane LOS	F	B	-	-	A	-	-	E	D
HCM 95th %tile Q(veh)	1.6	0.3	-	-	0	-	-	0.8	2.8

Intersection												
Int Delay, s/veh	3.5											
Movement	EBL	EBT	EBR	WBL	WBT	WBR	NBL	NBT	NBR	SBL	SBT	SBR
Lane Configurations												
Traffic Vol, veh/h	150	804	15	10	427	10	10	1	1	15	1	90
Future Vol, veh/h	150	804	15	10	427	10	10	1	1	15	1	90
Conflicting Peds, #/hr	0	0	0	0	0	0	0	0	0	0	0	0
Sign Control	Free	Free	Free	Free	Free	Free	Stop	Stop	Stop	Stop	Stop	Stop
RT Channelized	-	-	None	-	-	None	-	-	None	-	-	None
Storage Length	460	-	410	520	-	520	-	-	-	-	-	100
Veh in Median Storage, #	-	0	-	-	0	-	-	0	-	-	0	-
Grade, %	-	0	-	-	0	-	-	0	-	-	0	-
Peak Hour Factor	93	93	93	92	92	92	78	78	78	83	83	83
Heavy Vehicles, %	2	2	2	2	2	2	2	2	2	2	2	2
Mvmt Flow	161	865	16	11	464	11	13	1	1	18	1	108

Major/Minor	Major1			Major2			Minor1			Minor2		
Conflicting Flow All	475	0	0	881	0	0	1733	1684	865	1682	1689	464
Stage 1	-	-	-	-	-	-	1187	1187	-	486	486	-
Stage 2	-	-	-	-	-	-	546	497	-	1196	1203	-
Critical Hdwy	4.12	-	-	4.12	-	-	7.12	6.52	6.22	7.12	6.52	6.22
Critical Hdwy Stg 1	-	-	-	-	-	-	6.12	5.52	-	6.12	5.52	-
Critical Hdwy Stg 2	-	-	-	-	-	-	6.12	5.52	-	6.12	5.52	-
Follow-up Hdwy	2.218	-	-	2.218	-	-	3.518	4.018	3.318	3.518	4.018	3.318
Pot Cap-1 Maneuver	1087	-	-	767	-	-	69	94	353	75	93	598
Stage 1	-	-	-	-	-	-	230	262	-	563	551	-
Stage 2	-	-	-	-	-	-	522	545	-	227	257	-
Platoon blocked, %	-	-	-	-	-	-	-	-	-	-	-	-
Mov Cap-1 Maneuver	1087	-	-	767	-	-	49	79	353	65	78	598
Mov Cap-2 Maneuver	-	-	-	-	-	-	49	79	-	65	78	-
Stage 1	-	-	-	-	-	-	196	223	-	480	543	-
Stage 2	-	-	-	-	-	-	420	537	-	192	219	-

Approach	EB			WB			NB			SB		
HCM Control Delay, s	1.4			0.2			94.1			22.6		
HCM LOS							F			C		

Minor Lane/Major Mvmt	NBLn1	EBL	EBT	EBR	WBL	WBT	WBR	SBLn1	SBLn2
Capacity (veh/h)	55	1087	-	-	767	-	-	66	598
HCM Lane V/C Ratio	0.28	0.148	-	-	0.014	-	-	0.292	0.181
HCM Control Delay (s)	94.1	8.9	-	-	9.8	-	-	80.7	12.3
HCM Lane LOS	F	A	-	-	A	-	-	F	B
HCM 95th %tile Q(veh)	1	0.5	-	-	0	-	-	1	0.7