



ENTECH
ENGINEERING, INC.

505 ELKTON DRIVE
COLORADO SPRINGS, CO 80907
PHONE (719) 531-5599
FAX (719) 531-5238

**SUBSURFACE SOIL INVESTIGATION
WINDINGWALK FILINGS 1 AND 2 AND
STONEBRIDGE THE ENCLAVE FILINGS 4 AND 5
STAPLETON DRIVE AND EASTONVILLE ROAD
EL PASO COUNTY, COLORADO**

Prepared for:

Tech Contractors
3575 Kenyon Street, Suite 200
San Diego, California 92110

Add a section addressing EPC
Drainage Criteria Manual section
11.3.3 regarding "recommendations for
the foundation preparation and
embankment construction for all
permanent detention facilities."

Attn: Mr. Raul Guzman

November 8, 2017
Revised December 21, 2017
Revised January 2, 2018

Respectfully Submitted,

ENTECH ENGINEERING, INC.

Kristen A. Andrew-Hoeser, P.G.
Engineering Geologist

KAH/rm

Encl.

Entech Job No. 171198
AAprojects/2017/171198 SSI_rev2

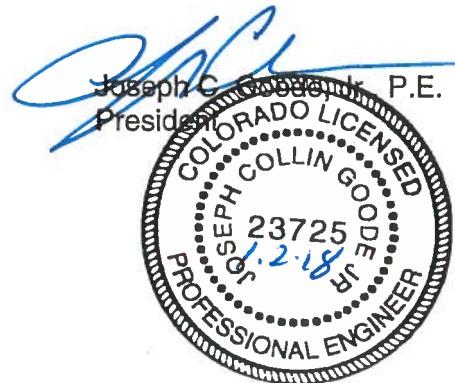

Add "PCD File No. PUDSP-18-002
& SF-18-002"

Table of Contents

1.0 INTRODUCTION.....2

2.0 PROJECT AND SITE DESCRIPTION.....3

3.0 SUBSURFACE EXPLORATIONS AND LABORATORY TESTING.....3

4.0 SUBSURFACE CONDITIONS.....4

 4.1 Soil and Bedrock4

 4.2 Groundwater.....7

5.0 DEVELOPMENT CONSIDERATIONS7

 5.1 Groundwater.....8

 5.2 Expansive Soils8

 5.3 Sandstone, Siltstone, and Claystone9

6.0 SITE GRADING.....9

 6.1 Stripping9

 6.2 Fill Preparation9

 6.3 Compaction10

7.0 UNDERGROUND UTILITY CONSTRUCTION.....10

8.0 UNDERDRAIN SYSTEM.....11

9.0 PAVEMENT CONSIDERATIONS.....11

10.0 ANTICIPATED RESIDENTIAL FOUNDATION SYSTEMS.....12

11.0 RESIDENCE ON-GRADE FLOOR SLABS.....12

12.0 CONCRETE DEGRADATION DUE TO SULFATE ATTACK13

13.0 EXCAVATION STABILITY13

14.0 SURFACE AND SUBSURFACE DRAINAGE.....13

15.0 WINTER CONSTRUCTION14

16.0 CONSTRUCTION OBSERVATIONS.....14

17.0 CLOSURE15

Tables

Table 1: Summary of Laboratory Test Results

Table 2: Summary of Estimated Cut/Fill, Bedrock and Depth to Groundwater Depths

Figures

Figure 1: Vicinity Location Map

Figure 2: Test Boring Location Plan

Figure 3: Overexcavation Drain Detail

Figure 4: Exterior Perimeter Drain Detail

List of Appendices

Appendix A: Test Boring Logs

Appendix B: Laboratory Test Results

**SUBSURFACE SOIL INVESTIGATION
WINDINGWALK FILINGS 1 AND 2 AND
STONEBRIDGE THE ENCLAVE FILINGS 4 AND 5
STAPLETON DRIVE AND EASTONVILLE ROAD
EL PASO COUNTY, COLORADO**

1.0 INTRODUCTION

The project consists of the development of the site for the construction of single-family residences. Development is expected to include site grading, installation of subsurface utilities, roadways, and drainage structures. The site is Windingwalk Filings 1 and 2 and Stonebridge The Enclave Filings 4 and 5, north of Stapleton Drive and west of Eastonville Road in El Paso County, Colorado. The approximate location of the project site is shown on the Vicinity Location Map, Figure 1. The test boring locations are shown on Figure 2, the Test Boring Location Plan.

This report describes the subsurface investigation conducted for the site and provides recommendations for development design and construction. The Subsurface Soil Investigation included the drilling of fifty-five test borings across the site, collecting samples of soil, and conducting a geotechnical evaluation of the investigation findings. All drilling and subsurface investigation activities were performed by Entech Engineering, Inc. (Entech). The contents of this report, including the geotechnical evaluation and recommendations, are subject to the limitations and assumptions presented in Section 17.0.

2.0 PROJECT AND SITE DESCRIPTION

The project will consist of developing the site for single family residential structures. The planned lots are located in Windingwalk Filings 1 and 2 and Stonebridge The Enclave Filings 4 and 5, north of Stapleton Drive and west of Eastonville Road, just north of Falcon, Colorado in El Paso County. Investigation was performed at predetermined locations designated based on the roadway alignment and proposed grading on the site plan provided to Entech. At the time of drilling, the site was vacant and not developed. Enclave Scenic Way and Fairway Glen Circle have been graded prior to this investigation. The site has general gradual slope towards the south. Vegetation consisted of field grasses and weeds. Existing residences were located to the north and northeast of the site. A golf course exists west of the site. Stapleton Drive borders the southern boundary of the site.

3.0 SUBSURFACE EXPLORATIONS AND LABORATORY TESTING

Subsurface conditions on the site were explored by drilling fifty-five test borings at the approximate locations shown on Figure 2. The borings were drilled to depths of 20 to 30 feet below the existing ground surface (bgs). The drilling was performed using a truck-mounted, continuous flight auger-drilling rig supplied and operated by Entech. Boring logs descriptive of the subsurface conditions encountered during drilling are presented in Appendix A. At the conclusion and subsequent to drilling, observations for groundwater levels were made in each of the open boreholes.

Soil and bedrock samples were obtained from the borings utilizing the Standard Penetration Test (ASTM D-1586) using 2-inch O.D. split-barrel and California samplers. Results of the Standard Penetration Test (SPT) are included on the boring logs in terms of N-values expressed in blows per foot (bpf). Soil and bedrock samples recovered from the borings were visually classified and recorded on the boring logs. The soil and bedrock classifications were later verified utilizing laboratory testing and grouped by soil type. The soil and bedrock type numbers are included on the boring logs. It should be understood that the soil and bedrock descriptions shown on the boring logs may vary between boring location and sample depth. It should also be noted that the lines of stratigraphic separation shown on the boring logs

represent approximate boundaries between soil and bedrock types and the actual stratigraphic transitions may be more gradual or variable with location.

Water content testing (ASTM D-2216) was performed on the samples recovered from the borings, and the results are shown on the boring logs. Grain-Size Analysis (ASTM D-422) and Atterberg Limits testing (ASTM D-4318) were performed on selected samples to assist in classifying the materials encountered in the borings. Volume change testing was performed on selected samples using the Swell/Consolidation Test (ASTM D-4546) and the FHA Swell Test in order to evaluate potential expansion/compression characteristics of the soil and bedrock. Soluble sulfate testing was performed on select soil samples to evaluate the potential for below grade degradation of concrete due to sulfate attack. The Laboratory Testing Results are summarized on Table 1 and are presented in Appendix B.

4.0 SUBSURFACE CONDITIONS

Three soil types and three bedrock types were encountered in the test borings drilled for the subsurface investigation: Type 1A: silty to clayey sand fill (SM, SC), Type 1: slightly silty to silty sand and clayey sand (SM-SW, SM, SC), Type 2: sandy to very sandy clay (CL), Type 3: slightly silty to very silty and clayey to very clayey sandstone (SM-SW, SM, SC), Type 4: sandy to very sandy claystone (CL), and Type 5: clayey, sandy siltstone (ML). Soils were classified in accordance with the Unified Soil Classification System (USCS) and American Association of State Highway and Transportation Officials (AASHTO) System using the laboratory testing results and the observations made during drilling.

4.1 Soil and Bedrock

Soil Type 1A classified as a silty to clayey sand fill (SM, SC, A-1-b). the sand fill was encountered in seven of the test borings, Test Boring Nos. 1, 2, 3, 36, 37, 38, and 39 at the existing ground surface and extending to depths ranging from 3 to 14 feet below the ground surface (bgs). The fill was located along Enclave Scenic Way and Fairway Glen Circle as noted in Figure 2. Reportedly the fill was observed and tested by others. Records of testing will be provided as required. Standard Penetration Testing resulted in SPT N-values ranging from 5 to 34 bpf, indicating loose to dense states. Water content and grain size testing resulted in water

contents ranging from 5 to 15 percent with approximately 15 to 32 percent of the soil size particles passing the No. 200 sieve. Atterberg Limits Testing resulted in the silty sand fill being non-plastic. FHA Swell Testing resulted in a swell pressure of 240 psf, indicating low expansion potential.

Stockpiles of fill are located in the vicinity of six of the test borings, Test Boring Nos. 11, 12, 13, 14, 43, and 50. These test borings were drilled adjacent to and on the stockpiled fill. These fill piles will require complete removals prior to any additional fill planned for this portion of the site. Based on the soil type encountered in the single boring drilled in this stockpiled fill, it is likely that this stockpiled fill can be used within this development. The fill removals should be observed by Entech to determine if additional soil sampling or laboratory testing is required.

Soil Type 1 classified as a slightly silty to silty sand and clayey sand (SM-SW, SM, SC, A-1-b, A-2-4, A-5, A-6). The sand was encountered in fifty-two of the test borings at depths ranging from the existing ground surface to 14 feet and extending to depths ranging from one foot to the termination of the borings (20 feet). Standard Penetration Testing conducted on the sand resulted in SPT N-values ranging from 8 to greater than 50 blows per foot (bpf), indicating the soil to be at loose to very dense states. Water content and grain size testing of soil samples resulted in a water content range of 2 to 23 percent with approximately 6 to 38 percent of the soil size particles passing the No. 200 sieve. Atterberg Limits testing resulted in liquid limits ranging from 29 to no value and plastic indexes of 15 to non-plastic. Sulfate testing on samples of Soil Type 1 resulted 0.00 to 0.01 percent soluble sulfate by weight, which indicates a negligible potential for below grade concrete degradation due to sulfate attack.

Soil Type 2 classified as sandy to very sandy clay (CL, A-4, A-6). The clay was encountered in four of the test borings at depths ranging from the ground surface to 14 feet below the ground surface (bgs) and extending to depths ranging from 3 to 16 feet bgs. Standard Penetration Testing on the clay resulted in SPT N-values of 10 to 32 bpf, indicating firm to very stiff consistencies. Water content and grain size testing resulted in approximately 11 to 20 percent water content with approximately 52 to 53 percent of the soil size particles passing the No. 200 sieve. Atterberg Limits testing resulted in liquid limits of 20 to 30 and plastic indexes of 10 to 14. A FHA Swell pressure of 1720 psf was measured on the clay, indicating moderate to high expansion potential. No swell (0.0 percent) was measured in the Swell/Consolidation Test

conducted on the clay. Sulfate testing resulted in less than 0.01 percent sulfate by weight indicating negligible potential for below grade concrete degradation due to sulfate attack.

Soil Type 3 classified as a slightly silty to very silty and clayey to very clayey sandstone (SM-SW, SM, SC, A-1-b, A-2-4, A-2-6, A-2-7, A-4, A-6). The sandstone was encountered in fifty-one of the test borings at depths ranging from 1 to 18 feet bgs and extending to depths ranging from 6 feet to 19 feet bgs and to the termination of the borings (20 to 30 feet). Standard Penetration Testing conducted on the sandstone resulted in SPT N-values from 37 to greater than 50 bpf, which indicates dense to very dense states. Water content and grain size testing resulted in approximately 4 to 21 percent water content with approximately 8 to 45 percent of the soil size particles passing the No. 200 sieve. Atterberg Limits testing resulted in liquid limits of 41 to no value and plastic indexes of 18 to non-plastic. FHA Swell testing on the sandstone resulted in a swell pressure of 30 psf, indicating low expansion potential. Swell/Consolidation testing on the very clayey sandstone resulted in volume change of 2.1 percent indicating moderate to high expansion potential. Sulfate testing on the sandstone resulted in 0.00 to less than 0.01 percent sulfate by weight indicating the sandstone exhibits negligible potential for below grade concrete degradation due to sulfate attack.

Soil Type 4 classified as a sandy to very sandy claystone (CL, A-4, A-5, A-6). The claystone was encountered in thirteen of the test borings at depths ranging from 1 to 24 feet bgs and extending to depths ranging from 8 to 28 feet bgs or to the termination of the borings (20 to 25 feet). Standard Penetration Testing conducted on the claystone resulted in SPT N-values of 40 to greater than 50 bpf, which indicates very stiff to hard consistencies. Water content and grain size testing resulted in approximately 10 to 17 percent water content with approximately 57 to 66 percent of the soil size particles passing the No. 200 sieve. Atterberg limits testing on the claystone resulted in liquid limits of 21 to 29 and plastic indexes of 8 to 13. FHA Swell Testing resulted in swell pressures of 1970 to 2060 psf, indicating the claystone exhibits high expansion potential. Swell/Consolidation testing on the claystone resulted in a volume change of 1.7 percent, indicating moderate expansion potential. Sulfate testing on the claystone resulted in 0.00 to less than 0.01 percent sulfate by weight indicating the claystone exhibits negligible degradation to concrete due to sulfate attack.

Soil Type 5 classified as a clayey, sandy siltstone (ML, A-6). The siltstone was encountered in two of the test borings at depths of 1 to 11 feet and extending to depths of 6 feet bgs to the

termination of the boring (20 feet). Standard Penetration Testing on the siltstone resulted in SPR N-values greater than 50 bpf, indicating hard consistencies. Water content and grain size testing resulted in water content of 9 to 19 percent with approximately 67 to 85 percent of the soil size particles passing the No. 200 sieve. Atterberg Limits Testing resulted in a liquid limit of 40 and a plastic index of 14. Swell/Consolidation conducted on the siltstone resulted in a volume change of 0.9 percent, indicating low to moderate expansion potential.

The test boring logs are included in Appendix A. Laboratory Test Results are included in Appendix B and Summarized in Table 1. Bedrock depths are summarized in Table 2.

4.2 Groundwater

Depth to groundwater was measured in each of the borings at the conclusion of drilling and subsequent to drilling. Groundwater was encountered in thirty-nine of the fifty-five test borings at depths ranging from 2.5 to 20.5 feet. Groundwater may affect construction and utilities construction on this site. Much of these areas are to be filled. The groundwater depths and estimated cuts and fills are summarized in Table 2. Unstable conditions may be encountered where excavations approach the groundwater level. Stabilization using shot rock or geogrids may be necessary. Typically the sandstone will remain stable when water is encountered. It should be noted that groundwater levels could change due to seasonal variations, changes in land runoff characteristics and future development including nearby areas. Table 2 presents depth to groundwater, estimated cut/fill and depth to bedrock.

5.0 DEVELOPMENT CONSIDERATIONS

The following discussion is based on the subsurface conditions encountered in the borings drilled at the site. This investigation is for the site discussed in 2.0 Project and Site Description. If subsurface conditions different from those described herein are encountered during construction or if the project elements change from those described, Entech Engineering, Inc. should be notified so that the evaluation and recommendations presented can be reviewed and revised if necessary.

Subsurface soil conditions encountered in the test borings drilled on the site generally consisted of sand fill, silty to clayey sand, and sandy clay overlying sandstone, claystone and siltstone bedrock. Bedrock was encountered at depths ranging from 1 to 16 feet bgs and greater than 20 feet in one of the test borings. The fill located along Enclave Scenic Way and Fairway Glen Circle is considered controlled, however records of fill placement should be provided to Entech for review to determine the extent of the testing in this area. Fill piles were encountered in the central portion of the site in the vicinity of Test Boring Nos. 11, 12, 13, 14, 43, and 50. All fill piles need to be completely removed. Complete removals of these undocumented fill piles will be required prior to developing this area or placing additional fill. Recommendations for site grading, fill preparation, and compaction efforts are described in Section 6.0. Consideration should be given to several conditions on this site in planning and excavating the development besides the fill pile mitigation described above including groundwater, expansive soils and bedrock materials.

5.1 Groundwater

Groundwater should be expected to impact the development. Table 2 presents depth to bedrock and groundwater. Subsequent to completion of overlot grading cuts per the grading plan presented to us, the measured water levels will be at 6 feet or shallower at locations of Test Boring Nos. 1, 5, 6, 8, 16, 19, 27 and 39. Groundwater measured as shallow as nine feet in planned fill areas is not expected to influence construction of fills. Unstable conditions should be expected where groundwater is shallow or close to excavated depths. Procedures and equipment to mitigate groundwater impact during and after construction should be anticipated. Pumps, cofferdams, wide area and localized drain systems and other procedures and equipment may be necessary. Shot rock and geotextiles may be appropriate for stabilizing excavations. An underdrain system can be considered for long term groundwater mitigation. Frequently, groundwater levels rise following development as result of increased irrigation and decreased potential area of evaporation.

5.2 Expansive Soils

Expansive soils (clayey sand, clay, very clayey sandstone, claystone and clayey siltstone) are present on the site exhibiting expansion potential ranging from low to high. Mitigation of expansive soils will be required on portions of the lots.

5.3 Sandstone, Siltstone and Claystone

Sandstone, siltstone and claystone were encountered at depths as shallow as one to four feet. Bedrock was encountered at shallow depths across the majority of the site. Excavation of sandstone, siltstone and claystone should be expected to be moderate to difficult. Track type equipment likely will be needed to accomplish excavations particularly where harder materials or lenses are present. Upon completion of site grading per the plan provided to us, sandstone is expected to be exposed across the majority of the areas tested.

6.0 SITE GRADING

Shallow bedrock (less than 6 feet) was encountered in thirty-nine of the fifty-five test borings drilled on the site. Excavation of most bedrock materials on site is expected to be moderate to difficult with heavy duty earthmoving equipment. Claystone, siltstone and sandstone materials may require track equipment and ripping teeth. For conditions with no groundwater seepage, cut and fill slopes no steeper than 3 to 1 (horizontal to vertical) should be considered. If seepage occurs, then flatter slopes or a drain system should be considered. Recommendations may be subject to change depending upon particular field conditions.

6.1 Stripping

Debris, topsoil and organic materials should be stripped from the ground surface of areas to be filled. The fill in Enclave Scenic Way and Fairway Glen Circle are believed to be controlled and tested by others and appeared to be prepared to the approved Stonebridge Filing 1 grading plans. Any uncontrolled fill materials should be completely removed. Fill was encountered in central portion of the site that is considered uncontrolled. The materials may be used as fill pending approval if they are free of organic material and debris. Any soft or loose soils should be stabilized or removed to expose suitable material prior to placement of fill. Topsoil may be stored in stock piles and placed at the surface in landscape areas.

6.2 Fill Preparation

Surfaces which will receive fill should be scarified to depths of 6 inches, moisture conditioned to within 2 percent of optimum moisture, and compacted to minimum of 95 percent of Standard Proctor Dry Density (ASTM D 698). On-site natural soils and bedrock are anticipated to be used

as site grading fill. Bedrock must be processed and broken down where placed in the fill. Expansive materials used for fill should be placed at sufficient moisture content to mitigate potential swell. The fill quality will influence the performance of foundations, slabs-on-grade, and pavements. Fill settlement can be minimized by placing thin lifts at suitable moisture content and by verification of compaction with frequent density tests.

6.3 Compaction

Overlot grading fill consisting of granular soils should be placed in lifts to exceed 6 inches following compaction and compacted to at least 95 percent of the maximum dry density determined by Modified Proctor (ASTM D-1557). Clay materials should be placed in compacted lifts less than 6 inches thick compacted to at least 95 percent of maximum Standard Proctor (ASTM D 698) Dry Density. Fills below 10 feet in depth should be moisture conditioned as above and compacted to 98 percent of Standard Proctor Dry Density (ASTM D 698) for cohesive materials or 98 percent of maximum Modified Proctor Dry Density (ASTM D 1557) for granular materials. The soil materials should be placed at a moisture content conducive to adequate compaction, usually within ± 2 percent of optimum moisture content. Fill placement and compaction should be observed and tested by Entech during construction to verify that adequate moisture and density has been achieved.

7.0 UNDERGROUND UTILITY CONSTRUCTION

Generally excavation is expected to be moderate to difficult utilizing heavy-duty trackhoes. Rock buckets and rock teeth will likely be required where excavations extend into very hard sandstone or cemented materials. Special procedures or equipment may be required to remove water and/or achieve stability in utility trenches where excavations approach or intercept groundwater.

Utilities including water and sewer lines are usually constructed beneath paved roads. Placement of fill and degree of compaction applied to trench backfill will influence performance of overlying structures including pavements. Fill placed into utility trenches should be compacted according to requirements of the local jurisdiction. Fill should be placed in horizontal lifts having compacted thickness of six inches or less and at a water content conducive adequate compaction, usually within ± 2 percent of optimum water content. Typical compaction

specifications would be similar to specifications in the Site Grading section. Mechanical methods should be used for fill placement, however, heavy equipment should be kept at a distance away from structures to avoid damage. No water flooding techniques of any type should be used for compaction or placement of utility trench backfill.

Trench backfill should be performed in accordance with El Paso County specifications and requirements. Excavations and excavation shoring/bracing should be performed in accordance with OSHA guidelines.

8.0 UNDERDRAIN SYSTEM

Depending on final site grading anticipated depths of excavations and structure foundations relative to groundwater occurrence, an underdrain system may be considered to be included as part of sewer system design and installation. The underdrain system drain pipe shall consist of smooth wall non perforated rigid PVC pipe placed at a minimum slope of 0.5 percent. Concrete or clay material fill may be strategically placed at the manhole locations to slow the water flow down the trench. The underdrain below sewer should be constructed with adequate depth to allow connection of residence foundation drain systems. Drain elements should be of appropriate slopes and sizes for anticipated flows. Maintenance of the underdrain system should be anticipated. Gravity outlet should be planned such that other developments and properties are not adversely affected.

9.0 PAVEMENT CONSIDERATIONS

Materials exposed at pavement subgrade elevations will be dependent upon native materials exposed at final overlot grading and the specific materials placed as fill at and near finish grade elevations after utility installation. The predominate materials are generally expected to be silty sand, sandstone, clayey sand, clay, claystone and siltstone. Materials anticipated at subgrade elevation generally would be rated as typically having good pavement support characteristics with some areas likely rated as having poor pavement support characteristics. AASHTO classifications of A-1-b, A-2-4, A-2-6, A-2-7, and A-4 were determined for the majority of the sandstone and upper granular soils. Based on depth to claystone and estimated cut, the

claystone may be exposed within the pavement subgrade. The claystone classifies as A-4, A-5, and A-6 using the AASHTO classification system which typically provide fair to poor pavement support and may be encountered on the site depending on the final grading plans. Thickness of asphalt pavement and aggregate base course sections may be 4 inches of asphalt overlying 6 to 10 inches of base course depending on specific subgrade materials and Roadway Classification of each particular street. Chemically treated soil subgrades may be used on this site with anticipated sections of 4 inches of asphalt overlying 10 inches of treated subgrade. For specific thickness determinations, a subsurface soil investigation and pavement design should be completed after completion of overlot grading and utility installation.

10.0 ANTICIPATED RESIDENTIAL FOUNDATION SYSTEMS

Subsurface soil conditions consisted of granular materials with some areas of expansive clay claystone or clayey siltstone materials. We anticipate conventional spread footing foundation systems will be appropriate for residences constructed on the majority of the site. Where expansive materials are encountered at or near foundation grades, use of spread footings with overexcavation and replacement with non-expansive fill should be expected. Drilled pier foundations may be a suitable alternative where expansive soils are encountered. A Subsurface Soils Investigation report should be prepared after completion of overlot grading to address appropriate foundation systems for each lot. Perimeter below grade foundation drain systems should be anticipated. Overexcavation drains may also be required. Figures 3 and 4 present typical drain overexcavation and building perimeter details. Shallow groundwater was encountered at Test Boring Nos. 1, 5, 6, 8, 16, 19, 27 and 39. Temporary and permanent dewatering systems may be necessary at various foundation excavations. Shotrock and geotextiles may be appropriate for stabilizing excavations. An area wide subdrain may be considered for discharge of collected water.

11.0 RESIDENCE ON-GRADE FLOOR SLABS

On-grade floor slabs for the planned structures could be supported by on-site non-expansive soils or compacted, non-expansive, structural fill. Loose or expansive soils encountered at or near floor slab grade should be penetrated or overexcavated a distance below slab subgrade

and replaced with a non-expansive structural fill to improve floor slab performance. If slab movement and cracks cannot be tolerated a structural floor system should be used. Evaluation of subgrade materials should be included within a Subsurface Soils Investigation for each specific lot.

12.0 CONCRETE DEGRADATION DUE TO SULFATE ATTACK

Sulfate solubility testing was conducted on twenty-two samples recovered from the test borings to evaluate the potential for sulfate attack on concrete placed below surface grade. The test results indicated 0.00 to 0.01 percent soluble sulfate (by weight). The test results indicate the sulfate component of the in-place soils presents a negligible exposure threat to concrete placed below the site grade. Type II cement is recommended for the on-site soils. Additional testing should be conducted following completion of overlot grading.

13.0 EXCAVATION STABILITY

Excavation walls must be properly sloped/benched or otherwise supported in order to maintain stable conditions. All excavation openings and work execution shall conform to OSHA standards as in CFR 29, Part 1926.650-652 (Subpart D).

14.0 SURFACE AND SUBSURFACE DRAINAGE

Surface drainage will influence performance of structures at the site including streets and residences. Drainage is recommended around each building perimeter at a minimum slope of 5 percent in the first 10 feet adjacent to exterior foundation walls and for unpaved areas, where possible. For paved areas and other impervious surfaces, a minimum slope of 2 percent is recommended. Drainage should be planned to avoid ponding of water. Collected water and irrigation should discharge well beyond foundation backfill zones. Surface runoff should be designed to avoid sheet flow and erosion. Slopes should be protected from erosion by materials such as mulch or appropriate plants or other methods. All fills and backfills should be properly compacted. Unprotected surfaces may be subject to undesirable, heavy erosion.

15.0 WINTER CONSTRUCTION

In the event construction occurs during winter, concrete and soil materials should be protected from freezing conditions. Concrete should not be placed on frozen soil and once concrete has been placed, it should not be allowed to freeze. Similarly, once exposed, the soil subgrades should not be allowed to freeze. During grading operations and subgrade preparation, care should be taken to avoid burial of snow, ice or frozen material within the planned construction area.

16.0 CONSTRUCTION OBSERVATIONS

It is recommended that Entech observe and document the following activities during construction of the building foundations.

- Excavated subgrades and subgrade preparation.
- Placement/compaction of fill materials.
- Placement/compaction of utility bedding and trench backfill.

17.0 CLOSURE

The subsurface investigation, geotechnical evaluation and recommendations presented in this report are intended for use by Tech Contractors with application to the planned development of the single-family residential project site located at Windingwalk Filings 1 and 2 and Stonebridge The Enclave Filings 4 and 5, in El Paso County, Colorado. In conducting the preliminary subsurface investigation, laboratory testing, engineering evaluation and reporting, Entech Engineering, Inc. endeavored to work in accordance with generally accepted professional geotechnical and geologic practices and principles consistent with the level of care and skill ordinarily exercised by members of the geotechnical profession currently practicing in same locality and under similar conditions. No other warranty, expressed or implied is made. During final design and/or construction, if conditions are encountered which appear different from those described in this report, Entech Engineering, Inc. requests that it be notified so that the evaluation and recommendations presented herein can be reviewed and modified as appropriate.

If there are any questions regarding the information provided herein or if Entech Engineering, Inc. can be of further assistance, please do not hesitate to contact us.

TABLES

TABLE 1

SUMMARY OF LABORATORY TEST RESULTS

CLIENT: TECH CONTRACTORS
 PROJECT: WINDINGWALK & STONEBRIDGE
 JOB NO.: 171198

SOIL TYPE	TEST BORING NO.	DEPTH (FT)	WATER (%)	DRY DENSITY (PCF)	PASSING NO. 200 SIEVE (%)	LIQUID LIMIT (%)	PLASTIC INDEX (%)	SULFATE (WT %)	FHA SWELL (PSF)	AASHTO CLASS.	SWELL/CONSOL (%)	UNIFIED CLASS.	SOIL DESCRIPTION
1A	36	2-3			15.3	NV	NP			A-1-b		SM	FILL, SAND, SILTY
1A	37	5			31.8				240			SC	FILL, SAND, CLAYEY
1	2	10			11.7							SM-SW	SAND, SLIGHTLY SILTY
1	4	2-3			35.5	29	9			A-5		SC	SAND, CLAYEY
1	8	2-3			6.1	NV	NP	<0.01		A-1-b		SM-SW	SAND, SLIGHTLY SILTY
1	13	2-3			38.4	28	15	<0.01		A-6		SC	SAND, CLAYEY
1	15	5			12.6							SM	SAND, SILTY
1	19	5			11.0	NV	NP	0.00		A-1-b		SM-SW	SAND, SLIGHTLY SILTY
1	30	2-3			26.9							SM	SAND, SILTY
1	34	5			13.7							SM	SAND, SILTY
1	35	2-3			28.2	NV	NP	<0.01		A-2-4		SM	SAND, SILTY
1	39	10			17.1			0.01				SM	SAND, SILTY
1	55	2-3			8.7	NV	NP	<0.01		A-1-b		SM-SW	SAND, SLIGHTLY SILTY
2	25	10			51.6	20	10	<0.01		A-4		CL	CLAY, VERY SANDY
2	3	15							1720			CL	CLAY, SANDY
2	28	2-3			53.2	30	14	<0.01		A-6	0.0	CL	CLAY, VERY SANDY
3	1	10			38.7	NV	NP	<0.01		A-4		SM	SANDSTONE, SILTY
3	3	20			29.2	36	12			A-2-6		SC	SANDSTONE, CLAYEY
3	5	5			28.7	41	14			A-2-7		SM	SANDSTONE, SILTY
3	7	20			16.9							SM	SANDSTONE, SILTY
3	9	10			27.1	NV	NP	<0.01		A-2-4		SM	SANDSTONE, SILTY
3	10	5			25.2							SM	SANDSTONE, SILTY
3	11	20			47.2	32	17	0.00		A-6	2.1	SC	SANDSTONE, VERY CLAYEY
3	12	10			15.1			0.00				SM	SANDSTONE, SILTY
3	14	15			38.2							SC	SANDSTONE, VERY CLAYEY
3	16	2-3			24.4							SM	SANDSTONE, SILTY
3	18	10			26.7							SM	SANDSTONE, SILTY
3	20	10			24.3							SM	SANDSTONE, SILTY
3	21	5			13.2							SM	SANDSTONE, SILTY
3	22	15			18.5							SM	SANDSTONE, SILTY
3	23	15			43.5						2.1	SC	SANDSTONE, VERY CLAYEY
3	29	5			15.6	NV	NP	<0.01		A-1-b		SM	SANDSTONE, SILTY
3	31	10			11.8	NV	NP	<0.01		A-1-b		SM-SW	SANDSTONE, SLIGHTLY SILTY
3	32	25			40.4	NV	NP	<0.01		A-4		SM	SANDSTONE, VERY SILTY
3	33	10			19.3							SM	SANDSTONE, SILTY
3	38	15			23.4							SM	SANDSTONE, SILTY

SOIL TYPE	TEST BORING NO.	DEPTH (FT)	WATER (%)	DRY DENSITY (PCF)	PASSING NO. 200 SIEVE (%)	LIQUID LIMIT (%)	PLASTIC INDEX (%)	SULFATE (WT %)	FHA SWELL (PSF)	AASTO CLASS.	SWELL/ CONSOL (%)	UNIFIED CLASS.	SOIL DESCRIPTION
3	40	2-3			12.0	NV	NP			A-1-b		SM	SANDSTONE, SILTY
3	41	5			22.2							SM	SANDSTONE, SILTY
3	42	20			45.3			<0.01				SM	SANDSTONE, VERY SILTY
3	45	5			8.4	NV	NP	0.00		A-1-b		SM-SW	SANDSTONE, SLIGHTLY SILTY
3	46	2-3			41.5	33	18	<0.01		A-6		SC	SANDSTONE, VERY CLAYEY
3	47	5			15.0				30			SM	SANDSTONE, SILTY
3	48	10			11.3							SM-SW	SANDSTONE, SLIGHTLY SILTY
3	49	15			15.1							SM	SANDSTONE, SILTY
3	50	2-3			27.7							SM	SANDSTONE, SILTY
3	51	5			18.3	NV	NP	0.00		A-1-b		SM	SANDSTONE, SILTY
3	52	10			9.7							SM-SW	SANDSTONE, SLIGHTLY SILTY
3	53	15			20.2							SM	SANDSTONE, SILTY
4	6	10			66.3	21	8	<0.01		A-5		CL	CLAYSTONE, SANDY
4	24	20	10.9	117.2	64.7	29	8	<0.01		A-4	1.7	CL	CLAYSTONE, SANDY
4	26	10			65.2				2060			CL	CLAYSTONE, SANDY
4	43	10			56.5				1970			CL	CLAYSTONE, VERY SANDY
4	44	5			60.3							CL	CLAYSTONE, VERY SANDY
4	54	15			63.3	27	13	0.00		A-6		CL	CLAYSTONE, SANDY
5	2	15			85.4	40	14			A-6		ML	SILTSTONE, SANDY, CLAYEY
5	17	2-3	15.6	111.1	66.5					A-6	0.9	ML	SILTSTONE, SANDY, CLAYEY

TABLE 2: Summary of Estimated Cut/Fill, Depth to Bedrock, and Groundwater Depths

Client: Tech Contractors

Project: Windingwalk Filings 1 and 2, and Stonebridge The Enclave Filings 4 and 5

Job No: 171198

Test Boring No.	Estimated Cut/Fill (ft.)	Depths to Bedrock (ft.) ¹	Depth to Groundwater (ft.) ¹
1	+ 0 - 2	8	2.5
2	+ 0 - 2	11	10.5
3	+ 0 - 2	16	12
4	+ 8 - 10	9*	4
5	+ 0 - 2	4	6
6	- 0 - 2	7	4
7	- 0 - 2	1	8.5
8	+ 0 - 2	11	6
9	+ 2 - 4	2	11.5
10	+ 0 - 2	2	9
11	- 2 - 4	1	15
12	- 0 - 2	1	13
13	- 6 - 8	6	>25
14	- 10 - 12	2	20.5
15	+ 0 - 2	6	>20
16	- 2 - 4	1	7.5
17	+ 0 - 2	1	9
18	- 0 - 2	5	16
19	- 0 - 2	8	6.5
20	+ 0 - 2	9	>20
21	+ 0 - 2	2	12.5
22	+ 2 - 4	2	14
23	+ 0 - 2	1	7.5
24	- 2 - 4	1	11
25	- 4 - 6	13	9
26	+ 0 - 2	4	7.5
27	+ 2 - 4	7	4
28	+ 0 - 2	3	11

**TABLE 2: Summary of Estimated Cut/Fill, Depth to Bedrock, and Groundwater Depths
continued**

Client: Tech Contractors

Project: Winding Walk

Job No: 171198

Test Boring No.	Estimated Cut/Fill (ft.)	Depths to Bedrock (ft.) ¹	Depth to Groundwater (ft.) ¹
29	+ 0 - 2	1	>20
30	+ 10 - 12	3	19
31	- 2 - 4	1	12.5
32	- 6 - 8	7	15.5
33	- 2 - 4	4	>20
34	+ 0 - 2	6	14.5
35	- 2 - 4	6	15
36	- 0 - 2	>20	17.5
37	- 0 - 2	14	>20
38	- 0 - 2	6	>20
39	- 0 - 2	12	6
40	+ 2 - 4	1	15
41	+ 0 - 2	1	15.5
42	+ 2 - 4	4	18
43	- 4 - 6	2*	>20
44	+ 2 - 4	1	20
45	+ 2 - 4	1	18
46	- 4 - 6	1	>20
47	- 2 - 4	4	>20
48	+ 0 - 2	1	18
49	- 2 - 4	1	>20
50	+ 2 - 4	1	>20
51	- 2 - 4	1	>20
52	+ 0 - 2	1	>20
53	- 0 - 2	1	>20
54	- 0 - 2	14	18.5
55	+ 0 - 2	9	>20

*Weathered Bedrock Depth

FIGURES

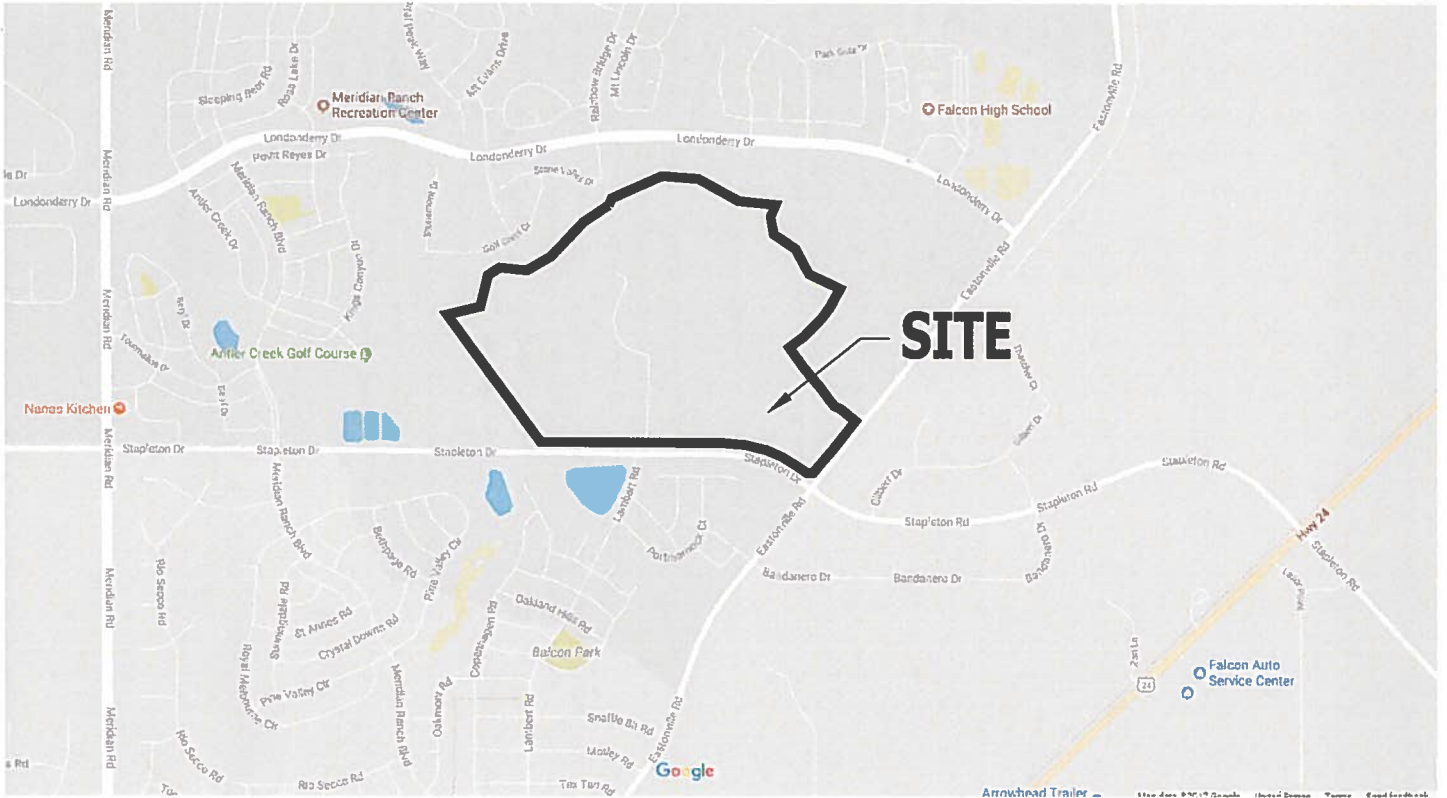

ENTECH
ENGINEERING, INC.
505 ELKTON DRIVE
COLORADO SPRINGS, CO. 80907 (719) 531-5599

VICINITY LOCATION MAP
WINDINGWALK FILINGS 1 AND 2, AND
STONEBRIDGE THE ENCLAVE FILINGS 4 AND 5
EL PASO COUNTY, CO
FOR: TECH CONTRACTORS

DRAWN BY:
TLC

DATE DRAWN:
11/08/17

DESIGNED BY:
KAH

CHECKED:
KAH

JOB NO.:
171198

FIG. NO.:

1

⊕ TB-2 - APPROXIMATE TEST BORING LOCATION AND NUMBER

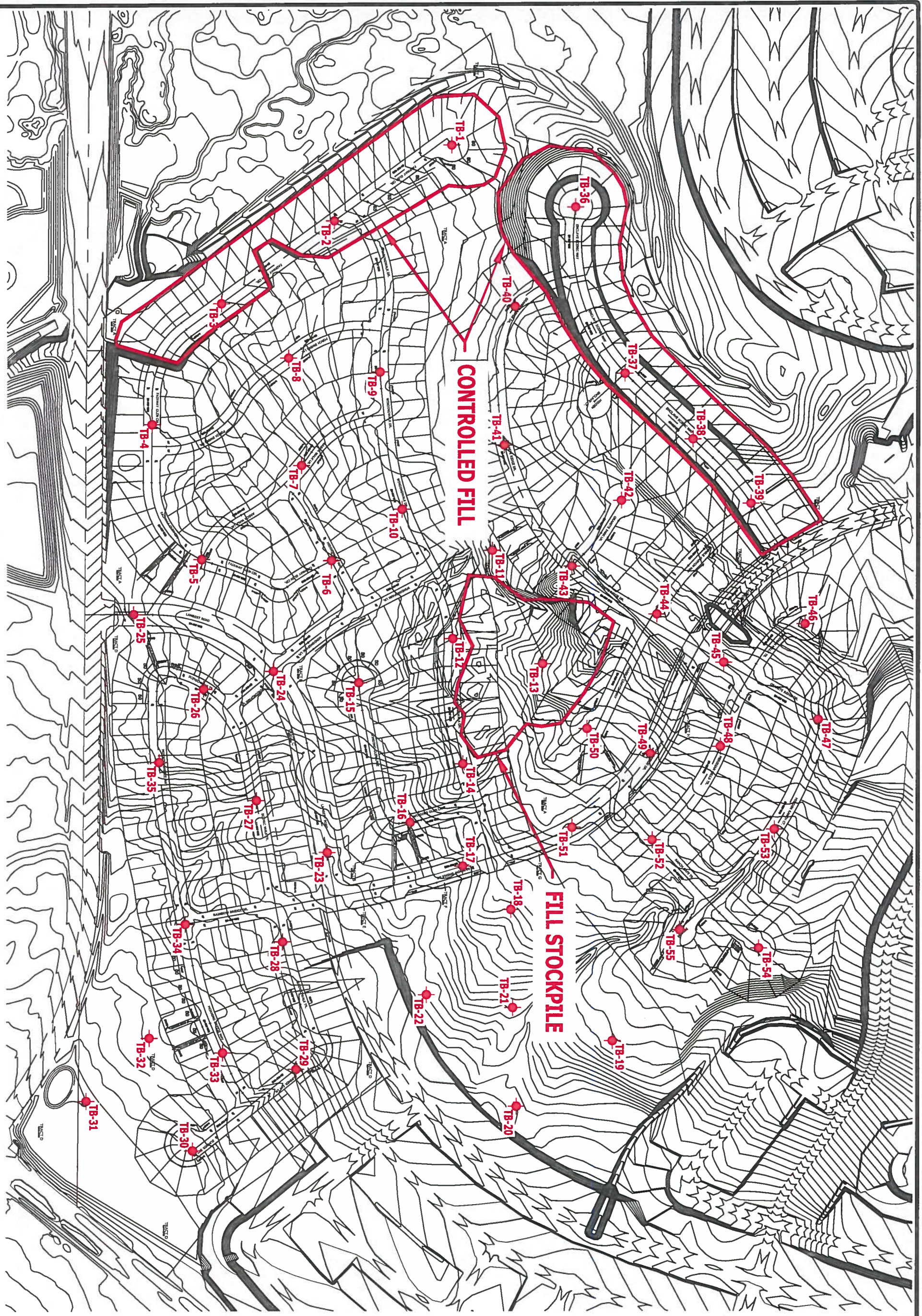

TEST BORING LOCATION PLAN
 WINDINGWALK FILINGS 1 AND 2, AND
 STONEBRIDGE THE ENCLAVE FILINGS 4 AND 5
 EL PASO COUNTY, CO.
 FOR: TECH CONTRACTORS



ENTECH
 ENGINEERING, INC.
 505 ELKTON DRIVE
 COLORADO SPRINGS, CO. 80907 (719) 531-5589

REVISION	BY

DATE	12/18/17
CHECKED	KARL
DRAWN	AS SHOWN
SCALE	AS SHOWN
PROJECT NO.	1771198
ISSUE NO.	2

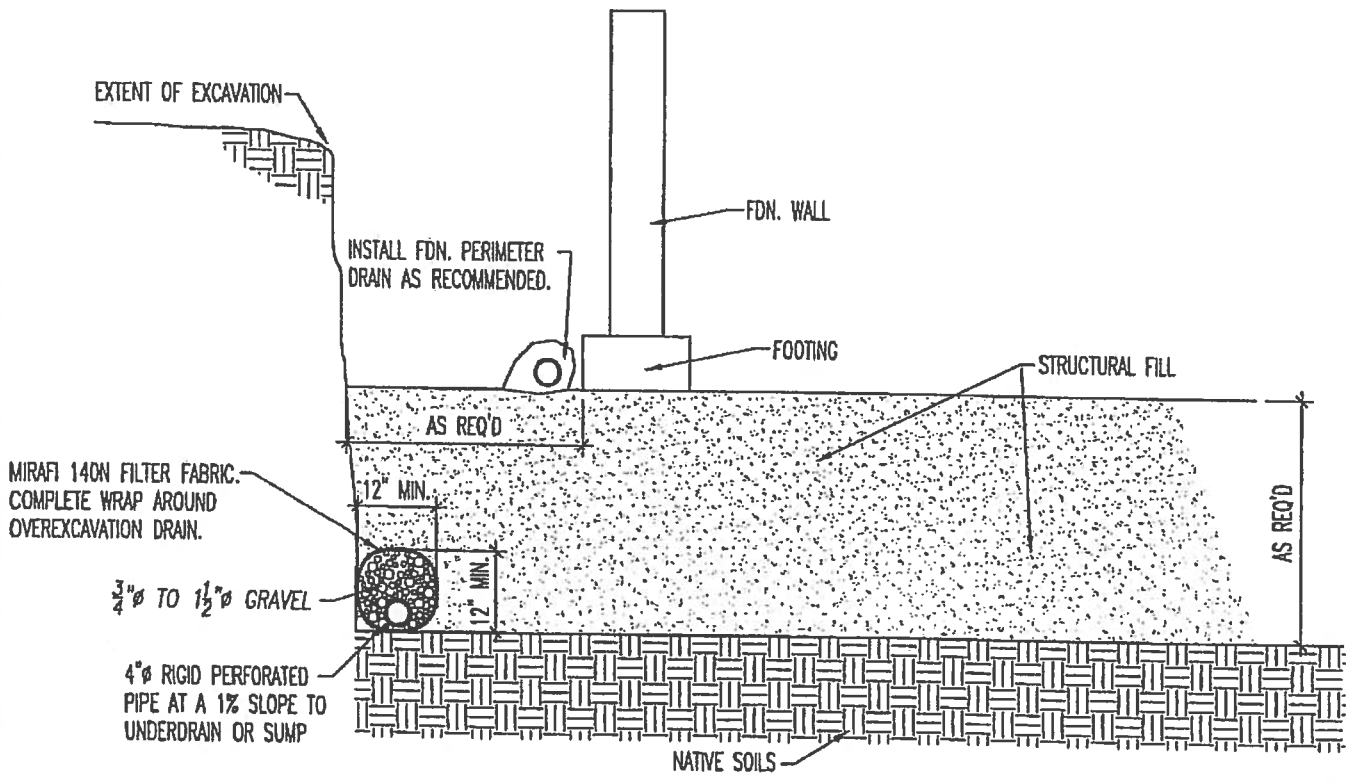

OVEREXCAVATION DRAIN DETAIL

N.T.S.

NOTE:
EXTEND DRAIN TO SUMP AS REQ'D.



ENTECH
ENGINEERING, INC.
505 ELKTON DRIVE
COLORADO SPRINGS, CO. 80907 (719) 531-5539

OVEREXCAVATION DRAIN DETAIL

DRAWN:	DATE: <i>9/26/17</i>	DESIGNED BY: D. STEGMAN	CHECKED: <i>DT</i>
--------	-------------------------	----------------------------	-----------------------

JOB NO.:
171198
FIG. NO.:
3

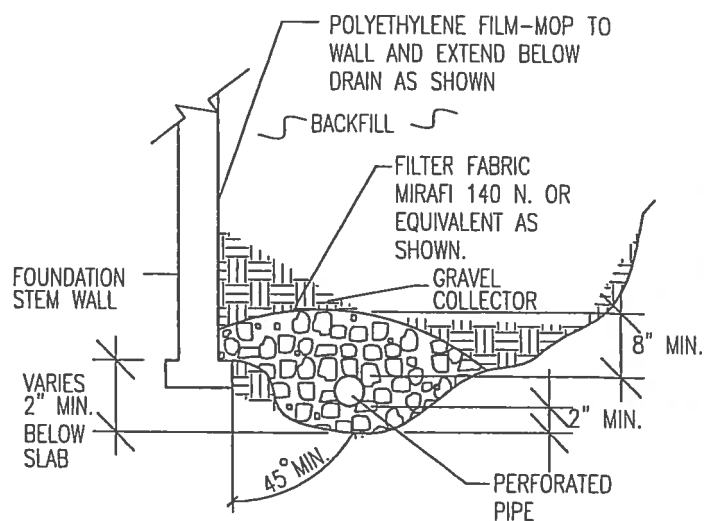
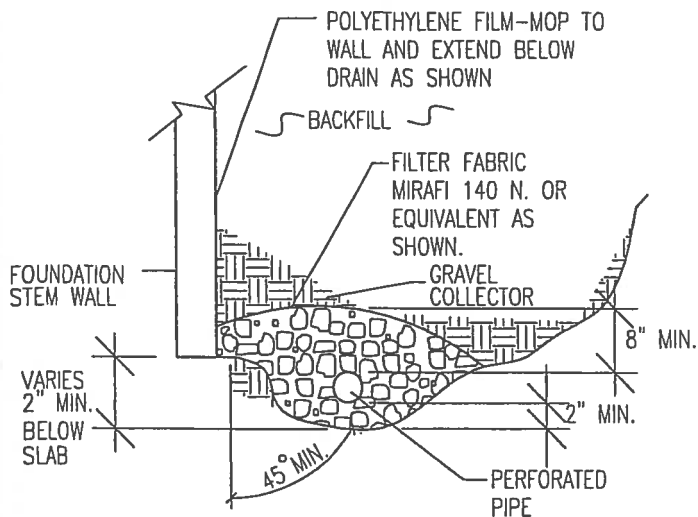

NOTES:

-GRAVEL SIZE IS RELATED TO DIAMETER OF PIPE PERFORATIONS-85% GRAVEL GREATER THAN 2x PERFORATION DIAMETER.

-PIPE DIAMETER DEPENDS UPON EXPECTED SEEPAGE. 4-INCH DIAMETER IS MOST OFTEN USED.

-ALL PIPE SHALL BE PERFORATED PLASTIC. THE DISCHARGE PORTION OF THE PIPE SHOULD BE NON-PERFORATED PIPE.

-FLEXIBLE PIPE MAY BE USED UP TO 8 FEET IN DEPTH, IF SUCH PIPE IS DESIGNED TO WITHSTAND THE PRESSURES. RIGID PLASTIC PIPE WOULD OTHERWISE BE REQUIRED.

-MINIMUM GRADE FOR DRAIN PIPE TO BE 1% OR 3 INCHES OF FALL IN 25 FEET.

-DRAIN TO BE PROVIDED WITH A FREE GRAVITY OUTFALL, IF POSSIBLE. A SUMP AND PUMP MAY BE USED IF GRAVITY OUT FALL IS NOT AVAILABLE.



ENTECH
ENGINEERING, INC.
505 ELKTON DRIVE
COLORADO SPRINGS, CO. 80907 (719) 531-5599

PERIMETER DRAIN DETAIL

DRAWN:

DATE:

9/26/17

DESIGNED:

DS

CHECKED:

W

JOB NO.:

171198

FIG NO.:

4

APPENDIX A: Test Boring Logs

TEST BORING NO. 1
 DATE DRILLED 8/16/2017
 Job # 171198

TEST BORING NO. 2
 DATE DRILLED 8/21/2017
 CLIENT TECH CONTRACTORS
 LOCATION WINDINGWALK & STONEBRIDGE

REMARKS	Depth (ft)	Symbol	Samples	Blows per foot	Watercontent %	Soil Type
WATER @ 2.5', 8/18/17						
FILL 0-3', SAND, SILTY, FINE TO COARSE GRAINED, TAN, MEDIUM DENSE, MOIST	0-3	[Symbol]		24	10.9	1A
SAND, CLAYEY, FINE TO COARSE GRAINED, GREEN BROWN, MEDIUM DENSE, MOIST	3-5	[Symbol]		18	16.4	1
SANDSTONE, SILTY, FINE TO COARSE GRAINED WITH FINE GRAINED LENSES, GREEN BROWN, VERY DENSE, MOIST	5-10	[Symbol]		50	14.1	3
				9"		
	10-15	[Symbol]		50	15.7	3
				10"		
	15-20	[Symbol]		50	13.7	3
				7"		

REMARKS	Depth (ft)	Symbol	Samples	Blows per foot	Watercontent %	Soil Type
WATER @ 10.5', 9/2/17						
FILL 0-4', SAND, SILTY, FINE TO COARSE GRAINED, BROWN, MEDIUM DENSE, MOIST	0-4	[Symbol]		22	8.3	1A
SAND, SLIGHTLY SILTY, FINE TO COARSE GRAINED, TAN, MEDIUM DENSE, MOIST	4-5	[Symbol]		11	8.4	1
SILTSTONE, CLAYEY, SANDY, GREEN BROWN, HARD, MOIST	5-10	[Symbol]		19	7.1	1
				50	18.8	5
				10"		
	15-20	[Symbol]		50	14.1	5
				9"		



ENTECH
 ENGINEERING, INC.

505 ELKTON DRIVE
 COLORADO SPRINGS, COLORADO 80907

TEST BORING LOG

DRAWN:

DATE:

CHECKED: *[Signature]*

DATE: 8/21/17

JOB NO.: 171198

FIG NO.: A-1

TEST BORING NO. 3
 DATE DRILLED 8/21/2017
 Job # 171198

TEST BORING NO. 4
 DATE DRILLED 8/21/2017
 CLIENT TECH CONTRACTORS
 LOCATION WINDINGWALK & STONEBRIDGE

REMARKS

REMARKS	Depth (ft)	Symbol	Samples	Blows per foot	Watercontent %	Soil Type
WATER @ 12', 9/2/17						
FILL 0-5', SAND, CLAYEY, FINE TO COARSE GRAINED, TAN, MEDIUM DENSE, MOIST	0-5	[Symbol]		10	11.6	1A
	5	[Symbol]		23	9.8	1A
SAND, SILTY TO SLIGHTLY SILTY, FINE TO COARSE GRAINED, DARK BROWN TO TAN, LOOSE, MOIST	5-10	[Symbol]		8	3.5	1
	10	[Symbol]				
CLAY, SANDY, DARK BROWN, VERY STIFF, MOIST	10-15	[Symbol]		30	18.4	2
SANDSTONE, CLAYEY, FINE GRAINED, GREEN BROWN, VERY DENSE, MOIST	15-20	[Symbol]		50	21.3	3
	20	[Symbol]		9"		

REMARKS

REMARKS	Depth (ft)	Symbol	Samples	Blows per foot	Watercontent %	Soil Type
WATER @ 4', 9/2/17						
SAND, CLAYEY, FINE TO MEDIUM GRAINED, GRAY BROWN, MEDIUM DENSE, MOIST	0-5	[Symbol]		12	23.0	1
	5	[Symbol]		23	16.7	1
WEATHERED TO FORMATIONAL SANDSTONE, SILTY, FINE TO COARSE GRAINED, GRAY BROWN, DENSE TO VERY DENSE, MOIST	5-10	[Symbol]		42	9.5	3
	10	[Symbol]				
	15	[Symbol]		50	9.3	3
				9"		
	20	[Symbol]		50	13.7	3
				8"		



ENTECH
ENGINEERING, INC.

505 ELKTON DRIVE
 COLORADO SPRINGS, COLORADO 80907

TEST BORING LOG

DRAWN:

DATE:

CHECKED: *[Signature]*

DATE: 8/18/17

JOB NO.:
 171198

FIG NO.:
 A- 2

TEST BORING NO. 5
 DATE DRILLED 8/21/2017
 Job # 171198

TEST BORING NO. 6
 DATE DRILLED 8/29/2017
 CLIENT TECH CONTRACTORS
 LOCATION WINDINGWALK & STONEBRIDGE

REMARKS

WATER @ 6', 92/17

SAND, SILTY, FINE TO COARSE
 GRAINED, GREEN BROWN,
 MEDIUM DENSE, MOIST

SANDSTONE, SILTY, FINE TO
 COARSE GRAINED, GRAY
 BROWN, VERY DENSE, MOIST

CLAYSTONE, SANDY TO
 VERY SANDY, GRAY BROWN,
 HARD, MOIST

Depth (ft)	Symbol	Samples	Blows per foot	Watercontent %	Soil Type
0 - 5	[Symbol]		12	7.7	1
5 - 10	[Symbol]		50 11"	12.7	3
10 - 15	[Symbol]		50 11"	16.9	4
15 - 20	[Symbol]		50 8"	17.4	4
20 - 25	[Symbol]		50 9"	13.9	4

REMARKS

WATER @ 4', 92/17

SAND, SILTY, FINE TO COARSE
 GRAINED, GREEN BROWN,
 MEDIUM DENSE, MOIST

CLAYSTONE, SANDY, BROWN
 TO BLUE GRAY, HARD, MOIST

Depth (ft)	Symbol	Samples	Blows per foot	Watercontent %	Soil Type
0 - 5	[Symbol]		12	5.3	1
5 - 10	[Symbol]		22	7.8	1
10 - 15	[Symbol]		50 5"	14.9	4
15 - 20	[Symbol]		50 5"	12.9	4
20 - 25	[Symbol]		50 7"	15.8	4



ENTECH
ENGINEERING, INC.

505 ELKTON DRIVE
 COLORADO SPRINGS, COLORADO 80907

TEST BORING LOG

DRAWN:

DATE:

CHECKED:

DATE:

[Signature] 11/16/17

JOB NO.:
 171198

FIG NO.:
 A- 3

TEST BORING NO. 7
 DATE DRILLED 8/21/2017
 Job # 171198

TEST BORING NO. 8
 DATE DRILLED 8/25/2017
 CLIENT TECH CONTRACTORS
 LOCATION WINDINGWALK & STONEBRIDGE

REMARKS

WATER @ 8.5', 92/17

SAND, SILTY, TAN
 SANDSTONE, SILTY, FINE
 TO COARSE GRAINED, GREEN
 BROWN TO TAN, VERY DENSE,
 MOIST TO WET

Depth (ft)	Symbol	Samples	Blows per foot	Watercontent %	Soil Type
5	[Symbol]		50	4.2	1
5	[Symbol]		50	8.7	3
			7"		
10	[Symbol]		50	9.1	3
			6"		
15	[Symbol]		50	8.9	3
			7"		
20	[Symbol]		50	20.6	3
			7"		

REMARKS

WATER @ 6', 92/17

SAND, SLIGHTLY SILTY TO
 SILTY, FINE TO COARSE
 GRAINED, TAN, MEDIUM
 DENSE TO DENSE, MOIST

CLAYSTONE, SANDY, GRAY
 BROWN, HARD, MOIST

WEATHERED ZONE

Depth (ft)	Symbol	Samples	Blows per foot	Watercontent %	Soil Type
5	[Symbol]		20	2.1	1
5	[Symbol]		25	10.1	1
10	[Symbol]		40	11.8	1
15	[Symbol]		50	12.8	4
			10"		
20	[Symbol]		40	16.4	4



ENTECH
ENGINEERING, INC.

505 ELKTON DRIVE
 COLORADO SPRINGS, COLORADO 80907

TEST BORING LOG

DRAWN: DATE: CHECKED: DATE: 8/17

JOB NO.:
 171198

FIG NO.:
 A- 4

TEST BORING NO. 9
 DATE DRILLED 8/25/2017
 Job # 171198

TEST BORING NO. 10
 DATE DRILLED 8/24/2017
 CLIENT TECH CONTRACTORS
 LOCATION WINDINGWALK & STONEBRIDGE

REMARKS

WATER @ 11.5', 9/2/17

SAND, SILTY, TAN

SANDSTONE, SILTY, FINE TO
 COARSE GRAINED, TAN, VERY
 DENSE, MOIST

CLAYSTONE, SANDY, GRAY
 BROWN, HARD, MOIST

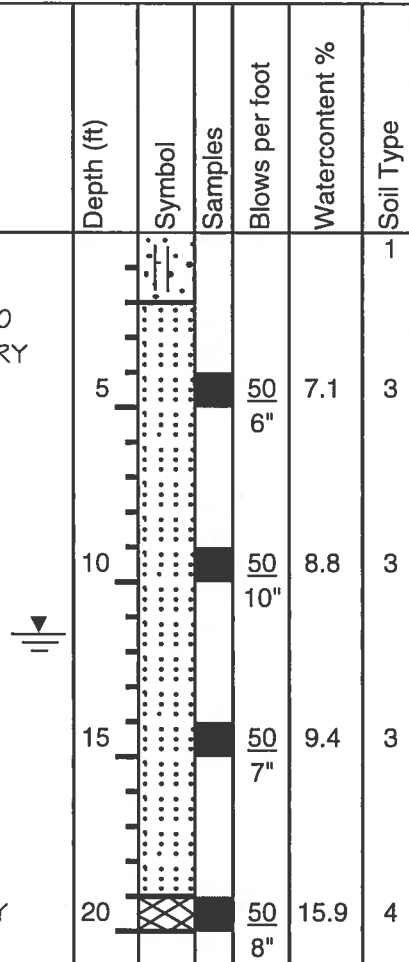

REMARKS

WATER @ 9', 9/2/17

SAND, SILTY, TAN

SANDSTONE, SILTY, FINE TO
 COARSE GRAINED WITH FINE
 GRAINED LENSES, TAN TO
 GRAY BROWN, VERY DENSE,
 MOIST

CLAYSTONE, SANDY, GRAY
 BROWN, HARD, MOIST

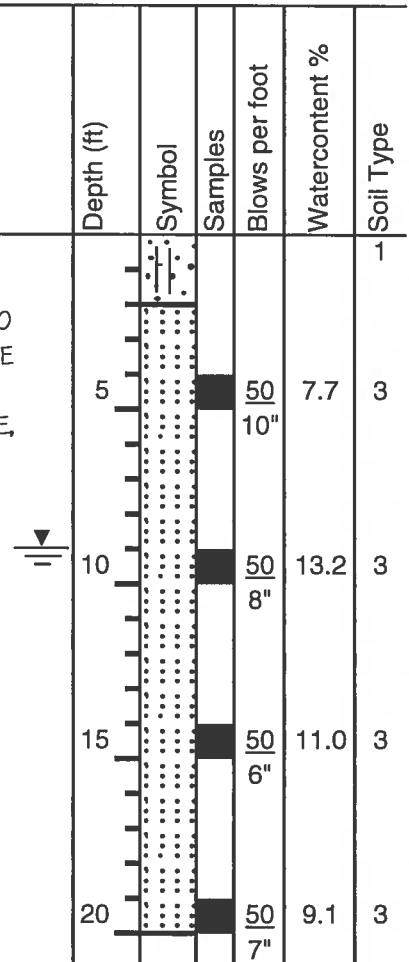

ENTECH
ENGINEERING, INC.

505 ELKTON DRIVE
 COLORADO SPRINGS, COLORADO 80907

TEST BORING LOG

DRAWN:

DATE:

CHECKED: *h*

DATE: 8/8/17

JOB NO.:
 171198

FIG NO.:
 A- 5

TEST BORING NO. 11
 DATE DRILLED 8/24/2017
 Job # 171198

TEST BORING NO. 12
 DATE DRILLED 8/30/2017
 CLIENT TECH CONTRACTORS
 LOCATION WINDINGWALK & STONEBRIDGE

REMARKS	Depth (ft)	Symbol	Samples	Blows per foot	Watercontent %	Soil Type
WATER @ 15', 9/2/17						
SAND, SILTY, TAN	1					1
SANDSTONE, SILTY, FINE TO COARSE GRAINED, GRAY BROWN TO TAN, VERY DENSE, MOIST	3			50 10"	5.4	3
	5			50 8"	10.0	3
	10			50 8"	7.8	3
	15			50 7"	11.2	3
SANDSTONE, CLAYEY TO VERY CLAYEY, FINE GRAINED, TAN, VERY DENSE, MOIST	20			50 7"	11.4	3
	25			50 11"	19.4	3

REMARKS	Depth (ft)	Symbol	Samples	Blows per foot	Watercontent %	Soil Type
WATER @ 13', 9/2/17						
SAND, SILTY, TAN	1					1
SANDSTONE, SILTY, FINE TO COARSE GRAINED, GRAY BROWN, VERY DENSE, MOIST	3			50	9.4	3
	5			50 7"	6.6	3
	10			50 7"	8.2	3
	15			50 6"	9.7	3
	20			50 7"	10.1	3



ENTECH
ENGINEERING, INC.

505 ELKTON DRIVE
 COLORADO SPRINGS, COLORADO 80907

TEST BORING LOG

DRAWN:

DATE:

CHECKED: *h*

DATE: 11/8/17

JOB NO.:
 171198

FIG NO.:
 A- 6

TEST BORING NO. 13
 DATE DRILLED 8/29/2017
 Job # 171198

TEST BORING NO. 14
 DATE DRILLED 8/29/2017
 CLIENT TECH CONTRACTORS
 LOCATION WINDINGWALK & STONEBRIDGE

REMARKS

REMARKS

DRY TO 25', 8/29/17

FILL 0-6', SAND, CLAYEY TO VERY CLAYEY, FINE TO COARSE GRAINED, GREEN BROWN, LOOSE TO MEDIUM DENSE, MOIST

SANDSTONE, SILTY, FINE TO COARSE GRAINED, GREEN BROWN, VERY DENSE, MOIST

SANDSTONE, SILTY, FINE GRAINED, TAN, VERY DENSE, MOIST

Depth (ft)	Symbol	Samples	Blows per foot	Watercontent %	Soil Type
0-5	[Symbol]		5	11.6	1A
5-10	[Symbol]		18	15.1	1A
10-15	[Symbol]		50 7"	7.0	3
15-20	[Symbol]		50 6"	7.3	3
20-25	[Symbol]		50 6"	9.6	3
25-30	[Symbol]		50 6"	9.4	3

WATER @ 20.5', 9/2/17

SAND, SILTY, TAN

SANDSTONE, CLAYEY TO VERY CLAYEY WITH SILTY LENSES, FINE TO COARSE GRAINED, TAN, VERY DENSE, MOIST

CLAYSTONE, SANDY, BLUE GRAY, HARD, MOIST

SANDSTONE, SILTY, FINE TO COARSE GRAINED, TAN, VERY DENSE, MOIST

Depth (ft)	Symbol	Samples	Blows per foot	Watercontent %	Soil Type
0-1	[Symbol]				1
1-5	[Symbol]		50 9"	7.2	3
5-10	[Symbol]		50 8"	10.3	3
10-15	[Symbol]		50 6"	8.5	3
15-20	[Symbol]		50 8"	10.9	3
20-25	[Symbol]		50 9"	13.3	4
25-30	[Symbol]		50 6"	12.8	3



ENTECH
ENGINEERING, INC.

505 ELKTON DRIVE
 COLORADO SPRINGS, COLORADO 80907

TEST BORING LOG

DRAWN:

DATE:

CHECKED: *[Signature]*

DATE: 8/29/17

JOB NO.:
 171198

FIG NO.:
 A-7

TEST BORING NO. 15
 DATE DRILLED 8/21/2017
 Job # 171198

TEST BORING NO. 16
 DATE DRILLED 8/25/2017
 CLIENT TECH CONTRACTORS
 LOCATION WINDINGWALK & STONEBRIDGE

REMARKS

DRY TO 20', 8/21/17

SAND, SILTY, FINE TO COARSE
 GRAINED, TAN, MEDIUM
 DENSE, MOIST

SANDSTONE, SILTY, FINE TO
 COARSE GRAINED, TAN,
 VERY DENSE, MOIST

Depth (ft)	Symbol	Samples	Blows per foot	Watercontent %	Soil Type
5			27	5.9	1
			24	8.6	1
10			50 6"	7.8	3
15			50 8"	12.0	3
20			50 7"	10.0	3

REMARKS

WATER @ 7.5', 9/2/17

SAND, SILTY, TAN
 SANDSTONE, SILTY, FINE
 TO COARSE GRAINED, TAN,
 VERY DENSE, MOIST

CLAYSTONE, VERY SANDY,
 BLUE GRAY, HARD, MOIST

Depth (ft)	Symbol	Samples	Blows per foot	Watercontent %	Soil Type
5			50 7"	5.4	3
10			50 5"	9.4	3
15			50 8"	10.7	3
20			50 6"	15.2	4



ENTECH
ENGINEERING, INC.

505 ELKTON DRIVE
 COLORADO SPRINGS, COLORADO 80907

TEST BORING LOG

DRAWN: DATE: CHECKED: *L* DATE: 11/8/17

JOB NO.:
 171198

FIG NO.:
 A- 8

TEST BORING NO. 17
 DATE DRILLED 8/30/2017
 Job # 171198

TEST BORING NO. 18
 DATE DRILLED 8/30/2017
 CLIENT TECH CONTRACTORS
 LOCATION WINDINGWALK & STONEBRIDGE

REMARKS	Depth (ft)	Symbol	Samples	Blows per foot	Watercontent %	Soil Type	REMARKS	Depth (ft)	Symbol	Samples	Blows per foot	Watercontent %	Soil Type
WATER @ 9', 9/2/17							WATER @ 16', 9/2/17						
SAND, SILTY, TAN SILTSTONE, CLAYEY, SANDY, TAN, MOIST	0-5	[Symbol]		*	14.1	1	SAND, CLAYEY, FINE TO COARSE GRAINED, BROWN, MEDIUM DENSE, MOIST	0-5	[Symbol]				
	5-10	[Symbol]		50 6"	9.3	5	SANDSTONE, SILTY, FINE TO COARSE GRAINED, TAN, VERY DENSE, MOIST	5-10	[Symbol]		12	17.1	1
SANDSTONE, SILTY, FINE TO COARSE GRAINED, TAN, VERY DENSE, MOIST TO WET	10-15	[Symbol]		50 7"	7.7	3	SANDSTONE, VERY CLAYEY, FINE GRAINED, TAN, VERY DENSE, MOIST	10-15	[Symbol]		50 8"	11.1	3
	15-20	[Symbol]		50 5"	10.9	3	SANDSTONE, SILTY, FINE TO COARSE GRAINED, BROWN, VERY DENSE, MOIST	15-20	[Symbol]		50 11"	16.0	3
	20-25	[Symbol]		50 5"	13.9	3	CLAYSTONE, SANDY, GREEN BROWN, HARD, MOIST	20-25	[Symbol]		50 5"	9.3	3
								25-30	[Symbol]		50 7"	15.3	4



**ENTECH
ENGINEERING, INC.**

505 ELKTON DRIVE
 COLORADO SPRINGS, COLORADO 80907

TEST BORING LOG

DRAWN:

DATE:

CHECKED: *h*

DATE: 11/8/17

JOB NO.:
171198

FIG NO.:
A- 9

TEST BORING NO. 19
 DATE DRILLED 8/30/2017
 Job # 171198

TEST BORING NO. 20
 DATE DRILLED 8/30/2017
 CLIENT TECH CONTRACTORS
 LOCATION WINDINGWALK & STONEBRIDGE

REMARKS

WATER @ 6.5', 9/2/17

SAND, SLIGHTLY SILTY, FINE TO COARSE GRAINED, TAN, MEDIUM DENSE, MOIST

SANDSTONE, SILTY, FINE TO COARSE GRAINED, TAN, VERY DENSE, MOIST

SANDSTONE, SILTY, FINE GRAINED, TAN, VERY DENSE, MOIST

Depth (ft)	Symbol	Samples	Blows per foot	Watercontent %	Soil Type
5			22	8.2	1
10			50 9"	7.7	3
15			50 3"	5.7	3
20			50 7"	9.4	3



REMARKS

DRY TO 20', 9/2/17

SAND, SILTY, FINE TO COARSE GRAINED, TAN, MEDIUM DENSE TO DENSE, MOIST

SANDSTONE, SILTY, FINE TO COARSE GRAINED, TAN, VERY DENSE, MOIST

Depth (ft)	Symbol	Samples	Blows per foot	Watercontent %	Soil Type
5			27	3.1	1
5			30	3.9	1
10			50 6"	8.6	3
15			50 6"	7.3	3
20			50 6"	6.3	3



ENTECH
ENGINEERING, INC.

505 ELKTON DRIVE
 COLORADO SPRINGS, COLORADO 80907

TEST BORING LOG

DRAWN:

DATE:

CHECKED: *h*

DATE: 11/8/17

JOB NO.:
 171198

FIG NO.:
 A- 10

TEST BORING NO. 21
 DATE DRILLED 8/30/2017
 Job # 171198

TEST BORING NO. 22
 DATE DRILLED 8/30/2017
 CLIENT TECH CONTRACTORS
 LOCATION WINDINGWALK & STONEBRIDGE

REMARKS

WATER @ 12.5', 9/2/17

SAND, SILTY, TAN

SANDSTONE, SILTY, FINE TO
 COARSE GRAINED, TAN, VERY
 DENSE, MOIST

Depth (ft)	Symbol	Samples	Blows per foot	Watercontent %	Soil Type
1					1
5			50	9.6	3
10			50 9"	7.2	3
15			50 7"	8.7	3
20			50 6"	11.5	3



REMARKS

WATER @ 14', 9/2/17

SAND, SILTY, TAN

SANDSTONE, SILTY, FINE TO
 COARSE GRAINED, TAN, VERY
 DENSE, MOIST TO WET

Depth (ft)	Symbol	Samples	Blows per foot	Watercontent %	Soil Type
1					1
5			50 9"	9.1	3
10			50 6"	8.4	3
15			50 6"	8.5	3
20			50 9"	14.9	3



ENTECH
ENGINEERING, INC.

505 ELKTON DRIVE
 COLORADO SPRINGS, COLORADO 80907

TEST BORING LOG

DRAWN:

DATE:

CHECKED: *h*

DATE: 11/8/17

JOB NO.:
 171198

FIG NO.:
 A- 11

TEST BORING NO. 23
 DATE DRILLED 8/30/2017
 Job # 171198

TEST BORING NO. 24
 DATE DRILLED 8/29/2017
 CLIENT TECH CONTRACTORS
 LOCATION WINDINGWALK & STONEBRIDGE

REMARKS	Depth (ft)	Symbol	Samples	Blows per foot	Watercontent %	Soil Type	REMARKS	Depth (ft)	Symbol	Samples	Blows per foot	Watercontent %	Soil Type
WATER @ 7.5', 9/2/17							WATER @ 11', 9/2/17						
SAND, SILTY, TAN SANDSTONE, CLAYEY TO VERY CLAYEY, FINE GRAINED, GREEN BROWN, VERY DENSE, MOIST	1	[Symbol]		*	8.5	1	SAND, SILTY, TAN	1	[Symbol]				1
	3	[Symbol]				3	SANDSTONE, SILTY, FINE TO COARSE GRAINED, TAN, VERY DENSE, MOIST	3	[Symbol]		50	8.1	3
	5	[Symbol]		7"	8.2	3		5	[Symbol]		9"	9.2	3
	10	[Symbol]		2"		3		10	[Symbol]		50	9.3	3
	15	[Symbol]		6"	17.3	3		15	[Symbol]		6"	8.4	3
	20	[Symbol]		6"	12.4	3	CLAYSTONE, SANDY, BLUE GRAY, HARD, MOIST	20	[Symbol]		50	13.5	4
							SANDSTONE, CLAYEY, FINE TO COARSE GRAINED, BLUE GRAY, VERY DENSE, MOIST	25	[Symbol]		50	11.7	3
											4"		



ENTECH
ENGINEERING, INC.

505 ELKTON DRIVE
 COLORADO SPRINGS, COLORADO 80907

TEST BORING LOG

DRAWN:

DATE:

CHECKED:

DATE:

[Signature] 11/2/17

JOB NO.:

171198

FIG NO.:

A- 12

TEST BORING NO. 25
 DATE DRILLED 8/29/2017
 Job # 171198

TEST BORING NO. 26
 DATE DRILLED 8/21/2017
 CLIENT TECH CONTRACTORS
 LOCATION WINDINGWALK & STONEBRIDGE

REMARKS	Depth (ft)	Symbol	Samples	Blows per foot	Watercontent %	Soil Type
WATER @ 9', 9/2/17						
SAND, SILTY, CLAYEY, FINE TO MEDIUM GRAINED, TAN, MEDIUM DENSE TO VERY DENSE, MOIST	0-5	[Symbol]		25	14.5	1
	5-9"	[Symbol]		50	14.3	1
	9"-10"	[Symbol]				
CLAY, VERY SANDY, TAN, VERY STIFF, MOIST	10-15	[Symbol]		32	10.7	2
	15-20	[Symbol]		50	9.2	3
	20-25	[Symbol]		50	13.5	3
	25-30	[Symbol]		50	15.4	3
	30-35	[Symbol]		50	12.8	3
	35-40	[Symbol]		50		

REMARKS	Depth (ft)	Symbol	Samples	Blows per foot	Watercontent %	Soil Type
WATER @ 7.5', 9/2/17						
SAND, SILTY, FINE TO COARSE GRAINED, TAN, MEDIUM DENSE, MOIST	0-5	[Symbol]		22	4.5	1
	5-7"	[Symbol]		50	6.7	3
	7"-10"	[Symbol]				
CLAYSTONE, SANDY, DARK BROWN, HARD, MOIST	10-15	[Symbol]		50	15.3	4
	15-20	[Symbol]		50	11.0	3
	20-25	[Symbol]		50	18.5	3
	25-30	[Symbol]				



ENTECH
ENGINEERING, INC.

505 ELKTON DRIVE
 COLORADO SPRINGS, COLORADO 80907

TEST BORING LOG

DRAWN:

DATE:

CHECKED: *[Signature]*

DATE: 8/18/17

JOB NO:
 171198

FIG NO:
 A- 13

TEST BORING NO. 27
 DATE DRILLED 8/21/2017
 Job # 171198

TEST BORING NO. 28
 DATE DRILLED 8/30/2017
 CLIENT TECH CONTRACTORS
 LOCATION WINDINGWALK & STONEBRIDGE

REMARKS	Depth (ft)	Symbol	Samples	Blows per foot	Watercontent %	Soil Type
WATER @ 4', 9/2/17						
SAND, CLAYEY, FINE TO COARSE GRAINED, GREEN BROWN, MEDIUM DENSE, MOIST	0 - 4'	[Symbol]		14	10.5	1
CLAY, SANDY, BROWN, FIRM, MOIST	4' - 5'	[Symbol]		10	19.5	2
SANDSTONE, CLAYEY, FINE TO COARSE GRAINED, GRAY BROWN, VERY DENSE, MOIST	5' - 10'	[Symbol]		50 6"	14.9	3
	10' - 15'	[Symbol]		50 5"	17.6	3
	15' - 20'	[Symbol]		50 5"	12.5	3

REMARKS	Depth (ft)	Symbol	Samples	Blows per foot	Watercontent %	Soil Type
WATER @ 11', 9/2/17						
CLAY, SANDY, TAN, STIFF, MOIST	0 - 4'	[Symbol]		21	17.8	2
SANDSTONE, SILTY, FINE TO COARSE GRAINED, GRAY BROWN, VERY DENSE, MOIST TO WET	4' - 5'	[Symbol]		50 8"	6.6	3
	5' - 10'	[Symbol]		50 8"	8.2	3
	10' - 15'	[Symbol]		50 10"	12.0	3
	15' - 20'	[Symbol]		50 5"	8.5	3



ENTECH
 ENGINEERING, INC.

505 ELKTON DRIVE
 COLORADO SPRINGS, COLORADO 80907

TEST BORING LOG

DRAWN:

DATE:

CHECKED: *[Signature]*

DATE: 8/30/17

JOB NO.: 171198

FIG NO.: A- 14

TEST BORING NO. 29
 DATE DRILLED 8/30/2017
 Job # 171198

TEST BORING NO. 30
 DATE DRILLED 8/30/2017
 CLIENT TECH CONTRACTORS
 LOCATION WINDINGWALK & STONEBRIDGE

REMARKS

DRY TO 19.5', 9/2/17

SAND, SILTY, TAN
 SANDSTONE, SILTY, FINE
 TO COARSE GRAINED, GREEN
 BROWN, VERY DENSE, MOIST

Depth (ft)	Symbol	Samples	Blows per foot	Watercontent %	Soil Type
1			*	6.9	3
3					3
5			50 7"	10.6	3
10			50 7"	8.6	3
15			50 7"	8.8	3
20			50 6"	8.3	3

* - BULK SAMPLE TAKEN

REMARKS

WATER @ 19', 9/2/17

SAND, SILTY, FINE TO COARSE
 GRAINED, GREEN BROWN,
 MOIST
 SANDSTONE, SILTY, FINE TO
 COARSE GRAINED, GREEN
 BROWN, VERY DENSE, MOIST

CLAYEY LENSES

* - BULK SAMPLE TAKEN



Depth (ft)	Symbol	Samples	Blows per foot	Watercontent %	Soil Type
1			*	8.7	1
3					3
5			50 10"	13.9	3
10			50	15.4	3
15			50 6"	5.9	3
20			50 7"	9.8	3



ENTECH
ENGINEERING, INC.

505 ELKTON DRIVE
 COLORADO SPRINGS, COLORADO 80907

TEST BORING LOG

DRAWN:

DATE:

CHECKED: *aw*

DATE: 11/2/17

JOB NO.:
 171198

FIG NO.:
 A- 15

TEST BORING NO. 31
 DATE DRILLED 8/29/2017
 Job # 171198

TEST BORING NO. 32
 DATE DRILLED 8/29/2017
 CLIENT TECH CONTRACTORS
 LOCATION WINDINGWALK & STONEBRIDGE

REMARKS

WATER @ 12.5', 9/2/17
 SAND, SILTY, TAN
 SANDSTONE, SLIGHTLY
 SILTY TO SILTY, FINE TO
 COARSE GRAINED, TAN,
 VERY DENSE, MOIST TO WET

Depth (ft)	Symbol	Samples	Blows per foot	Watercontent %	Soil Type
1					1
3			50	4.8	3
5			50 7"	4.8	3
10			50 11"	10.6	3
15			50 10"	20.5	3
20			50 7"	14.6	3
25			50 6"	16.6	3



REMARKS

WATER @ 15.5', 9/2/17
 SAND, SILTY, FINE TO MEDIUM
 GRAINED, TAN, MEDIUM
 DENSE TO DENSE, MOIST

 SANDSTONE, SILTY TO VERY
 SILTY, FINE TO MEDIUM
 GRAINED, TAN, VERY DENSE,
 MOIST TO WET

Depth (ft)	Symbol	Samples	Blows per foot	Watercontent %	Soil Type
1					1
3			15	5.7	1
5			33	9.3	1
10			50 7"	11.7	3
15			50 9"	11.5	3
20			50 8"	17.3	3
25			50 6"	14.9	3
30			50 4"	19.2	3



ENTECH
ENGINEERING, INC.

505 ELKTON DRIVE
 COLORADO SPRINGS, COLORADO 80907

TEST BORING LOG

DRAWN:

DATE:

CHECKED: *[Signature]*

DATE: 8/29/17

JOB NO.:
 171198

FIG NO.:
 A- 16

TEST BORING NO. 33
 DATE DRILLED 8/30/2017
 Job # 171198

TEST BORING NO. 34
 DATE DRILLED 8/30/2017
 CLIENT TECH CONTRACTORS
 LOCATION WINDINGWALK & STONEBRIDGE

REMARKS

DRY TO 19.5', 9/2/17

SAND, CLAYEY, FINE TO COARSE
 GRAINED, TAN, MEDIUM DENSE,
 MOIST

SANDSTONE, SILTY, FINE TO
 COARSE GRAINED, TAN,
 VERY DENSE, MOIST

Depth (ft)	Symbol	Samples	Blows per foot	Watercontent %	Soil Type
			19	9.9	1
5			50	8.9	3
10			50 9"	8.8	3
15			50 6"	6.2	3
20			50 6"	7.3	3

REMARKS

WATER @ 14.5', 9/2/17

SAND, SILTY, FINE GRAINED
 WITH COARSE GRAINED
 LENSES, TAN, MEDIUM DENSE,
 MOIST

SANDSTONE, SILTY, FINE TO
 COARSE GRAINED, TAN TO
 GREEN BROWN, VERY DENSE,
 MOIST

* - BULK SAMPLE TAKEN

SANDSTONE, CLAYEY, FINE
 GRAINED, GREEN BROWN,
 VERY DENSE, MOIST

Depth (ft)	Symbol	Samples	Blows per foot	Watercontent %	Soil Type
			*	8.8	1
5			17	11.2	1
10			50 8"	10.6	3
15			50 7"	9.1	3
20			50 7"	11.9	3



ENTECH
ENGINEERING, INC.

505 ELKTON DRIVE
 COLORADO SPRINGS, COLORADO 80907

TEST BORING LOG

DRAWN:

DATE:

CHECKED: *w*

DATE: 11/9/17

JOB NO.:
 171198

FIG NO.:
 A- 17

TEST BORING NO. 35
 DATE DRILLED 8/29/2017
 Job # 171198

TEST BORING NO. 36
 DATE DRILLED 8/16/2017
 CLIENT TECH CONTRACTORS
 LOCATION WINDINGWALK & STONEBRIDGE

REMARKS

WATER @ 15', 9/2/17

SAND, SILTY, FINE TO COARSE
 GRAINED, BROWN TO TAN,
 MEDIUM DENSE TO DENSE,
 MOIST

SANDSTONE, SILTY, FINE TO
 COARSE GRAINED, TAN,
 VERY DENSE, MOIST TO WET

Depth (ft)	Symbol	Samples	Blows per foot	Watercontent %	Soil Type
5			15	8.7	1
5			38	16.9	1
10			50 8"	9.3	3
15			50 8"	9.2	3
20			50 5"	9.1	3
25			50 9"	14.3	3



REMARKS

WATER @ 17.5', 8/16/17

FILL 0-14', SAND, SILTY, FINE
 TO COARSE GRAINED,
 BROWN, MEDIUM DENSE,
 MOIST

SAND, SILTY, FINE TO COARSE
 GRAINED, DARK BROWN TO
 GREEN BROWN, MEDIUM
 DENSE, MOIST TO WET



Depth (ft)	Symbol	Samples	Blows per foot	Watercontent %	Soil Type
5			18	11.9	1A
5			19	8.4	1A
10			23	9.4	1A
15			22	8.5	1
20			24	9.9	1



**ENTECH
 ENGINEERING, INC.**

505 ELKTON DRIVE
 COLORADO SPRINGS, COLORADO 80907

TEST BORING LOG

DRAWN:

DATE:

CHECKED: *h*

DATE: 11/8/17

JOB NO.:
 171198

FIG NO.:
 A- 18

TEST BORING NO. 37
 DATE DRILLED 8/16/2017
 Job # 171198

TEST BORING NO. 38
 DATE DRILLED 8/16/2017
 CLIENT TECH CONTRACTORS
 LOCATION WINDINGWALK & STONEBRIDGE

REMARKS	Depth (ft)	Symbol	Samples	Blows per foot	Watercontent %	Soil Type
DRY TO 19', 8/18/17						
FILL 0-8', SAND, SILTY TO CLAYEY, FINE TO COARSE GRAINED, BROWN, MEDIUM DENSE, MOIST	5			22	8.3	1A
	5			28	10.7	1A
SAND, SILTY, FINE TO COARSE GRAINED, BROWN, MEDIUM DENSE, MOIST	10			16	11.6	1
SANDSTONE, SILTY, FINE TO COARSE GRAINED, BROWN, VERY DENSE, MOIST	15			50 4"	12.0	3
	20			50 4"	5.8	3

REMARKS	Depth (ft)	Symbol	Samples	Blows per foot	Watercontent %	Soil Type
DRY TO 19.5', 8/18/17						
FILL 0-6', SAND, SILTY, FINE TO COARSE GRAINED, BROWN, DENSE TO MEDIUM DENSE, MOIST	5			34	6.3	1A
	5			16	9.0	1A
SANDSTONE, SILTY, FINE TO COARSE GRAINED, TAN, VERY DENSE, MOIST TO WET	10			50 5"	8.4	3
	15			50 5"	9.8	3
	20			50 4"	14.8	3



ENTECH
ENGINEERING, INC.

505 ELKTON DRIVE
 COLORADO SPRINGS, COLORADO 80907

TEST BORING LOG

DRAWN:

DATE:

CHECKED: *[Signature]*

DATE: 11/8/17

JOB NO.:
 171198

FIG NO.:
 A- 19

TEST BORING NO. 39
 DATE DRILLED 8/16/2017
 Job # 171198

TEST BORING NO. 40
 DATE DRILLED 8/16/2017
 CLIENT TECH CONTRACTORS
 LOCATION WINDINGWALK & STONEBRIDGE

REMARKS

WATER @ 6', 8/18/17

FILL 0-7', SAND, CLAYEY TO SILTY, FINE TO COARSE GRAINED, BROWN, MEDIUM DENSE, MOIST

SAND, SILTY, FINE TO COARSE GRAINED, DARK BROWN, MEDIUM DENSE, MOIST

SANDSTONE, SILTY, FINE TO COARSE GRAINED, TAN, VERY DENSE, MOIST

SANDSTONE, SILTY, FINE GRAINED, TAN, VERY DENSE, MOIST

Depth (ft)	Symbol	Samples	Blows per foot	Watercontent %	Soil Type
0-7	[Symbol]		21	10.8	1A
5	[Symbol]		15	10.2	1A
10	[Symbol]		20	8.5	1
15	[Symbol]		50 3"	7.1	3
20	[Symbol]		50 5"	14.8	3



REMARKS

WATER @ 15', 8/18/17

SAND, SILTY, TAN SANDSTONE, SILTY, FINE TO COARSE GRAINED, BROWN TO GRAY BROWN, VERY DENSE, MOIST

SAND, SILTY, TAN SANDSTONE, SILTY, FINE TO COARSE GRAINED, BROWN TO GRAY BROWN, VERY DENSE, MOIST

SAND, SILTY, TAN SANDSTONE, SILTY, FINE TO COARSE GRAINED, BROWN TO GRAY BROWN, VERY DENSE, MOIST

SAND, SILTY, TAN SANDSTONE, SILTY, FINE TO COARSE GRAINED, BROWN TO GRAY BROWN, VERY DENSE, MOIST

Depth (ft)	Symbol	Samples	Blows per foot	Watercontent %	Soil Type
0-7	[Symbol]		50	6.2	3
5	[Symbol]		50 10"	7.1	3
10	[Symbol]		50 7"	9.1	3
15	[Symbol]		50 6"	9.4	3
20	[Symbol]		50 6"	10.0	3



ENTECH
ENGINEERING, INC.

505 ELKTON DRIVE
 COLORADO SPRINGS, COLORADO 80907

TEST BORING LOG

DRAWN:

DATE:

CHECKED:

DATE:

JOB NO.:

171198

FIG NO.:

A- 20

TEST BORING NO. 41
 DATE DRILLED 8/16/2017
 Job # 171198

TEST BORING NO. 42
 DATE DRILLED 8/16/2017
 CLIENT TECH CONTRACTORS
 LOCATION WINDINGWALK & STONEBRIDGE

REMARKS

WATER @ 15.5', 8/18/17

SAND, SILTY, TAN
 SANDSTONE, SILTY, FINE
 TO COARSE GRAINED, BROWN,
 VERY DENSE, MOIST TO WET

Depth (ft)	Symbol	Samples	Blows per foot	Watercontent %	Soil Type
1					1
3				6.0	3
5			50 9"	8.1	3
10			50 7"	10.5	3
15			50 6"	8.5	3
20			50 8"	13.9	3



REMARKS

WATER @ 18', 8/18/17

SAND, SILTY, FINE TO COARSE
 GRAINED, TAN, MEDIUM DENSE,
 MOIST

SANDSTONE, SILTY, FINE TO
 COARSE GRAINED, BROWN,
 VERY DENSE, MOIST

SANDSTONE, VERY SILTY,
 FINE GRAINED, TAN, VERY
 DENSE, MOIST

Depth (ft)	Symbol	Samples	Blows per foot	Watercontent %	Soil Type
1					1
3				9.7	1
5			50	8.9	3
10			50 7"	9.1	3
15			50 7"	12.7	3
20			50 7"	8.8	3



ENTECH
ENGINEERING, INC.

505 ELKTON DRIVE
 COLORADO SPRINGS, COLORADO 80907

TEST BORING LOG

DRAWN:

DATE:

CHECKED: *h*

DATE: 8/18/17

JOB NO.:
 171198

FIG NO.:
 A- 21

TEST BORING NO. 43
 DATE DRILLED 8/16/2017
 Job # 171198

TEST BORING NO. 44
 DATE DRILLED 8/16/2017
 CLIENT TECH CONTRACTORS
 LOCATION WINDINGWALK & STONEBRIDGE

REMARKS

DRY TO 18.5', 8/18/17
 SAND, SILTY, TAN

WEATHERED TO FORMATIONAL
 SANDSTONE, SILTY, FINE
 TO COARSE GRAINED, GREEN
 BROWN, DENSE TO VERY
 DENSE, MOIST

CLAYSTONE, VERY SANDY,
 GREEN BROWN, HARD, MOIST

SANDSTONE, SILTY, FINE TO
 COARSE GRAINED, TAN, VERY
 DENSE, MOIST

Depth (ft)	Symbol	Samples	Blows per foot	Watercontent %	Soil Type
1					1
3			37	8.8	3
5			50 7"	7.8	3
10			50 7"	15.3	4
15			50 6"	6.3	3
20			50 6"	8.4	3

REMARKS

WATER @ 20', 8/18/17

SAND, SILTY, TAN
 CLAYSTONE, VERY SANDY,
 BLUE GRAY, HARD, MOIST

SANDSTONE, SILTY, FINE TO
 COARSE GRAINED, TAN TO
 GREEN BROWN, VERY DENSE,
 MOIST

Depth (ft)	Symbol	Samples	Blows per foot	Watercontent %	Soil Type
1					1
4			50 9"	16.1	4
5			50 8"	10.0	4
10			50 5"	7.0	3
15			50 6"	8.4	3
20			50 6"	12.5	3



ENTECH
ENGINEERING, INC.

505 ELKTON DRIVE
 COLORADO SPRINGS, COLORADO 80907

TEST BORING LOG

DRAWN:

DATE:

CHECKED: *h*

DATE: 8/18/17

JOB NO.:
 171198

FIG NO.:
 A- 22

TEST BORING NO. 45
 DATE DRILLED 8/29/2017
 Job # 171198

TEST BORING NO. 46
 DATE DRILLED 8/29/2017
 CLIENT TECH CONTRACTORS
 LOCATION WINDINGWALK & STONEBRIDGE

REMARKS

REMARKS

WATER @ 18', 9/2/17

DRY TO 19', 9/2/17

REMARKS	Depth (ft)	Symbol	Samples	Blows per foot	Watercontent %	Soil Type
SAND, SILTY, TAN	1	[Symbol]				1
SANDSTONE, SILTY TO SLIGHTLY SILTY, FINE TO COARSE GRAINED, TAN, VERY DENSE, MOIST	5	[Symbol]		50 10"	6.6	3
	5	[Symbol]		50 9"	5.7	3
	10	[Symbol]		50 7"	8.0	3
CLAYSTONE, SANDY, GREEN BROWN, HARD, MOIST	15	[Symbol]		50 6"	12.2	4
SANDSTONE, SILTY, FINE TO COARSE GRAINED, BROWN, VERY DENSE, MOIST	20	[Symbol]		50 9"	7.5	3

REMARKS	Depth (ft)	Symbol	Samples	Blows per foot	Watercontent %	Soil Type
SAND, SILTY, TAN	1	[Symbol]				1
SANDSTONE, VERY CLAYEY, FINE GRAINED, BROWN, VERY DENSE, MOIST	5	[Symbol]	*	50 6"	9.9	3
	5	[Symbol]		50 6"	11.9	3
	10	[Symbol]		50 4"	7.4	3
	15	[Symbol]		50 6"	7.9	3
	20	[Symbol]		50 4"	9.7	3



ENTECH
ENGINEERING, INC.

505 ELKTON DRIVE
 COLORADO SPRINGS, COLORADO 80907

TEST BORING LOG

DRAWN:

DATE:

CHECKED: *h*

DATE: 11/8/17

JOB NO.:
 171198

FIG NO.:
 A- 23

TEST BORING NO. 47
 DATE DRILLED 8/29/2017
 Job # 171198

TEST BORING NO. 48
 DATE DRILLED 8/29/2017
 CLIENT TECH CONTRACTORS
 LOCATION WINDINGWALK & STONEBRIDGE

REMARKS

DRY TO 19', 9/2/17
 SAND, SILTY, FINE TO COARSE
 GRAINED, GREEN BROWN,
 MEDIUM DENSE, MOIST

 SANDSTONE, SILTY, FINE TO
 COARSE GRAINED, TAN TO
 GREEN BROWN, VERY DENSE,
 MOIST

Depth (ft)	Symbol	Samples	Blows per foot	Watercontent %	Soil Type
0					
5			28	5.3	1
5			50	10.6	3
			8"		
10			50	5.1	3
			7"		
15			50	4.6	3
			5"		
20			50	7.7	3
			6"		

REMARKS

WATER @ 18', 9/2/17
 SAND, SILTY, TAN
 SANDSTONE, SLIGHTLY
 SILTY TO SILTY, FINE TO
 COARSE GRAINED, TAN TO
 GREEN BROWN, VERY DENSE,
 MOIST

Depth (ft)	Symbol	Samples	Blows per foot	Watercontent %	Soil Type
0					
5			50	6.7	3
			10"		
5			50	7.1	3
			6"		
10			50	6.2	3
			6"		
15			50	7.0	3
			6"		
20			50	9.0	3
			6"		



ENTECH
ENGINEERING, INC.

505 ELKTON DRIVE
 COLORADO SPRINGS, COLORADO 80907

TEST BORING LOG

DRAWN:	DATE:	CHECKED:	DATE:
		<i>W</i>	11/8/17

JOB NO.:
 171198

FIG NO.:
 A- 24

TEST BORING NO. 49
 DATE DRILLED 8/29/2017
 Job # 171198

TEST BORING NO. 50
 DATE DRILLED 8/29/2017
 CLIENT TECH CONTRACTORS
 LOCATION WINDINGWALK & STONEBRIDGE

REMARKS

DRY TO 20', 9/2/17

SAND, SILTY, TAN
 SANDSTONE, SILTY, FINE TO
 COARSE GRAINED WITH FINE
 GRAINED LENSES, TAN, VERY
 DENSE, MOIST

Depth (ft)	Symbol	Samples	Blows per foot	Watercontent %	Soil Type
1					1
3			50 11"	7.8	3
5			50 10"	8.2	3
10			50 5"	7.1	3
15			50 8"	7.6	3
20			50 7"	12.2	3

REMARKS

DRY TO 20', 8/29/17

SAND, SILTY, TAN
 SANDSTONE, SILTY, FINE TO
 COARSE GRAINED, TAN TO
 GREEN BROWN, VERY DENSE,
 MOIST

Depth (ft)	Symbol	Samples	Blows per foot	Watercontent %	Soil Type
1					1
3			50 11"	4.8	3
5			50 10"	8.4	3
10			50 6"	5.2	3
15			50 6"	8.6	3
20			50 7"	8.8	3



ENTECH
 ENGINEERING, INC.

505 ELKTON DRIVE
 COLORADO SPRINGS, COLORADO 80907

TEST BORING LOG

DRAWN:

DATE:

CHECKED:

DATE:

W 11/8/17

JOB NO.:
 171198

FIG NO.:
 A- 25

TEST BORING NO. 51
 DATE DRILLED 8/29/2017
 Job # 171198

TEST BORING NO. 52
 DATE DRILLED 8/29/2017
 CLIENT TECH CONTRACTORS
 LOCATION WINDINGWALK & STONEBRIDGE

REMARKS

DRY TO 18.5', 9/2/17

SAND, SILTY, TAN
 SANDSTONE, SILTY, FINE TO
 COARSE GRAINED, TAN TO
 GREEN BROWN, VERY DENSE,
 MOIST

Depth (ft)	Symbol	Samples	Blows per foot	Watercontent %	Soil Type
1					1
3			50	4.6	3
5			50 9"	6.2	3
10			50 7"	5.6	3
15			50 7"	8.5	3
20			50 4"	7.6	3

REMARKS

DRY TO 20', 8/29/17

SAND, SILTY, TAN
 SANDSTONE, SLIGHTLY
 SILTY TO SILTY, FINE TO
 COARSE GRAINED, TAN TO
 GREEN BROWN, VERY DENSE,
 MOIST

Depth (ft)	Symbol	Samples	Blows per foot	Watercontent %	Soil Type
1					1
3			*	10.1	3
5			50 7"	5.2	3
10			50 5"	5.2	3
15			50 6"	5.5	3
20			50 6"	9.5	3

* - BULK SAMPLE TAKEN



ENTECH
ENGINEERING, INC.

505 ELKTON DRIVE
 COLORADO SPRINGS, COLORADO 80907

TEST BORING LOG

DRAWN:

DATE:

CHECKED: *h*

DATE: 11/10/17

JOB NO.:
 171198

FIG NO.:
 A- 26

TEST BORING NO. 53
 DATE DRILLED 8/29/2017
 Job # 171198

TEST BORING NO. 54
 DATE DRILLED 8/30/2017
 CLIENT TECH CONTRACTORS
 LOCATION WINDINGWALK & STONEBRIDGE

REMARKS

DRY TO 19.5', 9/2/17

SAND, SILTY, TAN
 SANDSTONE, SILTY, FINE
 GRAINED, TAN, VERY DENSE,
 MOIST

SANDSTONE, SILTY, FINE TO
 COARSE GRAINED, GREEN
 BROWN, VERY DENSE, MOIST

* - BULK SAMPLE TAKEN

Depth (ft)	Symbol	Samples	Blows per foot	Watercontent %	Soil Type
0					1
3			*	20.9	3
5			50 6"	10.0	3
10			50 6"	12.3	3
15			50 7"	7.3	3
20			50 6"	7.0	3

REMARKS

WATER @ 18.5', 9/2/17

SAND, SILTY, FINE TO COARSE
 GRAINED, TAN, MEDIUM DENSE
 TO DENSE, MOIST

CLAYSTONE, SANDY, TAN,
 HARD, MOIST

SANDSTONE, SILTY, FINE
 TO COARSE GRAINED, TAN,
 VERY DENSE, MOIST



Depth (ft)	Symbol	Samples	Blows per foot	Watercontent %	Soil Type
0					
5			26	4.3	1
10			43	9.4	1
15			50	11.4	4
20			50 7"	8.3	3



ENTECH
ENGINEERING, INC.

505 ELKTON DRIVE
 COLORADO SPRINGS, COLORADO 80907

TEST BORING LOG

DRAWN:

DATE:

CHECKED: *h*

DATE: 11/8/17

JOB NO.:
 171198

FIG NO.:
 A- 27

TEST BORING NO. 55
 DATE DRILLED 8/30/2017
 Job # 171198

TEST BORING NO.
 DATE DRILLED
 CLIENT TECH CONTRACTORS
 LOCATION WINDINGWALK & STONEBRIDGE

REMARKS

REMARKS

DRY TO 20', 9/2/17

SAND, SLIGHTLY SILTY TO
 SILTY, FINE TO COARSE
 GRAINED, TAN, MEDIUM DENSE
 TO DENSE, MOIST

SANDSTONE, SILTY, FINE TO
 COARSE GRAINED, TAN, VERY
 DENSE, MOIST

Depth (ft)	Symbol	Samples	Blows per foot	Watercontent %	Soil Type	Depth (ft)	Symbol	Samples	Blows per foot	Watercontent %	Soil Type
5			12	2.7	1	5					
			40	6.9	1						
10			50	8.4	3	10					
			8'								
15			50	8.8	3	15					
			9"								
20			50	7.0	3	20					
			7"								



ENTECH
ENGINEERING, INC.

505 ELKTON DRIVE
 COLORADO SPRINGS, COLORADO 80907

TEST BORING LOG

DRAWN: DATE: CHECKED: *h* DATE: 11/2/17

JOB NO.:
 171198

FIG NO.:
 A- 28

APPENDIX B: Laboratory Testing Results

<u>UNIFIED CLASSIFICATION</u>	SM	<u>CLIENT</u>	TECH CONTRACTORS
<u>SOIL TYPE #</u>	1A	<u>PROJECT</u>	WINDINGWALK & STONEBRIDGE
<u>TEST BORING #</u>	36	<u>JOB NO.</u>	171198
<u>DEPTH (FT)</u>	2-3	<u>TEST BY</u>	BL

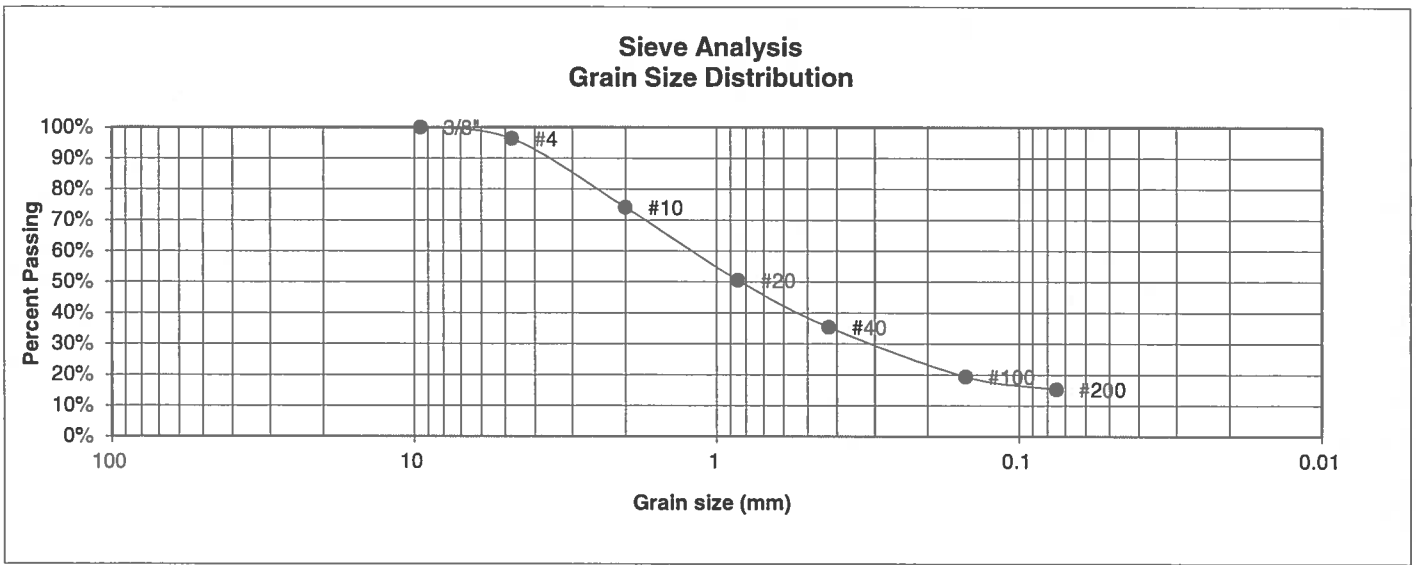

<u>U.S. Sieve #</u>	<u>Percent Finer</u>
3"	
1 1/2"	
3/4"	
1/2"	
3/8"	100.0%
4	96.3%
10	74.1%
20	50.6%
40	35.4%
100	19.4%
200	15.3%

Atterberg Limits

Plastic Limit	NP
Liquid Limit	NV
Plastic Index	NP

Swell

Moisture at start	
Moisture at finish	
Moisture increase	
Initial dry density (pcf)	
Swell (psf)	



**ENTECH
ENGINEERING, INC.**

505 ELKTON DRIVE
COLORADO SPRINGS, COLORADO 80907

**LABORATORY TEST
RESULTS**

DRAWN:	DATE:	CHECKED:	DATE:
		<i>W</i>	4/8/17

JOB NO.:
171198

FIG NO.:
B-1

<u>UNIFIED CLASSIFICATION</u>	SC	<u>CLIENT</u>	TECH CONTRACTORS
<u>SOIL TYPE #</u>	1A	<u>PROJECT</u>	WINDINGWALK & STONEBRIDGE
<u>TEST BORING #</u>	37	<u>JOB NO.</u>	171198
<u>DEPTH (FT)</u>	5	<u>TEST BY</u>	BL

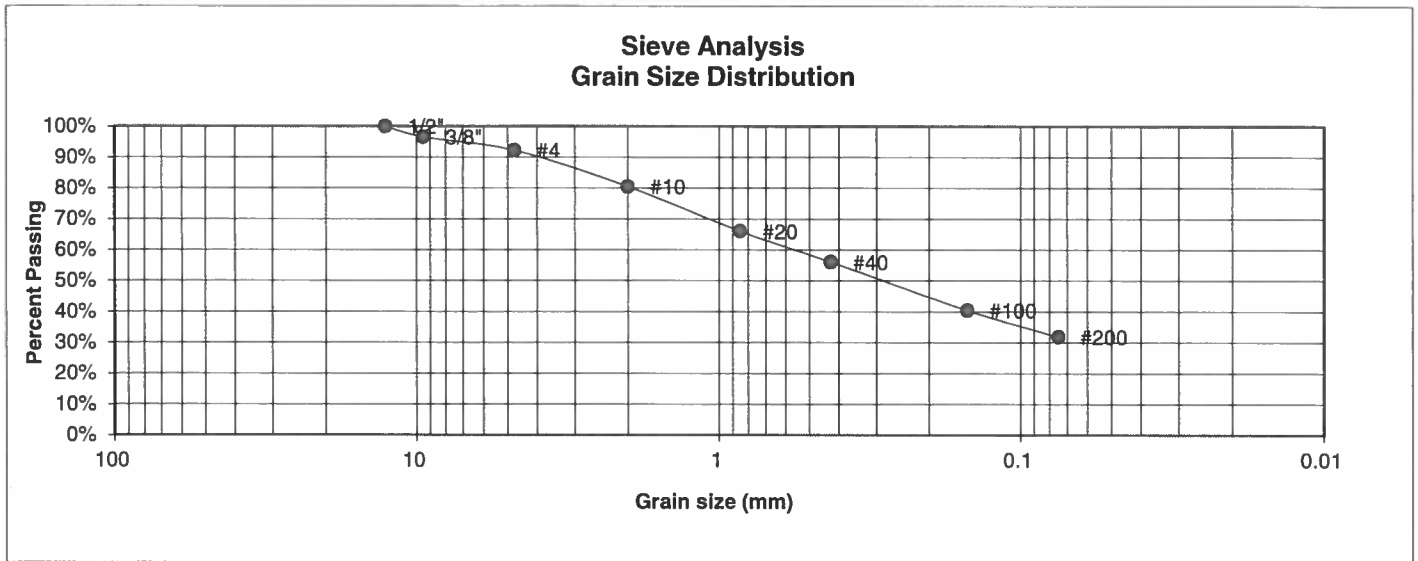

<u>U.S. Sieve #</u>	<u>Percent Finer</u>
3"	
1 1/2"	
3/4"	
1/2"	100.0%
3/8"	96.6%
4	92.2%
10	80.5%
20	66.0%
40	56.1%
100	40.4%
200	31.8%

Atterberg Limits
 Plastic Limit
 Liquid Limit
 Plastic Index

<u>Swell</u>	
Moisture at start	7.6%
Moisture at finish	16.3%
Moisture increase	8.8%
Initial dry density (pcf)	108
Swell (psf)	240



**ENTECH
ENGINEERING, INC.**

505 ELKTON DRIVE
COLORADO SPRINGS, COLORADO 80907

**LABORATORY TEST
RESULTS**

<u>DRAWN:</u>	<u>DATE:</u>	<u>CHECKED:</u>	<u>DATE:</u>
		<i>BL</i>	11/8/17

JOB NO.:
171198

FIG NO.:
B-2

<u>UNIFIED CLASSIFICATION</u>	SM-SW	<u>CLIENT</u>	TECH CONTRACTORS
<u>SOIL TYPE #</u>	1	<u>PROJECT</u>	WINDINGWALK & STONEBRIDGE
<u>TEST BORING #</u>	2	<u>JOB NO.</u>	171198
<u>DEPTH (FT)</u>	10	<u>TEST BY</u>	BL

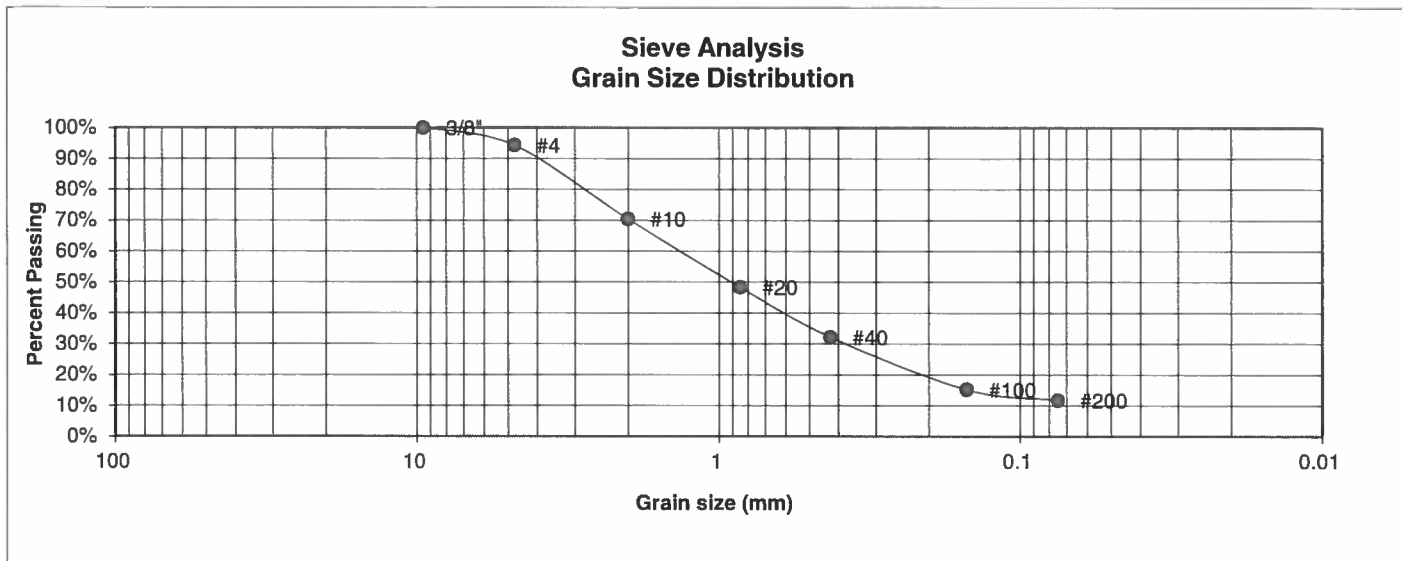

<u>U.S. Sieve #</u>	<u>Percent Finer</u>
3"	
1 1/2"	
3/4"	
1/2"	
3/8"	100.0%
4	94.3%
10	70.4%
20	48.3%
40	32.2%
100	15.2%
200	11.7%

Atterberg Limits
 Plastic Limit
 Liquid Limit
 Plastic Index

Swell
 Moisture at start
 Moisture at finish
 Moisture increase
 Initial dry density (pcf)
 Swell (psf)



**ENTECH
ENGINEERING, INC.**

505 ELKTON DRIVE
COLORADO SPRINGS, COLORADO 80907

**LABORATORY TEST
RESULTS**

DRAWN:	DATE:	CHECKED:	DATE:
		<i>W</i>	11/8/17

JOB NO.:
171198

FIG NO.:
B-3

UNIFIED CLASSIFICATION	SC	CLIENT	TECH CONTRACTORS
SOIL TYPE #	1	PROJECT	WINDINGWALK & STONEBRIDGE
TEST BORING #	4	JOB NO.	171198
DEPTH (FT)	2-3	TEST BY	BL

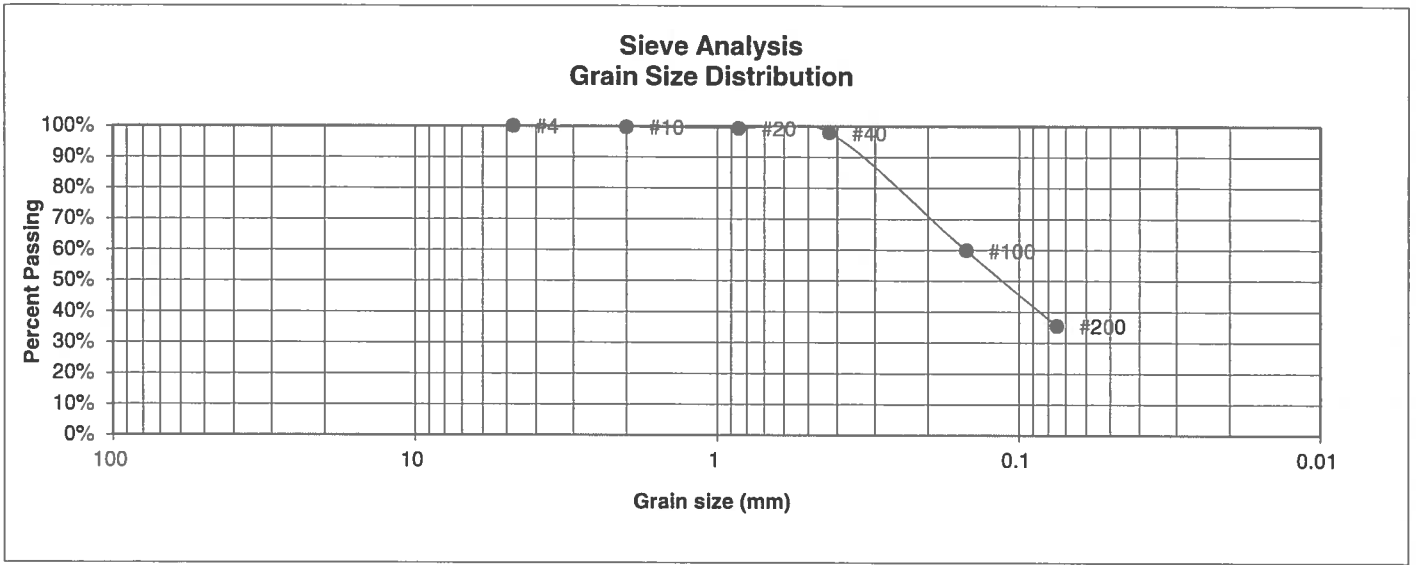

U.S. Sieve #	Percent Finer
3"	
1 1/2"	
3/4"	
1/2"	
3/8"	
4	100.0%
10	99.7%
20	97.9%
40	97.9%
100	59.8%
200	35.5%

Atterberg Limits	
Plastic Limit	20
Liquid Limit	29
Plastic Index	9

- Swell
- Moisture at start
 - Moisture at finish
 - Moisture increase
 - Initial dry density (pcf)
 - Swell (psf)



**ENTECH
ENGINEERING, INC.**
505 ELKTON DRIVE
COLORADO SPRINGS, COLORADO 80907

**LABORATORY TEST
RESULTS**

DRAWN:	DATE:	CHECKED:	DATE:
		<i>BL</i>	11/8/17

JOB NO.:
171198

FIG NO.:
B-4

<u>UNIFIED CLASSIFICATION</u>	SM-SW	<u>CLIENT</u>	TECH CONTRACTORS
<u>SOIL TYPE #</u>	1	<u>PROJECT</u>	WINDINGWALK & STONEBRIDGE
<u>TEST BORING #</u>	8	<u>JOB NO.</u>	171198
<u>DEPTH (FT)</u>	2-3	<u>TEST BY</u>	BL

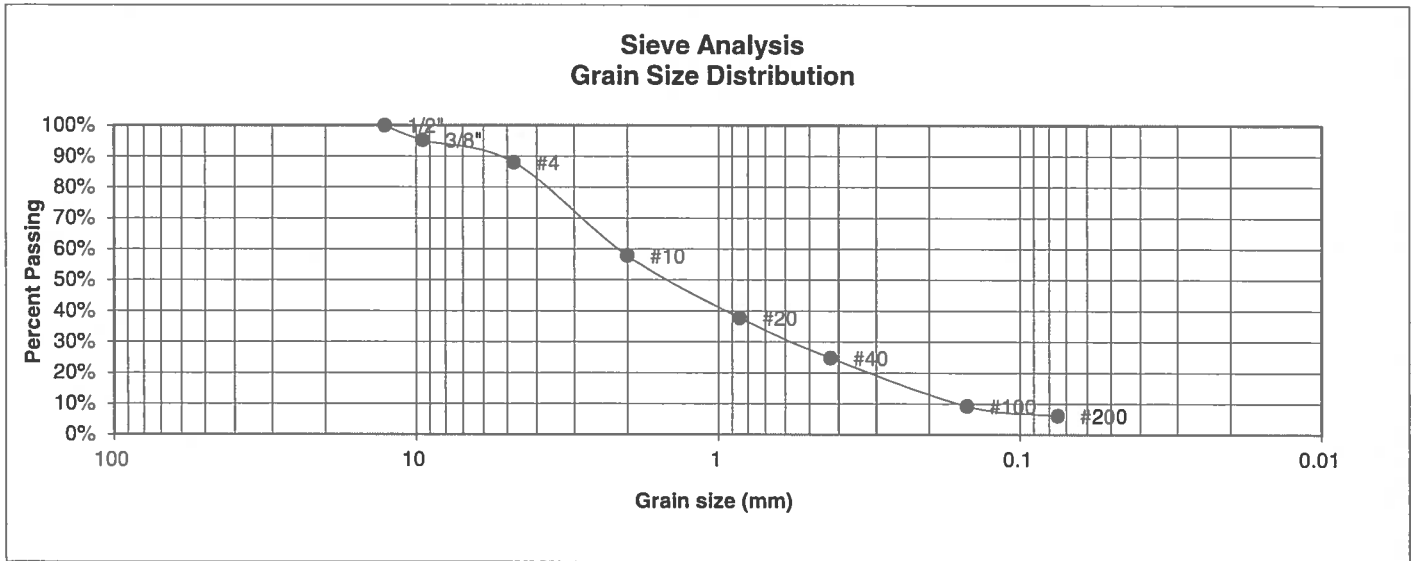

<u>U.S. Sieve #</u>	<u>Percent Finer</u>
3"	
1 1/2"	
3/4"	
1/2"	100.0%
3/8"	95.2%
4	88.0%
10	57.8%
20	37.8%
40	24.8%
100	9.2%
200	6.1%

<u>Atterberg Limits</u>	
Plastic Limit	NP
Liquid Limit	NV
Plastic Index	NP

<u>Swell</u>	
Moisture at start	
Moisture at finish	
Moisture increase	
Initial dry density (pcf)	
Swell (psf)	



**ENTECH
ENGINEERING, INC.**

505 ELKTON DRIVE
COLORADO SPRINGS, COLORADO 80907

**LABORATORY TEST
RESULTS**

DRAWN:

DATE:

CHECKED:

DATE:

n 11/8/17

JOB NO.:
171198

FIG NO.:

B-5

<u>UNIFIED CLASSIFICATION</u>	SC	<u>CLIENT</u>	TECH CONTRACTORS
<u>SOIL TYPE #</u>	1	<u>PROJECT</u>	WINDINGWALK & STONEBRIDGE
<u>TEST BORING #</u>	13	<u>JOB NO.</u>	171198
<u>DEPTH (FT)</u>	2-3	<u>TEST BY</u>	BL

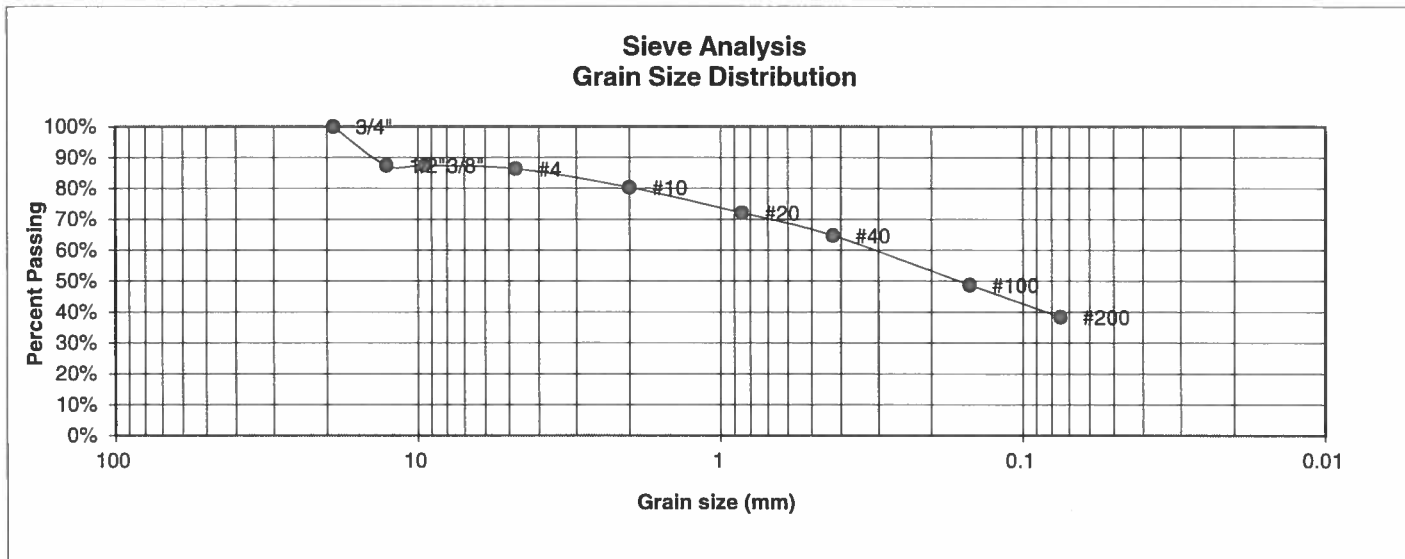

<u>U.S. Sieve #</u>	<u>Percent Finer</u>
3"	
1 1/2"	
3/4"	100.0%
1/2"	87.4%
3/8"	87.4%
4	86.4%
10	80.3%
20	72.1%
40	64.7%
100	48.8%
200	38.4%

<u>Atterberg Limits</u>	
Plastic Limit	13
Liquid Limit	28
Plastic Index	15

<u>Swell</u>	
Moisture at start	
Moisture at finish	
Moisture increase	
Initial dry density (pcf)	
Swell (psf)	



**ENTECH
ENGINEERING, INC.**

505 ELKTON DRIVE
COLORADO SPRINGS, COLORADO 80907

**LABORATORY TEST
RESULTS**

DRAWN:	DATE:	CHECKED:	DATE:
		<i>W</i>	11/8/17

JOB NO.:
171198

FIG NO.:

B-6

<u>UNIFIED CLASSIFICATION</u>	SM	<u>CLIENT</u>	TECH CONTRACTORS
<u>SOIL TYPE #</u>	1	<u>PROJECT</u>	WINDINGWALK & STONEBRIDGE
<u>TEST BORING #</u>	15	<u>JOB NO.</u>	171198
<u>DEPTH (FT)</u>	5	<u>TEST BY</u>	BL

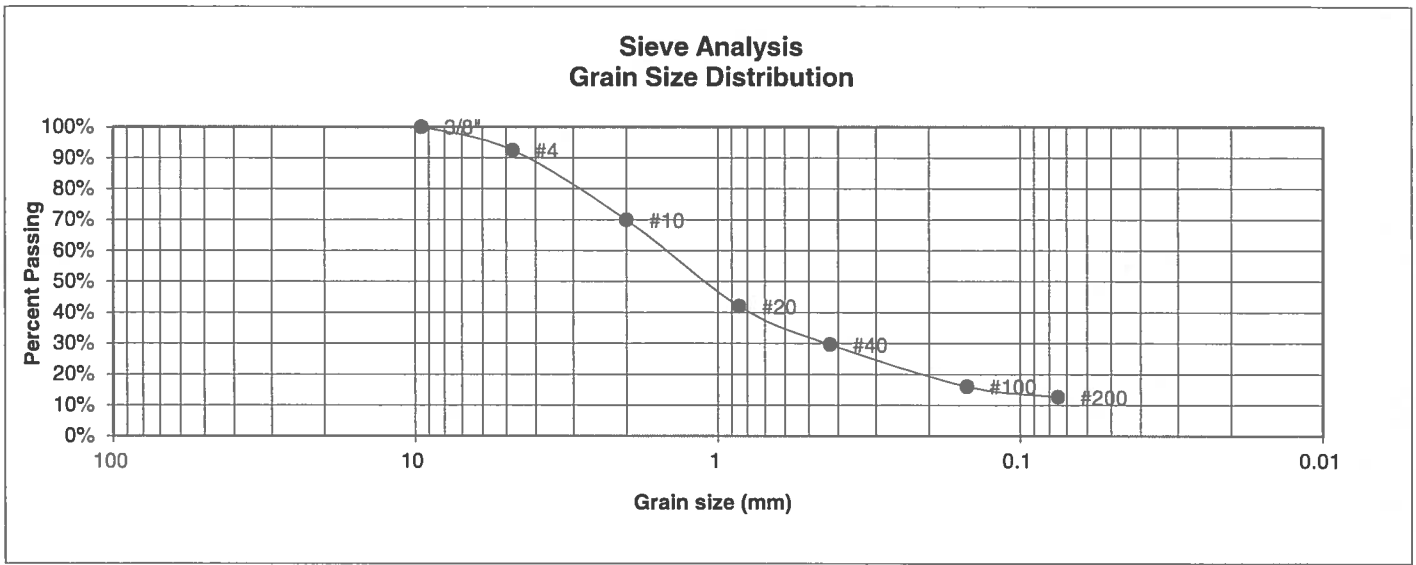

<u>U.S. Sieve #</u>	<u>Percent Finer</u>
3"	
1 1/2"	
3/4"	
1/2"	
3/8"	100.0%
4	92.4%
10	69.9%
20	42.0%
40	29.6%
100	16.1%
200	12.6%

Atterberg Limits
 Plastic Limit
 Liquid Limit
 Plastic Index

Swell
 Moisture at start
 Moisture at finish
 Moisture increase
 Initial dry density (pcf)
 Swell (psf)



ENTECH ENGINEERING, INC.
 505 ELKTON DRIVE
 COLORADO SPRINGS, COLORADO 80907

LABORATORY TEST RESULTS

<u>DRAWN:</u>	<u>DATE:</u>	<u>CHECKED:</u>	<u>DATE:</u>
		<i>BL</i>	11/8/17

JOB NO.:
171198

FIG NO.:
B-7

UNIFIED CLASSIFICATION	SM-SW	CLIENT	TECH CONTRACTORS
SOIL TYPE #	1	PROJECT	WINDINGWALK & STONEBRIDGE
TEST BORING #	19	JOB NO.	171198
DEPTH (FT)	5	TEST BY	BL

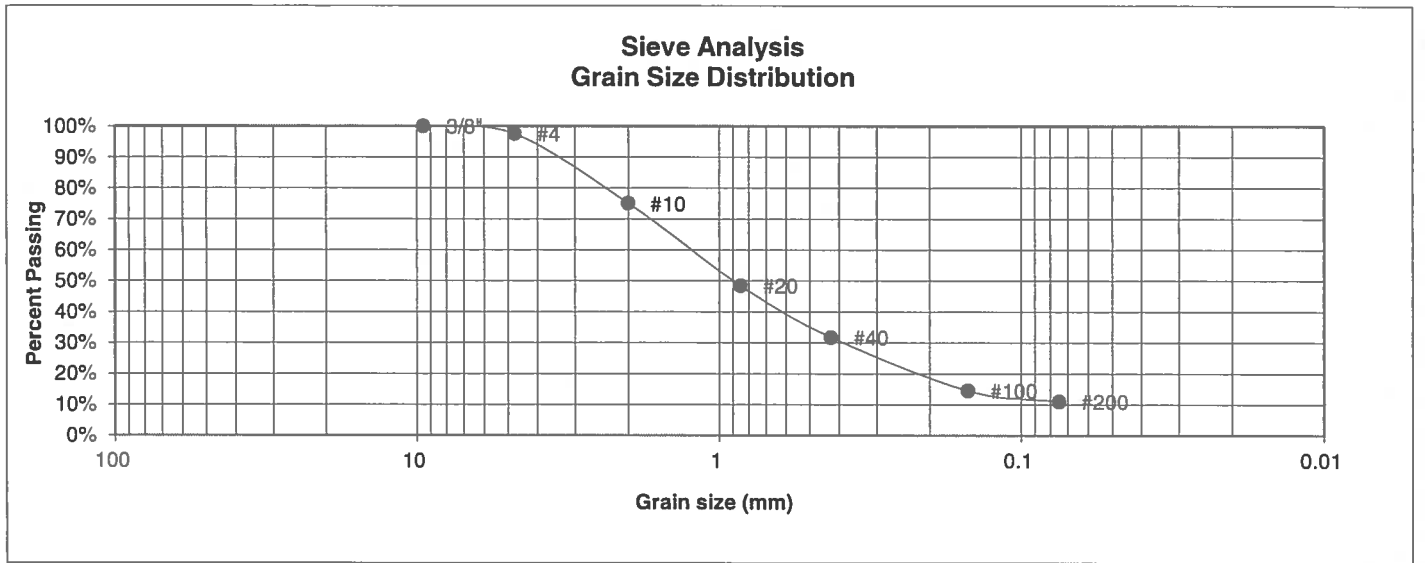

U.S. Sieve #	Percent Finer
3"	
1 1/2"	
3/4"	
1/2"	
3/8"	100.0%
4	97.5%
10	75.1%
20	48.5%
40	31.8%
100	14.5%
200	11.0%

Atterberg Limits	
Plastic Limit	NP
Liquid Limit	NV
Plastic Index	NP

Swell	
Moisture at start	
Moisture at finish	
Moisture increase	
Initial dry density (pcf)	
Swell (psf)	



**ENTECH
ENGINEERING, INC.**

505 ELKTON DRIVE
COLORADO SPRINGS, COLORADO 80907

**LABORATORY TEST
RESULTS**

DRAWN:	DATE:	CHECKED: <i>h</i>	DATE: 11/8/17
--------	-------	-------------------	---------------

JOB NO.:
171198

FIG NO.:
B-8

<u>UNIFIED CLASSIFICATION</u>	SM	<u>CLIENT</u>	TECH CONTRACTORS
<u>SOIL TYPE #</u>	1	<u>PROJECT</u>	WINDINGWALK & STONEBRIDGE
<u>TEST BORING #</u>	30	<u>JOB NO.</u>	171198
<u>DEPTH (FT)</u>	2-3	<u>TEST BY</u>	BL

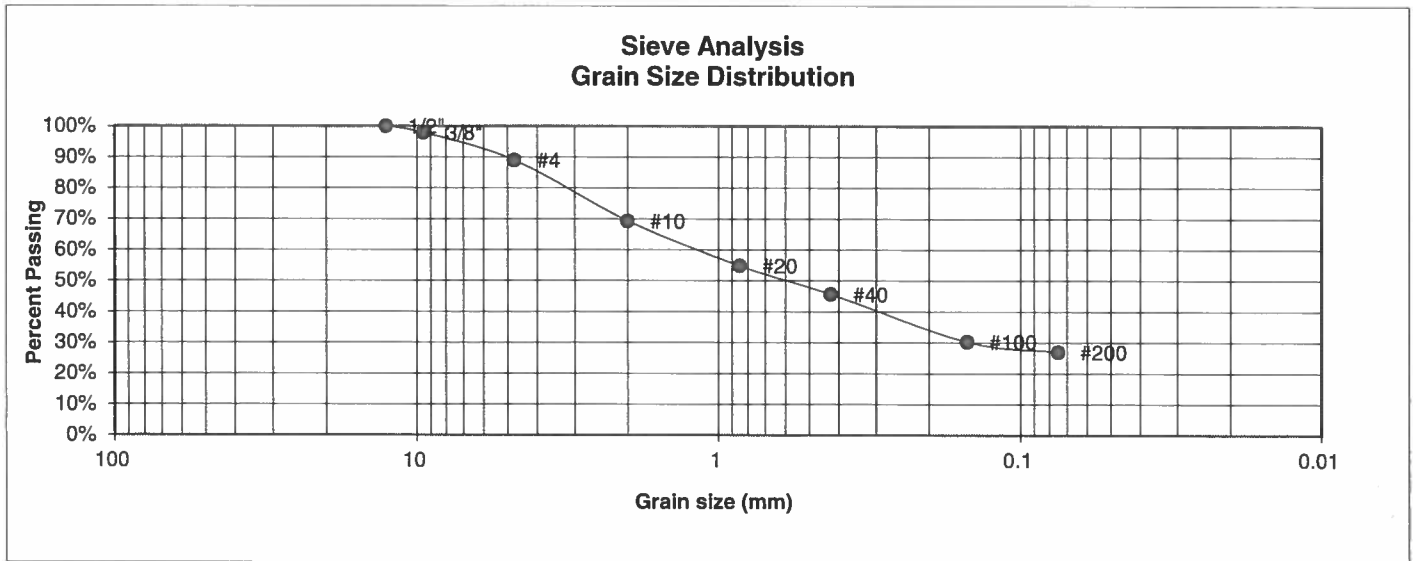

<u>U.S. Sieve #</u>	<u>Percent Finer</u>
3"	
1 1/2"	
3/4"	
1/2"	100.0%
3/8"	97.9%
4	89.0%
10	69.3%
20	54.8%
40	45.7%
100	30.3%
200	26.9%

Atterberg Limits
 Plastic Limit
 Liquid Limit
 Plastic Index

Swell
 Moisture at start
 Moisture at finish
 Moisture increase
 Initial dry density (pcf)
 Swell (psf)



**ENTECH
ENGINEERING, INC.**

505 ELKTON DRIVE
COLORADO SPRINGS, COLORADO 80907

**LABORATORY TEST
RESULTS**

<u>DRAWN:</u>	<u>DATE:</u>	<u>CHECKED:</u>	<u>DATE:</u>
		<i>h</i>	11/01/17

JOB NO.:
171198

FIG NO.:
B-9

<u>UNIFIED CLASSIFICATION</u>	SM	<u>CLIENT</u>	TECH CONTRACTORS
<u>SOIL TYPE #</u>	1	<u>PROJECT</u>	WINDINGWALK & STONEBRIDGE
<u>TEST BORING #</u>	34	<u>JOB NO.</u>	171198
<u>DEPTH (FT)</u>	5	<u>TEST BY</u>	BL

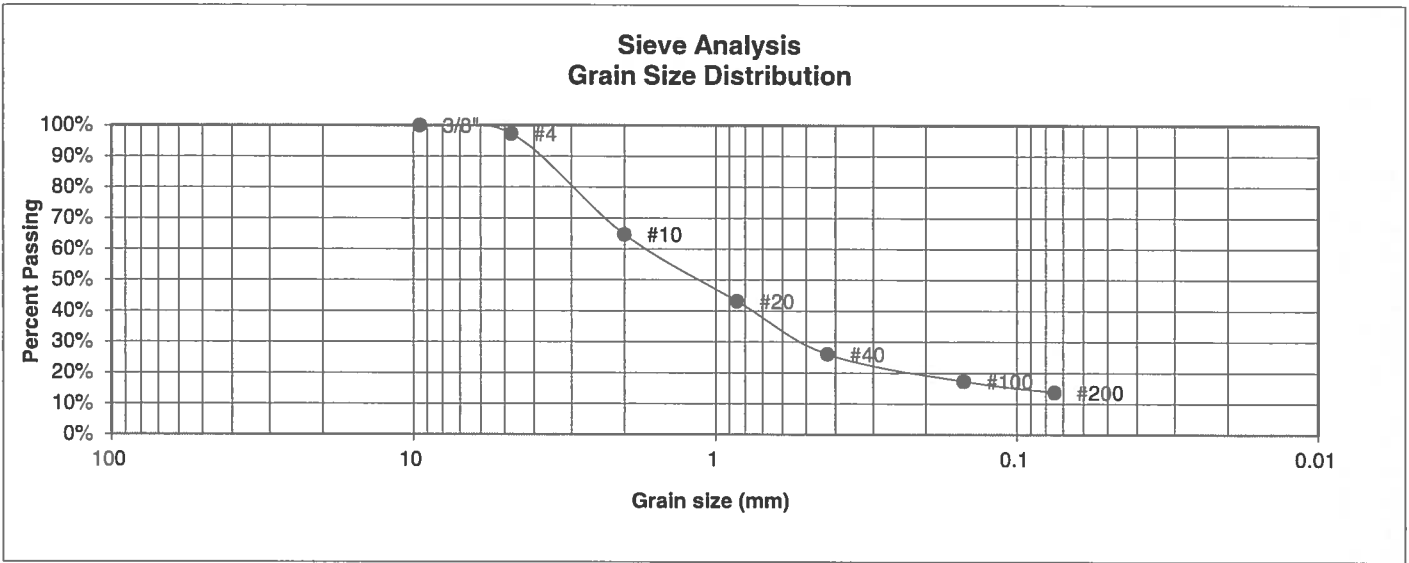

<u>U.S. Sieve #</u>	<u>Percent Finer</u>
3"	
1 1/2"	
3/4"	
1/2"	
3/8"	100.0%
4	97.3%
10	64.7%
20	43.1%
40	26.0%
100	17.3%
200	13.7%

Atterberg Limits
 Plastic Limit
 Liquid Limit
 Plastic Index

Swell
 Moisture at start
 Moisture at finish
 Moisture increase
 Initial dry density (pcf)
 Swell (psf)



**ENTECH
ENGINEERING, INC.**

505 ELKTON DRIVE
COLORADO SPRINGS, COLORADO 80907

**LABORATORY TEST
RESULTS**

<u>DRAWN:</u>	<u>DATE:</u>	<u>CHECKED:</u>	<u>DATE:</u>
		<i>BL</i>	11/8/17

JOB NO.:
171198

FIG NO.:
B-10

UNIFIED CLASSIFICATION	SM	CLIENT	TECH CONTRACTORS
SOIL TYPE #	1	PROJECT	WINDINGWALK & STONEBRIDGE
TEST BORING #	35	JOB NO.	171198
DEPTH (FT)	2-3	TEST BY	BL

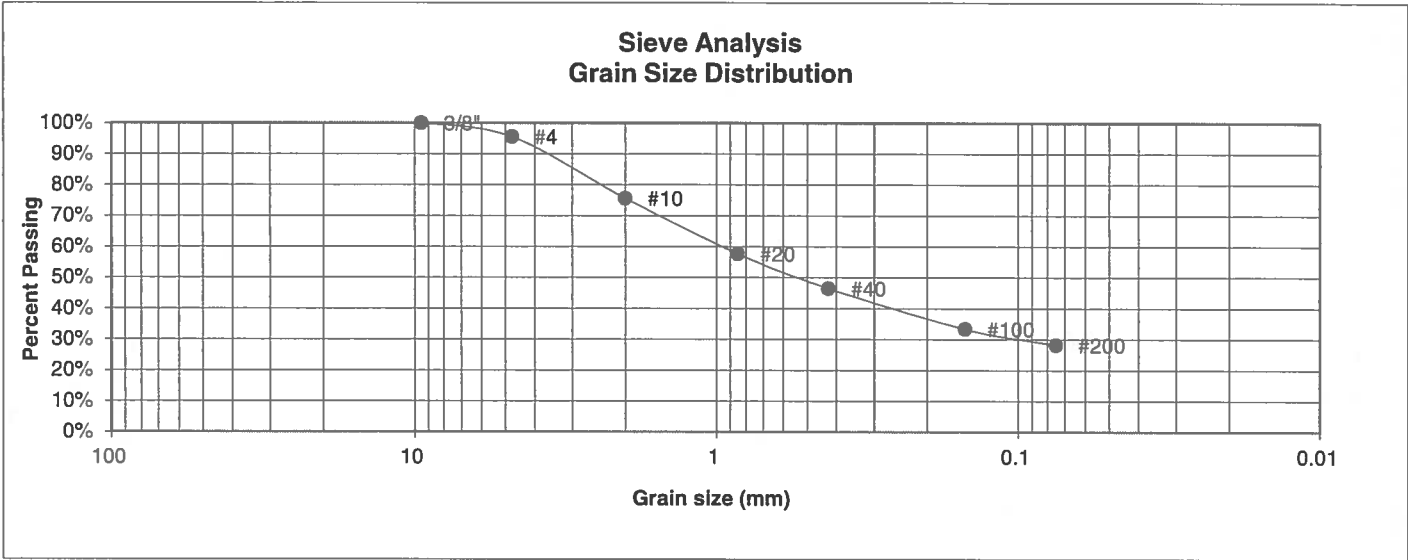

U.S. Sieve #	Percent Finer
3"	
1 1/2"	
3/4"	
1/2"	
3/8"	100.0%
4	95.5%
10	75.6%
20	57.7%
40	46.5%
100	33.4%
200	28.2%

Atterberg Limits

Plastic Limit NP
 Liquid Limit NV
 Plastic Index NP

Swell

Moisture at start
 Moisture at finish
 Moisture increase
 Initial dry density (pcf)
 Swell (psf)



**ENTECH
ENGINEERING, INC.**
 505 ELKTON DRIVE
 COLORADO SPRINGS, COLORADO 80907

LABORATORY TEST RESULTS

DRAWN:	DATE:	CHECKED:	DATE:
		<i>h</i>	4/18/17

JOB NO.:
171198

FIG NO.:
13-11

UNIFIED CLASSIFICATION	SM	CLIENT	TECH CONTRACTORS
SOIL TYPE #	1	PROJECT	WINDINGWALK & STONEBRIDGE
TEST BORING #	39	JOB NO.	171198
DEPTH (FT)	10	TEST BY	BL

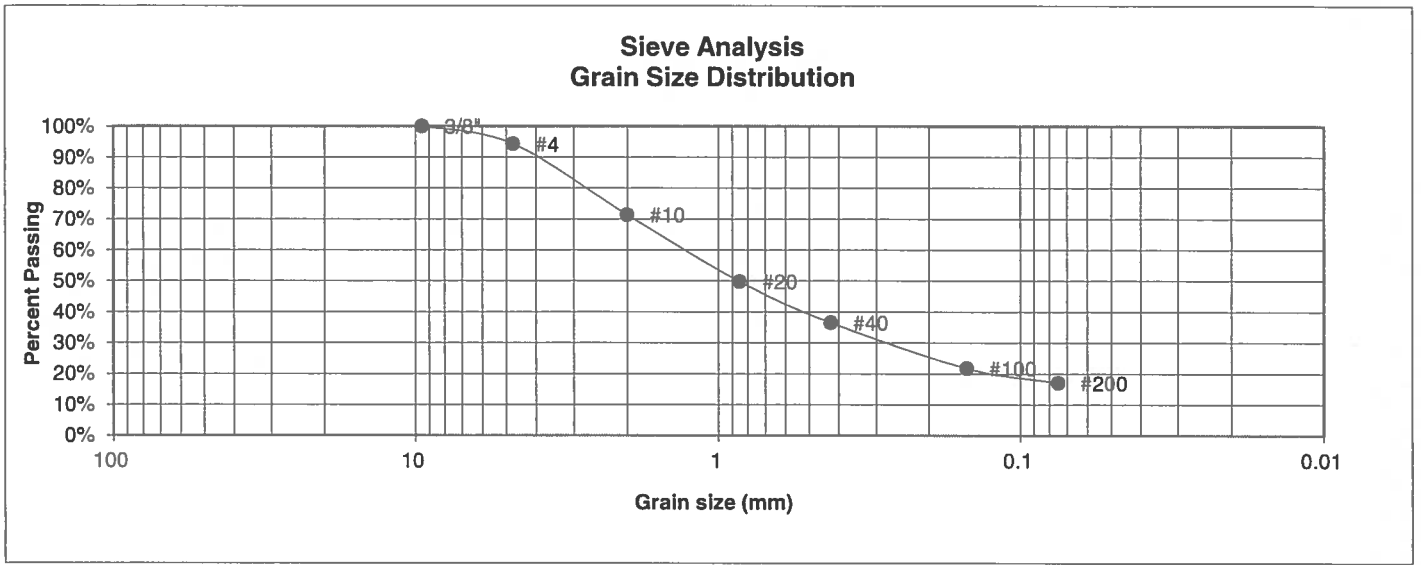

U.S. Sieve #	Percent Finer
3"	
1 1/2"	
3/4"	
1/2"	
3/8"	100.0%
4	94.3%
10	71.3%
20	49.8%
40	36.5%
100	21.8%
200	17.1%

Atterberg Limits
 Plastic Limit
 Liquid Limit
 Plastic Index

Swell
 Moisture at start
 Moisture at finish
 Moisture increase
 Initial dry density (pcf)
 Swell (psf)



**ENTECH
ENGINEERING, INC.**

505 ELKTON DRIVE
COLORADO SPRINGS, COLORADO 80907

**LABORATORY TEST
RESULTS**

DRAWN:	DATE:	CHECKED:	DATE:
		<i>W</i>	11/8/17

JOB NO.:
171198

FIG NO.:
B-12

UNIFIED CLASSIFICATION	SM-SW	CLIENT	TECH CONTRACTORS
SOIL TYPE #	1	PROJECT	WINDINGWALK & STONEBRIDGE
TEST BORING #	55	JOB NO.	171198
DEPTH (FT)	2-3	TEST BY	BL

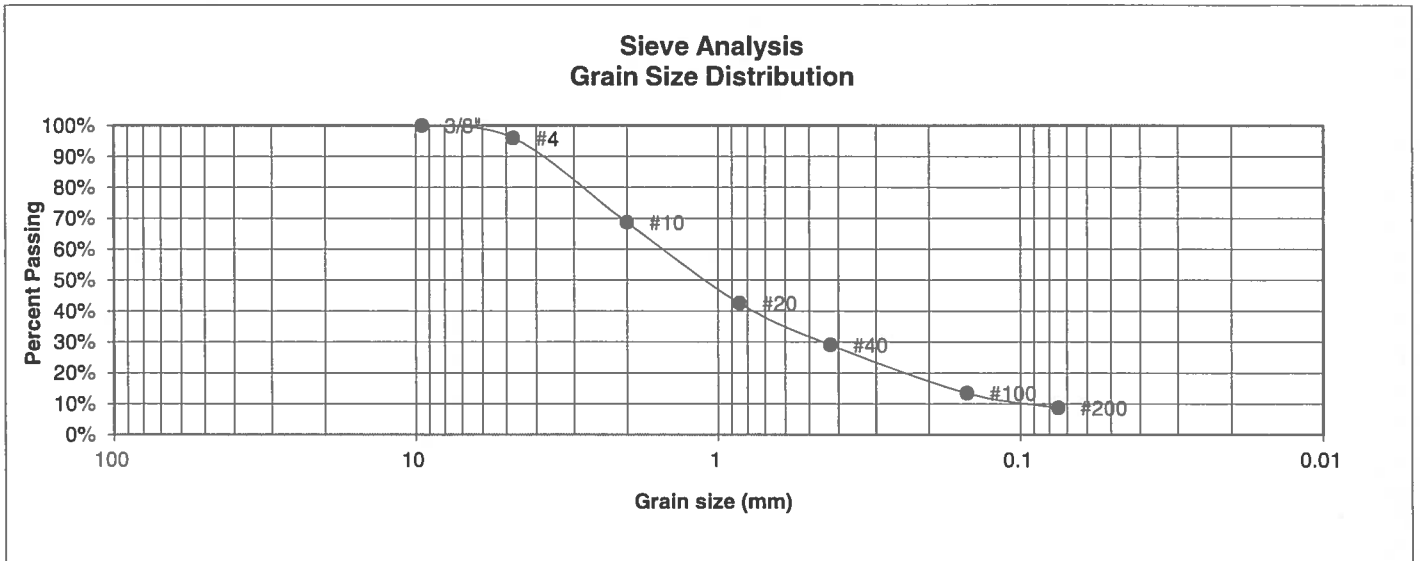

U.S. Sieve #	Percent Finer
3"	
1 1/2"	
3/4"	
1/2"	
3/8"	100.0%
4	96.0%
10	68.6%
20	42.5%
40	29.0%
100	13.5%
200	8.7%

Atterberg Limits	
Plastic Limit	NP
Liquid Limit	NV
Plastic Index	NP

Swell	
Moisture at start	
Moisture at finish	
Moisture increase	
Initial dry density (pcf)	
Swell (psf)	



**ENTECH
ENGINEERING, INC.**

505 ELKTON DRIVE
COLORADO SPRINGS, COLORADO 80907

**LABORATORY TEST
RESULTS**

DRAWN:	DATE:	CHECKED:	DATE:
		<i>h</i>	01/21/17

JOB NO.:
171198

FIG NO.:
73-13

<u>UNIFIED CLASSIFICATION</u>	CL	<u>CLIENT</u>	TECH CONTRACTORS
<u>SOIL TYPE #</u>	2	<u>PROJECT</u>	WINDINGWALK & STONEBRIDGE
<u>TEST BORING #</u>	3	<u>JOB NO.</u>	171198
<u>DEPTH (FT)</u>	15	<u>TEST BY</u>	BL

**Sieve Analysis
Grain Size Distribution**

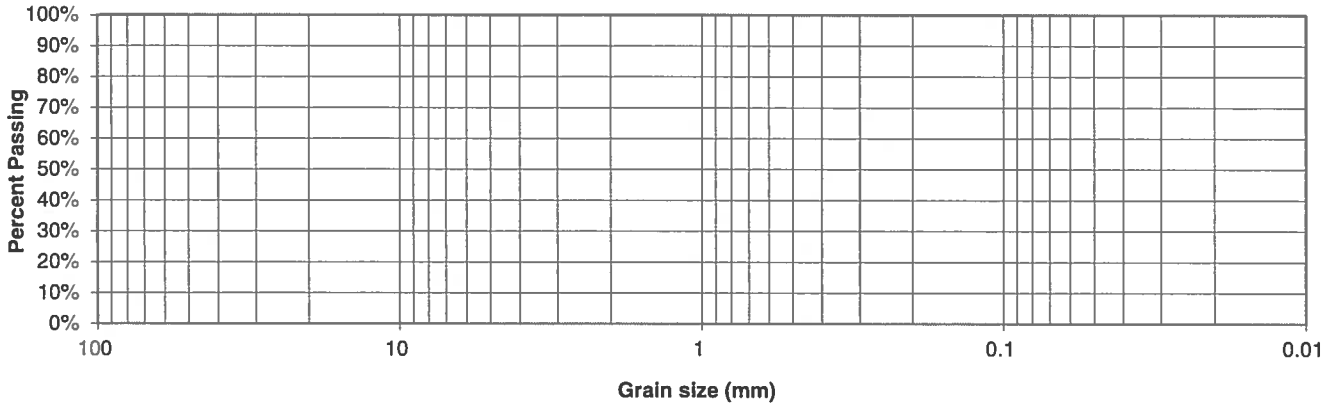

<u>U.S. Sieve #</u>	<u>Percent Finer</u>	<u>Atterberg Limits</u>	
3"		Plastic Limit	
1 1/2"		Liquid Limit	
3/4"		Plastic Index	
1/2"			
3/8"		<u>Swell</u>	
4		Moisture at start	13.6%
10		Moisture at finish	23.9%
20		Moisture increase	10.3%
40		Initial dry density (pcf)	101
100		Swell (psf)	1720
200			



**ENTECH
ENGINEERING, INC.**

505 ELKTON DRIVE
COLORADO SPRINGS, COLORADO 80907

**LABORATORY TEST
RESULTS**

DRAWN:	DATE:	CHECKED:	DATE:
		<i>h</i>	11/8/12

JOB NO.:
171198

FIG NO.:
B-14

<u>UNIFIED CLASSIFICATION</u>	CL	<u>CLIENT</u>	TECH CONTRACTORS
<u>SOIL TYPE #</u>	2	<u>PROJECT</u>	WINDINGWALK & STONEBRIDGE
<u>TEST BORING #</u>	25	<u>JOB NO.</u>	171198
<u>DEPTH (FT)</u>	10	<u>TEST BY</u>	BL

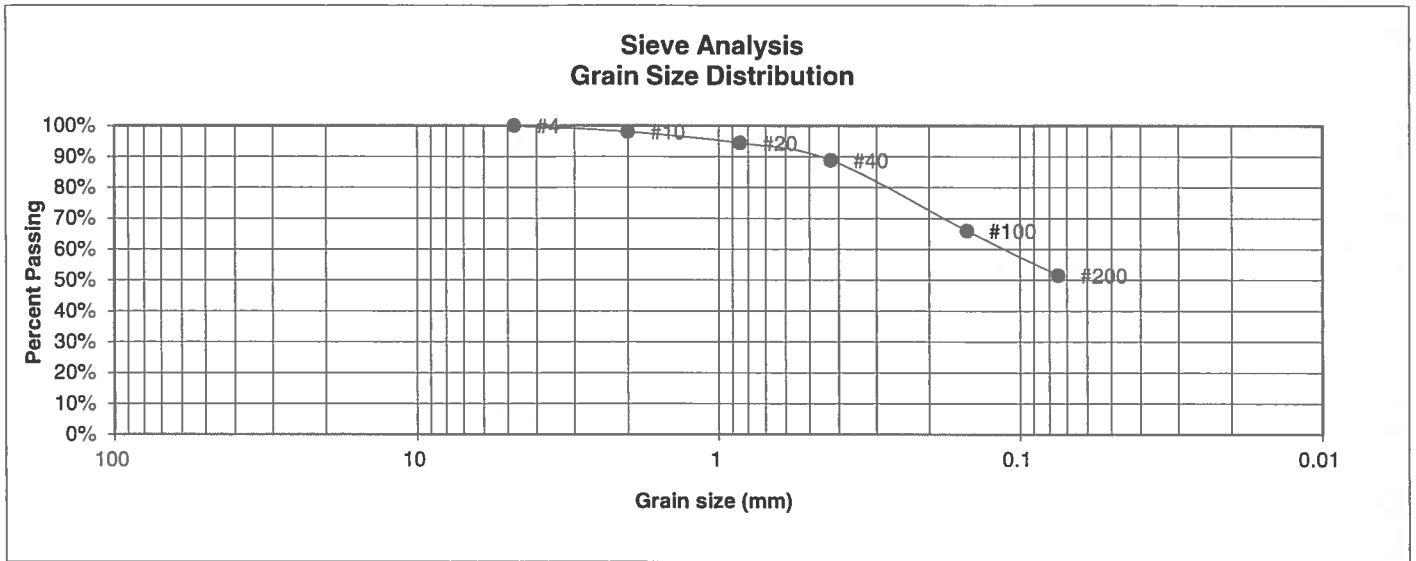

U.S. Sieve #	Percent Finer
3"	
1 1/2"	
3/4"	
1/2"	
3/8"	
4	100.0%
10	98.0%
20	94.4%
40	88.8%
100	66.0%
200	51.6%

<u>Atterberg Limits</u>	
Plastic Limit	10
Liquid Limit	20
Plastic Index	10

<u>Swell</u>	
Moisture at start	
Moisture at finish	
Moisture increase	
Initial dry density (pcf)	
Swell (psf)	



**ENTECH
ENGINEERING, INC.**

505 ELKTON DRIVE
COLORADO SPRINGS, COLORADO 80907

**LABORATORY TEST
RESULTS**

DRAWN:	DATE:	CHECKED:	DATE:
		<i>w</i>	11/8/17

JOB NO.:
171198

FIG NO.:
B-15

UNIFIED CLASSIFICATION	CL	CLIENT	TECH CONTRACTORS
SOIL TYPE #	2	PROJECT	WINDINGWALK & STONEBRIDGE
TEST BORING #	28	JOB NO.	171198
DEPTH (FT)	2-3	TEST BY	BL

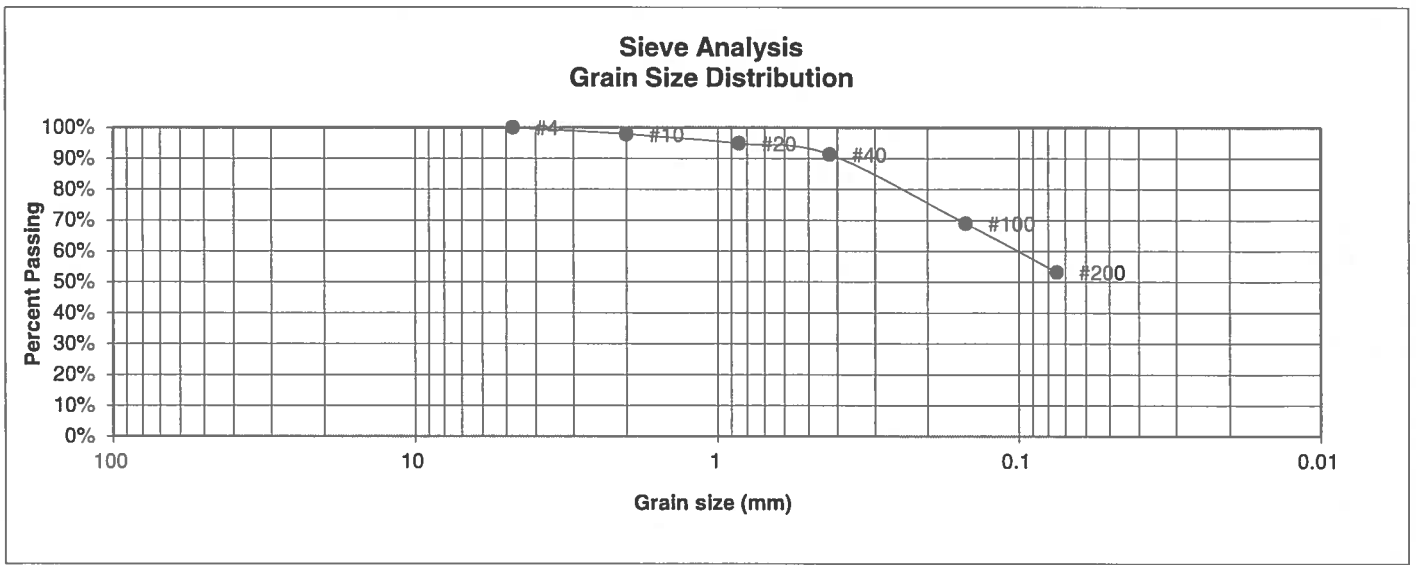

U.S. Sieve #	Percent Finer
3"	
1 1/2"	
3/4"	
1/2"	
3/8"	
4	100.0%
10	97.9%
20	94.9%
40	91.3%
100	69.0%
200	53.2%

Atterberg Limits	
Plastic Limit	16
Liquid Limit	30
Plastic Index	14
Swell	
Moisture at start	
Moisture at finish	
Moisture increase	
Initial dry density (pcf)	
Swell (psf)	



ENTECH ENGINEERING, INC.
505 ELKTON DRIVE
COLORADO SPRINGS, COLORADO 80907

LABORATORY TEST RESULTS

DRAWN:	DATE:	CHECKED:	DATE:
		<i>h</i>	11/8/17

JOB NO.:
171198

FIG NO.:
B-16

<u>UNIFIED CLASSIFICATION</u>	SM	<u>CLIENT</u>	TECH CONTRACTORS
<u>SOIL TYPE #</u>	3	<u>PROJECT</u>	WINDINGWALK & STONEBRIDGE
<u>TEST BORING #</u>	1	<u>JOB NO.</u>	171198
<u>DEPTH (FT)</u>	10	<u>TEST BY</u>	BL

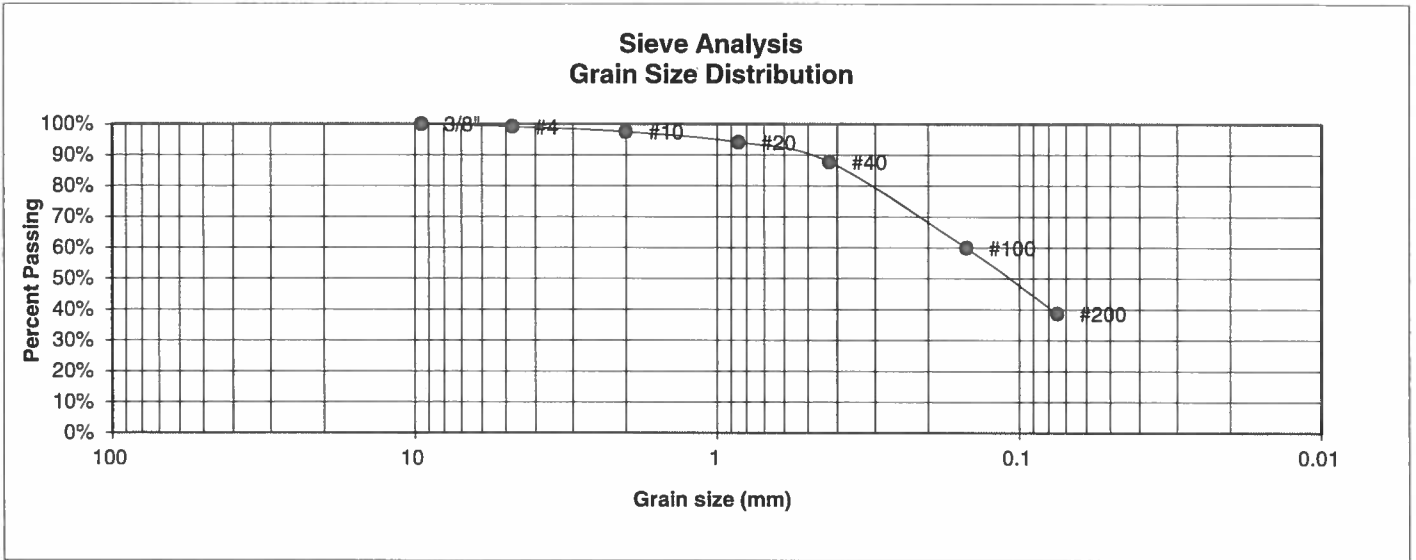

<u>U.S. Sieve #</u>	<u>Percent Finer</u>
3"	
1 1/2"	
3/4"	
1/2"	
3/8"	100.0%
4	99.1%
10	97.5%
20	94.1%
40	87.8%
100	59.9%
200	38.7%

<u>Atterberg Limits</u>	
Plastic Limit	NP
Liquid Limit	NV
Plastic Index	NP

<u>Swell</u>	
Moisture at start	
Moisture at finish	
Moisture increase	
Initial dry density (pcf)	
Swell (psf)	



**ENTECH
ENGINEERING, INC.**

505 ELKTON DRIVE
COLORADO SPRINGS, COLORADO 80907

**LABORATORY TEST
RESULTS**

<u>DRAWN:</u>	<u>DATE:</u>	<u>CHECKED:</u>	<u>DATE:</u>
		<i>h</i>	4/8/17

JOB NO.:
171198

FIG NO.:
B-17

UNIFIED CLASSIFICATION	SC	CLIENT	TECH CONTRACTORS
SOIL TYPE #	3	PROJECT	WINDINGWALK & STONEBRIDGE
TEST BORING #	3	JOB NO.	171198
DEPTH (FT)	20	TEST BY	BL

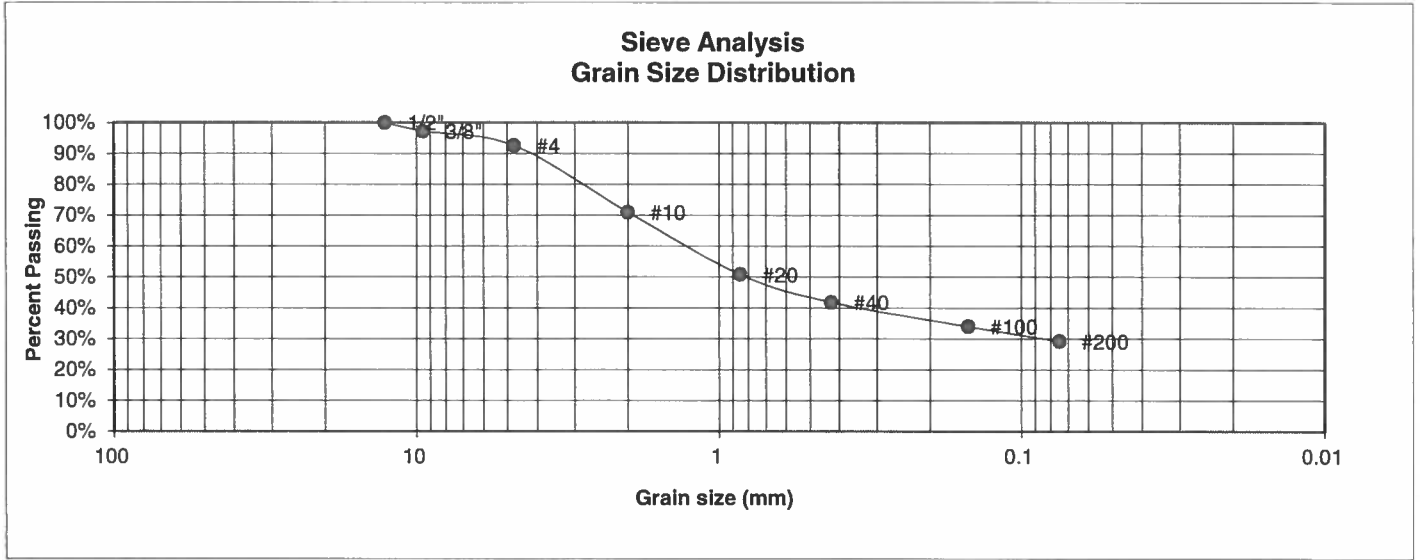

U.S. Sieve #	Percent Finer
3"	
1 1/2"	
3/4"	
1/2"	100.0%
3/8"	97.2%
4	92.6%
10	71.0%
20	50.8%
40	41.8%
100	34.0%
200	29.2%

Atterberg Limits

Plastic Limit	24
Liquid Limit	36
Plastic Index	12

Swell

Moisture at start	
Moisture at finish	
Moisture increase	
Initial dry density (pcf)	
Swell (psf)	



**ENTECH
ENGINEERING, INC.**
505 ELKTON DRIVE
COLORADO SPRINGS, COLORADO 80907

**LABORATORY TEST
RESULTS**

DRAWN:	DATE:	CHECKED: <i>W</i>	DATE: <i>11/8/17</i>
--------	-------	-------------------	----------------------

JOB NO.:
171198

FIG NO.:
B-18

<u>UNIFIED CLASSIFICATION</u>	SM	<u>CLIENT</u>	TECH CONTRACTORS
<u>SOIL TYPE #</u>	3	<u>PROJECT</u>	WINDINGWALK & STONEBRIDGE
<u>TEST BORING #</u>	5	<u>JOB NO.</u>	171198
<u>DEPTH (FT)</u>	5	<u>TEST BY</u>	BL

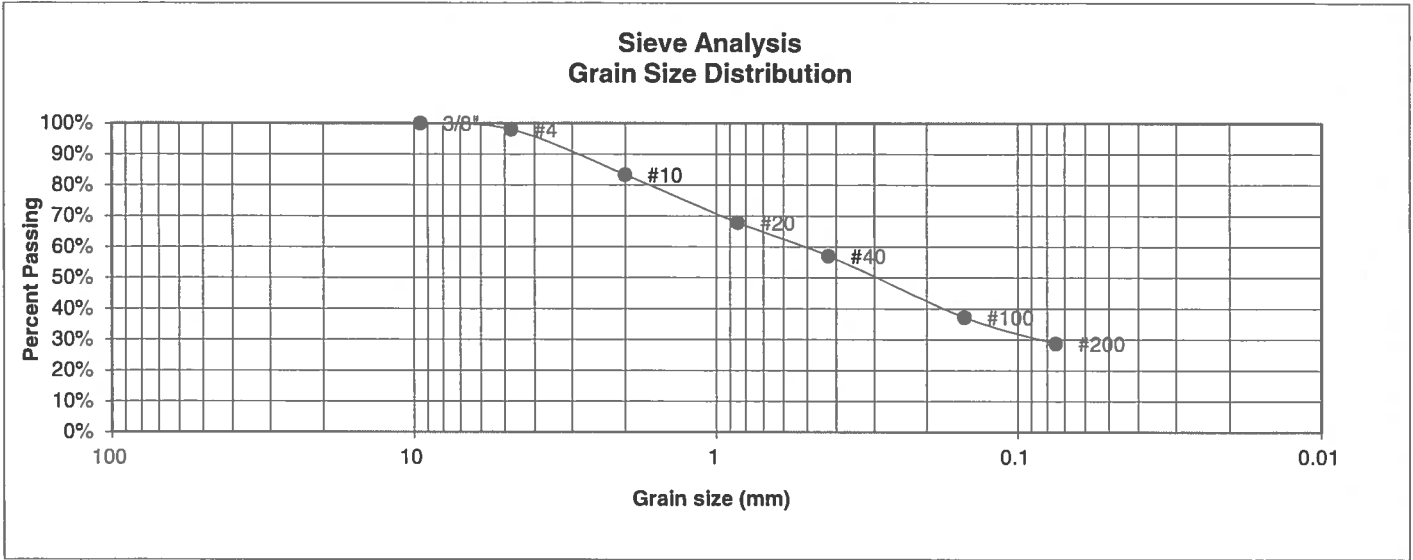

<u>U.S. Sieve #</u>	<u>Percent Finer</u>
3"	
1 1/2"	
3/4"	
1/2"	
3/8"	100.0%
4	98.0%
10	83.4%
20	67.9%
40	57.1%
100	37.3%
200	28.7%

<u>Atterberg Limits</u>	
Plastic Limit	27
Liquid Limit	41
Plastic Index	14

- Swell
- Moisture at start
 - Moisture at finish
 - Moisture increase
 - Initial dry density (pcf)
 - Swell (psf)



**ENTECH
ENGINEERING, INC.**
505 ELKTON DRIVE
COLORADO SPRINGS, COLORADO 80907

**LABORATORY TEST
RESULTS**

<u>DRAWN:</u>	<u>DATE:</u>	<u>CHECKED:</u>	<u>DATE:</u>
		<i>h</i>	11/8/17

JOB NO.:
171198

FIG NO.:
B-19

<u>UNIFIED CLASSIFICATION</u>	SM	<u>CLIENT</u>	TECH CONTRACTORS
<u>SOIL TYPE #</u>	3	<u>PROJECT</u>	WINDINGWALK & STONEBRIDGE
<u>TEST BORING #</u>	7	<u>JOB NO.</u>	171198
<u>DEPTH (FT)</u>	20	<u>TEST BY</u>	BL

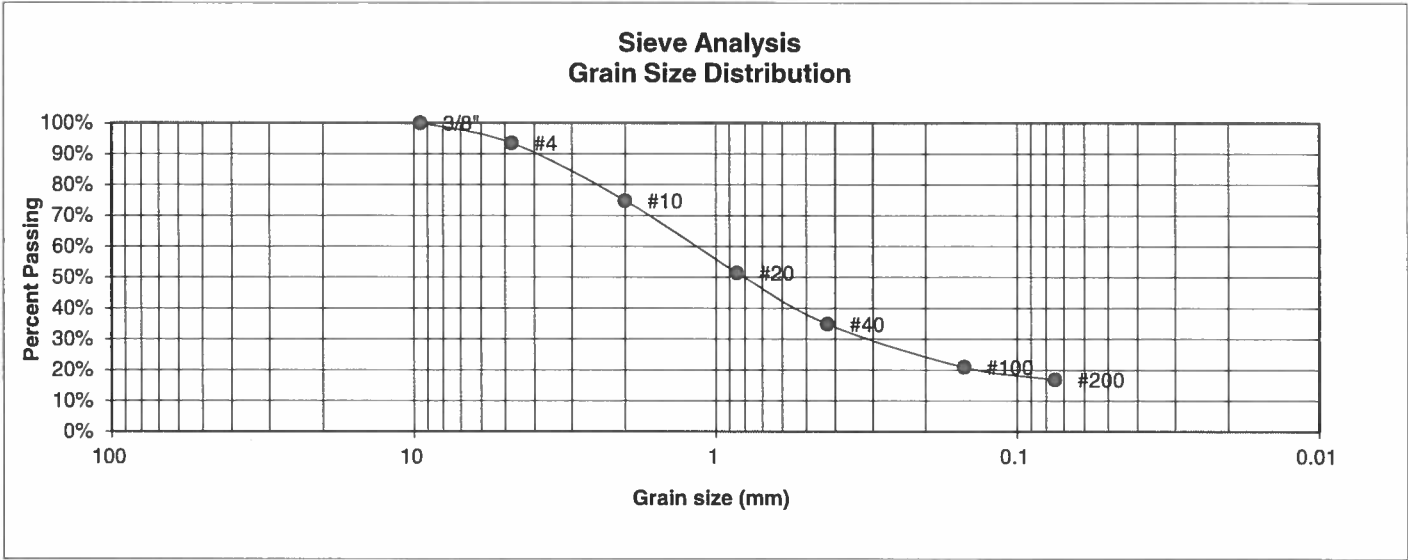

<u>U.S. Sieve #</u>	<u>Percent Finer</u>
3"	
1 1/2"	
3/4"	
1/2"	
3/8"	100.0%
4	93.5%
10	74.8%
20	51.5%
40	34.9%
100	20.9%
200	16.9%

Atterberg Limits
 Plastic Limit
 Liquid Limit
 Plastic Index

Swell
 Moisture at start
 Moisture at finish
 Moisture increase
 Initial dry density (pcf)
 Swell (psf)



**ENTECH
ENGINEERING, INC.**
 505 ELKTON DRIVE
 COLORADO SPRINGS, COLORADO 80907

**LABORATORY TEST
RESULTS**

<u>DRAWN:</u>	<u>DATE:</u>	<u>CHECKED:</u>	<u>DATE:</u>
		<i>h</i>	11/8/17

JOB NO.:
171198

 FIG NO.:
B-20

<u>UNIFIED CLASSIFICATION</u>	SM	<u>CLIENT</u>	TECH CONTRACTORS
<u>SOIL TYPE #</u>	3	<u>PROJECT</u>	WINDINGWALK & STONEBRIDGE
<u>TEST BORING #</u>	9	<u>JOB NO.</u>	171198
<u>DEPTH (FT)</u>	10	<u>TEST BY</u>	BL

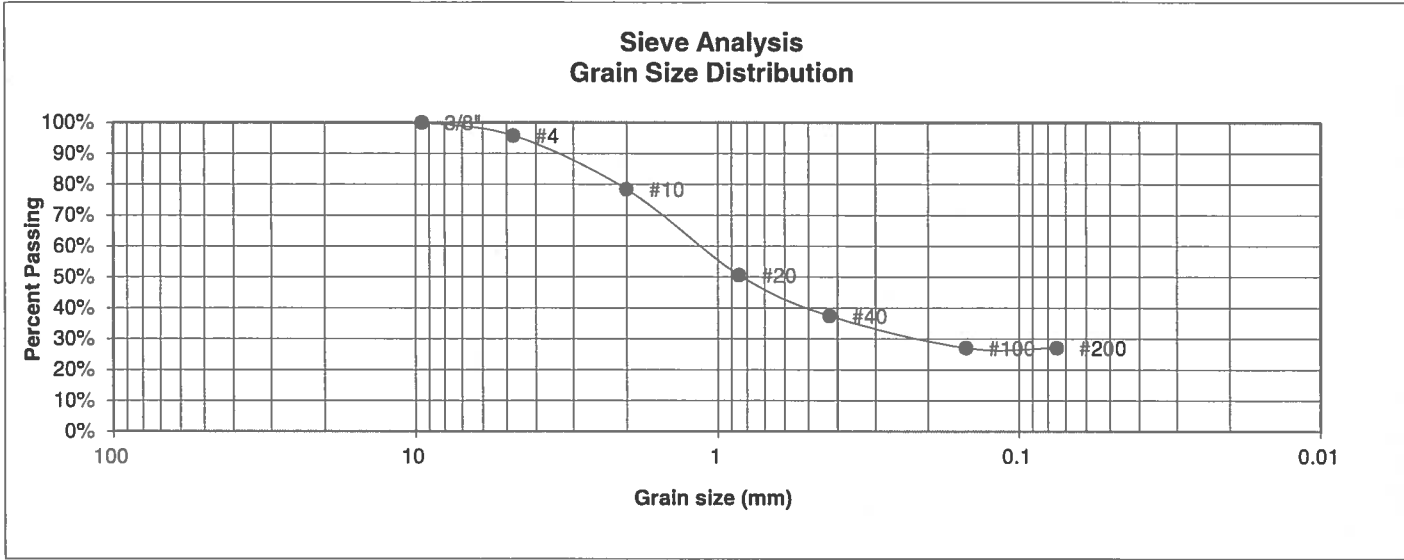

U.S. Sieve #	Percent Finer
3"	
1 1/2"	
3/4"	
1/2"	
3/8"	100.0%
4	95.8%
10	78.4%
20	50.7%
40	37.4%
100	27.1%
200	27.1%

Atterberg Limits

Plastic Limit	NP
Liquid Limit	NV
Plastic Index	NP

Swell

Moisture at start

Moisture at finish

Moisture increase

Initial dry density (pcf)

Swell (psf)



**ENTECH
ENGINEERING, INC.**
505 ELKTON DRIVE
COLORADO SPRINGS, COLORADO 80907

**LABORATORY TEST
RESULTS**

DRAWN:	DATE:	CHECKED:	DATE:
		<i>h</i>	11/8/17

JOB NO.:
171198

FIG NO.:
B-21

<u>UNIFIED CLASSIFICATION</u>	SM	<u>CLIENT</u>	TECH CONTRACTORS
<u>SOIL TYPE #</u>	3	<u>PROJECT</u>	WINDINGWALK & STONEBRIDGE
<u>TEST BORING #</u>	10	<u>JOB NO.</u>	171198
<u>DEPTH (FT)</u>	5	<u>TEST BY</u>	BL

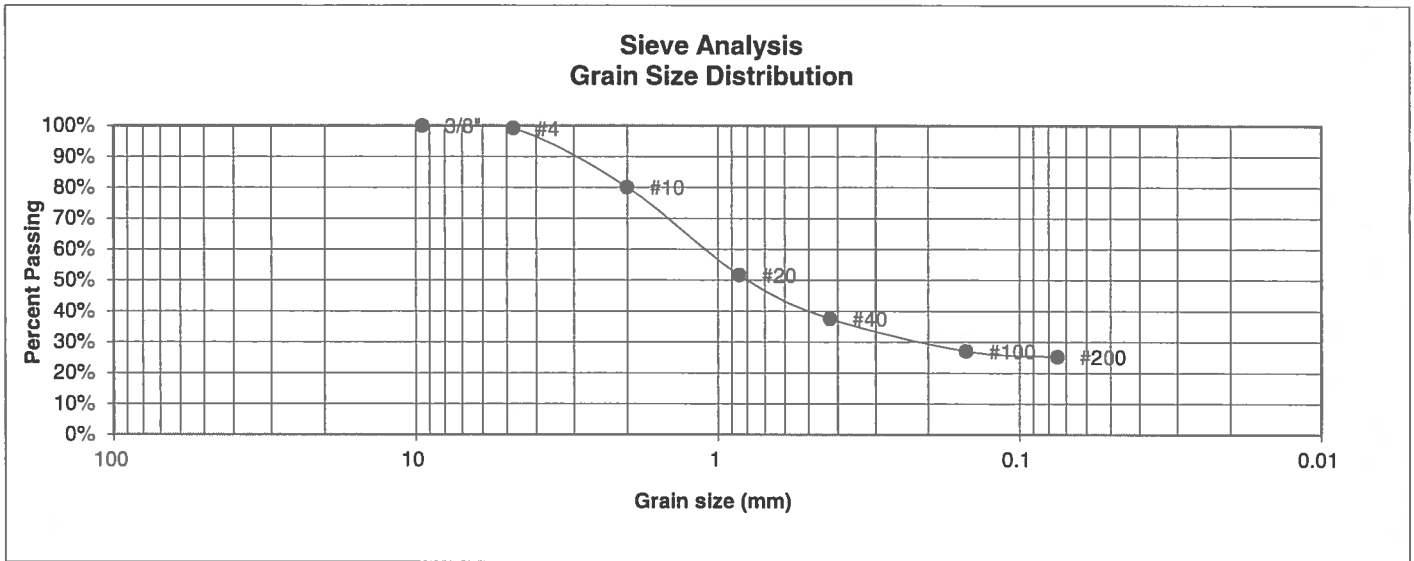

<u>U.S. Sieve #</u>	<u>Percent Finer</u>
3"	
1 1/2"	
3/4"	
1/2"	
3/8"	100.0%
4	99.1%
10	80.1%
20	51.7%
40	37.6%
100	27.1%
200	25.2%

Atterberg Limits
 Plastic Limit
 Liquid Limit
 Plastic Index

Swell
 Moisture at start
 Moisture at finish
 Moisture increase
 Initial dry density (pcf)
 Swell (psf)



**ENTECH
ENGINEERING, INC.**
 505 ELKTON DRIVE
 COLORADO SPRINGS, COLORADO 80907

**LABORATORY TEST
RESULTS**

DRAWN:	DATE:	CHECKED: <i>w</i>	DATE: 11/8/17
--------	-------	-------------------	---------------

JOB NO.:
171198

FIG NO.:
B-22

<u>UNIFIED CLASSIFICATION</u>	SC	<u>CLIENT</u>	TECH CONTRACTORS
<u>SOIL TYPE #</u>	3	<u>PROJECT</u>	WINDINGWALK & STONEBRIDGE
<u>TEST BORING #</u>	11	<u>JOB NO.</u>	171198
<u>DEPTH (FT)</u>	20	<u>TEST BY</u>	BL

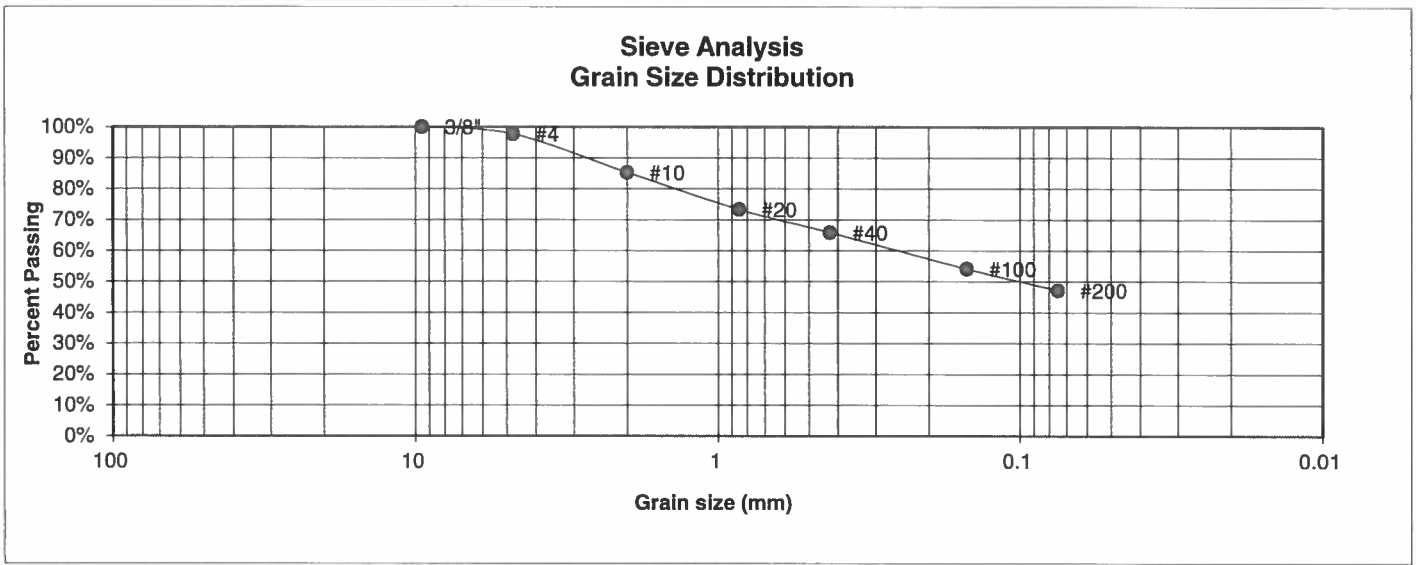

U.S. Sieve #	Percent Finer
3"	
1 1/2"	
3/4"	
1/2"	
3/8"	100.0%
4	97.7%
10	85.3%
20	73.3%
40	65.9%
100	54.1%
200	47.2%

<u>Atterberg Limits</u>	
Plastic Limit	15
Liquid Limit	32
Plastic Index	17

Swell
 Moisture at start
 Moisture at finish
 Moisture increase
 Initial dry density (pcf)
 Swell (psf)



ENTECH ENGINEERING, INC.
 505 ELKTON DRIVE
 COLORADO SPRINGS, COLORADO 80907

LABORATORY TEST RESULTS

DRAWN:	DATE:	CHECKED: <i>h</i>	DATE: 11/8/17
--------	-------	-------------------	---------------

JOB NO.: 171198
 FIG NO.: B-23

<u>UNIFIED CLASSIFICATION</u>	SM	<u>CLIENT</u>	TECH CONTRACTORS
<u>SOIL TYPE #</u>	3	<u>PROJECT</u>	WINDINGWALK & STONEBRIDGE
<u>TEST BORING #</u>	12	<u>JOB NO.</u>	171198
<u>DEPTH (FT)</u>	10	<u>TEST BY</u>	BL

**Sieve Analysis
Grain Size Distribution**

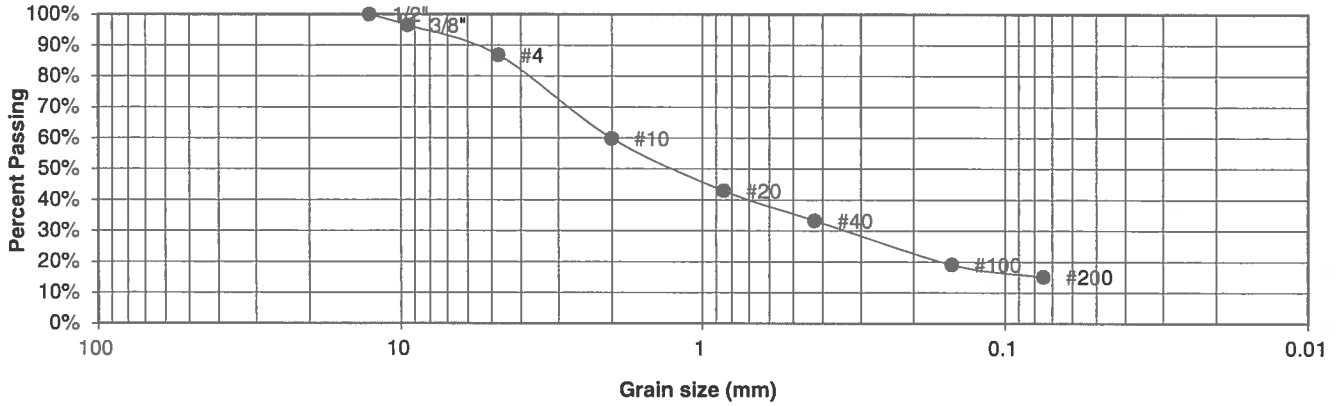

<u>U.S. Sieve #</u>	<u>Percent Finer</u>
3"	
1 1/2"	
3/4"	
1/2"	100.0%
3/8"	96.5%
4	86.9%
10	59.9%
20	43.0%
40	33.3%
100	19.1%
200	15.1%

Atterberg Limits
 Plastic Limit
 Liquid Limit
 Plastic Index

Swell
 Moisture at start
 Moisture at finish
 Moisture increase
 Initial dry density (pcf)
 Swell (psf)



**ENTECH
ENGINEERING, INC.**
 505 ELKTON DRIVE
 COLORADO SPRINGS, COLORADO 80907

**LABORATORY TEST
RESULTS**

<u>DRAWN:</u>	<u>DATE:</u>	<u>CHECKED:</u> <i>h</i>	<u>DATE:</u> 6/8/17
---------------	--------------	--------------------------	---------------------

JOB NO.:
171198

FIG NO.:
B-24

<u>UNIFIED CLASSIFICATION</u>	SC	<u>CLIENT</u>	TECH CONTRACTORS
<u>SOIL TYPE #</u>	3	<u>PROJECT</u>	WINDINGWALK & STONEBRIDGE
<u>TEST BORING #</u>	14	<u>JOB NO.</u>	171198
<u>DEPTH (FT)</u>	15	<u>TEST BY</u>	BL

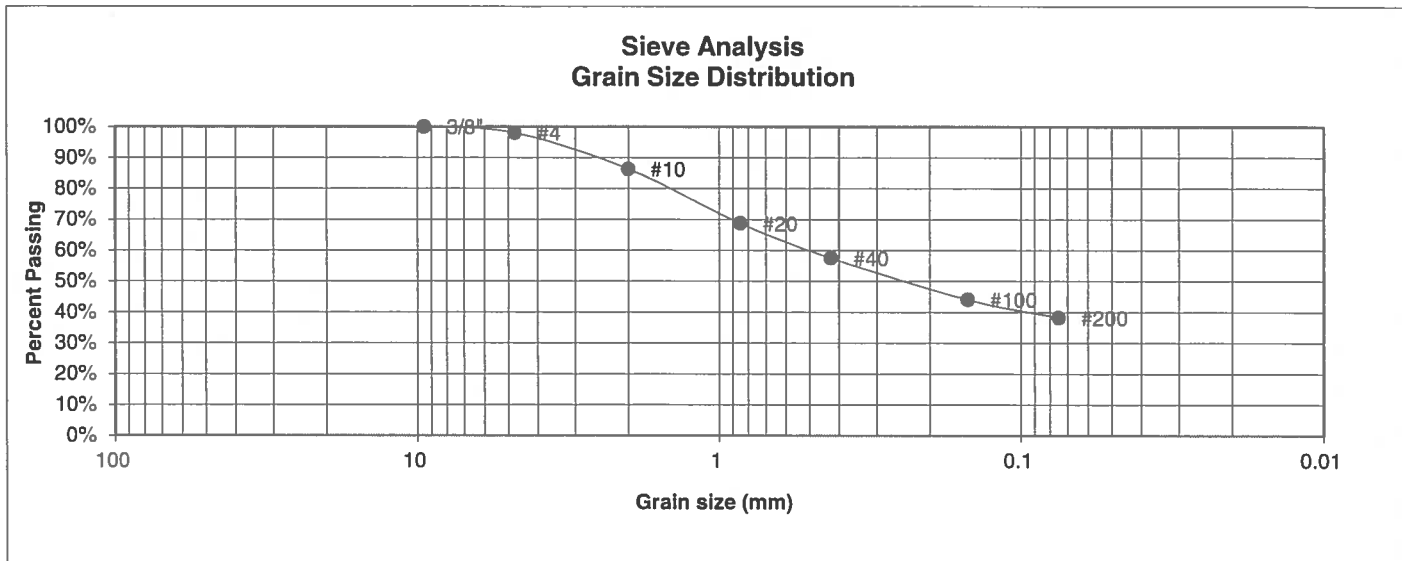

<u>U.S. Sieve #</u>	<u>Percent Finer</u>
3"	
1 1/2"	
3/4"	
1/2"	
3/8"	100.0%
4	98.0%
10	86.3%
20	68.7%
40	57.5%
100	44.1%
200	38.2%

Atterberg Limits
 Plastic Limit
 Liquid Limit
 Plastic Index

Swell
 Moisture at start
 Moisture at finish
 Moisture increase
 Initial dry density (pcf)
 Swell (psf)



**ENTECH
ENGINEERING, INC.**

505 ELKTON DRIVE
COLORADO SPRINGS, COLORADO 80907

**LABORATORY TEST
RESULTS**

DRAWN:

DATE:

CHECKED:

DATE:

h 11/01/17

JOB NO.:
171198

FIG NO.:

B-25

<u>UNIFIED CLASSIFICATION</u>	SM	<u>CLIENT</u>	TECH CONTRACTORS
<u>SOIL TYPE #</u>	3	<u>PROJECT</u>	WINDINGWALK & STONEBRIDGE
<u>TEST BORING #</u>	16	<u>JOB NO.</u>	171198
<u>DEPTH (FT)</u>	2-3	<u>TEST BY</u>	BL

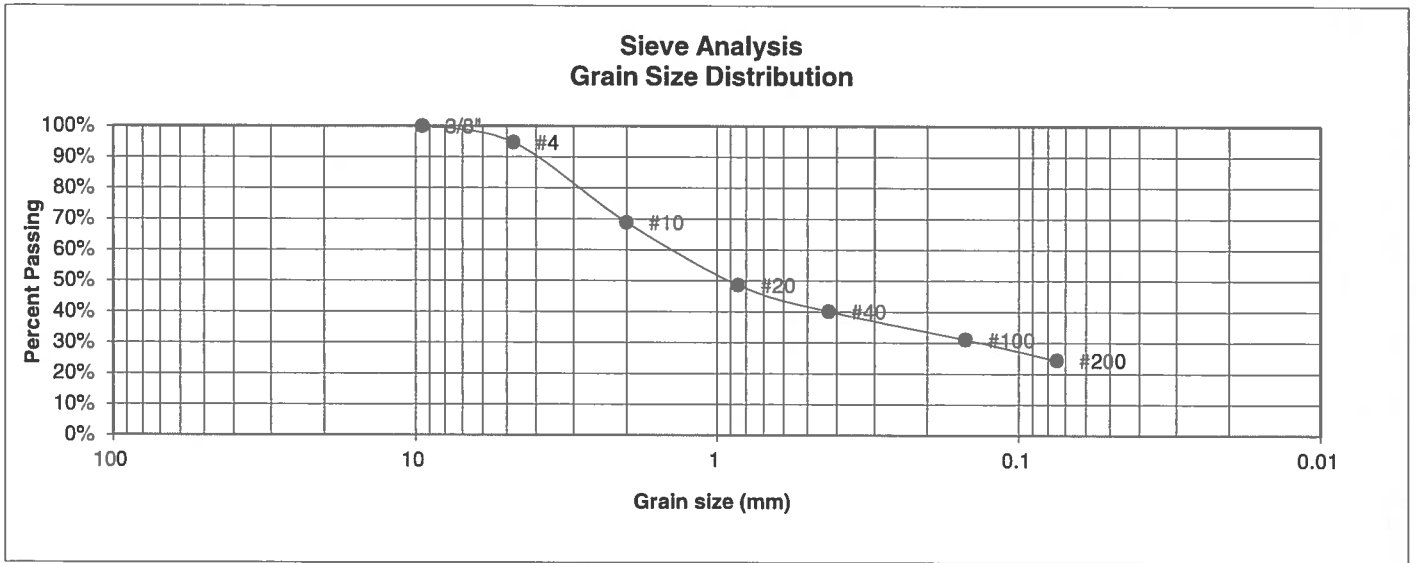

<u>U.S. Sieve #</u>	<u>Percent Finer</u>
3"	
1 1/2"	
3/4"	
1/2"	
3/8"	100.0%
4	94.7%
10	68.9%
20	48.6%
40	40.1%
100	31.1%
200	24.4%

Atterberg Limits
 Plastic Limit
 Liquid Limit
 Plastic Index

Swell
 Moisture at start
 Moisture at finish
 Moisture increase
 Initial dry density (pcf)
 Swell (psf)



**ENTECH
ENGINEERING, INC.**

505 ELKTON DRIVE
COLORADO SPRINGS, COLORADO 80907

**LABORATORY TEST
RESULTS**

DRAWN:	DATE:	CHECKED:	DATE:
		<i>h</i>	11/8/17

JOB NO.:
171198

FIG NO.:
B-26

<u>UNIFIED CLASSIFICATION</u>	SM	<u>CLIENT</u>	TECH CONTRACTORS
<u>SOIL TYPE #</u>	3	<u>PROJECT</u>	WINDINGWALK & STONEBRIDGE
<u>TEST BORING #</u>	18	<u>JOB NO.</u>	171198
<u>DEPTH (FT)</u>	10	<u>TEST BY</u>	BL

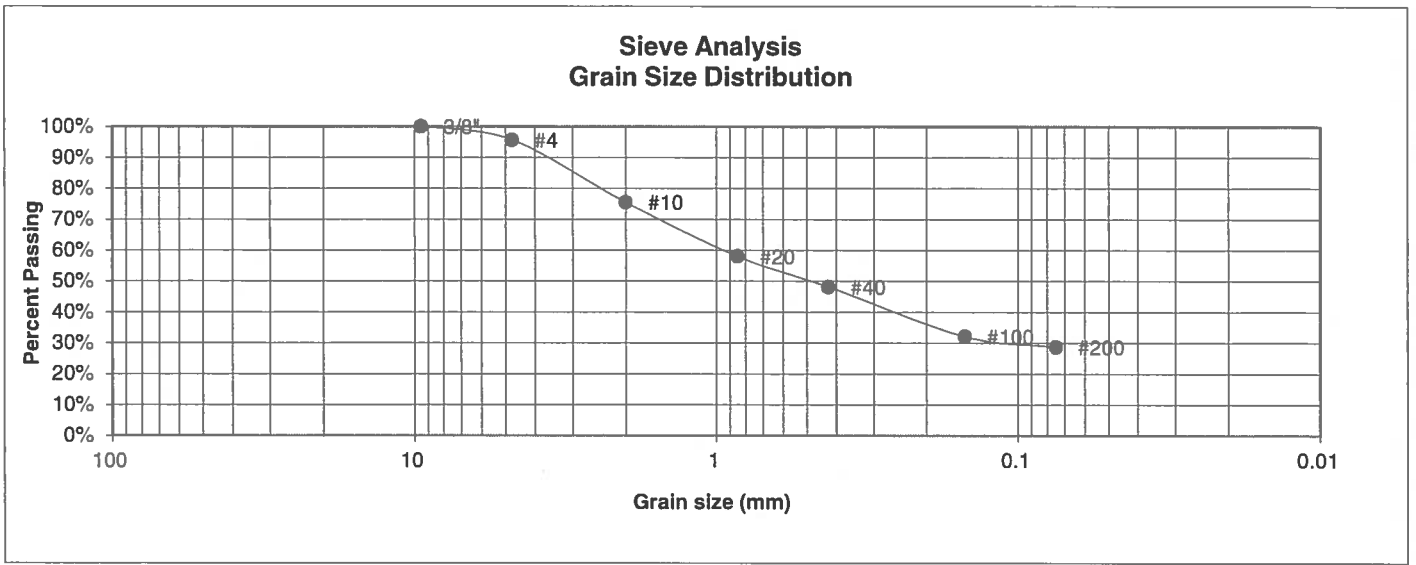

<u>U.S. Sieve #</u>	<u>Percent Finer</u>
3"	
1 1/2"	
3/4"	
1/2"	
3/8"	100.0%
4	95.7%
10	75.5%
20	58.0%
40	48.2%
100	32.1%
200	28.7%

Atterberg Limits
 Plastic Limit
 Liquid Limit
 Plastic Index

Swell
 Moisture at start
 Moisture at finish
 Moisture increase
 Initial dry density (pcf)
 Swell (psf)



**ENTECH
ENGINEERING, INC.**

505 ELKTON DRIVE
COLORADO SPRINGS, COLORADO 80907

**LABORATORY TEST
RESULTS**

<u>DRAWN:</u>	<u>DATE:</u>	<u>CHECKED:</u>	<u>DATE:</u>
		<i>W</i>	11/8/17

JOB NO.:
171198

FIG NO.:
B-27

<u>UNIFIED CLASSIFICATION</u>	SM	<u>CLIENT</u>	TECH CONTRACTORS
<u>SOIL TYPE #</u>	3	<u>PROJECT</u>	WINDINGWALK & STONEBRIDGE
<u>TEST BORING #</u>	20	<u>JOB NO.</u>	171198
<u>DEPTH (FT)</u>	10	<u>TEST BY</u>	BL

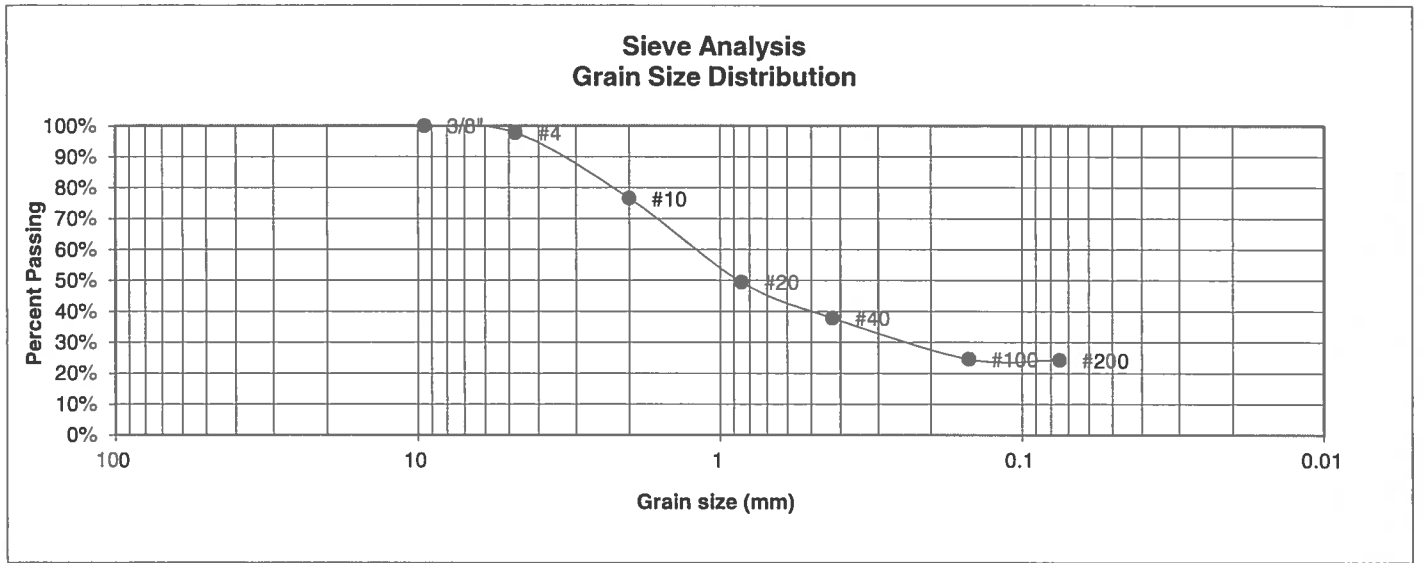

<u>U.S. Sieve #</u>	<u>Percent Finer</u>
3"	
1 1/2"	
3/4"	
1/2"	
3/8"	100.0%
4	97.8%
10	76.6%
20	49.5%
40	37.8%
100	24.6%
200	24.3%

Atterberg Limits
 Plastic Limit
 Liquid Limit
 Plastic Index

Swell
 Moisture at start
 Moisture at finish
 Moisture increase
 Initial dry density (pcf)
 Swell (psf)



**ENTECH
ENGINEERING, INC.**

505 ELKTON DRIVE
COLORADO SPRINGS, COLORADO 80907

**LABORATORY TEST
RESULTS**

<u>DRAWN:</u>	<u>DATE:</u>	<u>CHECKED:</u> <i>h</i>	<u>DATE:</u> <i>4/8/17</i>
---------------	--------------	--------------------------	----------------------------

JOB NO.:
171198

FIG NO.:
B-28

<u>UNIFIED CLASSIFICATION</u>	SM	<u>CLIENT</u>	TECH CONTRACTORS
<u>SOIL TYPE #</u>	3	<u>PROJECT</u>	WINDINGWALK & STONEBRIDGE
<u>TEST BORING #</u>	21	<u>JOB NO.</u>	171198
<u>DEPTH (FT)</u>	5	<u>TEST BY</u>	BL

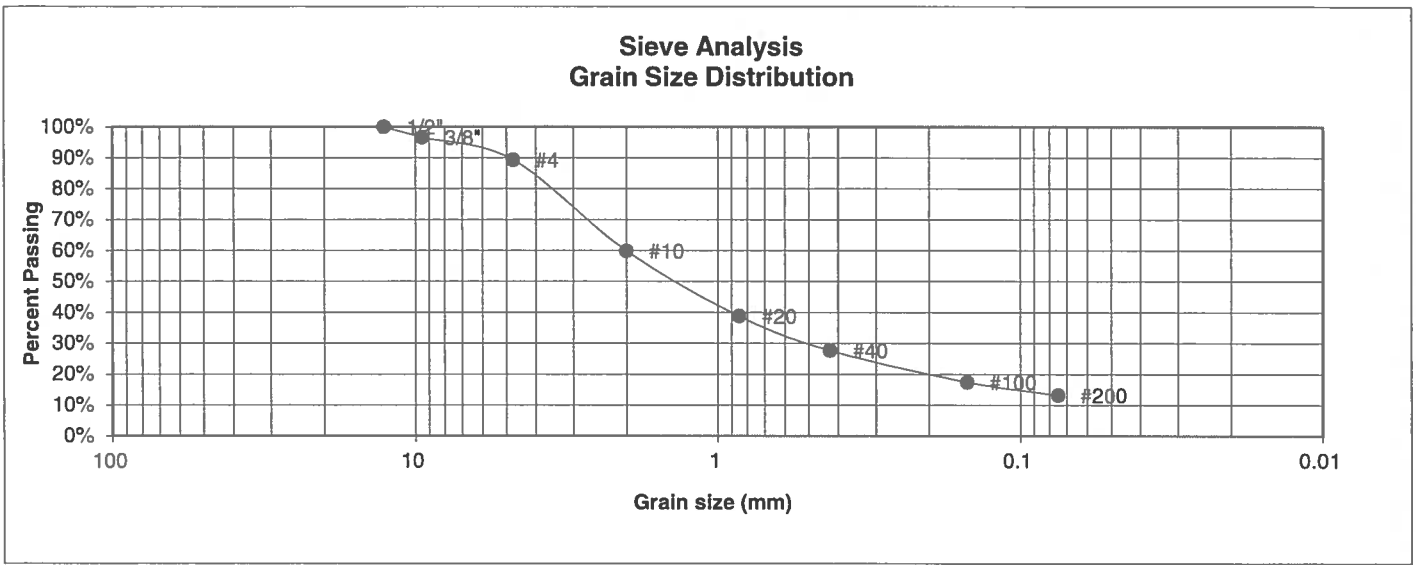

<u>U.S. Sieve #</u>	<u>Percent Finer</u>
3"	
1 1/2"	
3/4"	
1/2"	100.0%
3/8"	96.6%
4	89.3%
10	59.9%
20	38.8%
40	27.7%
100	17.5%
200	13.2%

Atterberg Limits
 Plastic Limit
 Liquid Limit
 Plastic Index

Swell
 Moisture at start
 Moisture at finish
 Moisture increase
 Initial dry density (pcf)
 Swell (psf)



**ENTECH
ENGINEERING, INC.**
 505 ELKTON DRIVE
 COLORADO SPRINGS, COLORADO 80907

**LABORATORY TEST
RESULTS**

<u>DRAWN:</u>	<u>DATE:</u>	<u>CHECKED:</u>	<u>DATE:</u>
		<i>h</i>	11/2/17

JOB NO.:
171198

 FIG NO.:
13-29

<u>UNIFIED CLASSIFICATION</u>	SM	<u>CLIENT</u>	TECH CONTRACTORS
<u>SOIL TYPE #</u>	3	<u>PROJECT</u>	WINDINGWALK & STONEBRIDGE
<u>TEST BORING #</u>	22	<u>JOB NO.</u>	171198
<u>DEPTH (FT)</u>	15	<u>TEST BY</u>	BL

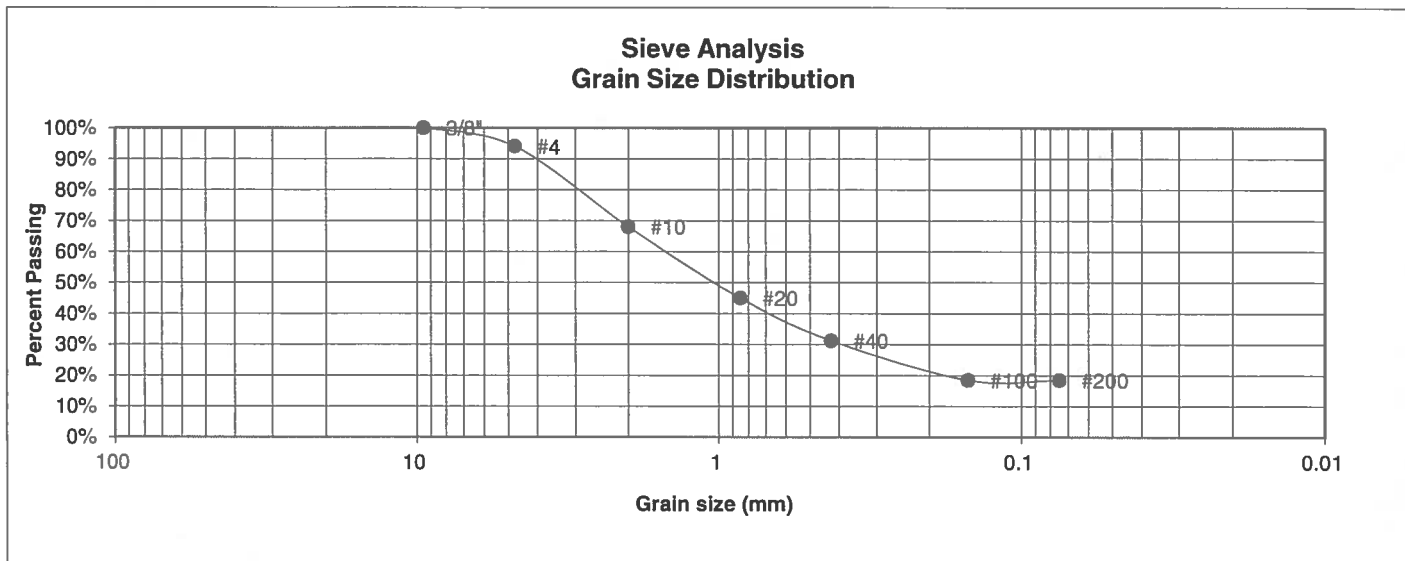

<u>U.S. Sieve #</u>	<u>Percent Finer</u>
3"	
1 1/2"	
3/4"	
1/2"	
3/8"	100.0%
4	94.1%
10	68.0%
20	45.0%
40	31.2%
100	18.5%
200	18.5%

Atterberg Limits
 Plastic Limit
 Liquid Limit
 Plastic Index

Swell
 Moisture at start
 Moisture at finish
 Moisture increase
 Initial dry density (pcf)
 Swell (psf)



**ENTECH
ENGINEERING, INC.**

505 ELKTON DRIVE
COLORADO SPRINGS, COLORADO 80907

**LABORATORY TEST
RESULTS**

DRAWN:

DATE:

CHECKED: *BL*

DATE: *9/2/12*

JOB NO.:
171198

FIG NO.:
B-30

UNIFIED CLASSIFICATION	SC	CLIENT	TECH CONTRACTORS
SOIL TYPE #	3	PROJECT	WINDINGWALK & STONEBRIDGE
TEST BORING #	23	JOB NO.	171198
DEPTH (FT)	15	TEST BY	BL

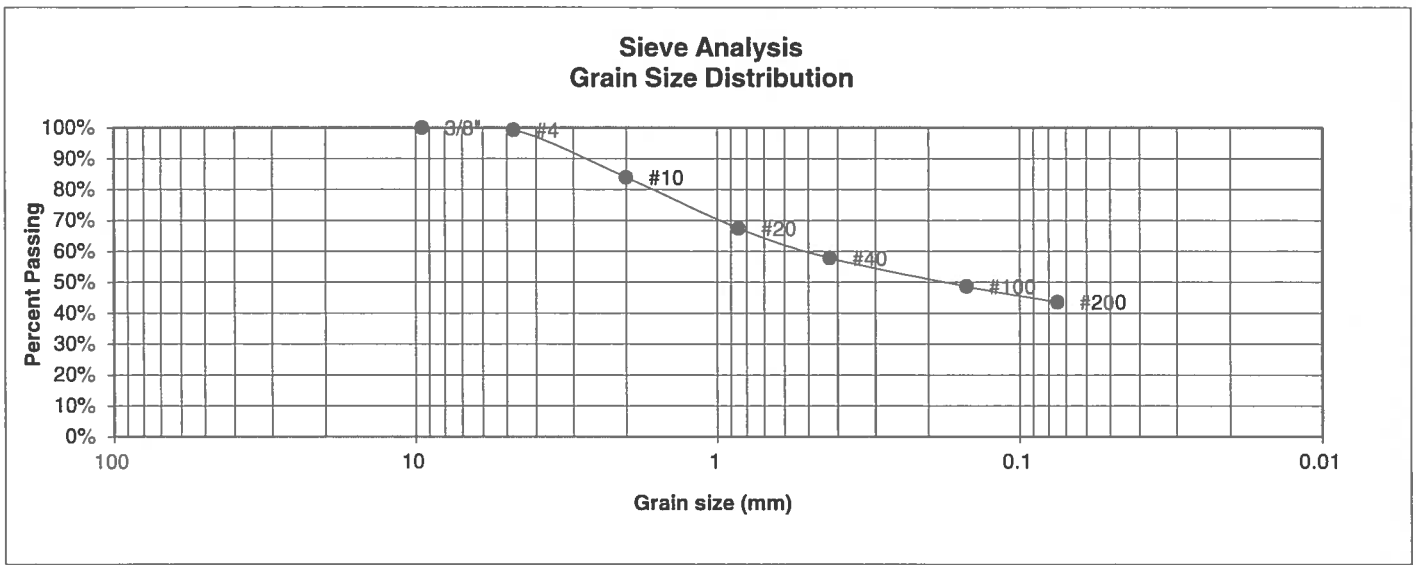

U.S. Sieve #	Percent Finer
3"	
1 1/2"	
3/4"	
1/2"	
3/8"	100.0%
4	99.3%
10	84.0%
20	67.5%
40	57.8%
100	48.6%
200	43.5%

Atterberg Limits
 Plastic Limit
 Liquid Limit
 Plastic Index

Swell
 Moisture at start
 Moisture at finish
 Moisture increase
 Initial dry density (pcf)
 Swell (psf)



**ENTECH
ENGINEERING, INC.**
 505 ELKTON DRIVE
 COLORADO SPRINGS, COLORADO 80907

LABORATORY TEST RESULTS

DRAWN:	DATE:	CHECKED:	DATE:
		<i>[Signature]</i>	11/8/17

JOB NO.:
171198

FIG NO.:
B-31

<u>UNIFIED CLASSIFICATION</u>	SM	<u>CLIENT</u>	TECH CONTRACTORS
<u>SOIL TYPE #</u>	3	<u>PROJECT</u>	WINDINGWALK & STONEBRIDGE
<u>TEST BORING #</u>	29	<u>JOB NO.</u>	171198
<u>DEPTH (FT)</u>	5	<u>TEST BY</u>	BL

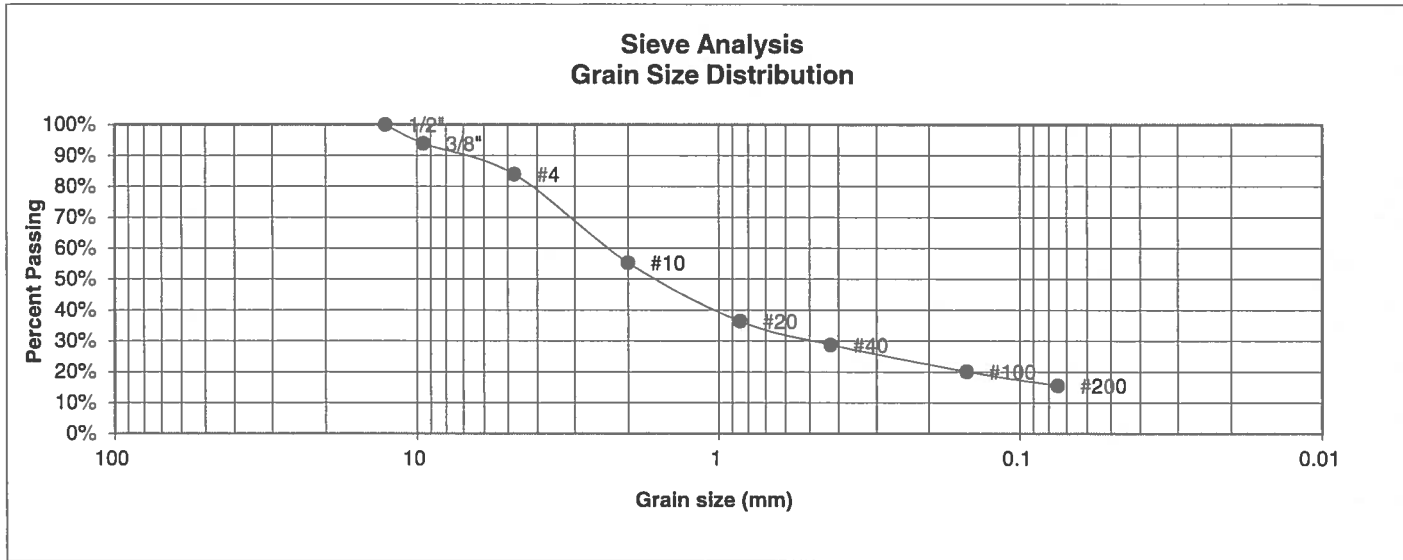

U.S. Sieve #	Percent Finer
3"	
1 1/2"	
3/4"	
1/2"	100.0%
3/8"	93.9%
4	83.9%
10	55.3%
20	36.4%
40	28.8%
100	20.1%
200	15.6%

Atterberg Limits

Plastic Limit	NP
Liquid Limit	NV
Plastic Index	NP

- Swell
- Moisture at start
 - Moisture at finish
 - Moisture increase
 - Initial dry density (pcf)
 - Swell (psf)



**ENTECH
ENGINEERING, INC.**

505 ELKTON DRIVE
COLORADO SPRINGS, COLORADO 80907

**LABORATORY TEST
RESULTS**

DRAWN:	DATE:	CHECKED: <i>h</i>	DATE: 11/20/17
--------	-------	-------------------	----------------

JOB NO:
171198

FIG NO:
B-32

UNIFIED CLASSIFICATION	SM-SW	CLIENT	TECH CONTRACTORS
SOIL TYPE #	3	PROJECT	WINDINGWALK & STONEBRIDGE
TEST BORING #	31	JOB NO.	171198
DEPTH (FT)	10	TEST BY	BL

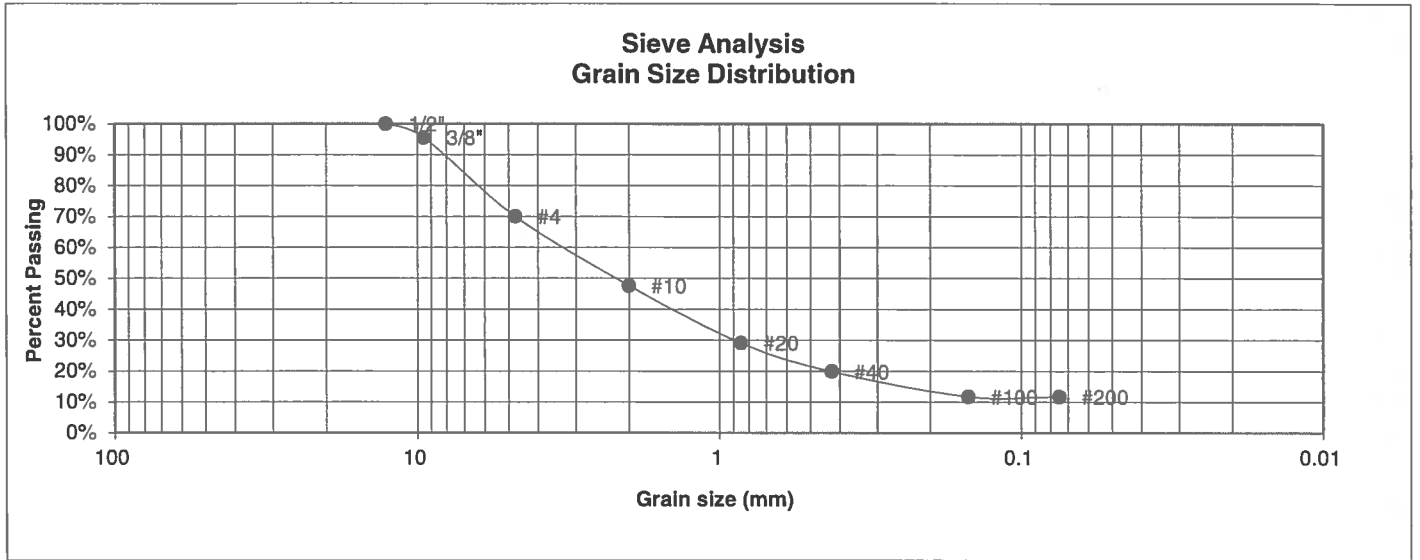

U.S. Sieve #	Percent Finer
3"	
1 1/2"	
3/4"	
1/2"	100.0%
3/8"	95.6%
4	70.0%
10	47.6%
20	29.1%
40	19.9%
100	11.8%
200	11.8%

Atterberg Limits

Plastic Limit	NP
Liquid Limit	NV
Plastic Index	NP

Swell

Moisture at start	
Moisture at finish	
Moisture increase	
Initial dry density (pcf)	
Swell (psf)	



**ENTECH
ENGINEERING, INC.**

505 ELKTON DRIVE
COLORADO SPRINGS, COLORADO 80907

**LABORATORY TEST
RESULTS**

DRAWN:	DATE:	CHECKED:	DATE:
		<i>BL</i>	11/8/17

JOB NO.:
171198

FIG NO.:

B-33

UNIFIED CLASSIFICATION	SM	CLIENT	TECH CONTRACTORS
SOIL TYPE #	3	PROJECT	WINDINGWALK & STONEBRIDGE
TEST BORING #	32	JOB NO.	171198
DEPTH (FT)	25	TEST BY	BL

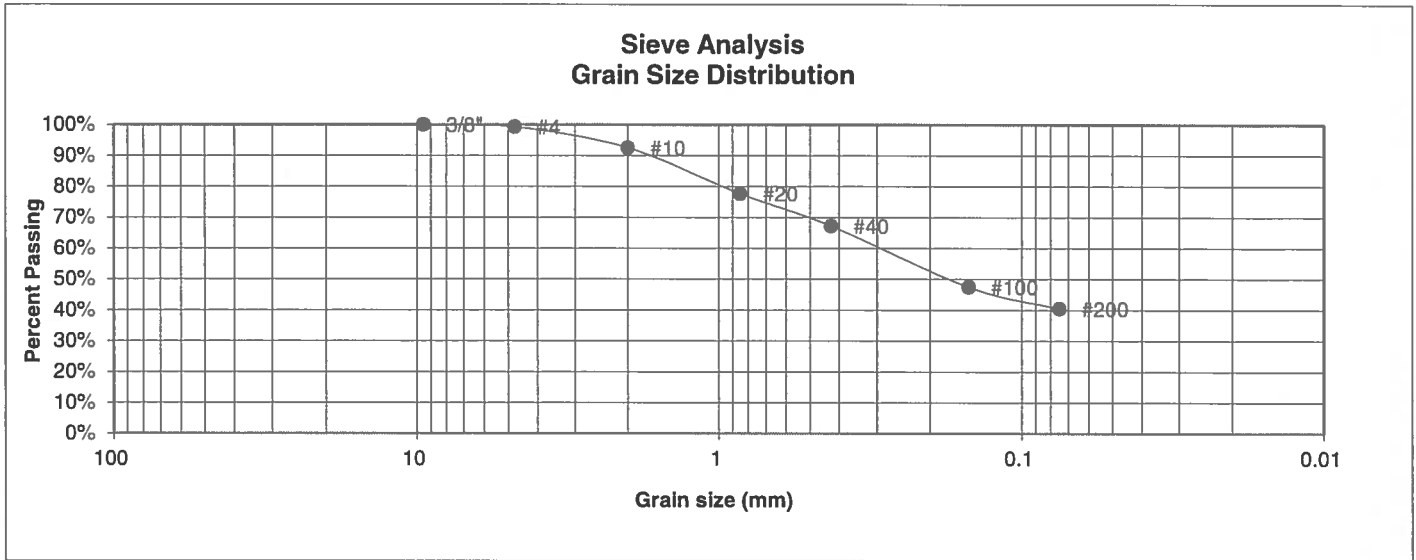

U.S. Sieve #	Percent Finer
3"	
1 1/2"	
3/4"	
1/2"	
3/8"	100.0%
4	99.3%
10	92.5%
20	77.7%
40	67.2%
100	47.5%
200	40.4%

Atterberg Limits

Plastic Limit	NP
Liquid Limit	NV
Plastic Index	NP

Swell

- Moisture at start
- Moisture at finish
- Moisture increase
- Initial dry density (pcf)
- Swell (psf)



**ENTECH
ENGINEERING, INC.**

505 ELKTON DRIVE
COLORADO SPRINGS, COLORADO 80907

**LABORATORY TEST
RESULTS**

DRAWN:	DATE:	CHECKED:	DATE:
		<i>W</i>	11/8/17

JOB NO.:
171198

FIG NO.:
B-34

UNIFIED CLASSIFICATION	SM	CLIENT	TECH CONTRACTORS
SOIL TYPE #	3	PROJECT	WINDINGWALK & STONEBRIDGE
TEST BORING #	33	JOB NO.	171198
DEPTH (FT)	10	TEST BY	BL

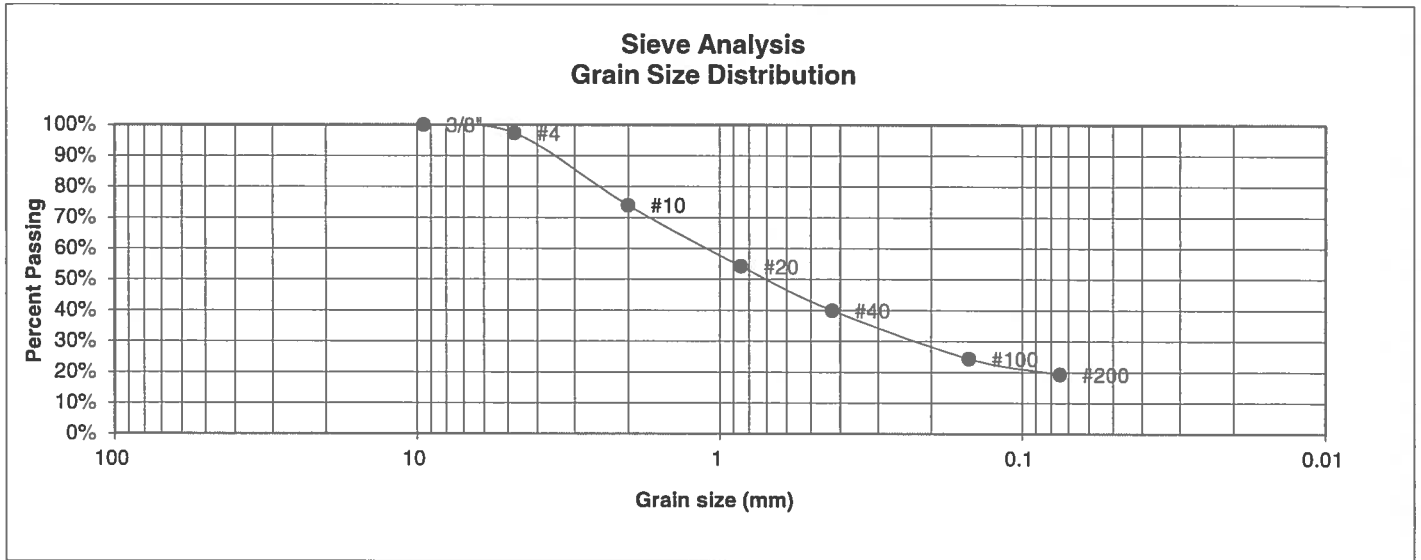

U.S. Sieve #	Percent Finer
3"	
1 1/2"	
3/4"	
1/2"	
3/8"	100.0%
4	97.3%
10	73.9%
20	54.2%
40	40.0%
100	24.4%
200	19.3%

Atterberg Limits
 Plastic Limit
 Liquid Limit
 Plastic Index

Swell
 Moisture at start
 Moisture at finish
 Moisture increase
 Initial dry density (pcf)
 Swell (psf)



**ENTECH
ENGINEERING, INC.**

505 ELKTON DRIVE
COLORADO SPRINGS, COLORADO 80907

**LABORATORY TEST
RESULTS**

DRAWN:	DATE:	CHECKED:	DATE:
		<i>a</i>	01/01/17

JOB NO.:
171198

FIG NO.:
B-35

UNIFIED CLASSIFICATION	SM	CLIENT	TECH CONTRACTORS
SOIL TYPE #	3	PROJECT	WINDINGWALK & STONEBRIDGE
TEST BORING #	38	JOB NO.	171198
DEPTH (FT)	15	TEST BY	BL

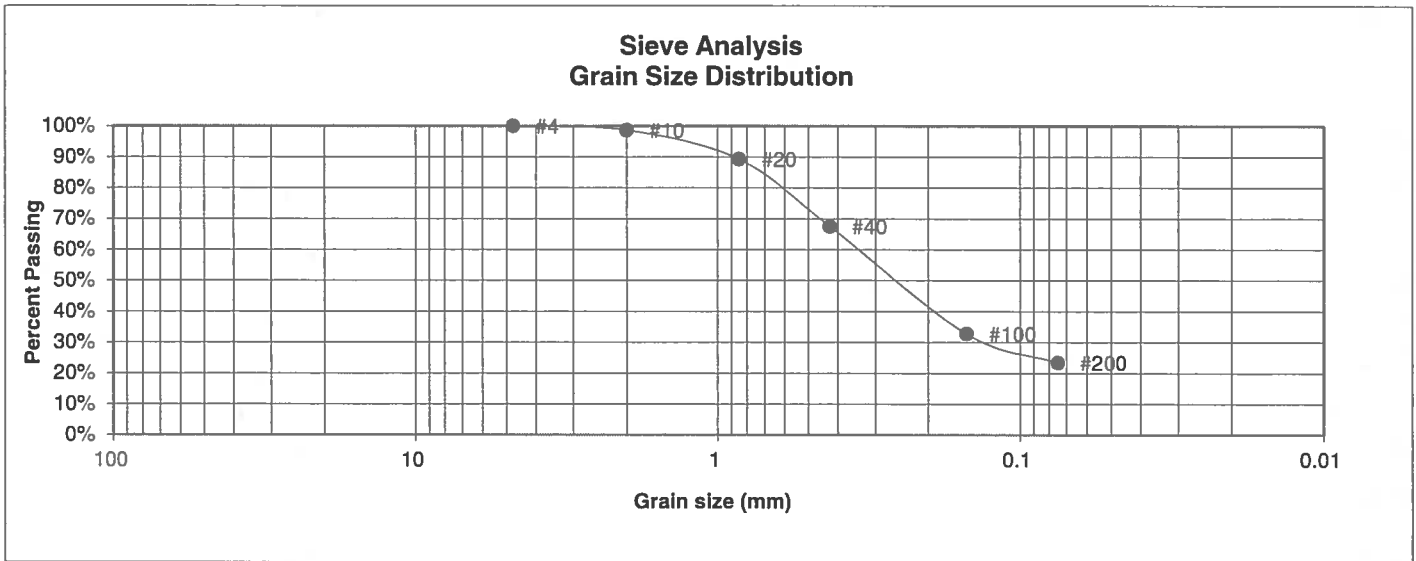

U.S. Sieve #	Percent Finer
3"	
1 1/2"	
3/4"	
1/2"	
3/8"	
4	100.0%
10	98.7%
20	89.3%
40	67.5%
100	32.8%
200	23.4%

Atterberg Limits
 Plastic Limit
 Liquid Limit
 Plastic Index

Swell
 Moisture at start
 Moisture at finish
 Moisture increase
 Initial dry density (pcf)
 Swell (psf)



**ENTECH
ENGINEERING, INC.**

505 ELKTON DRIVE
COLORADO SPRINGS, COLORADO 80907

**LABORATORY TEST
RESULTS**

DRAWN:	DATE:	CHECKED:	DATE:
		<i>W</i>	11/8/17

JOB NO.:
171198

FIG NO.:
B-36

<u>UNIFIED CLASSIFICATION</u>	SM	<u>CLIENT</u>	TECH CONTRACTORS
<u>SOIL TYPE #</u>	3	<u>PROJECT</u>	WINDINGWALK & STONEBRIDGE
<u>TEST BORING #</u>	40	<u>JOB NO.</u>	171198
<u>DEPTH (FT)</u>	2-3	<u>TEST BY</u>	BL

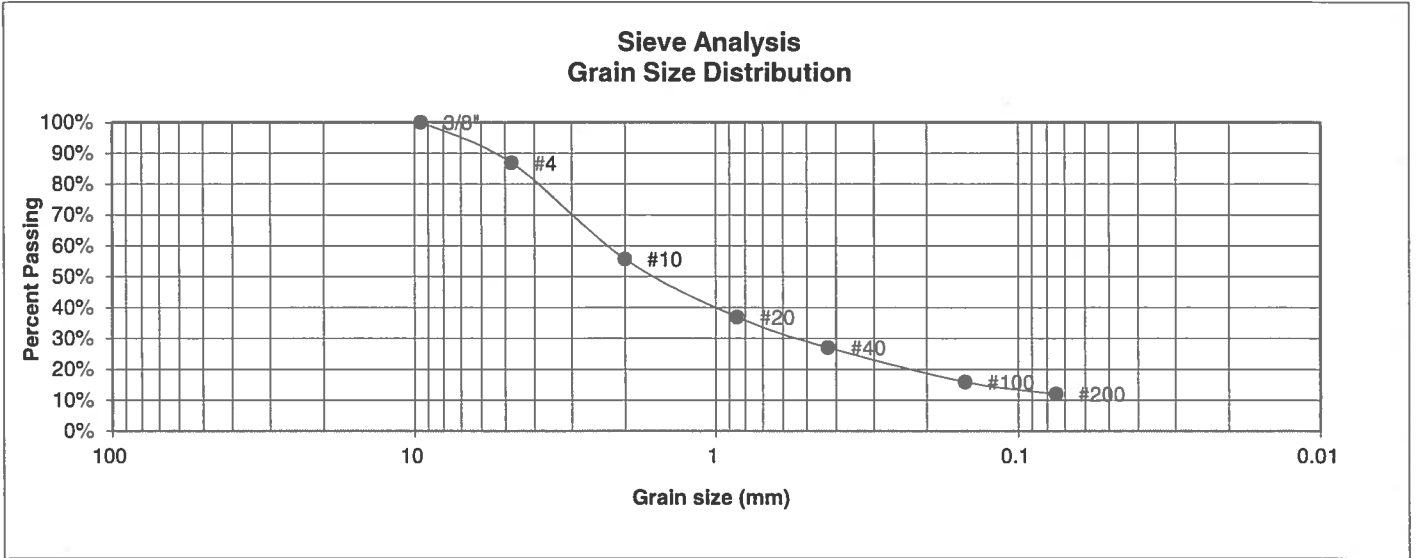

U.S. Sieve #	Percent Finer
3"	
1 1/2"	
3/4"	
1/2"	
3/8"	100.0%
4	86.9%
10	55.7%
20	37.0%
40	27.0%
100	15.9%
200	12.0%

Atterberg Limits

Plastic Limit	NP
Liquid Limit	NV
Plastic Index	NP

Swell

Moisture at start	
Moisture at finish	
Moisture increase	
Initial dry density (pcf)	
Swell (psf)	



**ENTECH
ENGINEERING, INC.**

505 ELKTON DRIVE
COLORADO SPRINGS, COLORADO 80907

**LABORATORY TEST
RESULTS**

DRAWN:	DATE:	CHECKED:	DATE:
		<i>u</i>	4/8/12

JOB NO.:
171198

FIG NO.:
B-37

UNIFIED CLASSIFICATION	SM	CLIENT	TECH CONTRACTORS
SOIL TYPE #	3	PROJECT	WINDINGWALK & STONEBRIDGE
TEST BORING #	41	JOB NO.	171198
DEPTH (FT)	5	TEST BY	BL

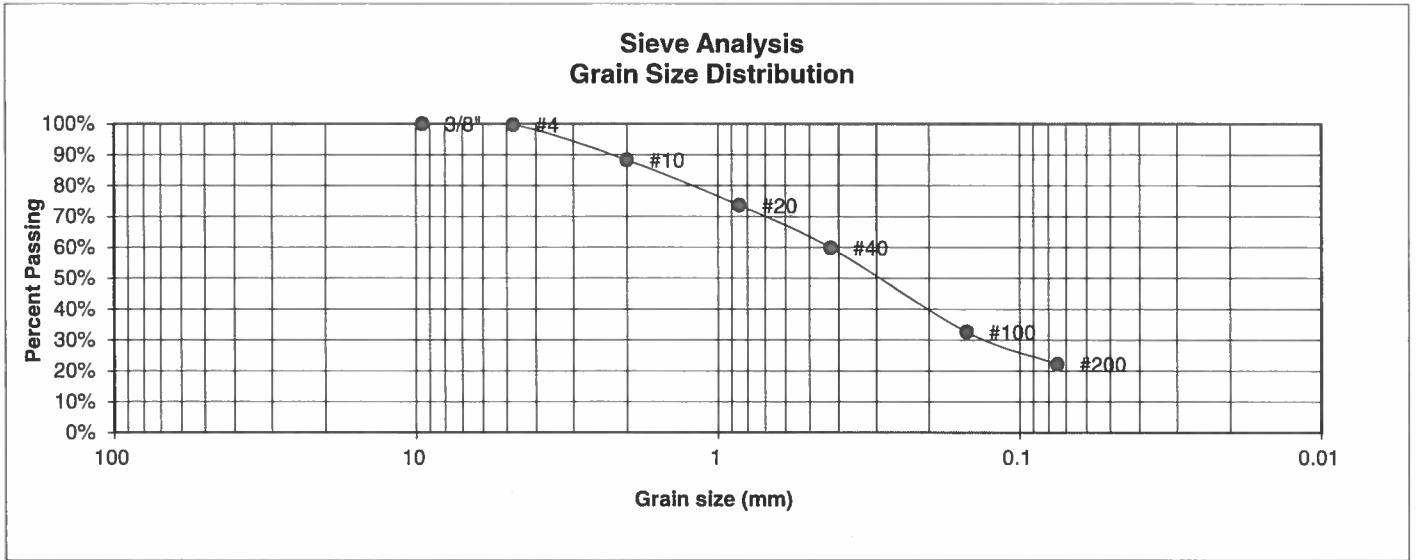

U.S. Sieve #	Percent Finer
3"	
1 1/2"	
3/4"	
1/2"	
3/8"	100.0%
4	99.7%
10	88.3%
20	73.6%
40	59.8%
100	32.6%
200	22.2%

Atterberg Limits
 Plastic Limit
 Liquid Limit
 Plastic Index

Swell
 Moisture at start
 Moisture at finish
 Moisture increase
 Initial dry density (pcf)
 Swell (psf)



**ENTECH
ENGINEERING, INC.**

505 ELKTON DRIVE
COLORADO SPRINGS, COLORADO 80907

**LABORATORY TEST
RESULTS**

DRAWN:	DATE:	CHECKED:	DATE:
		<i>BL</i>	11/8/17

JOB NO.:
171198

FIG NO.:
B-38

<u>UNIFIED CLASSIFICATION</u>	SM	<u>CLIENT</u>	TECH CONTRACTORS
<u>SOIL TYPE #</u>	3	<u>PROJECT</u>	WINDINGWALK & STONEBRIDGE
<u>TEST BORING #</u>	42	<u>JOB NO.</u>	171198
<u>DEPTH (FT)</u>	20	<u>TEST BY</u>	BL

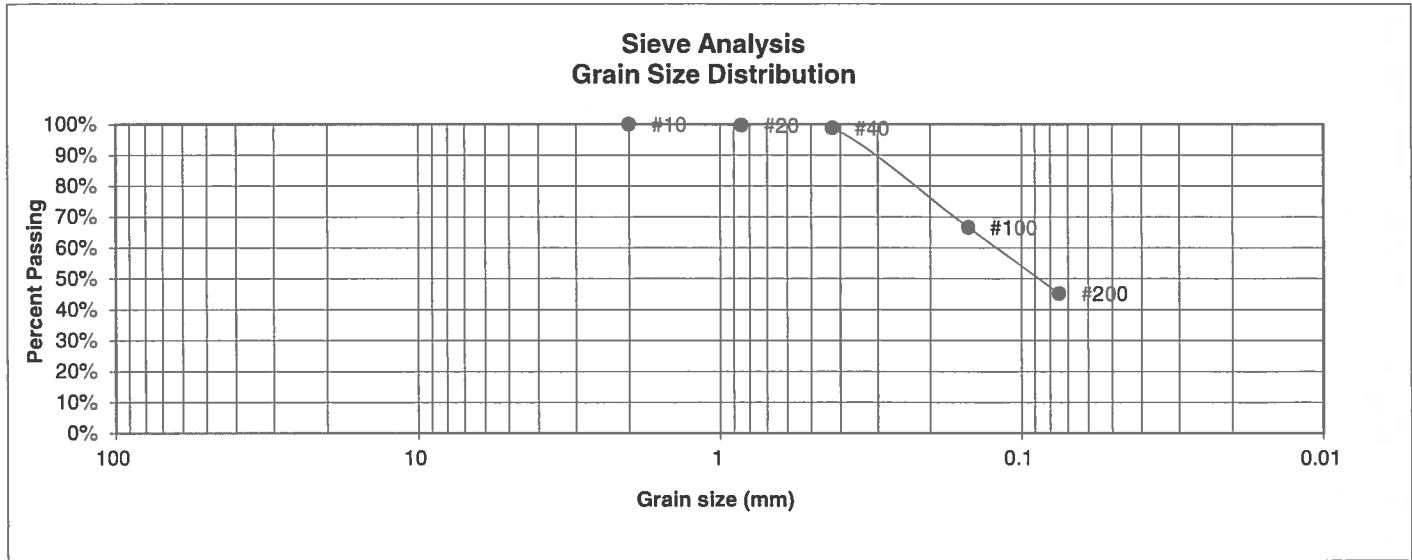

<u>U.S. Sieve #</u>	<u>Percent Finer</u>
3"	
1 1/2"	
3/4"	
1/2"	
3/8"	
4	
10	100.0%
20	99.7%
40	98.8%
100	66.6%
200	45.3%

Atterberg Limits
 Plastic Limit
 Liquid Limit
 Plastic Index

Swell
 Moisture at start
 Moisture at finish
 Moisture increase
 Initial dry density (pcf)
 Swell (psf)



**ENTECH
ENGINEERING, INC.**

505 ELKTON DRIVE
COLORADO SPRINGS, COLORADO 80907

**LABORATORY TEST
RESULTS**

<u>DRAWN:</u>	<u>DATE:</u>	<u>CHECKED:</u>	<u>DATE:</u>
		<i>W</i>	11/8/17

JOB NO.:
171198

FIG NO.:

B-39

<u>UNIFIED CLASSIFICATION</u>	SM-SW	<u>CLIENT</u>	TECH CONTRACTORS
<u>SOIL TYPE #</u>	3	<u>PROJECT</u>	WINDINGWALK & STONEBRIDGE
<u>TEST BORING #</u>	45	<u>JOB NO.</u>	171198
<u>DEPTH (FT)</u>	5	<u>TEST BY</u>	BL

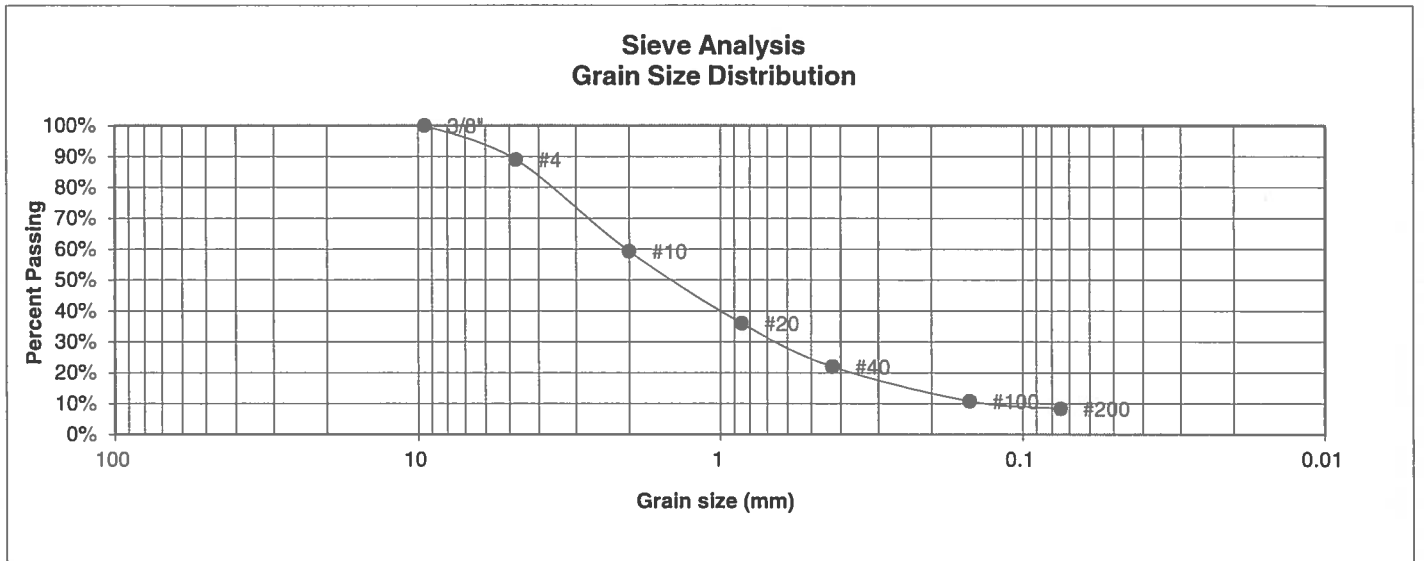

<u>U.S. Sieve #</u>	<u>Percent Finer</u>
3"	
1 1/2"	
3/4"	
1/2"	
3/8"	100.0%
4	89.0%
10	59.3%
20	36.0%
40	21.9%
100	10.8%
200	8.4%

<u>Atterberg Limits</u>	
Plastic Limit	NP
Liquid Limit	NV
Plastic Index	NP

<u>Swell</u>	
Moisture at start	
Moisture at finish	
Moisture increase	
Initial dry density (pcf)	
Swell (psf)	



**ENTECH
ENGINEERING, INC.**

505 ELKTON DRIVE
COLORADO SPRINGS, COLORADO 80907

**LABORATORY TEST
RESULTS**

<u>DRAWN:</u>	<u>DATE:</u>	<u>CHECKED:</u>	<u>DATE:</u>
		<i>[Signature]</i>	6/28/17

JOB NO.:
171198

FIG NO.:
TB-40

UNIFIED CLASSIFICATION	SC	CLIENT	TECH CONTRACTORS
SOIL TYPE #	3	PROJECT	WINDINGWALK & STONEBRIDGE
TEST BORING #	46	JOB NO.	171198
DEPTH (FT)	2-3	TEST BY	BL

**Sieve Analysis
Grain Size Distribution**

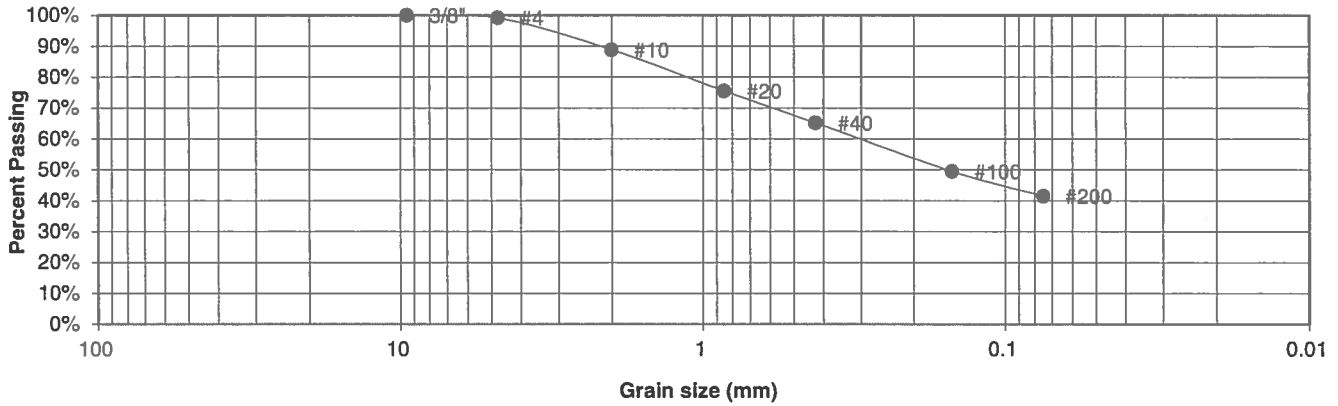

U.S. Sieve #	Percent Finer
3"	
1 1/2"	
3/4"	
1/2"	
3/8"	100.0%
4	99.2%
10	88.8%
20	75.5%
40	65.2%
100	49.5%
200	41.5%

Atterberg Limits	
Plastic Limit	15
Liquid Limit	33
Plastic Index	18

Swell	
Moisture at start	
Moisture at finish	
Moisture increase	
Initial dry density (pcf)	
Swell (psf)	



**ENTECH
ENGINEERING, INC.**

505 ELKTON DRIVE
COLORADO SPRINGS, COLORADO 80907

**LABORATORY TEST
RESULTS**

DRAWN:	DATE:	CHECKED:	DATE:
		<i>BL</i>	11/8/17

JOB NO.:
171198

FIG NO.:
B-41

UNIFIED CLASSIFICATION	SM	CLIENT	TECH CONTRACTORS
SOIL TYPE #	3	PROJECT	WINDINGWALK & STONEBRIDGE
TEST BORING #	47	JOB NO.	171198
DEPTH (FT)	5	TEST BY	BL

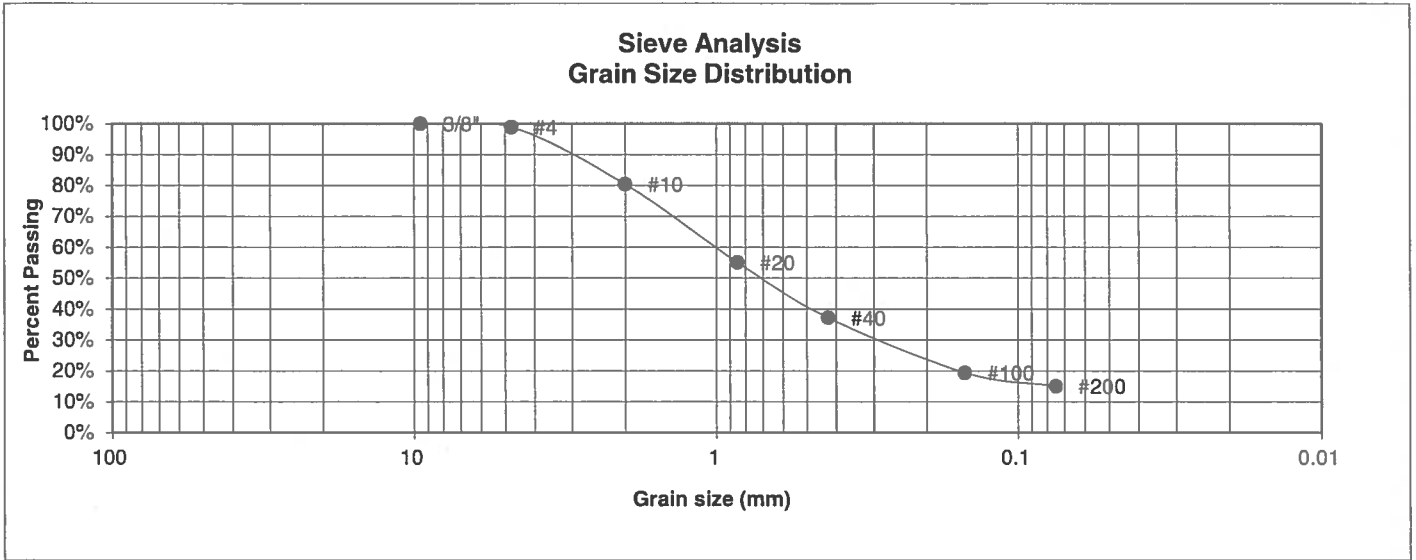

U.S. Sieve #	Percent Finer
3"	
1 1/2"	
3/4"	
1/2"	
3/8"	100.0%
4	98.9%
10	80.4%
20	55.1%
40	37.2%
100	19.4%
200	15.0%

<u>Atterberg Limits</u>	
Plastic Limit	
Liquid Limit	
Plastic Index	
<u>Swell</u>	
Moisture at start	9.0%
Moisture at finish	20.0%
Moisture increase	11.0%
Initial dry density (pcf)	99
Swell (psf)	30



ENTECH ENGINEERING, INC.
505 ELKTON DRIVE
COLORADO SPRINGS, COLORADO 80907

LABORATORY TEST RESULTS

DRAWN:	DATE:	CHECKED: <i>W</i>	DATE: <i>4/10/17</i>
--------	-------	-------------------	----------------------

JOB NO.: 171198
FIG NO.: *B-42*

<u>UNIFIED CLASSIFICATION</u>	SM-SW	<u>CLIENT</u>	TECH CONTRACTORS
<u>SOIL TYPE #</u>	3	<u>PROJECT</u>	WINDINGWALK & STONEBRIDGE
<u>TEST BORING #</u>	48	<u>JOB NO.</u>	171198
<u>DEPTH (FT)</u>	10	<u>TEST BY</u>	BL

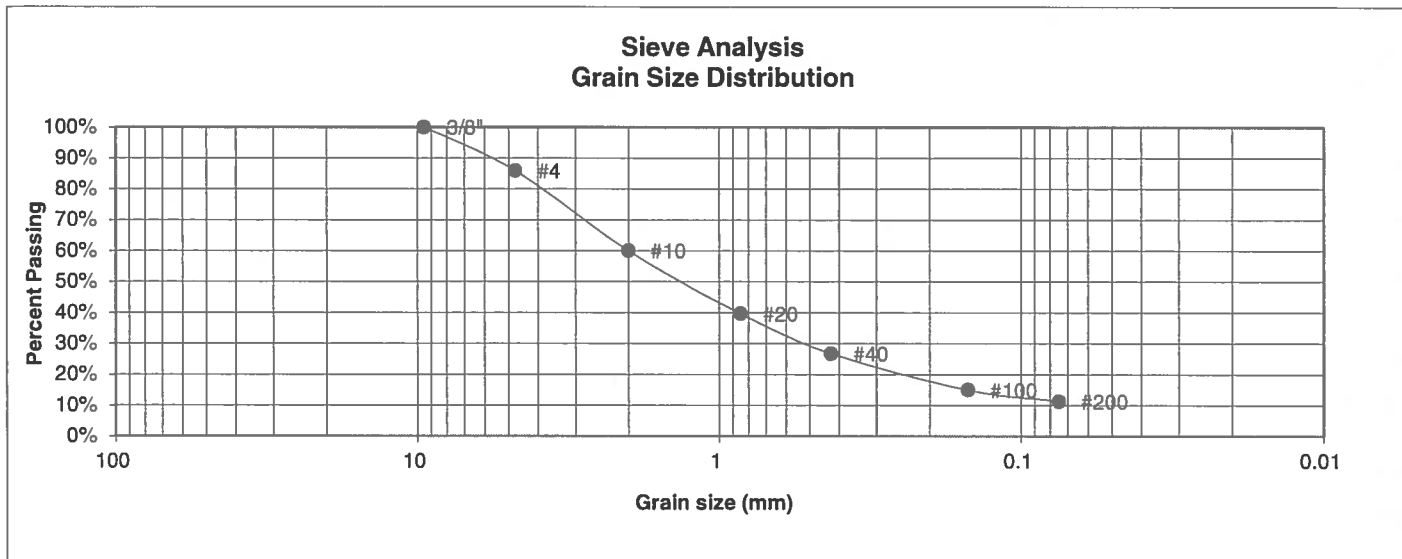

<u>U.S. Sieve #</u>	<u>Percent Finer</u>
3"	
1 1/2"	
3/4"	
1/2"	
3/8"	100.0%
4	85.9%
10	60.0%
20	39.7%
40	26.8%
100	15.0%
200	11.3%

Atterberg Limits
 Plastic Limit
 Liquid Limit
 Plastic Index

Swell
 Moisture at start
 Moisture at finish
 Moisture increase
 Initial dry density (pcf)
 Swell (psf)



**ENTECH
ENGINEERING, INC.**

505 ELKTON DRIVE
COLORADO SPRINGS, COLORADO 80907

**LABORATORY TEST
RESULTS**

DRAWN:

DATE:

CHECKED: *BL*

DATE: 11/8/17

JOB NO.:
171198

FIG NO.:

B-43

<u>UNIFIED CLASSIFICATION</u>	SM	<u>CLIENT</u>	TECH CONTRACTORS
<u>SOIL TYPE #</u>	3	<u>PROJECT</u>	WINDINGWALK & STONEBRIDGE
<u>TEST BORING #</u>	49	<u>JOB NO.</u>	171198
<u>DEPTH (FT)</u>	15	<u>TEST BY</u>	BL

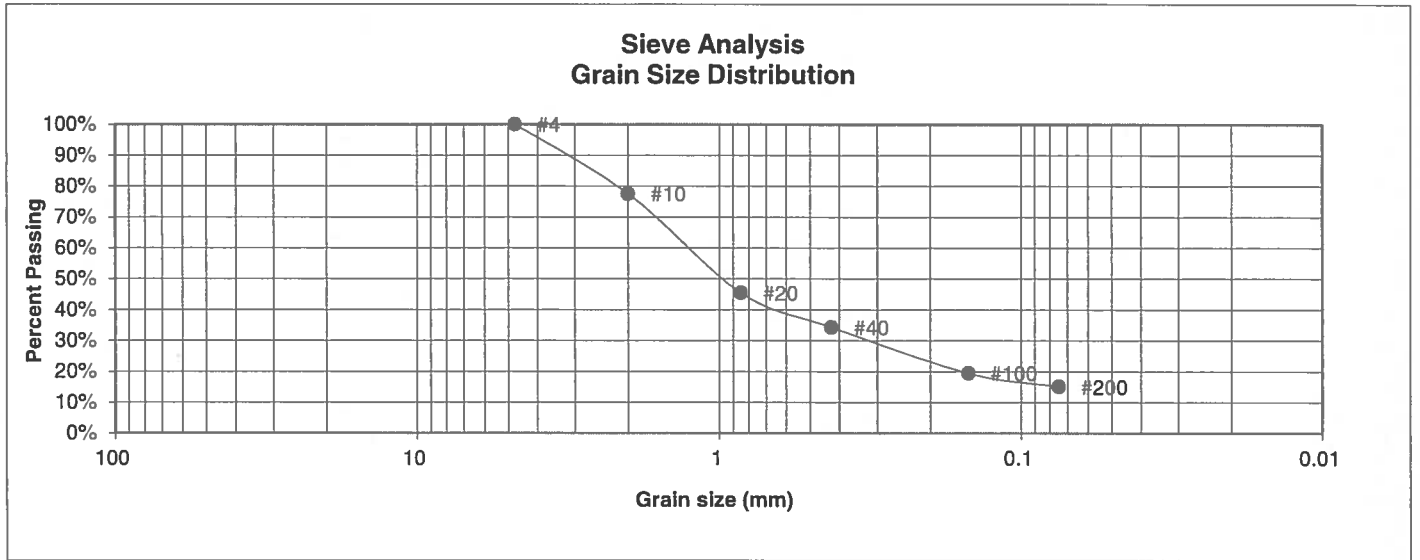

<u>U.S. Sieve #</u>	<u>Percent Finer</u>
3"	
1 1/2"	
3/4"	
1/2"	
3/8"	
4	100.0%
10	77.6%
20	45.5%
40	34.3%
100	19.5%
200	15.1%

Atterberg Limits
 Plastic Limit
 Liquid Limit
 Plastic Index

Swell
 Moisture at start
 Moisture at finish
 Moisture increase
 Initial dry density (pcf)
 Swell (psf)



**ENTECH
ENGINEERING, INC.**

505 ELKTON DRIVE
COLORADO SPRINGS, COLORADO 80907

**LABORATORY TEST
RESULTS**

<u>DRAWN:</u>	<u>DATE:</u>	<u>CHECKED:</u>	<u>DATE:</u>
		<i>BL</i>	11/8/17

JOB NO.:
171198

FIG NO.:
B-44

<u>UNIFIED CLASSIFICATION</u>	SM	<u>CLIENT</u>	TECH CONTRACTORS
<u>SOIL TYPE #</u>	3	<u>PROJECT</u>	WINDINGWALK & STONEBRIDGE
<u>TEST BORING #</u>	50	<u>JOB NO.</u>	171198
<u>DEPTH (FT)</u>	2-3	<u>TEST BY</u>	BL

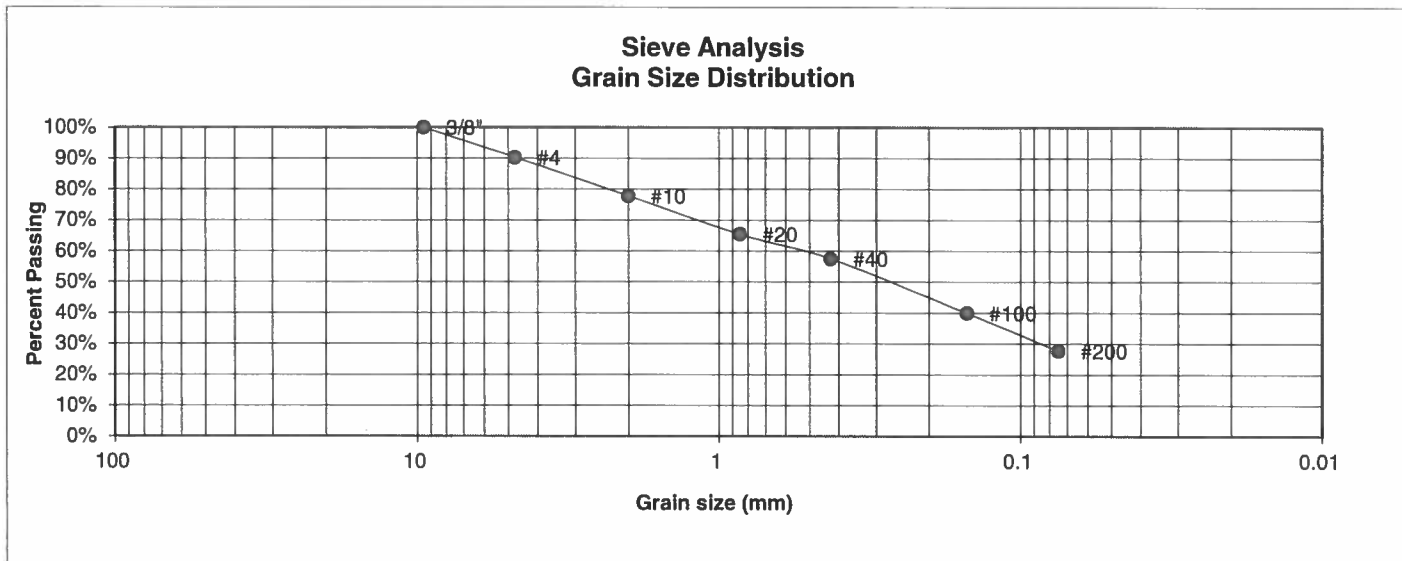

<u>U.S. Sieve #</u>	<u>Percent Finer</u>
3"	
1 1/2"	
3/4"	
1/2"	
3/8"	100.0%
4	90.3%
10	77.8%
20	65.4%
40	57.5%
100	40.0%
200	27.7%

Atterberg Limits
 Plastic Limit
 Liquid Limit
 Plastic Index

Swell
 Moisture at start
 Moisture at finish
 Moisture increase
 Initial dry density (pcf)
 Swell (psf)



**ENTECH
ENGINEERING, INC.**

505 ELKTON DRIVE
COLORADO SPRINGS, COLORADO 80907

**LABORATORY TEST
RESULTS**

DRAWN:

DATE:

CHECKED: *W*

DATE: 4/8/17

JOB NO.:
171198

FIG NO.:
B-45

<u>UNIFIED CLASSIFICATION</u>	SM	<u>CLIENT</u>	TECH CONTRACTORS
<u>SOIL TYPE #</u>	3	<u>PROJECT</u>	WINDINGWALK & STONEBRIDGE
<u>TEST BORING #</u>	51	<u>JOB NO.</u>	171198
<u>DEPTH (FT)</u>	5	<u>TEST BY</u>	BL

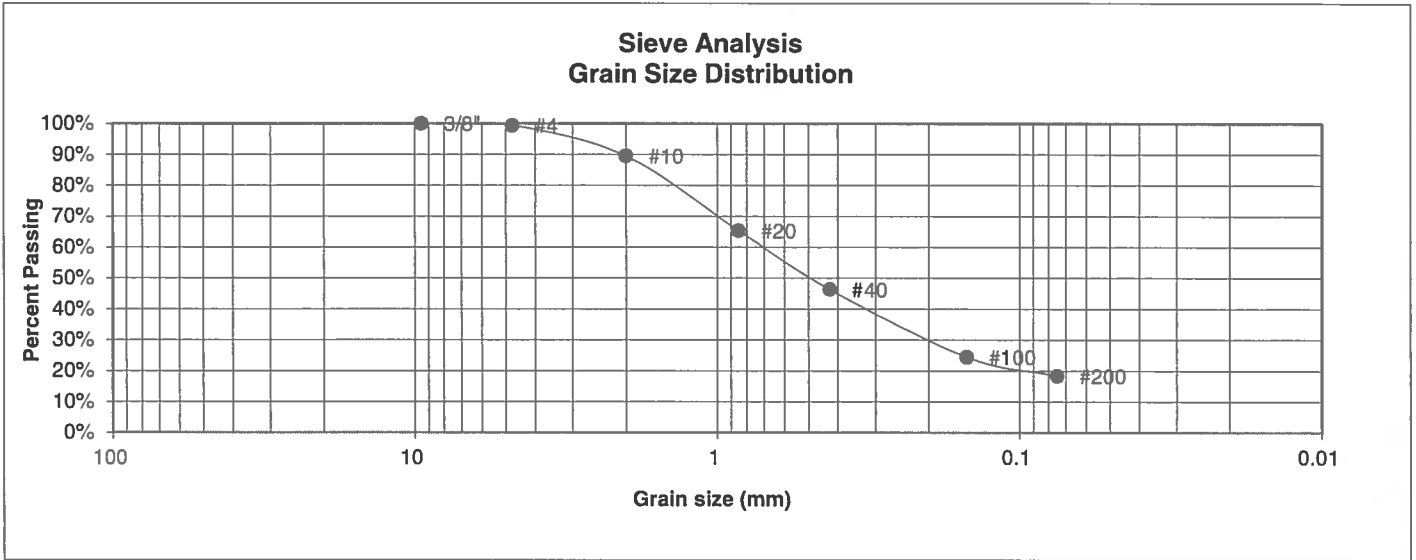

U.S. Sieve #	Percent Finer
3"	
1 1/2"	
3/4"	
1/2"	
3/8"	100.0%
4	99.4%
10	89.5%
20	65.4%
40	46.3%
100	24.5%
200	18.3%

Atterberg Limits

Plastic Limit	NP
Liquid Limit	NV
Plastic Index	NP

Swell

Moisture at start	
Moisture at finish	
Moisture increase	
Initial dry density (pcf)	
Swell (psf)	



**ENTECH
ENGINEERING, INC.**

505 ELKTON DRIVE
COLORADO SPRINGS, COLORADO 80907

**LABORATORY TEST
RESULTS**

DRAWN:	DATE:	CHECKED:	DATE:
		<i>W</i>	4/8/17

JOB NO.:
171198

FIG NO.:
B-46

UNIFIED CLASSIFICATION	SM-SW	CLIENT	TECH CONTRACTORS
SOIL TYPE #	3	PROJECT	WINDINGWALK & STONEBRIDGE
TEST BORING #	52	JOB NO.	171198
DEPTH (FT)	10	TEST BY	BL

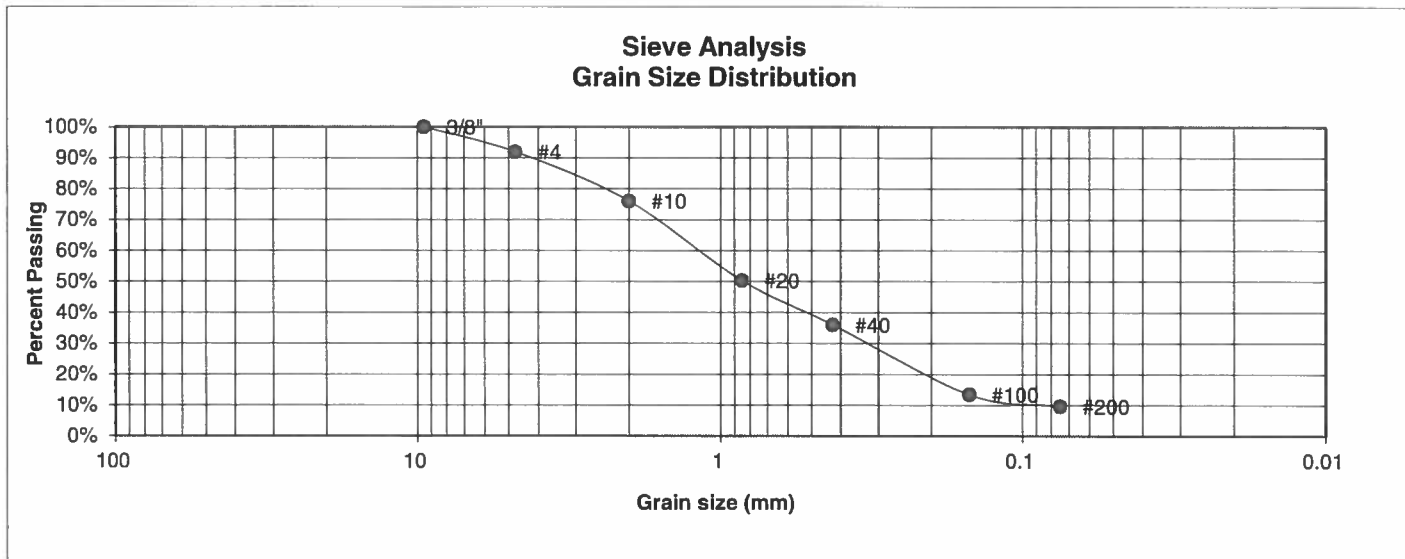

U.S. Sieve #	Percent Finer
3"	
1 1/2"	
3/4"	
1/2"	
3/8"	100.0%
4	91.9%
10	76.1%
20	50.3%
40	36.0%
100	13.4%
200	9.7%

Atterberg Limits
 Plastic Limit
 Liquid Limit
 Plastic Index

Swell
 Moisture at start
 Moisture at finish
 Moisture increase
 Initial dry density (pcf)
 Swell (psf)



**ENTECH
ENGINEERING, INC.**

505 ELKTON DRIVE
COLORADO SPRINGS, COLORADO 80907

**LABORATORY TEST
RESULTS**

DRAWN:	DATE:	CHECKED:	DATE:
		<i>m</i>	11/8/17

JOB NO.:
171198

FIG NO.:
B-47

<u>UNIFIED CLASSIFICATION</u>	SM	<u>CLIENT</u>	TECH CONTRACTORS
<u>SOIL TYPE #</u>	3	<u>PROJECT</u>	WINDINGWALK & STONEBRIDGE
<u>TEST BORING #</u>	53	<u>JOB NO.</u>	171198
<u>DEPTH (FT)</u>	15	<u>TEST BY</u>	BL

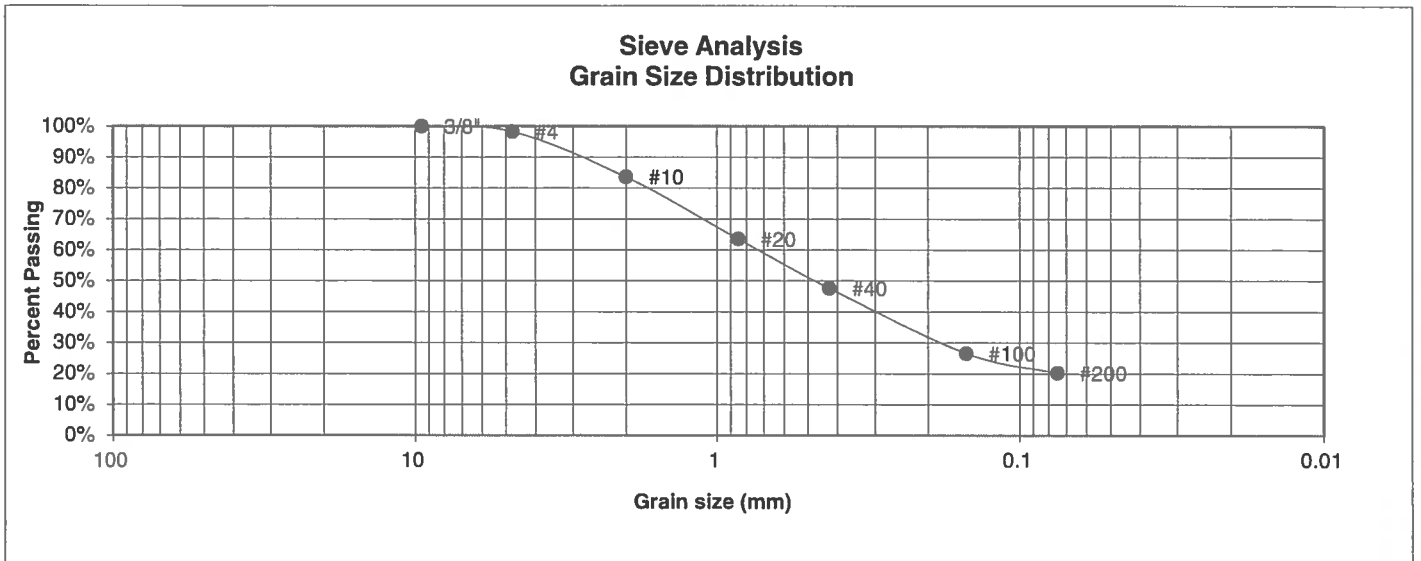

<u>U.S. Sieve #</u>	<u>Percent Finer</u>
3"	
1 1/2"	
3/4"	
1/2"	
3/8"	100.0%
4	98.2%
10	83.6%
20	63.5%
40	47.6%
100	26.6%
200	20.2%

Atterberg Limits
 Plastic Limit
 Liquid Limit
 Plastic Index

Swell
 Moisture at start
 Moisture at finish
 Moisture increase
 Initial dry density (pcf)
 Swell (psf)



**ENTECH
ENGINEERING, INC.**

505 ELKTON DRIVE
COLORADO SPRINGS, COLORADO 80907

**LABORATORY TEST
RESULTS**

<u>DRAWN:</u>	<u>DATE:</u>	<u>CHECKED:</u>	<u>DATE:</u>
		W	11/8/17

JOB NO.:
171198

FIG NO.:
B-48

<u>UNIFIED CLASSIFICATION</u>	CL	<u>CLIENT</u>	TECH CONTRACTORS
<u>SOIL TYPE #</u>	4	<u>PROJECT</u>	WINDINGWALK & STONEBRIDGE
<u>TEST BORING #</u>	6	<u>JOB NO.</u>	171198
<u>DEPTH (FT)</u>	10	<u>TEST BY</u>	BL

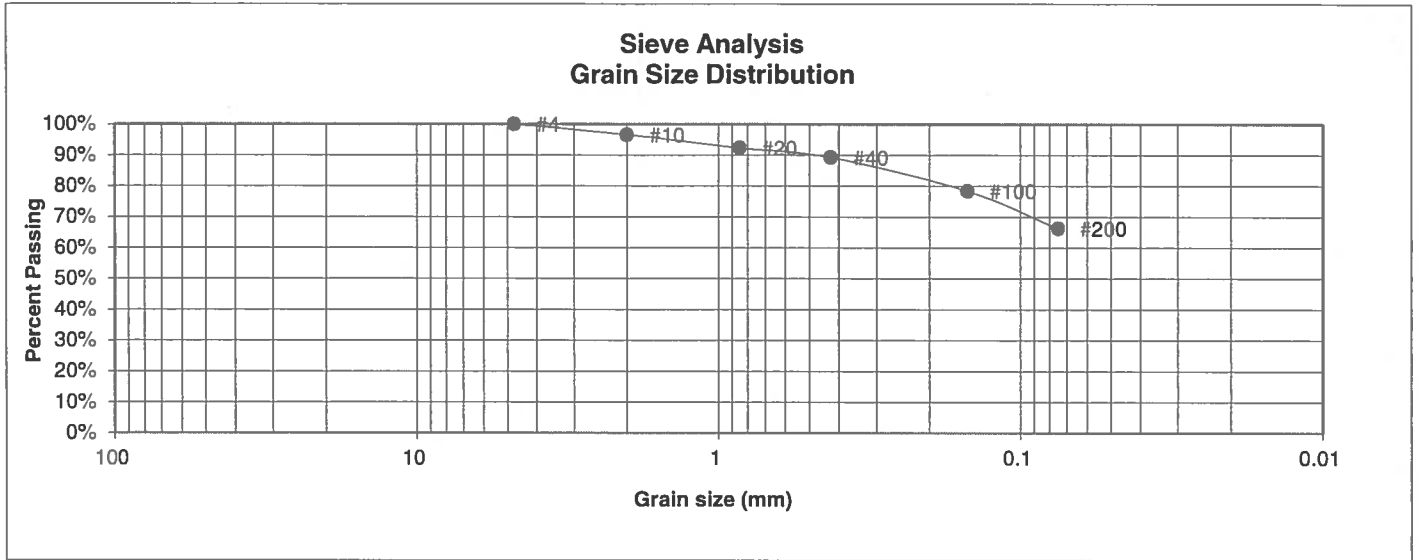

U.S. Sieve #	Percent Finer
3"	
1 1/2"	
3/4"	
1/2"	
3/8"	
4	100.0%
10	96.6%
20	92.3%
40	89.3%
100	78.4%
200	66.3%

Atterberg Limits	
Plastic Limit	13
Liquid Limit	21
Plastic Index	8

Swell	
Moisture at start	
Moisture at finish	
Moisture increase	
Initial dry density (pcf)	
Swell (psf)	



**ENTECH
ENGINEERING, INC.**
505 ELKTON DRIVE
COLORADO SPRINGS, COLORADO 80907

**LABORATORY TEST
RESULTS**

DRAWN:	DATE:	CHECKED:	DATE:
		<i>h</i>	1/8/17

JOB NO.:
171198

FIG NO.:

B-49

<u>UNIFIED CLASSIFICATION</u>	CL	<u>CLIENT</u>	TECH CONTRACTORS
<u>SOIL TYPE #</u>	4	<u>PROJECT</u>	WINDINGWALK & STONEBRIDGE
<u>TEST BORING #</u>	24	<u>JOB NO.</u>	171198
<u>DEPTH (FT)</u>	20	<u>TEST BY</u>	BL

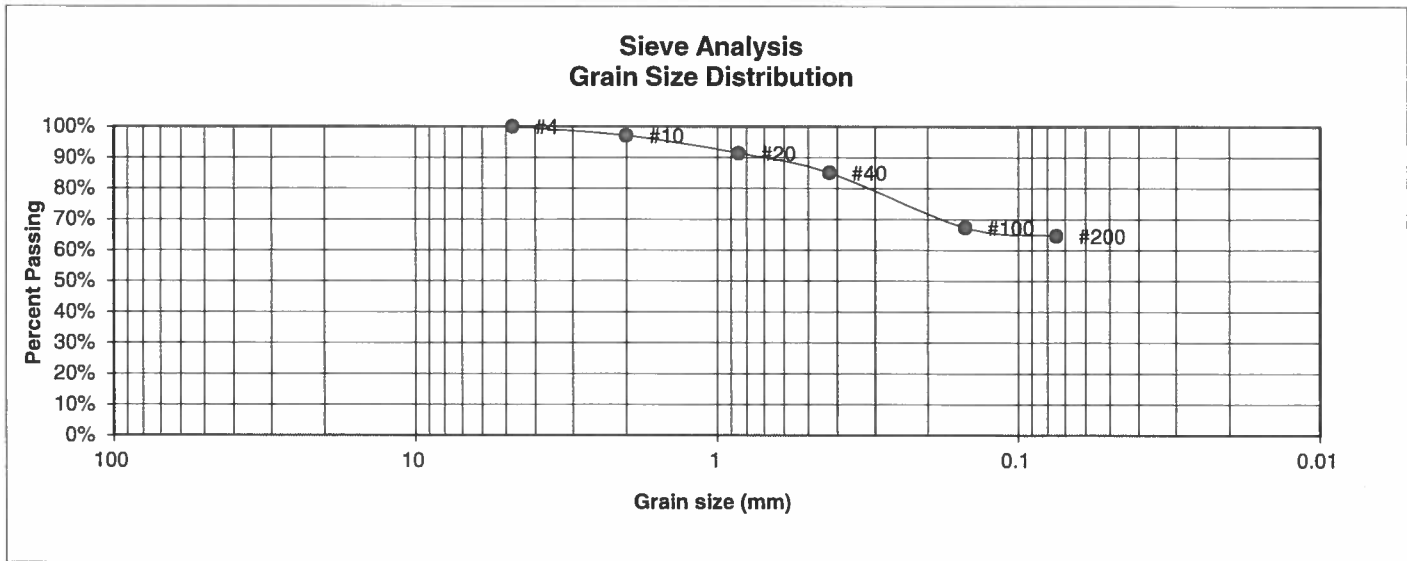

<u>U.S. Sieve #</u>	<u>Percent Finer</u>
3"	
1 1/2"	
3/4"	
1/2"	
3/8"	
4	100.0%
10	97.1%
20	91.4%
40	85.1%
100	67.3%
200	64.7%

<u>Atterberg Limits</u>	
Plastic Limit	21
Liquid Limit	29
Plastic Index	8

<u>Swell</u>	
Moisture at start	
Moisture at finish	
Moisture increase	
Initial dry density (pcf)	
Swell (psf)	



**ENTECH
ENGINEERING, INC.**
505 ELKTON DRIVE
COLORADO SPRINGS, COLORADO 80907

**LABORATORY TEST
RESULTS**

DRAWN:	DATE:	CHECKED:	DATE:
		<i>h</i>	4/9/17

JOB NO.:
171198

FIG NO.:
B-50

<u>UNIFIED CLASSIFICATION</u>	CL	<u>CLIENT</u>	TECH CONTRACTORS
<u>SOIL TYPE #</u>	4	<u>PROJECT</u>	WINDINGWALK & STONEBRIDGE
<u>TEST BORING #</u>	26	<u>JOB NO.</u>	171198
<u>DEPTH (FT)</u>	10	<u>TEST BY</u>	BL

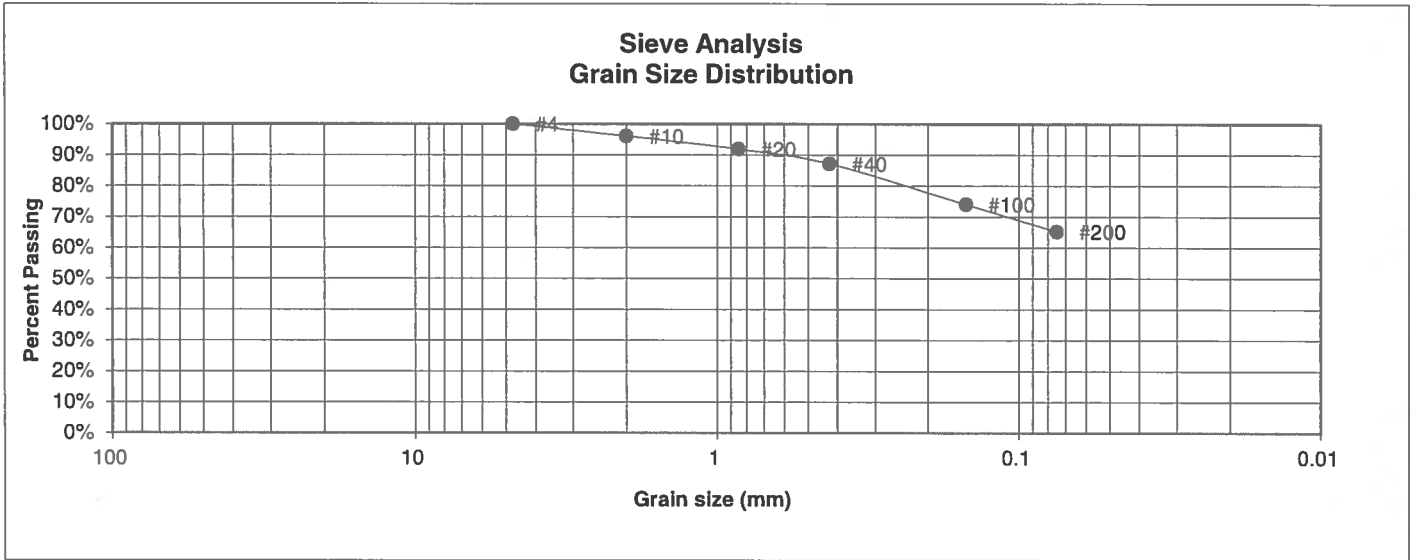

<u>U.S. Sieve #</u>	<u>Percent Finer</u>
3"	
1 1/2"	
3/4"	
1/2"	
3/8"	
4	100.0%
10	96.1%
20	91.9%
40	87.2%
100	74.0%
200	65.2%

Atterberg Limits
 Plastic Limit
 Liquid Limit
 Plastic Index

Swell

Moisture at start	14.4%
Moisture at finish	23.5%
Moisture increase	9.1%
Initial dry density (pcf)	100
Swell (psf)	2060



**ENTECH
ENGINEERING, INC.**

505 ELKTON DRIVE
COLORADO SPRINGS, COLORADO 80907

**LABORATORY TEST
RESULTS**

DRAWN:	DATE:	CHECKED:	DATE:
		<i>h</i>	11/01/17

JOB NO.:
171198

FIG NO.:
B-51

<u>UNIFIED CLASSIFICATION</u>	CL	<u>CLIENT</u>	TECH CONTRACTORS
<u>SOIL TYPE #</u>	4	<u>PROJECT</u>	WINDINGWALK & STONEBRIDGE
<u>TEST BORING #</u>	43	<u>JOB NO.</u>	171198
<u>DEPTH (FT)</u>	10	<u>TEST BY</u>	BL

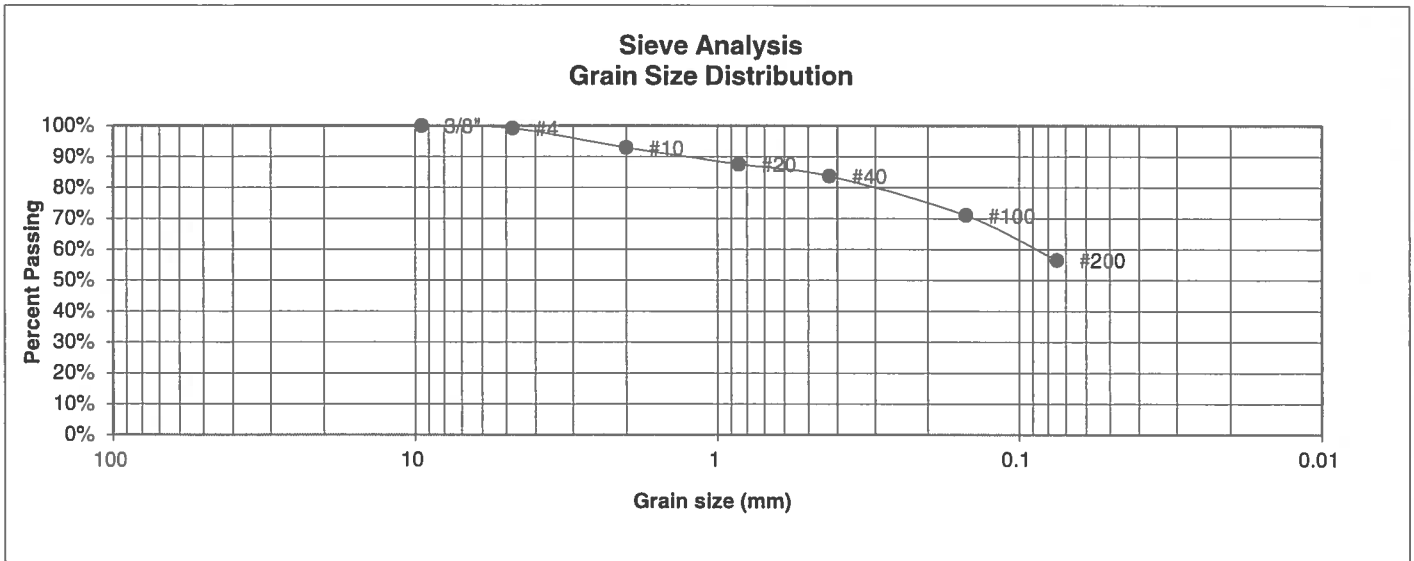

<u>U.S. Sieve #</u>	<u>Percent Finer</u>
3"	
1 1/2"	
3/4"	
1/2"	
3/8"	100.0%
4	99.2%
10	92.9%
20	87.6%
40	83.7%
100	71.0%
200	56.5%

Atterberg Limits
 Plastic Limit
 Liquid Limit
 Plastic Index

<u>Swell</u>	
Moisture at start	12.1%
Moisture at finish	21.6%
Moisture increase	9.5%
Initial dry density (pcf)	103
Swell (psf)	1970



**ENTECH
ENGINEERING, INC.**

505 ELKTON DRIVE
COLORADO SPRINGS, COLORADO 80907

**LABORATORY TEST
RESULTS**

<u>DRAWN:</u>	<u>DATE:</u>	<u>CHECKED:</u>	<u>DATE:</u>
		h	11/8/17

JOB NO.:
171198

FIG NO.:

B-52

<u>UNIFIED CLASSIFICATION</u>	CL	<u>CLIENT</u>	TECH CONTRACTORS
<u>SOIL TYPE #</u>	4	<u>PROJECT</u>	WINDINGWALK & STONEBRIDGE
<u>TEST BORING #</u>	44	<u>JOB NO.</u>	171198
<u>DEPTH (FT)</u>	5	<u>TEST BY</u>	BL

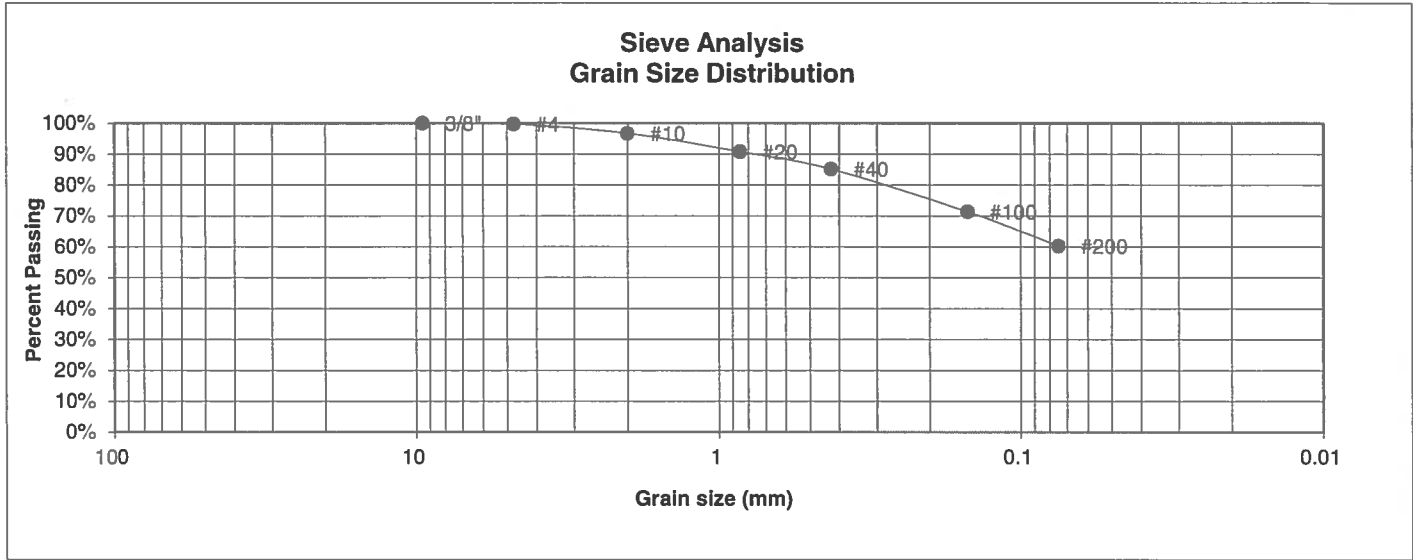

<u>U.S. Sieve #</u>	<u>Percent Finer</u>
3"	
1 1/2"	
3/4"	
1/2"	
3/8"	100.0%
4	99.7%
10	96.7%
20	90.8%
40	85.2%
100	71.3%
200	60.3%

Atterberg Limits
 Plastic Limit
 Liquid Limit
 Plastic Index

Swell
 Moisture at start
 Moisture at finish
 Moisture increase
 Initial dry density (pcf)
 Swell (psf)



**ENTECH
ENGINEERING, INC.**
 505 ELKTON DRIVE
 COLORADO SPRINGS, COLORADO 80907

**LABORATORY TEST
RESULTS**

<u>DRAWN:</u>	<u>DATE:</u>	<u>CHECKED:</u>	<u>DATE:</u>
		h	4/8/17

JOB NO.:
171198

FIG NO.:
13-53

<u>UNIFIED CLASSIFICATION</u>	CL	<u>CLIENT</u>	TECH CONTRACTORS
<u>SOIL TYPE #</u>	4	<u>PROJECT</u>	WINDINGWALK & STONEBRIDGE
<u>TEST BORING #</u>	54	<u>JOB NO.</u>	171198
<u>DEPTH (FT)</u>	15	<u>TEST BY</u>	BL

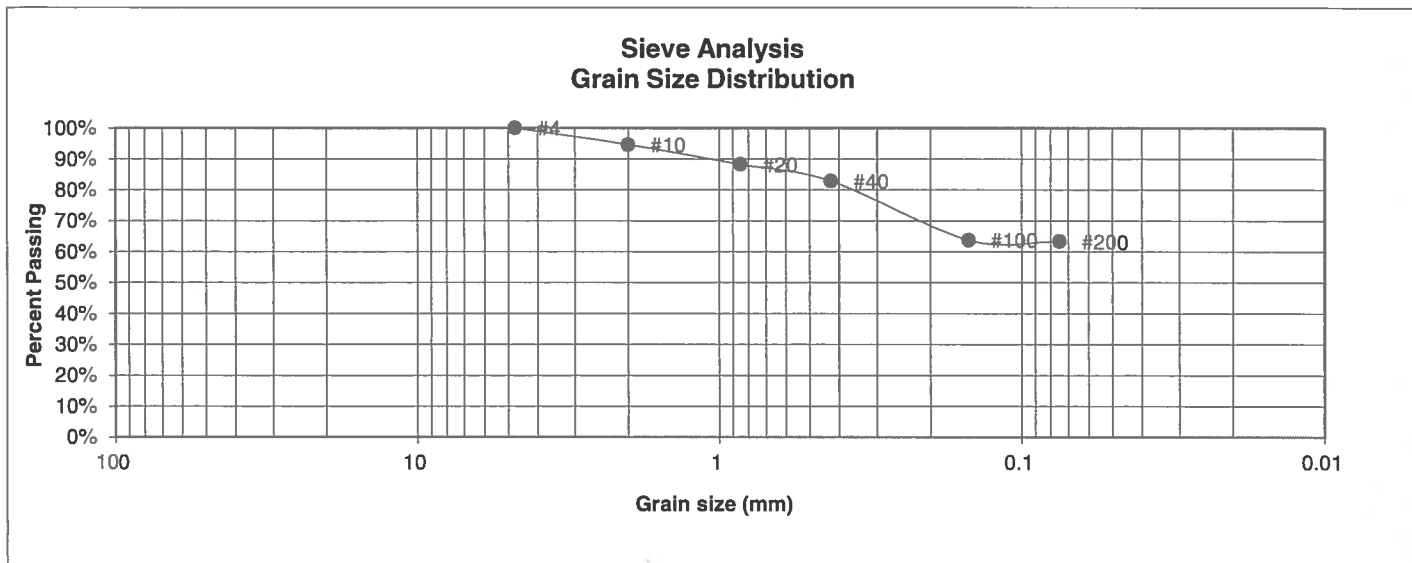

<u>U.S. Sieve #</u>	<u>Percent Finer</u>
3"	
1 1/2"	
3/4"	
1/2"	
3/8"	
4	100.0%
10	94.6%
20	88.2%
40	82.8%
100	63.8%
200	63.3%

<u>Atterberg Limits</u>	
Plastic Limit	14
Liquid Limit	27
Plastic Index	13

<u>Swell</u>	
Moisture at start	
Moisture at finish	
Moisture increase	
Initial dry density (pcf)	
Swell (psf)	



**ENTECH
ENGINEERING, INC.**

505 ELKTON DRIVE
COLORADO SPRINGS, COLORADO 80907

**LABORATORY TEST
RESULTS**

DRAWN:	DATE:	CHECKED:	DATE:
		<i>W</i>	11/8/17

JOB NO.:
171198

FIG NO.:
B-54

<u>UNIFIED CLASSIFICATION</u>	ML	<u>CLIENT</u>	TECH CONTRACTORS
<u>SOIL TYPE #</u>	5	<u>PROJECT</u>	WINDINGWALK & STONEBRIDGE
<u>TEST BORING #</u>	2	<u>JOB NO.</u>	171198
<u>DEPTH (FT)</u>	15	<u>TEST BY</u>	BL

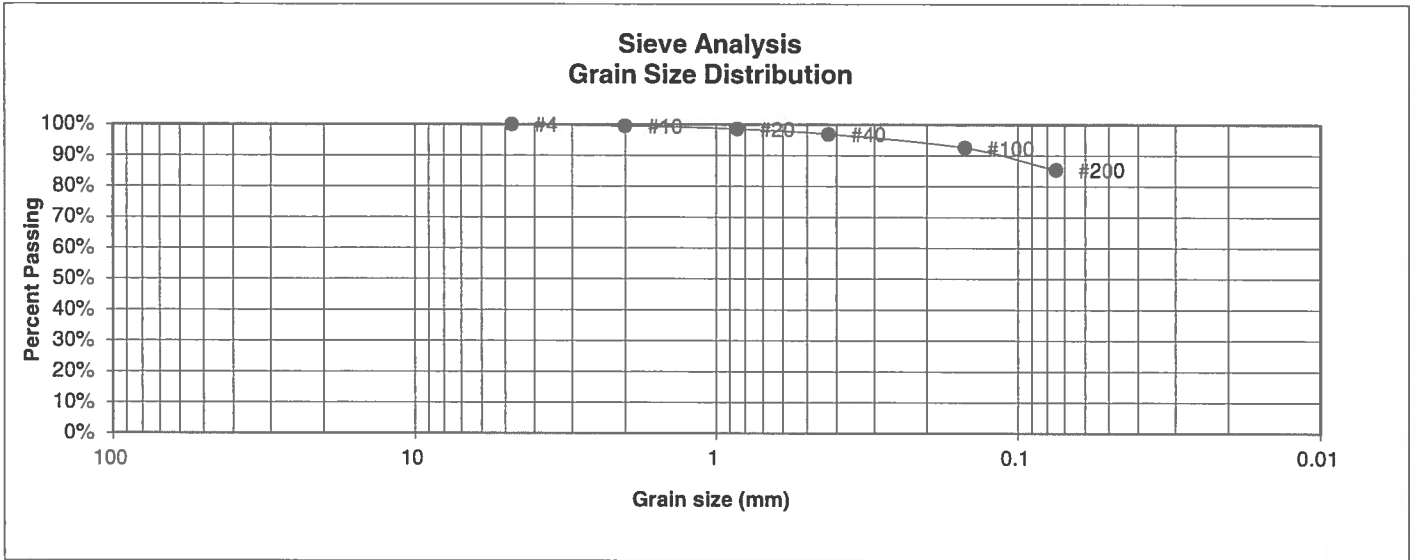

<u>U.S. Sieve #</u>	<u>Percent Finer</u>
3"	
1 1/2"	
3/4"	
1/2"	
3/8"	
4	100.0%
10	99.5%
20	98.6%
40	96.9%
100	92.5%
200	85.4%

<u>Atterberg Limits</u>	
Plastic Limit	26
Liquid Limit	40
Plastic Index	14

<u>Swell</u>	
Moisture at start	
Moisture at finish	
Moisture increase	
Initial dry density (pcf)	
Swell (psf)	



**ENTECH
ENGINEERING, INC.**

505 ELKTON DRIVE
COLORADO SPRINGS, COLORADO 80907

**LABORATORY TEST
RESULTS**

DRAWN:	DATE:	CHECKED: <i>h</i>	DATE: 11/8/17
--------	-------	-------------------	---------------

JOB NO.:
171198

FIG NO.:
B-55

<u>UNIFIED CLASSIFICATION</u>	ML	<u>CLIENT</u>	TECH CONTRACTORS
<u>SOIL TYPE #</u>	5	<u>PROJECT</u>	WINDINGWALK & STONEBRIDGE
<u>TEST BORING #</u>	17	<u>JOB NO.</u>	171198
<u>DEPTH (FT)</u>	2-3	<u>TEST BY</u>	BL

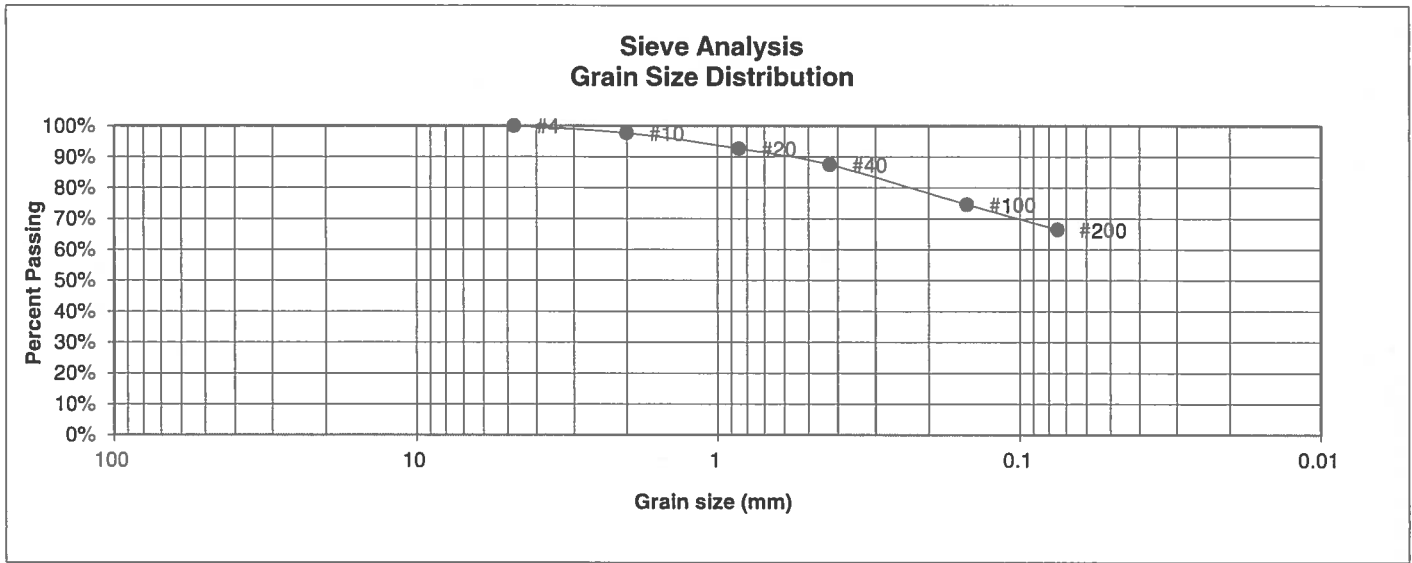

<u>U.S. Sieve #</u>	<u>Percent Finer</u>	<u>Atterberg Limits</u>
3"		Plastic Limit
1 1/2"		Liquid Limit
3/4"		Plastic Index
1/2"		
3/8"		<u>Swell</u>
4	100.0%	Moisture at start
10	97.7%	Moisture at finish
20	92.7%	Moisture increase
40	87.5%	Initial dry density (pcf)
100	74.6%	Swell (psf)
200	66.5%	



**ENTECH
ENGINEERING, INC.**

505 ELKTON DRIVE
COLORADO SPRINGS, COLORADO 80907

**LABORATORY TEST
RESULTS**

DRAWN:	DATE:	CHECKED:	DATE:
		<i>W</i>	11/8/17

JOB NO.:
171198

FIG NO.:
B-56

CONSOLIDATION TEST RESULTS

TEST BORING #	28	DEPTH(ft)	2-3
DESCRIPTION	CL	SOIL TYPE	2
NATURAL UNIT DRY WEIGHT (PCF)			101
NATURAL MOISTURE CONTENT			22.2%
SWELL/CONSOLIDATION (%)			0.0%

JOB NO. 171198
 CLIENT TECH CONTRACTORS
 PROJECT WINDINGWALK & STONEBRIDGE

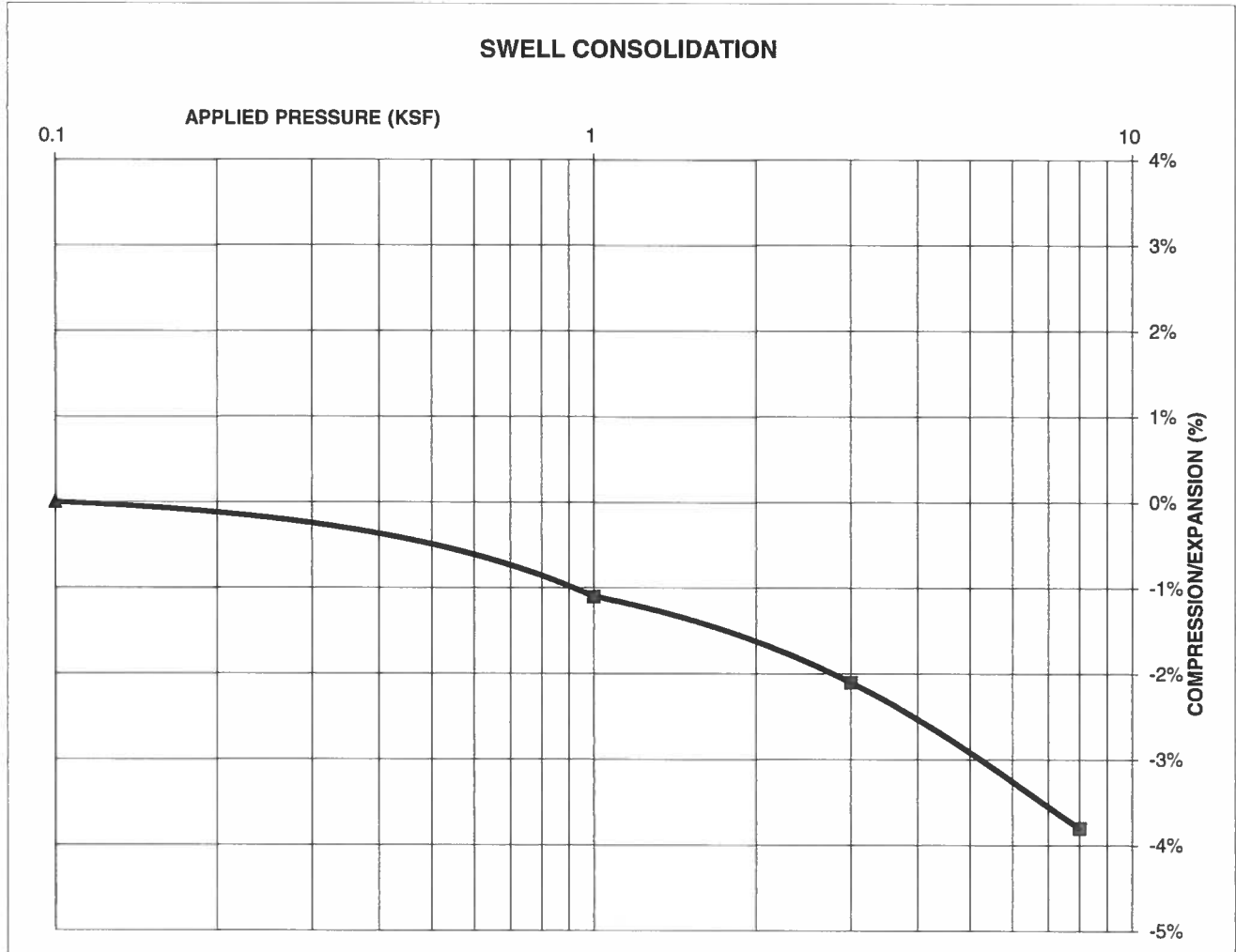

**ENTECH
ENGINEERING, INC.**

505 ELKTON DRIVE
 COLORADO SPRINGS, COLORADO 80907

**SWELL CONSOLIDATION
TEST RESULTS**

DRAWN:

DATE:

CHECKED: *h*

DATE:

11/8/17

JOB NO.:
171198

FIG NO.:
B-57

CONSOLIDATION TEST RESULTS

TEST BORING #	11	DEPTH(ft)	20
DESCRIPTION	SC	SOIL TYPE	3
NATURAL UNIT DRY WEIGHT (PCF)			112
NATURAL MOISTURE CONTENT			14.3%
SWELL/CONSOLIDATION (%)			2.1%

JOB NO. 171198
 CLIENT TECH CONTRACTORS
 PROJECT WINDINGWALK & STONEBRIDGE

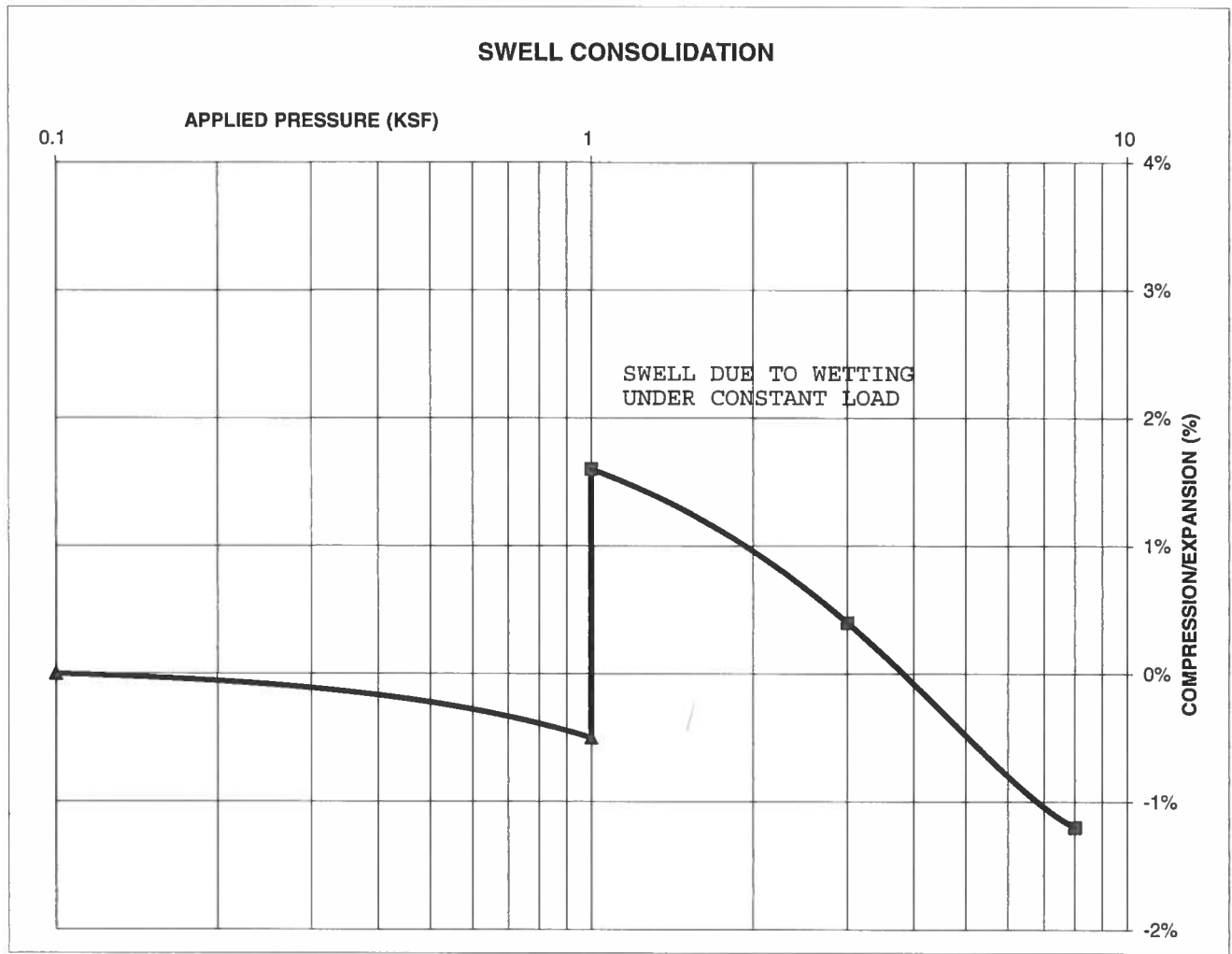

ENTECH
ENGINEERING, INC.

506 ELKTON DRIVE
 COLORADO SPRINGS, COLORADO 80907

**SWELL CONSOLIDATION
 TEST RESULTS**

DRAWN: DATE: CHECKED: *w* DATE: *11/8/17*

JOB NO.:
 171198

FIG NO.:
B-58

CONSOLIDATION TEST RESULTS

TEST BORING #	23	DEPTH(ft)	15
DESCRIPTION	SC	SOIL TYPE	3
NATURAL UNIT DRY WEIGHT (PCF)			108
NATURAL MOISTURE CONTENT			20.1%
SWELL/CONSOLIDATION (%)			2.1%

JOB NO. 171198
 CLIENT TECH CONTRACTORS
 PROJECT WINDINGWALK & STONEBRIDGE

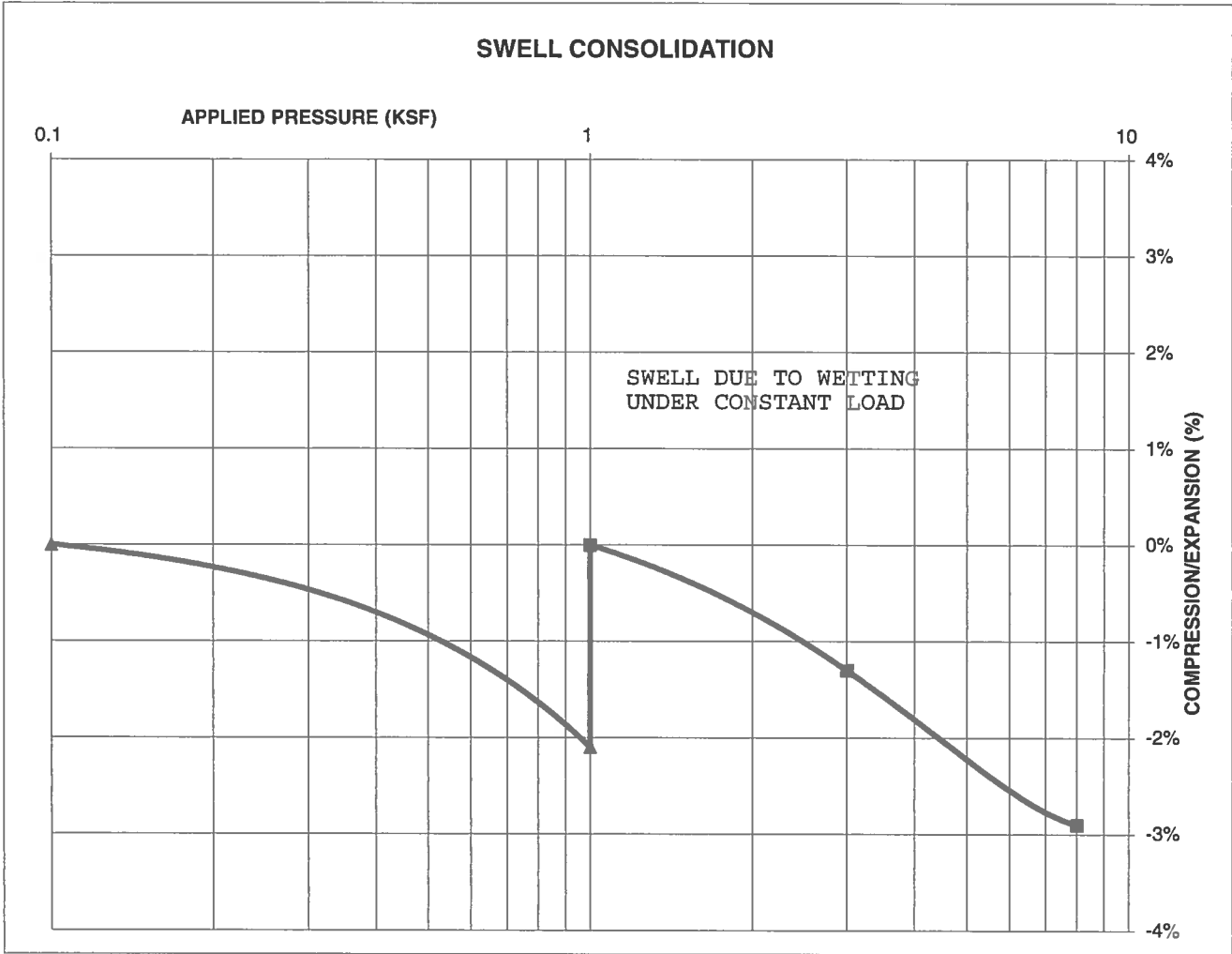

**ENTECH
ENGINEERING, INC.**

505 ELKTON DRIVE
 COLORADO SPRINGS, COLORADO 80907

**SWELL CONSOLIDATION
TEST RESULTS**

DRAWN:

DATE:

CHECKED: *W*

DATE: *11/9/17*

JOB NO.
171198

FIG NO:
B-59

CONSOLIDATION TEST RESULTS

TEST BORING #	24	DEPTH(ft)	20
DESCRIPTION	CL	SOIL TYPE	4
NATURAL UNIT DRY WEIGHT (PCF)			117
NATURAL MOISTURE CONTENT			10.9%
SWELL/CONSOLIDATION (%)			1.7%

JOB NO. 171198
 CLIENT TECH CONTRACTORS
 PROJECT WINDINGWALK & STONEBRIDGE

SWELL CONSOLIDATION

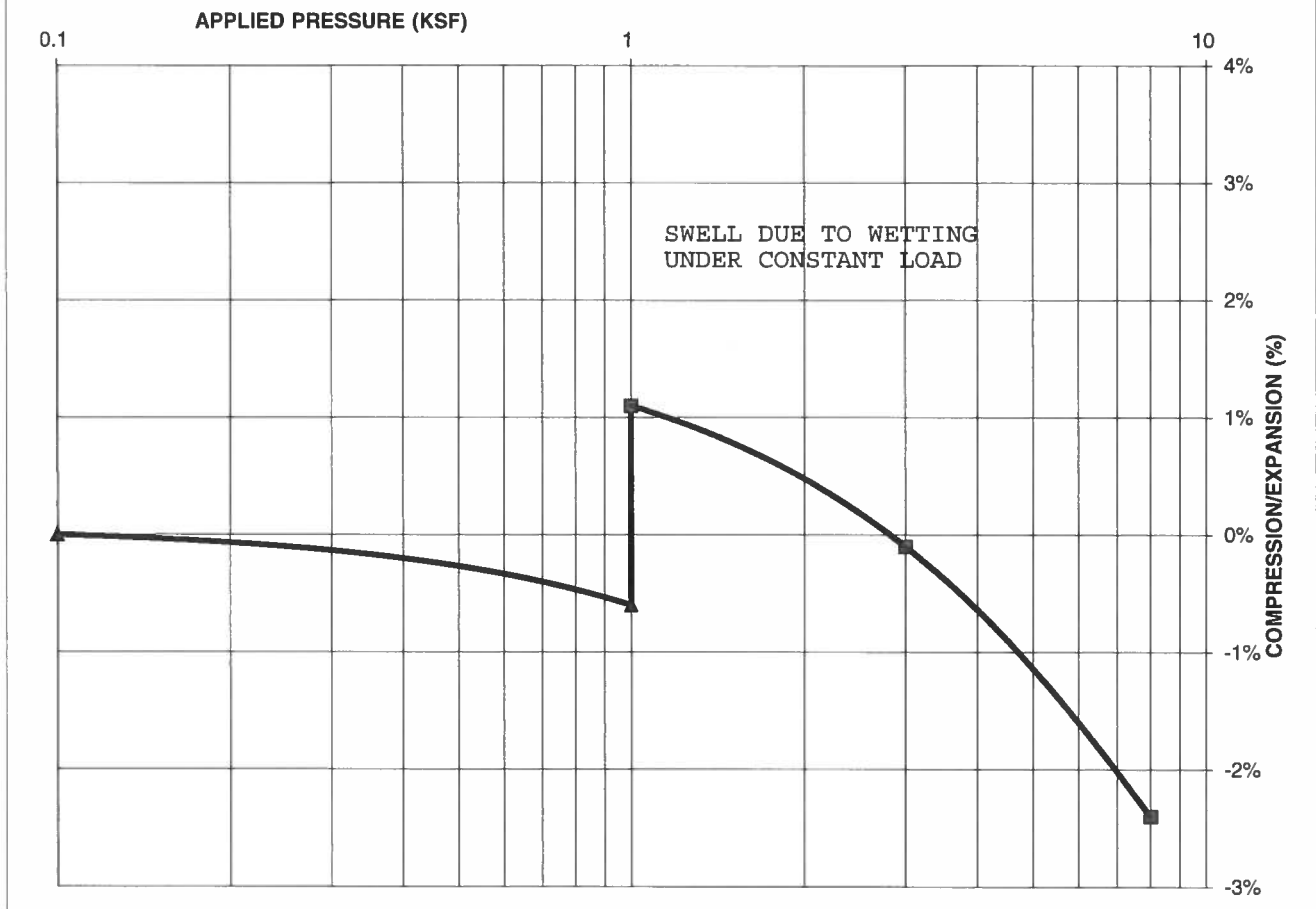

ENTECH ENGINEERING, INC.
 505 ELKTON DRIVE
 COLORADO SPRINGS, COLORADO 80907

SWELL CONSOLIDATION TEST RESULTS

DRAWN: DATE: CHECKED: *W* DATE: *11/8/17*

JOB NO.: 171198

FIG NO.: *B-60*

CONSOLIDATION TEST RESULTS

TEST BORING #	17	DEPTH(ft)	2-3
DESCRIPTION	ML	SOIL TYPE	5
NATURAL UNIT DRY WEIGHT (PCF)			111
NATURAL MOISTURE CONTENT			15.6%
SWELL/CONSOLIDATION (%)			0.9%

JOB NO. 171198
 CLIENT TECH CONTRACTORS
 PROJECT WINDINGWALK & STONEBRIDGE

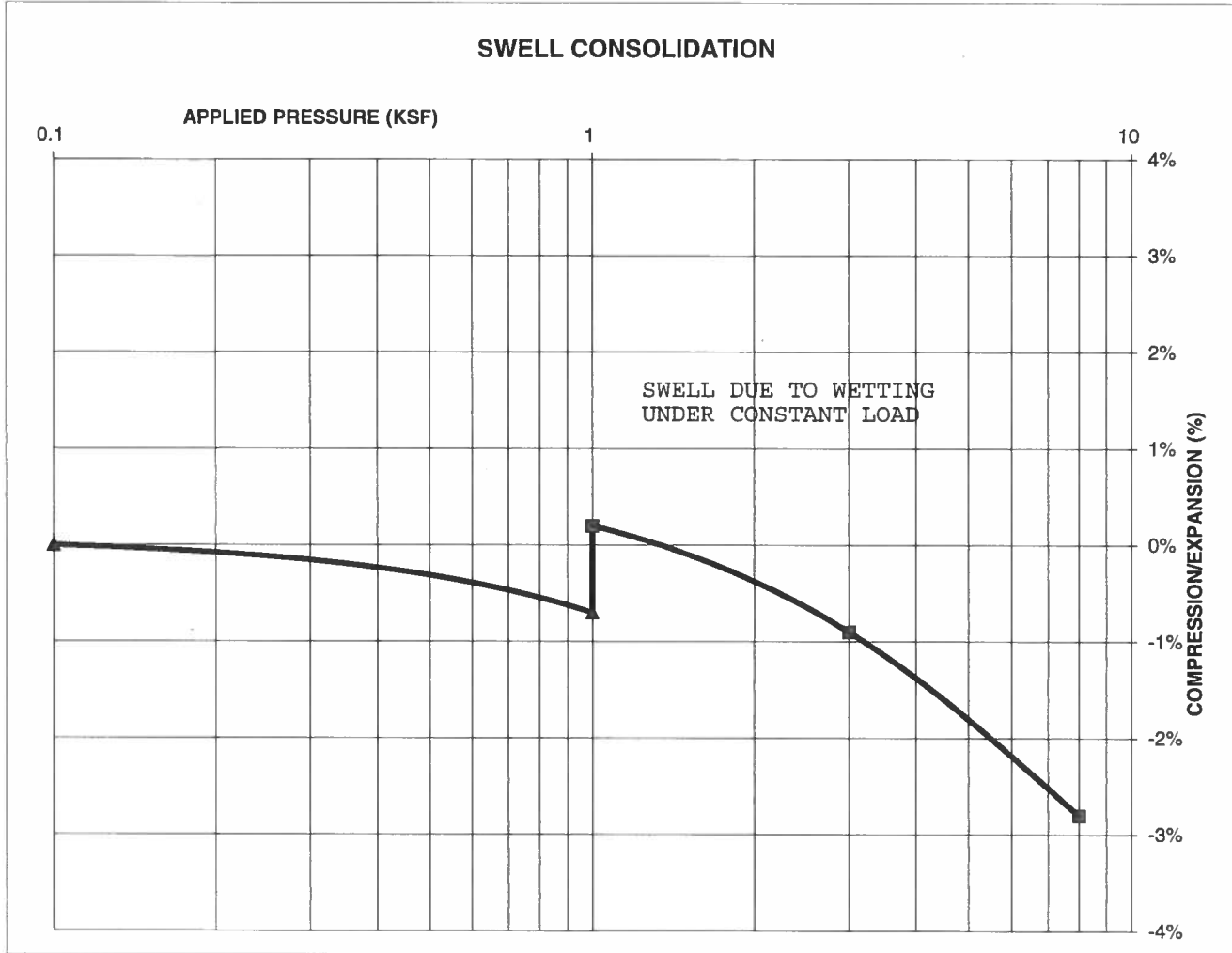

ENTECH
ENGINEERING, INC.

505 ELKTON DRIVE
 COLORADO SPRINGS, COLORADO 80907

**SWELL CONSOLIDATION
 TEST RESULTS**

DRAWN:

DATE:

CHECKED: *h*

DATE: 11/8/17

JOB NO.:
 171198

FIG NO.:
 B-61

CLIENT	TECH CONTRACTORS	JOB NO.	171198
PROJECT	WINDINGWALK & STONEBRIDGE	DATE	9/6/2017
LOCATION	WINDINGWALK & STONEBRIDGE	TEST BY	BL

BORING NUMBER	DEPTH, (ft)	SOIL TYPE NUMBER	UNIFIED CLASSIFICATION	WATER SOLUBLE SULFATE, (wt%)
TB-1	10	3	SM	<0.01
TB-39	10	1	SM	0.01
TB-42	20	3	SM	<0.01
TB-8	2-3	1	SM-SW	<0.01
TB-9	10	3	SM	<0.01
TB-11	20	3	SC	0.00
TB-6	10	4	CL	<0.01
TB-24	20	4	CL	<0.01
TB-25	10	2	CL	<0.01
TB-31	10	3	SM-SW	<0.01
TB-32	25	3	SM	<0.01
TB-35	2-3	1	SM	<0.01
TB-13	2-3	1	SC	<0.01
TB-45	5	3	SM-SW	0.00
TB-46	2-3	3	SC	<0.01
TB-51	5	3	SM	0.00
TB-12	10	3	SM	0.00
TB-29	5	3	SM	<0.01
TB-28	2-3	2	CL	<0.01
TB-19	5	1	SM-SW	0.00
TB-54	15	4	CL	0.00
TB-55	2-3	1	SM-SW	<0.01

QC BLANK PASS



ENTECH
ENGINEERING, INC.
 505 ELKTON DRIVE
 COLORADO SPRINGS, COLORADO 80907

**LABORATORY TEST
 SULFATE RESULTS**

DRAWN:

DATE:

CHECKED: *W*

DATE: 11/8/17

JOB NO.:
171198

FIG NO.:

13-62

**SUBSURFACE SOIL INVESTIGATION
WINDINGWALK FILINGS 1 AND 2 AND
STONEBRIDGE THE ENCLAVE FILINGS 4 AND 5
STAPLETON DRIVE AND EASTONVILLE ROAD
EL PASO COUNTY, COLORADO**

Prepared for:

Tech Contractors
3575 Kenyon Street, Suite 200
San Diego, California 92110

Attn: Mr. Raul Guzman

November 8, 2017
Revised December 21, 2017

Respectfully Submitted,

ENTECH ENGINEERING, INC.



Kristen A. Andrew-Hoeser, P.G.
Engineering Geologist

KAH/rm

Encl.

Entech Job No. 171198
AAprojects/2017/171198 SSI_rev

