

**FINAL DRAINAGE REPORT**  
for  
**LATIGO TRAILS FILING No. 10**

**AND**

**AMENDMENT TO MDDP/PRELIMINARY DRAINAGE PLAN  
FOR LATIGO TRAILS**

El Paso County, Colorado

**September 2024**

**PCD FILE NO. SF-21-037**

**SF2421**

Prepared for:

**BRJM, LLC**

101 N. Cascade, Suite 200  
Colorado Springs, CO 80903  
(719) 475-7474

Prepared by:

**Drexel, Barrell & Co.**

101 Sawatch Street, #100  
Colorado Springs, CO 80903  
Contact: Tim McConnell, P.E.  
(719) 260-0887

**TABLE OF CONTENTS**

<b>1.0</b>	<b>CERTIFICATION STATEMENTS .....</b>	<b>III</b>
<b>2.0</b>	<b>PURPOSE .....</b>	<b>1</b>
<b>3.0</b>	<b>GENERAL SITE DESCRIPTION .....</b>	<b>1</b>
<b>4.0</b>	<b>MAJOR DRAINAGE BASINS &amp; APPROVED REPORTS .....</b>	<b>2</b>
<b>5.0</b>	<b>ADDENDUM TO MDDP/PRELIMINARY DRAINAGE PLAN.....</b>	<b>2</b>
<b>6.0</b>	<b>MAJOR BASIN IMPROVEMENTS .....</b>	<b>2</b>
<b>7.0</b>	<b>DRAINAGE CRITERIA.....</b>	<b>3</b>
<b>8.0</b>	<b>EXISTING CONDITION.....</b>	<b>3</b>
<b>9.0</b>	<b>DEVELOPED CONDITION .....</b>	<b>7</b>
<b>10.0</b>	<b>PROPOSED FULL-SPECTRUM DETENTION FACILITIES.....</b>	<b>16</b>
<b>11.0</b>	<b>FOUR-STEP PROCESS.....</b>	<b>19</b>
<b>12.0</b>	<b>DRAINAGE/BRIDGE FEES .....</b>	<b>19</b>
<b>13.0</b>	<b>REFERENCES .....</b>	<b>20</b>

**APPENDICES**

VICINITY MAP  
SOILS MAP  
FLOODPLAIN MAP  
HYDROLOGY CALCULATIONS  
HYDRAULIC CALCULATIONS  
EXCERPTS  
DRAINAGE MAPS

**FINAL DRAINAGE REPORT for LATIGO TRAILS FILING No. 10 &  
ADDENDUM TO MDDP/PRELIMINARY PLAN LATIGO TRAILS**

El Paso County, Colorado

**1.0 CERTIFICATION STATEMENTS**

**ENGINEER'S STATEMENT**

The attached drainage plan and report were prepared under my direction and supervision and are correct to the best of my knowledge and belief. Said drainage report has been prepared according to the criteria established by El Paso County for drainage reports, and said report is in conformity with the master plan of the drainage basin. I accept responsibility for any liability caused by any negligent acts, errors or omission on my part in preparing this report.

---

Tim D. McConnell, P.E.  
Colorado P.E. License No. 33797  
For and on Behalf of Drexel, Barrell & Co.

Date

**DEVELOPER'S STATEMENT**

I, the developer have read and will comply with all the requirements specified in this drainage report and plan.

Business Name: BRJM, LLC

By:

Bob Irwin

Date

Title: Owner

Address: 101 N. Cascade, Suite 200  
Colorado Springs, CO 80903

**EL PASO COUNTY**

Filed in accordance with the requirements of the El Paso County Land Development Code, Drainage Criteria Manual Volumes 1 and 2, and the Engineering Criteria Manual, as amended.

---

Joshua Palmer, P.E.  
County Engineer/ECM Administrator  
CONDITIONS:

Date

# **FINAL DRAINAGE REPORT for LATIGO TRAILS FILING No. 10 & ADDENDUM TO MDDP/PRELIMINARY PLAN LATIGO TRAILS**

El Paso County, Colorado

## **2.0 PURPOSE**

This report is prepared by Drexel, Barrel & Co in support of the Latigo Trails Filing No. 10 project. The purpose of this report is to identify onsite and offsite drainage patterns, size drainage facilities and to safely route developed storm water runoff to adequate outfall facilities.

## **3.0 GENERAL SITE DESCRIPTION**

### Location

The Latigo Trails Development is located within portions of Sections 8,9,16 & 17, Township 12 South, Range 64 West of the 6<sup>th</sup> Principal Meridian, El Paso County, Colorado. Latigo Trails Filing 10 is bound by Latigo Trails Filing 9 to the west, Latigo Trails Filings 11 & 12 to the north, unplatted land to the east and Falcon Regional Park to the south. A vicinity map is presented in the appendix.

### Existing Site Conditions

The overall Latigo Trails Development contains approximately 497 acres and at full build-out will be comprised of 179, 2.5-acre or larger lots. Latigo Trails Filing 10 consists of 125.6 acres and covers 43 proposed lots. Filing No. 10 is currently undeveloped, with open grassland and sparse vegetation covering the ground. Latigo Trails Filings 2, 7, 8 & 9 are currently developed and as studied as part of the 2001 MDDP for Latigo Trails by URS and amended by subsequent drainage reports, will remain unchanged.

The Latigo Trails subdivision as a whole, is split by a major drainage basin boundary. In the ultimate full-build out condition approximately 263 acres will drain to the Gieck Ranch basin, while the remaining 234 acres will drain to the Upper Black Squirrel basin. In general, the Upper Black Squirrel basin drains from southwest to northeast across the site, while the Gieck Ranch basin flows from northwest to southeast. Latigo Trails Filing 10 sits at the southeast corner of the overall development, almost entirely within the Gieck Ranch Basin.

### Soils

According to the Soil Survey of El Paso County Area, Colorado, prepared by the U.S. Department of Agriculture Soil Conservation Service, the site is entirely underlain by Stapleton Sandy Loam (Soil No. 83). This soil is type 'B' hydrological soil group. See appendix for map.

## Floodplain Statement

According to the Federal Emergency Management Agency (FEMA) Flood Insurance Rate Map (FIRM) Panels 08041C0339G and 08041C0552G (December 7, 2018), no portion of Filing 10 lies within a designated 100-year floodplain.

### **4.0 MAJOR DRAINAGE BASINS & APPROVED REPORTS**

As mentioned above, the subdivision as a whole lies within two major drainage basins: the Gieck Ranch Drainage Basin and the Upper Black Squirrel Drainage basins. A Master Development Drainage Plan (MDDP) was approved for Latigo Trails and is titled "Master Development/Preliminary Drainage Plan for Latigo Trails," by URS, dated October 2001; it is referenced and used as a Master Plan for the project.

The following reports have also been reviewed and referenced for the preparation of this report:

"Final Drainage Report for The Trails Filing No. 7 Subdivision," by URS, dated March 07, 2005.

"Final Drainage Report for Latigo Trails Filing No. 9 and Addendum to Master Development/Preliminary Drainage Plan," by JR Engineering, March 29, 2023.

Excerpts from referenced reports are presented in the appendix.

### **5.0 ADDENDUM TO MDDP/PRELIMINARY DRAINAGE PLAN**

For Latigo Trails Filing No. 10, The Master Development/Preliminary Drainage Plan for Latigo Trails, by URS will be amended as follows:

1. The potential detention areas shown in the MDDP on the north side of Conestoga Trail are eliminated and instead flows are to be conveyed via roadside ditch and cross culverts to the proposed detention basin G14b (Location corresponds with MDDP Design Point G14b).
2. Proposed detention facilities G14b, G18 and G19 have been sized to meet current El Paso County Drainage Criteria. The existing South Pond sizing was established by the Filing 9 FDR/MDD Amendment and has been analyzed to confirm no modifications are necessary as part of this Filing 10 development.

### **6.0 MAJOR BASIN IMPROVEMENTS**

#### **Gieck Ranch Drainage Basin**

This report proposes that the drainage system for Filing 10 will be compromised of swales, culverts, and detention ponds. The proposed drainage design is in conformance with the approved "Master Development/Preliminary Drainage Plan for Latigo Trails" report as runoff flows within the Gieck Ranch Basin generally follow the historic drainage pattern to the south and east.

## **Upper Black Squirrel Basin**

A small portion of Filing 10 is currently located within the Upper Black Squirrel Basin. Flows from Basin A28 (NW corner of Lot 43) will follow the historic drainage pattern and discharge to the northwest into future Filing 11 and or 12. This area will be analyzed as an offsite basin in the design for Filings 11 and 12, with flows likely routed to the proposed Black Squirrel pond at the northeast corner of the Latigo Trails subdivision.

## **7.0 DRAINAGE CRITERIA**

The drainage analysis has been prepared in accordance with the current El Paso County Drainage Criteria Manual and the current Mile High Flood District Drainage Criteria Manual. Calculations were performed to determine runoff quantities during the 5-year and 100-year frequency storms for historic and developed conditions utilizing the Rational Method.

Mile High Flood District's UD-Detention, Version 4.06 workbook was used for pond sizing, with required detention volumes and allowable release rates designed per El Paso County criteria. Pond sizing spreadsheets are presented in the appendix.

The Federal Highway Administration's HY-8 program (Volume 8) was used to analyze the proposed culverts within the Latigo Trails development. Major cross culverts were sized as to not overtop the road in the 100 year storm event, driveway culverts were sized as to not exceed 6" overtopping of the driveway during the 100-year storm event. Culvert design sheets are presented in the appendix.

Autodesk Inc.'s Hydraflow Express Extension (Volume 10.5) was used for roadside ditch and conveyance ditch design. For the purposes of this FDR/MDDP, the maximum roadside ditch size was determined based on peak 100-year flows and maximum roadway slopes within each basin. Swales were checked for velocity per the EPC DCM Chapter 10, Table 10-4. Swale cross sections with a 100-year velocity greater than 5 ft/ will be lined with turf reinforcing mat and native grasses, or another approved method of stabilization, to limit erosive potential. Swale design sheets are presented in the appendix.

## **8.0 EXISTING CONDITION**

The existing project condition considers the adjacent filings in their current developed condition (2.5-acre residential subdivision). The undeveloped area is covered with native vegetation that consists mostly of grasses as well as some shrubs. The site generally slopes at approximately 1-15% to the east and to the south, where the flows leave the project site onto the adjacent properties. The site lies primarily within the Geick Ranch Drainage Basin, with a very small portion at the northwest corner lying within the Upper Black Squirrel Basin. See Existing Conditions Map in Appendix.

**A-group basins** represent flows for basins that are part of Filing 10, and offsite developed flows from adjacent filings. **B-group basins** represent offsite flows for tributary basins that are part of future Filing 12.

## RATIONAL METHOD RUNOFF SUMMARY

BASIN	DP	Area (Ac.)	Q <sub>5</sub> (cfs)	Q <sub>100</sub> (cfs)
OSA1	OSA1	3.68	3.6	7.9
OSA2	OSA2	92.80	33.1	128.7
OSA3	OSA3	69.15	29.3	113.6
OSA4	OSA4	32.65	16.0	60.5
OSA5	OSA5	11.33	7.3	28.1
A1	1	7.08	1.6	11.8
A2		19.70	4.5	33.3
	2	232.68	73.1	288.2
A3		11.68	2.6	19.3
	3	12.43	2.4	17.6
A4	4	4.24	1.0	7.4
A5		10.58	2.3	17.1
	5	15.37	2.8	20.9
A6	6	7.35	1.7	12.5
A7		13.62	2.5	18.7
	7	20.51	3.8	28.1
A8	8	2.24	0.6	4.2
A9	9	2.16	0.6	4.2
A10	10	8.08	1.7	12.5
A11	11	7.30	1.6	11.8
A12		8.71	1.9	13.8
	12	10.31	2.3	16.8
A13		13.96	3.0	22.0
	13	26.36	4.7	34.7
A14	14	8.24	1.7	12.7
A15		0.61	0.2	1.2
OSA6	OSA6	3.29	10.3	18.5
B1	B1	3.36	0.8	6.0
B2	B2	0.75	0.2	1.3
B3	B3	4.78	1.1	8.2
B4	B4	6.89	1.7	12.5
B5	B5	1.61	0.4	3.2
B6	B6	12.40	2.6	19.3

**Basin OSA1** is an offsite basin covering 3.68 acres of Conestoga Trail South to the west of the project site. Flows generated by this basin (Q<sub>5</sub>=3.6 cfs and Q<sub>100</sub>=7.9 cfs) travel via roadside ditch to the south and east before entering Filing 10 at **Design Point DPOSA1**.

**Basin OSA2** is an offsite basin covering 92.80 acres of Filing 9 to the north of Conestoga Trail South. Flows generated by this basin (Q<sub>5</sub>=33.1 cfs and Q<sub>100</sub>=128.7 cfs) ultimately travel via roadside ditch to the south and east before entering Filing 10 at **Design Point DPOSA2**

**Basin OSA3** is an offsite basin covering 69.15 acres of Filing 2-B to the northwest of Filing 10. Flows generated by this basin (Q<sub>5</sub>=29.3 cfs and Q<sub>100</sub>=113.4 cfs) travel via roadside ditch and cross lot drainage ditch to the southeast before entering Filing 10 at **Design Point DPOSA3**.

**Basin OSA4** is an offsite basin covering 32.65 acres of Filing 7-A to the northwest of Filing 10. Flows generated by this basin ( $Q_5=16.0$  cfs and  $Q_{100}=60.5$  cfs) travel via roadside ditch and cross lot drainage ditch to the southeast before entering Filing 10 at **Design Point DPOSA4**.

**Basin OSA5** is an offsite basin covering 11.33 acres of Filing 7-A to the north of Filing 10. Flows generated by this basin ( $Q_5=7.3$  cfs and  $Q_{100}=28.1$  cfs) travel via roadside ditch and cross lot drainage ditch to the south before entering Filing 10 at **Design Point DPOSA5**.

**Existing Basin A1** is located at the southwest corner of the site. Flows generated by this basin ( $Q_5=1.6$  cfs and  $Q_{100}=11.8$  cfs) are directed southeast to **Design Point DP1** along the southern boundary of Filing 10.

**Basin B1** is located at the northwest corner of future Filing 12. Flows generated by this basin ( $Q_5=0.8$  cfs and  $Q_{100}=6.0$  cfs) are directed south before entering Filing 10 at **Design Point DPB1**.

**Existing Basin A2** is located in the southwest portion of the site. Flows generated by this basin ( $Q_5=4.5$  cfs and  $Q_{100}=33.3$  cfs) combine with those from offsite basins OSA1-OSA5 and B1 and are directed southeast to the existing South Pond at **Design Point DP2**.

**Design Point DP2** is located at the bottom of the existing South Pond that was constructed previously and modified with the development of Filing 9. This design point represents the combining of flows of Basins OSA1-OSA5, B1 and A2.

**Basin B2** is located along the south edge of future Filing 12. Flows generated by this basin ( $Q_5=0.2$  cfs and  $Q_{100}=1.3$  cfs) are directed south before entering Filing 10 at **Design Point DPB2**.

**Existing Basin A3** is located in the southwest portion of the site, just east of Basin A2. Flows generated by this basin ( $Q_5=2.6$  cfs and  $Q_{100}=19.3$  cfs) combine with those from Basin B2 and are directed south to **Design Point DP3** along the southern boundary of Filing 10.

**Existing Basin A4** is located in the middle portion of the site, along the southern boundary. Flows generated by this basin ( $Q_5=1.0$  cfs and  $Q_{100}=7.4$  cfs) are directed south to **Design Point DP4**, along the south boundary of Filing 10.

**Basin B3** is located in the middle portion of the site. Flows generated by this basin ( $Q_5=1.1$  cfs and  $Q_{100}=8.2$  cfs) are directed to the south before entering Filing 10 at **Design Point DPB3**.

**Existing Basin A5** is located in the middle portion of the site. Flows generated by this basin ( $Q_5=2.3$  cfs and  $Q_{100}=17.1$  cfs) combine with flows from Basin B3 and are directed south to **Design Point DP5**, along the southern boundary.

**Existing Basin A6** is located in the middle portion of the site, along the southern boundary. Flows generated by this basin ( $Q_5=1.7$  cfs and  $Q_{100}=12.5$  cfs) are directed south to **Design Point DP6**, along the southern boundary.

**Basin B4** is located in the middle portion of the future Filing 12 site. Flows generated by this



basin ( $Q_5=1.7$  cfs and  $Q_{100}=12.8$  cfs) are directed east before entering Filing 10 at **Design Point DPB4**.

**Existing Basin A7** is located in the eastern portion of the site, along the southern boundary. Flows generated by this basin ( $Q_5=2.5$  cfs and  $Q_{100}=18.7$  cfs) combine with those from Basin B4 and are directed south to **Design Point DP7**, along the southern boundary.

**Existing Basin A8** is located in the southeast corner of the site, along the southern boundary. Flows generated by this basin ( $Q_5=0.6$  cfs and  $Q_{100}=4.2$  cfs) are directed south to **Design Point DP8**, along the southern boundary.

**Existing Basin A9** is located in the southeast corner of the site, along the eastern boundary. Flows generated by this basin ( $Q_5=0.6$  cfs and  $Q_{100}=4.2$  cfs) are directed east to **Design Point DP9** before discharging into the roadside ditch along Eastonville Road and continuing south.

**Existing Basin A10** is located in the middle portion of the site, along the eastern boundary. Flows generated by this basin ( $Q_5=1.7$  cfs and  $Q_{100}=12.5$  cfs) are directed east to **Design Point DP10** before discharging into the roadside ditch along Eastonville Road. Flows continue in the roadside ditch until ultimately reaching an existing 30"x42" HECMP cross culvert to the south.

**Existing Basin A11** is located in the middle portion of the site, along the eastern boundary. Flows generated by this basin ( $Q_5=1.6$  cfs and  $Q_{100}=11.8$  cfs) are directed east to **Design Point DP11** before discharging into the roadside ditch along Eastonville Road. Flows continue in the roadside ditch until ultimately reaching an existing 30"x42" HECMP cross culvert to the south.

**Basin B5** is located in the middle portion of the future Filing 11 site. Flows generated by this basin ( $Q_5=0.4$  cfs and  $Q_{100}=3.2$  cfs) are directed east before entering Filing 10 at **Design Point DPB5**.

**Existing Basin A12** is located in the middle portion of the site, along the eastern boundary. Flows generated by this basin ( $Q_5=1.7$  cfs and  $Q_{100}=12.5$  cfs) combine with those from basin B5 and are directed east to **Design Point DP12** before discharging into the roadside ditch along Eastonville Road. Flows continue in the roadside ditch until ultimately reaching an existing 30"x42" HECMP cross culvert to the south.

**Basin B6** is located in the middle portion of the future Filing 11 site. Flows generated by this basin ( $Q_5=2.6$  cfs and  $Q_{100}=19.3$  cfs) are directed northeast before entering Filing 10 at **Design Point DPB6**.

**Existing Basin A13** is located in the middle portion of the site, along the eastern boundary. Flows generated by this basin ( $Q_5=3.0$  cfs and  $Q_{100}=22.0$  cfs) combine with those from basin B6 and are directed east to **Design Point DP13** before discharging into the roadside ditch along Eastonville Road. Flows continue in the roadside ditch ultimately reach an existing 30" CMP cross culvert to the north.

**Existing Basin A14** is located at the northeast corner of the site, along the eastern boundary.

Flows generated by this basin ( $Q_5=4.9$  cfs and  $Q_{100}=35.9$  cfs) are directed east to **Design Point DP12** along the eastern boundary of Filing 10, before discharging into the roadside ditch along Eastonville Road. Flows ultimately reach an existing 30" CMP cross culvert to the south.

**Basin OSA3** is the offsite basin just north of Basin A12. Flows generated by this basin ( $Q_5=10.6$  cfs and  $Q_{100}=18.9$  cfs) are directed east to **Design Point DPOSA3**, along the eastern boundary of Filing 10, before discharging into the roadside ditch along Eastonville Road.

**Existing Basin A15** covers a small 0.61-acre area at the northwestern corner of Filing 10. This basin sits within the Upper Black Squirrel drainage basin. Flows generated by this basin ( $Q_5=0.2$  cfs and  $Q_{100}=1.2$  cfs) follow natural drainage paths to the northwest into the adjacent future Filing 12.

## 9.0 DEVELOPED CONDITION

In the developed condition, as with the adjacent filings, the majority of the generated flows are designed to be collected in roadside ditches and conveyed to the proposed detention areas. Basins along the south side of Conestoga Trail South and the east side of Irish Hunter Trail cover lot areas outside of the roadway. As these areas are proposed as large lot single family sites (2.5-acre lots with imperviousness less than 10%) ECM I.7.1.B.5 applies and the areas are considered excluded from post-construction stormwater management requirements.

Roadside and conveyance ditches have been designed in accordance with County criteria and sized to accommodate developed flows with 1' of freeboard above the water surface elevation. Ditches with flowrates greater than 5fps will be reinforced with SC250 Vmax TRM (Turf Reinforcement Mat), or equivalent.

Cross culverts at Conestoga Trail South and Irish Hunter Trail have been designed to not overtop the roadway during the 100-year storm event. The inlets and outlets of the proposed culverts will be protected with riprap to aid in erosion control. Future driveway culverts have been sized with an overtopping allowance of 6" during the 100-year storm event, and sizing requirements are tabulated in the appendix. Future engineered site plans for the individual lots will provide final details for the driveway locations and culverts that will be constructed by others. Detailed swale, culvert and riprap calculations, sections and TRM specifications are included in the appendix.

For the purposes of site specific analysis, the project site has been divided into several grouped drainage basins as shown on the proposed drainage plan. **A-group basins** represent flows for basins that are part of Filing 10, along with offsite basins from adjacent filings and **B-group basins** represent flows for basins that are part of future Filing 11. These basins are considered in their anticipated future developed condition for the purposes of this analysis. Development of Filing 11 will require confirmation that the actual developed condition does not adversely affect the downstream drainage design presented in this report.

### Rational Method Runoff Summary

BASIN	DP	Area (Ac.)	Q <sub>5</sub> (CFS)	Q <sub>100</sub> (CFS)
OSA1	OSA1	3.68	3.6	7.9
OSA2	OSA2	96.30	29.4	127.3
OSA3	OSA3	69.15	29.3	113.4
OSA4	OSA4	32.65	16.0	60.5
OSA5	OSA5	11.33	7.3	28.1
A1		13.55	7.2	29.0
	1	226.18	69.0	279.5
A2		7.24	3.9	14.8
	2	237.10	73.7	291.8
South Pond Out	2A		17.0	293.5
A3	3	6.48	3.1	13.5
A4		6.03	3.3	13.0
	4	7.26	3.8	16.5
A5		8.02	4.3	17.5
	5	13.26	6.7	27.8
	5A	20.52	9.5	40.0
A6	6	4.02	2.1	7.9
	6A	24.53	10.2	42.3
A7	7	0.63	0.7	2.0
A8	8	7.21	3.2	12.8
	8A	32.36	13.3	54.3
A9	9	3.23	4.3	9.7
A10		0.58	0.1	1.1
	10	36.18	17.1	63.1
A10A		1.49	0.8	3.4
G14b Out			0.2	52.1
	10A	1.49	1.0	55.5
A11		3.61	1.9	7.9
	11	5.20	2.7	11.3
A12	12	2.36	1.4	5.5
	12A	7.56	3.8	15.4
A13		3.34	1.8	7.3
	13	10.48	6.3	24.2
	13A	18.04	9.4	36.9
A14	14	1.25	2.2	4.9
	14A	19.29	10.7	39.2
A15		4.16	1.7	7.8

BASIN	DP	Area (Ac.)	Q <sub>5</sub> (CFS)	Q <sub>100</sub> (CFS)
	15	23.45	11.5	43.4
A15A		2.08	1.1	4.6
G18 Out			0.1	27.1
	15A	2.08	1.2	31.7
A16	16	4.41	1.9	8.2
A17	17	4.02	2.1	8.9
A18	18	1.81	0.9	4.1
A19	19	2.40	1.1	4.7
A20	20	2.18	1.5	5.4
A21	21	0.73	0.7	2.2
A22	22	2.03	1.1	4.7
A23		0.44	0.2	1.1
	23	3.21	1.9	7.5
OSA6	OSA6	0.81	0.6	2.3
A24		11.59	6.6	26.3
	24	19.51	10.1	41.6
	24A	20.33	10.6	43.4
A25	25	1.61	2.8	6.3
	25A	21.94	11.4	42.9
A26		4.70	2.1	9.4
	26	26.64	12.4	47.9
A26A		1.00	0.6	2.6
G19 Out			0.1	34.3
	26A	1.00	0.7	36.9
A27	27	5.25	2.6	11.4
A28	28	2.75	1.4	5.9
A29	29	4.75	2.3	10.0
A30	30	0.61	0.3	1.3
OSA7	OSA7	2.44	1.2	5.1
B1	B1	3.20	1.9	8.0
B2	B2	0.78	0.5	2.1
B3	B3	5.24	2.9	12.5
B4	B4	7.14	5.0	18.9
B5	B5	1.59	1.0	4.2
B6	B6	7.92	4.4	19.0

**Basin OSA1** is an offsite basin covering 3.68 acres of Conestoga Trail South to the west of the project site. Flows generated by this basin (Q<sub>5</sub>=3.6 cfs and Q<sub>100</sub>=7.9 cfs) travel via roadside ditch to the south and east before entering Filing 10 at **Design Point DPOSA1**. The roadside ditch from this point is proposed as a triangular section with a minimum of 2' depth to accommodate flows and provide for 1' freeboard.

**Basin OSA2** is an offsite basin covering 92.80 acres of Filing 9 to the north of Conestoga Trail South. Flows generated by this basin (Q<sub>5</sub>=29.4 cfs and Q<sub>100</sub>=127.3 cfs) ultimately travel via

roadside ditch to the south and east before entering Filing 10 at **Design Point DPOSA2**. The roadside ditch from this point is proposed as a triangular section with a minimum of 3' depth to accommodate flows and provide for 1' freeboard. As the velocity exceeds 5fps, this section will be reinforced with TRM as described above.

**Basin OSA3** is an offsite basin covering 69.15 acres of Filing 2-B to the northwest of Filing 10. Flows generated by this basin ( $Q_5=29.3$  cfs and  $Q_{100}=113.4$  cfs) travel via roadside ditch and cross lot drainage ditch to the southeast before entering Filing 10 at **Design Point DPOSA3**. Flows continue on from this point via a redefined trapezoidal ditch with a 10' bottom width and 4:1 side slopes to the southeast. This stretch of ditch through will be reinforced with TRF as described above.

**Basin OSA4** is an offsite basin covering 32.65 acres of Filing 7-A to the northwest of Filing 10. Flows generated by this basin ( $Q_5=16.0$  cfs and  $Q_{100}=60.5$  cfs) travel via roadside ditch and cross lot drainage ditch to the southeast before entering Filing 10 at **Design Point DPOSA4**. Flows continue on from this point via a redefined trapezoidal ditch with a 6' bottom width and 4:1 side slopes to the south. This stretch of ditch through will be reinforced with TRF as described above.

**Basin OSA5** is an offsite basin covering 11.33 acres of Filing 7-A to the north of Filing 10. Flows generated by this basin ( $Q_5=7.3$  cfs and  $Q_{100}=28.1$  cfs) travel via roadside ditch and cross lot drainage ditch to the south before entering Filing 10 at **Design Point DPOSA5**.

**Basin B1** is a 3.20-acre offsite basin located in future Filing 12. This basin is considered in its developed condition in order to adequately size the downstream facilities. Flows generated by this basin ( $Q_5=1.9$  cfs and  $Q_{100}=8.0$  cfs) follow natural drainage patterns to the southwest before entering Filing 10 at **Design Point DPB1**.

**Basin A1** is a 13.55-acre onsite basin covering the majority of proposed Lots 22 through 26, north of Conestoga Trail South. Flows generated by this basin ( $Q_5=7.2$  cfs and  $Q_{100}=29.0$  cfs) combine with those from offsite basins OS2-OS5 and Basin B1 and generally follow natural drainage patterns, some redefined, to the south towards **Design Point DP1**. The roadside ditch along the southern boundary of this basin is proposed as a triangular section with a minimum of 4' depth to accommodate flows and provide for 1' freeboard. As the velocity exceeds 5fps, this section will be reinforced with TRM as described above.

**Design Point DP1** represents the combined flows of Basins OSA3-OS5, B1 and A1. Flows continue from this point via the proposed 4-36" culverts that crosses under Conestoga Trail South. From there, a redefined trapezoidal ditch with a 10' bottom width and 4:1 side slopes will direct flows towards the existing South Pond detention facility. This stretch of ditch through Lot 2 will be reinforced with TRF as described above. The existing low-tailwater drop structure is sufficient to accommodate these flows.

**Basin A2** (7.24-acres) covers Lot 18 and a portion of proposed Lot 19, south of Conestoga Trail South, along with the South Pond detention facility. Flows generated by this basin ( $Q_5=3.9$  cfs and  $Q_{100}=14.8$  cfs) are directed to the South Pond at **Design Point DP2**.

**Design Point DP2** is located at the bottom of the South Pond and represents the flows from Basins OS1 and A2 in addition to those from DP1 to the north. See further discussion below

The discharge at DP3 appears higher than at DP1 (historical data). Water detention is required, and the exclusion applies only to water treatment, not detention. This comment applies to the basin highlighted in the table.

for facility design and discharge rates.

**Basin A3** (6.48-acres) covers Lots 20 & 21 and a portion of Lot 19, south of Conestoga Trail South. Flows generated by this basin ( $Q_5=3.1$  cfs and  $Q_{100}=13.5$  cfs) follow natural drainage patterns to the south and **Design Point DP3**. This basin covers large lots outside of any roadway, and as such ECM 1.7.1.B.5 applies, allowing drainage from this lot to discharge without detention or treatment. See below for a comparison of flows at similar design points in the existing and developed condition.

**Basin B2** is a 0.78-acre offsite basin located in future Filing 12 to the north of Filing 10. This basin is considered in its developed condition in order to adequately size the downstream facilities. Flows generated by this basin ( $Q_5=0.5$  cfs and  $Q_{100}=2.1$  cfs) follow natural drainage patterns to the south and **Design Point DP2**.

**Basin A4** (6.03-acres) covers the majority of Lots 27 & 28, north of Conestoga Trail South. Flows generated by this basin ( $Q_5=3.3$  cfs and  $Q_{100}=13.0$  cfs) combine with those from upstream basin B2 and follow natural drainage paths to the south where they are captured by the roadside ditch and carried east to **Design Point DP4**.

**Design Point DP4** represents the combined flows of Basins A4 and B2. Flows continue from this point via roadside ditch to the east. The roadside ditch from this point is proposed as a triangular section with a minimum of 2' depth to accommodate flows and provide for 1' freeboard.

**Basin B3** is a 5.24-acre offsite basin located in future Filing 12 to the north of Filing 10. This basin is considered in its developed condition in order to adequately size the downstream facilities. Flows generated by this basin ( $Q_5=2.9$  cfs and  $Q_{100}=12.5$  cfs) follow natural drainage patterns to the southeast and **Design Point DP3**.

**Basin A5** (8.02-acres) covers the majority of Lots 29-31, north of Conestoga Trail South. Flows generated by this basin ( $Q_5=4.3$  cfs and  $Q_{100}=17.5$  cfs) combine with those from basin B3 and follow natural drainage paths to the south where they are captured by the roadside ditch and carried east to **Design Point DP5**.

**Design Point DP5** represents the combined flows of Basins A5 and B3.

**Design Point DP5A** is located where the flows leave Basin A5 and represents the combined flows from DP4 and DP5. Flows continue from this point via roadside ditch to the east. The roadside ditch from this point is proposed as a triangular section with a minimum of 2.5' depth to accommodate flows and provide for 1' freeboard.

**Basin A6** (4.02-acres) covers the majority of Lot 32 and portions of Lots 31 & 33, north of Conestoga Trail South. Flows generated by this basin ( $Q_5=2.1$  cfs and  $Q_{100}=7.9$  cfs) are directed south where they are captured by the roadside ditch and carried east to **Design Point DP6**.

**Design Point DP6A** is located where the flows leave Basin A6 and represents the combined flows of DP5A and DP6. Flows continue from this point via roadside ditch to the east. The roadside ditch from this point is proposed as a triangular section with a minimum of 2.5'

depth to accommodate flows and provide for 1' freeboard. As the velocity exceeds 5fps, this section will be reinforced with TRM as described above.

**Basin A7** (0.63-acres) covers the eastern side of Irish Hunter Trail just north of Conestoga Trail South. Flows generated by this basin ( $Q_5=0.7$  cfs and  $Q_{100}=2.0$  cfs) follow the roadside ditch to the south where they are intercepted by a proposed public 18" culvert at **Design Point DP7**. Flows continue to the west via the culvert towards Basin A8. The roadside ditch along the west side of this basin is proposed as a triangular section with a minimum of 1.5' depth to accommodate flows and provide for 1' freeboard. As the velocity exceeds 5fps, this section will be reinforced with TRM as described above.

**Basin A8** (7.21-acres) covers the majority of Lots 34 & 35 and portions of Lots 32 & 33, at the northwest intersection of Conestoga Trail South & Irish Hunter Trail. Flows generated by this basin ( $Q_5=3.2$  cfs and  $Q_{100}=12.8$  cfs) follow natural drainage paths to the south & east where they are captured by the roadside ditches and carried to the southeast corner and **Design Point DP8**. The roadside ditch along the southern edge of this basin is proposed as a triangular section with a minimum of 3' depth to accommodate flows and provide for 1' freeboard. As the velocity exceeds 5fps, this section will be reinforced with TRM as described above.

**Design Point DP8A** represents the combined flows of DP 6A, 7 and 8. Flows continue southeast from this point via proposed public 36" culvert to ultimately reach the proposed G14b detention facility.

**Basin A9** (3.23-acres) covers the southern half of Conestoga Trail and northern portion of Lots 12 through 17. Flows generated by this basin ( $Q_5=4.3$  cfs and  $Q_{100}=9.7$  cfs) are directed to the roadside ditch and carried east towards a proposed Type D area inlet and low point at **Design Point DP9**. The roadside ditch along this basin is proposed as a triangular section with a minimum of 2' depth to accommodate flows and provide for 1' freeboard.

**Basin A10** covers a portion of Lots 11 & 12, south of Conestoga Trail South, and proposed detention facility G14b. Flows generated by this basin ( $Q_5=0.1$  cfs and  $Q_{100}=1.1$  cfs) are directed to the proposed G14b detention facility at **Design Point DP10**.

**Design Point DP10** is located at the bottom of Pond G14b and represents the flows from DP8A, 9 and 10. See further discussion below for facility design and discharge rates.

**Basin A10A** covers the portion of Lots 11 & 12, that will not drain to the G14b detention facility. Flows generated by this basin ( $Q_5=0.8$  cfs and  $Q_{100}=3.4$  cfs) will follow natural drainage patterns to the south towards **Design Point 10A** along the southern boundary of Filing 10, where they will combine with the discharge flows from G14b detention facility ( $Q_5=0.2$  cfs and  $Q_{100}=52.1$  cfs). This basin covers large lots outside of any roadway, and as such ECM I.7.1.B.5 applies, allowing drainage from this lot to discharge without detention or treatment. See below for a comparison of flows at similar design points in the existing and developed condition.

**Basin B5** is a 1.59-acre offsite basin located in future Filing 12 to the west of Filing 10. This basin is considered in its developed condition in order to adequately size the downstream facilities. Flows generated by this basin ( $Q_5=1.0$  cfs and  $Q_{100}=4.2$  cfs) follow natural

drainage paths to the southeast and **Design Point DPB5**.

**Basin A11** (3.61-acres) covers the majority of Lot 38 and a portion of Lot 39, west of Irish Hunter Trail. Flows generated by this basin ( $Q_5=1.9$  cfs and  $Q_{100}=7.9$  cfs) combine with those from upstream Basin B5 and follow natural drainage paths to the west where they are intercepted by the roadside ditch and carried to the south to **Design Point DP11**. The roadside ditch from this point is proposed as a triangular section with a minimum of 2' depth to accommodate flows and provide for 1' freeboard.

**Design Point DP11** is located where the flows leave Basin A11 and represents the combined flows of Basins A11 and B5.

**Basin A12** (2.36-acres) covers the majority of Lot 37 and a portion of Lot 36, west of Irish Hunter Trail. Flows generated by this basin ( $Q_5=1.4$  cfs and  $Q_{100}=5.5$  cfs) are directed east where they are captured by the roadside ditch and carried to the south to **Design Point DP12**. The roadside ditch along this basin is proposed as a triangular section with a minimum of 2' depth to accommodate flows and provide for 1' freeboard.

**Design Point DP12A** is located where the flows leave Basin A12 and represents the combined flows of DP11 and DP12.

**Basin B4** is a 7.14-acre offsite basin located in future Filing 12 to the west of Filing 10. This basin is considered in its developed condition in order to adequately size the downstream facilities. Flows generated by this basin ( $Q_5=5.0$  cfs and  $Q_{100}=18.9$  cfs) will follow natural drainage patterns to the southeast and **Design Point DPB4**. The future development of Filing 12 currently proposed a cul-de-sac and redefined drainage channel for Basin B4. Future design of Filing 12 will need to be analyzed at that time to confirm compatibility with this Filing 10.

**Basin A13** covers the majority of Lot 36 and a portion of Lots 35 & 37, west of Irish Hunter Trail. Flows generated by this basin ( $Q_5=1.8$  cfs and  $Q_{100}=7.3$  cfs) combine with those from Basin B4 and are directed east via redefined drainage channel where they are captured by the roadside ditch and carried to **Design Point DP13**. The roadside ditch along this basin is proposed as a triangular section with a minimum of 2.5' depth to accommodate flows and provide for 1' freeboard. As the velocity exceeds 5fps, this section will be reinforced with TRM as described above. The redefined drainage ditch through this area has been designed as a trapezoidal ditch with a 3' bottom width and 4:1 side slopes.

**Design Point DP13A** is located where the flows leave Basin A13 at a 36" culvert that crosses under Irish Hunter Trail to the east and represents the combined flows of DPB4, 12A and 13.

**Basin A14** covers the eastern half of Irish Hunter Trail and the western portion of Lots 5-8. Flows generated by this basin ( $Q_5=2.2$  cfs and  $Q_{100}=4.9$  cfs) are directed to the roadside ditch and carried to the south towards **Design Point DP14**. The roadside ditch from this point is proposed as a triangular section with a minimum of 2' depth to accommodate flows and provide for 1' freeboard.

**Design Point DP14A** is located where the flows leave Basin A14 and represents the combined flows from DP13A and 14. Flows continue on from this point via a redefined

trapezoidal ditch with a 3' bottom width and 4:1 side slopes, and will direct flows towards the proposed G18 detention facility. This stretch of ditch through will be reinforced with TRF as described above. A low-tailwater drop structure will receive these flows before discharge into the proposed detention facility.

**Basin A15** covers Lots 6 through 8 and a portion of Lots 9 & 10, east of Irish Hunter Trail, along with the proposed detention facility G18. Flows generated by this basin ( $Q_5=4.8$  cfs and  $Q_{100}=21.0$  cfs) follow natural drainage paths that carry the flows to **Design Point DP15**.

**Design Point DP15** is located at the bottom of Pond G18 and represents the flows from DP14A and Basin A15.

**Basin A15A** covers the portion of Lots 6, 8, 9 & 10, that will not drain to the G18 detention facility. Flows generated by this basin ( $Q_5=1.1$  cfs and  $Q_{100}=4.6$  cfs) will follow natural drainage patterns to the east towards **Design Point 15A** along the eastern boundary of Filing 10, where they will combine with the discharge flows from G18 detention facility ( $Q_5=0.1$  cfs and  $Q_{100}=27.1$  cfs). This basin covers large lots outside of any roadway, and as such ECM 1.7.1.B.5 applies, allowing drainage from this lot to discharge without detention or treatment. See below for a comparison of flows at similar design points in the existing and developed condition.

**Basin A16** covers the majority of Lots 16 & 17, south of Conestoga Trail South. Flows generated by this basin ( $Q_5=1.9$  cfs and  $Q_{100}=8.2$  cfs) follow natural drainage patterns to the south and **Design Point DP16** along the southern boundary of Filing 10. This basin covers large lots outside of any roadway, and as such ECM 1.7.1.B.5 applies, allowing drainage from this lot to discharge without detention or treatment. See below for a comparison of flows at similar design points in the existing and developed condition.

**Basin A17** covers the majority of Lots 14 & 15, south of Conestoga Trail South. Flows generated by this basin ( $Q_5=2.1$  cfs and  $Q_{100}=8.9$  cfs) are directed south to **Design Point DP17** along the southern boundary of Filing 10. This basin covers large lots outside of any roadway, and as such ECM 1.7.1.B.5 applies, allowing drainage from this lot to discharge without detention or treatment. See below for a comparison of flows at similar design points in the existing and developed condition.

**Basin A18** covers a portion of Lots 13 & 14, south of Conestoga Trail South. Flows generated by this basin ( $Q_5=0.9$  cfs and  $Q_{100}=4.1$  cfs) are directed south to **Design Point DP18** along the southern boundary of Filing 10. This basin covers large lots outside of any roadway, and as such ECM 1.7.1.B.5 applies, allowing drainage from this lot to discharge without detention or treatment. See below for a comparison of flows at similar design points in the existing and developed condition.

**Basin A19** covers a portion of Lots 12 & 13, south of Conestoga Trail South. Flows generated by this basin ( $Q_5=1.1$  cfs and  $Q_{100}=4.7$  cfs) are directed south to **Design Point DP19** along the southern boundary of Filing 10. This basin covers large lots outside of any roadway, and as such ECM 1.7.1.B.5 applies, allowing drainage from this lot to discharge without detention or treatment. See below for a comparison of flows at similar design points in the existing and developed condition.



**Basin A20** covers a portion of Lots 9 & 10, north of Conestoga Trail South. Flows generated by this basin ( $Q_5=1.1$  cfs and  $Q_{100}=4.8$  cfs) are directed south where they are captured by the roadside ditch and carried east to **Design Point DP20** before discharging into the existing roadside ditch along Eastonville Road. As this is an area of roadway that is not able to be treated by a proposed detention facility, runoff reduction calculations have been included to indicate that 100% runoff reduction will be achieved in this location. The roadside ditch along this basin is proposed as a triangular section with a minimum of 2' depth to accommodate flows and provide for 1' freeboard.

**Basin A21** covers the southern half of Conestoga Trail and northern portion of Lot 11. Flows generated by this basin ( $Q_5=0.7$  cfs and  $Q_{100}=2.2$  cfs) are directed to the roadside ditch and carried east to **Design Point DP21** before discharging into the existing roadside ditch along Eastonville Road. As this is an area of roadway that is not able to be treated by a proposed detention facility, runoff reduction calculations have been included to indicate that 100% runoff reduction will be achieved in this location. The roadside ditch along this basin is proposed as a triangular section with a minimum of 1.5' depth to accommodate flows and provide for 1' freeboard.

**Basin A22** covers the majority of Lot 11, south of Conestoga Trail South. Flows generated by this basin ( $Q_5=1.1$  cfs and  $Q_{100}=4.7$  cfs) follow natural drainage patterns south to **Design Point DP22** along the southern boundary of Filing 10. This basin covers large lots outside of any roadway, and as such ECM 1.7.1.B.5 applies, allowing drainage from this lot to discharge without detention or treatment. See below for a comparison of flows at similar design points in the existing and developed condition.

**Basin A23** covers a portion of Lot 11, south of Conestoga Trail South. Flows generated by this basin ( $Q_5=0.2$  cfs and  $Q_{100}=1.1$  cfs) are directed east to **Design Point DP23** before discharging into the existing roadside ditch along Eastonville Road. This basin covers a portion of Lot 11 along Eastonville Road that is encumbered by easements and setbacks, as such it can be considered to remain undeveloped and not subject to any permanent stormwater treatment requirements.

**Basin OSA6** is an offsite basin just north of Lot 43, west of Irish Hunter Trail at the north end of Filing 10. This basin is considered in its developed condition in order to adequately size the downstream facilities. Flows generated by this basin ( $Q_5=0.6$  cfs and  $Q_{100}=2.3$  cfs) follow natural drainage paths to the south and **Design Point DPOSA6**.

**Basin B6** is a 7.92-acre offsite basin located in future Filing 12 to the west of Filing 10. This basin is considered in its developed condition in order to adequately size the downstream facilities. Flows generated by this basin ( $Q_5=4.4$  cfs and  $Q_{100}=19.0$  cfs) are directed to **Design Point DPB6**.

**Basin A24** covers the majority of Lots 39 through 43, west of Irish Hunter Trail. Flows generated by this basin ( $Q_5=6.6$  cfs and  $Q_{100}=26.3$  cfs) combine with those from OSA6 and Basin B6 and follow natural drainage paths to the east where they are captured by the roadside ditch and carried south to a low point at **Design Point DP24**. The roadside ditch along this basin is proposed as a triangular section with a minimum of 2.5' depth to accommodate flows and provide for 1' freeboard. As the velocity exceeds 5fps, this section will be reinforced with TRM as described above.

**Design Point DP24A** is located where the flows leave Basin A24 via a 36" culvert that crosses under Irish Hunter Trail to the east and represents the combined flows of DPB6, DP24 and OSA2. Flows continue on from this point via a redefined trapezoidal ditch with a 3' bottom width and 4:1 side slopes, and will direct flows towards the proposed G19 detention facility. A low-tailwater drop structure will receive these flows before discharge into the proposed detention facility.

**Basin A25** covers the eastern half of Irish Hunter Trail and the western portion of Lots 1-4. Flows generated by this basin ( $Q_5=2.48$  cfs and  $Q_{100}=6.3$  cfs) are directed to the roadside ditch and carried to a low point at **Design Point DP25**. The roadside ditch along this basin is proposed as a triangular section with a minimum of 2.5' depth to accommodate flows and provide for 1' freeboard.

**Design Point DP25A** is located where the flows leave Basin A25 via a redefined drainage ditch and represents the combined flows from DP24A and DP25.

**Basin A26** covers Lots 1 through 4, east of Irish Hunter Trail. Flows generated by this basin ( $Q_5=5.1$  cfs and  $Q_{100}=22.1$  cfs) are directed to **Design Point DP26**.

**Design Point DP26** is located at the bottom of Pond G19 and represents the flows from DP25A, OSA4 and Basin A26.

**Basin A26A** covers the portion of Lots 1-4, that will not drain to the G19 detention facility. Flows generated by this basin ( $Q_5=0.6$  cfs and  $Q_{100}=2.6$  cfs) will follow natural drainage patterns to the east towards **Design Point 26A** along the eastern boundary of Filing 10, where they will combine with the discharge flows from G19 detention facility ( $Q_5=0.1$  cfs and  $Q_{100}=34.3$  cfs). This basin covers large lots outside of any roadway, and as such ECM 1.7.1.B.5 applies, allowing drainage from this lot to discharge without detention or treatment. See below for a comparison of flows at similar design points in the existing and developed condition.

**Basin OSA7** is an offsite basin just north of Lot 1, east of Irish Hunter Trail. Flows generated by this basin ( $Q_5=1.2$  cfs and  $Q_{100}=5.1$  cfs) follow natural drainage patterns to the east and **Design Point DPOSA7**. This basin is not being developed as part of Filing 10, but is considered due to the proximity of the major basin line to the north. See below for a comparison of flows at similar design points in the existing and developed condition.

**Basin A30** covers a small 0.61-acre area at the northwestern corner of Filing 10. This basin sits within the Upper Black Squirrel drainage basin. Flows generated by this basin ( $Q_5=0.3$  cfs and  $Q_{100}=1.3$  cfs) will follow natural drainage paths to the northwest into the adjacent Filing 12. This area will need to be analyzed as part of the Filing 12 development to ensure adequate sizing of downstream facilities.

See below for a comparison of flows at similar design points in the existing and developed condition.

## Flow Comparison

Existing			Developed		
DP	Q <sub>5</sub> (CFS)	Q <sub>100</sub> (CFS)	DP	Q <sub>5</sub> (CFS)	Q <sub>100</sub> (CFS)
1	1.6	12.1	3	3.1	13.5
2	76.4	299.0	2A	17.0	293.5
3	2.4	18.0	16	1.9	8.2
4	1.0	7.5	17	2.1	8.9
5	2.9	21.4	18	0.9	4.1
6	1.7	12.7	19	1.1	4.7
7	3.9	28.7	10A	1.0	55.5
8	0.6	4.3	22	1.1	4.7
9	0.6	4.3	20	1.5	5.4
			21	0.7	2.2
			23	1.9	7.5
10	1.7	12.7	15A	1.2	31.7
11	1.6	12.1	29	2.3	10.0
12	2.3	17.1	28	1.4	5.9
13	4.8	35.4	26A	0.7	36.9
14	1.8	12.9	27	2.6	11.4

### **South boundary combined**

Existing			Developed		
DP	Q <sub>5</sub> (CFS)	Q <sub>100</sub> (CFS)	DP	Q <sub>5</sub> (CFS)	Q <sub>100</sub> (CFS)
1-8	90.6	403.6		28.1	393.0

### **East boundary combined**

Existing			Developed		
DP	Q <sub>5</sub> (CFS)	Q <sub>100</sub> (CFS)	DP	Q <sub>5</sub> (CFS)	Q <sub>100</sub> (CFS)
8-14	12.9	94.5		12.2	111.0

## **10.0 PROPOSED FULL-SPECTRUM DETENTION FACILITIES**

### **Existing South Pond**

The existing South Pond was originally built with the development of Filing 7 and re-analyzed with the development of Filing 9 with modifications currently under construction. The Filing 9 analysis determined that an upstream watershed of 237.1-acres at 13.8% impervious was tributary to the South Pond, resulting in developed flows of Q<sub>5</sub>=92 cfs and Q<sub>100</sub>=347 cfs. This analysis accounts for the final design of this filing and results in a slightly lower imperviousness (13.3%) and subsequent flowrates (Q<sub>5</sub>=74 cfs and Q<sub>100</sub>=292 cfs). The MHFD spreadsheet with the modified imperviousness has been included in the appendix for reference, but as the impact to the detention facility is minor, no changes are proposed.

### **Proposed Pond G14b**

The G14b facility is proposed as a private full-spectrum Extended Detention Basin (EDB). MHFD-Detention v4.06 calculations are provided in the appendix. Based on a watershed area of 35.73 acres, with an effective site imperviousness of 14.879%, the required pond

volume for 100-yr detention is 1.57 acre-ft.

Flows enter the facility via 36" storm pipe and discharge directly into a concrete forebay. The forebay volume was calculated based on 3% of the WQCV volume. The forebay includes a dissipater as the flows enter, and a notch through which to exit to the trickle channel. In order to release the flows from the forebay at 2% of the peak 100-yr inflow the forebay has a minimum 6" wide notch. A 7' wide concrete trickle channel will run along the bottom of the pond from the forebay to the micropool.

The outlet structure will consist of a modified Type C outlet structure with an orifice plate and a grate on top. The orifice plate will have two 2.44 sq. inch orifices. The elevation of the grate is set at 7065.00, which is below the 100-year detention volume elevation. The outlet pipe has been set as a 36" private storm pipe that will release the 100-year flow at 100% of the predeveloped 100-year runoff rate, in accordance with drainage criteria. The outlet pipe discharges to the south following historic drainage patterns. A level spreader will be installed just downstream of the pipe outfall to mitigate the impact of the concentrated discharge point downstream. With these release rates the WQCV will drain in 40 hours, the EURV in 62 hours, and the 100-year storm volume in 77 hours. Given the smaller change in impervious coverage between the pre-developed and developed condition, the WQCV drain time becomes the controlling factor for the orifice plate. The lowest orifice hole has been sized to release the WQCV within 40 hours, the second hole is sized accordingly and results in a 62 hour release rate for the EURV.

A 25' long spillway is located on the south side of the pond and is placed 1.85' below the crest of the pond to allow for 1' of freeboard above the spillway design flow depth. In the event that water overtops the spillway, it will discharge to the south following historic drainage patterns.

### **Proposed Pond G18**

The G18 facility is proposed as a private full-spectrum Extended Detention Basin (EDB). MHFD-Detention v4.06 calculations are provided in the appendix. Based on a watershed area of 23.45 acres, with an effective site imperviousness of 13.47%, the required pond volume for 100-yr detention is 0.98 acre-ft.

In place of a standard concrete forebay, a riprap low-tailwater basin (LTWB) is proposed at the base of the riprap rundown into the detention facility. This LTWB design was based on sizing guidance from MHFD Volume 2, Figures 9-37 and 9-39, equating the trapezoidal swale wetted perimeter as equivalent to a rectangular box culvert.

<b>Pond G18</b>	<b>Top Width (ft)</b>	<b>Flow Depth + 1' freeboard (ft)</b>
Trapezoidal Swale	11.8	2.1
Equivalent Box Culvert	12.0	2.5

From there, LTWB sizing was determined as D=1.5', W=12' and L=20', to be protected by Type L riprap. See appendix for calculations. The LTWB is proposed to discharge into a 6-ft wide concrete trickle channel along the bottom of the facility towards the proposed micropool and outlet structure.

The outlet structure will consist of a modified Type C outlet structure with an orifice plate and a grate on top. The orifice plate will have two 1.57 sq. inch orifices. The elevation of the grate is set at 7058.00, which is below the 100-year detention volume elevation. The outlet pipe has been set as a 36" private storm pipe that will release the 100-year flow at 100% of the predeveloped 100-year runoff rate, in accordance with drainage criteria. The outlet pipe discharges to the east into the roadside ditch along the west side of Eastonville Road following historic drainage patterns. With these release rates the WQCV will drain in 40 hours, the EURV in 62 hours, and the 100-year storm volume in 92 hours. Given the smaller change in impervious coverage between the pre-developed and developed condition, the WQCV drain time becomes the controlling factor for the orifice plate. The lowest orifice hole has been sized to release the WQCV within 40 hours, the second hole is sized accordingly and results in a 62 hour release rate for the EURV.

A 20' long spillway is located on the east side of the pond and is placed 1.74' below the crest of the pond to allow for 1' of freeboard above the spillway design flow depth. In the event that water overtops the spillway, it will discharge to the east following historic drainage patterns.

Maintenance access will be provided and is further outlined in the detention facility construction documents.

**Proposed Pond G19**

The G19 facility is proposed as a private full-spectrum Extended Detention Basin (EDB). MHFD-Detention v4.06 calculations are provided in the appendix. Based on a watershed area of 26.64 acres, with an effective site imperviousness of 12.75%, the required pond volume for 100-yr detention is 1.083 acre-ft.

In place of a standard concrete forebay, a riprap low-tailwater basin (LTWB) is proposed at the base of the riprap rundown into the detention facility. This LTWB design was based on sizing guidance from MHFD Volume 2, Figures 9-37 and 9-39, equating the trapezoidal swale wetted perimeter as equivalent to a rectangular box culvert.

<b>Pond G19</b>	<b>Top Width (ft)</b>	<b>Flow Depth + 1' freeboard (ft)</b>
Trapezoidal Swale	11.8	2.1
Equivalent Box Culvert	12.0	2.5

From there, LTWB sizing was determined as D=1.5', W=12' and L=20', to be protected by Type L riprap. See appendix for calculations. The LTWB is proposed to discharge into a 6-ft wide concrete trickle channel along the bottom of the facility towards the proposed micropool and outlet structure.

The outlet structure will consist of a modified Type C outlet structure with an orifice plate and a grate on top. The orifice plate will have two 1.83 sq. inch orifices. The elevation of the grate is set at 7057.75, which is below the 100-year detention volume elevation. The outlet pipe has been set as a 36" private storm pipe that will release the 100-year flow at 100% of the predeveloped 100-year runoff rate, in accordance with drainage criteria.

The outlet pipe discharges to the east into the roadside ditch along the west side of Eastonville Road following historic drainage patterns. With these release rates the WQCV will drain in 40 hours, the EURV in 61 hours, and the 100-year storm volume in 99 hours. Given the smaller change in impervious coverage between the pre-developed and developed condition, the WQCV drain time becomes the controlling factor for the orifice plate. The lowest orifice hole has been sized to release the WQCV within 40 hours, the second hole is sized accordingly and results in a 61 hour release rate for the EURV.

A 25' long spillway is located on the east side of the pond and is placed 1.85' below the crest of the pond to allow for 1' of freeboard above the spillway design flow depth. In the event that water overtops the spillway, it will discharge to the east following historic drainage patterns.

Maintenance access will be provided and is further outlined in the detention facility construction documents.

## 11.0 FOUR-STEP PROCESS

- 1. Employ Runoff Reduction Practices:** The development of this project is proposed as single-family residential (2.5-acre). Roadways will utilize grass-lined roadside ditches to minimize directly connected impervious areas within the project site, while allowing for increased infiltration and reduced runoff volume.
- 2. Implement CM's that provide a Water Quality Capture Volume with slow release:** The majority of runoff generated by this project will be treated through capture and slow release of the WQCV in one of 3 permanent full spectrum extended detention facilities designed per current drainage criteria. The areas tributary to each of the detention facilities is described above. **4: 3 proposed, 1 existing**
- 3. Stabilize Drainage Ways:** This site will utilize roadside ditches with culvert crossings throughout the site. The roadside ditches will direct developed flows to the detention facilities, to be released at or below historic rates. In reaches where velocities exceed 4fps, the ditches are proposed to be reinforced with turf reinforcement mats.
- 4. Implement Site Specific and Other Source Control CM's:** Standard residential source control will be utilized in order to minimize potential pollutants entering the drainage system. Site specific permanent and temporary source control BMPs will be established by the Stormwater Quality and Control Plan for the project to protect receiving waters.

## 12.0 DRAINAGE/BRIDGE FEES

The Gieck Ranch Basin (CHMS0400) is not in the El Paso County Drainage Basin Fee program, and as such no drainage or bridge fees are due at the time of plat recordation.

## 13.0 REFERENCES

The sources of information used in the development of this study are listed below:

1. El Paso County Drainage Criteria Manual, October 2018.
2. El Paso County Engineering Criteria Manual, October 2020.
3. Urban Storm Drainage Criteria Manuals, Urban Drainage and Flood Control District. June 2001, Revised April 2008.
4. Natural Resources Conservation Service (NRCS) Web Soil Survey
5. Final Drainage Report for The Trails Filing No. 7 Subdivision, by URS, March 2005.
6. Final Drainage Report for Latigo Trails Filing No. 9 and Addendum to Master Development/Preliminary Drainage Plan, by JR Engineering, March 2023.

## Appendix



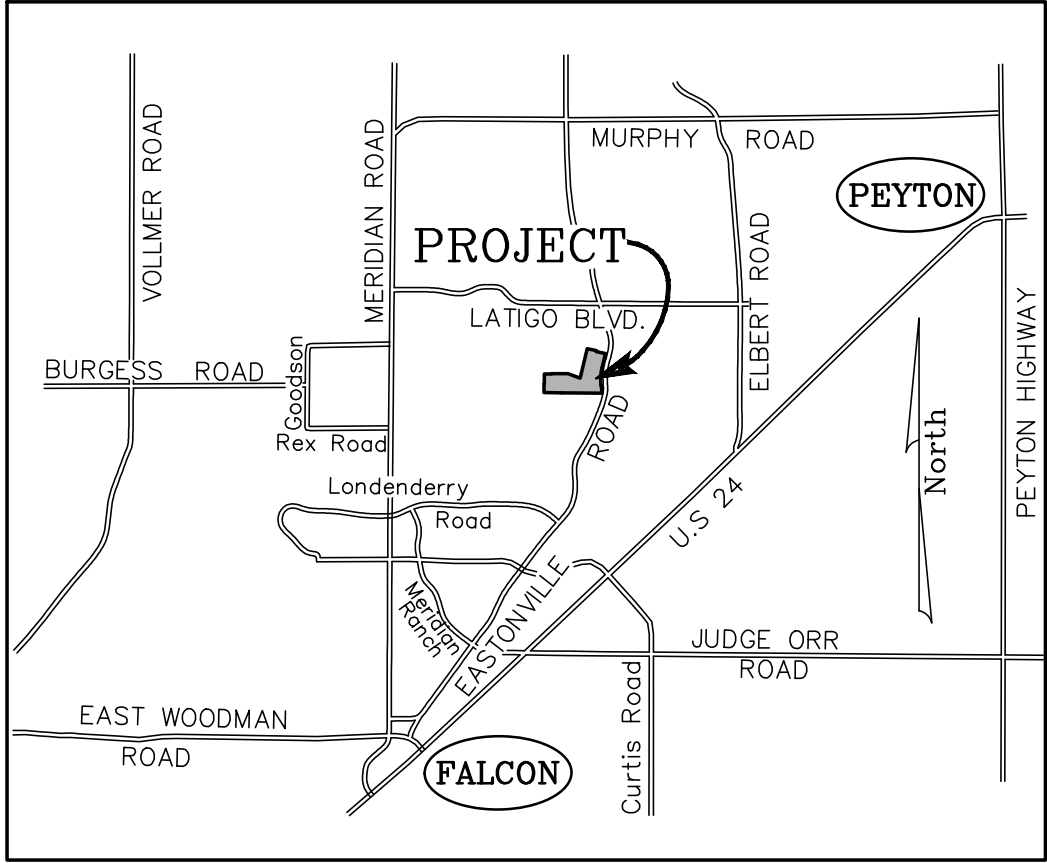

*Vicinity Map*  
Not to scale

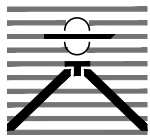

**LATIGO TRAILS FILING NO. 10  
VICINITY MAP**

**Drexel, Barrell & Co.**  
Engineers • Surveyors

DATE:

DWG. NO.

JOB NO:

**21820-01CSCV**

**VMAP**

SHEET 1 OF 1

# National Flood Hazard Layer FIRMette



104°34'22"W 39°0'18"N

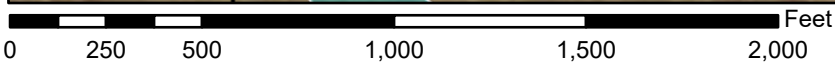

104°33'45"W 38°59'50"N

Basemap Imagery Source: USGS National Map 2023

## Legend

SEE FIS REPORT FOR DETAILED LEGEND AND INDEX MAP FOR FIRM PANEL LAYOUT

- |                                    |  |  |
|------------------------------------|--|--|
| <b>SPECIAL FLOOD HAZARD AREAS</b>  |  | Without Base Flood Elevation (BFE)<br><i>Zone A, V, A99</i>  |
|                                    |  | With BFE or Depth <i>Zone AE, AO, AH, VE, AR</i>   |
|                                    |  | Regulatory Floodway  |
| <b>OTHER AREAS OF FLOOD HAZARD</b> |  | 0.2% Annual Chance Flood Hazard, Areas of 1% annual chance flood with average depth less than one foot or with drainage areas of less than one square mile <i>Zone X</i> |
|                                    |  | Future Conditions 1% Annual Chance Flood Hazard <i>Zone X</i>  |
|                                    |  | Area with Reduced Flood Risk due to Levee. See Notes. <i>Zone X</i>  |
|                                    |  | Area with Flood Risk due to Levee <i>Zone D</i>  |
| <b>OTHER AREAS</b>                 |  | NO SCREEN Area of Minimal Flood Hazard <i>Zone X</i>   |
|                                    |  | Effective LOMRs  |
| <b>GENERAL STRUCTURES</b>          |  | Area of Undetermined Flood Hazard <i>Zone D</i>  |
|                                    |  | Channel, Culvert, or Storm Sewer   |
|                                    |  | Levee, Dike, or Floodwall  |
| <b>OTHER FEATURES</b>              |  | 20.2 Cross Sections with 1% Annual Chance Water Surface Elevation  |
|                                    |  | 17.5 Cross Sections with 1% Annual Chance Water Surface Elevation  |
|                                    |  | Coastal Transect   |
|                                    |  | Base Flood Elevation Line (BFE)  |
|                                    |  | Limit of Study   |
| <b>MAP PANELS</b>                  |  | Jurisdiction Boundary  |
|                                    |  | Coastal Transect Baseline  |
|                                    |  | Profile Baseline   |
|                                    |  | Hydrographic Feature   |
|                                    |  | Digital Data Available   |
|                                    |  | No Digital Data Available  |
|                                    |  | Unmapped   |



The pin displayed on the map is an approximate point selected by the user and does not represent an authoritative property location.

This map complies with FEMA's standards for the use of digital flood maps if it is not void as described below. The basemap shown complies with FEMA's basemap accuracy standards

The flood hazard information is derived directly from the authoritative NFHL web services provided by FEMA. This map was exported on 9/3/2024 at 1:17 PM and does not reflect changes or amendments subsequent to this date and time. The NFHL and effective information may change or become superseded by new data over time.

This map image is void if the one or more of the following map elements do not appear: basemap imagery, flood zone labels, legend, scale bar, map creation date, community identifiers, FIRM panel number, and FIRM effective date. Map images for unmapped and unmodernized areas cannot be used for regulatory purposes.

Hydrologic Soil Group—El Paso County Area, Colorado

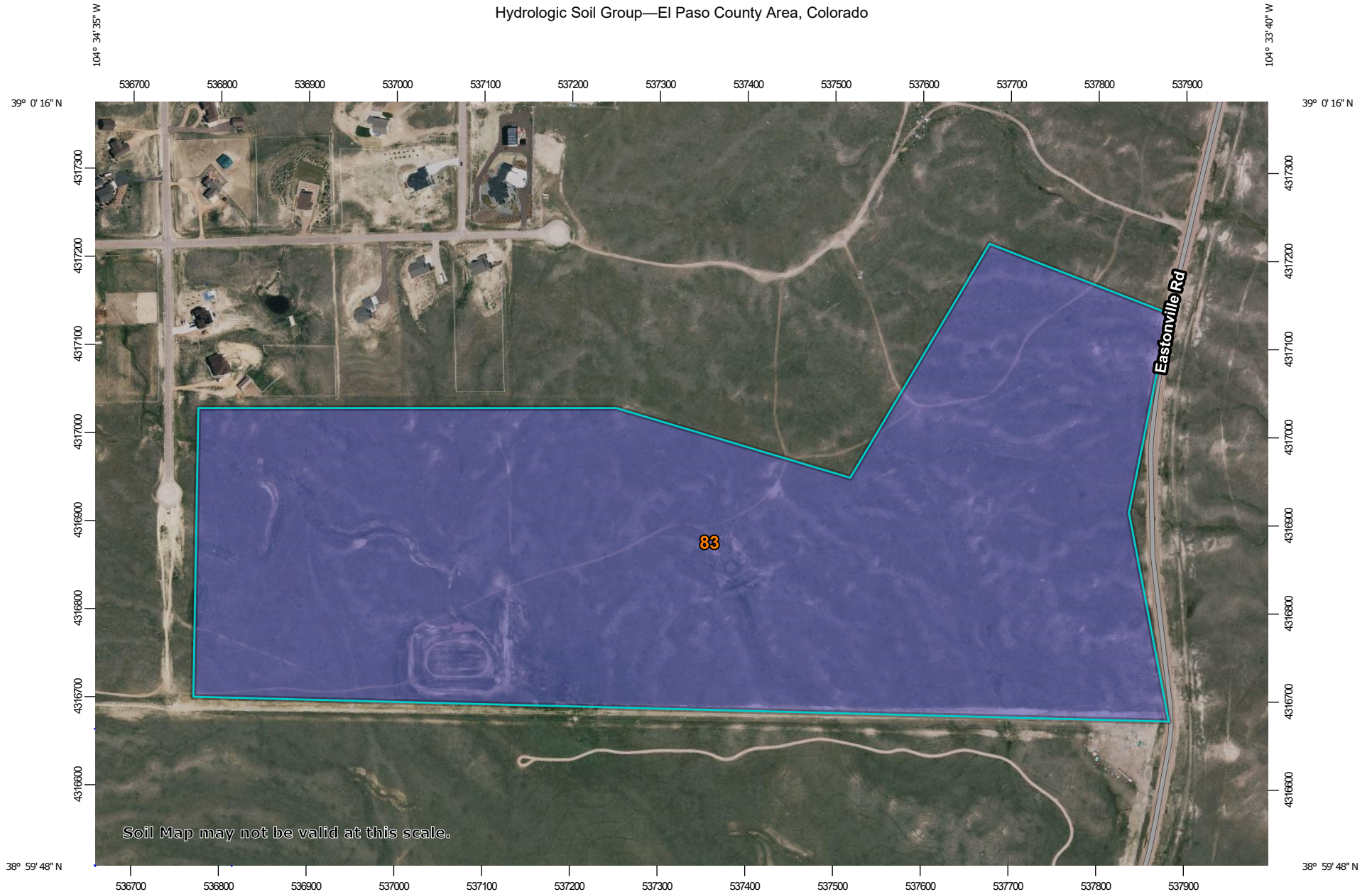



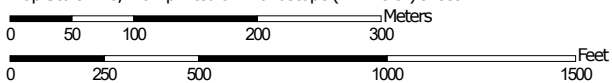





























Map Scale: 1:6,110 if printed on A landscape (11" x 8.5") sheet.



Map projection: Web Mercator Corner coordinates: WGS84 Edge tics: UTM Zone 13N WGS84



### MAP LEGEND

- Area of Interest (AOI)**
  -  Area of Interest (AOI)
- Soils**
  - Soil Rating Polygons**
    -  A
    -  A/D
    -  B
    -  B/D
    -  C
    -  C/D
    -  D
    -  Not rated or not available
  - Soil Rating Lines**
    -  A
    -  A/D
    -  B
    -  B/D
    -  C
    -  C/D
    -  D
    -  Not rated or not available
  - Soil Rating Points**
    -  A
    -  A/D
    -  B
    -  B/D
- Water Features**
  -  Streams and Canals
- Transportation**
  -  Rails
  -  Interstate Highways
  -  US Routes
  -  Major Roads
  -  Local Roads
- Background**
  -  Aerial Photography
- Other**
  -  C
  -  C/D
  -  D
  -  Not rated or not available

### MAP INFORMATION

The soil surveys that comprise your AOI were mapped at 1:24,000.

**Warning:** Soil Map may not be valid at this scale.  
 Enlargement of maps beyond the scale of mapping can cause misunderstanding of the detail of mapping and accuracy of soil line placement. The maps do not show the small areas of contrasting soils that could have been shown at a more detailed scale.

Please rely on the bar scale on each map sheet for map measurements.

Source of Map: Natural Resources Conservation Service  
 Web Soil Survey URL:  
 Coordinate System: Web Mercator (EPSG:3857)

Maps from the Web Soil Survey are based on the Web Mercator projection, which preserves direction and shape but distorts distance and area. A projection that preserves area, such as the Albers equal-area conic projection, should be used if more accurate calculations of distance or area are required.

This product is generated from the USDA-NRCS certified data as of the version date(s) listed below.

Soil Survey Area: El Paso County Area, Colorado  
 Survey Area Data: Version 21, Aug 24, 2023

Soil map units are labeled (as space allows) for map scales 1:50,000 or larger.

Date(s) aerial images were photographed: Jun 9, 2021—Jun 12, 2021

The orthophoto or other base map on which the soil lines were compiled and digitized probably differs from the background imagery displayed on these maps. As a result, some minor shifting of map unit boundaries may be evident.

## Hydrologic Soil Group

Map unit symbol	Map unit name	Rating	Acres in AOI	Percent of AOI
83	Stapleton sandy loam, 3 to 8 percent slopes	B	98.4	100.0%
<b>Totals for Area of Interest</b>			<b>98.4</b>	<b>100.0%</b>

### Description

Hydrologic soil groups are based on estimates of runoff potential. Soils are assigned to one of four groups according to the rate of water infiltration when the soils are not protected by vegetation, are thoroughly wet, and receive precipitation from long-duration storms.

The soils in the United States are assigned to four groups (A, B, C, and D) and three dual classes (A/D, B/D, and C/D). The groups are defined as follows:

Group A. Soils having a high infiltration rate (low runoff potential) when thoroughly wet. These consist mainly of deep, well drained to excessively drained sands or gravelly sands. These soils have a high rate of water transmission.

Group B. Soils having a moderate infiltration rate when thoroughly wet. These consist chiefly of moderately deep or deep, moderately well drained or well drained soils that have moderately fine texture to moderately coarse texture. These soils have a moderate rate of water transmission.

Group C. Soils having a slow infiltration rate when thoroughly wet. These consist chiefly of soils having a layer that impedes the downward movement of water or soils of moderately fine texture or fine texture. These soils have a slow rate of water transmission.

Group D. Soils having a very slow infiltration rate (high runoff potential) when thoroughly wet. These consist chiefly of clays that have a high shrink-swell potential, soils that have a high water table, soils that have a claypan or clay layer at or near the surface, and soils that are shallow over nearly impervious material. These soils have a very slow rate of water transmission.

If a soil is assigned to a dual hydrologic group (A/D, B/D, or C/D), the first letter is for drained areas and the second is for undrained areas. Only the soils that in their natural condition are in group D are assigned to dual classes.

### Rating Options

*Aggregation Method:* Dominant Condition

*Component Percent Cutoff:* None Specified

*Tie-break Rule:* Higher

# PROJECT INFORMATION

PROJECT: Latigo Trails Filing 10  
 PROJECT NO: 21820-01CSCV  
 DESIGN BY: CGH  
 REV. BY: TDM  
 AGENCY: El Paso County  
 REPORT TYPE: Final  
 DATE: 9/17/2024



	C2*	C5*	C10*	C100*	% IMPERV
Residential - 2.5 Acre		0.16		0.41	9.2
Pasture/Meadow/Lawn		0.08		0.35	0
Streets - Gravel		0.59		0.70	80
Streets - Paved		0.90		0.96	100

\*C-Values and Basin Imperviousness based on Table 6-6, City of Colorado Springs Drainage Criteria Manual

SUB-BASIN	SURFACE DESIGNATION	AREA ACRE	COMPOSITE RUNOFF COEFFICIENTS				% IMPERV
			C2	C5	C10	C100	
<b>EXISTING A-BASINS</b>							
<b>OSA1</b>	Residential - 2.5 Acre	0.00		0.16		0.41	9.2
	Pasture/Meadow/Lawn	1.65		0.08		0.35	0
	Streets - Gravel	0.00		0.59		0.70	80
	Streets - Paved	2.03		0.90		0.96	100
<b>OSA1 TOTAL</b>	<i>WEIGHTED AVERAGE</i>	3.68		0.53		0.69	55
<b>OSA2</b>	Residential - 2.5 Acre	92.80		0.16		0.41	9.2
	Pasture/Meadow/Lawn	0.00		0.08		0.35	0
	Streets - Gravel	0.00		0.59		0.70	80
	Streets - Paved	3.50		0.90		0.96	100
<b>OSA2 TOTAL</b>	<i>WEIGHTED AVERAGE</i>	96.30		0.19		0.43	13
<b>OSA3</b>	Residential - 2.5 Acre	66.55		0.16		0.41	9.2
	Pasture/Meadow/Lawn	0.00		0.08		0.35	0
	Streets - Gravel	0.00		0.59		0.70	80
	Streets - Paved	2.60		0.90		0.96	100
<b>OSA3 TOTAL</b>	<i>WEIGHTED AVERAGE</i>	69.15		0.19		0.43	13
<b>OSA4</b>	Residential - 2.5 Acre	31.11		0.16		0.41	9.2
	Pasture/Meadow/Lawn	0.00		0.08		0.35	0
	Streets - Gravel	0.00		0.59		0.70	80
	Streets - Paved	1.55		0.90		0.96	100
<b>OSA4 TOTAL</b>	<i>WEIGHTED AVERAGE</i>	32.65		0.20		0.44	14
<b>OSA5</b>	Residential - 2.5 Acre	10.86		0.16		0.41	9.2
	Pasture/Meadow/Lawn	0.00		0.08		0.35	0
	Streets - Gravel	0.00		0.59		0.70	80
	Streets - Paved	0.47		0.90		0.96	100
<b>OSA5 TOTAL</b>	<i>WEIGHTED AVERAGE</i>	11.33		0.19		0.43	13
<b>A1</b>	Residential - 2.5 Acre	0.00		0.16		0.41	9.2
	Pasture/Meadow/Lawn	7.08		0.08		0.35	0
	Streets - Paved	0.00		0.90		0.96	100
<b>A1 TOTAL</b>	<i>WEIGHTED AVERAGE</i>	7.08		0.08		0.35	0
<b>A2</b>	Residential - 2.5 Acre	0.00		0.16		0.41	9.2

# PROJECT INFORMATION

PROJECT: Latigo Trails Filing 10  
 PROJECT NO: 21820-01CSCV  
 DESIGN BY: CGH  
 REV. BY: TDM  
 AGENCY: El Paso County  
 REPORT TYPE: Final  
 DATE: 9/17/2024



	C2*	C5*	C10*	C100*	% IMPERV
Residential - 2.5 Acre		0.16		0.41	9.2
Pasture/Meadow/Lawn		0.08		0.35	0
Streets - Gravel		0.59		0.70	80
Streets - Paved		0.90		0.96	100

\*C-Values and Basin Imperviousness based on Table 6-6, City of Colorado Springs Drainage Criteria Manual

	Pasture/Meadow/Lawn	19.70		0.08		0.35	0
	Streets - Paved	0.00		0.90		0.96	100
<b>A2 TOTAL</b>	<b>WEIGHTED AVERAGE</b>	19.70		0.08		0.35	0
<b>A3</b>	Residential - 2.5 Acre	0.00		0.16		0.41	9.2
	Pasture/Meadow/Lawn	11.68		0.08		0.35	0
	Streets - Paved	0.00		0.90		0.96	100
<b>A3 TOTAL</b>	<b>WEIGHTED AVERAGE</b>	11.68		0.08		0.35	0
<b>A4</b>	Residential - 2.5 Acre	0.00		0.16		0.41	9.2
	Pasture/Meadow/Lawn	4.24		0.08		0.35	0
	Streets - Paved	0.00		0.90		0.96	100
<b>A4 TOTAL</b>	<b>WEIGHTED AVERAGE</b>	4.24		0.08		0.35	0
<b>A5</b>	Residential - 2.5 Acre	0.00		0.16		0.41	9.2
	Pasture/Meadow/Lawn	10.58		0.08		0.35	0
	Streets - Paved	0.00		0.90		0.96	100
<b>A5 TOTAL</b>	<b>WEIGHTED AVERAGE</b>	10.58		0.08		0.35	0
<b>A6</b>	Residential - 2.5 Acre	0.00		0.16		0.41	9.2
	Pasture/Meadow/Lawn	7.35		0.08		0.35	0
	Streets - Paved	0.00		0.90		0.96	100
<b>A6 TOTAL</b>	<b>WEIGHTED AVERAGE</b>	7.35		0.08		0.35	0
<b>A7</b>	Residential - 2.5 Acre	0.00		0.16		0.41	9.2
	Pasture/Meadow/Lawn	13.62		0.08		0.35	0
	Streets - Paved	0.00		0.90		0.96	100
<b>A7 TOTAL</b>	<b>WEIGHTED AVERAGE</b>	13.62		0.08		0.35	0
<b>A8</b>	Residential - 2.5 Acre	0.00		0.16		0.41	9.2
	Pasture/Meadow/Lawn	2.24		0.08		0.35	0
	Streets - Paved	0.00		0.90		0.96	100
<b>A8 TOTAL</b>	<b>WEIGHTED AVERAGE</b>	2.24		0.08		0.35	0
<b>A9</b>	Residential - 2.5 Acre	0.00		0.16		0.41	9.2
	Pasture/Meadow/Lawn	2.16		0.08		0.35	0
	Streets - Paved	0.00		0.90		0.96	100
<b>A9 TOTAL</b>	<b>WEIGHTED AVERAGE</b>	2.16		0.08		0.35	0
<b>A10</b>	Residential - 2.5 Acre	0.00		0.16		0.41	9.2
	Pasture/Meadow/Lawn	8.08		0.08		0.35	0



# PROJECT INFORMATION

PROJECT: Latigo Trails Filing 10  
 PROJECT NO: 21820-01CSCV  
 DESIGN BY: CGH  
 REV. BY: TDM  
 AGENCY: El Paso County  
 REPORT TYPE: Final  
 DATE: 9/17/2024



	C2*	C5*	C10*	C100*	% IMPERV
Residential - 2.5 Acre		0.16		0.41	9.2
Pasture/Meadow/Lawn		0.08		0.35	0
Streets - Gravel		0.59		0.70	80
Streets - Paved		0.90		0.96	100

\*C-Values and Basin Imperviousness based on Table 6-6, City of Colorado Springs Drainage Criteria Manual

	Streets - Paved	0.00		0.90		0.96	100
<b>A10 TOTAL</b>	<i>WEIGHTED AVERAGE</i>	8.08		0.08		0.35	0
<b>A11</b>	Residential - 2.5 Acre	0.00		0.16		0.41	9.2
	Pasture/Meadow/Lawn	7.30		0.08		0.35	0
	Streets - Paved	0.00		0.90		0.96	100
<b>A11 TOTAL</b>	<i>WEIGHTED AVERAGE</i>	7.30		0.08		0.35	0
<b>A12</b>	Residential - 2.5 Acre	0.00		0.16		0.41	9.2
	Pasture/Meadow/Lawn	8.71		0.08		0.35	0
	Streets - Paved	0.00		0.90		0.96	100
<b>A12 TOTAL</b>	<i>WEIGHTED AVERAGE</i>	8.71		0.08		0.35	0
<b>A13</b>	Residential - 2.5 Acre	0.00		0.16		0.41	9.2
	Pasture/Meadow/Lawn	13.96		0.08		0.35	0
	Streets - Paved	0.00		0.90		0.96	100
<b>A13 TOTAL</b>	<i>WEIGHTED AVERAGE</i>	13.96		0.08		0.35	0
<b>A14</b>	Residential - 2.5 Acre	0.00		0.16		0.41	9.2
	Pasture/Meadow/Lawn	8.24		0.08		0.35	0
	Streets - Paved	0.00		0.90		0.96	100
<b>A14 TOTAL</b>	<i>WEIGHTED AVERAGE</i>	8.24		0.08		0.35	0
<b>A15</b>	Residential - 2.5 Acre	0.00		0.16		0.41	9.2
	Pasture/Meadow/Lawn	0.61		0.08		0.35	0
	Streets - Paved	0.00		0.90		0.96	100
<b>A15 TOTAL</b>	<i>WEIGHTED AVERAGE</i>	0.61		0.08		0.35	0
<b>OSA6</b>	Residential - 2.5 Acre	0.00		0.16		0.41	9.2
	Pasture/Meadow/Lawn	3.29		0.08		0.35	0
	Streets - Gravel	0.00		0.59		0.70	80
	Streets - Paved	0.00		0.90		0.96	100
<b>OSA6 TOTAL</b>	<i>WEIGHTED AVERAGE</i>	3.29		0.08		0.35	0
<b>EXISTING B-BASINS</b>							
<b>B1</b>	Residential - 2.5 Acre	0.00		0.16		0.41	9.2
	Pasture/Meadow/Lawn	3.36		0.08		0.35	0
	Streets - Paved	0.00		0.90		0.96	100
<b>B1 TOTAL</b>	<i>WEIGHTED AVERAGE</i>	3.36		0.08		0.35	0
<b>B2</b>	Residential - 2.5 Acre	0.00		0.16		0.41	9.2

# PROJECT INFORMATION

PROJECT: Latigo Trails Filing 10  
 PROJECT NO: 21820-01CSCV  
 DESIGN BY: CGH  
 REV. BY: TDM  
 AGENCY: El Paso County  
 REPORT TYPE: Final  
 DATE: 9/17/2024



	C2*	C5*	C10*	C100*	% IMPERV
Residential - 2.5 Acre		0.16		0.41	9.2
Pasture/Meadow/Lawn		0.08		0.35	0
Streets - Gravel		0.59		0.70	80
Streets - Paved		0.90		0.96	100

\*C-Values and Basin Imperviousness based on Table 6-6, City of Colorado Springs Drainage Criteria Manual

	Pasture/Meadow/Lawn	0.75		0.08		0.35	0
	Streets - Paved	0.00		0.90		0.96	100
<b>B2 TOTAL</b>	<i>WEIGHTED AVERAGE</i>	0.75		0.08		0.35	0
<b>B3</b>	Residential - 2.5 Acre	0.00		0.16		0.41	9.2
	Pasture/Meadow/Lawn	4.78		0.08		0.35	0
	Streets - Paved	0.00		0.90		0.96	100
<b>B3 TOTAL</b>	<i>WEIGHTED AVERAGE</i>	4.78		0.08		0.35	0
<b>B4</b>	Residential - 2.5 Acre	0.00		0.16		0.41	9.2
	Pasture/Meadow/Lawn	6.89		0.08		0.35	0
	Streets - Paved	0.00		0.90		0.96	100
<b>B4 TOTAL</b>	<i>WEIGHTED AVERAGE</i>	6.89		0.08		0.35	0
<b>B5</b>	Residential - 2.5 Acre	0.00		0.16		0.41	9.2
	Pasture/Meadow/Lawn	1.61		0.08		0.35	0
	Streets - Paved	0.00		0.90		0.96	100
<b>B5 TOTAL</b>	<i>WEIGHTED AVERAGE</i>	1.61		0.08		0.35	0
<b>B6</b>	Residential - 2.5 Acre	0.00		0.16		0.41	9.2
	Pasture/Meadow/Lawn	12.40		0.08		0.35	0
	Streets - Paved	0.00		0.90		0.96	100
<b>B6 TOTAL</b>	<i>WEIGHTED AVERAGE</i>	12.40		0.08		0.35	0

## PROJECT INFORMATION

**PROJECT:** Latigo Trails Filing 10  
**PROJECT NO:** 21820-01CSCV  
**DESIGN BY:** CGH  
**REV. BY:** TDM  
**AGENCY:** El Paso County  
**REPORT TYPE:** Final  
**DATE:** 9/17/2024



### RATIONAL METHOD CALCULATIONS FOR STORM WATER RUNOFF

DEVELOPED TIME OF CONCENTRATION STANDARD FORM SF-2

SUB-BASIN DATA					INITIAL/OVERLAND TIME (t <sub>i</sub> )			TRAVEL TIME (t <sub>t</sub> )				TIME OF CONC. t <sub>c</sub>		FINAL t <sub>c</sub>
BASIN	DESIGN PT:	C <sub>5</sub>	C <sub>100</sub>	AREA	LENGTH	SLOPE	t <sub>i</sub>	LENGTH	SLOPE	VEL.	t <sub>t</sub>	COMP.	MINIMUM	
				Ac	Ft	%	Min	Ft	%	FPS	Min	t <sub>c</sub>	t <sub>c</sub>	Min
<b>EXISTING A BASINS</b>														
OSA1	<b>OSA1</b>	0.53	0.69	3.68	50	2.0	6.0	5815	1.0	1.5	64.6	70.6	42.3	<b>42.3</b>
OSA2	<b>OSA2</b>	0.19	0.43	92.80	100	2.0	13.6	5495	1.0	1.5	61.1	74.6	40.5	<b>40.5</b>
OSA3	<b>OSA3</b>	0.19	0.43	69.15	100	3.0	11.8	3750	1.5	1.8	34.0	45.8	30.8	<b>30.8</b>
OSA4	<b>OSA4</b>	0.20	0.44	32.65	100	2.0	13.4	2798	2.0	2.1	22.0	35.4	25.5	<b>25.5</b>
OSA5	<b>OSA5</b>	0.19	0.43	11.33	100	4.0	10.7	780	2.0	2.1	6.1	16.8	14.3	<b>14.3</b>
A1	<b>1</b>	0.08	0.35	7.08	100	2.0	15.1	710	2.0	2.1	5.6	20.7	13.9	<b>20.7</b>
A2		0.08	0.35	19.70	100	3.0	13.2	1090	3.0	2.6	7.0	20.2	16.1	<b>20.2</b>
OSA1-OSA5+A2+B1	<b>2</b>	0.18	0.43	232.68	From OSA1		42.3	710	2.0	2.1	5.6	47.9	13.9	<b>47.9</b>
A3		0.08	0.35	11.68	100	3.0	13.2	1000	2.0	2.1	7.9	21.1	15.6	<b>21.1</b>
B2+A3	<b>3</b>	0.08	0.35	12.43	From B2		20.0	1000	2.0	2.1	7.9	27.9	15.6	<b>27.9</b>
A4	<b>4</b>	0.08	0.35	4.24	100	2.0	15.1	364	1.0	1.5	4.0	19.2	12.0	<b>19.2</b>
A5		0.08	0.35	10.58	100	4.0	12.0	1260	2.0	2.1	9.9	21.9	17.0	<b>21.9</b>
B3+A5	<b>5</b>	0.08	0.35	15.37	From B3		19.9	1260	2.0	2.1	9.9	29.8	17.0	<b>29.8</b>
A6	<b>6</b>	0.08	0.35	7.35	100	3.0	13.2	878	2.0	2.1	6.9	20.1	14.9	<b>20.1</b>
A7		0.08	0.35	13.62	100	1.0	19.1	1315	2.0	2.1	10.3	29.4	17.3	<b>29.4</b>
B4+A7	<b>7</b>	0.08	0.35	20.51	From A7		29.4					29.4	10.0	<b>29.4</b>
A8	<b>8</b>	0.08	0.35	2.24	100	2.0	15.1	150	2.0	2.1	1.2	16.3	10.8	<b>16.3</b>
A9	<b>9</b>	0.08	0.35	2.16	100	3.0	13.2	300	3.0	2.6	1.9	15.1	11.7	<b>15.1</b>
A10	<b>10</b>	0.08	0.35	8.08	100	2.0	15.1	1130	2.0	2.1	8.9	24.0	16.3	<b>24.0</b>

A11	<b>11</b>	0.08	0.35	7.30	100	2.0	15.1	1050	3.0	2.6	6.7	21.9	15.8	<b>21.9</b>
A12		0.08	0.35	8.71	100	2.0	15.1	1190	3.0	2.6	7.6	22.8	16.6	<b>22.8</b>
B5+A12	<b>12</b>	0.08	0.35	10.31	From B6		14.2	1190	3.0	2.6	7.6	21.8	16.6	<b>21.8</b>
A13		0.08	0.35	13.96	100	2.0	15.1	1130	2.5	2.4	7.9	23.1	16.3	<b>23.1</b>
B6+A13	<b>13</b>	0.08	0.35	26.36	From B6		23.6	1130	2.5	2.4	7.9	31.6	16.3	<b>31.6</b>
A14	<b>14</b>	0.08	0.35	8.24	100	2.0	15.1	1150	2.0	2.1	9.0	24.2	16.4	<b>24.2</b>
A15		0.08	0.35	0.61	100	2.0	15.1	120	2.0	2.1	0.9	16.1	10.7	<b>16.1</b>
OSA6	<b>OSA6</b>	0.90	0.96	3.29	100	2.0	3.0	650	1.0	1.5	7.2	10.2	13.6	<b>13.6</b>
<b>EXISTING B BASINS</b>														
B1	<b>B1</b>	0.08	0.35	3.36	100	3.0	13.2	445	1.0	1.5	4.9	18.2	12.5	<b>18.2</b>
B2	<b>B2</b>	0.08	0.35	0.75	100	1.0	19.1	87	1.0	1.5	1.0	20.0	10.5	<b>20.0</b>
B3	<b>B3</b>	0.08	0.35	4.78	100	2.0	15.1	738	3.0	2.6	4.7	19.9	14.1	<b>19.9</b>
B4	<b>B4</b>	0.08	0.35	6.89	100	3.0	13.2	680	3.0	2.6	4.4	17.6	13.8	<b>17.6</b>
B5	<b>B5</b>	0.08	0.35	1.61	100	3.0	13.2	170	4.0	3.0	0.9	14.2	10.9	<b>14.2</b>
B6	<b>B6</b>	0.08	0.35	12.40	100	2.0	15.1	1080	2.0	2.1	8.5	23.6	16.0	<b>23.6</b>

**PROJECT INFORMATION**

PROJECT: Latigo Trails Filing 10  
 PROJECT NO: 21820-01CSCV  
 DESIGN BY: CGH  
 REV. BY: TDM  
 AGENCY: El Paso County  
 REPORT TYPE: Final  
 DATE: 9/17/2024



**RATIONAL METHOD CALCULATIONS FOR STORM WATER RUNOFF**

DEVELOPED RUNOFF 5 YR STORM P1= 1.46

BASIN (S)	DIRECT RUNOFF						
	DESIGN POINT	AREA (AC)	RUNOFF COEFF	t <sub>c</sub> (MIN)	C * A	I (IN/HR)	Q (CFS)
<b>EXISTING A - BASINS</b>							
OSA1	OSA1	3.68	0.53	42.3	1.96	1.86	3.6
OSA2	OSA2	92.80	0.19	40.5	17.34	1.91	33.1
OSA3	OSA3	69.15	0.19	30.8	12.99	2.25	29.3
OSA4	OSA4	32.65	0.20	25.5	6.37	2.51	16.0
OSA5	OSA5	11.33	0.19	14.3	2.16	3.39	7.3
A1	1	7.08	0.08	20.7	0.57	2.82	1.6
A2		19.70	0.08	20.2	1.58	2.86	4.5
OSA1-OSA5+A2+B1	2	232.68	0.18	47.9	42.67	1.71	73.1
A3		11.68	0.08	21.1	0.93	2.79	2.6
B2+A3	3	12.43	0.08	27.9	0.99	2.39	2.4
A4	4	4.24	0.08	19.2	0.34	2.93	1.0
A5		10.58	0.08	21.9	0.85	2.74	2.3
B3+A5	5	15.37	0.08	29.8	1.23	2.30	2.8
A6	6	7.35	0.08	20.1	0.59	2.86	1.7
A7		13.62	0.08	29.4	1.09	2.32	2.5
B4+A7	7	20.51	0.08	29.4	1.64	2.32	3.8
A8	8	2.24	0.08	16.3	0.18	3.18	0.6
A9	9	2.16	0.08	15.1	0.17	3.30	0.6
A10	10	8.08	0.08	24.0	0.65	2.60	1.7
A11	11	7.30	0.08	21.9	0.58	2.74	1.6
A12		8.71	0.08	22.8	0.70	2.68	1.9
B5+A12	12	10.31	0.08	21.8	0.83	2.74	2.3
A13		13.96	0.08	23.1	1.12	2.66	3.0
B6+A13	13	26.36	0.08	31.6	2.11	2.22	4.7
A14	14	8.24	0.08	24.2	0.66	2.59	1.7
A15		0.61	0.08	16.1	0.05	3.21	0.2
OSA6	OSA6	3.29	0.90	13.6	2.96	3.47	10.3
<b>EXISTING B BASINS</b>							
B1	B1	3.36	0.08	18.2	0.27	3.02	0.8
B2	B2	0.75	0.08	20.0	0.06	2.87	0.2
B3	B3	4.78	0.08	19.9	0.38	2.88	1.1
B4	B4	6.89	0.08	17.6	0.55	3.07	1.7
B5	B5	1.61	0.08	14.2	0.13	3.40	0.4
B6	B6	12.40	0.08	23.6	0.99	2.63	2.6

**PROJECT INFORMATION**

PROJECT: Latigo Trails Filing 10  
 PROJECT NO: 21820-01CSCV  
 DESIGN BY: CGH  
 REV. BY: TDM  
 AGENCY: El Paso County  
 REPORT TYPE: Final  
 DATE: 9/17/2024



**RATIONAL METHOD CALCULATIONS FOR STORM WATER RUNOFF**

DEVELOPED RUNOFF 100 YR STORM P1= 2.47

BASIN (S)	DIRECT RUNOFF						
	DESIGN POINT	AREA (AC)	RUNOFF COEFF	t <sub>c</sub> (MIN)	C * A	I (IN/HR)	Q (CFS)
<b>EXISTING A-BASINS</b>							
OSA1	OSA1	3.68	0.69	42.3	2.53	3.14	7.9
OSA2	OSA2	92.80	0.43	40.5	39.90	3.23	128.7
OSA3	OSA3	69.15	0.43	30.8	29.78	3.81	113.6
OSA4	OSA4	32.65	0.44	25.5	14.24	4.25	60.5
OSA5	OSA5	11.33	0.43	14.3	4.91	5.73	28.1
A1	1	7.08	0.35	20.7	2.48	4.77	11.8
A2		19.70	0.35	20.2	6.90	4.83	33.3
OSA1-OSA5+A2+B1	2	232.68	0.43	47.9	99.43	2.90	288.2
A3		11.68	0.35	21.1	4.09	4.73	19.3
B2+A3	3	12.43	0.35	27.9	4.35	4.04	17.6
A4	4	4.24	0.35	19.2	1.48	4.97	7.4
A5		10.58	0.35	21.9	3.70	4.63	17.1
B3+A5	5	15.37	0.35	29.8	5.38	3.89	20.9
A6	6	7.35	0.35	20.1	2.57	4.84	12.5
A7		13.62	0.35	29.4	4.77	3.92	18.7
B4+A7	7	20.51	0.35	29.4	7.18	3.92	28.1
A8	8	2.24	0.35	16.3	0.78	5.39	4.2
A9	9	2.16	0.35	15.1	0.76	5.58	4.2
A10	10	8.08	0.35	24.0	2.83	4.40	12.5
A11	11	7.30	0.35	21.9	2.56	4.63	11.8
A12		8.71	0.35	22.8	3.05	4.53	13.8
B5+A12	12	10.31	0.35	21.8	3.61	4.64	16.8
A13		13.96	0.35	23.1	4.89	4.50	22.0
B6+A13	13	26.36	0.35	31.6	9.23	3.76	34.7
A14	14	8.24	0.35	24.2	2.89	4.39	12.7
A15		0.61	0.35	16.1	0.21	5.42	1.2
OSA6	OSA6	3.29	0.96	13.6	3.16	5.87	18.5
<b>EXISTING B-BASINS</b>							
B1	B1	3.36	0.35	18.2	1.18	5.11	6.0
B2	B2	0.75	0.35	20.0	0.26	4.85	1.3
B3	B3	4.78	0.35	19.9	1.67	4.87	8.2
B4	B4	6.89	0.35	17.6	2.41	5.19	12.5
B5	B5	1.61	0.35	14.2	0.56	5.76	3.2
B6	B6	12.40	0.35	23.6	4.34	4.44	19.3

# PROJECT INFORMATION

**PROJECT:** Latigo Trails Filing 10  
**PROJECT NO:** 21820-01CSCV  
**DESIGN BY:** CGH  
**REV. BY:** KGV  
**AGENCY:** El Paso County  
**REPORT TYPE:** Final  
**DATE:** 9/17/2024



Drexel, Barrell & Co.

	C2*	C5*	C10*	C100*	% IMPERV
Residential - 2.5 Acre		0.16		0.41	9.2
Pasture/Meadow/Lawn		0.08		0.35	0
Streets - Gravel		0.59		0.70	80
Streets - Paved		0.90		0.96	100

\*C-Values and Basin Imperviousness based on Table 6-6, City of Colorado Springs Drainage Criteria Manual

SUB-BASIN	SURFACE DESIGNATION	AREA ACRE	COMPOSITE RUNOFF COEFFICIENTS				% IMPERV
			C2	C5	C10	C100	
<b>PROPOSED A-BASINS</b>							
<b>OSA1</b>	Residential - 2.5 Acre	0.00		0.16		0.41	9.2
	Pasture/Meadow/Lawn	1.65		0.08		0.35	0
	Streets - Gravel	0.00		0.59		0.70	80
	Streets - Paved	2.03		0.90		0.96	100
<b>OSA1 TOTAL</b>	<i>WEIGHTED AVERAGE</i>	3.68		0.53		0.69	55
<b>OSA2</b>	Residential - 2.5 Acre	92.80		0.16		0.41	9.2
	Pasture/Meadow/Lawn	0.00		0.08		0.35	0
	Streets - Gravel	0.00		0.59		0.70	80
	Streets - Paved	3.50		0.90		0.96	100
<b>OSA2 TOTAL</b>	<i>WEIGHTED AVERAGE</i>	96.30		0.19		0.43	13
<b>OSA3</b>	Residential - 2.5 Acre	66.55		0.16		0.41	9.2
	Pasture/Meadow/Lawn	0.00		0.08		0.35	0
	Streets - Gravel	0.00		0.59		0.70	80
	Streets - Paved	2.60		0.90		0.96	100
<b>OSA3 TOTAL</b>	<i>WEIGHTED AVERAGE</i>	69.15		0.19		0.43	13
<b>OSA4</b>	Residential - 2.5 Acre	31.11		0.16		0.41	9.2
	Pasture/Meadow/Lawn	0.00		0.08		0.35	0
	Streets - Gravel	0.00		0.59		0.70	80
	Streets - Paved	1.55		0.90		0.96	100
<b>OSA4 TOTAL</b>	<i>WEIGHTED AVERAGE</i>	32.65		0.20		0.44	14
<b>OSA5</b>	Residential - 2.5 Acre	10.86		0.16		0.41	9.2
	Pasture/Meadow/Lawn	0.00		0.08		0.35	0
	Streets - Gravel	0.00		0.59		0.70	80
	Streets - Paved	0.47		0.90		0.96	100
<b>OSA5 TOTAL</b>	<i>WEIGHTED AVERAGE</i>	11.33		0.19		0.43	13
<b>A1</b>	Residential - 2.5 Acre	13.23		0.16		0.41	9.2
	Pasture/Meadow/Lawn	0.00		0.08		0.35	0

# PROJECT INFORMATION

**PROJECT:** Latigo Trails Filing 10  
**PROJECT NO:** 21820-01CSCV  
**DESIGN BY:** CGH  
**REV. BY:** KGV  
**AGENCY:** El Paso County  
**REPORT TYPE:** Final  
**DATE:** 9/17/2024



Drexel, Barrell & Co.

	C2*	C5*	C10*	C100*	% IMPERV
<b>Residential - 2.5 Acre</b>		0.16		0.41	9.2
<b>Pasture/Meadow/Lawn</b>		0.08		0.35	0
<b>Streets - Gravel</b>		0.59		0.70	80
<b>Streets - Paved</b>		0.90		0.96	100

\*C-Values and Basin Imperviousness based on Table 6-6, City of Colorado Springs Drainage Criteria Manual

	Streets - Paved	0.32		0.90		0.96	100
<b>A1 TOTAL</b>	<i>WEIGHTED AVERAGE</i>	13.55		0.18		0.42	11
<b>A2</b>	Residential - 2.5 Acre	6.89		0.16		0.41	9.2
	Pasture/Meadow/Lawn	0.00		0.08		0.35	0
	Streets - Paved	0.35		0.90		0.96	100
<b>A2 TOTAL</b>	<i>WEIGHTED AVERAGE</i>	7.24		0.20		0.44	14
<b>A3</b>	Residential - 2.5 Acre	6.48		0.16		0.41	9.2
	Pasture/Meadow/Lawn	0.00		0.08		0.35	0
	Streets - Paved	0.00		0.90		0.96	100
<b>A3 TOTAL</b>	<i>WEIGHTED AVERAGE</i>	6.48		0.16		0.41	9
<b>A4</b>	Residential - 2.5 Acre	5.86		0.16		0.41	9.2
	Pasture/Meadow/Lawn	0.00		0.08		0.35	0
	Streets - Paved	0.18		0.90		0.96	100
<b>A4 TOTAL</b>	<i>WEIGHTED AVERAGE</i>	6.03		0.18		0.43	12
<b>A5</b>	Residential - 2.5 Acre	7.83		0.16		0.41	9.2
	Pasture/Meadow/Lawn	0.00		0.08		0.35	0
	Streets - Paved	0.19		0.90		0.96	100
<b>A5 TOTAL</b>	<i>WEIGHTED AVERAGE</i>	8.02		0.18		0.42	11
<b>A6</b>	Residential - 2.5 Acre	3.84		0.16		0.41	9.2
	Pasture/Meadow/Lawn	0.00		0.08		0.35	0
	Streets - Paved	0.18		0.90		0.96	100
<b>A6 TOTAL</b>	<i>WEIGHTED AVERAGE</i>	4.02		0.19		0.43	13
<b>A7</b>	Residential - 2.5 Acre	0.50		0.16		0.41	9.2
	Pasture/Meadow/Lawn	0.00		0.08		0.35	0
	Streets - Paved	0.12		0.90		0.96	100
<b>A7 TOTAL</b>	<i>WEIGHTED AVERAGE</i>	0.63		0.30		0.52	27
<b>A8</b>	Residential - 2.5 Acre	7.03		0.16		0.41	9.2
	Pasture/Meadow/Lawn	0.00		0.08		0.35	0
	Streets - Paved	0.17		0.90		0.96	100
<b>A8 TOTAL</b>	<i>WEIGHTED AVERAGE</i>	7.21		0.18		0.42	11
<b>A9</b>	Residential - 2.5 Acre	0.00		0.16		0.41	9.2



# PROJECT INFORMATION

**PROJECT:** Latigo Trails Filing 10  
**PROJECT NO:** 21820-01CSCV  
**DESIGN BY:** CGH  
**REV. BY:** KGV  
**AGENCY:** El Paso County  
**REPORT TYPE:** Final  
**DATE:** 9/17/2024



Drexel, Barrell & Co.

	C2*	C5*	C10*	C100*	% IMPERV
<b>Residential - 2.5 Acre</b>		0.16		0.41	9.2
<b>Pasture/Meadow/Lawn</b>		0.08		0.35	0
<b>Streets - Gravel</b>		0.59		0.70	80
<b>Streets - Paved</b>		0.90		0.96	100

\*C-Values and Basin Imperviousness based on Table 6-6, City of Colorado Springs Drainage Criteria Manual

	Pasture/Meadow/Lawn	1.62		0.08		0.35	0
	Streets - Paved	1.62		0.90		0.96	100
<b>A9 TOTAL</b>	<i>WEIGHTED AVERAGE</i>	3.23		0.49		0.66	50
<b>A10</b>	Residential - 2.5 Acre	0.00		0.16		0.41	9.2
	Pasture/Meadow/Lawn	0.58		0.08		0.35	0
	Streets - Paved	0.00		0.90		0.96	100
<b>A10 TOTAL</b>	<i>WEIGHTED AVERAGE</i>	0.58		0.08		0.35	0
<b>A10A</b>	Residential - 2.5 Acre	1.49		0.16		0.41	9.2
	Pasture/Meadow/Lawn	0.00		0.08		0.35	0
	Streets - Paved	0.00		0.90		0.96	100
<b>A10A TOTAL</b>	<i>WEIGHTED AVERAGE</i>	1.49		0.16		0.41	9
<b>A11</b>	Residential - 2.5 Acre	3.54		0.16		0.41	9.2
	Pasture/Meadow/Lawn	0.00		0.08		0.35	0
	Streets - Paved	0.07		0.90		0.96	100
<b>A11 TOTAL</b>	<i>WEIGHTED AVERAGE</i>	3.61		0.17		0.42	11
<b>A12</b>	Residential - 2.5 Acre	2.27		0.16		0.41	9.2
	Pasture/Meadow/Lawn	0.00		0.08		0.35	0
	Streets - Paved	0.09		0.90		0.96	100
<b>A12 TOTAL</b>	<i>WEIGHTED AVERAGE</i>	2.36		0.19		0.43	13
<b>A13</b>	Residential - 2.5 Acre	3.26		0.16		0.41	9.2
	Pasture/Meadow/Lawn	0.00		0.08		0.35	0
	Streets - Paved	0.07		0.90		0.96	100
<b>A13 TOTAL</b>	<i>WEIGHTED AVERAGE</i>	3.34		0.18		0.42	11
<b>A14</b>	Residential - 2.5 Acre	0.00		0.16		0.41	9.2
	Pasture/Meadow/Lawn	0.63		0.08		0.35	0
	Streets - Paved	0.63		0.90		0.96	100
<b>A14 TOTAL</b>	<i>WEIGHTED AVERAGE</i>	1.25		0.49		0.66	50
<b>A15</b>	Residential - 2.5 Acre	3.70		0.16		0.41	9.2
	Pasture/Meadow/Lawn	0.46		0.08		0.35	0
	Streets - Paved	0.00		0.90		0.96	100
<b>A15 TOTAL</b>	<i>WEIGHTED AVERAGE</i>	4.16		0.15		0.40	8

# PROJECT INFORMATION

**PROJECT:** Latigo Trails Filing 10  
**PROJECT NO:** 21820-01CSCV  
**DESIGN BY:** CGH  
**REV. BY:** KGV  
**AGENCY:** El Paso County  
**REPORT TYPE:** Final  
**DATE:** 9/17/2024



Drexel, Barrell & Co.

	C2*	C5*	C10*	C100*	% IMPERV
<b>Residential - 2.5 Acre</b>		0.16		0.41	9.2
<b>Pasture/Meadow/Lawn</b>		0.08		0.35	0
<b>Streets - Gravel</b>		0.59		0.70	80
<b>Streets - Paved</b>		0.90		0.96	100

\*C-Values and Basin Imperviousness based on Table 6-6, City of Colorado Springs Drainage Criteria Manual

<b>A15A</b>	Residential - 2.5 Acre	2.08		0.16		0.41	9.2
	Pasture/Meadow/Lawn	0.00		0.08		0.35	0
	Streets - Paved	0.00		0.90		0.96	100
<b>A15A TOTAL</b>	<i>WEIGHTED AVERAGE</i>	2.08		0.16		0.41	9
<b>A16</b>	Residential - 2.5 Acre	4.41		0.16		0.41	9.2
	Pasture/Meadow/Lawn	0.00		0.08		0.35	0
	Streets - Paved	0.00		0.90		0.96	100
<b>A16 TOTAL</b>	<i>WEIGHTED AVERAGE</i>	4.41		0.16		0.41	9
<b>A17</b>	Residential - 2.5 Acre	4.02		0.16		0.41	9.2
	Pasture/Meadow/Lawn	0.00		0.08		0.35	0
	Streets - Paved	0.00		0.90		0.96	100
<b>A17 TOTAL</b>	<i>WEIGHTED AVERAGE</i>	4.02		0.16		0.41	9
<b>A18</b>	Residential - 2.5 Acre	1.81		0.16		0.41	9.2
	Pasture/Meadow/Lawn	0.00		0.08		0.35	0
	Streets - Paved	0.00		0.90		0.96	100
<b>A18 TOTAL</b>	<i>WEIGHTED AVERAGE</i>	1.81		0.16		0.41	9
<b>A19</b>	Residential - 2.5 Acre	2.40		0.16		0.41	9.2
	Pasture/Meadow/Lawn	0.00		0.08		0.35	0
	Streets - Paved	0.00		0.90		0.96	100
<b>A19 TOTAL</b>	<i>WEIGHTED AVERAGE</i>	2.40		0.16		0.41	9
<b>A20</b>	Residential - 2.5 Acre	1.65		0.16		0.41	9.2
	Pasture/Meadow/Lawn	0.33		0.08		0.35	0
	Streets - Paved	0.20		0.90		0.96	100
<b>A20 TOTAL</b>	<i>WEIGHTED AVERAGE</i>	2.18		0.21		0.45	16
<b>A21</b>	Residential - 2.5 Acre	0.00		0.16		0.41	9.2
	Pasture/Meadow/Lawn	0.58		0.08		0.35	0
	Streets - Paved	0.15		0.90		0.96	100
<b>A21 TOTAL</b>	<i>WEIGHTED AVERAGE</i>	0.73		0.25		0.47	20
<b>A22</b>	Residential - 2.5 Acre	2.03		0.16		0.41	9.2
	Pasture/Meadow/Lawn	0.00		0.08		0.35	0
	Streets - Paved	0.00		0.90		0.96	100

# PROJECT INFORMATION

**PROJECT:** Latigo Trails Filing 10  
**PROJECT NO:** 21820-01CSCV  
**DESIGN BY:** CGH  
**REV. BY:** KGV  
**AGENCY:** El Paso County  
**REPORT TYPE:** Final  
**DATE:** 9/17/2024



	C2*	C5*	C10*	C100*	% IMPERV
Residential - 2.5 Acre		0.16		0.41	9.2
Pasture/Meadow/Lawn		0.08		0.35	0
Streets - Gravel		0.59		0.70	80
Streets - Paved		0.90		0.96	100

\*C-Values and Basin Imperviousness based on Table 6-6, City of Colorado Springs Drainage Criteria Manual

<b>A22 TOTAL</b>	<i>WEIGHTED AVERAGE</i>	2.03		0.16		0.41	9
<b>A23</b>	Residential - 2.5 Acre	0.44		0.16		0.41	9.2
	Pasture/Meadow/Lawn	0.00		0.08		0.35	0
	Streets - Paved	0.00		0.90		0.96	100
<b>A23 TOTAL</b>	<i>WEIGHTED AVERAGE</i>	0.44		0.16		0.41	9
<b>OSA6</b>	Residential - 2.5 Acre	0.78		0.16		0.41	9.2
	Pasture/Meadow/Lawn	0.00		0.08		0.35	0
	Streets - Paved	0.03		0.90		0.96	100
<b>OSA6 TOTAL</b>	<i>WEIGHTED AVERAGE</i>	0.81		0.19		0.43	13
<b>A24</b>	Residential - 2.5 Acre	11.25		0.16		0.41	9.2
	Pasture/Meadow/Lawn	0.00		0.08		0.35	0
	Streets - Paved	0.34		0.90		0.96	100
<b>A24 TOTAL</b>	<i>WEIGHTED AVERAGE</i>	11.59		0.18		0.43	12
<b>A25</b>	Residential - 2.5 Acre	0.00		0.16		0.41	9.2
	Pasture/Meadow/Lawn	0.81		0.08		0.35	0
	Streets - Paved	0.81		0.90		0.96	100
<b>A25 TOTAL</b>	<i>WEIGHTED AVERAGE</i>	1.61		0.49		0.66	50
<b>A26</b>	Residential - 2.5 Acre	4.12		0.16		0.41	9.2
	Pasture/Meadow/Lawn	0.58		0.08		0.35	0
	Streets - Paved	0.00		0.90		0.96	100
<b>A26 TOTAL</b>	<i>WEIGHTED AVERAGE</i>	4.70		0.15		0.40	8
<b>A26A</b>	Residential - 2.5 Acre	1.00		0.16		0.41	9.2
	Pasture/Meadow/Lawn	0.00		0.08		0.35	0
	Streets - Paved	0.00		0.90		0.96	100
<b>A26A TOTAL</b>	<i>WEIGHTED AVERAGE</i>	1.00		0.16		0.41	9
<b>A27</b>	Residential - 2.5 Acre	5.25		0.16		0.41	9.2
	Pasture/Meadow/Lawn	0.00		0.08		0.35	0
	Streets - Paved	0.00		0.90		0.96	100
<b>A27 TOTAL</b>	<i>WEIGHTED AVERAGE</i>	5.25		0.16		0.41	9
<b>A28</b>	Residential - 2.5 Acre	2.75		0.16		0.41	9.2
	Pasture/Meadow/Lawn	0.00		0.08		0.35	0

# PROJECT INFORMATION

**PROJECT:** Latigo Trails Filing 10  
**PROJECT NO:** 21820-01CSCV  
**DESIGN BY:** CGH  
**REV. BY:** KGV  
**AGENCY:** El Paso County  
**REPORT TYPE:** Final  
**DATE:** 9/17/2024



	C2*	C5*	C10*	C100*	% IMPERV
<b>Residential - 2.5 Acre</b>		0.16		0.41	9.2
<b>Pasture/Meadow/Lawn</b>		0.08		0.35	0
<b>Streets - Gravel</b>		0.59		0.70	80
<b>Streets - Paved</b>		0.90		0.96	100

\*C-Values and Basin Imperviousness based on Table 6-6, City of Colorado Springs Drainage Criteria Manual

	Streets - Paved	0.00		0.90		0.96	100
<b>A28 TOTAL</b>	<i>WEIGHTED AVERAGE</i>	2.75		0.16		0.41	9
<b>A29</b>	Residential - 2.5 Acre	4.75		0.16		0.41	9.2
	Pasture/Meadow/Lawn	0.00		0.08		0.35	0
	Streets - Paved	0.00		0.90		0.96	100
<b>A29 TOTAL</b>	<i>WEIGHTED AVERAGE</i>	4.75		0.16		0.41	9
<b>A30</b>	Residential - 2.5 Acre	0.61		0.16		0.41	9.2
	Pasture/Meadow/Lawn	0.00		0.08		0.35	0
	Streets - Paved	0.00		0.90		0.96	100
<b>A30 TOTAL</b>	<i>WEIGHTED AVERAGE</i>	0.61		0.16		0.41	9
<b>OSA7</b>	Residential - 2.5 Acre	2.44		0.16		0.41	9.2
	Pasture/Meadow/Lawn	0.00		0.08		0.35	0
	Streets - Paved	0.00		0.90		0.96	100
<b>OSA7 TOTAL</b>	<i>WEIGHTED AVERAGE</i>	2.44		0.16		0.41	9
<b>PROPOSED B-BASINS</b>							
<b>B1</b>	Residential - 2.5 Acre	3.20		0.16		0.41	9.2
	Pasture/Meadow/Lawn	0.00		0.08		0.35	0
	Streets - Paved	0.00		0.90		0.96	100
<b>B1 TOTAL</b>	<i>WEIGHTED AVERAGE</i>	3.20		0.16		0.41	9
<b>B2</b>	Residential - 2.5 Acre	0.78		0.16		0.41	9.2
	Pasture/Meadow/Lawn	0.00		0.08		0.35	0
	Streets - Paved	0.00		0.90		0.96	100
<b>B2 TOTAL</b>	<i>WEIGHTED AVERAGE</i>	0.78		0.16		0.41	9
<b>B3</b>	Residential - 2.5 Acre	5.24		0.16		0.41	9.2
	Pasture/Meadow/Lawn	0.00		0.08		0.35	0
	Streets - Paved	0.00		0.90		0.96	100
<b>B3 TOTAL</b>	<i>WEIGHTED AVERAGE</i>	5.24		0.16		0.41	9
<b>B4</b>	Residential - 2.5 Acre	6.79		0.16		0.41	9.2
	Pasture/Meadow/Lawn	0.00		0.08		0.35	0
	Streets - Paved	0.35		0.90		0.96	100
<b>B4 TOTAL</b>	<i>WEIGHTED AVERAGE</i>	7.14		0.20		0.44	14

# PROJECT INFORMATION

**PROJECT:** Latigo Trails Filing 10  
**PROJECT NO:** 21820-01CSCV  
**DESIGN BY:** CGH  
**REV. BY:** KGV  
**AGENCY:** El Paso County  
**REPORT TYPE:** Final  
**DATE:** 9/17/2024



Drexel, Barrell & Co.

	C2*	C5*	C10*	C100*	% IMPERV
<b>Residential - 2.5 Acre</b>		0.16		0.41	9.2
<b>Pasture/Meadow/Lawn</b>		0.08		0.35	0
<b>Streets - Gravel</b>		0.59		0.70	80
<b>Streets - Paved</b>		0.90		0.96	100

\*C-Values and Basin Imperviousness based on Table 6-6, City of Colorado Springs Drainage Criteria Manual

<b>B5</b>	Residential - 2.5 Acre	1.59		0.16		0.41	9.2
	Pasture/Meadow/Lawn	0.00		0.08		0.35	0
	Streets - Paved	0.00		0.90		0.96	100
<b>B5 TOTAL</b>	<i>WEIGHTED AVERAGE</i>	1.59		0.16		0.41	9
<b>B6</b>	Residential - 2.5 Acre	7.92		0.16		0.41	9.2
	Pasture/Meadow/Lawn	0.00		0.08		0.35	0
	Streets - Paved	0.00		0.90		0.96	100
<b>B6 TOTAL</b>	<i>WEIGHTED AVERAGE</i>	7.92		0.16		0.41	9

## Pond Tributary Areas

<b>South</b> OSA1-OSA5, A1-A2, B1	237.10	13.28
<b>G14b</b> A4-A10, B2-3	35.73	14.87
<b>G18</b> B4-B5, A11-A15	23.45	13.47
<b>G19</b> B6, OSA6, A24-A26	26.64	12.75

**PROJECT INFORMATION**

PROJECT: Latigo Trails Filing 10  
 PROJECT NO: 21820-01CSCV  
 DESIGN BY: CGH  
 REV. BY: KGV  
 AGENCY: El Paso County  
 REPORT TYPE: Final  
 DATE: 9/17/2024



**RATIONAL METHOD CALCULATIONS FOR STORM WATER RUNOFF**  
 DEVELOPED TIME OF CONCENTRATION STANDARD FORM SF-2

SUB-BASIN DATA					CA		INITIAL/OVERLAND TIME (t <sub>i</sub> )			TRAVEL TIME (t <sub>t</sub> )				TIME OF CONC. t <sub>c</sub>		FINAL t <sub>c</sub>
BASIN	DESIGN PT:	C <sub>5</sub>	C <sub>100</sub>	AREA	5	100	LENGTH	SLOPE	t <sub>i</sub>	LENGTH	SLOPE	VEL.	t <sub>t</sub>	COMP.	MINIMUM	
				Ac			Ft	%	Min	Ft	%	FPS	Min	t <sub>c</sub>	t <sub>c</sub>	Min
<b>PROPOSED A BASINS</b>																
OSA1	<b>OSA1</b>	0.53	0.69	3.68	1.96	2.53	50	2.0	6.0	5815	1.0	1.5	64.6	70.6	42.3	<b>42.3</b>
OSA2	<b>OSA2</b>	0.16	0.41	96.30	15.41	39.48	100	2.0	14.0	5495	1.0	1.5	61.1	75.0	40.5	<b>40.5</b>
OSA3	<b>OSA3</b>	0.19	0.43	69.15	12.99	29.73	100	3.0	11.8	3750	1.5	1.8	34.0	45.8	30.8	<b>30.8</b>
OSA4	<b>OSA4</b>	0.20	0.44	32.65	6.37	14.24	100	2.0	13.4	2798	2.0	2.1	22.0	35.4	25.5	<b>25.5</b>
OSA5	<b>OSA5</b>	0.19	0.43	11.33	2.16	4.91	100	4.0	10.7	780	2.0	2.1	6.1	16.8	14.3	<b>14.3</b>
A1		0.18	0.42	13.55	2.40	5.73	100	3.0	12.0	835	2.0	2.1	6.6	18.5	14.6	<b>18.5</b>
A1+OSA2+OSA3+OSA4+OSA5+DPB1	<b>1</b>	0.18	0.42	226.18	39.84	95.40	From OSA2		40.5	835	2.0	2.1	6.6	47.1	14.6	<b>47.1</b>
A2		0.20	0.44	7.24	1.42	3.16	50	1.0	12.0	1220	2.0	2.1	9.6	21.5	16.8	<b>21.5</b>
A2+OSA1+DP1	<b>2</b>	0.18	0.43	237.10	43.22	101.09	From DP1		47.1	100	1.0	1.5	1.1	48.2	10.6	<b>48.2</b>
A3	<b>3</b>	0.16	0.41	6.48	1.04	2.66	100	2.0	14.0	500	1.5	1.8	4.5	18.5	12.8	<b>18.5</b>
A4		0.18	0.43	6.03	1.10	2.57	100	2.0	13.6	435	1.0	1.5	4.8	18.5	12.4	<b>18.5</b>
A4+DPB2	<b>4</b>	0.16	0.41	7.26	1.16	2.98	From DPB2		10.4	435	1.0	1.5	4.8	15.3	12.4	<b>15.3</b>
A5		0.18	0.42	8.02	1.42	3.39	100	3.0	12.0	750	2.0	2.1	5.9	17.9	14.2	<b>17.9</b>
A5+DPB3	<b>5</b>	0.17	0.42	13.26	2.26	5.54	From DPB3		13.9	435	1.0	1.5	4.8	18.7	12.4	<b>18.7</b>
DP5+DP4	<b>5A</b>	0.17	0.42	20.52	3.42	8.51	From DP4		15.3	540	1.0	1.5	6.0	21.3	13.0	<b>21.3</b>
A6	<b>6</b>	0.19	0.43	4.02	0.77	1.74	100	1.0	17.0	540	1.0	1.5	6.0	23.0	13.0	<b>23.0</b>
DP5A+DP6	<b>6A</b>	0.17	0.42	24.53	4.19	10.26	From DP5A		21.3	510	1.0	1.5	5.7	26.9	12.8	<b>26.9</b>
A7	<b>7</b>	0.30	0.52	0.63	0.19	0.32	50	3.0	7.3	300	1.5	1.8	2.7	10.0	11.7	<b>11.7</b>
A8	<b>8</b>	0.18	0.42	7.21	1.28	3.05	100	1.0	17.2	800	1.0	1.5	8.9	26.1	14.4	<b>26.1</b>
A8+DP7+DP6A	<b>8A</b>	0.18	0.42	32.36	5.67	13.63	From DP6A		26.9	150	1.0	1.5	1.7	28.6	10.8	<b>28.6</b>
A9	<b>9</b>	0.49	0.66	3.23	1.58	2.12	50	4.0	5.1	1910	1.5	1.8	17.3	22.4	20.6	<b>22.4</b>
A10		0.08	0.35	0.58	0.05	0.20	100	2.0	15.1	150	1.5	1.8	1.4	16.5	10.8	<b>16.5</b>
A10+DP8A+DP9	<b>10</b>	0.20	0.44	36.18	7.30	15.95	DP8A		28.6	180	1.0	8.3	0.4	29.0	11.0	<b>29.0</b>
A10A		0.16	0.41	1.49	0.24	0.61	100	2.0	14.0	150	1.5	1.8	1.4	15.3	10.8	<b>15.3</b>
A10A+G14b Out	<b>10A</b>	0.16	0.41	1.49	0.24	0.61	From A10A		15.3					15.3	10.0	<b>15.3</b>
A11		0.17	0.42	3.61	0.63	1.52	100	2.0	13.7	409	1.5	1.8	3.7	17.5	12.3	<b>17.5</b>
DPB5+A11	<b>11</b>	0.17	0.42	5.20	0.88	2.17	From A11		17.5					17.5	10.0	<b>17.5</b>

A12	12	0.19	0.43	2.36	0.45	1.02	100	2.0	13.5	385	2.5	2.4	2.7	16.2	12.1	16.2
DP11+DP12	12A	0.18	0.42	7.56	1.33	3.19	From DP11		17.5	385	2.5	2.4	2.7	20.2	12.1	20.2
A13		0.18	0.42	3.34	0.59	1.41	100	2.0	13.7	440	1.5	1.8	4.0	17.7	12.4	17.7
A13+DPB4	13	0.19	0.43	10.48	1.99	4.53	From DPB4		12.6	440	1.5	1.8	4.0	16.6	12.4	16.6
DP12A+DP13	13A	0.18	0.43	18.04	3.32	7.72	From DP12A		20.2	50	1.5	1.8	0.5	20.6	10.3	20.6
A14	14	0.49	0.66	1.25	0.61	0.82	50	4.0	5.1	510	1.5	1.8	4.6	9.7	12.8	12.8
DP13A+DP14	14A	0.20	0.44	19.29	3.93	8.54	From DP13A		20.6	150	1.0	1.5	1.7	22.3	10.8	22.3
A15		0.15	0.40	4.16	0.63	1.68	100	2.0	14.1	700	1.0	1.5	7.8	21.9	13.9	21.9
DP14A+A15	15	0.19	0.44	23.45	4.56	10.22	From DP14A		22.3	300	1.0	1.5	3.3	25.6	11.7	25.6
A15A		0.16	0.41	2.08	0.33	0.85	100	2.0	14.0	200	1.0	1.5	2.2	16.2	11.1	16.2
DP15A+G18 Out	15A	0.16	0.41	2.08	0.33	0.85	From DP15A		16.2					16.2	10.0	16.2
A16	16	0.16	0.41	4.41	0.71	1.81	100	1.0	17.6	450	1.0	1.5	5.0	22.6	12.5	22.6
A17	17	0.16	0.41	4.02	0.64	1.65	100	2.0	14.0	250	1.5	1.8	2.3	16.2	11.4	16.2
A18	18	0.16	0.41	1.81	0.29	0.74	100	2.0	14.0	250	2.0	2.1	2.0	15.9	11.4	15.9
A19	19	0.16	0.41	2.40	0.38	0.98	100	1.0	17.6	290	1.0	1.5	3.2	20.8	11.6	20.8
A20	20	0.21	0.45	2.18	0.47	0.98	50	4.0	7.4	900	1.5	1.8	8.2	15.5	15.0	15.5
A21	21	0.25	0.47	0.73	0.18	0.35	50	4.0	7.1	350	1.5	1.8	3.2	10.3	11.9	11.9
A22	22	0.16	0.41	2.03	0.33	0.83	100	2.0	14.0	115	2.0	2.1	0.9	14.9	10.6	14.9
A23		0.16	0.41	0.44	0.07	0.18	50	1.0	12.4	55	1.0	1.5	0.6	13.0	10.3	13.0
DP20+DP21+A23	23	0.18	0.42	3.21	0.58	1.36	From DP22		14.9	55	1.0	1.5	0.6	15.5	10.3	15.5
OSA6	OSA6	0.19	0.43	0.81	0.16	0.35	50	3.0	8.3	200	3.0	2.6	1.3	9.6	11.1	11.1
A24		0.18	0.43	11.59	2.11	4.94	100	3.0	11.9	740	3.0	2.6	4.7	16.7	14.1	16.7
DPB6+A24	24	0.17	0.42	19.51	3.37	8.19	From DPB6		13.6	740	3.0	2.6	4.7	18.4	14.1	18.4
DPOSA3+DP24	24A	0.17	0.42	20.33	3.53	8.54	From DP24		18.4					18.4	10.0	18.4
A25	25	0.49	0.66	1.61	0.79	1.06	50	4.0	5.1	550	1.5	1.8	5.0	10.1	13.1	13.1
DP24A+DP25	25A	0.20	0.44	21.94	4.32	9.60	From DP24A		18.4	550	1.5	1.8	5.0	23.3	13.1	23.3
A26		0.15	0.40	4.70	0.71	1.89	100	2.0	14.1	650	2.0	2.1	5.1	19.2	13.6	19.2
DP25A+OSA4+A26	26	0.19	0.43	26.64	5.03	11.49	From DP25A		23.3	400	2.0	2.1	3.1	26.5	12.2	26.5
A26A		0.16	0.41	1.00	0.16	0.41	50	2.0	9.9	200	1.5	1.8	1.8	11.7	11.1	11.7
A26A+G19 Out	26A	0.16	0.41	1.00	0.16	0.41	From A26		11.7					11.7	10.0	11.7
A27	27	0.16	0.41	5.25	0.84	2.15	100	2.0	14.0	425	2.5	2.4	3.0	16.9	12.4	16.9
A28	28	0.16	0.41	2.75	0.44	1.13	100	2.0	14.0	400	2.0	2.1	3.1	17.1	12.2	17.1
A29	29	0.16	0.41	4.75	0.76	1.95	100	2.0	14.0	438	1.5	1.8	4.0	17.9	12.4	17.9
A30	30	0.16	0.41	0.61	0.10	0.25	100	2.0	14.0	350	2.0	2.1	2.7	16.7	11.9	16.7
OSA7	OSA7	0.16	0.41	2.44	0.39	1.00	100	2.0	14.0	375	1.0	1.5	4.2	18.1	12.1	18.1
<b>PROPOSED B BASINS</b>																
B1	B1	0.16	0.41	3.20	0.51	1.31	100	2.0	14.0	430	2.0	2.1	3.4	17.3	12.4	12.4
B2	B2	0.16	0.41	0.78	0.12	0.32	100	1.0	17.6	80	1.0	1.5	0.9	18.5	10.4	10.4
B3	B3	0.16	0.41	5.24	0.84	2.15	100	2.0	14.0	700	2.0	2.1	5.5	19.5	13.9	13.9
B4	B4	0.20	0.44	7.14	1.40	3.12	50	4.0	7.5	650	2.0	2.1	5.1	12.6	13.6	12.6
B5	B5	0.16	0.41	1.59	0.25	0.65	100	3.0	12.2	190	3.0	2.6	1.2	13.4	11.1	11.1
B6	B6	0.16	0.41	7.92	1.27	3.25	100	2.0	14.0	650	2.0	2.1	5.1	19.1	13.6	13.6

**PROJECT INFORMATION**

PROJECT: Latigo Trails Filing 10  
 PROJECT NO: 21820-01CSCV  
 DESIGN BY: CGH  
 REV. BY: KGV  
 AGENCY: El Paso County  
 REPORT TYPE: Final  
 DATE: 9/17/2024



**RATIONAL METHOD CALCULATIONS FOR STORM WATER RUNOFF**

DEVELOPED RUNOFF 5 YR STORM P1= 1.46

BASIN (S)	DIRECT RUNOFF						
	DESIGN POINT	AREA (AC)	RUNOFF COEFF	t <sub>c</sub> (MIN)	C * A	I (IN/HR)	Q (CFS)
<b>PROPOSED A-BASINS</b>							
OSA1	OSA1	3.68	0.53	42.3	1.96	1.86	3.6
OSA2	OSA2	96.30	0.16	40.5	15.41	1.91	29.4
OSA3	OSA3	69.15	0.19	30.8	12.99	2.25	29.3
OSA4	OSA4	32.65	0.20	25.5	6.37	2.51	16.0
OSA5	OSA5	11.33	0.19	14.3	2.16	3.39	7.3
A1		13.55	0.18	18.5	2.40	2.99	7.2
A1+OSA2+OSA3+OSA4+OSA5+DPB1	1	226.18	0.18	47.1	39.84	1.73	69.0
A2		7.24	0.20	21.5	1.42	2.76	3.9
A2+OSA1+DP1	2	237.10	0.18	48.2	43.22	1.71	73.7
South Pond Out	2A						17.0
A3	3	6.48	0.16	18.5	1.04	2.99	3.1
A4		6.03	0.18	18.5	1.10	2.99	3.3
A4+DPB2	4	7.26	0.16	15.3	1.16	3.29	3.8
A5		8.02	0.18	17.9	1.42	3.04	4.3
A5+DPB3	5	13.26	0.17	18.7	2.26	2.97	6.7
DP5+DP4	5A	20.52	0.17	21.3	3.42	2.78	9.5
A6	6	4.02	0.19	23.0	0.77	2.67	2.1
DP5A+DP6	6A	24.53	0.17	26.9	4.19	2.44	10.2
A7	7	0.63	0.30	11.7	0.19	3.71	0.7
A8	8	7.21	0.18	26.1	1.28	2.48	3.2
A8+DP7+DP6A	8A	32.36	0.18	28.6	5.67	2.36	13.3
A9	9	3.23	0.49	22.4	1.58	2.70	4.3
A10		0.58	0.08	16.5	0.05	3.17	0.1
A10+DP8A+DP9	10	36.18	0.20	29.0	7.30	2.34	17.1
A10A		1.49	0.16	15.3	0.24	3.28	0.8
G14b Out							0.2
A10A+G14b Out	10A	1.49	0.16	15.3	0.24	3.28	1.0
A11		3.61	0.17	17.5	0.63	3.08	1.9
DPB5+A11	11	5.20	0.17	17.5	0.88	3.08	2.7
A12	12	2.36	0.19	16.2	0.45	3.19	1.4
DP11+DP12	12A	7.56	0.18	20.2	1.33	2.86	3.8
A13		3.34	0.18	17.7	0.59	3.06	1.8
A13+DPB4	13	10.48	0.19	16.6	1.99	3.15	6.3
DP12A+DP13	13A	18.04	0.18	20.6	3.32	2.83	9.4
A14	14	1.25	0.49	12.8	0.61	3.56	2.2



DP13A+DP14	14A	19.29	0.20	22.3	3.93	2.71	<b>10.7</b>
A15		4.16	0.15	21.9	0.63	2.74	<b>1.7</b>
DP14A+A15	15	23.45	0.19	25.6	4.56	2.51	<b>11.5</b>
A15A		2.08	0.16	16.2	0.33	3.20	<b>1.1</b>
G18 Out							<b>0.1</b>
DP15A+G18 Out	15A	2.08	0.16	16.2	0.33	3.20	<b>1.2</b>
A16	16	4.41	0.16	22.6	0.71	2.69	<b>1.9</b>
A17	17	4.02	0.16	16.2	0.64	3.19	<b>2.1</b>
A18	18	1.81	0.16	15.9	0.29	3.22	<b>0.9</b>
A19	19	2.40	0.16	20.8	0.38	2.81	<b>1.1</b>
A20	20	2.18	0.21	15.5	0.47	3.26	<b>1.5</b>
A21	21	0.73	0.25	11.9	0.18	3.67	<b>0.7</b>
A22	22	2.03	0.16	14.9	0.33	3.33	<b>1.1</b>
A23		0.44	0.16	13.0	0.07	3.53	<b>0.2</b>
DP20+DP21+A23	23	3.21	0.18	15.5	0.58	3.27	<b>1.9</b>
OSA6	OSA6	0.81	0.19	11.1	0.16	3.79	<b>0.6</b>
A24		11.59	0.18	16.7	2.11	3.15	<b>6.6</b>
DPB6+A24	24	19.51	0.17	18.4	3.37	3.00	<b>10.1</b>
DPOSA3+DP24	24A	20.33	0.17	18.4	3.53	3.00	<b>10.6</b>
A25	25	1.61	0.49	13.1	0.79	3.53	<b>2.8</b>
DP24A+DP25	25A	21.94	0.20	23.3	4.32	2.64	<b>11.4</b>
A26		4.70	0.15	19.2	0.71	2.93	<b>2.1</b>
DP25A+OSA4+A26	26	26.64	0.19	26.5	5.03	2.46	<b>12.4</b>
A26A		1.00	0.16	11.7	0.16	3.71	<b>0.6</b>
G19 Out							<b>0.1</b>
A26A+G19 Out	26A	1.00	0.16	11.7	0.16	3.71	<b>0.7</b>
A27	27	5.25	0.16	16.9	0.84	3.13	<b>2.6</b>
A28	28	2.75	0.16	17.1	0.44	3.11	<b>1.4</b>
A29	29	4.75	0.16	17.9	0.76	3.04	<b>2.3</b>
A30	30	0.61	0.16	16.7	0.10	3.15	<b>0.3</b>
OSA7	OSA7	2.44	0.16	18.1	0.39	3.02	<b>1.2</b>
<b>PROPOSED B-BASINS</b>							
B1	B1	3.20	0.16	12.4	0.51	3.61	<b>1.9</b>
B2	B2	0.78	0.16	10.4	0.12	3.88	<b>0.5</b>
B3	B3	5.24	0.16	13.9	0.84	3.44	<b>2.9</b>
B4	B4	7.14	0.20	12.6	1.40	3.58	<b>5.0</b>
B5	B5	1.59	0.16	11.1	0.25	3.79	<b>1.0</b>
B6	B6	7.92	0.16	13.6	1.27	3.47	<b>4.4</b>

**PROJECT INFORMATION**

PROJECT: Latigo Trails Filing 10  
 PROJECT NO: 21820-01CSCV  
 DESIGN BY: CGH  
 REV. BY: KGV  
 AGENCY: El Paso County  
 REPORT TYPE: Final  
 DATE: 9/17/2024



**RATIONAL METHOD CALCULATIONS FOR STORM WATER RUNOFF**

DEVELOPED RUNOFF 100 YR STORM P1= **2.47**

BASIN (S)	DIRECT RUNOFF						
	DESIGN POINT	AREA (AC)	RUNOFF COEFF	t <sub>c</sub> (MIN)	C * A	I (IN/HR)	Q (CFS)
<b>PROPOSED A-BASINS</b>							
OSA1	OSA1	3.68	0.69	42.3	2.53	3.14	7.9
OSA2	OSA2	96.30	0.41	40.5	39.48	3.23	127.3
OSA3	OSA3	69.15	0.43	30.8	29.73	3.81	113.4
OSA4	OSA4	32.65	0.44	25.5	14.24	4.25	60.5
OSA5	OSA5	11.33	0.43	14.3	4.91	5.73	28.1
A1		13.55	0.42	18.5	5.73	5.06	29.0
A1+OSA2+OSA3+OSA4+OSA5+DPB1	1	226.18	0.42	47.1	95.40	2.93	279.5
A2		7.24	0.44	21.5	3.16	4.67	14.8
A2+OSA1+DP1	2	237.10	0.43	48.2	101.09	2.89	291.8
South Pond Out	2A						293.5
A3	3	6.48	0.41	18.5	2.66	5.06	13.5
A4		6.03	0.43	18.5	2.57	5.06	13.0
A4+DPB2	4	7.26	0.41	15.3	2.98	5.56	16.5
A5		8.02	0.42	17.9	3.39	5.15	17.5
A5+DPB3	5	13.26	0.42	18.7	5.54	5.03	27.8
DP5+DP4	5A	20.52	0.42	21.3	8.51	4.70	40.0
A6	6	4.02	0.43	23.0	1.74	4.51	7.9
DP5A+DP6	6A	24.53	0.42	26.9	10.26	4.13	42.3
A7	7	0.63	0.52	11.7	0.32	6.27	2.0
A8	8	7.21	0.42	26.1	3.05	4.20	12.8
A8+DP7+DP6A	8A	32.36	0.42	28.6	13.63	3.98	54.3
A9	9	3.23	0.66	22.4	2.12	4.57	9.7
A10		0.58	0.35	16.5	0.20	5.36	1.1
A10+DP8A+DP9	10	36.18	0.44	29.0	15.95	3.96	63.1
A10A		1.49	0.41	15.3	0.61	5.55	3.4
G14b Out							52.1
A10A+G14b Out	10A	1.49	0.41	15.3	0.61	5.55	55.5
A11		3.61	0.42	17.5	1.52	5.21	7.9
DPB5+A11	11	5.20	0.42	17.5	2.17	5.21	11.3
A12	12	2.36	0.43	16.2	1.02	5.40	5.5
DP11+DP12	12A	7.56	0.42	20.2	3.19	4.84	15.4
A13		3.34	0.42	17.7	1.41	5.17	7.3
A13+DPB4	13	10.48	0.43	16.6	4.53	5.34	24.2
DP12A+DP13	13A	18.04	0.43	20.6	7.72	4.78	36.9
A14	14	1.25	0.66	12.8	0.82	6.02	4.9

DP13A+DP14	14A	19.29	0.44	22.3	8.54	4.59	<b>39.2</b>
A15		4.16	0.40	21.9	1.68	4.63	<b>7.8</b>
DP14A+A15	15	23.45	0.44	25.6	10.22	4.25	<b>43.4</b>
A15A		2.08	0.41	16.2	0.85	5.41	<b>4.6</b>
G18 Out							<b>27.1</b>
DP15A+G18 Out	15A	2.08	0.41	16.2	0.85	5.41	<b>31.7</b>
A16	16	4.41	0.41	22.6	1.81	4.55	<b>8.2</b>
A17	17	4.02	0.41	16.2	1.65	5.40	<b>8.9</b>
A18	18	1.81	0.41	15.9	0.74	5.45	<b>4.1</b>
A19	19	2.40	0.41	20.8	0.98	4.76	<b>4.7</b>
A20	20	2.18	0.45	15.5	0.98	5.51	<b>5.4</b>
A21	21	0.73	0.47	11.9	0.35	6.21	<b>2.2</b>
A22	22	2.03	0.41	14.9	0.83	5.63	<b>4.7</b>
A23		0.44	0.41	13.0	0.18	5.98	<b>1.1</b>
DP20+DP21+A23	23	3.21	0.42	15.5	1.36	5.53	<b>7.5</b>
OSA6	OSA6	0.81	0.43	11.1	0.35	6.40	<b>2.3</b>
A24		11.59	0.43	16.7	4.94	5.33	<b>26.3</b>
DPB6+A24	24	19.51	0.42	18.4	8.19	5.08	<b>41.6</b>
DPOSA3+DP24	24A	20.33	0.42	18.4	8.54	5.08	<b>43.4</b>
A25	25	1.61	0.66	13.1	1.06	5.98	<b>6.3</b>
DP24A+DP25	25A	21.94	0.44	23.3	9.60	4.47	<b>42.9</b>
A26		4.70	0.40	19.2	1.89	4.96	<b>9.4</b>
DP25A+OSA4+A26	26	26.64	0.43	26.5	11.49	4.17	<b>47.9</b>
A26A		1.00	0.41	11.7	0.41	6.27	<b>2.6</b>
G19 Out							<b>34.3</b>
A26A+G19 Out	26A	1.00	0.41	11.7	0.41	6.27	<b>36.9</b>
A27	27	5.25	0.41	16.9	2.15	5.29	<b>11.4</b>
A28	28	2.75	0.41	17.1	1.13	5.26	<b>5.9</b>
A29	29	4.75	0.41	17.9	1.95	5.14	<b>10.0</b>
A30	30	0.61	0.41	16.7	0.25	5.32	<b>1.3</b>
OSA7	OSA7	2.44	0.41	18.1	1.00	5.11	<b>5.1</b>
<b>PROPOSED B-BASINS</b>							
B1	B1	3.20	0.41	12.4	1.31	6.12	<b>8.0</b>
B2	B2	0.78	0.41	10.4	0.32	6.57	<b>2.1</b>
B3	B3	5.24	0.41	13.9	2.15	5.81	<b>12.5</b>
B4	B4	7.14	0.44	12.6	3.12	6.06	<b>18.9</b>
B5	B5	1.59	0.41	11.1	0.65	6.42	<b>4.2</b>
B6	B6	7.92	0.41	13.6	3.25	5.87	<b>19.0</b>

# Channel Report

## Roadside Ditch - DP OSA1

### Triangular

Side Slopes (z:1) = 4.00, 4.00

Total Depth (ft) = 2.00

Invert Elev (ft) = 1.00

Slope (%) = 2.00

N-Value = 0.030

### Calculations

Compute by: Known Q

Known Q (cfs) = 7.90

### Highlighted

Depth (ft) = 0.75

Q (cfs) = 7.900

Area (sqft) = 2.25

Velocity (ft/s) = 3.51

Wetted Perim (ft) = 6.18

Crit Depth, Yc (ft) = 0.76

Top Width (ft) = 6.00

EGL (ft) = 0.94

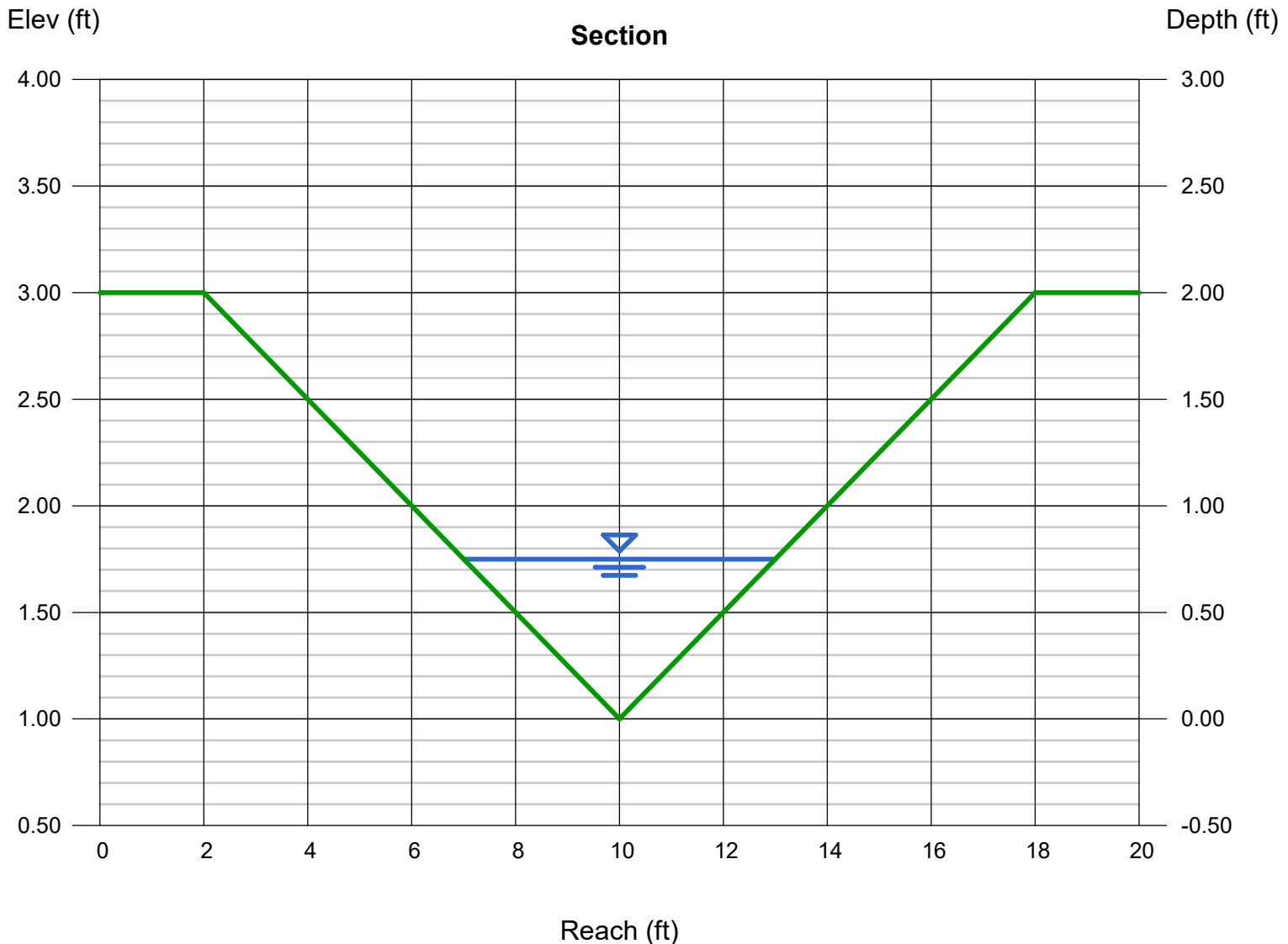

# Channel Report

## Roadside Ditch - DP OSA2

### Triangular

Side Slopes (z:1) = 4.00, 4.00

Total Depth (ft) = 3.00

Invert Elev (ft) = 1.00

Slope (%) = 2.20

N-Value = 0.030

### Calculations

Compute by: Known Q

Known Q (cfs) = 127.30

### Highlighted

Depth (ft) = 2.08

Q (cfs) = 127.30

Area (sqft) = 17.31

Velocity (ft/s) = 7.36

Wetted Perim (ft) = 17.15

Crit Depth,  $Y_c$  (ft) = 2.30

Top Width (ft) = 16.64

EGL (ft) = 2.92

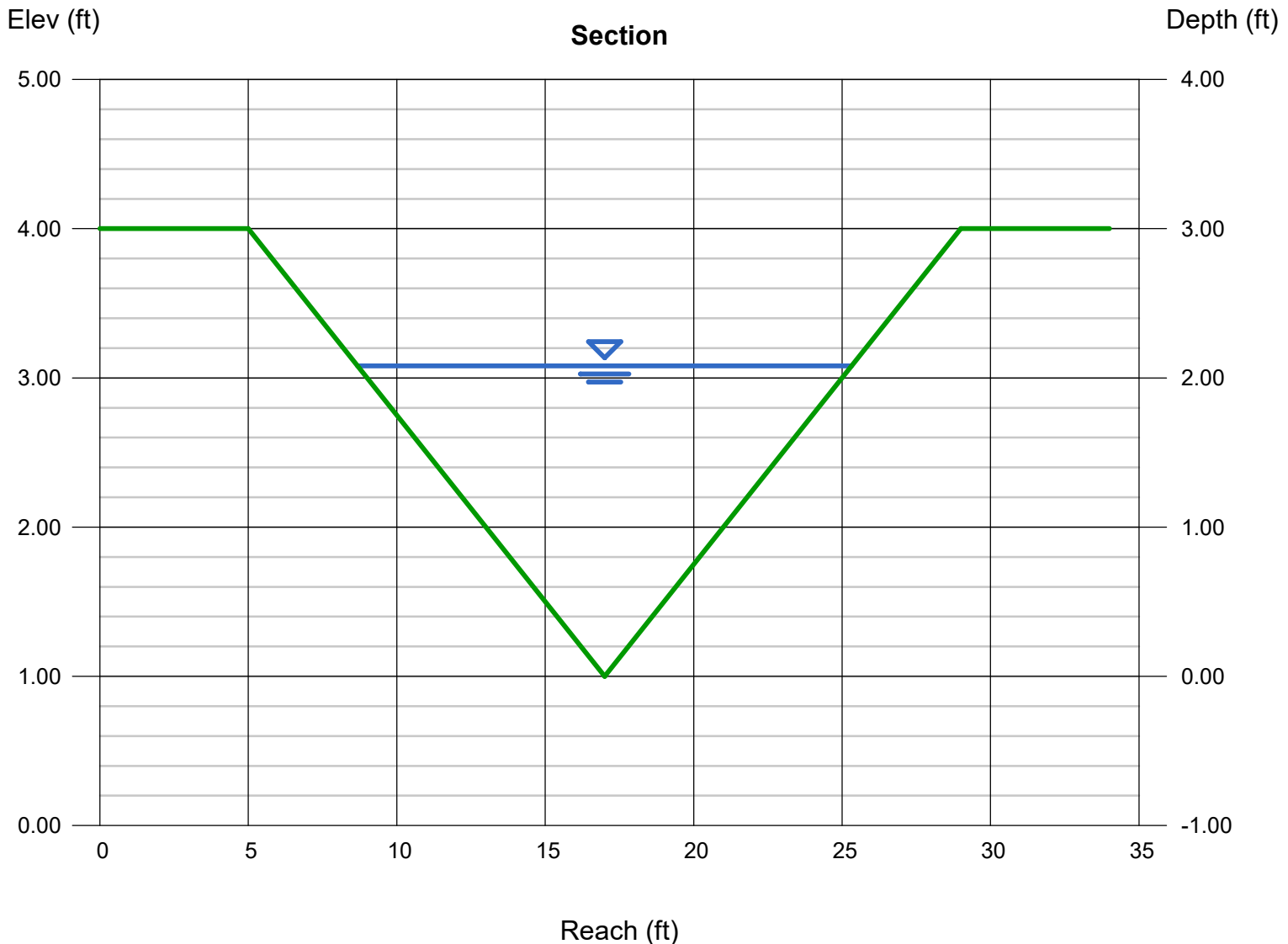

# Channel Report

## Roadside Ditch - DP 1

### Triangular

Side Slopes (z:1) = 4.00, 4.00  
Total Depth (ft) = 4.00

Invert Elev (ft) = 1.00  
Slope (%) = 2.00  
N-Value = 0.030

### Calculations

Compute by: Known Q  
Known Q (cfs) = 279.50

### Highlighted

Depth (ft) = 2.84  
Q (cfs) = 279.50  
Area (sqft) = 32.26  
Velocity (ft/s) = 8.66  
Wetted Perim (ft) = 23.42  
Crit Depth, Yc (ft) = 3.14  
Top Width (ft) = 22.72  
EGL (ft) = 4.01

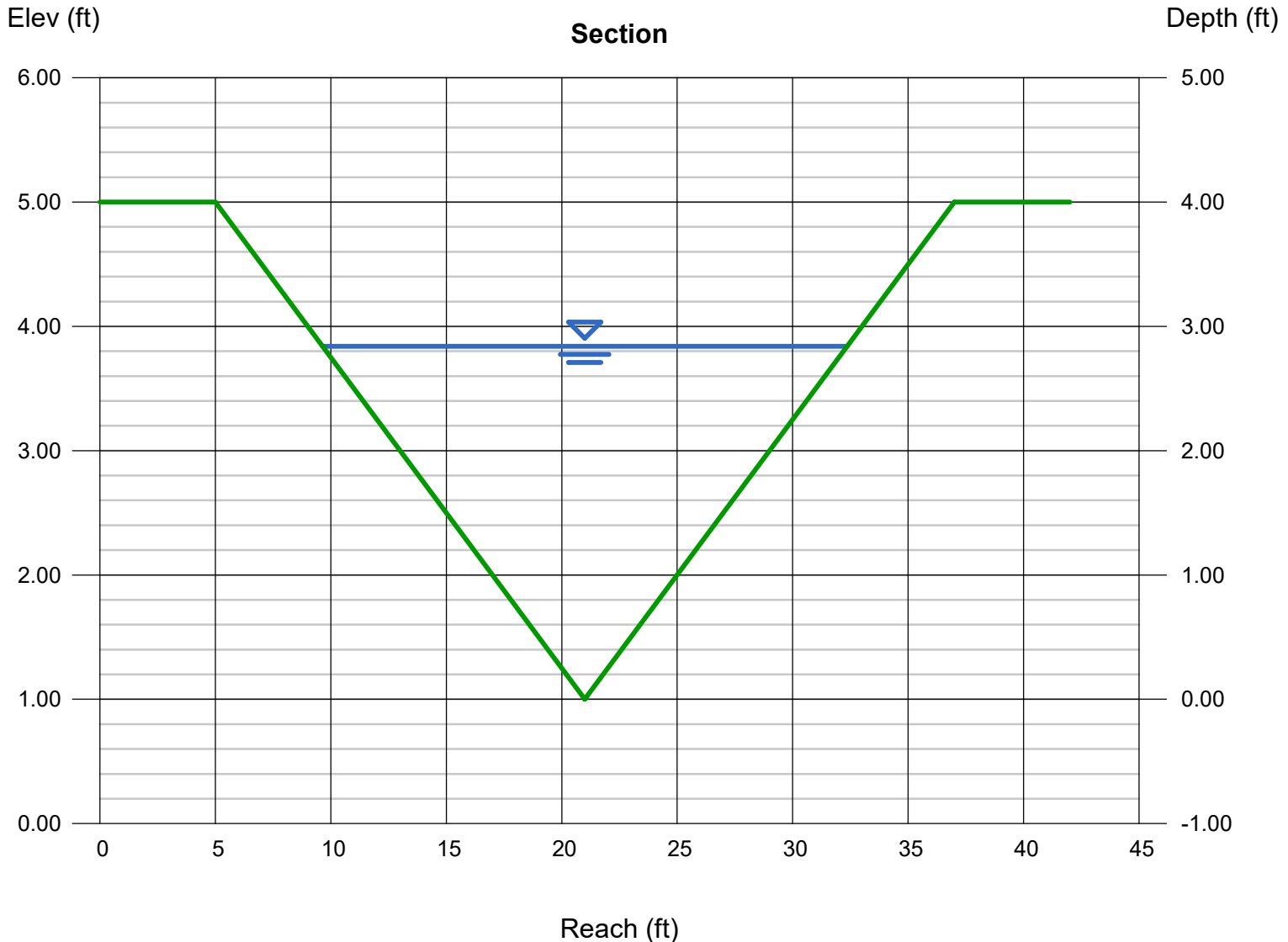

# Channel Report

## Roadside Ditch - DP 4

### Triangular

Side Slopes (z:1) = 4.00, 4.00

Total Depth (ft) = 2.00

Invert Elev (ft) = 1.00

Slope (%) = 1.70

N-Value = 0.030

### Calculations

Compute by: Known Q

Known Q (cfs) = 16.50

### Highlighted

Depth (ft) = 1.02

Q (cfs) = 16.50

Area (sqft) = 4.16

Velocity (ft/s) = 3.96

Wetted Perim (ft) = 8.41

Crit Depth, Yc (ft) = 1.02

Top Width (ft) = 8.16

EGL (ft) = 1.26

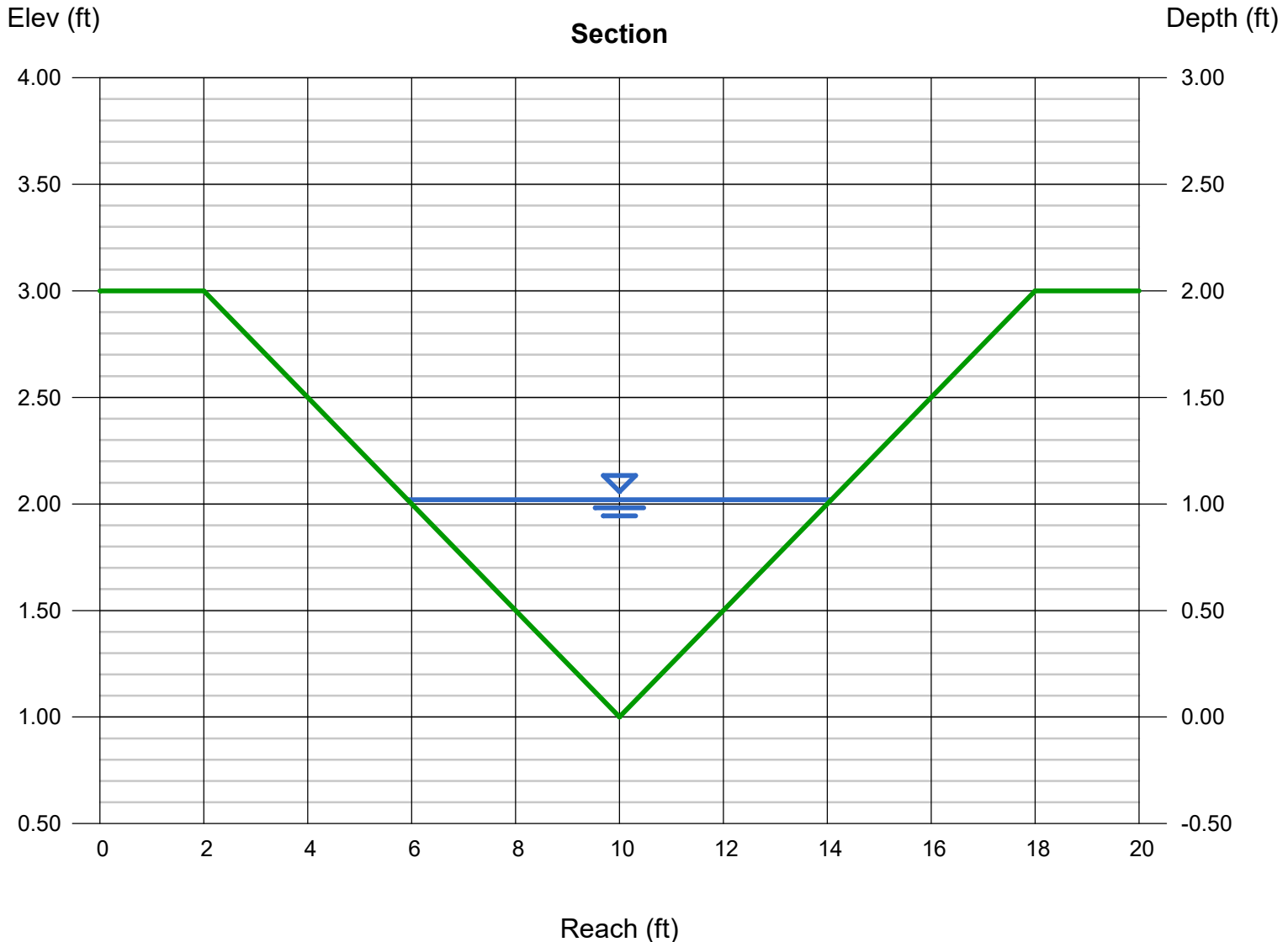

# Channel Report

## Roadside Ditch - DP 5A

### Triangular

Side Slopes (z:1) = 4.00, 4.00

Total Depth (ft) = 2.50

Invert Elev (ft) = 1.00

Slope (%) = 1.50

N-Value = 0.030

### Calculations

Compute by: Known Q

Known Q (cfs) = 40.00

### Highlighted

Depth (ft) = 1.45

Q (cfs) = 40.00

Area (sqft) = 8.41

Velocity (ft/s) = 4.76

Wetted Perim (ft) = 11.96

Crit Depth, Yc (ft) = 1.45

Top Width (ft) = 11.60

EGL (ft) = 1.80

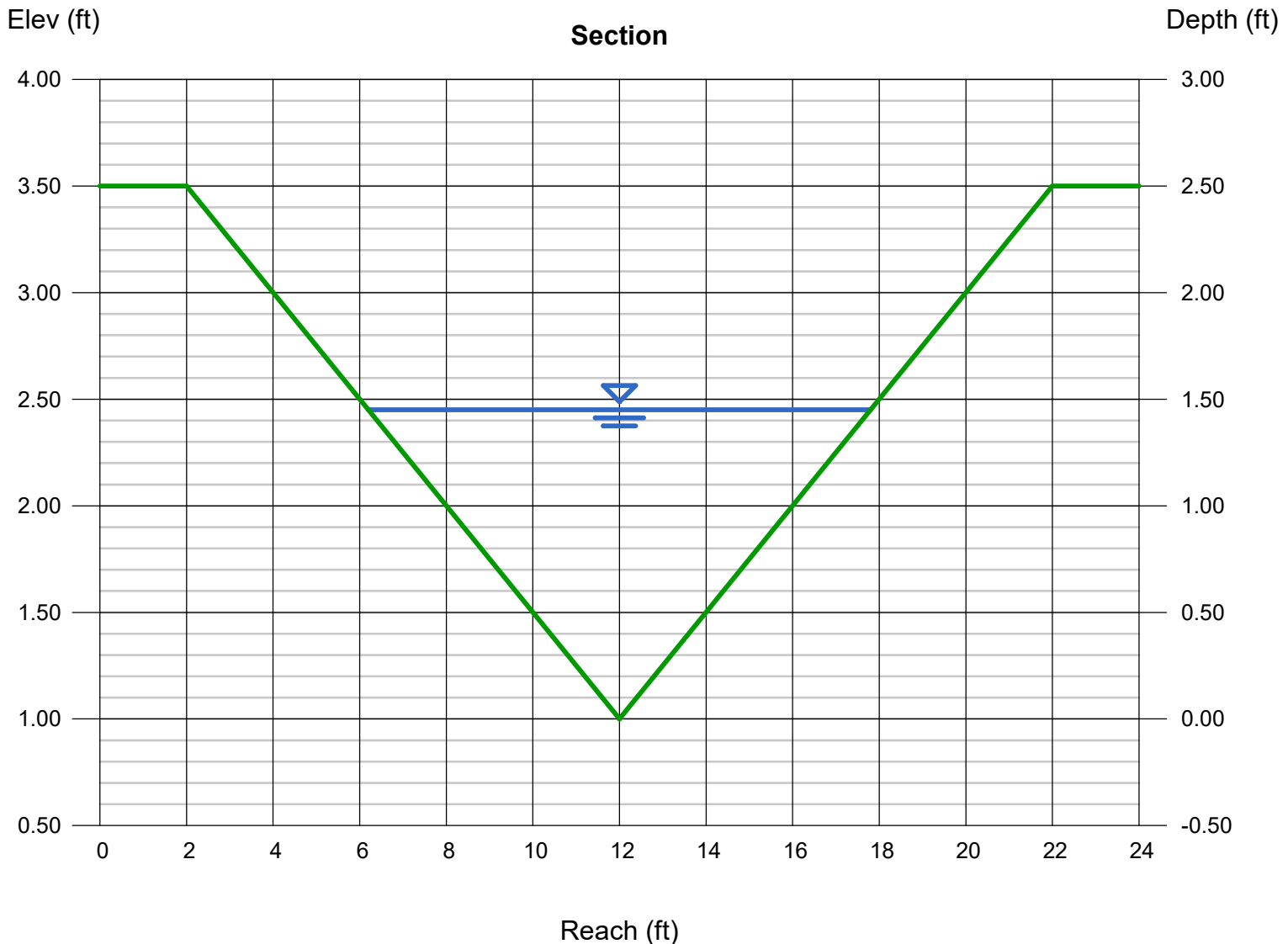



# Channel Report

## Roadside Ditch - DP 6A

### Triangular

Side Slopes (z:1) = 4.00, 4.00  
Total Depth (ft) = 2.50

Invert Elev (ft) = 1.00  
Slope (%) = 2.50  
N-Value = 0.030

### Calculations

Compute by: Known Q  
Known Q (cfs) = 42.30

### Highlighted

Depth (ft) = 1.35  
Q (cfs) = 42.30  
Area (sqft) = 7.29  
Velocity (ft/s) = 5.80  
Wetted Perim (ft) = 11.13  
Crit Depth, Yc (ft) = 1.48  
Top Width (ft) = 10.80  
EGL (ft) = 1.87

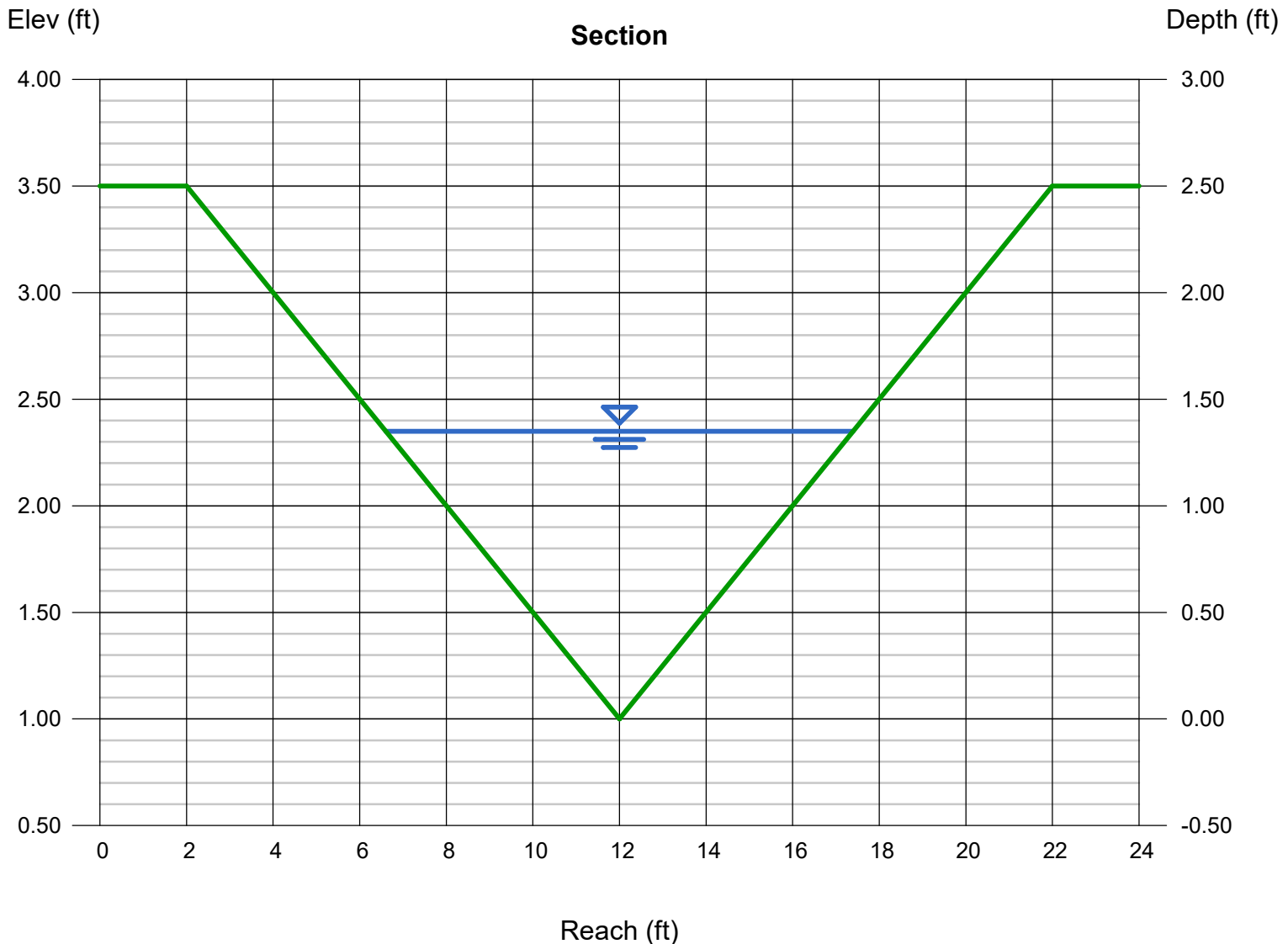

# Channel Report

## Roadside Ditch - DP 7

### Triangular

Side Slopes (z:1) = 4.00, 4.00  
Total Depth (ft) = 1.50

Invert Elev (ft) = 1.00  
Slope (%) = 3.40  
N-Value = 0.030

### Calculations

Compute by: Known Q  
Known Q (cfs) = 2.00

### Highlighted

Depth (ft) = 0.41  
Q (cfs) = 2.000  
Area (sqft) = 0.67  
Velocity (ft/s) = 2.97  
Wetted Perim (ft) = 3.38  
Crit Depth, Yc (ft) = 0.44  
Top Width (ft) = 3.28  
EGL (ft) = 0.55

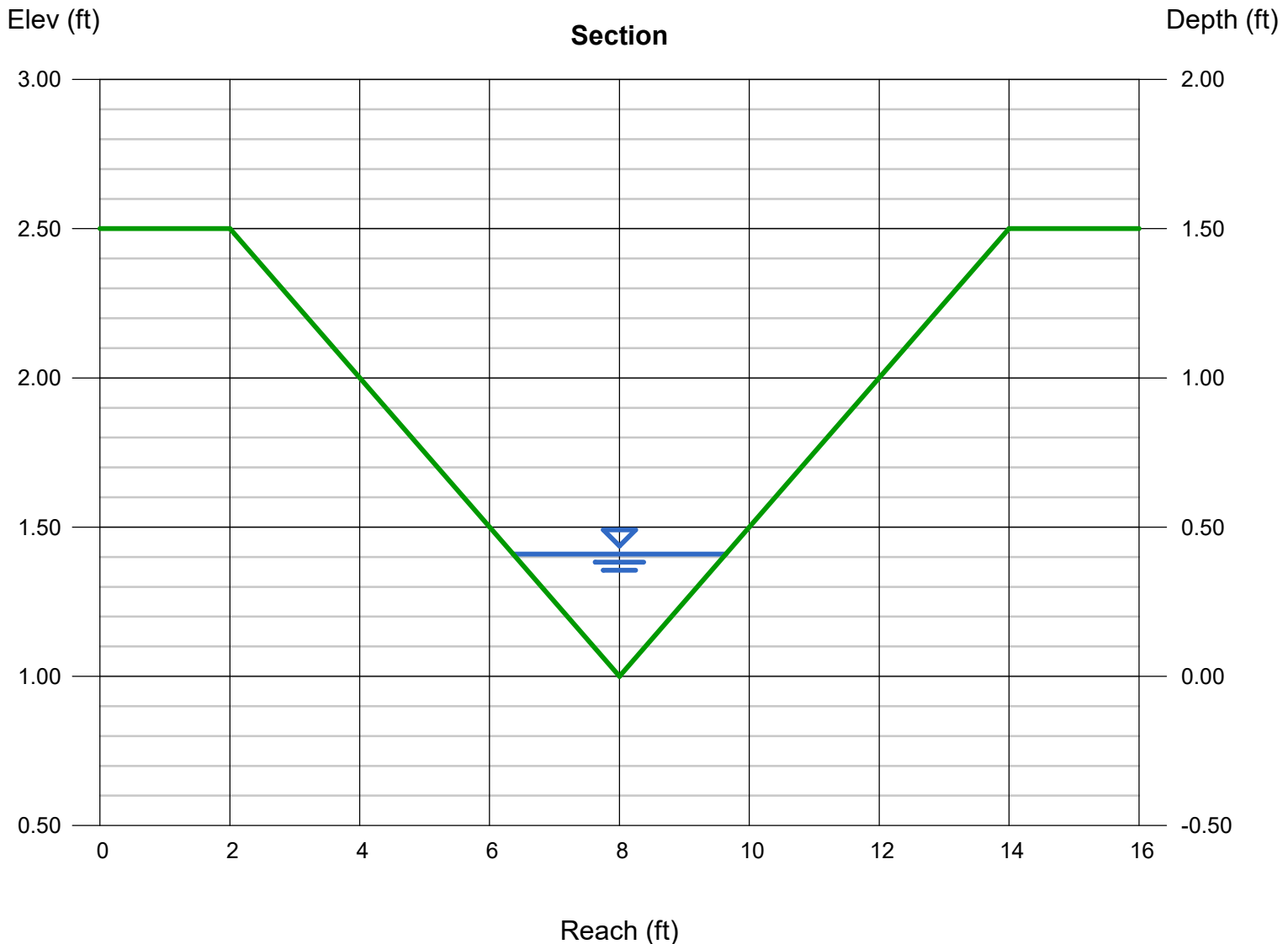

# Channel Report

## Roadside Ditch - DP 8A

### Triangular

Side Slopes (z:1) = 4.00, 4.00

Total Depth (ft) = 3.00

Invert Elev (ft) = 1.00

Slope (%) = 2.80

N-Value = 0.030

### Calculations

Compute by: Known Q

Known Q (cfs) = 54.30

### Highlighted

Depth (ft) = 1.45

Q (cfs) = 54.30

Area (sqft) = 8.41

Velocity (ft/s) = 6.46

Wetted Perim (ft) = 11.96

Crit Depth,  $Y_c$  (ft) = 1.63

Top Width (ft) = 11.60

EGL (ft) = 2.10

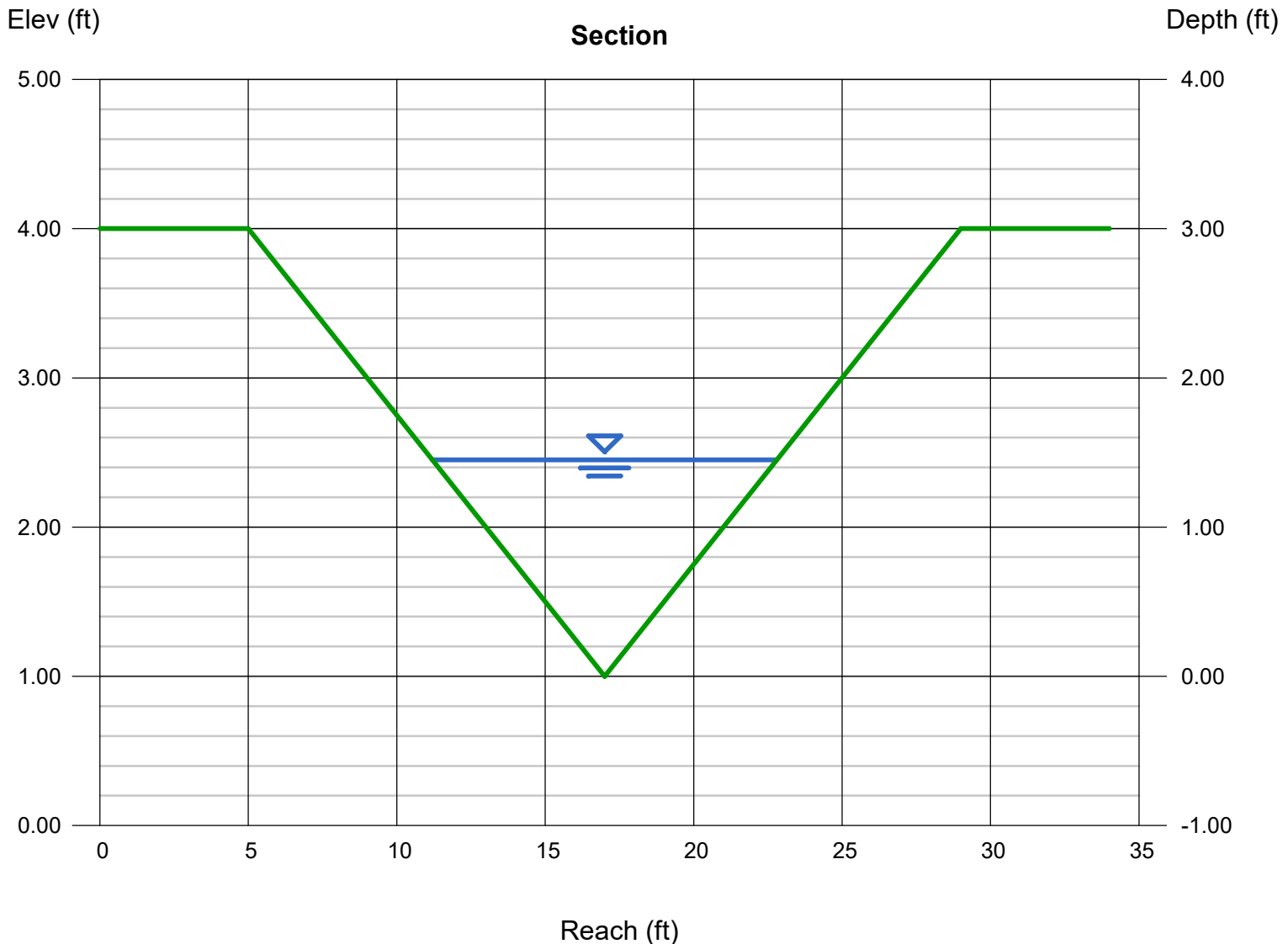

# Channel Report

## Roadside Ditch - DP 9

### Triangular

Side Slopes (z:1) = 4.00, 4.00  
Total Depth (ft) = 2.00

Invert Elev (ft) = 1.00  
Slope (%) = 2.00  
N-Value = 0.030

### Calculations

Compute by: Known Q  
Known Q (cfs) = 9.70

### Highlighted

Depth (ft) = 0.81  
Q (cfs) = 9.700  
Area (sqft) = 2.62  
Velocity (ft/s) = 3.70  
Wetted Perim (ft) = 6.68  
Crit Depth, Yc (ft) = 0.82  
Top Width (ft) = 6.48  
EGL (ft) = 1.02

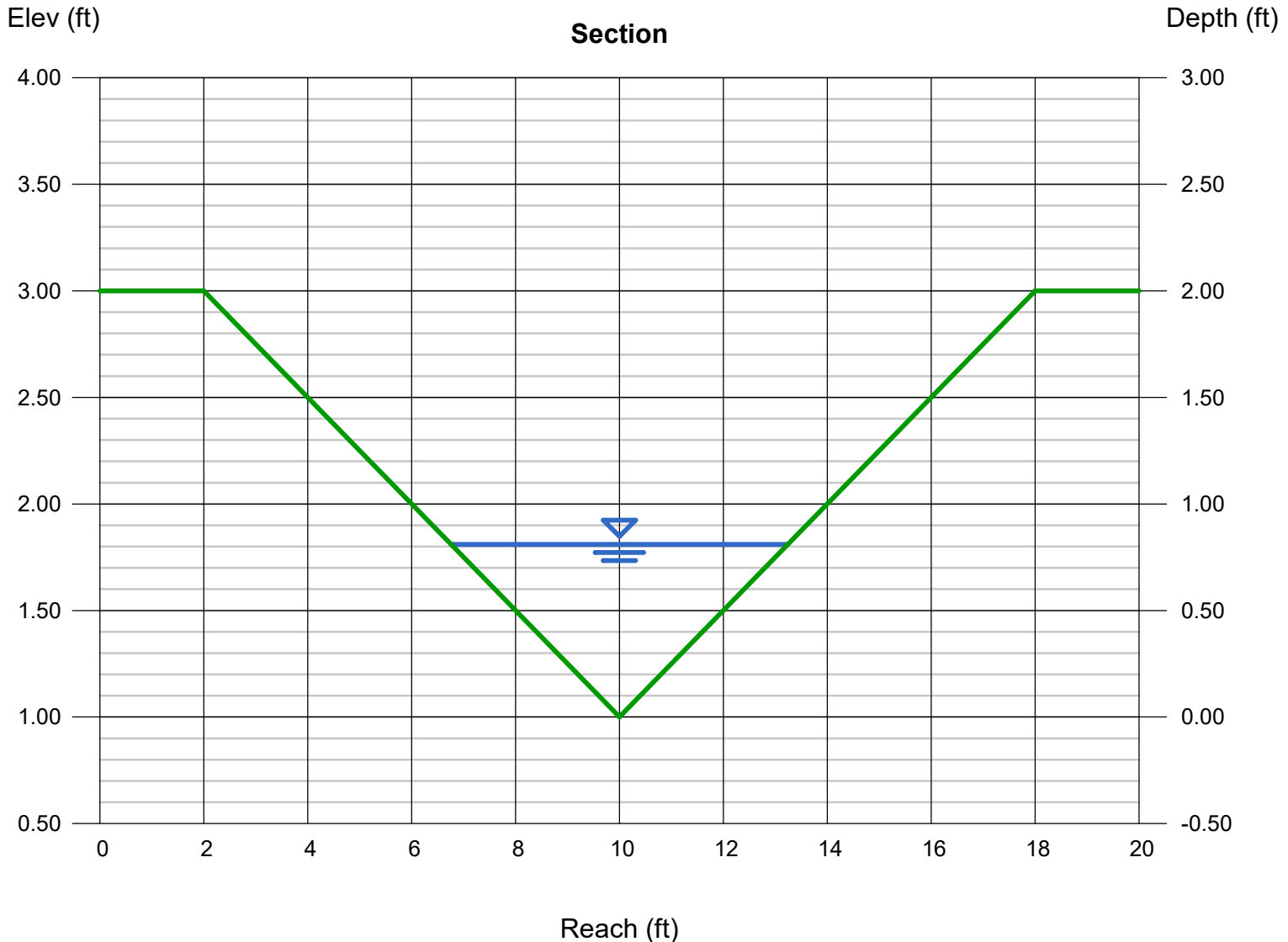

# Channel Report

## Roadside Ditch - DP 11

### Triangular

Side Slopes (z:1) = 4.00, 4.00

Total Depth (ft) = 2.00

Invert Elev (ft) = 1.00

Slope (%) = 1.50

N-Value = 0.030

### Calculations

Compute by: Known Q

Known Q (cfs) = 11.30

### Highlighted

Depth (ft) = 0.90

Q (cfs) = 11.30

Area (sqft) = 3.24

Velocity (ft/s) = 3.49

Wetted Perim (ft) = 7.42

Crit Depth, Yc (ft) = 0.87

Top Width (ft) = 7.20

EGL (ft) = 1.09

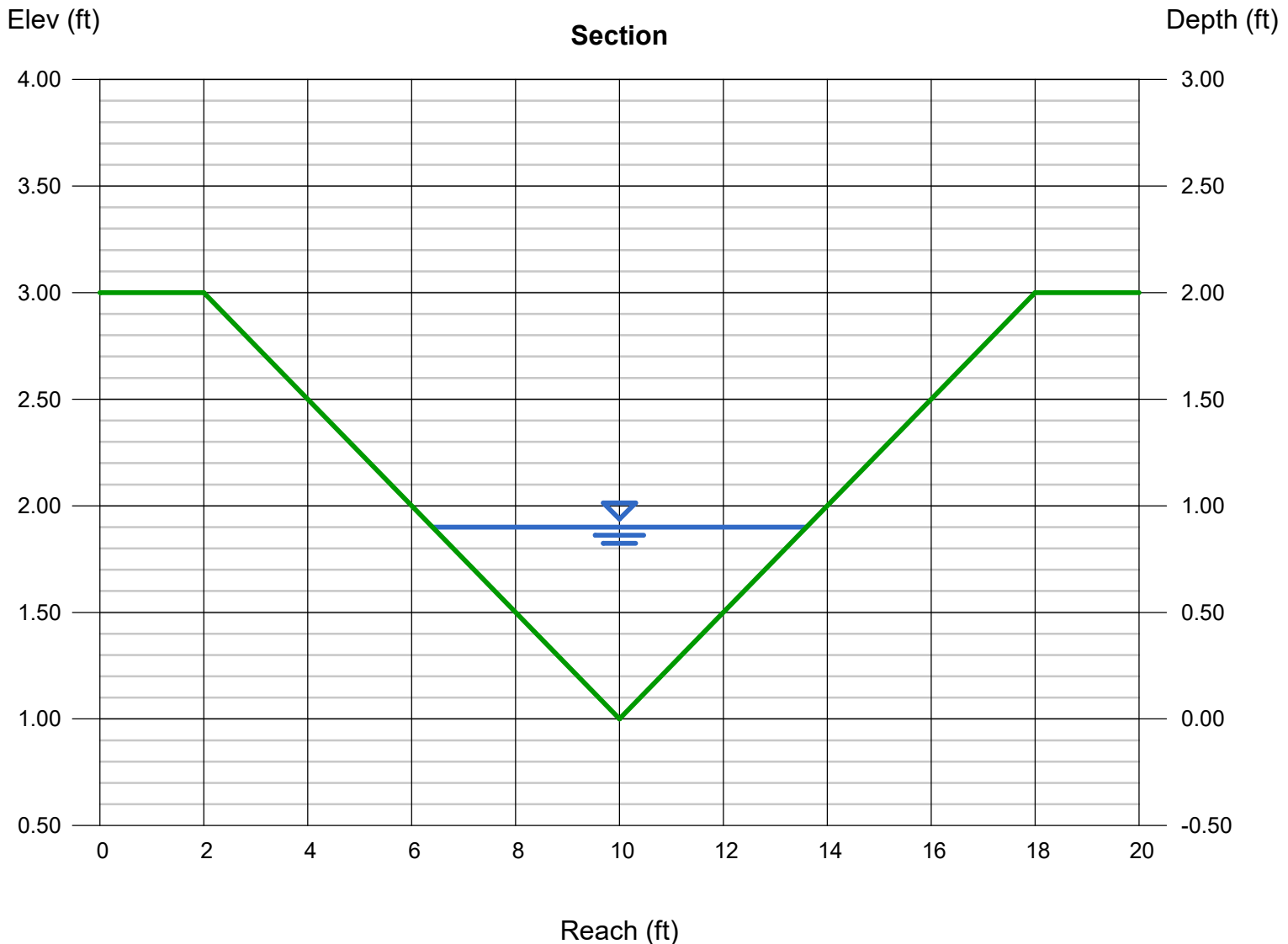

# Channel Report

## Roadside Ditch - DP 12A

### Triangular

Side Slopes (z:1) = 4.00, 4.00

Total Depth (ft) = 2.00

Invert Elev (ft) = 1.00

Slope (%) = 1.50

N-Value = 0.030

### Calculations

Compute by: Known Q

Known Q (cfs) = 15.40

### Highlighted

Depth (ft) = 1.02

Q (cfs) = 15.40

Area (sqft) = 4.16

Velocity (ft/s) = 3.70

Wetted Perim (ft) = 8.41

Crit Depth, Yc (ft) = 0.99

Top Width (ft) = 8.16

EGL (ft) = 1.23

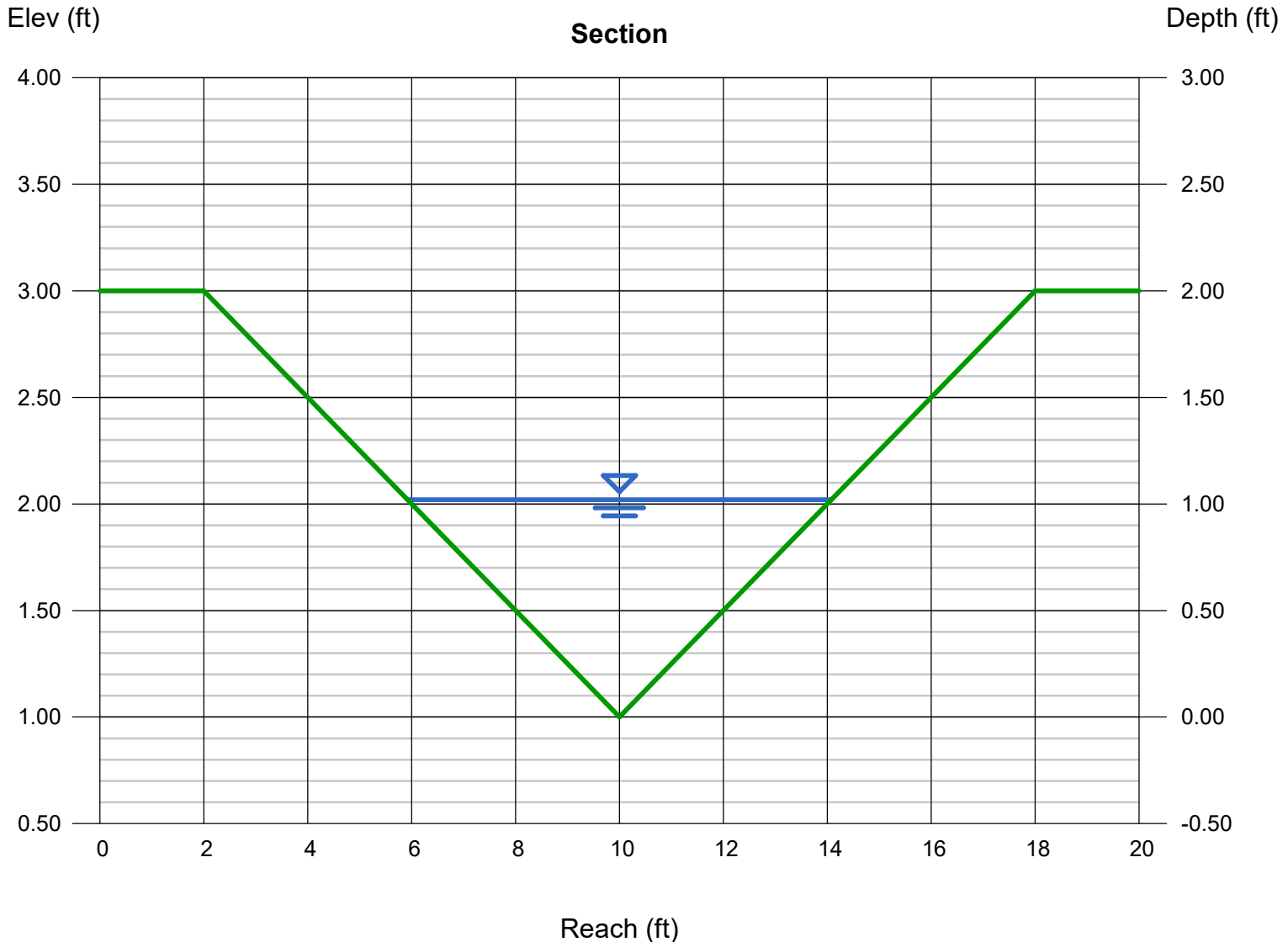

# Channel Report

## Roadside Ditch - DP 13A

### Triangular

Side Slopes (z:1) = 4.00, 4.00

Total Depth (ft) = 2.50

Invert Elev (ft) = 1.00

Slope (%) = 2.50

N-Value = 0.030

### Calculations

Compute by: Known Q

Known Q (cfs) = 36.90

### Highlighted

Depth (ft) = 1.28

Q (cfs) = 36.90

Area (sqft) = 6.55

Velocity (ft/s) = 5.63

Wetted Perim (ft) = 10.56

Crit Depth, Yc (ft) = 1.40

Top Width (ft) = 10.24

EGL (ft) = 1.77

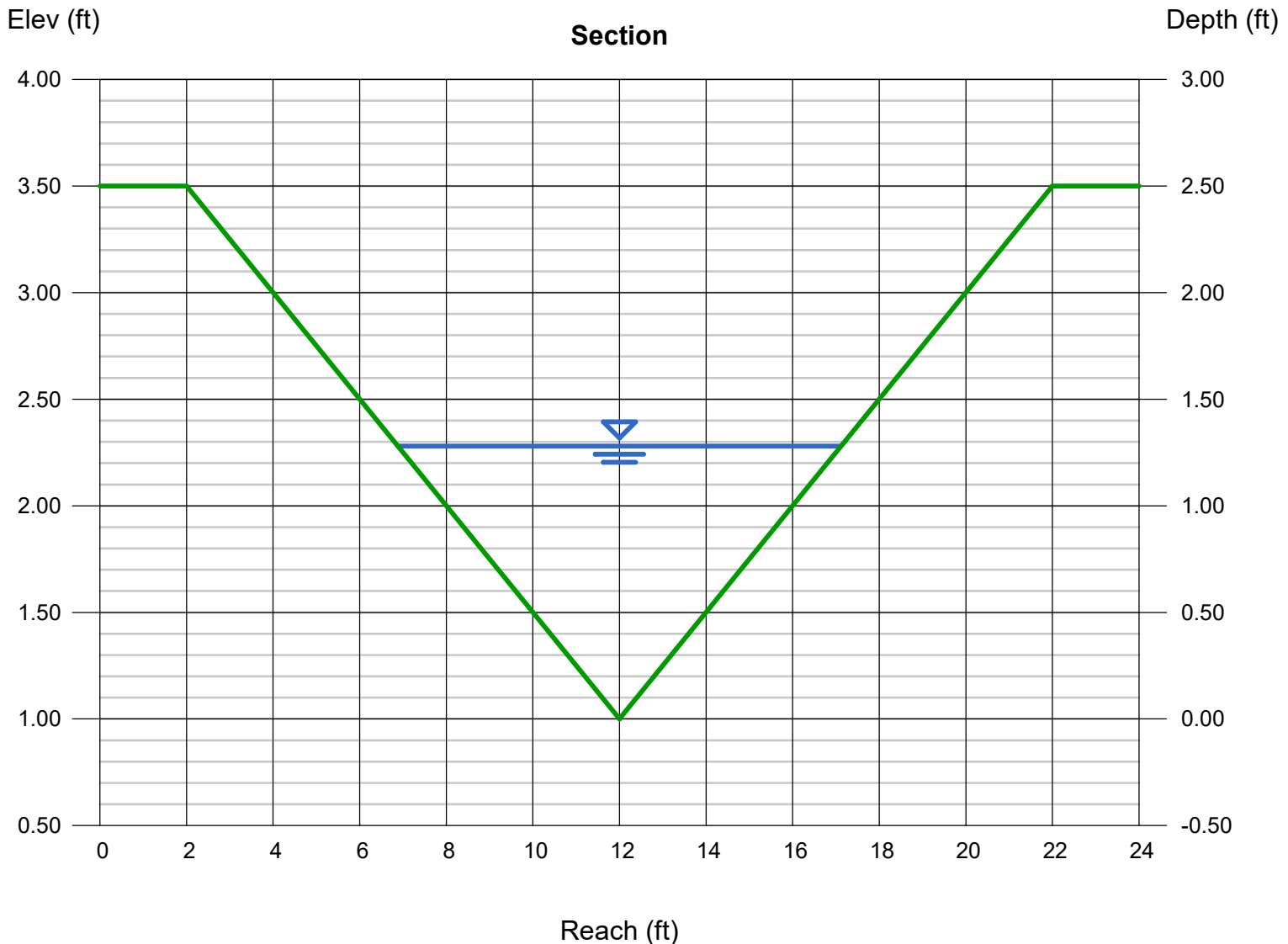

# Channel Report

## Roadside Ditch - DP 14

### Triangular

Side Slopes (z:1) = 4.00, 4.00

Total Depth (ft) = 2.00

Invert Elev (ft) = 1.00

Slope (%) = 2.50

N-Value = 0.030

### Calculations

Compute by: Known Q

Known Q (cfs) = 4.90

### Highlighted

Depth (ft) = 0.60

Q (cfs) = 4.900

Area (sqft) = 1.44

Velocity (ft/s) = 3.40

Wetted Perim (ft) = 4.95

Crit Depth, Yc (ft) = 0.63

Top Width (ft) = 4.80

EGL (ft) = 0.78

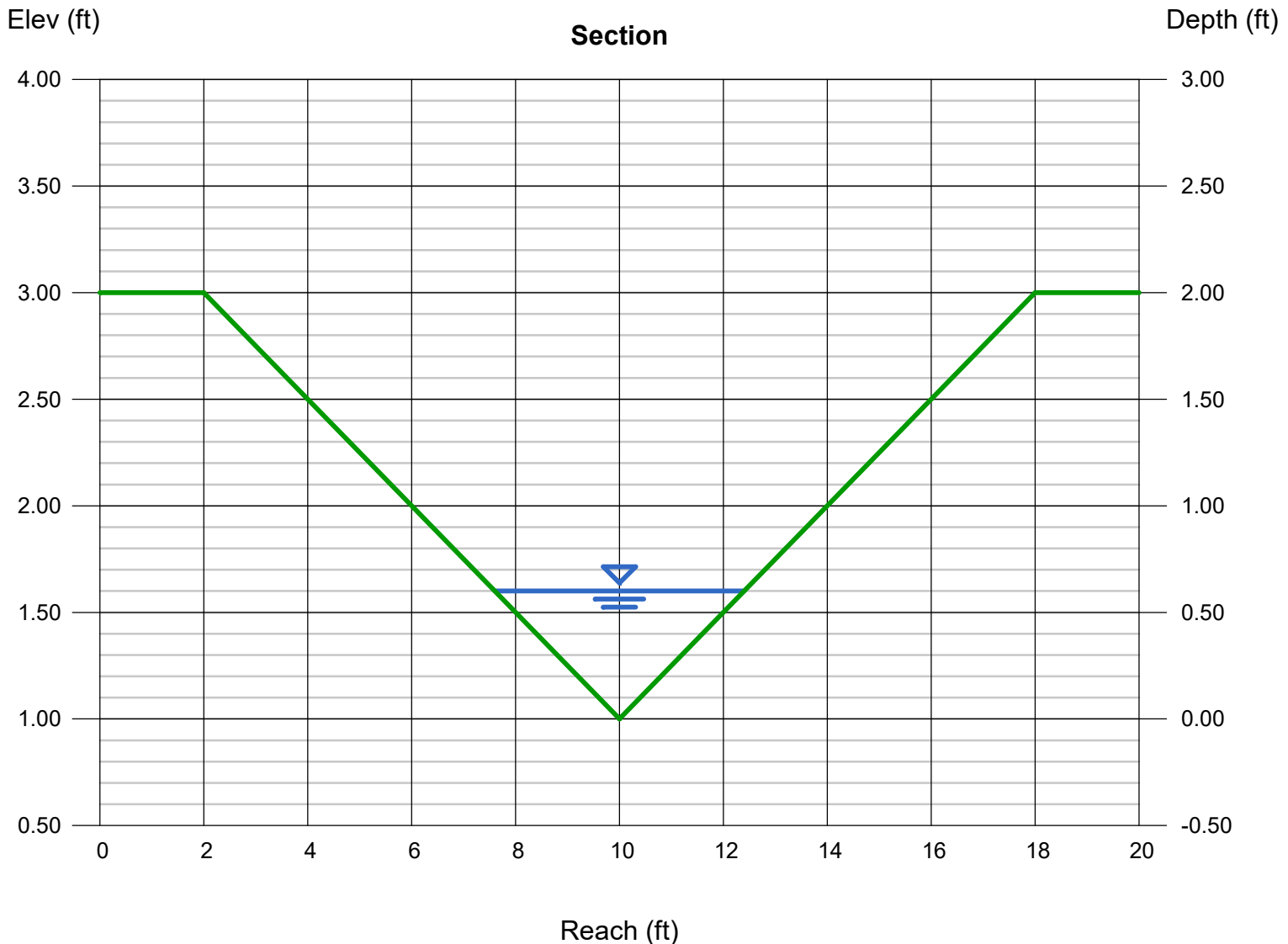



# Channel Report

## Roadside Ditch - DP 20

### Triangular

Side Slopes (z:1) = 4.00, 4.00

Total Depth (ft) = 2.00

Invert Elev (ft) = 1.00

Slope (%) = 5.20

N-Value = 0.030

### Calculations

Compute by: Known Q

Known Q (cfs) = 4.80

### Highlighted

Depth (ft) = 0.52

Q (cfs) = 4.800

Area (sqft) = 1.08

Velocity (ft/s) = 4.44

Wetted Perim (ft) = 4.29

Crit Depth, Yc (ft) = 0.62

Top Width (ft) = 4.16

EGL (ft) = 0.83

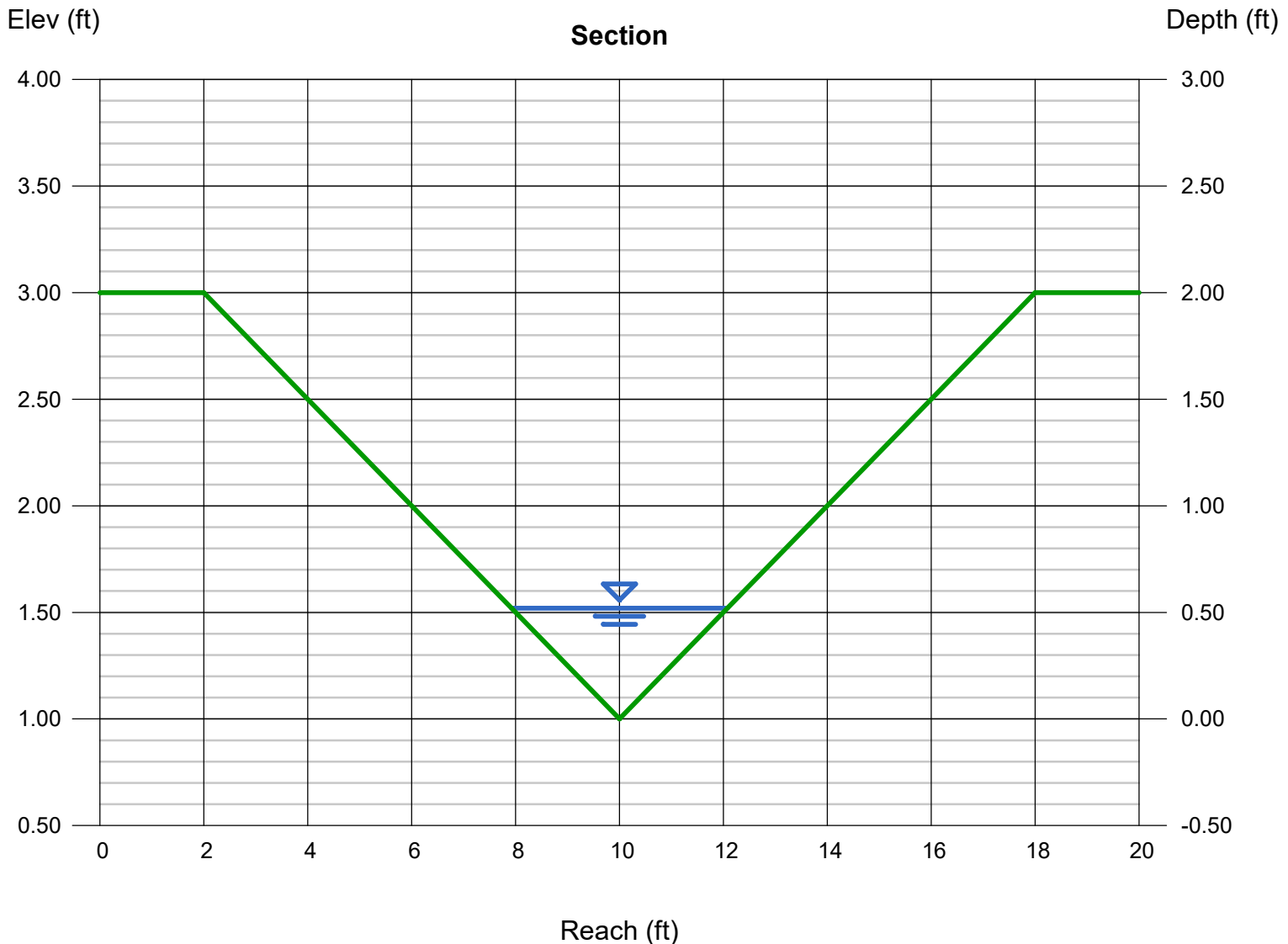

# Channel Report

## Roadside Ditch - DP 21

### Triangular

Side Slopes (z:1) = 4.00, 4.00  
Total Depth (ft) = 1.50

Invert Elev (ft) = 1.00  
Slope (%) = 5.20  
N-Value = 0.030

### Calculations

Compute by: Known Q  
Known Q (cfs) = 2.20

### Highlighted

Depth (ft) = 0.39  
Q (cfs) = 2.200  
Area (sqft) = 0.61  
Velocity (ft/s) = 3.62  
Wetted Perim (ft) = 3.22  
Crit Depth, Yc (ft) = 0.46  
Top Width (ft) = 3.12  
EGL (ft) = 0.59

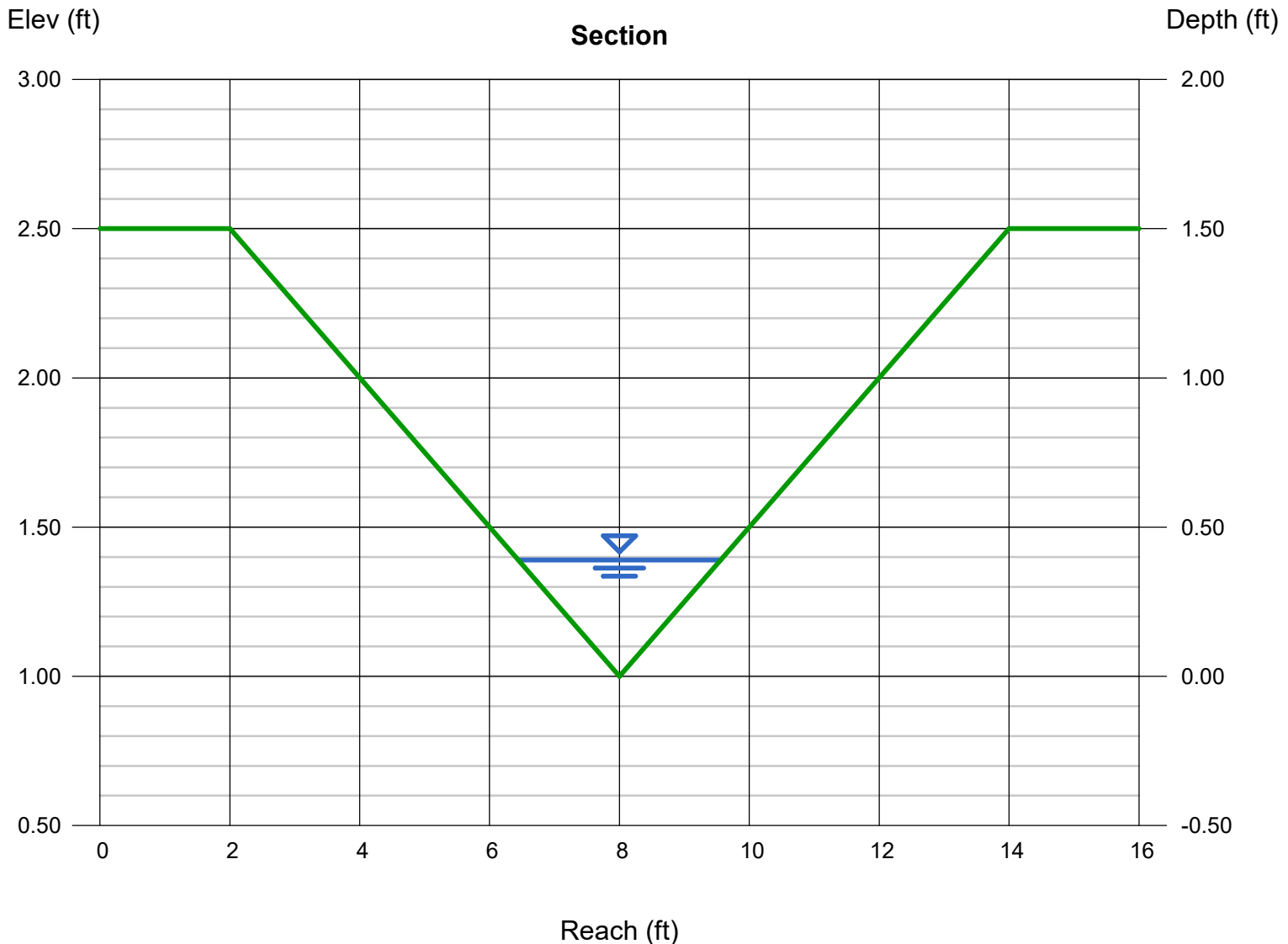

# Channel Report

## Roadside Ditch - DP 24A

### Triangular

Side Slopes (z:1) = 4.00, 4.00

Total Depth (ft) = 2.50

Invert Elev (ft) = 1.00

Slope (%) = 3.20

N-Value = 0.030

### Calculations

Compute by: Known Q

Known Q (cfs) = 43.40

### Highlighted

Depth (ft) = 1.30

Q (cfs) = 43.40

Area (sqft) = 6.76

Velocity (ft/s) = 6.42

Wetted Perim (ft) = 10.72

Crit Depth, Yc (ft) = 1.49

Top Width (ft) = 10.40

EGL (ft) = 1.94

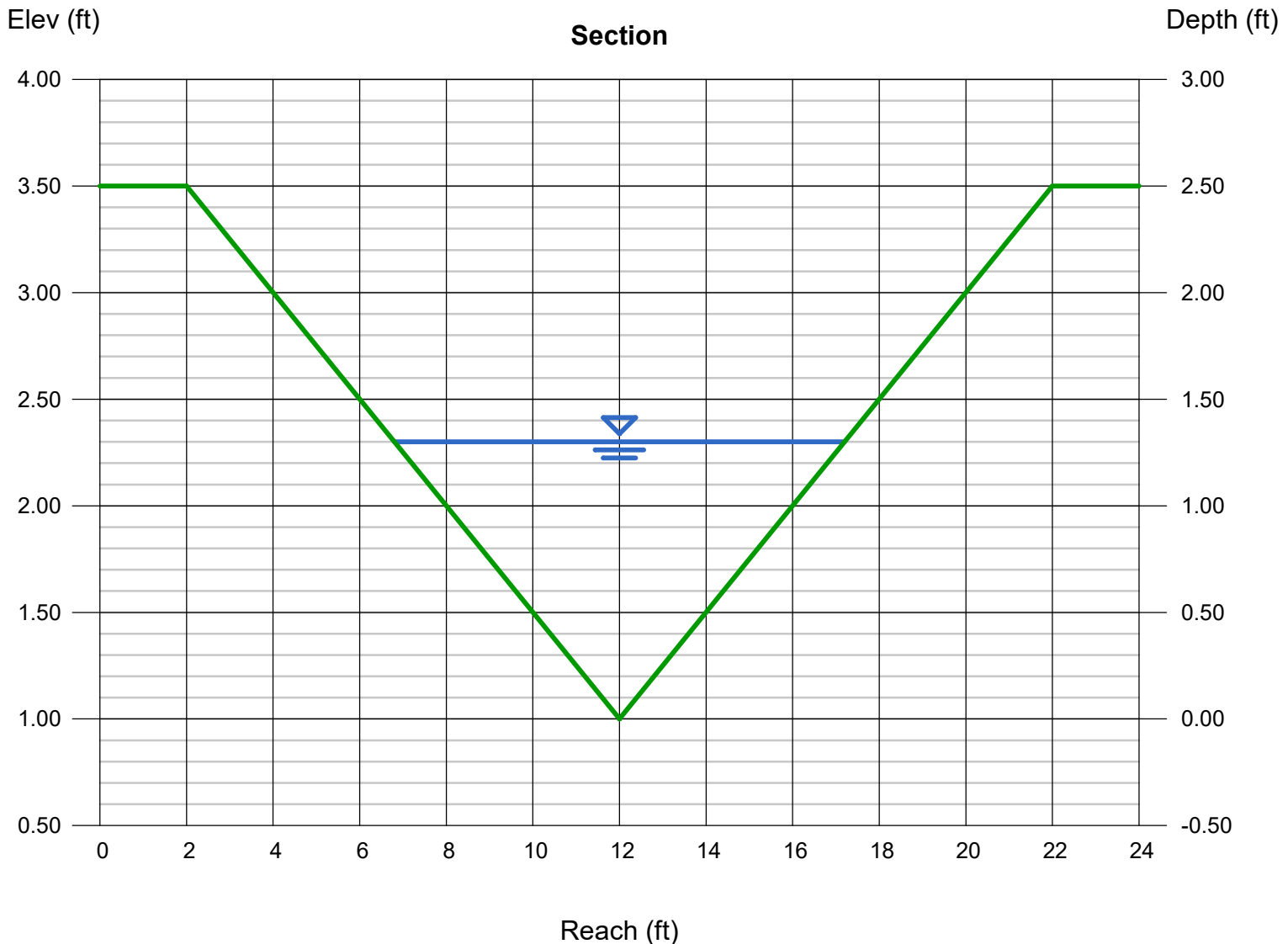

# Channel Report

## Roadside Ditch - DP 25

### Triangular

Side Slopes (z:1) = 4.00, 4.00

Total Depth (ft) = 2.50

Invert Elev (ft) = 1.00

Slope (%) = 3.20

N-Value = 0.030

### Calculations

Compute by: Known Q

Known Q (cfs) = 6.30

### Highlighted

Depth (ft) = 0.63

Q (cfs) = 6.300

Area (sqft) = 1.59

Velocity (ft/s) = 3.97

Wetted Perim (ft) = 5.20

Crit Depth,  $Y_c$  (ft) = 0.69

Top Width (ft) = 5.04

EGL (ft) = 0.87

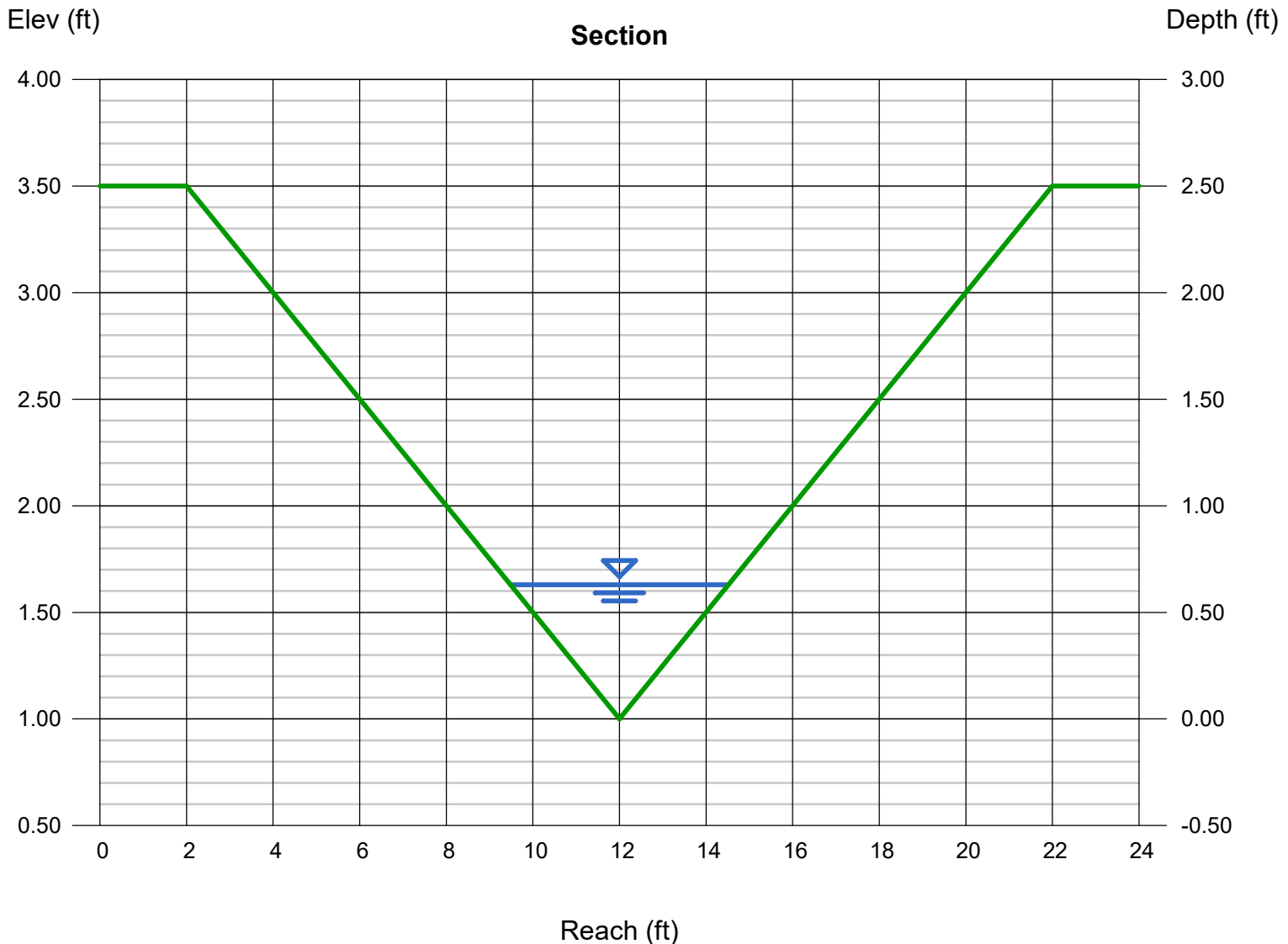

# Channel Report

## Drainage ditch - DP1

### Trapezoidal

Bottom Width (ft) = 10.00  
Side Slopes (z:1) = 4.00, 4.00  
Total Depth (ft) = 2.75  
Invert Elev (ft) = 1.00  
Slope (%) = 3.50  
N-Value = 0.030

### Highlighted

Depth (ft) = 1.65  
Q (cfs) = 279.50  
Area (sqft) = 27.39  
Velocity (ft/s) = 10.20  
Wetted Perim (ft) = 23.61  
Crit Depth, Yc (ft) = 2.17  
Top Width (ft) = 23.20  
EGL (ft) = 3.27

### Calculations

Compute by: Known Q  
Known Q (cfs) = 279.50

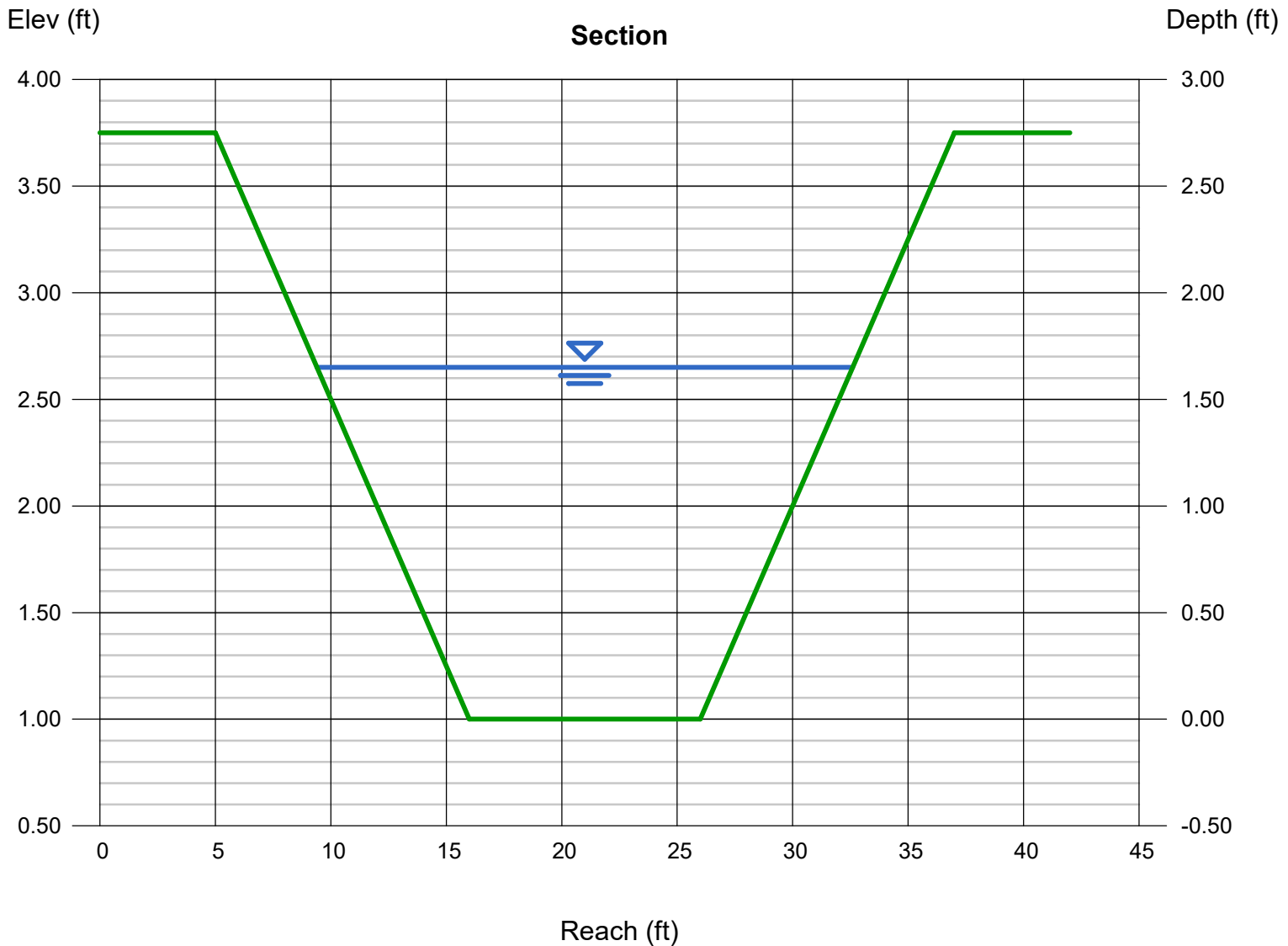

# Channel Report

## Drainage ditch - DP13

### Trapezoidal

Bottom Width (ft) = 3.00  
Side Slopes (z:1) = 4.00, 4.00  
Total Depth (ft) = 2.00  
Invert Elev (ft) = 1.00  
Slope (%) = 2.20  
N-Value = 0.030

### Highlighted

Depth (ft) = 0.82  
Q (cfs) = 24.20  
Area (sqft) = 5.15  
Velocity (ft/s) = 4.70  
Wetted Perim (ft) = 9.76  
Crit Depth, Yc (ft) = 0.88  
Top Width (ft) = 9.56  
EGL (ft) = 1.16

### Calculations

Compute by: Known Q  
Known Q (cfs) = 24.20

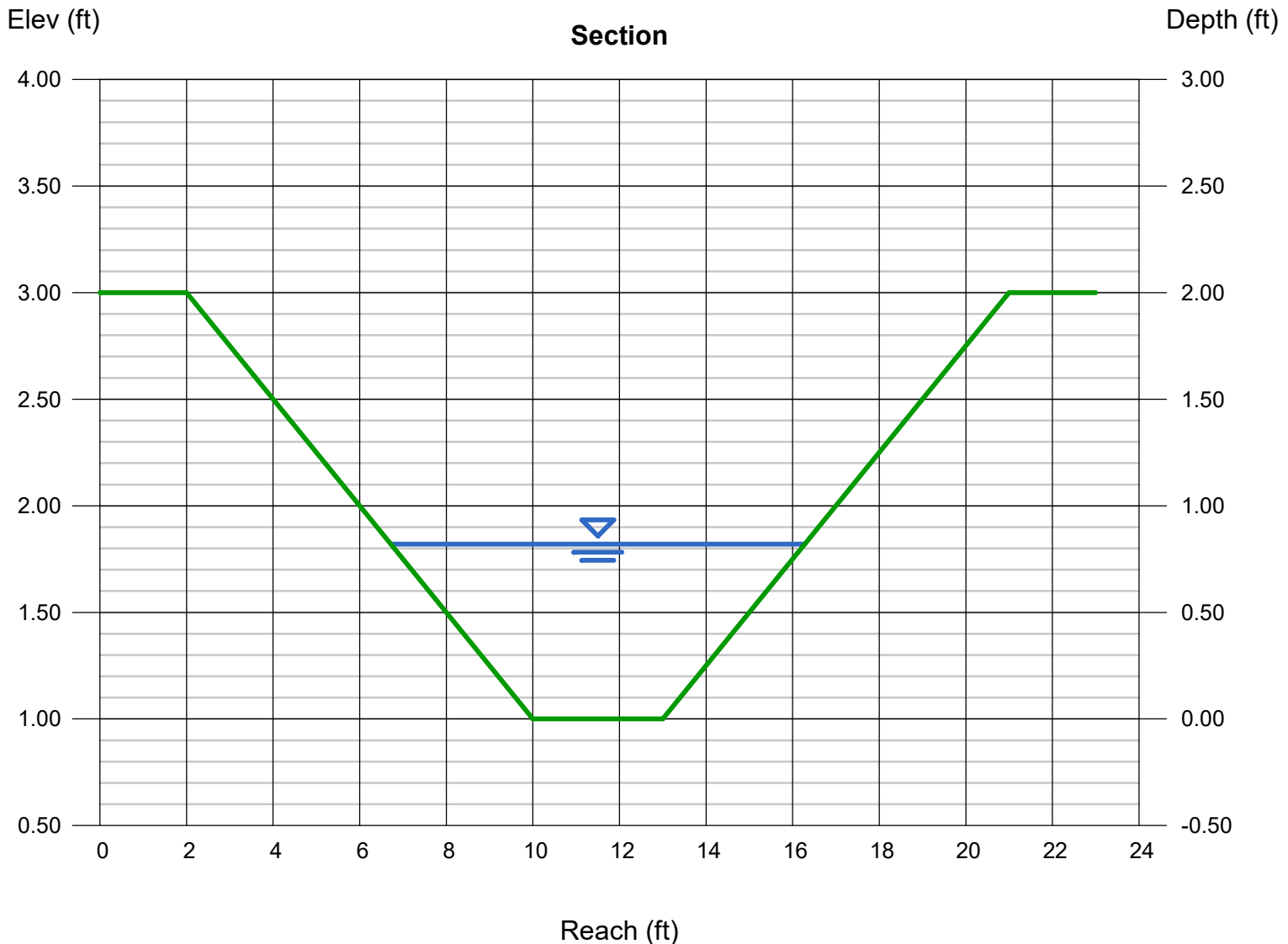

# Channel Report

## Drainage ditch - DP14A

### Trapezoidal

Bottom Width (ft) = 3.00  
Side Slopes (z:1) = 4.00, 4.00  
Total Depth (ft) = 2.00  
Invert Elev (ft) = 1.00  
Slope (%) = 2.70  
N-Value = 0.030

### Highlighted

Depth (ft) = 0.98  
Q (cfs) = 39.20  
Area (sqft) = 6.78  
Velocity (ft/s) = 5.78  
Wetted Perim (ft) = 11.08  
Crit Depth, Yc (ft) = 1.12  
Top Width (ft) = 10.84  
EGL (ft) = 1.50

### Calculations

Compute by: Known Q  
Known Q (cfs) = 39.20

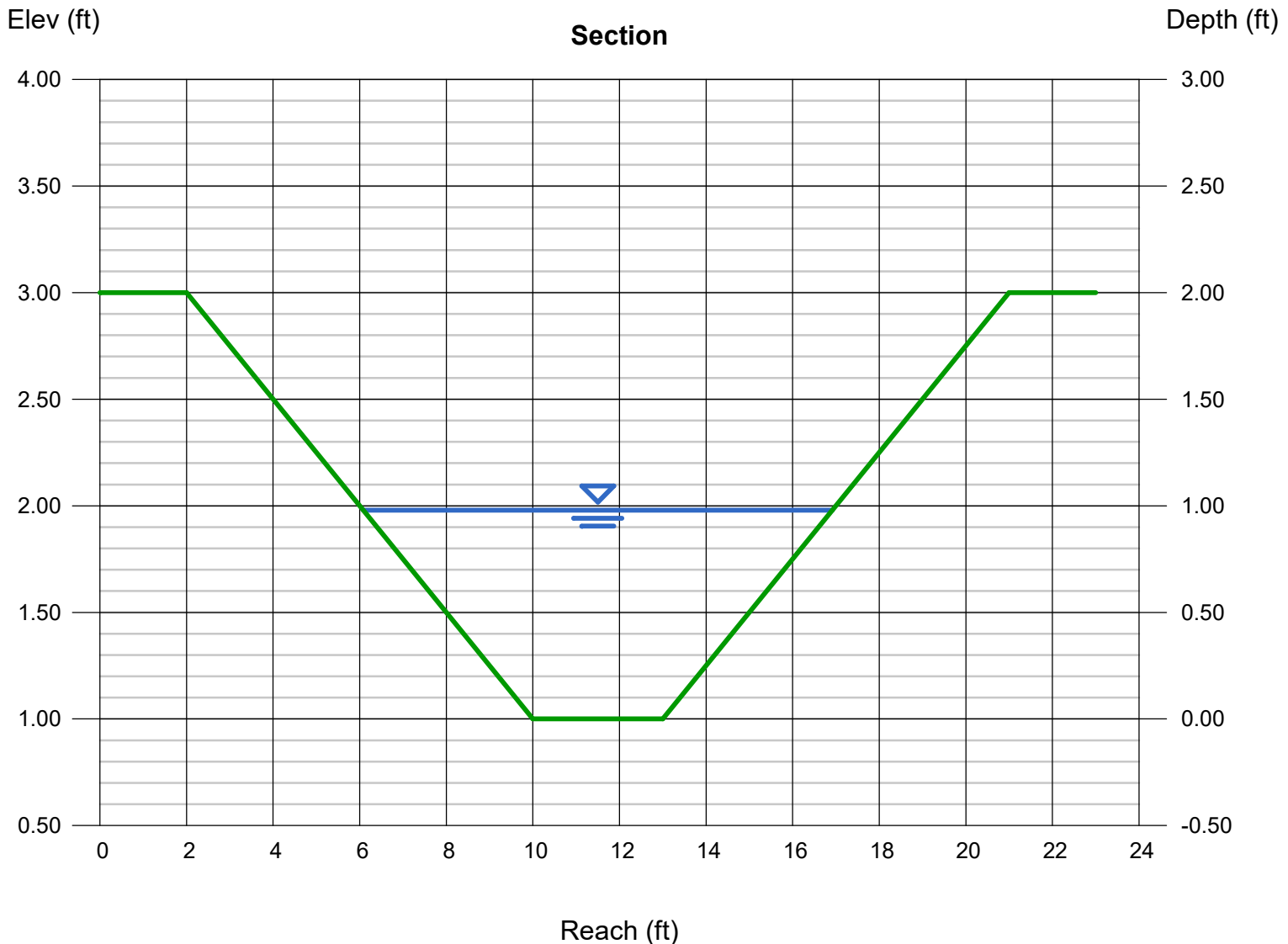

# Channel Report

## Drainage ditch - DP24A

### Trapezoidal

Bottom Width (ft) = 3.00  
Side Slopes (z:1) = 4.00, 4.00  
Total Depth (ft) = 2.25  
Invert Elev (ft) = 1.00  
Slope (%) = 1.10  
N-Value = 0.030

### Highlighted

Depth (ft) = 1.25  
Q (cfs) = 42.90  
Area (sqft) = 10.00  
Velocity (ft/s) = 4.29  
Wetted Perim (ft) = 13.31  
Crit Depth, Yc (ft) = 1.17  
Top Width (ft) = 13.00  
EGL (ft) = 1.54

### Calculations

Compute by: Known Q  
Known Q (cfs) = 42.90

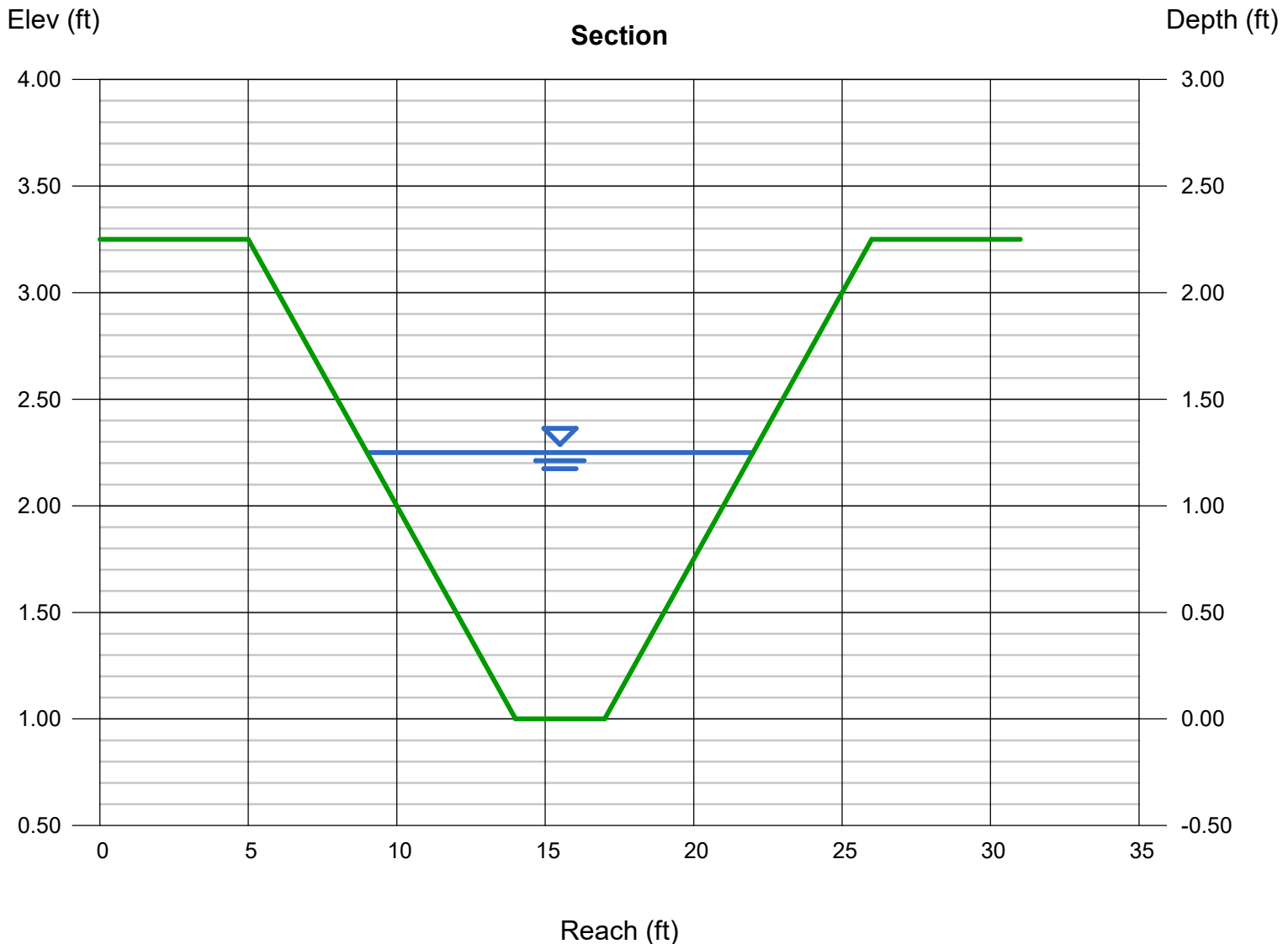



# Channel Report

## Drainage ditch - OSA3

### Trapezoidal

Bottom Width (ft) = 10.00  
Side Slopes (z:1) = 4.00, 4.00  
Total Depth (ft) = 2.00  
Invert Elev (ft) = 1.00  
Slope (%) = 2.75  
N-Value = 0.030

### Highlighted

Depth (ft) = 1.10  
Q (cfs) = 113.40  
Area (sqft) = 15.84  
Velocity (ft/s) = 7.16  
Wetted Perim (ft) = 19.07  
Crit Depth, Yc (ft) = 1.33  
Top Width (ft) = 18.80  
EGL (ft) = 1.90

### Calculations

Compute by: Known Q  
Known Q (cfs) = 113.40

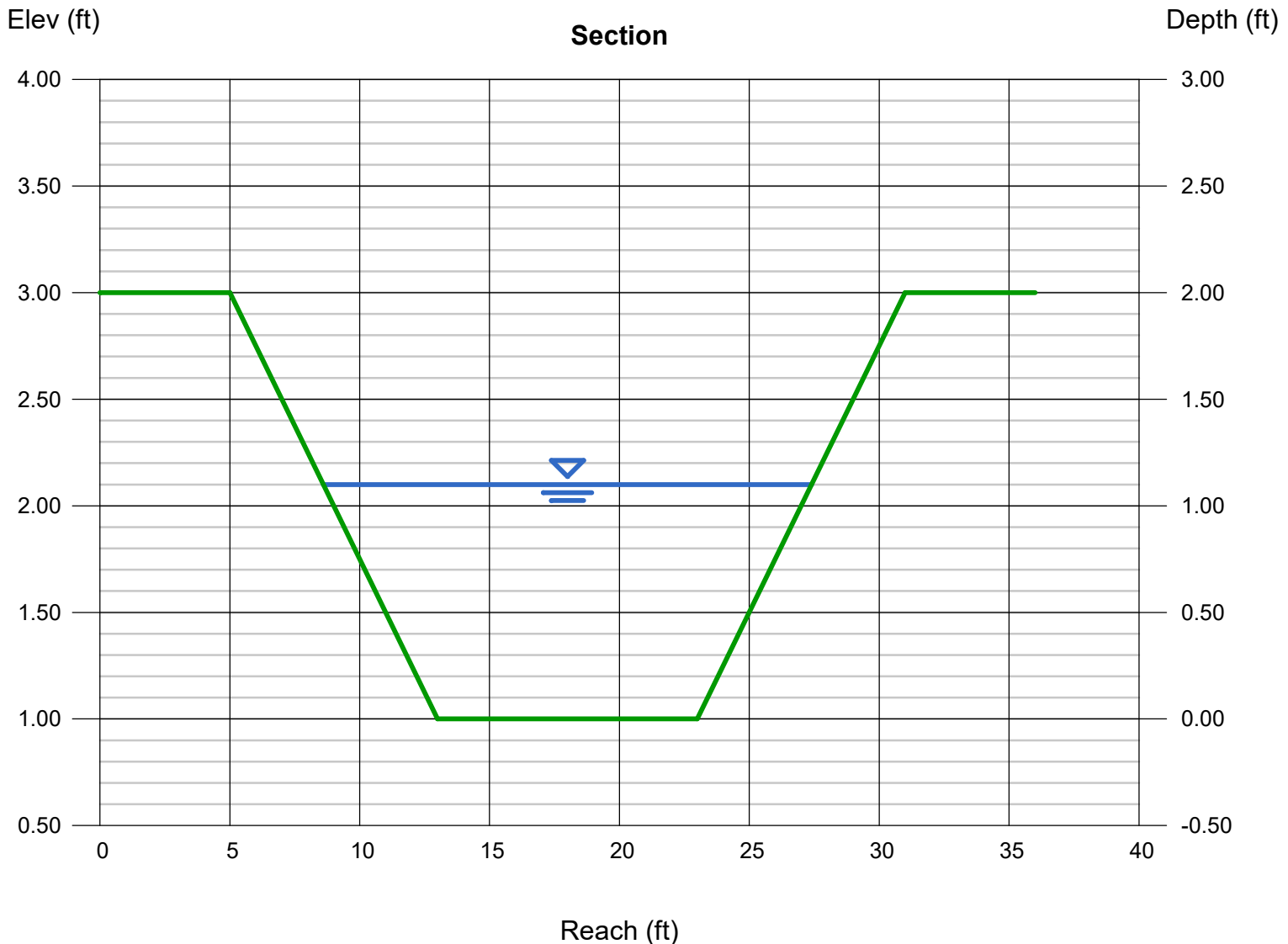

# Channel Report

## Drainage ditch - OSA3

### Trapezoidal

Bottom Width (ft) = 6.00  
Side Slopes (z:1) = 4.00, 4.00  
Total Depth (ft) = 2.00  
Invert Elev (ft) = 1.00  
Slope (%) = 3.50  
N-Value = 0.030

### Highlighted

Depth (ft) = 0.91  
Q (cfs) = 60.50  
Area (sqft) = 8.77  
Velocity (ft/s) = 6.90  
Wetted Perim (ft) = 13.50  
Crit Depth, Yc (ft) = 1.14  
Top Width (ft) = 13.28  
EGL (ft) = 1.65

### Calculations

Compute by: Known Q  
Known Q (cfs) = 60.50

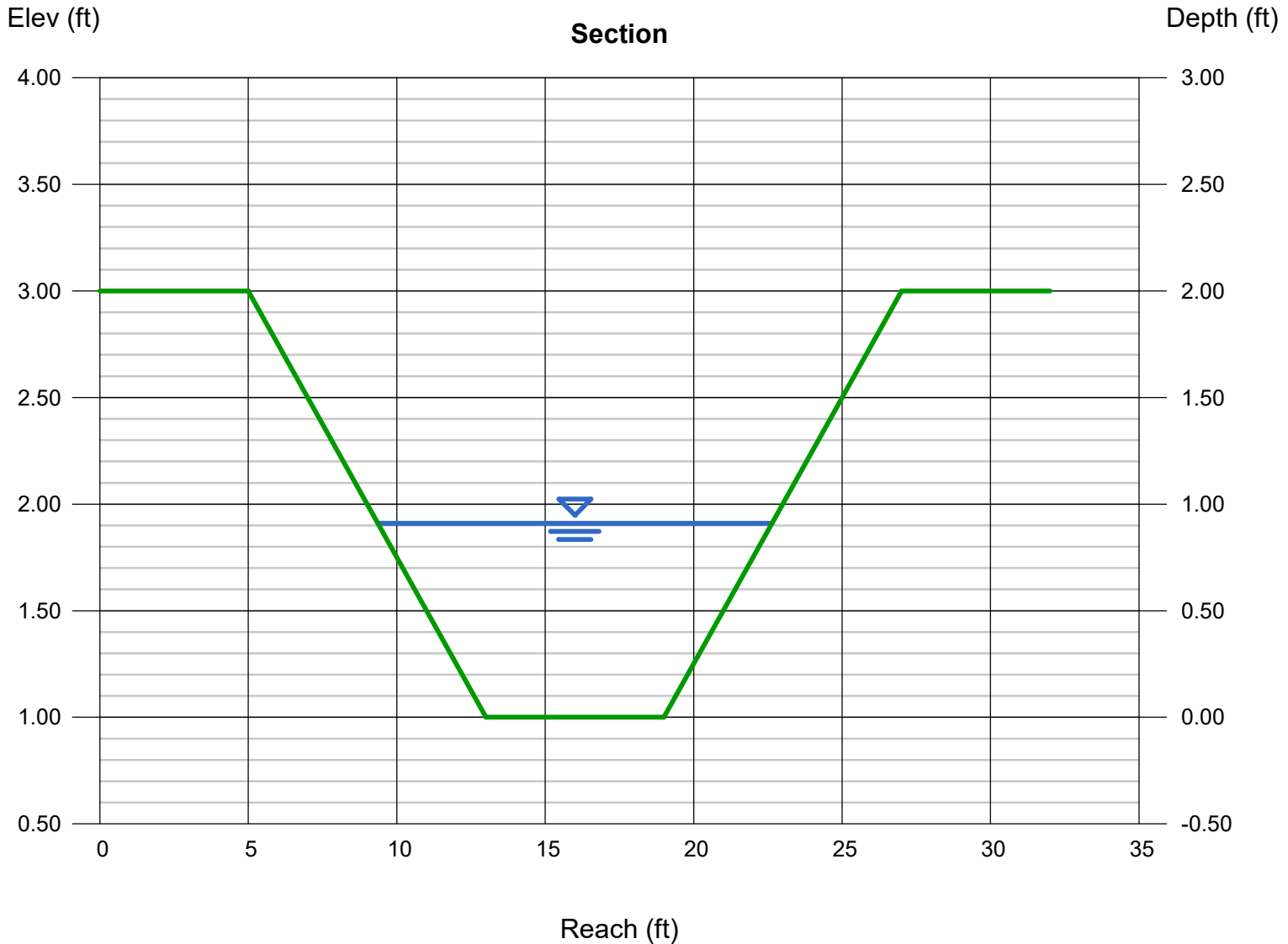

# VMax® TRMs

TRM areas need to be clearly shown on the GEC Plans and the proposed type needs to be added to the plans.



## A Permanent Turf Reinforcement Mat Solution for Every Design

The VMax system of permanent TRMs are ideal for high-flow channels, streambanks, shorelines, and other areas needing permanent vegetation reinforcement and protection from water and wind. Our VMax TRMs combine a three-dimensional matting and a fiber matrix material for all-out erosion protection, vegetation establishment and reinforcement. The VMax TRMs are available with various performance capabilities and support reinforced vegetative lining development from germination to maturity.

## VMax® Unique Three-Dimensional Design

North American Green VMax TRMs are each designed to maximize performance through all development phases of a reinforced vegetative lining. The corrugated matting structure lends a true reinforcement zone for vegetation entanglement, especially compared to flat net mats. The unique design of the corrugated matting also helps to create a shear plane that deflects flowing water away from the soil surface. And the incorporation of a fiber matrix supplements the 3-D structure by creating a ground cover that blocks soil movement and aids in vegetation establishment.

### Four VMax Turf Reinforcement Mats Designed for Every Level of Performance

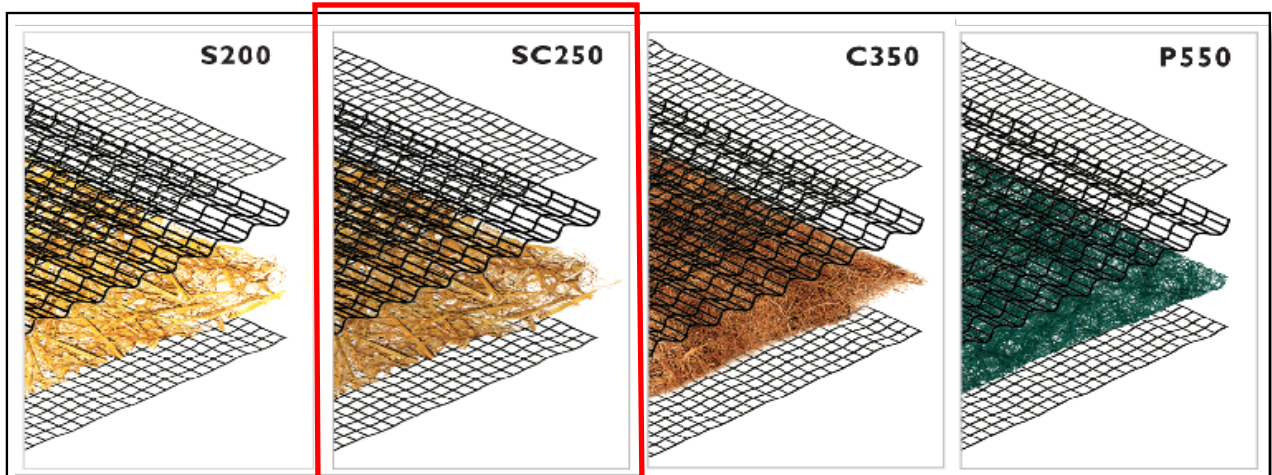

<b>Matrix Fiber</b>	100% Straw	70% Straw / 30% Coconut	100% Coconut	100% Polypropylene
<b>Netting Types</b>	Top and Bottom light-weight UV-stabilized PP, Crimped PP center net	Top and Bottom UV-stabilized PP, Crimped PP center net	Top and Bottom heavy-weight UV-stabilized PP, Crimped PP center net	Top and Bottom ultra heavy-weight UV-stabilized PP, Crimped PP center net
<b>Typical Slope Applications (H:V)</b>	1:1 and greater	1:1 and greater	1:1 and greater	1:1 and greater
<b>Channel Shear Stress Threshold</b>	Unvegetated: 2.3 psf Vegetated: 10.0 psf	Unvegetated: 3.0 psf Vegetated: 10.0 psf	Unvegetated: 3.2 psf Vegetated: 12.0 psf	Unvegetated: 4.0 psf Vegetated: 14.0 psf
<b>Channel Velocity Threshold</b>	Unvegetated: 8.5 fps Vegetated: 18 fps	Unvegetated: 9.5 fps Vegetated: 15 fps	Unvegetated: 10.5 fps Vegetated: 20 fps	Unvegetated: 12.5 fps Vegetated: 25 fps



Selected product that will work for all swales above 5 ft/s. Has maximum of 15 ft/s.

Copyright 2021.

North American Green, LLC.  
4609 E. Boonville-New Harmony Rd., Evansville, IN  
(800) 772-2040 | [www.nagreen.com](http://www.nagreen.com)

# VMax<sup>®</sup> TRMs cont.

## Selecting the Right VMax TRM

Choosing the right VMax TRM can be made easy by utilizing our Erosion Control Materials Design Software ([www.ecmds.com](http://www.ecmds.com)), which allows users to input project specific parameters for channels, slopes, spillways, and more and ensures proper evaluation, design, and product selection in return. Our four VMax TRMs offer varying performance values, fiber matrix longevities, and price points, to help you meet your project specific goals.



## Twist Pin + VMax TRM - an Ideal Installation

Utilizing the VMax TRMs in conjunction with Twist Pin fastener technology can result in an installed system that pushes TRM performance with increased factors of safety. The combined system has been shown to have superior pullout strength performance up to 200 lbs when compared to installation with traditional wire staples and pins. This is up to 10x the pullout resistance of wire staples and pins. Additionally, the use of the twist pins provides intimate contact between the TRM and the soil, and have been shown to be effective in a wide range of soil types. With a quick and easy installation using an electric drill and custom chuck, the TRM+Twist Pin system can eliminate time and labor costs from day 1 through project release.

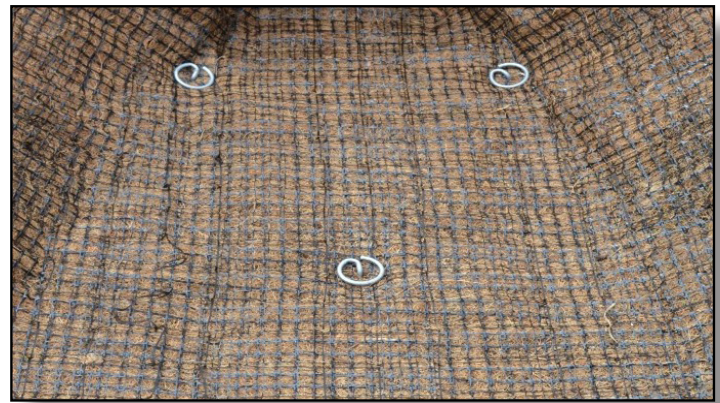

*VMax turf reinforcement mat being installed on a channel application (top right), twist pins installed with TRMs can have increased system performance and pullout resistance (middle right), twist pins are available in 8" and 12" lengths and two coil configurations designed for hard or soft soil types (lower right).*

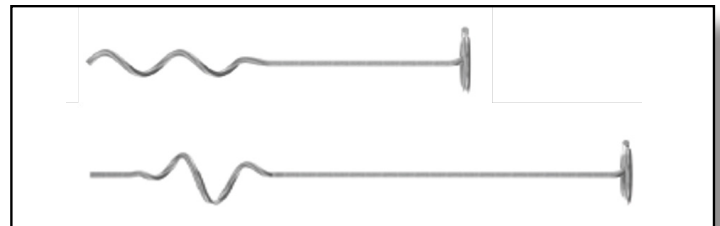

*Comparison of common TRM fasteners based on pullout performance and typical application (below).*

Fastener	Pullout Resistance (lb)	Comment
6" Round Top Pin	14	Best for hardened soils where other fasteners are damaged during installation.
6" Regular U-staple	42	Standard fastener that develops additional pullout as legs may deflect and add friction during installation.
12" Pin with Washer	35	Standard fastener good for soils where staples can be bent frequently and are too difficult to install.
18" Pin with Washer	27	Standard fastener good for soils where staples are frequently bent and 12" straight pins fail to provide sufficient pullout because surface soil is wet or loose.
Twist Pin	170	Upgraded fastener that provides high pullout and ideal for loose or soft soils.



Copyright 2021.

North American Green, LLC.  
4609 E. Boonville-New Harmony Rd., Evansville, IN  
(800) 772-2040 | [www.nagreen.com](http://www.nagreen.com)

# HY-8 Culvert Analysis Report

Table 1 - Culvert Summary Table: DP1

Total Discharge (cfs)	Culvert Discharge (cfs)	Headwater Elevation (ft)	Inlet Control Depth (ft)	Outlet Control Depth (ft)	HW / D (ft)	Flow Type	Normal Depth (ft)	Critical Depth (ft)	Outlet Depth (ft)	Tailwater Depth (ft)	Outlet Velocity (ft/s)	Tailwater Velocity (ft/s)
0.00	0.00	7096.00	0.00	0.000	0.00	0-NF	0.00	0.00	0.00	0.00	0.00	0.00
27.95	27.95	7097.13	1.13	0.0*	0.38	1-S2n	0.58	0.83	0.59	0.60	7.14	3.77
55.90	55.90	7097.66	1.66	0.307	0.55	1-S2n	0.81	1.19	0.85	0.88	8.49	4.69
83.85	83.85	7098.14	2.14	0.734	0.71	1-S2n	1.01	1.47	1.07	1.10	9.31	5.30
111.80	111.80	7098.56	2.56	1.178	0.85	1-S2n	1.17	1.71	1.26	1.28	9.95	5.77
139.75	139.75	7098.97	2.97	1.652	0.99	1-S2n	1.33	1.92	1.43	1.44	10.47	6.15
167.70	167.70	7099.41	3.41	2.163	1.14	5-S2n	1.47	2.11	1.60	1.58	10.93	6.48
195.65	195.65	7099.90	3.90	3.073	1.30	5-S2n	1.61	2.28	1.76	1.71	11.35	6.77
223.60	223.60	7100.46	4.46	3.586	1.49	5-S2n	1.75	2.42	1.91	1.83	11.76	7.03
251.55	251.55	7101.11	5.11	4.146	1.70	5-S2n	1.90	2.55	2.06	1.95	12.15	7.26
279.50	279.50	7101.84	5.84	4.755	1.95	5-S2n	2.04	2.66	2.21	2.05	12.54	7.47
355.73	307.10	7102.65	6.65	5.403	2.22	5-S2n	2.20	2.74	2.35	2.31	12.91	7.98

\* Full Flow Headwater elevation is below inlet invert.

### Water Surface Profile Plot for Culvert: DP1

Crossing - DP1 Conestoga, Design Discharge - 279.5 cfs

Culvert - DP1, Culvert Discharge - 279.5 cfs

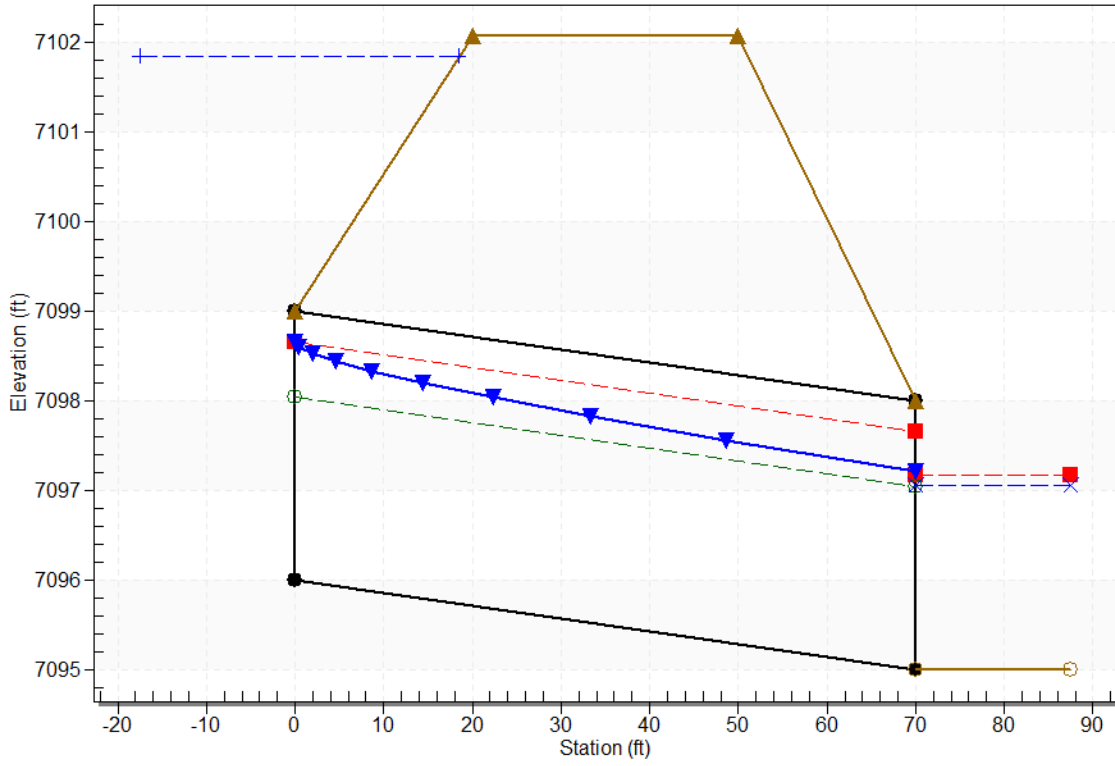

**Table 2 - Culvert Summary Table: DP8A**

<b>Total Discharge (cfs)</b>	<b>Culvert Discharge (cfs)</b>	<b>Headwater Elevation (ft)</b>	<b>Inlet Control Depth (ft)</b>	<b>Outlet Control Depth (ft)</b>	<b>HW / D (ft)</b>	<b>Flow Type</b>	<b>Normal Depth (ft)</b>	<b>Critical Depth (ft)</b>	<b>Outlet Depth (ft)</b>	<b>Tailwater Depth (ft)</b>	<b>Outlet Velocity (ft/s)</b>	<b>Tailwater Velocity (ft/s)</b>
<b>0.00</b>	0.00	7068.00	0.00	0.000	0.00	0-NF	0.00	0.00	0.00	0.00	0.00	0.00
<b>5.43</b>	5.43	7068.97	0.97	0.0*	0.32	1-S2n	0.41	0.73	0.41	0.38	9.37	2.86
<b>10.86</b>	10.86	7069.40	1.40	0.0*	0.47	1-S2n	0.57	1.04	0.57	0.59	11.49	3.67
<b>16.29</b>	16.29	7069.80	1.80	0.0*	0.60	1-S2n	0.70	1.29	0.72	0.77	12.41	4.22
<b>21.72</b>	21.72	7070.16	2.16	0.0*	0.72	1-S2n	0.81	1.50	0.84	0.94	13.43	4.65
<b>27.15</b>	27.15	7070.48	2.48	0.0*	0.83	1-S2n	0.91	1.68	0.91	1.09	14.96	4.99
<b>32.58</b>	32.58	7070.80	2.80	0.0*	0.93	1-S2n	1.00	1.85	1.04	1.23	15.04	5.28
<b>38.01</b>	38.01	7071.12	3.12	0.0*	1.04	5-S2n	1.09	2.01	1.13	1.37	15.68	5.54
<b>43.44</b>	43.44	7071.48	3.48	0.0*	1.16	5-S2n	1.17	2.15	1.21	1.51	16.18	5.76
<b>48.87</b>	48.87	7071.86	3.86	0.0*	1.29	5-S2n	1.25	2.28	1.30	1.64	16.59	5.96
<b>54.30</b>	54.30	7072.29	4.29	0.0*	1.43	5-S2n	1.32	2.39	1.39	1.77	17.01	6.15
<b>69.11</b>	60.22	7072.82	4.82	0.0*	1.61	5-S2n	1.40	2.51	1.48	2.11	17.39	6.56

\* Full Flow Headwater elevation is below inlet invert.

### Water Surface Profile Plot for Culvert: DP8A

Crossing - DP8A Conestoga, Design Discharge - 54.3 cfs

Culvert - DP8A, Culvert Discharge - 54.3 cfs

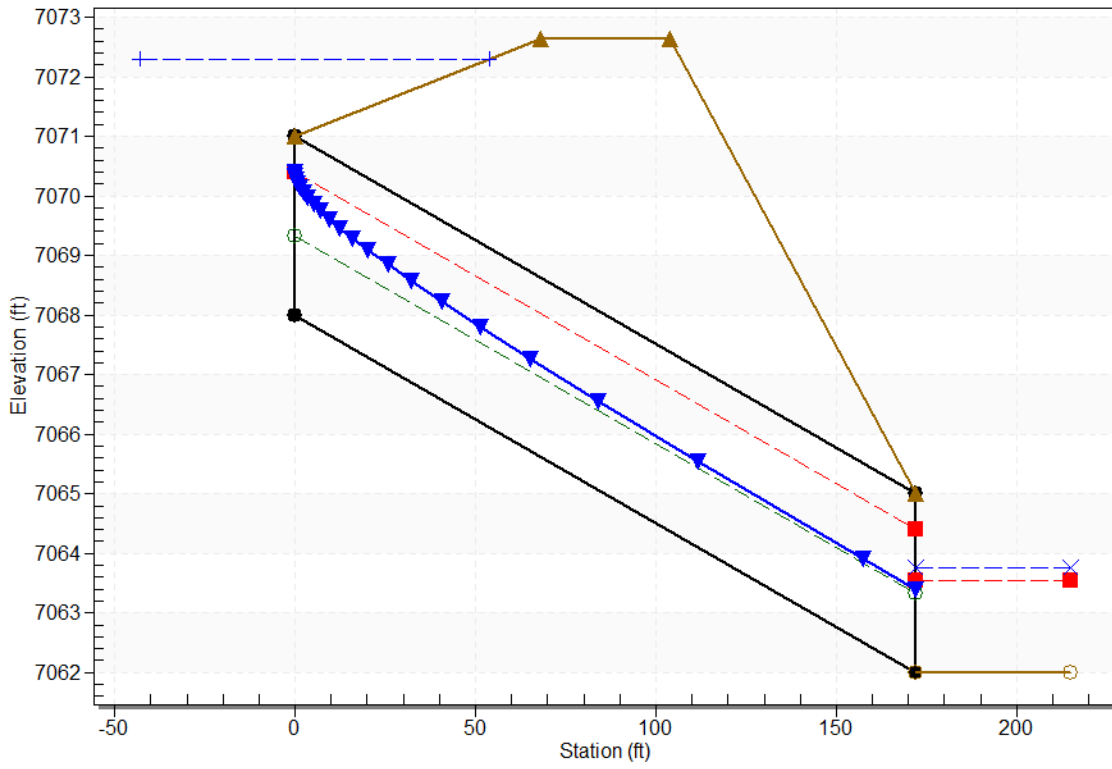



**Table 3 - Culvert Summary Table: DP7**

<b>Total Discharge (cfs)</b>	<b>Culvert Discharge (cfs)</b>	<b>Headwater Elevation (ft)</b>	<b>Inlet Control Depth (ft)</b>	<b>Outlet Control Depth (ft)</b>	<b>HW / D (ft)</b>	<b>Flow Type</b>	<b>Normal Depth (ft)</b>	<b>Critical Depth (ft)</b>	<b>Outlet Depth (ft)</b>	<b>Tailwater Depth (ft)</b>	<b>Outlet Velocity (ft/s)</b>	<b>Tailwater Velocity (ft/s)</b>
<b>0.00</b>	0.00	7069.40	0.00	0.000	0.00	0-NF	0.00	0.00	0.00	0.00	0.00	0.00
<b>0.20</b>	0.20	7069.64	0.24	0.0*	0.16	1-S2n	0.12	0.16	0.12	0.08	3.11	0.74
<b>0.40</b>	0.40	7069.74	0.34	0.0*	0.22	1-S2n	0.16	0.23	0.16	0.12	3.84	0.95
<b>0.60</b>	0.60	7069.81	0.41	0.0*	0.28	1-S2n	0.20	0.29	0.20	0.15	4.32	1.09
<b>0.80</b>	0.80	7069.88	0.48	0.0*	0.32	1-S2n	0.23	0.33	0.23	0.18	4.70	1.20
<b>1.00</b>	1.00	7069.94	0.54	0.0*	0.36	1-S2n	0.25	0.37	0.25	0.20	5.03	1.28
<b>1.20</b>	1.20	7070.00	0.60	0.0*	0.40	1-S2n	0.28	0.41	0.28	0.23	5.30	1.36
<b>1.40</b>	1.40	7070.05	0.65	0.0*	0.43	1-S2n	0.30	0.44	0.30	0.25	5.55	1.43
<b>1.60</b>	1.60	7070.09	0.69	0.0*	0.46	1-S2n	0.32	0.47	0.32	0.26	5.77	1.49
<b>1.80</b>	1.80	7070.14	0.74	0.0*	0.49	1-S2n	0.34	0.50	0.34	0.28	5.97	1.54
<b>2.00</b>	2.00	7070.18	0.78	0.0*	0.52	1-S2n	0.36	0.53	0.36	0.30	6.16	1.59
<b>11.27</b>	11.04	7072.32	2.92	1.692	1.94	5-S2n	0.92	1.27	0.95	0.73	9.39	2.60

\* Full Flow Headwater elevation is below inlet invert.

### Water Surface Profile Plot for Culvert: DP7

Crossing - DP7 Conestoga, Design Discharge - 2.0 cfs

Culvert - DP7, Culvert Discharge - 2.0 cfs

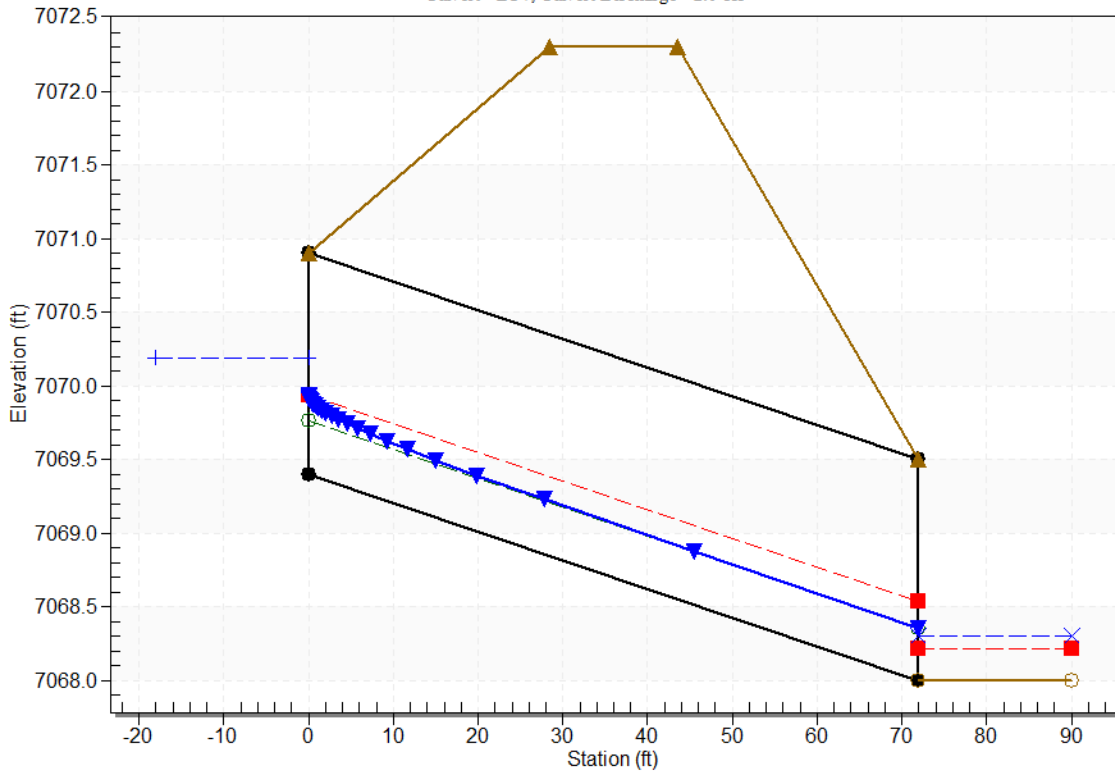

**Table 4 - Culvert Summary Table: DP13A**

<b>Total Discharge (cfs)</b>	<b>Culvert Discharge (cfs)</b>	<b>Headwater Elevation (ft)</b>	<b>Inlet Control Depth (ft)</b>	<b>Outlet Control Depth (ft)</b>	<b>HW / D (ft)</b>	<b>Flow Type</b>	<b>Normal Depth (ft)</b>	<b>Critical Depth (ft)</b>	<b>Outlet Depth (ft)</b>	<b>Tailwater Depth (ft)</b>	<b>Outlet Velocity (ft/s)</b>	<b>Tailwater Velocity (ft/s)</b>
<b>0.00</b>	0.00	7075.20	0.00	0.000	0.00	0-NF	0.00	0.00	0.00	0.00	0.00	0.00
<b>3.69</b>	3.69	7076.05	0.85	0.058	0.28	1-S2n	0.49	0.60	0.49	0.35	4.87	2.44
<b>7.38</b>	7.38	7076.43	1.23	0.341	0.41	1-S2n	0.69	0.86	0.70	0.50	5.89	2.98
<b>11.07</b>	11.07	7076.73	1.53	0.586	0.51	1-S2n	0.85	1.05	0.86	0.61	6.56	3.33
<b>14.76</b>	14.76	7076.99	1.79	0.820	0.60	1-S2n	0.99	1.22	1.01	0.70	7.08	3.60
<b>18.45</b>	18.45	7077.23	2.03	1.053	0.68	1-S2n	1.11	1.38	1.14	0.79	7.50	3.83
<b>22.14</b>	22.14	7077.46	2.26	1.290	0.75	1-S2n	1.23	1.51	1.26	0.86	7.85	4.02
<b>25.83</b>	25.83	7077.68	2.48	1.536	0.83	1-S2n	1.34	1.64	1.38	0.92	8.17	4.18
<b>29.52</b>	29.52	7077.90	2.70	1.791	0.90	1-S2n	1.45	1.76	1.49	0.98	8.45	4.33
<b>33.21</b>	33.21	7078.15	2.95	2.057	0.98	1-S2n	1.55	1.87	1.59	1.04	8.70	4.47
<b>36.90</b>	36.90	7078.41	3.21	2.334	1.07	5-S2n	1.65	1.98	1.70	1.09	8.93	4.59
<b>60.38</b>	57.09	7080.35	5.15	4.349	1.72	5-S2n	2.24	2.45	2.27	1.37	9.95	5.22

### Water Surface Profile Plot for Culvert: DP13A

Crossing - DP13A Irish Hunter, Design Discharge - 36.9 cfs

Culvert - DP13A, Culvert Discharge - 36.9 cfs

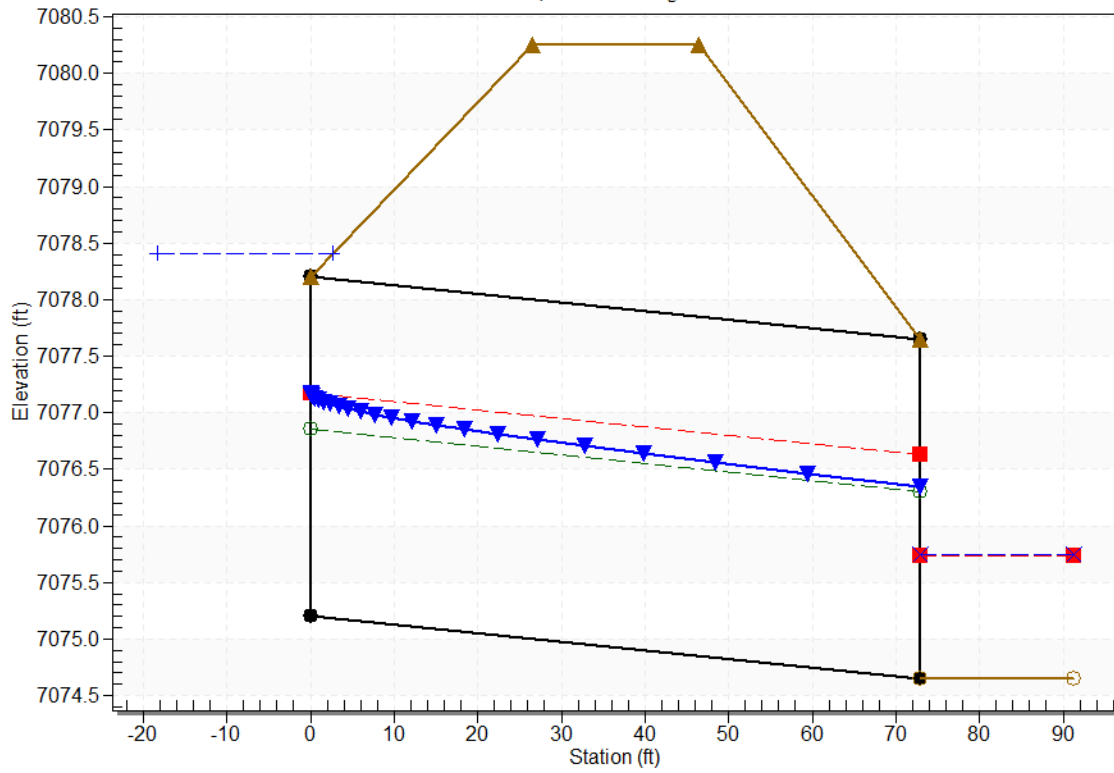

**Table 5 - Culvert Summary Table: DP24A**

<b>Total Discharge (cfs)</b>	<b>Culvert Discharge (cfs)</b>	<b>Headwater Elevation (ft)</b>	<b>Inlet Control Depth (ft)</b>	<b>Outlet Control Depth (ft)</b>	<b>HW / D (ft)</b>	<b>Flow Type</b>	<b>Normal Depth (ft)</b>	<b>Critical Depth (ft)</b>	<b>Outlet Depth (ft)</b>	<b>Tailwater Depth (ft)</b>	<b>Outlet Velocity (ft/s)</b>	<b>Tailwater Velocity (ft/s)</b>
<b>0.00</b>	0.00	7071.75	0.00	0.000	0.00	0-NF	0.00	0.00	0.00	0.00	0.00	0.00
<b>4.34</b>	4.34	7072.68	0.93	0.114	0.31	1-S2n	0.54	0.65	0.54	0.38	5.07	2.56
<b>8.68</b>	8.68	7073.09	1.34	0.430	0.45	1-S2n	0.76	0.93	0.76	0.54	6.12	3.12
<b>13.02</b>	13.02	7073.42	1.67	0.711	0.56	1-S2n	0.93	1.15	0.95	0.66	6.82	3.48
<b>17.36</b>	17.36	7073.71	1.96	0.984	0.65	1-S2n	1.08	1.33	1.10	0.76	7.35	3.76
<b>21.70</b>	21.70	7073.98	2.23	1.263	0.74	1-S2n	1.22	1.50	1.25	0.85	7.78	4.00
<b>26.04</b>	26.04	7074.24	2.49	1.552	0.83	1-S2n	1.35	1.65	1.39	0.93	8.15	4.19
<b>30.38</b>	30.38	7074.51	2.76	1.854	0.92	1-S2n	1.48	1.79	1.52	1.00	8.47	4.37
<b>34.72</b>	34.72	7074.80	3.05	2.172	1.02	5-S2n	1.60	1.91	1.64	1.06	8.76	4.52
<b>39.06</b>	39.06	7075.13	3.38	2.506	1.13	5-S2n	1.72	2.03	1.77	1.12	9.03	4.66
<b>43.40</b>	43.40	7075.49	3.74	2.857	1.25	5-S2n	1.84	2.15	1.89	1.18	9.27	4.79
<b>67.07</b>	61.26	7077.40	5.65	4.725	1.88	5-S2n	2.41	2.52	2.42	1.43	10.01	5.36

### Water Surface Profile Plot for Culvert: DP24A

Crossing - DP24A Irish Hunter, Design Discharge - 43.4 cfs

Culvert - DP24A, Culvert Discharge - 43.4 cfs

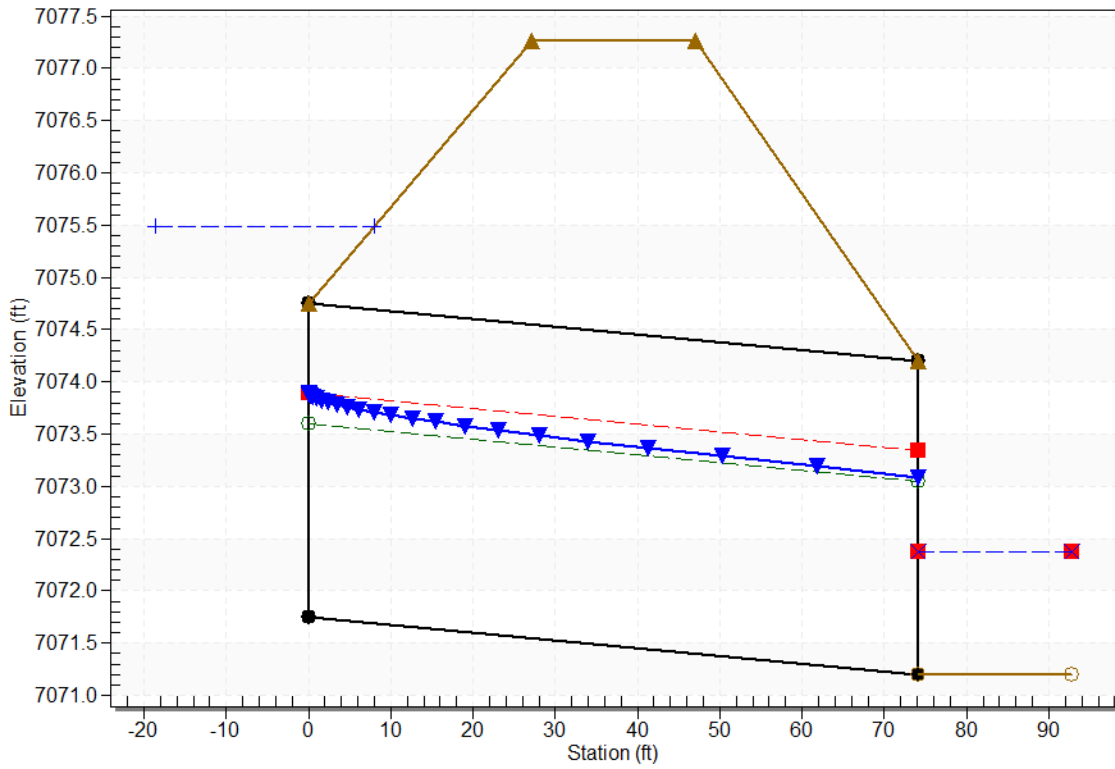

**Table 6 - Culvert Summary Table: 18 INCH DRIVEWAY**

<b>Total Discharge (cfs)</b>	<b>Culvert Discharge (cfs)</b>	<b>Headwater Elevation (ft)</b>	<b>Inlet Control Depth (ft)</b>	<b>Outlet Control Depth (ft)</b>	<b>HW / D (ft)</b>	<b>Flow Type</b>	<b>Normal Depth (ft)</b>	<b>Critical Depth (ft)</b>	<b>Outlet Depth (ft)</b>	<b>Tailwater Depth (ft)</b>	<b>Outlet Velocity (ft/s)</b>	<b>Tailwater Velocity (ft/s)</b>
<b>0.00</b>	0.00	100.00	0.00	0.000	0.00	0-NF	0.00	0.00	0.00	0.00	0.00	0.00
<b>1.20</b>	1.20	100.59	0.59	0.134	0.39	1-S2n	0.33	0.41	0.33	0.42	4.14	1.71
<b>2.40</b>	2.40	100.86	0.86	0.348	0.57	1-S2n	0.47	0.59	0.48	0.54	4.99	2.04
<b>3.60</b>	3.60	101.08	1.08	0.564	0.72	1-S2n	0.58	0.72	0.59	0.63	5.53	2.25
<b>4.80</b>	4.80	101.28	1.28	0.790	0.85	1-S2n	0.68	0.84	0.70	0.70	5.94	2.42
<b>6.00</b>	6.00	101.50	1.50	1.033	1.00	5-S2n	0.77	0.95	0.80	0.77	6.28	2.56
<b>7.20</b>	7.20	101.76	1.76	1.297	1.17	5-S2n	0.86	1.04	0.89	0.82	6.58	2.68
<b>8.40</b>	8.40	102.06	2.06	1.581	1.38	5-S2n	0.96	1.12	0.98	0.87	6.84	2.78
<b>9.60</b>	9.60	102.42	2.42	2.039	1.61	5-S2n	1.05	1.20	1.08	0.91	7.07	2.88
<b>10.80</b>	10.80	102.82	2.82	2.335	1.88	5-S2n	1.16	1.26	1.18	0.95	7.26	2.96
<b>12.00</b>	11.41	103.26	3.26	2.724	2.17	7-M2c	1.32	1.31	1.31	0.99	7.31	3.04
<b>13.09</b>	11.52	103.08	3.08	2.524	2.05	5-S2n	1.24	1.29	1.25	1.03	7.33	3.11

### Water Surface Profile Plot for Culvert: 18 INCH DRIVEWAY

Crossing - 18 Inch Driveway, Design Discharge - 12.0 cfs

Culvert - 18 INCH DRIVEWAY, Culvert Discharge - 11.4 cfs

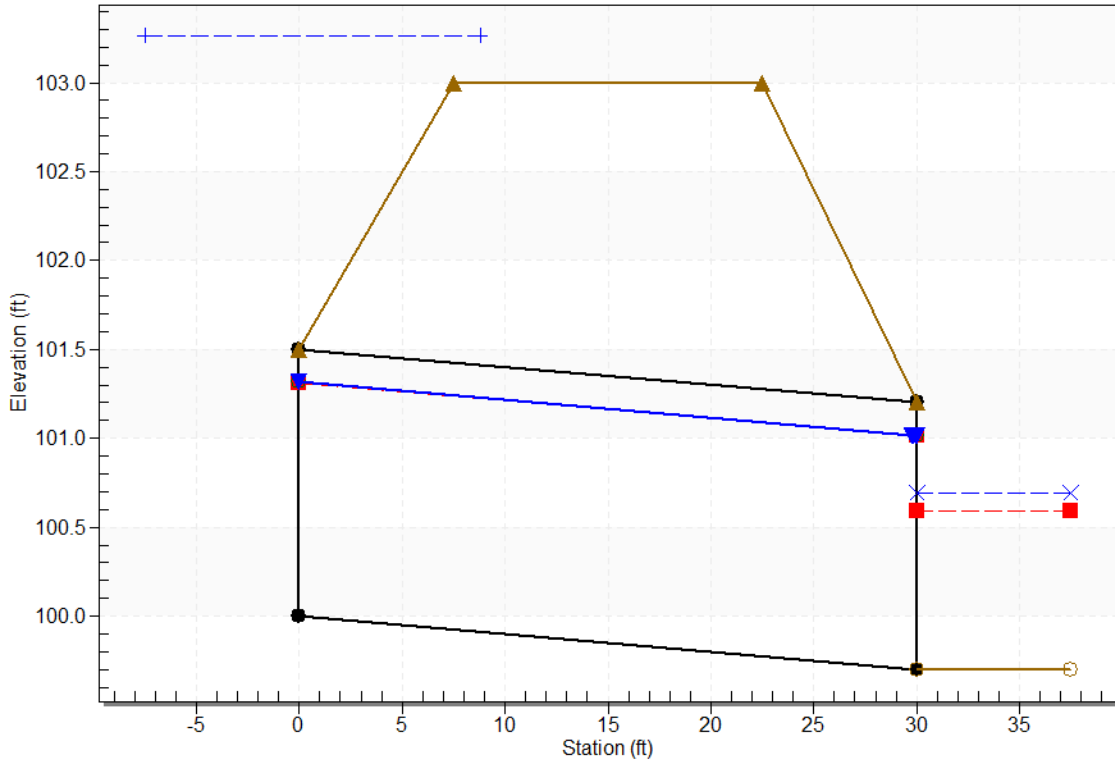



**Table 7 - Culvert Summary Table: 24 INCH DRIVEWAY**

<b>Total Discharge (cfs)</b>	<b>Culvert Discharge (cfs)</b>	<b>Headwater Elevation (ft)</b>	<b>Inlet Control Depth (ft)</b>	<b>Outlet Control Depth (ft)</b>	<b>HW / D (ft)</b>	<b>Flow Type</b>	<b>Normal Depth (ft)</b>	<b>Critical Depth (ft)</b>	<b>Outlet Depth (ft)</b>	<b>Tailwater Depth (ft)</b>	<b>Outlet Velocity (ft/s)</b>	<b>Tailwater Velocity (ft/s)</b>
<b>0.00</b>	0.00	100.00	0.00	0.000	0.00	0-NF	0.00	0.00	0.00	0.00	0.00	0.00
<b>2.20</b>	2.20	100.74	0.74	0.241	0.37	1-S2n	0.40	0.52	0.41	0.53	4.72	1.99
<b>4.40</b>	4.40	101.07	1.07	0.498	0.54	1-S2n	0.57	0.74	0.59	0.68	5.64	2.37
<b>6.60</b>	6.60	101.35	1.35	0.748	0.67	1-S2n	0.71	0.91	0.74	0.79	6.24	2.62
<b>8.80</b>	8.80	101.59	1.59	1.004	0.80	1-S2n	0.83	1.06	0.87	0.88	6.70	2.82
<b>11.00</b>	11.00	101.84	1.84	1.273	0.92	1-S2n	0.94	1.19	0.99	0.96	7.08	2.98
<b>13.20</b>	13.20	102.12	2.12	1.560	1.06	5-S2n	1.04	1.31	1.10	1.03	7.42	3.12
<b>15.40</b>	15.40	102.44	2.44	1.867	1.22	5-S2n	1.15	1.41	1.21	1.09	7.73	3.24
<b>17.60</b>	17.60	102.82	2.82	2.438	1.41	5-S2n	1.25	1.51	1.32	1.15	8.02	3.35
<b>19.80</b>	19.80	103.24	3.24	2.743	1.62	5-S2n	1.36	1.60	1.42	1.20	8.29	3.45
<b>22.00</b>	21.23	103.72	3.72	3.072	1.86	5-S2n	1.48	1.67	1.53	1.25	8.55	3.54
<b>24.00</b>	21.50	103.61	3.61	2.995	1.80	5-S2n	1.45	1.66	1.50	1.29	8.49	3.62

### Water Surface Profile Plot for Culvert: 24 INCH DRIVEWAY

Crossing - 24 Inch Driveway, Design Discharge - 22.0 cfs

Culvert - 24 INCH DRIVEWAY, Culvert Discharge - 21.2 cfs

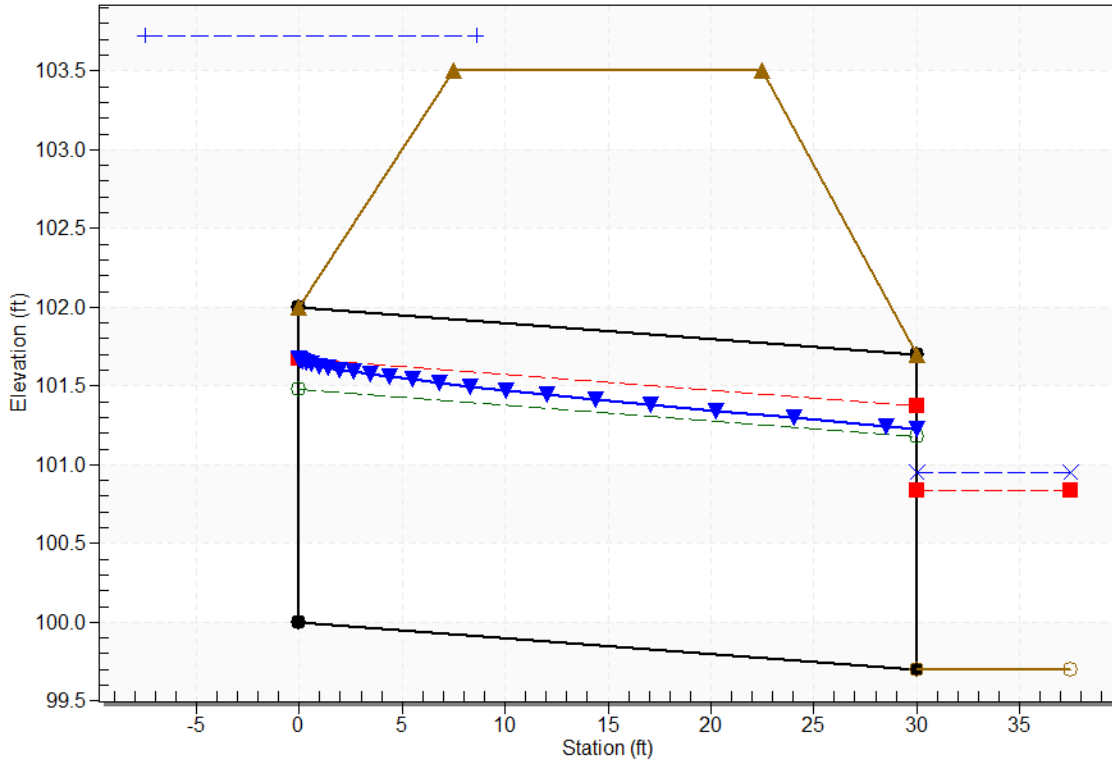

**Table 8 - Culvert Summary Table: 30 INCH DRIVEWAY**

<b>Total Discharge (cfs)</b>	<b>Culvert Discharge (cfs)</b>	<b>Headwater Elevation (ft)</b>	<b>Inlet Control Depth (ft)</b>	<b>Outlet Control Depth (ft)</b>	<b>HW / D (ft)</b>	<b>Flow Type</b>	<b>Normal Depth (ft)</b>	<b>Critical Depth (ft)</b>	<b>Outlet Depth (ft)</b>	<b>Tailwater Depth (ft)</b>	<b>Outlet Velocity (ft/s)</b>	<b>Tailwater Velocity (ft/s)</b>
<b>0.00</b>	0.00	100.00	0.00	0.000	0.00	0-NF	0.00	0.00	0.00	0.00	0.00	0.00
<b>3.50</b>	3.50	100.88	0.88	0.341	0.35	1-S2n	0.47	0.61	0.49	0.63	5.19	2.24
<b>7.00</b>	7.00	101.27	1.27	0.639	0.51	1-S2n	0.67	0.88	0.70	0.81	6.17	2.66
<b>10.50</b>	10.50	101.60	1.60	0.921	0.64	1-S2n	0.83	1.08	0.88	0.94	6.80	2.94
<b>14.00</b>	14.00	101.88	1.88	1.204	0.75	1-S2n	0.96	1.26	1.04	1.05	7.29	3.16
<b>17.50</b>	17.50	102.16	2.16	1.497	0.86	1-S2n	1.09	1.42	1.18	1.14	7.71	3.34
<b>21.00</b>	21.00	102.45	2.45	1.807	0.98	1-S2n	1.21	1.56	1.31	1.22	8.08	3.50
<b>24.50</b>	24.50	102.79	2.79	2.134	1.12	5-S2n	1.32	1.69	1.43	1.30	8.42	3.64
<b>28.00</b>	28.00	103.18	3.18	2.481	1.27	5-S2n	1.44	1.80	1.55	1.36	8.74	3.76
<b>31.50</b>	31.50	103.62	3.62	3.143	1.45	5-S2n	1.55	1.91	1.67	1.43	9.05	3.87
<b>35.00</b>	34.48	104.11	4.11	3.482	1.65	5-S2n	1.67	2.01	1.78	1.48	9.35	3.98
<b>41.36</b>	35.50	104.19	4.19	3.532	1.68	5-S2n	1.69	2.02	1.80	1.58	9.39	4.15

### Water Surface Profile Plot for Culvert: 30 INCH DRIVEWAY

Crossing - 30 Inch Driveway, Design Discharge - 35.0 cfs

Culvert - 30 INCH DRIVEWAY, Culvert Discharge - 34.5 cfs

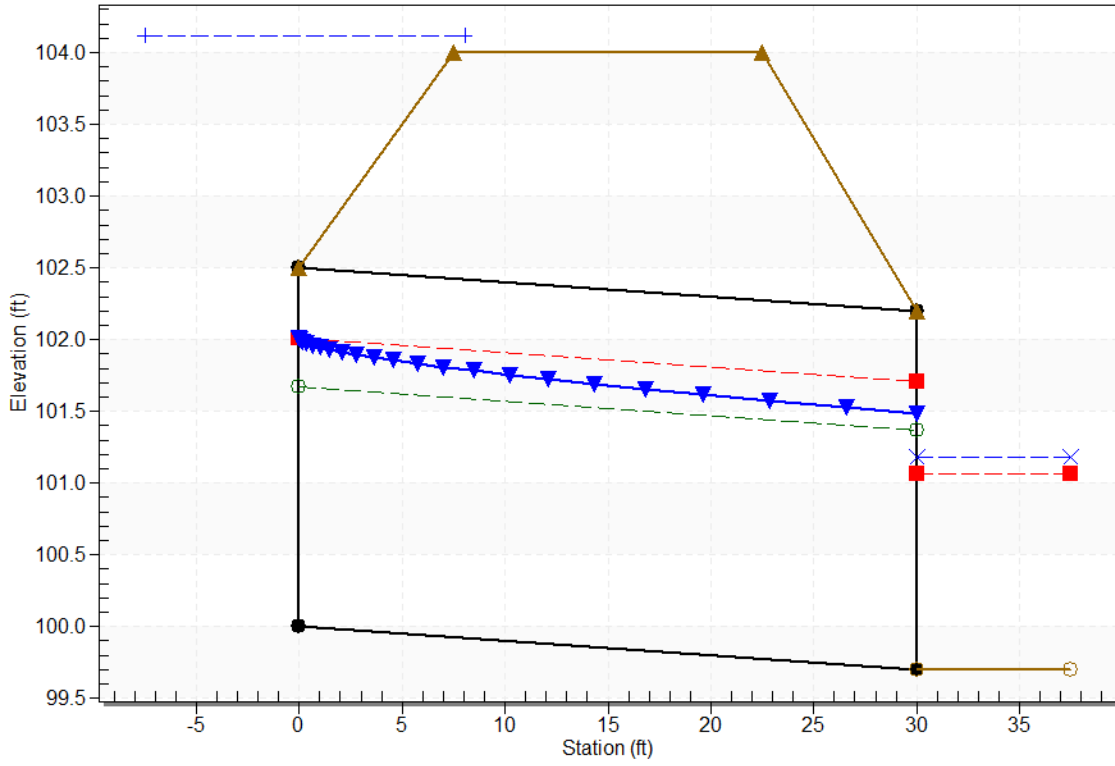

**Table 9 - Culvert Summary Table: 36 INCH DRIVEWAY**

<b>Total Discharge (cfs)</b>	<b>Culvert Discharge (cfs)</b>	<b>Headwater Elevation (ft)</b>	<b>Inlet Control Depth (ft)</b>	<b>Outlet Control Depth (ft)</b>	<b>HW / D (ft)</b>	<b>Flow Type</b>	<b>Normal Depth (ft)</b>	<b>Critical Depth (ft)</b>	<b>Outlet Depth (ft)</b>	<b>Tailwater Depth (ft)</b>	<b>Outlet Velocity (ft/s)</b>	<b>Tailwater Velocity (ft/s)</b>
<b>0.00</b>	0.00	100.00	0.00	0.000	0.00	0-NF	0.00	0.00	0.00	0.00	0.00	0.00
<b>5.50</b>	5.50	101.05	1.05	0.459	0.35	1-S2n	0.56	0.74	0.58	0.74	5.69	2.50
<b>11.00</b>	11.00	101.53	1.53	0.822	0.51	1-S2n	0.79	1.05	0.85	0.96	6.72	2.98
<b>16.50</b>	16.50	101.92	1.92	1.157	0.64	1-S2n	0.97	1.30	1.06	1.12	7.40	3.30
<b>22.00</b>	22.00	102.25	2.25	1.492	0.75	1-S2n	1.13	1.51	1.25	1.25	7.93	3.54
<b>27.50</b>	27.50	102.58	2.58	1.838	0.86	1-S2n	1.28	1.70	1.42	1.36	8.39	3.74
<b>33.00</b>	33.00	102.94	2.94	2.202	0.98	1-S2n	1.42	1.86	1.57	1.45	8.79	3.92
<b>38.50</b>	38.50	103.34	3.34	2.587	1.11	5-S2n	1.56	2.02	1.72	1.54	9.17	4.07
<b>44.00</b>	44.00	103.80	3.80	2.994	1.27	5-S2n	1.69	2.16	1.86	1.62	9.53	4.21
<b>49.50</b>	49.50	104.32	4.32	3.779	1.44	5-S2n	1.82	2.29	2.00	1.69	9.88	4.34
<b>55.00</b>	52.28	104.91	4.91	4.174	1.64	5-S2n	1.96	2.41	2.13	1.76	10.23	4.45
<b>60.00</b>	53.16	104.71	4.71	4.039	1.57	5-S2n	1.91	2.37	2.09	1.82	10.12	4.55

### Water Surface Profile Plot for Culvert: 36 INCH DRIVEWAY

Crossing - 36 Inch Driveway, Design Discharge - 55.0 cfs

Culvert - 36 INCH DRIVEWAY, Culvert Discharge - 52.3 cfs

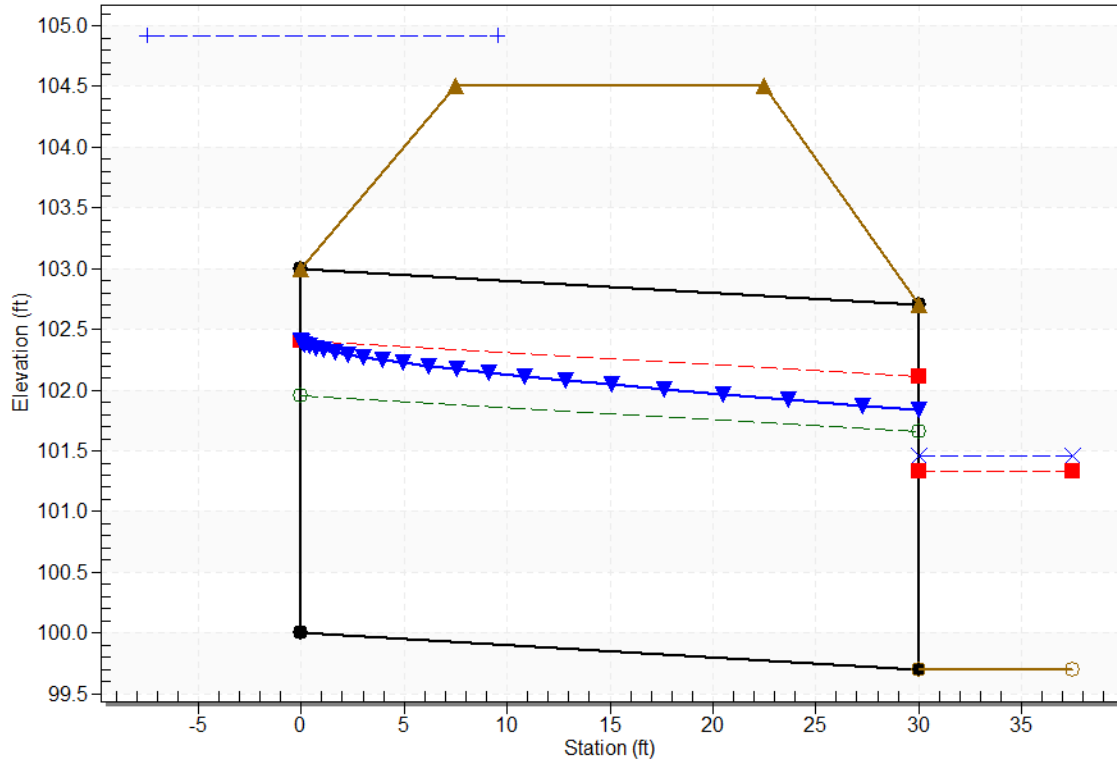

# DETERMINATION OF CULVERT HEADWATER AND OUTLET PROTECTION

*MHFD-Culvert, Version 4.00 (May 2020)*

**Project:** Latigo Filing 10  
**ID:** DP1

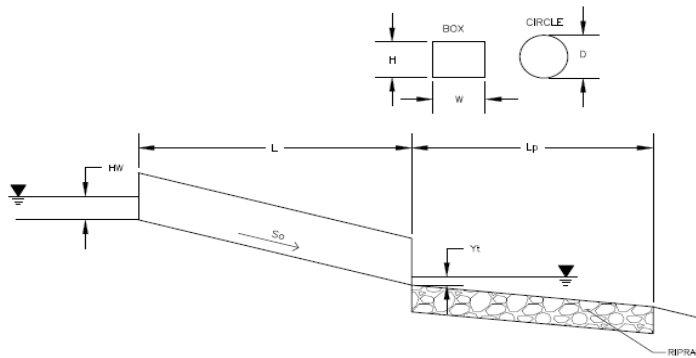

**Soil Type:**

Choose One:

- Sandy  
 Non-Sandy

**Supercritical Flow! Using Adjusted Diameter to calculate protection type.**

**Design Information:**

Design Discharge	Q = <input type="text" value="279.5"/> cfs
<b>Circular Culvert:</b>	
Barrel Diameter in Inches	D = <input type="text" value="36"/> inches
Inlet Edge Type (Choose from pull-down list)	Square Edge with Headwall
<b>OR:</b>	
<b>Box Culvert:</b>	
Barrel Height (Rise) in Feet	H (Rise) = <input type="text" value="OR"/> ft
Barrel Width (Span) in Feet	W (Span) = <input type="text" value="OR"/> ft
Inlet Edge Type (Choose from pull-down list)	
Number of Barrels	# Barrels = <input type="text" value="4"/>
Inlet Elevation	Elev IN = <input type="text" value="7097"/> ft
Outlet Elevation <b>OR</b> Slope	Elev OUT = <input type="text" value="7096"/> ft
Culvert Length	L = <input type="text" value="77"/> ft
Manning's Roughness	n = <input type="text" value="0.012"/>
Bend Loss Coefficient	k <sub>b</sub> = <input type="text" value="0"/>
Exit Loss Coefficient	k <sub>x</sub> = <input type="text" value="1"/>
Tailwater Surface Elevation	Y <sub>t</sub> , Elevation = <input type="text" value="OR"/> ft
Max Allowable Channel Velocity	V = <input type="text" value="5"/> ft/s

**Calculated Results:**

Culvert Cross Sectional Area Available	A = <input type="text" value="7.07"/> ft <sup>2</sup>
Culvert Normal Depth	Y <sub>n</sub> = <input type="text" value="2.12"/> ft
Culvert Critical Depth	Y <sub>c</sub> = <input type="text" value="2.66"/> ft
Froude Number	Fr = <input type="text" value="1.65"/> <b>Supercritical!</b>
Entrance Loss Coefficient	k <sub>e</sub> = <input type="text" value="0.50"/>
Friction Loss Coefficient	k <sub>f</sub> = <input type="text" value="0.47"/>
Sum of All Loss Coefficients	k <sub>s</sub> = <input type="text" value="1.97"/> ft
<b>Headwater:</b>	
Inlet Control Headwater	HW <sub>I</sub> = <input type="text" value="5.85"/> ft
Outlet Control Headwater	HW <sub>O</sub> = <input type="text" value="4.82"/> ft
<b>Design Headwater Elevation</b>	<b>HW = <input type="text" value="7102.85"/> ft</b>
<b>Headwater/Diameter <b>OR</b> Headwater/Rise Ratio</b>	<b>HW/D = <input type="text" value="1.95"/> <b>HW/D &gt; 1.5!</b></b>
<b>Outlet Protection:</b>	
Flow/(Diameter <sup>2.5</sup> )	Q/D <sup>2.5</sup> = <input type="text" value="4.48"/> ft <sup>0.5</sup> /s
Tailwater Surface Height	Y <sub>t</sub> = <input type="text" value="1.20"/> ft
Tailwater/Diameter	Y <sub>t</sub> /D = <input type="text" value="0.40"/>
Expansion Factor	1/(2*tan(θ)) = <input type="text" value="2.98"/>
Flow Area at Max Channel Velocity	A <sub>t</sub> = <input type="text" value="55.90"/> ft <sup>2</sup>
Width of Equivalent Conduit for Multiple Barrels	W <sub>eq</sub> = <input type="text" value="12.00"/> ft
<b>Length of Riprap Protection</b>	<b>L<sub>p</sub> = <input type="text" value="30"/> ft</b>
<b>Width of Riprap Protection at Downstream End</b>	<b>T = <input type="text" value="23"/> ft</b>
Adjusted Diameter for Supercritical Flow	Da = <input type="text" value="2.56"/> ft
Minimum Theoretical Riprap Size	d <sub>50 min</sub> = <input type="text" value="12"/> in
Nominal Riprap Size	d <sub>50 nominal</sub> = <input type="text" value="12"/> in
<b>MHFD Riprap Type</b>	<b>Type = <input type="text" value="M"/></b>

# DETERMINATION OF CULVERT HEADWATER AND OUTLET PROTECTION

MHFD-Culvert, Version 4.00 (May 2020)

**Project:** Latigo Filing 10  
**ID:** DP7

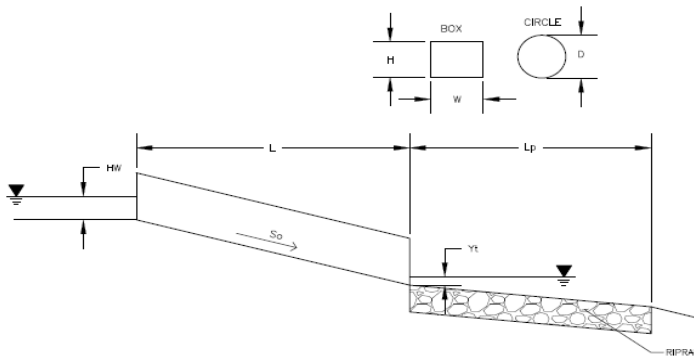

**Soil Type:**

Choose One:

- Sandy  
 Non-Sandy

**Supercritical Flow! Using Adjusted Diameter to calculate protection type.**

Design Information:	
Design Discharge	Q = <input type="text" value="2"/> cfs
<b>Circular Culvert:</b>	
Barrel Diameter in Inches	D = <input type="text" value="18"/> inches
Inlet Edge Type (Choose from pull-down list)	Square Edge with Headwall
<b>OR:</b>	
<b>Box Culvert:</b>	
Barrel Height (Rise) in Feet	H (Rise) = <input type="text"/> ft
Barrel Width (Span) in Feet	W (Span) = <input type="text"/> ft
Inlet Edge Type (Choose from pull-down list)	
Number of Barrels	# Barrels = <input type="text" value="1"/>
Inlet Elevation	Elev IN = <input type="text" value="7069"/> ft
Outlet Elevation <b>OR</b> Slope	Elev OUT = <input type="text" value="7068"/> ft
Culvert Length	L = <input type="text" value="72"/> ft
Manning's Roughness	n = <input type="text" value="0.012"/>
Bend Loss Coefficient	k <sub>b</sub> = <input type="text" value="0"/>
Exit Loss Coefficient	k <sub>x</sub> = <input type="text" value="1"/>
Tailwater Surface Elevation	Y <sub>t</sub> , Elevation = <input type="text"/> ft
Max Allowable Channel Velocity	V = <input type="text" value="5"/> ft/s
Calculated Results:	
Culvert Cross Sectional Area Available	A = <input type="text" value="1.77"/> ft <sup>2</sup>
Culvert Normal Depth	Y <sub>n</sub> = <input type="text" value="0.39"/> ft
Culvert Critical Depth	Y <sub>c</sub> = <input type="text" value="0.53"/> ft
Froude Number	Fr = <input type="text" value="1.82"/> <span style="color: red;">Supercritical!</span>
Entrance Loss Coefficient	k <sub>e</sub> = <input type="text" value="0.50"/>
Friction Loss Coefficient	k <sub>f</sub> = <input type="text" value="1.11"/>
Sum of All Loss Coefficients	k <sub>s</sub> = <input type="text" value="2.61"/> ft
<b>Headwater:</b>	
Inlet Control Headwater	HW <sub>I</sub> = <input type="text" value="0.73"/> ft
Outlet Control Headwater	HW <sub>O</sub> = <input type="text" value="N/A"/> ft
<b>Design Headwater Elevation</b>	<b>HW = <input type="text" value="N/A"/> ft</b>
<b>Headwater/Diameter <b>OR</b> Headwater/Rise Ratio</b>	<b>HW/D = <input type="text" value="N/A"/></b>
<b>Outlet Control Headwater Approximation Method Inaccurate for Low Flow - Backwater Calculations Required</b>	
<b>Outlet Protection:</b>	
Flow/(Diameter <sup>2.5</sup> )	Q/D <sup>2.5</sup> = <input type="text" value="0.73"/> ft <sup>0.5</sup> /s
Tailwater Surface Height	Y <sub>t</sub> = <input type="text" value="0.60"/> ft
Tailwater/Diameter	Y <sub>t</sub> /D = <input type="text" value="0.40"/>
Expansion Factor	1/(2*tan(θ)) = <input type="text" value="6.70"/>
Flow Area at Max Channel Velocity	A <sub>t</sub> = <input type="text" value="0.40"/> ft <sup>2</sup>
Width of Equivalent Conduit for Multiple Barrels	W <sub>eq</sub> = <input type="text" value="-"/> ft
<b>Length of Riprap Protection</b>	<b>L<sub>p</sub> = <input type="text" value="5"/> ft</b>
<b>Width of Riprap Protection at Downstream End</b>	<b>T = <input type="text" value="3"/> ft</b>
Adjusted Diameter for Supercritical Flow	Da = <input type="text" value="0.95"/> ft
Minimum Theoretical Riprap Size	d <sub>50 min</sub> = <input type="text" value="1"/> in
Nominal Riprap Size	d <sub>50 nominal</sub> = <input type="text" value="6"/> in
<b>MHFD Riprap Type</b>	<b>Type = <input type="text" value="VL"/></b>



# DETERMINATION OF CULVERT HEADWATER AND OUTLET PROTECTION

MHFD-Culvert, Version 4.00 (May 2020)

**Project:** Latigo Filing 10  
**ID:** DP8A

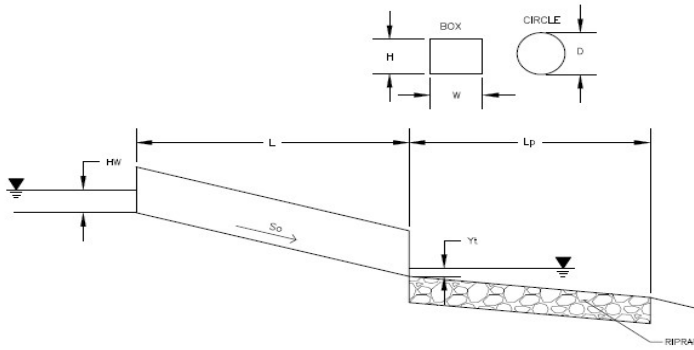

**Soil Type:**

Choose One:

Sandy

Non-Sandy

**Supercritical Flow! Using Adjusted Diameter to calculate protection type.**

Design Information:	
Design Discharge	Q = <input style="width: 100px;" type="text" value="54.3"/> cfs
Circular Culvert:	
Barrel Diameter in Inches	D = <input style="width: 100px;" type="text" value="36"/> inches
Inlet Edge Type (Choose from pull-down list)	Grooved Edge Projecting
<b>OR:</b>	
Box Culvert:	
Barrel Height (Rise) in Feet	H (Rise) = <input style="width: 100px;" type="text"/>
Barrel Width (Span) in Feet	W (Span) = <input style="width: 100px;" type="text"/>
Inlet Edge Type (Choose from pull-down list)	
Number of Barrels	# Barrels = <input style="width: 100px;" type="text" value="1"/>
Inlet Elevation	Elev IN = <input style="width: 100px;" type="text" value="7068"/> ft
Outlet Elevation <b>OR</b> Slope	Elev OUT = <input style="width: 100px;" type="text" value="7062"/> ft
Culvert Length	L = <input style="width: 100px;" type="text" value="172"/> ft
Manning's Roughness	n = <input style="width: 100px;" type="text" value="0.012"/>
Bend Loss Coefficient	k <sub>b</sub> = <input style="width: 100px;" type="text" value="0"/>
Exit Loss Coefficient	k <sub>x</sub> = <input style="width: 100px;" type="text" value="1"/>
Tailwater Surface Elevation	Y <sub>t</sub> Elevation = <input style="width: 100px;" type="text"/>
Max Allowable Channel Velocity	V = <input style="width: 100px;" type="text" value="5"/> ft/s
Calculated Results:	
Culvert Cross Sectional Area Available	A = <input style="width: 100px;" type="text" value="7.07"/> ft <sup>2</sup>
Culvert Normal Depth	Y <sub>n</sub> = <input style="width: 100px;" type="text" value="1.83"/> ft
Culvert Critical Depth	Y <sub>c</sub> = <input style="width: 100px;" type="text" value="2.15"/> ft
Froude Number	Fr = <input style="width: 100px;" type="text" value="1.36"/> <span style="color: red; font-weight: bold;">Supercritical!</span>
Entrance Loss Coefficient	k <sub>e</sub> = <input style="width: 100px;" type="text" value="0.20"/>
Friction Loss Coefficient	k <sub>f</sub> = <input style="width: 100px;" type="text" value="1.05"/>
Sum of All Loss Coefficients	k <sub>s</sub> = <input style="width: 100px;" type="text" value="2.25"/> ft
Headwater:	
Inlet Control Headwater	HW <sub>I</sub> = <input style="width: 100px;" type="text" value="3.26"/> ft
Outlet Control Headwater	HW <sub>O</sub> = <input style="width: 100px;" type="text" value="2.99"/> ft
<b>Design Headwater Elevation</b>	<b>HW = <input style="width: 100px;" type="text" value="7071.26"/> ft</b>
<b>Headwater/Diameter <b>OR</b> Headwater/Rise Ratio</b>	<b>HW/D = <input style="width: 100px;" type="text" value="1.09"/></b>
Outlet Protection:	
Flow/(Diameter <sup>2.5</sup> )	Q/D <sup>2.5</sup> = <input style="width: 100px;" type="text" value="3.48"/> ft <sup>0.5</sup> /s
Tailwater Surface Height	Y <sub>t</sub> = <input style="width: 100px;" type="text" value="1.20"/> ft
Tailwater/Diameter	Y <sub>t</sub> /D = <input style="width: 100px;" type="text" value="0.40"/>
Expansion Factor	1/(2*tan(θ)) = <input style="width: 100px;" type="text" value="3.96"/>
Flow Area at Max Channel Velocity	A <sub>t</sub> = <input style="width: 100px;" type="text" value="10.86"/> ft <sup>2</sup>
Width of Equivalent Conduit for Multiple Barrels	W <sub>eq</sub> = <input style="width: 100px;" type="text" value="-"/>
<b>Length of Riprap Protection</b>	<b>L<sub>p</sub> = <input style="width: 100px;" type="text" value="20"/> ft</b>
<b>Width of Riprap Protection at Downstream End</b>	<b>T = <input style="width: 100px;" type="text" value="9"/> ft</b>
Adjusted Diameter for Supercritical Flow	D <sub>a</sub> = <input style="width: 100px;" type="text" value="2.42"/> ft
Minimum Theoretical Riprap Size	d <sub>50</sub> min = <input style="width: 100px;" type="text" value="9"/> in
Nominal Riprap Size	d <sub>50</sub> nominal = <input style="width: 100px;" type="text" value="12"/> in
<b>MHFD Riprap Type</b>	<b>Type = <input style="width: 100px;" type="text" value="M"/></b>

# DETERMINATION OF CULVERT HEADWATER AND OUTLET PROTECTION

*MHFD-Culvert, Version 4.00 (May 2020)*

**Project:** Latigo Filing 10  
**ID:** DP13A

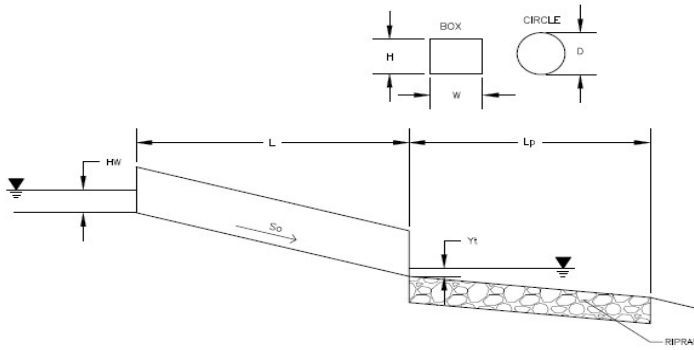

**Soil Type:**

Choose One:

Sandy

Non-Sandy

**Supercritical Flow! Using Adjusted Diameter to calculate protection type.**

Design Information:	
Design Discharge	Q = <input style="width: 100px;" type="text" value="36.9"/> cfs
Circular Culvert:	
Barrel Diameter in Inches	D = <input style="width: 100px;" type="text" value="36"/> inches
Inlet Edge Type (Choose from pull-down list)	Grooved Edge Projecting
<b>OR:</b>	
Box Culvert:	
Barrel Height (Rise) in Feet	H (Rise) = <input style="width: 100px;" type="text"/>
Barrel Width (Span) in Feet	W (Span) = <input style="width: 100px;" type="text"/>
Inlet Edge Type (Choose from pull-down list)	
<b>OR</b>	
Number of Barrels	# Barrels = <input style="width: 100px;" type="text" value="1"/>
Inlet Elevation	Elev IN = <input style="width: 100px;" type="text" value="7075.2"/> ft
Outlet Elevation <b>OR</b> Slope	Elev OUT = <input style="width: 100px;" type="text" value="7074.65"/> ft
Culvert Length	L = <input style="width: 100px;" type="text" value="73"/> ft
Manning's Roughness	n = <input style="width: 100px;" type="text" value="0.012"/>
Bend Loss Coefficient	k <sub>b</sub> = <input style="width: 100px;" type="text" value="0"/>
Exit Loss Coefficient	k <sub>x</sub> = <input style="width: 100px;" type="text" value="1"/>
Tailwater Surface Elevation	Y <sub>t</sub> Elevation = <input style="width: 100px;" type="text"/>
Max Allowable Channel Velocity	V = <input style="width: 100px;" type="text" value="5"/> ft/s
Calculated Results:	
Culvert Cross Sectional Area Available	A = <input style="width: 100px;" type="text" value="7.07"/> ft <sup>2</sup>
Culvert Normal Depth	Y <sub>n</sub> = <input style="width: 100px;" type="text" value="1.65"/> ft
Culvert Critical Depth	Y <sub>c</sub> = <input style="width: 100px;" type="text" value="1.98"/> ft
Froude Number	Fr = <input style="width: 100px;" type="text" value="1.41"/> <span style="color: red; font-weight: bold;">Supercritical!</span>
Entrance Loss Coefficient	k <sub>e</sub> = <input style="width: 100px;" type="text" value="0.20"/>
Friction Loss Coefficient	k <sub>f</sub> = <input style="width: 100px;" type="text" value="0.45"/>
Sum of All Loss Coefficients	k <sub>s</sub> = <input style="width: 100px;" type="text" value="1.65"/> ft
Headwater:	
Inlet Control Headwater	HW <sub>I</sub> = <input style="width: 100px;" type="text" value="2.92"/> ft
Outlet Control Headwater	HW <sub>O</sub> = <input style="width: 100px;" type="text" value="2.63"/> ft
<b>Design Headwater Elevation</b>	<b>HW = <input style="width: 100px;" type="text" value="7078.12"/> ft</b>
<b>Headwater/Diameter <b>OR</b> Headwater/Rise Ratio</b>	<b>HW/D = <input style="width: 100px;" type="text" value="0.97"/></b>
Outlet Protection:	
Flow/(Diameter <sup>2.5</sup> )	Q/D <sup>2.5</sup> = <input style="width: 100px;" type="text" value="2.37"/> ft <sup>0.5</sup> /s
Tailwater Surface Height	Y <sub>t</sub> = <input style="width: 100px;" type="text" value="1.20"/> ft
Tailwater/Diameter	Y <sub>t</sub> /D = <input style="width: 100px;" type="text" value="0.40"/>
Expansion Factor	1/(2*tan(θ)) = <input style="width: 100px;" type="text" value="5.24"/>
Flow Area at Max Channel Velocity	A <sub>t</sub> = <input style="width: 100px;" type="text" value="7.38"/> ft <sup>2</sup>
Width of Equivalent Conduit for Multiple Barrels	W <sub>eq</sub> = <input style="width: 100px;" type="text" value="-"/>
<b>Length of Riprap Protection</b>	<b>L<sub>p</sub> = <input style="width: 100px;" type="text" value="17"/> ft</b>
<b>Width of Riprap Protection at Downstream End</b>	<b>T = <input style="width: 100px;" type="text" value="7"/> ft</b>
Adjusted Diameter for Supercritical Flow	
Minimum Theoretical Riprap Size	D <sub>a</sub> = <input style="width: 100px;" type="text" value="2.33"/> ft
Nominal Riprap Size	d <sub>50</sub> min = <input style="width: 100px;" type="text" value="6"/> in
<b>MHFD Riprap Type</b>	d <sub>50</sub> nominal = <input style="width: 100px;" type="text" value="9"/> in
	<b>Type = <input style="width: 100px;" type="text" value="L"/></b>

# DETERMINATION OF CULVERT HEADWATER AND OUTLET PROTECTION

*MHFD-Culvert, Version 4.00 (May 2020)*

**Project:** Latigo Filing 10  
**ID:** DP24A

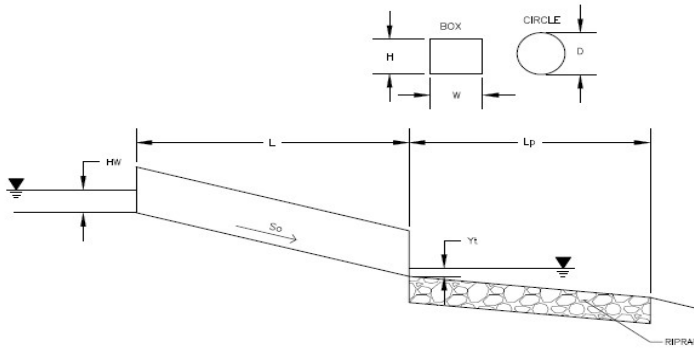

**Soil Type:**

Choose One:

Sandy

Non-Sandy

**Supercritical Flow! Using Adjusted Diameter to calculate protection type.**

Design Information:	
Design Discharge	Q = <input style="width: 100px;" type="text" value="43.4"/> cfs
Circular Culvert:	
Barrel Diameter in Inches	D = <input style="width: 100px;" type="text" value="36"/> inches
Inlet Edge Type (Choose from pull-down list)	Grooved Edge Projecting
<b>OR:</b>	
Box Culvert:	
Barrel Height (Rise) in Feet	H (Rise) = <input style="width: 100px;" type="text"/>
Barrel Width (Span) in Feet	W (Span) = <input style="width: 100px;" type="text"/>
Inlet Edge Type (Choose from pull-down list)	
Number of Barrels	# Barrels = <input style="width: 100px;" type="text" value="1"/>
Inlet Elevation	Elev IN = <input style="width: 100px;" type="text" value="7071.75"/> ft
Outlet Elevation <b>OR</b> Slope	Elev OUT = <input style="width: 100px;" type="text" value="7071.2"/> ft
Culvert Length	L = <input style="width: 100px;" type="text" value="74.2"/> ft
Manning's Roughness	n = <input style="width: 100px;" type="text" value="0.012"/>
Bend Loss Coefficient	k <sub>b</sub> = <input style="width: 100px;" type="text" value="0"/>
Exit Loss Coefficient	k <sub>x</sub> = <input style="width: 100px;" type="text" value="1"/>
Tailwater Surface Elevation	Y <sub>t</sub> Elevation = <input style="width: 100px;" type="text"/>
Max Allowable Channel Velocity	V = <input style="width: 100px;" type="text" value="5"/> ft/s
Calculated Results:	
Culvert Cross Sectional Area Available	A = <input style="width: 100px;" type="text" value="7.07"/> ft <sup>2</sup>
Culvert Normal Depth	Y <sub>n</sub> = <input style="width: 100px;" type="text" value="1.83"/> ft
Culvert Critical Depth	Y <sub>c</sub> = <input style="width: 100px;" type="text" value="2.15"/> ft
Froude Number	Fr = <input style="width: 100px;" type="text" value="1.36"/> <span style="color: red; font-weight: bold;">Supercritical!</span>
Entrance Loss Coefficient	k <sub>e</sub> = <input style="width: 100px;" type="text" value="0.20"/>
Friction Loss Coefficient	k <sub>f</sub> = <input style="width: 100px;" type="text" value="0.45"/>
Sum of All Loss Coefficients	k <sub>s</sub> = <input style="width: 100px;" type="text" value="1.65"/> ft
Headwater:	
Inlet Control Headwater	HW <sub>I</sub> = <input style="width: 100px;" type="text" value="3.26"/> ft
Outlet Control Headwater	HW <sub>O</sub> = <input style="width: 100px;" type="text" value="2.99"/> ft
<b>Design Headwater Elevation</b>	<b>HW = <input style="width: 100px;" type="text" value="7075.01"/> ft</b>
<b>Headwater/Diameter <b>OR</b> Headwater/Rise Ratio</b>	<b>HW/D = <input style="width: 100px;" type="text" value="1.09"/></b>
Outlet Protection:	
Flow/(Diameter <sup>2.5</sup> )	Q/D <sup>2.5</sup> = <input style="width: 100px;" type="text" value="2.78"/> ft <sup>0.5</sup> /s
Tailwater Surface Height	Y <sub>t</sub> = <input style="width: 100px;" type="text" value="1.20"/> ft
Tailwater/Diameter	Y <sub>t</sub> /D = <input style="width: 100px;" type="text" value="0.40"/>
Expansion Factor	1/(2*tan(θ)) = <input style="width: 100px;" type="text" value="4.67"/>
Flow Area at Max Channel Velocity	A <sub>t</sub> = <input style="width: 100px;" type="text" value="8.68"/> ft <sup>2</sup>
Width of Equivalent Conduit for Multiple Barrels	W <sub>eq</sub> = <input style="width: 100px;" type="text" value="-"/>
<b>Length of Riprap Protection</b>	<b>L<sub>p</sub> = <input style="width: 100px;" type="text" value="20"/> ft</b>
<b>Width of Riprap Protection at Downstream End</b>	<b>T = <input style="width: 100px;" type="text" value="8"/> ft</b>
Adjusted Diameter for Supercritical Flow	D <sub>a</sub> = <input style="width: 100px;" type="text" value="2.42"/> ft
Minimum Theoretical Riprap Size	d <sub>50</sub> min = <input style="width: 100px;" type="text" value="7"/> in
Nominal Riprap Size	d <sub>50</sub> nominal = <input style="width: 100px;" type="text" value="9"/> in
<b>MHFD Riprap Type</b>	<b>Type = <input style="width: 100px;" type="text" value="L"/></b>

# DETERMINATION OF CULVERT HEADWATER AND OUTLET PROTECTION

*MHFD-Culvert, Version 4.00 (May 2020)*

**Project:** Latigo Filing 10  
**ID:** 3-36" Driveway

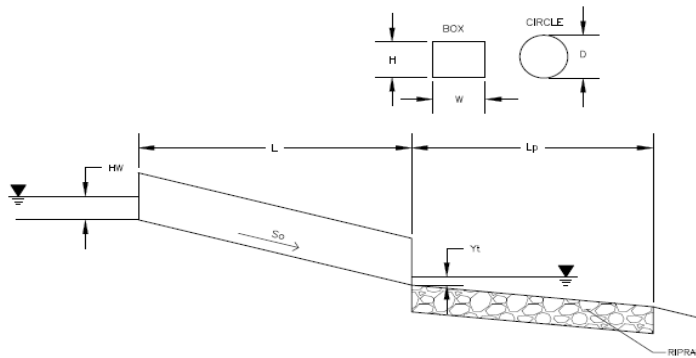

**Soil Type:**  
 Choose One:  
 Sandy  
 Non-Sandy

**Supercritical Flow! Using Adjusted Diameter to calculate protection type.**

Design Information:	
Design Discharge	Q = <input type="text" value="127.3"/> cfs
<b>Circular Culvert:</b>	
Barrel Diameter in Inches	D = <input type="text" value="36"/> inches
Inlet Edge Type (Choose from pull-down list)	Square Edge with Headwall
<b>OR:</b>	
<b>Box Culvert:</b>	
Barrel Height (Rise) in Feet	H (Rise) = <input type="text"/> ft
Barrel Width (Span) in Feet	W (Span) = <input type="text"/> ft
Inlet Edge Type (Choose from pull-down list)	
Number of Barrels	# Barrels = <input type="text" value="3"/>
Inlet Elevation	Elev IN = <input type="text" value="7050"/> ft
Outlet Elevation <b>OR</b> Slope	Elev OUT = <input type="text" value="7049.7"/> ft
Culvert Length	L = <input type="text" value="30"/> ft
Manning's Roughness	n = <input type="text" value="0.012"/>
Bend Loss Coefficient	k <sub>b</sub> = <input type="text" value="0"/>
Exit Loss Coefficient	k <sub>x</sub> = <input type="text" value="1"/>
Tailwater Surface Elevation	Y <sub>t</sub> , Elevation = <input type="text"/> ft
Max Allowable Channel Velocity	V = <input type="text" value="5"/> ft/s
Calculated Results:	
Culvert Cross Sectional Area Available	A = <input type="text" value="7.07"/> ft <sup>2</sup>
Culvert Normal Depth	Y <sub>n</sub> = <input type="text" value="1.65"/> ft
Culvert Critical Depth	Y <sub>c</sub> = <input type="text" value="2.12"/> ft
Froude Number	Fr = <input type="text" value="1.63"/> <span style="color: red; font-weight: bold;">Supercritical!</span>
Entrance Loss Coefficient	k <sub>e</sub> = <input type="text" value="0.50"/>
Friction Loss Coefficient	k <sub>f</sub> = <input type="text" value="0.18"/>
Sum of All Loss Coefficients	k <sub>s</sub> = <input type="text" value="1.68"/> ft
<b>Headwater:</b>	
Inlet Control Headwater	HW <sub>I</sub> = <input type="text" value="3.45"/> ft
Outlet Control Headwater	HW <sub>O</sub> = <input type="text" value="3.20"/> ft
<b>Design Headwater Elevation</b>	<b>HW = <input type="text" value="7053.45"/> ft</b>
<b>Headwater/Diameter <u>OR</u> Headwater/Rise Ratio</b>	<b>HW/D = <input type="text" value="1.15"/></b>
<b>Outlet Protection:</b>	
Flow/(Diameter <sup>2.5</sup> )	Q/D <sup>2.5</sup> = <input type="text" value="2.72"/> ft <sup>0.5</sup> /s
Tailwater Surface Height	Y <sub>t</sub> = <input type="text" value="1.20"/> ft
Tailwater/Diameter	Y <sub>t</sub> /D = <input type="text" value="0.40"/>
Expansion Factor	1/(2*tan(Θ)) = <input type="text" value="4.76"/>
Flow Area at Max Channel Velocity	A <sub>t</sub> = <input type="text" value="25.46"/> ft <sup>2</sup>
Width of Equivalent Conduit for Multiple Barrels	W <sub>eq</sub> = <input type="text" value="9.00"/> ft
<b>Length of Riprap Protection</b>	<b>L<sub>p</sub> = <input type="text" value="30"/> ft</b>
<b>Width of Riprap Protection at Downstream End</b>	<b>T = <input type="text" value="16"/> ft</b>
Adjusted Diameter for Supercritical Flow	Da = <input type="text" value="2.33"/> ft
Minimum Theoretical Riprap Size	d <sub>50</sub> min = <input type="text" value="7"/> in
Nominal Riprap Size	d <sub>50</sub> nominal = <input type="text" value="9"/> in
<b>MHFD Riprap Type</b>	<b>Type = <input type="text" value="L"/></b>

# DETERMINATION OF CULVERT HEADWATER AND OUTLET PROTECTION

MHFD-Culvert, Version 4.00 (May 2020)

**Project:** Latigo Filing 10  
**ID:** 4-36" Driveway

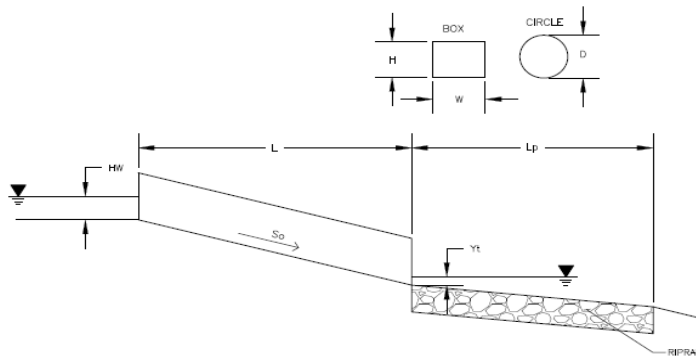

**Soil Type:**  
 Choose One:  
 Sandy  
 Non-Sandy

**Supercritical Flow! Using Adjusted Diameter to calculate protection type.**

Design Information:	
Design Discharge	Q = <input type="text" value="279.5"/> cfs
<b>Circular Culvert:</b>	
Barrel Diameter in Inches	D = <input type="text" value="36"/> inches
Inlet Edge Type (Choose from pull-down list)	Square Edge with Headwall
<b>OR:</b>	
<b>Box Culvert:</b>	
Barrel Height (Rise) in Feet	H (Rise) = <input type="text"/> ft
Barrel Width (Span) in Feet	W (Span) = <input type="text"/> ft
Inlet Edge Type (Choose from pull-down list)	
Number of Barrels	# Barrels = <input type="text" value="4"/>
Inlet Elevation	Elev IN = <input type="text" value="7050"/> ft
Outlet Elevation <b>OR</b> Slope	Elev OUT = <input type="text" value="7049.7"/> ft
Culvert Length	L = <input type="text" value="30"/> ft
Manning's Roughness	n = <input type="text" value="0.012"/>
Bend Loss Coefficient	k <sub>b</sub> = <input type="text" value="0"/>
Exit Loss Coefficient	k <sub>x</sub> = <input type="text" value="1"/>
Tailwater Surface Elevation	Y <sub>t</sub> , Elevation = <input type="text"/> ft
Max Allowable Channel Velocity	V = <input type="text" value="5"/> ft/s
Calculated Results:	
Culvert Cross Sectional Area Available	A = <input type="text" value="7.07"/> ft <sup>2</sup>
Culvert Normal Depth	Y <sub>n</sub> = <input type="text" value="2.37"/> ft
Culvert Critical Depth	Y <sub>c</sub> = <input type="text" value="2.66"/> ft
Froude Number	Fr = <input type="text" value="1.32"/> <span style="color: red;">Supercritical!</span>
Entrance Loss Coefficient	k <sub>e</sub> = <input type="text" value="0.50"/>
Friction Loss Coefficient	k <sub>f</sub> = <input type="text" value="0.18"/>
Sum of All Loss Coefficients	k <sub>s</sub> = <input type="text" value="1.68"/> ft
<b>Headwater:</b>	
Inlet Control Headwater	HW <sub>I</sub> = <input type="text" value="5.85"/> ft
Outlet Control Headwater	HW <sub>O</sub> = <input type="text" value="5.08"/> ft
<b>Design Headwater Elevation</b>	<b>HW = <input type="text" value="7055.85"/> ft</b>
<b>Headwater/Diameter <u>OR</u> Headwater/Rise Ratio</b>	<b>HW/D = <input type="text" value="1.95"/> <span style="color: red;">HW/D &gt; 1.5!</span></b>
<b>Outlet Protection:</b>	
Flow/(Diameter <sup>2.5</sup> )	Q/D <sup>2.5</sup> = <input type="text" value="4.48"/> ft <sup>0.5</sup> /s
Tailwater Surface Height	Y <sub>t</sub> = <input type="text" value="1.20"/> ft
Tailwater/Diameter	Y <sub>t</sub> /D = <input type="text" value="0.40"/>
Expansion Factor	1/(2*tan(Θ)) = <input type="text" value="2.98"/>
Flow Area at Max Channel Velocity	A <sub>t</sub> = <input type="text" value="55.90"/> ft <sup>2</sup>
Width of Equivalent Conduit for Multiple Barrels	W <sub>eq</sub> = <input type="text" value="12.00"/> ft
<b>Length of Riprap Protection</b>	<b>L<sub>p</sub> = <input type="text" value="30"/> ft</b>
<b>Width of Riprap Protection at Downstream End</b>	<b>T = <input type="text" value="23"/> ft</b>
Adjusted Diameter for Supercritical Flow	Da = <input type="text" value="2.68"/> ft
Minimum Theoretical Riprap Size	d <sub>50</sub> min = <input type="text" value="12"/> in
Nominal Riprap Size	d <sub>50</sub> nominal = <input type="text" value="12"/> in
<b>MHFD Riprap Type</b>	<b>Type = <input type="text" value="M"/></b>

# DETERMINATION OF CULVERT HEADWATER AND OUTLET PROTECTION

MHFD-Culvert, Version 4.00 (May 2020)

**Project:** Latigo Filing 10  
**ID:** 18" Driveway

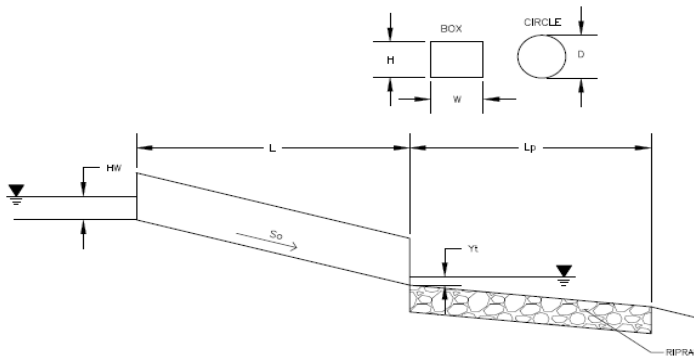

**Soil Type:**  
 Choose One:  
 Sandy  
 Non-Sandy

**Supercritical Flow! Using Adjusted Diameter to calculate protection type.**

Design Information:	
Design Discharge	Q = <input type="text" value="11.4"/> cfs
<b>Circular Culvert:</b>	
Barrel Diameter in Inches	D = <input type="text" value="18"/> inches
Inlet Edge Type (Choose from pull-down list)	Square Edge with Headwall
<b>OR:</b>	
<b>Box Culvert:</b>	
Barrel Height (Rise) in Feet	H (Rise) = <input type="text"/> ft
Barrel Width (Span) in Feet	W (Span) = <input type="text"/> ft
Inlet Edge Type (Choose from pull-down list)	
Number of Barrels	# Barrels = <input type="text" value="1"/>
Inlet Elevation	Elev IN = <input type="text" value="7050"/> ft
Outlet Elevation <b>OR</b> Slope	Elev OUT = <input type="text" value="7049.7"/> ft
Culvert Length	L = <input type="text" value="30"/> ft
Manning's Roughness	n = <input type="text" value="0.012"/>
Bend Loss Coefficient	k <sub>b</sub> = <input type="text" value="0"/>
Exit Loss Coefficient	k <sub>x</sub> = <input type="text" value="1"/>
Tailwater Surface Elevation	Y <sub>t</sub> , Elevation = <input type="text"/> ft
Max Allowable Channel Velocity	V = <input type="text" value="5"/> ft/s
Calculated Results:	
Culvert Cross Sectional Area Available	A = <input type="text" value="1.77"/> ft <sup>2</sup>
Culvert Normal Depth	Y <sub>n</sub> = <input type="text" value="1.23"/> ft
Culvert Critical Depth	Y <sub>c</sub> = <input type="text" value="1.29"/> ft
Froude Number	Fr = <input type="text" value="1.12"/> <b>Supercritical!</b>
Entrance Loss Coefficient	k <sub>e</sub> = <input type="text" value="0.50"/>
Friction Loss Coefficient	k <sub>f</sub> = <input type="text" value="0.46"/>
Sum of All Loss Coefficients	k <sub>s</sub> = <input type="text" value="1.96"/> ft
<b>Headwater:</b>	
Inlet Control Headwater	HW <sub>I</sub> = <input type="text" value="2.64"/> ft
Outlet Control Headwater	HW <sub>O</sub> = <input type="text" value="2.36"/> ft
<b>Design Headwater Elevation</b>	<b>HW = <input type="text" value="7052.64"/> ft</b>
<b>Headwater/Diameter <u>OR</u> Headwater/Rise Ratio</b>	<b>HW/D = <input type="text" value="1.76"/> <span style="color: red;">HW/D &gt; 1.5!</span></b>
<b>Outlet Protection:</b>	
Flow/(Diameter <sup>2.5</sup> )	Q/D <sup>2.5</sup> = <input type="text" value="4.14"/> ft <sup>0.5</sup> /s
Tailwater Surface Height	Y <sub>t</sub> = <input type="text" value="0.60"/> ft
Tailwater/Diameter	Y <sub>t</sub> /D = <input type="text" value="0.40"/>
Expansion Factor	1/(2*tan(θ)) = <input type="text" value="3.35"/>
Flow Area at Max Channel Velocity	A <sub>t</sub> = <input type="text" value="2.28"/> ft <sup>2</sup>
Width of Equivalent Conduit for Multiple Barrels	W <sub>eq</sub> = <input type="text" value="-"/> ft
<b>Length of Riprap Protection</b>	<b>L<sub>p</sub> = <input type="text" value="8"/> ft</b>
<b>Width of Riprap Protection at Downstream End</b>	<b>T = <input type="text" value="4"/> ft</b>
Adjusted Diameter for Supercritical Flow	Da = <input type="text" value="1.36"/> ft
Minimum Theoretical Riprap Size	d <sub>50</sub> min = <input type="text" value="5"/> in
Nominal Riprap Size	d <sub>50</sub> nominal = <input type="text" value="6"/> in
<b>MHFD Riprap Type</b>	<b>Type = <input type="text" value="VL"/></b>

# DETERMINATION OF CULVERT HEADWATER AND OUTLET PROTECTION

*MHFD-Culvert, Version 4.00 (May 2020)*

**Project:** Latigo Filing 10  
**ID:** 24" Driveway

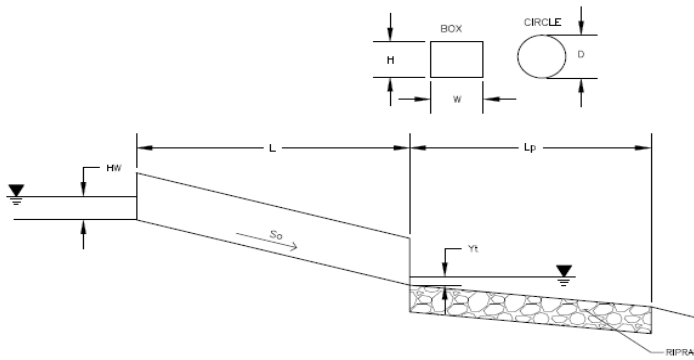

**Soil Type:**  
 Choose One:  
 Sandy  
 Non-Sandy

**Supercritical Flow! Using Adjusted Diameter to calculate protection type.**

Design Information:	
Design Discharge	Q = <input type="text" value="21.2"/> cfs
<b>Circular Culvert:</b>	
Barrel Diameter in Inches	D = <input type="text" value="24"/> inches
Inlet Edge Type (Choose from pull-down list)	Square Edge with Headwall
<b>OR:</b>	
<b>Box Culvert:</b>	
Barrel Height (Rise) in Feet	H (Rise) = <input type="text"/> ft
Barrel Width (Span) in Feet	W (Span) = <input type="text"/> ft
Inlet Edge Type (Choose from pull-down list)	
Number of Barrels	# Barrels = <input type="text" value="1"/>
Inlet Elevation	Elev IN = <input type="text" value="7050"/> ft
Outlet Elevation <b>OR</b> Slope	Elev OUT = <input type="text" value="7049.7"/> ft
Culvert Length	L = <input type="text" value="30"/> ft
Manning's Roughness	n = <input type="text" value="0.012"/>
Bend Loss Coefficient	k <sub>b</sub> = <input type="text" value="0"/>
Exit Loss Coefficient	k <sub>x</sub> = <input type="text" value="1"/>
Tailwater Surface Elevation	Y <sub>t</sub> , Elevation = <input type="text"/> ft
Max Allowable Channel Velocity	V = <input type="text" value="5"/> ft/s
Calculated Results:	
Culvert Cross Sectional Area Available	A = <input type="text" value="3.14"/> ft <sup>2</sup>
Culvert Normal Depth	Y <sub>n</sub> = <input type="text" value="1.43"/> ft
Culvert Critical Depth	Y <sub>c</sub> = <input type="text" value="1.65"/> ft
Froude Number	Fr = <input type="text" value="1.34"/> <b>Supercritical!</b>
Entrance Loss Coefficient	k <sub>e</sub> = <input type="text" value="0.50"/>
Friction Loss Coefficient	k <sub>f</sub> = <input type="text" value="0.32"/>
Sum of All Loss Coefficients	k <sub>s</sub> = <input type="text" value="1.82"/> ft
<b>Headwater:</b>	
Inlet Control Headwater	HW <sub>I</sub> = <input type="text" value="3.13"/> ft
Outlet Control Headwater	HW <sub>O</sub> = <input type="text" value="2.81"/> ft
<b>Design Headwater Elevation</b>	<b>HW = <input type="text" value="7053.13"/> ft</b>
<b>Headwater/Diameter <u>OR</u> Headwater/Rise Ratio</b>	<b>HW/D = <input type="text" value="1.56"/> <b>HW/D &gt; 1.5!</b></b>
<b>Outlet Protection:</b>	
Flow/(Diameter <sup>2.5</sup> )	Q/D <sup>2.5</sup> = <input type="text" value="3.75"/> ft <sup>0.5</sup> /s
Tailwater Surface Height	Y <sub>t</sub> = <input type="text" value="0.80"/> ft
Tailwater/Diameter	Y <sub>t</sub> /D = <input type="text" value="0.40"/>
Expansion Factor	1/(2*tan(Θ)) = <input type="text" value="3.73"/>
Flow Area at Max Channel Velocity	A <sub>t</sub> = <input type="text" value="4.24"/> ft <sup>2</sup>
Width of Equivalent Conduit for Multiple Barrels	W <sub>eq</sub> = <input type="text" value="-"/> ft
<b>Length of Riprap Protection</b>	<b>L<sub>p</sub> = <input type="text" value="13"/> ft</b>
<b>Width of Riprap Protection at Downstream End</b>	<b>T = <input type="text" value="6"/> ft</b>
Adjusted Diameter for Supercritical Flow	Da = <input type="text" value="1.72"/> ft
Minimum Theoretical Riprap Size	d <sub>50</sub> min = <input type="text" value="7"/> in
Nominal Riprap Size	d <sub>50</sub> nominal = <input type="text" value="9"/> in
<b>MHFD Riprap Type</b>	<b>Type = <input type="text" value="L"/></b>

# DETERMINATION OF CULVERT HEADWATER AND OUTLET PROTECTION

*MHFD-Culvert, Version 4.00 (May 2020)*

**Project:** Latigo Filing 10  
**ID:** 30" Driveway

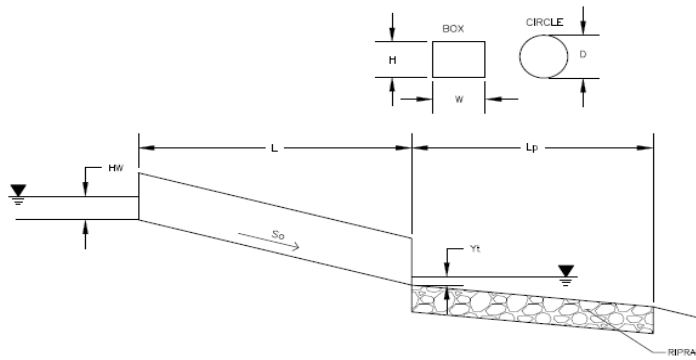

**Soil Type:**

Choose One:  Sandy  Non-Sandy

**Supercritical Flow! Using Adjusted Diameter to calculate protection type.**

Design Information:	
Design Discharge	Q = <input type="text" value="34.5"/> cfs
<b>Circular Culvert:</b>	
Barrel Diameter in Inches	D = <input type="text" value="30"/> inches
Inlet Edge Type (Choose from pull-down list)	Square Edge with Headwall
<b>OR:</b>	
<b>Box Culvert:</b>	
Barrel Height (Rise) in Feet	H (Rise) = <input type="text"/> ft
Barrel Width (Span) in Feet	W (Span) = <input type="text"/> ft
Inlet Edge Type (Choose from pull-down list)	OR
Number of Barrels	# Barrels = <input type="text" value="1"/>
Inlet Elevation	Elev IN = <input type="text" value="7050"/> ft
Outlet Elevation <b>OR</b> Slope	Elev OUT = <input type="text" value="7049.7"/> ft
Culvert Length	L = <input type="text" value="30"/> ft
Manning's Roughness	n = <input type="text" value="0.012"/>
Bend Loss Coefficient	k <sub>b</sub> = <input type="text" value="0"/>
Exit Loss Coefficient	k <sub>x</sub> = <input type="text" value="1"/>
Tailwater Surface Elevation	Y <sub>t</sub> , Elevation = <input type="text"/> ft
Max Allowable Channel Velocity	V = <input type="text" value="5"/> ft/s
Calculated Results:	
Culvert Cross Sectional Area Available	A = <input type="text" value="4.91"/> ft <sup>2</sup>
Culvert Normal Depth	Y <sub>n</sub> = <input type="text" value="1.65"/> ft
Culvert Critical Depth	Y <sub>c</sub> = <input type="text" value="2.00"/> ft
Froude Number	Fr = <input type="text" value="1.46"/> <span style="color: red; font-weight: bold;">Supercritical!</span>
Entrance Loss Coefficient	k <sub>e</sub> = <input type="text" value="0.50"/>
Friction Loss Coefficient	k <sub>f</sub> = <input type="text" value="0.23"/>
Sum of All Loss Coefficients	k <sub>s</sub> = <input type="text" value="1.73"/> ft
<b>Headwater:</b>	
Inlet Control Headwater	HW <sub>I</sub> = <input type="text" value="3.62"/> ft
Outlet Control Headwater	HW <sub>O</sub> = <input type="text" value="3.28"/> ft
<b>Design Headwater Elevation</b>	<b>HW = <input type="text" value="7053.62"/> ft</b>
<b>Headwater/Diameter <b>OR</b> Headwater/Rise Ratio</b>	<b>HW/D = <input type="text" value="1.45"/></b>
<b>Outlet Protection:</b>	
Flow/(Diameter <sup>2.5</sup> )	Q/D <sup>2.5</sup> = <input type="text" value="3.49"/> ft <sup>0.5</sup> /s
Tailwater Surface Height	Y <sub>t</sub> = <input type="text" value="1.00"/> ft
Tailwater/Diameter	Y <sub>t</sub> /D = <input type="text" value="0.40"/>
Expansion Factor	1/(2*tan(θ)) = <input type="text" value="3.95"/>
Flow Area at Max Channel Velocity	A <sub>t</sub> = <input type="text" value="6.90"/> ft <sup>2</sup>
Width of Equivalent Conduit for Multiple Barrels	W <sub>eq</sub> = <input type="text" value="-"/> ft
<b>Length of Riprap Protection</b>	<b>L<sub>p</sub> = <input type="text" value="18"/> ft</b>
<b>Width of Riprap Protection at Downstream End</b>	<b>T = <input type="text" value="8"/> ft</b>
<b>Adjusted Diameter for Supercritical Flow</b>	
Minimum Theoretical Riprap Size	Da = <input type="text" value="2.08"/> ft
Nominal Riprap Size	d <sub>50</sub> min = <input type="text" value="8"/> in
<b>MHFD Riprap Type</b>	d <sub>50</sub> nominal = <input type="text" value="9"/> in
	<b>Type = <input type="text" value="L"/></b>



# DETERMINATION OF CULVERT HEADWATER AND OUTLET PROTECTION

MHFD-Culvert, Version 4.00 (May 2020)

**Project:** Latigo Filing 10  
**ID:** 36" Driveway

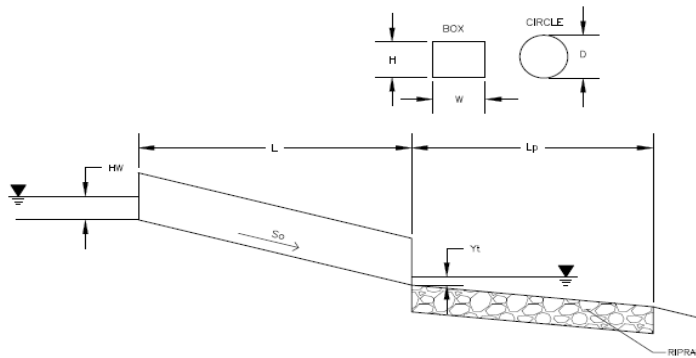

**Soil Type:**

Choose One:

- Sandy  
 Non-Sandy

**Supercritical Flow! Using Adjusted Diameter to calculate protection type.**

**Design Information:**

Design Discharge	Q = <input type="text" value="52.3"/> cfs
<b>Circular Culvert:</b>	
Barrel Diameter in Inches	D = <input type="text" value="36"/> inches
Inlet Edge Type (Choose from pull-down list)	Square Edge with Headwall
<b>OR:</b>	
<b>Box Culvert:</b>	
Barrel Height (Rise) in Feet	H (Rise) = <input type="text"/> ft
Barrel Width (Span) in Feet	W (Span) = <input type="text"/> ft
Inlet Edge Type (Choose from pull-down list)	
Number of Barrels	# Barrels = <input type="text" value="1"/>
Inlet Elevation	Elev IN = <input type="text" value="7050"/> ft
Outlet Elevation <b>OR</b> Slope	Elev OUT = <input type="text" value="7049.7"/> ft
Culvert Length	L = <input type="text" value="30"/> ft
Manning's Roughness	n = <input type="text" value="0.012"/>
Bend Loss Coefficient	$k_b$ = <input type="text" value="0"/>
Exit Loss Coefficient	$k_x$ = <input type="text" value="1"/>
Tailwater Surface Elevation	$Y_t$ , Elevation = <input type="text"/> ft
Max Allowable Channel Velocity	V = <input type="text" value="5"/> ft/s

**Calculated Results:**

Culvert Cross Sectional Area Available	A = <input type="text" value="7.07"/> ft <sup>2</sup>
Culvert Normal Depth	$Y_n$ = <input type="text" value="1.89"/> ft
Culvert Critical Depth	$Y_c$ = <input type="text" value="2.35"/> ft
Froude Number	Fr = <input type="text" value="1.55"/> <span style="color: red; font-weight: bold;">Supercritical!</span>
Entrance Loss Coefficient	$k_e$ = <input type="text" value="0.50"/>
Friction Loss Coefficient	$k_f$ = <input type="text" value="0.18"/>
Sum of All Loss Coefficients	$k_s$ = <input type="text" value="1.68"/> ft
<b>Headwater:</b>	
Inlet Control Headwater	$HW_i$ = <input type="text" value="4.17"/> ft
Outlet Control Headwater	$HW_o$ = <input type="text" value="3.81"/> ft
<b>Design Headwater Elevation</b>	<b>HW = <input type="text" value="7054.17"/> ft</b>
<b>Headwater/Diameter <b>OR</b> Headwater/Rise Ratio</b>	<b>HW/D = <input type="text" value="1.39"/></b>
<b>Outlet Protection:</b>	
Flow/(Diameter <sup>2.5</sup> )	$Q/D^{2.5}$ = <input type="text" value="3.36"/> ft <sup>0.5</sup> /s
Tailwater Surface Height	$Y_t$ = <input type="text" value="1.20"/> ft
Tailwater/Diameter	$Y_t/D$ = <input type="text" value="0.40"/>
Expansion Factor	$1/(2*\tan(\theta))$ = <input type="text" value="4.07"/>
Flow Area at Max Channel Velocity	$A_t$ = <input type="text" value="10.46"/> ft <sup>2</sup>
Width of Equivalent Conduit for Multiple Barrels	$W_{eq}$ = <input type="text" value="-"/> ft
<b>Length of Riprap Protection</b>	<b><math>L_p</math> = <input type="text" value="24"/> ft</b>
<b>Width of Riprap Protection at Downstream End</b>	<b>T = <input type="text" value="9"/> ft</b>
Adjusted Diameter for Supercritical Flow	Da = <input type="text" value="2.44"/> ft
Minimum Theoretical Riprap Size	$d_{50 \text{ min}}$ = <input type="text" value="9"/> in
Nominal Riprap Size	$d_{50 \text{ nominal}}$ = <input type="text" value="9"/> in
<b>MHFD Riprap Type</b>	<b>Type = <input type="text" value="L"/></b>

DETENTION BASIN STAGE-STORAGE TABLE BUILDER

MHFD- Detention, Version 4.06 (July 2022)

Project: Latigo Trails
Basin ID: South Pond

Watershed updated to values established by this report. See later in the appendix for original calculations for comparison

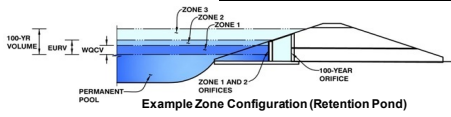

Watershed Information

Table with watershed parameters: Selected BMP Type (EDB), Watershed Area (237.10 acres), Watershed Length (4,610 ft), Watershed Length to Centroid (1,845 ft), Watershed Slope (0.035 ft/ft), Watershed Imperviousness (13.309%), Percentage Hydrologic Soil Group A (0.0%), Percentage Hydrologic Soil Group B (100.0%), Percentage Hydrologic Soil Groups C/D (0.0%), Target WQC Drain Time (40.0 hours), Location for 1-hr Rainfall Depths (User Input).

After providing required inputs above including 1-hour rainfall depths, click 'Run CUHP' to generate runoff hydrographs using the embedded Colorado Urban Hydrograph Procedure.

Table with runoff volumes: Water Quality Capture Volume (WQC) = 1.676 acre-feet, Excess Urban Runoff Volume (EURV) = 3.032 acre-feet, 2-yr Runoff Volume (P1 = 0.93 in.) = 1.627 acre-feet, 5-yr Runoff Volume (P1 = 1.21 in.) = 3.639 acre-feet, 10-yr Runoff Volume (P1 = 1.46 in.) = 6.817 acre-feet, 25-yr Runoff Volume (P1 = 1.83 in.) = 15.350 acre-feet, 50-yr Runoff Volume (P1 = 2.14 in.) = 21.061 acre-feet, 100-yr Runoff Volume (P1 = 2.47 in.) = 28.847 acre-feet, 500-yr Runoff Volume (P1 = 3.33 in.) = 45,905 acre-feet, Approximate 2-yr Detention Volume = 1,558 acre-feet, Approximate 5-yr Detention Volume = 2,464 acre-feet, Approximate 10-yr Detention Volume = 4,712 acre-feet, Approximate 25-yr Detention Volume = 6,876 acre-feet, Approximate 50-yr Detention Volume = 7,525 acre-feet, Approximate 100-yr Detention Volume = 9,842 acre-feet.

Optional User Overrides

Table for optional user overrides with columns for Stage (ft), Length (ft), Width (ft), Area (ft^2), and Volume (ac-ft).

Define Zones and Basin Geometry

Table with basin geometry parameters: Zone 1 Volume (WQC) = 1.676 acre-feet, Zone 2 Volume (EURV - Zone 1) = 1.356 acre-feet, Zone 3 Volume (100-year - Zones 1 & 2) = 6.810 acre-feet, Total Detention Basin Volume = 9.842 acre-feet, Initial Surge Volume (ISV) = user ft^3, Initial Surge Depth (ISD) = user ft, Total Available Detention Depth (Htotal) = user ft, Depth of Trickle Channel (Htc) = user ft, Slope of Trickle Channel (Stc) = user ft/ft, Slopes of Main Basin Sides (Smain) = user H:V, Basin Length-to-Width Ratio (RLW) = user.

Table with basin geometry parameters: Initial Surge Area (ASV) = user ft^2, Surge Volume Length (LSV) = user ft, Surge Volume Width (WSV) = user ft, Depth of Basin Floor (HfLOOR) = user ft, Length of Basin Floor (LfLOOR) = user ft, Width of Basin Floor (WfLOOR) = user ft, Area of Basin Floor (AfLOOR) = user ft^2, Volume of Basin Floor (VfLOOR) = user ft^3, Depth of Main Basin (HMAN) = user ft, Length of Main Basin (LMAN) = user ft, Width of Main Basin (WMAN) = user ft, Area of Main Basin (AMAN) = user ft^2, Volume of Main Basin (VMAN) = user ft^3, Calculated Total Basin Volume (Vtotal) = user acre-feet.

Main stage-storage table with columns: Stage - Storage Description, Stage (ft), Optional Override Stage (ft), Length (ft), Width (ft), Area (ft^2), Optional Override Area (ft^2), Area (acre), Volume (ft^3), Volume (ac-ft). Rows include stages 7088 through 7097.16 and a final row for 7097.16.

# DETENTION BASIN STAGE-STORAGE TABLE BUILDER

*MHFD-Detention, Version 4.06 (July 2022)*

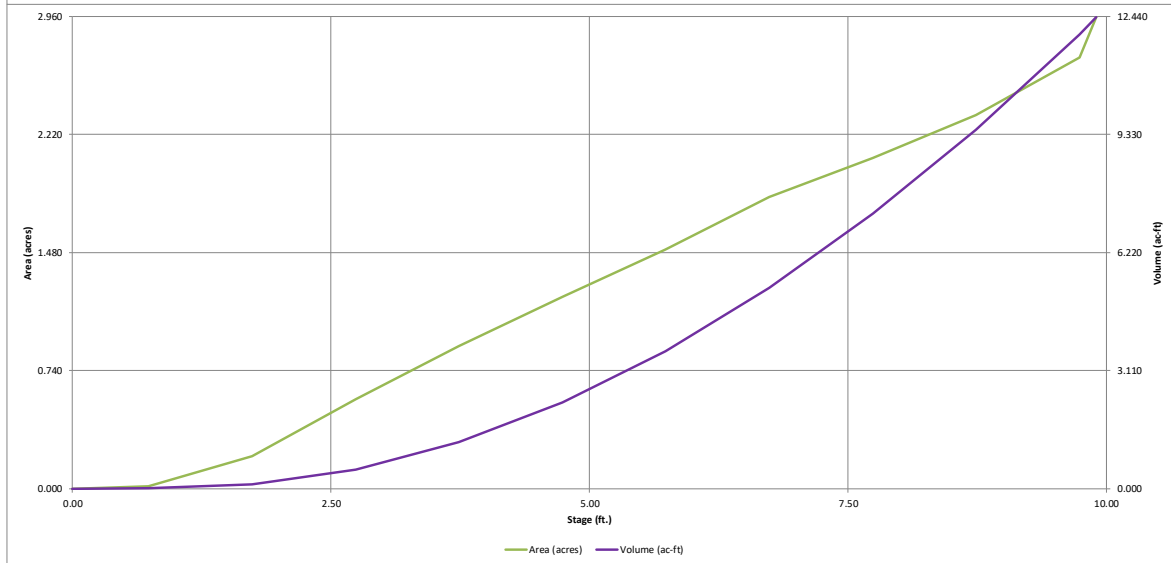
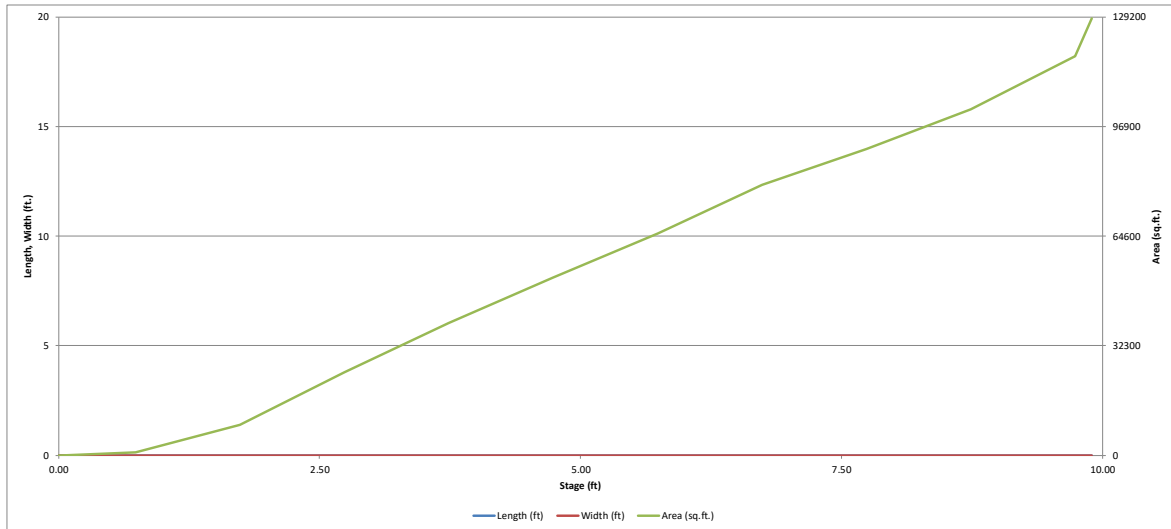

# DETENTION BASIN OUTLET STRUCTURE DESIGN

MHFD-Detention, Version 4.06 (July 2022)

Watershed updated to values established by this report. See later in the appendix for original calculations for comparison. No changes made to pond structures.

**Project:** Latigo Trails  
**Basin ID:** South Pond

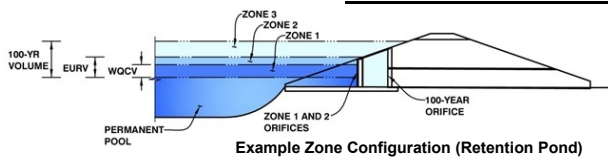

	Estimated Stage (ft)	Estimated Volume (ac-ft)	Outlet Type
Zone 1 (WQCV)	4.21	1.676	Orifice Plate
Zone 2 (EURV)	5.33	1.356	Rectangular Orifice
Zone 3 (100-year)	8.91	6.810	Weir&Pipe (Rect.)
<b>Total (all zones)</b>		<b>9.842</b>	

**User Input:** Orifice at Underdrain Outlet (typically used to drain WQCV in a Filtration BMP)

Underdrain Orifice Invert Depth =	N/A	ft (distance below the filtration media surface)
Underdrain Orifice Diameter =	N/A	inches

**Calculated Parameters for Underdrain**

Underdrain Orifice Area =	N/A	ft <sup>2</sup>
Underdrain Orifice Centroid =	N/A	feet

**User Input:** Orifice Plate with one or more orifices or Elliptical Slot Weir (typically used to drain WQCV and/or EURV in a sedimentation BMP)

Centroid of Lowest Orifice =	0.00	ft (relative to basin bottom at Stage = 0 ft)
Depth at top of Zone using Orifice Plate =	4.26	ft (relative to basin bottom at Stage = 0 ft)
Orifice Plate: Orifice Vertical Spacing =	N/A	inches
Orifice Plate: Orifice Area per Row =	N/A	sq. inches

**Calculated Parameters for Plate**

WQ Orifice Area per Row =	N/A	ft <sup>2</sup>
Elliptical Half-Width =	N/A	feet
Elliptical Slot Centroid =	N/A	feet
Elliptical Slot Area =	N/A	ft <sup>2</sup>

**User Input:** Stage and Total Area of Each Orifice Row (numbered from lowest to highest)

	Row 1 (required)	Row 2 (optional)	Row 3 (optional)	Row 4 (optional)	Row 5 (optional)	Row 6 (optional)	Row 7 (optional)	Row 8 (optional)
Stage of Orifice Centroid (ft)	0.00	0.00	0.00	0.50	0.50	0.50	1.00	1.00
Orifice Area (sq. inches)	1.11	1.11	1.11	1.00	1.00	1.00	1.00	1.00
	Row 9 (optional)	Row 10 (optional)	Row 11 (optional)	Row 12 (optional)	Row 13 (optional)	Row 14 (optional)	Row 15 (optional)	Row 16 (optional)
Stage of Orifice Centroid (ft)	1.00							
Orifice Area (sq. inches)	1.00							

**User Input:** Vertical Orifice (Circular or Rectangular)

	Zone 2 Rectangular	Not Selected	
Invert of Vertical Orifice =	3.98	N/A	ft (relative to basin bottom at Stage = 0 ft)
Depth at top of Zone using Vertical Orifice =	5.42	N/A	ft (relative to basin bottom at Stage = 0 ft)
Vertical Orifice Height =	15.00	N/A	inches
Vertical Orifice Width =	100.00	N/A	inches

**Calculated Parameters for Vertical Orific**

	Zone 2 Rectangular	Not Selected
Vertical Orifice Area =	10.42	N/A
Vertical Orifice Centroid =	0.63	N/A

**User Input:** Overflow Weir (Dropbox with Flat or Sloped Grate and Outlet Pipe OR Rectangular/Trapezoidal Weir and No Outlet Pipe)

	Zone 3 Weir	Not Selected	
Overflow Weir Front Edge Height, Ho =	5.90	N/A	ft (relative to basin bottom at Stage = 0 ft)
Overflow Weir Front Edge Length =	8.33	N/A	feet
Overflow Weir Grate Slope =	0.00	N/A	H:V
Horiz. Length of Weir Sides =	5.84	N/A	feet
Overflow Grate Type =	Type C Grate	N/A	
Debris Clogging % =	0%	N/A	%

**Calculated Parameters for Overflow Weir**

	Zone 3 Weir	Not Selected
Height of Grate Upper Edge, H <sub>t</sub> =	5.90	N/A
Overflow Weir Slope Length =	5.84	N/A
Grate Open Area / 100-yr Orifice Area =	1.41	N/A
Overflow Grate Open Area w/o Debris =	33.86	N/A
Overflow Grate Open Area w/ Debris =	33.86	N/A

**User Input:** Outlet Pipe w/ Flow Restriction Plate (Circular Orifice, Restrictor Plate, or Rectangular Orifice)

	Zone 3 Rectangular	Not Selected	
Depth to Invert of Outlet Pipe =	0.33	N/A	ft (distance below basin bottom at Stage = 0 ft)
Rectangular Orifice Width =	96.00	N/A	inches
Rectangular Orifice Height =	36.00	N/A	inches

**Calculated Parameters for Outlet Pipe w/ Flow Restriction Plate**

	Zone 3 Rectangular	Not Selected
Outlet Orifice Area =	24.00	N/A
Outlet Orifice Centroid =	1.50	N/A
Half-Central Angle of Restrictor Plate on Pipe =	N/A	N/A

**User Input:** Emergency Spillway (Rectangular or Trapezoidal)

Spillway Invert Stage =	7.90	ft (relative to basin bottom at Stage = 0 ft)
Spillway Crest Length =	120.00	feet
Spillway End Slopes =	4.00	H:V
Freeboard above Max Water Surface =	1.00	feet

**Calculated Parameters for Spillway**

Spillway Design Flow Depth =	0.96	feet
Stage at Top of Freeboard =	9.86	feet
Basin Area at Top of Freeboard =	2.89	acres
Basin Volume at Top of Freeboard =	12.31	acre-ft

## Routed Hydrograph Results

The user can override the default CUHP hydrographs and runoff volumes by entering new values in the Inflow Hydrographs table (Columns W through AF)

	WQCV	EURV	2 Year	5 Year	10 Year	25 Year	50 Year	100 Year
Design Storm Return Period =	N/A	N/A	0.93	1.21	1.46	1.83	2.14	2.47
One-Hour Rainfall Depth (in) =	N/A	N/A	0.93	1.21	1.46	1.83	2.14	2.47
CUHP Runoff Volume (acre-ft) =	1.676	3.032	1.627	3.639	6.817	15.350	21.061	28.847
Inflow Hydrograph Volume (acre-ft) =	N/A	N/A	1.627	3.639	6.817	15.350	21.061	28.847
CUHP Predevelopment Peak Q (cfs) =	N/A	N/A	2.9	22.0	62.0	170.2	236.2	317.9
OPTIONAL Override Predevelopment Peak Q (cfs) =	N/A	N/A						
Predevelopment Unit Peak Flow, q (cfs/acre) =	N/A	N/A	0.01	0.09	0.26	0.72	1.00	1.34
Peak Inflow Q (cfs) =	N/A	N/A	20.4	46.1	87.3	196.7	263.6	347.7
Peak Outflow Q (cfs) =	2.3	40.1	0.7	17.0	44.5	140.9	206.1	293.5
Ratio Peak Outflow to Predevelopment Q =	N/A	N/A	N/A	0.8	0.7	0.8	0.9	0.9
Structure Controlling Flow =	Vertical Orifice 1	Vertical Orifice 1	Vertical Orifice 1	Vertical Orifice 1	Vertical Orifice 1	Overflow Weir 1	Overflow Weir 1	Outlet Plate 1
Max Velocity through Gate 1 (fps) =	N/A	N/A	N/A	N/A	N/A	2.0	3.7	6.1
Max Velocity through Gate 2 (fps) =	N/A	N/A	N/A	N/A	N/A	N/A	N/A	N/A
Time to Drain 97% of Inflow Volume (hours) =	38	38	39	39	36	29	25	20
Time to Drain 99% of Inflow Volume (hours) =	40	41	41	42	41	38	37	34
Maximum Ponding Depth (ft) =	4.21	5.33	4.03	4.75	5.37	6.72	7.14	7.63
Area at Maximum Ponding Depth (acres) =	1.04	1.38	0.98	1.20	1.39	1.82	1.92	2.04
Maximum Volume Stored (acre-ft) =	1.681	3.036	1.499	2.275	3.078	5.237	6.024	6.996

# DETENTION BASIN OUTLET STRUCTURE DESIGN

*MHFD-Detention, Version 4.06 (July 2022)*

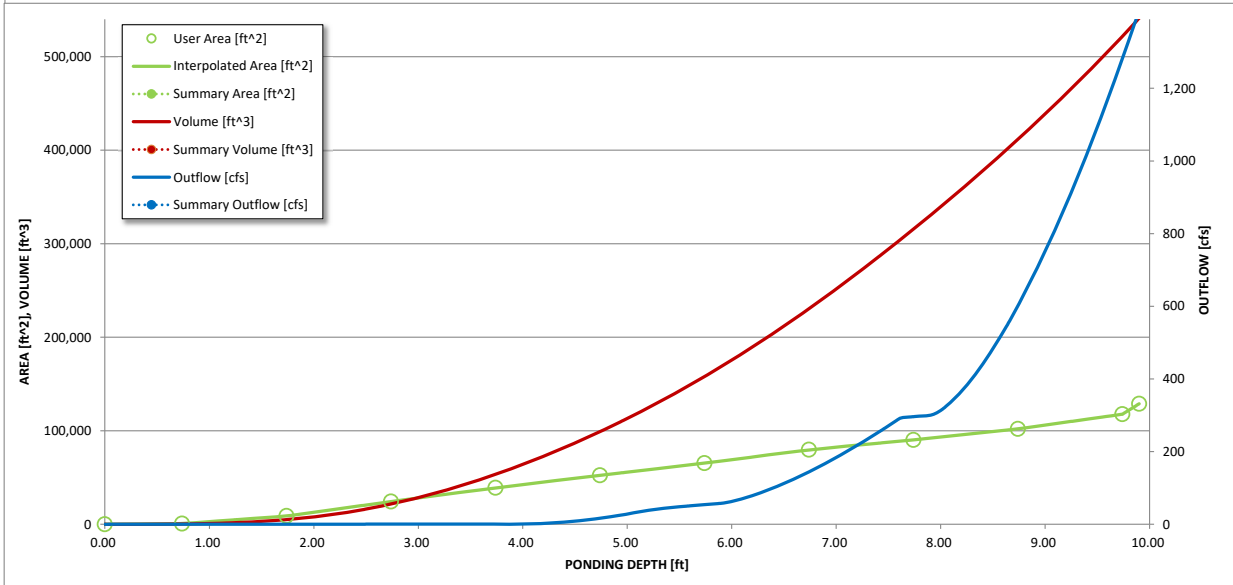
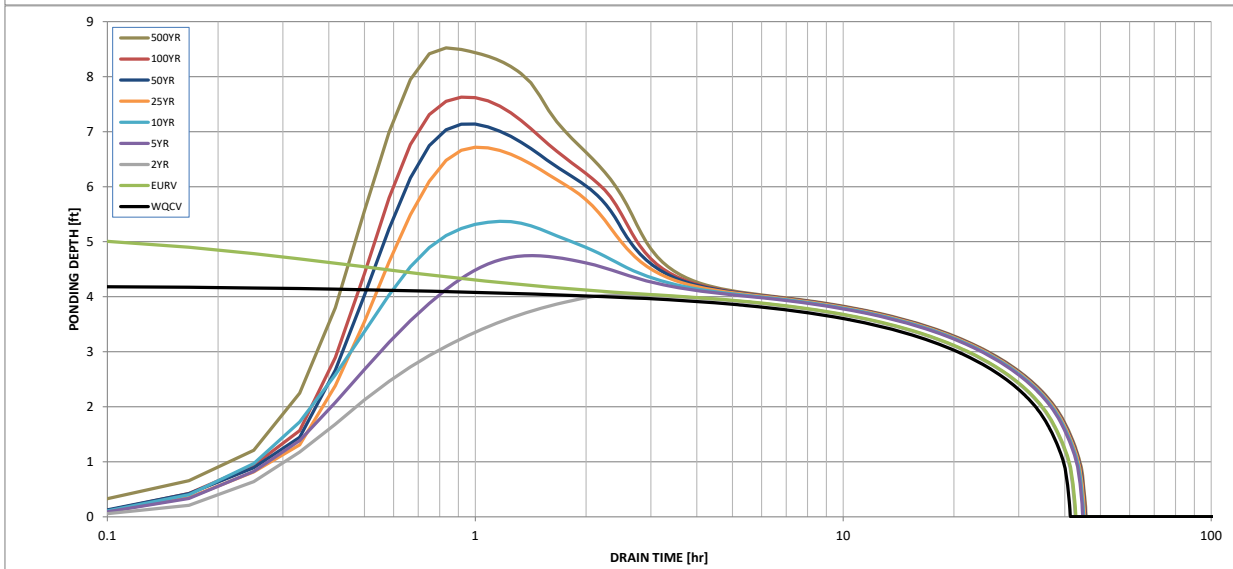
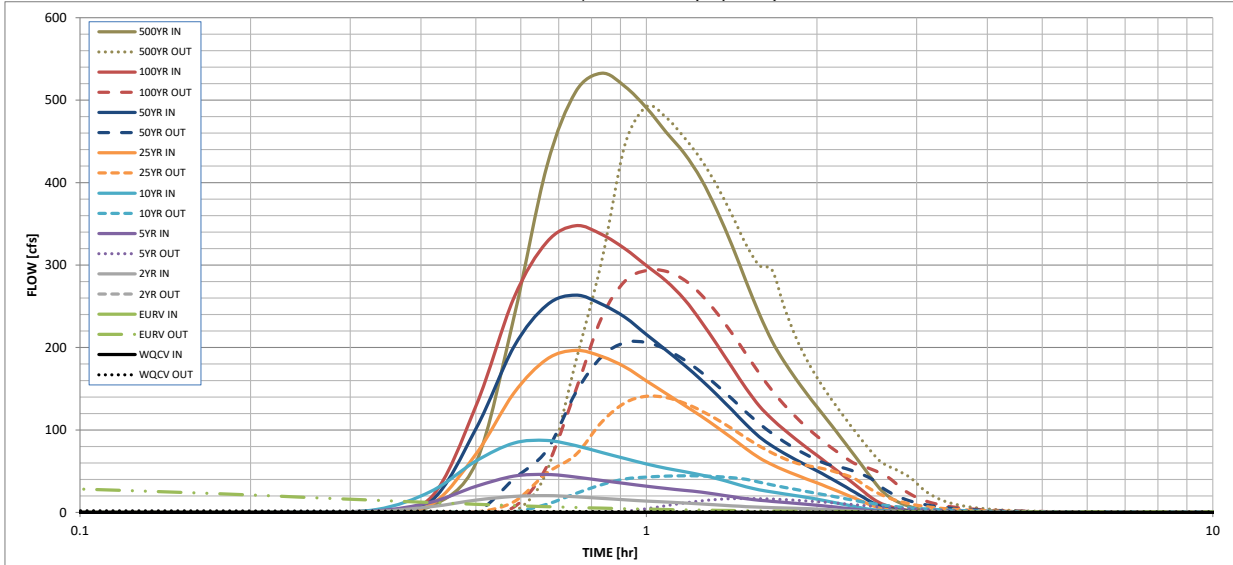

S-A-V-D Chart Axis Override	X-axis	Left Y-Axis	Right Y-Axis
minimum bound			
maximum bound			

# DETENTION BASIN OUTLET STRUCTURE DESIGN

Outflow Hydrograph Workbook Filename: \_\_\_\_\_

## Inflow Hydrographs

The user can override the calculated inflow hydrographs from this workbook with inflow hydrographs developed in a separate program.

Time Interval	SOURCE	CUHP	CUHP	CUHP	CUHP	CUHP	CUHP	CUHP	CUHP	CUHP
	TIME	WQCV [cfs]	EURV [cfs]	2 Year [cfs]	5 Year [cfs]	10 Year [cfs]	25 Year [cfs]	50 Year [cfs]	100 Year [cfs]	500 Year [cfs]
5.00 min	0:00:00	0.00	0.00	0.00	0.00	0.00	0.00	0.00	0.00	0.00
	0:05:00	0.00	0.00	0.00	0.00	0.00	0.00	0.00	0.00	0.00
	0:10:00	0.00	0.00	0.00	0.00	0.00	0.00	0.02	0.00	0.20
	0:15:00	0.00	0.00	0.20	0.44	0.61	0.47	0.67	0.68	1.29
	0:20:00	0.00	0.00	1.22	1.88	3.47	1.73	2.21	2.82	7.76
	0:25:00	0.00	0.00	6.95	12.43	25.59	9.69	13.71	18.26	59.83
	0:30:00	0.00	0.00	14.97	31.60	62.30	70.75	101.25	128.80	235.82
	0:35:00	0.00	0.00	19.47	44.02	84.10	144.56	200.56	259.90	419.11
	0:40:00	0.00	0.00	20.44	46.12	87.25	185.71	251.37	327.71	510.00
	0:45:00	0.00	0.00	19.08	42.96	81.13	196.65	263.59	347.67	532.59
	0:50:00	0.00	0.00	17.11	38.77	72.75	189.23	252.65	337.16	516.55
	0:55:00	0.00	0.00	15.36	35.21	65.46	176.42	236.65	319.74	490.71
	1:00:00	0.00	0.00	13.79	31.83	58.82	159.58	215.76	299.33	461.28
	1:05:00	0.00	0.00	12.63	29.09	53.62	144.15	196.79	280.76	435.36
	1:10:00	0.00	0.00	11.53	26.90	49.45	130.00	178.75	258.52	403.98
	1:15:00	0.00	0.00	10.37	24.59	45.43	116.59	160.65	231.37	365.63
	1:20:00	0.00	0.00	9.21	21.95	41.02	103.27	142.36	203.29	323.51
	1:25:00	0.00	0.00	8.07	19.18	35.96	90.08	124.15	175.75	280.23
	1:30:00	0.00	0.00	7.08	16.68	31.10	77.32	106.66	150.40	240.63
	1:35:00	0.00	0.00	6.39	14.86	27.48	66.17	91.67	129.02	207.81
	1:40:00	0.00	0.00	5.90	13.50	24.86	57.97	80.74	113.27	183.12
	1:45:00	0.00	0.00	5.47	12.23	22.57	51.42	71.87	100.47	162.71
	1:50:00	0.00	0.00	5.07	11.03	20.44	45.78	64.13	89.15	144.59
	1:55:00	0.00	0.00	4.62	9.88	18.32	40.67	57.10	78.88	128.13
	2:00:00	0.00	0.00	4.13	8.76	16.14	35.92	50.56	69.33	112.78
	2:05:00	0.00	0.00	3.59	7.58	13.86	31.17	43.94	60.03	97.62
	2:10:00	0.00	0.00	3.02	6.35	11.54	26.44	37.29	51.06	82.81
	2:15:00	0.00	0.00	2.46	5.15	9.28	21.80	30.79	42.41	68.56
	2:20:00	0.00	0.00	1.92	4.00	7.12	17.24	24.42	33.86	54.64
	2:25:00	0.00	0.00	1.42	2.91	5.10	12.77	18.20	25.47	41.15
	2:30:00	0.00	0.00	1.01	2.00	3.49	8.49	12.26	17.43	28.85
	2:35:00	0.00	0.00	0.75	1.44	2.54	5.35	8.05	11.60	20.13
	2:40:00	0.00	0.00	0.60	1.14	2.01	3.50	5.53	7.97	14.42
	2:45:00	0.00	0.00	0.48	0.91	1.61	2.37	3.89	5.48	10.30
	2:50:00	0.00	0.00	0.40	0.73	1.29	1.61	2.74	3.68	7.23
	2:55:00	0.00	0.00	0.33	0.57	1.02	1.12	1.95	2.40	4.95
	3:00:00	0.00	0.00	0.27	0.45	0.80	0.79	1.39	1.49	3.27
	3:05:00	0.00	0.00	0.22	0.35	0.61	0.55	0.99	0.91	2.13
	3:10:00	0.00	0.00	0.18	0.27	0.46	0.40	0.74	0.64	1.52
	3:15:00	0.00	0.00	0.14	0.20	0.34	0.30	0.57	0.50	1.14
	3:20:00	0.00	0.00	0.12	0.16	0.26	0.22	0.43	0.40	0.89
	3:25:00	0.00	0.00	0.09	0.12	0.19	0.16	0.33	0.31	0.70
	3:30:00	0.00	0.00	0.07	0.09	0.14	0.12	0.25	0.24	0.53
	3:35:00	0.00	0.00	0.05	0.06	0.10	0.09	0.18	0.17	0.39
	3:40:00	0.00	0.00	0.03	0.04	0.07	0.06	0.13	0.12	0.27
	3:45:00	0.00	0.00	0.02	0.03	0.04	0.04	0.08	0.08	0.17
	3:50:00	0.00	0.00	0.01	0.01	0.02	0.02	0.04	0.04	0.09
	3:55:00	0.00	0.00	0.00	0.01	0.01	0.01	0.02	0.02	0.04
	4:00:00	0.00	0.00	0.00	0.00	0.00	0.00	0.00	0.00	0.01
	4:05:00	0.00	0.00	0.00	0.00	0.00	0.00	0.00	0.00	0.00
	4:10:00	0.00	0.00	0.00	0.00	0.00	0.00	0.00	0.00	0.00
	4:15:00	0.00	0.00	0.00	0.00	0.00	0.00	0.00	0.00	0.00
	4:20:00	0.00	0.00	0.00	0.00	0.00	0.00	0.00	0.00	0.00
	4:25:00	0.00	0.00	0.00	0.00	0.00	0.00	0.00	0.00	0.00
	4:30:00	0.00	0.00	0.00	0.00	0.00	0.00	0.00	0.00	0.00
	4:35:00	0.00	0.00	0.00	0.00	0.00	0.00	0.00	0.00	0.00
	4:40:00	0.00	0.00	0.00	0.00	0.00	0.00	0.00	0.00	0.00
	4:45:00	0.00	0.00	0.00	0.00	0.00	0.00	0.00	0.00	0.00
	4:50:00	0.00	0.00	0.00	0.00	0.00	0.00	0.00	0.00	0.00
	4:55:00	0.00	0.00	0.00	0.00	0.00	0.00	0.00	0.00	0.00
	5:00:00	0.00	0.00	0.00	0.00	0.00	0.00	0.00	0.00	0.00
	5:05:00	0.00	0.00	0.00	0.00	0.00	0.00	0.00	0.00	0.00
	5:10:00	0.00	0.00	0.00	0.00	0.00	0.00	0.00	0.00	0.00
	5:15:00	0.00	0.00	0.00	0.00	0.00	0.00	0.00	0.00	0.00
	5:20:00	0.00	0.00	0.00	0.00	0.00	0.00	0.00	0.00	0.00
	5:25:00	0.00	0.00	0.00	0.00	0.00	0.00	0.00	0.00	0.00
	5:30:00	0.00	0.00	0.00	0.00	0.00	0.00	0.00	0.00	0.00
	5:35:00	0.00	0.00	0.00	0.00	0.00	0.00	0.00	0.00	0.00
	5:40:00	0.00	0.00	0.00	0.00	0.00	0.00	0.00	0.00	0.00
	5:45:00	0.00	0.00	0.00	0.00	0.00	0.00	0.00	0.00	0.00
	5:50:00	0.00	0.00	0.00	0.00	0.00	0.00	0.00	0.00	0.00
	5:55:00	0.00	0.00	0.00	0.00	0.00	0.00	0.00	0.00	0.00
	6:00:00	0.00	0.00	0.00	0.00	0.00	0.00	0.00	0.00	0.00



# DETENTION BASIN OUTLET STRUCTURE DESIGN

*MHFD-Detention, Version 4.06 (July 2022)*

**Project:** Latigo Trails  
**Basin ID:** South Pond

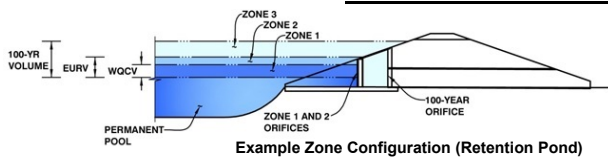

	Estimated Stage (ft)	Estimated Volume (ac-ft)	Outlet Type
Zone 1 (WQCV)	4.21	1.676	Orifice Plate
Zone 2 (EURV)	5.33	1.356	Rectangular Orifice
Zone 3 (100-year)	8.91	6.810	Weir&Pipe (Rect.)
Total (all zones)		9.842	

**User Input:** Orifice at Underdrain Outlet (typically used to drain WQCV in a Filtration BMP)

Underdrain Orifice Invert Depth =	N/A	ft (distance below the filtration media surface)
Underdrain Orifice Diameter =	N/A	inches

**Calculated Parameters for Underdrain**

Underdrain Orifice Area =	N/A	ft <sup>2</sup>
Underdrain Orifice Centroid =	N/A	feet

**User Input:** Orifice Plate with one or more orifices or Elliptical Slot Weir (typically used to drain WQCV and/or EURV in a sedimentation BMP)

Centroid of Lowest Orifice =	0.00	ft (relative to basin bottom at Stage = 0 ft)
Depth at top of Zone using Orifice Plate =	4.26	ft (relative to basin bottom at Stage = 0 ft)
Orifice Plate: Orifice Vertical Spacing =	N/A	inches
Orifice Plate: Orifice Area per Row =	N/A	sq. inches

**Calculated Parameters for Plate**

WQ Orifice Area per Row =	N/A	ft <sup>2</sup>
Elliptical Half-Width =	N/A	feet
Elliptical Slot Centroid =	N/A	feet
Elliptical Slot Area =	N/A	ft <sup>2</sup>

**User Input:** Stage and Total Area of Each Orifice Row (numbered from lowest to highest)

	Row 1 (required)	Row 2 (optional)	Row 3 (optional)	Row 4 (optional)	Row 5 (optional)	Row 6 (optional)	Row 7 (optional)	Row 8 (optional)
Stage of Orifice Centroid (ft)	0.00	0.00	0.00	0.50	0.50	0.50	1.00	1.00
Orifice Area (sq. inches)	1.11	1.11	1.11	1.00	1.00	1.00	1.00	1.00

	Row 9 (optional)	Row 10 (optional)	Row 11 (optional)	Row 12 (optional)	Row 13 (optional)	Row 14 (optional)	Row 15 (optional)	Row 16 (optional)
Stage of Orifice Centroid (ft)	1.00							
Orifice Area (sq. inches)	1.00							

**User Input:** Vertical Orifice (Circular or Rectangular)

	Zone 2 Rectangular	Not Selected	
Invert of Vertical Orifice =	3.98	N/A	ft (relative to basin bottom at Stage = 0 ft)
Depth at top of Zone using Vertical Orifice =	5.42	N/A	ft (relative to basin bottom at Stage = 0 ft)
Vertical Orifice Height =	15.00	N/A	inches
Vertical Orifice Width =	100.00		inches

**Calculated Parameters for Vertical Orific**

	Zone 2 Rectangular	Not Selected
Vertical Orifice Area =	10.42	N/A
Vertical Orifice Centroid =	0.63	N/A

**User Input:** Overflow Weir (Dropbox with Flat or Sloped Grate and Outlet Pipe OR Rectangular/Trapezoidal Weir and No Outlet Pipe)

	Zone 3 Weir	Not Selected	
Overflow Weir Front Edge Height, Ho =	5.90	N/A	ft (relative to basin bottom at Stage = 0 ft)
Overflow Weir Front Edge Length =	8.33	N/A	feet
Overflow Weir Grate Slope =	0.00	N/A	H:V
Horiz. Length of Weir Sides =	5.84	N/A	feet
Overflow Grate Type =	Type C Grate	N/A	
Debris Clogging % =	0%	N/A	%

**Calculated Parameters for Overflow We**

	Zone 3 Weir	Not Selected
Height of Grate Upper Edge, H <sub>t</sub> =	5.90	N/A
Overflow Weir Slope Length =	5.84	N/A
Grate Open Area / 100-yr Orifice Area =	1.41	N/A
Overflow Grate Open Area w/o Debris =	33.86	N/A
Overflow Grate Open Area w/ Debris =	33.86	N/A

**User Input:** Outlet Pipe w/ Flow Restriction Plate (Circular Orifice, Restrictor Plate, or Rectangular Orifice)

	Zone 3 Rectangular	Not Selected	
Depth to Invert of Outlet Pipe =	0.33	N/A	ft (distance below basin bottom at Stage = 0 ft)
Rectangular Orifice Width =	96.00	N/A	inches
Rectangular Orifice Height =	36.00		inches

**Calculated Parameters for Outlet Pipe w/ Flow Restriction Pl**

	Zone 3 Rectangular	Not Selected
Outlet Orifice Area =	24.00	N/A
Outlet Orifice Centroid =	1.50	N/A
Half-Central Angle of Restrictor Plate on Pipe =	N/A	N/A

**User Input:** Emergency Spillway (Rectangular or Trapezoidal)

Spillway Invert Stage =	7.90	ft (relative to basin bottom at Stage = 0 ft)
Spillway Crest Length =	120.00	feet
Spillway End Slopes =	4.00	H:V
Freeboard above Max Water Surface =	1.00	feet

**Calculated Parameters for Spillway**

Spillway Design Flow Depth =	0.96	feet
Stage at Top of Freeboard =	9.86	feet
Basin Area at Top of Freeboard =	2.89	acres
Basin Volume at Top of Freeboard =	12.31	acre-ft

## Routed Hydrograph Results

*The user can override the default CUHP hydrographs and runoff volumes by entering new values in the Inflow Hydrographs table (Columns W through AF)*

	WQCV	EURV	2 Year	5 Year	10 Year	25 Year	50 Year	100 Year
Design Storm Return Period =	N/A	N/A	0.93	1.21	1.46	1.83	2.14	2.47
One-Hour Rainfall Depth (in)	N/A	N/A	0.93	1.21	1.46	1.83	2.14	2.47
CUHP Runoff Volume (acre-ft)	1.676	3.032	1.627	3.639	6.817	15.350	21.061	28.847
Inflow Hydrograph Volume (acre-ft)	N/A	N/A	1.627	3.639	6.817	15.350	21.061	28.847
CUHP Predevelopment Peak Q (cfs)	N/A	N/A	2.9	22.0	62.0	170.2	236.2	317.9
OPTIONAL Override Predevelopment Peak Q (cfs)	N/A	N/A						
Predevelopment Unit Peak Flow, q (cfs/acre)	N/A	N/A	0.01	0.09	0.26	0.72	1.00	1.34
Peak Inflow Q (cfs)	N/A	N/A	20.4	46.1	87.3	196.7	263.6	347.7
Peak Outflow Q (cfs)	2.3	40.1	0.7	17.0	44.5	140.9	206.1	293.5
Ratio Peak Outflow to Predevelopment Q	N/A	N/A	N/A	0.8	0.7	0.8	0.9	0.9
Structure Controlling Flow	Vertical Orifice 1	Vertical Orifice 1	Vertical Orifice 1	Vertical Orifice 1	Vertical Orifice 1	Overflow Weir 1	Overflow Weir 1	Outlet Plate 1
Max Velocity through Gate 1 (fps)	N/A	N/A	N/A	N/A	N/A	2.0	3.7	6.1
Max Velocity through Gate 2 (fps)	N/A	N/A	N/A	N/A	N/A	N/A	N/A	N/A
Time to Drain 97% of Inflow Volume (hours)	38	38	39	39	36	29	25	20
Time to Drain 99% of Inflow Volume (hours)	40	41	41	42	41	38	37	34
Maximum Ponding Depth (ft)	4.21	5.33	4.03	4.75	5.37	6.72	7.14	7.63
Area at Maximum Ponding Depth (acres)	1.04	1.38	0.98	1.20	1.39	1.82	1.92	2.04
Maximum Volume Stored (acre-ft)	1.681	3.036	1.499	2.275	3.078	5.237	6.024	6.996



# DETENTION BASIN OUTLET STRUCTURE DESIGN

*MHFD-Detention, Version 4.06 (July 2022)*

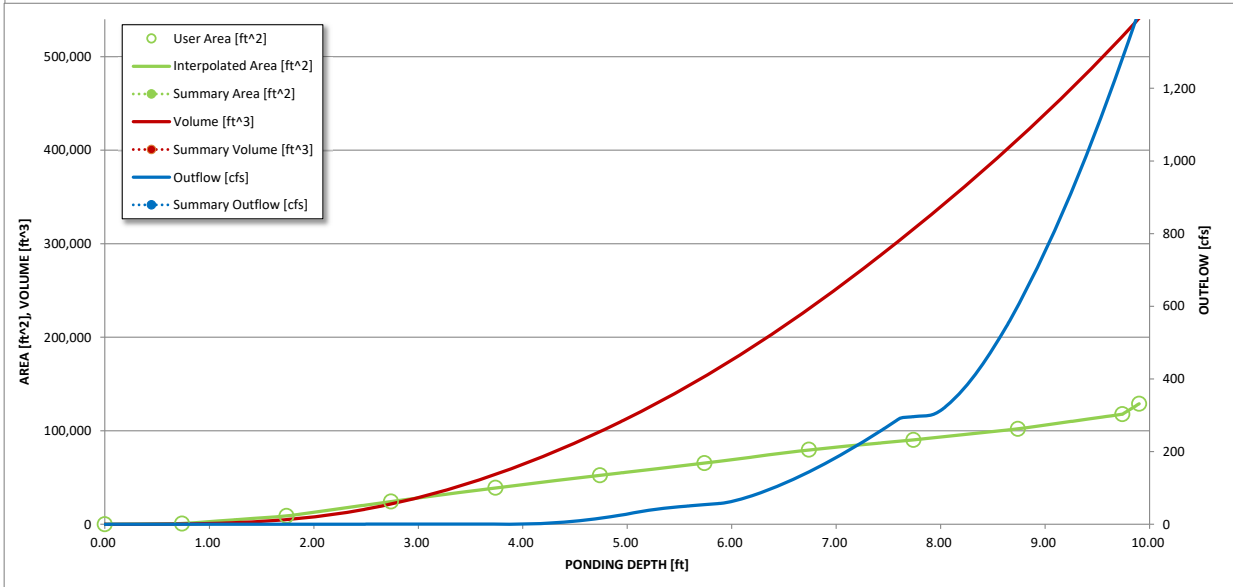
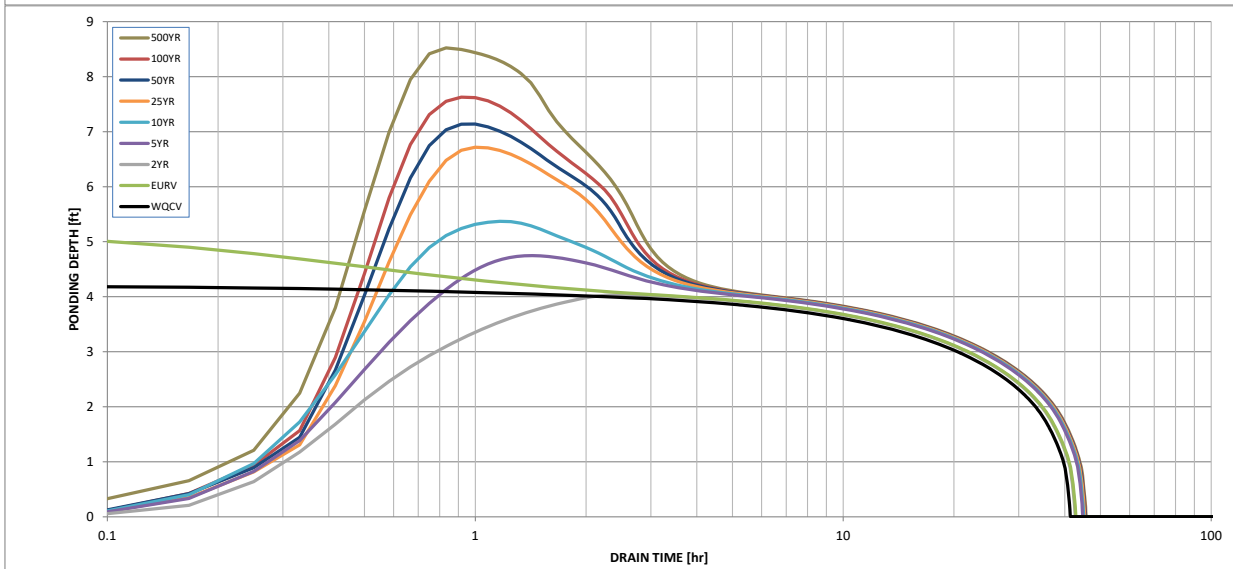
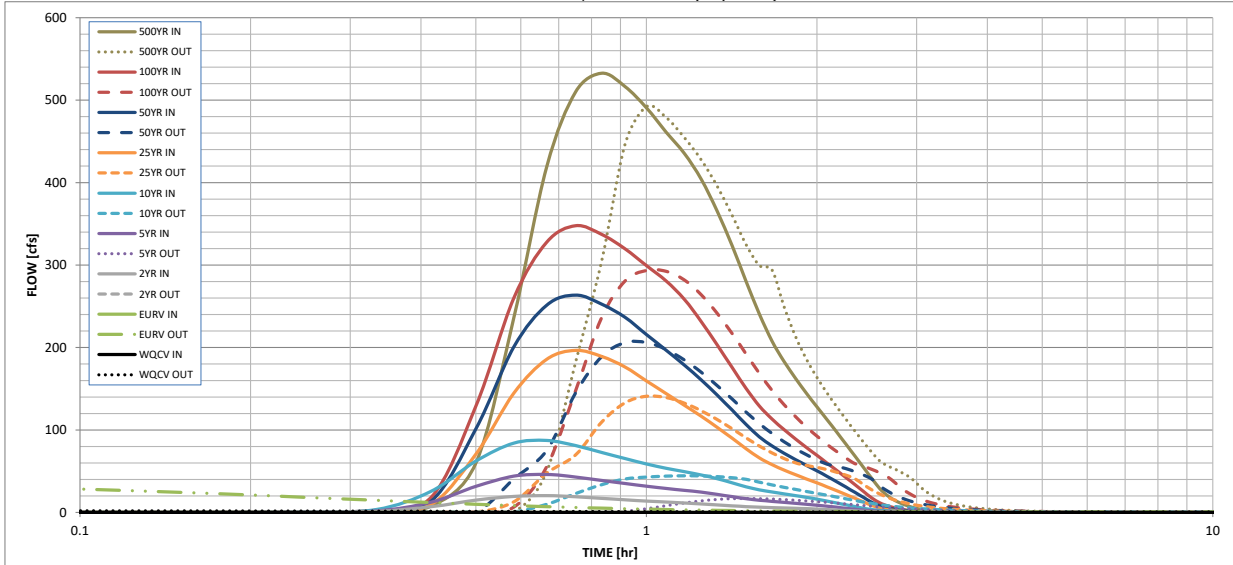

S-A-V-D Chart Axis Override	X-axis	Left Y-Axis	Right Y-Axis
minimum bound			
maximum bound			

# DETENTION BASIN OUTLET STRUCTURE DESIGN

Outflow Hydrograph Workbook Filename: \_\_\_\_\_

## Inflow Hydrographs

The user can override the calculated inflow hydrographs from this workbook with inflow hydrographs developed in a separate program.

Time Interval	SOURCE	CUHP	CUHP	CUHP	CUHP	CUHP	CUHP	CUHP	CUHP	CUHP
	TIME	WQCV [cfs]	EURV [cfs]	2 Year [cfs]	5 Year [cfs]	10 Year [cfs]	25 Year [cfs]	50 Year [cfs]	100 Year [cfs]	500 Year [cfs]
5.00 min	0:00:00	0.00	0.00	0.00	0.00	0.00	0.00	0.00	0.00	0.00
	0:05:00	0.00	0.00	0.00	0.00	0.00	0.00	0.00	0.00	0.00
	0:10:00	0.00	0.00	0.00	0.00	0.00	0.00	0.02	0.00	0.20
	0:15:00	0.00	0.00	0.20	0.44	0.61	0.47	0.67	0.68	1.29
	0:20:00	0.00	0.00	1.22	1.88	3.47	1.73	2.21	2.82	7.76
	0:25:00	0.00	0.00	6.95	12.43	25.59	9.69	13.71	18.26	59.83
	0:30:00	0.00	0.00	14.97	31.60	62.30	70.75	101.25	128.80	235.82
	0:35:00	0.00	0.00	19.47	44.02	84.10	144.56	200.56	259.90	419.11
	0:40:00	0.00	0.00	20.44	46.12	87.25	185.71	251.37	327.71	510.00
	0:45:00	0.00	0.00	19.08	42.96	81.13	196.65	263.59	347.67	532.59
	0:50:00	0.00	0.00	17.11	38.77	72.75	189.23	252.65	337.16	516.55
	0:55:00	0.00	0.00	15.36	35.21	65.46	176.42	236.65	319.74	490.71
	1:00:00	0.00	0.00	13.79	31.83	58.82	159.58	215.76	299.33	461.28
	1:05:00	0.00	0.00	12.63	29.09	53.62	144.15	196.79	280.76	435.36
	1:10:00	0.00	0.00	11.53	26.90	49.45	130.00	178.75	258.52	403.98
	1:15:00	0.00	0.00	10.37	24.59	45.43	116.59	160.65	231.37	365.63
	1:20:00	0.00	0.00	9.21	21.95	41.02	103.27	142.36	203.29	323.51
	1:25:00	0.00	0.00	8.07	19.18	35.96	90.08	124.15	175.75	280.23
	1:30:00	0.00	0.00	7.08	16.68	31.10	77.32	106.66	150.40	240.63
	1:35:00	0.00	0.00	6.39	14.86	27.48	66.17	91.67	129.02	207.81
	1:40:00	0.00	0.00	5.90	13.50	24.86	57.97	80.74	113.27	183.12
	1:45:00	0.00	0.00	5.47	12.23	22.57	51.42	71.87	100.47	162.71
	1:50:00	0.00	0.00	5.07	11.03	20.44	45.78	64.13	89.15	144.59
	1:55:00	0.00	0.00	4.62	9.88	18.32	40.67	57.10	78.88	128.13
	2:00:00	0.00	0.00	4.13	8.76	16.14	35.92	50.56	69.33	112.78
	2:05:00	0.00	0.00	3.59	7.58	13.86	31.17	43.94	60.03	97.62
	2:10:00	0.00	0.00	3.02	6.35	11.54	26.44	37.29	51.06	82.81
	2:15:00	0.00	0.00	2.46	5.15	9.28	21.80	30.79	42.41	68.56
	2:20:00	0.00	0.00	1.92	4.00	7.12	17.24	24.42	33.86	54.64
	2:25:00	0.00	0.00	1.42	2.91	5.10	12.77	18.20	25.47	41.15
	2:30:00	0.00	0.00	1.01	2.00	3.49	8.49	12.26	17.43	28.85
	2:35:00	0.00	0.00	0.75	1.44	2.54	5.35	8.05	11.60	20.13
	2:40:00	0.00	0.00	0.60	1.14	2.01	3.50	5.53	7.97	14.42
	2:45:00	0.00	0.00	0.48	0.91	1.61	2.37	3.89	5.48	10.30
	2:50:00	0.00	0.00	0.40	0.73	1.29	1.61	2.74	3.68	7.23
	2:55:00	0.00	0.00	0.33	0.57	1.02	1.12	1.95	2.40	4.95
	3:00:00	0.00	0.00	0.27	0.45	0.80	0.79	1.39	1.49	3.27
	3:05:00	0.00	0.00	0.22	0.35	0.61	0.55	0.99	0.91	2.13
	3:10:00	0.00	0.00	0.18	0.27	0.46	0.40	0.74	0.64	1.52
	3:15:00	0.00	0.00	0.14	0.20	0.34	0.30	0.57	0.50	1.14
	3:20:00	0.00	0.00	0.12	0.16	0.26	0.22	0.43	0.40	0.89
	3:25:00	0.00	0.00	0.09	0.12	0.19	0.16	0.33	0.31	0.70
	3:30:00	0.00	0.00	0.07	0.09	0.14	0.12	0.25	0.24	0.53
	3:35:00	0.00	0.00	0.05	0.06	0.10	0.09	0.18	0.17	0.39
	3:40:00	0.00	0.00	0.03	0.04	0.07	0.06	0.13	0.12	0.27
	3:45:00	0.00	0.00	0.02	0.03	0.04	0.04	0.08	0.08	0.17
	3:50:00	0.00	0.00	0.01	0.01	0.02	0.02	0.04	0.04	0.09
	3:55:00	0.00	0.00	0.00	0.01	0.01	0.01	0.02	0.02	0.04
	4:00:00	0.00	0.00	0.00	0.00	0.00	0.00	0.00	0.00	0.01
	4:05:00	0.00	0.00	0.00	0.00	0.00	0.00	0.00	0.00	0.00
	4:10:00	0.00	0.00	0.00	0.00	0.00	0.00	0.00	0.00	0.00
	4:15:00	0.00	0.00	0.00	0.00	0.00	0.00	0.00	0.00	0.00
	4:20:00	0.00	0.00	0.00	0.00	0.00	0.00	0.00	0.00	0.00
	4:25:00	0.00	0.00	0.00	0.00	0.00	0.00	0.00	0.00	0.00
	4:30:00	0.00	0.00	0.00	0.00	0.00	0.00	0.00	0.00	0.00
	4:35:00	0.00	0.00	0.00	0.00	0.00	0.00	0.00	0.00	0.00
	4:40:00	0.00	0.00	0.00	0.00	0.00	0.00	0.00	0.00	0.00
	4:45:00	0.00	0.00	0.00	0.00	0.00	0.00	0.00	0.00	0.00
	4:50:00	0.00	0.00	0.00	0.00	0.00	0.00	0.00	0.00	0.00
	4:55:00	0.00	0.00	0.00	0.00	0.00	0.00	0.00	0.00	0.00
	5:00:00	0.00	0.00	0.00	0.00	0.00	0.00	0.00	0.00	0.00
	5:05:00	0.00	0.00	0.00	0.00	0.00	0.00	0.00	0.00	0.00
	5:10:00	0.00	0.00	0.00	0.00	0.00	0.00	0.00	0.00	0.00
	5:15:00	0.00	0.00	0.00	0.00	0.00	0.00	0.00	0.00	0.00
	5:20:00	0.00	0.00	0.00	0.00	0.00	0.00	0.00	0.00	0.00
	5:25:00	0.00	0.00	0.00	0.00	0.00	0.00	0.00	0.00	0.00
	5:30:00	0.00	0.00	0.00	0.00	0.00	0.00	0.00	0.00	0.00
	5:35:00	0.00	0.00	0.00	0.00	0.00	0.00	0.00	0.00	0.00
	5:40:00	0.00	0.00	0.00	0.00	0.00	0.00	0.00	0.00	0.00
	5:45:00	0.00	0.00	0.00	0.00	0.00	0.00	0.00	0.00	0.00
	5:50:00	0.00	0.00	0.00	0.00	0.00	0.00	0.00	0.00	0.00
	5:55:00	0.00	0.00	0.00	0.00	0.00	0.00	0.00	0.00	0.00
	6:00:00	0.00	0.00	0.00	0.00	0.00	0.00	0.00	0.00	0.00





# DETENTION BASIN STAGE-STORAGE TABLE BUILDER

*MHFD-Detention, Version 4.06 (July 2022)*

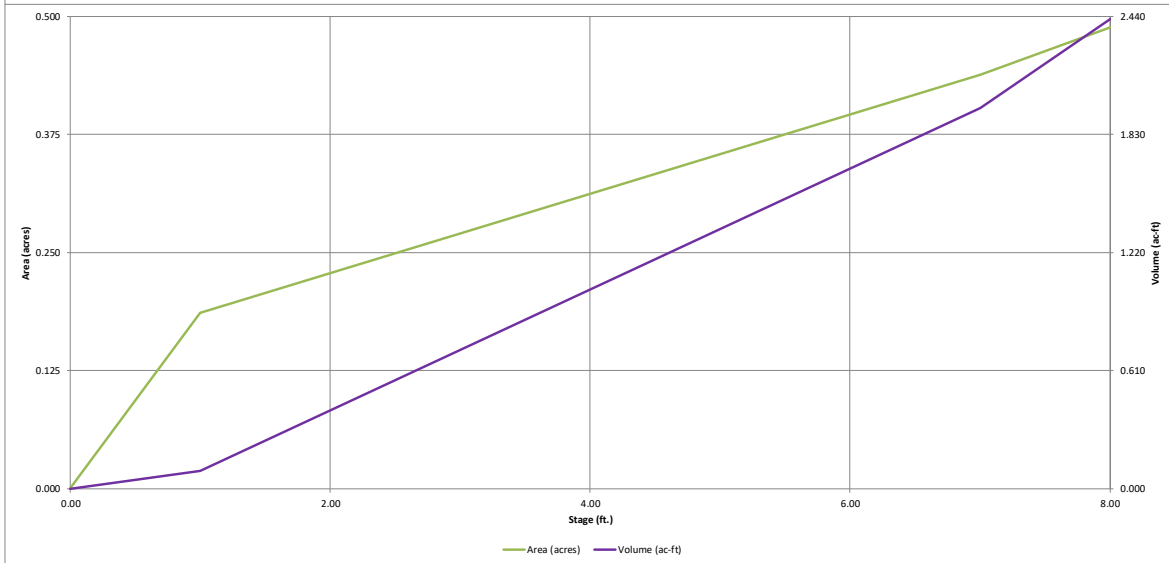
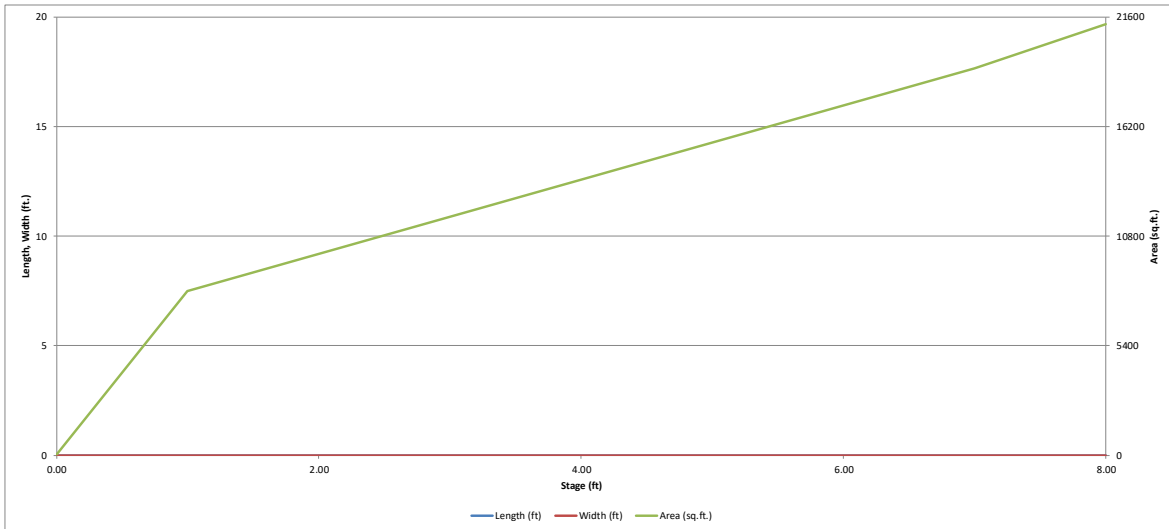

# DETENTION BASIN OUTLET STRUCTURE DESIGN

MHFD-Detention, Version 4.06 (July 2022)

**Project: Latigo Trails**  
**Basin ID: Pond G14b**

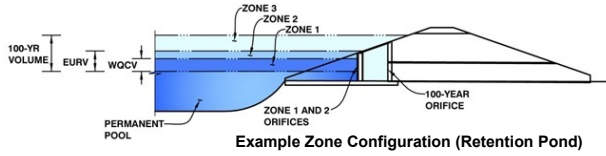

	Estimated Stage (ft)	Estimated Volume (ac-ft)	Outlet Type
Zone 1 (WQCV)	1.90	0.276	Orifice Plate
Zone 2 (EURV)	2.88	0.240	Orifice Plate
Zone 3 (100-year)	6.06	1.054	Weir&Pipe (Circular)
Total (all zones)		1.569	

**User Input: Orifice at Underdrain Outlet** (typically used to drain WQCV in a Filtration BMP)

Underdrain Orifice Invert Depth =	N/A	ft (distance below the filtration media surface)
Underdrain Orifice Diameter =	N/A	inches

Calculated Parameters for Underdrain	
Underdrain Orifice Area =	N/A ft <sup>2</sup>
Underdrain Orifice Centroid =	N/A feet

**User Input: Orifice Plate with one or more orifices or Elliptical Slot Weir** (typically used to drain WQCV and/or EURV in a sedimentation BMP)

Centroid of Lowest Orifice =	0.00	ft (relative to basin bottom at Stage = 0 ft)
Depth at top of Zone using Orifice Plate =	2.88	ft (relative to basin bottom at Stage = 0 ft)
Orifice Plate: Orifice Vertical Spacing =	N/A	inches
Orifice Plate: Orifice Area per Row =	2.44	sq. inches (diameter = 1-3/4 inches)

Calculated Parameters for Plate	
WQ Orifice Area per Row =	1.694E-02 ft <sup>2</sup>
Elliptical Half-Width =	N/A feet
Elliptical Slot Centroid =	N/A feet
Elliptical Slot Area =	N/A ft <sup>2</sup>

**User Input: Stage and Total Area of Each Orifice Row** (numbered from lowest to highest)

	Row 1 (required)	Row 2 (optional)	Row 3 (optional)	Row 4 (optional)	Row 5 (optional)	Row 6 (optional)	Row 7 (optional)	Row 8 (optional)
Stage of Orifice Centroid (ft)	0.00	2.90						
Orifice Area (sq. inches)	2.44	2.44						

	Row 9 (optional)	Row 10 (optional)	Row 11 (optional)	Row 12 (optional)	Row 13 (optional)	Row 14 (optional)	Row 15 (optional)	Row 16 (optional)
Stage of Orifice Centroid (ft)								
Orifice Area (sq. inches)								

**User Input: Vertical Orifice (Circular or Rectangular)**

	Not Selected	Not Selected	
Invert of Vertical Orifice =	N/A	N/A	ft (relative to basin bottom at Stage = 0 ft)
Depth at top of Zone using Vertical Orifice =	N/A	N/A	ft (relative to basin bottom at Stage = 0 ft)
Vertical Orifice Diameter =	N/A	N/A	inches

Calculated Parameters for Vertical Orific	
Vertical Orifice Area =	N/A
Vertical Orifice Centroid =	N/A

**User Input: Overflow Weir (Dropbox with Flat or Sloped Gate and Outlet Pipe OR Rectangular/Trapezoidal Weir and No Outlet Pipe)**

	Zone 3 Weir	Not Selected	
Overflow Weir Front Edge Height, Ho =	5.00	N/A	ft (relative to basin bottom at Stage = 0 ft)
Overflow Weir Front Edge Length =	8.00	N/A	feet
Overflow Weir Gate Slope =	0.00	N/A	H:V
Horiz. Length of Weir Sides =	8.00	N/A	feet
Overflow Gate Type =	Type C Gate	N/A	
Debris Clogging % =	50%	N/A	%

Calculated Parameters for Overflow Weir	
Height of Gate Upper Edge, H <sub>t</sub> =	5.00
Overflow Weir Slope Length =	8.00
Gate Open Area / 100-yr Orifice Area =	6.30
Overflow Gate Open Area w/o Debris =	44.54
Overflow Gate Open Area w/ Debris =	22.27

**User Input: Outlet Pipe w/ Flow Restriction Plate (Circular Orifice, Restrictor Plate, or Rectangular Orifice)**

	Zone 3 Circular	Not Selected	
Depth to Invert of Outlet Pipe =	2.50	N/A	ft (distance below basin bottom at Stage = 0 ft)
Circular Orifice Diameter =	36.00	N/A	inches

Calculated Parameters for Outlet Pipe w/ Flow Restriction Plate	
Outlet Orifice Area =	7.07
Outlet Orifice Centroid =	1.50
Half-Central Angle of Restrictor Plate on Pipe =	N/A

**User Input: Emergency Spillway (Rectangular or Trapezoidal)**

Spillway Invert Stage =	6.10	ft (relative to basin bottom at Stage = 0 ft)
Spillway Crest Length =	25.00	feet
Spillway End Slopes =	4.00	H:V
Freeboard above Max Water Surface =	1.00	feet

Calculated Parameters for Spillway	
Spillway Design Flow Depth =	0.85
Stage at Top of Freeboard =	7.95
Basin Area at Top of Freeboard =	0.49
Basin Volume at Top of Freeboard =	2.40

## Routed Hydrograph Results

The user can override the default CUHP hydrographs and runoff volumes by entering new values in the Inflow Hydrographs table (Columns W through AF)

	WQCV	EURV	2 Year	5 Year	10 Year	25 Year	50 Year	100 Year
Design Storm Return Period =	N/A	N/A	0.93	1.21	1.46	1.83	2.14	2.47
One-Hour Rainfall Depth (in) =	0.276	0.515	0.282	0.598	1.083	2.362	3.222	4.388
CUHP Runoff Volume (acre-ft) =	N/A	N/A	0.282	0.598	1.083	2.362	3.222	4.388
Inflow Hydrograph Volume (acre-ft) =	N/A	N/A	0.5	4.2	11.4	30.6	42.3	56.2
OPTIONAL Override Predevelopment Peak Q (cfs) =	N/A	N/A						
Predevelopment Unit Peak Flow, q (cfs/acre) =	N/A	N/A	0.01	0.12	0.32	0.86	1.18	1.57
Peak Inflow Q (cfs) =	N/A	N/A	4.1	9.0	16.5	35.8	47.7	61.9
Peak Outflow Q (cfs) =	0.1	0.1	0.1	0.2	0.3	20.3	34.3	52.1
Ratio Peak Outflow to Predevelopment Q =	N/A	N/A	N/A	0.0	0.0	0.7	0.8	0.9
Structure Controlling Flow =	Plate	Plate	Plate	Plate	Plate	Overflow Weir 1	Overflow Weir 1	Overflow Weir 1
Max Velocity through Gate 1 (fps) =	N/A	N/A	N/A	N/A	N/A	0.4	0.8	1.2
Max Velocity through Gate 2 (fps) =	N/A	N/A	N/A	N/A	N/A	N/A	N/A	N/A
Time to Drain 97% of Inflow Volume (hours) =	38	59	39	66	87	86	82	77
Time to Drain 99% of Inflow Volume (hours) =	40	62	41	69	92	95	93	91
Maximum Ponding Depth (ft) =	1.90	2.88	1.83	3.08	4.60	5.53	5.76	6.00
Area at Maximum Ponding Depth (acres) =	0.22	0.26	0.22	0.27	0.34	0.38	0.39	0.40
Maximum Volume Stored (acre-ft) =	0.278	0.517	0.260	0.568	1.035	1.367	1.451	1.549

# DETENTION BASIN OUTLET STRUCTURE DESIGN

*MHFD-Detention, Version 4.06 (July 2022)*

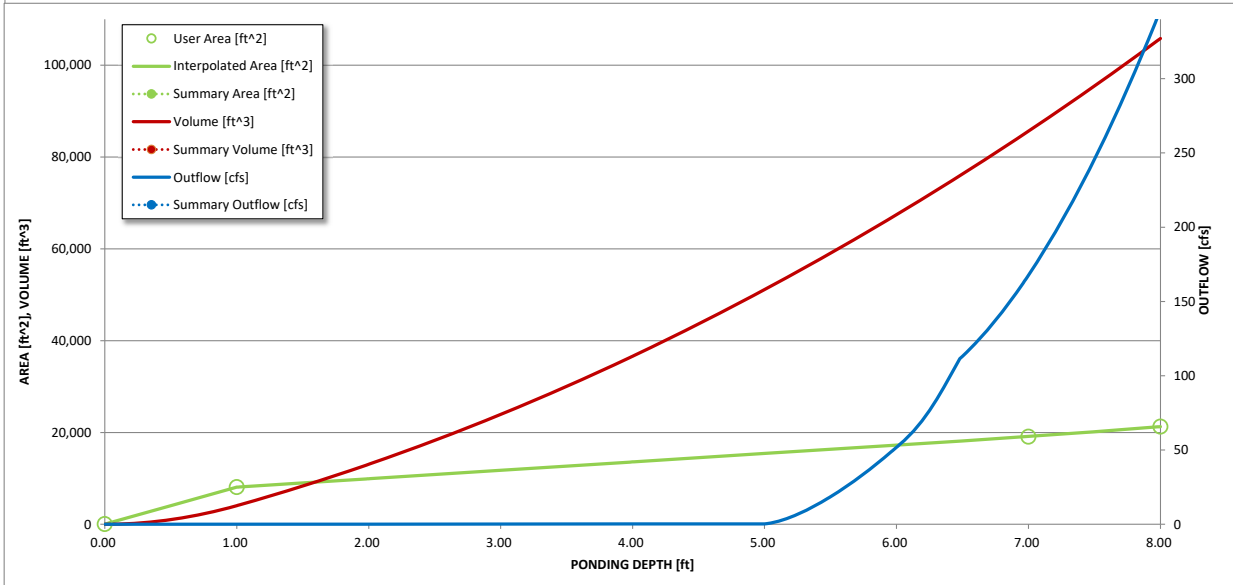
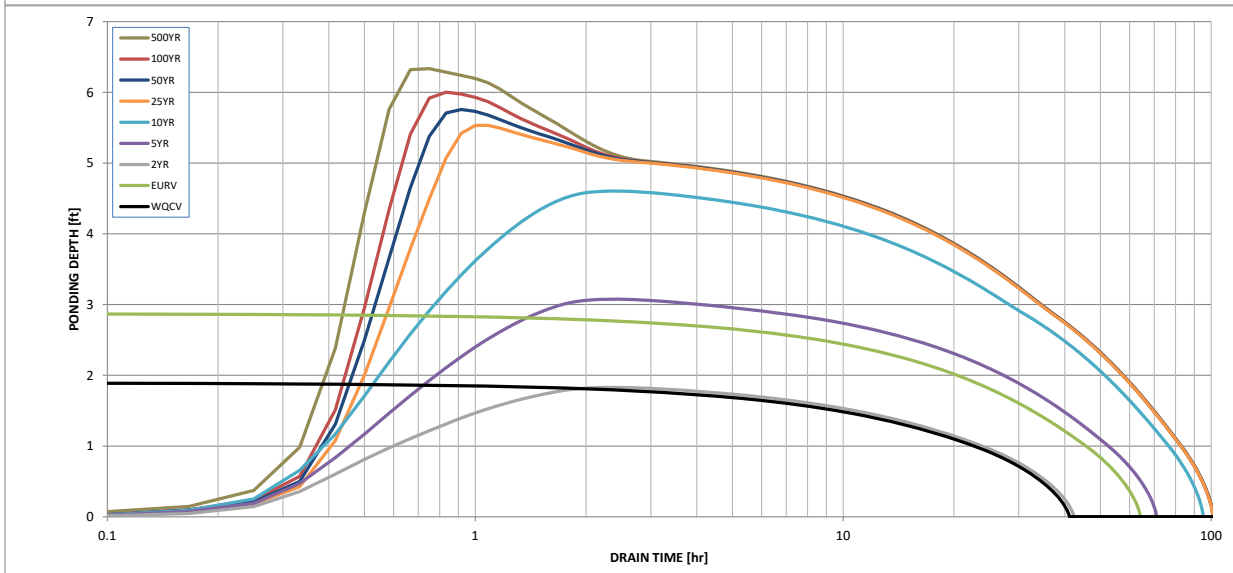
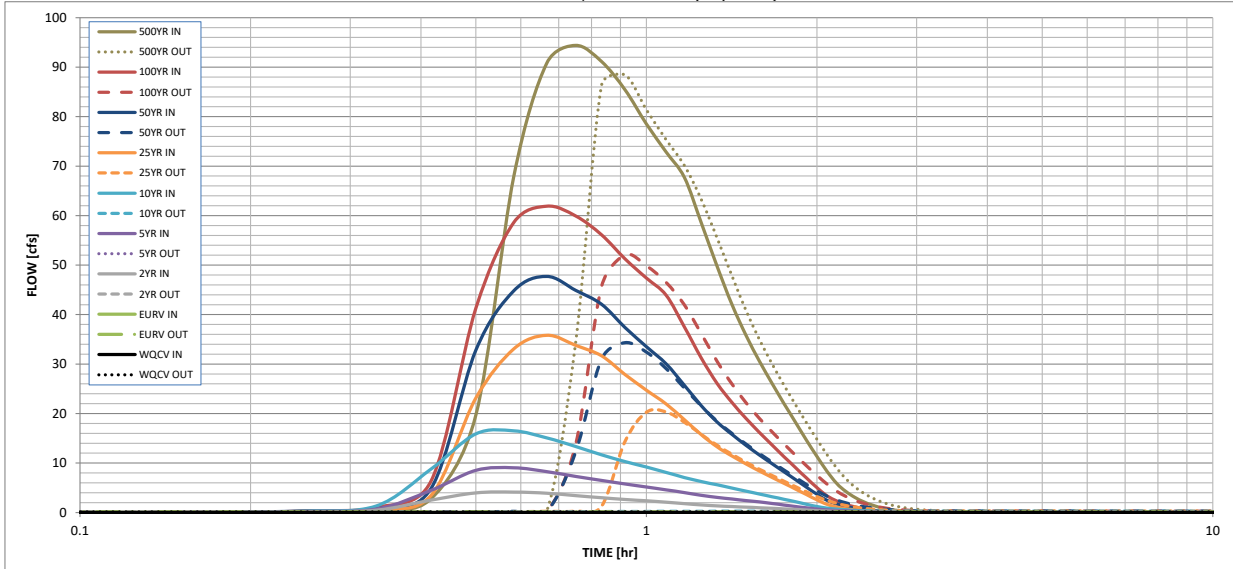

S-A-V-D Chart Axis Override	X-axis	Left Y-Axis	Right Y-Axis
minimum bound			
maximum bound			

# DETENTION BASIN OUTLET STRUCTURE DESIGN

*Outflow Hydrograph Workbook Filename:*

## Inflow Hydrographs

The user can override the calculated inflow hydrographs from this workbook with inflow hydrographs developed in a separate program.

Time Interval	SOURCE	CUHP	CUHP	CUHP	CUHP	CUHP	CUHP	CUHP	CUHP	CUHP
	TIME	WQCV [cfs]	EURV [cfs]	2 Year [cfs]	5 Year [cfs]	10 Year [cfs]	25 Year [cfs]	50 Year [cfs]	100 Year [cfs]	500 Year [cfs]
5.00 min	0:00:00	0.00	0.00	0.00	0.00	0.00	0.00	0.00	0.00	0.00
	0:05:00	0.00	0.00	0.00	0.00	0.00	0.00	0.00	0.00	0.00
	0:10:00	0.00	0.00	0.00	0.00	0.00	0.00	0.01	0.00	0.09
	0:15:00	0.00	0.00	0.09	0.19	0.27	0.21	0.29	0.30	0.50
	0:20:00	0.00	0.00	0.48	0.68	1.32	0.60	0.74	1.06	2.79
	0:25:00	0.00	0.00	2.52	4.47	8.78	3.46	4.87	6.35	19.67
	0:30:00	0.00	0.00	3.98	8.52	15.88	23.12	32.79	41.26	67.89
	0:35:00	0.00	0.00	4.13	9.04	16.49	33.05	44.80	58.60	90.77
	0:40:00	0.00	0.00	3.90	8.25	15.09	35.82	47.71	61.89	94.40
	0:45:00	0.00	0.00	3.41	7.29	13.34	33.78	44.89	59.92	91.11
	0:50:00	0.00	0.00	2.98	6.49	11.65	31.66	42.08	56.11	85.43
	0:55:00	0.00	0.00	2.64	5.77	10.30	27.90	37.40	51.25	78.52
	1:00:00	0.00	0.00	2.36	5.16	9.18	24.72	33.51	47.37	72.86
	1:05:00	0.00	0.00	2.09	4.59	8.11	21.94	30.04	43.93	67.74
	1:10:00	0.00	0.00	1.78	4.03	7.07	18.76	25.73	37.52	58.53
	1:15:00	0.00	0.00	1.52	3.48	6.26	15.72	21.58	31.21	49.75
	1:20:00	0.00	0.00	1.34	3.06	5.59	13.26	18.27	26.09	41.94
	1:25:00	0.00	0.00	1.20	2.72	4.93	11.41	15.76	22.20	35.76
	1:30:00	0.00	0.00	1.08	2.42	4.31	9.80	13.57	18.98	30.59
	1:35:00	0.00	0.00	0.96	2.14	3.74	8.38	11.63	16.20	26.10
	1:40:00	0.00	0.00	0.85	1.82	3.20	7.10	9.87	13.65	22.01
	1:45:00	0.00	0.00	0.74	1.52	2.68	5.90	8.22	11.28	18.21
	1:50:00	0.00	0.00	0.63	1.22	2.18	4.74	6.64	9.05	14.64
	1:55:00	0.00	0.00	0.50	0.95	1.65	3.62	5.13	6.99	11.34
	2:00:00	0.00	0.00	0.38	0.71	1.20	2.56	3.69	5.03	8.36
	2:05:00	0.00	0.00	0.29	0.52	0.89	1.65	2.47	3.39	5.89
	2:10:00	0.00	0.00	0.23	0.41	0.70	1.11	1.72	2.36	4.24
	2:15:00	0.00	0.00	0.18	0.32	0.55	0.76	1.22	1.64	3.06
	2:20:00	0.00	0.00	0.15	0.26	0.44	0.54	0.88	1.13	2.18
	2:25:00	0.00	0.00	0.12	0.20	0.35	0.38	0.63	0.76	1.52
	2:30:00	0.00	0.00	0.09	0.16	0.27	0.28	0.46	0.49	1.03
	2:35:00	0.00	0.00	0.07	0.12	0.20	0.20	0.33	0.31	0.68
	2:40:00	0.00	0.00	0.06	0.09	0.15	0.14	0.24	0.21	0.47
	2:45:00	0.00	0.00	0.05	0.07	0.11	0.10	0.18	0.16	0.34
	2:50:00	0.00	0.00	0.04	0.05	0.08	0.08	0.14	0.13	0.26
	2:55:00	0.00	0.00	0.03	0.04	0.06	0.06	0.10	0.10	0.21
	3:00:00	0.00	0.00	0.02	0.03	0.05	0.04	0.08	0.08	0.16
	3:05:00	0.00	0.00	0.02	0.02	0.03	0.03	0.06	0.06	0.12
	3:10:00	0.00	0.00	0.01	0.01	0.02	0.02	0.04	0.04	0.08
	3:15:00	0.00	0.00	0.01	0.01	0.01	0.01	0.03	0.02	0.05
	3:20:00	0.00	0.00	0.00	0.00	0.01	0.01	0.01	0.01	0.03
	3:25:00	0.00	0.00	0.00	0.00	0.00	0.00	0.01	0.01	0.01
	3:30:00	0.00	0.00	0.00	0.00	0.00	0.00	0.00	0.00	0.00
	3:35:00	0.00	0.00	0.00	0.00	0.00	0.00	0.00	0.00	0.00
	3:40:00	0.00	0.00	0.00	0.00	0.00	0.00	0.00	0.00	0.00
	3:45:00	0.00	0.00	0.00	0.00	0.00	0.00	0.00	0.00	0.00
	3:50:00	0.00	0.00	0.00	0.00	0.00	0.00	0.00	0.00	0.00
	3:55:00	0.00	0.00	0.00	0.00	0.00	0.00	0.00	0.00	0.00
	4:00:00	0.00	0.00	0.00	0.00	0.00	0.00	0.00	0.00	0.00
	4:05:00	0.00	0.00	0.00	0.00	0.00	0.00	0.00	0.00	0.00
	4:10:00	0.00	0.00	0.00	0.00	0.00	0.00	0.00	0.00	0.00
	4:15:00	0.00	0.00	0.00	0.00	0.00	0.00	0.00	0.00	0.00
	4:20:00	0.00	0.00	0.00	0.00	0.00	0.00	0.00	0.00	0.00
	4:25:00	0.00	0.00	0.00	0.00	0.00	0.00	0.00	0.00	0.00
	4:30:00	0.00	0.00	0.00	0.00	0.00	0.00	0.00	0.00	0.00
	4:35:00	0.00	0.00	0.00	0.00	0.00	0.00	0.00	0.00	0.00
	4:40:00	0.00	0.00	0.00	0.00	0.00	0.00	0.00	0.00	0.00
	4:45:00	0.00	0.00	0.00	0.00	0.00	0.00	0.00	0.00	0.00
	4:50:00	0.00	0.00	0.00	0.00	0.00	0.00	0.00	0.00	0.00
	4:55:00	0.00	0.00	0.00	0.00	0.00	0.00	0.00	0.00	0.00
	5:00:00	0.00	0.00	0.00	0.00	0.00	0.00	0.00	0.00	0.00
	5:05:00	0.00	0.00	0.00	0.00	0.00	0.00	0.00	0.00	0.00
	5:10:00	0.00	0.00	0.00	0.00	0.00	0.00	0.00	0.00	0.00
	5:15:00	0.00	0.00	0.00	0.00	0.00	0.00	0.00	0.00	0.00
	5:20:00	0.00	0.00	0.00	0.00	0.00	0.00	0.00	0.00	0.00
	5:25:00	0.00	0.00	0.00	0.00	0.00	0.00	0.00	0.00	0.00
	5:30:00	0.00	0.00	0.00	0.00	0.00	0.00	0.00	0.00	0.00
	5:35:00	0.00	0.00	0.00	0.00	0.00	0.00	0.00	0.00	0.00
	5:40:00	0.00	0.00	0.00	0.00	0.00	0.00	0.00	0.00	0.00
	5:45:00	0.00	0.00	0.00	0.00	0.00	0.00	0.00	0.00	0.00
	5:50:00	0.00	0.00	0.00	0.00	0.00	0.00	0.00	0.00	0.00
	5:55:00	0.00	0.00	0.00	0.00	0.00	0.00	0.00	0.00	0.00
	6:00:00	0.00	0.00	0.00	0.00	0.00	0.00	0.00	0.00	0.00





### G14b FOREBAY VOLUME

Req'd  $V=3\% \times WQCV$

WQCV=	0.286 ac-ft
V=	0.0086 ac-ft
Actual V	0.0087 ac-ft

### FOREBAY RELEASE NOTCH WIDTH

$$Q=CLH^{3/2}$$

$Q_{100}$ =	61.9 cfs
2% of Q=	1.24 cfs
C=	2.6
H (height of forebay wall)=	1 ft
L=	0.48 ft
	5.7 in

3 in min.

6 in min

# Channel Report **Pond G14b**

Hydraflow Express Extension for Autodesk® AutoCAD® Civil 3D® by Autodesk, Inc.

Thursday, Aug 29 2024

## <Name>

### Rectangular

Bottom Width (ft) = 6.00

Total Depth (ft) = 0.50

Invert Elev (ft) = 1.00

Slope (%) = 0.50

N-Value = 0.012

### Highlighted

Depth (ft) = 0.10

Q (cfs) = 1.100

Area (sqft) = 0.60

Velocity (ft/s) = 1.83

Wetted Perim (ft) = 6.20

Crit Depth, Yc (ft) = 0.11

Top Width (ft) = 6.00

EGL (ft) = 0.15

### Calculations

Compute by:

Known Q

Known Q (cfs)

= 1.10 **55.2 cfs x 2%**

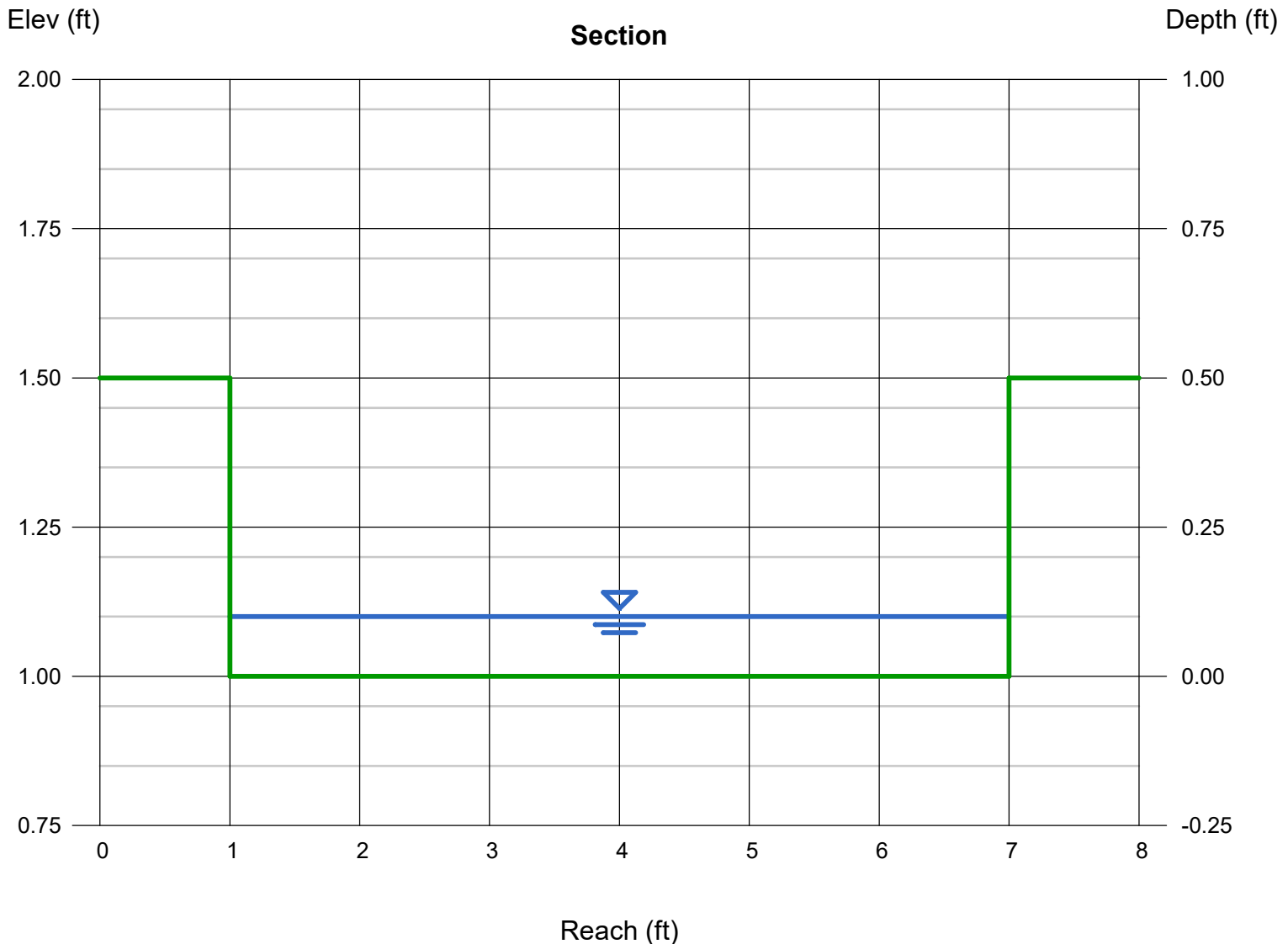

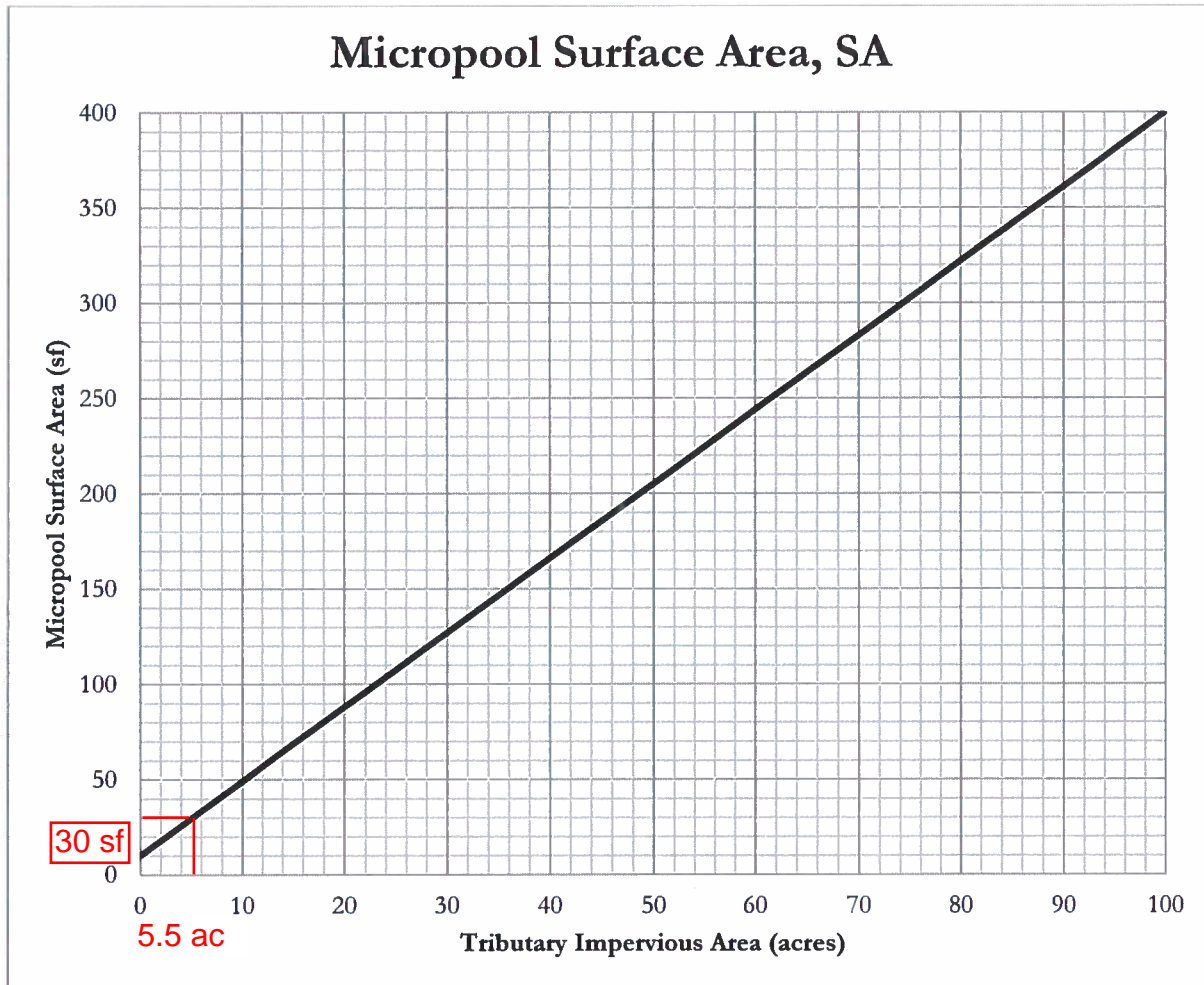

Figure 1 – Micropool surface area (SA) determination chart

The tributary impervious area is the effective number of impervious acres that will be treated by the extended detention basin (EDB). It is calculated by multiplying the tributary area to be treated by the impervious fraction of that area.

$$TIA = I \times A = (14.8/100) \times 37.22 \text{ ac} = 5.5 \text{ ac}$$

- TIA = Tributary impervious area (acres)
- I = Imperviousness (fraction)
- A = Tributary catchment area upstream (acres)

For EDBs with tributary impervious areas greater than 100 acres, the micropool surface area is 400 sf. The initial surcharge depth (ISD) is defined as the depth of the initial surcharge volume (ISV). The surface area determined using Figure 1 assumes an ISD of 4 inches. The initial surcharge volume is thus calculated by multiplying the micropool surface area by 4 inches.

$$ISV = SA \times 4 \text{ inches}$$

- ISV = Initial surcharge volume (cf)
- SA = Surface area (from Figure 1, sf)

**Figure 13-12c. Emergency Spillway Protection**

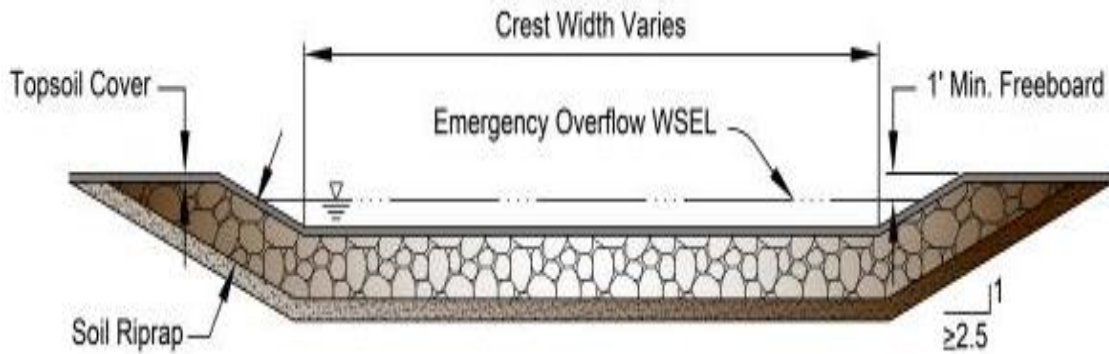

**Figure 13-12d. Riprap Types for Emergency Spillway Protection**

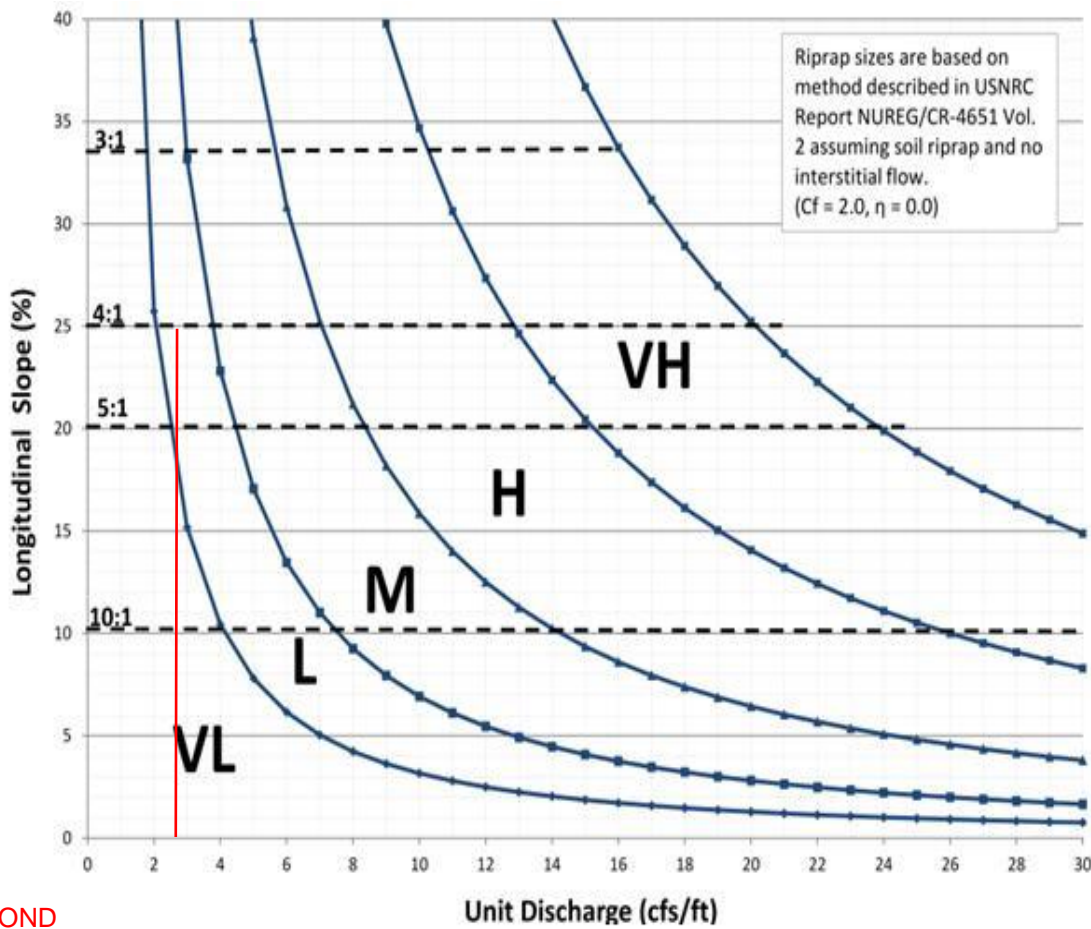

POND  
 UNIT DISCHARGE =  $65.2/25 = 2.61 \text{ cfs/ft}$



# DETENTION BASIN STAGE-STORAGE TABLE BUILDER

*MHFD-Detention, Version 4.06 (July 2022)*

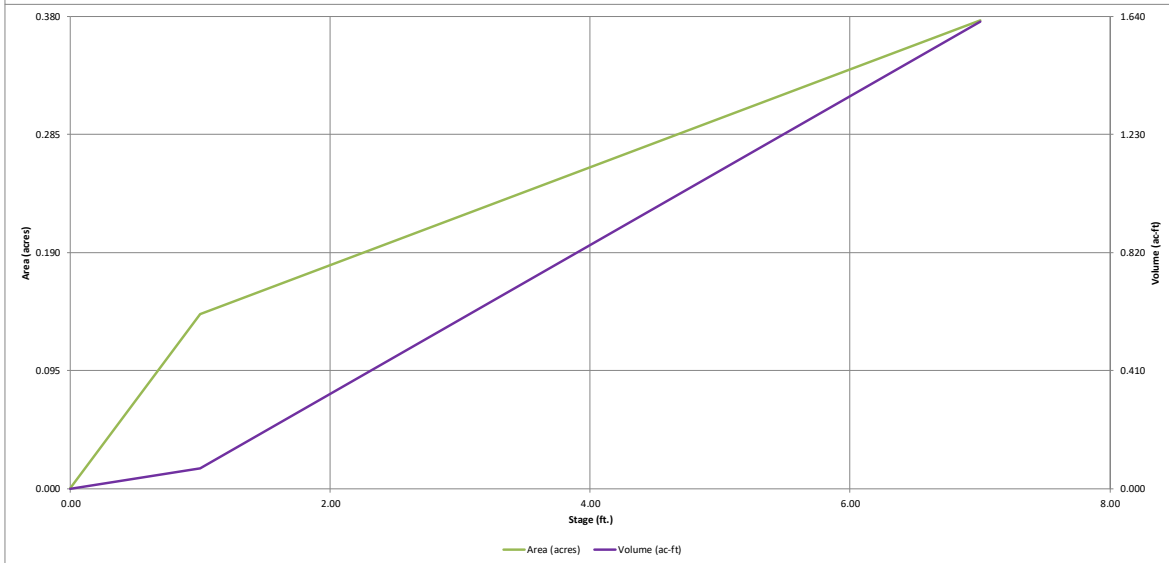
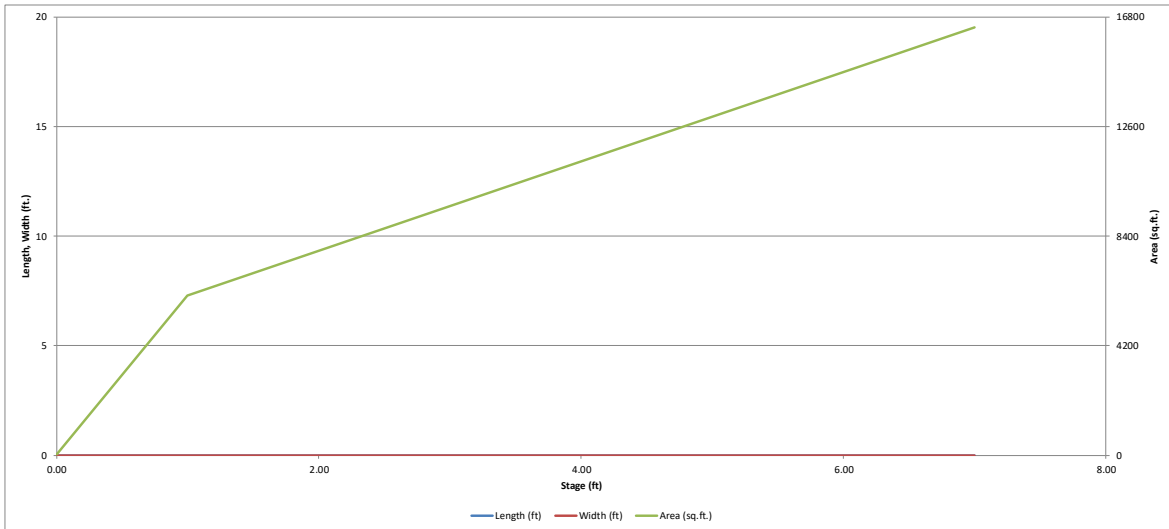

✓ = calcs match details in plans  
✗ = calcs do not match details in plans

## DETENTION BASIN OUTLET STRUCTURE DESIGN

MHFD-Detention, Version 4.06 (July 2022)

**Project:** Latigo Trails  
**Basin ID:** Pond G18

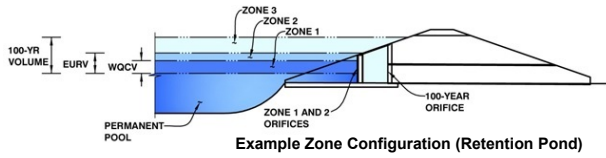

	Estimated Stage (ft)	Estimated Volume (ac-ft)	Outlet Type
Zone 1 (WQCV)	1.64	0.167	Orifice Plate
Zone 2 (EURV)	2.39	0.137	Orifice Plate
Zone 3 (100-year)	5.11	0.676	Weir&Pipe (Circular)
Total (all zones)		0.980	

**User Input:** Orifice at Underdrain Outlet (typically used to drain WQCV in a Filtration BMP)

Underdrain Orifice Invert Depth =	N/A	ft (distance below the filtration media surface)
Underdrain Orifice Diameter =	N/A	inches

**Calculated Parameters for Underdrain**

Underdrain Orifice Area =	N/A	ft <sup>2</sup>
Underdrain Orifice Centroid =	N/A	feet

**User Input:** Orifice Plate with one or more orifices or Elliptical Slot Weir (typically used to drain WQCV and/or EURV in a sedimentation BMP)

Centroid of Lowest Orifice =	0.00	ft (relative to basin bottom at Stage = 0 ft)
Depth at top of Zone using Orifice Plate =	2.39 ✗	ft (relative to basin bottom at Stage = 0 ft)
Orifice Plate: Orifice Vertical Spacing =	N/A	inches
Orifice Plate: Orifice Area per Row =	1.57 ✗	sq. inches (diameter = 1-3/8 inches)

**Calculated Parameters for Plate**

WQ Orifice Area per Row =	1.090E-02	ft <sup>2</sup>
Elliptical Half-Width =	N/A	feet
Elliptical Slot Centroid =	N/A	feet
Elliptical Slot Area =	N/A	ft <sup>2</sup>

**User Input:** Stage and Total Area of Each Orifice Row (numbered from lowest to highest)

	Row 1 (required)	Row 2 (optional)	Row 3 (optional)	Row 4 (optional)	Row 5 (optional)	Row 6 (optional)	Row 7 (optional)	Row 8 (optional)
Stage of Orifice Centroid (ft)	0.00	2.65						
Orifice Area (sq. inches)	1.57 ✗	1.57 ✗						
	<b>1.84</b>	<b>12</b>						
	Row 9 (optional)	Row 10 (optional)	Row 11 (optional)	Row 12 (optional)	Row 13 (optional)	Row 14 (optional)	Row 15 (optional)	Row 16 (optional)
Stage of Orifice Centroid (ft)								
Orifice Area (sq. inches)								

**User Input:** Vertical Orifice (Circular or Rectangular)

	Not Selected	Not Selected	
Invert of Vertical Orifice =	N/A	N/A	ft (relative to basin bottom at Stage = 0 ft)
Depth at top of Zone using Vertical Orifice =	N/A	N/A	ft (relative to basin bottom at Stage = 0 ft)
Vertical Orifice Diameter =	N/A	N/A	inches

**Calculated Parameters for Vertical Orific**

	Not Selected	Not Selected
Vertical Orifice Area =	N/A	N/A
Vertical Orifice Centroid =	N/A	N/A

**User Input:** Overflow Weir (Dropbox with Flat or Sloped Gate and Outlet Pipe OR Rectangular/Trapezoidal Weir and No Outlet Pipe)

	Zone 3 Weir	Not Selected	
Overflow Weir Front Edge Height, Ho =	4.00 ✓	N/A	ft (relative to basin bottom at Stage = 0 ft)
Overflow Weir Front Edge Length =	6.00 ✓	N/A	feet
Overflow Weir Gate Slope =	0.00 ✓	N/A	H:V
Horiz. Length of Weir Sides =	6.00 ✓	N/A	feet
Overflow Gate Type =	Type C Grate ✓	N/A	
Debris Clogging % =	50% ✓	N/A	%

**Calculated Parameters for Overflow Weir**

	Zone 3 Weir	Not Selected
Height of Gate Upper Edge, H <sub>t</sub> =	4.00	N/A
Overflow Weir Slope Length =	6.00	N/A
Gate Open Area / 100-yr Orifice Area =	3.54	N/A
Overflow Gate Open Area w/o Debris =	25.06	N/A
Overflow Gate Open Area w/ Debris =	12.53	N/A

**User Input:** Outlet Pipe w/ Flow Restriction Plate (Circular Orifice, Restrictor Plate, or Rectangular Orifice)

	Zone 3 Circular	Not Selected	
Depth to Invert of Outlet Pipe =	0.00 ✓	N/A	ft (distance below basin bottom at Stage = 0 ft)
Circular Orifice Diameter =	36.00 ✓	N/A	inches

**Calculated Parameters for Outlet Pipe w/ Flow Restriction Plate**

	Zone 3 Circular	Not Selected
Outlet Orifice Area =	7.07	N/A
Outlet Orifice Centroid =	1.50	N/A
Half-Central Angle of Restrictor Plate on Pipe =	N/A	N/A

**User Input:** Emergency Spillway (Rectangular or Trapezoidal)

Spillway Invert Stage =	4.85 ✗	ft (relative to basin bottom at Stage = 0 ft)
Spillway Crest Length =	20.00 ✗	feet
Spillway End Slopes =	4.00 ✗	H:V
Freeboard above Max Water Surface =	1.00 ✗	feet

**Calculated Parameters for Spillway**

Spillway Design Flow Depth =	0.74	feet
Stage at Top of Freeboard =	6.59	feet
Basin Area at Top of Freeboard =	0.36	acres
Basin Volume at Top of Freeboard =	1.47	acre-ft

**Routed Hydrograph Results**

The user can override the default CUHP hydrographs and runoff volumes by entering new values in the Inflow Hydrographs table (Columns W through AF)

	WQCV	EURV	2 Year	5 Year	10 Year	25 Year	50 Year	100 Year
Design Storm Return Period =	N/A	N/A	0.93	1.21	1.46	1.83	2.14	2.47
One-Hour Rainfall Depth (in) =	0.167	0.304	0.163	0.363	0.677	1.519	2.082	2.850
CUHP Runoff Volume (acre-ft) =	N/A	N/A	0.163	0.363	0.677	1.519	2.082	2.850
Inflow Hydrograph Volume (acre-ft) =	N/A	N/A	0.3	1.9	5.4	15.0	20.8	28.2
OPTIONAL Predevelopment Peak Q (cfs) =	N/A	N/A	0.01	0.08	0.23	0.64	0.89	1.20
Predevelopment Unit Peak Flow, q (cfs/acre) =	N/A	N/A	1.8	4.1	7.7	17.3	23.2	30.8
Peak Inflow Q (cfs) =	0.1	0.1	0.1	0.1	0.2	11.1	18.0	27.1
Peak Outflow Q (cfs) =	N/A	N/A	N/A	0.0	0.0	0.7	0.9	1.0
Ratio Peak Outflow to Predevelopment Q =	Plate	Plate	Plate	Plate	Plate	Overflow Weir 1	Overflow Weir 1	Overflow Weir 1
Structure Controlling Flow =	N/A	N/A	N/A	N/A	N/A	0.4	0.7	1.1
Max Velocity through Gate 1 (fps) =	N/A	N/A	N/A	N/A	N/A	N/A	N/A	N/A
Max Velocity through Gate 2 (fps) =	38	59	38	67	92	87	83	78
Time to Drain 97% of Inflow Volume (hours) =	<b>40</b>	62	40	70	97	96	94	92
Time to Drain 99% of Inflow Volume (hours) =	1.63	2.39	1.52	2.59	3.91	4.43	4.60	4.79
Maximum Ponding Depth (ft) =	0.17	0.20	0.16	0.20	0.25	0.28	0.28	0.29
Area at Maximum Ponding Depth (acres) =	0.167	0.304	0.149	0.344	0.644	0.782	0.830	0.884
Maximum Volume Stored (acre-ft) =								



# DETENTION BASIN OUTLET STRUCTURE DESIGN

*MHFD-Detention, Version 4.06 (July 2022)*

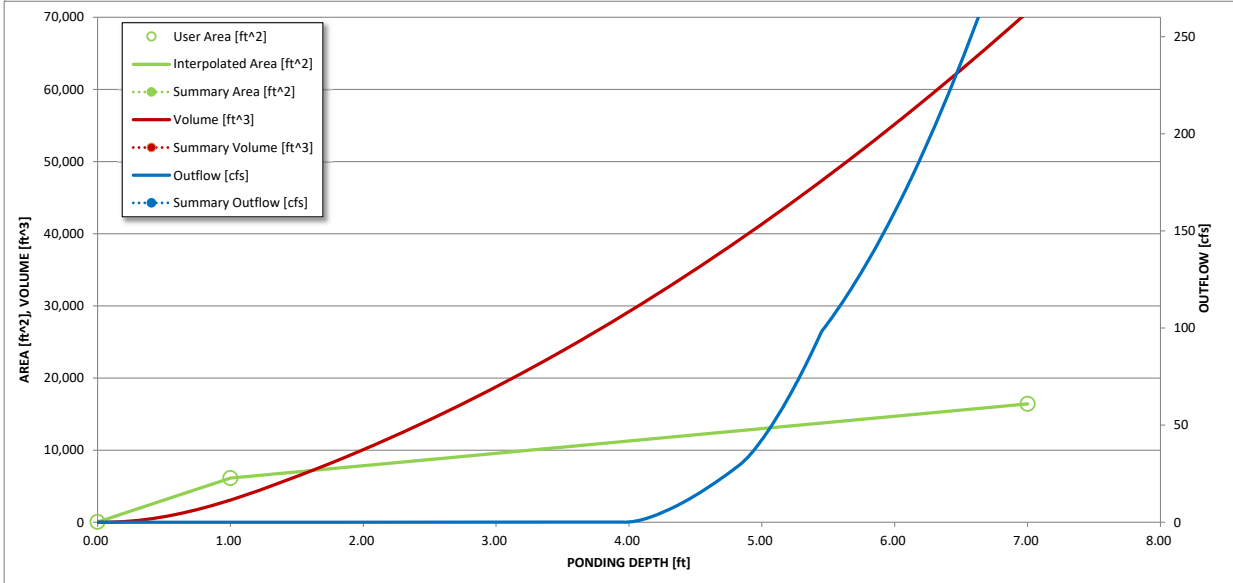
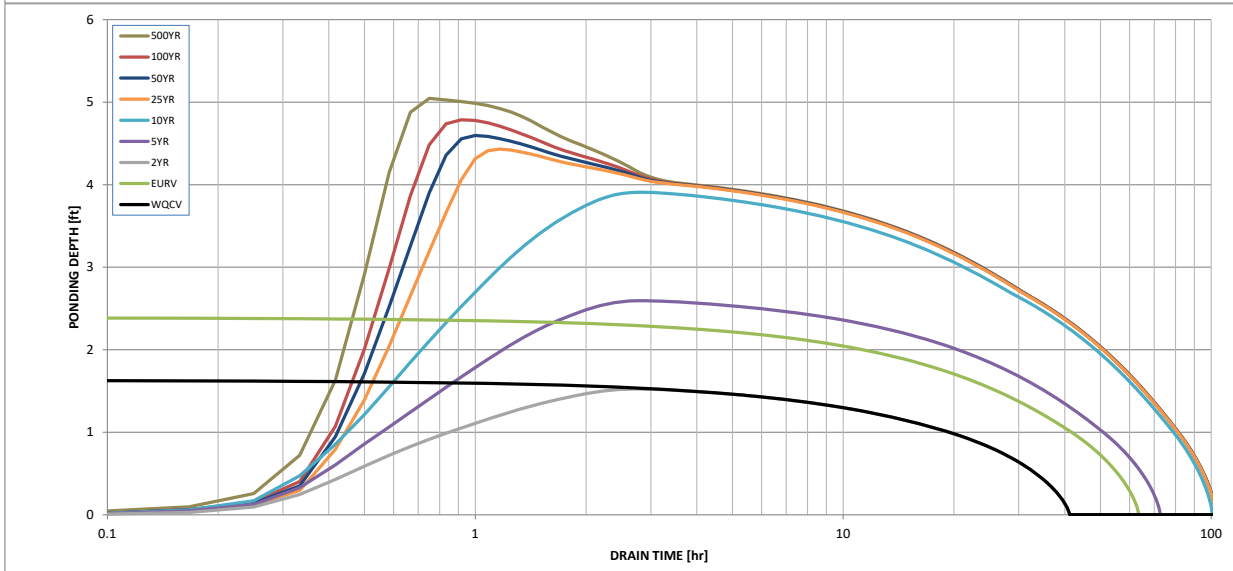
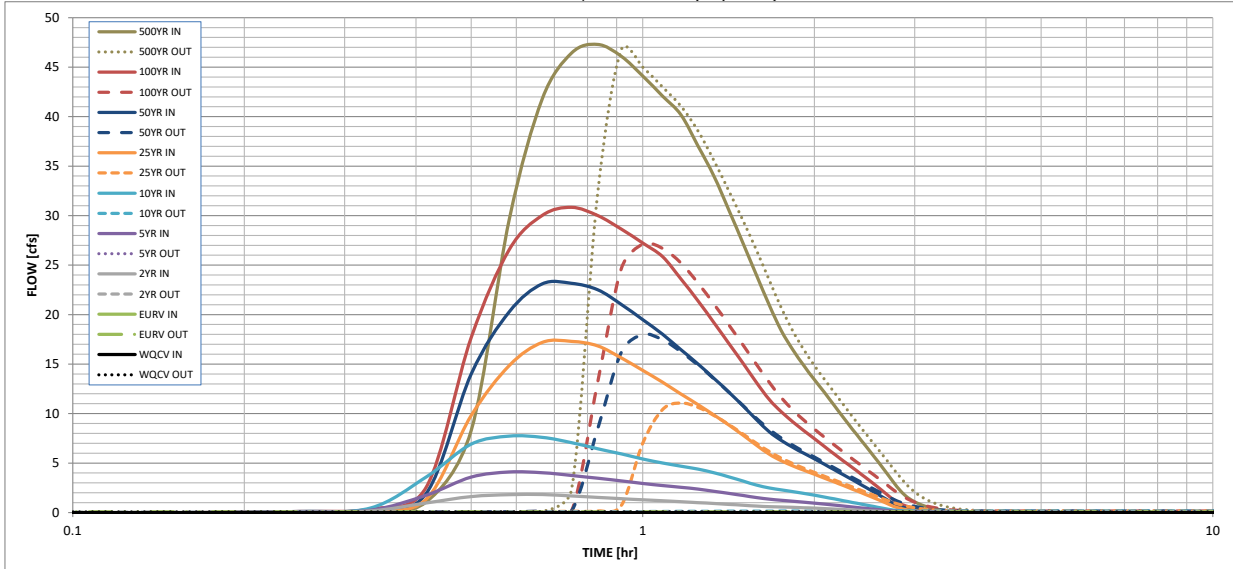

S-A-V-D Chart Axis Override	X-axis	Left Y-Axis	Right Y-Axis
minimum bound			
maximum bound			

# DETENTION BASIN OUTLET STRUCTURE DESIGN

Outflow Hydrograph Workbook Filename: \_\_\_\_\_

## Inflow Hydrographs

The user can override the calculated inflow hydrographs from this workbook with inflow hydrographs developed in a separate program.

Time Interval	SOURCE	CUHP	CUHP	CUHP	CUHP	CUHP	CUHP	CUHP	CUHP	CUHP
	TIME	WQCV [cfs]	EURV [cfs]	2 Year [cfs]	5 Year [cfs]	10 Year [cfs]	25 Year [cfs]	50 Year [cfs]	100 Year [cfs]	500 Year [cfs]
5.00 min	0:00:00	0.00	0.00	0.00	0.00	0.00	0.00	0.00	0.00	0.00
	0:05:00	0.00	0.00	0.00	0.00	0.00	0.00	0.00	0.00	0.00
	0:10:00	0.00	0.00	0.00	0.00	0.00	0.00	0.00	0.00	0.03
	0:15:00	0.00	0.00	0.03	0.07	0.10	0.07	0.10	0.10	0.18
	0:20:00	0.00	0.00	0.17	0.24	0.47	0.22	0.27	0.37	1.06
	0:25:00	0.00	0.00	0.96	1.75	3.59	1.34	1.91	2.53	8.29
	0:30:00	0.00	0.00	1.62	3.59	6.91	9.81	13.99	17.69	29.63
	0:35:00	0.00	0.00	1.80	4.10	7.72	14.86	20.29	26.57	41.83
	0:40:00	0.00	0.00	1.82	4.03	7.60	17.20	23.10	30.03	46.42
	0:45:00	0.00	0.00	1.67	3.75	7.07	17.30	23.16	30.83	47.30
	0:50:00	0.00	0.00	1.53	3.47	6.45	16.85	22.51	30.01	46.10
	0:55:00	0.00	0.00	1.40	3.20	5.92	15.62	21.03	28.63	44.11
	1:00:00	0.00	0.00	1.29	2.94	5.42	14.37	19.50	27.24	42.08
	1:05:00	0.00	0.00	1.19	2.72	5.00	13.17	18.01	25.86	40.18
	1:10:00	0.00	0.00	1.10	2.56	4.69	11.97	16.44	23.60	37.05
	1:15:00	0.00	0.00	1.01	2.37	4.39	10.91	15.01	21.40	33.99
	1:20:00	0.00	0.00	0.92	2.15	4.03	9.86	13.56	19.18	30.53
	1:25:00	0.00	0.00	0.83	1.93	3.61	8.83	12.15	17.06	27.17
	1:30:00	0.00	0.00	0.74	1.72	3.18	7.81	10.76	15.06	23.99
	1:35:00	0.00	0.00	0.66	1.52	2.78	6.80	9.39	13.14	20.96
	1:40:00	0.00	0.00	0.60	1.35	2.49	5.89	8.16	11.42	18.38
	1:45:00	0.00	0.00	0.56	1.24	2.29	5.23	7.29	10.18	16.45
	1:50:00	0.00	0.00	0.53	1.14	2.11	4.71	6.59	9.17	14.84
	1:55:00	0.00	0.00	0.49	1.05	1.94	4.27	5.99	8.28	13.43
	2:00:00	0.00	0.00	0.45	0.96	1.76	3.87	5.43	7.47	12.14
	2:05:00	0.00	0.00	0.40	0.85	1.57	3.48	4.88	6.67	10.83
	2:10:00	0.00	0.00	0.35	0.75	1.38	3.09	4.33	5.92	9.58
	2:15:00	0.00	0.00	0.31	0.66	1.20	2.72	3.81	5.21	8.41
	2:20:00	0.00	0.00	0.27	0.56	1.02	2.36	3.31	4.54	7.31
	2:25:00	0.00	0.00	0.22	0.47	0.86	2.01	2.81	3.88	6.23
	2:30:00	0.00	0.00	0.18	0.39	0.69	1.66	2.33	3.23	5.18
	2:35:00	0.00	0.00	0.14	0.30	0.54	1.32	1.85	2.58	4.14
	2:40:00	0.00	0.00	0.11	0.22	0.38	0.98	1.38	1.94	3.11
	2:45:00	0.00	0.00	0.07	0.15	0.26	0.65	0.93	1.33	2.18
	2:50:00	0.00	0.00	0.06	0.11	0.19	0.41	0.61	0.88	1.52
	2:55:00	0.00	0.00	0.04	0.09	0.15	0.27	0.42	0.60	1.08
	3:00:00	0.00	0.00	0.04	0.07	0.12	0.18	0.29	0.42	0.77
	3:05:00	0.00	0.00	0.03	0.06	0.10	0.12	0.21	0.28	0.54
	3:10:00	0.00	0.00	0.03	0.04	0.08	0.09	0.15	0.18	0.38
	3:15:00	0.00	0.00	0.02	0.04	0.06	0.06	0.11	0.12	0.25
	3:20:00	0.00	0.00	0.02	0.03	0.05	0.04	0.08	0.07	0.17
	3:25:00	0.00	0.00	0.01	0.02	0.04	0.03	0.06	0.05	0.12
	3:30:00	0.00	0.00	0.01	0.02	0.03	0.02	0.04	0.04	0.09
	3:35:00	0.00	0.00	0.01	0.01	0.02	0.02	0.03	0.03	0.07
	3:40:00	0.00	0.00	0.01	0.01	0.02	0.01	0.03	0.02	0.05
	3:45:00	0.00	0.00	0.01	0.01	0.01	0.01	0.02	0.02	0.04
	3:50:00	0.00	0.00	0.00	0.00	0.01	0.01	0.01	0.01	0.03
	3:55:00	0.00	0.00	0.00	0.00	0.01	0.00	0.01	0.01	0.02
	4:00:00	0.00	0.00	0.00	0.00	0.00	0.00	0.01	0.01	0.01
	4:05:00	0.00	0.00	0.00	0.00	0.00	0.00	0.00	0.00	0.01
	4:10:00	0.00	0.00	0.00	0.00	0.00	0.00	0.00	0.00	0.00
	4:15:00	0.00	0.00	0.00	0.00	0.00	0.00	0.00	0.00	0.00
	4:20:00	0.00	0.00	0.00	0.00	0.00	0.00	0.00	0.00	0.00
	4:25:00	0.00	0.00	0.00	0.00	0.00	0.00	0.00	0.00	0.00
	4:30:00	0.00	0.00	0.00	0.00	0.00	0.00	0.00	0.00	0.00
	4:35:00	0.00	0.00	0.00	0.00	0.00	0.00	0.00	0.00	0.00
	4:40:00	0.00	0.00	0.00	0.00	0.00	0.00	0.00	0.00	0.00
	4:45:00	0.00	0.00	0.00	0.00	0.00	0.00	0.00	0.00	0.00
	4:50:00	0.00	0.00	0.00	0.00	0.00	0.00	0.00	0.00	0.00
	4:55:00	0.00	0.00	0.00	0.00	0.00	0.00	0.00	0.00	0.00
	5:00:00	0.00	0.00	0.00	0.00	0.00	0.00	0.00	0.00	0.00
	5:05:00	0.00	0.00	0.00	0.00	0.00	0.00	0.00	0.00	0.00
	5:10:00	0.00	0.00	0.00	0.00	0.00	0.00	0.00	0.00	0.00
	5:15:00	0.00	0.00	0.00	0.00	0.00	0.00	0.00	0.00	0.00
	5:20:00	0.00	0.00	0.00	0.00	0.00	0.00	0.00	0.00	0.00
	5:25:00	0.00	0.00	0.00	0.00	0.00	0.00	0.00	0.00	0.00
	5:30:00	0.00	0.00	0.00	0.00	0.00	0.00	0.00	0.00	0.00
	5:35:00	0.00	0.00	0.00	0.00	0.00	0.00	0.00	0.00	0.00
	5:40:00	0.00	0.00	0.00	0.00	0.00	0.00	0.00	0.00	0.00
	5:45:00	0.00	0.00	0.00	0.00	0.00	0.00	0.00	0.00	0.00
	5:50:00	0.00	0.00	0.00	0.00	0.00	0.00	0.00	0.00	0.00
	5:55:00	0.00	0.00	0.00	0.00	0.00	0.00	0.00	0.00	0.00
	6:00:00	0.00	0.00	0.00	0.00	0.00	0.00	0.00	0.00	0.00



POND G18 LOW-TAILWATER BASIN

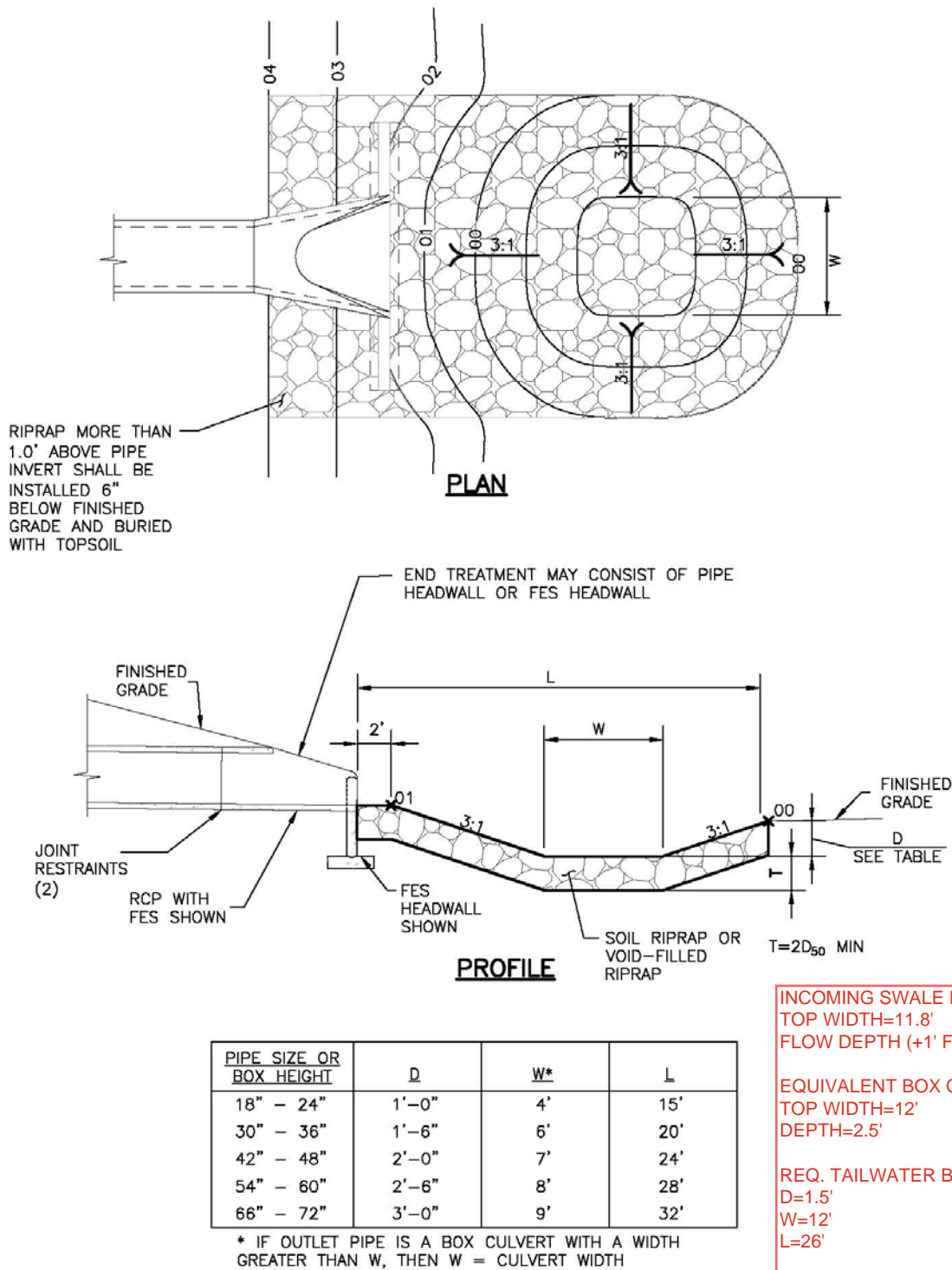

Figure 9-37. Low tailwater riprap basin

DP14A Q100=39.2cfs, W=12', H=2.5'

$Q/WH^{1.5}=0.8 < 8.0$  chart ok to use

$Q/WH^{0.5}=2.1$

$Y_t=0.4H=1.0$  ft

$Y_t/H=0.4$  ft

TYPE L RIPRAP REQUIRED

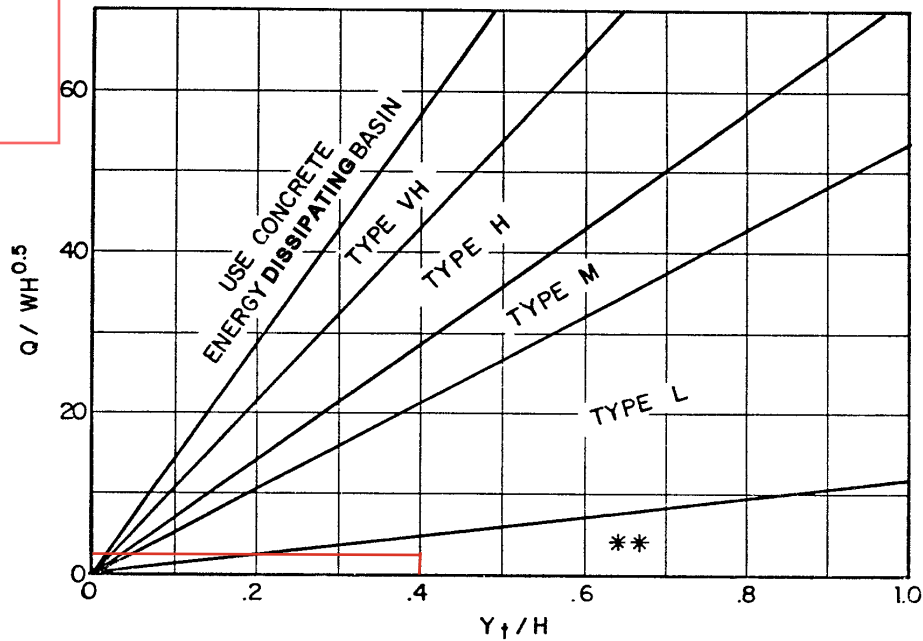

Use  $H_d$  instead of  $H$  whenever culvert has supercritical flow in the barrel.

\*\*Use Type L for a distance of  $3H$  downstream.

Figure 9-39. Riprap erosion protection at rectangular conduit outlet (valid for  $Q/WH^{1.5} \leq 8.0$ )

### 3.2.4 Outfalls and Rundowns

A grouted boulder outfall or “rundown” dissipates energy and provides erosion control protection. Grouted boulder outfalls are most commonly used in large rivers like the South Platte. Figure 9-40 provides a plan view and cross section for a standard grouted boulder rundown. See the grouted boulder drop profiles (A1, A2, and A3) in Figure 9-12 for site specific profile options, (i.e., depressed or free-draining basin for use with a stable downstream channel or with no basin for use in channels subject to degradation). Figure 9-41 provides a plan view of the same structure for use when the structure is in-line with the channel. Evaluate the following when designing a grouted boulder outfall or rundown:

- Minimize disturbance to channel bank
- Determine water surface elevation in receiving channel for base flow and design storm(s)
- Determine flow rate, velocity, depth, etc. of flow exiting the outfall pipe for the design storm(s)
- Evaluate permitting procedures and requirements for construction adjacent to large river system.

# Channel Report **Pond G18**

Hydraflow Express Extension for Autodesk® AutoCAD® Civil 3D® by Autodesk, Inc.

Thursday, Aug 29 2024

## <Name>

### Rectangular

Bottom Width (ft) = 6.00

Total Depth (ft) = 0.50

Invert Elev (ft) = 1.00

Slope (%) = 0.50

N-Value = 0.012

### Highlighted

Depth (ft) = 0.10

Q (cfs) = 1.100

Area (sqft) = 0.60

Velocity (ft/s) = 1.83

Wetted Perim (ft) = 6.20

Crit Depth, Yc (ft) = 0.11

Top Width (ft) = 6.00

EGL (ft) = 0.15

### Calculations

Compute by:

Known Q

Known Q (cfs) = 1.10 **55.4 cfs x 2%**

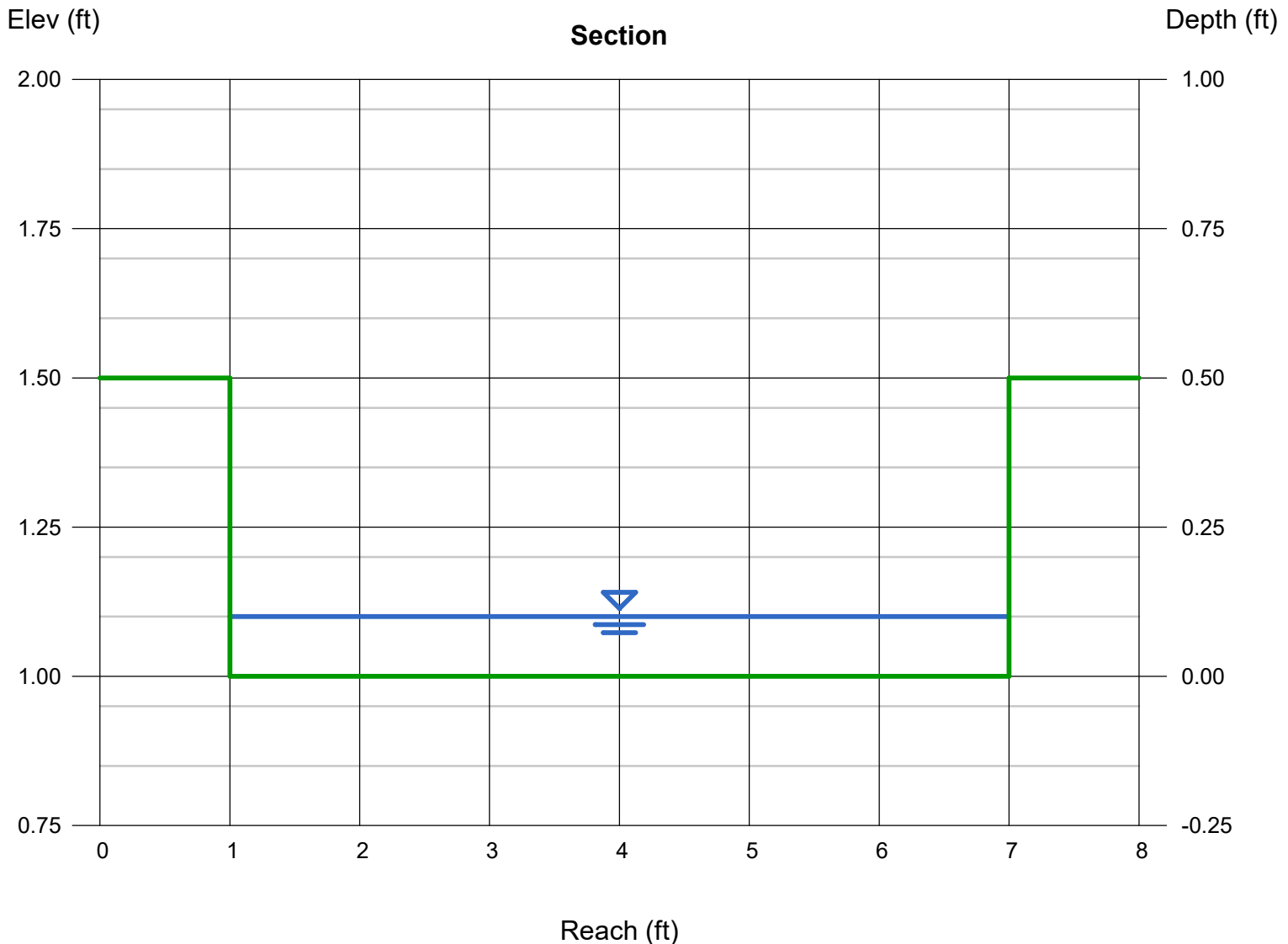

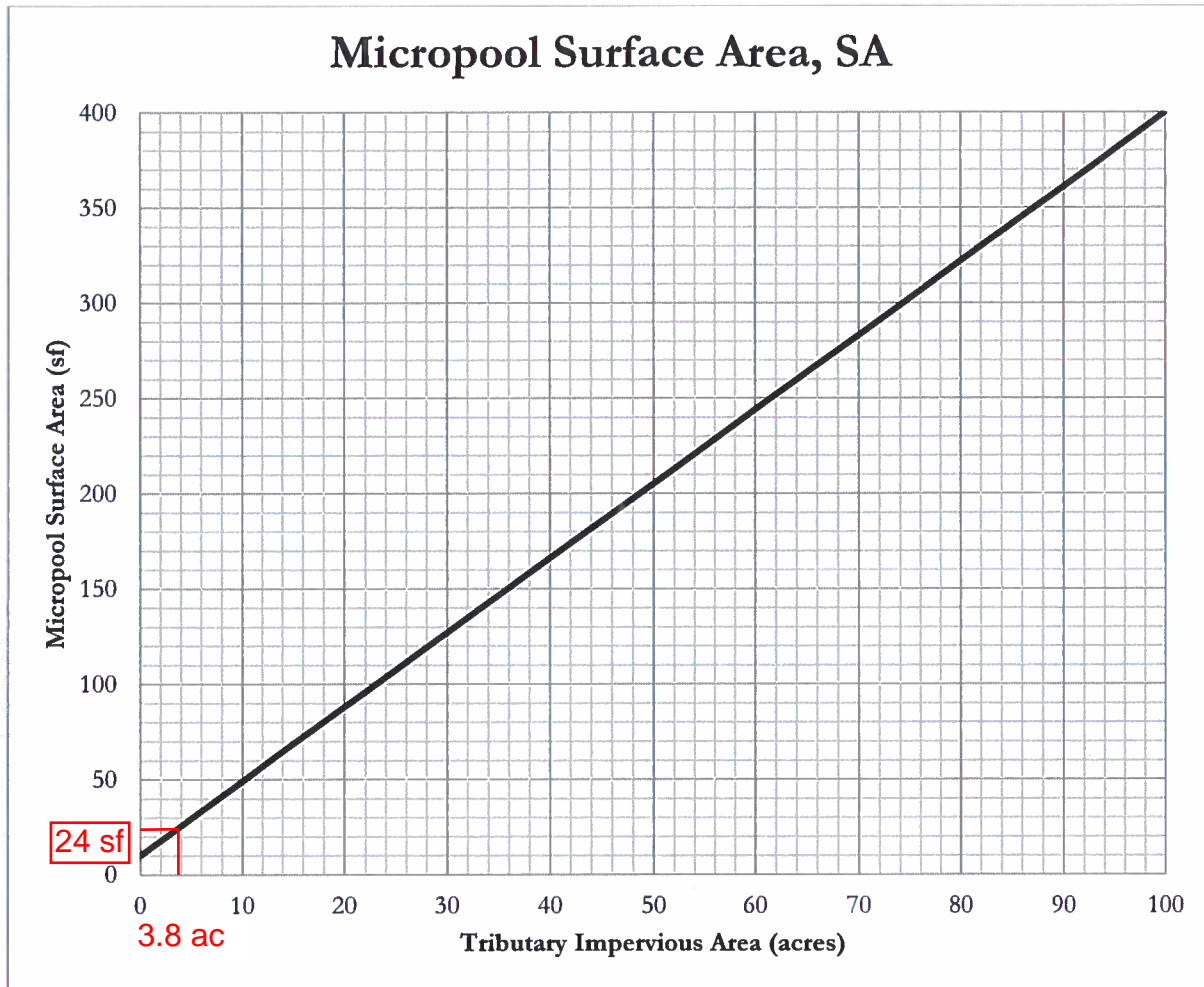

**Figure 1 – Micropool surface area (SA) determination chart**

The tributary impervious area is the effective number of impervious acres that will be treated by the extended detention basin (EDB). It is calculated by multiplying the tributary area to be treated by the impervious fraction of that area.

$$TIA = I \times A = (12.6/100) \times 30.29 \text{ ac} = 3.8 \text{ ac}$$

- TIA = Tributary impervious area (acres)
- I = Imperviousness (fraction)
- A = Tributary catchment area upstream (acres)

For EDBs with tributary impervious areas greater than 100 acres, the micropool surface area is 400 sf. The initial surcharge depth (ISD) is defined as the depth of the initial surcharge volume (ISV). The surface area determined using Figure 1 assumes an ISD of 4 inches. The initial surcharge volume is thus calculated by multiplying the micropool surface area by 4 inches.

$$ISV = SA \times 4 \text{ inches}$$

- ISV = Initial surcharge volume (cf)
- SA = Surface area (from Figure 1, sf)

**Figure 13-12c. Emergency Spillway Protection**

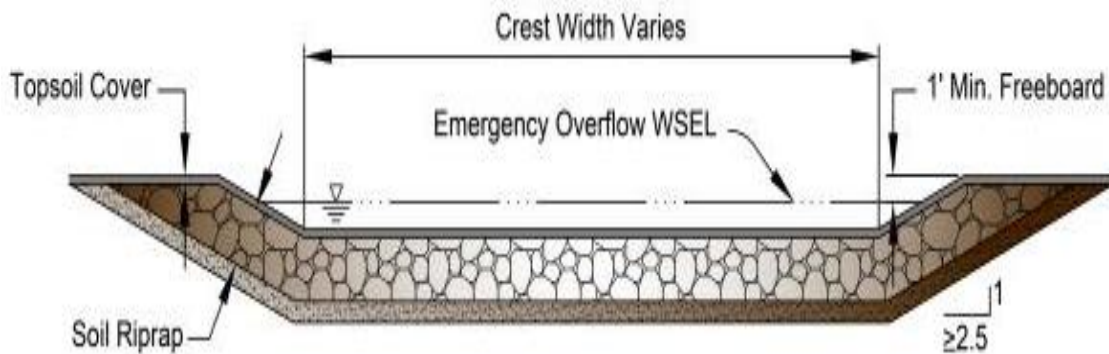

**Figure 13-12d. Riprap Types for Emergency Spillway Protection**

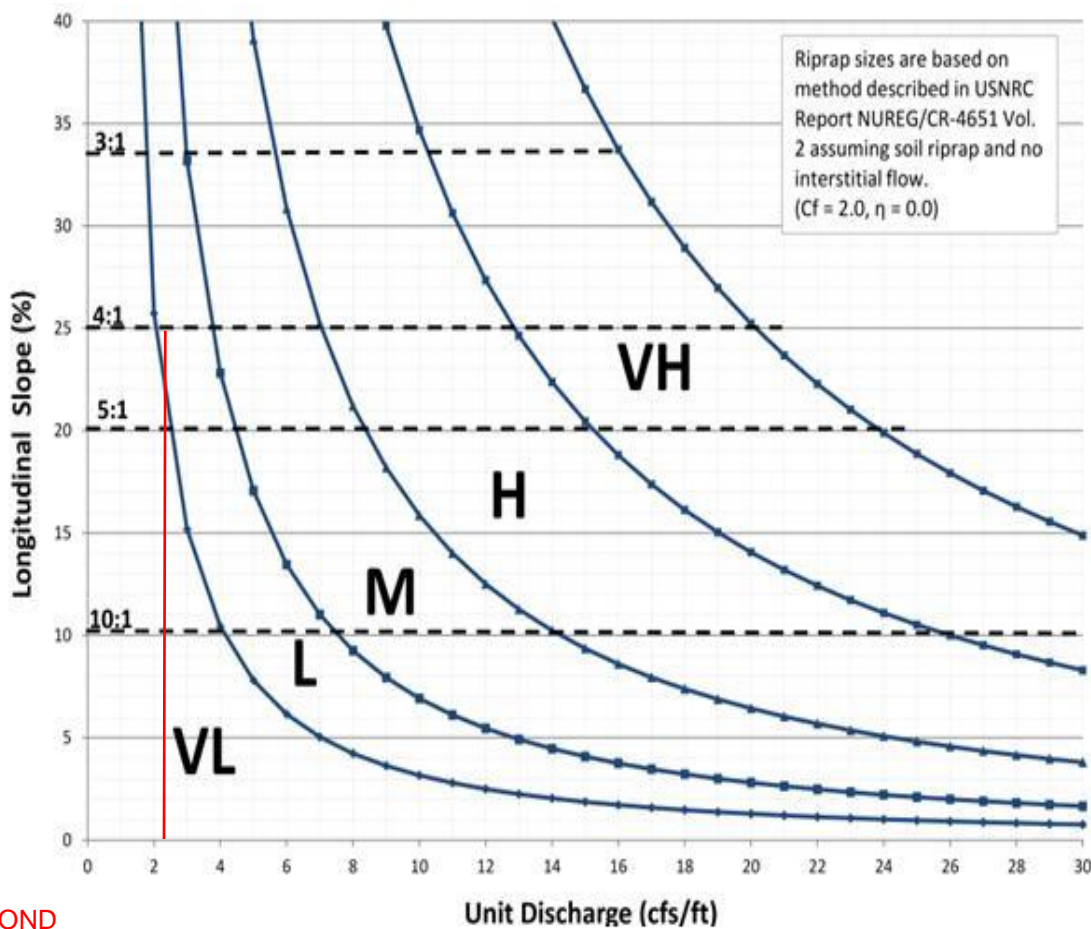

POND  
 UNIT DISCHARGE =  $42.8/20 = 2.14 \text{ cfs/ft}$





# DETENTION BASIN STAGE-STORAGE TABLE BUILDER

*MHFD-Detention, Version 4.06 (July 2022)*

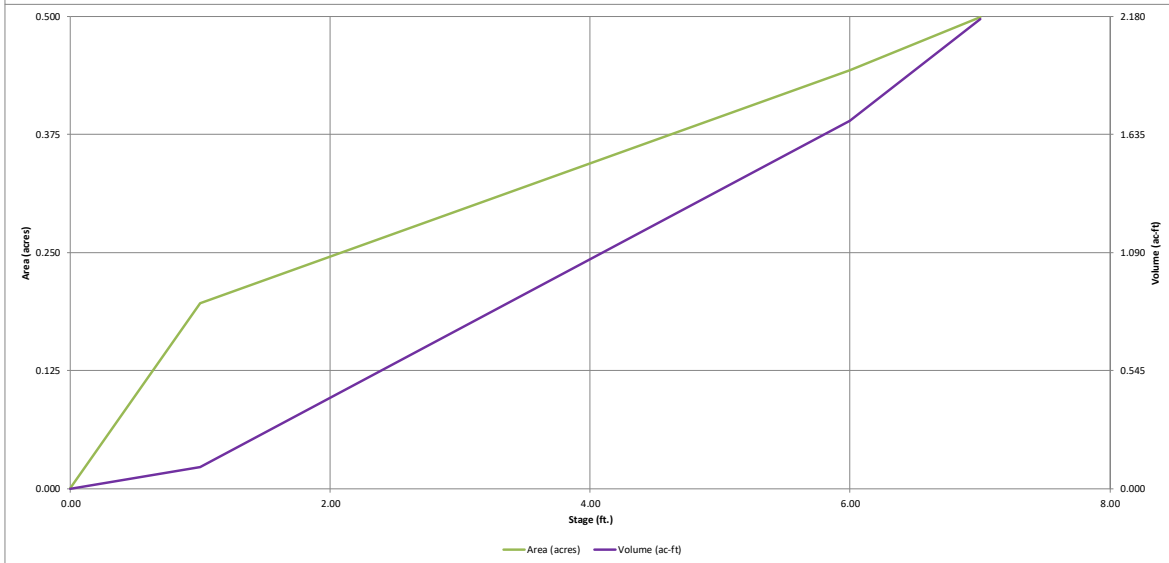
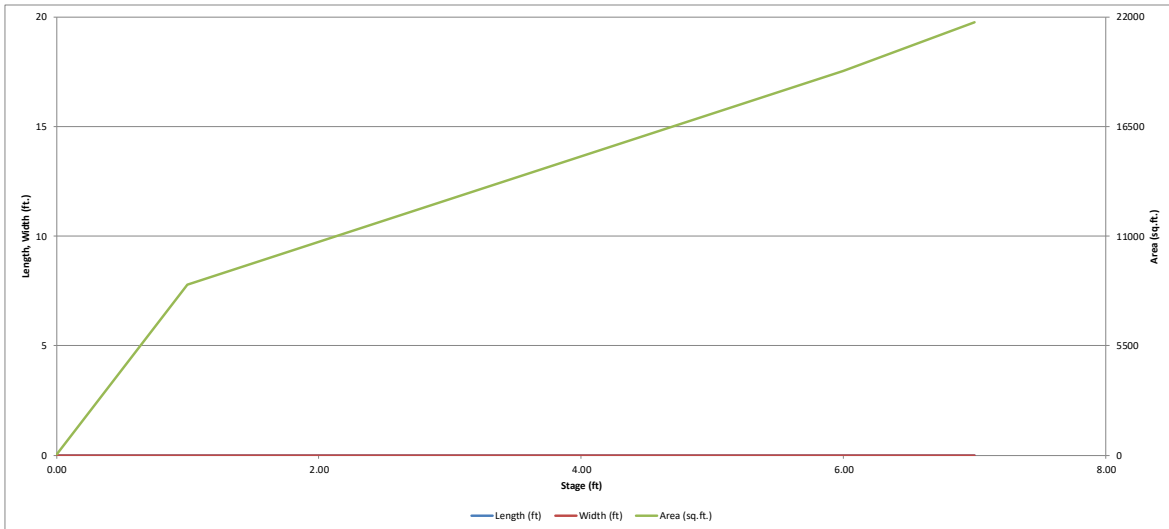

✓ = calcs match details in plans  
 ✗ = calcs do not match details in plans

## DETENTION BASIN OUTLET STRUCTURE DESIGN

MHFD-Detention, Version 4.06 (July 2022)

**Project:** Latigo Trails  
**Basin ID:** Pond G19

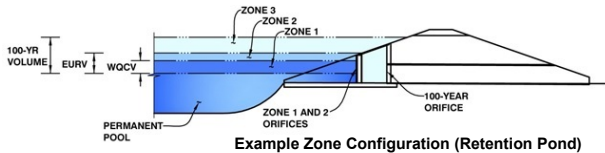

	Estimated Stage (ft)	Estimated Volume (ac-ft)	Outlet Type
Zone 1 (WQCV)	1.41	0.182	Orifice Plate
Zone 2 (EURV)	2.03	0.143	Orifice Plate
Zone 3 (100-year)	4.49	0.757	Weir&Pipe (Circular)
Total (all zones)	1.083		

**User Input:** Orifice at Underdrain Outlet (typically used to drain WQCV in a Filtration BMP)

Underdrain Orifice Invert Depth =	N/A	ft (distance below the filtration media surface)
Underdrain Orifice Diameter =	N/A	inches

Calculated Parameters for Underdrain		
Underdrain Orifice Area =	N/A	ft <sup>2</sup>
Underdrain Orifice Centroid =	N/A	feet

**User Input:** Orifice Plate with one or more orifices or Elliptical Slot Weir (typically used to drain WQCV and/or EURV in a sedimentation BMP)

Centroid of Lowest Orifice =	0.00	ft (relative to basin bottom at Stage = 0 ft)
Depth at top of Zone using Orifice Plate =	2.03 ✗	ft (relative to basin bottom at Stage = 0 ft)
Orifice Plate: Orifice Vertical Spacing =	N/A	inches
Orifice Plate: Orifice Area per Row =	1.83 ✓	sq. inches (diameter = 1-1/2 inches)

Calculated Parameters for Plate		
WQ Orifice Area per Row =	1.271E-02	ft <sup>2</sup>
Elliptical Half-Width =	N/A	feet
Elliptical Slot Centroid =	N/A	feet
Elliptical Slot Area =	N/A	ft <sup>2</sup>

**User Input:** Stage and Total Area of Each Orifice Row (numbered from lowest to highest)

	Row 1 (required)	Row 2 (optional)	Row 3 (optional)	Row 4 (optional)	Row 5 (optional)	Row 6 (optional)	Row 7 (optional)	Row 8 (optional)
Stage of Orifice Centroid (ft)	0.00 ✓	2.35 ✓						
Orifice Area (sq. inches)	1.83 ✓	1.83 ✓						

	Row 9 (optional)	Row 10 (optional)	Row 11 (optional)	Row 12 (optional)	Row 13 (optional)	Row 14 (optional)	Row 15 (optional)	Row 16 (optional)
Stage of Orifice Centroid (ft)								
Orifice Area (sq. inches)								

**User Input:** Vertical Orifice (Circular or Rectangular)

	Not Selected	Not Selected	
Invert of Vertical Orifice =	N/A	N/A	ft (relative to basin bottom at Stage = 0 ft)
Depth at top of Zone using Vertical Orifice =	N/A	N/A	ft (relative to basin bottom at Stage = 0 ft)
Vertical Orifice Diameter =	N/A	N/A	inches

Calculated Parameters for Vertical Orific		
Vertical Orifice Area =	N/A	N/A
Vertical Orifice Centroid =	N/A	N/A

**User Input:** Overflow Weir (Dropbox with Flat or Sloped Gate and Outlet Pipe OR Rectangular/Trapezoidal Weir and No Outlet Pipe)

	Zone 3 Weir	Not Selected	
Overflow Weir Front Edge Height, Ho =	3.75 ✓	N/A	ft (relative to basin bottom at Stage = 0 ft)
Overflow Weir Front Edge Length =	7.00 ✓	N/A	feet
Overflow Weir Gate Slope =	0.00	N/A	H:V
Horiz. Length of Weir Sides =	7.00 ✓	N/A	feet
Overflow Gate Type =	Type C Gate ✓	N/A	
Debris Clogging % =	50% ✓	N/A	%

Calculated Parameters for Overflow Weir		
Height of Gate Upper Edge, H <sub>t</sub> =	3.75	N/A
Overflow Weir Slope Length =	7.00	N/A
Gate Open Area / 100-yr Orifice Area =	4.82	N/A
Overflow Gate Open Area w/o Debris =	34.10	N/A
Overflow Gate Open Area w/ Debris =	17.05	N/A

**User Input:** Outlet Pipe w/ Flow Restriction Plate (Circular Orifice, Restrictor Plate, or Rectangular Orifice)

	Zone 3 Circular	Not Selected	
Depth to Invert of Outlet Pipe =	0.00 ✓	N/A	ft (distance below basin bottom at Stage = 0 ft)
Circular Orifice Diameter =	36.00 ✓	N/A	inches

Calculated Parameters for Outlet Pipe w/ Flow Restriction Plate		
Outlet Orifice Area =	7.07	N/A
Outlet Orifice Centroid =	1.50	N/A
Half-Central Angle of Restrictor Plate on Pipe =	N/A	N/A

**User Input:** Emergency Spillway (Rectangular or Trapezoidal)

Spillway Invert Stage =	4.75 ✗	ft (relative to basin bottom at Stage = 0 ft)
Spillway Crest Length =	25.00 ✗	feet
Spillway End Slopes =	4.00 ✗	H:V
Freeboard above Max Water Surface =	1.00	feet

Calculated Parameters for Spillway		
Spillway Design Flow Depth =	0.84	feet
Stage at Top of Freeboard =	6.59	feet
Basin Area at Top of Freeboard =	0.48	acres
Basin Volume at Top of Freeboard =	1.97	acre-ft

### Routed Hydrograph Results

The user can override the default CUHP hydrographs and runoff volumes by entering new values in the Inflow Hydrographs table (Columns W through AF)

	WQCV	EURV	2 Year	5 Year	10 Year	25 Year	50 Year	100 Year
Design Storm Return Period =	N/A	N/A	0.93	1.21	1.46	1.83	2.14	2.47
One-Hour Rainfall Depth (in)	0.182	0.326	0.172	0.394	0.748	1.703	2.341	3.213
CUHP Runoff Volume (acre-ft)	N/A	N/A	0.172	0.394	0.748	1.703	2.341	3.213
Inflow Hydrograph Volume (acre-ft)	N/A	N/A	0.3	2.7	7.6	20.5	28.3	37.7
CUHP Predevelopment Peak Q (cfs)	N/A	N/A	0.01	0.10	0.28	0.77	1.06	1.41
OPTIONAL Override Predevelopment Peak Q (cfs)	N/A	N/A	0.1	0.1	0.2	13.3	22.4	34.3
Predevelopment Unit Peak Flow, q (cfs/acre)	N/A	N/A	0.1	0.1	0.2	0.6	0.8	0.9
Peak Inflow Q (cfs)	N/A	N/A	2.3	5.5	10.5	23.5	31.5	41.0
Peak Outflow Q (cfs)	0.1	0.1	0.1	0.1	0.2	13.3	22.4	34.3
Ratio Peak Outflow to Predevelopment Q	N/A	N/A	N/A	0.0	0.0	0.6	0.8	0.9
Structure Controlling Flow	Plate	Plate	Plate	Plate	Plate	Overflow Weir 1	Overflow Weir 1	Overflow Weir 1
Max Velocity through Gate 1 (fps)	N/A	N/A	N/A	N/A	N/A	0.4	0.6	1.0
Max Velocity through Gate 2 (fps)	N/A	N/A	N/A	N/A	N/A	N/A	N/A	N/A
Time to Drain 97% of Inflow Volume (hours)	38	58	37	67	94	95	90	85
Time to Drain 99% of Inflow Volume (hours)	40	61	39	70	99	103	102	99
Maximum Ponding Depth (ft)	1.41	2.03	1.30	2.23	3.42	4.19	4.37	4.58
Area at Maximum Ponding Depth (acres)	0.22	0.25	0.21	0.26	0.32	0.35	0.36	0.37
Maximum Volume Stored (acre-ft)	0.183	0.327	0.158	0.375	0.716	0.973	1.041	1.115

# DETENTION BASIN OUTLET STRUCTURE DESIGN

*MHFD-Detention, Version 4.06 (July 2022)*

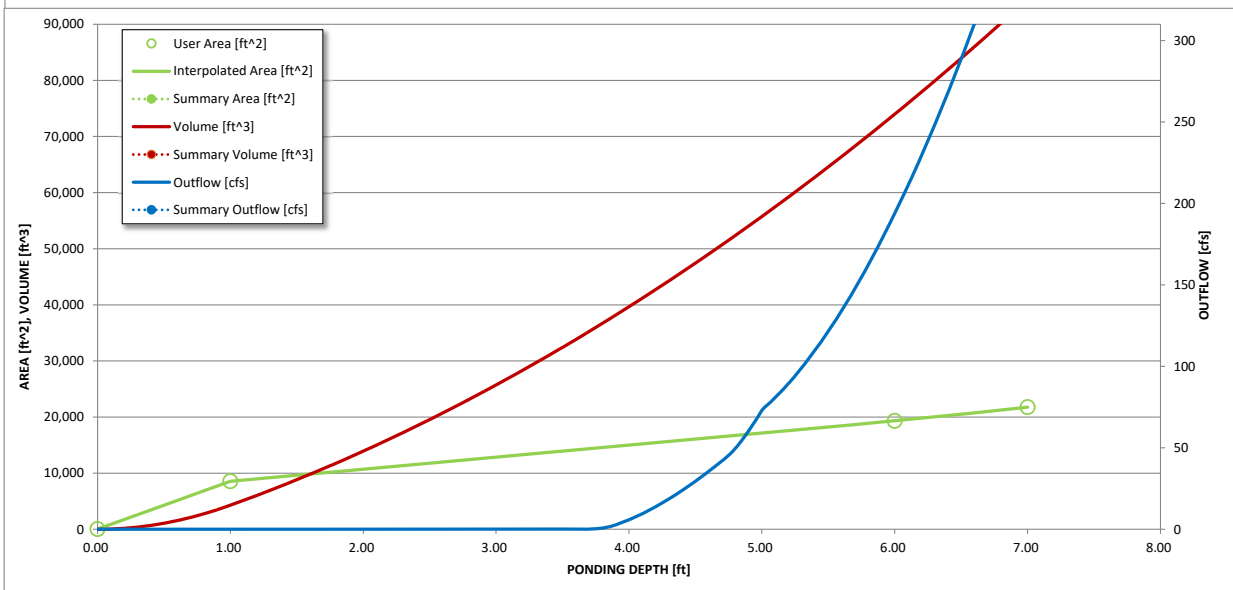
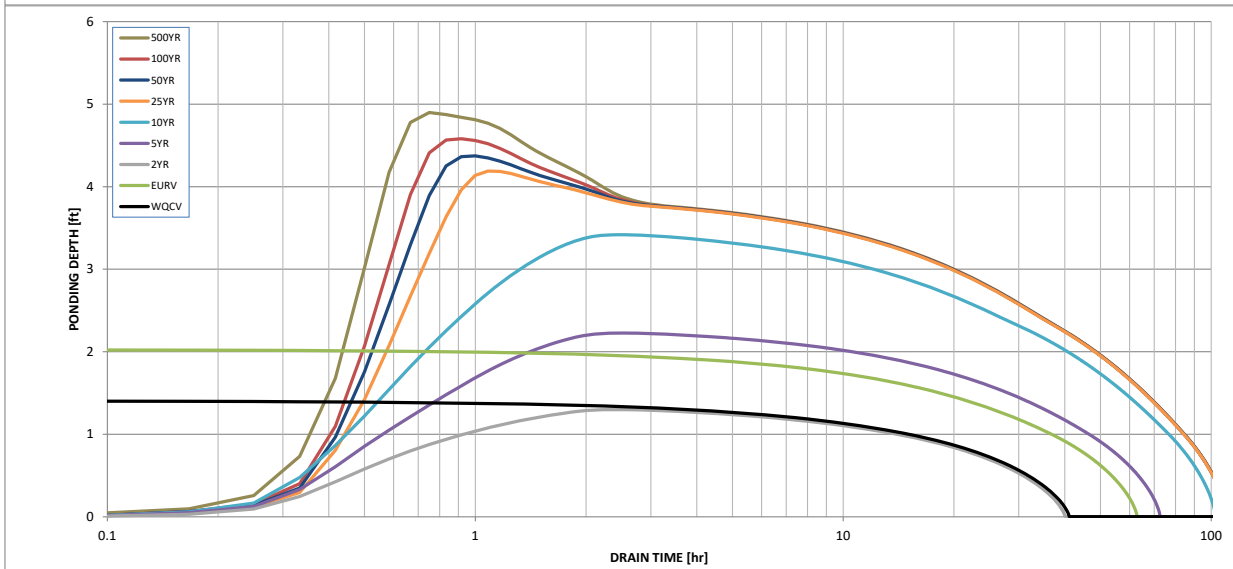
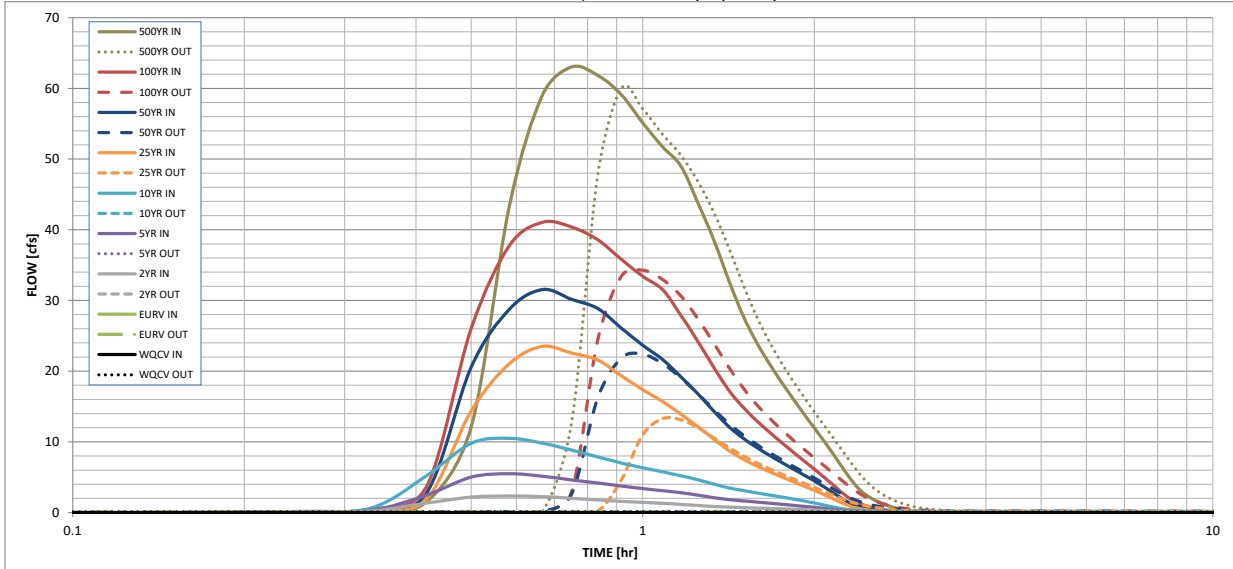

S-A-V-D Chart Axis Override	X-axis	Left Y-Axis	Right Y-Axis
minimum bound			
maximum bound			

# DETENTION BASIN OUTLET STRUCTURE DESIGN

*Outflow Hydrograph Workbook Filename:*

## Inflow Hydrographs

The user can override the calculated inflow hydrographs from this workbook with inflow hydrographs developed in a separate program.

Time Interval	SOURCE	CUHP	CUHP	CUHP	CUHP	CUHP	CUHP	CUHP	CUHP	CUHP
	TIME	WQCV [cfs]	EURV [cfs]	2 Year [cfs]	5 Year [cfs]	10 Year [cfs]	25 Year [cfs]	50 Year [cfs]	100 Year [cfs]	500 Year [cfs]
5.00 min	0:00:00	0.00	0.00	0.00	0.00	0.00	0.00	0.00	0.00	0.00
	0:05:00	0.00	0.00	0.00	0.00	0.00	0.00	0.00	0.00	0.00
	0:10:00	0.00	0.00	0.00	0.00	0.00	0.00	0.00	0.00	0.04
	0:15:00	0.00	0.00	0.04	0.09	0.13	0.10	0.14	0.14	0.23
	0:20:00	0.00	0.00	0.23	0.32	0.62	0.28	0.35	0.46	1.46
	0:25:00	0.00	0.00	1.32	2.44	5.15	1.85	2.67	3.57	12.11
	0:30:00	0.00	0.00	2.18	5.02	9.80	14.37	20.57	26.03	43.29
	0:35:00	0.00	0.00	2.34	5.50	10.49	21.04	28.73	37.73	59.03
	0:40:00	0.00	0.00	2.26	5.14	9.82	23.51	31.54	41.05	63.02
	0:45:00	0.00	0.00	2.01	4.61	8.83	22.55	30.16	40.38	61.86
	0:50:00	0.00	0.00	1.78	4.18	7.87	21.58	28.88	38.59	59.11
	0:55:00	0.00	0.00	1.59	3.74	7.01	19.35	26.09	35.81	55.13
	1:00:00	0.00	0.00	1.44	3.39	6.34	17.37	23.66	33.41	51.73
	1:05:00	0.00	0.00	1.31	3.09	5.76	15.72	21.64	31.53	49.00
	1:10:00	0.00	0.00	1.15	2.80	5.19	13.90	19.19	27.88	43.79
	1:15:00	0.00	0.00	1.00	2.46	4.63	12.14	16.78	24.19	38.52
	1:20:00	0.00	0.00	0.86	2.11	4.02	10.36	14.32	20.49	32.76
	1:25:00	0.00	0.00	0.76	1.83	3.49	8.76	12.13	17.25	27.82
	1:30:00	0.00	0.00	0.69	1.65	3.11	7.55	10.51	14.88	24.08
	1:35:00	0.00	0.00	0.63	1.49	2.78	6.59	9.22	13.01	21.10
	1:40:00	0.00	0.00	0.58	1.33	2.48	5.79	8.12	11.39	18.49
	1:45:00	0.00	0.00	0.53	1.17	2.20	5.06	7.11	9.93	16.14
	1:50:00	0.00	0.00	0.47	1.02	1.92	4.40	6.20	8.59	13.97
	1:55:00	0.00	0.00	0.41	0.88	1.64	3.76	5.31	7.32	11.94
	2:00:00	0.00	0.00	0.35	0.73	1.35	3.14	4.47	6.14	10.03
	2:05:00	0.00	0.00	0.27	0.58	1.04	2.51	3.58	4.95	8.07
	2:10:00	0.00	0.00	0.20	0.42	0.75	1.88	2.70	3.77	6.14
	2:15:00	0.00	0.00	0.14	0.29	0.51	1.28	1.86	2.63	4.37
	2:20:00	0.00	0.00	0.11	0.20	0.36	0.79	1.20	1.74	3.03
	2:25:00	0.00	0.00	0.08	0.16	0.28	0.51	0.82	1.18	2.15
	2:30:00	0.00	0.00	0.07	0.13	0.23	0.34	0.57	0.82	1.54
	2:35:00	0.00	0.00	0.06	0.10	0.18	0.23	0.40	0.55	1.09
	2:40:00	0.00	0.00	0.04	0.08	0.14	0.16	0.28	0.36	0.75
	2:45:00	0.00	0.00	0.04	0.06	0.11	0.11	0.20	0.22	0.49
	2:50:00	0.00	0.00	0.03	0.05	0.08	0.08	0.14	0.13	0.32
	2:55:00	0.00	0.00	0.02	0.04	0.06	0.05	0.10	0.09	0.21
	3:00:00	0.00	0.00	0.02	0.03	0.05	0.04	0.08	0.07	0.16
	3:05:00	0.00	0.00	0.02	0.02	0.03	0.03	0.06	0.05	0.12
	3:10:00	0.00	0.00	0.01	0.02	0.03	0.02	0.04	0.04	0.10
	3:15:00	0.00	0.00	0.01	0.01	0.02	0.02	0.03	0.03	0.07
	3:20:00	0.00	0.00	0.01	0.01	0.01	0.01	0.02	0.02	0.06
	3:25:00	0.00	0.00	0.00	0.01	0.01	0.01	0.02	0.02	0.04
	3:30:00	0.00	0.00	0.00	0.00	0.01	0.01	0.01	0.01	0.02
	3:35:00	0.00	0.00	0.00	0.00	0.00	0.00	0.01	0.01	0.01
	3:40:00	0.00	0.00	0.00	0.00	0.00	0.00	0.00	0.00	0.01
	3:45:00	0.00	0.00	0.00	0.00	0.00	0.00	0.00	0.00	0.00
	3:50:00	0.00	0.00	0.00	0.00	0.00	0.00	0.00	0.00	0.00
	3:55:00	0.00	0.00	0.00	0.00	0.00	0.00	0.00	0.00	0.00
	4:00:00	0.00	0.00	0.00	0.00	0.00	0.00	0.00	0.00	0.00
	4:05:00	0.00	0.00	0.00	0.00	0.00	0.00	0.00	0.00	0.00
	4:10:00	0.00	0.00	0.00	0.00	0.00	0.00	0.00	0.00	0.00
	4:15:00	0.00	0.00	0.00	0.00	0.00	0.00	0.00	0.00	0.00
	4:20:00	0.00	0.00	0.00	0.00	0.00	0.00	0.00	0.00	0.00
	4:25:00	0.00	0.00	0.00	0.00	0.00	0.00	0.00	0.00	0.00
	4:30:00	0.00	0.00	0.00	0.00	0.00	0.00	0.00	0.00	0.00
	4:35:00	0.00	0.00	0.00	0.00	0.00	0.00	0.00	0.00	0.00
	4:40:00	0.00	0.00	0.00	0.00	0.00	0.00	0.00	0.00	0.00
	4:45:00	0.00	0.00	0.00	0.00	0.00	0.00	0.00	0.00	0.00
	4:50:00	0.00	0.00	0.00	0.00	0.00	0.00	0.00	0.00	0.00
	4:55:00	0.00	0.00	0.00	0.00	0.00	0.00	0.00	0.00	0.00
	5:00:00	0.00	0.00	0.00	0.00	0.00	0.00	0.00	0.00	0.00
	5:05:00	0.00	0.00	0.00	0.00	0.00	0.00	0.00	0.00	0.00
	5:10:00	0.00	0.00	0.00	0.00	0.00	0.00	0.00	0.00	0.00
	5:15:00	0.00	0.00	0.00	0.00	0.00	0.00	0.00	0.00	0.00
	5:20:00	0.00	0.00	0.00	0.00	0.00	0.00	0.00	0.00	0.00
	5:25:00	0.00	0.00	0.00	0.00	0.00	0.00	0.00	0.00	0.00
	5:30:00	0.00	0.00	0.00	0.00	0.00	0.00	0.00	0.00	0.00
	5:35:00	0.00	0.00	0.00	0.00	0.00	0.00	0.00	0.00	0.00
	5:40:00	0.00	0.00	0.00	0.00	0.00	0.00	0.00	0.00	0.00
	5:45:00	0.00	0.00	0.00	0.00	0.00	0.00	0.00	0.00	0.00
	5:50:00	0.00	0.00	0.00	0.00	0.00	0.00	0.00	0.00	0.00
	5:55:00	0.00	0.00	0.00	0.00	0.00	0.00	0.00	0.00	0.00
	6:00:00	0.00	0.00	0.00	0.00	0.00	0.00	0.00	0.00	0.00



POND G19 LOW-TAILWATER BASIN

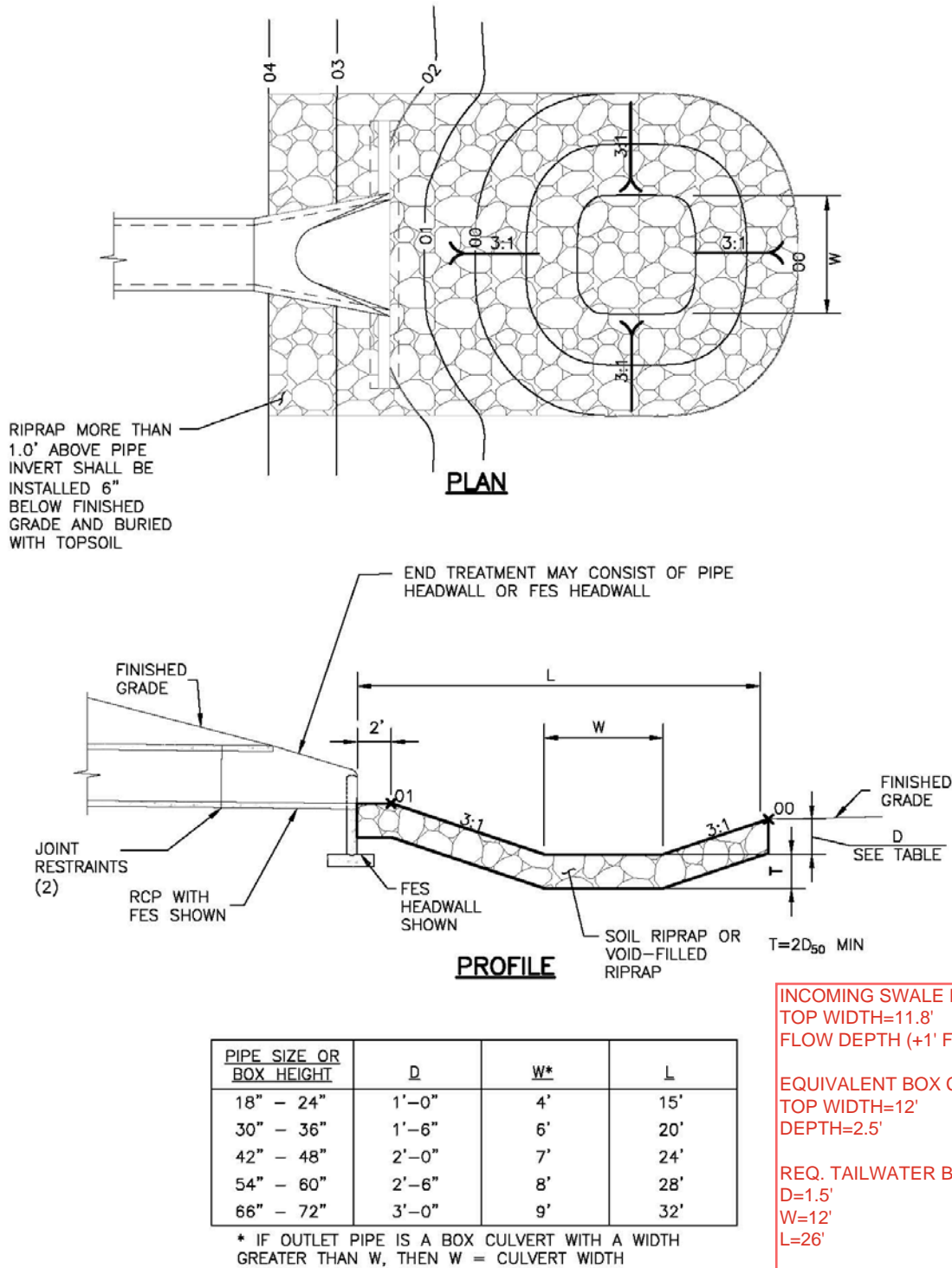

Figure 9-37. Low tailwater riprap basin

DP25A Q100=42.9cfs, W=12',  
H=2.5'

$Q/WH^{1.5}=0.9 < 8.0$  chart ok to use

$Q/WH^{0.5}=2.26$

$Y_t=0.4H=1.0$  ft  
 $Y_t/H=0.4$  ft

**TYPE L RIPRAP REQUIRED**

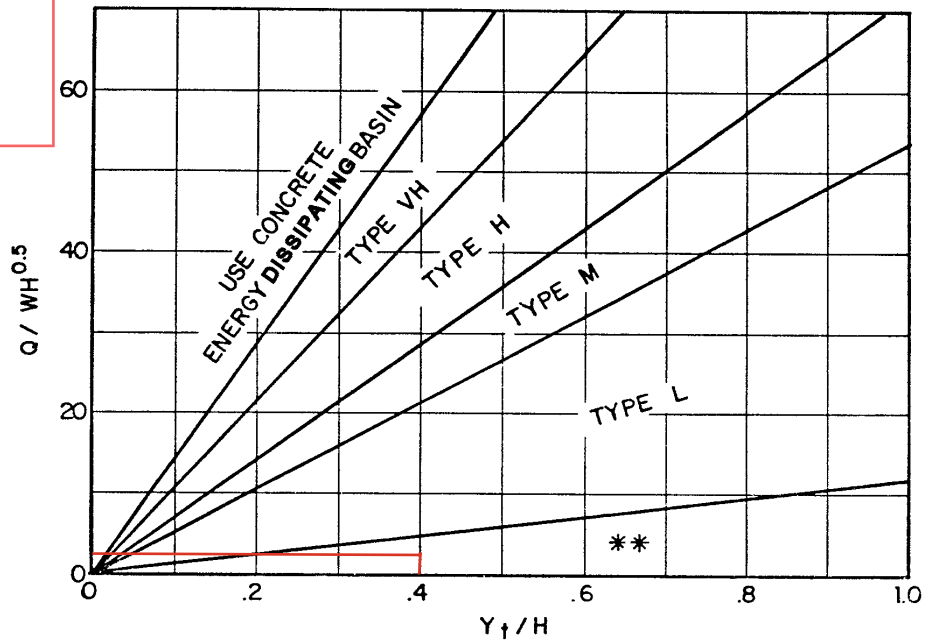

Use  $H_d$  instead of H whenever culvert has supercritical flow in the barrel.  
 \*\*Use Type L for a distance of  $3H$  downstream.

**Figure 9-39. Riprap erosion protection at rectangular conduit outlet (valid for  $Q/WH^{1.5} \leq 8.0$ )**

### 3.2.4 Outfalls and Rundowns

A grouted boulder outfall or “rundown” dissipates energy and provides erosion control protection. Grouted boulder outfalls are most commonly used in large rivers like the South Platte. Figure 9-40 provides a plan view and cross section for a standard grouted boulder rundown. See the grouted boulder drop profiles (A1, A2, and A3) in Figure 9-12 for site specific profile options, (i.e., depressed or free-draining basin for use with a stable downstream channel or with no basin for use in channels subject to degradation). Figure 9-41 provides a plan view of the same structure for use when the structure is in-line with the channel. Evaluate the following when designing a grouted boulder outfall or rundown:

- Minimize disturbance to channel bank
- Determine water surface elevation in receiving channel for base flow and design storm(s)
- Determine flow rate, velocity, depth, etc. of flow exiting the outfall pipe for the design storm(s)
- Evaluate permitting procedures and requirements for construction adjacent to large river system.



# Channel Report **Pond G19**

## <Name>

### Rectangular

Bottom Width (ft) = 6.00

Total Depth (ft) = 0.50

Invert Elev (ft) = 1.00

Slope (%) = 0.50

N-Value = 0.012

### Highlighted

Depth (ft) = 0.10

Q (cfs) = 1.100

Area (sqft) = 0.60

Velocity (ft/s) = 1.83

Wetted Perim (ft) = 6.20

Crit Depth, Yc (ft) = 0.11

Top Width (ft) = 6.00

EGL (ft) = 0.15

### Calculations

Compute by:

Known Q

Known Q (cfs) = 1.10 **55.3 cfs x 2%**

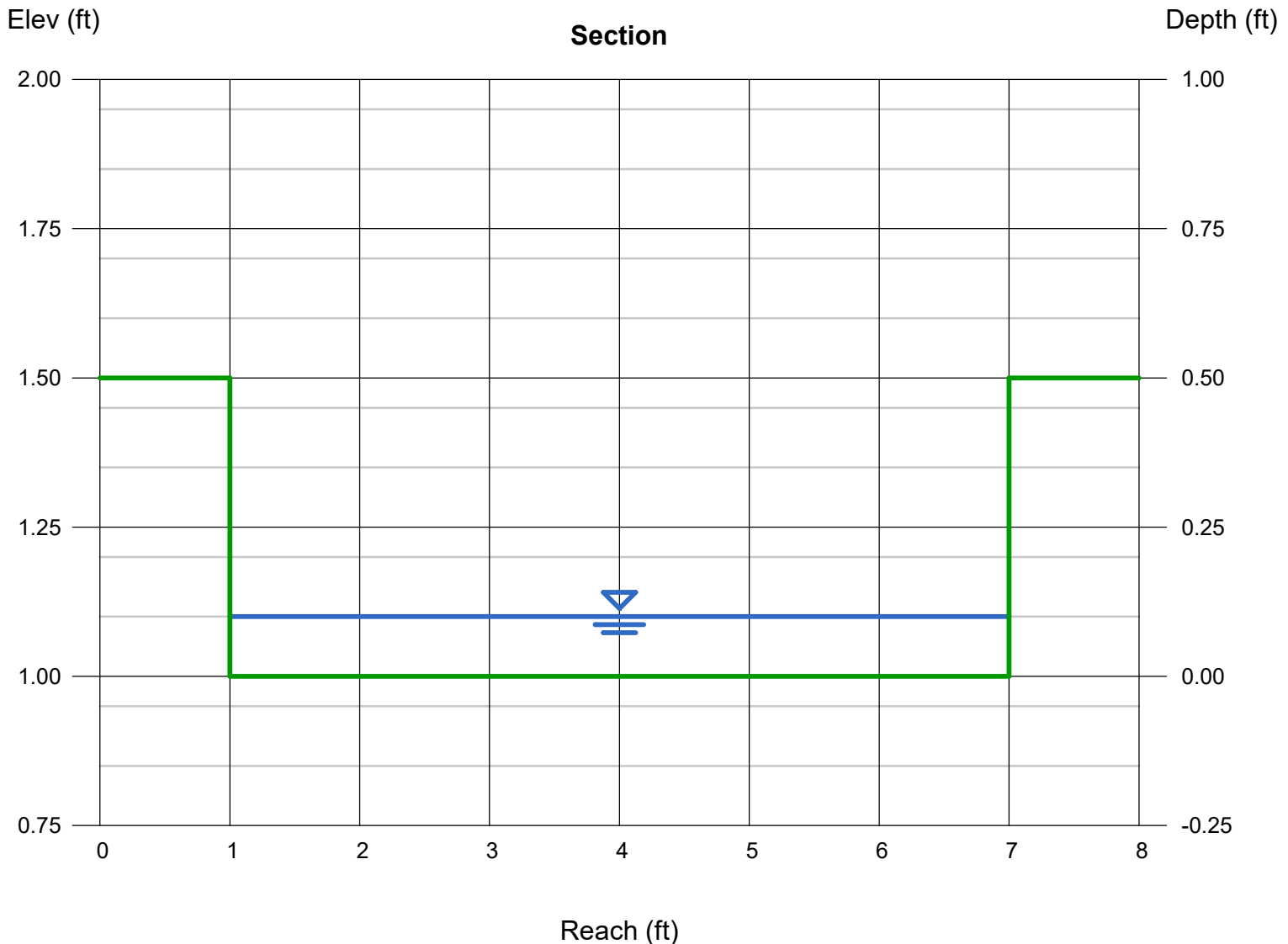

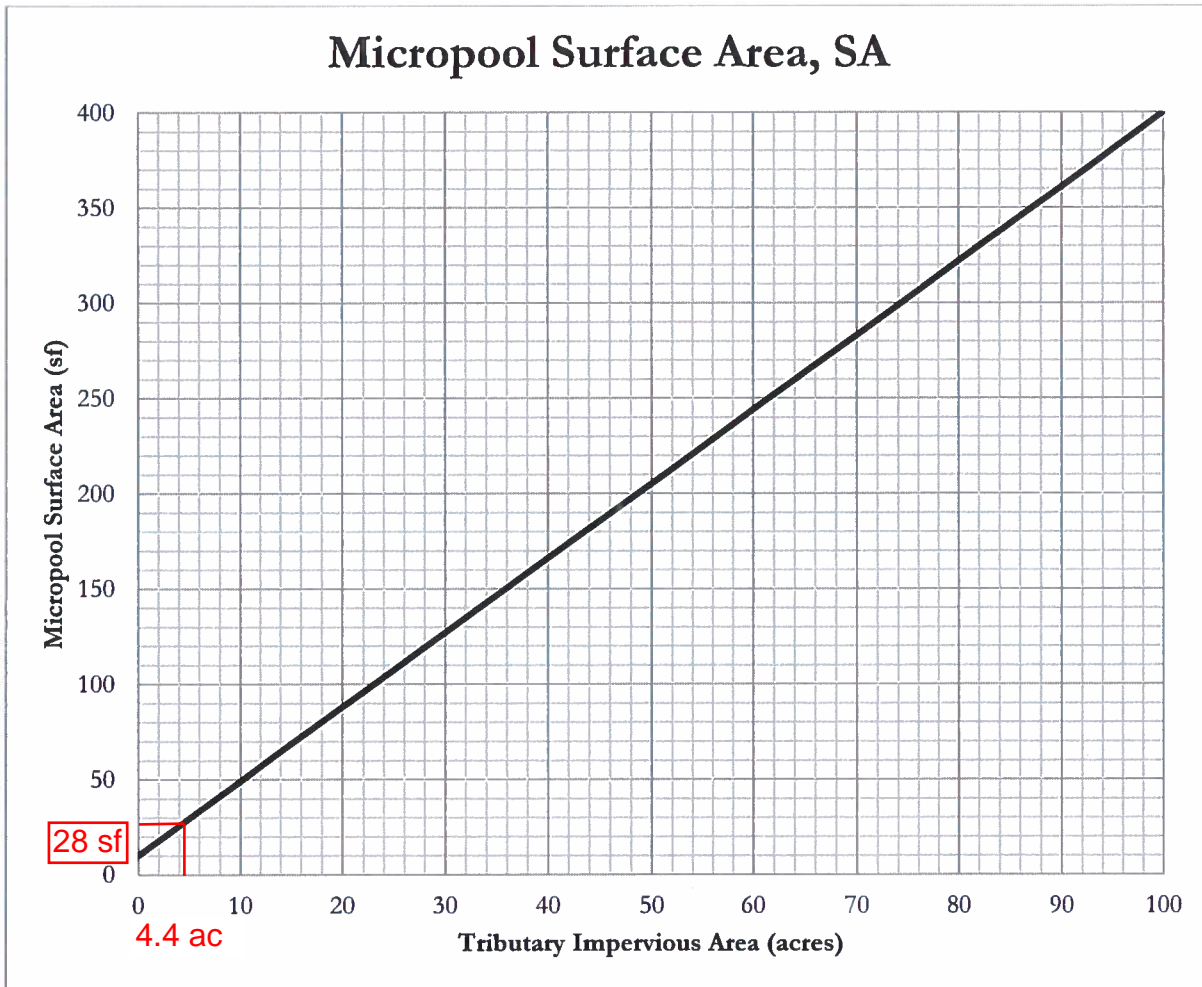

**Figure 1 – Micropool surface area (SA) determination chart**

The tributary impervious area is the effective number of impervious acres that will be treated by the extended detention basin (EDB). It is calculated by multiplying the tributary area to be treated by the impervious fraction of that area.

$$TIA = I \times A = (11.6/100) \times 37.67 \text{ ac} = 4.4 \text{ ac}$$

- TIA = Tributary impervious area (acres)
- I = Imperviousness (fraction)
- A = Tributary catchment area upstream (acres)

For EDBs with tributary impervious areas greater than 100 acres, the micropool surface area is 400 sf. The initial surcharge depth (ISD) is defined as the depth of the initial surcharge volume (ISV). The surface area determined using Figure 1 assumes an ISD of 4 inches. The initial surcharge volume is thus calculated by multiplying the micropool surface area by 4 inches.

$$ISV = SA \times 4 \text{ inches}$$

- ISV = Initial surcharge volume (cf)
- SA = Surface area (from Figure 1, sf)

**Figure 13-12c. Emergency Spillway Protection**

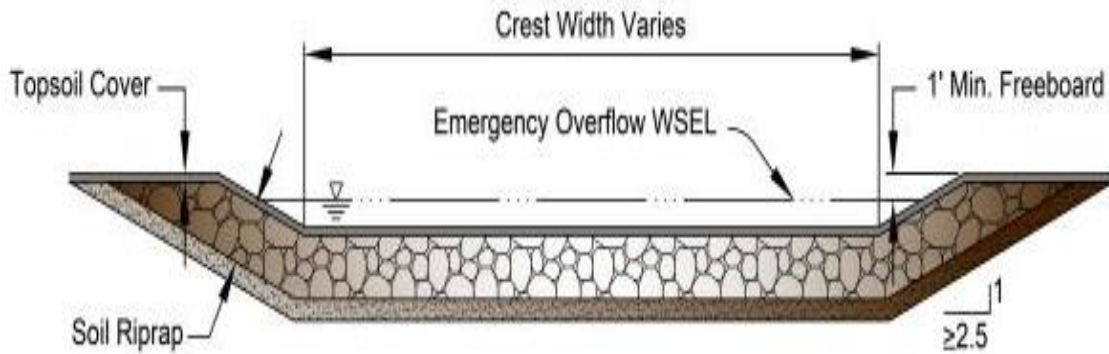

**Figure 13-12d. Riprap Types for Emergency Spillway Protection**

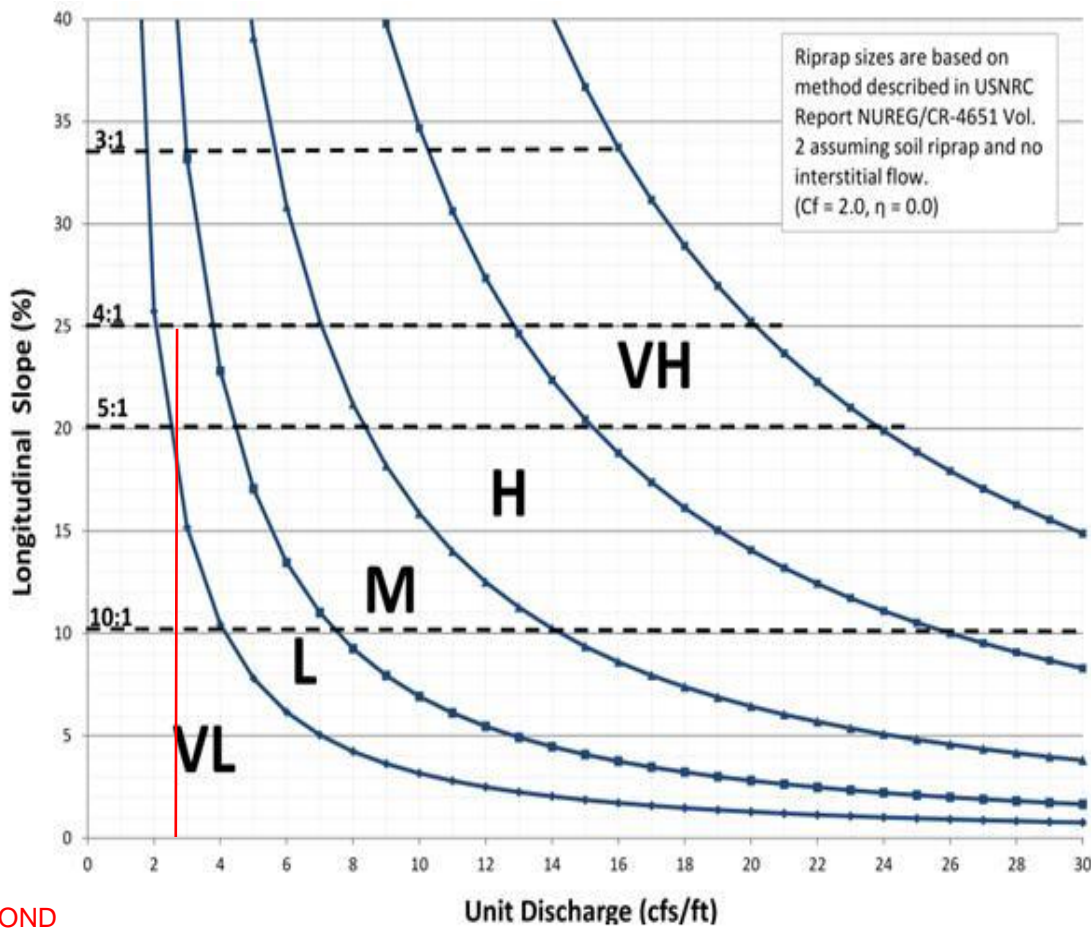

POND  
 UNIT DISCHARGE =  $66.9/25 = 2.68 \text{ cfs/ft}$



**MASTER DEVELOPMENT /  
PRELIMINARY DRAINAGE PLAN  
LATIGO TRAILS  
EL PASO COUNTY, COLORADO**

October 4, 2001

Prepared for:

**RMBG, LLC #2  
5170 Mark Dabling Blvd.  
COLORADO SPRINGS, CO 80918**

PREPARED BY:

**URS**

9960 Federal Drive, Suite 300  
Colorado Springs, CO 80921

URS PROJECT NO. 67-00042443

MDDP EXCERPT

Four sub-basins, varying from 3 to 53 acres, lie north of Latigo Blvd, draining mainly to the east, with excess runoff ponding at Eastonville Road and eventually overtopping it. One of these basins (9.71) drains directly to Upper Black Squirrel Creek. There is a Zone-A, unstudied FEMA floodplain to the north of the proposed development, in the open space / Upper Black Squirrel Creek area.

#### *Gieck Ranch Basin*

The Gieck Ranch Basin covers the southern half of the subject area. Runoff is generally southeasterly, draining to Meridian Ranch to the south, and crossing Eastonville Road at three points to the east. As with the Upper Black Squirrel Creek Basin, many of the existing drainageways (mainly to the south) are not clearly defined.

The major drainage course begins at the west-central portion of the site, traversing the Gieck Ranch Basin to design point G11 to the southeast. Six sub-basins, varying from 19 to 39 acres, contribute to this drainage course, which collects approximately 65% of the runoff generated within the Gieck Basin in Latigo Trails. To the west of this, eight sub-basins drain to five design points along the Meridian Ranch boundary, two of which (G5 and G6) combine shortly after entering Meridian Ranch, at G6b.

There are eight small sub-basins east of the major drainage course, varying from 2 to 41 acres. All but one drain at their own design point, either crossing Eastonville Road or onto Meridian Ranch. The three culverts crossing Eastonville Road include an 18" CMP, a 30" CMP, and a 42"x28" Arch CMP. The 30" CMP has the capacity for 31 cfs, which is inadequate for existing flows. The other two pipes are adequate for existing and developed flows. The drainageways entering Meridian Ranch are not very well defined.

Four stock ponds exist on the site, but are assumed to be full at the beginning of a storm as part of this analysis. If the ponds were empty, flows at G2 may be reduced by about 30 cfs, flows at G10 and G11 may be reduced by about 34 cfs, flows at G13 may be reduced by about 23 cfs, and flows at B1, B2 and B3 may be reduced by about 45 cfs (for flows up to 100-year storm estimates).

See Tables 3 and 4 for flow calculations at specific design points and further comments.

Table 4 - Design Points

THE TRAILS MDDP  
 HYDROLOGY OUTPUT: DESIGN POINTS  
 URS Job No. 6742443

DESIGN FLOWS (cfs)										
DESIGN POINT		Basin	EXISTING		DEVELOPED-BASE			DEVELOPED-DETN		
DP			5-YR	100-YR	Method	5-YR**	100-YR	Area*	5-YR	100-YR
GIECKIRANCH BASIN TRMEGxxx.OUT TRMDGxxx.OUT										
G1	B	3.12	15	38	rat	21	48	20.3		
G2	B	+	22	55		21	50	25.3		
V1	D	2.62			scs	20	34	12.6		
V2	D	2.72			scs	5	11	4.8		
V3	D	3.22			rat	8	19	8.6		
G3	E	2.61	14	34						
G4/V4	B	+	24	95		57	121	61.8	48	108
V5	D	2.52			scs	4	11	4.3		
V6	D	5.12			scs	8	15	8.6		
G5	B	+	24	107		68	156	81.1	58	137
V7	D	5.22			rat	11	25	11.8		
G6	B	+	4	20		17	35	18.2		
G6b	B	+	28	122		83	191	99.3	75	145
V10	D	2.12			scs	12	29	13.3		
V9N	D	+				43	92	44.1		
V9	D	+				50	103	48.4		
G7	E	2.21	18	44						
V11	D	2.34				4	11	4.9		
V12	B	+	7	34		20	41	17.9	20	35
G8/V14	B	+	17	75		63	134	72.1		
V15	D	6.42			scs	6	12	5.7		
V15b						25	52	23.5	10	45
V16	D	6.44			scs	2	4	2.1		
V17	D	6.46			scs	2	4	2.0		
DA5						84	182	107.9	80	170
DA6						107	240	117.9	90	165
G10/V19	B	+	38	184		123	282	140.9	107	207
G11a	B	+	43	208		123	282	147.4	107	207
V20	D	6.62				6	13	6.7		
G11b						17	33	13.3		
V13	D	6.22			rat	11	26	12.3		
G12	B	6.24	18	44	rat	18	43	19.9		
V21	D	4.32			rat	11	26	12.5	5	15
G13	B	+	10	24		13	31	15.5	7	20
V22	D	4.42			rat	4	9	3.7		
V23	D	4.52			rat	9	22	10.3		
V24	D	+				17	39	18.8	15	25
G14a			6	15		7	17	7.5		
G14b	B	+	13	31		18	42	20.5	16	28
G15	B	+	29	70		40	92	48.5	38	78
G16	B	4.82	2	5	rat	3	6	2.4		
G17a	D	4.94				1	3	0.9		
G17b	B	+	3	6		3	7	2.3		
V25	D	4.64				3	7	2.9		
V26	D	4.62			rat	5	12	5.2		
G18	B	+	18	42		21	49	24.6	18	40
V27	D	4.72				26	60	21.0		
G19	B	+	28	67		37	86	37.2	28	65

\*Area in acres

\*\*If SCS, multiplied by 1.67 (Average correlation SCS/Rational calculation) (5-year flows only)

# LATIGO TRAILS PRELIMINARY DRAINAGE PLAN

IN SECTIONS 8, 9, 16 & 17, T12S, R64W OF THE 6TH P.M.  
EL PASO COUNTY, COLORADO

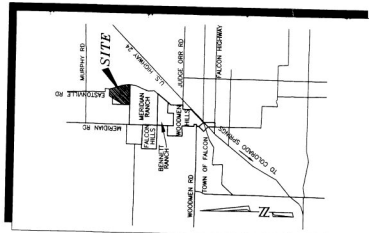
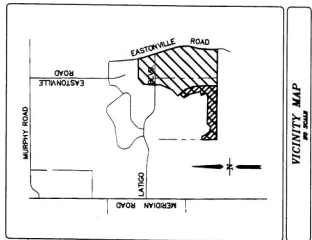

Design Point	Q <sub>a</sub> (CFS)	Q <sub>b</sub> (CFS)	Q <sub>c</sub> (CFS)	Q <sub>d</sub> (CFS)
V1	20	8	18	34
V2	8	18	18	18
V3	22	7.4	4.0	31
V4	4	4	4	11
V5	8	15	15	15
V6	8	4.5	52	64.5
V7	12	12	29	51
V8	4	4	11	15
V9	20	20	41	61
V10	6.3	6.3	13.4	19.7

Design Point	Q <sub>a</sub> (CFS)	Q <sub>b</sub> (CFS)	Q <sub>c</sub> (CFS)	Q <sub>d</sub> (CFS)
G1	21	21	48	69
G2	21	50	71	92
G3	17	17	35	52
G4	8.5	8.5	19.1	27.6

- NOTES:
- 1) EASEMENTS: All lot lines and boundaries will be plotted with easements for utility, drainage and easements purposes (not shown). The Homeowners' ponds and drainage easements.
  - 2) CHANNEL DESIGN: The pipes shown with 4:1 slopes. Natural channels will be utilized, undisturbed, where possible. See Drainage Report Table 8 for specific channel design details.
  - 3) CULVERT DESIGN: USE OF R509 depends on location and size. See Drainage Report Table 7 for preliminary sizes.

- ADJOINING PROPERTY OWNERS
- | PARCEL NO.      | OWNER                            |
|-----------------|----------------------------------|
| DD 40000-00-383 | LEE, WILLIAM & PATRICIA ET AL    |
| EE 40000-00-86  | C/O FOUR WAY RANCH               |
| FF 40000-00-79  | LATIGO INVESTMENTS, LP           |
| GG 40000-00-78  | MERIDIAN RANCH INVESTMENTS, INC. |
| JJ 40000-00-84  | BOLAND, WALTER & LEAH            |
| KK 40000-00-208 | LEON, JOSE & MARGARITA           |
| LL 40000-00-201 |                                  |

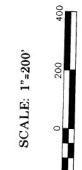
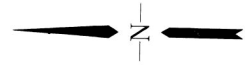
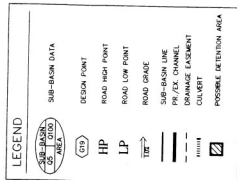
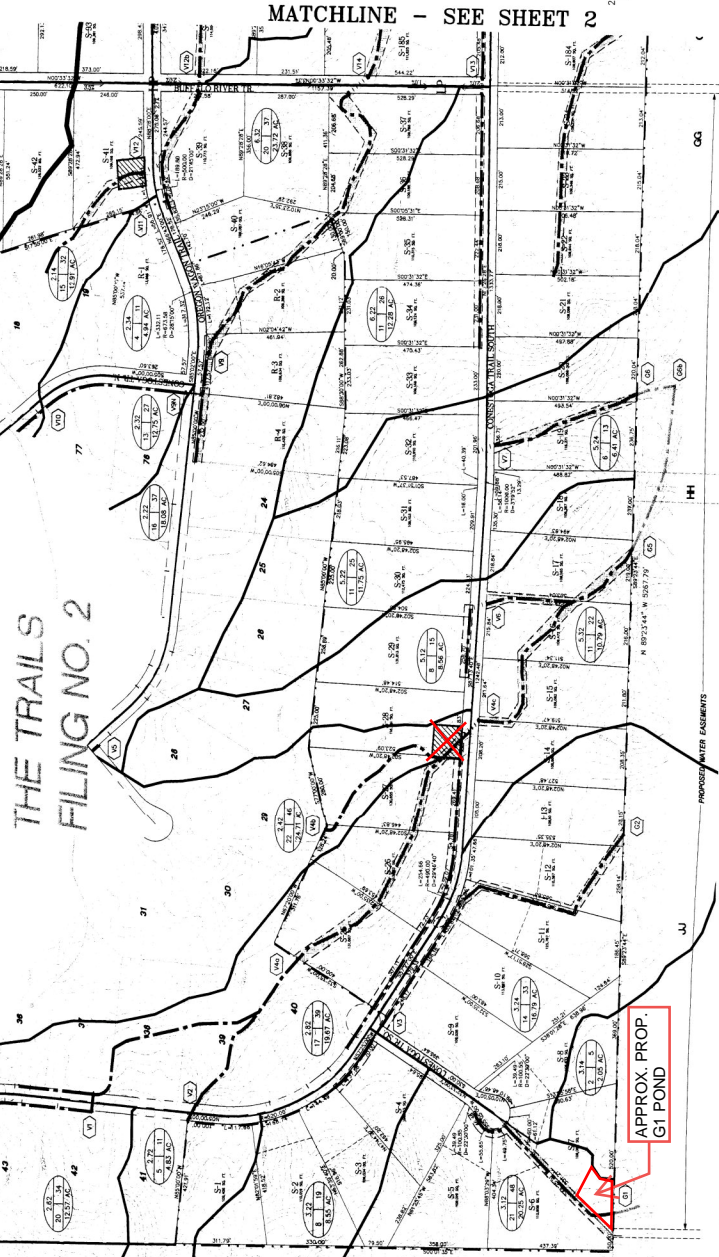

ITRS  
MARGARITA DRIVE, SUITE 300  
COLORADO SPRINGS, COLORADO 80921  
DATE: 10/19/07 (S17-007)  
SHEET 1 OF 4

MDDP EXCERPT

FIGURE 8

# LATIGO TRAILS PRELIMINARY DRAINAGE PLAN

IN SECTIONS 8, 9, 16 & 17, T12S, R64W OF THE 6TH P.M.  
EL PASO COUNTY, COLORADO

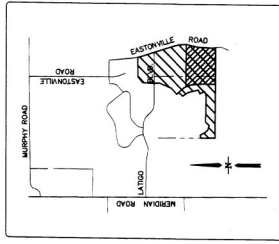

Design Point	Ch. (FPS)	Qw (FPS)
V15	6	12
V58b	25	52
V17	2	4
V20	6	12
V21	13	26
V22	4	8
V23	9	18
V24	3	6
V25	7	14
V27	26	52

Design Point	Ch. (FPS)	Qw (FPS)
S14	9	18
S15	1	3

Design Point	Ch. (FPS)	Qw (FPS)
G11	123	252
G11b	17	33
G13	13	26
G14	31	64
G16	18	36
G15	40	82
G17a	3	6
G17b	7	14
G18	27	56

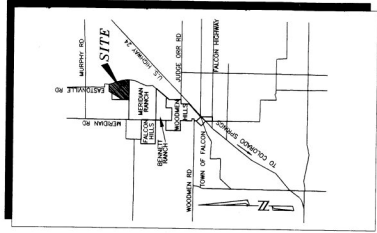

**LEGEND**

- SUB-BASIN DATA
- DESIGN POINT
- ROAD HIGH POINT
- ROAD LOW POINT
- ROAD GRADE
- SUB-BASIN LINE
- PAVE CHANNEL
- CULVERT
- POSSIBLE DETENTION AREA

HP  
LP  
HP  
LP  
HP  
LP  
HP  
LP  
HP  
LP

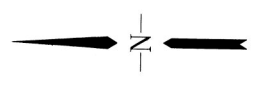

SCALE: 1" = 200'

**URS**  
1000 PAVAN DRIVE, SUITE 300  
DENVER, COLORADO 80202  
PHONE: (719) 531-0001  
DATE: 9/25/01  
SHEET 2 OF 4

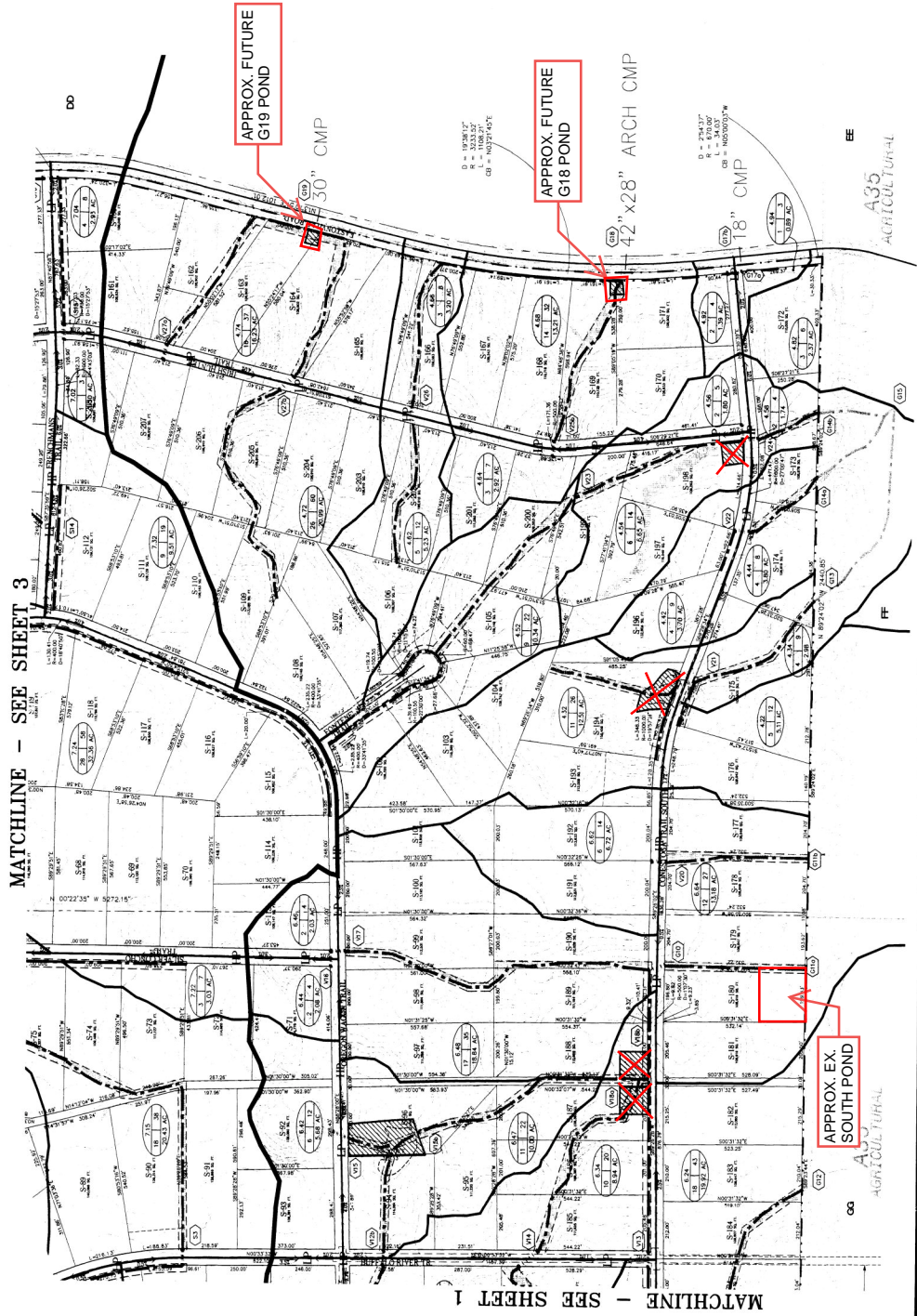

FIGURE 8



**FINAL DRAINAGE REPORT  
FOR  
LATIGO TRAILS FILING NO. 9  
AND  
ADDENDUM TO MASTER DEVELOPMENT/  
PRELIMINARY DRAINAGE PLAN  
FOR LATIGO TRAILS,  
EL PASO COUNTY, COLORADO**

September 2022

Prepared For:

**BRJM, LLC**  
101 N. Cascade, Suite 200  
Colorado Springs CO 80903  
(719) 475-7474

Prepared By:

**JR ENGINEERING**  
5475 Tech Center Drive  
Colorado Springs, CO 80919  
(719) 593-2593

Job No. 25175.02

PCD File No.: SF2136

FILING 9 FDR EXCERPT

**APPENDIX D**

**WATER QUALITY AND DETENTION CALCULATIONS**



# DETENTION BASIN STAGE-STORAGE TABLE BUILDER

MHFD-Detention, Version 4.04 (February 2021)

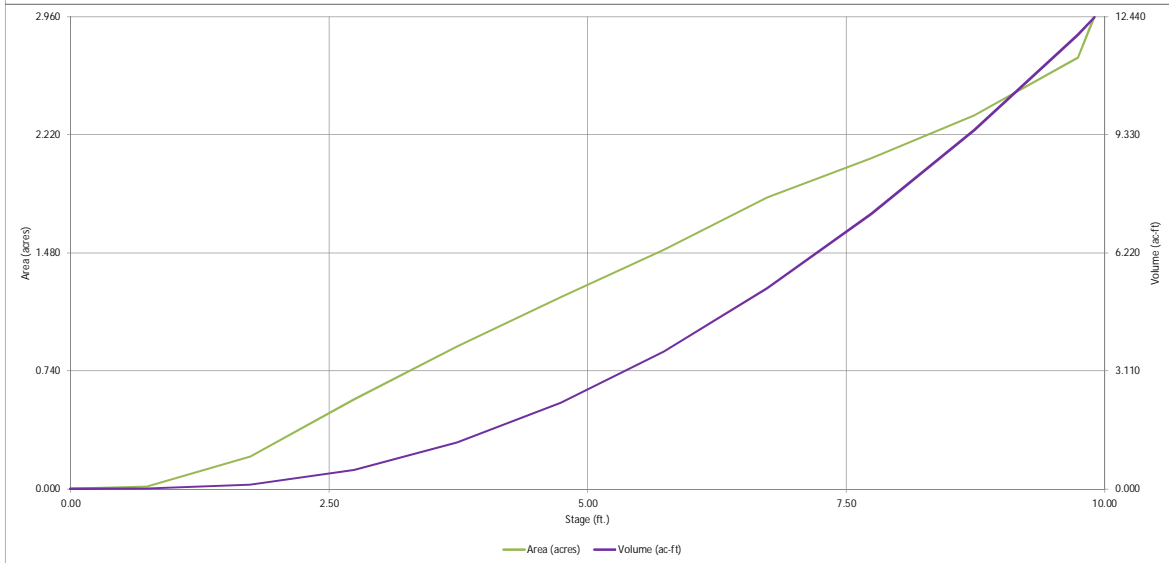
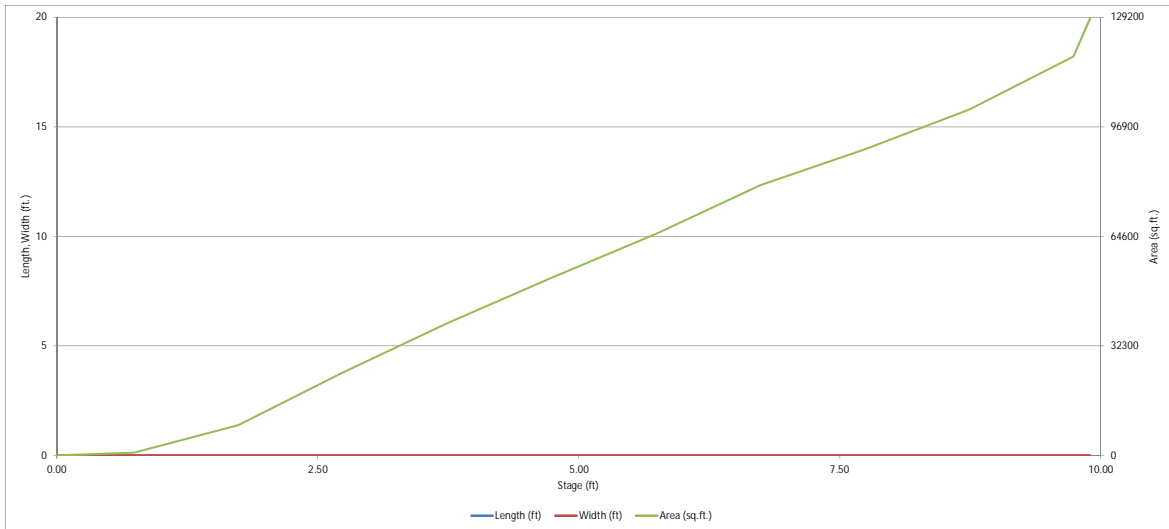

FILING 9 FDR EXCERPT

# DETENTION BASIN OUTLET STRUCTURE DESIGN

MHFD-Detention, Version 4.04 (February 2021)

Project: Latigo Trails Filling 9  
Basin ID: South Pond

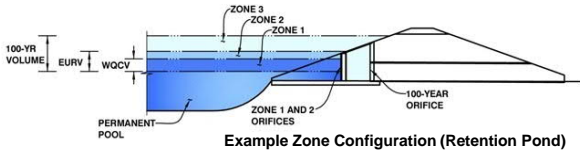

	Estimated Stage (ft)	Estimated Volume (ac-ft)	Outlet Type
Zone 1 (WOCV)	4.26	1.726	Orifice Plate
Zone 2 (EURV)	5.42	1.429	Rectangular Orifice
Zone 3 (100-year)	9.07	7.073	Weir&Pipe (Rect.)
<b>Total (all zones)</b>		<b>10.228</b>	

User Input: Orifice at Underdrain Outlet (typically used to drain WOCV in a Filtration BMP)

Underdrain Orifice Invert Depth =  ft (distance below the filtration media surface)  
Underdrain Orifice Diameter =  inches

Calculated Parameters for Underdrain  
Underdrain Orifice Area =  ft<sup>2</sup>  
Underdrain Orifice Centroid =  feet

User Input: Orifice Plate with one or more orifices or Elliptical Slot Weir (typically used to drain WOCV and/or EURV in a sedimentation BMP)

Invert of Lowest Orifice =  ft (relative to basin bottom at Stage = 0 ft)  
Depth at top of Zone using Orifice Plate =  ft (relative to basin bottom at Stage = 0 ft)  
Orifice Plate: Orifice Vertical Spacing =  inches  
Orifice Plate: Orifice Area per Row =  inches

Calculated Parameters for Plate  
WO Orifice Area per Row =  ft<sup>2</sup>  
Elliptical Half-Width =  feet  
Elliptical Slot Centroid =  feet  
Elliptical Slot Area =  ft<sup>2</sup>

User Input: Stage and Total Area of Each Orifice Row (numbered from lowest to highest)

	Row 1 (required)	Row 2 (optional)	Row 3 (optional)	Row 4 (optional)	Row 5 (optional)	Row 6 (optional)	Row 7 (optional)	Row 8 (optional)
Stage of Orifice Centroid (ft)	0.00	0.00	0.00	0.50	0.50	0.50	1.00	1.00
Orifice Area (sq. inches)	1.11	1.11	1.11	1.00	1.00	1.00	1.00	1.00

	Row 9 (optional)	Row 10 (optional)	Row 11 (optional)	Row 12 (optional)	Row 13 (optional)	Row 14 (optional)	Row 15 (optional)	Row 16 (optional)
Stage of Orifice Centroid (ft)	1.00							
Orifice Area (sq. inches)	1.00							

User Input: Vertical Orifice (Circular or Rectangular)

	Zone 2 Rectangular	Not Selected	
Invert of Vertical Orifice =	3.98	N/A	ft (relative to basin bottom at Stage = 0 ft)
Depth at top of Zone using Vertical Orifice =	5.42	N/A	ft (relative to basin bottom at Stage = 0 ft)
Vertical Orifice Height =	15.00	N/A	inches
Vertical Orifice Width =	100.00		inches

Calculated Parameters for Vertical Orifice  
Vertical Orifice Area =  ft<sup>2</sup>  
Vertical Orifice Centroid =  feet

User Input: Overflow Weir (Dropbox with Flat or Sloped Gate and Outlet Pipe OR Rectangular/Trapezoidal Weir (and No Outlet Pipe))

	Zone 3 Weir	Not Selected	
Overflow Weir Front Edge Height, Ho =	5.90	N/A	ft (relative to basin bottom at Stage = 0 ft)
Overflow Weir Front Edge Length =	8.33	N/A	feet
Overflow Weir Gate Slope =	0.00	N/A	H:V
Horiz. Length of Weir Sides =	5.84	N/A	feet
Overflow Gate Type =	Type C Gate	N/A	
Debris Clogging % =	0%	N/A	%

Calculated Parameters for Overflow Weir  
Height of Gate Upper Edge, H<sub>1</sub> =  feet  
Overflow Weir Slope Length =  feet  
Gate Open Area / 100-yr Orifice Area =    
Overflow Gate Open Area w/o Debris =  ft<sup>2</sup>  
Overflow Gate Open Area w/ Debris =  ft<sup>2</sup>

User Input: Outlet Pipe w/ Flow Restriction Plate (Circular Orifice, Restrictor Plate, or Rectangular Orifice)

	Zone 3 Rectangular	Not Selected	
Depth to Invert of Outlet Pipe =	0.33	N/A	ft (distance below basin bottom at Stage = 0 ft)
Rectangular Orifice Width =	96.00	N/A	inches
Rectangular Orifice Height =	36.00		inches

Calculated Parameters for Outlet Pipe w/ Flow Restriction Plate  
Outlet Orifice Area =  ft<sup>2</sup>  
Outlet Orifice Centroid =  feet  
Half-Central Angle of Restrictor Plate on Pipe =  radians

User Input: Emergency Spillway (Rectangular or Trapezoidal)

Spillway Invert Stage =  ft (relative to basin bottom at Stage = 0 ft)  
Spillway Crest Length =  feet  
Spillway End Slopes =  H:V  
Freeboard above Max Water Surface =  feet

Calculated Parameters for Spillway  
Spillway Design Flow Depth =  feet  
Stage at Top of Freeboard =  feet  
Basin Area at Top of Freeboard =  acres  
Basin Volume at Top of Freeboard =  acre-ft

## Routed Hydrograph Results

The user can override the default CUHP hydrographs and runoff volumes by entering new values in the Inflow Hydrographs table (Columns W through AF).

	WOCV	EURV	2 Year	5 Year	10 Year	25 Year	50 Year	100 Year	500 Year
Design Storm Return Period	N/A	N/A	1.19	1.50	1.75	2.00	2.25	2.52	3.00
One-Hour Rainfall Depth (in)	1.726	3.156	3.918	7.929	11.853	18.594	23.283	29.934	39.350
CUHP Runoff Volume (acre-ft)	N/A	N/A	3.918	7.929	11.853	18.594	23.283	29.934	39.350
Inflow Hydrograph Volume (acre-ft)	N/A	N/A	26.9	76.5	116.4	206.4	259.5	328.3	428.1
CUHP Predevelopment Peak Q (cfs)	N/A	N/A	26.9	76.5	116.4	206.4	259.5	328.3	428.1
OPTIONAL Override Predevelopment Peak Q (cfs)	N/A	N/A							
Predevelopment Unit Peak Flow, q (cfs/acre)	N/A	N/A	0.11	0.32	0.49	0.87	1.09	1.38	1.81
Peak Inflow Q (cfs)	N/A	N/A	52.3	103.7	144.0	234.8	288.8	360.0	461.8
Peak Outflow Q (cfs)	3.0	42.8	20.0	51.8	86.9	179.1	231.7	295.9	407.1
Ratio Peak Outflow to Predevelopment Q	N/A	N/A	N/A	0.7	0.7	0.9	0.9	0.9	1.0
Structure Controlling Flow	Vertical Orifice 1	Vertical Orifice 1	Vertical Orifice 1	Vertical Orifice 1	Overflow Weir 1	Overflow Weir 1	Overflow Weir 1	Outlet Plate 1	Spillway
Max Velocity through Gate 1 (fps)	N/A	N/A	N/A	N/A	0.6	3.0	4.4	6.1	6.2
Max Velocity through Gate 2 (fps)	N/A	N/A	N/A	N/A	N/A	N/A	N/A	N/A	N/A
Time to Drain 97% of Inflow Volume (hours)	38	38	39	35	32	27	24	19	13
Time to Drain 99% of Inflow Volume (hours)	40	41	42	41	39	37	36	34	31
Maximum Ponding Depth (ft)	4.26	5.42	4.82	5.64	6.28	6.97	7.28	7.73	8.32
Area at Maximum Ponding Depth (acres)	1.05	1.41	1.23	1.47	1.68	1.89	1.96	2.07	2.23
Maximum Volume Stored (acre-ft)	1.733	3.161	2.372	3.478	4.468	5.719	6.315	7.201	8.468

FILING 9 FDR EXCERPT

# DETENTION BASIN OUTLET STRUCTURE DESIGN

*MHFD-Detention, Version 4.04 (February 2021)*

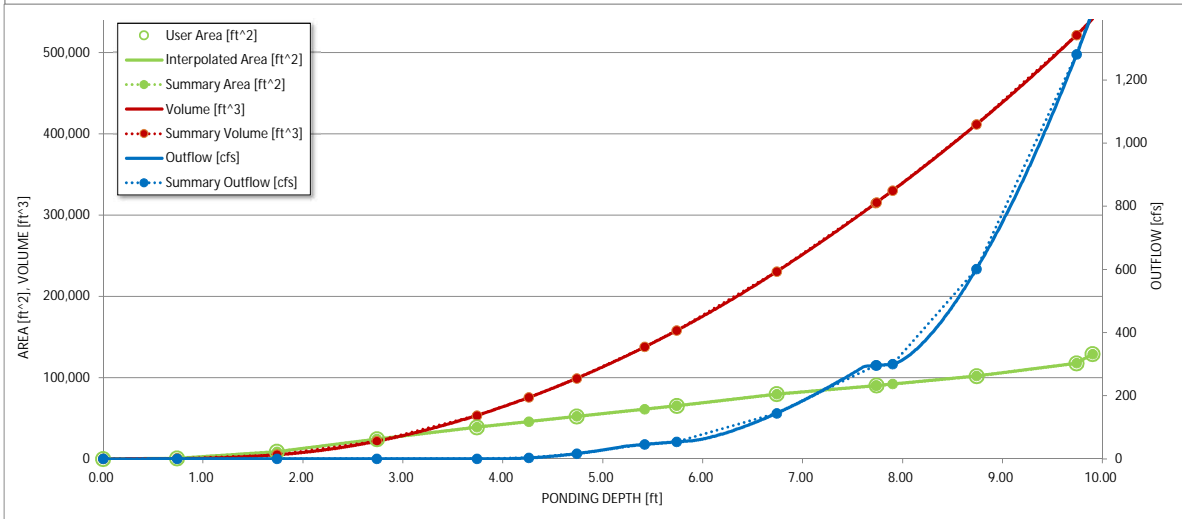
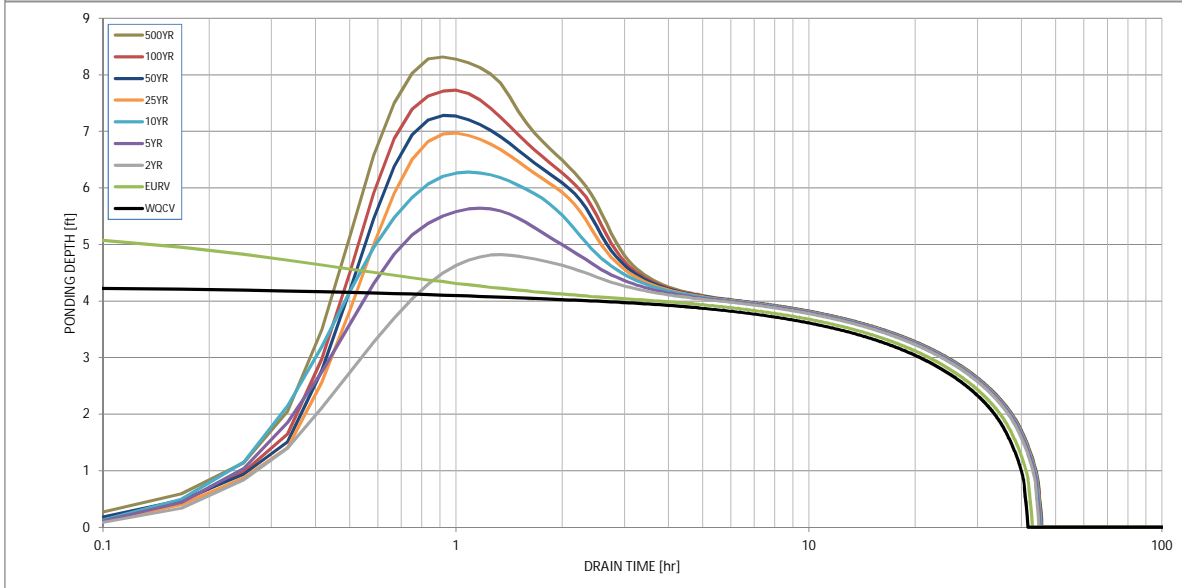
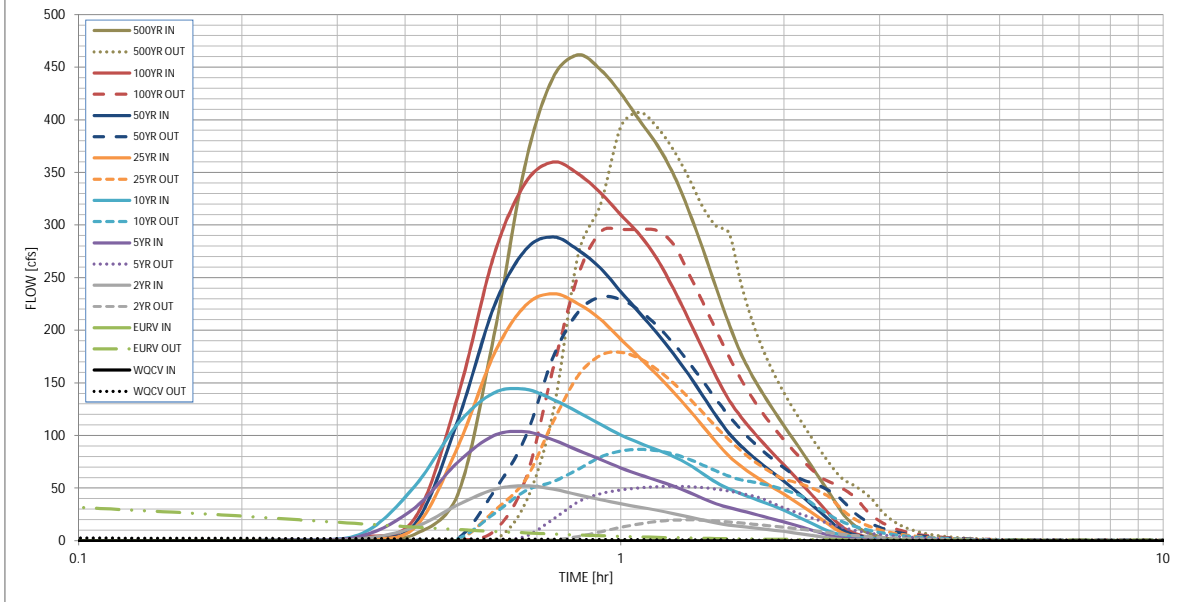

S-A-V-D Chart Axis Override	X-axis	Left Y-Axis	Right Y-Axis
minimum bound			
maximum bound			

FILING 9 FDR EXCERPT

# DETENTION BASIN OUTLET STRUCTURE DESIGN

*Outflow Hydrograph Workbook Filename:* \_\_\_\_\_

**Inflow Hydrographs**

The user can override the calculated inflow hydrographs from this workbook with inflow hydrographs developed in a separate program.

Time Interval	SOURCE	CUHP	CUHP	CUHP	CUHP	CUHP	CUHP	CUHP	CUHP	CUHP
	TIME	WOCV [cfs]	EURV [cfs]	2 Year [cfs]	5 Year [cfs]	10 Year [cfs]	25 Year [cfs]	50 Year [cfs]	100 Year [cfs]	500 Year [cfs]
5.00 min	0:00:00	0.00	0.00	0.00	0.00	0.00	0.00	0.00	0.00	0.00
	0:05:00	0.00	0.00	0.00	0.00	0.00	0.00	0.00	0.00	0.00
	0:10:00	0.00	0.00	0.00	0.00	0.00	0.00	0.05	0.01	0.13
	0:15:00	0.00	0.00	0.46	0.75	0.93	0.62	0.83	0.77	1.14
	0:20:00	0.00	0.00	2.04	4.76	7.12	2.16	2.58	3.43	6.28
	0:25:00	0.00	0.00	12.94	31.39	51.97	12.57	15.84	21.48	43.77
	0:30:00	0.00	0.00	34.10	74.62	111.11	89.16	113.91	136.95	195.01
	0:35:00	0.00	0.00	48.79	100.07	140.66	177.27	222.56	271.44	358.61
	0:40:00	0.00	0.00	52.32	103.67	144.00	223.52	276.51	340.26	440.40
	0:45:00	0.00	0.00	49.14	95.96	134.27	234.82	288.78	359.95	461.81
	0:50:00	0.00	0.00	43.74	86.04	122.30	225.33	276.46	348.93	447.84
	0:55:00	0.00	0.00	39.20	77.44	110.81	210.59	259.12	330.82	425.17
	1:00:00	0.00	0.00	35.15	69.27	100.58	191.38	236.63	309.72	399.16
	1:05:00	0.00	0.00	31.99	62.76	92.83	173.99	216.41	290.73	376.18
	1:10:00	0.00	0.00	29.04	57.37	86.44	157.54	197.20	267.71	348.19
	1:15:00	0.00	0.00	25.89	51.96	80.21	141.30	177.88	239.57	313.96
	1:20:00	0.00	0.00	22.75	46.16	72.66	125.07	157.94	210.42	277.09
	1:25:00	0.00	0.00	19.66	40.28	63.68	109.01	137.77	181.82	239.77
	1:30:00	0.00	0.00	16.94	35.15	55.44	93.60	118.36	155.55	205.61
	1:35:00	0.00	0.00	14.94	31.55	49.35	80.44	101.98	133.68	177.40
	1:40:00	0.00	0.00	13.57	28.67	44.64	70.77	89.98	117.48	156.24
	1:45:00	0.00	0.00	12.40	25.81	40.48	62.94	80.17	104.24	138.77
	1:50:00	0.00	0.00	11.30	23.07	36.66	56.13	71.57	92.51	123.27
	1:55:00	0.00	0.00	10.14	20.44	32.91	49.94	63.76	81.85	109.18
	2:00:00	0.00	0.00	8.95	17.92	28.95	44.18	56.48	71.93	96.04
	2:05:00	0.00	0.00	7.70	15.34	24.77	38.35	49.06	62.24	83.09
	2:10:00	0.00	0.00	6.42	12.72	20.57	32.50	41.58	52.85	70.45
	2:15:00	0.00	0.00	5.17	10.16	16.54	26.76	34.26	43.79	58.26
	2:20:00	0.00	0.00	3.95	7.69	12.72	21.13	27.12	34.84	46.33
	2:25:00	0.00	0.00	2.79	5.35	9.18	15.63	20.18	26.07	34.73
	2:30:00	0.00	0.00	1.83	3.54	6.59	10.41	13.59	17.74	24.05
	2:35:00	0.00	0.00	1.25	2.54	5.06	6.79	9.13	11.93	16.66
	2:40:00	0.00	0.00	0.95	1.99	4.03	4.61	6.40	8.26	11.85
	2:45:00	0.00	0.00	0.75	1.59	3.21	3.22	4.58	5.71	8.40
	2:50:00	0.00	0.00	0.60	1.27	2.56	2.25	3.27	3.86	5.84
	2:55:00	0.00	0.00	0.48	1.01	2.01	1.60	2.36	2.54	3.96
	3:00:00	0.00	0.00	0.37	0.79	1.56	1.15	1.70	1.59	2.59
	3:05:00	0.00	0.00	0.30	0.61	1.18	0.82	1.22	0.99	1.68
	3:10:00	0.00	0.00	0.24	0.46	0.88	0.61	0.91	0.72	1.21
	3:15:00	0.00	0.00	0.20	0.35	0.65	0.47	0.69	0.57	0.93
	3:20:00	0.00	0.00	0.15	0.26	0.49	0.36	0.53	0.45	0.73
	3:25:00	0.00	0.00	0.12	0.18	0.37	0.27	0.41	0.35	0.57
	3:30:00	0.00	0.00	0.09	0.12	0.27	0.20	0.31	0.27	0.43
	3:35:00	0.00	0.00	0.06	0.08	0.19	0.15	0.22	0.19	0.32
	3:40:00	0.00	0.00	0.04	0.05	0.12	0.10	0.15	0.13	0.21
	3:45:00	0.00	0.00	0.02	0.03	0.07	0.06	0.10	0.08	0.13
	3:50:00	0.00	0.00	0.01	0.02	0.03	0.03	0.05	0.04	0.07
	3:55:00	0.00	0.00	0.00	0.01	0.01	0.01	0.02	0.02	0.03
	4:00:00	0.00	0.00	0.00	0.00	0.00	0.00	0.00	0.00	0.00
	4:05:00	0.00	0.00	0.00	0.00	0.00	0.00	0.00	0.00	0.00
	4:10:00	0.00	0.00	0.00	0.00	0.00	0.00	0.00	0.00	0.00
	4:15:00	0.00	0.00	0.00	0.00	0.00	0.00	0.00	0.00	0.00
	4:20:00	0.00	0.00	0.00	0.00	0.00	0.00	0.00	0.00	0.00
	4:25:00	0.00	0.00	0.00	0.00	0.00	0.00	0.00	0.00	0.00
	4:30:00	0.00	0.00	0.00	0.00	0.00	0.00	0.00	0.00	0.00
	4:35:00	0.00	0.00	0.00	0.00	0.00	0.00	0.00	0.00	0.00
	4:40:00	0.00	0.00	0.00	0.00	0.00	0.00	0.00	0.00	0.00
	4:45:00	0.00	0.00	0.00	0.00	0.00	0.00	0.00	0.00	0.00
	4:50:00	0.00	0.00	0.00	0.00	0.00	0.00	0.00	0.00	0.00
	4:55:00	0.00	0.00	0.00	0.00	0.00	0.00	0.00	0.00	0.00
	5:00:00	0.00	0.00	0.00	0.00	0.00	0.00	0.00	0.00	0.00
	5:05:00	0.00	0.00	0.00	0.00	0.00	0.00	0.00	0.00	0.00
	5:10:00	0.00	0.00	0.00	0.00	0.00	0.00	0.00	0.00	0.00
	5:15:00	0.00	0.00	0.00	0.00	0.00	0.00	0.00	0.00	0.00
	5:20:00	0.00	0.00	0.00	0.00	0.00	0.00	0.00	0.00	0.00
	5:25:00	0.00	0.00	0.00	0.00	0.00	0.00	0.00	0.00	0.00
	5:30:00	0.00	0.00	0.00	0.00	0.00	0.00	0.00	0.00	0.00
	5:35:00	0.00	0.00	0.00	0.00	0.00	0.00	0.00	0.00	0.00
	5:40:00	0.00	0.00	0.00	0.00	0.00	0.00	0.00	0.00	0.00
	5:45:00	0.00	0.00	0.00	0.00	0.00	0.00	0.00	0.00	0.00
	5:50:00	0.00	0.00	0.00	0.00	0.00	0.00	0.00	0.00	0.00
	5:55:00	0.00	0.00	0.00	0.00	0.00	0.00	0.00	0.00	0.00
	6:00:00	0.00	0.00	0.00	0.00	0.00	0.00	0.00	0.00	0.00

FILING 9 FDR EXCERPT





BASIN	DP	Area (Ac.)	Q <sub>s</sub> (cfs)	Q <sub>100</sub> (cfs)
OSA1	OSA1	3.68	3.6	7.9
OSA2	OSA2	92.80	33.1	128.7
OSA3	OSA3	69.15	29.3	113.6
OSA4	OSA4	32.65	16.0	60.5
OSA5	OSA5	11.33	7.3	28.1
A1	1	7.08	1.6	11.8
A2	2	19.70	4.5	33.3
A3	3	232.69	73.1	288.2
A4	4	11.68	2.6	19.3
A5	5	12.43	2.4	17.6
A6	6	4.24	1.0	7.4
A7	7	10.58	2.3	17.1
A8	8	15.37	2.8	20.9
A9	9	7.35	1.7	12.5
A10	10	13.62	2.5	18.7
A11	11	20.51	3.8	28.1
A12	12	8.71	1.9	13.8
A13	13	10.31	2.3	16.8
A14	14	13.96	3.0	22.0
A15	15	26.36	4.7	34.7
A16	16	8.24	1.7	12.7
A17	17	0.61	0.2	1.2
OSA6	OSA6	3.29	10.3	18.5
B1	B1	3.36	0.8	6.0
B2	B2	0.75	0.2	1.3
B3	B3	4.78	1.1	8.2
B4	B4	6.89	1.7	12.5
B5	B5	1.61	0.4	3.2
B6	B6	12.40	2.6	19.3

**LEGEND**

- EX. MINOR CONTOUR
- 6800--- EX. MAJOR CONTOUR
- FILING 10 BOUNDARY
- BASIN BOUNDARY
- MAJOR DRAINAGE BASIN BOUNDARY
- FLOW DIRECTION
- ▲ DESIGN POINT
- BASIN
- C5
- C100

AREA (ACRE) **E5**  
5.91 0.12 0.36

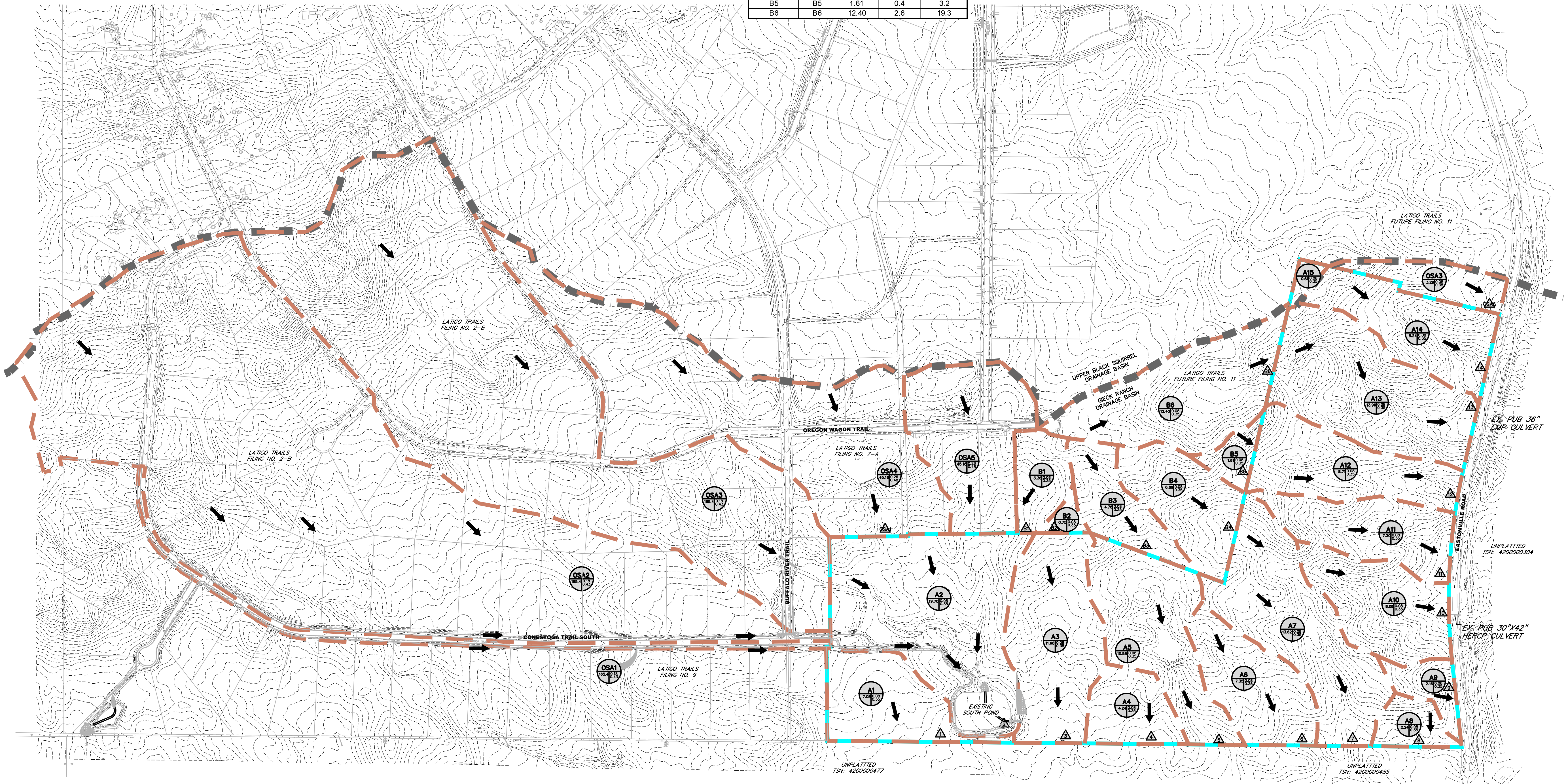
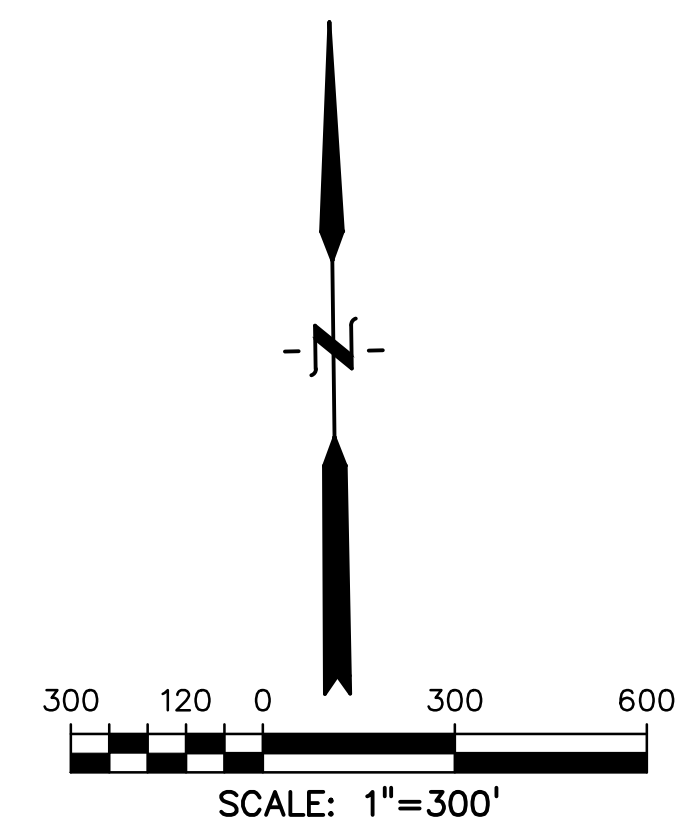

PREPARED BY:



CLIENT:

FALCON LATIGO, LLC  
5350 S. ROSLYN ST. STE #400  
ENGLEWOOD, CO 80111-2125  
(303) 694-0862

DRAINAGE DOCUMENTS FOR:  
**LATIGO TRAILS  
FILING NO. 10**  
EL PASO COUNTY  
FALCON, COLORADO

ISSUE	DATE
INITIAL ISSUE	9-18-2024

DESIGNED BY: TDM  
DRAWN BY: CGH  
CHECKED BY: KGV  
FILE NAME: 21820-01-DRN-EX

PREPARED UNDER MY DIRECT SUPERVISION FOR AND ON BEHALF OF DREXEL, BARRELL & CO.  
DRAWING SCALE:  
HORIZONTAL: 1" = 300"  
VERTICAL: N/A

**OVERALL  
EXISTING  
DRAINAGE MAP**

PROJECT NO. 21820-01CSCV  
DRAWING NO.

**DR1**

SHEET: 1 OF 6

PREPARED BY:



CLIENT:

FALCON LATIGO, LLC  
5350 S. ROSLYN ST. STE #400  
ENGLEWOOD, CO 80111-2125  
(303) 694-0862

DRAINAGE DOCUMENTS FOR:  
**LATIGO TRAILS  
FILING NO. 10**  
EL PASO COUNTY  
FALCON, COLORADO

ISSUE	DATE
INITIAL ISSUE	9-18-2024

DESIGNED BY:	TDM
DRAWN BY:	CGH
CHECKED BY:	KGV
FILE NAME:	21820-01-DRN-EX

PREPARED UNDER MY DIRECT SUPERVISION FOR AND ON BEHALF OF DREXEL, BARRELL & CO.

DRAWING SCALE:  
HORIZONTAL: 1" = 200"  
VERTICAL: N/A

**EXISTING  
FILING 10  
DRAINAGE MAP**

PROJECT NO. 21820-01CSCV  
DRAWING NO.

**DR2**

SHEET: 2 OF 6

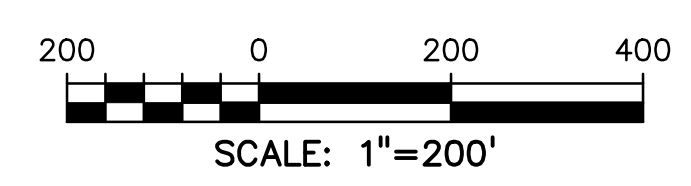
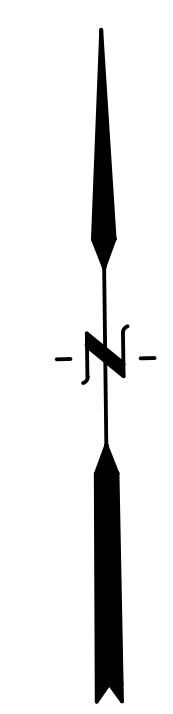

**LEGEND**

- EX. MINOR CONTOUR
- - - - - EX. MAJOR CONTOUR
- FILING 10 BOUNDARY
- BASIN BOUNDARY
- MAJOR DRAINAGE BASIN BOUNDARY
- FLOW DIRECTION
- ▲ DESIGN POINT
- BASIN
- AREA (ACRE)
- C5
- C100

BASIN	DP	Area (Ac.)	Q <sub>c</sub> (cfs)	Q <sub>100</sub> (cfs)
OSA1	OSA1	3.68	3.6	7.9
OSA2	OSA2	92.80	33.1	128.7
OSA3	OSA3	69.15	29.3	113.6
OSA4	OSA4	32.65	16.0	60.5
OSA5	OSA5	11.33	7.3	28.1
A1	1	7.08	1.6	11.8
A2	2	19.70	4.5	33.3
A3	3	232.68	73.1	288.2
A4	4	11.68	2.6	19.3
A5	5	12.43	2.4	17.6
A6	6	4.24	1.0	7.4
A7	7	10.58	2.3	17.1
A8	8	15.37	2.8	20.9
A9	9	7.35	1.7	12.5
A10	10	13.62	2.5	18.7
A11	11	20.51	3.8	28.1
A12	12	2.24	0.6	4.2
A13	13	2.16	0.6	4.2
A14	14	8.08	1.7	12.5
A15	15	7.30	1.6	11.8
OSA6	OSA6	8.71	1.9	13.8
B1	B1	10.31	2.3	16.8
B2	B2	13.96	3.0	22.0
B3	B3	26.36	4.7	34.7
B4	B4	8.24	1.7	12.7
B5	B5	0.61	0.2	1.2
B6	B6	3.29	10.3	18.5
C5	C5	3.36	0.8	6.0
C100	C100	0.75	0.2	1.3
E5	E5	4.78	1.1	8.2
E5	E5	6.89	1.7	12.5
E5	E5	1.61	0.4	3.2
E5	E5	12.40	2.6	19.3

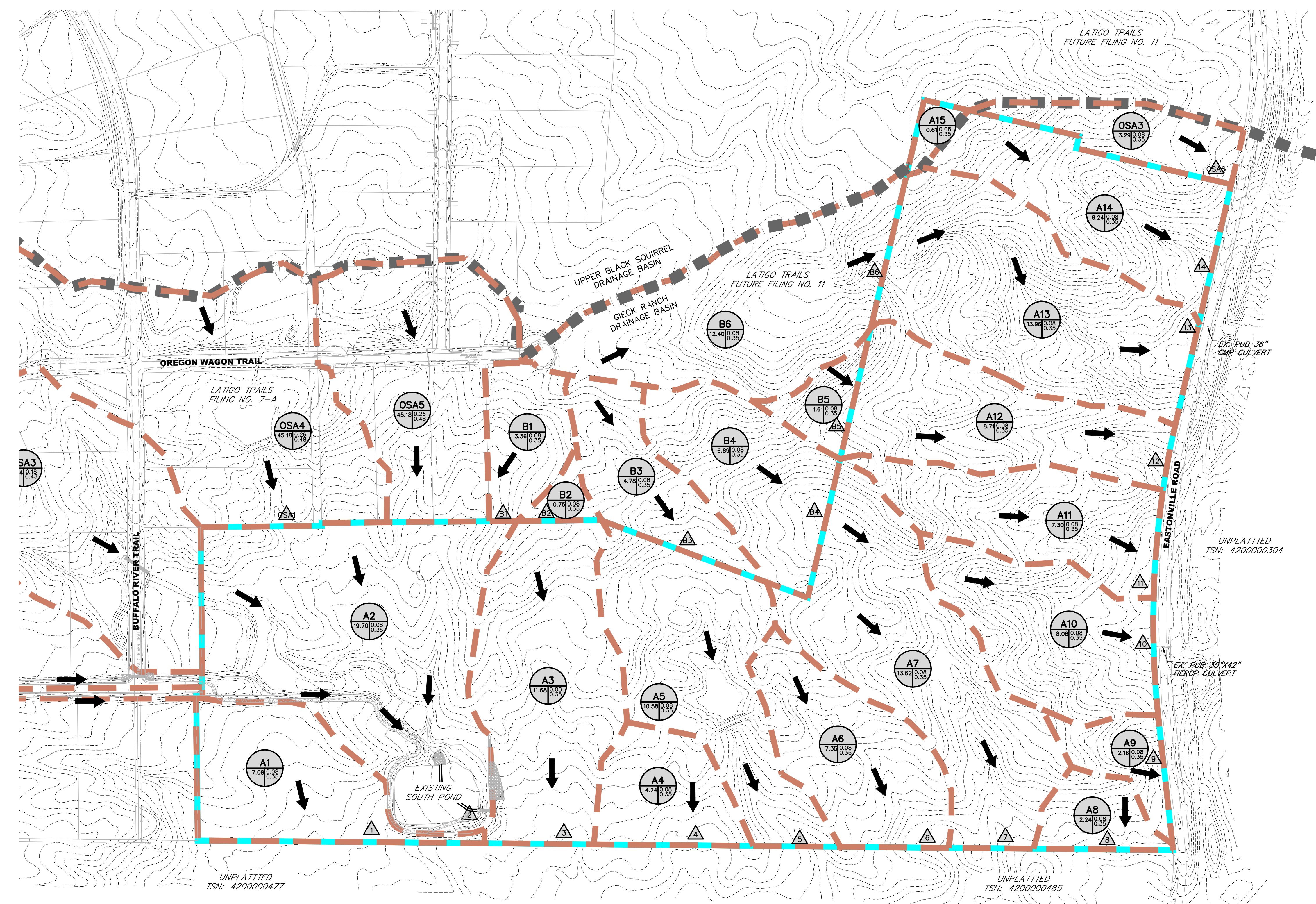

PREPARED BY:

DREXEL, BARRELL & CO.  
Engineers • Surveyors  
101 SAWATCH ST., STE #100  
COLORADO SPGS, COLORADO 80903  
CONTACT: TIM D. MCCONNELL, P.E.  
(719)260-0887  
COLORADO SPRINGS • LAFAYETTE

CLIENT:

FALCON LATIGO, LLC  
5350 S. ROSLYN ST., STE #400  
ENGLEWOOD, CO 80111-2125  
(303) 694-0862

DRAINAGE DOCUMENTS FOR:  
**LATIGO TRAILS  
FILING NO. 10**  
EL PASO COUNTY  
FALCON, COLORADO

ISSUE	DATE
INITIAL ISSUE	9-18-2024

DESIGNED BY:	TDM
DRAWN BY:	CGH
CHECKED BY:	KGV
FILE NAME:	21820-01-DRN-PF

PREPARED UNDER MY DIRECT SUPERVISION FOR AND ON BEHALF OF DREXEL, BARRELL & CO.  
DRAWING SCALE:  
HORIZONTAL: 1" = 300"  
VERTICAL: N/A

**OVERALL  
DEVELOPED  
DRAINAGE MAP**

PROJECT NO. 21820-01CSCV  
DRAWING NO.

**DR3**

SHEET: 3 OF 4

LEGEND

- EX. MINOR CONTOUR
- - - - - EX. MAJOR CONTOUR
- FILING 10 BOUNDARY
- - - - - BASIN BOUNDARY
- MAJOR DRAINAGE BASIN BOUNDARY
- FLOW DIRECTION
- ▲ DESIGN POINT
- BASIN
- AREA (ACRE)
- E5
- C5
- C100

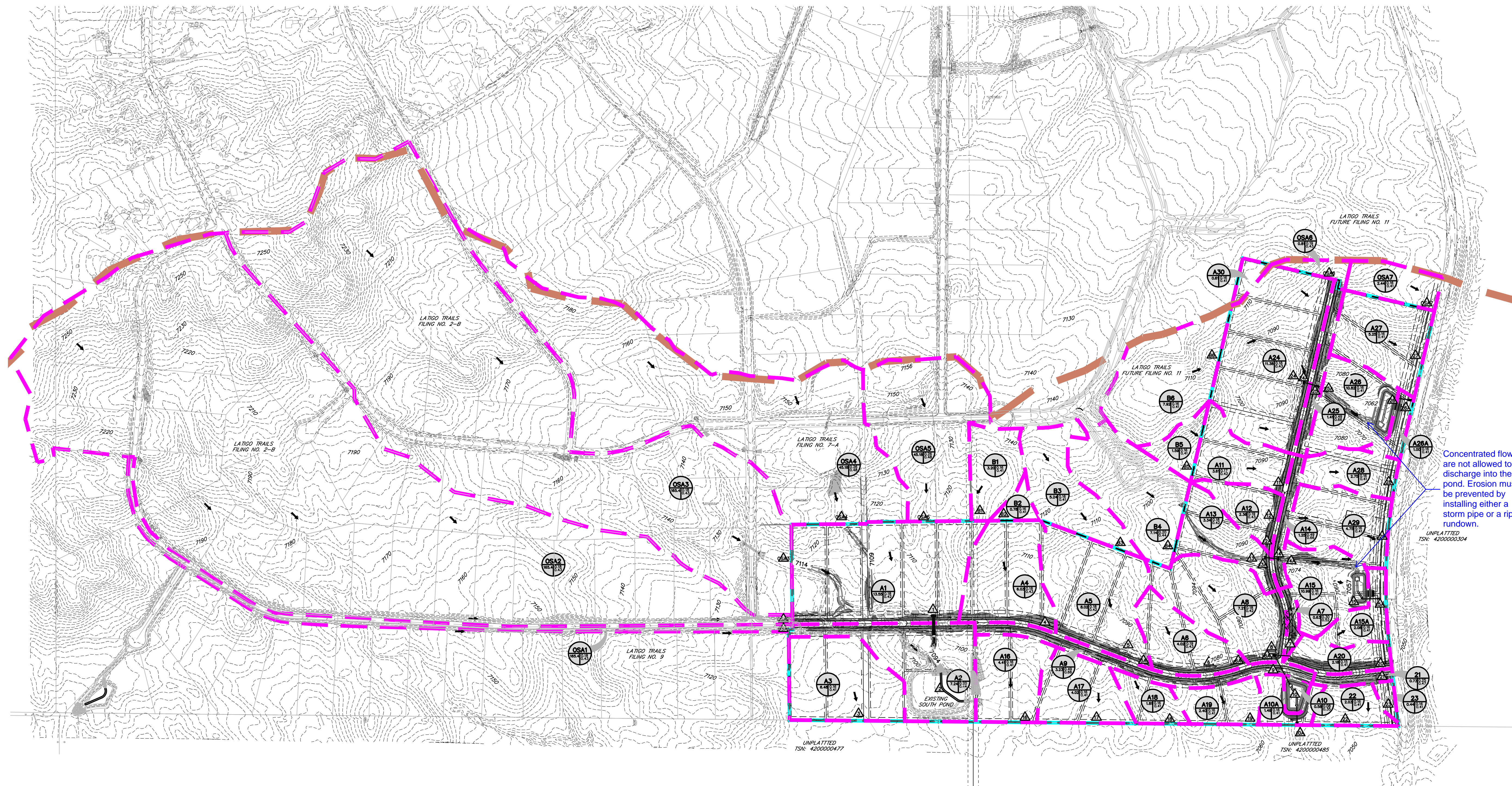
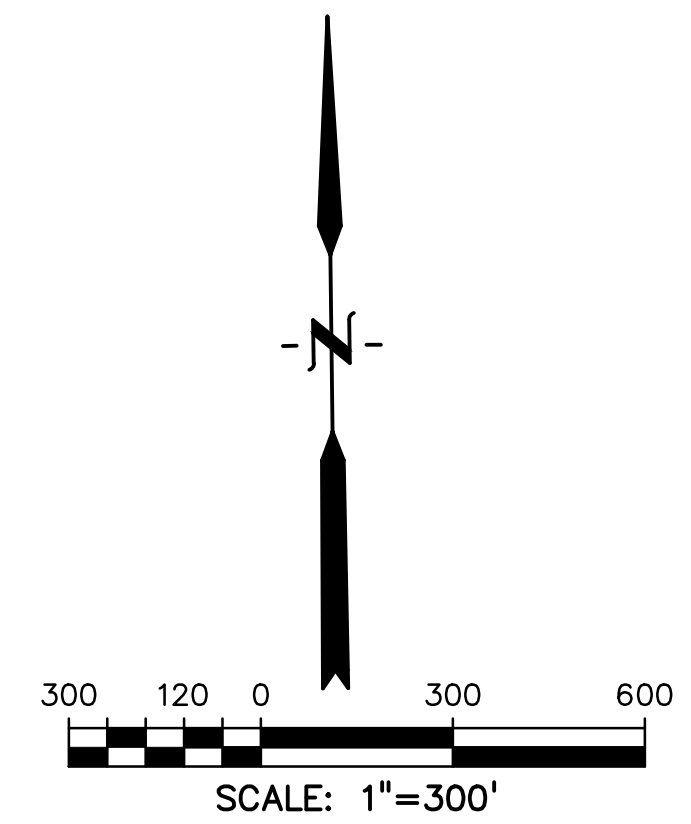

ISSUE	DATE
INITIAL ISSUE	9-18-2024

DESIGNED BY: TDM  
 DRAWN BY: CGH  
 CHECKED BY: KGV  
 FILE NAME: 21820-01-DRN-PP

PREPARED UNDER MY DIRECT SUPERVISION FOR AND ON BEHALF OF DREXEL, BARRELL & CO.  
 DRAWING SCALE:  
 HORIZONTAL: 1" = 200'  
 VERTICAL: N/A

DEVELOPED FILING 10 DRAINAGE MAP  
 PROJECT NO. 21820-01CSCV  
 DRAWING NO.

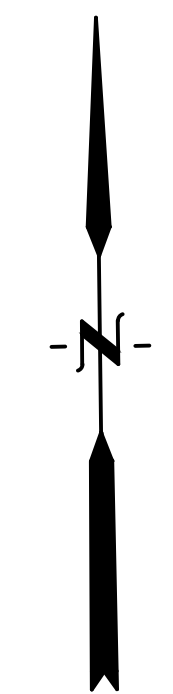
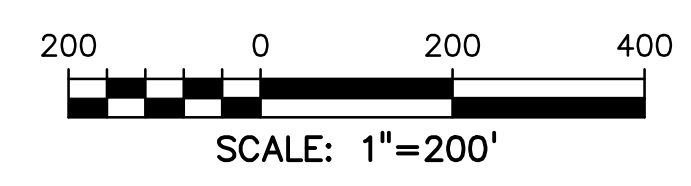

**LEGEND**

- EX. MINOR CONTOUR
- 6800--- EX. MAJOR CONTOUR
- FILING 10 BOUNDARY
- BASIN BOUNDARY
- MAJOR DRAINAGE BASIN BOUNDARY
- FLOW DIRECTION
- △ DESIGN POINT
- BASIN
- C5
- C100
- LARGE LOT SINGLE FAMILY DEVELOPMENT UNDETAINED
- UNDETAINED AREA SUBJECT TO RUNOFF REDUCTION

Runoff Reduction is currently selected to partially or entirely meet the County's water quality treatment requirements, the following requirements apply for the design, construction, and maintenance of runoff reduction PCMs:  
 •All RPAs and SPAs are considered PCMs and therefore require a signed PCM Maintenance Agreement and an O&M Manual.  
 •All RPAs and SPAs will need to be within a no build drainage easement or tract shown in the project Drainage Report, GEC Plans, and Site Plat.  
 •RPA and SPA cannot be located in County ROW.  
 •Vegetation in RPAs and SPAs should have a uniform density of at least 80%.  
 •In the GEC Plans, the RPA and SPA limits shall be delineated.  
 •In the Drainage Report, runoff reduction calculations (UD-BMP spreadsheet or equivalent) shall be included.  
 •In the Drainage Report, include a figure delineating all proposed UIA, RPA, and SPA areas to be utilized for runoff reduction.

Isn't most of A20 utilizing the large lot exclusion? what is the actual roadway and ditch area that is not excluded with the large lot exclusion? Specify

BASIN	DP	Area (Ac.)	Q <sub>2</sub> (CFS)	Q <sub>100</sub> (CFS)
OSA1	OSA1	3.68	3.9	7.9
OSA2	OSA2	96.30	29.4	127.3
OSA3	OSA3	69.15	29.3	113.4
OSA4	OSA4	32.65	16.0	60.5
OSA5	OSA5	11.33	7.3	26.1
OSA5	OSA5	13.55	7.2	28.0
A1	1	226.18	69.0	279.5
A2	2	7.24	3.9	14.8
A2	2	237.10	73.7	291.8
South Pond Out	2A	24.53	10.2	42.3
A3	3	6.48	3.1	13.5
A4	4	6.03	3.3	13.0
A5	4	7.26	3.8	16.5
A5	5	8.02	4.3	17.5
A5	5	13.26	6.7	27.8
A5A	5A	20.52	9.5	40.0
A6	6	4.02	2.1	7.9
A6	6A	24.53	10.2	42.3
A7	7	0.63	0.7	2.0
A8	8	7.21	3.2	12.8
A8	8A	32.36	13.3	54.3
A9	9	0.58	0.1	1.1
A10	10	36.18	17.1	63.1
A10A	10A	1.49	0.8	3.4
G14b Out	10A	1.49	1.0	55.5
A11	11	3.61	1.9	7.9
A11	11	5.20	2.7	11.3
A12	12	2.36	1.4	5.3
A12	12A	7.96	3.8	15.4
A13	13	3.34	1.8	7.3
A13	13A	18.04	9.4	36.9
A14	14	1.25	0.2	4.8
A14	14A	19.29	10.7	39.2
A15	15	4.16	1.7	7.8

BASIN	DP	Area (Ac.)	Q <sub>2</sub> (CFS)	Q <sub>100</sub> (CFS)
A15A	15	23.45	11.5	43.4
G18 Out	15A	2.08	1.1	27.1
A16	16	4.41	1.9	8.2
A17	17	4.02	2.1	8.9
A18	18	1.81	0.9	4.1
A19	19	2.40	1.1	4.7
A20	20	2.78	1.5	5.4
A21	21	0.75	0.7	2.2
A22	22	2.03	1.1	4.7
A23	23	0.44	0.2	1.1
A23	23	3.21	1.9	7.5
OSA6	OSA6	0.81	0.6	2.3
A24	24	11.59	6.6	26.3
A24	24	19.51	10.1	41.6
A24	24A	20.33	10.6	43.4
A25	25	1.61	2.8	6.3
A26	26A	21.94	11.4	42.9
A26	26	4.70	2.1	9.4
A26	26	26.64	12.4	47.9
A28A	28	1.00	0.6	2.6
G19 Out	28A	1.00	0.1	34.3
A27	27	5.25	2.6	11.4
A28	28	2.75	1.4	5.9
A29	29	4.75	2.3	10.0
A30	30	0.61	0.3	1.3
OSA7	OSA7	2.44	1.2	5.1
B1	B1	3.20	1.9	8.0
B2	B2	0.78	0.5	2.1
B3	B3	5.24	2.9	12.5
B4	B4	7.14	5.0	18.9
B5	B5	1.59	1.0	4.2
B6	B6	7.92	4.4	19.0

Lot Number	Flow Source	100 yr. Flow (cfs)	Culvert Size (in.)	Anticipated Driveway Location (2x width max.)	Ditch Slope (%)	RipRap Sizing
1	DP25	11.6	36	West side of lot	0.9	L
2	DP25	41.6	36	West side of lot	1.8	L
3	DP25	41.6	36	West side of lot	3.2	L
4	DP25	41.6	36	West side of lot	3.1	L
5	DP14	4.9	18	West side of lot	0.9	VL
6	DP14	4.9	18	West side of lot	1.4	VL
7	DP14	4.9	18	West side of lot	1	VL
8	DP14	4.9	18	West side of lot	0.9	VL
9	DP20	4.1	18	South side of lot	1.5	VL
10	DP20	4.1	18	South side of lot	3.8	VL
11	DP21	4.7	18	North side of lot	3.1	VL
12	DP9	9.7	18	North side of lot	1.8	VL
13	DP9	9.7	18	North side of lot	1.7	VL
14	DP9	9.7	18	North side of lot	1.5	VL
15	DP9	9.7	18	North side of lot	1.5	VL
16	DP9	9.7	18	North side of lot	1.6	VL
17	DP9	9.7	18	North side of lot	1.4	VL
18	HIGH PT	0.6	18	North side of lot	0.6	VL
19	OSA1	7.9	18	North side of lot	2.4	VL
20	OSA1	7.9	18	North side of lot	2.2	VL
21	OSA1	7.9	18	North side of lot	1.9	VL
22	OSA2	127.3	36 Triple	South side of lot	1.8	VL
23	DP1	279.5	36 Quad	South side of lot	2.3	M
24	DP1	279.5	36 Quad	South side of lot	2.3	M
25	DP1	279.5	36 Quad	South side of lot	0.2	M
26	MINOR	18.5	18	South side of lot	1.1	L
27	DP4	18.5	24	South side of lot	1.4	L
28	DP4	18.5	24	South side of lot	1.3	L
29	DP5A	40.0	36	South side of lot	1.6	L
30	DP5A	40.0	36	South side of lot	1.5	L
31	DP5A	40.0	36	South side of lot	1.5	L
32	DP6A	42.3	36	South side of lot	1.6	L
33	DP6A	42.3	36	South side of lot	2.5	L
34	DP6A	44.3	36	South side of lot	2.1	L
35	DP13A	36.9	36	East side of lot	1.4	L
36	DP13A	36.9	36	East side of lot	0.1	L
37	DP12A	7.9	18	East side of lot	1.3	VL
38	DP11	52.1	36	East side of lot	1.4	L
39	DP24A	26.3	30	East side of lot	1.6	L
40	DP24A	26.3	30	East side of lot	3.4	L
41	DP24A	26.3	30	East side of lot	2.8	L
42	DP24A	26.3	30	East side of lot	3.5	L
43	DP24A	26.3	30	East side of lot	0.3	L

