



LSC TRANSPORTATION CONSULTANTS, INC.
2504 East Pikes Peak Avenue, Suite 304
Colorado Springs, CO 80909
(719) 633-2868
FAX (719) 633-5430
E-mail: lsc@lsctrans.com
Website: <http://www.lsctrans.com>

Meridian Ranch Fieldhouse Traffic Impact Study (LSC #S234410) February 8, 2024

Traffic Engineer's Statement

This traffic report and supporting information were prepared under my responsible charge and they comport with the standard of care. So far as is consistent with the standard of care, said report was prepared in general conformance with the criteria established by the County for traffic reports.

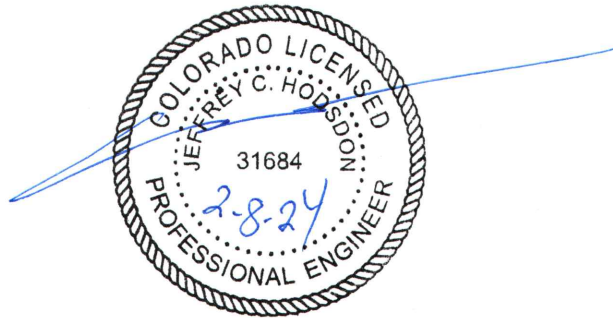

Developer's Statement

I, the Developer, have read and will comply with all commitments made on my behalf within this report.

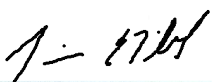

Jim Nikkel, General Manager
Meridian Service Metropolitan District

02/09/2024

Date

Meridian Ranch Fieldhouse

Traffic Impact Analysis

Jim Nikkel
General Manager
Meridian Service Metropolitan District
11886 Stapleton Drive
Falcon, CO 80831

FEBRUARY 8, 2024

LSC Transportation Consultants
Prepared by: Kirstin D. Ferrin, P.E.
Reviewed by: Jeffrey C. Hodsdon, P.E.

LSC #S234410



CONTENTS

REPORT CONTENTS 1

PREVIOUS TRAFFIC REPORTS COMPLETED IN THE AREA 2

LAND USE AND ACCESS 2

 Land Use..... 2

 Access..... 3

 Pedestrian Facilities 3

 Sight Distance..... 3

ROADWAY AND TRAFFIC CONDITIONS 4

 Area Roadways..... 4

 Existing Traffic Volumes..... 5

 Existing Levels of Service 5

 Londonderry Drive/Rainbow Bridge Drive..... 5

 Rex Road/Pyramid Peak Drive 5

2043 BACKGROUND TRAFFIC..... 6

TRIP GENERATION..... 6

TRIP DISTRIBUTION AND ASSIGNMENT 7

 Trip Distribution 7

 Assignment of Site-Generated Trips..... 7

TOTAL TRAFFIC..... 7

 Short Term 7

 Long Term 7

PROJECTED LEVELS OF SERVICE 7

 Londonderry Drive/Rainbow Bridge Drive..... 8

 Rex Road/Pyramid Peak Drive 8

 Rainbow Bridge Drive Access Points..... 8

FUNCTIONAL CLASSIFICATION 8

CONCLUSIONS AND RECOMMENDATIONS..... 8

Enclosures: 10

 Table 2

 Figures 1-11

 Traffic Counts

 Level of Service Reports

 MTCP Maps

 Appendix 1



LSC TRANSPORTATION CONSULTANTS, INC.
2504 East Pikes Peak Avenue, Suite 304
Colorado Springs, CO 80909
(719) 633-2868
FAX (719) 633-5430
E-mail: lsc@lsctrans.com
Website: <http://www.lsctrans.com>

February 8, 2024

Jim Nikkel
General Manager
Meridian Service Metropolitan District
11886 Stapleton Drive
Falcon, CO 80831

RE: Meridian Ranch Fieldhouse
El Paso County, CO
Traffic Impact Analysis
LSC #S234410

Dear Mr. Nikkel,

In response to your request, LSC Transportation Consultants, Inc. has prepared this traffic impact analysis for the currently-proposed Meridian Ranch Fieldhouse. As shown in Figure 1, the site of the proposed Meridian Ranch fieldhouse is located east of Rainbow Bridge Drive about a half mile north of Londonderry Drive in El Paso County, Colorado.

The fieldhouse facility is proposed as the second recreation center to serve Meridian Ranch residents and will provide space for recreational sports and exercise. Two full-movement vehicular-access points are proposed to Rainbow Bridge Drive. Pedestrian/bicycle connections are also proposed for non-motorized access to the facility from the surrounding Meridian Ranch neighborhoods.

REPORT CONTENTS

This report is being prepared as part of a submittal to El Paso County. The report identifies the traffic impacts of the proposed site on the streets and roadways in the vicinity of the site and presents recommendations for the transportation system. The report contains the following:

- The existing roadway and traffic conditions in the site's vicinity, including the roadway widths, lane geometries, and traffic controls, etc.;
- The peak-hour turning-movement traffic counts at key intersections in the vicinity of the site;
- The average week-day and peak-hour vehicle trips to be generated by the site;

- The assignment of these trips to the area streets, roadways, and intersections; projections of long-term background traffic volumes;
- Resulting total traffic volumes on the area roadways;
- The projected levels of service at the key area intersections, following buildout; and
- The recommended transportation system, including functional classification of streets and roadways, number of lanes, intersection lane geometry/auxiliary turn lanes, and intersection traffic control.

PREVIOUS TRAFFIC REPORTS COMPLETED IN THE AREA

LSC completed the *Meridian Ranch Sketch Plan 2017 Amendment Traffic Impact Study* (TIS) ([SKP-171](#)) October 3, 2017 and the *Meridian Ranch Sketch Plan 2021 Amendment Traffic Impact Study* ([SKP-213](#)) June 25, 2021. Both sketch plan studies assumed this site developed as a community park with four soccer fields and access to Rainbow Bridge Drive.

A list of other traffic studies in the area of study completed within the past five years (that LSC is aware of) is attached for reference. This study accounts for the land use, trip generation, and the roadway network included in these studies.

A traffic report, entitled *Eastonville Road Project Conceptual Design Report*, was also recently completed for Eastonville Road by Wilson & Company (for El Paso County).

LAND USE AND ACCESS

Land Use

Figure 1 shows the site location. The site for the fieldhouse building, parking areas, and fields is part of a district-owned 19-acre parcel (EPC parcel no. 4220303093).

Figure 2 shows the proposed site plan for the Meridian Ranch Fieldhouse. The fieldhouse will provide space for recreational sports and exercise as an extension of the Meridian Ranch Recreation Center located on the northeast of the intersection of Londonderry Drive and Angels Road. The site is planned to include a 53,965-square-foot building that will include an indoor soccer field, a basketball/volleyball court, an exercise studio, a cardio/weights floor, a walking track, a childcare area, offices, and locker rooms. The site plan also includes a future 2,488-square-foot office building and a future outdoor soccer field.

The facility will not be open to the general-public use as a for-profit business, but rather for use by Meridian Ranch residents.

Access

Two full-movement access points are proposed to Rainbow Bridge Drive. The first access will be located about 397 feet southeast of Culebra Peak Drive and the second access will be located about 340 feet southeast of the first access.

The locations of these access points are generally consistent with those shown on the 2017 Sketch Plan TIA.

Pedestrian Facilities

Figure 3 shows the location of existing bicycle lanes, marked pedestrian crossings, and trail connections in the vicinity of the site. There are currently detached sidewalks along both sides of all the streets in the vicinity of the site. As shown in Figure 2, an existing trail that currently goes through the site to the Rolling Hills Ranch subdivision to the west is planned to be rerouted through the parking areas along new sidewalks.

There are existing pedestrian crosswalk markings on all legs of the all-way, stop-sign-controlled intersection of Londonderry Drive/Rainbow Bridge and a crossing guard is posted at this intersection during school arrival and dismissal times.

Sight Distance

Figure 4 shows an analysis of the required sight-distance at the proposed access points to Rainbow Bridge Drive. Based on the posted speed limit of 25 miles per hour (mph) on Rainbow Bridge Drive and the information contained in Table 2-21 of the *Engineering Criteria Manual (ECM)*, the required intersection sight distance at these intersections is 280 feet. Based on the criteria contained in Table 2-17 of the *ECM*, the required stopping sight distance approaching these intersections is 155 feet. As shown in Figure 3, these criteria can be met at both intersections.

The available sight distance at the access points was measured in the field. The available sight distance at the north access is about 444 feet to the north and 533 feet to the south. The available sight distance at the south access is about 675 feet to the north and 635 feet to the south. The available sight distance exceeds the required sight distance at both access points.

ROADWAY AND TRAFFIC CONDITIONS

Area Roadways

The major area roadways within and adjacent to Meridian Ranch are described below. Copies of the 2016 *El Paso County Major Transportation Corridors Plan (MTCP) 2040 Roadway Plan* and 2016 *MTCP 2060 Corridor Preservation Plan* with the site location identified on them have been attached to this report.

Londonderry Drive is a two-lane Collector extending east from the Falcon Hills neighborhood to Eastonville Road. Londonderry Drive has one through lane in each direction and a raised center median. The posted speed limit on Londonderry Drive is 35 miles per hour (mph)

Rex Road extends east from Goodson Road to Estate Ridge Drive within the Meridian Ranch development. Rex Road is classified as an Urban Minor Arterial in the *2016 El Paso County Major Transportation Corridors Plan (MTCP) 2040 Roadway Plan*. The posted speed limit on Rex Road is 45 mph between Meridian Road and Mount Gateway Drive and 35 mph east of Mount Gateway Drive. Rex Road is currently being constructed as a 2-lane Urban Minor Arterial from its existing terminus at Estate Ridge Drive to Eastonville Road. The new section is anticipated to be open to traffic by spring 2024. A short section is also proposed to be constructed east of Eastonville Road in the short-term future as part of the approved Grandview Reserve Phase 1 development. The west leg of Rex Road approaching Eastonville Road will be a temporary asphalt connection until a roundabout is constructed as part of the Grandview Reserve Phase 1 development. In the future, Rex Road is planned to be constructed southeast through Grandview Reserve and will intersect US Highway 24 as part of future development within the Grandview Reserve Sketch Plan area, coordination with El Paso County, the Colorado Department of Transportation (CDOT), other local agencies, and associated applications to CDOT.

Rainbow Bridge Drive is a two-lane Collector extending north from Lambert Road to Mount Antero Drive. Rainbow Bridge Drive has a posted speed limit of 25 mph north of Londonderry Drive. Rainbow Bridge Drive has a three-lane cross section (one through lane in each direction and a center two-way left-turn lane) from Londonderry Drive to Mount Harvard Drive. The section of Rainbow Bridge Drive adjacent to the site has one through lane in each direction.

Mount Antero Drive is an Urban Local which extends northwest from the terminus of Rainbow Bridge Drive to Pyramid Peak Drive.

Pyramid Peak Drive is an Urban Local which extends northeast from Mount Evans Drive to just north of Rex Road.

Existing Traffic Volumes

Figure 5 shows the existing morning, mid-afternoon (3:00-4:00 p.m.), and late-afternoon peak-hour traffic volumes at the key intersections from the attached traffic counts conducted by LSC in December 2023.

Existing Levels of Service

Level of service (LOS) is a quantitative measure of the level of delay at an intersection. Level of service is indicated on a scale from "A" to "F." LOS A represents control delay of less than 10 seconds for unsignalized and signalized intersections. LOS F represents control delay of more than 50 seconds for unsignalized intersections and more than 80 seconds for signalized intersections. Table 1 shows the level of service delay ranges.

Table 1: Level of Service Delay Ranges

Level of Service	Signalized Intersections	Unsignalized Intersections
	Average Control Delay (seconds per vehicle)	Average Control Delay (seconds per vehicle) ⁽¹⁾
A	10.0 sec or less	10.0 sec or less
B	10.1-20.0 sec	10.1-15.0 sec
C	20.1-35.0 sec	15.1-25.0 sec
D	35.1-55.0 sec	25.1-35.0 sec
E	55.1-80.0 sec	35.1-50.0 sec
F	80.1 sec or more	50.1 sec or more

(1) For unsignalized intersections, if V/C ratio is greater than 1.0 the level of service is LOS F, regardless of the projected average control delay per vehicle.

Figure 5 presents the results of the existing intersection level of service analysis. The levels of service on Rex Road are based on the unsignalized method of analysis procedures from the *Highway Capacity Manual, 6th Edition* by the Transportation Research Board. The level of service reports are attached.

Londonderry Drive/Rainbow Bridge Drive

The intersection of Londonderry/Rainbow Bridge is currently all-way, stop-sign controlled. All approaches are currently operating at LOS C or better during the peak hours.

Rex Road/Pyramid Peak Drive

The intersection of Rex Road/Pyramid Peak is currently two-way, stop-sign controlled. All approaches at this intersection are currently operating at LOS B or better during the peak hours.

2043 BACKGROUND TRAFFIC

Background traffic is the traffic estimated to be on the study-area streets without consideration of the proposed fieldhouse. It includes through traffic and traffic generated by adjacent/nearby developments.

Figure 6 shows the projected 20-year background traffic volumes for the year 2043. These volumes assume that Rex Road has been extended east to US Highway 24. The 2043 background traffic volumes were based on previous work completed by LSC in the area, including the *Meridian Ranch Sketch Plan 2021 Amendment Traffic Impact Study* ([SKP-213](#)), dated June 25, 2021.

TRIP GENERATION

The site-generated vehicle trips were estimated using nationally-published trip-generation rates for Land Use 495: Recreational Community Center from *Trip Generation, 11th Edition, 2021* by the Institute of Transportation Engineers (ITE). Note that the data for this land use are based on public facilities, but membership at the proposed fieldhouse is planned to be restricted to residents of Meridian Ranch. The ITE estimates may be conservative.

The ITE trip-generation estimates for land use No. 495 are for vehicle trips. Limited/no ITE data is available for trips by alternate transportation modes. To be conservative, no reductions to the trip-generation estimate were made due to mode split. However, due to the location of the proposed site within a residential area and the availability of existing pedestrian and bicycle facilities as shown on Figure 3, it is likely that some visitors will choose to walk or ride their bicycle to and from the site. Table 2 shows the results of the trip-generation estimate. Table 2 also shows the trip-generation estimate from the Sketch Plan report completed by LSC in October 2017.

The proposed fieldhouse, based on ITE trip-generation rates for land use No.495, is estimated to generate about 1,662 vehicle trips on the average weekday, with about half entering and half exiting the site during a 24-hour period. This is about 1,377 more weekdays trips than was assumed for this same parcel in the 2017 *Sketch Plan Update TIS*.

During the morning peak hour, which generally occurs for one hour between 6:30 a.m. and 8:30 a.m., about nine vehicles would enter and four vehicles would exit the site. During the mid-afternoon school peak hour (3:00 – 4:00 p.m.), about 45 vehicles would enter and 54 vehicles would exit the site. During the afternoon peak hour, which generally occurs for one hour between 4:15 p.m. and 6:15 p.m., about 76 vehicles would enter and 80 vehicles would exit.

TRIP DISTRIBUTION AND ASSIGNMENT

Trip Distribution

The area/directional distribution of the trips to be generated by the proposed fieldhouse on the area roadways is an important factor in determining the traffic impacts. Figure 7 shows the overall trip-distribution estimate for the trips estimated to be generated by the proposed fieldhouse. The estimates were based on the following factors: the location of the Meridian Ranch fieldhouse with respect to Meridian Ranch neighborhoods and number of housing units, area schools, and the Meridian Ranch street network. The trip distribution assumes a majority of the trips generated by the proposed fieldhouse would have origins or destinations within the overall Meridian Ranch development.

The distribution estimate accounts for diverted or “chained” trips, such as residents traveling to the facility in the morning from home, then departing for a workplace destination after using the facility.

Assignment of Site-Generated Trips

When the trip-distribution percentages (from Figure 7) are applied to the trip-generation estimates (from Table 2), the resulting site-generated traffic volumes can be determined. Figure 8 shows the site-generated traffic volumes.

TOTAL TRAFFIC

Short Term

Figure 9 shows the sum of the existing traffic volumes (from Figure 5) and site-generated traffic volumes (from Figure 8). These volumes represent the short-term impacts of the fieldhouse-generated trips.

Long Term

Figure 10 shows the projected 2043 total traffic volumes. These volumes are the sum of the 2043 background traffic volumes (from Figure 6) and the site-generated traffic volumes (from Figure 8).

PROJECTED LEVELS OF SERVICE

The key area intersections and access points were analyzed to determine the projected levels of service for the short-term and 2043 background and total traffic volumes, based on the unsignalized-intersection analysis procedures from the Highway Capacity Manual and the

signalized-intersection analysis procedures from the Synchro computer program. Figures 6, 9, and 10 show the level of service analysis results. The level of service reports are attached.

Londonderry Drive/Rainbow Bridge Drive

The intersection of Londonderry/Rainbow Bridge is currently all-way, stop-sign controlled. All approaches are projected to operate at LOS D or better during the peak hours through 2043.

Rex Road/Pyramid Peak Drive

The intersection of Rex Road/Pyramid Peak is currently two-way, stop-sign controlled. All movements at this intersection are projected to operate at LOS D or better during the peak hours through 2043.

Rainbow Bridge Drive Access Points

Both full-movement access points to Rainbow Bridge Drive are projected to operate at LOS A for all movements during the peak hours through 2043 as stop-sign-controlled intersections.

FUNCTIONAL CLASSIFICATION

Figure 11 shows the functional classifications for the roadways in the vicinity of the site. Figure 11 also shows a comparison of the projected 2043 average weekday traffic volumes and the design average weekday traffic volume by classification per the criteria contained in Tables 2-6 and 2-7 of the *El Paso County Engineering Criteria Manual (ECM)* on key street segments. As shown in Figure 10, all the projected average weekday traffic volumes are less than the design volumes.

CONCLUSIONS AND RECOMMENDATIONS

- The proposed fieldhouse, based on ITE trip-generation rates for land use No.495, is estimated to generate about 1,662 vehicle trips on the average weekday, with about half entering and half exiting the site during a 24-hour period. This is about 1,377 more weekdays trips than was assumed for this same parcel in the 2017 Sketch Plan Update TIS.
- During the morning peak hour, which generally occurs for one hour between 6:30 a.m. and 8:30 a.m., about nine vehicles would enter and four vehicles would exit the site. During the mid-afternoon school peak hour (3:00 – 4:00 p.m.) about 45 vehicles would enter and 54 vehicles would exit the site. During the afternoon peak hour, which generally occurs for one hour between 4:15 p.m. and 6:15 p.m., about 76 vehicles would enter and 80 vehicles would exit the amendment area.
- The intersection of Londonderry/Rainbow Bridge is projected to continue to operate at a satisfactory level of service as an all-way, stop-sign-controlled intersection through 2043.
- The intersection of Rex/Pyramid Peak is projected to continue to operate at a satisfactory level of service as two-way, stop-sign-controlled intersections through 2043.

- Both proposed full-movement access points to Rainbow Bridge Drive are projected to operate at a satisfactory level of service as two-way, stop-sign-controlled intersections through 2043.
- Based on the **existing** traffic volumes shown in Figure 4 and the criteria contained in the *ECM*, the following auxiliary lanes would be required at the intersection of Londonderry Drive/Rainbow Bridge Drive:
 - An eastbound right-turn lane on Londonderry Drive approaching Rainbow Bridge Drive
 - A northbound left-turn lane on Rainbow Bridge Drive approaching Londonderry Drive.
 - A southbound right-turn lane on Rainbow Bridge Drive approaching Londonderry Drive.

However, auxiliary turn lanes for the purposes of mitigating “speed-change differential” between through traffic and turning traffic are not necessary at this intersection as it is all-way, stop-sign controlled and all vehicles approaching the intersection decelerate to a stop. Additionally, LSC completed a Pedestrian Operation and Safety Study for this intersection dated February 8, 2017. All the improvements recommended in that study have since been implemented. That study did not recommend additional auxiliary lanes, likely because this would result in longer crossing distances for pedestrians. For these reasons, LSC does not recommend any improvements at this intersection.

- At the intersection of Rex Road/Pyramid Peak Road, the **existing** traffic volume during the school peak hour (shown in Figure 3) currently exceeds the 50-vph threshold in the *ECM* above which an eastbound right-turn deceleration lane is prescribed. The threshold is not currently exceeded during the morning and evening peak hours. Regarding the projected traffic impact of this project: This project is anticipated to add less than one vehicle per hour to that turning movement during the peak hours and, further, the diverted-trip component during the afternoon peak may actually reduce the net increase in right-turning trips.
- The minimal additional site-generated eastbound right-turning volume during the school peak hour would represent less than a one-percent increase over the existing turning volume during the school peak hour, which is the time period during which the 50 vph is exceeded.
- Also note: although the existing right-turning volume during the school peak hour currently exceeds the 50 vph threshold, the road has been built and infrastructure is in-place - including sidewalk and storm-sewer inlet.
- Based on the above reasons, LSC does not recommend a requirement of this project to add an eastbound right-turn deceleration lane at the intersection of Rex Road/Pyramid Peak Road.
- At the intersection of Rex Road/Pyramid Peak Road, the **existing** traffic volumes during the morning, school and evening peak hours (shown in Figure 3) currently exceed the 25-vph threshold in the *ECM* above which a northbound left-turn deceleration lane is prescribed. However, LSC recommends the existing

single-lane northbound approach be allowed to remain as currently configured/built for the following reasons:

- Pyramid Peak Drive is classified as an Urban Local and the typical cross section for that classification does not have turn lanes.
 - Auxiliary turn lanes for the purposes of mitigating “speed-change differential” between through traffic and turning traffic are not necessary as the northbound approach is **Stop-sign controlled** and all vehicles approaching the intersection decelerate to a stop prior to proceeding to enter the intersection.
 - The opposing volumes are less than 20 vehicles per hour. The Colorado Highway Access code allows for a left-turn lane to be dropped if the opposing volume is predicted to be below 100 vehicles per hour.
 - The northbound approach is projected to operate at a satisfactory level of service with a single-lane approach.
 - The minimal site-generated northbound left-turning volume during the peak hours would represent less than a five-percent increase over the corresponding existing northbound left-turning volumes.
 - Based on the above reasons, LSC does not recommend any modifications to the northbound approach at the intersection of Rex Road/Pyramid Peak Road.
- Based on the projected 2043 total traffic volumes shown in Figure 9 and the criteria contained in the *ECM*, no auxiliary turn lanes are required on Rainbow Bridge Drive approaching the site-access points.
 - No offsite improvements are recommended.

* * * * *

Please contact me if you have any questions regarding this report.

Sincerely,

LSC TRANSPORTATION CONSULTANTS, INC.

By Jeffrey C. Hodsdon, P.E.
Principal

JCH/KDF:jas

Enclosures: Table 2
Figures 1-11
Traffic Counts
Level of Service Reports
MTCP Maps
Appendix 1

Table 2



**Table 2
Trip Generation Estimate
Meridian Ranch Field House**

Land Use Code	Land Use Description	Trip Generation Units	Trip Generation Rates ⁽¹⁾						Total Trips Generated							
			Average Weekday Traffic	Morning Peak-Hour		Midday Peak-Hour		Afternoon Peak-Hour		Average Weekday Traffic	Morning Peak-Hour		Afternoon Peak-Hour			
				In	Out	In	Out	In	Out		In	Out	In	Out	In	Out
Trip Generation Estimate Based on the Currently Proposed Plan																
495	Recreational Community Center	53.965 KSF ⁽³⁾	28.82	1.26	0.65	0.76	0.92	1.18	1.33	1,555	5	3	41	50	63	72
488	Soccer Complex	1 field	71.33	0.60	0.39	1.88	2.27	10.84	5.59	71	1	0	2	2	11	5
712	Small Office Building	2.468 KSF	14.39	1.37	0.30	0.74	0.82	0.73	1.43	36	3	1	2	2	2	3
Total										1,662	9	4	45	54	76	80
Trip Generation Estimate For the Same Parcel From the Meridian Ranch Sketch Plan 2017 Amendment Traffic Impact Analysis , October 3, 2017 (SKP171)																
488	Soccer Complex	4 fields	71.33	0.70	0.70	---	---	14.26	6.41	285	3	3	---	---	57	26
Change (increase) in Trip Generation Estimate										1,377	6	1	---	---	19	54

Notes:
(1) Source: *Trip Generation* , 11th Edition, 2021 by the Institute of Transportation Engineers (ITE)
(2) KSF = 1,000 square feet

Figures 1-11



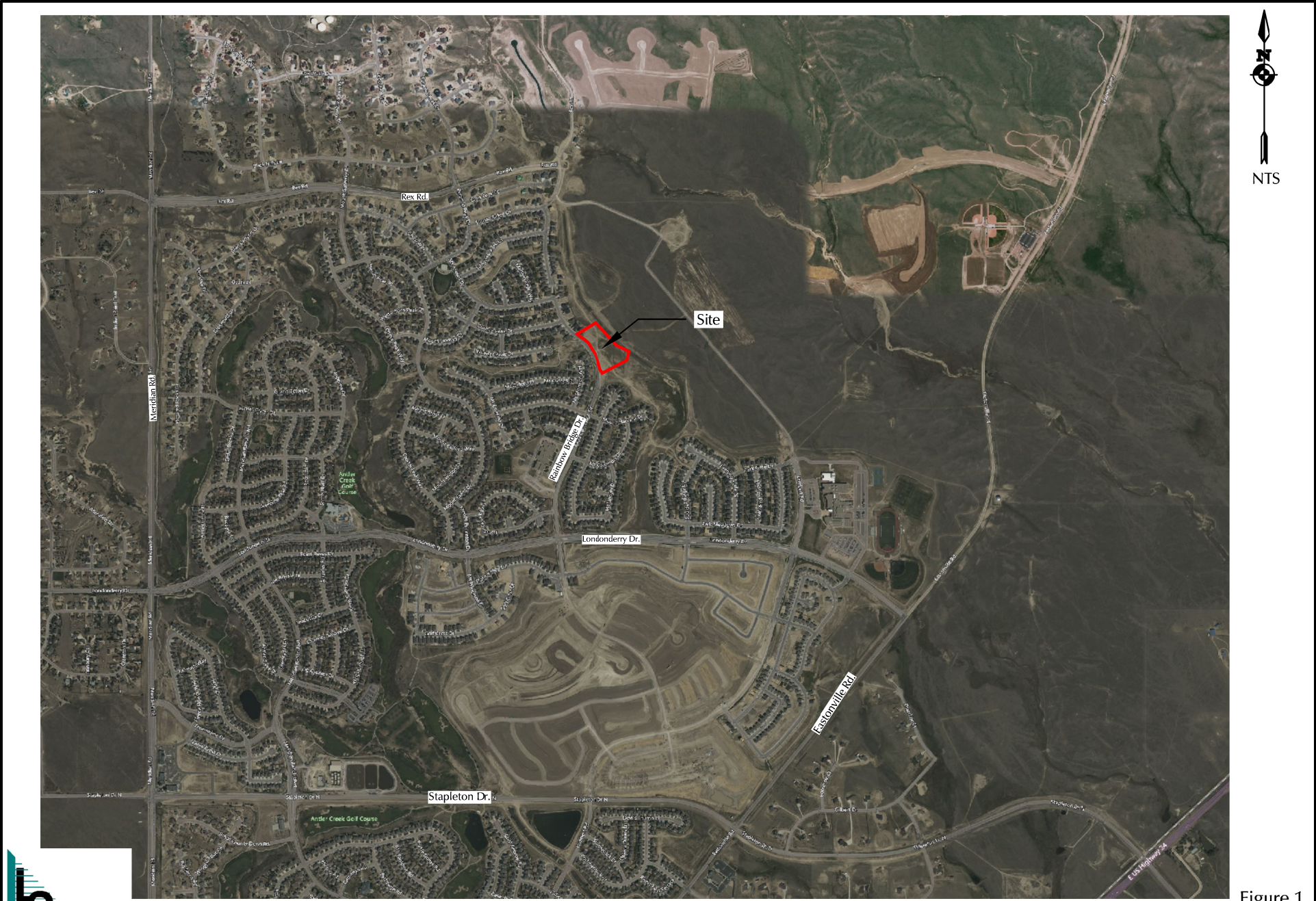

Figure 1

Vicinity Map

Meridian Ranch Fieldhouse (LSC # S234410)

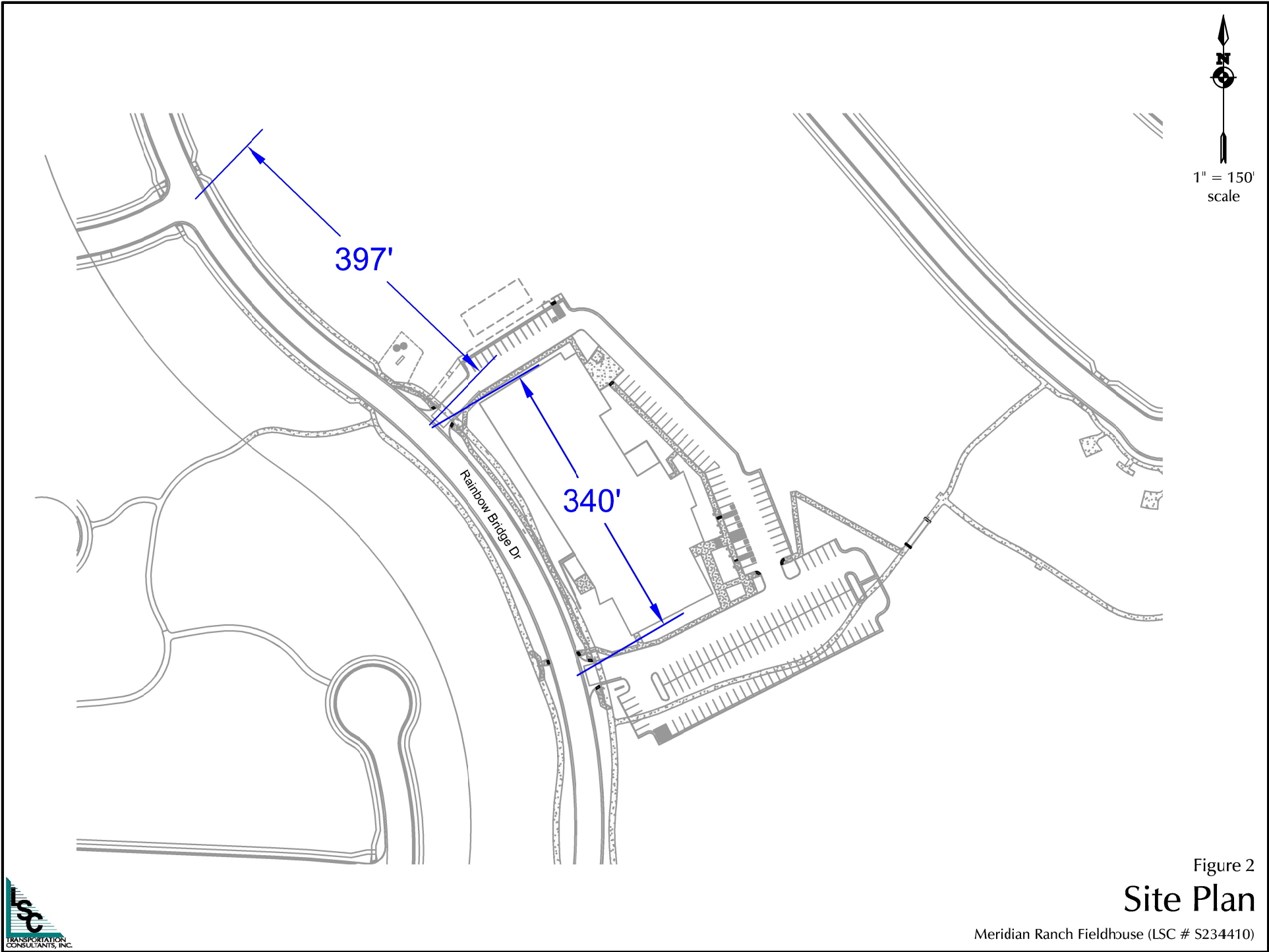
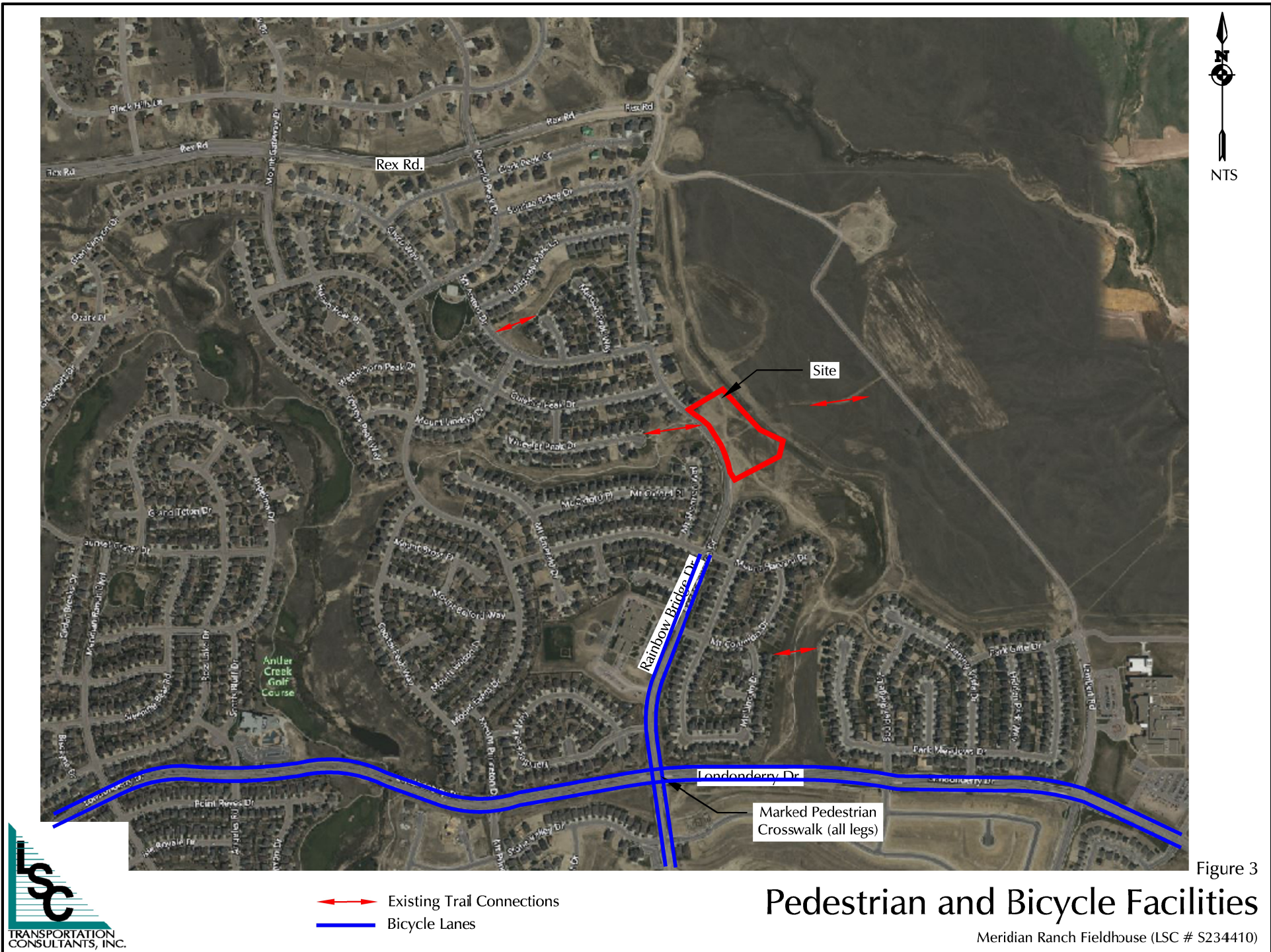
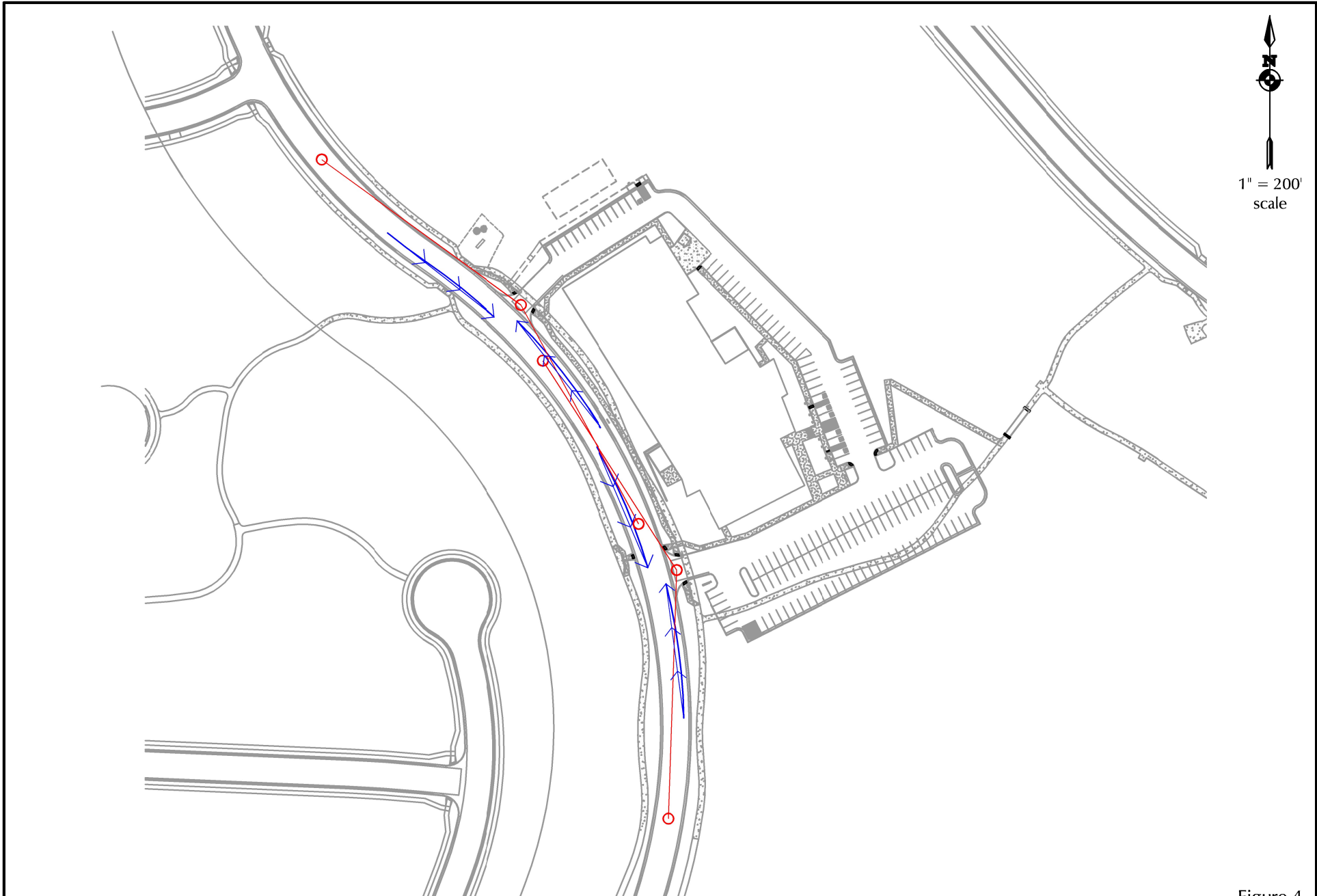

Figure 2
Site Plan

Meridian Ranch Fieldhouse (LSC # S234410)





1" = 200'
scale

- ECM Required Intersection Sight Distance (280' based on a design speed of 25 mph (from table 2-21))
- ECM Required Stopping Sight Distance (155' based on a design speed of 25 mph (from table 2-17))

Figure 4
Sight Distance
 Meridian Ranch Fieldhouse (LSC # S234410)



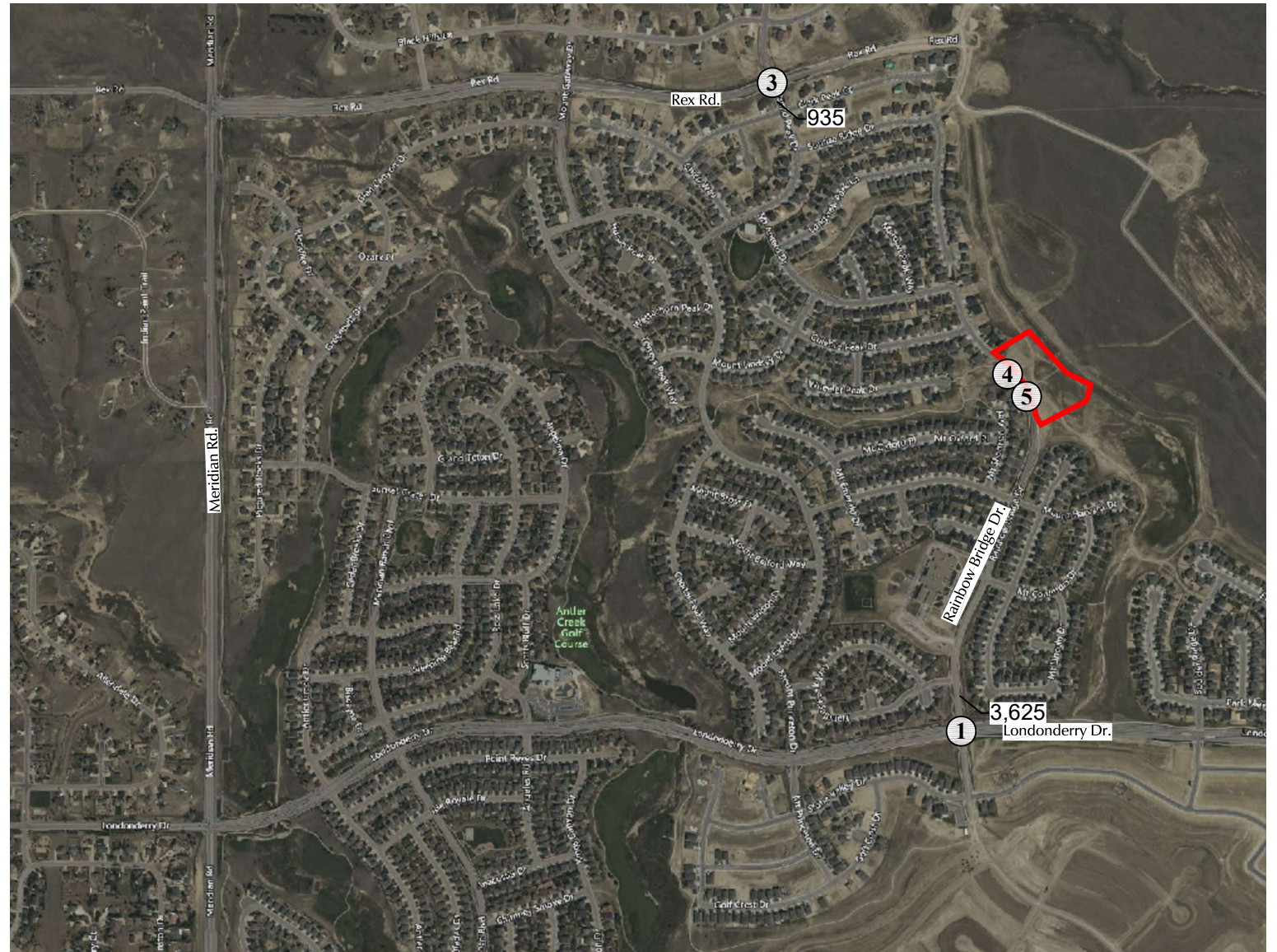
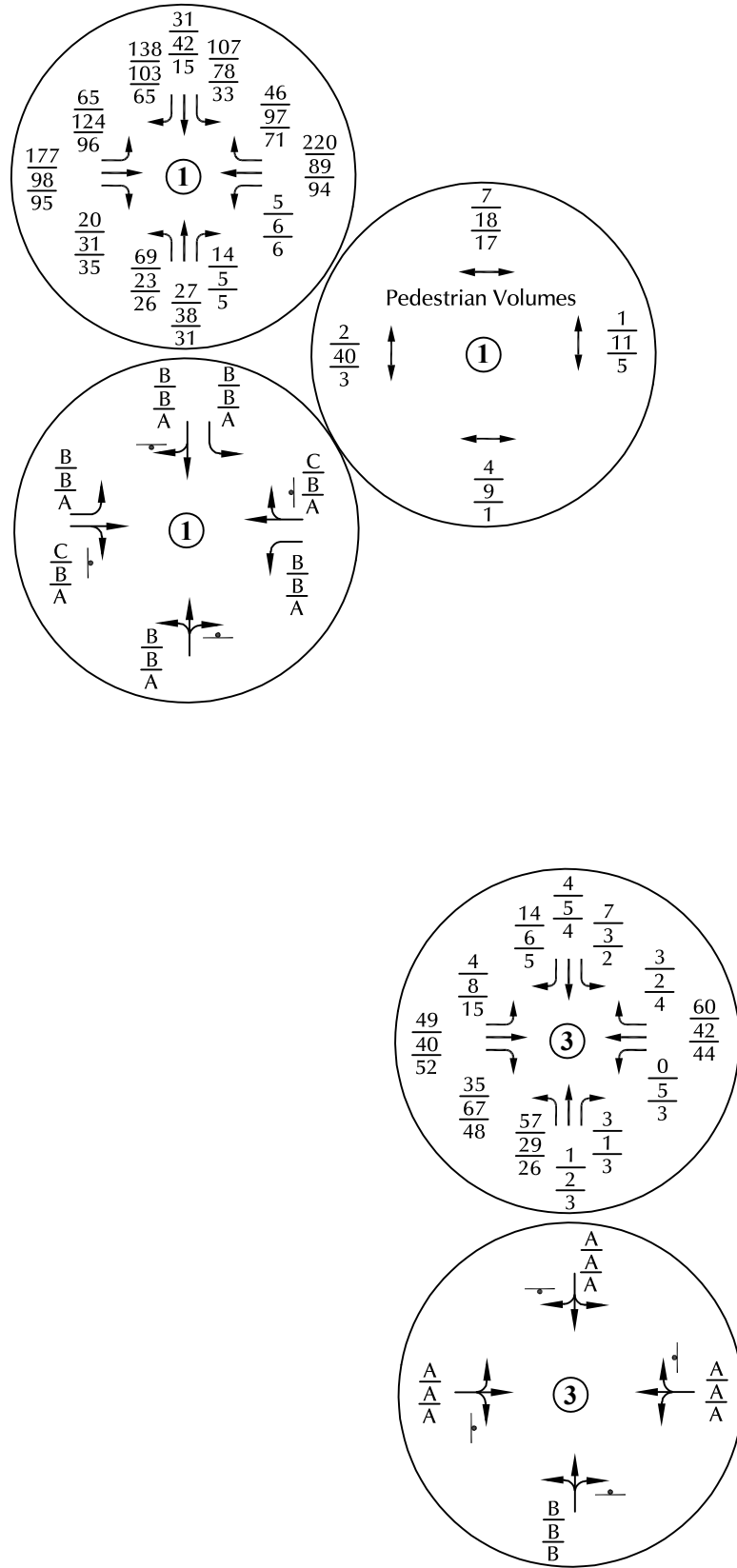

LEGEND:

- $\frac{X}{X}$ = AM Individual Movement Peak-Hour LOS
- $\frac{X}{X}$ = 3:00-4:00 PM Individual Movement Peak-Hour LOS
- $\frac{X}{X}$ = PM Individual Movement Peak-Hour LOS
- $\frac{XX}{XX}$ = AM Weekday Peak-Hour Traffic (Veh/Hour)
- $\frac{XX}{XX}$ = 3:00-4:00 PM Weekday Peak-Hour Traffic (Veh/Hour) Counts by LSC 12/2023
- $\frac{XX}{XX}$ = PM Peak-Hour Traffic (Veh/Hour)
- X,XXX = Average Daily Traffic (Vehicles/Day)

Figure 5
Existing Traffic, Lane Geometry,
Traffic Control, and Level of Service

Meridian Ranch Fieldhouse (LSC # S234410)



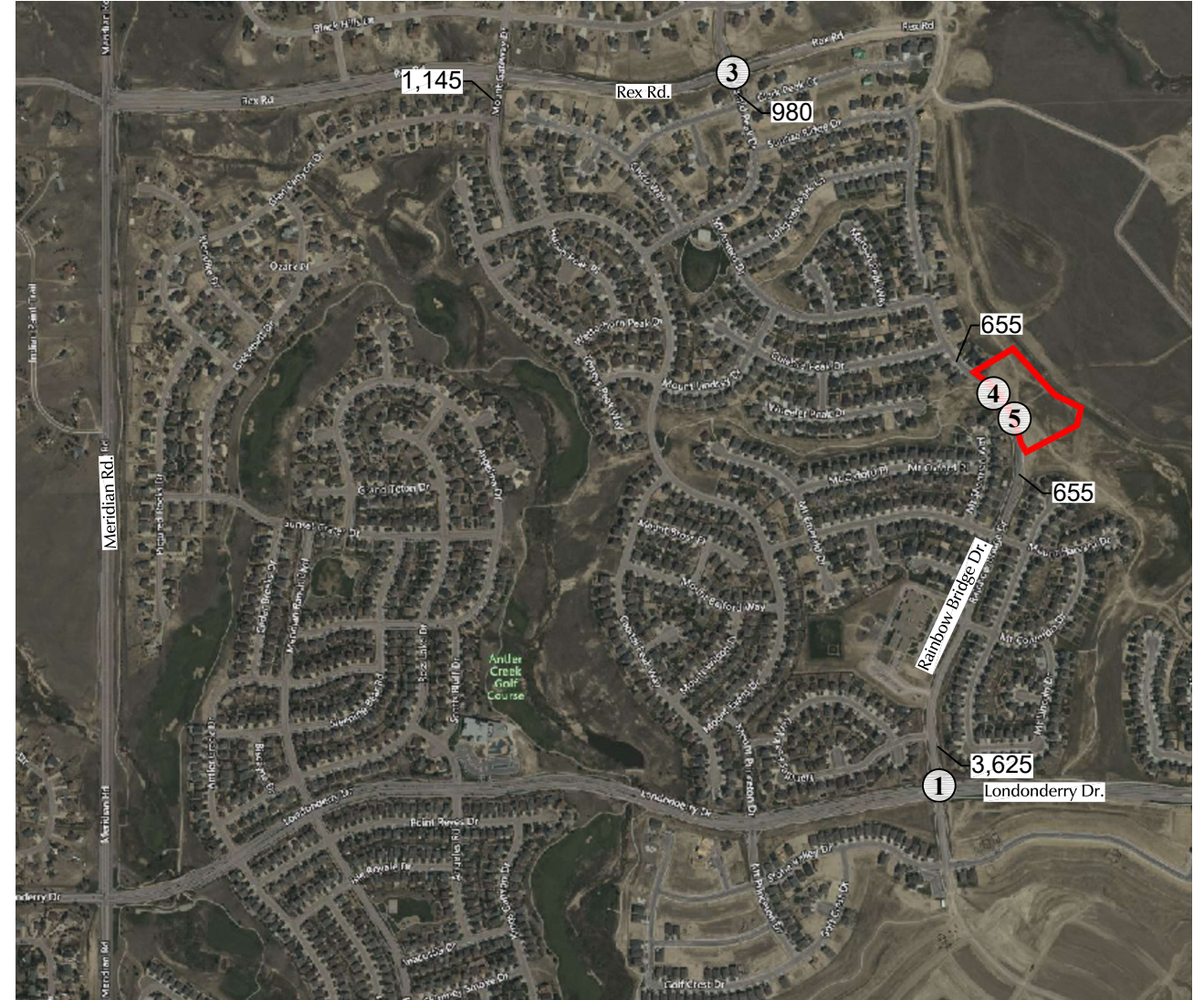
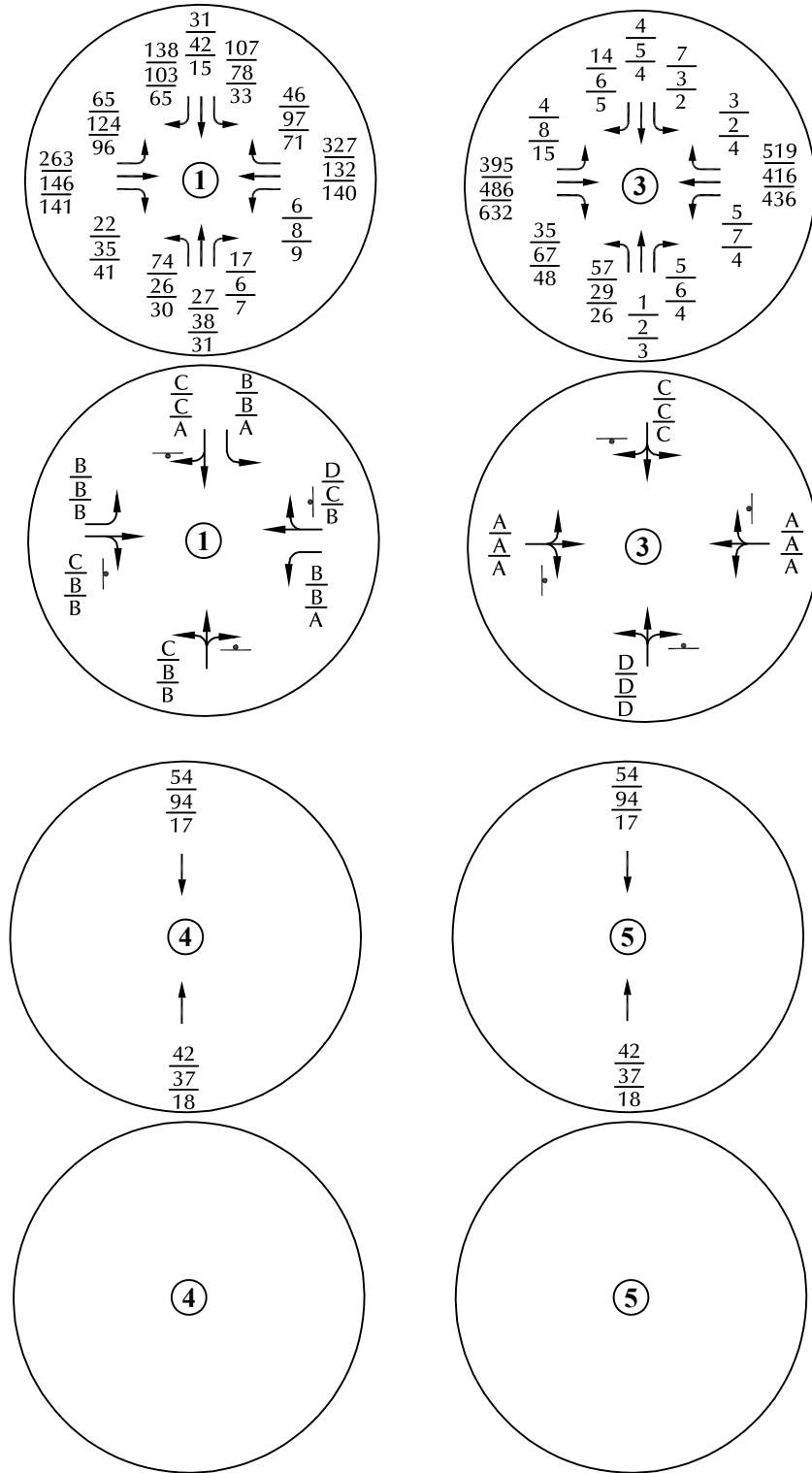

LEGEND:

- $\frac{X}{X}$ = AM Individual Movement Peak-Hour LOS
- $\frac{X}{X}$ = 3:00-4:00 PM Individual Movement Peak-Hour LOS
- $\frac{X}{X}$ = PM Individual Movement Peak-Hour LOS
- $\frac{XX}{XX}$ = AM Weekday Peak-Hour Traffic (Veh/Hour)
- $\frac{XX}{XX}$ = 3:00-4:00 PM Weekday Peak-Hour Traffic (Veh/Hour)
- $\frac{XX}{XX}$ = PM Peak-Hour Traffic (Veh/Hour)
- X,XXX = Average Daily Traffic (Vehicles/Day)

Figure 6
 2043 Background Traffic, Lane Geometry,
 Traffic Control, and Level of Service

Meridian Ranch Fieldhouse (LSC # S234410)

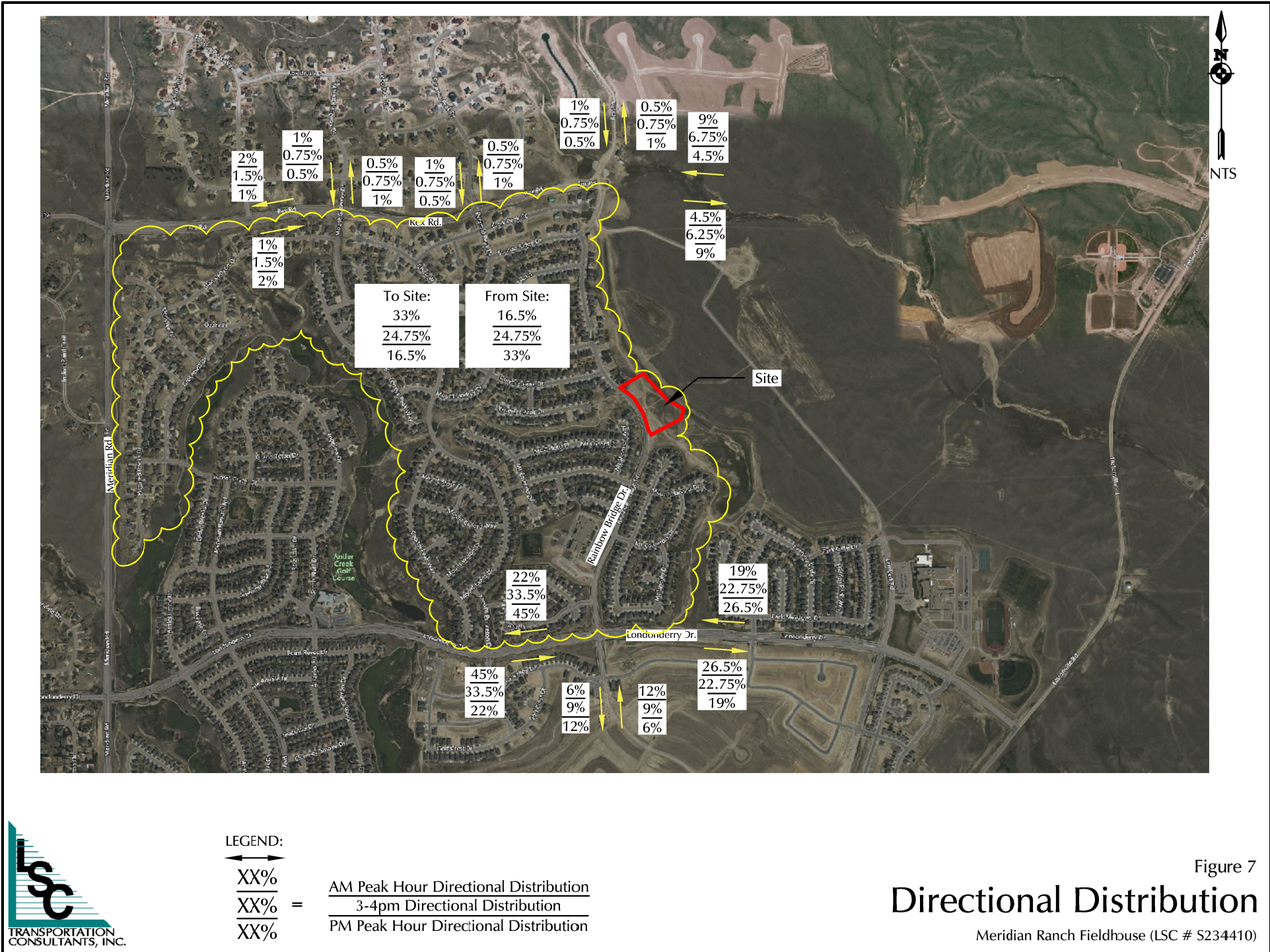
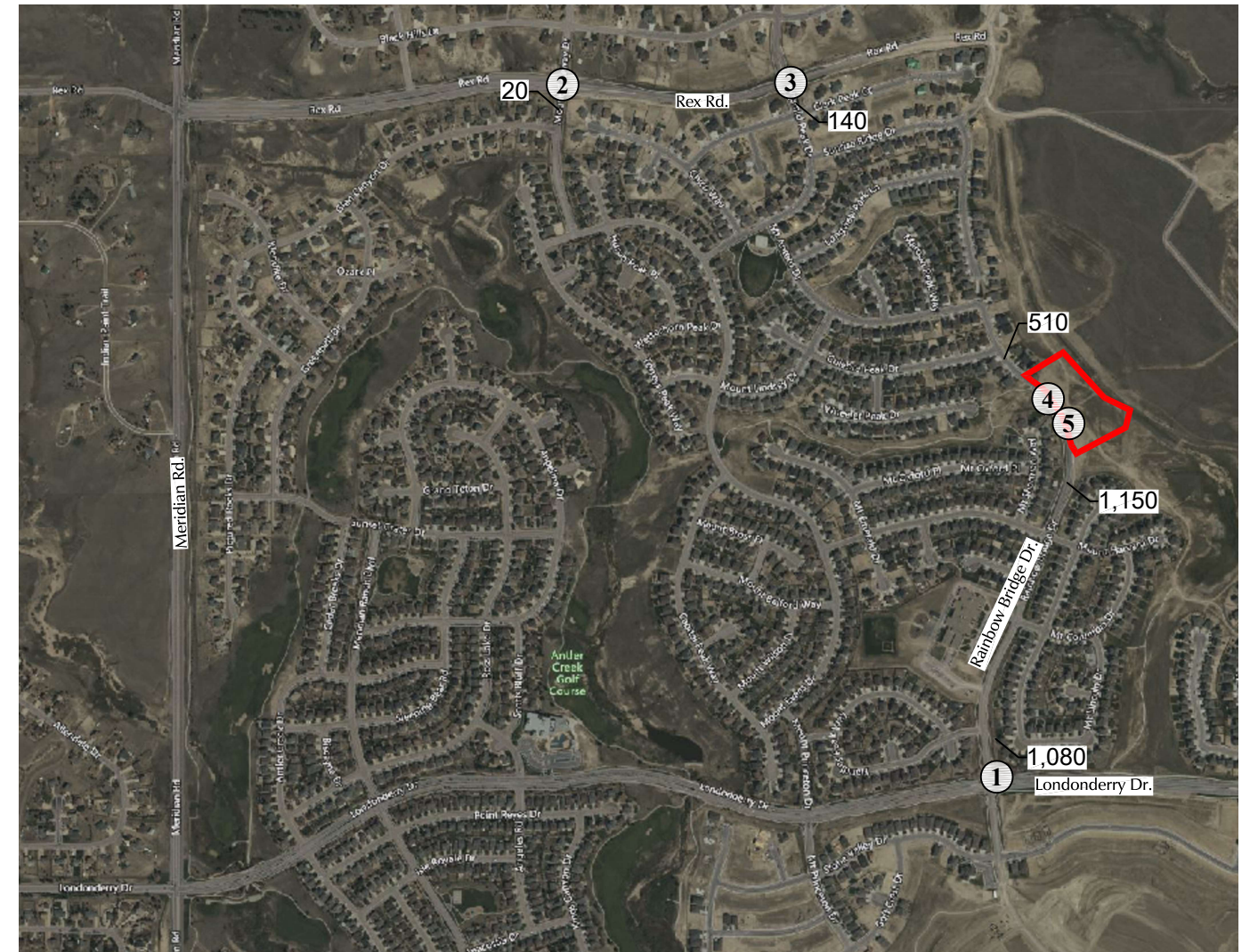
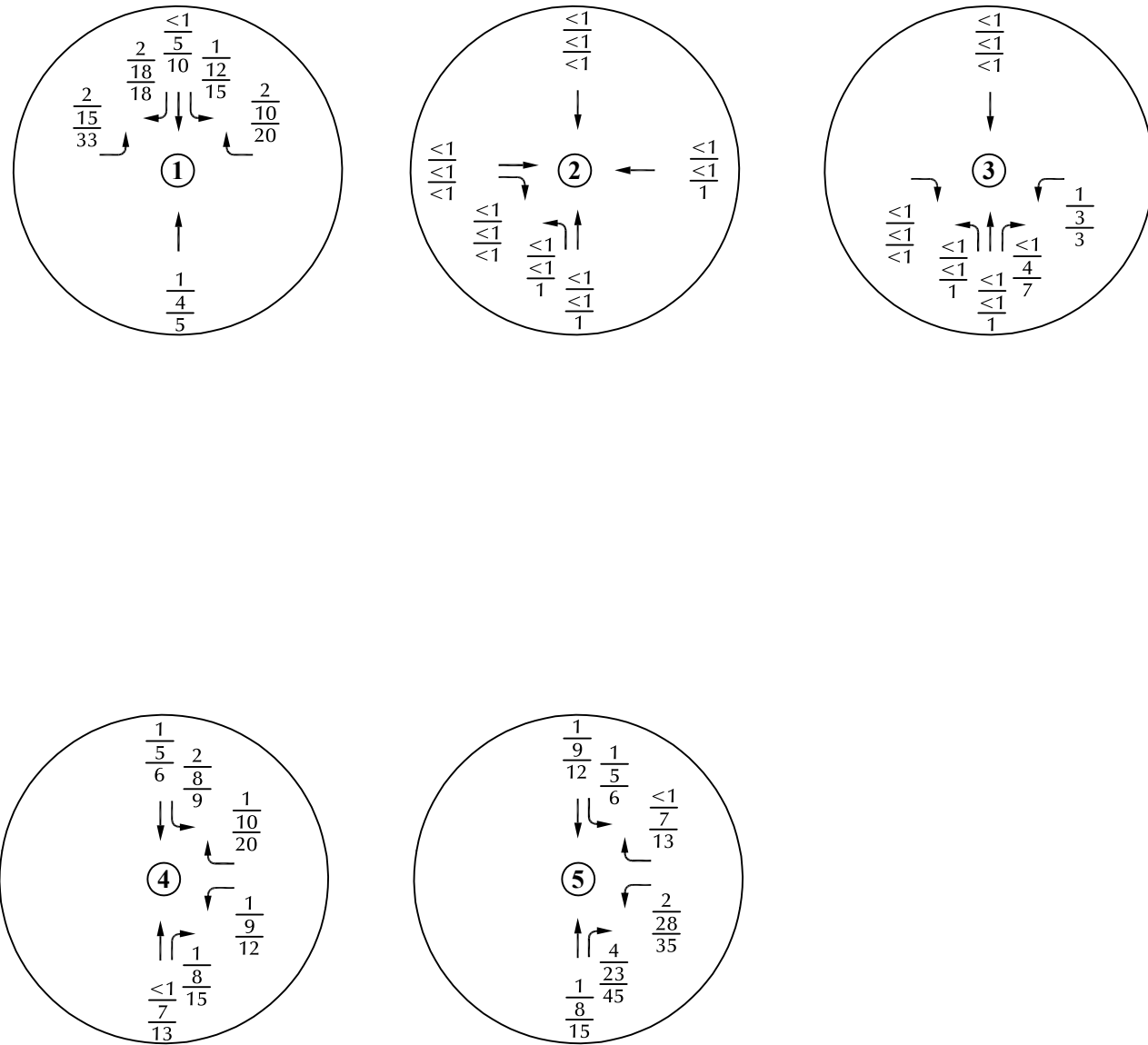

Figure 7

Directional Distribution

Meridian Ranch Fieldhouse (LSC # S234410)



LEGEND:

- $\frac{XX}{XX}$ = AM Weekday Peak-Hour Traffic (Veh/Hour)
- $\frac{XX}{XX}$ = 3:00-4:00 PM Weekday Peak-Hour Traffic (Veh/Hour)
- $\frac{XX}{XX}$ = PM Peak-Hour Traffic (Veh/Hour)
- X,XXX = Average Daily Traffic (Vehicles/Day)



Figure 8
Estimated Site Generated Traffic

Meridian Ranch Fieldhouse (LSC # S234410)

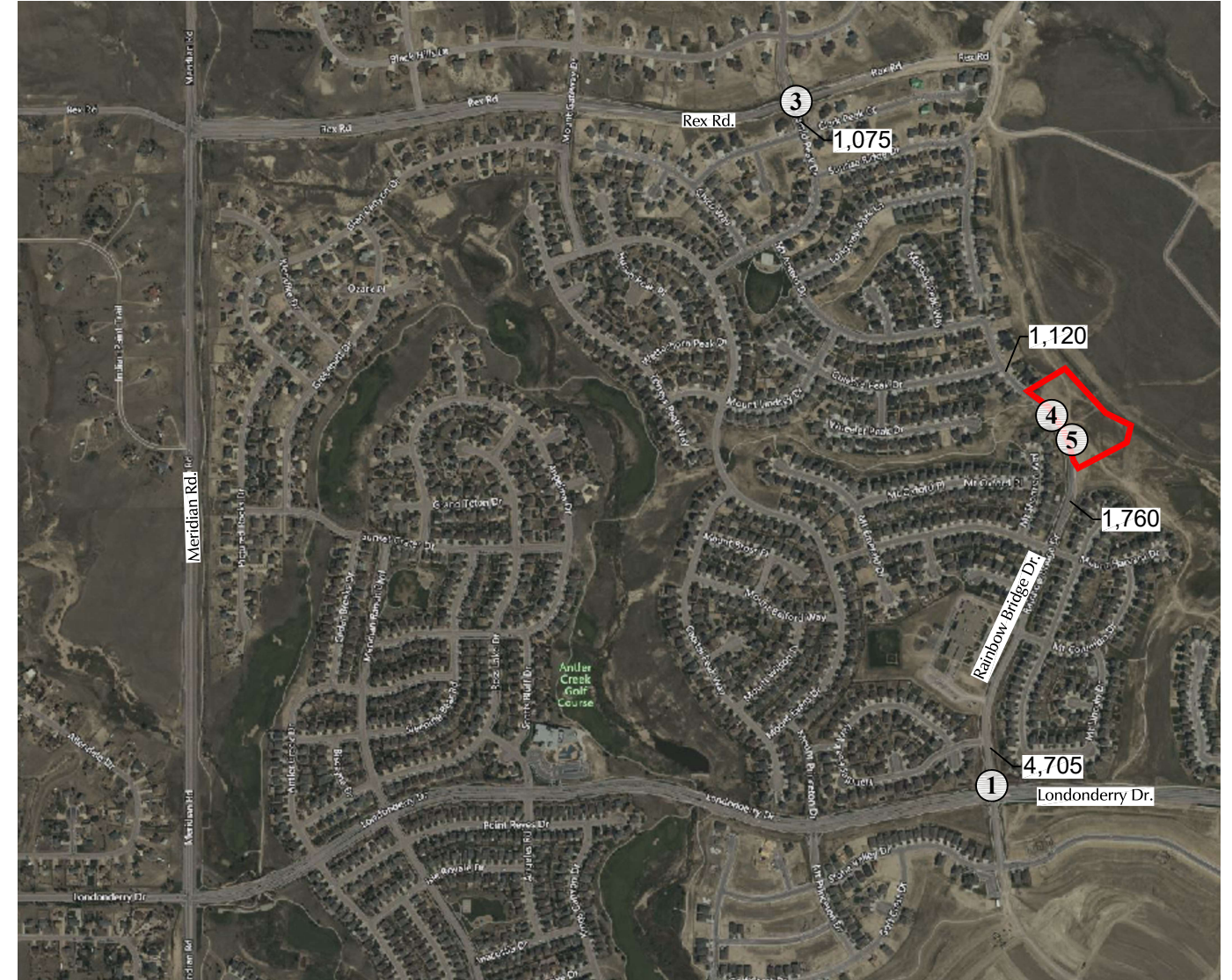
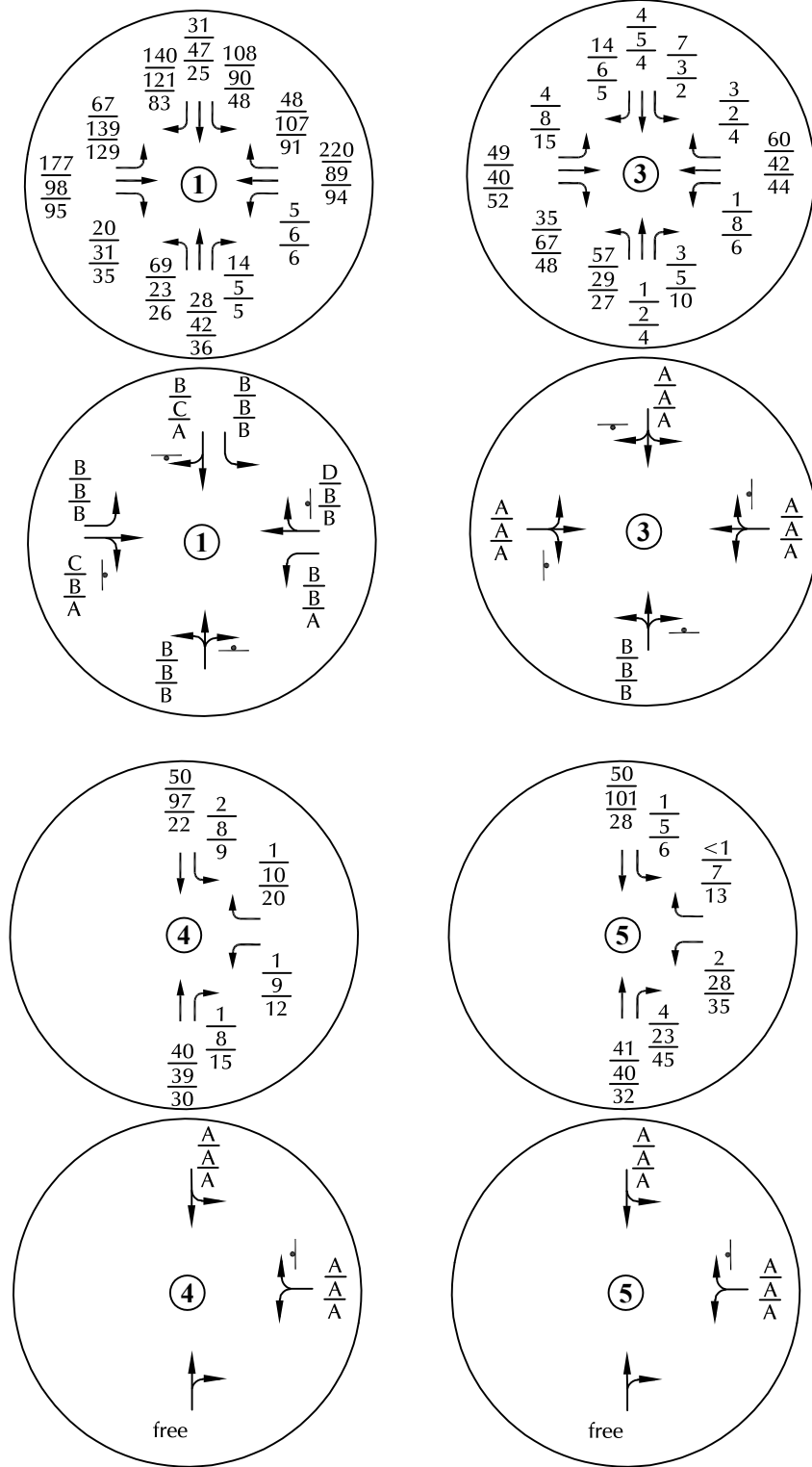

LEGEND:

- $\frac{X}{X}$ = AM Individual Movement Peak-Hour LOS
- $\frac{X}{X}$ = 3:00-4:00 PM Individual Movement Peak-Hour LOS
- $\frac{X}{X}$ = PM Individual Movement Peak-Hour LOS
- $\frac{XX}{XX}$ = AM Weekday Peak-Hour Traffic (Veh/Hour)
- $\frac{XX}{XX}$ = 3:00-4:00 PM Weekday Peak-Hour Traffic (Veh/Hour)
- $\frac{XX}{XX}$ = PM Peak-Hour Traffic (Veh/Hour)
- X,XXX = Average Daily Traffic (Vehicles/Day)

Figure 9
Existing + Site-Generated Traffic, Lane
Geometry, Traffic Control, and Level of Service

Meridian Ranch Fieldhouse (LSC # S234410)

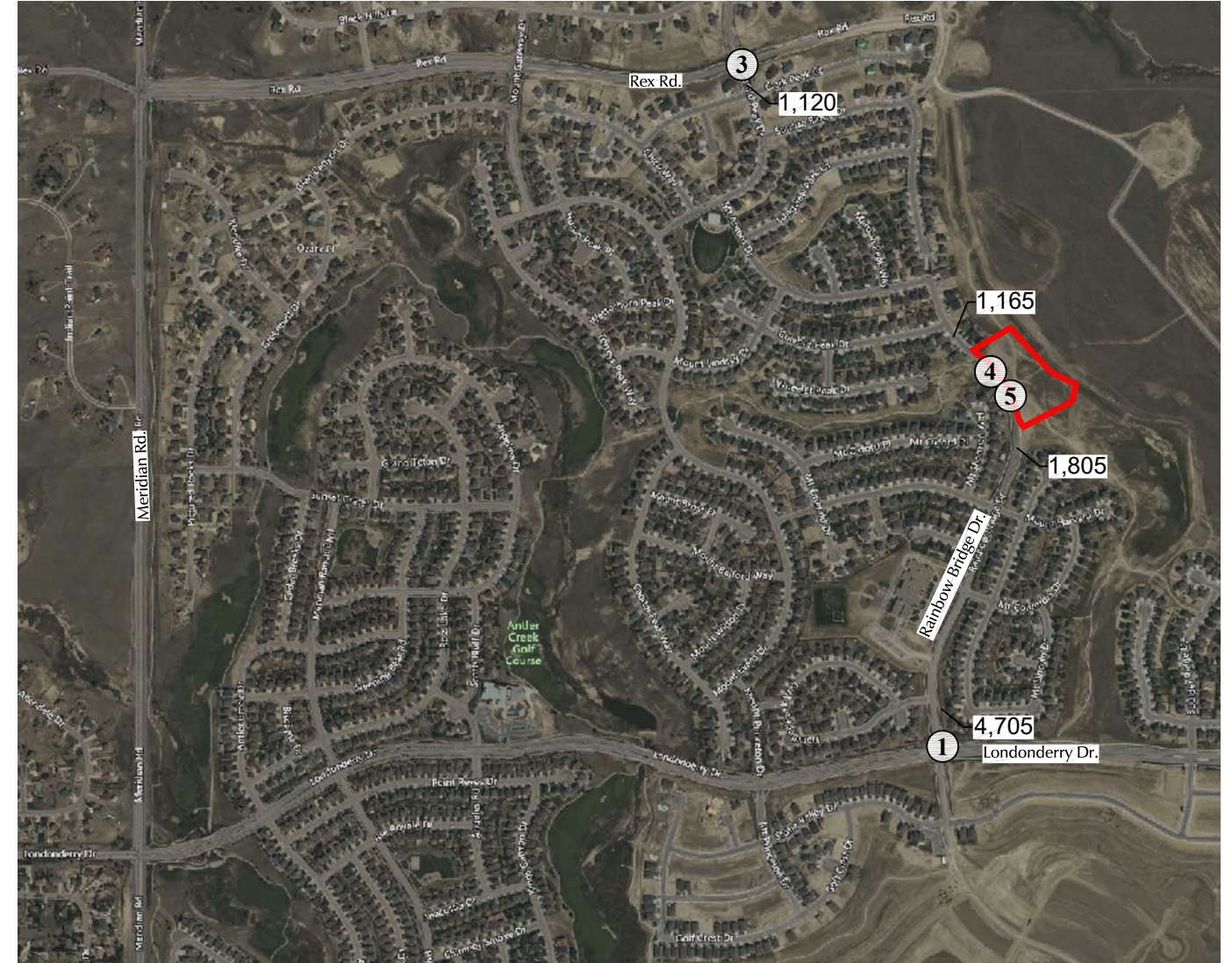
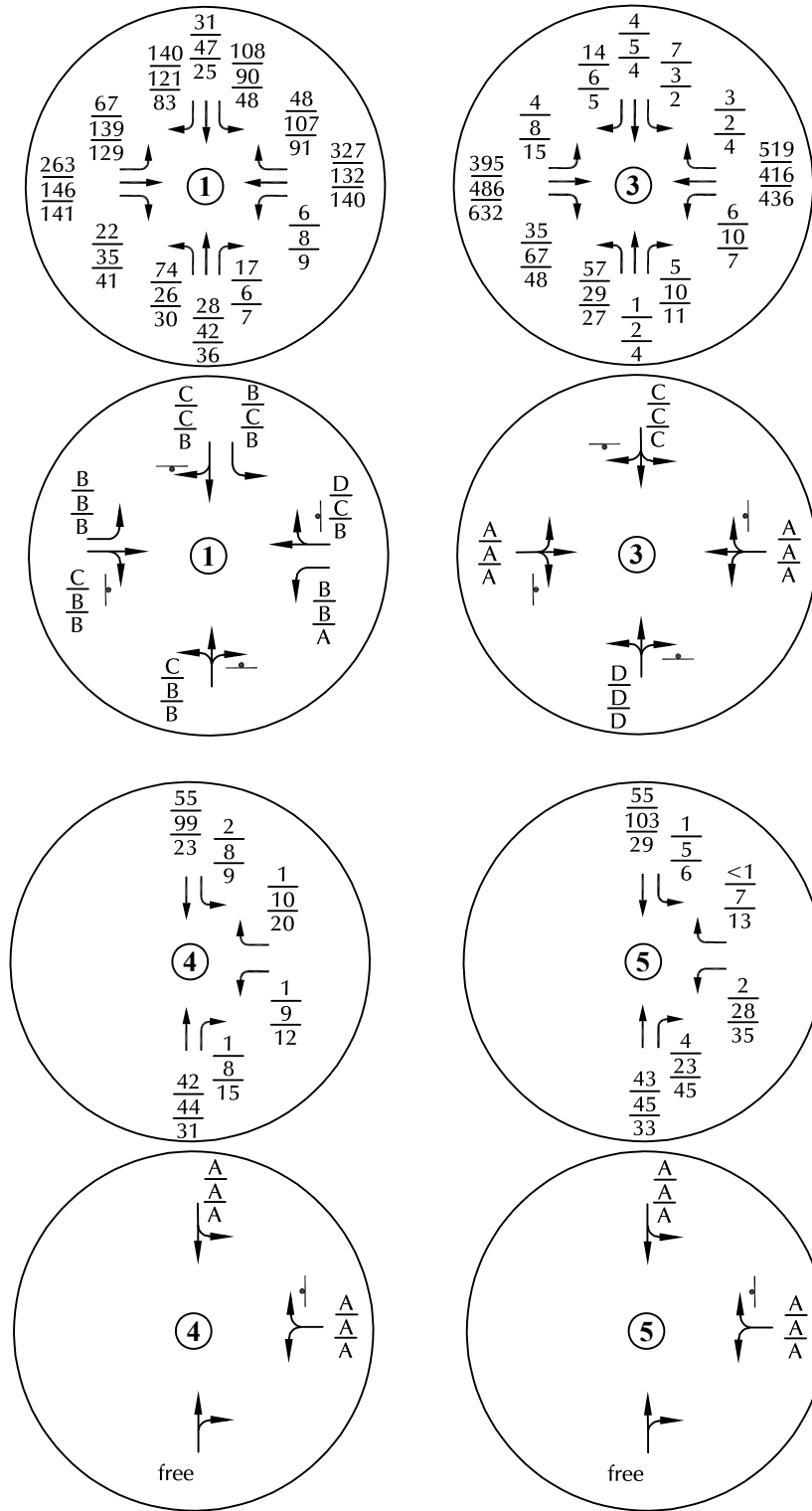

LEGEND:

- $\frac{X}{X}$ = AM Individual Movement Peak-Hour LOS
- $\frac{X}{X}$ = 3:00-4:00 PM Individual Movement Peak-Hour LOS
- $\frac{X}{X}$ = PM Individual Movement Peak-Hour LOS
- $\frac{XX}{XX}$ = AM Weekday Peak-Hour Traffic (Veh/Hour)
- $\frac{XX}{XX}$ = 3:00-4:00 PM Weekday Peak-Hour Traffic (Veh/Hour)
- $\frac{XX}{XX}$ = PM Peak-Hour Traffic (Veh/Hour)
- X,XXX = Average Daily Traffic (Vehicles/Day)

Figure 10
 2043 Total Traffic, Lane Geometry, Traffic Control, and Level of Service

Meridian Ranch Fieldhouse (LSC # S234410)

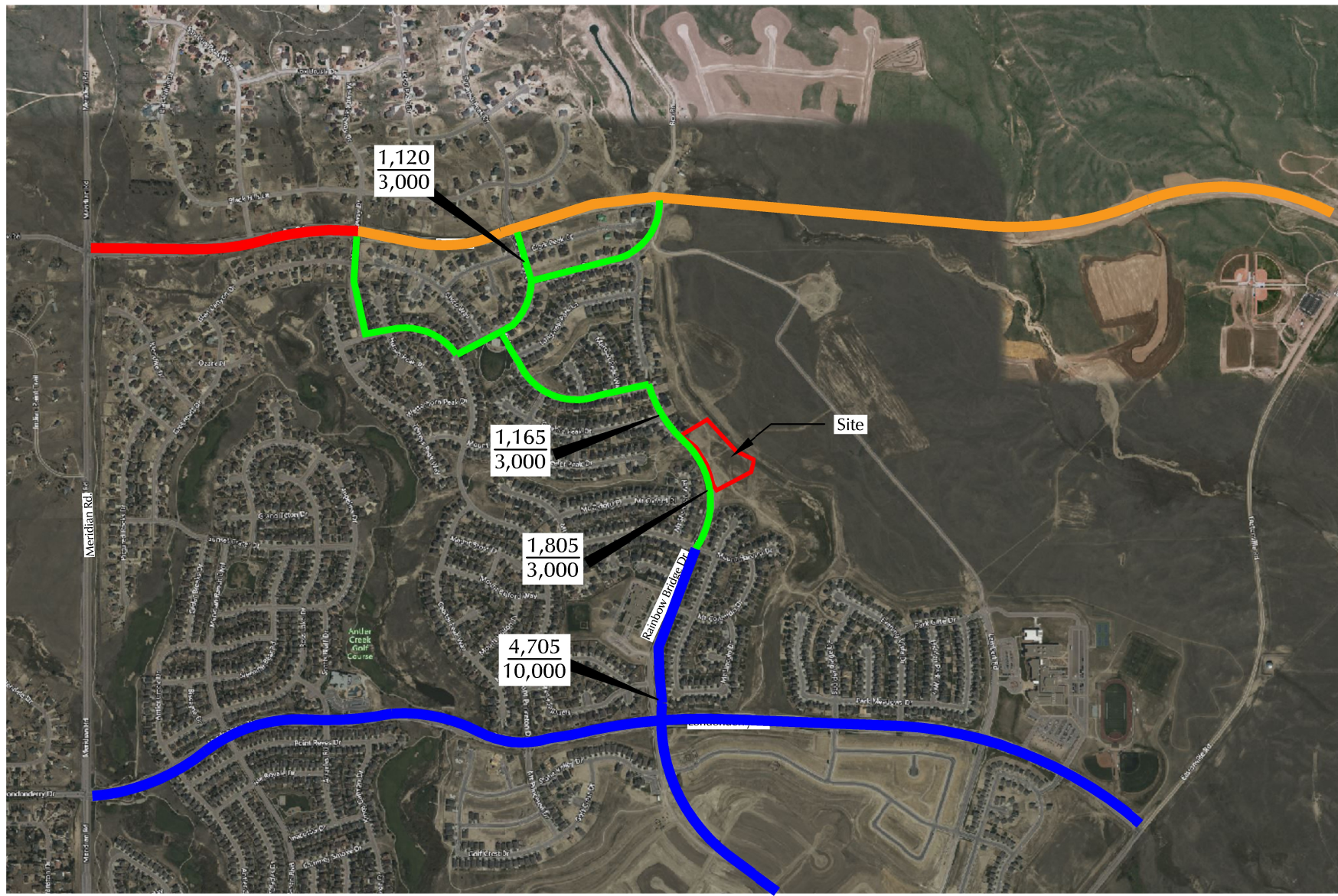

LEGEND:

$$\frac{XX\%}{XX\%} = \frac{\text{Project Average Weekday Traffic}}{\text{Design Average Daily Traffic}}$$

- Urban Minor Arterial (4 lane)
- Urban Minor Arterial (2 lane)
- 2-lane Urban Residential Collector
- Urban Local

Figure 11
Roadway Classifications

Meridian Ranch Fieldhouse (LSC # S234410)



Traffic Counts



LSC Transportation Consultants, Inc.

2504 E. Pikes Peak Ave, Suite 304
 Colorado Springs, CO 80909
 719-633-2868

File Name : Rainbow Bridge Dr - Londonderry Dr AM

Site Code : S234410

Start Date : 12/6/2023

Page No : 1

Groups Printed- Unshifted

Start Time	Rainbow Bridge Dr Southbound					Londonderry Dr Westbound					Rainbow Bridge Dr Northbound					Londonderry Dr Eastbound					Int. Total
	Right	Thru	Left	Peds	App. Total	Right	Thru	Left	Peds	App. Total	Right	Thru	Left	Peds	App. Total	Right	Thru	Left	Peds	App. Total	
06:45	9	1	8	0	18	2	8	1	0	11	0	1	2	0	3	0	11	1	0	12	44
06:50	9	2	12	1	24	2	11	0	0	13	1	0	3	0	4	1	10	3	1	15	56
06:55	7	2	4	0	13	6	18	0	0	24	1	0	3	0	4	1	9	4	0	14	55
Total	25	5	24	1	55	10	37	1	0	48	2	1	8	0	11	2	30	8	1	41	155
07:00	10	3	11	3	27	2	11	0	1	14	1	0	6	0	7	1	13	2	1	17	65
07:05	10	2	13	1	26	2	21	1	0	24	2	3	4	0	9	1	21	3	0	25	84
07:10	20	1	14	1	36	3	31	1	0	35	1	0	4	1	6	1	24	4	0	29	106
07:15	15	3	13	0	31	9	28	0	0	37	3	8	5	0	16	1	29	5	0	35	119
07:20	13	4	14	0	31	2	37	0	0	39	2	2	10	2	16	2	20	5	0	27	113
07:25	11	9	9	0	29	7	22	2	0	31	1	3	3	1	8	0	14	6	0	20	88
07:30	13	0	4	0	17	1	14	0	0	15	1	3	8	0	12	2	11	6	0	19	63
07:35	9	3	3	0	15	4	10	0	0	14	0	2	11	0	13	5	5	6	0	16	58
07:40	10	0	4	1	15	4	12	1	0	17	1	3	9	0	13	2	10	6	0	18	63
07:45	11	2	6	0	19	4	5	0	0	9	0	3	3	0	6	3	11	15	0	29	63
07:50	4	0	3	1	8	2	7	0	0	9	0	3	2	0	5	5	11	3	1	20	42
07:55	3	2	6	0	11	12	6	1	0	19	0	3	2	0	5	4	1	14	0	19	54
Total	129	29	100	7	265	52	204	6	1	263	12	33	67	4	116	27	170	75	2	274	918
08:00	11	1	6	0	18	7	11	1	0	19	1	1	1	0	3	5	5	13	0	23	63
08:05	12	6	8	0	26	9	5	0	0	14	2	8	3	2	15	2	8	9	8	27	82
08:10	14	3	7	1	25	14	4	1	0	19	1	9	3	2	15	4	2	16	7	29	88
08:15	22	8	16	0	46	19	3	0	0	22	0	7	1	0	8	2	4	14	0	20	96
08:20	22	5	13	0	40	6	3	0	0	9	0	7	1	0	8	0	8	11	0	19	76
08:25	21	8	9	1	39	4	7	1	0	12	0	2	2	1	5	0	4	9	0	13	69
08:30	10	2	0	0	12	1	6	0	0	7	1	3	1	1	6	1	4	1	0	6	31
08:35	7	3	0	0	10	2	7	0	0	9	1	0	3	0	4	0	4	4	0	8	31
08:40	9	0	2	0	11	1	4	0	0	5	1	0	0	0	1	3	6	2	0	11	28
Grand Total	282	70	185	10	547	125	291	10	1	427	21	71	90	10	192	46	245	162	18	471	1637
Apprch %	51.6	12.8	33.8	1.8		29.3	68.1	2.3	0.2		10.9	37	46.9	5.2		9.8	52	34.4	3.8		
Total %	17.2	4.3	11.3	0.6	33.4	7.6	17.8	0.6	0.1	26.1	1.3	4.3	5.5	0.6	11.7	2.8	15	9.9	1.1	28.8	

LSC Transportation Consultants, Inc.

2504 E. Pikes Peak Ave, Suite 304
 Colorado Springs, CO 80909
 719-633-2868

File Name : Rainbow Bridge Dr - Londonderry Dr AM

Site Code : S234410

Start Date : 12/6/2023

Page No : 2

Start Time	Rainbow Bridge Dr Southbound					Londonderry Dr Westbound					Rainbow Bridge Dr Northbound					Londonderry Dr Eastbound					Int. Total
	Right	Thru	Left	Peds	App. Total	Right	Thru	Left	Peds	App. Total	Right	Thru	Left	Peds	App. Total	Right	Thru	Left	Peds	App. Total	
Peak Hour Analysis From 06:45 to 08:40 - Peak 1 of 1																					
Peak Hour for Entire Intersection Begins at 06:50																					
06:50	9	2	12	1	24	2	11	0	0	13	1	0	3	0	4	1	10	3	1	15	56
06:55	7	2	4	0	13	6	18	0	0	24	1	0	3	0	4	1	9	4	0	14	55
07:00	10	3	11	3	27	2	11	0	1	14	1	0	6	0	7	1	13	2	1	17	65
07:05	10	2	13	1	26	2	21	1	0	24	2	3	4	0	9	1	21	3	0	25	84
07:10	20	1	14	1	36	3	31	1	0	35	1	0	4	1	6	1	24	4	0	29	106
07:15	15	3	13	0	31	9	28	0	0	37	3	8	5	0	16	1	29	5	0	35	119
07:20	13	4	14	0	31	2	37	0	0	39	2	2	10	2	16	2	20	5	0	27	113
07:25	11	9	9	0	29	7	22	2	0	31	1	3	3	1	8	0	14	6	0	20	88
07:30	13	0	4	0	17	1	14	0	0	15	1	3	8	0	12	2	11	6	0	19	63
07:35	9	3	3	0	15	4	10	0	0	14	0	2	11	0	13	5	5	6	0	16	58
07:40	10	0	4	1	15	4	12	1	0	17	1	3	9	0	13	2	10	6	0	18	63
07:45	11	2	6	0	19	4	5	0	0	9	0	3	3	0	6	3	11	15	0	29	63
Total Volume	138	31	107	7	283	46	220	5	1	272	14	27	69	4	114	20	177	65	2	264	933
% App. Total	48.8	11	37.8	2.5		16.9	80.9	1.8	0.4		12.3	23.7	60.5	3.5		7.6	67	24.6	0.8		
PHF	.575	.287	.637	.194	.655	.426	.495	.208	.083	.581	.389	.281	.523	.167	.594	.333	.509	.361	.167	.629	.653

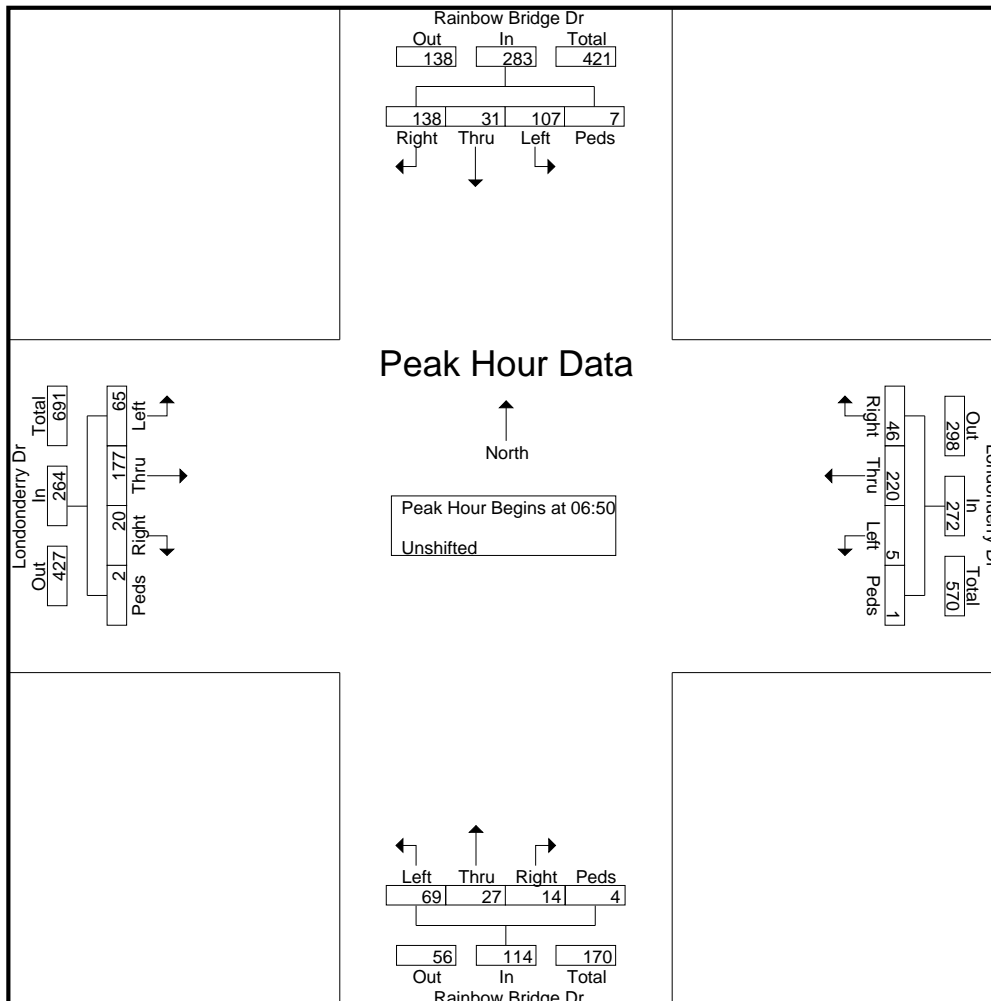

LSC Transportation Consultants, Inc.

2504 E. Pikes Peak Ave, Suite 304
 Colorado Springs, CO 80909
 719-633-2868

File Name : Rainbow Bridge Dr - Londonderry Dr PM

Site Code : S234410

Start Date : 12/5/2023

Page No : 1

Groups Printed- Unshifted

Start Time	Rainbow Bridge Dr Southbound					Londonderry Dr Westbound					Rainbow Bridge Dr Northbound					Londonderry Dr Eastbound					Int. Total
	Right	Thru	Left	Peds	App. Total	Right	Thru	Left	Peds	App. Total	Right	Thru	Left	Peds	App. Total	Right	Thru	Left	Peds	App. Total	
15:00	7	0	2	0	9	3	11	2	3	19	1	1	3	3	8	0	7	6	0	13	49
15:05	5	2	2	6	15	7	9	1	3	20	0	2	3	0	5	4	9	9	0	22	62
15:10	5	0	5	3	13	10	9	0	0	19	1	3	2	0	6	2	10	16	0	28	66
15:15	3	2	4	1	10	8	8	0	0	16	1	5	0	0	6	3	9	18	0	30	62
15:20	7	2	3	0	12	7	11	2	1	21	1	2	2	0	5	1	12	8	0	21	59
15:25	2	1	7	1	11	11	8	1	0	20	0	2	1	0	3	3	8	17	0	28	62
15:30	5	4	0	2	11	15	5	0	1	21	0	7	3	0	10	1	9	15	0	25	67
15:35	3	0	1	0	4	7	5	0	1	13	0	3	1	0	4	3	9	10	0	22	43
15:40	13	4	11	2	30	6	5	0	0	11	0	5	6	1	12	7	5	5	12	29	82
15:45	17	11	15	3	46	12	5	0	2	19	0	4	0	4	8	3	8	7	27	45	118
15:50	28	14	20	0	62	6	4	0	0	10	0	2	2	0	4	3	6	7	0	16	92
15:55	8	2	8	0	18	5	9	0	0	14	1	2	0	1	4	1	6	6	1	14	50
Total	103	42	78	18	241	97	89	6	11	203	5	38	23	9	75	31	98	124	40	293	812
16:00	6	3	5	0	14	6	7	1	1	15	0	3	2	0	5	0	7	4	2	13	47
16:05	7	2	3	0	12	4	6	0	0	10	1	2	3	0	6	0	8	4	1	13	41
16:10	5	1	1	4	11	2	8	0	2	12	1	1	3	0	5	4	11	5	3	23	51
16:15	5	1	1	0	7	8	6	1	0	15	0	4	0	1	5	1	6	8	0	15	42
16:20	8	2	3	0	13	3	4	1	0	8	1	3	2	0	6	2	9	8	0	19	46
16:25	7	1	3	0	11	3	8	1	0	12	1	4	0	0	5	3	3	6	0	12	40
16:30	3	1	3	0	7	4	4	2	0	10	0	2	5	0	7	2	8	8	0	18	42
16:35	3	0	4	0	7	11	6	0	0	17	0	1	3	0	4	3	6	14	0	23	51
16:40	2	0	4	0	6	7	5	0	2	14	1	4	2	0	7	4	10	7	0	21	48
16:45	12	6	7	0	25	10	8	0	1	19	1	3	2	0	6	4	5	3	0	12	62
16:50	4	0	2	6	12	4	19	0	0	23	0	3	4	0	7	3	6	9	0	18	60
16:55	3	2	3	5	13	9	7	0	0	16	0	1	0	0	1	2	11	14	0	27	57
Total	65	19	39	15	138	71	88	6	6	171	6	31	26	1	64	28	90	90	6	214	587
17:00	10	1	0	0	11	7	8	0	0	15	0	3	2	0	5	5	10	5	0	20	51
17:05	3	0	2	2	7	3	11	1	0	15	0	2	3	0	5	2	10	9	0	21	48
17:10	8	4	6	1	19	6	11	1	0	18	0	0	2	0	2	2	6	4	0	12	51
17:15	5	3	2	0	10	7	6	0	0	13	0	1	0	0	1	4	6	2	0	12	36
17:20	4	0	2	0	6	5	10	0	0	15	1	1	0	0	2	5	4	10	0	19	42
17:25	6	1	0	0	7	4	6	0	0	10	0	4	2	0	6	4	5	2	0	11	34
17:30	7	2	1	0	10	3	5	1	0	9	0	2	3	0	5	5	3	10	0	18	42
17:35	3	0	3	0	6	5	6	0	0	11	0	1	3	0	4	5	6	6	0	17	38
17:40	3	1	2	0	6	5	8	0	0	13	0	2	2	0	4	5	5	10	0	20	43
Grand Total	217	73	135	36	461	213	248	15	17	493	12	85	66	10	173	96	243	272	46	657	1784
Apprch %	47.1	15.8	29.3	7.8		43.2	50.3	3	3.4		6.9	49.1	38.2	5.8		14.6	37	41.4	7		
Total %	12.2	4.1	7.6	2	25.8	11.9	13.9	0.8	1	27.6	0.7	4.8	3.7	0.6	9.7	5.4	13.6	15.2	2.6	36.8	

LSC Transportation Consultants, Inc.

2504 E. Pikes Peak Ave, Suite 304
 Colorado Springs, CO 80909
 719-633-2868

File Name : Rainbow Bridge Dr - Londonderry Dr PM

Site Code : S234410

Start Date : 12/5/2023

Page No : 2

Start Time	Rainbow Bridge Dr Southbound					Londonderry Dr Westbound					Rainbow Bridge Dr Northbound					Londonderry Dr Eastbound					Int. Total
	Right	Thru	Left	Peds	App. Total	Right	Thru	Left	Peds	App. Total	Right	Thru	Left	Peds	App. Total	Right	Thru	Left	Peds	App. Total	
Peak Hour Analysis From 15:00 to 17:40 - Peak 1 of 1																					
Peak Hour for Entire Intersection Begins at 15:00																					
15:00	7	0	2	0	9	3	11	2	3	19	1	1	3	3	8	0	7	6	0	13	49
15:05	5	2	2	6	15	7	9	1	3	20	0	2	3	0	5	4	9	9	0	22	62
15:10	5	0	5	3	13	10	9	0	0	19	1	3	2	0	6	2	10	16	0	28	66
15:15	3	2	4	1	10	8	8	0	0	16	1	5	0	0	6	3	9	18	0	30	62
15:20	7	2	3	0	12	7	11	2	1	21	1	2	2	0	5	1	12	8	0	21	59
15:25	2	1	7	1	11	11	8	1	0	20	0	2	1	0	3	3	8	17	0	28	62
15:30	5	4	0	2	11	15	5	0	1	21	0	7	3	0	10	1	9	15	0	25	67
15:35	3	0	1	0	4	7	5	0	1	13	0	3	1	0	4	3	9	10	0	22	43
15:40	13	4	11	2	30	6	5	0	0	11	0	5	6	1	12	7	5	5	12	29	82
15:45	17	11	15	3	46	12	5	0	2	19	0	4	0	4	8	3	8	7	27	45	118
15:50	28	14	20	0	62	6	4	0	0	10	0	2	2	0	4	3	6	7	0	16	92
15:55	8	2	8	0	18	5	9	0	0	14	1	2	0	1	4	1	6	6	1	14	50
Total Volume	103	42	78	18	241	97	89	6	11	203	5	38	23	9	75	31	98	124	40	293	812
% App. Total	42.7	17.4	32.4	7.5		47.8	43.8	3	5.4		6.7	50.7	30.7	12		10.6	33.4	42.3	13.7		
PHF	.307	.250	.325	.250	.324	.539	.674	.250	.306	.806	.417	.452	.319	.188	.521	.369	.681	.574	.123	.543	.573

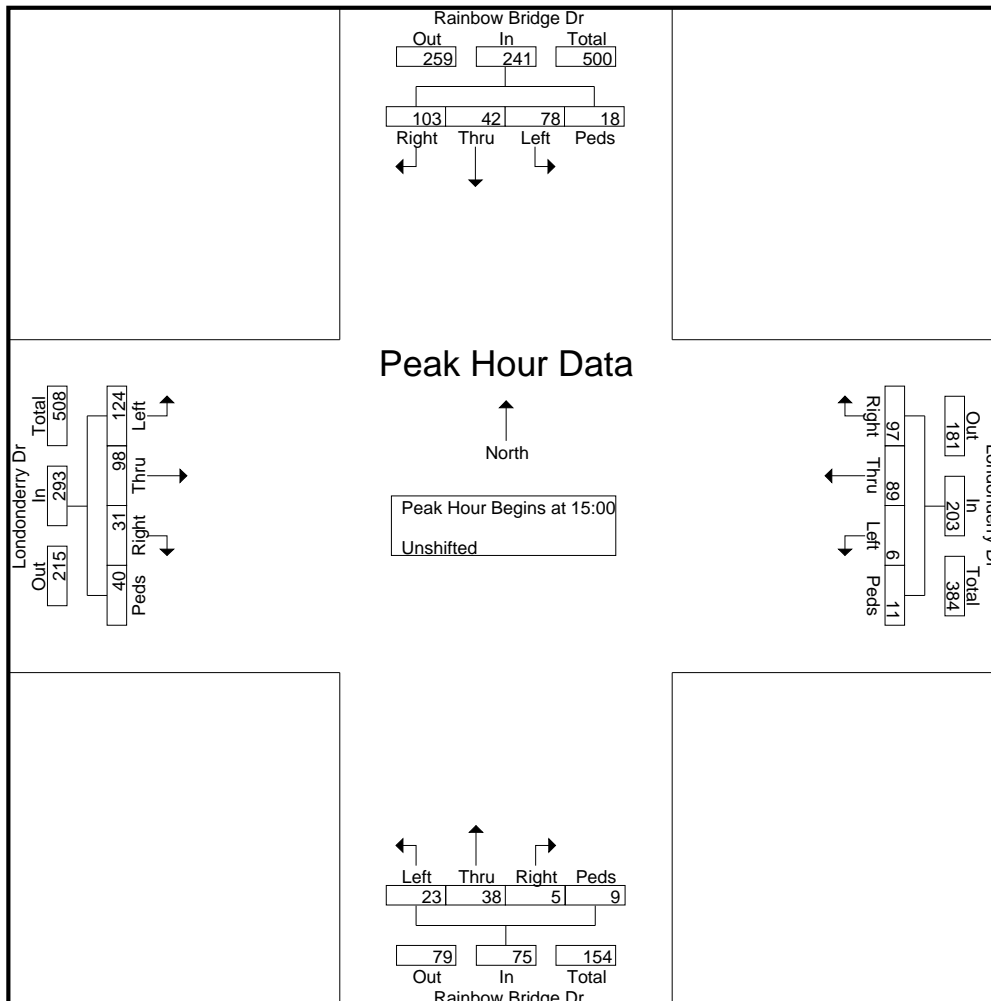

LSC Transportation Consultants, Inc.

2504 E. Pikes Peak Ave, Suite 304
 Colorado Springs, CO 80909
 719-633-2868

File Name : Pyramid Peak Dr - Rex Rd AM
 Site Code : S234410
 Start Date : 12/7/2023
 Page No : 1

Groups Printed- Unshifted

Start Time	Pyramid Peak Dr Southbound					Rex Rd Westbound					Pyramid Peak Dr Northbound					Rex Rd Eastbound					Int. Total
	Right	Thru	Left	Peds	App. Total	Right	Thru	Left	Peds	App. Total	Right	Thru	Left	Peds	App. Total	Right	Thru	Left	Peds	App. Total	
06:45	3	1	0	0	4	0	3	0	0	3	0	0	6	0	6	2	5	0	0	7	20
06:50	4	0	0	0	4	0	4	0	0	4	0	0	3	0	3	0	3	0	0	3	14
06:55	1	0	0	0	1	0	8	0	0	8	0	0	9	0	9	0	3	2	1	6	24
Total	8	1	0	0	9	0	15	0	0	15	0	0	18	0	18	2	11	2	1	16	58
07:00	2	0	0	0	2	0	0	0	0	0	0	0	4	0	4	1	7	0	0	8	14
07:05	3	1	0	0	4	1	8	0	0	9	0	0	4	0	4	1	1	0	0	2	19
07:10	0	0	2	0	2	0	2	0	0	2	0	0	8	0	8	1	5	0	0	6	18
07:15	3	0	2	0	5	0	3	0	0	3	2	0	3	0	5	1	6	0	0	7	20
07:20	0	1	0	0	1	0	11	0	0	11	0	1	5	0	6	1	1	0	0	2	20
07:25	2	0	0	0	2	1	8	0	0	9	0	0	7	0	7	1	5	1	0	7	25
07:30	0	0	1	0	1	0	4	0	0	4	0	0	5	0	5	4	8	1	0	13	23
07:35	1	0	1	0	2	0	8	0	0	8	0	0	7	0	7	2	1	0	0	3	20
07:40	0	0	0	0	0	0	6	0	0	6	0	0	4	0	4	5	2	0	0	7	17
07:45	0	0	0	0	0	0	4	0	0	4	0	0	6	0	6	3	4	0	0	7	17
07:50	1	1	1	0	3	0	1	0	0	1	0	0	2	0	2	4	8	0	0	12	18
07:55	1	0	0	0	1	1	5	0	0	6	0	0	4	0	4	5	5	1	0	11	22
Total	13	3	7	0	23	3	60	0	0	63	2	1	59	0	62	29	53	3	0	85	233
08:00	3	1	0	0	4	0	0	0	0	0	1	0	2	0	3	7	3	1	0	11	18
08:05	1	1	0	0	2	1	4	0	0	5	0	0	3	0	3	1	4	0	0	5	15
08:10	0	0	0	0	0	0	4	0	0	4	0	0	2	0	2	5	3	0	0	8	14
08:15	0	0	0	0	0	0	1	0	0	1	0	1	2	0	3	1	3	0	0	4	8
08:20	0	0	0	0	0	0	4	0	1	5	0	0	10	0	10	4	4	0	0	8	23
08:25	1	1	0	0	2	0	5	0	0	5	0	0	4	0	4	1	3	1	0	5	16
08:30	1	0	0	0	1	0	1	0	0	1	1	0	7	0	8	2	1	0	0	3	13
08:35	1	1	0	0	2	0	2	0	0	2	0	2	3	0	5	0	3	0	0	3	12
08:40	1	1	0	0	2	0	2	1	0	3	0	1	1	0	2	2	2	1	0	5	12
Grand Total	29	9	7	0	45	4	98	1	1	104	4	5	111	0	120	54	90	8	1	153	422
Apprch %	64.4	20	15.6	0		3.8	94.2	1	1		3.3	4.2	92.5	0		35.3	58.8	5.2	0.7		
Total %	6.9	2.1	1.7	0	10.7	0.9	23.2	0.2	0.2	24.6	0.9	1.2	26.3	0	28.4	12.8	21.3	1.9	0.2	36.3	

LSC Transportation Consultants, Inc.

2504 E. Pikes Peak Ave, Suite 304
 Colorado Springs, CO 80909
 719-633-2868

File Name : Pyramid Peak Dr - Rex Rd AM
 Site Code : S234410
 Start Date : 12/7/2023
 Page No : 2

Start Time	Pyramid Peak Dr Southbound					Rex Rd Westbound					Pyramid Peak Dr Northbound					Rex Rd Eastbound					Int. Total
	Right	Thru	Left	Peds	App. Total	Right	Thru	Left	Peds	App. Total	Right	Thru	Left	Peds	App. Total	Right	Thru	Left	Peds	App. Total	
Peak Hour Analysis From 06:45 to 08:40 - Peak 1 of 1																					
Peak Hour for Entire Intersection Begins at 07:05																					
07:05	3	1	0	0	4	1	8	0	0	9	0	0	4	0	4	1	1	0	0	2	19
07:10	0	0	2	0	2	0	2	0	0	2	0	0	8	0	8	1	5	0	0	6	18
07:15	3	0	2	0	5	0	3	0	0	3	2	0	3	0	5	1	6	0	0	7	20
07:20	0	1	0	0	1	0	11	0	0	11	0	1	5	0	6	1	1	0	0	2	20
07:25	2	0	0	0	2	1	8	0	0	9	0	0	7	0	7	1	5	1	0	7	25
07:30	0	0	1	0	1	0	4	0	0	4	0	0	5	0	5	4	8	1	0	13	23
07:35	1	0	1	0	2	0	8	0	0	8	0	0	7	0	7	2	1	0	0	3	20
07:40	0	0	0	0	0	0	6	0	0	6	0	0	4	0	4	5	2	0	0	7	17
07:45	0	0	0	0	0	0	4	0	0	4	0	0	6	0	6	3	4	0	0	7	17
07:50	1	1	1	0	3	0	1	0	0	1	0	0	2	0	2	4	8	0	0	12	18
07:55	1	0	0	0	1	1	5	0	0	6	0	0	4	0	4	5	5	1	0	11	22
08:00	3	1	0	0	4	0	0	0	0	0	1	0	2	0	3	7	3	1	0	11	18
Total Volume	14	4	7	0	25	3	60	0	0	63	3	1	57	0	61	35	49	4	0	88	237
% App. Total	56	16	28	0		4.8	95.2	0	0		4.9	1.6	93.4	0		39.8	55.7	4.5	0		
PHF	.389	.333	.292	.000	.417	.250	.455	.000	.000	.477	.125	.083	.594	.000	.635	.417	.510	.333	.000	.564	.790

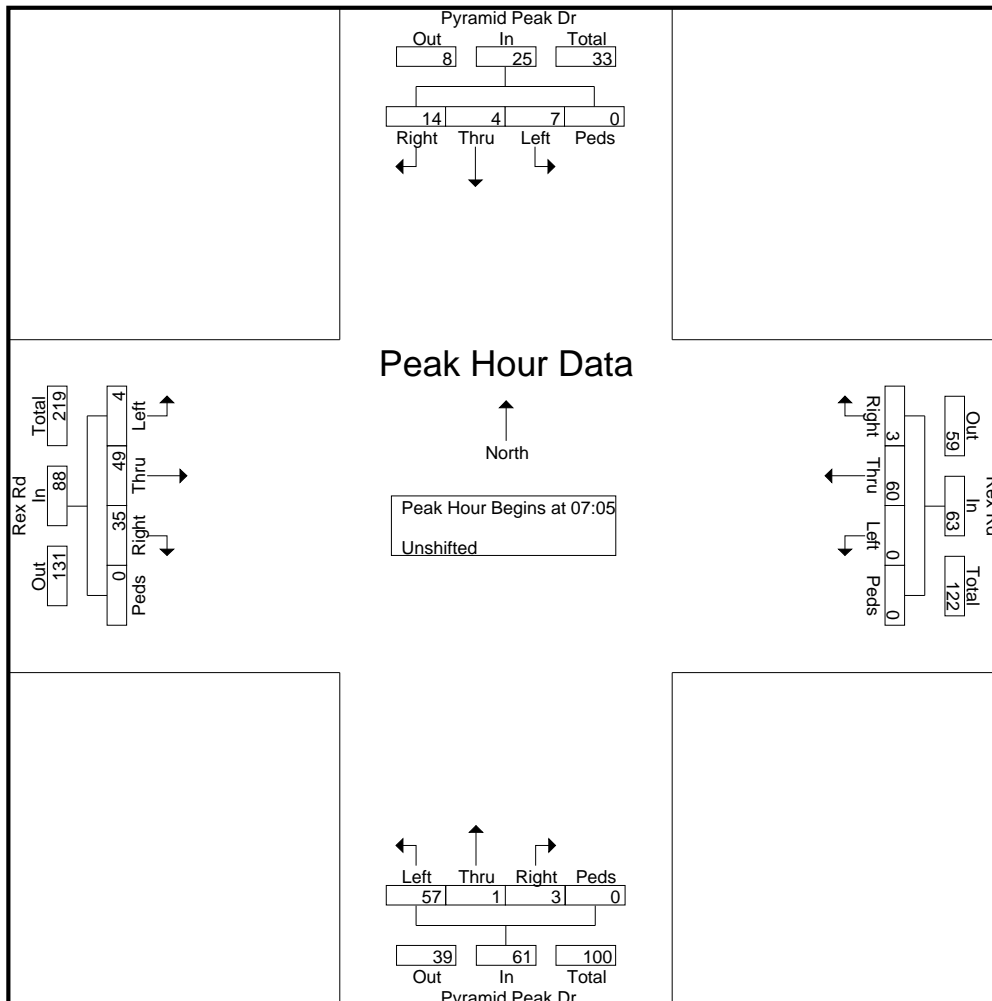

LSC Transportation Consultants, Inc.

2504 E. Pikes Peak Ave, Suite 304
 Colorado Springs, CO 80909
 719-633-2868

File Name : Pyramid Peak Dr - Rex Rd PM
 Site Code : S234410
 Start Date : 12/6/2023
 Page No : 1

Groups Printed- Unshifted

Start Time	Pyramid Peak Dr Southbound					Rex Rd Westbound					Pyramid Peak Dr Northbound					Rex Rd Eastbound					Int. Total
	Right	Thru	Left	Peds	App. Total	Right	Thru	Left	Peds	App. Total	Right	Thru	Left	Peds	App. Total	Right	Thru	Left	Peds	App. Total	
15:00	1	1	1	0	3	1	4	0	0	5	0	0	0	0	0	2	3	1	2	8	16
15:05	2	0	0	0	2	0	5	0	0	5	0	0	2	0	2	3	1	1	0	5	14
15:10	2	1	0	0	3	0	3	0	0	3	0	0	2	0	2	3	2	0	0	5	13
15:15	0	0	0	0	0	0	2	1	0	3	0	0	1	0	1	1	2	0	0	3	7
15:20	0	0	1	0	1	0	3	0	0	3	0	0	1	0	1	5	4	1	0	10	15
15:25	0	1	1	0	2	0	6	2	0	8	0	0	2	1	3	6	5	0	0	11	24
15:30	1	0	0	0	1	0	6	0	0	6	0	0	4	0	4	12	4	2	0	18	29
15:35	0	0	0	0	0	0	3	1	0	4	0	0	3	1	4	9	2	0	0	11	19
15:40	0	1	0	0	1	0	3	0	0	3	0	1	1	0	2	12	4	2	0	18	24
15:45	0	0	0	0	0	0	1	0	0	1	1	0	3	0	4	5	6	1	0	12	17
15:50	0	1	0	0	1	1	5	0	0	6	0	0	8	0	8	2	5	0	0	7	22
15:55	0	0	0	0	0	0	1	1	0	2	0	1	2	0	3	7	2	0	0	9	14
Total	6	5	3	0	14	2	42	5	0	49	1	2	29	2	34	67	40	8	2	117	214
16:00	1	0	0	0	1	0	7	0	0	7	1	0	2	0	3	6	4	1	0	11	22
16:05	0	3	2	0	5	0	5	0	0	5	0	0	1	0	1	3	4	0	0	7	18
16:10	0	1	0	0	1	0	3	0	0	3	0	1	1	0	2	3	5	0	0	8	14
16:15	0	0	0	0	0	2	3	0	0	5	0	0	2	0	2	7	5	2	0	14	21
16:20	1	0	0	0	1	0	4	0	0	4	0	0	3	0	3	3	3	1	0	7	15
16:25	0	0	0	0	0	0	5	0	0	5	0	0	2	0	2	4	3	3	0	10	17
16:30	2	0	0	0	2	1	2	0	0	3	0	0	3	0	3	3	3	1	0	7	15
16:35	1	0	0	0	1	0	4	3	0	7	1	0	2	0	3	2	4	2	0	8	19
16:40	0	0	0	0	0	0	5	0	0	5	0	0	5	0	5	2	3	2	0	7	17
16:45	0	0	0	0	0	0	2	0	0	2	0	0	2	0	2	4	8	2	0	14	18
16:50	0	0	0	0	0	1	3	0	0	4	0	1	2	1	4	5	6	0	0	11	19
16:55	0	0	0	0	0	0	1	0	0	1	1	1	1	1	4	6	4	1	0	11	16
Total	5	4	2	0	11	4	44	3	0	51	3	3	26	2	34	48	52	15	0	115	211
17:00	0	0	0	0	0	0	2	0	0	2	0	0	2	0	2	3	3	1	0	7	11
17:05	0	0	1	0	1	0	0	0	0	0	0	0	4	0	4	4	5	0	0	9	14
17:10	0	0	0	0	0	0	4	0	0	4	0	0	1	0	1	0	3	1	0	4	9
17:15	1	0	0	0	1	0	2	0	0	2	0	0	0	0	0	8	5	2	0	15	18
17:20	0	0	0	0	0	0	1	0	0	1	0	0	3	0	3	4	4	2	0	10	14
17:25	0	2	0	0	2	0	2	1	0	3	0	0	4	0	4	7	2	0	0	9	18
17:30	0	0	0	0	0	1	5	0	0	6	0	0	4	0	4	3	8	2	0	13	23
17:35	0	0	0	0	0	0	6	0	0	6	0	1	4	0	5	8	6	1	0	15	26
17:40	1	0	0	0	1	0	6	0	0	6	0	0	5	0	5	5	3	1	0	9	21
Grand Total	13	11	6	0	30	7	114	9	0	130	4	6	82	4	96	157	131	33	2	323	579
Apprch %	43.3	36.7	20	0		5.4	87.7	6.9	0		4.2	6.2	85.4	4.2		48.6	40.6	10.2	0.6		
Total %	2.2	1.9	1	0	5.2	1.2	19.7	1.6	0	22.5	0.7	1	14.2	0.7	16.6	27.1	22.6	5.7	0.3	55.8	

Level of Service Reports



HCM 6th AWSC
1: Rainbow Bridge Dr & Londonderry Dr

Existing Traffic
AM Peak Hour

Intersection	
Intersection Delay, s/veh	17.6
Intersection LOS	C

Movement	EBL	EBT	EBR	WBL	WBT	WBR	NBL	NBT	NBR	SBL	SBT	SBR
Lane Configurations	↶	↷		↶	↷			↕		↶	↷	
Traffic Vol, veh/h	65	177	20	5	220	46	69	27	14	107	31	138
Future Vol, veh/h	65	177	20	5	220	46	69	27	14	107	31	138
Peak Hour Factor	0.74	0.74	0.74	0.71	0.71	0.71	0.83	0.83	0.83	0.76	0.76	0.76
Heavy Vehicles, %	2	2	2	2	2	2	2	2	2	2	2	2
Mvmt Flow	88	239	27	7	310	65	83	33	17	141	41	182
Number of Lanes	1	1	0	1	1	0	0	1	0	1	1	0

Approach	EB	WB	NB	SB
Opposing Approach	WB	EB	SB	NB
Opposing Lanes	2	2	2	1
Conflicting Approach Left	SB	NB	EB	WB
Conflicting Lanes Left	2	1	2	2
Conflicting Approach Right	NB	SB	WB	EB
Conflicting Lanes Right	1	2	2	2
HCM Control Delay	15.6	24.2	14.2	14
HCM LOS	C	C	B	B

Lane	NBLn1	EBLn1	EBLn2	WBLn1	WBLn2	SBLn1	SBLn2
Vol Left, %	63%	100%	0%	100%	0%	100%	0%
Vol Thru, %	25%	0%	90%	0%	83%	0%	18%
Vol Right, %	13%	0%	10%	0%	17%	0%	82%
Sign Control	Stop	Stop	Stop	Stop	Stop	Stop	Stop
Traffic Vol by Lane	110	65	197	5	266	107	169
LT Vol	69	65	0	5	0	107	0
Through Vol	27	0	177	0	220	0	31
RT Vol	14	0	20	0	46	0	138
Lane Flow Rate	133	88	266	7	375	141	222
Geometry Grp	4b	5	5	5	5	5	5
Degree of Util (X)	0.29	0.184	0.513	0.015	0.708	0.303	0.411
Departure Headway (Hd)	7.875	7.521	6.936	7.442	6.806	7.752	6.656
Convergence, Y/N	Yes	Yes	Yes	Yes	Yes	Yes	Yes
Cap	456	477	519	481	532	463	540
Service Time	5.941	5.271	4.685	5.189	4.553	5.504	4.408
HCM Lane V/C Ratio	0.292	0.184	0.513	0.015	0.705	0.305	0.411
HCM Control Delay	14.2	12	16.8	10.3	24.5	13.9	14
HCM Lane LOS	B	B	C	B	C	B	B
HCM 95th-tile Q	1.2	0.7	2.9	0	5.6	1.3	2

HCM 6th TWSC
3: Pyramid Peak Dr & Rex Road

Existing Traffic
AM Peak Hour

Intersection												
Int Delay, s/veh	3.4											
Movement	EBL	EBT	EBR	WBL	WBT	WBR	NBL	NBT	NBR	SBL	SBT	SBR
Lane Configurations		↕			↕			↕			↕	
Traffic Vol, veh/h	4	49	35	0	60	3	57	1	3	7	4	14
Future Vol, veh/h	4	49	35	0	60	3	57	1	3	7	4	14
Conflicting Peds, #/hr	0	0	0	0	0	0	0	0	0	0	0	0
Sign Control	Free	Free	Free	Free	Free	Free	Stop	Stop	Stop	Stop	Stop	Stop
RT Channelized	-	-	None	-	-	None	-	-	None	-	-	None
Storage Length	-	-	-	-	-	-	-	-	-	-	-	-
Veh in Median Storage, #	-	0	-	-	0	-	-	0	-	-	0	-
Grade, %	-	0	-	-	0	-	-	0	-	-	0	-
Peak Hour Factor	78	78	78	66	66	66	85	85	85	78	78	78
Heavy Vehicles, %	2	2	2	2	2	2	2	2	2	2	2	2
Mvmt Flow	5	63	45	0	91	5	67	1	4	9	5	18

Major/Minor	Major1			Major2			Minor1			Minor2		
Conflicting Flow All	96	0	0	108	0	0	201	192	86	192	212	94
Stage 1	-	-	-	-	-	-	96	96	-	94	94	-
Stage 2	-	-	-	-	-	-	105	96	-	98	118	-
Critical Hdwy	4.12	-	-	4.12	-	-	7.12	6.52	6.22	7.12	6.52	6.22
Critical Hdwy Stg 1	-	-	-	-	-	-	6.12	5.52	-	6.12	5.52	-
Critical Hdwy Stg 2	-	-	-	-	-	-	6.12	5.52	-	6.12	5.52	-
Follow-up Hdwy	2.218	-	-	2.218	-	-	3.518	4.018	3.318	3.518	4.018	3.318
Pot Cap-1 Maneuver	1498	-	-	1483	-	-	757	703	973	768	685	963
Stage 1	-	-	-	-	-	-	911	815	-	913	817	-
Stage 2	-	-	-	-	-	-	901	815	-	908	798	-
Platoon blocked, %		-	-		-	-						
Mov Cap-1 Maneuver	1498	-	-	1483	-	-	737	700	973	762	682	963
Mov Cap-2 Maneuver	-	-	-	-	-	-	737	700	-	762	682	-
Stage 1	-	-	-	-	-	-	907	812	-	909	817	-
Stage 2	-	-	-	-	-	-	879	815	-	900	795	-

Approach	EB	WB	NB	SB
HCM Control Delay, s	0.3	0	10.3	9.4
HCM LOS			B	A

Minor Lane/Major Mvmt	NBLn1	EBL	EBT	EBR	WBL	WBT	WBR	SBLn1
Capacity (veh/h)	745	1498	-	-	1483	-	-	845
HCM Lane V/C Ratio	0.096	0.003	-	-	-	-	-	0.038
HCM Control Delay (s)	10.3	7.4	0	-	0	-	-	9.4
HCM Lane LOS	B	A	A	-	A	-	-	A
HCM 95th %tile Q(veh)	0.3	0	-	-	0	-	-	0.1

Intersection	
Intersection Delay, s/veh	13.1
Intersection LOS	B

Movement	EBL	EBT	EBR	WBL	WBT	WBR	NBL	NBT	NBR	SBL	SBT	SBR
Lane Configurations	↶	↷		↶	↷			↕		↶	↷	
Traffic Vol, veh/h	124	98	31	6	89	97	23	38	5	78	42	103
Future Vol, veh/h	124	98	31	6	89	97	23	38	5	78	42	103
Peak Hour Factor	0.87	0.87	0.87	0.83	0.83	0.83	0.78	0.78	0.78	0.45	0.45	0.45
Heavy Vehicles, %	2	2	2	2	2	2	2	2	2	2	2	2
Mvmt Flow	143	113	36	7	107	117	29	49	6	173	93	229
Number of Lanes	1	1	0	1	1	0	0	1	0	1	1	0

Approach	EB	WB	NB	SB
Opposing Approach	WB	EB	SB	NB
Opposing Lanes	2	2	2	1
Conflicting Approach Left	SB	NB	EB	WB
Conflicting Lanes Left	2	1	2	2
Conflicting Approach Right	NB	SB	WB	EB
Conflicting Lanes Right	1	2	2	2
HCM Control Delay	12.1	13.1	11.5	14
HCM LOS	B	B	B	B

Lane	NBLn1	EBLn1	EBLn2	WBLn1	WBLn2	SBLn1	SBLn2
Vol Left, %	35%	100%	0%	100%	0%	100%	0%
Vol Thru, %	58%	0%	76%	0%	48%	0%	29%
Vol Right, %	8%	0%	24%	0%	52%	0%	71%
Sign Control	Stop	Stop	Stop	Stop	Stop	Stop	Stop
Traffic Vol by Lane	66	124	129	6	186	78	145
LT Vol	23	124	0	6	0	78	0
Through Vol	38	0	98	0	89	0	42
RT Vol	5	0	31	0	97	0	103
Lane Flow Rate	85	143	148	7	224	173	322
Geometry Grp	4b	5	5	5	5	5	5
Degree of Util (X)	0.164	0.281	0.265	0.015	0.395	0.327	0.517
Departure Headway (Hd)	6.994	7.108	6.427	7.222	6.339	6.783	5.773
Convergence, Y/N	Yes	Yes	Yes	Yes	Yes	Yes	Yes
Cap	509	503	556	494	565	529	622
Service Time	5.084	4.879	4.197	4.994	4.111	4.545	3.535
HCM Lane V/C Ratio	0.167	0.284	0.266	0.014	0.396	0.327	0.518
HCM Control Delay	11.5	12.7	11.5	10.1	13.2	12.8	14.6
HCM Lane LOS	B	B	B	B	B	B	B
HCM 95th-tile Q	0.6	1.1	1.1	0	1.9	1.4	3

Intersection												
Int Delay, s/veh	2.4											
Movement	EBL	EBT	EBR	WBL	WBT	WBR	NBL	NBT	NBR	SBL	SBT	SBR
Lane Configurations		↕			↕			↕			↕	
Traffic Vol, veh/h	8	40	67	5	42	2	29	2	1	3	5	6
Future Vol, veh/h	8	40	67	5	42	2	29	2	1	3	5	6
Conflicting Peds, #/hr	0	0	0	0	0	0	0	0	0	0	0	0
Sign Control	Free	Free	Free	Free	Free	Free	Stop	Stop	Stop	Stop	Stop	Stop
RT Channelized	-	-	None	-	-	None	-	-	None	-	-	None
Storage Length	-	-	-	-	-	-	-	-	-	-	-	-
Veh in Median Storage, #	-	0	-	-	0	-	-	0	-	-	0	-
Grade, %	-	0	-	-	0	-	-	0	-	-	0	-
Peak Hour Factor	61	61	61	94	94	94	78	78	78	78	78	78
Heavy Vehicles, %	2	2	2	2	2	2	2	2	2	2	2	2
Mvmt Flow	13	66	110	5	45	2	37	3	1	4	6	8

Major/Minor	Major1			Major2			Minor1			Minor2		
Conflicting Flow All	47	0	0	176	0	0	210	204	121	205	258	46
Stage 1	-	-	-	-	-	-	147	147	-	56	56	-
Stage 2	-	-	-	-	-	-	63	57	-	149	202	-
Critical Hdwy	4.12	-	-	4.12	-	-	7.12	6.52	6.22	7.12	6.52	6.22
Critical Hdwy Stg 1	-	-	-	-	-	-	6.12	5.52	-	6.12	5.52	-
Critical Hdwy Stg 2	-	-	-	-	-	-	6.12	5.52	-	6.12	5.52	-
Follow-up Hdwy	2.218	-	-	2.218	-	-	3.518	4.018	3.318	3.518	4.018	3.318
Pot Cap-1 Maneuver	1560	-	-	1400	-	-	747	692	930	753	646	1023
Stage 1	-	-	-	-	-	-	856	775	-	956	848	-
Stage 2	-	-	-	-	-	-	948	847	-	854	734	-
Platoon blocked, %		-	-		-	-						
Mov Cap-1 Maneuver	1560	-	-	1400	-	-	728	683	930	742	638	1023
Mov Cap-2 Maneuver	-	-	-	-	-	-	728	683	-	742	638	-
Stage 1	-	-	-	-	-	-	848	768	-	947	845	-
Stage 2	-	-	-	-	-	-	930	844	-	842	727	-

Approach	EB			WB			NB			SB		
HCM Control Delay, s	0.5			0.8			10.2			9.7		
HCM LOS							B			A		

Minor Lane/Major Mvmt	NBLn1	EBL	EBT	EBR	WBL	WBT	WBR	SBLn1
Capacity (veh/h)	730	1560	-	-	1400	-	-	789
HCM Lane V/C Ratio	0.056	0.008	-	-	0.004	-	-	0.023
HCM Control Delay (s)	10.2	7.3	0	-	7.6	0	-	9.7
HCM Lane LOS	B	A	A	-	A	A	-	A
HCM 95th %tile Q(veh)	0.2	0	-	-	0	-	-	0.1

HCM 6th AWSC
1: Rainbow Bridge Dr & Londonderry Dr

Existing Traffic
PM Peak Hour

Intersection	
Intersection Delay, s/veh	9.7
Intersection LOS	A

Movement	EBL	EBT	EBR	WBL	WBT	WBR	NBL	NBT	NBR	SBL	SBT	SBR
Lane Configurations	↶	↷		↶	↷			↕		↶	↷	
Traffic Vol, veh/h	96	95	35	6	94	71	26	31	5	33	15	65
Future Vol, veh/h	96	95	35	6	94	71	26	31	5	33	15	65
Peak Hour Factor	0.87	0.87	0.87	0.81	0.81	0.81	0.78	0.78	0.78	0.76	0.76	0.76
Heavy Vehicles, %	2	2	2	2	2	2	2	2	2	2	2	2
Mvmt Flow	110	109	40	7	116	88	33	40	6	43	20	86
Number of Lanes	1	1	0	1	1	0	0	1	0	1	1	0

Approach	EB	WB	NB	SB
Opposing Approach	WB	EB	SB	NB
Opposing Lanes	2	2	2	1
Conflicting Approach Left	SB	NB	EB	WB
Conflicting Lanes Left	2	1	2	2
Conflicting Approach Right	NB	SB	WB	EB
Conflicting Lanes Right	1	2	2	2
HCM Control Delay	9.7	10	9.9	9.2
HCM LOS	A	A	A	A

Lane	NBLn1	EBLn1	EBLn2	WBLn1	WBLn2	SBLn1	SBLn2
Vol Left, %	42%	100%	0%	100%	0%	100%	0%
Vol Thru, %	50%	0%	73%	0%	57%	0%	19%
Vol Right, %	8%	0%	27%	0%	43%	0%	81%
Sign Control	Stop	Stop	Stop	Stop	Stop	Stop	Stop
Traffic Vol by Lane	62	96	130	6	165	33	80
LT Vol	26	96	0	6	0	33	0
Through Vol	31	0	95	0	94	0	15
RT Vol	5	0	35	0	71	0	65
Lane Flow Rate	79	110	149	7	204	43	105
Geometry Grp	4b	5	5	5	5	5	5
Degree of Util (X)	0.131	0.18	0.215	0.012	0.291	0.076	0.153
Departure Headway (Hd)	5.942	5.877	5.183	5.951	5.143	6.307	5.23
Convergence, Y/N	Yes	Yes	Yes	Yes	Yes	Yes	Yes
Cap	598	607	687	598	693	564	679
Service Time	4.036	3.649	2.955	3.726	2.917	4.092	3.013
HCM Lane V/C Ratio	0.132	0.181	0.217	0.012	0.294	0.076	0.155
HCM Control Delay	9.9	10	9.4	8.8	10	9.6	9
HCM Lane LOS	A	A	A	A	A	A	A
HCM 95th-tile Q	0.4	0.7	0.8	0	1.2	0.2	0.5

HCM 6th TWSC
3: Pyramid Peak Dr & Rex Road

Existing Traffic
PM Peak Hour

Intersection												
Int Delay, s/veh	3.2											
Movement	EBL	EBT	EBR	WBL	WBT	WBR	NBL	NBT	NBR	SBL	SBT	SBR
Lane Configurations		↕			↕			↕			↕	
Traffic Vol, veh/h	15	52	48	3	44	4	26	3	3	2	4	5
Future Vol, veh/h	15	52	48	3	44	4	26	3	3	2	4	5
Conflicting Peds, #/hr	0	0	0	0	0	0	0	0	0	0	0	0
Sign Control	Free	Free	Free	Free	Free	Free	Stop	Stop	Stop	Stop	Stop	Stop
RT Channelized	-	-	None	-	-	None	-	-	None	-	-	None
Storage Length	-	-	-	-	-	-	-	-	-	-	-	-
Veh in Median Storage, #	-	0	-	-	0	-	-	0	-	-	0	-
Grade, %	-	0	-	-	0	-	-	0	-	-	0	-
Peak Hour Factor	83	83	83	85	85	85	78	78	78	39	39	39
Heavy Vehicles, %	2	2	2	2	2	2	2	2	2	2	2	2
Mvmt Flow	18	63	58	4	52	5	33	4	4	5	10	13

Major/Minor	Major1			Major2			Minor1			Minor2		
Conflicting Flow All	57	0	0	121	0	0	202	193	92	195	220	55
Stage 1	-	-	-	-	-	-	128	128	-	63	63	-
Stage 2	-	-	-	-	-	-	74	65	-	132	157	-
Critical Hdwy	4.12	-	-	4.12	-	-	7.12	6.52	6.22	7.12	6.52	6.22
Critical Hdwy Stg 1	-	-	-	-	-	-	6.12	5.52	-	6.12	5.52	-
Critical Hdwy Stg 2	-	-	-	-	-	-	6.12	5.52	-	6.12	5.52	-
Follow-up Hdwy	2.218	-	-	2.218	-	-	3.518	4.018	3.318	3.518	4.018	3.318
Pot Cap-1 Maneuver	1547	-	-	1467	-	-	756	702	965	764	678	1012
Stage 1	-	-	-	-	-	-	876	790	-	948	842	-
Stage 2	-	-	-	-	-	-	935	841	-	871	768	-
Platoon blocked, %		-	-		-	-						
Mov Cap-1 Maneuver	1547	-	-	1467	-	-	729	691	965	749	667	1012
Mov Cap-2 Maneuver	-	-	-	-	-	-	729	691	-	749	667	-
Stage 1	-	-	-	-	-	-	865	780	-	936	839	-
Stage 2	-	-	-	-	-	-	909	838	-	852	758	-

Approach	EB			WB			NB			SB		
HCM Control Delay, s	1			0.4			10.1			9.6		
HCM LOS							B			A		

Minor Lane/Major Mvmt	NBLn1	EBL	EBT	EBR	WBL	WBT	WBR	SBLn1
Capacity (veh/h)	742	1547	-	-	1467	-	-	808
HCM Lane V/C Ratio	0.055	0.012	-	-	0.002	-	-	0.035
HCM Control Delay (s)	10.1	7.4	0	-	7.5	0	-	9.6
HCM Lane LOS	B	A	A	-	A	A	-	A
HCM 95th %tile Q(veh)	0.2	0	-	-	0	-	-	0.1

Intersection	
Intersection Delay, s/veh	22.1
Intersection LOS	C

Movement	EBL	EBT	EBR	WBL	WBT	WBR	NBL	NBT	NBR	SBL	SBT	SBR
Lane Configurations	↶	↷		↶	↷			↕		↶	↷	
Traffic Vol, veh/h	65	263	22	6	327	46	74	27	17	107	31	138
Future Vol, veh/h	65	263	22	6	327	46	74	27	17	107	31	138
Peak Hour Factor	0.74	0.94	0.74	0.71	0.94	0.71	0.83	0.83	0.83	0.76	0.76	0.76
Heavy Vehicles, %	2	2	2	2	2	2	2	2	2	2	2	2
Mvmt Flow	88	280	30	8	348	65	89	33	20	141	41	182
Number of Lanes	1	1	0	1	1	0	0	1	0	1	1	0

Approach	EB	WB	NB	SB
Opposing Approach	WB	EB	SB	NB
Opposing Lanes	2	2	2	1
Conflicting Approach Left	SB	NB	EB	WB
Conflicting Lanes Left	2	1	2	2
Conflicting Approach Right	NB	SB	WB	EB
Conflicting Lanes Right	1	2	2	2
HCM Control Delay	19.2	33.3	15.4	15
HCM LOS	C	D	C	B

Lane	NBLn1	EBLn1	EBLn2	WBLn1	WBLn2	SBLn1	SBLn2
Vol Left, %	63%	100%	0%	100%	0%	100%	0%
Vol Thru, %	23%	0%	92%	0%	88%	0%	18%
Vol Right, %	14%	0%	8%	0%	12%	0%	82%
Sign Control	Stop	Stop	Stop	Stop	Stop	Stop	Stop
Traffic Vol by Lane	118	65	285	6	373	107	169
LT Vol	74	65	0	6	0	107	0
Through Vol	27	0	263	0	327	0	31
RT Vol	17	0	22	0	46	0	138
Lane Flow Rate	142	88	310	8	413	141	222
Geometry Grp	4b	5	5	5	5	5	5
Degree of Util (X)	0.328	0.19	0.619	0.018	0.811	0.318	0.435
Departure Headway (Hd)	8.303	7.771	7.202	7.681	7.079	8.137	7.037
Convergence, Y/N	Yes	Yes	Yes	Yes	Yes	Yes	Yes
Cap	431	460	498	465	512	441	509
Service Time	6.394	5.542	4.972	5.446	4.844	5.907	4.806
HCM Lane V/C Ratio	0.329	0.191	0.622	0.017	0.807	0.32	0.436
HCM Control Delay	15.4	12.4	21.1	10.6	33.8	14.7	15.2
HCM Lane LOS	C	B	C	B	D	B	C
HCM 95th-tile Q	1.4	0.7	4.1	0.1	7.8	1.4	2.2

Intersection												
Int Delay, s/veh	2.6											
Movement	EBL	EBT	EBR	WBL	WBT	WBR	NBL	NBT	NBR	SBL	SBT	SBR
Lane Configurations		↕			↕			↕			↕	
Traffic Vol, veh/h	4	395	35	5	519	3	57	1	5	7	4	14
Future Vol, veh/h	4	395	35	5	519	3	57	1	5	7	4	14
Conflicting Peds, #/hr	0	0	0	0	0	0	0	0	0	0	0	0
Sign Control	Free	Free	Free	Free	Free	Free	Stop	Stop	Stop	Stop	Stop	Stop
RT Channelized	-	-	None	-	-	None	-	-	None	-	-	None
Storage Length	-	-	-	-	-	-	-	-	-	-	-	-
Veh in Median Storage, #	-	0	-	-	0	-	-	0	-	-	0	-
Grade, %	-	0	-	-	0	-	-	0	-	-	0	-
Peak Hour Factor	78	94	78	66	94	66	85	85	85	78	78	78
Heavy Vehicles, %	2	2	2	2	2	2	2	2	2	2	2	2
Mvmt Flow	5	420	45	8	552	5	67	1	6	9	5	18

Major/Minor	Major1			Major2			Minor1			Minor2		
Conflicting Flow All	557	0	0	465	0	0	1035	1026	443	1027	1046	555
Stage 1	-	-	-	-	-	-	453	453	-	571	571	-
Stage 2	-	-	-	-	-	-	582	573	-	456	475	-
Critical Hdwy	4.12	-	-	4.12	-	-	7.12	6.52	6.22	7.12	6.52	6.22
Critical Hdwy Stg 1	-	-	-	-	-	-	6.12	5.52	-	6.12	5.52	-
Critical Hdwy Stg 2	-	-	-	-	-	-	6.12	5.52	-	6.12	5.52	-
Follow-up Hdwy	2.218	-	-	2.218	-	-	3.518	4.018	3.318	3.518	4.018	3.318
Pot Cap-1 Maneuver	1014	-	-	1096	-	-	210	235	615	213	228	531
Stage 1	-	-	-	-	-	-	586	570	-	506	505	-
Stage 2	-	-	-	-	-	-	499	504	-	584	557	-
Platoon blocked, %		-	-		-	-						
Mov Cap-1 Maneuver	1014	-	-	1096	-	-	197	231	615	207	224	531
Mov Cap-2 Maneuver	-	-	-	-	-	-	197	231	-	207	224	-
Stage 1	-	-	-	-	-	-	582	566	-	502	499	-
Stage 2	-	-	-	-	-	-	472	498	-	573	553	-

Approach	EB			WB			NB			SB		
HCM Control Delay, s	0.1			0.1			31.4			17.5		
HCM LOS							D			C		

Minor Lane/Major Mvmt	NBLn1	EBL	EBT	EBR	WBL	WBT	WBR	SBLn1
Capacity (veh/h)	209	1014	-	-	1096	-	-	320
HCM Lane V/C Ratio	0.355	0.005	-	-	0.007	-	-	0.1
HCM Control Delay (s)	31.4	8.6	0	-	8.3	0	-	17.5
HCM Lane LOS	D	A	A	-	A	A	-	C
HCM 95th %tile Q(veh)	1.5	0	-	-	0	-	-	0.3

Intersection	
Intersection Delay, s/veh	14.3
Intersection LOS	B

Movement	EBL	EBT	EBR	WBL	WBT	WBR	NBL	NBT	NBR	SBL	SBT	SBR
Lane Configurations	↶	↷		↶	↷			↕		↶	↷	
Traffic Vol, veh/h	124	146	35	8	132	97	26	38	6	78	42	103
Future Vol, veh/h	124	146	35	8	132	97	26	38	6	78	42	103
Peak Hour Factor	0.87	0.94	0.87	0.83	0.94	0.83	0.78	0.78	0.78	0.45	0.45	0.45
Heavy Vehicles, %	2	2	2	2	2	2	2	2	2	2	2	2
Mvmt Flow	143	155	40	10	140	117	33	49	8	173	93	229
Number of Lanes	1	1	0	1	1	0	0	1	0	1	1	0

Approach	EB	WB	NB	SB
Opposing Approach	WB	EB	SB	NB
Opposing Lanes	2	2	2	1
Conflicting Approach Left	SB	NB	EB	WB
Conflicting Lanes Left	2	1	2	2
Conflicting Approach Right	NB	SB	WB	EB
Conflicting Lanes Right	1	2	2	2
HCM Control Delay	13.1	15	12.1	15.1
HCM LOS	B	B	B	C

Lane	NBLn1	EBLn1	EBLn2	WBLn1	WBLn2	SBLn1	SBLn2
Vol Left, %	37%	100%	0%	100%	0%	100%	0%
Vol Thru, %	54%	0%	81%	0%	58%	0%	29%
Vol Right, %	9%	0%	19%	0%	42%	0%	71%
Sign Control	Stop	Stop	Stop	Stop	Stop	Stop	Stop
Traffic Vol by Lane	70	124	181	8	229	78	145
LT Vol	26	124	0	8	0	78	0
Through Vol	38	0	146	0	132	0	42
RT Vol	6	0	35	0	97	0	103
Lane Flow Rate	90	143	196	10	257	173	322
Geometry Grp	4b	5	5	5	5	5	5
Degree of Util (X)	0.186	0.288	0.359	0.02	0.47	0.34	0.542
Departure Headway (Hd)	7.452	7.267	6.618	7.392	6.578	7.065	6.052
Convergence, Y/N	Yes	Yes	Yes	Yes	Yes	Yes	Yes
Cap	485	490	540	481	543	506	593
Service Time	5.452	5.064	4.414	5.19	4.375	4.849	3.836
HCM Lane V/C Ratio	0.186	0.292	0.363	0.021	0.473	0.342	0.543
HCM Control Delay	12.1	13	13.1	10.3	15.2	13.5	15.9
HCM Lane LOS	B	B	B	B	C	B	C
HCM 95th-tile Q	0.7	1.2	1.6	0.1	2.5	1.5	3.2

Intersection												
Int Delay, s/veh	1.5											
Movement	EBL	EBT	EBR	WBL	WBT	WBR	NBL	NBT	NBR	SBL	SBT	SBR
Lane Configurations		↕			↕			↕			↕	
Traffic Vol, veh/h	8	486	67	7	416	2	29	2	6	3	5	6
Future Vol, veh/h	8	486	67	7	416	2	29	2	6	3	5	6
Conflicting Peds, #/hr	0	0	0	0	0	0	0	0	0	0	0	0
Sign Control	Free	Free	Free	Free	Free	Free	Stop	Stop	Stop	Stop	Stop	Stop
RT Channelized	-	-	None	-	-	None	-	-	None	-	-	None
Storage Length	-	-	-	-	-	-	-	-	-	-	-	-
Veh in Median Storage, #	-	0	-	-	0	-	-	0	-	-	0	-
Grade, %	-	0	-	-	0	-	-	0	-	-	0	-
Peak Hour Factor	61	94	61	94	94	94	78	78	78	78	78	78
Heavy Vehicles, %	2	2	2	2	2	2	2	2	2	2	2	2
Mvmt Flow	13	517	110	7	443	2	37	3	8	4	6	8

Major/Minor	Major1			Major2			Minor1			Minor2		
Conflicting Flow All	445	0	0	627	0	0	1063	1057	572	1062	1111	444
Stage 1	-	-	-	-	-	-	598	598	-	458	458	-
Stage 2	-	-	-	-	-	-	465	459	-	604	653	-
Critical Hdwy	4.12	-	-	4.12	-	-	7.12	6.52	6.22	7.12	6.52	6.22
Critical Hdwy Stg 1	-	-	-	-	-	-	6.12	5.52	-	6.12	5.52	-
Critical Hdwy Stg 2	-	-	-	-	-	-	6.12	5.52	-	6.12	5.52	-
Follow-up Hdwy	2.218	-	-	2.218	-	-	3.518	4.018	3.318	3.518	4.018	3.318
Pot Cap-1 Maneuver	1115	-	-	955	-	-	201	225	520	201	209	614
Stage 1	-	-	-	-	-	-	489	491	-	583	567	-
Stage 2	-	-	-	-	-	-	578	566	-	485	464	-
Platoon blocked, %		-	-		-	-						
Mov Cap-1 Maneuver	1115	-	-	955	-	-	190	219	520	192	203	614
Mov Cap-2 Maneuver	-	-	-	-	-	-	190	219	-	192	203	-
Stage 1	-	-	-	-	-	-	480	482	-	573	561	-
Stage 2	-	-	-	-	-	-	559	560	-	467	456	-

Approach	EB			WB			NB			SB		
HCM Control Delay, s	0.2			0.1			26.7			18.7		
HCM LOS							D			C		

Minor Lane/Major Mvmt	NBLn1	EBL	EBT	EBR	WBL	WBT	WBR	SBLn1
Capacity (veh/h)	213	1115	-	-	955	-	-	280
HCM Lane V/C Ratio	0.223	0.012	-	-	0.008	-	-	0.064
HCM Control Delay (s)	26.7	8.3	0	-	8.8	0	-	18.7
HCM Lane LOS	D	A	A	-	A	A	-	C
HCM 95th %tile Q(veh)	0.8	0	-	-	0	-	-	0.2

Intersection	
Intersection Delay, s/veh	10.4
Intersection LOS	B

Movement	EBL	EBT	EBR	WBL	WBT	WBR	NBL	NBT	NBR	SBL	SBT	SBR
Lane Configurations	↶	↷		↶	↷			↕		↶	↷	
Traffic Vol, veh/h	96	141	41	9	140	71	30	31	7	33	15	65
Future Vol, veh/h	96	141	41	9	140	71	30	31	7	33	15	65
Peak Hour Factor	0.87	0.94	0.87	0.81	0.94	0.81	0.78	0.78	0.78	0.76	0.76	0.76
Heavy Vehicles, %	2	2	2	2	2	2	2	2	2	2	2	2
Mvmt Flow	110	150	47	11	149	88	38	40	9	43	20	86
Number of Lanes	1	1	0	1	1	0	0	1	0	1	1	0

Approach	EB	WB	NB	SB
Opposing Approach	WB	EB	SB	NB
Opposing Lanes	2	2	2	1
Conflicting Approach Left	SB	NB	EB	WB
Conflicting Lanes Left	2	1	2	2
Conflicting Approach Right	NB	SB	WB	EB
Conflicting Lanes Right	1	2	2	2
HCM Control Delay	10.3	11	10.4	9.6
HCM LOS	B	B	B	A

Lane	NBLn1	EBLn1	EBLn2	WBLn1	WBLn2	SBLn1	SBLn2
Vol Left, %	44%	100%	0%	100%	0%	100%	0%
Vol Thru, %	46%	0%	77%	0%	66%	0%	19%
Vol Right, %	10%	0%	23%	0%	34%	0%	81%
Sign Control	Stop	Stop	Stop	Stop	Stop	Stop	Stop
Traffic Vol by Lane	68	96	182	9	211	33	80
LT Vol	30	96	0	9	0	33	0
Through Vol	31	0	141	0	140	0	15
RT Vol	7	0	41	0	71	0	65
Lane Flow Rate	87	110	197	11	237	43	105
Geometry Grp	4b	5	5	5	5	5	5
Degree of Util (X)	0.152	0.186	0.296	0.019	0.356	0.08	0.163
Departure Headway (Hd)	6.274	6.073	5.409	6.161	5.418	6.648	5.567
Convergence, Y/N	Yes	Yes	Yes	Yes	Yes	Yes	Yes
Cap	572	594	668	584	667	540	645
Service Time	4.306	3.779	3.115	3.869	3.125	4.377	3.296
HCM Lane V/C Ratio	0.152	0.185	0.295	0.019	0.355	0.08	0.163
HCM Control Delay	10.4	10.2	10.4	9	11.1	10	9.4
HCM Lane LOS	B	B	B	A	B	A	A
HCM 95th-tile Q	0.5	0.7	1.2	0.1	1.6	0.3	0.6

Intersection												
Int Delay, s/veh	1.4											
Movement	EBL	EBT	EBR	WBL	WBT	WBR	NBL	NBT	NBR	SBL	SBT	SBR
Lane Configurations		↕			↕			↕			↕	
Traffic Vol, veh/h	15	632	48	4	436	4	26	3	4	2	4	5
Future Vol, veh/h	15	632	48	4	436	4	26	3	4	2	4	5
Conflicting Peds, #/hr	0	0	0	0	0	0	0	0	0	0	0	0
Sign Control	Free	Free	Free	Free	Free	Free	Stop	Stop	Stop	Stop	Stop	Stop
RT Channelized	-	-	None	-	-	None	-	-	None	-	-	None
Storage Length	-	-	-	-	-	-	-	-	-	-	-	-
Veh in Median Storage, #	-	0	-	-	0	-	-	0	-	-	0	-
Grade, %	-	0	-	-	0	-	-	0	-	-	0	-
Peak Hour Factor	85	94	85	85	94	85	85	85	85	85	85	85
Heavy Vehicles, %	2	2	2	2	2	2	2	2	2	2	2	2
Mvmt Flow	18	672	56	5	464	5	31	4	5	2	5	6

Major/Minor	Major1			Major2			Minor1			Minor2		
Conflicting Flow All	469	0	0	728	0	0	1218	1215	700	1218	1241	467
Stage 1	-	-	-	-	-	-	736	736	-	477	477	-
Stage 2	-	-	-	-	-	-	482	479	-	741	764	-
Critical Hdwy	4.12	-	-	4.12	-	-	7.12	6.52	6.22	7.12	6.52	6.22
Critical Hdwy Stg 1	-	-	-	-	-	-	6.12	5.52	-	6.12	5.52	-
Critical Hdwy Stg 2	-	-	-	-	-	-	6.12	5.52	-	6.12	5.52	-
Follow-up Hdwy	2.218	-	-	2.218	-	-	3.518	4.018	3.318	3.518	4.018	3.318
Pot Cap-1 Maneuver	1093	-	-	876	-	-	157	181	439	157	175	596
Stage 1	-	-	-	-	-	-	411	425	-	569	556	-
Stage 2	-	-	-	-	-	-	565	555	-	408	413	-
Platoon blocked, %		-	-	-	-	-						
Mov Cap-1 Maneuver	1093	-	-	876	-	-	148	174	439	149	169	596
Mov Cap-2 Maneuver	-	-	-	-	-	-	148	174	-	149	169	-
Stage 1	-	-	-	-	-	-	399	413	-	553	552	-
Stage 2	-	-	-	-	-	-	550	551	-	389	401	-

Approach	EB			WB			NB			SB		
HCM Control Delay, s	0.2			0.1			33.9			20.7		
HCM LOS							D			C		

Minor Lane/Major Mvmt	NBLn1	EBL	EBT	EBR	WBL	WBT	WBR	SBLn1
Capacity (veh/h)	163	1093	-	-	876	-	-	242
HCM Lane V/C Ratio	0.238	0.016	-	-	0.005	-	-	0.053
HCM Control Delay (s)	33.9	8.3	0	-	9.1	0	-	20.7
HCM Lane LOS	D	A	A	-	A	A	-	C
HCM 95th %tile Q(veh)	0.9	0	-	-	0	-	-	0.2

Intersection	
Intersection Delay, s/veh	17.9
Intersection LOS	C

Movement	EBL	EBT	EBR	WBL	WBT	WBR	NBL	NBT	NBR	SBL	SBT	SBR
Lane Configurations	↶	↷		↶	↷			↕		↶	↷	
Traffic Vol, veh/h	67	177	20	5	220	48	69	28	14	108	31	140
Future Vol, veh/h	67	177	20	5	220	48	69	28	14	108	31	140
Peak Hour Factor	0.74	0.74	0.74	0.71	0.71	0.71	0.83	0.83	0.83	0.76	0.76	0.76
Heavy Vehicles, %	2	2	2	2	2	2	2	2	2	2	2	2
Mvmt Flow	91	239	27	7	310	68	83	34	17	142	41	184
Number of Lanes	1	1	0	1	1	0	0	1	0	1	1	0

Approach	EB	WB	NB	SB
Opposing Approach	WB	EB	SB	NB
Opposing Lanes	2	2	2	1
Conflicting Approach Left	SB	NB	EB	WB
Conflicting Lanes Left	2	1	2	2
Conflicting Approach Right	NB	SB	WB	EB
Conflicting Lanes Right	1	2	2	2
HCM Control Delay	15.7	24.8	14.3	14.1
HCM LOS	C	C	B	B

Lane	NBLn1	EBLn1	EBLn2	WBLn1	WBLn2	SBLn1	SBLn2
Vol Left, %	62%	100%	0%	100%	0%	100%	0%
Vol Thru, %	25%	0%	90%	0%	82%	0%	18%
Vol Right, %	13%	0%	10%	0%	18%	0%	82%
Sign Control	Stop	Stop	Stop	Stop	Stop	Stop	Stop
Traffic Vol by Lane	111	67	197	5	268	108	171
LT Vol	69	67	0	5	0	108	0
Through Vol	28	0	177	0	220	0	31
RT Vol	14	0	20	0	48	0	140
Lane Flow Rate	134	91	266	7	377	142	225
Geometry Grp	4b	5	5	5	5	5	5
Degree of Util (X)	0.294	0.19	0.515	0.015	0.717	0.307	0.418
Departure Headway (Hd)	7.914	7.555	6.97	7.474	6.834	7.782	6.685
Convergence, Y/N	Yes	Yes	Yes	Yes	Yes	Yes	Yes
Cap	453	474	516	479	528	462	538
Service Time	5.983	5.308	4.722	5.221	4.581	5.535	4.437
HCM Lane V/C Ratio	0.296	0.192	0.516	0.015	0.714	0.307	0.418
HCM Control Delay	14.3	12.1	16.9	10.3	25.1	14	14.2
HCM Lane LOS	B	B	C	B	D	B	B
HCM 95th-tile Q	1.2	0.7	2.9	0	5.8	1.3	2

Intersection												
Int Delay, s/veh	3.5											
Movement	EBL	EBT	EBR	WBL	WBT	WBR	NBL	NBT	NBR	SBL	SBT	SBR
Lane Configurations		↕			↕			↕			↕	
Traffic Vol, veh/h	4	49	35	1	60	3	57	1	3	7	4	14
Future Vol, veh/h	4	49	35	1	60	3	57	1	3	7	4	14
Conflicting Peds, #/hr	0	0	0	0	0	0	0	0	0	0	0	0
Sign Control	Free	Free	Free	Free	Free	Free	Stop	Stop	Stop	Stop	Stop	Stop
RT Channelized	-	-	None	-	-	None	-	-	None	-	-	None
Storage Length	-	-	-	-	-	-	-	-	-	-	-	-
Veh in Median Storage, #	-	0	-	-	0	-	-	0	-	-	0	-
Grade, %	-	0	-	-	0	-	-	0	-	-	0	-
Peak Hour Factor	78	78	78	66	66	66	85	85	85	78	78	78
Heavy Vehicles, %	2	2	2	2	2	2	2	2	2	2	2	2
Mvmt Flow	5	63	45	2	91	5	67	1	4	9	5	18

Major/Minor	Major1			Major2			Minor1			Minor2		
Conflicting Flow All	96	0	0	108	0	0	205	196	86	196	216	94
Stage 1	-	-	-	-	-	-	96	96	-	98	98	-
Stage 2	-	-	-	-	-	-	109	100	-	98	118	-
Critical Hdwy	4.12	-	-	4.12	-	-	7.12	6.52	6.22	7.12	6.52	6.22
Critical Hdwy Stg 1	-	-	-	-	-	-	6.12	5.52	-	6.12	5.52	-
Critical Hdwy Stg 2	-	-	-	-	-	-	6.12	5.52	-	6.12	5.52	-
Follow-up Hdwy	2.218	-	-	2.218	-	-	3.518	4.018	3.318	3.518	4.018	3.318
Pot Cap-1 Maneuver	1498	-	-	1483	-	-	753	699	973	763	682	963
Stage 1	-	-	-	-	-	-	911	815	-	908	814	-
Stage 2	-	-	-	-	-	-	896	812	-	908	798	-
Platoon blocked, %		-	-		-	-						
Mov Cap-1 Maneuver	1498	-	-	1483	-	-	732	696	973	756	679	963
Mov Cap-2 Maneuver	-	-	-	-	-	-	732	696	-	756	679	-
Stage 1	-	-	-	-	-	-	907	812	-	904	813	-
Stage 2	-	-	-	-	-	-	873	811	-	900	795	-

Approach	EB			WB			NB			SB		
HCM Control Delay, s	0.3			0.1			10.4			9.4		
HCM LOS							B			A		

Minor Lane/Major Mvmt	NBLn1	EBL	EBT	EBR	WBL	WBT	WBR	SBLn1
Capacity (veh/h)	740	1498	-	-	1483	-	-	842
HCM Lane V/C Ratio	0.097	0.003	-	-	0.001	-	-	0.038
HCM Control Delay (s)	10.4	7.4	0	-	7.4	0	-	9.4
HCM Lane LOS	B	A	A	-	A	A	-	A
HCM 95th %tile Q(veh)	0.3	0	-	-	0	-	-	0.1

HCM 6th TWSC
4: Rainbow Bridge Dr & North Site Access

Existing Plus Site-Generated Traffic
AM Peak Hour

Intersection						
Int Delay, s/veh	0.3					
Movement	WBL	WBR	NBT	NBR	SBL	SBT
Lane Configurations						
Traffic Vol, veh/h	1	1	40	1	2	50
Future Vol, veh/h	1	1	40	1	2	50
Conflicting Peds, #/hr	0	0	0	0	0	0
Sign Control	Stop	Stop	Free	Free	Free	Free
RT Channelized	-	None	-	None	-	None
Storage Length	0	-	-	-	-	-
Veh in Median Storage, #	0	-	0	-	-	0
Grade, %	0	-	0	-	-	0
Peak Hour Factor	85	85	85	85	85	85
Heavy Vehicles, %	2	2	2	2	2	2
Mvmt Flow	1	1	47	1	2	59

Major/Minor	Minor1	Major1	Major2			
Conflicting Flow All	111	48	0	0	48	0
Stage 1	48	-	-	-	-	-
Stage 2	63	-	-	-	-	-
Critical Hdwy	6.42	6.22	-	-	4.12	-
Critical Hdwy Stg 1	5.42	-	-	-	-	-
Critical Hdwy Stg 2	5.42	-	-	-	-	-
Follow-up Hdwy	3.518	3.318	-	-	2.218	-
Pot Cap-1 Maneuver	886	1021	-	-	1559	-
Stage 1	974	-	-	-	-	-
Stage 2	960	-	-	-	-	-
Platoon blocked, %			-	-		-
Mov Cap-1 Maneuver	885	1021	-	-	1559	-
Mov Cap-2 Maneuver	885	-	-	-	-	-
Stage 1	974	-	-	-	-	-
Stage 2	959	-	-	-	-	-

Approach	WB	NB	SB
HCM Control Delay, s	8.8	0	0.3
HCM LOS	A		

Minor Lane/Major Mvmt	NBT	NBRWBLn1	SBL	SBT
Capacity (veh/h)	-	-	948	1559
HCM Lane V/C Ratio	-	-	0.002	0.002
HCM Control Delay (s)	-	-	8.8	7.3
HCM Lane LOS	-	-	A	A
HCM 95th %tile Q(veh)	-	-	0	0

Intersection						
Int Delay, s/veh	0.2					
Movement	WBL	WBR	NBT	NBR	SBL	SBT
Lane Configurations	W		T			T
Traffic Vol, veh/h	2	0	41	4	1	50
Future Vol, veh/h	2	0	41	4	1	50
Conflicting Peds, #/hr	0	0	0	0	0	0
Sign Control	Stop	Stop	Free	Free	Free	Free
RT Channelized	-	None	-	None	-	None
Storage Length	0	-	-	-	-	-
Veh in Median Storage, #	0	-	0	-	-	0
Grade, %	0	-	0	-	-	0
Peak Hour Factor	85	85	85	85	85	85
Heavy Vehicles, %	2	2	2	2	2	2
Mvmt Flow	2	0	48	5	1	59

Major/Minor	Minor1	Major1	Major2			
Conflicting Flow All	112	51	0	0	53	0
Stage 1	51	-	-	-	-	-
Stage 2	61	-	-	-	-	-
Critical Hdwy	6.42	6.22	-	-	4.12	-
Critical Hdwy Stg 1	5.42	-	-	-	-	-
Critical Hdwy Stg 2	5.42	-	-	-	-	-
Follow-up Hdwy	3.518	3.318	-	-	2.218	-
Pot Cap-1 Maneuver	885	1017	-	-	1553	-
Stage 1	971	-	-	-	-	-
Stage 2	962	-	-	-	-	-
Platoon blocked, %			-	-		-
Mov Cap-1 Maneuver	884	1017	-	-	1553	-
Mov Cap-2 Maneuver	884	-	-	-	-	-
Stage 1	971	-	-	-	-	-
Stage 2	961	-	-	-	-	-

Approach	WB	NB	SB
HCM Control Delay, s	9.1	0	0.1
HCM LOS	A		

Minor Lane/Major Mvmt	NBT	NBRWBLn1	SBL	SBT
Capacity (veh/h)	-	-	884	1553
HCM Lane V/C Ratio	-	-	0.003	0.001
HCM Control Delay (s)	-	-	9.1	7.3
HCM Lane LOS	-	-	A	A
HCM 95th %tile Q(veh)	-	-	0	0

Intersection	
Intersection Delay, s/veh	14.9
Intersection LOS	B

Movement	EBL	EBT	EBR	WBL	WBT	WBR	NBL	NBT	NBR	SBL	SBT	SBR
Lane Configurations	↶	↷		↶	↷			↷		↶	↷	
Traffic Vol, veh/h	139	98	31	6	89	107	23	42	5	90	47	121
Future Vol, veh/h	139	98	31	6	89	107	23	42	5	90	47	121
Peak Hour Factor	0.87	0.87	0.87	0.83	0.83	0.83	0.78	0.78	0.78	0.45	0.45	0.45
Heavy Vehicles, %	2	2	2	2	2	2	2	2	2	2	2	2
Mvmt Flow	160	113	36	7	107	129	29	54	6	200	104	269
Number of Lanes	1	1	0	1	1	0	0	1	0	1	1	0

Approach	EB	WB	NB	SB
Opposing Approach	WB	EB	SB	NB
Opposing Lanes	2	2	2	1
Conflicting Approach Left	SB	NB	EB	WB
Conflicting Lanes Left	2	1	2	2
Conflicting Approach Right	NB	SB	WB	EB
Conflicting Lanes Right	1	2	2	2
HCM Control Delay	13	14.4	12.1	16.5
HCM LOS	B	B	B	C

Lane	NBLn1	EBLn1	EBLn2	WBLn1	WBLn2	SBLn1	SBLn2
Vol Left, %	33%	100%	0%	100%	0%	100%	0%
Vol Thru, %	60%	0%	76%	0%	45%	0%	28%
Vol Right, %	7%	0%	24%	0%	55%	0%	72%
Sign Control	Stop	Stop	Stop	Stop	Stop	Stop	Stop
Traffic Vol by Lane	70	139	129	6	196	90	168
LT Vol	23	139	0	6	0	90	0
Through Vol	42	0	98	0	89	0	47
RT Vol	5	0	31	0	107	0	121
Lane Flow Rate	90	160	148	7	236	200	373
Geometry Grp	4b	5	5	5	5	5	5
Degree of Util (X)	0.184	0.328	0.276	0.015	0.434	0.386	0.614
Departure Headway (Hd)	7.395	7.391	6.708	7.519	6.616	6.943	5.925
Convergence, Y/N	Yes	Yes	Yes	Yes	Yes	Yes	Yes
Cap	488	484	532	473	541	516	605
Service Time	5.395	5.183	4.499	5.313	4.41	4.72	3.701
HCM Lane V/C Ratio	0.184	0.331	0.278	0.015	0.436	0.388	0.617
HCM Control Delay	12.1	13.8	12.1	10.4	14.5	14.1	17.8
HCM Lane LOS	B	B	B	B	B	B	C
HCM 95th-tile Q	0.7	1.4	1.1	0	2.2	1.8	4.2

Intersection												
Int Delay, s/veh	2.6											
Movement	EBL	EBT	EBR	WBL	WBT	WBR	NBL	NBT	NBR	SBL	SBT	SBR
Lane Configurations		↕			↕			↕			↕	
Traffic Vol, veh/h	8	40	67	8	42	2	29	2	5	3	5	6
Future Vol, veh/h	8	40	67	8	42	2	29	2	5	3	5	6
Conflicting Peds, #/hr	0	0	0	0	0	0	0	0	0	0	0	0
Sign Control	Free	Free	Free	Free	Free	Free	Stop	Stop	Stop	Stop	Stop	Stop
RT Channelized	-	-	None	-	-	None	-	-	None	-	-	None
Storage Length	-	-	-	-	-	-	-	-	-	-	-	-
Veh in Median Storage, #	-	0	-	-	0	-	-	0	-	-	0	-
Grade, %	-	0	-	-	0	-	-	0	-	-	0	-
Peak Hour Factor	61	61	61	94	94	94	78	78	78	78	78	78
Heavy Vehicles, %	2	2	2	2	2	2	2	2	2	2	2	2
Mvmt Flow	13	66	110	9	45	2	37	3	6	4	6	8

Major/Minor	Major1			Major2			Minor1			Minor2		
Conflicting Flow All	47	0	0	176	0	0	218	212	121	216	266	46
Stage 1	-	-	-	-	-	-	147	147	-	64	64	-
Stage 2	-	-	-	-	-	-	71	65	-	152	202	-
Critical Hdwy	4.12	-	-	4.12	-	-	7.12	6.52	6.22	7.12	6.52	6.22
Critical Hdwy Stg 1	-	-	-	-	-	-	6.12	5.52	-	6.12	5.52	-
Critical Hdwy Stg 2	-	-	-	-	-	-	6.12	5.52	-	6.12	5.52	-
Follow-up Hdwy	2.218	-	-	2.218	-	-	3.518	4.018	3.318	3.518	4.018	3.318
Pot Cap-1 Maneuver	1560	-	-	1400	-	-	738	685	930	740	640	1023
Stage 1	-	-	-	-	-	-	856	775	-	947	842	-
Stage 2	-	-	-	-	-	-	939	841	-	850	734	-
Platoon blocked, %		-	-		-	-						
Mov Cap-1 Maneuver	1560	-	-	1400	-	-	718	674	930	724	630	1023
Mov Cap-2 Maneuver	-	-	-	-	-	-	718	674	-	724	630	-
Stage 1	-	-	-	-	-	-	848	768	-	938	836	-
Stage 2	-	-	-	-	-	-	918	835	-	834	727	-

Approach	EB			WB			NB			SB		
HCM Control Delay, s	0.5			1.2			10.2			9.7		
HCM LOS							B			A		

Minor Lane/Major Mvmt	NBLn1	EBL	EBT	EBR	WBL	WBT	WBR	SBLn1
Capacity (veh/h)	739	1560	-	-	1400	-	-	780
HCM Lane V/C Ratio	0.062	0.008	-	-	0.006	-	-	0.023
HCM Control Delay (s)	10.2	7.3	0	-	7.6	0	-	9.7
HCM Lane LOS	B	A	A	-	A	A	-	A
HCM 95th %tile Q(veh)	0.2	0	-	-	0	-	-	0.1

Intersection						
Int Delay, s/veh	1.4					
Movement	WBL	WBR	NBT	NBR	SBL	SBT
Lane Configurations						
Traffic Vol, veh/h	9	10	39	8	8	97
Future Vol, veh/h	9	10	39	8	8	97
Conflicting Peds, #/hr	0	0	0	0	0	0
Sign Control	Stop	Stop	Free	Free	Free	Free
RT Channelized	-	None	-	None	-	None
Storage Length	0	-	-	-	-	-
Veh in Median Storage, #	0	-	0	-	-	0
Grade, %	0	-	0	-	-	0
Peak Hour Factor	85	85	85	85	85	85
Heavy Vehicles, %	2	2	2	2	2	2
Mvmt Flow	11	12	46	9	9	114

Major/Minor	Minor1	Major1	Major2		
Conflicting Flow All	183	51	0	0	55
Stage 1	51	-	-	-	-
Stage 2	132	-	-	-	-
Critical Hdwy	6.42	6.22	-	-	4.12
Critical Hdwy Stg 1	5.42	-	-	-	-
Critical Hdwy Stg 2	5.42	-	-	-	-
Follow-up Hdwy	3.518	3.318	-	-	2.218
Pot Cap-1 Maneuver	806	1017	-	-	1550
Stage 1	971	-	-	-	-
Stage 2	894	-	-	-	-
Platoon blocked, %			-	-	-
Mov Cap-1 Maneuver	801	1017	-	-	1550
Mov Cap-2 Maneuver	801	-	-	-	-
Stage 1	971	-	-	-	-
Stage 2	889	-	-	-	-

Approach	WB	NB	SB
HCM Control Delay, s	9.1	0	0.6
HCM LOS	A		

Minor Lane/Major Mvmt	NBT	NBRWBLn1	SBL	SBT
Capacity (veh/h)	-	-	902	1550
HCM Lane V/C Ratio	-	-	0.025	0.006
HCM Control Delay (s)	-	-	9.1	7.3
HCM Lane LOS	-	-	A	A
HCM 95th %tile Q(veh)	-	-	0.1	0

Intersection						
Int Delay, s/veh	1.8					
Movement	WBL	WBR	NBT	NBR	SBL	SBT
Lane Configurations						
Traffic Vol, veh/h	28	7	40	23	5	101
Future Vol, veh/h	28	7	40	23	5	101
Conflicting Peds, #/hr	0	0	0	0	0	0
Sign Control	Stop	Stop	Free	Free	Free	Free
RT Channelized	-	None	-	None	-	None
Storage Length	0	-	-	-	-	-
Veh in Median Storage, #	0	-	0	-	-	0
Grade, %	0	-	0	-	-	0
Peak Hour Factor	85	85	85	85	85	85
Heavy Vehicles, %	2	2	2	2	2	2
Mvmt Flow	33	8	47	27	6	119

Major/Minor	Minor1	Major1	Major2		
Conflicting Flow All	192	61	0	0	74
Stage 1	61	-	-	-	-
Stage 2	131	-	-	-	-
Critical Hdwy	6.42	6.22	-	-	4.12
Critical Hdwy Stg 1	5.42	-	-	-	-
Critical Hdwy Stg 2	5.42	-	-	-	-
Follow-up Hdwy	3.518	3.318	-	-	2.218
Pot Cap-1 Maneuver	797	1004	-	-	1526
Stage 1	962	-	-	-	-
Stage 2	895	-	-	-	-
Platoon blocked, %			-	-	-
Mov Cap-1 Maneuver	794	1004	-	-	1526
Mov Cap-2 Maneuver	794	-	-	-	-
Stage 1	962	-	-	-	-
Stage 2	891	-	-	-	-

Approach	WB	NB	SB
HCM Control Delay, s	9.6	0	0.3
HCM LOS	A		

Minor Lane/Major Mvmt	NBT	NBRWBLn1	SBL	SBT
Capacity (veh/h)	-	-	829	1526
HCM Lane V/C Ratio	-	-	0.05	0.004
HCM Control Delay (s)	-	-	9.6	7.4
HCM Lane LOS	-	-	A	A
HCM 95th %tile Q(veh)	-	-	0.2	0

Intersection	
Intersection Delay, s/veh	10.5
Intersection LOS	B

Movement	EBL	EBT	EBR	WBL	WBT	WBR	NBL	NBT	NBR	SBL	SBT	SBR
Lane Configurations	↶	↷		↶	↷			↕		↶	↷	
Traffic Vol, veh/h	129	95	35	6	94	91	26	36	5	48	25	83
Future Vol, veh/h	129	95	35	6	94	91	26	36	5	48	25	83
Peak Hour Factor	0.87	0.87	0.87	0.81	0.81	0.81	0.78	0.78	0.78	0.76	0.76	0.76
Heavy Vehicles, %	2	2	2	2	2	2	2	2	2	2	2	2
Mvmt Flow	148	109	40	7	116	112	33	46	6	63	33	109
Number of Lanes	1	1	0	1	1	0	0	1	0	1	1	0

Approach	EB	WB	NB	SB
Opposing Approach	WB	EB	SB	NB
Opposing Lanes	2	2	2	1
Conflicting Approach Left	SB	NB	EB	WB
Conflicting Lanes Left	2	1	2	2
Conflicting Approach Right	NB	SB	WB	EB
Conflicting Lanes Right	1	2	2	2
HCM Control Delay	10.5	11	10.5	10
HCM LOS	B	B	B	A

Lane	NBLn1	EBLn1	EBLn2	WBLn1	WBLn2	SBLn1	SBLn2
Vol Left, %	39%	100%	0%	100%	0%	100%	0%
Vol Thru, %	54%	0%	73%	0%	51%	0%	23%
Vol Right, %	7%	0%	27%	0%	49%	0%	77%
Sign Control	Stop	Stop	Stop	Stop	Stop	Stop	Stop
Traffic Vol by Lane	67	129	130	6	185	48	108
LT Vol	26	129	0	6	0	48	0
Through Vol	36	0	95	0	94	0	25
RT Vol	5	0	35	0	91	0	83
Lane Flow Rate	86	148	149	7	228	63	142
Geometry Grp	4b	5	5	5	5	5	5
Degree of Util (X)	0.152	0.256	0.229	0.013	0.347	0.116	0.22
Departure Headway (Hd)	6.36	6.218	5.522	6.322	5.468	6.624	5.575
Convergence, Y/N	Yes	Yes	Yes	Yes	Yes	Yes	Yes
Cap	564	578	651	567	658	542	644
Service Time	4.395	3.946	3.249	4.051	3.197	4.355	3.305
HCM Lane V/C Ratio	0.152	0.256	0.229	0.012	0.347	0.116	0.22
HCM Control Delay	10.5	11.1	9.9	9.1	11.1	10.2	9.9
HCM Lane LOS	B	B	A	A	B	B	A
HCM 95th-tile Q	0.5	1	0.9	0	1.5	0.4	0.8

Intersection												
Int Delay, s/veh	3.5											
Movement	EBL	EBT	EBR	WBL	WBT	WBR	NBL	NBT	NBR	SBL	SBT	SBR
Lane Configurations		↕			↕			↕			↕	
Traffic Vol, veh/h	15	52	48	6	44	4	27	4	10	2	4	5
Future Vol, veh/h	15	52	48	6	44	4	27	4	10	2	4	5
Conflicting Peds, #/hr	0	0	0	0	0	0	0	0	0	0	0	0
Sign Control	Free	Free	Free	Free	Free	Free	Stop	Stop	Stop	Stop	Stop	Stop
RT Channelized	-	-	None	-	-	None	-	-	None	-	-	None
Storage Length	-	-	-	-	-	-	-	-	-	-	-	-
Veh in Median Storage, #	-	0	-	-	0	-	-	0	-	-	0	-
Grade, %	-	0	-	-	0	-	-	0	-	-	0	-
Peak Hour Factor	83	83	83	85	85	85	78	78	78	39	39	39
Heavy Vehicles, %	2	2	2	2	2	2	2	2	2	2	2	2
Mvmt Flow	18	63	58	7	52	5	35	5	13	5	10	13

Major/Minor	Major1			Major2			Minor1			Minor2		
Conflicting Flow All	57	0	0	121	0	0	208	199	92	206	226	55
Stage 1	-	-	-	-	-	-	128	128	-	69	69	-
Stage 2	-	-	-	-	-	-	80	71	-	137	157	-
Critical Hdwy	4.12	-	-	4.12	-	-	7.12	6.52	6.22	7.12	6.52	6.22
Critical Hdwy Stg 1	-	-	-	-	-	-	6.12	5.52	-	6.12	5.52	-
Critical Hdwy Stg 2	-	-	-	-	-	-	6.12	5.52	-	6.12	5.52	-
Follow-up Hdwy	2.218	-	-	2.218	-	-	3.518	4.018	3.318	3.518	4.018	3.318
Pot Cap-1 Maneuver	1547	-	-	1467	-	-	749	697	965	752	673	1012
Stage 1	-	-	-	-	-	-	876	790	-	941	837	-
Stage 2	-	-	-	-	-	-	929	836	-	866	768	-
Platoon blocked, %		-	-		-	-						
Mov Cap-1 Maneuver	1547	-	-	1467	-	-	721	684	965	728	661	1012
Mov Cap-2 Maneuver	-	-	-	-	-	-	721	684	-	728	661	-
Stage 1	-	-	-	-	-	-	865	780	-	929	833	-
Stage 2	-	-	-	-	-	-	901	832	-	838	758	-

Approach	EB			WB			NB			SB		
HCM Control Delay, s	1			0.8			10.1			9.7		
HCM LOS							B			A		

Minor Lane/Major Mvmt	NBLn1	EBL	EBT	EBR	WBL	WBT	WBR	SBLn1
Capacity (veh/h)	764	1547	-	-	1467	-	-	801
HCM Lane V/C Ratio	0.069	0.012	-	-	0.005	-	-	0.035
HCM Control Delay (s)	10.1	7.4	0	-	7.5	0	-	9.7
HCM Lane LOS	B	A	A	-	A	A	-	A
HCM 95th %tile Q(veh)	0.2	0	-	-	0	-	-	0.1

Intersection						
Int Delay, s/veh	3.2					
Movement	WBL	WBR	NBT	NBR	SBL	SBT
Lane Configurations						
Traffic Vol, veh/h	12	20	30	15	9	22
Future Vol, veh/h	12	20	30	15	9	22
Conflicting Peds, #/hr	0	0	0	0	0	0
Sign Control	Stop	Stop	Free	Free	Free	Free
RT Channelized	-	None	-	None	-	None
Storage Length	0	-	-	-	-	-
Veh in Median Storage, #	0	-	0	-	-	0
Grade, %	0	-	0	-	-	0
Peak Hour Factor	85	85	85	85	85	85
Heavy Vehicles, %	2	2	2	2	2	2
Mvmt Flow	14	24	35	18	11	26

Major/Minor	Minor1	Major1	Major2			
Conflicting Flow All	92	44	0	0	53	0
Stage 1	44	-	-	-	-	-
Stage 2	48	-	-	-	-	-
Critical Hdwy	6.42	6.22	-	-	4.12	-
Critical Hdwy Stg 1	5.42	-	-	-	-	-
Critical Hdwy Stg 2	5.42	-	-	-	-	-
Follow-up Hdwy	3.518	3.318	-	-	2.218	-
Pot Cap-1 Maneuver	908	1026	-	-	1553	-
Stage 1	978	-	-	-	-	-
Stage 2	974	-	-	-	-	-
Platoon blocked, %			-	-		-
Mov Cap-1 Maneuver	902	1026	-	-	1553	-
Mov Cap-2 Maneuver	902	-	-	-	-	-
Stage 1	978	-	-	-	-	-
Stage 2	967	-	-	-	-	-

Approach	WB	NB	SB
HCM Control Delay, s	8.8	0	2.1
HCM LOS	A		

Minor Lane/Major Mvmt	NBT	NBRWBLn1	SBL	SBT
Capacity (veh/h)	-	-	976	1553
HCM Lane V/C Ratio	-	-	0.039	0.007
HCM Control Delay (s)	-	-	8.8	7.3
HCM Lane LOS	-	-	A	A
HCM 95th %tile Q(veh)	-	-	0.1	0

Intersection						
Int Delay, s/veh	3.1					
Movement	WBL	WBR	NBT	NBR	SBL	SBT
Lane Configurations						
Traffic Vol, veh/h	35	13	32	45	6	28
Future Vol, veh/h	35	13	32	45	6	28
Conflicting Peds, #/hr	0	0	0	0	0	0
Sign Control	Stop	Stop	Free	Free	Free	Free
RT Channelized	-	None	-	None	-	None
Storage Length	0	-	-	-	-	-
Veh in Median Storage, #	0	-	0	-	-	0
Grade, %	0	-	0	-	-	0
Peak Hour Factor	85	85	85	85	85	85
Heavy Vehicles, %	2	2	2	2	2	2
Mvmt Flow	41	15	38	53	7	33

Major/Minor	Minor1	Major1	Major2			
Conflicting Flow All	112	65	0	0	91	0
Stage 1	65	-	-	-	-	-
Stage 2	47	-	-	-	-	-
Critical Hdwy	6.42	6.22	-	-	4.12	-
Critical Hdwy Stg 1	5.42	-	-	-	-	-
Critical Hdwy Stg 2	5.42	-	-	-	-	-
Follow-up Hdwy	3.518	3.318	-	-	2.218	-
Pot Cap-1 Maneuver	885	999	-	-	1504	-
Stage 1	958	-	-	-	-	-
Stage 2	975	-	-	-	-	-
Platoon blocked, %			-	-	-	-
Mov Cap-1 Maneuver	881	999	-	-	1504	-
Mov Cap-2 Maneuver	881	-	-	-	-	-
Stage 1	958	-	-	-	-	-
Stage 2	970	-	-	-	-	-

Approach	WB	NB	SB
HCM Control Delay, s	9.2	0	1.3
HCM LOS	A		

Minor Lane/Major Mvmt	NBT	NBRWBLn1	SBL	SBT
Capacity (veh/h)	-	-	910	1504
HCM Lane V/C Ratio	-	-	0.062	0.005
HCM Control Delay (s)	-	-	9.2	7.4
HCM Lane LOS	-	-	A	A
HCM 95th %tile Q(veh)	-	-	0.2	0

Intersection	
Intersection Delay, s/veh	22.5
Intersection LOS	C

Movement	EBL	EBT	EBR	WBL	WBT	WBR	NBL	NBT	NBR	SBL	SBT	SBR
Lane Configurations	↶	↷		↶	↷			↕		↶	↷	
Traffic Vol, veh/h	67	263	22	6	327	48	74	28	17	108	31	140
Future Vol, veh/h	67	263	22	6	327	48	74	28	17	108	31	140
Peak Hour Factor	0.74	0.94	0.74	0.71	0.94	0.71	0.83	0.83	0.83	0.76	0.76	0.76
Heavy Vehicles, %	2	2	2	2	2	2	2	2	2	2	2	2
Mvmt Flow	91	280	30	8	348	68	89	34	20	142	41	184
Number of Lanes	1	1	0	1	1	0	0	1	0	1	1	0

Approach	EB	WB	NB	SB
Opposing Approach	WB	EB	SB	NB
Opposing Lanes	2	2	2	1
Conflicting Approach Left	SB	NB	EB	WB
Conflicting Lanes Left	2	1	2	2
Conflicting Approach Right	NB	SB	WB	EB
Conflicting Lanes Right	1	2	2	2
HCM Control Delay	19.3	34.3	15.6	15.2
HCM LOS	C	D	C	C

Lane	NBLn1	EBLn1	EBLn2	WBLn1	WBLn2	SBLn1	SBLn2
Vol Left, %	62%	100%	0%	100%	0%	100%	0%
Vol Thru, %	24%	0%	92%	0%	87%	0%	18%
Vol Right, %	14%	0%	8%	0%	13%	0%	82%
Sign Control	Stop	Stop	Stop	Stop	Stop	Stop	Stop
Traffic Vol by Lane	119	67	285	6	375	108	171
LT Vol	74	67	0	6	0	108	0
Through Vol	28	0	263	0	327	0	31
RT Vol	17	0	22	0	48	0	140
Lane Flow Rate	143	91	310	8	415	142	225
Geometry Grp	4b	5	5	5	5	5	5
Degree of Util (X)	0.332	0.196	0.622	0.018	0.82	0.322	0.442
Departure Headway (Hd)	8.345	7.809	7.239	7.713	7.108	8.168	7.065
Convergence, Y/N	Yes	Yes	Yes	Yes	Yes	Yes	Yes
Cap	429	458	498	463	507	439	509
Service Time	6.437	5.58	5.01	5.479	4.873	5.939	4.836
HCM Lane V/C Ratio	0.333	0.199	0.622	0.017	0.819	0.323	0.442
HCM Control Delay	15.6	12.5	21.3	10.6	34.8	14.8	15.4
HCM Lane LOS	C	B	C	B	D	B	C
HCM 95th-tile Q	1.4	0.7	4.2	0.1	8	1.4	2.2

Intersection												
Int Delay, s/veh	2.6											
Movement	EBL	EBT	EBR	WBL	WBT	WBR	NBL	NBT	NBR	SBL	SBT	SBR
Lane Configurations		↕			↕			↕			↕	
Traffic Vol, veh/h	4	395	35	6	519	3	57	1	5	7	4	14
Future Vol, veh/h	4	395	35	6	519	3	57	1	5	7	4	14
Conflicting Peds, #/hr	0	0	0	0	0	0	0	0	0	0	0	0
Sign Control	Free	Free	Free	Free	Free	Free	Stop	Stop	Stop	Stop	Stop	Stop
RT Channelized	-	-	None	-	-	None	-	-	None	-	-	None
Storage Length	-	-	-	-	-	-	-	-	-	-	-	-
Veh in Median Storage, #	-	0	-	-	0	-	-	0	-	-	0	-
Grade, %	-	0	-	-	0	-	-	0	-	-	0	-
Peak Hour Factor	78	94	78	66	94	66	85	85	85	78	78	78
Heavy Vehicles, %	2	2	2	2	2	2	2	2	2	2	2	2
Mvmt Flow	5	420	45	9	552	5	67	1	6	9	5	18

Major/Minor	Major1			Major2			Minor1			Minor2		
Conflicting Flow All	557	0	0	465	0	0	1037	1028	443	1029	1048	555
Stage 1	-	-	-	-	-	-	453	453	-	573	573	-
Stage 2	-	-	-	-	-	-	584	575	-	456	475	-
Critical Hdwy	4.12	-	-	4.12	-	-	7.12	6.52	6.22	7.12	6.52	6.22
Critical Hdwy Stg 1	-	-	-	-	-	-	6.12	5.52	-	6.12	5.52	-
Critical Hdwy Stg 2	-	-	-	-	-	-	6.12	5.52	-	6.12	5.52	-
Follow-up Hdwy	2.218	-	-	2.218	-	-	3.518	4.018	3.318	3.518	4.018	3.318
Pot Cap-1 Maneuver	1014	-	-	1096	-	-	209	234	615	212	228	531
Stage 1	-	-	-	-	-	-	586	570	-	505	504	-
Stage 2	-	-	-	-	-	-	498	503	-	584	557	-
Platoon blocked, %		-	-		-	-						
Mov Cap-1 Maneuver	1014	-	-	1096	-	-	196	230	615	206	224	531
Mov Cap-2 Maneuver	-	-	-	-	-	-	196	230	-	206	224	-
Stage 1	-	-	-	-	-	-	582	566	-	501	498	-
Stage 2	-	-	-	-	-	-	470	497	-	573	553	-

Approach	EB			WB			NB			SB		
HCM Control Delay, s	0.1			0.1			31.6			17.5		
HCM LOS							D			C		

Minor Lane/Major Mvmt	NBLn1	EBL	EBT	EBR	WBL	WBT	WBR	SBLn1
Capacity (veh/h)	208	1014	-	-	1096	-	-	320
HCM Lane V/C Ratio	0.356	0.005	-	-	0.008	-	-	0.1
HCM Control Delay (s)	31.6	8.6	0	-	8.3	0	-	17.5
HCM Lane LOS	D	A	A	-	A	A	-	C
HCM 95th %tile Q(veh)	1.5	0	-	-	0	-	-	0.3

HCM 6th TWSC
4: Rainbow Bridge Dr & North Site Access

2043 Total Traffic
AM Peak Hour

Intersection						
Int Delay, s/veh	0.3					
Movement	WBL	WBR	NBT	NBR	SBL	SBT
Lane Configurations						
Traffic Vol, veh/h	1	1	42	1	2	55
Future Vol, veh/h	1	1	42	1	2	55
Conflicting Peds, #/hr	0	0	0	0	0	0
Sign Control	Stop	Stop	Free	Free	Free	Free
RT Channelized	-	None	-	None	-	None
Storage Length	0	-	-	-	-	-
Veh in Median Storage, #	0	-	0	-	-	0
Grade, %	0	-	0	-	-	0
Peak Hour Factor	85	85	85	85	85	85
Heavy Vehicles, %	2	2	2	2	2	2
Mvmt Flow	1	1	49	1	2	65

Major/Minor	Minor1	Major1	Major2		
Conflicting Flow All	119	50	0	0	50
Stage 1	50	-	-	-	-
Stage 2	69	-	-	-	-
Critical Hdwy	6.42	6.22	-	-	4.12
Critical Hdwy Stg 1	5.42	-	-	-	-
Critical Hdwy Stg 2	5.42	-	-	-	-
Follow-up Hdwy	3.518	3.318	-	-	2.218
Pot Cap-1 Maneuver	877	1018	-	-	1557
Stage 1	972	-	-	-	-
Stage 2	954	-	-	-	-
Platoon blocked, %			-	-	-
Mov Cap-1 Maneuver	876	1018	-	-	1557
Mov Cap-2 Maneuver	876	-	-	-	-
Stage 1	972	-	-	-	-
Stage 2	953	-	-	-	-

Approach	WB	NB	SB
HCM Control Delay, s	8.8	0	0.3
HCM LOS	A		

Minor Lane/Major Mvmt	NBT	NBRWBLn1	SBL	SBT
Capacity (veh/h)	-	-	942	1557
HCM Lane V/C Ratio	-	-	0.002	0.002
HCM Control Delay (s)	-	-	8.8	7.3
HCM Lane LOS	-	-	A	A
HCM 95th %tile Q(veh)	-	-	0	0

HCM 6th TWSC
5: Rainbow Bridge Dr & South Site Access

2043 Total Traffic
AM Peak Hour

Intersection						
Int Delay, s/veh	0.2					
Movement	WBL	WBR	NBT	NBR	SBL	SBT
Lane Configurations						
Traffic Vol, veh/h	2	0	43	4	1	55
Future Vol, veh/h	2	0	43	4	1	55
Conflicting Peds, #/hr	0	0	0	0	0	0
Sign Control	Stop	Stop	Free	Free	Free	Free
RT Channelized	-	None	-	None	-	None
Storage Length	0	-	-	-	-	-
Veh in Median Storage, #	0	-	0	-	-	0
Grade, %	0	-	0	-	-	0
Peak Hour Factor	85	85	85	85	85	85
Heavy Vehicles, %	2	2	2	2	2	2
Mvmt Flow	2	0	51	5	1	65

Major/Minor	Minor1	Major1	Major2			
Conflicting Flow All	121	54	0	0	56	0
Stage 1	54	-	-	-	-	-
Stage 2	67	-	-	-	-	-
Critical Hdwy	6.42	6.22	-	-	4.12	-
Critical Hdwy Stg 1	5.42	-	-	-	-	-
Critical Hdwy Stg 2	5.42	-	-	-	-	-
Follow-up Hdwy	3.518	3.318	-	-	2.218	-
Pot Cap-1 Maneuver	874	1013	-	-	1549	-
Stage 1	969	-	-	-	-	-
Stage 2	956	-	-	-	-	-
Platoon blocked, %			-	-		-
Mov Cap-1 Maneuver	873	1013	-	-	1549	-
Mov Cap-2 Maneuver	873	-	-	-	-	-
Stage 1	969	-	-	-	-	-
Stage 2	955	-	-	-	-	-

Approach	WB	NB	SB
HCM Control Delay, s	9.1	0	0.1
HCM LOS	A		

Minor Lane/Major Mvmt	NBT	NBRWBLn1	SBL	SBT
Capacity (veh/h)	-	-	873	1549
HCM Lane V/C Ratio	-	-	0.003	0.001
HCM Control Delay (s)	-	-	9.1	7.3
HCM Lane LOS	-	-	A	A
HCM 95th %tile Q(veh)	-	-	0	0

Intersection	
Intersection Delay, s/veh	16.6
Intersection LOS	C

Movement	EBL	EBT	EBR	WBL	WBT	WBR	NBL	NBT	NBR	SBL	SBT	SBR
Lane Configurations	↶	↷		↶	↷			↕		↶	↷	
Traffic Vol, veh/h	139	146	35	8	132	107	26	42	6	90	47	121
Future Vol, veh/h	139	146	35	8	132	107	26	42	6	90	47	121
Peak Hour Factor	0.87	0.94	0.87	0.83	0.94	0.83	0.78	0.78	0.78	0.45	0.45	0.45
Heavy Vehicles, %	2	2	2	2	2	2	2	2	2	2	2	2
Mvmt Flow	160	155	40	10	140	129	33	54	8	200	104	269
Number of Lanes	1	1	0	1	1	0	0	1	0	1	1	0

Approach	EB	WB	NB	SB
Opposing Approach	WB	EB	SB	NB
Opposing Lanes	2	2	2	1
Conflicting Approach Left	SB	NB	EB	WB
Conflicting Lanes Left	2	1	2	2
Conflicting Approach Right	NB	SB	WB	EB
Conflicting Lanes Right	1	2	2	2
HCM Control Delay	14.2	16.9	12.9	18.5
HCM LOS	B	C	B	C

Lane	NBLn1	EBLn1	EBLn2	WBLn1	WBLn2	SBLn1	SBLn2
Vol Left, %	35%	100%	0%	100%	0%	100%	0%
Vol Thru, %	57%	0%	81%	0%	55%	0%	28%
Vol Right, %	8%	0%	19%	0%	45%	0%	72%
Sign Control	Stop	Stop	Stop	Stop	Stop	Stop	Stop
Traffic Vol by Lane	74	139	181	8	239	90	168
LT Vol	26	139	0	8	0	90	0
Through Vol	42	0	146	0	132	0	47
RT Vol	6	0	35	0	107	0	121
Lane Flow Rate	95	160	196	10	269	200	373
Geometry Grp	4b	5	5	5	5	5	5
Degree of Util (X)	0.205	0.341	0.381	0.021	0.522	0.409	0.657
Departure Headway (Hd)	7.788	7.673	7.022	7.811	6.976	7.36	6.338
Convergence, Y/N	Yes	Yes	Yes	Yes	Yes	Yes	Yes
Cap	460	468	512	458	517	492	575
Service Time	5.843	5.418	4.766	5.556	4.721	5.06	4.038
HCM Lane V/C Ratio	0.207	0.342	0.383	0.022	0.52	0.407	0.649
HCM Control Delay	12.9	14.4	14	10.7	17.1	15.1	20.3
HCM Lane LOS	B	B	B	B	C	C	C
HCM 95th-tile Q	0.8	1.5	1.8	0.1	3	2	4.8

Intersection												
Int Delay, s/veh	1.7											
Movement	EBL	EBT	EBR	WBL	WBT	WBR	NBL	NBT	NBR	SBL	SBT	SBR
Lane Configurations		↕			↕			↕			↕	
Traffic Vol, veh/h	8	486	67	10	416	2	29	2	10	3	5	6
Future Vol, veh/h	8	486	67	10	416	2	29	2	10	3	5	6
Conflicting Peds, #/hr	0	0	0	0	0	0	0	0	0	0	0	0
Sign Control	Free	Free	Free	Free	Free	Free	Stop	Stop	Stop	Stop	Stop	Stop
RT Channelized	-	-	None	-	-	None	-	-	None	-	-	None
Storage Length	-	-	-	-	-	-	-	-	-	-	-	-
Veh in Median Storage, #	-	0	-	-	0	-	-	0	-	-	0	-
Grade, %	-	0	-	-	0	-	-	0	-	-	0	-
Peak Hour Factor	61	94	61	94	94	94	78	78	78	78	78	78
Heavy Vehicles, %	2	2	2	2	2	2	2	2	2	2	2	2
Mvmt Flow	13	517	110	11	443	2	37	3	13	4	6	8

Major/Minor	Major1			Major2			Minor1			Minor2		
Conflicting Flow All	445	0	0	627	0	0	1071	1065	572	1072	1119	444
Stage 1	-	-	-	-	-	-	598	598	-	466	466	-
Stage 2	-	-	-	-	-	-	473	467	-	606	653	-
Critical Hdwy	4.12	-	-	4.12	-	-	7.12	6.52	6.22	7.12	6.52	6.22
Critical Hdwy Stg 1	-	-	-	-	-	-	6.12	5.52	-	6.12	5.52	-
Critical Hdwy Stg 2	-	-	-	-	-	-	6.12	5.52	-	6.12	5.52	-
Follow-up Hdwy	2.218	-	-	2.218	-	-	3.518	4.018	3.318	3.518	4.018	3.318
Pot Cap-1 Maneuver	1115	-	-	955	-	-	198	223	520	198	207	614
Stage 1	-	-	-	-	-	-	489	491	-	577	562	-
Stage 2	-	-	-	-	-	-	572	562	-	484	464	-
Platoon blocked, %		-	-		-	-						
Mov Cap-1 Maneuver	1115	-	-	955	-	-	186	216	520	187	200	614
Mov Cap-2 Maneuver	-	-	-	-	-	-	186	216	-	187	200	-
Stage 1	-	-	-	-	-	-	480	482	-	567	554	-
Stage 2	-	-	-	-	-	-	550	554	-	461	456	-

Approach	EB			WB			NB			SB		
HCM Control Delay, s	0.2			0.2			26.2			18.9		
HCM LOS							D			C		

Minor Lane/Major Mvmt	NBLn1	EBL	EBT	EBR	WBL	WBT	WBR	SBLn1
Capacity (veh/h)	222	1115	-	-	955	-	-	276
HCM Lane V/C Ratio	0.237	0.012	-	-	0.011	-	-	0.065
HCM Control Delay (s)	26.2	8.3	0	-	8.8	0	-	18.9
HCM Lane LOS	D	A	A	-	A	A	-	C
HCM 95th %tile Q(veh)	0.9	0	-	-	0	-	-	0.2

Intersection						
Int Delay, s/veh	1.3					
Movement	WBL	WBR	NBT	NBR	SBL	SBT
Lane Configurations						
Traffic Vol, veh/h	9	10	44	8	8	99
Future Vol, veh/h	9	10	44	8	8	99
Conflicting Peds, #/hr	0	0	0	0	0	0
Sign Control	Stop	Stop	Free	Free	Free	Free
RT Channelized	-	None	-	None	-	None
Storage Length	0	-	-	-	-	-
Veh in Median Storage, #	0	-	0	-	-	0
Grade, %	0	-	0	-	-	0
Peak Hour Factor	85	85	85	85	85	85
Heavy Vehicles, %	2	2	2	2	2	2
Mvmt Flow	11	12	52	9	9	116

Major/Minor	Minor1	Major1	Major2			
Conflicting Flow All	191	57	0	0	61	0
Stage 1	57	-	-	-	-	-
Stage 2	134	-	-	-	-	-
Critical Hdwy	6.42	6.22	-	-	4.12	-
Critical Hdwy Stg 1	5.42	-	-	-	-	-
Critical Hdwy Stg 2	5.42	-	-	-	-	-
Follow-up Hdwy	3.518	3.318	-	-	2.218	-
Pot Cap-1 Maneuver	798	1009	-	-	1542	-
Stage 1	966	-	-	-	-	-
Stage 2	892	-	-	-	-	-
Platoon blocked, %			-	-		-
Mov Cap-1 Maneuver	793	1009	-	-	1542	-
Mov Cap-2 Maneuver	793	-	-	-	-	-
Stage 1	966	-	-	-	-	-
Stage 2	887	-	-	-	-	-

Approach	WB	NB	SB
HCM Control Delay, s	9.1	0	0.5
HCM LOS	A		

Minor Lane/Major Mvmt	NBT	NBRWBLn1	SBL	SBT
Capacity (veh/h)	-	-	894	1542
HCM Lane V/C Ratio	-	-	0.025	0.006
HCM Control Delay (s)	-	-	9.1	7.3
HCM Lane LOS	-	-	A	A
HCM 95th %tile Q(veh)	-	-	0.1	0

Intersection						
Int Delay, s/veh	1.7					
Movement	WBL	WBR	NBT	NBR	SBL	SBT
Lane Configurations						
Traffic Vol, veh/h	28	7	45	23	5	103
Future Vol, veh/h	28	7	45	23	5	103
Conflicting Peds, #/hr	0	0	0	0	0	0
Sign Control	Stop	Stop	Free	Free	Free	Free
RT Channelized	-	None	-	None	-	None
Storage Length	0	-	-	-	-	-
Veh in Median Storage, #	0	-	0	-	-	0
Grade, %	0	-	0	-	-	0
Peak Hour Factor	85	85	85	85	85	85
Heavy Vehicles, %	2	2	2	2	2	2
Mvmt Flow	33	8	53	27	6	121

Major/Minor	Minor1	Major1	Major2		
Conflicting Flow All	200	67	0	0	80
Stage 1	67	-	-	-	-
Stage 2	133	-	-	-	-
Critical Hdwy	6.42	6.22	-	-	4.12
Critical Hdwy Stg 1	5.42	-	-	-	-
Critical Hdwy Stg 2	5.42	-	-	-	-
Follow-up Hdwy	3.518	3.318	-	-	2.218
Pot Cap-1 Maneuver	789	997	-	-	1518
Stage 1	956	-	-	-	-
Stage 2	893	-	-	-	-
Platoon blocked, %			-	-	-
Mov Cap-1 Maneuver	786	997	-	-	1518
Mov Cap-2 Maneuver	786	-	-	-	-
Stage 1	956	-	-	-	-
Stage 2	889	-	-	-	-

Approach	WB	NB	SB
HCM Control Delay, s	9.6	0	0.3
HCM LOS	A		

Minor Lane/Major Mvmt	NBT	NBRWBLn1	SBL	SBT
Capacity (veh/h)	-	-	821	1518
HCM Lane V/C Ratio	-	-	0.05	0.004
HCM Control Delay (s)	-	-	9.6	7.4
HCM Lane LOS	-	-	A	A
HCM 95th %tile Q(veh)	-	-	0.2	0

Intersection	
Intersection Delay, s/veh	11.3
Intersection LOS	B

Movement	EBL	EBT	EBR	WBL	WBT	WBR	NBL	NBT	NBR	SBL	SBT	SBR
Lane Configurations	↶	↷		↶	↷			↕		↶	↷	
Traffic Vol, veh/h	129	141	41	9	140	91	30	36	7	48	25	83
Future Vol, veh/h	129	141	41	9	140	91	30	36	7	48	25	83
Peak Hour Factor	0.87	0.94	0.87	0.81	0.94	0.81	0.78	0.78	0.78	0.76	0.76	0.76
Heavy Vehicles, %	2	2	2	2	2	2	2	2	2	2	2	2
Mvmt Flow	148	150	47	11	149	112	38	46	9	63	33	109
Number of Lanes	1	1	0	1	1	0	0	1	0	1	1	0

Approach	EB	WB	NB	SB
Opposing Approach	WB	EB	SB	NB
Opposing Lanes	2	2	2	1
Conflicting Approach Left	SB	NB	EB	WB
Conflicting Lanes Left	2	1	2	2
Conflicting Approach Right	NB	SB	WB	EB
Conflicting Lanes Right	1	2	2	2
HCM Control Delay	11.1	12.3	11	10.4
HCM LOS	B	B	B	B

Lane	NBLn1	EBLn1	EBLn2	WBLn1	WBLn2	SBLn1	SBLn2
Vol Left, %	41%	100%	0%	100%	0%	100%	0%
Vol Thru, %	49%	0%	77%	0%	61%	0%	23%
Vol Right, %	10%	0%	23%	0%	39%	0%	77%
Sign Control	Stop	Stop	Stop	Stop	Stop	Stop	Stop
Traffic Vol by Lane	73	129	182	9	231	48	108
LT Vol	30	129	0	9	0	48	0
Through Vol	36	0	141	0	140	0	25
RT Vol	7	0	41	0	91	0	83
Lane Flow Rate	94	148	197	11	261	63	142
Geometry Grp	4b	5	5	5	5	5	5
Degree of Util (X)	0.172	0.261	0.311	0.02	0.412	0.121	0.23
Departure Headway (Hd)	6.609	6.341	5.675	6.457	5.671	6.882	5.83
Convergence, Y/N	Yes	Yes	Yes	Yes	Yes	Yes	Yes
Cap	542	566	633	554	635	520	615
Service Time	4.662	4.08	3.413	4.197	3.41	4.628	3.576
HCM Lane V/C Ratio	0.173	0.261	0.311	0.02	0.411	0.121	0.231
HCM Control Delay	11	11.3	11	9.3	12.4	10.6	10.3
HCM Lane LOS	B	B	B	A	B	B	B
HCM 95th-tile Q	0.6	1	1.3	0.1	2	0.4	0.9

Intersection												
Int Delay, s/veh	1.6											
Movement	EBL	EBT	EBR	WBL	WBT	WBR	NBL	NBT	NBR	SBL	SBT	SBR
Lane Configurations		↕			↕			↕			↕	
Traffic Vol, veh/h	15	632	48	7	436	4	27	4	11	2	4	5
Future Vol, veh/h	15	632	48	7	436	4	27	4	11	2	4	5
Conflicting Peds, #/hr	0	0	0	0	0	0	0	0	0	0	0	0
Sign Control	Free	Free	Free	Free	Free	Free	Stop	Stop	Stop	Stop	Stop	Stop
RT Channelized	-	-	None	-	-	None	-	-	None	-	-	None
Storage Length	-	-	-	-	-	-	-	-	-	-	-	-
Veh in Median Storage, #	-	0	-	-	0	-	-	0	-	-	0	-
Grade, %	-	0	-	-	0	-	-	0	-	-	0	-
Peak Hour Factor	85	94	85	85	94	85	85	85	85	85	85	85
Heavy Vehicles, %	2	2	2	2	2	2	2	2	2	2	2	2
Mvmt Flow	18	672	56	8	464	5	32	5	13	2	5	6

Major/Minor	Major1			Major2			Minor1			Minor2		
Conflicting Flow All	469	0	0	728	0	0	1224	1221	700	1228	1247	467
Stage 1	-	-	-	-	-	-	736	736	-	483	483	-
Stage 2	-	-	-	-	-	-	488	485	-	745	764	-
Critical Hdwy	4.12	-	-	4.12	-	-	7.12	6.52	6.22	7.12	6.52	6.22
Critical Hdwy Stg 1	-	-	-	-	-	-	6.12	5.52	-	6.12	5.52	-
Critical Hdwy Stg 2	-	-	-	-	-	-	6.12	5.52	-	6.12	5.52	-
Follow-up Hdwy	2.218	-	-	2.218	-	-	3.518	4.018	3.318	3.518	4.018	3.318
Pot Cap-1 Maneuver	1093	-	-	876	-	-	156	180	439	155	173	596
Stage 1	-	-	-	-	-	-	411	425	-	565	553	-
Stage 2	-	-	-	-	-	-	561	552	-	406	413	-
Platoon blocked, %		-	-		-	-						
Mov Cap-1 Maneuver	1093	-	-	876	-	-	146	173	439	143	166	596
Mov Cap-2 Maneuver	-	-	-	-	-	-	146	173	-	143	166	-
Stage 1	-	-	-	-	-	-	399	413	-	549	546	-
Stage 2	-	-	-	-	-	-	544	545	-	379	401	-

Approach	EB			WB			NB			SB		
HCM Control Delay, s	0.2			0.2			32.4			21.1		
HCM LOS							D			C		

Minor Lane/Major Mvmt	NBLn1	EBL	EBT	EBR	WBL	WBT	WBR	SBLn1
Capacity (veh/h)	180	1093	-	-	876	-	-	237
HCM Lane V/C Ratio	0.275	0.016	-	-	0.009	-	-	0.055
HCM Control Delay (s)	32.4	8.3	0	-	9.1	0	-	21.1
HCM Lane LOS	D	A	A	-	A	A	-	C
HCM 95th %tile Q(veh)	1.1	0	-	-	0	-	-	0.2

Intersection						
Int Delay, s/veh	3.2					
Movement	WBL	WBR	NBT	NBR	SBL	SBT
Lane Configurations						
Traffic Vol, veh/h	12	20	31	15	9	23
Future Vol, veh/h	12	20	31	15	9	23
Conflicting Peds, #/hr	0	0	0	0	0	0
Sign Control	Stop	Stop	Free	Free	Free	Free
RT Channelized	-	None	-	None	-	None
Storage Length	0	-	-	-	-	-
Veh in Median Storage, #	0	-	0	-	-	0
Grade, %	0	-	0	-	-	0
Peak Hour Factor	85	85	85	85	85	85
Heavy Vehicles, %	2	2	2	2	2	2
Mvmt Flow	14	24	36	18	11	27

Major/Minor	Minor1	Major1	Major2			
Conflicting Flow All	94	45	0	0	54	0
Stage 1	45	-	-	-	-	-
Stage 2	49	-	-	-	-	-
Critical Hdwy	6.42	6.22	-	-	4.12	-
Critical Hdwy Stg 1	5.42	-	-	-	-	-
Critical Hdwy Stg 2	5.42	-	-	-	-	-
Follow-up Hdwy	3.518	3.318	-	-	2.218	-
Pot Cap-1 Maneuver	906	1025	-	-	1551	-
Stage 1	977	-	-	-	-	-
Stage 2	973	-	-	-	-	-
Platoon blocked, %			-	-		-
Mov Cap-1 Maneuver	900	1025	-	-	1551	-
Mov Cap-2 Maneuver	900	-	-	-	-	-
Stage 1	977	-	-	-	-	-
Stage 2	966	-	-	-	-	-

Approach	WB	NB	SB
HCM Control Delay, s	8.8	0	2.1
HCM LOS	A		

Minor Lane/Major Mvmt	NBT	NBRWBLn1	SBL	SBT
Capacity (veh/h)	-	-	974	1551
HCM Lane V/C Ratio	-	-	0.039	0.007
HCM Control Delay (s)	-	-	8.8	7.3
HCM Lane LOS	-	-	A	A
HCM 95th %tile Q(veh)	-	-	0.1	0

HCM 6th TWSC
5: Rainbow Bridge Dr & South Site Access

2043 Total Traffic
PM Peak Hour

Intersection						
Int Delay, s/veh	3					
Movement	WBL	WBR	NBT	NBR	SBL	SBT
Lane Configurations						
Traffic Vol, veh/h	35	13	33	45	6	29
Future Vol, veh/h	35	13	33	45	6	29
Conflicting Peds, #/hr	0	0	0	0	0	0
Sign Control	Stop	Stop	Free	Free	Free	Free
RT Channelized	-	None	-	None	-	None
Storage Length	0	-	-	-	-	-
Veh in Median Storage, #	0	-	0	-	-	0
Grade, %	0	-	0	-	-	0
Peak Hour Factor	85	85	85	85	85	85
Heavy Vehicles, %	2	2	2	2	2	2
Mvmt Flow	41	15	39	53	7	34

Major/Minor	Minor1	Major1	Major2		
Conflicting Flow All	114	66	0	0	92
Stage 1	66	-	-	-	-
Stage 2	48	-	-	-	-
Critical Hdwy	6.42	6.22	-	-	4.12
Critical Hdwy Stg 1	5.42	-	-	-	-
Critical Hdwy Stg 2	5.42	-	-	-	-
Follow-up Hdwy	3.518	3.318	-	-	2.218
Pot Cap-1 Maneuver	882	998	-	-	1503
Stage 1	957	-	-	-	-
Stage 2	974	-	-	-	-
Platoon blocked, %			-	-	-
Mov Cap-1 Maneuver	878	998	-	-	1503
Mov Cap-2 Maneuver	878	-	-	-	-
Stage 1	957	-	-	-	-
Stage 2	969	-	-	-	-

Approach	WB	NB	SB
HCM Control Delay, s	9.2	0	1.3
HCM LOS	A		

Minor Lane/Major Mvmt	NBT	NBRWBLn1	SBL	SBT
Capacity (veh/h)	-	-	908	1503
HCM Lane V/C Ratio	-	-	0.062	0.005
HCM Control Delay (s)	-	-	9.2	7.4
HCM Lane LOS	-	-	A	A
HCM 95th %tile Q(veh)	-	-	0.2	0

MTCP Maps



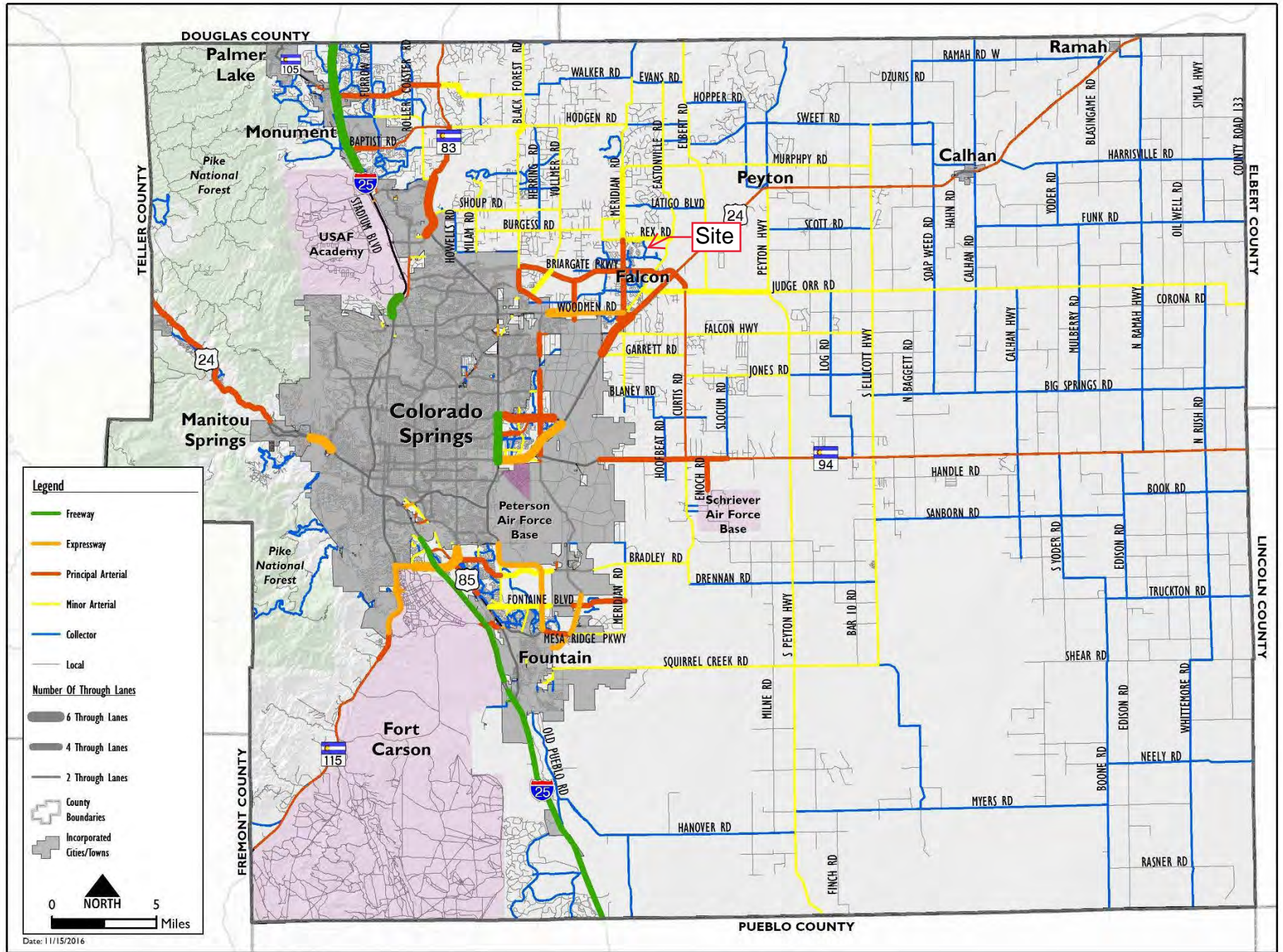

Map 14: 2040 Roadway Plan (Classification and Lanes)

Map 17: 2060 Corridor Preservation

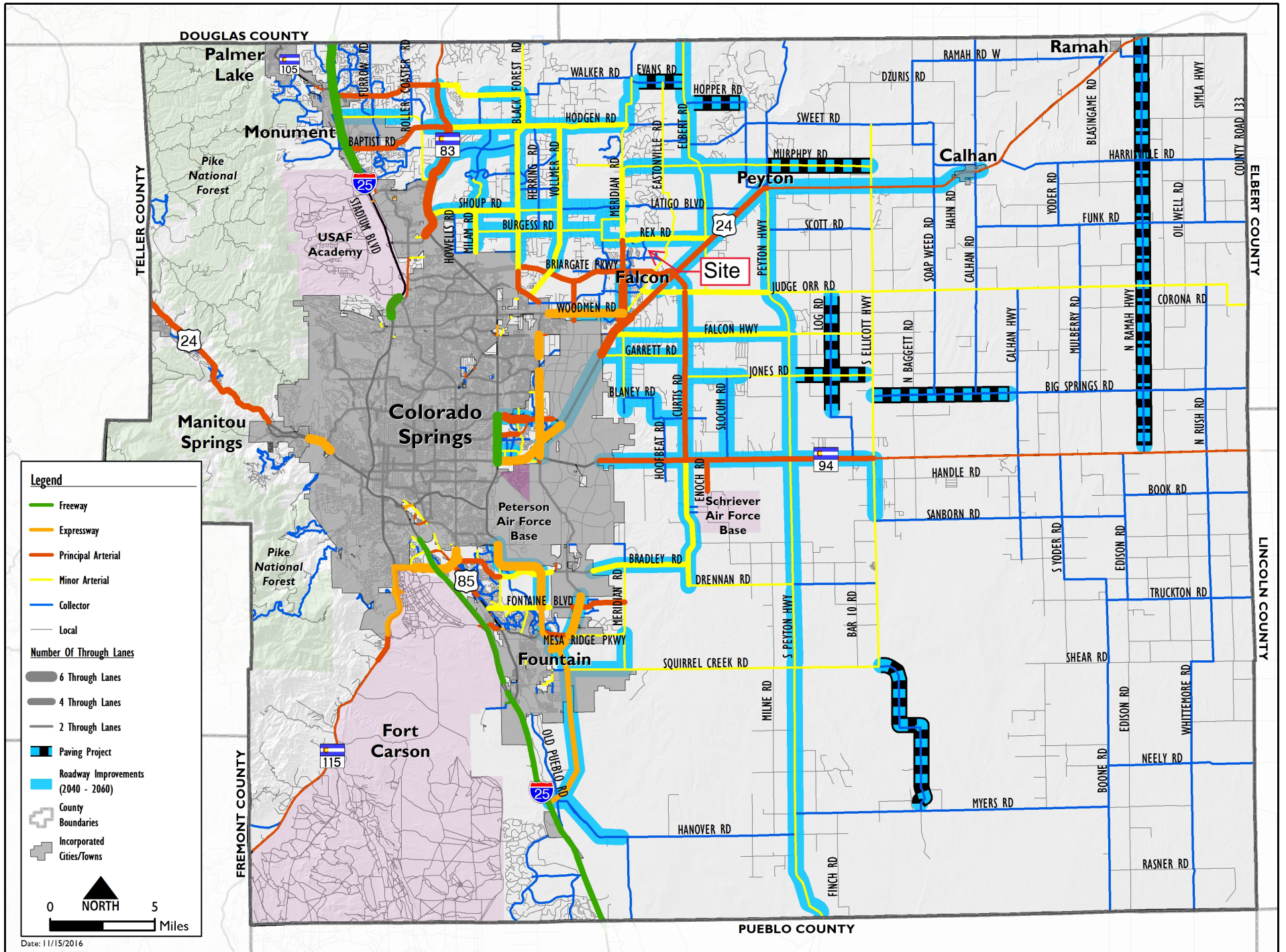

Legend

- Freeway
- Expressway
- Principal Arterial
- Minor Arterial
- Collector
- Local

Number Of Through Lanes

- 6 Through Lanes
- 4 Through Lanes
- 2 Through Lanes

- Paving Project
- Roadway Improvements (2040 - 2060)
- County Boundaries
- Incorporated Cities/Towns

0 NORTH 5 Miles

Appendix 1



Appendix Table 1
Area Traffic Impact Studies by LSC
Meridian Ranch Field House

Study	Date
4-Way Ranch/Waterbury	
4-Way Ranch Updated TIA	January 29, 2009
Waterbury PUD Development Plan Updated TIA	January 10, 2013
Waterbury Filing Nos. 1 and 2 TIA	December 18, 2020
4-Way Ranch Commercial Master Traffic Impact Analysis	December 20, 2022
4-Way Ranch Commercial Phase 1 Traffic Technical Memorandum	November 30, 2023
Meridian Ranch	
Meridian Ranch Sketch Plan TIA	April 11, 2011
Meridian Ranch Filing 11 Updated TIA	November 26, 2013
Stonebridge at Meridian Ranch Filing No. 1 Updated TIA	April 23, 2014
Stonebridge at Meridian Ranch Transportation Memorandum	July 28, 2015
Meridian Ranch Filing 8 Updated TIA	December 23, 2014
Meridian Ranch Filing 9 Updated TIA	May 21, 2015
Meridian Ranch Sketch Plan 2015 Amendment TIA	July 30, 2015
The Vistas at Meridian Ranch TIA	March 24, 2016
Meridian Ranch Estates Filing No. 2 Transportation Memorandum	August 27, 2015
The Vistas at Meridian Ranch Updated Transportation Memorandum	June 20, 2017
Londonderry Drive Pedestrian Operations and Safety Study	February 8, 2017
Stonebridge Filing 3 at Meridian Ranch Updated TIA	March 20, 2017
Meridian Ranch Sketch Plan 2017 Amendment TIA	October 3, 2017
WindingWalk at Meridian Ranch and The Enclave at Stonebridge at Meridian Ranch Updated Traffic Impact Analysis	May 10, 2018
Rolling Hills Ranch at Meridian Ranch PUDSP Traffic Impact Analysis	June 29, 2020
The Estates at Rolling Hills Ranch Filing No. 1 Traffic Impact Analysis	May 13, 2020
Rolling Hills Ranch at Meridian Ranch Filing No. 1 Traffic Impact Analysis	July 14, 2020
The Estates at Rolling Hills Ranch Filing No. 2 Traffic Impact Study	October 8, 2020
Rolling Hills Ranch at Meridian Ranch Filing No. 2 Transportation Memorandum	December 29, 2020
Rolling Hills Ranch at Meridian Ranch Filing No. 3 Transportation Memorandum	June 29, 2021
Meridian Ranch 2021 Sketch Plan Amendment Traffic Impact Study	June 25, 2021
The Sanctuary at Meridian Ranch Transportation Memorandum	May 3, 2022
Rolling Hills Ranch North PUD Transportation Memorandum	October 30, 2023
Grandview Reserve	
Grandview Reserve Updated Master TIA	December 5, 2020
Grandview Reserve Phase 1 TIA	May 9, 2022
Grandview Reserve Phases 2 and 3 TIA	December 21, 2022
Meadowlake Ranch	
Meadowlake Ranch Traffic Impact Analysis	May 29, 2019
Latigo Preserve	
Latigo Preserve Filing No. 10	March 31, 2022
<i>Source: LSC Transportation Consultants, Inc.</i>	
<i>Dec-23</i>	