

Final Drainage Report
for
Meridian Service Metropolitan District
Recreation Center East Fieldhouse



MERIDIAN RANCH
A GOLF & RECREATIONAL COMMUNITY

EL PASO COUNTY, COLORADO

June 2024

Prepared For:

GTL DEVELOPMENT, INC.
P.O. Box 80036
San Diego, CA 92138

Prepared By:

Tech Contractors
11910 Tourmaline Dr., Suite 130
Falcon, CO 80831
719.495.7444

PCD Project No. PPR246

CERTIFICATIONS

Design Engineer's Statement:

The attached drainage plan and report were prepared under my direction and supervision and are correct to the best of my knowledge and belief. Said drainage report has been prepared according to the criteria established by the County for drainage reports and said report is in conformity with the applicable master plan of the drainage basin. I accept responsibility for any liability caused by any negligent acts, errors or omissions on my part in preparing this report.

Thomas A. Kerby, P.E. #31429

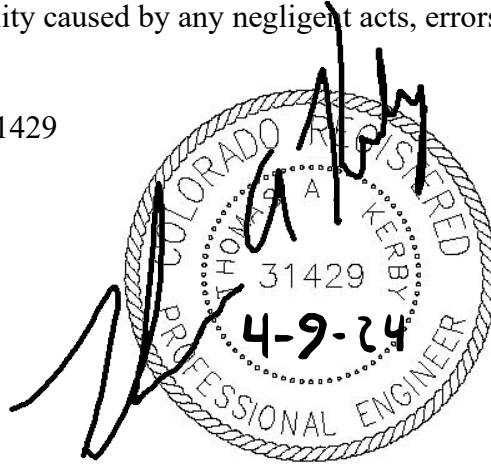

Owner/Developer's Statement:

I, the owner/developer have read and will comply with all of the requirements specified in this drainage report and plan.

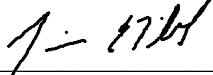

Jim Nikkel, General Manager
Meridian Service Metropolitan District
11886 Stapleton Drive
Falcon, CO 80831

04/11/2024
Date

El Paso County:

Filed in accordance with the requirements of the Drainage Criteria Manual, Volumes 1 & 2, El Paso County Engineering Criteria Manual and Land Development Code as amended.

Joshua Palmer, P.E.
County Engineer / ECM Administrator

8/13/2024
Date

**Meridian Service Metropolitan District
Recreation Center East Fieldhouse
Final Drainage Report**

Table of Contents

EXECUTIVE SUMMARY	<i>i</i>
INTRODUCTION	<i>1</i>
Purpose	<i>1</i>
Scope	<i>1</i>
Background	<i>1</i>
EXISTING CONDITIONS	<i>3</i>
General Location	<i>3</i>
Land Use	<i>3</i>
Climate	<i>3</i>
Topography and Floodplains	<i>3</i>
Geology	<i>3</i>
Natural Hazards Analysis	<i>6</i>
DRAINAGE BASINS AND SUB-BASINS	<i>6</i>
DRAINAGE DESIGN CRITERIA	<i>6</i>
SCS Hydrograph Procedure	<i>6</i>
Full Spectrum Design	<i>7</i>
DRAINAGE CALCULATIONS	<i>7</i>
SCS General Overview	<i>7</i>
SCS Calculations	<i>8</i>
Existing Drainage - SCS Calculation Method	<i>8</i>
Developed Drainage - SCS Calculation Method	<i>9</i>
Rational Calculations	<i>10</i>
Rational Narrative	<i>10</i>
DETENTION PONDS	<i>11</i>
Existing Pond D Detention Storage Criteria	<i>11</i>
DRAINAGE FEES	<i>13</i>
CONCLUSIONS	<i>13</i>
EROSION CONTROL DESIGN	<i>14</i>
General Concept	<i>14</i>
Four Step Process	<i>14</i>
Temporary Sedimentation Pond	<i>17</i>
Detention Pond	<i>17</i>
Silt Fence	<i>17</i>
Miscellaneous	<i>17</i>
REFERENCES	<i>18</i>

Figures

Figure 1: Vicinity Map2
Figure 2: FEMA Floodplain Map4
Figure 3: Soils Map5
Figure 4 - Meridian Ranch Rational Method – Basin Map APPENDIX F
Figure 5 - Meridian Ranch SCS Method – Existing Basin Map..... APPENDIX F
Figure 6 - Meridian Ranch SCS Method – Developed Basin Map APPENDIX F

Tables

Table 1: SCS Runoff Curve Numbers7
Table 2: Detention Ponds Summary:8
Table 3: Existing Drainage Basins – SCS9
Table 4: Developed Drainage Basins-SCS9
Table 5: Existing Pond D Summary Data.....12

Appendices:

- Appendix A – Rational Calculations
- Appendix B - HEC-HMS Data
- Appendix C - Detention Pond Information
- Appendix D – Outlet Protection Design
- Appendix E – Drainageway & Floodplain Information
- Appendix F – Soil Resource Report
- Appendix G – Drainage Maps

EXECUTIVE SUMMARY

The purpose of the following Final Drainage Report (FDR) is to present the changes to the drainage patterns as a result the Meridian Service Metropolitan District Recreation Center East Fieldhouse (the Fieldhouse) development. Runoff quantities and proposed facilities have been calculated using the current City of Colorado Springs/El Paso County Drainage Criteria Manual (DCM) (1994 version) and portions of the City of Colorado Springs Drainage Criteria Manual, Volume 1 (DCM-1) ((2014 version).

This report is based on the Meridian Ranch 2017 Sketch Plan Amendment as adopted by the El Paso County Board of Commissioners on March 13, 2018 by Resolution 18-104. Hydrologic calculations follow method outlined in Chapter 6 of the 2014 version of the City of Colorado Springs Drainage Criteria Manual (COSDCM) as adopted by the El Paso County Board of County Commissioners by Resolution 15-042. Chapter 6 addresses the hydrologic calculation methods and includes an updated hydrograph to be used with storm drainage runoff. The Board adopted by the same resolution, Section 3.2.1 of Chapter 13 of the COSDCM referencing Full Spectrum Detention; the concept “provides better control of the full range of runoff rates that pass-through detention facilities than the convention multi-stage concept. This section of the COSDCM identifies the necessity to provide full spectrum detention but does not prescribe a methodology to reach such the detention requirements. This report includes hydrologic models from HEC-HMS for the existing and developed conditions for the 2-yr, 5-yr, 10-yr, 50-yr, and 100-yr design storm frequencies. The developed conditions include detention facilities sized and modeled such that “*frequent and infrequent inflows are released at rates approximating undeveloped conditions.*” The developed condition is compared with the calculated results from the Rolling Hills Ranch Filing 3 Final Drainage Report.

The Fieldhouse will be sited on Tract C of Rolling Hills Ranch Filing 1, recorded by Reception No. 221714712 in the El Paso County Records. Tract C is 18.886 acres and is located in Section 20, Township 12 South, Range 64 West of the 6th Principal Meridian. The project will be located on approximately 4.6 acres of Tract C. It is approximately 12 miles northeast of the city of Colorado Springs, 2.5 miles north of the unincorporated town of Falcon.

The Fieldhouse is located within Gieck Ranch Drainage Basin. The Gieck Ranch Basin has been studied but has not received final approval from El Paso County, therefore there are no drainage fees associated with this project.

Based on the aforementioned design parameters the development of the project will not adversely affect downstream properties.

INTRODUCTION

Purpose

The purpose of the following Final Drainage Report (FDR) is to present proposed changes to the drainage patterns as a result of the development of the Fieldhouse. The report outlines the proposed drainage mitigation based on calculated developed flows in excess of allowable exiting runoff discharge.

Scope

The scope of this report includes:

- Location and description of the proposed development stating the proposed land use, acreage and adjacent features to the site.
- Calculations for design peak flows from all off-site tributary drainage areas.
- Calculations for design peak flows within the proposed project area for all drainage areas.
- Discussion and analysis of the proposed facilities.

Runoff quantities and proposed facilities have been calculated using the current City of Colorado Springs/El Paso County Drainage Criteria Manual (DCM) (1994 version) and those portions of the City of Colorado Springs Drainage Criteria Manual, Volume 1 (DCM-1) ((2014 version) adopted by Resolution 15-042 of the El Paso County Board of County Commissioners.

Background

The Meridian Ranch 2017 Sketch Plan Amendment (SKP-17-001) was processed and approved in 2018 by the El Paso County Board of County Commissioners by resolution 18-104. A 10.6-acre community park and future recreation center was identified for this general location and anticipated in all subsequent drainage reports.

The Rolling Hills Ranch PUD was processed and approved by the El Paso County Board of County Commissioners by resolution 20-273. Tract C was identified as a tract for future a park and recreation center.

The downstream drainage facilities constructed with the improvements for Rolling Hills Ranch Filing 1 were calculated and constructed in expectation of a larger recreation facility. The Rolling Hills Ranch Filing 1 Final Drainage Report anticipated the development of a 10.6-acre recreation complex. The proposed Fieldhouse will develop less than half the area set aside for the project with no future buildings expected other than the office building shown on the development plan.

MSMD Fieldhouse

Figure 1: Vicinity Map

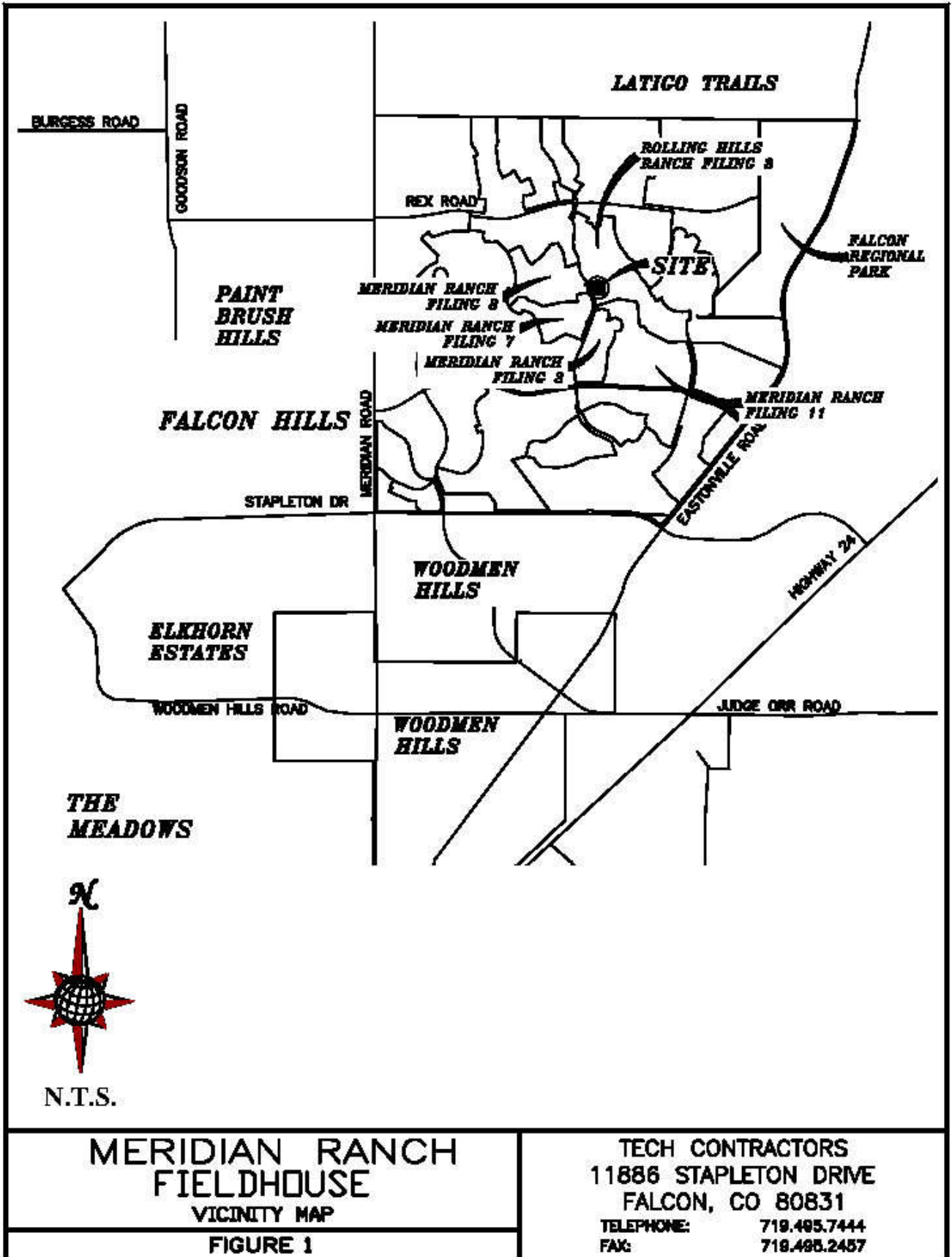

EXISTING CONDITIONS

General Location

The Fieldhouse will be sited on Tract C of Rolling Hills Ranch Filing 1, recorded by Reception No. 221714712 in the El Paso County Records. Tract C is 18.886 acres and is located in Section 20, Township 12 South, Range 64 West of the 6th Principal Meridian. The project will be located on approximately 4.6 acres of Tract C. It is approximately 12 miles northeast of the city of Colorado Springs, 2.5 miles north of the unincorporated town of Falcon.

Land Use

Historically, ranching dominated the area surrounding Meridian Ranch; however, currently urbanization has occurred in the general vicinity. Most notably, urbanization is occurring to the north with Latigo Trails, to the south in the Woodmen Hills Subdivision, to the east in Four Way Ranch, to the west in the Paint Brush Hills subdivision.

Climate

Mild summers and winters, light precipitation; high evaporation and moderately high wind velocities characterize the climate of the study area. The average annual monthly temperature is 48.4°F with an average monthly low of 30.3 F in the winter and an average monthly high of 68.1°F in the summer. Two years in ten will have a maximum temperature higher than 98°F and a minimum temperature lower than -16°F. Precipitation averages 15.73” annually, with 80% of this occurring during the months of April through September. The average annual Class A pan evaporation is 45 inches. (Soil Survey of El Paso County Area, Colorado).

Topography and Floodplains

The topography of the site is typical of a high desert, short prairie grass with relatively flat slopes generally ranging from 2% to 4%. The project site drains generally from the northwest to southeast and is tributary to the Black Squirrel Creek.

The Flood Insurance Rate Maps (FIRM No. 08041C0552G, dated 12/07/2018) indicates the project is located within a designated floodplain. Please see Figure 2: FEMA Floodplain Map. The project is located adjacent to a drainageway designated with a Base Flood Elevation (BFE) of 7060 ft. The bottom of the drainageway has an average elevation of 7079 along the frontage of the project. The flow rates within the drainageway are approximately 235 cfs during the 100-year storm event, yielding a flow depth of 2.0 ft. The project has proposed finished floor elevation of 7093.5 or approximately 33’ above the BFE. Please see Appendix D and the Final Drainage Report for Meridian Ranch Filing 8 (SF152) for detailed design information for the drainageway and flow parameters.

Geology

The National Resources Conservation Service (NRCS) soil survey records indicate that the service area is predominately covered by soils classified from the Stapleton series. These soils are categorized in the Hydrological Soil Group B.

This soil is used mainly for grazing livestock, for wildlife habitat and for home sites. The main limitation of this soil for urban development is a hazard of flooding in some areas. The Stapleton (83) sandy loam is a deep, non-calcareous, well-drained soil formed in alluvium derived from arkosic bedrock on uplands. The permeability of this soil is rapid. Available

Figure 2: FEMA Floodplain Map

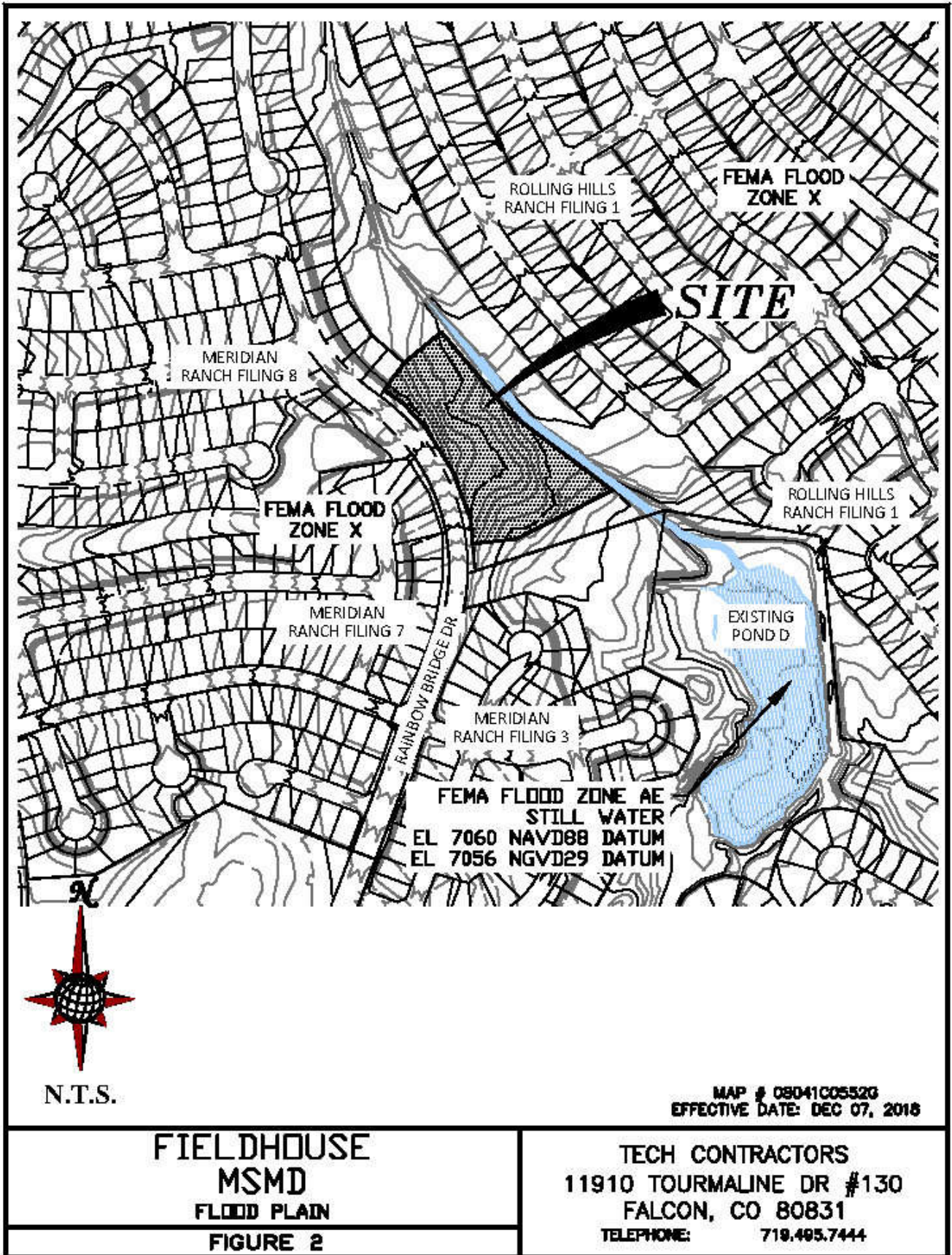

MSMD Fieldhouse

Figure 3: Soils Map

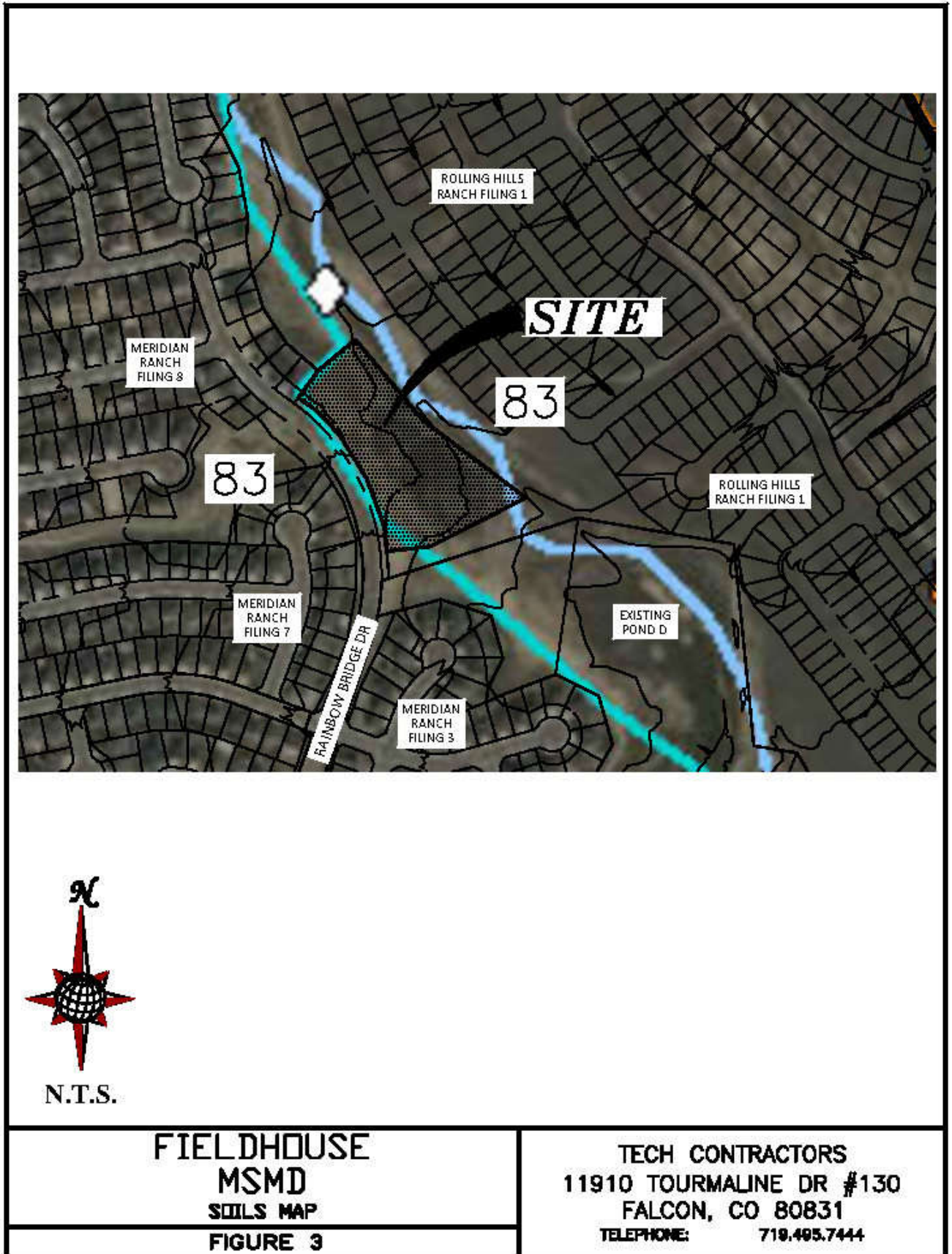

water capacity is moderate, surface runoff is slow, and the hazard of erosion and soil blowing is moderate. The Stapleton series is categorized as a Hydrological Soil Group B.

This soil is suited to habitat for open land and rangeland wildlife. The main limitation of this soil for urban development is frost-action potential.

Typically, these soils are well-drained, gravelly sandy loams that form on alluvial terraces and fans and exhibit high permeability and low available water capacity with depth to bedrock greater than 6 feet.

Note: (#) indicates Soil Conservation Survey soil classification number. See Figure 3 the Fieldhouse – Soils Map.

Natural Hazards Analysis

Natural hazards analysis indicates that no unusual surface or subsurface hazards are located near the vicinity. However, because the soil is cohesionless, sloughing of steep banks during drilling and/or excavation could occur. By citing improvements in a manner that provides an opportunity to lay the banks of excavations back at a 1:1 slope during construction, the problems associated with sloughing soils can be minimized.

DRAINAGE BASINS AND SUB-BASINS

The site is near the top of the Gieck Ranch Drainage Basin and accepts flow from areas north of the project site within portions of Meridian Ranch.

Two different scenarios were analyzed for the drainage conditions for the project.

The first scenario analyzes the existing condition for property, this condition has all of the area tributary to Pond D at the assumed full developed state. The existing analysis assumes that the tributary areas to Pond D from Meridian Ranch Filing 7, 8, & 9 and Rolling Hills Ranch Filing 1 are completely built out with homes on every lot.

The second scenario analyzes the build out condition, where the Fieldhouse and Future Office projects are completed. The results of the SCS calculations for the various design storms from this analysis are compared to the original design to ensure the proposed Fieldhouse does not adversely impact the operations of the existing detention Pond D. The analysis includes the comparison of the storage volume, storage elevation, and the discharge flow from the various design storms between the approved Rolling Hills Ranch Filing 3 FDR and this project.

DRAINAGE DESIGN CRITERIA

SCS Hydrograph Procedure

The US Army Corp of Engineers HEC-HMS computer program was used to model the Soil Conservation Service (SCS) Hydrograph procedure to determine final design parameters for the major drainage facilities within the project. Onsite basin areas were calculated using as-built topography of the site and other approved final design data. Times of concentration were estimated using the SCS procedures described in the DCM. Based upon the hydrologic soil

type, the natural conditions found in the basins and the runoff curve numbers (CN) chart from Table 6-10 of the City of Colorado Springs DCM for Antecedent Runoff Condition II (ARC II), the following CN values were used for the given conditions.

Table 1: SCS Runoff Curve Numbers

Condition	CN*		
Residential Lots (5 acre)	63	School	80
Residential Lots (2.5 acre)	66	Parks/Open Space	62
Residential Lots (1 acre)	68	Commercial	85
Residential Lots (1/2 acre)	70	Roadways	98
Residential Lots (1/3 acre)	72	Graded	67
Residential Lots (1/4 acre)	75	Golf Course	62
Residential Lots (1/5 acre)	78	Latigo Undeveloped	65
Residential Lots (1/6 acre)	80	Undeveloped	61

*Curve Numbers were interpolated and based on amount of impervious area per lot. The 24 hour storm precipitation values were selected from the NOAA Atlas 14, Volume 8, Version 2 for the Meridian Ranch location (Latitude 38.9783°, Longitude -104.5842°, Elevation 7054 ft). These numbers along with SCS information were used as input to the U.S. Army Corp of Engineers HEC-HMS computer model to determine design runoffs. See the table for all the design storm events in Appendix A. These numbers along with SCS information were used as input to the U.S. Army Corp of Engineers HEC-HMS computer model to determine design runoffs.

Full Spectrum Design

The City of Colorado Springs adopted a new Drainage Criteria Manual (DCM) in 2014 which incorporated the use of *Full Spectrum Design* for storm drainage analysis for projects located within the city limits. El Paso County adopted portions of the City’s 2014 DCM by resolution in January 2015; the County resolution adopted Chapter 6 (Hydrology) and Section 3.2.1 of Chapter 13 (Full Spectrum Detention) for projects outside of the City of Colorado Springs establishing a 1 year review period to analyze the impacts of the Full Spectrum Design on the storm drainage analysis of projects. This report has incorporated the use of full spectrum in the analysis using the SCS Method to determine the size requirements for the detention pond during the interim and future conditions.

Note that Pond D was designed and constructed prior to the County adoption of the 2014 City of Colorado Springs Drainage Criteria Manual. It should also be noted that Pond D was completed and in operation at the effective date of Senate Bill 15-212 and is therefore except from the various reporting requirements identified in the Bill.

The idea behind full spectrum detention is to release the developed runoff flow rates that will approximate those of the pre-developed condition. Although existing Pond D was completed prior to the implementation of *Full Spectrum Design*, the outlet control structure meets or exceeds the intent and spirit of the concept.

DRAINAGE CALCULATIONS

SCS General Overview

The project is located within the Gieck Ranch Drainage Basin; storm water runoff tributary to the existing Pond D will be conveyed across tributary areas overland and within existing and proposed storm drain networks the existing Pond D. The detention facilities have been

adequately sized such that the developed flows detained and released will approximate the historic flow rates for the various design storm events as outlined in the El Paso County DCM.

Table 2: Detention Ponds Summary:

EXISTING POND D				
	PEAK INFLOW	PEAK OUTFLOW	PEAK STORAGE	PEAK ELEVATION
	CFS	CFS	AC-FT	FT
EXISTING CONDITIONS				
2-YEAR STORM	51	3.4	4.5	7053.1
5-YEAR STORM	106	10	6.9	7053.7
10-YEAR STORM	170	17	10.3	7054.5
50-YEAR STORM	393	86	19.5	7056.2
100-YEAR STORM	517	129	24.8	7057.0
RHR F3 POND D FINAL FUTURE CALCULATIONS				
2-YEAR STORM	53	3.7	4.6	7053.1
5-YEAR STORM	111	11	7.1	7053.8
10-YEAR STORM	177	18	10.7	7054.6
50-YEAR STORM	405	90	20.0	7056.3
100-YEAR STORM	531	134	25.3	7057.0
DEVELOPED CONDITIONS				
2-YEAR STORM	52	3.5	4.5	7053.1
5-YEAR STORM	108	11	7.0	7053.8
10-YEAR STORM	173	17	10.5	7054.6
50-YEAR STORM	398	88	19.7	7056.2
100-YEAR STORM	523	131	25.0	7057.0

Figure 5: MSMD Fieldhouse SCS Calculations – Existing Conditions Map and Figure 6: MSMD Fieldhouse SCS Calculations – Developed Conditions Map depict the existing and developed general drainage patterns for the area tributary to Pond D, including the proposed MSMD Fieldhouse.

The purpose of this report is to show that the development of the Fieldhouse site will not adversely impact the existing drainage facilities adjacent to and downstream of the project area and that the existing Pond D is properly sized for the anticipated Fieldhouse project.

SCS Calculations

Existing Drainage - SCS Calculation Method

Following is a tabulation of the surface drainage characteristics under Existing Conditions using the SCS calculation method. Please refer to Figure 5 – MSMD Fieldhouse SCS Calculations - Existing Basin Map.

Table 3: Existing Drainage Basins – SCS

EXISTING MDDP						
	DRAINAGE AREA (SQ. MI.)	PEAK DISCHARGE Q100 (CFS)	PEAK DISCHARGE Q50 (CFS)	PEAK DISCHARGE Q10 (CFS)	PEAK DISCHARGE Q5 (CFS)	PEAK DISCHARGE Q2 (CFS)
FG10A	0.0806	103	77	32	20	8.6
FG08A	0.0750	116	90	41	27	13
FG08A-G05	0.0750	110	86	41	27	13
FG08B	0.0630	86	67	31	20	10
FG08B-G05	0.0630	84	65	29	19	10
FG11	0.0625	75	59	28	19	9.8
FG09	0.0484	48	36	14	8.3	3.2
FG09-G05	0.0484	48	36	14	8.0	3.2
FG10B	0.0416	28	19	5.3	2.1	0.4
G05	0.3711	441	335	146	90	44
FG13	0.0534	34	24	7.5	3.6	0.9
FG12	0.0328	50	40	20	14	7.8
POND D IN	0.4573	517	393	170	106	51
POND D	0.4573	129	86	17	10	3.4
POND D OUT	0.4573	129	86	17	10	3.4

See approved Meridian Ranch MDDP (EPC File SKP171) dated January 2018 for complete hydrologic calculations and maps.

Developed Drainage - SCS Calculation Method

Following is a tabulation of the surface drainage characteristics for the developed conditions using the SCS calculation method. Please refer to Figure 6 – MSMD Fieldhouse SCS Calculations – Developed Basins Map

Table 4: Developed Drainage Basins-SCS

DEVELOPED MDDP						
	DRAINAGE AREA (SQ. MI.)	PEAK DISCHARGE Q100 (CFS)	PEAK DISCHARGE Q50 (CFS)	PEAK DISCHARGE Q10 (CFS)	PEAK DISCHARGE Q5 (CFS)	PEAK DISCHARGE Q2 (CFS)
FG10A	0.0806	103	77	32	20	8.6
FG08A	0.0750	116	90	41	27	13
FG08A-G05	0.0750	110	86	41	27	13
FG08B	0.0630	86	67	31	20	10
FG08B-G05	0.0630	84	65	29	19	10
FG11	0.0625	75	59	28	19	9.8
FG09	0.0484	48	36	14	8.3	3.2
FG09-G05	0.0484	48	36	14	8.0	3.2
FG10B	0.0415	34	24	8.2	4.0	1.1
G05	0.3710	447	341	149	92	44
FG13	0.0534	34	24	7.5	3.6	0.9
FG12	0.0328	50	40	20	14	7.8
POND D IN	0.4572	523	398	173	108	52
POND D	0.4572	131	88	17	11	3.5
POND D OUT	0.4572	131	88	17	11	3.5

See approved Meridian Ranch MDDP (EPC File SKP171) dated January 2018 for complete hydrologic calculations and maps.

Rational Calculations

The Rational Hydrologic Calculation Method was used to estimate the total runoff from the 5-year and the 100-year design storm and thus establish the on-site storm drainage system design. Using the rational calculation methodology outlined in the Hydrology Section (Ch 6) of the COSDCM coupled with the El Paso County EPCDCM an effective storm drainage design for the Fieldhouse has been designed. The storm drainage facilities have been designed such that the storm surface will be captured by the inlets and conveyed the adjacent storm drainage channel.

The project will discharge the collected surface flow from the project into existing downstream facilities properly sized to safely convey the storm water flows away from the project without damaging adjacent property.

Rational hydrologic and hydraulic calculations were performed for the project based on full buildout conditions. This is done to ensure the storm drain system is properly sized for future full buildout. The storm drain runoff will be collected by inlets and storm drainpipe then discharges the storm drainage the flow to the adjacent drainage channel and conveyed to the existing Pond D. The adjacent drainage channel is located within the same property as the project. The drainageway is owned and maintained by the district. Pond D is located within the same property approximately 400' downstream of the project.

Rational Narrative

The following is a detailed narrative of the storm drainage system located in the Fieldhouse. The description is organized by storm drain system.

Storm Drainage System meets the requirements of as found in the El Paso County Engineering Criteria Manual I.7.1.C.5. (ECM) for storm water quality and discharge. This catchment discharges the collected stormwater is directed toward the exiting Regional Detention Facility Pond D with WQCV incorporated into the design and construction.

- Basins A1, A2, A3, & A4 (1.0 acres, $Q_5 = 3.2$ CFS, $Q_{100} = 6.0$ CFS) contains the runoff from the roof of the Fieldhouse building. The runoff will be directed to various roof drains and conveyed via PVC pipes to the proposed Design Points 1 & 2 on the east side of the building. The captured flow is then conveyed downstream to Inlet I01.
- Basin B (0.91 acres, $Q_5 = 3.1$ CFS, $Q_{100} = 6.0$ CFS) contains the northern portion of the proposed parking lot and the landscaped areas between the building and the parking lot. The runoff will be directed overland toward Inlet I01 where it will be combined with the runoff from the roof drains and discharge across a grouted rip-rap outlet pad to the adjacent channel. The total flow within the proposed 18" HDPE pipe is $Q_5 = 5.9$ CFS and $Q_{100} = 11$ CFS.
- Basin C (0.98 acres, $Q_5 = 3.1$ CFS, $Q_{100} = 5.9$ CFS) contains the southern portion of the proposed parking lot and the landscaped areas between the building and the parking lot. The runoff will be directed overland toward Inlet I02 where it will discharge across

a grouted rip-rap outlet pad to the adjacent channel. The total flow within the proposed 12" HDPE pipe is $Q_5 = 3.7$ CFS and $Q_{100} = 6.9$ CFS.

- Basin D (0.43 acres, $Q_5 = 0.3$ CFS, $Q_{100} = 1.2$ CFS) contains the most northern portion including the future MSMD Administration Building and surrounding landscaped areas. The runoff from the roof will be directed overland toward grass lined swales toward the drainage channel where the flow will exit the site as sheet flow.
- Existing 48" RCP Relocation ($Q_5 = 27$ CFS, $Q_{100} = 66$ CFS) contains tributary areas from existing areas of Meridian Ranch Filings 7 & 8. The storm drain was constructed in 2015 and based on the FDR for Meridian Ranch Filing 8, approved February 2015. Roughly 65 LF of 48" storm drain needs to be removed and relocated to accommodate the proposed building. Hydrologic information was taken from the approved FDR and hydraulics were analyzed to verify the design.

DETENTION PONDS

The storm water runoff from the MSMD Fieldhouse is ultimately discharged into existing Detention Pond D. The pond was constructed prior to the passage of Senate Bill 15-212 and is exempt from providing support calculations showing drain time compliance.

Existing Pond D Detention Storage Criteria

The existing Detention Pond D is located east of Rainbow Bridge Dr., northeast of Meridian Ranch Filing 3, and was constructed as a part of the Meridian Ranch Filing 3 improvement in 2011; the pond is owned and maintained by the Meridian Service Metropolitan District (MSMD). It has been in operation since 2012 with no reported issues. A maintenance agreement between the Meridian Service Metropolitan District and El Paso County has been recorded (reception #212031863) as a part of the Meridian Ranch Filing 3 Final Plat process on March 21, 2012.

A visual inspection of the pond and an analysis of the SCS calculations show the construction of the Fieldhouse will not adversely impact the downstream drainage patterns. The SCS calculation method was used to determine inflow and outflow from the detention pond to ensure the developed runoff does not overcharge the pond and the discharges do not adversely impact drainage patterns downstream. Pond D and existing downstream Pond E work in series such that the peak flow rates from the Meridian Ranch development do not adversely affect the drainage patterns downstream of Eastonville Road. Storm drainage runoff will enter the pond from upstream development via existing drainage swales and pipe networks. The adjacent drainage swale is within the same property as the project and is owned and maintained by the District. The ultimate future build-out design of the tributary areas was analyzed to ensure the sizing of the pond would be adequate after the construction of the MSMD Fieldhouse. This SCS calculation can be found in the appendix. No additional improvements or modifications are necessary to this pond as a result of the construction.

Pond D was constructed with the improvements associated with Meridian Ranch Filing 3 (SF0912). The original design had 345 acres of tributary area with a percent impervious of 32.5% generating approximately 55.2 acre-ft of volume and a peak inflow rate of 615 cfs into

the pond. The buildout design at the time of construction estimated peak outflow rate at 137 cfs, a maximum storage of 29.0 acre-ft at a storage elevation of 7057.1. The constructed capacity of Pond D is 35.6 acre-ft at a maximum storage elevation of 7058.0. By comparison, the current tributary area is 293 acres with a percent impervious of 34.0% generating approximately 56.3 acre-ft of volume and a peak inflow rate of 523 cfs into the pond. A buildout design estimated peak outflow rate of 131 cfs, and a maximum storage of 25.0 acre-ft at a storage elevation of 7057.0

The Rolling Hills Ranch Filing 3 FDR calculations anticipated the recreation center project to be larger with more impervious acreage producing more runoff. The RHR#3 drainage report included over 10 acres for the recreation center, whereas the proposed project is limited to less than 5 acres. The calculations show the smaller recreation center having less of an impact on the existing Pond D with lower peak volumes for each of the design storms. Table 5 compares the flow data for the various design storms from the most recently approved Final Drainage Report (Rolling Hills Ranch Filing 3) for areas tributary to Pond D and after the construction of the Fieldhouse. With all other factors being equal, the comparison shows that the runoff generated by the Fieldhouse will cause discharges from Pond D to be less than the anticipated discharges in the RHR#3 FDR.

Table 5: Existing Pond D Summary Data

EXISTING POND D				
	PEAK INFLOW	PEAK OUTFLOW	PEAK STORAGE	PEAK ELEVATION
	CFS	CFS	AC-FT	FT
EXISTING CONDITIONS				
2-YEAR STORM	51	3.4	4.5	7053.1
5-YEAR STORM	106	10	6.9	7053.7
10-YEAR STORM	170	17	10.3	7054.5
50-YEAR STORM	393	86	19.5	7056.2
100-YEAR STORM	517	129	24.8	7057.0
RHR F3 POND D FINAL FUTURE CALCULATIONS				
2-YEAR STORM	53	3.7	4.6	7053.1
5-YEAR STORM	111	11	7.1	7053.8
10-YEAR STORM	177	18	10.7	7054.6
50-YEAR STORM	405	90	20.0	7056.3
100-YEAR STORM	531	134	25.3	7057.0
DEVELOPED CONDITIONS				
2-YEAR STORM	52	3.5	4.5	7053.1
5-YEAR STORM	108	11	7.0	7053.8
10-YEAR STORM	173	17	10.5	7054.6
50-YEAR STORM	398	88	19.7	7056.2
100-YEAR STORM	523	131	25.0	7057.0

Water quality capture volume (WQCV) was added to the required storage volume for the final build out condition. The purpose of the WQCV is to allow particulates to settle out and accumulate over time to improve water quality and to maintain full volume for detention during the life of the facility for a major storm event. The WQCV of 1.0 ac-ft. was added to the detention of the minor storm and half (0.5 ac-ft.) was added to the detention volume of the major storm. This was accomplished with respect to the HEC-HMS computer run by providing a starting detention volume of 1.0 ft. for the 5-year storm and 0.5 ft. for the 100-year storm. The resulting storage elevations remain well below the emergency spillway elevation. See Appendix B for more information.

The WQCV was calculated by using the equations found in Volume 2, of the Drainage Criteria Manual (DCM). The release rate from the WQCV is generally very small, which helps minimize downstream impacts. Detaining the WQCV also serves to cleanse the “first flush” of runoff from the higher initial concentration of sediment and pollutants by allowing for settlement to occur. This greatly improves the quality of runoff, leaving the facility and reduces the potential for erosion. The positive impact on water quality is expected to be significant, particularly during the construction phase of the development.

DRAINAGE FEES

The proposed development is located within the Rolling Hills Ranch Filing 1 subdivision and the Gieck Drainage Basin. There are no bridge or drainage fees for this drainage basin or this project..

Drainage Basin Fees: There are no drainage fees for this basin.

Bridge Fees: There are no bridge fees for this basin.

CONCLUSIONS

Based upon the above analysis and calculations, this project will not cause any additional adverse impacts to downstream property nor existing facilities. The existing storm drain system and detention ponds have been designed and properly constructed to accept and convey the storm drain runoff from this project.

EROSION CONTROL DESIGN

General Concept

Historically, erosion on this property has been held to a minimum by a variety of natural features and agricultural practices including:

- Substantial prairie grass growth
- Construction of drainage arresting berms
- Construction of multiple stock ponds along drainage courses

Existing established vegetation and Pond D will also help to minimize erosion by reducing both the volume and velocity of the peak runoff.

During construction, best management practices (BMP) for erosion control will be employed based on El Paso County Criteria. BMP's will be utilized as deemed necessary by the contractor and/or engineer and are not limited to the measures shown on the construction drawing set. The contractor shall minimize the amount of area disturbed during all construction activities.

In general the following shall be applied in developing the sequence of major activities:

- Install down-slope and side-slope perimeter BMPs before the land disturbing activity occurs.
- Do not disturb an area until it is necessary for the construction activity to proceed.
- Cover or stabilize as soon as possible.
- Time the construction activities to reduce the impacts from seasonal climatic changes or weather events.
- Do not remove the temporary perimeter controls until all upstream areas are stabilized.

Four Step Process

The following four step process is recommended for selecting structural BMP's in developing urban areas:

Step 1: Employ Runoff Reduction Practices

To reduce runoff peaks and volumes from urbanizing areas, employ a practice generally termed "minimizing directly connected impervious areas" (MDCIA). The principle behind MDCIA is twofold — to reduce impervious areas and to route runoff from impervious surfaces over grassy areas to slow down runoff and promote infiltration. The benefits are less runoff, less stormwater pollution, and less cost for drainage infrastructure.

Although this project does not employ a significant number of runoff reduction practices, the greater development of Meridian Ranch does have many including:

- Grass Buffers
- Grass Swales
- Reduced Pavement Area

The greater project has many open space tracts, including the one surrounding this project. Grass drainageways are found throughout the development. The development adopted a wider right of way than standard in order to promote increased pervious area.

Runoff reduction is implemented at the area surrounding the future MSMD Administration building. The roof drains will discharge onto the ground surface and be conveyed overland approximately 300 feet to an adjacent drainageway.

Step 2: Stabilize Drainageways

The engineered channel located adjacent to and east of the project was analyzed with Rolling Hills Ranch Filing 1 project for stability and was determined to be mostly stable. Areas of instability were protected with rip-rap along the sides and bottom of the arroyo to reduce velocities and erosion. No additional measures are anticipated except for proposed rip-rap at the storm drainage outlets into the channel. The adjacent drainageway is owned and maintained by the District.

Step 3: Provide Water Quality Capture Volume (WQCV)

The existing extended detention Pond D with water quality capture volume is located downstream of the project has been designed to accommodate the runoff from this development. There is sufficient capacity within Pond D to accommodate the runoff from this project.

Storm Drainage System meets the requirements of as found in the El Paso County Engineering Criteria Manual I.7.1.C.5. (ECM) for storm water quality and discharge. The regional WQCV facility meets the following requirements:

- a. *The regional WQCV facility must be implemented, functional, and maintained following good engineering, hydrologic and pollution control practices.*

The existing regional WQCV facility (Pond D) functions as designed and constructed and maintained by the Meridian Service Metropolitan District per the recorded Maintenance Agreement (reception #213031863, EPC records).

- b. *The regional WQCV facility must be designed and maintained for 100% WQCV for its entire drainage area.*

Pond D was designed to provide WQCV for the entirety of the tributary area during the subdivision process for Meridian Ranch Filing 3, PDR/FDR for Meridian Ranch Filing 3, approved November 2011 (SF0912)

- c. *The regional WQCV facility must have capacity to accommodate the drainage from the applicable development site.*

Pond D was designed to have a spillway elevation of 7058.0 and a capacity of 35.6 ac-ft. An initial design peak storage elevation of 7057.1 and peak storage of 29.0 ac-ft. After development of this project the calculated peak storage elevation will be 7057.0 and peak volume of 25.0 ac-ft. There is sufficient capacity in the facility.

- d. *The regional WQCV facility must be designed and built to comply with all assumptions for the development activities planned by the County within its drainage area, including the imperviousness of its drainage area and the applicable development site.*

Pond D was designed and constructed to comply with assumptions laid out in PDR/FDR for Meridian Ranch Filing 3 (SF0912). The peak storage after this project is calculated to be less than the originally anticipated peak storage.

- e. *Evaluation of the minimum drain time shall be based on the pollutant removal mechanism and functionality of the facility. Consideration of drain time shall include maintaining vegetation necessary for operation of the facility (e.g., wetland vegetation).*

Pond D is well vegetated with native grasses and wetland vegetation to aid in pollutant removal.

f. *The County shall require site plans and perform a site plan review consistent with the requirements of this ECM to ensure the regional WQCV facility and control measures for the applicable development site plans include:*

i. *Design details for all structural control measures implemented to meet the requirements of Part I.E.4.*

Design details for structural control measures used meet the requirements.

ii. *A narrative reference for all non-structural control measures for the site, if applicable.*

Drainage Basin D incorporates runoff directed across pervious areas prior to entering the drainage channel.

iii. *Documentation of operation and maintenance procedures to ensure the long-term observation, maintenance, and operation of the control measures. The documentation shall include frequencies for routine inspections and maintenance activities.*

MSMD has an operation and maintenance manual on file with EPC.

iv. *Documentation regarding easements or other legal means for access of the control measure sites for operation, maintenance, and inspection of control measures.*

Pond D and this project are located on open space tracts owned and maintained by the District.

v. *Confirmation that control measures meet the requirements of section I.7.C*

The control measures meet the “base design standard.

vi. *Confirmation that site plans meet the requirements of County's site plan review and approval requirements.*

This project is undergoing the site plan review and approval process by EPC.

g. *The regional WQCV facility must be subject to the County's authority consistent with requirements and actions for a Control Measure in accordance with a base design standard.*

Pond D is subject to EPC authority by virtue of the recorded maintenance agreement.

h. *Regional Facilities must be designed and implemented with flood control or water quality as the primary use. Recreational ponds and reservoirs may not be considered Regional Facilities. Water bodies listed by name in surface water quality classifications and standards regulations (5 CCR 1002-32 through 5 CCR 1002-38) may not be considered regional facilities.*

Pond D is not a recreation pond with a sole function as a stormwater control facility.

Step 4: Consider Need for Industrial and Commercial BMP's

This project is neither industrial nor commercial and therefore this section does not apply.

Temporary Sedimentation Pond

Temporary sedimentation ponds are not anticipated with this project. If however they are deemed necessary during construction activities, it will be added to the documents as appropriate.

Detention Pond

Existing Pond D will act as the primary water quality control for the project. Runoff will be collected by the proposed onsite storm drainage facilities, discharged directly into the adjacent drainageway and conveyed 400' downstream into Pond D. The pond will serve a dual purpose: first, by facilitating the settling of sediment in runoff during and after construction (by means of the WQCV). Secondly, the pond will attenuate the peak runoff rates to approximate historic flow rates or below as the stormwater is discharge out of Meridian Ranch across Eastonville.

Silt Fence

Silt fence will be placed along downstream limits of disturbed areas. This will prevent suspended sediment from leaving the site during infrastructure construction. Silt fencing is to remain in place until vegetation is reestablished.

Miscellaneous

Best erosion control practices will be utilized as deemed necessary by the Contractor or Engineer and are not limited to the measures described above.

REFERENCES

1. “City of Colorado Springs/El Paso County Drainage Criteria Manual” September 1987, Revised November 1991, Revised October 1994.
2. Chapter 6, Hydrology and Chapter 11, Storage, Section 3.2.1 of the “City of Colorado Springs Drainage Criteria Manual” May 2014.
3. “Volume 2, El Paso County/City of Colorado Springs Drainage Criteria Manual- Stormwater Quality Policies, Procedures and Best Management Practices” November 1, 2002.
4. “Urban Storm Drainage Criteria Manual” September 1969, Revised January 2016.
5. Flood Insurance Rate Study for El Paso County, Colorado and Incorporated Areas. Federal Emergency Management Agency, December 7, 2018.
6. Soils Survey of El Paso County area, Natural Resources Conservation Services of Colorado.
7. Revision to Master Development Drainage Plan Meridian Ranch. January 2018. Prepared by Tech Contractors.
8. Final Drainage Report for Meridian Ranch Filing 3. August 2011. Prepared by Tech Contractors.
9. Final Drainage Report for Meridian Ranch Filing 8. February 2015. Prepared by Tech Contractors.
10. Final Drainage Report for Rolling Hills Ranch Filing 1 at Meridian Ranch PUD. June 2020. Prepared by Tech Contractors.
11. Final Drainage Report for Rolling Hills Ranch Filing 3 at Meridian Ranch. May 2021. Prepared by Tech Contractors.

Appendices

Appendix A – Rational Calculations

Table 6-6. Runoff Coefficients for Rational Method
(Source: UDFCD 2001)

Land Use or Surface Characteristics	Percent Impervious	Runoff Coefficients											
		2-year		5-year		10-year		25-year		50-year		100-year	
		HSG A&B	HSG C&D	HSG A&B	HSG C&D	HSG A&B	HSG C&D	HSG A&B	HSG C&D	HSG A&B	HSG C&D	HSG A&B	HSG C&D
Business													
Commercial Areas	95	0.79	0.80	0.81	0.82	0.83	0.84	0.85	0.87	0.87	0.88	0.88	0.89
Neighborhood Areas	70	0.45	0.49	0.49	0.53	0.53	0.57	0.58	0.62	0.60	0.65	0.62	0.68
Residential													
1/8 Acre or less	65	0.41	0.45	0.45	0.49	0.49	0.54	0.54	0.59	0.57	0.62	0.59	0.65
1/4 Acre	40	0.23	0.28	0.30	0.35	0.36	0.42	0.42	0.50	0.46	0.54	0.50	0.58
1/3 Acre	30	0.18	0.22	0.25	0.30	0.32	0.38	0.39	0.47	0.43	0.52	0.47	0.57
1/2 Acre	25	0.15	0.20	0.22	0.28	0.30	0.36	0.37	0.46	0.41	0.51	0.46	0.56
1 Acre	20	0.12	0.17	0.20	0.26	0.27	0.34	0.35	0.44	0.40	0.50	0.44	0.55
Industrial													
Light Areas	80	0.57	0.60	0.59	0.63	0.63	0.66	0.66	0.70	0.68	0.72	0.70	0.74
Heavy Areas	90	0.71	0.73	0.73	0.75	0.75	0.77	0.78	0.80	0.80	0.82	0.81	0.83
Parks and Cemeteries													
Parks and Cemeteries	7	0.05	0.09	0.12	0.19	0.20	0.29	0.30	0.40	0.34	0.46	0.39	0.52
Playgrounds	13	0.07	0.13	0.16	0.23	0.24	0.31	0.32	0.42	0.37	0.48	0.41	0.54
Railroad Yard Areas	40	0.23	0.28	0.30	0.35	0.36	0.42	0.42	0.50	0.46	0.54	0.50	0.58
Undeveloped Areas													
Historic Flow Analysis-- Greenbelts, Agriculture	2	0.03	0.05	0.09	0.16	0.17	0.26	0.26	0.38	0.31	0.45	0.36	0.51
Pasture/Meadow	0	0.02	0.04	0.08	0.15	0.15	0.25	0.25	0.37	0.30	0.44	0.35	0.50
Forest	0	0.02	0.04	0.08	0.15	0.15	0.25	0.25	0.37	0.30	0.44	0.35	0.50
Exposed Rock	100	0.89	0.89	0.90	0.90	0.92	0.92	0.94	0.94	0.95	0.95	0.96	0.96
Offsite Flow Analysis (when landuse is undefined)	45	0.26	0.31	0.32	0.37	0.38	0.44	0.44	0.51	0.48	0.55	0.51	0.59
Streets													
Paved	100	0.89	0.89	0.90	0.90	0.92	0.92	0.94	0.94	0.95	0.95	0.96	0.96
Gravel	80	0.57	0.60	0.59	0.63	0.63	0.66	0.66	0.70	0.68	0.72	0.70	0.74
Drive and Walks													
Drive and Walks	100	0.89	0.89	0.90	0.90	0.92	0.92	0.94	0.94	0.95	0.95	0.96	0.96
Roofs	90	0.71	0.73	0.73	0.75	0.75	0.77	0.78	0.80	0.80	0.82	0.81	0.83
Lawns	0	0.02	0.04	0.08	0.15	0.15	0.25	0.25	0.37	0.30	0.44	0.35	0.50

Figure 6-5. Colorado Springs Rainfall Intensity Duration Frequency

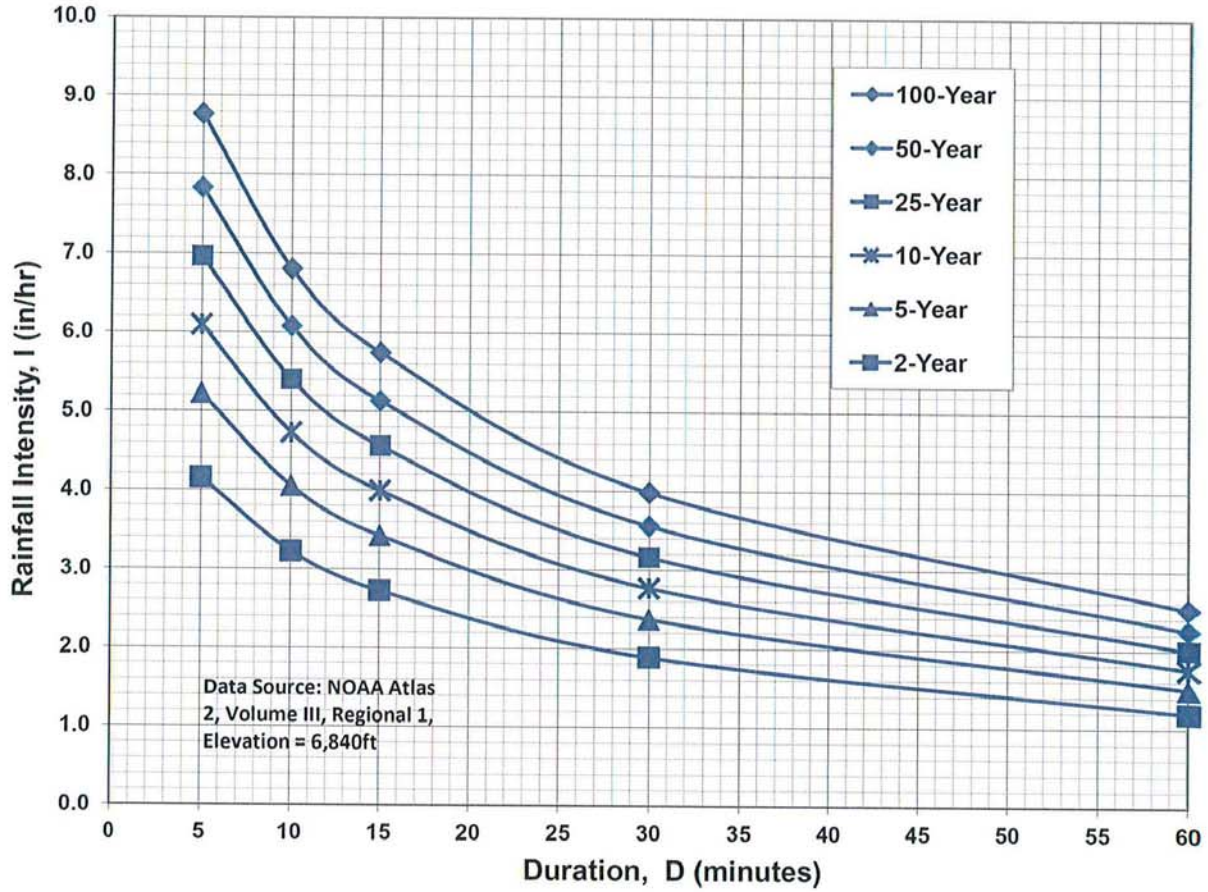

IDF Equations

$$I_{100} = -2.52 \ln(D) + 12.735$$

$$I_{50} = -2.25 \ln(D) + 11.375$$

$$I_{25} = -2.00 \ln(D) + 10.111$$

$$I_{10} = -1.75 \ln(D) + 8.847$$

$$I_5 = -1.50 \ln(D) + 7.583$$

$$I_2 = -1.19 \ln(D) + 6.035$$

Note: Values calculated by equations may not precisely duplicate values read from figure.

COMPOSITE 'C' FACTORS							
PROJECT: MSMD Fieldhouse					6/17/2024		
BASIN DESIGNATION	AREA (AC.)				COMPOSITE FACTOR		Percent Impervious
	STREETS SIDEWALKS	ROOFS	LANDSCAPE GRASS	TOTAL	5-year	100-year	
A1		0.252		0.252	0.73	0.81	90.0%
A2		0.306		0.306	0.73	0.81	90.0%
A3		0.439		0.439	0.73	0.81	90.0%
A4		0.036		0.036	0.73	0.81	90.0%
B	0.711		0.197	0.908	0.72	0.83	78.3%
C	0.822		0.158	0.980	0.77	0.86	83.8%
D		0.063	0.365	0.428	0.18	0.42	13.2%
TOTAL	1.532	1.096	0.720	3.348	0.67	0.78	75.2%

TIME OF CONCENTRATION

PROJECT: **MSMD Fieldhouse**

DATE: 6/17/2024

TIME OF CONCENTRATION																		
SUBBASIN DATA			INT./OVERLAND TIME (T _i)				TRAVEL TIME (T _t)							TOTAL T _i +T _t (Min.)	T _c Check (Urbanized Basins)		FINAL T _c (min)	
BASIN DESIGNATION	C _s	AREA (AC)	LENGTH (FT)	ΔH	SLOPE %	T _i (Min.)*	LENGTH (FT)	ΔH	SLOPE %	CONVEYANCE		VEL. (FPS)	T _t (Min.)**		L (FT)	T _c = (L/180)+10		
										TYPE	COEF.							
A1	0.73	0.25	58	0.6	1.0%	5.1	460	4.7	1.0%	P	20	2.0	3.8	8.9	518.00	12.9	8.9	
A2	0.73	0.31	58	0.6	1.0%	5.1	80	0.7	0.9%	P	20	1.9	0.7	5.8	138.00	10.8	5.8	
A3	0.73	0.44	100	1.0	1.0%	6.8	130	1.4	1.1%	P	20	2.1	1.0	7.8	230.00	11.3	7.8	
A4	0.73	0.04	55	0.6	1.1%	5.0	85	1.1	1.3%	P	20	2.3	0.6	5.6	140.00	10.8	5.6	
B	0.72	0.91	30	0.6	2.0%	5.0	460	22	4.8%	P	20	4.4	1.8	6.8	490.00	12.7	6.8	
C	0.77	0.98	125	1.3	1.0%	6.8	465	8.0	1.7%	P	20	2.6	3.0	9.8	590.00	13.3	9.8	
D	0.18	0.43	75	1.5	2.0%	11.6	210	8.0	3.8%	G	15	2.9	1.2	12.8	285.00	11.6	11.6	

Notes:	$* T_i = \frac{* T_i = 0.395 (1.1 - C_s)L^{0.5}}{S^{0.33}}$	
	$V = C_v S_w^{0.5}$	$** T_t = L \times V$

TYPE OF SURFACE		C _v
HEAVY MEADOW	H	2.5
TILLAGE/FIELD	T	5
RIPRAP (not buried)	R	6.5
SHORT PASTURE AND LAWNS	L	7
NEARLY BARE GROUND	B	10
GRASSED WATERWAY	G	15
PAVED AREAS	P	20

**STORM DRAINAGE SYSTEM DESIGN
(RATIONAL METHOD PROCEDURE)
SURFACE ROUTING**

PROJECT: **MSMD Fieldhouse**

Date: 6/17/2024

DESIGN POINT	DIRECT RUNOFF											
	BASIN	AREA (AC)	T _c (Min.)	I (in./ hr.)		COEFF. ©		CA		Q		PIPE DIA (Inches)
				(5 YR)	(100 YR)	(5 YR)	(100 YR)	(5 YR)	(100 YR)	(5 YR)	(100 YR)	
DP1	A1	0.25	8.9	4.30	7.23	0.73	0.81	0.18	0.20	0.8	1.5	8
DP1	A2	0.31	5.8	4.94	8.30	0.73	0.81	0.22	0.25	1.1	2.1	8
DP1			8.9	4.30	7.23			0.41	0.45	1.8	3.3	10
DP2	A3	0.44	7.8	4.50	7.55	0.73	0.81	0.32	0.36	1.4	2.7	4
DP2	A4	0.04	5.6	4.99	8.38	0.73	0.81	0.03	0.03	0.1	0.2	4
DP2			7.8	4.50	7.55			0.35	0.38	1.6	2.9	10
I01	B	0.91	6.8	4.72	7.92	0.72	0.83	0.66	0.75	3.1	6.0	18
I02	C	0.98	9.8	4.16	6.99	0.77	0.86	0.75	0.84	3.1	5.9	12
DP3	D	0.43	11.6	3.91	6.56	0.18	0.42	0.08	0.18	0.3	1.2	

TYPE OF SURFACE		C _v
HEAVY MEADOW	H	3
TILLAGE/FIELD	T	5
RIPRAP (not buried)	R	7
SHORT PASTURE AND LAWN	L	7
NEARLY BARE GROUND	B	10
GRASSED WATERWAY	G	15
PAVED AREAS	P	20

**STORM DRAINAGE SYSTEM DESIGN
INLET CALCULATIONS**

PROJECT: **MSMD Fieldhouse**

Date: 6/17/2024

DP	BASIN	Inlet size L(i)	Proposed or Existing	INLET TYPE	CROSS SLOPE	STREET SLOPE	T _c	Q _{Total}		Q _{Capture}				DEPTH (max)	
								Q ₅ (cfs)	Q ₁₀₀ (cfs)	Q ₅ (cfs)	Q ₁₀₀ (cfs)	CA _{eqv.} (5-yr)	CA _{eqv.} (100-yr)	Q ₅ (ft)	Q ₁₀₀ (ft)
101	B	5	PROP	SUMP	2.0%		6.8	3.1	6.0	3.1	6.0	0.66	0.75	0.50	0.50
102	C	5	PROP	SUMP	2.0%		9.8	3.1	5.9	3.1	5.9	0.75	0.84	0.50	0.60

**STORM DRAINAGE SYSTEM DESIGN
(RATIONAL METHOD PROCEDURE)
PIPE ROUTING**

PROJECT: **MSMD Fieldhouse**

Date: 6/17/2024

UPSTREAM DESIGN POINT	UPSTREAM BASIN	INLET FLOW							SYSTEM FLOW						TRAVEL TIME							
		T _c (Min.)	I (in./ hr.)		CA		Q		Sum T _c (min.)	I (in./ hr.)		CA		Q		PIPE DIA	ROUGHNESS (n)	DESTINATION DP	SLOPE %	LENGTH (FT)	VEL. (FPS) (Estimate)*	TRAVEL TIME Tt
			(5 YR)	(100 YR)	(5 YR)	(100 YR)	(5 YR)	(100 YR)		(5 YR)	(100 YR)	(5 YR)	(100 YR)	(5 YR)	(100 YR)							
DP1	A1 & A2	8.9	4.30	7.23	0.41	0.45	1.8	3.3						1.8	3.3	10	0.010	DP2	1.0%	45	5.2	0.1
DP2	A3 & A4	7.8	4.50	7.55	0.35	0.38	1.6	2.9						1.6	2.9							
									9.0	4.28	7.19	0.75	0.84	3.2	6.0	12	0.011	I01	1.0%	75	5.4	0.2
I01	B	6.8	4.72	7.92	0.66	0.75	3.1	6.0	9.3	4.24	7.12	1.41	1.59	6.0	11	18	0.011		8.6%	35	21	0.0
I02	C	9.8	4.16	6.99	0.75	0.84	3.1	5.9						3.1	5.9	12	0.011		5.3%	65	12	0.1

* Velocity estimated for calculation of travel time. Refer to Hydraulics for calculated velocity.

**STORM DRAINAGE SYSTEM DESIGN
HYDRAULICS**

PROJECT: **MSMD Fieldhouse**

Date: **6/17/2024**

Label	Upstrm Node	Dnstrm Node	Inlet CA (acres)	Inlet Tc (min)	Inlet Flow (ft ³ /s)	System CA (acres)	System Flow Time (min)	System Intensity (in/hr)	Section Size (in)	Length (ft)	Slope (%)	Capacity (Full Flow) (ft ³ /s)	System Flow (ft ³ /s)	Velocity (Ave) (ft/s)	Elev. Ground (Upstrm) (ft)	Hydraulic Grade Line (Upstrm) (ft)	Invert (Upstrm) (ft)	Elev. Ground (Dnstrm) (ft)	Hydraulic Grade Line (Dnstrm) (ft)	Invert (Dnstrm) (ft)
46	DP2	I01	0.75	9.5	5.3	0.75	9.5	7.06	12	74	2.95%	7.2	5.3	10	7092.00	7086.6	7085.70	7087.51	7084.2	7083.50
47	I01	ES01	0.84	9.3	6.0	1.58	9.6	7.03	18	35	8.60%	36	11	18	7087.51	7084.3	7083.00	7082.00	7080.7	7080.00
50	I02	ES02	0.84	9.8	5.9	0.84	9.8	6.98	12	64	5.33%	10	5.9	13	7082.67	7079.0	7078.00	7076.60	7075.2	7074.60
P183	EX-F7-48	EX-J18	15.43	40.5	53.0	15.43	40.5	3.41	48	105	0.50%	102	53	8.2	7100.00	7094.5	7092.29	7103.04	7093.8	7091.76
P184	EX-J18	EX-J18A				19.25	40.7	3.39	48	83	0.50%	101	66	8.6	7103.04	7093.7	7091.26	7099.50	7093.2	7090.85
P185	EX-J18A	J18B				19.25	40.9	3.38	48	76	3.89%	283	66	18	7099.50	7092.3	7089.85	7097.19	7089.7	7086.88
P186	J18B	J18C				19.25	40.9	3.38	48	41	4.71%	312	66	20	7097.19	7089.3	7086.88	7094.82	7087.9	7084.93
P187	J18C	J18D				19.25	41.0	3.38	48	23	4.70%	312	66	20	7094.82	7087.4	7084.93	7094.00	7086.7	7083.86
P188	J18D	EX-OS6				19.25	41.0	3.38	48	80	3.88%	283	66	18	7094.00	7086.3	7083.86	7087.00	7082.2	7080.75

Appendix B - HEC-HMS Data

Input Data

MSMD Fieldhouse

BASIN	AREA		CURVE NO.	LAG TIME (min)
	(acre)	(mi ²)		
EXISTING				
FG08A	48	0.0750	76.8	13.3
FG08B	40	0.0630	76.7	16.6
FG09	31	0.0484	71.7	20.8
FG10a	52	0.0806	73.2	14.5
FG10b	27	0.0415	63.6	20.0
FG11	40	0.0625	78.2	23.2
FG12	21	0.0328	80.0	16.1
FG13	34	0.0534	66.3	29.6
PROPOSED				
FG08A	48	0.0750	76.8	13.3
FG08B	40	0.0630	76.7	16.6
FG09	31	0.0484	71.7	20.8
FG10a	52	0.0806	73.2	14.5
FG10b	27	0.0415	67.2	20.0
FG11	40	0.0625	78.2	23.2
FG12	21	0.0328	80.0	16.1
FG13	34	0.0534	66.3	29.6



POINT PRECIPITATION FREQUENCY ESTIMATES

Sanja Perica, Deborah Martin, Sandra Pavlovic, Ishani Roy, Michael St. Laurent, Carl Trypaluk,
 Dale Unruh, Michael Yekta, Geoffery Bonnin

NOAA, National Weather Service, Silver Spring, Maryland

[PF_tabular](#) | [PF_graphical](#) | [Maps & aeriels](#)

PF tabular

PDS-based point precipitation frequency estimates with 90% confidence intervals (in inches)¹										
Duration	Average recurrence interval (years)									
	1	2	5	10	25	50	100	200	500	1000
5-min	0.239 (0.190-0.301)	0.291 (0.232-0.367)	0.381 (0.302-0.482)	0.460 (0.363-0.585)	0.576 (0.442-0.764)	0.670 (0.501-0.899)	0.770 (0.556-1.06)	0.875 (0.606-1.23)	1.02 (0.680-1.48)	1.14 (0.737-1.66)
10-min	0.349 (0.278-0.441)	0.426 (0.339-0.538)	0.558 (0.443-0.706)	0.674 (0.532-0.857)	0.843 (0.647-1.12)	0.982 (0.734-1.32)	1.13 (0.814-1.55)	1.28 (0.888-1.80)	1.50 (0.996-2.16)	1.67 (1.08-2.44)
15-min	0.426 (0.340-0.538)	0.519 (0.413-0.656)	0.680 (0.540-0.861)	0.822 (0.648-1.04)	1.03 (0.789-1.36)	1.20 (0.895-1.61)	1.37 (0.993-1.89)	1.56 (1.08-2.20)	1.82 (1.22-2.64)	2.03 (1.31-2.97)
30-min	0.608 (0.485-0.768)	0.741 (0.590-0.936)	0.969 (0.769-1.23)	1.17 (0.923-1.49)	1.46 (1.12-1.94)	1.70 (1.27-2.28)	1.95 (1.41-2.68)	2.21 (1.53-3.12)	2.58 (1.72-3.73)	2.87 (1.86-4.20)
60-min	0.778 (0.620-0.982)	0.934 (0.744-1.18)	1.21 (0.962-1.54)	1.47 (1.16-1.86)	1.84 (1.42-2.46)	2.16 (1.62-2.91)	2.50 (1.81-3.44)	2.87 (1.99-4.05)	3.38 (2.26-4.91)	3.80 (2.46-5.56)
2-hr	0.948 (0.762-1.19)	1.13 (0.905-1.41)	1.46 (1.16-1.83)	1.76 (1.40-2.22)	2.23 (1.73-2.96)	2.62 (1.99-3.51)	3.05 (2.23-4.18)	3.52 (2.47-4.95)	4.19 (2.82-6.04)	4.73 (3.09-6.87)
3-hr	1.04 (0.839-1.29)	1.22 (0.986-1.52)	1.57 (1.26-1.96)	1.90 (1.51-2.38)	2.41 (1.90-3.21)	2.86 (2.18-3.83)	3.35 (2.47-4.59)	3.90 (2.75-5.47)	4.68 (3.18-6.75)	5.33 (3.50-7.71)
6-hr	1.21 (0.980-1.49)	1.40 (1.14-1.73)	1.78 (1.44-2.21)	2.16 (1.74-2.68)	2.76 (2.19-3.65)	3.29 (2.53-4.38)	3.88 (2.88-5.28)	4.53 (3.23-6.34)	5.49 (3.76-7.88)	6.29 (4.17-9.04)
12-hr	1.39 (1.14-1.70)	1.62 (1.33-1.98)	2.06 (1.68-2.53)	2.48 (2.02-3.06)	3.16 (2.53-4.14)	3.76 (2.92-4.96)	4.42 (3.31-5.97)	5.15 (3.70-7.14)	6.22 (4.30-8.85)	7.10 (4.75-10.1)
24-hr	1.61 (1.33-1.95)	1.88 (1.55-2.29)	2.39 (1.97-2.92)	2.88 (2.35-3.52)	3.63 (2.91-4.69)	4.27 (3.34-5.58)	4.98 (3.75-6.66)	5.75 (4.17-7.90)	6.87 (4.78-9.70)	7.79 (5.25-11.1)
2-day	1.86 (1.55-2.24)	2.19 (1.83-2.64)	2.79 (2.31-3.36)	3.33 (2.75-4.04)	4.15 (3.35-5.30)	4.85 (3.81-6.25)	5.59 (4.25-7.39)	6.40 (4.67-8.70)	7.55 (5.30-10.6)	8.49 (5.77-12.0)
3-day	2.04 (1.71-2.45)	2.41 (2.01-2.88)	3.05 (2.54-3.66)	3.63 (3.01-4.38)	4.51 (3.65-5.71)	5.24 (4.14-6.72)	6.03 (4.59-7.92)	6.87 (5.03-9.29)	8.07 (5.69-11.2)	9.04 (6.18-12.7)
4-day	2.20 (1.85-2.62)	2.58 (2.16-3.08)	3.25 (2.72-3.89)	3.86 (3.21-4.63)	4.77 (3.87-6.01)	5.53 (4.38-7.06)	6.34 (4.85-8.31)	7.22 (5.31-9.73)	8.46 (5.98-11.7)	9.46 (6.50-13.2)
7-day	2.60 (2.20-3.08)	3.00 (2.54-3.56)	3.71 (3.13-4.41)	4.36 (3.65-5.20)	5.33 (4.36-6.67)	6.14 (4.89-7.78)	7.00 (5.40-9.11)	7.93 (5.87-10.6)	9.26 (6.59-12.8)	10.3 (7.14-14.4)
10-day	2.96 (2.51-3.48)	3.39 (2.88-4.00)	4.16 (3.52-4.92)	4.85 (4.08-5.76)	5.88 (4.82-7.31)	6.73 (5.38-8.48)	7.63 (5.91-9.88)	8.61 (6.39-11.5)	9.97 (7.13-13.7)	11.1 (7.70-15.4)
20-day	3.95 (3.38-4.61)	4.55 (3.89-5.32)	5.57 (4.75-6.52)	6.44 (5.46-7.58)	7.68 (6.32-9.39)	8.67 (6.97-10.8)	9.69 (7.54-12.4)	10.8 (8.04-14.1)	12.2 (8.79-16.6)	13.3 (9.36-18.4)
30-day	4.75 (4.09-5.51)	5.49 (4.72-6.38)	6.70 (5.74-7.81)	7.72 (6.58-9.04)	9.12 (7.52-11.1)	10.2 (8.24-12.6)	11.3 (8.83-14.3)	12.4 (9.32-16.2)	13.9 (10.1-18.7)	15.0 (10.6-20.6)
45-day	5.73 (4.96-6.62)	6.62 (5.72-7.65)	8.05 (6.93-9.33)	9.21 (7.89-10.7)	10.8 (8.91-12.9)	12.0 (9.68-14.6)	13.1 (10.3-16.5)	14.3 (10.7-18.5)	15.8 (11.4-21.1)	16.9 (12.0-23.0)
60-day	6.56 (5.70-7.55)	7.55 (6.55-8.69)	9.12 (7.88-10.5)	10.4 (8.92-12.0)	12.1 (9.98-14.4)	13.3 (10.8-16.1)	14.5 (11.4-18.1)	15.6 (11.8-20.2)	17.1 (12.5-22.8)	18.2 (12.9-24.8)

¹ Precipitation frequency (PF) estimates in this table are based on frequency analysis of partial duration series (PDS).

Numbers in parenthesis are PF estimates at lower and upper bounds of the 90% confidence interval. The probability that precipitation frequency estimates (for a given duration and average recurrence interval) will be greater than the upper bound (or less than the lower bound) is 5%. Estimates at upper bounds are not checked against probable maximum precipitation (PMP) estimates and may be higher than currently valid PMP values.

Please refer to NOAA Atlas 14 document for more information.

COMPOSITE 'C' FACTORS

PROJECT:	MSMD Fieldhouse									Date	12/13/2023	
BASIN DESIGNATION	AREA (AC.)									AREA (MI ²)	COMPOSITE 'C' FACTOR	PERCENT IMPERV.
	UNDEV	3 DU/AC	4 DU/AC	5 DU/AC	6 DU/AC	STREETS	SCHOOL, CLUB HSE, REC CTR	OPEN SPACE PARKS/GC	TOTAL			
EXISTING												
FG08A			22.6	18.7		3.3		3.4	48	0.0750	76.8	42.6%
FG08B				35.2		0.8		4.3	40	0.0630	76.7	39.8%
FG09				18.8				12.2	31	0.0484	71.7	26.9%
FG10a		24.6	25.7					1.3	52	0.0806	73.2	34.3%
FG10b	21.0	3.0	2.6						27	0.0415	63.6	7.2%
FG11				35.2			4.8		40	0.0625	78.2	44.1%
FG12					21.0				21	0.0328	80.0	47.0%
FG13			11.4					22.8	34	0.0534	66.3	14.7%
										0.4573	Composite:	33.1%
	21	28	62	108	21	4	5	44	293			
PROPOSED												
FG08A			22.6	18.7		3.3		3.4	48	0.0750	76.8	42.6%
FG08B				35.2		0.8		4.3	40	0.0630	76.7	39.8%
FG09				18.8				12.2	31	0.0484	71.7	26.9%
FG10a		24.6	25.7					1.3	52	0.0806	73.2	34.3%
FG10b	8.2	3.0	2.6				4.6	8.2	27	0.0415	67.2	16.9%
FG11				35.2			4.8		40	0.0625	78.2	44.1%
FG12					21.0				21	0.0328	80.0	47.0%
FG13			11.4					22.8	34	0.0534	66.3	14.7%
										0.4573	Composite:	34.0%
	8	28	62	108	21	4	9	52	293			

TIME OF CONCENTRATION

SCS Calculations

PROJECT: **MSMD Fieldhouse**

DATE: 6/17/2024

TIME OF CONCENTRATION																
SUBBASIN DATA			INITIAL/OVERLAND TIME (T _i)						TRAVEL TIME (T _t)					TOTAL	FINAL	
BASIN DESIGNATION	P ₂	AREA (SQ.MI)	LENGTH (FT)	ΔH	SLOPE %	OVERLAND CONVEYANCE TYPE	n	T _i (Min.)*	LENGTH (FT)	ΔH	TRAVEL CONVEYANCE TYPE	VEL (FPS)	T _t (Min.)**	T _i +T _t (Min.)	T _{lag} (min)	
FG08A	1.88	0.075	FROM APPROVED MERIDIAN RANCH FILING MDDP, JAN 2018												22.2	13.3
FG08B	1.88	0.063													27.7	16.6
FG09	1.88	0.048													34.6	20.8
FG10a	1.88	0.081	FROM APPROVED ROLLING HILLS RANCH FILING 1 FDR, JUNE 2020												24.2	14.5
FG10b	1.88	0.041	210	12.0	5.7%	GP	0.15	15.2	2460	56	G	2.3	18.1	33.3	20.0	
FG11	1.88	0.063	FROM APPROVED MERIDIAN RANCH FILING MDDP, JAN 2018												38.7	23.2
FG12	1.88	0.033													26.8	16.1
FG13	1.88	0.053													49.4	29.6

TYPE OF SURFACE	n
SMOOTH SURFACES (conc, asph, gravel, bare soil, etc)	S 0.0110
FALLOW (no cover)	F 0.0500
CULTIVATED SOILS (<20% cover)	CL 0.0600
CULTIVATED SOILS (>20% cover)	CG 0.1700
GRASS (Short prairie grass)	GP 0.1500
GRASS (Dense grass)	GD 0.2400
GRASS (Bermuda grass)	GB 0.4100
RANGE (Natural)	R 0.1300
WOODS (Light Underbrush)	VL 0.4000
WOODS (Dense Underbrush)	VD 0.8000

Notes: * T_i = 0.42 (n•L)^{0.8} / (P₂)^{0.5} • S^{0.4} (min)
 ** T_t = L / 60 • V (min)

TYPE OF SURFACE	n
HEAVY MEADOW	H
TILLAGE/FIELD	T
RIPRAP (not buried)	R
SHORT PASTURE AND LAWNS	L
NEARLY BARE GROUND	B
GRASSED WATERWAY	G
NATURAL SANDY CHANNEL	N
PAVED AREAS	P

EXISTING

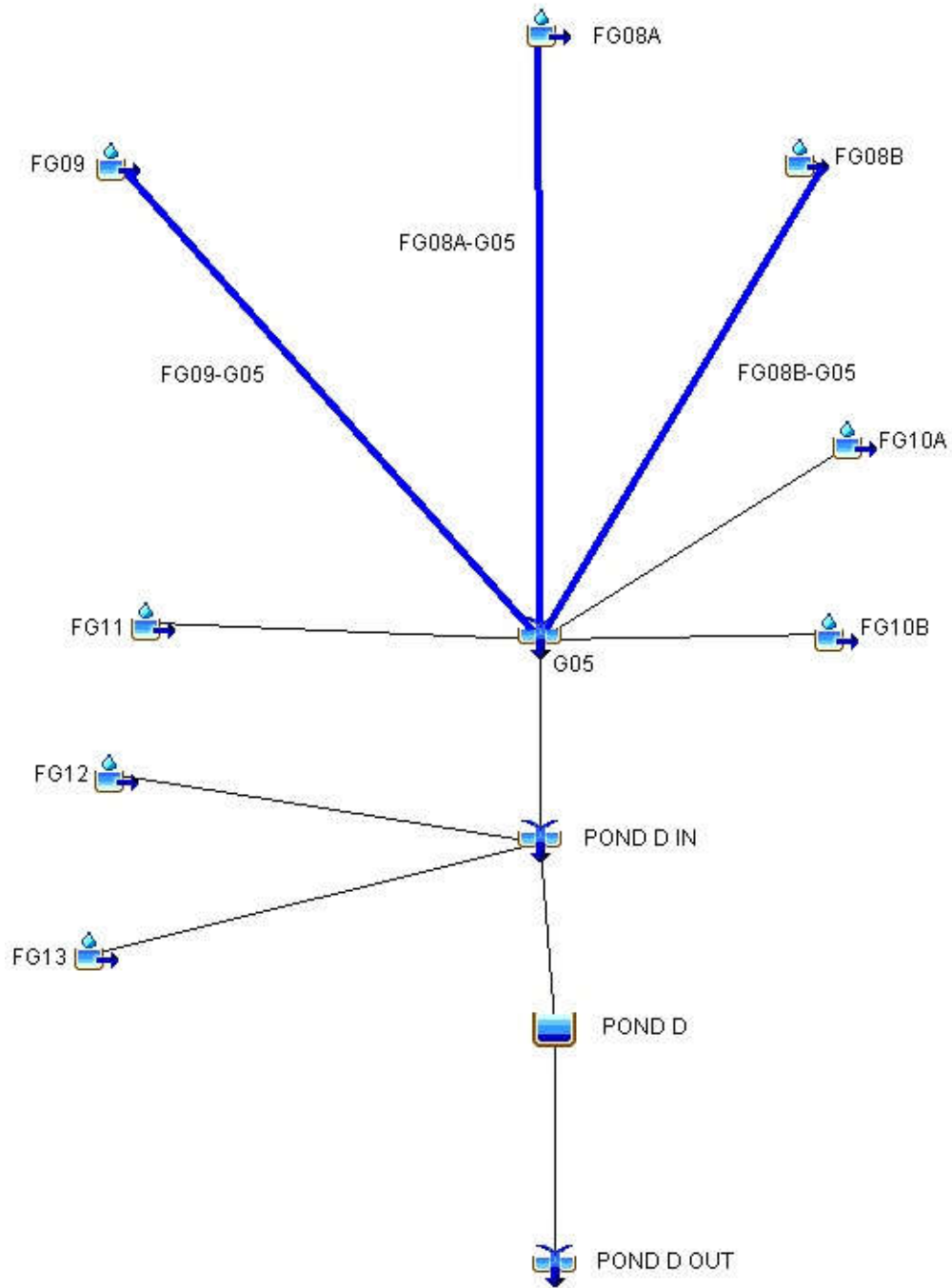

EXISTING (100-YEAR)				
HYDROLOGIC ELEMENT	DRAINAGE AREA (SQ. MI.)	DISCHARGE PEAK Q100 (CFS)	TIME OF PEAK	TOTAL VOLUME Q100 (AC. FT.)
FG10A	0.0806	103	01Jul2015, 12:06	9.7
FG08A	0.0750	116	01Jul2015, 12:06	10
FG08A-G05	0.0750	110	01Jul2015, 12:12	10
FG08B	0.0630	86	01Jul2015, 12:12	8.5
FG08B-G05	0.0630	84	01Jul2015, 12:12	8.5
FG11	0.0625	75	01Jul2015, 12:18	8.9
FG09	0.0484	48	01Jul2015, 12:12	5.5
FG09-G05	0.0484	48	01Jul2015, 12:18	5.5
FG10B	0.0416	28	01Jul2015, 12:12	3.3
G05	0.3711	441	01Jul2015, 12:12	46
FG13	0.0534	34	01Jul2015, 12:24	4.8
FG12	0.0328	50	01Jul2015, 12:12	5.0
POND D IN	0.4573	517	01Jul2015, 12:12	56
POND D	0.4573	129	01Jul2015, 13:00	45
POND D OUT	0.4573	129	01Jul2015, 13:00	45

EXISTING (50-YEAR)				
HYDROLOGIC ELEMENT	DRAINAGE AREA (SQ. MI.)	DISCHARGE PEAK Q50 (CFS)	TIME OF PEAK	TOTAL VOLUME Q50 (AC. FT.)
FG10A	0.0806	77	01Jul2015, 12:06	7.4
FG08A	0.0750	90	01Jul2015, 12:06	7.9
FG08A-G05	0.0750	86	01Jul2015, 12:12	7.9
FG08B	0.0630	67	01Jul2015, 12:12	6.6
FG08B-G05	0.0630	65	01Jul2015, 12:12	6.6
FG11	0.0625	59	01Jul2015, 12:18	7.0
FG09	0.0484	36	01Jul2015, 12:12	4.1
FG09-G05	0.0484	36	01Jul2015, 12:18	4.1
FG10B	0.0416	19	01Jul2015, 12:18	2.4
G05	0.3711	335	01Jul2015, 12:12	35
FG13	0.0534	24	01Jul2015, 12:24	3.5
FG12	0.0328	40	01Jul2015, 12:12	3.9
POND D IN	0.4573	393	01Jul2015, 12:12	43
POND D	0.4573	86	01Jul2015, 13:06	33
POND D OUT	0.4573	86	01Jul2015, 13:06	33

EXISTING (10-YEAR)				
HYDROLOGIC ELEMENT	DRAINAGE AREA (SQ. MI.)	DISCHARGE PEAK Q10 (CFS)	TIME OF PEAK	TOTAL VOLUME Q10 (AC. FT.)
FG10A	0.0806	32	01Jul2015, 12:12	3.3
FG08A	0.0750	41	01Jul2015, 12:06	3.8
FG08A-G05	0.0750	41	01Jul2015, 12:12	3.8
FG08B	0.0630	31	01Jul2015, 12:12	3.2
FG08B-G05	0.0630	29	01Jul2015, 12:18	3.2
FG11	0.0625	28	01Jul2015, 12:18	3.4
FG09	0.0484	14	01Jul2015, 12:18	1.8
FG09-G05	0.0484	14	01Jul2015, 12:18	1.8
FG10B	0.0416	5.3	01Jul2015, 12:18	0.9
G05	0.3711	146	01Jul2015, 12:12	16
FG13	0.0534	7.5	01Jul2015, 12:30	1.4
FG12	0.0328	20	01Jul2015, 12:12	2.0
POND D IN	0.4573	170	01Jul2015, 12:12	20
POND D	0.4573	17	01Jul2015, 14:30	13
POND D OUT	0.4573	17	01Jul2015, 14:30	13

EXISTING (5-YEAR)				
HYDROLOGIC ELEMENT	DRAINAGE AREA (SQ. MI.)	DISCHARGE PEAK Q5 (CFS)	TIME OF PEAK	TOTAL VOLUME Q5 (AC. FT.)
FG10A	0.0806	20	01Jul2015, 12:12	2.2
FG08A	0.0750	27	01Jul2015, 12:06	2.6
FG08A-G05	0.0750	27	01Jul2015, 12:12	2.6
FG08B	0.0630	20	01Jul2015, 12:12	2.2
FG08B-G05	0.0630	19	01Jul2015, 12:18	2.2
FG11	0.0625	19	01Jul2015, 12:18	2.4
FG09	0.0484	8.3	01Jul2015, 12:18	1.2
FG09-G05	0.0484	8.0	01Jul2015, 12:24	1.2
FG10B	0.0416	2.1	01Jul2015, 12:24	0.5
G05	0.3711	90	01Jul2015, 12:12	11
FG13	0.0534	3.6	01Jul2015, 12:30	0.8
FG12	0.0328	14	01Jul2015, 12:12	1.4
POND D IN	0.4573	106	01Jul2015, 12:12	13
POND D	0.4573	10	01Jul2015, 14:54	7.8
POND D OUT	0.4573	10	01Jul2015, 14:54	7.8

EXISTING (2-YEAR)				
HYDROLOGIC ELEMENT	DRAINAGE AREA (SQ. MI.)	DISCHARGE PEAK Q2 (CFS)	TIME OF PEAK	TOTAL VOLUME Q2 (AC. FT.)
FG10A	0.0806	8.6	01Jul2015, 12:12	1.2
FG08A	0.0750	13	01Jul2015, 12:12	1.5
FG08A-G05	0.0750	13	01Jul2015, 12:18	1.5
FG08B	0.0630	10	01Jul2015, 12:12	1.2
FG08B-G05	0.0630	10	01Jul2015, 12:18	1.2
FG11	0.0625	9.8	01Jul2015, 12:18	1.4
FG09	0.0484	3.2	01Jul2015, 12:18	0.6
FG09-G05	0.0484	3.2	01Jul2015, 12:24	0.6
FG10B	0.0416	0.4	01Jul2015, 12:54	0.2
G05	0.3711	44	01Jul2015, 12:18	6.0
FG13	0.0534	0.9	01Jul2015, 12:42	0.3
FG12	0.0328	7.8	01Jul2015, 12:12	0.8
POND D IN	0.4573	51	01Jul2015, 12:18	7.2
POND D	0.4573	3.4	01Jul2015, 20:06	2.8
POND D OUT	0.4573	3.4	01Jul2015, 20:06	2.8

DEVELOPED

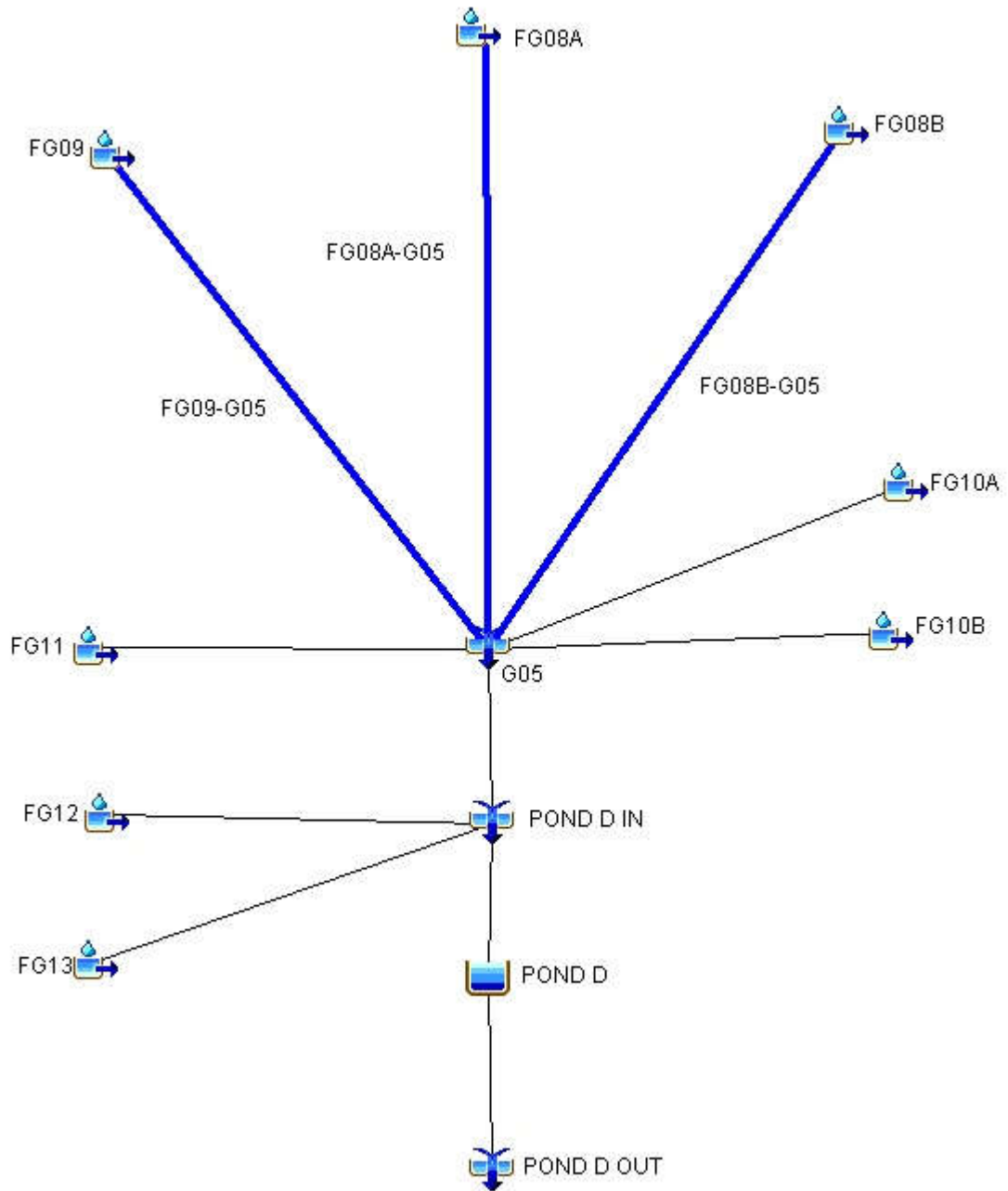

DEVELOPED (100-YEAR)				
HYDROLOGIC ELEMENT	DRAINAGE AREA (SQ. MI.)	PEAK DISCHARGE Q100 (CFS)	TIME OF PEAK	TOTAL VOLUME Q100 (AC. FT.)
FG10A	0.0806	103	01Jul2015, 12:06	9.7
FG08A	0.0750	116	01Jul2015, 12:06	10
FG08A-G05	0.0750	110	01Jul2015, 12:12	10
FG08B	0.0630	86	01Jul2015, 12:12	8.5
FG08B-G05	0.0630	84	01Jul2015, 12:12	8.5
FG11	0.0625	75	01Jul2015, 12:18	8.9
FG09	0.0484	48	01Jul2015, 12:12	5.5
FG09-G05	0.0484	48	01Jul2015, 12:18	5.5
FG10B	0.0415	34	01Jul2015, 12:12	3.9
G05	0.3710	447	01Jul2015, 12:12	47
FG13	0.0534	34	01Jul2015, 12:24	4.8
FG12	0.0328	50	01Jul2015, 12:12	5.0
POND D IN	0.4572	523	01Jul2015, 12:12	56
POND D	0.4572	131	01Jul2015, 12:54	46
POND D OUT	0.4572	131	01Jul2015, 12:54	46

DEVELOPED (50-YEAR)				
HYDROLOGIC ELEMENT	DRAINAGE AREA (SQ. MI.)	PEAK DISCHARGE Q50 (CFS)	TIME OF PEAK	TOTAL VOLUME Q50 (AC. FT.)
FG10A	0.0806	77	01Jul2015, 12:06	7.4
FG08A	0.0750	90	01Jul2015, 12:06	7.9
FG08A-G05	0.0750	86	01Jul2015, 12:12	7.9
FG08B	0.0630	67	01Jul2015, 12:12	6.6
FG08B-G05	0.0630	65	01Jul2015, 12:12	6.6
FG11	0.0625	59	01Jul2015, 12:18	7.0
FG09	0.0484	36	01Jul2015, 12:12	4.1
FG09-G05	0.0484	36	01Jul2015, 12:18	4.1
FG10B	0.0415	24	01Jul2015, 12:12	2.9
G05	0.3710	341	01Jul2015, 12:12	36
FG13	0.0534	24	01Jul2015, 12:24	3.5
FG12	0.0328	40	01Jul2015, 12:12	3.9
POND D IN	0.4572	398	01Jul2015, 12:12	43
POND D	0.4572	88	01Jul2015, 13:06	34
POND D OUT	0.4572	88	01Jul2015, 13:06	34

DEVELOPED (10-YEAR)				
HYDROLOGIC ELEMENT	DRAINAGE AREA (SQ. MI.)	PEAK DISCHARGE Q10 (CFS)	TIME OF PEAK	TOTAL VOLUME Q10 (AC. FT.)
FG10A	0.0806	32	01Jul2015, 12:12	3.3
FG08A	0.0750	41	01Jul2015, 12:06	3.8
FG08A-G05	0.0750	41	01Jul2015, 12:12	3.8
FG08B	0.0630	31	01Jul2015, 12:12	3.2
FG08B-G05	0.0630	29	01Jul2015, 12:18	3.2
FG11	0.0625	28	01Jul2015, 12:18	3.4
FG09	0.0484	14	01Jul2015, 12:18	1.8
FG09-G05	0.0484	14	01Jul2015, 12:18	1.8
FG10B	0.0415	8.2	01Jul2015, 12:18	1.2
G05	0.3710	149	01Jul2015, 12:12	17
FG13	0.0534	7.5	01Jul2015, 12:30	1.4
FG12	0.0328	20	01Jul2015, 12:12	2.0
POND D IN	0.4572	173	01Jul2015, 12:12	20
POND D	0.4572	17	01Jul2015, 14:24	14
POND D OUT	0.4572	17	01Jul2015, 14:24	14

DEVELOPED (5-YEAR)				
HYDROLOGIC ELEMENT	DRAINAGE AREA (SQ. MI.)	PEAK DISCHARGE Q5 (CFS)	TIME OF PEAK	TOTAL VOLUME Q5 (AC. FT.)
FG10A	0.0806	20	01Jul2015, 12:12	2.2
FG08A	0.0750	27	01Jul2015, 12:06	2.6
FG08A-G05	0.0750	27	01Jul2015, 12:12	2.6
FG08B	0.0630	20	01Jul2015, 12:12	2.2
FG08B-G05	0.0630	19	01Jul2015, 12:18	2.2
FG11	0.0625	19	01Jul2015, 12:18	2.4
FG09	0.0484	8.3	01Jul2015, 12:18	1.2
FG09-G05	0.0484	8.0	01Jul2015, 12:24	1.2
FG10B	0.0415	4.0	01Jul2015, 12:18	0.7
G05	0.3710	92	01Jul2015, 12:12	11
FG13	0.0534	3.6	01Jul2015, 12:30	0.8
FG12	0.0328	14	01Jul2015, 12:12	1.4
POND D IN	0.4572	108	01Jul2015, 12:12	13
POND D	0.4572	11	01Jul2015, 14:48	8.0
POND D OUT	0.4572	11	01Jul2015, 14:48	8.0

DEVELOPED (2-YEAR)				
HYDROLOGIC ELEMENT	DRAINAGE AREA (SQ. MI.)	PEAK DISCHARGE Q2 (CFS)	TIME OF PEAK	TOTAL VOLUME Q2 (AC. FT.)
FG10A	0.0806	8.6	01Jul2015, 12:12	1.2
FG08A	0.0750	13	01Jul2015, 12:12	1.5
FG08A-G05	0.0750	13	01Jul2015, 12:18	1.5
FG08B	0.0630	10	01Jul2015, 12:12	1.2
FG08B-G05	0.0630	10	01Jul2015, 12:18	1.2
FG11	0.0625	9.8	01Jul2015, 12:18	1.4
FG09	0.0484	3.2	01Jul2015, 12:18	0.6
FG09-G05	0.0484	3.2	01Jul2015, 12:24	0.6
FG10B	0.0415	1.1	01Jul2015, 12:24	0.3
G05	0.3710	44	01Jul2015, 12:18	6.1
FG13	0.0534	0.9	01Jul2015, 12:42	0.3
FG12	0.0328	7.8	01Jul2015, 12:12	0.8
POND D IN	0.4572	52	01Jul2015, 12:18	7.3
POND D	0.4572	3.5	01Jul2015, 20:00	2.9
POND D OUT	0.4572	3.5	01Jul2015, 20:00	2.9

Appendix C - Detention Pond Information

STAGE/STORAGE/DISCHARGE CURVES FOR DETENTION POND ANALYSIS

Meridian Ranch Detention Pond D - AS-BUILT

EXISTING CONDITIONS

Geick Basin - El Paso County, Colorado

Data for spillway and embankment:

embankment length =	710
embankment elev =	7060
spillway length =	100
spillway elevation =	7058
100 year storage elev.=	7057.0
100 year storage vol.=	24.8
100 year discharge=	129
5 year storage elev.=	7053.7
5 year storage vol.=	6.9
5 year discharge=	10
WQCV storage vol.=	1.0
WQCV depth =	2.42
1/2 WQCV storage vol.=	0.50

Data for outlet pipe and grate:

		Dimensions				
Type	Width (ft.)	X Height (ft.)	Dia.(in)		(sqft)	
Rectangular	Orifice 1:	0.03	2.42		Area =	0.072 Elev to cl = 7050.21
Circular	Orifice 2:			8	Area =	0.349 Elev to cl = 7051.42
Rectangular	Orifice 3:	5	0.5		Area =	2.500 Elev to cl = 7053.35
None Selected	Orifice 4:				Area =	0.000 Elev to cl =
Stand Pipe Dimensions						
Rec Grate		6	x	4.25	Elev =	7054.9
Circ. Grate			dia.		Elev =	
Outlet Culvert Dimensions						
Outlet Culvert			x		Height (ft.)	Dia. (ft.)
Area		12.6			TOP	
Outlet I. E.		7048.1			7052.5	
Wall Thick.		5	in.			
						Type Circular

50 year storage elev.=	7056.2
50 year discharge=	86
50 year storage vol.=	19.5
10 year storage elev.=	7054.5
10 year discharge=	17
10 year storage vol.=	10.3
2 year storage elev.=	7053.1
2 year discharge=	3.4
2 year storage vol.=	4.5

STAGE		STORAGE				DISCHARGE										
ELEV	HEIGHT	AREA		VOLUME		TOP OF BANK	SPILLWAY	ORIFICE (max outflow)				GRATE (max outflow)	PIPE		REALIZED CULVERT OUTFLOW	TOTAL FLOW
		sqft	acre	acft	cum acft			1	2	3	4		1	2		
7049	0	0	0.0	0.00	0.00	-	-	-	-	-	-	-	-	-	-	-
7050	1	10705	0.2	0.1	0.12	-	-	0.2	-	-	-	-	13	-	0.2	0.15
7051	2	36676	0.8	0.5	0.67	-	-	0.3	-	-	-	-	33	-	0.3	0.31
7052	3	71989	1.7	1.2	1.91	-	-	0.5	1.3	-	-	-	60	-	1.8	1.8
7053	4	133440	3.1	2.4	4.27	-	-	0.6	2.1	-	-	-	90	-	2.7	2.7
7054	5	178828	4.1	3.6	7.86	-	-	0.7	2.7	9.7	-	-	119	-	13.1	13
7055	6	221269	5.1	4.6	12.45	-	-	0.8	3.2	15.5	-	1.4	139	-	21	21
7055.5	6.5	245509	5.6	2.7	15.13	-	-	0.8	3.4	17.7	-	20.2	148	-	42	42
7056	7	269749	6.2	5.6	18.08	-	-	0.8	3.6	20	-	50	157	-	74	74
7058	9	337508	7.7	13.9	32.03	-	-	1.0	4.3	26	-	216	188	-	188	188
7060	11	405520	9.3	31.0	49.09	-	848.5	1.1	4.9	31	-	277	214	-	214	1,063
						-	-	-	-	-	-	-	-	-	-	-

- Notes:
- 1) Top-of-bank and spillway flows are weir equations from section 11.3.1 in the DCM. $Q=CLH^{1.5}$ (C=3.0)
 - 2) Orifice flows are also from section 11.3.1. $Q=CA(2gH)^{0.5}$ (C=6)
 - 3) Grate flows are determined from equations 7-2 and 7-3. Weir Flow $Q=(3PH^{1.5})/F$, Orifice Flow $Q=4.815*AH^{0.5}$
 - 4) Pipe flows use the lesser of: 1) Inlet control equations 27 & 28, page 146 of HDS No. 5 - or - 2) Allowable Pipe Flow equation on page 11-9 of the DCM. Use Table 9, page 147-148, HDS No. 5 for formulas 26 & 27.

STAGE/STORAGE/DISCHARGE CURVES FOR DETENTION POND ANALYSIS

Meridian Ranch Detention Pond D - AS-BUILT

DEVELOPED CONDITIONS

Geick Basin - El Paso County, Colorado

Data for spillway and embankment:

embankment length =	710
embankment elev =	7060
spillway length =	100
spillway elevation =	7058
100 year storage elev.=	7057.0
100 year storage vol.=	25.0
100 year discharge=	131
5 year storage elev.=	7053.8
5 year storage vol.=	7.0
5 year discharge=	11
WQCV storage vol.=	1.0
WQCV depth =	2.42
1/2 WQCV storage vol.=	0.50

Data for outlet pipe and grate:

		Dimensions					
Type	Orifice	Width (ft.)	X Height (ft.)	Dia.(in)	Area =	Elev to cl =	(sqft)
Rectangular	Orifice 1:	0.03	2.42		0.072	7050.21	
Circular	Orifice 2:			8	0.349	7051.42	
Rectangular	Orifice 3:	5	0.5		2.500	7053.35	
None Selected	Orifice 4:				0.000		

Stand Pipe Dimensions					
Rec Grate	6	x	4.25	Elev =	7054.9
Circ. Grate		dia.		Elev =	

Outlet Culvert Dimensions					
Outlet Culvert	Width (ft.)	x	Height (ft.)	Dia. (ft.)	Type
Outlet Culvert				4	Circular
Area	12.6		TOP		
Outlet I. E.	7048.1		7052.5		
Wall Thick.	5	in.			

50 year storage elev.=	7056.2
50 year storage vol.=	19.7
50 year discharge=	88
10 year storage elev.=	7054.6
10 year storage vol.=	10.5
10 year discharge=	17
2 year storage elev.=	7053.1
2 year storage vol.=	4.5
2 year discharge=	3.5

STAGE		STORAGE				DISCHARGE								GRATE (max outflow)		PIPE		REALIZED CULVERT OUTFLOW	TOTAL FLOW
ELEV	HEIGHT	AREA		VOLUME		TOP OF BANK	SPILLWAY	ORIFICE (max outflow)				Rectangular	PIPE		REALIZED CULVERT OUTFLOW	TOTAL FLOW			
		sqft	acre	acft	cumacft			1	2	3	4		1	2					
7049	0	0	0.0	0.00	0.00	-	-	-	-	-	-	-	-	-	-	-	-	-	
7050	1	10705	0.2	0.1	0.12	-	-	0.2	-	-	-	-	-	13	-	-	0.2	0.15	
7051	2	36676	0.8	0.5	0.67	-	-	0.3	-	-	-	-	-	33	-	-	0.3	0.31	
7052	3	71989	1.7	1.2	1.91	-	-	0.5	1.3	-	-	-	-	60	-	-	1.8	1.8	
7053	4	133440	3.1	2.4	4.27	-	-	0.6	2.1	-	-	-	-	90	-	-	2.7	2.7	
7054	5	178828	4.1	3.6	7.86	-	-	0.7	2.7	9.7	-	-	-	119	-	-	13.1	13	
7055	6	221269	5.1	4.6	12.45	-	-	0.8	3.2	15.5	-	-	1.4	139	-	-	21	21	
7055.5	6.5	245509	5.6	2.7	15.13	-	-	0.8	3.4	17.7	-	-	20.2	148	-	-	42	42	
7056	7	269749	6.2	5.6	18.08	-	-	0.8	3.6	20	-	-	50	157	-	-	74	74	
7058	9	337508	7.7	13.9	32.03	-	-	1.0	4.3	26	-	-	216	188	-	-	188	188	
7060	11	405520	9.3	31.0	49.09	-	848.5	1.1	4.9	31	-	-	277	214	-	-	214	1,063	

- Notes:
- 1) Top-of-bank and spillway flows are weir equations from section 11.3.1 in the DCM. $Q=CLH^{1.5}$ (C=3.0)
 - 2) Orifice flows are also from section 11.3.1. $Q=CA(2gH)^{0.5}$ (C=6)
 - 3) Grate flows are determined from equations 7-2 and 7-3. Weir Flow $Q=(3PH^{1.5})/F$, Orifice Flow $Q=4.815*AH^{0.5}$
 - 4) Pipe flows use the lesser of: 1) Inlet control equations 27 & 28, page 146 of HDS No. 5 - or - 2) Allowable Pipe Flow equation on page 11-9 of the DCM. Use Table 9, page 147-148, HDS No. 5 for formulas 26 & 27.

STAGE/STORAGE/DISCHARGE CURVES FOR DETENTION POND ANALYSIS

Meridian Ranch Detention Pond D - AS-BUILT

ORIGINAL FUTURE MODEL

Geick Basin - El Paso County, Colorado

Data for spillway and embankment:

embankment length =	710
embankment elev =	7060
spillway length =	100
spillway elevation =	7058
100 year storage elev.=	7057.0
100 year storage vol.=	25.3
100 year discharge=	134
5 year storage elev.=	7053.8
5 year storage vol.=	7.1
5 year discharge=	11
WQCV storage vol.=	1.0
WQCV depth =	2.42
1/2 WQCV storage vol.=	0.50

Data for outlet pipe and grate:

		Dimensions				
Type		Width (ft.) X Height (ft.)	Dia.(in)		(sqft)	
Rectangular	Orifice 1:	0.03	2.42		0.072	Elev to cl = 7050.21
Circular	Orifice 2:			8	0.349	Elev to cl = 7051.42
Rectangular	Orifice 3:	5	0.5		2.500	Elev to cl = 7053.35
None Selected	Orifice 4:				0.000	Elev to cl =

Stand Pipe Dimensions	
Rec Grate	6 x 4.25 Elev = 7054.9
Circ. Grate	dia. Elev =

Outlet Culvert Dimensions				
	Width (ft.)	Height (ft.)	Dia. (ft.)	Type
Outlet Culvert		x	4	Circular
Area	12.6		TOP	
Outlet I. E.	7048.1		7052.5	
Wall Thick.	5	in.		

50 year storage elev.=	7056.3
50 year storage vol.=	20.0
50 year discharge=	90
10 year storage elev.=	7054.6
10 year storage vol.=	10.7
10 year discharge=	18
2 year storage elev.=	7053.1
2 year storage vol.=	4.6
2 year discharge=	3.7

STAGE		STORAGE				DISCHARGE								REALIZED CULVERT OUTFLOW		TOTAL FLOW	
ELEV	HEIGHT	AREA		VOLUME		TOP OF BANK	SPILLWAY	ORIFICE (max outflow)				GRATE (max outflow)	PIPE		REALIZED CULVERT OUTFLOW	TOTAL FLOW	
		sqft	acre	acft	cum acft			1	2	3	4		1	2			
7049	0	0	0.0	0.00	0.00	-	-	-	-	-	-	-	-	-	-	-	-
7050	1	10705	0.2	0.1	0.12	-	-	0.2	-	-	-	-	-	13	-	0.2	0.15
7051	2	36676	0.8	0.5	0.67	-	-	0.3	-	-	-	-	-	33	-	0.3	0.31
7052	3	71989	1.7	1.2	1.91	-	-	0.5	1.3	-	-	-	-	60	-	1.8	1.8
7053	4	133440	3.1	2.4	4.27	-	-	0.6	2.1	-	-	-	-	90	-	2.7	2.7
7054	5	178828	4.1	3.6	7.86	-	-	0.7	2.7	9.7	-	-	-	119	-	13.1	13
7055	6	221269	5.1	4.6	12.45	-	-	0.8	3.2	15.5	-	-	1.4	139	-	21	21
7055.5	6.5	245509	5.6	2.7	15.13	-	-	0.8	3.4	17.7	-	-	20.2	148	-	42	42
7056	7	269749	6.2	5.6	18.08	-	-	0.8	3.6	20	-	-	50	157	-	74	74
7058	9	337508	7.7	13.9	32.03	-	-	1.0	4.3	26	-	-	216	188	-	188	188
7060	11	405520	9.3	31.0	49.09	-	848.5	1.1	4.9	31	-	-	277	214	-	214	1,063

- Notes:
- 1) Top-of-bank and spillway flows are weir equations from section 11.3.1 in the DCM. $Q=CLH^{1.5}$ (C=3.0)
 - 2) Orifice flows are also from section 11.3.1. $Q=CA(2gH)^{0.5}$ (C=6)
 - 3) Grate flows are determined from equations 7-2 and 7-3. Weir Flow $Q=(3PH^{1.5})/F$, Orifice Flow $Q=4.815*AH^{0.5}$
 - 4) Pipe flows use the lesser of: 1) Inlet control equations 27 & 28, page 146 of HDS No. 5 - or - 2) Allowable Pipe Flow equation on page 11-9 of the DCM. Use Table 9, page 147-148, HDS No. 5 for formulas 26 & 27.

MSMD FIELDHOUSE EXISTING CONDITION

Simulation Run: FHEX-100 YR Reservoir: POND D

Start of Run: 01Jul2015, 00:00 Basin Model: FHEX
End of Run: 02Jul2015, 00:00 Meteorologic Model: SCS TYPE IIA 100YR
Compute Time: 17Oct2023 13:18:14 Control Specifications: 24 HR-2 MIN.
Volume Units: AC-FT

Computed Results:

Peak Inflow: 517(CFS) Date/Time of Peak Inflow: 01Jul2015, 12:12
Peak Outflow: 129 (CFS) Date/Time of Peak Outflow: 01Jul2015, 13:00
Total Inflow : 55.8 (AC-FT) Peak Storage: 24.8 (AC-FT)
Total Outflow: 45.1 (AC-FT) Peak Elevation: 7057.0 (FT)

Simulation Run: FHEX-005 YR Reservoir: POND D

Start of Run: 01Jul2015, 00:00 Basin Model: FHEX
End of Run: 02Jul2015, 00:00 Meteorologic Model: SCS TYPE IIA 005YR
Compute Time: 17Oct2023 13:18:01 Control Specifications: 24 HR-2 MIN.
Volume Units: AC-FT

Computed Results:

Peak Inflow: 106 (CFS) Date/Time of Peak Inflow: 01Jul2015, 12:13
Peak Outflow: 10 (CFS) Date/Time of Peak Outflow: 01Jul2015, 14:54
Total Inflow : 13.1 (AC-FT) Peak Storage: 6.9 (AC-FT)
Total Outflow: 7.8 (AC-FT) Peak Elevation: 7053.7 (FT)

MSMD FIELDHOUSE PROPOSED CONDITION

Simulation Run: FHPR-100 YR Reservoir: POND D

Start of Run:	01Jul2015, 00:00	Basin Model:	FHPR
End of Run:	02Jul2015, 00:00	Meteorologic Model:	SCS TYPE IIA 100YR
Compute Time:	17Oct2023 13:08:57	Control Specifications:	24 HR-2 MIN.
		Volume Units:	AC-FT

Computed Results:

Peak Inflow:	523 (CFS)	Date/Time of Peak Inflow:	01Jul2015, 12:12
Peak Outflow:	131 (CFS)	Date/Time of Peak Outflow:	01Jul2015, 12:54
Total Inflow:	56.3 (AC-FT)	Peak Storage:	25.0 (AC-FT)
Total Outflow:	45.6 (AC-FT)	Peak Elevation:	7057.0 (FT)

Simulation Run: FHPR-005 YR Reservoir: POND D

Start of Run:	01Jul2015, 00:00	Basin Model:	FHPR
End of Run:	02Jul2015, 00:00	Meteorologic Model:	SCS TYPE IIA 005YR
Compute Time:	17Oct2023 13:08:44	Control Specifications:	24 HR-2 MIN.
		Volume Units:	AC-FT

Computed Results:

Peak Inflow:	108 (CFS)	Date/Time of Peak Inflow:	01Jul2015, 12:12
Peak Outflow:	11 (CFS)	Date/Time of Peak Outflow:	01Jul2015, 14:48
Total Inflow :	13.4 (AC-FT)	Peak Storage:	7.0 (AC-FT)
Total Outflow:	8.0 (AC-FT)	Peak Elevation:	7053.8 (FT)

ORIGINAL FUTURE MODEL (RHR3)
Simulation Run: F-100 YR Reservoir: POND D

Start of Run:	01Jul2015, 00:00	Basin Model:	Future SCS
End of Run:	02Jul2015, 00:00	Meteorologic Model:	SCS TYPE IIA 100YR
Compute Time:	14Mar2018 13:11:34	Control Specifications:	24 HR-2 MIN.

Volume Units: AC-FT

Computed Results:

Peak Inflow:	531(CFS)	Date/Time of Peak Inflow:	01Jul2015, 12:12
Peak Outflow:	134 (CFS)	Date/Time of Peak Outflow:	01Jul2015, 13:00
Total Inflow :	57.1 (AC-FT)	Peak Storage:	25.3 (AC-FT)
Total Outflow:	46.3 (AC-FT)	Peak Elevation:	7057.0 (FT)

Simulation Run: F-005 YR Reservoir: POND D

Start of Run:	01Jul2015, 00:00	Basin Model:	Future SCS
End of Run:	02Jul2015, 00:00	Meteorologic Model:	SCS TYPE IIA 005YR
Compute Time:	14Mar2018 13:26:34	Control Specifications:	24 HR-2 MIN.

Volume Units: AC-FT

Computed Results:

Peak Inflow:	111 (CFS)	Date/Time of Peak Inflow:	01Jul2015, 12:18
Peak Outflow:	11 (CFS)	Date/Time of Peak Outflow:	01Jul2015, 14:36
Total Inflow :	13.6 (AC-FT)	Peak Storage:	7.1 (AC-FT)
Total Outflow:	8.2 (AC-FT)	Peak Elevation:	7053.8 (FT)

Appendix D – Outlet Protection Design

Again, enter Figure HS-19a using the smaller d/D (or d/H) ratio to find the A/A_{full} ratio. Then,

$$A = (A/A_{full})A_{full} \quad (\text{HS-16c})$$

Finally,

$$V = Q/A \quad (\text{HS-16d})$$

In which for Equations 16a through 16d above:

A_{full} = cross-sectional area of the pipe (ft²)

A = area of the design flow in the end of the pipe (ft²)

n = Manning's n for the pipe full depth

Q_{full} = pipe full discharge at its slope (cfs)

R = hydraulic radius of the pipe flowing full, ft [$R_{full} = D/4$ for circular pipes, $R_{full} = A_{full}/(2H + 2w)$ for rectangular pipes, where D = diameter of a circular conduit, H = height of a rectangular conduit, and w = width of a rectangular conduit (ft)]

S_o = longitudinal slope of the pipe (ft/ft)

V = design flow velocity at the pipe outlet (ft/sec)

V_{full} = flow velocity of the pipe flowing full (ft/sec)

3.4.3.2 Riprap Size

For the design velocity, use [Figure HS-20c](#) to find the size and type of the riprap to use in the scour protection basin downstream of the pipe outlet (i.e., B18, H, M or L). First, calculate the riprap sizing design parameter, P_d , namely,

$$P_d = (V^2 + gd)^{1/2} \quad (\text{HS-16e})$$

in which:

V = design flow velocity at pipe outlet (ft/sec)

g = acceleration due to gravity = 32.2 ft/sec²

d = design depth of flow at pipe outlet (ft)

necessary when the receiving or downstream channel may have little or no flow or tailwater at time when the pipe or culvert is in operation. Design criteria are provided in Figures HS-19a through HS-20c.

3.4.2 Objective

By providing a low tailwater basin at the end of a storm sewer conduit or culvert, the kinetic energy of the discharge is dissipated under controlled conditions without causing scour at the channel bottom.

[Photograph HS-12](#) shows a fairly large low tailwater basin.

3.4.3 Low Tailwater Basin Design

Low tailwater is defined as being equal to or less than $\frac{1}{3}$ of the height of the storm sewer, that is:

$$y_t \leq \frac{D}{3} \quad \text{or} \quad y_t \leq \frac{H}{3}$$

in which:

y_t = tailwater depth at design

D = diameter of circular pipe (ft)

H = height of rectangular pipe (ft)

3.4.3.1 Finding Flow Depth and Velocity of Storm Sewer Outlet Pipe

The first step in the design of a scour protection basin at the outlet of a storm sewer is to find the depth and velocity of flow at the outlet. Pipe-full flow can be found using Manning's equation.

$$Q_{full} = \frac{1.49}{n} A_{full} (R_{full})^{2/3} S_o^{1/2} \quad (\text{HS-16a})$$

Then and the pipe-full velocity can be found using the continuity equation.

$$V_{full} = Q_{full} / A_{full} \quad (\text{HS-16a})$$

The normal depth of flow, d , and the velocity in a conduit can be found with the aid of [Figure HS-20a](#) and [Figure HS-20b](#). Using the known design discharge, Q , and the calculated pipe-full discharge, Q_{full} , enter Figure HS-20a with the value of Q/Q_{full} and find d/D for a circular pipe or d/H for a rectangular pipe.

Compare the value of d/D (or d/H) with the one obtained from Figure HS-20b using the Froude parameter.

$$Q/D^{2.5} \quad \text{or} \quad Q/(wH^{1/5}) \quad (\text{HS-16a})$$

Choose the smaller of the two (d/D or d/H) ratios to calculate the flow depth at the end of the pipe.

$$d = D(d/D) \quad \text{or} \quad d = H(d/H) \quad (\text{HS-16b})$$

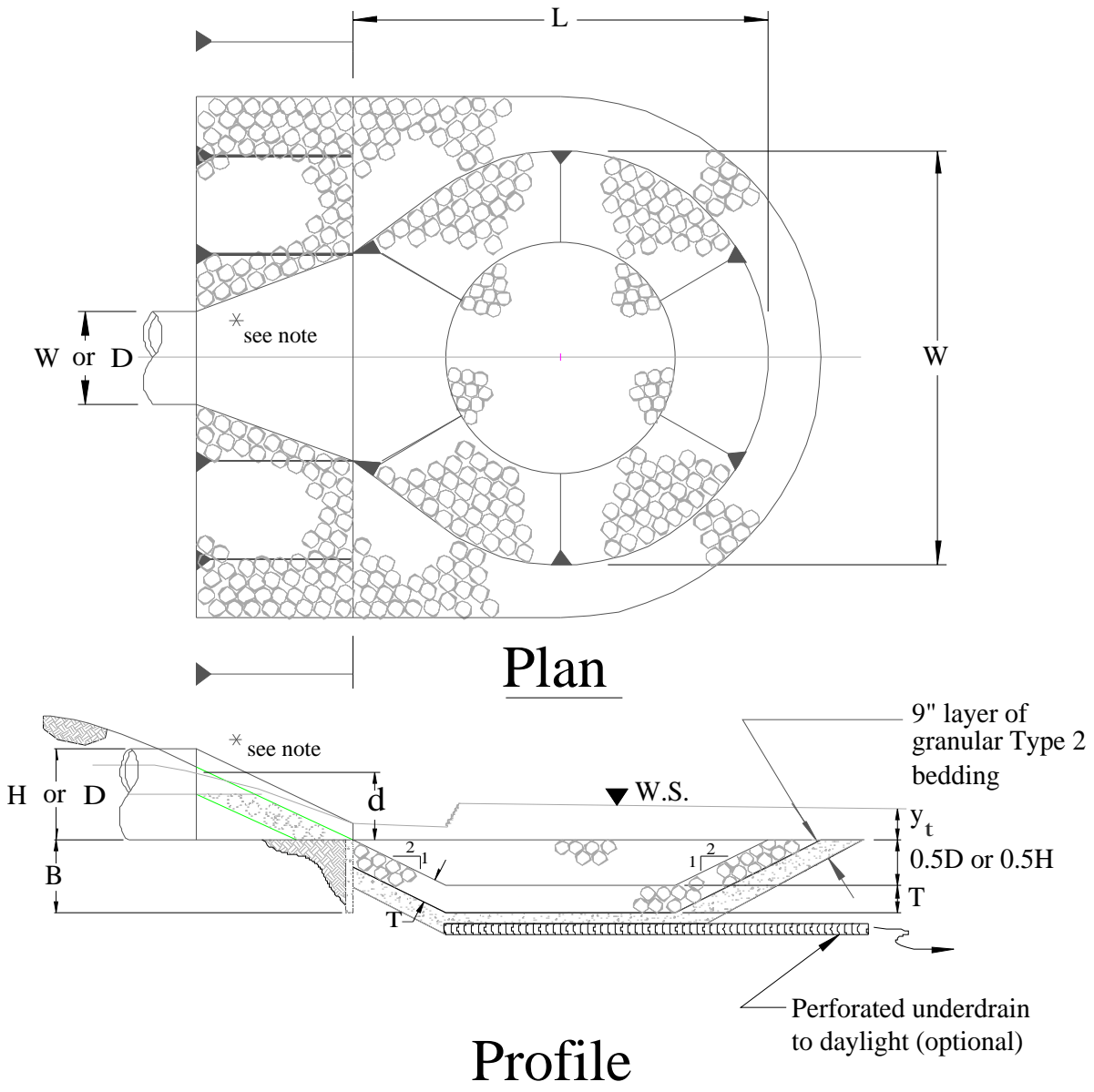

* Note: For rectangular conduits use a standard design for a headwall with wingwalls, paved bottom between the wingwalls, with an end cutoff wall extending to a minimum depth equal to B

**Figure HS-19—Low Tailwater Riprap Basins for Storm Sewer Pipe Outlets—
Low Tailwater Basin at Pipe Outlets
(Stevens and Urbonas 1996)**

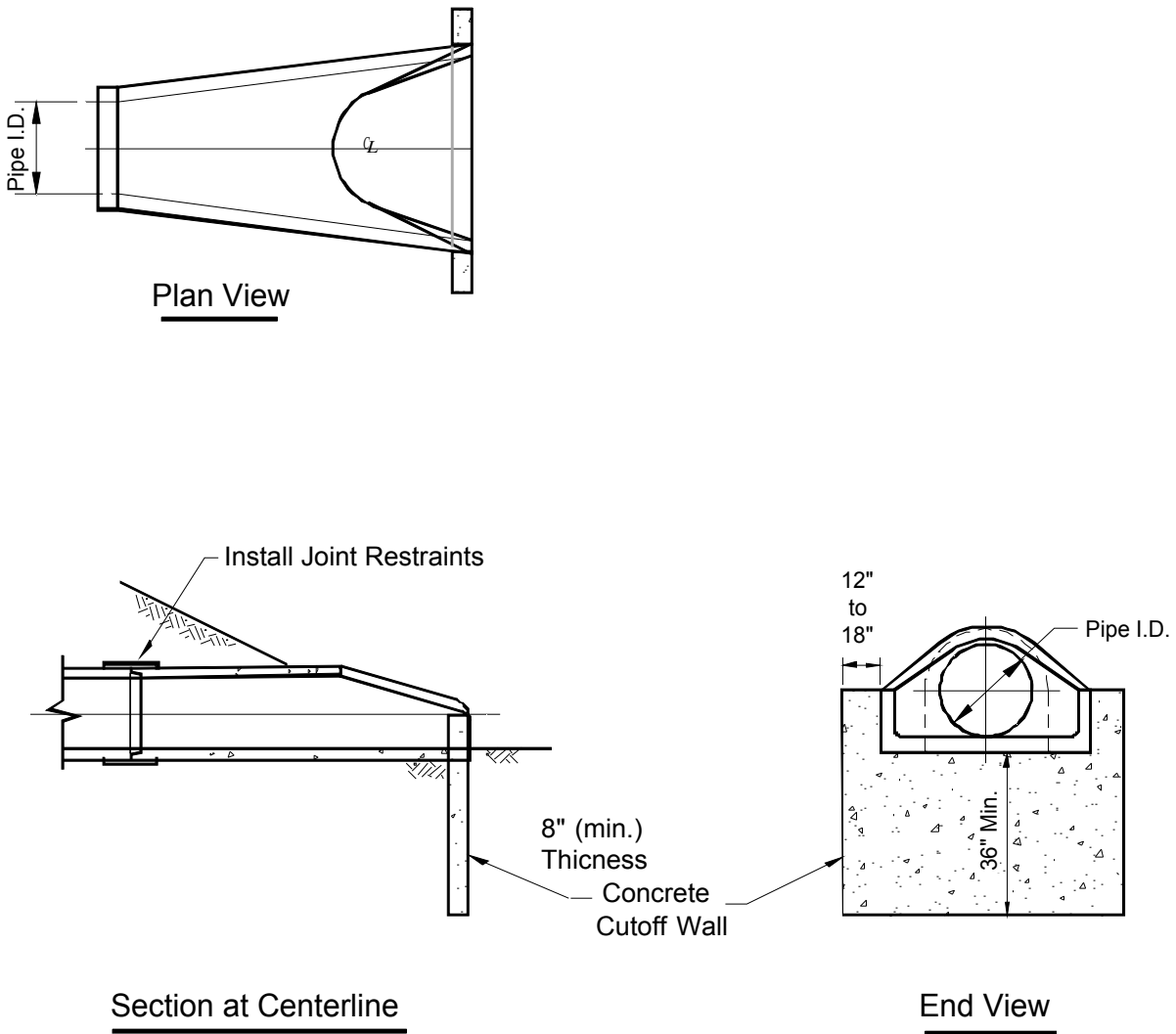

Figure HS-19a—Concrete Flared End Section with Cutoff Wall for all Pipe Outlets



Photograph HS-12—Upstream and downstream views of a low tailwater basin in Douglas County protecting downstream wetland area. Burying and revegetation of the rock would blend the structure better with the adjacent terrain.

When the riprap sizing design parameter indicates conditions that place the design above the Type H riprap line in [Figure HS-20](#), use B18, or larger, grouted boulders. An alternative to a grouted boulder or loose riprap basin is to use the standard USBR Impact Basin VI or one of its modified versions, described earlier in this Chapter of the *Manual*.

After the riprap size has been selected, the minimum thickness of the riprap layer, T , in feet, in the basin is set at:

$$T = 1.75D_{50} \quad (\text{HS-17})$$

in which:

D_{50} = the median size of the riprap (see Table HS-9.)

Table HS-9—Median (i.e., D_{50}) Size of District's Riprap/Boulder

Riprap Type	D_{50} —Median Rock Size (inches)
L	9
M	12
H	18
B18	18 (minimum dimension of grouted boulders)

3.4.3.3 Basin Length

The minimum length of the basin, L , in [Figure HS-19](#), is defined as being the greater of the following:

for circular pipe: $L = 4D$ or $L = (D)^{1/2} \left(\frac{V}{2} \right)$ (HS-18)

for rectangular pipe: $L = 4H$ or $L = (H)^{1/2} \left(\frac{V}{2} \right)$ (HS-19)

in which:

L = basin length

H = height of rectangular conduit

V = design flow velocity at outlet

D = diameter of circular conduit

3.4.3.4 Basin Width

The minimum width, W , of the basin downstream of the pipe's flared end section is set as follows:

for circular pipes: $W = 4D$ (HS-20)

for rectangular pipe: $W = w + 4H$ (HS-21)

in which,

W = basin width ([Figure HS-19](#))

D = diameter of circular conduit

w = width of rectangular conduit

3.4.3.5 Other Design Requirements

All slopes in the pre-shaped riprapped basin are 2H to 1V.

Provide pipe joint fasteners and a structural concrete cutoff wall at the end of the flared end section for a circular pipe or a headwall with wingwalls and a paved bottom between the walls, both with a cutoff wall that extends down to a depth of:

$$B = \frac{D}{2} + T \text{ or } B = \frac{H}{2} + T \quad (\text{HS-22})$$

in which,

B = cutoff wall depth

D = diameter of circular conduit

T = Equation HS-17

The riprap must be extended up the outlet embankment's slope to the mid-pipe level.

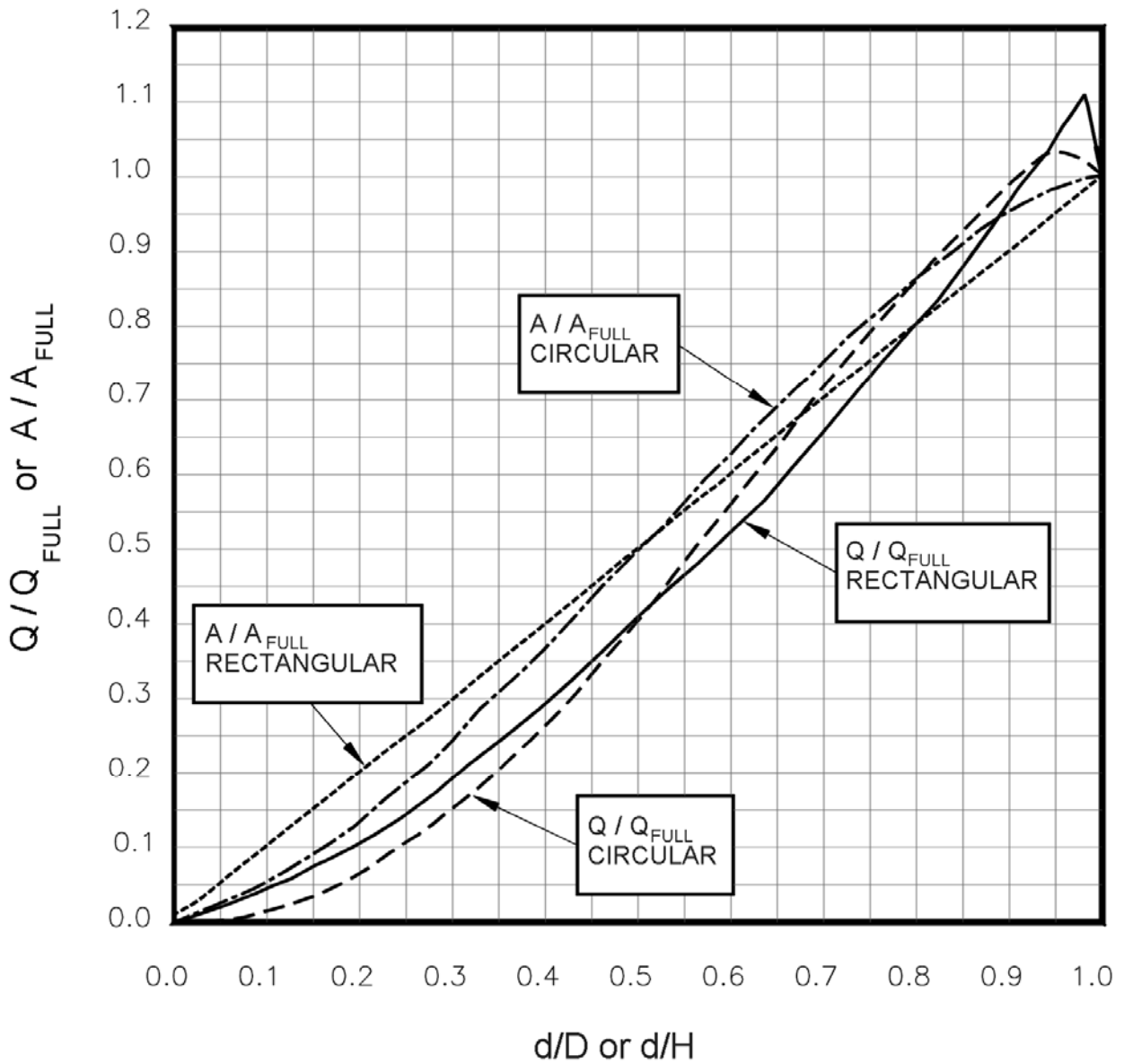

**Figure HS-20a—Low Tailwater Riprap Basins for Storm Sewer Pipe Outlets—
Discharge and Flow Area Relationships for Circular and Rectangular Pipes**
(Ratios for Flow Based on Manning's n Varying With Depth)
(Stevens and Urbonas 1996)

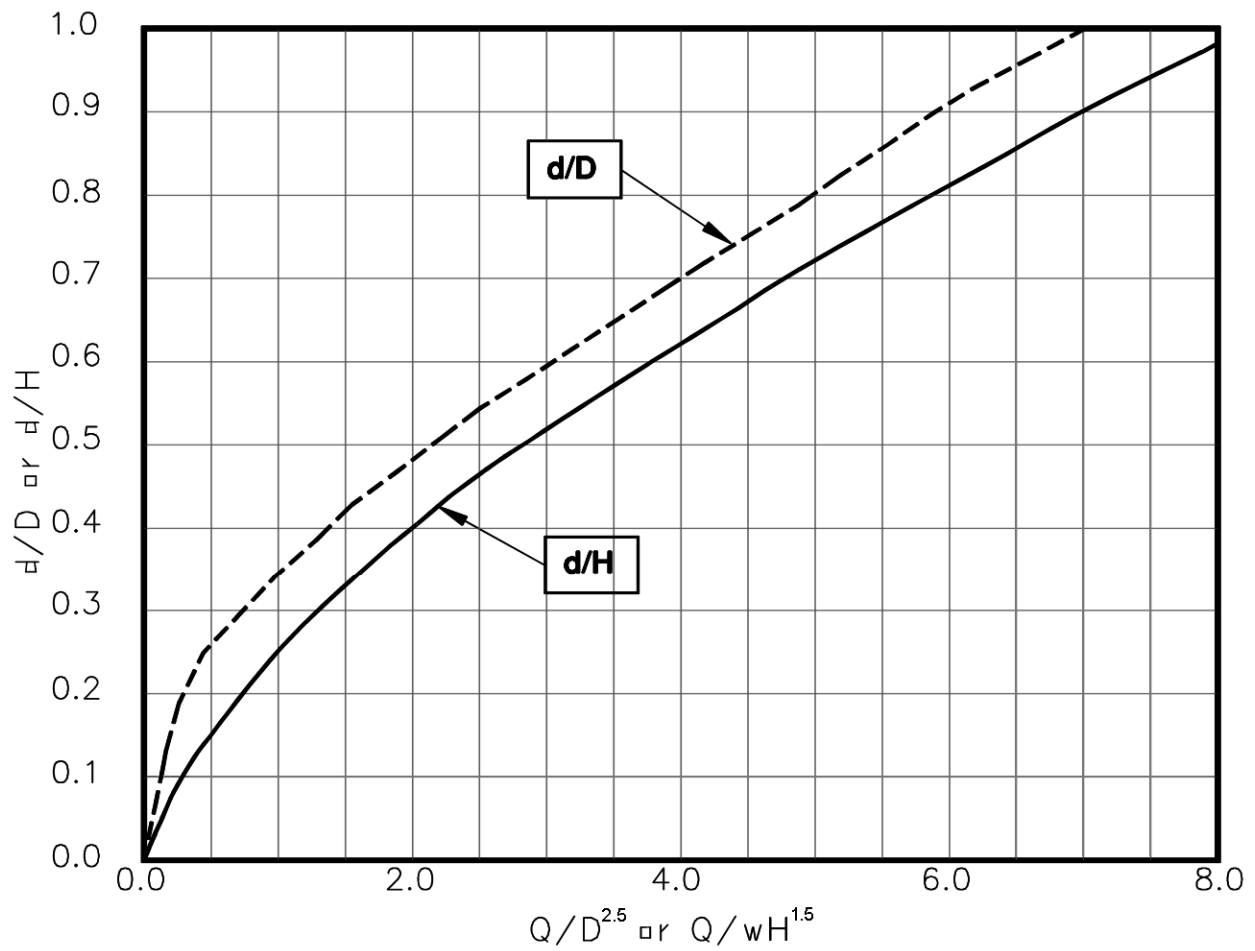

**Figure HS-20b—Low Tailwater Riprap Basins for Storm Sewer Pipe Outlets—
Brink Depth for Horizontal Pipe Outlets**
(Stevens and Urbonas 1996)

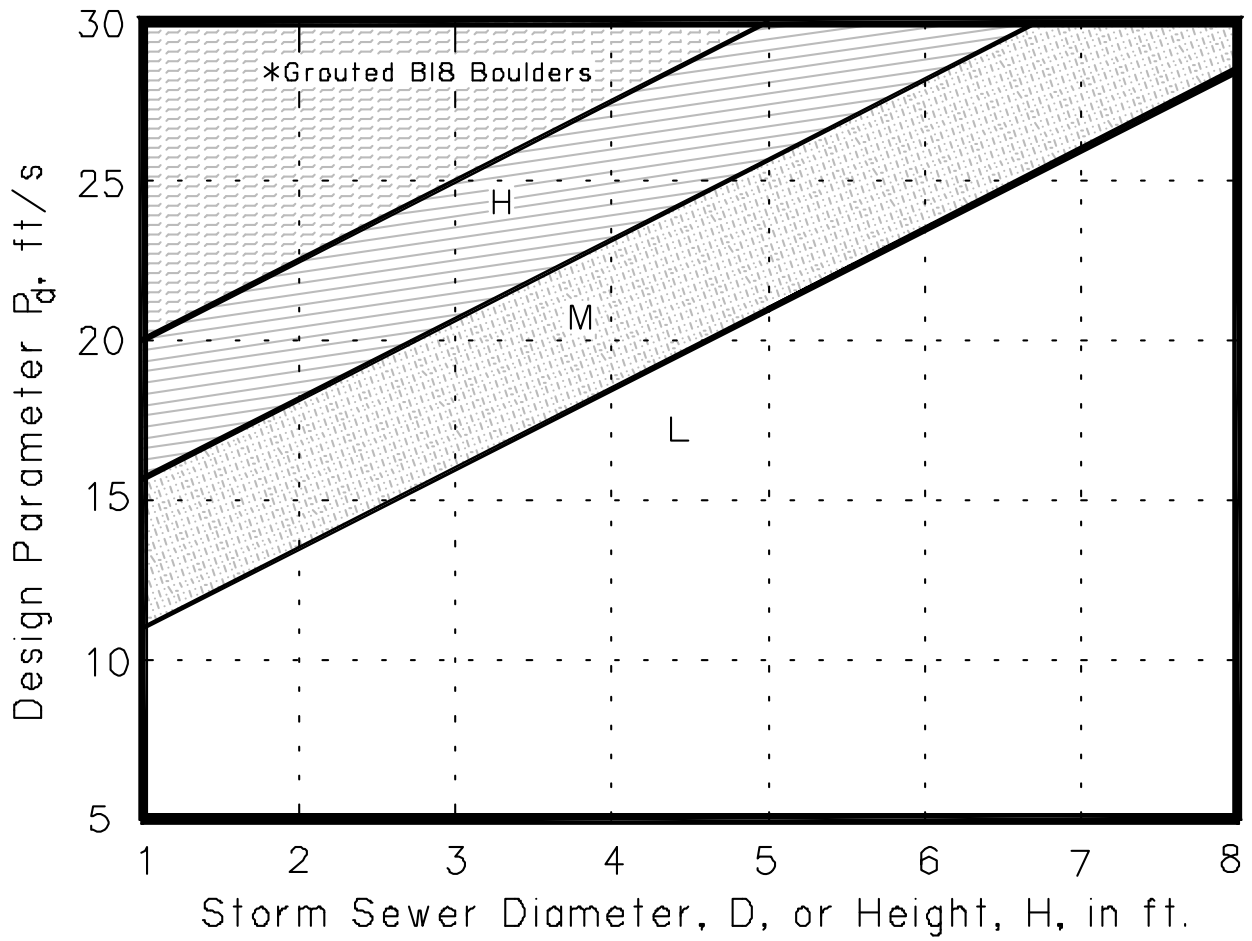

**Figure HS-20c—Low Tailwater Riprap Basins for Storm Sewer Pipe Outlets—
Riprap Selection Chart for Low Tailwater Basin at Pipe Outlet
(Stevens and Urbonas 1996)**

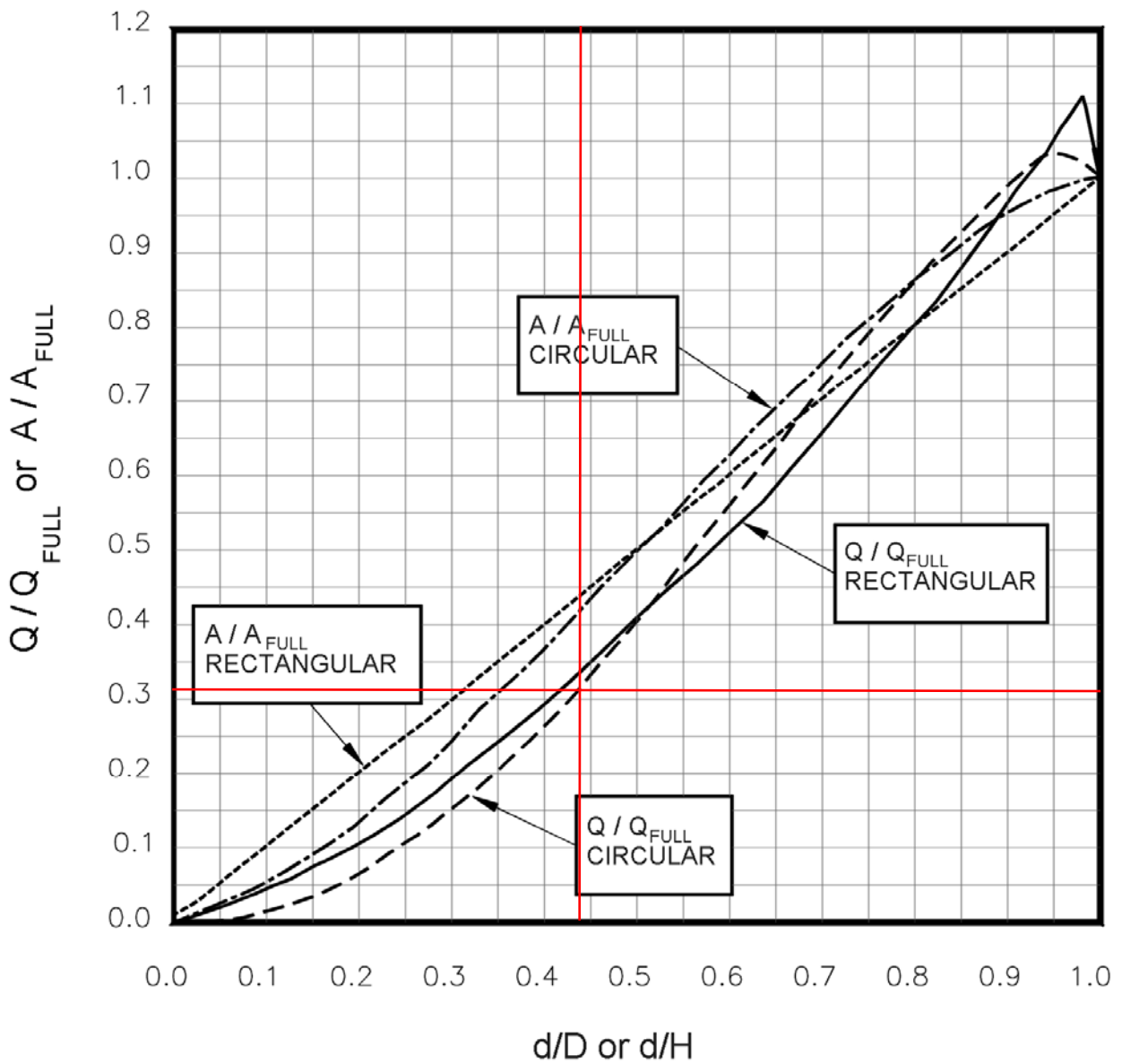

**Figure HS-20a—Low Tailwater Riprap Basins for Storm Sewer Pipe Outlets—
Discharge and Flow Area Relationships for Circular and Rectangular Pipes**
(Ratios for Flow Based on Manning's n Varying With Depth)
(Stevens and Urbonas 1996)

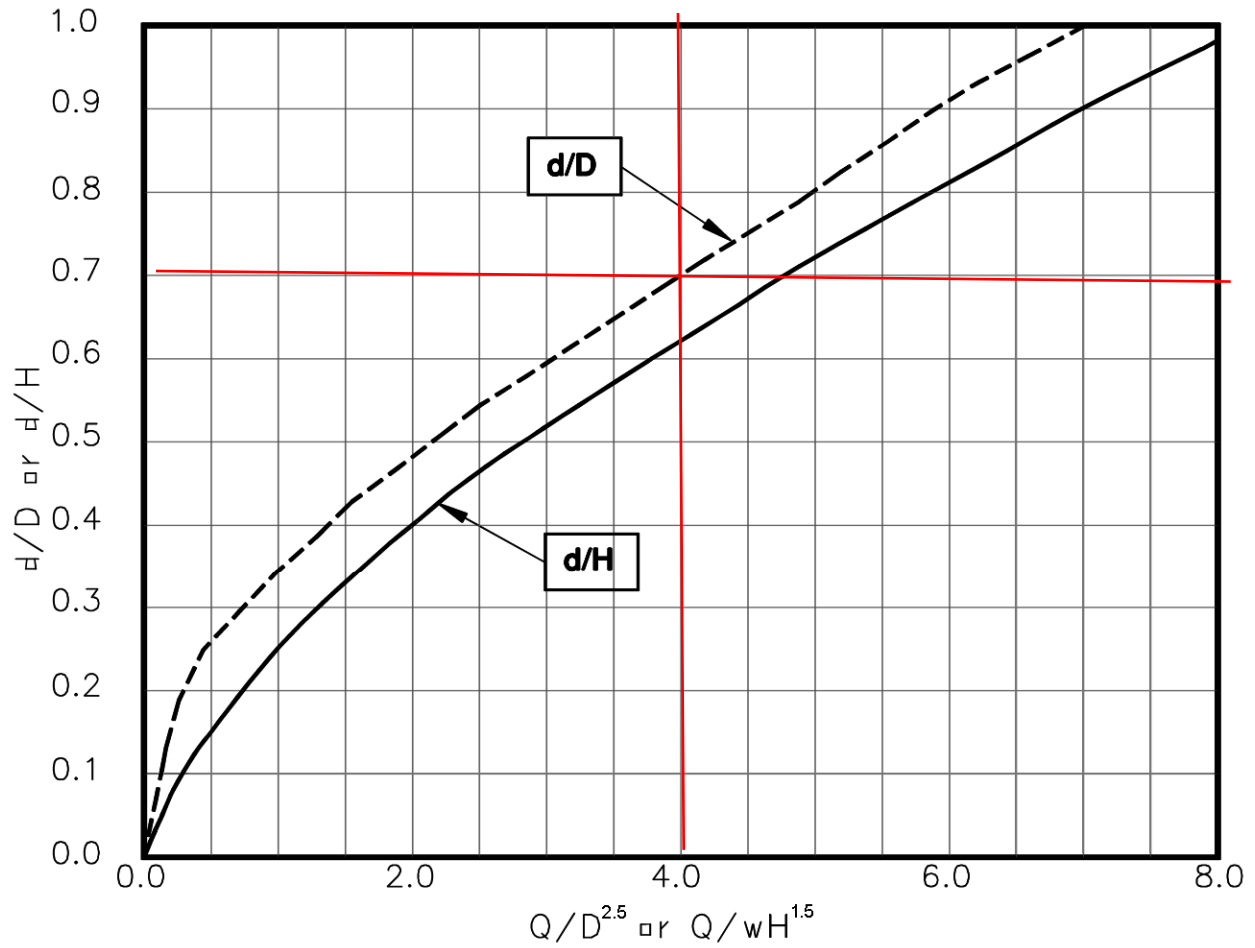

**Figure HS-20b—Low Tailwater Riprap Basins for Storm Sewer Pipe Outlets—
Brink Depth for Horizontal Pipe Outlets**
(Stevens and Urbonas 1996)

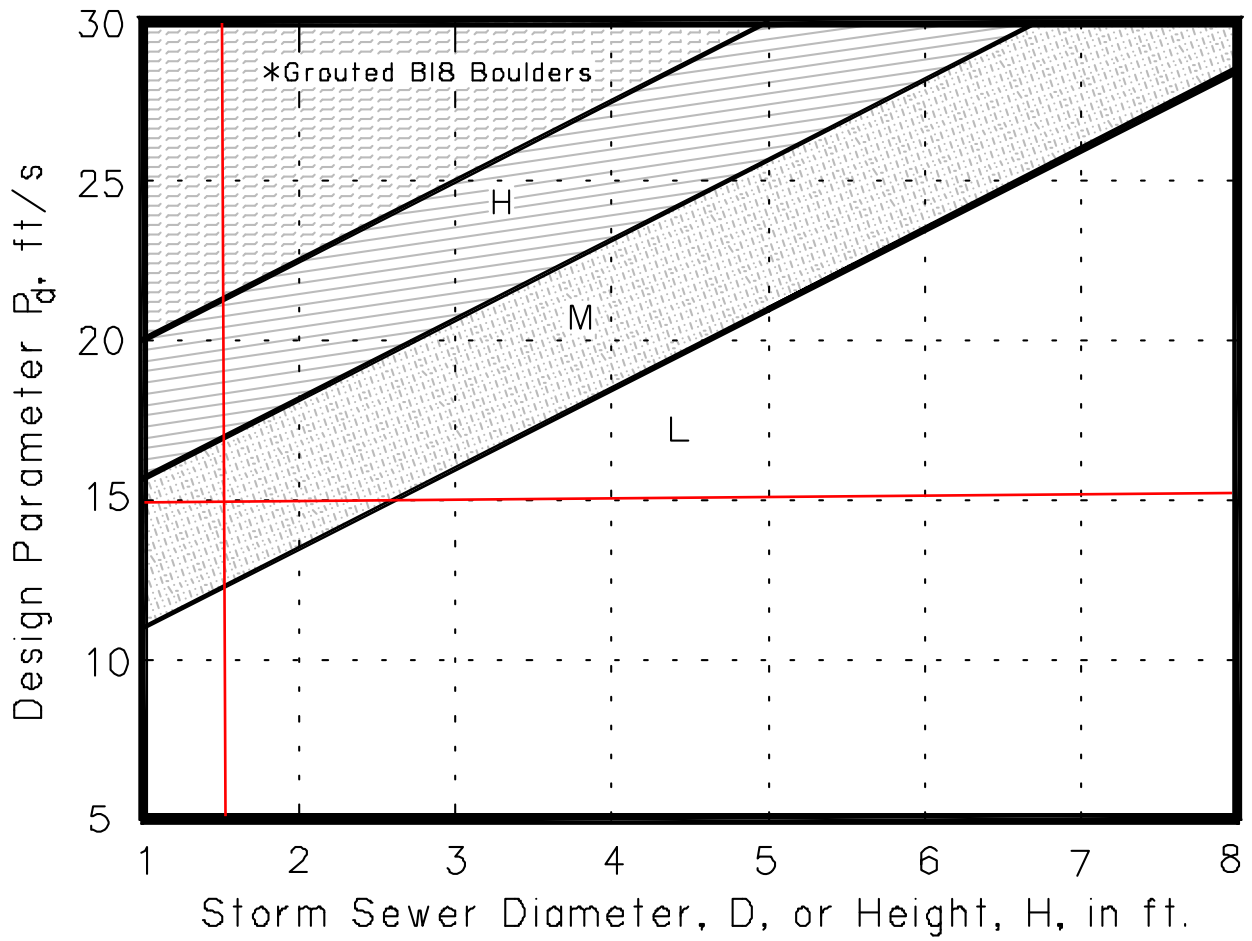

**Figure HS-20c—Low Tailwater Riprap Basins for Storm Sewer Pipe Outlets—
Riprap Selection Chart for Low Tailwater Basin at Pipe Outlet
(Stevens and Urbonas 1996)**

RIP RAP PLUNGE POOL

Urban Drainage & Flood Control District Pipe Outlet Design
Low Tailwater Design ($y_t \leq D/3$)

OUTLET # **OS-1**

Outlet Size (D) :	18	in.	Discharge (q):	11	CFS
Capacity (Q): (full flow)	36	CFS	Flow depth (d): (calculated)	7.9	in.

Q _{full} =	36 CFS	q/Q _{full} =	0.31
A _{full} =	1.8 SF		
V _{full} =	20.4 FPS	Q/D ^{2.5} =	4.0

d/D	0.44	from HS-20a using q/Q _{full}
d/D	0.70	from HS-20b using Q/D ^{2.5}

A' (A/A _{full})	0.44	from HS-20a using smaller d/D from above	Flow Area (a=A' x A _{full})	0.8	SF
------------------------------	------	---	--	-----	----

Outlet Velocity (V = q/a) 14.1 FPS

$P_d = (V^2 + gd)^{1/2} = 15$

RIP-RAP SIZE: **M** from HS-20c

d₅₀ = 12 in T = 1.75 x d₅₀ 1.75 ft

Basin Length (L)	8.7 FT.	Cutoff Wall Depth (B=D/2+T)	2.5	FT
Basin Width (W)	6.0 FT.			

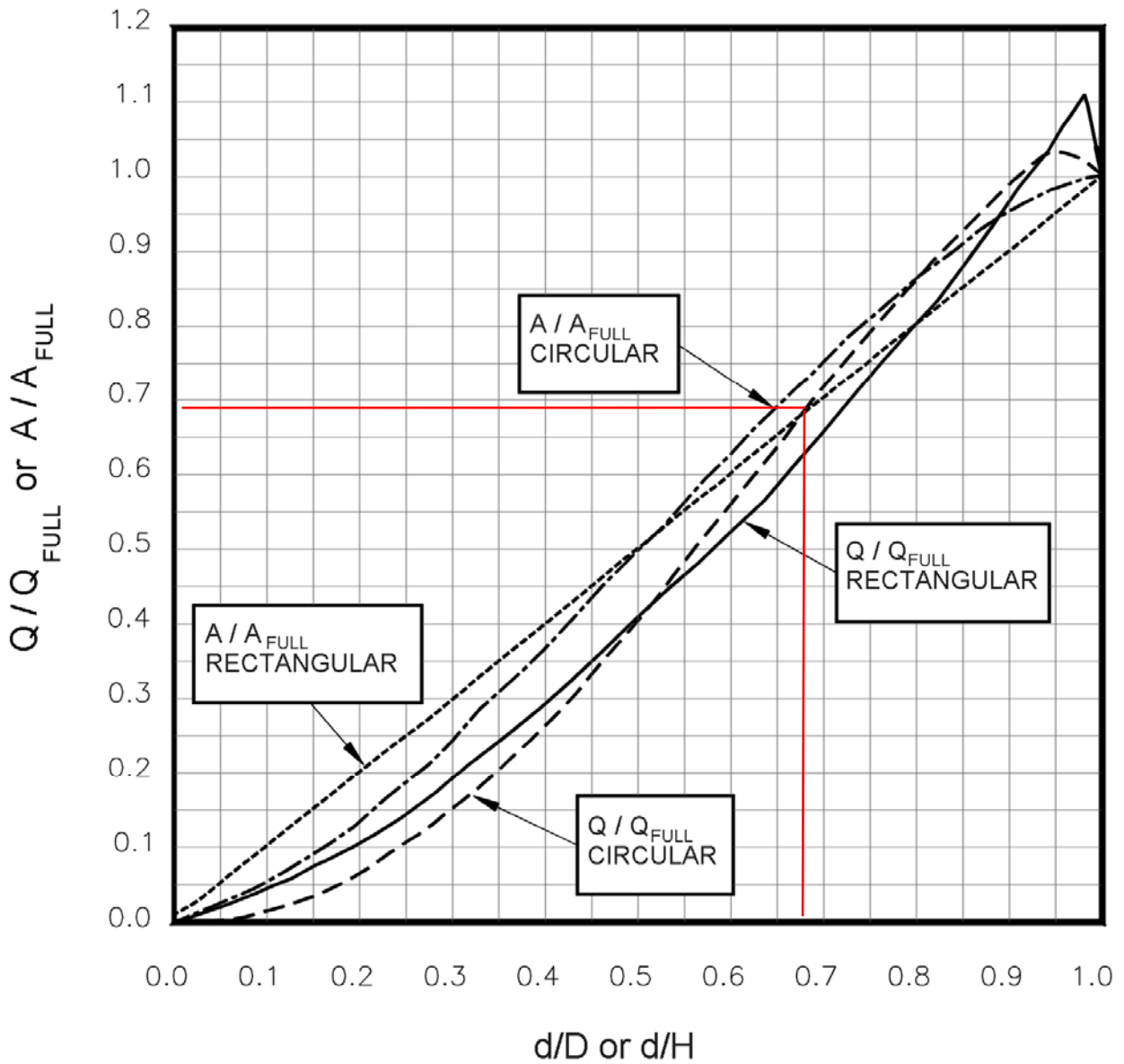

**Figure HS-20a—Low Tailwater Riprap Basins for Storm Sewer Pipe Outlets—
Discharge and Flow Area Relationships for Circular and Rectangular Pipes**
(Ratios for Flow Based on Manning's n Varying With Depth)
(Stevens and Urbonas 1996)

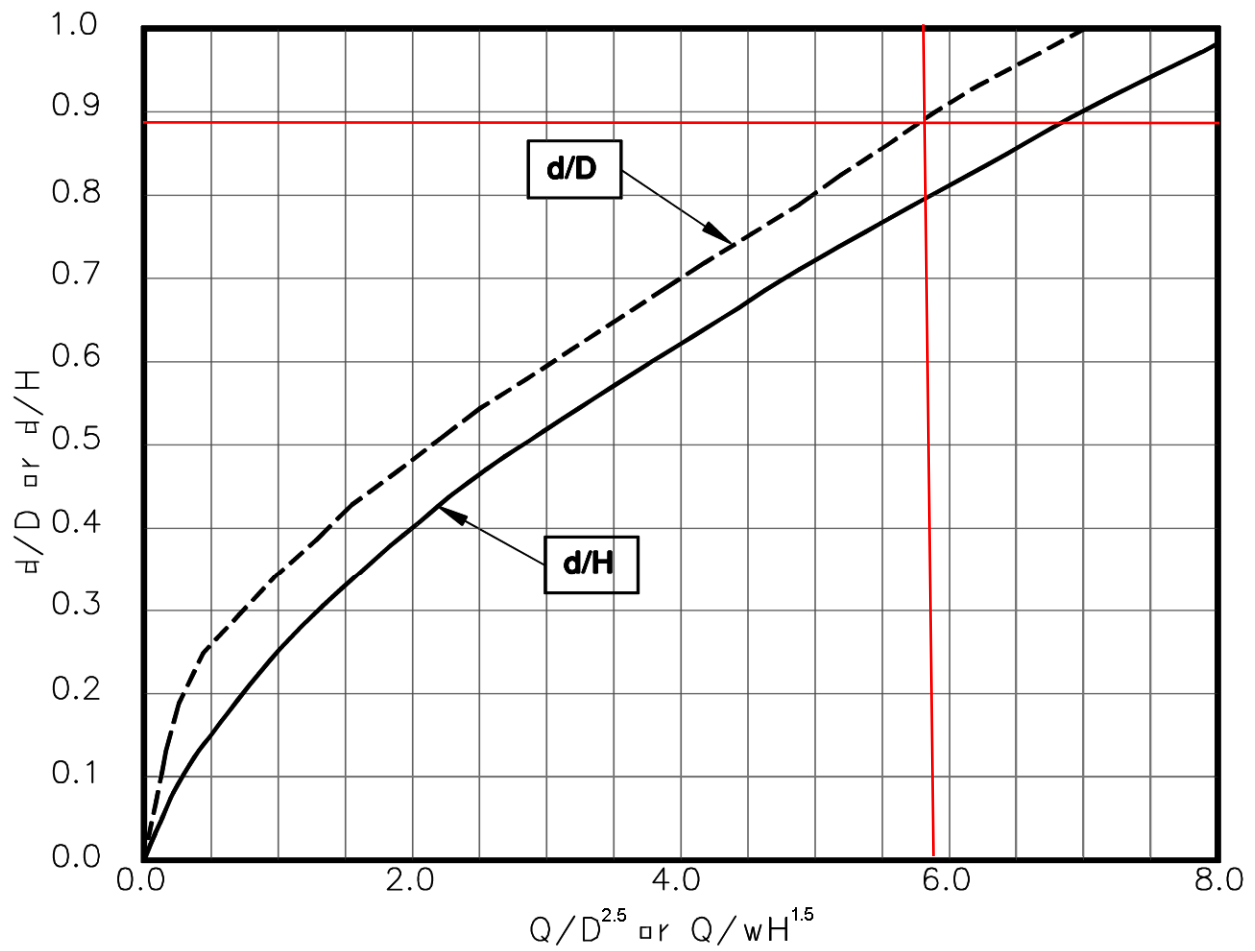

**Figure HS-20b—Low Tailwater Riprap Basins for Storm Sewer Pipe Outlets—
Brink Depth for Horizontal Pipe Outlets**
(Stevens and Urbonas 1996)

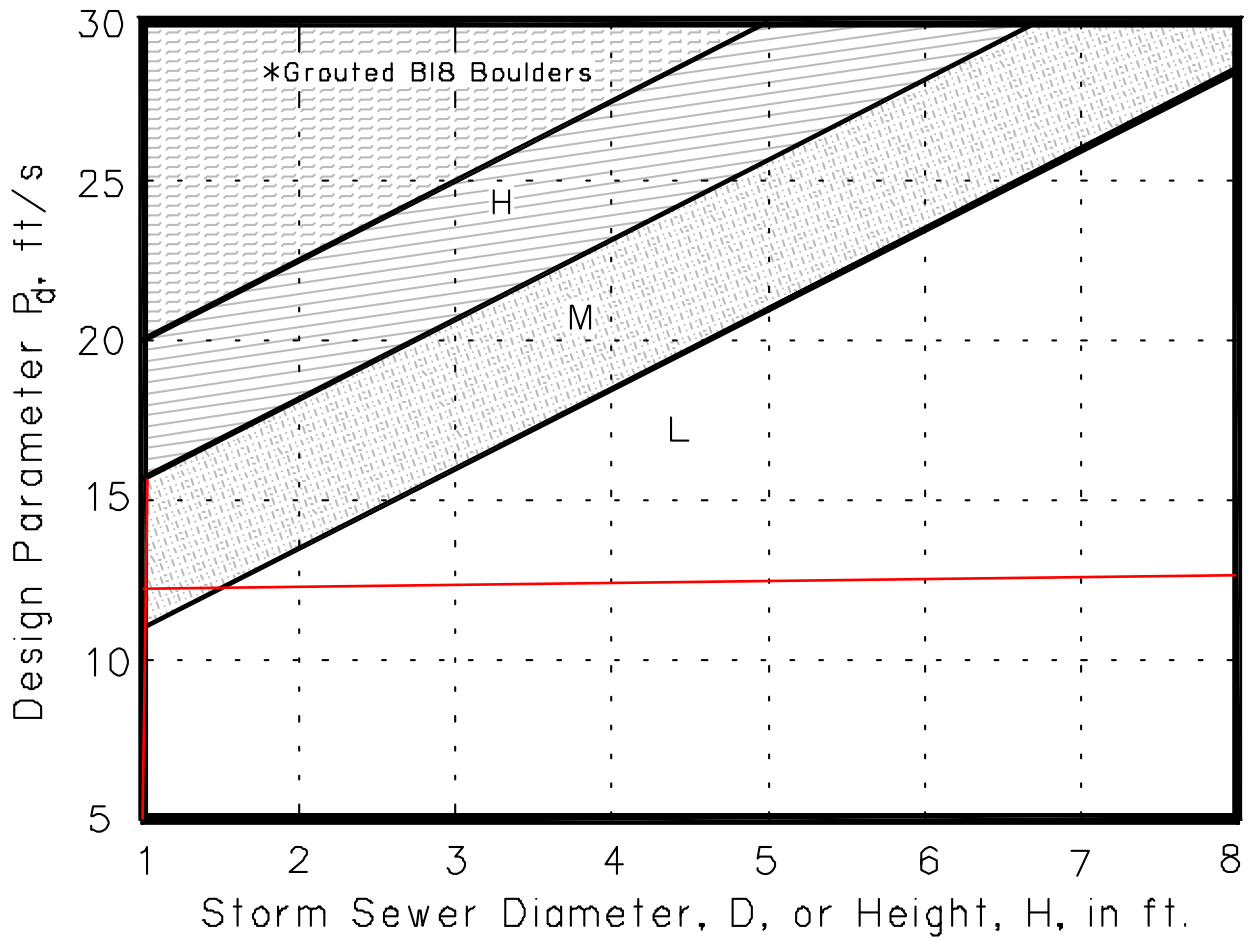

**Figure HS-20c—Low Tailwater Riprap Basins for Storm Sewer Pipe Outlets—
Riprap Selection Chart for Low Tailwater Basin at Pipe Outlet
(Stevens and Urbonas 1996)**

RIP RAP PLUNGE POOL

Urban Drainage & Flood Control District Pipe Outlet Design
 Low Tailwater Design ($y_t \leq D/3$)

OUTLET # **OS-2**

Outlet Size (D) :	12	in.	Discharge (q):	5.9	CFS
Capacity (Q): (full flow)	10	CFS	Flow depth (d): (calculated)	8.2	in.

$Q_{full} =$	10 CFS	$q/Q_{full} =$	0.59
$A_{full} =$	0.8 SF		
$V_{full} =$	12.7 FPS	$Q/D^{2.5} =$	5.9

d/D	0.68	from HS-20a using q/Q_{full}
d/D	0.89	from HS-20b using $Q/D^{2.5}$

A' (A/A_{full})	0.68	from HS-20a using smaller d/D from above	Flow Area ($a=A' \times A_{full}$)	0.5	SF
--------------------------	------	---	---	-----	----

Outlet Velocity (V) = q/a 11.0 FPS

$$P_d = (V^2 + gd)^{1/2} = 12$$

RIP-RAP SIZE: **M** from HS-20c

$$d_{50} = 12 \text{ in} \quad T = 1.75d_{50} = 1.75 \text{ ft}$$

Basin Length (L)	5.5 FT.	Cutoff Wall Depth	2.25	FT
Basin Width (W)	4.0 FT.	($B=D/2+T$)		

Appendix E – Drainageway & Floodplain Information

The following pages contain floodplain information regarding the drainageway adjacent to the project.

A LOMR was approved by FEMA for this area in March 2015, approval found on following pages. The approval designated the swale as a Shaded Flood Zone with average depths of less than 1 ft. (see profile in following pages).

At the same time as the processing of the LOMR through FEMA, Meridian Ranch Filing 8 was processed through El Paso County for approval. Part of the project included improving the drainageway from a shallow natural swale to an engineered trapezoidal channel with protected 4:1 side slopes and drop structures. The new drainageway has a 10 ft bottom providing increased carrying capacity with normal flow depths varying between one and two feet. See the attached appendix from the Final Drainage Report for Meridian Ranch Filing 8 for calculations and more information.

It appears that after the development of subdivisions surrounding the project area, circa 2018, FEMA revised the entirety of the drainageway a Zone AE with a BFE of 7060. Found at the end of this appendix is a FIRMette depicting the current flood hazard area.

The channel bottom adjacent to the project ranges in elevation from roughly elevation 7072 at the downstream end of the project to approximately 7086 at the upstream end. The drainageway has an average depth of 4 feet along the entire frontage of the project and the maximum depth of flow does not exceed 2 feet. The finished floor of the proposed recreation center is 7093.5 and is sufficiently clear of the floodway. There is no proposed fill within the drainageway as a part of this project.

This project does not impact the drainageway, increase nor decrease the flood elevation. The project itself is not impacted by the adjacent drainageway and is not in danger of being subject to the Flood Zone A.



Federal Emergency Management Agency

Washington, D.C. 20472

November 6, 2014

CERTIFIED MAIL
RETURN RECEIPT REQUESTED

The Honorable Dennis Hisey
Chairman, El Paso County Board of Commissioners
200 South Cascade Avenue, Suite 100
Colorado Springs, CO 80903

IN REPLY REFER TO:

Case No.: 14-08-1121P
Follows Conditional Case No.: 05-08-0050R
Community Name: El Paso County, CO
Community No.: 080059
Effective Date of
This Revision: **March 24, 2015**

Dear Mr. Hisey:

The Flood Insurance Study Report and Flood Insurance Rate Map for your community have been revised by this Letter of Map Revision (LOMR). Please use the enclosed annotated map panel(s) revised by this LOMR for floodplain management purposes and for all flood insurance policies and renewals issued in your community.

Additional documents are enclosed which provide information regarding this LOMR. Please see the List of Enclosures below to determine which documents are included. Other attachments specific to this request may be included as referenced in the Determination Document. If you have any questions regarding floodplain management regulations for your community or the National Flood Insurance Program (NFIP) in general, please contact the Consultation Coordination Officer for your community. If you have any technical questions regarding this LOMR, please contact the Director, Mitigation Division of the Department of Homeland Security's Federal Emergency Management Agency (FEMA) in Denver, Colorado, at (303) 235-4830, or the FEMA Map Information eXchange toll free at 1-877-336-2627 (1-877-FEMA MAP). Additional information about the NFIP is available on our website at <http://www.fema.gov/business/nfip>.

Sincerely,

Luis Rodriguez, P.E., Chief
Engineering Management Branch
Federal Insurance and Mitigation Administration

List of Enclosures:

Letter of Map Revision Determination Document
Annotated Flood Insurance Rate Map
Annotated Flood Insurance Study Report

cc: Mr. Keith Curtis
Floodplain Administrator
El Paso County

Mr. Thomas Kerby, P.E.
Project Manager
Tech Contractors

Follows Conditional Case No.: 05-08-0050R



Federal Emergency Management Agency

Washington, D.C. 20472

LETTER OF MAP REVISION DETERMINATION DOCUMENT

COMMUNITY AND REVISION INFORMATION		PROJECT DESCRIPTION	BASIS OF REQUEST
COMMUNITY	El Paso County Colorado (Unincorporated Areas)	CHANNELIZATION CULVERT DETENTION BASIN FILL OTHER	HYDRAULIC ANALYSIS HYDROLOGIC ANALYSIS NEW TOPOGRAPHIC DATA
	COMMUNITY NO.: 080059		
IDENTIFIER	Meridian Ranch	APPROXIMATE LATITUDE & LONGITUDE: 38.977, -104.575 SOURCE: Precision Mapping Streets DATUM: NAD 83	
ANNOTATED MAPPING ENCLOSURES		ANNOTATED STUDY ENCLOSURES	
TYPE: FIRM* NO.: 08041C0575F DATE: March 17, 1997		DATE OF EFFECTIVE FLOOD INSURANCE STUDY: August 23, 1999 SUMMARY OF DISCHARGES TABLE: 3 STILLWATER ELEVATION TABLE: 7	

Enclosures reflect changes to flooding sources affected by this revision.

* FIRM - Flood Insurance Rate Map; ** FBFM - Flood Boundary and Floodway Map; *** FHBM - Flood Hazard Boundary Map

FLOODING SOURCE(S) & REVISED REACH(ES)

See Page 2 for Additional Flooding Sources

Haegler Ranch Tributary 1A - from Eastonville Road to approximately 815 feet upstream of Eastonville Road
Haegler Ranch Tributary 1 - from Eastonville Road to approximately 610 feet upstream of Eastonville Road

SUMMARY OF REVISIONS

Flooding Source	Effective Flooding	Revised Flooding	Increases	Decreases
Haegler Ranch Tributary 1A	Zone A	Zone X (shaded)	YES	YES
Haegler Ranch Tributary 1	Zone A	Zone AE	YES	YES
	No BFEs	BFEs	YES	NONE
	Zone A	Zone A	YES	YES

* BFEs - Base Flood Elevations

DETERMINATION

This document provides the determination from the Department of Homeland Security's Federal Emergency Management Agency (FEMA) regarding a request for a Letter of Map Revision (LOMR) for the area described above. Using the information submitted, we have determined that a revision to the flood hazards depicted in the Flood Insurance Study (FIS) report and/or National Flood Insurance Program (NFIP) map is warranted. This document revises the effective NFIP map, as indicated in the attached documentation. Please use the enclosed annotated map panels revised by this LOMR for floodplain management purposes and for all flood insurance policies and renewals in your community.

This determination is based on the flood data presently available. The enclosed documents provide additional information regarding this determination. If you have any questions about this document, please contact the FEMA Map Information eXchange toll free at 1-877-336-2627 (1-877-FEMA MAP) or by letter addressed to the LOMC Clearinghouse, 847 South Pickett Street, Alexandria, VA 22304-4605. Additional Information about the NFIP is available on our website at <http://www.fema.gov/nfip>.

Luis Rodriguez, P.E., Chief
Engineering Management Branch
Federal Insurance and Mitigation Administration



Federal Emergency Management Agency
Washington, D.C. 20472

**LETTER OF MAP REVISION
DETERMINATION DOCUMENT (CONTINUED)**

OTHER FLOODING SOURCES AFFECTED BY THIS REVISION

FLOODING SOURCE(S) & REVISED REACH(ES)

Haegler Ranch Tributary 2 - from Eastonville Road to approximately 6,820 feet upstream of Eastonville Road

SUMMARY OF REVISIONS

Flooding Source	Effective Flooding	Revised Flooding	Increases	Decreases
Haegler Ranch Tributary 2	Zone A	Zone AE	YES	YES
	Zone A	Zone X (shaded)	NONE	YES
	No BFEs	BFEs	YES	NONE
	Zone A	Zone X (unshaded)	NONE	YES

* BFEs - Base Flood Elevations

This determination is based on the flood data presently available. The enclosed documents provide additional information regarding this determination. If you have any questions about this document, please contact the FEMA Map Information eXchange toll free at 1-877-336-2627 (1-877-FEMA MAP) or by letter addressed to the LOMC Clearinghouse, 847 South Pickett Street, Alexandria, VA 22304-4605. Additional Information about the NFIP is available on our website at <http://www.fema.gov/nfip>.

Luis Rodriguez, P.E., Chief
Engineering Management Branch
Federal Insurance and Mitigation Administration



Federal Emergency Management Agency

Washington, D.C. 20472

LETTER OF MAP REVISION DETERMINATION DOCUMENT (CONTINUED)

COMMUNITY INFORMATION

APPLICABLE NFIP REGULATIONS/COMMUNITY OBLIGATION

We have made this determination pursuant to Section 206 of the Flood Disaster Protection Act of 1973 (P.L. 93-234) and in accordance with the National Flood Insurance Act of 1968, as amended (Title XIII of the Housing and Urban Development Act of 1968, P.L. 90-448), 42 U.S.C. 4001-4128, and 44 CFR Part 65. Pursuant to Section 1361 of the National Flood Insurance Act of 1968, as amended, communities participating in the NFIP are required to adopt and enforce floodplain management regulations that meet or exceed NFIP criteria. These criteria, including adoption of the FIS report and FIRM, and the modifications made by this LOMR, are the minimum requirements for continued NFIP participation and do not supersede more stringent State/Commonwealth or local requirements to which the regulations apply.

NFIP regulations Subparagraph 60.3(b)(7) requires communities to ensure that the flood-carrying capacity within the altered or relocated portion of any watercourse is maintained. This provision is incorporated into your community's existing floodplain management ordinances; therefore, responsibility for maintenance of the altered or relocated watercourse, including any related appurtenances such as bridges, culverts, and other drainage structures, rests with your community. We may request that your community submit a description and schedule of maintenance activities necessary to ensure this requirement.

COMMUNITY REMINDERS

We based this determination on the base (1-percent-annual-chance) flood discharges computed in the submitted hydrologic model. Future development of projects upstream could cause increased discharges, which could cause increased flood hazards. A comprehensive restudy of your community's flood hazards would consider the cumulative effects of development on discharges and could, therefore, indicate that greater flood hazards exist in this area.

Your community must regulate all proposed floodplain development and ensure that permits required by Federal and/or State/Commonwealth law have been obtained. State/Commonwealth or community officials, based on knowledge of local conditions and in the interest of safety, may set higher standards for construction or may limit development in floodplain areas. If your State/Commonwealth or community has adopted more restrictive or comprehensive floodplain management criteria, those criteria take precedence over the minimum NFIP requirements.

We will not print and distribute this LOMR to primary users, such as local insurance agents or mortgage lenders; instead, the community will serve as a repository for the new data. We encourage you to disseminate the information in this LOMR by preparing a news release for publication in your community's newspaper that describes the revision and explains how your community will provide the data and help interpret the NFIP maps. In that way, interested persons, such as property owners, insurance agents, and mortgage lenders, can benefit from the information.

This revision has met our criteria for removing an area from the 1-percent-annual-chance floodplain to reflect the placement of fill. However, we encourage you to require that the lowest adjacent grade and lowest floor (including basement) of any structure placed within the subject area be elevated to or above the Base (1-percent-annual-chance) Flood Elevation.

This determination is based on the flood data presently available. The enclosed documents provide additional information regarding this determination. If you have any questions about this document, please contact the FEMA Map Information eXchange toll free at 1-877-336-2627 (1-877-FEMA MAP) or by letter addressed to the LOMC Clearinghouse, 847 South Pickett Street, Alexandria, VA 22304-4605. Additional Information about the NFIP is available on our website at <http://www.fema.gov/nfip>.

A handwritten signature in black ink, appearing to read "Luis Rodriguez".

Luis Rodriguez, P.E., Chief
Engineering Management Branch
Federal Insurance and Mitigation Administration



Federal Emergency Management Agency

Washington, D.C. 20472

LETTER OF MAP REVISION DETERMINATION DOCUMENT (CONTINUED)

We have designated a Consultation Coordination Officer (CCO) to assist your community. The CCO will be the primary liaison between your community and FEMA. For information regarding your CCO, please contact:

Ms. Jeanine D. Petterson
Director, Mitigation Division
Federal Emergency Management Agency, Region VIII
Denver Federal Center, Building 710
P.O. Box 25267
Denver, CO 80225-0267
(303) 235-4830

STATUS OF THE COMMUNITY NFIP MAPS

We will not physically revise and republish the FIRM and FIS report for your community to reflect the modifications made by this LOMR at this time. When changes to the previously cited FIRM panel(s) and FIS report warrant physical revision and republication in the future, we will incorporate the modifications made by this LOMR at that time.

This determination is based on the flood data presently available. The enclosed documents provide additional information regarding this determination. If you have any questions about this document, please contact the FEMA Map Information eXchange toll free at 1-877-336-2627 (1-877-FEMA MAP) or by letter addressed to the LOMC Clearinghouse, 847 South Pickett Street, Alexandria, VA 22304-4605. Additional information about the NFIP is available on our website at <http://www.fema.gov/nfip>.

A handwritten signature in black ink, appearing to read "Luis Rodriguez".

Luis Rodriguez, P.E., Chief
Engineering Management Branch
Federal Insurance and Mitigation Administration



Federal Emergency Management Agency

Washington, D.C. 20472

LETTER OF MAP REVISION DETERMINATION DOCUMENT (CONTINUED)

PUBLIC NOTIFICATION OF REVISION

A notice of changes will be published in the *Federal Register*. This information also will be published in your local newspaper on or about the dates listed below and through FEMA's Flood Hazard Mapping website at https://www.floodmaps.fema.gov/fhm/Scripts/bfe_main.asp.

LOCAL NEWSPAPER Name: *The Colorado Springs Gazette*
 Dates: November 17, 2014 and November 24, 2014

Within 90 days of the second publication in the local newspaper, a citizen may request that we reconsider this determination. Any request for reconsideration must be based on scientific or technical data. Therefore, this letter will be effective only after the 90-day appeal period has elapsed and we have resolved any appeals that we receive during this appeal period. Until this LOMR is effective, the revised flood hazard determination information presented in this LOMR may be changed.

This determination is based on the flood data presently available. The enclosed documents provide additional information regarding this determination. If you have any questions about this document, please contact the FEMA Map Information eXchange toll free at 1-877-336-2627 (1-877-FEMA MAP) or by letter addressed to the LOMC Clearinghouse, 847 South Pickett Street, Alexandria, VA 22304-4605. Additional Information about the NFIP is available on our website at <http://www.fema.gov/nfip>.

A handwritten signature in black ink, appearing to read "Luis Rodriguez".

Luis Rodriguez, P.E., Chief
Engineering Management Branch
Federal Insurance and Mitigation Administration

Table 7. Summary of Stillwater Elevations

<u>Flooding Source</u>	Elevation (Feet NGVD ¹)			
	<u>10-Year</u>	<u>50-Year</u>	<u>100-Year</u>	<u>500-Year</u>
Pond D	--	--	7,055.5	--
Pond E	--	--	6,971.3	--

¹National Geodetic Vertical Datum of 1929

**REVISED TO
REFLECT LOMR
EFFECTIVE: March 24, 2015**

Table 3. Summary of Discharges (Cont'd)

Flooding Source and Location	Drainage Area (square miles)	Peak Discharges (Cubic Feet per Second)			
		10-Year	50-Year	100-Year	500-Year
Fisher's Canyon-Above Loomis Avenue At West Meadow Drive	3.59	-- ¹	-- ¹	1,640	-- ¹
Upstream of Fisher's Canyon-South Branch	2.36	-- ¹	-- ¹	440	-- ¹
Fiaher's Canyon-South Branch At confluence with Fisher's Canyon	1.23	-- ¹	-- ¹	1,290	-- ¹
Fountain Creek					
At El Paso-Pueblo County Line	772.0	21,300	64,000	93,000	215,000
Downstream of confluence with Sand Creek	456.0	12,700	38,000	57,000	132,000
Downstream of confluence with Monument Creek	358.0	9,200	28,500	42,200	98,000
Upstream of confluence with Monument Creek	120.0	4,400	14,000	20,500	47,000
Upstream of City of Colorado Springs corporate limits	71.0	3,750	11,800	17,100	40,000
At El Paso-Teller County Line	7.8	2,200	5,800	7,500	14,000
Franceville Tributary to Jimmy Camp Creek At confluence with Jimmy Camp Creek	4.1	1,700	2,800	3,500	4,300
Haegler Ranch Tributary 1 At Eastonville Road	0.96	-- ¹	-- ¹	80	-- ¹
Haegler Ranch Tributary 1A At Eastonville Road	0.07	-- ¹	-- ¹	70	-- ¹
Haegler Ranch Tributary 2 At Eastonville Road	0.96	-- ¹	-- ¹	40	-- ¹
Jimmy Camp Creek At confluence with Fountain Creek	66.4	8,500	12,400	16,000	20,500
Jimmy Camp Creek East Tributary At confluence with Jimmy Camp Creek	9.2	2,800	4,600	5,500	6,900
Jimmy Camp Creek West Tributary At confluence with Jimmy Camp Creek	3.93	1,160	2,280	2,780	4,500
Kettle Creek At State Highway 83	16.3	2,600	6,600	9,300	19,300

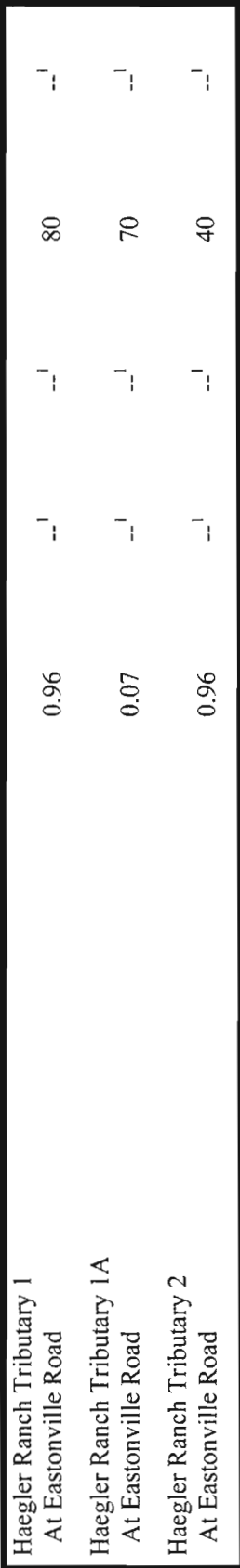



REVISED
DATA

REVISED TO
REFLECT LOMR
EFFECTIVE: March 24, 2015

¹Data not available

Legend

-  1% annual chance (100-Year) Floodplain
-  1% annual chance (100-Year) Floodway
-  0.2% annual chance (500-Year) Floodplain



APPROXIMATE SCALE IN FEET

NATIONAL FLOOD INSURANCE PROGRAM

FIRM
 FLOOD INSURANCE RATE MAP

EL PASO COUNTY,
 COLORADO AND
 INCORPORATED AREAS

PANEL 0575 OF 1300
 (SEE MAP INDEX FOR PANELS NOT PRINTED)

CONTAINS:

COMMUNITY	NUMBER	PANEL SUFFIX
EL PASO COUNTY, INCORPORATED AREAS	080059	0575 F
CITY OF GOOD SPRINGS	080060	0575 F

REVISED TO REFLECT LOMR EFFECTIVE: March 24, 2015

MAP NUMBER
 08041C0575 F

EFFECTIVE DATE:
 MARCH 17, 1997



Federal Emergency Management Agency

NOTE: MAP AREA SHOWN ON THIS PANEL IS LOCATED WITHIN TOWNSHIP 12 SOUTH, RANGE 64 WEST AND TOWNSHIP 13 SOUTH, RANGE 65 WEST.

JOINS PANEL 0350

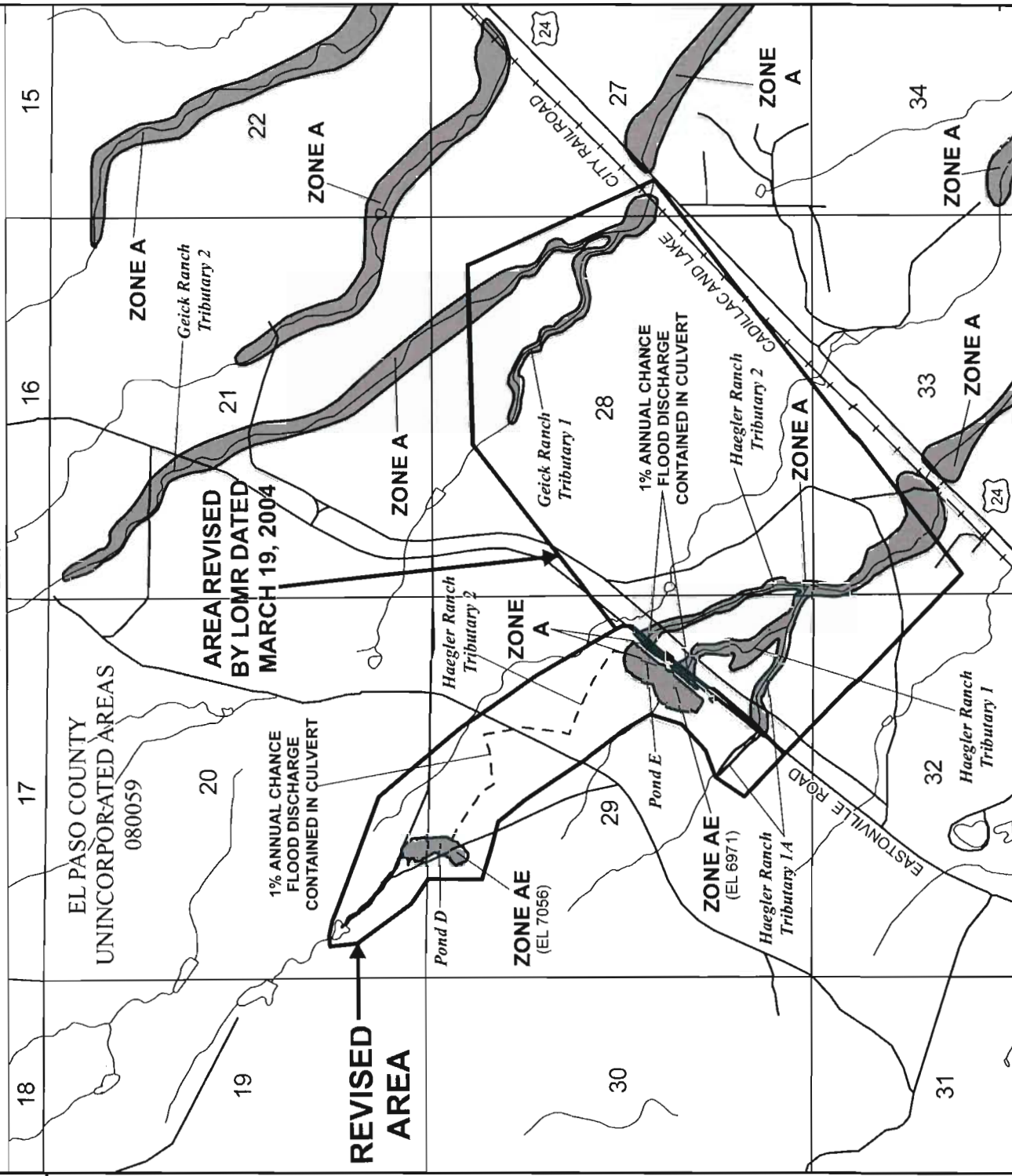

TOPOGRAPHY COMPILED USING DATA FROM SURVEY PERFORMED BY RIDGELINE LAND SURVEYING, INC.
 AS-BUILT INFORMATION IN THE AREA OF POND D: NOV. 2012.
 POND E: MAR. 2014.
 ELEVATIONS BASED ON THE NGVD 29.

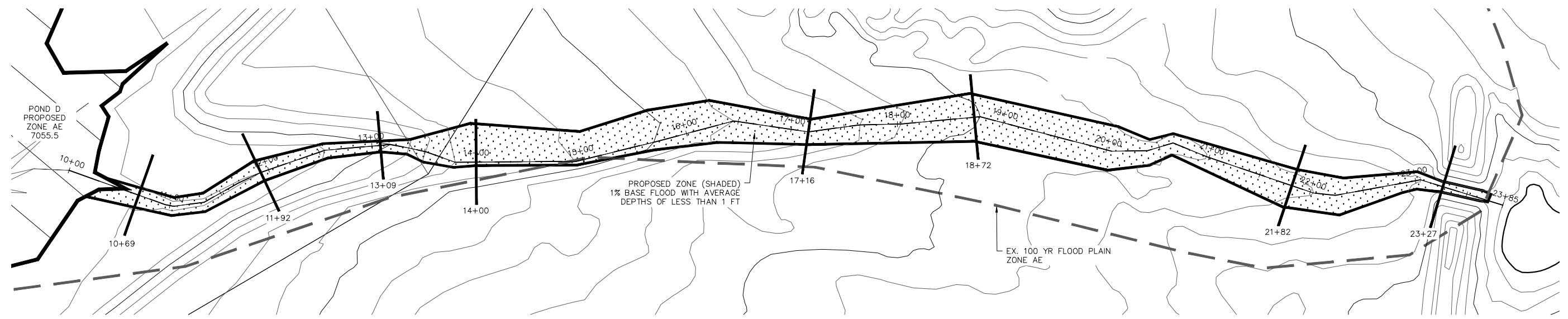

CROSS SECTIONS
 ORIENTED LEFT TO RIGHT
 FACING UPSTREAM

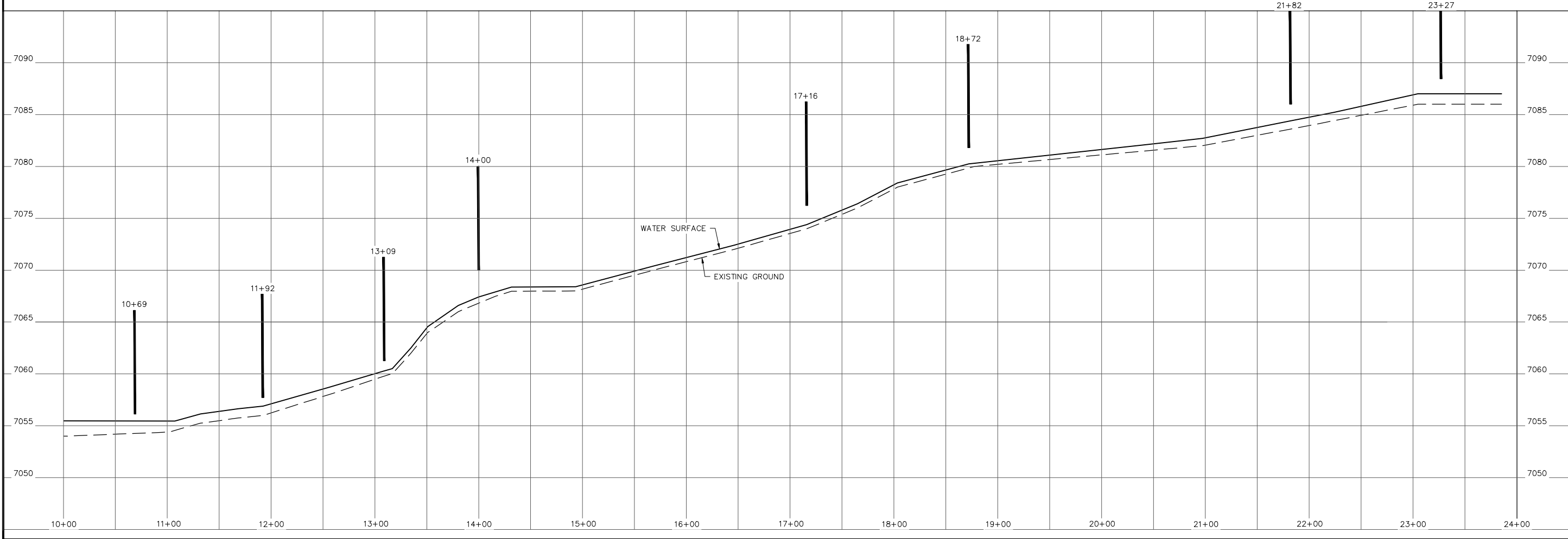
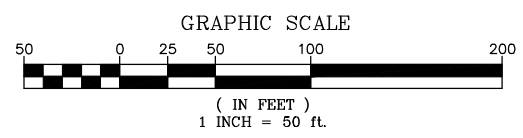

No.	Revisions	Date	Instr.	Appr.	Date

TECH CONTRACTORS
 12311 REX ROAD
 FALCON, CO 80831
 TELEPHONE: 719.495.7444
 FAX: 719.495.2457

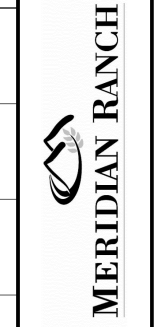

MERIDIAN RANCH
 LETTER OF MAP REVISION
 TRIBUTARY 2 AT POND D

Scale	Drawn by	Tak	Checked by	RG	Date	OCT 2014
	AS SHOWN	4	of	4		

S:\drawing\CONTRACTOR\Drawings\SWALE PLAN AND PROFILES.dwg, 10/12/2014 4:46:49 PM

Preliminary/Final Drainage Report
for
Meridian Ranch Filing 8



EL PASO COUNTY, COLORADO

December 2014

Prepared For:

GTL DEVELOPMENT, INC.
P.O. Box 80036
San Diego, CA 92138

Prepared By:
Tech Contractors
12311 Rex Road
Falcon, CO 80831
719.495.7444

Appendix E – Channel Design

**STORM DRAINAGE SYSTEM DESIGN
(RATIONAL METHOD PROCEDURE)
SURFACE ROUTING**

Date: 11/25/2014
EL PASO COUNTY

PROJECT: Meridian Ranch Filing 8

DESIGN POINT	DIRECT RUNOFF							TOTAL RUNOFF							OVERLAND TRAVEL TIME								
	Tc (Min.)	I (in./hr.)		CA		Q		Sum Tc (min.)	I (in./hr.)		CA		Q		DITCH OR GUTTER	ROUGHNESS	DESTINATION DP	SLOPE %	LENGTH (FT)	VEL. (FPS)	TRAVEL TIME (T)		
		(5 YR)	(100 YR)	(5 YR)	(100 YR)	(5 YR)	(100 YR)		(5 YR)	(100 YR)	(5 YR)	(100 YR)	(5 YR)	(100 YR)									
OS-1	34.4	2.07	3.83	12.05	16.03	25	61							25	61	D	0.030	DP3	1.50%	665	4.6	2.4	
OS-2	20.5	2.78	5.14	4.95	6.71	14	34							14	34	D	0.030	DP3	1.00%	30	3.5	0.1	
FG10-A	26.1	2.43	4.51	5.22	7.93	13	36							13	36								
DP3								36.8	1.98	3.68	22.22	30.66	44	113	D	0.030	DP4	1.00%	400	4.7	1.4		
OS-3	22.1	2.66	4.94	3.60	4.30	10	21							10	21	D	0.030	DP4	1.00%	30	3.1	0.2	
DP4								38.2	1.94	3.59	25.81	34.97	50	126	D	0.030	DP5	1.00%	245	4.8	0.8		
FG10-B	32.3	2.15	3.98	5.75	6.90	12	27							12	27								
OS-4	27.7	2.35	4.36	18.03	23.03	42	100							42	100	D	0.030	DP5	1.00%	42	5.1	0.1	
DP5								39.1	1.91	3.54	49.59	64.89	95	230	D	0.030	DP6	1.00%	532	6.2	1.4		
OS-6	41.1	1.85	3.43	14.64	19.25	27	66							27	66	D	0.030	DP6	1.00%	27	4.3	0.1	
FG10-C	28.1	2.33	4.32	16.95	21.39	40	92							40	92								
DP6								41.2	1.85	3.42	81.18	105.53	150	361	D	0.030	DP7	1.00%	435	7.0	1.0		
DP7								42.2	1.82	3.37	81.18	105.53	148	356	D	0.030	POND D	4.50%	360	12.0	0.5		

FLOWMASTER CHANNEL RESULTS					
OS-1 To DP3			OS-4 TO DP5		
Roughness	0.03	Mannings n	Roughness	0.03	Mannings n
Channel Slope	1.50%	ft/ft	Channel Slope	1.00%	ft/ft
Normal Depth	0.89	ft/ft	Normal Depth	1.57	ft/ft
Side Slopes	6	ft/ft	Side Slopes	4	ft/ft
Bottom Width	10	ft/ft	Bottom Width	6.5	ft/ft
Discharge	62	ft ³ /s	Discharge	101	ft ³ /s
Velocity	4.57	ft/s	Velocity	5.05	ft/s
Critical Depth	0.88	ft	Critical Depth	1.45	ft
Top Width	20.64	ft	Top Width	19.03	ft
OS-2 TO DP3			DP5 TO DP6		
Roughness	0.03	Mannings n	Roughness	0.03	Mannings n
Channel Slope	1.02%	ft/ft	Channel Slope	1.00%	ft/ft
Normal Depth	0.92	ft/ft	Normal Depth	2.06	ft/ft
Side Slopes	6	ft/ft	Side Slopes	4	ft/ft
Bottom Width	5	ft/ft	Bottom Width	10	ft/ft
Discharge	34	ft ³ /s	Discharge	232	ft ³ /s
Velocity	3.51	ft/s	Velocity	6.17	ft/s
Critical Depth	0.82	ft	Critical Depth	1.96	ft
Top Width	16.04	ft	Top Width	26.48	ft
DP3 TO DP4			OS-6 TO DP6		
Roughness	0.03	Mannings n	Roughness	0.03	Mannings n
Channel Slope	1.00%	ft/ft	Channel Slope	1.00%	ft/ft
Normal Depth	1.34	ft/ft	Normal Depth	1.07	ft/ft
Side Slopes	6	ft/ft	Side Slopes	4	ft/ft
Bottom Width	10	ft/ft	Bottom Width	10	ft/ft
Discharge	114	ft ³ /s	Discharge	66	ft ³ /s
Velocity	4.69	ft/s	Velocity	4.31	ft/s
Critical Depth	1.24	ft	Critical Depth	0.97	ft
Top Width	26.14	ft	Top Width	18.57	ft
OS-3 TO DP4			DP6 TO DP7		
Roughness	0.03	Mannings n	Roughness	0.03	Mannings n
Channel Slope	1.00%	ft/ft	Channel Slope	1.00%	ft/ft
Normal Depth	0.78	ft/ft	Normal Depth	2.57	ft/ft
Side Slopes	6	ft/ft	Side Slopes	4	ft/ft
Bottom Width	4	ft/ft	Bottom Width	10	ft/ft
Discharge	21	ft ³ /s	Discharge	363	ft ³ /s
Velocity	3.12	ft/s	Velocity	6.97	ft/s
Critical Depth	0.68	ft	Critical Depth	2.49	ft
Top Width	13.32	ft	Top Width	30.55	ft
DP4 TO DP5			DP7 TO POND D		
Roughness	0.03	Mannings n	Roughness	0.03	Mannings n
Channel Slope	1.00%	ft/ft	Channel Slope	4.50%	ft/ft
Normal Depth	1.42	ft/ft	Normal Depth	1.75	ft/ft
Side Slopes	6	ft/ft	Side Slopes	4	ft/ft
Bottom Width	10	ft/ft	Bottom Width	10	ft/ft
Discharge	127	ft ³ /s	Discharge	358	ft ³ /s
Velocity	4.83	ft/s	Velocity	12	ft/s
Critical Depth	1.31	ft	Critical Depth	2.47	ft
Top Width	27.03	ft	Top Width	24.03	ft

Rip Rap Outlet Protection Design

<p>OS-01</p> <p>Q = 62 cfs Circular 36 Dia. (in)</p> <p>TW = 12.0 Tailwater (in) Box Culvert</p> <table style="margin-left: 200px;"> <tr><td style="width: 50px; height: 20px;"></td><td>Height (in)</td></tr> <tr><td style="width: 50px; height: 20px;"></td><td>Width (in)</td></tr> </table> <p>TYPE: Circular</p> <p>HYDRAULIC CHARACTERISTICS</p> <p>33.00 Normal Depth (in)</p> <p>$Y_o/D = 0.69$ 0.70</p> <p>TW/$Y_o = 0.48$ LOW TAILWATER DEPTH</p> <p>$Y_o = 24.84$ Brink Depth (in)</p> <p>A = 749 Brink Area (sq in)</p> <p>5.2 Brink Area (sf)</p> <p>$V_o = 11.9$ Brink Velocity (fps)</p> <p>$Y_c = 1.61$ Equivalent Brink Depth (ft)</p> <p>F = 1.65 Froude</p> <p>Supercritical Test: Supercritical</p> <p>D = 30.4</p> <table style="margin-left: 20px;"> <tr><td>$Q/D^{2.5} = 3.98$</td><td>Rounded: 4.00</td></tr> <tr><td>$Q/D^{1.5} = 15.36$</td><td>Rounded: 15.35</td></tr> <tr><td>TW/D = 0.33</td><td>Rounded: 0.35</td></tr> <tr><td>If TW unknown use: 0.40</td><td>TW: 1.00</td></tr> </table>		Height (in)		Width (in)	$Q/D^{2.5} = 3.98$	Rounded: 4.00	$Q/D^{1.5} = 15.36$	Rounded: 15.35	TW/D = 0.33	Rounded: 0.35	If TW unknown use: 0.40	TW: 1.00	<p style="text-align: center;">RIP-RAP SIZING</p> <div style="border: 1px solid black; padding: 5px; margin: 5px;"> $\text{Rip-Rap Sizing} = \frac{\left(\frac{d_{50}}{D}\right) \left(\frac{TW}{D}\right)^{1.2}}{\left(\frac{Q}{D^{2.5}}\right)}$ </div> <table border="1" style="margin: 5px auto; border-collapse: collapse;"> <tr><td style="padding: 2px;">$d_{50} =$</td><td style="padding: 2px;">12</td><td style="padding: 2px;">inch</td></tr> <tr><td style="padding: 2px;">Rip-rap Type:</td><td colspan="2" style="padding: 2px;">M</td></tr> </table> <p style="text-align: center;">EXTENT OF PROTECTION</p> <div style="border: 1px solid black; padding: 5px; margin: 5px;"> $L_p = \left(\frac{1}{2\tan\theta}\right) \left(\frac{A_r}{TW} - W\right)$ </div> <p>$L_p =$ Length of Protection</p> <p>W = Width of the conduit</p> <p>TW = Tailwater depth</p> <p>$\theta =$ Expansion angle of the culvert flow</p> <p>$A_r =$ Required area of flow at allowable velocity</p> <p>$A_r = 11.3$ sf</p> <table style="margin-left: 20px;"> <tr><td>$\frac{1}{2\tan\theta}$</td><td>Expansion Factor</td><td>2.84</td></tr> </table> <p>$L_p = 23$</p>	$d_{50} =$	12	inch	Rip-rap Type:	M		$\frac{1}{2\tan\theta}$	Expansion Factor	2.84
	Height (in)																					
	Width (in)																					
$Q/D^{2.5} = 3.98$	Rounded: 4.00																					
$Q/D^{1.5} = 15.36$	Rounded: 15.35																					
TW/D = 0.33	Rounded: 0.35																					
If TW unknown use: 0.40	TW: 1.00																					
$d_{50} =$	12	inch																				
Rip-rap Type:	M																					
$\frac{1}{2\tan\theta}$	Expansion Factor	2.84																				

Rip Rap Outlet Protection Design

<p>OS-02</p> <p>Q = 34 cfs Circular 30 Dia. (in)</p> <p>TW = 12.0 Tailwater (in) Box Culvert</p> <table style="margin-left: 200px;"> <tr><td style="width: 50px; height: 20px;"></td><td>Height (in)</td></tr> <tr><td style="width: 50px; height: 20px;"></td><td>Width (in)</td></tr> </table> <p>TYPE: Circular</p> <p>HYDRAULIC CHARACTERISTICS</p> <p>21.00 Normal Depth (in)</p> <p>$Y_o/D = 0.65$ 0.65</p> <p>TW/$Y_o = 0.62$ LOW TAILWATER DEPTH</p> <p>$Y_o = 19.50$ Brink Depth (in)</p> <p>A = 486 Brink Area (sq in)</p> <p>3.4 Brink Area (sf)</p> <p>$V_o = 10.1$ Brink Velocity (fps)</p> <p>$Y_c = 1.30$ Equivalent Brink Depth (ft)</p> <p>F = 1.56 Froude</p> <p>Supercritical Test: Supercritical</p> <p>D = 24.8</p> <table style="margin-left: 20px;"> <tr><td>$Q/D^{2.5} = 3.44$</td><td>Rounded: 3.50</td></tr> <tr><td>$Q/D^{1.5} = 11.48$</td><td>Rounded: 11.50</td></tr> <tr><td>TW/D = 0.40</td><td>Rounded: 0.40</td></tr> <tr><td>If TW unknown use: 0.40</td><td>TW: 1.00</td></tr> </table>		Height (in)		Width (in)	$Q/D^{2.5} = 3.44$	Rounded: 3.50	$Q/D^{1.5} = 11.48$	Rounded: 11.50	TW/D = 0.40	Rounded: 0.40	If TW unknown use: 0.40	TW: 1.00	<p style="text-align: center;">RIP-RAP SIZING</p> <div style="border: 1px solid black; padding: 5px; margin: 5px;"> $\text{Rip-Rap Sizing} = \frac{\left(\frac{d_{50}}{D}\right) \left(\frac{TW}{D}\right)^{1.2}}{\left(\frac{Q}{D^{2.5}}\right)}$ </div> <table border="1" style="margin: 5px auto; border-collapse: collapse;"> <tr><td style="padding: 2px;">$d_{50} =$</td><td style="padding: 2px;">9</td><td style="padding: 2px;">inch</td></tr> <tr><td style="padding: 2px;">Rip-rap Type:</td><td colspan="2" style="padding: 2px;">L</td></tr> </table> <p style="text-align: center;">EXTENT OF PROTECTION</p> <div style="border: 1px solid black; padding: 5px; margin: 5px;"> $L_p = \left(\frac{1}{2\tan\theta}\right) \left(\frac{A_r}{TW} - W\right)$ </div> <p>$L_p =$ Length of Protection</p> <p>W = Width of the conduit</p> <p>TW = Tailwater depth</p> <p>$\theta =$ Expansion angle of the culvert flow</p> <p>$A_r =$ Required area of flow at allowable velocity</p> <p>$A_r = 6.2$ sf</p> <table style="margin-left: 20px;"> <tr><td>$\frac{1}{2\tan\theta}$</td><td>Expansion Factor</td><td>3.98</td></tr> </table> <p>$L_p = 15$</p>	$d_{50} =$	9	inch	Rip-rap Type:	L		$\frac{1}{2\tan\theta}$	Expansion Factor	3.98
	Height (in)																					
	Width (in)																					
$Q/D^{2.5} = 3.44$	Rounded: 3.50																					
$Q/D^{1.5} = 11.48$	Rounded: 11.50																					
TW/D = 0.40	Rounded: 0.40																					
If TW unknown use: 0.40	TW: 1.00																					
$d_{50} =$	9	inch																				
Rip-rap Type:	L																					
$\frac{1}{2\tan\theta}$	Expansion Factor	3.98																				

Rip Rap Outlet Protection Design

OS-03		Circular	
Q	21	cfs	24
			Dia. (in)
TW	9.0	Tailwater (in)	Box Culvert
			Height (in)
			Width (in)
TYPE: Circular			
HYDRAULIC CHARACTERISTICS			
	12.00	Normal Depth (in)	
$Y_o/D =$	0.65		0.65
$TW/Y_o =$	0.75	HIGH	TAILWATER DEPTH
$Y_o =$	12.00	Brink Depth (in)	
$A =$	226	Brink Area (sq in)	
	1.6	Brink Area (sf)	
$V_o =$	13.4	Brink Velocity (fps)	
$Y_c =$	0.89	Equivalent Brink Depth (ft)	
$F =$	2.50	Froude	
Supercritical Test: Supercritical			
$D =$	18.0		
$Q/D^{2.5} =$	3.71	Rounded:	3.50
$Q/D^{1.5} =$	11.43	Rounded:	11.45
$TW/D =$	0.38	Rounded:	0.40
If TW unknown use:	0.40	TW:	0.75

RIP-RAP SIZING	
$\text{Rip-Rap Sizing} = \frac{\left(\frac{d_{50}}{D}\right) \left(\frac{TW}{D}\right)^{1.2}}{\left(\frac{Q}{D^{2.5}}\right)}$	
$d_{50} =$	9 inch
Rip-rap Type:	L
EXTENT OF PROTECTION	
$L_p = \left(\frac{1}{2 \tan \theta}\right) \left(\frac{A_i}{TW} - W\right)$	
$L_p =$	Length of Protection
$W =$	Width of the conduit
$TW =$	Tailwater depth
$\theta =$	Expansion angle of the culvert flow
$A_i =$	Required area of flow at allowable velocity
$A_i =$	3.8 sf
$\frac{1}{2 \tan \theta}$	Expansion Factor 3.98
$L_p =$	12

Rip Rap Outlet Protection Design

OS-04		Circular	
Q	101	cfs	42
			Dia. (in)
TW	19.0	Tailwater (in)	Box Culvert
			Height (in)
			Width (in)
TYPE: Circular			
HYDRAULIC CHARACTERISTICS			
	24.00	Normal Depth (in)	
$Y_o/D =$	0.77		0.75
$TW/Y_o =$	0.79	HIGH	TAILWATER DEPTH
$Y_o =$	24.00	Brink Depth (in)	
$A =$	816	Brink Area (sq in)	
	5.7	Brink Area (sf)	
$V_o =$	17.8	Brink Velocity (fps)	
$Y_c =$	1.68	Equivalent Brink Depth (ft)	
$F =$	2.42	Froude	
Supercritical Test: Supercritical			
$D =$	33.0		
$Q/D^{2.5} =$	4.41	Rounded:	4.50
$Q/D^{1.5} =$	22.15	Rounded:	22.15
$TW/D =$	0.45	Rounded:	0.45
If TW unknown use:	0.40	TW:	1.58

RIP-RAP SIZING	
$\text{Rip-Rap Sizing} = \frac{\left(\frac{d_{50}}{D}\right) \left(\frac{TW}{D}\right)^{1.2}}{\left(\frac{Q}{D^{2.5}}\right)}$	
$d_{50} =$	12 inch
Rip-rap Type:	M
EXTENT OF PROTECTION	
$L_p = \left(\frac{1}{2 \tan \theta}\right) \left(\frac{A_i}{TW} - W\right)$	
$L_p =$	Length of Protection
$W =$	Width of the conduit
$TW =$	Tailwater depth
$\theta =$	Expansion angle of the culvert flow
$A_i =$	Required area of flow at allowable velocity
$A_i =$	18.4 sf
$\frac{1}{2 \tan \theta}$	Expansion Factor 3.58
$L_p =$	29

Rip Rap Outlet Protection Design

OS-05		Circular	
Q	30	cfs	24
			Dia. (in)
TW	12.0	Tailwater (in)	Box Culvert
			Height (in)
			Width (in)
TYPE: Circular			
HYDRAULIC CHARACTERISTICS			
	24.00	Normal Depth (in)	
$Y_o/D =$	0.93		0.95
$TW/Y_o =$	0.54	LOW	TAILWATER DEPTH
$Y_o =$	22.32	Brink Depth (in)	
$A =$	438	Brink Area (sq in)	
	3.0	Brink Area (sf)	
$V_o =$	9.9	Brink Velocity (fps)	
$Y_c =$	1.23	Equivalent Brink Depth (ft)	
$F =$	1.56	Froude	
Supercritical Test: Supercritical			
$D =$	23.2		
$Q/D^{2.5} =$	5.30	Rounded:	5.50
$Q/D^{1.5} =$	11.19	Rounded:	11.20
$TW/D =$	0.50	Rounded:	0.50
If TW unknown use:	0.40	TW:	1.00

RIP-RAP SIZING	
$\text{Rip-Rap Sizing} = \frac{\left(\frac{d_{50}}{D}\right) \left(\frac{TW}{D}\right)^{1.2}}{\left(\frac{Q}{D^{2.5}}\right)}$	
$d_{50} =$	6 inch
Rip-rap Type:	VL
EXTENT OF PROTECTION	
$L_p = \left(\frac{1}{2\tan\theta}\right) \left(\frac{A_1}{TW} - W\right)$	
$L_p =$	Length of Protection
$W =$	Width of the conduit
$TW =$	Tailwater depth
$\theta =$	Expansion angle of the culvert flow
$A_1 =$	Required area of flow at allowable velocity
$A_1 =$	5.5 sf
$\frac{1}{2\tan\theta}$	Expansion Factor
	3.02
$L_p =$	10

Rip Rap Outlet Protection Design

OS-06		Circular	
Q	66	cfs	48
			Dia. (in)
TW	13.0	Tailwater (in)	Box Culvert
			Height (in)
			Width (in)
TYPE: Circular			
HYDRAULIC CHARACTERISTICS			
	16.00	Normal Depth (in)	
$Y_o/D =$	0.51		0.50
$TW/Y_o =$	0.81	HIGH	TAILWATER DEPTH
$Y_o =$	16.00	Brink Depth (in)	
$A =$	521	Brink Area (sq in)	
	3.6	Brink Area (sf)	
$V_o =$	18.3	Brink Velocity (fps)	
$Y_c =$	1.34	Equivalent Brink Depth (ft)	
$F =$	2.77	Froude	
Supercritical Test: Supercritical			
$D =$	32.0		
$Q/D^{2.5} =$	2.06	Rounded:	2.00
$Q/D^{1.5} =$	15.16	Rounded:	15.15
$TW/D =$	0.27	Rounded:	0.25
If TW unknown use:	0.40	TW:	1.08

RIP-RAP SIZING	
$\text{Rip-Rap Sizing} = \frac{\left(\frac{d_{50}}{D}\right) \left(\frac{TW}{D}\right)^{1.2}}{\left(\frac{Q}{D^{2.5}}\right)}$	
$d_{50} =$	12 inch
Rip-rap Type:	M
EXTENT OF PROTECTION	
$L_p = \left(\frac{1}{2\tan\theta}\right) \left(\frac{A_1}{TW} - W\right)$	
$L_p =$	Length of Protection
$W =$	Width of the conduit
$TW =$	Tailwater depth
$\theta =$	Expansion angle of the culvert flow
$A_1 =$	Required area of flow at allowable velocity
$A_1 =$	12.0 sf
$\frac{1}{2\tan\theta}$	Expansion Factor
	3.07
$L_p =$	22

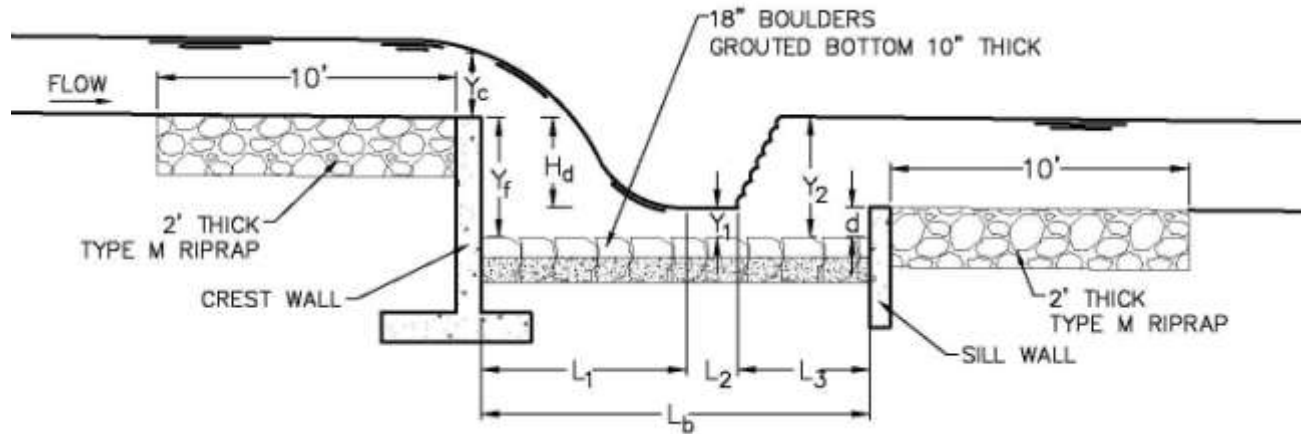

	DROP 1 & 2	DROP 3	DROP 4 & 5	DROP 6	
Q	114	127	232	363	channel flow(cfs)
B	18.07	18.52	18.24	20.28	average channel flow width
q	6.31	6.86	12.72	17.90	Q/B
Y _f	4.00	4.00	4.00	4.00	total drop height
d	1.00	1.00	1.00	1.00	basin depression
H _d	3.00	3.00	3.00	3.00	drop height
D _n	0.02	0.02	0.08	0.16	$q^2/(32.2 \times Y_f^3)$
Y _c	1.07	1.13	1.71	2.15	$(q^2/32.2)^{1/3}$
Y ₁	0.40	0.43	0.73	0.98	$0.54 \times D_n^{0.425} \times Y_f$
Y ₂	2.29	2.39	3.34	4.02	$1.66 \times D_n^{0.27} \times Y_f$
Normal Depth	1.34	1.42	2.06	2.57	
Critical Depth	1.24	1.31	1.96	2.49	
H ₂	-1.66	-1.58	-0.94	-0.43	$-(H_d-TW)$
L ₁	4.44	4.59	5.89	6.86	$(L_r+L_s)/2$
L _f	4.30	4.43	5.57	6.36	$(-0.406+(3.195+4.368 \times Y_f/Y_c)^{0.5}) \times Y_c$
L _s	4.58	4.74	6.20	7.35	$[(0.691+0.228 \times (L_t/Y_c)^2+Y_f/Y_c) \times Y_c]/(0.185+0.456 \times L_t/Y_c)$
L _t	2.95	3.00	3.35	3.47	$[-0.406+(3.195-4.368 \times H_2/Y_c)^{0.5}] \times Y_c$
L ₂	0.86	0.91	1.37	1.72	$0.8 \times Y_c$
L ₃	1.88	1.99	3.00	3.76	$1.75 \times Y_c$
L_b	8.0	8.0	11.0	13.0	

National Flood Hazard Layer FIRMMette



104°35'31"W 38°59'24"N

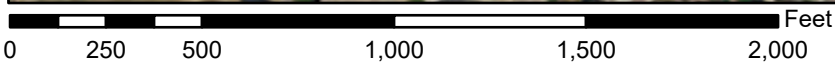

1:6,000

104°34'54"W 38°58'56"N

Basemap Imagery Source: USGS National Map 2023

Legend

SEE FIS REPORT FOR DETAILED LEGEND AND INDEX MAP FOR FIRM PANEL LAYOUT

SPECIAL FLOOD HAZARD AREAS		Without Base Flood Elevation (BFE) Zone A, V, A99
		With BFE or Depth Zone AE, AO, AH, VE, AR
		Regulatory Floodway
OTHER AREAS OF FLOOD HAZARD		0.2% Annual Chance Flood Hazard, Areas of 1% annual chance flood with average depth less than one foot or with drainage areas of less than one square mile Zone X
		Future Conditions 1% Annual Chance Flood Hazard Zone X
		Area with Reduced Flood Risk due to Levee. See Notes. Zone X
		Area with Flood Risk due to Levee Zone D
OTHER AREAS		NO SCREEN Area of Minimal Flood Hazard Zone X
		Effective LOMRs
GENERAL STRUCTURES		Area of Undetermined Flood Hazard Zone D
		Channel, Culvert, or Storm Sewer
		Levee, Dike, or Floodwall
OTHER FEATURES		20.2 Cross Sections with 1% Annual Chance
		17.5 Water Surface Elevation
		Coastal Transect
		Base Flood Elevation Line (BFE)
		Limit of Study
		Jurisdiction Boundary
MAP PANELS		Coastal Transect Baseline
		Profile Baseline
		Hydrographic Feature
		Digital Data Available
		No Digital Data Available
		Unmapped
		The pin displayed on the map is an approximate point selected by the user and does not represent an authoritative property location.



This map complies with FEMA's standards for the use of digital flood maps if it is not void as described below. The basemap shown complies with FEMA's basemap accuracy standards

The flood hazard information is derived directly from the authoritative NFHL web services provided by FEMA. This map was exported on 1/23/2024 at 1:44 PM and does not reflect changes or amendments subsequent to this date and time. The NFHL and effective information may change or become superseded by new data over time.

This map image is void if the one or more of the following map elements do not appear: basemap imagery, flood zone labels, legend, scale bar, map creation date, community identifiers, FIRM panel number, and FIRM effective date. Map images for unmapped and unmodernized areas cannot be used for regulatory purposes.

Appendix F – Soil Resource Report



United States
Department of
Agriculture

NRCS

Natural
Resources
Conservation
Service

A product of the National
Cooperative Soil Survey,
a joint effort of the United
States Department of
Agriculture and other
Federal agencies, State
agencies including the
Agricultural Experiment
Stations, and local
participants

Custom Soil Resource Report for El Paso County Area, Colorado

MSMD Fieldhouse



Preface

Soil surveys contain information that affects land use planning in survey areas. They highlight soil limitations that affect various land uses and provide information about the properties of the soils in the survey areas. Soil surveys are designed for many different users, including farmers, ranchers, foresters, agronomists, urban planners, community officials, engineers, developers, builders, and home buyers. Also, conservationists, teachers, students, and specialists in recreation, waste disposal, and pollution control can use the surveys to help them understand, protect, or enhance the environment.

Various land use regulations of Federal, State, and local governments may impose special restrictions on land use or land treatment. Soil surveys identify soil properties that are used in making various land use or land treatment decisions. The information is intended to help the land users identify and reduce the effects of soil limitations on various land uses. The landowner or user is responsible for identifying and complying with existing laws and regulations.

Although soil survey information can be used for general farm, local, and wider area planning, onsite investigation is needed to supplement this information in some cases. Examples include soil quality assessments (<http://www.nrcs.usda.gov/wps/portal/nrcs/main/soils/health/>) and certain conservation and engineering applications. For more detailed information, contact your local USDA Service Center (<https://offices.sc.egov.usda.gov/locator/app?agency=nrcs>) or your NRCS State Soil Scientist (http://www.nrcs.usda.gov/wps/portal/nrcs/detail/soils/contactus/?cid=nrcs142p2_053951).

Great differences in soil properties can occur within short distances. Some soils are seasonally wet or subject to flooding. Some are too unstable to be used as a foundation for buildings or roads. Clayey or wet soils are poorly suited to use as septic tank absorption fields. A high water table makes a soil poorly suited to basements or underground installations.

The National Cooperative Soil Survey is a joint effort of the United States Department of Agriculture and other Federal agencies, State agencies including the Agricultural Experiment Stations, and local agencies. The Natural Resources Conservation Service (NRCS) has leadership for the Federal part of the National Cooperative Soil Survey.

Information about soils is updated periodically. Updated information is available through the NRCS Web Soil Survey, the site for official soil survey information.

The U.S. Department of Agriculture (USDA) prohibits discrimination in all its programs and activities on the basis of race, color, national origin, age, disability, and where applicable, sex, marital status, familial status, parental status, religion, sexual orientation, genetic information, political beliefs, reprisal, or because all or a part of an individual's income is derived from any public assistance program. (Not all prohibited bases apply to all programs.) Persons with disabilities who require

alternative means for communication of program information (Braille, large print, audiotape, etc.) should contact USDA's TARGET Center at (202) 720-2600 (voice and TDD). To file a complaint of discrimination, write to USDA, Director, Office of Civil Rights, 1400 Independence Avenue, S.W., Washington, D.C. 20250-9410 or call (800) 795-3272 (voice) or (202) 720-6382 (TDD). USDA is an equal opportunity provider and employer.

Contents

Preface	2
How Soil Surveys Are Made	5
Soil Map	8
Soil Map.....	9
Legend.....	10
Map Unit Legend.....	11
Map Unit Descriptions.....	11
El Paso County Area, Colorado.....	13
83—Stapleton sandy loam, 3 to 8 percent slopes.....	13
References	15

How Soil Surveys Are Made

Soil surveys are made to provide information about the soils and miscellaneous areas in a specific area. They include a description of the soils and miscellaneous areas and their location on the landscape and tables that show soil properties and limitations affecting various uses. Soil scientists observed the steepness, length, and shape of the slopes; the general pattern of drainage; the kinds of crops and native plants; and the kinds of bedrock. They observed and described many soil profiles. A soil profile is the sequence of natural layers, or horizons, in a soil. The profile extends from the surface down into the unconsolidated material in which the soil formed or from the surface down to bedrock. The unconsolidated material is devoid of roots and other living organisms and has not been changed by other biological activity.

Currently, soils are mapped according to the boundaries of major land resource areas (MLRAs). MLRAs are geographically associated land resource units that share common characteristics related to physiography, geology, climate, water resources, soils, biological resources, and land uses (USDA, 2006). Soil survey areas typically consist of parts of one or more MLRA.

The soils and miscellaneous areas in a survey area occur in an orderly pattern that is related to the geology, landforms, relief, climate, and natural vegetation of the area. Each kind of soil and miscellaneous area is associated with a particular kind of landform or with a segment of the landform. By observing the soils and miscellaneous areas in the survey area and relating their position to specific segments of the landform, a soil scientist develops a concept, or model, of how they were formed. Thus, during mapping, this model enables the soil scientist to predict with a considerable degree of accuracy the kind of soil or miscellaneous area at a specific location on the landscape.

Commonly, individual soils on the landscape merge into one another as their characteristics gradually change. To construct an accurate soil map, however, soil scientists must determine the boundaries between the soils. They can observe only a limited number of soil profiles. Nevertheless, these observations, supplemented by an understanding of the soil-vegetation-landscape relationship, are sufficient to verify predictions of the kinds of soil in an area and to determine the boundaries.

Soil scientists recorded the characteristics of the soil profiles that they studied. They noted soil color, texture, size and shape of soil aggregates, kind and amount of rock fragments, distribution of plant roots, reaction, and other features that enable them to identify soils. After describing the soils in the survey area and determining their properties, the soil scientists assigned the soils to taxonomic classes (units). Taxonomic classes are concepts. Each taxonomic class has a set of soil characteristics with precisely defined limits. The classes are used as a basis for comparison to classify soils systematically. Soil taxonomy, the system of taxonomic classification used in the United States, is based mainly on the kind and character of soil properties and the arrangement of horizons within the profile. After the soil

Custom Soil Resource Report

scientists classified and named the soils in the survey area, they compared the individual soils with similar soils in the same taxonomic class in other areas so that they could confirm data and assemble additional data based on experience and research.

The objective of soil mapping is not to delineate pure map unit components; the objective is to separate the landscape into landforms or landform segments that have similar use and management requirements. Each map unit is defined by a unique combination of soil components and/or miscellaneous areas in predictable proportions. Some components may be highly contrasting to the other components of the map unit. The presence of minor components in a map unit in no way diminishes the usefulness or accuracy of the data. The delineation of such landforms and landform segments on the map provides sufficient information for the development of resource plans. If intensive use of small areas is planned, onsite investigation is needed to define and locate the soils and miscellaneous areas.

Soil scientists make many field observations in the process of producing a soil map. The frequency of observation is dependent upon several factors, including scale of mapping, intensity of mapping, design of map units, complexity of the landscape, and experience of the soil scientist. Observations are made to test and refine the soil-landscape model and predictions and to verify the classification of the soils at specific locations. Once the soil-landscape model is refined, a significantly smaller number of measurements of individual soil properties are made and recorded. These measurements may include field measurements, such as those for color, depth to bedrock, and texture, and laboratory measurements, such as those for content of sand, silt, clay, salt, and other components. Properties of each soil typically vary from one point to another across the landscape.

Observations for map unit components are aggregated to develop ranges of characteristics for the components. The aggregated values are presented. Direct measurements do not exist for every property presented for every map unit component. Values for some properties are estimated from combinations of other properties.

While a soil survey is in progress, samples of some of the soils in the area generally are collected for laboratory analyses and for engineering tests. Soil scientists interpret the data from these analyses and tests as well as the field-observed characteristics and the soil properties to determine the expected behavior of the soils under different uses. Interpretations for all of the soils are field tested through observation of the soils in different uses and under different levels of management. Some interpretations are modified to fit local conditions, and some new interpretations are developed to meet local needs. Data are assembled from other sources, such as research information, production records, and field experience of specialists. For example, data on crop yields under defined levels of management are assembled from farm records and from field or plot experiments on the same kinds of soil.

Predictions about soil behavior are based not only on soil properties but also on such variables as climate and biological activity. Soil conditions are predictable over long periods of time, but they are not predictable from year to year. For example, soil scientists can predict with a fairly high degree of accuracy that a given soil will have a high water table within certain depths in most years, but they cannot predict that a high water table will always be at a specific level in the soil on a specific date.

After soil scientists located and identified the significant natural bodies of soil in the survey area, they drew the boundaries of these bodies on aerial photographs and

Custom Soil Resource Report

identified each as a specific map unit. Aerial photographs show trees, buildings, fields, roads, and rivers, all of which help in locating boundaries accurately.

Soil Map

The soil map section includes the soil map for the defined area of interest, a list of soil map units on the map and extent of each map unit, and cartographic symbols displayed on the map. Also presented are various metadata about data used to produce the map, and a description of each soil map unit.

Custom Soil Resource Report Soil Map



Soil Map may not be valid at this scale.

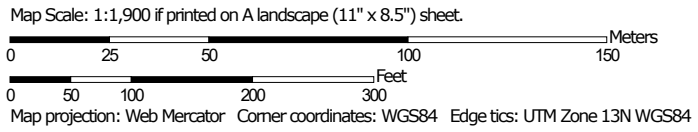

MAP LEGEND

Area of Interest (AOI)

 Area of Interest (AOI)

Soils

 Soil Map Unit Polygons

 Soil Map Unit Lines

 Soil Map Unit Points

Special Point Features





-  Blowout
-  Borrow Pit
-  Clay Spot
-  Closed Depression
-  Gravel Pit
-  Gravelly Spot
-  Landfill
-  Lava Flow
-  Marsh or swamp
-  Mine or Quarry
-  Miscellaneous Water
-  Perennial Water
-  Rock Outcrop
-  Saline Spot
-  Sandy Spot
-  Severely Eroded Spot
-  Sinkhole
-  Slide or Slip
-  Sodic Spot

-  Spoil Area
-  Stony Spot
-  Very Stony Spot
-  Wet Spot
-  Other
-  Special Line Features

Water Features

 Streams and Canals

Transportation

-  Rails
-  Interstate Highways
-  US Routes
-  Major Roads
-  Local Roads

Background

 Aerial Photography

MAP INFORMATION

The soil surveys that comprise your AOI were mapped at 1:24,000.

Warning: Soil Map may not be valid at this scale.

Enlargement of maps beyond the scale of mapping can cause misunderstanding of the detail of mapping and accuracy of soil line placement. The maps do not show the small areas of contrasting soils that could have been shown at a more detailed scale.

Please rely on the bar scale on each map sheet for map measurements.

Source of Map: Natural Resources Conservation Service
 Web Soil Survey URL:
 Coordinate System: Web Mercator (EPSG:3857)

Maps from the Web Soil Survey are based on the Web Mercator projection, which preserves direction and shape but distorts distance and area. A projection that preserves area, such as the Albers equal-area conic projection, should be used if more accurate calculations of distance or area are required.

This product is generated from the USDA-NRCS certified data as of the version date(s) listed below.

Soil Survey Area: El Paso County Area, Colorado
 Survey Area Data: Version 21, Aug 24, 2023

Soil map units are labeled (as space allows) for map scales 1:50,000 or larger.

Date(s) aerial images were photographed: Sep 11, 2018—Oct 20, 2018

The orthophoto or other base map on which the soil lines were compiled and digitized probably differs from the background imagery displayed on these maps. As a result, some minor shifting of map unit boundaries may be evident.

Map Unit Legend

Map Unit Symbol	Map Unit Name	Acres in AOI	Percent of AOI
83	Stapleton sandy loam, 3 to 8 percent slopes	5.5	100.0%
Totals for Area of Interest		5.5	100.0%

Map Unit Descriptions

The map units delineated on the detailed soil maps in a soil survey represent the soils or miscellaneous areas in the survey area. The map unit descriptions, along with the maps, can be used to determine the composition and properties of a unit.

A map unit delineation on a soil map represents an area dominated by one or more major kinds of soil or miscellaneous areas. A map unit is identified and named according to the taxonomic classification of the dominant soils. Within a taxonomic class there are precisely defined limits for the properties of the soils. On the landscape, however, the soils are natural phenomena, and they have the characteristic variability of all natural phenomena. Thus, the range of some observed properties may extend beyond the limits defined for a taxonomic class. Areas of soils of a single taxonomic class rarely, if ever, can be mapped without including areas of other taxonomic classes. Consequently, every map unit is made up of the soils or miscellaneous areas for which it is named and some minor components that belong to taxonomic classes other than those of the major soils.

Most minor soils have properties similar to those of the dominant soil or soils in the map unit, and thus they do not affect use and management. These are called noncontrasting, or similar, components. They may or may not be mentioned in a particular map unit description. Other minor components, however, have properties and behavioral characteristics divergent enough to affect use or to require different management. These are called contrasting, or dissimilar, components. They generally are in small areas and could not be mapped separately because of the scale used. Some small areas of strongly contrasting soils or miscellaneous areas are identified by a special symbol on the maps. If included in the database for a given area, the contrasting minor components are identified in the map unit descriptions along with some characteristics of each. A few areas of minor components may not have been observed, and consequently they are not mentioned in the descriptions, especially where the pattern was so complex that it was impractical to make enough observations to identify all the soils and miscellaneous areas on the landscape.

The presence of minor components in a map unit in no way diminishes the usefulness or accuracy of the data. The objective of mapping is not to delineate pure taxonomic classes but rather to separate the landscape into landforms or landform segments that have similar use and management requirements. The delineation of such segments on the map provides sufficient information for the development of resource plans. If intensive use of small areas is planned, however, onsite investigation is needed to define and locate the soils and miscellaneous areas.

Custom Soil Resource Report

An identifying symbol precedes the map unit name in the map unit descriptions. Each description includes general facts about the unit and gives important soil properties and qualities.

Soils that have profiles that are almost alike make up a *soil series*. Except for differences in texture of the surface layer, all the soils of a series have major horizons that are similar in composition, thickness, and arrangement.

Soils of one series can differ in texture of the surface layer, slope, stoniness, salinity, degree of erosion, and other characteristics that affect their use. On the basis of such differences, a soil series is divided into *soil phases*. Most of the areas shown on the detailed soil maps are phases of soil series. The name of a soil phase commonly indicates a feature that affects use or management. For example, Alpha silt loam, 0 to 2 percent slopes, is a phase of the Alpha series.

Some map units are made up of two or more major soils or miscellaneous areas. These map units are complexes, associations, or undifferentiated groups.

A *complex* consists of two or more soils or miscellaneous areas in such an intricate pattern or in such small areas that they cannot be shown separately on the maps. The pattern and proportion of the soils or miscellaneous areas are somewhat similar in all areas. Alpha-Beta complex, 0 to 6 percent slopes, is an example.

An *association* is made up of two or more geographically associated soils or miscellaneous areas that are shown as one unit on the maps. Because of present or anticipated uses of the map units in the survey area, it was not considered practical or necessary to map the soils or miscellaneous areas separately. The pattern and relative proportion of the soils or miscellaneous areas are somewhat similar. Alpha-Beta association, 0 to 2 percent slopes, is an example.

An *undifferentiated group* is made up of two or more soils or miscellaneous areas that could be mapped individually but are mapped as one unit because similar interpretations can be made for use and management. The pattern and proportion of the soils or miscellaneous areas in a mapped area are not uniform. An area can be made up of only one of the major soils or miscellaneous areas, or it can be made up of all of them. Alpha and Beta soils, 0 to 2 percent slopes, is an example.

Some surveys include *miscellaneous areas*. Such areas have little or no soil material and support little or no vegetation. Rock outcrop is an example.

El Paso County Area, Colorado

83—Stapleton sandy loam, 3 to 8 percent slopes

Map Unit Setting

National map unit symbol: 369z
Elevation: 6,500 to 7,300 feet
Mean annual precipitation: 14 to 16 inches
Mean annual air temperature: 46 to 48 degrees F
Frost-free period: 125 to 145 days
Farmland classification: Not prime farmland

Map Unit Composition

Stapleton and similar soils: 97 percent
Minor components: 3 percent
Estimates are based on observations, descriptions, and transects of the mapunit.

Description of Stapleton

Setting

Landform: Hills
Landform position (three-dimensional): Side slope
Down-slope shape: Linear
Across-slope shape: Linear
Parent material: Sandy alluvium derived from arkose

Typical profile

A - 0 to 11 inches: sandy loam
Bw - 11 to 17 inches: gravelly sandy loam
C - 17 to 60 inches: gravelly loamy sand

Properties and qualities

Slope: 3 to 8 percent
Depth to restrictive feature: More than 80 inches
Drainage class: Well drained
Runoff class: Low
Capacity of the most limiting layer to transmit water (Ksat): High (2.00 to 6.00 in/hr)
Depth to water table: More than 80 inches
Frequency of flooding: None
Frequency of ponding: None
Available water supply, 0 to 60 inches: Low (about 4.7 inches)

Interpretive groups

Land capability classification (irrigated): None specified
Land capability classification (nonirrigated): 3e
Hydrologic Soil Group: B
Ecological site: R049XY214CO - Gravelly Foothill
Hydric soil rating: No

Minor Components

Fluvaquentic haplaquolls

Percent of map unit: 1 percent
Landform: Swales
Hydric soil rating: Yes

Custom Soil Resource Report

Other soils

Percent of map unit: 1 percent

Hydric soil rating: No

Pleasant

Percent of map unit: 1 percent

Landform: Depressions

Hydric soil rating: Yes

References

- American Association of State Highway and Transportation Officials (AASHTO). 2004. Standard specifications for transportation materials and methods of sampling and testing. 24th edition.
- American Society for Testing and Materials (ASTM). 2005. Standard classification of soils for engineering purposes. ASTM Standard D2487-00.
- Cowardin, L.M., V. Carter, F.C. Golet, and E.T. LaRoe. 1979. Classification of wetlands and deep-water habitats of the United States. U.S. Fish and Wildlife Service FWS/OBS-79/31.
- Federal Register. July 13, 1994. Changes in hydric soils of the United States.
- Federal Register. September 18, 2002. Hydric soils of the United States.
- Hurt, G.W., and L.M. Vasilas, editors. Version 6.0, 2006. Field indicators of hydric soils in the United States.
- National Research Council. 1995. Wetlands: Characteristics and boundaries.
- Soil Survey Division Staff. 1993. Soil survey manual. Soil Conservation Service. U.S. Department of Agriculture Handbook 18. http://www.nrcs.usda.gov/wps/portal/nrcs/detail/national/soils/?cid=nrcs142p2_054262
- Soil Survey Staff. 1999. Soil taxonomy: A basic system of soil classification for making and interpreting soil surveys. 2nd edition. Natural Resources Conservation Service, U.S. Department of Agriculture Handbook 436. http://www.nrcs.usda.gov/wps/portal/nrcs/detail/national/soils/?cid=nrcs142p2_053577
- Soil Survey Staff. 2010. Keys to soil taxonomy. 11th edition. U.S. Department of Agriculture, Natural Resources Conservation Service. http://www.nrcs.usda.gov/wps/portal/nrcs/detail/national/soils/?cid=nrcs142p2_053580
- Tiner, R.W., Jr. 1985. Wetlands of Delaware. U.S. Fish and Wildlife Service and Delaware Department of Natural Resources and Environmental Control, Wetlands Section.
- United States Army Corps of Engineers, Environmental Laboratory. 1987. Corps of Engineers wetlands delineation manual. Waterways Experiment Station Technical Report Y-87-1.
- United States Department of Agriculture, Natural Resources Conservation Service. National forestry manual. http://www.nrcs.usda.gov/wps/portal/nrcs/detail/soils/home/?cid=nrcs142p2_053374
- United States Department of Agriculture, Natural Resources Conservation Service. National range and pasture handbook. <http://www.nrcs.usda.gov/wps/portal/nrcs/detail/national/landuse/rangepasture/?cid=stelprdb1043084>

Custom Soil Resource Report

United States Department of Agriculture, Natural Resources Conservation Service. National soil survey handbook, title 430-VI. http://www.nrcs.usda.gov/wps/portal/nrcs/detail/soils/scientists/?cid=nrcs142p2_054242

United States Department of Agriculture, Natural Resources Conservation Service. 2006. Land resource regions and major land resource areas of the United States, the Caribbean, and the Pacific Basin. U.S. Department of Agriculture Handbook 296. http://www.nrcs.usda.gov/wps/portal/nrcs/detail/national/soils/?cid=nrcs142p2_053624

United States Department of Agriculture, Soil Conservation Service. 1961. Land capability classification. U.S. Department of Agriculture Handbook 210. http://www.nrcs.usda.gov/Internet/FSE_DOCUMENTS/nrcs142p2_052290.pdf

Appendix G – Drainage Maps

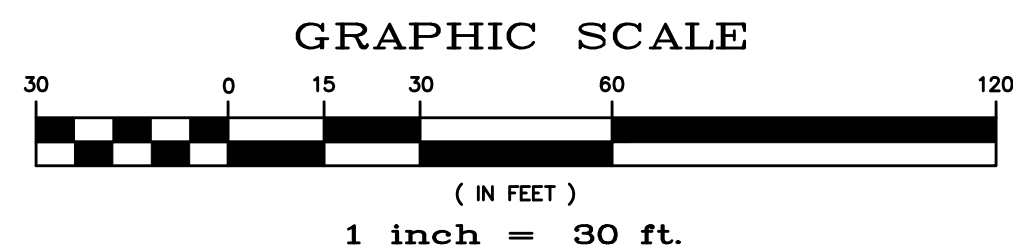
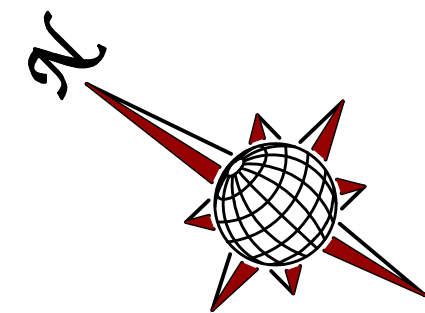

DP	BASIN	AREA (AC)	Q(5) (CFS)	Q(100) (CFS)	INLET	Q(5) (CFS)	Q(100) (CFS)	PIPE
DP2	A4	0.04	0.1	0.2		0.1	0.2	4" PVC
DP2	A3	0.44	1.4	2.7		1.4	2.7	4" PVC
	A1 & A2					1.6	2.9	10" PVC
DP1	A1	0.25	0.8	1.5		0.8	1.5	8" PVC
DP1	A2	0.31	1.1	2.1		1.1	2.1	8" PVC
DP1	A3 & A4					1.8	3.3	10" PVC
DP2						3.2	6.0	12" HDPE
I01	B	0.91	3.1	6.0	PR 5' SUMP	6.0	11	18" HDPE
I02	C	0.98	3.1	5.9	PR 5' SUMP	3.1	5.9	12" HDPE
DP3	D	0.43	0.3	1.2		0.3	1.2	

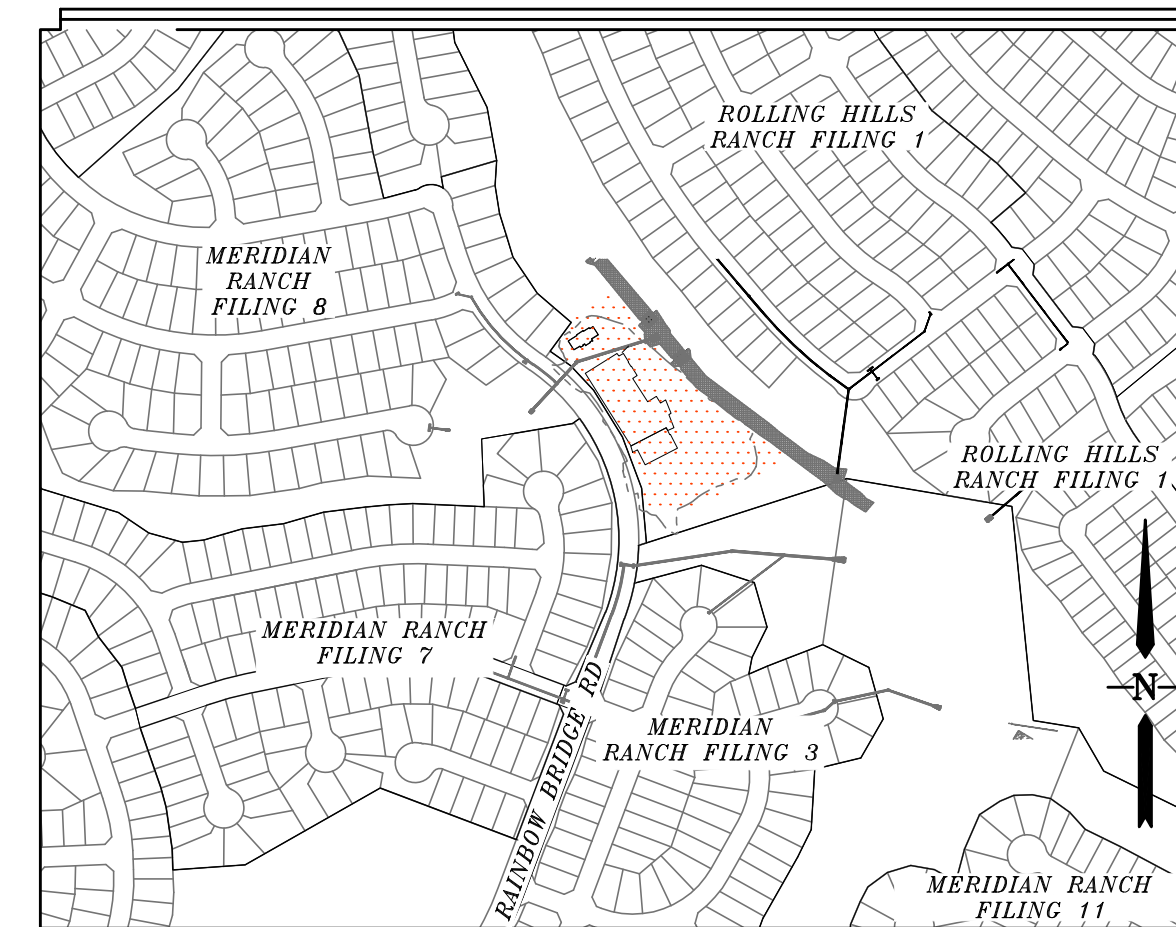

INDEX MAP
N.T.S.

- G01** BASIN DESIGNATION
- 2.7** SUB-WATERSHED DESIGNATION
- 0.40** MINOR/MAJOR STORM COEFFICIENT
- 0.55** BASIN AREA IN ACRES
- 61** DESIGN POINT DESIGNATION
- MAJOR BASIN BOUNDARY
- SUB-BASIN BOUNDARY
- 6130 EXISTING CONTOUR
- 6130 PROPOSED CONTOUR
- PROPOSED STORM SEWER
- INITIAL OVERLAND TIME (Ti)
- TRAVEL TIME (Tt)
- OVERLAND TIME (To)

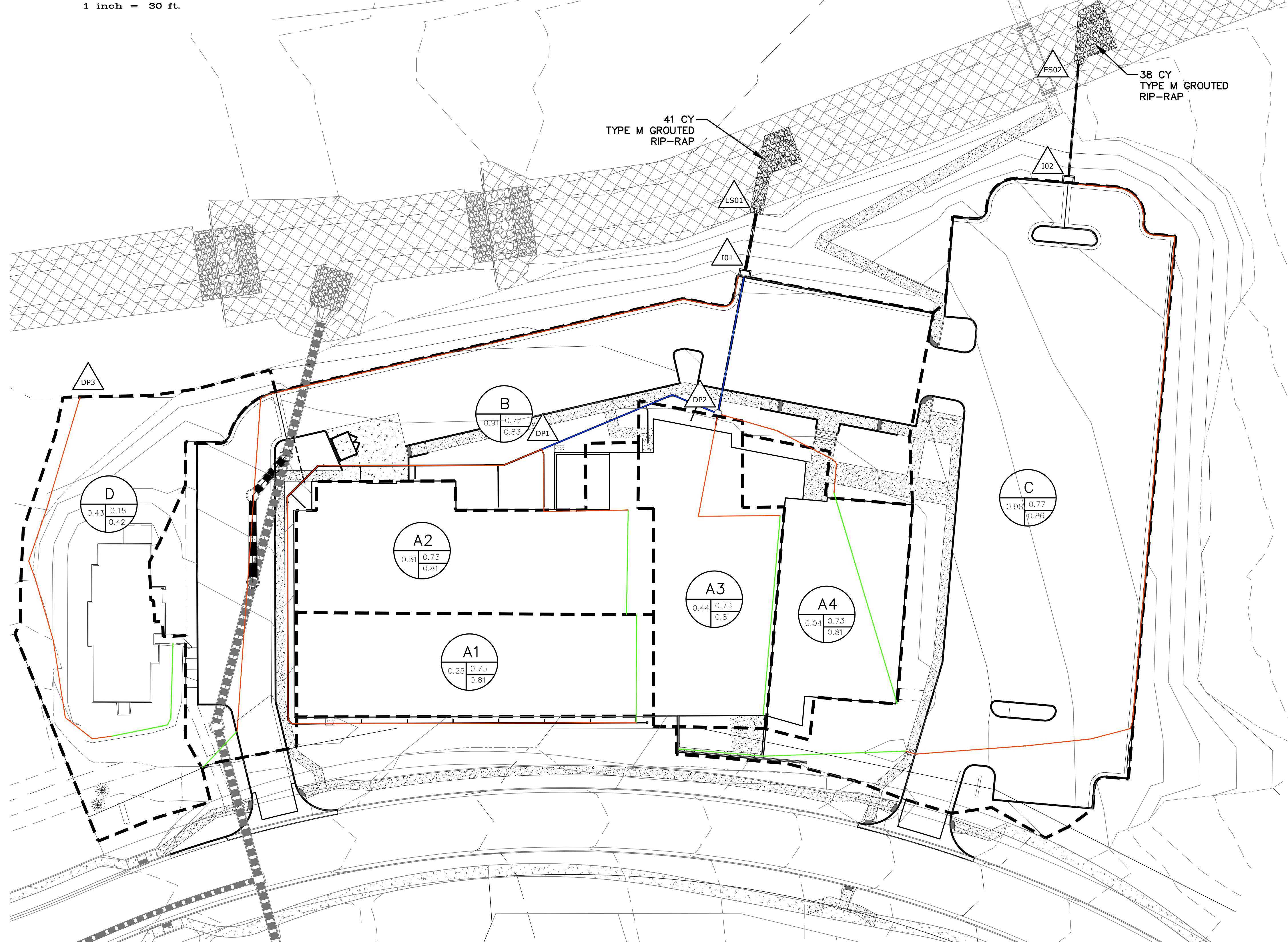

No.	Revisions	Date	Inst.	Appr.	Date	Date

TECH CONTRACTORS
11886 STAPLETON DRIVE
FALCON, CO 80831
TELEPHONE: 719.495.7444
FAX: 719.495.3349

MERIDIAN RANCH

RATIONAL DRAINAGE MAP
FINAL DRAINAGE REPORT
MSMD FELDHOUSE

Drawn by	TAK	Checked by	-	Date	JUN 2024
----------	-----	------------	---	------	----------

Scale: 1" = 40'

1 of 1

NOTE:
COUNTY PLAN REVIEW IS PROVIDED ONLY FOR GENERAL CONFORMANCE WITH COUNTY DESIGN CRITERIA. THE COUNTY IS NOT RESPONSIBLE FOR THE ACCURACY AND ADEQUACY OF THE DESIGN, DIMENSIONS, AND/OR ELEVATIONS WHICH SHALL BE CONFIRMED AT THE JOB SITE. THE COUNTY THROUGH THE APPROVAL OF THIS DOCUMENT ASSUMES NO RESPONSIBILITY FOR THE COMPLETENESS AND/OR ACCURACY OF THIS DOCUMENT.

BENCH MARK:
INTERSECTION OF WOODMEN RD AND MERIDIAN ROAD AT SW CORNER (BRASS CAP W/ NO. GF-9)
ELEVATION = 6874.00

S:\chicago\msmd\Projects\FELDHOUSE\WFOPLAN_SHEETS\MSMD_FELDHOUSE\DR - RATIONAL MAP.dwg, 6/14/2024 12:25:34 PM

MSMD FIELDHOUSE - FDR

EXISTING CONDITIONS

LEGEND

- MAJOR BASIN BOUNDARY
- MINOR BASIN BOUNDARY
- SCS MODEL ID BASIN IDENTIFICATION
- SIZE ACRES BASIN IDENTIFICATION
- DESIGN POINT
- MAJOR CONTOUR INTERVAL
- MINOR CONTOUR INTERVAL
- 100 YEAR FLOOD PLAIN
- INITIAL TIME
- OVERLAND TIME
- ROUTING

EXISTING MDDP (Full Spectrum)						
	DRAINAGE AREA (SQ. MI.)	PEAK DISCHARGE Q100 (CFS)	PEAK DISCHARGE Q50 (CFS)	PEAK DISCHARGE Q10 (CFS)	PEAK DISCHARGE Q5 (CFS)	PEAK DISCHARGE Q2 (CFS)
FG10A	0.0806	103	77	32	20	8.6
FG08A	0.0750	116	90	41	27	13
FG08A-G05	0.0750	110	86	41	27	13
FG08B	0.0630	86	67	31	20	10
FG08B-G05	0.0630	84	65	29	19	10
FG11	0.0625	75	59	28	19	9.8
FG09	0.0484	48	36	14	8.3	3.2
FG09-G05	0.0484	48	36	14	8.0	3.2
FG10B	0.0416	28	19	5.3	2.1	0.4
G05	0.3711	441	335	146	90	44
FG13	0.0534	34	24	7.5	3.6	0.9
FG12	0.0328	50	40	20	14	7.8
POND D IN	0.4573	517	393	170	106	51
POND D	0.4573	129	86	17	10	3.4
POND D OUT	0.4573	129	86	17	10	3.4

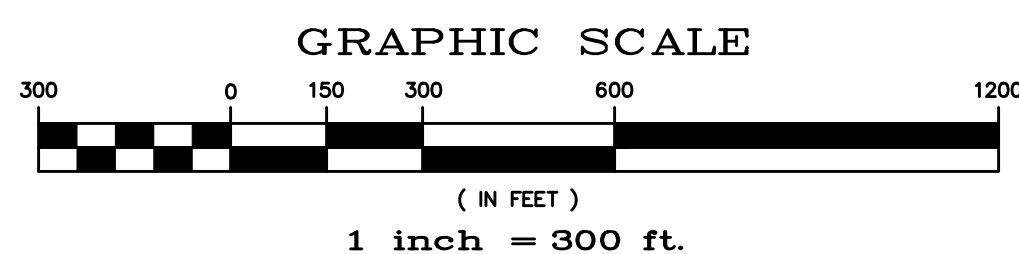
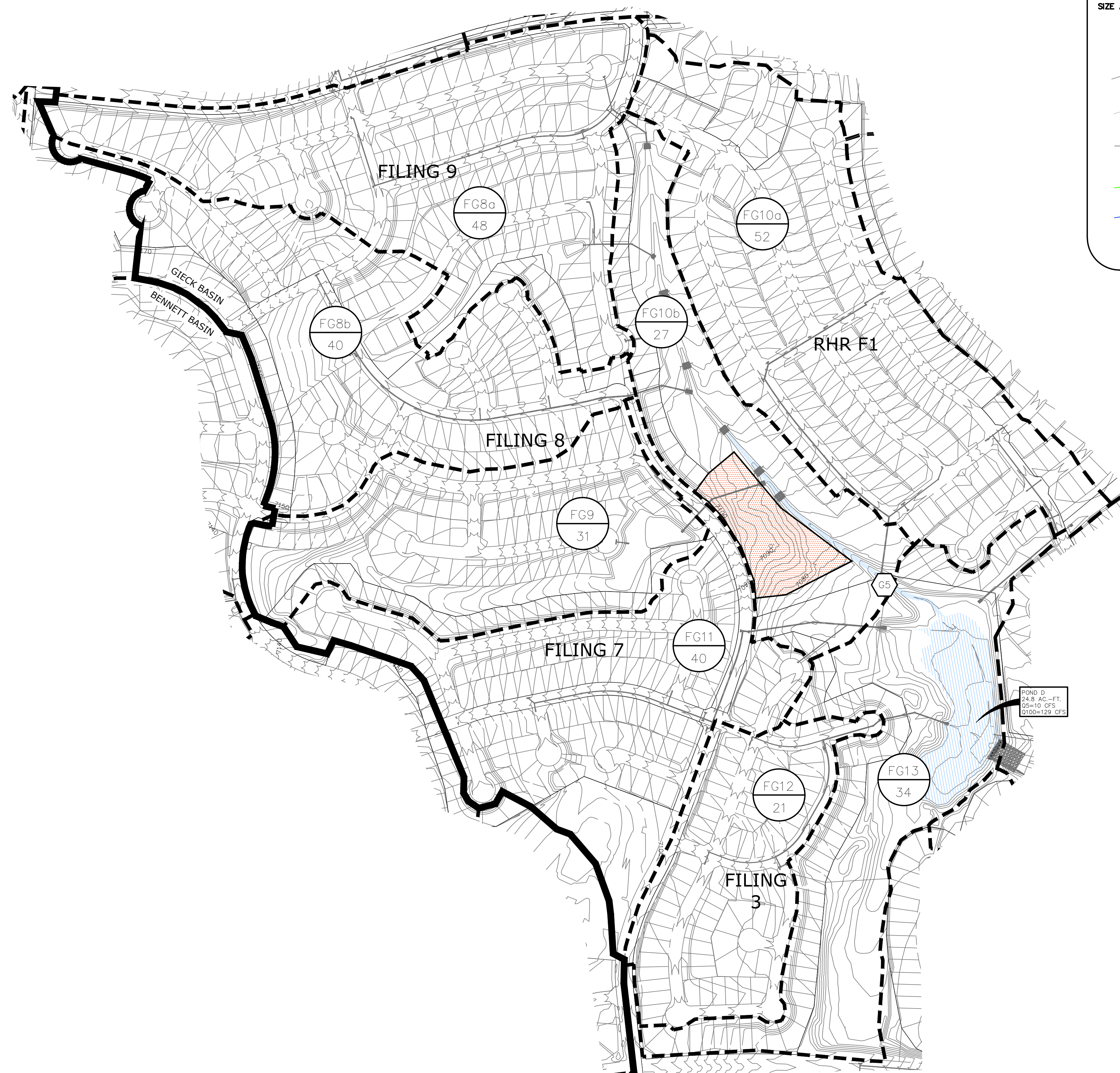

*NOTE: PRELIMINARY STORAGE VOLUMES AND OUTFLOW QUANTITIES HAVE BEEN PROVIDED FOR EACH OF THE FUTURE DETENTION FACILITIES LOCATED WITHIN THE DEVELOPMENT. THE ACTUAL STORAGE VOLUMES AND DISCHARGE RATES WILL BE DETERMINED UPON A COMPLETE ANALYSIS FOR EACH DETENTION FACILITY PRIOR TO CONSTRUCTION. THE VALUES GIVEN FOR DISCHARGE AND VOLUME ARE ESTIMATES FOR PLANNING PURPOSES ONLY.

SCS CALCULATIONS MAP

FIGURE 5

Scale	AS SHOWN	5 of 6	Date	JUN 2024
	Drawn by	TAK		Checked by
MSMD FIELDHOUSE EXISTING CONDITIONS SCS CALCULATION MAP		TECH CONTRACTORS 11910 TOURMALINE DR #130 FALCON, CO 80831 TELEPHONE: 719.495.7444		
MERIDIAN RANCH				
		Revisions		
No.		Date	Inst.	Date

MSMD FIELDHOUSE - FDR DEVELOPED CONDITIONS

LEGEND

- MAJOR BASIN BOUNDARY
- MINOR BASIN BOUNDARY
- SCS MODEL ID BASIN IDENTIFICATION
- SIZE ACRES BASIN IDENTIFICATION
- DESIGN POINT
- MAJOR CONTOUR INTERVAL
- MINOR CONTOUR INTERVAL
- 100 YEAR FLOOD PLAIN
- INITIAL TIME
- OVERLAND TIME
- ROUTING

DEVELOPED MDDP (Full Spectrum)						
	DRAINAGE AREA (SQ. MI.)	PEAK DISCHARGE Q100 (CFS)	PEAK DISCHARGE Q50 (CFS)	PEAK DISCHARGE Q10 (CFS)	PEAK DISCHARGE Q5 (CFS)	PEAK DISCHARGE Q2 (CFS)
FG10A	0.0806	103	77	32	20	8.6
FG08A	0.0750	116	90	41	27	13
FG08A-G05	0.0750	110	86	41	27	13
FG08B	0.0630	86	67	31	20	10
FG08B-G05	0.0630	84	65	29	19	10
FG11	0.0625	75	59	28	19	9.8
FG09	0.0484	48	36	14	8.3	3.2
FG09-G05	0.0484	48	36	14	8.0	3.2
FG10B	0.0415	34	24	8.2	4.0	1.1
G05	0.3710	447	341	149	92	44
FG13	0.0534	34	24	7.5	3.6	0.9
FG12	0.0328	50	40	20	14	7.8
POND D IN	0.4572	523	398	173	108	52
POND D	0.4572	131	88	17	11	3.5
POND D OUT	0.4572	131	88	17	11	3.5

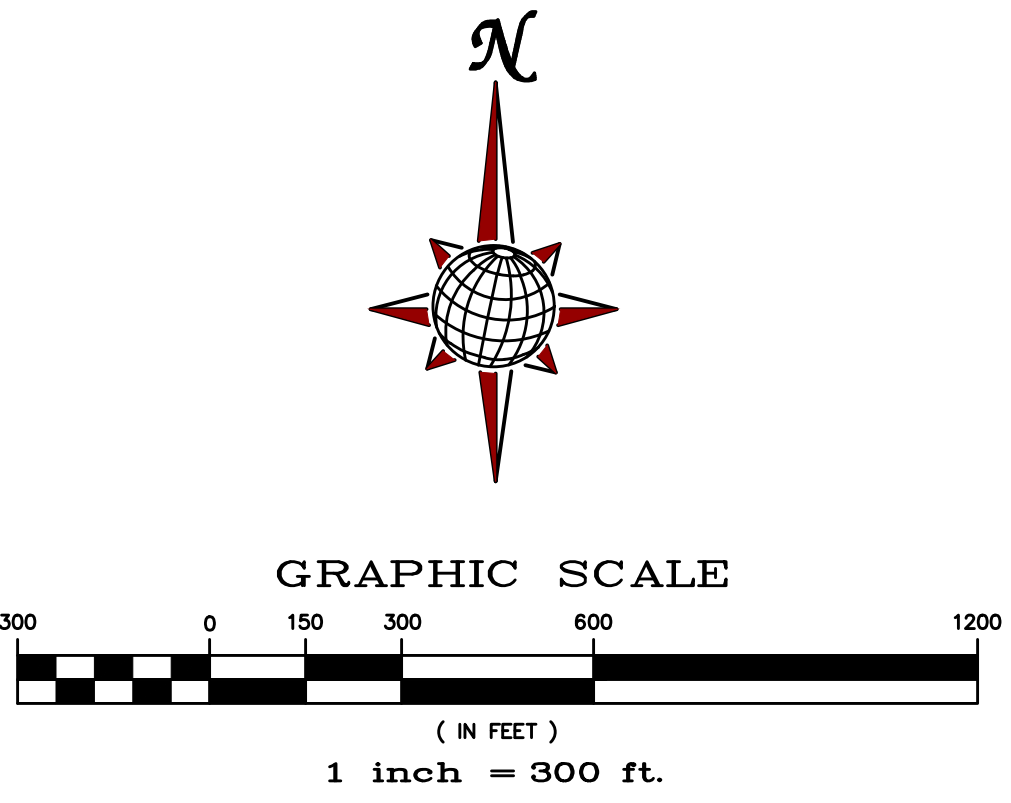

*NOTE: PRELIMINARY STORAGE VOLUMES AND OUTFLOW QUANTITIES HAVE BEEN PROVIDED FOR EACH OF THE FUTURE DETENTION FACILITIES LOCATED WITHIN THE DEVELOPMENT. THE ACTUAL STORAGE VOLUMES AND DISCHARGE RATES WILL BE DETERMINED UPON A COMPLETE ANALYSIS FOR EACH DETENTION FACILITY PRIOR TO CONSTRUCTION. THE VALUES GIVEN FOR DISCHARGE AND VOLUME ARE ESTIMATES FOR PLANNING PURPOSES ONLY.

TECH CONTRACTORS 11910 TOURMALINE DR #130 FALCON, CO 80831 TELEPHONE: 719.495.7444	 MERIDIAN RANCH		MSMD FIELDHOUSE DEVELOPED CONDITIONS SCS CALCULATIONS MAP		Drawn by TAK	Checked by JN	Date JUN 2024
Scale AS SHOWN	6	of	6				

SCS CALCULATIONS MAP

FIGURE 6