

**PRIVATE DETENTION BASIN /
STORMWATER QUALITY BEST MANAGEMENT PRACTICE
MAINTENANCE AGREEMENT AND EASEMENT**

This PRIVATE DETENTION BASIN / STORMWATER QUALITY BEST MANAGEMENT PRACTICE MAINTENANCE AGREEMENT AND EASEMENT (Agreement) is made by and between EL PASO COUNTY by and through THE BOARD OF COUNTY COMMISSIONERS OF EL PASO COUNTY, COLORADO (Board or County) and THOUSAND HILLS LAND & CATTLE CO. (Developer), a Colorado Limited Liability Corporation. The above may occasionally be referred to herein singularly as “Party” and collectively as “Parties.”

Recitals

A. WHEREAS, Developer is the owner of certain real estate (the Property or Subdivision) in El Paso County, Colorado, which Property is legally described in Exhibit A attached hereto and incorporated herein by this reference; and

B. WHEREAS, Developer desires to plat and develop on the Property a subdivision to be known as Falcon Acres; and

C. WHEREAS, the development of this Property will substantially increase the volume of water runoff and will decrease the quality of the stormwater runoff from the Property, and, therefore, it is in the best interest of public health, safety and welfare for the County to condition approval of this subdivision on Developer’s promise to construct adequate drainage, water runoff control facilities, and stormwater quality structural Best Management Practices (“BMPs”) for the land use; and

D. WHEREAS, Chapter 8, Section 8.4.5 of the El Paso County Land Development Code, as periodically amended, promulgated pursuant to Section 30-28-133(1), Colorado Revised Statutes (C.R.S.), requires the County to condition approval of all subdivisions on a developer’s promise to so construct adequate drainage, water runoff control facilities, and BMPs in subdivisions; and

E. WHEREAS, the Drainage Criteria Manual, Volume 2, as amended by Appendix I of the El Paso County Engineering Criteria Manual (ECM), as each may be periodically amended, promulgated pursuant to the County’s Colorado Discharge Permit System General Permit (MS4 Permit) as required by Phase II of the National Pollutant Discharge Elimination System (NPDES), which MS4 Permit requires that the County take measures to protect the quality of stormwater from sediment and other contaminants, requires subdividers, developers, landowners, and owners of facilities located in the County’s rights-of-way or easements to provide adequate permanent stormwater quality BMPs with new development or significant redevelopment; and

F. WHEREAS, Section 2.9 of the El Paso County Drainage Criteria Manual provides for a developer’s promise to maintain a subdivision’s drainage facilities in the event the County does not assume such responsibility; and

G. WHEREAS, developers in El Paso County have historically chosen water runoff detention basins as a means to provide adequate drainage and water runoff control in subdivisions, which basins,

while effective, are less expensive for developers to construct than other methods of providing drainage and water runoff control; and

H. WHEREAS, Developer desires to construct for the land use two detention basins/stormwater quality BMP(s) (“detention basins/BMP(s)”) as the means for providing adequate drainage and stormwater runoff control and to meet requirements of the County’s MS4 Permit, and to provide for operating, cleaning, maintaining and repairing such detention basin/BMP(s); and

I. WHEREAS, Developer desires to construct the retention basin/BMP(s) on property that will be platted as Falcon Acres Lots 1-8, as indicated on the final plat of the subdivision, and as depicted on Exhibit B attached hereto; and

J. WHEREAS, Developer shall be charged with the duty of constructing the detention basins/BMP(s) and shall be charged in the Subdivision’s covenants with the duties of operating, maintaining and repairing the detention basins/BMP(s) on the portions of the Property described herein and depicted in Exhibit B; and

K. WHEREAS, it is the County’s experience that developers historically have not properly cleaned and otherwise not properly maintained and repaired these detention basins/BMPs, and that these detention basins/BMPs, when not so properly cleaned, maintained, and repaired, threaten the public health, safety and welfare; and

L. WHEREAS, the County, in order to protect the public health, safety and welfare, has historically expended valuable and limited public resources to so properly clean, maintain, and repair these detention basins/BMPs when developers have failed in their responsibilities, and therefore, the County desires the means to recover its costs incurred in the event the burden falls on the County to so clean, maintain and repair the detention basin/BMP(s) serving this subdivision due to the Developer’s failure to meet its obligations to do the same; and

M. WHEREAS, the County conditions approval of this subdivision on the Developer’s promise to so construct the detention basins/BMP(s), and further conditions approval on the Developer’s promise to reimburse the County in the event the burden falls upon the County to so clean, maintain and/or repair the detention basins/BMP(s) serving this subdivision; and

N. WHEREAS, the County could condition land use approval on the Developer’s promise to construct a different and more expensive drainage, water runoff control system and BMPs than those proposed herein, which more expensive system would not create the possibility of the burden of cleaning, maintenance and repair expenses falling on the County; however, the County is willing to forego such right upon the performance of Developer’s promises contained herein; and

O. WHEREAS, the County, in order to secure performance of the promises contained herein, conditions approval of this land use upon the Developer’s grant herein of a perpetual Easement over a portion of the Property for the purpose of allowing the County to periodically access, inspect, and, when so necessary, to clean, maintain and/or repair the retention basins/BMP(s); and

Agreement

NOW, THEREFORE, in consideration of the mutual Promises contained herein, the sufficiency of which are hereby acknowledged, the Parties agree as follows:

1. Incorporation of Recitals: The Parties incorporate the Recitals above into this Agreement.
2. Covenants Running with the Land: Developer agrees that this entire Agreement and the performance thereof shall become a covenant running with the land, which land is legally described in Exhibit A attached hereto, and that this entire Agreement and the performance thereof shall be binding upon itself and its respective successors and assigns, including individual lot owners within the Subdivision.

Any liability imposed under this Agreement against an individual lot owner shall only be for those portions of the detention basin/BMP(s) located on his or her respective lot.

3. Construction: Developer shall construct on those portions of the Property depicted as hatched areas and labelled as “No-Build No-Storage Area” or “Drainage Easement” on pp. 3-4 of Exhibit B attached hereto and incorporated herein by this reference, hereafter referred to as “No-Build Drainage Easements,” two detention basins/BMP(s). Developer shall not commence construction of the detention basins/BMP(s) until the El Paso County Planning and Community Development Department (PCD) has approved in writing the plans and specifications for the detention basins/BMP(s) and this Agreement has been signed by all Parties and returned to the PCD. Developer shall complete construction of the detention basins/BMP(s) in substantial compliance with the County-approved plans and specifications for the detention basins/BMP(s). Failure to meet these requirements shall be a material breach of this Agreement and shall entitle the County to pursue any remedies available to it at law or in equity to enforce the same. Construction of the detention basins/BMP(s) shall be substantially completed within one year (defined as 365 days), which one year period will commence to run on the date the approved plat of this Subdivision is recorded in the records of the El Paso County Clerk and Recorder. Rough grading of the detention basin/BMP(s) must be completed and inspected by the El Paso County PCD prior to commencing road construction.

In the event construction is not substantially completed within the one year period, then the County may exercise its discretion to complete the project, and shall have the right to seek reimbursement from the Developer and their respective successors and assigns, including individual lot owners in the Subdivision, for its actual costs and expenses incurred in the process of completing construction. The term actual costs and expenses shall be liberally construed in favor of the County, and shall include, but shall not be limited to, labor costs, tool and equipment costs, supply costs, and engineering and design costs, regardless of whether the County uses its own personnel, tools, equipment and supplies, etc. to correct the matter. In the event the County initiates any litigation or engages the services of legal counsel in order to enforce the Provisions arising herein, the County shall be entitled to its damages and costs, including reasonable attorney fees, regardless of whether the County contracts with outside legal counsel or utilizes in-house legal counsel for the same. The scope of liability therefor of the Developer and the individual lot owners shall be as set forth in Paragraph Two (2) above.

4. Maintenance: The Developer agrees for itself and its successors and assigns, including individual lot owners within the Subdivision, that they will regularly and routinely inspect, clean and maintain the No-Build Drainage Easements and detention basins/BMP(s) in compliance with the County-reviewed Operation and Maintenance Manual, attached hereto and incorporated herein by this reference as Exhibit C, and otherwise keep the same in good repair, all at their own cost and expense. No trees or shrubs that will impair the structural integrity of the detention basins/BMP(s) shall be planted or allowed to grow on the detention basins/BMP(s). No activities in violation of Notes 14 or 15 on the recorded final plat may occur within the No-Build Drainage Easements.

5. Creation of Easement: Developer hereby grants the County a non-exclusive perpetual easement upon and across the No-Build Drainage Easements depicted as Drainage Easements in Exhibit B. The purpose of the easement is to allow the County to access, inspect, clean, repair and maintain the detention basins/BMP(s); however, the creation of the easement does not expressly or implicitly impose on the County a duty to so inspect, clean, repair or maintain the detention basins/BMP(s).

6. County's Rights and Obligations: Any time the County determines, in the sole exercise of its discretion, that the detention basins/BMP(s) is not properly cleaned, maintained and/or otherwise kept in good repair, the County shall give reasonable notice to the Developer and its successors and assigns, including the individual lot owners within the Subdivision, that the detention basins/BMP(s) needs to be cleaned, maintained and/or otherwise repaired. The notice shall provide a reasonable time to correct the problem(s). Should the responsible parties fail to correct the specified problem(s), the County may enter upon the Property to so correct the specified problem(s). Notice shall be effective to the above by the County's deposit of the same into the regular United States mail, postage pre-paid. Notwithstanding the foregoing, this Agreement does not expressly or implicitly impose on the County a duty to so inspect, clean, repair or maintain the detention basins/BMP(s).

7. Reimbursement of County's Costs / Covenant Running With the Land: The Developer agrees for itself and its successors and assigns, including individual lot owners within the Subdivision, that they will reimburse the County for its costs and expenses incurred in the process of completing construction of, cleaning, maintaining, and/or repairing the detention basins/BMP(s) pursuant to the provisions of this Agreement; however, the obligation and liability of the Developer hereunder shall only continue until such time as the Developer has conveyed all lots within the Subdivision. Notwithstanding the previous sentence, the individual lot owners within the Subdivision shall always remain obligated and liable hereunder, and as per the provisions of Paragraph Two (2) above.

The term "actual costs and expenses" shall be liberally construed in favor of the County, and shall include, but shall not be limited to, labor costs, tools and equipment costs, supply costs, and engineering and design costs, regardless of whether the County uses its own personnel, tools, equipment and supplies, etc. to correct the matter. In the event the County initiates any litigation or engages the services of legal counsel in order to enforce the provisions arising herein, the County shall be entitled to its damages and costs, including reasonable attorney's fees, regardless of whether the County contracts with outside legal counsel or utilizes in-house legal counsel for the same. The scope of liability therefore of the Developer and the individual lot owners shall be as set forth in Paragraph Two (2) above.

8. Contingencies of Subdivision Approval: Developer's execution of this Agreement is a condition of subdivision approval. Additional conditions of this Agreement include, but are not limited to, the following:

- a. A copy of the Covenants of the Subdivision establishing that the Developer/Lot owners are obligated to inspect, clean, maintain, and repair the detention basin/BMP(s).
- b. A copy of the Covenants of the Subdivision establishing that this Agreement is incorporated into the Covenants, and that such Agreement touches and concerns each and every lot within the Subdivision.

The County shall have the right, in the sole exercise of its discretion, to approve or disapprove any documentation submitted to it under the conditions of this Paragraph, including but not limited to, any separate agreement or amendment, if applicable, identifying any specific maintenance responsibilities not addressed herein. The County's rejection of any documentation submitted hereunder shall mean that the appropriate condition of this Agreement has not been fulfilled.

9. Distribution to Lot Purchasers: Upon the initial sale of any lot within the Subdivision, prior to closing on such sale, the Developer shall give a copy of this Agreement to the potential Buyer.

10. Agreement Monitored by El Paso County Planning and Community Development Department and/or El Paso County Department of Public Works: Any and all actions and decisions to be made hereunder by the County shall be made by the Director of the El Paso County Planning and Community Development Department and/or the Director of the El Paso County Department of Public Works. Accordingly, any and all documents, submissions, plan approvals, inspections, etc. shall be submitted to and shall be made by the Director of the Planning and Community Development Department and/or the Director of the El Paso County Department of Public Works.

11. Indemnification and Hold Harmless: Developer for itself and its respective successors and assigns, including individual lot owners in the Subdivision, that they will indemnify, defend, and hold the County harmless from any and all loss, costs, damage, injury, liability, claim, lien, demand, action and causes of action whatsoever, whether at law or in equity, arising from or related to their respective intentional or negligent acts, errors or omissions or that of their agents, officers, servants, employees, invitees and licensees in the construction, operation, inspection, cleaning (including analyzing and disposing of any solid or hazardous wastes as defined by State and/or Federal environmental laws and regulations), maintenance, and repair of the detention basins/BMP(s), and such obligation arising under this Paragraph shall be joint and several. Nothing in this Paragraph shall be deemed to waive or otherwise limit the defense available to the County pursuant to the Colorado Governmental Immunity Act, Sections 24-10-101, *et seq.* C.R.S., or as otherwise provided by law. However, the obligation and liability of the Developer hereunder shall only continue until such time as the Developer transfers the entire property to the individual lot owners within the Subdivision.

12. Severability: In the event any Court of competent jurisdiction declares any part of this Agreement to be unenforceable, such declaration shall not affect the enforceability of the remaining parts of this Agreement.

13. Third Parties: This Agreement does not and shall not be deemed to confer upon or grant to any third party any right to claim damages or to bring any lawsuit, action or other proceeding against either the County, the Developer, or their respective successors and assigns, including any individual lot

owners in the Subdivision, because of any breach hereof or because of any terms, covenants, agreements or conditions contained herein.

14. Solid Waste or Hazardous Materials: Should any refuse from the detention basins/BMP(s) be suspected or identified as solid waste or petroleum products, hazardous substances or hazardous materials (collectively referred to herein as "hazardous materials"), the Developer shall take all necessary and proper steps to characterize the solid waste or hazardous materials and properly dispose of it in accordance with applicable State and/or Federal environmental laws and regulations, including, but not limited to, the following: Solid Wastes Disposal Sites and Facilities Acts, §§ 30-20-100.5 – 30-20-119, C.R.S., Colorado Regulations Pertaining to Solid Waste Disposal Sites and Facilities, 6 C.C.R. 1007-2, *et seq.*, Solid Waste Disposal Act, 42 U.S.C. §§ 6901-6992k, and Federal Solid Waste Regulations 40 CFR Ch. I. The County shall not be responsible or liable for identifying, characterizing, cleaning up, or disposing of such solid waste or hazardous materials. Notwithstanding the previous sentence, should any refuse cleaned up and disposed of by the County be determined to be solid waste or hazardous materials, the Developer but not the County, shall be responsible and liable as the owner, generator, and/or transporter of said solid waste or hazardous materials.

15. Applicable Law and Venue: The laws, rules, and regulations of the State of Colorado and El Paso County shall be applicable in the enforcement, interpretation, and execution of this Agreement, except that Federal law may be applicable regarding solid waste or hazardous materials. Venue shall be in the El Paso County District Court.

IN WITNESS WHEREOF, the Parties affix their signatures below.

Executed this 6th day of December, 20 24, by:

THOUSAND HILLS LAND & CATTLE CO. LLC

By: *Richard Elliott* managing member
Richard Elliott, Managing Member

The foregoing instrument was acknowledged before me this 6th day of December, 20 24, by Richard Elliott, Authorized Signing Agent, Thousand Hills Land & Cattle Co. LLC.

Witness my hand and official seal.

My commission expires: Jan 8th 2028



Raelee Lucero
Notary Public

Executed this _____ day of _____, 20____, by:

BOARD OF COUNTY COMMISSIONERS
OF EL PASO COUNTY, COLORADO

By: _____

Meggan Herington, Executive Director
El Paso County Planning and Community Development
Authorized signatory pursuant to LDC

The foregoing instrument was acknowledged before me this _____ day of _____,
20____, by _____, Executive Director of the El Paso County Planning and Community
Development Department.

Witness my hand and official seal.

My commission expires: _____

Notary Public

Approved as to Content and Form:

Lori L. Seago

Assistant County Attorney

Exhibit A – Legal Description

FALCON ACRES
LEGAL DESCRIPTION

LOT 1, ALSO KNOWN AS THE NORTHEAST QUARTER OF THE NORTHEAST QUARTER AND A PORTION OF LOT 2, ALSO KNOWN AS THE EAST HALF OF THE EAST HALF OF THE NORTHWEST QUARTER OF SECTION 4, TOWNSHIP 14 SOUTH, RANGE 64 WEST OF THE 6TH P.M., EXCEPT ANY PORTION THEREOF LYING WITHIN DAVIS ROAD AND CURTIS ROAD, COUNTY OF EL PASO, STATE OF COLORADO MORE PARTICULARLY DESCRIBED AS FOLLOWS: COMMENCING AT THE NORTHEAST CORNER OF SAID SECTION 4; THENCE S 00°29'24" E, ALONG THE EAST LINE OF SAID NORTHEAST QUARTER OF THE NORTHEAST QUARTER, 30.00 FEET; THENCE N 89°56'26" W, 30.00 FEET, TO THE POINT OF BEGINNING; THENCE S 00°29'24" E, 30.00 FEET FROM AND PARALLEL WITH SAID EAST LINE, 1285.42 FEET TO A POINT ON THE SOUTH LINE OF SAID NORTHEAST QUARTER OF THE NORTHEAST QUARTER; THENCE N 89°53'49" W, 1641.50 FEET TO THE SOUTHWEST CORNER OF SAID EAST HALF OF THE EAST HALF OF NORTHWEST QUARTER OF THE NORTHEAST QUARTER; THENCE N 00°38'11" W, 1284.23 FEET TO A POINT 30.00 FEET AND PARALLEL WITH THE NORTH LINE OF SAID SECTION 4, 1614.77 FEET, TO THE POINT OF BEGINNING AND CONTAINING 47.577 ACRES MORE OR LESS.

Exhibit B – Plat

FALCON ACRES

A Portion of the Northeast One-Quarter of Section 4, Township 14 South, Range 64 West of the 6th P.M.,
El Paso County, Colorado

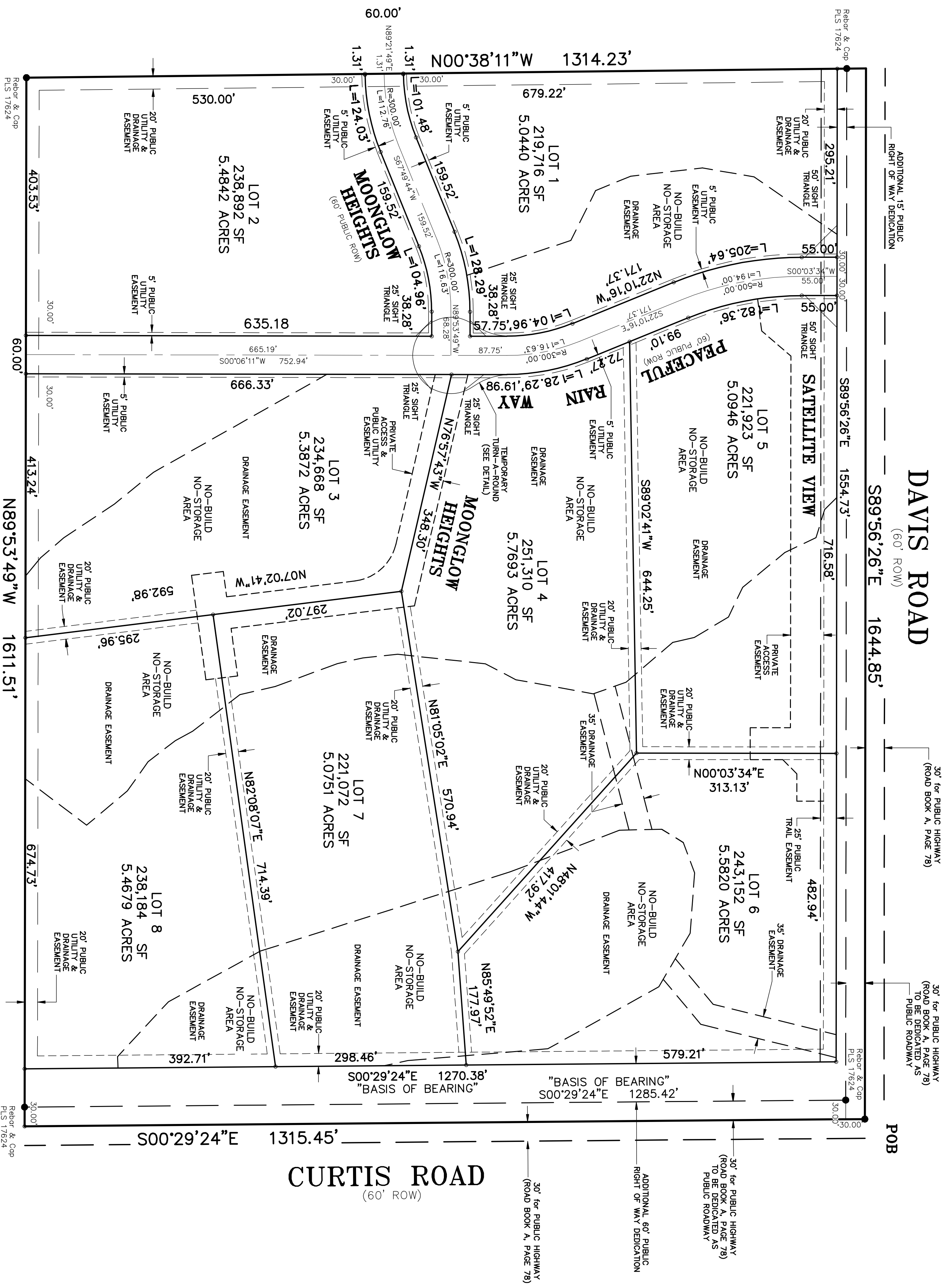

DAVIS ROAD
(60' ROW)
S89°56'26"E 1644.85'

CURTIS ROAD
(60' ROW)
S00°29'24"E 1315.45'

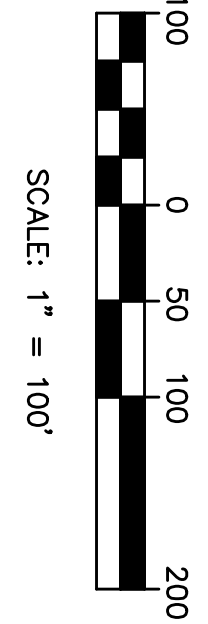
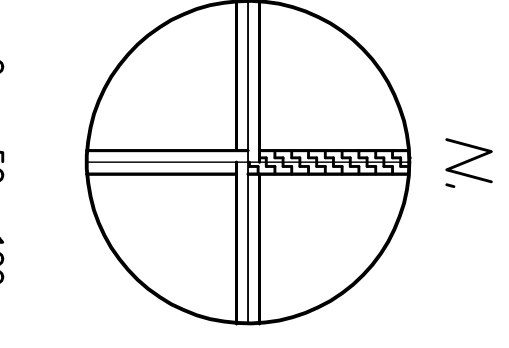
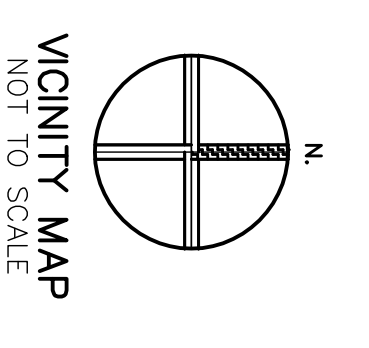

LOT 1
SCALE: 1" = 50'

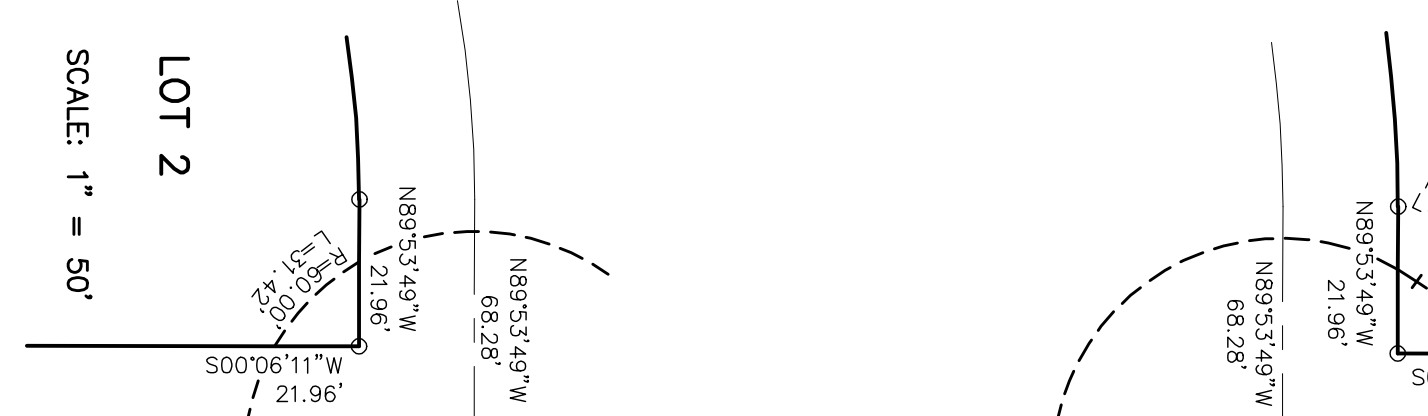

LOT 2
SCALE: 1" = 50'

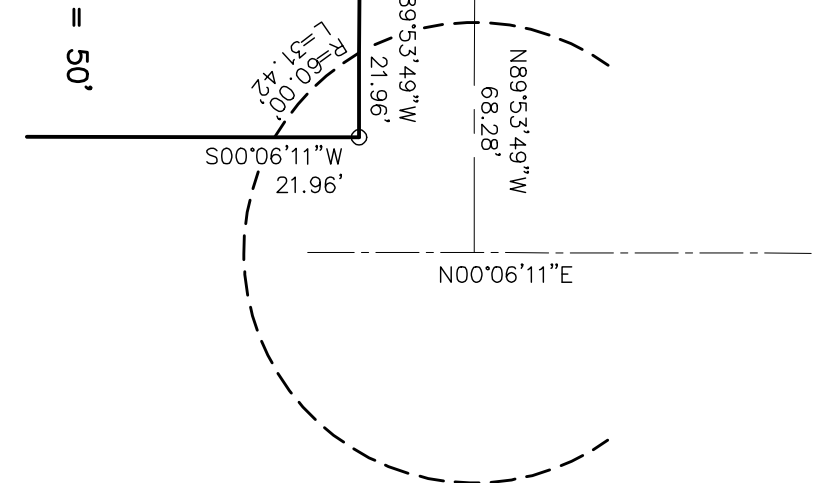

LOT 3
SCALE: 1" = 50'

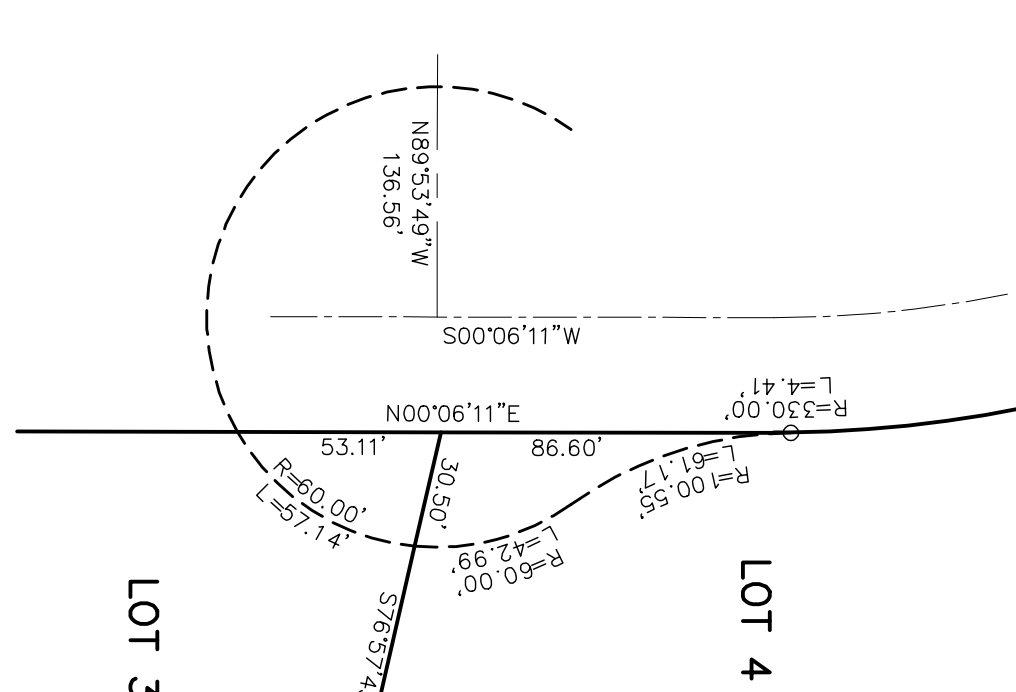

LOT 4
SCALE: 1" = 50'

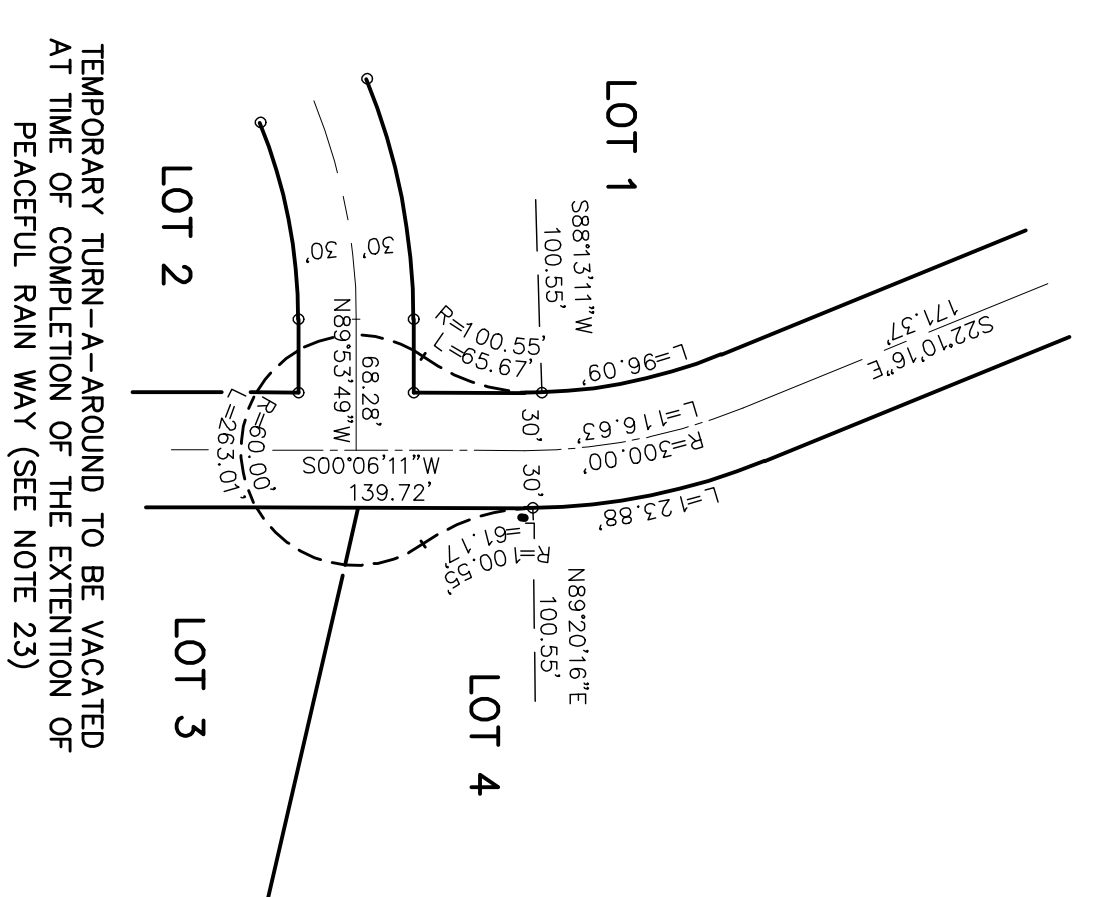

TEMPORARY TURN-A-ROUND TO BE VACATED
AT TIME OF COMPLETION OF THE EXTENSION OF
PEACEFUL RAIN WAY (SEE NOTE 23)

DETAIL
TEMPORARY
TURN-A-ROUND
SCALE: 1" = 100'

PCD file No. SF223

no.	date	revisions	scale: 1" = 100'	drawn by: JPB	by
4.	10/16	Satellite View Easement width		JPB	JPB
3.	09/21	County Comments		JPB	JPB
2.	08/17	dimension correction		JPB	JPB
1.	07/24	County Comments		JPB	JPB

drawing date: February 20, 2023
 dwg. file: 2203001Dp222.dwg
 project no.: 22033001
 sheet: 2 of 4

**FALCON ACRES
SUBDIVISION PLAT**

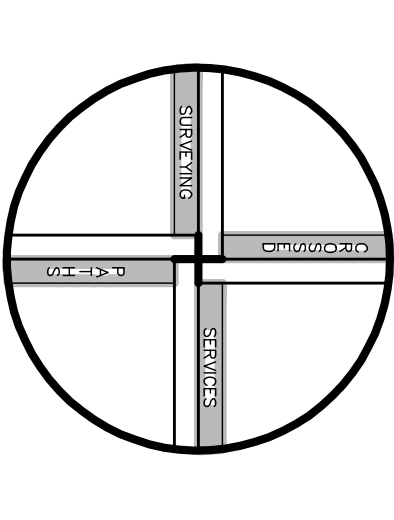

CROSSED PATHS SURVEYING SERVICES, INC.
 COLORADO
 P.O. BOX 49742
 DENVER, CO 80249-9742
 PHONE: 303-681-2349
 EMAIL: info@spshinc.com

FALCON ACRES

A Portion of the Northeast One-Quarter of Section 4, Township 14 South, Range 64 West of the 6th P.M.,
El Paso County, Colorado

DAVIS ROAD

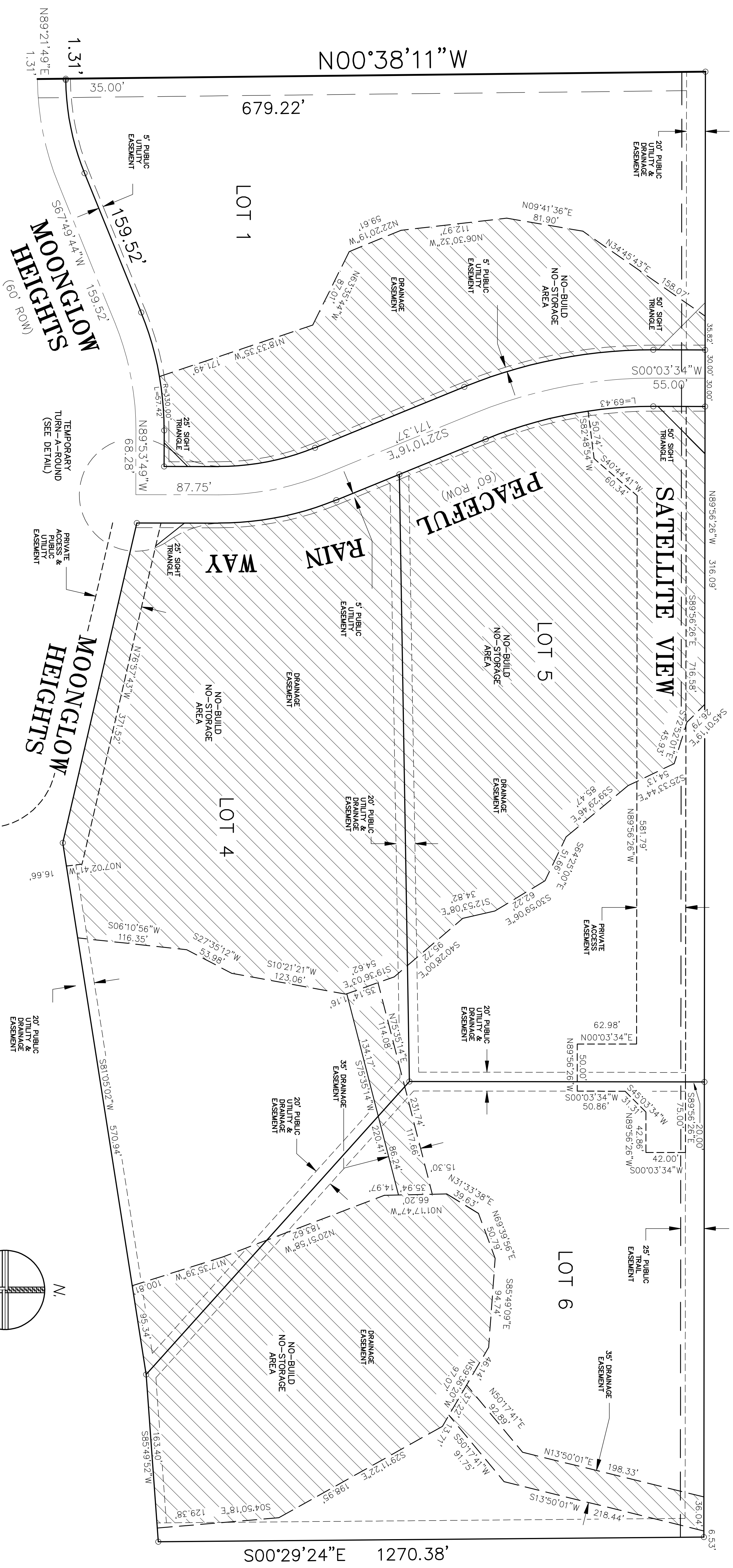

CURTIS ROAD

FALCON ACRES SUBDIVISION PLAT

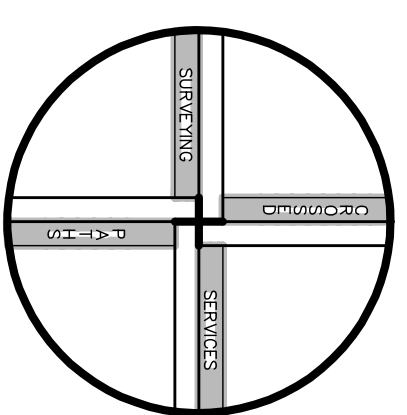

PCD file No. SF223

no.	date	revisions	by
4.	10/16	Satellite View Easement width	JPB
3.	09/21	County Comments	JPB
2.	08/17	dimension correction	JPB
1.	07/24	County Comments	JPB

drawing date: February 20, 2023
 scale: 1" = 60'
 dwg. file: 2203001D3p4f2.dwg
 sheet: 3 of 4

CROSSED PATHS SURVEYING SERVICES, INC.
 COLORADO
 PHONE: 719-681-2349
 EMAIL: info@cpssinc.com

FALCON ACRES
*A Portion of the Northeast One-Quarter of Section 4, Township 14 South, Range 64 West of the 6th P.M.,
 El Paso County, Colorado*

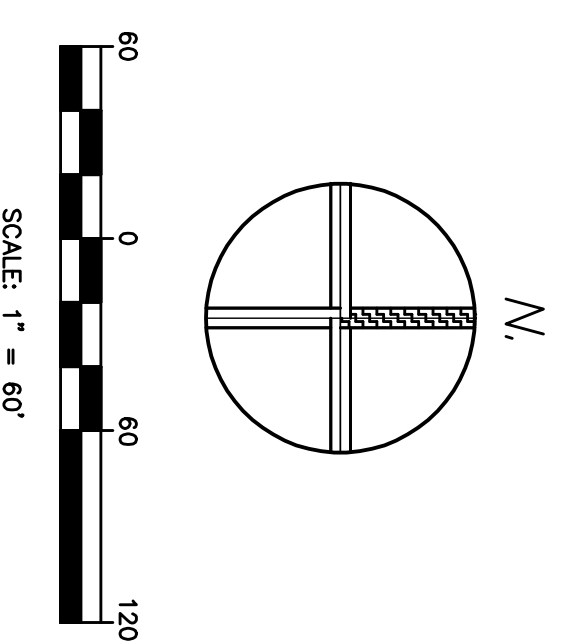
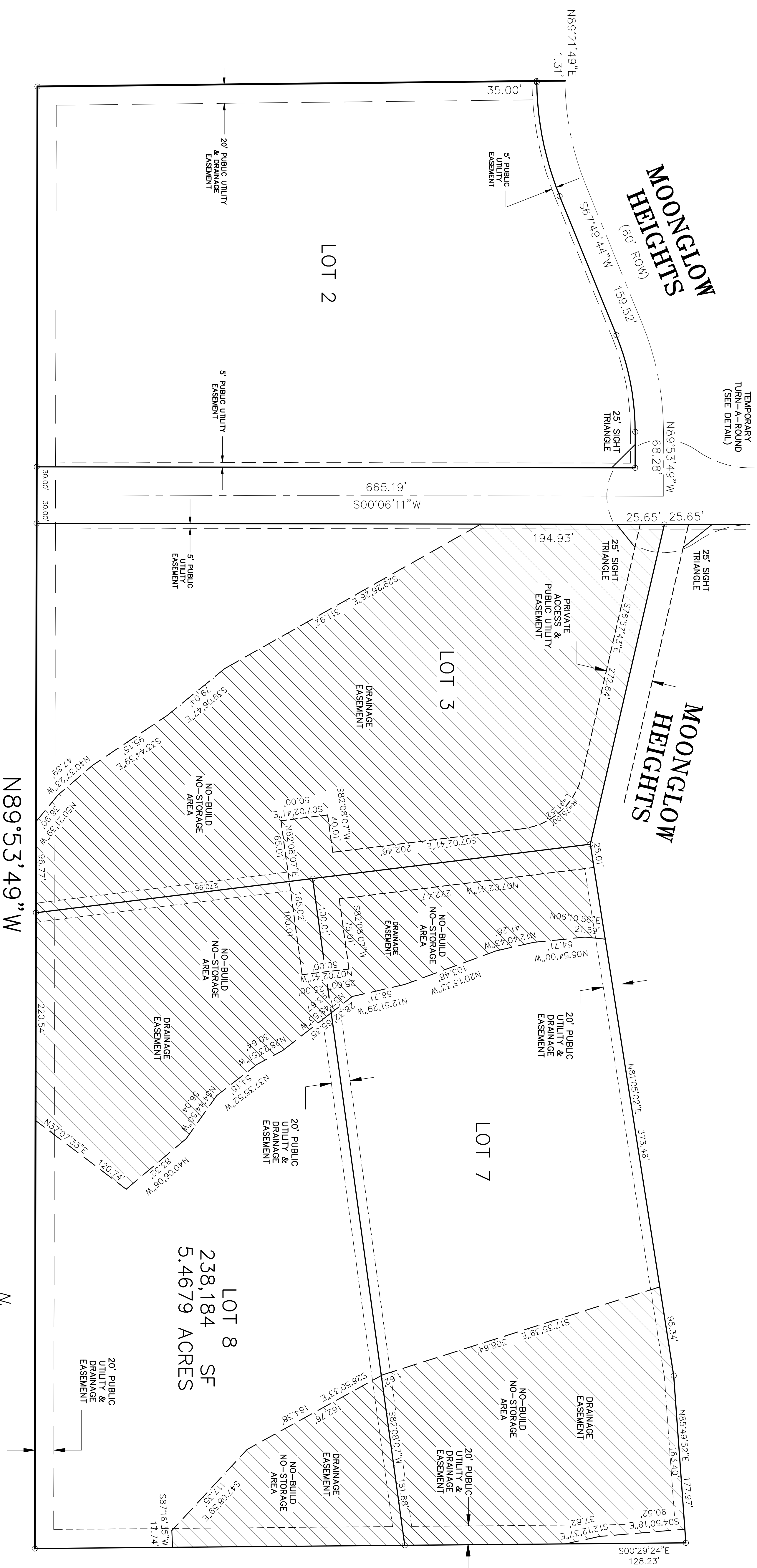

CURTIS ROAD

LOT 8
 238,184 SF
 5.4679 ACRES

PCD file No. SF223

no.	date	revisions	by
4.	10/16	Satellite View Easement width	JPB
3.	09/21	County Comments	JPB
2.	08/17	dimension correction	JPB
1.	07/24	County Comments	JPB

drawing date: February 20, 2023
 scale: 1" = 60'
 dwg. file: 220300193442.dwg
 drawn by: JPB
 project no: 2203001
 sheet: 4 of 4

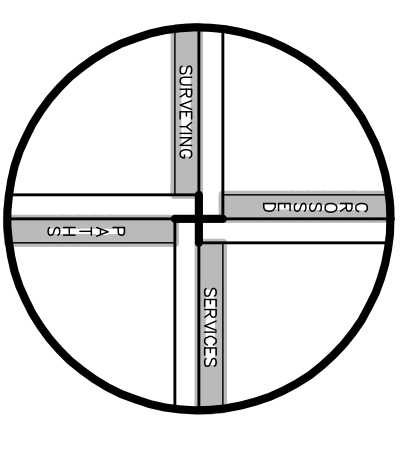

**FALCON ACRES
 SUBDIVISION PLAT**

CROSSED PATHS SURVEYING SERVICES, INC.
 COLORADO
 P.O. BOX 493742
 DENVER, CO 80249
 PHONE: 303-681-2349
 EMAIL: jpb@cpssinc.com

Exhibit C – O & M Manual

Falcon Acres Operations and Maintenance Manual Retention Pond

County Job No.

Retention ponds have low to moderate maintenance requirements. Routine and non-routine maintenance is necessary to assure performance, enhance aesthetics, and protect structural integrity. Wet basins can result in nuisance complaints if not properly designed or maintained. Bio-degradable pesticides may be required to limit insect problems. Frequent debris removal and grass-mowing can reduce aesthetic complaints. Mosquito breeding and nuisance odors could occur if the water becomes stagnant.

Falcon Acres Contact Info

Contact Person: Richard Elliott

Phone: (719) 238-4234

Email: thousandhills88@gmail.com

Mailing Address: 812 E Monument Street, Colorado Springs, CO, 80903

1. Falcon Acres Retention Ponds Maintained by Thousand Hills Land & Cattle Co.

There are two retention ponds on the Falcon Acres property that Thousand Hills Land & Cattle Co. owns and maintains. The following are details of these retention ponds. Attached to this manual is a map showing the retention pond locations.

Retention Ponds – These retention ponds will be built in 2022-2023. The final drainage report for Falcon Acres covers the drainage calculations for this pond.

2. Access

The retention ponds can be accessed from the drive aisles on the property.

3. Inspections

Inspection and Frequency

□ Annually inspect retention pond to insure that the basins continue to function as initially intended. The annual inspection should evaluate the pond side slopes, the spillway conditions, downstream channel, the culverts connecting areas of the pond beneath drive aisles, and the condition of the downstream face of the ponds. A site survey will be the best indication of excessive sediment buildup and degradation of the spillway. In addition, an inspection of the vegetation on the downstream face of the spillway should be conducted. Any bare areas should be noted and repaired using native grasses. Any sloughing or erosion of the embankment should be noted and repaired. Items to record will include any items inspected and the mowing frequency of the vegetation on the facility.

- Just before annual storm seasons (that is, April and May) and following significant rainfall events, inspect for litter and debris that may plug culverts.
- A baseline survey should be performed at the time of construction and comparison surveys conducted every ten to twenty years after to monitor overall performance of the ponds. Results of inspections should be recorded and kept at a central location for review and recording by the district.

Inspection Personnel

A qualified engineer, surveyor, or certified storm water inspector should conduct inspections of the facility.

4.0 Operations

No specific operating instructions are required.

5.0 Maintenance

Maintenance of the retention ponds shall be in accordance with the guidelines included in Table RP-1, below.

Table RP-1		
Required Action	Maintenance Objective	Frequency of Action
Debris and litter removal	Remove debris and litter from the entire pond to minimize culvert clogging and improve aesthetics.	Routine – Including just before annual storm seasons (that is, April and May) and following significant rainfall events.
Erosion and sediment control	Repair and revegetate eroded areas in the basin and channels.	Nonroutine – Periodic and repair as necessary based on inspection.
Structural	Repair culverts whenever damage is discovered.	Nonroutine – Repair as needed based on regular inspections.
Inspections	Inspect basins to insure that the basins continue to function as initially intended. Examine the culverts for clogging, erosion, slumping, excessive sedimentation levels, overgrowth, embankment and spillway integrity, and damage.	Routine – Annual inspection of hydraulic and structural facilities. Also check for obvious problems during routine maintenance visits, especially for plugging of culverts.

Nuisance control	Address odor, insects, and overgrowth issues associated with stagnant or standing water in the bottom zone.	Nonroutine – Handle as necessary per inspection or local complaints.
Sediment removal	Remove accumulated sediment from the culverts and the bottom of the basins.	Nonroutine – Performed when sediment accumulation occupies 20 percent of the WQCV. This may vary considerably, but expect to do this every 10 to 20 years, as necessary per inspection if no construction activities take place in the tributary watershed. More often if they do.