



ENTECH
ENGINEERING, INC.

505 ELKTON DRIVE
COLORADO SPRINGS, CO 80907
PHONE (719) 531-5599

**SOILS AND GEOLOGY STUDY
OVERLOOK AT HOMESTEAD – FILING NO. 1
ELBERT ROAD
EL PASO COUNTY, COLORADO**

Prepared for:

PT Overlook, LLC
1864 Woodmoor Drive, Suite 100
Monument, Colorado 80132

Attn: Joe DesJardin

June 7, 2024

Respectfully Submitted,

ENTECH ENGINEERING, INC.

Logan L. Langford, P.G.
Sr. Geologist

Reviewed by:



Joseph C. Goode Jr., P.E.
President

LLL

PCD No.

Table of Contents

1 SUMMARY..... 1

2 GENERAL SITE CONDITIONS AND PROJECT DESCRIPTION 1

3 SCOPE OF THE REPORT 2

4 FIELD INVESTIGATION 2

5 SOIL, GEOLOGY, AND ENGINEERING GEOLOGY..... 3

 5.1 General Geology 3

 5.1 Soil Conservation Survey 4

 5.2 Site Stratigraphy 4

 5.3 Soil Conditions 5

 5.4 Groundwater 6

6 ENGINEERING GEOLOGY – IDENTIFICATION AND MITIGATION OF GEOLOGIC HAZARDS..... 7

 6.1 Relevance of Geologic Conditions to Land Use Planning 11

7 ECONOMIC MINERAL RESOURCES 14

8 EROSION CONTROL 15

9 ROADWAY, EMBANKMENT, and STORMWATER FACILITY CONSTRUCTION RECOMMENDATIONS..... 16

10 CLOSURE..... 17

11 REFERENCES..... 18

FIGURES

- Figure 1: Vicinity Map
- Figure 2: USGS Map
- Figure 3: Overall Site Plan
- Figure 4: Development Plan/Test Boring Location Map
- Figure 5: Soil Survey Map
- Figure 6: Eastonville Quadrangle Geology Map
- Figure 7: Geology Map/Engineering Geology
- Figure 8: Floodplain Map
- Figure 9: Debris Flow Susceptibility Map
- Figure 10: Typical Perimeter Drain Details
- Figure 11: Underslab Drainage Layer (Capillary Break)
- Figure 12: Interceptor Drain Detail

- APPENDIX A: Site Photographs
- APPENDIX B: Test Boring Logs
- APPENDIX C: Laboratory Test Results
- APPENDIX D: Soil Survey Descriptions

1 SUMMARY

Project Location

The project lies in portions of the S½ of Section 22 and N½ of Section 27, Township 11 South, Range 64 West of the 6th Principal Meridian in El Paso County, Colorado. The site is located approximately 3½ miles northwest of Peyton, Colorado.

Project Description

Overlook at Homestead Filing No. 1 Subdivision is approximately 202 acres, with thirty-six (36) 5-acre rural residential lots proposed (Lots 21 – 56). The development will be serviced by individual water wells and on-site wastewater systems (OWTS).

Scope of Report

This report presents the results of our geologic evaluation and treatment of engineering geologic hazard study.

Land Use and Engineering Geology

This site was found to be suitable for the proposed development. Areas were encountered where the geologic conditions will impose some constraints/hazards on development and land use. These include areas of artificial fill, expansive soils, shallow bedrock, seasonally shallow and potential seasonally shallow groundwater areas, springs, potentially unstable slopes, shallow bedrock. Rockfall, and debris flow susceptible areas affect lots in the southeast portion of the site. Based on the proposed development plan, it appears that these areas will have some impact on the development. These conditions will be discussed in greater detail in the report.

In general, it is our opinion that the development can be achieved if the observed geologic conditions on site are either avoided or properly mitigated. All recommendations are subject to the limitations discussed in the report.

2 GENERAL SITE CONDITIONS AND PROJECT DESCRIPTION

The site is located in portions of the S½ of Section 22 and N½ of Section 27, Township 11 South, Range 64 West of the 6th Principal Meridian in El Paso County, Colorado. The site is located approximately 3½ miles northwest of Peyton, Colorado, northeast of Elbert Road and Sweet Road. The location of the site is as shown on the Vicinity Map, Figure 1.

The topography of the site is generally gradually to moderately sloping to the south with steep slopes along the mesa. Several drainages and minor drainage swales, ponds, and springs were on the site. The ponds and portions of the drainages had water at the time of our initial site visit. The site boundaries are indicated on the USGS Map, Figure 2. Previous land uses have included grazing and pasture land with an older farmhouse and out buildings in the northern portion of the site. The site contains primarily field grasses, ponderosa pines, cacti, yucca, and weeds. Site photographs, taken May 2 and 24, 2023, are included in Appendix A.

Overlook at Homestead Filing No. 1 Subdivision is approximately 202 acres, with thirty-six (36) 5-acre rural residential lots proposed (Lots 21 – 56). Preliminary grading plans indicate three extended detention basins (EDBs) across the southern side of Filing No. 1 to be located on Lots 31-32, 37-38, and 39-40. Grading will primarily be associated with the construction of roads and extended detention basins. The Overall Site Plan is presented in Figure 3, and the Development Plan/Test Boring Location Map is presented in Figure 4.

3 SCOPE OF THE REPORT

The scope of the report will include a general geologic analysis utilizing published geologic data. Detailed site-specific mapping will be conducted to obtain general information in respect to major geographic and geologic features, geologic descriptions and their effects on the development of the property.

4 FIELD INVESTIGATION

Our field investigation consisted of the preparation of a geologic map of any bedrock features and significant surficial deposits. The Natural Resource Conservation Service (NRCS), previously the Soil Conservation Service (SCS) survey was also reviewed to evaluate the site. The position of mappable units within the subject property are shown on the Geologic Map. Our mapping procedures involved both field reconnaissance and measurements and air photo reconnaissance and interpretation. The same mapping procedures have also been utilized to produce the Engineering Geology Map which identified pertinent geologic conditions affecting development. The field mapping was performed by personnel of Entech Engineering, Inc. on May 2 and 24, 2023 (References 1 and 2). The site was revisited on May 28, 2024 to verify previous mapping and evaluate current site conditions.

Sixteen test borings (TB-1 – TB-16) were drilled as part of this investigation to determine general soil and bedrock characteristics. Six additional test borings (TB-17 – TB-22) were drilled across the site in the proposed EDBs, and in the proposed cut area for Apex Ranch Road near Lots 20 and 57. Test Boring Nos. 1 – 10, and 17 – 19 are located within Filing No. 1, and Test Boring No. 22 was placed in the proposed cut area for Apex Ranch Road. The locations of the test borings are indicated on the Development Plan/Test Boring Location Map, Figure 4. The Test Boring Logs are presented in Appendix B, and Summarized on Table B-1. Results of this testing will be discussed later in this report.

Laboratory testing was performed on some of the soils to classify and determine the soils engineering characteristics. Laboratory tests included grain-size analysis ASTM D-422, Atterberg Limits ASTM D-4318, volume change testing using Swell/Consolidation test. Sulfate testing was performed on select samples to evaluate potential for below grade concrete degradation due to sulfate attack. Results of the laboratory testing are included in Appendix C. A Summary of Laboratory Test Results is presented in Table C-1.

5 SOIL, GEOLOGY, AND ENGINEERING GEOLOGY

5.1 General Geology

Physiographically, the site lies in the western portion of the Great Plains Physiographic Province. Approximately 20 miles to the west is a major structural feature known as the Rampart Range Fault. This fault marks the boundary between the Great Plains Physiographic Province and the Southern Rocky Mountain Province. The site exists within the southeastern edge of a large structural feature known as the Denver Basin. Bedrock in the area tends to be very gently dipping in a northwesterly direction (Reference 3). The rocks in the area of the site are sedimentary in nature and typically Upper Cretaceous in age. The bedrock underlying the site consists of the Dawson Formation. Overlying this formation are unconsolidated deposits of man-made fill and alluvial soils of Quaternary Age. The alluvial soils were deposited by water on site and as stream terraces along drainages, and alluvial fan deposits originating from the mesa located in the southeastern portion of the site. Man-made deposits exist as fill/trash piles, and earthen embankments across the site. The site's stratigraphy will be discussed in more detail in Section 5.3.

5.1 Soil Conservation Survey

The Natural Resource Conservation Service (Reference 4), previously the Soil Conservation Service (Reference 5) has mapped four soil types on the site (Figure 5). In general, the soils classify as coarse sandy loam, sandy loam, and rock outcrops. The soils are described as follows:

Type	Description
42	Kettle – rock outcrop complex, 8 to 60% slopes
66	Peyton – sandy loam, 1 to 5% slopes
68	Peyton-Pring Complex, 3 to 8% slopes
71	Pring – coarse sandy loam, 3 to 8% slopes

Complete descriptions of each soil type are presented in Appendix D. The soils have generally been described to have moderate to moderately rapid permeabilities. Possible hazards with soil erosion are present on the site. The erosion potential can be controlled with vegetation. The majority of the soils have been described to have moderate erosion hazards

5.2 Site Stratigraphy

The Eastonville Quadrangle Geology Map showing the site is presented in (Figure 6, Reference 6). The Geology Map prepared for the site is presented in Figure 6. Five mappable units were identified on this site which are described as follows:

Qaf Artificial Fill of Holocene Age: These recent man-made deposits associated with earthen embankments in the southern portion of the site.

Qa₂ Alluvium two of Early Holocene Age: This material is a water-deposited alluvium, typically classified as a silty to well-graded sand, brown to dark brown in color and of moderate density. This deposit can sometimes be very highly stratified containing thin layers of very silty and clayey soil. Alluvium two correlates with the Piney Creek Alluvium in the Denver Area.

- Qc Colluvial deposits of Holocene to late Pleistocene Age:** These materials consist of silty sands and gravel deposited by the action of sheetwash and gravity as well as the in-situ weathering of the bedrock materials on-site. The colluvium is mapped along the slopes of the mesa and contain localized areas of rockfall and fan deposits.
- Qpg Gravel of Palmer Divide of early Pleistocene? or late Pliocene Age:** These materials consist of alluvial deposited fine to coarse sand interbedded with pinkish brown to brownish gray pebble and cobble gravel. Clast types within the gravel consist of quartz, granite, red sandstone, tan arkosic sandstone, ironstone, petrified wood, and porphyritic and tuffaceous volcanic clasts. The gravel occurs in weakly stratified to massive beds or as lenses within fluvial sand, and caps the mesa on the site.
- Tkd Dawson Formation of Tertiary to Cretaceous Age:** The Dawson formation typically consists of arkosic sandstone with interbedded fine-grained sandstone, siltstone and claystone. Overlying this formation is a variable layer of residual and/or colluvial soils. The residual soils were derived from the in-situ weathering of the bedrock materials on-site. The colluvial soils have been transported by the action of sheetwash and gravity. These soils consisted of silty to clayey sands and sandy clays.

The bedrock underlying the site consists of the Dawson Formation of Tertiary to Cretaceous Age. The Dawson Formation typically consists of arkosic sandstone with interbedded fine-grained sandstone, siltstone and claystone. Overlying this formation are variable layers of alluvial deposits, and residual soil. The residual soils were derived from the in-situ weathering of the bedrock materials on-site. These soils consisted of silty to clayey sands and sandy clays.

The soils listed above were mapped from site-specific mapping, the *Geologic Map of the Eastonville Quadrangle* distributed by the Colorado Geological Survey in 2012 (Reference 6), the *Geologic Map of the Colorado Springs-Castle Rock Area*, distributed by the US Geological Survey in 1978 (Reference 7), and the *Geologic Map of the Denver 1^o x 2^o Quadrangle*, distributed by the US Geological Survey in 1981 (Reference 8). The Test Borings used in evaluating the site and are included in Appendix B. The Geology Map prepared for the site is presented in Figure 7.

5.3 Soil Conditions

The soils encountered in the Test Borings can be grouped into four general soil and rock types. The soils were classified using the Unified Soil Classification System (USCS).

Soil Type 1 classified as silty sand (SM). The sand was encountered in seventeen of the test borings at the ground surface extending to depths ranging from 3 to 13 feet bgs. The sand was encountered at very loose to dense states. The majority of the samples indicated medium dense states.

Soil Type 2 classified as sandy clay and sandy silty (CL, ML). The clay and silt were encountered in TB-9, TB-12, and TB-17 in thin lenses at 2 to 3 feet bgs. The clay and silt were encountered at very stiff consistencies. FHA Swell Testing on a sample of clay resulted in a volume change of 1150 psf, which indicates a low expansion potential. Swell/Consolidation Testing on a sample of siltstone resulted in an expansion of 1.7, which indicates a moderate expansion potential

Soil Type 3 classified as sandstone with silt and silty sandstone (SM-SW, SM). The sandstone was encountered in all of the test borings at depths ranging from the ground surface to 13 feet bgs, and extended to depths ranging from 14 feet to the termination of the borings (8 to 35 feet). The sandstone was encountered at dense states.

Soil Type 4 classified as sandy siltstone (ML). The siltstone was encountered in TB-2, TB-3, and TB-19 at 14 feet bgs, and extended to the termination of the test borings (20 feet). The siltstone was encountered at hard consistencies. Swell/Consolidation Testing on a sample of siltstone resulted in a consolidation of 0.1 percent and an expansion of 3.0, which indicates a low consolidation potential and moderate to high expansion potential.

The Test Boring Logs are presented in Appendix B. Laboratory Test Results are presented in Appendix C, and a Summary of Laboratory Test Results is presented in Table C-1.

5.4 Groundwater

Groundwater was encountered in twelve of the test borings at depths of 3 to 18 feet. Shallow water was encountered in or adjacent to drainages. These areas are discussed in the following section. Fluctuation in groundwater conditions may occur due to variations in rainfall and other factors not readily apparent at this time. It should be noted that in the sandy materials on-site, some groundwater conditions might be encountered due to the variability in the soil profile. Isolated sand and gravel layers within the soils, sometimes only a few feet in thickness and width, can carry water in the subsurface. Groundwater may also flow on top of the underlying bedrock. Builders and planners should be cognizant of the potential for the occurrence of such subsurface

water features during construction on-site and deal with each individual problem as necessary at the time of construction.

6 ENGINEERING GEOLOGY – IDENTIFICATION AND MITIGATION OF GEOLOGIC HAZARDS

Detailed mapping has been performed on this site to produce an Engineering Geology Map Figure 7. This map shows the location of various geologic conditions of which the developers should be cognizant during the planning, design and construction stages of the project. These hazards and the recommended mitigation techniques are as follows:

Artificial Fill – Constraint

These are areas of man-made fill associated with earthen embankments in the southern portion of the site.

Mitigation: The fill on this site is considered uncontrolled for construction purposes. Any uncontrolled fill encountered beneath foundations will require removal and recompaction at a minimum of 95% of its maximum Modified Proctor Dry Density, ASTM D-1557.

Expansive Soils – Constraint

Low expansion soils were encountered in the test borings drilled on site. Highly expansive soil is typically interbedded in the Dawson Formation. These occurrences are typically sporadic; therefore, none have been indicated on the maps. The clays and claystone, if encountered at foundation grade, can cause differential movement in structures. These occurrences should be identified and dealt with on an individual lot basis.

Mitigation Should expansive soils be encountered beneath foundations; mitigation will be necessary. Mitigation of expansive soils may require special foundation design. Overexcavation 3 to 5 feet and replacement with non-expansive soils at a minimum of 95% of its maximum Modified Proctor Dry Density, ASTM D-1557 is a suitable mitigation, which is common in the area. Floor slabs on expansive soils should be expected to experience movement. Overexcavation and replacement has been successful in minimizing slab movements. The use of structural floors should be considered for basement construction on highly expansive clays. Final recommendations should be determined after additional investigation of each building site.

Groundwater and Floodplain Areas – Constraint

The main drainage is located in the southwestern portion of the site. Several minor drainages are located across the site that generally flow in southerly directions. None of the drainages on the site have been mapped within floodplain zones according to the FEMA Map No. 08041CO350G, (Figure 8, Reference 12). Areas where potentially seasonal shallow, seasonal shallow, ponded water, and springs have been indicated on the site geology/engineering geology map, Figure 7. Lots adjacent to the drainages may experience higher groundwater levels during peak flows. Subsurface perimeter drains are recommended for structures adjacent to the floodplains and drainages to help prevent the intrusion of water into areas below grade. Typical drain details are presented in Figure 9. Finished floor levels must be a minimum of one floor above the floodplain level. **Exact floodplain locations and drainage studies are beyond the scope of this report.**

Groundwater was encountered in nine of the test borings at depths ranging from 3 to 18 feet. Water was encountered at 3 feet in TB-7. Water depths ranged from 8.5 to 19.5 feet in TB-1, 2, 3, 5, 6, 8, 14, 16, 17, 18, and 21. The remaining borings which were drilled to depths ranging from 8 to 35 feet were dry. A minimum separation of 3 feet between foundation components and groundwater levels is recommended. These areas are discussed as follows:

Seasonal Shallow and Potential Seasonally Shallow Groundwater – Constraint

In these areas, we would anticipate the potential for periodically high subsurface moisture conditions and possible frost heave potential, depending on the soil conditions. These areas are located within some of the drainages in the eastern and southeastern portion of the site. Due to the proposed lot sizes it is anticipated these areas would be avoided by the development. Areas of shallow groundwater may exhibit unstable subgrade conditions in terms of bearing support of construction equipment during grading for the roadways. Areas immediately adjacent to drainage may also experience higher subsurface moisture conditions during periods of higher flows.

Three EDBs are proposed across the southern side of Filing No. 1 to be located on Lots 31-32, 37-38, and 39-40. The ponds will be located in or near areas identified with the potential for seasonally shallow groundwater (Lots 31-32, 37-38, and 39-40). These pond areas were dry during our site observations did not exhibit signs of constant shallow groundwater conditions. Test Boring Nos. 17 – 19 placed in the EDBs the southern side of the site. Groundwater was encountered in TB-1 (16.2'), TB-2 (8'), TB-3 (15.3'), TB-4 (dry to 20 feet), TB-17 (8.5'), TB-18 (8'), and TB-19 (dry to 15'). Preliminary plans indicate pond depths in ranging from approximately 5 to 8 feet in depth.

Mitigation: In these locations, foundations subject to severe frost heave potential should penetrate sufficient depth so as to discourage the formation of ice lenses beneath foundations. At this location and elevation, foundation depth for frost protection is 30 inches. In areas where high subsurface moisture conditions are anticipated periodically, a subsurface perimeter drain will be necessary to help prevent the intrusion of water into areas located below grade. Subsurface perimeter drains may be necessary to prevent the intrusion of water into areas below grade. Typical drain details are presented in Figure 10. Where shallow groundwater is encountered, underslab drains or interceptor drains may be necessary. Typical drain details are presented in Figure 11 and 12. Specific recommendations should be made after additional investigation has been completed and building locations have been identified on a lot by lot basis. Swales should be created to intercept surface runoff and carry it safely around and away from structures.

Areas of Ponded Water – Constraint

Areas of ponded water exists behind the earthen dams in the southwestern portion of the site (Lots 36 and 38). Due to the lot sizes it is anticipated these areas can be avoided by the proposed development. Should construction or regrading of the pond areas on the site be considered, all organic matter and soft, wet soils should be completely removed before filling. Any drainage into these areas should be rerouted in a non-erosive manner where it does not create areas of ponded water around any proposed structures.

Spring – Constraint

Two springs were observed in the west-central portion of the site. The springs should be avoided by development and will likely be located within drainage easements. Springs other than those indicated on Figure 7 may be present on the site.

Debris Fans/Debris Flow Susceptibility – Hazard

The site is mapped within an area susceptible to debris flows according to the *Debris Flow Susceptibility Map of El Paso County, Colorado*, by McCoy, Morgan, and Berry (Reference 14, Figure 9). Based on site observations, recent minor debris fans/erosion were observed on the site along minor drainages originating off of the mesa in the southeastern portion of the site. Due to the material type and steepness of the slopes, the potential for significant erosion and sediment laden flows originating along the heads of these drainages in the southeastern portion of the site following significant precipitation events exist. Any site grading should direct surface flows around the structures in a non-erosive manor. Drainage culverts and other drainage infrastructure should

be adequately sized for the potential sediment laden flows. Lots 23 – 35 are located within the area indicated as Debris Flow Susceptible (Figure 9).

Mitigation

Channel armoring consisting of riprap and/or other forms of erosion protection should be utilized in areas of concentrated flows to include permanent channel armoring to prevent accelerated erosion, creating unstable conditions. Building sites in these areas can be elevated lowering the effect of potential for sediment laden flows, and grading improvements diverting surface flows around the foundations are recommended for these affected lots. Any diversion swales should be created up gradient of the structures and should have permanent channel armoring. Riprap sizing should be based off potential flow velocities. The erosion protection must utilize proper fabric/grid grading to prevent piping and undermining. Erosion control measures and riprap sizing should be determined by a qualified professional.

Rockfall – Hazard

Based on our site observation, some of the rock outcrops along the mesa have the potential for minor rockfall hazards. These areas are associated with the cliff-forming portions of the Dawson Formation along the slopes of the mesa. These areas have been identified on the Geology/Engineering Geology Map, Figure 7.

Mitigation: Based on the proposed lot sizes in these areas, there should be sufficient room on the lots to avoid the potential hazard with designated preservation/no-build easements. Additional investigation is recommended on a lot specific basis once building locations have been determined.

Slope Stability and Landslide Hazard

The majority of the slopes on-site are gradually to moderately sloping and do not exhibit any past or potential unstable slopes or landslides. The steeper slopes are primarily located along the edges of the mesa. The mitigation recommendations for these areas are as follows:

Potentially Unstable Slope Areas – Constraint

These slopes are considered stable in their present condition; however, care must be exercised in these areas not to create a condition which would tend to activate instability. The steeper slopes along mesa should be avoided by development. A minimum setback of 30 feet from the crest of the cliffs/steep slopes is recommended. Structures can also be placed at a sufficient distance from the potentially unstable slopes. Additional investigation may be warranted once building

locations are determined on the lots with this constraint. Based on the size of the site and anticipated development these areas can likely be avoided or mitigated.

Mitigation: It is anticipated the majority of these areas can be avoided. Building should be avoided on the potentially unstable slopes unless they are stabilized. A minimum setback of 30 feet from the crest of these slopes is recommended. Stabilization could involve regrading to slope angles no steeper than 3:1 or the use of engineer-designed retaining walls, tiebacks, or buttresses. Where retaining walls are not used, erosion protection may be necessary to prevent undercutting by the creek during periods of high water.

Shallow Bedrock – Constraint

Bedrock was encountered in all the test borings at depths ranging from the existing surface to 13 feet. A Summary of the Depth to Bedrock is included in Table B-1. Shallow bedrock will be encountered across the majority of this site. Where bedrock is encountered, excavation/grading may be difficult requiring track-mounted excavators with ripper attachments. Bedrock will likely be encountered cuts for utility excavations.

Radon – Hazard

Radon levels for the area have been reported by the Colorado Geologic Survey in the open file, Report No. 91-4 (Reference 12). Average Radon levels for the 80831-zip code is 4.50 pCi/l. The following is a table of radon levels in this area:

Average Radon Levels for the 80831 Zip Code	
0 < 4 pCi/L	0.00%
4 < 10 pCi/L	100.00%
10 < 20 pCi/L	0.00%
> 20 pCi/L	0.00%

Mitigation:

The potential for high radon levels is present for the site. Build-up of radon gas can usually be mitigated by providing increased ventilation of basement and crawlspace and sealing joints.

Specific requirements for mitigation should be based on site specific testing.

6.1 Relevance of Geologic Conditions to Land Use Planning

We understand that the development will be single-family rural residential utilizing individual water wells and OWTS. It is our opinion that the existing geologic and engineering geologic conditions

will impose some constraints on the proposed development and construction. The most significant problems affecting development will be those associated with the artificial fill, expansive soils, shallow bedrock, seasonally shallow and potential seasonally shallow groundwater areas, springs. Potentially unstable slopes, rockfall, and debris flow susceptible areas will be encountered on lots located at the base of the bluff (Lots 23 – 35). These constraints/hazards on site can be satisfactorily mitigated through proper engineering design and construction practices or avoidance.

The upper materials are typically at loose to dense states. The granular soils encountered in the upper soil profiles of the test borings should provide good support for foundations. Loose soils if encountered at foundation depth will require mitigation. Foundations anticipated for the site are standard spread footings possibly in conjunction with overexcavation in areas of expansive soils or recompaction in areas of loose soils. Excavation is anticipated to be moderate with rubber-tired equipment for the site sand materials, and will require track mounted equipment with ripper attachments for the dense sandstone and hard siltstone. Blasting may be required in areas of very dense bedrock.

Expansive layers may be encountered in the soil and bedrock on this site. Areas of expansive soils encountered on site are sporadic; therefore, none have been indicated on the maps. Expansive soils, if encountered, will require special foundation design and/or overexcavation. These soils will not prohibit development.

Areas of seasonal shallow and potential seasonally shallow groundwater were observed on site. These areas will likely be avoided due to the proposed lot sizes. Drains may be necessary for structures adjacent to these areas to help prevent the intrusion of water into areas below grade. Basements should be feasible across the majority of the site, however, lot specific subsurface soil investigations will be required. Typical drain details are presented in Figures 10 through 12. The site does not lie within any floodplain zones according to the FEMA Map No. 08041CO350G, dated December 7, 2018 (Figure 8, Reference 9). **Exact locations of floodplain and specific drainage studies are beyond the scope of this report.**

Three EDBs are proposed across the southern side of Filing No. 1 to be located on Lots 31-32, 37-38, and 39-40. The ponds will be located in or near areas identified with the potential for seasonally shallow groundwater (Lots 31-32, 37-38, and 39-40). These pond areas were dry during our site observations did not exhibit signs of constant shallow groundwater conditions. Test

Boring Nos. 17 – 19 placed in the EDBs the southern side of the site. Groundwater was encountered in TB-1 (16.2'), TB-2 (8'), TB-3 (15.3'), TB-4 (dry to 20 feet), TB-17 (8.5'), TB-18 (8'), and TB-19 (dry to 15'). Preliminary plans indicate pond depths ranging from 5 to 8 feet in depth. The groundwater was encountered below anticipated pond depths.

Areas of erosion and gullyng may require the construction of check dams and revegetation of the site soils after construction. General recommendations for erosion control are discussed under Section 8.0 "Erosion Control".

Potentially unstable slope areas were observed along the edges of the mesa. These slopes are considered stable in their present condition; however, care must be exercised in these areas not to create conditions which would tend to activate instability. The steeper slopes along the mesa should be avoided by development. A minimum setback of 30 feet from the crest of the cliffs/steep slopes is recommended. Structures can also be placed at a sufficient distance from the potentially unstable slopes. Additional investigation may be warranted once building locations are determined on the lots with this constraint. Based on the size of the lots and anticipated development these areas can likely be avoided.

The site is mapped within an area susceptible to debris flows according to the *Debris Flow Susceptibility Map of El Paso County, Colorado*, by McCoy, Morgan, and Berry (Reference 14, Figure 8). Based on site observations, recent minor debris fans/erosion were observed on the site along minor drainages originating off of the mesa in the southeastern portion of the site. Due to the material type and steepness of the slopes, the potential for significant erosion and sediment laden flows originating along the heads of these drainages in the southeastern portion of the of the site following significant precipitation events exist. Any site grading should direct surface flows around the structures in a non-erosive manor. Drainage culverts and other drainage infrastructure should be adequately sized for the potential sediment laden flows. Lots 23 – 35 are located within the area indicated as Debris Flow Susceptible, Figure 9.

Based on our site observation, some of the rock outcrops along the mesa have the potential for minor rockfall hazards. These areas are associated with the cliff-forming portions of the Dawson Formation along the slopes of the mesa. These areas have been identified on the Geology/Engineering Geology Map, Figure 7. Based on the proposed lot sizes in these areas, there should be sufficient room on the lots to avoid the potential hazard with designated

preservation/no-build easements. Additional investigation is recommended on a lot specific basis once building locations have been determined.

Channel armoring consisting of riprap and/or other forms of erosion protection should be utilized in areas of concentrated flows to include permanent channel armoring to prevent accelerated erosion, creating unstable conditions. Building sites in these areas can be elevated lowering the effect of potential for sediment laden flows, and grading improvements diverting surface flows around the foundations are recommended for these affected lots. Any diversion swales should be created up gradient of the structures and should have permanent channel armoring. Riprap sizing should be based off potential flow velocities. The erosion protection must utilize proper fabric/grid grading to prevent piping and undermining. Erosion control measures and riprap sizing should be determined by a qualified professional.

In summary, development of the site can be achieved if the items mentioned above are mitigated. These items can be mitigated through proper design and construction or through avoidance. Investigation on each lot is recommended prior to construction.

7 ECONOMIC MINERAL RESOURCES

Some of the sandy materials on-site could be considered a low-grade sand resource. According to the *El Paso County Aggregate Resource Evaluation Map* (Reference 13), the area is not mapped with any aggregate deposits. According to the *Atlas of Sand, Gravel and Quarry Aggregate Resources, Colorado Front Range Counties* distributed by the Colorado Geological Survey (Reference 14), areas of the site are not mapped with any resources. According to the *Evaluation of Mineral and Mineral Fuel Potential* (Reference 15), the area of the site has been mapped as “Fair” for industrial minerals. However, considering the silty nature of much of these materials and abundance of similar materials through the region and the close proximity to developed land, they would be considered to have little significance as an economic resource.

According to the *Evaluation of Mineral and Mineral Fuel Potential of El Paso County State Mineral Lands* (Reference 15), the site is mapped within the Denver Basin Coal Region. However, the area of the site has been mapped as “Poor” for coal resources. No active or inactive mines have been mapped in the area of the site. No metallic mineral resources have been mapped on-site (Reference 15).

The site has been mapped as “Fair” for oil and gas resources (Reference 15). No oil or gas fields have been discovered in the area of the site. The sedimentary rocks in the area may lack the geologic structure for trapping oil or gas; therefore, it may not be considered a significant resource. Hydraulic fracturing is a new method that is being used to extract oil and gas from rocks. It utilizes pressurized fluid to extract oil and gas from rocks that would not normally be productive. The area of the site has not been explored to determine if the rocks underlying the site would be commercially viable utilizing hydraulic fracturing. The practice of hydraulic fracturing has come under review due to concerns about environmental impacts, health and safety.

8 EROSION CONTROL

The soil types observed on the site are mildly to highly susceptible to wind erosion, and moderately to highly susceptible to water erosion. A minor wind erosion and dust problem may be created for a short time during and immediately after construction. Should the problem be considered severe enough during this time, watering of the cut areas or the use of chemical palliative may be required to control dust. However, once construction has been completed and vegetation re-established, the potential for wind erosion should be considerably reduced.

With regard to water erosion, loosely compacted soils will be the most susceptible to water erosion, residually weathered soils become increasingly less susceptible to water erosion. For the typical soils observed on-site, allowable velocities on unvegetated and unlined earth channels would be on the order of 3 to 4 feet/second, depending upon the sediment load carried by the water. Permissible velocities may be increased through the use of vegetation to something on the order of 4 to 7 feet/second, depending upon the type of vegetation established. Should the anticipated velocities exceed these values, some form of channel lining material may be required to reduce erosion potential. These might consist of some of the synthetic channel lining materials on the market or conventional riprap. In cases where ditch-lining materials are still insufficient to control erosion, small check dams or sediment traps may be required. The check dams will serve to reduce flow velocities, as well as provide small traps for containing sediment. The determination of the amount, location and placement of ditch linings, check dams and of the special erosion control features should be performed by or in conjunction with the drainage engineer who is more familiar with the flow quantities and velocities.

Cut and fill slope areas will be subjected primarily to sheetwash and rill erosion. Unchecked rill erosion can eventually lead to concentrated flows of water and gully erosion. The best means to

combat this type of erosion is, where possible, the adequate re-vegetation of cut and fill slopes. Cut and fill slopes having gradients more than three (3) horizontal to one (1) vertical become increasingly more difficult to revegetate successfully. Therefore, recommendations pertaining to the vegetation of the cut and fill slopes may require input from a qualified landscape architect and/or the Soil Conservation Service.

9 ROADWAY, EMBANKMENT, and STORMWATER FACILITY CONSTRUCTION RECOMMENDATIONS

In general, the site soils are suitable for the proposed roadways and embankments. Groundwater should be expected to be encountered in deeper cuts and along or near drainages and low-lying areas. If road or embankment excavations encroach on the groundwater level unstable soil conditions may be encountered. Unstable soils are not anticipated in areas of shallow bedrock. Excavation of saturated soils will be difficult with rubber-tired equipment. Stabilization using shot rock or geogrids may be necessary.

Any areas to receive fill should have all topsoil, organic material or debris removed. Prior to fill placement Entech should observe the subgrade. Fill must be properly benched and compacted to minimize potentially unstable conditions in slope areas. Fill slopes should be 3:1. The subgrade should be scarified and moisture conditioned to within 2% of optimum moisture content and compacted to a minimum of 95% of its maximum Modified Proctor Dry Density, ASTM D-1557, prior to placing new fill. Areas receiving fill may require stabilization with rock or fabric if shallow groundwater conditions are encountered. Cut slopes 2:1 in areas where shallow sandstone is encountered are suitable for Apex Ranch Road. In areas where undisturbed sandstone is encountered slopes 1½:1 can likely be used. Observations during site work should be completed to provide final recommendations.

New fill should be placed in thin lifts not to exceed 6 inches after compaction while maintaining at least 95% of its maximum Modified Proctor Dry Density, ASTM D-1557. These materials should be placed at a moisture content conducive to compaction, usually 0 to ±2% of Proctor optimum moisture content. The placement and compaction of fill should be observed and tested by Entech during construction. Entech should approve any import materials prior to placing or hauling them to the site. Additional investigation will be required for pavement designs once roadway grading is completed and utilities are installed.

10 CLOSURE

It is our opinion that the existing geologic engineering and geologic conditions will impose some constraints on development and construction of the site. The majority of these conditions can be mitigated through proper engineering design and construction practices. The proposed development and use are consistent with anticipated geologic and engineering geologic conditions.

It should be pointed out that because of the nature of data obtained by random sampling of such variable and non-homogeneous materials as soil and rock, it is important that we be informed of any differences observed between surface and subsurface conditions encountered in construction and those assumed in the body of this report. Individual investigations for building sites will be required prior to construction. Construction and design personnel should be made familiar with the contents of this report. Reporting such discrepancies to Entech Engineering, Inc. soon after they are discovered would be greatly appreciated and could possibly help avoid construction and development problems.

This report has been prepared for PT Overlook, LLC. for application to the proposed project in accordance with generally accepted geologic soil and engineering practices. No other warranty expressed or implied is made.

We trust that this report has provided you with all the information that you required. Should you require additional information, please do not hesitate to contact Entech Engineering, Inc.

11 REFERENCES

1. Entech Engineering, Inc., Revised date December 1, 2023. *Soils and Geology Study, Overlook at Homestead, Elbert Road, El Paso County, Colorado*. Entech Job No. 230677.
2. Entech Engineering, Inc., Revised date December 1, 2023. *Wastewater Study, Overlook at Homestead, Elbert Road, El Paso County, Colorado*. Entech Job No. 230677.
3. Bryant, Bruce; McGraw, Laura W.; and Wobus, Reinhard A. 1981. *Geologic Structure Map of the Denver 1° x 2° Quadrangle, North-Central Colorado*. Sheet 2. U.S. Geologic Survey. Map I-1163, Sheet 2.
4. Natural Resource Conservation Service, September 22, 2015. *Web Soil Survey*. United States Department Agriculture, <http://websoilsurvey.sc.egov.usda.gov/App/HomePage.htm>.
5. United States Department of Agriculture Soil Conservation Service. June 1981. *Soil Survey of El Paso County Area, Colorado*.
6. Morgan, Matthew L., and Barkmann, Peter E. 2012. *Geologic Map of the Eastonville Quadrangle, El Paso County, Colorado*. Colorado Geological Survey. Open-File Report 12-03.
7. Trimble, Donald E. and Machette, Michael N. 1979. *Geologic Map of the Colorado Springs-Castle Rock Area, Front Range Urban Corridor, Colorado*. USGS, Map I-857-F.
8. Bryant, Bruce; McGraw, Laura W.; and Wobus, Reinhard A. 1981. *Geologic Map of the Denver 1° x 2° Quadrangle, South-Central Colorado*. U.S. Geologic Survey. Map I-1163, Sheet 1.
9. Federal Emergency Management Agency. December 7, 2018. *Flood Insurance Rate Maps for El Paso County, Colorado and Incorporated Areas*. Map Number 08041CO350G.
10. McCoy, Kevin M., Morgan, Matthew L., and Berry, Karen A., 2018. *Debris Flow Susceptibility Map of El Paso County, Colorado*. Colorado Geological Survey. Open-File Report 18-11.
11. Kirkman, Robert M. and Rogers, William P. 1981. *Earthquake Potential in Colorado*. Colorado Geological Survey. Bulletin 43.
12. Colorado Geological Survey. 1991. *Results of the 1987-88 EPA Supported Radon Study in Colorado*. Open-file Report 91-4.
13. El Paso County Planning Development. December 1995. *El Paso County Aggregate Resource Evaluation Maps*.
14. Schwochow, S.D.; Shroba, R.R. and Wicklein, P.C. 1974. *Atlas of Sand, Gravel, and Quarry Aggregate Resources, Colorado Front Range Counties*. Colorado Geological Survey. Special Publication 5-B.
15. Keller, John W.; TerBest, Harry and Garrison, Rachel E. 2003. *Evaluation of Mineral and Mineral Fuel Potential of El Paso County State Mineral Lands Administered by the Colorado State Land Board*. Colorado Geological Survey. Open-File Report 03-07.

FIGURES

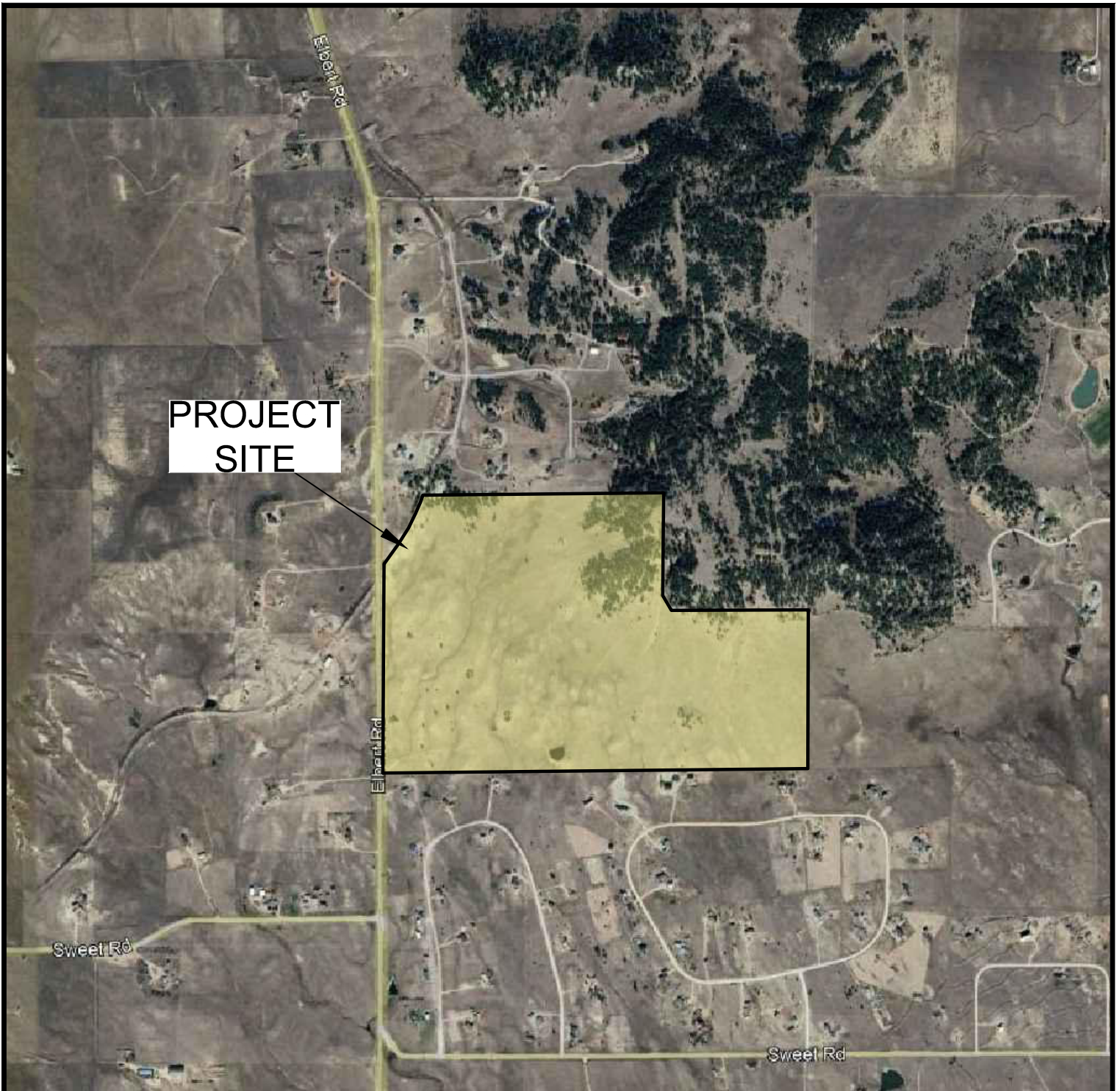

PROJECT
SITE



VICINITY MAP
OVERLOOK AT HOMESTEAD, FILING NO. 1
PT OVERLOOK, LLC

JOB NO.
230677

FIG. 1

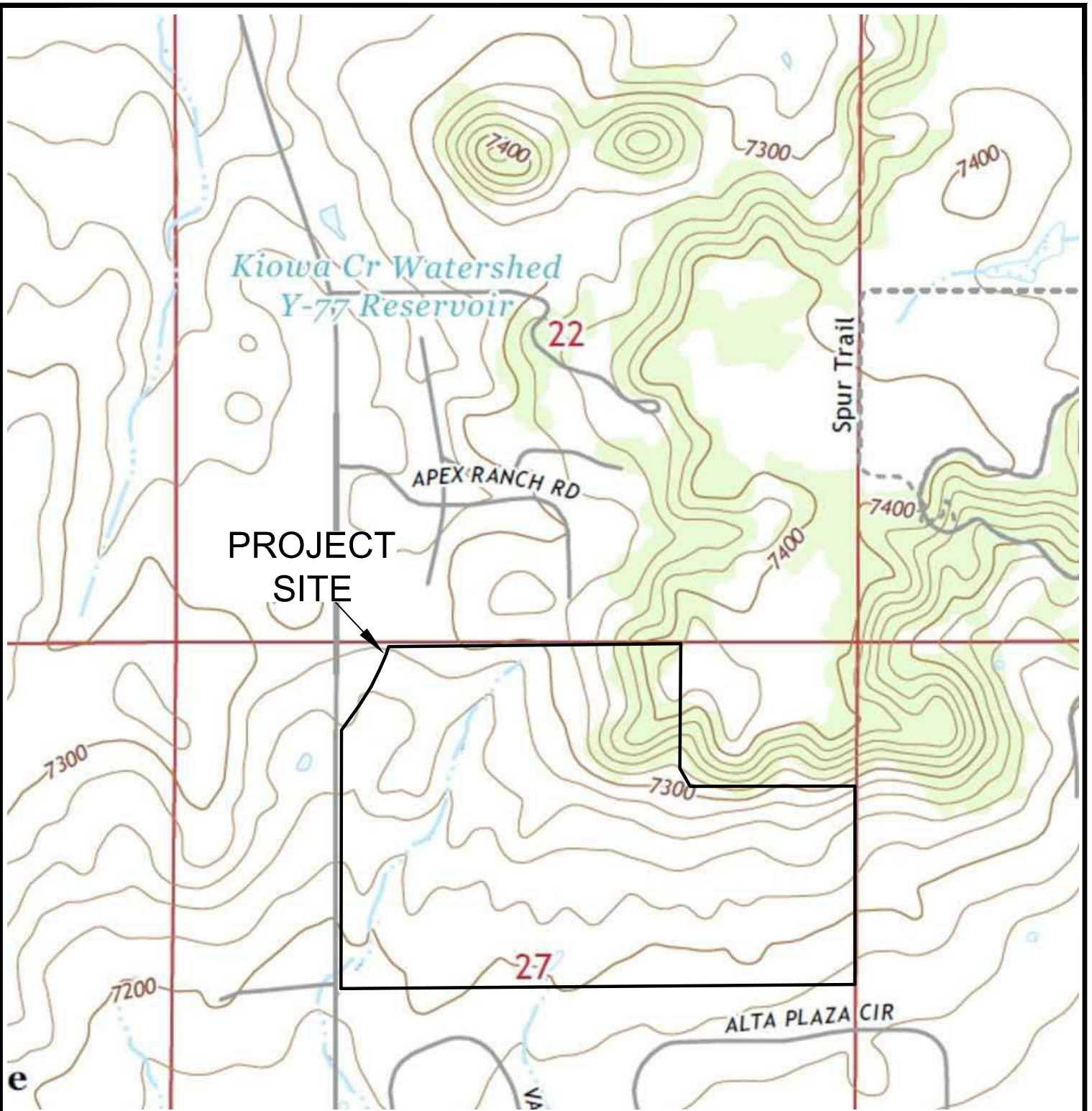

USGS TOPOGRAPHY MAP
OVERLOOK AT HOMESTEAD, FILING NO. 1
PT OVERLOOK, LLC

JOB NO.
230677
FIG. 2

REVISION	BY



OVERALL SITE PLAN
OVERLOOK AT HOMESTEAD, FILING NO. 1
PT OVERLOOK, LLC

JOB NO.
230677
FIG. 3



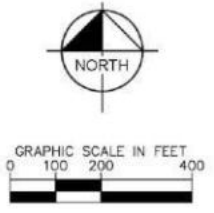

LEGEND:

---	PROPERTY LINE
- - -	ROW LINE
---	LOT LINE
---	CENTER LINE
- - -	EASEMENT LINE
- - -	GRADE BREAK LINE
- - -	DITCH LINE
- x - x -	EXISTING FENCE
- - -	PUBLIC IMPROVEMENTS EASEMENT
- - -	PUBLIC UTILITY EASEMENT

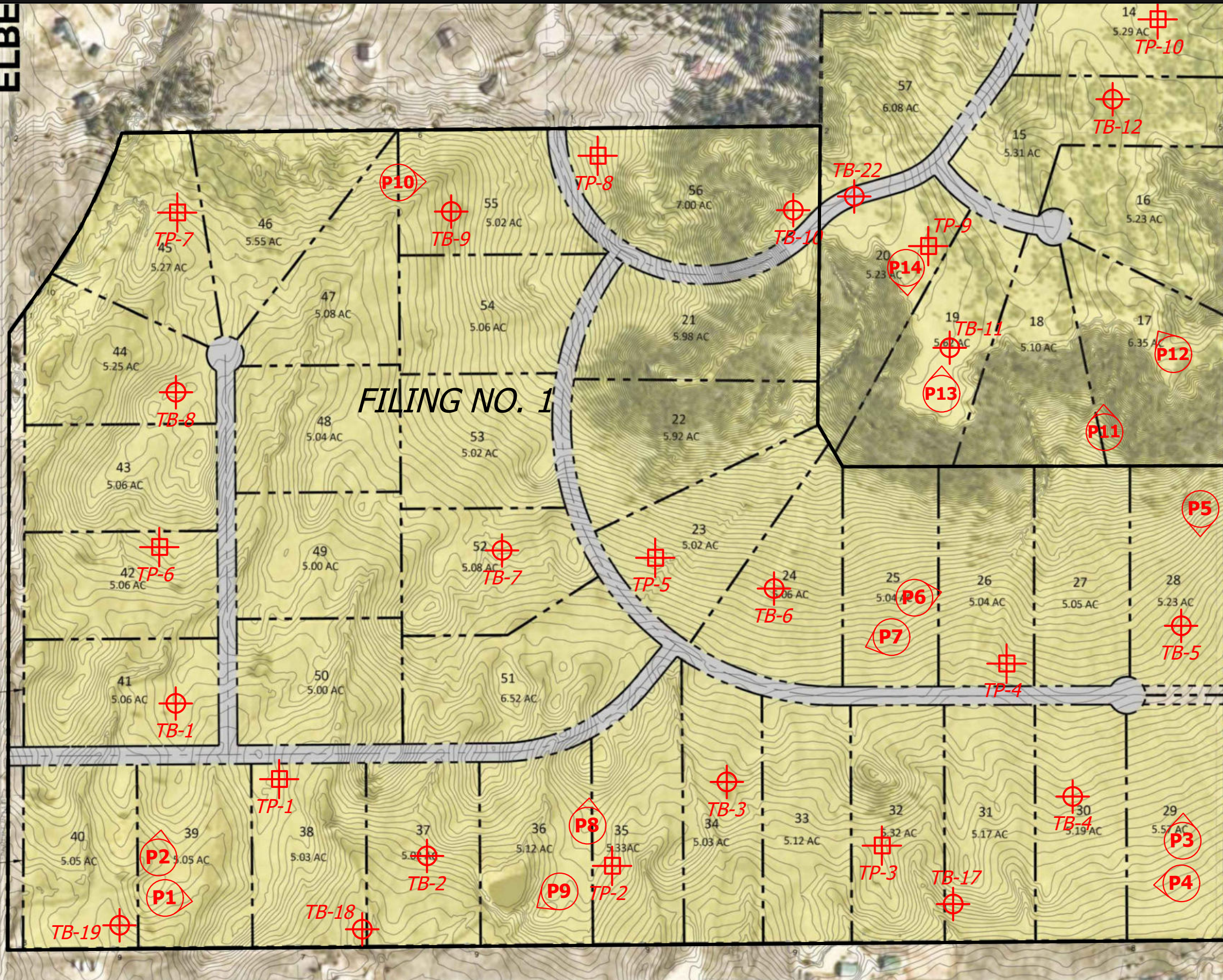

ELBE



-  - APPROXIMATE TEST BORING LOCATION AND NUMBER
-  - APPROXIMATE PHOTOGRAPH LOCATION AND NUMBER

REVISION	BY



SITE PLAN/TESTING LOCATION MAP
OVERLOOK AT HOMESTEAD, FILING NO. 1
PT OVERLOOK, LLC

JOB NO.
230677
FIG. 4

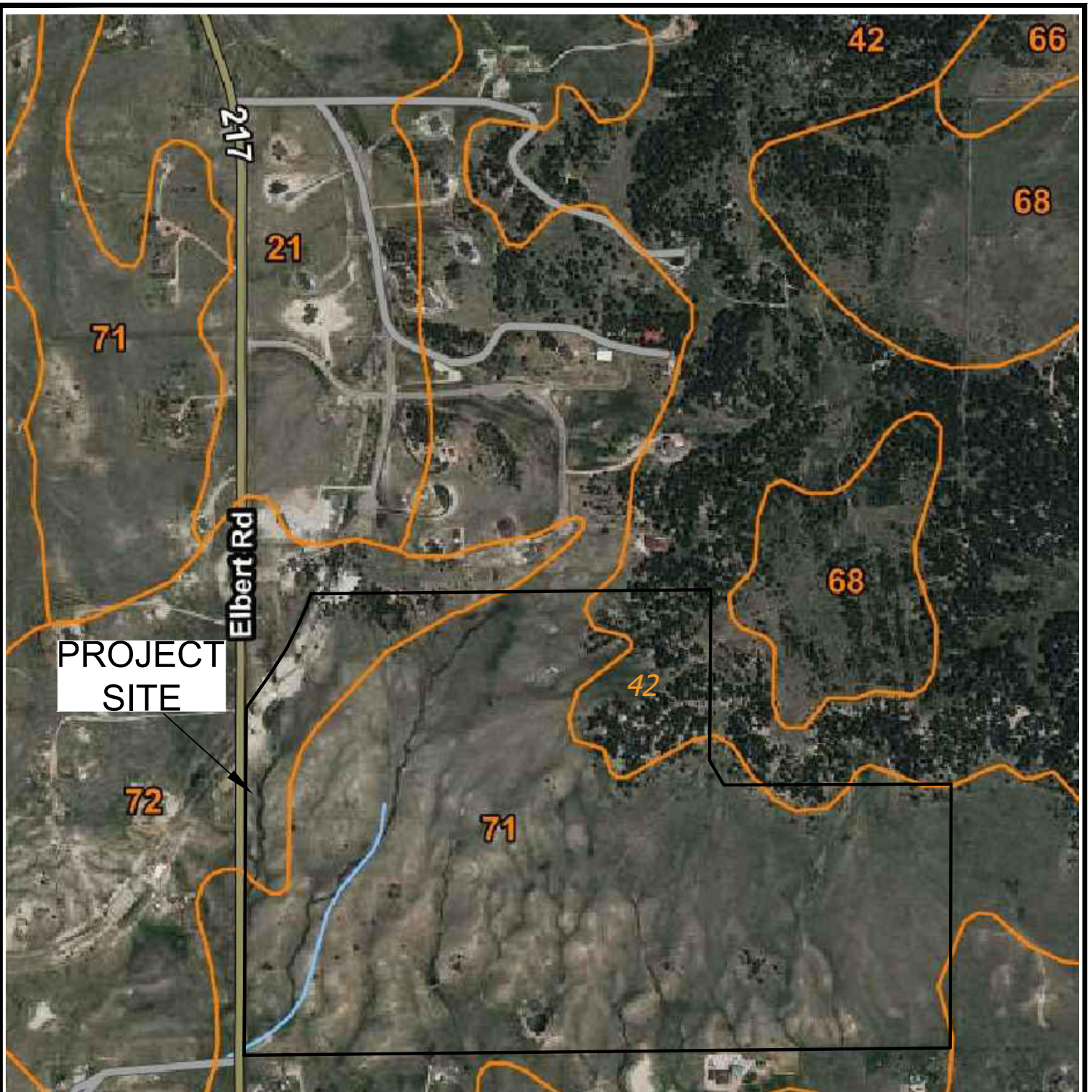

SOIL SURVEY MAP
OVERLOOK AT HOMESTEAD, FILING NO. 1
PT OVERLOOK, LLC

JOB NO.
230677

FIG. 5

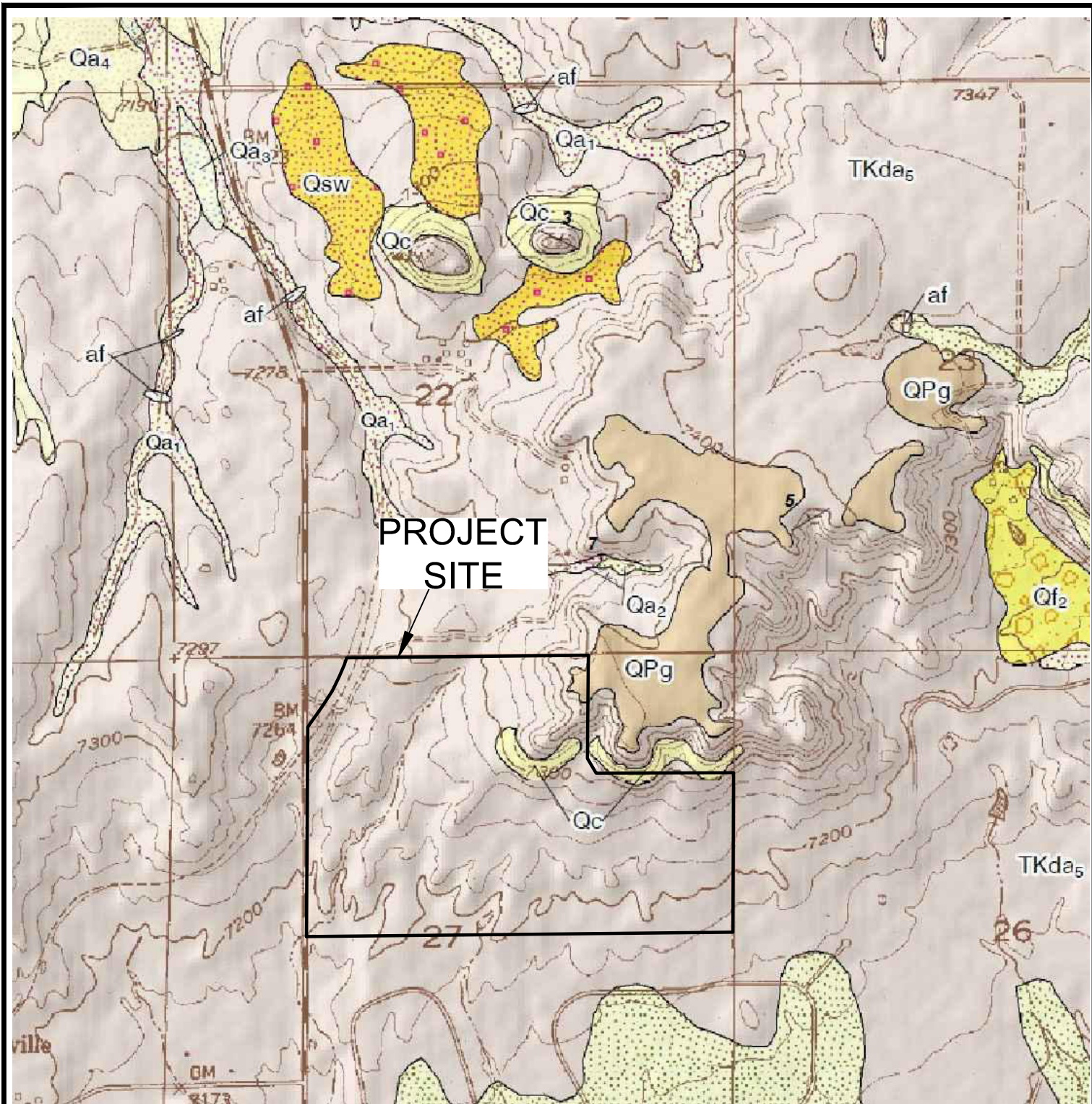

**PROJECT
SITE**



**EASTONVILLE QUADRANGLE GEOLOGIC
MAP**

OVERLOOK AT HOMESTEAD, FILING NO. 1
PT OVERLOOK, LLC

JOB NO.
230677

FIG. 6

REVISION	BY



GEOLOGY/ENGINEERING MAP
 OVERLOOK AT HOMESTEAD, FILING NO. 1
 PT OVERLOOK, LLC

JOB NO.
230677
FIG. 7

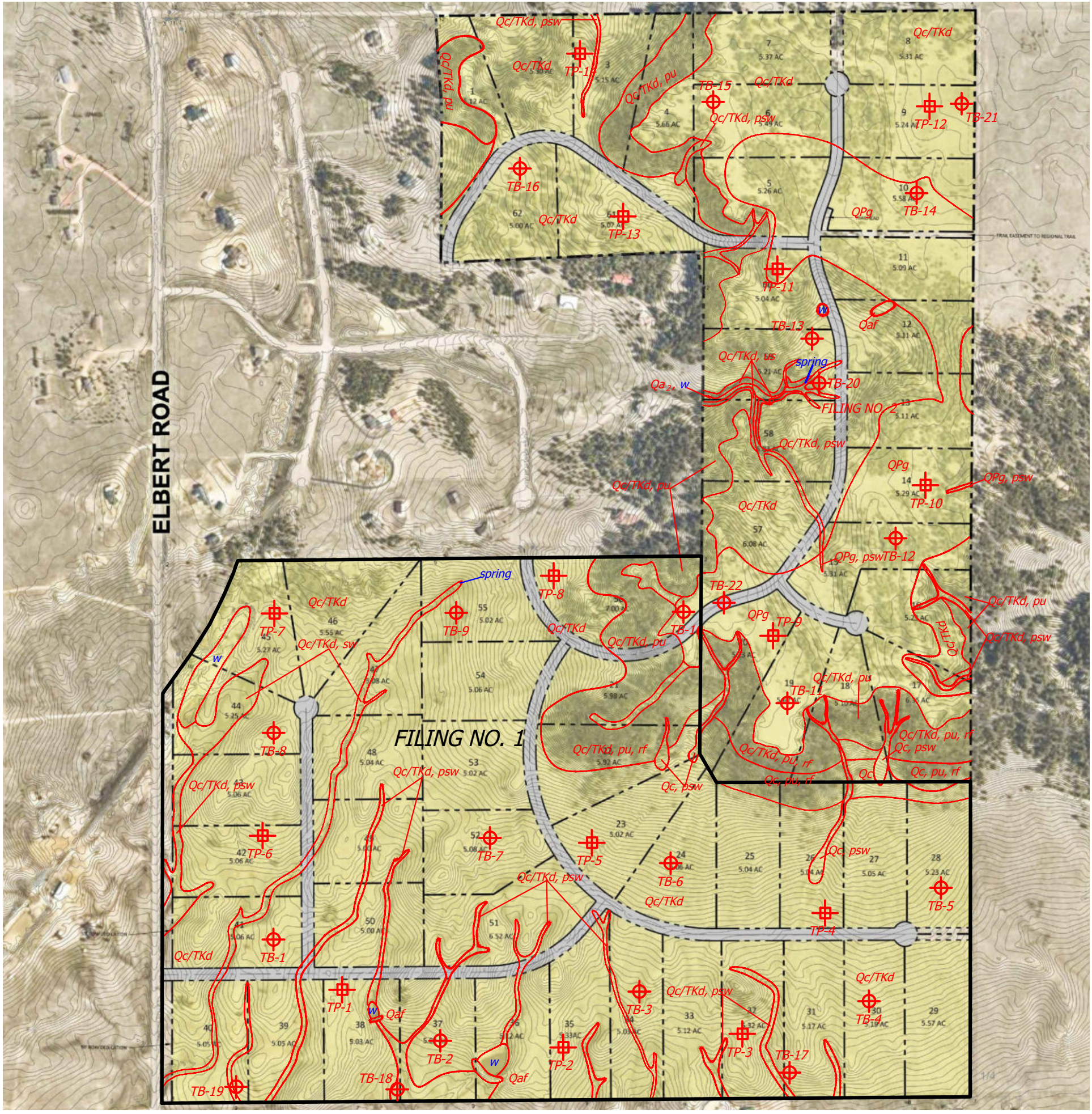

- Legend:**
- Qaf - Artificial Fill of Holocene Age: man-made fill deposits associated with existing earthen berms and trash pile on lot 12
 - Qa₂ - Alluvium Two of Early Holocene Age: water deposited alluvium within drainage on Lot 59
 - Qc - Colluvial deposits of Holocene to Late Pleistocene Age: rockfall, sheetwash, and minor fan deposits
 - QPg - Gravel of the Palmer Divide of early Pleistocene? or late Pliocene Age: alluvial deposited sands with pebble and cobble gravel
 - pu - potentially unstable slopes
 - psw - potentially seasonal shallow groundwater
 - sw - seasonal shallow groundwater
 - w - ponded or flowing water
 - rf - rockfall

Debris Flow Susceptibility - (Figure 9) Lots affecting by this potential hazard include Lots 23 - 35



ENTECH
ENGINEERING, INC.

FEMA FLOODPLAIN MAP
OVERLOOK AT HOMESTEAD, FILING NO. 1
PT OVERLOOK, LLC

JOB NO.
230677

FIG. 8

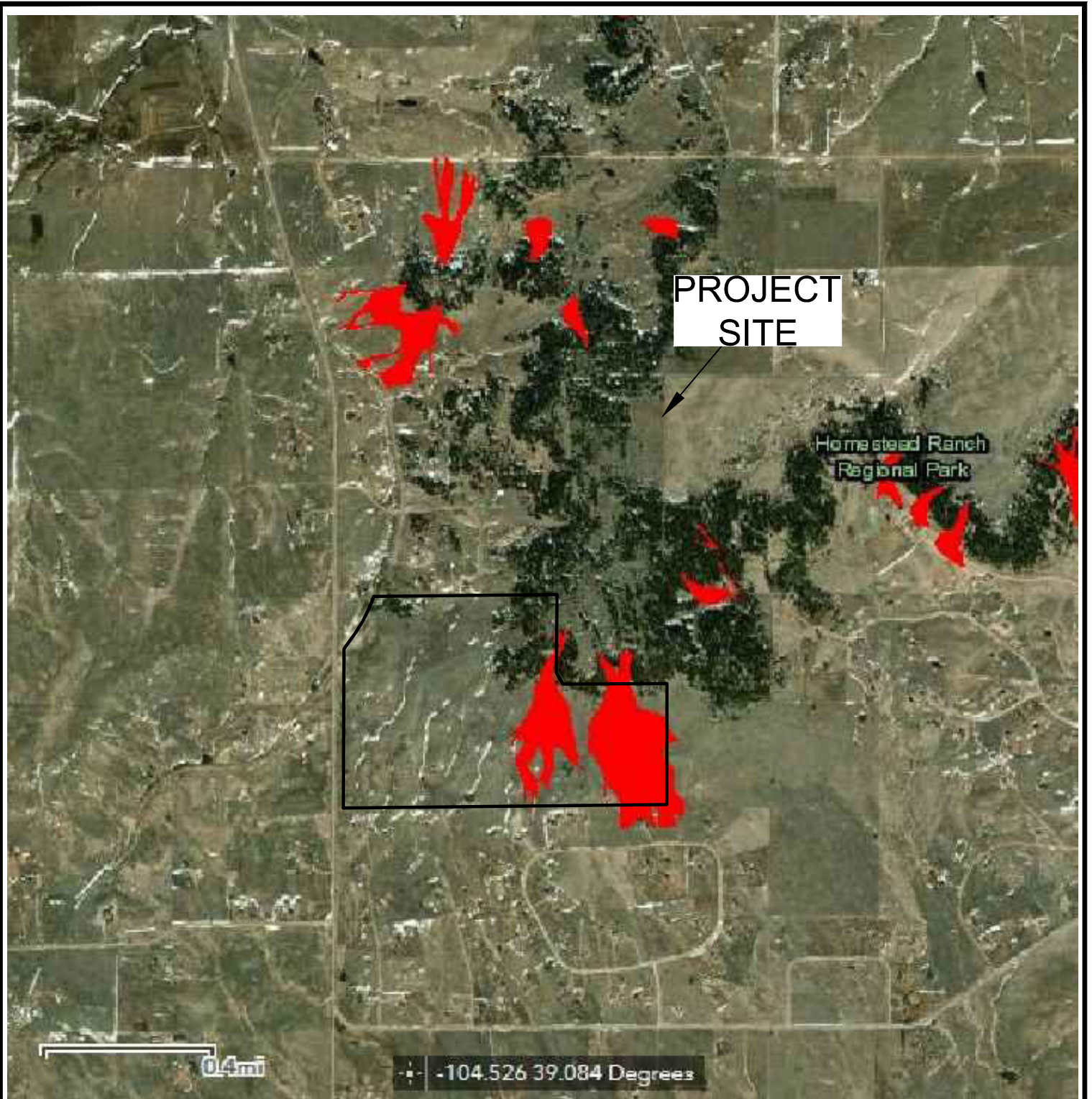

DEBRIS FLOW SUSCEPTIBILITY MAP

OVERLOOK AT HOMESTEAD, FILING NO. 1
PT OVERLOOK, LLC

JOB NO.
230677

FIG. 9

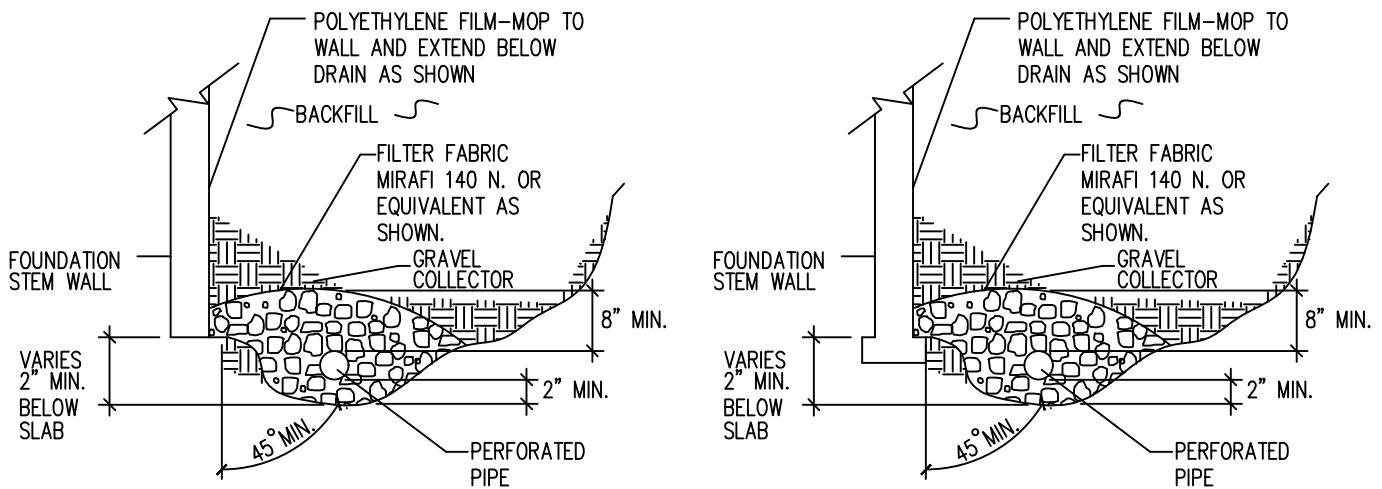

NOTES:

-GRAVEL SIZE IS RELATED TO DIAMETER OF PIPE PERFORATIONS-85% GRAVEL GREATER THAN 2x PERFORATION DIAMETER.

-PIPE DIAMETER DEPENDS UPON EXPECTED SEEPAGE. 4-INCH DIAMETER IS MOST OFTEN USED.

-ALL PIPE SHALL BE PERFORATED PLASTIC. THE DISCHARGE PORTION OF THE PIPE SHOULD BE NON-PERFORATED PIPE.

-FLEXIBLE PIPE MAY BE USED UP TO 8 FEET IN DEPTH, IF SUCH PIPE IS DESIGNED TO WITHSTAND THE PRESSURES. RIGID PLASTIC PIPE WOULD OTHERWISE BE REQUIRED.

-MINIMUM GRADE FOR DRAIN PIPE TO BE 1% OR 3 INCHES OF FALL IN 25 FEET.

-DRAIN TO BE PROVIDED WITH A FREE GRAVITY OUTFALL, IF POSSIBLE. A SUMP AND PUMP MAY BE USED IF GRAVITY OUTFALL IS NOT AVAILABLE.



PERIMETER DRAIN DETAIL
 OVERLOOK AT HOMESTEAD, FILING NO. 1
 PT OVERLOOK, LLC

JOB NO.
 230677

FIG. 10

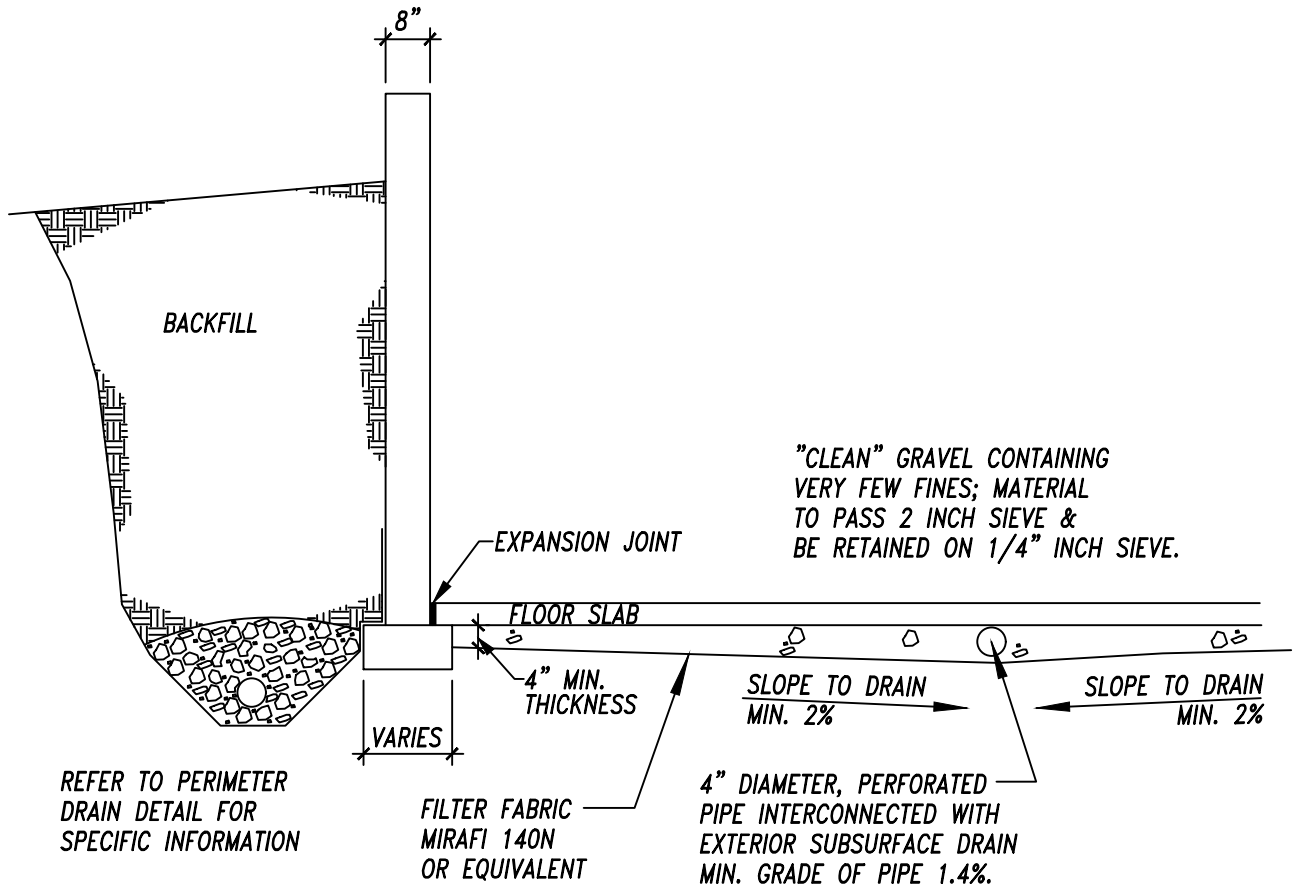

**TYP. UNDERSLAB DRAINAGE LAYER
(CAPILLARY BREAK)**

OVERLOOK AT HOMESTEAD, FILING NO. 1
PT OVERLOOK, LLC

JOB NO.
230677

FIG. 11

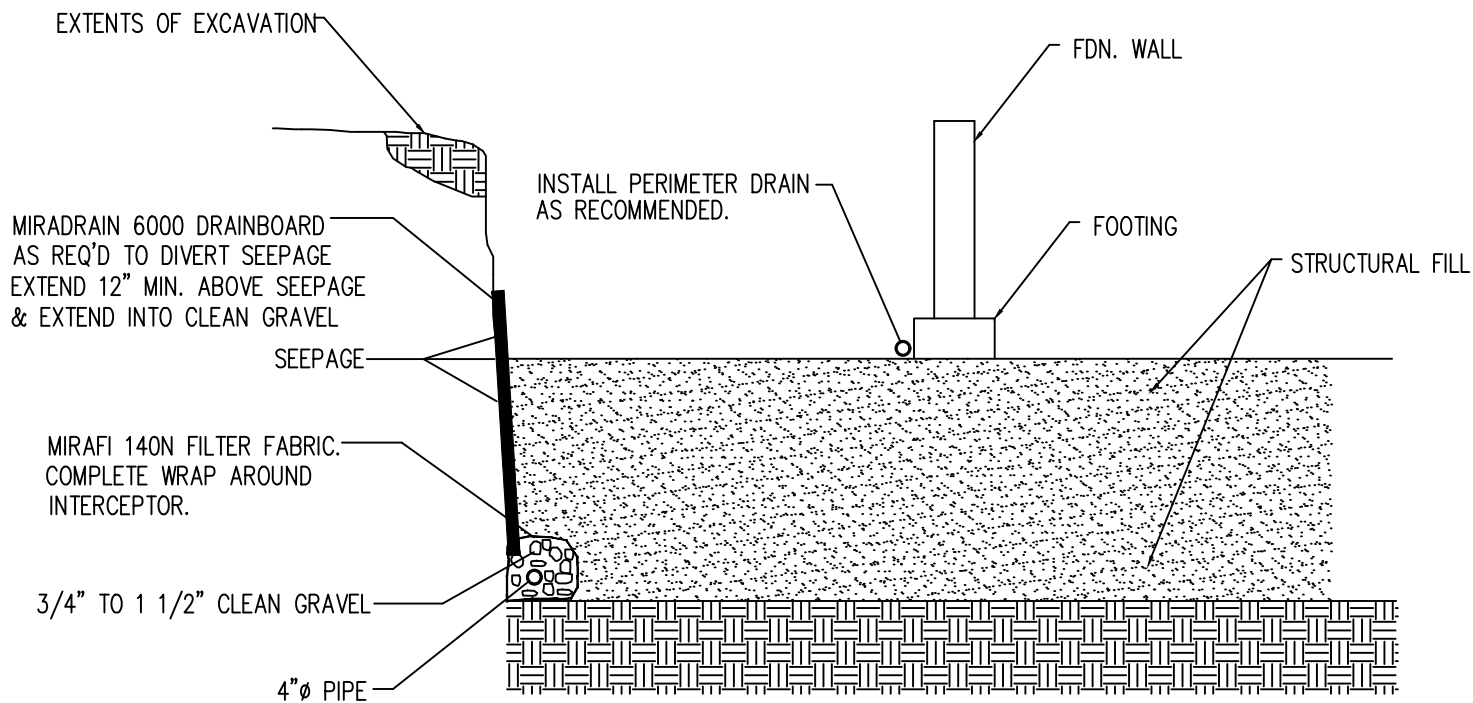

NOTE:
 EXTEND INTERCEPTOR DRAIN TO UNDERDRAIN OR TO SUMP.
 BENCH DRAIN INTO NATIVE SOILS 12 INCHES MINIMUM.

INTERCEPTOR DRAIN DETAIL

N.T.S.



INTERCEPTOR DRAIN DETAIL
 OVERLOOK AT HOMESTEAD, FILING NO. 1
 PT OVERLOOK, LLC

JOB NO.
 230677

FIG. 12



APPENDIX A: Site Photographs

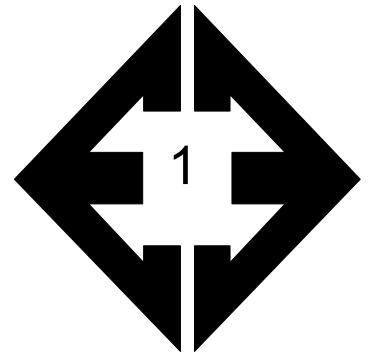

**Looking northeast
from the southwestern
side of the site.**

May 2, 2023

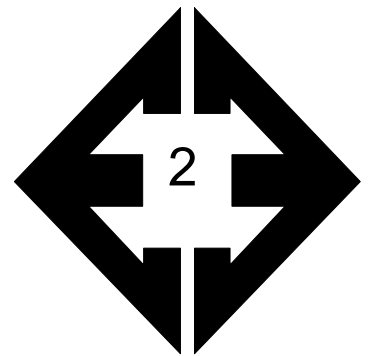

**Looking north from the
southwestern side of
the site.**

May 2, 2023

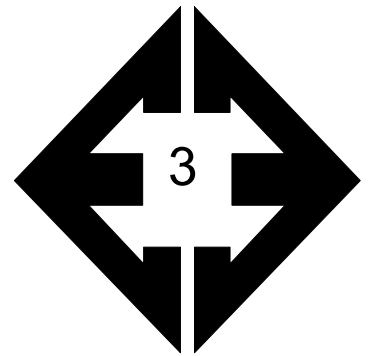

**Looking west from the
southeast corner of
the site.**

May 2, 2023

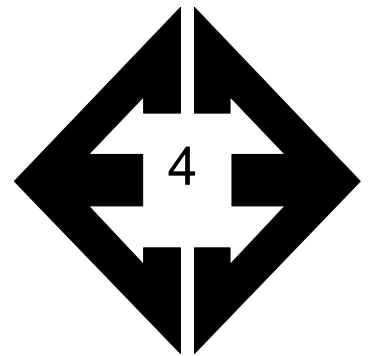

**Looking north from the
southeastern corner of
the site.**

May 2, 2023

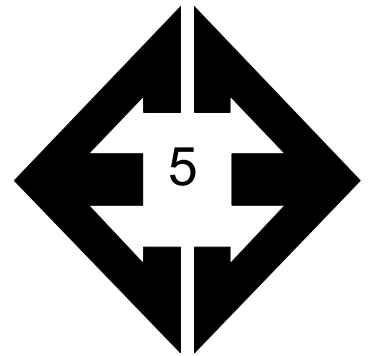

**Looking south from
the eastern side of the
site.**

May 2, 2023

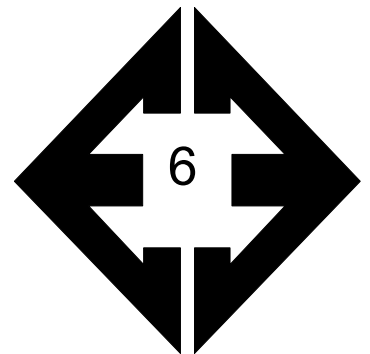

**Looking east from the
southeastern portion
of the site.**

May 2, 2023

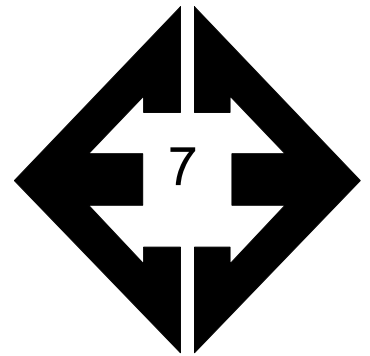

Looking west from the southeastern side of the site.

May 2, 2023

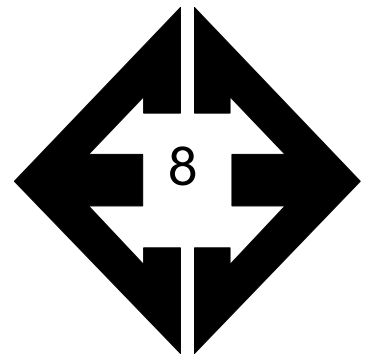

Looking north from the southern side of the site.

May 2, 2023

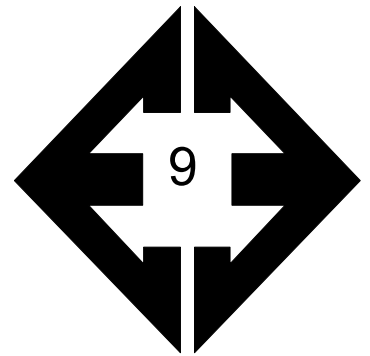

Looking west towards pond in the southern side of the site.

May 2, 2023

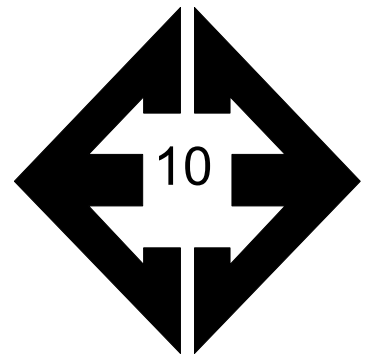

Looking east towards spring in the area of Lots 47 and 55.

May 2, 2023

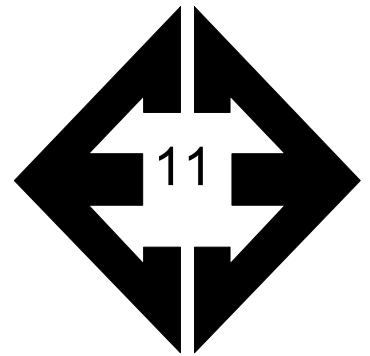

**Looking towards cliff
in the southeastern
portion of the site.**

May 2, 2023

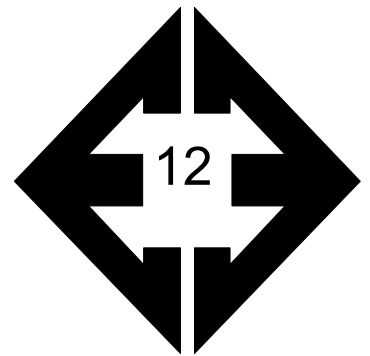

**Looking north from the
eastern side of the site
on Lot 17.**

May 2, 2023

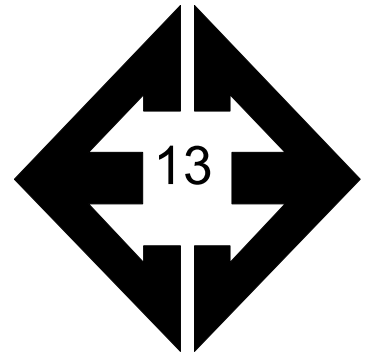

Looking north from the western side of Filing No. 3.

May 24, 2023

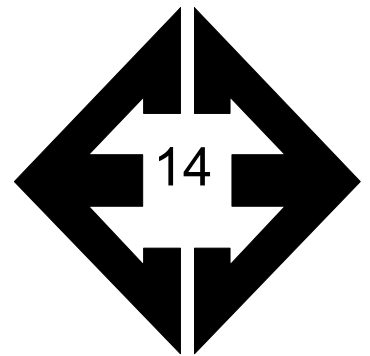

Looking south along steep slope in the area of Lot 20.

May 24, 2023

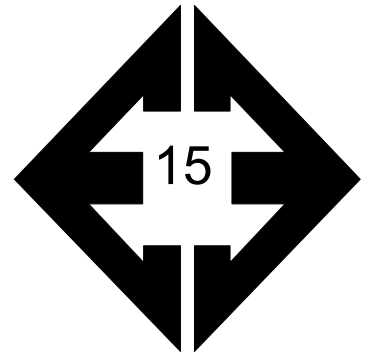

**Looking northeast the
north central portion of
the site.**

May 24, 2023

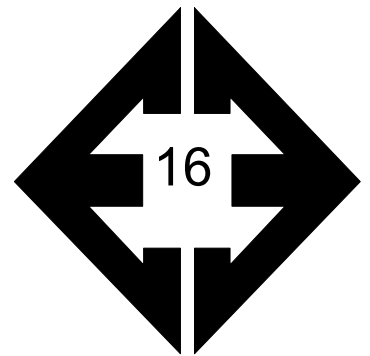

**Looking east along
drainage on Lot 59.**

May 24, 2023

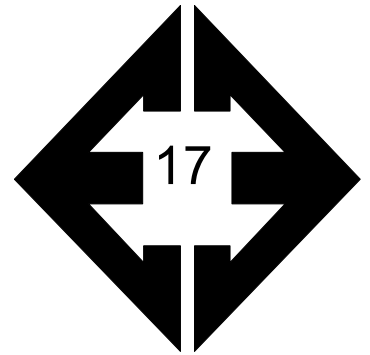

**Looking north from the
central portion of the
site.**

May 24, 2023

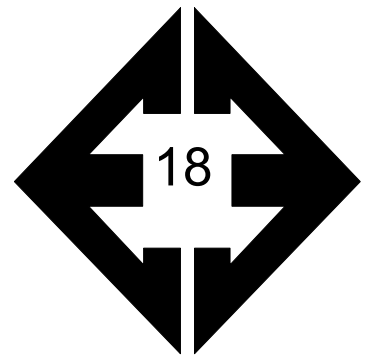

**Looking southwest
toward trash pile on
Lot 12.**

May 24, 2023

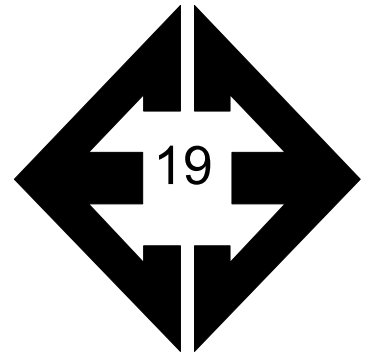

**Looking south from
the northeastern side
of the site.**

May 24, 2023

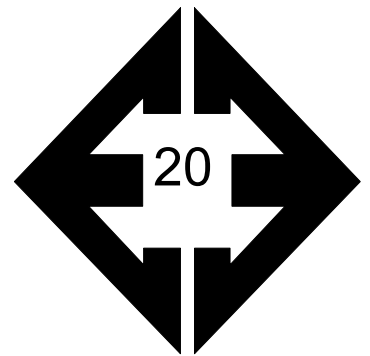

**Looking southwest
from northeastern side
of the site.**

May 24, 2023

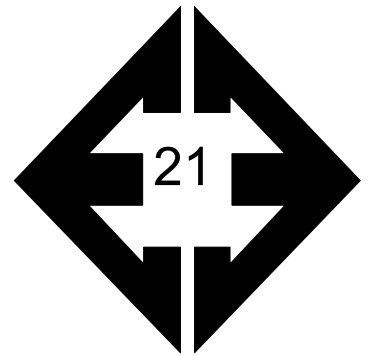

**Looking southwest
along cliff and slope
northern portion of the
site.**

May 24, 2023



**Looking east
northwestern side of
the site.**

May 24, 2023



APPENDIX B: Test Boring Logs

TABLE B-1
DEPTH TO BEDROCK

TEST BORING	DEPTH TO BEDROCK (ft.)	DEPTH TO GROUNDWATER (ft.)
1	SURFACE	16.2
2	6	8
3	SURFACE	15.3
4	9	>20
5	9	19.5
6	6	19
7	5	3
8	4	8
9	6	>20
10	13	>20
11	12	>20
12	8	>20
13	13	>20
14	3	15
15	4	>20
16	13	18

TEST BORING 1
 DATE DRILLED 5/2/2023

TEST BORING 2
 DATE DRILLED 5/2/2023

REMARKS

REMARKS

WATER @ 16.2', 5/17/23

SANDSTONE, SILTY, VERY WEAK,
 TAN TO LIGHT BROWN, VERY
 DENSE, MOIST

WATER @ 8.4', 5/17/23

SAND, SILTY, DARK BROWN,
 MEDIUM DENSE TO DENSE,

SANDSTONE, SILTY, VERY WEAK,
 TAN TO LIGHT BROWN, VERY
 DENSE, MOIST

SILTSTONE, SANDY, GREEN-GRAY,
 HARD, MOIST

Depth (ft)	Symbol	Samples	Blows per foot	Watercontent %	Soil Type	Depth (ft)	Symbol	Samples	Blows per foot	Watercontent %	Soil Type
5	[Symbol]		50 8"	5.6	3	5	[Symbol]		25	9.1	1
			50 9"	9.1	3				32	6.6	1
10	[Symbol]		50 10"	7.4	3	10	[Symbol]		50 11"	11.7	3
15	[Symbol]		50 8"	10.0	3	15	[Symbol]		50 9"	15.4	4
20	[Symbol]		50 7"	12.3	3	20	[Symbol]		50 6"	7.8	4



TEST BORING LOGS

ELBERT ROAD
 PT OVERLOOK

JOB NO.
 230677

FIG. B-1

TEST BORING 3
 DATE DRILLED 5/2/2023

TEST BORING 4
 DATE DRILLED 5/2/2023

REMARKS

REMARKS

WATER @ 15.3', 5/17/23

SANDSTONE, SILTY, VERY WEAK,
 TAN, VERY DENSE, MOIST

SILTSTONE, SANDY, GREEN-GRAY,
 HARD, MOIST

Depth (ft)	Symbol	Samples	Blows per foot	Watercontent %	Soil Type
5			50 9"	4.9	3
5			50 10"	6.2	3
10			50 10"	6.3	3
15			46	14.6	4
20			50 9"	11.2	4

DRY TO 20', 5/17/23

SAND, SILTY, DARK BROWN,
 MEDIUM DENSE TO DENSE, DRY
 TO MOIST

SANDSTONE, SILTY, VERY WEAK,
 TAN TO LIGHT BROWN, VERY
 DENSE, MOIST

Depth (ft)	Symbol	Samples	Blows per foot	Watercontent %	Soil Type
5			11	2.5	1
5			14	7.1	1
10			44	13.8	3
15			50 8"	11.0	3
20			50 11"	14.0	3



TEST BORING LOGS

ELBERT ROAD
 PT OVERLOOK

JOB NO.
 230677

FIG. B-2

TEST BORING 5
 DATE DRILLED 5/2/2023

TEST BORING 6
 DATE DRILLED 5/3/2023

REMARKS

REMARKS

WATER AT 19.5', 5/17/23

SAND, SILTY, DARK BROWN,
 MEDIUM DENSE TO DENSE, DRY
 TO MOIST

SANDSTONE, SILTY, VERY WEAK,
 TAN TO LIGHT BROWN, VERY
 DENSE, MOIST

Depth (ft)	Symbol	Samples	Blows per foot	Watercontent %	Soil Type
5			24	4.1	1
5			22	7.2	1
10			<u>50</u> 9"	9.4	3
15			<u>50</u> 7"	9.2	3
20			50	16.7	3

WATER AT 19', 5/17/23

SAND, SILTY, DARK BROWN,
 MEDIUM DENSE TO DENSE, DRY
 TO MOIST

SANDSTONE, SILTY, VERY WEAK,
 TAN TO LIGHT BROWN, VERY
 DENSE, MOIST

Depth (ft)	Symbol	Samples	Blows per foot	Watercontent %	Soil Type
5			13	2.5	1
5			16	6.8	1
10			50	6.4	3
15			50	10.6	3
20			<u>50</u> 11"	12.2	3



TEST BORING LOGS

ELBERT ROAD
 PT OVERLOOK

JOB NO.
 230677

FIG. B-3

TEST BORING 7
 DATE DRILLED 5/3/2023

TEST BORING 8
 DATE DRILLED 5/3/2023

REMARKS	Depth (ft)	Symbol	Samples	Blows per foot	Watercontent %	Soil Type
WATER @ 3', 5/17/23						
SAND, SILTY, TAN, MEDIUM DENSE TO DENSE, MOIST	0-3			16	3.7	1
	3-5			34	9.3	1
SANDSTONE, SILTY, VERY WEAK, TAN, DENSE TO VERY DENSE, MOIST	5-10			45	10.2	3
	10-15			50	8.1	3
	15-20			50	4.6	3

REMARKS	Depth (ft)	Symbol	Samples	Blows per foot	Watercontent %	Soil Type
WATER AT 18', 5/17/23						
SAND, SILTY, TAN, LOOSE, MOIST	0-5			8	3.7	1
SANDSTONE, SILTY, VERY WEAK, TAN TO OLIVE, VERY DENSE,	5-10			50 9"	3.8	3
	10-15			50 9"	6.4	3
	15-20			50 8"	7.2	3
	20-25			50 8"	8.0	3



TEST BORING LOGS

ELBERT ROAD
 PT OVERLOOK

JOB NO.
 230677

FIG. B-4

TEST BORING 9
 DATE DRILLED 5/3/2023

TEST BORING 10
 DATE DRILLED 5/3/2023

REMARKS	Depth (ft)	Symbol	Samples	Blows per foot	Watercontent %	Soil Type
DRY TO 19.5', 5/17/23						
SAND, SILTY, TAN, MEDIUM DENSE, MOIST	5			26	12.2	1
	5			20	5.7	1
SANDSTONE, SILTY, VERY WEAK, TAN, VERY DENSE, MOIST	10			<u>50</u> 3"	7.6	3
	15			<u>50</u> 7"	9.3	3
	20			<u>50</u> 7"	8.8	3

REMARKS	Depth (ft)	Symbol	Samples	Blows per foot	Watercontent %	Soil Type
DRY TO 20', 5/17/23						
SAND, SILTY, TAN, MEDIUM DENSE TO DENSE, MOIST	5			27	5.0	1
	5			32	4.7	1
	10			36	7.5	1
SANDSTONE, SILTY, VERY WEAK, TAN, VERY DENSE, MOIST	15			<u>50</u> 11"	9.1	3
	20			<u>50</u> 7"	10.0	3



TEST BORING LOGS

ELBERT ROAD
 PT OVERLOOK

JOB NO.
 230677

FIG. B-5

TEST BORING 11
 DATE DRILLED 5/3/2023

TEST BORING 12
 DATE DRILLED 5/3/2023

REMARKS	Depth (ft)	Symbol	Samples	Blows per foot	Watercontent %	Soil Type
DRY TO 20', 5/17/23						
SAND, SILTY, BROWN TO TAN, LOOSE TO DENSE, MOIST	5		6	5.5	1	
	5		3	6.2	1	
	10		31	10.3	1	
SANDSTONE, SILTY, VERY WEAK, TAN, VERY DENSE TO DENSE, MOIST	15		50 9"	12.7	3	
	20		40	13.6	3	

REMARKS	Depth (ft)	Symbol	Samples	Blows per foot	Watercontent %	Soil Type
DRY TO 5', 5/17/23						
SAND, SILTY, BROWN TO TAN, MEDIUM DENSE TO DENSE,	5		22	5.4	1	
	5		36	11.9	1	
SANDSTONE, SILTY, VERY WEAK, TAN, VERY DENSE, MOIST	10		*	8.0	3	
AUGER REFUSAL AT 8'						
* - BULK SAMPLE TAKEN						



TEST BORING LOGS

ELBERT ROAD
 PT OVERLOOK

JOB NO.
 230677

FIG. B-6

TEST BORING 13
 DATE DRILLED 5/5/2023

TEST BORING 14
 DATE DRILLED 5/5/2023

REMARKS	Depth (ft)	Symbol	Samples	Blows per foot	Watercontent %	Soil Type
DRY TO 19.5', 5/17/23						
SAND, SILTY, DARK BROWN TO TAN, MEDIUM DENSE TO DENSE, MOIST	5			22	7.4	1
	5			40	7.1	1
	10			47	7.5	1
	15			47	15.9	3
SANDSTONE, SILTY, VERY WEAK, TAN, DENSE TO VERY DENSE, MOIST	20			50 8"	11.0	3

REMARKS	Depth (ft)	Symbol	Samples	Blows per foot	Watercontent %	Soil Type
WATER AT 15.1', 5/17/23						
SAND, SILTY, TAN, DENSE, MOIST	5			43	10.4	1
SANDSTONE, SILTY, VERY WEAK, TAN, VERY DENSE TO MEDIUM DENSE, MOIST	5			50 5"	12.7	3
EXTREMELY WEAK LENS	10			23	14.0	3
	15			50 6"	8.2	3
	20			50 4"	7.6	3



TEST BORING LOGS

ELBERT ROAD
 PT OVERLOOK

JOB NO.
 230677

FIG. B-7

TEST BORING 15
 DATE DRILLED 5/5/2023

TEST BORING 16
 DATE DRILLED 5/5/2023

REMARKS	Depth (ft)	Symbol	Samples	Blows per foot	Watercontent %	Soil Type
DRY TO 8.5', 5/17/23						
SAND, SILTY, TAN, DENSE, MOIST				*	5.1	1
SANDSTONE, SILTY, VERY WEAK, TAN, VERY DENSE, MOIST	5			<u>50</u> 1"	3.9	3
	10			<u>50</u> 3"	8.4	3
	15					
	20					

* - BULK SAMPLE TAKEN

REMARKS	Depth (ft)	Symbol	Samples	Blows per foot	Watercontent %	Soil Type
WATER AT 18.1', 5/17/23						
SAND, SILTY, BROWN TO TAN, MEDIUM DENSE, MOIST				14	5.3	1
	5			15	8.7	1
	10			19	11.7	1
	15			34	17.9	3
	20			<u>50</u> 11"	10.7	3



TEST BORING LOGS

ELBERT ROAD
 PT OVERLOOK

JOB NO.
 230677

FIG. B-8

TEST BORING 17
DATE DRILLED 2/21/2024

TEST BORING 18
DATE DRILLED 2/21/2024

REMARKS

REMARKS

POND B8

WATER @ 8.5',
3/6/24

CLAY, SANDY, LIGHT BROWN,
VERY STIFF, MOIST

SANDSTONE, EXTREMELY WEAK,
TAN to GRAY, SLIGHTLY
WEATHERED (SAND, SILTY, VERY
DENSE, MOIST)

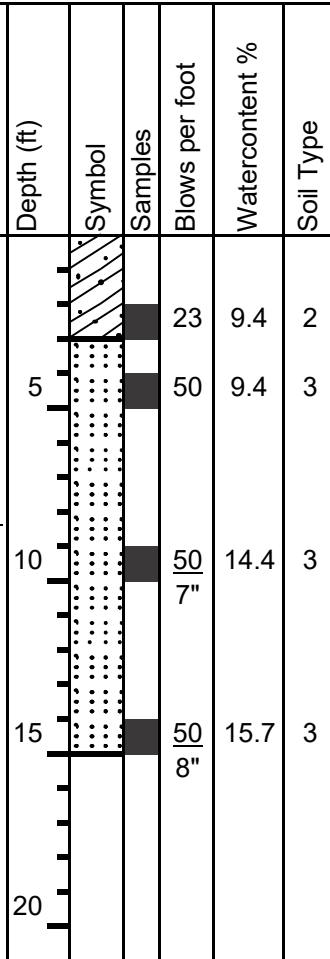

POND B1

WATER @ 8', 3/6/24

SAND, SILTY, BROWN, MEDIUM
DENSE, MOIST

CLAY, SANDY, LIGHT BROWN to
GRAY, VERY STIFF to HARD,
MOIST

SANDSTONE, VERY WEAK, GRAY,
MODERATELY WEATHERED
(SAND, SILTY, VERY DENSE,
MOIST)

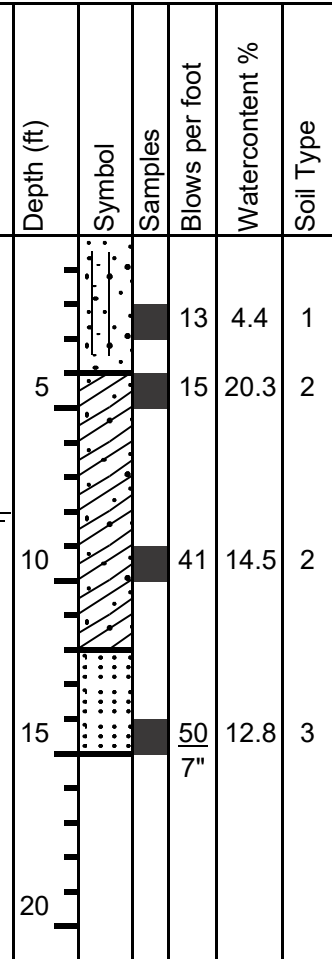

TEST BORING LOGS

ELBERT ROAD
PT OVERLOOK, LLC

JOB NO.
230677

FIG. B-9

TEST BORING 19
 DATE DRILLED 2/21/2024

TEST BORING 20
 DATE DRILLED 2/21/2024

REMARKS

REMARKS

POND A2

POND C6

DRY TO 15', 3/6/24

DRY TO 15', 3/6/24

CLAY, SANDY, LIGHT BROWN,
 HARD, MOIST

SANDSTONE, WEAK, TAN, FRESH
 (SAND, SILTY, VERY DENSE,
 MOIST)

SANDSTONE, EXTREMELY WEAK,
 TAN, MODERATELY WEATHERED
 (SAND, SILTY, VERY DENSE,
 MOIST)

CLAYSTONE, VERY WEAK, BROWN
 to GRAY, SLIGHTLY WEATHERED
 (CLAY, SANDY, HARD, MOIST)

Depth (ft)	Symbol	Samples	Blows per foot	Watercontent %	Soil Type
0 - 3.9	[Diagonal Hatching]		39	14.0	2
3.9 - 5.0	[Dotted]		50	11.6	3
5.0 - 9.9	[Dotted]		50		
9.9 - 10.0	[Dotted]		9"		
10.0 - 15.0	[Cross-hatching]		50	16.1	4
15.0 - 19.9	[Cross-hatching]		50	13.6	4
19.9 - 20.0	[Cross-hatching]		10"		

Depth (ft)	Symbol	Samples	Blows per foot	Watercontent %	Soil Type
0 - 5.0	[Dotted]		50	9.1	3
5.0 - 6.0	[Dotted]		6"		
6.0 - 8.1	[Dotted]		50	8.1	3
8.1 - 9.9	[Dotted]		2"		
9.9 - 10.0	[Dotted]		50	8.3	3
10.0 - 15.0	[Dotted]		2"		
15.0 - 19.9	[Dotted]		50	15.3	3
19.9 - 20.0	[Dotted]		9"		



TEST BORING LOGS

ELBERT ROAD
 PT OVERLOOK, LLC

JOB NO.
 230677

FIG. B-10

TEST BORING 21
DATE DRILLED 2/21/2024

TEST BORING 22
DATE DRILLED 2/21/2024

REMARKS

REMARKS

POND D1

WATER @ 14',
3/6/24

SAND, SILTY, LIGHT BROWN,
MEDIUM DENSE to DENSE,
MOIST

SANDSTONE, WEAK, TAN, FRESH
(SAND, SILTY, VERY DENSE to
DENSE, MOIST)



Depth (ft)	Symbol	Samples	Blows per foot	Watercontent %	Soil Type
0-5	[Symbol]		18	3.5	1
5-10	[Symbol]		36	9.9	1
10-15	[Symbol]		50 9"	10.4	3
15-20	[Symbol]		40	14.4	3
20-25	[Symbol]				
25-30	[Symbol]				
30-35	[Symbol]				

APEX RD., STA 15+45

DRY TO 35', 3/6/24

SAND, SILTY, TAN, MEDIUM
DENSE, MOIST

SANDSTONE, EXTREMELY WEAK,
TAN, EXTREMELY WEATHERED
(SAND, GRAVELLY, SILTY, VERY
DENSE to DENSE, MOIST)

SANDSTONE, VERY WEAK, TAN,
SLIGHTLY WEATHERED (SAND,
CLAYEY, VERY DENSE, MOIST)

Depth (ft)	Symbol	Samples	Blows per foot	Watercontent %	Soil Type
0-5	[Symbol]		29	6.9	1
5-10	[Symbol]		50	5.5	3
10-15	[Symbol]		46	9.3	3
15-20	[Symbol]		42	10.1	3
20-25	[Symbol]		50 4"	10.9	3
25-30	[Symbol]		B	11.2	3
30-35	[Symbol]		50 6"	16.5	3
35-40	[Symbol]		50 7"	7.3	3



TEST BORING LOGS

ELBERT ROAD
PT OVERLOOK, LLC

JOB NO.
230677

FIG. B-11



APPENDIX C: Laboratory Test Results

**TABLE C-1
SUMMARY OF LABORATORY TEST RESULTS**

SOIL TYPE	TEST BORING NO.	DEPTH (FT)	WATER (%)	DRY DENSITY (PCF)	PASSING NO. 200 SIEVE (%)	LIQUID LIMIT	PLASTIC LIMIT	PLASTIC INDEX	FHA SWELL (PSF)	SWELL/ CONSOL (%)	UNIFIED CLASSIFICATION	SOIL DESCRIPTION
1	2	2-3			19.5						SM	SAND, SILTY
1	4	2-3			13.7						SM	SAND, SILTY
1	5	5			33.9						SM	SAND, SILTY
1	6	2-3			12.7						SM	SAND, SILTY
1	8	5			24.8						SM	SAND, SILTY
1	10	5			13.6	NV	NP	NP			SM	SAND, SILTY
1	13	2-3			41.0						SM	SAND, SILTY
1	16	5			25.9						SM	SAND, SILTY
1	17	2-3			22.8	NV	NP	NP			SM	SAND, SILTY
1	20	5			34.4						SM	SAND, SILTY
1	21	5			16.1						SM	SAND, SILTY
1	22	2-3			24.5						SM	SAND, SILTY
2	9	2-3			58.4				1150		CL	CLAY, SANDY
2	12	2-3			59.5						ML	SILT, SANDY
2	17	2-3	14.9	109.1	62.7	36	9	27		1.7	CL	CLAY, SANDY
3	1	10			10.0						SM-SW	SANDSTONE, WITH SILT
3	7	15			14.4						SM	SANDSTONE, SILTY
3	9	10			29.7						SM	SANDSTONE, SILTY
3	11	15			25.4	NV	NP	NP			SM	SANDSTONE, SILTY
3	14	15			16.5						SM	SANDSTONE, SILTY
3	15	10			31.2						SM	SANDSTONE, SILTY
3	22	10			17.3						SM	SANDSTONE, SILTY
3	22	30			47.3						SC	SANDSTONE, CLAYEY
4	3	15	15.0	108.3	57.8	NV	NP	NP		-0.1	ML	SILTSTONE, SANDY
4	19	10	17.3	112.2	71.0	46	24	22		3.0	CL	CLAYSTONE, SANDY

TEST BORING 2
DEPTH (FT) 2-3
SOIL TYPE 1

SOIL DESCRIPTION SAND, SILTY
USCS CLASSIFICATION SM

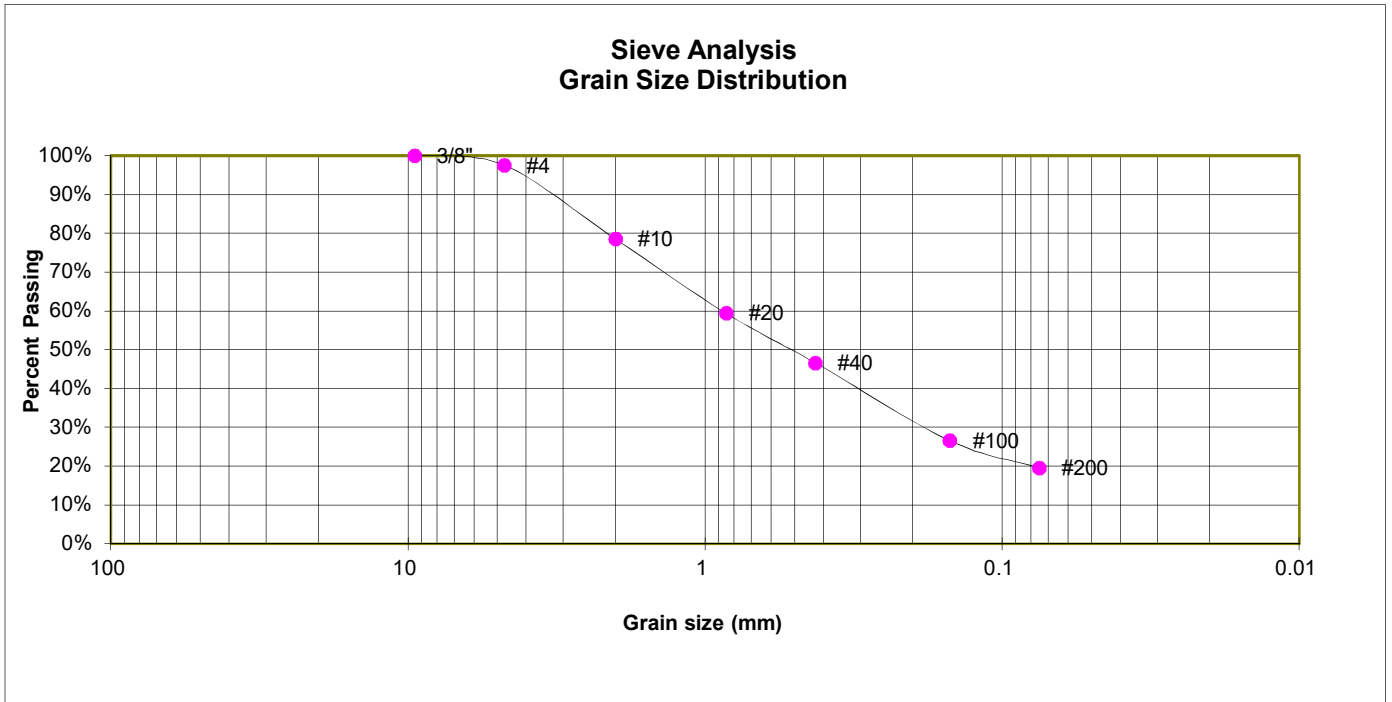

<u>U.S. Sieve #</u>	<u>Percent Finer</u>
3"	
1 1/2"	
3/4"	
1/2"	
3/8"	100.0%
4	97.6%
10	78.5%
20	59.4%
40	46.6%
100	26.5%
200	19.5%



LABORATORY TEST RESULTS

ELBERT ROAD
PT OVERLOOK

JOB NO.
230677

FIG. C-1

TEST BORING 4
DEPTH (FT) 2-3
SOIL TYPE 1

SOIL DESCRIPTION SAND, SILTY
USCS CLASSIFICATION SM

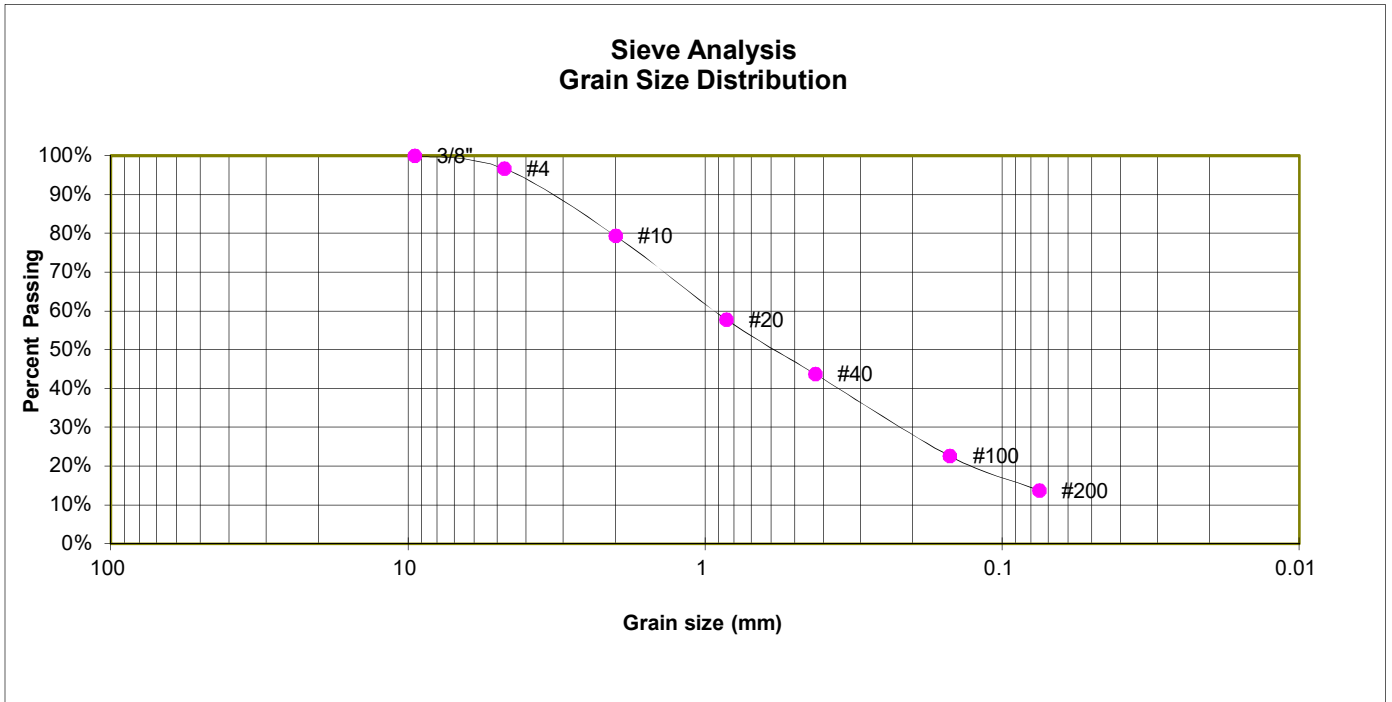

<u>U.S. Sieve #</u>	<u>Percent Finer</u>
3"	
1 1/2"	
3/4"	
1/2"	
3/8"	100.0%
4	96.7%
10	79.3%
20	57.8%
40	43.7%
100	22.6%
200	13.7%



LABORATORY TEST RESULTS

ELBERT ROAD
PT OVERLOOK

JOB NO.
230677

FIG. C-2

TEST BORING 5
DEPTH (FT) 5
SOIL TYPE 1

SOIL DESCRIPTION SAND, SILTY
USCS CLASSIFICATION SM

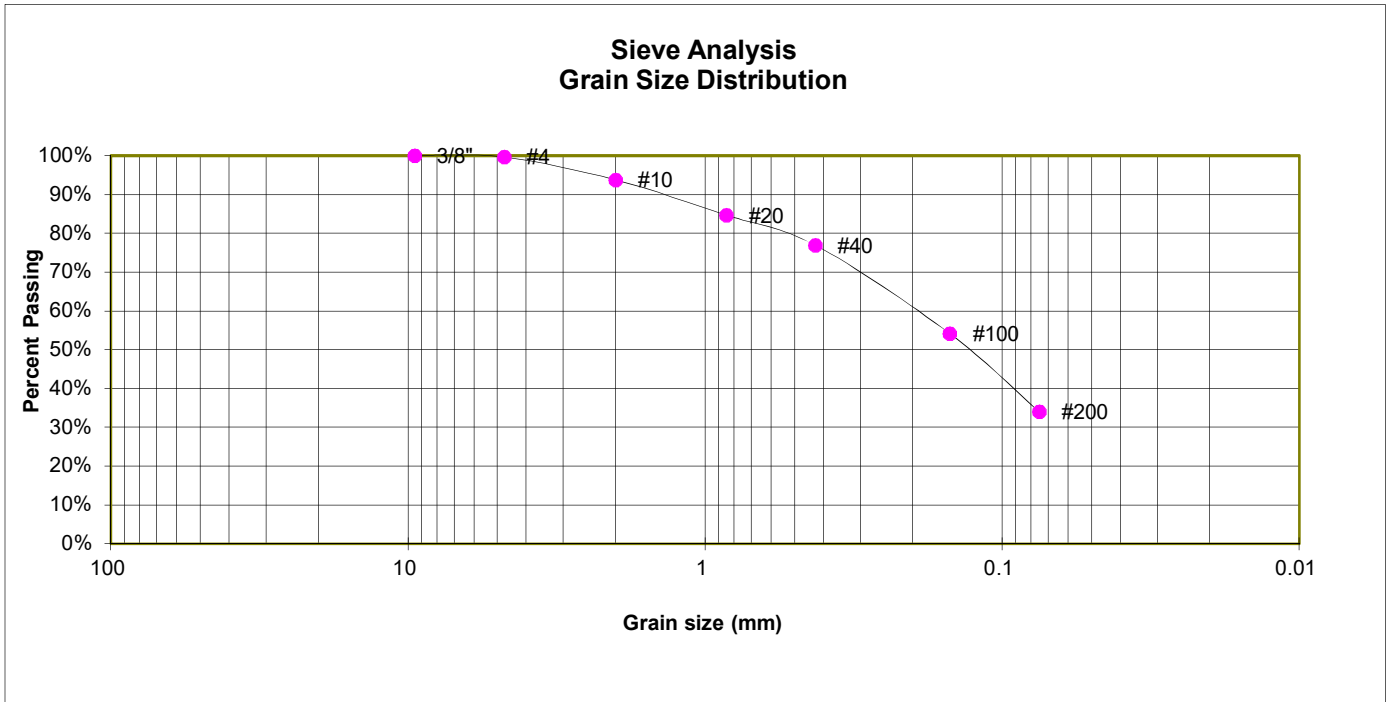

<u>U.S. Sieve #</u>	<u>Percent Finer</u>
3"	
1 1/2"	
3/4"	
1/2"	
3/8"	100.0%
4	99.7%
10	93.8%
20	84.7%
40	76.9%
100	54.2%
200	33.9%



LABORATORY TEST RESULTS

ELBERT ROAD
PT OVERLOOK

JOB NO.
230677

FIG. C-3

TEST BORING 6
DEPTH (FT) 2-3
SOIL TYPE 1

SOIL DESCRIPTION SAND, SILTY
USCS CLASSIFICATION SM

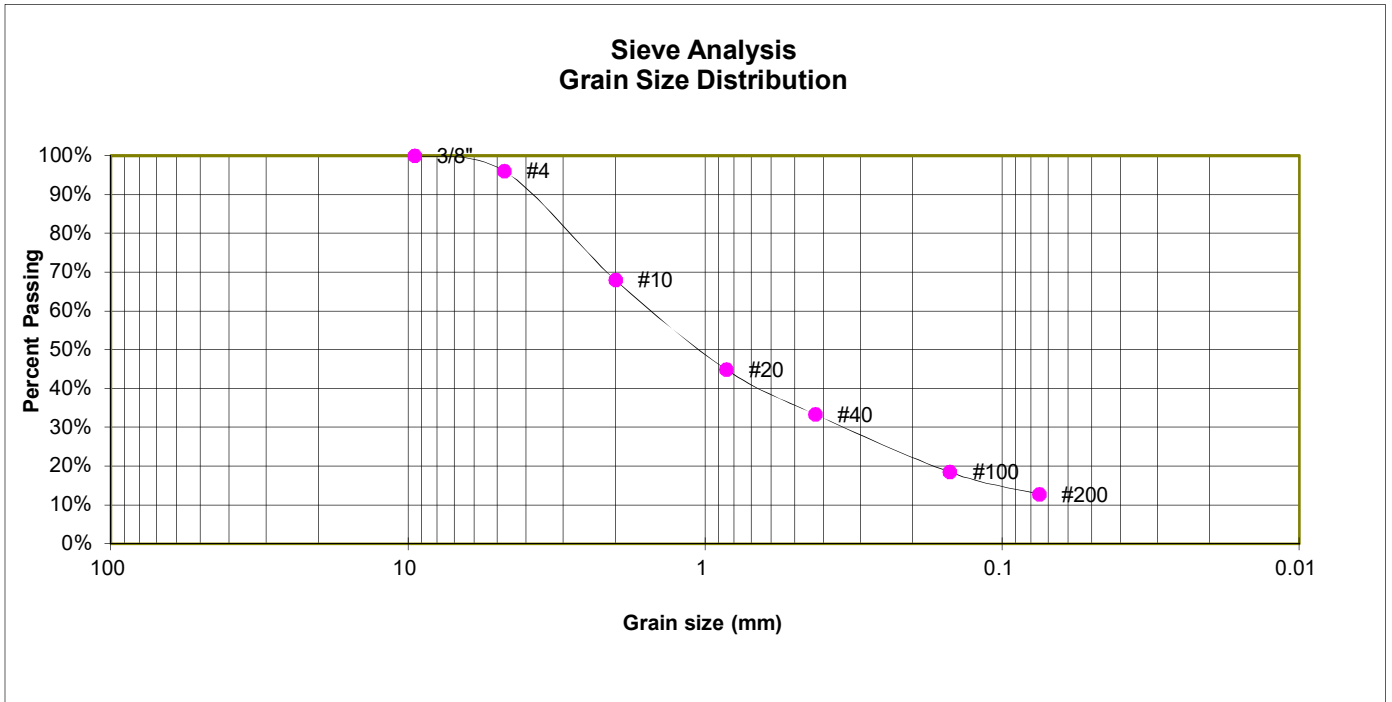

U.S. Sieve #	Percent Finer
3"	
1 1/2"	
3/4"	
1/2"	
3/8"	100.0%
4	96.1%
10	67.9%
20	44.9%
40	33.3%
100	18.4%
200	12.7%



LABORATORY TEST RESULTS

ELBERT ROAD
PT OVERLOOK

JOB NO.
230677

FIG. C-4

TEST BORING 8
DEPTH (FT) 5
SOIL TYPE 1

SOIL DESCRIPTION SAND, SILTY
USCS CLASSIFICATION SM

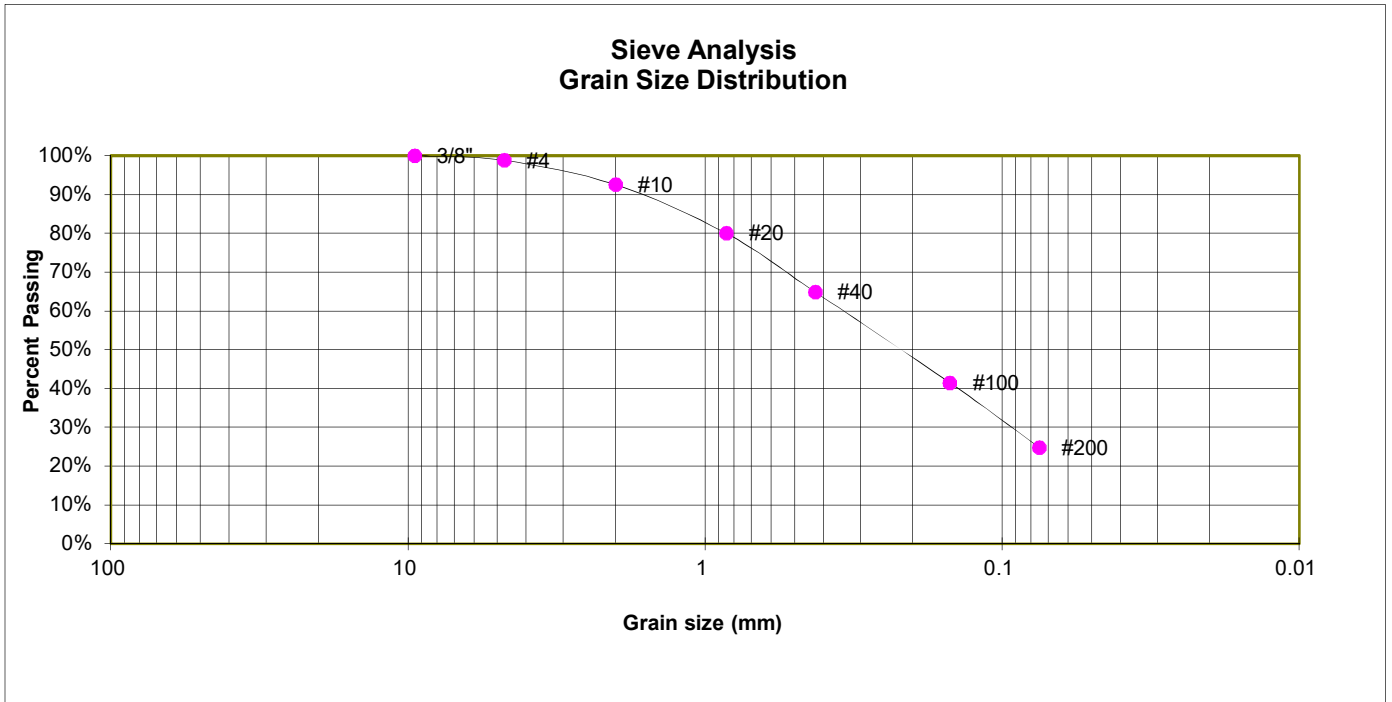

U.S. Sieve #	Percent Finer
3"	
1 1/2"	
3/4"	
1/2"	
3/8"	100.0%
4	98.8%
10	92.5%
20	80.0%
40	64.8%
100	41.5%
200	24.8%



LABORATORY TEST RESULTS

ELBERT ROAD
PT OVERLOOK

JOB NO.
230677

FIG. C-5

TEST BORING 10
 DEPTH (FT) 5
 SOIL TYPE 1

SOIL DESCRIPTION SAND, SILTY
 USCS CLASSIFICATION SM

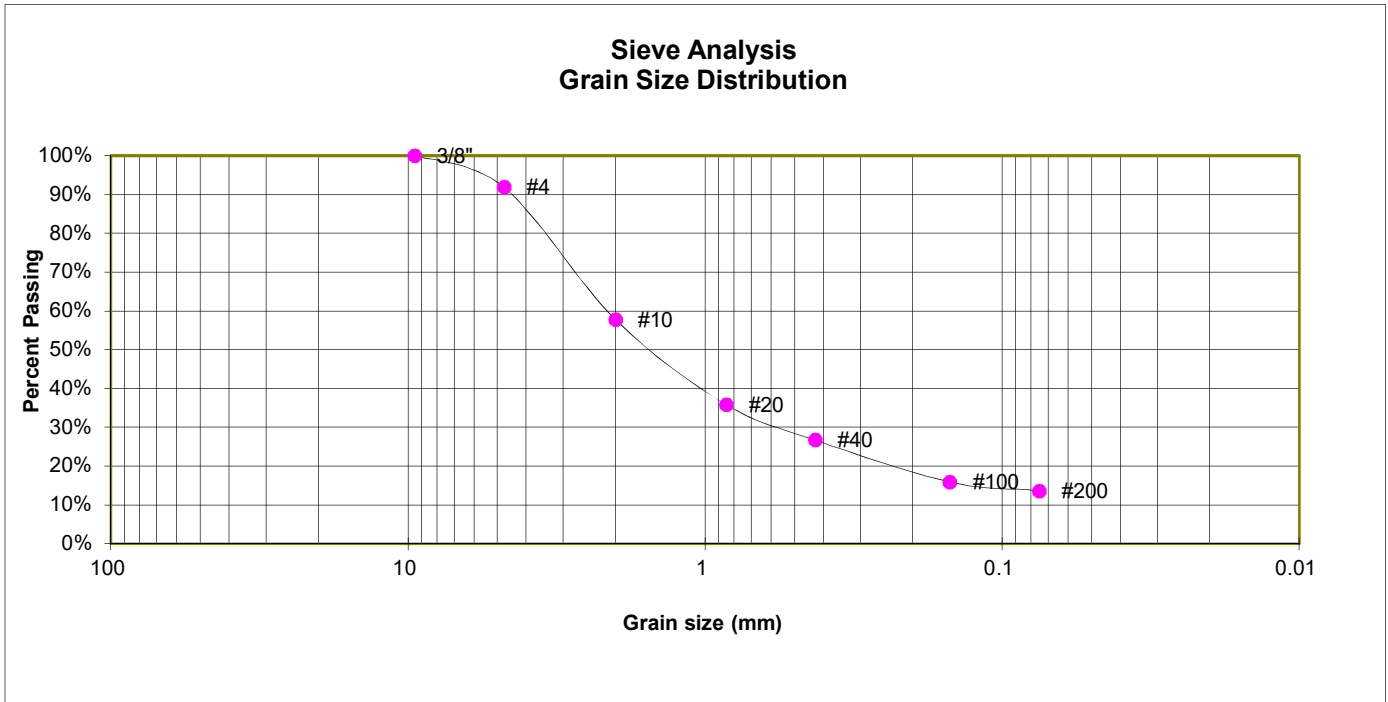

U.S. Sieve #	Percent Finer
3"	
1 1/2"	
3/4"	
1/2"	
3/8"	100.0%
4	91.9%
10	57.7%
20	35.9%
40	26.7%
100	15.9%
200	13.6%

Atterberg Limits
 Plastic Limit NP
 Liquid Limit NV
 Plastic Index NP



LABORATORY TEST RESULTS

ELBERT ROAD
 PT OVERLOOK

JOB NO.
 230677

FIG. C-6

TEST BORING 13
DEPTH (FT) 2-3
SOIL TYPE 1

SOIL DESCRIPTION SAND, SILTY
USCS CLASSIFICATION SM

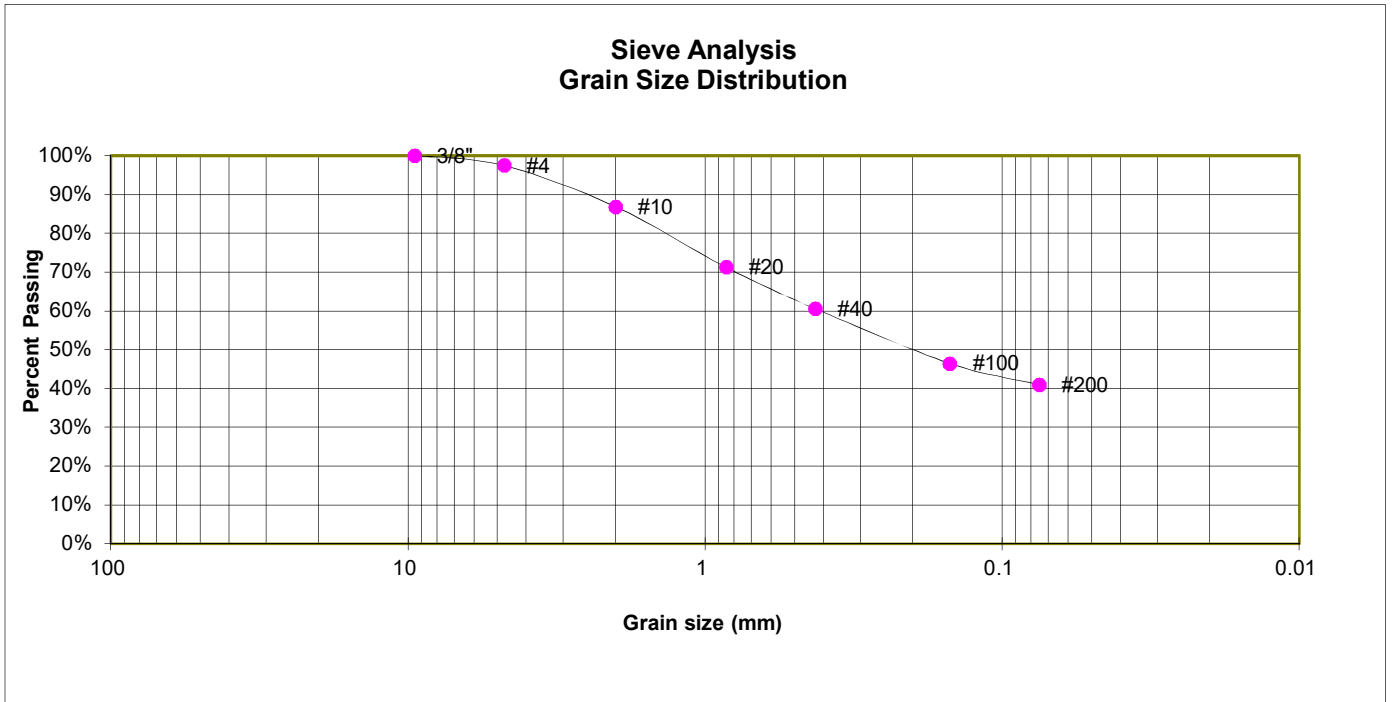

U.S. Sieve #	Percent Finer
3"	
1 1/2"	
3/4"	
1/2"	
3/8"	100.0%
4	97.5%
10	86.8%
20	71.3%
40	60.5%
100	46.5%
200	41.0%



LABORATORY TEST RESULTS

ELBERT ROAD
PT OVERLOOK

JOB NO.
230677

FIG. C-7

TEST BORING 16
DEPTH (FT) 5
SOIL TYPE 1

SOIL DESCRIPTION SAND, SILTY
USCS CLASSIFICATION SM

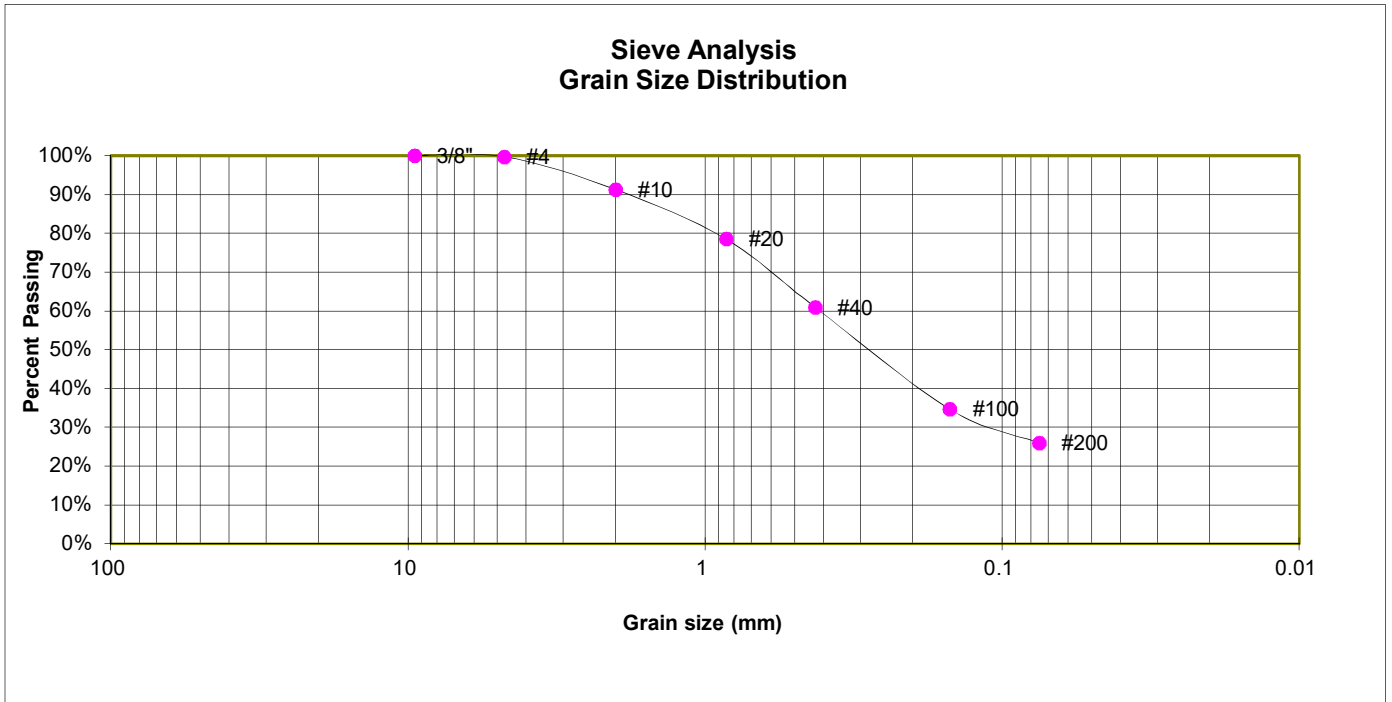

U.S. Sieve #	Percent Finer
3"	
1 1/2"	
3/4"	
1/2"	
3/8"	100.0%
4	99.7%
10	91.3%
20	78.5%
40	60.9%
100	34.6%
200	25.9%



LABORATORY TEST RESULTS

ELBERT ROAD
PT OVERLOOK

JOB NO.
230677

FIG. C-8

TEST BORING 17
 DEPTH (FT) 2-3

SOIL DESCRIPTION SAND, SILTY
 SOIL TYPE 1

**Sieve Analysis
 Grain Size Distribution**

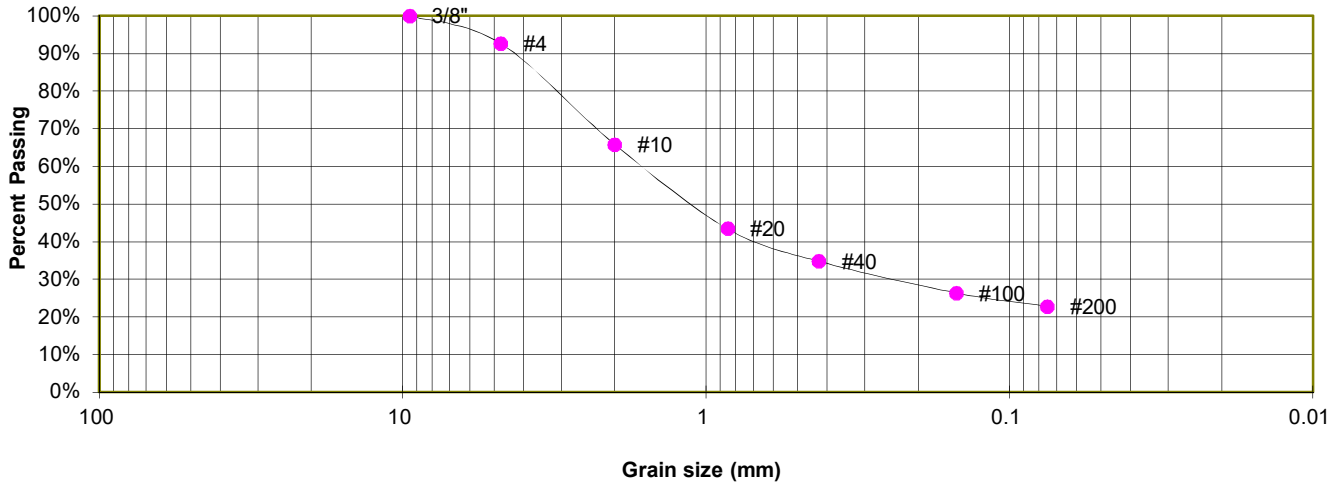

GRAIN SIZE ANALYSIS

U.S. Sieve #	Percent Finer
3"	
1 1/2"	
3/4"	
1/2"	
3/8"	100.0%
4	92.7%
10	65.8%
20	43.4%
40	34.8%
100	26.4%
200	22.8%

ATTERBERG LIMITS

Plastic Limit	NP
Liquid Limit	NV
Plastic Index	NP

SOIL CLASSIFICATION

USCS CLASSIFICATION: SM



LABORATORY TEST RESULTS

ELBERT ROAD
 PT OVERLOOK, LLC

JOB NO.
 230677

FIG. C-9

TEST BORING 20
DEPTH (FT) 5

SOIL DESCRIPTION SAND, SILTY
SOIL TYPE 1

Sieve Analysis Grain Size Distribution

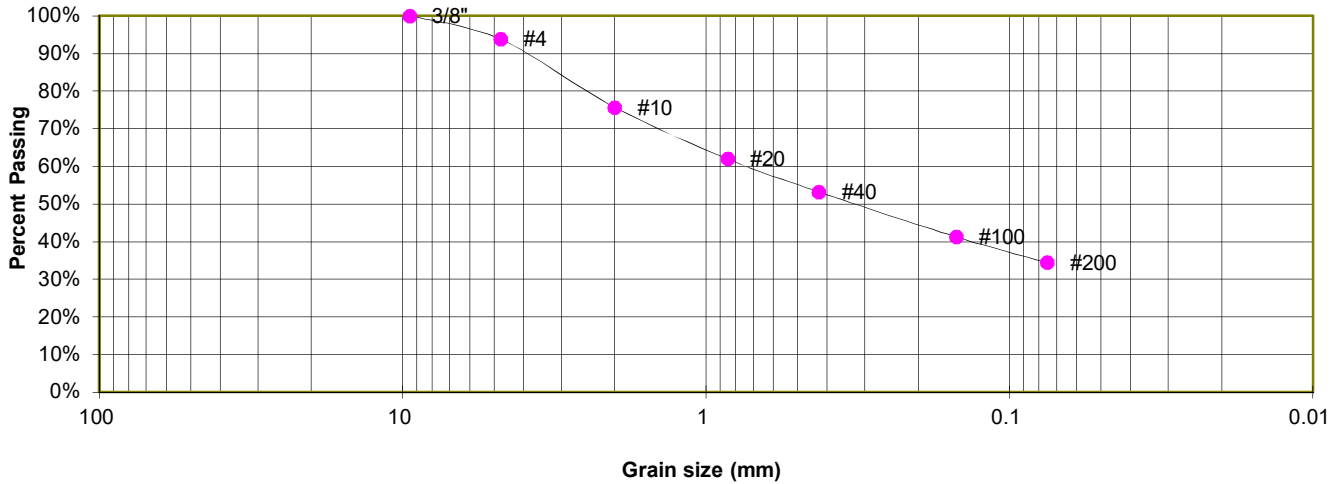

GRAIN SIZE ANALYSIS

U.S. Sieve #	Percent Finer
3"	
1 1/2"	
3/4"	
1/2"	
3/8"	100.0%
4	93.8%
10	75.7%
20	62.0%
40	53.2%
100	41.3%
200	34.4%

SOIL CLASSIFICATION

USCS CLASSIFICATION: SM



LABORATORY TEST RESULTS

ELBERT ROAD
PT OVERLOOK, LLC

JOB NO.
230677

FIG. C-10

TEST BORING 21
DEPTH (FT) 5

SOIL DESCRIPTION SAND, SILTY
SOIL TYPE 1

Sieve Analysis Grain Size Distribution

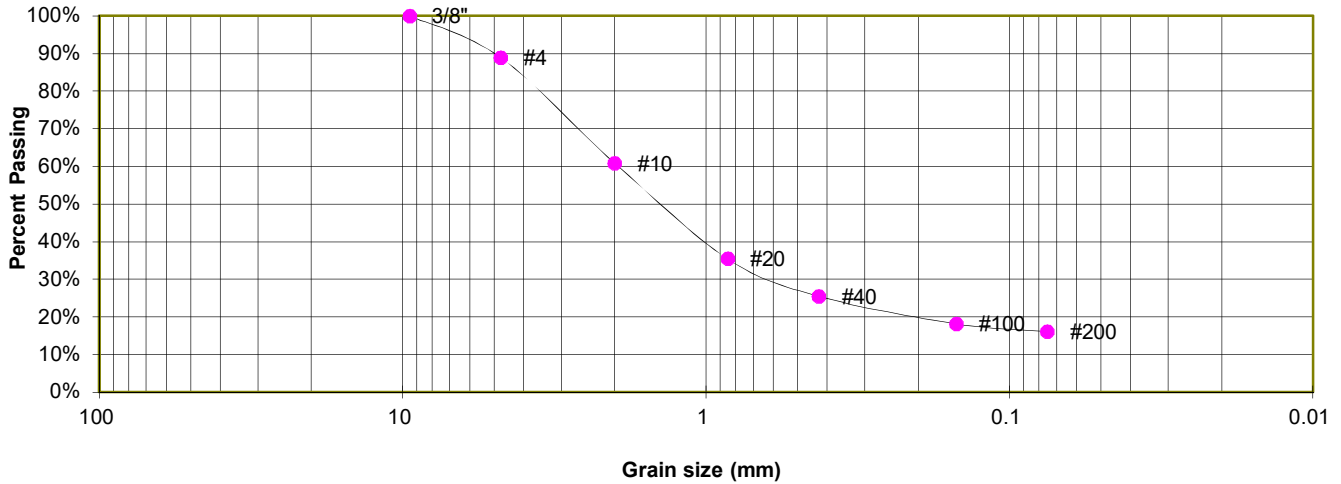

GRAIN SIZE ANALYSIS

U.S. Sieve #	Percent Finer
3"	
1 1/2"	
3/4"	
1/2"	
3/8"	100.0%
4	88.9%
10	60.9%
20	35.5%
40	25.5%
100	18.2%
200	16.1%

SOIL CLASSIFICATION

USCS CLASSIFICATION: SM



LABORATORY TEST RESULTS

ELBERT ROAD
PT OVERLOOK, LLC

JOB NO.
230677

FIG. C-11

TEST BORING 22
DEPTH (FT) 2-3

SOIL DESCRIPTION SAND, SILTY
SOIL TYPE 1

Sieve Analysis Grain Size Distribution

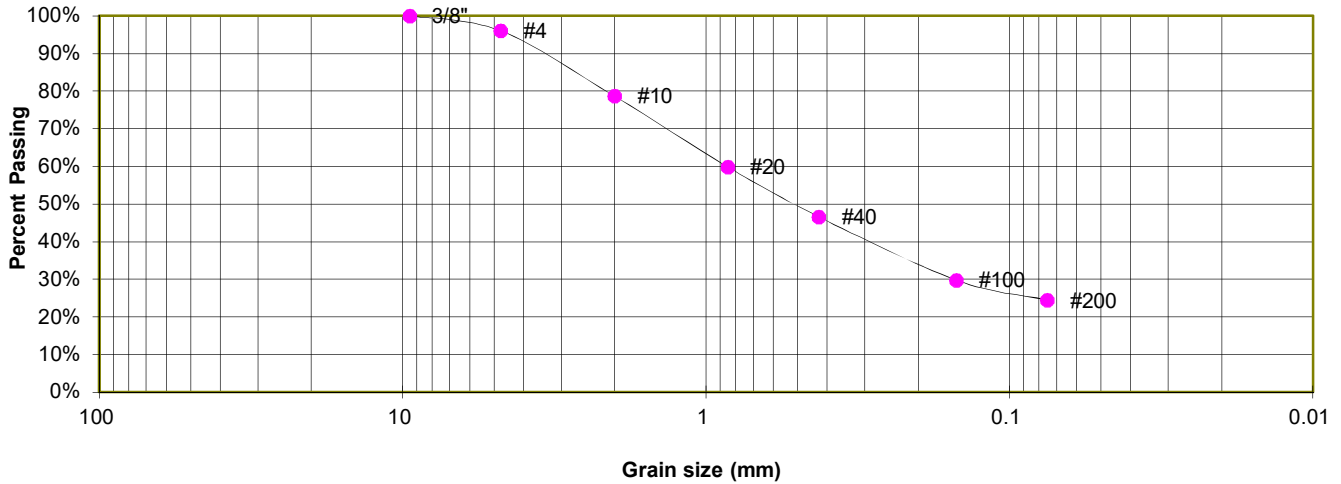

GRAIN SIZE ANALYSIS

U.S. Sieve #	Percent Finer
3"	
1 1/2"	
3/4"	
1/2"	
3/8"	100.0%
4	96.0%
10	78.6%
20	59.9%
40	46.6%
100	29.8%
200	24.5%

SOIL CLASSIFICATION

USCS CLASSIFICATION: SM



LABORATORY TEST RESULTS

ELBERT ROAD
PT OVERLOOK, LLC

JOB NO.
230677

FIG. C-12

TEST BORING 9
 DEPTH (FT) 2-3
 SOIL TYPE 2

SOIL DESCRIPTION CLAY, SANDY
 USCS CLASSIFICATION CL

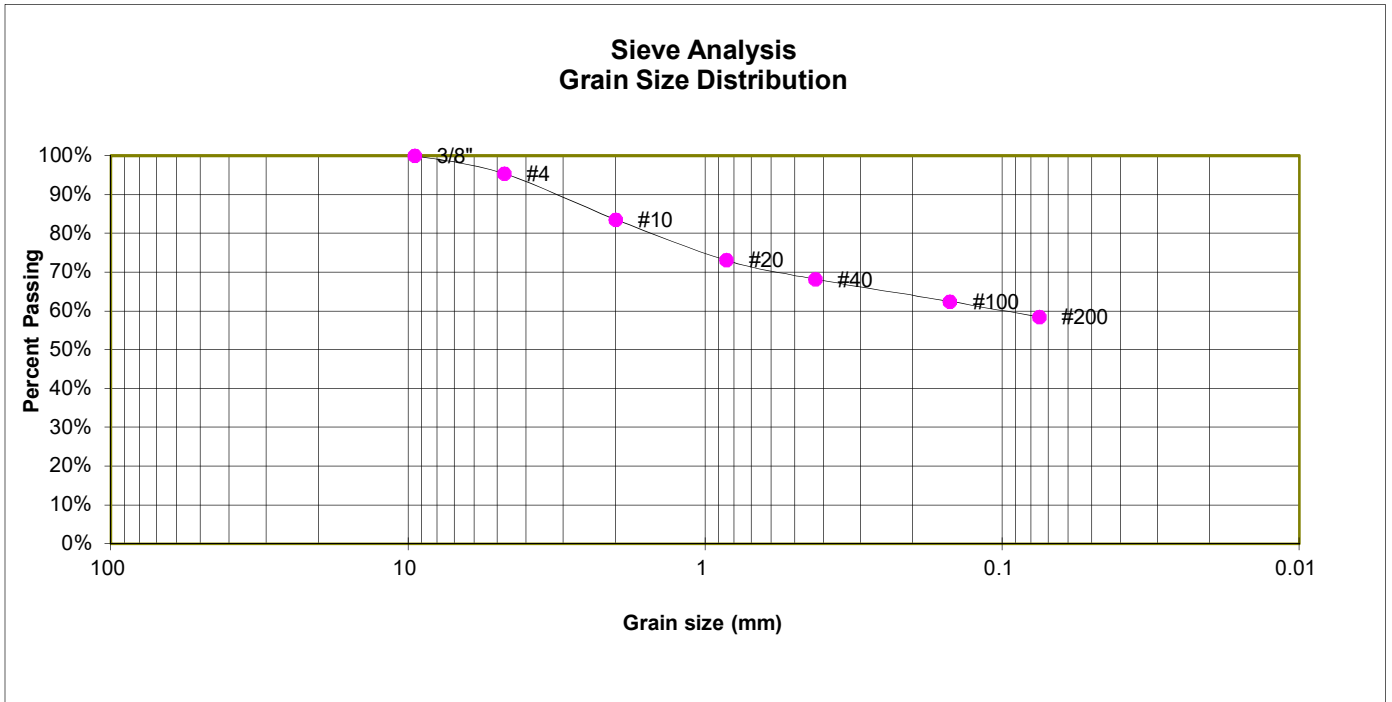

U.S. Sieve #	Percent Finer
3"	
1 1/2"	
3/4"	
1/2"	
3/8"	100.0%
4	95.4%
10	83.5%
20	73.1%
40	68.2%
100	62.4%
200	58.4%

FHA Swell

Moisture at start	16.6%
Moisture at finish	22.0%
Moisture increase	5.4%
Initial dry density (pcf)	101
Swell (psf)	1150



LABORATORY TEST RESULTS

ELBERT ROAD
 PT OVERLOOK

JOB NO.
 230677

FIG. C-13

TEST BORING 12
DEPTH (FT) 2-3
SOIL TYPE 2

SOIL DESCRIPTION SILT, SANDY
USCS CLASSIFICATION ML

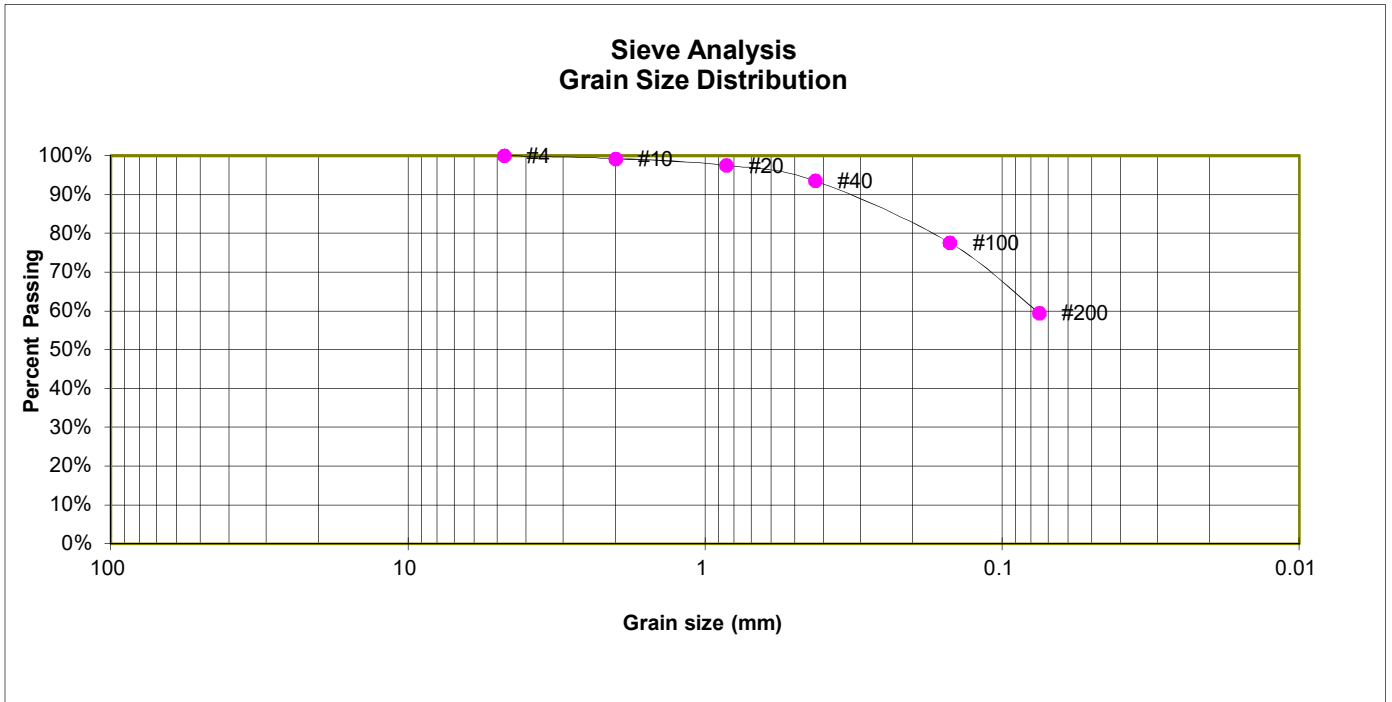

U.S. Sieve #	Percent Finer
3"	
1 1/2"	
3/4"	
1/2"	
3/8"	
4	100.0%
10	99.2%
20	97.5%
40	93.5%
100	77.6%
200	59.5%



LABORATORY TEST RESULTS

ELBERT ROAD
PT OVERLOOK

JOB NO.
230677

FIG. C-14

TEST BORING 17
 DEPTH (FT) 2-3

SOIL DESCRIPTION CLAY, SANDY
 SOIL TYPE 2

**Sieve Analysis
 Grain Size Distribution**

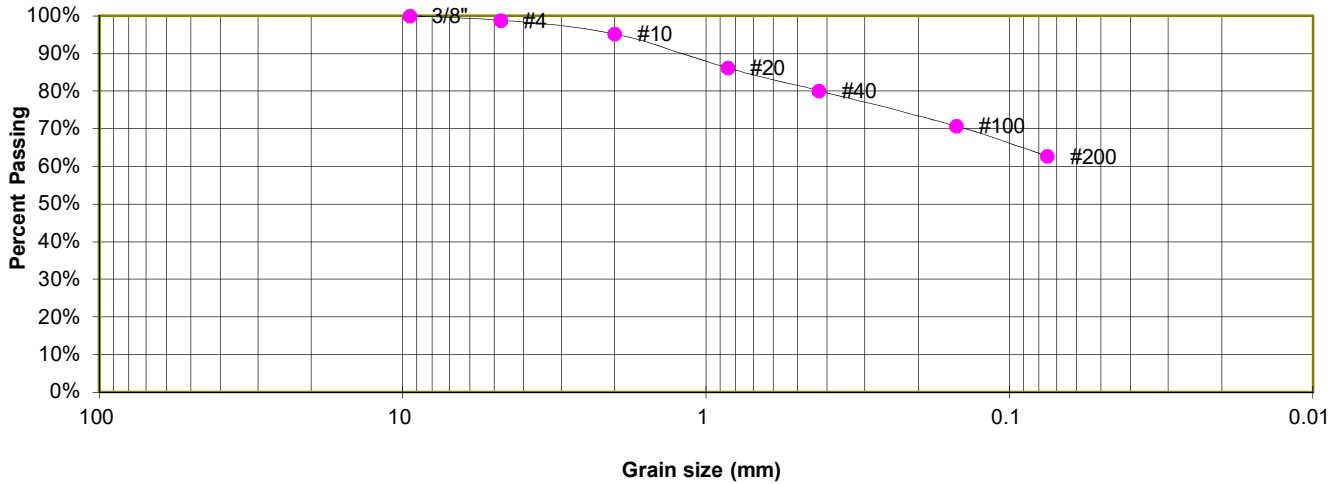

GRAIN SIZE ANALYSIS

U.S. Sieve #	Percent Finer
3"	
1 1/2"	
3/4"	
1/2"	
3/8"	100.0%
4	98.8%
10	95.2%
20	86.2%
40	80.2%
100	70.8%
200	62.7%

ATTERBERG LIMITS

Plastic Limit	9
Liquid Limit	36
Plastic Index	27

SOIL CLASSIFICATION

USCS CLASSIFICATION: CL



LABORATORY TEST RESULTS

ELBERT ROAD
 PT OVERLOOK, LLC

JOB NO.
 230677

FIG. C-15

TEST BORING 1
DEPTH (FT) 10
SOIL TYPE 3

SOIL DESCRIPTION SANDSTONE, WITH SILT
USCS CLASSIFICATION SM-SW

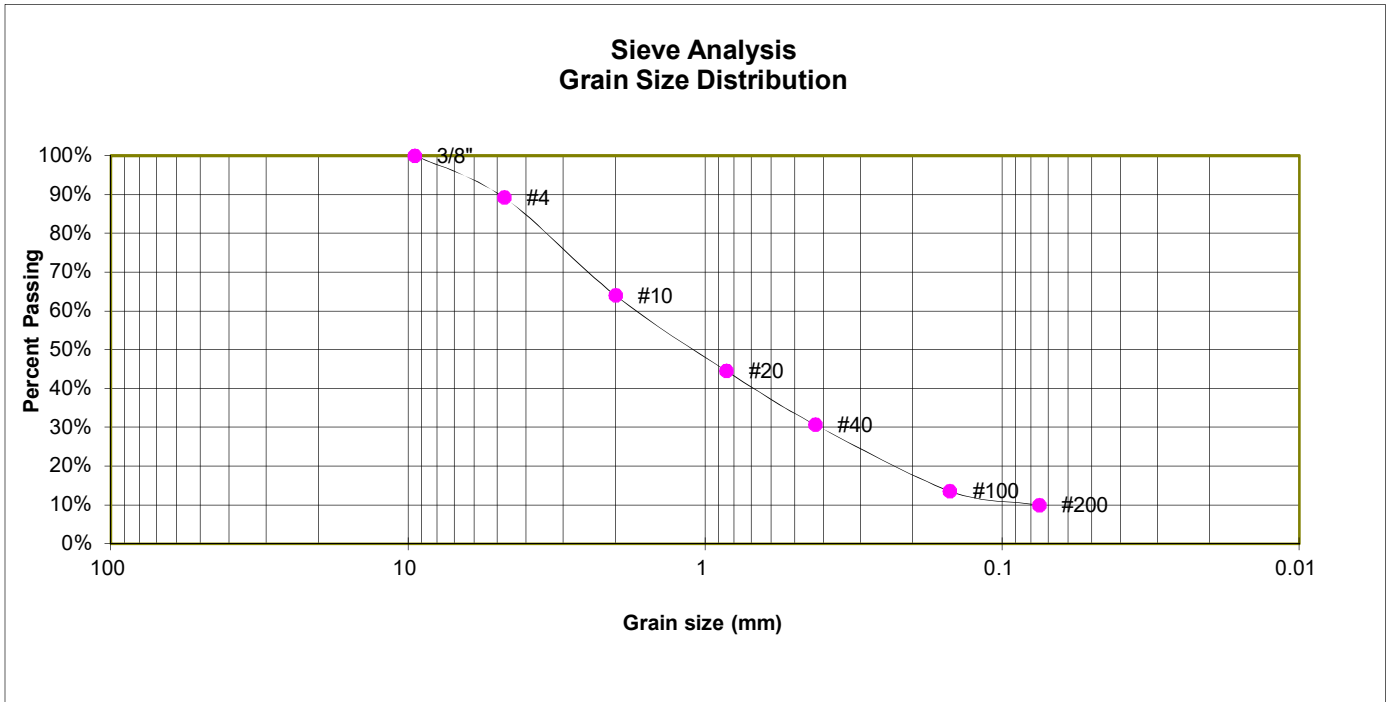

U.S. Sieve #	Percent Finer
3"	
1 1/2"	
3/4"	
1/2"	
3/8"	100.0%
4	89.2%
10	64.0%
20	44.6%
40	30.6%
100	13.6%
200	10.0%



LABORATORY TEST RESULTS

ELBERT ROAD
PT OVERLOOK

JOB NO.
230677

FIG. C-16

TEST BORING 7
DEPTH (FT) 15
SOIL TYPE 3

SOIL DESCRIPTION SANDSTONE, S ILTY
USCS CLASSIFICATION SM

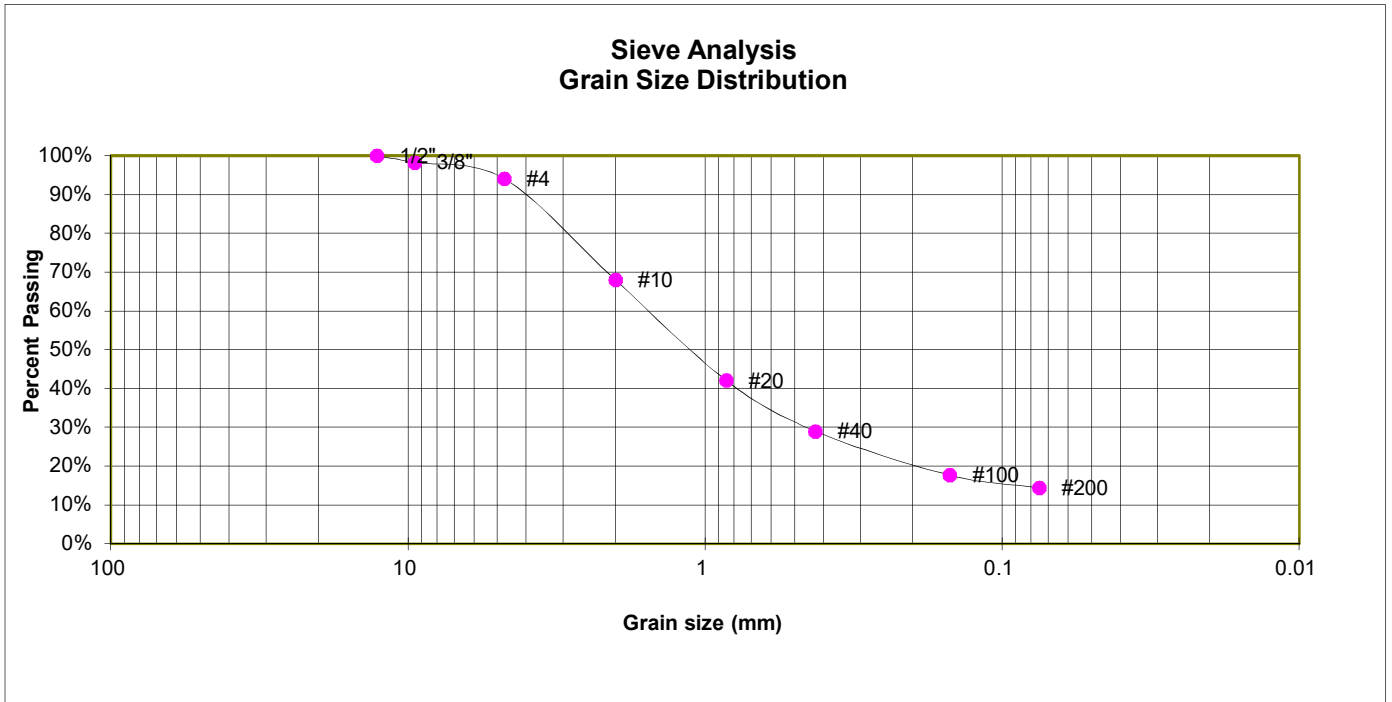

U.S. Sieve #	Percent Finer
3"	
1 1/2"	
3/4"	
1/2"	100.0%
3/8"	98.3%
4	94.1%
10	67.9%
20	42.1%
40	29.0%
100	17.6%
200	14.4%



LABORATORY TEST RESULTS

ELBERT ROAD
PT OVERLOOK

JOB NO.
230677

FIG. C-17

TEST BORING 9
 DEPTH (FT) 10
 SOIL TYPE 3

SOIL DESCRIPTION SANDSTONE, SILTY
 USCS CLASSIFICATION SM

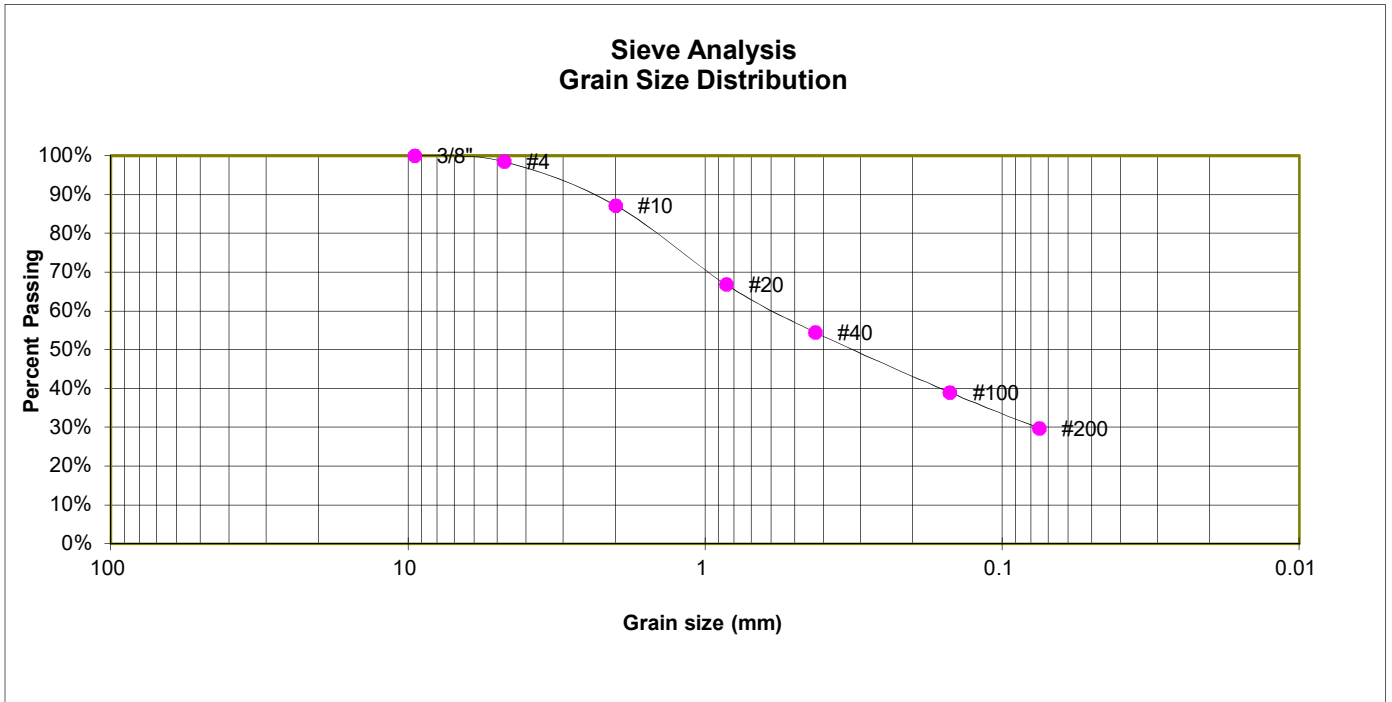

U.S. Sieve #	Percent Finer
3"	
1 1/2"	
3/4"	
1/2"	
3/8"	100.0%
4	98.5%
10	87.2%
20	66.8%
40	54.4%
100	39.0%
200	29.7%



LABORATORY TEST RESULTS

ELBERT ROAD
 PT OVERLOOK

JOB NO.
 230677

FIG. C-18

TEST BORING 11
 DEPTH (FT) 15
 SOIL TYPE 3

SOIL DESCRIPTION SANDSTONE, SILTY
 USCS CLASSIFICATION SM

**Sieve Analysis
 Grain Size Distribution**

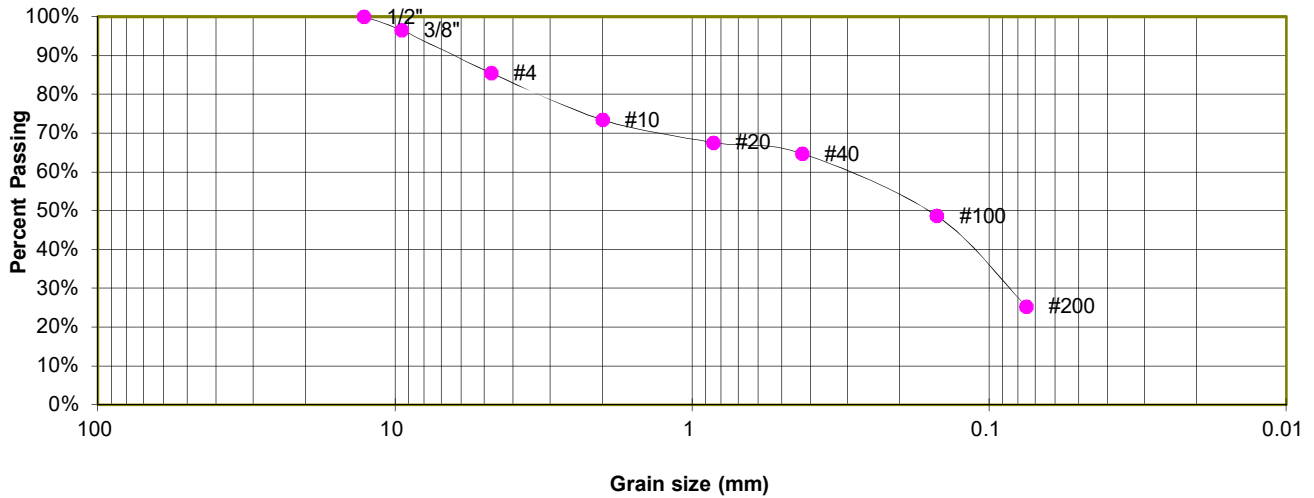

U.S. Sieve #	Percent Finer
3"	
1 1/2"	
3/4"	
1/2"	100.0%
3/8"	96.5%
4	85.5%
10	73.4%
20	67.6%
40	64.7%
100	48.6%
200	25.4%

Atterberg Limits
 Plastic Limit NP
 Liquid Limit NV
 Plastic Index NP



LABORATORY TEST RESULTS

ELBERT ROAD
 PT OVERLOOK

JOB NO.
 230677

FIG. C-19

TEST BORING 14
DEPTH (FT) 15
SOIL TYPE 3

SOIL DESCRIPTION SANDSTONE, SILTY
USCS CLASSIFICATION SM

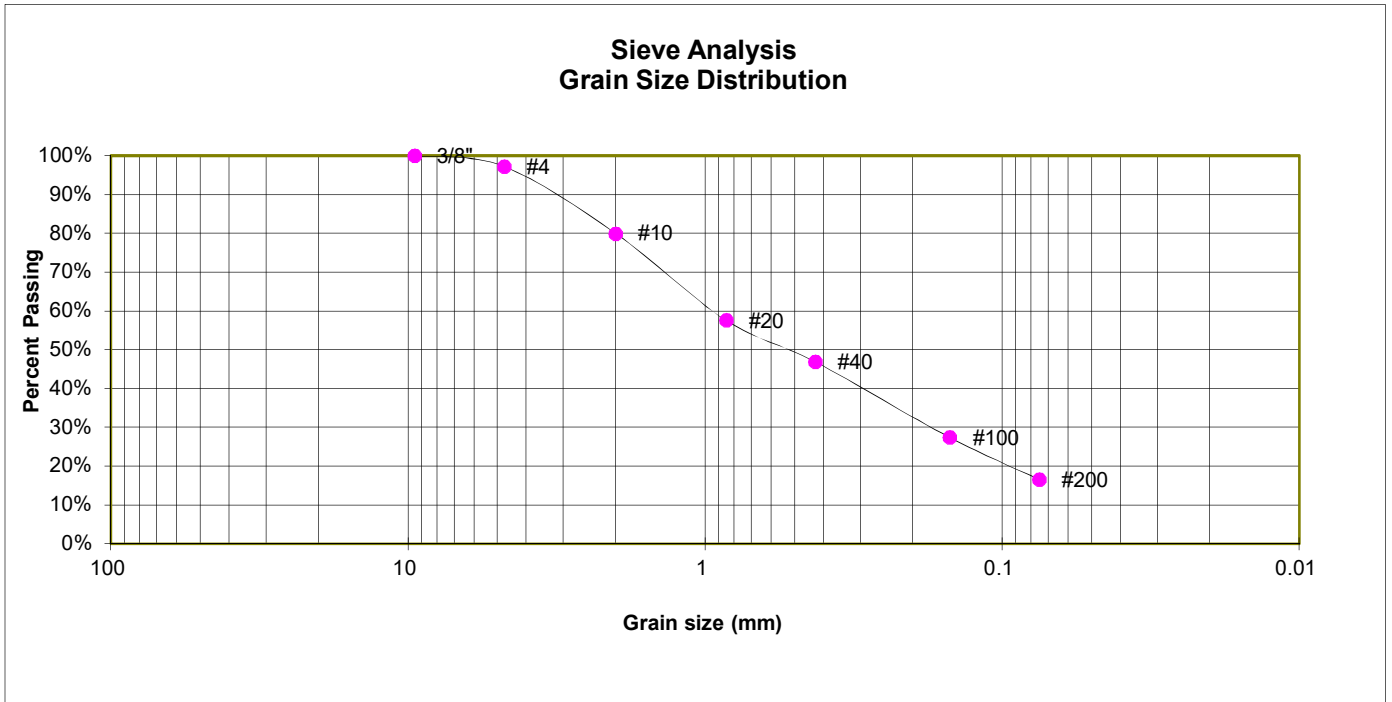

<u>U.S. Sieve #</u>	<u>Percent Finer</u>
3"	
1 1/2"	
3/4"	
1/2"	
3/8"	100.0%
4	97.2%
10	79.9%
20	57.6%
40	46.8%
100	27.4%
200	16.5%



LABORATORY TEST RESULTS

ELBERT ROAD
PT OVERLOOK

JOB NO.
230677

FIG. C-20

TEST BORING 15
DEPTH (FT) 10
SOIL TYPE 3

SOIL DESCRIPTION SANDSTONE, SILTY
USCS CLASSIFICATION SM

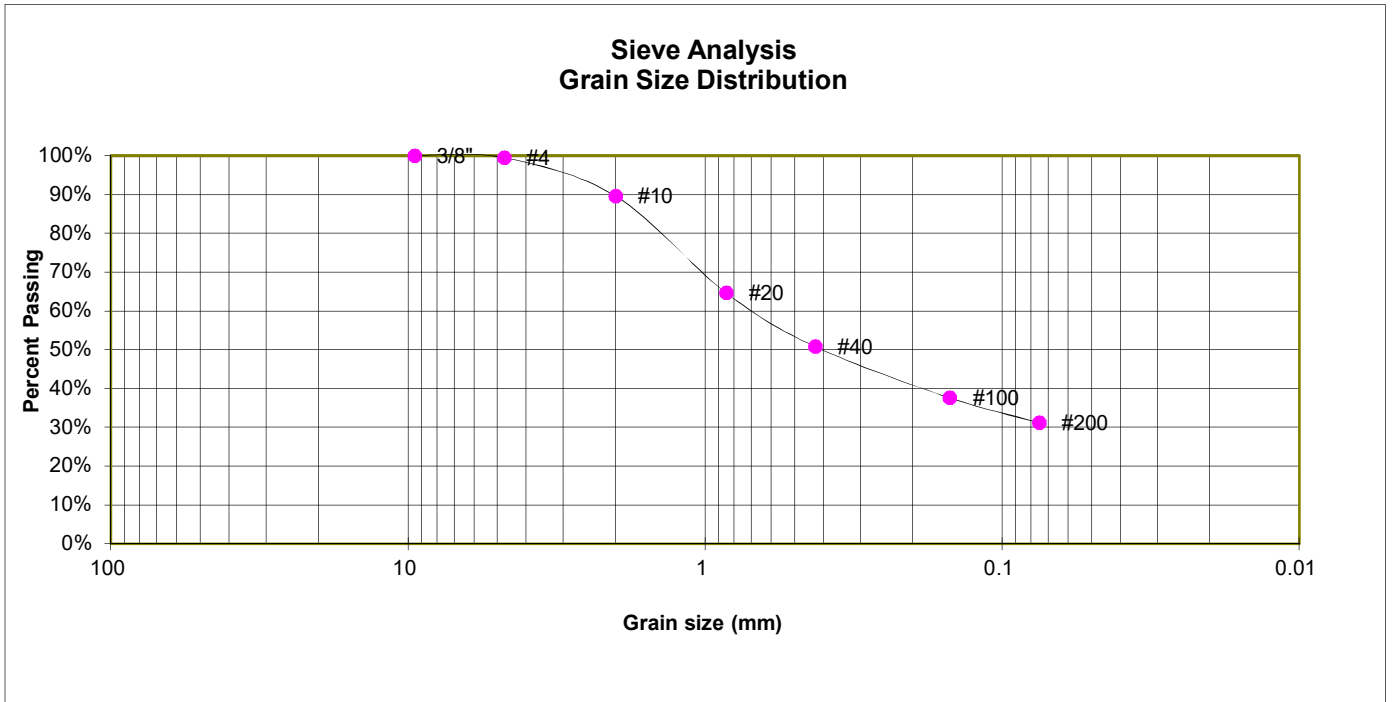

U.S. Sieve #	Percent Finer
3"	
1 1/2"	
3/4"	
1/2"	
3/8"	100.0%
4	99.5%
10	89.6%
20	64.6%
40	50.8%
100	37.6%
200	31.2%



LABORATORY TEST RESULTS

ELBERT ROAD
PT OVERLOOK

JOB NO.
230677

FIG. C-21

TEST BORING	22	SOIL DESCRIPTION	SANDSTONE (SAND, GRAVELLY, SILTY)
DEPTH (FT)	10	SOIL TYPE	3

**Sieve Analysis
Grain Size Distribution**

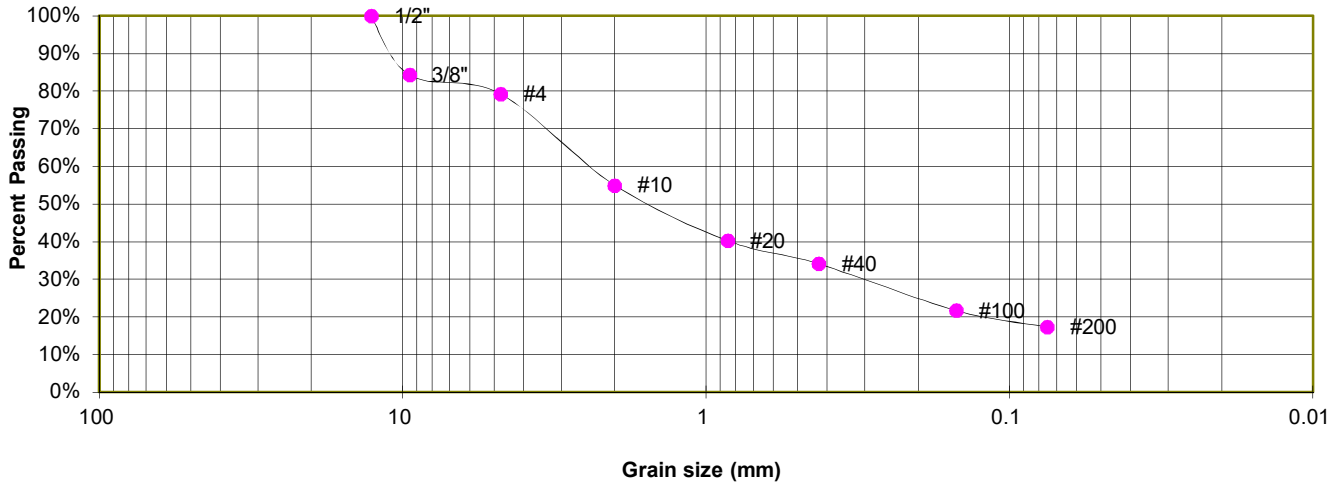

GRAIN SIZE ANALYSIS

U.S. Sieve #	Percent Finer
3"	
1 1/2"	
3/4"	
1/2"	100.0%
3/8"	84.2%
4	79.2%
10	55.0%
20	40.3%
40	34.1%
100	21.7%
200	17.3%

SOIL CLASSIFICATION

USCS CLASSIFICATION: SM



LABORATORY TEST RESULTS

ELBERT ROAD
PT OVERLOOK, LLC

JOB NO.
230677

FIG. C-22

TEST BORING 22
DEPTH (FT) 30

SOIL DESCRIPTION SANDSTONE (SAND, CLAYEY)
SOIL TYPE 3

**Sieve Analysis
Grain Size Distribution**

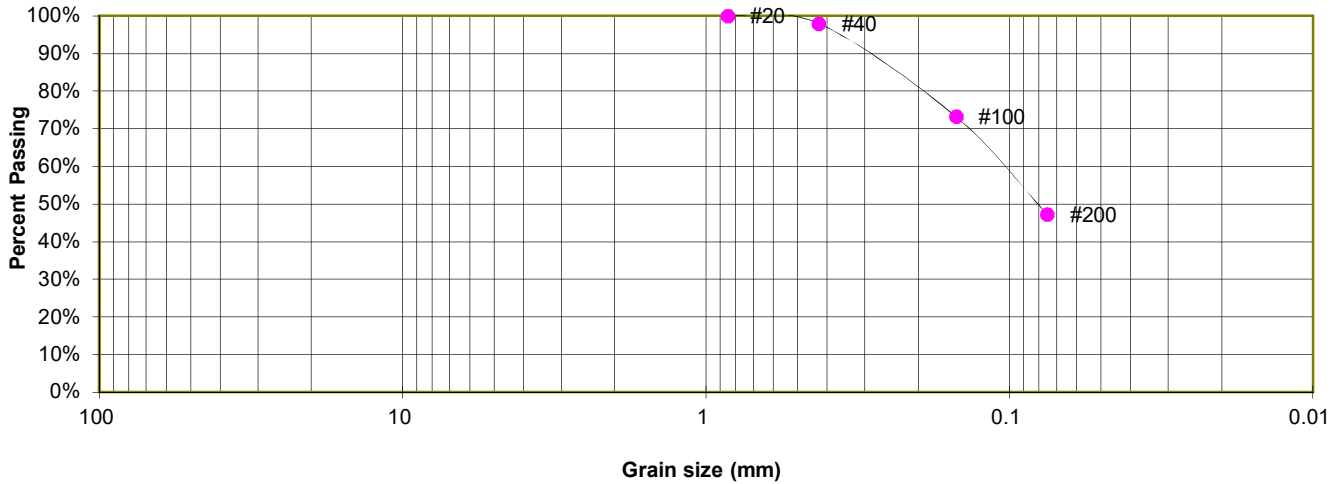

GRAIN SIZE ANALYSIS

U.S. Sieve #	Percent Finer
3"	
1 1/2"	
3/4"	
1/2"	
3/8"	
4	
10	
20	100.0%
40	98.0%
100	73.2%
200	47.3%

SOIL CLASSIFICATION

USCS CLASSIFICATION: SC



LABORATORY TEST RESULTS

ELBERT ROAD
PT OVERLOOK, LLC

JOB NO.
230677

FIG. C-23

TEST BORING 3
 DEPTH (FT) 15
 SOIL TYPE 4

SOIL DESCRIPTION SILTSTONE, SANDY
 USCS CLASSIFICATION ML

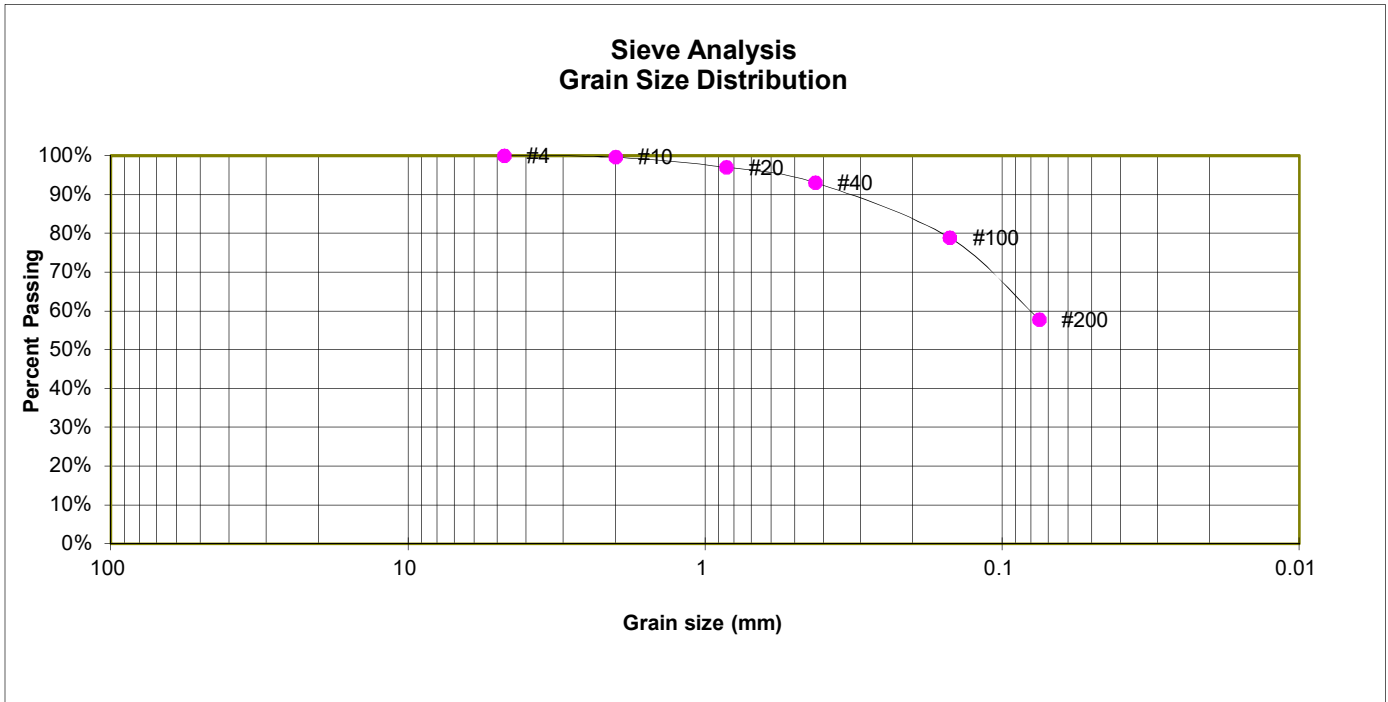

U.S. Sieve #	Percent Finer
3"	
1 1/2"	
3/4"	
1/2"	
3/8"	
4	100.0%
10	99.6%
20	97.0%
40	93.0%
100	78.8%
200	57.8%

Atterberg Limits
 Plastic Limit NP
 Liquid Limit NV
 Plastic Index NP



LABORATORY TEST RESULTS

ELBERT ROAD
 PT OVERLOOK

JOB NO.
 230677

FIG. C-24

TEST BORING 19
 DEPTH (FT) 10

SOIL DESCRIPTION CLAYSTONE (CLAY, SANDY)
 SOIL TYPE 4

**Sieve Analysis
 Grain Size Distribution**

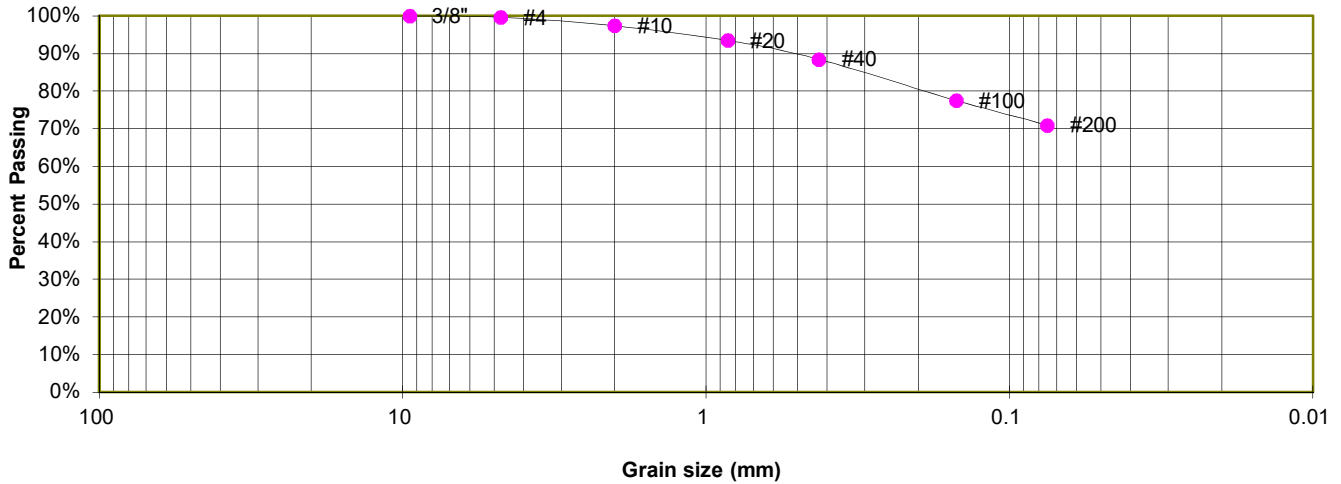

GRAIN SIZE ANALYSIS

U.S. Sieve #	Percent Finer
3"	
1 1/2"	
3/4"	
1/2"	
3/8"	100.0%
4	99.7%
10	97.4%
20	93.5%
40	88.5%
100	77.5%
200	71.0%

ATTERBERG LIMITS

Plastic Limit	24
Liquid Limit	46
Plastic Index	22

SOIL CLASSIFICATION

USCS CLASSIFICATION: CL



LABORATORY TEST RESULTS

ELBERT ROAD
 PT OVERLOOK, LLC

JOB NO.
 230677

FIG. C-25

TEST BORING 17
DEPTH (FT) 2-3

SOIL DESCRIPTION CLAY, SANDY
SOIL TYPE 2

SWELL CONSOLIDATION

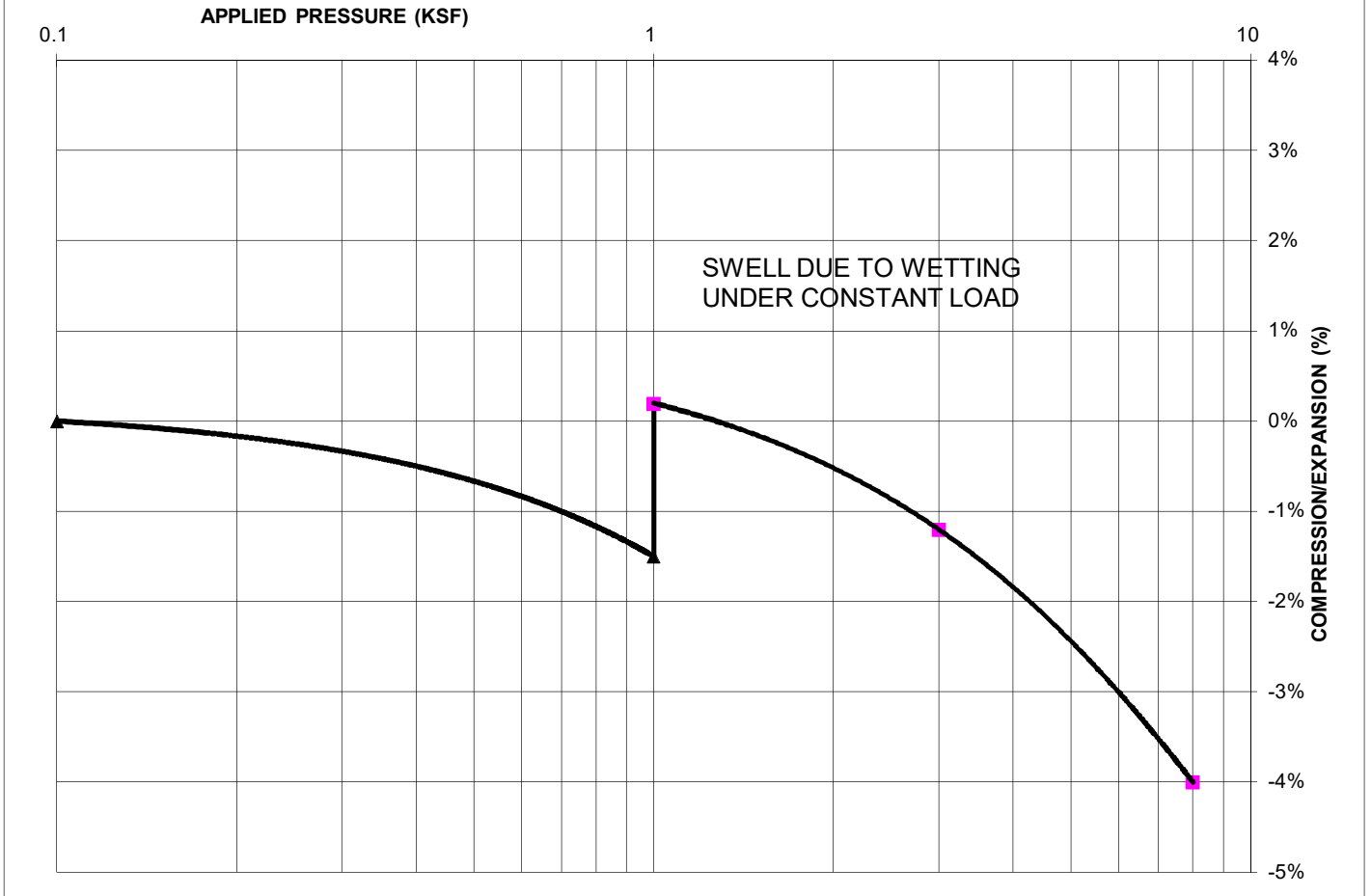

SWELL/COLLAPSE TEST RESULTS

NATURAL UNIT DRY WEIGHT (PCF): 109
NATURAL MOISTURE CONTENT: 14.9%
SWELL/COLLAPSE (%): 1.7%



SWELL TEST RESULTS

ELBERT ROAD
PT OVERLOOK, LLC

JOB NO.
230677

FIG. C-26

TEST BORING 3
DEPTH (FT) 15

SOIL DESCRIPTION SILTSTONE, SANDY
SOIL TYPE 4

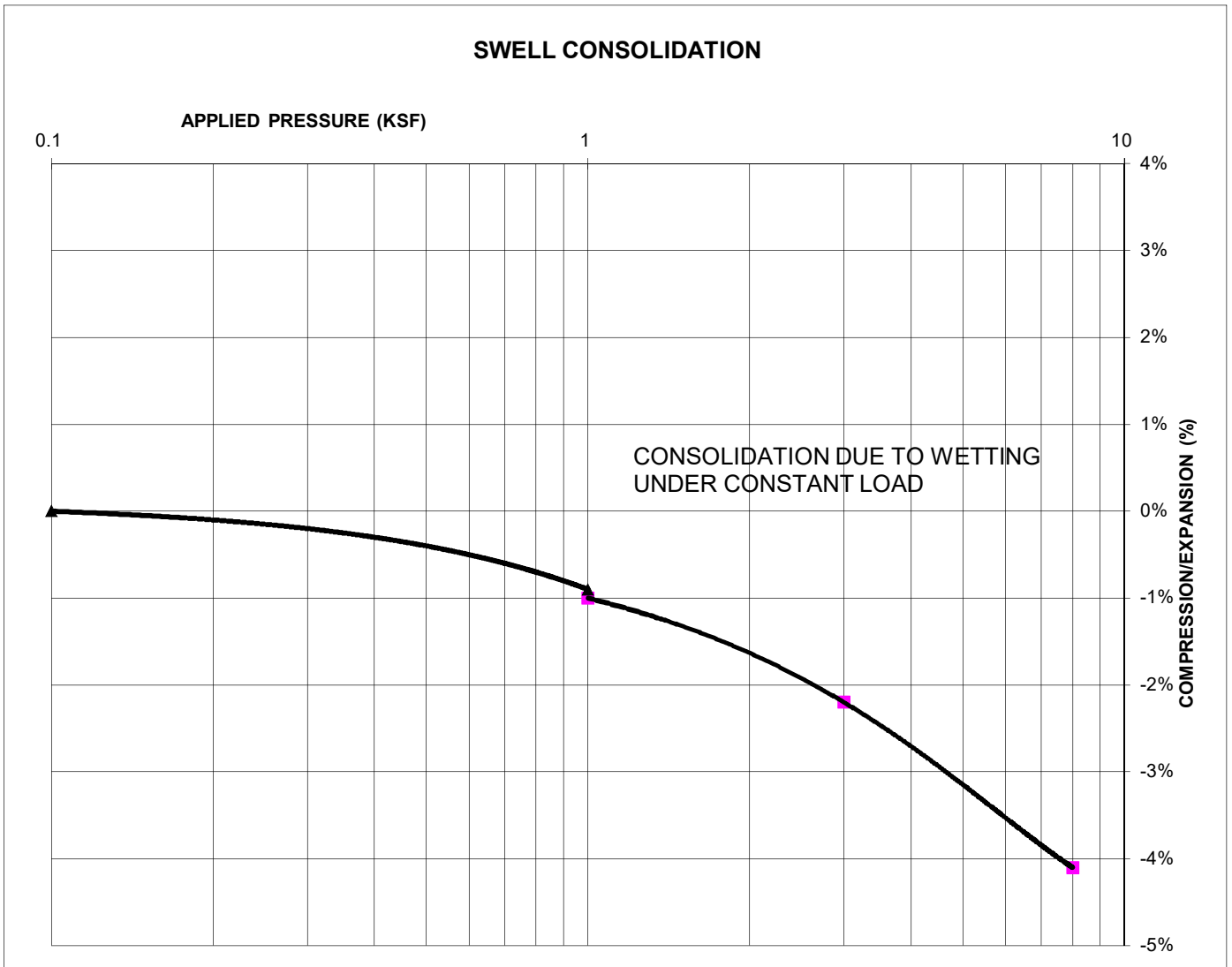

SWELL/CONSOLIDATION TEST RESULTS

NATURAL UNIT DRY WEIGHT (PCF): 108
NATURAL MOISTURE CONTENT: 15.0%
SWELL/CONSOLIDATION (%): -0.1%



LABORATORY TEST RESULTS

ELBERT ROAD
PT OVERLOOK

JOB NO.
230677

FIG. C-27

TEST BORING 19
DEPTH (FT) 10

SOIL DESCRIPTION CLAYSTONE (CLAY, SANDY)
SOIL TYPE 4

SWELL CONSOLIDATION

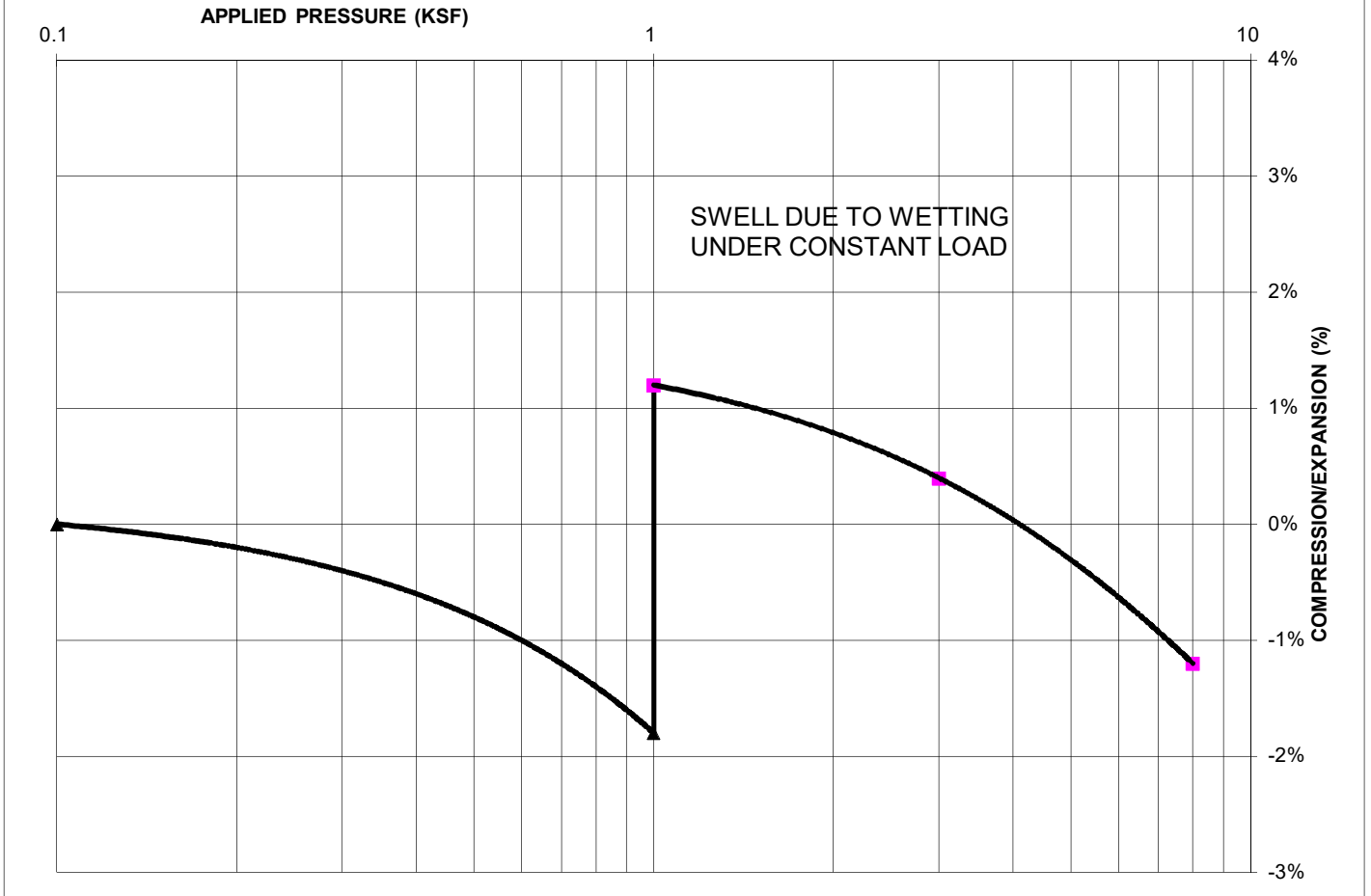

SWELL/COLLAPSE TEST RESULTS

NATURAL UNIT DRY WEIGHT (PCF): 112
NATURAL MOISTURE CONTENT: 17.3%
SWELL/COLLAPSE (%): 3.0%



SWELL TEST RESULTS

ELBERT ROAD
PT OVERLOOK, LLC

JOB NO.
230677

FIG. C-28

APPENDIX D: Soil Survey Descriptions

El Paso County Area, Colorado

42—Kettle-Rock outcrop complex

Map Unit Setting

National map unit symbol: 368j
Elevation: 6,800 to 7,700 feet
Frost-free period: 110 to 130 days
Farmland classification: Not prime farmland

Map Unit Composition

Kettle and similar soils: 60 percent
Rock outcrop: 20 percent
Estimates are based on observations, descriptions, and transects of the mapunit.

Description of Kettle

Setting

Landform: Hills
Landform position (three-dimensional): Side slope
Down-slope shape: Linear
Across-slope shape: Linear
Parent material: Sandy alluvium derived from arkose

Typical profile

E - 0 to 16 inches: gravelly loamy sand
Bt - 16 to 40 inches: gravelly sandy loam
C - 40 to 60 inches: extremely gravelly loamy sand

Properties and qualities

Slope: 8 to 40 percent
Depth to restrictive feature: More than 80 inches
Drainage class: Somewhat excessively drained
Runoff class: Medium
Capacity of the most limiting layer to transmit water (Ksat): High
(2.00 to 6.00 in/hr)
Depth to water table: More than 80 inches
Frequency of flooding: None
Frequency of ponding: None
Available water supply, 0 to 60 inches: Low (about 3.4 inches)

Interpretive groups

Land capability classification (irrigated): None specified
Land capability classification (nonirrigated): 7e
Hydrologic Soil Group: B
Ecological site: F048AY908CO - Mixed Conifer
Hydric soil rating: No

Description of Rock Outcrop

Typical profile

R - 0 to 60 inches: unweathered bedrock

Properties and qualities

Slope: 8 to 60 percent

Depth to restrictive feature: 0 inches to lithic bedrock

Available water supply, 0 to 60 inches: Very low (about 0.0 inches)

Interpretive groups

Land capability classification (irrigated): None specified

Land capability classification (nonirrigated): 8s

Hydrologic Soil Group: D

Hydric soil rating: No

Minor Components

Other soils

Percent of map unit:

Hydric soil rating: No

Data Source Information

Soil Survey Area: El Paso County Area, Colorado

Survey Area Data: Version 20, Sep 2, 2022

El Paso County Area, Colorado

66—Peyton sandy loam, 1 to 5 percent slopes

Map Unit Setting

National map unit symbol: 369c

Elevation: 6,800 to 7,600 feet

Farmland classification: Prime farmland if irrigated and the product of
I (soil erodibility) x C (climate factor) does not exceed 60

Map Unit Composition

Peyton and similar soils: 85 percent

*Estimates are based on observations, descriptions, and transects of
the mapunit.*

Description of Peyton

Setting

Landform: Flats, hills

Landform position (three-dimensional): Side slope, talf

Down-slope shape: Linear

Across-slope shape: Linear

Parent material: Arkosic alluvium derived from sedimentary rock
and/or arkosic residuum weathered from sedimentary rock

Typical profile

A - 0 to 12 inches: sandy loam

Bt - 12 to 25 inches: sandy clay loam

BC - 25 to 35 inches: sandy loam

C - 35 to 60 inches: sandy loam

Properties and qualities

Slope: 1 to 5 percent

Depth to restrictive feature: More than 80 inches

Drainage class: Well drained

Runoff class: Low

Capacity of the most limiting layer to transmit water

(Ksat): Moderately high (0.20 to 0.60 in/hr)

Depth to water table: More than 80 inches

Frequency of flooding: None

Frequency of ponding: None

Available water supply, 0 to 60 inches: Moderate (about 7.3
inches)

Interpretive groups

Land capability classification (irrigated): None specified

Land capability classification (nonirrigated): 4c

Hydrologic Soil Group: B

Ecological site: R049XY216CO - Sandy Divide

Hydric soil rating: No

Minor Components

Other soils

Percent of map unit:

Hydric soil rating: No

Pleasant

Percent of map unit:

Landform: Depressions

Hydric soil rating: Yes

Data Source Information

Soil Survey Area: El Paso County Area, Colorado

Survey Area Data: Version 20, Sep 2, 2022

El Paso County Area, Colorado

68—Peyton-Pring complex, 3 to 8 percent slopes

Map Unit Setting

National map unit symbol: 369f

Elevation: 6,800 to 7,600 feet

Farmland classification: Not prime farmland

Map Unit Composition

Peyton and similar soils: 40 percent

Pring and similar soils: 30 percent

Estimates are based on observations, descriptions, and transects of the mapunit.

Description of Peyton

Setting

Landform: Hills

Landform position (three-dimensional): Side slope

Down-slope shape: Linear

Across-slope shape: Linear

Parent material: Arkosic alluvium derived from sedimentary rock and/or arkosic residuum weathered from sedimentary rock

Typical profile

A - 0 to 12 inches: sandy loam

Bt - 12 to 25 inches: sandy clay loam

BC - 25 to 35 inches: sandy loam

C - 35 to 60 inches: sandy loam

Properties and qualities

Slope: 3 to 5 percent

Depth to restrictive feature: More than 80 inches

Drainage class: Well drained

Runoff class: Low

Capacity of the most limiting layer to transmit water

(Ksat): Moderately high (0.20 to 0.60 in/hr)

Depth to water table: More than 80 inches

Frequency of flooding: None

Frequency of ponding: None

Available water supply, 0 to 60 inches: Moderate (about 7.3 inches)

Interpretive groups

Land capability classification (irrigated): None specified

Land capability classification (nonirrigated): 4c

Hydrologic Soil Group: B

Ecological site: R049XY216CO - Sandy Divide

Hydric soil rating: No

Description of Pring

Setting

Landform: Hills

Landform position (three-dimensional): Side slope

Down-slope shape: Linear

Across-slope shape: Linear

Parent material: Arkosic alluvium derived from sedimentary rock

Typical profile

A - 0 to 14 inches: coarse sandy loam

C - 14 to 60 inches: gravelly sandy loam

Properties and qualities

Slope: 3 to 8 percent

Depth to restrictive feature: More than 80 inches

Drainage class: Well drained

Runoff class: Low

Capacity of the most limiting layer to transmit water (Ksat): High
(2.00 to 6.00 in/hr)

Depth to water table: More than 80 inches

Frequency of flooding: None

Frequency of ponding: None

Available water supply, 0 to 60 inches: Low (about 6.0 inches)

Interpretive groups

Land capability classification (irrigated): None specified

Land capability classification (nonirrigated): 3e

Hydrologic Soil Group: B

Ecological site: R048AY222CO - Loamy Park

Hydric soil rating: No

Minor Components

Other soils

Percent of map unit:

Hydric soil rating: No

Pleasant

Percent of map unit:

Landform: Depressions

Hydric soil rating: Yes

Data Source Information

Soil Survey Area: El Paso County Area, Colorado

Survey Area Data: Version 20, Sep 2, 2022

El Paso County Area, Colorado

71—Pring coarse sandy loam, 3 to 8 percent slopes

Map Unit Setting

National map unit symbol: 369k

Elevation: 6,800 to 7,600 feet

Farmland classification: Not prime farmland

Map Unit Composition

Pring and similar soils: 85 percent

Estimates are based on observations, descriptions, and transects of the mapunit.

Description of Pring

Setting

Landform: Hills

Landform position (three-dimensional): Side slope

Down-slope shape: Linear

Across-slope shape: Linear

Parent material: Arkosic alluvium derived from sedimentary rock

Typical profile

A - 0 to 14 inches: coarse sandy loam

C - 14 to 60 inches: gravelly sandy loam

Properties and qualities

Slope: 3 to 8 percent

Depth to restrictive feature: More than 80 inches

Drainage class: Well drained

Runoff class: Low

Capacity of the most limiting layer to transmit water (Ksat): High
(2.00 to 6.00 in/hr)

Depth to water table: More than 80 inches

Frequency of flooding: None

Frequency of ponding: None

Available water supply, 0 to 60 inches: Low (about 6.0 inches)

Interpretive groups

Land capability classification (irrigated): None specified

Land capability classification (nonirrigated): 3e

Hydrologic Soil Group: B

Ecological site: R048AY222CO - Loamy Park

Hydric soil rating: No

Minor Components

Pleasant

Percent of map unit:

Landform: Depressions

Hydric soil rating: Yes

Other soils

Percent of map unit:

Hydric soil rating: No

Data Source Information

Soil Survey Area: El Paso County Area, Colorado

Survey Area Data: Version 20, Sep 2, 2022