

Traffic Impact Study

Barbarick Waste Transfer Station

El Paso County, Colorado

PCD File No. AL2310

Accepted for File

By: **Gilbert LaForce, P.E.**
Engineering Manager

Date: **09/07/2023 9:21:21 AM**

El Paso County Department of Public Works



Prepared for:

Graham Construction Management

Kimley»Horn

T R A F F I C I M P A C T S T U D Y

Traffic Engineer's Statement

The attached traffic report and supporting information were prepared under my responsible charge and they comport with the standard of care. So far as is consistent with the standard of care, said report was prepared in general conformance with the criteria established by the County for traffic reports.

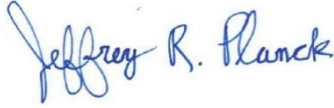

August 16, 2023

Jeffrey R. Planck, P.E., PE #53006

Date

Developer's Statement

I, the Developer, have read and will comply with all commitments made on my behalf within this report.

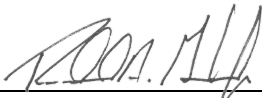

Mr. Richard Graham, Jr.
Graham Construction Management
4615 Northpark Drive
Colorado Springs, CO 80918

06/27/2023

Date

Barbarick Waste Transfer Station

PCD File No. AL2310

El Paso County, Colorado

Prepared for
Graham Construction Management
4615 Northpark Drive
Colorado Springs, CO 80918

Prepared by
Kimley-Horn and Associates, Inc.
2 North Nevada Avenue
Suite 300
Colorado Springs, Colorado 80903
(719) 453-0180

August 2023



This document, together with the concepts and designs presented herein, as an instrument of service, is intended only for the specific purpose and client for which it was prepared. Reuse of and improper reliance on this document without written authorization and adaptation by Kimley-Horn and Associates, Inc. shall be without liability to Kimley-Horn and Associates, Inc.

TABLE OF CONTENTS

TABLE OF CONTENTS	i
LIST OF TABLES	ii
LIST OF FIGURES	ii
1.0 EXECUTIVE SUMMARY	1
2.0 INTRODUCTION	1
3.0 EXISTING AND FUTURE CONDITIONS	3
3.1 Existing Study Area	3
3.2 Existing Roadway Network	3
3.3 Existing Traffic Volumes	6
3.4 Unspecified Development Traffic Growth	6
4.0 PROJECT TRAFFIC CHARACTERISTICS	10
4.1 Trip Generation	10
4.2 Trip Distribution	11
4.3 Traffic Assignment	11
4.4 Total (Background Plus Project) Traffic	11
5.0 TRAFFIC OPERATIONS ANALYSIS	16
5.1 Analysis Methodology	16
5.2 Key Intersection Operational Analysis	17
5.3 El Paso County Turn Lane Requirement Analysis	19
5.4 Vehicle Queuing Analysis	19
5.5 Roadway Classifications and Internal Private Roadway Evaluation	20
5.6 Sight Distance Evaluation	22
5.7 Bicycle and Pedestrian Access	22
5.8 Road Impact Fees	23
5.9 Heavy Vehicle Assessment	23
5.10 Improvement Summary	24
6.0 CONCLUSIONS AND RECOMMENDATIONS	26

APPENDICES

- Appendix A – Traffic Impact Study Checklist
- Appendix B – Intersection Count Sheets
- Appendix C – Future Traffic Projections
- Appendix D – Background Traffic Study
- Appendix E – Intersection Analysis Worksheets
- Appendix F – Maintenance and Repair Barbarick Subdivision Declaration & Bylaws
- Appendix G – Conceptual Site Plan

LIST OF TABLES

Table 1 – Barbarick Waste Transfer Station Traffic Generation.....	11
Table 2 – Level of Service Definitions	16
Table 3 – Lochwinnoch Lane/Carah Dawn View & Vollmer Road LOS Results.....	18
Table 4 – Turn Lane Queuing Analysis Results.....	19
Table 5 – Road Impact Fees	23

LIST OF FIGURES

Figure 1 – Vicinity Map.....	2
Figure 2 – Existing Geometry and Control.....	5
Figure 3 – 2022 Existing Traffic Volumes	7
Figure 4 – 2025 Background Traffic Volumes.....	8
Figure 5 – 2045 Background Traffic Volumes.....	9
Figure 6 – Project Trip Distribution	12
Figure 7 – Project Traffic Assignment	13
Figure 8 – 2025 Total Traffic Volumes	14
Figure 9 – 2045 Total Traffic Volumes	15
Figure 10 – Roadway Classification Map	21
Figure 11 – 2045 Recommended Geometry and Control	25

1.0 EXECUTIVE SUMMARY

This report has been prepared to document the results of a Traffic Impact Study for the Barbarick Waste Transfer Station project proposed at 8812 Cliff Allen Point in El Paso County, Colorado. Specifically, the project is located near the southeast corner of the Lochwinnoch Lane/Carah Dawn View and Vollmer Road intersection. For the purposes of this study, Barbarick Waste Transfer Station is anticipated to include an intermediate transfer facility. It is expected that Barbarick Waste Transfer Station will be completed in the next several years; therefore, analysis was conducted for the 2025 short-term horizon as well as the 2045 long-term horizon.

The purpose of this traffic study is to identify project traffic generation characteristics to determine potential project traffic related impacts on the local street system and to develop the necessary mitigation measures required for the identified traffic impacts. The intersection of Vollmer Road and Lochwinnoch Lane/Carah Dawn View was incorporated into this traffic study in accordance with El Paso County standards and requirements.

Regional access to Barbarick Waste Transfer Station will be provided by SH-21 and US-24. Primary access will be provided by Vollmer Road. Direct access will be provided by the existing east leg at the intersection of Lochwinnoch Lane/Carah Dawn View and Vollmer Road.

Barbarick Waste Transfer Station is expected to generate approximately 280 weekday daily trips, with 36 of trips occurring during both the morning and afternoon peak hours. Of the 280 daily trips, 10 are anticipated to be heavy vehicle trips with two (2) truck trips during both peak hours.

Based on the analysis presented in this report, Kimley-Horn believes Barbarick Waste Transfer Station will be successfully incorporated into the existing and future roadway network with the existing geometry and control. The road impact fee associated with the project is expected to be \$43,812. The intersection of Vollmer Road and Lochwinnoch Lane/Carah Dawn View is anticipated to operate acceptably throughout 2025 and all vehicle queues are anticipated to be maintained within the existing storage lengths. If future 2045 traffic volume projections are realized, northbound and southbound left turn lanes with 245 feet of length plus 180-foot tapers may be needed at the intersection of Lochwinnoch Lane/Carah Dawn View and Vollmer Road to meet El Paso County Standards.

2.0 INTRODUCTION

Kimley-Horn and Associates, Inc. has prepared this report to document the results of a Traffic Impact Study for the Barbarick Waste Transfer Station project proposed at 8812 Cliff Allen Point in El Paso County, Colorado. Specifically, the project is located near the southeast corner of the Lochwinnoch Lane/Carah Dawn View and Vollmer Road intersection. A vicinity map illustrating the Barbarick Waste Transfer Station development location is shown in **Figure 1**. For the purposes of this study, Barbarick Waste Transfer Station is anticipated to include an intermediate transfer facility. A conceptual site plan is attached in **Appendix G**. It is expected that Barbarick Waste Transfer Station will be completed in the next couple years; therefore, analysis was conducted for the 2025 short-term buildout horizon as well as the 2045 long-term twenty-year planning horizon. The Traffic Impact Study Checklist is attached in **Appendix A**.

The purpose of this traffic study is to identify project traffic generation characteristics to determine potential project traffic related impacts on the local street system and to develop the necessary mitigation measures required for the identified traffic impacts. The intersection of Vollmer Road and Lochwinnoch Lane/Carah Dawn View was incorporated into this traffic study in accordance with El Paso County standards and requirements.

Regional access to Barbarick Waste Transfer Station will be provided by SH-21 and US-24. Primary access will be provided by Vollmer Road. Direct access will be provided by the existing east leg at the intersection of Lochwinnoch Lane/Carah Dawn View and Vollmer Road.

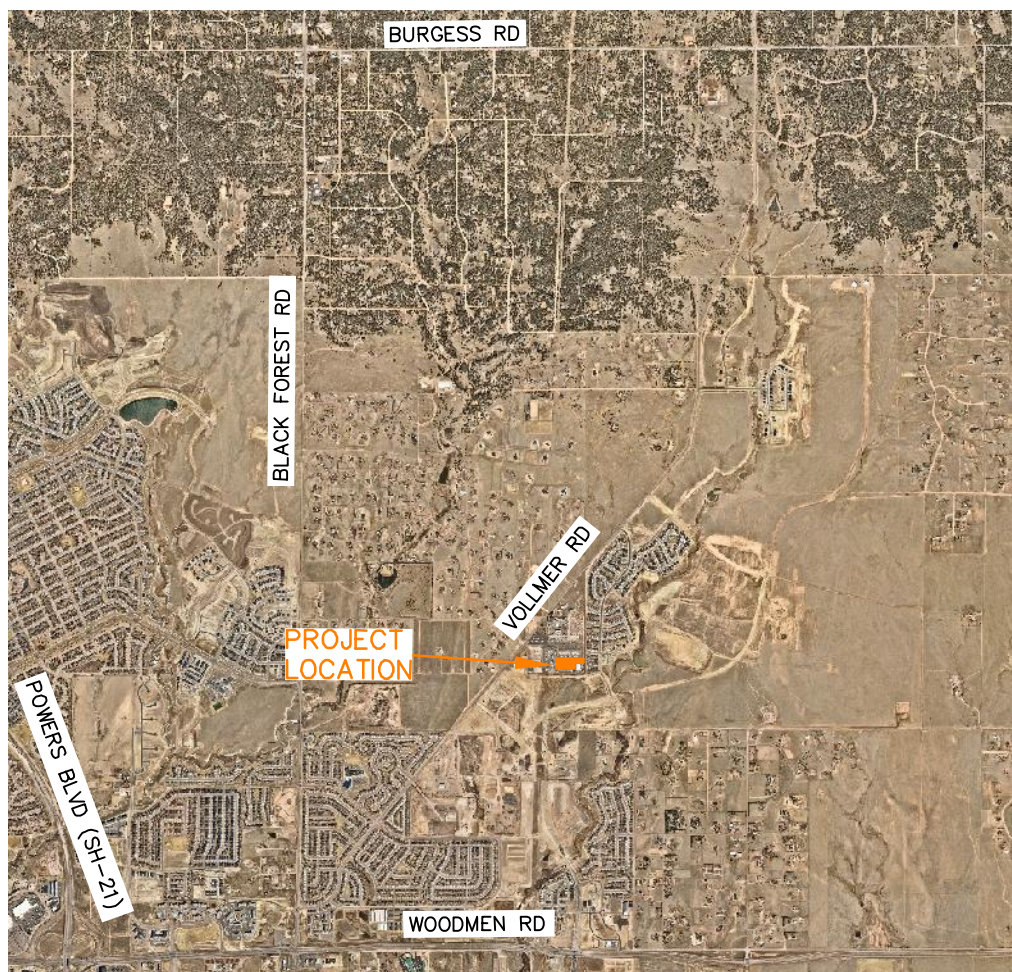

BARBARICK WASTE TRANSFER STATION
EL PASO COUNTY, COLORADO
VICINITY MAP

FIGURE 1

3.0 EXISTING AND FUTURE CONDITIONS

3.1 Existing Study Area

The existing site is comprised of a diesel engine repair service. West of the site are single family homes. East of the site is vacant land that is currently being developed. Vacant land, industrial uses, and single-family homes are located to the south. An RV and boat storage facility is located to the north of the site. Access to the project site is currently provided by Cliff Allen Point on the south side of Carah Dawn View.

3.2 Existing Roadway Network

Vollmer Road provides one through lane of travel in each direction, northeastbound and southwestbound, with a 45 mile per hour speed limit through the study area. Lochwinnoch Lane/Carah Dawn View consists of one through lane in each direction extending primarily eastbound and westbound at the study area key intersection.

The unsignalized intersection of Lochwinnoch Lane/Carah Dawn View and Vollmer Road operates with stop-control on the eastbound Lochwinnoch Lane/Carah Dawn View and westbound Carah Dawn View approaches. For the purposes of this analysis, Vollmer Road is considered a north/south roadway while Lochwinnoch Lane/Carah Dawn View is considered an east/west roadway. The northbound and westbound approaches provide a shared left turn/through lane and a separate right turn lane. The southbound and eastbound approaches provide one shared lane for all movements. An aerial photo of the existing intersection configuration is below (north is up - typical).



Lochwinnoch Lane/Carah Dawn View & Vollmer Road

The intersection lane configuration and control for the study area intersection are shown in **Figure 2**.

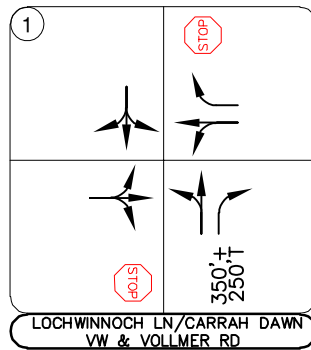

LEGEND

- (X) Study Area Key Intersection
- STOP Stop Controlled Approach
- XX Roadway Speed Limit
- 100' Turn Lane Length (feet)

BARBARICK WASTE TRANSFER STATION
 EL PASO COUNTY, COLORADO
 EXISTING GEOMETRY AND CONTROL

FIGURE 2

3.3 Existing Traffic Volumes

Existing turning movement counts were conducted at the study intersection on Thursday, August 25, 2022, during the morning and afternoon peak hours. The counts were conducted during the morning and afternoon peak hours of adjacent street traffic in 15-minute intervals from 7:00 AM to 9:00 AM and 4:00 PM to 6:00 PM on this count date. The existing intersection traffic volumes are shown in **Figure 3** with count sheets provided in **Appendix B**.

3.4 Unspecified Development Traffic Growth

According to the 2040 traffic projections from the El Paso County Major Transportation Corridor Plan (MTCP) traffic model compared to the existing traffic volumes, the area surrounding the site is expected to have an average 18-year growth factor of 1.43. This growth factor equates to an annual growth rate of 1.99 percent. Future traffic volume projections and growth rate calculations are provided in **Appendix C**. Therefore, a 1.99 percent annual growth rate was used to calculate future traffic volumes at the study area intersection. This annual growth rate was used to estimate short-term 2025 and long-term 2045 traffic volume projections at the key intersection. Additionally, project traffic volumes for the proposed Sterling Ranch development were added to the background volumes for the 2045 horizon. Applicable documents from the Sterling Ranch Master Traffic Impact Study are included in **Appendix D**. Sterling Ranch is the only known traffic study completed in the last five years within the study limits. The calculated background traffic volumes for 2025 and 2045 are shown in **Figure 4** and **Figure 5**, respectively.

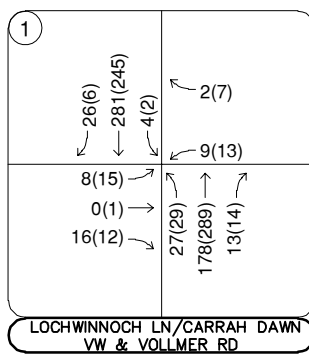
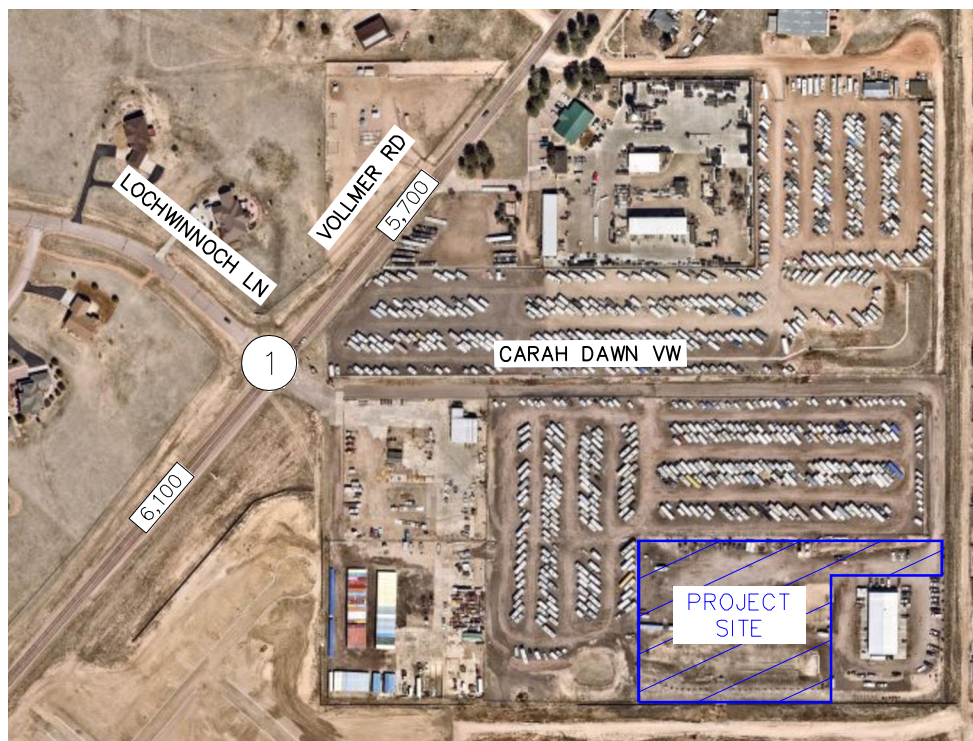

Thursday, August 25, 2022
7:00 to 8:00AM (4:15 to 5:15PM)

LEGEND

- (X) Study Area Key Intersection
- XXX(XXX) Weekday AM(PM)
Peak Hour Traffic Volumes
- XX,X00 Estimated Daily Traffic Volume

BARBARICK WASTE TRANSFER STATION
EL PASO COUNTY, COLORADO
2022 EXISTING TRAFFIC VOLUMES

FIGURE 3

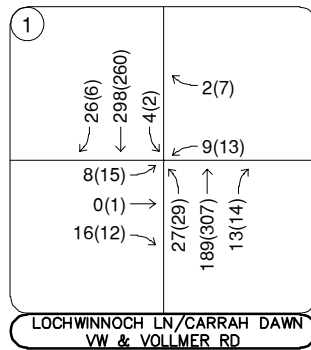

LEGEND

⊗ Study Area Key Intersection

XXX(XXX) Weekday AM(PM)
Peak Hour Traffic Volumes

XX,X00 Estimated Daily Traffic Volume

BARBARICK WASTE TRANSFER STATION
 EL PASO COUNTY, COLORADO
 2025 BACKGROUND TRAFFIC VOLUMES

FIGURE 4

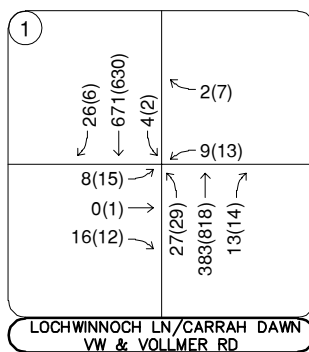
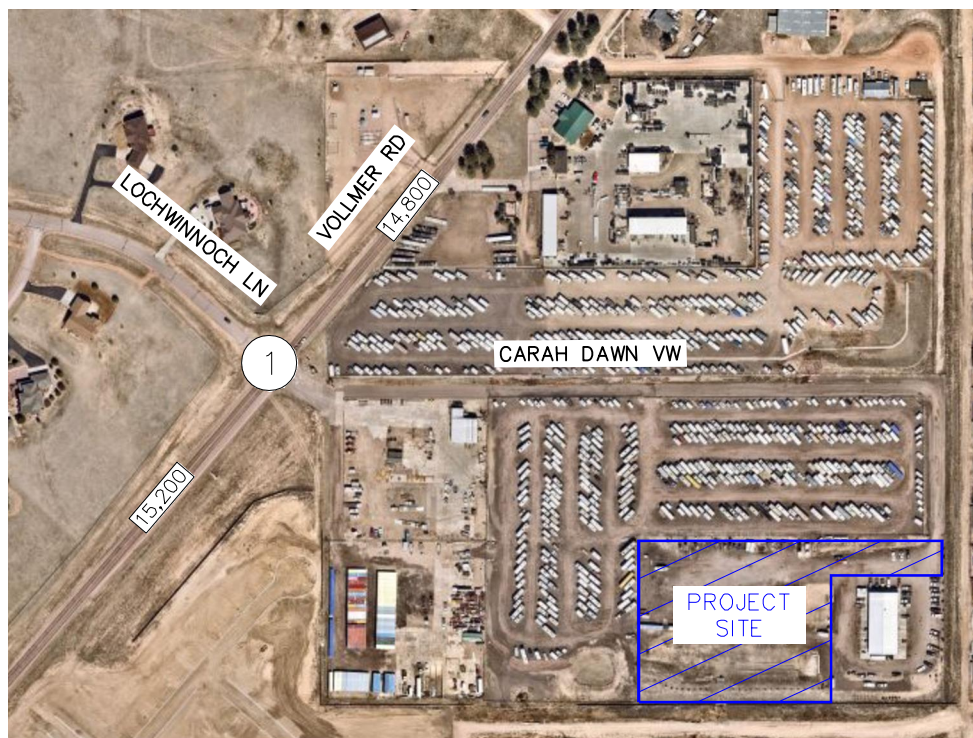

LEGEND

⊗ Study Area Key Intersection

XXX(XXX) Weekday AM(PM)
Peak Hour Traffic Volumes

XX,X00 Estimated Daily Traffic Volume

BARBARICK WASTE TRANSFER STATION
 EL PASO COUNTY, COLORADO
 2045 BACKGROUND TRAFFIC VOLUMES

FIGURE 5

4.0 PROJECT TRAFFIC CHARACTERISTICS

4.1 Trip Generation

Site-generated traffic estimates are determined through a process known as trip generation. Rates and equations are applied to the proposed land use to estimate traffic generated by the development during a specific time interval. The acknowledged source for trip generation rates is the *Trip Generation Manual*¹ published by the Institute of Transportation Engineers (ITE). ITE has established trip rates in nationwide studies of similar land uses. However, for this study, Kimley-Horn used user-specific trip generation based on trips at a similar Peak Disposal and Recycling facility located at 856 Washington Street in Monument, Colorado, for traffic associated with the development. Further, steel recycling collection data from Colorado Industrial Recycling located at 2730 E. Las Vegas Street in Colorado Springs as well as data from the Green for Life trash collection facility were used for site generated traffic. Trips at the existing site were collected daily from August 2018 to July 2022. To be conservative, the month with highest number of trips, June 2022, was used for the trip generation. Of note, operations significantly decrease during the winter season and colder months. The operations primarily consist of personal vehicles utilizing the site to unload waste or recycle steel materials while trucks with 40-yard dumpster containers will haul out recycled steel and waste. The peak month for waste trucks occurred in June 2022 with 73 trucks collecting waste from the facility and hauling off-site. Likewise, the peak month for steel recycling trucks occurred in June 2022 with 7 trucks collecting recycled steel and hauling off-site. Further, trips generated on the existing diesel engine repair site were not subtracted from the existing counts to conservatively evaluate the key intersection.

Barbarick Waste Transfer Station is expected to generate approximately 280 weekday daily trips, with 36 of these trips occurring during both the morning and afternoon peak hours. Of the 280, weekday daily trips, 10 trips are anticipated to be heavy vehicle trips with two (2) heavy vehicle trips during both peak hours. **Table 1** summarizes the estimated trip generation for the Barbarick Waste Transfer Station.

¹ Institute of Transportation Engineers, *Trip Generation Manual*, Eleventh Edition, Washington DC, 2021.

Table 1 – Barbarick Waste Transfer Station Traffic Generation

Vehicle and Trip Type	Weekday Vehicle Trips						
	Daily	AM Peak Hour			PM Peak Hour		
		In	Out	Total	In	Out	Total
Passenger Vehicle Trash/Recycle Drop-off	270	17	17	34	17	17	34
Truck - GFL Boxes Picked up	8	1	1	2	1	1	2
Truck - Recycled Steel Pick up	2	0	0	0	0	0	0
Total Site Generated Trips	280	18	18	36	18	18	36

4.2 Trip Distribution

Distribution of site traffic on the street system was based on the area street system characteristics, existing traffic patterns, existing and anticipated surrounding demographic information, and the proposed access system for the project. The directional distribution of traffic is a means to quantify the percentage of site-generated traffic that approaches the site from a given direction and departs the site back to the original source. The project trip distribution for the proposed development is illustrated in **Figure 6**.

4.3 Traffic Assignment

Barbarick Waste Transfer Station traffic assignment was obtained by applying the project trip distribution to the estimated traffic generation of the development shown in **Table 1**. Traffic assignment is shown in **Figure 7**.

4.4 Total (Background Plus Project) Traffic

Site traffic volumes were added to the background volumes to represent estimated traffic conditions for the short-term 2025 buildout horizon and long-term 2045 twenty-year planning horizon. These total traffic volumes for the study area are illustrated for the 2025 and 2045 horizon years in **Figures 8** and **9**, respectively.

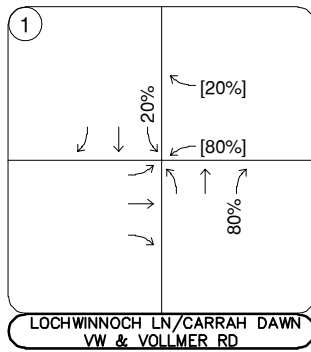
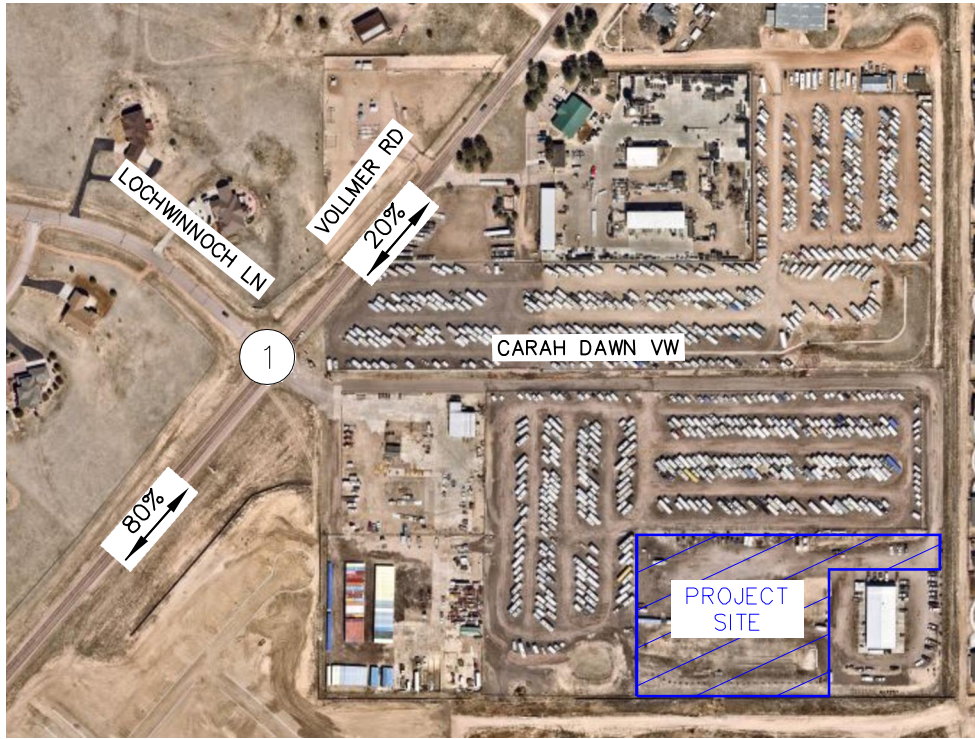

LEGEND

(X) Study Area Key Intersection

XX% External Trip Distribution Percentage

XX%[XX%] Entering[Exiting] Trip Distribution Percentage

BARBARICK WASTE TRANSFER STATION
 EL PASO COUNTY, COLORADO
 PROJECT TRIP DISTRIBUTION

FIGURE 6

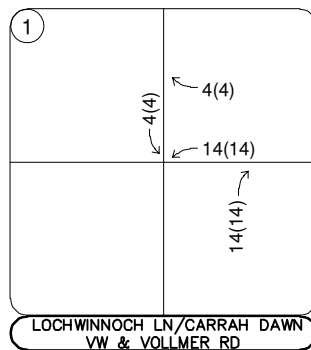

LEGEND

- (X) Study Area Key Intersection
- XXX(XXX) Weekday AM(PM) Peak Hour Traffic Volumes
- XX,X00 Estimated Daily Traffic Volume

BARBARICK WASTE TRANSFER STATION
 EL PASO COUNTY, COLORADO
 PROJECT TRAFFIC ASSIGNMENT

FIGURE 7

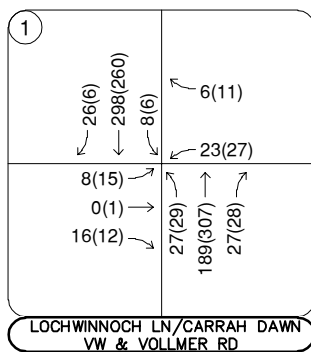

LEGEND

⊗ Study Area Key Intersection

XXX(XXX) Weekday AM(PM)
Peak Hour Traffic Volumes

XX,X00 Estimated Daily Traffic Volume

BARBARICK WASTE TRANSFER STATION
 EL PASO COUNTY, COLORADO
 2025 TOTAL TRAFFIC VOLUMES

FIGURE 8

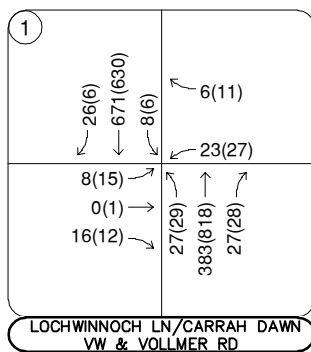

LEGEND

⊗ Study Area Key Intersection

XXX(XXX) Weekday AM(PM)
Peak Hour Traffic Volumes

XX,X00 Estimated Daily Traffic Volume

BARBARICK WASTE TRANSFER STATION
EL PASO COUNTY, COLORADO
2045 TOTAL TRAFFIC VOLUMES

FIGURE 9

5.0 TRAFFIC OPERATIONS ANALYSIS

Kimley-Horn’s analysis of traffic operations in the site vicinity was conducted to determine potential capacity deficiencies in the 2025 and 2045 development horizons at the identified key intersection. The acknowledged source for determining overall capacity is the current edition of the *Highway Capacity Manual (HCM)*².

5.1 Analysis Methodology

Capacity analysis results are listed in terms of Level of Service (LOS). LOS is a qualitative term describing operating conditions a driver will experience while traveling on a particular street or highway during a specific time interval. It ranges from A (very little delay) to F (long delays and congestion). Based on El Paso County standards, the threshold for acceptable LOS is not less than LOS D during peak hours. **Table 2** shows the definition of level of service for signalized and unsignalized intersections.

Table 2 – Level of Service Definitions

Level of Service	Signalized Intersection Average Total Delay (sec/veh)	Unsignalized Intersection Average Total Delay (sec/veh)
A	≤ 10	≤ 10
B	> 10 and ≤ 20	> 10 and ≤ 15
C	> 20 and ≤ 35	> 15 and ≤ 25
D	> 35 and ≤ 55	> 25 and ≤ 35
E	> 55 and ≤ 80	> 35 and ≤ 50
F	> 80	> 50

Definitions provided from the Highway Capacity Manual, Sixth Edition, Transportation Research Board, 2016.

The study area intersection was analyzed based on average total delay analysis for unsignalized intersections. Under the unsignalized analysis, the LOS for a two-way stop-controlled intersection is determined by the computed or measured control delay and is defined for each minor movement.

² Transportation Research Board, *Highway Capacity Manual*, Sixth Edition, Washington DC, 2016.

5.2 Key Intersection Operational Analysis

Calculations for the operational level of service at the key intersection for the study area are provided in **Appendix E**. The existing year analysis is based on the lane geometry and intersection control shown in **Figure 2**. Existing peak hour factors were used for all horizons. Additionally, truck percentages were used for all horizons. Synchro traffic analysis software was used to analyze the unsignalized key intersection for HCM level of service.

Lochwinnoch Lane/Carah Dawn View & Vollmer Road

The unsignalized intersection of Lochwinnoch Lane/Carah Dawn View and Vollmer Road operates with stop-control on the eastbound and westbound Vollmer Road approaches. The intersection movements operate acceptably at LOS C or better during both peak hours under existing conditions. With project traffic, all movements are anticipated to continue operating at an acceptable level of service throughout the 2025 horizon. With the standard growth rate and addition of project traffic, this intersection is anticipated to operate acceptably throughout 2045. However, Sterling Ranch is proposed to be constructed adjacent to this project by 2045. With Sterling Ranch traffic volumes, some movements are anticipated to operate poorly without the addition of project traffic in the 2045 horizon. Therefore, if future traffic volumes are realized northbound and southbound left turn lanes may be needed at this intersection with or without the addition of project traffic by 2045. Of note, the Sterling Ranch Traffic Impact Study recommended two northbound and southbound through lanes along Vollmer Road. If Vollmer Road is ever improved to a five-lane roadway, this intersection will operate with less vehicle delays than reported in this study. However, it is believed that this intersection can operate acceptably as a three-lane section by 2045. **Table 3** provides the results of the LOS analysis conducted at this intersection.

Table 3 – Lochwinnoch Lane/Carah Dawn View & Vollmer Road LOS Results

Scenario	AM Peak Hour		PM Peak Hour	
	Delay (sec/veh)	LOS	Delay (sec/veh)	LOS
2022 Existing				
Northbound Left	8.2	A	7.9	A
Eastbound Approach	12.6	B	13.3	B
Westbound Through/Left	16.1	C	15.5	C
Westbound Right	9.5	A	10.0	B
Southbound Left	7.8	A	8.0	A
2025 Background				
Northbound Left	8.3	A	7.9	A
Eastbound Approach	12.9	B	13.7	B
Westbound Through/Left	16.8	C	16.2	C
Westbound Right	9.6	A	10.2	B
Southbound Left	7.8	A	8.0	A
2025 Background Plus Project				
Northbound Left	8.3	A	7.9	A
Eastbound Approach	13.1	B	14.0	B
Westbound Through/Left	17.8	C	16.9	C
Westbound Right	9.6	A	10.2	B
Southbound Left	7.9	A	8.1	A
2045 Background (without Sterling Ranch)				
Northbound Left	8.3	A	8.3	A
Eastbound Approach	12.9	B	18.6	C
Westbound Through/Left	16.8	C	23.3	C
Westbound Right	9.6	A	11.4	B
Southbound Left	7.8	A	8.5	A
2045 Background (with Sterling Ranch)				
Northbound Left	10.0	B	9.2	A
Eastbound Approach	27.1	D	48.7	E
Westbound Through/Left	47.5	E	67.9	F
Westbound Right	11.3	B	15.9	C
Southbound Left	8.5	A	9.9	A
2045 Background Plus Project (without Sterling Ranch)				
Northbound Left	8.9	A	8.3	A
Eastbound Approach	17.0	C	19.0	C
Westbound Through/Left	27.1	D	25.4	D
Westbound Right	10.3	B	11.4	B
Southbound Left	8.2	A	8.5	A
2045 Background Plus Project (with Sterling Ranch) #				
Northbound Left	10.0	B	8.3	A
Eastbound Approach	19.0	C	14.4	B
Westbound Through/Left	26.2	D	16.9	C
Westbound Right	11.4	B	11.4	B
Southbound Left	8.5	A	8.5	A

= Northbound and southbound left turn lanes

5.3 El Paso County Turn Lane Requirement Analysis

The El Paso County Engineering Criteria Manual (ECM) was used to determine if left and right turn lanes are warranted along Vollmer Road. El Paso County classifies Vollmer Road as a Minor Arterial roadway. According to El Paso County ECM guidelines for Minor Arterials, a left turn lane is required for any access with a projected peak hour left turning volume of 25 vehicles per hour or greater, a right turn lane is required for any access with a projected peak hour right turning volume of 50 vehicles per hour or greater, and a right turn acceleration lane is generally not required.

Based on Vollmer Road providing a posted speed limit of 45 miles per hour, the turn lane requirements that the project traffic contributes to are as follows:

Lochwinnoch Lane/Carah Dawn View and Vollmer Road:

- A southbound left turn lane **is not** warranted at this intersection based on projected 2045 total traffic volumes being eight (8) southbound left turns during the peak hour and the threshold being 25 vehicles per hour.
- A northbound right turn lane exists but **is not** warranted at this intersection based on projected 2045 total traffic volumes being 28 northbound right turns during the peak hour and the threshold being 50 vehicles per hour.

5.4 Vehicle Queuing Analysis

A vehicle queuing analysis was conducted for the study area intersection. The queuing analysis was performed using Synchro presenting the results of the 95th percentile queue lengths. Results are shown in the following **Table 4** with calculations provided within the level of service operational sheets of **Appendix E**.

Table 4 – Turn Lane Queuing Analysis Results

Intersection Turn Lane	Existing Turn Lane Length (feet)	2025 Calculated Queue (feet)	2025 Recommended Length (feet)	2045 Calculated Queue (feet)	2045 Recommended Length (feet)
Lochwinnoch Ln/Carah Dawn View & Vollmer Rd					
Northbound Left	DNE	-	-	25'	245'+180'T
Northbound Right	350'	25'	350'	25'	350'
Southbound Left	DNE	-	-	25'	245'+180'T
Westbound Left/Through	100'	25'	100'	25'	100'
Westbound Right	C	25'	C	25'	C

DNE = Does Not Exist; C = Continuous Lane; T = Taper; **Blue** Text = Recommendation

As shown in the table above, vehicle queues are all anticipated to remain within the existing turn lane lengths through 2045. If future traffic volumes are realized by 2045, northbound and southbound left turn lanes could be needed at the intersection of Lochwinnoch Lane/Carah Dawn View and Vollmer Road and should be designated to a length of 245 feet with a 180 foot taper to meet El Paso County Standards. The southbound left turn lane is not needed operationally at this intersection. However, it is recommended based on the need for a northbound left turn lane due to the development of Sterling Ranch. This southbound left turn lane would be designated to shadow the northbound left turn lane.

5.5 Roadway Classifications and Internal Private Roadway Evaluation

According to El Paso County 2016 Major Transportation Corridors Plan Update, Vollmer Road is classified as a Minor Arterial, and Lochwinnoch Lane/Carah Dawn View is not explicitly classified which typically indicates a local street classification. The El Paso County ECM identifies a design average daily traffic (ADT) volume of 20,000 vehicles per day along an urban minor arterial while an urban local street has a design volume of 3,000 vehicles per day. Based on the volume projections identified in Figures 8-10, projected ADT volumes along Vollmer Road and Carah Dawn View are within the volume limits of the existing classification of roadways, and it is believed that the roadway segments meet the cross-section standards for the designated classifications.

Figure 10 illustrates the circulation plan and street classification map for roadways internal and external to the Barbarick Waste Transfer Station project.

Carah Dawn View and Cliff Allen Point are the existing paved private roads serving the site; jointly owned and maintained by the property owners within the Barbarick Subdivision. Both Carah Dawn View and Cliff Allen Point have a 22-foot paved, crowned, section with gravel/asphalt milling shoulders. Minor fatigue cracking and potholing exist with minimal to no alligator cracking. Pavement thickness for the roads are not known at this time. The site, 8812 Cliff Allen Point, is the only site to be accessed via Cliff Allen Point which would indicate approximately 280 vehicles per day along Cliff Allen Point. This would fall within the El Paso County ECM 300 daily volume limits of an urban low volume local street. The adjacent industrial properties are accessed by Carah Dawn View or Hot Mix Heights. If and when it is determined that improvements to Carah Dawn View and Cliff Allen Point need to be made, it is of the responsibility of the property owners within the Barbarick Subdivision to do so. See Article IV, 4.2 Maintenance and Repair, of the Declaration and Bylaws of Barbarick Subdivision Property Owners Association, Inc. (Recordation No.: 208016289) located in **Appendix F**.

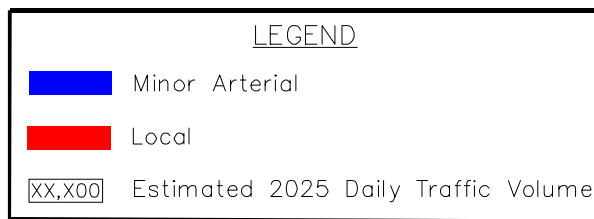
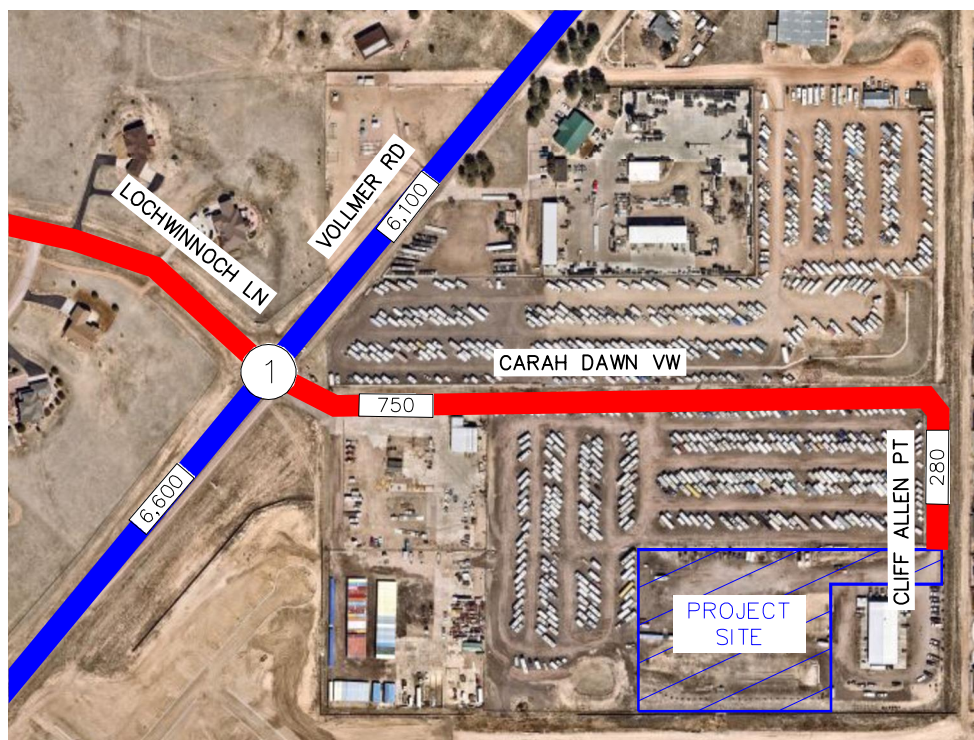

BARBARICK WASTE TRANSFER STATION
 EL PASO COUNTY, COLORADO
 ROADWAY CLASSIFICATION MAP

FIGURE 10

5.6 Sight Distance Evaluation

It is recommended that sight triangles be provided at all site access points to give drivers exiting the site a clear view of oncoming traffic. Landscaping and objects within sight triangles must not obstruct drivers' views of the adjacent travel lanes. ECM design sight distances for left turn from stop from public street intersections (Table 2-21) was evaluated at the intersection of Vollmer Road and Lochwinnoch Lane/Carah Dawn View. ECM does not provide sight distances for right-turning vehicles from stop for public street intersections; therefore, AASHTO standards were used for right-turn from stop distances at the intersection of Vollmer Road and Lochwinnoch Lane/Carah Dawn View.

According to Table 2-21 from ECM and a roadway design speed of 45 miles per hour along Vollmer Road, the intersection sight distance for a vehicle turning left from stop is 500 feet for a two-lane roadway. With AASHTO standards, the sight distance for a vehicle turning right from stop is 430 feet. Therefore, all obstructions for left turning vehicles from stop should be clear to the right within the triangle created with a vertex point located 10 feet from the edge of the major road traveled way (typical position of the minor road driver's eye when stopped) and a line-of-sight distance of 500 feet located in the middle of the nearest southbound through lane along Vollmer Road. Likewise, all obstructions for right turning vehicles from stop should be clear to the left within the triangle created with a vertex point located 10 feet from the edge of the major road traveled way and a line-of-sight distance of 430 feet located in the middle of the nearest northbound through lane along Vollmer Road. It is believed that the intersection of Vollmer Road and Lochwinnoch Lane/Carah Dawn View is appropriately located to provide necessary sight distances.

5.7 Bicycle and Pedestrian Access

Sidewalks are not present on either side of the Vollmer Road and Lochwinnoch Lane/Carah Dawn View intersection. Sidewalks and bicycle lanes are not provided along Vollmer Road or Lochwinnoch Lane/Carah Dawn View.

5.8 Road Impact Fees

Road impact fees were evaluated based on the El Paso County Road Impact Fee Schedule. Based on these fee schedule guidelines, the fee per 1,000 square feet of industrial space is \$3,651. Therefore, the road impact fee for the proposed 12,000 square foot building is expected to be \$43,812. Road impact fee calculations are shown in **Table 5**.

Table 5 – Road Impact Fees

Use	Units	Fee / Unit	Total Fee
Industrial	12.00 KSF	\$3,651	\$43,812

Road Impact Fees will be due at the time of building permit approval or land use approval, whichever comes first.

5.9 Heavy Vehicle Assessment

The heavy vehicle percentage adjacent to the intersection of Lochwinnoch Lane/Carah Dawn View and Vollmer Road is currently 6.2 percent during the morning peak hour and 4.4 percent during the afternoon peak hour. An industry standard 10 percent K-factor was utilized to estimate an average daily traffic volume of 6,100 vehicles per day along Vollmer Road. The afternoon heavy vehicle percentage of 4.4 percent was utilized to estimate a daily heavy vehicle estimate of 268 trucks (6,100 x 0.044). The project is anticipated to add 10 daily truck trips during the peak day of the peak month. This equates to a 3.7 percent (10/268) increase in the overall number of daily trucks along Vollmer Road. However, the heavy vehicle usage of 4.4 percent along Vollmer Road remains the same due to the small number of trucks added daily by this project. This is due to passenger vehicles generated by the project being added to Vollmer Road as well as trucks and the overall truck percentage along Vollmer Road remaining the same ((268 existing trucks + 10 project trucks) / (6,100 existing vehicles + 280 project vehicles)). It should also be noted that this is calculated with the highest project generated volume day in the entire calendar year and the not the average project generation. Therefore, an approximate total of five heavy vehicles (10 trips) are expected to be added to the roadway network on a peak day, and this is expected to have a negligible impact to the surrounding roadway.

5.10 Improvement Summary

Based on the results of the intersection operational, turn lane evaluations, and vehicle queuing analysis, the key intersection recommended improvements and control are shown in **Figure 11** for the 2045 horizon. Of note, the existing geometry and control is anticipated to operate acceptably in the 2025 horizon. Therefore, no improvements are anticipated to be needed for the short term 2025 horizon.

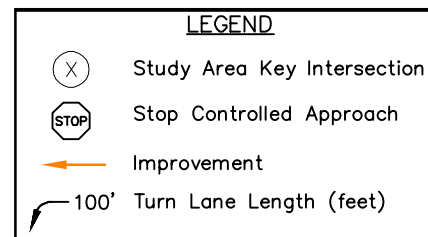
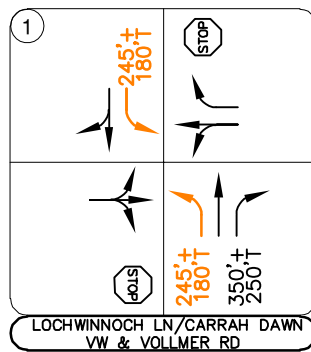

BARBARICK WASTE TRANSFER STATION
 EL PASO COUNTY, COLORADO
 2045 RECOMMENDED GEOMETRY AND
 CONTROL

FIGURE 11

6.0 CONCLUSIONS AND RECOMMENDATIONS

Based on the analysis presented in this report, Kimley-Horn believes Barbarick Waste Transfer Station will be successfully incorporated into the existing and future roadway network with the existing geometry and control. The road impact fee associated with the project is expected to be \$43,812. The intersection of Vollmer Road and Lochwinnoch Lane/Carah Dawn View is anticipated to operate acceptably throughout 2025 and all vehicle queues are anticipated to be maintained within the existing storage lengths.

If future 2045 traffic volume projections are realized, northbound and southbound left turn lanes with 245 feet of length plus 180-foot tapers may be needed at the intersection of Lochwinnoch Lane/Carah Dawn View and Vollmer Road to meet El Paso County Standards. The southbound left turn lane is not needed operationally at this intersection. However, it is recommended based on the need for a northbound left turn lane due to the development of Sterling Ranch. This southbound left turn lane would be designated to shadow the northbound left turn lane. Escrow for this turn lane will be coordinated in the future through discussions with the project team and County staff.

APPENDICES

APPENDIX A

Traffic Impact Study Checklist



2880 International Circle, Suite 110
 Colorado Springs, CO 80910
 Phone 719-520-6300
 Fax 719-520-6695
 www.elpasoco.com

**EL PASO COUNTY PLANNING AND
 COMMUNITY DEVELOPMENT
 DEPARTMENT**

TRAFFIC IMPACT STUDY

Revised: January 2022

Traffic Impact Study Report						
<p>The purpose of the traffic impact study is to provide detailed recommendations for the preparation of plans for all necessary transportation facility improvements and adequate access to those facilities for proposed development. The facilities include roadways and their structures, as well as extrinsic structures that support the use of the transportation facility. El Paso County standards and technical criteria shall be used to plan, design, construct, choose materials, locate, repair, maintain, reconstruct, and use roadways and other transportation facilities and the associated extrinsic structures. The Traffic Impact Study shall be prepared by a qualified professional engineer and shall be tailored to the stage of development application and the stage of subdivision-related construction.</p>						
<p>The report preparer shall verify type and level of TIS/memorandum required in accordance with ECM Section B.1.</p>						
		<table border="1"> <thead> <tr> <th>Applicant</th> <th>PCD</th> </tr> </thead> <tbody> <tr> <td style="text-align: center;">✓</td> <td style="text-align: center;">Office use only</td> </tr> </tbody> </table>	Applicant	PCD	✓	Office use only
Applicant	PCD					
✓	Office use only					
<p>Please confirm each item below has been included by placing a check mark in the "Applicant" column. See right for an example. The "PCD" column is for office use only.</p>						
1	Signature Page (ECM B.8)	✓				
2	Table of contents, pages numbered	✓				
3	Existing/background conditions narrative to include at a minimum:	✓				
	Vicinity map showing the subdivision in relation to section lines and existing or proposed arterial or collector roadways.	✓				
	Label all roads discussed in the report	✓				
	Graphically indicate all intersections evaluated	✓				
	Accurately depict the site location and boundaries	✓				
	Study Area – Provide calculations showing that the study area includes all affected intersections, address ECM B.2.3 requirements	✓				
	Background traffic	✓				
	Clearly explain how background traffic was derived	✓				
	List other traffic studies in the area of study within the past five years identified by County staff or that the applicant is aware of. State whether the current study is consistent with those studies and explain any discrepancies.	✓				
	Excerpts from studies of those developments are included in the appendices.	✓				
	Sketch diagrams of all existing intersections evaluated in the study showing widths of all approach lanes and lengths of auxiliary lanes and tapers.	✓				
	Description, classification, and link ADT of major roads in the study area (collector classification and higher).	✓				
	Specify MTCP functional and corridor preservation classifications	✓				
	Description of intersections evaluated in the study including existing controls	✓				
	Do existing road segments meet cross section standards for designated classifications?	✓				
	Traffic Count Data	✓				
	24 Hour Counts for ADT for major road segments K-factor estimates	✓				
	Peak-hour counts for all intersections evaluated in the study	✓				
4	Proposed development and trip generation narrative shall include at a minimum:	✓				
	Site Plan	✓				
	Land Use – Type and extent correspond with associated application documents	✓				



2880 International Circle, Suite 110
 Colorado Springs, CO 80910
 Phone 719-520-6300
 Fax 719-520-6695
 www.elpasoco.com

**EL PASO COUNTY PLANNING AND
 COMMUNITY DEVELOPMENT
 DEPARTMENT**

TRAFFIC IMPACT STUDY

Revised: January 2022

	Discussion of applicable ITE land use type(s) (including ITE code(s)) and comparison between the proposed use(s) and the codified use Client provided trip gen	✓	
	Total traffic generated by the proposed development using ITE trip generation; provide footnotes on the methods used (equation/chart/interpolation) Client provided trip gen	✓	
	Adjustments to trip generation including pass-by trips and internal trip capture	N/A	
	Trip distribution assumptions and map	✓	
	Specify expected year of completion (build-out) and intermediate years if phasing is proposed	✓	
	On-site road classification figure including ADT numbers	✓	
	On-site Traffic control recommendations (particularly stop controls at intersections)	✓	
	Evaluation of intersection spacing along all interior roads, and new intersections on adjacent or off-site roads, and confirmation that the spacing meet criteria No new access	✓	
	List ECM criteria for stacking, storage, and taper for every affected auxiliary lane and access and state whether this access can be met. If it cannot be met, state the required modifications so that it can be met.	✓	
	State what the sight distance is for every affected access and whether it can be met. If it cannot be met, state the required modifications so that it can be met.	✓	
5	Evaluation and Mitigation of Impacts shall include a minimum:	✓	
	Short-term, intermediate and long-term analysis horizon years are clearly stated and years are labeled on the corresponding figures.	✓	
	Capacity analysis of major road segments. Results presented in a figure or table showing short-term and long-term ADTs against maximum allowable ADT		
	Capacity analysis of all existing intersections evaluated in the study and all proposed access locations onto existing public roads	✓	
	For capacity analysis of signalized intersections, provide discussion of the following parameters:	✓	
	Cycle length	✓	
	Provisions for left turns ~ permissive/protected; lead/lag	✓	
	Free right turns	✓	
	Identification of any sub-standard LOS situations and discussion of recommendations for mitigation.	✓	
	Evaluation of safety-based warrants for turn lanes at unsignalized intersections (speed change lanes).	✓	
	Weaving analysis if applicable	N/A	
	Summary table of necessary turn lane improvements including design speed, taper rates and taper lengths, storage lengths, deceleration or acceleration lengths, and the resulting full-width lane lengths.	✓	
	Signal warrant analysis; estimated projected need if not currently warranted	N/A	
	Graphical depiction of improvements required to meet level-of-service standards No improvements	✓	
	Trigger points for the construction of all required future improvements including but not limited to turn lanes, signals, widenings, and openings or closings of accesses. ("Trigger points" are the conditions that, when met, will call for the construction of said improvements.)	✓	
	Summary of accident history within the study area.	N/A	
	Accident history data presented in tabular form by location and including annual vehicle use volume and accident rate calculations	N/A	
	Discussion of pedestrian/bicyclist needs and provisions.	✓	



2880 International Circle, Suite 110
 Colorado Springs, CO 80910
 Phone 719-520-6300
 Fax 719-520-6695
 www.elpasoco.com

**EL PASO COUNTY PLANNING AND
 COMMUNITY DEVELOPMENT
 DEPARTMENT**

TRAFFIC IMPACT STUDY

Revised: January 2022

	School and pedestrian routing plans	N/A	
	School traffic analysis per North Carolina DOT MSTA https://connect.ncdot.gov/municipalities/School/pages/default.aspx	N/A	
	Master-planned trails	N/A	
	Project Traffic modeling and figures	✓	
	Short Term Background Plus Project Traffic lanes, intersection control and LOS modeling and figures for all affected intersection movements	✓	
	Long Term Background Plus Project Traffic lanes, intersection control and LOS modeling and figures for all affected intersection movements	✓	
	Assess and summarize all project impacts (roadways, intersections, pedestrians, bicycles, etc.)	✓	
	Describe proposed mitigation measures	✓	
	Specifically address all deviations requested (separate form(s) required)	✓	
	Address any special studies that apply (access management plan, neighborhood impact evaluation, sight distance evaluation, traffic speed study, etc.)	✓	
6	Recommendations and Report Conclusions shall include a minimum of:	✓	
	Narrative recommendations and conclusions	✓	
	For final plats, state definitively what improvements the developer will be constructing with the project.	✓	
	State whether or not any improvements affected by the project are reimbursable under the current Major Transportation Corridors Plan (MTCP) and Road Fee program.	✓	
	State whether the MTCP or other approved corridor study calls for the construction of improvements in the immediate area.		
	State what the current applicable Road Impact Fees are and what option the developer will be selecting for payment. If the site is in a special district, so state and summarize the applicable fees.	✓	
	Provide a description of how transportation improvements will be financed (responsibility) and a Recommended Improvements Summary Table per ECM section B.6.1.D.	✓	
	List of References.	✓	
7	A minimum of the following appendices:	✓	
	Complete modeling for all existing and proposed development horizons	✓	
	Modeled lanes match improvements table and CDs	✓	

APPENDIX B

Intersection Count Sheets

Two-Hour Count Summaries - Heavy Vehicles																		
Interval Start	Lochwinnoch Ln				Project Access				Vollmer Rd				Vollmer Rd				15-min Total	Rolling One Hour
	Eastbound				Westbound				Northbound				Southbound					
	UT	LT	TH	RT	UT	LT	TH	RT	UT	LT	TH	RT	UT	LT	TH	RT		
7:00 AM	0	0	0	0	0	0	0	0	0	0	5	0	0	0	0	1	6	0
7:15 AM	0	1	0	0	0	0	0	0	0	0	8	0	0	1	1	0	11	0
7:30 AM	0	0	0	0	0	1	0	0	0	0	2	4	1	0	0	2	10	0
7:45 AM	0	0	0	0	0	2	0	0	0	0	0	4	1	0	0	1	8	35
8:00 AM	0	0	0	0	0	1	0	0	0	0	0	6	1	0	0	1	9	38
8:15 AM	0	0	0	1	0	1	0	0	0	0	0	4	1	0	0	1	8	35
8:30 AM	0	0	0	0	0	1	0	1	0	0	0	3	0	0	1	1	7	32
8:45 AM	0	0	0	0	0	0	0	0	0	0	0	3	0	0	0	1	4	28
Count Total	0	1	0	1	0	6	0	1	0	2	37	4	0	2	8	1	63	0
Peak Hour	0	1	0	0	0	3	0	0	0	2	21	2	0	1	4	1	35	0

Two-Hour Count Summaries - Bikes																		
Interval Start	Lochwinnoch Ln			Project Access			Vollmer Rd			Vollmer Rd			15-min Total	Rolling One Hour				
	Eastbound			Westbound			Northbound			Southbound								
	LT	TH	RT	LT	TH	RT	LT	TH	RT	LT	TH	RT						
7:00 AM	0	0	0	0	0	0	0	0	0	0	0	0	0	0	0	0	0	0
7:15 AM	0	0	0	0	0	0	0	0	0	0	0	0	0	0	0	0	0	0
7:30 AM	0	0	0	0	0	0	0	0	0	0	0	0	0	0	0	0	0	0
7:45 AM	0	0	0	0	0	0	0	0	0	0	0	0	0	0	0	0	0	0
8:00 AM	0	0	0	0	0	0	0	0	0	0	0	0	0	0	0	0	0	0
8:15 AM	0	0	0	0	0	0	0	0	0	0	0	0	0	0	0	0	0	0
8:30 AM	0	0	0	0	0	0	0	0	0	0	0	0	0	0	0	0	0	0
8:45 AM	0	0	0	0	0	0	0	0	0	0	0	0	0	0	0	0	0	0
Count Total	0	0	0	0	0	0	0	0	0	0	0	0	0	0	0	0	0	0
Peak Hour	0	0	0	0	0	0	0	0	0	0	0	0	0	0	0	0	0	0

Note: U-Turn volumes for bikes are included in Left-Turn, if any.

Vollmer Rd Lochwinnoch Ln



Peak Hour

Date: 08/25/2022
Count Period: 4:00 PM to 6:00 PM
Peak Hour: 4:15 PM to 5:15 PM

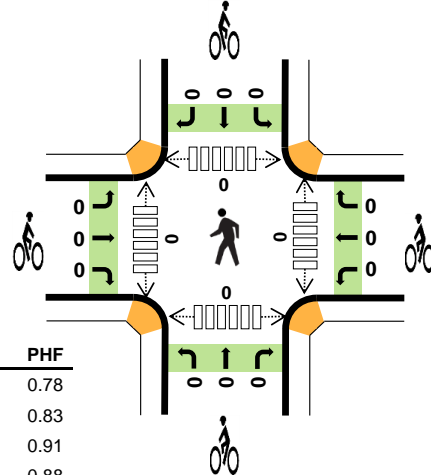
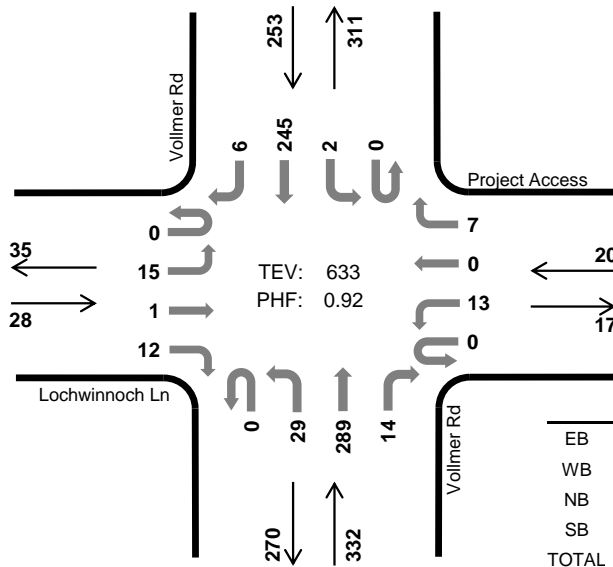

	HV %:	PHF
EB	3.6%	0.78
WB	10.0%	0.83
NB	3.6%	0.91
SB	5.1%	0.88
TOTAL	4.4%	0.92

Two-Hour Count Summaries

Interval Start	Lochwinnoch Ln				Project Access				Vollmer Rd				Vollmer Rd				15-min Total	Rolling One Hour	
	Eastbound		Westbound		Northbound		Southbound		UT	LT	TH	RT	UT	LT	TH	RT			
4:00 PM	0	1	0	5	0	3	0	1	0	7	52	2	0	0	51	1	123	0	
4:15 PM	0	3	0	3	0	3	0	2	0	5	68	3	0	0	63	3	153	0	
4:30 PM	0	3	0	6	0	2	0	4	0	6	80	3	0	0	59	1	164	0	
4:45 PM	0	2	1	2	0	4	0	0	0	10	78	3	0	2	69	1	172	612	
5:00 PM	0	7	0	1	0	4	0	1	0	8	63	5	0	0	54	1	144	633	
5:15 PM	0	1	1	3	0	2	0	0	0	8	63	2	0	0	68	1	149	629	
5:30 PM	0	2	0	4	0	5	2	2	0	6	62	1	0	1	41	4	130	595	
5:45 PM	0	1	1	1	0	1	0	1	0	3	89	1	0	0	44	3	145	568	
Count Total	0	20	3	25	0	24	2	11	0	53	555	20	0	3	449	15	1,180	0	
Peak Hour	All	0	15	1	12	0	13	0	7	0	29	289	14	0	2	245	6	633	0
	HV	0	0	0	1	0	1	0	1	0	0	11	1	0	1	11	1	28	0
	HV%	-	0%	0%	8%	-	8%	-	14%	-	0%	4%	7%	-	50%	4%	17%	4%	0

Note: Two-hour count summary volumes include heavy vehicles but exclude bicycles in overall count.

Interval Start	Heavy Vehicle Totals					Bicycles					Pedestrians (Crossing Leg)				
	EB	WB	NB	SB	Total	EB	WB	NB	SB	Total	East	West	North	South	Total
4:00 PM	0	1	1	6	8	0	0	0	0	0	0	0	0	0	0
4:15 PM	1	1	6	2	10	0	0	0	0	0	0	0	0	0	0
4:30 PM	0	1	3	1	5	0	0	0	0	0	0	0	0	0	0
4:45 PM	0	0	1	6	7	0	0	0	0	0	0	0	0	0	0
5:00 PM	0	0	2	4	6	0	0	0	0	0	0	0	0	0	0
5:15 PM	0	0	0	2	2	0	0	0	0	0	0	0	0	0	0
5:30 PM	0	0	1	3	4	0	0	0	0	0	0	0	0	0	0
5:45 PM	0	0	0	3	3	0	0	0	0	0	0	0	0	0	0
Count Total	1	3	14	27	45	0	0	0	0	0	0	0	0	0	0
Peak Hour	1	2	12	13	28	0	0	0	0	0	0	0	0	0	0

Two-Hour Count Summaries - Heavy Vehicles																			
Interval Start	Lochwinnoch Ln				Project Access				Vollmer Rd				Vollmer Rd				15-min Total	Rolling One Hour	
	Eastbound				Westbound				Northbound				Southbound						
	UT	LT	TH	RT	UT	LT	TH	RT	UT	LT	TH	RT	UT	LT	TH	RT			
4:00 PM	0	0	0	0	0	1	0	0	0	1	0	0	0	0	6	0	8	0	
4:15 PM	0	0	0	1	0	1	0	0	0	0	0	6	0	0	0	2	0	10	0
4:30 PM	0	0	0	0	0	0	0	1	0	0	2	1	0	0	1	0	5	0	
4:45 PM	0	0	0	0	0	0	0	0	0	0	1	0	0	1	4	1	7	30	
5:00 PM	0	0	0	0	0	0	0	0	0	0	2	0	0	0	4	0	6	28	
5:15 PM	0	0	0	0	0	0	0	0	0	0	0	0	0	0	2	0	2	20	
5:30 PM	0	0	0	0	0	0	0	0	0	0	1	0	0	0	3	0	4	19	
5:45 PM	0	0	0	0	0	0	0	0	0	0	0	0	0	0	3	0	3	15	
Count Total	0	0	0	1	0	2	0	1	0	1	12	1	0	1	25	1	45	0	
Peak Hour	0	0	0	1	0	1	0	1	0	0	11	1	0	1	11	1	28	0	
Two-Hour Count Summaries - Bikes																			
Interval Start	Lochwinnoch Ln			Project Access			Vollmer Rd			Vollmer Rd			15-min Total	Rolling One Hour					
	Eastbound			Westbound			Northbound			Southbound									
	LT	TH	RT	LT	TH	RT	LT	TH	RT	LT	TH	RT							
4:00 PM	0	0	0	0	0	0	0	0	0	0	0	0	0	0	0	0	0	0	
4:15 PM	0	0	0	0	0	0	0	0	0	0	0	0	0	0	0	0	0	0	
4:30 PM	0	0	0	0	0	0	0	0	0	0	0	0	0	0	0	0	0	0	
4:45 PM	0	0	0	0	0	0	0	0	0	0	0	0	0	0	0	0	0	0	
5:00 PM	0	0	0	0	0	0	0	0	0	0	0	0	0	0	0	0	0	0	
5:15 PM	0	0	0	0	0	0	0	0	0	0	0	0	0	0	0	0	0	0	
5:30 PM	0	0	0	0	0	0	0	0	0	0	0	0	0	0	0	0	0	0	
5:45 PM	0	0	0	0	0	0	0	0	0	0	0	0	0	0	0	0	0	0	
Count Total	0	0	0	0	0	0	0	0	0	0	0	0	0	0	0	0	0	0	
Peak Hour	0	0	0	0	0	0	0	0	0	0	0	0	0	0	0	0	0	0	
<i>Note: U-Turn volumes for bikes are included in Left-Turn, if any.</i>																			

APPENDIX C

Future Traffic Projections

MTCP Growth Rate: Barbarick Waste Transfer Station

Location	2022 AADT	2040 AADT	Growth Factor	Growth Rate
Vollmer Rd S/O Burgess Rd	6100	8700	1.43	1.99%

APPENDIX D

Background Traffic Study



LSC TRANSPORTATION CONSULTANTS, INC.
 2504 East Pikes Peak Avenue, Suite 304
 Colorado Springs, CO 80909
 (719) 633-2868
 FAX (719) 633-5430
 E-mail: lsc@lscstrans.com
 Website: <http://www.lscstrans.com>

Condition:
 The applicant/developer and/or property owner(s) shall be required to participate in a fair and equitable manner in the onsite and offsite transportation improvements required by the Sterling Ranch development's traffic impacts as identified in each subsequent TIS. This includes but is not limited to potential roadway and intersection upgrades to and construction of Briargate Parkway, Vollmer Road, Marksheffel Road, Woodmen Road, and Banning-Lewis Parkway. Participation shall be through construction of specified improvements and inclusion in El Paso County's Road Impact Fee program. Specific responsibilities and obligations of the development shall be determined with rezoning, preliminary plan, and final plat approvals.

ACCEPTED for FILE
 Engineering Review
 04/04/2023 1:30:31 PM
 Elizabeth Nijkamp, PE
 EPC Department of Public Works
 See condition at left.

**Sterling Ranch Sketch Plan Amendment
 Master Traffic Impact Study
 SKP-22-004
 (LSC #S224440)
 March 17, 2023**

Traffic Engineer's Statement

This traffic report and supporting information were prepared under my responsible charge and they comport with the standard of care. So far as is consistent with the standard of care, said report was prepared in general conformance with the criteria established by the County for traffic reports.



Developer's Statement

I, the Developer, have read and will comply with all commitments made on my behalf within this report.

3/25/2023
 Date

Sterling Ranch Sketch Plan Amendment Master Traffic Impact Study

Prepared for:
Loren J. Moreland
Vice President/ Project Manager
Classic SRJ
2138 Flying Horse Club Drive
Colorado Springs, CO 80921

MARCH 17, 2023

LSC Transportation Consultants
Prepared by: Kirstin D. Ferrin, P.E.
Reviewed by: Jeffrey C. Hodsdon, P.E.

LSC #S224440

PCD File No.: SKP-22-004



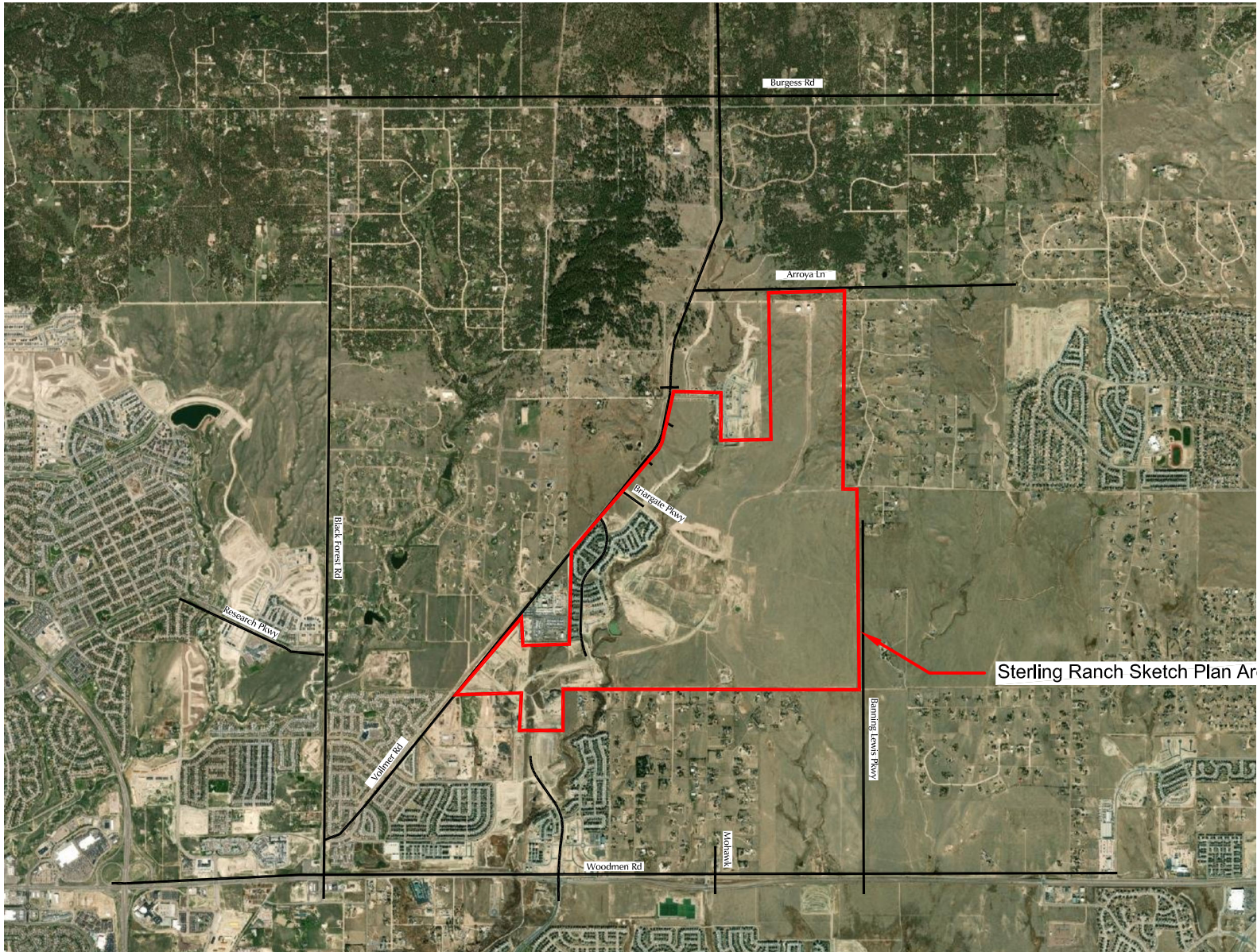
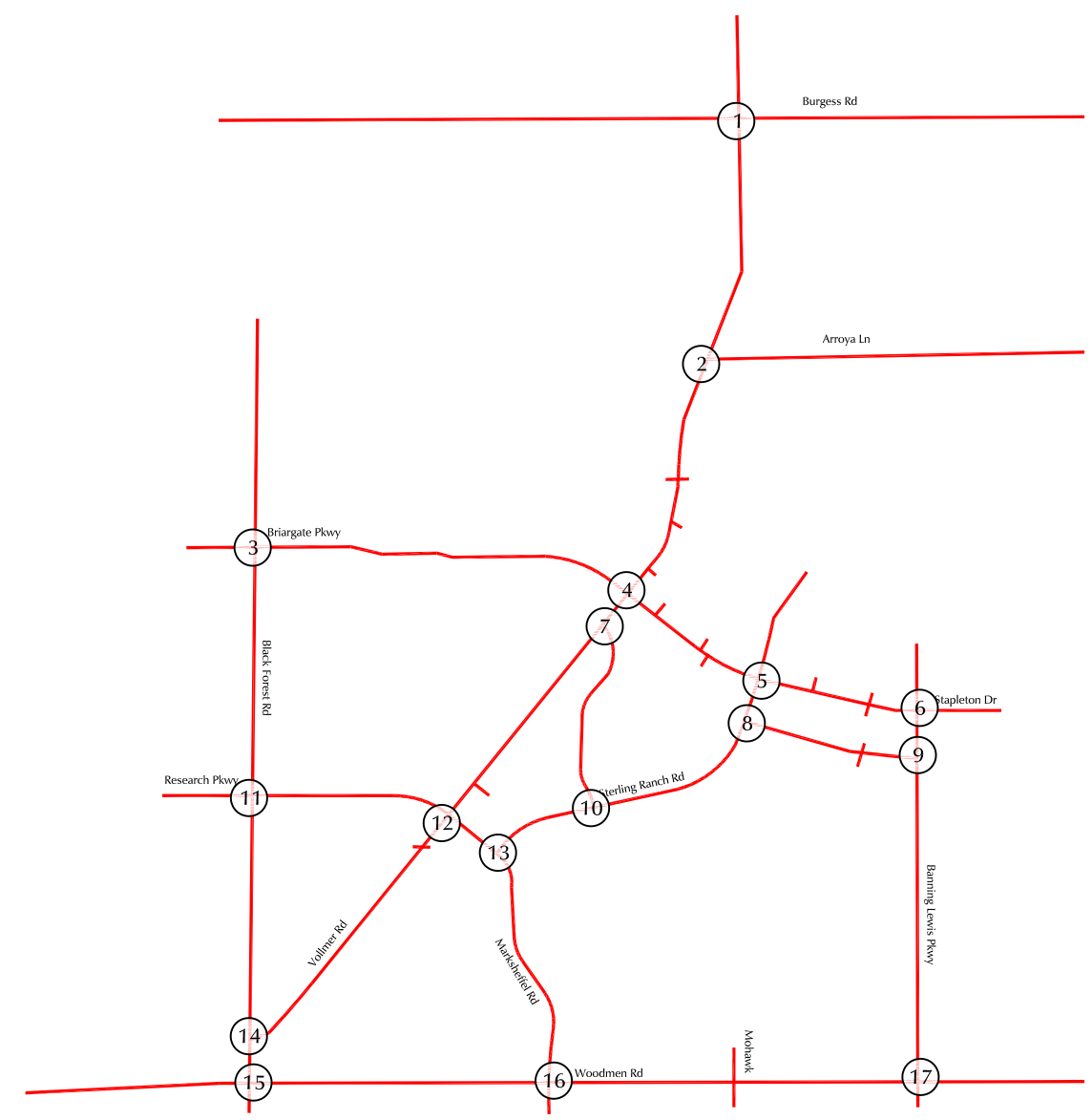
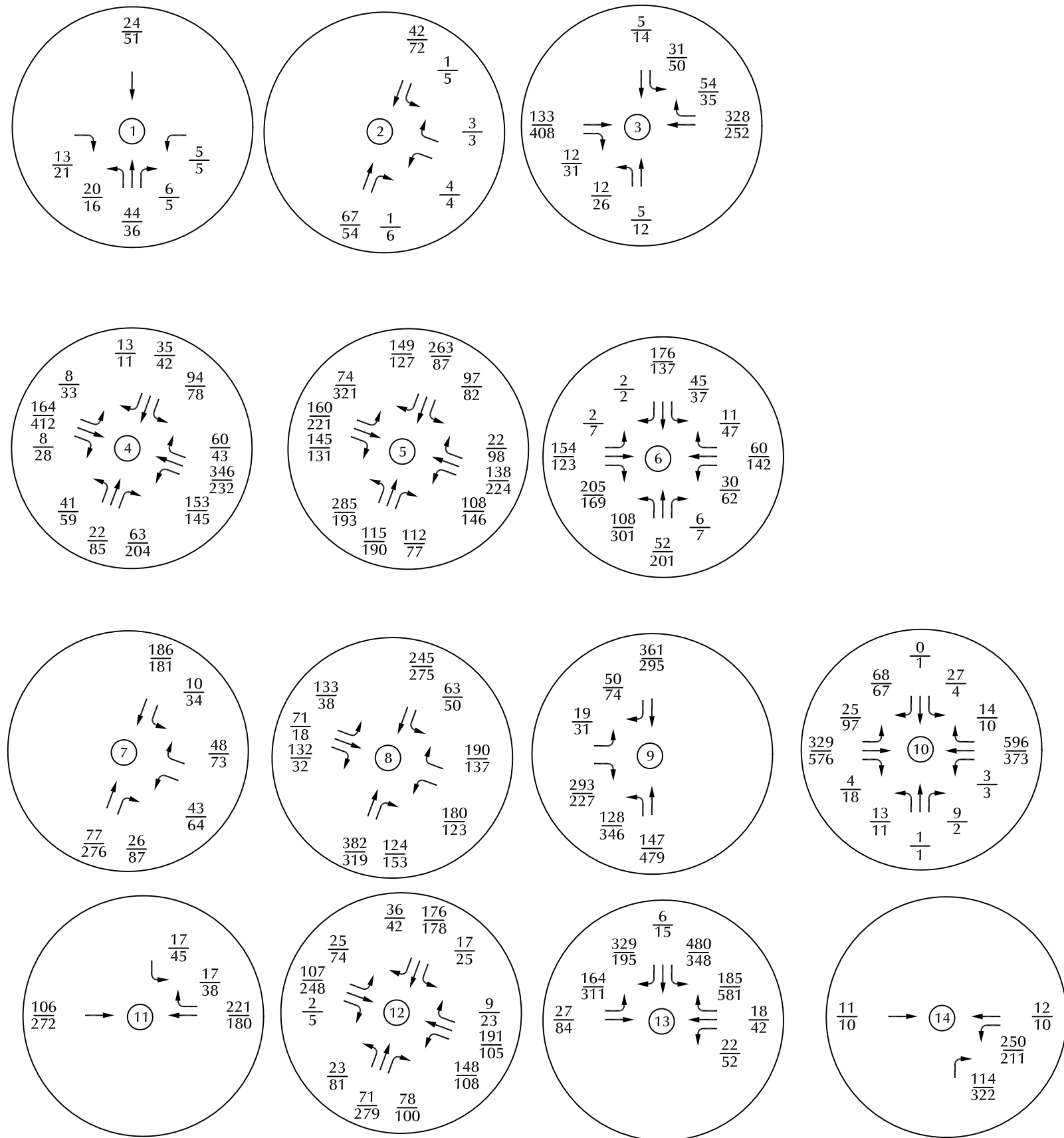

Figure 1

Vicinity

Sterling Ranch East Rezoning and Preliminary Plan (LSC# S224440)







LEGEND: $\frac{XX}{XX} = \frac{\text{AM Peak-Hour Traffic (veh/hr)}}{\text{PM Peak-Hour Traffic (veh/hr)}}$

Figure 9b
Site-Generated Peak-Hour Traffic

Sterling Ranch Sketch Plan - 2022 Amendment (LSC# S224440)

LAND USE LEGEND:

44 AC. RESIDENTIAL: 0.2 DU/AC	9 D.U.
33 AC. RESIDENTIAL: 0.4 DU/AC	13 D.U.
35 AC. RESIDENTIAL: 1 DU/AC	35 D.U.
163 AC. RESIDENTIAL: 2 DU/AC	326 D.U.
790 AC. RESIDENTIAL: 3-5 DU/AC	3,642 D.U.
86 AC. RESIDENTIAL: 5-8 DU/AC	600 D.U.
47 AC. MIXED USE 8-25 DU/AC *	600 D.U.
57 AC. ELEMENTARY / K-8 SCHOOL	
18 AC. NEIGHBORHOOD PARK	
25 AC. COMMUNITY PARK	
62 AC. OPEN SPACE / PARK / GREENWAY	
43 AC. OPEN SPACE / BUFFER	
9 AC. UTILITY PARCEL	
5 AC. INDUSTRIAL	

TOTAL: 1,444 AC. TOTAL: 4,800 D.U. Max
 * COMMERCIAL/MULTIFAMILY UP TO 25 DU/AC

LEGAL DESCRIPTION:

THE WEST HALF OF THE WEST HALF OF THE EAST HALF AND EAST HALF OF THE WEST HALF AND THE SOUTHWEST QUARTER OF THE SOUTHWEST QUARTER OF SECTION 27; THE EAST HALF OF THE SOUTHWEST QUARTER AND THAT PORTION OF THE SOUTHWEST QUARTER OF THE SOUTHWEST QUARTER LYING SOUTH AND EAST OF THE COUNTY ROAD KNOWN AS VOLLMER ROAD, OF SECTION 28; THE WEST HALF OF THE EAST HALF AND THE WEST HALF OF SECTION 34; THE EAST HALF AND THE EAST HALF OF THE SOUTHWEST QUARTER AND THE SOUTHWEST QUARTER OF THE SOUTHWEST QUARTER OF SECTION 33, AND ALL THAT PART OF THE NORTHWEST QUARTER OF SECTION 33 LYING SOUTH AND EAST OF THE COUNTY ROAD KNOWN AS VOLLMER ROAD, EXCEPT THAT PORTION OF THE SOUTHWEST QUARTER OF THE NORTHWEST QUARTER OF SAID SECTION 33 LYING SOUTH AND EAST OF SAID COUNTY ROAD AS DEEDED TO COLORADO INTERSTATE GAS COMPANY BY WARRANTY DEED RECORDED IN BOOK 1173 AT PAGE 359; AND THAT PORTION OF THE NORTHEAST QUARTER OF THE SOUTHWEST QUARTER AND THE SOUTHWEST QUARTER OF THE SOUTHWEST QUARTER OF SECTION 33, AND ALL THAT PART OF THE NORTHWEST QUARTER OF SECTION 33 LYING SOUTH AND EAST OF THE COUNTY ROAD KNOWN AS VOLLMER ROAD, EXCEPT THAT PORTION OF THE NORTHWEST QUARTER OF THE SOUTHWEST QUARTER OF SAID SECTION 32 DEEDED TO J. MARCUS BROWN BY TRUSTEES' DEED RECORDED IN BOOK 3292 AT PAGE 168; ALL IN TOWNSHIP 12 SOUTH, RANGE 65 WEST OF THE 6TH P.M., EL PASO COUNTY, COLORADO. ALL THAT PORTION OF THE NORTHWEST QUARTER OF THE SOUTHWEST QUARTER OF SECTION 28, TOWNSHIP 12 SOUTH, RANGE 65 WEST OF THE 6TH P.M., EL PASO COUNTY, COLORADO LYING SOUTH AND EAST OF THE COUNTY ROAD (VOLLMER ROAD), ALSO; THE NORTHWEST QUARTER OF THE NORTHWEST QUARTER OF SECTION 4, TOWNSHIP 13 SOUTH, RANGE 65 WEST OF THE SIXTH PRINCIPAL MERIDIAN, LYING SOUTHERLY OF AN EXISTING EAST-WEST FENCE AS DESCRIBED IN SPECIAL WARRANTY DEED RECORDED DECEMBER 23, 2004 AT RECEPTION NO. 204209417, COUNTY OF EL PASO, STATE OF COLORADO, ALSO; THE SOUTHWEST QUARTER OF THE SOUTHWEST QUARTER OF THE SOUTHWEST QUARTER OF SECTION 32, TOWNSHIP 12 SOUTH, RANGE 65 WEST OF THE 6TH P.M., LYING SOUTHEASTERLY OF THE PUBLIC ROAD KNOWN AS VOLLMER ROAD, EL PASO COUNTY, COLORADO, AND CONTAINING 1443.695 ACRES MORE OR LESS.

OWNERS:

SR LAND, LLC.
20 BOULDER CRESCENT STREET, SUITE 102
COLORADO SPRINGS, CO 80903-3300

CLASSIC SRJ LAND, LLC
2138 FLYING HORSE CLUB DRIVE
COLORADO SPRINGS, CO 80921

CHALLENGER COMMUNITIES, LLC.
8605 EXPLORER DRIVE, SUITE 250
COLORADO SPRINGS, CO 80920-1013

SYMBOL LEGEND:

- ROAD
- FULL MOVEMENT ACCESS POINT
- 3/4 MOVEMENT
- R/W/O
- 100-YEAR FLOODPLAIN
- TRAIL
- BUFFER / OS TRAIL CORRIDOR / EASEMENT
- NEIGHBORHOOD PARK
- ACCESS SPACING (FEET)

VICINITY MAP:

Overall Development Dwelling Unit Table

Dwelling Units	Homestead Fil 1 SF 04-029	Banding Iron Fil 1 SF-06-017	Homestead Fil 2 SF 19-004	Banding Iron Fil 2 SF-19-018	Sterling Ranch Fil 2 SF-20-015	Total Entitled Units	Remaining Developable Units	Maximum Dwelling Units
72	51	104	75	49	351	449	4800	

ROAD CLASSIFICATION TABLE

Roadway	Existing	2040 MTC/P	2060 MTC/CP	Sterling Ranch Proposed
Voller Road	2 lane Collector - 60'	4 lane Minor - 100'	4 lane Minor - 100'	4 lane Minor - 100'
Briargate Parkway	4 lane Principal - 130'	4 lane Principal - 130'	4 lane Principal - 130'	4 lane Principal - 130'
Banning Lewis Ranch Parkway	4 lane Principal - 130'	4 lane Principal - 130'	4 lane Principal - 130'	4 lane Principal - 130'
Winkelman Road	2 lane Principal - 130'	4 lane Principal - 130'	4 lane Principal - 130'	4 lane Principal - 130'

* A deviation is approved for Marksheffel Road to be built to the City of Colorado Springs standards.

STERLING RANCH SKETCH PLAN AMENDMENT

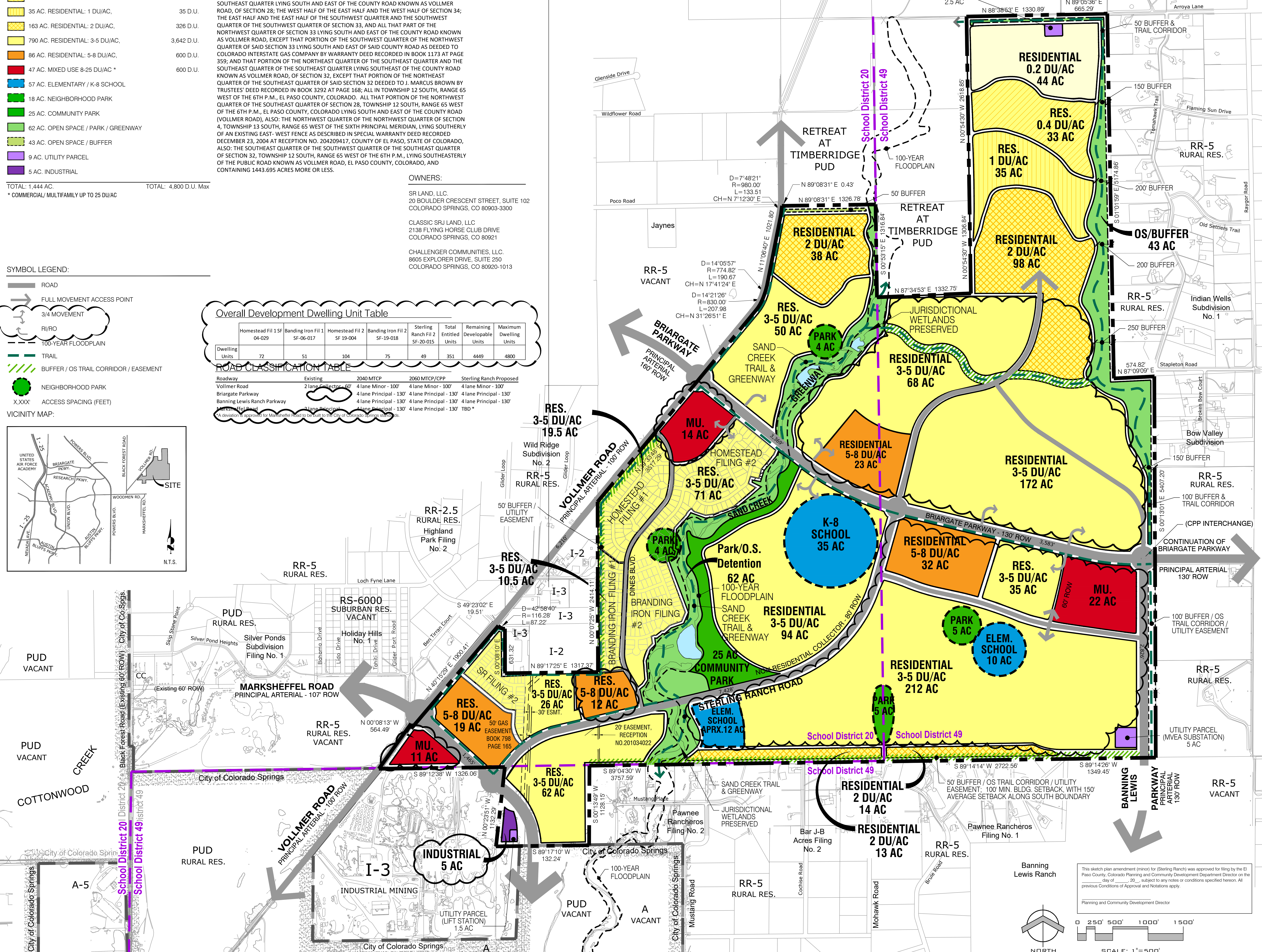

Land Planning
Landscape Architecture
Urban Design

NES

N.E.S. Inc.
619 N. Cascade Avenue, Suite 200
Colorado Springs, CO 80903

Tel. 719.471.0073
Fax 719.471.0267

www.nescolorado.com

© 2012. All Rights Reserved.

STERLING RANCH SKETCH PLAN AMENDMENT

MORLEY-BENTLEY INVESTMENTS, LLC.

DATE: OCTOBER 29, 2007
 PROJECT MGR: J. MANNARDI/ROMEO
 PREPARED BY: J. KUHNEL/M. SWIFT

REVISIONS:

DATE	BY	DESCRIPTION
05.22.2009	JKL	APPROVED SKETCH PLAN PER COUNTY - NOV. 2008
12.05.2018	BE	APPROVED SKETCH PLAN AMENDMENT - DEC. 2018
07.01.2022	BE	SKETCH PLAN AMEND 2022
08.30.2022	AL	SKETCH PLAN AMEND 2022
12.22.2022	JS	SKETCH PLAN AMEND 2022

1 OF 1

SKP 22-004

P:\Morley-Bentley\Sterling Ranch Sketch Plan\Sketch Plan Amendment_2022\Drawings\Planning\MORLEY-BENTLEY SKP AMEND 22.dwg [507] 12/22/2022 4:00:18 PM Jennifer Shagin

APPENDIX E

Intersection Analysis Worksheets

Intersection												
Int Delay, s/veh	1.3											
Movement	EBL	EBT	EBR	WBL	WBT	WBR	NBL	NBT	NBR	SBL	SBT	SBR
Lane Configurations		↔			↔	↔		↔	↔		↔	
Traffic Vol, veh/h	8	0	16	9	0	2	27	178	13	4	281	26
Future Vol, veh/h	8	0	16	9	0	2	27	178	13	4	281	26
Conflicting Peds, #/hr	0	0	0	0	0	0	0	0	0	0	0	0
Sign Control	Stop	Stop	Stop	Stop	Stop	Stop	Free	Free	Free	Free	Free	Free
RT Channelized	-	-	None	-	-	None	-	-	None	-	-	None
Storage Length	-	-	-	-	-	0	-	-	350	-	-	-
Veh in Median Storage, #	-	0	-	-	0	-	-	0	-	-	0	-
Grade, %	-	0	-	-	0	-	-	0	-	-	0	-
Peak Hour Factor	79	79	79	79	79	79	79	79	79	79	79	79
Heavy Vehicles, %	6	6	6	6	6	6	6	6	6	6	6	6
Mvmt Flow	10	0	20	11	0	3	34	225	16	5	356	33

Major/Minor	Minor2		Minor1		Major1		Major2					
Conflicting Flow All	686	692	373	686	692	225	389	0	0	241	0	0
Stage 1	383	383	-	293	293	-	-	-	-	-	-	-
Stage 2	303	309	-	393	399	-	-	-	-	-	-	-
Critical Hdwy	7.16	6.56	6.26	7.16	6.56	6.26	4.16	-	-	4.16	-	-
Critical Hdwy Stg 1	6.16	5.56	-	6.16	5.56	-	-	-	-	-	-	-
Critical Hdwy Stg 2	6.16	5.56	-	6.16	5.56	-	-	-	-	-	-	-
Follow-up Hdwy	3.554	4.054	3.354	3.554	4.054	3.354	2.254	-	-	2.254	-	-
Pot Cap-1 Maneuver	356	362	664	356	362	805	1148	-	-	1302	-	-
Stage 1	632	605	-	707	663	-	-	-	-	-	-	-
Stage 2	698	652	-	624	595	-	-	-	-	-	-	-
Platoon blocked, %								-	-	-	-	-
Mov Cap-1 Maneuver	344	348	664	335	348	805	1148	-	-	1302	-	-
Mov Cap-2 Maneuver	344	348	-	335	348	-	-	-	-	-	-	-
Stage 1	611	602	-	683	640	-	-	-	-	-	-	-
Stage 2	672	630	-	602	592	-	-	-	-	-	-	-

Approach	EB		WB		NB		SB	
HCM Control Delay, s	12.6		14.9		1		0.1	
HCM LOS	B		B					

Minor Lane/Major Mvmt	NBL	NBT	NBR	EBLn1	WBLn1	WBLn2	SBL	SBT	SBR
Capacity (veh/h)	1148	-	-	507	335	805	1302	-	-
HCM Lane V/C Ratio	0.03	-	-	0.06	0.034	0.003	0.004	-	-
HCM Control Delay (s)	8.2	0	-	12.6	16.1	9.5	7.8	0	-
HCM Lane LOS	A	A	-	B	C	A	A	A	-
HCM 95th %tile Q(veh)	0.1	-	-	0.2	0.1	0	0	-	-

Intersection												
Int Delay, s/veh	1.4											
Movement	EBL	EBT	EBR	WBL	WBT	WBR	NBL	NBT	NBR	SBL	SBT	SBR
Lane Configurations		↕			↕	↕		↕	↕		↕	
Traffic Vol, veh/h	15	1	12	13	0	7	29	289	14	2	245	6
Future Vol, veh/h	15	1	12	13	0	7	29	289	14	2	245	6
Conflicting Peds, #/hr	0	0	0	0	0	0	0	0	0	0	0	0
Sign Control	Stop	Stop	Stop	Stop	Stop	Stop	Free	Free	Free	Free	Free	Free
RT Channelized	-	-	None	-	-	None	-	-	None	-	-	None
Storage Length	-	-	-	-	-	0	-	-	350	-	-	-
Veh in Median Storage, #	-	0	-	-	0	-	-	0	-	-	0	-
Grade, %	-	0	-	-	0	-	-	0	-	-	0	-
Peak Hour Factor	92	92	92	92	92	92	92	92	92	92	92	92
Heavy Vehicles, %	4	4	4	4	4	4	4	4	4	4	4	4
Mvmt Flow	16	1	13	14	0	8	32	314	15	2	266	7

Major/Minor	Minor2		Minor1		Major1			Major2				
Conflicting Flow All	664	667	270	659	655	314	273	0	0	329	0	0
Stage 1	274	274	-	378	378	-	-	-	-	-	-	-
Stage 2	390	393	-	281	277	-	-	-	-	-	-	-
Critical Hdwy	7.14	6.54	6.24	7.14	6.54	6.24	4.14	-	-	4.14	-	-
Critical Hdwy Stg 1	6.14	5.54	-	6.14	5.54	-	-	-	-	-	-	-
Critical Hdwy Stg 2	6.14	5.54	-	6.14	5.54	-	-	-	-	-	-	-
Follow-up Hdwy	3.536	4.036	3.336	3.536	4.036	3.336	2.236	-	-	2.236	-	-
Pot Cap-1 Maneuver	371	377	764	374	383	722	1279	-	-	1219	-	-
Stage 1	728	680	-	640	612	-	-	-	-	-	-	-
Stage 2	630	602	-	721	678	-	-	-	-	-	-	-
Platoon blocked, %								-	-	-	-	-
Mov Cap-1 Maneuver	358	365	764	358	370	722	1279	-	-	1219	-	-
Mov Cap-2 Maneuver	358	365	-	358	370	-	-	-	-	-	-	-
Stage 1	705	679	-	620	593	-	-	-	-	-	-	-
Stage 2	604	583	-	706	677	-	-	-	-	-	-	-

Approach	EB		WB		NB		SB	
HCM Control Delay, s	13.3		13.6		0.7		0.1	
HCM LOS	B		B					

Minor Lane/Major Mvmt	NBL	NBT	NBR	EBLn1	WBLn1	WBLn2	SBL	SBT	SBR
Capacity (veh/h)	1279	-	-	464	358	722	1219	-	-
HCM Lane V/C Ratio	0.025	-	-	0.066	0.039	0.011	0.002	-	-
HCM Control Delay (s)	7.9	0	-	13.3	15.5	10	8	0	-
HCM Lane LOS	A	A	-	B	C	B	A	A	-
HCM 95th %tile Q(veh)	0.1	-	-	0.2	0.1	0	0	-	-

Intersection												
Int Delay, s/veh	1.3											
Movement	EBL	EBT	EBR	WBL	WBT	WBR	NBL	NBT	NBR	SBL	SBT	SBR
Lane Configurations		↕			↕	↕		↕	↕		↕	
Traffic Vol, veh/h	8	0	16	9	0	2	27	189	13	4	298	26
Future Vol, veh/h	8	0	16	9	0	2	27	189	13	4	298	26
Conflicting Peds, #/hr	0	0	0	0	0	0	0	0	0	0	0	0
Sign Control	Stop	Stop	Stop	Stop	Stop	Stop	Free	Free	Free	Free	Free	Free
RT Channelized	-	-	None	-	-	None	-	-	None	-	-	None
Storage Length	-	-	-	-	-	0	-	-	350	-	-	-
Veh in Median Storage, #	-	0	-	-	0	-	-	0	-	-	0	-
Grade, %	-	0	-	-	0	-	-	0	-	-	0	-
Peak Hour Factor	79	79	79	79	79	79	79	79	79	79	79	79
Heavy Vehicles, %	6	6	6	6	6	6	6	6	6	6	6	6
Mvmt Flow	10	0	20	11	0	3	34	239	16	5	377	33

Major/Minor	Minor2		Minor1		Major1		Major2					
Conflicting Flow All	721	727	394	721	727	239	410	0	0	255	0	0
Stage 1	404	404	-	307	307	-	-	-	-	-	-	-
Stage 2	317	323	-	414	420	-	-	-	-	-	-	-
Critical Hdwy	7.16	6.56	6.26	7.16	6.56	6.26	4.16	-	-	4.16	-	-
Critical Hdwy Stg 1	6.16	5.56	-	6.16	5.56	-	-	-	-	-	-	-
Critical Hdwy Stg 2	6.16	5.56	-	6.16	5.56	-	-	-	-	-	-	-
Follow-up Hdwy	3.554	4.054	3.354	3.554	4.054	3.354	2.254	-	-	2.254	-	-
Pot Cap-1 Maneuver	337	346	646	337	346	790	1128	-	-	1287	-	-
Stage 1	615	592	-	694	654	-	-	-	-	-	-	-
Stage 2	686	643	-	608	583	-	-	-	-	-	-	-
Platoon blocked, %								-	-	-	-	-
Mov Cap-1 Maneuver	326	332	646	316	332	790	1128	-	-	1287	-	-
Mov Cap-2 Maneuver	326	332	-	316	332	-	-	-	-	-	-	-
Stage 1	593	589	-	670	631	-	-	-	-	-	-	-
Stage 2	660	620	-	586	580	-	-	-	-	-	-	-

Approach	EB		WB		NB		SB		
HCM Control Delay, s	12.9		15.5		1		0.1		
HCM LOS	B		C						

Minor Lane/Major Mvmt	NBL	NBT	NBR	EBLn1	WBLn1	WBLn2	SBL	SBT	SBR
Capacity (veh/h)	1128	-	-	487	316	790	1287	-	-
HCM Lane V/C Ratio	0.03	-	-	0.062	0.036	0.003	0.004	-	-
HCM Control Delay (s)	8.3	0	-	12.9	16.8	9.6	7.8	0	-
HCM Lane LOS	A	A	-	B	C	A	A	A	-
HCM 95th %tile Q(veh)	0.1	-	-	0.2	0.1	0	0	-	-

Intersection												
Int Delay, s/veh	1.4											
Movement	EBL	EBT	EBR	WBL	WBT	WBR	NBL	NBT	NBR	SBL	SBT	SBR
Lane Configurations		↕			↕	↕		↕	↕		↕	
Traffic Vol, veh/h	15	1	12	13	0	7	29	307	14	2	260	6
Future Vol, veh/h	15	1	12	13	0	7	29	307	14	2	260	6
Conflicting Peds, #/hr	0	0	0	0	0	0	0	0	0	0	0	0
Sign Control	Stop	Stop	Stop	Stop	Stop	Stop	Free	Free	Free	Free	Free	Free
RT Channelized	-	-	None	-	-	None	-	-	None	-	-	None
Storage Length	-	-	-	-	-	0	-	-	350	-	-	-
Veh in Median Storage, #	-	0	-	-	0	-	-	0	-	-	0	-
Grade, %	-	0	-	-	0	-	-	0	-	-	0	-
Peak Hour Factor	92	92	92	92	92	92	92	92	92	92	92	92
Heavy Vehicles, %	4	4	4	4	4	4	4	4	4	4	4	4
Mvmt Flow	16	1	13	14	0	8	32	334	15	2	283	7

Major/Minor	Minor2		Minor1			Major1			Major2			
Conflicting Flow All	701	704	287	696	692	334	290	0	0	349	0	0
Stage 1	291	291	-	398	398	-	-	-	-	-	-	-
Stage 2	410	413	-	298	294	-	-	-	-	-	-	-
Critical Hdwy	7.14	6.54	6.24	7.14	6.54	6.24	4.14	-	-	4.14	-	-
Critical Hdwy Stg 1	6.14	5.54	-	6.14	5.54	-	-	-	-	-	-	-
Critical Hdwy Stg 2	6.14	5.54	-	6.14	5.54	-	-	-	-	-	-	-
Follow-up Hdwy	3.536	4.036	3.336	3.536	4.036	3.336	2.236	-	-	2.236	-	-
Pot Cap-1 Maneuver	351	359	747	353	365	703	1260	-	-	1199	-	-
Stage 1	713	668	-	624	599	-	-	-	-	-	-	-
Stage 2	615	590	-	706	666	-	-	-	-	-	-	-
Platoon blocked, %								-	-	-	-	-
Mov Cap-1 Maneuver	338	347	747	337	353	703	1260	-	-	1199	-	-
Mov Cap-2 Maneuver	338	347	-	337	353	-	-	-	-	-	-	-
Stage 1	690	667	-	604	580	-	-	-	-	-	-	-
Stage 2	589	571	-	691	665	-	-	-	-	-	-	-

Approach	EB		WB			NB			SB		
HCM Control Delay, s	13.7		14.1			0.7			0.1		
HCM LOS	B		B								

Minor Lane/Major Mvmt	NBL	NBT	NBR	EBLn1	WBLn1	WBLn2	SBL	SBT	SBR
Capacity (veh/h)	1260	-	-	442	337	703	1199	-	-
HCM Lane V/C Ratio	0.025	-	-	0.069	0.042	0.011	0.002	-	-
HCM Control Delay (s)	7.9	0	-	13.7	16.2	10.2	8	0	-
HCM Lane LOS	A	A	-	B	C	B	A	A	-
HCM 95th %tile Q(veh)	0.1	-	-	0.2	0.1	0	0	-	-

Intersection												
Int Delay, s/veh	1.7											
Movement	EBL	EBT	EBR	WBL	WBT	WBR	NBL	NBT	NBR	SBL	SBT	SBR
Lane Configurations		↕			↕	↕		↕	↕		↕	
Traffic Vol, veh/h	8	0	16	23	0	6	27	189	27	8	298	26
Future Vol, veh/h	8	0	16	23	0	6	27	189	27	8	298	26
Conflicting Peds, #/hr	0	0	0	0	0	0	0	0	0	0	0	0
Sign Control	Stop	Stop	Stop	Stop	Stop	Stop	Free	Free	Free	Free	Free	Free
RT Channelized	-	-	None	-	-	None	-	-	None	-	-	None
Storage Length	-	-	-	-	-	0	-	-	350	-	-	-
Veh in Median Storage, #	-	0	-	-	0	-	-	0	-	-	0	-
Grade, %	-	0	-	-	0	-	-	0	-	-	0	-
Peak Hour Factor	79	79	79	79	79	79	79	79	79	79	79	79
Heavy Vehicles, %	6	6	6	6	6	6	6	6	6	6	6	6
Mvmt Flow	10	0	20	29	0	8	34	239	34	10	377	33

Major/Minor	Minor2		Minor1		Major1			Major2				
Conflicting Flow All	742	755	394	731	737	239	410	0	0	273	0	0
Stage 1	414	414	-	307	307	-	-	-	-	-	-	-
Stage 2	328	341	-	424	430	-	-	-	-	-	-	-
Critical Hdwy	7.16	6.56	6.26	7.16	6.56	6.26	4.16	-	-	4.16	-	-
Critical Hdwy Stg 1	6.16	5.56	-	6.16	5.56	-	-	-	-	-	-	-
Critical Hdwy Stg 2	6.16	5.56	-	6.16	5.56	-	-	-	-	-	-	-
Follow-up Hdwy	3.554	4.054	3.354	3.554	4.054	3.354	2.254	-	-	2.254	-	-
Pot Cap-1 Maneuver	327	333	646	332	341	790	1128	-	-	1267	-	-
Stage 1	608	586	-	694	654	-	-	-	-	-	-	-
Stage 2	676	632	-	600	577	-	-	-	-	-	-	-
Platoon blocked, %								-	-	-	-	-
Mov Cap-1 Maneuver	313	318	646	310	325	790	1128	-	-	1267	-	-
Mov Cap-2 Maneuver	313	318	-	310	325	-	-	-	-	-	-	-
Stage 1	586	580	-	669	630	-	-	-	-	-	-	-
Stage 2	645	609	-	575	571	-	-	-	-	-	-	-

Approach	EB		WB		NB		SB	
HCM Control Delay, s	13.1		16.1		0.9		0.2	
HCM LOS	B		C					

Minor Lane/Major Mvmt	NBL	NBT	NBR	EBLn1	WBLn1	WBLn2	SBL	SBT	SBR
Capacity (veh/h)	1128	-	-	477	310	790	1267	-	-
HCM Lane V/C Ratio	0.03	-	-	0.064	0.094	0.01	0.008	-	-
HCM Control Delay (s)	8.3	0	-	13.1	17.8	9.6	7.9	0	-
HCM Lane LOS	A	A	-	B	C	A	A	A	-
HCM 95th %tile Q(veh)	0.1	-	-	0.2	0.3	0	0	-	-

Intersection												
Int Delay, s/veh	1.8											
Movement	EBL	EBT	EBR	WBL	WBT	WBR	NBL	NBT	NBR	SBL	SBT	SBR
Lane Configurations		↕			↕	↕		↕	↕		↕	
Traffic Vol, veh/h	15	1	12	27	0	11	29	307	28	6	260	6
Future Vol, veh/h	15	1	12	27	0	11	29	307	28	6	260	6
Conflicting Peds, #/hr	0	0	0	0	0	0	0	0	0	0	0	0
Sign Control	Stop	Stop	Stop	Stop	Stop	Stop	Free	Free	Free	Free	Free	Free
RT Channelized	-	-	None	-	-	None	-	-	None	-	-	None
Storage Length	-	-	-	-	-	0	-	-	350	-	-	-
Veh in Median Storage, #	-	0	-	-	0	-	-	0	-	-	0	-
Grade, %	-	0	-	-	0	-	-	0	-	-	0	-
Peak Hour Factor	92	92	92	92	92	92	92	92	92	92	92	92
Heavy Vehicles, %	4	4	4	4	4	4	4	4	4	4	4	4
Mvmt Flow	16	1	13	29	0	12	32	334	30	7	283	7

Major/Minor	Minor2		Minor1		Major1			Major2				
Conflicting Flow All	720	729	287	706	702	334	290	0	0	364	0	0
Stage 1	301	301	-	398	398	-	-	-	-	-	-	-
Stage 2	419	428	-	308	304	-	-	-	-	-	-	-
Critical Hdwy	7.14	6.54	6.24	7.14	6.54	6.24	4.14	-	-	4.14	-	-
Critical Hdwy Stg 1	6.14	5.54	-	6.14	5.54	-	-	-	-	-	-	-
Critical Hdwy Stg 2	6.14	5.54	-	6.14	5.54	-	-	-	-	-	-	-
Follow-up Hdwy	3.536	4.036	3.336	3.536	4.036	3.336	2.236	-	-	2.236	-	-
Pot Cap-1 Maneuver	341	347	747	348	360	703	1260	-	-	1184	-	-
Stage 1	704	661	-	624	599	-	-	-	-	-	-	-
Stage 2	608	581	-	698	659	-	-	-	-	-	-	-
Platoon blocked, %								-	-	-	-	-
Mov Cap-1 Maneuver	325	333	747	331	346	703	1260	-	-	1184	-	-
Mov Cap-2 Maneuver	325	333	-	331	346	-	-	-	-	-	-	-
Stage 1	681	656	-	604	580	-	-	-	-	-	-	-
Stage 2	579	562	-	680	654	-	-	-	-	-	-	-

Approach	EB		WB		NB		SB	
HCM Control Delay, s	14		15		0.6		0.2	
HCM LOS	B		C					

Minor Lane/Major Mvmt	NBL	NBT	NBR	EBLn1	WBLn1	WBLn2	SBL	SBT	SBR
Capacity (veh/h)	1260	-	-	429	331	703	1184	-	-
HCM Lane V/C Ratio	0.025	-	-	0.071	0.089	0.017	0.006	-	-
HCM Control Delay (s)	7.9	0	-	14	16.9	10.2	8.1	0	-
HCM Lane LOS	A	A	-	B	C	B	A	A	-
HCM 95th %tile Q(veh)	0.1	-	-	0.2	0.3	0.1	0	-	-

Intersection												
Int Delay, s/veh	1.3											
Movement	EBL	EBT	EBR	WBL	WBT	WBR	NBL	NBT	NBR	SBL	SBT	SBR
Lane Configurations		↔			↔	↔		↔	↔		↔	
Traffic Vol, veh/h	8	0	16	9	0	2	27	189	13	4	298	26
Future Vol, veh/h	8	0	16	9	0	2	27	189	13	4	298	26
Conflicting Peds, #/hr	0	0	0	0	0	0	0	0	0	0	0	0
Sign Control	Stop	Stop	Stop	Stop	Stop	Stop	Free	Free	Free	Free	Free	Free
RT Channelized	-	-	None	-	-	None	-	-	None	-	-	None
Storage Length	-	-	-	-	-	0	-	-	350	-	-	-
Veh in Median Storage, #	-	0	-	-	0	-	-	0	-	-	0	-
Grade, %	-	0	-	-	0	-	-	0	-	-	0	-
Peak Hour Factor	79	79	79	79	79	79	79	79	79	79	79	79
Heavy Vehicles, %	6	6	6	6	6	6	6	6	6	6	6	6
Mvmt Flow	10	0	20	11	0	3	34	239	16	5	377	33

Major/Minor	Minor2		Minor1		Major1		Major2					
Conflicting Flow All	721	727	394	721	727	239	410	0	0	255	0	0
Stage 1	404	404	-	307	307	-	-	-	-	-	-	-
Stage 2	317	323	-	414	420	-	-	-	-	-	-	-
Critical Hdwy	7.16	6.56	6.26	7.16	6.56	6.26	4.16	-	-	4.16	-	-
Critical Hdwy Stg 1	6.16	5.56	-	6.16	5.56	-	-	-	-	-	-	-
Critical Hdwy Stg 2	6.16	5.56	-	6.16	5.56	-	-	-	-	-	-	-
Follow-up Hdwy	3.554	4.054	3.354	3.554	4.054	3.354	2.254	-	-	2.254	-	-
Pot Cap-1 Maneuver	337	346	646	337	346	790	1128	-	-	1287	-	-
Stage 1	615	592	-	694	654	-	-	-	-	-	-	-
Stage 2	686	643	-	608	583	-	-	-	-	-	-	-
Platoon blocked, %								-	-	-	-	-
Mov Cap-1 Maneuver	326	332	646	316	332	790	1128	-	-	1287	-	-
Mov Cap-2 Maneuver	326	332	-	316	332	-	-	-	-	-	-	-
Stage 1	593	589	-	670	631	-	-	-	-	-	-	-
Stage 2	660	620	-	586	580	-	-	-	-	-	-	-

Approach	EB		WB		NB		SB	
HCM Control Delay, s	12.9		15.5		1		0.1	
HCM LOS	B		C					

Minor Lane/Major Mvmt	NBL	NBT	NBR	EBLn1	WBLn1	WBLn2	SBL	SBT	SBR
Capacity (veh/h)	1128	-	-	487	316	790	1287	-	-
HCM Lane V/C Ratio	0.03	-	-	0.062	0.036	0.003	0.004	-	-
HCM Control Delay (s)	8.3	0	-	12.9	16.8	9.6	7.8	0	-
HCM Lane LOS	A	A	-	B	C	A	A	A	-
HCM 95th %tile Q(veh)	0.1	-	-	0.2	0.1	0	0	-	-

Intersection												
Int Delay, s/veh	1.2											
Movement	EBL	EBT	EBR	WBL	WBT	WBR	NBL	NBT	NBR	SBL	SBT	SBR
Lane Configurations		↕			↕	↕		↕	↕		↕	
Traffic Vol, veh/h	15	1	12	13	0	7	29	455	14	2	385	6
Future Vol, veh/h	15	1	12	13	0	7	29	455	14	2	385	6
Conflicting Peds, #/hr	0	0	0	0	0	0	0	0	0	0	0	0
Sign Control	Stop	Stop	Stop	Stop	Stop	Stop	Free	Free	Free	Free	Free	Free
RT Channelized	-	-	None	-	-	None	-	-	None	-	-	None
Storage Length	-	-	-	-	-	0	-	-	350	-	-	-
Veh in Median Storage, #	-	0	-	-	0	-	-	0	-	-	0	-
Grade, %	-	0	-	-	0	-	-	0	-	-	0	-
Peak Hour Factor	92	92	92	92	92	92	92	92	92	92	92	92
Heavy Vehicles, %	4	4	4	4	4	4	4	4	4	4	4	4
Mvmt Flow	16	1	13	14	0	8	32	495	15	2	418	7

Major/Minor	Minor2		Minor1		Major1			Major2				
Conflicting Flow All	997	1000	422	992	988	495	425	0	0	510	0	0
Stage 1	426	426	-	559	559	-	-	-	-	-	-	-
Stage 2	571	574	-	433	429	-	-	-	-	-	-	-
Critical Hdwy	7.14	6.54	6.24	7.14	6.54	6.24	4.14	-	-	4.14	-	-
Critical Hdwy Stg 1	6.14	5.54	-	6.14	5.54	-	-	-	-	-	-	-
Critical Hdwy Stg 2	6.14	5.54	-	6.14	5.54	-	-	-	-	-	-	-
Follow-up Hdwy	3.536	4.036	3.336	3.536	4.036	3.336	2.236	-	-	2.236	-	-
Pot Cap-1 Maneuver	221	241	627	223	245	571	1124	-	-	1045	-	-
Stage 1	602	582	-	510	508	-	-	-	-	-	-	-
Stage 2	502	500	-	597	581	-	-	-	-	-	-	-
Platoon blocked, %								-	-	-	-	-
Mov Cap-1 Maneuver	211	231	627	211	234	571	1124	-	-	1045	-	-
Mov Cap-2 Maneuver	211	231	-	211	234	-	-	-	-	-	-	-
Stage 1	578	580	-	490	488	-	-	-	-	-	-	-
Stage 2	475	480	-	582	579	-	-	-	-	-	-	-

Approach	EB		WB		NB		SB	
HCM Control Delay, s	18.6		19.1		0.5		0	
HCM LOS	C		C					

Minor Lane/Major Mvmt	NBL	NBT	NBR	EBLn1	WBLn1	WBLn2	SBL	SBT	SBR
Capacity (veh/h)	1124	-	-	296	211	571	1045	-	-
HCM Lane V/C Ratio	0.028	-	-	0.103	0.067	0.013	0.002	-	-
HCM Control Delay (s)	8.3	0	-	18.6	23.3	11.4	8.5	0	-
HCM Lane LOS	A	A	-	C	C	B	A	A	-
HCM 95th %tile Q(veh)	0.1	-	-	0.3	0.2	0	0	-	-

Intersection												
Int Delay, s/veh	1.2											
Movement	EBL	EBT	EBR	WBL	WBT	WBR	NBL	NBT	NBR	SBL	SBT	SBR
Lane Configurations		↕			↕	↕		↕	↕		↕	
Traffic Vol, veh/h	8	0	16	9	0	2	27	383	13	4	671	26
Future Vol, veh/h	8	0	16	9	0	2	27	383	13	4	671	26
Conflicting Peds, #/hr	0	0	0	0	0	0	0	0	0	0	0	0
Sign Control	Stop	Stop	Stop	Stop	Stop	Stop	Free	Free	Free	Free	Free	Free
RT Channelized	-	-	None	-	-	None	-	-	None	-	-	None
Storage Length	-	-	-	-	-	0	-	-	350	-	-	-
Veh in Median Storage, #	-	0	-	-	0	-	-	0	-	-	0	-
Grade, %	-	0	-	-	0	-	-	0	-	-	0	-
Peak Hour Factor	79	79	79	79	79	79	79	79	79	79	79	79
Heavy Vehicles, %	6	6	6	6	6	6	6	6	6	6	6	6
Mvmt Flow	10	0	20	11	0	3	34	485	16	5	849	33

Major/Minor	Minor2		Minor1		Major1		Major2					
Conflicting Flow All	1439	1445	866	1439	1445	485	882	0	0	501	0	0
Stage 1	876	876	-	553	553	-	-	-	-	-	-	-
Stage 2	563	569	-	886	892	-	-	-	-	-	-	-
Critical Hdwy	7.16	6.56	6.26	7.16	6.56	6.26	4.16	-	-	4.16	-	-
Critical Hdwy Stg 1	6.16	5.56	-	6.16	5.56	-	-	-	-	-	-	-
Critical Hdwy Stg 2	6.16	5.56	-	6.16	5.56	-	-	-	-	-	-	-
Follow-up Hdwy	3.554	4.054	3.354	3.554	4.054	3.354	2.254	-	-	2.254	-	-
Pot Cap-1 Maneuver	108	129	347	108	129	574	750	-	-	1043	-	-
Stage 1	338	361	-	510	508	-	-	-	-	-	-	-
Stage 2	504	499	-	334	355	-	-	-	-	-	-	-
Platoon blocked, %								-	-	-	-	-
Mov Cap-1 Maneuver	102	120	347	96	120	574	750	-	-	1043	-	-
Mov Cap-2 Maneuver	102	120	-	96	120	-	-	-	-	-	-	-
Stage 1	317	358	-	478	476	-	-	-	-	-	-	-
Stage 2	470	468	-	312	352	-	-	-	-	-	-	-

Approach	EB		WB		NB		SB	
HCM Control Delay, s	27.1		40.9		0.6		0	
HCM LOS	D		E					

Minor Lane/Major Mvmt	NBL	NBT	NBR	EBLn1	WBLn1	WBLn2	SBL	SBT	SBR
Capacity (veh/h)	750	-	-	193	96	574	1043	-	-
HCM Lane V/C Ratio	0.046	-	-	0.157	0.119	0.004	0.005	-	-
HCM Control Delay (s)	10	0	-	27.1	47.5	11.3	8.5	0	-
HCM Lane LOS	B	A	-	D	E	B	A	A	-
HCM 95th %tile Q(veh)	0.1	-	-	0.5	0.4	0	0	-	-

Intersection												
Int Delay, s/veh	1.7											
Movement	EBL	EBT	EBR	WBL	WBT	WBR	NBL	NBT	NBR	SBL	SBT	SBR
Lane Configurations		↔			↔	↔		↔	↔		↔	
Traffic Vol, veh/h	15	1	12	13	0	7	29	818	14	2	630	6
Future Vol, veh/h	15	1	12	13	0	7	29	818	14	2	630	6
Conflicting Peds, #/hr	0	0	0	0	0	0	0	0	0	0	0	0
Sign Control	Stop	Stop	Stop	Stop	Stop	Stop	Free	Free	Free	Free	Free	Free
RT Channelized	-	-	None	-	-	None	-	-	None	-	-	None
Storage Length	-	-	-	-	-	0	-	-	350	-	-	-
Veh in Median Storage, #	-	0	-	-	0	-	-	0	-	-	0	-
Grade, %	-	0	-	-	0	-	-	0	-	-	0	-
Peak Hour Factor	92	92	92	92	92	92	92	92	92	92	92	92
Heavy Vehicles, %	4	4	4	4	4	4	4	4	4	4	4	4
Mvmt Flow	16	1	13	14	0	8	32	889	15	2	685	7

Major/Minor	Minor2		Minor1		Major1		Major2					
Conflicting Flow All	1658	1661	689	1653	1649	889	692	0	0	904	0	0
Stage 1	693	693	-	953	953	-	-	-	-	-	-	-
Stage 2	965	968	-	700	696	-	-	-	-	-	-	-
Critical Hdwy	7.14	6.54	6.24	7.14	6.54	6.24	4.14	-	-	4.14	-	-
Critical Hdwy Stg 1	6.14	5.54	-	6.14	5.54	-	-	-	-	-	-	-
Critical Hdwy Stg 2	6.14	5.54	-	6.14	5.54	-	-	-	-	-	-	-
Follow-up Hdwy	3.536	4.036	3.336	3.536	4.036	3.336	2.236	-	-	2.236	-	-
Pot Cap-1 Maneuver	77	96	442	78	98	339	894	-	-	744	-	-
Stage 1	430	442	-	309	335	-	-	-	-	-	-	-
Stage 2	304	330	-	427	440	-	-	-	-	-	-	-
Platoon blocked, %								-	-	-	-	-
Mov Cap-1 Maneuver	71	89	442	71	91	339	894	-	-	744	-	-
Mov Cap-2 Maneuver	71	89	-	71	91	-	-	-	-	-	-	-
Stage 1	399	440	-	287	311	-	-	-	-	-	-	-
Stage 2	276	306	-	412	438	-	-	-	-	-	-	-

Approach	EB		WB		NB		SB			
HCM Control Delay, s	48.7		49.7		0.3		0			
HCM LOS	E		E							

Minor Lane/Major Mvmt	NBL	NBT	NBR	EBLn1	WBLn1	WBLn2	SBL	SBT	SBR
Capacity (veh/h)	894	-	-	112	71	339	744	-	-
HCM Lane V/C Ratio	0.035	-	-	0.272	0.199	0.022	0.003	-	-
HCM Control Delay (s)	9.2	0	-	48.7	67.9	15.9	9.9	0	-
HCM Lane LOS	A	A	-	E	F	C	A	A	-
HCM 95th %tile Q(veh)	0.1	-	-	1	0.7	0.1	0	-	-

Intersection												
Int Delay, s/veh	1.6											
Movement	EBL	EBT	EBR	WBL	WBT	WBR	NBL	NBT	NBR	SBL	SBT	SBR
Lane Configurations		↕			↕	↕		↕	↕		↕	
Traffic Vol, veh/h	8	0	16	23	0	6	27	280	27	8	442	26
Future Vol, veh/h	8	0	16	23	0	6	27	280	27	8	442	26
Conflicting Peds, #/hr	0	0	0	0	0	0	0	0	0	0	0	0
Sign Control	Stop	Stop	Stop	Stop	Stop	Stop	Free	Free	Free	Free	Free	Free
RT Channelized	-	-	None	-	-	None	-	-	None	-	-	None
Storage Length	-	-	-	-	-	0	-	-	350	-	-	-
Veh in Median Storage, #	-	0	-	-	0	-	-	0	-	-	0	-
Grade, %	-	0	-	-	0	-	-	0	-	-	0	-
Peak Hour Factor	79	79	79	79	79	79	79	79	79	79	79	79
Heavy Vehicles, %	6	6	6	6	6	6	6	6	6	6	6	6
Mvmt Flow	10	0	20	29	0	8	34	354	34	10	559	33

Major/Minor	Minor2		Minor1		Major1		Major2					
Conflicting Flow All	1039	1052	576	1028	1034	354	592	0	0	388	0	0
Stage 1	596	596	-	422	422	-	-	-	-	-	-	-
Stage 2	443	456	-	606	612	-	-	-	-	-	-	-
Critical Hdwy	7.16	6.56	6.26	7.16	6.56	6.26	4.16	-	-	4.16	-	-
Critical Hdwy Stg 1	6.16	5.56	-	6.16	5.56	-	-	-	-	-	-	-
Critical Hdwy Stg 2	6.16	5.56	-	6.16	5.56	-	-	-	-	-	-	-
Follow-up Hdwy	3.554	4.054	3.354	3.554	4.054	3.354	2.254	-	-	2.254	-	-
Pot Cap-1 Maneuver	205	223	509	209	228	681	964	-	-	1149	-	-
Stage 1	483	486	-	602	581	-	-	-	-	-	-	-
Stage 2	586	561	-	477	478	-	-	-	-	-	-	-
Platoon blocked, %								-	-	-	-	-
Mov Cap-1 Maneuver	194	210	509	192	215	681	964	-	-	1149	-	-
Mov Cap-2 Maneuver	194	210	-	192	215	-	-	-	-	-	-	-
Stage 1	461	480	-	575	555	-	-	-	-	-	-	-
Stage 2	553	536	-	452	472	-	-	-	-	-	-	-

Approach	EB		WB		NB		SB	
HCM Control Delay, s	17		23.6		0.7		0.1	
HCM LOS	C		C					

Minor Lane/Major Mvmt	NBL	NBT	NBR	EBLn1	WBLn1	WBLn2	SBL	SBT	SBR
Capacity (veh/h)	964	-	-	330	192	681	1149	-	-
HCM Lane V/C Ratio	0.035	-	-	0.092	0.152	0.011	0.009	-	-
HCM Control Delay (s)	8.9	0	-	17	27.1	10.3	8.2	0	-
HCM Lane LOS	A	A	-	C	D	B	A	A	-
HCM 95th %tile Q(veh)	0.1	-	-	0.3	0.5	0	0	-	-

Intersection												
Int Delay, s/veh	1.7											
Movement	EBL	EBT	EBR	WBL	WBT	WBR	NBL	NBT	NBR	SBL	SBT	SBR
Lane Configurations		↔			↔	↔		↔	↔		↔	
Traffic Vol, veh/h	15	1	12	27	0	11	29	455	28	6	385	6
Future Vol, veh/h	15	1	12	27	0	11	29	455	28	6	385	6
Conflicting Peds, #/hr	0	0	0	0	0	0	0	0	0	0	0	0
Sign Control	Stop	Stop	Stop	Stop	Stop	Stop	Free	Free	Free	Free	Free	Free
RT Channelized	-	-	None	-	-	None	-	-	None	-	-	None
Storage Length	-	-	-	-	-	0	-	-	350	-	-	-
Veh in Median Storage, #	-	0	-	-	0	-	-	0	-	-	0	-
Grade, %	-	0	-	-	0	-	-	0	-	-	0	-
Peak Hour Factor	92	92	92	92	92	92	92	92	92	92	92	92
Heavy Vehicles, %	4	4	4	4	4	4	4	4	4	4	4	4
Mvmt Flow	16	1	13	29	0	12	32	495	30	7	418	7

Major/Minor	Minor2		Minor1		Major1			Major2				
Conflicting Flow All	1016	1025	422	1002	998	495	425	0	0	525	0	0
Stage 1	436	436	-	559	559	-	-	-	-	-	-	-
Stage 2	580	589	-	443	439	-	-	-	-	-	-	-
Critical Hdwy	7.14	6.54	6.24	7.14	6.54	6.24	4.14	-	-	4.14	-	-
Critical Hdwy Stg 1	6.14	5.54	-	6.14	5.54	-	-	-	-	-	-	-
Critical Hdwy Stg 2	6.14	5.54	-	6.14	5.54	-	-	-	-	-	-	-
Follow-up Hdwy	3.536	4.036	3.336	3.536	4.036	3.336	2.236	-	-	2.236	-	-
Pot Cap-1 Maneuver	215	233	627	219	242	571	1124	-	-	1032	-	-
Stage 1	595	576	-	510	508	-	-	-	-	-	-	-
Stage 2	497	492	-	590	575	-	-	-	-	-	-	-
Platoon blocked, %								-	-	-	-	-
Mov Cap-1 Maneuver	203	222	627	206	230	571	1124	-	-	1032	-	-
Mov Cap-2 Maneuver	203	222	-	206	230	-	-	-	-	-	-	-
Stage 1	571	571	-	490	488	-	-	-	-	-	-	-
Stage 2	467	472	-	571	570	-	-	-	-	-	-	-

Approach	EB	WB	NB	SB
HCM Control Delay, s	19	21.3	0.5	0.1
HCM LOS	C	C		

Minor Lane/Major Mvmt	NBL	NBT	NBR	EBLn1	WBLn1	WBLn2	SBL	SBT	SBR
Capacity (veh/h)	1124	-	-	287	206	571	1032	-	-
HCM Lane V/C Ratio	0.028	-	-	0.106	0.142	0.021	0.006	-	-
HCM Control Delay (s)	8.3	0	-	19	25.4	11.4	8.5	0	-
HCM Lane LOS	A	A	-	C	D	B	A	A	-
HCM 95th %tile Q(veh)	0.1	-	-	0.4	0.5	0.1	0	-	-

Intersection												
Int Delay, s/veh	1.2											
Movement	EBL	EBT	EBR	WBL	WBT	WBR	NBL	NBT	NBR	SBL	SBT	SBR
Lane Configurations		↔			↔	↔	↔	↔	↔	↔	↔	↔
Traffic Vol, veh/h	8	0	16	23	0	6	27	383	27	8	671	26
Future Vol, veh/h	8	0	16	23	0	6	27	383	27	8	671	26
Conflicting Peds, #/hr	0	0	0	0	0	0	0	0	0	0	0	0
Sign Control	Stop	Stop	Stop	Stop	Stop	Stop	Free	Free	Free	Free	Free	Free
RT Channelized	-	-	None	-	-	None	-	-	None	-	-	None
Storage Length	-	-	-	-	-	0	0	-	350	0	-	-
Veh in Median Storage, #	-	1	-	-	1	-	-	0	-	-	0	-
Grade, %	-	0	-	-	0	-	-	0	-	-	0	-
Peak Hour Factor	79	79	79	79	79	79	79	79	79	79	79	79
Heavy Vehicles, %	6	6	6	6	6	6	6	6	6	6	6	6
Mvmt Flow	10	0	20	29	0	8	34	485	34	10	849	33

Major/Minor	Minor2		Minor1		Major1		Major2					
Conflicting Flow All	1460	1473	866	1449	1455	485	882	0	0	519	0	0
Stage 1	886	886	-	553	553	-	-	-	-	-	-	-
Stage 2	574	587	-	896	902	-	-	-	-	-	-	-
Critical Hdwy	7.16	6.56	6.26	7.16	6.56	6.26	4.16	-	-	4.16	-	-
Critical Hdwy Stg 1	6.16	5.56	-	6.16	5.56	-	-	-	-	-	-	-
Critical Hdwy Stg 2	6.16	5.56	-	6.16	5.56	-	-	-	-	-	-	-
Follow-up Hdwy	3.554	4.054	3.354	3.554	4.054	3.354	2.254	-	-	2.254	-	-
Pot Cap-1 Maneuver	105	124	347	107	127	574	750	-	-	1027	-	-
Stage 1	334	357	-	510	508	-	-	-	-	-	-	-
Stage 2	497	490	-	329	351	-	-	-	-	-	-	-
Platoon blocked, %								-	-	-	-	-
Mov Cap-1 Maneuver	99	117	347	97	120	574	750	-	-	1027	-	-
Mov Cap-2 Maneuver	215	234	-	199	225	-	-	-	-	-	-	-
Stage 1	319	353	-	487	485	-	-	-	-	-	-	-
Stage 2	468	468	-	307	347	-	-	-	-	-	-	-

Approach	EB	WB	NB	SB
HCM Control Delay, s	19	23.1	0.6	0.1
HCM LOS	C	C		

Minor Lane/Major Mvmt	NBL	NBT	NBR	EBLn1WBLn1WBLn2	SBL	SBT	SBR
Capacity (veh/h)	750	-	-	288	199	574	1027
HCM Lane V/C Ratio	0.046	-	-	0.105	0.146	0.013	0.01
HCM Control Delay (s)	10	-	-	19	26.2	11.4	8.5
HCM Lane LOS	B	-	-	C	D	B	A
HCM 95th %tile Q(veh)	0.1	-	-	0.3	0.5	0	0

Intersection												
Int Delay, s/veh	1.3											
Movement	EBL	EBT	EBR	WBL	WBT	WBR	NBL	NBT	NBR	SBL	SBT	SBR
Lane Configurations		↔			↔	↔	↔	↔	↔	↔	↔	↔
Traffic Vol, veh/h	15	1	12	27	0	11	29	455	28	6	385	6
Future Vol, veh/h	15	1	12	27	0	11	29	455	28	6	385	6
Conflicting Peds, #/hr	0	0	0	0	0	0	0	0	0	0	0	0
Sign Control	Stop	Stop	Stop	Stop	Stop	Stop	Free	Free	Free	Free	Free	Free
RT Channelized	-	-	None	-	-	None	-	-	None	-	-	None
Storage Length	-	-	-	-	-	0	0	-	350	0	-	-
Veh in Median Storage, #	-	1	-	-	1	-	-	0	-	-	0	-
Grade, %	-	0	-	-	0	-	-	0	-	-	0	-
Peak Hour Factor	92	92	92	92	92	92	92	92	92	92	92	92
Heavy Vehicles, %	4	4	4	4	4	4	4	4	4	4	4	4
Mvmt Flow	16	1	13	29	0	12	32	495	30	7	418	7

Major/Minor	Minor2		Minor1		Major1			Major2				
Conflicting Flow All	1016	1025	422	1002	998	495	425	0	0	525	0	0
Stage 1	436	436	-	559	559	-	-	-	-	-	-	-
Stage 2	580	589	-	443	439	-	-	-	-	-	-	-
Critical Hdwy	7.14	6.54	6.24	7.14	6.54	6.24	4.14	-	-	4.14	-	-
Critical Hdwy Stg 1	6.14	5.54	-	6.14	5.54	-	-	-	-	-	-	-
Critical Hdwy Stg 2	6.14	5.54	-	6.14	5.54	-	-	-	-	-	-	-
Follow-up Hdwy	3.536	4.036	3.336	3.536	4.036	3.336	2.236	-	-	2.236	-	-
Pot Cap-1 Maneuver	215	233	627	219	242	571	1124	-	-	1032	-	-
Stage 1	595	576	-	510	508	-	-	-	-	-	-	-
Stage 2	497	492	-	590	575	-	-	-	-	-	-	-
Platoon blocked, %								-	-	-	-	-
Mov Cap-1 Maneuver	205	225	627	208	234	571	1124	-	-	1032	-	-
Mov Cap-2 Maneuver	327	337	-	331	342	-	-	-	-	-	-	-
Stage 1	578	572	-	496	494	-	-	-	-	-	-	-
Stage 2	473	478	-	573	571	-	-	-	-	-	-	-

Approach	EB		WB		NB		SB	
HCM Control Delay, s	14.4		15.3		0.5		0.1	
HCM LOS	B		C					

Minor Lane/Major Mvmt	NBL	NBT	NBR	EBLn1	WBLn1	WBLn2	SBL	SBT	SBR
Capacity (veh/h)	1124	-	-	412	331	571	1032	-	-
HCM Lane V/C Ratio	0.028	-	-	0.074	0.089	0.021	0.006	-	-
HCM Control Delay (s)	8.3	-	-	14.4	16.9	11.4	8.5	-	-
HCM Lane LOS	A	-	-	B	C	B	A	-	-
HCM 95th %tile Q(veh)	0.1	-	-	0.2	0.3	0.1	0	-	-

APPENDIX F

Maintenance and Repair Barbarick Subdivision Bylaws



ROBERT C. "BOB" BALINK El Paso County, CO
02/12/2008 07:54:37 AM
Doc \$0.00 Page
Rec \$141.00 1 of 28 208016289



**DECLARATION AND BYLAWS
OF
BARBARICK SUBDIVISION PROPERTY OWNERS ASSOCIATION, INC.**

The following Declaration and Bylaws of BARBARICK SUBDIVISION PROPERTY OWNERS ASSOCIATION, INC., were duly adopted pursuant to the Colorado Non-Profit Corporation Act.

WITNESSETH:

WHEREAS, Vollmer Investments, LLC, a Colorado limited liability company ("Declarant"), is the owner of certain real property described on Exhibit A attached hereto and made a part hereof (the "Property").

WHEREAS, Declarant has subdivided the Property into four separate lots (each a "Lot");

WHEREAS, Declarant desires to (a) subject the Lots to the covenants, conditions, restrictions, easements, charges and liens set forth herein, each and all of which is and are for the benefit of said Lots and each Owner thereof; and (b) set forth certain Bylaws for Barbarick Subdivision Property Owners Association, Inc. (hereinafter referred to as "Association"), a non-profit corporation incorporated under the laws of the State of Colorado for the purpose of exercising the powers and functions granted to it by this Declaration and the Association's Articles of Incorporation.

NOW, THEREFORE, Declarant hereby declares that the Property shall be held, transferred, sold, conveyed, improved and occupied subject to the covenants, conditions, restrictions, easements, charges and liens hereinafter set forth, which shall run with the Property and be binding on all parties having any right, title or interest in the Lots, their heirs, successors and assigns, and shall inure to the benefit of each Owner thereof.

ARTICLE I

NAME AND LOCATION OF ASSOCIATION

The name of the corporation is BARBARICK SUBDIVISION PROPERTY OWNERS ASSOCIATION, INC., a Colorado non-profit corporation, hereinafter referred to as the "Association." The initial principal office of the Association shall be located at 8715 Vollmer Road, Colorado Springs, CO 80908, but meetings of the Members and Directors may be held at such places within the County of El Paso as may be designated by the Board of Directors.

RECEIVED 1
NOV 08 2016 VERSION 1

RETURN TO COUNTY PLANNING DEPT.

FILE NO. VR6503

ARTICLE II

DEFINITIONS

2.1 Access Easement. "Access Easement" means the perpetual, non-exclusive ingress and egress easement located along the northerly and westerly boundaries of Lot 1 that provides access to and from Vollmer Road to Lots 2 and 3, and the perpetual, non-exclusive ingress and egress easement located along the northerly and easterly boundaries of Lot 3 that provides access to and from Vollmer Road and Vollmer Place to Lot 4, all as illustrated on the Plat.

2.2 Access Improvements. "Access Improvements" shall mean any grading, paving, curb, gutter, sidewalk and related improvements constructed on the Access Easement.

2.3 Articles of Incorporation. "Articles of Incorporation" shall mean the Articles of Incorporation of Barbarick Subdivision Property Owners Association, Inc., a Colorado non-profit corporation, as filed with the Secretary of State of Colorado on _____, 2008, under entity number _____, as the same may be amended from time to time.

2.4 Association. "Association" shall mean Barbarick Subdivision Property Owners Association, Inc., a Colorado nonprofit corporation.

2.5 Assessment. "Assessment" shall mean the Annual Assessment or Special Assessments imposed on the Owners in accordance with Article V below and any other costs, fees, or assessments that may be imposed on the Owners in accordance with the Articles or this Declaration.

2.6 Augmentation Plan. "Augmentation Plan" shall mean that certain Judgment and Decree Granting Underground Water Rights and Plan for Augmentation dated April 6, 2007, of the District Court for Water Division 2, State of Colorado, in Case No. 06CW35. The Augmentation Plan is recorded at Reception No. 207060552 of the El Paso County Recorder. The Augmentation Plan is incorporated herein by reference.

2.7 Board of Directors or Board. "Board of Directors" or "Board" shall mean the Board of Directors of the Association elected in accordance with this Declaration.

2.8 County. "County" shall mean El Paso County, Colorado.

2.9 Declarant. "Declarant" shall mean Vollmer Investments, LLC, a Colorado limited liability company.

2.10 Declaration. "Declaration" shall mean this Declaration as the same may be amended from time to time. The provisions in this Declaration shall also constitute the Bylaws of the

Association.

2.11 Designated Users. The "Designated Users" of an Owner shall mean any person or party, including, without limitation, the tenants, agents, licensees and invitees of an Owner of a Lot that is benefitted by the Access Easement and the Detention Easement.

2.12 Detention Agreement. "Detention Agreement" shall mean that certain Private Detention Basin/Stormwater Quality Best Management Practice Maintenance Agreement and Easement entered into between Declarant and El Paso County, by and through The Board of County Commissions of El Paso County, Colorado, recorded on Feb. 12, 2008, at Reception Number 208016288, which provides further obligations relating to the Detention Improvements, the terms of which, where applicable, are incorporated herein by this reference.

2.13 Detention Easement. "Detention Easement" means a perpetual, non-exclusive easement over and across portions of Lots 2 and 4 as illustrated on the Plat to be utilized solely for the purpose of constructing and maintaining drainage basins to provide storm water detention and control for the Lots.

2.14 Detention Improvements. "Detention Improvements" means the drainage basins and water runoff control facilities constructed by Declarant on Lots 2 and 4 in accordance with the Detention Agreement. The location of the Detention Improvements are illustrated on the Plat.

2.15 Easements. "Easements" shall refer to the Access Easement and the Detention Easement.

2.16 First Mortgage. "First Mortgage" shall mean any unpaid and outstanding mortgage, deed or trust or other security instrument recorded in the records of the office of the Clerk and Recorder of the County of El Paso, Colorado, pertaining to a Lot and having priority of record over all other recorded liens except those governmental liens made superior by statute (such as general ad valorem tax liens and special assessments).

2.17 First Mortgagee. "First Mortgagee" shall mean any person or entity named as a mortgagee or beneficiary under any First Mortgage.

2.18 Improvements. "Improvements" shall refer to the Access Improvements and the Detention Improvements.

2.19 Lot. "Lot" shall mean Lots 1, 2, 3, and 4 as designated on the Plat. "Lots" shall mean more than one Lot.

2.20 Member. "Member" shall mean each Owner holding fee title to a Lot and, therefore, holding a membership interest in the Association.

2.21 Owner or Owners. "Owner" shall mean the person or parties comprising of the fee title holder to Lots. "Owners" shall mean one or more of the Owners.

2.22 Plat. "Plat" shall mean the plat titled " _____ " as recorded in the real property records of El Paso County, Colorado, on February 12, 2008, under reception number 21872754, a copy of which is attached hereto as Exhibit B.

2.23 Property. "Property" shall mean that certain real property located in El Paso County, Colorado, legally described on Exhibit A attached hereto and incorporated herein by this reference.

2.24 Subdivision. "Subdivision" shall mean Barbarick Subdivision, El Paso County, Colorado.

2.25 Vollmer Road and Vollmer Place. "Vollmer Road" and "Vollmer Place" shall mean those public right-of-ways from which access to and from the Property is provided, both of which are illustrated on the Plat.

ARTICLE III

CREATION AND USE OF EASEMENTS.

3.1 Grant of Access Easement / Scope of Use. Subject to the terms, covenants, agreements, restrictions, and conditions of this Declaration and in consideration for the Assessments to be paid to the Association as provided herein, Declarant hereby declares, creates, and grants the Access Easement over, across, and upon portions of Lots 1 and 3 for the purpose of providing vehicular and pedestrian access, ingress, and egress to and from the Lots. The Access Easement shall be for the benefit of the Lots and may be used by the Owners of the Lots and their Designated Users. The Owners, their respective Designated Users, and their respective successors and assigns, shall use the Access Easement solely for the purpose of providing vehicular and pedestrian ingress and egress to and from Vollmer Road and Vollmer Place to the Lots only in compliance with all applicable laws and regulations.

3.2 Grant of Detention Facility Easement / Scope of Use. Subject to the terms, covenants, agreements, restrictions, and conditions of this Declaration and in consideration for the Assessments to be paid to the Association as provided herein, Declarant hereby declares, creates, and grants the Detention Easement over, across, and upon portions of Lot 2 and Lot 4 for the sole purpose of providing storm water detention and control for the Lots. The Detention Easement shall be for the benefit of the Lots and El Paso County, and may be used by the Owners of the Lots and their Designated Users. The Owners, their respective Designated Users, successors and assigns, and El Paso County shall use the Detention Easement solely for the purpose of providing storm water detention and control for their respective Lots and only in compliance with all applicable laws and regulations and the Detention Agreement.

3.3 Compliance. The Owners, their respective Designated Users, and their respective successors and assigns, shall use the Access Easement in compliance with all applicable laws and regulations.

3.4 No Barriers or Impediments. No Owner party shall construct, erect, or install any fences, barriers, impediments, gates, or other improvements ("Impediments") within the Easements. The Access Easement shall at all times be kept open to allow unrestricted access to and from Vollmer Road, Vollmer Place and the Lots. Each Owner shall have the right to remove any Impediments from the Easements, and shall have no liability to the other party for any damage caused to such Impediment. If an Owner has caused or allowed an Impediment to be constructed, erected, installed or maintained in the Easements, such Owner shall bear the costs of the removal of such Impediment.

ARTICLE IV

CONSTRUCTION OF IMPROVEMENTS; MAINTENANCE AND REPAIR

4.1 Construction. Declarant shall be solely responsible for all costs and expenses associated with the initial construction of the Improvements. Construction of the Detention Improvements shall be completed in accordance with the Detention Agreement. The Access Improvements shall consist of a graded, gravel road.

4.2 Maintenance and Repair. After the Improvements have been completed, the Owners agree to exercise all ordinary and reasonable care in their respective use of the Easements. The Owners shall, at their joint cost and expense, cause to be performed all maintenance and repair of the Access Improvements in order to maintain the Access Improvements in a good, safe and driveable condition. Such maintenance and repair shall include, without limitation, snow removal, resealing, resurfacing, pot hole repair, and re-striping. Additionally, the Owners shall, at their joint cost and expense, cause to be performed all maintenance and repair of the Detention Improvements in order to maintain the Detention Improvements in good and operable condition. Such maintenance and repair shall include, without limitation, maintaining the structural integrity of the drainage basins, maintaining the side slopes of the Detention Improvements, keeping the drainage basins free of trees, shrubs, vegetation, or other debris that impairs or impedes the flow and control of storm water drainage from the Lots, and satisfying the obligations, costs, and expenses of the Developer/Owner under the Detention Agreement.

4.3 Allocation of Costs and Expenses. The decision to incur expenses in improving, repairing, and maintaining the Easements and Improvements shall be made by the Board of Directors. The costs associated with improving, repairing, and maintaining the Easements and Improvements shall be shared equally between all the Lots with each Lot paying a one-fourth share as further set forth in Article V below. Payment of each Owner's one-fourth share of the costs and expenses associated with the improvement, maintenance, and repair of the Easements and Improvements shall be due and payable as provided in Article V below.

ARTICLE V

ASSESSMENTS.

5.1 Creation of the Obligation for Assessments. Each Owner, for each Lot owned by acceptance of a deed therefor, or interest therein, whether or not it shall be so expressed in such deed or instrument creating the interest in the Lot, shall be deemed to covenant and agree to pay to the Association, in the manner, amounts and times prescribed herein, all Assessments, charges, fees, fines and other sums which are described in this Declaration and which shall be both a personal obligation of the Owner and a lien against the Owner's Lot as provided herein. Each Owner shall be jointly and severally liable to the Association for the payment of all Assessments, charges, fees and other sums attributable to such Owner's Lot. The personal obligation for delinquent Assessments and sums shall pass to an Owner's successors in title or interest. No Owner may waive or otherwise escape personal liability for the payment of the Assessments, charges, fees and other sums provided for herein by non use of the Easements, by abandonment or leasing of such Owner's Lot, or by asserting any claims against the Association, or any other person or entity.

5.2 Purpose of Assessments. The Assessments levied by the Association shall be used exclusively to (a) to pay for the costs associated with the repair, operation, and maintenance of the Improvements, to include without limitation, cleaning, maintaining, and repairing the "detention basin/BMP(s)" (as such term is defined in the Detention Agreement), and (b) to pay for the general administrative and overhead costs associated with the operations of the Association as provided herein, including, but not limited to, the cost of casualty and liability insurance.

5.3 Annual Assessments. The Annual Assessments shall specifically include, but shall not be limited to, the following expenses:

- (a) repair and maintenance of the Improvements, including, but not limited to, all costs and expenses incurred under the Detention Agreement;
- (b) legal and accounting fees;
- (c) any deficit remaining from a previous assessment year;
- (d) insurance; and
- (e) any other costs, expenses and fees which may be incurred or may reasonable be expected to be incurred by the Association for the benefit of the Owners under or by reason of this Declaration.

The Association shall also have authority, to the extent it deems proper, to provide any other services requested by particular Owners, but only on a contract basis under which those Owners pay the cost thereof.

5.4 Fixing the Annual Assessment. For the calendar year 2008, the Annual Assessment shall be _____ dollars (\$ _____ .00) per Lot. Each year thereafter the Association's Board of Directors may fix the Annual Assessment at an amount deemed sufficient to meet the needs of the Association and cover the costs and expenses set forth in Section 5.3 above.

5.5 Special Assessments. In addition to the Annual Assessment authorized above, the Association may levy, in any assessment year, a Special Assessment applicable to that year only for the purpose of defraying, in whole or in part, the cost of an emergency situation or of any construction, reconstruction, improvement, cleaning, maintaining, repair or replacement of a capital improvement within the Easements or the detention basin/BMP(s).

5.6 Assessment Procedure.

(a) Annual Assessments. No later than ten (10) days before the beginning of each calendar year commencing with calendar year 2009, the Board of Directors of the Association shall set the new Annual Assessment based upon the budget setting forth the cash requirements needed by the Association to provide for the administration and performance of its duties during the following assessment year. The Association shall cause to be prepared, delivered or mailed to each Owner, on or before December 31 of each calendar year, a payment statement setting forth the Annual Assessment for the following calendar year. The Annual Assessment shall be payable on or before the later of (i) January 1 for each assessment year, or (ii) ten (10) days after receipt of the notice setting forth the Annual Assessment.

(b) Special Assessments and Other Sums. Special Assessments and other sums imposed hereunder shall be due and payable on the date specified by the Board of Directors in written notice to each Owner, but such date shall not be less than ten (10) days after such notice is sent. In the event that the Association incurs any expense or liability as a result of the willful, negligent or wrongful act of an Owner or his Designated Users, and the same is not paid for by insurance, the cost thereof shall be deemed to be a Special Assessment against such Owner and his Lot, and shall be enforceable as provided herein, except that such Assessment shall not require any vote of the Members. Any other sums imposed by the Board as provided hereunder shall also be deemed a Special Assessment but shall not require a vote of the Members.

(c) Notice. Failure of the Board to give timely notice of any Assessment as provided herein shall not affect the liability of the Owner of his Lot for such Assessment, but if notice is not given, the date when payments shall be due shall be deferred to a date after such notice given.

5.7 Certificate of Payment. The Association shall, upon demand, and for a reasonable

charge, furnish a certificate signed by an officer of the Association setting forth whether the Assessments on a specified Lot have been paid. A properly executed certificate of the Association as to the status of Assessments on a Lot is binding upon the Association as of the date of its issuance.

5.8 Effect of Nonpayment of Assessments-Remedies of the Association.

(a) General. Any Assessments that are not paid when due shall be delinquent. If any Assessment is not paid when due, the Association may impose a reasonable late charge/administrative fee for each delinquent Assessment as set by the Board. Any Assessment not paid within thirty (30) days after the due date thereof shall bear interest from the due date at the rate of eighteen percent (18%) per annum, and the Association may bring an action at law against the Owner personally obligated to pay the same, and/or foreclose the lien against such Owner's Lot, and/or may suspend the delinquent Owner's right to vote. In the event a judgment is obtained, such judgment shall include interest on the Assessment as above provided, and a reasonable attorney's fee to be fixed by the court, together with the expenses, late charges and costs of the action.

(b) Lien. Any unpaid Assessment, charge, fee or other sum assessed against an Owner of a Lot, including without limitation (i) interest thereon at the rate of eighteen percent (18%) per annum, (ii) administrative charges relating to such unpaid Assessment or other charge, (iii) court costs, and (iv) all other collection costs, and reasonable attorney's fees, shall be a charge on the interest of the Owner of that Lot. All payments on account shall be first applied to interest, then late charges, costs or fees, and then to Assessment payment first due. The Board may enforce such lien by filing with the Clerk and Recorder of El Paso County, Colorado, a statement of lien with respect to the Lot, setting forth the name of the Owner, the legal description of the Lot and the Owners interest therein, the name of the Association and the amount of delinquent Assessments then owing. The lien statement shall be duly signed and acknowledged by an officer or authorized agent of the Association, and notice thereof shall be mailed to the Owner of the Lot, at the address of the Lot or at such other address as the Association may have in its records for the Owner of the Lot. Such a claim of lien shall also secure all Assessments, charges, fees and sums that come due thereafter until the lien, together with all costs, attorney's fees, administrative charges and interest, has been fully paid or otherwise satisfied. Thirty (30) days following the mailing of such notice, the Board may proceed to foreclose the statement of lien in the same manner as provided for in the foreclosure of mortgages in the State of Colorado. Foreclosure or attempted foreclosure by the Association of its lien shall not be deemed to estop or otherwise preclude the Association from suing the Owner personally liable therefor, or from thereafter again foreclosing or attempting to foreclose its lien for any subsequent Assessments, charges, fees or other sums, which are not fully paid when due.

(c) Authority. Each such Owner, by his acceptance of a deed to a Lot, hereby expressly vests in the Association or its agents, the right and power to bring all actions against such Owner personally for the collection of such charges as a debt and to enforce the aforesaid lien by all methods available for the enforcement of such liens, including foreclosure by an action brought in the name of the Association in a like manner as a mortgage or deed of trust lien on real property, and

such Owner hereby expressly grants to the Association a power of sale in connection with said lien. The lien provided for in this section shall be in favor of the Association and shall be for the benefit of all other Lot Owners. The Association, acting on behalf of the Lot Owners shall have the power to bid at foreclosure sale and to acquire and hold, lease, mortgage and convey the same, if acquired by the Association at the foreclosure sale or by deed in lieu of foreclosure.

5.9 Subordination of the Lien to Mortgages. The lien of the Assessments provided for herein shall be subordinate to the lien of any bona fide purchase money loan evidenced by a First Mortgage of record (including a deed of trust). Sale or transfer of any Lot shall not affect the lien for said Assessment charges except that transfer of title to any Lot pursuant to foreclosure of any such First Mortgage or any proceeding in lieu thereof, including deed in lieu of foreclosure, shall extinguish the lien of Assessment charges that became due prior to any such transfer, or foreclosure, or any proceeding in lieu thereof, including deed in lieu of foreclosure. No such transfer, foreclosure, or any proceeding in lieu thereof, including deed in lieu of foreclosure shall relieve any Lot from liability for any Assessment charges thereafter becoming due, not for the lien thereof, provided, however, that in the event of a foreclosures of a First Mortgage or the taking of a deed in lieu thereof, the holder of the First Mortgage shall not be liable for the unpaid charges and Assessments that accrue prior to acquisition of title.

5.10 Notice to Mortgages and Inspection of Books. Upon written request, a First Mortgagee shall be entitled to written notification from the Association of any default in the performance by the Owner of any obligation under this Declaration, which is not cured within sixty (60) days after the Board of Directors has actual knowledge thereof, and the First Mortgagee may, at its option but without any obligation, cure such default. The Association shall grant to each First Mortgagee the right to examine the books and records of the Association at any reasonable time.

5.11 Homestead. The lien of the Association Assessments shall be superior to any homestead or other exemption as is now or may hereafter be provided by Colorado or Federal law. The acceptance of a deed to a Lot subject to these Covenants shall constitute a waiver of the homestead exemption as against said Assessment lien.

ARTICLE VI

MEETING OF THE MEMBERS

6.1 Membership and Voting Rights. *The requirements and conditions of membership and of voting rights shall be as provided in the Articles of Incorporation.*

6.2 Annual Meetings. The first annual meeting of the Members shall be held within one year of the date of incorporation, and each subsequent annual meeting of the Members shall be held during the same month each year thereafter at a place, date and time, within the State of Colorado, as the Board of Directors may determine.

6.3 Special Meetings. Special meetings of the Members may be called at any time by the President or by the Board of Directors, or upon written request of the Members who are entitled to vote one-half (½) of all of the votes in the Association.

6.4 Notice of Meetings. Written notice of each meeting of the Members shall be given by, or at the direction of, the Secretary or person authorized to call the meeting, by mailing a copy of such notice, postage prepaid, at least thirty (30) but not more than sixty (60) days prior to such meeting, to each Member entitled to vote at such meeting addressed to the Member's address last appearing on the books of the Association, or supplied by such Member to the Association for the purpose of notice. Such notice shall specify the place, day and hour of the meeting, and in the case of a special meeting, the purpose of the meeting.

6.5 Action Taken Without Meeting. Notwithstanding any provision to the contrary, any action required or permitted to be taken at any meeting of Members may be taken without a meeting, prior notice or vote, if a consent in writing setting forth the action so taken is signed by all Members of the Association.

6.6 Quorum. The presence at the meeting of Members entitled to cast, or of proxies entitled to cast, three-fourths (3/4) of the votes of the Members shall constitute a quorum for any action except as otherwise provided in the Articles of Incorporation, or this Declaration. If, however, such quorum shall not be present or represented at any meeting, the Members entitled to vote at such meeting shall have power to adjourn the meeting, from time to time, without notice other than announcement at the meeting, until a quorum as aforesaid shall be present and represented.

6.7 Proxies. At all meetings of Members, each Member may vote in person or by proxy. All proxies shall be in writing and filed with the Secretary prior to the meeting. Every proxy shall be revocable upon written notice to the Secretary and shall automatically cease upon conveyance by the Member of his/her Lot.

6.8 Majority of Members. As used in this Declaration, the term "majority of Members" shall mean fifty-one percent (51%) of the combined votes cast by all Members present at a meeting, in person or by proxy, containing a quorum. An affirmative vote of a majority of the Members present, in person or by proxy, shall be required to transact the business of the meeting and shall be *valid and binding upon all Owners.*

6.9 Order of Business. The order of business at all meetings of the Members shall be as described and decided by the Board in accordance with the customary parliamentary procedure.

ARTICLE VII

BOARD OF DIRECTORS: SELECTION, TERM OF OFFICE

7.1 Number. The property, business and affairs of the Association shall be managed by a Board of Directors. The initial Board of Directors shall be composed of one (1) director, who shall be appointed by the Declarant.

(a) Notwithstanding anything herein to the contrary the Declarant shall have the right to appoint the Board of Directors and to control the Association as follows: During the Period of Declarant Control, the Declarant, or persons designed by him or her, subject to certain limitations, may appoint and remove the officers and members of the Board. The "Period of Declarant Control" shall terminate no later than the earlier of: (i) Sixty (60) days after conveyance of seventy-five percent (75%) of the Lots to Owners other than Declarant; or (ii) Two (2) years after Declarant has last conveyed a Lot in the ordinary course of business. Declarant may voluntarily surrender the right to appoint and remove officers and members of the Board before termination of the Period of the Declarant Control, but in that event, the Declarant may require, for the duration of the Period of Declarant Control, that specified actions of the Association or Board, as described in a recorded instrument executed by the Declarant before the become effective.

(b) Except as otherwise provided above, not later than the termination of any Period of Declarant Control, the Owners shall elect a Board of at least one (1) and no more than four (4) Members. The Board shall elect the officers. These Board members and officers shall take office upon termination of the Period of Declarant Control.

(c) Notwithstanding any provision of this Declaration to the contrary, the Owners, by a seventy-five percent (75%) vote of all persons present and entitled to vote at any meeting of the Owners at which a quorum is present, may remove any member of the Board without cause, other than a member appointed by the Declarant.

7.2 Resignation. Any Director may resign at any time by giving written notice of such resignation to the President or the Secretary. Unless otherwise specified in such written notice, such resignation shall take effect upon receipt thereof by such officer.

7.3 Removal. Any director appointed by the Declarant may be removed, with or without cause, by the Declarant in its sole discretion, Any other director may be removed from the Board, with or without cause, by at least a seventy-five percent (75%) vote of the Members. In the event of death, resignation or removal of a director, his or her successor shall be selected by the Declarant, if applicable, or otherwise by a majority of the remaining directors of the Board, and shall serve for the unexpired term of his of her predecessor.

7.4 Compensation. No director shall receive compensation for any service he or she may render to the Association. However, any director may be reimbursed for his or her actual expenses incurred in the performance of his or her duties.

7.5 Action Taken Without a Meeting. The directors shall have the right to take any action in the absence of a meeting which they could take at a meeting by obtaining the written approval of all the directors. Any action so approved shall have the same effect as though taken at a meeting of the directors.

ARTICLE VIII

MEETINGS OF DIRECTORS

8.1 Regular Meetings. Regular meetings of the Board of Directors shall be held with such frequency and at such times and places as shall be determined by a majority of the directors. Notice of regular meetings of the Board of Directors shall be given to each director personally if by mail, facsimile, or electronic mail, at least seven (7) days prior to the day named for such meeting.

8.2 Organizational Meeting. The first meeting of a newly elected Board of Directors following the annual meeting of the Members shall be held within ten (10) days after such directors were elected and no notice shall be necessary to the newly elected directors in order to legally constitute such meeting, provided a majority of the whole Board shall be present.

8.3 Special Meetings. Special meetings of the Board of Directors may be called by the President of the Association, if one is appointed, or by any director, upon three (3) days notice to each director, given personally or by mail, telephone or telegraph, which notice shall state the time, the place and the purpose of the meeting.

8.4 Waiver of Notice. Before or at any meeting of the Board of Directors, any director may, in writing, waive notice of such meeting and such waiver shall be deemed equivalent to the giving of such notice. Attendance by a director at any meeting of the Board shall be a waiver of notice by him or her of the time and place thereof. If all of the directors are present at any meeting of the Board, no such notice shall be required and any business may be transacted at such meeting.

8.5 Quorum. At all meetings of the Board of Directors, a majority of the directors shall constitute a quorum for the transaction of business, and the acts of the majority of the directors present at a meeting at which a quorum is present shall be the acts of the Board of Directors. If, at any meeting of the Board, there be less than a quorum present, those present may adjourn the meeting from time to time. Business at any such adjourned meetings as originally called may be transacted without further notice.

ARTICLE IX

POWERS AND DUTIES OF THE BOARD OF DIRECTORS

9.1 Powers. The Board of Directors shall have the power to:

(a) adopt and publish rules and regulations governing the use of the Association property, and to establish penalties for the infraction thereof. A rule or regulation shall not be in conflict with the Articles of Incorporation or this Declaration. A copy of such rules and regulations shall be delivered by hand to each Lot or mailed to each Member upon the adoption thereof;

(b) suspend any Member's right to vote during any period in which such Member shall be in default including, without limitation, the non-payment of any Assessment levied by the Association. Such rights may also be suspended after notice and hearing, for a period not to exceed sixty (60) days, for each infraction of published rules and regulations;

(c) exercise for the Association all powers, duties and authority vested in or delegated to the Association and not reserved to the membership by other provisions of this Declaration or the Articles of Incorporation, as may be necessary for the administration of the affairs of the Association;

(d) incur such costs and expenses as may be necessary to perform Association duties;

(e) declare the office of a director of the Board of Directors to be vacant in the event such director shall be absent from three (3) consecutive regular meetings of the Board of Directors; and

(f) employ a property manager, an independent contractor or such other employees as the Board deems necessary, and to prescribe their duties; provided however, the Board when so delegating shall not be relieved of its responsibilities under this Declaration.

9.2 Duties. It shall be the duty if the Board of Directors to:

(a) cause to be kept a complete record of all its acts and corporate affairs and to present a statement thereof to the Members at the annual meeting of the Members, or at any special meeting when such statement is requested in writing by one-fourth (1/4) of the Members who are entitled to vote;

(b) provide such supervision of all officers, agents and employees of this Association as the Board deems reasonably necessary and appropriate;

- (c) as more fully provided in this Declaration to:
- (i) fix the amount of the Annual Assessment;
 - (ii) levy Special Assessments as may be required to defray, in whole or in part, the cost of an emergency situation or of any construction, reconstruction, repair or replacement of a capital improvement upon the Easements.
 - (iii) send written notice of each Assessment to every Owner subject thereof; and
 - (iv) enforce the terms of this Declaration including taking action to file a lien against any property for which Assessments are not paid or bring an action at law against the Owner personally obligated to pay the same or take such other action as it deems appropriate.
- (d) issue, or to cause an appropriate officer to issue, upon demand by any person, a certificate setting forth whether or not any Assessment has been paid. A reasonable charge may be made by the Board for the issuance of these certificates. If a certificate states an Assessment has been paid, such certificate shall be conclusive evidence of payment;
- (e) procure and maintain adequate liability insurance determined necessary by the Board;
- (f) provide maintenance and make repairs, additions, alterations and improvements to the Easements in the manner consistent with this Declaration;
- (g) establish a bank account or accounts for the common treasury and for all separate funds that are required or may be deemed advisable, and to keep and maintain full and accurate books and records showing all receipts, expenses or disbursements and to permit examination thereof by any Owner, and to cause a complete review of the books and accounts by an accountant once each year, and
- (h) Meet as often as the Board deems reasonable and appropriate.

9.3 No Waiver of Rights. The omission or failure of the Association or any Member to enforce the covenants, conditions, restrictions, easements, uses, limitations, obligations or other provisions of this Declaration or rules and regulations adopted pursuant thereto, shall not constitute or be deemed a waiver, modification or release thereof, and the Board of Directors, the Association or any Member shall have the right to enforce the same thereafter.

ARTICLE X

OFFICERS AND THEIR DUTIES

10.1 Enumeration of Officers. The officers of the Association shall be a President, who shall at all times be a Member of the Board of Directors, a Secretary, a Treasurer, and such other officers as the Board of Directors shall from time to time elect. The office of President, Treasurer and Secretary may be held by the same person. The offices of Secretary and Treasurer need not be held by Members of the Board of Directors.

10.2 Election of the Officers. The officers shall be elected by the Board of Directors at the first meeting following each annual meeting of the Members.

10.3 Term. Each officer of the Association shall be elected annually by the Board and shall hold office for one (1) year unless he or she shall sooner resign, or shall be removed, or otherwise disqualified to serve.

10.4 Special Appointments. The Board may elect such other officers as the affairs of the Association may require, each of whom hold office for such period, have such authority, and perform such duties as the Board may, from time to time, determine.

10.5 Resignation and Removal. Any officer may be removed from office with or without cause by the Board. Any officer may resign at any time without giving written notice to the Board, the President or the Secretary. Such resignation shall take effect on the date of the receipt of such notice or at any later time specified therein, and unless otherwise specified therein, the acceptance of such resignation shall not be necessary to make it effective.

10.6 Vacancies. A vacancy in any office may be filled by appointment of the Board. The officer appointed to such vacancy shall serve for the remainder of the term of the office he or she replaces.

10.7 Duties. The duties of the officers are as follows:

(a) The President shall preside at all meetings of the Board of Directors; shall see that orders and resolutions of the Board are carried out; shall sign all leases, mortgages, deeds and other written instruments and shall, unless otherwise directed by the Board, co-sign all checks and promissory notes. Further, he or she shall have all of the general powers and duties which are usually vested in the office of President of an association, including, but not limited to the power to appoint committees from among the Owners from time to time as he or she may, in his or her discretion, decides is appropriate to assist in the conduct of the affairs of the Association, or as may be established by the Board or by the Members of the Association at any regular or special meetings.

(b) The Secretary shall: (i) keep the minutes of the proceedings of meetings of the Members and the Board; (ii) see that all notices are duly given in accordance with the provisions of this Declaration or as required by law; (iii) be custodian of the Association records and of the seal of the Association and affix the seal to all documents when authorized by the Board; and (iv) keep at its registered office or principal place of business a record containing the names and addresses of all Members.

(c) The Treasurer shall be the principal financial officer of the Association and shall have the care and custody of all funds, securities, evidences of indebtedness and other personal property of the company, and shall deposit the same in accordance with the instruction of the Board. The Treasurer shall receive and give receipts and acquittances for monies paid in on account of the Association, and shall pay out of the funds on hand all bills, payrolls and other just debts of the Association of whatever nature upon maturity. The Treasurer shall perform all other duties incident to the office of Treasurer, and upon request of the Board, shall make such reports to it as may be required at any time. The Treasurer, if required by the Board, shall give the Association a bond in such sums and with such sureties as shall be satisfactory to the Board. The Treasurer shall have such other powers and perform such other duties as may be from time to time prescribed by the Board or the President.

ARTICLE XI

OFFICERS AND DIRECTORS AS AGENTS OF ASSOCIATION

Contracts or other commitments made by the Board of Directors or officers shall be made as agent for the Association, and they shall have no personal responsibility on any such contract or commitment.

ARTICLE XII

BOOKS AND RECORDS

The Association shall make available to Owners and First Mortgagees current copies of the records and financial statements of the Association. "Available" means available for inspection, upon request, during normal business hours or under other reasonable circumstances.

ARTICLE XIII

DUTIES AND POWERS OF ASSOCIATION

13.1 General Duties and Powers of Association. The Association has been formed solely to further the common interests of the Members. The Association, acting through the Board or representatives to whom the Board has delegated such powers, shall have the duties and powers

given non-profit corporations, including without limitation those set forth herein and in the Articles of Incorporation and, in general, the power to do anything that may be necessary or desirable to further the common interests of the Members, to maintain, improve and enhance the Subdivision. The Association shall have and may exercise all powers enumerated in the Colorado Common Interest Ownership Act.

13.2 Duty to Accept Property and Facilities Transferred by Declarant. The Association shall accept title to any property, including without any limitations any improvements thereon, any easement or any other right, and personal property transferred to the Association by Declarant or by any third party with Declarant's permission, and equipment related thereto, together with the responsibility to perform any and all Association functions associated therewith, provided that such property and function are not inconsistent with the terms of this Declaration. Property interests transferred to the Association by the Declarant may include fee simple title, easements, leasehold interests and contractual rights or license to use property. Any property or interest in property transferred to the Association by Declarant shall, except to the extent otherwise specifically approved by resolution of the Board of Directors, be transferred to the Association free and clear of all liens (other than the lien of property and taxes and assessments not then due and payable), but shall be subject to the terms of this Declaration. No representation or warranty, express or implied, relating to property transferred to the Association that is not otherwise set forth in the conveyance document shall be required of or attributed to Declarant.

13.3 Duty to Manage and Care for Property. The Association shall manage, operate, care for, and maintain the Improvements and keep the same in a safe and operable condition for the use and enjoyment of the Members. This maintenance obligation specifically includes the obligation to maintain the Improvements regardless of whether legal title to the Improvements is transferred to the Association.

13.4 Duty to Pay Taxes. The Association shall pay all taxes and assessments levied upon the property owned by the Association, if any, and all other taxes and assessments payable to the Association. The Association shall have the right to contest any such taxes or assessments provided that the Association shall protest the same provided by appropriate legal proceedings which shall have the effect of preventing the of the tax or assessment and the sale or foreclosure of any lien for such tax or assessment, and provided that the Association shall keep and hold sufficient funds to pay and discharge the taxes and assessments, together with any interest and penalties which may accrue with respect thereto, if the contest of such taxes is unsuccessful. The Association may maintain a tax reserve fund for payment of any taxes, including additional taxes which could be incurred as a result of an adverse ruling on any position taken by the association.

13.5 Duty to Maintain Insurance. The Association shall maintain and keep in full force and effect at all times adequate insurance coverage for the Association's property in such amounts as determined by the Board of Directors.

13.6 Power to Acquire and Maintain Property and Construct Improvements. The

Association may acquire property or interests of property for the common benefit of Owners, including improvements and personal property. The Association may construct, repair, maintain, improve, or reconstruct the Improvements. Both the Declarant (for purpose of construction) and, thereafter, the Association shall have the right to enter onto each Lot for purposes of performing their respective obligations with respect to the construction, repair, and maintenance of the Improvements.

13.7 Power to Adopt Rules and Regulations. The Association may adopt, amend, repeal, and enforce such rules and regulations as may be deemed necessary or desirable with respect to the interpretation and implementation to this Declaration and matters related thereto, the operation of the Association, the use and enjoyment of the Improvements. Any such rules and regulations shall be reasonable and uniformly applied as determined by the Board in its sole discretion. Rules and regulations shall be effective upon adoption by resolution of the Board of Directors. Written notice of the adoption, amendment or repeal of any rule or regulation shall be provided to all Members by the Association, and copies of the currently effective rules and regulations shall be made available to each member upon request and payment of the copying costs. Each Owner shall comply with such rules and regulations and shall see that their respective tenants, guests and invitees comply with the rules and regulations.

13.8 Power and Duty to Enforce Association Documents. The Association shall have the power and duty to enforce the covenants, terms and provisions of this Declaration including, but not limited to, the power to set and collect the Assessments.

13.9 Power to Grant Easements. The Association shall have the power to grant access, utility, drainage, water facility and any other easements in, on, over or under the Easements for any lawful purpose, including, without limitation, the provision of emergency services, utilities, telephone, television, or other uses or services to some or all of the Members.

13.10 Power to Engage Employees, Agents and Consultants. The Association shall have the power to hire and discharge employees and agents (except as otherwise provided in management contracts) and to retain and pay for such legal and accounting services as may be necessary or desirable in connection with the performance of any duties or the exercise of any powers of the Association under this Declaration, or the Articles of Incorporation (collectively the "Association Documents").

13.11 General Corporate Powers. The Association shall have all of the ordinary powers and rights of a Colorado corporation formed under the Colorado Nonprofit Corporation Act subject to any limitations, restrictions, or requirements expressly set forth in the Association Documents.

ARTICLE XIV

AMENDMENTS

14.1 This Declaration may be amended, at a regular or special Meeting of the Members, with a quorum present, by a vote of three-fourths (3/4) of the Members present in person or by proxy. The Declarant reserves the right, until the Period of Declarant Control is terminated, but without the vote of the Owners or Mortgagees, to make amendments to this Declaration.

14.2 In the case of any conflict between the Articles of Incorporation and this Declaration, this Declaration shall control.

ARTICLE XV

WATER RIGHTS AND AUGMENTATION PLAN

15.1 Water Augmentation Plan. The Lots shall be subject to the obligations and requirements as set forth in the April 6, 2007 Judgment and Decree Granting Underground Water Rights and Plan for Augmentation of the District Court for Water Division 2, State of Colorado, in Case No. 06CW35 ("Augmentation Plan"). The Augmentation Plan is recorded at Reception No. 207060552 of the El Paso County Clerk and Recorder. The Augmentation Plan is incorporated by reference. The water supply for the Subdivision shall be by individual wells under the Augmentation Plan.

The Augmentation Plan concerns the water rights and water supply for the Lots and creates obligations upon the Owners, the Lots and the Association that run with the land. The diversions from all wells within the Subdivision shall be considered as one Augmentation Plan and shall be administered by Declarant and its assigns as set forth in this Section as a single augmentation plan as allowed by the decree. All of the provisions set forth below for the Augmentation Plan shall apply to all Lots within the Subdivision.

15.2 Water Rights Ownership.

(a) Declarant will assign to the Owners their respective interest in the Augmentation Plan and water rights thereunder. Those water rights assigned consist of ground water in Denver aquifer of the Denver Basin as adjudicated in the Augmentation Plan (i.e. 0.87 acre feet annually (261 acre feet 30 years)). Each Lot Owner shall own their proportionate interest in the Augmentation Plan and Denver aquifer water rights decreed thereunder based upon the proportion of their respective Lot Ownership under the Augmentation Plan.

(b) The Declarant will assign to the Association the ground water rights in the Arapahoe aquifer under the Augmentation Plan for purposes of meeting post pumping stream depletions under the Augmentation Plan, together with the obligations and responsibilities for

compliance with the Augmentation Plan. The Association shall assume and perform these obligations and responsibilities. By this assignment to the Association, the Declarant is relieved of any and all responsibilities and obligations for the administration, enforcement and operation of the Augmentation Plan for all Lots. Such conveyance shall be subject to the obligations and responsibilities of the Augmentation Plan and said water rights committed to meet post pumping obligations under the Augmentation Plan may not be separately assigned, transferred or encumbered by the Association. The Declarant shall assign the following ground water rights to the Association to meet post pumping depletions under the Augmentation Plan for all Lots:

Aquifer	Average Annual Withdrawal (Acre Feet)	Total Acre Feet
Arapahoe (NT)	3.02	908

Provided, however, to the extent these ground water rights are not needed to meet post pumping depletions under the Augmentation Plan, those ground water rights may be conveyed *pro rata* to the Owners of the Lots within the Subdivision.

(c) Each Lot Owner's water rights under the Augmentation Plan shall transfer automatically upon the transfer of title to a Lot as an appurtenance, including the transfer by the Declarant to the initial Owner of a lot. The ground water rights under the Augmentation Plan committed to the 300 year water supply for the Subdivision cannot and shall not be severable from their respective Lot, and each Owner covenants that it cannot sell or transfer such ground water rights to any party separate from the conveyance of the lot.

15.3 Administration

(a) The Association shall administer and enforce the Augmentation Plan for all Lots within this Declaration. Such administration shall include, without limitation, accountings to the Colorado Division of Water Resources under the Augmentation Plan and taking all necessary and required actions under the Augmentation Plan to protect and preserve the ground water rights for Lot Owners. The Association shall have the right to specifically enforce, by injunction if necessary, the Augmentation Plan against any Lot Owner failing to comply with the Owner's obligations under the Augmentation Plan, including the enforcement of the terms and conditions of well permits issued pursuant to the Augmentation Plan. A Lot Owner shall also have the individual right to enforce, administer and require specific performance of the Augmentation Plan upon the failure of the Association to do so. The use of the ground water rights by each Owner is restricted and regulated by the terms and conditions of the Augmentation Plan, including, without limitation, that each Lot Owner is subject to the annual well pumping limitations under the Augmentation Plan of 0.87 acre foot. Any additional water usage shall be approved, as necessary, through a Water Court decree pursuant to a plan for augmentation that is not inconsistent with the Augmentation Plan or the El Paso County's 300 year water supply rules. Failure of the Association or the Owners to comply with the terms of the Augmentation Plan may result in an order from the Division of Water

Resources under the Augmentation Plan to curtail use of ground water rights.

(b) Each Owner shall promptly and fully provide to the Association any and all information necessary for the Association to comply with its obligation to administer and enforce the Augmentation Plan. The frequency of such accounting shall be in the Association's discretion, whether monthly, quarterly, or annually. The Association shall have the power to impose fines upon any Owner who fails to provide well diversion records or otherwise fails to comply with the Augmentation Plan or this Declaration, in such reasonable amounts as determined by the Association to compensate it for its time and expenses and to discourage noncompliance by Owners.

15.4 Well Permits.

(a) Each Owner shall be responsible for obtaining a well permit for the water supply to their respective Lot and for the physical delivery of water to their Lot. All wells shall be constructed and operated in compliance with the Augmentation Plan, the well permit obtained from the Colorado Division of Water Resources, and the applicable rules and regulations of the Colorado Division of Water Resources. The costs of the construction, operation, maintenance and repair of such well and delivery of water to the Lot shall be at the Owner's expense. Owners shall comply with any requirements to log their well and shall install and maintain in good working order an accurate totalizing flow meter on the well in order to provide the diversion information necessary for the accounting and administration of the Augmentation Plan.

(b) No party, including Declarant, guarantees to the Owners the physical availability of water or the adequacy of water quality from any well to be drilled under the Augmentation Plan. The Denver Basin aquifers which are the subject of the Augmentation Plan are considered a nonrenewable water resource and due to anticipated water level declines the useful or economic life of the aquifers' water supply may be less than the 100 years allocated by State statutes or the 300 years of the El Paso County water supply requirements.

15.5 Compliance. The Association and the Lot Owners shall perform and comply with the terms, conditions, and obligations of the Augmentation Plan, and the Owners shall further comply with the terms and conditions of the well permits issued to them under the Augmentation Plan.

15.6 Rules and Regulations. The Association may adopt and enforce reasonable rules and regulations for the administration and enforcement of the Augmentation Plan. Those rules and regulations may include, without limitation, fines for an Owner's noncompliance with the Augmentation Plan or this Declaration, provision for pro rata rationing of water usage between Lot Owners in the event of water shortage or other emergency, and the recovery of the costs and expenses of the Association, including reasonable attorney fees, in the enforcement of the Augmentation Plan against an Owner.

15.7 Amendments. No changes or deletions to this Article may be made which would

alter, impair, or in any manner compromise the Augmentation Plan or the water rights of the Owners without the written approval/order of said parties, the Water Court, and El Paso County. Amendments of this Article XV shall be allowed that meet the above requirements.

15.8 El Paso County Requirements. The County may enforce the provisions regarding the Augmentation Plan as set forth in this Declaration.

ARTICLE XVI

MISCELLANEOUS

Unless the Board otherwise determines, the fiscal year of the Association shall begin on the first day of January and end of the 31st day of December every year, except that the first fiscal year shall begin on the date of incorporation.

IN WITNESS WHEREOF, the Declarant has executed this Declaration on this 31 day of JANUARY, 2008.

Vollmer Investments, LLC

By: Bruce A. Barbarick
Bruce A. Barbarick, Manager

EXHIBIT A
LEGAL DESCRIPTION OF PROPERTY

OLIVER E. WATTS PE-LS
OLIVER E. WATTS, CONSULTING ENGINEER, INC.
CIVIL ENGINEERING AND SURVEYING
614 ELKTON DRIVE
COLORADO SPRINGS, COLORADO 80907
(719) 593-0173
FAX (719) 265-9660
CELL (719) 964-0733
olliewatts@aol.com

January 29, 2008

SUBJECT: Legal Descriptions, Proposed Barbarick Subdivision Lots

Proposed Lot 1, Barbarick Subdivision:

That portion of Lot D McClintock Station, El Paso County, Colorado, according to the plat thereof recorded in plat book H-3 at page 9 of the records of said County, described as follows;
Beginning at the northwest corner of said Lot D; thence N89°57'08"E along the north line of said Lot D, 673.10'; thence S01°05'00"W, 345.46'; thence S89°59'51"W, 670.32' to the west line of said Lot D; thence N00°37'21" E, 344.88' along said west line to the point of beginning and containing 231,825 square feet.

Proposed Lot 2, Barbarick Subdivision:

That portion of Lot D McClintock Station, El Paso County, Colorado, according to the plat thereof recorded in plat book H-3 at page 9 of the records of said County, described as follows;
Commencing at the northwest corner of said Lot D; thence S00°37'21"W along the west line of said Lot D, 344.88' to the point of beginning; thence N89°59'51"E, 670.32'; thence S01°05'00"W, 346.83' to the south line of said Lot D; Thence N89°58'06"W, along said south line, 667.52' to the southwest corner of said Lot D; thence N00°37'21"E along the west line of said Lot D, 346.39' to the point of beginning, and containing 231,825 square feet.

Proposed Lot 3, Barbarick Subdivision:

That portion of Lot D McClintock Station, El Paso County, Colorado, according to the plat thereof recorded in plat book H-3 at page 9 of the records of said County, described as follows;
Commencing at the northwest corner of said Lot D; thence N89°57'08"E along the north line of said Lot D, 673.10' to the point of beginning; thence continuing N89°57'08"E, 614.41' to the southwest corner of that 30' access easement recorded under reception no. 203185890, being also a portion of said Lot D; thence N00°37'24"E along the west edge of said easement and Lot D, 627.94' to the south right-of-way line of Vollmer Place; thence N89°57'08"E along said south right-of-way, 30.01' to the east line of said Lot D and said access easement; thence S00°37'24"W, along said east line 965.25'; thence S89°57'08"W, 647.13'; thence N01°05'00"E, 337.34' to the point of beginning and containing 236,649 square feet.

Proposed Lot 4, Barbarick Subdivision:

That portion of Lot D McClintock Station, El Paso County, Colorado, according to the plat thereof recorded in plat book H-3 at page 9 of the records of said County, described as follows;
Commencing at the northwest corner of said Lot D; thence N89°57'08"E along the north line of said Lot D, 673.10'; thence S01°05'00"W, 337.34' to the point of beginning; thence N89°57'08"E, 647.13' to the east line of said Lot D; thence S00°37'24"W, along said east line, 355.79' to the southeast corner of said Lot D; thence N89°58'06"W along the south line of said Lot D, 649.97'; thence N01°05'00"E, 354.94' to the point of beginning, and containing, 230,444 square feet.

EXHIBIT B

PLAT

**MINUTES OF ACTION OF THE BOARD OF DIRECTORS
OF
BARBARICK SUBDIVISION PROPERTY OWNERS ASSOCIATION, INC.**

Pursuant to the provisions of the Colorado Non-Profit Corporation Act, the undersigned Director of Barbarick Subdivision Property Owners Association, Inc., who constitutes the initial Director of the Corporation, hereby consents to, votes in favor of and adopts each of the following resolutions.

RESOLVED, that the Articles of Incorporation filed for record in the office of the Secretary of State of Colorado on January __, 2008, under Entity Identification Number _____, be filed in the corporate minute books as a permanent part of the corporate records.

RESOLVED, that the Declaration and Bylaws of the Corporation recorded in the real property records of El Paso County, Colorado, on _____, 2008, at Reception Number _____ be adopted as the Declaration and By-Laws of this Corporation and govern the management and regulation of the internal affairs of the Corporation, and that the Declaration be made a permanent part of the records of the Corporation.

RESOLVED, that the following individuals are appointed as Officers of the Corporation:

President	Bruce A. Barbarick
Secretary	Bruce A. Barbarick
Treasurer	Bruce A. Barbarick

RESOLVED, that the Treasurer, at such time as the Corporation shall acquire corporate funds, is authorized and directed to open one or more operating and trust or escrow bank accounts for the Corporation at any banking institution in Colorado or in any other state, approved by the President and the Treasurer, and to do any and all things necessary in order to conduct banking for the Corporation, and for such purposes, the President, any Vice President, or Treasurer may complete any banking resolution(s) for the conduct of the routine banking business of the Corporation required by such bank and certify that said resolution(s) was (were) duly adopted at a meeting of the Board of Directors of this Corporation. A copy of such resolution form, complete in all respects as filed with any such bank, shall be filed in the permanent records of the Corporation along with the Minutes. This authority is given to expedite the propitious conduct of the routine banking business of the Corporation without first having to conduct a special or other meeting of the Board of Directors in order to adopt the standard resolution form cards, signature cards, and materials generally required by banking institutions. Without thereby intending a limitation upon the permitted contents of any such resolution(s), such resolution(s) may provide for the establishment, maintenance, administration, authorized signatory officers and their sample signatures, and payment of banking fees and charges in connection with checking accounts, savings accounts, and safety deposit boxes. Each action heretofore or hereafter taken in accord with the authority of this resolution is hereby ratified, affirmed, confirmed, and adopted. Annually, or at such other time as a majority of the Board of Directors may direct, any such resolution(s) shall be presented to the Board in meeting for review, amendment, repeal, or any other action which the Board may wish to take with respect thereto.

RESOLVED, that all actions of the Officers and Directors of the Corporation since the last meeting of the Board of Directors be and they hereby are ratified, confirmed and approved; and

FURTHER RESOLVED, that the Officers of the Corporation are hereby authorized to take any and all actions and to execute or deliver any and all documents necessary to effectuate the above resolutions.

Dated: January 31, 2008.



Bruce A. Barbarick, Director

The undersigned, being the Secretary of the Corporation, hereby attests that the foregoing action is an accurate recitation of the action taken by the Board of Directors on January 31, 2008.



Secretary

APPENDIX G

Conceptual Site Plan

BARBARICK WASTE TRANSFER STATION SITE PLAN EXHIBIT

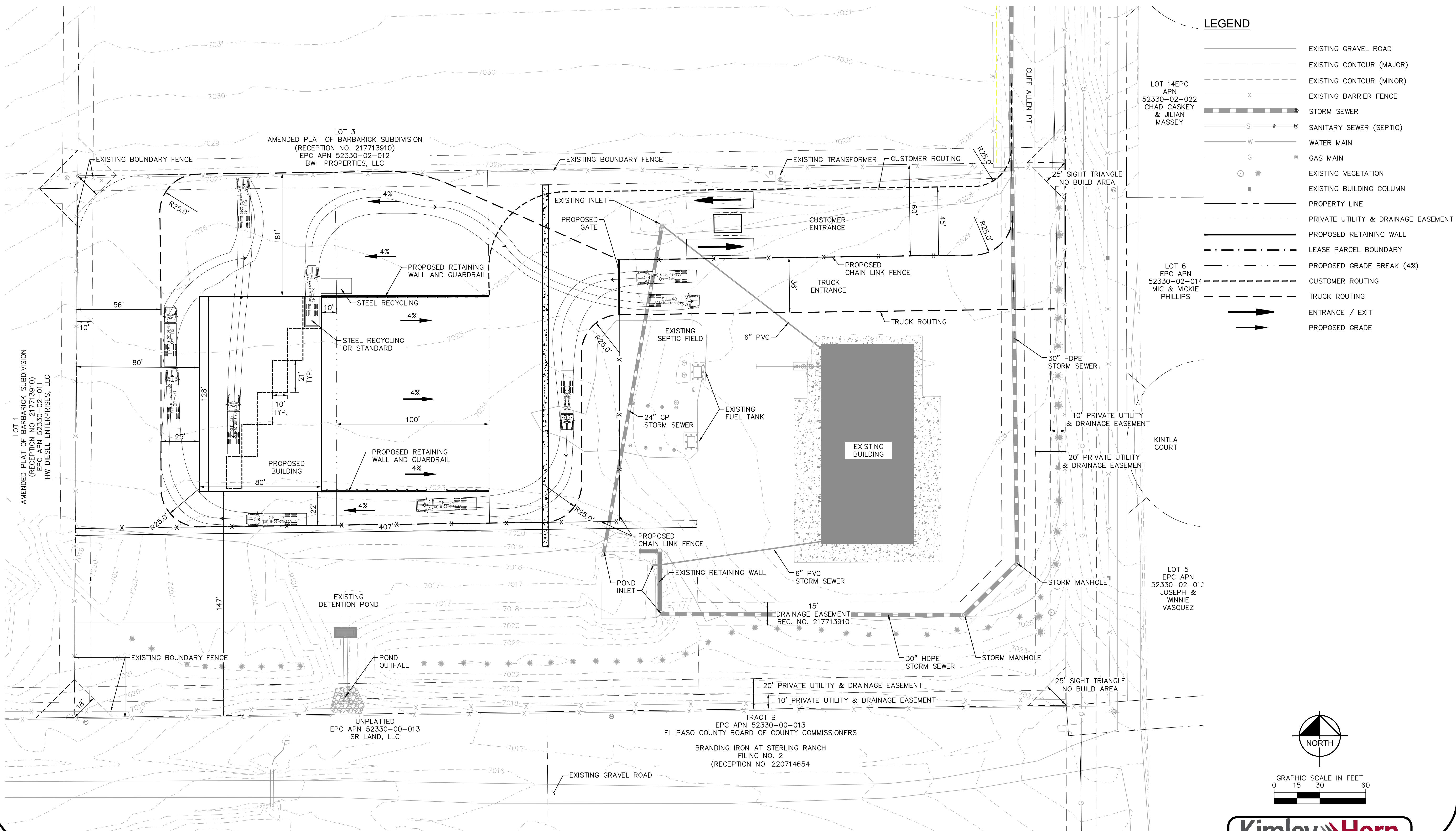

LEGEND

- EXISTING GRAVEL ROAD
- - - EXISTING CONTOUR (MAJOR)
- - - EXISTING CONTOUR (MINOR)
- X EXISTING BARRIER FENCE
- STORM SEWER
- S ● SANITARY SEWER (SEPTIC)
- W WATER MAIN
- G ● GAS MAIN
- ● EXISTING VEGETATION
- EXISTING BUILDING COLUMN
- - - PROPERTY LINE
- - - PRIVATE UTILITY & DRAINAGE EASEMENT
- PROPOSED RETAINING WALL
- - - LEASE PARCEL BOUNDARY
- - - PROPOSED GRADE BREAK (4%)
- - - CUSTOMER ROUTING
- - - TRUCK ROUTING
- ENTRANCE / EXIT
- PROPOSED GRADE

