

K:\COS_Civil\196288000_Eagleview\CADD\PlanSheets\Early GEC\EG_CF.dwg Kofford, Kevin 9/25/2024 3:15 PM

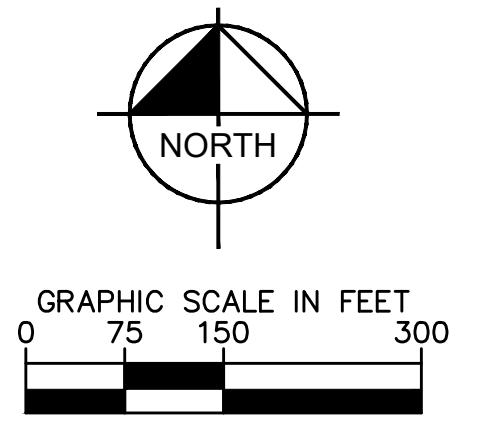

CALL UTILITY NOTIFICATION CENTER OF COLORADO 1-800-922-1987 CALL 2-BUSINESS DAYS IN ADVANCE BEFORE YOU DIG, GRADE, OR EXCAVATE FOR THE MARKING OF UNDERGROUND MEMBER UTILITIES

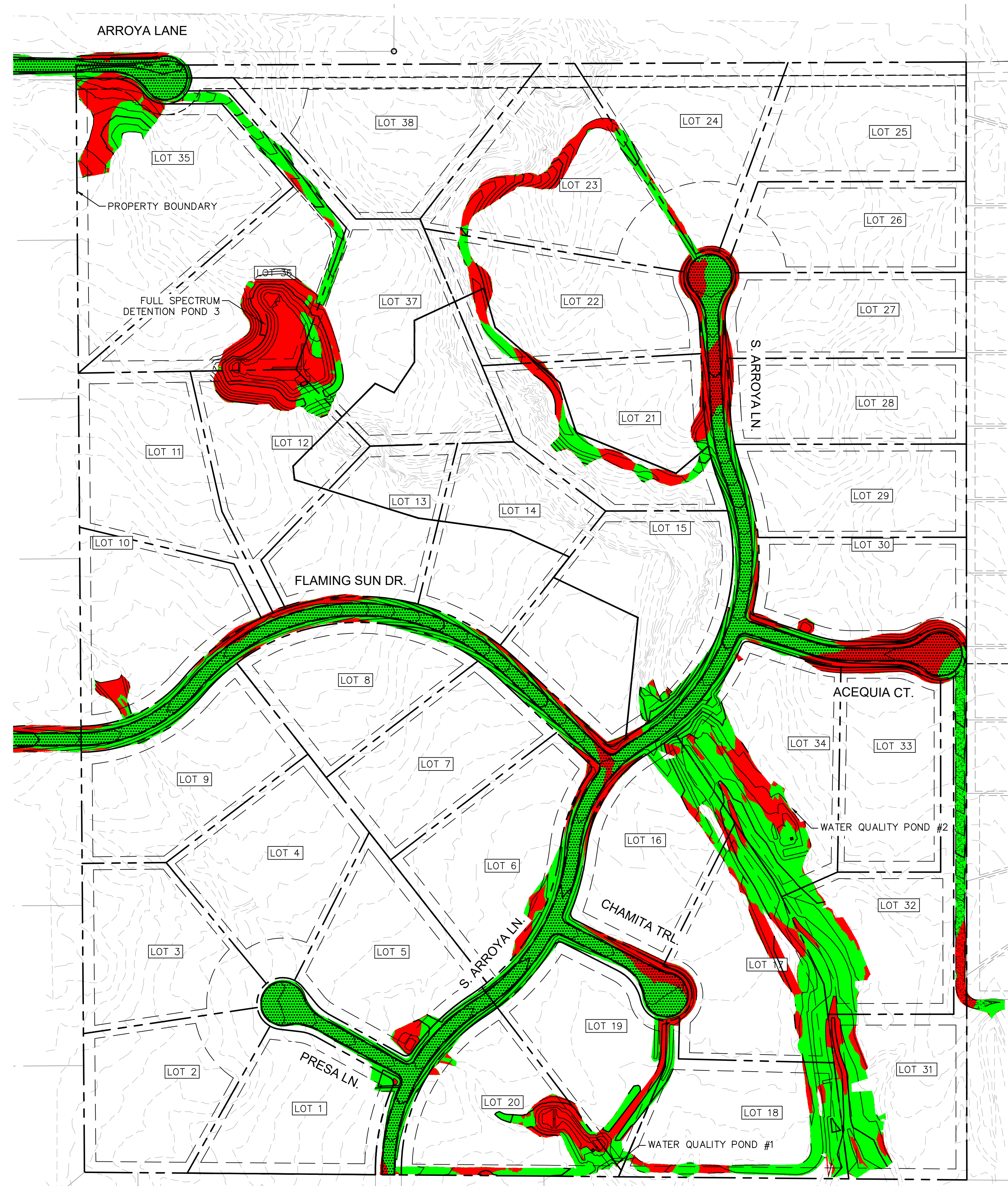

LEGEND
CUT AREA
FILL AREA

TOTAL CUT: 24,320 CY + 6575 CY ROADWAY EXCAVATION + 130 CY CHECK STRUCTURES
TOTAL FILL: 39,620 CY
NET: 8595 CY (FILL)*
*RAW NET VALUE - NO FILL FACTOR APPLIED

NO.	REVISION	BY	DATE	APPR

Kimley»Horn
2024 KIMLEY-HORN AND ASSOCIATES, INC.
2 North Nevada Avenue Suite 900
Colorado Springs, Colorado 80903 (719) 453-0180

DESIGNED BY: MJK
DRAWN BY: MJK
CHECKED BY: KRK
DATE: 08/15/2024

EAGLEVIEW
EL PASO COUNTY, COLORADO
GRADING AND EROSION CONTROL PLAN
CUT FILL MAP

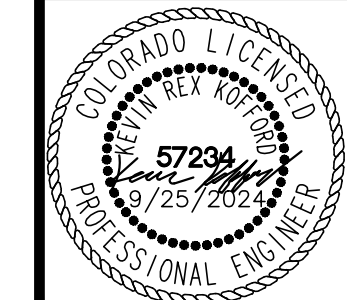

K:\COS_Civil\196288000_Eagleview\CADD\PlanSheets\Early GEC\EG_INITIAL.dwg Kofford, Kevin 9/25/2024 3:05 PM

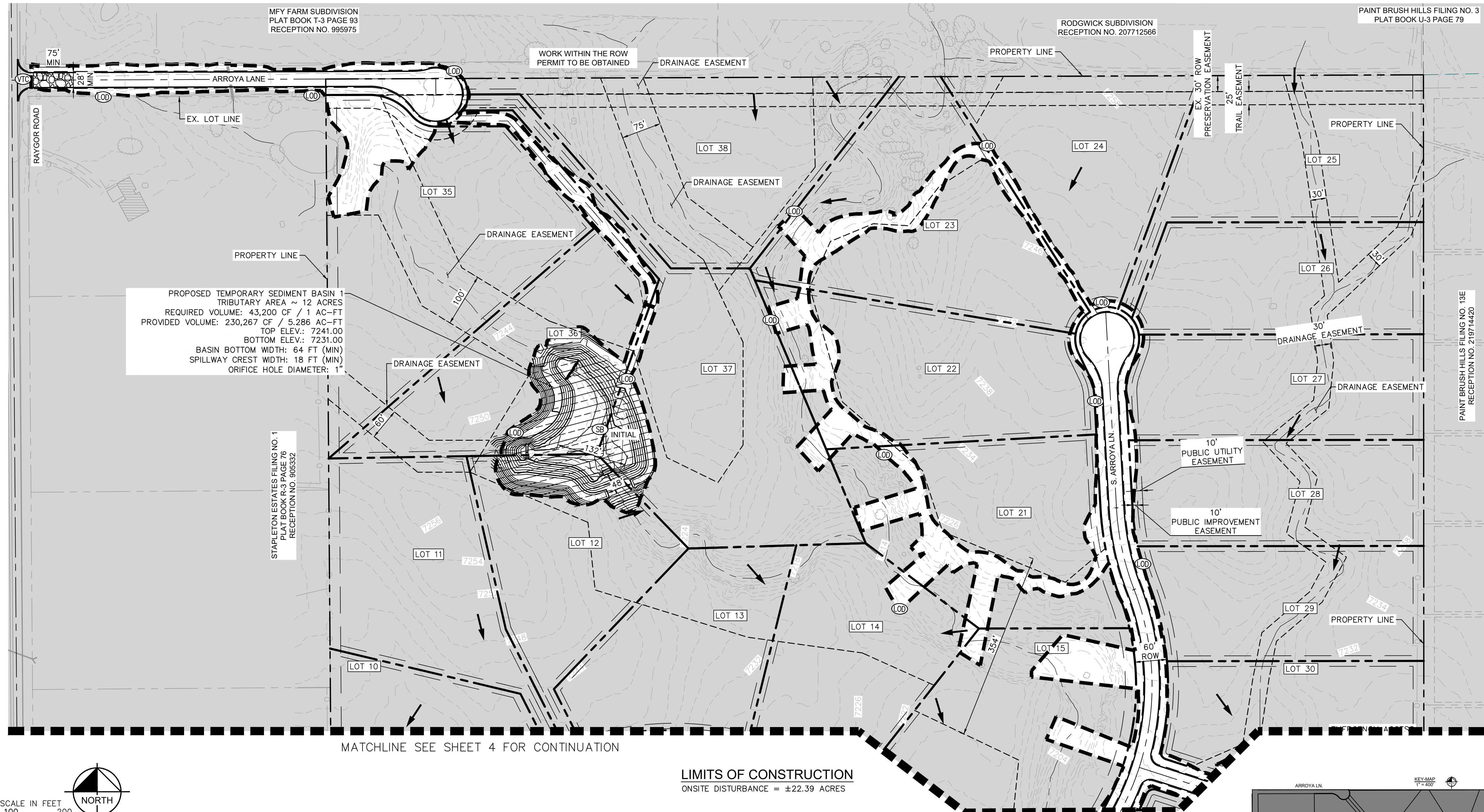

PROPOSED TEMPORARY SEDIMENT BASIN 1
TRIBUTARY AREA ~ 12 ACRES
REQUIRED VOLUME: 43,200 CF / 1 AC-FT
PROVIDED VOLUME: 230,267 CF / 5.286 AC-FT
TOP ELEV.: 7241.00
BOTTOM ELEV.: 7231.00
BASIN BOTTOM WIDTH: 64 FT (MIN)
SPILLWAY CREST WIDTH: 18 FT (MIN)
ORIFICE HOLE DIAMETER: 1'

STAPLETON ESTATES FILING NO. 1
PLAT BOOK T-3 PAGE 76
RECEPTION NO. 905332

MFY FARM SUBDIVISION
PLAT BOOK T-3 PAGE 93
RECEPTION NO. 995975

RODGWICK SUBDIVISION
RECEPTION NO. 207712566

PAINT BRUSH HILLS FILING NO. 3
PLAT BOOK U-3 PAGE 79

PAINT BRUSH HILLS FILING NO. 19E
RECEPTION NO. 219714420

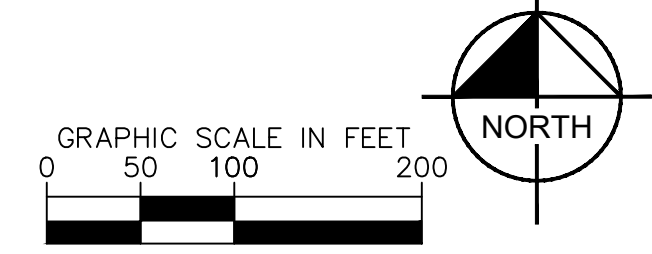

MATCHLINE SEE SHEET 4 FOR CONTINUATION

LIMITS OF CONSTRUCTION
ONSITE DISTURBANCE = ±22.39 ACRES

NOTES

- 1. THE INTENT OF THIS PLAN IS TO IDENTIFY THE EROSION CONTROL PRACTICES RECOMMENDED. THE CONTRACTOR SHALL REFERENCE ADDITIONAL CONSTRUCTION PLANS FOR DEMOLITION OF EXISTING AND CONSTRUCTION OF PROPOSED IMPROVEMENTS. ADJACENT STREETS SHALL BE KEPT CLEAN AND FREE OF SEDIMENT AND/OR DEBRIS AT ALL TIMES.
2. TEMPORARY STABILIZATION (TS) SHALL BE IMPLEMENTED WITHIN THE DISTURBED PORTIONS OF THE PROJECT SITE NO LATER THAN 14 DAYS FOLLOWING THE CEASE OF CONSTRUCTION ACTIVITIES WITHIN THE DISTURBED AREAS.
3. PERMANENT STABILIZATION (PS) MAY BE USED WITHIN AREAS OF TEMPORARY STABILIZATION (TS) AT THE CONTRACTOR'S DISCRETION. STABILIZATION SHALL BE APPLIED IN ACCORDANCE WITH APPLICABLE TEMPORARY STABILIZATION SEQUENCING REQUIREMENTS.
4. CONTRACTOR SHALL UTILIZE ROLLED EROSION CONTROL PRODUCTS (STRAW-SINGLE NET EROSION CONTROL BLANKETS AND OPEN WEAVE TEXTILES) ON ALL SLOPES 3H:1V OR GREATER TO ACHIEVE REQUIRED STABILIZATION.
5. CONTRACTOR SHALL MAINTAIN ACCEPTABLE EROSION CONTROL PRACTICES WITHIN THE ANTICIPATED LIMITS OF CONSTRUCTION IDENTIFIED HEREIN. BEST MANAGEMENT PRACTICES AND STABILIZATION SHALL BE COMPLETED AS IDENTIFIED HEREIN IN ACCORDANCE WITH OWNER REQUIREMENTS.
6. SILT FENCE TO BE INSTALLED PRIOR TO COMMENCEMENT OF ONSITE GRADING AND CONSTRUCTION ACTIVITIES.
7. DEMOLITION, REMOVAL, OVEREXCAVATION AND SOIL TREATMENT SHALL BE IN ACCORDANCE WITH THE GEOTECHNICAL ENGINEER RECOMMENDATIONS AS NOTED IN THE APPROVED PROJECT GEOTECHNICAL REPORT.
8. VEGETATION COVER IS ABOUT 90% CONSISTING OF NATIVE GRASSES, TREES AND SHRUBS, BASED ON VISUAL INSPECTION
9. NO ASPHALT OR CONCRETE BATCH PLANTS SHALL BE USED FOR THIS PROJECT.

LEGEND

- PROPERTY LINE
DRAINAGE EASEMENT
LIMITS OF DISTURBANCE/CONSTRUCTION
SILT FENCE
CONSTRUCTION FENCE
SEDIMENT CONTROL LOGS
CONCRETE WASHOUT AREA
STABILIZED STAGING AREA
EROSION CONTROL BLANKET
VEHICLE TRACKING CONTROL
SOIL STOCKPILE
TEMPORARY SEDIMENT BASIN
EXISTING FLOW ARROW
EXISTING MINOR CONTOUR
EXISTING MAJOR CONTOUR
PROPOSED MAJOR CONTOUR
PROPOSED MINOR CONTOUR

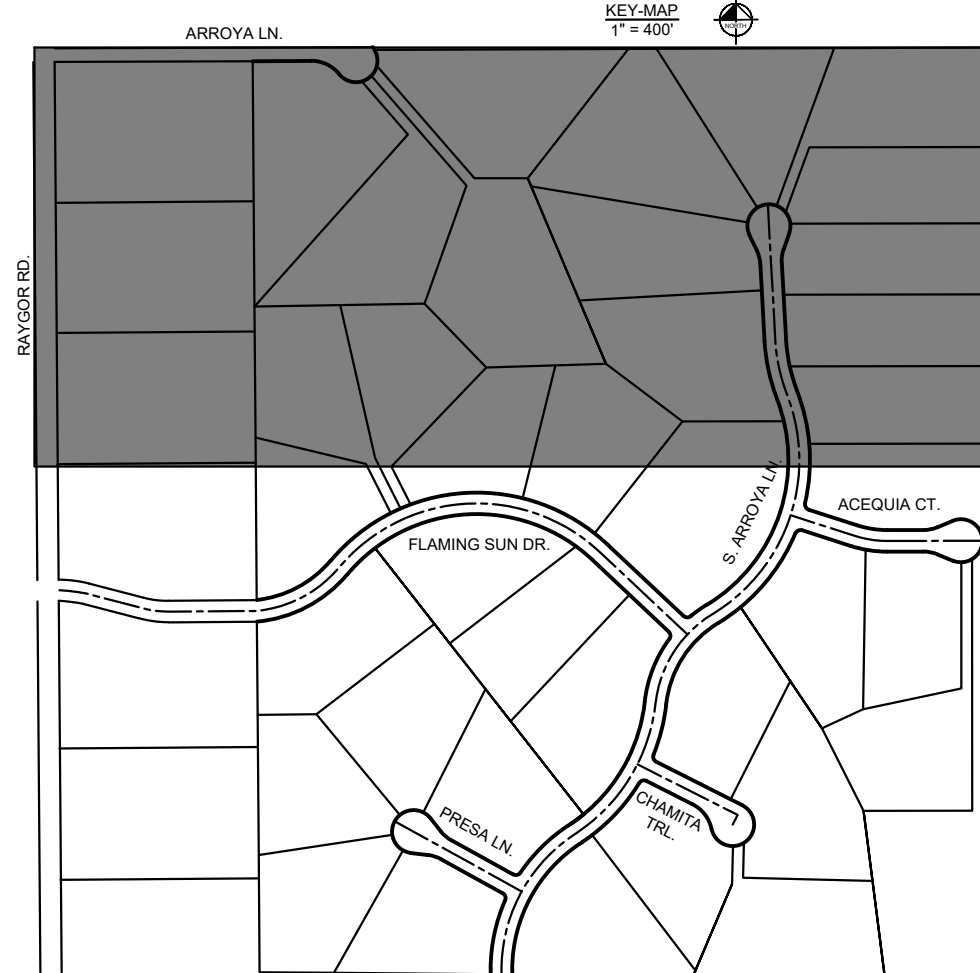

811 Know what's below. Call before you dig. CALL UTILITY NOTIFICATION CENTER OF COLORADO 1-800-922-1987

Table with columns for NO., REVISION, BY, DATE, APPR.

Kimley Horn
2024, KIMLEY-HORN AND ASSOCIATES, INC.
2 North Nevada Avenue Suite 900
Colorado Springs, Colorado 80903 (719) 453-0180
DESIGNED BY: MJK
DRAWN BY: MJK
CHECKED BY: KRK
DATE: 08/15/2024

EAGLEVIEW
EL PASO COUNTY, COLORADO
GRADING AND EROSION CONTROL PLAN
INITIAL GEC PLAN

Professional Engineer seal for Kevin Kofford, License No. 57234. PROJECT NO. 196106001 SHEET 3

K:_COS_Civil\196288000_Eagleview\CADD\PlanSheets\Early GEC\EG_GEC_INITIAL.dwg Koford, Kevin 9/25/2024 3:05 PM

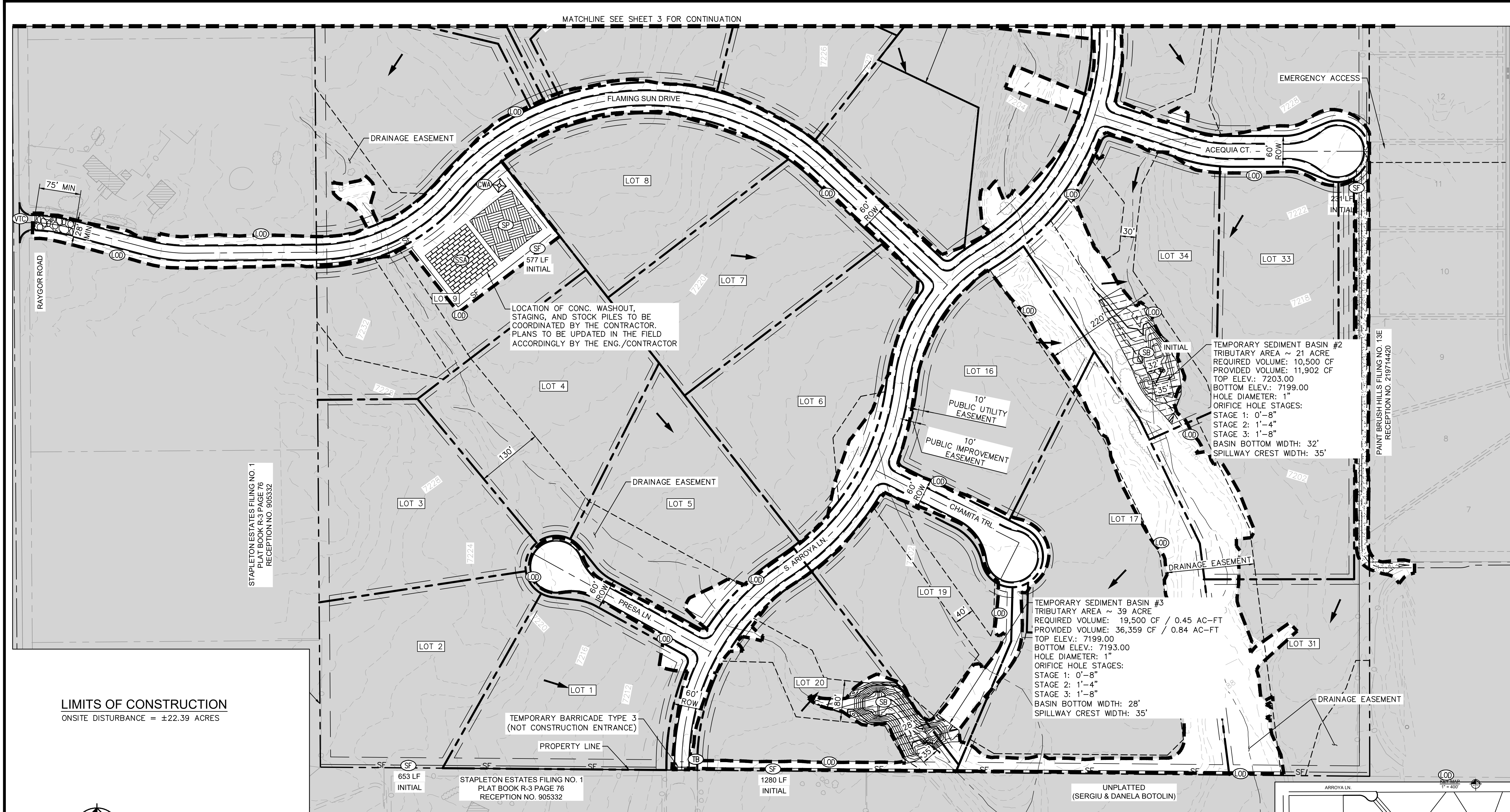

LIMITS OF CONSTRUCTION
ONSITE DISTURBANCE = ±22.39 ACRES

STAPLETON ESTATES FILING NO. 1
PLAT BOOK R-3 PAGE 76
RECEPTION NO. 905332

STAPLETON ESTATES FILING NO. 1
PLAT BOOK R-3 PAGE 76
RECEPTION NO. 905332

1280 LF
INITIAL

UNPLATTED
(SERGIU & DANELA BOTOLIN)

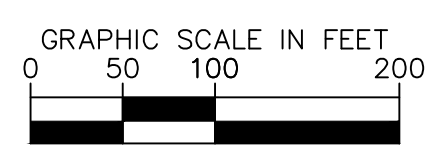
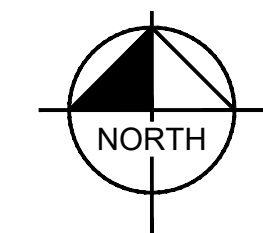

811 Know what's below.
Call before you dig.

CALL UTILITY NOTIFICATION
CENTER OF COLORADO
1-800-922-1987
CALL 2-BUSINESS DAYS IN ADVANCE
BEFORE YOU DIG, GRADE, OR EXCAVATE
FOR THE MARKING OF UNDERGROUND
MEMBER UTILITIES

NOTES

1. THE INTENT OF THIS PLAN IS TO IDENTIFY THE EROSION CONTROL PRACTICES RECOMMENDED. THE CONTRACTOR SHALL REFERENCE ADDITIONAL CONSTRUCTION PLANS FOR DEMOLITION OF EXISTING AND CONSTRUCTION OF PROPOSED IMPROVEMENTS.
2. ADJACENT STREETS SHALL BE KEPT CLEAN AND FREE OF SEDIMENT AND/OR DEBRIS AT ALL TIMES.
3. TEMPORARY STABILIZATION (TS) SHALL BE IMPLEMENTED WITHIN THE DISTURBED PORTIONS OF THE PROJECT SITE NO LATER THAN 14 DAYS FOLLOWING THE CEASE OF CONSTRUCTION ACTIVITIES WITHIN THE DISTURBED AREAS.
4. PERMANENT STABILIZATION (PS) MAY BE USED WITHIN AREAS OF TEMPORARY STABILIZATION (TS) AT THE CONTRACTOR'S DISCRETION. STABILIZATION SHALL BE APPLIED IN ACCORDANCE WITH APPLICABLE TEMPORARY STABILIZATION SEQUENCING REQUIREMENTS.
5. CONTRACTOR SHALL UTILIZE ROLLED EROSION CONTROL PRODUCTS (STRAW-SINGLE NET EROSION CONTROL BLANKETS AND OPEN WEAVE TEXTILES) ON ALL SLOPES 3H:1V OR GREATER TO ACHIEVE REQUIRED STABILIZATION.
6. CONTRACTOR SHALL MAINTAIN ACCEPTABLE EROSION CONTROL PRACTICES WITHIN THE ANTICIPATED LIMITS OF CONSTRUCTION IDENTIFIED HEREIN. BEST MANAGEMENT PRACTICES AND STABILIZATION SHALL BE COMPLETED AS IDENTIFIED HEREIN IN ACCORDANCE WITH OWNER REQUIREMENTS.
7. SILT FENCE TO BE INSTALLED PRIOR TO COMMENCEMENT OF ONSITE GRADING AND CONSTRUCTION ACTIVITIES.
8. DEMOLITION, REMOVAL, OVEREXCAVATION AND SOIL TREATMENT SHALL BE IN ACCORDANCE WITH THE GEOTECHNICAL ENGINEER RECOMMENDATIONS AS NOTED IN THE APPROVED PROJECT GEOTECHNICAL REPORT.
9. VEGETATION COVER IS ABOUT 90% CONSISTING OF NATIVE GRASSES, TREES AND SHRUBS, BASED ON VISUAL INSPECTION
10. NO ASPHALT OR CONCRETE BATCH PLANTS SHALL BE USED FOR THIS PROJECT.

LEGEND

	PROPERTY LINE		ECB	EROSION CONTROL BLANKET
	DRAINAGE EASEMENT		VTC	VEHICLE TRACKING CONTROL
	LIMITS OF DISTURBANCE/CONSTRUCTION		SS	SOIL STOCKPILE
	SILT FENCE		SB	TEMPORARY SEDIMENT BASIN
	CONSTRUCTION FENCE			EXISTING FLOW ARROW
	SEDIMENT CONTROL LOGS			EXISTING MINOR CONTOUR
	TEMPORARY BARRICADE TYPE 3			EXISTING MAJOR CONTOUR
	CONCRETE WASHOUT AREA			PROPOSED MAJOR CONTOUR
	STABILIZED STAGING AREA			PROPOSED MINOR CONTOUR



NO.	REVISION	BY	DATE	APPR.

Kimley»Horn
2024 KIMLEY-HORN AND ASSOCIATES, INC.
2 North Nevada Avenue Suite 900
Colorado Springs, Colorado 80903 (719) 453-0180

DESIGNED BY: MJK
DRAWN BY: MJK
CHECKED BY: KRK
DATE: 08/15/2024

EAGLEVIEW
EL PASO COUNTY, COLORADO
GRADING AND EROSION CONTROL PLAN
INITIAL GEC PLAN

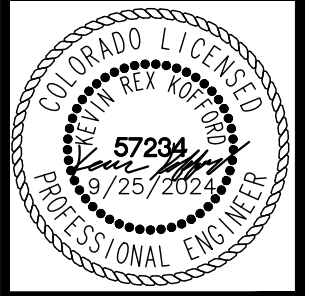

PROJECT NO.
196106001

SHEET
4

K:\COS_Civil\196288000_Eagleview\CADD\PlanSheets\CDA\GESC_OFFSITE_INITIAL.dwg Kofford, Kevin 9/25/2024 3:05 PM

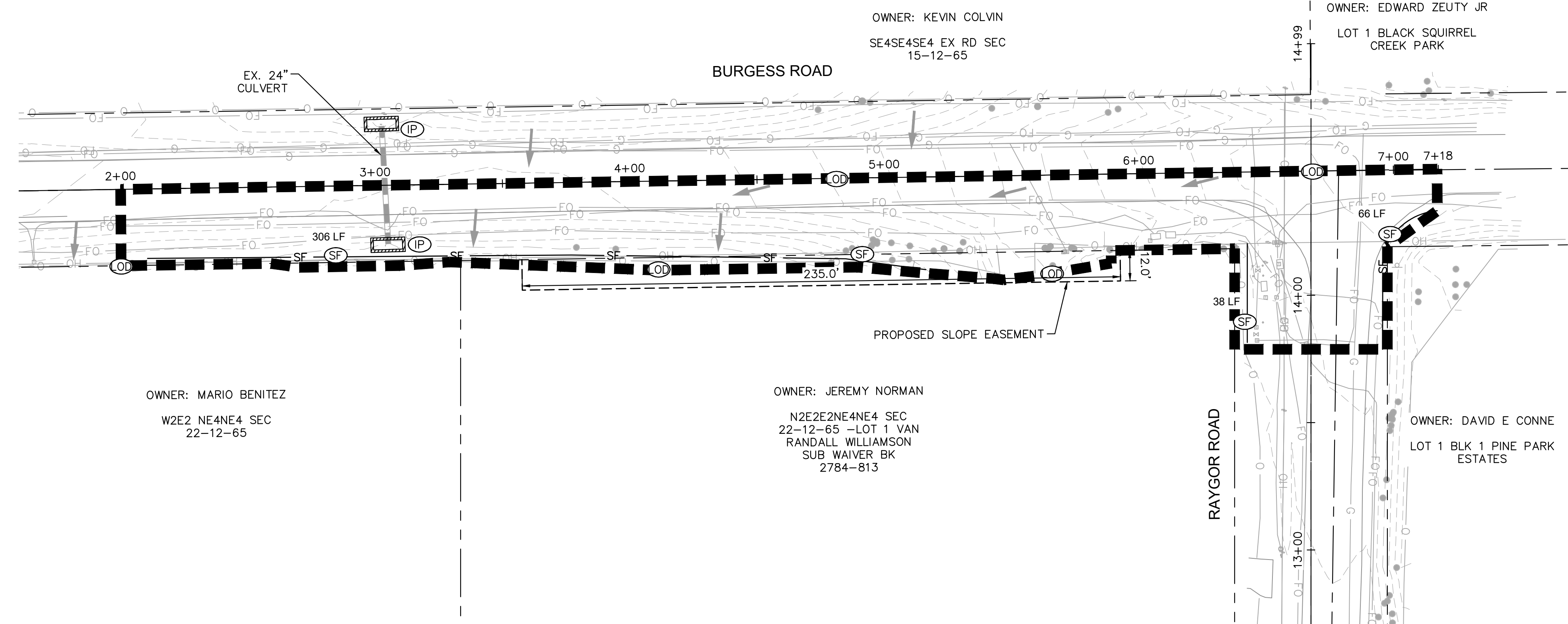

NOTES

1. THE INTENT OF THIS PLAN IS TO IDENTIFY THE EROSION CONTROL PRACTICES RECOMMENDED. THE CONTRACTOR SHALL REFERENCE ADDITIONAL CONSTRUCTION PLANS FOR DEMOLITION OF EXISTING AND CONSTRUCTION OF PROPOSED IMPROVEMENTS.
2. ADJACENT STREETS SHALL BE KEPT CLEAN AND FREE OF SEDIMENT AND/OR DEBRIS AT ALL TIMES.
3. TEMPORARY STABILIZATION (TS) SHALL BE IMPLEMENTED WITHIN THE DISTURBED PORTIONS OF THE PROJECT SITE NO LATER THAN 14 DAYS FOLLOWING THE CEASE OF CONSTRUCTION ACTIVITIES WITHIN THE DISTURBED AREAS.
4. PERMANENT STABILIZATION (PS) MAY BE USED WITHIN AREAS OF TEMPORARY STABILIZATION (TS) AT THE CONTRACTOR'S DISCRETION. STABILIZATION SHALL BE APPLIED IN ACCORDANCE WITH APPLICABLE TEMPORARY STABILIZATION SEQUENCING REQUIREMENTS.
5. CONTRACTOR SHALL UTILIZE ROLLED EROSION CONTROL PRODUCTS (STRAW-SINGLE NET EROSION CONTROL BLANKETS AND OPEN WEAVE TEXTILES) ON ALL SLOPES 3H:1V OR GREATER TO ACHIEVE REQUIRED STABILIZATION.
6. CONTRACTOR SHALL MAINTAIN ACCEPTABLE EROSION CONTROL PRACTICES WITHIN THE ANTICIPATED LIMITS OF CONSTRUCTION IDENTIFIED HEREIN. BEST MANAGEMENT PRACTICES AND STABILIZATION SHALL BE COMPLETED AS IDENTIFIED HEREIN IN ACCORDANCE WITH OWNER REQUIREMENTS.
7. SILT FENCE TO BE INSTALLED PRIOR TO COMMENCEMENT OF ONSITE GRADING AND CONSTRUCTION ACTIVITIES.
8. ROCK CHECK DAMS (CD) MAY BE SUBSTITUTED FOR SEDIMENT CONTROL LOGS (SCL) OR STRAW WADDLES. CONTRACTOR TO DETERMINE LOCATION OF CD WITHIN THE ROADSIDE DITCH (SEE TABLE FOR MIN. SPACING REQUIREMENTS) IN COORDINATION WITH COUNTY INSPECTORS.
9. DEMOLITION, REMOVAL, OVEREXCAVATION AND SOIL TREATMENT SHALL BE IN ACCORDANCE WITH THE GEOTECHNICAL ENGINEER RECOMMENDATIONS AS NOTED IN THE APPROVED PROJECT GEOTECHNICAL REPORT.
10. VEGETATION COVER IS ABOUT 90% CONSISTING OF NATIVE GRASSES, TREES AND SHRUBS, BASED ON VISUAL INSPECTION
11. NO ASPHALT OR CONCRETE BATCH PLANTS SHALL BE USED FOR THIS PROJECT.

LEGEND

- — — — — PROPERTY LINE
- - - - - PROPOSED EASEMENT
- - - - - (OD) LIMITS OF DISTURBANCE/CONSTRUCTION
- SF — (SF) SILT FENCE
- (CD) CHECK DAMS (NOTE 8)
- (IP) CULVERT INLET/OUTLET PROTECTION
- FLOW ARROW
- - - - -64XX- - - - - EXISTING MINOR CONTOUR
- - - - -64XX- - - - - EXISTING MAJOR CONTOUR
- 54XX — PROPOSED MAJOR CONTOUR
- 54XX — PROPOSED MINOR CONTOUR

LIMITS OF CONSTRUCTION

OFFSITE DISTURBANCE = ±0.44 ACRES

SIZE OF SCL (STRAW WADDLE)	SPACING (PER VERTICAL FEET OF FALL)
9 INCH	1.5 FEET
12 INCH	2 FEET
16 INCH	2.67 FEET

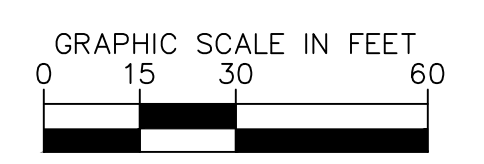

811 Know what's below. Call before you dig.

CALL UTILITY NOTIFICATION CENTER OF COLORADO
1-800-922-1987
CALL 2-BUSINESS DAYS IN ADVANCE BEFORE YOU DIG, GRADE, OR EXCAVATE FOR THE MARKING OF UNDERGROUND MEMBER UTILITIES

NO.	REVISION	BY	DATE	APPR.

Kimley»Horn
2024 KIMLEY-HORN AND ASSOCIATES, INC.
2 North Nevada Avenue Suite 900
Colorado Springs, Colorado 80903 (719) 453-0180

DESIGNED BY: MJK
DRAWN BY: MJK
CHECKED BY: KKK
DATE: 08/15/2024

**EAGLEVIEW
EL PASO COUNTY, COLORADO
GRADING AND EROSION CONTROL PLAN
OFF-SITE INITIAL GEC PLAN**



PROJECT NO. 196106001

SHEET

K:\COS_Civil\196288000_Eagleview\CADD\PlanSheets\Early_GEC\EG_GEC_INTERIM.dwg Kofford, Kevin 9/25/2024 3:06 PM

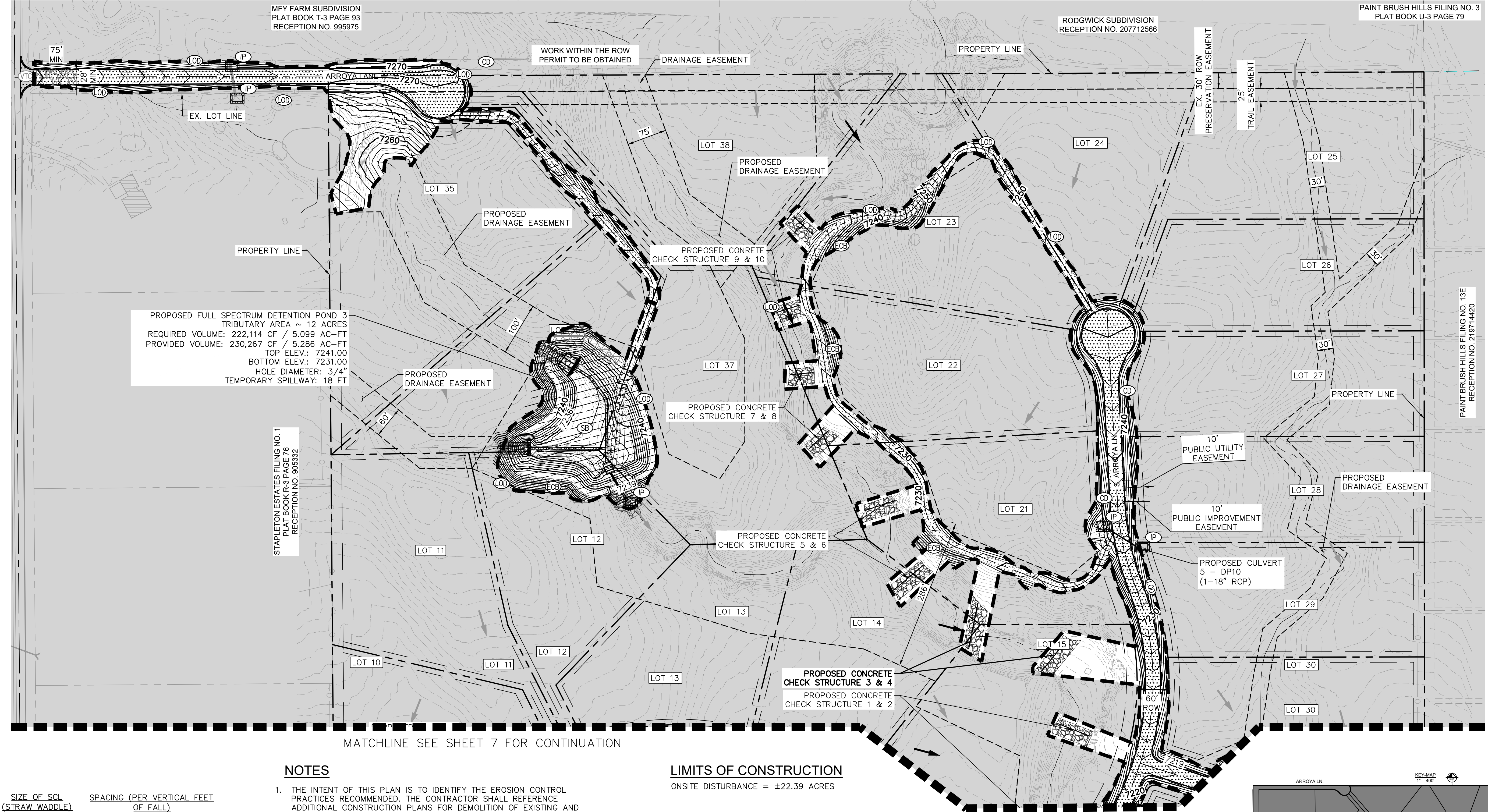

PROPOSED FULL SPECTRUM DETENTION POND 3
 TRIBUTARY AREA ~ 12 ACRES
 REQUIRED VOLUME: 222,114 CF / 5.099 AC-FT
 PROVIDED VOLUME: 230,267 CF / 5.286 AC-FT
 TOP ELEV.: 7241.00
 BOTTOM ELEV.: 7231.00
 HOLE DIAMETER: 3/4"
 TEMPORARY SPILLWAY: 18 FT

STAPLETON ESTATES FILING NO. 1
 PLAT BOOK R-3 PAGE 76
 RECEPTION NO. 905332

MATCHLINE SEE SHEET 7 FOR CONTINUATION

SIZE OF SCL (STRAW WADDLE)	SPACING (PER VERTICAL FEET OF FALL)
9 INCH	1.5 FEET
12 INCH	2 FEET
16 INCH	2.67 FEET

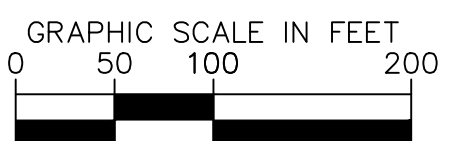
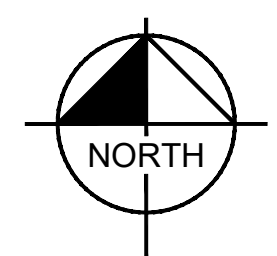

NOTES

1. THE INTENT OF THIS PLAN IS TO IDENTIFY THE EROSION CONTROL PRACTICES RECOMMENDED. THE CONTRACTOR SHALL REFERENCE ADDITIONAL CONSTRUCTION PLANS FOR DEMOLITION OF EXISTING AND CONSTRUCTION OF PROPOSED IMPROVEMENTS.
2. TEMPORARY STABILIZATION (TS) SHALL BE IMPLEMENTED WITHIN THE DISTURBED PORTIONS OF THE PROJECT SITE NO LATER THAN 14 DAYS FOLLOWING THE CEASE OF CONSTRUCTION ACTIVITIES WITHIN THE DISTURBED AREAS.
3. PERMANENT STABILIZATION (PS) MAY BE USED WITHIN AREAS OF TEMPORARY STABILIZATION (TS) AT THE CONTRACTOR'S DISCRETION. STABILIZATION SHALL BE APPLIED IN ACCORDANCE WITH APPLICABLE TEMPORARY STABILIZATION SEQUENCING REQUIREMENTS.
4. CONTRACTOR SHALL UTILIZE ROLLED EROSION CONTROL PRODUCTS (STRAW-SINGLE NET EROSION CONTROL BLANKETS AND OPEN WEAVE TEXTILES) ON ALL SLOPES 3H:1V OR GREATER TO ACHIEVE REQUIRED STABILIZATION.
5. SILT FENCE TO BE INSTALLED PRIOR TO COMMENCEMENT OF ONSITE GRADING AND CONSTRUCTION ACTIVITIES.
6. DEMOLITION, REMOVAL, OVEREXCAVATION AND SOIL TREATMENT SHALL BE IN ACCORDANCE WITH THE GEOTECHNICAL ENGINEER RECOMMENDATIONS AS NOTED IN THE APPROVED PROJECT GEOTECHNICAL REPORT.
7. VEGETATION COVER IS ABOUT 90% CONSISTING OF NATIVE GRASSES, TREES AND SHRUBS. BASED ON VISUAL INSPECTION
8. ROCK CHECK DAMS (CD) MAY BE SUBSTITUTED FOR SEDIMENT CONTROL LOGS (SCL) OR STRAW WADDLES. CONTRACTOR TO DETERMINE LOCATION OF CD WITHIN THE ROADSIDE DITCH (SEE TABLE ON THIS SHEET FOR MIN. SPACING REQUIREMENTS) IN COORDINATION WITH COUNTY INSPECTORS.

LIMITS OF CONSTRUCTION

ONSITE DISTURBANCE = ±22.39 ACRES

LEGEND

- PROPERTY LINE
- - - DRAINAGE EASEMENT
- PROPOSED ASPHALT PAVEMENT
- LIMITS OF DISTURBANCE/CONSTRUCTION
- - - SF SILT FENCE
- - - CF CONSTRUCTION FENCE
- IP CULVERT INLET/OUTLET PROTECTION
- CWA CONCRETE WASHOUT AREA
- SSA STABILIZED STAGING AREA
- CD CHECK DAMS (NOTE 8)
- ECB EROSION CONTROL BLANKET
- VT VEHICLE TRACKING CONTROL
- SS SOIL STOCKPILE
- SB TEMPORARY SEDIMENT BASIN
- SM TEMP./PERM. SEEDING AND MULCHING
- EXISTING FLOW ARROW
- - - 64XX EXISTING MINOR CONTOUR
- - - 64XX EXISTING MAJOR CONTOUR
- 54XX PROPOSED MAJOR CONTOUR
- 54XX PROPOSED MINOR CONTOUR

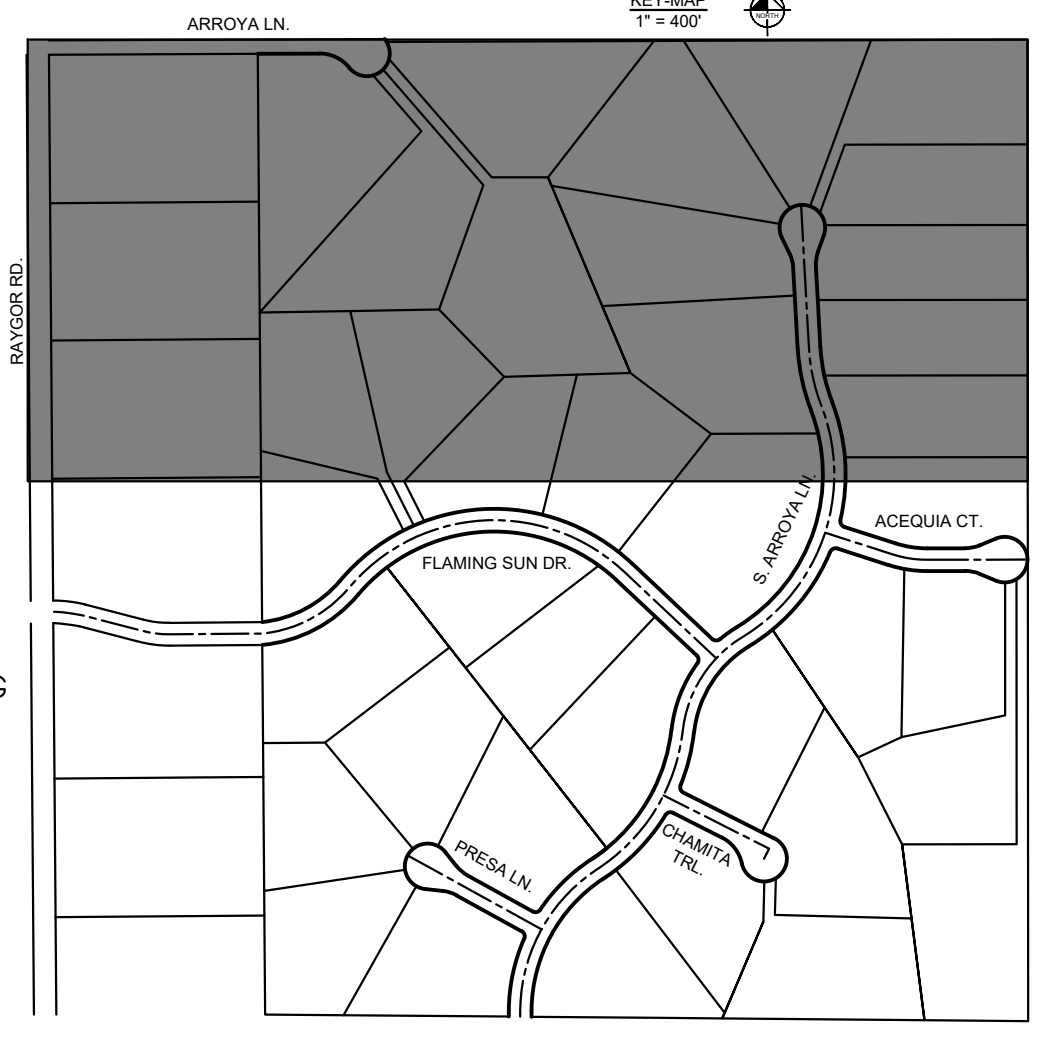

811 Know what's below. Call before you dig.

CALL UTILITY NOTIFICATION CENTER OF COLORADO
 1-800-922-1987
 CALL 2-BUSINESS DAYS IN ADVANCE BEFORE YOU DIG, GRADE, OR EXCAVATE FOR THE MARKING OF UNDERGROUND MEMBER UTILITIES

NO.	REVISION	BY	DATE	APPR

Kimley Horn
 2024 KIMLEY-HORN AND ASSOCIATES, INC.
 2 North Nevada Avenue Suite 900
 Colorado Springs, Colorado 80903 (719) 453-0180

DESIGNED BY: MJK
 DRAWN BY: MJK
 CHECKED BY: KRK
 DATE: 08/15/2024

**EAGLEVIEW
 EL PASO COUNTY, COLORADO
 GRADING AND EROSION CONTROL PLAN
 INTERIM GEC PLAN**



PROJECT NO. 196106001

SHEET

6

K:\COS_Civil\196288000_Eagleview\CADD\PlanSheets\Early GEC\EG_GEC_INTERIM.dwg Kofford, Kevin 9/25/2024 3:06 PM

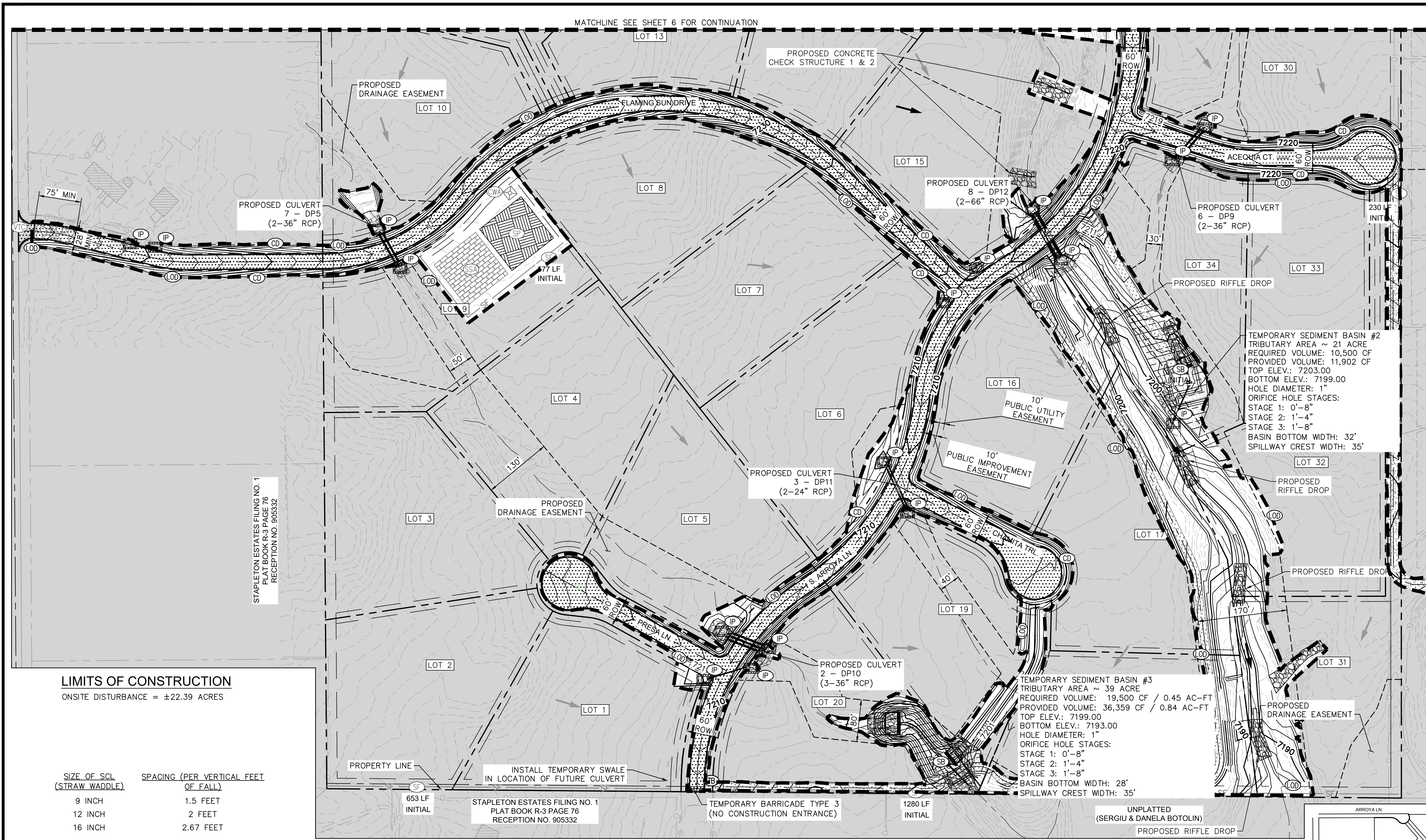

LIMITS OF CONSTRUCTION
ONSITE DISTURBANCE = ±22.39 ACRES

SIZE OF SCL (STRAW WADDLE)	SPACING (PER VERTICAL FEET OF FALL)
9 INCH	1.5 FEET
12 INCH	2 FEET
16 INCH	2.67 FEET

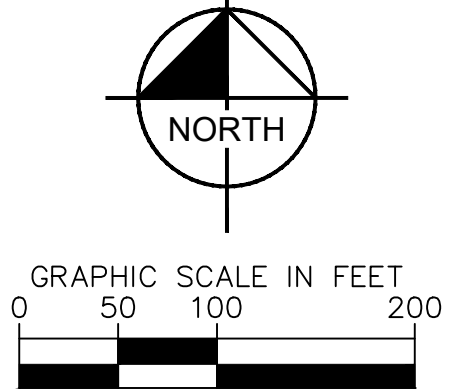

NOTES

- THE INTENT OF THIS PLAN IS TO IDENTIFY THE EROSION CONTROL PRACTICES RECOMMENDED. THE CONTRACTOR SHALL REFERENCE ADDITIONAL CONSTRUCTION PLANS FOR DEMOLITION OF EXISTING AND CONSTRUCTION OF PROPOSED IMPROVEMENTS.
- TEMPORARY STABILIZATION (TS) SHALL BE IMPLEMENTED WITHIN THE DISTURBED PORTIONS OF THE PROJECT SITE NO LATER THAN 14 DAYS FOLLOWING THE CEASE OF CONSTRUCTION ACTIVITIES WITHIN THE DISTURBED AREAS.
- PERMANENT STABILIZATION (PS) MAY BE USED WITHIN AREAS OF TEMPORARY STABILIZATION (TS) AT THE CONTRACTOR'S DISCRETION. STABILIZATION SHALL BE APPLIED IN ACCORDANCE WITH APPLICABLE TEMPORARY STABILIZATION SEQUENCING REQUIREMENTS.
- CONTRACTOR SHALL UTILIZE ROLLED EROSION CONTROL PRODUCTS (STRAW-SINGLE NET EROSION CONTROL BLANKETS AND OPEN WEAVE TEXTILES) ON ALL SLOPES 3H:1V OR GREATER TO ACHIEVE REQUIRED STABILIZATION.
- SILT FENCE TO BE INSTALLED PRIOR TO COMMENCEMENT OF ONSITE GRADING AND CONSTRUCTION ACTIVITIES.
- DEMOLITION, REMOVAL, OVEREXCAVATION AND SOIL TREATMENT SHALL BE IN ACCORDANCE WITH THE GEOTECHNICAL ENGINEER RECOMMENDATIONS AS NOTED IN THE APPROVED PROJECT GEOTECHNICAL REPORT.
- VEGETATION COVER IS ABOUT 90% CONSISTING OF NATIVE GRASSES, TREES AND SHRUBS, BASED ON VISUAL INSPECTION
- ROCK CHECK DAMS (CD) MAY BE SUBSTITUTED FOR SEDIMENT CONTROL LOGS (SCL) OR STRAW WADDLES. CONTRACTOR TO DETERMINE LOCATION OF CD WITHIN THE ROADSIDE DITCH (SEE TABLE ON THIS SHEET FOR MIN. SPACING REQUIREMENTS) IN COORDINATION WITH COUNTY INSPECTORS.

LEGEND

	PROPERTY LINE		EROSION CONTROL BLANKET (NOTE 4)
	DRAINAGE EASEMENT		VEHICLE TRACKING CONTROL
	PROPOSED ASPHALT PAVEMENT		SOIL STOCKPILE
	LIMITS OF DISTURBANCE/CONSTRUCTION		TEMPORARY SEDIMENT BASIN
	SILT FENCE		TEMP./PERM. SEEDING AND MULCHING
	CONSTRUCTION FENCE		EXISTING FLOW ARROW
	TEMPORARY BARRICADE TYPE 3		EXISTING MINOR CONTOUR
	CULVERT INLET/OUTLET PROTECTION		EXISTING MAJOR CONTOUR
	CONCRETE WASHOUT AREA		PROPOSED MAJOR CONTOUR
	STABILIZED STAGING AREA		PROPOSED MINOR CONTOUR
	CHECK DAMS (NOTE 8)		

811 Know what's below. Call before you dig.

CALL UTILITY NOTIFICATION CENTER OF COLORADO 1-800-922-1987
CALL 2-BUSINESS DAYS IN ADVANCE BEFORE YOU DIG, GRADE, OR EXCAVATE FOR THE MARKING OF UNDERGROUND MEMBER UTILITIES

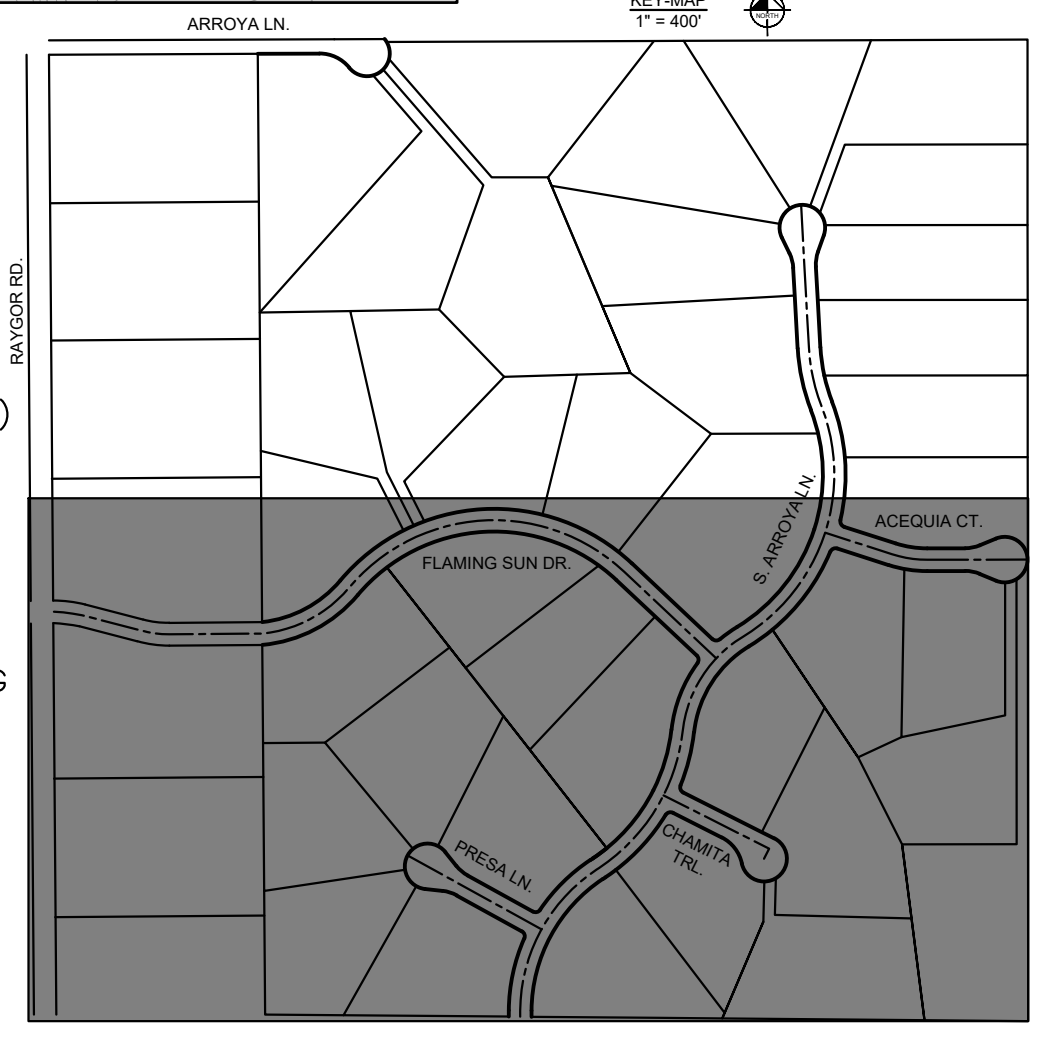

NO.	REVISION	BY	DATE

Kimley»Horn
2024 KIMLEY-HORN AND ASSOCIATES, INC.
2 North Nevada Avenue Suite 900
Colorado Springs, Colorado 80903 (719) 453-0180

DESIGNED BY: MJK
DRAWN BY: MJK
CHECKED BY: KRK
DATE: 08/15/2024

EAGLEVIEW
EL PASO COUNTY, COLORADO
GRADING AND EROSION CONTROL PLAN
INTERIM GEC PLAN



PROJECT NO. 196106001
SHEET 7

K:\COS_Civil\196288000_Eagleview\CADD\PlanSheets\CDA\GESC_OFFSITE_INTERIM.dwg Kofford, Kevin 9/25/2024 3:06 PM

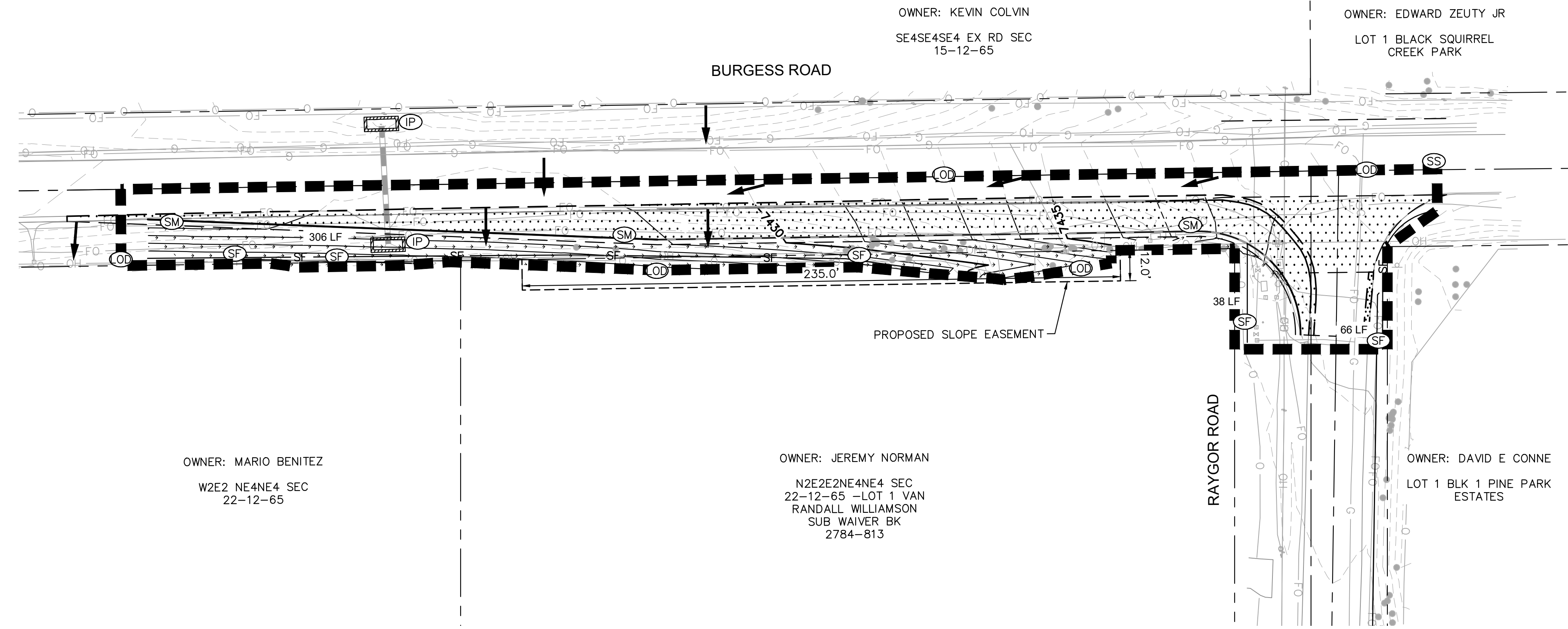

NOTES

1. THE INTENT OF THIS PLAN IS TO IDENTIFY THE EROSION CONTROL PRACTICES RECOMMENDED. THE CONTRACTOR SHALL REFERENCE ADDITIONAL CONSTRUCTION PLANS FOR DEMOLITION OF EXISTING AND CONSTRUCTION OF PROPOSED IMPROVEMENTS.
2. TEMPORARY STABILIZATION (TS) SHALL BE IMPLEMENTED WITHIN THE DISTURBED PORTIONS OF THE PROJECT SITE NO LATER THAN 14 DAYS FOLLOWING THE CEASE OF CONSTRUCTION ACTIVITIES WITHIN THE DISTURBED AREAS.
3. PERMANENT STABILIZATION (PS) MAY BE USED WITHIN AREAS OF TEMPORARY STABILIZATION (TS) AT THE CONTRACTOR'S DISCRETION. STABILIZATION SHALL BE APPLIED IN ACCORDANCE WITH APPLICABLE TEMPORARY STABILIZATION SEQUENCING REQUIREMENTS.
4. CONTRACTOR SHALL UTILIZE ROLLED EROSION CONTROL PRODUCTS (STRAW-SINGLE NET EROSION CONTROL BLANKETS AND OPEN WEAVE TEXTILES) ON ALL SLOPES 3:1V OR GREATER TO ACHIEVE REQUIRED STABILIZATION. SILT FENCE TO BE INSTALLED PRIOR TO COMMENCEMENT OF ONSITE GRADING AND CONSTRUCTION ACTIVITIES.
5. DEMOLITION, REMOVAL, OVEREXCAVATION AND SOIL TREATMENT SHALL BE IN ACCORDANCE WITH THE GEOTECHNICAL ENGINEER RECOMMENDATIONS AS NOTED IN THE APPROVED PROJECT GEOTECHNICAL REPORT.
6. VEGETATION COVER IS ABOUT 90% CONSISTING OF NATIVE GRASSES, TREES AND SHRUBS, BASED ON VISUAL INSPECTION.
7. ROCK CHECK DAMS (CD) MAY BE SUBSTITUTED FOR SEDIMENT CONTROL LOGS (SCL) OR STRAW WADDLES. CONTRACTOR TO DETERMINE LOCATION OF CD WITHIN THE ROADSIDE DITCH (SEE TABLE FOR MIN. SPACING REQUIREMENTS) IN COORDINATION WITH COUNTY INSPECTORS.

LEGEND

- PROPERTY LINE
- - - PROPOSED EASEMENT
- PROPOSED ASPHALT PAVEMENT
- (OD)--- LIMITS OF DISTURBANCE/CONSTRUCTION
- (SF)--- SILT FENCE
- (CD)--- CHECK DAMS (NOTE 8)
- (IP)--- CULVERT INLET/OUTLET PROTECTION
- (SS)--- STREET SWEEPING
- (SM)--- TEMP./PERM. SEEDING AND MULCHING
- FLOW ARROW
- - -64XX- - - EXISTING MINOR CONTOUR
- - -64XX- - - EXISTING MAJOR CONTOUR
- 54XX--- PROPOSED MAJOR CONTOUR
- 54XX--- PROPOSED MINOR CONTOUR

SIZE OF SCL (STRAW WADDLE)	SPACING (PER VERTICAL FEET OF FALL)
9 INCH	1.5 FEET
12 INCH	2 FEET
16 INCH	2.67 FEET

LIMITS OF CONSTRUCTION

OFFSITE DISTURBANCE = ±0.44 ACRES

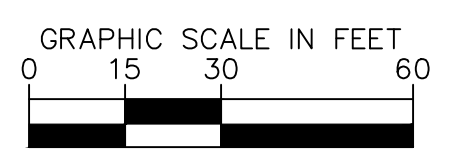
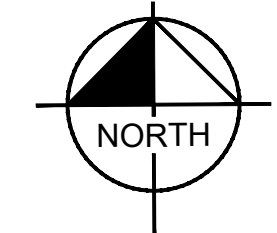

811 Know what's below. Call before you dig.

CALL UTILITY NOTIFICATION CENTER OF COLORADO
1-800-922-1987
CALL 2-BUSINESS DAYS IN ADVANCE BEFORE YOU DIG, GRADE, OR EXCAVATE FOR THE MARKING OF UNDERGROUND MEMBER UTILITIES

NO.	REVISION	BY	DATE	APPR.

Kimley»Horn
2024 KIMLEY-HORN AND ASSOCIATES, INC.
2 North Nevada Avenue Suite 900
Colorado Springs, Colorado 80903 (719) 453-0180

DESIGNED BY: MJK
DRAWN BY: MJK
CHECKED BY: KKK
DATE: 08/15/2024

**EAGLEVIEW
EL PASO COUNTY, COLORADO
GRADING AND EROSION CONTROL PLAN
OFFSITE-INTERIM GEC PLAN**



PROJECT NO.
196106001
SHEET
8

K:\COS_Civil\196288000_Eagleview\CADD\PlanSheets\Early GEC\EG_GEC_FINAL.dwg Kofford, Kevin 9/25/2024 3:06 PM

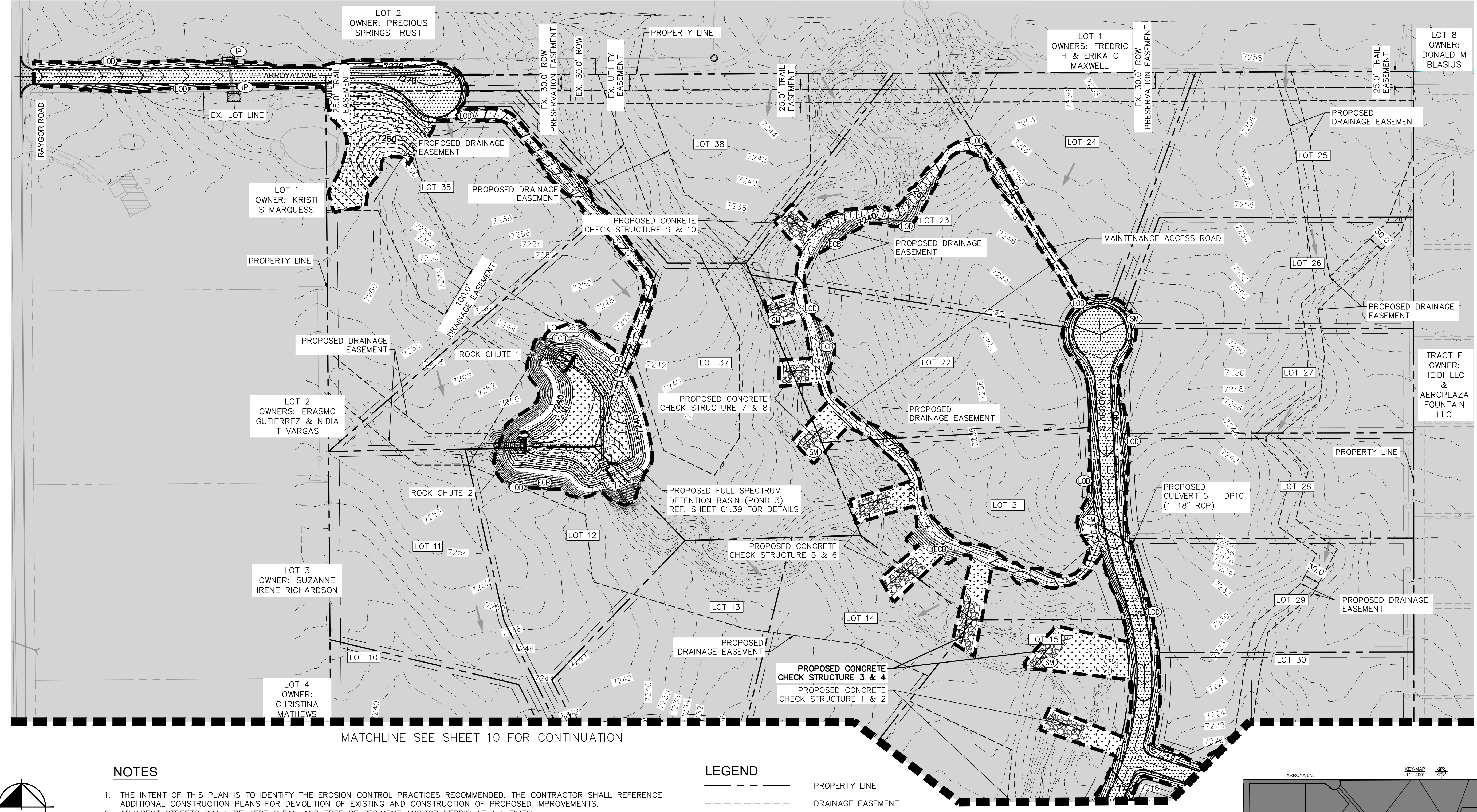

MATCHLINE SEE SHEET 10 FOR CONTINUATION

NOTES

- 1. THE INTENT OF THIS PLAN IS TO IDENTIFY THE EROSION CONTROL PRACTICES RECOMMENDED...
2. ADJACENT STREETS SHALL BE KEPT CLEAN AND FREE OF SEDIMENT AND/OR DEBRIS AT ALL TIMES...
3. TEMPORARY STABILIZATION (TS) SHALL BE IMPLEMENTED WITHIN THE DISTURBED PORTIONS OF THE PROJECT SITE NO LATER THAN 14 DAYS FOLLOWING THE CEASE OF CONSTRUCTION ACTIVITIES WITHIN THE DISTURBED AREAS...
4. PERMANENT STABILIZATION (PS) MAY BE USED WITHIN AREAS OF TEMPORARY STABILIZATION (TS) AT THE CONTRACTOR'S DISCRETION...
5. CONTRACTOR SHALL UTILIZE ROLLED EROSION CONTROL PRODUCTS (STRAW-SINGLE NET EROSION CONTROL BLANKETS AND OPEN WEAVE TEXTILES) ON ALL SLOPES 3H:1V OR GREATER TO ACHIEVE REQUIRED STABILIZATION...
6. CONTRACTOR SHALL MAINTAIN ACCEPTABLE EROSION CONTROL PRACTICES WITHIN THE ANTICIPATED LIMITS OF CONSTRUCTION IDENTIFIED HEREIN...
7. ALL WORK IN THE HODGEN ROAD AND MERIDIAN ROAD ROW REQUIRES A ROW PERMIT FROM EL PASO COUNTY...
8. SILT FENCE TO BE INSTALLED PRIOR TO COMMENCEMENT OF ONSITE GRADING AND CONSTRUCTION ACTIVITIES...
9. DEMOLITION, REMOVAL, OVEREXCAVATION AND SOIL TREATMENT SHALL BE IN ACCORDANCE WITH THE GEOTECHNICAL ENGINEER RECOMMENDATIONS AS NOTED IN THE APPROVED PROJECT GEOTECHNICAL REPORT...
10. VEGETATION COVER IS ABOUT 90% CONSISTING OF NATIVE GRASSES, TREES AND SHRUBS, BASED ON VISUAL INSPECTION...
11. NO ASPHALT OR CONCRETE BATCH PLANTS SHALL BE USED FOR THIS PROJECT...
12. CHECK DAMS TO BE PLACED IN TEMPORARY AND PERMANENT DRAINAGE SWALES AND ROADSIDE DITCHES AND TO BE SPACED AS DEEMED NECESSARY...
13. TRM MATTING DEPICTED IN PLAN VIEW SHALL BE PLACED BY THE CONTRACTOR SUCH THAT IT COVERS THE CHANNEL BOTTOM AND EXTENDS 2 VERTICAL FEET UP THE SIDE SLOPES FROM THE TOE OF SLOPE.

LEGEND

- PROPERTY LINE
DRAINAGE EASEMENT
PROPOSED ASPHALT PAVEMENT
LIMITS OF DISTURBANCE
EROSION CONTROL BLANKET
PERMANENT SEEDING AND MULCHING
CULVERT INLET/OUTLET PROTECTION
EXISTING FLOW ARROW
PROPOSED FLOW ARROW
EXISTING MINOR CONTOUR
EXISTING MAJOR CONTOUR
PROPOSED MAJOR CONTOUR
PROPOSED MINOR CONTOUR

LIMITS OF CONSTRUCTION
ONSITE DISTURBANCE = ±22.39 ACRES

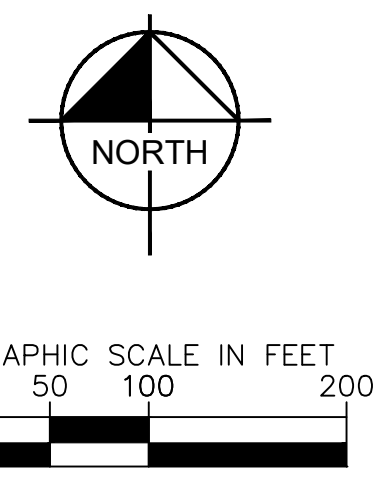

811 Know what's below. Call before you dig. CALL UTILITY NOTIFICATION CENTER OF COLORADO 1-800-922-1987

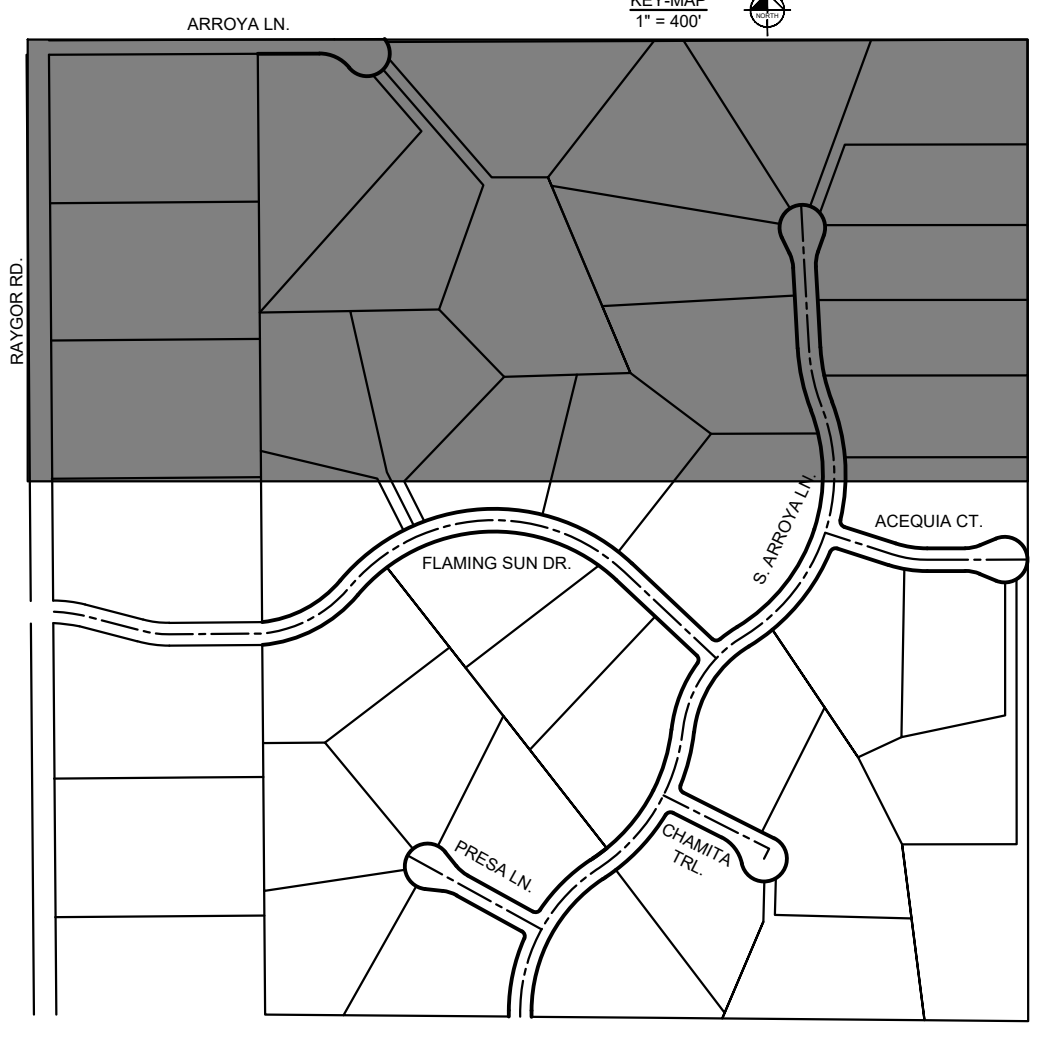

Table with columns for NO., REVISION, BY, DATE, APPR.

Kimley Horn
2024 KIMLEY-HORN AND ASSOCIATES, INC.
2 North Nevada Avenue Suite 900
Colorado Springs, Colorado 80903 (719) 453-0180
DESIGNED BY: MJK
DRAWN BY: MJK
CHECKED BY: KRK
DATE: 08/15/2024

EAGLEVIEW
EL PASO COUNTY, COLORADO
GRADING AND EROSION CONTROL PLAN
FINAL GEC PLAN

Professional Engineer Seal for Kevin R. Kofford, No. 57294, State of Colorado. PROJECT NO. 196106001 SHEET 9

K:\COS_Civil\196288000_Eagleview\CADD\PlanSheets\Early GEC\EG_GEC_FINAL.dwg Kofford, Kevin 9/25/2024 3:07 PM

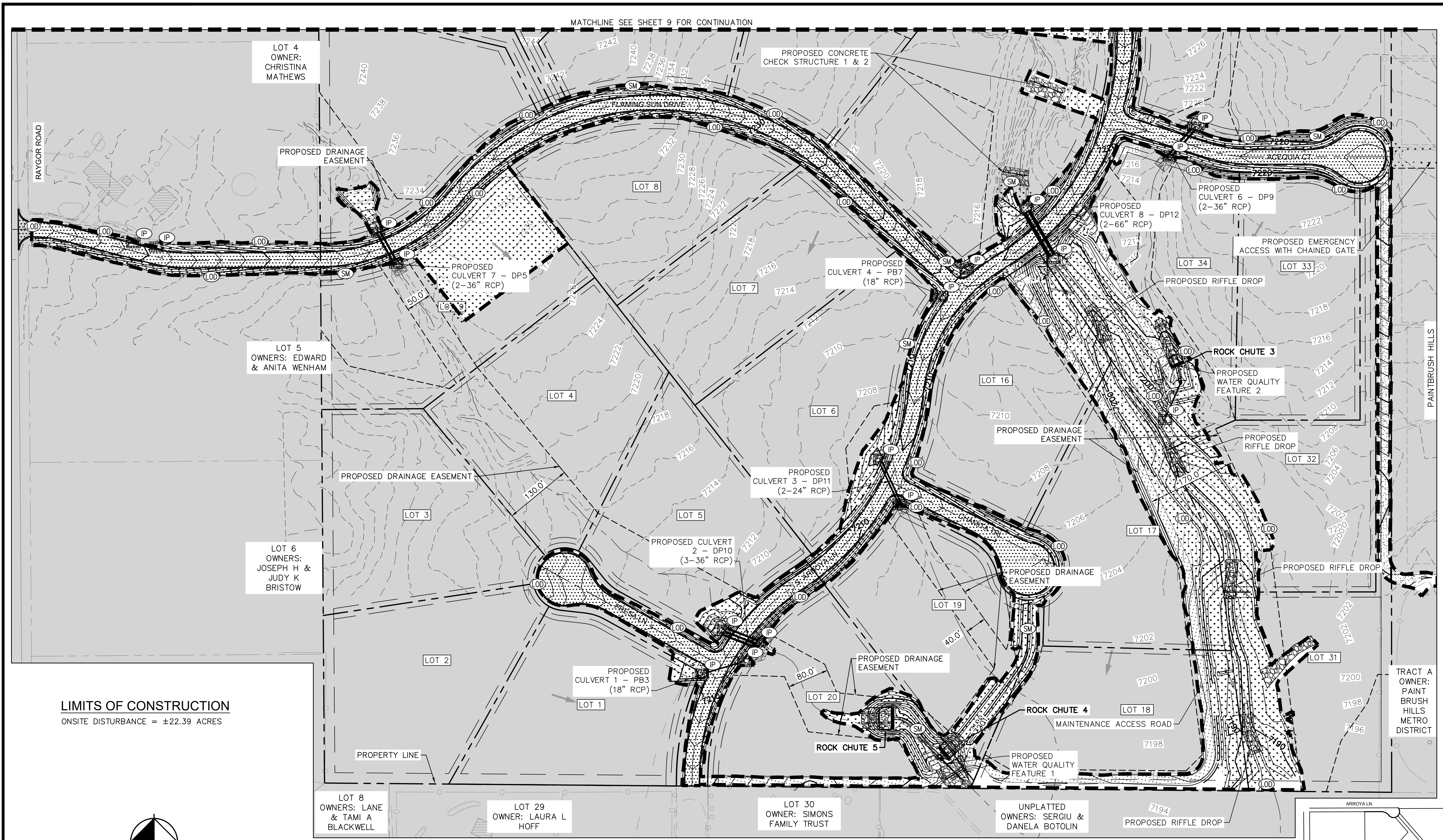

LIMITS OF CONSTRUCTION
ONSITE DISTURBANCE = ±22.39 ACRES

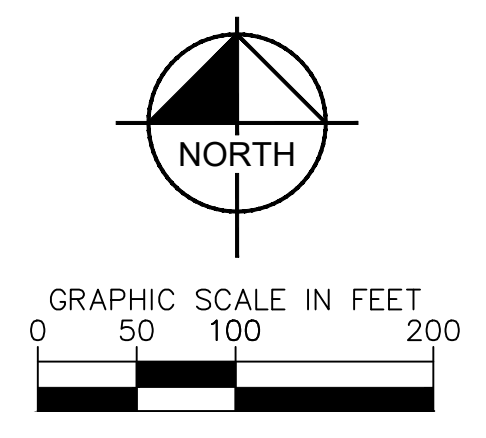

NOTES

1. THE INTENT OF THIS PLAN IS TO IDENTIFY THE EROSION CONTROL PRACTICES RECOMMENDED. THE CONTRACTOR SHALL REFERENCE ADDITIONAL CONSTRUCTION PLANS FOR DEMOLITION OF EXISTING AND CONSTRUCTION OF PROPOSED IMPROVEMENTS.
2. ADJACENT STREETS SHALL BE KEPT CLEAN AND FREE OF SEDIMENT AND/OR DEBRIS AT ALL TIMES.
3. TEMPORARY STABILIZATION (TS) SHALL BE IMPLEMENTED WITHIN THE DISTURBED PORTIONS OF THE PROJECT SITE NO LATER THAN 14 DAYS FOLLOWING THE CEASE OF CONSTRUCTION ACTIVITIES WITHIN THE DISTURBED AREAS.
4. PERMANENT STABILIZATION (PS) MAY BE USED WITHIN AREAS OF TEMPORARY STABILIZATION (TS) AT THE CONTRACTOR'S DISCRETION. STABILIZATION SHALL BE APPLIED IN ACCORDANCE WITH APPLICABLE TEMPORARY STABILIZATION SEQUENCING REQUIREMENTS.
5. CONTRACTOR SHALL UTILIZE ROLLED EROSION CONTROL PRODUCTS (STRAW-SINGLE NET EROSION CONTROL BLANKETS AND OPEN WEAVE TEXTILES) ON ALL SLOPES 3H:1V OR GREATER TO ACHIEVE REQUIRED STABILIZATION.
6. CONTRACTOR SHALL MAINTAIN ACCEPTABLE EROSION CONTROL PRACTICES WITHIN THE ANTICIPATED LIMITS OF CONSTRUCTION IDENTIFIED HEREIN. BEST MANAGEMENT PRACTICES AND STABILIZATION SHALL BE COMPLETED AS IDENTIFIED HEREIN IN ACCORDANCE WITH OWNER REQUIREMENTS.
7. ALL WORK IN THE HODGEN ROAD AND MERDIAN ROAD ROW REQUIRES A ROW PERMIT FROM EL PASO COUNTY. CONTRACTOR IS RESPONSIBLE FOR APPLYING FOR AND OBTAINING ALL NECESSARY ROW PERMITS.
8. SILT FENCE TO BE INSTALLED PRIOR TO COMMENCEMENT OF ONSITE GRADING AND CONSTRUCTION ACTIVITIES.
9. DEMOLITION, REMOVAL, OVEREXCAVATION AND SOIL TREATMENT SHALL BE IN ACCORDANCE WITH THE GEOTECHNICAL ENGINEER RECOMMENDATIONS AS NOTED IN THE APPROVED PROJECT GEOTECHNICAL REPORT.
10. VEGETATION COVER IS ABOUT 90% CONSISTING OF NATIVE GRASSES, TREES AND SHRUBS, BASED ON VISUAL INSPECTION
11. NO ASPHALT OR CONCRETE BATCH PLANTS SHALL BE USED FOR THIS PROJECT.
12. CHECK DAMS TO BE PLACED IN TEMPORARY AND PERMANENT DRAINAGE SWALES AND ROADSIDE DITCHES AND TO BE SPACED AS DEEMED NECESSARY. RIRPRAP IN CHECK DAMS TO BE SUBSTITUTED WITH SCL.
13. TRM MATTING DEPICTED IN PLAN VIEW SHALL BE PLACED BY THE CONTRACTOR SUCH THAT IT COVERS THE CHANNEL BOTTOM EXTENDS 2 VERTICAL FEET UP THE SIDE SLOPES FROM THE TOE OF SLOPE.

LEGEND

- PROPERTY LINE
- - - DRAINAGE EASEMENT
- ▨ PROPOSED ASPHALT PAVEMENT
- ⊙ LIMITS OF DISTURBANCE
- ⊞ EROSION CONTROL BLANKET
- ⊞ PERMANENT SEEDING AND MULCHING
- ⊞ CULVERT INLET/OUTLET PROTECTION
- EXISTING FLOW ARROW
- X-XX% PROPOSED FLOW ARROW
- - -64XX- - - EXISTING MINOR CONTOUR
- - -64XX- - - EXISTING MAJOR CONTOUR
- - -54XX- - - PROPOSED MAJOR CONTOUR
- - -54XX- - - PROPOSED MINOR CONTOUR

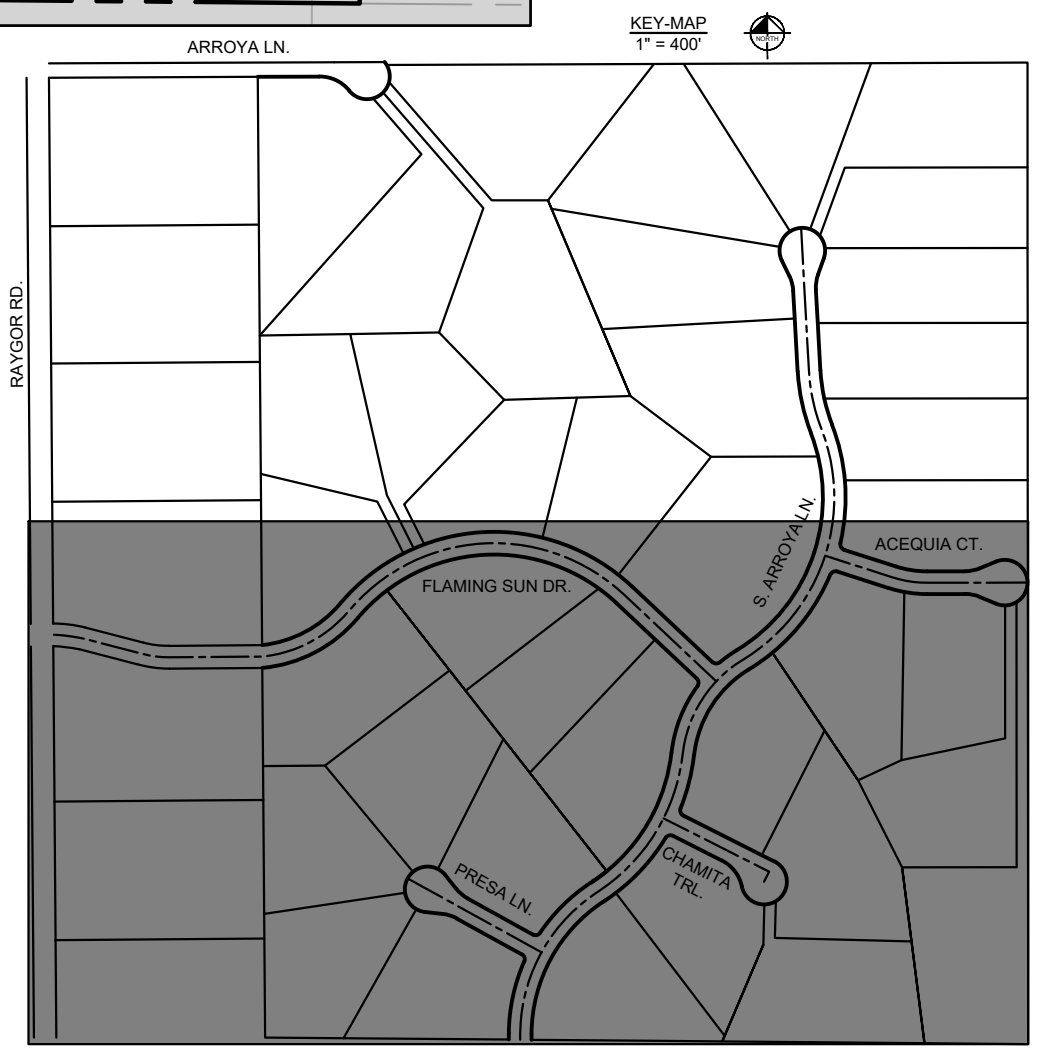

811 Know what's below. Call before you dig.

CALL UTILITY NOTIFICATION CENTER OF COLORADO
1-800-922-1987
CALL 2-BUSINESS DAYS IN ADVANCE BEFORE YOU DIG, GRADE, OR EXCAVATE FOR THE MARKING OF UNDERGROUND MEMBER UTILITIES

NO.	REVISION	BY	DATE

Kimley»Horn
2024 KIMLEY-HORN AND ASSOCIATES, INC.
2 North Nevada Avenue Suite 900
Colorado Springs, Colorado 80903 (719) 453-0180

DESIGNED BY: MJK
DRAWN BY: MJK
CHECKED BY: KRK
DATE: 08/15/2024

EAGLEVIEW
EL PASO COUNTY, COLORADO
GRADING AND EROSION CONTROL PLAN
FINAL GEC PLAN

PROJECT NO. 196106001
SHEET 10

PROFESSIONAL ENGINEER
57296
9/25/2024

K:\COS_Civil\196288000_Eagleview\CADD\PlanSheets\CDA\GESC_OFFSITE_FINAL.dwg Kofford, Kevin 9/25/2024 3:07 PM

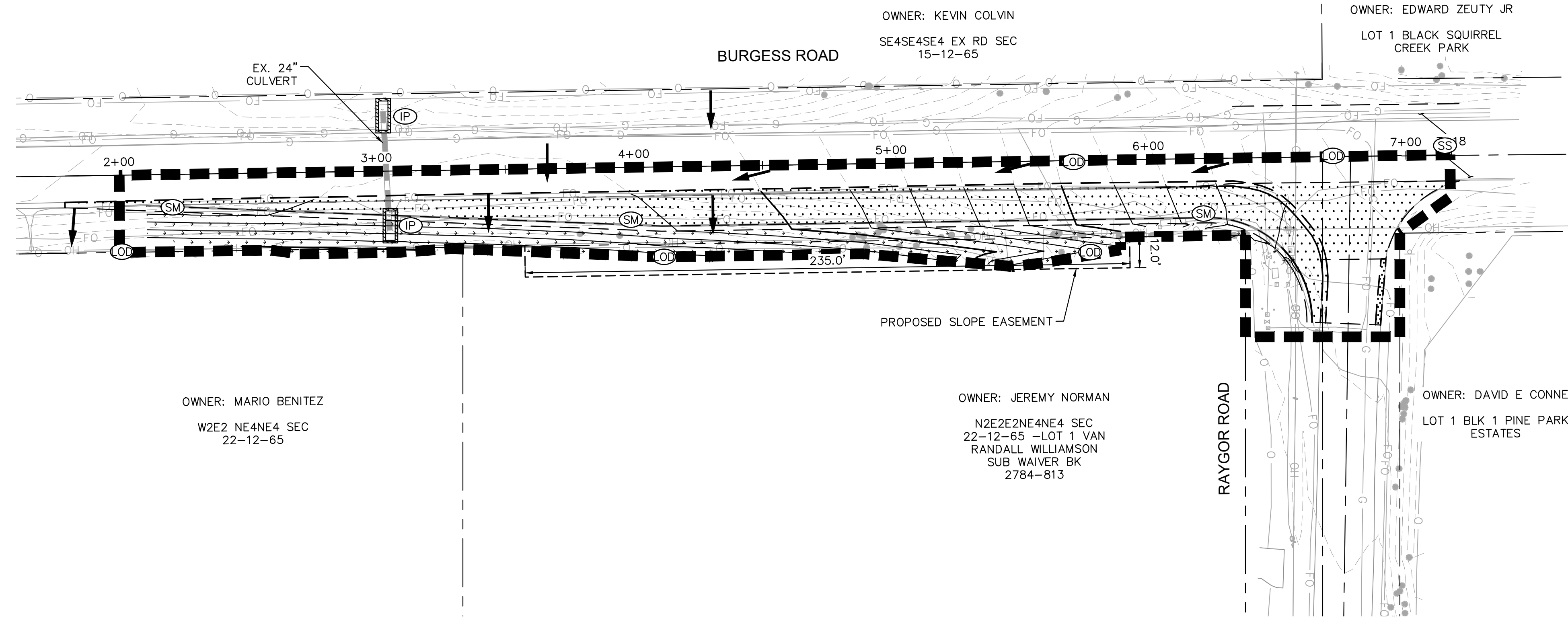

NOTES

1. THE INTENT OF THIS PLAN IS TO IDENTIFY THE EROSION CONTROL PRACTICES RECOMMENDED. THE CONTRACTOR SHALL REFERENCE ADDITIONAL CONSTRUCTION PLANS FOR DEMOLITION OF EXISTING AND CONSTRUCTION OF PROPOSED IMPROVEMENTS.
2. ADJACENT STREETS SHALL BE KEPT CLEAN AND FREE OF SEDIMENT AND/OR DEBRIS AT ALL TIMES.
3. TEMPORARY STABILIZATION (TS) SHALL BE IMPLEMENTED WITHIN THE DISTURBED PORTIONS OF THE PROJECT SITE NO LATER THAN 14 DAYS FOLLOWING THE CEASE OF CONSTRUCTION ACTIVITIES WITHIN THE DISTURBED AREAS.
4. PERMANENT STABILIZATION (PS) MAY BE USED WITHIN AREAS OF TEMPORARY STABILIZATION (TS) AT THE CONTRACTOR'S DISCRETION. STABILIZATION SHALL BE APPLIED IN ACCORDANCE WITH APPLICABLE TEMPORARY STABILIZATION SEQUENCING REQUIREMENTS.
5. CONTRACTOR SHALL UTILIZE ROLLED EROSION CONTROL PRODUCTS (STRAW-SINGLE NET EROSION CONTROL BLANKETS AND OPEN WEAVE TEXTILES) ON ALL SLOPES 3H:1V OR GREATER TO ACHIEVE REQUIRED STABILIZATION.
6. CONTRACTOR SHALL MAINTAIN ACCEPTABLE EROSION CONTROL PRACTICES WITHIN THE ANTICIPATED LIMITS OF CONSTRUCTION IDENTIFIED HEREIN. BEST MANAGEMENT PRACTICES AND STABILIZATION SHALL BE COMPLETED AS IDENTIFIED HEREIN IN ACCORDANCE WITH OWNER REQUIREMENTS.
7. ALL WORK IN THE HODGEN ROAD AND MERIDIAN ROAD ROW REQUIRES A ROW PERMIT FROM EL PASO COUNTY. CONTRACTOR IS RESPONSIBLE FOR APPLYING FOR AND OBTAINING ALL NECESSARY ROW PERMITS.
8. SILT FENCE TO BE INSTALLED PRIOR TO COMMENCEMENT OF ONSITE GRADING AND CONSTRUCTION ACTIVITIES.
9. DEMOLITION, REMOVAL, OVEREXCAVATION AND SOIL TREATMENT SHALL BE IN ACCORDANCE WITH THE GEOTECHNICAL ENGINEER RECOMMENDATIONS AS NOTED IN THE APPROVED PROJECT GEOTECHNICAL REPORT.
10. VEGETATION COVER IS ABOUT 90% CONSISTING OF NATIVE GRASSES, TREES AND SHRUBS, BASED ON VISUAL INSPECTION.
11. NO ASPHALT OR CONCRETE BATCH PLANTS SHALL BE USED FOR THIS PROJECT.
12. CHECK DAMS TO BE PLACED IN TEMPORARY AND PERMANENT DRAINAGE SWALES AND ROADSIDE DITCHES AND TO BE SPACED AS DEEMED NECESSARY. RIRPRAP IN CHECK DAMS TO BE SUBSTITUTED WITH SCL.

LEGEND

- — — — — PROPERTY LINE
- - - - - PROPOSED EASEMENT
- - - - - (LO) LIMITS OF DISTURBANCE/CONSTRUCTION
- (SM) TEMP./PERM. SEEDING AND MULCHING
- (IP) CULVERT INLET/OUTLET PROTECTION
- FLOW ARROW
- - - - - 64XX EXISTING MINOR CONTOUR
- - - - - 64XX EXISTING MAJOR CONTOUR
- 54XX — PROPOSED MAJOR CONTOUR
- 54XX — PROPOSED MINOR CONTOUR

LIMITS OF CONSTRUCTION

OFFSITE DISTURBANCE = ±0.44 ACRES

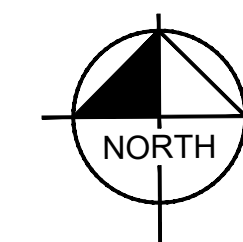

CALL UTILITY NOTIFICATION
CENTER OF COLORADO
1-800-922-1987
CALL 2-BUSINESS DAYS IN ADVANCE
BEFORE YOU DIG, GRADE, OR EXCAVATE
FOR THE MARKING OF UNDERGROUND
MEMBER UTILITIES

NO.	REVISION	BY	DATE	APPR.

Kimley»Horn
2024 KIMLEY-HORN AND ASSOCIATES, INC.
2 North Nevada Avenue Suite 900
Colorado Springs, Colorado 80903 (719) 453-0180

DESIGNED BY: MJK
DRAWN BY: MJK
CHECKED BY: KKK
DATE: 08/15/2024

**EAGLEVIEW
EL PASO COUNTY, COLORADO
GRADING AND EROSION CONTROL PLAN
OFF-SITE FINAL GEC PLAN**

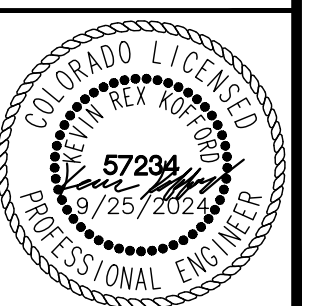

PROJECT NO.
196106001

SHEET

11

K:\COS_Civil\196288000_Eagleview\CADD\PlanSheets\Early GEC\EG_GEC_DETAILS.dwg Kofford, Kevin 9/25/2024 3:07 PM

Silt Fence (SF)

SC-1

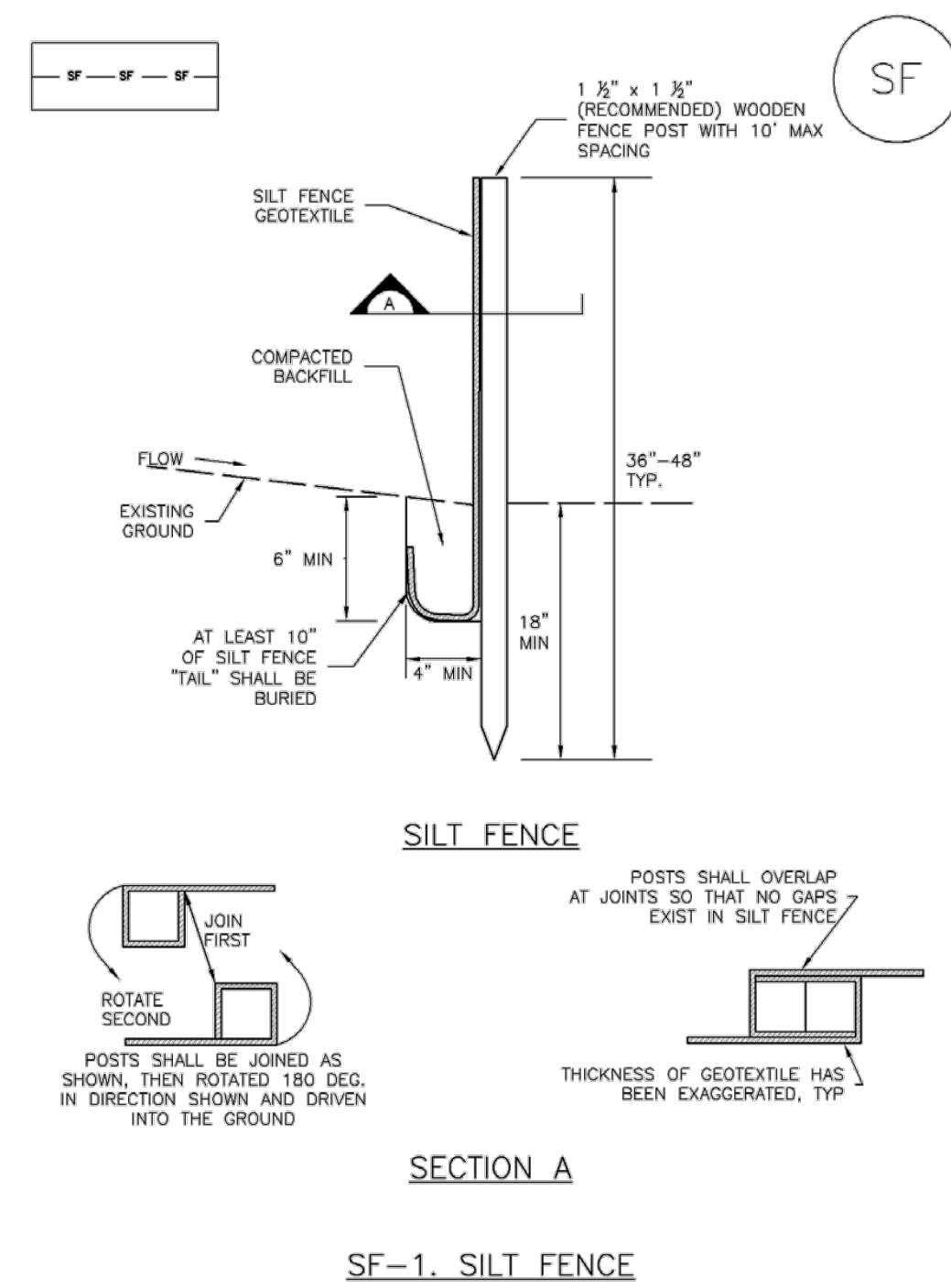

November 2010 Urban Drainage and Flood Control District Urban Storm Drainage Criteria Manual Volume 3 SF-3

SC-1

Silt Fence (SF)

SILT FENCE INSTALLATION NOTES

- SILT FENCE MUST BE PLACED AWAY FROM THE TOE OF THE SLOPE TO ALLOW FOR WATER PONDING. SILT FENCE AT THE TOE OF A SLOPE SHOULD BE INSTALLED IN A FLAT LOCATION AT LEAST SEVERAL FEET (2-5 FT) FROM THE TOE OF THE SLOPE TO ALLOW ROOM FOR PONDING AND DEPOSITION.
- A UNIFORM 6" X 4" ANCHOR TRENCH SHALL BE EXCAVATED USING TRENCHER OR SILT FENCE INSTALLATION DEVICE. NO ROAD GRADERS, BACKHOES, OR SIMILAR EQUIPMENT SHALL BE USED.
- COMPACT ANCHOR TRENCH BY HAND WITH A "JUMPING JACK" OR BY WHEEL ROLLING. COMPACTION SHALL BE SUCH THAT SILT FENCE RESISTS BEING PULLED OUT OF ANCHOR TRENCH BY HAND.
- SILT FENCE SHALL BE PULLED TIGHT AS IT IS ANCHORED TO THE STAKES. THERE SHOULD BE NO NOTICEABLE SAG BETWEEN STAKES AFTER IT HAS BEEN ANCHORED TO THE STAKES.
- SILT FENCE FABRIC SHALL BE ANCHORED TO THE STAKES USING 1" HEAVY DUTY STAPLES OR NAILS WITH 1" HEADS. STAPLES AND NAILS SHOULD BE PLACED 3" ALONG THE FABRIC DOWN THE STAKE.
- AT THE END OF A RUN OF SILT FENCE ALONG A CONTOUR, THE SILT FENCE SHOULD BE TURNED PERPENDICULAR TO THE CONTOUR TO CREATE A "J-HOOK." THE "J-HOOK" EXTENDING PERPENDICULAR TO THE CONTOUR SHOULD BE OF SUFFICIENT LENGTH TO KEEP RUNOFF FROM FLOWING AROUND THE END OF THE SILT FENCE (TYPICALLY 10' - 20').
- SILT FENCE SHALL BE INSTALLED PRIOR TO ANY LAND DISTURBING ACTIVITIES.

SILT FENCE MAINTENANCE NOTES

- INSPECT BMPs EACH WORKDAY, AND MAINTAIN THEM IN EFFECTIVE OPERATING CONDITION. MAINTENANCE OF BMPs SHOULD BE PROACTIVE, NOT REACTIVE. INSPECT BMPs AS SOON AS POSSIBLE (AND ALWAYS WITHIN 24 HOURS) FOLLOWING A STORM THAT CAUSES SURFACE EROSION, AND PERFORM NECESSARY MAINTENANCE.
- FREQUENT OBSERVATIONS AND MAINTENANCE ARE NECESSARY TO MAINTAIN BMPs IN EFFECTIVE OPERATING CONDITION. INSPECTIONS AND CORRECTIVE MEASURES SHOULD BE DOCUMENTED THOROUGHLY.
- WHERE BMPs HAVE FAILED, REPAIR OR REPLACEMENT SHOULD BE INITIATED UPON DISCOVERY OF THE FAILURE.
- SEDIMENT ACCUMULATED UPSTREAM OF THE SILT FENCE SHALL BE REMOVED AS NEEDED TO MAINTAIN THE FUNCTIONALITY OF THE BMP, TYPICALLY WHEN DEPTH OF ACCUMULATED SEDIMENTS IS APPROXIMATELY 6".
- REPAIR OR REPLACE SILT FENCE WHEN THERE ARE SIGNS OF WEAR, SUCH AS SAGGING, TEARING, OR COLLAPSE.
- SILT FENCE IS TO REMAIN IN PLACE UNTIL THE UPSTREAM DISTURBED AREA IS STABILIZED AND APPROVED BY THE LOCAL JURISDICTION, OR IS REPLACED BY AN EQUIVALENT PERIMETER SEDIMENT CONTROL BMP.
- WHEN SILT FENCE IS REMOVED, ALL DISTURBED AREAS SHALL BE COVERED WITH TOPSOIL, SEEDED AND MULCHED OR OTHERWISE STABILIZED AS APPROVED BY LOCAL JURISDICTION.

(DETAIL ADAPTED FROM TOWN OF PARKER, COLORADO AND CITY OF AURORA, NOT AVAILABLE IN AUTOCAD)

NOTE: MANY JURISDICTIONS HAVE BMP DETAILS THAT VARY FROM UDFCD STANDARD DETAILS. CONSULT WITH LOCAL JURISDICTIONS AS TO WHICH DETAIL SHOULD BE USED WHEN DIFFERENCES ARE NOTED.

SF-4 Urban Drainage and Flood Control District Urban Storm Drainage Criteria Manual Volume 3 November 2010

Stabilized Staging Area (SSA)

SM-6

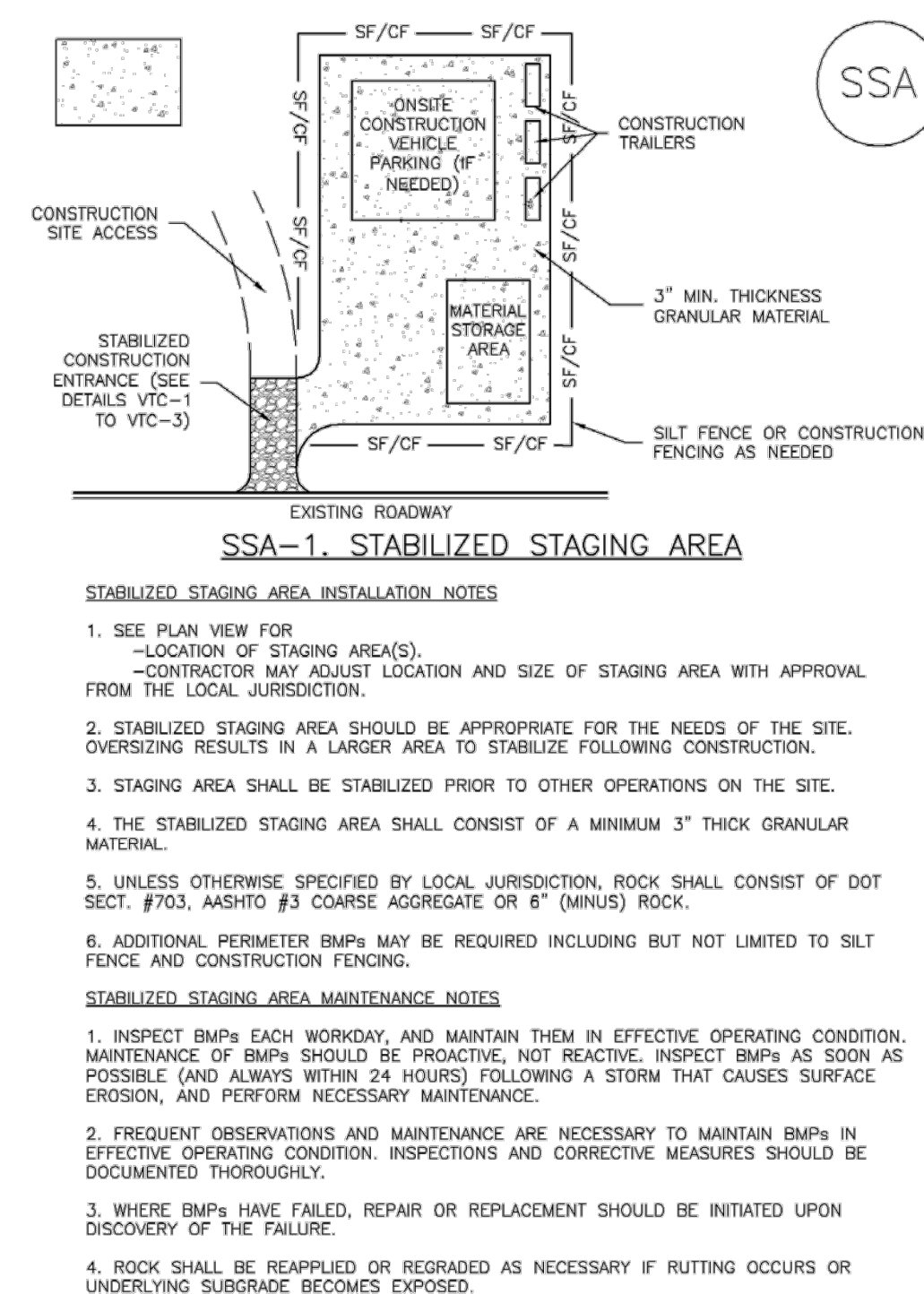

November 2010 Urban Drainage and Flood Control District Urban Storm Drainage Criteria Manual Volume 3 SSA-3

SM-6

Stabilized Staging Area (SSA)

STABILIZED STAGING AREA MAINTENANCE NOTES

- STABILIZED STAGING AREA SHALL BE ENLARGED IF NECESSARY TO CONTAIN PARKING, STORAGE, AND UNLOADING/LOADING OPERATIONS.
- THE STABILIZED STAGING AREA SHALL BE REMOVED AT THE END OF CONSTRUCTION. THE GRANULAR MATERIAL SHALL BE REMOVED OR, IF APPROVED BY THE LOCAL JURISDICTION, USED ON SITE, AND THE AREA COVERED WITH TOPSOIL, SEEDED AND MULCHED OR OTHERWISE STABILIZED IN A MANNER APPROVED BY LOCAL JURISDICTION.
- NOTE: MANY MUNICIPALITIES PROHIBIT THE USE OF RECYCLED CONCRETE AS GRANULAR MATERIAL FOR STABILIZED STAGING AREAS DUE TO DIFFICULTIES WITH RE-ESTABLISHMENT OF VEGETATION IN AREAS WHERE RECYCLED CONCRETE WAS PLACED.
- NOTE: MANY JURISDICTIONS HAVE BMP DETAILS THAT VARY FROM UDFCD STANDARD DETAILS. CONSULT WITH LOCAL JURISDICTIONS AS TO WHICH DETAIL SHOULD BE USED WHEN DIFFERENCES ARE NOTED.

(DETAILS ADAPTED FROM DOUGLAS COUNTY, COLORADO, NOT AVAILABLE IN AUTOCAD)

SSA-4 Urban Drainage and Flood Control District Urban Storm Drainage Criteria Manual Volume 3 November 2010

Vehicle Tracking Control (VTC)

SM-4

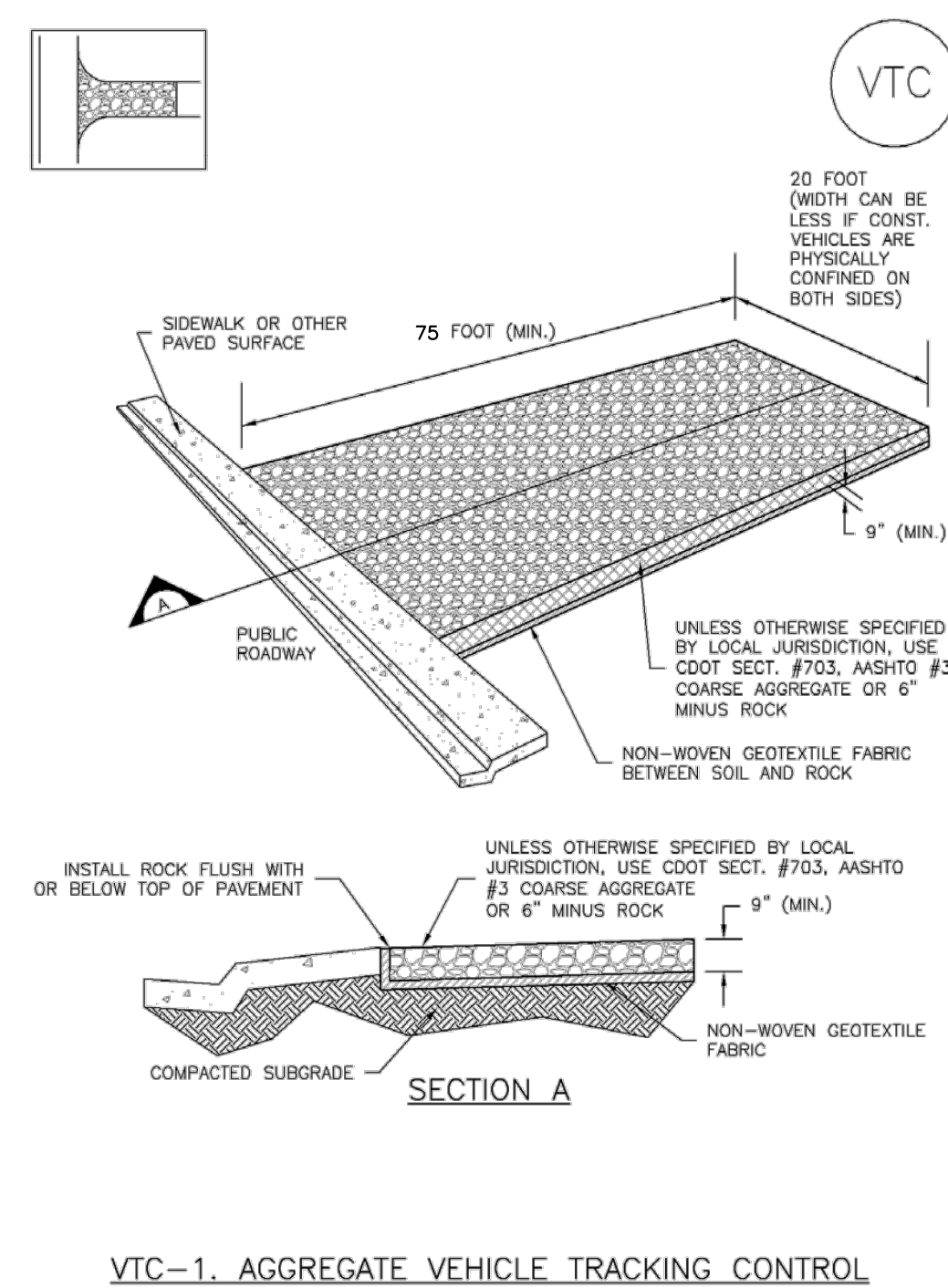

November 2010 Urban Drainage and Flood Control District Urban Storm Drainage Criteria Manual Volume 3 VTC-3

SM-4

Vehicle Tracking Control (VTC)

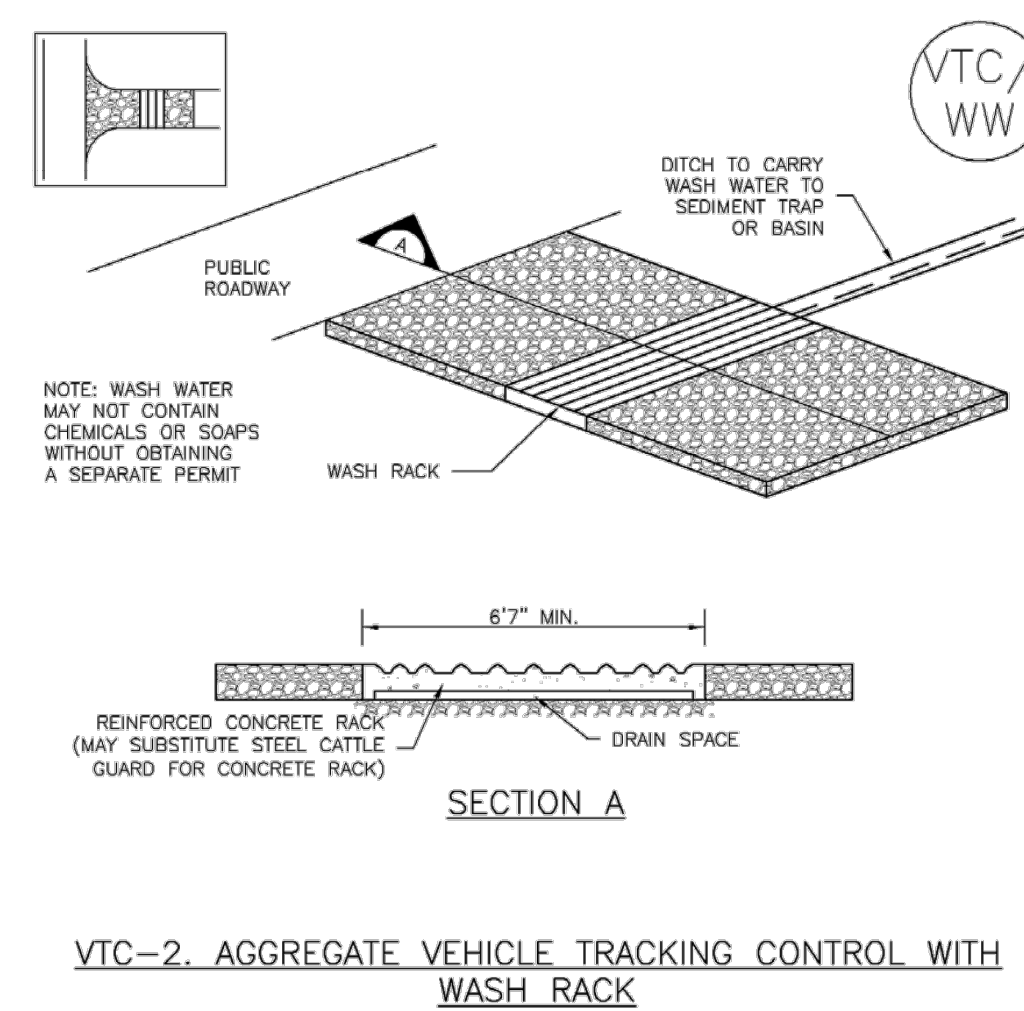

VTC-4 Urban Drainage and Flood Control District Urban Storm Drainage Criteria Manual Volume 3 November 2010

Vehicle Tracking Control (VTC)

SM-4

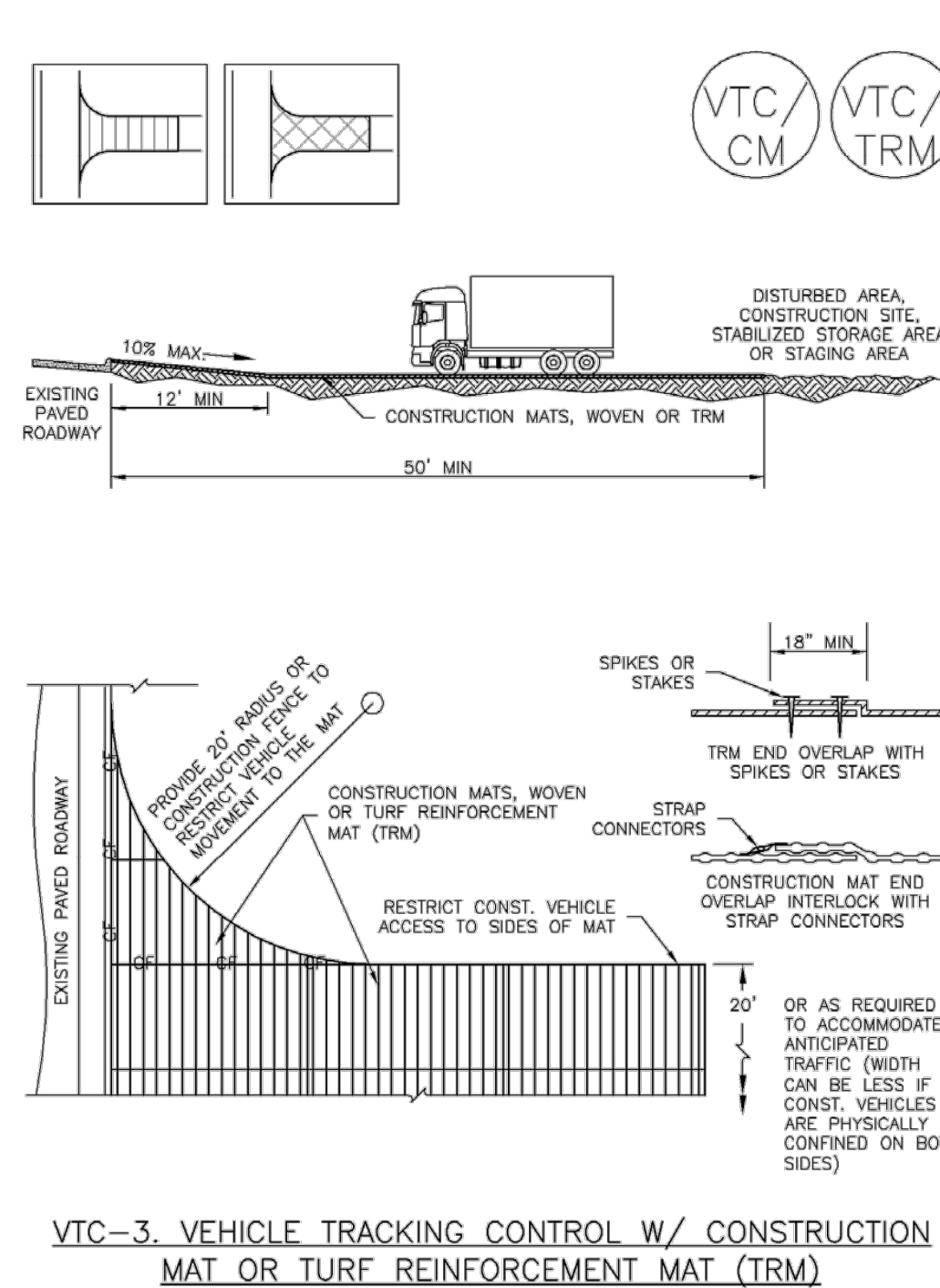

November 2010 Urban Drainage and Flood Control District Urban Storm Drainage Criteria Manual Volume 3 VTC-5

SM-4

Vehicle Tracking Control (VTC)

STABILIZED CONSTRUCTION ENTRANCE/EXIT INSTALLATION NOTES

- SEE PLAN VIEW FOR -LOCATION OF CONSTRUCTION ENTRANCE(S)/EXIT(S). -TYPE OF CONSTRUCTION ENTRANCE(S)/EXIT(S) (WITH/WITHOUT WHEEL WASH, CONSTRUCTION MAT OR TRM).
- CONSTRUCTION MAT OR TRM STABILIZED CONSTRUCTION ENTRANCES ARE ONLY TO BE USED ON SHORT DURATION PROJECTS (TYPICALLY RANGING FROM A WEEK TO A MONTH) WHERE THERE WILL BE LIMITED VEHICULAR ACCESS.
- A STABILIZED CONSTRUCTION ENTRANCE/EXIT SHALL BE LOCATED AT ALL ACCESS POINTS WHERE VEHICLES ACCESS THE CONSTRUCTION SITE FROM PAVED RIGHT-OF-WAYS.
- STABILIZED CONSTRUCTION ENTRANCE/EXIT SHALL BE INSTALLED PRIOR TO ANY LAND DISTURBING ACTIVITIES.
- A NON-WOVEN GEOTEXTILE FABRIC SHALL BE PLACED UNDER THE STABILIZED CONSTRUCTION ENTRANCE/EXIT PRIOR TO THE PLACEMENT OF ROCK.
- UNLESS OTHERWISE SPECIFIED BY LOCAL JURISDICTION, ROCK SHALL CONSIST OF DOT SECT. #703, AASHTO #3 COARSE AGGREGATE OR 6" (MINUS) ROCK.

STABILIZED CONSTRUCTION ENTRANCE/EXIT MAINTENANCE NOTES

- INSPECT BMPs EACH WORKDAY, AND MAINTAIN THEM IN EFFECTIVE OPERATING CONDITION. MAINTENANCE OF BMPs SHOULD BE PROACTIVE, NOT REACTIVE. INSPECT BMPs AS SOON AS POSSIBLE (AND ALWAYS WITHIN 24 HOURS) FOLLOWING A STORM THAT CAUSES SURFACE EROSION, AND PERFORM NECESSARY MAINTENANCE.
- FREQUENT OBSERVATIONS AND MAINTENANCE ARE NECESSARY TO MAINTAIN BMPs IN EFFECTIVE OPERATING CONDITION. INSPECTIONS AND CORRECTIVE MEASURES SHOULD BE DOCUMENTED THOROUGHLY.
- WHERE BMPs HAVE FAILED, REPAIR OR REPLACEMENT SHOULD BE INITIATED UPON DISCOVERY OF THE FAILURE.
- ROCK SHALL BE REAPPLIED OR REGRADED AS NECESSARY TO THE STABILIZED ENTRANCE/EXIT TO MAINTAIN A CONSISTENT DEPTH.
- SEDIMENT TRACKED ONTO PAVED ROADS IS TO BE REMOVED THROUGHOUT THE DAY AND AT THE END OF THE DAY BY SHOVELING OR SWEEPING. SEDIMENT MAY NOT BE WASHED DOWN STORM SEWER DRAINS.

NOTE: MANY JURISDICTIONS HAVE BMP DETAILS THAT VARY FROM UDFCD STANDARD DETAILS. CONSULT WITH LOCAL JURISDICTIONS AS TO WHICH DETAIL SHOULD BE USED WHEN DIFFERENCES ARE NOTED.

(DETAILS ADAPTED FROM CITY OF BROOKFIELD, COLORADO, NOT AVAILABLE IN AUTOCAD)

VTC-6 Urban Drainage and Flood Control District Urban Storm Drainage Criteria Manual Volume 3 November 2010

NO.	REVISION	BY	DATE	APPR

Kimley-Horn
 2024 KIMLEY-HORN AND ASSOCIATES, INC.
 2 North Nevada Avenue Suite 900
 Colorado Springs, Colorado 80903 (719) 453-0180

DESIGNED BY: MJK
 DRAWN BY: MJK
 CHECKED BY: KRK
 DATE: 08/15/2024

EAGLEVIEW
 EL PASO COUNTY, COLORADO
 GRADING AND EROSION CONTROL PLAN
 GEC DETAILS

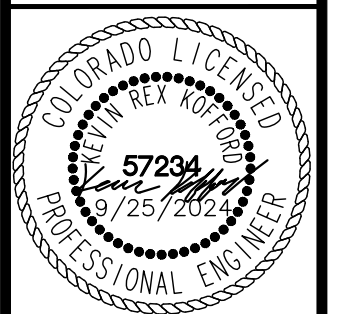

PROJECT NO.
196106001

SHEET
13

Sediment Basin (SB)

SC-7

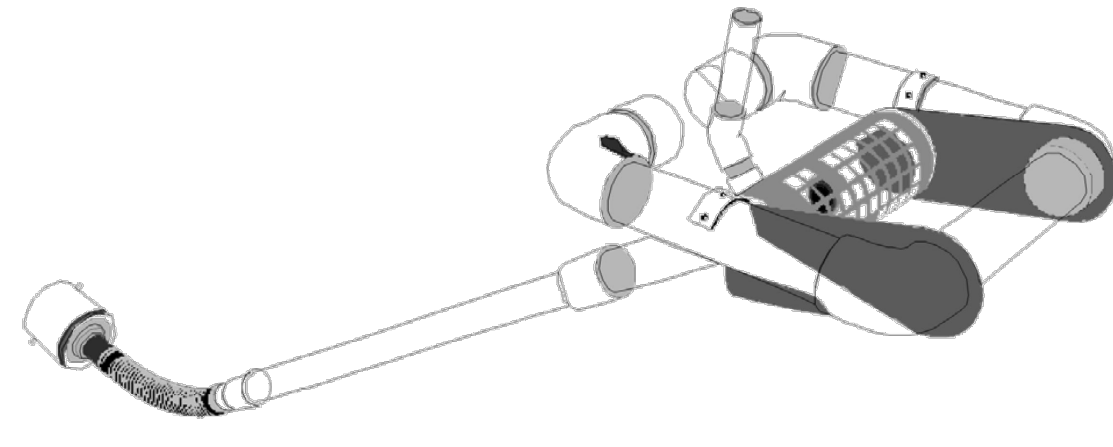

Illustration SB-1. Outlet structure for a temporary sediment basin - Faircloth Skimmer Floating Outlet. Illustration courtesy of J. W. Faircloth & Sons, Inc., FairclothSkimmer.com.

- **Outlet Protection and Spillway:** Consider all flow paths for runoff leaving the basin, including protection at the typical point of discharge as well as overtopping.
 - **Outlet Protection:** Outlet protection should be provided where the velocity of flow will exceed the maximum permissible velocity of the material of the waterway into which discharge occurs. This may require the use of a riprap apron at the outlet location and/or other measures to keep the waterway from eroding.
 - **Emergency Spillway:** Provide a stabilized emergency overflow spillway for rainstorms that exceed the capacity of the sediment basin volume and its outlet. Protect basin embankments from erosion and overtopping. If the sediment basin will be converted to a permanent detention basin, design and construct the emergency spillway(s) as required for the permanent facility. If the sediment basin will not become a permanent detention basin, it may be possible to substitute a heavy polyvinyl membrane or properly bedded rock cover to line the spillway and downstream embankment, depending on the height, slope, and width of the embankments.

SC-7

Sediment Basin (SB)

Maintenance and Removal

Maintenance activities include the following:

- Dredge sediment from the basin, as needed to maintain BMP effectiveness, typically when the design storage volume is no more than one-third filled with sediment.
- Inspect the sediment basin embankments for stability and seepage.
- Inspect the inlet and outlet of the basin, repair damage, and remove debris. Remove, clean and replace the gravel around the outlet on a regular basis to remove the accumulated sediment within it and keep the outlet functioning.
- Be aware that removal of a sediment basin may require dewatering and associated permit requirements.
- Do not remove a sediment basin until the upstream area has been stabilized with vegetation.

Final disposition of the sediment basin depends on whether the basin will be converted to a permanent post-construction stormwater basin or whether the basin area will be returned to grade. For basins being converted to permanent detention basins, remove accumulated sediment and reconfigure the basin and outlet to meet the requirements of the final design for the detention facility. If the sediment basin is not to be used as a permanent detention facility, fill the excavated area with soil and stabilize with vegetation.

Sediment Basin (SB)

SC-7

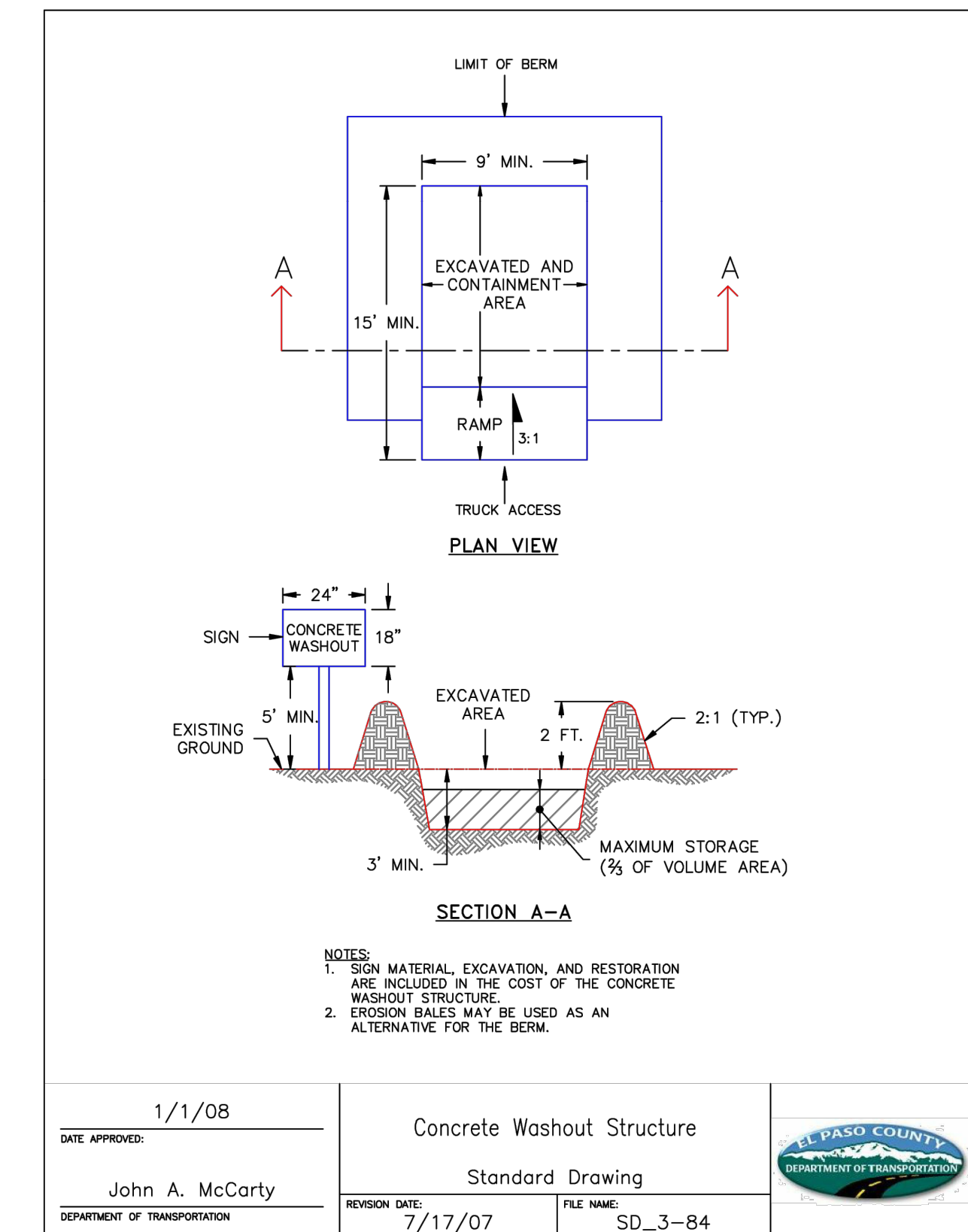
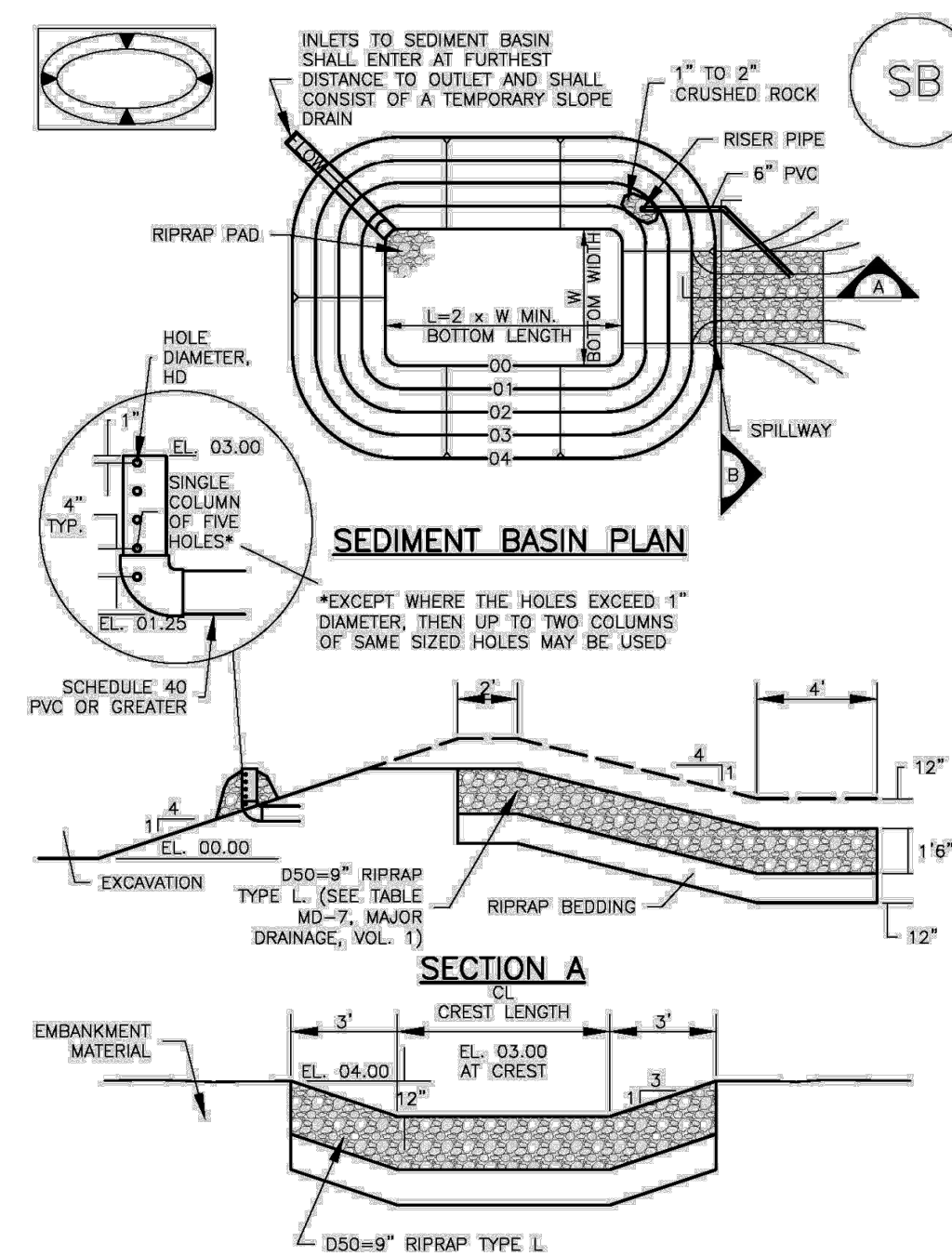

DATE APPROVED: 1/1/08	Concrete Washout Structure	EL PASO COUNTY DEPARTMENT OF TRANSPORTATION
DESIGNED BY: John A. McCarty	Standard Drawing	
DEPARTMENT OF TRANSPORTATION	REVISION DATE: 7/17/07	FILE NAME: SD_3-B4

MM-1

Concrete Washout Area (CWA)

- CWA MAINTENANCE NOTES**
1. INSPECT BMPs EACH WORKDAY, AND MAINTAIN THEM IN EFFECTIVE OPERATING CONDITION. MAINTENANCE OF BMPs SHOULD BE PROACTIVE, NOT REACTIVE. INSPECT BMPs AS SOON AS POSSIBLE (AND ALWAYS WITHIN 24 HOURS) FOLLOWING A STORM THAT CAUSES SURFACE EROSION, AND PERFORM NECESSARY MAINTENANCE.
 2. FREQUENT OBSERVATIONS AND MAINTENANCE ARE NECESSARY TO MAINTAIN BMPs IN EFFECTIVE OPERATING CONDITION. INSPECTIONS AND CORRECTIVE MEASURES SHOULD BE DOCUMENTED THOROUGHLY.
 3. WHERE BMPs HAVE FAILED, REPAIR OR REPLACEMENT SHOULD BE INITIATED UPON DISCOVERY OF THE FAILURE.
 4. THE CWA SHALL BE REPAIRED, CLEANED, OR ENLARGED AS NECESSARY TO MAINTAIN CAPACITY FOR CONCRETE WASTE. CONCRETE MATERIALS, ACCUMULATED IN PIT, SHALL BE REMOVED ONCE THE MATERIALS HAVE REACHED A DEPTH OF 2'.
 5. CONCRETE WASHOUT WATER, WASTED PIECES OF CONCRETE AND ALL OTHER DEBRIS IN THE SUBSURFACE PIT SHALL BE TRANSPORTED FROM THE JOB SITE IN A WATER-TIGHT CONTAINER AND DISPOSED OF PROPERLY.
 6. THE CWA SHALL REMAIN IN PLACE UNTIL ALL CONCRETE FOR THE PROJECT IS PLACED.
 7. WHEN THE CWA IS REMOVED, COVER THE DISTURBED AREA WITH TOP SOIL, SEED AND MULCH OR OTHERWISE STABILIZED IN A MANNER APPROVED BY THE LOCAL JURISDICTION.
- (DETAILS ADAPTED FROM DOUGLAS COUNTY, COLORADO AND THE CITY OF PARKER, COLORADO, NOT AVAILABLE IN AUTOCAD).
NOTE: MANY JURISDICTIONS HAVE BMP DETAILS THAT VARY FROM UDFCD STANDARD DETAILS. CONSULT WITH LOCAL JURISDICTIONS AS TO WHICH DETAIL SHOULD BE USED WHEN DIFFERENCES ARE NOTED.

SC-7

Sediment Basin (SB)

TABLE SB-1. SIZING INFORMATION FOR STANDARD SEDIMENT BASIN

Upstream Drainage Area (rounded to nearest acre), (ac)	Basin Bottom Width (W), (ft)	Spillway Crest Length (CL), (ft)	Hole Diameter (HD), (in)
1	12 1/2	2	9 3/4
2	21	3	14 1/4
3	28	5	16 1/2
4	33 1/2	6	17 1/2
5	38 1/2	8	19 1/2
6	43	9	20 1/2
7	47 1/2	11	21 1/2
8	51	12	22 1/2
9	55	13	23 1/2
10	58 1/2	15	24 1/2
11	61	16	25 1/2
12	64	18	26 1/2
13	67 1/2	19	27 1/2
14	70 1/2	21	28 1/2
15	73 1/2	22	29 1/2

- SEDIMENT BASIN INSTALLATION NOTES**
1. SEE PLAN VIEW FOR:
 - LOCATION OF SEDIMENT BASIN.
 - TYPE OF BASIN (STANDARD BASIN OR NONSTANDARD BASIN).
 - FOR STANDARD BASIN, BOTTOM WIDTH W, CREST LENGTH CL, AND HOLE DIAMETER, HD.
 - FOR NONSTANDARD BASIN, SEE CONSTRUCTION DRAWINGS FOR DESIGN OF BASIN INCLUDING RISER HEIGHT H, NUMBER OF COLUMNS N, HOLE DIAMETER HD AND PIPE DIAMETER D.
 2. FOR STANDARD BASIN, BOTTOM DIMENSION MAY BE MODIFIED AS LONG AS BOTTOM AREA IS NOT REDUCED.
 3. SEDIMENT BASINS SHALL BE INSTALLED PRIOR TO ANY OTHER LAND-DISTURBING ACTIVITY THAT RELIES ON BASINS AS A STORMWATER CONTROL.
 4. EMBANKMENT MATERIAL SHALL CONSIST OF SOIL FREE OF DEBRIS, ORGANIC MATERIAL, AND ROCKS OR CONCRETE GREATER THAN 3 INCHES AND SHALL HAVE A MINIMUM OF 15 PERCENT BY WEIGHT PASSING THE NO. 200 SIEVE.
 5. EMBANKMENT MATERIAL SHALL BE COMPACTED TO AT LEAST 95 PERCENT OF MAXIMUM DENSITY IN ACCORDANCE WITH ASTM D698.
 6. PIPE SCH 40 OR GREATER SHALL BE USED.
 7. THE DETAILS SHOWN ON THESE SHEETS PERTAIN TO STANDARD SEDIMENT BASIN(S) FOR DRAINAGE AREAS LESS THAN 15 ACRES. SEE CONSTRUCTION DRAWINGS FOR EMBANKMENT, STORAGE VOLUME, SPILLWAY, OUTLET, AND OUTLET PROTECTION DETAILS FOR ANY SEDIMENT BASIN(S) THAT HAVE BEEN INDIVIDUALLY DESIGNED FOR DRAINAGE AREAS LARGER THAN 15 ACRES.

Sediment Basin (SB)

SC-7

- SEDIMENT BASIN MAINTENANCE NOTES**
1. INSPECT BMPs EACH WORKDAY, AND MAINTAIN THEM IN EFFECTIVE OPERATING CONDITION. MAINTENANCE OF BMPs SHOULD BE PROACTIVE, NOT REACTIVE. INSPECT BMPs AS SOON AS POSSIBLE (AND ALWAYS WITHIN 24 HOURS) FOLLOWING A STORM THAT CAUSES SURFACE EROSION, AND PERFORM NECESSARY MAINTENANCE.
 2. FREQUENT OBSERVATIONS AND MAINTENANCE ARE NECESSARY TO MAINTAIN BMPs IN EFFECTIVE OPERATING CONDITION. INSPECTIONS AND CORRECTIVE MEASURES SHOULD BE DOCUMENTED THOROUGHLY.
 3. WHERE BMPs HAVE FAILED, REPAIR OR REPLACEMENT SHOULD BE INITIATED UPON DISCOVERY OF THE FAILURE.
 4. SEDIMENT ACCUMULATED IN BASIN SHALL BE REMOVED AS NEEDED TO MAINTAIN BMP EFFECTIVENESS, TYPICALLY WHEN SEDIMENT DEPTH REACHES ONE FOOT (I.E., TWO FEET BELOW THE SPILLWAY CREST).
 5. SEDIMENT BASINS ARE TO REMAIN IN PLACE UNTIL THE UPSTREAM DISTURBED AREA IS STABILIZED AND GRASS COVER IS ACCEPTED BY THE LOCAL JURISDICTION.
 6. WHEN SEDIMENT BASINS ARE REMOVED, ALL DISTURBED AREAS SHALL BE COVERED WITH TOPSOIL, SEEDING AND MULCHED OR OTHERWISE STABILIZED AS APPROVED BY LOCAL JURISDICTION.
- (DETAILS ADAPTED FROM DOUGLAS COUNTY, COLORADO)
NOTE: MANY JURISDICTIONS HAVE BMP DETAILS THAT VARY FROM UDFCD STANDARD DETAILS. CONSULT WITH LOCAL JURISDICTIONS AS TO WHICH DETAIL SHOULD BE USED WHEN DIFFERENCES ARE NOTED.

Concrete Washout Area (CWA)

MM-1

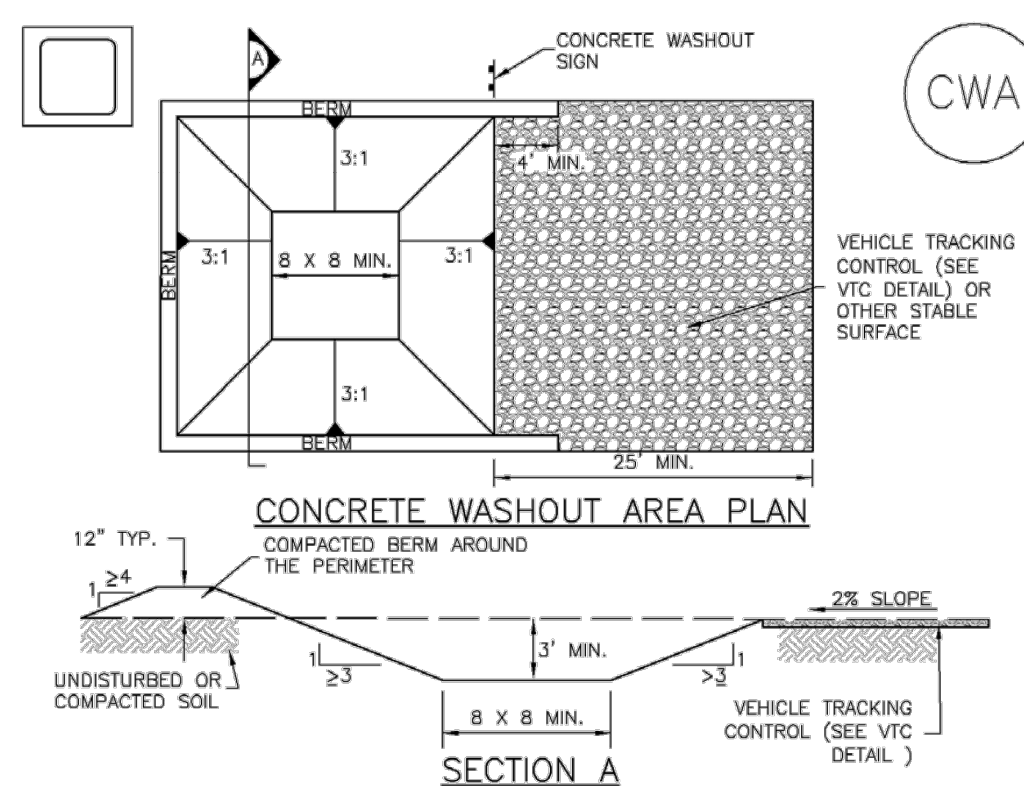

- CWA-1. CONCRETE WASHOUT AREA**
- CWA INSTALLATION NOTES**
1. SEE PLAN VIEW FOR:
 - CWA INSTALLATION LOCATION.
 2. DO NOT LOCATE AN UNLINED CWA WITHIN 400' OF ANY NATURAL DRAINAGE PATHWAY OR WATERBODY. DO NOT LOCATE WITHIN 1,000' OF ANY WELLS OR DRINKING WATER SOURCES. IF SITE CONSTRAINTS MAKE THIS INFEASIBLE, OR IF HIGHLY PERMEABLE SOILS EXIST ON SITE, THE CWA MUST BE INSTALLED WITH AN IMPERMEABLE LINER (1/8 IN. MIN. THICKNESS) OR SURFACE STORAGE ALTERNATIVES USING PREFABRICATED CONCRETE WASHOUT DEVICES OR A LINED ABOVE GROUND STORAGE ARE SHOULD BE USED.
 3. THE CWA SHALL BE INSTALLED PRIOR TO CONCRETE PLACEMENT ON SITE.
 4. CWA SHALL INCLUDE A FLAT SUBSURFACE PIT THAT IS AT LEAST 8' BY 8' SLOPES LEADING OUT OF THE SUBSURFACE PIT SHALL BE 3:1 OR FLATTER. THE PIT SHALL BE AT LEAST 3' DEEP.
 5. BERM SURROUNDING SIDES AND BACK OF THE CWA SHALL HAVE MINIMUM HEIGHT OF 1'.
 6. VEHICLE TRACKING PAD SHALL BE SLOPED 2% TOWARDS THE CWA.
 7. SIGNS SHALL BE PLACED AT THE CONSTRUCTION ENTRANCE, AT THE CWA, AND ELSEWHERE AS NECESSARY TO CLEARLY INDICATE THE LOCATION OF THE CWA TO OPERATORS OF CONCRETE TRUCKS AND PUMP RIGS.
 8. USE EXCAVATED MATERIAL FOR PERIMETER BERM CONSTRUCTION.

NO.	REVISION	BY	DATE	APPR

Kimley-Horn
2024 KIMLEY-HORN AND ASSOCIATES, INC.
2 North Nevada Avenue Suite 900
Colorado Springs, Colorado 80903 (719) 453-0180

DESIGNED BY: MJK
DRAWN BY: MJK
CHECKED BY: KRK
DATE: 08/15/2024

EAGLEVIEW
EL PASO COUNTY, COLORADO
GRADING AND EROSION CONTROL PLAN
GEC DETAILS

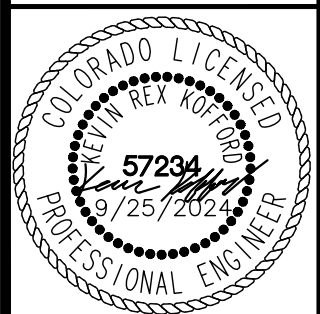

PROJECT NO. 196106001
SHEET 14

K:\COS_Civil\196288000_Eagleview\CADD\PlanSheets\Carry_GEC\EG_GEC_DETAILS.dwg Kofford, Kevin 9/25/2024 3:08 PM

Roller Erosion Control Products (RECP) EC-6

Table RECP-1. ECTC Standard Specification for Temporary Rolled Erosion Control Products
(Adapted from Erosion Control Technology Council 2005)

Product Description	Slope Applications*		Channel Applications*	Minimum Tensile Strength ¹	Expected Longevity
	Maximum Gradient	C Factor ^{2,5}			
Mulch Control Nets	5:1 (H:V)	≤0.10 @ 5:1	0.25 lbs/ft ² (12 Pa)	5 lbs/ft (0.073 kN/m)	Up to 12 months
Netless Rolled Erosion Control Blankets	4:1 (H:V)	≤0.10 @ 4:1	0.5 lbs/ft ² (24 Pa)	5 lbs/ft (0.073 kN/m)	
Single-net Erosion Control Blankets & Open Weave Textiles	3:1 (H:V)	≤0.15 @ 3:1	1.5 lbs/ft ² (72 Pa)	50 lbs/ft (0.73 kN/m)	
Double-net Erosion Control Blankets	2:1 (H:V)	≤0.20 @ 2:1	1.75 lbs/ft ² (84 Pa)	75 lbs/ft (1.09 kN/m)	
Mulch Control Nets	5:1 (H:V)	≤0.10 @ 5:1	0.25 lbs/ft ² (12 Pa)	25 lbs/ft (0.36 kN/m)	
Erosion Control Blankets & Open Weave Textiles (slowly degrading)	1.5:1 (H:V)	≤0.25 @ 1.5:1	2.00 lbs/ft ² (96 Pa)	100 lbs/ft (1.45 kN/m)	24 months
Erosion Control Blankets & Open Weave Textiles	1:1 (H:V)	≤0.25 @ 1:1	2.25 lbs/ft ² (108 Pa)	125 lbs/ft (1.82 kN/m)	36 months

* C Factor and shear stress for mulch control nettings must be obtained with netting used in conjunction with pre-applied mulch material. (See Section 5.3 of Chapter 7 Construction BMPs for more information on the C Factor.)

¹ Minimum Average Roll Values, Machine direction using ECTC Mod. ASTM D 5035.

² C Factor calculated as ratio of soil loss from RECP protected slope (tested at specified or greater gradient, H:V) to ratio of soil loss from unprotected (control) plot in large-scale testing.

³ Required minimum shear stress RECP (unvegetated) can sustain without physical damage or excess erosion (> 12.7 mm (0.5 in) soil loss) during a 30-minute flow event in large-scale testing.

⁴ The permissible shear stress levels established for each performance category are based on historical experience with products characterized by Manning's roughness coefficients in the range of 0.01 - 0.05.

⁵ Acceptable large-scale test methods may include ASTM D 6459, or other independent testing deemed acceptable by the engineer.

⁶ Per the engineer's discretion. Recommended acceptable large-scale testing protocol may include ASTM D 6460, or other independent testing deemed acceptable by the engineer.

November 2010 Urban Drainage and Flood Control District RECP-3
Urban Storm Drainage Criteria Manual Volume 3

You created this PDF from an application that is not licensed to print to novaPDF printer (<http://www.novapdf.com>)

Roller Erosion Control Products (RECP) EC-6

Table RECP-2. ECTC Standard Specification for Permanent¹ Rolled Erosion Control Products
(Adapted from: Erosion Control Technology Council 2005)

Product Type	Slope Applications	Channel Applications	Minimum Tensile Strength ^{2,3}
	Maximum Gradient	Maximum Shear Stress ^{4,5}	
TRMs with a minimum thickness of 0.25 inches (6.35 mm) per ASTM D 6525 and UV stability of 80% per ASTM D 4355 (500 hours exposure).	0.5:1 (H:V)	6.0 lbs/ft ² (288 Pa)	125 lbs/ft (1.82 kN/m)
	0.5:1 (H:V)	8.0 lbs/ft ² (384 Pa)	150 lbs/ft (2.19 kN/m)
	0.5:1 (H:V)	10.0 lbs/ft ² (480 Pa)	175 lbs/ft (2.55 kN/m)

¹ For TRMs containing degradable components, all property values must be obtained on the non-degradable portion of the matting alone.

² Minimum Average Roll Values, machine direction only for tensile strength determination using ASTM D 6818 (Supersedes Mod. ASTM D 5035 for RECPs).

³ Field conditions with high loading and/or high survivability requirements may warrant the use of a TRM with a tensile strength of 44 kN/m (3,000 lb ft) or greater.

⁴ Required minimum shear stress TRM (fully vegetated) can sustain without physical damage or excess erosion (> 12.7 mm (0.5 in.) soil loss) during a 30-minute flow event in large scale testing.

⁵ Acceptable large-scale testing protocols may include ASTM D 6460, or other independent testing deemed acceptable by the engineer.

Design and Installation

RECPs should be installed according to manufacturer's specifications and guidelines. Regardless of the type of product used, it is important to ensure no gaps or voids exist under the material and that all corners of the material are secured using stakes and trenching. Continuous contact between the product and the soil is necessary to avoid failure. Never use metal stakes to secure temporary erosion control products. Often wooden stakes are used to anchor RECPs; however, wood stakes may present installation and maintenance challenges and generally take a long time to biodegrade. Some local jurisdictions have had favorable experiences using biodegradable stakes.

This BMP Fact Sheet provides design details for several commonly used ECB applications, including:

ECB-1 Pipe Outlet to Drainageway

ECB-2 Small Ditch or Drainageway

ECB-3 Outside of Drainageway

November 2010 Urban Drainage and Flood Control District RECP-4
Urban Storm Drainage Criteria Manual Volume 3

You created this PDF from an application that is not licensed to print to novaPDF printer (<http://www.novapdf.com>)

Roller Erosion Control Products (RECP) EC-6

Staking patterns are also provided in the design details according to these factors:

- ECB type
- Slope or channel type

For other types of RECPs including TRMs, these design details are intended to serve as general guidelines for design and installation; however, engineers should adhere to manufacturer's installation recommendations.

Maintenance and Removal

Inspection of erosion control blankets and other RECPs includes:

- Check for general signs of erosion, including voids beneath the mat. If voids are apparent, fill the void with suitable soil and replace the erosion control blanket, following the appropriate staking pattern.
- Check for damaged or loose stakes and secure loose portions of the blanket.

Erosion control blankets and other RECPs that are biodegradable typically do not need to be removed after construction. If they must be removed, then an alternate soil stabilization method should be installed promptly following removal.

Turf reinforcement mats, although generally resistant to biodegradation, are typically left in place as a dense vegetated cover grows in through the mat matrix. The turf reinforcement mat provides long-term stability and helps the established vegetation resist erosive forces.

November 2010 Urban Drainage and Flood Control District RECP-5
Urban Storm Drainage Criteria Manual Volume 3

You created this PDF from an application that is not licensed to print to novaPDF printer (<http://www.novapdf.com>)

Roller Erosion Control Products (RECP) EC-6

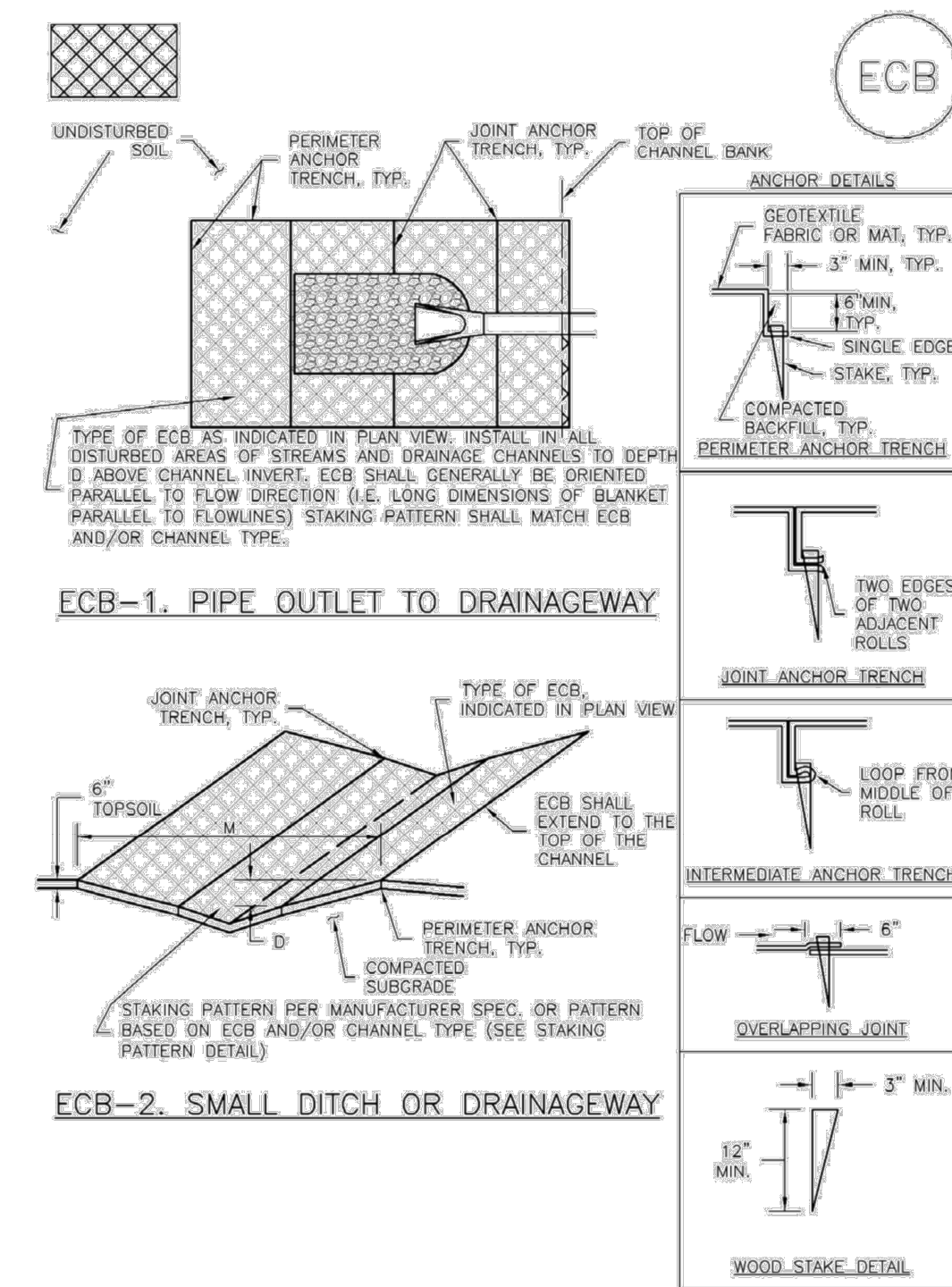

November 2010 Urban Drainage and Flood Control District RECP-6
Urban Storm Drainage Criteria Manual Volume 3

You created this PDF from an application that is not licensed to print to novaPDF printer (<http://www.novapdf.com>)

Roller Erosion Control Products (RECP) EC-6

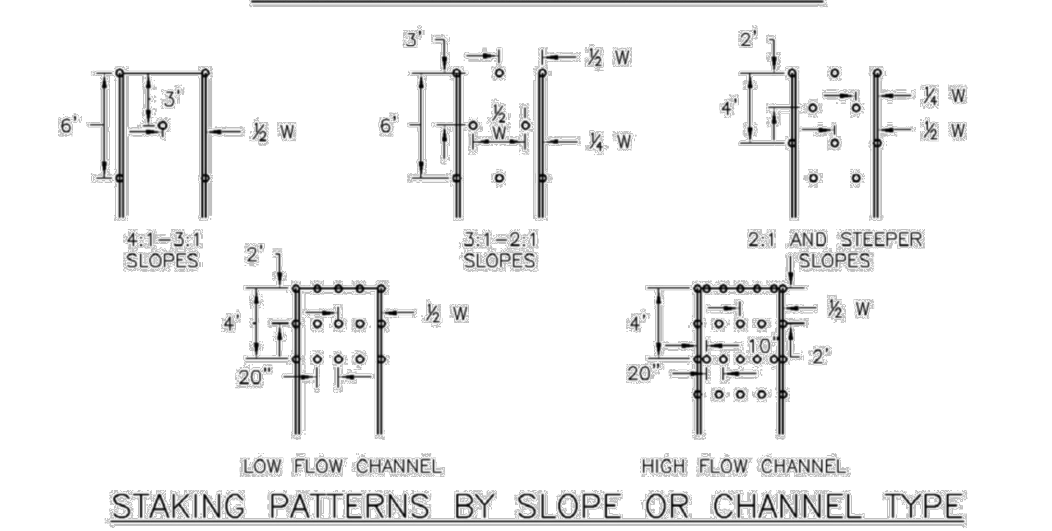
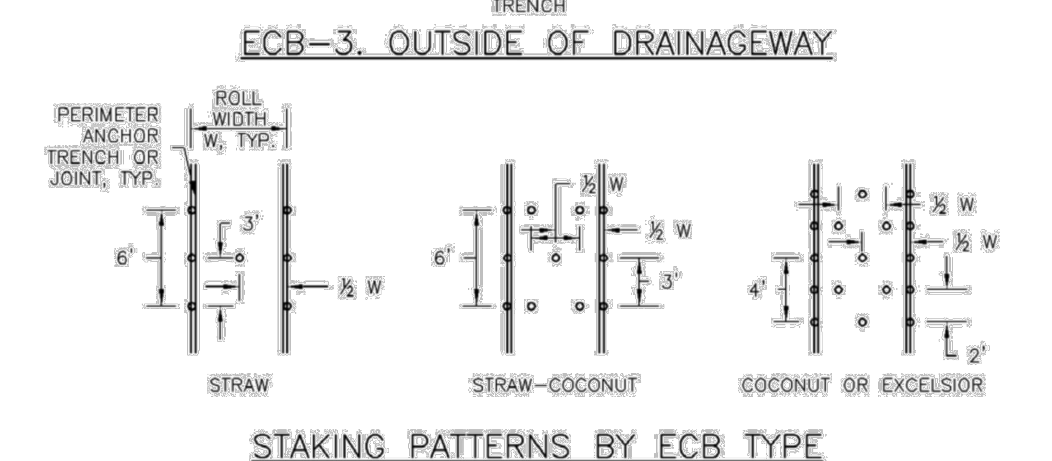
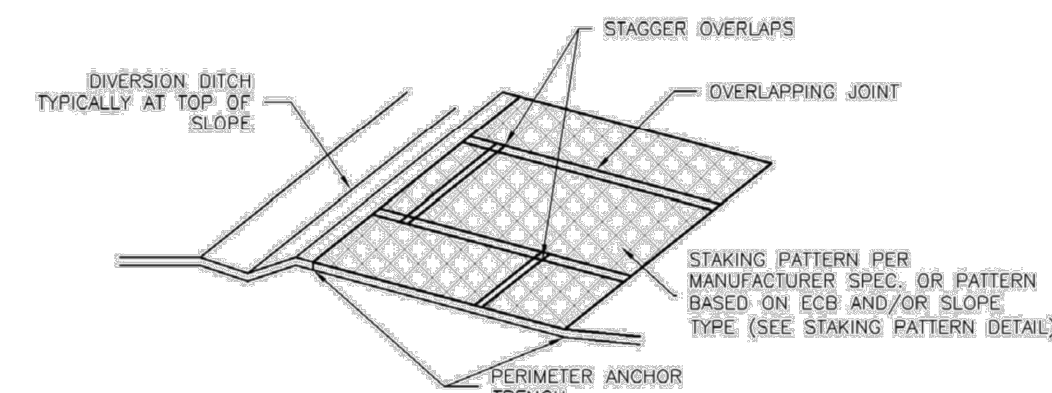

November 2010 Urban Drainage and Flood Control District RECP-7
Urban Storm Drainage Criteria Manual Volume 3

You created this PDF from an application that is not licensed to print to novaPDF printer (<http://www.novapdf.com>)

Roller Erosion Control Products (RECP) EC-6

EROSION CONTROL BLANKET INSTALLATION NOTES

- SEE PLAN VIEW FOR:
 - LOCATION OF ECB.
 - TYPE OF ECB (STRAW, STRAW-COCONUT, COCONUT, OR EXCELSIOR).
 - AREA A, IN SQUARE YARDS OF EACH TYPE OF ECB.
- 100% NATURAL AND BIODEGRADABLE MATERIALS ARE PREFERRED FOR RECPs, ALTHOUGH SOME JURISDICTIONS MAY ALLOW OTHER MATERIALS IN SOME APPLICATIONS.
- IN AREAS WHERE ECBs ARE SHOWN ON THE PLANS, THE PERMITTEE SHALL PLACE TOPSOIL AND PERFORM FINAL GRADING, SURFACE PREPARATION, AND SEEDING AND MULCHING. SUBGRADE SHALL BE SMOOTH AND MOST PRIOR TO ECB INSTALLATION AND THE ECB SHALL BE IN FULL CONTACT WITH SUBGRADE. NO GAPS OR VOIDS SHALL EXIST UNDER THE BLANKET.
- PERIMETER ANCHOR TRENCH SHALL BE USED ALONG THE OUTSIDE PERIMETER OF ALL BLANKET AREAS.
- JOINT ANCHOR TRENCH SHALL BE USED TO JOIN ROLLS OF ECBs TOGETHER (LONGITUDINALLY AND TRANSVERSELY) FOR ALL ECBs EXCEPT STRAW WHICH MAY USE AN OVERLAPPING JOINT.
- INTERMEDIATE ANCHOR TRENCH SHALL BE USED AT SPACING OF ONE-HALF ROLL LENGTH FOR COCONUT AND EXCELSIOR ECBs.
- OVERLAPPING JOINT DETAIL SHALL BE USED TO JOIN ROLLS OF ECBs TOGETHER FOR ECBs ON SLOPES.
- MATERIAL SPECIFICATIONS OF ECBs SHALL CONFORM TO TABLE ECB-1.
- ANY AREAS OF SEEDING AND MULCHING DISTURBED IN THE PROCESS OF INSTALLING ECBs SHALL BE RESEEDED AND MULCHED.
- DETAILS ON DESIGN PLANS FOR MAJOR DRAINAGEWAY STABILIZATION WILL GOVERN IF DIFFERENT FROM THOSE SHOWN HERE.

TABLE ECB-1. ECB MATERIAL SPECIFICATIONS				
TYPE	COCONUT CONTENT	STRAW CONTENT	EXCELSIOR CONTENT	RECOMMENDED NETTING*
STRAW*	-	100%	-	DOUBLE/NATURAL
STRAW-COCONUT	30% MIN	70% MAX	-	DOUBLE/NATURAL
COCONUT	100%	-	-	DOUBLE/NATURAL
EXCELSIOR	-	-	100%	DOUBLE/NATURAL

*MINOR ECBs MAY ONLY BE USED OUTSIDE OF URBANE AND DRAINAGE CHANNELS.
*ALTERNATE NETTING MAY BE ACCEPTABLE IN SOME JURISDICTIONS.

November 2010 Urban Drainage and Flood Control District RECP-8
Urban Storm Drainage Criteria Manual Volume 3

You created this PDF from an application that is not licensed to print to novaPDF printer (<http://www.novapdf.com>)

Roller Erosion Control Products (RECP) EC-6

EROSION CONTROL BLANKET MAINTENANCE NOTES

- INSPECT BMPs EACH WORKDAY, AND MAINTAIN THEM IN EFFECTIVE OPERATING CONDITION. MAINTENANCE OF BMPs SHOULD BE PROACTIVE, NOT REACTIVE. INSPECT BMPs AS SOON AS POSSIBLE (AND ALWAYS WITHIN 24 HOURS) FOLLOWING A STORM THAT CAUSES SURFACE EROSION, AND PERFORM NECESSARY MAINTENANCE.
 - FREQUENT OBSERVATIONS AND MAINTENANCE ARE NECESSARY TO MAINTAIN BMPs IN EFFECTIVE OPERATING CONDITION. INSPECTIONS AND CORRECTIVE MEASURES SHOULD BE DOCUMENTED THOROUGHLY.
 - WHERE BMPs HAVE FAILED, REPAIR OR REPLACEMENT SHOULD BE INITIATED UPON DISCOVERY OF THE FAILURE.
 - ECBs SHALL BE LEFT IN PLACE TO EVENTUALLY BIODEGRADE, UNLESS REQUESTED TO BE REMOVED BY THE LOCAL JURISDICTION.
 - ANY ECB PULLED OUT, TORN, OR OTHERWISE DAMAGED SHALL BE REPAIRED OR REINSTALLED. ANY SUBGRADE AREAS BELOW THE ECOTEXTILE THAT HAVE ERODED TO CREATED A VOID UNDER THE BLANKET, OR THAT REMAIN COVOID OF GRASS SHALL BE REPAIRED, RESEEDED AND MULCHED AND THE ECB REINSTALLED.
- NOTE: MANY JURISDICTIONS HAVE BMP DETAILS THAT VARY FROM UDFCD STANDARD DETAILS. CONSULT WITH LOCAL JURISDICTIONS AS TO WHICH DETAIL SHOULD BE USED WHEN DIFFERENCES ARE NOTED.
- (DETAILS ADAPTED FROM DOUGLAS COUNTY, COLORADO AND TOWN OF PARKER, COLORADO, NOT AVAILABLE IN AUTOCAD)

November 2010 Urban Drainage and Flood Control District RECP-9
Urban Storm Drainage Criteria Manual Volume 3

You created this PDF from an application that is not licensed to print to novaPDF printer (<http://www.novapdf.com>)

DESIGNED BY: MJK
DRAWN BY: MJK
CHECKED BY: KRK
DATE: 08/15/2024

Kimley-Horn
2024, KIMLEY-HORN AND ASSOCIATES, INC.
2 North Nevada Avenue Suite 900
Colorado Springs, Colorado 80903 (719) 453-0180

NO. _____
REVISION _____
BY _____
DATE _____

APPR

DESIGNED BY: MJK
DRAWN BY: MJK
CHECKED BY: KRK
DATE: 08/15/2024

EAGLEVIEW
EL PASO COUNTY, COLORADO
GRADING AND EROSION CONTROL PLAN
GEC DETAILS

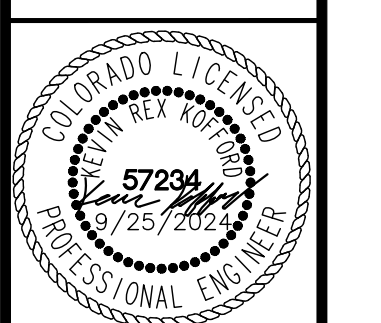

PROJECT NO.
196106001

SHEET
15

Inlet Protection (IP)

SC-6

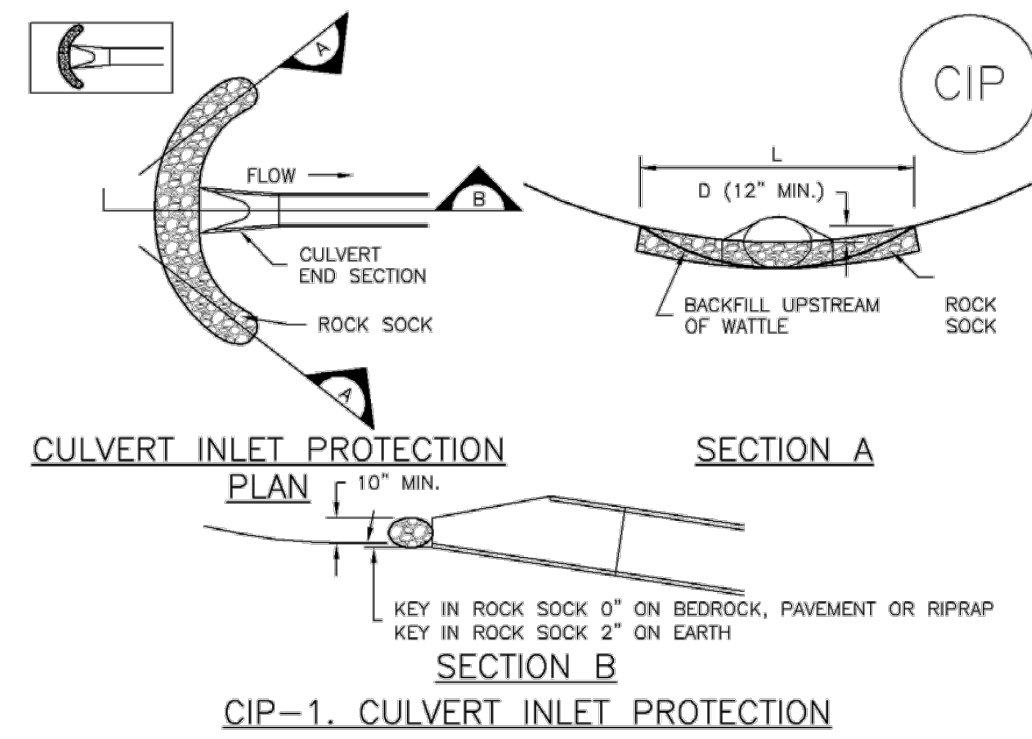

- GENERAL INLET PROTECTION INSTALLATION NOTES
1. SEE PLAN VIEW FOR:
- LOCATION OF INLET PROTECTION
- TYPE OF INLET PROTECTION (IP-1, IP-2, IP-3, IP-4, IP-5, IP-6)
2. INLET PROTECTION SHALL BE INSTALLED PROMPTLY AFTER INLET CONSTRUCTION OR PAVING IS COMPLETE...
3. MANY JURISDICTIONS HAVE BMP DETAILS THAT VARY FROM UDFCD STANDARD DETAILS...
4. FREQUENT OBSERVATIONS AND MAINTENANCE ARE NECESSARY TO MAINTAIN BMPs IN EFFECTIVE OPERATING CONDITION...
5. WHERE BMPs HAVE FAILED, REPAIR OR REPLACEMENT SHOULD BE INITIATED UPON DISCOVERY OF THE FAILURE...
6. SEDIMENT ACCUMULATED UPSTREAM OF INLET PROTECTION SHALL BE REMOVED AS NECESSARY...
7. WHEN INLET PROTECTION AT AREA INLETS IS REMOVED, THE DISTURBED AREA SHALL BE COVERED WITH TOP SOIL, SEEDED AND MULCHED...
8. INLET PROTECTION IS TO REMAIN IN PLACE UNTIL THE UPSTREAM DISTURBED AREA IS PERMANENTLY STABILIZED...
9. INLET PROTECTION SHALL REMAIN IN PLACE UNTIL THE UPSTREAM DISTURBED AREA IS PERMANENTLY STABILIZED AND APPROVED BY THE LOCAL JURISDICTION.

August 2013 Urban Drainage and Flood Control District IP-7
Urban Storm Drainage Criteria Manual Volume 3

Inlet Protection (IP)

IP-8 Urban Drainage and Flood Control District
Urban Storm Drainage Criteria Manual Volume 3 August 2013

Check Dams (CD)

EC-12

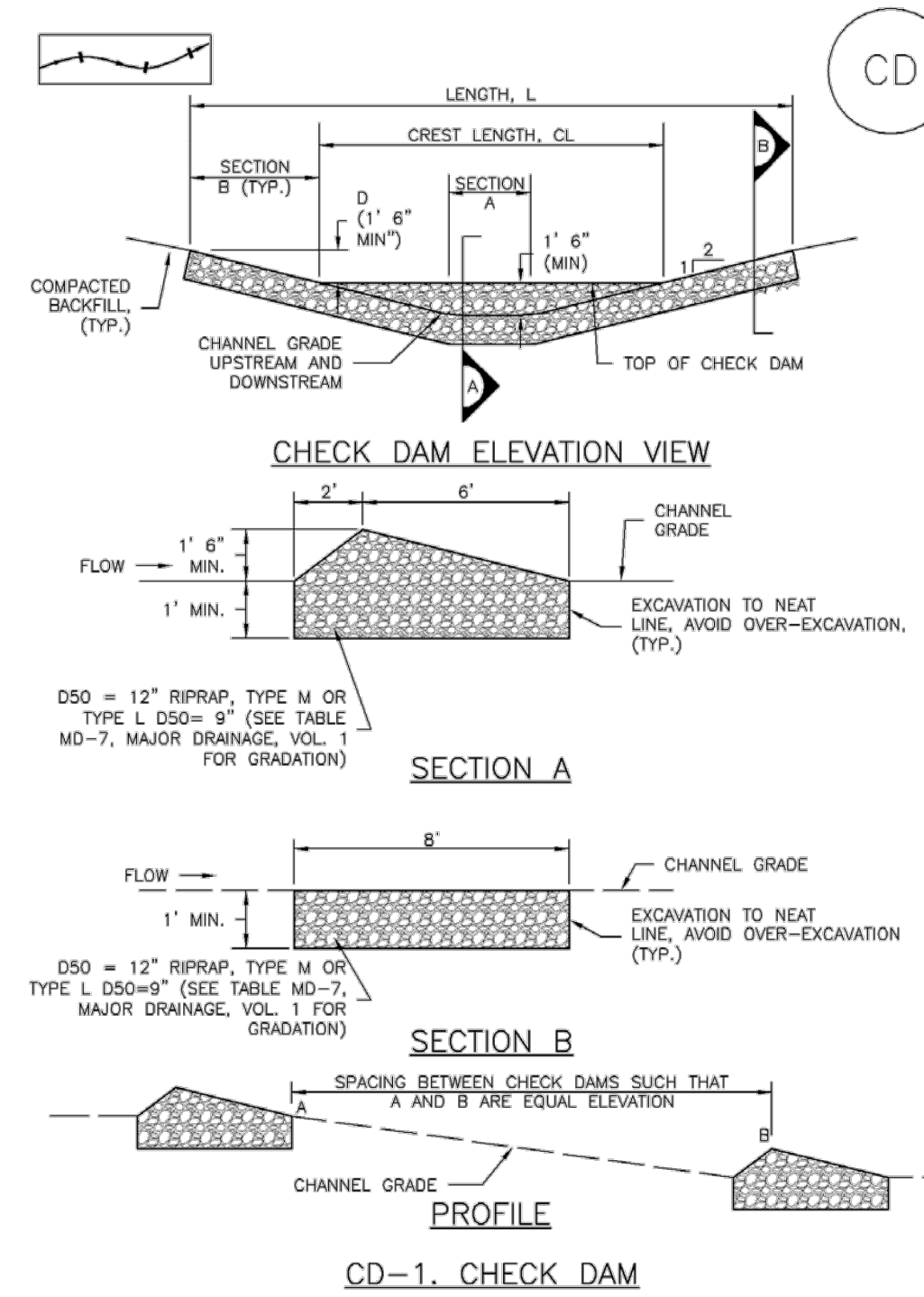

November 2010 Urban Drainage and Flood Control District CD-3
Urban Storm Drainage Criteria Manual Volume 3

Check Dams (CD)

CD-4 Urban Drainage and Flood Control District
Urban Storm Drainage Criteria Manual Volume 3 November 2010

Sediment Control Log (SCL)

SC-2

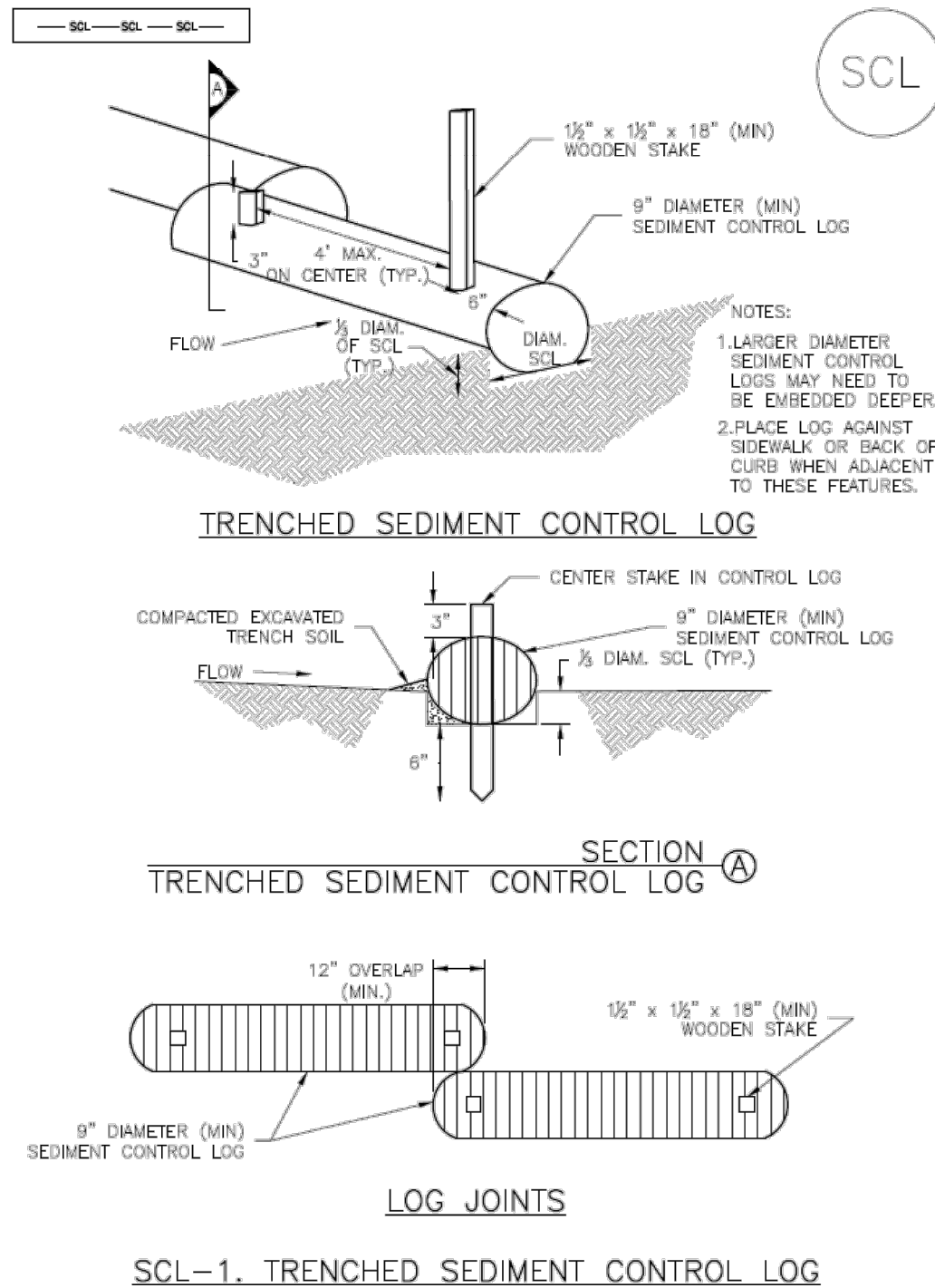

November 2015 Urban Drainage and Flood Control District SCL-3
Urban Storm Drainage Criteria Manual Volume 3

Sediment Control Log (SCL)

SCL-4 Urban Drainage and Flood Control District
Urban Storm Drainage Criteria Manual Volume 3 November 2015

Sediment Control Log (SCL)

SC-2

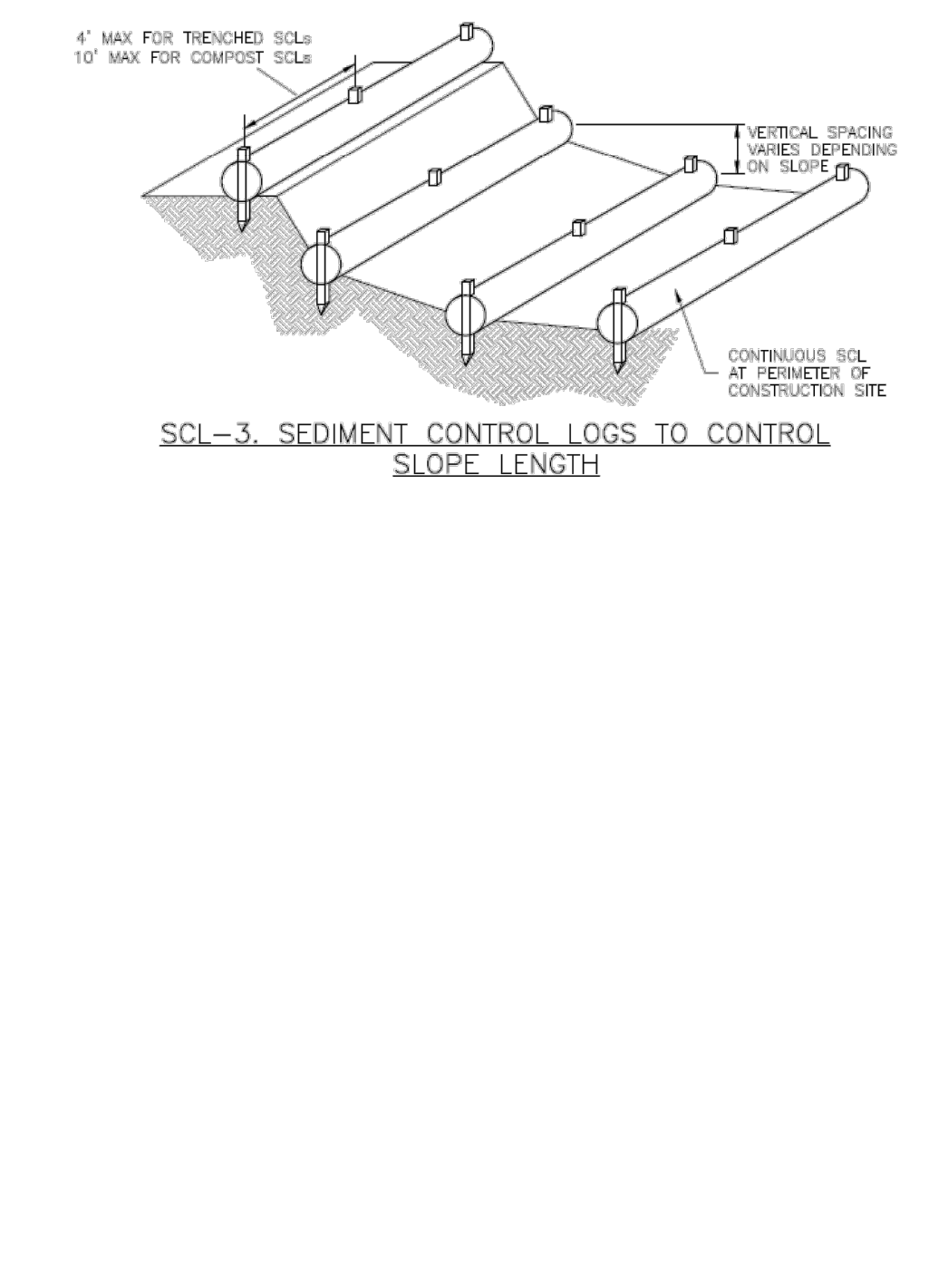

November 2015 Urban Drainage and Flood Control District SCL-5
Urban Storm Drainage Criteria Manual Volume 3

Sediment Control Log (SCL)

SCL-6 Urban Drainage and Flood Control District
Urban Storm Drainage Criteria Manual Volume 3 November 2015

Revision table with columns for NO., REVISION, BY, and DATE.

Kimley-Horn & Associates, Inc. logo and contact information: 2024 KIMLEY-HORN AND ASSOCIATES, INC. 2 North Nevada Avenue Suite 900 Colorado Springs, Colorado 80903 (719) 453-0180

DESIGNED BY: MJK
DRAWN BY: MJK
CHECKED BY: KRK
DATE: 08/15/2024

EAGLEVIEW
EL PASO COUNTY, COLORADO
GRADING AND EROSION CONTROL PLAN
GEC DETAILS



PROJECT NO. 196106001
SHEET 16