

**FINAL DRAINAGE REPORT**  
**for**  
**SETTLERS VIEW SUBDIVISION**

**Prepared for:**

**Hannigan and Associates, Inc.**  
19360 Spring Valley Road  
Monument, CO 80132

July 31, 2018  
Revised January 28, 2019  
Revised March 5, 2019

**Prepared by:**

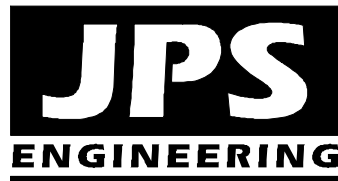

19 E. Willamette Avenue  
Colorado Springs, CO 80903  
(719)-477-9429  
(719)-471-0766 fax  
[www.jpsegr.com](http://www.jpsegr.com)

**JPS Project No. 111603**  
**PCD File No.: SF-18-041**

**SETTLERS VIEW SUBDIVISION  
FINAL DRAINAGE REPORT  
TABLE OF CONTENTS**

	<u>PAGE</u>
EXECUTIVE SUMMARY .....	i
DRAINAGE STATEMENT .....	ii
FLOODPLAIN STATEMENT .....	iii
I. GENERAL LOCATION AND DESCRIPTION.....	1
II. DRAINAGE BASINS AND SUB-BASINS.....	3
III. DRAINAGE DESIGN CRITERIA .....	4
IV. DRAINAGE PLANNING FOUR STEP PROCESS.....	5
V. DRAINAGE FACILITY DESIGN .....	6
VI. EROSION / SEDIMENT CONTROL .....	10
VII. COST ESTIMATE AND DRAINAGE FEES.....	11
VIII. SUMMARY .....	11

APPENDICES

APPENDIX A	Hydrologic Calculations
APPENDIX B	Hydraulic Calculations
APPENDIX C	Detention Pond Calculations
APPENDIX D	Drainage Cost Estimate
APPENDIX E	Figures
Figure A1	Vicinity Map
Figure FIRM	Floodplain Map
Sheet EX1	Historic Drainage Plan
Sheet D1	Developed Drainage Plan
Sheet D1.1	Enlarged Developed Drainage Plan
Sheet C1	Site Grading & Erosion Control Plan

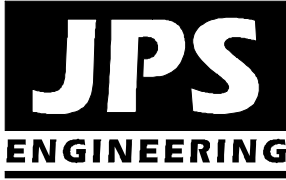

## SETTLERS VIEW– FINAL DRAINAGE REPORT EXECUTIVE SUMMARY

### A. Background

- Settlers View is a proposed residential subdivision of a 40-acre parcel located northwest of Hodgen Road and Stepler Road in El Paso County.
- The proposed subdivision consists of 14 rural residential lots with 2.5-acre minimum lot sizes.
- Settlers View is located within the East and West Cherry Creek Drainage Basins, each of which comprise total drainage areas in excess of 30 square miles. The Settlers View property represents less than 0.2 percent of the total basin area.

### B. General Drainage Concept

- Developed drainage within the site will be conveyed along paved streets with roadside ditches and culverts, as well as grass-lined channels through drainage easements, following historic drainage patterns.
- Developed flows from the subdivision will be detained to historic levels through an on-site private stormwater detention pond.
- Subdivision drainage improvements will be designed and constructed to meet El Paso County standards,

### C. Drainage Impacts

- The proposed detention pond will detain to historic flows at the downstream property boundary, ensuring no significant adverse developed drainage impact on downstream properties.
- Drainage facilities within public road rights-of-way will be dedicated to the County for maintenance. The proposed stormwater detention pond will be maintained by the subdivision HOA.

DRAINAGE STATEMENT

Engineer's Statement:

The attached drainage plan and report were prepared under my direction and supervision and are correct to the best of my knowledge and belief. Said drainage report has been prepared according to the criteria established by the County for drainage reports and said report is in conformity with the master plan of the drainage basin. I accept responsibility for liability caused by negligent acts, errors or omissions on my part in preparing this report.

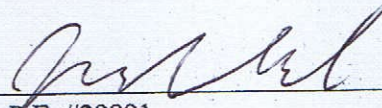
  
\_\_\_\_\_  
John P. Schwab, P.E. #29891



Developer's Statement:

I, the developer have read and will comply with all of the requirements specified in this drainage report and plan.

By:  \_\_\_\_\_ *03-02-18*  
Date

Printed Name: Brenda Brinkman, Owner  
4507 Silver Nell Drive, Colorado Springs, CO 80908

*J.W. HANNIGAN FOR THE OWNER*

El Paso County's Statement

Filed in accordance with the requirements of the El Paso County Land Development Code, Drainage Criteria Manual, Volumes 1 and 2, and Engineering Criteria Manual as amended.

Approved   
by Elizabeth Nijkamp  
El Paso County Planning and Community Development  
on behalf of Jennifer Irvine, County Engineer, ECM Administrator  
\_\_\_\_\_  
Jennifer Irvine, P.E. **03/11/2019 4:20:37 PM** \_\_\_\_\_ Date  
County Engineer / ECM Administrator

Conditions:



FLOODPLAIN STATEMENT

To the best of my knowledge and belief, no parts of the Settlers View Subdivision are located in a FEMA designated floodplain, as shown on FIRM panel No. 08041C0305G, dated December 7, 2018.



---

John P. Schwab, P.E. #29891

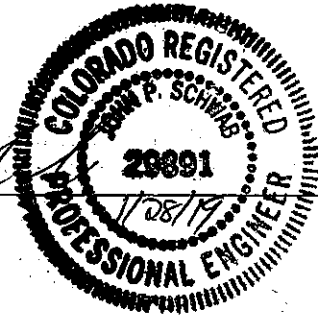

## **I. GENERAL LOCATION AND DESCRIPTION**

### **A. Background**

Settlers View is a proposed rural residential subdivision located in northeastern El Paso County, Colorado. The Settlers View parcel (El Paso County Assessor's Number 61000-00-463) is located between Grandview Subdivision and Settlers Ranch Subdivision, west of Stepler Road, as shown in Figure A1 (Appendix E). Settlers Ranch Subdivision will consist of 14 low-density residential lots (2.5-acre minimum size) on a 40-acre parcel. The north boundary of this site adjoins the current termination of Silver Nell Drive in Grandview Subdivision.

### **B. Scope**

This report is intended to fulfill the El Paso County requirements for a Final Drainage Report (FDR) for submittal in support of the Final Plat application. JPS Engineering previously prepared the "Preliminary Drainage Report for Settlers View Subdivision" dated February 14, 2018, which was approved by El Paso County in support of the Preliminary Plan approval for this subdivision.

This Final Drainage Report provides a summary of site drainage issues impacting the proposed development, including analysis of impacts from upstream drainage areas, site-specific developed drainage patterns, and impacts on downstream facilities. The FDR has been prepared based on the guidelines and criteria presented in the El Paso County Drainage Criteria Manual.

### **C. Site Location and Description**

The Settlers View parcel is located in the Northeast Quarter of Section 23, Township 11 South, Range 66 West of the 6th Principal Meridian. The site is currently a vacant meadow tract, with some existing trees at the north end of the property.

The property is currently zoned RR-5 (Rural Residential; 5-acre minimum lots), and the proposed subdivision will include re-zoning the property to RR-2.5 (Rural Residential; 2.5-acre minimum lots). The proposed low-density lots will be served by individual wells and septic systems.

The north boundary of the property borders the existing Grandview Subdivision, and the south boundary of the property adjoins the approved Settlers Ranch Subdivision, both of which consist primarily of 2.5-acre lots. The west boundary of the borders an undeveloped 40-acre ranch property, and the east boundary of the site adjoins a currently vacant 40-acre property which is proposed for development as the Abert Ranch Subdivision, with 2.5-acre minimum lots.

Access through Settlers View Subdivision will be provided by extension of Silver Nell Drive southeasterly through the property, along with construction of the proposed Settlers View Road extending southwest from Silver Nell Drive. Subdivision infrastructure improvements will include paving of new public roadways through the site, as well as grading, drainage, and utility

service improvements for the proposed residential lots. Local roads will be classified as rural local roads, with 60-foot rights-of-way and paved widths of 28-feet.

Ground elevations within the parcel range from a low point of approximately 7,570 feet above mean sea level at the west boundary of the parcel, to a high point of 7,650 feet near the north boundary.

This site is located along the ridge between the East and West Cherry Creek drainage basins. Surface drainage from the east edge of the property flows easterly towards tributaries of East Cherry Creek, and surface drainage from the western part of the site flows southwesterly towards tributaries of West Cherry Creek. The terrain is rolling with slopes ranging from 2% to 8%. Existing vegetation is typical eastern Colorado prairie grass.

#### **D. General Soil Conditions**

According to the Soil Survey of El Paso County prepared by the Soil Conservation Service, on-site soils are comprised of the following soil types (see Appendix A):

- Type 25 – Elbeth sandy loam: Hydrologic Group B (northwest corner of site)
- Type 67 – Peyton sandy loam: Hydrologic Group B (east side of property)
- Type 92 – Tomah-Crowfoot: Hydrologic Group B (southwest part of property; majority of site)

#### **E. References**

City of Colorado Springs & El Paso County “Drainage Criteria Manual, Volumes 1 and 2,” revised May, 2014.

El Paso County “Engineering Criteria Manual,” January 9, 2006.

FEMA, Flood Insurance Rate Map (FIRM) Number 08041C0305G, December 7, 2018.

JPS Engineering, Inc., “Final Drainage Report for Grandview Subdivision,” September 7, 2007 (approved by El Paso County 9/14/07).

JPS Engineering, Inc., “Master Development Drainage Plan (MDDP) and Preliminary Drainage Report for Walden Preserve Subdivision,” December 10, 2004 (approved by El Paso County 12/20/04).

JPS Engineering, Inc., “Final Drainage Report for Settlers Ranch Subdivision Filing No. 1,” October 18, 2005 (approved by El Paso County 10/19/05).

JPS Engineering, Inc., “Final Drainage Report for Settlers Ranch Subdivision Filing No. 2,” May 30, 2008 (approved by El Paso County 3/31/09).

JPS Engineering, Inc., “Preliminary Drainage Report for Settlers View Subdivision,” February 14, 2018.

JPS Engineering, Inc., “Final Drainage Report for Walden Pines Subdivision,” March 24, 2004.

JPS Engineering, Inc., “Final Drainage Report for Walden Preserve Subdivision Filing No. 1,” May 11, 2005.

## **II. DRAINAGE BASINS AND SUB-BASINS**

### **A. Major Basin Description**

The proposed development lies within both the West Cherry Creek Drainage Basin (CYCY 0400) and East Cherry Creek Drainage Basin (CYCY 0200), as classified by El Paso County. Drainage from the west part of the site flows southwesterly to an eastern tributary of West Cherry Creek, which flows to a confluence with the main channel north of Walker Road. Downstream agricultural areas generally drain northerly towards the main channel of West Cherry Creek.

Drainage from the east part of the site flows easterly to a tributary of East Cherry Creek.

No drainage planning study has been completed for this drainage basin or any adjacent drainage basins. In the absence of plans for regional drainage facilities, El Paso County generally requires new developments to provide stormwater detention to maintain historic runoff flows leaving developed areas.

The major drainage basins lying in and around the proposed development are depicted in Figure EX1. The Settlers View parcel is located near the southerly limits of the West Cherry Creek and East Cherry Creek Drainage Basins, each of which comprise total drainage areas in excess of 30 square miles. As such, the proposed 40-acre Settlers View subdivision represents less than 0.2 percent of the total basin area, which is primarily ranch land.

### **B. Floodplain Impacts**

The proposed development area is located beyond the limits of any 100-year floodplain delineated by the Federal Emergency Management Agency (FEMA). The floodplain limits in the vicinity of the site are shown in Flood Insurance Rate Map (FIRM) Panel Number 08041C0305G, dated December 7, 2018, as shown in Figure FIRM (Appendix E).

### **C. Sub-Basin Description**

The existing drainage basins lying in and around the proposed development are depicted in Figure EX1 (Appendix E). The existing on-site topography has been delineated as several sub-basins draining to design points at the east and west boundaries of the site.



The developed drainage basins lying within the proposed development are depicted on Figure D1. The developed site layout has been divided into sub-basins based on the proposed road layout within the site. The natural drainage patterns will be impacted through development by site grading and concentration of runoff in subdivision roadside ditches and channels.

On-site flows will be diverted to the existing natural drainage swales and channels running through the property, following historic drainage paths.

### III. DRAINAGE DESIGN CRITERIA

#### A. Development Criteria Reference

No Drainage Basin Planning Study (DBPS) has been completed for either the West Cherry Creek Drainage Basin or the East Cherry Creek Drainage Basin. Previous drainage reports for completed subdivision filings have proposed to provide on-site detention for mitigation of developed flows.

#### B. Hydrologic Criteria

In accordance with the El Paso County Drainage Criteria Manual, Rational Method procedures were utilized for hydrologic calculations since the tributary drainage basins are below 100 acres.

Rational Method hydrologic calculations were based on the following assumptions:

• Design storm (minor)	5-year	
• Design storm (major)	100-year	
• Time of Concentration – Overland Flow	“Airport” equation (300’ max. developed)	
• Time of Concentration – Gutter/Ditch Flow	“SCS Upland” equation	
• Rainfall Intensities	El Paso County I-D-F Curve	
• Hydrologic soil type	B	
	<u>C5</u>	<u>C100</u>
• Runoff Coefficients - undeveloped: Existing pasture/range areas	0.08	0.35
• Runoff Coefficients - developed: Proposed lot areas (2.5-acre lots)	0.170	0.417

Hydrologic calculations are enclosed in Appendix A, and peak design flows are identified on the drainage basin drawings.

#### **IV. DRAINAGE PLANNING FOUR STEP PROCESS**

El Paso County Drainage Criteria require drainage planning to include a Four Step Process for receiving water protection that focuses on reducing runoff volumes, treating the water quality capture volume (WQCV), stabilizing drainageways, and implementing long-term source controls.

As stated in DCM Volume 2, the Four Step Process is applicable to all new and re-development projects with construction activities that disturb 1 acre or greater or that disturb less than 1 acre but are part of a larger common plan of development.

The Four Step Process has been implemented as follows in the planning of this project:

##### Step 1: Employ Runoff Reduction Practices

- **Minimize Impacts:** The proposed rural residential subdivision development with 2.5-acre minimum lot sizes provides for inherently minimal drainage impacts based on the limited impervious areas associated with rural residential development.
- **Minimize Directly Connected Impervious Areas (MDCIA):** The rural residential development will have roadside ditches along all roads, providing for impervious areas to drain across pervious areas. Based on the roadside ditches throughout the subdivision, the subdivision is classified as MDCIA Level One.
- **Grass Swales:** The proposed roadside ditches will drain to existing and proposed grass-lined drainage swales following historic drainage patterns through the property.

##### Step 2: Stabilize Drainageways

- Proper erosion control measures will be implemented along the roadside ditches and grass-lined drainage channels to provide stabilized drainageways within the site.

##### Step 3: Provide Water Quality Capture Volume (WQCV)

- **FSD:** A Full-Spectrum Detention Pond will be provided at the west boundary of the site. On-site drainage will be routed through the extended detention basin, which will capture and slowly release the WQCV over a 72-hour design release period.

##### Step 4: Consider Need for Industrial and Commercial BMPs

- No industrial or commercial land uses are proposed within this rural residential subdivision.
- On-site drainage will be routed through the private Full-Spectrum Detention (FSD) basin to minimize introduction of contaminants to the County's public drainage system.

## **V. DRAINAGE FACILITY DESIGN**

### **A. General Concept**

Development of the Settlers View Subdivision will require site grading and paving, resulting in additional impervious areas across the site. The general drainage pattern will consist of grading away from home sites to swales and roadside ditches along the internal roads within the subdivision, conveying runoff flows through the site. Runoff from the site will flow by roadside ditches to cross culverts at low points in the road profiles, and grass-lined channels connecting to existing natural swales at the site boundaries.

The stormwater management concept for the Settlers View development will be to provide roadside ditches and natural swales as required to convey developed drainage through the site to existing natural outfalls.

Individual lot grading will provide positive drainage away from building sites, and direct developed flows into the system of roadside ditches and drainage swales running through the subdivision.

A stormwater detention pond will be constructed at the west boundary of the subdivision to mitigate the impact of developed flows and maintain historic peak flows downstream of the property.

### **B. Specific Details**

#### **1. Existing Drainage Conditions**

Historic drainage conditions within the site are depicted in Figure EX1. Basin A comprises the eastern side of the property, which drains easterly along several existing natural swales. Basin A flows easterly to Design Pont #A, with historic peak flows calculated as  $Q_5 = 3.0$  cfs and  $Q_{100} = 21.6$  cfs.

Basin A discharges to an existing grass-lined drainage swale flowing easterly across the adjoining 40-acre property to an existing stock pond, ultimately crossing Stepler Road in an existing 48-inch RCP Culvert.

The west side of the property has been delineated as Basin S, which flows southwesterly to an existing grass-lined drainage swale at the west boundary of the site. Off-site Basin OS1 comprises a relatively small area within the adjoining Grandview Subdivision, which flows southwesterly into the northwest corner of Basin S. Additionally, off-site drainage from Basin D9 of the adjoining Settlers Ranch Subdivision flows northwesterly through Basin S. Flows from Basins OS1, D9, and S combine at Design Pont #S, with historic peak flows calculated as  $Q_5 = 10.0$  cfs and  $Q_{100} = 73.1$  cfs.

Basin S discharges to an existing grass-lined drainage swale flowing westerly across the adjoining 40-acre property to the existing downstream drainage channel and series of ponds within the Walden Preserve Subdivision.

## **2. Developed Drainage Conditions**

The developed drainage basins and projected flows are shown in Figure D1, and hydrologic calculations are enclosed in Appendix B.

The east side of the property has been delineated as Basins A, B, and C in the developed condition, and these basins will continue to sheet flow easterly through the proposed Abert Ranch Subdivision.

Basin A flows easterly to Design Point #A, with developed peak flows calculated as  $Q_5 = 5.5$  cfs and  $Q_{100} = 22.4$  cfs. Basin B flows easterly to Design Point #B, with developed peak flows calculated as  $Q_5 = 1.7$  cfs and  $Q_{100} = 6.8$  cfs. Basin C flows easterly to Design Point #C, with developed peak flows calculated as  $Q_5 = 0.8$  cfs and  $Q_{100} = 3.1$  cfs. Combined developed flows from Basins A, B, and C are calculated as  $Q_5 = 7.6$  cfs and  $Q_{100} = 31.2$  cfs (Design Point #A1).

Development plans for the proposed Abert Ranch Subdivision on the adjoining ranch property to the east include upgrade of an existing stock pond to meet stormwater detention requirements for the Abert Ranch site, including the minimal developed drainage contribution from Settlers View Basins A, B, and C. Recognizing the minimal developed area along the east side of Settlers View Subdivision, there will be no significant adverse impact on the Abert Ranch property if Settlers View is fully developed before development of Abert Ranch Subdivision and the upgrade to the existing stock pond.

The west side of the property has been delineated as Basins S1-S4 based on the developed road configuration, and these basins will continue to flow westerly to the existing drainage swale at the western property boundary.

Developed Basin S1 will flow southwesterly to the proposed Culvert S1 crossing Silver Nell Drive at Design Point #S1. Culvert S1 will flow southwesterly along Ditch S3 on the west side of Settlers View Road to a proposed Full-Spectrum Detention Pond (Pond S3) at the west boundary of the subdivision. Ditch S3 will be stabilized with erosion control blanket lining.

Off-site drainage from Basin D9 of the adjoining Settlers Ranch Subdivision will flow northwesterly through Basin S2 to the proposed Culvert S2 crossing Settlers View Road at Design Point #S2, continuing through a grass-lined channel to Detention Pond S3.



Flows from Basins D9 and S1-S3 combine at Design Point #S3, with developed peak flows of  $Q_5 = 19.0$  cfs and  $Q_{100} = 78.1$  cfs. Developed flow impacts from the subdivision will be mitigated by routing flows through Detention Pond #S3.

Off-site Basin OS1 will continue to flow northwesterly through Basin S4 to the west boundary of the site.

Flows from Basins D9, OS1, and S1-S4 ultimately combine at downstream Design Point #S, with developed peak flows calculated as  $Q_5 = 22.0$  cfs and  $Q_{100} = 90.6$  cfs.

### C. Comparison of Developed to Historic Discharges

Based on the hydrologic calculations in Appendix B, the proposed development will result in developed flows exceeding historic flows from the parcel. The increase in developed flows will be mitigated through on-site stormwater detention facilities.

The comparison of developed to historic discharges at key design points is summarized as follows:

Design Point	Historic Flow			Developed Flow			Comparison of Developed to Historic Flow ( $Q_5\%/Q_{100}\%$ )
	Area (ac)	$Q_5$ (cfs)	$Q_{100}$ (cfs)	Area (ac)	$Q_5$ (cfs)	$Q_{100}$ (cfs)	
A1	15.0	3.0	21.6	15.0	7.6	31.2	253% / 144% (increase)
S	46.8	10.0	73.1	46.8	22.0	90.6	220% / 124% (increase)

### D. Detention Ponds

The Developed storm runoff downstream of the proposed subdivision will be maintained at historic levels by routing flows through a proposed detention pond at the west boundary of the property. Pond #S3 will be constructed as a Full-Spectrum Detention (FSD) Pond to mitigate developed flow impacts from the proposed subdivision. The pond outlet structure has been designed with multiple orifice openings to detain the full spectrum of storm events.

Detailed pond routing calculations have been performed utilizing the Denver Urban Drainage “UD-Detention” software package (see Appendix C). The pond outlet structure configuration has been designed to maintain the calculated pond discharge below the target outflow, while maintaining the maximum water surface elevation below the pond spillway. Final detention pond design parameters are summarized as follows:

Pond	Inflow ( $Q_{100}$ , cfs)	Outflow ( $Q_{100}$ , cfs)	Volume (ac-ft)	Outlet Structure
Pond #S3	68.2	39.0	1.3	30-inch SD w/ orifice plates

15-foot wide gravel maintenance access roads will be provided for all stormwater detention facilities. The proposed detention ponds will be privately owned and maintained by the subdivision homeowners association (HOA).

The proposed detention pond will discharge through a flared end section and riprap apron upstream of the westerly subdivision boundary, draining to an existing grass lined drainage swale which flows westerly across the adjoining Morehead property. The existing downstream swale flows into a stock pond within the Morehead property. The proposed outfall meets the definition of a suitable outfall in accordance with ECM Chapter 3, Section 3.2.4, as the existing downstream drainage swales are stable grass-lined channels with no significant signs of erosion.

## **E. On-Site Drainage Facility Design**

Developed sub-basins and proposed drainage improvements are depicted in the enclosed Drainage Plan (Sheet D1). In accordance with El Paso County standards, new roadways will be graded with a minimum longitudinal slope of 1.0 percent. The typical local road section will consist of a 28-foot paved width with 2-foot gravel shoulders and 4:1 slopes to 2.5-foot ditches.

On-site drainage facilities will consist of roadside ditches, grass-lined channels, and culverts. Hydraulic calculations for preliminary sizing of major on-site drainage facilities are enclosed in Appendix D, and design criteria are summarized as follows:

### **1. Culverts**

The internal road system has been graded to drain roadside ditches to low points along the road profile, where cross-culverts will convey developed flows into grass-lined channels following historic drainage paths. Culvert pipes have been specified as reinforced concrete pipe (RCP) with a minimum diameter of 18-inches. Culvert sizes have been identified based on a maximum headwater-to-depth ratio (HW/D) of 1.0 for the minor (5-year) design storm. Final culvert design calculations were performed utilizing the FHWA HY-8 software package to perform a detailed analysis of inlet and outlet control conditions, meeting El Paso County criteria for allowable overtopping. HY8 calculation results are summarized in the "Culvert Sizing Summary" Table in Appendix B. Riprap outlet protection will be provided at all culverts.

### **2. Open Channels**

Drainage easements will be dedicated along major drainage channels following historic drainage paths through the subdivision. These channels will generally be grass-lined channels designed to convey 100-year flows, with a trapezoidal cross-section, variable bottom width and depth, 4:1 maximum side slopes, 1-foot freeboard, and a minimum slope of 0.5 percent.

The proposed drainage channels have been sized utilizing Manning's equation for open channel flow, assuming a friction factor ("n") of 0.030 for dry-land grass channels. Maximum allowable velocities will be evaluated based on El Paso County drainage criteria, typically allowing for a maximum 100-year velocity of 5 feet per second. Erosion control mats have been specified for channel segments with maximum 100-year velocities up to 8 feet per second.

The proposed channels will generally be seeded with native grasses for erosion control. Erosion control mats, ditch checks, and/or riprap channel lining will be provided where required based on erosive velocities. Ditch flows will be diverted to drainage channels at the nearest practical location to minimize excessive roadside ditch sizes. Detailed channel hydraulic calculations are enclosed in Appendix B.

Primary drainage swales crossing proposed lots have been placed in drainage easements, with variable widths based on the required channel sections.

#### **F. Anticipated Drainage Problems and Solutions**

The proposed stormwater Detention Pond #S3 has been designed to mitigate the impacts of developed drainage from this project. The overall drainage plan for the subdivision includes a system of roadside ditches, channels, and culverts to convey developed flows through the site. The primary drainage problems anticipated within this development will consist of maintenance of these drainage channels, culverts, and detention pond facilities. Care will need to be taken to implement proper erosion control measures in the proposed roadside ditches, channels, and swales. Ditches will be designed to meet allowable velocity criteria. Erosion control mats, ditch checks, and riprap channel lining will be installed where necessary to minimize erosion concerns. Proper construction and maintenance of the proposed detention facilities will minimize downstream drainage impacts. Public roadway improvements and ditches within the public right-of-way will be owned and maintained by El Paso County. The proposed stormwater detention pond and drainage channels located within open space tracts will be owned and maintained by the subdivision HOA.

#### **VI. EROSION / SEDIMENT CONTROL**

The Contractor will be required to implement Best Management Practices (BMP's) for erosion control through the course of construction. Sediment control measures will include installation of silt fence at the toe of disturbed slopes and hay bales protecting drainage ditches. Cut slopes will be stabilized during excavation as necessary and vegetation will be established for stabilization of disturbed areas as soon as possible. All ditches will be designed to meet El Paso County criteria for slope and velocity. The proposed detention pond will serve as a sediment basin during the construction phase of the project.

## **VII. COST ESTIMATE AND DRAINAGE FEES**

A cost estimate for proposed drainage improvements is enclosed in Appendix D, with a total estimated cost of approximately \$55,425 for subdivision drainage improvements. The developer will finance all construction costs for proposed roadway and drainage improvements, and public facilities will be owned and maintained by El Paso County upon final acceptance. Private drainage facilities will be owned and maintained by the subdivision HOA. This parcel is located in the West Cherry Creek and East Cherry Creek Drainage Basins. No drainage and bridge fees will be due at time of recordation of the final plat as the subject site is not located in a fee basin.

## **VIII. SUMMARY**

Settlers View is a proposed residential subdivision consisting of 14 lots on a 40-acre parcel located between Grandview Subdivision and Settlers Ranch Subdivision on the west side of Stepler Road in northeastern El Paso County. Development of the proposed Settlers View Subdivision will generate an increase in developed runoff from the site, which will be mitigated through construction of on-site stormwater detention facilities. The proposed drainage patterns will remain consistent with historic conditions, and new drainage facilities constructed to El Paso County standards will safely convey runoff to suitable outfalls. Based on the on-site stormwater detention concept, no new downstream drainage facilities are proposed.

The proposed detention pond will ensure that overall developed flows from the Settlers View Subdivision remain consistent with historic levels. Construction and proper maintenance of the proposed drainage and erosion control facilities will ensure that this subdivision has no significant adverse drainage impact on downstream or surrounding areas.



**APPENDIX A**  
**HYDROLOGIC CALCULATIONS**

Hydrologic Soil Group—El Paso County Area, Colorado  
(Settlers View)

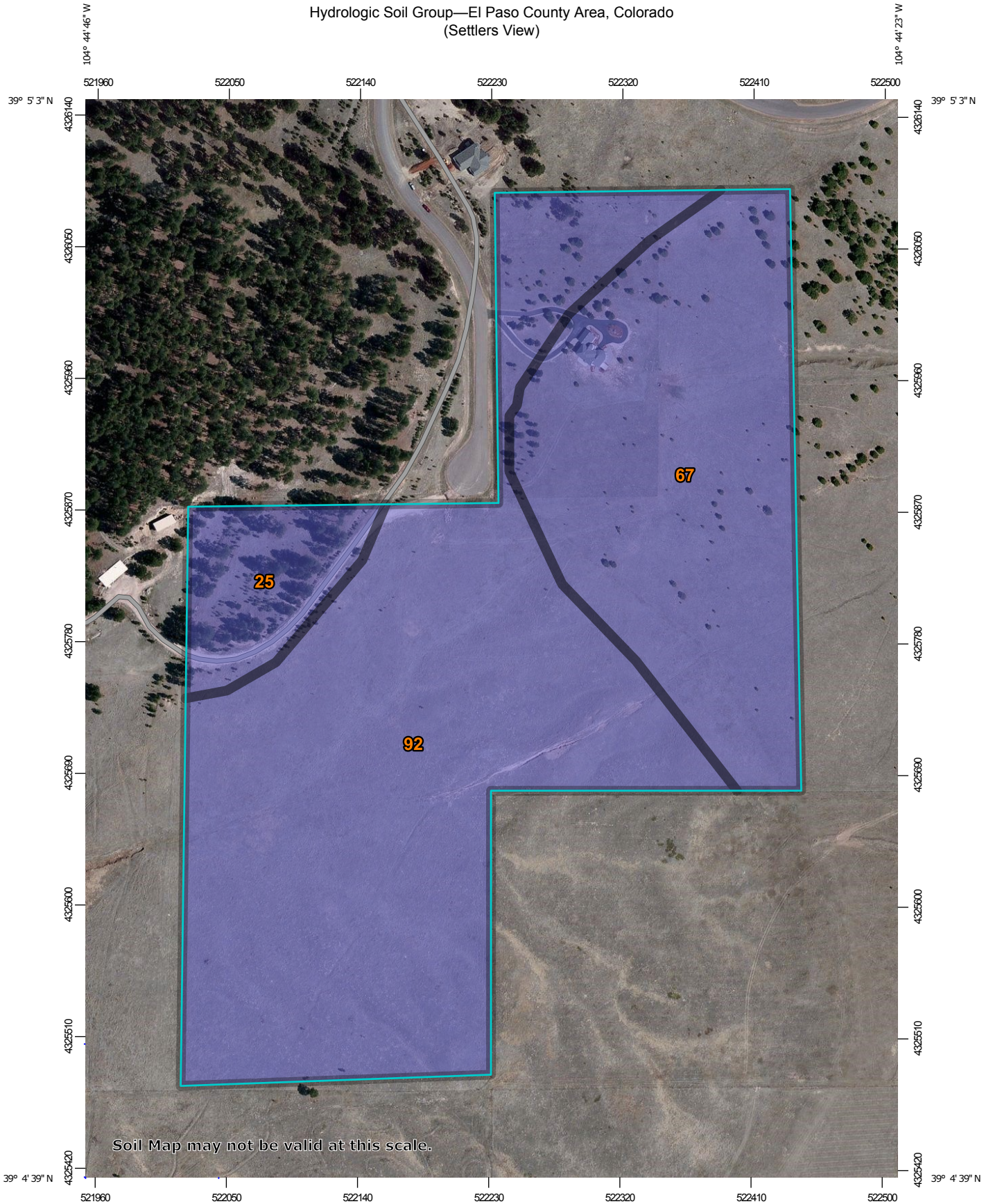



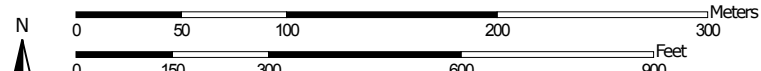





























Map Scale: 1:3,590 if printed on A portrait (8.5" x 11") sheet.



Map projection: Web Mercator Corner coordinates: WGS84 Edge tics: UTM Zone 13N WGS84



## MAP LEGEND

<b>Area of Interest (AOI)</b>	 C
 Area of Interest (AOI)	 C/D
<b>Soils</b>	 D
<b>Soil Rating Polygons</b>	 Not rated or not available
 A	<b>Water Features</b>
 A/D	 Streams and Canals
 B	<b>Transportation</b>
 B/D	 Rails
 C	 Interstate Highways
 C/D	 US Routes
 D	 Major Roads
 Not rated or not available	 Local Roads
<b>Soil Rating Lines</b>	<b>Background</b>
 A	 Aerial Photography
 A/D	
 B	
 B/D	
 C	
 C/D	
 D	
 Not rated or not available	
<b>Soil Rating Points</b>	
 A	
 A/D	
 B	
 B/D	

## MAP INFORMATION

The soil surveys that comprise your AOI were mapped at 1:24,000.

Warning: Soil Map may not be valid at this scale.

Enlargement of maps beyond the scale of mapping can cause misunderstanding of the detail of mapping and accuracy of soil line placement. The maps do not show the small areas of contrasting soils that could have been shown at a more detailed scale.

Please rely on the bar scale on each map sheet for map measurements.

Source of Map: Natural Resources Conservation Service  
Web Soil Survey URL:  
Coordinate System: Web Mercator (EPSG:3857)

Maps from the Web Soil Survey are based on the Web Mercator projection, which preserves direction and shape but distorts distance and area. A projection that preserves area, such as the Albers equal-area conic projection, should be used if more accurate calculations of distance or area are required.

This product is generated from the USDA-NRCS certified data as of the version date(s) listed below.

Soil Survey Area: El Paso County Area, Colorado  
Survey Area Data: Version 14, Sep 23, 2016

Soil map units are labeled (as space allows) for map scales 1:50,000 or larger.

Date(s) aerial images were photographed: Apr 15, 2011—Sep 22, 2011

The orthophoto or other base map on which the soil lines were compiled and digitized probably differs from the background imagery displayed on these maps. As a result, some minor shifting of map unit boundaries may be evident.

## Hydrologic Soil Group

Hydrologic Soil Group— Summary by Map Unit — El Paso County Area, Colorado (CO625)				
Map unit symbol	Map unit name	Rating	Acres in AOI	Percent of AOI
25	Elbeth sandy loam, 3 to 8 percent slopes	B	3.0	7.2%
67	Peyton sandy loam, 5 to 9 percent slopes	B	14.0	33.6%
92	Tomah-Crowfoot loamy sands, 3 to 8 percent slopes	B	24.6	59.2%
<b>Totals for Area of Interest</b>			<b>41.6</b>	<b>100.0%</b>

### Description

Hydrologic soil groups are based on estimates of runoff potential. Soils are assigned to one of four groups according to the rate of water infiltration when the soils are not protected by vegetation, are thoroughly wet, and receive precipitation from long-duration storms.

The soils in the United States are assigned to four groups (A, B, C, and D) and three dual classes (A/D, B/D, and C/D). The groups are defined as follows:

Group A. Soils having a high infiltration rate (low runoff potential) when thoroughly wet. These consist mainly of deep, well drained to excessively drained sands or gravelly sands. These soils have a high rate of water transmission.

Group B. Soils having a moderate infiltration rate when thoroughly wet. These consist chiefly of moderately deep or deep, moderately well drained or well drained soils that have moderately fine texture to moderately coarse texture. These soils have a moderate rate of water transmission.

Group C. Soils having a slow infiltration rate when thoroughly wet. These consist chiefly of soils having a layer that impedes the downward movement of water or soils of moderately fine texture or fine texture. These soils have a slow rate of water transmission.

Group D. Soils having a very slow infiltration rate (high runoff potential) when thoroughly wet. These consist chiefly of clays that have a high shrink-swell potential, soils that have a high water table, soils that have a claypan or clay layer at or near the surface, and soils that are shallow over nearly impervious material. These soils have a very slow rate of water transmission.

If a soil is assigned to a dual hydrologic group (A/D, B/D, or C/D), the first letter is for drained areas and the second is for undrained areas. Only the soils that in their natural condition are in group D are assigned to dual classes.



## Rating Options

*Aggregation Method:* Dominant Condition

*Component Percent Cutoff:* None Specified

*Tie-break Rule:* Higher



United States  
Department of  
Agriculture

**NRCS**

Natural  
Resources  
Conservation  
Service

A product of the National  
Cooperative Soil Survey,  
a joint effort of the United  
States Department of  
Agriculture and other  
Federal agencies, State  
agencies including the  
Agricultural Experiment  
Stations, and local  
participants

# Custom Soil Resource Report for El Paso County Area, Colorado

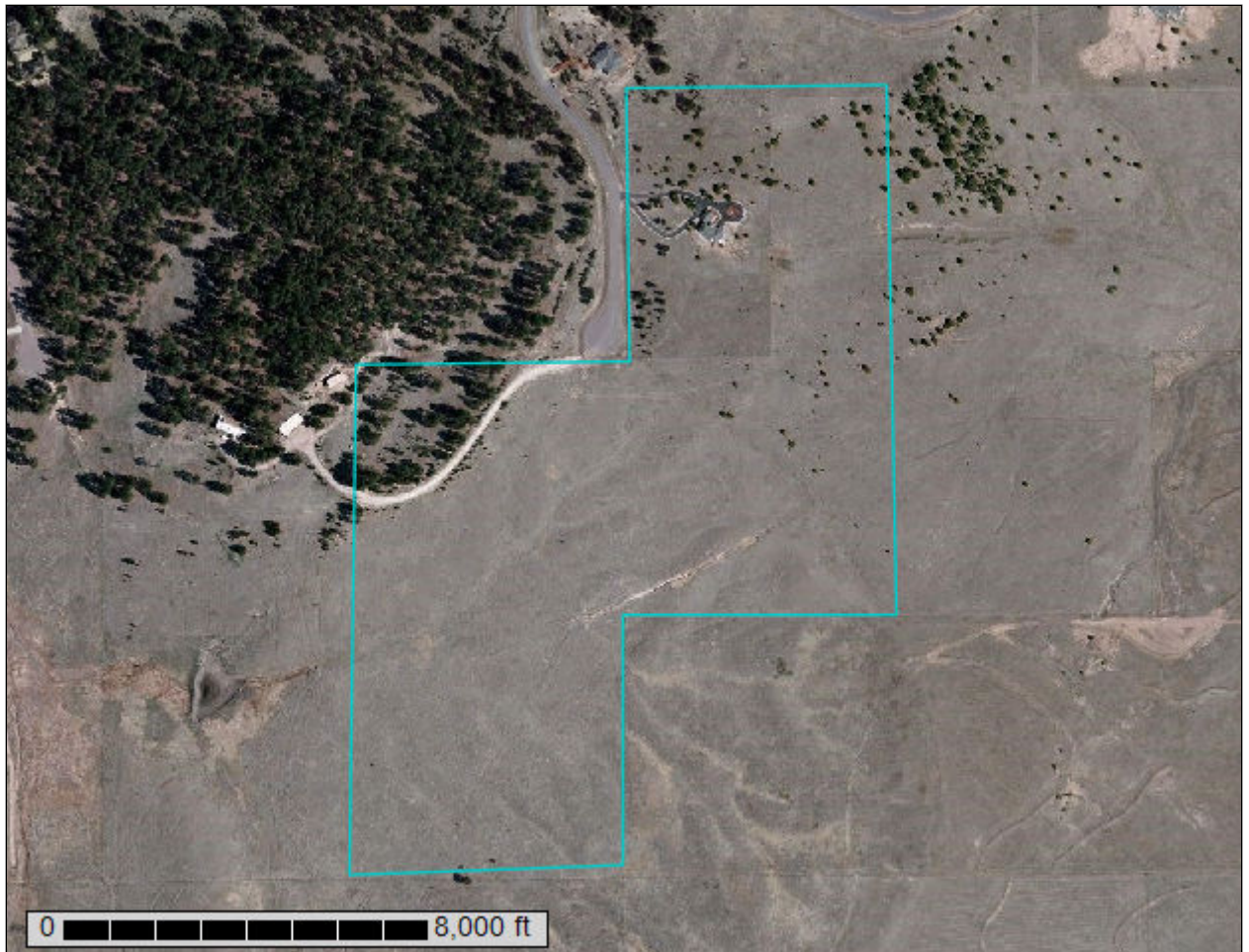

# Preface

---

Soil surveys contain information that affects land use planning in survey areas. They highlight soil limitations that affect various land uses and provide information about the properties of the soils in the survey areas. Soil surveys are designed for many different users, including farmers, ranchers, foresters, agronomists, urban planners, community officials, engineers, developers, builders, and home buyers. Also, conservationists, teachers, students, and specialists in recreation, waste disposal, and pollution control can use the surveys to help them understand, protect, or enhance the environment.

Various land use regulations of Federal, State, and local governments may impose special restrictions on land use or land treatment. Soil surveys identify soil properties that are used in making various land use or land treatment decisions. The information is intended to help the land users identify and reduce the effects of soil limitations on various land uses. The landowner or user is responsible for identifying and complying with existing laws and regulations.

Although soil survey information can be used for general farm, local, and wider area planning, onsite investigation is needed to supplement this information in some cases. Examples include soil quality assessments (<http://www.nrcs.usda.gov/wps/portal/nrcs/main/soils/health/>) and certain conservation and engineering applications. For more detailed information, contact your local USDA Service Center (<https://offices.sc.egov.usda.gov/locator/app?agency=nrcs>) or your NRCS State Soil Scientist ([http://www.nrcs.usda.gov/wps/portal/nrcs/detail/soils/contactus/?cid=nrcs142p2\\_053951](http://www.nrcs.usda.gov/wps/portal/nrcs/detail/soils/contactus/?cid=nrcs142p2_053951)).

Great differences in soil properties can occur within short distances. Some soils are seasonally wet or subject to flooding. Some are too unstable to be used as a foundation for buildings or roads. Clayey or wet soils are poorly suited to use as septic tank absorption fields. A high water table makes a soil poorly suited to basements or underground installations.

The National Cooperative Soil Survey is a joint effort of the United States Department of Agriculture and other Federal agencies, State agencies including the Agricultural Experiment Stations, and local agencies. The Natural Resources Conservation Service (NRCS) has leadership for the Federal part of the National Cooperative Soil Survey.

Information about soils is updated periodically. Updated information is available through the NRCS Web Soil Survey, the site for official soil survey information.

The U.S. Department of Agriculture (USDA) prohibits discrimination in all its programs and activities on the basis of race, color, national origin, age, disability, and where applicable, sex, marital status, familial status, parental status, religion, sexual orientation, genetic information, political beliefs, reprisal, or because all or a part of an individual's income is derived from any public assistance program. (Not all prohibited bases apply to all programs.) Persons with disabilities who require

alternative means for communication of program information (Braille, large print, audiotape, etc.) should contact USDA's TARGET Center at (202) 720-2600 (voice and TDD). To file a complaint of discrimination, write to USDA, Director, Office of Civil Rights, 1400 Independence Avenue, S.W., Washington, D.C. 20250-9410 or call (800) 795-3272 (voice) or (202) 720-6382 (TDD). USDA is an equal opportunity provider and employer.

# Contents

---

<b>Preface</b> .....	2
<b>How Soil Surveys Are Made</b> .....	5
<b>Soil Map</b> .....	8
Soil Map.....	9
Legend.....	10
Map Unit Legend.....	11
Map Unit Descriptions.....	11
El Paso County Area, Colorado.....	13
25—Elbeth sandy loam, 3 to 8 percent slopes.....	13
67—Peyton sandy loam, 5 to 9 percent slopes.....	14
92—Tomah-Crowfoot loamy sands, 3 to 8 percent slopes.....	15
<b>References</b> .....	17

# How Soil Surveys Are Made

---

Soil surveys are made to provide information about the soils and miscellaneous areas in a specific area. They include a description of the soils and miscellaneous areas and their location on the landscape and tables that show soil properties and limitations affecting various uses. Soil scientists observed the steepness, length, and shape of the slopes; the general pattern of drainage; the kinds of crops and native plants; and the kinds of bedrock. They observed and described many soil profiles. A soil profile is the sequence of natural layers, or horizons, in a soil. The profile extends from the surface down into the unconsolidated material in which the soil formed or from the surface down to bedrock. The unconsolidated material is devoid of roots and other living organisms and has not been changed by other biological activity.

Currently, soils are mapped according to the boundaries of major land resource areas (MLRAs). MLRAs are geographically associated land resource units that share common characteristics related to physiography, geology, climate, water resources, soils, biological resources, and land uses (USDA, 2006). Soil survey areas typically consist of parts of one or more MLRA.

The soils and miscellaneous areas in a survey area occur in an orderly pattern that is related to the geology, landforms, relief, climate, and natural vegetation of the area. Each kind of soil and miscellaneous area is associated with a particular kind of landform or with a segment of the landform. By observing the soils and miscellaneous areas in the survey area and relating their position to specific segments of the landform, a soil scientist develops a concept, or model, of how they were formed. Thus, during mapping, this model enables the soil scientist to predict with a considerable degree of accuracy the kind of soil or miscellaneous area at a specific location on the landscape.

Commonly, individual soils on the landscape merge into one another as their characteristics gradually change. To construct an accurate soil map, however, soil scientists must determine the boundaries between the soils. They can observe only a limited number of soil profiles. Nevertheless, these observations, supplemented by an understanding of the soil-vegetation-landscape relationship, are sufficient to verify predictions of the kinds of soil in an area and to determine the boundaries.

Soil scientists recorded the characteristics of the soil profiles that they studied. They noted soil color, texture, size and shape of soil aggregates, kind and amount of rock fragments, distribution of plant roots, reaction, and other features that enable them to identify soils. After describing the soils in the survey area and determining their properties, the soil scientists assigned the soils to taxonomic classes (units). Taxonomic classes are concepts. Each taxonomic class has a set of soil characteristics with precisely defined limits. The classes are used as a basis for comparison to classify soils systematically. Soil taxonomy, the system of taxonomic classification used in the United States, is based mainly on the kind and character of soil properties and the arrangement of horizons within the profile. After the soil

## Custom Soil Resource Report

scientists classified and named the soils in the survey area, they compared the individual soils with similar soils in the same taxonomic class in other areas so that they could confirm data and assemble additional data based on experience and research.

The objective of soil mapping is not to delineate pure map unit components; the objective is to separate the landscape into landforms or landform segments that have similar use and management requirements. Each map unit is defined by a unique combination of soil components and/or miscellaneous areas in predictable proportions. Some components may be highly contrasting to the other components of the map unit. The presence of minor components in a map unit in no way diminishes the usefulness or accuracy of the data. The delineation of such landforms and landform segments on the map provides sufficient information for the development of resource plans. If intensive use of small areas is planned, onsite investigation is needed to define and locate the soils and miscellaneous areas.

Soil scientists make many field observations in the process of producing a soil map. The frequency of observation is dependent upon several factors, including scale of mapping, intensity of mapping, design of map units, complexity of the landscape, and experience of the soil scientist. Observations are made to test and refine the soil-landscape model and predictions and to verify the classification of the soils at specific locations. Once the soil-landscape model is refined, a significantly smaller number of measurements of individual soil properties are made and recorded. These measurements may include field measurements, such as those for color, depth to bedrock, and texture, and laboratory measurements, such as those for content of sand, silt, clay, salt, and other components. Properties of each soil typically vary from one point to another across the landscape.

Observations for map unit components are aggregated to develop ranges of characteristics for the components. The aggregated values are presented. Direct measurements do not exist for every property presented for every map unit component. Values for some properties are estimated from combinations of other properties.

While a soil survey is in progress, samples of some of the soils in the area generally are collected for laboratory analyses and for engineering tests. Soil scientists interpret the data from these analyses and tests as well as the field-observed characteristics and the soil properties to determine the expected behavior of the soils under different uses. Interpretations for all of the soils are field tested through observation of the soils in different uses and under different levels of management. Some interpretations are modified to fit local conditions, and some new interpretations are developed to meet local needs. Data are assembled from other sources, such as research information, production records, and field experience of specialists. For example, data on crop yields under defined levels of management are assembled from farm records and from field or plot experiments on the same kinds of soil.

Predictions about soil behavior are based not only on soil properties but also on such variables as climate and biological activity. Soil conditions are predictable over long periods of time, but they are not predictable from year to year. For example, soil scientists can predict with a fairly high degree of accuracy that a given soil will have a high water table within certain depths in most years, but they cannot predict that a high water table will always be at a specific level in the soil on a specific date.

After soil scientists located and identified the significant natural bodies of soil in the survey area, they drew the boundaries of these bodies on aerial photographs and

## Custom Soil Resource Report

identified each as a specific map unit. Aerial photographs show trees, buildings, fields, roads, and rivers, all of which help in locating boundaries accurately.



# Soil Map

---

The soil map section includes the soil map for the defined area of interest, a list of soil map units on the map and extent of each map unit, and cartographic symbols displayed on the map. Also presented are various metadata about data used to produce the map, and a description of each soil map unit.

# Custom Soil Resource Report Soil Map

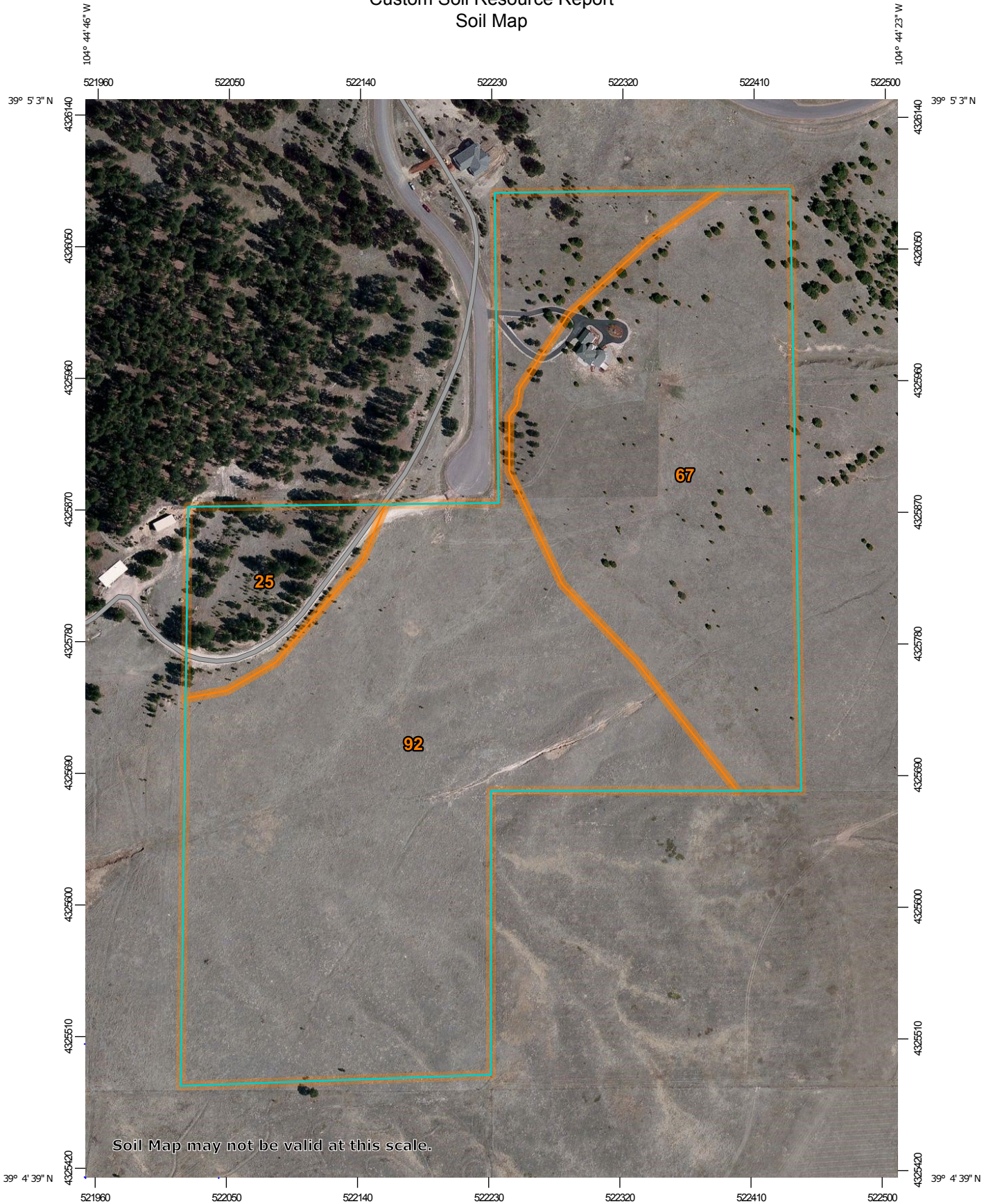

Map Scale: 1:3,590 if printed on A portrait (8.5" x 11") sheet.

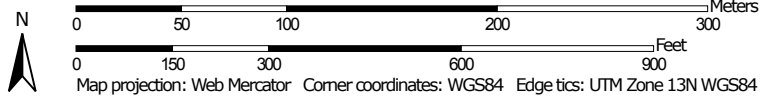

## MAP LEGEND

- Area of Interest (AOI)**
  -  Area of Interest (AOI)
- Soils**
  -  Soil Map Unit Polygons
  -  Soil Map Unit Lines
  -  Soil Map Unit Points
- Special Point Features**
  -  Blowout
  -  Borrow Pit
  -  Clay Spot
  -  Closed Depression
  -  Gravel Pit
  -  Gravelly Spot
  -  Landfill
  -  Lava Flow
  -  Marsh or swamp
  -  Mine or Quarry
  -  Miscellaneous Water
  -  Perennial Water
  -  Rock Outcrop
  -  Saline Spot
  -  Sandy Spot
  -  Severely Eroded Spot
  -  Sinkhole
  -  Slide or Slip
  -  Sodic Spot
- Water Features**
  -  Streams and Canals
- Transportation**
  -  Rails
  -  Interstate Highways
  -  US Routes
  -  Major Roads
  -  Local Roads
- Background**
  -  Aerial Photography
- Other Features**
  -  Spoil Area
  -  Stony Spot
  -  Very Stony Spot
  -  Wet Spot
  -  Other
  -  Special Line Features

## MAP INFORMATION

The soil surveys that comprise your AOI were mapped at 1:24,000.

Warning: Soil Map may not be valid at this scale.

Enlargement of maps beyond the scale of mapping can cause misunderstanding of the detail of mapping and accuracy of soil line placement. The maps do not show the small areas of contrasting soils that could have been shown at a more detailed scale.

Please rely on the bar scale on each map sheet for map measurements.

Source of Map: Natural Resources Conservation Service  
 Web Soil Survey URL:  
 Coordinate System: Web Mercator (EPSG:3857)

Maps from the Web Soil Survey are based on the Web Mercator projection, which preserves direction and shape but distorts distance and area. A projection that preserves area, such as the Albers equal-area conic projection, should be used if more accurate calculations of distance or area are required.

This product is generated from the USDA-NRCS certified data as of the version date(s) listed below.

Soil Survey Area: El Paso County Area, Colorado  
 Survey Area Data: Version 14, Sep 23, 2016

Soil map units are labeled (as space allows) for map scales 1:50,000 or larger.

Date(s) aerial images were photographed: Apr 15, 2011—Sep 22, 2011

The orthophoto or other base map on which the soil lines were compiled and digitized probably differs from the background imagery displayed on these maps. As a result, some minor shifting of map unit boundaries may be evident.

## Map Unit Legend

El Paso County Area, Colorado (CO625)			
Map Unit Symbol	Map Unit Name	Acres in AOI	Percent of AOI
25	Elbeth sandy loam, 3 to 8 percent slopes	3.0	7.2%
67	Peyton sandy loam, 5 to 9 percent slopes	14.0	33.6%
92	Tomah-Crowfoot loamy sands, 3 to 8 percent slopes	24.6	59.2%
<b>Totals for Area of Interest</b>		<b>41.6</b>	<b>100.0%</b>

## Map Unit Descriptions

The map units delineated on the detailed soil maps in a soil survey represent the soils or miscellaneous areas in the survey area. The map unit descriptions, along with the maps, can be used to determine the composition and properties of a unit.

A map unit delineation on a soil map represents an area dominated by one or more major kinds of soil or miscellaneous areas. A map unit is identified and named according to the taxonomic classification of the dominant soils. Within a taxonomic class there are precisely defined limits for the properties of the soils. On the landscape, however, the soils are natural phenomena, and they have the characteristic variability of all natural phenomena. Thus, the range of some observed properties may extend beyond the limits defined for a taxonomic class. Areas of soils of a single taxonomic class rarely, if ever, can be mapped without including areas of other taxonomic classes. Consequently, every map unit is made up of the soils or miscellaneous areas for which it is named and some minor components that belong to taxonomic classes other than those of the major soils.

Most minor soils have properties similar to those of the dominant soil or soils in the map unit, and thus they do not affect use and management. These are called noncontrasting, or similar, components. They may or may not be mentioned in a particular map unit description. Other minor components, however, have properties and behavioral characteristics divergent enough to affect use or to require different management. These are called contrasting, or dissimilar, components. They generally are in small areas and could not be mapped separately because of the scale used. Some small areas of strongly contrasting soils or miscellaneous areas are identified by a special symbol on the maps. If included in the database for a given area, the contrasting minor components are identified in the map unit descriptions along with some characteristics of each. A few areas of minor components may not have been observed, and consequently they are not mentioned in the descriptions, especially where the pattern was so complex that it was impractical to make enough observations to identify all the soils and miscellaneous areas on the landscape.

The presence of minor components in a map unit in no way diminishes the usefulness or accuracy of the data. The objective of mapping is not to delineate pure taxonomic classes but rather to separate the landscape into landforms or



## Custom Soil Resource Report

landform segments that have similar use and management requirements. The delineation of such segments on the map provides sufficient information for the development of resource plans. If intensive use of small areas is planned, however, onsite investigation is needed to define and locate the soils and miscellaneous areas.

An identifying symbol precedes the map unit name in the map unit descriptions. Each description includes general facts about the unit and gives important soil properties and qualities.

Soils that have profiles that are almost alike make up a *soil series*. Except for differences in texture of the surface layer, all the soils of a series have major horizons that are similar in composition, thickness, and arrangement.

Soils of one series can differ in texture of the surface layer, slope, stoniness, salinity, degree of erosion, and other characteristics that affect their use. On the basis of such differences, a soil series is divided into *soil phases*. Most of the areas shown on the detailed soil maps are phases of soil series. The name of a soil phase commonly indicates a feature that affects use or management. For example, Alpha silt loam, 0 to 2 percent slopes, is a phase of the Alpha series.

Some map units are made up of two or more major soils or miscellaneous areas. These map units are complexes, associations, or undifferentiated groups.

A *complex* consists of two or more soils or miscellaneous areas in such an intricate pattern or in such small areas that they cannot be shown separately on the maps. The pattern and proportion of the soils or miscellaneous areas are somewhat similar in all areas. Alpha-Beta complex, 0 to 6 percent slopes, is an example.

An *association* is made up of two or more geographically associated soils or miscellaneous areas that are shown as one unit on the maps. Because of present or anticipated uses of the map units in the survey area, it was not considered practical or necessary to map the soils or miscellaneous areas separately. The pattern and relative proportion of the soils or miscellaneous areas are somewhat similar. Alpha-Beta association, 0 to 2 percent slopes, is an example.

An *undifferentiated group* is made up of two or more soils or miscellaneous areas that could be mapped individually but are mapped as one unit because similar interpretations can be made for use and management. The pattern and proportion of the soils or miscellaneous areas in a mapped area are not uniform. An area can be made up of only one of the major soils or miscellaneous areas, or it can be made up of all of them. Alpha and Beta soils, 0 to 2 percent slopes, is an example.

Some surveys include *miscellaneous areas*. Such areas have little or no soil material and support little or no vegetation. Rock outcrop is an example.

## El Paso County Area, Colorado

### 25—Elbeth sandy loam, 3 to 8 percent slopes

#### Map Unit Setting

*National map unit symbol:* 367x  
*Elevation:* 7,300 to 7,600 feet  
*Farmland classification:* Not prime farmland

#### Map Unit Composition

*Elbeth and similar soils:* 85 percent  
*Estimates are based on observations, descriptions, and transects of the mapunit.*

#### Description of Elbeth

##### Setting

*Landform:* Hills  
*Landform position (three-dimensional):* Side slope  
*Down-slope shape:* Linear  
*Across-slope shape:* Linear  
*Parent material:* Alluvium derived from arkose

##### Typical profile

*A - 0 to 3 inches:* sandy loam  
*E - 3 to 23 inches:* loamy sand  
*Bt - 23 to 68 inches:* sandy clay loam  
*C - 68 to 74 inches:* sandy clay loam

##### Properties and qualities

*Slope:* 3 to 8 percent  
*Depth to restrictive feature:* More than 80 inches  
*Natural drainage class:* Well drained  
*Runoff class:* Medium  
*Capacity of the most limiting layer to transmit water (Ksat):* Moderately high (0.20 to 0.60 in/hr)  
*Depth to water table:* More than 80 inches  
*Frequency of flooding:* None  
*Frequency of ponding:* None  
*Available water storage in profile:* Moderate (about 7.1 inches)

##### Interpretive groups

*Land capability classification (irrigated):* None specified  
*Land capability classification (nonirrigated):* 4e  
*Hydrologic Soil Group:* B  
*Hydric soil rating:* No

#### Minor Components

##### Other soils

*Percent of map unit:*  
*Hydric soil rating:* No

## 67—Peyton sandy loam, 5 to 9 percent slopes

### Map Unit Setting

*National map unit symbol:* 369d  
*Elevation:* 6,800 to 7,600 feet  
*Mean annual air temperature:* 43 to 45 degrees F  
*Frost-free period:* 115 to 125 days  
*Farmland classification:* Not prime farmland

### Map Unit Composition

*Peyton and similar soils:* 85 percent  
*Estimates are based on observations, descriptions, and transects of the mapunit.*

### Description of Peyton

#### Setting

*Landform:* Hills  
*Landform position (three-dimensional):* Side slope  
*Down-slope shape:* Linear  
*Across-slope shape:* Linear  
*Parent material:* Arkosic alluvium derived from sedimentary rock and/or arkosic residuum weathered from sedimentary rock

#### Typical profile

*A - 0 to 12 inches:* sandy loam  
*Bt - 12 to 25 inches:* sandy clay loam  
*BC - 25 to 35 inches:* sandy loam  
*C - 35 to 60 inches:* sandy loam

#### Properties and qualities

*Slope:* 5 to 9 percent  
*Depth to restrictive feature:* More than 80 inches  
*Natural drainage class:* Well drained  
*Runoff class:* Medium  
*Capacity of the most limiting layer to transmit water (Ksat):* Moderately high (0.20 to 0.60 in/hr)  
*Depth to water table:* More than 80 inches  
*Frequency of flooding:* None  
*Frequency of ponding:* None  
*Available water storage in profile:* Moderate (about 7.3 inches)

#### Interpretive groups

*Land capability classification (irrigated):* None specified  
*Land capability classification (nonirrigated):* 4e  
*Hydrologic Soil Group:* B  
*Ecological site:* Sandy Divide (R049BY216CO)  
*Hydric soil rating:* No

**Minor Components**

**Other soils**

*Percent of map unit:*  
*Hydric soil rating:* No

**Pleasant**

*Percent of map unit:*  
*Landform:* Depressions  
*Hydric soil rating:* Yes

**92—Tomah-Crowfoot loamy sands, 3 to 8 percent slopes**

**Map Unit Setting**

*National map unit symbol:* 36b9  
*Elevation:* 7,300 to 7,600 feet  
*Farmland classification:* Not prime farmland

**Map Unit Composition**

*Tomah and similar soils:* 50 percent  
*Crowfoot and similar soils:* 30 percent  
*Estimates are based on observations, descriptions, and transects of the mapunit.*

**Description of Tomah**

**Setting**

*Landform:* Alluvial fans, hills  
*Landform position (three-dimensional):* Side slope, crest  
*Down-slope shape:* Linear  
*Across-slope shape:* Linear  
*Parent material:* Alluvium derived from arkose and/or residuum weathered from arkose

**Typical profile**

*A - 0 to 10 inches:* loamy sand  
*E - 10 to 22 inches:* coarse sand  
*C - 48 to 60 inches:* coarse sand

**Properties and qualities**

*Slope:* 3 to 8 percent  
*Depth to restrictive feature:* More than 80 inches  
*Natural drainage class:* Well drained  
*Runoff class:* Medium  
*Capacity of the most limiting layer to transmit water (Ksat):* Moderately high to high (0.60 to 2.00 in/hr)  
*Depth to water table:* More than 80 inches  
*Frequency of flooding:* None  
*Frequency of ponding:* None  
*Available water storage in profile:* Very low (about 2.0 inches)



## Custom Soil Resource Report

### Interpretive groups

*Land capability classification (irrigated):* None specified  
*Land capability classification (nonirrigated):* 4e  
*Hydrologic Soil Group:* B  
*Ecological site:* Sandy Divide (R049BY216CO)  
*Hydric soil rating:* No

### Description of Crowfoot

#### Setting

*Landform:* Alluvial fans, hills  
*Landform position (three-dimensional):* Side slope, crest  
*Down-slope shape:* Linear  
*Across-slope shape:* Linear  
*Parent material:* Alluvium

#### Typical profile

*A - 0 to 12 inches:* loamy sand  
*E - 12 to 23 inches:* sand  
*Bt - 23 to 36 inches:* sandy clay loam  
*C - 36 to 60 inches:* coarse sand

#### Properties and qualities

*Slope:* 3 to 8 percent  
*Depth to restrictive feature:* More than 80 inches  
*Natural drainage class:* Well drained  
*Runoff class:* Medium  
*Capacity of the most limiting layer to transmit water (Ksat):* Moderately high to high (0.60 to 2.00 in/hr)  
*Depth to water table:* More than 80 inches  
*Frequency of flooding:* None  
*Frequency of ponding:* None  
*Available water storage in profile:* Low (about 4.7 inches)

### Interpretive groups

*Land capability classification (irrigated):* None specified  
*Land capability classification (nonirrigated):* 4e  
*Hydrologic Soil Group:* B  
*Ecological site:* Sandy Divide (R049BY216CO)  
*Hydric soil rating:* No

### Minor Components

#### Other soils

*Percent of map unit:*  
*Hydric soil rating:* No

#### Pleasant

*Percent of map unit:*  
*Landform:* Depressions  
*Hydric soil rating:* Yes

# References

---

- American Association of State Highway and Transportation Officials (AASHTO). 2004. Standard specifications for transportation materials and methods of sampling and testing. 24th edition.
- American Society for Testing and Materials (ASTM). 2005. Standard classification of soils for engineering purposes. ASTM Standard D2487-00.
- Cowardin, L.M., V. Carter, F.C. Golet, and E.T. LaRoe. 1979. Classification of wetlands and deep-water habitats of the United States. U.S. Fish and Wildlife Service FWS/OBS-79/31.
- Federal Register. July 13, 1994. Changes in hydric soils of the United States.
- Federal Register. September 18, 2002. Hydric soils of the United States.
- Hurt, G.W., and L.M. Vasilas, editors. Version 6.0, 2006. Field indicators of hydric soils in the United States.
- National Research Council. 1995. Wetlands: Characteristics and boundaries.
- Soil Survey Division Staff. 1993. Soil survey manual. Soil Conservation Service. U.S. Department of Agriculture Handbook 18. [http://www.nrcs.usda.gov/wps/portal/nrcs/detail/national/soils/?cid=nrcs142p2\\_054262](http://www.nrcs.usda.gov/wps/portal/nrcs/detail/national/soils/?cid=nrcs142p2_054262)
- Soil Survey Staff. 1999. Soil taxonomy: A basic system of soil classification for making and interpreting soil surveys. 2nd edition. Natural Resources Conservation Service, U.S. Department of Agriculture Handbook 436. [http://www.nrcs.usda.gov/wps/portal/nrcs/detail/national/soils/?cid=nrcs142p2\\_053577](http://www.nrcs.usda.gov/wps/portal/nrcs/detail/national/soils/?cid=nrcs142p2_053577)
- Soil Survey Staff. 2010. Keys to soil taxonomy. 11th edition. U.S. Department of Agriculture, Natural Resources Conservation Service. [http://www.nrcs.usda.gov/wps/portal/nrcs/detail/national/soils/?cid=nrcs142p2\\_053580](http://www.nrcs.usda.gov/wps/portal/nrcs/detail/national/soils/?cid=nrcs142p2_053580)
- Tiner, R.W., Jr. 1985. Wetlands of Delaware. U.S. Fish and Wildlife Service and Delaware Department of Natural Resources and Environmental Control, Wetlands Section.
- United States Army Corps of Engineers, Environmental Laboratory. 1987. Corps of Engineers wetlands delineation manual. Waterways Experiment Station Technical Report Y-87-1.
- United States Department of Agriculture, Natural Resources Conservation Service. National forestry manual. [http://www.nrcs.usda.gov/wps/portal/nrcs/detail/soils/home/?cid=nrcs142p2\\_053374](http://www.nrcs.usda.gov/wps/portal/nrcs/detail/soils/home/?cid=nrcs142p2_053374)
- United States Department of Agriculture, Natural Resources Conservation Service. National range and pasture handbook. <http://www.nrcs.usda.gov/wps/portal/nrcs/detail/national/landuse/rangepasture/?cid=stelprdb1043084>

## Custom Soil Resource Report

United States Department of Agriculture, Natural Resources Conservation Service. National soil survey handbook, title 430-VI. [http://www.nrcs.usda.gov/wps/portal/nrcs/detail/soils/scientists/?cid=nrcs142p2\\_054242](http://www.nrcs.usda.gov/wps/portal/nrcs/detail/soils/scientists/?cid=nrcs142p2_054242)

United States Department of Agriculture, Natural Resources Conservation Service. 2006. Land resource regions and major land resource areas of the United States, the Caribbean, and the Pacific Basin. U.S. Department of Agriculture Handbook 296. [http://www.nrcs.usda.gov/wps/portal/nrcs/detail/national/soils/?cid=nrcs142p2\\_053624](http://www.nrcs.usda.gov/wps/portal/nrcs/detail/national/soils/?cid=nrcs142p2_053624)

United States Department of Agriculture, Soil Conservation Service. 1961. Land capability classification. U.S. Department of Agriculture Handbook 210. [http://www.nrcs.usda.gov/Internet/FSE\\_DOCUMENTS/nrcs142p2\\_052290.pdf](http://www.nrcs.usda.gov/Internet/FSE_DOCUMENTS/nrcs142p2_052290.pdf)

**Table 6-6. Runoff Coefficients for Rational Method**

(Source: UDFCD 2001)

Land Use or Surface Characteristics	Percent Impervious	Runoff Coefficients											
		2-year		5-year		10-year		25-year		50-year		100-year	
		HSG A&B	HSG C&D	HSG A&B	HSG C&D	HSG A&B	HSG C&D	HSG A&B	HSG C&D	HSG A&B	HSG C&D	HSG A&B	HSG C&D
Business													
Commercial Areas	95	0.79	0.80	0.81	0.82	0.83	0.84	0.85	0.87	0.87	0.88	0.88	0.89
Neighborhood Areas	70	0.45	0.49	0.49	0.53	0.53	0.57	0.58	0.62	0.60	0.65	0.62	0.68
Residential													
1/8 Acre or less	65	0.41	0.45	0.45	0.49	0.49	0.54	0.54	0.59	0.57	0.62	0.59	0.65
1/4 Acre	40	0.23	0.28	0.30	0.35	0.36	0.42	0.42	0.50	0.46	0.54	0.50	0.58
1/3 Acre	30	0.18	0.22	0.25	0.30	0.32	0.38	0.39	0.47	0.43	0.52	0.47	0.57
1/2 Acre	25	0.15	0.20	0.22	0.28	0.30	0.36	0.37	0.46	0.41	0.51	0.46	0.56
1 Acre	20	0.12	0.17	0.20	0.26	0.27	0.34	0.35	0.44	0.40	0.50	0.44	0.55
Industrial													
Light Areas	80	0.57	0.60	0.59	0.63	0.63	0.66	0.66	0.70	0.68	0.72	0.70	0.74
Heavy Areas	90	0.71	0.73	0.73	0.75	0.75	0.77	0.78	0.80	0.80	0.82	0.81	0.83
Parks and Cemeteries	7	0.05	0.09	0.12	0.19	0.20	0.29	0.30	0.40	0.34	0.46	0.39	0.52
Playgrounds	13	0.07	0.13	0.16	0.23	0.24	0.31	0.32	0.42	0.37	0.48	0.41	0.54
Railroad Yard Areas	40	0.23	0.28	0.30	0.35	0.36	0.42	0.42	0.50	0.46	0.54	0.50	0.58
Undeveloped Areas													
Historic Flow Analysis-- Greenbelts, Agriculture	2	0.03	0.05	0.09	0.16	0.17	0.26	0.26	0.38	0.31	0.45	0.36	0.51
Pasture/Meadow	0	0.02	0.04	0.08	0.15	0.15	0.25	0.25	0.37	0.30	0.44	0.35	0.50
Forest	0	0.02	0.04	0.08	0.15	0.15	0.25	0.25	0.37	0.30	0.44	0.35	0.50
Exposed Rock	100	0.89	0.89	0.90	0.90	0.92	0.92	0.94	0.94	0.95	0.95	0.96	0.96
Offsite Flow Analysis (when landuse is undefined)	45	0.26	0.31	0.32	0.37	0.38	0.44	0.44	0.51	0.48	0.55	0.51	0.59
Streets													
Paved	100	0.89	0.89	0.90	0.90	0.92	0.92	0.94	0.94	0.95	0.95	0.96	0.96
Gravel	80	0.57	0.60	0.59	0.63	0.63	0.66	0.66	0.70	0.68	0.72	0.70	0.74
Drive and Walks	100	0.89	0.89	0.90	0.90	0.92	0.92	0.94	0.94	0.95	0.95	0.96	0.96
Roofs	90	0.71	0.73	0.73	0.75	0.75	0.77	0.78	0.80	0.80	0.82	0.81	0.83
Lawns	0	0.02	0.04	0.08	0.15	0.15	0.25	0.25	0.37	0.30	0.44	0.35	0.50

### 3.2 Time of Concentration

One of the basic assumptions underlying the Rational Method is that runoff is a function of the average rainfall rate during the time required for water to flow from the hydraulically most remote part of the drainage area under consideration to the design point. However, in practice, the time of concentration can be an empirical value that results in reasonable and acceptable peak flow calculations.

For urban areas, the time of concentration ( $t_c$ ) consists of an initial time or overland flow time ( $t_i$ ) plus the travel time ( $t_r$ ) in the storm sewer, paved gutter, roadside drainage ditch, or drainage channel. For non-urban areas, the time of concentration consists of an overland flow time ( $t_i$ ) plus the time of travel in a concentrated form, such as a swale or drainageway. The travel portion ( $t_r$ ) of the time of concentration can be estimated from the hydraulic properties of the storm sewer, gutter, swale, ditch, or drainageway. Initial time, on the other hand, will vary with surface slope, depression storage, surface cover, antecedent rainfall, and infiltration capacity of the soil, as well as distance of surface flow. The time of concentration is represented by Equation 6-7 for both urban and non-urban areas.

$$t_c = t_i + t_t \quad (\text{Eq. 6-7})$$

Where:

$t_c$  = time of concentration (min)

$t_i$  = overland (initial) flow time (min)

$t_t$  = travel time in the ditch, channel, gutter, storm sewer, etc. (min)

### 3.2.1 Overland (Initial) Flow Time

The overland flow time,  $t_i$ , may be calculated using Equation 6-8.

$$t_i = \frac{0.395(1.1 - C_5)\sqrt{L}}{S^{0.33}} \quad (\text{Eq. 6-8})$$

Where:

$t_i$  = overland (initial) flow time (min)

$C_5$  = runoff coefficient for 5-year frequency (see Table 6-6)

$L$  = length of overland flow (300 ft maximum for non-urban land uses, 100 ft maximum for urban land uses)

$S$  = average basin slope (ft/ft)

Note that in some urban watersheds, the overland flow time may be very small because flows quickly concentrate and channelize.

### 3.2.2 Travel Time

For catchments with overland and channelized flow, the time of concentration needs to be considered in combination with the travel time,  $t_t$ , which is calculated using the hydraulic properties of the swale, ditch, or channel. For preliminary work, the overland travel time,  $t_t$ , can be estimated with the help of Figure 6-25 or Equation 6-9 (Guo 1999).

$$V = C_v S_w^{0.5} \quad (\text{Eq. 6-9})$$

Where:

$V$  = velocity (ft/s)

$C_v$  = conveyance coefficient (from Table 6-7)

$S_w$  = watercourse slope (ft/ft)

**Table 6-7. Conveyance Coefficient,  $C_v$** 

Type of Land Surface	$C_v$
Heavy meadow	2.5
Tillage/field	5
Riprap (not buried)*	6.5
Short pasture and lawns	7
Nearly bare ground	10
Grassed waterway	15
Paved areas and shallow paved swales	20

\* For buried riprap, select  $C_v$  value based on type of vegetative cover.

The travel time is calculated by dividing the flow distance (in feet) by the velocity calculated using Equation 6-9 and converting units to minutes.

The time of concentration ( $t_c$ ) is then the sum of the overland flow time ( $t_i$ ) and the travel time ( $t_t$ ) per Equation 6-7.

### 3.2.3 First Design Point Time of Concentration in Urban Catchments

Using this procedure, the time of concentration at the first design point (typically the first inlet in the system) in an urbanized catchment should not exceed the time of concentration calculated using Equation 6-10. The first design point is defined as the point where runoff first enters the storm sewer system.

$$t_c = \frac{L}{180} + 10 \quad (\text{Eq. 6-10})$$

Where:

$t_c$  = maximum time of concentration at the first design point in an urban watershed (min)

$L$  = waterway length (ft)

Equation 6-10 was developed using the rainfall-runoff data collected in the Denver region and, in essence, represents regional “calibration” of the Rational Method. Normally, Equation 6-10 will result in a lesser time of concentration at the first design point and will govern in an urbanized watershed. For subsequent design points, the time of concentration is calculated by accumulating the travel times in downstream drainageway reaches.

### 3.2.4 Minimum Time of Concentration

If the calculations result in a  $t_c$  of less than 10 minutes for undeveloped conditions, it is recommended that a minimum value of 10 minutes be used. The minimum  $t_c$  for urbanized areas is 5 minutes.

### 3.2.5 Post-Development Time of Concentration

As Equation 6-8 indicates, the time of concentration is a function of the 5-year runoff coefficient for a drainage basin. Typically, higher levels of imperviousness (higher 5-year runoff coefficients) correspond to shorter times of concentration, and lower levels of imperviousness correspond to longer times of

**Figure 6-5. Colorado Springs Rainfall Intensity Duration Frequency**

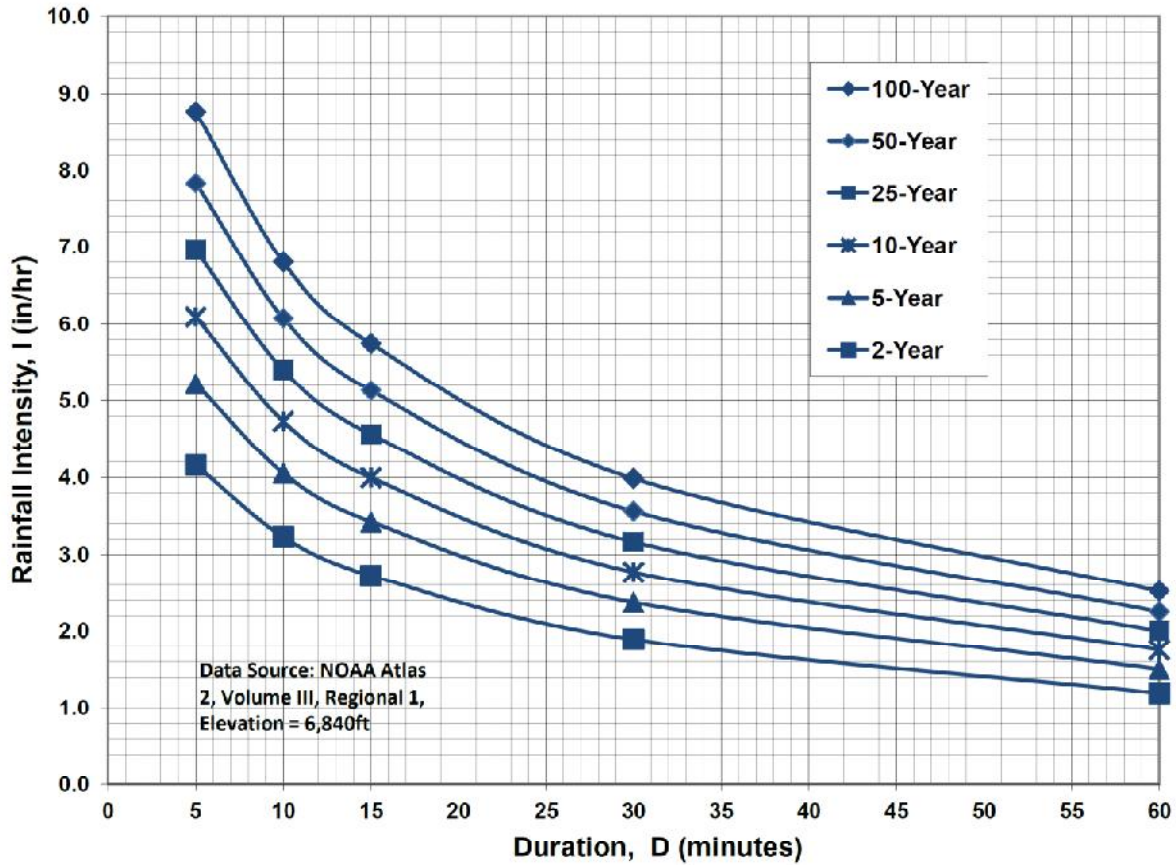

**IDF Equations**

$$I_{100} = -2.52 \ln(D) + 12.735$$

$$I_{50} = -2.25 \ln(D) + 11.375$$

$$I_{25} = -2.00 \ln(D) + 10.111$$

$$I_{10} = -1.75 \ln(D) + 8.847$$

$$I_5 = -1.50 \ln(D) + 7.583$$

$$I_2 = -1.19 \ln(D) + 6.035$$

Note: Values calculated by equations may not precisely duplicate values read from figure.

**SETTLERS VIEW SUBDIVISION  
COMPOSITE RUNOFF COEFFICIENTS - TYPICAL RURAL RESIDENTIAL LOTS**

<b>DEVELOPED CONDITIONS</b>											
<b>5-YEAR C VALUES</b>											
BASIN	TOTAL AREA (AC)	AREA (%)	SUB-AREA 1 DEVELOPMENT/ COVER	C	AREA (%)	SUB-AREA 2 DEVELOPMENT/ COVER	C	AREA (%)	SUB-AREA 3 DEVELOPMENT/ COVER	WEIGHTED C VALUE	
2.5-ACRE LOTS	2.50	11.00	BUILDING / PAVEMENT	0.90	89.00	LANDSCAPED	0.08			0.170	
5-ACRE LOTS	2.50	7.00	BUILDING / PAVEMENT	0.90	93.00	LANDSCAPED	0.08			0.137	
<b>100-YEAR C VALUES</b>											
BASIN	TOTAL AREA (AC)	AREA (%)	SUB-AREA 1 DEVELOPMENT/ COVER	C	AREA (AC)	SUB-AREA 2 DEVELOPMENT/ COVER	C	AREA (%)	SUB-AREA 3 DEVELOPMENT/ COVER	WEIGHTED C VALUE	
2.5-ACRE LOTS	2.50	11.00	BUILDING / PAVEMENT	0.96	89.00	LANDSCAPED	0.35			0.417	
5-ACRE LOTS	2.50	7.00	BUILDING / PAVEMENT	0.96	93.00	LANDSCAPED	0.35			0.393	
<b>IMPERVIOUS AREAS</b>											
BASIN	TOTAL AREA (AC)	AREA (%)	SUB-AREA 1 DEVELOPMENT/ COVER	PERCENT IMPERVIOUS	AREA (%)	SUB-AREA 2 DEVELOPMENT/ COVER	PERCENT IMPERVIOUS	AREA (%)	SUB-AREA 3 DEVELOPMENT/ COVER	PERCENT IMPERVIOUS	WEIGHTED % IMP
2.5-ACRE LOTS	2.50	11.00	BUILDING / PAVEMENT	100	89.00	LANDSCAPED	0				11.000
5-ACRE LOTS	2.50	7.00	BUILDING / PAVEMENT	100	93.00	LANDSCAPED	0				7.000



SETTLERS VIEW  
RATIONAL METHOD

HISTORIC FLOWS

BASIN	DESIGN POINT	AREA (AC)	C		Overland Flow			Channel flow					TOTAL		TOTAL		INTENSITY <sup>(6)</sup>		PEAK FLOW	
			5-YEAR <sup>(7)</sup>	100-YEAR <sup>(7)</sup>	LENGTH (FT)	SLOPE (FT/FT)	T <sub>co</sub> <sup>(1)</sup> (MIN)	CHANNEL LENGTH (FT)	CONVEYANCE COEFFICIENT C	SLOPE (FT/FT)	SCS <sup>(2)</sup> VELOCITY (FT/S)	T <sub>t</sub> <sup>(3)</sup> (MIN)	T <sub>c</sub> <sup>(4)</sup> (MIN)	T <sub>c</sub> <sup>(4)</sup> (MIN)	5-YR (IN/HR)	100-YR (IN/HR)	Q <sub>5</sub> <sup>(6)</sup> (CFS)	Q <sub>100</sub> <sup>(6)</sup> (CFS)		
<b>WEST CHERRY CREEK BASIN</b>																				
OS1		4.01	0.080	0.350	300	0.073	16.7	450	15.00	0.0578	3.61	2.1	18.8	18.8	3.19	5.35	1.02	7.50		
D9		14.30	0.080	0.350	250	0.080	14.8	700	15.00	0.074	4.08	2.9	17.6	17.6	3.28	5.50	3.75	27.54		
S		28.47	0.080	0.350	300	0.033	21.7	1000	15.00	0.051	3.39	4.9	26.7	26.7	2.66	4.46	6.06	44.46		
OA1,D9,S		46.78	0.080	0.350									26.7	26.7	2.66	4.46	9.95	73.06		
<b>EAST CHERRY CREEK BASIN</b>																				
A	A1	14.95	0.080	0.350	750	0.048	30.3	0				0.0	30.3	30.3	2.46	4.14	2.95	21.64		

1) OVERLAND FLOW T<sub>co</sub> = (0.395\*(1.1-RUNOFF COEFFICIENT)\*(OVERLAND FLOW LENGTH<sup>0.5</sup>)/(SLOPE<sup>0.333</sup>))

2) SCS VELOCITY = C \* ((SLOPE(FT/FT)<sup>0.5</sup>)

C = 2.5 FOR HEAVY MEADOW

C = 5 FOR TILLAGE/FIELD

C = 7 FOR SHORT PASTURE AND LAWNS

C = 10 FOR NEARLY BARE GROUND

C = 15 FOR GRASSED WATERWAY

C = 20 FOR PAVED AREAS AND SHALLOW PAVED SWALES

3) MANNING'S CHANNEL TRAVEL TIME = L/V (WHEN CHANNEL VELOCITY IS KNOWN)

4) T<sub>c</sub> = T<sub>co</sub> + T<sub>t</sub>

\*\*\* IF TOTAL TIME OF CONCENTRATION IS LESS THAN 5 MINUTES, THEN 5 MINUTES IS USED

5) INTENSITY BASED ON I-D-F EQUATIONS IN CITY OF COLORADO SPRINGS DRAINAGE CRITERIA MANUAL

$$I_5 = -1.5 * \ln(T_c) + 7.583$$

$$I_{100} = -2.52 * \ln(T_c) + 12.735$$

6) Q = C<sub>i</sub>A

SETTLERS VIEW  
RATIONAL METHOD

DEVELOPED FLOWS

BASIN	DESIGN POINT	AREA (AC)	C		Overland Flow			Channel flow					TOTAL		INTENSITY <sup>(6)</sup>		PEAK FLOW	
			5-YEAR <sup>(7)</sup>	100-YEAR <sup>(7)</sup>	LENGTH (FT)	SLOPE (FT/FT)	Tco <sup>(1)</sup> (MIN)	CHANNEL LENGTH (FT)	CONVEYANCE COEFFICIENT C	SLOPE (FT/FT)	SCS <sup>(2)</sup> VELOCITY (FT/S)	Tt <sup>(3)</sup> (MIN)	Tc <sup>(4)</sup> (MIN)	Tc <sup>(4)</sup> (MIN)	5-YR (IN/HR)	100-YR (IN/HR)	Q5 <sup>(6)</sup> (CFS)	Q100 <sup>(6)</sup> (CFS)
<b>WEST CHERRY CREEK BASIN</b>																		
OS1	OS1	4.01	0.170	0.417	300	0.073	15.2	450	15.00	3.61	2.1	17.3	17.3	3.31	5.55	2.25	9.28	
S4		2.46	0.080	0.350			0.0	200	15.00	3.35	1.0	1.0	5.0	5.17	8.68	1.02	7.47	
OS1,S4	S4	6.47	0.136	0.392								18.3	18.3	3.22	5.41	2.83	13.71	
S1	S1	4.30	0.170	0.417	300	0.033	19.8	0	15.00	4.08	0.0	19.8	19.8	3.10	5.21	2.27	9.34	
D9	D9	14.30	0.170	0.417	250	0.080	13.5	700	15.00	3.33	2.9	16.3	16.3	3.39	5.70	8.25	33.97	
S2	S2a	9.04	0.170	0.417	300	0.073	15.2	650	15.00	3.33	3.3	18.4	18.4	3.21	5.39	4.93	20.32	
Tc Channel S2							0.0	280	15.00	2.37	2.0	2.0	5.0					
D9,S2	S2	23.34	0.170	0.417								18.4	18.4	3.21	5.39	12.74	52.46	
S3	S3a	12.67	0.170	0.417	300	0.060	16.2	1000	15.00	3.31	5.0	21.3	21.3	3.00	5.03	6.46	26.58	
Tc Channel S3							0.0	1000	15.00	3.35	5.0	5.0	5.0					
D9,S1-S3	S3	40.31	0.170	0.417								24.8	24.8	2.77	4.65	18.97	78.09	
OS1,D9,S1-S4	S	46.78	0.170	0.417								24.8	24.8	2.77	4.65	22.01	90.62	
<b>EAST CHERRY CREEK BASIN</b>																		
A	A	10.74	0.170	0.417	300	0.033	19.8	400	15.00	4.11	1.6	21.4	21.4	2.99	5.01	5.45	22.44	
B	B	2.93	0.170	0.417	300	0.050	17.3	0			0.0	17.3	17.3	3.31	5.56	1.65	6.79	
C	C	1.28	0.170	0.417	300	0.067	15.7	0			0.0	15.7	15.7	3.45	5.80	0.75	3.10	
A,B,C	A1	14.95	0.170	0.417								21.4	21.4	2.99	5.01	7.59	31.24	

1) OVERLAND FLOW Tco = (0.395\*(1.1-RUNOFF COEFFICIENT)\*(OVERLAND FLOW LENGTH\*(0.5)/(SLOPE\*(0.333)))

2) SCS VELOCITY = C \* ((SLOPE/FT)\*0.5)

C = 2.5 FOR HEAVY MEADOW

C = 5 FOR TILLAGE/FIELD

C = 7 FOR SHORT PASTURE AND LAWNS

C = 10 FOR NEARLY BARE GROUND

C = 15 FOR GRASSED WATERWAY

C = 20 FOR PAVED AREAS AND SHALLOW PAVED SWALES

3) MANNINGS CHANNEL TRAVEL TIME = L/V (WHEN CHANNEL VELOCITY IS KNOWN)

4) Tc = Tco + Tt

\*\*\* IF TOTAL TIME OF CONCENTRATION IS LESS THAN 5 MINUTES, THEN 5 MINUTES IS USED

5) INTENSITY BASED ON I-D-F EQUATIONS IN CITY OF COLORADO SPRINGS DRAINAGE CRITERIA MANUAL

$$I_5 = -1.5 * \ln(Tc) + 7.583$$

$$I_{100} = -2.52 * \ln(Tc) + 12.735$$

$$Q = C/A$$

7) WEIGHTED AVERAGE C VALUES FOR COMBINED BASINS

**APPENDIX B**  
**HYDRAULIC CALCULATIONS**

SETTLERS VIEW  
DITCH CALCULATION SUMMARY

PROPOSED ROADSIDE DITCHES

ROADWAY	FROM STA	TO STA	SIDE	PROPOSED SLOPE (%)	SIDE SLOPE (Z)	CHANNEL DEPTH (FT)	FRICTION FACTOR (n)	ROW WIDTH (ft)	BASIN	Q100 FLOW (CFS)	DITCH FLOW % OF BASIN	DITCH FLOW (CFS)	Q100 DEPTH (FT)	Q100 VELOCITY (FT/S)	DITCH LINING
SILVER NELL DRIVE	1425	1636	N	3.76	4:1/3:1	2.5	0.030	60	B	6.8	15	1.0	0.3	2.8	GRASS
SILVER NELL DRIVE	1425	1636	S	3.76	4:1/3:1	2.5	0.030	60	C	3.1	50	1.6	0.4	3.1	GRASS
SILVER NELL DRIVE	1636	2099	N	5.00	4:1/3:1	2.5	0.030	60	S1	9.3	35	3.3	0.5	4.1	GRASS / ECB
SILVER NELL DRIVE	1636	2099	S	5.00	4:1/3:1	2.5	0.030	60	S2a	20.3	10	2.0	0.4	3.7	GRASS
SILVER NELL DRIVE	2099	2323	E	6.00	4:1/3:1	2.5	0.030	60	S1	9.3	65	6.1	0.6	5.2	GRASS / ECB
SILVER NELL DRIVE	2099	2323	W	6.00	4:1/3:1	2.5	0.030	60	S3a	26.6	5	1.3	0.3	3.5	GRASS
ELK BASIN COURT	1100	1629	E	6.50	4:1/3:1	2.5	0.030	60	S2a	20.3	70	14.2	0.8	6.6	GRASS / ECB
ELK BASIN COURT	1100	1629	W	6.50	4:1/3:1	2.5	0.030	60	S3a	26.6	20	5.3	0.5	5.2	GRASS / ECB
ELK BASIN COURT	1629	1932	E	2.00	4:1/3:1	2.5	0.030	60	S2a	20.3	30	6.1	0.7	3.4	GRASS
ELK BASIN COURT	1629	1932	W	2.00	4:1/3:1	2.5	0.030	60	S3	78.1	5	3.9	0.6	3.1	GRASS

- 1) Channel flow calculations based on Manning's Equation
- 2) Channel depth includes 1' minimum freeboard
- 3) n = 0.03 for grass-lined non-irrigated channels (minimum)
- 4) n = 0.04 for riprap-lined channels
- 5) Vmax = 4.0 fps for 100-year flows w/ Native Grass-Lining (per ECM Table 10-4 & NRCS Companion Document 580-10)
- 6) Vmax = 8.0 fps with Erosion Control Blankets (Tensar Eronet SC150 or equal)

**ALLOWABLE VELOCITY AND MAXIMUM SHEAR STRESS  
Streambank and Shoreland Protection Code 580**

Type of Treatment	Allowable Shear lb/sq ft	Velocity ft/sec
<b>Brush Mattresses<sup>1</sup></b>		
Staked only w/ rock riprap toe (initial)	0.8 - 4.1	5
Staked only w/ rock riprap toe (grown)	4.0 - 8.0	12
<b>Coir Geotextile Roll<sup>2</sup></b>		
Roll with coir rope mesh staked only without rock riprap toe	0.2 - 0.8	< 5
Roll with Polypropylene rope mesh staked only without rock riprap toe	0.8 - 3.0	< 8
Roll with Polypropylene rope mesh staked and with rock riprap toe	3.0 - 4.0	< 12
<b>Live Fascine<sup>3</sup></b>		
LF Bundle w/ rock riprap toe	2.0 - 3.1	8
<b>Soils<sup>4</sup></b>		
Fine colloidal sand	0.02-0.03	1.5
Sandy loam (noncolloidal)	0.03-0.04	1.75
Alluvial silt (noncolloidal)	0.045-0.05	2
Silty loam (noncolloidal)	0.045-0.05	1.75-2.25
Firm loam	0.075	2.5
Fine gravels	0.075	2.5
Stiff clay	0.26	3-4.5
Alluvial silt (colloidal)	0.26	3.75
Graded loam to cobbles	0.38	3.75
Graded silts to cobbles	0.43	4
Shales and hardpan	0.67	6
<b>Gravel/Cobble<sup>4</sup></b>		
1-inch	0.33	2.5-5
2-inch	0.67	3-6
6-inch	2	4-7.5
12-inch	4	5.5-12
<b>Vegetation<sup>4</sup></b>		
Class A turf (ret class)	3.7	6-8
Class B turf (ret class)	2.1	4-7
Class C turf (ret class)	1	3.5
Retardance Class D	0.6	Design of roadside channels HEC-15
Retardance Class E	0.35	
Long native grasses	1.2-1.7	4-6
Short native and bunch grass	0.7-0.95	3-4

The complete line of RollMax™ products offers a variety of options for both short-term and permanent erosion control needs. Reference the RollMax Products Chart below to find the right solution for your next project.



## RollMax Product Selection Chart

	TEMPORARY						
	ERONET						BIONET
	DS75	DS150	S75	S150	SC150	C125	S75BN
<b>Longevity</b>	45 days	60 days	12 mo.	12 mo.	24 mo.	36 mo.	12 mo.
<b>Applications</b>	Low Flow Channels 4:1-3:1 Slopes	Moderate Flow Channels 3:1-2:1 Slopes	Low Flow Channels 4:1-3:1 Slopes	Moderate Flow Channels 3:1-2:1 Slopes	Medium Flow Channels 2:1-1:1 Slopes	High-Flow Channels 1:1 and Greater Slopes	Low Flow Channels 4:1-3:1 Slopes
<b>Design Permissible Shear Stress</b> lbs/ft <sup>2</sup> (Pa)	Unvegetated 1.55 (74)	Unvegetated 1.75 (84)	Unvegetated 1.55 (74)	Unvegetated 1.75 (84)	Unvegetated 2.00 (96)	Unvegetated 2.25 (108)	Unvegetated 1.60 (76)
<b>Design Permissible Velocity</b> ft/s (m/s)	Unvegetated 5.00 (1.52)	Unvegetated 6.00 (1.52)	Unvegetated 5.00 (1.2)	Unvegetated 6.00 (1.83)	Unvegetated 8.00 (2.44)	Unvegetated 10.00 (3.05)	Unvegetated 5.00 (1.52)
<b>Top Net</b>	Lightweight accelerated photodegradable polypropylene 1.50 lbs/1000 ft <sup>2</sup> (0.73 kg/100 m <sup>2</sup> ) approx wt	Lightweight accelerated photodegradable polypropylene 1.50 lbs/1000 ft <sup>2</sup> (0.73 kg/100 m <sup>2</sup> ) approx wt	Lightweight photodegradable polypropylene 1.50 lbs/1000 ft <sup>2</sup> (0.73 kg/100 m <sup>2</sup> ) approx wt	Lightweight photodegradable polypropylene 1.50 lbs/1000 ft <sup>2</sup> (0.73 kg/100 m <sup>2</sup> ) approx wt	Heavyweight UV-stabilized polypropylene 2.9 lbs/1000 ft <sup>2</sup> (1.47 kg/100 m <sup>2</sup> ) approx wt	Heavyweight UV-stabilized polypropylene 2.9 lbs/1000 ft <sup>2</sup> (1.47 kg/100 m <sup>2</sup> ) approx wt	Leno woven, 100% biodegradable jute fiber 9.30 lbs/1000 ft <sup>2</sup> (4.53 kg/100 m <sup>2</sup> ) approx wt
<b>Center Net</b>	N/A	N/A	N/A	N/A	N/A	N/A	N/A
<b>Fiber Matrix</b>	Straw fiber 0.50 lbs/yd <sup>2</sup> (0.27 kg/m <sup>2</sup> )	Straw fiber 0.50 lbs/yd <sup>2</sup> (0.27 kg/m <sup>2</sup> )	Straw fiber 0.50 lbs/yd <sup>2</sup> (0.27 kg/m <sup>2</sup> )	Straw fiber 0.50 lbs/yd <sup>2</sup> (0.27 kg/m <sup>2</sup> )	Straw/coconut matrix 70% Straw 0.35 lbs/yd <sup>2</sup> (0.19 kg/m <sup>2</sup> ) 30% Coconut 0.15 lbs/yd <sup>2</sup> (0.08 kg/m <sup>2</sup> )	Coconut fiber 0.50 lbs/yd <sup>2</sup> (0.27 kg/m <sup>2</sup> )	Straw fiber 0.50 lbs/yd <sup>2</sup> (0.27 kg/m <sup>2</sup> )
<b>Bottom Net</b>	N/A	Lightweight accelerated photodegradable polypropylene 1.50 lbs/1000 ft <sup>2</sup> (0.73 kg/100 m <sup>2</sup> ) approx wt	N/A	Lightweight photodegradable polypropylene 1.50 lbs/1000 ft <sup>2</sup> (0.73 kg/100 m <sup>2</sup> ) approx wt	Lightweight photodegradable polypropylene 1.50 lbs/1000 ft <sup>2</sup> (0.73 kg/100 m <sup>2</sup> ) approx wt	Heavyweight UV-stabilized polypropylene 2.9 lbs/1000 ft <sup>2</sup> (1.47 kg/100 m <sup>2</sup> ) approx wt	N/A
<b>Thread</b>	Accelerated degradable	Accelerated degradable	Degradable	Degradable	Degradable	UV-stabilized polypropylene	Biodegradable

# Hydraulic Analysis Report

## Project Data

Project Title: Settlers-View-Ditches  
Designer: JPS  
Project Date: Sunday, January 27, 2019  
Project Units: U.S. Customary Units  
Notes:

## Channel Analysis: Ditch-Silver-Nell-1425-1636-N

Notes:

## Input Parameters

Channel Type: Triangular  
Side Slope 1 (Z1): 4.0000 ft/ft  
Side Slope 2 (Z2): 3.0000 ft/ft  
Longitudinal Slope: 0.0376 ft/ft  
Manning's n: 0.0300  
Flow: 1.0000 cfs

## Result Parameters

Depth: 0.3215 ft  
Area of Flow: 0.3617 ft<sup>2</sup>  
Wetted Perimeter: 2.3420 ft  
Hydraulic Radius: 0.1544 ft  
Average Velocity: 2.7648 ft/s  
Top Width: 2.2503 ft  
Froude Number: 1.2153  
Critical Depth: 0.3490 ft  
Critical Velocity: 2.3460 ft/s  
Critical Slope: 0.0243 ft/ft  
Critical Top Width: 2.49 ft  
Calculated Max Shear Stress: 0.7542 lb/ft<sup>2</sup>  
Calculated Avg Shear Stress: 0.3623 lb/ft<sup>2</sup>

## Channel Analysis: Ditch-Silver-Nell-1425-1636-S

Notes:

### Input Parameters

Channel Type: Triangular  
Side Slope 1 (Z1): 4.0000 ft/ft  
Side Slope 2 (Z2): 3.0000 ft/ft  
Longitudinal Slope: 0.0376 ft/ft  
Manning's n: 0.0300  
Flow: 1.6000 cfs

### Result Parameters

Depth: 0.3834 ft  
Area of Flow: 0.5146 ft<sup>2</sup>  
Wetted Perimeter: 2.7934 ft  
Hydraulic Radius: 0.1842 ft  
Average Velocity: 3.1095 ft/s  
Top Width: 2.6840 ft  
Froude Number: 1.2515  
Critical Depth: 0.4212 ft  
Critical Velocity: 2.5773 ft/s  
Critical Slope: 0.0228 ft/ft  
Critical Top Width: 3.01 ft  
Calculated Max Shear Stress: 0.8996 lb/ft<sup>2</sup>  
Calculated Avg Shear Stress: 0.4322 lb/ft<sup>2</sup>



## Channel Analysis: Ditch-Silver-Nell-1636-2099-N

Notes:

### Input Parameters

Channel Type: Triangular  
Side Slope 1 (Z1): 4.0000 ft/ft  
Side Slope 2 (Z2): 3.0000 ft/ft  
Longitudinal Slope: 0.0500 ft/ft  
Manning's n: 0.0300  
Flow: 3.3000 cfs

### Result Parameters

Depth: 0.4768 ft  
Area of Flow: 0.7958 ft<sup>2</sup>  
Wetted Perimeter: 3.4739 ft  
Hydraulic Radius: 0.2291 ft  
Average Velocity: 4.1467 ft/s  
Top Width: 3.3379 ft  
Froude Number: 1.4966  
Critical Depth: 0.5626 ft  
Critical Velocity: 2.9788 ft/s  
Critical Slope: 0.0207 ft/ft  
Critical Top Width: 4.02 ft  
Calculated Max Shear Stress: 1.4877 lb/ft<sup>2</sup>  
Calculated Avg Shear Stress: 0.7147 lb/ft<sup>2</sup>

## Channel Analysis: Ditch-Silver-Nell-1636-2099-S

Notes:

### Input Parameters

Channel Type: Triangular  
Side Slope 1 (Z1): 4.0000 ft/ft  
Side Slope 2 (Z2): 3.0000 ft/ft  
Longitudinal Slope: 0.0500 ft/ft  
Manning's n: 0.0300  
Flow: 2.0000 cfs

### Result Parameters

Depth: 0.3952 ft  
Area of Flow: 0.5466 ft<sup>2</sup>  
Wetted Perimeter: 2.8792 ft  
Hydraulic Radius: 0.1899 ft  
Average Velocity: 3.6588 ft/s  
Top Width: 2.7664 ft  
Froude Number: 1.4505  
Critical Depth: 0.4605 ft  
Critical Velocity: 2.6949 ft/s  
Critical Slope: 0.0221 ft/ft  
Critical Top Width: 3.29 ft  
Calculated Max Shear Stress: 1.2330 lb/ft<sup>2</sup>  
Calculated Avg Shear Stress: 0.5924 lb/ft<sup>2</sup>

## Channel Analysis: Ditch-Silver-Nell-2099-2323-E

Notes:

### Input Parameters

Channel Type: Triangular  
Side Slope 1 (Z1): 4.0000 ft/ft  
Side Slope 2 (Z2): 3.0000 ft/ft  
Longitudinal Slope: 0.0600 ft/ft  
Manning's n: 0.0300  
Flow: 6.1000 cfs

### Result Parameters

Depth: 0.5802 ft  
Area of Flow: 1.1782 ft<sup>2</sup>  
Wetted Perimeter: 4.2270 ft  
Hydraulic Radius: 0.2787 ft  
Average Velocity: 5.1773 ft/s  
Top Width: 4.0614 ft  
Froude Number: 1.6939  
Critical Depth: 0.7193 ft  
Critical Velocity: 3.3682 ft/s  
Critical Slope: 0.0191 ft/ft  
Critical Top Width: 5.14 ft  
Calculated Max Shear Stress: 2.1723 lb/ft<sup>2</sup>  
Calculated Avg Shear Stress: 1.0436 lb/ft<sup>2</sup>

## Channel Analysis: Ditch-Silver-Nell-2099-2323-W

Notes:

### Input Parameters

Channel Type: Triangular  
Side Slope 1 (Z1): 4.0000 ft/ft  
Side Slope 2 (Z2): 3.0000 ft/ft  
Longitudinal Slope: 0.0600 ft/ft  
Manning's n: 0.0300  
Flow: 1.3000 cfs

### Result Parameters

Depth: 0.3249 ft  
Area of Flow: 0.3696 ft<sup>2</sup>  
Wetted Perimeter: 2.3673 ft  
Hydraulic Radius: 0.1561 ft  
Average Velocity: 3.5177 ft/s  
Top Width: 2.2746 ft  
Froude Number: 1.5379  
Critical Depth: 0.3876 ft  
Critical Velocity: 2.4724 ft/s  
Critical Slope: 0.0234 ft/ft  
Critical Top Width: 2.77 ft  
Calculated Max Shear Stress: 1.2166 lb/ft<sup>2</sup>  
Calculated Avg Shear Stress: 0.5845 lb/ft<sup>2</sup>

## Channel Analysis: Ditch-Elk-Basin-Ct-1100-1629-E

Notes:

### Input Parameters

Channel Type: Triangular  
Side Slope 1 (Z1): 4.0000 ft/ft  
Side Slope 2 (Z2): 3.0000 ft/ft  
Longitudinal Slope: 0.0650 ft/ft  
Manning's n: 0.0300  
Flow: 14.2000 cfs

### Result Parameters

Depth: 0.7846 ft  
Area of Flow: 2.1548 ft<sup>2</sup>  
Wetted Perimeter: 5.7164 ft  
Hydraulic Radius: 0.3770 ft  
Average Velocity: 6.5899 ft/s  
Top Width: 5.4925 ft  
Froude Number: 1.8541  
Critical Depth: 1.0086 ft  
Critical Velocity: 3.9883 ft/s  
Critical Slope: 0.0170 ft/ft  
Critical Top Width: 7.21 ft  
Calculated Max Shear Stress: 3.1825 lb/ft<sup>2</sup>  
Calculated Avg Shear Stress: 1.5289 lb/ft<sup>2</sup>

## Channel Analysis: Ditch-Elk-Basin-Ct-1100-1629-W

Notes:

### Input Parameters

Channel Type: Triangular  
Side Slope 1 (Z1): 4.0000 ft/ft  
Side Slope 2 (Z2): 3.0000 ft/ft  
Longitudinal Slope: 0.0650 ft/ft  
Manning's n: 0.0300  
Flow: 5.3000 cfs

### Result Parameters

Depth: 0.5422 ft  
Area of Flow: 1.0290 ft<sup>2</sup>  
Wetted Perimeter: 3.9502 ft  
Hydraulic Radius: 0.2605 ft  
Average Velocity: 5.1508 ft/s  
Top Width: 3.7955 ft  
Froude Number: 1.7433  
Critical Depth: 0.6800 ft  
Critical Velocity: 3.2748 ft/s  
Critical Slope: 0.0194 ft/ft  
Critical Top Width: 4.86 ft  
Calculated Max Shear Stress: 2.1992 lb/ft<sup>2</sup>  
Calculated Avg Shear Stress: 1.0565 lb/ft<sup>2</sup>

## Channel Analysis: Ditch-Elk-Basin-Ct-1629-1932-E

Notes:

### Input Parameters

Channel Type: Triangular  
Side Slope 1 (Z1): 4.0000 ft/ft  
Side Slope 2 (Z2): 3.0000 ft/ft  
Longitudinal Slope: 0.0200 ft/ft  
Manning's n: 0.0300  
Flow: 6.1000 cfs

### Result Parameters

Depth: 0.7129 ft  
Area of Flow: 1.7789 ft<sup>2</sup>  
Wetted Perimeter: 5.1939 ft  
Hydraulic Radius: 0.3425 ft  
Average Velocity: 3.4291 ft/s  
Top Width: 4.9904 ft  
Froude Number: 1.0122  
Critical Depth: 0.7193 ft  
Critical Velocity: 3.3682 ft/s  
Critical Slope: 0.0191 ft/ft  
Critical Top Width: 5.14 ft  
Calculated Max Shear Stress: 0.8897 lb/ft<sup>2</sup>  
Calculated Avg Shear Stress: 0.4274 lb/ft<sup>2</sup>

## Channel Analysis: Ditch-Elk-Basin-Ct-1629-1932-W

Notes:

### Input Parameters

Channel Type: Triangular  
Side Slope 1 (Z1): 4.0000 ft/ft  
Side Slope 2 (Z2): 3.0000 ft/ft  
Longitudinal Slope: 0.0200 ft/ft  
Manning's n: 0.0300  
Flow: 3.9000 cfs

### Result Parameters

Depth: 0.6028 ft  
Area of Flow: 1.2719 ft<sup>2</sup>  
Wetted Perimeter: 4.3918 ft  
Hydraulic Radius: 0.2896 ft  
Average Velocity: 3.0663 ft/s  
Top Width: 4.2198 ft  
Froude Number: 0.9843  
Critical Depth: 0.6015 ft  
Critical Velocity: 3.0800 ft/s  
Critical Slope: 0.0202 ft/ft  
Critical Top Width: 4.30 ft  
Calculated Max Shear Stress: 0.7523 lb/ft<sup>2</sup>  
Calculated Avg Shear Stress: 0.3614 lb/ft<sup>2</sup>



**SETTLERS VIEW  
CHANNEL CALCULATIONS  
DEVELOPED FLOWS**

**EXISTING / PROPOSED CHANNELS**

CHANNEL	DESIGN POINT	PROPOSED SLOPE (%)	BOTTOM WIDTH (B, FT)	SIDE SLOPE (Z)	CHANNEL DEPTH (FT)	FRICTION FACTOR (n)	Q100 FLOW (CFS)	Q100 DEPTH (FT)	Q100 VELOCITY (FT/S)	CHANNEL LINING
S1	S1	0.051	0	3:1	2.0	0.030	9.3	0.7	5.6	<b>GRASS / ECB</b>
S2	S2	0.025	4	4:1	2.0	0.030	52.5	1.1	6.1	<b>GRASS / ECB</b>
S3.1	S3	0.040	6	4:1	2.0	0.030	78.1	1.0	7.8	<b>GRASS / ECB</b>
S3.2 (RR RUNDOWN)	S3	0.120	6	3:1	2.0	0.040	78.1	0.9	9.9	<b>RIPRAP</b>

- 1) Channel flow calculations based on Manning's Equation
- 2) Channel depth includes 1' minimum freeboard
- 3) n = 0.03 for grass-lined non-irrigated channels (minimum)
- 4) n = 0.04 for riprap-lined channels
- 5) Vmax = 4.0 fps for 100-year flows w/ grass-lined channels
- 6) Vmax = 8.0 fps for 100-year flows w/ Erosion Control Blankets (NAG C150 or equal)

# Hydraulic Analysis Report

## Project Data

Project Title: Settlers View Subdivision  
Designer: JPS  
Project Date: Friday, February 10, 2017  
Project Units: U.S. Customary Units  
Notes:

## Channel Analysis: Channel-S1

Notes:

## Input Parameters

Channel Type: Triangular  
Side Slope 1 (Z1): 3.0000 ft/ft  
Side Slope 2 (Z2): 3.0000 ft/ft  
Longitudinal Slope: 0.0510 ft/ft  
Manning's n: 0.0300  
Flow: 9.3000 cfs

## Result Parameters

Depth: 0.7447 ft  
Area of Flow: 1.6637 ft<sup>2</sup>  
Wetted Perimeter: 4.7099 ft  
Hydraulic Radius: 0.3532 ft  
Average Velocity: 5.5898 ft/s  
Top Width: 4.4682 ft  
Froude Number: 1.6143  
Critical Depth: 0.9019 ft  
Critical Velocity: 3.8107 ft/s  
Critical Slope: 0.0184 ft/ft  
Critical Top Width: 5.41 ft  
Calculated Max Shear Stress: 2.3699 lb/ft<sup>2</sup>  
Calculated Avg Shear Stress: 1.1242 lb/ft<sup>2</sup>

## Channel Analysis: Channel-S2

Notes:

### Input Parameters

Channel Type: Trapezoidal  
Side Slope 1 (Z1): 4.0000 ft/ft  
Side Slope 2 (Z2): 4.0000 ft/ft  
Channel Width: 4.0000 ft  
Longitudinal Slope: 0.0250 ft/ft  
Manning's n: 0.0300  
Flow: 52.5000 cfs

### Result Parameters

Depth: 1.0536 ft  
Area of Flow: 8.6543 ft<sup>2</sup>  
Wetted Perimeter: 12.6879 ft  
Hydraulic Radius: 0.6821 ft  
Average Velocity: 6.0664 ft/s  
Top Width: 12.4285 ft  
Froude Number: 1.2811  
Critical Depth: 1.1965 ft  
Critical Velocity: 4.9938 ft/s  
Critical Slope: 0.0147 ft/ft  
Critical Top Width: 13.57 ft  
Calculated Max Shear Stress: 1.6436 lb/ft<sup>2</sup>  
Calculated Avg Shear Stress: 1.0641 lb/ft<sup>2</sup>

## Channel Analysis: Channel-S3.1

Notes:

### Input Parameters

Channel Type: Trapezoidal  
Side Slope 1 (Z1): 4.0000 ft/ft  
Side Slope 2 (Z2): 4.0000 ft/ft  
Channel Width: 6.0000 ft  
Longitudinal Slope: 0.0400 ft/ft  
Manning's n: 0.0300  
Flow: 78.1000 cfs

### Result Parameters

Depth: 0.9987 ft  
Area of Flow: 9.9811 ft<sup>2</sup>  
Wetted Perimeter: 14.2351 ft  
Hydraulic Radius: 0.7012 ft  
Average Velocity: 7.8248 ft/s  
Top Width: 13.9892 ft  
Froude Number: 1.6325  
Critical Depth: 1.3025 ft  
Critical Velocity: 5.3492 ft/s  
Critical Slope: 0.0140 ft/ft  
Critical Top Width: 16.42 ft  
Calculated Max Shear Stress: 2.4926 lb/ft<sup>2</sup>  
Calculated Avg Shear Stress: 1.7501 lb/ft<sup>2</sup>

## Channel Analysis: Channel-S3.2

Notes:

### Input Parameters

Channel Type: Trapezoidal  
Side Slope 1 (Z1): 3.0000 ft/ft  
Side Slope 2 (Z2): 3.0000 ft/ft  
Channel Width: 6.0000 ft  
Longitudinal Slope: 0.1200 ft/ft  
Manning's n: 0.0400  
Lining Type: Rock Riprap - 300 mm (12-inch)  
Flow: 78.1000 cfs

### Result Parameters

Depth: 0.9063 ft  
Area of Flow: 7.9018 ft<sup>2</sup>  
Wetted Perimeter: 11.7319 ft  
Hydraulic Radius: 0.6735 ft  
Average Velocity: 9.8838 ft/s  
Top Width: 11.4378 ft  
Froude Number: 2.0956  
Critical Depth: 1.3754 ft  
Critical Velocity: 5.6077 ft/s  
Critical Slope: 0.0245 ft/ft  
Critical Top Width: 14.25 ft  
Calculated Max Shear Stress: 6.7863 lb/ft<sup>2</sup>  
Calculated Avg Shear Stress: 5.0434 lb/ft<sup>2</sup>

SETTLERS VIEW  
CULVERT DESIGN SUMMARY

BASIN	DESIGN POINT	RD CL ELEV	INV IN ELEV	INV OUT ELEV	PIPE LENGTH (FT)	# of CULVERTS	PIPE DIA (FT)	TOTAL Q <sub>5</sub> (CFS)	PER PIPE Q <sub>5</sub> (CFS)	Q <sub>5</sub> MAX ALLOWABLE HEADWATER <sup>1</sup>	CALC Q <sub>5</sub> HW ELEV	TOTAL Q <sub>100</sub> (CFS)	PER PIPE Q <sub>100</sub> (CFS)	Q <sub>100</sub> MAX ALLOWABLE HEADWATER <sup>2</sup>	CALC Q <sub>100</sub> HW ELEV
S1	S1	7622.10	7617.90	7615.10	56.0	1	1.5	2.3	2.3	7619.4	7618.7	9.3	9.34	7622.3	7619.8
S2	S2	7590.16	7585.61	7584.61	50.0	1	2.5	12.7	12.7	7588.1	7587.3	52.5	52.50	7590.3	7590.2

<sup>1</sup> Q<sub>5</sub> MAX. ALLOWABLE HEADWATER, HW/D = 1.0

<sup>2</sup> Q<sub>100</sub> MAX. ALLOWABLE HEADWATER = 6" DEPTH AT SHOULDER (PER DCM TABLE 6-1)

# **HY-8 Culvert Analysis Report – Culvert S1**

### **Crossing Discharge Data**

Discharge Selection Method: Specify Minimum, Design, and Maximum Flow

Minimum Flow: 1 cfs

Design Flow: 2.3 cfs

Maximum Flow: 9.3 cfs



**Table 1 - Summary of Culvert Flows at Crossing: Crossing S1**

Headwater Elevation (ft)	Total Discharge (cfs)	Culvert S1 Discharge (cfs)	Roadway Discharge (cfs)	Iterations
7618.39	1.00	1.00	0.00	1
7618.57	1.83	1.83	0.00	1
7618.66	2.30	2.30	0.00	1
7618.88	3.49	3.49	0.00	1
7619.01	4.32	4.32	0.00	1
7619.13	5.15	5.15	0.00	1
7619.25	5.98	5.98	0.00	1
7619.37	6.81	6.81	0.00	1
7619.49	7.64	7.64	0.00	1
7619.63	8.47	8.47	0.00	1
7619.78	9.30	9.30	0.00	1
7622.10	17.71	17.71	0.00	Overtopping

Rating Curve Plot for Crossing: Crossing S1

Total Rating Curve

Crossing: Crossing S1

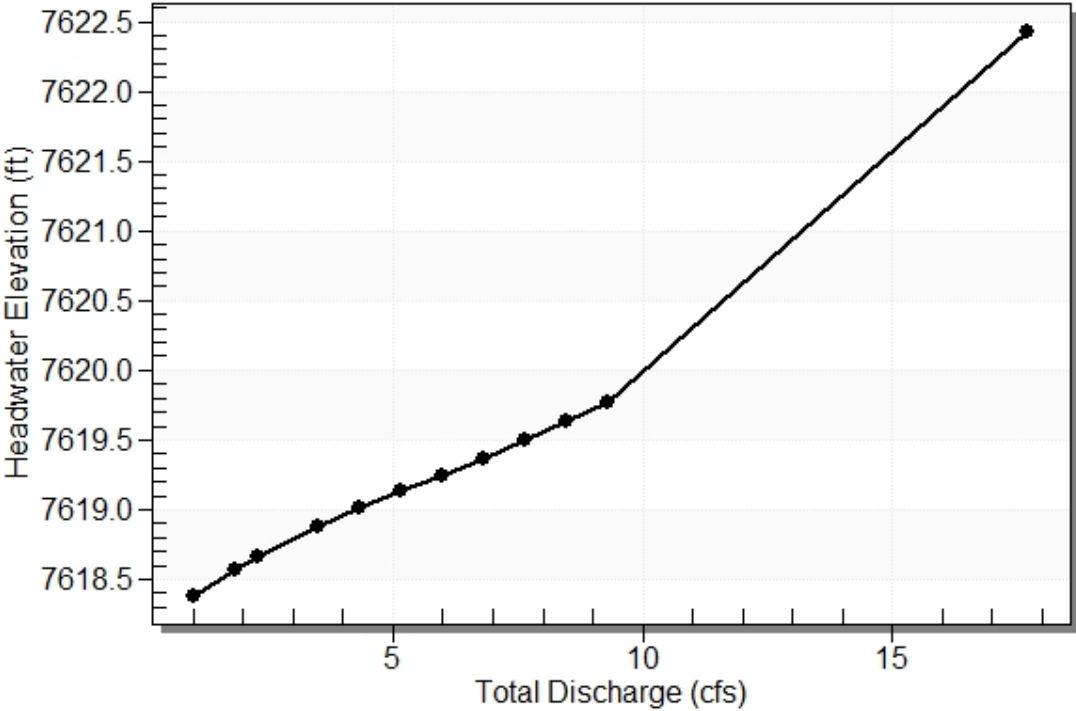

**Table 2 - Culvert Summary Table: Culvert S1**

Total Discharge (cfs)	Culvert Discharge (cfs)	Headwater Elevation (ft)	Inlet Control Depth (ft)	Outlet Control Depth (ft)	Flow Type	Normal Depth (ft)	Critical Depth (ft)	Outlet Depth (ft)	Tailwater Depth (ft)	Outlet Velocity (ft/s)	Tailwater Velocity (ft/s)
1.00	1.00	7618.39	0.486	0.0*	1-S2n	0.205	0.369	0.210	0.132	6.438	1.678
1.83	1.83	7618.57	0.669	0.0*	1-S2n	0.275	0.506	0.284	0.187	7.590	2.064
2.30	2.30	7618.66	0.757	0.0*	1-S2n	0.309	0.569	0.320	0.213	8.053	2.228
3.49	3.49	7618.88	0.978	0.0*	1-S2n	0.380	0.713	0.399	0.269	8.951	2.552
4.32	4.32	7619.01	1.109	0.0*	1-S2n	0.424	0.796	0.447	0.304	9.460	2.730
5.15	5.15	7619.13	1.230	0.0*	1-S2n	0.464	0.868	0.490	0.335	9.924	2.884
5.98	5.98	7619.25	1.348	0.0*	1-S2n	0.502	0.940	0.502	0.363	11.150	3.020
6.81	6.81	7619.37	1.468	0.0*	1-S2n	0.538	1.007	0.578	0.390	10.492	3.142
7.64	7.64	7619.49	1.593	0.0*	5-S2n	0.573	1.067	0.617	0.415	10.786	3.253
8.47	8.47	7619.63	1.728	0.0*	5-S2n	0.606	1.123	0.658	0.439	10.981	3.355
9.30	9.30	7619.78	1.875	0.0*	5-S2n	0.638	1.177	0.689	0.461	11.352	3.449

\* Full Flow Headwater elevation is below inlet invert.

\*\*\*\*\*

Straight Culvert

Inlet Elevation (invert): 7617.90 ft, Outlet Elevation (invert): 7615.10 ft

Culvert Length: 56.07 ft, Culvert Slope: 0.0500

\*\*\*\*\*

Culvert Performance Curve Plot: Culvert S1

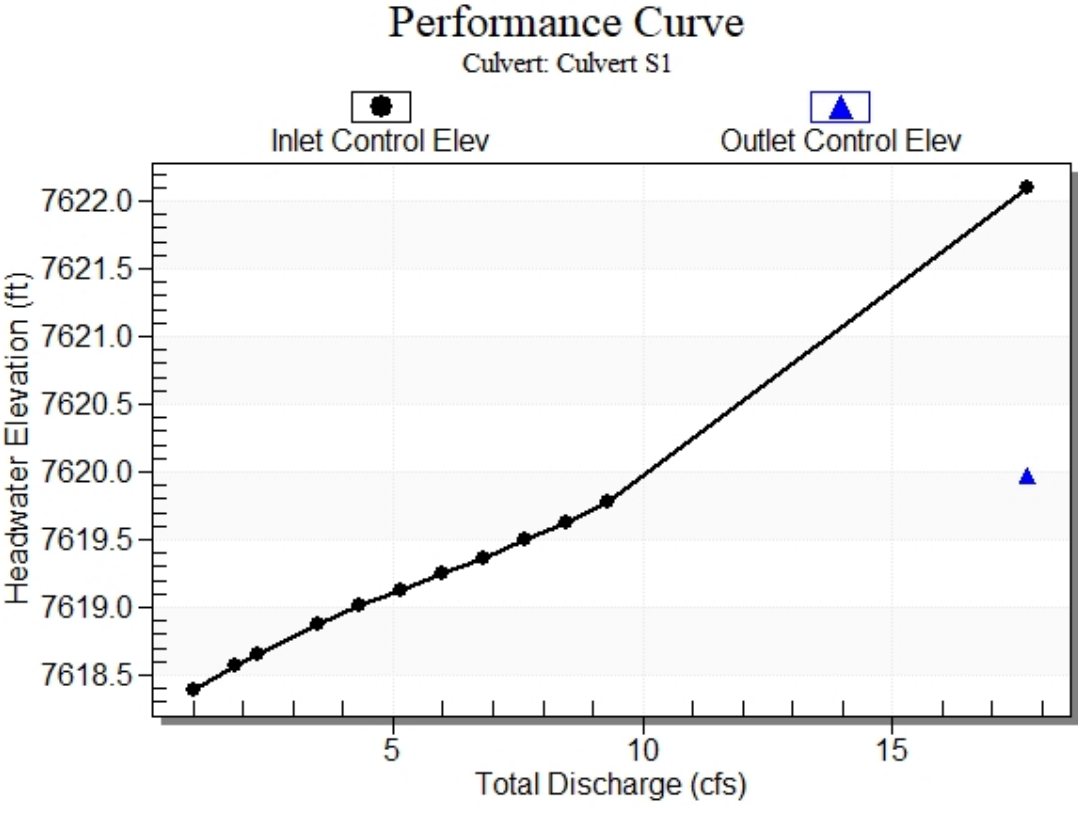

### Water Surface Profile Plot for Culvert: Culvert S1

#### Crossing - Crossing S1, Design Discharge - 2.3 cfs

Culvert - Culvert S1, Culvert Discharge - 2.3 cfs

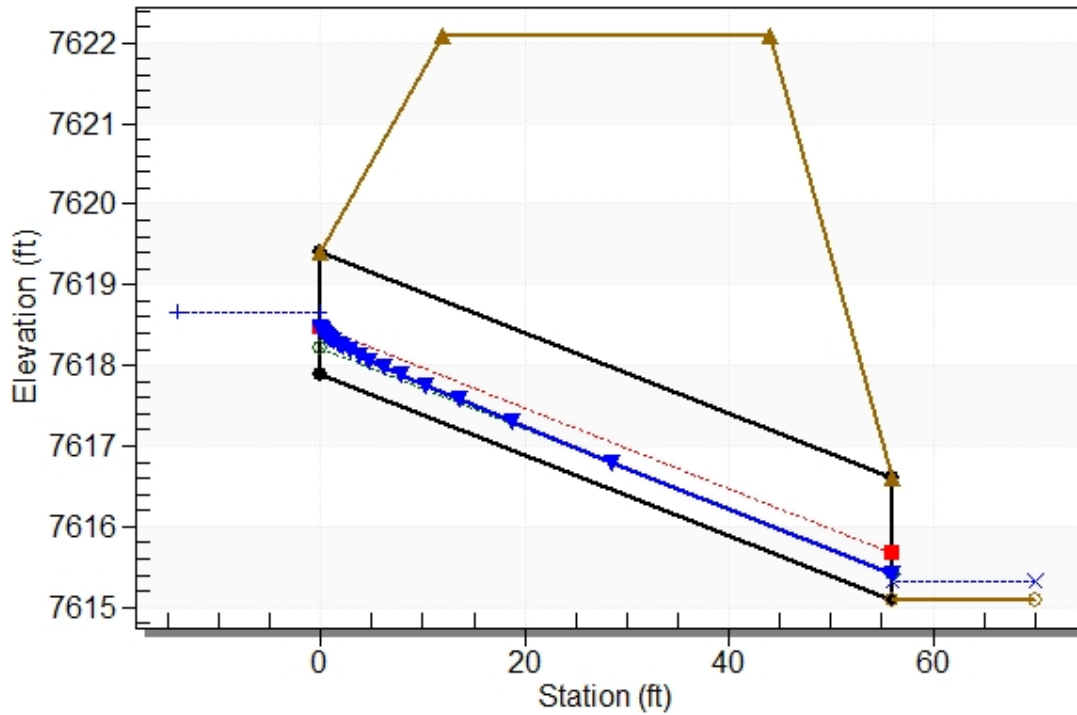

### Site Data - Culvert S1

Site Data Option: Culvert Invert Data

Inlet Station: 0.00 ft

Inlet Elevation: 7617.90 ft

Outlet Station: 56.00 ft

Outlet Elevation: 7615.10 ft

Number of Barrels: 1

### Culvert Data Summary - Culvert S1

Barrel Shape: Circular

Barrel Diameter: 1.50 ft

Barrel Material: Concrete

Embedment: 0.00 in

Barrel Manning's n: 0.0130

Culvert Type: Straight

Inlet Configuration: Grooved End Projecting

Inlet Depression: None

**Table 3 - Downstream Channel Rating Curve (Crossing: Crossing S1)**

Flow (cfs)	Water Surface Elev (ft)	Depth (ft)	Velocity (ft/s)	Shear (psf)	Froude Number
1.00	7615.23	0.13	1.68	0.16	0.86
1.83	7615.29	0.19	2.06	0.23	0.91
2.30	7615.31	0.21	2.23	0.27	0.92
3.49	7615.37	0.27	2.55	0.34	0.95
4.32	7615.40	0.30	2.73	0.38	0.97
5.15	7615.43	0.33	2.88	0.42	0.98
5.98	7615.46	0.36	3.02	0.45	0.99
6.81	7615.49	0.39	3.14	0.49	1.00
7.64	7615.51	0.41	3.25	0.52	1.01
8.47	7615.54	0.44	3.36	0.55	1.02
9.30	7615.56	0.46	3.45	0.58	1.03

**Tailwater Channel Data - Crossing S1**

Tailwater Channel Option: Trapezoidal Channel

Bottom Width: 4.00 ft

Side Slope (H:V): 4.00 (\_:1)

Channel Slope: 0.0200

Channel Manning's n: 0.0300

Channel Invert Elevation: 7615.10 ft

**Roadway Data for Crossing: Crossing S1**

Roadway Profile Shape: Constant Roadway Elevation

Crest Length: 100.00 ft

Crest Elevation: 7622.10 ft

Roadway Surface: Paved

Roadway Top Width: 32.00 ft

# CIRCULAR CONDUIT FLOW (Normal & Critical Depth Computation)

Project: **Settlers View**

Pipe ID: **S1**

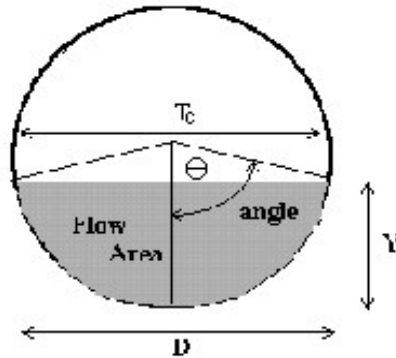

### Design Information (Input)

Pipe Invert Slope	So =	0.0500	ft/ft
Pipe Manning's n-value	n =	0.0130	
Pipe Diameter	D =	18.00	inches
<b>Design discharge</b>	<b>Q =</b>	<b>9.34</b>	<b>cfs</b>

### Full-flow Capacity (Calculated)

Full-flow area	Af =	1.77	sq ft
Full-flow wetted perimeter	Pf =	4.71	ft
Half Central Angle	Theta =	3.14	radians
Full-flow capacity	Qf =	23.55	cfs

### Calculation of Normal Flow Condition

Half Central Angle ( $0 < \text{Theta} < 3.14$ )	Theta =	1.45	radians
Flow area	An =	0.74	sq ft
Top width	Tn =	1.49	ft
Wetted perimeter	Pn =	2.17	ft
Flow depth	Yn =	0.66	ft
Flow velocity	Vn =	12.56	fps
Discharge	Qn =	9.34	cfs
Percent Full Flow	Flow =	39.7%	of full flow
Normal Depth Froude Number	Fr <sub>n</sub> =	3.13	supercritical

### Calculation of Critical Flow Condition

Half Central Angle ( $0 < \text{Theta-c} < 3.14$ )	Theta-c =	2.18	radians
Critical flow area	Ac =	1.49	sq ft
Critical top width	Tc =	1.23	ft
Critical flow depth	Yc =	1.18	ft
Critical flow velocity	Vc =	6.26	fps
Critical Depth Froude Number	Fr <sub>c</sub> =	1.00	





CULVERT STAGE-DISCHARGE SIZING (INLET vs. OUTLET CONTROL WITH TAILWATER EFFECTS)

Project: Settlers View  
Basin ID: S1

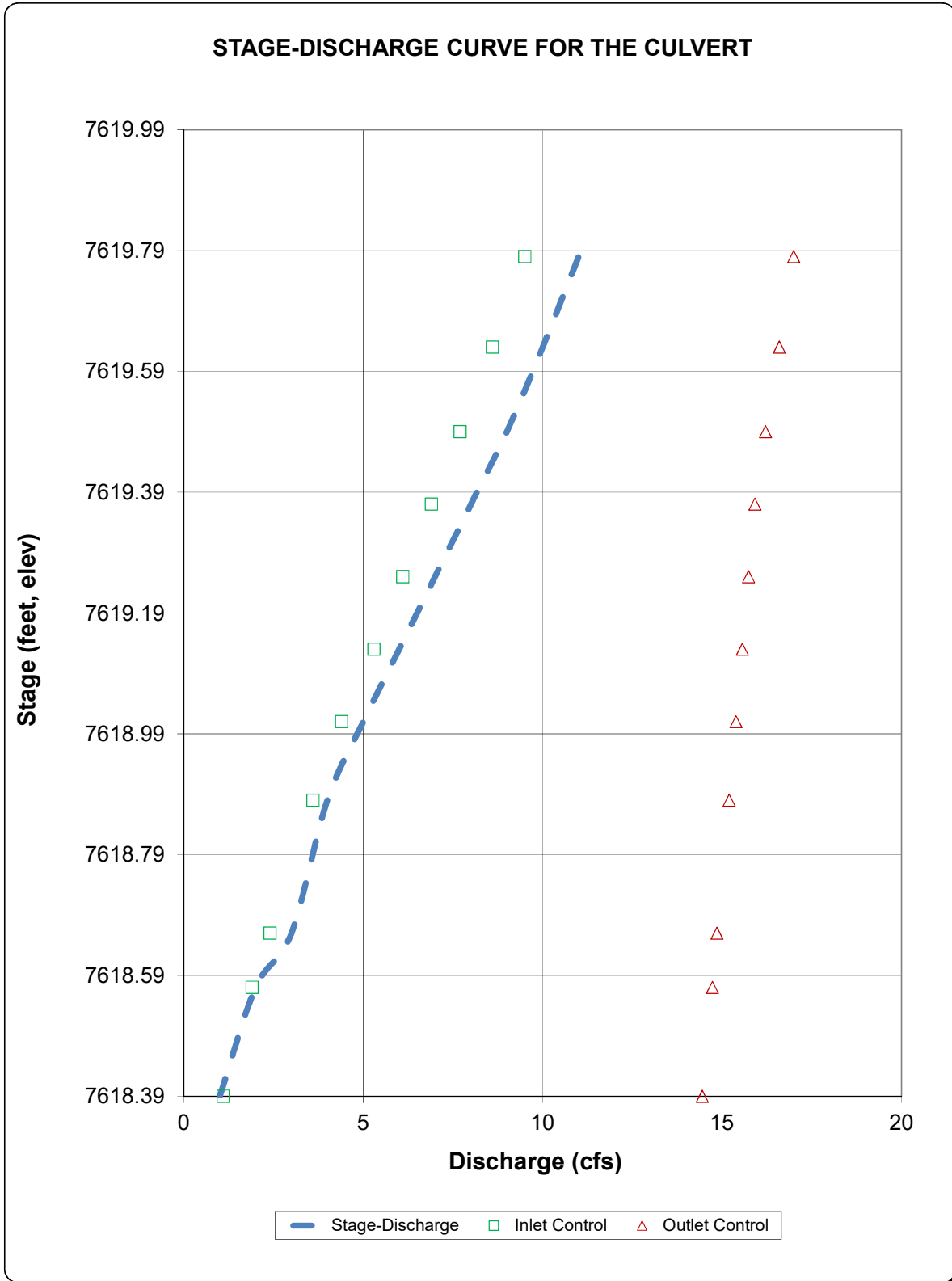

## Determination of Culvert Headwater and Outlet Protection

Project: **Settlers View**

Basin ID: **S1**

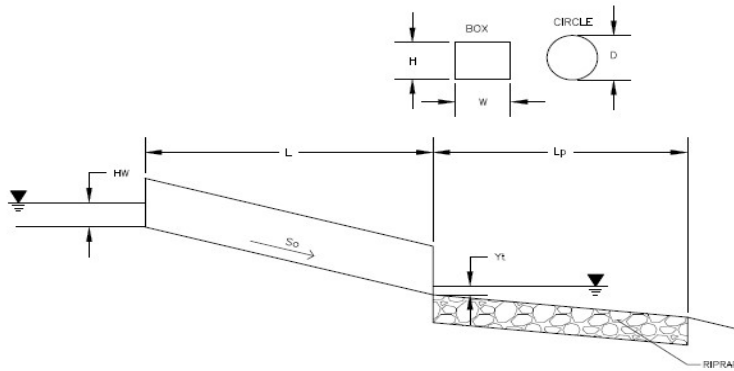

**Soil Type:**

Choose One:

Sandy

Non-Sandy

**Supercritical Flow! Using  $D_a$  to calculate protection type.**

**Design Information (Input):**

<p>Design Discharge</p> <p><b>Circular Culvert:</b>                  Barrel Diameter in Inches                  Inlet Edge Type (Choose from pull-down list)</p> <p><b>Box Culvert:</b>                  Barrel Height (Rise) in Feet                  Barrel Width (Span) in Feet                  Inlet Edge Type (Choose from pull-down list)</p> <p>Number of Barrels                  Inlet Elevation                  Outlet Elevation <b>OR</b> Slope                  Culvert Length                  Manning's Roughness                  Bend Loss Coefficient                  Exit Loss Coefficient                  Tailwater Surface Elevation                  Max Allowable Channel Velocity</p>	<p>Q = <input style="width: 50px;" type="text" value="9.3"/> cfs</p> <p>D = <input style="width: 50px;" type="text" value="18"/> inches</p> <p style="text-align: center;"><b>OR</b></p> <p>Height (Rise) = <input style="width: 50px;" type="text"/> ft</p> <p>Width (Span) = <input style="width: 50px;" type="text"/> ft</p> <p>No = <input style="width: 50px;" type="text" value="1"/></p> <p>Elev IN = <input style="width: 50px;" type="text" value="7617.9"/> ft</p> <p>Elev OUT = <input style="width: 50px;" type="text" value="7615.1"/> ft</p> <p>L = <input style="width: 50px;" type="text" value="56"/> ft</p> <p>n = <input style="width: 50px;" type="text" value="0.013"/></p> <p><math>k_b</math> = <input style="width: 50px;" type="text" value="0"/></p> <p><math>k_x</math> = <input style="width: 50px;" type="text" value="1"/></p> <p>Elev <math>Y_t</math> = <input style="width: 50px;" type="text" value="7615.56"/> ft</p> <p>V = <input style="width: 50px;" type="text" value="5"/> ft/s</p>
--	--

**Required Protection (Output):**

<p>Tailwater Surface Height</p> <p>Flow Area at Max Channel Velocity</p> <p>Culvert Cross Sectional Area Available</p> <p>Entrance Loss Coefficient</p> <p>Friction Loss Coefficient</p> <p>Sum of All Losses Coefficients</p> <p>Culvert Normal Depth</p> <p>Culvert Critical Depth</p> <p>Tailwater Depth for Design</p> <p>Adjusted Diameter <b>OR</b> Adjusted Rise</p> <p>Expansion Factor</p> <p>Flow/Diameter<sup>2.5</sup> <b>OR</b> Flow/(Span * Rise<sup>1.5</sup>)</p> <p>Froude Number</p> <p>Tailwater/Adjusted Diameter <b>OR</b> Tailwater/Adjusted Rise</p> <p>Inlet Control Headwater</p> <p>Outlet Control Headwater</p> <p><b>Design Headwater Elevation</b></p> <p><b>Headwater/Diameter <b>OR</b> Headwater/Rise Ratio</b></p> <p>Minimum Theoretical Riprap Size</p> <p>Nominal Riprap Size</p> <p><b>UDFCD Riprap Type</b></p> <p><b>Length of Protection</b></p> <p><b>Width of Protection</b></p>	<p><math>Y_t</math> = <input style="width: 50px;" type="text" value="0.46"/> ft</p> <p><math>A_t</math> = <input style="width: 50px;" type="text" value="1.86"/> ft<sup>2</sup></p> <p>A = <input style="width: 50px;" type="text" value="1.77"/> ft<sup>2</sup></p> <p><math>k_e</math> = <input style="width: 50px;" type="text" value="0.20"/></p> <p><math>k_f</math> = <input style="width: 50px;" type="text" value="1.01"/></p> <p><math>k_s</math> = <input style="width: 50px;" type="text" value="2.21"/> ft</p> <p><math>Y_n</math> = <input style="width: 50px;" type="text" value="0.66"/> ft</p> <p><math>Y_c</math> = <input style="width: 50px;" type="text" value="1.18"/> ft</p> <p>d = <input style="width: 50px;" type="text" value="1.34"/> ft</p> <p><math>D_a</math> = <input style="width: 50px;" type="text" value="1.08"/> ft</p> <p>1/(2*tan(<math>\theta</math>)) = <input style="width: 50px;" type="text" value="4.49"/></p> <p><math>Q/D^{2.5}</math> = <input style="width: 50px;" type="text" value="3.37"/> ft<sup>0.5</sup>/s</p> <p>Fr = <input style="width: 50px;" type="text" value="3.13"/> <span style="color: red; font-weight: bold;">Supercritical!</span></p> <p><math>Y_t/D</math> = <input style="width: 50px;" type="text" value="0.43"/></p> <p><math>HW_i</math> = <input style="width: 50px;" type="text" value="1.88"/> ft</p> <p><math>HW_o</math> = <input style="width: 50px;" type="text" value="-0.51"/> ft</p> <p><b>HW</b> = <input style="width: 50px;" type="text" value="7,619.78"/> ft</p> <p><b>HW/D</b> = <input style="width: 50px;" type="text" value="1.25"/></p> <p><math>d_{50}</math> = <input style="width: 50px;" type="text" value="6"/> in</p> <p><math>d_{50}</math> = <input style="width: 50px;" type="text" value="9"/> in</p> <p><b>Type</b> = <input style="width: 50px;" type="text" value="L"/></p> <p><math>L_p</math> = <input style="width: 50px;" type="text" value="12"/> ft</p> <p>T = <input style="width: 50px;" type="text" value="5"/> ft</p>
--	--

## Vertical Profile for the Culvert

Project = **Settlers View**

Box ID = **S1**

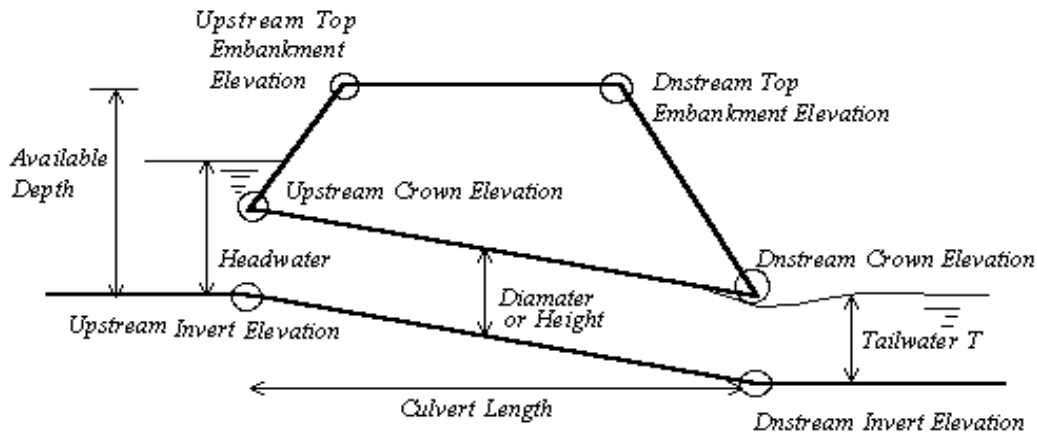

<b>Culvert Information (Input)</b>	
Barrel Diameter or Height	D or H = <input style="width: 100px;" type="text" value="18.00"/> inches
Barrel Length	L = <input style="width: 100px;" type="text" value="56.00"/> ft
Barrel Invert Slope	So = <input style="width: 100px;" type="text" value="0.0500"/> ft/ft
Downstream Invert Elevation	EDI = <input style="width: 100px;" type="text" value="7615.10"/> ft
Downstream Top Embankment Elevation	EDT = <input style="width: 100px;" type="text" value="7621.78"/> ft
Upstream Top Embankment Elevation	EUT = <input style="width: 100px;" type="text" value="7621.78"/> ft
Design Headwater Depth (not elev.)	Hw = <input style="width: 100px;" type="text" value="1.88"/> ft
Tailwater Depth (not elev.)	Yt = <input style="width: 100px;" type="text" value="0.46"/> ft
<b>Culvert Hydraulics (Calculated)</b>	
Available Headwater Depth	HW-a = <input style="width: 100px;" type="text" value="3.88"/> ft
Design Hw/D ratio	Hw/D = <input style="width: 100px;" type="text" value="1.25"/>
<b>Culvert Vertical Profile</b>	
Upstream Invert Elevation	EUI = <input style="width: 100px;" type="text" value="7617.90"/> ft
Upstream Crown Elevation	EUC = <input style="width: 100px;" type="text" value="7619.40"/> ft
Upstream Soil Cover Depth	Upsoil = <input style="width: 100px;" type="text" value="2.38"/> ft
Downstream Invert Elevation	EDI = <input style="width: 100px;" type="text" value="7615.10"/> ft
Downstream Crown Elevation	EDC = <input style="width: 100px;" type="text" value="7616.60"/> ft
Downstream Soil Cover Depth	Dnsoil = <input style="width: 100px;" type="text" value="5.18"/> ft

# **HY-8 Culvert Analysis Report – Culvert S2**

### **Crossing Discharge Data**

Discharge Selection Method: Specify Minimum, Design, and Maximum Flow

Minimum Flow: 5 cfs

Design Flow: 12.7 cfs

Maximum Flow: 52.5 cfs

**Table 1 - Summary of Culvert Flows at Crossing: Crossing S2**

Headwater Elevation (ft)	Total Discharge (cfs)	Culvert S2 Discharge (cfs)	Roadway Discharge (cfs)	Iterations
7586.60	5.00	5.00	0.00	1
7587.05	9.75	9.75	0.00	1
7587.29	12.70	12.70	0.00	1
7587.75	19.25	19.25	0.00	1
7588.06	24.00	24.00	0.00	1
7588.40	28.75	28.75	0.00	1
7588.79	33.50	33.50	0.00	1
7589.23	38.25	38.25	0.00	1
7589.73	43.00	43.00	0.00	1
7590.18	47.75	46.76	0.87	27
7590.23	52.50	47.14	5.18	5
7590.16	46.59	46.59	0.00	Overtopping

Rating Curve Plot for Crossing: Crossing S2

### Total Rating Curve

Crossing: Crossing S2

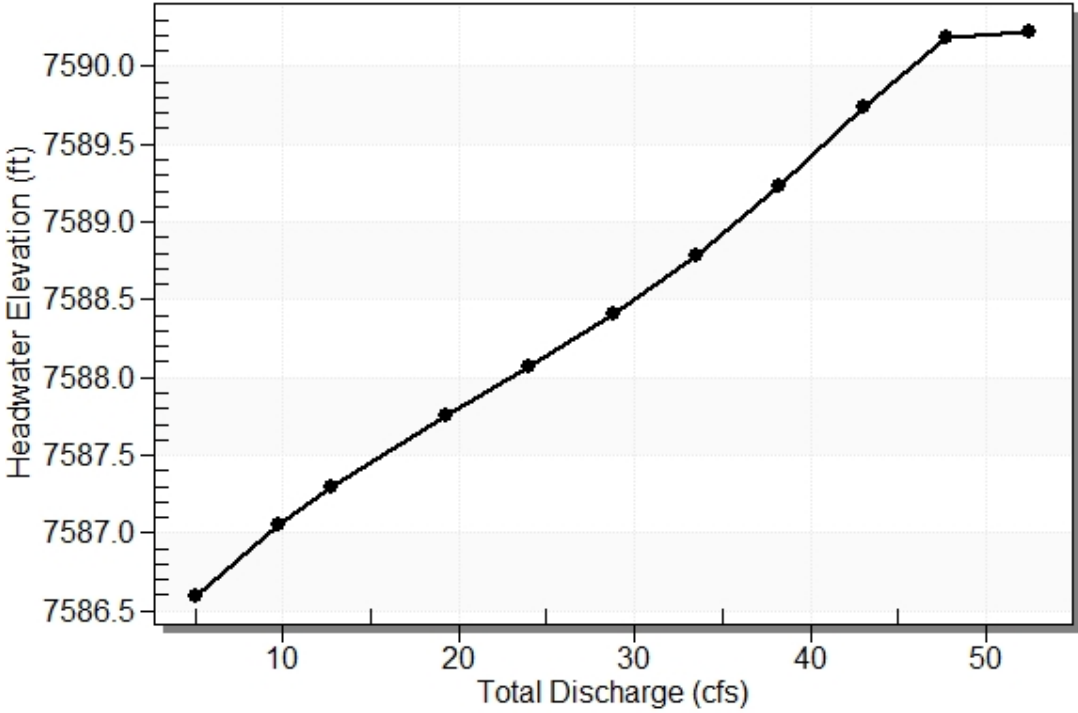



**Table 2 - Culvert Summary Table: Culvert S2**

Total Discharge (cfs)	Culvert Discharge (cfs)	Headwater Elevation (ft)	Inlet Control Depth (ft)	Outlet Control Depth (ft)	Flow Type	Normal Depth (ft)	Critical Depth (ft)	Outlet Depth (ft)	Tailwater Depth (ft)	Outlet Velocity (ft/s)	Tailwater Velocity (ft/s)
5.00	5.00	7586.60	0.990	0.0*	1-S2n	0.482	0.733	0.505	0.329	6.787	2.858
9.75	9.75	7587.05	1.438	0.141	1-S2n	0.674	1.040	0.723	0.473	7.993	3.498
12.70	12.70	7587.29	1.681	0.370	1-S2n	0.773	1.197	0.839	0.544	8.484	3.778
19.25	19.25	7587.75	2.139	0.880	1-S2n	0.965	1.484	1.069	0.675	9.289	4.253
24.00	24.00	7588.06	2.455	1.280	1-S2n	1.091	1.664	1.214	0.756	9.821	4.522
28.75	28.75	7588.40	2.793	1.709	5-S2n	1.210	1.826	1.358	0.828	10.222	4.753
33.50	33.50	7588.79	3.176	2.433	5-S2n	1.326	1.967	1.492	0.893	10.627	4.955
38.25	38.25	7589.23	3.617	2.858	5-S2n	1.442	2.088	1.622	0.953	11.017	5.136
43.00	43.00	7589.73	4.123	3.321	5-S2n	1.559	2.189	1.747	1.009	11.409	5.301
47.75	46.76	7590.18	4.571	3.714	5-S2n	1.655	2.254	1.847	1.062	11.712	5.451
52.50	47.14	7590.23	4.618	3.755	5-S2n	1.665	2.260	1.856	1.112	11.746	5.592

\* Full Flow Headwater elevation is below inlet invert.

\*\*\*\*\*

Straight Culvert

Inlet Elevation (invert): 7585.61 ft,    Outlet Elevation (invert): 7584.61 ft

Culvert Length: 50.01 ft,    Culvert Slope: 0.0200

\*\*\*\*\*

Culvert Performance Curve Plot: Culvert S2

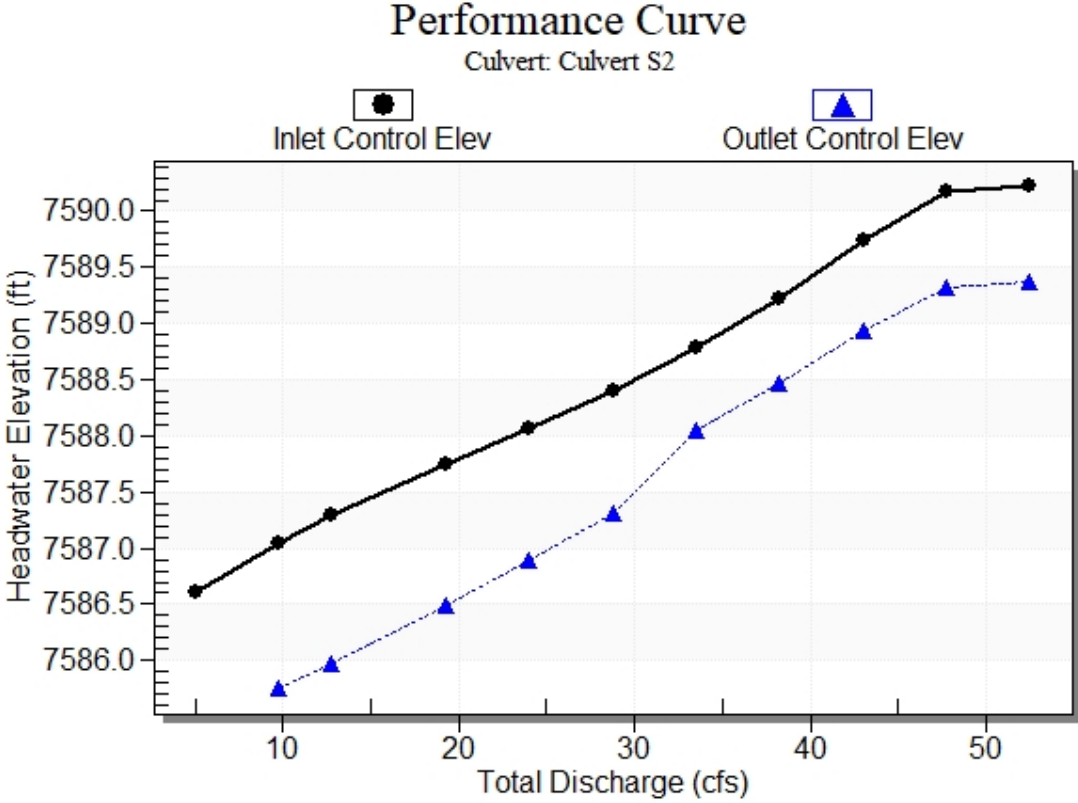

## Water Surface Profile Plot for Culvert: Culvert S2

Crossing - Crossing S2, Design Discharge - 12.7 cfs

Culvert - Culvert S2, Culvert Discharge - 12.7 cfs

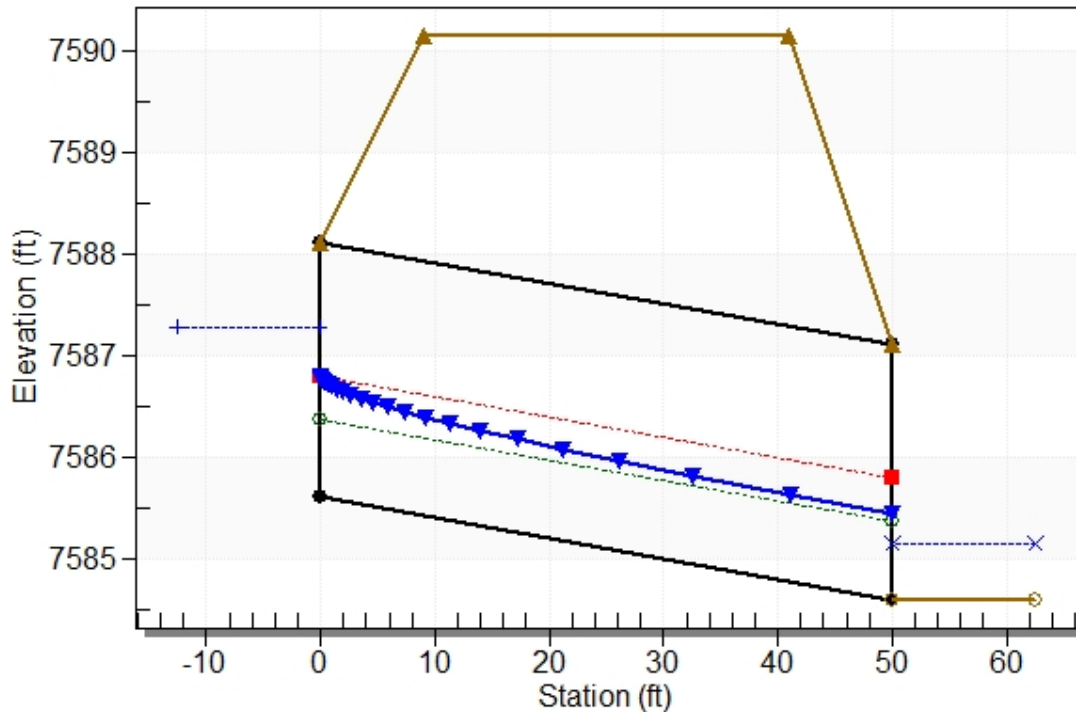

### Site Data - Culvert S2

Site Data Option: Culvert Invert Data

Inlet Station: 0.00 ft

Inlet Elevation: 7585.61 ft

Outlet Station: 50.00 ft

Outlet Elevation: 7584.61 ft

Number of Barrels: 1

### Culvert Data Summary - Culvert S2

Barrel Shape: Circular

Barrel Diameter: 2.50 ft

Barrel Material: Concrete

Embedment: 0.00 in

Barrel Manning's n: 0.0130

Culvert Type: Straight

Inlet Configuration: Grooved End Projecting

Inlet Depression: None

**Table 3 - Downstream Channel Rating Curve (Crossing: Crossing S2)**

Flow (cfs)	Water Surface Elev (ft)	Depth (ft)	Velocity (ft/s)	Shear (psf)	Froude Number
5.00	7584.94	0.33	2.86	0.41	0.98
9.75	7585.08	0.47	3.50	0.59	1.03
12.70	7585.15	0.54	3.78	0.68	1.05
19.25	7585.29	0.68	4.25	0.84	1.08
24.00	7585.37	0.76	4.52	0.94	1.10
28.75	7585.44	0.83	4.75	1.03	1.11
33.50	7585.50	0.89	4.95	1.11	1.12
38.25	7585.56	0.95	5.14	1.19	1.13
43.00	7585.62	1.01	5.30	1.26	1.14
47.75	7585.67	1.06	5.45	1.33	1.15
52.50	7585.72	1.11	5.59	1.39	1.15

**Tailwater Channel Data - Crossing S2**

Tailwater Channel Option: Trapezoidal Channel

Bottom Width: 4.00 ft

Side Slope (H:V): 4.00 (\_:1)

Channel Slope: 0.0200

Channel Manning's n: 0.0300

Channel Invert Elevation: 7584.61 ft

**Roadway Data for Crossing: Crossing S2**

Roadway Profile Shape: Constant Roadway Elevation

Crest Length: 100.00 ft

Crest Elevation: 7590.16 ft

Roadway Surface: Paved

Roadway Top Width: 32.00 ft

## CIRCULAR CONDUIT FLOW (Normal & Critical Depth Computation)

Project: **Settlers View**

Pipe ID: **S2**

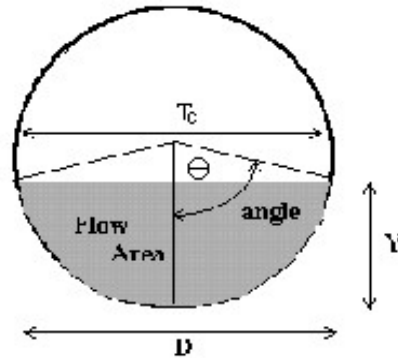

### Design Information (Input)

Pipe Invert Slope	So =	0.0200	ft/ft
Pipe Manning's n-value	n =	0.0130	
Pipe Diameter	D =	30.00	inches
<b>Design discharge</b>	<b>Q =</b>	<b>52.50</b>	<b>cfs</b>

### Full-flow Capacity (Calculated)

Full-flow area	Af =	4.91	sq ft
Full-flow wetted perimeter	Pf =	7.85	ft
Half Central Angle	Theta =	3.14	radians
Full-flow capacity	Qf =	58.16	cfs

### Calculation of Normal Flow Condition

Half Central Angle ( $0 < \theta < 3.14$ )	Theta =	2.08	radians
Flow area	An =	3.91	sq ft
Top width	Tn =	2.18	ft
Wetted perimeter	Pn =	5.20	ft
Flow depth	Yn =	1.86	ft
Flow velocity	Vn =	13.41	fps
Discharge	Qn =	52.50	cfs
Percent Full Flow	Flow =	90.3%	of full flow
Normal Depth Froude Number	Fr <sub>n</sub> =	1.77	supercritical

### Calculation of Critical Flow Condition

Half Central Angle ( $0 < \theta_c < 3.14$ )	Theta-c =	2.61	radians
Critical flow area	Ac =	4.76	sq ft
Critical top width	Tc =	1.26	ft
Critical flow depth	Yc =	2.33	ft
Critical flow velocity	Vc =	11.02	fps
Critical Depth Froude Number	Fr <sub>c</sub> =	1.00	



CULVERT STAGE-DISCHARGE SIZING (INLET vs. OUTLET CONTROL WITH TAILWATER EFFECTS)

Project: Settlers View  
Basin ID: S2

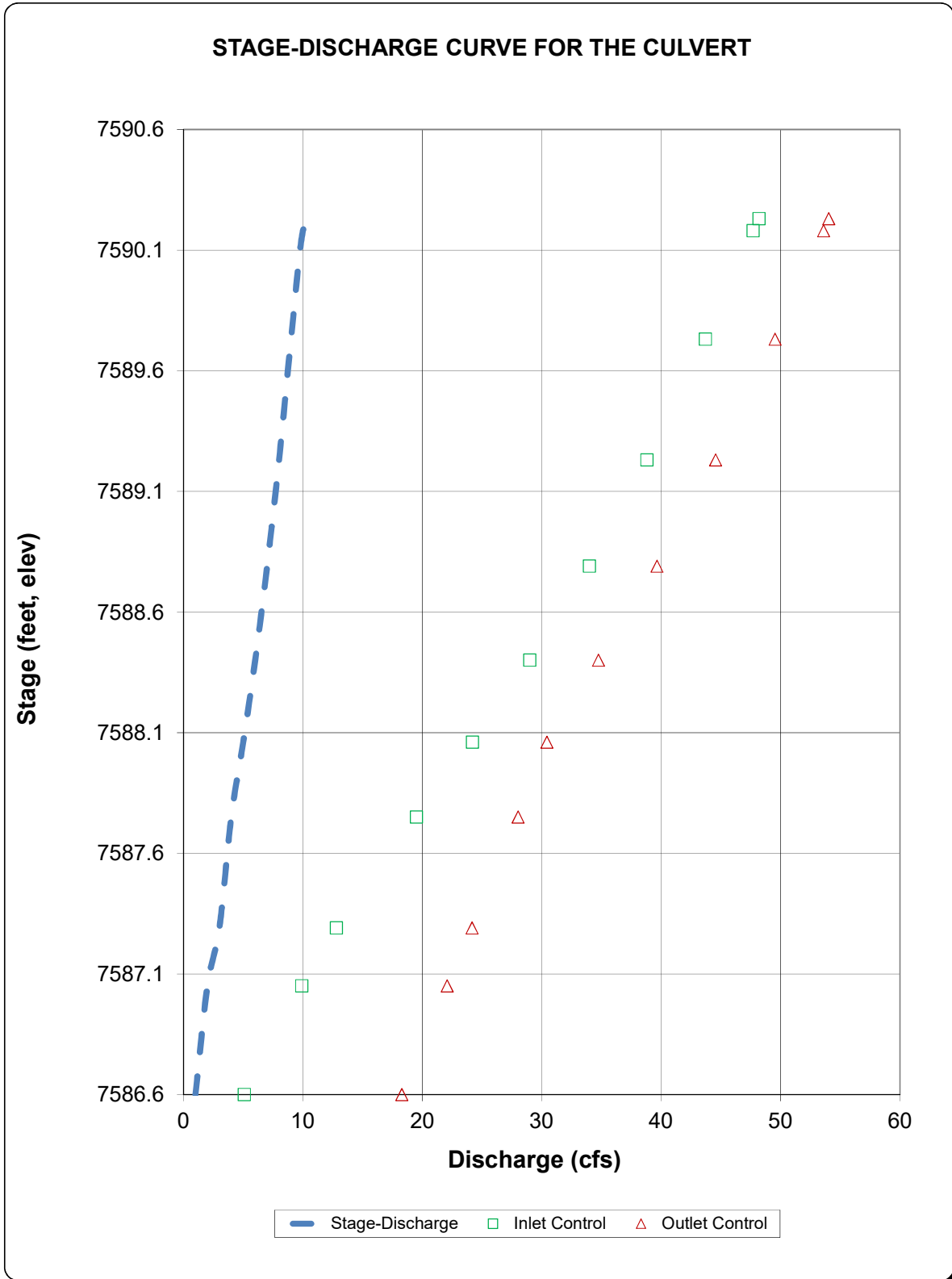



## Determination of Culvert Headwater and Outlet Protection

Project: **Settlers View**

Basin ID: **S2**

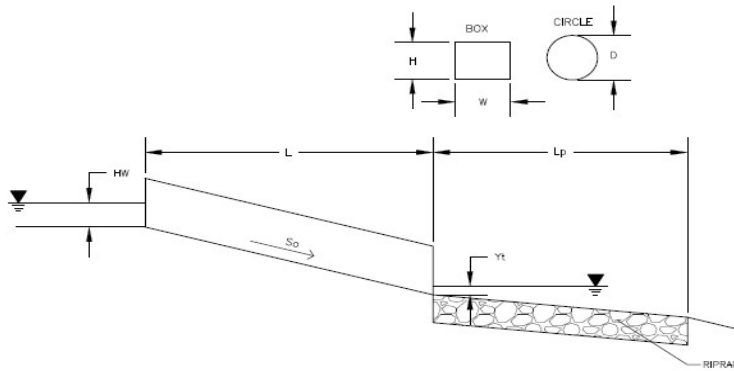

**Soil Type:**

Choose One:

Sandy

Non-Sandy

**Supercritical Flow! Using Da to calculate protection type.**

### Design Information (Input):

Design Discharge	Q = <input style="width: 100px;" type="text" value="52.5"/> cfs
<b>Circular Culvert:</b>	
Barrel Diameter in Inches	D = <input style="width: 100px;" type="text" value="30"/> inches
Inlet Edge Type (Choose from pull-down list)	Grooved End Projection <input type="button" value="v"/>
<b>Box Culvert:</b>	<b>OR</b>
Barrel Height (Rise) in Feet	Height (Rise) = <input style="width: 100px;" type="text"/>
Barrel Width (Span) in Feet	Width (Span) = <input style="width: 100px;" type="text"/>
Inlet Edge Type (Choose from pull-down list)	<input type="button" value="v"/>
Number of Barrels	No = <input style="width: 100px;" type="text" value="1"/>
Inlet Elevation	Elev IN = <input style="width: 100px;" type="text" value="7585.61"/> ft
Outlet Elevation <b>OR</b> Slope	Elev OUT = <input style="width: 100px;" type="text" value="7584.61"/> ft
Culvert Length	L = <input style="width: 100px;" type="text" value="50"/> ft
Manning's Roughness	n = <input style="width: 100px;" type="text" value="0.013"/>
Bend Loss Coefficient	k <sub>b</sub> = <input style="width: 100px;" type="text" value="0"/>
Exit Loss Coefficient	k <sub>x</sub> = <input style="width: 100px;" type="text" value="1"/>
Tailwater Surface Elevation	Elev Y <sub>t</sub> = <input style="width: 100px;" type="text" value="7585.72"/> ft
Max Allowable Channel Velocity	V = <input style="width: 100px;" type="text" value="5"/> ft/s

### Required Protection (Output):

Tailwater Surface Height	Y <sub>t</sub> = <input style="width: 100px;" type="text" value="1.11"/> ft
Flow Area at Max Channel Velocity	A <sub>t</sub> = <input style="width: 100px;" type="text" value="10.50"/> ft <sup>2</sup>
Culvert Cross Sectional Area Available	A = <input style="width: 100px;" type="text" value="4.91"/> ft <sup>2</sup>
Entrance Loss Coefficient	k <sub>e</sub> = <input style="width: 100px;" type="text" value="0.20"/>
Friction Loss Coefficient	k <sub>f</sub> = <input style="width: 100px;" type="text" value="0.46"/>
Sum of All Losses Coefficients	k <sub>s</sub> = <input style="width: 100px;" type="text" value="1.66"/> ft
Culvert Normal Depth	Y <sub>n</sub> = <input style="width: 100px;" type="text" value="1.86"/> ft
Culvert Critical Depth	Y <sub>c</sub> = <input style="width: 100px;" type="text" value="2.33"/> ft
Tailwater Depth for Design	d = <input style="width: 100px;" type="text" value="2.41"/> ft
Adjusted Diameter <b>OR</b> Adjusted Rise	D <sub>a</sub> = <input style="width: 100px;" type="text" value="2.18"/> ft
Expansion Factor	1/(2*tan(θ)) = <input style="width: 100px;" type="text" value="3.26"/>
Flow/Diameter <sup>2.5</sup> <b>OR</b> Flow/(Span * Rise <sup>1.5</sup> )	Q/D <sup>2.5</sup> = <input style="width: 100px;" type="text" value="5.31"/> ft <sup>0.5</sup> /s
Froude Number	Fr = <input style="width: 100px;" type="text" value="1.77"/> <b>Supercritical!</b>
Tailwater/Adjusted Diameter <b>OR</b> Tailwater/Adjusted Rise	Y <sub>t</sub> /D = <input style="width: 100px;" type="text" value="0.51"/>
Inlet Control Headwater	HW <sub>i</sub> = <input style="width: 100px;" type="text" value="5.33"/> ft
Outlet Control Headwater	HW <sub>o</sub> = <input style="width: 100px;" type="text" value="4.36"/> ft
<b>Design Headwater Elevation</b>	<b>HW = <input style="width: 100px;" type="text" value="7,590.94"/> ft</b>
<b>Headwater/Diameter <b>OR</b> Headwater/Rise Ratio</b>	<b>HW/D = <input style="width: 100px;" type="text" value="2.13"/> <b>HW/D &gt; 1.5!</b></b>
Minimum Theoretical Riprap Size	d <sub>50</sub> = <input style="width: 100px;" type="text" value="10"/> in
Nominal Riprap Size	d <sub>50</sub> = <input style="width: 100px;" type="text" value="12"/> in
<b>UDFCD Riprap Type</b>	<b>Type = <input style="width: 100px;" type="text" value="M"/></b>
<b>Length of Protection</b>	<b>L<sub>p</sub> = <input style="width: 100px;" type="text" value="23"/> ft</b>
<b>Width of Protection</b>	<b>T = <input style="width: 100px;" type="text" value="10"/> ft</b>

## Vertical Profile for the Culvert

Project = **Settlers View**

Box ID = **S2**

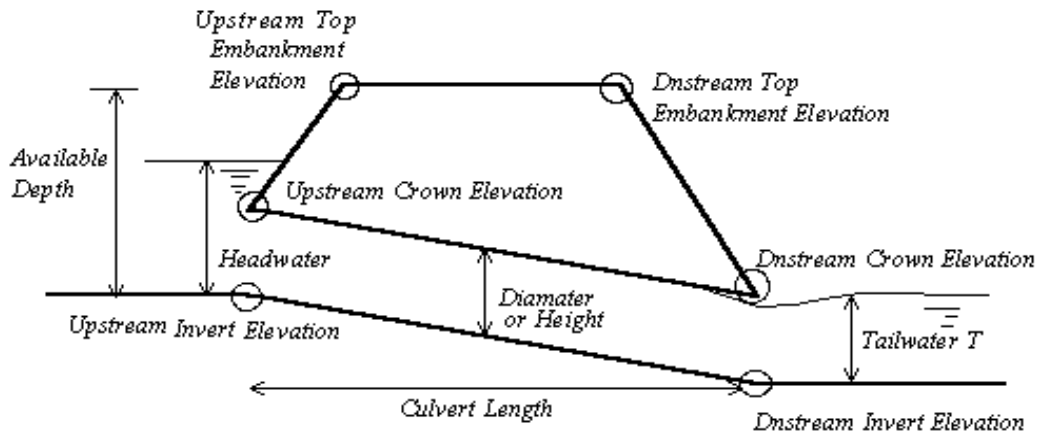

<b>Culvert Information (Input)</b>	
Barrel Diameter or Height	D or H = <input style="width: 100px;" type="text" value="30.00"/> inches
Barrel Length	L = <input style="width: 100px;" type="text" value="50.00"/> ft
Barrel Invert Slope	So = <input style="width: 100px;" type="text" value="0.0200"/> ft/ft
Downstream Invert Elevation	EDI = <input style="width: 100px;" type="text" value="7584.61"/> ft
Downstream Top Embankment Elevation	EDT = <input style="width: 100px;" type="text" value="7589.84"/> ft
Upstream Top Embankment Elevation	EUT = <input style="width: 100px;" type="text" value="7589.84"/> ft
Design Headwater Depth (not elev.)	Hw = <input style="width: 100px;" type="text" value="4.62"/> ft
Tailwater Depth (not elev.)	Yt = <input style="width: 100px;" type="text" value="1.11"/> ft
<b>Culvert Hydraulics (Calculated)</b>	
Available Headwater Depth	HW-a = <input style="width: 100px;" type="text" value="4.23"/> ft
Design Hw/D ratio	Hw/D = <input style="width: 100px;" type="text" value="1.85"/>
<b>Culvert Vertical Profile</b>	
Upstream Invert Elevation	EUI = <input style="width: 100px;" type="text" value="7585.61"/> ft
Upstream Crown Elevation	EUC = <input style="width: 100px;" type="text" value="7588.11"/> ft
Upstream Soil Cover Depth	Upsoil = <input style="width: 100px;" type="text" value="1.73"/> ft
Downstream Invert Elevation	EDI = <input style="width: 100px;" type="text" value="7584.61"/> ft
Downstream Crown Elevation	EDC = <input style="width: 100px;" type="text" value="7587.11"/> ft
Downstream Soil Cover Depth	Dnsoil = <input style="width: 100px;" type="text" value="2.73"/> ft

**APPENDIX C**

**DETENTION POND CALCULATIONS**



## Detention Basin Outlet Structure Design

UD-Detention, Version 3.07 (February 2017)

Project: **SETTLERS VIEW**

Basin ID: **S3**

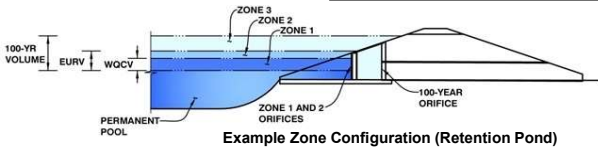

	Stage (ft)	Zone Volume (ac-ft)	Outlet Type
Zone 1 (WQCV)	1.95	0.172	Orifice Plate
Zone 2 (EURV)	2.79	0.124	Orifice Plate
Zone 3 (100-year)	6.47	0.803	Weir&Pipe (Restrict)
		1.100	<b>Total</b>

**User Input: Orifice at Underdrain Outlet (typically used to drain WQCV in a Filtration BMP)**

Underdrain Orifice Invert Depth =  ft (distance below the filtration media surface)  
 Underdrain Orifice Diameter =  inches

**Calculated Parameters for Underdrain**

Underdrain Orifice Area =  ft<sup>2</sup>  
 Underdrain Orifice Centroid =  feet

**User Input: Orifice Plate with one or more orifices or Elliptical Slot Weir (typically used to drain WQCV and/or EURV in a sedimentation BMP)**

Invert of Lowest Orifice =  ft (relative to basin bottom at Stage = 0 ft)  
 Depth at top of Zone using Orifice Plate =  ft (relative to basin bottom at Stage = 0 ft)  
 Orifice Plate: Orifice Vertical Spacing =  inches  
 Orifice Plate: Orifice Area per Row =  sq. inches (diameter = 1-3/16 inches)

**Calculated Parameters for Plate**

WQ Orifice Area per Row =  ft<sup>2</sup>  
 Elliptical Half-Width =  feet  
 Elliptical Slot Centroid =  feet  
 Elliptical Slot Area =  ft<sup>2</sup>

**User Input: Stage and Total Area of Each Orifice Row (numbered from lowest to highest)**

	Row 1 (required)	Row 2 (optional)	Row 3 (optional)	Row 4 (optional)	Row 5 (optional)	Row 6 (optional)	Row 7 (optional)	Row 8 (optional)
Stage of Orifice Centroid (ft)	0.00	0.93	1.86					
Orifice Area (sq. inches)	1.18	1.18	1.18					
	Row 9 (optional)	Row 10 (optional)	Row 11 (optional)	Row 12 (optional)	Row 13 (optional)	Row 14 (optional)	Row 15 (optional)	Row 16 (optional)
Stage of Orifice Centroid (ft)								
Orifice Area (sq. inches)								

**User Input: Vertical Orifice (Circular or Rectangular)**

	Not Selected	Not Selected
Invert of Vertical Orifice =	<input type="text" value="N/A"/>	<input type="text" value="N/A"/>
Depth at top of Zone using Vertical Orifice =	<input type="text" value="N/A"/>	<input type="text" value="N/A"/>
Vertical Orifice Diameter =	<input type="text" value="N/A"/>	<input type="text" value="N/A"/>

ft (relative to basin bottom at Stage = 0 ft)  
 ft (relative to basin bottom at Stage = 0 ft)  
 inches

**Calculated Parameters for Vertical Orifice**

	Not Selected	Not Selected
Vertical Orifice Area =	<input type="text" value="N/A"/>	<input type="text" value="N/A"/>
Vertical Orifice Centroid =	<input type="text" value="N/A"/>	<input type="text" value="N/A"/>

ft<sup>2</sup>  
 feet

**User Input: Overflow Weir (Dropbox) and Grate (Flat or Sloped)**

	Zone 3 Weir	Not Selected
Overflow Weir Front Edge Height, Ho =	<input type="text" value="3.00"/>	<input type="text" value="N/A"/>
Overflow Weir Front Edge Length =	<input type="text" value="4.00"/>	<input type="text" value="N/A"/>
Overflow Weir Slope =	<input type="text" value="0.00"/>	<input type="text" value="N/A"/>
Horiz. Length of Weir Sides =	<input type="text" value="2.50"/>	<input type="text" value="N/A"/>
Overflow Grate Open Area % =	<input type="text" value="70%"/>	<input type="text" value="N/A"/>
Debris Clogging % =	<input type="text" value="50%"/>	<input type="text" value="N/A"/>

ft (relative to basin bottom at Stage = 0 ft)  
 feet  
 H:V (enter zero for flat grate)  
 feet  
 %, grate open area/total area  
 %

**Calculated Parameters for Overflow Weir**

	Zone 3 Weir	Not Selected
Height of Grate Upper Edge, H <sub>i</sub> =	<input type="text" value="3.00"/>	<input type="text" value="N/A"/>
Over Flow Weir Slope Length =	<input type="text" value="2.50"/>	<input type="text" value="N/A"/>
Grate Open Area / 100-yr Orifice Area =	<input type="text" value="1.89"/>	<input type="text" value="N/A"/>
Overflow Grate Open Area w/o Debris =	<input type="text" value="7.00"/>	<input type="text" value="N/A"/>
Overflow Grate Open Area w/ Debris =	<input type="text" value="3.50"/>	<input type="text" value="N/A"/>

feet  
 feet  
 should be ≥ 4  
 ft<sup>2</sup>  
 ft<sup>2</sup>

**User Input: Outlet Pipe w/ Flow Restriction Plate (Circular Orifice, Restrictor Plate, or Rectangular Orifice)**

	Zone 3 Restrictor	Not Selected
Depth to Invert of Outlet Pipe =	<input type="text" value="0.00"/>	<input type="text" value="N/A"/>
Outlet Pipe Diameter =	<input type="text" value="30.00"/>	<input type="text" value="N/A"/>
Restrictor Plate Height Above Pipe Invert =	<input type="text" value="21.20"/>	<input type="text" value="N/A"/>

ft (distance below basin bottom at Stage = 0 ft)  
 inches  
 inches

**Calculated Parameters for Outlet Pipe w/ Flow Restriction Plate**

	Zone 3 Restrictor	Not Selected
Outlet Orifice Area =	<input type="text" value="3.71"/>	<input type="text" value="N/A"/>
Outlet Orifice Centroid =	<input type="text" value="0.98"/>	<input type="text" value="N/A"/>
Half-Central Angle of Restrictor Plate on Pipe =	<input type="text" value="2.00"/>	<input type="text" value="N/A"/>

ft<sup>2</sup>  
 feet  
 radians

**User Input: Emergency Spillway (Rectangular or Trapezoidal)**

Spillway Invert Stage =  ft (relative to basin bottom at Stage = 0 ft)  
 Spillway Crest Length =  feet  
 Spillway End Slopes =  H:V  
 Freeboard above Max Water Surface =  feet

**Calculated Parameters for Spillway**

Spillway Design Flow Depth =  feet  
 Stage at Top of Freeboard =  feet  
 Basin Area at Top of Freeboard =  acres

### Routed Hydrograph Results

	WQCV	EURV	2 Year	5 Year	10 Year	25 Year	50 Year	100 Year	500 Year
Design Storm Return Period =									
One-Hour Rainfall Depth (in) =	0.53	1.07	1.19	1.50	1.75	2.00	2.25	2.52	3.14
Calculated Runoff Volume (acre-ft) =	0.172	0.297	0.206	0.318	0.694	1.763	2.433	3.308	5.008
OPTIONAL Override Runoff Volume (acre-ft) =									
Inflow Hydrograph Volume (acre-ft) =	0.172	0.296	0.205	0.317	0.693	1.761	2.430	3.305	4.996
Predevelopment Unit Peak Flow, q (cfs/acre) =	0.00	0.00	0.02	0.03	0.28	0.87	1.20	1.59	2.34
Predevelopment Peak Q (cfs) =	0.0	0.0	0.5	0.8	7.8	24.7	34.1	45.4	66.7
Peak Inflow Q (cfs) =	3.7	6.3	4.4	6.7	14.6	36.7	50.4	68.2	102.3
Peak Outflow Q (cfs) =	0.1	0.2	0.1	0.2	8.0	24.6	31.4	39.0	83.1
Ratio Peak Outflow to Predevelopment Q =	N/A	N/A	N/A	0.2	1.0	1.0	0.9	0.9	1.2
Structure Controlling Flow =	Plate	Plate	Plate	Plate	Overflow Grate 1	Overflow Grate 1	Overflow Grate 1	Overflow Grate 1	Spillway
Max Velocity through Grate 1 (fps) =	N/A	N/A	N/A	N/A	1.1	3.5	4.5	5.5	6.2
Max Velocity through Grate 2 (fps) =	N/A	N/A	N/A	N/A	N/A	N/A	N/A	N/A	N/A
Time to Drain 97% of Inflow Volume (hours) =	38	47	41	49	47	36	32	27	19
Time to Drain 99% of Inflow Volume (hours) =	40	51	43	52	53	48	45	42	37
Maximum Ponding Depth (ft) =	1.86	2.68	2.09	2.80	3.43	4.48	5.41	6.71	7.65
Area at Maximum Ponding Depth (acres) =	0.13	0.16	0.14	0.16	0.18	0.21	0.24	0.29	0.32
Maximum Volume Stored (acre-ft) =	0.161	0.278	0.192	0.299	0.403	0.611	0.820	1.172	1.463

# Detention Basin Outlet Structure Design

UD-Detention, Version 3.07 (February 2017)

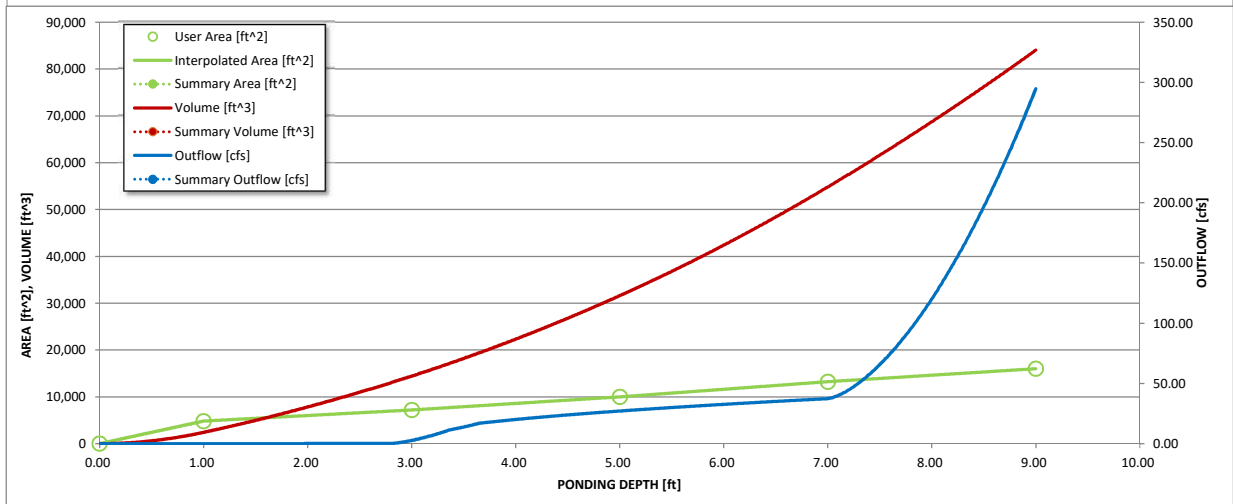
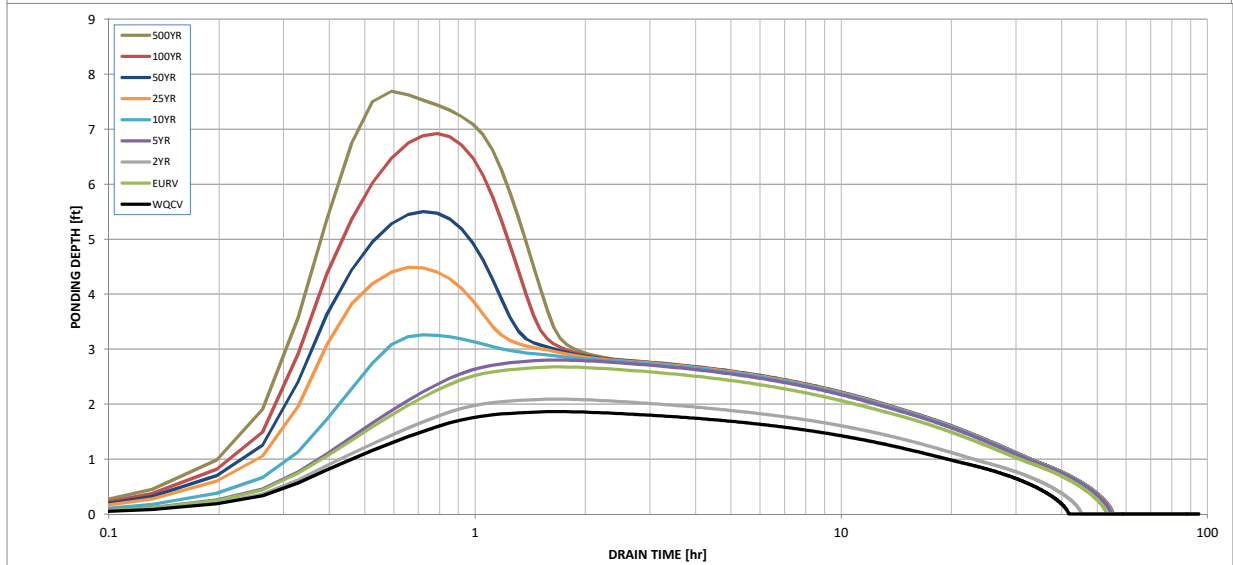
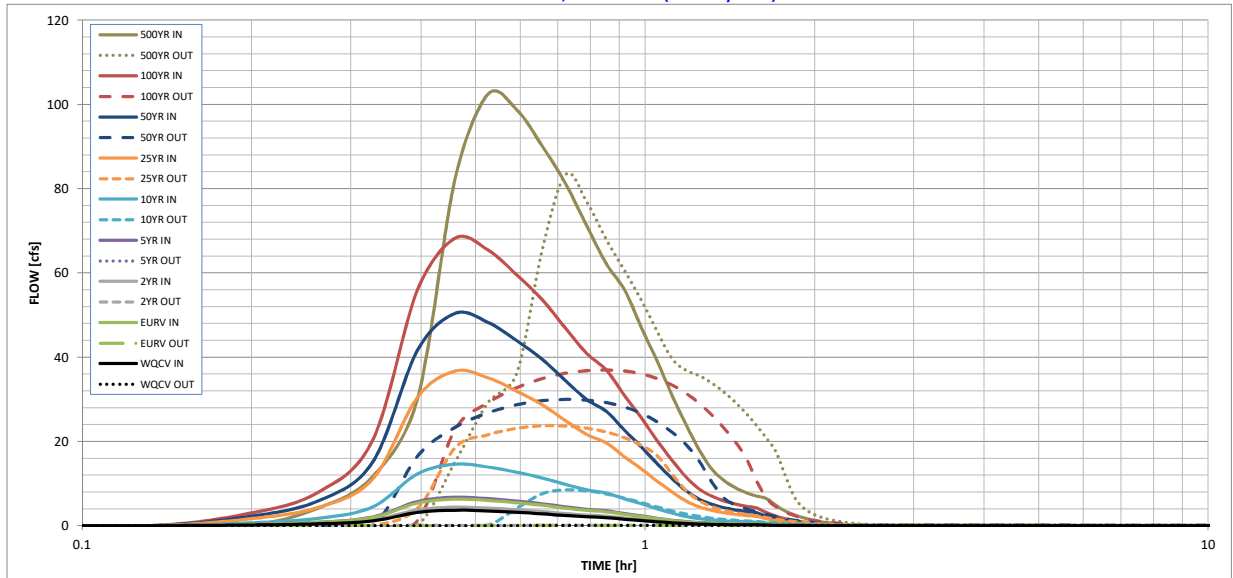

**S-A-V-D Chart Axis Override**

	X-axis	Left Y-Axis	Right Y-Axis
minimum bound			
maximum bound			

**Design Procedure Form: Extended Detention Basin (EDB)**

UD-BMP (Version 3.06, November 2016)

Sheet 1 of 4

**Designer:** JPS  
**Company:** JPS  
**Date:** July 31, 2018  
**Project:** SETTLERS VIEW SUBDIVISION  
**Location:** POND S3

<p>1. Basin Storage Volume</p> <p>A) Effective Imperviousness of Tributary Area, <math>I_a</math></p> <p>B) Tributary Area's Imperviousness Ratio (<math>i = I_a / 100</math>)</p> <p>C) Contributing Watershed Area</p> <p>D) For Watersheds Outside of the Denver Region, Depth of Average Runoff Producing Storm</p> <p>E) Design Concept (Select EURV when also designing for flood control)</p> <p>F) Design Volume (WQCV) Based on 40-hour Drain Time (<math>V_{DESIGN} = (1.0 * (0.91 * i^3 - 1.19 * i^2 + 0.78 * i) / 12 * Area)</math>)</p> <p>G) For Watersheds Outside of the Denver Region, Water Quality Capture Volume (WQCV) Design Volume (<math>V_{WQCV\ OTHER} = (d_6 * (V_{DESIGN} / 0.43))</math>)</p> <p>H) User Input of Water Quality Capture Volume (WQCV) Design Volume (Only if a different WQCV Design Volume is desired)</p> <p>I) Predominant Watershed NRCS Soil Group</p> <p>J) Excess Urban Runoff Volume (EURV) Design Volume                  For HSG A: <math>EURV_A = 1.68 * i^{1.28}</math>                  For HSG B: <math>EURV_B = 1.36 * i^{1.08}</math>                  For HSG C/D: <math>EURV_{C/D} = 1.20 * i^{1.08}</math> </p>	<p><math>I_a =</math> <u>11.0</u> %</p> <p><math>i =</math> <u>0.110</u></p> <p>Area = <u>28.500</u> ac</p> <p><math>d_6 =</math> _____ in</p> <div style="border: 1px solid black; padding: 2px; margin-bottom: 5px;">                 Choose One  <input type="radio"/> Water Quality Capture Volume (WQCV)  <input checked="" type="radio"/> Excess Urban Runoff Volume (EURV)             </div> <p><math>V_{DESIGN} =</math> <u>0.172</u> ac-ft</p> <p><math>V_{DESIGN\ OTHER} =</math> _____ ac-ft</p> <p><math>V_{DESIGN\ USER} =</math> _____ ac-ft</p> <div style="border: 1px solid black; padding: 2px; margin-bottom: 5px;">                 Choose One  <input type="radio"/> A  <input checked="" type="radio"/> B  <input type="radio"/> C / D             </div> <p>EURV = <u>0.298</u> ac-ft</p>
<p>2. Basin Shape: Length to Width Ratio (A basin length to width ratio of at least 2:1 will improve TSS reduction.)</p>	<p>L : W = <u>2.0</u> : 1</p>
<p>3. Basin Side Slopes</p> <p>A) Basin Maximum Side Slopes (Horizontal distance per unit vertical, 4:1 or flatter preferred)</p>	<p>Z = <u>4.00</u> ft / ft</p>
<p>4. Inlet</p> <p>A) Describe means of providing energy dissipation at concentrated inflow locations:</p>	<p><u>Concrete Forebay</u></p> <hr/> <hr/> <hr/>

**Design Procedure Form: Extended Detention Basin (EDB)**

Sheet 2 of 4

**Designer:** JPS  
**Company:** JPS  
**Date:** July 31, 2018  
**Project:** SETTLERS VIEW SUBDIVISION  
**Location:** POND S3

<p>5. Forebay</p> <p>A) Minimum Forebay Volume (<math>V_{FMIN} =</math> <u>2%</u> of the WQCV)</p> <p>B) Actual Forebay Volume</p> <p>C) Forebay Depth (<math>D_F =</math> <u>18</u> inch maximum)</p> <p>D) Forebay Discharge</p> <p style="margin-left: 40px;">i) Undetained 100-year Peak Discharge</p> <p style="margin-left: 40px;">ii) Forebay Discharge Design Flow (<math>Q_F = 0.02 * Q_{100}</math>)</p> <p>E) Forebay Discharge Design</p> <p>F) Discharge Pipe Size (minimum 8-inches)</p> <p>G) Rectangular Notch Width</p>	<p><math>V_{FMIN} =</math> <u>0.003</u> ac-ft</p> <p><math>V_F =</math> <u>0.007</u> ac-ft</p> <p><math>D_F =</math> <u>18.0</u> in</p> <p><math>Q_{100} =</math> <u>68.20</u> cfs</p> <p><math>Q_F =</math> <u>1.36</u> cfs</p> <div style="border: 1px solid black; padding: 2px; margin: 5px 0;"> <p>Choose One</p> <p><input type="radio"/> Berm With Pipe</p> <p><input checked="" type="radio"/> Wall with Rect. Notch</p> <p><input type="radio"/> Wall with V-Notch Weir</p> </div> <p align="right" style="color: blue; font-size: small;">(flow too small for berm w/ pipe)</p> <p>Calculated <math>D_p =</math> <u>          </u> in</p> <p>Calculated <math>W_N =</math> <u>6.3</u> in</p>
<p>6. Trickle Channel</p> <p>A) Type of Trickle Channel</p> <p>F) Slope of Trickle Channel</p>	<div style="border: 1px solid black; padding: 2px; margin: 5px 0;"> <p>Choose One</p> <p><input type="radio"/> Concrete</p> <p><input checked="" type="radio"/> Soft Bottom</p> </div> <p><math>S =</math> <u>0.0050</u> ft / ft</p> <p align="right" style="color: blue; font-size: small;">                 PROVIDE A CONSISTENT LONGITUDINAL SLOPE FROM FOREBAY TO MICROPOOL WITH NO MEANDERING. RIPRAP AND SOIL RIPRAP LINED CHANNELS ARE NOT RECOMMENDED. MINIMUM DEPTH OF 1.5 FEET             </p>
<p>7. Micropool and Outlet Structure</p> <p>A) Depth of Micropool (2.5-feet minimum)</p> <p>B) Surface Area of Micropool (10 ft<sup>2</sup> minimum)</p> <p>C) Outlet Type</p> <p>D) Smallest Dimension of Orifice Opening Based on Hydrograph Routing (Use UD-Detention)</p> <p>E) Total Outlet Area</p>	<p><math>D_M =</math> <u>2.5</u> ft</p> <p><math>A_M =</math> <u>10</u> sq ft</p> <div style="border: 1px solid black; padding: 2px; margin: 5px 0;"> <p>Choose One</p> <p><input checked="" type="radio"/> Orifice Plate</p> <p><input type="radio"/> Other (Describe):</p> </div> <hr style="border: 0; border-top: 1px solid black; margin: 5px 0;"/> <hr style="border: 0; border-top: 1px solid black; margin: 5px 0;"/> <hr style="border: 0; border-top: 1px solid black; margin: 5px 0;"/> <p><math>D_{orifice} =</math> <u>1.19</u> inches</p> <p><math>A_{ot} =</math> <u>3.54</u> square inches</p>



**Design Procedure Form: Extended Detention Basin (EDB)**

Sheet 3 of 4

**Designer:** JPS  
**Company:** JPS  
**Date:** July 31, 2018  
**Project:** SETTLERS VIEW SUBDIVISION  
**Location:** POND S3

8. Initial Surcharge Volume

- A) Depth of Initial Surcharge Volume  
(Minimum recommended depth is 4 inches)
- B) Minimum Initial Surcharge Volume  
(Minimum volume of 0.3% of the WQCV)
- C) Initial Surcharge Provided Above Micropool

$D_{IS} =$  6 in

$V_{IS} =$             cu ft

$V_s =$  5.0 cu ft

9. Trash Rack

- A) Water Quality Screen Open Area:  $A_t = A_{qt} * 38.5 * (e^{-0.095D})$
- B) Type of Screen (If specifying an alternative to the materials recommended in the USDCM, indicate "other" and enter the ratio of the total open are to the total screen are for the material specified.)  
  
Other (Y/N): N
- C) Ratio of Total Open Area to Total Area (only for type 'Other')
- D) Total Water Quality Screen Area (based on screen type)
- E) Depth of Design Volume (EURV or WQCV)  
(Based on design concept chosen under 1E)
- F) Height of Water Quality Screen ( $H_{TR}$ )
- G) Width of Water Quality Screen Opening ( $W_{opening}$ )  
(Minimum of 12 inches is recommended)

$A_t =$  122 square inches

S.S. Well Screen with 60% Open Area

User Ratio =

$A_{total} =$  203 sq. in.

$H =$  2.79 feet

$H_{TR} =$  61.48 inches

$W_{opening} =$  12.0 inches

**Design Procedure Form: Extended Detention Basin (EDB)**

Sheet 4 of 4

**Designer:** JPS  
**Company:** JPS  
**Date:** July 31, 2018  
**Project:** SETTLERS VIEW SUBDIVISION  
**Location:** POND S3

<p>10. Overflow Embankment</p> <p>A) Describe embankment protection for 100-year and greater overtopping:</p> <p>B) Slope of Overflow Embankment (Horizontal distance per unit vertical, 4:1 or flatter preferred)</p>	<p><u>Buried Riprap</u></p> <hr/> <hr/> <p align="center"><u>4.00</u></p>
<p>11. Vegetation</p>	<p>Choose One</p> <p><input type="radio"/> Irrigated</p> <p><input checked="" type="radio"/> Not Irrigated</p>
<p>12. Access</p> <p>A) Describe Sediment Removal Procedures</p>	<p><u>Periodic inspection and sediment removal as required</u></p> <hr/> <hr/> <hr/> <hr/>
<p>Notes: _____</p> <hr/> <hr/> <hr/>	

**APPENDIX D**  
**DRAINAGE COST ESTIMATE**

SETTLERS VIEW DRAINAGE IMPROVEMENTS COST ESTIMATE					
Item No.	Description	Quantity	Unit	Unit Cost (\$\$)	Total Cost (\$\$)
<b>PRIVATE DRAINAGE IMPROVEMENTS</b>					
506	Riprap Aprons (d <sub>50</sub> = 12")	100	CY	\$98	\$9,800
603	30" HDPE Pond Discharge Pipe w/ FES	78	LF	\$94	\$7,332
603	30" FES	1	EA	\$564	\$564
604	Detention Pond Grading	1000	CY	\$5	\$5,000
604	Detention Pond Forebay	1	EA	\$3,000	\$3,000
604	Detention Pond Outlet Structure	1	LS	\$8,000	\$8,000
604	Detention Pond Spillway	1	LS	\$3,000	\$3,000
	<b>SUBTOTAL</b>				<b>\$36,696</b>
	Contingency @ 15%				\$5,504
	<b>TOTAL</b>				<b>\$42,200</b>
<b>PUBLIC DRAINAGE IMPROVEMENTS (NON-REIMBURSABLE)</b>					
506	Riprap Culvert Aprons (d <sub>50</sub> = 12")	10	CY	\$98	\$980
603	18" RCP Culvert w/ FES	56	LF	\$69	\$3,864
603	30" RCP Culvert w/ FES	50	LF	\$94	\$4,700
603	18" FES	2	EA	\$414	\$828
603	30" FES	2	EA	\$564	\$1,128
	<b>SUBTOTAL</b>				<b>\$11,500</b>
	Contingency @ 15%				\$1,725
	<b>TOTAL</b>				<b>\$13,225</b>
	<b>TOTAL DRAINAGE IMPROVEMENTS</b>				<b>\$55,425</b>

## **APPENDIX E**

### **FIGURES**

J:\jpsprojects\111603.settlers-view\dwg\civil\FIGURE A1.dwg, 2/17/2017 12:37:31 PM

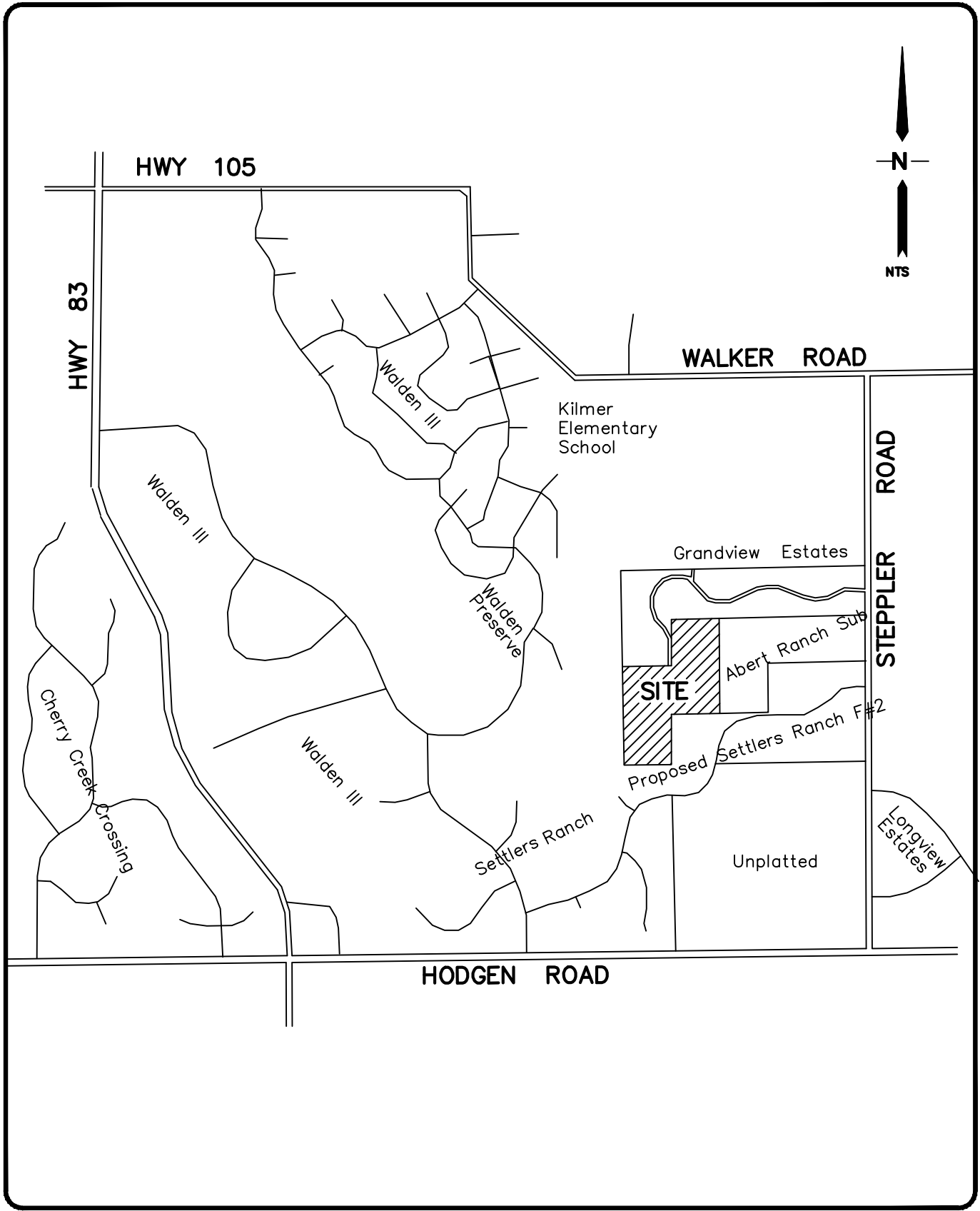

**VICINITY MAP**

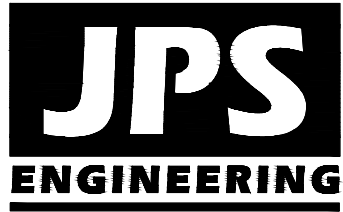

**SETTLERS VIEW**

**FIGURE A1**  
JPS PROJ NO. 111603

# National Flood Hazard Layer FIRMette



## Legend

SEE FIS REPORT FOR DETAILED LEGEND AND INDEX MAP FOR FIRM PANEL LAYOUT

SPECIAL FLOOD HAZARD AREAS		Without Base Flood Elevation (BFE) <i>Zone A, V, A99</i>
		With BFE or Depth <i>Zone AE, AO, AH, VE, AR</i>
		Regulatory Floodway
OTHER AREAS OF FLOOD HAZARD		0.2% Annual Chance Flood Hazard, Areas of 1% annual chance flood with average depth less than one foot or with drainage areas of less than one square mile <i>Zone X</i>
		Future Conditions 1% Annual Chance Flood Hazard <i>Zone X</i>
		Area with Reduced Flood Risk due to Levee. See Notes. <i>Zone X</i>
		Area with Flood Risk due to Levee <i>Zone D</i>
OTHER AREAS		NO SCREEN Area of Minimal Flood Hazard <i>Zone X</i>
		Effective LOMRs
GENERAL STRUCTURES		Area of Undetermined Flood Hazard <i>Zone D</i>
		Channel, Culvert, or Storm Sewer
		Levee, Dike, or Floodwall
OTHER FEATURES		Cross Sections with 1% Annual Chance Water Surface Elevation
		Coastal Transect
		Base Flood Elevation Line (BFE)
		Limit of Study
		Jurisdiction Boundary
MAP PANELS		Coastal Transect Baseline
		Profile Baseline
		Hydrographic Feature
		Digital Data Available
		No Digital Data Available
		Unmapped



The pin displayed on the map is an approximate point selected by the user and does not represent an authoritative property location.

This map complies with FEMA's standards for the use of digital flood maps if it is not void as described below. The basemap shown complies with FEMA's basemap accuracy standards

The flood hazard information is derived directly from the authoritative NFHL web services provided by FEMA. This map was exported on **1/29/2019 at 10:50:00 AM** and does not reflect changes or amendments subsequent to this date and time. The NFHL and effective information may change or become superseded by new data over time.

This map image is void if the one or more of the following map elements do not appear: basemap imagery, flood zone labels, legend, scale bar, map creation date, community identifiers, FIRM panel number, and FIRM effective date. Map images for unmapped and unmodernized areas cannot be used for regulatory purposes.



39°5'3.46"N

104°44'51.87"W

USGS The National Map: Orthoimagery. Data refreshed October, 2017.

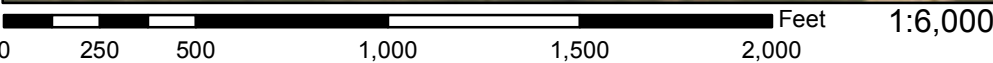

39°4'35.53"N

104°44'14.42"W



SUMMARY HYDROLOGY TABLE		
DESIGN POINT	Q5 (CFS)	Q100 (CFS)
A1	3.0	21.6
S	10.0	73.1
I	13.9	102.2

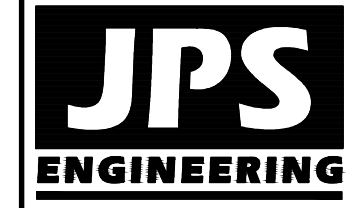
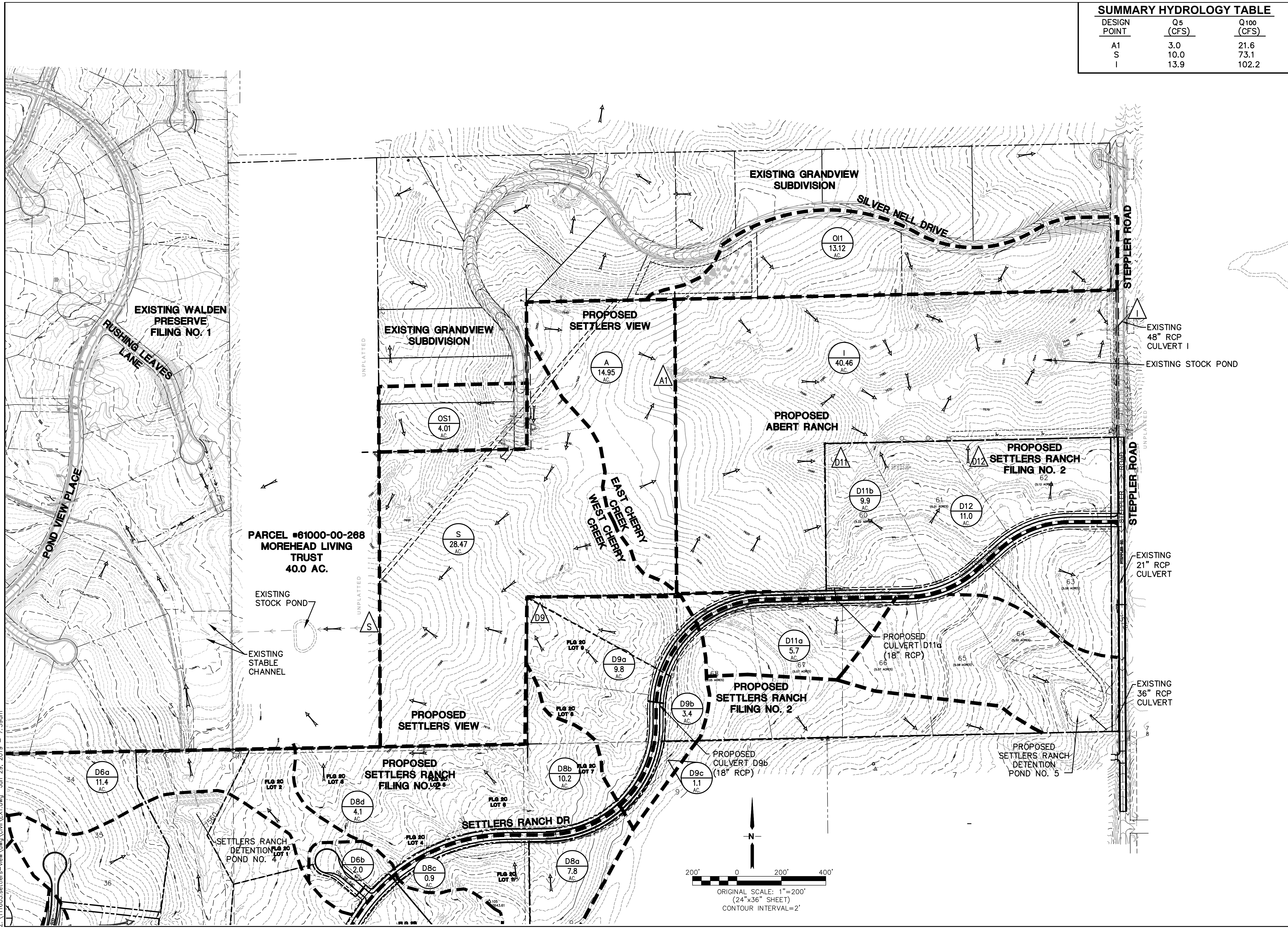

19 E. Willamette Ave.  
 Colorado Springs, CO  
 80903  
 PH: 719-477-9429  
 FAX: 719-471-0766  
 www.jpsegr.com



CALL UTILITY NOTIFICATION  
 CENTER OF COLORADO  
 1-800-922-1987  
 BEFORE YOU DIG, GRADE, OR EXCAVATE  
 FOR THE MARKING OF UNDERGROUND  
 MEMBER UTILITIES

# SETTLEERS VIEW & ABERT RANCH

NO.	REVISION	DATE

## HISTORIC DRAINAGE PLAN

HORZ. SCALE: 1"=200'	DRAWN: BJJ
VERT. SCALE: N/A	DESIGNED: JPS
SURVEYED: HANNIGAN	CHECKED: JPS
CREATED: 2/14/17	LAST MODIFIED: 1/28/19
PROJECT NO: 111603	MODIFIED BY: BJJ

SHEET: EX1

Z:\111603\settleers-view\dwg\Civil\EX1.dwg Jan 29, 2019 - 7:39am



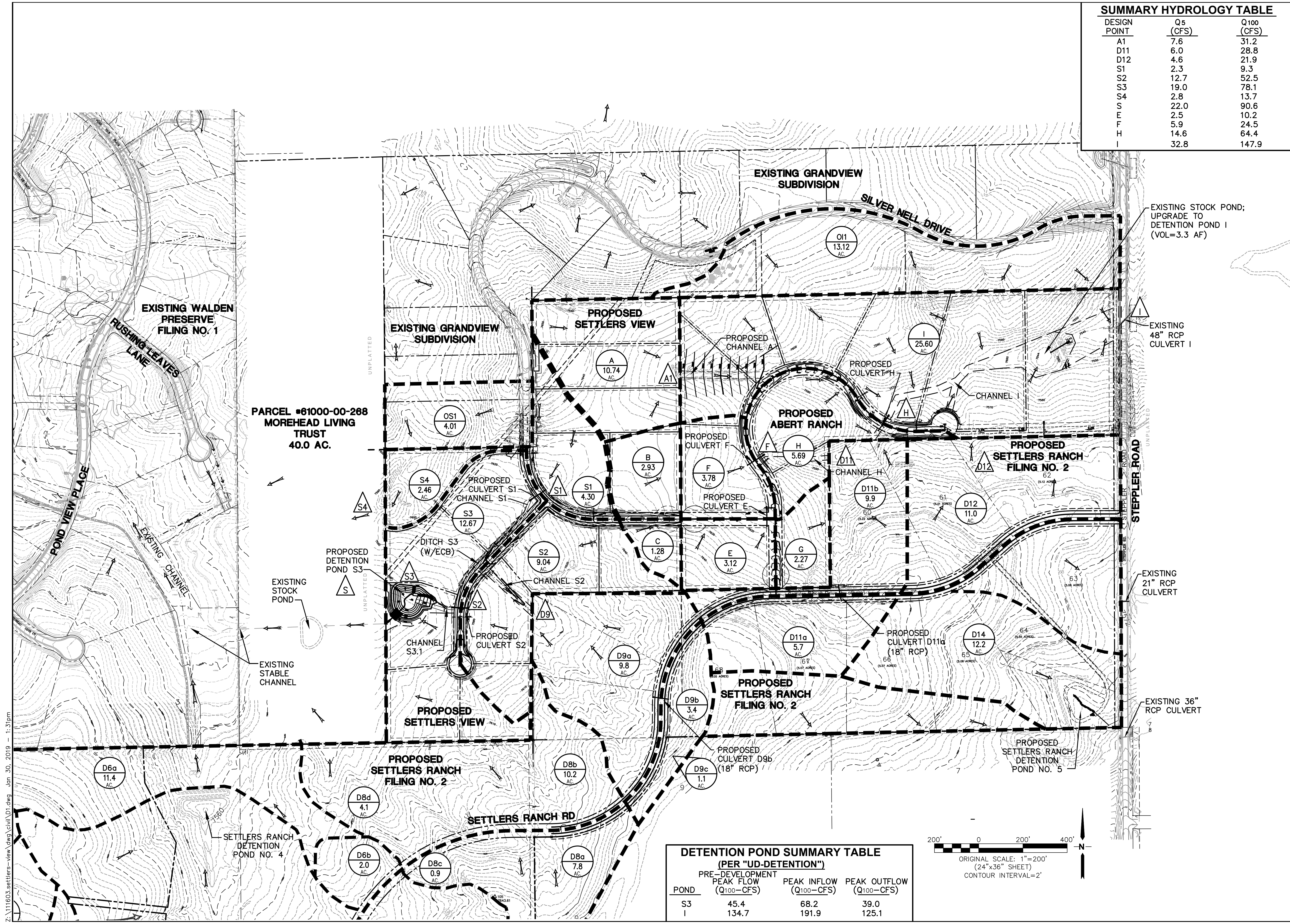

DESIGN POINT	Q5 (CFS)	Q100 (CFS)
A1	7.6	31.2
D11	6.0	28.8
D12	4.6	21.9
S1	2.3	9.3
S2	12.7	52.5
S3	19.0	78.1
S4	2.8	13.7
S	22.0	90.6
F	2.5	10.2
E	5.9	24.5
H	14.6	64.4
I	32.8	147.9

PARCEL #61000-00-288  
MOREHEAD LIVING TRUST  
40.0 AC.

POND	PRE-DEVELOPMENT PEAK FLOW (Q100-CFS)	PEAK INFLOW (Q100-CFS)	PEAK OUTFLOW (Q100-CFS)
S3	45.4	68.2	39.0
I	134.7	191.9	125.1

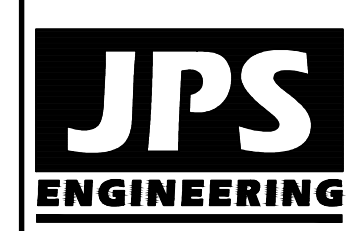
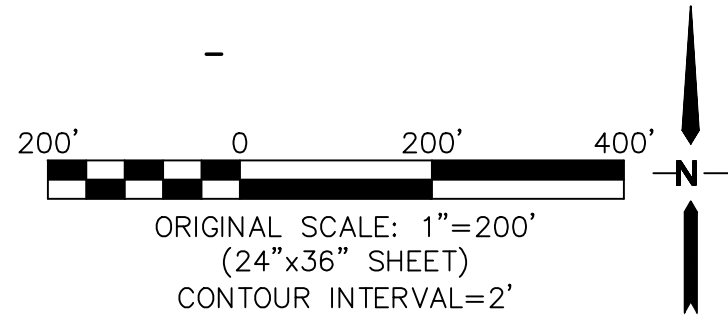

19 E. Willamette Ave.  
Colorado Springs, CO  
80903  
PH: 719-477-9429  
FAX: 719-471-0766  
www.jpsegr.com



CALL UTILITY NOTIFICATION CENTER OF COLORADO 1-800-922-1987  
CALL BEFORE YOU DIG. IN ADVANCE BEFORE YOU DIG, GRADE, OR EXCAVATE FOR THE MARKING OF UNDERGROUND MEMBER UTILITIES.

NO.	REVISION	BY	DATE

# SETTLERS VIEW & ABERT RANCH

## DEVELOPED DRAINAGE PLAN

HORZ. SCALE: 1"=200'	DRAWN: BJJ
VERT. SCALE: N/A	DESIGNED: JPS
SURVEYED: HANNIGAN	CHECKED: JPS
CREATED: 12/26/16	LAST MODIFIED: 1/30/19
PROJECT NO: 111603	MODIFIED BY: BJJ
SHEET:	

D1

Z:\111603\settlers-view\dwg\Civil\DI.dwg Jan 30, 2019 1:31pm



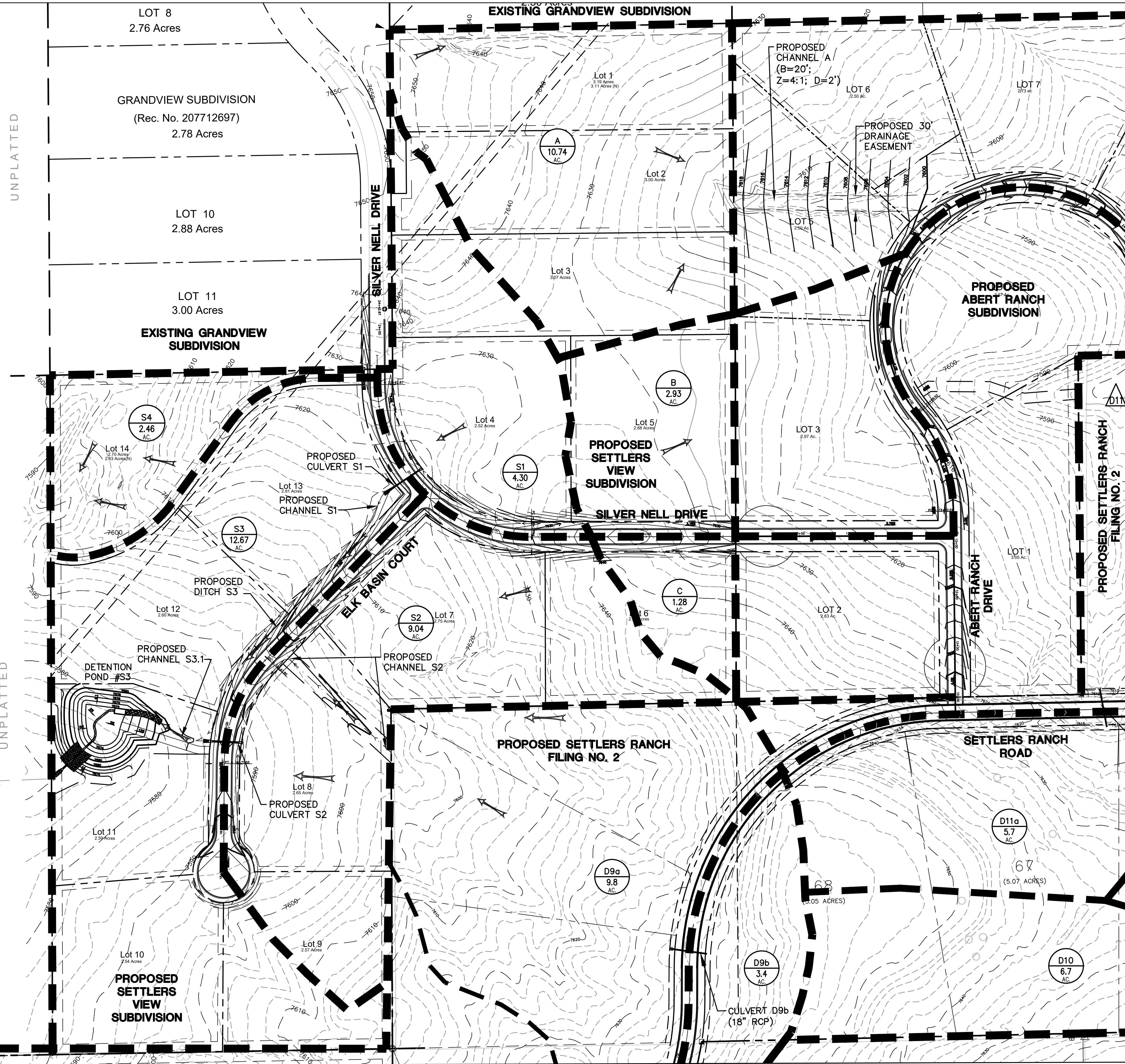
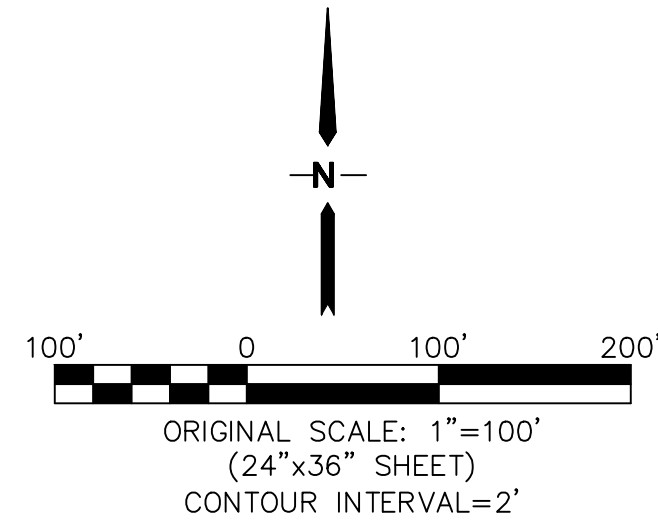

**PARCEL**  
**#61000-00-268**  
**MOREHEAD LIVING**  
**TRUST**  
**40.0 AC.**

# SETTLERS VIEW

## ENLARGED DEVELOPED DRAINAGE PLAN

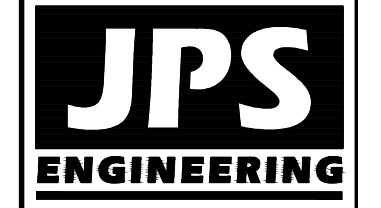

19 E. Willamette Ave.  
 Colorado Springs, CO  
 80903  
 PH: 719-477-9429  
 FAX: 719-471-0766  
 www.jpsegr.com



CALL UTILITY NOTIFICATION  
 CENTER OF COLORADO  
 1-800-922-1987  
 BEFORE YOU DIG, GRADE, OR EXCAVATE  
 FOR THE MARKING OF UNDERGROUND  
 MEMBER UTILITIES.

No.	REVISION	BY	DATE

HORZ. SCALE: 1"=100'	DRAWN: BJJ
VERT. SCALE: N/A	DESIGNED: JPS
SURVEYED: HANNIGAN	CHECKED: JPS
CREATED: 12/26/16	LAST MODIFIED: 1/30/19
PROJECT NO: 111603	MODIFIED BY: BJJ

SHEET: **D1.1**

Z:\111603\settlers-view\dwg\civil\D1.1.dwg, Jan. 30, 2019 - 3:35pm



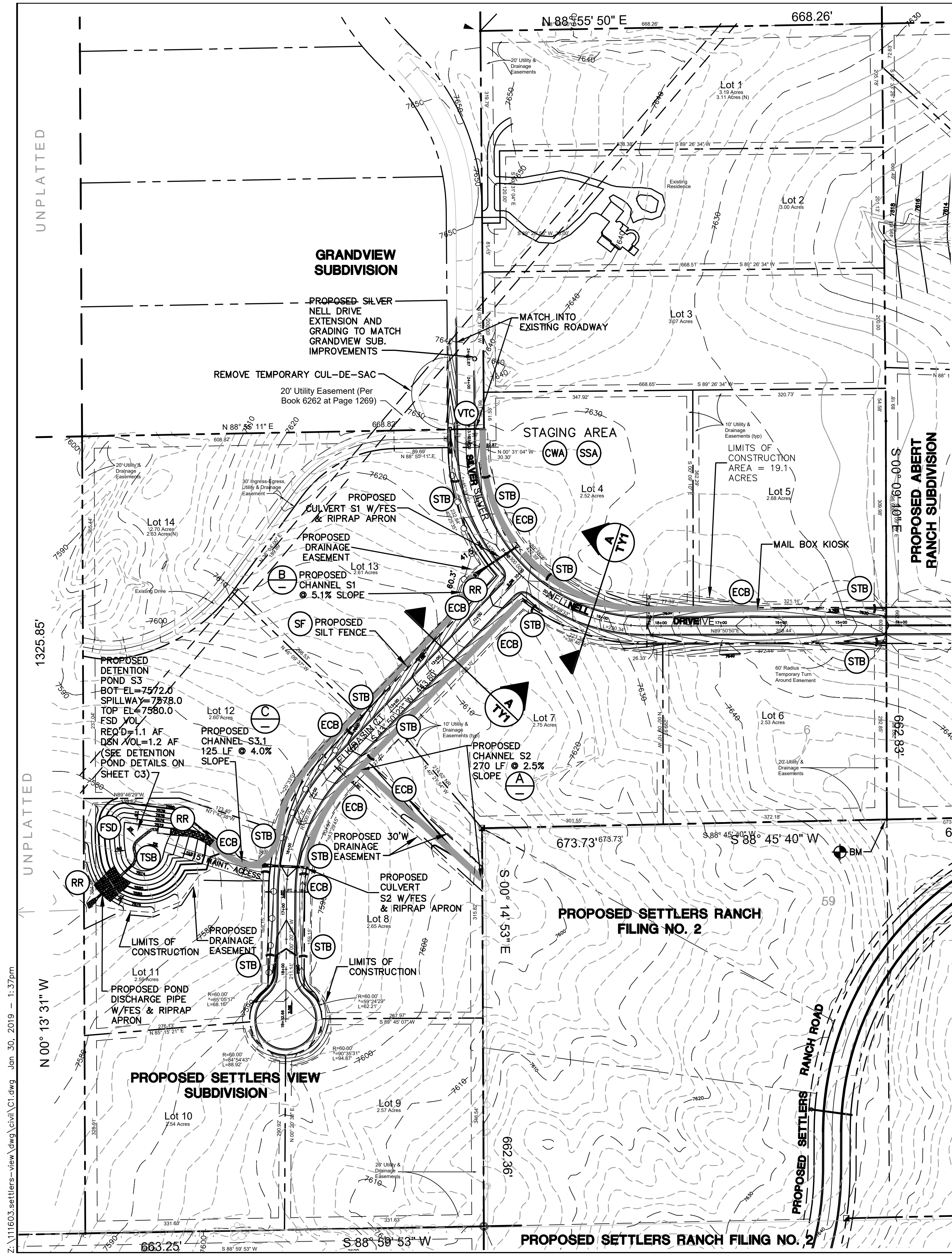

NOTE:  
EXISTING VEGETATION CONSISTS OF NATIVE GRASSES.

GENERAL DRAINAGE NOTES:  
1. INDIVIDUAL BUILDERS SHALL PROVIDE POSITIVE DRAINAGE AWAY FROM STRUCTURES AND ACCOUNT FOR POTENTIAL CROSS-LOT DRAINAGE IMPACTS WITHIN EACH LOT.  
2. BUILDERS AND PROPERTY OWNERS SHALL IMPLEMENT & MAINTAIN EROSION CONTROL BEST MANAGEMENT PRACTICES FOR PROTECTION OF DOWNSTREAM PROPERTIES AND FACILITIES INCLUDING PROTECTION OF EXISTING GRASS BUFFER STRIPS ALONG THE DOWNSTREAM PROPERTY BOUNDARIES.

ESTIMATED EARTHWORK QUANTITY:  
UNCLASSIFIED EXCAVATION (TOTAL CUT) = 6,072 CY  
EMBANKMENT FILL = 7,144 CY  
NET (FILL) = 1,072 CY  
\*(ASSUMES 15% COMPACTION FACTOR)

NOTE: THIS ESTIMATE IS PROVIDED FOR INFORMATION ONLY, REPRESENTING THE CALCULATED BULK EARTHWORK VOLUME NOT INCLUDING ANY ADJUSTMENTS FOR PAVEMENT DEPTHS. CONTRACTOR SHALL MAKE HIS OWN DETERMINATION OF EARTHWORK QUANTITIES AS BASIS FOR BID PRICING AND NOTIFY ENGINEER OF ANY DISCREPANCIES.

KEYED NOTES:  
① CONTRACTOR MAY WASTE EXCESS CUT MATERIAL OR BORROW SUITABLE FILL MATERIAL FROM THIS AREA. MATCH INTO EXISTING GRADES WITH 3:1 MAX CUT AND FILL SLOPES AND MAINTAIN POSITIVE DRAINAGE IN ALL AREAS.

**BMP PHASING**

- INITIAL BMP'S
- INSTALL VTC
  - INSTALL SILT FENCE
  - TEMPORARY SEDIMENT BASIN
- INTERIM BMP'S
- STRAW BALE CHECK DAMS
- FINAL BMP'S
- RIPRAP APRONS
  - SEEDING

**LEGEND**

- BOUNDARY LINES
- - - DRAINAGE BASIN BOUNDARY
- 6520 EXISTING CONTOUR
- x 82.0 PROPOSED SPOT ELEVATION (FLOWLINE)
- x 82.0 EXISTING SPOT ELEVATION (FLOWLINE)
- DRAINAGE CHANNEL
- PROPOSED FLOW DIRECTION ARROW
- PROPOSED CULVERT W/ FLARED END SECTIONS
- IP INLET PROTECTION
- RR RIPRAP
- VTC VEHICLE TRACKING CONTROL PAD
- STB OR SCL STRAW BALE BARRIER @ 300' SPACING
- SF SILT FENCE
- TM STRAW BALES
- TM TEMPORARY SEED AND MULCH ON DISTURBED SLOPES
- ECB EROSION CONTROL BLANKET DITCH LINING (SC 150 OR EQUAL)
- TSB TEMPORARY SEDIMENT BASIN (DURING CONSTRUCTION)
- CWA CONCRETE WASHOUT AREA
- SSA STABILIZED STAGING AREA
- LIMITS OF CONSTRUCTION

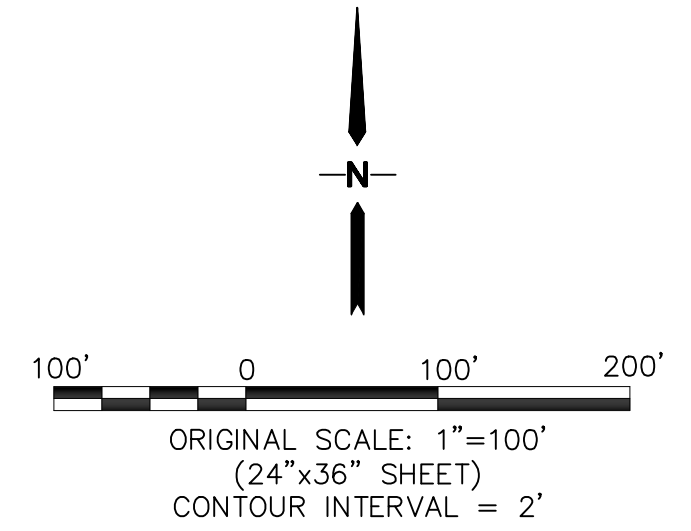
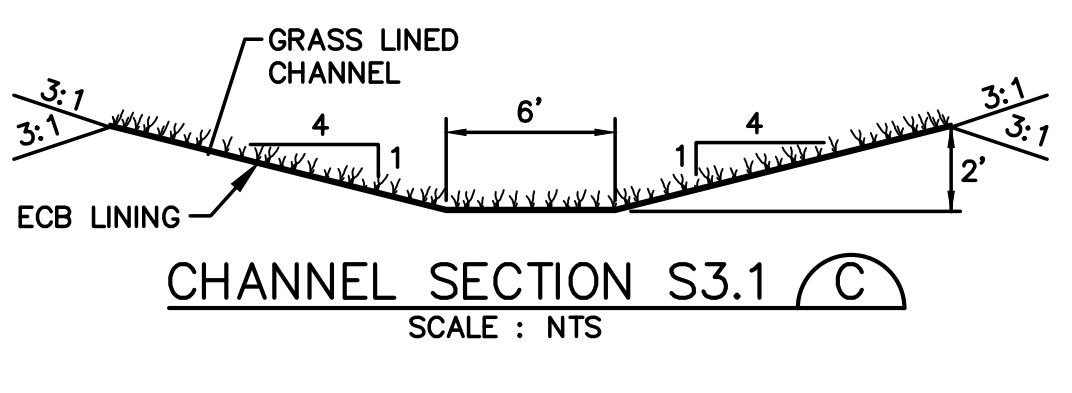
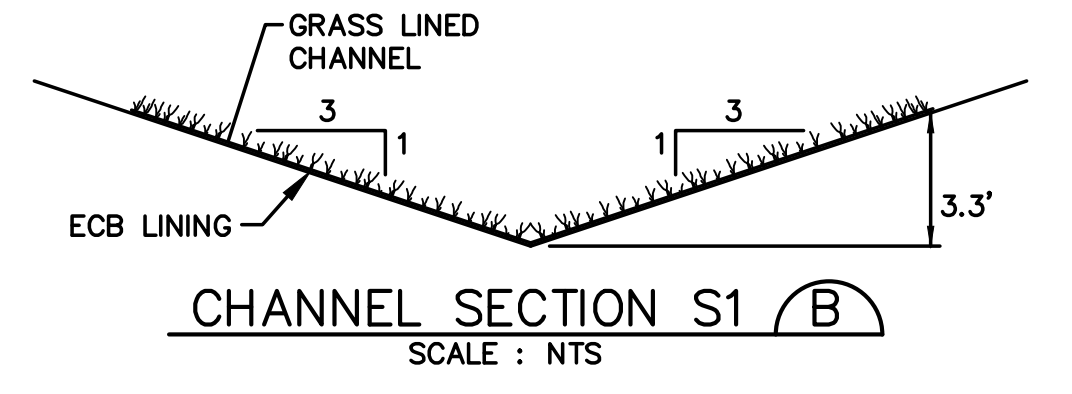
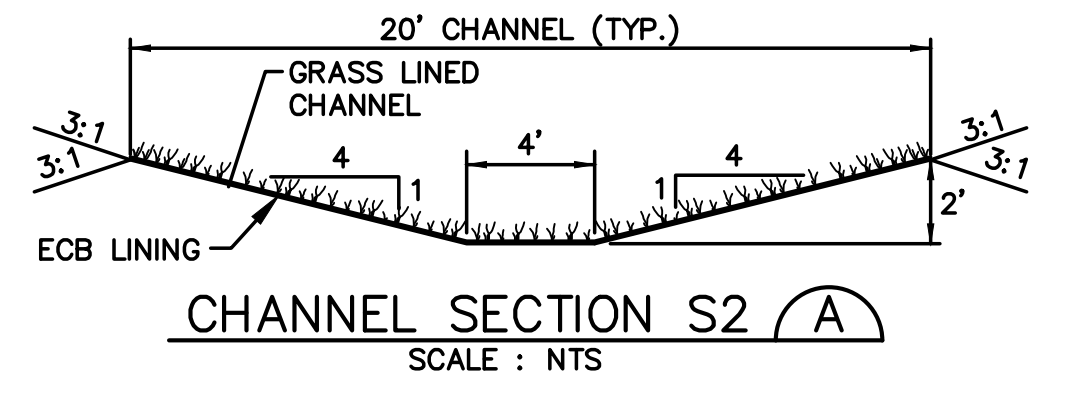

BENCHMARK  
THE MONUMENT AT THE SOUTHEAST PROPERTY CORNER, HAVING AN ASSUMED ELEVATION OF 7650.0 DATUM IS NAVD '88.

**SETTLERS VIEW SUBDIVISION**

**SITE GRADING & EROSION CONTROL PLAN**

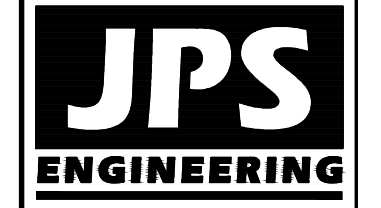

19 E. Willamette Ave.  
Colorado Springs, CO 80903  
PH: 719-477-9429  
FAX: 719-471-0766  
www.jpsegr.com



CALL UTILITY NOTIFICATION CENTER OF COLORADO  
1-800-922-1987  
CALL BEFORE YOU DIG. IN ALL AREAS BEFORE YOU DIG, GRADE, OR EXCAVATE FOR THE MARKINGS OF UNDERGROUND MEMBER UTILITIES.

NO.	REVISION	DATE	BY
1	COUNTY COMMENTS	2/13/18	JPS
2	COUNTY COMMENTS	7/31/18	JPS
3	FINAL PLAT SUBMITTAL	1/30/19	JPS

HORZ. SCALE: 1"=100'	DRAWN: BJJ
VERT. SCALE: N/A	DESIGNED: JPS
SURVEYED: N/A	CHECKED: JPS
CREATED: 11/23/16	LAST MODIFIED: JPS
PROJECT NO: 111603	MODIFIED BY: BJJ

SHEET: **C1**

PCD File No. SF-18-041

Z:\111603\settlers-view\dwg\civil\C1.dwg Jan 30, 2019 - 1:37pm