

**FINAL DRAINAGE REPORT
FOR
MVEA YODER ELECTRIC SUBSTATION
EL PASO COUNTY, COLORADO**

AUGUST 2018

Prepared For:
MOUNTAIN VIEW ELECTRIC ASSOCIATION
David Waldner
11140 E Woodmen Rd, Peyton, CO 80831
(719) 495-2283

Prepared By:
TERRA NOVA ENGINEERING, INC.
721 S 23rd Street
Colorado Springs, CO 80904
(719) 635-6422

Job No. 1802.00

**FINAL DRAINAGE REPORT
FOR
MVEA YODER ELECTRIC SUBSTATION**

TABLE OF CONTENTS

Engineer's Statement	Page 3
Purpose	Page 4
General Description	Page 4
Floodplain Statement	Page 5
Existing Drainage Conditions	Page 5
Proposed Drainage Conditions	Page 6
Hydrologic Calculations	Page 8
Hydraulic Calculations	Page 8
Erosion Control	Page 8
Maintenance	Page 9
Construction Cost Opinion	Page 9
Drainage Fees	Page 9
Summary	Page 10
Bibliography	Page 11

REQUIRED MAPS AND DRAWINGS

VICINITY MAP

S.C.S. SOILS MAP

FEMA FIRM MAP

HYDROLOGIC CALCULATIONS

DRAINAGE PLAN

CERTIFICATION STATEMENT:

Engineers Statement

This attached drainage plan and report were prepared under my direction and supervision and are correct to the best of my knowledge and belief. Said drainage report has been prepared according to the criteria established by the County for drainage reports and said report is in conformity with the master plan of the drainage basin. I accept responsibility for any liability caused by any negligent acts, errors or omissions on my part in preparing this report.

Quentin Armijo, P.E. 37170

Seal

Developers Statements

I, Mountain View Electric Association, the developer have read and will comply with all of the requirements specified in this drainage report and plan.

Mountain View Electric Association

Business Name

By: _____

Title: _____

Address: _____

El Paso County Approval:

Filed in accordance with the requirements of the Drainage Criteria Manual, Volumes 1 & 2, El Paso County Engineering Criteria Manual and Land Development Code as amended.

Jennifer Irvine,
County Engineer / ECM Administrator

Date

Conditions:

**FINAL DRAINAGE REPORT
FOR
MVEA YODER ELECTRIC SUBSTATION**

PURPOSE

The purpose of this Final Drainage Report is to identify and analyze the proposed drainage patterns, determine proposed runoff quantities, size drainage structures for conveyance of developed runoff, and present solutions to drainage impacts on-site and off-site resulting from this development. In an effort to protect receiving water and as part of the “four step process to minimize adverse impacts of urbanization” this site was analyzed in the following manner:

1. Reduce Runoff- The new improvements to the site, which consist of adding gravel to the yard will be routed to a proposed private Sediment Basin. By capturing these flows in the sediment basin the developed runoff will be detained and reduce the quantity of downstream runoff.
2. Treat Slowly Release WQCV- The sediment basins will capture the developed flows and allow them to infiltrate, thereby also allowing solids and contaminants to settle out thus stopping downstream transport.
3. Stabilize Stream Channel- By reducing the rate of runoff the site is helping to stabilize the downstream Upper Pond creek and ultimately Chico Creek.
4. Source Controls- As this development will not include outdoor storage or the potential for the introduction of contaminants to the County’s MS4, since it is not an industrial or commercial site, no source controls are proposed or necessary.

GENERAL DESCRIPTION

This Final Drainage Report (FDR) is an analysis of approximately 5.0 acres of undeveloped land located just east of the residential house at 1625 N. Yoder Road. This site is being developed by our client to include an electric substation. The development will also include improving the dirt access road to gravel. The site is located in the southwest quarter of Section 3, Township 14 South, Range 61 West of the 6th Principal

Meridian currently within El Paso County, Colorado. The site is bounded to the north, west, & south by a 40 acres single family lots, and to the east by undeveloped open space. The site is contained within the Upper Pond Creek Basin.

Soils for this project are delineated by the map in the appendix as Bresser sandy loam (11) 0 to 3 percent slopes and Truckton sandy loam (97), 3 to 9 percent slopes. Soils in the study area are shown as mapped by S.C.S. in the “Soils Survey of El Paso County Area” and contains soils of Hydrologic Group B and A respectively.

FLOODPLAIN STATEMENT

No portion of this site is within a designated F.E.M.A. floodplain, as determined by Flood Insurance Rate Map No. 08041C0875 F, dated March 17, 1997 (see appendix).

EXISTING DRAINAGE CONDITIONS

The site has not been previously developed and is currently part of a 40 acre single family parcel. The site consists mostly of natural vegetative grass and weeds, with some areas of bare ground. There is a natural ridge that runs north south through the site and splits it. The site has been broken down into two existing design points 1 & 2, two existing onsite basins EXA & EXB and three existing offsite basins OS-1, OS-2 & OS-3 in order to show the historic drainage flows. Below is a description of them. See appendix for calculations.

The drainage map shows thee existing design points.

Offsite Basin OS-1 (11.85 acres; $Q_5=2.7$ cfs and $Q_{100}=17.4$ cfs) consist of undeveloped open space prairie. Drainage in this basin sheet flows from north to south and drains onto Basin EXA.

Basin EXA (3.83 acres; $Q_5=1.1$ cfs and $Q_{100}=7.4$ cfs) consist of undeveloped open space prairie. Drainage in this basin sheet flows from north to south. The combined flow ($Q_5=3.5$ cfs and $Q_{100}=23.0$ cfs) of Basin OS-1 and EXA sheet flows south in an existing broad swale and then to a low point at the south boundary (Design Point 1) where it ponds and then overtops offsite.

What is being over-topped?

Offsite Basin OS-2 (0.33 acres; $Q_5=0.1$ cfs and $Q_{100}=0.7$ cfs) consist of undeveloped open space prairie. Drainage in this basin sheet flows from northwest to southeast and partially drains onto Basin EXB.

Basin EXB (1.17 acres; $Q_5=0.4$ cfs and $Q_{100}=2.7$ cfs) consist of undeveloped open space prairie. Drainage in this basin sheet flows from northwest to southeast. The combined flow ($Q_5=0.5$ cfs and $Q_{100}=3.4$ cfs) of Basin OS-2 and EXB sheet flows southeast into an existing offsite natural channel (Design Point 2).

Offsite Basin OS-3 (7.79 acres; $Q_5=1.8$ cfs and $Q_{100}=11.5$ cfs) consist of undeveloped open space prairie and a section of a dirt access road. Drainage in this basin sheet flows from north to south and drains across the existing dirt access road along the south part of the basin and continues south onto the adjacent lot.

An extended detention basin is not part of the proposed design. Please correct throughout the FDR accordingly.

PROPOSED DRAINAGE CONDITIONS

Runoff in the developed conditions will closely flow the historic drainage patterns with the exception of adding an Extended Detention Basin to capture and treat the runoff from the developed substation yard. For analysis the site has been broken down into three design points 1, 2, & 1A, four onsite basins A, A1, A2, & B and the same three existing offsite basins OS-1, OS-2 & OS-3. Below is a description of the runoff in the developed conditions and how it will be safely routed and treated. See appendix for calculations.

The drainage map shows four design points

Offsite Basin OS-1 (11.85 acres; $Q_5=2.7$ cfs and $Q_{100}=17.4$ cfs) consist of undeveloped open space prairie. Drainage in this basin sheet flows from north to south and drains onto Basin A1.

Basin A1 (1.70 acres; $Q_5=0.5$ cfs and $Q_{100}=3.4$ cfs) consist of undeveloped open space prairie that will be inside the site boundary but will not have any improvements other than placing a 2' high berm on the north side of the yard to direct runoff to a broad swale,

so the offsite flow can be routed around the substation yard. Drainage in this basin sheet flows to the broad swale (Design Point 1A). The combined flow ($Q_5=3.1$ cfs and $Q_{100}=19.9$ cfs) of Basin OS-1 and A1 is directed south in the broad swale and then to a low point at the south boundary (Design Point 1).

Basin A (1.65 acres; $Q_5=1.3$ cfs and $Q_{100}=4.3$ cfs) will consist of the proposed substation yard with ground cover comprised of loose gravel. Drainage in this basin sheet flows south to a proposed 2' deep depression acting as a sediment trap (Design Point 1B). At the depression the runoff from the gravel covered yard will be treated by allowing it to infiltrate and also detaining developed flows from the new improvements within the electric yard. In a major storm event an armored 5' weir is set 0.5' below the top will allow for the flow to be safely routed downstream offsite to Design Point 1.

Basin A2 (0.47 acres; $Q_5=0.2$ cfs and $Q_{100}=1.1$ cfs) will consist undeveloped land with some gravel drive in the area just south of the proposed sediment trap. Drainage in this basin sheet flows south to Design Point 1. The combined flow of Basins OS-1, A, A1, & A2 at Design Point 1 is $Q_5=4.2$ cfs and $Q_{100}=23.7$ cfs without the sediment trap. The sediment trap will reduce the overall flow by capturing Basin A's flow and allowing it to infiltrate.

As in the historic condition Offsite Basin OS-2 (0.33 acres; $Q_5=0.1$ cfs and $Q_{100}=0.7$ cfs) consist of undeveloped open space prairie. Drainage in this basin sheet flows from northwest to southeast and partially drains onto Basin EXB.

Basin B (1.17 acres; $Q_5=0.4$ cfs and $Q_{100}=2.7$ cfs) consist of undeveloped open space prairie inside the property, but is not being improved. Drainage in this basin sheet flows from northwest to southeast. The combined flow ($Q_5=0.5$ cfs and $Q_{100}=3.4$ cfs) of Basin OS-2 and EXB sheet flows southeast into an existing offsite natural channel (Design Point 2).

Provide the Q_5 and Q_{100} values for the flow with the sediment trap and state that it is less than the historic flows.

State whether water rights will be impacted by any potential retention of water.

Offsite Basin OS-3 (7.79 acres; $Q_5=1.9$ cfs and $Q_{100}=11.6$ cfs) consist of undeveloped open space prairie and a section of a gravel access road. Drainage in this basin sheet flows from north to south in order to limit the small increase ($Q_5=0.1$ cfs and $Q_{100}=0.1$ cfs) in developed flow and to slow the runoff down before crossing the gravel road and washing the gravel away we have installed a sediment basin. The runoff will be allowed to infiltrate thus reducing the runoff while treating it for water quality. drains across the gravel access road along the south part of the basin and continues south onto the adjacent lot.

Please also state that the gravel road will be maintained appropriately to prevent any runoff of gravel onto the adjacent property.

HYDROLOGIC CALCULATIONS

Hydrologic calculations were performed using the El Paso County Storm Drainage Design Criteria Manual - Volumes 1 & 2, latest editions. The Rational Method was used to estimate storm water runoff anticipated from design storms with 5-year and 100-year recurrence intervals. The Urban Drainage Criteria Manual was used to calculate the detention and water quality volume.

HYDRAULIC CALCULATIONS

Hydraulic calculations were estimated using the Manning's Formula and the methods described in the El Paso County Storm Drainage Design Criteria Manual – Volumes 1 & 2, latest editions. The pertinent data sheets are included in the appendix of this report.

EROSION CONTROL

An erosion control plan is included with this drainage report. Vehicle Tracking Control (VTC) will be placed at any entrance to the site. A Concrete Washout (CW) will be placed on site, as well as a Materials Staging Area (SSA) and a Dirt Stockpile (SP) location. Silt Fence (SF) will be placed around the SP and Sediment Control Logs (SCL) are to be placed at the southern border of the site to keep runoff in place.

MAINTENANCE

The Sediment Basins are private and therefore must be maintained by the owner. A systematic inspection of all the above mentioned protective devices shall be performed

using the operation and maintenance manual associated with this project once every 14 days. Additional inspections may be required prior to anticipated precipitation events and after precipitation events. Post-storm event inspections must be conducted within 24 hours after the end of any precipitation or snowmelt event that causes surface erosion. Provided the timing is appropriate, the post storm inspections may be used to fulfill the 14-day routine inspection requirement. A more frequent inspection schedule than the minimum inspections described may be necessary to ensure that BMPs continue to operate as needed to comply with the plan.

CONSTRUCTION COST OPINION

Public Non Reimbursable

NOT APPLICABLE

Private Non Reimbursable

1. Sediment Trap	2 EA	\$ 5,000	<u> \$ 10,000</u>
			Total \$ 10,000

DRAINAGE FEES

The existing site is in the Upper Pond Creek Basin. This is an unstudied basin and therefore no basin fees are due at the time of final plat.

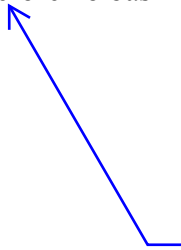

Please remove "therefore". It is an unstudied basin, but that is not the reason that it is a no fee basin. Please just state that it has no established fee.

SUMMARY

Development of this site will not adversely affect the surrounding development. Proposed flows, as detailed in this report, will follow the drainage patterns outlined in

this report showing how runoff will be safely routed downstream. The Extended Detention Basins will control developed flow to historic levels and provide water quality for this site. These water features will need to be periodically maintained by the owner in order to maintain their effectiveness in cleaning the discharge form the site.

PREPARED BY:
TERRA NOVA ENGINEERING, INC.

Quentin Armijo, P.E.
Senior Project Manager
Jobs/1802.00/drainage/180200 - FDR.doc

REFERENCE

“El Paso County Drainage Criteria Manual-Volumes 1 & 2, latest edition”

SCS Soils Map for El Paso County

Federal Emergency Management Agency (FEMA) flood maps

VICINITY MAP

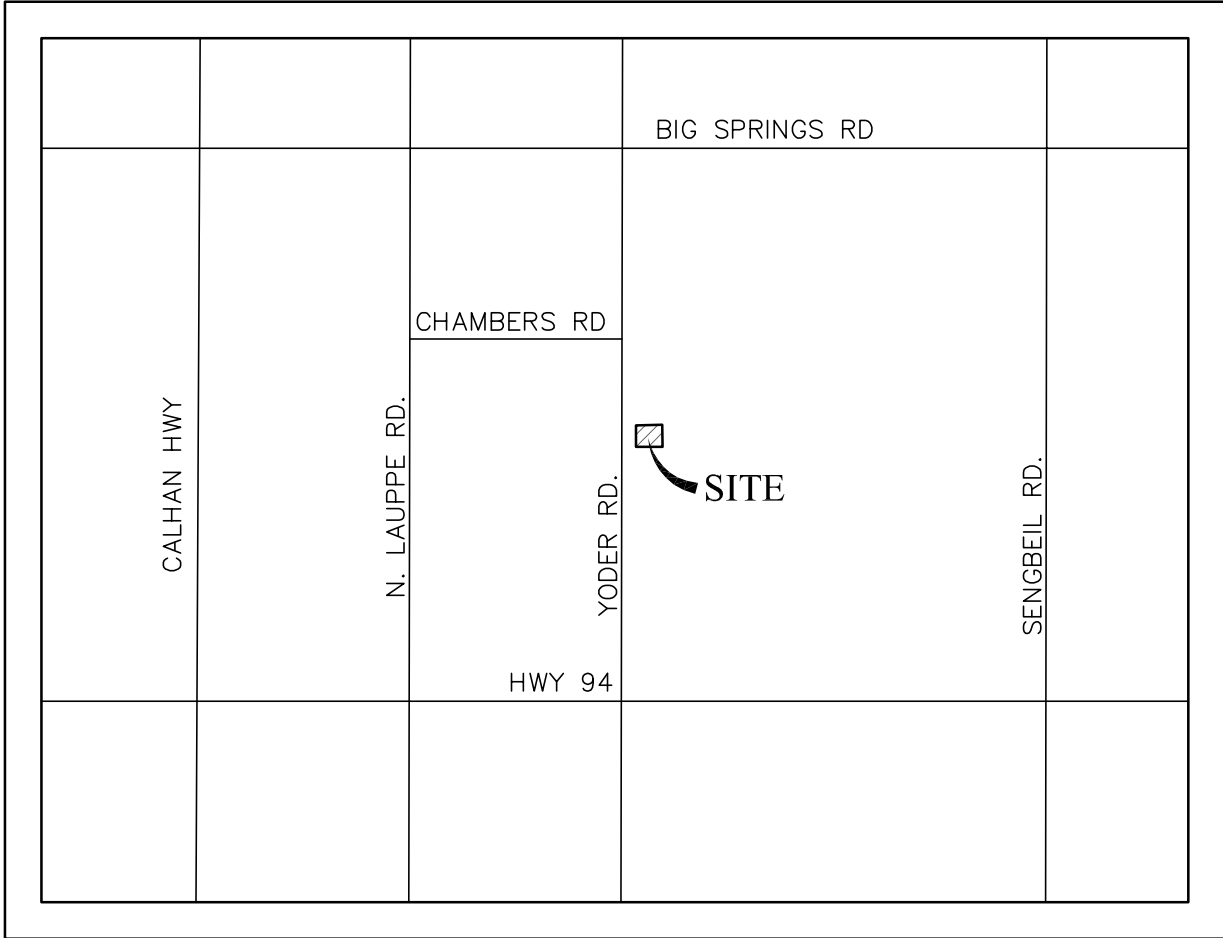

VICINITY MAP
N.T.S.

S.C.S. SOILS MAP

Soil Map—El Paso County Area, Colorado



MAP LEGEND

- Area of Interest (AOI)
- Soil Map Unit Polygons
- Soil Map Unit Lines
- Soil Map Unit Points
- Special Point Features**
 - Blowout
 - Borrow Pit
 - Clay Spot
 - Closed Depression
 - Gravel Pit
 - Gravelly Spot
 - Landfill
 - Lava Flow
 - Marsh or swamp
 - Mine or Quarry
 - Miscellaneous Water
 - Perennial Water
 - Rock Outcrop
 - Saline Spot
 - Sandy Spot
 - Severely Eroded Spot
 - Sinkhole
 - Slide or Slip
 - Sodic Spot
- Water Features**
 - Streams and Canals
- Transportation**
 - Rails
 - Interstate Highways
 - US Routes
 - Major Roads
 - Local Roads
- Background**
 - Aerial Photography
- Spoil Area
- Stony Spot
- Very Stony Spot
- Wet Spot
- Other
- Special Line Features

MAP INFORMATION

The soil surveys that comprise your AOI were mapped at 1:24,000.

Warning: Soil Map may not be valid at this scale.

Enlargement of maps beyond the scale of mapping can cause misunderstanding of the detail of mapping and accuracy of soil line placement. The maps do not show the small areas of contrasting soils that could have been shown at a more detailed scale.

Please rely on the bar scale on each map sheet for map measurements.

Source of Map: Natural Resources Conservation Service
 Web Soil Survey URL:
 Coordinate System: Web Mercator (EPSG:3857)

Maps from the Web Soil Survey are based on the Web Mercator projection, which preserves direction and shape but distorts distance and area. A projection that preserves area, such as the Albers equal-area conic projection, should be used if more accurate calculations of distance or area are required.

This product is generated from the USDA-NRCS certified data as of the version date(s) listed below.

Soil Survey Area: El Paso County Area, Colorado
 Survey Area Data: Version 15, Oct 10, 2017

Soil map units are labeled (as space allows) for map scales 1:50,000 or larger.

Date(s) aerial images were photographed: May 22, 2016—Mar 9, 2017

The orthophoto or other base map on which the soil lines were compiled and digitized probably differs from the background imagery displayed on these maps. As a result, some minor shifting of map unit boundaries may be evident.

Map Unit Legend

Map Unit Symbol	Map Unit Name	Acres in AOI	Percent of AOI
11	Bresser sandy loam, cool, 0 to 3 percent slopes	1.2	24.5%
97	Truckton sandy loam, 3 to 9 percent slopes	3.8	75.5%
Totals for Area of Interest		5.0	100.0%

FEMA FIRM MAP

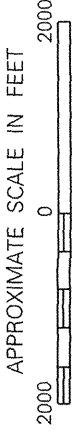

APPROXIMATE SCALE IN FEET

NATIONAL FLOOD INSURANCE PROGRAM

FIRM
FLOOD INSURANCE RATE MAP
 EL PASO COUNTY,
 COLORADO AND
 INCORPORATED AREAS

PANEL 875 OF 1300
 (SEE MAP INDEX FOR PANELS NOT PRINTED)

CONTAINS:
 COMMUNITY _____ NUMBER _____ PANEL _____ SUFFIX _____

EL PASO COUNTY,
 UNINCORPORATED AREAS 080059 0875 F

MAP NUMBER 08041C0875 F
EFFECTIVE DATE: MARCH 17, 1997



Federal Emergency Management Agency

This is an official copy of a portion of the above referenced flood map. It was extracted using F-MIT On-Line. This map does not reflect changes or amendments which may have been made subsequent to the date on the title block. For the latest product information about National Flood Insurance Program flood maps, check the FEMA Flood Map Store at www.msc.fema.gov

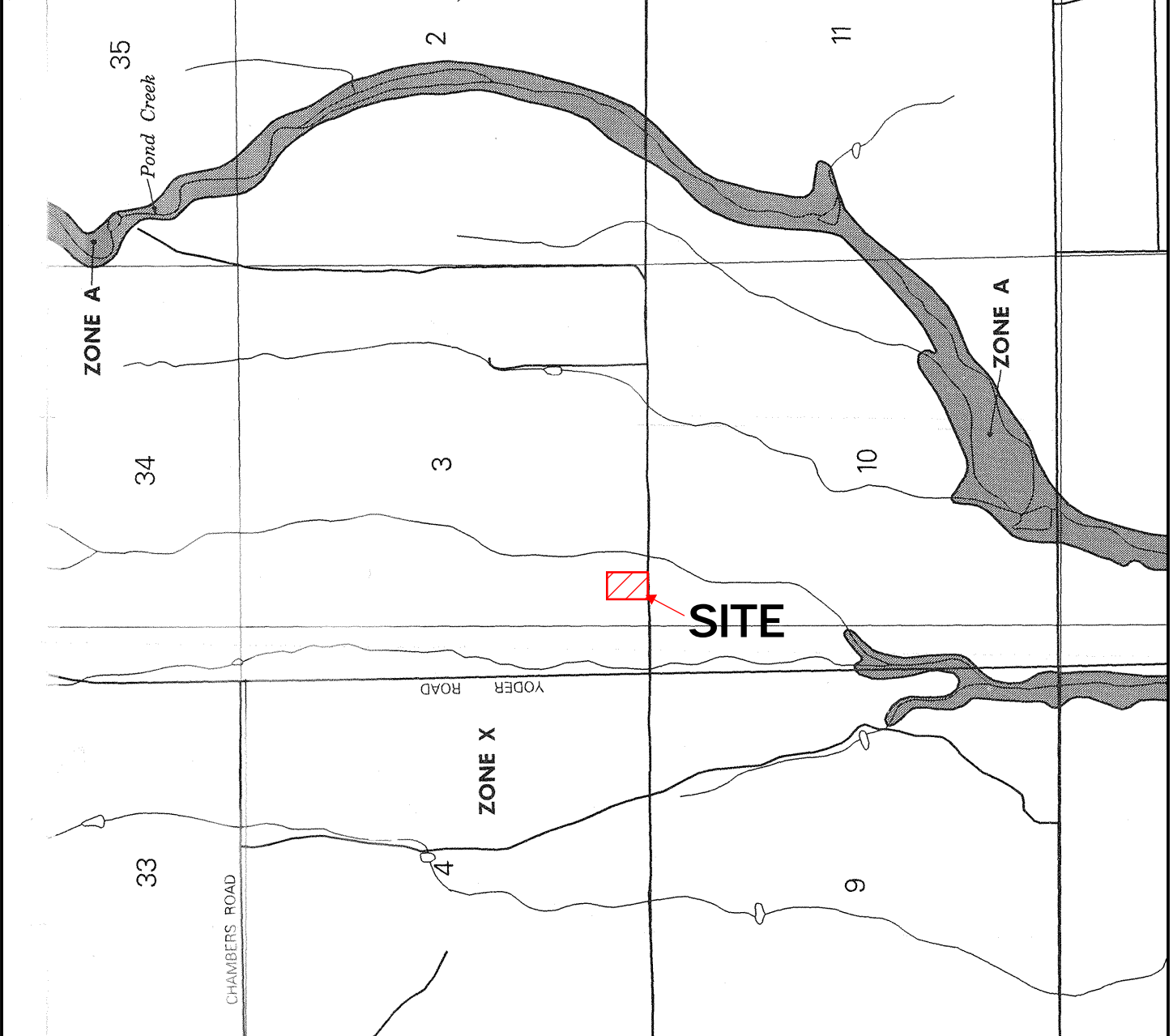

HYDROLOGIC CALCULATIONS

MVEA YODER ELECTRIC SUBSTATION
(Area Runoff Coefficient Summary)

HISTORIC

BASIN	DEVELOPED			UNDEVELOPED			WEIGHTED		
	TOTAL AREA (Acres)	AREA (Acres)	C ₅	C ₁₀₀	AREA (Acres)	C ₅	C ₁₀₀	C ₅	C ₁₀₀
OS-1	11.85	0.00	0.30	0.50	11.85	0.09	0.36	0.09	0.36
OS-2	0.33	0.00	0.30	0.50	0.33	0.09	0.36	0.09	0.36
OS-3	7.79	0.00	0.30	0.50	7.79	0.09	0.36	0.09	0.36
EXA	3.83	0.00	0.30	0.50	3.83	0.09	0.36	0.09	0.36
EXB	1.17	0.00	0.30	0.50	1.17	0.09	0.36	0.09	0.36

QNA

Date: 8/3/2018

Checked by: _____

DEVELOPED

BASIN	DEVELOPED			UNDEVELOPED			WEIGHTED		
	TOTAL AREA (Acres)	AREA (Acres)	C ₅	C ₁₀₀	AREA (Acres)	C ₅	C ₁₀₀	C ₅	C ₁₀₀
OS-1	11.85	0.00	0.30	0.50	11.85	0.09	0.36	0.09	0.36
OS-2	0.33	0.00	0.30	0.50	0.33	0.09	0.36	0.09	0.36
OS-3	7.79	0.23	0.30	0.50	7.56	0.09	0.36	0.10	0.36
A	1.65	1.07	0.30	0.50	0.58	0.09	0.36	0.23	0.45
A1	1.70	0.06	0.30	0.50	1.65	0.09	0.36	0.10	0.36
A2	0.47	0.11	0.30	0.50	0.36	0.09	0.36	0.14	0.39
B	1.17	0.00	0.30	0.50	1.17	0.09	0.36	0.09	0.36

QNA

Date: 8/3/2018

Checked by: _____

MVEA YODER SUBSTATION AREA DRAINAGE SUMMARY

HISTORIC

BASIN	AREA TOTAL (Acres)	WEIGHTED		OVERLAND			STREET / CHANNEL FLOW				INTENSITY		TOTAL FLOWS		
		C ₅	C ₁₀₀	Length (ft)	Height (ft)	T _c (min)	Length (ft)	Slope (%)	Velocity (fps)	T _t (min)	T _t TOTAL (min)	I ₅ (in/hr)	I ₁₀₀ (in/hr)	Q ₅ (c.f.s.)	Q ₁₀₀ (c.f.s.)
OS-1	11.85	0.09	0.36	100	1.2	17.8	1565	2.8%	2.2	11.9	29.6	2.5	4.1	2.7	17.4
OS-2	0.33	0.09	0.36	100	5.0	11.1	205	1.7%	2.1	1.6	12.7	3.7	6.4	0.1	0.7
OS-3	7.79	0.09	0.36	100	1.2	17.8	1555	2.6%	2.2	11.8	29.6	2.5	4.1	1.8	11.5
EXA	3.83	0.09	0.36	86	1.9	13.5	531	1.3%	2.0	4.4	17.9	3.2	5.4	1.1	7.4
EXB	1.17	0.09	0.36	100	5.0	11.1	170	2.4%	2.6	1.1	12.2	3.8	6.5	0.4	2.7

Calculated by: QNA

Date: 8/3/2018

Checked by: _____

DEVELOPED

BASIN	AREA TOTAL (Acres)	WEIGHTED		OVERLAND			STREET / CHANNEL FLOW				INTENSITY		TOTAL FLOWS		
		C ₅	C ₁₀₀	Length (ft)	Height (ft)	T _c (min)	Length (ft)	Slope (%)	Velocity (fps)	T _t (min)	T _t TOTAL (min)	I ₅ (in/hr)	I ₁₀₀ (in/hr)	Q ₅ (c.f.s.)	Q ₁₀₀ (c.f.s.)
OS-1	11.85	0.09	0.36	100	1.2	17.8	1565	2.8%	2.2	11.9	29.6	2.5	4.1	2.7	17.4
OS-2	0.33	0.09	0.36	100	5.0	11.1	205	1.7%	2.0	1.7	12.8	3.7	6.3	0.1	0.7
OS-3	7.79	0.10	0.36	100	1.2	17.8	1555	2.6%	2.2	11.8	29.6	2.5	4.1	1.9	11.6
A	1.65	0.23	0.45	100	1.3	13.7	173	1.4%	2.0	1.4	15.2	3.5	5.9	1.3	4.3
A1	1.70	0.10	0.36	100	5.0	11.1	550	0.9%	1.5	6.1	17.2	3.3	5.5	0.5	3.4
A2	0.47	0.14	0.39	100	3.0	13.1	62	1.6%	2.1	0.5	13.6	3.6	6.2	0.2	1.1
B	1.17	0.09	0.36	100	3.0	13.1	63	5.4%	3.7	0.3	13.4	3.6	6.2	0.4	2.6

Calculated by: QNA

Date: 8/3/2018

Checked by: _____

**MVEA YODER SUBSTATION
SURFACE ROUTING SUMMARY**

HISTORIC									
Design Point(s)	Contributing Basins	Area (Acres)	Equivalent CA₅	Equivalent CA₁₀₀	Maximum T_C	Intensity		Flow	
						I₅	I₁₀₀	Q₅	Q₁₀₀
1	OS-1 & EXA	15.69	1.41	5.65	29.6	2.5	4.1	3.5	23.0
2	OS-2, & EXB	1.49	0.13	0.54	12.7	3.7	6.4	0.5	3.4
3	OS-2, & EXB	7.79	0.70	2.81	29.6	2.5	4.1	1.8	11.5

DEVELOPED									
Design Point(s)	Contributing Basins	Area (Acres)	Equivalent CA₅	Equivalent CA₁₀₀	Maximum T_C	Intensity		Flow	
						I₅	I₁₀₀	Q₅	Q₁₀₀
1A	OS-1 & A1	13.55	1.23	4.89	29.6	2.5	4.1	3.1	19.9
1B	A	1.65	0.37	0.74	15.2	3.5	5.9	1.3	4.3
1	OS-1, A, A1, & A2	15.67	1.67	5.82	29.6	2.5	4.1	4.2	23.7
2	OS-1, & B	1.49	0.13	0.54	12.8	3.7	6.3	0.5	3.4
3	OS-3	7.79	0.75	2.84	29.6	2.5	4.1	1.9	11.6

Date: 8/3/2018
Checked by: _____

MVEA YODER SUBSTAION WEIR OUTLETS

Broad Crested Weir

DESIGN POINT 1B

The general form of the equation for horizontal crested weirs is $Q = CLH^{3/2}$ where:

Q = Weir flow discharge (cfs)	4.3	
C = Weir flow coefficient	2.640	
H = Depth of flow over the weir (ft)	0.50	Opening Height
L = Length of the weir (ft)	4.7	Length

DESIGN POINT 3

The general form of the equation for horizontal crested weirs is $Q = CLH^{3/2}$ where:

Q = Weir flow discharge (cfs)	11.6	
C = Weir flow coefficient	2.640	
H = Depth of flow over the weir (ft)	0.50	Opening Height
L = Length of the weir (ft)	12.4	Length

DRAINAGE MAPS

MVEA YODER SUBSTATION

EL PASO COUNTY, CO

DEVELOPED DRAINAGE MAP

AUGUST 2018

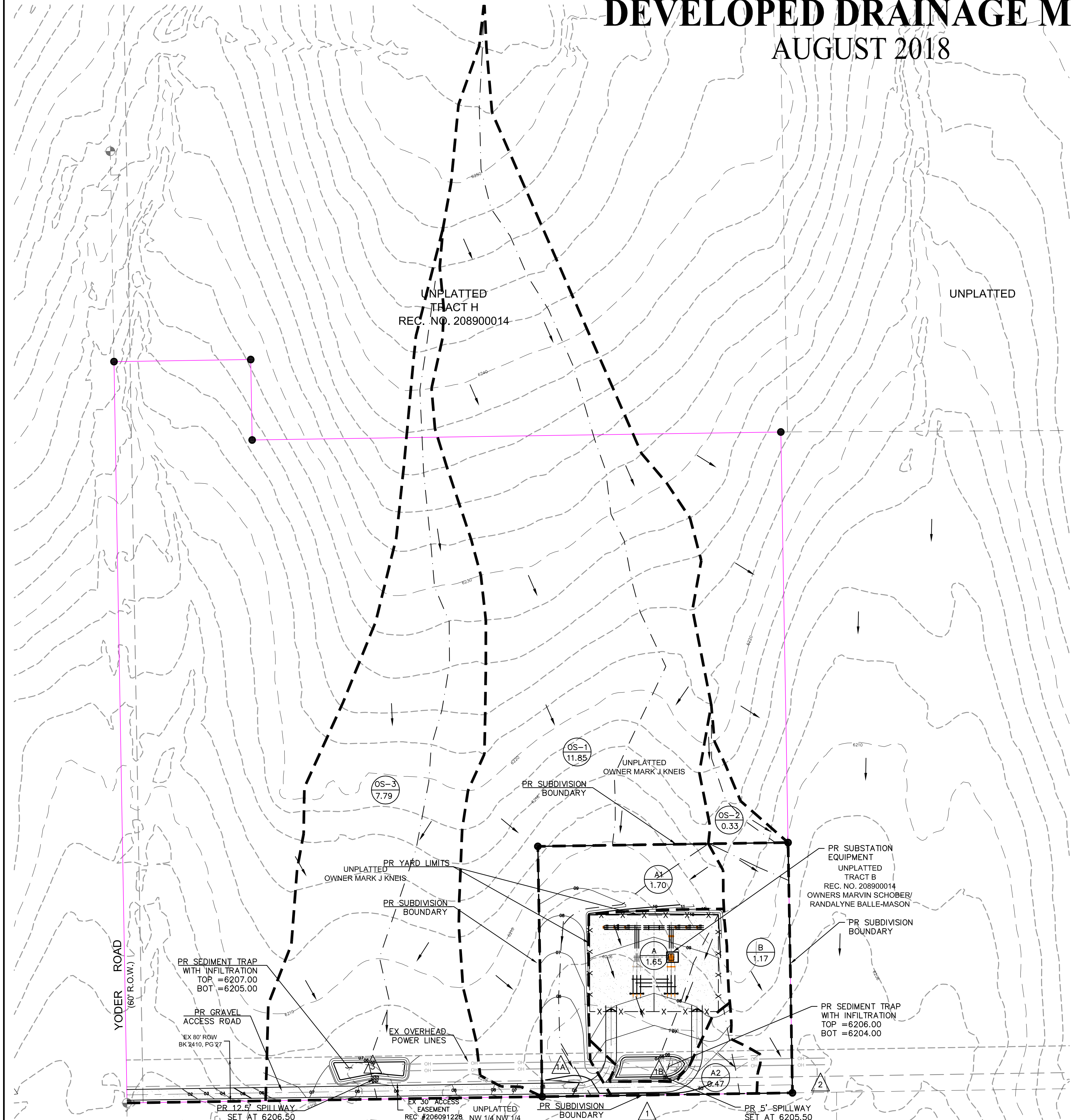

DESIGN POINT SUMMARY

DP	CONTRIBUTING BASINS	AREA AC.	Q5 CFS	Q100 CFS
1A	OS-A & A1	13.55	3.1	19.9
1	OS-A, A, A1, & A2	15.69	3.3	21.9
2	OS-1 & OS-B	1.49	0.5	3.4

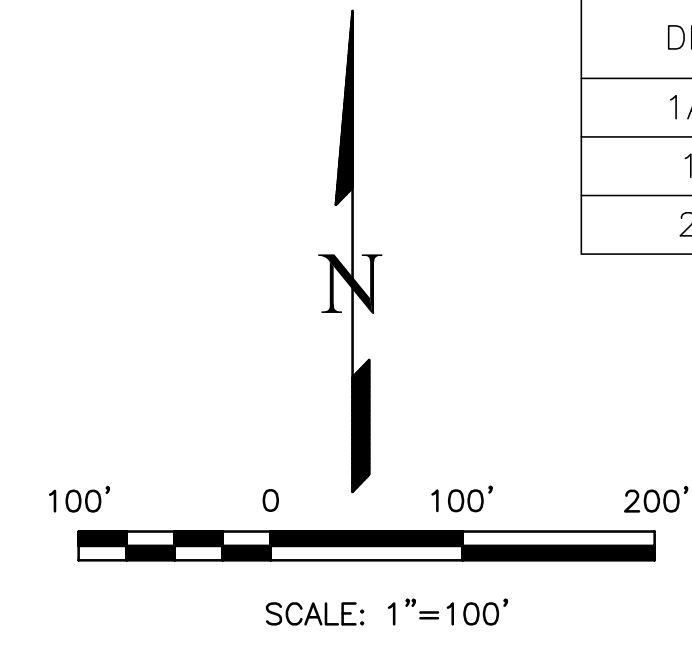

PROPOSED CONDITIONS

BASIN	ACRES	Q5 CFS	Q100 CFS
OS-1	11.85	2.7	17.4
OS-2	0.33	0.1	0.7
OS-3	7.79	1.9	11.6
A	1.38	1.2	3.8
A1	1.70	0.5	3.4
A2	0.75	0.4	1.8
B	1.17	0.4	2.6

Include design points 1B and 3

LEGEND

- 10' EX CONTOUR ----- 6810 -----
- 2' EX CONTOUR ----- 6802 -----
- 10' PROP. CONTOUR ----- 6810 -----
- 2' PROP. CONTOUR ----- 6802 -----
- PROPOSED FLOW DIRECTION →
- BASIN BOUNDARY -----
- TIME OF CONCENTRATION -----
- BASIN ID ⊙ A
- ACREAGE ⊙ 0.37
- DESIGN POINT △ 3
- PROPOSED PR
- EXISTING EX

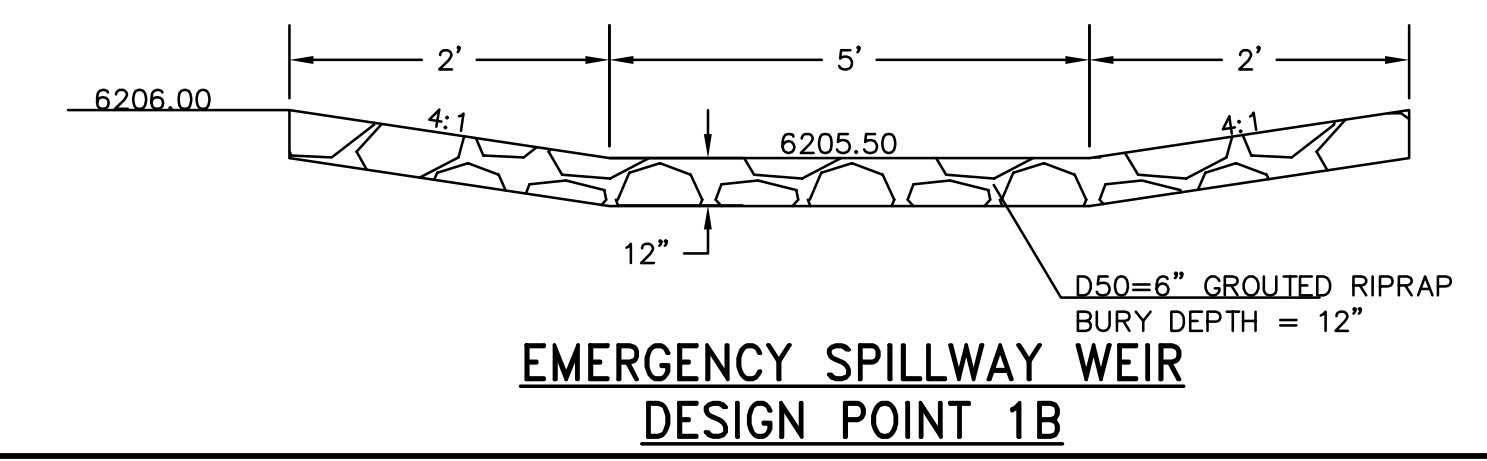
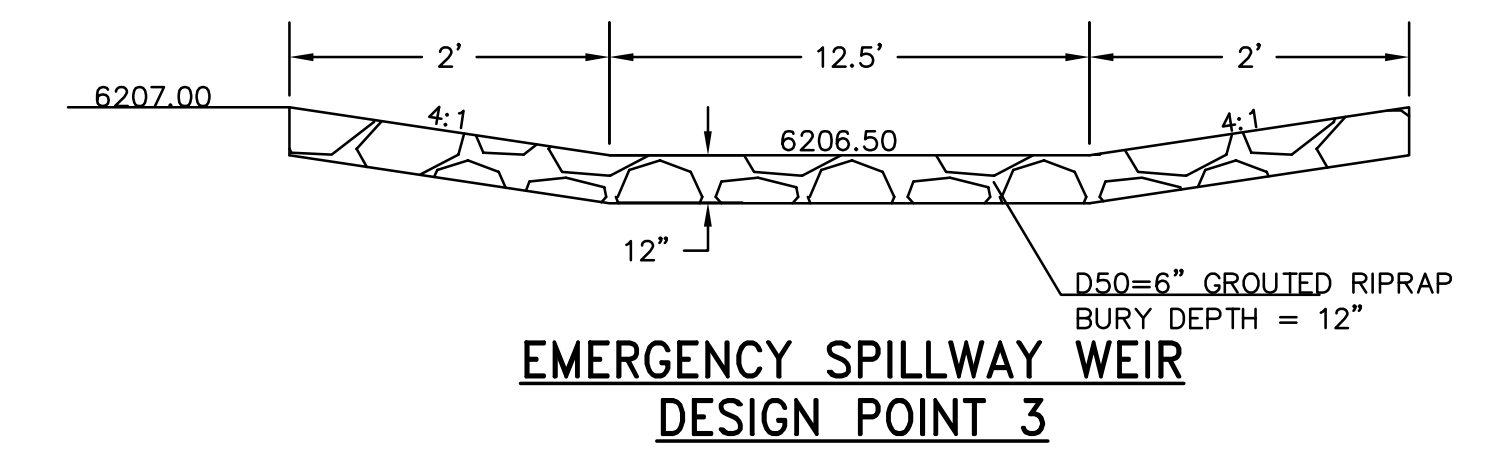

REVISIONS NO.	DESCRIPTION	DATE

UNTIL SUCH TIME AS THESE DRAWINGS ARE APPROVED BY THE ENGINEERING BOARD OF THE STATE OF COLORADO, TERRA NOVA ENGINEERING, INC. APPROVES THEIR USE ONLY FOR THE PROJECT AND SITE SPECIFICALLY IDENTIFIED BY WRITTEN AUTHORIZATION.

PREPARED FOR:
MVEA
ATTN: DAVE WALDNER
11140 E. WOODMEN RD
PEYTON, CO 80831
(719) 495-2283

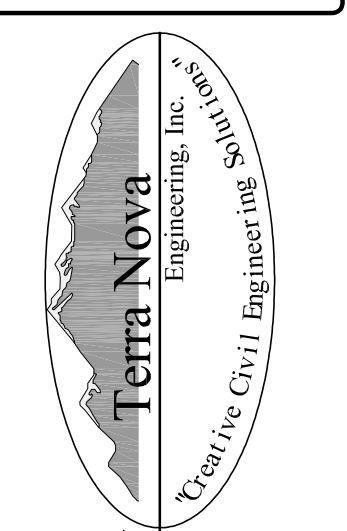

721 S. 2900 STREET
COLORADO SPRINGS, CO 80904
OFFICE: 719-635-6422
FAX: 719-635-6426
www.tnengine.com

MVEA YODER SUBSTATION
DEVELOPED DRAINAGE MAP

DESIGNED BY QNA
DRAWN BY QNA
CHECKED BY
H-SCALE 1"=100'
V-SCALE NA
JOB NO. 1802.00
DATE ISSUED 8/3/18
SHEET NO. 1 OF 1

N:\pos\1802.00\Drawings\cd\180200_FDM.dwg, 8/3/2018 2:06:22 PM, Bluebeam PDF

MVEA YODER SUBSTATION

EL PASO COUNTY, CO

EXISTING DRAINAGE MAP

AUGUST 2018

DESIGN POINT SUMMARY

DP	CONTRIBUTING BASINS	AREA AC.	Q5 CFS	Q100 CFS
1	OS-1 & EXA	15.69	3.5	23.0
2	OS-2 & EXB	1.49	0.5	3.4
3	OS-3	7.79	1.8	11.5

PROPOSED CONDITIONS

BASIN	ACRES	Q5 CFS	Q100 CFS
OS-1	11.85	2.7	17.4
OS-2	0.33	0.1	0.7
OS-3	7.79	1.8	11.5
EXA	3.83	1.1	7.4
EXB	1.17	0.4	2.7

This is the existing drainage map, so existing conditions should be shown.

LEGEND

- 10' EX CONTOUR --- 6810
- 2' EX CONTOUR --- 6802
- FLOW DIRECTION →
- BASIN BOUNDARY ---
- TIME OF CONCENTRATION ---
- BASIN ID ○ A
- ACREAGE ○ 0.37
- DESIGN POINT △ 3
- EXISTING EX
- PROPOSED PR

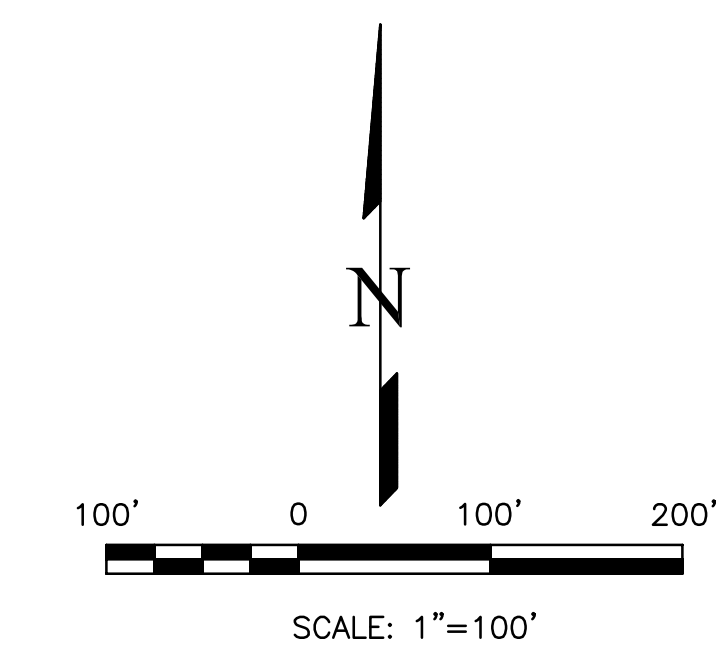
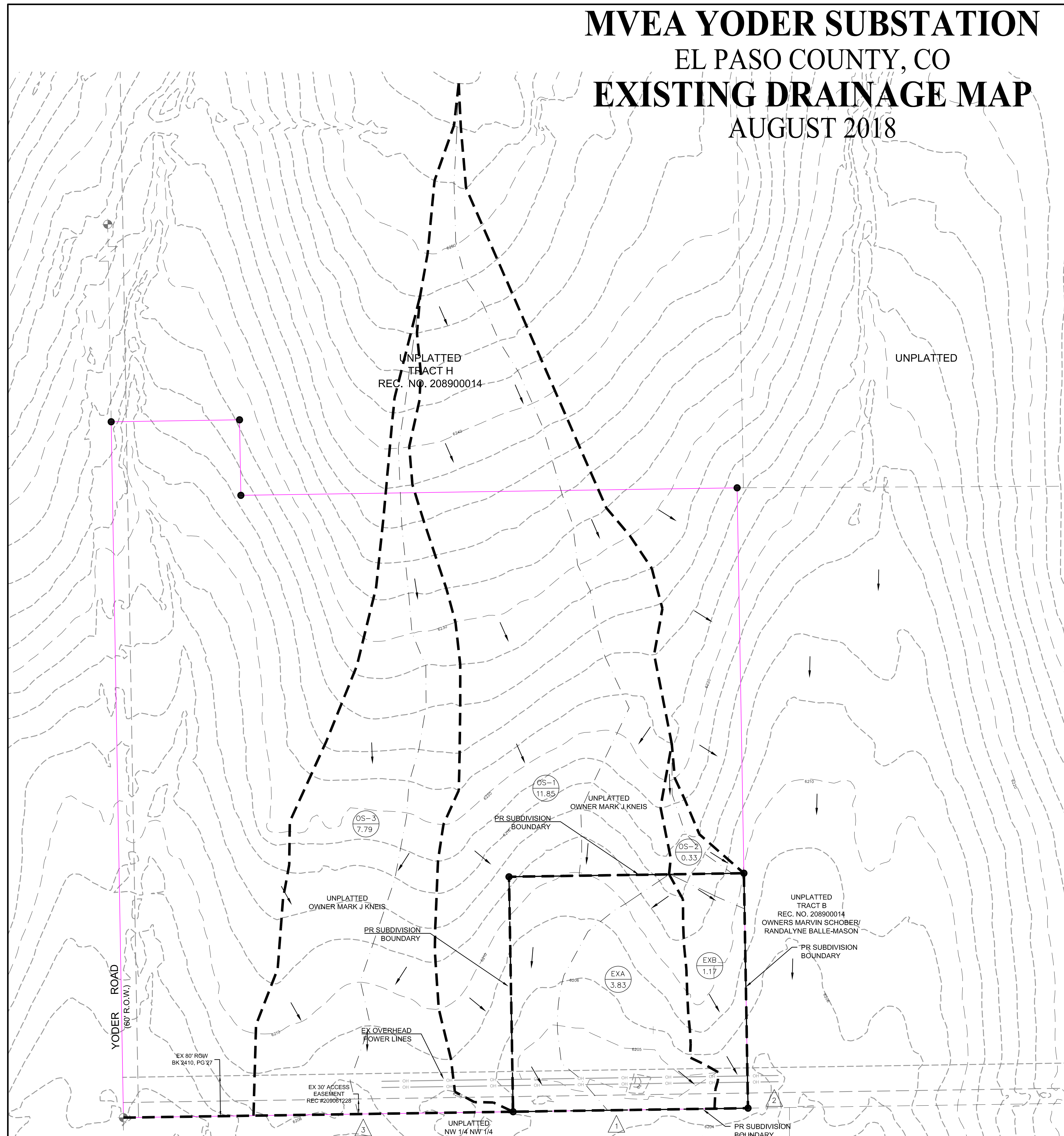

REVISIONS	NO.	DESCRIPTION	DATE

UNTIL SUCH TIME AS THESE DRAWINGS ARE APPROVED BY THE REVIEWING AGENCIES, TERRA NOVA ENGINEERING, INC. APPROVES THEIR USE ONLY FOR THE PROJECT AND FOR THE PURPOSES AUTHORIZED BY WRITTEN AUTHORIZATION.

PREPARED FOR:
MVEA
 ATTN: DAVE WALDNER
 11140 E. WOODMEN RD
 PEYTON, CO 80831
 (719) 495-2283

721 S. 2900 STREET
 COLORADO SPRINGS, CO 80904
 OFFICE: 719-635-6422
 FAX: 719-635-6426
 www.tnaseinc.com

Terra Nova
 Engineering, Inc.
 Professional Engineers
 No. 111115

MVEA YODER SUBSTATION
 EXISTING DRAINAGE MAP

DESIGNED BY QNA
DRAWN BY QNA
CHECKED BY
H-SCALE 1"=100'
V-SCALE NA
JOB NO. 1802.00
DATE ISSUED 8/2/18
SHEET NO. 1 OF 1

N:\pos\1802.00\drawings\cd\180200_FDM.dwg, 8/3/2018 2:06:56 PM, Bluebeam PDF

Markup Summary

An extended detention basin is not part of the proposed design. Please correct throughout the FDR accordingly. (1)

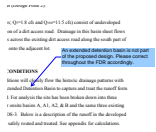

Subject: Engineer
Page Label: 6
Lock: Locked
Author: dsdgrimm
Date: 9/6/2018 3:15:06 PM
Color: ■

An extended detention basin is not part of the proposed design. Please correct throughout the FDR accordingly.

Include design points 1B and 3 (1)

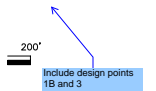

Subject: Engineer
Page Label: 26
Lock: Locked
Author: dsdgrimm
Date: 9/6/2018 3:15:20 PM
Color: ■

Include design points 1B and 3

Please also state that the gravel road will be maintained appropriately to prevent any runoff of gravel onto the adjacent property. (1)

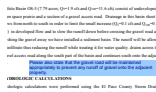

Subject: Engineer
Page Label: 8
Lock: Locked
Author: dsdgrimm
Date: 9/6/2018 3:15:08 PM
Color: ■

Please also state that the gravel road will be maintained appropriately to prevent any runoff of gravel onto the adjacent property.

Please remove "therefore". It is an unstudied basin, but that is not the reason that it is a no fee basin. Please just state that it has no established fee. (1)

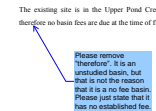

Subject: Engineer
Page Label: 9
Lock: Locked
Author: dsdgrimm
Date: 9/6/2018 3:15:11 PM
Color: ■

Please remove "therefore". It is an unstudied basin, but that is not the reason that it is a no fee basin. Please just state that it has no established fee.

Provide the Q5 and Q100 values for the flow with the sediment trap and state that it is less than the historic flows. (1)



Subject: Engineer
Page Label: 7
Lock: Locked
Author: dsdgrimm
Date: 9/6/2018 3:15:12 PM
Color: ■

Provide the Q5 and Q100 values for the flow with the sediment trap and state that it is less than the historic flows.

SITE (1)



Subject: Text Box
Page Label: 19
Lock: Locked
Author: Quentin
Date: 9/6/2018 3:15:21 PM
Color: ■

SITE

State whether water rights will be impacted by any potential retention of water. (1)

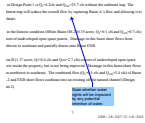

Subject: Engineer
Page Label: 7
Lock: Locked
Author: dsdgrimm
Date: 9/6/2018 3:15:13 PM
Color: ■

State whether water rights will be impacted by any potential retention of water.

The drainage map shows four design points (1)

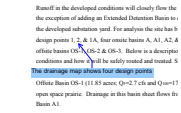

Subject: Engineer
Page Label: 6
Lock: Locked
Author: dsdgrimm
Date: 9/6/2018 3:15:15 PM
Color: ■

The drainage map shows four design points

The drainage map shows thee existing design points. (1)

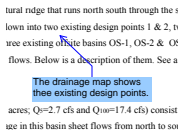

Subject: Engineer
Page Label: 5
Lock: Locked
Author: dsdgrimm
Date: 9/6/2018 3:15:15 PM
Color: ■

The drainage map shows thee existing design points.

This is the existing drainage map, so existing conditions should be shown. (1)

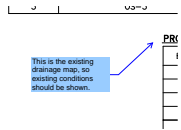

Subject: Engineer
Page Label: 27
Lock: Locked
Author: dsdgrimm
Date: 9/6/2018 3:15:22 PM
Color: ■

This is the existing drainage map, so existing conditions should be shown.

What is being over-topped? (1)

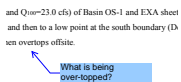

Subject: Engineer
Page Label: 5
Lock: Locked
Author: dsdgrimm
Date: 9/6/2018 3:15:16 PM
Color: ■

What is being over-topped?

(2)

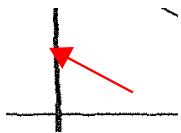

Subject: Arrow
Page Label: 19
Lock: Locked
Author: Quentin
Date: 9/6/2018 3:15:19 PM
Color: ■

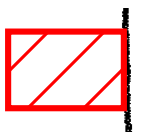

Subject: Rectangle
Page Label: 19
Lock: Locked
Author: Quentin
Date: 9/6/2018 3:15:17 PM
Color: ■