

TRAFFIC IMPACT STUDY

For

3980 Walker Road
El Paso County, Colorado
PCD File No. PPR2350

April 2024
Revised June 2024

Prepared for:

Valens Capital, LLC
3980 Walker Road
Colorado Springs, Colorado 80908

Prepared by:



SM ROCHA, LLC
TRAFFIC AND TRANSPORTATION CONSULTANTS

8700 Turnpike Drive, Suite 240
Westminster, Colorado 80031
(303) 458-9798

6 South Tejon Street, Suite 618
Colorado Springs, Colorado 80903
(719) 203-6639

Project Manager:
Brandon Wilson, EIT

Project Engineer:
Zac Trotter, EIT

Engineer in Responsible Charge:
Fred Lantz, PE



23-071949

Traffic Engineer's Statement

The attached traffic report and supporting information were prepared under my responsible charge and they comport with the standard of care. So far as is consistent with the standard of care, said report was prepared in general conformance with the criteria established by the County for traffic reports.



06/26/2024

Fred Lantz, P.E. #23410

Date

Developer's Statement

I, the Developer, have read and will comply with all commitments made on my behalf within this report.



06/26/2024

Valens Capital, LLC
3980 Walker Road
Colorado Springs, CO 80908

Date

Table of Contents

I. Introduction	1
Project Overview.....	1
Study Area Boundaries	1
Site Description.....	1
Existing and Committed Surface Transportation Network.....	4
II. Existing Traffic Conditions	6
Peak Hour Intersection Levels of Service – Existing Traffic.....	8
Existing Traffic Analysis Results	8
III. Future Traffic Conditions Without Proposed Development.....	9
Peak Hour Intersection Levels of Service – Background Traffic	12
Background Traffic Analysis Results – Year 2026	12
Background Traffic Analysis Results – Year 2040	13
IV. Proposed Project Traffic	14
Trip Generation.....	14
Adjustments to Trip Generation Rates	15
Trip Distribution.....	15
Trip Assignment.....	15
V. Future Traffic Conditions With Proposed Developments	17
VI. Project Impacts	20
Peak Hour Intersection Levels of Service – Total Traffic	20
Total Traffic Analysis Results Upon Development Build-Out	21
Queue Length Analysis.....	21
Total Traffic Auxiliary Lane Analysis	22
Recommended Improvements.....	22
VII. Conclusion	23

List of Figures

Figure 1 – Location.....	2
Figure 2 – Conceptual Site Plan.....	3
Figure 3 – Existing Traffic Volumes & Intersection Geometry	7
Figure 4 – Background Traffic Volumes & Intersection Geometry – Year 2026.....	10
Figure 5 – Background Traffic Volumes & Intersection Geometry – Year 2040.....	11
Figure 6 – Distribution and Site-Generated Assignment.....	16
Figure 7 – Total Traffic Volumes & Intersection Geometry – Year 2026.....	18
Figure 8 – Total Traffic Volumes & Intersection Geometry – Year 2040.....	19

List of Tables

Table 1 – Intersection Capacity Analysis Summary – Existing Traffic	8
Table 2 – Intersection Capacity Analysis Summary – Background Traffic – Year 2026	12
Table 3 – Intersection Capacity Analysis Summary – Background Traffic – Year 2040	13
Table 4 – Trip Generation Summary	14
Table 5 – Intersection Capacity Analysis Summary – Total Traffic – Year 2026	20
Table 6 – Intersection Capacity Analysis Summary – Total Traffic – Year 2040	20
Table 7 – Turn Lane Queues and Storage Requirements – Total Traffic – Year 2040.....	21

Appendices

APPENDIX A	TRAFFIC COUNT DATA
	SIGNAL TIMING INFORMATION
APPENDIX B	LEVEL OF SERVICE DEFINITIONS
APPENDIX C	CAPACITY WORKSHEETS

I. Introduction

Project Overview

This traffic impact study is provided as a planning document and addresses the capacity, geometric, and control requirements associated with the development entitled 3980 Walker Road. The development is located near the northeast corner of Walker Road and Kerry Run Road in El Paso County, Colorado.

This traffic impact study has been revised to reflect an updated density.

Study Area Boundaries

The study area to be examined in this analysis encompasses the segment of Walker Road bounded by State Highway 83 and Kerry Run Road.

Figure 1 illustrates location of the site and study intersections.

Site Description

Land for the development is currently occupied by one single-family home and storage area for farm equipment and is surrounded by a mix of institutional and residential land uses.

The proposed development is conceptual in nature as no specific user has been determined. However, for purposes of this analysis, the proposed development is understood to entail the new construction of an approximate 11,100 square foot modular building intended to be used as a religious institution, such as for bible study groups, supporting a maximum 95 attendees, as allowed within the County's RR-5 (Rural Residential) zoning district.

Existing access to the development is provided via one full-movement access onto Walker Road (referred to as Site Access). The Site Access intersection with Walker Road was excluded from analysis as internal intersection operations are expected to be comparable to, or better than, those projected for the above-described intersections.

For purposes of this study, it is anticipated that development construction would be completed by end of Year 2026.

General site and access locations are shown on Figure 1.

A conceptual site plan, as prepared by Valens Capital, LLC, is shown on Figure 2. This plan is provided for illustrative purposes only.



Not to Scale

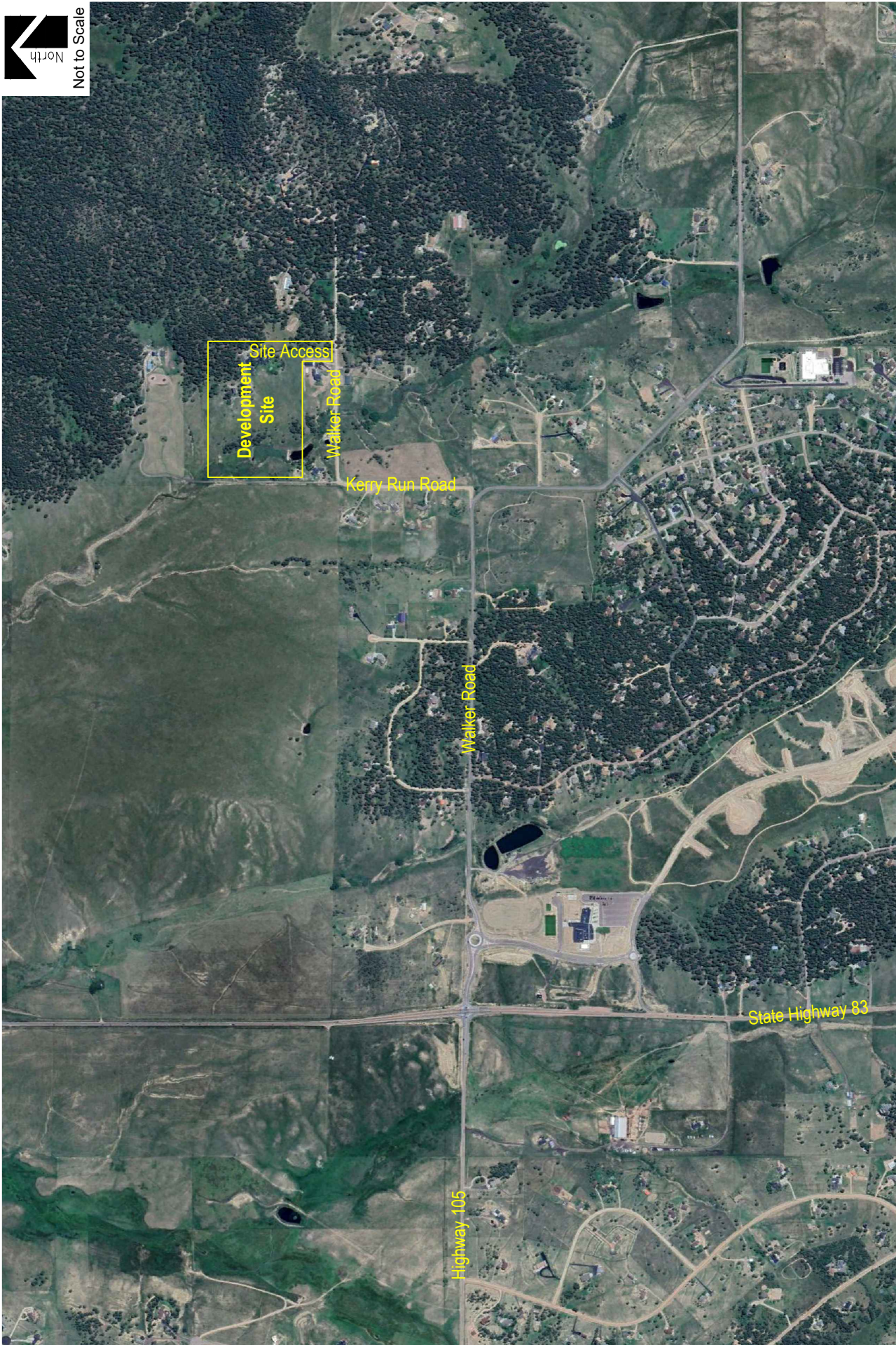

3980 WALKER ROAD
Traffic Impact Study

Figure 1
SITE LOCATION



SM ROCHA, LLC
Traffic and Transportation Consultants

June 2024
Page 2



Figure 2
CONCEPTUAL SITE PLAN
June 2024
Page 3



Existing and Committed Surface Transportation Network

Within the study area, Kerry Run Road is the primary roadway that will accommodate traffic to and from the proposed development. The secondary roadways include Walker Road, State Highway 83, and Highway 105. A brief description of each roadway, based on El Paso County's 2016 Major Transportation Corridors Plan Update (MTCP)¹, is provided below:

Kerry Run Road is a north-south rural, local, gravel roadway having two through lanes (one lane in each direction) with shared turn lanes at the intersection within the study area. Kerry Run Road does not provide a posted speed limit within the study area. In accordance with the County's Engineering Criteria Manual (ECM)², Kerry Run Road is assumed to provide a posted speed limit of 30 MPH.

Walker Road is an east-west collector roadway having two through lanes (one lane in each direction) with a combination of shared and exclusive turn lanes at the intersections within the study area. Walker Road provides a posted speed limit of 35 MPH. Walker Road ends at State Highway 83 and continues west as Highway 105.

East of Kerry Run Road and adjacent to the development, Walker Road is an east-west rural, local, gravel roadway that provides two through lanes with shared turn lanes at the intersections within the study area. Walker Road does not provide a posted speed limit within the study area. In accordance with the County's ECM, Walker Road is assumed to provide a posted speed limit of 30 MPH.

Highway 105 is an east-west principal arterial roadway having two through lanes (one lane in each direction) with a combination of shared and exclusive turn lanes at the intersection within the study area. Highway 105 provides a posted speed limit of 50 MPH. Highway 105 ends at State Highway 83 and continues east as Walker Road.

State Highway 83 is a north-south state roadway having two through lanes (one lane in each direction) with exclusive turn lanes at the intersection within the study area. The Colorado Department of Transportation (CDOT) categorizes the adjacent segment of State Highway 83 as a Regional Highway (R-A) and provides a posted speed limit of 60 MPH.

The study intersection of Walker Road and State Highway 83 is signalized. The intersection of Kerry Run Road and Walker Road operates under a stop-controlled condition. A stop-controlled intersection is defined as a roadway intersection where vehicle rights-of-way are controlled by one or more "STOP" signs.

¹ El Paso County 2016 Major Transportation Corridors Plan Update, Felsburg Holt & Ullevig, December 2016.

² El Paso County Engineering Criteria Manual, El Paso County, October 2020.

Pursuant to County's MTCP, Highway 105 and Walker Road (collector) will be widened from two to four through lanes from Knollwood Boulevard to Stepler Boulevard. However, the County's MTCP plan does not mention when this will occur.

No other regional or specific improvements for the above described roadways are known to be planned or committed at this time. All other study area roadways appear to be built to their ultimate cross-sections.

A sight distance evaluation was considered for the intersection of Kerry Run Road and Walker Road. However, upon visual inspection of the existing intersection and roadway, it is observed that no significant landscaping is present, and the terrain is relatively flat. As such, it is believed that sight distances are satisfactory.

II. Existing Traffic Conditions

Morning (AM) and afternoon (PM) peak hour traffic counts were collected at the Walker Road intersections with Kerry Run Road and State Highway 83. Average daily traffic (ADT) volumes were collected over a 24-hour period on Kerry Run Road. Counts were collected on Wednesday, January 31, 2024, with AM peak hour counts being collected during the period of 7:00 a.m. to 9:00 a.m. and PM peak hour counts being collected during the period of 4:00 p.m. to 6:00 p.m.

Existing volumes and intersection geometry are shown on Figure 3. Traffic count data is included for reference in Appendix A.

Existing signal timing parameters for State Highway 83 and Walker Road were obtained from CDOT and used throughout this study to the best extent possible in order to remain consistent with existing signal coordination plans. CDOT signal timing information received is included for reference in Appendix A.



Not to Scale

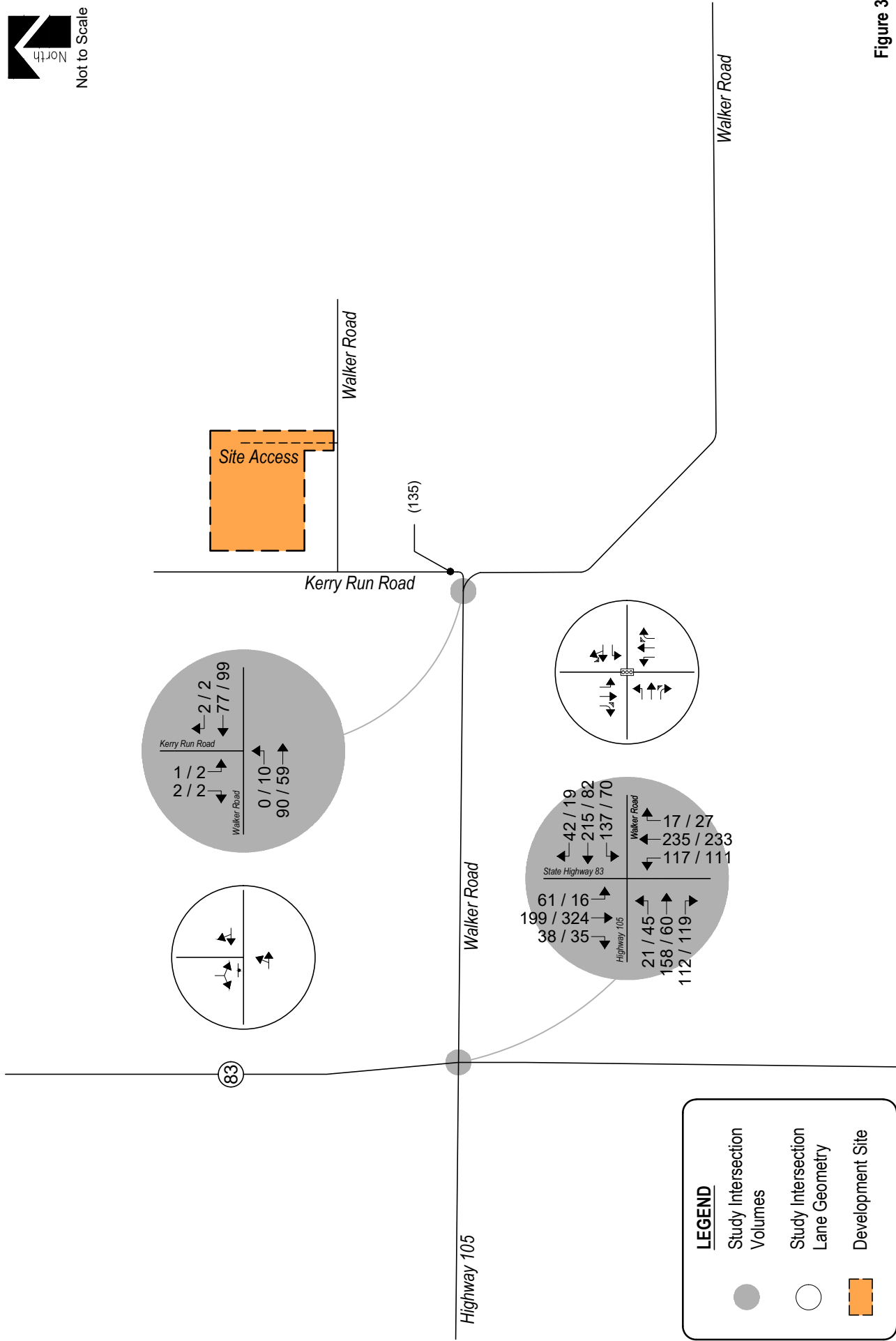

Figure 3
EXISTING TRAFFIC
 Volumes & Intersection Geometry
 AM / PM Peak Hour
 (ADT) : Average Daily Traffic

3980 WALKER ROAD
 Traffic Impact Study



SM ROCHA, LLC
 Traffic and Transportation Consultants

Peak Hour Intersection Levels of Service – Existing Traffic

The Signalized and Unsignalized Intersection Analysis techniques, as published in the Highway Capacity Manual (HCM), 6th Edition, by the Transportation Research Board and as incorporated into the SYNCHRO computer program, were used to analyze the study intersections for existing and future traffic conditions. These nationally accepted techniques allow for the determination of intersection level of service (LOS) based on the congestion and delay of each traffic movement.

Pursuant to Section B.4.1.A of the County’s ECM, the design objective for each scenario of this study shall be level of service “D”. Level of service is a method of measurement used by transportation professionals to quantify a driver’s perception of travel conditions that include travel time, number of stops, and total amount of stopped delay experienced on a roadway network. The HCM categorizes level of service into a range from “A” which indicates little, if any, vehicle delay, to “F” which indicates a level of operation considered unacceptable to most drivers. These levels of service grades with brief descriptions of the operating condition, for unsignalized and signalized intersections, are included for reference in Appendix B and have been used throughout this study.

The level of service analyses results for existing conditions are summarized in Table 1.

Intersection capacity worksheets developed for this study are provided in Appendix C.

Table 1 – Intersection Capacity Analysis Summary – Existing Traffic

INTERSECTION LANE GROUPS	LEVEL OF SERVICE	
	AM PEAK HOUR	PM PEAK HOUR
State Highway 83 / Highway 105 / Walker Road (Signalized)	C (20.6)	B (15.3)
Walker Road / Kerry Run Road (Stop-Controlled)		
Eastbound Left and Through	A	A
Southbound Left and Right	A	A

Key: Signalized Intersection: Level of Service (Control Delay in sec/veh)
Stop-Controlled Intersection: Level of Service

Existing Traffic Analysis Results

Under existing conditions, operational analysis shows that the signalized intersection of State Highway 83 with Highway 105 and Walker Road has overall operations at LOS C during the morning peak traffic hour and LOS B during the afternoon peak traffic hour.

The unsignalized intersection of Walker Road and Kerry Run Road has turning movement operations at LOS A during the morning and afternoon peak traffic hours.

III. Future Traffic Conditions Without Proposed Development

Background traffic is the traffic projected to be on area roadways without consideration of the proposed development. Background traffic includes traffic generated by development of vacant parcels in the area.

To account for projected increases in background traffic for Years 2026 and 2040, a compounded annual growth rate was determined using historical traffic data for the surrounding area provided by CDOT's Online Transportation Information System (OTIS) along the adjacent segment of State Highway 83 which shows a 20-year growth rate between one and two percent. Therefore, in order to provide for a conservative analysis, a growth rate of approximately two percent was applied to existing traffic volumes.

It is important to note that ingress and egress traffic volumes along Kerry Run Road are not subject to annual growth patterns since this access drive does not provide connection to other roadways, therefore does not serve regional traffic.

As discussed in Section I, the expansion of Highway 105 and Walker Road from two through lanes to four through lanes is planned in order to accommodate regional transportation demands. However, in order to provide a conservative analysis, Year 2026 and Year 2040 background traffic conditions assume no roadway improvements to accommodate regional transportation demands. Year 2040 does, however, assume existing signal timing parameters for State Highway 83 and Walker Road with optimized intersection splits in effort to better long-term intersection performance.

Projected background traffic volumes and intersection geometry for Years 2026 and 2040 are shown on Figure 4 and Figure 5, respectively.



Not to Scale

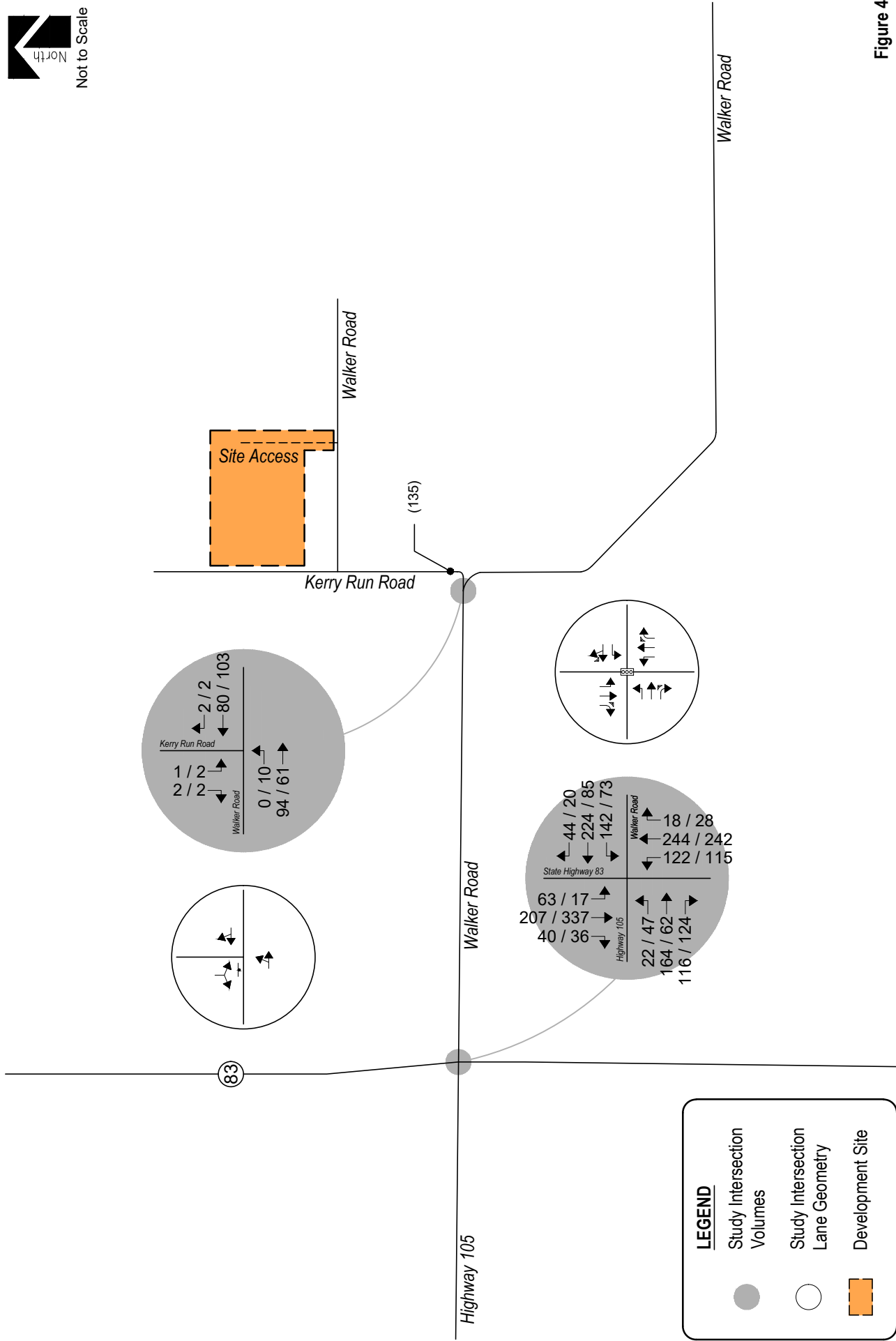

Figure 4
BACKGROUND TRAFFIC - YEAR 2026
 Volumes & Intersection Geometry
 AM / PM Peak Hour
 (ADT) : Average Daily Traffic

3980 WALKER ROAD
 Traffic Impact Study



SM ROCHA, LLC
 Traffic and Transportation Consultants



Not to Scale

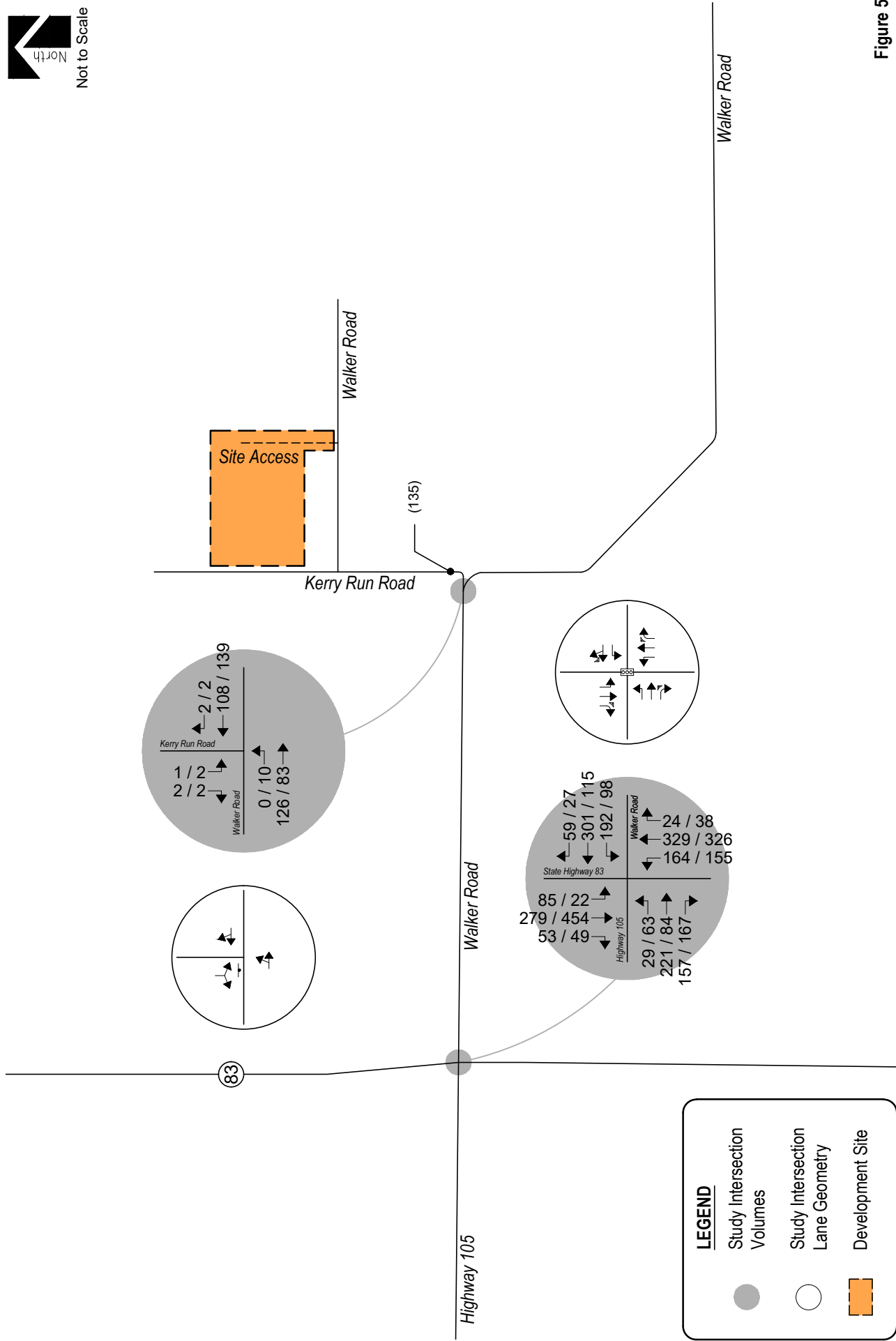

Figure 5
BACKGROUND TRAFFIC - YEAR 2040
 Volumes & Intersection Geometry
 AM / PM Peak Hour
 (ADT) : Average Daily Traffic

3980 WALKER ROAD
 Traffic Impact Study



SM ROCHA, LLC
 Traffic and Transportation Consultants

Peak Hour Intersection Levels of Service – Background Traffic

As with existing traffic conditions, the operations of study intersections were analyzed under background conditions, without the proposed development, using the SYNCHRO computer program.

Background traffic level of service analysis results for Year 2026 are listed in Table 2. Year 2040 operational results are summarized in Table 3.

Definitions of levels of service are given in Appendix B. Intersection capacity worksheets are provided in Appendix C.

Table 2 – Intersection Capacity Analysis Summary – Background Traffic – Year 2026

INTERSECTION LANE GROUPS	LEVEL OF SERVICE	
	AM PEAK HOUR	PM PEAK HOUR
State Highway 83 / Highway 105 / Walker Road (Signalized)	C (21.2)	B (15.5)
Walker Road / Kerry Run Road (Stop-Controlled)		
Eastbound Left and Through	A	A
Southbound Left and Right	A	A

Key: Signalized Intersection: Level of Service (Control Delay in sec/veh)
Stop-Controlled Intersection: Level of Service

Background Traffic Analysis Results – Year 2026

Year 2026 background traffic analysis indicates that the signalized intersection of State Highway 83 with Highway 105 and Walker Road continues to project overall operations at LOS C during the AM peak traffic hour and LOS B during the PM peak traffic hour.

The unsignalized intersection of Walker Road and Kerry Run Road continues to have turning movement operations at LOS A during both AM and PM peak traffic periods.

Table 3 – Intersection Capacity Analysis Summary – Background Traffic – Year 2040

INTERSECTION LANE GROUPS	LEVEL OF SERVICE	
	AM PEAK HOUR	PM PEAK HOUR
State Highway 83 / Highway 105 / Walker Road (Signalized)	C (24.1)	B (18.1)
Walker Road / Kerry Run Road (Stop-Controlled)		
Eastbound Left and Through	A	A
Southbound Left and Right	A	A

Key: Signalized Intersection: Level of Service (Control Delay in sec/veh)
 Stop-Controlled Intersection: Level of Service

Background Traffic Analysis Results – Year 2040

By Year 2040 and without the proposed development, the study intersection of State Highway 83 with Highway 105 and Walker Road continues to experience LOS C operations during the AM peak traffic hour and LOS B operations during the PM peak traffic hour.

The unsignalized intersection of Walker Road and Kerry Run Road continues to project turning movement operations at LOS A during both the morning and afternoon peak traffic hour.

These intersection operations are similar to existing conditions.

IV. Proposed Project Traffic

Trip Generation

Standard traffic generation characteristics compiled by the Institute of Transportation Engineers (ITE) in their report entitled Trip Generation Manual, 11th Edition, were considered to the proposed land use in order to estimate average daily traffic (ADT), AM Peak Hour, and PM Peak Hour vehicle trips. A vehicle trip is defined as a one-way vehicle movement from a point of origin to a point of destination.

Proposed facility operations, as described by the developer, were instead evaluated to estimate average daily and weekday peak hour trip information for the proposed land use. It is expected that the proposed development will have a maximum capacity of 95 attendees supported by a total of 38 off-street parking spaces.

Using the above information, the maximum number of daily and peak hour trips were then calculated. Considering how religious land uses are considered as family destinations, a single-occupant vehicle (SOV) rate of 4.0 was used.

Table 4 illustrates projected ADT, AM Peak Hour, and PM Peak Hour traffic volumes likely generated by the proposed development upon build-out.

Table 4 – Trip Generation Summary

ITE CODE	LAND USE	SIZE	TOTAL TRIPS GENERATED						
			24 HOUR	AM PEAK HOUR			PM PEAK HOUR		
				ENTER	EXIT	TOTAL	ENTER	EXIT	TOTAL
-	Religious Institution	95 ATT	48	24	0	24	0	24	24
<i>Total:</i>			48	24	0	24	0	24	24

Key: ATT = Attendees.

Note: All data and calculations above are subject to being rounded to nearest value.

Upon build-out, Table 4 illustrates that the proposed development has the potential to generate approximately 48 daily vehicle trips with 24 of those occurring during the morning peak hour and 24 during the afternoon peak hour. It is important to note that the above volumes are based on the expected worst-case conditions that occur during a typical weekday. Furthermore, it is understood that the proposed development will not always be at maximum occupancy, nor are operations expected to occur outside of peak hours of adjacent street traffic.

Unresolved: Per ECM section B.3.3.A, trip generation shall be calculated from the latest data contained within the Institute of Transportation Engineers' Trip Generation Manual. Please provide a basis for the trip generation. Coordinate with the applicant to provide more clarity as to the intended uses so that a more accurate trip generation can be provided. For example use as a church would generate weekday trips of 0.90 trips per seat. For 95 seats, that generates 86 daily trips.

Adjustments to Trip Generation Rates

A development of this type is not likely to attract trips from within area land uses nor pass-by or diverted link trips from the adjacent roadway system, therefore no trip reduction was taken in this analysis.

Trip Distribution

The overall directional distribution of site-generated traffic was determined based on the location of development site within the County, proposed and existing area land uses, allowed turning movements, available roadway network, and in reference to distribution patterns of existing traffic count data.

Overall trip distribution patterns for the development are shown on Figure 6.

Trip Assignment

Trip assignment is how generated and distributed vehicle trips are expected to be loaded onto the available roadway network.

Applying trip distribution patterns to site-generated traffic provides the overall site-generated trip assignments shown on Figure 6.



Not to Scale

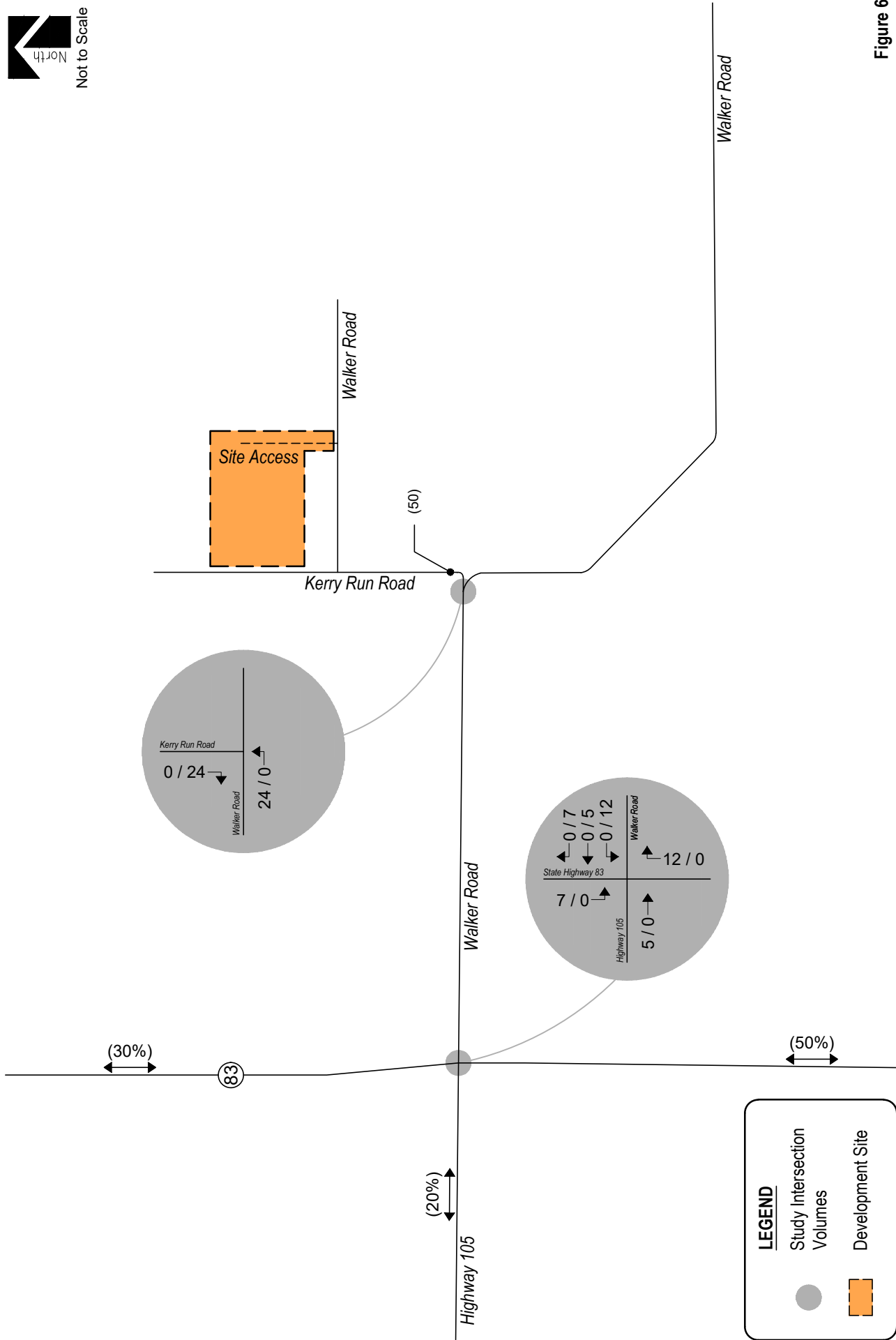

Figure 6
SITE DEVELOPMENT DISTRIBUTION
 (%): Overall
SITE-GENERATED TRIPS
 AM / PM Peak Hour

3980 WALKER ROAD
 Traffic Impact Study



SM ROCHA, LLC
 Traffic and Transportation Consultants

V. Future Traffic Conditions With Proposed Developments

Total traffic is the traffic projected to be on area roadways with consideration of the proposed development. Total traffic includes background traffic projections for Years 2026 and 2040 with consideration of site-generated traffic. For analysis purposes, it was assumed that development construction would be completed by end of Year 2026.

Pursuant to area roadway improvement discussions provided in Section III, Year 2026 total traffic conditions assume no roadway improvements to accommodate regional transportation demands. Year 2040 total traffic conditions assume that Highway 105 and Walker Road are expanded to four through lanes to accommodate regional transportation demands. Roadway improvements associated with site development are expected to be limited to site access and frontage as required by the governing agency.

Projected Year 2026 total traffic volumes and intersection geometry are shown in Figure 7.

Figure 8 shows projected total traffic volumes and intersection geometry for Year 2040.



Not to Scale

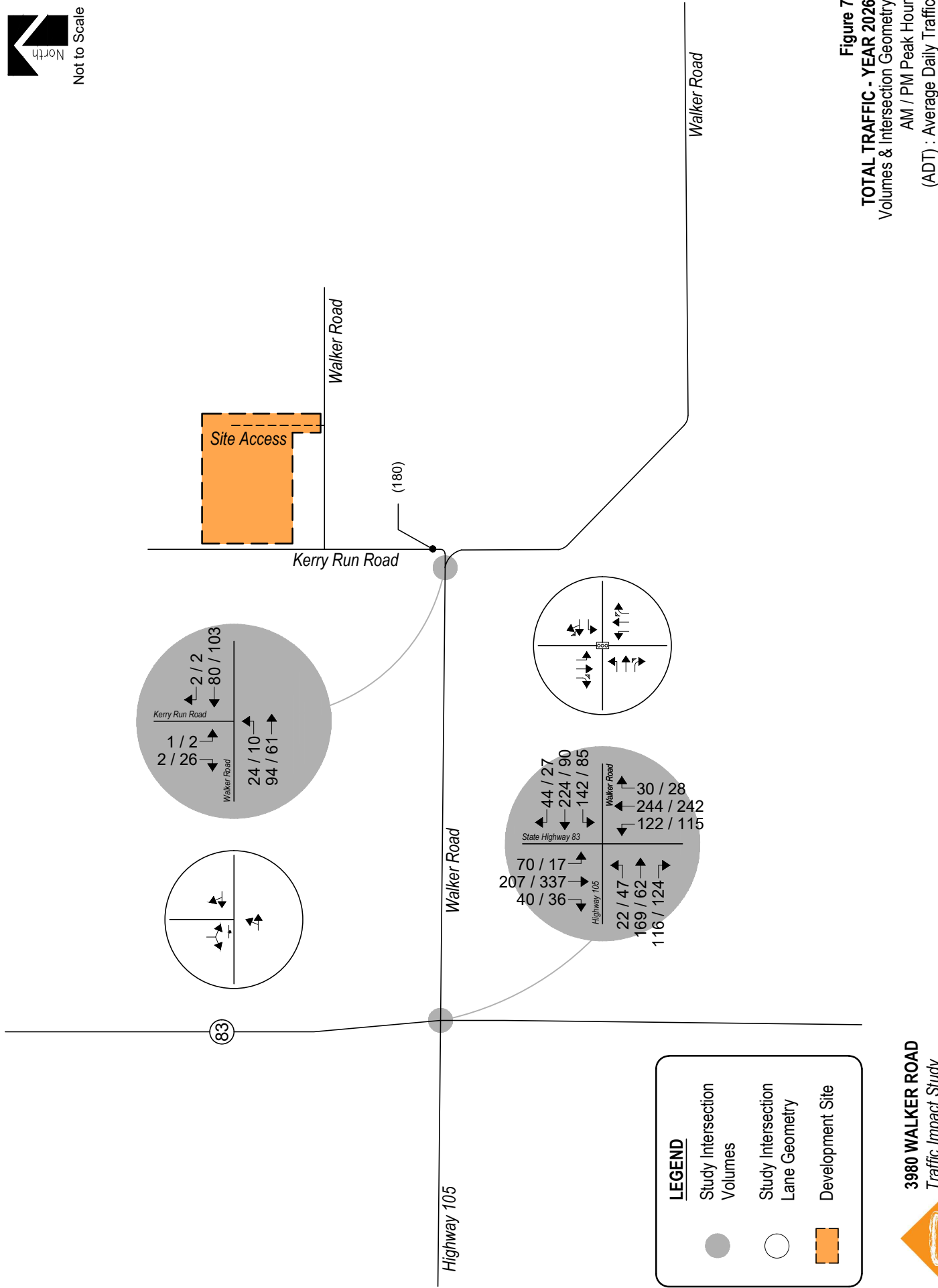

Figure 7
TOTAL TRAFFIC - YEAR 2026
 Volumes & Intersection Geometry
 AM / PM Peak Hour
 (ADT) : Average Daily Traffic

3980 WALKER ROAD
 Traffic Impact Study



SM ROCHA, LLC
 Traffic and Transportation Consultants



Not to Scale

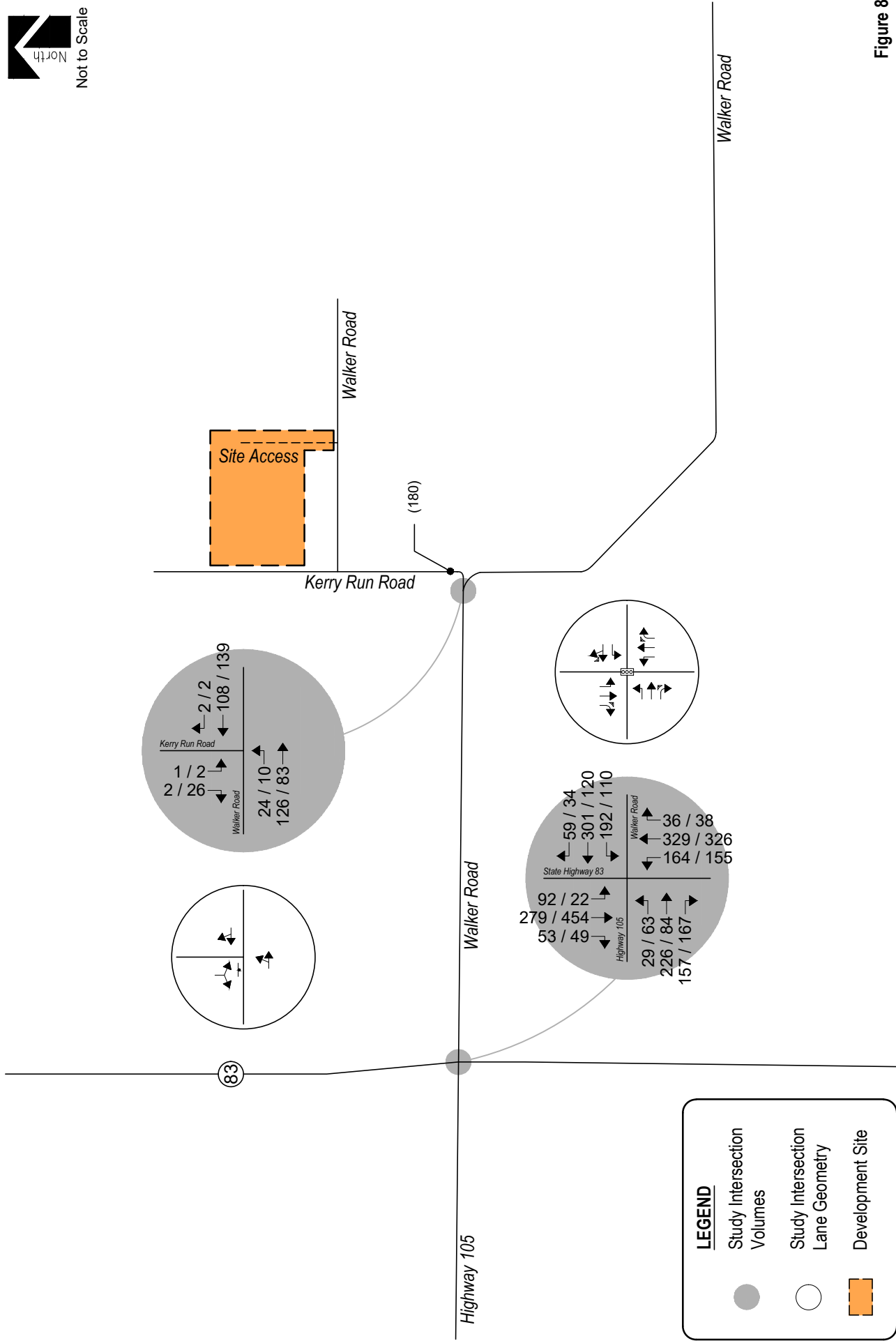

Figure 8
TOTAL TRAFFIC - YEAR 2040
 Volumes & Intersection Geometry
 AM / PM Peak Hour
 (ADT) : Average Daily Traffic

3980 WALKER ROAD
 Traffic Impact Study



SM ROCHA, LLC
 Traffic and Transportation Consultants

VI. Project Impacts

The analyses and procedures described in this study were performed in accordance with the latest (HCM) and are again based upon the worst-case conditions that occur during a typical weekday upon build-out of site development and analyzed land uses. Therefore, study intersections are likely to operate with traffic conditions better than those described within this study, which represent the peak hours of weekday operations only.

Peak Hour Intersection Levels of Service – Total Traffic

As with background traffic, the operations of the study intersections were analyzed under projected total traffic conditions using the SYNCHRO computer program. Total traffic level of service analysis results for Years 2026 and 2040 are summarized in Table 5 and Table 6, respectively.

Definitions of levels of service are given in Appendix B. Intersection capacity worksheets are provided in Appendix C.

Table 5 – Intersection Capacity Analysis Summary – Total Traffic – Year 2026

INTERSECTION LANE GROUPS	LEVEL OF SERVICE	
	AM PEAK HOUR	PM PEAK HOUR
State Highway 83 / Highway 105 / Walker Road (Signalized)	C (21.1)	B (15.8)
Walker Road / Kerry Run Road (Stop-Controlled)		
Eastbound Left and Through	A	A
Southbound Left and Right	A	A

Key: Signalized Intersection: Level of Service (Control Delay in sec/veh)
 Stop-Controlled Intersection: Level of Service

Table 6 – Intersection Capacity Analysis Summary – Total Traffic – Year 2040

INTERSECTION LANE GROUPS	LEVEL OF SERVICE	
	AM PEAK HOUR	PM PEAK HOUR
State Highway 83 / Highway 105 / Walker Road (Signalized)	C (24.1)	B (18.6)
Walker Road / Kerry Run Road (Stop-Controlled)		
Eastbound Left and Through	A	A
Southbound Left and Right	A	A

Key: Signalized Intersection: Level of Service (Control Delay in sec/veh)
 Stop-Controlled Intersection: Level of Service

Total Traffic Analysis Results Upon Development Build-Out

Table 6 illustrates how, by Year 2040 and upon development build-out, the signalized intersection of State Highway 83 with Highway 105 and Walker Road continues to show an overall LOS C operation during the morning peak traffic hour and LOS B operation during the afternoon peak traffic hour.

The stop-controlled intersection of Walker Road and Kerry Run Road continues to project turning movement operations at LOS A for the morning and afternoon peak traffic hours.

These intersection operations are similar to existing and background conditions.

Queue Length Analysis

Queue lengths for the study intersections were analyzed using Year 2040 total traffic conditions. The analysis yields estimate of 95th percentile queue lengths, which have only a five percent probability of being exceeded during the analysis time period. An average vehicle length of 25 feet was assumed. Queue lengths were modeled and are included with the Synchro worksheets in Appendix C.

Table 7 summarizes the 95th percentile queue results in comparison to the projected storage requirements for turn movements within study area for Year 2040.

Table 7 – Turn Lane Queues and Storage Requirements – Total Traffic – Year 2040

Intersection	Turn Movement		Existing Turn Lane Length (feet)	AM Peak Hour		PM Peak Hour		Recommended Turn Lane Length (feet)
				95th Percentile Queue Length (feet)	Vehicle Equivalent (vehicles)	95th Percentile Queue Length (feet)	Vehicle Equivalent (vehicles)	
Signalized Intersections								
State Highway 83 / Highway 105 / Walker Road	EB	L	250'	28'	2	59'	3	250'
		T	-	194'	8	91'	4	-
		R	350'	0'	0	0'	0	350'
	WB	L	270'	128'	6	94'	4	270'
		T,R	-	332'	14	143'	6	-
	NB	L	410'	91'	4	63'	3	410'
		T	-	240'	10	189'	8	-
		R	370'	0'	0	0'	0	370'
	SB	L	430'	55'	3	14'	1	430'
		T	-	200'	8	295'	12	-
		R	430'	0'	0	0'	0	430'
	Signalized Intersections							
Walker Road / Kerry Run Road	EB	L,T	-	3'	1	0'	0	-
		T,R	-	0'	0	0'	0	-
	SB	L,R	-	0'	0	3'	1	-

Note: Turn Lane Length does not include taper length.

As Table 7 shows, all turn lane lengths have sufficient storage to accommodate future traffic volumes.

Total Traffic Auxiliary Lane Analysis

Auxiliary lanes for Walker Road are to be based on the County's ECM.

Considering development build-out, an evaluation of auxiliary lane requirements, pursuant to Section 2.3.7.D of the County's ECM, reveals that a left turn deceleration lane at Kerry Run Road along Walker Road is not required since the projected peak hour left turn ingress volume is less than the County's threshold of 25 vehicles per hour.

Recommended Improvements

Roadway adequacy for Walker Road and Kerry Run Road were assessed pursuant to the County's ECM. As discussed in Section I, Walker Road and Kerry Run Road adjacent to the property have rural, local, gravel roadway classifications.

Pursuant to Section 2.3.2, Table 2-5 of the County's ECM, rural, local, gravel roadways have a design ADT of 200 trips/day. Therefore, in review of long-term total traffic volumes along Walker Road and Kerry Run Road, no roadway improvements are necessary nor recommended as projected ADT volumes are within the County's 200 trips/day threshold.

Furthermore, pursuant to projected intersection operations illustrated in Tables 6 and 7, no improvements to the existing Kerry Run Road and Walker Road intersection are recommended nor believed to be needed in order to improve operations. Anticipated level of service and 95th percentile queuing results indicate the study intersection will have long-term operations within the County's expectations.

Is the private road up to adequate standard to accommodate the additional traffic generated without an improvements?

This will need to be determined once a use has been defined and the trip generation is more representative for the property

VII. Conclusion

This traffic impact study addressed the capacity, geometric, and control requirements associated with the development entitled 3980 Walker Road. This proposed development consists of an approximate 11,100 square foot modular building intended to be used as a religious institution supporting a maximum of 95 attendees, as allowed within the County's RR-5 zoning district. The development is located near the northeast corner of Walker Road and Kerry Run Road in El Paso County, Colorado.

The study area to be examined in this analysis encompassed the segment of Walker Road bounded by State Highway 83 and Kerry Run Road

Analysis was conducted for critical AM Peak Hour and PM Peak Hour traffic operations for existing traffic conditions, Year 2026 and Year 2040 background traffic conditions, and Year 2026 and Year 2040 total traffic conditions.

Analysis of existing traffic conditions indicates that the signalized intersection of Walker Road with State Highway 83 and Highway 105 has operations at LOS C or better during morning and afternoon peak traffic hours.

The stop-controlled intersection of Walker Road and Kerry Run Road has turning movement operations at LOS A during the morning and afternoon peak traffic hour.

Without the proposed development, Year 2026 background operational analysis shows that the signalized intersection of Walker Road with State Highway 83 and Highway 105 continues to project operations at LOS C or better during morning and afternoon peak traffic hours.

The stop-controlled intersection of Walker Road and Kerry Run Road continues to project turning movement operations at LOS A during the morning and afternoon peak traffic hours.

By Year 2040 and without the proposed development, the signalized intersection of Walker Road with State Highway 83 and Highway 105 continues to expect overall operations at LOS C or better during the morning and afternoon peak traffic hours.

The stop-controlled intersection of Walker Road and Kerry Run Road continues to expect turning movement operations at LOS A during the morning and afternoon peak traffic hours.

Analysis of future traffic conditions indicates that the addition of site-generated traffic is expected to create no negative impact to traffic operations for the existing and surrounding roadway system upon roadway improvements assumed within this analysis. With all conservative assumptions defined in this analysis, the study intersections are projected to operate at future levels of service comparable to Year 2040 background traffic conditions. Kerry Run Road has long-term operations at LOS A during peak traffic periods and upon build-out.

APPENDIX A

Traffic Count Data Signal Timing Information

Peak Hour - Motorized Vehicles

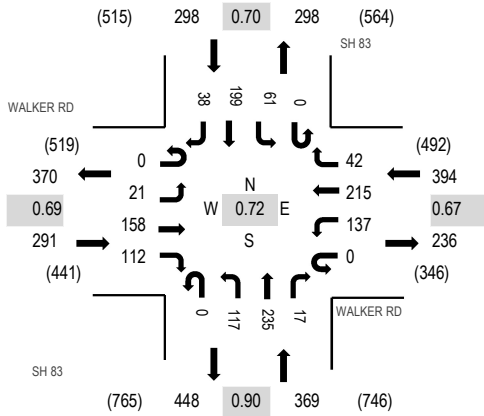

Peak Hour - Bicycles

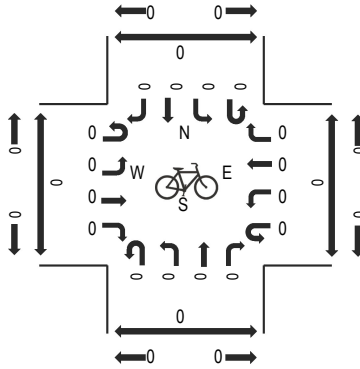

Peak Hour - Pedestrians

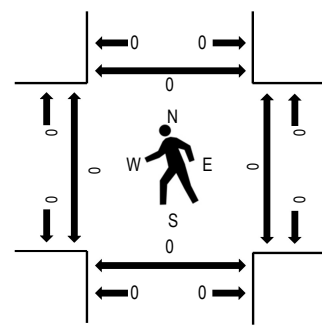

Note: Total study counts contained in parentheses.

Traffic Counts - Motorized Vehicles

Interval Start Time	WALKER RD Eastbound				WALKER RD Westbound				SH 83 Northbound			SH 83 Southbound				Total	Rolling Hour	Pedestrian Crossings				
	U-Turn	Left	Thru	Right	U-Turn	Left	Thru	Right	U-Turn	Left	Thru	Right	U-Turn	Left	Thru			Right	West	East	South	North
7:00 AM	0	7	11	22	0	11	17	2	0	24	56	1	0	5	45	9	210	1,352	0	0	0	0
7:15 AM	0	4	50	26	0	13	42	15	0	25	50	4	0	14	48	17	308	1,334	0	0	0	0
7:30 AM	0	6	72	28	0	49	87	12	0	35	69	3	0	35	64	7	467	1,222	0	0	0	0
7:45 AM	0	4	25	36	0	64	69	13	0	33	60	9	0	7	42	5	367	963	0	0	0	0
8:00 AM	0	5	8	29	0	8	8	4	0	24	45	9	0	2	47	3	192	842	0	0	0	0
8:15 AM	0	4	13	16	0	7	7	3	0	27	65	7	0	4	39	4	196		0	0	0	0
8:30 AM	0	4	10	21	0	11	5	3	0	22	60	15	0	6	46	5	208		0	0	0	0
8:45 AM	0	4	11	25	0	20	14	8	0	25	61	17	0	8	48	5	246		0	0	0	0
Count Total	0	38	200	203	0	183	249	60	0	215	466	65	0	81	379	55	2,194		0	0	0	0
Peak Hour	0	21	158	112	0	137	215	42	0	117	235	17	0	61	199	38	1,352		0	0	0	0

Peak Hour - Motorized Vehicles

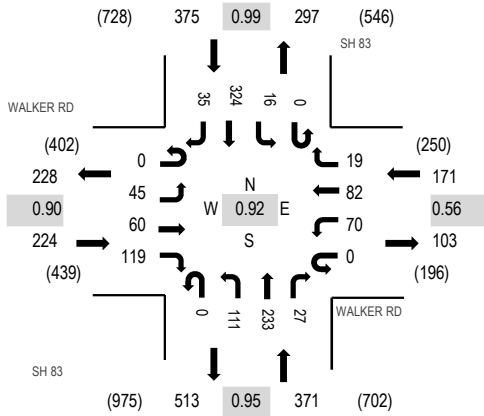

Peak Hour - Bicycles

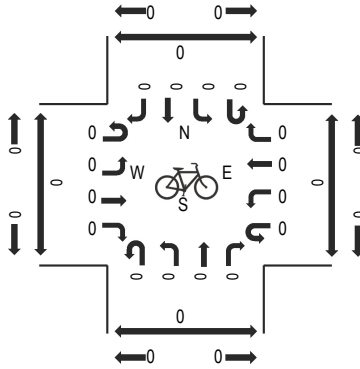

Peak Hour - Pedestrians

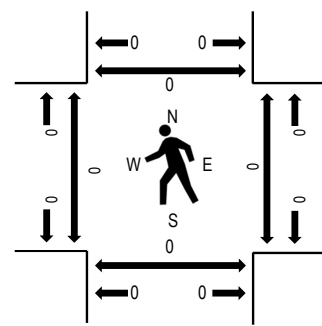

Note: Total study counts contained in parentheses.

Traffic Counts - Motorized Vehicles

Interval Start Time	WALKER RD Eastbound				WALKER RD Westbound				SH 83 Northbound				SH 83 Southbound				Total	Rolling Hour	Pedestrian Crossings			
	U-Turn	Left	Thru	Right	U-Turn	Left	Thru	Right	U-Turn	Left	Thru	Right	U-Turn	Left	Thru	Right			West	East	South	North
4:00 PM	0	11	17	32	0	29	39	8	0	31	53	7	0	3	74	5	309	1,141	0	0	0	0
4:15 PM	0	16	13	21	0	14	12	3	0	28	53	12	0	3	87	6	268	1,103	0	0	0	0
4:30 PM	0	8	12	31	0	18	17	6	0	26	59	3	0	3	83	13	279	1,071	0	0	0	0
4:45 PM	0	10	18	35	0	9	14	2	0	26	68	5	0	7	80	11	285	1,036	0	0	0	0
5:00 PM	0	9	16	37	0	7	6	2	0	25	63	8	0	8	81	9	271	978	0	0	0	0
5:15 PM	0	8	10	33	0	9	7	1	0	32	43	9	0	1	75	8	236		0	0	0	0
5:30 PM	0	9	9	33	0	11	13	6	0	26	40	7	0	5	76	9	244		0	0	0	0
5:45 PM	0	18	11	22	0	9	5	3	0	25	47	6	0	3	69	9	227		0	0	0	0
Count Total	0	89	106	244	0	106	113	31	0	219	426	57	0	33	625	70	2,119		0	0	0	0
Peak Hour	0	45	60	119	0	70	82	19	0	111	233	27	0	16	324	35	1,141		0	0	0	0

Peak Hour - Motorized Vehicles

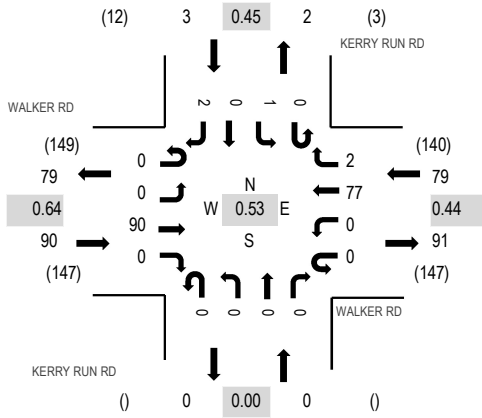

Peak Hour - Bicycles

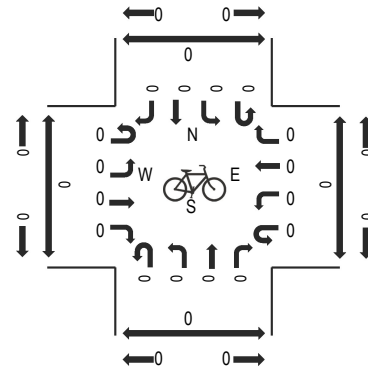

Peak Hour - Pedestrians

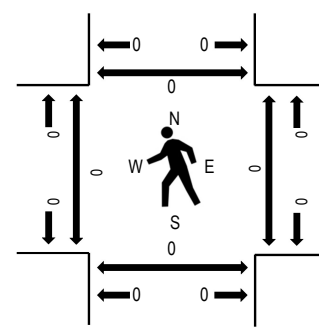

Note: Total study counts contained in parentheses.

Traffic Counts - Motorized Vehicles

Interval Start Time	WALKER RD Eastbound				WALKER RD Westbound				KERRY RUN RD Northbound				KERRY RUN RD Southbound				Total	Rolling Hour	Pedestrian Crossings				
	U-Turn	Left	Thru	Right	U-Turn	Left	Thru	Right	U-Turn	Left	Thru	Right	U-Turn	Left	Thru	Right			West	East	South	North	
7:00 AM	0	0	3	0	0	0	13	0	0	0	0	0	0	0	0	0	2	18	127	0	0	0	0
7:15 AM	0	0	12	0	0	0	25	0	0	0	0	0	0	0	0	0	0	37	135	0	0	0	0
7:30 AM	0	0	12	0	0	0	14	0	0	0	0	0	0	0	0	0	5	31	126	0	0	0	0
7:45 AM	0	1	29	0	0	0	9	0	0	0	0	0	0	0	0	0	2	41	132	0	0	0	0
8:00 AM	0	0	15	0	0	0	9	0	0	0	0	0	0	0	0	0	2	26	172	0	0	0	0
8:15 AM	0	0	18	0	0	0	10	0	0	0	0	0	0	0	0	0	0	28		0	0	0	0
8:30 AM	0	0	22	0	0	0	13	2	0	0	0	0	0	0	0	0	0	37		0	0	0	0
8:45 AM	0	0	35	0	0	0	45	0	0	0	0	0	0	1	0	0	0	81		0	0	0	0
Count Total	0	1	146	0	0	0	138	2	0	0	0	0	0	1	0	11	299		0	0	0	0	0
Peak Hour	0	0	90	0	0	0	77	2	0	0	0	0	0	1	0	2	172		0	0	0	0	0

Peak Hour - Motorized Vehicles

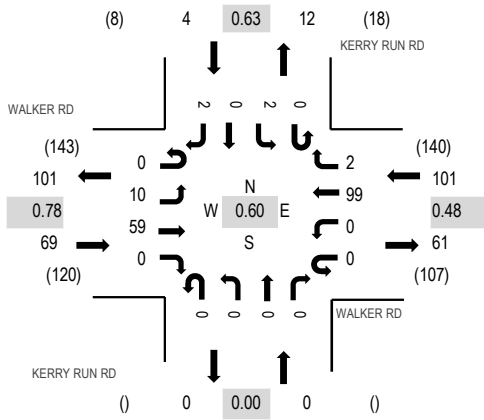

Peak Hour - Bicycles

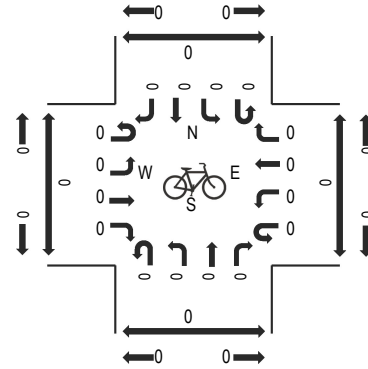

Peak Hour - Pedestrians

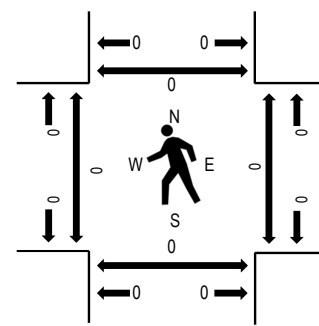

Note: Total study counts contained in parentheses.

Traffic Counts - Motorized Vehicles

Interval Start Time	WALKER RD Eastbound				WALKER RD Westbound				KERRY RUN RD Northbound				KERRY RUN RD Southbound				Total	Rolling Hour	Pedestrian Crossings			
	U-Turn	Left	Thru	Right	U-Turn	Left	Thru	Right	U-Turn	Left	Thru	Right	U-Turn	Left	Thru	Right			West	East	South	North
4:00 PM	0	1	19	0	0	0	52	1	0	0	0	0	0	0	0	0	73	174	0	0	0	0
4:15 PM	0	3	14	0	0	0	18	0	0	0	0	0	0	1	0	1	37	125	0	0	0	0
4:30 PM	0	3	7	0	0	0	19	1	0	0	0	0	0	0	0	0	30	112	0	0	0	0
4:45 PM	0	3	19	0	0	0	10	0	0	0	0	0	0	1	0	1	34	110	0	0	0	0
5:00 PM	0	2	13	0	0	0	9	0	0	0	0	0	0	0	0	0	24	94	0	0	0	0
5:15 PM	0	0	12	0	0	0	9	1	0	0	0	0	0	0	0	2	24		0	0	0	0
5:30 PM	0	1	14	0	0	0	12	0	0	0	0	0	0	0	0	1	28		0	0	0	0
5:45 PM	0	2	7	0	0	0	8	0	0	0	0	0	0	0	0	1	18		0	0	0	0
Count Total	0	15	105	0	0	0	137	3	0	0	0	0	0	2	0	6	268		0	0	0	0
Peak Hour	0	10	59	0	0	0	99	2	0	0	0	0	0	2	0	2	174		0	0	0	0

Start Time	31-Jan-24 Wed	NB	SB	Total
12:00 AM		0	0	0
01:00		0	0	0
02:00		0	0	0
03:00		0	0	0
04:00		0	1	1
05:00		0	2	2
06:00		0	3	3
07:00		1	9	10
08:00		2	3	5
09:00		7	6	13
10:00		5	7	12
11:00		2	1	3
12:00 PM		10	5	15
01:00		5	7	12
02:00		0	7	7
03:00		5	4	9
04:00		12	4	16
05:00		6	4	10
06:00		2	1	3
07:00		3	3	6
08:00		2	0	2
09:00		4	0	4
10:00		0	0	0
11:00		0	0	0
Total		66	67	133
Percent		49.6%	50.4%	
AM Peak	-	09:00	07:00	-
Vol.	-	7	9	-
PM Peak	-	16:00	13:00	-
Vol.	-	12	7	-
Grand Total		66	67	133
Percent		49.6%	50.4%	
ADT		ADT 133	ADT 133	AADT 133

Ped Service Limit	0	0	0	0	0	0	0	0	0	0	0	0	0	0	0	0	0	0	0
Pre Green	0.0	0.0	0.0	0.0	0.0	0.0	0.0	0.0	0.0	0.0	0.0	0.0	0.0	0.0	0.0	0.0	0.0	0.0	0.0
Pre Clearance	0.0	6.0	0.0	0.0	0.0	6.0	0.0	0.0	0.0	0.0	0.0	0.0	0.0	0.0	0.0	0.0	0.0	0.0	0.0

Phases	1	2	3	4	5	6	7	8	9	10	11	12	13	14	15	16	17	18	19	20
Pre Clearance 2	0.0	0.0	0.0	0.0	0.0	0.0	0.0	0.0	0.0	0.0	0.0	0.0	0.0	0.0	0.0	0.0	0.0	0.0	0.0	0.0
Red Clear Ext Max	0.0	0.0	0.0	0.0	0.0	0.0	0.0	0.0	0.0	0.0	0.0	0.0	0.0	0.0	0.0	0.0	0.0	0.0	0.0	0.0
Red Clear Ext Pass	0.0	0.0	0.0	0.0	0.0	0.0	0.0	0.0	0.0	0.0	0.0	0.0	0.0	0.0	0.0	0.0	0.0	0.0	0.0	0.0
Queue Jump	0.0	0.0	0.0	0.0	0.0	0.0	0.0	0.0	0.0	0.0	0.0	0.0	0.0	0.0	0.0	0.0	0.0	0.0	0.0	0.0
Adv Warning Ext	0.0	0.0	0.0	0.0	0.0	0.0	0.0	0.0	0.0	0.0	0.0	0.0	0.0	0.0	0.0	0.0	0.0	0.0	0.0	0.0

Phase Options

Phases	1	2	3	4	5	6	7	8	9	10	11	12	13	14	15	16	17	18	19	20
Enable	X	X	X	X	X	X	X	X												
Auto Flash Ent.		X				X														
Auto Flash Exit		X				X														
Non Actuated I																				
Non Actuated II																				
Non Lock Mem	X	X	X	X	X	X	X	X												
Min Veh Recall																				
Max Veh Recall																				
Ped Recall																				
Soft Veh Recall																				
Dual Entry				X				X												
Sim Gap Dis																				
Guaranteed Pass																				
Act Rest Walk																				
Cond Service																				
Add Initial																				
Ped Clr During Yel																				
Ped Clr During Red																				
Cond Reservice																				
Yel Min Override																				
No Startup Call																				
Adv. Warn Flasher		X				X														
No Ped Str Up Call																				
Ped Clr OVTG																				
Flash Exit Call																				
Flash Exit Ped Call																				
MinGreen2																				
MaxGreen2																				
MaxGreen3																				
Ped2																				
Ped Clear Pre Clear																				
Ped NA+ Mode																				
Red Rest																				
Serve Evy Oth Even																				
Serve Evy Oth Odd																				
Coord Ped Yield																				
Ped Recycle																				
Coutdown																				

No Serve Phases

Sequence 1		Sequence 2		Sequence 3		Sequence 4	
Ph.	No Serve Phases	Ph.	No Serve Phases	Ph.	No Serve Phases	Ph.	No Serve Phases
1		1		1		1	
2		2		2		2	

3		3		3		3	
4		4		4		4	
5		5		5		5	
6		6		6		6	
7		7		7		7	
8		8		8		8	

Sequence 1		Sequence 2		Sequence 3		Sequence 4	
9		9		9		9	
10		10		10		10	
11		11		11		11	
12		12		12		12	
13		13		13		13	
14		14		14		14	
15		15		15		15	
16		16		16		16	

Phase Configuration

Ph.	Startup	Ring	Concurrent	Startup Min	Description
1	Phase Not On	1	5,6	0	SB LT
2	Green No Walk	1	5,6	0	NB
3	Phase Not On	1	7,8	0	WB LT
4	Phase Not On	1	7,8	0	EB
5	Phase Not On	2	1,2	0	NB LT
6	Green No Walk	2	1,2	0	SB
7	Phase Not On	2	3,4	0	EB LT
8	Phase Not On	2	3,4	0	WB
9	None	0		0	
10	None	0		0	
11	None	0		0	
12	None	0		0	
13	None	0		0	
14	None	0		0	
15	None	0		0	
16	None	0		0	
17	None	0		0	
18	None	0		0	
19	None	0		0	
20	None	0		0	

Sequence Configuration

Sequence 1		Sequence 2		Sequence 3		Sequence 4	
Ring	Phases	Ring	Phases	Ring	Phases	Ring	Phases
1	1,2,a,3,4,b	1	2,1,a,3,4,b	1	1,2,a,4,3,b	1	2,1,a,4,3,b
2	5,6,a,7,8,b	2	5,6,a,7,8,b	2	5,6,a,7,8,b	2	5,6,a,7,8,b
3		3		3		3	
4		4		4		4	
5		5		5		5	
6		6		6		6	
7		7		7		7	
8		8		8		8	
9		9		9		9	
10		10		10		10	
11		11		11		11	
12		12		12		12	
13		13		13		13	
14		14		14		14	

15	
16	

15	
16	

15	
16	

15	
16	

Sequence 5

Ring	Phases
1	1,2,a,3,4,b
2	6,5,a,7,8,b
3	
4	
5	
6	

Sequence 6

Ring	Phases
1	2,1,a,3,4,b
2	6,5,a,7,8,b
3	
4	
5	
6	

Sequence 7

Ring	Phases
1	1,2,a,4,3,b
2	6,5,a,7,8,b
3	
4	
5	
6	

Sequence 8

Ring	Phases
1	2,1,a,4,3,b
2	6,5,a,7,8,b
3	
4	
5	
6	

Sequence 5

7	
8	
9	
10	
11	
12	
13	
14	
15	
16	

Sequence 6

7	
8	
9	
10	
11	
12	
13	
14	
15	
16	

Sequence 7

7	
8	
9	
10	
11	
12	
13	
14	
15	
16	

Sequence 8

7	
8	
9	
10	
11	
12	
13	
14	
15	
16	

Sequence 9

Ring	Phases
1	1,2,a,3,4,b
2	5,6,a,8,7,b
3	
4	
5	
6	
7	
8	
9	
10	
11	
12	
13	
14	
15	
16	

Sequence 10

Ring	Phases
1	2,1,a,3,4,b
2	5,6,a,8,7,b
3	
4	
5	
6	
7	
8	
9	
10	
11	
12	
13	
14	
15	
16	

Sequence 11

Ring	Phases
1	1,2,a,4,3,b
2	5,6,a,8,7,b
3	
4	
5	
6	
7	
8	
9	
10	
11	
12	
13	
14	
15	
16	

Sequence 12

Ring	Phases
1	2,1,a,4,3,b
2	5,6,a,8,7,b
3	
4	
5	
6	
7	
8	
9	
10	
11	
12	
13	
14	
15	
16	

Sequence 13

Ring	Phases
1	1,2,a,3,4,b
2	6,5,a,8,7,b
3	
4	
5	
6	
7	
8	
9	
10	
11	
12	
13	

Sequence 14

Ring	Phases
1	2,1,a,3,4,b
2	6,5,a,8,7,b
3	
4	
5	
6	
7	
8	
9	
10	
11	
12	
13	

Sequence 15

Ring	Phases
1	1,2,a,4,3,b
2	6,5,a,8,7,b
3	
4	
5	
6	
7	
8	
9	
10	
11	
12	
13	

Sequence 16

Ring	Phases
1	2,1,a,4,3,b
2	6,5,a,8,7,b
3	
4	
5	
6	
7	
8	
9	
10	
11	
12	
13	

14	
15	
16	

14	
15	
16	

14	
15	
16	

14	
15	
16	

Sequence 17

Ring	Phases
1	
2	
3	
4	
5	
6	
7	
8	

Sequence 18

Ring	Phases
1	
2	
3	
4	
5	
6	
7	
8	

Sequence 19

Ring	Phases
1	
2	
3	
4	
5	
6	
7	
8	

Sequence 20

Ring	Phases
1	
2	
3	
4	
5	
6	
7	
8	

Sequence 17

9	
10	
11	
12	
13	
14	
15	
16	

Sequence 18

9	
10	
11	
12	
13	
14	
15	
16	

Sequence 19

9	
10	
11	
12	
13	
14	
15	
16	

Sequence 20

9	
10	
11	
12	
13	
14	
15	
16	

Global Phase Recalls

Phase	1	2	3	4	5	6	7	8	9	1	1	1	1	1	1	1	1	1	2
Min																			
Max	X					X													
Ped																			
Act Walk Rest																			

Global Veh Det Diagnostics

Global No Activity	0
Global Max Presence	0
Global Erractic Count	0
Global Failed Recall	None
Detector Reset Enable	Enabled

Global Ped Det Diagnostics

Global No Activity	0
Global Max Presence	0
Global Erractic Count	0

Global Pri/Pre Det Diag

Global No Activity	0
Global Max Presence	0
Global Erractic Count	0

Vehicle Detection Parameters

Det.	Call Phs	Call Ped	Call Ovl	Add Call Phases	Sw Phs	Delay	Extend	Queue Limit	Ext Hold	No Activity	Max Pres	Erratic Counts	Failed Time	Failed Recall	Fail Link	Description
1	1	0	0		0	0.0	0.0	0	0.0	0	0	0	0	None	0	
2	2	0	0		0	0.0	0.0	0	0.0	0	0	0	0	None	0	
3	2	0	0		0	0.0	0.0	0	0.0	0	0	0	0	None	0	
4	2	0	0		0	0.0	0.0	0	0.0	0	0	0	0	None	0	
5	2	0	0		0	0.0	0.0	0	0.0	0	0	0	0	None	0	
6	2	0	0		0	0.0	0.0	0	0.0	0	0	0	0	None	0	
7	7	0	0		0	0.0	0.0	0	0.0	0	0	0	0	None	0	
8	4	0	0		0	0.0	0.0	0	0.0	0	0	0	0	None	0	
9	4	0	0		0	0.0	0.0	0	0.0	0	0	0	0	None	0	
10	4	0	0		0	0.0	0.0	0	0.0	0	0	0	0	None	0	
11	4	0	0		0	0.0	0.0	0	0.0	0	0	0	0	None	0	
12	4	0	0		0	0.0	0.0	0	0.0	0	0	0	0	None	0	
13	1	0	0		0	0.0	0.0	0	0.0	0	0	0	0	None	0	
14	3	0	0		0	0.0	0.0	0	0.0	0	0	0	0	None	0	
15	5	0	0		0	0.0	0.0	0	0.0	0	0	0	0	None	0	

16	6	0	0		0	0.0	0.0	0	0.0	0	0	0	0	None	0
17	6	0	0		0	0.0	0.0	0	0.0	0	0	0	0	None	0
18	6	0	0		0	0.0	0.0	0	0.0	0	0	0	0	None	0
19	6	0	0		0	0.0	0.0	0	0.0	0	0	0	0	None	0
20	6	0	0		0	0.0	0.0	0	0.0	0	0	0	0	None	0
21	3	0	0		0	0.0	0.0	0	0.0	0	0	0	0	None	0
22	8	0	0		0	0.0	0.0	0	0.0	0	0	0	0	None	0
23	8	0	0		0	0.0	0.0	0	0.0	0	0	0	0	None	0
24	8	0	0		0	0.0	0.0	0	0.0	0	0	0	0	None	0
25	8	0	0		0	0.0	0.0	0	0.0	0	0	0	0	None	0
26	8	0	0		0	0.0	0.0	0	0.0	0	0	0	0	None	0
27	5	0	0		0	0.0	0.0	0	0.0	0	0	0	0	None	0
28	7	0	0		0	0.0	0.0	0	0.0	0	0	0	0	None	0
29	0	0	0		0	0.0	0.0	0	0.0	0	0	0	0	None	0
30	0	0	0		0	0.0	0.0	0	0.0	0	0	0	0	None	0
31	0	0	0		0	0.0	0.0	0	0.0	0	0	0	0	None	0
32	0	0	0		0	0.0	0.0	0	0.0	0	0	0	0	None	0

Det.	Call	Call	Call	Add Call	Sw			Queue	Ext	No	Max	Erratic	Failed	Failed	Fail	Description
	Phs	Ped	Ovl			Phases	Phs									
33	1	0	0		0	0.0	0.0	0	0.0	0	0	0	15	Min	0	
34	2	0	0		0	0.0	0.0	0	0.0	0	0	0	15	Min	0	
35	3	0	0		0	0.0	0.0	0	0.0	0	0	0	15	Min	0	
36	4	0	0		0	0.0	0.0	0	0.0	0	0	0	15	Min	0	
37	5	0	0		0	0.0	0.0	0	0.0	0	0	0	15	Min	0	
38	6	0	0		0	0.0	0.0	0	0.0	0	0	0	15	Min	0	
39	7	0	0		0	0.0	0.0	0	0.0	0	0	0	15	Min	0	
40	8	0	0		0	0.0	0.0	0	0.0	0	0	0	15	Min	0	
41	0	0	0		0	0.0	0.0	0	0.0	0	0	0	0	None	0	
42	0	0	0		0	0.0	0.0	0	0.0	0	0	0	0	None	0	
43	0	0	0		0	0.0	0.0	0	0.0	0	0	0	0	None	0	
44	0	0	0		0	0.0	0.0	0	0.0	0	0	0	0	None	0	
45	0	0	0		0	0.0	0.0	0	0.0	0	0	0	0	None	0	
46	0	0	0		0	0.0	0.0	0	0.0	0	0	0	0	None	0	
47	0	0	0		0	0.0	0.0	0	0.0	0	0	0	0	None	0	
48	0	0	0		0	0.0	0.0	0	0.0	0	0	0	0	None	0	
49	0	0	0		0	0.0	0.0	0	0.0	0	0	0	0	None	0	
50	0	0	0		0	0.0	0.0	0	0.0	0	0	0	0	None	0	
51	0	0	0		0	0.0	0.0	0	0.0	0	0	0	0	None	0	
52	0	0	0		0	0.0	0.0	0	0.0	0	0	0	0	None	0	
53	0	0	0		0	0.0	0.0	0	0.0	0	0	0	0	None	0	
54	0	0	0		0	0.0	0.0	0	0.0	0	0	0	0	None	0	
55	0	0	0		0	0.0	0.0	0	0.0	0	0	0	0	None	0	
56	0	0	0		0	0.0	0.0	0	0.0	0	0	0	0	None	0	
57	0	0	0		0	0.0	0.0	0	0.0	0	0	0	0	None	0	
58	0	0	0		0	0.0	0.0	0	0.0	0	0	0	0	None	0	
59	0	0	0		0	0.0	0.0	0	0.0	0	0	0	0	None	0	
60	0	0	0		0	0.0	0.0	0	0.0	0	0	0	0	None	0	
61	0	0	0		0	0.0	0.0	0	0.0	0	0	0	0	None	0	
62	0	0	0		0	0.0	0.0	0	0.0	0	0	0	0	None	0	
63	0	0	0		0	0.0	0.0	0	0.0	0	0	0	0	None	0	
64	0	0	0		0	0.0	0.0	0	0.0	0	0	0	0	None	0	
65	0	0	0		0	0.0	0.0	0	0.0	0	0	0	0	None	0	
66	0	0	0		0	0.0	0.0	0	0.0	0	0	0	0	None	0	
67	0	0	0		0	0.0	0.0	0	0.0	0	0	0	0	None	0	
68	0	0	0		0	0.0	0.0	0	0.0	0	0	0	0	None	0	
69	0	0	0		0	0.0	0.0	0	0.0	0	0	0	0	None	0	
70	0	0	0		0	0.0	0.0	0	0.0	0	0	0	0	None	0	

71	0	0	0		0	0.0	0.0	0	0.0	0	0	0	0	0	0	None	0
72	0	0	0		0	0.0	0.0	0	0.0	0	0	0	0	0	0	None	0

Vehicle Detection Options

Detector	1	2	3	4	5	6	7	8	9	10	11	12	13	14	15	16	17	18	19	20
Volume Detector																				
Occupancy																				
Yellow Lock Call																				
Red Lock call																				
Extend	X	X	X	X	X	X	X	X	X	X	X	X	X	X	X	X	X	X	X	X
Added Initial																				
Queue																				
Call	X	X	X	X	X	X	X	X	X	X	X	X	X	X	X	X	X	X	X	X
Terminate																				
Min Green 2																				
Protected Perm																				
Disable Dly Lead																				
Disable TS2 Diag																				

Detector	21	22	23	24	25	26	27	28	29	30	31	32	33	34	35	36	37	38	39	40
Volume Detector																				
Occupancy																				
Yellow Lock Call																				
Red Lock call																				
Extend	X	X	X	X	X	X	X	X	X	X	X	X	X	X	X	X	X	X	X	X
Added Initial																				
Queue																				
Call	X	X	X	X	X	X	X	X	X	X	X	X	X	X	X	X	X	X	X	X
Terminate																				
Min Green 2																				
Protected Perm																				
Disable Dly Lead																				
Disable TS2 Diag																				

Detector	41	42	43	44	45	46	47	48	49	50	51	52	53	54	55	56	57	58	59	60
Volume Detector																				
Occupancy																				
Yellow Lock Call																				
Red Lock call																				
Extend	X	X	X	X	X	X	X	X	X	X	X	X	X	X	X	X	X	X	X	X
Added Initial																				
Queue																				
Call	X	X	X	X	X	X	X	X	X	X	X	X	X	X	X	X	X	X	X	X
Terminate																				
Min Green 2																				
Protected Perm																				
Disable Dly Lead																				
Disable TS2 Diag																				

Detector	61	62	63	64	65	66	67	68	69	70	71	72
Volume Detector												
Occupancy												
Yellow Lock Call												
Red Lock call												
Extend	X	X	X	X	X	X	X	X	X	X	X	X
Added Initial												
Queue												

Data Collection Period	0
Number of Periods	1

Call	X	X	X	X	X	X	X	X	X	X	X	X	X
Terminate													
Min Green 2													
Protected Perm													
Disable Dly Lead													
Disable TS2 Diag													

Speed Detectors

Det	Enable	Type	Units	Min Log	Max Log	Car Length	Det Length	Trail Det	Trap Length
1		Single	Inches	5	80	0	0	0	0
2		Single	Inches	5	80	0	0	0	0
3		Single	Inches	5	80	0	0	0	0
4		Single	Inches	5	80	0	0	0	0
5		Single	Inches	5	80	0	0	0	0
6		Single	Inches	5	80	0	0	0	0
7		Single	Inches	5	80	0	0	0	0
8		Single	Inches	5	80	0	0	0	0

Pedestrian Detectors

Det	Call Phs	Call Ovlp	Add Call Phs	Walk 2	Clear 2	No Act	Max Pres	Erratic Count
1	0	0		0	0	0	0	0
2	2	0		0	0	0	0	0
3	0	0		0	0	0	0	0
4	4	0		0	0	0	0	0
5	0	0		0	0	0	0	0
6	6	0		0	0	0	0	0
7	0	0		0	0	0	0	0
8	8	0		0	0	0	0	0
9	0	0		0	0	0	0	0
10	0	0		0	0	0	0	0
11	0	0		0	0	0	0	0
12	0	0		0	0	0	0	0
13	0	0		0	0	0	0	0
14	0	0		0	0	0	0	0
15	0	0		0	0	0	0	0
16	0	0		0	0	0	0	0
17	0	0		0	0	0	0	0
18	0	0		0	0	0	0	0
19	0	0		0	0	0	0	0
20	0	0		0	0	0	0	0

Det	Call Phs	Call Ovlp	Add Call Phs	Walk 2	Clear 2	No Act	Max Pres	Erratic Count
21	0	0		0	0	0	0	0
22	0	0		0	0	0	0	0
23	0	0		0	0	0	0	0
24	0	0		0	0	0	0	0
25	0	0		0	0	0	0	0
26	0	0		0	0	0	0	0
27	0	0		0	0	0	0	0
28	0	0		0	0	0	0	0
29	0	0		0	0	0	0	0
30	0	0		0	0	0	0	0
31	0	0		0	0	0	0	0
32	0	0		0	0	0	0	0
33	0	0		0	0	0	0	0
34	0	0		0	0	0	0	0
35	0	0		0	0	0	0	0
36	0	0		0	0	0	0	0
37	0	0		0	0	0	0	0
38	0	0		0	0	0	0	0
39	0	0		0	0	0	0	0
40	0	0		0	0	0	0	0

Pri/Pre Detectors

Det	Description	Low Call	High Call	Low Num	High Num	Lead/Trail	Arrival Time	Pri Delay	Ext	Min On	Pri Ovlp	No Act	Max Pres	Erratic Count
1		None	None	0	0	None	0	0	0	0		0	0	0
2		None	None	0	0	None	0	0	0	0		0	0	0
3		None	None	0	0	None	0	0	0	0		0	0	0
4		None	None	0	0	None	0	0	0	0		0	0	0
5		None	None	0	0	None	0	0	0	0		0	0	0
6		None	None	0	0	None	0	0	0	0		0	0	0
7		None	None	0	0	None	0	0	0	0		0	0	0
8		None	None	0	0	None	0	0	0	0		0	0	0

Overlaps

OLP	Enabled	Type	Included Phs	Modifier Phs	Modifier Ovlps	Neg Phases	Inhibit Neg Phs	Neg Ovlps
1	Enabled	FYA - 4 Sec	2	1				
2	Enabled	Off						
3	Enabled	FYA - 4 Sec	4	3				

No Veh Reserv																			
No Hold Trail Exit																			
Ped Recycle																			
No Yellow Protect																			
No Bridging																			
LRT Prepare Go																			

FYA Prot. Red Cl																			
Phs Intvl Override																			
Queue Jump																			
No FYA Ped Wlk																			
Term After Call																			

Custom Overlap Rules

Rule	Custom Ovlp	Incl. State	Mod. State	Neg. State	Output	Flash
1	Disable	Any	Any	Any	Not Set	Not Set
2	Disable	Any	Any	Any	Not Set	Not Set
3	Disable	Any	Any	Any	Not Set	Not Set
4	Disable	Any	Any	Any	Not Set	Not Set
5	Disable	Any	Any	Any	Not Set	Not Set
6	Disable	Any	Any	Any	Not Set	Not Set
7	Disable	Any	Any	Any	Not Set	Not Set
8	Disable	Any	Any	Any	Not Set	Not Set
9	Disable	Any	Any	Any	Not Set	Not Set
10	Disable	Any	Any	Any	Not Set	Not Set

Coordination Parameters

Operational Mode	Manual Free
Coordination Mode	Pattern
Correction Mode	Shortway (Auto)

Maximum Mode	Per Pattern
Force Mode	Per Pattern
Transition Cover Ped	Pattern

Max Cyc Limit %	15
Min Cyc Limit %	15
Max Dwell	0

Patterns

Patt.	Cycle	Offset					Ref	Coord	Force	Max	Trans	Min	Phs	Det	Ped	Ovlp	Pri	Description
		1	2	3	Split	Seq												
1	0	0	0	0	0	0	Yel	Auto	Fixed	Inh	Phase	Phs Only	1	1	1	1	1	
2	0	0	0	0	0	0	Yel	Auto	Fixed	Inh	Phase	Phs Only	1	1	1	1	1	
3	0	0	0	0	0	0	Yel	Auto	Fixed	Inh	Phase	Phs Only	1	1	1	1	1	
4	0	0	0	0	0	0	Yel	Auto	Fixed	Inh	Phase	Phs Only	1	1	1	1	1	
5	0	0	0	0	0	0	Yel	Auto	Fixed	Inh	Phase	Phs Only	1	1	1	1	1	
6	0	0	0	0	0	0	Yel	Auto	Fixed	Inh	Phase	Phs Only	1	1	1	1	1	
7	0	0	0	0	0	0	Yel	Auto	Fixed	Inh	Phase	Phs Only	1	1	1	1	1	
8	0	0	0	0	0	0	Yel	Auto	Fixed	Inh	Phase	Phs Only	1	1	1	1	1	
9	0	0	0	0	0	0	Yel	Auto	Fixed	Inh	Phase	Phs Only	1	1	1	1	1	
10	0	0	0	0	0	0	Yel	Auto	Fixed	Inh	Phase	Phs Only	1	1	1	1	1	
11	0	0	0	0	0	0	Yel	Auto	Fixed	Inh	Phase	Phs Only	1	1	1	1	1	
12	0	0	0	0	0	0	Yel	Auto	Fixed	Inh	Phase	Phs Only	1	1	1	1	1	
13	0	0	0	0	0	0	Yel	Auto	Fixed	Inh	Phase	Phs Only	1	1	1	1	1	
14	0	0	0	0	0	0	Yel	Auto	Fixed	Inh	Phase	Phs Only	1	1	1	1	1	
15	0	0	0	0	0	0	Yel	Auto	Fixed	Inh	Phase	Phs Only	1	1	1	1	1	
16	0	0	0	0	0	0	Yel	Auto	Fixed	Inh	Phase	Phs Only	1	1	1	1	1	
17	0	0	0	0	0	0	Yel	Auto	Fixed	Inh	Phase	Phs Only	1	1	1	1	1	
18	0	0	0	0	0	0	Yel	Auto	Fixed	Inh	Phase	Phs Only	1	1	1	1	1	
19	0	0	0	0	0	0	Yel	Auto	Fixed	Inh	Phase	Phs Only	1	1	1	1	1	
20	0	0	0	0	0	0	Yel	Auto	Fixed	Inh	Phase	Phs Only	1	1	1	1	1	

Split Parameters

Split 1				Coord	Ref	Cover	Force Off	Pri	Pri	Pri	
PH.	Time	Min	Max								PH
1	0	0	0				Fix	None	0	0	Float
2	0	0	0				Fix	None	0	0	Float
3	0	0	0				Fix	None	0	0	Float
4	0	0	0				Fix	None	0	0	Float
5	0	0	0				Fix	None	0	0	Float
6	0	0	0				Fix	None	0	0	Float
7	0	0	0				Fix	None	0	0	Float

8	0	0	0				Fix	None	0	0	Float
9	0	0	0				Fix	None	0	0	Float
10	0	0	0				Fix	None	0	0	Float
11	0	0	0				Fix	None	0	0	Float
12	0	0	0				Fix	None	0	0	Float
13	0	0	0				Fix	None	0	0	Float
14	0	0	0				Fix	None	0	0	Float
15	0	0	0				Fix	None	0	0	Float
16	0	0	0				Fix	None	0	0	Float

Split 2

				Coord	Ref	Cover	Force Off				
PH.	Time	Min	Max	PH	PH	Ped	Mode	Mode	Pri	Pri	Pri
									Min	Max	F. Off
1	0	0	0				Fix	None	0	0	Float
2	0	0	0				Fix	None	0	0	Float
3	0	0	0				Fix	None	0	0	Float
4	0	0	0				Fix	None	0	0	Float
5	0	0	0				Fix	None	0	0	Float
6	0	0	0				Fix	None	0	0	Float
7	0	0	0				Fix	None	0	0	Float
8	0	0	0				Fix	None	0	0	Float
9	0	0	0				Fix	None	0	0	Float
10	0	0	0				Fix	None	0	0	Float
11	0	0	0				Fix	None	0	0	Float
12	0	0	0				Fix	None	0	0	Float
13	0	0	0				Fix	None	0	0	Float
14	0	0	0				Fix	None	0	0	Float
15	0	0	0				Fix	None	0	0	Float
16	0	0	0				Fix	None	0	0	Float

Split 3

				Coord	Ref	Cover	Force Off				
PH.	Time	Min	Max	PH	PH	Ped	Mode	Mode	Pri	Pri	Pri
									Min	Max	F. Off
1	0	0	0				Fix	None	0	0	Float
2	0	0	0				Fix	None	0	0	Float
3	0	0	0				Fix	None	0	0	Float
4	0	0	0				Fix	None	0	0	Float
5	0	0	0				Fix	None	0	0	Float
6	0	0	0				Fix	None	0	0	Float
7	0	0	0				Fix	None	0	0	Float
8	0	0	0				Fix	None	0	0	Float
9	0	0	0				Fix	None	0	0	Float
10	0	0	0				Fix	None	0	0	Float
11	0	0	0				Fix	None	0	0	Float
12	0	0	0				Fix	None	0	0	Float
13	0	0	0				Fix	None	0	0	Float
14	0	0	0				Fix	None	0	0	Float
15	0	0	0				Fix	None	0	0	Float
16	0	0	0				Fix	None	0	0	Float

Split 4

				Coord	Ref	Cover	Force Off				
PH.	Time	Min	Max	PH	PH	Ped	Mode	Mode	Pri	Pri	Pri
									Min	Max	F. Off
1	0	0	0				Fix	None	0	0	Float
2	0	0	0				Fix	None	0	0	Float
3	0	0	0				Fix	None	0	0	Float
4	0	0	0				Fix	None	0	0	Float
5	0	0	0				Fix	None	0	0	Float
6	0	0	0				Fix	None	0	0	Float
7	0	0	0				Fix	None	0	0	Float

8	0	0	0				Fix	None	0	0	Float
9	0	0	0				Fix	None	0	0	Float
10	0	0	0				Fix	None	0	0	Float
11	0	0	0				Fix	None	0	0	Float
12	0	0	0				Fix	None	0	0	Float
13	0	0	0				Fix	None	0	0	Float
14	0	0	0				Fix	None	0	0	Float
15	0	0	0				Fix	None	0	0	Float
16	0	0	0				Fix	None	0	0	Float

Split 5				Coord	Ref	Cover	Force Off		Pri	Pri	Pri
PH.	Time	Min	Max	PH	PH	Ped	Mode	Mode	Min	Max	F. Off
1	0	0	0				Fix	None	0	0	Float
2	0	0	0				Fix	None	0	0	Float
3	0	0	0				Fix	None	0	0	Float
4	0	0	0				Fix	None	0	0	Float
5	0	0	0				Fix	None	0	0	Float
6	0	0	0				Fix	None	0	0	Float
7	0	0	0				Fix	None	0	0	Float
8	0	0	0				Fix	None	0	0	Float
9	0	0	0				Fix	None	0	0	Float
10	0	0	0				Fix	None	0	0	Float
11	0	0	0				Fix	None	0	0	Float
12	0	0	0				Fix	None	0	0	Float
13	0	0	0				Fix	None	0	0	Float
14	0	0	0				Fix	None	0	0	Float
15	0	0	0				Fix	None	0	0	Float
16	0	0	0				Fix	None	0	0	Float

Split 6				Coord	Ref	Cover	Force Off		Pri	Pri	Pri
PH.	Time	Min	Max	PH	PH	Ped	Mode	Mode	Min	Max	F. Off
1	0	0	0				Fix	None	0	0	Float
2	0	0	0				Fix	None	0	0	Float

Split 6				Coord	Ref	Cover	Force Off		Pri	Pri	Pri
PH.	Time	Min	Max	PH	PH	Ped	Mode	Mode	Min	Max	F. Off
3	0	0	0				Fix	None	0	0	Float
4	0	0	0				Fix	None	0	0	Float
5	0	0	0				Fix	None	0	0	Float
6	0	0	0				Fix	None	0	0	Float
7	0	0	0				Fix	None	0	0	Float
8	0	0	0				Fix	None	0	0	Float
9	0	0	0				Fix	None	0	0	Float
10	0	0	0				Fix	None	0	0	Float
11	0	0	0				Fix	None	0	0	Float
12	0	0	0				Fix	None	0	0	Float
13	0	0	0				Fix	None	0	0	Float
14	0	0	0				Fix	None	0	0	Float
15	0	0	0				Fix	None	0	0	Float
16	0	0	0				Fix	None	0	0	Float

Split 7				Coord	Ref	Cover	Force Off		Pri	Pri	Pri
PH.	Time	Min	Max	PH	PH	Ped	Mode	Mode	Min	Max	F. Off
1	0	0	0				Fix	None	0	0	Float
2	0	0	0				Fix	None	0	0	Float
3	0	0	0				Fix	None	0	0	Float
4	0	0	0				Fix	None	0	0	Float
5	0	0	0				Fix	None	0	0	Float

6	0	0	0				Fix	None	0	0	Float
7	0	0	0				Fix	None	0	0	Float
8	0	0	0				Fix	None	0	0	Float
9	0	0	0				Fix	None	0	0	Float
10	0	0	0				Fix	None	0	0	Float
11	0	0	0				Fix	None	0	0	Float
12	0	0	0				Fix	None	0	0	Float
13	0	0	0				Fix	None	0	0	Float
14	0	0	0				Fix	None	0	0	Float
15	0	0	0				Fix	None	0	0	Float
16	0	0	0				Fix	None	0	0	Float

Split 8

				Coord	Ref	Cover	Force Off				
PH.	Time	Min	Max	PH	PH	Ped	Mode	Mode	Pri	Pri	Pri
									Min	Max	F. Off
1	0	0	0				Fix	None	0	0	Float
2	0	0	0				Fix	None	0	0	Float
3	0	0	0				Fix	None	0	0	Float
4	0	0	0				Fix	None	0	0	Float
5	0	0	0				Fix	None	0	0	Float
6	0	0	0				Fix	None	0	0	Float
7	0	0	0				Fix	None	0	0	Float
8	0	0	0				Fix	None	0	0	Float
9	0	0	0				Fix	None	0	0	Float
10	0	0	0				Fix	None	0	0	Float
11	0	0	0				Fix	None	0	0	Float
12	0	0	0				Fix	None	0	0	Float
13	0	0	0				Fix	None	0	0	Float
14	0	0	0				Fix	None	0	0	Float
15	0	0	0				Fix	None	0	0	Float
16	0	0	0				Fix	None	0	0	Float

Split 9

				Coord	Ref	Cover	Force Off				
PH.	Time	Min	Max	PH	PH	Ped	Mode	Mode	Pri	Pri	Pri
									Min	Max	F. Off
1	0	0	0				Fix	None	0	0	Float
2	0	0	0				Fix	None	0	0	Float
3	0	0	0				Fix	None	0	0	Float
4	0	0	0				Fix	None	0	0	Float

Split 9

				Coord	Ref	Cover	Force Off				
PH.	Time	Min	Max	PH	PH	Ped	Mode	Mode	Pri	Pri	Pri
									Min	Max	F. Off
5	0	0	0				Fix	None	0	0	Float
6	0	0	0				Fix	None	0	0	Float
7	0	0	0				Fix	None	0	0	Float
8	0	0	0				Fix	None	0	0	Float
9	0	0	0				Fix	None	0	0	Float
10	0	0	0				Fix	None	0	0	Float
11	0	0	0				Fix	None	0	0	Float
12	0	0	0				Fix	None	0	0	Float
13	0	0	0				Fix	None	0	0	Float
14	0	0	0				Fix	None	0	0	Float
15	0	0	0				Fix	None	0	0	Float
16	0	0	0				Fix	None	0	0	Float

Split 10

				Coord	Ref	Cover	Force Off				
PH.	Time	Min	Max	PH	PH	Ped	Mode	Mode	Pri	Pri	Pri
									Min	Max	F. Off
1	0	0	0				Fix	None	0	0	Float
2	0	0	0				Fix	None	0	0	Float

J	A	S	O	N	D

17	18	19	20	21	22	23	24	25	26	27	28	29	30	31

Day Plan On _____

Month of Year					Days of Week					Days of Month																			
J	F	M	A	M	J	S	M	T	W	T	F	S	1	2	3	4	5	6	7	8	9	10	11	12	13	14	15	16	
J	A	S	O	N	D								17	18	19	20	21	22	23	24	25	26	27	28	29	30	31		

Day Plan

Event	Hour	Min.	Act
1	0	0	
2	0	0	
3	0	0	
4	0	0	
5	0	0	
6	0	0	
7	0	0	
8	0	0	
9	0	0	
10	0	0	

Day Plan

Event	Hour	Min.	Act
1	0	0	
2	0	0	
3	0	0	
4	0	0	
5	0	0	
6	0	0	
7	0	0	
8	0	0	
9	0	0	
10	0	0	

Day Plan

Event	Hour	Min.	Act
1	0	0	
2	0	0	
3	0	0	
4	0	0	
5	0	0	
6	0	0	
7	0	0	
8	0	0	
9	0	0	
10	0	0	

Day Plan

Event	Hour	Min.	Act
1	0	0	
2	0	0	
3	0	0	
4	0	0	
5	0	0	
6	0	0	
7	0	0	
8	0	0	
9	0	0	
10	0	0	

Day Plan

Event	Hour	Min.	Act
1	0	0	
2	0	0	
3	0	0	
4	0	0	
5	0	0	
6	0	0	
7	0	0	
8	0	0	
9	0	0	
10	0	0	

Day Plan

Event	Hour	Min.	Act
1	0	0	
2	0	0	
3	0	0	
4	0	0	
5	0	0	
6	0	0	
7	0	0	
8	0	0	
9	0	0	
10	0	0	

Day Plan

Event	Hour	Min.	Act
1	0	0	
2	0	0	
3	0	0	
4	0	0	
5	0	0	
6	0	0	
7	0	0	
8	0	0	
9	0	0	
10	0	0	

Day Plan

Event	Hour	Min.	Act
1	0	0	
2	0	0	
3	0	0	
4	0	0	
5	0	0	
6	0	0	
7	0	0	
8	0	0	
9	0	0	
10	0	0	

Day Plan

Event	Hour	Min.	Act
1	0	0	
2	0	0	
3	0	0	
4	0	0	
5	0	0	
6	0	0	
7	0	0	
8	0	0	
9	0	0	
10	0	0	

Day Plan

Event	Hour	Min.	Act
1	0	0	
2	0	0	
3	0	0	
4	0	0	
5	0	0	
6	0	0	
7	0	0	
8	0	0	
9	0	0	
10	0	0	

Day Plan

Event	Hour	Min.	Act
1	0	0	
2	0	0	
3	0	0	
4	0	0	
5	0	0	
6	0	0	
7	0	0	
8	0	0	
9	0	0	
10	0	0	

Day Plan

Event	Hour	Min.	Act
1	0	0	
2	0	0	
3	0	0	
4	0	0	
5	0	0	
6	0	0	
7	0	0	
8	0	0	
9	0	0	
10	0	0	

Day Plan

Event	Hour	Min.	Act
1	0	0	
2	0	0	
3	0	0	
4	0	0	
5	0	0	
6	0	0	

Day Plan

Event	Hour	Min.	Act
1	0	0	
2	0	0	
3	0	0	
4	0	0	
5	0	0	
6	0	0	

Day Plan

Event	Hour	Min.	Act
1	0	0	
2	0	0	
3	0	0	
4	0	0	
5	0	0	
6	0	0	

Day Plan

Event	Hour	Min.	Act
1	0	0	
2	0	0	
3	0	0	
4	0	0	
5	0	0	
6	0	0	

7	0	0	
8	0	0	
9	0	0	
10	0	0	

7	0	0	
8	0	0	
9	0	0	
10	0	0	

7	0	0	
8	0	0	
9	0	0	
10	0	0	

7	0	0	
8	0	0	
9	0	0	
10	0	0	

Day Plan 17

Event	Hour	Min.	Act
1	0	0	
2	0	0	
3	0	0	
4	0	0	
5	0	0	
6	0	0	
7	0	0	
8	0	0	
9	0	0	
10	0	0	

Day Plan 18

Event	Hour	Min.	Act
1	0	0	
2	0	0	
3	0	0	
4	0	0	
5	0	0	
6	0	0	
7	0	0	
8	0	0	
9	0	0	
10	0	0	

Day Plan 19

Event	Hour	Min.	Act
1	0	0	
2	0	0	
3	0	0	
4	0	0	
5	0	0	
6	0	0	
7	0	0	
8	0	0	
9	0	0	
10	0	0	

Day Plan 20

Event	Hour	Min.	Act
1	0	0	
2	0	0	
3	0	0	
4	0	0	
5	0	0	
6	0	0	
7	0	0	
8	0	0	
9	0	0	
10	0	0	

Actions		Aux.			Special Functions							
Act	Pattern	1	2	3	1	2	3	4	5	6	7	8
1	Pattern 1											
2	Pattern 2											
3	Pattern 3											
4	Pattern 4											
5	Pattern 5											
6	Pattern 6											
7	Pattern 7											
8	Pattern 8											
9	Pattern 9											
10	Pattern 10											
11	None											
12	None											
13	None											
14	None											
15	None											
16	None											
17	None											
18	None											
19	None											
20	None											
21	None											
22	None											
23	None											
24	None											
25	None											
26	None											
27	None											
28	None											
29	None											
30	None											
31	None											
32	None											

Actions		Aux.			Special Functions							
Act	Pattern	1	2	3	1	2	3	4	5	6	7	8
33	None											
34	None											
35	None											
36	None											
37	None											
38	None											
39	None											
40	None											
41	None											
42	None											
43	None											
44	None											
45	None											
46	None											
47	None											
48	None											
49	None											
50	None											
51	None											
52	None											
53	None											
54	None											
55	None											
56	None											
57	None											
58	None											
59	None											
60	None											
61	None											
62	None											
63	None											
64	None											

Action Commands

Action 1

Cmd	Command	Indexes
1	None	
2	None	

Action 2

Cmd	Command	Indexes
1	None	
2	None	

3	None	
4	None	
5	None	
6	None	
7	None	
8	None	
9	None	
10	None	

3	None	
4	None	
5	None	
6	None	
7	None	
8	None	
9	None	
10	None	

Master Sections By TOD

Action	1	2	3	4	5	6	7	8	9	0	1
Master Section 1											
Master Section 2											
Master Section 3											
Master Section 4											
Master Section 5											
Master Section 6											
Master Section 7											
Master Section 8											
Master Section 9											
Master Section 10											
Master Section 11											
Master Section 12											
Master Section 13											
Master Section 14											
Master Section 15											
Master Section 16											

Queue Responsive By TOD

Action	1	2	3	4	5	6	7	8	9	0	1
Queue Resp Plan 1											
Queue Resp Plan 2											
Queue Resp Plan 3											
Queue Resp Plan 4											
Queue Resp Plan 5											
Queue Resp Plan 6											
Queue Resp Plan 7											
Queue Resp Plan 8											
Queue Resp Plan 9											
Queue Resp Plan 10											
Queue Resp Plan 11											
Queue Resp Plan 12											
Queue Resp Plan 13											
Queue Resp Plan 14											
Queue Resp Plan 15											
Queue Resp Plan 16											

Preemption Parameters

Preempt	1	2	3	4	5	6	7	8
Link	0	0	0	0	0	0	0	0
Delay	0	0	0	0	0	0	0	0
Min Duration	0	0	0	0	0	0	0	0
Min Presence	0.0	0.0	0.0	0.0	0.0	0.0	0.0	0.0
Max Presence	0	0	0	0	0	0	0	0
Enter Min Green	0	0	0	0	0	0	0	0
Enter Yellow	25.5	25.5	25.5	25.5	25.5	25.5	25.5	25.5
Ent. Red Clear	25.5	25.5	25.5	25.5	25.5	25.5	25.5	25.5
Min Walk	0	0	0	0	0	0	0	0
Ent. Ped Clear	255	255	255	255	255	255	255	255
Track Green	0	0	0	0	0	0	0	0
Max Track Grn	0	0	0	0	0	0	0	0
Track Yellow	25.5	25.5	25.5	25.5	25.5	25.5	25.5	25.5
Track Red Clear	25.5	25.5	25.5	25.5	25.5	25.5	25.5	25.5
Track 2 Green	0	0	0	0	0	0	0	0
Track 2 Yellow	25.5	25.5	25.5	25.5	25.5	25.5	25.5	25.5
Track 2 Red	25.5	25.5	25.5	25.5	25.5	25.5	25.5	25.5
Track Ext Gate Dn	0	0	0	0	0	0	0	0
Dwell Green	0	0	0	0	0	0	0	0
Exit Ped Clear	255	255	255	255	255	255	255	255
Exit Yellow	25.5	25.5	25.5	25.5	25.5	25.5	25.5	25.5
Exit Red	25.5	25.5	25.5	25.5	25.5	25.5	25.5	25.5
Dwell Ext Time	0.0	0.0	0.0	0.0	0.0	0.0	0.0	0.0
Max Exit Green	0	0	0	0	0	0	0	0
Exit Max Time	0	0	0	0	0	0	0	0

Preempt	1	2	3	4	5	6	7	8
Non Lock Mem								
Not Override Flash								
NotOverrideNextPre								
Flash Dwell								
Ped Recycle								
Imm Ped Clear								
Dwell Only Status								
All Red Flash Dwell								
Allow All Overlaps								
Req All Red Entry								
Req Gate Dwn Trck Exit								
Req Gate Up Dwl Exit								
Normal On/Off Input								
Track Clear Override								
Aux Function 1								
Aux Function 2								
Aux Function 3								
Special Function 1								
Special Function 2								
Special Function 3								
Special Function 4								
Special Function 5								
Special Function 6								
Special Function 7								
Special Function 8								

Require CRC
Disabled

Pre	1	2	3	4	5	6	7	8
-----	---	---	---	---	---	---	---	---

Pre	1	2	3	4	5	6	7	8
-----	---	---	---	---	---	---	---	---

Pre	1	2	3	4	5	6	7	8
-----	---	---	---	---	---	---	---	---

Pre	1	2	3	4	5	6	7	8
-----	---	---	---	---	---	---	---	---

Sp F9																				Sp F11																			Sp F13																			Sp F15																		
Sp F10																				Sp F12																		Sp F14																		Sp F16																				

Preemption Configuration

Preempt	1	2	3	4	5	6	7	8
Enabled	Disabled	Disabled	Disabled	Disabled	Disabled	Disabled	Disabled	Disabled
Type	Rail Road	Rail Road	Emerg Veh	Emerg Veh	Emerg Veh	Emerg Veh	Emerg Veh	Emerg Veh
Description								
Track Phases								
Track 2 Phases								
Track Overlaps								
Track 2 Overlaps								
Dwell Phase								
Dwell Ped								
Dwell Overlaps								
Cycling Phases								
Cycling Peds								
Cycling Overlaps								
Exit Phases								
Exit Overlaps								
Exit Veh Calls								
Exit Ped Calls								
Recovery Omit Phs								
Max Pres Action	0	0	0	0	0	0	0	0
Exit Type	Exit Phases	Exit Phases	Exit Phases	Exit Phases	Exit Phases	Exit Phases	Exit Phases	Exit Phases
Exit Max Mode	Disabled	Disabled	Disabled	Disabled	Disabled	Disabled	Disabled	Disabled

Cabinet Config

Run ITS on NEMA port 1	No	Enable TS2/ATC Stop Time		Disable TS2 Fault Flash	X
Run ITS on 2070-1C C13S	No	Disable TS2 Startup Call		Disable TS2 Cab. Alarms	X

IO Modules

IO Mod	TYPE
1	Caltrans 332
2	TS2 DR3 BIU
3	None
4	None
5	None
6	None
7	None
8	None
9	None
10	None

Channel Configuration

Chan	Ctrl Type	Source	MMU Channel	Chan	Ctrl Type	Source	MMU Channel
1	Phs Veh	1	1	11	Wrn Flash	6	11
2	Phs Veh	2	2	12	None	7	12
3	Phs Veh	3	3	13	None	2	13
4	Phs Veh	4	4	14	None	2	14
5	Phs Veh	5	5	15	None	6	15
6	Phs Veh	6	6	16	None	6	16
7	Phs Veh	7	7	17	None	0	17
8	Phs Veh	8	8	18	None	0	18
9	Wrn Flash	2	9	19	None	0	19
10	None	3	10	20	None	0	20

Channel Options

Channel	1	2	3	4	5	6	7	8	9	10	11	12	13	14	15	16
Flash Yellow		X				X										
Flash Red	X		X	X	X		X	X	X	X	X					
Alt Flash	X			X	X			X								
Channel	17	18	19	20	21	22	23	24	25	26	27	28	29	30	31	32
Flash Yellow																
Flash Red																
Alt Flash																

Phase Intervals

Interval	Description	Red	Yel	Grn	Type	Interval	Description	Red	Yel	Grn	Type
1	Not Act	On	Off	Off	Red	7	Pre Clr	Off	Off	On	Green

Peer Configuration

Ctrl	Peer ID	Device Type	IP address	IP Port	Http Port	Serial Port	Serial Addr.	Master Sect.	P2P TO	Description
1	0	Peer MaxTime		161	80	0	0	0	15	
2	0	Peer MaxTime		161	80	0	0	0	15	
3	0	Peer MaxTime		161	80	0	0	0	15	
4	0	Peer MaxTime		161	80	0	0	0	15	
5	0	Peer MaxTime		161	80	0	0	0	15	
6	0	Peer MaxTime		161	80	0	0	0	15	
7	0	Peer MaxTime		161	80	0	0	0	15	
8	0	Peer MaxTime		161	80	0	0	0	15	
9	0	Peer MaxTime		161	80	0	0	0	15	
10	0	Peer MaxTime		161	80	0	0	0	15	

Master Section Configuration

Section	Control	Poll	Req #	Fail Time	Algorithm Period	Description
1	None	60	1	300	240	
2	None	60	1	300	240	
3	None	60	1	300	240	
4	None	60	1	300	240	
5	None	60	1	300	240	
6	None	60	1	300	240	
7	None	60	1	300	240	
8	None	60	1	300	240	
9	None	60	1	300	240	
10	None	60	1	300	240	
11	None	60	1	300	240	
12	None	60	1	300	240	
13	None	60	1	300	240	
14	None	60	1	300	240	
15	None	60	1	300	240	
16	None	60	1	300	240	

User Program Info

Pgrm	Description	Pgrm	Description
1		17	
2		18	
3		19	
4		20	
5		21	
6		22	
7		23	
8		24	
9		25	
10		26	
11		27	
12		28	
13		29	
14		30	
15		31	
16		32	

APPENDIX B

Level of Service Definitions

The following information is referenced from the Highway Capacity Manual: A Guide for Multimodal Mobility Analysis, 6th Edition, Transportation Research Board, 2016: Chapter 19 – Signalized Intersections.

Motorized Vehicle Level of Service (LOS) for Signalized Intersections

Levels of service are defined to represent reasonable ranges in control delay.

LOS A Describes operations with a control delay of 10 s/veh or less and a volume-to-capacity ratio no greater than 1.0. This level is typically assigned when the volume-to-capacity ratio is low and either progression is exceptionally favorable or the cycle length is very short. If it is due to favorable progression, most vehicles arrive during the green indication and travel through the intersection without stopping.

LOS B Describes operations with control delay between 10 and 20 s/veh and a volume-to-capacity ratio no greater than 1.0. This level is typically assigned when the volume-to-capacity ratio is low and either progression is highly favorable or the cycle length is short. More vehicles stop than with LOS A.

LOS C Describes operations with control delay between 20 and 35 s/veh and a volume-to-capacity ratio no greater than 1.0. This level is typically assigned when progression is favorable or the cycle length is moderate. Individual *cycle failures* (i.e., one or more queued vehicles are not able to depart as a result of insufficient capacity during the cycle) may begin to appear at this level. The number of vehicles stopping is significant, although many vehicles still pass through the intersection without stopping.

LOS D Describes operations with control delay between 35 and 55 s/veh and a volume-to-capacity ratio no greater than 1.0. This level is typically assigned when the volume-to-capacity ratio is high and either progression is ineffective or the cycle length is long. Many vehicles stop and individual cycle failures are noticeable.

LOS E Describes operations with control delay between 55 and 80 s/veh and a volume-to-capacity ratio no greater than 1.0. This level is typically assigned when the volume-to-capacity ratio is high, progression is unfavorable, and the cycle length is long. Individual cycle failures are frequent.

LOS F Describes operations with control delay exceeding 80 s/veh or a volume-to-capacity ratio greater than 1.0. This level is typically assigned when the volume-to-capacity ratio is very high, progression is very poor, and the cycle length is long. Most cycles fail to clear the queue.

Control Delay (s/veh)	LOS by Volume-to-Capacity Ratio ^a	
	$v/c \leq 1.0$	$v/c > 1.0$
≤ 10	A	F
> 10 – 20	B	F
> 20 – 35	C	F
> 35 – 55	D	F
> 55 – 80	E	F
> 80	F	F

Note: ^a For approach-based and intersectionwide assessments, LOS is defined solely by control delay.

The following information is referenced from the Highway Capacity Manual: A Guide for Multimodal Mobility Analysis, 6th Edition, Transportation Research Board, 2016: Chapter 20 – Two-Way Stop-Controlled Intersections, Chapter 21 – All-Way Stop-Controlled Intersections, and Chapter 22 - Roundabouts.

Motorized Vehicle Level of Service (LOS) for Unsignalized & Roundabout Intersections

LOS is a quantitative stratification of performance measure(s) representing quality of service. Quality of service describes how well a transportation facility or service operates from a traveler’s perspective. LOS is measured on an A – F scale, with LOS A representing the best operating conditions from a traveler’s perspective.

Control Delay (s/veh)	LOS by Volume-to-Capacity Ratio ^a	
	v/c ≤ 1.0	v/c > 1.0
0 – 10	A	F
> 10 – 15	B	F
> 15 – 25	C	F
> 25 – 35	D	F
> 35 – 50	E	F
> 50	F	F

Note: The LOS criteria apply to each lane on a given approach and to each approach on the minor street. LOS is not calculated for major-street approaches or for the intersection as a whole.























^a For approaches and intersectionwide assessment, LOS is defined solely by control delay.

APPENDIX C

Capacity Worksheets

Timings
1: State Highway 83 & Highway 105/Walker Road

Existing Traffic Volumes
AM Peak Hour

												
Lane Group	EBL	EBT	EBR	WBL	WBT	WBR	NBL	NBT	NBR	SBL	SBT	SBR
Lane Configurations												
Traffic Volume (vph)	21	158	112	137	215	42	117	235	17	61	199	38
Future Volume (vph)	21	158	112	137	215	42	117	235	17	61	199	38
Satd. Flow (prot)	1770	1863	1583	1770	1816	0	1770	1863	1583	1770	1863	1583
Flt Permitted	0.567			0.488			0.616			0.573		
Satd. Flow (perm)	1056	1863	1583	909	1816	0	1147	1863	1583	1067	1863	1583
Satd. Flow (RTOR)			254		11				165			165
Lane Group Flow (vph)	23	172	122	149	280	0	127	255	18	66	216	41
Turn Type	pm+pt	NA	Free	pm+pt	NA		pm+pt	NA	Perm	pm+pt	NA	Perm
Protected Phases	7	4		3	8		5	2		1	6	
Permitted Phases	4		Free	8			2		2	6		6
Detector Phase	7	4		3	8		5	2	2	1	6	6
Switch Phase												
Minimum Initial (s)	5.0	6.0		5.0	6.0		5.0	30.0	30.0	5.0	30.0	30.0
Minimum Split (s)	10.0	12.0		10.0	12.0		10.0	37.0	37.0	10.0	37.0	37.0
Total Split (s)	12.0	26.0		12.0	26.0		12.0	36.0	36.0	12.0	36.0	36.0
Total Split (%)	14.0%	30.2%		14.0%	30.2%		14.0%	41.9%	41.9%	14.0%	41.9%	41.9%
Yellow Time (s)	3.0	4.0		3.0	4.0		3.0	5.0	5.0	3.0	5.0	5.0
All-Red Time (s)	2.0	2.0		2.0	2.0		2.0	2.0	2.0	2.0	2.0	2.0
Lost Time Adjust (s)	0.0	0.0		0.0	0.0		0.0	0.0	0.0	0.0	0.0	0.0
Total Lost Time (s)	5.0	6.0		5.0	6.0		5.0	7.0	7.0	5.0	7.0	7.0
Lead/Lag	Lead	Lag		Lead	Lag		Lead	Lag	Lag	Lead	Lag	Lag
Lead-Lag Optimize?	Yes	Yes		Yes	Yes		Yes	Yes	Yes	Yes	Yes	Yes
Recall Mode	None	None		None	None		None	Max	Max	None	Max	Max
Act Effct Green (s)	21.0	13.7	77.6	25.1	21.5		37.0	29.6	29.6	36.6	29.4	29.4
Actuated g/C Ratio	0.27	0.18	1.00	0.32	0.28		0.48	0.38	0.38	0.47	0.38	0.38
v/c Ratio	0.07	0.52	0.08	0.40	0.55		0.21	0.36	0.03	0.12	0.31	0.06
Control Delay	17.7	35.3	0.1	22.5	29.9		11.6	21.3	0.1	11.0	20.7	0.2
Queue Delay	0.0	0.0	0.0	0.0	0.0		0.0	0.0	0.0	0.0	0.0	0.0
Total Delay	17.7	35.3	0.1	22.5	29.9		11.6	21.3	0.1	11.0	20.7	0.2
LOS	B	D	A	C	C		B	C	A	B	C	A
Approach Delay		20.5			27.4			17.2			16.1	
Approach LOS		C			C			B			B	
Queue Length 50th (ft)	8	79	0	53	105		28	89	0	14	74	0
Queue Length 95th (ft)	23	138	0	96	216		65	171	0	38	145	0
Internal Link Dist (ft)		557			487			435			486	
Turn Bay Length (ft)	250		350				410		370	430		430
Base Capacity (vph)	362	487	1583	372	514		603	711	706	570	706	702
Starvation Cap Reductn	0	0	0	0	0		0	0	0	0	0	0
Spillback Cap Reductn	0	0	0	0	0		0	0	0	0	0	0
Storage Cap Reductn	0	0	0	0	0		0	0	0	0	0	0
Reduced v/c Ratio	0.06	0.35	0.08	0.40	0.54		0.21	0.36	0.03	0.12	0.31	0.06

Intersection Summary









Cycle Length: 86
 Actuated Cycle Length: 77.6
 Natural Cycle: 75
 Control Type: Actuated-Uncoordinated
 Maximum v/c Ratio: 0.55

Timings
 1: State Highway 83 & Highway 105/Walker Road

Existing Traffic Volumes
 AM Peak Hour

Intersection Signal Delay: 20.6	Intersection LOS: C
Intersection Capacity Utilization 68.7%	ICU Level of Service C
Analysis Period (min) 15	

Splits and Phases: 1: State Highway 83 & Highway 105/Walker Road

 Ø1	 Ø2	 Ø3	 Ø4
12 s	36 s	12 s	26 s
 Ø5	 Ø6	 Ø7	 Ø8
12 s	36 s	12 s	26 s

HCM 6th TWSC
2: Walker Road & Kerry Run Road

Existing Traffic Volumes
AM Peak Hour

Intersection						
Int Delay, s/veh	0.2					
Movement	EBL	EBT	WBT	WBR	SBL	SBR
Lane Configurations		↕	↕		↕	
Traffic Vol, veh/h	0	90	77	2	1	2
Future Vol, veh/h	0	90	77	2	1	2
Conflicting Peds, #/hr	0	0	0	0	0	0
Sign Control	Free	Free	Free	Free	Stop	Stop
RT Channelized	-	None	-	None	-	None
Storage Length	-	-	-	-	0	-
Veh in Median Storage, #	-	0	0	-	0	-
Grade, %	-	0	0	-	0	-
Peak Hour Factor	92	92	92	92	92	92
Heavy Vehicles, %	2	2	2	2	2	2
Mvmt Flow	0	98	84	2	1	2























Major/Minor	Major1	Major2	Minor2		
Conflicting Flow All	86	0	-	0	183 85
Stage 1	-	-	-	-	85 -
Stage 2	-	-	-	-	98 -
Critical Hdwy	4.12	-	-	-	6.42 6.22
Critical Hdwy Stg 1	-	-	-	-	5.42 -
Critical Hdwy Stg 2	-	-	-	-	5.42 -
Follow-up Hdwy	2.218	-	-	-	3.518 3.318
Pot Cap-1 Maneuver	1510	-	-	-	806 974
Stage 1	-	-	-	-	938 -
Stage 2	-	-	-	-	926 -
Platoon blocked, %		-	-	-	
Mov Cap-1 Maneuver	1510	-	-	-	806 974
Mov Cap-2 Maneuver	-	-	-	-	806 -
Stage 1	-	-	-	-	938 -
Stage 2	-	-	-	-	926 -

Approach	EB	WB	SB
HCM Control Delay, s	0	0	9
HCM LOS			A

Minor Lane/Major Mvmt	EBL	EBT	WBT	WBR	SBLn1
Capacity (veh/h)	1510	-	-	-	911
HCM Lane V/C Ratio	-	-	-	-	0.004
HCM Control Delay (s)	0	-	-	-	9
HCM Lane LOS	A	-	-	-	A
HCM 95th %tile Q(veh)	0	-	-	-	0

Timings
1: State Highway 83 & Highway 105/Walker Road

Existing Traffic Volumes
PM Peak Hour

												
Lane Group	EBL	EBT	EBR	WBL	WBT	WBR	NBL	NBT	NBR	SBL	SBT	SBR
Lane Configurations												
Traffic Volume (vph)	45	60	119	70	82	19	111	233	27	16	324	35
Future Volume (vph)	45	60	119	70	82	19	111	233	27	16	324	35
Satd. Flow (prot)	1770	1863	1583	1770	1809	0	1770	1863	1583	1770	1863	1583
Flt Permitted	0.686			0.620			0.453			0.602		
Satd. Flow (perm)	1278	1863	1583	1155	1809	0	844	1863	1583	1121	1863	1583
Satd. Flow (RTOR)			254		13				165			165
Lane Group Flow (vph)	49	65	129	76	110	0	121	253	29	17	352	38
Turn Type	pm+pt	NA	Free	pm+pt	NA		pm+pt	NA	Perm	pm+pt	NA	Perm
Protected Phases	7	4		3	8		5	2		1	6	
Permitted Phases	4		Free	8			2		2	6		6
Detector Phase	7	4		3	8		5	2	2	1	6	6
Switch Phase												
Minimum Initial (s)	5.0	6.0		5.0	6.0		5.0	30.0	30.0	5.0	30.0	30.0
Minimum Split (s)	10.0	12.0		10.0	12.0		10.0	37.0	37.0	10.0	37.0	37.0
Total Split (s)	12.0	26.0		12.0	26.0		12.0	36.0	36.0	12.0	36.0	36.0
Total Split (%)	14.0%	30.2%		14.0%	30.2%		14.0%	41.9%	41.9%	14.0%	41.9%	41.9%
Yellow Time (s)	3.0	4.0		3.0	4.0		3.0	5.0	5.0	3.0	5.0	5.0
All-Red Time (s)	2.0	2.0		2.0	2.0		2.0	2.0	2.0	2.0	2.0	2.0
Lost Time Adjust (s)	0.0	0.0		0.0	0.0		0.0	0.0	0.0	0.0	0.0	0.0
Total Lost Time (s)	5.0	6.0		5.0	6.0		5.0	7.0	7.0	5.0	7.0	7.0
Lead/Lag	Lead	Lag		Lead	Lag		Lead	Lag	Lag	Lead	Lag	Lag
Lead-Lag Optimize?	Yes	Yes		Yes	Yes		Yes	Yes	Yes	Yes	Yes	Yes
Recall Mode	None	None		None	None		None	Max	Max	None	Max	Max
Act Effct Green (s)	14.9	9.2	70.9	16.0	11.5		44.0	42.7	42.7	40.3	35.8	35.8
Actuated g/C Ratio	0.21	0.13	1.00	0.23	0.16		0.62	0.60	0.60	0.57	0.50	0.50
v/c Ratio	0.16	0.27	0.08	0.24	0.36		0.20	0.23	0.03	0.02	0.37	0.04
Control Delay	20.3	32.5	0.1	21.4	29.8		9.0	12.4	0.0	8.2	18.6	0.1
Queue Delay	0.0	0.0	0.0	0.0	0.0		0.0	0.0	0.0	0.0	0.0	0.0
Total Delay	20.3	32.5	0.1	21.4	29.8		9.0	12.4	0.0	8.2	18.6	0.1
LOS	C	C	A	C	C		A	B	A	A	B	A
Approach Delay		12.8			26.4			10.5			16.4	
Approach LOS		B			C			B			B	
Queue Length 50th (ft)	16	28	0	26	43		24	58	0	3	122	0
Queue Length 95th (ft)	40	63	0	56	89		53	148	0	12	213	0
Internal Link Dist (ft)		557			487			435			486	
Turn Bay Length (ft)	250		350				410		370	430		430
Base Capacity (vph)	328	541	1583	329	534		618	1122	1019	716	941	881
Starvation Cap Reductn	0	0	0	0	0		0	0	0	0	0	0
Spillback Cap Reductn	0	0	0	0	0		0	0	0	0	0	0
Storage Cap Reductn	0	0	0	0	0		0	0	0	0	0	0
Reduced v/c Ratio	0.15	0.12	0.08	0.23	0.21		0.20	0.23	0.03	0.02	0.37	0.04

Intersection Summary









Cycle Length: 86
 Actuated Cycle Length: 70.9
 Natural Cycle: 70
 Control Type: Actuated-Uncoordinated
 Maximum v/c Ratio: 0.37

Timings
 1: State Highway 83 & Highway 105/Walker Road

Existing Traffic Volumes
 PM Peak Hour

Intersection Signal Delay: 15.3	Intersection LOS: B
Intersection Capacity Utilization 56.7%	ICU Level of Service B
Analysis Period (min) 15	

Splits and Phases: 1: State Highway 83 & Highway 105/Walker Road

 Ø1	 Ø2	 Ø3	 Ø4
12 s	36 s	12 s	26 s
 Ø5	 Ø6	 Ø7	 Ø8
12 s	36 s	12 s	26 s

HCM 6th TWSC
2: Walker Road & Kerry Run Road

Existing Traffic Volumes
PM Peak Hour

Intersection						
Int Delay, s/veh	0.6					
Movement	EBL	EBT	WBT	WBR	SBL	SBR
Lane Configurations		↕	↕		↕	
Traffic Vol, veh/h	10	59	99	2	2	2
Future Vol, veh/h	10	59	99	2	2	2
Conflicting Peds, #/hr	0	0	0	0	0	0
Sign Control	Free	Free	Free	Free	Stop	Stop
RT Channelized	-	None	-	None	-	None
Storage Length	-	-	-	-	0	-
Veh in Median Storage, #	-	0	0	-	0	-
Grade, %	-	0	0	-	0	-
Peak Hour Factor	92	92	92	92	92	92
Heavy Vehicles, %	2	2	2	2	2	2
Mvmt Flow	11	64	108	2	2	2























Major/Minor	Major1	Major2	Minor2		
Conflicting Flow All	110	0	-	0	195
Stage 1	-	-	-	-	109
Stage 2	-	-	-	-	86
Critical Hdwy	4.12	-	-	-	6.42
Critical Hdwy Stg 1	-	-	-	-	5.42
Critical Hdwy Stg 2	-	-	-	-	5.42
Follow-up Hdwy	2.218	-	-	-	3.518
Pot Cap-1 Maneuver	1480	-	-	-	794
Stage 1	-	-	-	-	916
Stage 2	-	-	-	-	937
Platoon blocked, %		-	-	-	
Mov Cap-1 Maneuver	1480	-	-	-	788
Mov Cap-2 Maneuver	-	-	-	-	788
Stage 1	-	-	-	-	909
Stage 2	-	-	-	-	937

Approach	EB	WB	SB
HCM Control Delay, s	1.1	0	9.2
HCM LOS			A

Minor Lane/Major Mvmt	EBL	EBT	WBT	WBR	SBLn1
Capacity (veh/h)	1480	-	-	-	859
HCM Lane V/C Ratio	0.007	-	-	-	0.005
HCM Control Delay (s)	7.5	0	-	-	9.2
HCM Lane LOS	A	A	-	-	A
HCM 95th %tile Q(veh)	0	-	-	-	0

Timings
1: State Highway 83 & Highway 105/Walker Road

Background Traffic Volumes
AM Peak Hour - Year 2026

												
Lane Group	EBL	EBT	EBR	WBL	WBT	WBR	NBL	NBT	NBR	SBL	SBT	SBR
Lane Configurations												
Traffic Volume (vph)	22	164	116	142	224	44	122	244	18	63	207	40
Future Volume (vph)	22	164	116	142	224	44	122	244	18	63	207	40
Satd. Flow (prot)	1770	1863	1583	1770	1816	0	1770	1863	1583	1770	1863	1583
Flt Permitted	0.525			0.473			0.573			0.587		
Satd. Flow (perm)	978	1863	1583	881	1816	0	1067	1863	1583	1093	1863	1583
Satd. Flow (RTOR)			254		11				165			165
Lane Group Flow (vph)	24	178	126	154	291	0	133	265	20	68	225	43
Turn Type	pm+pt	NA	Free	pm+pt	NA		pm+pt	NA	Perm	pm+pt	NA	Perm
Protected Phases	7	4		3	8		5	2		1	6	
Permitted Phases	4		Free	8			2		2	6		6
Detector Phase	7	4		3	8		5	2	2	1	6	6
Switch Phase												
Minimum Initial (s)	5.0	6.0		5.0	6.0		5.0	30.0	30.0	5.0	30.0	30.0
Minimum Split (s)	10.0	12.0		10.0	12.0		10.0	37.0	37.0	10.0	37.0	37.0
Total Split (s)	12.0	26.0		12.0	26.0		12.0	36.0	36.0	12.0	36.0	36.0
Total Split (%)	14.0%	30.2%		14.0%	30.2%		14.0%	41.9%	41.9%	14.0%	41.9%	41.9%
Yellow Time (s)	3.0	4.0		3.0	4.0		3.0	5.0	5.0	3.0	5.0	5.0
All-Red Time (s)	2.0	2.0		2.0	2.0		2.0	2.0	2.0	2.0	2.0	2.0
Lost Time Adjust (s)	0.0	0.0		0.0	0.0		0.0	0.0	0.0	0.0	0.0	0.0
Total Lost Time (s)	5.0	6.0		5.0	6.0		5.0	7.0	7.0	5.0	7.0	7.0
Lead/Lag	Lead	Lag		Lead	Lag		Lead	Lag	Lag	Lead	Lag	Lag
Lead-Lag Optimize?	Yes	Yes		Yes	Yes		Yes	Yes	Yes	Yes	Yes	Yes
Recall Mode	None	None		None	None		None	Max	Max	None	Max	Max
Act Effct Green (s)	21.2	14.0	80.1	25.2	21.6		39.3	31.8	31.8	37.6	29.1	29.1
Actuated g/C Ratio	0.26	0.17	1.00	0.31	0.27		0.49	0.40	0.40	0.47	0.36	0.36
v/c Ratio	0.07	0.55	0.08	0.43	0.59		0.23	0.36	0.03	0.12	0.33	0.06
Control Delay	17.8	36.4	0.1	23.4	31.3		11.6	21.2	0.1	11.0	21.4	0.2
Queue Delay	0.0	0.0	0.0	0.0	0.0		0.0	0.0	0.0	0.0	0.0	0.0
Total Delay	17.8	36.4	0.1	23.4	31.3		11.6	21.2	0.1	11.0	21.4	0.2
LOS	B	D	A	C	C		B	C	A	B	C	A
Approach Delay		21.1			28.6			17.1			16.6	
Approach LOS		C			C			B			B	
Queue Length 50th (ft)	8	82	0	55	111		30	94	0	15	78	0
Queue Length 95th (ft)	23	142	0	98	226		68	177	0	39	151	0
Internal Link Dist (ft)		557			487			435			486	
Turn Bay Length (ft)	250		350				410		370	430		430
Base Capacity (vph)	338	466	1583	355	497		584	739	727	579	677	680
Starvation Cap Reductn	0	0	0	0	0		0	0	0	0	0	0
Spillback Cap Reductn	0	0	0	0	0		0	0	0	0	0	0
Storage Cap Reductn	0	0	0	0	0		0	0	0	0	0	0
Reduced v/c Ratio	0.07	0.38	0.08	0.43	0.59		0.23	0.36	0.03	0.12	0.33	0.06

Intersection Summary

Cycle Length: 86
 Actuated Cycle Length: 80.1
 Natural Cycle: 75
 Control Type: Actuated-Uncoordinated
 Maximum v/c Ratio: 0.59

Timings

1: State Highway 83 & Highway 105/Walker Road

Background Traffic Volumes

AM Peak Hour - Year 2026

Intersection Signal Delay: 21.2









Intersection LOS: C

Intersection Capacity Utilization 69.6%

ICU Level of Service C

Analysis Period (min) 15

Splits and Phases: 1: State Highway 83 & Highway 105/Walker Road

 Ø1	 Ø2	 Ø3	 Ø4
12 s	36 s	12 s	26 s
 Ø5	 Ø6	 Ø7	 Ø8
12 s	36 s	12 s	26 s

HCM 6th TWSC
2: Walker Road & Kerry Run Road

Background Traffic Volumes
AM Peak Hour - Year 2026

Intersection						
Int Delay, s/veh	0.2					
Movement	EBL	EBT	WBT	WBR	SBL	SBR
Lane Configurations		↕	↕		↕	
Traffic Vol, veh/h	0	94	80	2	1	2
Future Vol, veh/h	0	94	80	2	1	2
Conflicting Peds, #/hr	0	0	0	0	0	0
Sign Control	Free	Free	Free	Free	Stop	Stop
RT Channelized	-	None	-	None	-	None
Storage Length	-	-	-	-	0	-
Veh in Median Storage, #	-	0	0	-	0	-
Grade, %	-	0	0	-	0	-
Peak Hour Factor	92	92	92	92	92	92
Heavy Vehicles, %	2	2	2	2	2	2
Mvmt Flow	0	102	87	2	1	2























Major/Minor	Major1	Major2	Minor2		
Conflicting Flow All	89	0	-	0	190 88
Stage 1	-	-	-	-	88 -
Stage 2	-	-	-	-	102 -
Critical Hdwy	4.12	-	-	-	6.42 6.22
Critical Hdwy Stg 1	-	-	-	-	5.42 -
Critical Hdwy Stg 2	-	-	-	-	5.42 -
Follow-up Hdwy	2.218	-	-	-	3.518 3.318
Pot Cap-1 Maneuver	1506	-	-	-	799 970
Stage 1	-	-	-	-	935 -
Stage 2	-	-	-	-	922 -
Platoon blocked, %		-	-	-	
Mov Cap-1 Maneuver	1506	-	-	-	799 970
Mov Cap-2 Maneuver	-	-	-	-	799 -
Stage 1	-	-	-	-	935 -
Stage 2	-	-	-	-	922 -

Approach	EB	WB	SB
HCM Control Delay, s	0	0	9
HCM LOS			A

Minor Lane/Major Mvmt	EBL	EBT	WBT	WBR	SBLn1
Capacity (veh/h)	1506	-	-	-	905
HCM Lane V/C Ratio	-	-	-	-	0.004
HCM Control Delay (s)	0	-	-	-	9
HCM Lane LOS	A	-	-	-	A
HCM 95th %tile Q(veh)	0	-	-	-	0

Timings
1: State Highway 83 & Highway 105/Walker Road

Background Traffic Volumes
PM Peak Hour - Year 2026

												
Lane Group	EBL	EBT	EBR	WBL	WBT	WBR	NBL	NBT	NBR	SBL	SBT	SBR
Lane Configurations												
Traffic Volume (vph)	47	62	124	73	85	20	115	242	28	17	337	36
Future Volume (vph)	47	62	124	73	85	20	115	242	28	17	337	36
Satd. Flow (prot)	1770	1863	1583	1770	1809	0	1770	1863	1583	1770	1863	1583
Flt Permitted	0.684			0.611			0.440			0.597		
Satd. Flow (perm)	1274	1863	1583	1138	1809	0	820	1863	1583	1112	1863	1583
Satd. Flow (RTOR)			254		13				165			165
Lane Group Flow (vph)	51	67	135	79	114	0	125	263	30	18	366	39
Turn Type	pm+pt	NA	Free	pm+pt	NA		pm+pt	NA	Perm	pm+pt	NA	Perm
Protected Phases	7	4		3	8		5	2		1	6	
Permitted Phases	4		Free	8			2		2	6		6
Detector Phase	7	4		3	8		5	2	2	1	6	6
Switch Phase												
Minimum Initial (s)	5.0	6.0		5.0	6.0		5.0	30.0	30.0	5.0	30.0	30.0
Minimum Split (s)	10.0	12.0		10.0	12.0		10.0	37.0	37.0	10.0	37.0	37.0
Total Split (s)	12.0	26.0		12.0	26.0		12.0	36.0	36.0	12.0	36.0	36.0
Total Split (%)	14.0%	30.2%		14.0%	30.2%		14.0%	41.9%	41.9%	14.0%	41.9%	41.9%
Yellow Time (s)	3.0	4.0		3.0	4.0		3.0	5.0	5.0	3.0	5.0	5.0
All-Red Time (s)	2.0	2.0		2.0	2.0		2.0	2.0	2.0	2.0	2.0	2.0
Lost Time Adjust (s)	0.0	0.0		0.0	0.0		0.0	0.0	0.0	0.0	0.0	0.0
Total Lost Time (s)	5.0	6.0		5.0	6.0		5.0	7.0	7.0	5.0	7.0	7.0
Lead/Lag	Lead	Lag		Lead	Lag		Lead	Lag	Lag	Lead	Lag	Lag
Lead-Lag Optimize?	Yes	Yes		Yes	Yes		Yes	Yes	Yes	Yes	Yes	Yes
Recall Mode	None	None		None	None		None	Max	Max	None	Max	Max
Act Effct Green (s)	15.0	9.3	70.3	16.1	11.7		43.5	42.3	42.3	39.8	35.5	35.5
Actuated g/C Ratio	0.21	0.13	1.00	0.23	0.17		0.62	0.60	0.60	0.57	0.50	0.50
v/c Ratio	0.16	0.27	0.09	0.25	0.37		0.21	0.23	0.03	0.03	0.39	0.04
Control Delay	20.3	32.5	0.1	21.4	29.9		9.2	12.6	0.1	8.4	19.0	0.1
Queue Delay	0.0	0.0	0.0	0.0	0.0		0.0	0.0	0.0	0.0	0.0	0.0
Total Delay	20.3	32.5	0.1	21.4	29.9		9.2	12.6	0.1	8.4	19.0	0.1
LOS	C	C	A	C	C		A	B	A	A	B	A
Approach Delay		12.7			26.4			10.7			16.8	
Approach LOS		B			C			B			B	
Queue Length 50th (ft)	17	29	0	27	45		25	61	0	3	128	0
Queue Length 95th (ft)	41	64	0	57	92		55	155	0	13	223	0
Internal Link Dist (ft)		557			487			435			486	
Turn Bay Length (ft)	250		350				410		370	430		430
Base Capacity (vph)	333	551	1583	332	544		605	1120	1017	710	939	880
Starvation Cap Reductn	0	0	0	0	0		0	0	0	0	0	0
Spillback Cap Reductn	0	0	0	0	0		0	0	0	0	0	0
Storage Cap Reductn	0	0	0	0	0		0	0	0	0	0	0
Reduced v/c Ratio	0.15	0.12	0.09	0.24	0.21		0.21	0.23	0.03	0.03	0.39	0.04

Intersection Summary









Cycle Length: 86
 Actuated Cycle Length: 70.3
 Natural Cycle: 70
 Control Type: Actuated-Uncoordinated
 Maximum v/c Ratio: 0.39

Timings
 1: State Highway 83 & Highway 105/Walker Road

Background Traffic Volumes
 PM Peak Hour - Year 2026

Intersection Signal Delay: 15.5	Intersection LOS: B
Intersection Capacity Utilization 57.1%	ICU Level of Service B
Analysis Period (min) 15	

Splits and Phases: 1: State Highway 83 & Highway 105/Walker Road

 Ø1	 Ø2	 Ø3	 Ø4
12 s	36 s	12 s	26 s
 Ø5	 Ø6	 Ø7	 Ø8
12 s	36 s	12 s	26 s

HCM 6th TWSC
2: Walker Road & Kerry Run Road

Background Traffic Volumes
PM Peak Hour - Year 2026

Intersection						
Int Delay, s/veh	0.6					
Movement	EBL	EBT	WBT	WBR	SBL	SBR
Lane Configurations		↕	↕		↕	
Traffic Vol, veh/h	10	61	103	2	2	2
Future Vol, veh/h	10	61	103	2	2	2
Conflicting Peds, #/hr	0	0	0	0	0	0
Sign Control	Free	Free	Free	Free	Stop	Stop
RT Channelized	-	None	-	None	-	None
Storage Length	-	-	-	-	0	-
Veh in Median Storage, #	-	0	0	-	0	-
Grade, %	-	0	0	-	0	-
Peak Hour Factor	92	92	92	92	92	92
Heavy Vehicles, %	2	2	2	2	2	2
Mvmt Flow	11	66	112	2	2	2























Major/Minor	Major1	Major2	Minor2		
Conflicting Flow All	114	0	-	0	201 113
Stage 1	-	-	-	-	113 -
Stage 2	-	-	-	-	88 -
Critical Hdwy	4.12	-	-	-	6.42 6.22
Critical Hdwy Stg 1	-	-	-	-	5.42 -
Critical Hdwy Stg 2	-	-	-	-	5.42 -
Follow-up Hdwy	2.218	-	-	-	3.518 3.318
Pot Cap-1 Maneuver	1475	-	-	-	788 940
Stage 1	-	-	-	-	912 -
Stage 2	-	-	-	-	935 -
Platoon blocked, %		-	-	-	
Mov Cap-1 Maneuver	1475	-	-	-	782 940
Mov Cap-2 Maneuver	-	-	-	-	782 -
Stage 1	-	-	-	-	905 -
Stage 2	-	-	-	-	935 -

Approach	EB	WB	SB
HCM Control Delay, s	1.1	0	9.2
HCM LOS			A

Minor Lane/Major Mvmt	EBL	EBT	WBT	WBR	SBLn1
Capacity (veh/h)	1475	-	-	-	854
HCM Lane V/C Ratio	0.007	-	-	-	0.005
HCM Control Delay (s)	7.5	0	-	-	9.2
HCM Lane LOS	A	A	-	-	A
HCM 95th %tile Q(veh)	0	-	-	-	0

Timings
1: State Highway 83 & Highway 105/Walker Road

Background Traffic Volumes
AM Peak Hour - Year 2040

												
Lane Group	EBL	EBT	EBR	WBL	WBT	WBR	NBL	NBT	NBR	SBL	SBT	SBR
Lane Configurations												
Traffic Volume (vph)	29	221	157	192	301	59	164	329	24	85	279	53
Future Volume (vph)	29	221	157	192	301	59	164	329	24	85	279	53
Satd. Flow (prot)	1770	1863	1583	1770	1816	0	1770	1863	1583	1770	1863	1583
Flt Permitted	0.356			0.368			0.484			0.456		
Satd. Flow (perm)	663	1863	1583	685	1816	0	902	1863	1583	849	1863	1583
Satd. Flow (RTOR)			254		11				165			165
Lane Group Flow (vph)	32	240	171	209	391	0	178	358	26	92	303	58
Turn Type	pm+pt	NA	Free	pm+pt	NA		pm+pt	NA	Perm	pm+pt	NA	Perm
Protected Phases	7	4		3	8		5	2		1	6	
Permitted Phases	4		Free	8			2		2	6		6
Detector Phase	7	4		3	8		5	2	2	1	6	6
Switch Phase												
Minimum Initial (s)	5.0	6.0		5.0	6.0		5.0	30.0	30.0	5.0	30.0	30.0
Minimum Split (s)	10.0	12.0		10.0	12.0		10.0	37.0	37.0	10.0	37.0	37.0
Total Split (s)	10.0	26.0		13.0	29.0		10.0	37.0	37.0	10.0	37.0	37.0
Total Split (%)	11.6%	30.2%		15.1%	33.7%		11.6%	43.0%	43.0%	11.6%	43.0%	43.0%
Yellow Time (s)	3.0	4.0		3.0	4.0		3.0	5.0	5.0	3.0	5.0	5.0
All-Red Time (s)	2.0	2.0		2.0	2.0		2.0	2.0	2.0	2.0	2.0	2.0
Lost Time Adjust (s)	0.0	0.0		0.0	0.0		0.0	0.0	0.0	0.0	0.0	0.0
Total Lost Time (s)	5.0	6.0		5.0	6.0		5.0	7.0	7.0	5.0	7.0	7.0
Lead/Lag	Lead	Lag		Lead	Lag		Lead	Lag	Lag	Lead	Lag	Lag
Lead-Lag Optimize?	Yes	Yes		Yes	Yes		Yes	Yes	Yes	Yes	Yes	Yes
Recall Mode	None	None		None	None		None	Max	Max	None	Max	Max
Act Effct Green (s)	22.4	16.4	82.6	29.3	23.7		38.2	32.3	32.3	37.1	30.1	30.1
Actuated g/C Ratio	0.27	0.20	1.00	0.35	0.29		0.46	0.39	0.39	0.45	0.36	0.36
v/c Ratio	0.13	0.65	0.11	0.60	0.74		0.38	0.49	0.04	0.21	0.45	0.09
Control Delay	17.8	39.0	0.1	26.8	37.2		15.5	23.8	0.1	13.0	23.4	0.2
Queue Delay	0.0	0.0	0.0	0.0	0.0		0.0	0.0	0.0	0.0	0.0	0.0
Total Delay	17.8	39.0	0.1	26.8	37.2		15.5	23.8	0.1	13.0	23.4	0.2
LOS	B	D	A	C	D		B	C	A	B	C	A
Approach Delay		22.5			33.6			20.1			18.3	
Approach LOS		C			C			C			B	
Queue Length 50th (ft)	10	115	0	76	191		52	154	0	26	126	0
Queue Length 95th (ft)	28	189	0	128	#332		91	240	0	51	200	0
Internal Link Dist (ft)		557			487			435			486	
Turn Bay Length (ft)	250		350				410		370	430		430
Base Capacity (vph)	247	452	1583	348	529		469	727	718	437	678	681
Starvation Cap Reductn	0	0	0	0	0		0	0	0	0	0	0
Spillback Cap Reductn	0	0	0	0	0		0	0	0	0	0	0
Storage Cap Reductn	0	0	0	0	0		0	0	0	0	0	0
Reduced v/c Ratio	0.13	0.53	0.11	0.60	0.74		0.38	0.49	0.04	0.21	0.45	0.09

Intersection Summary

Cycle Length: 86
 Actuated Cycle Length: 82.6
 Natural Cycle: 80
 Control Type: Actuated-Uncoordinated
 Maximum v/c Ratio: 0.74

Timings









1: State Highway 83 & Highway 105/Walker Road

Background Traffic Volumes

AM Peak Hour - Year 2040

Intersection Signal Delay: 24.1
 Intersection LOS: C
 Intersection Capacity Utilization 76.8%
 ICU Level of Service D
 Analysis Period (min) 15
 # 95th percentile volume exceeds capacity, queue may be longer.
 Queue shown is maximum after two cycles.

Splits and Phases: 1: State Highway 83 & Highway 105/Walker Road

 Ø1	 Ø2	 Ø3	 Ø4
10 s	37 s	13 s	26 s
 Ø5	 Ø6	 Ø7	 Ø8
10 s	37 s	10 s	29 s

HCM 6th TWSC
2: Walker Road & Kerry Run Road

Background Traffic Volumes
AM Peak Hour - Year 2040

Intersection						
Int Delay, s/veh	0.1					
Movement	EBL	EBT	WBT	WBR	SBL	SBR
Lane Configurations		↕	↕		↕	
Traffic Vol, veh/h	0	126	108	2	1	2
Future Vol, veh/h	0	126	108	2	1	2
Conflicting Peds, #/hr	0	0	0	0	0	0
Sign Control	Free	Free	Free	Free	Stop	Stop
RT Channelized	-	None	-	None	-	None
Storage Length	-	-	-	-	0	-
Veh in Median Storage, #	-	0	0	-	0	-
Grade, %	-	0	0	-	0	-
Peak Hour Factor	92	92	92	92	92	92
Heavy Vehicles, %	2	2	2	2	2	2
Mvmt Flow	0	137	117	2	1	2























Major/Minor	Major1	Major2	Minor2		
Conflicting Flow All	119	0	-	0	255 118
Stage 1	-	-	-	-	118 -
Stage 2	-	-	-	-	137 -
Critical Hdwy	4.12	-	-	-	6.42 6.22
Critical Hdwy Stg 1	-	-	-	-	5.42 -
Critical Hdwy Stg 2	-	-	-	-	5.42 -
Follow-up Hdwy	2.218	-	-	-	3.518 3.318
Pot Cap-1 Maneuver	1469	-	-	-	734 934
Stage 1	-	-	-	-	907 -
Stage 2	-	-	-	-	890 -
Platoon blocked, %		-	-	-	
Mov Cap-1 Maneuver	1469	-	-	-	734 934
Mov Cap-2 Maneuver	-	-	-	-	734 -
Stage 1	-	-	-	-	907 -
Stage 2	-	-	-	-	890 -

Approach	EB	WB	SB
HCM Control Delay, s	0	0	9.2
HCM LOS			A

Minor Lane/Major Mvmt	EBL	EBT	WBT	WBR	SBLn1
Capacity (veh/h)	1469	-	-	-	856
HCM Lane V/C Ratio	-	-	-	-	0.004
HCM Control Delay (s)	0	-	-	-	9.2
HCM Lane LOS	A	-	-	-	A
HCM 95th %tile Q(veh)	0	-	-	-	0

Timings
1: State Highway 83 & Highway 105/Walker Road

Background Traffic Volumes
PM Peak Hour - Year 2040

												
Lane Group	EBL	EBT	EBR	WBL	WBT	WBR	NBL	NBT	NBR	SBL	SBT	SBR
Lane Configurations												
Traffic Volume (vph)	63	84	167	98	115	27	155	326	38	22	454	49
Future Volume (vph)	63	84	167	98	115	27	155	326	38	22	454	49
Satd. Flow (prot)	1770	1863	1583	1770	1811	0	1770	1863	1583	1770	1863	1583
Flt Permitted	0.637			0.653			0.329			0.549		
Satd. Flow (perm)	1187	1863	1583	1216	1811	0	613	1863	1583	1023	1863	1583
Satd. Flow (RTOR)			254		11				165			165
Lane Group Flow (vph)	68	91	182	107	154	0	168	354	41	24	493	53
Turn Type	pm+pt	NA	Free	pm+pt	NA		pm+pt	NA	Perm	pm+pt	NA	Perm
Protected Phases	7	4		3	8		5	2		1	6	
Permitted Phases	4		Free	8			2		2	6		6
Detector Phase	7	4		3	8		5	2	2	1	6	6
Switch Phase												
Minimum Initial (s)	5.0	6.0		5.0	6.0		5.0	30.0	30.0	5.0	30.0	30.0
Minimum Split (s)	10.0	12.0		10.0	12.0		10.0	37.0	37.0	10.0	37.0	37.0
Total Split (s)	10.0	18.0		11.0	19.0		12.0	47.0	47.0	10.0	45.0	45.0
Total Split (%)	11.6%	20.9%		12.8%	22.1%		14.0%	54.7%	54.7%	11.6%	52.3%	52.3%
Yellow Time (s)	3.0	4.0		3.0	4.0		3.0	5.0	5.0	3.0	5.0	5.0
All-Red Time (s)	2.0	2.0		2.0	2.0		2.0	2.0	2.0	2.0	2.0	2.0
Lost Time Adjust (s)	0.0	0.0		0.0	0.0		0.0	0.0	0.0	0.0	0.0	0.0
Total Lost Time (s)	5.0	6.0		5.0	6.0		5.0	7.0	7.0	5.0	7.0	7.0
Lead/Lag	Lead	Lag		Lead	Lag		Lead	Lag	Lag	Lead	Lag	Lag
Lead-Lag Optimize?	Yes	Yes		Yes	Yes		Yes	Yes	Yes	Yes	Yes	Yes
Recall Mode	None	None		None	None		None	Max	Max	None	Max	Max
Act Effct Green (s)	14.9	10.1	81.8	16.5	10.8		51.0	46.4	46.4	45.3	38.2	38.2
Actuated g/C Ratio	0.18	0.12	1.00	0.20	0.13		0.62	0.57	0.57	0.55	0.47	0.47
v/c Ratio	0.27	0.40	0.11	0.38	0.62		0.35	0.34	0.04	0.04	0.57	0.06
Control Delay	26.7	39.5	0.1	28.7	43.0		9.2	13.0	0.1	7.2	20.2	0.1
Queue Delay	0.0	0.0	0.0	0.0	0.0		0.0	0.0	0.0	0.0	0.0	0.0
Total Delay	26.7	39.5	0.1	28.7	43.0		9.2	13.0	0.1	7.2	20.2	0.1
LOS	C	D	A	C	D		A	B	A	A	C	A
Approach Delay		15.9			37.2			10.9			17.8	
Approach LOS		B			D			B			B	
Queue Length 50th (ft)	28	45	0	44	72		35	88	0	5	191	0
Queue Length 95th (ft)	59	91	0	85	133		63	189	0	14	295	0
Internal Link Dist (ft)		557			487			435			486	
Turn Bay Length (ft)	250		350				410		370	430		430
Base Capacity (vph)	252	274	1583	285	299		482	1056	968	612	870	827
Starvation Cap Reductn	0	0	0	0	0		0	0	0	0	0	0
Spillback Cap Reductn	0	0	0	0	0		0	0	0	0	0	0
Storage Cap Reductn	0	0	0	0	0		0	0	0	0	0	0
Reduced v/c Ratio	0.27	0.33	0.11	0.38	0.52		0.35	0.34	0.04	0.04	0.57	0.06

Intersection Summary









Cycle Length: 86
 Actuated Cycle Length: 81.8
 Natural Cycle: 70
 Control Type: Actuated-Uncoordinated
 Maximum v/c Ratio: 0.62

Timings
 1: State Highway 83 & Highway 105/Walker Road

Background Traffic Volumes
 PM Peak Hour - Year 2040

Intersection Signal Delay: 18.1	Intersection LOS: B
Intersection Capacity Utilization 64.6%	ICU Level of Service C
Analysis Period (min) 15	

Splits and Phases: 1: State Highway 83 & Highway 105/Walker Road

 Ø1	 Ø2	 Ø3	 Ø4
10 s	47 s	11 s	18 s
 Ø5	 Ø6	 Ø7	 Ø8
12 s	45 s	10 s	19 s

HCM 6th TWSC
2: Walker Road & Kerry Run Road

Background Traffic Volumes
PM Peak Hour - Year 2040

Intersection						
Int Delay, s/veh	0.5					
Movement	EBL	EBT	WBT	WBR	SBL	SBR
Lane Configurations		↕	↕		↕	
Traffic Vol, veh/h	10	83	139	2	2	2
Future Vol, veh/h	10	83	139	2	2	2
Conflicting Peds, #/hr	0	0	0	0	0	0
Sign Control	Free	Free	Free	Free	Stop	Stop
RT Channelized	-	None	-	None	-	None
Storage Length	-	-	-	-	0	-
Veh in Median Storage, #	-	0	0	-	0	-
Grade, %	-	0	0	-	0	-
Peak Hour Factor	92	92	92	92	92	92
Heavy Vehicles, %	2	2	2	2	2	2
Mvmt Flow	11	90	151	2	2	2























Major/Minor	Major1	Major2	Minor2		
Conflicting Flow All	153	0	-	0	264
Stage 1	-	-	-	-	152
Stage 2	-	-	-	-	112
Critical Hdwy	4.12	-	-	-	6.42
Critical Hdwy Stg 1	-	-	-	-	5.42
Critical Hdwy Stg 2	-	-	-	-	5.42
Follow-up Hdwy	2.218	-	-	-	3.518
Pot Cap-1 Maneuver	1428	-	-	-	725
Stage 1	-	-	-	-	876
Stage 2	-	-	-	-	913
Platoon blocked, %		-	-	-	
Mov Cap-1 Maneuver	1428	-	-	-	719
Mov Cap-2 Maneuver	-	-	-	-	719
Stage 1	-	-	-	-	869
Stage 2	-	-	-	-	913

Approach	EB	WB	SB
HCM Control Delay, s	0.8	0	9.5
HCM LOS			A

Minor Lane/Major Mvmt	EBL	EBT	WBT	WBR	SBLn1
Capacity (veh/h)	1428	-	-	-	797
HCM Lane V/C Ratio	0.008	-	-	-	0.005
HCM Control Delay (s)	7.5	0	-	-	9.5
HCM Lane LOS	A	A	-	-	A
HCM 95th %tile Q(veh)	0	-	-	-	0

Timings
1: State Highway 83 & Highway 105/Walker Road

Total Traffic Volumes
AM Peak Hour - Year 2026

												
Lane Group	EBL	EBT	EBR	WBL	WBT	WBR	NBL	NBT	NBR	SBL	SBT	SBR
Lane Configurations												
Traffic Volume (vph)	22	169	116	142	224	44	122	244	30	70	207	40
Future Volume (vph)	22	169	116	142	224	44	122	244	30	70	207	40
Satd. Flow (prot)	1770	1863	1583	1770	1816	0	1770	1863	1583	1770	1863	1583
Flt Permitted	0.525			0.463			0.574			0.584		
Satd. Flow (perm)	978	1863	1583	862	1816	0	1069	1863	1583	1088	1863	1583
Satd. Flow (RTOR)			254		11				165			165
Lane Group Flow (vph)	24	184	126	154	291	0	133	265	33	76	225	43
Turn Type	pm+pt	NA	Free	pm+pt	NA		pm+pt	NA	Perm	pm+pt	NA	Perm
Protected Phases	7	4		3	8		5	2		1	6	
Permitted Phases	4		Free	8			2		2	6		6
Detector Phase	7	4		3	8		5	2	2	1	6	6
Switch Phase												
Minimum Initial (s)	5.0	6.0		5.0	6.0		5.0	30.0	30.0	5.0	30.0	30.0
Minimum Split (s)	10.0	12.0		10.0	12.0		10.0	37.0	37.0	10.0	37.0	37.0
Total Split (s)	12.0	26.0		12.0	26.0		12.0	36.0	36.0	12.0	36.0	36.0
Total Split (%)	14.0%	30.2%		14.0%	30.2%		14.0%	41.9%	41.9%	14.0%	41.9%	41.9%
Yellow Time (s)	3.0	4.0		3.0	4.0		3.0	5.0	5.0	3.0	5.0	5.0
All-Red Time (s)	2.0	2.0		2.0	2.0		2.0	2.0	2.0	2.0	2.0	2.0
Lost Time Adjust (s)	0.0	0.0		0.0	0.0		0.0	0.0	0.0	0.0	0.0	0.0
Total Lost Time (s)	5.0	6.0		5.0	6.0		5.0	7.0	7.0	5.0	7.0	7.0
Lead/Lag	Lead	Lag		Lead	Lag		Lead	Lag	Lag	Lead	Lag	Lag
Lead-Lag Optimize?	Yes	Yes		Yes	Yes		Yes	Yes	Yes	Yes	Yes	Yes
Recall Mode	None	None		None	None		None	Max	Max	None	Max	Max
Act Effct Green (s)	21.3	14.1	80.2	25.3	21.7		39.2	31.7	31.7	37.7	29.1	29.1
Actuated g/C Ratio	0.27	0.18	1.00	0.32	0.27		0.49	0.40	0.40	0.47	0.36	0.36
v/c Ratio	0.07	0.56	0.07	0.43	0.58		0.22	0.36	0.04	0.13	0.33	0.06
Control Delay (s/veh)	17.7	36.7	0.0	23.4	31.2		11.6	21.2	0.1	11.1	21.4	0.1
Queue Delay	0.0	0.0	0.0	0.0	0.0		0.0	0.0	0.0	0.0	0.0	0.0
Total Delay (s/veh)	17.7	36.7	0.0	23.4	31.2		11.6	21.2	0.1	11.1	21.4	0.1
LOS	B	D	A	C	C		B	C	A	B	C	A
Approach Delay (s/veh)		21.6			28.6			16.7			16.5	
Approach LOS		C			C			B			B	
Queue Length 50th (ft)	8	85	0	55	111		30	94	0	17	78	0
Queue Length 95th (ft)	23	146	0	98	226		68	177	0	43	151	0
Internal Link Dist (ft)		557			487			435			486	
Turn Bay Length (ft)	250		350				410		370	430		430
Base Capacity (vph)	339	466	1583	351	499		584	736	725	576	675	679
Starvation Cap Reductn	0	0	0	0	0		0	0	0	0	0	0
Spillback Cap Reductn	0	0	0	0	0		0	0	0	0	0	0
Storage Cap Reductn	0	0	0	0	0		0	0	0	0	0	0
Reduced v/c Ratio	0.07	0.39	0.08	0.44	0.58		0.23	0.36	0.05	0.13	0.33	0.06

Intersection Summary









Cycle Length: 86
 Actuated Cycle Length: 80.2
 Natural Cycle: 75
 Control Type: Actuated-Uncoordinated
 Maximum v/c Ratio: 0.58

Timings
 1: State Highway 83 & Highway 105/Walker Road

Total Traffic Volumes
 AM Peak Hour - Year 2026

Intersection Signal Delay (s/veh): 21.1	Intersection LOS: C
Intersection Capacity Utilization 69.6%	ICU Level of Service C
Analysis Period (min) 15	

Splits and Phases: 1: State Highway 83 & Highway 105/Walker Road

 Ø1 12 s	 Ø2 36 s	 Ø3 12 s	 Ø4 26 s
 Ø5 12 s	 Ø6 36 s	 Ø7 12 s	 Ø8 26 s

HCM 6th TWSC
2: Walker Road & Kerry Run Road

Total Traffic Volumes
AM Peak Hour - Year 2026

Intersection						
Int Delay, s/veh	1					
Movement	EBL	EBT	WBT	WBR	SBL	SBR
Lane Configurations		↕	↕		↕	
Traffic Vol, veh/h	24	94	80	2	1	2
Future Vol, veh/h	24	94	80	2	1	2
Conflicting Peds, #/hr	0	0	0	0	0	0
Sign Control	Free	Free	Free	Free	Stop	Stop
RT Channelized	-	None	-	None	-	None
Storage Length	-	-	-	-	0	-
Veh in Median Storage, #	-	0	0	-	0	-
Grade, %	-	0	0	-	0	-
Peak Hour Factor	92	92	92	92	92	92
Heavy Vehicles, %	2	2	2	2	2	2
Mvmt Flow	26	102	87	2	1	2























Major/Minor	Major1	Major2	Minor2		
Conflicting Flow All	89	0	0	242	88
Stage 1	-	-	-	88	-
Stage 2	-	-	-	154	-
Critical Hdwy	4.12	-	-	6.42	6.22
Critical Hdwy Stg 1	-	-	-	5.42	-
Critical Hdwy Stg 2	-	-	-	5.42	-
Follow-up Hdwy	2.218	-	-	3.518	3.318
Pot Cap-1 Maneuver	1506	-	-	746	970
Stage 1	-	-	-	935	-
Stage 2	-	-	-	874	-
Platoon blocked, %		-	-		
Mov Cap-1 Maneuver	1506	-	-	733	970
Mov Cap-2 Maneuver	-	-	-	733	-
Stage 1	-	-	-	918	-
Stage 2	-	-	-	874	-

Approach	EB	WB	SB
HCM Control Delay, s/v	1.5	0	9.1
HCM LOS			A

Minor Lane/Major Mvmt	EBL	EBT	WBT	WBR	SBLn1
Capacity (veh/h)	1506	-	-	-	876
HCM Lane V/C Ratio	0.017	-	-	-	0.004
HCM Control Delay (s/veh)	7.4	0	-	-	9.1
HCM Lane LOS	A	A	-	-	A
HCM 95th %tile Q (veh)	0.1	-	-	-	0

Timings
1: State Highway 83 & Highway 105/Walker Road

Total Traffic Volumes
PM Peak Hour - Year 2026

												
Lane Group	EBL	EBT	EBR	WBL	WBT	WBR	NBL	NBT	NBR	SBL	SBT	SBR
Lane Configurations												
Traffic Volume (vph)	47	62	124	85	90	27	115	242	28	17	337	36
Future Volume (vph)	47	62	124	85	90	27	115	242	28	17	337	36
Satd. Flow (prot)	1770	1863	1583	1770	1799	0	1770	1863	1583	1770	1863	1583
Flt Permitted	0.676			0.620			0.438			0.597		
Satd. Flow (perm)	1259	1863	1583	1155	1799	0	816	1863	1583	1112	1863	1583
Satd. Flow (RTOR)			254		16				165			165
Lane Group Flow (vph)	51	67	135	92	127	0	125	263	30	18	366	39
Turn Type	pm+pt	NA	Free	pm+pt	NA		pm+pt	NA	Perm	pm+pt	NA	Perm
Protected Phases	7	4		3	8		5	2		1	6	
Permitted Phases	4		Free	8			2		2	6		6
Detector Phase	7	4		3	8		5	2	2	1	6	6
Switch Phase												
Minimum Initial (s)	5.0	6.0		5.0	6.0		5.0	30.0	30.0	5.0	30.0	30.0
Minimum Split (s)	10.0	12.0		10.0	12.0		10.0	37.0	37.0	10.0	37.0	37.0
Total Split (s)	12.0	26.0		12.0	26.0		12.0	36.0	36.0	12.0	36.0	36.0
Total Split (%)	14.0%	30.2%		14.0%	30.2%		14.0%	41.9%	41.9%	14.0%	41.9%	41.9%
Yellow Time (s)	3.0	4.0		3.0	4.0		3.0	5.0	5.0	3.0	5.0	5.0
All-Red Time (s)	2.0	2.0		2.0	2.0		2.0	2.0	2.0	2.0	2.0	2.0
Lost Time Adjust (s)	0.0	0.0		0.0	0.0		0.0	0.0	0.0	0.0	0.0	0.0
Total Lost Time (s)	5.0	6.0		5.0	6.0		5.0	7.0	7.0	5.0	7.0	7.0
Lead/Lag	Lead	Lag		Lead	Lag		Lead	Lag	Lag	Lead	Lag	Lag
Lead-Lag Optimize?	Yes	Yes		Yes	Yes		Yes	Yes	Yes	Yes	Yes	Yes
Recall Mode	None	None		None	None		None	Max	Max	None	Max	Max
Act Effct Green (s)	15.3	9.8	69.0	16.4	12.1		42.2	41.3	41.3	38.6	34.7	34.7
Actuated g/C Ratio	0.22	0.14	1.00	0.24	0.18		0.61	0.60	0.60	0.56	0.50	0.50
v/c Ratio	0.15	0.25	0.08	0.27	0.38		0.20	0.23	0.02	0.02	0.39	0.04
Control Delay (s/veh)	20.0	31.8	0.1	21.6	29.6		9.4	12.9	0.0	8.5	19.4	0.0
Queue Delay	0.0	0.0	0.0	0.0	0.0		0.0	0.0	0.0	0.0	0.0	0.0
Total Delay (s/veh)	20.0	31.8	0.1	21.6	29.6		9.4	12.9	0.0	8.5	19.4	0.0
LOS	C	C	A	C	C		A	B	A	A	B	A
Approach Delay (s/veh)		12.5			26.3			11.0			17.2	
Approach LOS		B			C			B			B	
Queue Length 50th (ft)	17	29	0	32	49		25	62	0	3	130	0
Queue Length 95th (ft)	41	64	0	65	100		56	158	0	13	227	0
Internal Link Dist (ft)		557			487			435			486	
Turn Bay Length (ft)	250		350				410		370	430		430
Base Capacity (vph)	347	584	1583	350	575		603	1116	1014	706	936	878
Starvation Cap Reductn	0	0	0	0	0		0	0	0	0	0	0
Spillback Cap Reductn	0	0	0	0	0		0	0	0	0	0	0
Storage Cap Reductn	0	0	0	0	0		0	0	0	0	0	0
Reduced v/c Ratio	0.15	0.11	0.09	0.26	0.22		0.21	0.24	0.03	0.03	0.39	0.04

Intersection Summary

Cycle Length: 86
 Actuated Cycle Length: 69
 Natural Cycle: 70
 Control Type: Actuated-Uncoordinated
 Maximum v/c Ratio: 0.39

Timings

1: State Highway 83 & Highway 105/Walker Road

Total Traffic Volumes

PM Peak Hour - Year 2026

Intersection Signal Delay (s/veh): 15.8









Intersection LOS: B

Intersection Capacity Utilization 57.7%

ICU Level of Service B

Analysis Period (min) 15

Splits and Phases: 1: State Highway 83 & Highway 105/Walker Road

 <p>Ø1</p> <p>12 s</p>	 <p>Ø2</p> <p>36 s</p>	 <p>Ø3</p> <p>12 s</p>	 <p>Ø4</p> <p>26 s</p>
 <p>Ø5</p> <p>12 s</p>	 <p>Ø6</p> <p>36 s</p>	 <p>Ø7</p> <p>12 s</p>	 <p>Ø8</p> <p>26 s</p>

HCM 6th TWSC
2: Walker Road & Kerry Run Road

Total Traffic Volumes
PM Peak Hour - Year 2026

Intersection						
Int Delay, s/veh	1.6					
Movement	EBL	EBT	WBT	WBR	SBL	SBR
Lane Configurations		↕	↕		↕	
Traffic Vol, veh/h	10	61	103	2	2	26
Future Vol, veh/h	10	61	103	2	2	26
Conflicting Peds, #/hr	0	0	0	0	0	0
Sign Control	Free	Free	Free	Free	Stop	Stop
RT Channelized	-	None	-	None	-	None
Storage Length	-	-	-	-	0	-
Veh in Median Storage, #	-	0	0	-	0	-
Grade, %	-	0	0	-	0	-
Peak Hour Factor	92	92	92	92	92	92
Heavy Vehicles, %	2	2	2	2	2	2
Mvmt Flow	11	66	112	2	2	28























Major/Minor	Major1	Major2	Minor2		
Conflicting Flow All	114	0	0	201	113
Stage 1	-	-	-	113	-
Stage 2	-	-	-	88	-
Critical Hdwy	4.12	-	-	6.42	6.22
Critical Hdwy Stg 1	-	-	-	5.42	-
Critical Hdwy Stg 2	-	-	-	5.42	-
Follow-up Hdwy	2.218	-	-	3.518	3.318
Pot Cap-1 Maneuver	1475	-	-	788	940
Stage 1	-	-	-	912	-
Stage 2	-	-	-	935	-
Platoon blocked, %		-	-		
Mov Cap-1 Maneuver	1475	-	-	782	940
Mov Cap-2 Maneuver	-	-	-	782	-
Stage 1	-	-	-	905	-
Stage 2	-	-	-	935	-

Approach	EB	WB	SB
HCM Control Delay, s/v	1.1	0	9
HCM LOS			A

Minor Lane/Major Mvmt	EBL	EBT	WBT	WBR	SBLn1
Capacity (veh/h)	1475	-	-	-	927
HCM Lane V/C Ratio	0.007	-	-	-	0.033
HCM Control Delay (s/veh)	7.5	0	-	-	9
HCM Lane LOS	A	A	-	-	A
HCM 95th %tile Q (veh)	0	-	-	-	0.1

Timings
1: State Highway 83 & Highway 105/Walker Road

Total Traffic Volumes
AM Peak Hour - Year 2040

												
Lane Group	EBL	EBT	EBR	WBL	WBT	WBR	NBL	NBT	NBR	SBL	SBT	SBR
Lane Configurations												
Traffic Volume (vph)	29	226	157	192	301	59	164	329	36	92	279	53
Future Volume (vph)	29	226	157	192	301	59	164	329	36	92	279	53
Satd. Flow (prot)	1770	1863	1583	1770	1816	0	1770	1863	1583	1770	1863	1583
Flt Permitted	0.357			0.360			0.483			0.456		
Satd. Flow (perm)	665	1863	1583	671	1816	0	900	1863	1583	849	1863	1583
Satd. Flow (RTOR)			254		11				165			165
Lane Group Flow (vph)	32	246	171	209	391	0	178	358	39	100	303	58
Turn Type	pm+pt	NA	Free	pm+pt	NA		pm+pt	NA	Perm	pm+pt	NA	Perm
Protected Phases	7	4		3	8		5	2		1	6	
Permitted Phases	4		Free	8			2		2	6		6
Detector Phase	7	4		3	8		5	2	2	1	6	6
Switch Phase												
Minimum Initial (s)	5.0	6.0		5.0	6.0		5.0	30.0	30.0	5.0	30.0	30.0
Minimum Split (s)	10.0	12.0		10.0	12.0		10.0	37.0	37.0	10.0	37.0	37.0
Total Split (s)	10.0	26.0		13.0	29.0		10.0	37.0	37.0	10.0	37.0	37.0
Total Split (%)	11.6%	30.2%		15.1%	33.7%		11.6%	43.0%	43.0%	11.6%	43.0%	43.0%
Yellow Time (s)	3.0	4.0		3.0	4.0		3.0	5.0	5.0	3.0	5.0	5.0
All-Red Time (s)	2.0	2.0		2.0	2.0		2.0	2.0	2.0	2.0	2.0	2.0
Lost Time Adjust (s)	0.0	0.0		0.0	0.0		0.0	0.0	0.0	0.0	0.0	0.0
Total Lost Time (s)	5.0	6.0		5.0	6.0		5.0	7.0	7.0	5.0	7.0	7.0
Lead/Lag	Lead	Lag		Lead	Lag		Lead	Lag	Lag	Lead	Lag	Lag
Lead-Lag Optimize?	Yes	Yes		Yes	Yes		Yes	Yes	Yes	Yes	Yes	Yes
Recall Mode	None	None		None	None		None	Max	Max	None	Max	Max
Act Effct Green (s)	22.5	16.5	82.7	29.4	23.8		38.2	32.3	32.3	37.1	30.1	30.1
Actuated g/C Ratio	0.27	0.20	1.00	0.36	0.29		0.46	0.39	0.39	0.45	0.36	0.36
v/c Ratio	0.12	0.66	0.10	0.60	0.73		0.38	0.49	0.05	0.22	0.44	0.08
Control Delay (s/veh)	17.7	39.4	0.1	27.0	37.0		15.5	23.8	0.1	13.1	23.4	0.2
Queue Delay	0.0	0.0	0.0	0.0	0.0		0.0	0.0	0.0	0.0	0.0	0.0
Total Delay (s/veh)	17.7	39.4	0.1	27.0	37.0		15.5	23.8	0.1	13.1	23.4	0.2
LOS	B	D	A	C	D		B	C	A	B	C	A
Approach Delay (s/veh)		22.9			33.6			19.7			18.3	
Approach LOS		C			C			B			B	
Queue Length 50th (ft)	10	118	0	76	191		52	154	0	28	126	0
Queue Length 95th (ft)	28	194	0	128	#332		91	240	0	55	200	0
Internal Link Dist (ft)		557			487			435			486	
Turn Bay Length (ft)	250		350				410		370	430		430
Base Capacity (vph)	248	452	1583	344	529		468	726	718	436	677	680
Starvation Cap Reductn	0	0	0	0	0		0	0	0	0	0	0
Spillback Cap Reductn	0	0	0	0	0		0	0	0	0	0	0
Storage Cap Reductn	0	0	0	0	0		0	0	0	0	0	0
Reduced v/c Ratio	0.13	0.54	0.11	0.61	0.74		0.38	0.49	0.05	0.23	0.45	0.09

Intersection Summary









Cycle Length: 86
 Actuated Cycle Length: 82.7
 Natural Cycle: 80
 Control Type: Actuated-Uncoordinated
 Maximum v/c Ratio: 0.74

Timings
 1: State Highway 83 & Highway 105/Walker Road

Total Traffic Volumes
 AM Peak Hour - Year 2040

Intersection Signal Delay (s/veh): 24.1	Intersection LOS: C
Intersection Capacity Utilization 76.8%	ICU Level of Service D
Analysis Period (min) 15	
# 95th percentile volume exceeds capacity, queue may be longer.	
Queue shown is maximum after two cycles.	

Splits and Phases: 1: State Highway 83 & Highway 105/Walker Road

 Ø1 10 s	 Ø2 37 s	 Ø3 13 s	 Ø4 26 s
 Ø5 10 s	 Ø6 37 s	 Ø7 10 s	 Ø8 29 s

HCM 6th TWSC
2: Walker Road & Kerry Run Road

Total Traffic Volumes
AM Peak Hour - Year 2040

Intersection						
Int Delay, s/veh	0.8					
Movement	EBL	EBT	WBT	WBR	SBL	SBR
Lane Configurations		↕	↕		↕	
Traffic Vol, veh/h	24	126	108	2	1	2
Future Vol, veh/h	24	126	108	2	1	2
Conflicting Peds, #/hr	0	0	0	0	0	0
Sign Control	Free	Free	Free	Free	Stop	Stop
RT Channelized	-	None	-	None	-	None
Storage Length	-	-	-	-	0	-
Veh in Median Storage, #	-	0	0	-	0	-
Grade, %	-	0	0	-	0	-
Peak Hour Factor	92	92	92	92	92	92
Heavy Vehicles, %	2	2	2	2	2	2
Mvmt Flow	26	137	117	2	1	2























Major/Minor	Major1	Major2	Minor2		
Conflicting Flow All	119	0	0	307	118
Stage 1	-	-	-	118	-
Stage 2	-	-	-	189	-
Critical Hdwy	4.12	-	-	6.42	6.22
Critical Hdwy Stg 1	-	-	-	5.42	-
Critical Hdwy Stg 2	-	-	-	5.42	-
Follow-up Hdwy	2.218	-	-	3.518	3.318
Pot Cap-1 Maneuver	1469	-	-	685	934
Stage 1	-	-	-	907	-
Stage 2	-	-	-	843	-
Platoon blocked, %		-	-		
Mov Cap-1 Maneuver	1469	-	-	672	934
Mov Cap-2 Maneuver	-	-	-	672	-
Stage 1	-	-	-	890	-
Stage 2	-	-	-	843	-

Approach	EB	WB	SB
HCM Control Delay, s/v	1.2	0	9.4
HCM LOS			A

Minor Lane/Major Mvmt	EBL	EBT	WBT	WBR	SBLn1
Capacity (veh/h)	1469	-	-	-	827
HCM Lane V/C Ratio	0.018	-	-	-	0.004
HCM Control Delay (s/veh)	7.5	0	-	-	9.4
HCM Lane LOS	A	A	-	-	A
HCM 95th %tile Q (veh)	0.1	-	-	-	0

Timings
1: State Highway 83 & Highway 105/Walker Road

Total Traffic Volumes
PM Peak Hour - Year 2040

												
Lane Group	EBL	EBT	EBR	WBL	WBT	WBR	NBL	NBT	NBR	SBL	SBT	SBR
Lane Configurations												
Traffic Volume (vph)	63	84	167	110	120	34	155	326	38	22	454	49
Future Volume (vph)	63	84	167	110	120	34	155	326	38	22	454	49
Satd. Flow (prot)	1770	1863	1583	1770	1801	0	1770	1863	1583	1770	1863	1583
Flt Permitted	0.589			0.654			0.328			0.549		
Satd. Flow (perm)	1097	1863	1583	1218	1801	0	611	1863	1583	1023	1863	1583
Satd. Flow (RTOR)			254		14				165			165
Lane Group Flow (vph)	68	91	182	120	167	0	168	354	41	24	493	53
Turn Type	pm+pt	NA	Free	pm+pt	NA		pm+pt	NA	Perm	pm+pt	NA	Perm
Protected Phases	7	4		3	8		5	2		1	6	
Permitted Phases	4		Free	8			2		2	6		6
Detector Phase	7	4		3	8		5	2	2	1	6	6
Switch Phase												
Minimum Initial (s)	5.0	6.0		5.0	6.0		5.0	30.0	30.0	5.0	30.0	30.0
Minimum Split (s)	10.0	12.0		10.0	12.0		10.0	37.0	37.0	10.0	37.0	37.0
Total Split (s)	10.0	18.0		11.0	19.0		12.0	47.0	47.0	10.0	45.0	45.0
Total Split (%)	11.6%	20.9%		12.8%	22.1%		14.0%	54.7%	54.7%	11.6%	52.3%	52.3%
Yellow Time (s)	3.0	4.0		3.0	4.0		3.0	5.0	5.0	3.0	5.0	5.0
All-Red Time (s)	2.0	2.0		2.0	2.0		2.0	2.0	2.0	2.0	2.0	2.0
Lost Time Adjust (s)	0.0	0.0		0.0	0.0		0.0	0.0	0.0	0.0	0.0	0.0
Total Lost Time (s)	5.0	6.0		5.0	6.0		5.0	7.0	7.0	5.0	7.0	7.0
Lead/Lag	Lead	Lag		Lead	Lag		Lead	Lag	Lag	Lead	Lag	Lag
Lead-Lag Optimize?	Yes	Yes		Yes	Yes		Yes	Yes	Yes	Yes	Yes	Yes
Recall Mode	None	None		None	None		None	Max	Max	None	Max	Max
Act Effct Green (s)	15.2	10.3	82.1	16.7	11.1		51.1	46.4	46.4	45.3	38.3	38.3
Actuated g/C Ratio	0.19	0.13	1.00	0.20	0.14		0.62	0.57	0.57	0.55	0.47	0.47
v/c Ratio	0.27	0.38	0.11	0.41	0.65		0.35	0.33	0.04	0.03	0.56	0.06
Control Delay (s/veh)	26.9	39.1	0.1	29.6	44.1		9.2	13.0	0.0	7.2	20.3	0.1
Queue Delay	0.0	0.0	0.0	0.0	0.0		0.0	0.0	0.0	0.0	0.0	0.0
Total Delay (s/veh)	26.9	39.1	0.1	29.6	44.1		9.2	13.0	0.0	7.2	20.3	0.1
LOS	C	D	A	C	D		A	B	A	A	C	A
Approach Delay (s/veh)		15.9			38.1			11.0			17.9	
Approach LOS		B			D			B			B	
Queue Length 50th (ft)	28	45	0	50	78		36	90	0	5	193	0
Queue Length 95th (ft)	59	91	0	94	143		63	189	0	14	295	0
Internal Link Dist (ft)		557			487			435			486	
Turn Bay Length (ft)	250		350				410		370	430		430
Base Capacity (vph)	244	274	1583	288	298		479	1052	966	610	868	825
Starvation Cap Reductn	0	0	0	0	0		0	0	0	0	0	0
Spillback Cap Reductn	0	0	0	0	0		0	0	0	0	0	0
Storage Cap Reductn	0	0	0	0	0		0	0	0	0	0	0
Reduced v/c Ratio	0.28	0.33	0.11	0.42	0.56		0.35	0.34	0.04	0.04	0.57	0.06

Intersection Summary

Cycle Length: 86
 Actuated Cycle Length: 82.1
 Natural Cycle: 70
 Control Type: Actuated-Uncoordinated
 Maximum v/c Ratio: 0.65

Timings
 1: State Highway 83 & Highway 105/Walker Road

Total Traffic Volumes
 PM Peak Hour - Year 2040

Intersection Signal Delay (s/veh): 18.6	Intersection LOS: B
Intersection Capacity Utilization 65.3%	ICU Level of Service C
Analysis Period (min) 15	

Splits and Phases: 1: State Highway 83 & Highway 105/Walker Road

 Ø1 10 s	 Ø2 47 s	 Ø3 11 s	 Ø4 18 s
 Ø5 12 s	 Ø6 45 s	 Ø7 10 s	 Ø8 19 s

HCM 6th TWSC
2: Walker Road & Kerry Run Road

Total Traffic Volumes
PM Peak Hour - Year 2040

Intersection						
Int Delay, s/veh	1.3					
Movement	EBL	EBT	WBT	WBR	SBL	SBR
Lane Configurations		↕	↕		↕	
Traffic Vol, veh/h	10	83	139	2	2	26
Future Vol, veh/h	10	83	139	2	2	26
Conflicting Peds, #/hr	0	0	0	0	0	0
Sign Control	Free	Free	Free	Free	Stop	Stop
RT Channelized	-	None	-	None	-	None
Storage Length	-	-	-	-	0	-
Veh in Median Storage, #	-	0	0	-	0	-
Grade, %	-	0	0	-	0	-
Peak Hour Factor	92	92	92	92	92	92
Heavy Vehicles, %	2	2	2	2	2	2
Mvmt Flow	11	90	151	2	2	28

Major/Minor	Major1	Major2	Minor2		
Conflicting Flow All	153	0	0	264	152
Stage 1	-	-	-	152	-
Stage 2	-	-	-	112	-
Critical Hdwy	4.12	-	-	6.42	6.22
Critical Hdwy Stg 1	-	-	-	5.42	-
Critical Hdwy Stg 2	-	-	-	5.42	-
Follow-up Hdwy	2.218	-	-	3.518	3.318
Pot Cap-1 Maneuver	1428	-	-	725	894
Stage 1	-	-	-	876	-
Stage 2	-	-	-	913	-
Platoon blocked, %		-	-		
Mov Cap-1 Maneuver	1428	-	-	719	894
Mov Cap-2 Maneuver	-	-	-	719	-
Stage 1	-	-	-	869	-
Stage 2	-	-	-	913	-

Approach	EB	WB	SB
HCM Control Delay, s/v	0.8	0	9.2
HCM LOS			A

Minor Lane/Major Mvmt	EBL	EBT	WBT	WBR	SBLn1
Capacity (veh/h)	1428	-	-	-	879
HCM Lane V/C Ratio	0.008	-	-	-	0.035
HCM Control Delay (s/veh)	7.5	0	-	-	9.2
HCM Lane LOS	A	A	-	-	A
HCM 95th %tile Q (veh)	0	-	-	-	0.1

V3_Traffic Impact Study.pdf Markup Summary

Engineer (3)

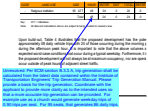

Subject: Engineer
Page Label: 18
Author: Bret
Date: 7/17/2024 10:23:36 AM
Status:
Color: ■
Layer:
Space:

Unresolved: Per ECM section B.3.3.A, trip generation shall be calculated from the latest data contained within the Institute of Transportation Engineers' Trip Generation Manual. Please provide a basis for the trip generation. Coordinate with the applicant to provide more clarity as to the intended uses so that a more accurate trip generation can be provided. For example use as a church would generate weekday trips of 0.90 trips per seat. For 95 seats, that generates 86 daily trips.

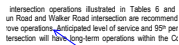

This will need to be determined once a use has been defined and the trip generation is more representative for the property

Subject: Engineer
Page Label: 26
Author: Bret
Date: 7/17/2024 10:36:39 AM
Status:
Color: ■
Layer:
Space:

This will need to be determined once a use has been defined and the trip generation is more representative for the property

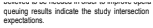

Is the private road up to adequate standard to accommodate the additional traffic generated without an improvements?

Subject: Engineer
Page Label: 26
Author: Bret
Date: 7/17/2024 10:37:40 AM
Status:
Color: ■
Layer:
Space:

Is the private road up to adequate standard to accommodate the additional traffic generated without an improvements?