

**FINAL DRAINAGE REPORT FOR
HIGH VIEW ESTATES
6665 WALKER ROAD
COLORADO SPRINGS, COLORADO 80908**

March, 2022
Revised May, 2022

Prepared For:

Collin Brones
954 Pinenut Court
Colorado Springs, CO 80921
(719) 660-2601
&
Paul Smith
8205 E Palmer Divide
Larkspur, CO 80118
(719) 660-3351

Prepared By:

TERRA NOVA ENGINEERING, INC.
721 S. 23RD STREET
Colorado Springs, CO 80904
(719) 635-6422

PCD File No. MS-222

Job No. 2160.00

**FINAL DRAINAGE REPORT FOR
HIGH VIEW ESTATES
6665 WALKER ROAD
COLORADO SPRINGS, COLORADO 80908**

TABLE OF CONTENTS

Engineer’s Statement	Page 3
Purpose.....	Page 4
General Description	Page 4
Soils Condition.....	Page 4
Drainage Criteria.....	Page 4
Existing Drainage Conditions	Page 4
Developed Drainage Conditions	Page 5
FSEDB	Page 6
Floodplain Statement	Page 7
Construction Cost Opinion	Page 7
Drainage And Bridge Fees.....	Page 8
Maintenance	Page 8
Summary	Page 8
References	Page 8

APPENDICIES

- Vicinity Map
- Site Map
- Soils Map
- FEMA Floodplain Map
- Hydrologic Calculations
- Hydraulic Calculations
- FSEDB Calculations
- Drainage Maps

DRAINAGE REPORT STATEMENT

Design Engineer’s Statement

This attached drainage plan and report were prepared under my direction and supervision and are correct to the best of my knowledge and belief. Said drainage report has been prepared according to the criteria established by the County for drainage reports and said report is in conformity with the master plan of the drainage basin. I accept responsibility for any liability caused by any negligent acts, errors or omissions on my part in preparing this report.

L DUCETT, P.E. 32339 Seal

Developers Statement

I, _____ the developer have read and will comply with all of the requirements specified in this drainage report and plan.

Business Name
By: _____
Title: _____
Address: _____

El Paso County Approval:

Filed in accordance with the requirements of the Drainage Criteria Manual, Volumes 1 & 2, El Paso County Engineering Criteria Manual and Land Development Code as amended.

Jennifer Irvine, Date
County Engineer / ECM Administrator

Conditions:

Purpose

The purpose of this Final Drainage Report is to identify and analyze the existing and proposed drainage patterns, determine proposed runoff quantities, size drainage structures to safely convey the developed runoff, and present solutions to drainage impacts on-site and off-site resulting from this development.

General Description

This Final Drainage Report is an analysis of the development of High View Estates (AKA NW4SE4 Sec 18-11-65, Ex Any Pt Ly Within Walker Rd) owned by Collin G Brones. The site is located at 6665 Walker Road, Colorado Springs, CO 80908 in Section 18, Township 11S, Range 65 West of the 6th Principal Meridian in El Paso County. The site is bounded on the north by Walker Road, on the east and south by W2SW4 Ex Rd Sec 17-11-65 E2SE4, SW4SE4, SE4SW4 Sec 18-11-65, and on the west by NE4SW4 Sec 18-11-65. The site is currently unplatted.

The site is currently zoned RR-5. There is an existing residence and accessory buildings on the east side of the parcel along with two associated driveways.

Proposed is the subdivision of this unplatted lot into five rural residential lots. An access easement is being provided with this subdivision for each lot to achieve access to Walker Road through an existing drive. The extension of this drive to reach all five lots is not being constructed at this time.

The site lies within the East Cherry Creek Drainage Basin.

Soils Condition

The soil for this project is composed of about 62% Peyton-Pring complex and about 38% Peyton sandy loam per the "Soils Survey of El Paso County Area. Both soils are in Hydrologic Soil Group B.

Drainage Criteria

Hydrologic and Hydraulic calculations were performed using the El Paso County Storm Drainage Design Criteria Manual Volumes 1 & 2, latest editions. The Rational Method was used to estimate storm water runoff and the design of the sand filter was performed using UD-Detention v3.07.

Existing (Historic) Drainage Conditions

No previous drainage reports or studies could be found for this site. A drainage map for the existing conditions is included in the Appendix of this report. The site lies within the East Cherry Creek Drainage Basin. The existing topography generally has 5% to 15% slopes directed radially from near the center of the site to the perimeter in all directions. The surface cover is composed of native grass in the undeveloped portions of the site while the developed area is

Unresolved. Reach out to find pond status by contacting state dam engineer John Hunyadi at john.hunyadi@state.co.us. Provide correspondence.

covered in some areas by a residence, a few barns, areas of gravel and asphalt. There is an existing pond on the southern portion of this site.

Runoff primarily sheet flows from near the center of the site and leaves the site at multiple locations at the property lines which are designated as Design Points (DP) for analysis. At the northwest property corner (DP X1), runoff exits into a roadside ditch along Walker Road where it then travels west along this ditch. This ditch was analyzed and determined to have sufficient drainage capacity in the appendix. At the north-central portion of the site (DP X2), runoff drains from a rectangular existing basin towards a culvert which carries drainage across Walker Road into an existing channel north of the site. This culvert was analyzed and determined to have sufficient drainage capacity in the appendix. At the southwest property corner (DP X3), runoff from a small area sheet flows onto the neighbor's property to the south. At the south-central property line (DP X4), runoff currently is directed towards an existing stock pond which, if over capacity, would then flow south onto the adjacent property. Also, at the south-central property line (DP X5), a basin east of the stock pond directs drainage towards the adjacent southern property. At southwestern portion of the site (DP X6), stormwater sheet flows towards the eastern property line. At the northeastern portion of the site (DP X7), near the existing driveways, drainage is directed west along the side of Walker Road towards the existing culvert (DP X2).

Basin EX-A contributes to DP X1 and has an area of 8.00 acres consisting mostly of native grass, generating runoff amounts of $Q_5= 1.94$ cfs and $Q_{100}= 11.40$ cfs.

Basin EX-B contributes to DP X2 and has an area of 7.06 acres consisting of native grass, generating runoff amounts of $Q_5= 1.87$ cfs and $Q_{100}= 11.04$ cfs. Basin EX-B combines with Basin EX-G for a total runoff amount of $Q_5=5.04$ cfs and $Q_{100}=23.01$ cfs at DP X2.

Basin EX-C contributes to DP X3 and has an area of 2.19 acres consisting of native grass, generating runoff amounts of $Q_5= 0.62$ cfs and $Q_{100}= 4.14$ cfs.

Basin EX-D contributes to DP X4 and has an area of 7.30 acres consisting of both native grass and an the existing stock pond, generating runoff amounts of $Q_5= 1.70$ cfs and $Q_{100}= 11.12$ cfs.

Basin EX-E contributes to DP X5 and has an area of 4.48 acres consisting of both native grass and a horse paddock, generating runoff amounts of $Q_5= 1.03$ cfs and $Q_{100}= 6.76$ cfs.

Basin EX-F contributes to DP X6 and has an area of 4.45 acres consisting of both native grass and areas of residential development, generating runoff amounts of $Q_5= 3.63$ cfs and $Q_{100}= 10.30$ cfs.

Basin EX-G contributes to DP X7 and has an area of 6.71 acres consisting of native grass and areas of residential development, generating runoff amounts of $Q_5= 3.17$ cfs and $Q_{100}= 11.97$ cfs.

Developed Drainage Conditions

A drainage map and a summary of the flowrates for the proposed condition is included in the appendix of this report.

The proposed plans include subdivision of this site into 5 rural residential lots. The drainage pattern for the site remains the same; The exception being that the runoff would slightly increase

due to the proposed residential land use. The runoff coefficient for 1 acre residential land use is used for all proposed conditions. Flow and velocity increase impacts have been determined to be negligible in terms of erosion effects on downstream infrastructure and there is sufficient downstream conveyance capacity for the expected increase in flows.

Runoff continues to exit into the ditch along Walker Road (DP 1) as in the historic conditions. This basin will include the majority of Lot 5. Runoff will increase by 1.98 cfs in the 5-year storm and by 2.67 cfs in the 100-year storm.

Runoff entering the existing culvert at the north-central area of the site (DP 2) includes runoff from most of the proposed Lot 2 as well as a portion of the proposed Lot 5. Runoff will increase by 2.17 cfs in the 5-year storm and by 3.02 cfs in the 100-year storm. The existing 36" steel culvert has the capacity to handle the total proposed 5-year flows of 7.21 cfs and 100-year flows of 26.03 cfs from the combination of DP 2 and DP 7.

Runoff exits DP 3 in similar quantities as in the historic conditions as the basin has not changed. This area is now a small portion of the proposed Lot 4 and releases onto the adjacent property to the south. Runoff will increase by 0.83 cfs in the 5-year storm and by 1.23 cfs in the 100-year storm.

Runoff exits DP 4 in similar quantities as in the historic conditions as the basin remains the same. This area now includes portions of the proposed Lot 4 & Lot 5 and releases onto the adjacent property to the south. Runoff will increase by 2.21 cfs in the 5-year storm and by 3.04 cfs in the 100-year storm.

The basin releasing to DP 5 remains the same. This area now includes portions of the proposed Lot 1 & Lot 3 and releases runoff to the same location as in the historic conditions. Runoff will increase by 1.37 cfs in the 5-year storm and by 1.93 cfs in the 100-year storm.

DP 6 remains unchanged from the historic conditions. The discrepancy in flows is a result of calculating the runoff coefficient manually in the historic conditions and by using the runoff coefficient for 1 acre residential land use in the developed conditions.

DP 7 remains unchanged from the historic conditions. The discrepancy in flows is a result of calculating the runoff coefficient manually in the historic conditions and by using the runoff coefficient for 1 acre residential land use in the developed conditions.

Basin A contributes to DP 1 and has an area of 8.00 acres consisting of proposed residential development, generating runoff amounts of $Q_5 = 3.92$ cfs and $Q_{100} = 14.07$ cfs.

Basin B contributes to DP 2 and has an area of 7.06 acres consisting of proposed residential development, generating runoff amounts of $Q_5 = 3.79$ cfs and $Q_{100} = 13.71$ cfs.

Basin C contributes to DP 3 and has an area of 2.19 acres consisting of proposed residential development, generating runoff amounts of $Q_5 = 1.45$ cfs and $Q_{100} = 5.37$ cfs.

Basin D contributes to DP 4 and has an area of 7.30 acres consisting of proposed residential development, generating runoff amounts of $Q_5 = 3.91$ cfs and $Q_{100} = 14.16$ cfs.

Basin E contributes to DP 5 and has an area of 4.48 acres consisting of existing and proposed residential development, generating runoff amounts of $Q_5 = 2.40$ cfs and $Q_{100} = 8.69$ cfs.

Basin F contributes to DP 6 and has an area of 4.45 acres consisting of existing residential development, generating runoff amounts of $Q_5 = 2.39$ cfs and $Q_{100} = 8.65$ cfs.

Basin G contributes to DP 7 and has an area of 6.71 acres consisting of existing residential development, generating runoff amounts of Q5= 3.42 cfs and Q100= 12.32 cfs.

Hydrologic Calculations

Hydrologic calculations were performed using the El Paso County Storm Drainage Design Criteria Manual – Volumes 1 & 2, latest editions. The Rational Method was used to estimate stormwater runoff anticipated from design storms with 5-year and 100-year recurrence intervals. The Urban Drainage Criteria Manual was used to calculate water quality volume.

Floodplain Statement

According to FEMA’s FIRM No. 08041CO305G (eff. 12/7/2018), this site is not within a designated FEMA floodplain.

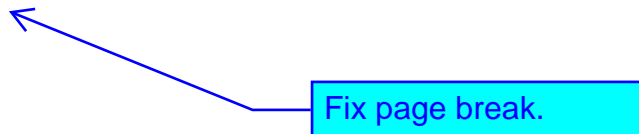

Drainage And Bridge Fees

This currently unplatted site is in the East Cherry Creek Drainage Basin. The site is 39.27 acres. The combined Drainage Fees (2022) are due prior to final plat recordation.

Fee Type	% Imp.	Parcel Area (acre)	Imp. Area (acre)	Fee per Imp Acre	Mod %	Fee Cost
Drainage	7.0	39.27	2.75	\$0	100	\$0
Bridge	7.0	39.27	2.75	\$0	100	\$0
				Total		\$0

Summary

This Final Drainage Report analyzed the development of High View Estates owned by Collin G Brones & Paul Smith, located at 6665 Walker Road, Colorado Springs, CO 80908. Runoff from the development will not adversely affect the surrounding or downstream developments. Proposed flows, as detailed in this report, will follow existing drainage patterns and will not significantly increase. No public storm drainage modifications or design changes are necessary as a result of the development.

References

- 1) *City of Colorado Springs/County of El Paso Drainage Criteria Manual, dated May 2014.*
- 2) *Soil survey of El Paso County Area, Colorado, Prepared by United States Department of Agriculture Soil Conservation Service, dated June 1981.*
- 3) *Federal Emergency Management Agency (FEMA) Flood Insurance Rate Map Numbers 08041C0554G & 08041C0558G.*

APPENDICES

VICINITY MAP

EXHIBIT 2

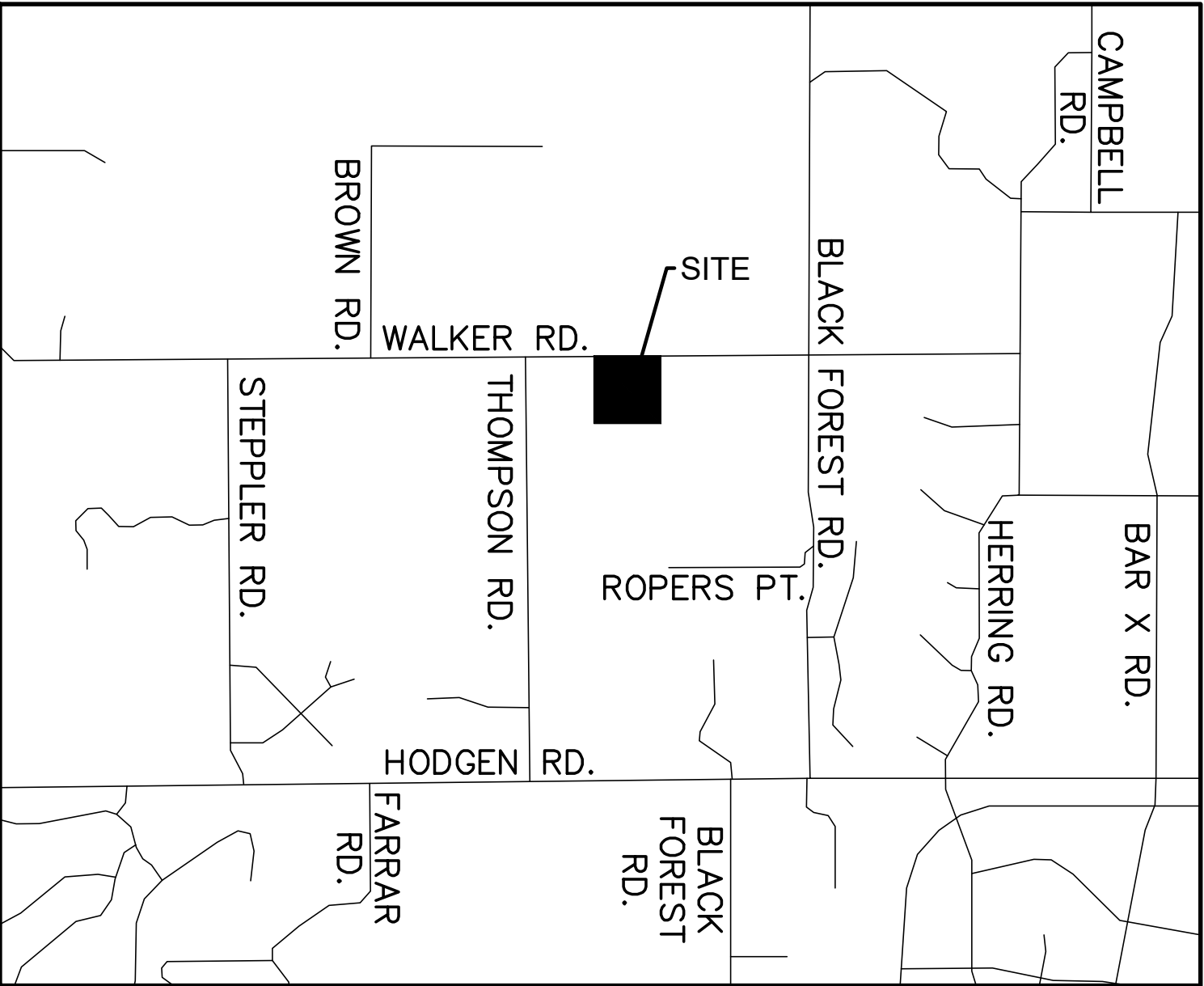

SOILS MAP

Soil Map—El Paso County Area, Colorado

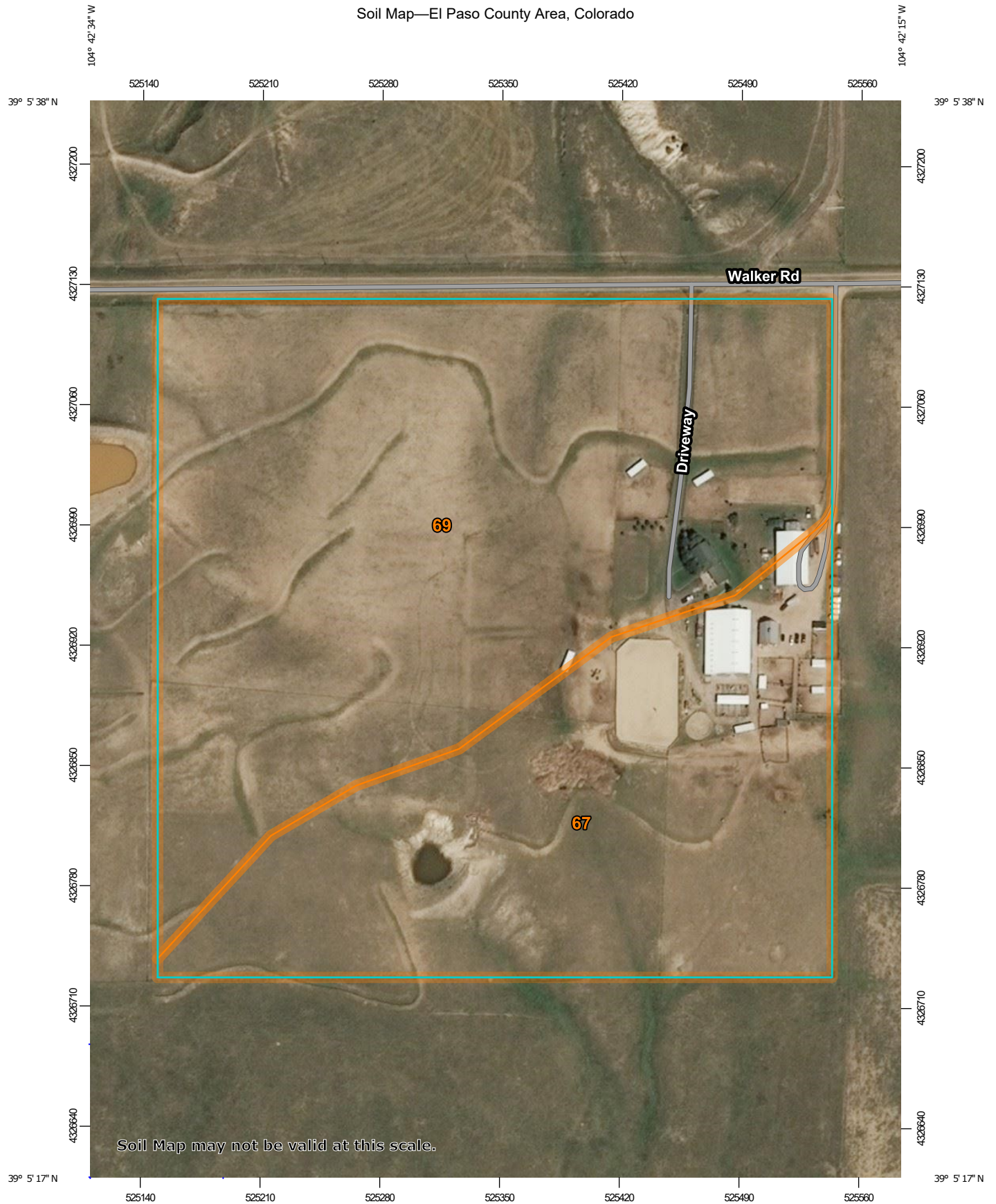

Soil Map may not be valid at this scale.

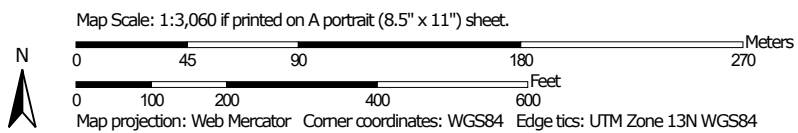

MAP LEGEND

Area of Interest (AOI)

 Area of Interest (AOI)

Soils

 Soil Map Unit Polygons

 Soil Map Unit Lines

 Soil Map Unit Points

Special Point Features



Blowout



Borrow Pit



Clay Spot



Closed Depression



Gravel Pit



Gravelly Spot



Landfill



Lava Flow



Marsh or swamp



Mine or Quarry



Miscellaneous Water



Perennial Water



Rock Outcrop



Saline Spot



Sandy Spot



Severely Eroded Spot



Sinkhole



Slide or Slip



Sodic Spot



Spoil Area



Stony Spot



Very Stony Spot



Wet Spot



Other



Special Line Features

Water Features



Streams and Canals

Transportation



Rails



Interstate Highways



US Routes



Major Roads



Local Roads

Background



Aerial Photography

MAP INFORMATION

The soil surveys that comprise your AOI were mapped at 1:24,000.

Warning: Soil Map may not be valid at this scale.

Enlargement of maps beyond the scale of mapping can cause misunderstanding of the detail of mapping and accuracy of soil line placement. The maps do not show the small areas of contrasting soils that could have been shown at a more detailed scale.

Please rely on the bar scale on each map sheet for map measurements.

Source of Map: Natural Resources Conservation Service
Web Soil Survey URL:
Coordinate System: Web Mercator (EPSG:3857)

Maps from the Web Soil Survey are based on the Web Mercator projection, which preserves direction and shape but distorts distance and area. A projection that preserves area, such as the Albers equal-area conic projection, should be used if more accurate calculations of distance or area are required.

This product is generated from the USDA-NRCS certified data as of the version date(s) listed below.

Soil Survey Area: El Paso County Area, Colorado
Survey Area Data: Version 18, Jun 5, 2020

Soil map units are labeled (as space allows) for map scales 1:50,000 or larger.

Date(s) aerial images were photographed: Sep 8, 2018—May 26, 2019

The orthophoto or other base map on which the soil lines were compiled and digitized probably differs from the background imagery displayed on these maps. As a result, some minor shifting of map unit boundaries may be evident.

Map Unit Legend

Map Unit Symbol	Map Unit Name	Acres in AOI	Percent of AOI
67	Peyton sandy loam, 5 to 9 percent slopes	14.7	38.0%
69	Peyton-Pring complex, 8 to 15 percent slopes	24.0	62.0%
Totals for Area of Interest		38.6	100.0%

El Paso County Area, Colorado

67—Peyton sandy loam, 5 to 9 percent slopes

Map Unit Setting

National map unit symbol: 369d

Elevation: 6,800 to 7,600 feet

Mean annual air temperature: 43 to 45 degrees F

Frost-free period: 115 to 125 days

Farmland classification: Not prime farmland

Map Unit Composition

Peyton and similar soils: 85 percent

Estimates are based on observations, descriptions, and transects of the mapunit.

Description of Peyton

Setting

Landform: Hills

Landform position (three-dimensional): Side slope

Down-slope shape: Linear

Across-slope shape: Linear

Parent material: Arkosic alluvium derived from sedimentary rock and/or arkosic residuum weathered from sedimentary rock

Typical profile

A - 0 to 12 inches: sandy loam

Bt - 12 to 25 inches: sandy clay loam

BC - 25 to 35 inches: sandy loam

C - 35 to 60 inches: sandy loam

Properties and qualities

Slope: 5 to 9 percent

Depth to restrictive feature: More than 80 inches

Drainage class: Well drained

Runoff class: Medium

Capacity of the most limiting layer to transmit water

(Ksat): Moderately high (0.20 to 0.60 in/hr)

Depth to water table: More than 80 inches

Frequency of flooding: None

Frequency of ponding: None

Available water supply, 0 to 60 inches: Moderate (about 7.3 inches)

Interpretive groups

Land capability classification (irrigated): None specified

Land capability classification (nonirrigated): 4e

Hydrologic Soil Group: B

Ecological site: R049XB216CO - Sandy Divide

Hydric soil rating: No

Minor Components

Pleasant

Percent of map unit:

Landform: Depressions

Hydric soil rating: Yes

Other soils

Percent of map unit:

Hydric soil rating: No

Data Source Information

Soil Survey Area: El Paso County Area, Colorado

Survey Area Data: Version 18, Jun 5, 2020

El Paso County Area, Colorado

69—Peyton-Pring complex, 8 to 15 percent slopes

Map Unit Setting

National map unit symbol: 369g

Elevation: 6,800 to 7,600 feet

Farmland classification: Not prime farmland

Map Unit Composition

Peyton and similar soils: 40 percent

Pring and similar soils: 30 percent

Estimates are based on observations, descriptions, and transects of the mapunit.

Description of Peyton

Setting

Landform: Hills

Landform position (three-dimensional): Side slope

Down-slope shape: Linear

Across-slope shape: Linear

Parent material: Arkosic alluvium derived from sedimentary rock and/or arkosic residuum weathered from sedimentary rock

Typical profile

A - 0 to 12 inches: sandy loam

Bt - 12 to 25 inches: sandy clay loam

BC - 25 to 35 inches: sandy clay loam

C - 35 to 60 inches: sandy loam

Properties and qualities

Slope: 8 to 9 percent

Depth to restrictive feature: More than 80 inches

Drainage class: Well drained

Runoff class: Medium

Capacity of the most limiting layer to transmit water

(Ksat): Moderately high (0.20 to 0.60 in/hr)

Depth to water table: More than 80 inches

Frequency of flooding: None

Frequency of ponding: None

Available water supply, 0 to 60 inches: Moderate (about 7.3 inches)

Interpretive groups

Land capability classification (irrigated): None specified

Land capability classification (nonirrigated): 4e

Hydrologic Soil Group: B

Ecological site: R049XB216CO - Sandy Divide

Hydric soil rating: No

Description of Pring

Setting

Landform: Hills

Landform position (three-dimensional): Side slope

Down-slope shape: Linear

Across-slope shape: Linear

Parent material: Arkosic alluvium derived from sedimentary rock

Typical profile

A - 0 to 14 inches: coarse sandy loam

C - 14 to 60 inches: gravelly sandy loam

Properties and qualities

Slope: 8 to 15 percent

Depth to restrictive feature: More than 80 inches

Drainage class: Well drained

Runoff class: Low

Capacity of the most limiting layer to transmit water (Ksat): High
(2.00 to 6.00 in/hr)

Depth to water table: More than 80 inches

Frequency of flooding: None

Frequency of ponding: None

Available water supply, 0 to 60 inches: Low (about 6.0 inches)

Interpretive groups

Land capability classification (irrigated): None specified

Land capability classification (nonirrigated): 6e

Hydrologic Soil Group: B

Ecological site: R049XB222CO - Loamy Park

Hydric soil rating: No

Minor Components

Pleasant

Percent of map unit:

Landform: Depressions

Hydric soil rating: Yes

Other soils

Percent of map unit:

Hydric soil rating: No

Data Source Information

Soil Survey Area: El Paso County Area, Colorado

Survey Area Data: Version 18, Jun 5, 2020

FEMA FLOODPLAIN MAP

National Flood Hazard Layer FIRMette



104°42'38"W 39°5'42"N

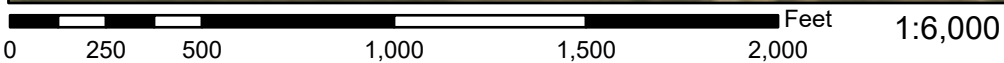

Basemap: USGS National Map: Orthoimagery: Data refreshed October, 2020

Legend

SEE FIS REPORT FOR DETAILED LEGEND AND INDEX MAP FOR FIRM PANEL LAYOUT

SPECIAL FLOOD HAZARD AREAS		Without Base Flood Elevation (BFE) <i>Zone A, V, A99</i>
		With BFE or Depth <i>Zone AE, AO, AH, VE, AR</i>
		Regulatory Floodway
OTHER AREAS OF FLOOD HAZARD		0.2% Annual Chance Flood Hazard, Areas of 1% annual chance flood with average depth less than one foot or with drainage areas of less than one square mile <i>Zone X</i>
		Future Conditions 1% Annual Chance Flood Hazard <i>Zone X</i>
		Area with Reduced Flood Risk due to Levee. See Notes. <i>Zone X</i>
		Area with Flood Risk due to Levee <i>Zone D</i>
OTHER AREAS		NO SCREEN Area of Minimal Flood Hazard <i>Zone X</i>
		Effective LOMRs
GENERAL STRUCTURES		Area of Undetermined Flood Hazard <i>Zone D</i>
		Channel, Culvert, or Storm Sewer
		Levee, Dike, or Floodwall
OTHER FEATURES		20.2 Cross Sections with 1% Annual Chance
		17.5 Water Surface Elevation
		Coastal Transect
		Base Flood Elevation Line (BFE)
		Limit of Study
MAP PANELS		Jurisdiction Boundary
		Coastal Transect Baseline
		Profile Baseline
		Hydrographic Feature
		Digital Data Available
		No Digital Data Available
		Unmapped
		The pin displayed on the map is an approximate point selected by the user and does not represent an authoritative property location.



This map complies with FEMA's standards for the use of digital flood maps if it is not void as described below. The basemap shown complies with FEMA's basemap accuracy standards

The flood hazard information is derived directly from the authoritative NFHL web services provided by FEMA. This map was exported on **1/4/2022 at 11:54 AM** and does not reflect changes or amendments subsequent to this date and time. The NFHL and effective information may change or become superseded by new data over time.

This map image is void if the one or more of the following map elements do not appear: basemap imagery, flood zone labels, legend, scale bar, map creation date, community identifiers, FIRM panel number, and FIRM effective date. Map images for unmapped and unmodernized areas cannot be used for regulatory purposes.

HYDROLOGIC CALCULATIONS

6665 Walker Road Minor Subdivision Area Runoff Coefficient (C) Summary

HSG - B

EXISTING

		<i>GREENBELT</i>			<i>GRAVEL LOT</i>			<i>PAVEMENT/ROOF</i>			<i>WEIGHTED</i>		<i>WEIGHTED CA</i>	
BASIN	TOTAL AREA	AREA	C5	C100	AREA	C5	C100	AREA	C5	C100	C5	C100	CA5	CA100
	<i>(Acres)</i>	<i>(Acres)</i>			<i>(Acres)</i>			<i>(Acres)</i>						
<i>EX-A</i>	8.00	7.88	0.09	0.36	0.00	0.59	0.70	0.12	0.90	0.96	0.10	0.37	0.82	2.95
<i>EX-B</i>	7.06	6.95	0.09	0.36	0.00	0.59	0.70	0.11	0.90	0.96	0.10	0.37	0.72	2.61
<i>EX-C</i>	2.19	2.19	0.09	0.36	0.00	0.59	0.70	0.00	0.90	0.96	0.09	0.36	0.20	0.79
<i>EX-D</i>	7.30	7.30	0.09	0.36	0.00	0.59	0.70	0.00	0.90	0.96	0.09	0.36	0.66	2.63
<i>EX-E</i>	4.48	4.48	0.09	0.36	0.00	0.59	0.70	0.00	0.90	0.96	0.09	0.36	0.40	1.61
<i>EX-F</i>	4.45	2.81	0.09	0.36	1.39	0.59	0.70	0.25	0.90	0.96	0.29	0.50	1.30	2.22
<i>EX-G</i>	6.71	5.81	0.09	0.36	0.26	0.59	0.70	0.64	0.90	0.96	0.19	0.43	1.25	2.89

25.5

DEVELOPED

		<i>GRAVEL LOT</i>			<i>PAVEMENT/ROOF</i>			<i>RESIDENTIAL (1 ACRE)</i>			<i>WEIGHTED</i>		<i>WEIGHTED CA</i>	
BASIN	TOTAL AREA	AREA	C5	C100	AREA	C5	C100	AREA	C5	C100	C5	C100	CA5	CA100
	<i>(Acres)</i>	<i>(Acres)</i>			<i>(Acres)</i>			<i>(Acres)</i>						
<i>A</i>	8.00	0.00	0.59	0.70	0.00	0.90	0.96	8.00	0.20	0.44	0.20	0.44	1.60	3.52
<i>B</i>	7.06	0.00	0.59	0.70	0.00	0.90	0.96	7.06	0.20	0.44	0.20	0.44	1.41	3.11
<i>C</i>	2.19	0.00	0.59	0.70	0.00	0.90	0.96	2.19	0.20	0.44	0.20	0.44	0.44	0.96
<i>D</i>	7.30	0.00	0.59	0.70	0.00	0.90	0.96	7.30	0.20	0.44	0.20	0.44	1.46	3.21
<i>E</i>	4.48	0.00	0.59	0.70	0.00	0.90	0.96	4.48	0.20	0.44	0.20	0.44	0.90	1.97
<i>F</i>	4.45	0.00	0.59	0.70	0.00	0.90	0.96	4.45	0.20	0.44	0.20	0.44	0.89	1.96
<i>G</i>	6.71	0.00	0.59	0.70	0.00	0.90	0.96	6.71	0.20	0.44	0.20	0.44	1.34	2.95

Date: 3/6/2022 Checked by: _____

6665 WALKER ROAD MINOR SUBDIVISION Runoff Summary

EXISTING

		WEIGHTED		OVERLAND				SHALLOW CONCENTRATED FLOW				T _C	INTENSITY		TOTAL FLOWS	
BASIN	AREA TOTAL (Acres)	C ₅	C ₁₀₀	C ₅	Length (ft)	Slope (ft/ft)	T _t (min)	Length (ft)	Slope (%)	Velocity (fps)	T _t (min)	TOTAL (min)	I ₅ (in/hr)	I ₁₀₀ (in/hr)	Q ₅ (c.f.s.)	Q ₁₀₀ (c.f.s.)
		<i>* For Calcs See Runoff Summary</i>														
EX-A	8.00	0.10	0.37	0.10	300	0.048	18.6	500	5.2%	0.6	13.9	32.5	2.4	3.9	1.94	11.40
EX-B	7.06	0.10	0.37	0.10	300	0.038	20.1	510	4.8%	1.1	7.8	27.8	2.6	4.2	1.87	11.04
EX-C	2.19	0.09	0.36	0.09	300	0.048	18.8	0	3.5%	0.9	0.0	18.8	3.1	5.3	0.62	4.14
EX-D	7.30	0.09	0.36	0.09	170	0.026	17.3	710	5.1%	1.1	10.5	27.8	2.6	4.2	1.70	11.12
EX-E	4.48	0.09	0.36	0.09	300	0.032	21.5	490	5.8%	1.2	6.8	28.3	2.6	4.2	1.03	6.76
EX-F	4.45	0.29	0.50	0.29	300	0.027	18.2	335	4.0%	1.0	5.6	23.8	2.8	4.6	3.63	10.30
EX-G	6.71	0.19	0.43	0.19	300	0.023	21.7	460	4.6%	1.1	7.1	28.8	2.5	4.1	3.17	11.97

DEVELOPED

		WEIGHTED		OVERLAND				SHALLOW CONCENTRATED FLOW				T _C	INTENSITY		TOTAL FLOWS	
BASIN	AREA TOTAL (Acres)	C ₅	C ₁₀₀	C ₅	Length (ft)	Slope (ft/ft)	T _t (min)	Length (ft)	Slope (%)	Velocity (fps)	T _t (min)	TOTAL (min)	I ₅ (in/hr)	I ₁₀₀ (in/hr)	Q ₅ (c.f.s.)	Q ₁₀₀ (c.f.s.)
		<i>* For Calcs See Runoff Summary</i>														
A	8.00	0.20	0.44	0.20	300	0.048	16.8	500	5.2%	0.6	13.9	30.7	2.5	4.0	3.92	14.07
B	7.06	0.20	0.44	0.20	300	0.038	18.1	510	4.8%	1.1	7.8	25.9	2.7	4.4	3.79	13.71
C	2.19	0.20	0.44	0.20	300	0.048	16.8	0	3.5%	0.9	0.0	16.8	3.3	5.6	1.45	5.37
D	7.30	0.20	0.44	0.20	170	0.026	15.5	710	5.1%	1.1	10.5	25.9	2.7	4.4	3.91	14.16
E	4.48	0.20	0.44	0.20	300	0.032	19.2	490	5.8%	1.2	6.8	26.0	2.7	4.4	2.40	8.69
F	4.45	0.20	0.44	0.20	300	0.027	20.3	335	4.0%	1.0	5.6	25.9	2.7	4.4	2.39	8.65
G	6.71	0.20	0.44	0.20	300	0.023	21.4	460	4.6%	1.1	7.1	28.5	2.5	4.2	3.42	12.32

6665 WALKER ROAD MINOR SUBDIVISION
Surface Routing

EXISTING CONDITIONS				
Design Point(s)	Contributing Basins	Area (Acres)	Flow	
			Q_5	Q_{100}
X1	EX-A	8.00	1.94	11.40
X2	EX-B, EX-G	13.77	5.04	23.01
X3	EX-C	2.19	0.62	4.14
X4	EX-D	7.30	1.70	11.12
X5	EX-E	4.48	1.03	6.76
X6	EX-F	4.45	3.63	10.30
X7	EX-G	6.71	3.17	11.97

PROPOSED CONDITIONS				
Design Point(s)	Contributing Basins	Area (Acres)	Flow	
			Q_5	Q_{100}
1	A	8.00	3.92	14.07
2	B, G	13.77	7.21	26.03
3	C	2.19	1.45	5.37
4	D	7.30	3.91	14.16
5	E	4.48	2.40	8.69
6	F	4.45	2.39	8.65
7	G	6.71	3.42	12.32

HYDRAULIC CALCULATIONS

MANNING'S EQUATION for OPEN CHANNEL FLOW

Project: **High View Estates** Location: **Existing Swale A-A**
 By: **John F** Date: **5/23/2022**
 Chk By: _____ Date: _____ version 12-2004

Mannings Formula

$$Q = (1.486/n)AR_n^{2/3}S^{1/2}$$

$$R = A/P$$

A = cross sectional area

P= wetted perimeter

S = slope of channel

n = Manning's roughness coefficient

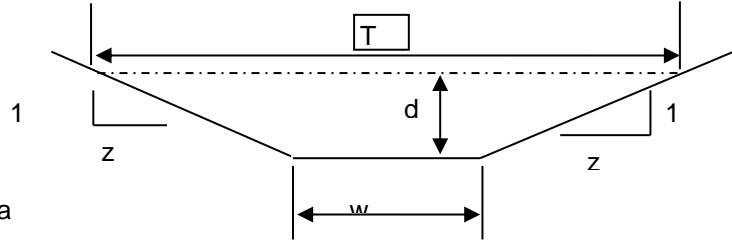

$$V = (1.49/n)R_n^{2/3}S^{1/2}$$

$$Q = V \times A$$

INPUT

z (sideslope)= 5
 z (sideslope)= 3
 b (btm width, ft)= 0
 d (depth, ft)= 2
 S (slope, ft/ft) 0.007
 n low = 0.035
 n high = 0.035

Clear Data
Entry Cells

Depth, ft	Area, sf	Wetted Perimeter, ft	Hydraulic Radius, ft	Low N		High N		T =	Dm =
				Velocity, fps	Flow, cfs	Velocity, fps	Flow, cfs		
2	16.00	16.52	0.97	3.47691293	55.6306	3.476913	55.6306	16	1.000

Sc low = 0.0186 Sc high = 0.0186

s_c = critical slope ft / ft

T = top width of the stream

d_m = a/T = mean depth of flow

.7 Sc	1.3 Sc	.7 Sc	1.3 Sc
0.0130	0.0242	0.0130	0.0242

CIRCULAR CONDUIT FLOW (Normal & Critical Depth Computation)

Project: **Blue cells are for user data entry**

Pipe ID: **Green cells are calculated values**

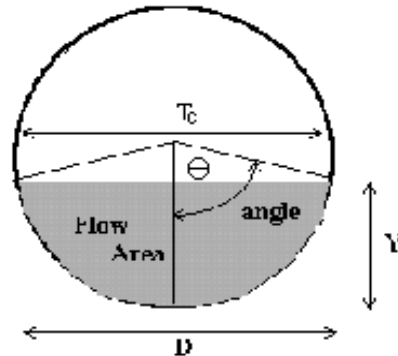

Design Information (Input)

Pipe Invert Slope	So =	0.0050	ft/ft
Pipe Manning's n-value	n =	0.0130	
Pipe Diameter	D =	36.00	inches
Design discharge	Q =	26.03	cfs

Full-flow Capacity (Calculated)

Full-flow area	Af =	7.07	sq ft
Full-flow wetted perimeter	Pf =	9.42	ft
Half Central Angle	Theta =	3.14	radians
Full-flow capacity	Qf =	47.29	cfs

Calculation of Normal Flow Condition

Half Central Angle ($0 < \theta < 3.14$)	Theta =	1.63	radians
Flow area	An =	3.80	sq ft
Top width	Tn =	2.99	ft
Wetted perimeter	Pn =	4.89	ft
Flow depth	Yn =	1.59	ft
Flow velocity	Vn =	6.85	fps
Discharge	Qn =	26.03	cfs
Percent Full Flow	Flow =	55.0%	of full flow
Normal Depth Froude Number	Fr _n =	1.07	supercritical

Calculation of Critical Flow Condition

Half Central Angle ($0 < \theta_c < 3.14$)	Theta-c =	1.67	radians
Critical flow area	Ac =	3.98	sq ft
Critical top width	Tc =	2.99	ft
Critical flow depth	Yc =	1.65	ft
Critical flow velocity	Vc =	6.55	fps
Critical Depth Froude Number	Fr _c =	1.00	

Determination of Culvert Headwater and Outlet Protection

Project: **Blue cells are for user data entry**

Basin ID: **Green cells are calculated values**

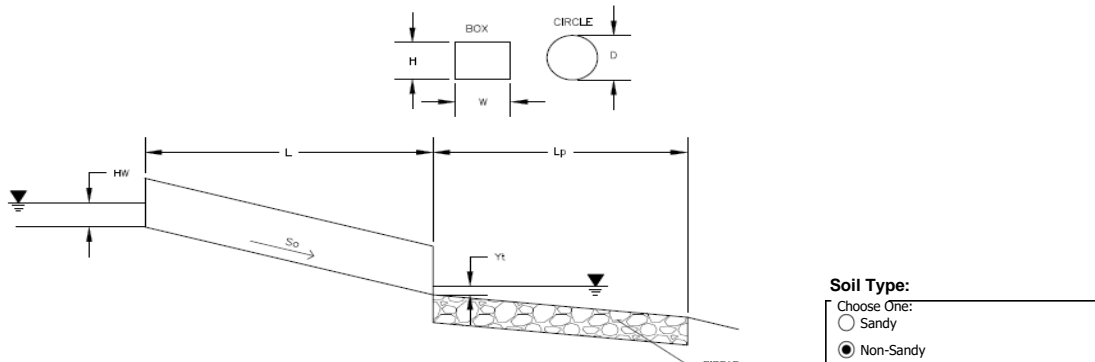

Supercritical Flow! Using Da to calculate protection type.

Design Information (Input):	
Design Discharge	Q = <input style="width: 100px;" type="text" value="26.03"/> cfs
Circular Culvert:	
Barrel Diameter in Inches	D = <input style="width: 100px;" type="text" value="36"/> inches
Inlet Edge Type (Choose from pull-down list)	Grooved End Projection <input type="button" value="v"/>
OR	
Box Culvert:	
Barrel Height (Rise) in Feet	Height (Rise) = <input style="width: 100px;" type="text"/>
Barrel Width (Span) in Feet	Width (Span) = <input style="width: 100px;" type="text"/>
Inlet Edge Type (Choose from pull-down list)	<input type="button" value="v"/>
Number of Barrels	No = <input style="width: 100px;" type="text" value="1"/>
Inlet Elevation	Elev IN = <input style="width: 100px;" type="text" value="7491.05"/> ft
Outlet Elevation OR Slope	Elev OUT = <input style="width: 100px;" type="text" value="7490.85"/> ft
Culvert Length	L = <input style="width: 100px;" type="text" value="40"/> ft
Manning's Roughness	n = <input style="width: 100px;" type="text" value="0.013"/>
Bend Loss Coefficient	k _b = <input style="width: 100px;" type="text" value="0"/>
Exit Loss Coefficient	k _x = <input style="width: 100px;" type="text" value="1"/>
Tailwater Surface Elevation	Elev Y _t = <input style="width: 100px;" type="text"/>
Max Allowable Channel Velocity	V = <input style="width: 100px;" type="text" value="7"/> ft/s
Required Protection (Output):	
Tailwater Surface Height	Y _t = <input style="width: 100px;" type="text" value="1.20"/> ft
Flow Area at Max Channel Velocity	A _t = <input style="width: 100px;" type="text" value="3.72"/> ft ²
Culvert Cross Sectional Area Available	A = <input style="width: 100px;" type="text" value="7.07"/> ft ²
Entrance Loss Coefficient	k _e = <input style="width: 100px;" type="text" value="0.20"/>
Friction Loss Coefficient	k _f = <input style="width: 100px;" type="text" value="0.29"/>
Sum of All Losses Coefficients	k _s = <input style="width: 100px;" type="text" value="1.49"/> ft
Culvert Normal Depth	Y _n = <input style="width: 100px;" type="text" value="1.59"/> ft
Culvert Critical Depth	Y _c = <input style="width: 100px;" type="text" value="1.65"/> ft
Tailwater Depth for Design	d = <input style="width: 100px;" type="text" value="2.32"/> ft
Adjusted Diameter OR Adjusted Rise	D _a = <input style="width: 100px;" type="text" value="2.29"/> ft
Expansion Factor	1/(2*tan(θ)) = <input style="width: 100px;" type="text" value="6.70"/>
Flow/Diameter ^{2.5} OR Flow/(Span * Rise ^{1.5})	Q/D ^{2.5} = <input style="width: 100px;" type="text" value="1.67"/> ft ^{0.5} /s
Froude Number	Fr = <input style="width: 100px;" type="text" value="1.07"/> Supercritical!
Tailwater/Adjusted Diameter OR Tailwater/Adjusted Rise	Y _t /D = <input style="width: 100px;" type="text" value="0.52"/>
Inlet Control Headwater	HW _i = <input style="width: 100px;" type="text" value="2.37"/> ft
Outlet Control Headwater	HW _o = <input style="width: 100px;" type="text" value="2.44"/> ft
Design Headwater Elevation	HW = <input style="width: 100px;" type="text" value="7,493.49"/> ft
Headwater/Diameter OR Headwater/Rise Ratio	HW/D = <input style="width: 100px;" type="text" value="0.81"/>
Minimum Theoretical Riprap Size	d ₅₀ = <input style="width: 100px;" type="text" value="4"/> in
Nominal Riprap Size	d ₅₀ = <input style="width: 100px;" type="text" value="6"/> in
UDFCD Riprap Type	Type = <input style="width: 100px;" type="text" value="VL"/>
Length of Protection	L _p = <input style="width: 100px;" type="text" value="9"/> ft
Width of Protection	T = <input style="width: 100px;" type="text" value="5"/> ft

DRAINAGE MAPS

N:\jobs\216000\Drawings\216000 DRAINAGE.dwg, 5/24/2022, 9:01:11 AM, DWG To PDF.pc3

17815 THOMPSON ROAD
RICHARD G BLOOM &
KAREN K
TSN: 5100000420

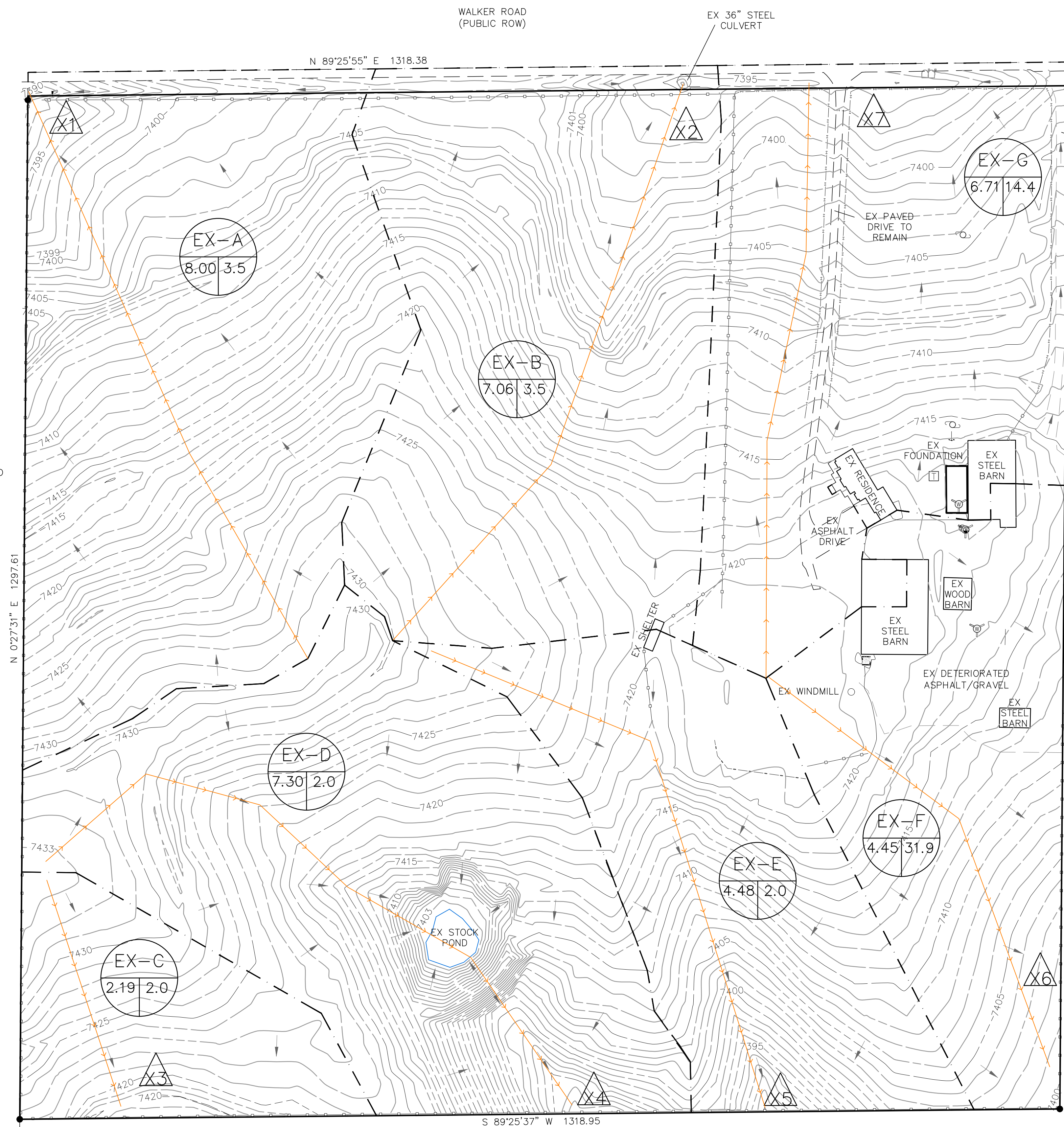

17810 BLACK FOREST ROAD
DAVISSON DELMER L
TSN: 5100000028

LEGEND

- EXISTING FLOW
- UTILITY POLE
- ↓ GUY WIRE
- TELECOMMS PEDESTAL
- WATER WELL HEAD
- YARD HYDRANT
- SANITARY MANHOLE (CONCRETE)
- STORM CULVERT
- SPLIT RAIL FENCE
- WIRE FENCE
- STEEL FENCE
- - - EXISTING CONTOURS - MINOR
- - - EXISTING CONTOUR - MAJOR
- - - EXISTING EASEMENT
- - - EXISTING PAVEMENT EDGE
- - - PROPOSED PROPERTY LINE

BENCHMARK

AN ALUMINUM CAP ON A 3/4" X 30" REBAR
35.00 FEET FROM TRUE CORNER LOCATION.
ELEV = 7386.46 (NAVD88)

LEGEND

- B ASIN DESIGNATION
- AREA IN BASIN (AC) 1.12 | 7.7
- % IMPERVIOUSNESS
- △ DESIGN POINT
- - - BASIN BOUNDARY
- TIME OF CONCENTRATION PATH

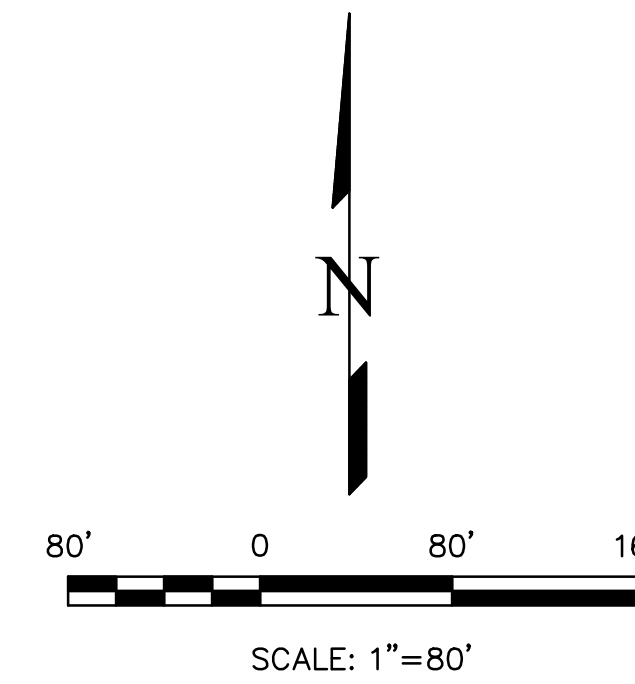

DRAINAGE SUMMARY

BASIN NAME	AREA (ACRES)	FLOW	
		5 YR (cfs)	100 YR (cfs)
EX-A	8.00	1.94	11.40
EX-B	7.06	1.87	11.04
EX-C	2.19	0.62	4.14
EX-D	7.30	1.70	11.12
EX-E	4.48	1.03	6.76
EX-F	4.45	3.63	10.30
EX-G	6.71	3.17	11.97

DESIGN POINT SUMMARY

DP	CONTRIBUTING BASINS	AREA AC.	Q5 CFS	Q100 CFS
X1	EX-A	8.00	1.94	11.40
X2	EX-B, EX-G	13.77	5.04	23.01
X3	EX-C	2.19	0.62	4.14
X4	EX-D	7.30	1.70	11.12
X5	EX-E	4.48	1.03	6.76
X6	EX-F	4.45	3.63	10.30
X7	EX-G	6.71	3.17	11.97

REVISIONS	NO.	DESCRIPTION	DATE

UNTIL SUCH TIME AS THESE DRAWINGS ARE APPROVED BY THE APPROPRIATE REVIEWING AGENCIES, INCORPORATING THEIR USE FOR THE PURPOSES DESIGNATED BY WRITTEN AUTHORIZATION.

PREPARED FOR:
COLLIN BRONES
ATTN:
954 PINENUT COURT
COLORADO SPRINGS, CO 80921
(719) 660-2601

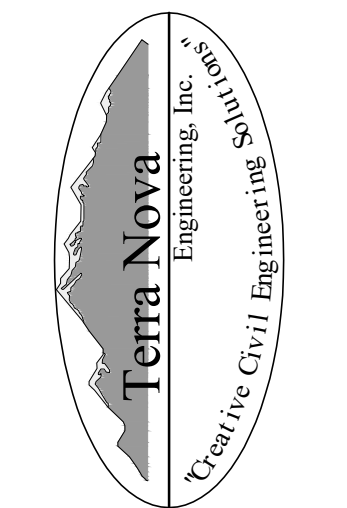

721 S. 29RD STREET
COLORADO SPRINGS, CO 80904
OFFICE: 719-635-6422
FAX: 719-635-6426
www.tneng.com

HIGH VIEW ESTATES
6665 WALKER ROAD
EXISTING DRAINAGE PLAN

DESIGNED BY JF
DRAWN BY JF
CHECKED BY LD
H-SCALE AS SHOWN
V-SCALE N/A
JOB NO. 2160.00
DATE ISSUED 5/12/22
SHEET NO. 1 OF 2

N:\jobs\216000\Drawings\216000 DRAINAGE.dwg, 5/24/2022, 9:01:32 AM, DWG To PDF.pc3

17815 THOMPSON ROAD
RICHARD G BLOOM &
KAREN K
TSN: 5100000420

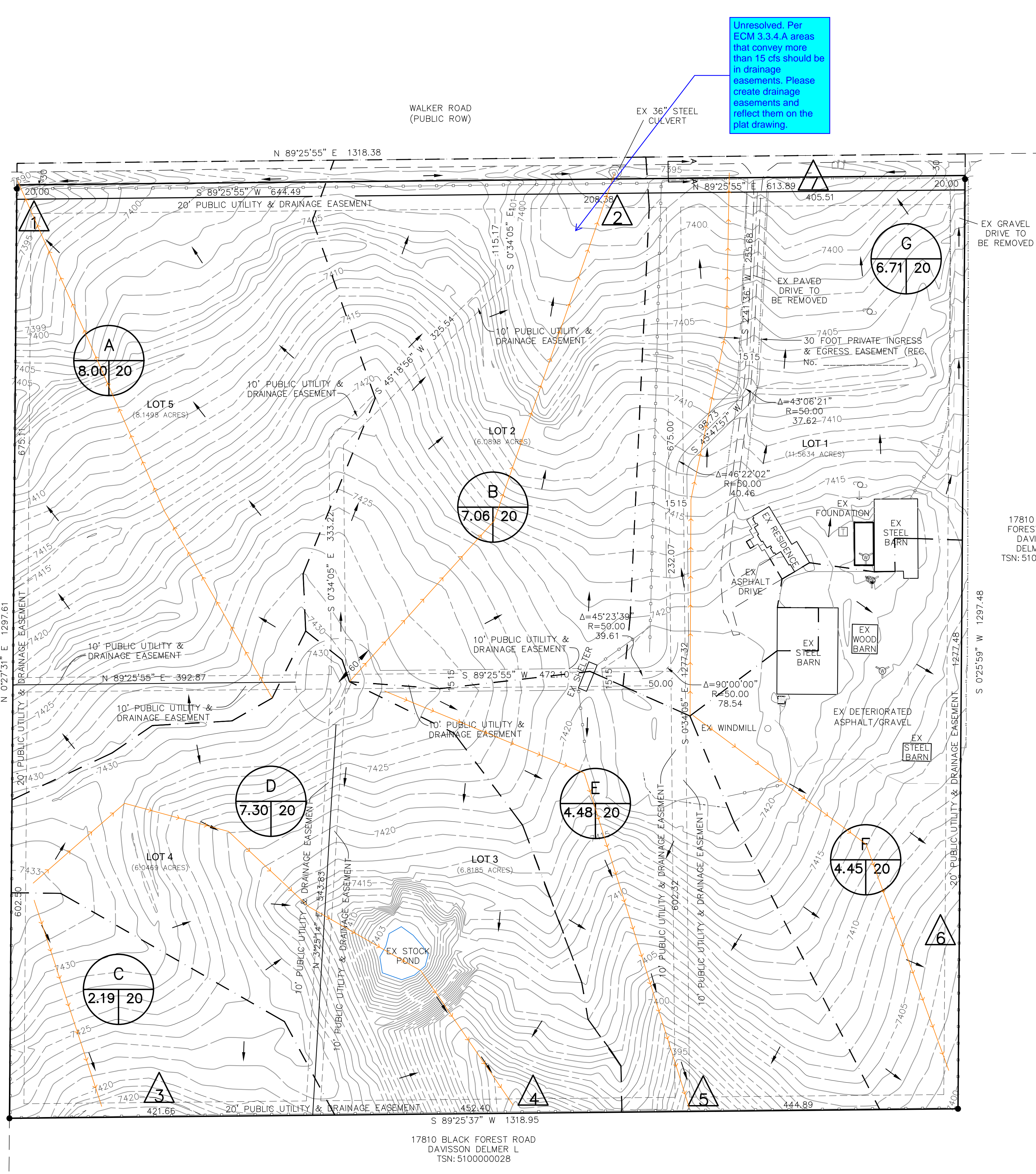

Unresolved. Per
ECM 3.3.4.A areas
that convey more
than 15 cfs should be
in drainage
easements. Please
create drainage
easements and
reflect them on the
plat drawing.

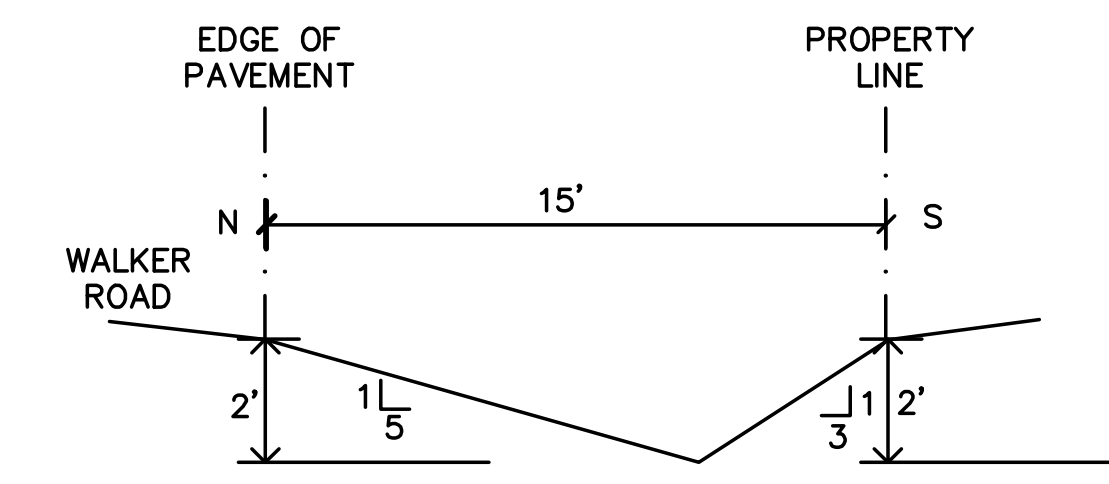

Q CAP MIN = 12.32 CFS
SLOPE = 0.7%±
n VALUE = 0.035
DEPTH = 2.0'
VELOCITY = 3.5 FT/S

EX SWALE CROSS SECTION A-A
N.T.S.

BENCHMARK

AN ALUMINUM CAP ON A 3" X 30" REBAR
35.00 FEET FROM TRUE CORNER LOCATION.
ELEV = 7386.46 (NAVD88)

LEGEND

- EXISTING FLOW
- UTILITY POLE
- ⊥ GUY WIRE
- TELECOMMS PEDESTAL
- WATER WELL HEAD
- ⊕ YARD HYDRANT
- ⊙ SANITARY MANHOLE (CONCRETE)
- STORM CULVERT
- SPLIT RAIL FENCE
- WIRE FENCE
- STEEL FENCE
- - - EXISTING CONTOURS - MINOR
- - - EXISTING CONTOUR - MAJOR
- - - PROPOSED ACCESS EASEMENT
- - - EXISTING PAVEMENT EDGE
- - - PROPOSED PROPERTY LINE
- PROPOSED FLOW
- - - PROPOSED CONTOURS - MINOR
- - - PROPOSED CONTOURS - MAJOR
- - - PROPOSED UTILITY AND DRAINAGE EASEMENT

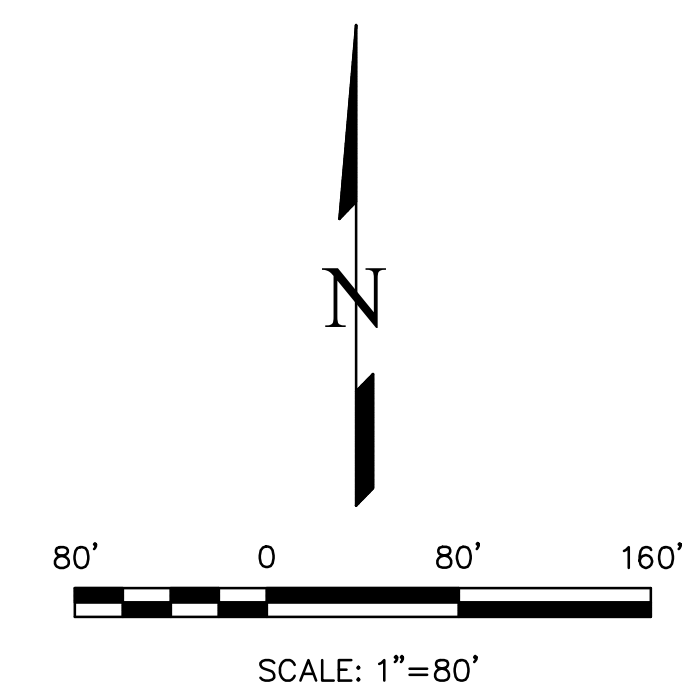

- LEGEND**
- B ASIN DESIGNATION
 - % IMPERVIOUSNESS
 - △ DESIGN POINT
 - - - BASIN BOUNDARY
 - TIME OF CONCENTRATION PATH

DRAINAGE SUMMARY

BASIN NAME	AREA (ACRES)	FLOW	
		5 YR (cfs)	100 YR (cfs)
A	8.00	3.92	14.07
B	7.06	3.79	13.71
C	2.19	1.45	5.37
D	7.30	3.91	14.16
E	4.48	2.40	8.69
F	4.45	2.39	8.65
G	6.71	3.42	12.32

DESIGN POINT SUMMARY

DP	CONTRIBUTING BASINS	AREA AC.	Q5 CFS	Q100 CFS
1	A	8.00	3.92	14.07
2	B, G	13.77	7.21	26.03
3	C	2.19	1.45	5.37
4	D	7.30	3.91	14.16
5	E	4.48	2.40	8.69
6	F	4.45	2.39	8.65
7	G	6.71	3.42	12.32

REVISIONS	NO.	DESCRIPTION	DATE

UNTIL SUCH TIME AS THESE DRAWINGS ARE APPROVED BY THE APPROPRIATE REVIEWING AGENCIES, INCORPORATING THEIR USE ONLY FOR THE PURPOSES DESIGNATED BY WRITTEN AUTHORIZATION.

PREPARED FOR:
COLLIN BRONES
ATTN:
954 PINENUT COURT
COLORADO SPRINGS, CO 80921
(719) 660-2601

Terra Nova
Engineering, Inc.
Creative City/IT Engineering

721 S. 23RD STREET
COLORADO SPRINGS, CO 80904
OFFICE: 719-635-6422
FAX: 719-635-6426
www.terra-nova.com

HIGH VIEW ESTATES
6665 WALKER ROAD
PROPOSED DRAINAGE PLAN

DESIGNED BY JF
DRAWN BY JF
CHECKED BY LD

H-SCALE AS SHOWN
V-SCALE N/A

JOB NO. 2160.00
DATE ISSUED 5/12/22
SHEET NO. 2 OF 2