



**STORMWATER MANAGEMENT PLAN
FOR
STERLING RANCH FILING 4**

PCD Filing No.: SF2230

Prepared For:

SR Land, LLC
20 Boulder Crescent, Suite 200
Colorado Springs, CO 80903
720-491-3024

Contractor Information

: _____

Qualified Stormwater Manager

: _____

Prepared By:

JR Engineering, LLC
5475 Tech Center Drive, Suite 235
Colorado Springs, Colorado 80919
(303) 267-6240
Contact: Mike Bramlett

JR Project No. 25188.11

April 2023

ENGINEER OF RECORD:

The Stormwater Management Plan was prepared under my direction and supervision and is correct to the best of my knowledge and belief. Said Plan has been prepared according to the criteria established by the County and State for Stormwater Management Plans.

Mike Bramlett, P.E.

Date

Registered Professional Engineer

State of Colorado No. 32314

For and on behalf of JR Engineering, LLC.

TABLE OF CONTENTS

1.	Applicant / Contact Information	1
2.	Site Description and Location.....	1
3.	Proposed Sequence of Major Activities	3
4.	BMPs for Stormwater Pollution Prevention	3
5.	Final Stabilization and Long-Term Stormwater Management.....	6
6.	Inspection and Maintenance.....	7

Appendices

- A. Vicinity Map
- B. Soils Map
- C. FIRM
- D. GEC Plans and Details
- E. SWMP Checklist

1. Applicant / Contact Information

Owner/Developer: SR Land, LLC
Attn: Jim Morley
20 Boulder Crest, Suite 200
Colorado Springs, CO 80903
(720) 491-3024

Engineer: JR Engineering, LLC
5475 Tech Center Drive, Suite 235
Colorado Springs, CO 80919
Attn: Mike Bramlett (303) 267-6240
mbramlett@jrengineering.com

SWMP Administrator: The QSM will be sufficiently qualified for the required duties per the ECM appendix I.5

Contractor: To Be Determined

2. Site Description and Location

Sterling Filing Number 4 (hereby referred to as the “site”) is a proposed development within the Sterling Ranch master planned community with a total area of approximately 55 acres and includes a replat of tracts B and J of Sterling Ranch Filing No. 2 and the regional detention pond W-5 built during Sterling Ranch Filing No. 2. The site is currently being designed to accommodate approximately 146 single-family residential lots. West of the site adjacent to the pond W-5 Marksheffel road will be extended to a planned residential subdivision.

The site is located in portion a Portion of the Southwest Quarter Of Section 33, Township 12 South, Range 65 West Of The 6th Principal Meridian & A Portion Of The Northwest Quarter Of The Northwest Quarter Of Section 4, Township 13S South, Range 65 West Of The 6th Principal Meridian County Of El Paso, State Of Colorado. The site is separated by Sterling Ranch Road into a north and south region. Barbarick Subdivision borders the northern portion of the site to the north, to the west by Sterling Ranch Filing No. 2, and to the east, the site is bounded by unplatted vacant land that is currently undeveloped. The southern portion of the site is bounded by Sterling Ranch road to the north, Sterling Ranch Filing No. 3, and Pawnee Rancheros border the site directly to the east. To the west, the southern portion of the site borders the proposed extension of Marksheffel Road, and to the south, the site borders unplatted and undeveloped land that is planned for residential use.

The property will be primarily be single-family residential development (approximately 55 acres), Open space and drainage tracts. The site is comprised of variable sloping grasslands that generally slope(s) downward to the southeast at 3 to 8% towards the Sand Creek tributary basin.

Soil characteristics are comprised of Type A and B hydrologic Soil groups. Refer to the soil survey map in Appendix A for additional information.

There are no major drainage ways running through the site, although a tributary to the Sand Creek basin is immediately to the east of the site. Currently, JR Engineering, LLC is performing studies and plans to address Sand Creek stabilization.

There are no known irrigation facilities located on the project site.

Site details:

- a. Estimated area to undergo disturbance: 39 acres (Total Area = 55 acres)
- b. Per an NRCS web soil survey, the site is made up of Type A and B soils. Group A soils have a high infiltration rate when thoroughly wet. Type B soils have a moderate infiltration when thoroughly wet. A NRCS soil survey map has been presented in Appendix B. BMPs will be installed and maintained to mitigate adverse impacts due to soil erosion. OSHA classifies soils into three main groups: Type A, Type B, and Type C. Type A is the most stable, and Type C is the least stable soil. Type A soil is cohesive and has a high unconfined compressive. Type A soil includes clay, silty clay, sandy clay, and clay loam. Type B soil is cohesive and has often been cracked or disturbed, with pieces that don't stick together as well as Type A soil. Type B soil includes angular gravel, silt, silt loam, and soils that are more susceptible to crack/break near to sources of vibration. Erosion can be mitigated on the site by abiding by the site geotech report and following the BMPs such as silt fence placement, vehicle tracking control, inlet protection, check dams, and seeding. If strong winds are present before stabilization is established, then the erosion control manager may find it necessary to use water to control the dust. The adverse impacts of soil erosion include stream/water pollution associated with increased turbidity.
- c. Existing vegetation: An aerial survey was used to determine percent cover of native grasses (approximately 30% coverage).
- d. Location and description of potential pollution sources: Potential sources of pollution include:
 - Vehicle, equipment maintenance, and fueling – all designated fueling and maintenance areas shall be located a minimum of 100 feet from any drainage course whenever possible. If the fueling area is located on a pervious surface, the area shall be covered with a non-pervious lining so as to prevent soil contamination by way of infiltration. Any spillage shall be cleaned up immediately.
 - All exposed and stored soils – all exposed soils will be seeded and mulched upon completion of construction within the vicinity. Silt fence will be utilized to contain sediment deposited by runoff until seeding can take. Silt fence or a similar barrier should be installed as needed around long-term stockpiles (30 days+). Vehicle Tracking Control should be installed at

access points to minimize sediment deposition from vehicles exiting the site.

- Vehicle tracking of sediments – if sediment is tracked onto the street, a reasonable attempt shall be made to clean up sediment and mud deposits as soon as possible. A street sweeper may be used as necessary. Vehicle Tracking Control shall be installed at all vehicular access points to the site.

-Management of contaminated soils – appropriate measures will be taken to clean up the cause of the contaminated soil. All contaminated soils must be disposed of offsite in an appropriate manner.

- Vehicle, equipment maintenance, and fueling – all designated fueling and maintenance areas shall be located a minimum of 100 feet from any drainage course whenever possible. If the fueling area is located on a pervious surface, the area shall be covered with a non-pervious lining so as to prevent soil contamination by way of infiltration. Any spillage shall be cleaned up immediately.

- On-site waste management practices (waste piles, liquid wastes, dumpsters, etc.) – dumpsters will be utilized as needed to remove trash from the site. Any waste material found on-site or generated by construction activities will be disposed of in a manner that prevents polluting of storm water discharges. In the event that waste is to be stored on-site, it shall be in an area located a minimum of 100 feet from any drainage course whenever possible. Whenever waste is not stored in a non-porous container, it shall be in an area enclosed by a 12-inch high compacted earthen ridge. If the enclosed waste area is located on porous soil, the area shall be covered with a non-porous lining to prevent soil contamination. Whenever precipitation is predicted, the waste shall be covered with a non-porous cover, anchored on all sides to prevent its removal by wind, in order to prevent precipitation from leaching out potential pollutants from the waste.

- Non-industrial waste sources such as worker trash and portable toilets – all portable toilets should be kept a minimum of 50 feet from a storm drain inlet and secured to the ground. Portable toilets will be located a minimum of 50 feet from state waters. They shall be adequately staked and cleaned on a weekly basis. They will be inspected daily for spills.

The locations of these sources are shown in the GEC plans in Appendix C or will be determined by the contractor.

- e. Spill prevention and pollution controls for dedicated batch plants: Not applicable for this site since there will be no dedicated batch plants.
- f. Location and description of anticipated non-stormwater components of discharge: A potential source of non-stormwater discharge could be the irrigation of permanent seeding (PS). Irrigation will be kept at a rate so as to not create runoff. The groundwater discharge on the site is not expected to have an adverse impact to the downstream water quality.
- g. Ultimate receiving waters: Roughly 12.87 acres of the site slopes from northeast to southwest at slopes ranging from 2-8% with an ultimate outfall to Sand Creek. The filing 2 existing full-spectrum detention pond will outfall to Sand Creek via a proposed 84” RCP pipe with a low tail water basin for outlet protection. Sand Creek

is located along the eastern edge of the site.

3. Proposed Sequence and Phasing of Major Activities

The project will follow standard construction sequences for construction, ie., grading, utility installation, street paving, and landscaping. The contractor will be responsible for implementing and maintaining the erosion and sediment control measures described in this document and the accompanying design drawings. The contractor may designate these tasks to certain subcontractors as they see fit, but the ultimate responsibility for implementing these controls and their proposed function at each phase of the project remains with the contractor. The order of major activities (with estimated completion dates) will be as follows:

1. Install VTC and other perimeter soil erosion control measures (Summer 2023).
2. Clear and rough grade for improvements (Summer 2023).
3. Fine grading and placement of gravel drive aisles, lights, water, cesspool, and paving (Summer 2023).
4. Install landscaping/vegetated surface treatments (Summer2023).
5. Clean up and final stabilization (Summer 2023).
6. Remove BMPs once final stabilization is achieved (Summer 2024)

*** Total construction timeframe < 1 month, with the exception of establishing vegetation. Site does not require a phasing plan.*

4. BMPs for Stormwater Pollution Prevention

See GEC plans in Appendix C for BMP locations and detail sheets. The total area of disturbance on the site is 189,700 SY. This storm water management report does not rely on control measures owned or operated by another entity.

a. Erosion and Sediment Controls

i. Structural BMPs:

1. Temporary sediment basins and permanent detention pond (SBs) to collect runoff before it enters receiving waters
2. Silt fence (SF) along downstream limits of disturbed areas to filter sediment from runoff
3. Construction marker (CM) to identify limits of construction (LOC)
4. Vehicle tracking control (VTC) at site entrance to prevent sediment from leaving the site via vehicle tires
5. Erosion control blanket (ECB) placed on any slopes of 3:1 or greater, including the sides of sediment basins
6. Inlet protection (IP) around culvert entrances
7. Outlet protection (OP) at culvert outlets

8. Check Dam (CD) to counteract erosion by reducing energy
 9. Site grading around entire stockpile area, all road slope toward detention pond. No developed storm water offsite.
 10. Temporary stock pile and permanent stock pile (TSP) to consolidate materials such as topsoil in a controlled area bounded by silt fence
 11. Stabilized staging area (SSA) near site entrance to consolidate construction equipment in a stabilized location
 12. Concrete washout area (CWA) to allow a controlled area for concrete trucks to be washed
- ii. Non-structural BMPs:
 1. Permanent seeding (PS) to stabilize disturbed areas
- b. Materials Handling and Spill Prevention
- i. General Materials Handling Practices:
 1. Potential pollutants shall be stored and used in a manner consistent with the manufacturer's instructions in a secure location. To the extent practical, material storage areas should not be located near storm drain inlets and should be equipped with covers, roofs, or secondary containment as required to prevent storm water from contacting stored materials. Chemicals that are not compatible shall be stored in segregated areas so that spilled materials cannot combine and react.
 2. Disposal of materials shall be in accordance with the manufacturer's instructions and applicable local, state, and federal regulations.
 3. Materials no longer required for construction shall be removed from the site as soon as possible.
 4. Adequate garbage, construction waste, and sanitary waste handling and disposal facilities shall be provided as necessary to keep the site clear of obstruction and BMPs clear and functional.
 - ii. Specific Materials Handling Practices
 1. All pollutants, including waste materials and demolition debris, that occur onsite during construction shall be handled in a way that does not contaminate storm water.
 2. All chemicals including liquid products, petroleum products, water treatment chemicals, and wastes stored onsite shall be covered and protected from vandalism.
 3. Maintenance, fueling, and repair of all equipment and vehicles involving oil changes, hydraulic system drain down, degreasing operations, fuel tank drain down and removal, and other activities which may result in the accidental release of contaminants, shall be conducted under cover during wet weather and on an impervious surface to prevent release of contaminants onto the ground. Materials spilled during maintenance operations shall be cleaned up immediately and properly disposed of. There will be no batch plants onsite.
 4. Wheel wash water shall be settled and discharged onsite by infiltration.

5. Application of agricultural chemicals, including fertilizers and pesticides, shall be conducted in a manner and at application rates that will not result in loss of chemical to storm water runoff. Follow manufacturer's recommendations for application rates and procedures.
6. pH-modifying sources shall be managed to prevent contamination of runoff and storm water collected onsite. The most common sources of pH-modifying materials are bulk cement, cement kiln dust (CKD), fly ash, new concrete washing and curing waters, waste streams generated from concrete grinding and sawing, exposed aggregate processes, and concrete pumping and mixer washout waters.

iii. Spill Prevention and Response Procedures

1. The primary objective in responding to a spill is to quickly contain the material(s) and prevent or minimize their migration into storm water runoff and conveyance systems. If the release has impacted onsite storm water, it is critical to contain the released materials onsite and prevent their release into receiving waters.
2. Spill Response Procedures:
 - a. Notify site superintendent immediately when a spill, or the threat of a spill, is observed. The superintendent shall assess the situation and determine the appropriate response.
 - b. If spills represent an imminent threat of escaping onsite facilities and entering the receiving waters, site personnel shall respond immediately to contain the release and notify the superintendent after the situation has stabilized.
 - c. The site superintendent, or his/her designee, shall be responsible for completing a spill reporting form and for reporting the spill to the appropriate agency.
 - d. Spill response equipment shall be inspected and maintained as necessary to replace any materials used in spill response activities.
3. Spill kits shall be on-hand at all fueling sites. Spill kit location(s) shall be reported to the SWMP administrator.
4. Absorbent materials shall be on-hand at all fueling areas for use in containing inadvertent spills. Containers shall be on-hand at all fueling sites for disposal of used absorbents.
5. Recommended components of spill kits include the following:
 - a. Oil absorbent pads (one bale)
 - b. Oil absorbent booms (40 feet)
 - c. 55-gallon drums (2)
 - d. 9-mil plastic bags (10)
 - e. Personal protective equipment including gloves and goggles
6. Concrete wash water: unless confined in a pre-defined, bermed containment area, the cleaning of concrete truck delivery chutes is prohibited at the job site.

7. Notification procedures:
 - a. In the event of an accident or spill, the SWMP administrator shall be notified.
 - b. Depending on the nature of the spill material involved, the Colorado Department of Public Health and Environment (24-hour spill reporting line: 887-518-5608), downstream water users, or other agencies may also need to be notified.
 - c. Any spill of oil which 1) violates water quality standards, 2) produces a “sheen” on a surface water, or 3) causes a sludge or emulsion, or any hazardous substance release, or hazardous waste release which exceeds the reportable quantity, must be reported immediately by telephone to the National Response Center Hotline at (800) 424-8802.

5. Final Stabilization and Long-Term Stormwater Management

- a. Permanent seeding will be provided to achieve long-term stabilization of the site.
- b. Seed Mix: “Foothills” or approved equal.
- c. Seeding Application Rate: Drill seed 0.25” to 0.5” into the soil. In small areas not accessible to a drill, hand broadcast at double the rate and rake 0.25” to 0.5” into the soil. Apply seed at the following rates:
 - i. Dryland: 20-25 lbs/acre
 - ii. Irrigated: 40 lbs/acre
- d. Soil stabilization Practices:
 - i. Mulching Application: Apply 1-1/2 tons of certified weed free hay per acre mechanically crimped into the soil in combination with an organic mulch tackifier. On slopes and ditches requiring a blanket, the blanket shall be placed in lieu of mulch and mulch tackifier.
- e. Soil Conditioning and Fertilization Requirements:
 - i. Soil conditioner, organic amendment shall be applied to all seeded areas at 3 CY / 1000 SF.
 - ii. Fertilizer shall consist of 90% fungal biomass (mycelium) and 10% potassium-magnesia with a grade of 6-1-3 or approved equal. Fertilizer shall be applied as recommended by seed supplier.
- f. A full spectrum extended basin detention pond will provided long-term stormwater management of the site. This pond will provide better control of the of the runoff rates over an extended period of time (up to 72 hours). A trickle channel will be place within the pond/basin to improve the water quality and aesthetic value. The contractor will be responsible for any re-excavation of sediment and debris that collects in the existing pond required to ensure that the pond meets the design grades following construction. The storm lines shall also be cleaned and free of sediment once the site becomes stabilized.
- g. Final stabilization is reached when all soil-disturbing activities at the site have been completed, and uniform vegetative cover has been established with an individual

plan density of at least 70 percent of pre-disturbance levels, or equivalent permanent, physical erosion reduction methods have been employed.

6. Inspection and Maintenance

- a. Inspection Schedules:
 - i. The contractor shall inspect BMPs once every 14 days at a minimum, and immediately (within 24 hours) after any precipitation or snowmelt event that causes surface erosion (i.e. that results in storm water running across the ground), to ensure that BMPs are maintained in effective operating condition.
- b. Inspection Procedures:
 - i. Site Inspection / Observation Items:
 - 1. Construction site perimeter and discharge points
 - 2. All disturbed areas
 - 3. Areas used for material / waste storage that are exposed to precipitation
 - 4. Other areas having a significant potential for storm water pollution, such as demolition areas or concrete washout areas, or locations where vehicles enter or leave the site
 - 5. Erosion and sediment control measures identified in the SWMP
 - 6. Any other structural BMPs that may require maintenance, such as secondary containment around fuel tanks, or the conditions of spill response kits.
 - ii. Inspection Requirements:
 - 1. Determine if there is any evidence of, or potential for, pollutants entering the receiving waters.
 - 2. Review BMPs to determine if they still meet design and operational criteria in the SWMP, and if they continue to adequately control pollutants at the site.
 - 3. Upgrade and/or revise any BMPs not operating in accordance with the SWMP and update the SWMP to reflect any revisions.
 - iii. BMP Maintenance / Replacement and Failed BMPs:
 - 1. The contractor shall remove sediment that has been collected by perimeter controls, such as silt fence and inlet protection, on a regular basis to prevent failure of BMPs, and remove potential of sediment from being discharged from the site in the event of BMP failure.
 - 2. Removed sediment must be moved to an appropriate location where it will not become an additional pollutant source, and should never be placed in ditches or streams.
 - 3. The contractor shall update the GEC as required with any new BMPs added during the construction period.
 - 4. The contractor shall address BMPs that have failed or have the potential to fail without maintenance or modifications, as soon as

possible, immediately in most cases, to prevent discharge of pollutants.

iv. Record Keeping and Documenting Inspections:

1. The contractor shall maintain records of all inspection reports, including signed inspection logs, at the project site.
 2. The permittee shall document inspection results and maintain a record of the results for a period of 3 years following expiration or inactivation of permit coverage.
 3. Site inspection records shall include the following:
 - a. Inspection date
 - b. Name and title of personnel making the inspection
 - c. Location of discharges of sediment or other pollutants from the site
 - d. Location(s) of BMPs in need of maintenance
 - e. Location(s) of BMPs that failed to operate as designed or proved inadequate for a particular location
 - f. Location(s) where additional BMPs are needed that were not in place at the time of inspection
 - g. Deviations from the minimum inspection schedule
- c. This SWMP should be viewed as a “living document” that is continuously being reviewed and modified as a part of the overall process of evaluating and managing stormwater quality issues at the site. The Qualified Stormwater Manager shall amend the SWMP when there is a change in design, construction, operation or maintenance of the site which would require the implementation of new or revised BMPs or if the SWMP proves to be ineffective in achieving the general objectives of controlling pollutants in stormwater discharges associated with construction activity or when BMPs are no longer necessary and are removed.

APPENDIX A – VICINITY MAP

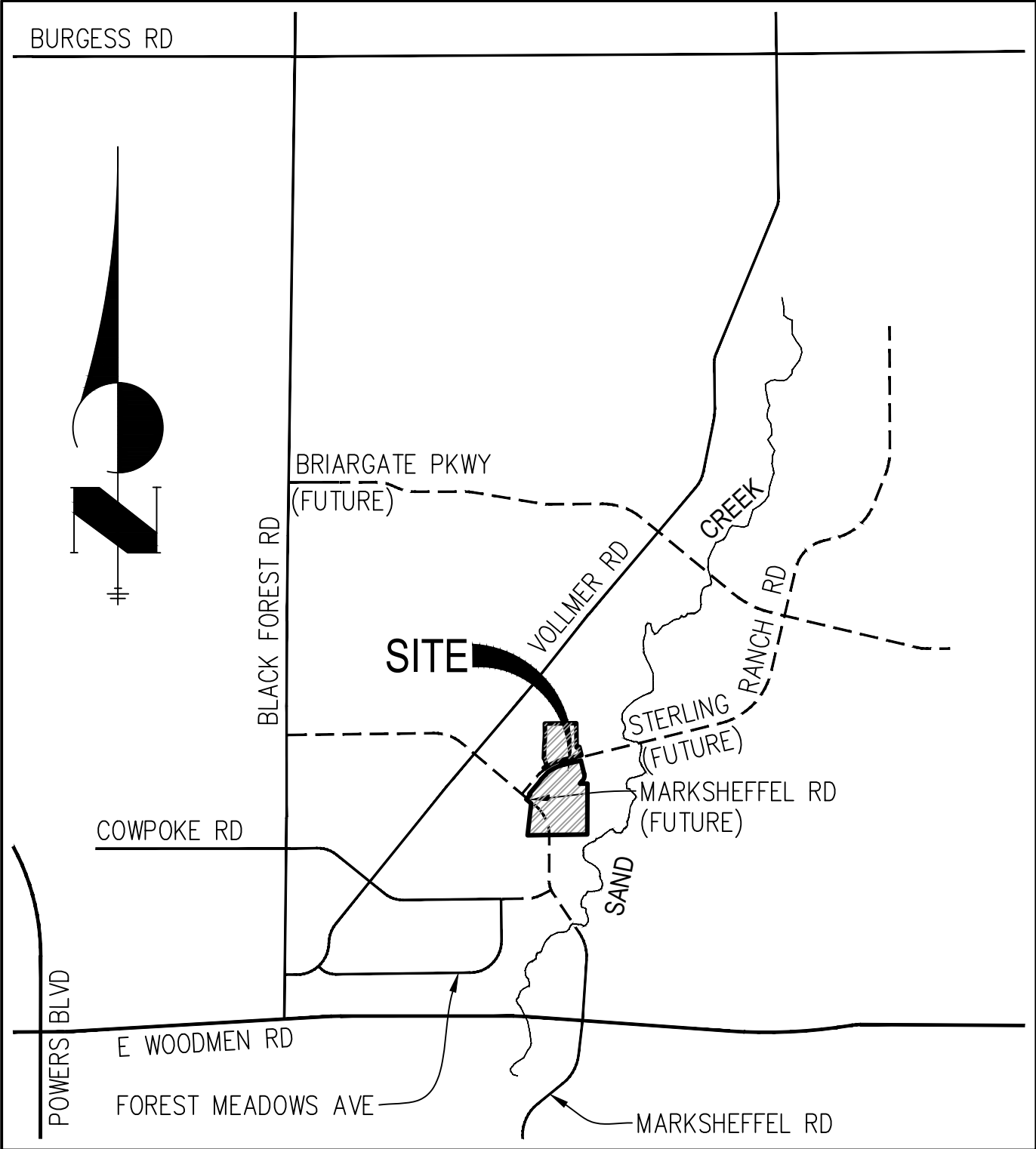

VICINITY MAP

N.T.S.

VICINITY MAP
 STERLING RANCH FILING NO. 4
 JOB NO. 25188.11
 4/27/22
 SHEET 1 OF 1



Centennial 303-740-9393 • Colorado Springs 719-593-2593
 Fort Collins 970-491-9888 • www.jrengineering.com

APPENDIX B – SOILS MAP

Hydrologic Soil Group—El Paso County Area, Colorado

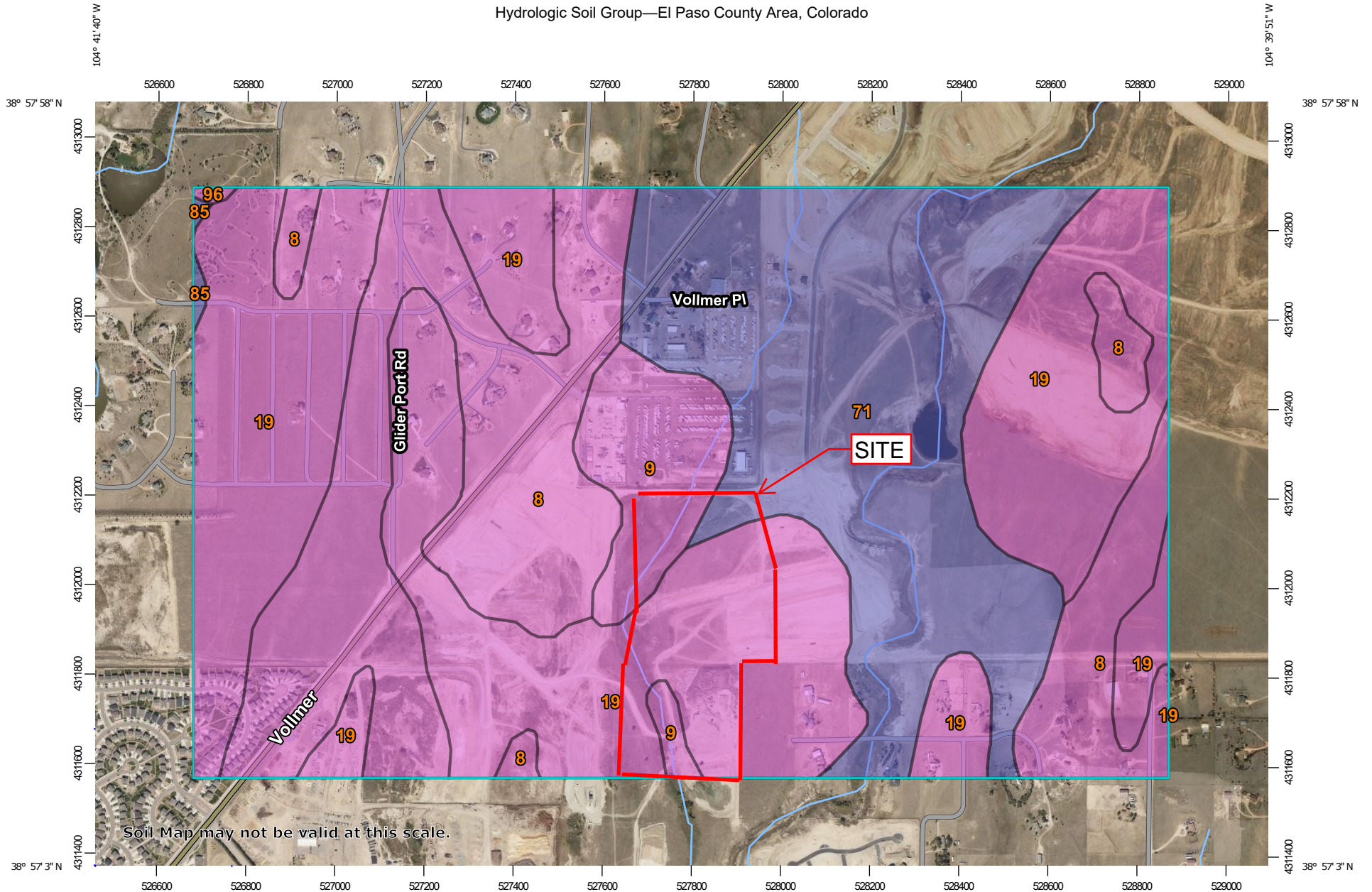

Map Scale: 1:12,000 if printed on A landscape (11" x 8.5") sheet.



Map projection: Web Mercator Corner coordinates: WGS84 Edge tics: UTM Zone 13N WGS84



MAP LEGEND

Area of Interest (AOI)









 Area of Interest (AOI)

Soils

Soil Rating Polygons





-  A
-  A/D
-  B
-  B/D
-  C
-  C/D
-  D
-  Not rated or not available

Soil Rating Lines

-  A
-  A/D
-  B
-  B/D
-  C
-  C/D
-  D
-  Not rated or not available

Soil Rating Points





-  A
-  A/D
-  B
-  B/D

-  C
-  C/D
-  D
-  Not rated or not available

Water Features

 Streams and Canals

Transportation

-  Rails
-  Interstate Highways
-  US Routes
-  Major Roads
-  Local Roads

Background

 Aerial Photography

MAP INFORMATION

The soil surveys that comprise your AOI were mapped at 1:24,000.

Warning: Soil Map may not be valid at this scale.

Enlargement of maps beyond the scale of mapping can cause misunderstanding of the detail of mapping and accuracy of soil line placement. The maps do not show the small areas of contrasting soils that could have been shown at a more detailed scale.

Please rely on the bar scale on each map sheet for map measurements.

Source of Map: Natural Resources Conservation Service
 Web Soil Survey URL:
 Coordinate System: Web Mercator (EPSG:3857)

Maps from the Web Soil Survey are based on the Web Mercator projection, which preserves direction and shape but distorts distance and area. A projection that preserves area, such as the Albers equal-area conic projection, should be used if more accurate calculations of distance or area are required.

This product is generated from the USDA-NRCS certified data as of the version date(s) listed below.

Soil Survey Area: El Paso County Area, Colorado
 Survey Area Data: Version 17, Sep 13, 2019

Soil map units are labeled (as space allows) for map scales 1:50,000 or larger.

Date(s) aerial images were photographed: Aug 19, 2018—May 26, 2019

The orthophoto or other base map on which the soil lines were compiled and digitized probably differs from the background imagery displayed on these maps. As a result, some minor shifting of map unit boundaries may be evident.

Hydrologic Soil Group

Map unit symbol	Map unit name	Rating	Acres in AOI	Percent of AOI
8	Blakeland loamy sand, 1 to 9 percent slopes	A	182.3	25.4%
9	Blakeland-Fluvaquentic Haplaquolls	A	36.8	5.1%
19	Columbine gravelly sandy loam, 0 to 3 percent slopes	A	307.5	42.9%
71	Pring coarse sandy loam, 3 to 8 percent slopes	B	188.4	26.3%
85	Stapleton-Bernal sandy loams, 3 to 20 percent slopes	B	1.2	0.2%
96	Truckton sandy loam, 0 to 3 percent slopes	A	0.6	0.1%
Totals for Area of Interest			716.9	100.0%

Description

Hydrologic soil groups are based on estimates of runoff potential. Soils are assigned to one of four groups according to the rate of water infiltration when the soils are not protected by vegetation, are thoroughly wet, and receive precipitation from long-duration storms.

The soils in the United States are assigned to four groups (A, B, C, and D) and three dual classes (A/D, B/D, and C/D). The groups are defined as follows:

Group A. Soils having a high infiltration rate (low runoff potential) when thoroughly wet. These consist mainly of deep, well drained to excessively drained sands or gravelly sands. These soils have a high rate of water transmission.

Group B. Soils having a moderate infiltration rate when thoroughly wet. These consist chiefly of moderately deep or deep, moderately well drained or well drained soils that have moderately fine texture to moderately coarse texture. These soils have a moderate rate of water transmission.

Group C. Soils having a slow infiltration rate when thoroughly wet. These consist chiefly of soils having a layer that impedes the downward movement of water or soils of moderately fine texture or fine texture. These soils have a slow rate of water transmission.

Group D. Soils having a very slow infiltration rate (high runoff potential) when thoroughly wet. These consist chiefly of clays that have a high shrink-swell potential, soils that have a high water table, soils that have a claypan or clay layer at or near the surface, and soils that are shallow over nearly impervious material. These soils have a very slow rate of water transmission.

If a soil is assigned to a dual hydrologic group (A/D, B/D, or C/D), the first letter is for drained areas and the second is for undrained areas. Only the soils that in their natural condition are in group D are assigned to dual classes.

Rating Options

Aggregation Method: Dominant Condition

Component Percent Cutoff: None Specified

Tie-break Rule: Higher

APPENDIX C – FIRM

NOTES TO USERS

This map is for use in administering the National Flood Insurance Program. It does not necessarily identify all areas subject to flooding, particularly from local drainage sources of small size. The community map repository should be consulted for possible updated or additional flood hazard information.

To obtain more detailed information in areas where Base Flood Elevations (BFEs) and/or floodways have been determined, users are encouraged to consult the Flood Profiles and Floodway Data and/or Summary of Stillwater Elevations tables contained within the Flood Insurance Study (FIS) report that accompanies this FIRI. Users should be aware that BFEs shown on the FIRI represent rounded whole-foot elevations. These BFEs are intended for flood insurance rating purposes only and should not be used as the sole source of flood elevation information. Accordingly, flood elevation data presented in the FIS report should be utilized in conjunction with the FIRI for purposes of construction and/or floodplain management.

Coastal Base Flood Elevations shown on this map apply only landward of 0.0' North American Vertical Datum of 1988 (NAVD88). Users of this FIRI should be aware that coastal flood elevations are also provided in the Summary of Stillwater Elevations table in the Flood Insurance Study report for this jurisdiction. Elevations shown in the Summary of Stillwater Elevations table should be used for construction and/or floodplain management purposes when they are higher than the elevations shown on this FIRI.

Boundaries of the floodways were computed at cross sections and interpolated between cross sections. The floodways were based on hydraulic considerations with regard to requirements of the National Flood Insurance Program. Floodway widths and other pertinent floodway data are provided in the Flood Insurance Study report for this jurisdiction.

Certain areas not in Special Flood Hazard Areas may be protected by flood control structures. Refer to section 2.4 "Flood Protection Measures" of the Flood Insurance Study report for information on flood control structures for this jurisdiction.

The projection used in the preparation of this map was Universal Transverse Mercator (UTM) zone 13. The horizontal datum was NAD83, GRS80 spheroid. Differences in datum, spheroid, projection or UTM zones across users in the production of FIRIs for adjacent jurisdictions may result in slight positional differences in map features across jurisdiction boundaries. These differences do not affect the accuracy of this FIRI.

Flood elevations on this map are referenced to the North American Vertical Datum of 1988 (NAVD88). These flood elevations must be compared to structure and ground elevations referenced to the same vertical datum. For information regarding conversion between the National Geodetic Vertical Datum of 1929 and the North American Vertical Datum of 1988, visit the National Geodetic Survey website at <http://www.ngs.noaa.gov/> or contact the National Geodetic Survey at the following address:

NGS Information Services
 NOAA, NNGS12
 National Geodetic Survey
 SSMC-3, #9222
 1315 East-West Highway
 Silver Spring, MD 20910-3282

To obtain current elevation, description, and/or location information for bench marks shown on this map, please contact the information Services Branch of the National Geodetic Survey at (201) 713-3242 or visit its website at <http://www.ngs.noaa.gov/>.

Base Map information shown on this FIRI was provided in digital format by El Paso County, Colorado Springs Utilities, and Anderson Consulting Engineers, Inc. These data are current as of 2008.

This map reflects more detailed and up-to-date stream channel configurations and floodplain delineations than those shown on the previous FIRI for this jurisdiction. The floodplains and floodways that were transferred from the previous FIRI may have been adjusted to conform to these new stream channel configurations. As a result, the Flood Profiles and Floodway Data tables in the Flood Insurance Study Report (which contains authoritative hydraulic data) may reflect stream channel distances that differ from what is shown on this map. The profile baselines depicted on this map represent the hydraulic modeling baselines that match the flood profiles and Floodway Data Tables if applicable in the FIS report. As a result, the profile baselines may deviate significantly from the new base map channel representation and may appear outside of the floodplain.

Corporate limits shown on this map are based on the best data available at the time of publication. Because changes due to annexations or de-annexations may have occurred after this map was published, map users should contact appropriate community officials to verify current corporate limit locations.

Please refer to the separately printed Map Index for an overview map of the county showing the layout of map panels, community map repository addresses, and a Listing of Communities table containing National Flood Insurance Program dates for each community as well as a listing of the panels on which each community is located.

Contact FEMA Map Service Center (MSC) via the FEMA Map Information eXchange (FMIX) 1-877-336-2627 for information on available products associated with this FIRI. Available products may include previously issued Letters of Map Change, a Flood Insurance Study Report, and/or digital versions of this map. The MSC may also be reached by Fax at 1-800-368-9620 and its website at <http://www.msc.fema.gov/>.

If you have questions about this map or questions concerning the National Flood Insurance Program in general, please call 1-877-FEMA MAP (1-877-336-2627) or visit the FEMA website at <http://www.fema.gov/business/inf>.

El Paso County Vertical Datum Offset Table

Flooding Source	Vertical Datum Offset (ft)
REFER TO SECTION 3.3 OF THE EL PASO COUNTY FLOOD INSURANCE STUDY FOR STREAM/STREAM VERTICAL DATUM CONVERSION INFORMATION	

Panel Location Map

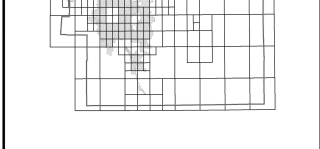

This Digital Flood Insurance Rate Map (DFIRM) was produced through a Cooperating Technical Plan (CTP) agreement between the State of Colorado Water Conservation Board (CWCB) and the Federal Emergency Management Agency (FEMA).

Additional Flood Hazard information and resources are available from local communities and the Colorado Water Conservation Board.

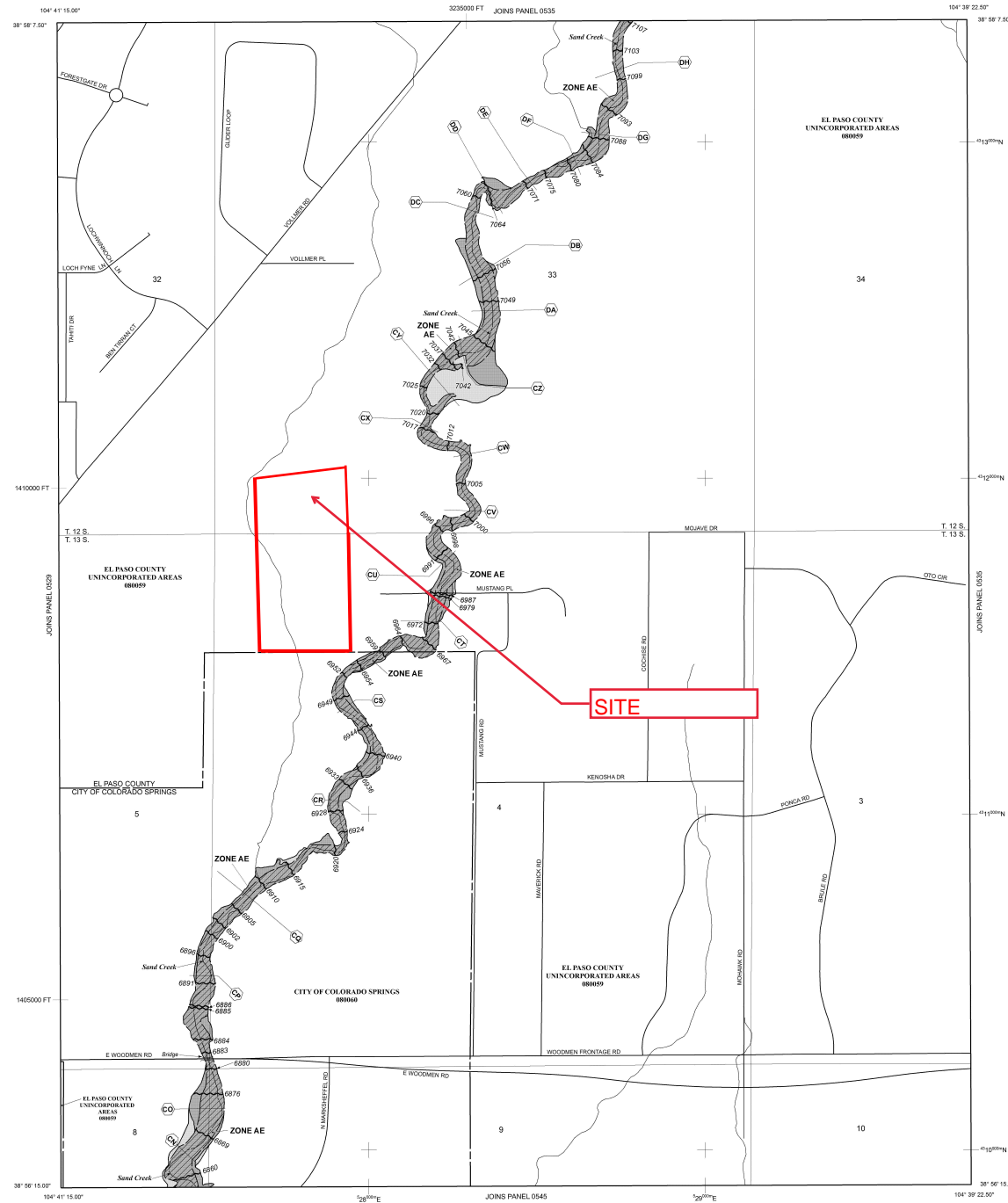

LEGEND

- SPECIAL FLOOD HAZARD AREAS (SFHAs) SUBJECT TO INUNDATION BY THE 1% ANNUAL CHANCE FLOOD
- The 1% annual chance flood (100-year flood), also known as the base flood, is the flood that has a 1% chance of being equaled or exceeded in any given year. The Special Flood Hazard Area is the area subject to flooding by the 1% annual chance flood. Areas of Special Flood Hazard include Zones A, AE, AH, AO, AR, AV, and VE. The Base Flood Elevation is the water-surface elevation of the 1% annual chance flood.
- ZONE A** No Base Flood Elevations determined.
- ZONE AE** Base Flood Elevations determined.
- ZONE AH** Flood depths of 1 to 3 feet (usually areas of ponding); Base Flood Elevations determined.
- ZONE AO** Flood depths of 1 to 3 feet (usually sheet flow on sloping terrain); average depths determined. For areas of alluvial fan flooding, velocities also determined.
- ZONE AR** Special Flood Hazard Area Formerly protected from the 1% annual chance flood by a flood control system that was previously determined. Zone AR indicates that the former flood control system is being retained to provide protection from the 1% annual chance or greater flood.
- ZONE AV** Area to be protected from 1% annual chance flood by a Federal flood protection system under construction; no Base Flood Elevations determined.
- ZONE V** Coastal flood zone with velocity hazard (wave action); no Base Flood Elevations determined.
- ZONE VE** Coastal flood zone with velocity hazard (wave action); Base Flood Elevations determined.
- FLOODWAY AREAS IN ZONE AE
- The floodway is the channel of a stream plus any adjacent floodplain areas that must be kept free of encroachment so that the 1% annual chance flood can be carried without substantial increase in flood heights.
- OTHER FLOOD AREAS**
- ZONE X** Areas of 0.2% annual chance flood; areas of 1% annual chance flood with average depths of less than 1 foot or with depths of 1 to 3 feet and areas protected by levees from 1% annual chance flood.
- OTHER AREAS**
- ZONE X** Areas determined to be outside the 0.2% annual chance floodplain.
- ZONE D** Areas in which flood hazards are undetermined, but possible.
- COASTAL BARRIER PROTECTION SYSTEM (CBRS) AREAS
- OTHERWISE PROTECTED AREAS (OPA)
- CBRS areas and OPAs are normally located within or adjacent to Special Flood Hazard Areas.
- Floodplain boundary
- Floodway boundary
- Zone D boundary
- CBRS and OPA boundary
- Boundary of Special Flood Hazard Area of different Base Flood Elevations, Flood Depths or Flood Velocities
- Base Flood Elevation line and value, elevation in feet (EL 5.87)
- Base Flood Elevation where uniform within zone; elevation in feet
- Cross section line
- Transect line
- Geographic coordinates referenced to the North American Datum of 1983 (NAD 83)
- 1000-meter Universal Transverse Mercator grid ticks, zone 13
- 500-foot grid ticks; Colorado State Plane coordinate system; central zone 10 (SPROJCOG2)
- Lambert Conformal Conic Projection
- Bench mark (see explanation in Notes to Users section of this FIRI report)
- River file
- M15** River file
- MIP REPOSITORIES**
 Refer to Map Repository list on Map Index
- EFFECTIVE DATE OF COUNTYWIDE FLOOD INSURANCE RATE MAP**
 MARCH 17, 1997
- EFFECTIVE DATE(S) OF REVISION(S) TO THIS PANEL**
 DECEMBER 7, 2018 to update cartographic information, change Base Flood Elevations and Special Flood Hazard Areas, to update map format, to add roads and road names, and to incorporate previously issued Letters of Map Change.
- For community map revision history prior to cartographic mapping, refer to the Community Map History Table located in the Flood Insurance Study report for this jurisdiction.
- To determine if flood insurance is available in this community, contact your insurance agent or call the National Flood Insurance Program at 1-800-638-6620.



NATIONAL FLOOD INSURANCE PROGRAM

PANEL 0533G

FIRM
 FLOOD INSURANCE RATE MAP
 EL PASO COUNTY,
 COLORADO
 AND INCORPORATED AREAS

PANEL 533 OF 1300
 (SEE MAP INDEX FOR FIRM PANEL LAYOUT)

CONTAINS:

COMMUNITY	NUMBER	PANEL	SUFFIX
COLORADO SPRINGS CITY OF	08008	0033	0
EL PASO COUNTY	08008	0033	0

MAP NUMBER
 08041C0533G

MAP REVISED
 DECEMBER 7, 2018

Federal Emergency Management Agency

NOTE: MAP AREA SHOWN ON THIS PANEL IS LOCATED WITHIN TOWNSHIP 12 SOUTH, RANGE 65 WEST, AND TOWNSHIP 13 SOUTH, RANGE 65 WEST.

APPENDIX D – GEC PLANS AND DETAILS

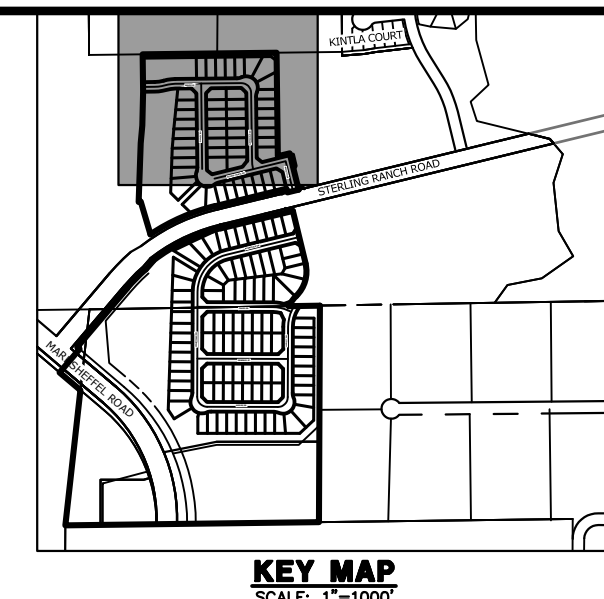
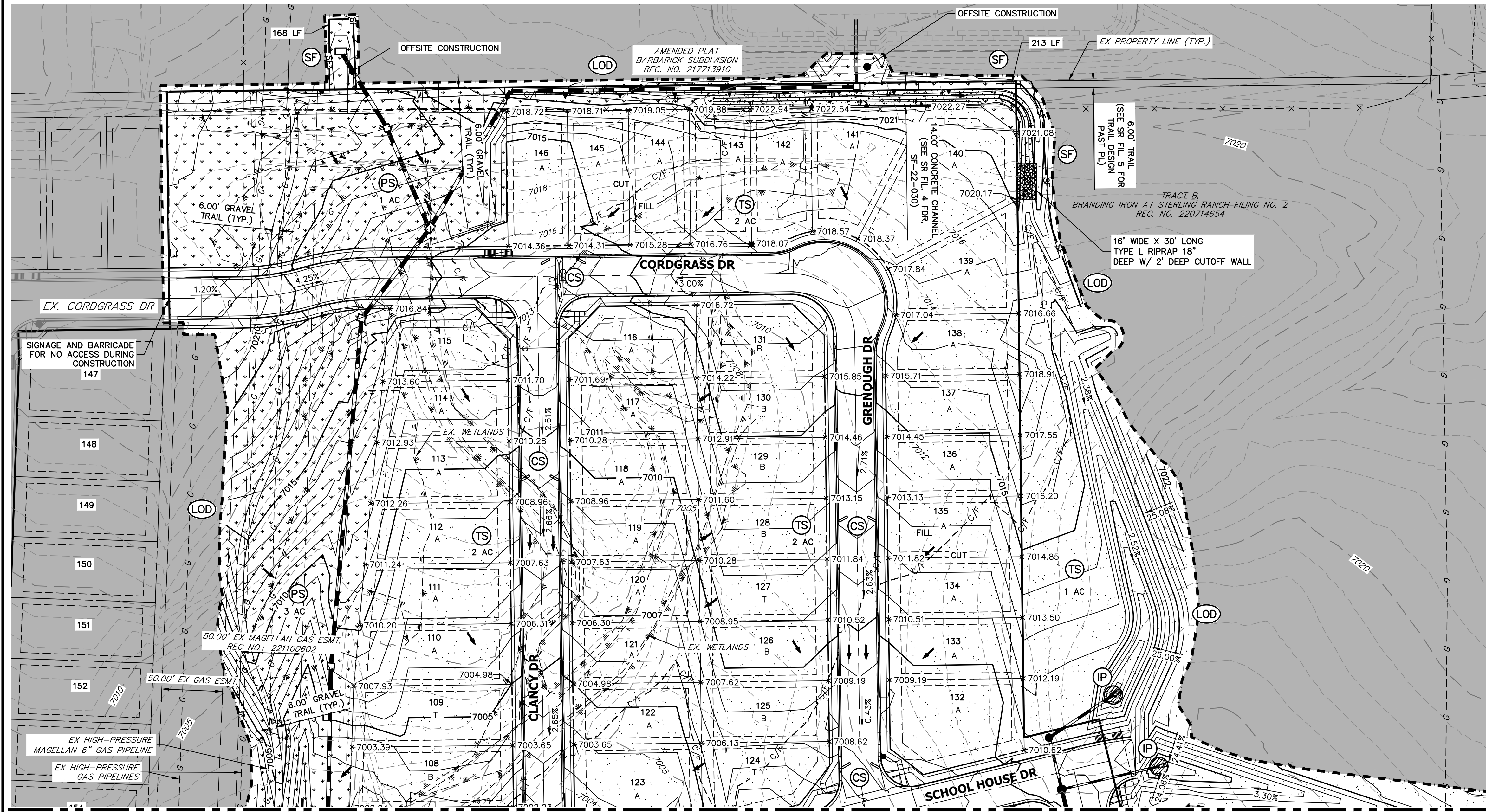

LEGEND

KEY	SYMBOL
CURB SOCK (INITIAL/ INTERIM)	CS
CONCRETE WASHOUT AREA (INITIAL)	CWA
DIVERSION DITCH AND DIKE, TEMPORARY (INTERIM/ FINAL)	DD
INLET PROTECTION (INITIAL/ INTERIM)	IP
OUTLET PROTECTION (INITIAL/ INTERIM)	OP
LIMITS OF CONSTRUCTION/DISTURBANCE	LOD
PERMANENT SEEDING (FINAL)	PS
FLOW ARROW	→
SEDIMENT CONTROL LOG (INITIAL/ INTERIM)	SCL
CUT/FILL MARK	- - - - C/F
SILT FENCE (INITIAL)	SF
STABILIZED STAGING AREA (INITIAL)	SSA
TEMPORARY SEEDING (FINAL)	TS
VEHICLE TRACKING CONTROL (INITIAL)	VTC
EXISTING WETLANDS	Wetland Symbol

EARTHWORK NOTES

PARCEL A & B:
 AREA OF CUT = 72,009 CY
 AREA OF FILL = 61,016 CY
 NET VOLUME = 10,993 CY

MARKSHEFFEL RD:
 AREA OF CUT = 2,079 CY
 AREA OF FILL = 6,030 CY
 NET VOLUME = 3,951 CY

ADDITIONAL NOTES

STAGING AREA TO BE DETERMINED BY CONTRACTOR IN THE FIELD. THE LOCATIONS SHALL BE DELINEATED ON THIS PLAN BY THE CONTRACTOR.

THE EROSION CONTROL DELINEATED ON THIS PLAN SHALL BE REGULARLY UPDATED BY THE CONTRACTOR.

EXISTING VEGETATION: AN AERIAL SURVEY WAS USED TO DETERMINE A 50% COVER OF NATIVE GRASSES.

QUANTITIES:

Item	Unit of Measure	Quantity
Vehicle Tracking Control (VTC)	EA	4
Concrete Washout Area (CWA)	EA	3
Inlet/Outlet Protection (IP)(OP)	EA	25
Silt Fence (SF)	LF	6587
Temporary Stock Pile (SP)	EA	1
Temporary Seeding (TS)	AC	22
Permanent Seeding (PS)	AC	8
Straw Wattle/Rock Sock	LF	797
Diversion Ditch (DD)	LF	215
Stabilized Staging Area (SSA)	AC	7.5

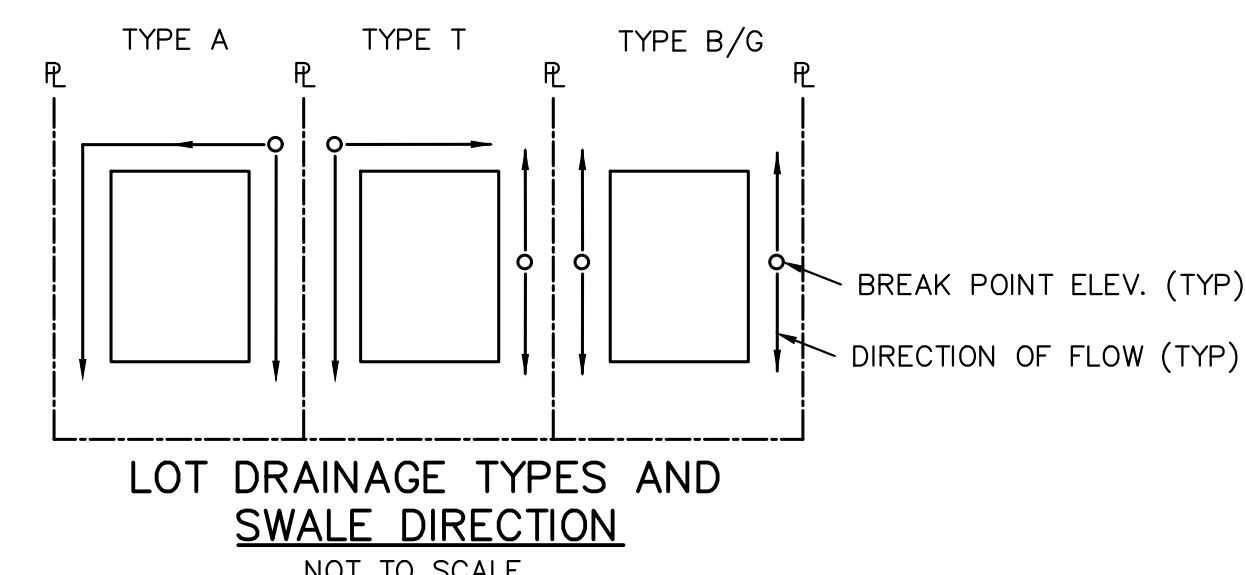
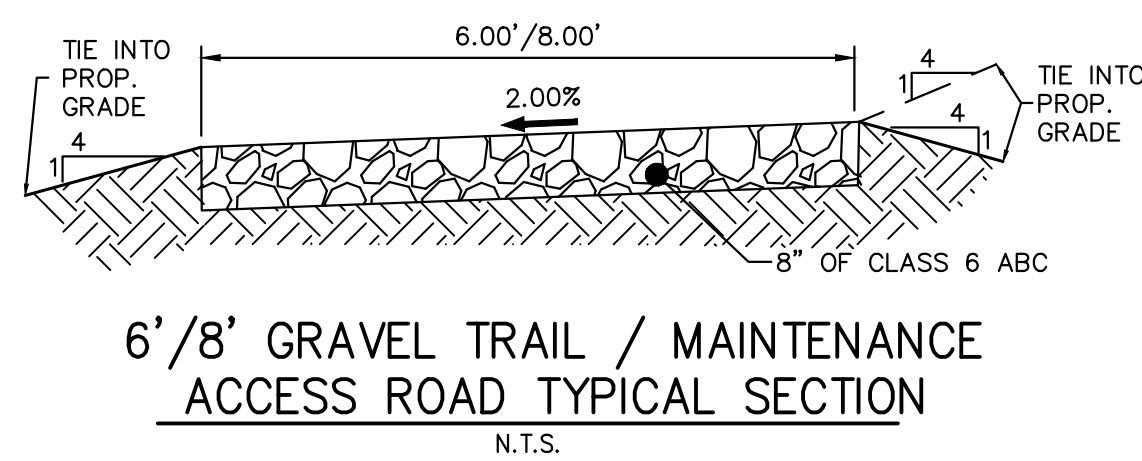
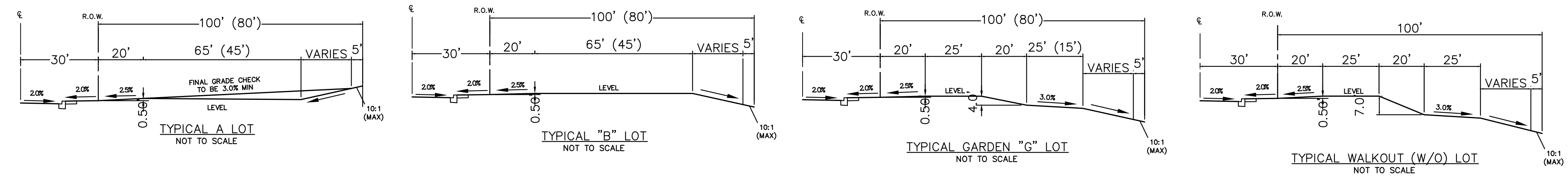

WARNING HIGH-PRESSURE PIPELINE(S)
 EXCAVATION AND/OR CONSTRUCTION PROHIBITED WITHOUT COMPLIANCE WITH STATE ONE-CALL, AND WITHOUT WRITTEN PERMISSION FROM MAGELLAN PIPELINE COMPANY, L.P.

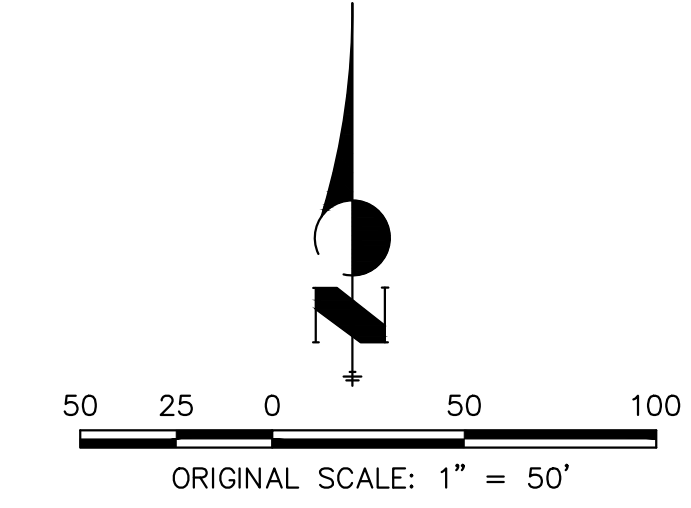

ENGINEER'S STATEMENT

PREPARED UNDER MY DIRECT SUPERVISION AND ON BEHALF OF JR ENGINEERING

MIKE A. BRAMLETT, P.E.
 COLORADO P.E. 32314
 FOR AND ON BEHALF OF JR ENGINEERING, LOCAL ENGINEER



UNTIL SUCH TIME AS THESE DRAWINGS ARE APPROVED BY THE APPROPRIATE REVIEWING AGENCIES, OR ENGINEERING APPROVES THEIR USE, THESE DRAWINGS ARE DESIGNATED BY WRITTEN AUTHORIZATION.

PREPARED FOR
 SR LAND, LLC
 20 BOULDER CRESCENT
 SUITE 201
 COLORADO SPRINGS, CO 80903
 JAMES F. MORLEY
 (719) 471-1742

J.R. ENGINEERING
 A Westman Company
 Centennial 303-740-9888 • Colorado Springs 719-583-2583
 Fort Collins 970-491-9888 • www.jrengineering.com

No.	REVISION	BY	DATE
1			
2			
3			
4			
5			
6			
7			
8			
9			
10			

STERLING RANCH FILING 4
 GRADING & EROSION CONTROL PLAN

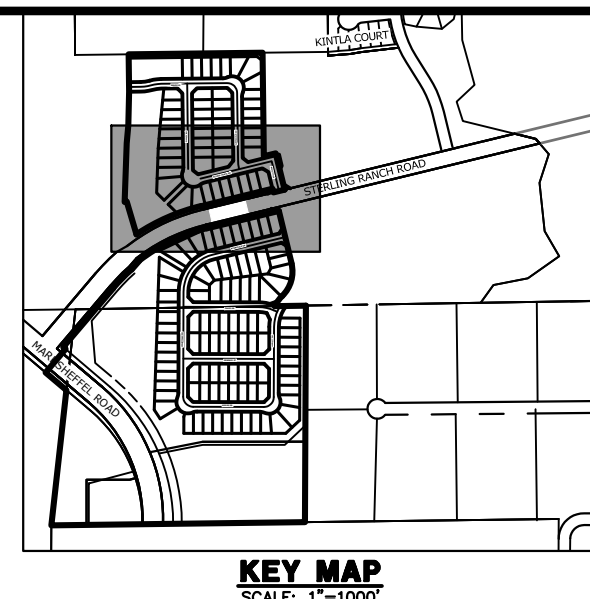
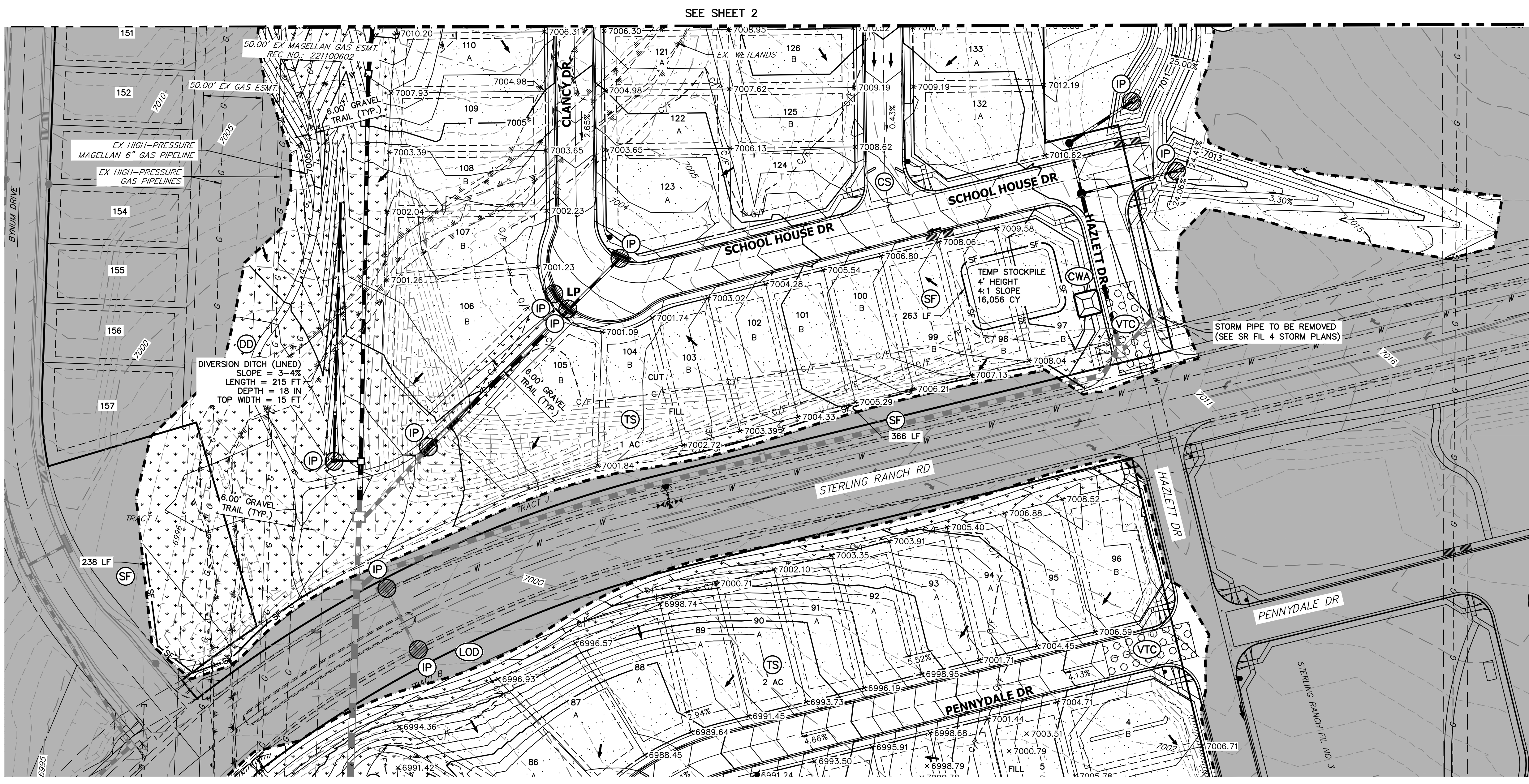

LEGEND

KEY	SYMBOL
CURB SOCK (INITIAL/ INTERIM)	(CS) -
CONCRETE WASHOUT AREA (INITIAL)	(CWA) [Symbol]
DIVERSION DITCH AND DIKE, TEMPORARY (INTERIM/ FINAL)	(DD) [Symbol]
INLET PROTECTION (INITIAL/ INTERIM)	(IP) [Symbol]
OUTLET PROTECTION (INITIAL/ INTERIM)	(OP) [Symbol]
LIMITS OF CONSTRUCTION/DISTURBANCE	(LOD) [Symbol]
PERMANENT SEEDING (FINAL)	(PS) [Symbol]
FLOW ARROW	[Symbol]
SEDIMENT CONTROL LOG (INITIAL/ INTERIM)	(SCL) [Symbol]
CUT/FILL MARK	C/F [Symbol]
SILT FENCE (INITIAL)	(SF) [Symbol]
STABILIZED STAGING AREA (INITIAL)	(SSA) [Symbol]
TEMPORARY SEEDING (FINAL)	(TS) [Symbol]
VEHICLE TRACKING CONTROL (INITIAL)	(VTC) [Symbol]
EXISTING WETLANDS	[Symbol]

UNTIL SUCH TIME AS THESE DRAWINGS ARE APPROVED BY THE APPROPRIATE REVIEWING AGENCIES, OR ENGINEERING APPROVES THEIR USE, THESE DRAWINGS ARE DESIGNATED BY WRITTEN AUTHORIZATION.

PREPARED FOR
SR LAND, LLC
 20 BOULDER CRESCENT
 SUITE 201
 COLORADO SPRINGS, CO 80903
 JAMES F. MORLEY
 (719) 471-1742

J.R. ENGINEERING
 A Westman Company
 Centennial 303-740-9888 • Colorado Springs 719-583-2583
 Fort Collins 970-491-9888 • www.jrengineering.com

No.	REVISION	BY	DATE

SEE SHEET 2

SEE SHEET 4

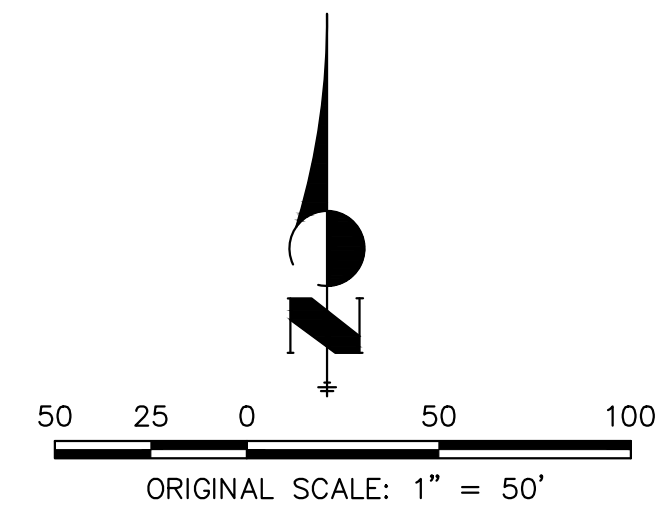
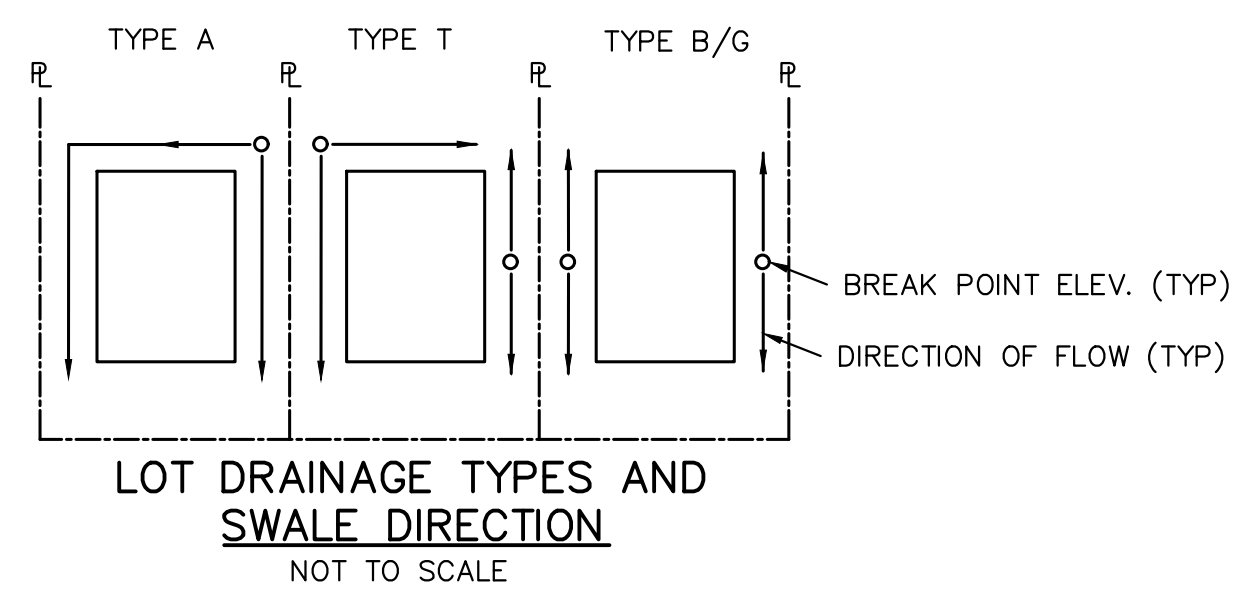
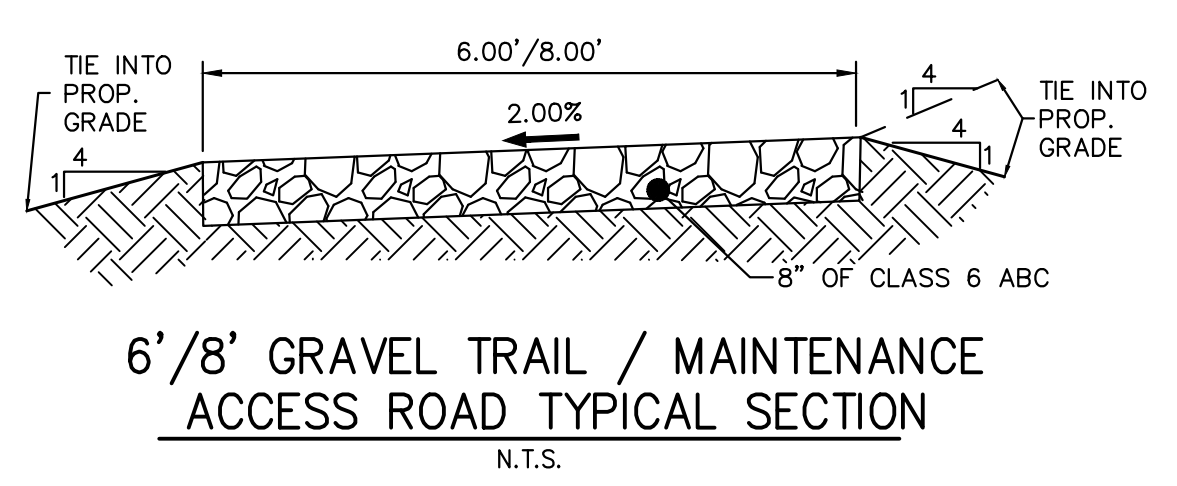
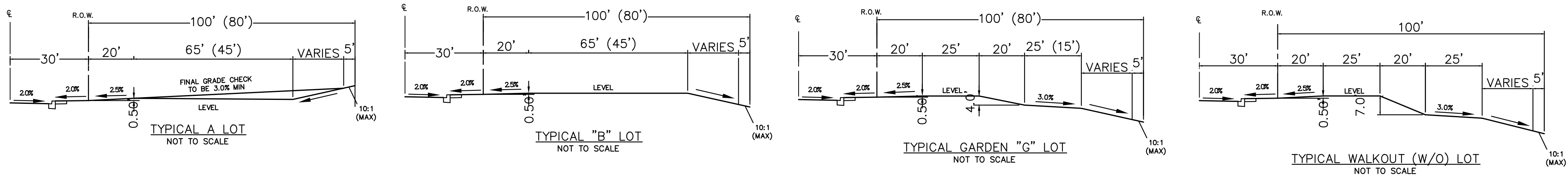

EARTHWORK NOTES

PARCEL A & B:
 AREA OF CUT = 72,009 CY
 AREA OF FILL = 61,016 CY
 NET VOLUME = 10,993 CY

MARKSHEFFEL RD:
 AREA OF CUT = 2,079 CY
 AREA OF FILL = 6,030 CY
 NET VOLUME = 3,951 CY

ADDITIONAL NOTES

STAGING AREA TO BE DETERMINED BY CONTRACTOR IN THE FIELD. THE LOCATIONS SHALL BE DELINEATED ON THIS PLAN BY THE CONTRACTOR.

THE EROSION CONTROL DELINEATED ON THIS PLAN SHALL BE REGULARLY UPDATED BY THE CONTRACTOR.

EXISTING VEGETATION: AN AERIAL SURVEY WAS USED TO DETERMINE A 50% COVER OF NATIVE GRASSES.

ENGINEER'S STATEMENT

PREPARED UNDER MY DIRECT SUPERVISION AND ON BEHALF OF JR ENGINEERING

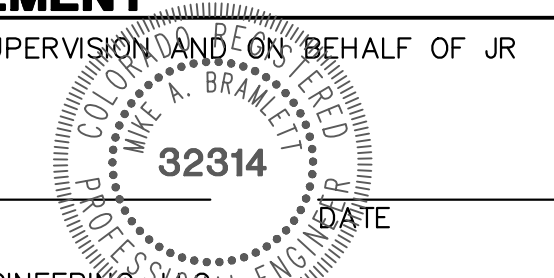

MIKE A. BRAMLETT, P.E.
 COLORADO P.E. 32314
 FOR AND ON BEHALF OF JR ENGINEERING

WARNING HIGH-PRESSURE PIPELINE(S)
 EXCAVATION AND/OR CONSTRUCTION PROHIBITED WITHOUT COMPLIANCE WITH STATE ONE-CALL, AND WITHOUT WRITTEN PERMISSION FROM MAGELLAN PIPELINE COMPANY, L.P.



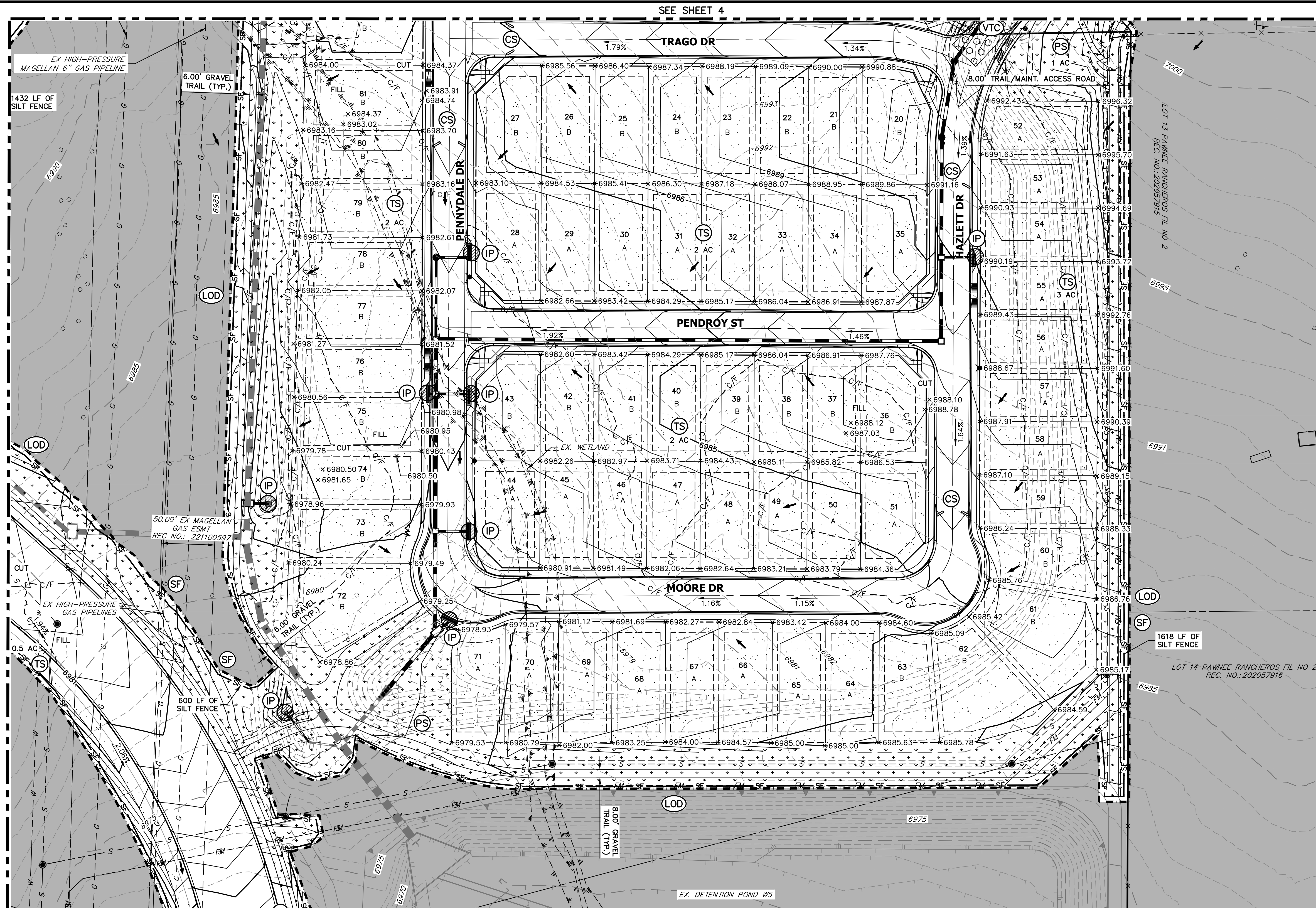

LEGEND

KEY	SYMBOL
CURB SOCK (INITIAL/ INTERIM)	CS
CONCRETE WASHOUT AREA (INITIAL)	CWA
DIVERSION DITCH AND DIKE, TEMPORARY (INTERIM/ FINAL)	DD
INLET PROTECTION (INITIAL/ INTERIM)	IP
OUTLET PROTECTION (INITIAL/ INTERIM)	OP
LIMITS OF CONSTRUCTION/DISTURBANCE	LOD
PERMANENT SEEDING (FINAL)	PS
FLOW ARROW	→
SEDIMENT CONTROL LOG (INITIAL/ INTERIM)	SCL
CUT/FILL MARK	C/F
SILT FENCE (INITIAL)	SF
STABILIZED STAGING AREA (INITIAL)	SSA
TEMPORARY SEEDING (FINAL)	TS
VEHICLE TRACKING CONTROL (INITIAL)	VTC
EXISTING WETLANDS	WETLAND SYMBOL

EARTHWORK NOTES

PARCEL A & B:
 AREA OF CUT = 72,009 CY
 AREA OF FILL = 61,016 CY
 NET VOLUME = 10,993 CY

MARKSHEFFEL RD:
 AREA OF CUT = 2,079 CY
 AREA OF FILL = 6,030 CY
 NET VOLUME = 3,951 CY

ADDITIONAL NOTES

STAGING AREA TO BE DETERMINED BY CONTRACTOR IN THE FIELD. THE LOCATIONS SHALL BE DELINEATED ON THIS PLAN BY THE CONTRACTOR.

THE EROSION CONTROL DELINEATED ON THIS PLAN SHALL BE REGULARLY UPDATED BY THE CONTRACTOR.

EXISTING VEGETATION: AN AERIAL SURVEY WAS USED TO DETERMINE A 50% COVER OF NATIVE GRASSES.

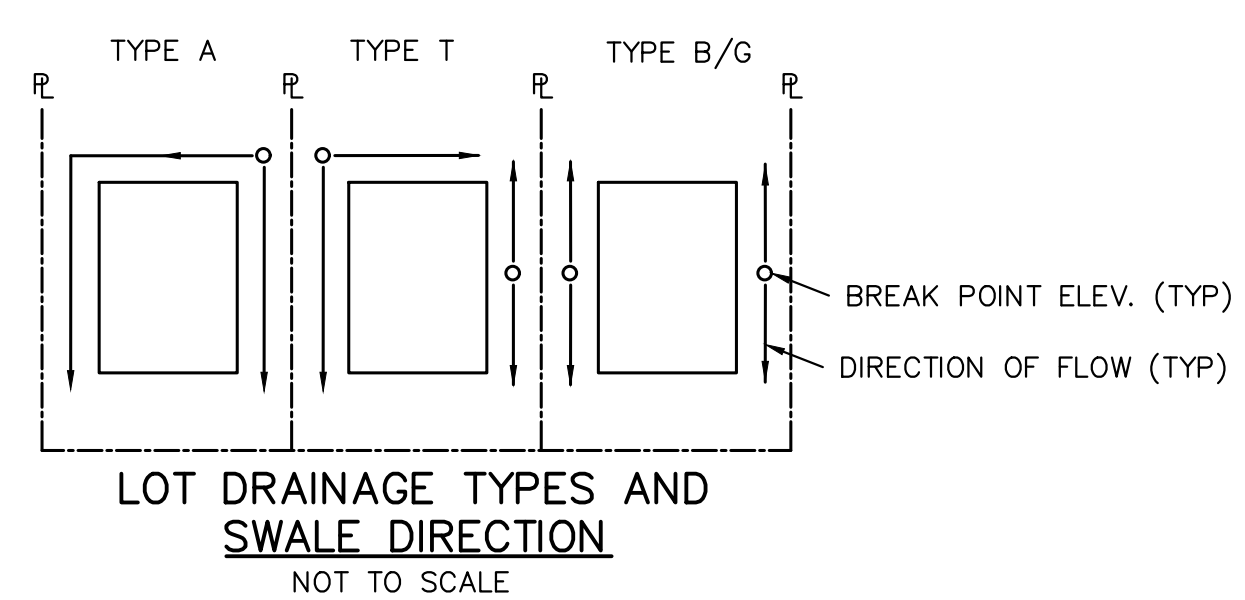
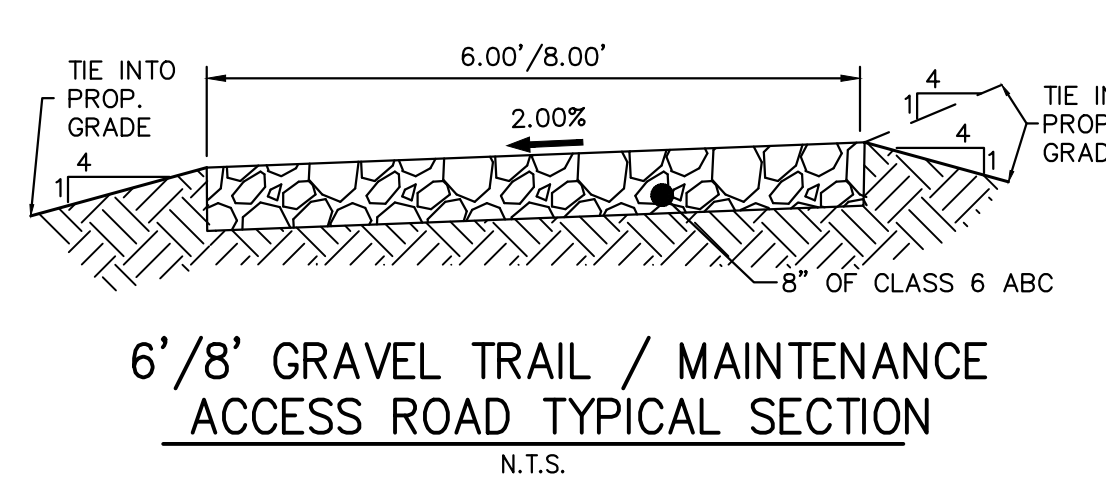
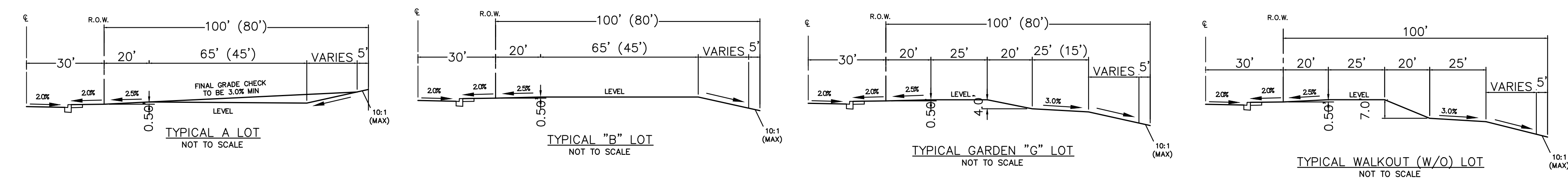

WARNING HIGH-PRESSURE PIPELINE(S)
 EXCAVATION AND/OR CONSTRUCTION PROHIBITED WITHOUT COMPLIANCE WITH STATE ONE-CALL, AND WITHOUT WRITTEN PERMISSION FROM MAGELLAN PIPELINE COMPANY, L.P.

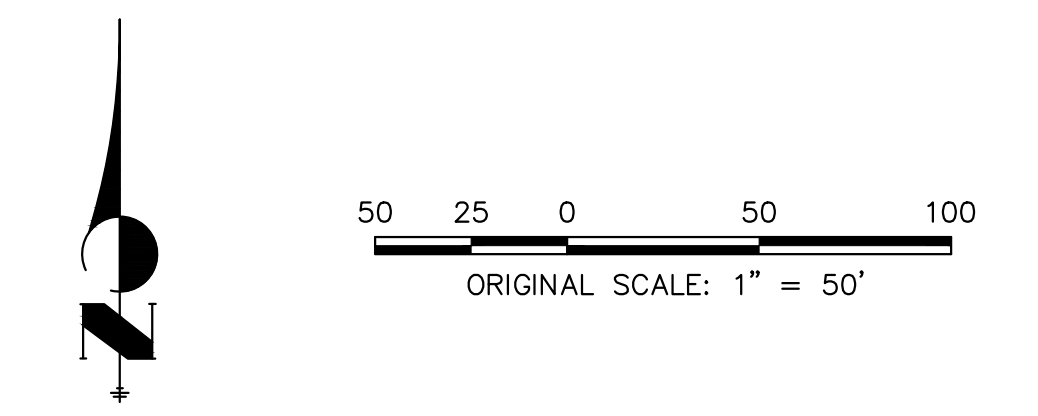

ENGINEER'S STATEMENT

PREPARED UNDER MY DIRECT SUPERVISION AND, ON BEHALF OF JR ENGINEERING

MIKE A. BRAMLETT, P.E.
 COLORADO P.E. 32314
 FOR AND ON BEHALF OF JR ENGINEERING

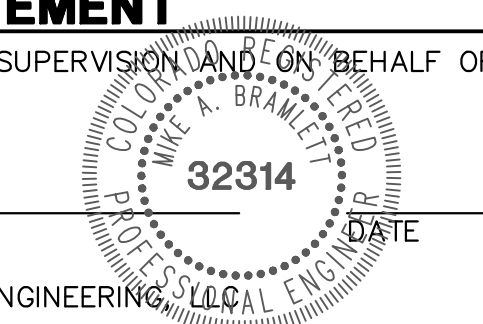

PREPARED FOR
SR LAND, LLC
 20 BOULDER CRESCENT
 SUITE 201
 COLORADO SPRINGS, CO 80903
 JAMES F. MORLEY
 (719) 471-1742

UNLESS SHOWN OTHERWISE, THESE DRAWINGS ARE APPROVED BY THE APPROPRIATE REVIEWING AGENCIES, OR ENGINEERING APPROVES THEIR USE AS DESIGNATED BY WRITTEN AUTHORIZATION.

J.R. ENGINEERING
 A Westman Company
 Centennial 300-740-9888 • Colorado Springs 719-583-2583
 Fort Collins 970-491-9888 • www.jrengineering.com

NO.	REVISION	DATE

H-SCALE 1"=50'
 V-SCALE N/A
 DATE 04/26/23
 DESIGNED BY AMT
 DRAWN BY AMT
 CHECKED BY

STERLING RANCH FILING 4

GRADING & EROSION CONTROL PLAN

SHEET 5 OF 10
 JOB NO. 25188.11

Vehicle Tracking Control (VTC) SM-4

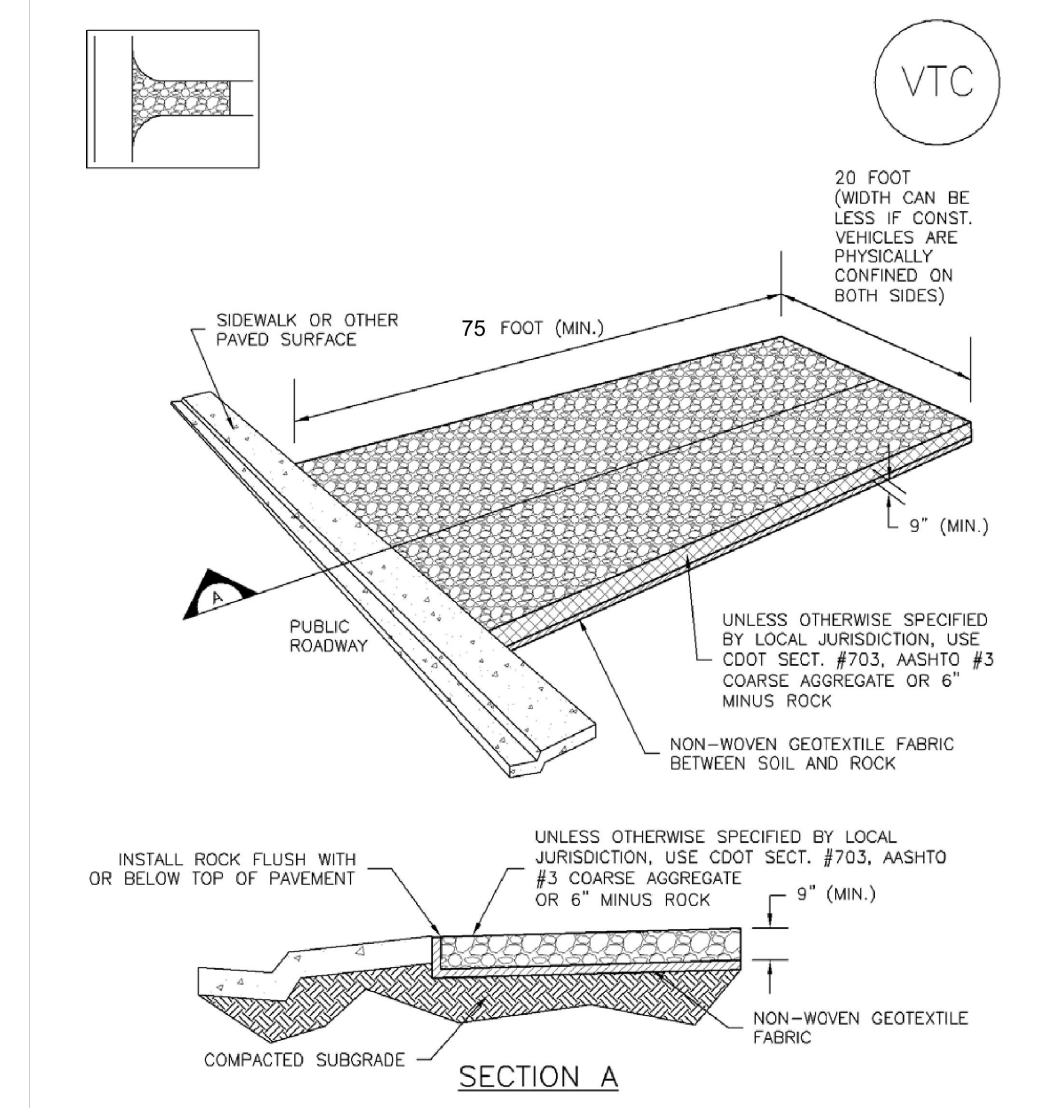

VTC-1. AGGREGATE VEHICLE TRACKING CONTROL

November 2010 Urban Drainage and Flood Control District Urban Storm Drainage Criteria Manual Volume 3 VTC-3

SM-4 Vehicle Tracking Control (VTC)

- STABILIZED CONSTRUCTION ENTRANCE/EXIT INSTALLATION NOTES**
- SEE PLAN VIEW FOR:
 - LOCATION OF CONSTRUCTION ENTRANCE(S)/EXIT(S).
 - TYPE OF CONSTRUCTION ENTRANCE(S)/EXIT(S) (WITH/WITHOUT WHEEL WASH, CONSTRUCTION MAT OR TRM).
 - CONSTRUCTION MAT OR TRM STABILIZED CONSTRUCTION ENTRANCES ARE ONLY TO BE USED ON SHORT DURATION PROJECTS (TYPICALLY RANGING FROM A WEEK TO A MONTH) WHERE THERE WILL BE LIMITED VEHICULAR ACCESS.
 - A STABILIZED CONSTRUCTION ENTRANCE/EXIT SHALL BE LOCATED AT ALL ACCESS POINTS WHERE VEHICLES ACCESS THE CONSTRUCTION SITE FROM PAVED RIGHT-OF-WAYS.
 - STABILIZED CONSTRUCTION ENTRANCE/EXIT SHALL BE INSTALLED PRIOR TO ANY LAND DISTURBING ACTIVITIES.
 - A NON-WOVEN GEOTEXTILE FABRIC SHALL BE PLACED UNDER THE STABILIZED CONSTRUCTION ENTRANCE/EXIT PRIOR TO THE PLACEMENT OF ROCK.
 - UNLESS OTHERWISE SPECIFIED BY LOCAL JURISDICTION, ROCK SHALL CONSIST OF DOT SECT. #703, ASHTO #3 COARSE AGGREGATE OR 6" (MINUS) ROCK.
- STABILIZED CONSTRUCTION ENTRANCE/EXIT MAINTENANCE NOTES**
- INSPECT BMPs EACH WORKDAY, AND MAINTAIN THEM IN EFFECTIVE OPERATING CONDITION. MAINTENANCE OF BMPs SHOULD BE PROACTIVE, NOT REACTIVE. INSPECT BMPs AS SOON AS POSSIBLE (AND ALWAYS WITHIN 24 HOURS) FOLLOWING A STORM THAT CAUSES SURFACE EROSION, AND PERFORM NECESSARY MAINTENANCE.
 - FREQUENT OBSERVATIONS AND MAINTENANCE ARE NECESSARY TO MAINTAIN BMPs IN EFFECTIVE OPERATING CONDITION. INSPECTIONS AND CORRECTIVE MEASURES SHOULD BE DOCUMENTED THOROUGHLY.
 - WHERE BMPs HAVE FAILED, REPAIR OR REPLACEMENT SHOULD BE INITIATED UPON DISCOVERY OF THE FAILURE.
 - ROCK SHALL BE REAPPLIED OR REGRADDED AS NECESSARY TO THE STABILIZED ENTRANCE/EXIT TO MAINTAIN A CONSISTENT DEPTH.
 - SEDIMENT TRACKED ONTO PAVED ROADS IS TO BE REMOVED THROUGHOUT THE DAY AND AT THE END OF THE DAY BY SHOVELING OR SWEEPING. SEDIMENT MAY NOT BE WASHED DOWN STORM SEWER DRAINS.
- NOTE: MANY JURISDICTIONS HAVE BMP DETAILS THAT VARY FROM UDFCD STANDARD DETAILS. CONSULT WITH LOCAL JURISDICTIONS AS TO WHICH DETAIL SHOULD BE USED WHEN DIFFERENCES ARE NOTED.
- (DETAILS ADAPTED FROM CITY OF DENVER, COLORADO, NOT AVAILABLE IN AUTOCAD)

VTC-6 Urban Drainage and Flood Control District Urban Storm Drainage Criteria Manual Volume 3 November 2010

Silt Fence (SF) SC-1

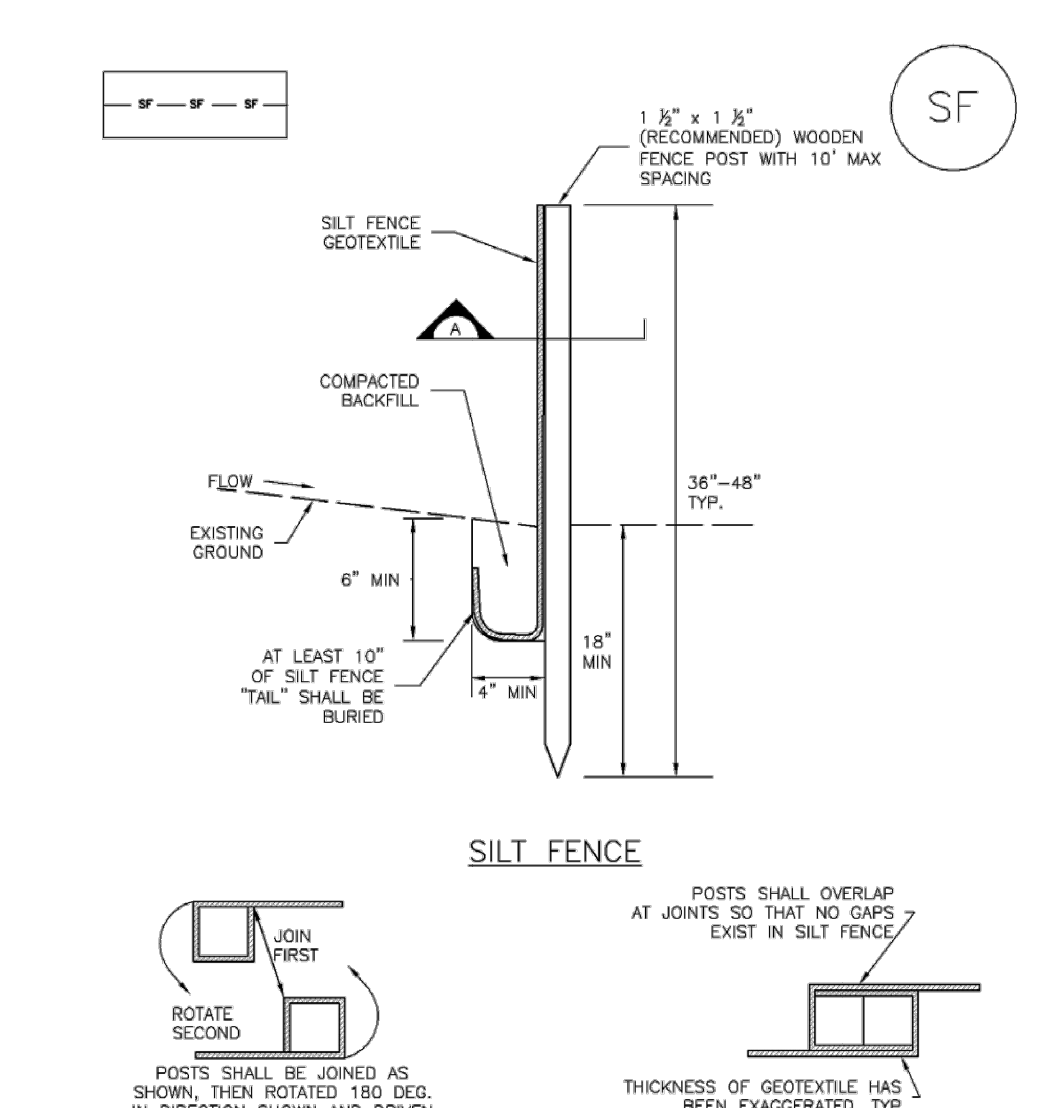

SILT FENCE

SECTION A

SF-1. SILT FENCE

November 2010 Urban Drainage and Flood Control District Urban Storm Drainage Criteria Manual Volume 3 SF-3

SC-1 Silt Fence (SF)

- SILT FENCE INSTALLATION NOTES**
- SILT FENCE MUST BE PLACED AWAY FROM THE TOE OF THE SLOPE TO ALLOW FOR WATER PONDING. SILT FENCE AT THE TOE OF A SLOPE SHOULD BE INSTALLED IN A FLAT LOCATION AT LEAST SEVERAL FEET (2-3 FT) FROM THE TOE OF THE SLOPE TO ALLOW ROOM FOR PONDING AND DEPOSITION.
 - A UNIFORM 6" X 4" ANCHOR TRENCH SHALL BE EXCAVATED USING TRENCHER OR SILT FENCE INSTALLATION DEVICE. NO ROAD GRADERS, BACKHOES, OR SIMILAR EQUIPMENT SHALL BE USED.
 - COMPACT ANCHOR TRENCH BY HAND WITH A "JUMPING JACK" OR BY WHEEL ROLLING. COMPACTION SHALL BE SUCH THAT SILT FENCE RESISTS BEING PULLED OUT OF ANCHOR TRENCH BY HAND.
 - SILT FENCE SHALL BE PULLED TIGHT AS IT IS ANCHORED TO THE STAKES. THERE SHOULD BE NO NOTICEABLE SAG BETWEEN STAKES AFTER IT HAS BEEN ANCHORED TO THE STAKES.
 - SILT FENCE FABRIC SHALL BE ANCHORED TO THE STAKES USING 1" HEAVY DUTY STAPLES OR NAILS WITH 1" HEADS. STAPLES AND NAILS SHOULD BE PLACED 3" ALONG THE FABRIC DOWN THE STAKE.
 - AT THE END OF A RUN OF SILT FENCE ALONG A CONTOUR, THE SILT FENCE SHOULD BE TURNED PERPENDICULAR TO THE CONTOUR TO CREATE A "J-HOOK." THE "J-HOOK" EXTENDING PERPENDICULAR TO THE CONTOUR SHOULD BE OF SUFFICIENT LENGTH TO KEEP RUNOFF FROM FLOWING AROUND THE END OF THE SILT FENCE (TYPICALLY 10' - 20').
 - SILT FENCE SHALL BE INSTALLED PRIOR TO ANY LAND DISTURBING ACTIVITIES.
- SILT FENCE MAINTENANCE NOTES**
- INSPECT BMPs EACH WORKDAY, AND MAINTAIN THEM IN EFFECTIVE OPERATING CONDITION. MAINTENANCE OF BMPs SHOULD BE PROACTIVE, NOT REACTIVE. INSPECT BMPs AS SOON AS POSSIBLE (AND ALWAYS WITHIN 24 HOURS) FOLLOWING A STORM THAT CAUSES SURFACE EROSION, AND PERFORM NECESSARY MAINTENANCE.
 - FREQUENT OBSERVATIONS AND MAINTENANCE ARE NECESSARY TO MAINTAIN BMPs IN EFFECTIVE OPERATING CONDITION. INSPECTIONS AND CORRECTIVE MEASURES SHOULD BE DOCUMENTED THOROUGHLY.
 - WHERE BMPs HAVE FAILED, REPAIR OR REPLACEMENT SHOULD BE INITIATED UPON DISCOVERY OF THE FAILURE.
 - SEDIMENT ACCUMULATED UPSTREAM OF THE SILT FENCE SHALL BE REMOVED AS NEEDED TO MAINTAIN THE FUNCTIONALITY OF THE BMP. TYPICALLY WHEN DEPTH OF ACCUMULATED SEDIMENTS IS APPROXIMATELY 6".
 - REPAIR OR REPLACE SILT FENCE WHEN THERE ARE SIGNS OF WEAR, SUCH AS SAGGING, TEARING, OR COLLAPSE.
 - SILT FENCE IS TO REMAIN IN PLACE UNTIL THE UPSTREAM DISTURBED AREA IS STABILIZED AND APPROVED BY THE LOCAL JURISDICTION, OR IS REPLACED BY AN EQUIVALENT PERIMETER SEDIMENT CONTROL BMP.
 - WHEN SILT FENCE IS REMOVED, ALL DISTURBED AREAS SHALL BE COVERED WITH TOPSOIL, SEEDED AND MULCHED OR OTHERWISE STABILIZED AS APPROVED BY LOCAL JURISDICTION.
- (DETAILS ADAPTED FROM TOWN OF PARKER, COLORADO AND CITY OF AURORA, NOT AVAILABLE IN AUTOCAD)
- NOTE: MANY JURISDICTIONS HAVE BMP DETAILS THAT VARY FROM UDFCD STANDARD DETAILS. CONSULT WITH LOCAL JURISDICTIONS AS TO WHICH DETAIL SHOULD BE USED WHEN DIFFERENCES ARE NOTED.

SF-4 Urban Drainage and Flood Control District Urban Storm Drainage Criteria Manual Volume 3 November 2010

SC-6 Inlet Protection (IP)

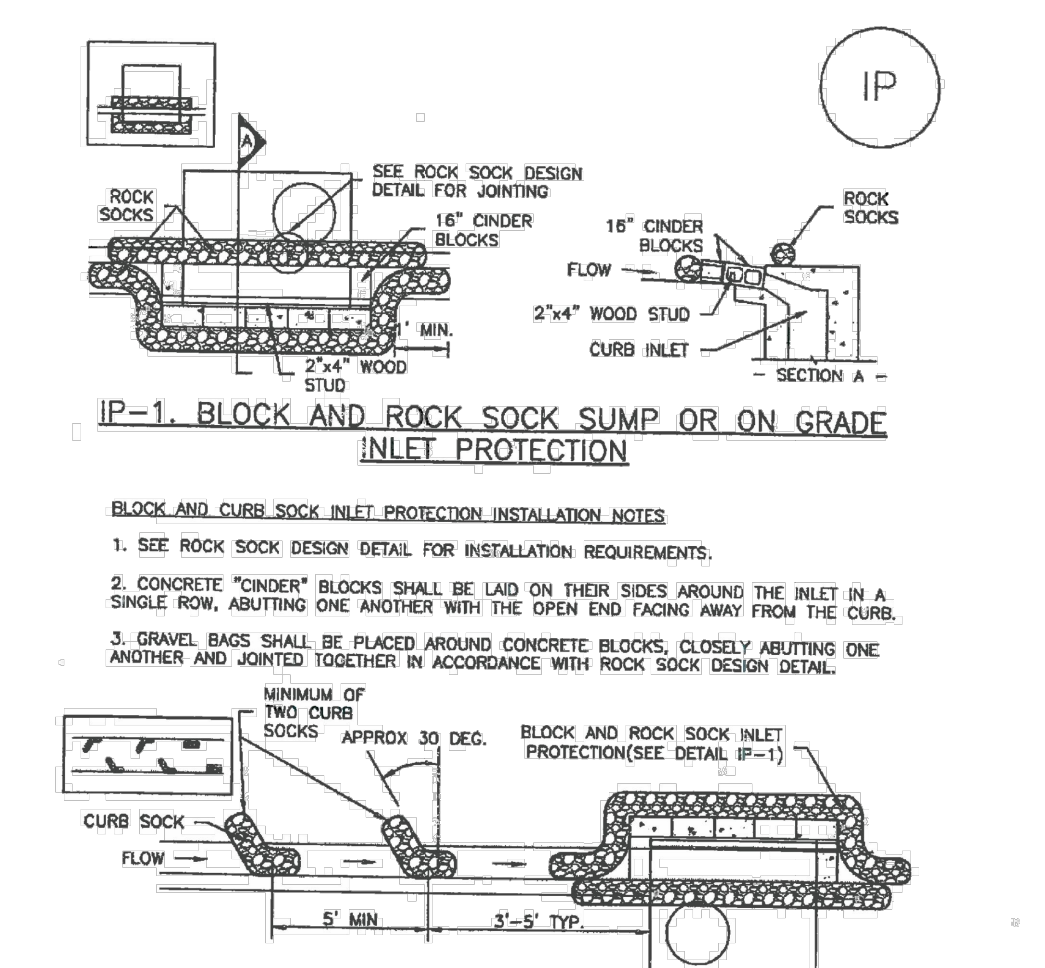

IP-1. BLOCK AND ROCK SOCK SUMP OR ON GRADE INLET PROTECTION

IP-2. CURB ROCK SOCKS UPSTREAM OF INLET PROTECTION

- BLOCK AND CURB SOCK INLET PROTECTION INSTALLATION NOTES**
- SEE ROCK SOCK DESIGN DETAIL FOR INSTALLATION REQUIREMENTS.
 - CONCRETE "CURB" BLOCKS SHALL BE LAD ON THEIR SIDES AROUND THE INLET IN A SINGLE ROW ABUTTING ONE ANOTHER WITH THE OPEN END FACING AWAY FROM THE CURB.
 - GRAVEL BAGS SHALL BE PLACED AROUND CONCRETE BLOCKS, CLOSELY ABUTTING ONE ANOTHER AND JOINTED TOGETHER IN ACCORDANCE WITH ROCK SOCK DESIGN DETAIL.
- CURB ROCK SOCK INLET PROTECTION INSTALLATION NOTES**
- SEE ROCK SOCK DESIGN DETAIL INSTALLATION REQUIREMENTS.
 - PLACEMENT OF THE SOCK SHALL BE APPROXIMATELY 30 DEGREES FROM PERPENDICULAR IN THE OPPOSITE DIRECTION OF FLOW.
 - SOCKS ARE TO BE FLUSH WITH THE CURB AND SPACED A MINIMUM OF 5 FEET APART.
 - AT LEAST TWO CURB SOCKS IN SIZES ARE REQUIRED UPSTREAM OF ON-GRADE INLETS.

IP-4 Urban Drainage and Flood Control District Urban Storm Drainage Criteria Manual Volume 3 August 2013

SC-6 Inlet Protection (IP)

- GENERAL INLET PROTECTION INSTALLATION NOTES**
- SEE PLAN VIEW FOR:
 - LOCATION OF INLET PROTECTION.
 - TYPE OF INLET PROTECTION (IP-1, IP-2, IP-3, IP-4, IP-5, IP-6).
 - INLET PROTECTION SHALL BE INSTALLED PROMPTLY AFTER INLET CONSTRUCTION OR PAVING IS COMPLETE (TYPICALLY WITHIN 48 HOURS), IF A RAINFALL/RUNOFF EVENT IS FORECAST. INSTALL INLET PROTECTION PRIOR TO ONSET OF EVENT.
 - MANY JURISDICTIONS HAVE BMP DETAILS THAT VARY FROM UDFCD STANDARD DETAILS. CONSULT WITH LOCAL JURISDICTIONS AS TO WHICH DETAIL SHOULD BE USED WHEN DIFFERENCES ARE NOTED.
- INLET PROTECTION MAINTENANCE NOTES**
- INSPECT BMPs EACH WORKDAY, AND MAINTAIN THEM IN EFFECTIVE OPERATING CONDITION. MAINTENANCE OF BMPs SHOULD BE PROACTIVE, NOT REACTIVE. INSPECT BMPs AS SOON AS POSSIBLE (AND ALWAYS WITHIN 24 HOURS) FOLLOWING A STORM THAT CAUSES SURFACE EROSION, AND PERFORM NECESSARY MAINTENANCE.
 - FREQUENT OBSERVATIONS AND MAINTENANCE ARE NECESSARY TO MAINTAIN BMPs IN EFFECTIVE OPERATING CONDITION. INSPECTIONS AND CORRECTIVE MEASURES SHOULD BE DOCUMENTED THOROUGHLY.
 - WHERE BMPs HAVE FAILED, REPAIR OR REPLACEMENT SHOULD BE INITIATED UPON DISCOVERY OF THE FAILURE.
 - SEDIMENT ACCUMULATED UPSTREAM OF INLET PROTECTION SHALL BE REMOVED AS NECESSARY TO MAINTAIN BMP EFFECTIVENESS. TYPICALLY WHEN STORAGE VOLUME REACHES 50% OF CAPACITY, A DEPTH OF 6" WHEN SILT FENCE IS USED, OR 1/4 OF THE HEIGHT FOR STRAW BALES.
 - INLET PROTECTION IS TO REMAIN IN PLACE UNTIL THE UPSTREAM DISTURBED AREA IS PERMANENTLY STABILIZED, UNLESS THE LOCAL JURISDICTION APPROVES EARLIER REMOVAL OF INLET PROTECTION IN STREETS.
 - WHEN INLET PROTECTION AT AREA INLETS IS REMOVED, THE DISTURBED AREA SHALL BE COVERED WITH TOP SOIL, SEEDED AND MULCHED, OR OTHERWISE STABILIZED IN A MANNER APPROVED BY THE LOCAL JURISDICTION.
- NOTE: THE DETAILS INCLUDED WITH THIS FACT SHEET SHOW COMMONLY USED, CONVENTIONAL METHODS OF INLET PROTECTION IN THE DENVER METROPOLITAN AREA. THERE ARE MANY PROPRIETARY INLET PROTECTION METHODS ON THE MARKET. UDFCD NEITHER ENDORSES NOR DISCOURAGES USE OF PROPRIETARY INLET PROTECTION. HOWEVER, IN THE EVENT PROPRIETARY METHODS ARE USED, THE APPROPRIATE DETAIL FROM THE MANUFACTURER MUST BE INCLUDED IN THE SWAP AND THE BMP MUST BE INSTALLED AND MAINTAINED AS SHOWN IN THE MANUFACTURER'S DETAILS.
- NOTE: SOME MUNICIPALITIES DISCOURAGE OR PROHIBIT THE USE OF STRAW BALES FOR INLET PROTECTION. CHECK WITH LOCAL JURISDICTION TO DETERMINE IF STRAW BALE INLET PROTECTION IS ACCEPTABLE.
- (DETAILS ADAPTED FROM TOWN OF PARKER, COLORADO AND CITY OF AURORA, DENVER, NOT AVAILABLE IN AUTOCAD)
- NOTE: MANY JURISDICTIONS HAVE BMP DETAILS THAT VARY FROM UDFCD STANDARD DETAILS. CONSULT WITH LOCAL JURISDICTIONS AS TO WHICH DETAIL SHOULD BE USED WHEN DIFFERENCES ARE NOTED.

IP-8 Urban Drainage and Flood Control District Urban Storm Drainage Criteria Manual Volume 3 August 2013

Concrete Washout Area (CWA) MM-1

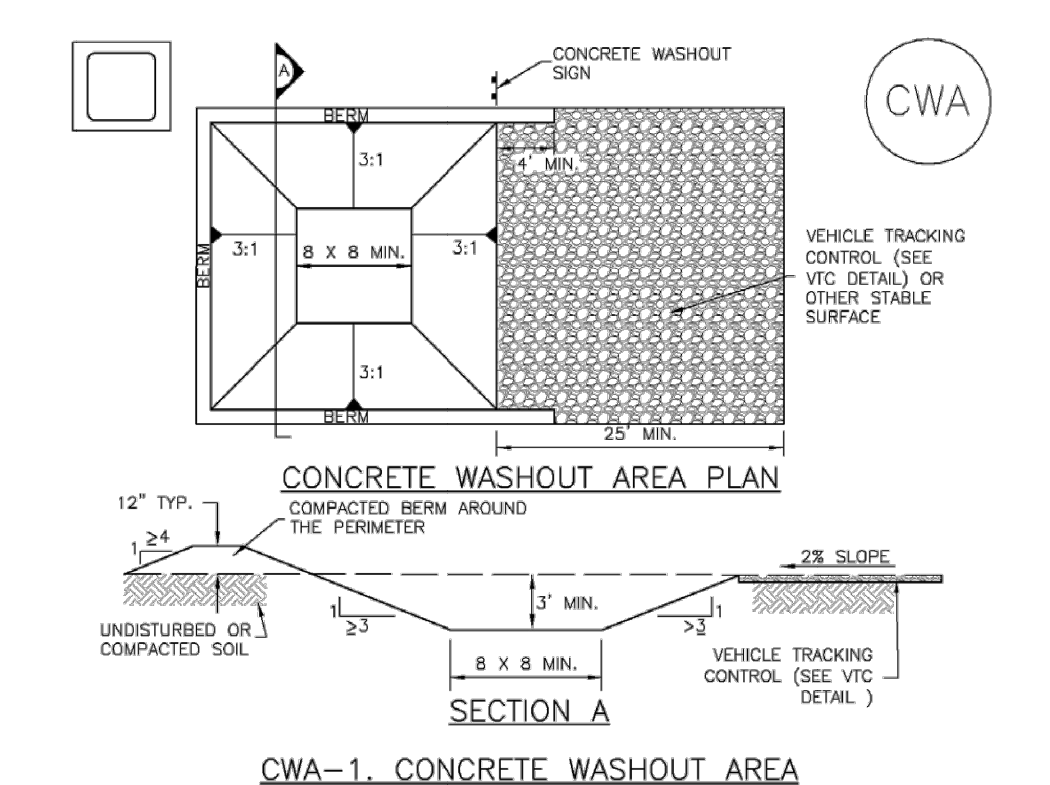

CONCRETE WASHOUT AREA PLAN

SECTION A

CWA-1. CONCRETE WASHOUT AREA

- CWA INSTALLATION NOTES**
- SEE PLAN VIEW FOR:
 - CWA INSTALLATION LOCATION.
 - DO NOT LOCATE AN UNLINED CWA WITHIN 400' OF ANY NATURAL DRAINAGE PATHWAY OR WATERBODY. DO NOT LOCATE WITHIN 1,000' OF ANY WELLS OR DRINKING WATER SOURCES. IF SITE CONSTRAINTS MAKE THIS UNFEASIBLE, OR IF HIGHLY PERMEABLE SOILS EXIST ON SITE, THE CWA MUST BE INSTALLED WITH AN IMPERMEABLE LINER (15 MIL MIN. THICKNESS) OR SURFACE STORAGE ALTERNATIVES USING PREFABRICATED CONCRETE WASHOUT DEVICES OR A LINED ABOVE GROUND STORAGE ARE SHOULD BE USED.
 - THE CWA SHALL BE INSTALLED PRIOR TO CONCRETE PLACEMENT ON SITE.
 - CWA SHALL INCLUDE A FLAT SUBSURFACE PIT THAT IS AT LEAST 8" BY 8" SLOPES LEADING OUT OF THE SUBSURFACE PIT SHALL BE 3:1 OR FLATTER. THE PIT SHALL BE AT LEAST 3' DEEP.
 - BERM SURROUNDING SIDES AND BACK OF THE CWA SHALL HAVE MINIMUM HEIGHT OF 1'.
 - VEHICLE TRACKING PAD SHALL BE SLOPED 2% TOWARDS THE CWA.
 - SOBRS SHALL BE PLACED AT THE CONSTRUCTION ENTRANCE, AT THE CWA, AND ELSEWHERE AS NECESSARY TO CLEARLY INDICATE THE LOCATION OF THE CWA TO OPERATORS OF CONCRETE TRUCKS AND PUMP RIGS.
 - USE EXCAVATED MATERIAL FOR PERIMETER BERM CONSTRUCTION.

November 2010 Urban Drainage and Flood Control District Urban Storm Drainage Criteria Manual Volume 3 CWA-3

MM-1 Concrete Washout Area (CWA)

- CWA MAINTENANCE NOTES**
- INSPECT BMPs EACH WORKDAY, AND MAINTAIN THEM IN EFFECTIVE OPERATING CONDITION. MAINTENANCE OF BMPs SHOULD BE PROACTIVE, NOT REACTIVE. INSPECT BMPs AS SOON AS POSSIBLE (AND ALWAYS WITHIN 24 HOURS) FOLLOWING A STORM THAT CAUSES SURFACE EROSION, AND PERFORM NECESSARY MAINTENANCE.
 - FREQUENT OBSERVATIONS AND MAINTENANCE ARE NECESSARY TO MAINTAIN BMPs IN EFFECTIVE OPERATING CONDITION. INSPECTIONS AND CORRECTIVE MEASURES SHOULD BE DOCUMENTED THOROUGHLY.
 - WHERE BMPs HAVE FAILED, REPAIR OR REPLACEMENT SHOULD BE INITIATED UPON DISCOVERY OF THE FAILURE.
 - THE CWA SHALL BE REPAIRED, CLEANED, OR ENLARGED AS NECESSARY TO MAINTAIN CAPACITY FOR CONCRETE WASTE. CONCRETE MATERIALS, ACCUMULATED IN PIT, SHALL BE REMOVED ONCE THE MATERIALS HAVE REACHED A DEPTH OF 2'.
 - CONCRETE WASHOUT WATER, WASTED PIECES OF CONCRETE AND ALL OTHER DEBRIS IN THE SUBSURFACE PIT SHALL BE TRANSPORTED FROM THE JOB SITE IN A WATER-TIGHT CONTAINER AND DISPOSED OF PROPERLY.
 - THE CWA SHALL REMAIN IN PLACE UNTIL ALL CONCRETE FOR THE PROJECT IS PLACED.
 - WHEN THE CWA IS REMOVED, COVER THE DISTURBED AREA WITH TOP SOIL, SEED AND MULCH OR OTHERWISE STABILIZED IN A MANNER APPROVED BY THE LOCAL JURISDICTION.
- (DETAILS ADAPTED FROM DENVER COUNTY, COLORADO AND THE CITY OF PARKER, COLORADO, NOT AVAILABLE IN AUTOCAD)
- NOTE: MANY JURISDICTIONS HAVE BMP DETAILS THAT VARY FROM UDFCD STANDARD DETAILS. CONSULT WITH LOCAL JURISDICTIONS AS TO WHICH DETAIL SHOULD BE USED WHEN DIFFERENCES ARE NOTED.

CWA-4 Urban Drainage and Flood Control District Urban Storm Drainage Criteria Manual Volume 3 November 2010

ENGINEER'S STATEMENT

PREPARED UNDER MY DIRECT SUPERVISION AND ON BEHALF OF JR ENGINEERING

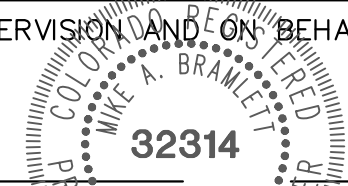

MIKE A. BRAMLETT, P.E.
COLORADO P.E. 32314
FOR AND ON BEHALF OF JR ENGINEERING

STERLING RANCH FILING 4	DATE	
	BY	
DETAIL SHEETS	REVISION	
	NO.	
DESIGNED BY	H-SCALE	N/A
	V-SCALE	N/A
DRAWN BY	DATE	04/26/23
	CHECKED BY	AMT
JOB NO.	DESIGNED BY	AMT
	CHECKED BY	
SHEET	7	OF 10

UNTIL SUCH TIME AS THESE DRAWINGS ARE APPROVED BY THE APPROPRIATE REVIEWING AGENCIES, JR ENGINEERING APPROVES THEIR USE. THESE DRAWINGS ARE DESIGNATED BY WRITTEN AUTHORIZATION.

PREPARED FOR
SR LAND, LLC
20 BOULDER CRESCENT
SUITE 201
COLORADO SPRINGS, CO 80903
JAMES F. MORLEY
(719) 471-1742

J.R. ENGINEERING
A Westman Company
Central 303-740-9383 • Colorado Springs 719-583-2583
Fort Collins 970-491-9888 • www.jrengineering.com

EC-6 Rolled Erosion Control Products (RECP)

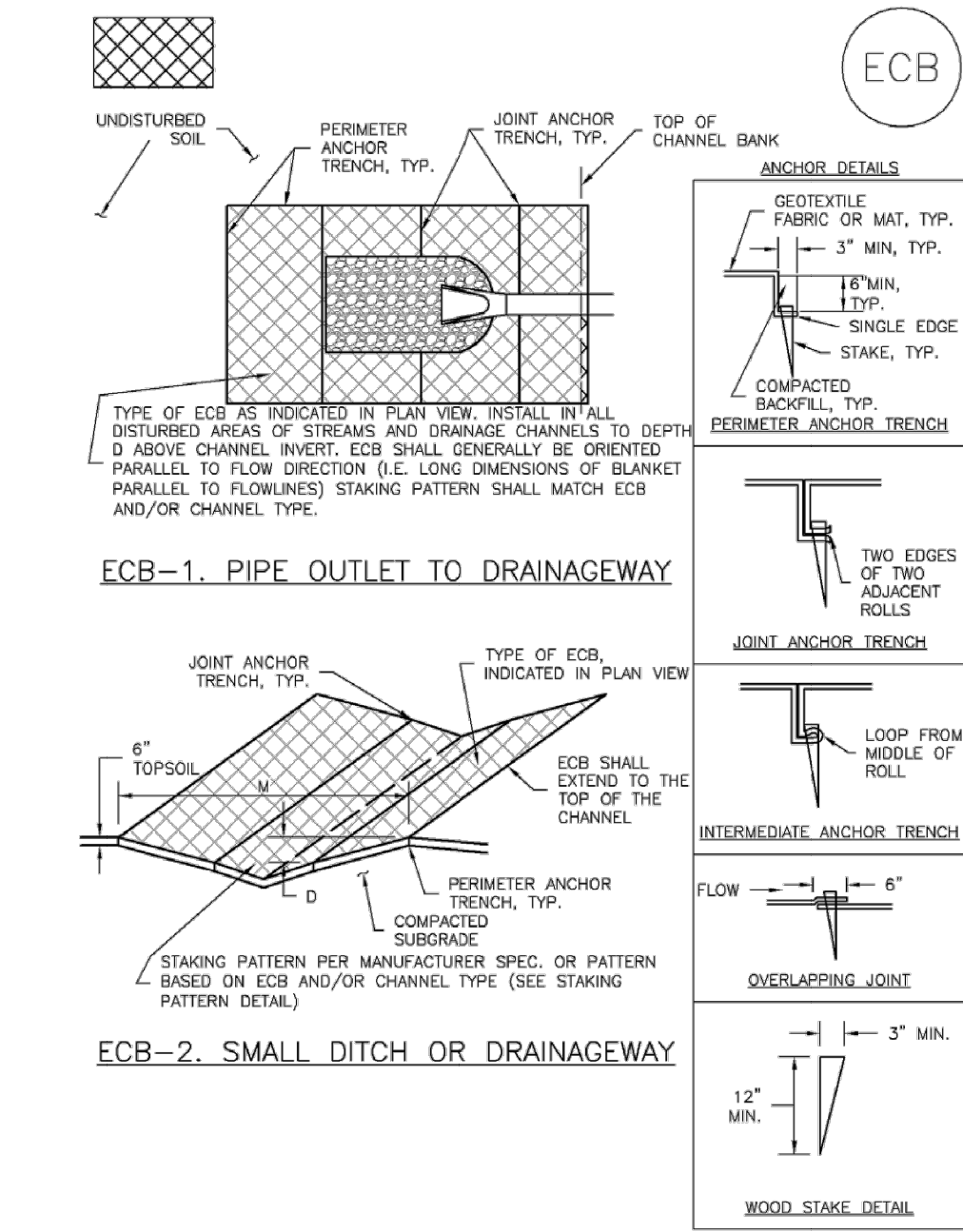

RECP-6 Urban Drainage and Flood Control District Urban Storm Drainage Criteria Manual Volume 3 November 2010

Rolled Erosion Control Products (RECP) EC-6

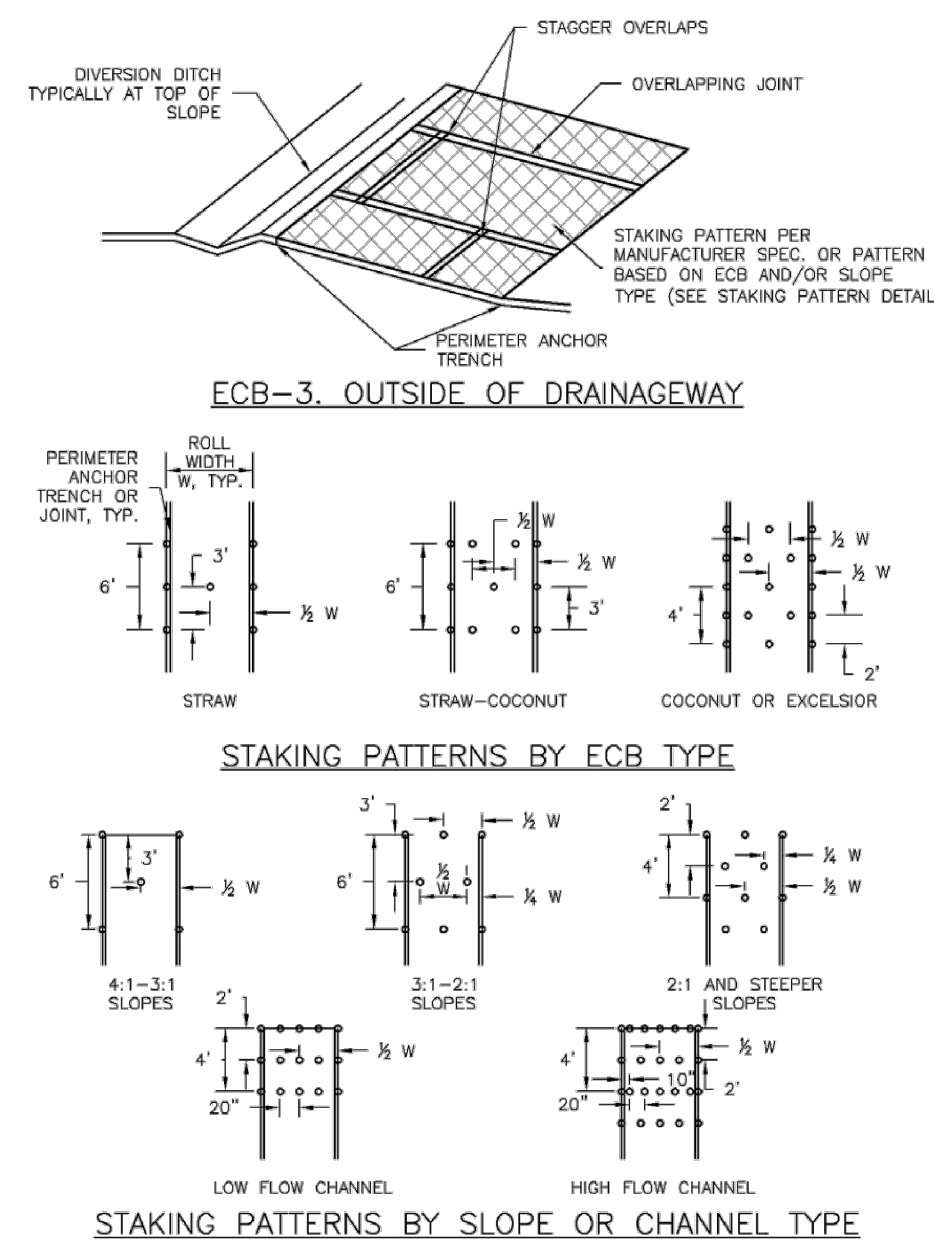

RECP-7 November 2010 Urban Drainage and Flood Control District Urban Storm Drainage Criteria Manual Volume 3

EC-6 Rolled Erosion Control Products (RECP)

EROSION CONTROL BLANKET INSTALLATION NOTES

- SEE PLAN VIEW FOR:
 - LOCATION OF ECB
 - TYPE OF ECB (STRAW, STRAW-COCOONUT, COCONUT, OR EXCELSIOR)
 - AREA, A, IN SQUARE YARDS OF EACH TYPE OF ECB
- 100% NATURAL AND BIODEGRADABLE MATERIALS ARE PREFERRED FOR RECPs, ALTHOUGH SOME JURISDICTIONS MAY ALLOW OTHER MATERIALS IN SOME APPLICATIONS
- IN AREAS WHERE ECBs ARE SHOWN ON THE PLANS, THE PERMITTEE SHALL PLACE TOPSOIL AND PERFORM FINAL GRADING, SURFACE PREPARATION, AND SEEDING AND MULCHING. SUBGRADE SHALL BE SMOOTH AND MOST PRIOR TO ECB INSTALLATION AND THE ECB SHALL BE IN FULL CONTACT WITH SUBGRADE. NO GAPS OR VOIDS SHALL EXIST UNDER THE BLANKET.
- PERIMETER ANCHOR TRENCH SHALL BE USED ALONG THE OUTSIDE PERIMETER OF ALL BLANKET AREAS.
- JOINT ANCHOR TRENCH SHALL BE USED TO JOIN ROLLS OF ECBs TOGETHER (LONGITUDINALLY AND TRANSVERSELY) FOR ALL ECBs EXCEPT STRAW WHICH MAY USE AN OVERLAPPING JOINT.
- INTERMEDIATE ANCHOR TRENCH SHALL BE USED AT SPACING OF ONE-HALF ROLL LENGTH FOR COCONUT AND EXCELSIOR ECBs.
- OVERLAPPING JOINT DETAIL SHALL BE USED TO JOIN ROLLS OF ECBs TOGETHER FOR ECBs ON SLOPES.
- MATERIAL SPECIFICATIONS OF ECBs SHALL CONFORM TO TABLE ECB-1.
- ANY AREAS OF SEEDING AND MULCHING DISTURBED IN THE PROCESS OF INSTALLING ECBs SHALL BE RESEEDED AND MULCHED.
- DETAILS ON DESIGN PLANS FOR MAJOR DRAINAGEWAY STABILIZATION WILL GOVERN IF DIFFERENT FROM THOSE SHOWN HERE.

TABLE ECB-1. ECB MATERIAL SPECIFICATIONS

TYPE	COCONUT CONTENT	STRAW CONTENT	EXCELSIOR CONTENT	RECOMMENDED NETTING
STRAW*	-	100%	-	DOUBLE/NATURAL
STRAW-COCOONUT	30% MIN	70% MAX	-	DOUBLE/NATURAL
COCONUT	100%	-	-	DOUBLE/NATURAL
EXCELSIOR	-	-	100%	DOUBLE/NATURAL

*STRAW ECBs MAY ONLY BE USED OUTSIDE OF THE MAJOR DRAINAGEWAY CHANNEL. PERIMETER TRENCH MAY BE ACCEPTABLE IN SOME JURISDICTIONS

RECP-8 Urban Drainage and Flood Control District Urban Storm Drainage Criteria Manual Volume 3 November 2010

Rolled Erosion Control Products (RECP) EC-6

EROSION CONTROL BLANKET MAINTENANCE NOTES

- INSPECT BMPs EACH WORKDAY, AND MAINTAIN THEM IN EFFECTIVE OPERATING CONDITION. MAINTENANCE OF BMPs SHOULD BE PROACTIVE, NOT REACTIVE. INSPECT BMPs AS SOON AS POSSIBLE (AND ALWAYS WITHIN 24 HOURS) FOLLOWING A STORM THAT CAUSES SURFACE EROSION AND PERFORM NECESSARY MAINTENANCE.
 - FREQUENT OBSERVATIONS AND MAINTENANCE ARE NECESSARY TO MAINTAIN BMPs IN EFFECTIVE OPERATING CONDITION. INSPECTIONS AND CORRECTIVE MEASURES SHOULD BE DOCUMENTED THOROUGHLY.
 - WHERE BMPs HAVE FAILED, REPAIR OR REPLACEMENT SHOULD BE INITIATED UPON DISCOVERY OF THE FAILURE.
 - ECBs SHALL BE LEFT IN PLACE TO EVENTUALLY BIODEGRADE, UNLESS REQUESTED TO BE REMOVED BY THE LOCAL JURISDICTION.
 - ANY ECB PULLED OUT, TORN, OR OTHERWISE DAMAGED SHALL BE REPAIRED OR REPLACED. ANY SUBGRADE AREAS BELOW THE GEOTEXTILE THAT HAVE ERODED TO CREATED A VOID UNDER THE BLANKET, OR THAT REMAIN DEVOID OF GRASS SHALL BE REPAIRED, RESEEDED AND MULCHED AND THE ECB REINSTALLED.
- NOTE: MANY JURISDICTIONS HAVE BMP DETAILS THAT VARY FROM USDC STANDARD DETAILS. CONSULT WITH LOCAL JURISDICTIONS AS TO WHICH DETAIL SHOULD BE USED WHEN DIFFERENCES ARE NOTED.
- (DETAILS ADAPTED FROM DOUGLAS COUNTY, COLORADO AND TOWN OF PARKER, COLORADO, NOT AVAILABLE IN AUTOCAD)

RECP-9 November 2010 Urban Drainage and Flood Control District Urban Storm Drainage Criteria Manual Volume 3

UNTIL SUCH TIME AS THESE DRAWINGS ARE APPROVED BY THE APPROPRIATE REVIEWING AGENCIES, JR ENGINEERING APPROVES THEIR USE. THESE DRAWINGS ARE DESIGNATED BY WRITTEN AUTHORIZATION.

PREPARED FOR
SR LAND, LLC
 20 BOULDER CRESCENT
 SUITE 201
 COLORADO SPRINGS, CO 80903
 JAMES F. MORLEY
 (719) 471-1742

J.R. ENGINEERING
 A Westman Company
 Centennial 303-740-9383 • Colorado Springs 719-583-2593
 Fort Collins 970-491-9888 • www.jrengineering.com

SM-6 Stabilized Staging Area (SSA)

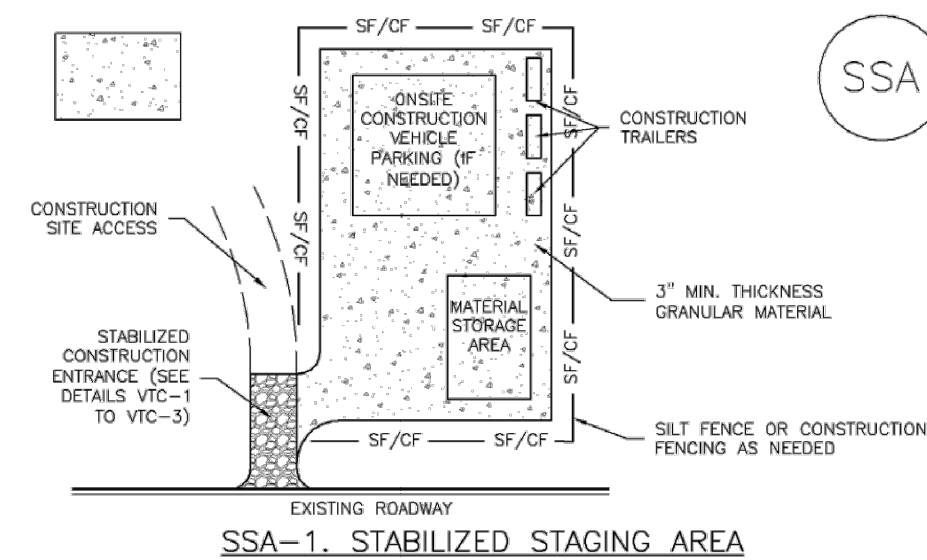

- STABILIZED STAGING AREA INSTALLATION NOTES**
- SEE PLAN VIEW FOR:
 - LOCATION OF STAGING AREA(S)
 - CONTRACTOR MAY ADJUST LOCATION AND SIZE OF STAGING AREA WITH APPROVAL FROM THE LOCAL JURISDICTION.
 - STABILIZED STAGING AREA SHOULD BE APPROPRIATE FOR THE NEEDS OF THE SITE. OVERSIZING RESULTS IN A LARGER AREA TO STABILIZE FOLLOWING CONSTRUCTION.
 - STAGING AREA SHALL BE STABILIZED PRIOR TO OTHER OPERATIONS ON THE SITE.
 - THE STABILIZED STAGING AREA SHALL CONSIST OF A MINIMUM 3" THICK GRANULAR MATERIAL.
 - UNLESS OTHERWISE SPECIFIED BY LOCAL JURISDICTION, ROCK SHALL CONSIST OF DOT SECT. #703, #810 TO #3 COARSE AGGREGATE OR 4" (MINUS) ROCK.
 - ADDITIONAL PERIMETER BMPs MAY BE REQUIRED INCLUDING BUT NOT LIMITED TO SILT FENCE AND CONSTRUCTION FENCING AS NEEDED.

- STABILIZED STAGING AREA MAINTENANCE NOTES**
- INSPECT BMPs EACH WORKDAY, AND MAINTAIN THEM IN EFFECTIVE OPERATING CONDITION. MAINTENANCE OF BMPs SHOULD BE PROACTIVE, NOT REACTIVE. INSPECT BMPs AS SOON AS POSSIBLE (AND ALWAYS WITHIN 24 HOURS) FOLLOWING A STORM THAT CAUSES SURFACE EROSION, AND PERFORM NECESSARY MAINTENANCE.
 - FREQUENT OBSERVATIONS AND MAINTENANCE ARE NECESSARY TO MAINTAIN BMPs IN EFFECTIVE OPERATING CONDITION. INSPECTIONS AND CORRECTIVE MEASURES SHOULD BE DOCUMENTED THOROUGHLY.
 - WHERE BMPs HAVE FAILED, REPAIR OR REPLACEMENT SHOULD BE INITIATED UPON DISCOVERY OF THE FAILURE.
 - ROCK SHALL BE REAPPLIED OR REGRADED AS NECESSARY IF RUTTING OCCURS OR UNDERLYING SUBGRADE BECOMES EXPOSED.

SSA-3 November 2010 Urban Drainage and Flood Control District Urban Storm Drainage Criteria Manual Volume 3

SM-6 Stabilized Staging Area (SSA)

- STABILIZED STAGING AREA MAINTENANCE NOTES**
- STABILIZED STAGING AREA SHALL BE ENLARGED IF NECESSARY TO CONTAIN PARKING, STORAGE, AND UNLOADING/LOADING OPERATIONS.
 - THE STABILIZED STAGING AREA SHALL BE REMOVED AT THE END OF CONSTRUCTION. THE GRANULAR MATERIAL SHALL BE REMOVED OR, IF APPROVED BY THE LOCAL JURISDICTION, USED ON SITE, AND THE AREA COVERED WITH TOPSOIL, SEEDING AND MULCHED OR OTHERWISE STABILIZED IN A MANNER APPROVED BY LOCAL JURISDICTION.
- NOTE: MANY MUNICIPALITIES PROHIBIT THE USE OF RECYCLED CONCRETE AS GRANULAR MATERIAL FOR STABILIZED STAGING AREAS DUE TO DIFFICULTIES WITH RE-ESTABLISHMENT OF VEGETATION IN AREAS WHERE RECYCLED CONCRETE WAS PLACED.
- NOTE: MANY JURISDICTIONS HAVE BMP DETAILS THAT VARY FROM USDC STANDARD DETAILS. CONSULT WITH LOCAL JURISDICTIONS AS TO WHICH DETAIL SHOULD BE USED WHEN DIFFERENCES ARE NOTED.
- (DETAILS ADAPTED FROM DOUGLAS COUNTY, COLORADO, NOT AVAILABLE IN AUTOCAD)

SSA-4 November 2010 Urban Drainage and Flood Control District Urban Storm Drainage Criteria Manual Volume 3

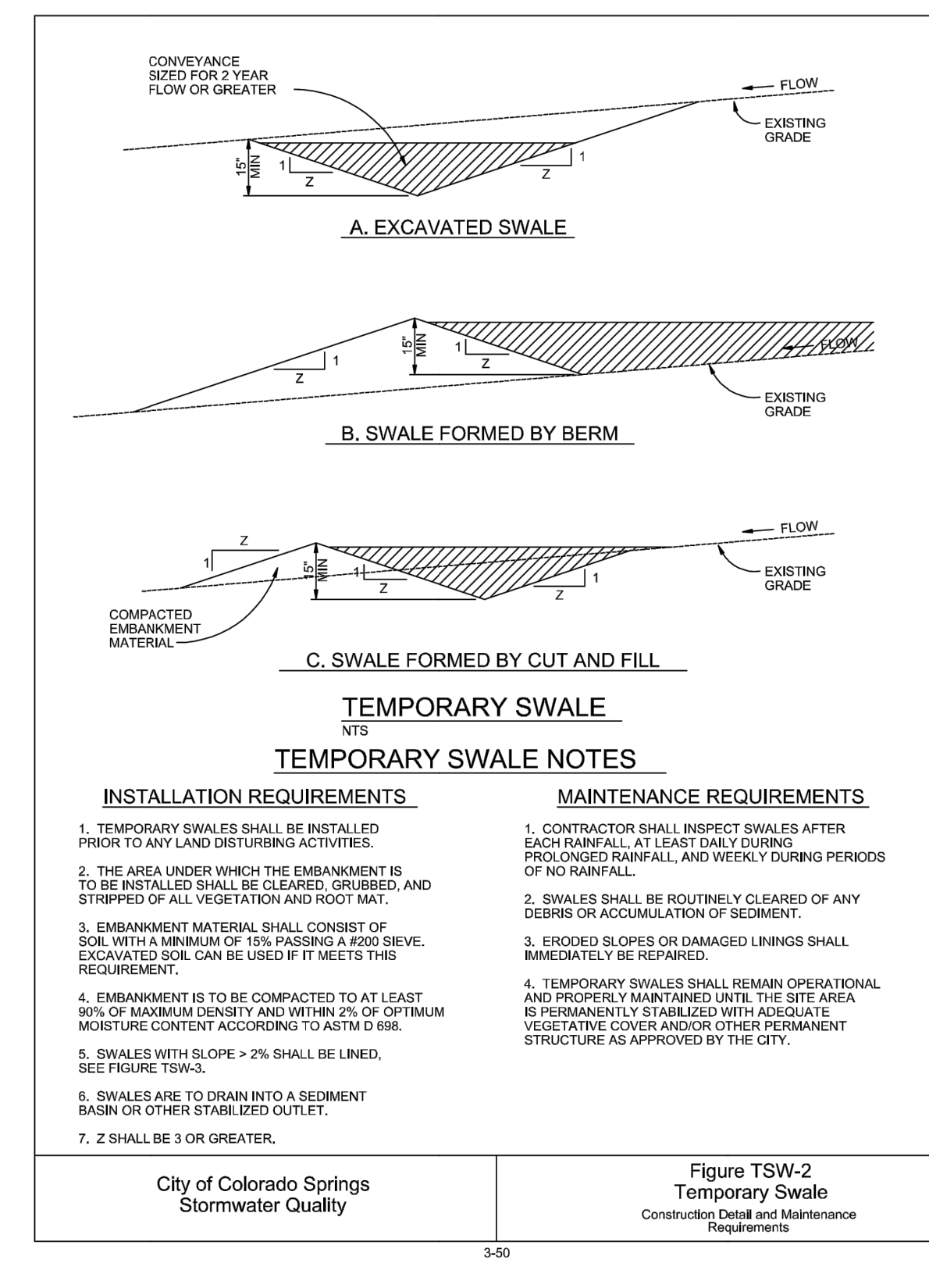

ENGINEER'S STATEMENT

PREPARED UNDER MY DIRECT SUPERVISION AND ON BEHALF OF JR ENGINEERING

MIKE A. BRAMLETT, P.E.
 COLORADO P.E. 32314
 FOR AND ON BEHALF OF JR ENGINEERING

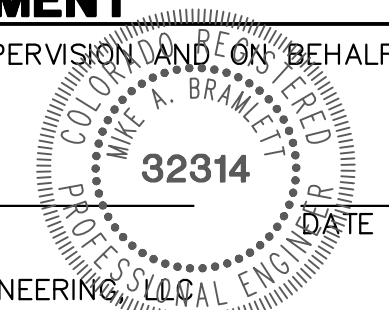

H-SCALE	V-SCALE	DATE	DESIGNED BY	DRAWN BY	CHECKED BY	No.	REVISION	BY	DATE
STERLING RANCH FILING 4									
DETAIL SHEETS									
SHEET 10 OF 10									
JOB NO. 25188.11									

Description

Vehicle tracking controls provide stabilized construction site access where vehicles exit the site onto paved public roads. An effective vehicle tracking control helps remove sediment (mud or dirt) from vehicles, reducing tracking onto the paved surface.



Photograph VTC-1. A vehicle tracking control pad constructed with properly sized rock reduces off-site sediment tracking.

Appropriate Uses

Implement a stabilized construction entrance or vehicle tracking control where frequent heavy vehicle traffic exits the construction site onto a paved roadway. An effective vehicle tracking control is particularly important during the following conditions:

- Wet weather periods when mud is easily tracked off site.
- During dry weather periods where dust is a concern.
- When poorly drained, clayey soils are present on site.

Although wheel washes are not required in designs of vehicle tracking controls, they may be needed at particularly muddy sites.

Design and Installation

Construct the vehicle tracking control on a level surface. Where feasible, grade the tracking control towards the construction site to reduce off-site runoff. Place signage, as needed, to direct construction vehicles to the designated exit through the vehicle tracking control. There are several different types of stabilized construction entrances including:

VTC-1. Aggregate Vehicle Tracking Control. This is a coarse-aggregate surfaced pad underlain by a geotextile. This is the most common vehicle tracking control, and when properly maintained can be effective at removing sediment from vehicle tires.

VTC-2. Vehicle Tracking Control with Construction Mat or Turf Reinforcement Mat. This type of control may be appropriate for site access at very small construction sites with low traffic volume over vegetated areas. Although this application does not typically remove sediment from vehicles, it helps protect existing vegetation and provides a stabilized entrance.

Vehicle Tracking Control	
Functions	
Erosion Control	Moderate
Sediment Control	Yes
Site/Material Management	Yes

VTC-3. Stabilized Construction Entrance/Exit with Wheel Wash. This is an aggregate pad, similar to VTC-1, but includes equipment for tire washing. The wheel wash equipment may be as simple as hand-held power washing equipment to more advance proprietary systems. When a wheel wash is provided, it is important to direct wash water to a sediment trap prior to discharge from the site.

Vehicle tracking controls are sometimes installed in combination with a sediment trap to treat runoff.

Maintenance and Removal

Inspect the area for degradation and replace aggregate or material used for a stabilized entrance/exit as needed. If the area becomes clogged and ponds water, remove and dispose of excess sediment or replace material with a fresh layer of aggregate as necessary.

With aggregate vehicle tracking controls, ensure rock and debris from this area do not enter the public right-of-way.

Remove sediment that is tracked onto the public right of way daily or more frequently as needed. Excess sediment in the roadway indicates that the stabilized construction entrance needs maintenance.

Ensure that drainage ditches at the entrance/exit area remain clear.

A stabilized entrance should be removed only when there is no longer the potential for vehicle tracking to occur. This is typically after the site has been stabilized.

When wheel wash equipment is used, be sure that the wash water is discharged to a sediment trap prior to discharge. Also inspect channels conveying the water from the wash area to the sediment trap and stabilize areas that may be eroding.

When a construction entrance/exit is removed, excess sediment from the aggregate should be removed and disposed of appropriately. The entrance should be promptly stabilized with a permanent surface following removal, typically by paving.



Photograph VTC-2. A vehicle tracking control pad with wheel wash facility. Photo courtesy of Tom Gore.

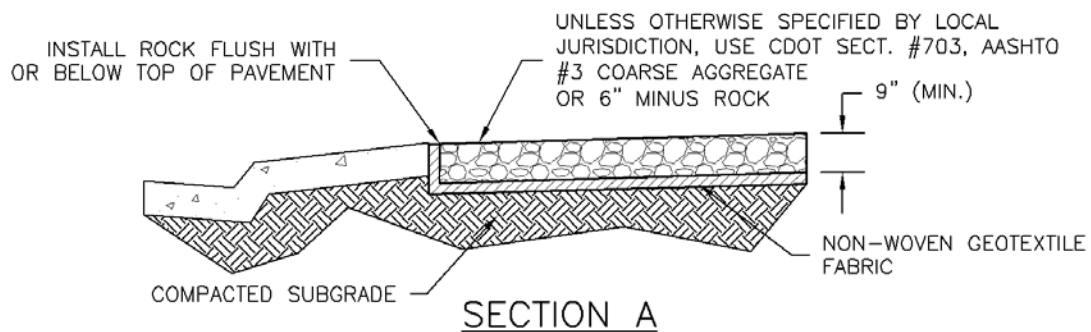
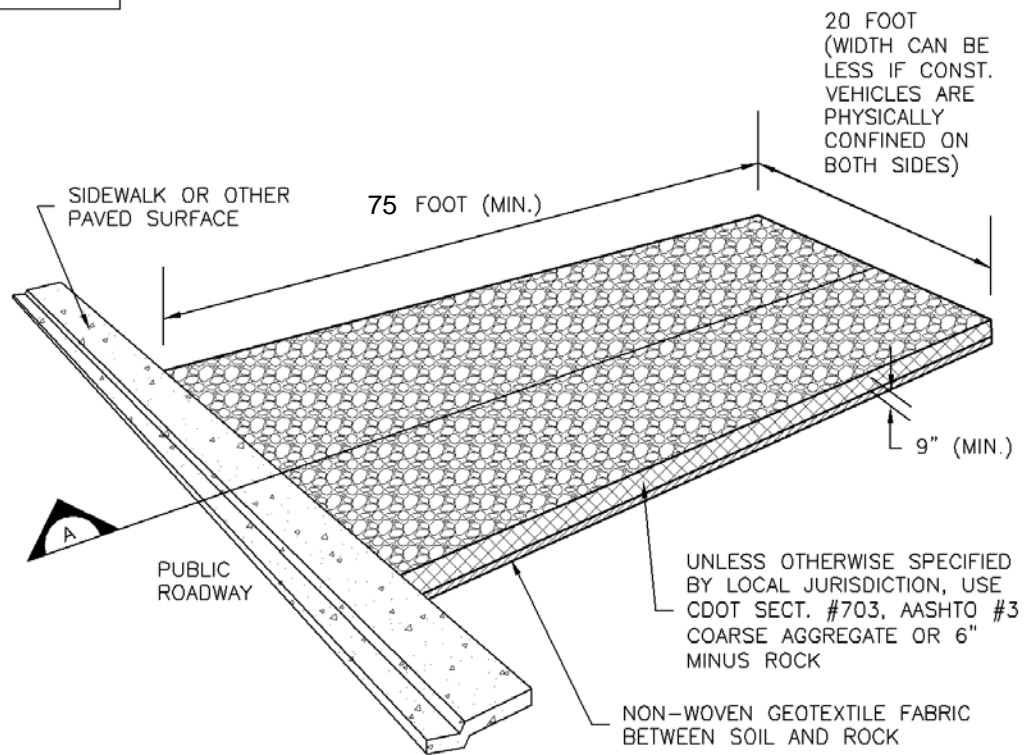
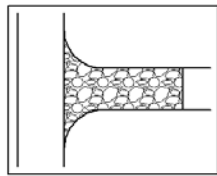

VTC-1. AGGREGATE VEHICLE TRACKING CONTROL

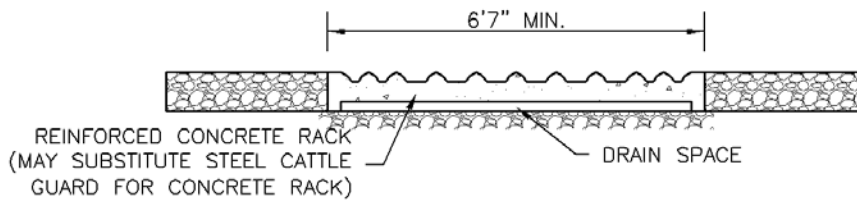
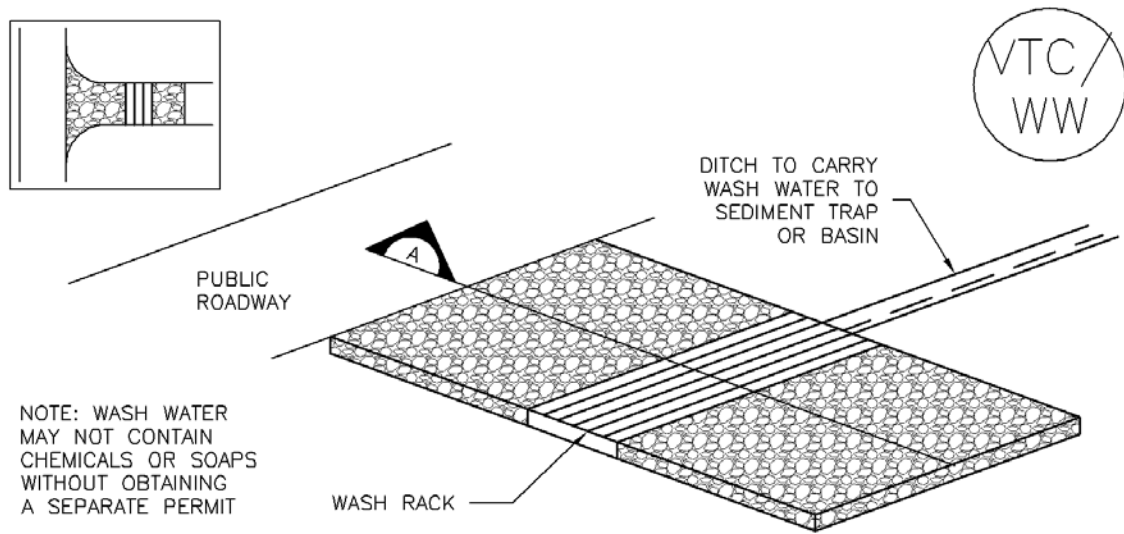

SECTION A

VTC-2. AGGREGATE VEHICLE TRACKING CONTROL WITH WASH RACK

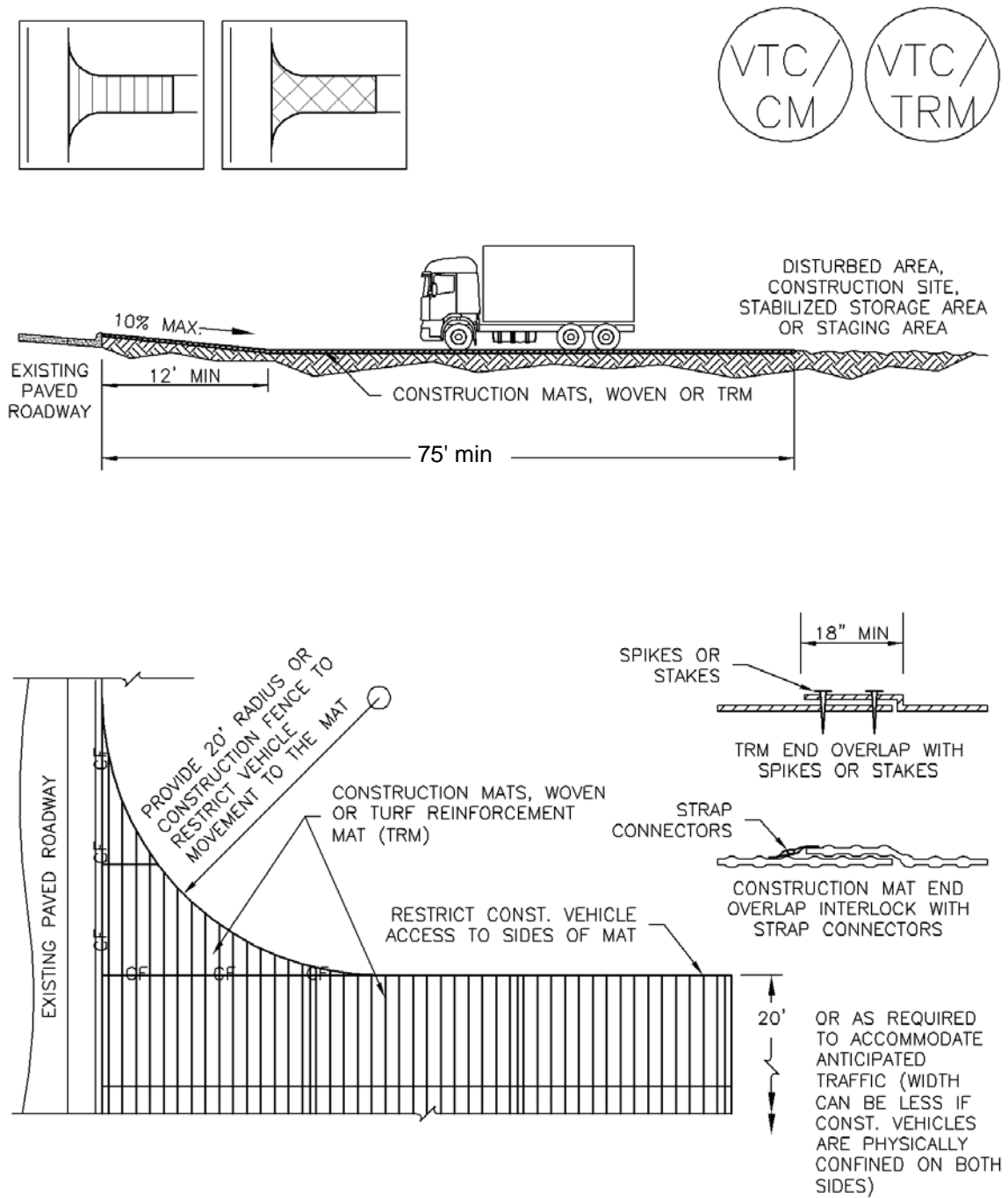

VTC-3. VEHICLE TRACKING CONTROL W/ CONSTRUCTION MAT OR TURF REINFORCEMENT MAT (TRM)

STABILIZED CONSTRUCTION ENTRANCE/EXIT INSTALLATION NOTES

1. SEE PLAN VIEW FOR
 - LOCATION OF CONSTRUCTION ENTRANCE(S)/EXIT(S).
 - TYPE OF CONSTRUCTION ENTRANCE(S)/EXITS(S) (WITH/WITHOUT WHEEL WASH, CONSTRUCTION MAT OR TRM).
2. CONSTRUCTION MAT OR TRM STABILIZED CONSTRUCTION ENTRANCES ARE ONLY TO BE USED ON SHORT DURATION PROJECTS (TYPICALLY RANGING FROM A WEEK TO A MONTH) WHERE THERE WILL BE LIMITED VEHICULAR ACCESS.
3. A STABILIZED CONSTRUCTION ENTRANCE/EXIT SHALL BE LOCATED AT ALL ACCESS POINTS WHERE VEHICLES ACCESS THE CONSTRUCTION SITE FROM PAVED RIGHT-OF-WAYS.
4. STABILIZED CONSTRUCTION ENTRANCE/EXIT SHALL BE INSTALLED PRIOR TO ANY LAND DISTURBING ACTIVITIES.
5. A NON-WOVEN GEOTEXTILE FABRIC SHALL BE PLACED UNDER THE STABILIZED CONSTRUCTION ENTRANCE/EXIT PRIOR TO THE PLACEMENT OF ROCK.
6. UNLESS OTHERWISE SPECIFIED BY LOCAL JURISDICTION, ROCK SHALL CONSIST OF DOT SECT. #703, AASHTO #3 COARSE AGGREGATE OR 6" (MINUS) ROCK.

STABILIZED CONSTRUCTION ENTRANCE/EXIT MAINTENANCE NOTES

1. INSPECT BMPs EACH WORKDAY, AND MAINTAIN THEM IN EFFECTIVE OPERATING CONDITION. MAINTENANCE OF BMPs SHOULD BE PROACTIVE, NOT REACTIVE. INSPECT BMPs AS SOON AS POSSIBLE (AND ALWAYS WITHIN 24 HOURS) FOLLOWING A STORM THAT CAUSES SURFACE EROSION, AND PERFORM NECESSARY MAINTENANCE.
2. FREQUENT OBSERVATIONS AND MAINTENANCE ARE NECESSARY TO MAINTAIN BMPs IN EFFECTIVE OPERATING CONDITION. INSPECTIONS AND CORRECTIVE MEASURES SHOULD BE DOCUMENTED THOROUGHLY.
3. WHERE BMPs HAVE FAILED, REPAIR OR REPLACEMENT SHOULD BE INITIATED UPON DISCOVERY OF THE FAILURE.
4. ROCK SHALL BE REAPPLIED OR REGRADED AS NECESSARY TO THE STABILIZED ENTRANCE/EXIT TO MAINTAIN A CONSISTENT DEPTH.
5. SEDIMENT TRACKED ONTO PAVED ROADS IS TO BE REMOVED THROUGHOUT THE DAY AND AT THE END OF THE DAY BY SHOVELING OR SWEEPING. SEDIMENT MAY NOT BE WASHED DOWN STORM SEWER DRAINS.

NOTE: MANY JURISDICTIONS HAVE BMP DETAILS THAT VARY FROM UDFCD STANDARD DETAILS. CONSULT WITH LOCAL JURISDICTIONS AS TO WHICH DETAIL SHOULD BE USED WHEN DIFFERENCES ARE NOTED.

(DETAILS ADAPTED FROM CITY OF BROOMFIELD, COLORADO, NOT AVAILABLE IN AUTOCAD)

Description

A silt fence is a woven geotextile fabric attached to wooden posts and trenched into the ground. It is designed as a sediment barrier to intercept sheet flow runoff from disturbed areas.

Appropriate Uses

A silt fence can be used where runoff is conveyed from a disturbed area as sheet flow. Silt fence is not designed to receive concentrated flow or to be used as a filter fabric. Typical uses include:

- Down slope of a disturbed area to accept sheet flow.
- Along the perimeter of a receiving water such as a stream, pond or wetland.
- At the perimeter of a construction site.



Photograph SF-1. Silt fence creates a sediment barrier, forcing sheet flow runoff to evaporate or infiltrate.

Design and Installation

Silt fence should be installed along the contour of slopes so that it intercepts sheet flow. The maximum recommended tributary drainage area per 100 lineal feet of silt fence, installed along the contour, is approximately 0.25 acres with a disturbed slope length of up to 150 feet and a tributary slope gradient no steeper than 3:1. Longer and steeper slopes require additional measures. This recommendation only applies to silt fence installed along the contour. Silt fence installed for other uses, such as perimeter control, should be installed in a way that will not produce concentrated flows. For example, a "J-hook" installation may be appropriate to force runoff to pond and evaporate or infiltrate in multiple areas rather than concentrate and cause erosive conditions parallel to the silt fence.

See Detail SF-1 for proper silt fence installation, which involves proper trenching, staking, securing the fabric to the stakes, and backfilling the silt fence. Properly installed silt fence should not be easily pulled out by hand and there should be no gaps between the ground and the fabric.

Silt fence must meet the minimum allowable strength requirements, depth of installation requirement, and other specifications in the design details. Improper installation of silt fence is a common reason for silt fence failure; however, when properly installed and used for the appropriate purposes, it can be highly effective.

Silt Fence	
Functions	
Erosion Control	No
Sediment Control	Yes
Site/Material Management	No

Maintenance and Removal

Inspection of silt fence includes observing the material for tears or holes and checking for slumping fence and undercut areas bypassing flows. Repair of silt fence typically involves replacing the damaged section with a new section. Sediment accumulated behind silt fence should be removed, as needed to maintain BMP effectiveness, typically before it reaches a depth of 6 inches.

Silt fence may be removed when the upstream area has reached final stabilization.



Photograph SF-2. When silt fence is not installed along the contour, a "J-hook" installation may be appropriate to ensure that the BMP does not create concentrated flow parallel to the silt fence. Photo courtesy of Tom Gore.

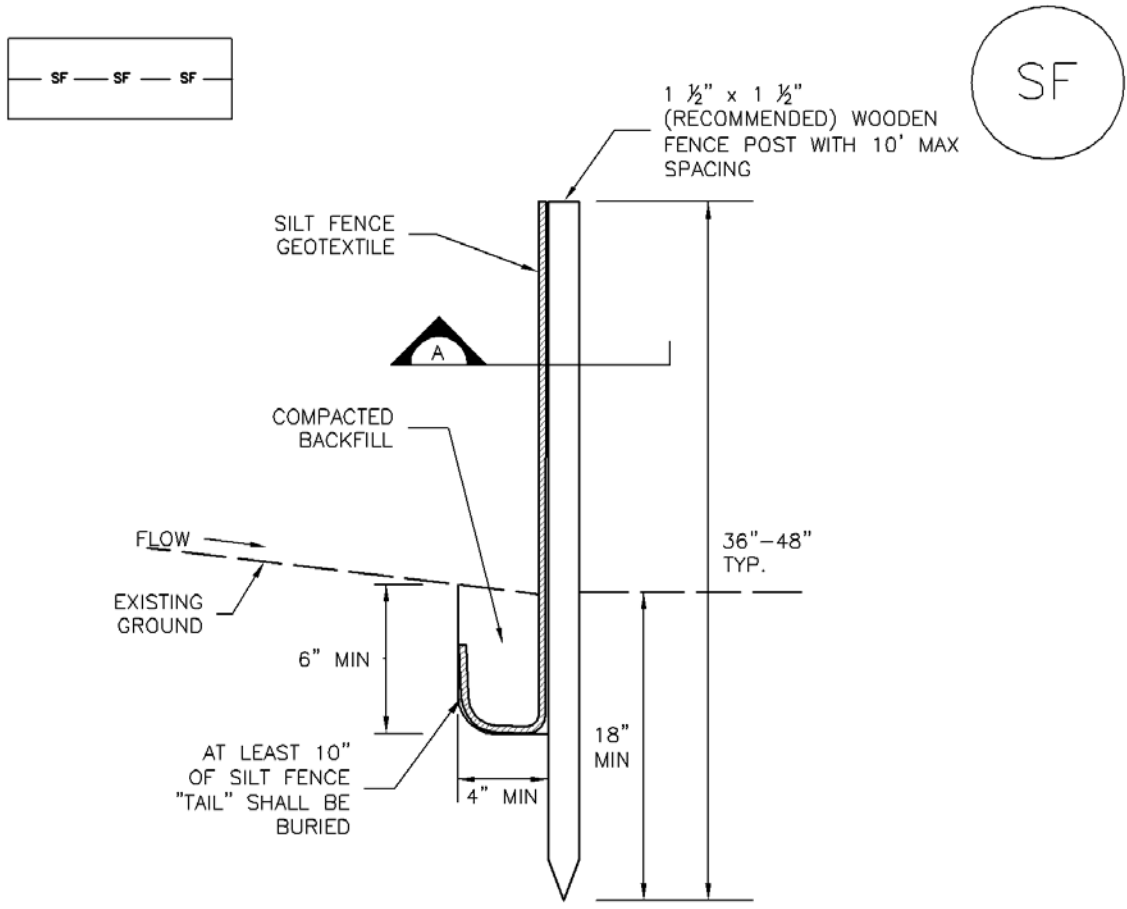

SILT FENCE

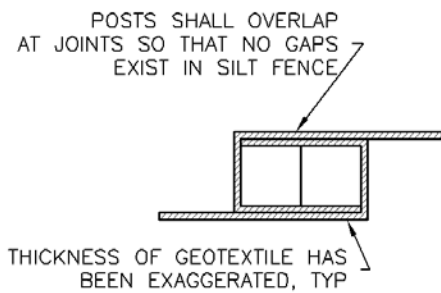
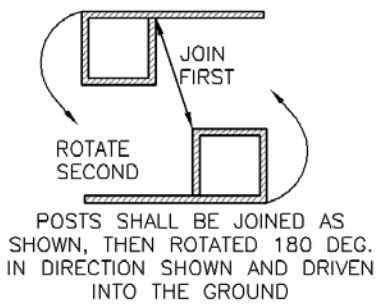

SECTION A

SF-1. SILT FENCE

SILT FENCE INSTALLATION NOTES

1. SILT FENCE MUST BE PLACED AWAY FROM THE TOE OF THE SLOPE TO ALLOW FOR WATER PONDING. SILT FENCE AT THE TOE OF A SLOPE SHOULD BE INSTALLED IN A FLAT LOCATION AT LEAST SEVERAL FEET (2-5 FT) FROM THE TOE OF THE SLOPE TO ALLOW ROOM FOR PONDING AND DEPOSITION.
2. A UNIFORM 6" X 4" ANCHOR TRENCH SHALL BE EXCAVATED USING TRENCHER OR SILT FENCE INSTALLATION DEVICE. NO ROAD GRADERS, BACKHOES, OR SIMILAR EQUIPMENT SHALL BE USED.
3. COMPACT ANCHOR TRENCH BY HAND WITH A "JUMPING JACK" OR BY WHEEL ROLLING. COMPACTION SHALL BE SUCH THAT SILT FENCE RESISTS BEING PULLED OUT OF ANCHOR TRENCH BY HAND.
4. SILT FENCE SHALL BE PULLED TIGHT AS IT IS ANCHORED TO THE STAKES. THERE SHOULD BE NO NOTICEABLE SAG BETWEEN STAKES AFTER IT HAS BEEN ANCHORED TO THE STAKES.
5. SILT FENCE FABRIC SHALL BE ANCHORED TO THE STAKES USING 1" HEAVY DUTY STAPLES OR NAILS WITH 1" HEADS. STAPLES AND NAILS SHOULD BE PLACED 3" ALONG THE FABRIC DOWN THE STAKE.
6. AT THE END OF A RUN OF SILT FENCE ALONG A CONTOUR, THE SILT FENCE SHOULD BE TURNED PERPENDICULAR TO THE CONTOUR TO CREATE A "J-HOOK." THE "J-HOOK" EXTENDING PERPENDICULAR TO THE CONTOUR SHOULD BE OF SUFFICIENT LENGTH TO KEEP RUNOFF FROM FLOWING AROUND THE END OF THE SILT FENCE (TYPICALLY 10' - 20').
7. SILT FENCE SHALL BE INSTALLED PRIOR TO ANY LAND DISTURBING ACTIVITIES.

SILT FENCE MAINTENANCE NOTES

1. INSPECT BMPs EACH WORKDAY, AND MAINTAIN THEM IN EFFECTIVE OPERATING CONDITION. MAINTENANCE OF BMPs SHOULD BE PROACTIVE, NOT REACTIVE. INSPECT BMPs AS SOON AS POSSIBLE (AND ALWAYS WITHIN 24 HOURS) FOLLOWING A STORM THAT CAUSES SURFACE EROSION, AND PERFORM NECESSARY MAINTENANCE.
2. FREQUENT OBSERVATIONS AND MAINTENANCE ARE NECESSARY TO MAINTAIN BMPs IN EFFECTIVE OPERATING CONDITION. INSPECTIONS AND CORRECTIVE MEASURES SHOULD BE DOCUMENTED THOROUGHLY.
3. WHERE BMPs HAVE FAILED, REPAIR OR REPLACEMENT SHOULD BE INITIATED UPON DISCOVERY OF THE FAILURE.
4. SEDIMENT ACCUMULATED UPSTREAM OF THE SILT FENCE SHALL BE REMOVED AS NEEDED TO MAINTAIN THE FUNCTIONALITY OF THE BMP, TYPICALLY WHEN DEPTH OF ACCUMULATED SEDIMENTS IS APPROXIMATELY 6".
5. REPAIR OR REPLACE SILT FENCE WHEN THERE ARE SIGNS OF WEAR, SUCH AS SAGGING, TEARING, OR COLLAPSE.
6. SILT FENCE IS TO REMAIN IN PLACE UNTIL THE UPSTREAM DISTURBED AREA IS STABILIZED AND APPROVED BY THE LOCAL JURISDICTION, OR IS REPLACED BY AN EQUIVALENT PERIMETER SEDIMENT CONTROL BMP.
7. WHEN SILT FENCE IS REMOVED, ALL DISTURBED AREAS SHALL BE COVERED WITH TOPSOIL, SEEDED AND MULCHED OR OTHERWISE STABILIZED AS APPROVED BY LOCAL JURISDICTION.

(DETAIL ADAPTED FROM TOWN OF PARKER, COLORADO AND CITY OF AURORA, NOT AVAILABLE IN AUTOCAD)

NOTE: MANY JURISDICTIONS HAVE BMP DETAILS THAT VARY FROM UDFCD STANDARD DETAILS. CONSULT WITH LOCAL JURISDICTIONS AS TO WHICH DETAIL SHOULD BE USED WHEN DIFFERENCES ARE NOTED.

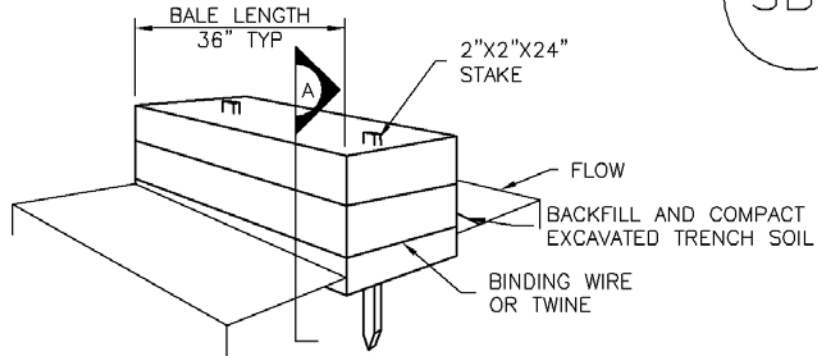

STRAW BALE

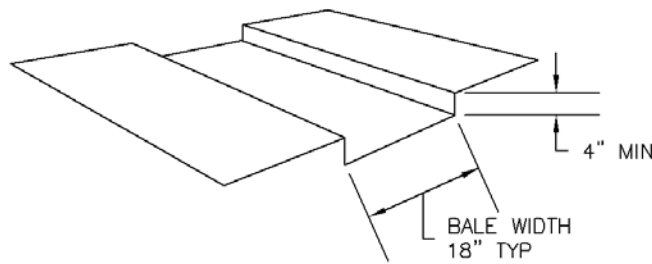

TRENCH FOR STRAW BALE

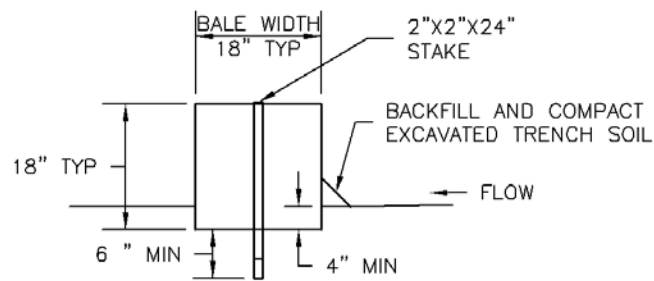

SECTION A

SBB-1. STRAW BALE

STRAW BALE INSTALLATION NOTES

1. SEE PLAN VIEW FOR:
-LOCATION(S) OF STRAW BALES.
2. STRAW BALES SHALL CONSIST OF CERTIFIED WEED FREE STRAW OR HAY. LOCAL JURISDICTIONS MAY REQUIRE PROOF THAT BALES ARE WEED FREE.
3. STRAW BALES SHALL CONSIST OF APPROXIMATELY 5 CUBIC FEET OF STRAW OR HAY AND WEIGH NOT LESS THAN 35 POUNDS.
4. WHEN STRAW BALES ARE USED IN SERIES AS A BARRIER, THE END OF EACH BALE SHALL BE TIGHTLY ABUTTING ONE ANOTHER.
5. STRAW BALE DIMENSIONS SHALL BE APPROXIMATELY 36"X18"X18".
6. A UNIFORM ANCHOR TRENCH SHALL BE EXCAVATED TO A DEPTH OF 4". STRAW BALES SHALL BE PLACED SO THAT BINDING TWINE IS ENCOMPASSING THE VERTICAL SIDES OF THE BALE(S). ALL EXCAVATED SOIL SHALL BE PLACED ON THE UPHILL SIDE OF THE STRAW BALE(S) AND COMPACTED.
7. TWO (2) WOODEN STAKES SHALL BE USED TO HOLD EACH BALE IN PLACE. WOODEN STAKES SHALL BE 2"X2"X24". WOODEN STAKES SHALL BE DRIVEN 6" INTO THE GROUND.

STRAW BALE MAINTENANCE NOTES

1. INSPECT BMPs EACH WORKDAY, AND MAINTAIN THEM IN EFFECTIVE OPERATING CONDITION. MAINTENANCE OF BMPs SHOULD BE PROACTIVE, NOT REACTIVE. INSPECT BMPs AS SOON AS POSSIBLE (AND ALWAYS WITHIN 24 HOURS) FOLLOWING A STORM THAT CAUSES SURFACE EROSION, AND PERFORM NECESSARY MAINTENANCE.
2. FREQUENT OBSERVATIONS AND MAINTENANCE ARE NECESSARY TO MAINTAIN BMPs IN EFFECTIVE OPERATING CONDITION. INSPECTIONS AND CORRECTIVE MEASURES SHOULD BE DOCUMENTED THOROUGHLY.
3. WHERE BMPs HAVE FAILED, REPAIR OR REPLACEMENT SHOULD BE INITIATED UPON DISCOVERY OF THE FAILURE.
4. STRAW BALES SHALL BE REPLACED IF THEY BECOME HEAVILY SOILED, ROTTEN, OR DAMAGED BEYOND REPAIR.
5. SEDIMENT ACCUMULATED UPSTREAM OF STRAW BALE BARRIER SHALL BE REMOVED AS NEEDED TO MAINTAIN FUNCTIONALITY OF THE BMP, TYPICALLY WHEN DEPTH OF ACCUMULATED SEDIMENTS IS APPROXIMATELY $\frac{1}{4}$ OF THE HEIGHT OF THE STRAW BALE BARRIER.
6. STRAW BALES ARE TO REMAIN IN PLACE UNTIL THE UPSTREAM DISTURBED AREA IS STABILIZED AND APPROVED BY THE LOCAL JURISDICTION.
7. WHEN STRAW BALES ARE REMOVED, ALL DISTURBED AREAS SHALL BE COVERED WITH TOPSOIL, SEEDED AND MULCHED OR OTHERWISE STABILIZED AS APPROVED BY LOCAL JURISDICTION.

(DETAILS ADAPTED FROM TOWN OF PARKER, COLORADO, NOT AVAILABLE IN AUTOCAD)

NOTE: MANY JURISDICTIONS HAVE BMP DETAILS THAT VARY FROM UDFCD STANDARD DETAILS. CONSULT WITH LOCAL JURISDICTIONS AS TO WHICH DETAIL SHOULD BE USED WHEN DIFFERENCES ARE NOTED.

Description

Inlet protection consists of permeable barriers installed around an inlet to filter runoff and remove sediment prior to entering a storm drain inlet. Inlet protection can be constructed from rock socks, sediment control logs, silt fence, block and rock socks, or other materials approved by the local jurisdiction. Area inlets can also be protected by over-excavating around the inlet to form a sediment trap.



Photograph IP-1. Inlet protection for a curb opening inlet.

Appropriate Uses

Install protection at storm sewer inlets that are operable during construction. Consider the potential for tracked-out sediment or temporary stockpile areas to contribute sediment to inlets when determining which inlets must be protected. This may include inlets in the general proximity of the construction area, not limited to downgradient inlets. Inlet protection is not a stand-alone BMP and should be used in conjunction with other upgradient BMPs.

Design and Installation

To function effectively, inlet protection measures must be installed to ensure that flows do not bypass the inlet protection and enter the storm drain without treatment. However, designs must also enable the inlet to function without completely blocking flows into the inlet in a manner that causes localized flooding. When selecting the type of inlet protection, consider factors such as type of inlet (e.g., curb or area, sump or on-grade conditions), traffic, anticipated flows, ability to secure the BMP properly, safety and other site-specific conditions. For example, block and rock socks will be better suited to a curb and gutter along a roadway, as opposed to silt fence or sediment control logs, which cannot be properly secured in a curb and gutter setting, but are effective area inlet protection measures.

Several inlet protection designs are provided in the Design Details. Additionally, a variety of proprietary products are available for inlet protection that may be approved for use by local governments. If proprietary products are used, design details and installation procedures from the manufacturer must be followed. Regardless of the type of inlet protection selected, inlet protection is most effective when combined with other BMPs such as curb socks and check dams. Inlet protection is often the last barrier before runoff enters the storm sewer or receiving water.

Design details with notes are provided for these forms of inlet protection:

- IP-1. Block and Rock Sock Inlet Protection for Sump or On-grade Inlets
- IP-2. Curb (Rock) Socks Upstream of Inlet Protection, On-grade Inlets

Inlet Protection (various forms)	
Functions	
Erosion Control	No
Sediment Control	Yes
Site/Material Management	No

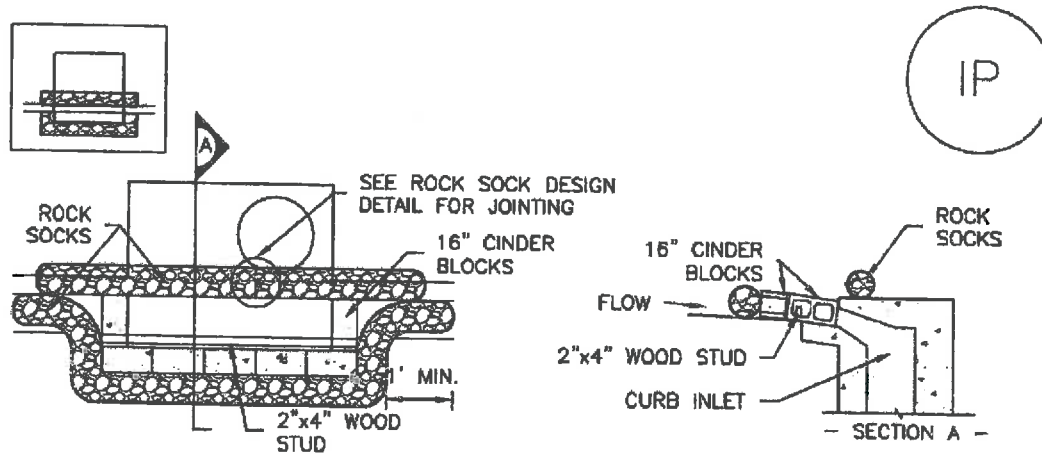

IP-1. BLOCK AND ROCK SOCK SUMP OR ON GRADE INLET PROTECTION

BLOCK AND CURB SOCK INLET PROTECTION INSTALLATION NOTES

1. SEE ROCK SOCK DESIGN DETAIL FOR INSTALLATION REQUIREMENTS.
2. CONCRETE "CINDER" BLOCKS SHALL BE LAID ON THEIR SIDES AROUND THE INLET IN A SINGLE ROW, ABUTTING ONE ANOTHER WITH THE OPEN END FACING AWAY FROM THE CURB.
3. GRAVEL BAGS SHALL BE PLACED AROUND CONCRETE BLOCKS, CLOSELY ABUTTING ONE ANOTHER AND JOINTED TOGETHER IN ACCORDANCE WITH ROCK SOCK DESIGN DETAIL.

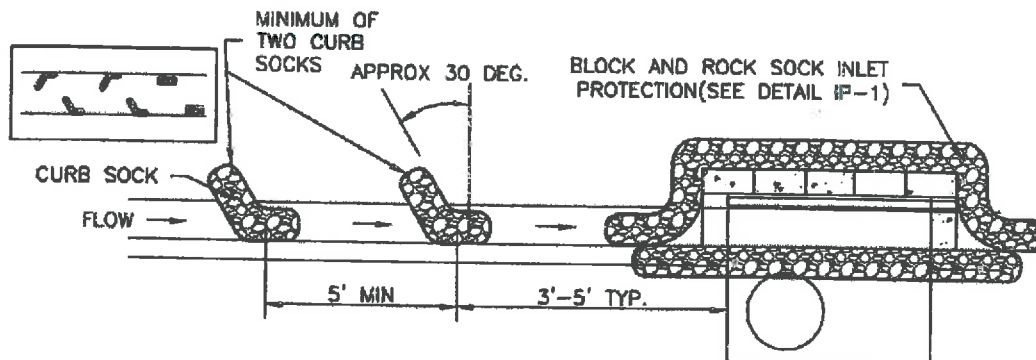

IP-2. CURB ROCK SOCKS UPSTREAM OF INLET PROTECTION

CURB ROCK SOCK INLET PROTECTION INSTALLATION NOTES

1. SEE ROCK SOCK DESIGN DETAIL INSTALLATION REQUIREMENTS.
2. PLACEMENT OF THE SOCK SHALL BE APPROXIMATELY 30 DEGREES FROM PERPENDICULAR IN THE OPPOSITE DIRECTION OF FLOW.
3. SOCKS ARE TO BE FLUSH WITH THE CURB AND SPACED A MINIMUM OF 5 FEET APART.
4. AT LEAST TWO CURB SOCKS IN SERIES ARE REQUIRED UPSTREAM OF ON-GRADE INLETS.

GENERAL INLET PROTECTION INSTALLATION NOTES

1. SEE PLAN VIEW FOR:
 - LOCATION OF INLET PROTECTION.
 - TYPE OF INLET PROTECTION (IP.1, IP.2, IP.3, IP.4, IP.5, IP.6)
2. INLET PROTECTION SHALL BE INSTALLED PROMPTLY AFTER INLET CONSTRUCTION OR PAVING IS COMPLETE (TYPICALLY WITHIN 48 HOURS). IF A RAINFALL/RUNOFF EVENT IS FORECAST, INSTALL INLET PROTECTION PRIOR TO ONSET OF EVENT.
3. MANY JURISDICTIONS HAVE BMP DETAILS THAT VARY FROM UDFCD STANDARD DETAILS. CONSULT WITH LOCAL JURISDICTIONS AS TO WHICH DETAIL SHOULD BE USED WHEN DIFFERENCES ARE NOTED.

INLET PROTECTION MAINTENANCE NOTES

1. INSPECT BMPs EACH WORKDAY, AND MAINTAIN THEM IN EFFECTIVE OPERATING CONDITION. MAINTENANCE OF BMPs SHOULD BE PROACTIVE, NOT REACTIVE. INSPECT BMPs AS SOON AS POSSIBLE (AND ALWAYS WITHIN 24 HOURS) FOLLOWING A STORM THAT CAUSES SURFACE EROSION, AND PERFORM NECESSARY MAINTENANCE.
2. FREQUENT OBSERVATIONS AND MAINTENANCE ARE NECESSARY TO MAINTAIN BMPs IN EFFECTIVE OPERATING CONDITION. INSPECTIONS AND CORRECTIVE MEASURES SHOULD BE DOCUMENTED THOROUGHLY.
3. WHERE BMPs HAVE FAILED, REPAIR OR REPLACEMENT SHOULD BE INITIATED UPON DISCOVERY OF THE FAILURE.
4. SEDIMENT ACCUMULATED UPSTREAM OF INLET PROTECTION SHALL BE REMOVED AS NECESSARY TO MAINTAIN BMP EFFECTIVENESS, TYPICALLY WHEN STORAGE VOLUME REACHES 50% OF CAPACITY, A DEPTH OF 6" WHEN SILT FENCE IS USED, OR ¼ OF THE HEIGHT FOR STRAW BALES.
5. INLET PROTECTION IS TO REMAIN IN PLACE UNTIL THE UPSTREAM DISTURBED AREA IS PERMANENTLY STABILIZED, UNLESS THE LOCAL JURISDICTION APPROVES EARLIER REMOVAL OF INLET PROTECTION IN STREETS.
6. WHEN INLET PROTECTION AT AREA INLETS IS REMOVED, THE DISTURBED AREA SHALL BE COVERED WITH TOP SOIL, SEEDED AND MULCHED, OR OTHERWISE STABILIZED IN A MANNER APPROVED BY THE LOCAL JURISDICTION.

(DETAIL ADAPTED FROM TOWN OF PARKER, COLORADO AND CITY OF AURORA, COLORADO, NOT AVAILABLE IN AUTOCAD)

NOTE: MANY JURISDICTIONS HAVE BMP DETAILS THAT VARY FROM UDFCD STANDARD DETAILS. CONSULT WITH LOCAL JURISDICTIONS AS TO WHICH DETAIL SHOULD BE USED WHEN DIFFERENCES ARE NOTED.

NOTE: THE DETAILS INCLUDED WITH THIS FACT SHEET SHOW COMMONLY USED, CONVENTIONAL METHODS OF INLET PROTECTION IN THE DENVER METROPOLITAN AREA. THERE ARE MANY PROPRIETARY INLET PROTECTION METHODS ON THE MARKET. UDFCD NEITHER ENDORSES NOR DISCOURAGES USE OF PROPRIETARY INLET PROTECTION; HOWEVER, IN THE EVENT PROPRIETARY METHODS ARE USED, THE APPROPRIATE DETAIL FROM THE MANUFACTURER MUST BE INCLUDED IN THE SWMP AND THE BMP MUST BE INSTALLED AND MAINTAINED AS SHOWN IN THE MANUFACTURER'S DETAILS.

NOTE: SOME MUNICIPALITIES DISCOURAGE OR PROHIBIT THE USE OF STRAW BALES FOR INLET PROTECTION. CHECK WITH LOCAL JURISDICTION TO DETERMINE IF STRAW BALE INLET PROTECTION IS ACCEPTABLE.

IP-3. Rock Sock Inlet Protection for Sump/Area Inlet

IP-4. Silt Fence Inlet Protection for Sump/Area Inlet

IP-5. Over-excavation Inlet Protection

IP-6. Straw Bale Inlet Protection for Sump/Area Inlet

CIP-1. Culvert Inlet Protection

Proprietary inlet protection devices should be installed in accordance with manufacturer specifications.

More information is provided below on selecting inlet protection for sump and on-grade locations.

Inlets Located in a Sump

When applying inlet protection in sump conditions, it is important that the inlet continue to function during larger runoff events. For curb inlets, the maximum height of the protective barrier should be lower than the top of the curb opening to allow overflow into the inlet during larger storms without excessive localized flooding. If the inlet protection height is greater than the curb elevation, particularly if the filter becomes clogged with sediment, runoff will not enter the inlet and may bypass it, possibly causing localized flooding, public safety issues, and downstream erosion and damage from bypassed flows.

Area inlets located in a sump setting can be protected through the use of silt fence, concrete block and rock socks (on paved surfaces), sediment control logs/straw wattles embedded in the adjacent soil and stacked around the area inlet (on pervious surfaces), over-excavation around the inlet, and proprietary products providing equivalent functions.

Inlets Located on a Slope

For curb and gutter inlets on paved sloping streets, block and rock sock inlet protection is recommended in conjunction with curb socks in the gutter leading to the inlet. For inlets located along unpaved roads, also see the Check Dam Fact Sheet.

Maintenance and Removal

Inspect inlet protection frequently. Inspection and maintenance guidance includes:

- Inspect for tears that can result in sediment directly entering the inlet, as well as result in the contents of the BMP (e.g., gravel) washing into the inlet.
- Check for improper installation resulting in untreated flows bypassing the BMP and directly entering the inlet or bypassing to an unprotected downstream inlet. For example, silt fence that has not been properly trenched around the inlet can result in flows under the silt fence and directly into the inlet.
- Look for displaced BMPs that are no longer protecting the inlet. Displacement may occur following larger storm events that wash away or reposition the inlet protection. Traffic or equipment may also crush or displace the BMP.
- Monitor sediment accumulation upgradient of the inlet protection.

- Remove sediment accumulation from the area upstream of the inlet protection, as needed to maintain BMP effectiveness, typically when it reaches no more than half the storage capacity of the inlet protection. For silt fence, remove sediment when it accumulates to a depth of no more than 6 inches. Remove sediment accumulation from the area upstream of the inlet protection as needed to maintain the functionality of the BMP.
- Proprietary inlet protection devices should be inspected and maintained in accordance with manufacturer specifications. If proprietary inlet insert devices are used, sediment should be removed in a timely manner to prevent devices from breaking and spilling sediment into the storm drain.

Inlet protection must be removed and properly disposed of when the drainage area for the inlet has reached final stabilization.

Description

Concrete waste management involves designating and properly managing a specific area of the construction site as a concrete washout area. A concrete washout area can be created using one of several approaches designed to receive wash water from washing of tools and concrete mixer chutes, liquid concrete waste from dump trucks, mobile batch mixers, or pump trucks. Three basic approaches are available: excavation of a pit in the ground, use of an above ground storage area, or use of prefabricated haul-away concrete washout containers. Surface discharges of concrete washout water from construction sites are prohibited.



Photograph CWA-1. Example of concrete washout area. Note gravel tracking pad for access and sign.

Appropriate Uses

Concrete washout areas must be designated on all sites that will generate concrete wash water or liquid concrete waste from onsite concrete mixing or concrete delivery.

Because pH is a pollutant of concern for washout activities, when unlined pits are used for concrete washout, the soil must have adequate buffering capacity to result in protection of state groundwater standards; otherwise, a liner/containment must be used. The following management practices are recommended to prevent an impact from unlined pits to groundwater:

- The use of the washout site should be temporary (less than 1 year), and
- The washout site should be not be located in an area where shallow groundwater may be present, such as near natural drainages, springs, or wetlands.

Design and Installation

Concrete washout activities must be conducted in a manner that does not contribute pollutants to surface waters or stormwater runoff. Concrete washout areas may be lined or unlined excavated pits in the ground, commercially manufactured prefabricated washout containers, or aboveground holding areas constructed of berms, sandbags or straw bales with a plastic liner.

Although unlined washout areas may be used, lined pits may be required to protect groundwater under certain conditions.

Do not locate an unlined washout area within 400 feet of any natural drainage pathway or waterbody or within 1,000 feet of any wells or drinking water sources. Even for lined concrete washouts, it is advisable to locate the facility away from waterbodies and drainage paths. If site constraints make these

Concrete Washout Area	
Functions	
Erosion Control	No
Sediment Control	No
Site/Material Management	Yes

setbacks infeasible or if highly permeable soils exist in the area, then the pit must be installed with an impermeable liner (16 mil minimum thickness) or surface storage alternatives using prefabricated concrete washout devices or a lined aboveground storage area should be used.

Design details with notes are provided in Detail CWA-1 for pits and CWA-2 for aboveground storage areas. Pre-fabricated concrete washout container information can be obtained from vendors.

Maintenance and Removal

A key consideration for concrete washout areas is to ensure that adequate signage is in place identifying the location of the washout area. Part of inspecting and maintaining washout areas is ensuring that adequate signage is provided and in good repair and that the washout area is being used, as opposed to washout in non-designated areas of the site.

Remove concrete waste in the washout area, as needed to maintain BMP function (typically when filled to about two-thirds of its capacity). Collect concrete waste and deliver offsite to a designated disposal location.

Upon termination of use of the washout site, accumulated solid waste, including concrete waste and any contaminated soils, must be removed from the site to prevent on-site disposal of solid waste. If the wash water is allowed to evaporate and the concrete hardens, it may be recycled.



Photograph CWA-2. Prefabricated concrete washout. Photo courtesy of CDOT.



Photograph CWA-3. Earthen concrete washout. Photo courtesy of CDOT.

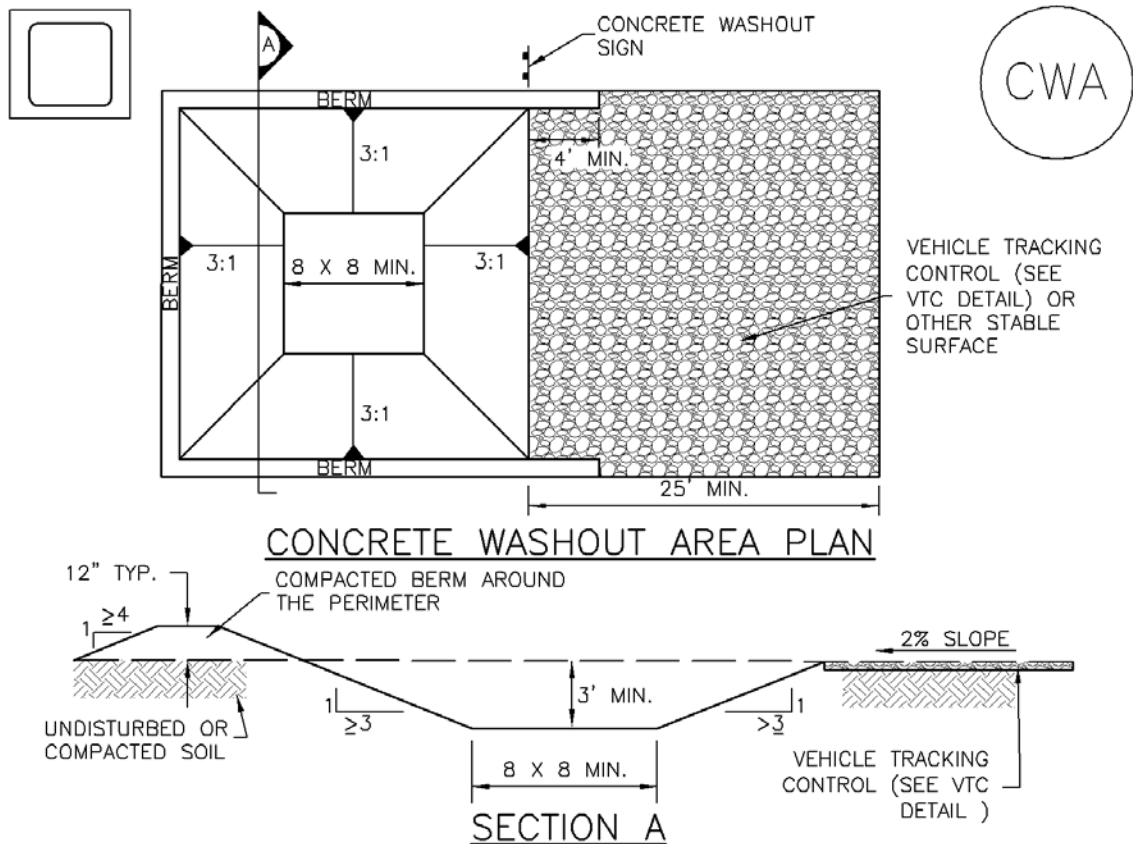

CWA-1. CONCRETE WASHOUT AREA

CWA INSTALLATION NOTES

1. SEE PLAN VIEW FOR:
-CWA INSTALLATION LOCATION.
2. DO NOT LOCATE AN UNLINED CWA WITHIN 400' OF ANY NATURAL DRAINAGE PATHWAY OR WATERBODY. DO NOT LOCATE WITHIN 1,000' OF ANY WELLS OR DRINKING WATER SOURCES. IF SITE CONSTRAINTS MAKE THIS INFEASIBLE, OR IF HIGHLY PERMEABLE SOILS EXIST ON SITE, THE CWA MUST BE INSTALLED WITH AN IMPERMEABLE LINER (16 MIL MIN. THICKNESS) OR SURFACE STORAGE ALTERNATIVES USING PREFABRICATED CONCRETE WASHOUT DEVICES OR A LINED ABOVE GROUND STORAGE ARE SHOULD BE USED.
3. THE CWA SHALL BE INSTALLED PRIOR TO CONCRETE PLACEMENT ON SITE.
4. CWA SHALL INCLUDE A FLAT SUBSURFACE PIT THAT IS AT LEAST 8' BY 8' SLOPES LEADING OUT OF THE SUBSURFACE PIT SHALL BE 3:1 OR FLATTER. THE PIT SHALL BE AT LEAST 3' DEEP.
5. BERM SURROUNDING SIDES AND BACK OF THE CWA SHALL HAVE MINIMUM HEIGHT OF 1'.
6. VEHICLE TRACKING PAD SHALL BE SLOPED 2% TOWARDS THE CWA.
7. SIGNS SHALL BE PLACED AT THE CONSTRUCTION ENTRANCE, AT THE CWA, AND ELSEWHERE AS NECESSARY TO CLEARLY INDICATE THE LOCATION OF THE CWA TO OPERATORS OF CONCRETE TRUCKS AND PUMP RIGS.
8. USE EXCAVATED MATERIAL FOR PERIMETER BERM CONSTRUCTION.

CWA MAINTENANCE NOTES

1. INSPECT BMPs EACH WORKDAY, AND MAINTAIN THEM IN EFFECTIVE OPERATING CONDITION. MAINTENANCE OF BMPs SHOULD BE PROACTIVE, NOT REACTIVE. INSPECT BMPs AS SOON AS POSSIBLE (AND ALWAYS WITHIN 24 HOURS) FOLLOWING A STORM THAT CAUSES SURFACE EROSION, AND PERFORM NECESSARY MAINTENANCE.

2. FREQUENT OBSERVATIONS AND MAINTENANCE ARE NECESSARY TO MAINTAIN BMPs IN EFFECTIVE OPERATING CONDITION. INSPECTIONS AND CORRECTIVE MEASURES SHOULD BE DOCUMENTED THOROUGHLY.

3. WHERE BMPs HAVE FAILED, REPAIR OR REPLACEMENT SHOULD BE INITIATED UPON DISCOVERY OF THE FAILURE.

4. THE CWA SHALL BE REPAIRED, CLEANED, OR ENLARGED AS NECESSARY TO MAINTAIN CAPACITY FOR CONCRETE WASTE. CONCRETE MATERIALS, ACCUMULATED IN PIT, SHALL BE REMOVED ONCE THE MATERIALS HAVE REACHED A DEPTH OF 2'.

5. CONCRETE WASHOUT WATER, WASTED PIECES OF CONCRETE AND ALL OTHER DEBRIS IN THE SUBSURFACE PIT SHALL BE TRANSPORTED FROM THE JOB SITE IN A WATER-TIGHT CONTAINER AND DISPOSED OF PROPERLY.

6. THE CWA SHALL REMAIN IN PLACE UNTIL ALL CONCRETE FOR THE PROJECT IS PLACED.

7. WHEN THE CWA IS REMOVED, COVER THE DISTURBED AREA WITH TOP SOIL, SEED AND MULCH OR OTHERWISE STABILIZED IN A MANNER APPROVED BY THE LOCAL JURISDICTION.

(DETAIL ADAPTED FROM DOUGLAS COUNTY, COLORADO AND THE CITY OF PARKER, COLORADO, NOT AVAILABLE IN AUTOCAD).

NOTE: MANY JURISDICTIONS HAVE BMP DETAILS THAT VARY FROM UDFCD STANDARD DETAILS. CONSULT WITH LOCAL JURISDICTIONS AS TO WHICH DETAIL SHOULD BE USED WHEN DIFFERENCES ARE NOTED.

Description

Temporary seeding can be used to stabilize disturbed areas that will be inactive for an extended period. Permanent seeding should be used to stabilize areas at final grade that will not be otherwise stabilized. Effective seeding includes preparation of a seedbed, selection of an appropriate seed mixture, proper planting techniques, and protection of the seeded area with mulch, geotextiles, or other appropriate measures.



Photograph TS/PS -1. Equipment used to drill seed. Photo courtesy of Douglas County.

Appropriate Uses

When the soil surface is disturbed and will remain inactive for an extended period (typically 30 days or longer), proactive stabilization measures should be implemented. If the inactive period is short-lived (on the order of two weeks), techniques such as surface roughening may be appropriate. For longer periods of inactivity, temporary seeding and mulching can provide effective erosion control. Permanent seeding should be used on finished areas that have not been otherwise stabilized.

Typically, local governments have their own seed mixes and timelines for seeding. Check jurisdictional requirements for seeding and temporary stabilization.

Design and Installation

Effective seeding requires proper seedbed preparation, selection of an appropriate seed mixture, use of appropriate seeding equipment to ensure proper coverage and density, and protection with mulch or fabric until plants are established.

The USDCM Volume 2 *Revegetation* Chapter contains detailed seed mix, soil preparations, and seeding and mulching recommendations that may be referenced to supplement this Fact Sheet.

Drill seeding is the preferred seeding method. Hydroseeding is not recommended except in areas where steep slopes prevent use of drill seeding equipment, and even in these instances it is preferable to hand seed and mulch. Some jurisdictions do not allow hydroseeding or hydromulching.

Seedbed Preparation

Prior to seeding, ensure that areas to be revegetated have soil conditions capable of supporting vegetation. Overlot grading can result in loss of topsoil, resulting in poor quality subsoils at the ground surface that have low nutrient value, little organic matter content, few soil microorganisms, rooting restrictions, and conditions less conducive to infiltration of precipitation. As a result, it is typically necessary to provide stockpiled topsoil, compost, or other

Temporary and Permanent Seeding	
Functions	
Erosion Control	Yes
Sediment Control	No
Site/Material Management	No

EC-2 Temporary and Permanent Seeding (TS/PS)

soil amendments and rototill them into the soil to a depth of 6 inches or more.

Topsoil should be salvaged during grading operations for use and spread on areas to be revegetated later. Topsoil should be viewed as an important resource to be utilized for vegetation establishment, due to its water-holding capacity, structure, texture, organic matter content, biological activity, and nutrient content. The rooting depth of most native grasses in the semi-arid Denver metropolitan area is 6 to 18 inches. At a minimum, the upper 6 inches of topsoil should be stripped, stockpiled, and ultimately respread across areas that will be revegetated.

Where topsoil is not available, subsoils should be amended to provide an appropriate plant-growth medium. Organic matter, such as well digested compost, can be added to improve soil characteristics conducive to plant growth. Other treatments can be used to adjust soil pH conditions when needed. Soil testing, which is typically inexpensive, should be completed to determine and optimize the types and amounts of amendments that are required.

If the disturbed ground surface is compacted, rip or rototill the surface prior to placing topsoil. If adding compost to the existing soil surface, rototilling is necessary. Surface roughening will assist in placement of a stable topsoil layer on steeper slopes, and allow infiltration and root penetration to greater depth.

Prior to seeding, the soil surface should be rough and the seedbed should be firm, but neither too loose nor compacted. The upper layer of soil should be in a condition suitable for seeding at the proper depth and conducive to plant growth. Seed-to-soil contact is the key to good germination.

Seed Mix for Temporary Vegetation

To provide temporary vegetative cover on disturbed areas which will not be paved, built upon, or fully landscaped or worked for an extended period (typically 30 days or more), plant an annual grass appropriate for the time of planting and mulch the planted areas. Annual grasses suitable for the Denver metropolitan area are listed in Table TS/PS-1. These are to be considered only as general recommendations when specific design guidance for a particular site is not available. Local governments typically specify seed mixes appropriate for their jurisdiction.

Seed Mix for Permanent Revegetation

To provide vegetative cover on disturbed areas that have reached final grade, a perennial grass mix should be established. Permanent seeding should be performed promptly (typically within 14 days) after reaching final grade. Each site will have different characteristics and a landscape professional or the local jurisdiction should be contacted to determine the most suitable seed mix for a specific site. In lieu of a specific recommendation, one of the perennial grass mixes appropriate for site conditions and growth season listed in Table TS/PS-2 can be used. The pure live seed (PLS) rates of application recommended in these tables are considered to be absolute minimum rates for seed applied using proper drill-seeding equipment.

If desired for wildlife habitat or landscape diversity, shrubs such as rubber rabbitbrush (*Chrysothamnus nauseosus*), fourwing saltbush (*Atriplex canescens*) and skunkbrush sumac (*Rhus trilobata*) could be added to the upland seedmixes at 0.25, 0.5 and 1 pound PLS/acre, respectively. In riparian zones, planting root stock of such species as American plum (*Prunus americana*), woods rose (*Rosa woodsii*), plains cottonwood (*Populus sargentii*), and willow (*Populus spp.*) may be considered. On non-topsoiled upland sites, a legume such as Ladak alfalfa at 1 pound PLS/acre can be included as a source of nitrogen for perennial grasses.

Seeding dates for the highest success probability of perennial species along the Front Range are generally in the spring from April through early May and in the fall after the first of September until the ground freezes. If the area is irrigated, seeding may occur in summer months, as well. See Table TS/PS-3 for appropriate seeding dates.

Table TS/PS-1. Minimum Drill Seeding Rates for Various Temporary Annual Grasses

Species ^a (Common name)	Growth Season ^b	Pounds of Pure Live Seed (PLS)/acre ^c	Planting Depth (inches)
1. Oats	Cool	35 - 50	1 - 2
2. Spring wheat	Cool	25 - 35	1 - 2
3. Spring barley	Cool	25 - 35	1 - 2
4. Annual ryegrass	Cool	10 - 15	½
5. Millet	Warm	3 - 15	½ - ¾
6. Sudangrass	Warm	5-10	½ - ¾
7. Sorghum	Warm	5-10	½ - ¾
8. Winter wheat	Cool	20-35	1 - 2
9. Winter barley	Cool	20-35	1 - 2
10. Winter rye	Cool	20-35	1 - 2
11. Triticale	Cool	25-40	1 - 2

^a Successful seeding of annual grass resulting in adequate plant growth will usually produce enough dead-plant residue to provide protection from wind and water erosion for an additional year. This assumes that the cover is not disturbed or mowed closer than 8 inches.

Hydraulic seeding may be substituted for drilling only where slopes are steeper than 3:1 or where access limitations exist. When hydraulic seeding is used, hydraulic mulching should be applied as a separate operation, when practical, to prevent the seeds from being encapsulated in the mulch.

^b See Table TS/PS-3 for seeding dates. Irrigation, if consistently applied, may extend the use of cool season species during the summer months.

^c Seeding rates should be doubled if seed is broadcast, or increased by 50 percent if done using a Brillion Drill or by hydraulic seeding.

EC-2 Temporary and Permanent Seeding (TS/PS)

Table TS/PS-2. Minimum Drill Seeding Rates for Perennial Grasses

Common ^a Name	Botanical Name	Growth Season ^b	Growth Form	Seeds/ Pound	Pounds of PLS/acre
Alakali Soil Seed Mix					
Alkali sacaton	<i>Sporobolus airoides</i>	Cool	Bunch	1,750,000	0.25
Basin wildrye	<i>Elymus cinereus</i>	Cool	Bunch	165,000	2.5
Sodar streambank wheatgrass	<i>Agropyron riparium 'Sodar'</i>	Cool	Sod	170,000	2.5
Jose tall wheatgrass	<i>Agropyron elongatum 'Jose'</i>	Cool	Bunch	79,000	7.0
Arriba western wheatgrass	<i>Agropyron smithii 'Arriba'</i>	Cool	Sod	110,000	5.5
Total					17.75
Fertile Loamy Soil Seed Mix					
Ephriam crested wheatgrass	<i>Agropyron cristatum 'Ephriam'</i>	Cool	Sod	175,000	2.0
Dural hard fescue	<i>Festuca ovina 'duriuscula'</i>	Cool	Bunch	565,000	1.0
Lincoln smooth brome	<i>Bromus inermis leys 'Lincoln'</i>	Cool	Sod	130,000	3.0
Sodar streambank wheatgrass	<i>Agropyron riparium 'Sodar'</i>	Cool	Sod	170,000	2.5
Arriba western wheatgrass	<i>Agropyron smithii 'Arriba'</i>	Cool	Sod	110,000	7.0
Total					15.5
High Water Table Soil Seed Mix					
Meadow foxtail	<i>Alopecurus pratensis</i>	Cool	Sod	900,000	0.5
Redtop	<i>Agrostis alba</i>	Warm	Open sod	5,000,000	0.25
Reed canarygrass	<i>Phalaris arundinacea</i>	Cool	Sod	68,000	0.5
Lincoln smooth brome	<i>Bromus inermis leys 'Lincoln'</i>	Cool	Sod	130,000	3.0
Pathfinder switchgrass	<i>Panicum virgatum 'Pathfinder'</i>	Warm	Sod	389,000	1.0
Alkar tall wheatgrass	<i>Agropyron elongatum 'Alkar'</i>	Cool	Bunch	79,000	5.5
Total					10.75
Transition Turf Seed Mix^c					
Ruebens Canadian bluegrass	<i>Poa compressa 'Ruebens'</i>	Cool	Sod	2,500,000	0.5
Dural hard fescue	<i>Festuca ovina 'duriuscula'</i>	Cool	Bunch	565,000	1.0
Citation perennial ryegrass	<i>Lolium perenne 'Citation'</i>	Cool	Sod	247,000	3.0
Lincoln smooth brome	<i>Bromus inermis leys 'Lincoln'</i>	Cool	Sod	130,000	3.0
Total					7.5

Table TS/PS-2. Minimum Drill Seeding Rates for Perennial Grasses (cont.)

Common Name	Botanical Name	Growth Season ^b	Growth Form	Seeds/Pound	Pounds of PLS/acre
Sandy Soil Seed Mix					
Blue grama	<i>Bouteloua gracilis</i>	Warm	Sod-forming bunchgrass	825,000	0.5
Camper little bluestem	<i>Schizachyrium scoparium</i> 'Camper'	Warm	Bunch	240,000	1.0
Prairie sandreed	<i>Calamovilfa longifolia</i>	Warm	Open sod	274,000	1.0
Sand dropseed	<i>Sporobolus cryptandrus</i>	Cool	Bunch	5,298,000	0.25
Vaughn sideoats grama	<i>Bouteloua curtipendula</i> 'Vaughn'	Warm	Sod	191,000	2.0
Arriba western wheatgrass	<i>Agropyron smithii</i> 'Arriba'	Cool	Sod	110,000	5.5
Total					10.25
Heavy Clay, Rocky Foothill Seed Mix					
Ephriam crested wheatgrass ^d	<i>Agropyron cristatum</i> 'Ephriam'	Cool	Sod	175,000	1.5
Oahe Intermediate wheatgrass	<i>Agropyron intermedium</i> 'Oahe'	Cool	Sod	115,000	5.5
Vaughn sideoats grama ^e	<i>Bouteloua curtipendula</i> 'Vaughn'	Warm	Sod	191,000	2.0
Lincoln smooth brome	<i>Bromus inermis</i> leys 'Lincoln'	Cool	Sod	130,000	3.0
Arriba western wheatgrass	<i>Agropyron smithii</i> 'Arriba'	Cool	Sod	110,000	5.5
Total					17.5
<p>^a All of the above seeding mixes and rates are based on drill seeding followed by crimped straw mulch. These rates should be doubled if seed is broadcast and should be increased by 50 percent if the seeding is done using a Brillion Drill or is applied through hydraulic seeding. Hydraulic seeding may be substituted for drilling only where slopes are steeper than 3:1. If hydraulic seeding is used, hydraulic mulching should be done as a separate operation.</p> <p>^b See Table TS/PS-3 for seeding dates.</p> <p>^c If site is to be irrigated, the transition turf seed rates should be doubled.</p> <p>^d Crested wheatgrass should not be used on slopes steeper than 6H to 1V.</p> <p>^e Can substitute 0.5 lbs PLS of blue grama for the 2.0 lbs PLS of Vaughn sideoats grama.</p>					

EC-2 Temporary and Permanent Seeding (TS/PS)

Table TS/PS-3. Seeding Dates for Annual and Perennial Grasses

Seeding Dates	Annual Grasses (Numbers in table reference species in Table TS/PS-1)		Perennial Grasses	
	Warm	Cool	Warm	Cool
January 1–March 15			✓	✓
March 16–April 30	4	1,2,3	✓	✓
May 1–May 15	4		✓	
May 16–June 30	4,5,6,7			
July 1–July 15	5,6,7			
July 16–August 31				
September 1–September 30		8,9,10,11		
October 1–December 31			✓	✓

Mulch

Cover seeded areas with mulch or an appropriate rolled erosion control product to promote establishment of vegetation. Anchor mulch by crimping, netting or use of a non-toxic tackifier. See the Mulching BMP Fact Sheet for additional guidance.

Maintenance and Removal

Monitor and observe seeded areas to identify areas of poor growth or areas that fail to germinate. Reseed and mulch these areas, as needed.

An area that has been permanently seeded should have a good stand of vegetation within one growing season if irrigated and within three growing seasons without irrigation in Colorado. Reseed portions of the site that fail to germinate or remain bare after the first growing season.

Seeded areas may require irrigation, particularly during extended dry periods. Targeted weed control may also be necessary.

Protect seeded areas from construction equipment and vehicle access.

Description

Mulching consists of evenly applying straw, hay, shredded wood mulch, rock, bark or compost to disturbed soils and securing the mulch by crimping, tackifiers, netting or other measures. Mulching helps reduce erosion by protecting bare soil from rainfall impact, increasing infiltration, and reducing runoff. Although often applied in conjunction with temporary or permanent seeding, it can also be used for temporary stabilization of areas that cannot be reseeded due to seasonal constraints.

Mulch can be applied either using standard mechanical dry application methods or using hydromulching equipment that hydraulically applies a slurry of water, wood fiber mulch, and often a tackifier.



Photograph MU-1. An area that was recently seeded, mulched, and crimped.

Appropriate Uses

Use mulch in conjunction with seeding to help protect the seedbed and stabilize the soil. Mulch can also be used as a temporary cover on low to mild slopes to help temporarily stabilize disturbed areas where growing season constraints prevent effective reseeded. Disturbed areas should be properly mulched and tacked, or seeded, mulched and tacked promptly after final grade is reached (typically within no longer than 14 days) on portions of the site not otherwise permanently stabilized.

Standard dry mulching is encouraged in most jurisdictions; however, hydromulching may not be allowed in certain jurisdictions or may not be allowed near waterways.

Do not apply mulch during windy conditions.

Design and Installation

Prior to mulching, surface-roughen areas by rolling with a crimping or punching type roller or by track walking. Track walking should only be used where other methods are impractical because track walking with heavy equipment typically compacts the soil.

A variety of mulches can be used effectively at construction sites. Consider the following:

Mulch	
Functions	
Erosion Control	Yes
Sediment Control	Moderate
Site/Material Management	No

- Clean, weed-free and seed-free cereal grain straw should be applied evenly at a rate of 2 tons per acre and must be tacked or fastened by a method suitable for the condition of the site. Straw mulch must be anchored (and not merely placed) on the surface. This can be accomplished mechanically by crimping or with the aid of tackifiers or nets. Anchoring with a crimping implement is preferred, and is the recommended method for areas flatter than 3:1. Mechanical crimpers must be capable of tucking the long mulch fibers into the soil to a depth of 3 inches without cutting them. An agricultural disk, while not an ideal substitute, may work if the disk blades are dull or blunted and set vertically; however, the frame may have to be weighted to afford proper soil penetration.
- Grass hay may be used in place of straw; however, because hay is comprised of the entire plant including seed, mulching with hay may seed the site with non-native grass species which might in turn out-compete the native seed. Alternatively, native species of grass hay may be purchased, but can be difficult to find and are more expensive than straw. Purchasing and utilizing a certified weed-free straw is an easier and less costly mulching method. When using grass hay, follow the same guidelines as for straw (provided above).
- On small areas sheltered from the wind and heavy runoff, spraying a tackifier on the mulch is satisfactory for holding it in place. For steep slopes and special situations where greater control is needed, erosion control blankets anchored with stakes should be used instead of mulch.
- Hydraulic mulching consists of wood cellulose fibers mixed with water and a tackifying agent and should be applied at a rate of no less than 1,500 pounds per acre (1,425 lbs of fibers mixed with at least 75 lbs of tackifier) with a hydraulic mulcher. For steeper slopes, up to 2000 pounds per acre may be required for effective hydroseeding. Hydromulch typically requires up to 24 hours to dry; therefore, it should not be applied immediately prior to inclement weather. Application to roads, waterways and existing vegetation should be avoided.
- Erosion control mats, blankets, or nets are recommended to help stabilize steep slopes (generally 3:1 and steeper) and waterways. Depending on the product, these may be used alone or in conjunction with grass or straw mulch. Normally, use of these products will be restricted to relatively small areas. Biodegradable mats made of straw and jute, straw-coconut, coconut fiber, or excelsior can be used instead of mulch. (See the ECM/TRM BMP for more information.)
- Some tackifiers or binders may be used to anchor mulch. Check with the local jurisdiction for allowed tackifiers. Manufacturer's recommendations should be followed at all times. (See the Soil Binder BMP for more information on general types of tackifiers.)
- Rock can also be used as mulch. It provides protection of exposed soils to wind and water erosion and allows infiltration of precipitation. An aggregate base course can be spread on disturbed areas for temporary or permanent stabilization. The rock mulch layer should be thick enough to provide full coverage of exposed soil on the area it is applied.

Maintenance and Removal

After mulching, the bare ground surface should not be more than 10 percent exposed. Reapply mulch, as needed, to cover bare areas.

Description

Rolled Erosion Control Products (RECPs) include a variety of temporary or permanently installed manufactured products designed to control erosion and enhance vegetation establishment and survivability, particularly on slopes and in channels. For applications where natural vegetation alone will provide sufficient permanent erosion protection, temporary products such as netting, open weave textiles and a variety of erosion control blankets (ECBs) made of biodegradable natural materials (e.g., straw, coconut fiber) can be used. For applications where natural vegetation alone will not be sustainable under expected flow conditions, permanent rolled erosion control products such as turf reinforcement mats (TRMs) can be used. In particular, turf reinforcement mats are designed for discharges that exert velocities and shear stresses that exceed the typical limits of mature natural vegetation.



Photograph RECP-1. Erosion control blanket protecting the slope from erosion and providing favorable conditions for revegetation.

Appropriate Uses

RECPs can be used to control erosion in conjunction with revegetation efforts, providing seedbed protection from wind and water erosion. These products are often used on disturbed areas on steep slopes, in areas with highly erosive soils, or as part of drainageway stabilization. In order to select the appropriate RECP for site conditions, it is important to have a general understanding of the general types of these products, their expected longevity, and general characteristics.

The Erosion Control Technology Council (ECTC 2005) characterizes rolled erosion control products according to these categories:

- **Mulch control netting:** A planar woven natural fiber or extruded geosynthetic mesh used as a temporary degradable rolled erosion control product to anchor loose fiber mulches.
- **Open weave textile:** A temporary degradable rolled erosion control product composed of processed natural or polymer yarns woven into a matrix, used to provide erosion control and facilitate vegetation establishment.
- **Erosion control blanket (ECB):** A temporary degradable rolled erosion control product composed of processed natural or polymer fibers which are mechanically, structurally or chemically bound together to form a continuous matrix to provide erosion control and facilitate vegetation establishment. ECBs can be further differentiated into rapidly degrading single-net and double-net types or slowly degrading types.

Rolled Erosion Control Products	
Functions	
Erosion Control	Yes
Sediment Control	No
Site/Material Management	No

EC-6 Rolled Erosion Control Products (RECP)

- **Turf Reinforcement Mat (TRM):** A rolled erosion control product composed of non-degradable synthetic fibers, filaments, nets, wire mesh, and/or other elements, processed into a permanent, three-dimensional matrix of sufficient thickness. TRMs, which may be supplemented with degradable components, are designed to impart immediate erosion protection, enhance vegetation establishment and provide long-term functionality by permanently reinforcing vegetation during and after maturation. Note: TRMs are typically used in hydraulic applications, such as high flow ditches and channels, steep slopes, stream banks, and shorelines, where erosive forces may exceed the limits of natural, unreinforced vegetation or in areas where limited vegetation establishment is anticipated.

Tables RECP-1 and RECP-2 provide guidelines for selecting rolled erosion control products appropriate to site conditions and desired longevity. Table RECP-1 is for conditions where natural vegetation alone will provide permanent erosion control, whereas Table RECP-2 is for conditions where vegetation alone will not be adequately stable to provide long-term erosion protection due to flow or other conditions.

Table RECP-1. ECTC Standard Specification for Temporary Rolled Erosion Control Products
(Adapted from Erosion Control Technology Council 2005)

Product Description	Slope Applications*		Channel Applications*	Minimum Tensile Strength ¹	Expected Longevity
	Maximum Gradient	C Factor ^{2,5}			
Mulch Control Nets	5:1 (H:V)	≤0.10 @ 5:1	0.25 lbs/ft ² (12 Pa)	5 lbs/ft (0.073 kN/m)	Up to 12 months
Netless Rolled Erosion Control Blankets	4:1 (H:V)	≤0.10 @ 4:1	0.5 lbs/ft ² (24 Pa)	5 lbs/ft (0.073 kN/m)	
Single-net Erosion Control Blankets & Open Weave Textiles	3:1 (H:V)	≤0.15 @ 3:1	1.5 lbs/ft ² (72 Pa)	50 lbs/ft (0.73 kN/m)	
Double-net Erosion Control Blankets	2:1 (H:V)	≤0.20 @ 2:1	1.75 lbs/ft ² (84 Pa)	75 lbs/ft (1.09 kN/m)	
Mulch Control Nets	5:1 (H:V)	≤0.10 @ 5:1	0.25 lbs/ft ² (12 Pa)	25 lbs/ft (0.36 kN/m)	24 months
Erosion Control Blankets & Open Weave Textiles (slowly degrading)	1.5:1 (H:V)	≤0.25 @ 1.5:1	2.00 lbs/ft ² (96 Pa)	100 lbs/ft (1.45 kN/m)	24 months
Erosion Control Blankets & Open Weave Textiles	1:1 (H:V)	≤0.25 @ 1:1	2.25 lbs/ft ² (108 Pa)	125 lbs/ft (1.82 kN/m)	36 months

* C Factor and shear stress for mulch control nettings must be obtained with netting used in conjunction with pre-applied mulch material. (See Section 5.3 of Chapter 7 Construction BMPs for more information on the C Factor.)

¹ Minimum Average Roll Values, Machine direction using ECTC Mod. ASTM D 5035.

² C Factor calculated as ratio of soil loss from RECP protected slope (tested at specified or greater gradient, H:V) to ratio of soil loss from unprotected (control) plot in large-scale testing.

³ Required minimum shear stress RECP (unvegetated) can sustain without physical damage or excess erosion (> 12.7 mm (0.5 in) soil loss) during a 30-minute flow event in large-scale testing.

⁴ The permissible shear stress levels established for each performance category are based on historical experience with products characterized by Manning's roughness coefficients in the range of 0.01 - 0.05.

⁵ Acceptable large-scale test methods may include ASTM D 6459, or other independent testing deemed acceptable by the engineer.

⁶ Per the engineer's discretion. Recommended acceptable large-scale testing protocol may include ASTM D 6460, or other independent testing deemed acceptable by the engineer.

Table RECP-2. ECTC Standard Specification for Permanent¹ Rolled Erosion Control Products
 (Adapted from: Erosion Control Technology Council 2005)

Product Type	Slope Applications	Channel Applications	
TRMs with a minimum thickness of 0.25 inches (6.35 mm) per ASTM D 6525 and UV stability of 80% per ASTM D 4355 (500 hours exposure).	Maximum Gradient	Maximum Shear Stress ^{4,5}	Minimum Tensile Strength ^{2,3}
	0.5:1 (H:V)	6.0 lbs/ft ² (288 Pa)	125 lbs/ft (1.82 kN/m)
	0.5:1 (H:V)	8.0 lbs/ft ² (384 Pa)	150 lbs/ft (2.19 kN/m)
	0.5:1 (H:V)	10.0 lbs/ft ² (480 Pa)	175 lbs/ft (2.55 kN/m)

¹ For TRMs containing degradable components, all property values must be obtained on the non-degradable portion of the matting alone.

² Minimum Average Roll Values, machine direction only for tensile strength determination using [ASTM D 6818](#) (Supersedes Mod. [ASTM D 5035](#) for RECPs)

³ Field conditions with high loading and/or high survivability requirements may warrant the use of a TRM with a tensile strength of 44 kN/m (3,000 lb/ft) or greater.

⁴ Required minimum shear stress TRM (fully vegetated) can sustain without physical damage or excess erosion (> 12.7 mm (0.5 in.) soil loss) during a 30-minute flow event in large scale testing.

⁵ Acceptable large-scale testing protocols may include [ASTM D 6460](#), or other independent testing deemed acceptable by the engineer.

Design and Installation

RECPs should be installed according to manufacturer’s specifications and guidelines. Regardless of the type of product used, it is important to ensure no gaps or voids exist under the material and that all corners of the material are secured using stakes and trenching. Continuous contact between the product and the soil is necessary to avoid failure. Never use metal stakes to secure temporary erosion control products. Often wooden stakes are used to anchor RECPs; however, wood stakes may present installation and maintenance challenges and generally take a long time to biodegrade. Some local jurisdictions have had favorable experiences using biodegradable stakes.

This BMP Fact Sheet provides design details for several commonly used ECB applications, including:

ECB-1 Pipe Outlet to Drainageway

ECB-2 Small Ditch or Drainageway

ECB-3 Outside of Drainageway

Staking patterns are also provided in the design details according to these factors:

- ECB type
- Slope or channel type

For other types of RECPs including TRMs, these design details are intended to serve as general guidelines for design and installation; however, engineers should adhere to manufacturer's installation recommendations.

Maintenance and Removal

Inspection of erosion control blankets and other RECPs includes:

- Check for general signs of erosion, including voids beneath the mat. If voids are apparent, fill the void with suitable soil and replace the erosion control blanket, following the appropriate staking pattern.
- Check for damaged or loose stakes and secure loose portions of the blanket.

Erosion control blankets and other RECPs that are biodegradable typically do not need to be removed after construction. If they must be removed, then an alternate soil stabilization method should be installed promptly following removal.

Turf reinforcement mats, although generally resistant to biodegradation, are typically left in place as a dense vegetated cover grows in through the mat matrix. The turf reinforcement mat provides long-term stability and helps the established vegetation resist erosive forces.

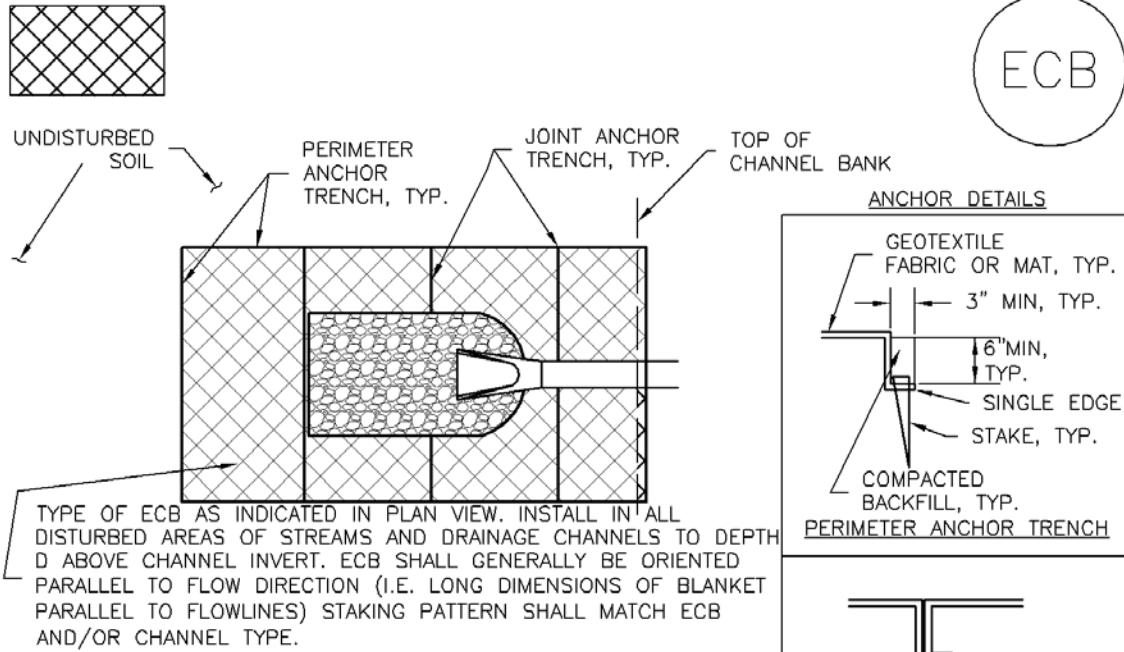

ECB-1. PIPE OUTLET TO DRAINAGEWAY

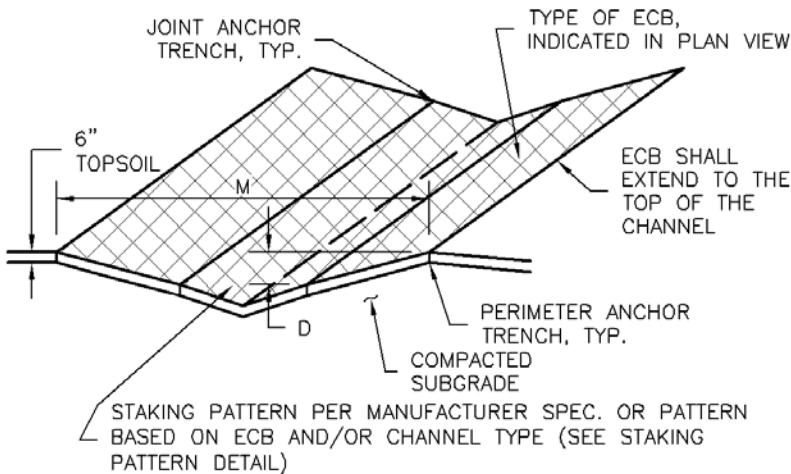

ECB-2. SMALL DITCH OR DRAINAGEWAY

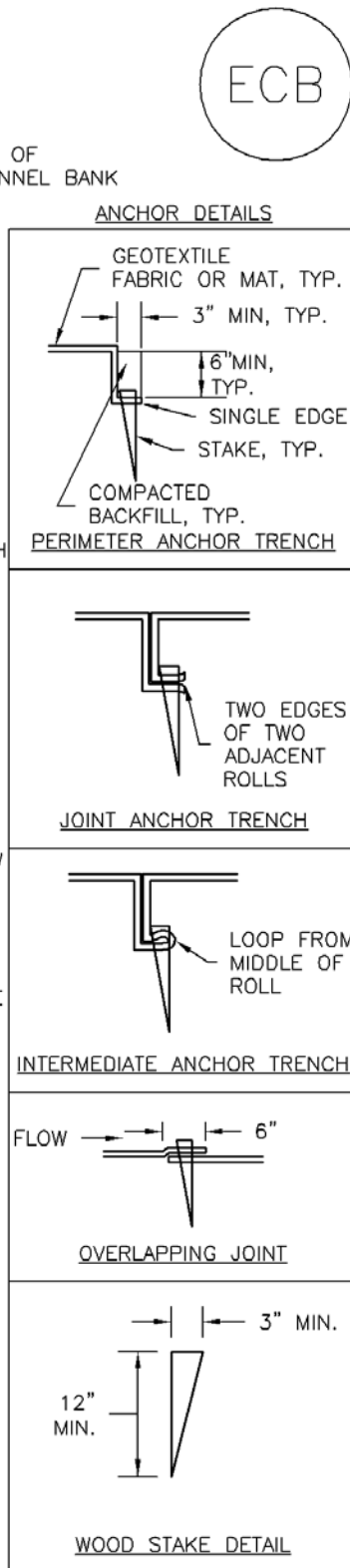

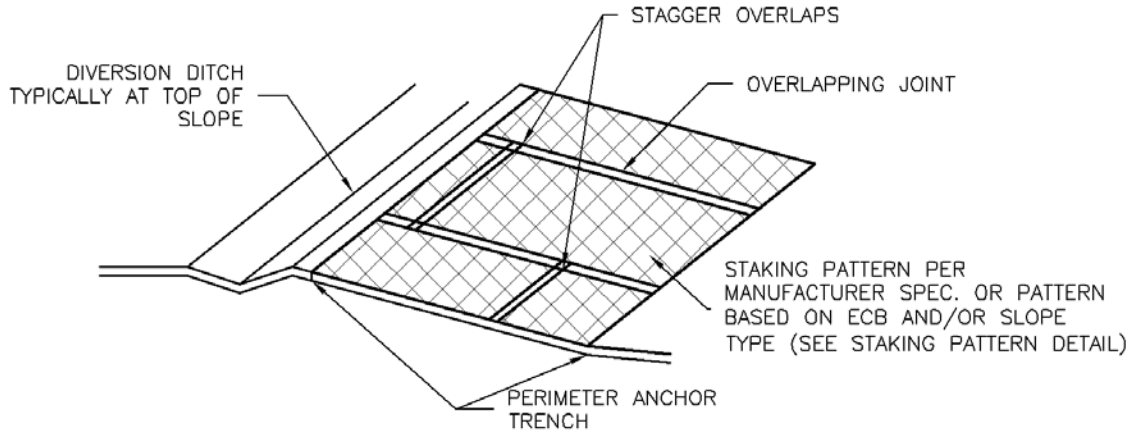

ECB-3. OUTSIDE OF DRAINAGEWAY

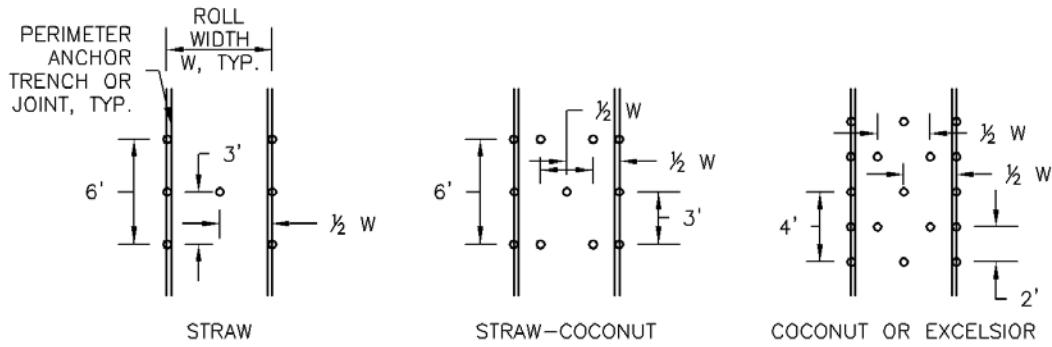

STAKING PATTERNS BY ECB TYPE

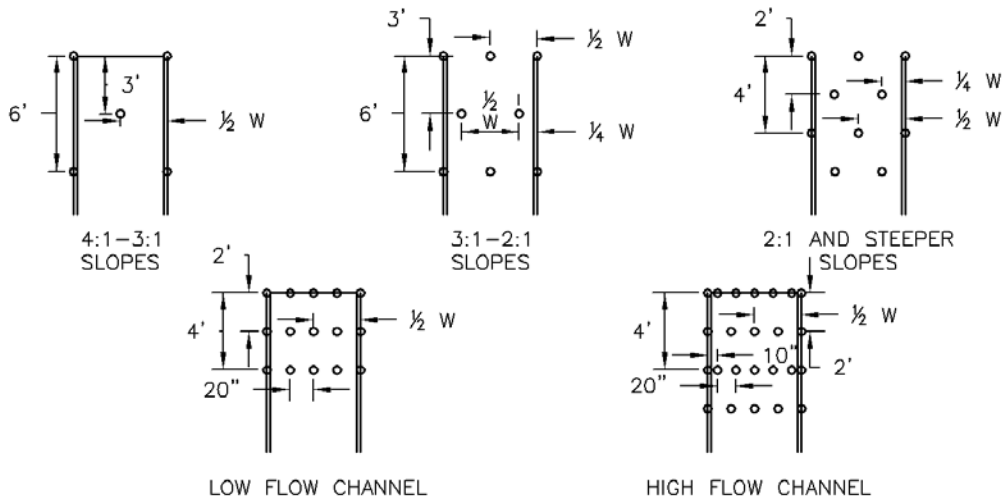

STAKING PATTERNS BY SLOPE OR CHANNEL TYPE

EROSION CONTROL BLANKET INSTALLATION NOTES

1. SEE PLAN VIEW FOR:
 - LOCATION OF ECB.
 - TYPE OF ECB (STRAW, STRAW-COCONUT, COCONUT, OR EXCELSIOR).
 - AREA, A, IN SQUARE YARDS OF EACH TYPE OF ECB.
2. 100% NATURAL AND BIODEGRADABLE MATERIALS ARE PREFERRED FOR RECPs, ALTHOUGH SOME JURISDICTIONS MAY ALLOW OTHER MATERIALS IN SOME APPLICATIONS.
3. IN AREAS WHERE ECBs ARE SHOWN ON THE PLANS, THE PERMITTEE SHALL PLACE TOPSOIL AND PERFORM FINAL GRADING, SURFACE PREPARATION, AND SEEDING AND MULCHING. SUBGRADE SHALL BE SMOOTH AND MOIST PRIOR TO ECB INSTALLATION AND THE ECB SHALL BE IN FULL CONTACT WITH SUBGRADE. NO GAPS OR VOIDS SHALL EXIST UNDER THE BLANKET.
4. PERIMETER ANCHOR TRENCH SHALL BE USED ALONG THE OUTSIDE PERIMETER OF ALL BLANKET AREAS.
5. JOINT ANCHOR TRENCH SHALL BE USED TO JOIN ROLLS OF ECBs TOGETHER (LONGITUDINALLY AND TRANSVERSELY) FOR ALL ECBs EXCEPT STRAW WHICH MAY USE AN OVERLAPPING JOINT.
6. INTERMEDIATE ANCHOR TRENCH SHALL BE USED AT SPACING OF ONE-HALF ROLL LENGTH FOR COCONUT AND EXCELSIOR ECBs.
7. OVERLAPPING JOINT DETAIL SHALL BE USED TO JOIN ROLLS OF ECBs TOGETHER FOR ECBs ON SLOPES.
8. MATERIAL SPECIFICATIONS OF ECBs SHALL CONFORM TO TABLE ECB-1.
9. ANY AREAS OF SEEDING AND MULCHING DISTURBED IN THE PROCESS OF INSTALLING ECBs SHALL BE RESEEDED AND MULCHED.
10. DETAILS ON DESIGN PLANS FOR MAJOR DRAINAGEWAY STABILIZATION WILL GOVERN IF DIFFERENT FROM THOSE SHOWN HERE.

TABLE ECB-1. ECB MATERIAL SPECIFICATIONS				
TYPE	COCONUT CONTENT	STRAW CONTENT	EXCELSIOR CONTENT	RECOMMENDED NETTING**
STRAW*	-	100%	-	DOUBLE/ NATURAL
STRAW-COCONUT	30% MIN	70% MAX	-	DOUBLE/ NATURAL
COCONUT	100%	-	-	DOUBLE/ NATURAL
EXCELSIOR	-	-	100%	DOUBLE/ NATURAL

*STRAW ECBs MAY ONLY BE USED OUTSIDE OF STREAMS AND DRAINAGE CHANNEL.
 **ALTERNATE NETTING MAY BE ACCEPTABLE IN SOME JURISDICTIONS

EROSION CONTROL BLANKET MAINTENANCE NOTES

1. INSPECT BMPs EACH WORKDAY, AND MAINTAIN THEM IN EFFECTIVE OPERATING CONDITION. MAINTENANCE OF BMPs SHOULD BE PROACTIVE, NOT REACTIVE. INSPECT BMPs AS SOON AS POSSIBLE (AND ALWAYS WITHIN 24 HOURS) FOLLOWING A STORM THAT CAUSES SURFACE EROSION, AND PERFORM NECESSARY MAINTENANCE.
2. FREQUENT OBSERVATIONS AND MAINTENANCE ARE NECESSARY TO MAINTAIN BMPs IN EFFECTIVE OPERATING CONDITION. INSPECTIONS AND CORRECTIVE MEASURES SHOULD BE DOCUMENTED THOROUGHLY.
3. WHERE BMPs HAVE FAILED, REPAIR OR REPLACEMENT SHOULD BE INITIATED UPON DISCOVERY OF THE FAILURE.
4. ECBs SHALL BE LEFT IN PLACE TO EVENTUALLY BIODEGRADE, UNLESS REQUESTED TO BE REMOVED BY THE LOCAL JURISDICTION.
5. ANY ECB PULLED OUT, TORN, OR OTHERWISE DAMAGED SHALL BE REPAIRED OR REINSTALLED. ANY SUBGRADE AREAS BELOW THE GEOTEXTILE THAT HAVE ERODED TO CREATED A VOID UNDER THE BLANKET, OR THAT REMAIN DEVOID OF GRASS SHALL BE REPAIRED, RESEDED AND MULCHED AND THE ECB REINSTALLED.

NOTE: MANY JURISDICTIONS HAVE BMP DETAILS THAT VARY FROM UDFCD STANDARD DETAILS. CONSULT WITH LOCAL JURISDICTIONS AS TO WHICH DETAIL SHOULD BE USED WHEN DIFFERENCES ARE NOTED.

(DETAILS ADAPTED FROM DOUGLAS COUNTY, COLORADO AND TOWN OF PARKER COLORADO, NOT AVAILABLE IN AUTOCAD)

Description

A stabilized staging area is a clearly designated area where construction equipment and vehicles, stockpiles, waste bins, and other construction-related materials are stored. The contractor office trailer may also be located in this area. Depending on the size of the construction site, more than one staging area may be necessary.



Photograph SSA-1. Example of a staging area with a gravel surface to prevent mud tracking and reduce runoff. Photo courtesy of Douglas County.

Appropriate Uses

Most construction sites will require a staging area, which should be clearly designated in SWMP drawings. The layout of the staging area may vary depending on the type of construction activity. Staging areas located in roadways due to space constraints require special measures to avoid materials being washed into storm inlets.

Design and Installation

Stabilized staging areas should be completed prior to other construction activities beginning on the site. Major components of a stabilized staging area include:

- Appropriate space to contain storage and provide for loading/unloading operations, as well as parking if necessary.
- A stabilized surface, either paved or covered, with 3-inch diameter aggregate or larger.
- Perimeter controls such as silt fence, sediment control logs, or other measures.
- Construction fencing to prevent unauthorized access to construction materials.
- Provisions for Good Housekeeping practices related to materials storage and disposal, as described in the Good Housekeeping BMP Fact Sheet.
- A stabilized construction entrance/exit, as described in the Vehicle Tracking Control BMP Fact Sheet, to accommodate traffic associated with material delivery and waste disposal vehicles.

Over-sizing the stabilized staging area may result in disturbance of existing vegetation in excess of that required for the project. This increases costs, as well as requirements for long-term stabilization following the construction period. When designing the stabilized staging area, minimize the area of disturbance to the extent practical.

Stabilized Staging Area	
Functions	
Erosion Control	Yes
Sediment Control	Moderate
Site/Material	Yes

Minimizing Long-Term Stabilization Requirements

- Utilize off-site parking and restrict vehicle access to the site.
- Use construction mats in lieu of rock when staging is provided in an area that will not be disturbed otherwise.
- Consider use of a bermed contained area for materials and equipment that do not require a stabilized surface.
- Consider phasing of staging areas to avoid disturbance in an area that will not be otherwise disturbed.

See Detail SSA-1 for a typical stabilized staging area and SSA-2 for a stabilized staging area when materials staging in roadways is required.

Maintenance and Removal

Maintenance of stabilized staging areas includes maintaining a stable surface cover of gravel, repairing perimeter controls, and following good housekeeping practices.

When construction is complete, debris, unused stockpiles and materials should be recycled or properly disposed. In some cases, this will require disposal of contaminated soil from equipment leaks in an appropriate landfill. Staging areas should then be permanently stabilized with vegetation or other surface cover planned for the development.

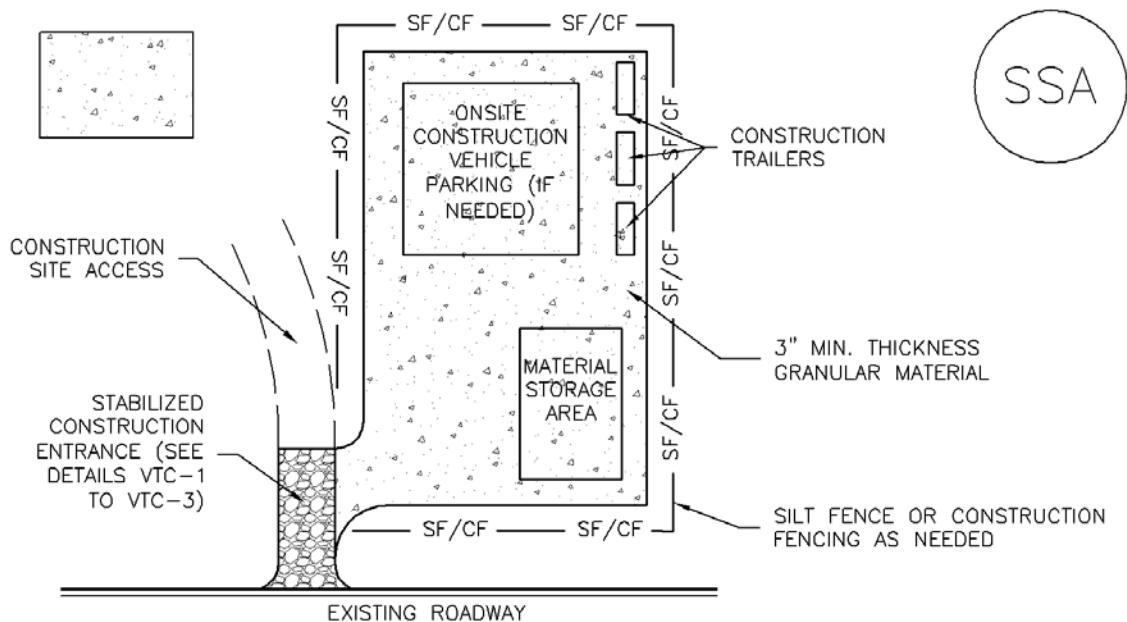

SSA-1. STABILIZED STAGING AREA

STABILIZED STAGING AREA INSTALLATION NOTES

1. SEE PLAN VIEW FOR
 - LOCATION OF STAGING AREA(S).
 - CONTRACTOR MAY ADJUST LOCATION AND SIZE OF STAGING AREA WITH APPROVAL FROM THE LOCAL JURISDICTION.
2. STABILIZED STAGING AREA SHOULD BE APPROPRIATE FOR THE NEEDS OF THE SITE. OVERSIZING RESULTS IN A LARGER AREA TO STABILIZE FOLLOWING CONSTRUCTION.
3. STAGING AREA SHALL BE STABILIZED PRIOR TO OTHER OPERATIONS ON THE SITE.
4. THE STABILIZED STAGING AREA SHALL CONSIST OF A MINIMUM 3" THICK GRANULAR MATERIAL.
5. UNLESS OTHERWISE SPECIFIED BY LOCAL JURISDICTION, ROCK SHALL CONSIST OF DOT SECT. #703, AASHTO #3 COARSE AGGREGATE OR 6" (MINUS) ROCK.
6. ADDITIONAL PERIMETER BMPs MAY BE REQUIRED INCLUDING BUT NOT LIMITED TO SILT FENCE AND CONSTRUCTION FENCING.

STABILIZED STAGING AREA MAINTENANCE NOTES

1. INSPECT BMPs EACH WORKDAY, AND MAINTAIN THEM IN EFFECTIVE OPERATING CONDITION. MAINTENANCE OF BMPs SHOULD BE PROACTIVE, NOT REACTIVE. INSPECT BMPs AS SOON AS POSSIBLE (AND ALWAYS WITHIN 24 HOURS) FOLLOWING A STORM THAT CAUSES SURFACE EROSION, AND PERFORM NECESSARY MAINTENANCE.
2. FREQUENT OBSERVATIONS AND MAINTENANCE ARE NECESSARY TO MAINTAIN BMPs IN EFFECTIVE OPERATING CONDITION. INSPECTIONS AND CORRECTIVE MEASURES SHOULD BE DOCUMENTED THOROUGHLY.
3. WHERE BMPs HAVE FAILED, REPAIR OR REPLACEMENT SHOULD BE INITIATED UPON DISCOVERY OF THE FAILURE.
4. ROCK SHALL BE REAPPLIED OR REGRADED AS NECESSARY IF RUTTING OCCURS OR UNDERLYING SUBGRADE BECOMES EXPOSED.

STABILIZED STAGING AREA MAINTENANCE NOTES

5. STABILIZED STAGING AREA SHALL BE ENLARGED IF NECESSARY TO CONTAIN PARKING, STORAGE, AND UNLOADING/LOADING OPERATIONS.

6. THE STABILIZED STAGING AREA SHALL BE REMOVED AT THE END OF CONSTRUCTION. THE GRANULAR MATERIAL SHALL BE REMOVED OR, IF APPROVED BY THE LOCAL JURISDICTION, USED ON SITE, AND THE AREA COVERED WITH TOPSOIL, SEEDED AND MULCHED OR OTHERWISE STABILIZED IN A MANNER APPROVED BY LOCAL JURISDICTION.

NOTE: MANY MUNICIPALITIES PROHIBIT THE USE OF RECYCLED CONCRETE AS GRANULAR MATERIAL FOR STABILIZED STAGING AREAS DUE TO DIFFICULTIES WITH RE-ESTABLISHMENT OF VEGETATION IN AREAS WHERE RECYCLED CONCRETE WAS PLACED.

NOTE: MANY JURISDICTIONS HAVE BMP DETAILS THAT VARY FROM UDFCD STANDARD DETAILS. CONSULT WITH LOCAL JURISDICTIONS AS TO WHICH DETAIL SHOULD BE USED WHEN DIFFERENCES ARE NOTED.

(DETAILS ADAPTED FROM DOUGLAS COUNTY, COLORADO, NOT AVAILABLE IN AUTOCAD)

Temporary Swale

What it is

A temporary swale is an earth channel used to convey runoff. A temporary swale can be excavated or formed upslope from an earthen berm, and may be lined or unlined.



When and Where to use it

- At the top of a slope to divert upland runoff away from the slope face.
- At the bottom of a slope to convey sediment-laden runoff to a sediment-trapping device such as a sediment basin.
- Along the perimeter of the construction site to keep runoff from leaving the site.

Figure TSW-1 illustrates cases where temporary swales are most effective.

When and Where NOT to use it

- Where longitudinal slope exceeds 10 percent (lining is required where longitudinal slope exceeds 2 percent).
- In areas where concentrated flow will overtop the swale transversely.

Construction Detail and Maintenance Requirements

Figure TSW-2 provides a construction detail and maintenance requirements for a temporary swale. Figure TSW-3 provides a construction detail and maintenance requirements for swale linings.

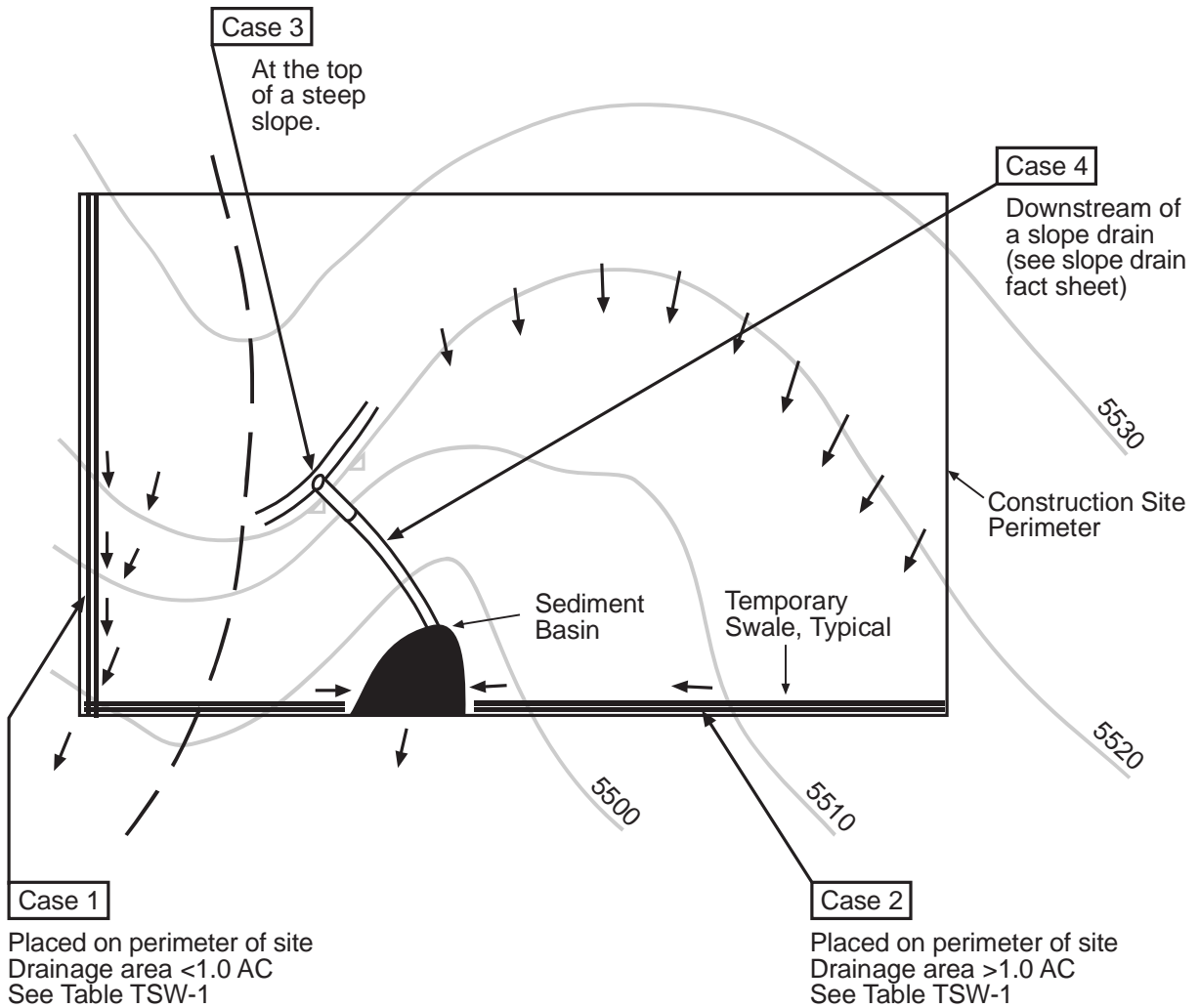

Table TSW-1

Temporary Swale Used as Perimeter Control	Case 1 DA < 1.0 AC	Case 2 DA > 1.0 AC
Continuous Grade	OK ⁽¹⁾	OK ⁽¹⁾
Area of Concentrated Flow	NO ⁽³⁾	NO ⁽²⁾

(1) Silt Fence or Straw Bale Barrier may be used as alternative to a Temporary Swale.

(2) With Temporary Swales Sediment Basin is required for concentrated flow from drainage areas > 1.0 AC.

(3) Check Dam is required at concentrated flow for drainage areas > 1.0 acres.

CONVEYANCE
SIZED FOR 2 YEAR
FLOW OR GREATER

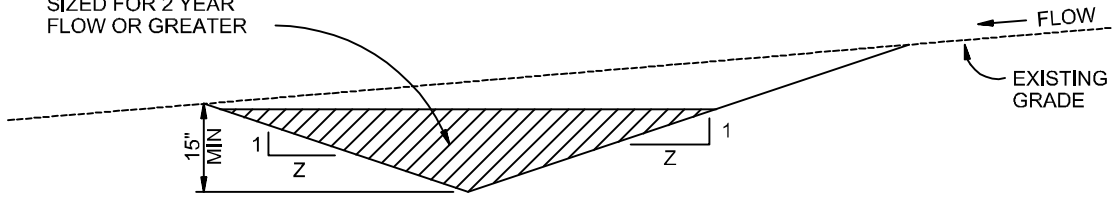

A. EXCAVATED SWALE

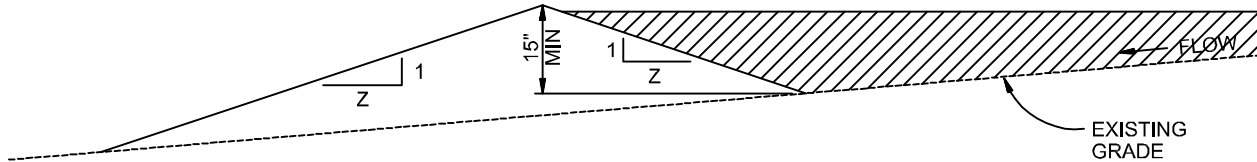

B. SWALE FORMED BY BERM

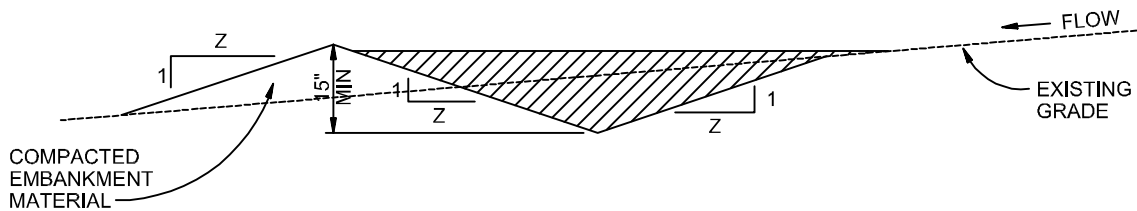

C. SWALE FORMED BY CUT AND FILL

COMPACTED
EMBANKMENT
MATERIAL

TEMPORARY SWALE

NTS

TEMPORARY SWALE NOTES

INSTALLATION REQUIREMENTS

1. TEMPORARY SWALES SHALL BE INSTALLED PRIOR TO ANY LAND DISTURBING ACTIVITIES.
2. THE AREA UNDER WHICH THE EMBANKMENT IS TO BE INSTALLED SHALL BE CLEARED, GRUBBED, AND STRIPPED OF ALL VEGETATION AND ROOT MAT.
3. EMBANKMENT MATERIAL SHALL CONSIST OF SOIL WITH A MINIMUM OF 15% PASSING A #200 SIEVE. EXCAVATED SOIL CAN BE USED IF IT MEETS THIS REQUIREMENT.
4. EMBANKMENT IS TO BE COMPACTED TO AT LEAST 90% OF MAXIMUM DENSITY AND WITHIN 2% OF OPTIMUM MOISTURE CONTENT ACCORDING TO ASTM D 698.
5. SWALES WITH SLOPE > 2% SHALL BE LINED, SEE FIGURE TSW-3.
6. SWALES ARE TO DRAIN INTO A SEDIMENT BASIN OR OTHER STABILIZED OUTLET.
7. Z SHALL BE 3 OR GREATER.

MAINTENANCE REQUIREMENTS

1. CONTRACTOR SHALL INSPECT SWALES AFTER EACH RAINFALL, AT LEAST DAILY DURING PROLONGED RAINFALL, AND WEEKLY DURING PERIODS OF NO RAINFALL.
2. SWALES SHALL BE ROUTINELY CLEARED OF ANY DEBRIS OR ACCUMULATION OF SEDIMENT.
3. ERODED SLOPES OR DAMAGED LININGS SHALL IMMEDIATELY BE REPAIRED.
4. TEMPORARY SWALES SHALL REMAIN OPERATIONAL AND PROPERLY MAINTAINED UNTIL THE SITE AREA IS PERMANENTLY STABILIZED WITH ADEQUATE VEGETATIVE COVER AND/OR OTHER PERMANENT STRUCTURE AS APPROVED BY THE CITY.

City of Colorado Springs
Stormwater Quality

Figure TSW-2
Temporary Swale
Construction Detail and Maintenance
Requirements

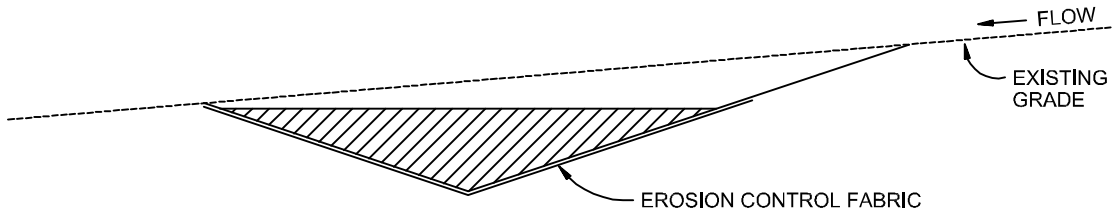

A. EROSION CONTROL FABRIC
 $2\% \leq \text{SLOPE} \leq 5\%$ AND VELOCITY ≤ 8 FPS

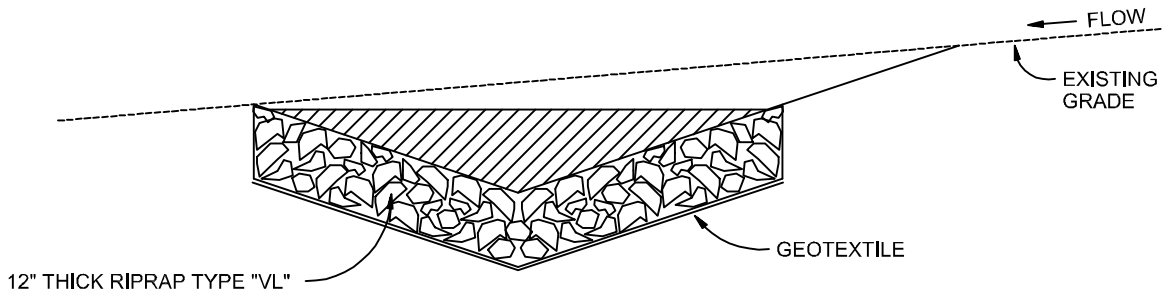

B. RIPRAP
 SLOPE $> 5\%$ OR VELOCITY > 8 FPS

SWALE LINING
 NTS

SWALE LINING NOTES

INSTALLATION REQUIREMENTS

1. REFER TO THE EROSION CONTROL BLANKETS FACTSHEET FOR PROPER INSTALLATION OF EROSION CONTROL FABRIC LINING.
2. SWALES WITH EASILY EROSIVE SOILS AND SLOPES LESS THAN 2%, SHALL BE LINED WITH EROSION CONTROL FABRIC.
3. VELOCITIES FOR EROSION CONTROL FABRICS SHALL NOT EXCEED 8 FPS. SWALES WITH VELOCITIES GREATER THAN 8 FPS SHALL BE LINED WITH RIP RAP.

MAINTENANCE REQUIREMENTS

1. CONTRACTOR SHALL INSPECT SWALE LININGS AFTER EACH RAINFALL, AT LEAST DAILY DURING PROLONGED RAINFALL AND WEEKLY DURING PERIODS OF NO RAINFALL.
2. DAMAGED LININGS SHALL IMMEDIATELY BE REPAIRED.
3. REFER TO THE EROSION CONTROL BLANKETS FACTSHEET FOR PROPER MAINTENANCE.
4. DISPLACED RIPRAP OR COARSE AGGREGATE IS TO BE REPLACED AS SOON AS POSSIBLE.
5. SWALE LININGS ARE TO REMAIN IN PLACE AND BE PROPERLY MAINTAINED UNTIL THE TEMPORARY SWALE IS REMOVED.

Temporary Swale

What it is

A temporary swale is an earth channel used to convey runoff. A temporary swale can be excavated or formed upslope from an earthen berm, and may be lined or unlined.



When and Where to use it

- At the top of a slope to divert upland runoff away from the slope face.
- At the bottom of a slope to convey sediment-laden runoff to a sediment-trapping device such as a sediment basin.
- Along the perimeter of the construction site to keep runoff from leaving the site.

Figure TSW-1 illustrates cases where temporary swales are most effective.

When and Where NOT to use it

- Where longitudinal slope exceeds 10 percent (lining is required where longitudinal slope exceeds 2 percent).
- In areas where concentrated flow will overtop the swale transversely.

Construction Detail and Maintenance Requirements

Figure TSW-2 provides a construction detail and maintenance requirements for a temporary swale. Figure TSW-3 provides a construction detail and maintenance requirements for swale linings.

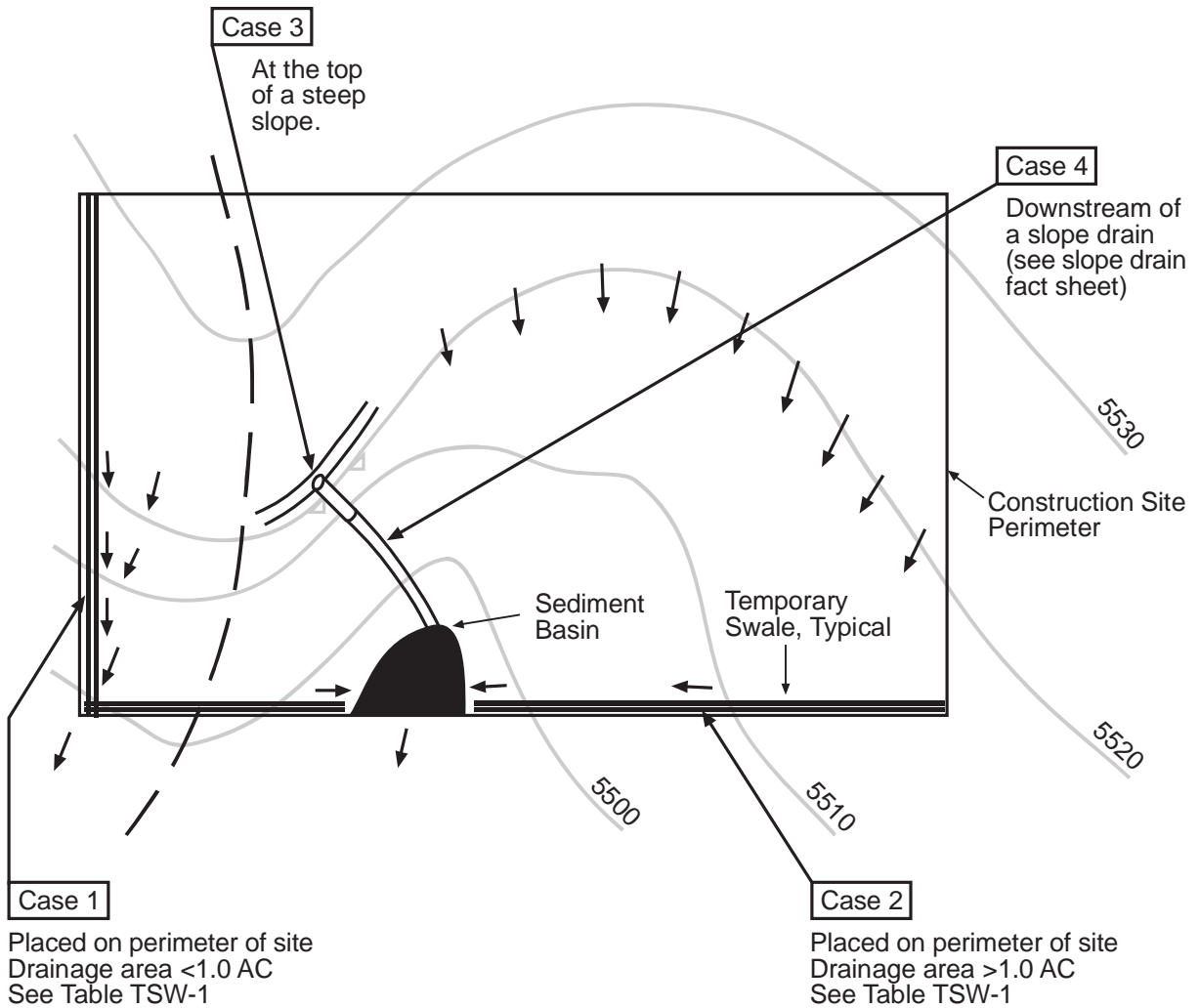

Table TSW-1

Temporary Swale Used as Perimeter Control	Case 1 DA < 1.0 AC	Case 2 DA > 1.0 AC
Continuous Grade	OK ⁽¹⁾	OK ⁽¹⁾
Area of Concentrated Flow	NO ⁽³⁾	NO ⁽²⁾

(1) Silt Fence or Straw Bale Barrier may be used as alternative to a Temporary Swale.

(2) With Temporary Swales Sediment Basin is required for concentrated flow from drainage areas > 1.0 AC.

(3) Check Dam is required at concentrated flow for drainage areas > 1.0 acres.

CONVEYANCE
SIZED FOR 2 YEAR
FLOW OR GREATER

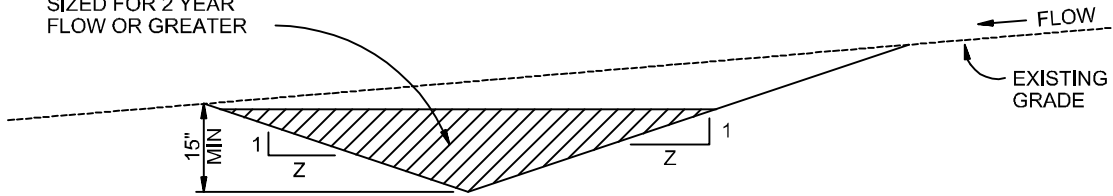

A. EXCAVATED SWALE

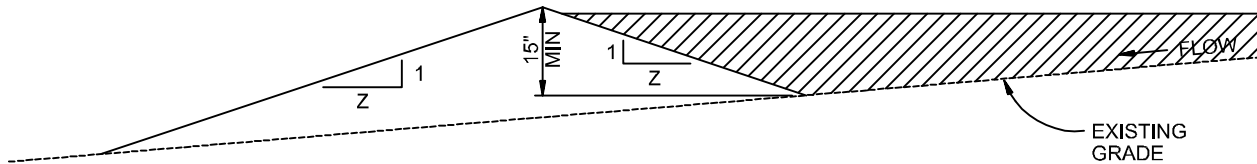

B. SWALE FORMED BY BERM

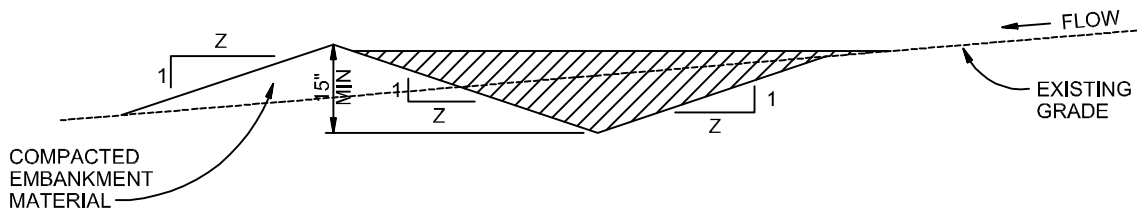

C. SWALE FORMED BY CUT AND FILL

COMPACTED
EMBANKMENT
MATERIAL

TEMPORARY SWALE

NTS

TEMPORARY SWALE NOTES

INSTALLATION REQUIREMENTS

1. TEMPORARY SWALES SHALL BE INSTALLED PRIOR TO ANY LAND DISTURBING ACTIVITIES.
2. THE AREA UNDER WHICH THE EMBANKMENT IS TO BE INSTALLED SHALL BE CLEARED, GRUBBED, AND STRIPPED OF ALL VEGETATION AND ROOT MAT.
3. EMBANKMENT MATERIAL SHALL CONSIST OF SOIL WITH A MINIMUM OF 15% PASSING A #200 SIEVE. EXCAVATED SOIL CAN BE USED IF IT MEETS THIS REQUIREMENT.
4. EMBANKMENT IS TO BE COMPACTED TO AT LEAST 90% OF MAXIMUM DENSITY AND WITHIN 2% OF OPTIMUM MOISTURE CONTENT ACCORDING TO ASTM D 698.
5. SWALES WITH SLOPE > 2% SHALL BE LINED, SEE FIGURE TSW-3.
6. SWALES ARE TO DRAIN INTO A SEDIMENT BASIN OR OTHER STABILIZED OUTLET.
7. Z SHALL BE 3 OR GREATER.

MAINTENANCE REQUIREMENTS

1. CONTRACTOR SHALL INSPECT SWALES AFTER EACH RAINFALL, AT LEAST DAILY DURING PROLONGED RAINFALL, AND WEEKLY DURING PERIODS OF NO RAINFALL.
2. SWALES SHALL BE ROUTINELY CLEARED OF ANY DEBRIS OR ACCUMULATION OF SEDIMENT.
3. ERODED SLOPES OR DAMAGED LININGS SHALL IMMEDIATELY BE REPAIRED.
4. TEMPORARY SWALES SHALL REMAIN OPERATIONAL AND PROPERLY MAINTAINED UNTIL THE SITE AREA IS PERMANENTLY STABILIZED WITH ADEQUATE VEGETATIVE COVER AND/OR OTHER PERMANENT STRUCTURE AS APPROVED BY THE CITY.

City of Colorado Springs
Stormwater Quality

Figure TSW-2
Temporary Swale
Construction Detail and Maintenance
Requirements

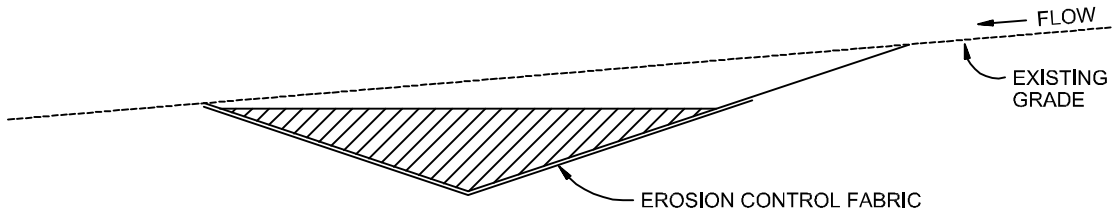

A. EROSION CONTROL FABRIC
 $2\% \leq \text{SLOPE} \leq 5\%$ AND VELOCITY ≤ 8 FPS

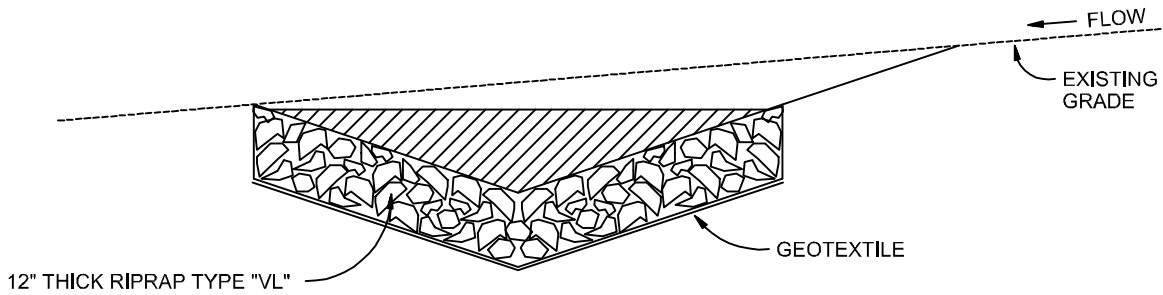

B. RIPRAP
 SLOPE $> 5\%$ OR VELOCITY > 8 FPS

SWALE LINING
 NTS

SWALE LINING NOTES

INSTALLATION REQUIREMENTS

1. REFER TO THE EROSION CONTROL BLANKETS FACTSHEET FOR PROPER INSTALLATION OF EROSION CONTROL FABRIC LINING.
2. SWALES WITH EASILY EROSIVE SOILS AND SLOPES LESS THAN 2%, SHALL BE LINED WITH EROSION CONTROL FABRIC.
3. VELOCITIES FOR EROSION CONTROL FABRICS SHALL NOT EXCEED 8 FPS. SWALES WITH VELOCITIES GREATER THAN 8 FPS SHALL BE LINED WITH RIP RAP.

MAINTENANCE REQUIREMENTS

1. CONTRACTOR SHALL INSPECT SWALE LININGS AFTER EACH RAINFALL, AT LEAST DAILY DURING PROLONGED RAINFALL AND WEEKLY DURING PERIODS OF NO RAINFALL.
2. DAMAGED LININGS SHALL IMMEDIATELY BE REPAIRED.
3. REFER TO THE EROSION CONTROL BLANKETS FACTSHEET FOR PROPER MAINTENANCE.
4. DISPLACED RIPRAP OR COARSE AGGREGATE IS TO BE REPLACED AS SOON AS POSSIBLE.
5. SWALE LININGS ARE TO REMAIN IN PLACE AND BE PROPERLY MAINTAINED UNTIL THE TEMPORARY SWALE IS REMOVED.

APPENDIX E – SWMP CHECKLIST



3275 Akers Drive
 Colorado Springs, CO 80922
 Phone 719-520-6460
 Fax 719-520-6879
 www.elpasoco.com

EL PASO COUNTY STORMWATER MANAGEMENT PLAN CHECKLIST

EPC Project Number:

Revised: October 2021

		Applicant	EPC
1. STORMWATER MANAGEMENT PLAN (in the "Applicant" column specify the page number for each item)			
1	Applicant (owner/designated operator), SWMP Preparer, Qualified Stormwater Manager, and Contractor Information. (On cover/title sheet)	Y	
2	Table of Contents	Y	
3	Site description and location to include: vicinity map with nearest street/crossroads description	Y	
4	Narrative description of construction activities proposed (e.g., may include clearing and grubbing, temporary stabilization, road grading, utility / storm installation, final grading, final stabilization, and removal of temporary control measures)	Y	
5	Phasing plan – may require separate drawings indicating initial, interim, and final site phases for larger projects. Provide "living maps" that can be revised in the field as conditions dictate	Y	
6	Proposed sequence for major activities: Provide a construction schedule of anticipated starting and completion dates for each stage of land-disturbing activity depicting conservation measures anticipated, including the expected date on which the final stabilization will be completed	Y	
7	Estimates of the total site area and area to undergo disturbance; current area of disturbance must be updated on the SWMP as changes occur	Y	
8	Soil erosion potential and impacts on discharge that includes a summary of the data used to determine soil erosion potential	Y	
9	A description of existing vegetation at the site and percent ground cover and method used to determine ground cover	Y	
10	Location and description of all potential pollution sources including but not limited to: disturbed and stored soils; vehicle tracking; management of contaminated soils; loading and unloading operations; outdoor storage of materials; vehicle and equipment maintenance and fueling; significant dust generating process; routine maintenance activities involving fertilizers, pesticides, herbicides, detergents, fuels, solvents, oils, etc.; on-site waste management; concrete truck/equipment washing; dedicated asphalt, concrete batch plants and masonry mixing stations; non-industrial waste such as trash and portable toilets	Y	
11	Material handling to include spill prevention and response plan and procedures	Y	
12	Spill prevention and pollution controls for dedicated batch plants	Y	
13	Other SW pollutant control measures to include waste disposal and off-site soil tracking	Y	
14	Location and description of any anticipated allowable non-stormwater discharge (ground water, springs, irrigation, discharge covered by CDPHE Low Risk Guidance, etc.)	Y	
15	Name(s) of ultimate receiving waters; size, type and location of stormwater outfall or storm sewer system discharge	Y	
16	Description of all stream crossings located within the project area or statement that no streams cross the project area	Y	



3275 Akers Drive
 Colorado Springs, CO 80922
 Phone 719-520-6460
 Fax 719-520-6879
 www.elpasoco.com

EL PASO COUNTY STORMWATER MANAGEMENT PLAN CHECKLIST

EPC Project Number:

Revised: October 2021

		Applicant	EPC
17	SWMP Map to include:	Y	
17a	construction site boundaries	Y	
17b	flow arrows to depict stormwater flow directions	Y	
17c	all areas of disturbance	Y	
17d	areas of cut and fill	Y	
17e	areas used for storage of building materials, soils (stockpiles) or wastes	Y	
17f	location of any dedicated asphalt / concrete batch plants	Y	
17g	location of all structural control measures	Y	
17h	location of all non-structural control measures	Y	
17i	springs, streams, wetlands and other surface waters, including areas that require maintenance of pre-existing vegetation within 50 feet of a receiving water	Y	
18	Narrative description of all structural control measures to be used. Modifications to EPC standard control measures must meet or exceed County-approved details	Y	
19	Description of all non-structural control measures to be used including seeding, mulching, protection of existing vegetation, site watering, sod placement, etc.	Y	
20	Technical drawing details for all control measure installation and maintenance; custom or other jurisdiction's details used must meet or exceed EPC standards	Y	
21	Procedure describing how the SWMP is to be revised	Y	
22	Description of Final Stabilization and Long-term Stormwater Quality (describe nonstructural and structural measures to control SW pollutants after construction operations have been completed, including detention, water quality control measure etc.)	Y	
23	Specification that final vegetative cover density is to be 70% of pre-disturbed levels	Y	
24	Outline of permit holder inspection procedures to install, maintain, and effectively operate control measures to manage erosion and sediment	Y	
25	Record keeping procedures identified to include signature on inspection logs and location of SWMP records on-site	Y	
26	If this project relies on control measures owned or operated by another entity, a documented agreement must be included in the SWMP that identifies location, installation and design specifications, and maintenance requirements and responsibility of the control measure(s)	Y	
	Please note: all items above must be addressed. If not applicable, explain why, simply identifying "not applicable" will not satisfy CDPHE requirement of explanation.	Y	
2. ADDITIONAL REPORTS/PERMITS/DOCUMENTS			
a	Grading and Erosion Control Plan (signed)	Y	
b	Erosion and Stormwater Quality Control Permit (ESQCP) (signed)	Y	



3275 Akers Drive
 Colorado Springs, CO 80922
 Phone 719-520-6460
 Fax 719-520-6879
 www.elpasoco.com

EL PASO COUNTY STORMWATER MANAGEMENT PLAN CHECKLIST

EPC Project Number:

Revised: October 2021

		Applicant	EPC
3. APPLICANT COMMENTS			
a			
b			
c			
4. CHECKLIST REVIEW CERTIFICATIONS			
a	<p>Applicant: The Stormwater Management Plan was prepared under my direction and supervision and is correct to the best of my knowledge and belief. Said Plan has been prepared according to the criteria established by the County and State for Stormwater Management Plans.</p> <p>_____ Date</p> <p>Engineer of Record and/or Qualified Stormwater Manager Signature</p>		
b	<p>Review Engineer: The Stormwater Management Plan was reviewed and found to meet the checklist requirements except where otherwise noted or allowed by an approved deviation request.</p> <p>_____ Date</p> <p>Review Engineer</p>		