



LSC TRANSPORTATION CONSULTANTS, INC.
2504 East Pikes Peak Avenue, Suite 304
Colorado Springs, CO 80909
(719) 633-2868
FAX (719) 633-5430
E-mail: lsc@lsctrans.com
Website: <http://www.lsctrans.com>

Ellicott Sand and Gravel
Traffic Impact Analysis
PCD File No. AL2014
(LSC #194980)
September 28, 2020

Traffic Engineer's Statement

This traffic report and supporting information were prepared under my responsible charge and they comport with the standard of care. So far as is consistent with the standard of care, said report was prepared in general conformance with the criteria established by the County for traffic reports.

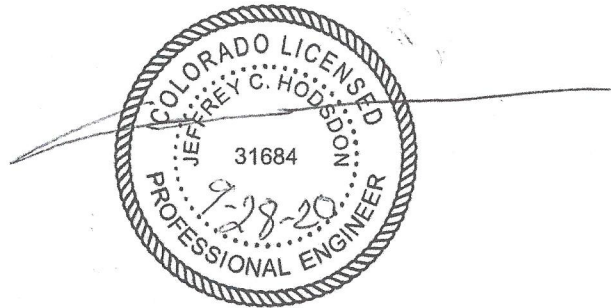

Developer's Statement

I, the Developer, have read and will comply with all commitments made on my behalf within this report.

Date



LSC TRANSPORTATION CONSULTANTS, INC.
2504 East Pikes Peak Avenue, Suite 304
Colorado Springs, CO 80909
(719) 633-2868
FAX (719) 633-5430
E-mail: lsc@lscstrans.com
Website: <http://www.lscstrans.com>

Ellicott Sand and Gravel
Traffic Impact Analysis
PCD File No. AL2014
(LSC #194980)
September 28, 2020

Traffic Engineer's Statement

This traffic report and supporting information were prepared under my responsible charge and they comport with the standard of care. So far as is consistent with the standard of care, said report was prepared in general conformance with the criteria established by the County for traffic reports.



Developer's Statement

I, the Developer, have read and will comply with all commitments made on my behalf within this report.

Christina

9-29-2020

Date



LSC TRANSPORTATION CONSULTANTS, INC.
2504 East Pikes Peak Avenue, Suite 304
Colorado Springs, CO 80909
(719) 633-2868
FAX (719) 633-5430
E-mail: lsc@lsctrans.com
Website: <http://www.lsctrans.com>

September 28, 2020

Christine Wilson
Ellicott Sand & Gravel
c/o Mr. Bruce Humphries
<via email>

RE: Ellicott Sand and Gravel
El Paso County, CO
Traffic Impact Analysis
LSC #194980
PCD File No. AL2014

Dear Ms. Wilson,

LSC Transportation Consultants, Inc. has prepared this traffic impact study for the proposed Schubert Ranch/Ellicott Sand & Gravel extraction operation in El Paso County, Colorado. The site is located west of Baggett Road and north (and south) of Sanborn Road. One access is proposed to Sanborn Road about one quarter-mile west of Baggett Road (access GPS location: 38°47'43.5875" N, 104°21'17.6006" W).

The proposed haul route would have trucks utilize State Highway (SH) 94 to/from the west, Baggett Road between SH 94 and Sanborn Road and the segment of Sanborn Road east of the access. Per the applicant, 94 truck trips would be generated during the average 24-hour period.

This report has been prepared for submittal to the El Paso County Planning and Community Development department and CDOT.

REPORT CONTENTS

The report contains the following:

- Existing street and traffic conditions adjacent to and in the vicinity of the site, including the intersection lane geometries, traffic controls, posted speed limits, functional classifications, intersection spacing and alignment, sight distances, etc.
- Existing peak-hour turning movement traffic counts at the intersections of SH 94/Baggett Road and Baggett Road/Sanborn Road
- Estimates of existing and projections of 5 and 20-year daily traffic volumes adjacent to the site using EPC and CDOT data/available projections

- Description of the existing land uses adjacent to and in the vicinity of the site
- Estimates of the proposed development's peak-hour and daily trip generation
- Estimated assignment of peak-hour and daily site-generated traffic volumes on the streets providing access to/from the site, including:
 - State Highway 94/Baggett Road
 - Baggett Road/Sanborn Road
 - Sanborn Road/proposed site access
- Identification of existing and estimate future baseline/background traffic at key haul route intersections and road segments
- Estimated total average daily, and peak-hour trip generation for the proposed sand and gravel operation, including trips by vehicle type
- Estimated directional distribution of mine-generated trips on roadways to be used for hauling
- Resulting traffic impacts of the proposed sand and gravel operation on the roadways along the haul route relative to the ECM "design ADTs."
- Intersection levels of service analysis at key intersections along the proposed haul route:
 - State Highway 94/Baggett Road
 - Baggett Road/Sanborn Road
 - Sanborn Road/proposed site access
- Auxiliary right-/left-turn lane analysis at the following intersections based on the projected volumes and criteria in El Paso County's *Engineering Criteria Manual (ECM)* and the *State Highway Access Code*:
 - State Highway 94/Baggett Road
 - Baggett Road/Sanborn Road
 - Sanborn Road/proposed site access
- Identification of roadway system deficiencies with or without mine traffic and roadway improvement recommendations needed, per CDOT and El Paso County criteria
- Findings and recommendations

SAND & GRAVEL PIT SITE LOCATION & ACCESS

As shown in Figure 1 and Figure 2 , the proposed Schubert Ranch/Ellicott Sand & Gravel extraction operation in El Paso County, Colorado is located west of Baggett Road and north (and south) of Sanborn Road. Located at El Paso County parcel ID 2400000276, the 783-acre parcel is currently vacant.

The proposed access would be located one-quarter mile west of the intersection of Baggett Road/Sanborn Road (access GPS location: 38°47'43.5875" N, 104°21'17.6006" W). This access is for Stage I of the operation. The applicant will request different access points in the future as the active mining areas change in the future (subsequent "Stages"). Access for future stages are shown in the **attached access exhibit** from the LOI. The applicant would be required to obtain a new driveway permit from El Paso County for any future access. Future access for future stages will likely require a transportation memorandum.

PROPOSED DAILY OPERATIONS

Hours of operation for the mine range from 7:00 a.m. – 7:00 p.m. or sunrise-to-sunset, depending on time of year. Empty heavy vehicles would begin arriving around 7:00 a.m. each weekday and depart shortly after being loaded. Drivers would transport raw materials to the west via SH 94. Per information provided by the applicant, up to 47 empty trucks would arrive at the site for loading each day and up to 47 loaded trucks will leave the mine each day.

Table 1 shows the number of trucks programmed to arrive at the site by hour of the day.

Table 1: Entering Trucks by Hour of the Day

Hourly Period		Trucks Programmed to Arrive at the Site
Start Time	End Time	Entering Trucks
07:00	08:00	5
08:00	09:00	5
09:00	10:00	5
10:00	11:00	4
11:00	12:00	4
12:00	13:00	4
13:00	14:00	4
14:00	15:00	4
15:00	16:00	4
16:00	17:00	3
17:00	18:00	1
18:00	19:00	4
Total Daily Entering Trucks		47

No trucks (empty or loaded) would be parked on-site overnight. Thus, haul vehicles would originate from offsite location(s) each morning and return to offsite location(s) each afternoon.

Per the applicant, six employees (including two loaders, two operators, one crusher, and another staff member) would remain on-site throughout the day. These employees would drive to the proposed mine each morning using their personal vehicles and leave during the late afternoon using their personal vehicles. Employee personal vehicles are anticipated to arrive slightly before heavy vehicles would arrive to begin preparing for the day's workload.

APPLICANT-PROPOSED HAUL ROUTE

The following haul route proposed by the applicant is shown in Figure 3 and described below. Approximately half of haul trips (loaded and empty) would be controlled by Ellicott, while the other half would be operated by outside hauling companies. The applicant will direct the trucking company and outside hauling companies to use this specific route when departing the site, which may be used for truck loads up to 88,000 lbs. gross vehicle weight (GVW):

1. From the mine entrance, turn left and continue eastbound on Sanborn Road for 0.25 miles
2. Turn left onto Baggett Road and continue northbound for 3.0 miles
3. Turn left onto State Highway 94 and travel west.

Truck drivers would be required to travel to the site using this route in the reverse direction.

SIGHT DISTANCE

Access sight distance is acceptable at the proposed entrance on Sanborn Road, meeting all sight distance requirements in the ECM. No horizontal or vertical sight distance issues exist at key intersections along the proposed haul route, including:

- Sanborn Road/proposed site access
- State Highway 94/Baggett Road
- Baggett Road/Sanborn Road

Based on a 45-mph posted speed limit, sight distances for both approaches on Sanborn Road from the proposed site access location exceed the required 680-foot requirement for multi-unit trucks, per *ECM* Table 2-35

ROADWAYS AND TRAFFIC CONDITIONS

Area Roadways

Major roadways in the site vicinity are shown in Figure 1 and identified below, followed by a brief description of each. Roadway functional classifications are shown in Figure 4, while detailed existing roadway conditions are shown in Figure 5.

State Highway (SH) 94 is a two-lane, paved rural highway with a posted speed limit of 65 miles per hour (mph) in the vicinity of Baggett Road. The highway extends east from US Highway 24 near Peterson Air Force Base about 85 miles to Highway 287 in Cheyenne County. CDOT classifies SH 94 as an NR-A highway west of Ellicott Highway and R-A east of Ellicott Highway. CDOT has identified the governing document with respect to access management for SH 94 in the vicinity of the site as the *State Highway 94 Access Management Plan (2012)*. The El Paso County 2040 *Major Transportation Corridors Plan (MTCP)* identifies SH 94 as a two-lane Principal Arterial in

the Ellicott area. The MTCP 2060 *Corridor Preservation Plan* identifies SH 94 as a future four-lane Principal Arterial. However, future right-of-way needs will be identified by CDOT.

Ellicott Highway is classified as a two-lane Minor Arterial on the 2040 El Paso County MTCP. The posted speed limit on Ellicott Highway south of SH 94 is 45 mph. Auxiliary left-turn lanes currently exist on the eastbound and westbound approaches at the TWSC intersection of Ellicott Highway/SH 94.

Baggett Road is classified as a two-lane Rural Local roadway on the 2040 El Paso County MTCP. No auxiliary lanes currently exist at the TWSC intersection of Baggett Road/SH 94. Currently, Baggett Road is a 24-foot wide gravel roadway with 4-foot shoulders and 60 feet of right-of-way (ROW). The posted speed limit on Baggett Road is 45 mph.

Sanborn Road is classified as a two-lane Collector on the 2040 El Paso County MTCP. No auxiliary lanes currently exist at the TWSC intersections of Baggett Road/Sanborn Road and Sanborn Road/Ellicott Highway. Currently, Sanborn Road is a 32-foot wide gravel roadway with 4-foot shoulders and 90 feet of ROW. The posted speed limit on Sanborn Road is 45 mph.

Handle Road is classified as a two-lane Rural Local street on the 2040 El Paso County MTCP. No auxiliary lanes currently exist at the TWSC intersection of Handle Road/Baggett Road. Currently, Handle Road is a 24-foot wide gravel roadway with 4-foot shoulders and a 60-foot ROW. The posted speed limit on Handle Road is 45 mph.

Ellicott Road is classified as a two-lane Rural Local roadway on the 2040 El Paso County MTCP. No auxiliary lanes currently exist at the TWSC intersections of Handle Road/Ellicott Road and Sanborn Road/Ellicott Road. Currently, Ellicott Road is paved north of Handle Road and has a gravel roadway surface to the south. A 24-foot wide roadway with 4-foot shoulders and a 60-foot ROW, Ellicott Road has a posted speed limit of 45 mph.

Existing Traffic Volumes

Vehicular turning movement counts were conducted at the following intersections:

- State Highway 94/Baggett Road
 - Wednesday, November 13, 2019 from 6:30 to 8:30 a.m.
 - Wednesday, December 11, 2019 from 4:00 to 6:00 p.m.
- Baggett Road/Sanborn Road
 - Wednesday, December 11, 2019 from 6:30 to 8:30 a.m.
 - Wednesday, December 18, 2019 from 4:00 to 6:00 p.m.

Existing morning and evening weekday peak-hour traffic volumes at this intersection are shown in Figure 6. Raw count reports are attached. Figure 6 also shows estimates by LSC of average weekday traffic for the key roadway segments along the proposed haul route.

TRIP GENERATION

Typically, site-generated vehicle-trips for developments/land uses are estimated using the nationally published trip generation rates from *Trip Generation, 10th Edition, 2017* by the Institute of Transportation Engineers (ITE). Due to the unique land use proposed, however, LSC has estimated the trip generation based on the information presented in the “Proposed Daily Operations” section below.

Per information provided by the applicant:

- Up to 47 empty trucks would arrive at the site for loading each day and up to 47 loaded trucks will leave the mine each day. Thus, the proposed mining operation would generate up to 94 haul **truck-trips** on the average weekday.
- Additionally, about 12 passenger vehicle trips (employees, visitors, etc.) are projected. Six would enter during the morning peak hour and 6 would exit the site during the evening peak hour (or potentially outside of the peak hour of the area roadways - depending on demand daily variability).

Table 2 shows the trip generation estimate:

- Approximately 108 vehicle-trips (haul trips and employee trips combined) would occur on the average weekday (half entering and exiting every 24 hours)
- During the morning peak hour, 11 total vehicles are projected to enter the site, while 5 total vehicles are projected to exit.
- Approximately 3 total vehicles would enter, and 9 total vehicles would exit the site during the afternoon peak hour.

Table 2: Estimated Site Vehicle-Trip Generation

Analysis Period	In			Out			Total		
	Trucks	Employees	Total	Trucks	Employees	Total	Trucks	Employees	Total
Morning Peak Hour	5	6	11	5	0	5	10	6	16
Afternoon Peak Hour	3	0	3	3	6	9	6	6	12
Daily 24-Hour	47	6	53	47	8	55	94	14	108

Trip Distribution and Assignment

An estimate of directional distribution of site-generated vehicle-trips to the study area roads is a necessary component in determining the site’s traffic impacts. Figure 7 shows the estimated distribution/proportion of site-generated trips on the area roadway network. Haul vehicle distribution and passenger vehicle distribution splits are shown separately.

Estimates were based on the following factors: the proposed haul route and employee trip routing provided by the applicant, the area roadway system that will provide access to the site, and the site’s geographic location. The truck distribution reflects the applicant’s requirement for haul vehicle drivers

to utilize the proposed haul route. Also, the distribution reflects the applicant's intent to require employees to arrive from and depart to the west via Sanborn Road (rather than Baggett Road).

Site-Generated Traffic

Site-generated traffic volumes at the following intersections have been calculated by applying the distribution percentages (from Figure 7) to the trip generation estimates (from Table 2).

- State Highway 94/Baggett Road
- Baggett Road/Sanborn Road
- Sanborn Road/proposed site access

Figure 8 shows the projected site-generated daily traffic volumes at these intersections for the weekday morning and evening peak hours.

Existing-Plus-Site-Generated Traffic Volumes

Figure 9 shows the sum of the existing traffic volumes (from Figure 6) and site-generated peak-hour traffic volumes (shown in Figure 8). These volumes represent the projected short-term total traffic. Also shown are applicable projected short-term total traffic turning movements, after being adjusted for passenger car equivalent volumes.

2025 Background Traffic Volumes

Five-year background ADT volumes have been shown in Figure 10. The five-year projected background volumes on Baggett Road segments assume linear growth rate between existing conditions and 2040. The five-year volume on Sanborn Road just west of Baggett Road assumes a similar growth rate as Baggett Road north of Sanborn.

Long-Term Baseline Traffic Volumes

Figure 11 shows the projected 2040 background traffic volumes. Background traffic on SH 94 has been based on CDOT growth factors and estimates by LSC. Traffic volumes to be generated by the proposed mining operation are **not** included in this figure. Long-term background growth estimates on Sanborn Road and Baggett Road were made using projections from the *MTCP*, and estimates by LSC, respectively as noted in the legend Figure 10.

LEVEL OF SERVICE ANALYSIS

Level of service (LOS) is a quantitative measure of the level of congestion or delay at an intersection and is indicated on a scale from "A" to "F." LOS A is indicative of little congestion or delay. LOS F indicates a high level of congestion or delay. Table 3 shows the level of service delay ranges for signalized and unsignalized intersections.

Table 3: Intersection Levels of Service Delay Ranges

Level of Service	Signalized Intersections	Unsignalized Intersections
	Average Control Delay (seconds per vehicle) ¹	Average Control Delay (seconds per vehicle) ¹
A	0.0 - 10.0 sec	0.0 - 10.0 sec
B	10.1 - 20.0 sec	10.1 - 15.0 sec
C	20.1 - 35.0 sec	15.1 - 25.0 sec
D	35.1 - 55.0 sec	25.1 - 35.0 sec
E	55.1 - 80.0 sec	35.1 - 50.0 sec
F	80.1 sec or more	50.1 sec or more

¹ For unsignalized intersections, if v/c ratio is greater than 1.0, the level of service is LOS F regardless of the projected average control delay per vehicle

The following intersections have been analyzed to determine the projected short- and long-term (following the opening of mining operations) LOS for the key intersection turning movements:

- State Highway 94/Baggett Road
- Baggett Road/Sanborn Road
- Sanborn Road/proposed site access

Summaries of existing, existing-plus-site, 2040 Background, and 2040 Total traffic scenario levels of service during the weekday morning and evening peak hours are shown in the following figures:

- Figure 6: Existing Traffic, Lane Geometry, Traffic Control, and LOS
- Figure 9: Existing + Site Traffic, Lane Geometry, Traffic Control, and LOS
- Figure 11: 2040 Background Traffic, Lane Geometry, Traffic Control, and LOS
- Figure 13: 2040 Background + Site Traffic, Lane Geometry, Traffic Control, and LOS

Note: levels of service for 2025 (five-years) has not been included as 2040 represents the “worst case” for the future, with higher volumes. Please refer to the Synchro reports (attached) for additional details.

State Highway 94/Baggett Road

Short-Term

All individual turning movements and minor street single-lane approaches currently operate at and are projected to remain at LOS B or better upon site buildout if the intersection were to remain two-way stop sign-controlled in the short term.

Long-Term

All individual turning movements and minor street single-lane approaches currently operate at and are projected to remain at LOS C or better upon site buildout if the intersection were to remain two-way stop sign-controlled in the long term.

Baggett Road/Sanborn Road

All single-lane approaches at the intersection of Baggett Road/Sanborn Road are projected to operate at LOS A through the 2040 horizon.

Sanborn Road/Site Access

All single-lane approaches at the proposed site access on Sanborn Road are projected to operate at LOS A through the 2040 horizon. The analysis assumes the access to be stop sign controlled.

AUXILIARY TURN LANE NEEDS EVALUATION

State Highway 94/Baggett Road

According to criteria in the *State Highway Access Code*, exclusive auxiliary turn lanes shall be provided for any access on an NR-A highway with a projected peak-hour ingress exceeding the following turning volume thresholds:

- Left-turn lane – 10 vehicles per hour (vph) or greater
- Right-turn lane – 25 vph or greater

Short-Term

Approximately 10 vehicles are projected to make an eastbound right-turning movement during the morning peak hour, which does **not** exceed the 25 vph right-turn lane threshold in the *State Highway Access Code*. Based on the combination of operations for the proposed sand/gravel pit and existing traffic volumes along the haul route, **no auxiliary turn lanes (left or right) would be required based on the *Access Code* turning volume threshold during the short term.**

Long-Term

Background traffic volumes in the study area are anticipated to grow over time due to additional background development.

An eastbound right turn lane would **not** be required based on the projections contained in this report and the *Access Code* turning volume threshold for right turn lanes.

Due to background (**non-site traffic**), approximately 15 vehicles per hour are projected to make an eastbound left turn during the afternoon peak hour, which would exceed the 10-vph threshold for a left-turn deceleration lane in the *State Highway Access Code*. **NOTE: This information is provided for reference only (as required by El Paso County), as the proposed gravel pit would not add traffic to this turning movement.** The figure shows a left-turn arrow – representing a potential matching short westbound left-turn bay – not triggered by volume (and not triggered by traffic generated by this project) – but shown for purposes of maintaining lane alignment. This potential short turn bay would likely be constructed as part of redirect tapers for the eastbound left-turn lane (**not by this applicant**).

Sanborn Road Intersections/Access Point (El Paso County)

According to criteria in the *Engineering Criteria Manual*, exclusive auxiliary turn lanes shall be provided at intersections/access point on a Collector roadway with a projected peak-hour ingress exceeding the following turning volume thresholds:

- Left-turn lane – 25 vehicles per hour (vph)
- Right-turn lane – 50 vph or greater

Baggett Road/Sanborn Road

No modifications are required to the existing single-lane approaches at the intersection of Baggett Road/Sanborn Road. Auxiliary right- or left-turn lanes would **not** be required on any approach on Sanborn Road or Baggett Road based on projected site-generated traffic volumes and criteria in the ECM.

Site Access Point on Sanborn Road

No auxiliary right- or left-turn lanes would be required at the proposed site access point on Sanborn Road based on projected site-generated traffic volumes and criteria in the ECM.

AVERAGE DAILY TRAFFIC IMPACTS RELATIVE TO ROADWAY DESIGN ADT BY CLASSIFICATION

The projected buildout ADTs have been compared to the roadway design ADTs shown in Tables 2-4 and 2-5 of the *Engineering Criteria Manual* (ECM). Figure 4 shows existing roadway classifications along the haul route and has been provided as a general reference. The actual current roadway capacities for specific roadway segments may differ from these ECM-identified “Design ADT” values for county-standard roadways by classification.

Baggett Road

Existing and Short Term

Baggett Road is a Local, gravel roadway. The ECM design ADT for this type of roadway is 200 ADT. Figure 9 and Figure 12 show the LSC-estimated existing plus site and projected short-term total ADT volumes, respectively, on the section just south of SH 94 and the section north of Sanborn Road. With the addition of projected site generated traffic to the roadway, the section just north of Sanborn Road is likely to remain under the 200 ADT threshold in the short term. The section just south of SH 94 is estimated to currently be in the range of 150 to 200 ADT. The projected short-term (2025) background volume is shown at 200 ADT. With the addition of haul route site-generated trips, the section of Baggett Road just south of SH 94 is projected to exceed 200 ADT, whereas the section between Handle Road and Sanborn Road is projected to remain just under the 200 ADT ("by design"- meaning the applicant truck trip programming is based on the intent to limit the total volume on this segment to just below 200 ADT).

Long Term

The 2040 MTCP shows residential household growth in the general area north of Sanborn Road. Figure 13 shows LSC's estimates of 2040 volumes on Baggett Road. Future volumes may vary significantly depending on location of the growth, development access points and area roadway conditions. The section just north of Sanborn Road, at 244 vehicles per day, is projected to exceed the 200 ADT threshold in the long term. The section just south of SH 94 is projected to be approximately 369 ADT in the long term.

Sanborn Road

This project's traffic added to the existing volume and short-term (2025) background volume is projected to bring the roadway segment between the site access and Baggett Road to a volume over 200 ADT. The short-term (2025) projected total is 244 ADT, which would exceed the 200 ADT threshold. Although this segment of Sanborn Road to be used by haul-route vehicles is only one-quarter mile in length, the county may require mitigation for a volume exceeding 200 ADT on a gravel roadway.

Based on MTCP projected 2040 background traffic volumes, current cross section, and functional classification, the MTCP 2040 "Gravel Road Analysis" shows Sanborn Road as "Deficient." MTCP project P9 Roadway paving project is shown due to this background volume and resulting deficiency. Map 7 of the MTCP also indicates that the condition of the existing gravel roadway on Sanborn is "adequate."

Based on MTCP projected 2040 volume, the site traffic would represent a relatively minor percentage of the projected future background traffic.

DESIGN VEHICLE ACCOMMODATION AT HAUL ROUTE INTERSECTIONS AND ALONG ROADWAYS

Intersections

The largest anticipated haul vehicles should be considered the “design vehicle” for purposes of evaluating the geometry of existing intersections along the anticipated haul route. Intersections along the haul route (SH 94/Baggett Road and Baggett Road/Sanborn Road, as well as the site access intersection) will likely require some intersection corner radius and potentially other geometric improvements to meet criteria 2.3.7.G of the El Paso County *Engineering Criteria Manual*.

State Highway 94/Baggett Road

- The southwest corner radius will likely need to be improved to accommodate right-turning multi-unit truck haul vehicles. This would likely entail grading and paving of a compound radius and potentially pavement markings.
- The turning path of the northbound left turn should be analyzed to determine intersection geometric improvements will be needed to accommodate this turning movement.
- If there is the potential for haul trucks to turn to the east on SH 94, the southeast corner radius should also accommodate northbound to eastbound right turns by multi-unit trucks.

Baggett Road/Sanborn Road

- **Short Term:** Based on the existing traffic volumes along Sanborn Road, the existing intersection may be able to accommodate a turning vehicle without modification (assuming the truck could utilize the entire intersection footprint to complete the turn). Minor modifications to the northwest corner radius may be needed if truck turning analysis shows insufficient geometry.
- **Long Term:** As volumes increase as projected along Sanborn in the MTCP, the following may be necessary in the future:
 - The northwest corner radius will likely need to be improved to accommodate southbound right-turning multi-unit truck haul vehicles. This would likely entail grading and installing a compound radius.
 - The turning path of the eastbound to northbound left turn should be analyzed to determine intersection geometric improvements will be needed to accommodate this turning movement by haul vehicles.

Sanborn Road/proposed site access

- The northeast corner radius will likely need to be designed to accommodate right-turning multi-unit truck haul vehicles. The northwest corner radius should also be designed for truck turning movements, even though the current haul route shows trucks turning to the east.
- The turning path of the southbound left turn should be accommodated as part of the access design. The eastbound left turning movement should also be designed to accommodate multi-unit trucks even though the current haul route shows trucks entering from the east.

Note: Intersection AutoTurn analysis, findings, and recommendations for design vehicle accommodation will be provided with the site development plan application.

FINDINGS AND CONCLUSIONS

Land Use (Applicant-Provided Programming Information)

The applicant has provided LSC with operations information including the anticipated number of haul trucks per day, hours and days of operation and employee counts. This trip-generation estimate has been based on this information. The applicant truck trip programming is based on the intent to limit the total volume on the majority of Baggett Road to below 200 ADT through 2025.

Trip Generation Estimate

Due to the unique land use proposed, LSC has estimated the trip generation based on the information presented in the "Proposed Daily Operations" section above:

- The proposed mining operation would generate up to 94 haul truck trips on the average weekday (one-half entering and one-half exiting in a 24-hour period).
- Per information provided by the applicant, up to 47 empty trucks would arrive at the site for loading each day and up to 47 loaded trucks will leave the mine each day
- Additionally, about 12 passenger vehicle trips (employees, visitors, etc.) are projected. Six would enter during the morning peak hour and 6 would exit the site during the evening peak hour (or potentially outside of the peak hour of the area roadways - depending on demand daily variability).

Proposed Haul Route

Please refer to Figure 3 for a map detailing the proposed haul route between the mine and destinations west of the site.

Level of Service Analysis

All individual turning movements/approaches at the following intersection currently operate at and are projected to remain at LOS B or better through the 2040 horizon, with or without the addition of site-generated traffic:

- State Highway 94/Baggett Road
- Baggett Road/Sanborn Road
- Sanborn Road/proposed site access

Auxiliary Turn Lanes

Based on the analysis in this report, no auxiliary turn lanes would be required. Please refer to the "Auxiliary Turn Lane Need Evaluation" section above for a detailed auxiliary turn lane needs assessment.

Average Daily Traffic Impacts Relative to Roadway Design ADT (by Classification)

The following summarizes our findings. Please refer to the above section for additional details.

Baggett Road

The segment between Handle Road and SH 94 is more likely to exceed the 200 ADT design ADT for a gravel road and is projected to exceed 200 ADT in the short term. The site is projected to add 94 daily truck trips on this roadway. Therefore, the percentage of short-term impact on this segment is projected to be 32 percent (2025). This percentage could be used to calculate the applicant's share of short-term mitigation for volume over 200 ADT for the section of Baggett Road between Handle Road and SH 94.

LSC projects 2040 total volumes of about 244 to 369 ADT on Baggett Road, depending on the segment. Due to the relatively low volumes, future volumes may vary significantly from these estimates. These would exceed 200 ADT and future mitigation would be needed. Long-term (beyond five years) mitigation could potentially be addressed through an intermediate term special use application and approval process.

Sanborn Road

This project's traffic added to the existing volume and short-term (2025) background volume is projected to bring the roadway segment between the site access and Baggett Road to a volume over 200 ADT. The short-term (2025) projected total is 244 ADT, which would exceed the 200 ADT threshold. Although this segment of Sanborn Road to be used by haul route vehicles is only one-quarter mile in length, the county may require mitigation for a volume exceeding 200 ADT on a gravel roadway.

The MTCP shows Sanborn Road as “deficient” by 2040, based on MTCP 2040 traffic projections. The proposed haul route includes the section of Sanborn Road between Baggett Road and the site access.

As mentioned above, additional site traffic would constitute up to about six percent of the projected 2040 traffic volumes along the section of Sanborn Road between Baggett Road and the site access. The applicant will be paying fees into the countywide fee program. If at some point, the applicant is required to complete paving, there would be opportunity for fee program credit (per fee program provisions) if constructed to county standards for a paving project. A contribution may also be “creditable,” once the paving project is completed. Long-term (beyond five years) mitigation could potentially be addressed through an intermediate-term special use application and approval process.

Haul Vehicle (Design Vehicle) Accommodation

Please refer to the section “Design Vehicle Accommodation at Haul Route Intersections and Along Roadways” for potential intersection corner radius improvements that may be necessary to accommodate multi-unit haul trucks.

El Paso County Roadway Improvement Fee Program

This development will be subject to participation in the El Paso County Roadway Improvement Fee Program. Staff has indicated that it will investigate how the impact fees will be calculated for this site. A developer agreement may be required.

LIST OF DEVIATIONS REQUESTED

ECM Appendix B requires traffic studies to, “State whether the *MTCP* or other approved corridor study calls for the construction of improvements in the immediate area.” The following deviation request form has been prepared:

- Access is not permitted on a Rural Major Collector, per *ECM* Table 2-5. The applicant is requesting site access on Sanborn Road, a Rural Major Collector.

* * * * *

Ms. Christine Wilson
Ellicott Sand and Gravel

Page 16

September 28, 2020
Traffic Impact Analysis

Please contact me if you have any questions regarding this report.

Respectfully Submitted,

LSC TRANSPORTATION CONSULTANTS, INC.

By: Jeffrey C. Hodsdon, P.E.
Principal

JCH:JAB:jas

Enclosures: Figure 1-Figure 13
Traffic Count Reports
LOS Synchro Reports
Access Exhibit by Stage

Figures



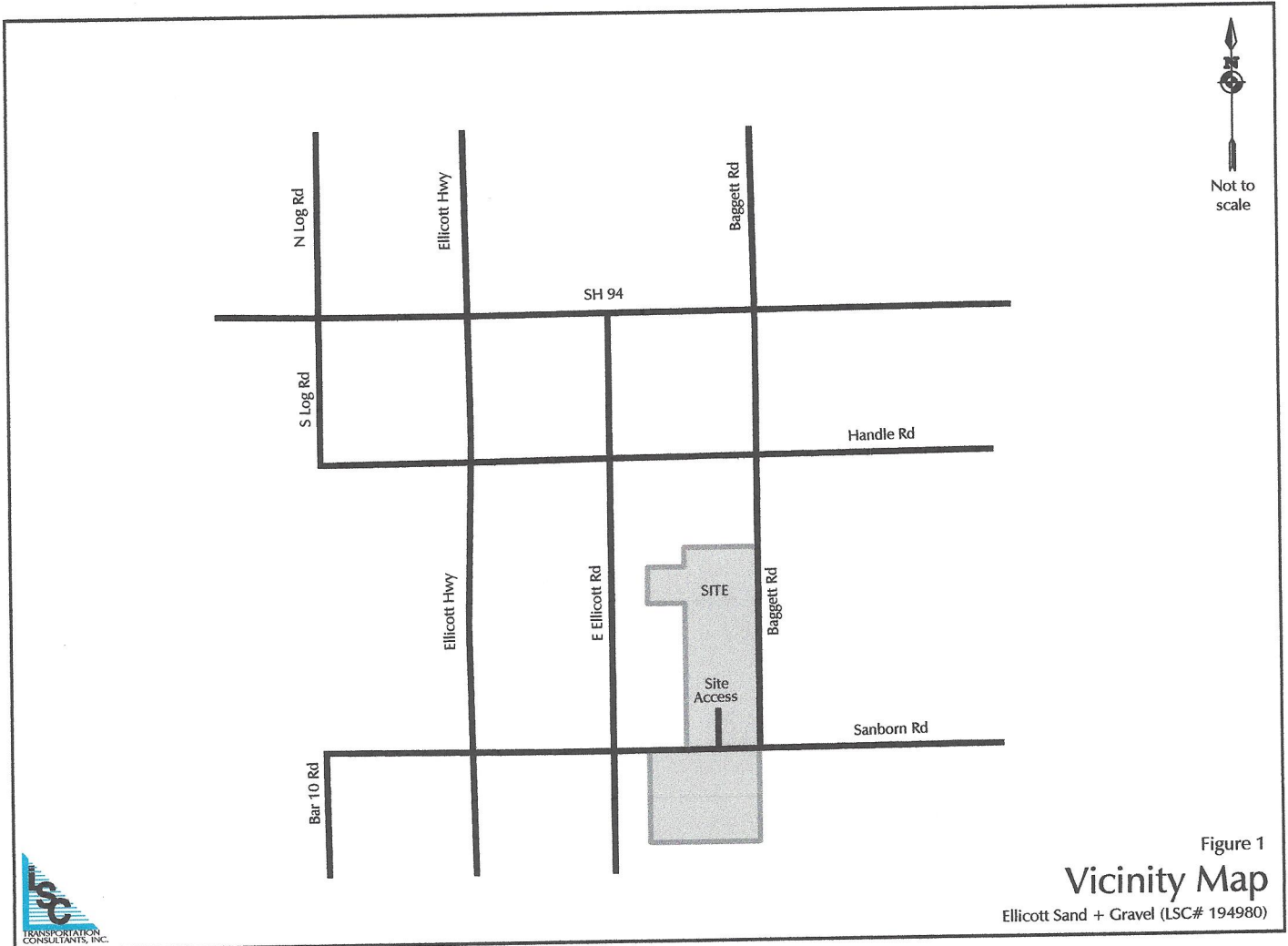

Figure 1
Vicinity Map

Ellicott Sand + Gravel (LSC# 194980)

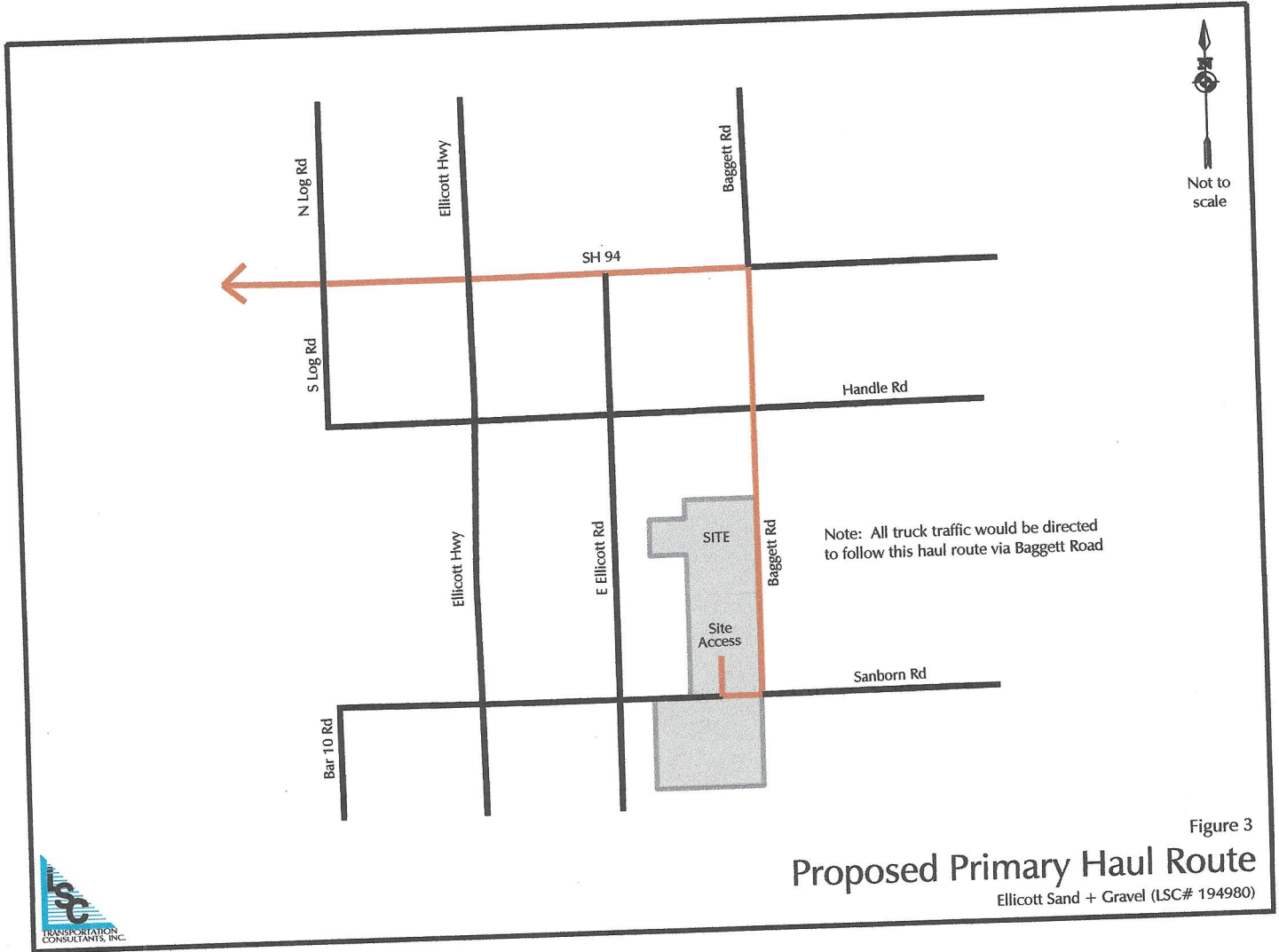

Figure 3
Proposed Primary Haul Route
 Ellicott Sand + Gravel (LSC# 194980)

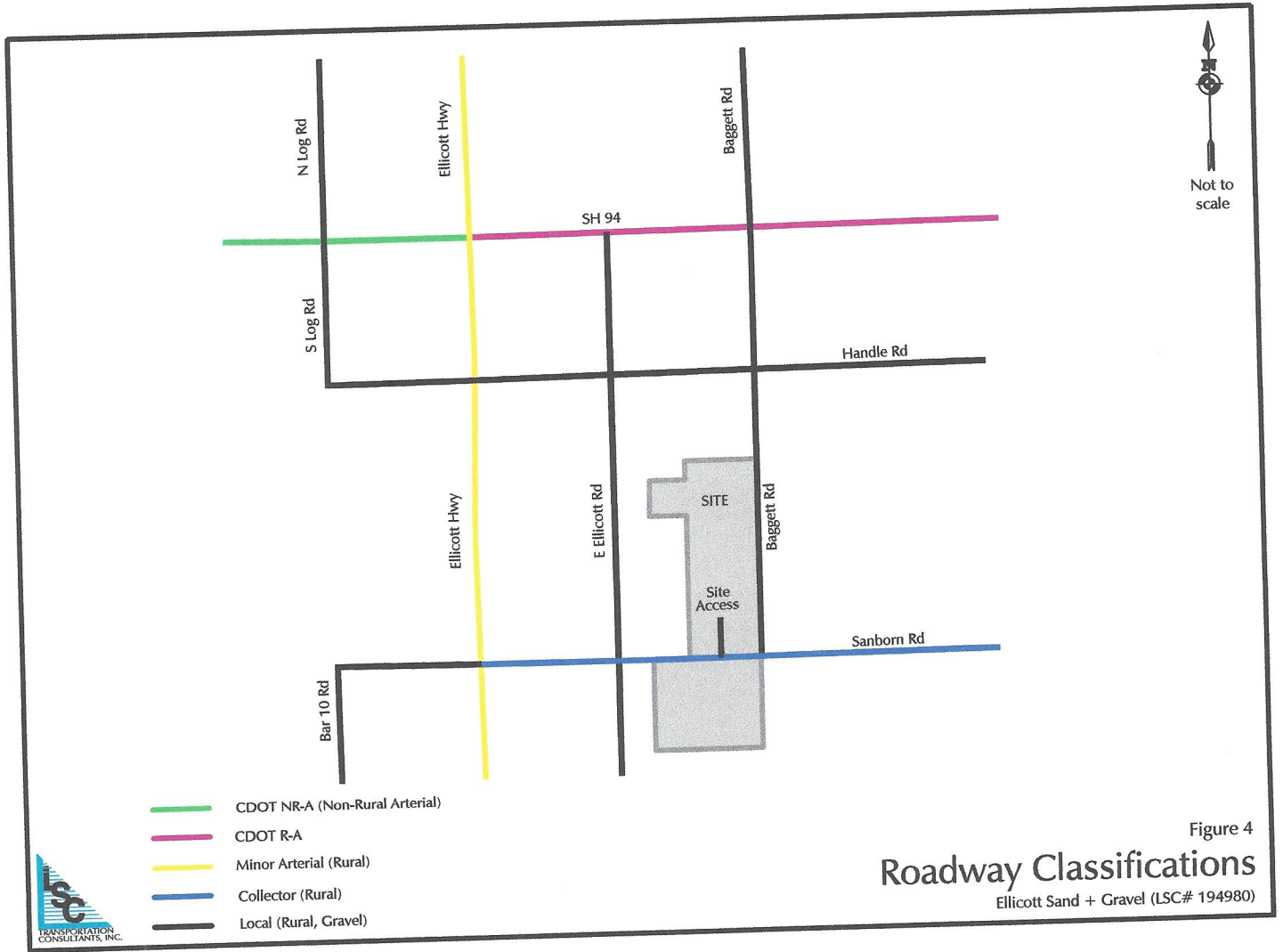
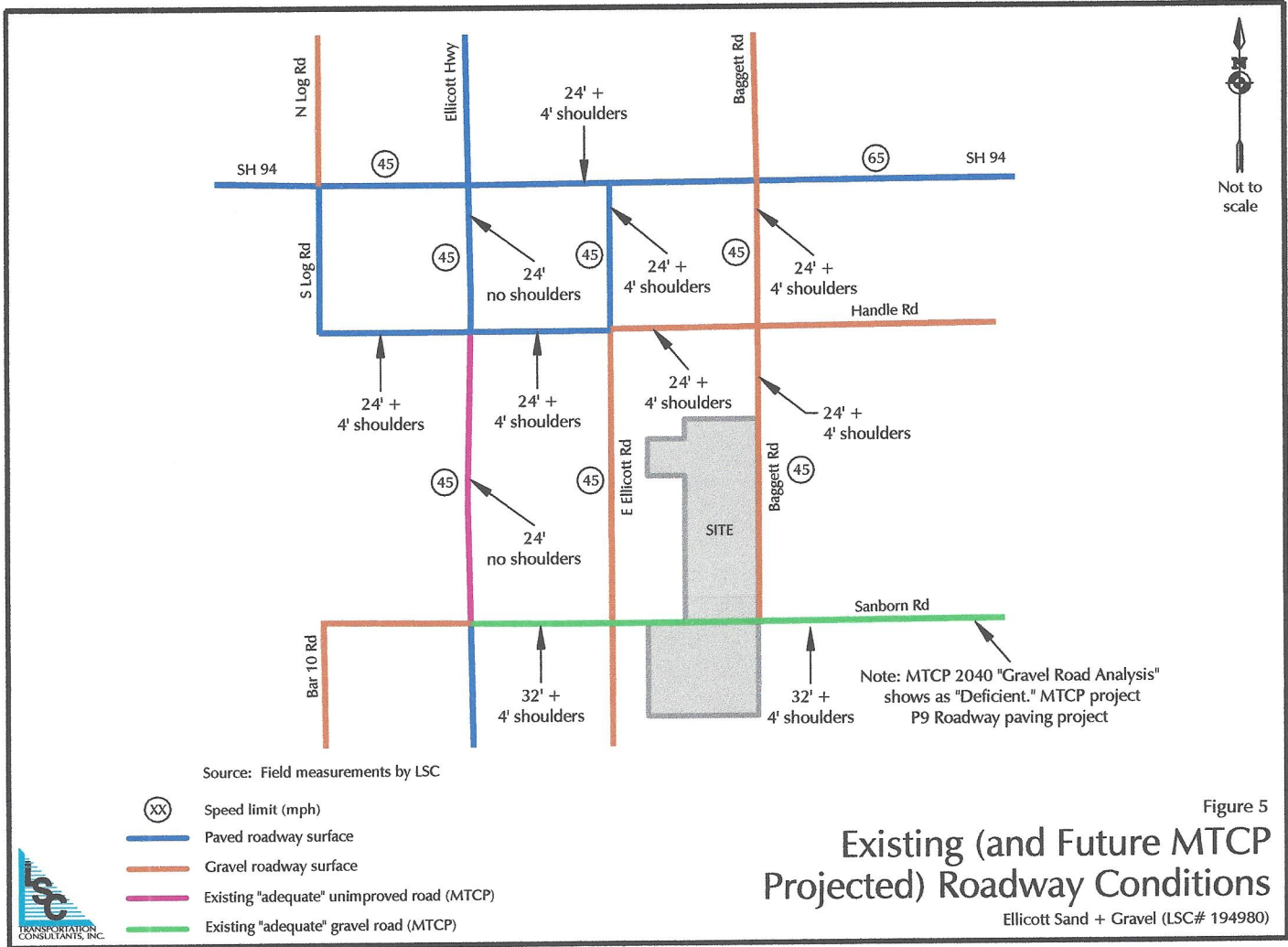
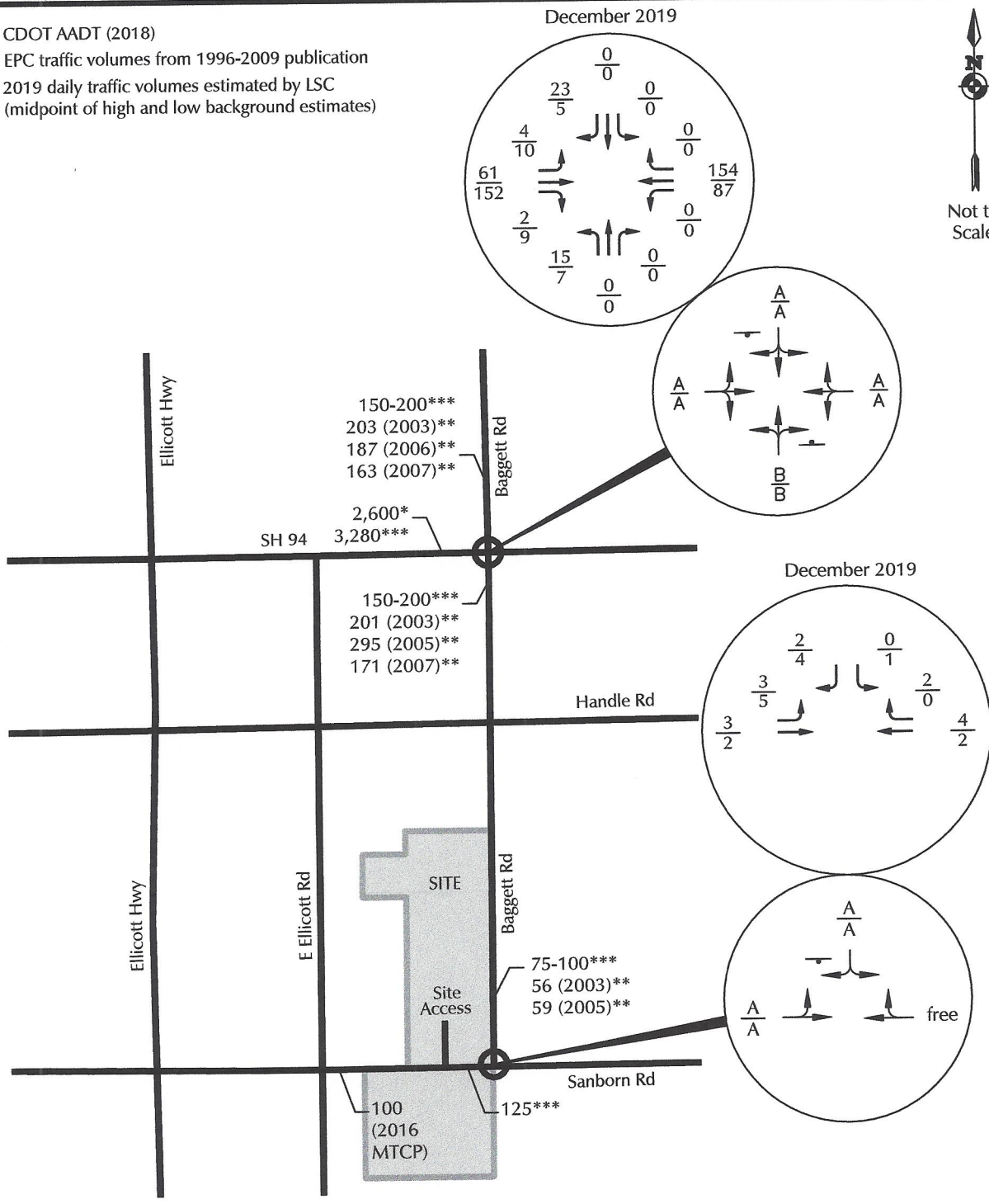

Figure 4
Roadway Classifications
 Ellicott Sand + Gravel (LSC# 194980)





- * CDOT AADT (2018)
- ** EPC traffic volumes from 1996-2009 publication
- *** 2019 daily traffic volumes estimated by LSC (midpoint of high and low background estimates)



- $\frac{XX}{XX}$ = AM Weekday Peak-Hour Traffic (vehicles per hour)
- $\frac{XX}{XX}$ = PM Weekday Peak-Hour Traffic (vehicles per hour)
- X,XXX = Average Daily Traffic (vehicles per day)
- $\frac{X}{X}$ = AM Individual Movement Peak-Hour LOS
- $\frac{X}{X}$ = PM Individual Movement Peak-Hour LOS
- $\frac{X}{X}$ = AM Entire Intersection Peak-Hour LOS
- $\frac{X}{X}$ = PM Entire Intersection Peak-Hour LOS
- ⊥ = Stop Sign



Figure 6
2019 Existing Traffic Volumes, Lane Geometry, Traffic Control, and LOS
 Ellicott Sand + Gravel (LSC# 194980)

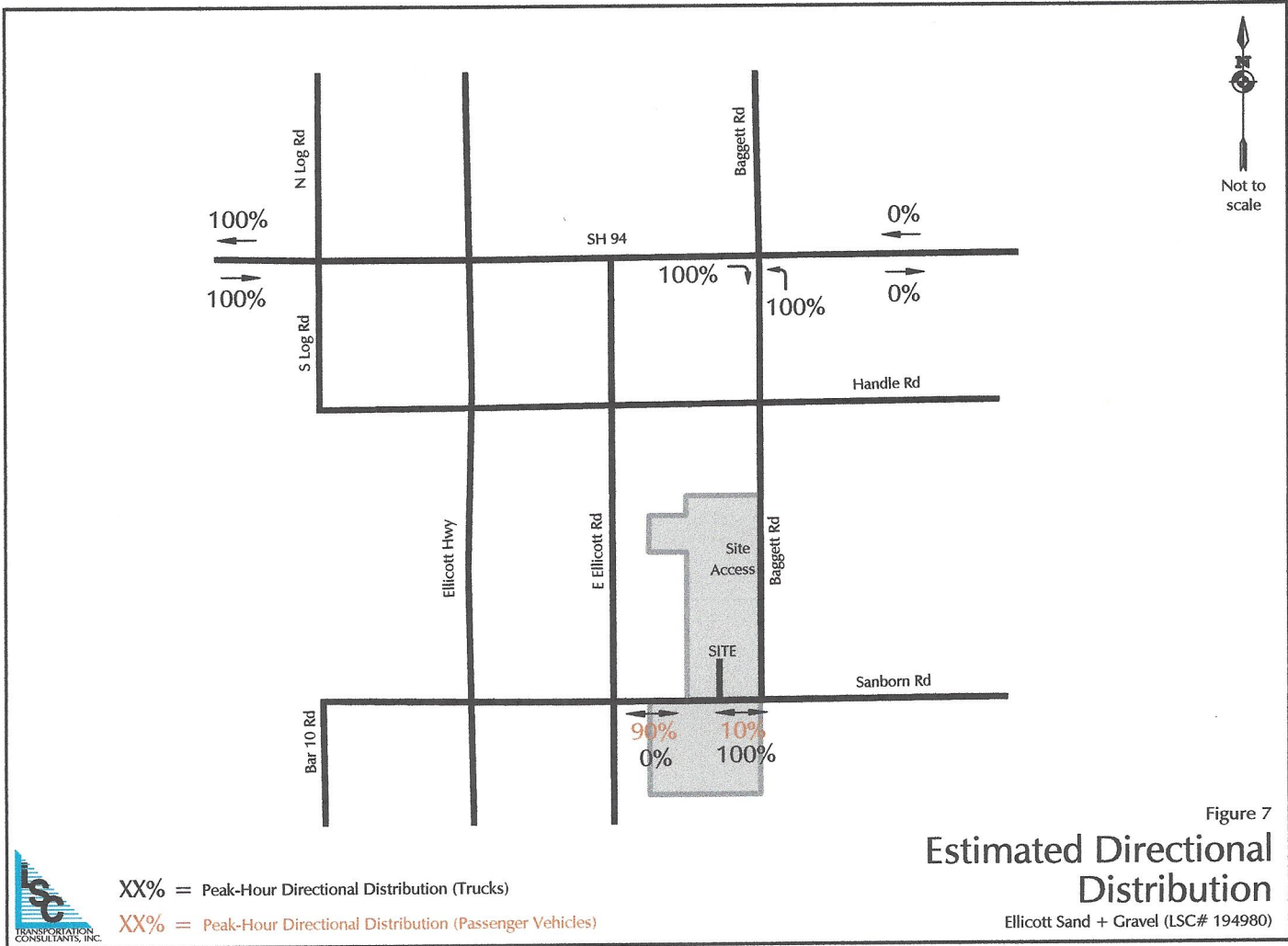

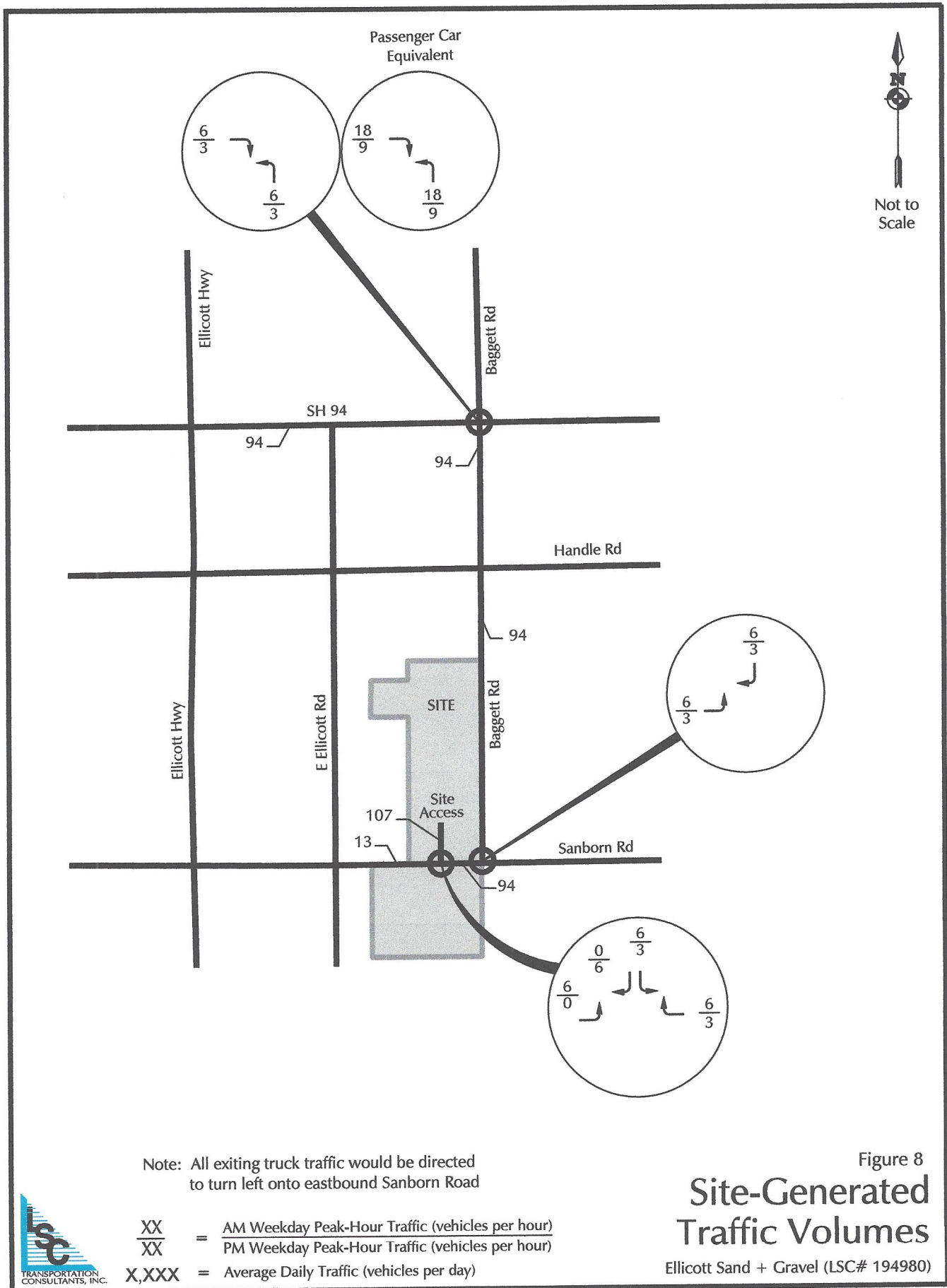

Note: All exiting truck traffic would be directed to turn left onto eastbound Sanborn Road

Figure 8
**Site-Generated
Traffic Volumes**
Ellicott Sand + Gravel (LSC# 194980)



$\frac{XX}{XX}$ = AM Weekday Peak-Hour Traffic (vehicles per hour)
 $\frac{XX}{XX}$ = PM Weekday Peak-Hour Traffic (vehicles per hour)
 X,XXX = Average Daily Traffic (vehicles per day)

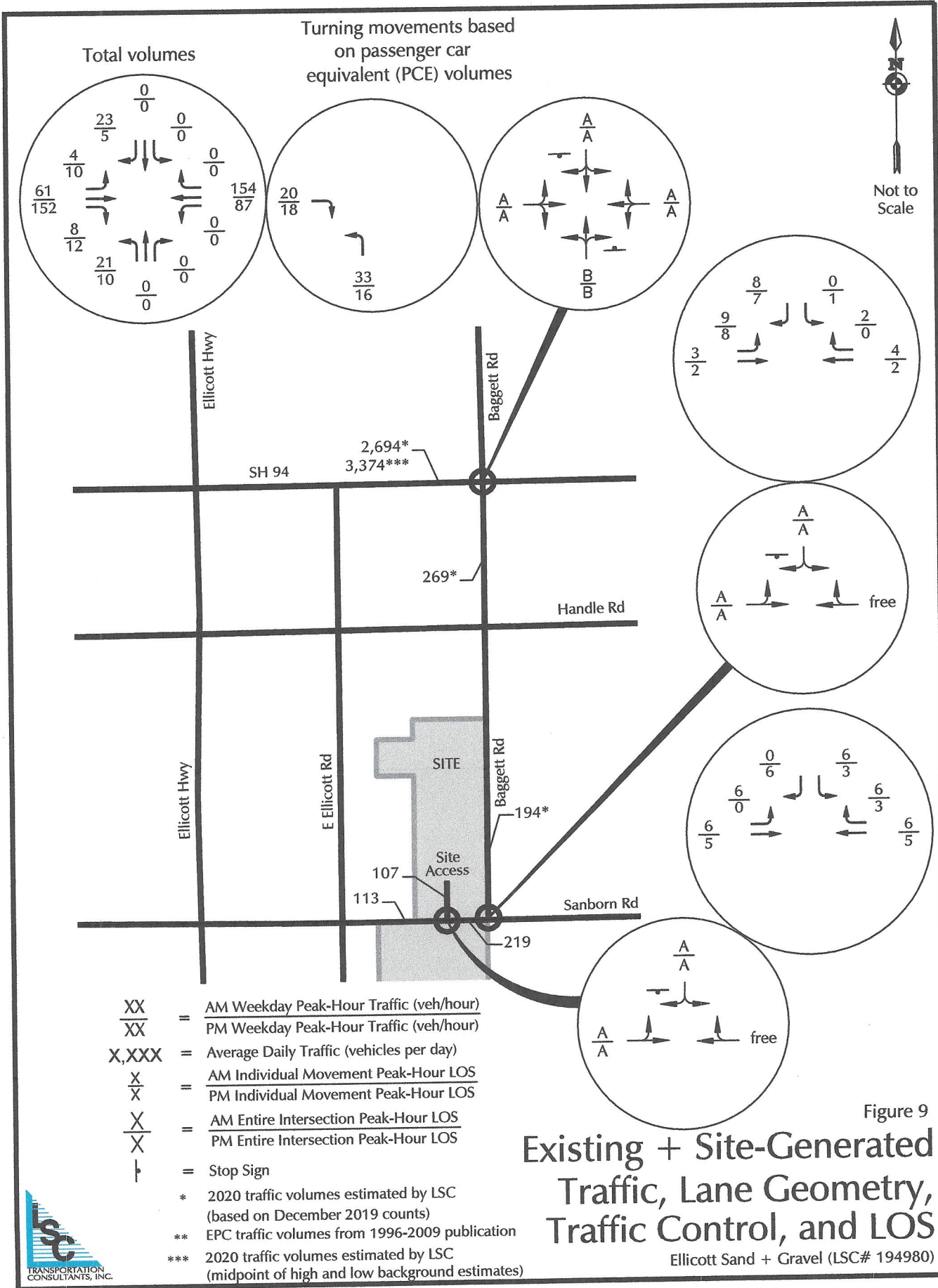

2025 traffic volumes estimated by LSC
(midpoint of high and low background estimates)



Not to Scale

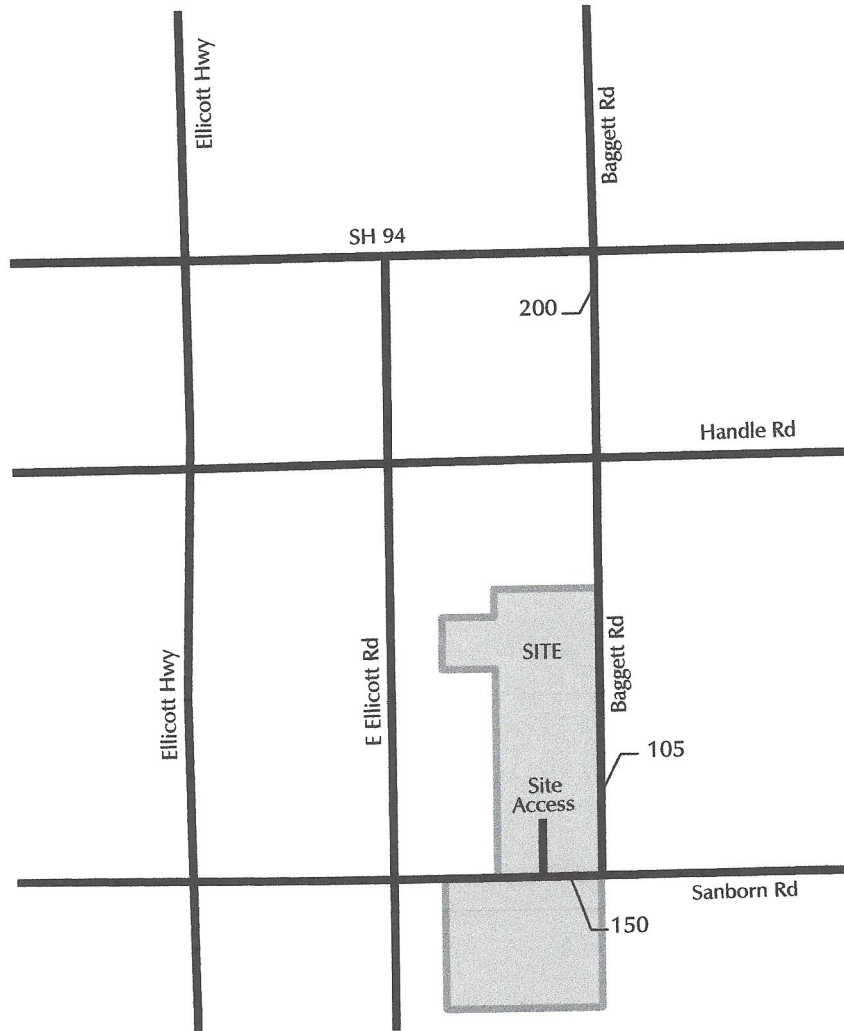

Figure 10

2025 Background ADT Volumes

Ellicott Sand + Gravel (LSC# 194980)



X,XXX = Average Daily Traffic (vehicles per day)

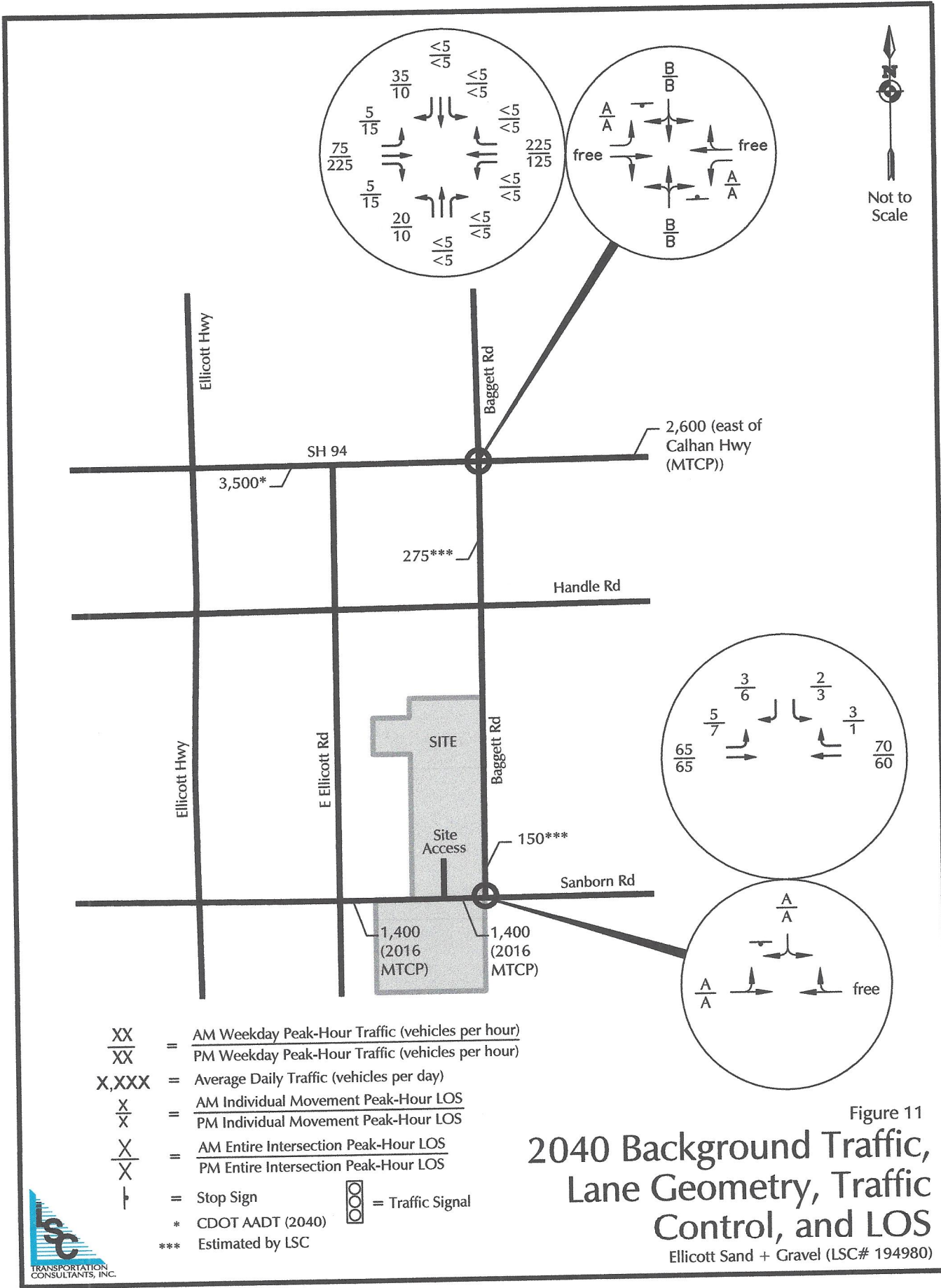

Figure 11
**2040 Background Traffic,
 Lane Geometry, Traffic
 Control, and LOS**
 Ellicott Sand + Gravel (LSC# 194980)



2025 traffic volumes estimated by LSC
(midpoint of high and low background estimates)



Not to
Scale

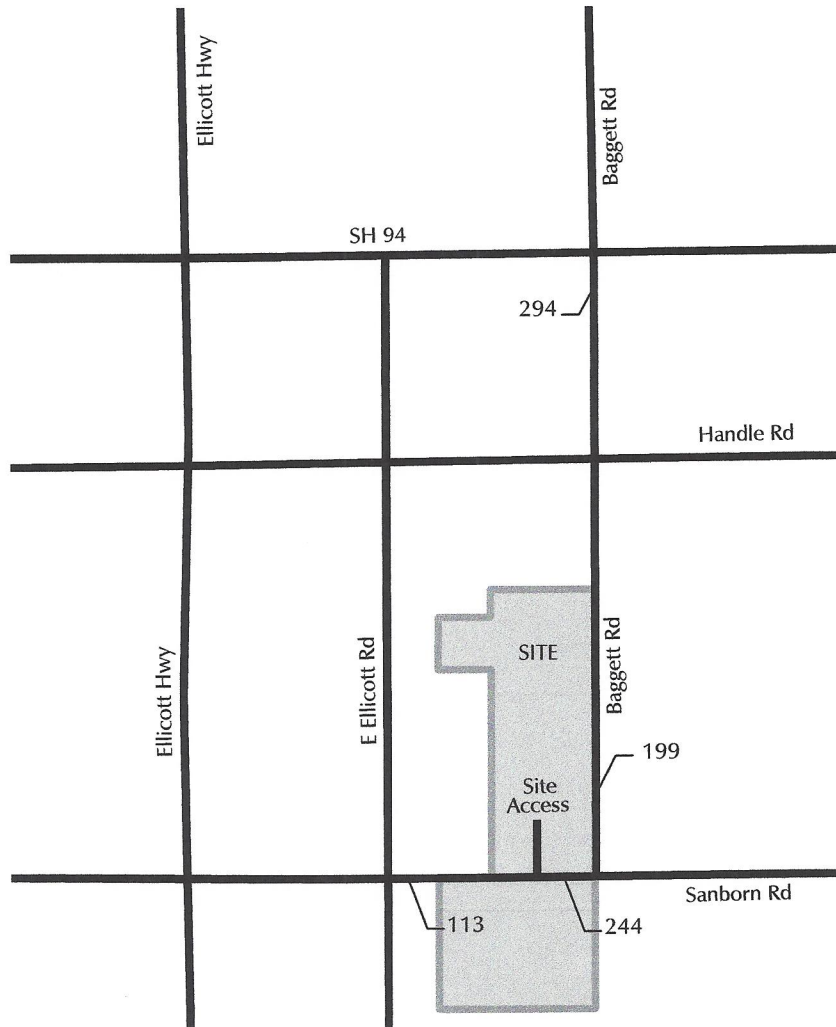

Figure 12
**2025 Total
ADT Volumes**

Ellicott Sand + Gravel (LSC# 194980)



X,XXX = Average Daily Traffic (vehicles per day)

Turning movements based on passenger car equivalent (PCE) volumes

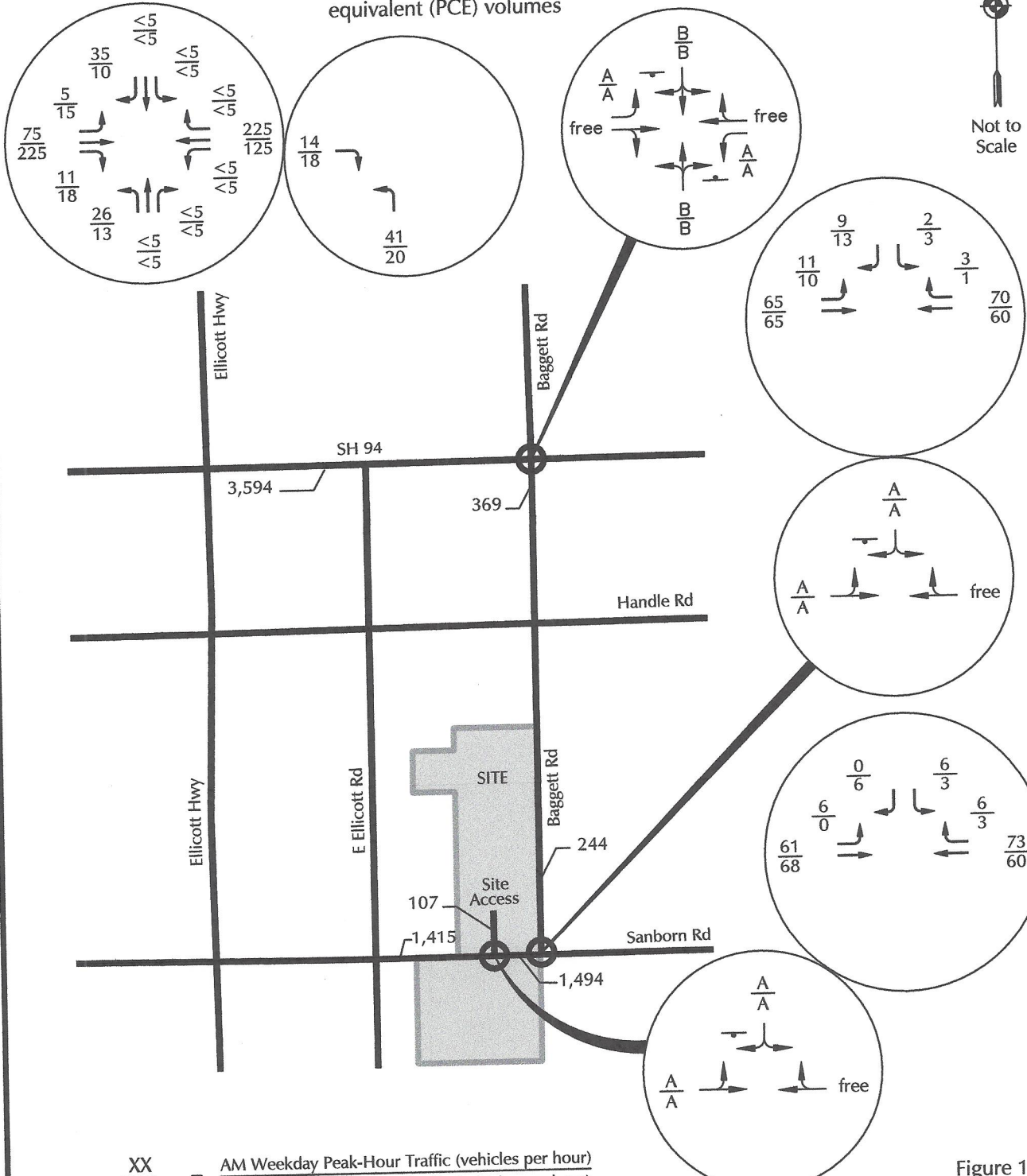

- $\frac{XX}{XX}$ = AM Weekday Peak-Hour Traffic (vehicles per hour)
PM Weekday Peak-Hour Traffic (vehicles per hour)
- X,XXX = Average Daily Traffic (vehicles per day)
- $\frac{X}{X}$ = AM Individual Movement Peak-Hour LOS
PM Individual Movement Peak-Hour LOS
- $\frac{X}{X}$ = AM Entire Intersection Peak-Hour LOS
PM Entire Intersection Peak-Hour LOS
- ⊥ = Stop Sign



Figure 13
2040 Background + Site Traffic, Lane Geometry, Traffic Control, and LOS
 Ellicott Sand + Gravel (LSC# 194980)

Traffic Counts



LSC Transportation Consultants, Inc.

545 E Pikes Peak Ave, Suite 210
 Colorado Springs, CO 80905
 719-633-2868

File Name : Baggett Rd - Hwy 94 AM
 Site Code : 00194980
 Start Date : 11/13/2019
 Page No : 1

Groups Printed- Unshifted

Start Time	Baggette Rd Southbound					Hwy 94 Westbound					Baggette Rd Northbound					Hwy 94 Eastbound					Int. Total
	Left	Through	Right	Peds	App. Total	Left	Through	Right	Peds	App. Total	Left	Through	Right	Peds	App. Total	Left	Through	Right	Peds	App. Total	
06:30 AM	0	0	2	0	2	0	19	0	0	19	2	0	0	0	2	0	8	1	0	9	32
06:45 AM	0	0	0	0	0	0	21	0	0	21	2	0	0	0	2	1	9	0	0	10	33
Total	0	0	2	0	2	0	40	0	0	40	4	0	0	0	4	1	17	1	0	19	65
07:00 AM	0	0	3	0	3	0	50	0	0	50	8	0	0	0	8	0	13	1	0	14	75
07:15 AM	0	0	9	0	9	0	39	0	0	39	3	0	0	0	3	0	14	1	0	15	66
07:30 AM	0	0	8	0	8	0	31	0	0	31	0	0	0	0	0	0	17	2	0	19	58
07:45 AM	0	0	3	0	3	0	34	0	0	34	4	0	0	0	4	2	17	0	0	19	60
Total	0	0	23	0	23	0	154	0	0	154	15	0	0	0	15	2	61	4	0	67	259
08:00 AM	0	0	0	0	0	0	20	0	0	20	2	0	0	0	2	2	13	1	0	16	38
*** BREAK ***																					
Grand Total	0	0	25	0	25	0	214	0	0	214	21	0	0	0	21	5	91	6	0	102	362
Apprch %	0	0	100	0		0	100	0	0		100	0	0	0		4.9	89.2	5.9	0		
Total %	0	0	6.9	0	6.9	0	59.1	0	0	59.1	5.8	0	0	0	5.8	1.4	25.1	1.7	0	28.2	

LSC Transportation Consultants, Inc.
 545 E Pikes Peak Ave, Suite 210
 Colorado Springs, CO 80905
 719-633-2868

File Name : Baggett Rd - Hwy 94 AM
 Site Code : 00194980
 Start Date : 11/13/2019
 Page No : 2

Start Time	Baggette Rd Southbound					Hwy 94 Westbound					Baggette Rd Northbound					Hwy 94 Eastbound					Int. Total
	Left	Through	Right	Peds	App. Total	Left	Through	Right	Peds	App. Total	Left	Through	Right	Peds	App. Total	Left	Through	Right	Peds	App. Total	
Peak Hour Analysis From 06:30 AM to 08:15 AM - Peak 1 of 1																					
Peak Hour for Entire Intersection Begins at 07:00 AM																					
07:00 AM	0	0	3	0	3	0	50	0	0	50	8	0	0	0	8	0	13	1	0	14	75
07:15 AM	0	0	9	0	9	0	39	0	0	39	3	0	0	0	3	0	14	1	0	15	66
07:30 AM	0	0	8	0	8	0	31	0	0	31	0	0	0	0	0	0	17	2	0	19	58
07:45 AM	0	0	3	0	3	0	34	0	0	34	4	0	0	0	4	2	17	0	0	19	60
Total Volume	0	0	23	0	23	0	154	0	0	154	15	0	0	0	15	2	61	4	0	67	259
% App. Total	0	0	100	0		0	100	0	0		100	0	0	0		3	91	6	0		
PHF	.000	.000	.639	.000	.639	.000	.770	.000	.000	.770	.469	.000	.000	.000	.469	.250	.897	.500	.000	.882	.863

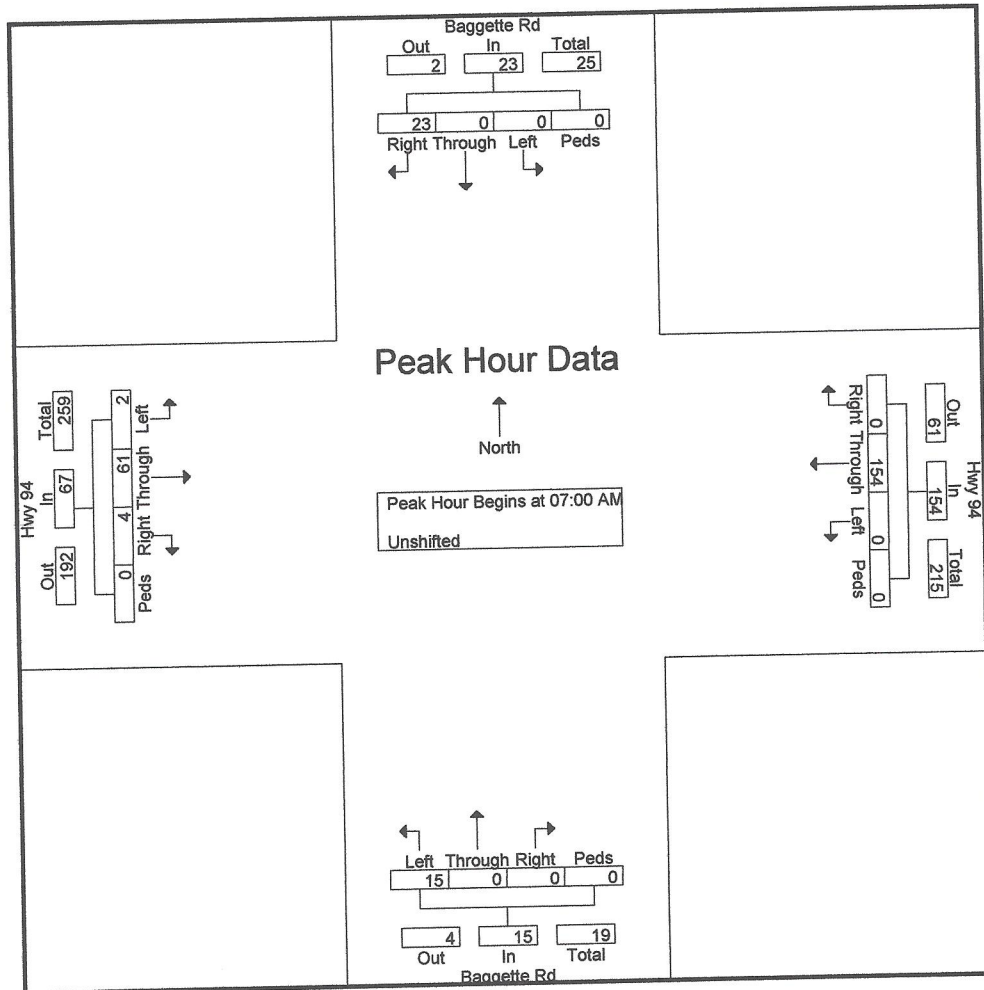

LSC Transportation Consultants, Inc.

545 E Pikes Peak Ave, Suite 210

Colorado Springs, CO 80905

719-633-2868

File Name : Baggett Rd - Hwy 94 AM

Site Code : 00194980

Start Date : 11/13/2019

Page No : 3

Start Time	Baggette Rd Southbound				Hwy 94 Westbound				Baggette Rd Northbound				Hwy 94 Eastbound				Int. Total
	Left	Through	Right	Peds	App. Total	Left	Through	Right	Peds	App. Total	Left	Through	Right	Peds	App. Total		

Peak Hour Analysis From 06:30 AM to 08:15 AM - Peak 1 of 1

Peak Hour for Each Approach Begins at:

	07:00 AM					07:00 AM					06:30 AM					07:15 AM				
+0 mins.	0	0	3	0	3	0	50	0	0	50	2	0	0	0	2	0	14	1	0	15
+15 mins.	0	0	9	0	9	0	39	0	0	39	2	0	0	0	2	0	17	2	0	19
+30 mins.	0	0	8	0	8	0	31	0	0	31	8	0	0	0	8	2	17	0	0	19
+45 mins.	0	0	3	0	3	0	34	0	0	34	3	0	0	0	3	2	13	1	0	16
Total Volume	0	0	23	0	23	0	154	0	0	154	15	0	0	0	15	4	61	4	0	69
% App. Total	0	0	100	0		0	100	0	0		100	0	0	0		5.8	88.4	5.8	0	
PHF	.000	.000	.639	.000	.639	.000	.770	.000	.000	.770	.469	.000	.000	.000	.469	.500	.897	.500	.000	.908

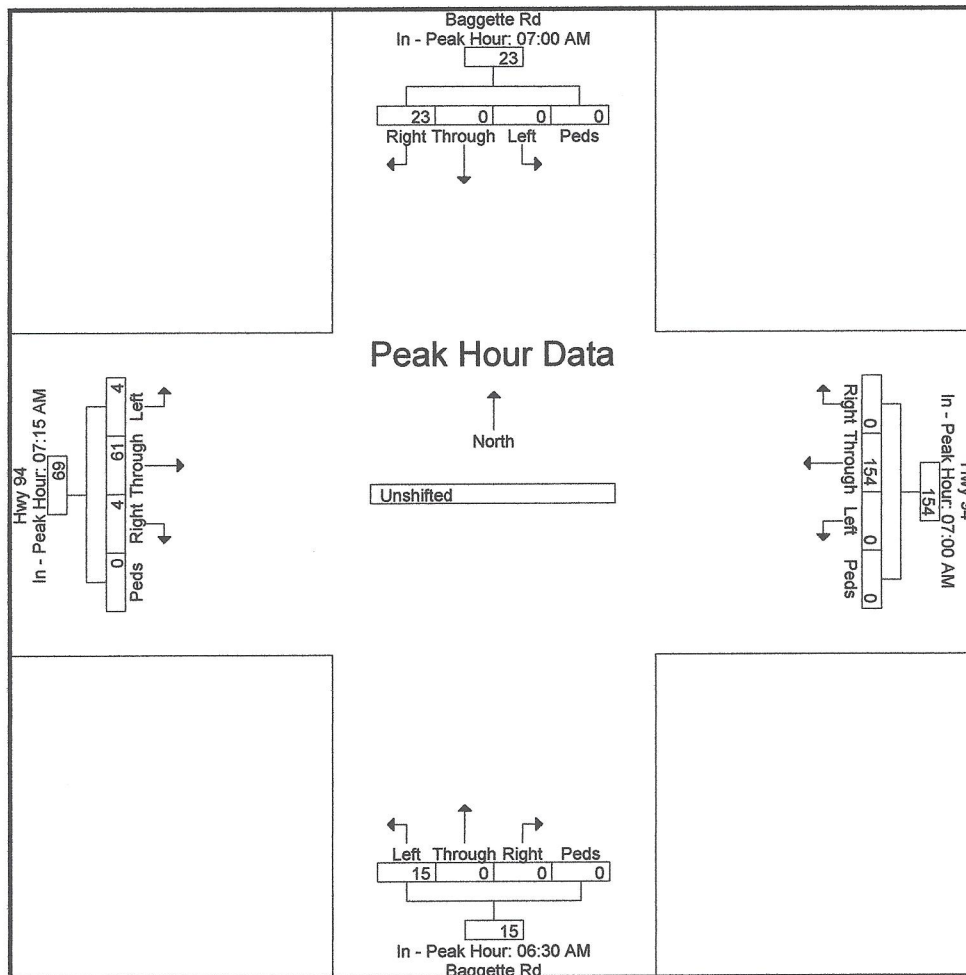



LSC Transportation Consultants, Inc.

545 E Pikes Peak Ave, Suite 210
 Colorado Springs, CO 80905
 719-633-2868

File Name : Baggett Rd - Hwy 94 PM
 Site Code : 00194980
 Start Date : 12/11/2019
 Page No : 1

Groups Printed- Unshifted

Start Time	Bagette Rd Southbound					Hwy 94 Westbound					Bagette Rd Northbound					Hwy 94 Eastbound					Int. Total
	Left	Through	Right	Peds	App. Total	Left	Through	Right	Peds	App. Total	Left	Through	Right	Peds	App. Total	Left	Through	Right	Peds	App. Total	
04:00 PM	0	1	1	0	2	0	20	0	0	20	0	0	0	0	0	3	25	1	0	29	51
04:15 PM	0	0	2	0	2	0	28	0	0	28	3	0	0	0	3	0	31	5	0	36	69
04:30 PM	0	0	1	0	1	0	22	0	0	22	0	0	0	0	0	7	35	2	0	44	67
04:45 PM	0	0	1	0	1	0	15	0	0	15	3	0	0	0	3	2	37	1	0	40	59
Total	0	1	5	0	6	0	85	0	0	85	6	0	0	0	6	12	128	9	0	149	246
05:00 PM	0	0	1	0	1	0	22	0	0	22	1	0	0	0	1	1	49	1	0	51	75
05:15 PM	0	0	0	0	0	0	10	0	0	10	0	0	0	0	0	5	41	6	0	52	62
05:30 PM	0	0	1	0	1	0	19	0	0	19	0	0	0	0	0	6	39	5	0	50	70
05:45 PM	0	0	0	0	0	0	17	0	0	17	0	0	0	0	0	3	37	0	0	40	57
Total	0	0	2	0	2	0	68	0	0	68	1	0	0	0	1	15	166	12	0	193	264
Grand Total	0	1	7	0	8	0	153	0	0	153	7	0	0	0	7	27	294	21	0	342	510
Apprch %	0	12.5	87.5	0		0	100	0	0		100	0	0	0		7.9	86	6.1	0		
Total %	0	0.2	1.4	0	1.6	0	30	0	0	30	1.4	0	0	0	1.4	5.3	57.6	4.1	0	67.1	



LSC Transportation Consultants, Inc.

545 E Pikes Peak Ave, Suite 210
 Colorado Springs, CO 80905
 719-633-2868

File Name : Baggett Rd - Hwy 94 PM
 Site Code : 00194980
 Start Date : 12/11/2019
 Page No : 2

Start Time	Bagette Rd Southbound					Hwy 94 Westbound					Bagette Rd Northbound					Hwy 94 Eastbound					Int. Total
	Left	Through	Right	Peds	App. Total	Left	Through	Right	Peds	App. Total	Left	Through	Right	Peds	App. Total	Left	Through	Right	Peds	App. Total	
Peak Hour Analysis From 04:00 PM to 05:45 PM - Peak 1 of 1																					
Peak Hour for Entire Intersection Begins at 04:15 PM																					
04:15 PM	0	0	2	0	2	0	28	0	0	28	3	0	0	0	3	0	31	5	0	36	69
04:30 PM	0	0	1	0	1	0	22	0	0	22	0	0	0	0	0	7	35	2	0	44	67
04:45 PM	0	0	1	0	1	0	15	0	0	15	3	0	0	0	3	2	37	1	0	40	59
05:00 PM	0	0	1	0	1	0	22	0	0	22	1	0	0	0	1	1	49	1	0	51	75
Total Volume	0	0	5	0	5	0	87	0	0	87	7	0	0	0	7	10	152	9	0	171	270
% App. Total	0	0	100	0		0	100	0	0		100	0	0	0		5.8	88.9	5.3	0		
PHF	.000	.000	.625	.000	.625	.000	.777	.000	.000	.777	.583	.000	.000	.000	.583	.357	.776	.450	.000	.838	.900

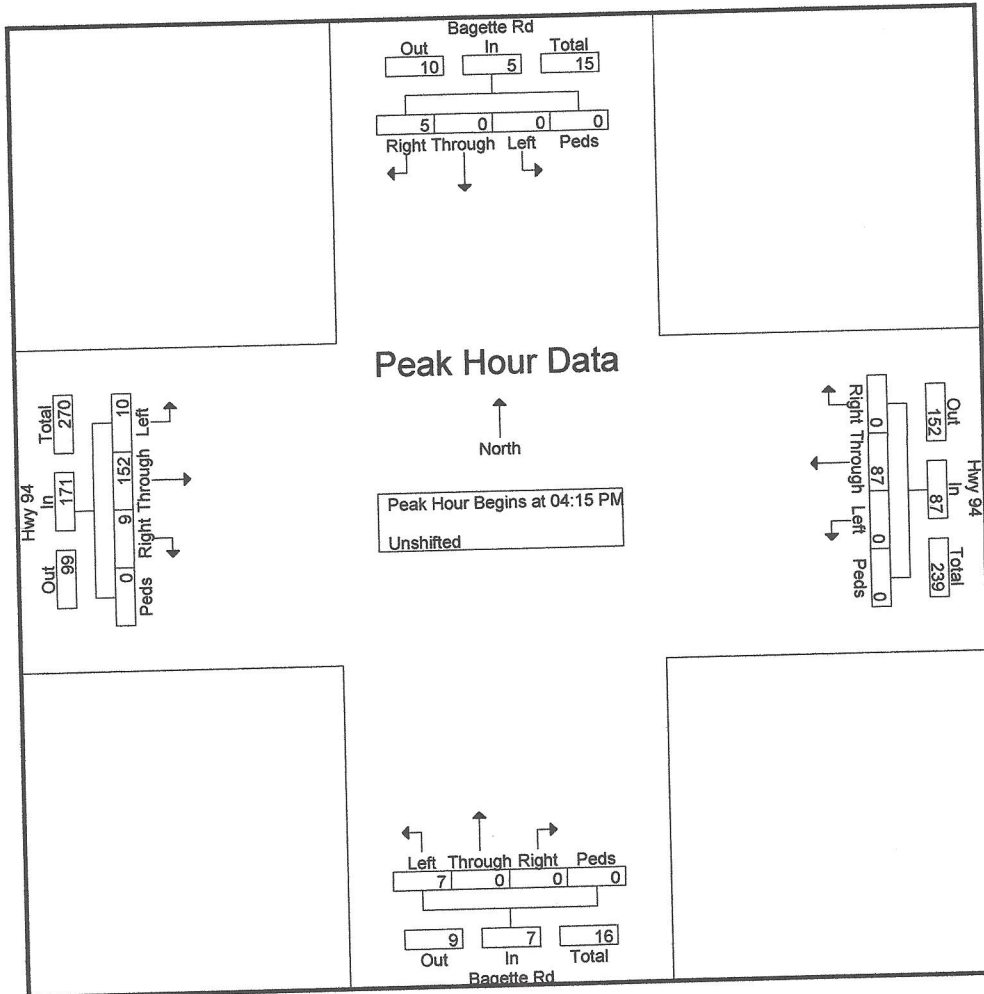



LSC Transportation Consultants, Inc.

545 E Pikes Peak Ave, Suite 210

Colorado Springs, CO 80905

719-633-2868

File Name : Baggett Rd - Hwy 94 PM

Site Code : 00194980

Start Date : 12/11/2019

Page No : 3

Start Time	Bagette Rd Southbound					Hwy 94 Westbound					Bagette Rd Northbound					Hwy 94 Eastbound					Int. Total
	Left	Through	Right	Peds	App. Total	Left	Through	Right	Peds	App. Total	Left	Through	Right	Peds	App. Total	Left	Through	Right	Peds	App. Total	

Peak Hour Analysis From 04:00 PM to 05:45 PM - Peak 1 of 1

Peak Hour for Each Approach Begins at:

	04:00 PM					04:15 PM					04:45 PM									
+0 mins.	0	1	1	0	2	0	28	0	0	28	3	0	0	0	3	2	37	1	0	40
+15 mins.	0	0	2	0	2	0	22	0	0	22	0	0	0	0	0	1	49	1	0	51
+30 mins.	0	0	1	0	1	0	15	0	0	15	3	0	0	0	3	5	41	6	0	52
+45 mins.	0	0	1	0	1	0	22	0	0	22	1	0	0	0	1	6	39	5	0	50
Total Volume	0	1	5	0	6	0	87	0	0	87	7	0	0	0	7	14	166	13	0	193
% App. Total	0	16.7	83.3	0		0	100	0	0		100	0	0	0		7.3	86	6.7	0	
PHF	.000	.250	.625	.000	.750	.000	.777	.000	.000	.777	.583	.000	.000	.000	.583	.583	.847	.542	.000	.928

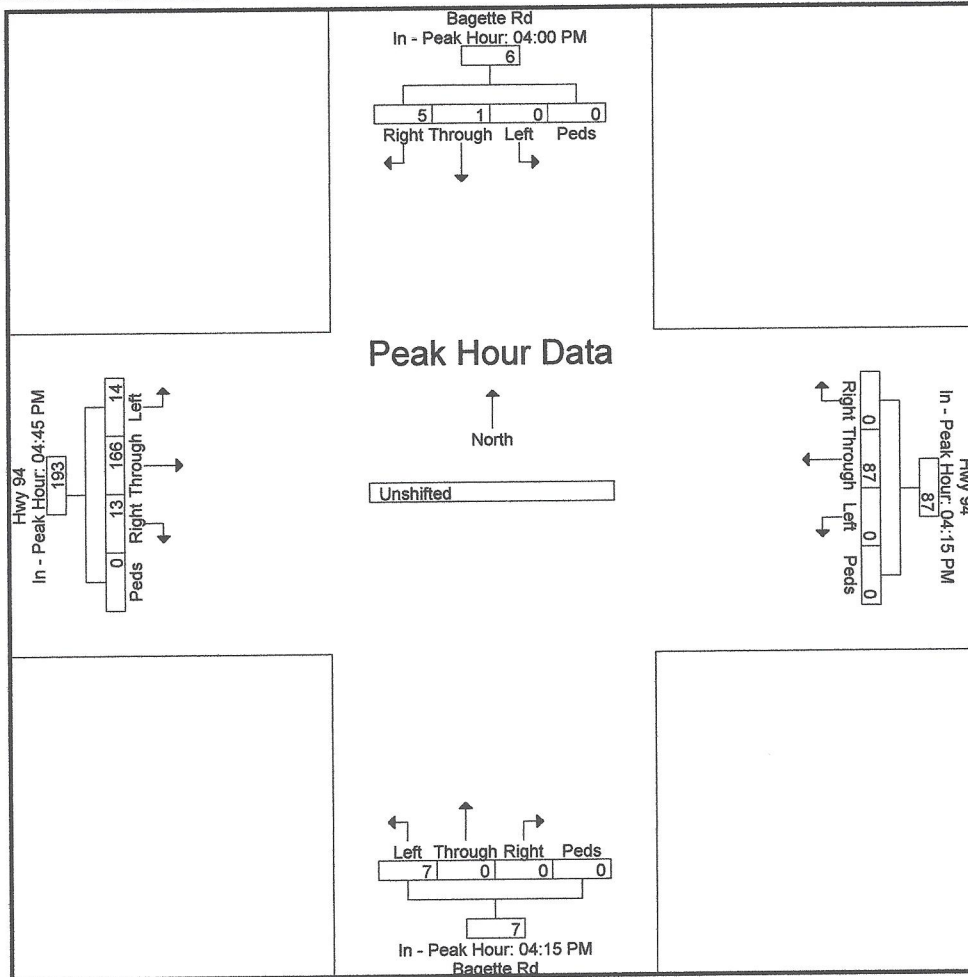



LSC Transportation Consultants, Inc.

545 E Pikes Peak Ave, Suite 210
 Colorado Springs, CO 80905
 719-633-2868

File Name : Baggette Rd - Sanborn Rd AM
 Site Code : 00194980
 Start Date : 12/11/2019
 Page No : 1

Groups Printed- Unshifted

Start Time	Baggett Rd Southbound					Sanborn Rd Westbound					Northbound					Baggett Rd Eastbound					Int. Total
	Left	Through	Right	Peds	App. Total	Left	Through	Right	Peds	App. Total	Left	Through	Right	Peds	App. Total	Left	Through	Right	Peds	App. Total	
06:30 AM	0	0	0	0	0	0	1	0	0	1	0	0	0	0	0	1	0	0	0	1	2
06:45 AM	0	0	0	0	0	0	3	0	0	3	0	0	1	0	1	2	0	0	0	2	6
Total	0	0	0	0	0	0	4	0	0	4	0	0	1	0	1	3	0	0	0	3	8
07:00 AM	0	0	2	0	2	0	0	1	0	1	0	0	0	0	0	0	1	0	0	1	4
07:15 AM	0	0	0	0	0	0	0	0	0	0	0	0	0	0	0	1	1	0	0	2	2
07:30 AM	0	0	0	0	0	0	1	1	0	2	0	0	0	0	0	0	1	0	0	1	3
*** BREAK ***																1	3	0	0	4	9
Total	0	0	2	0	2	0	1	2	0	3	0	0	0	0	0	1	3	0	0	4	9
*** BREAK ***													1	0	1	4	3	0	0	7	17
Grand Total	0	0	2	0	2	0	5	2	0	7	0	0	1	0	1	57.1	42.9	0	0		
Apprch %	0	0	100	0		0	71.4	28.6	0		0	0	100	0		23.5	17.6	0	0	41.2	
Total %	0	0	11.8	0	11.8	0	29.4	11.8	0	41.2	0	0	5.9	0	5.9						



LSC Transportation Consultants, Inc.

545 E Pikes Peak Ave, Suite 210
 Colorado Springs, CO 80905
 719-633-2868

File Name : Baggette Rd - Sanborn Rd AM
 Site Code : 00194980
 Start Date : 12/11/2019
 Page No : 2

Start Time	Baggett Rd Southbound					Sanborn Rd Westbound					Northbound					Baggett Rd Eastbound					Int. Total
	Left	Through	Right	Peds	App. Total	Left	Through	Right	Peds	App. Total	Left	Through	Right	Peds	App. Total	Left	Through	Right	Peds	App. Total	
Peak Hour Analysis From 06:30 AM to 08:15 AM - Peak 1 of 1																					
Peak Hour for Entire Intersection Begins at 06:45 AM																					
06:45 AM	0	0	0	0	0	0	3	0	0	3	0	0	1	0	1	2	0	0	0	2	6
07:00 AM	0	0	2	0	2	0	0	1	0	1	0	0	0	0	0	0	1	0	0	1	4
07:15 AM	0	0	0	0	0	0	0	0	0	0	0	0	0	0	0	1	1	0	0	2	2
07:30 AM	0	0	0	0	0	0	1	1	0	2	0	0	0	0	0	0	1	0	0	1	3
Total Volume	0	0	2	0	2	0	4	2	0	6	0	0	1	0	1	3	3	0	0	6	15
% App. Total	0	0	100	0		0	66.7	33.3	0		0	0	100	0		50	50	0	0		
PHF	.000	.000	.250	.000	.250	.000	.333	.500	.000	.500	.000	.000	.250	.000	.250	.375	.750	.000	.000	.750	.625

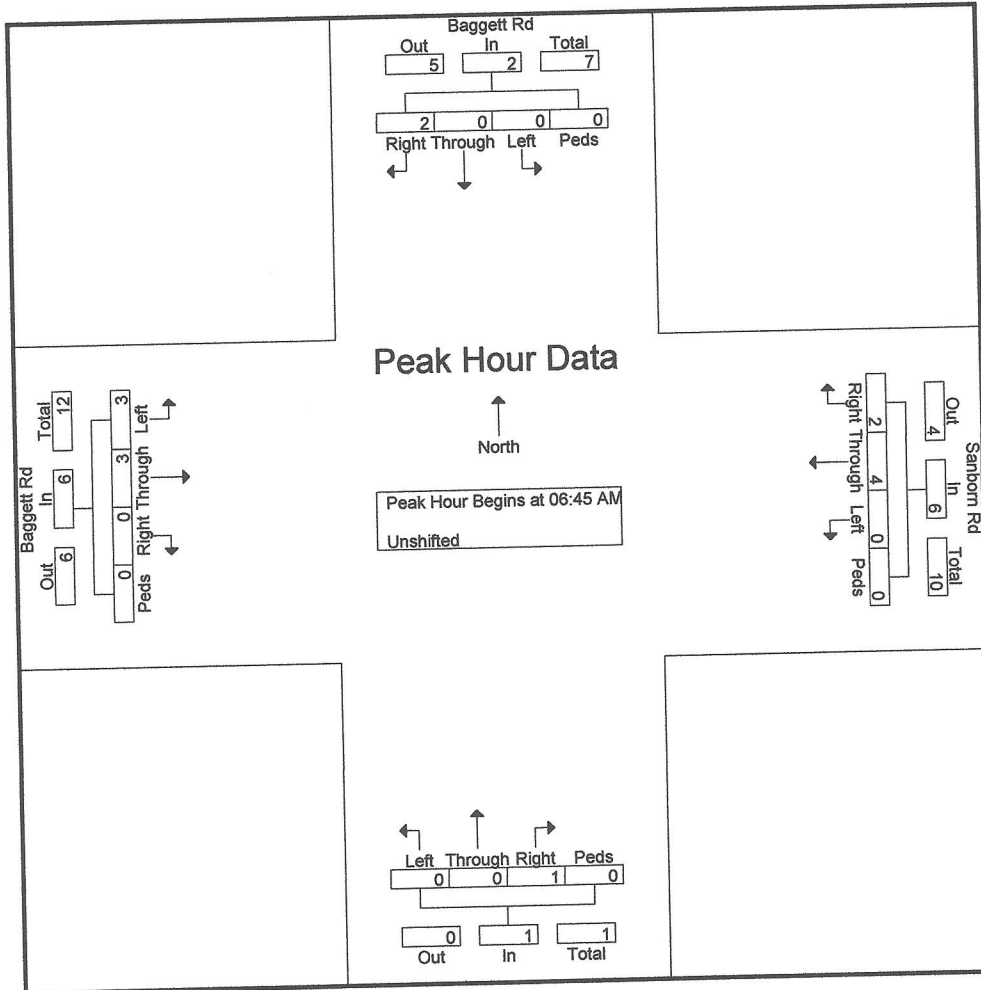



LSC Transportation Consultants, Inc.

545 E Pikes Peak Ave, Suite 210
 Colorado Springs, CO 80905
 719-633-2868

File Name : Baggette Rd - Sanborn Rd AM
 Site Code : 00194980
 Start Date : 12/11/2019
 Page No : 3

Start Time	Baggett Rd Southbound					Sanborn Rd Westbound					Northbound					Baggett Rd Eastbound					Int. Total	
	Left	Through	Right	Peds	App. Total	Left	Through	Right	Peds	App. Total	Left	Through	Right	Peds	App. Total	Left	Through	Right	Peds	App. Total		
Peak Hour Analysis From 06:30 AM to 08:15 AM - Peak 1 of 1																						
Peak Hour for Each Approach Begins at:																						
	06:30 AM					06:45 AM					06:30 AM					06:30 AM						
+0 mins.	0	0	0	0	0	0	3	0	0	3	0	0	0	0	0	1	0	0	0	0	1	2
+15 mins.	0	0	0	0	0	0	0	1	0	1	0	0	1	0	1	0	1	0	0	0	1	1
+30 mins.	0	0	2	0	2	0	0	0	0	0	0	0	0	0	0	1	1	0	0	0	2	2
+45 mins.	0	0	0	0	0	0	1	1	0	2	0	0	0	0	0	4	2	0	0	0	6	6
Total Volume	0	0	2	0	2	0	4	2	0	6	0	0	1	0	1	66.7	33.3	0	0	0		
% App. Total	0	0	100	0		0	66.7	33.3	0		0	0	100	0		.500	.500	.000	.000	.750		
PHF	.000	.000	.250	.000	.250	.000	.333	.500	.000	.500	.000	.000	.250	.000	.250	.500	.500	.000	.000	.750		

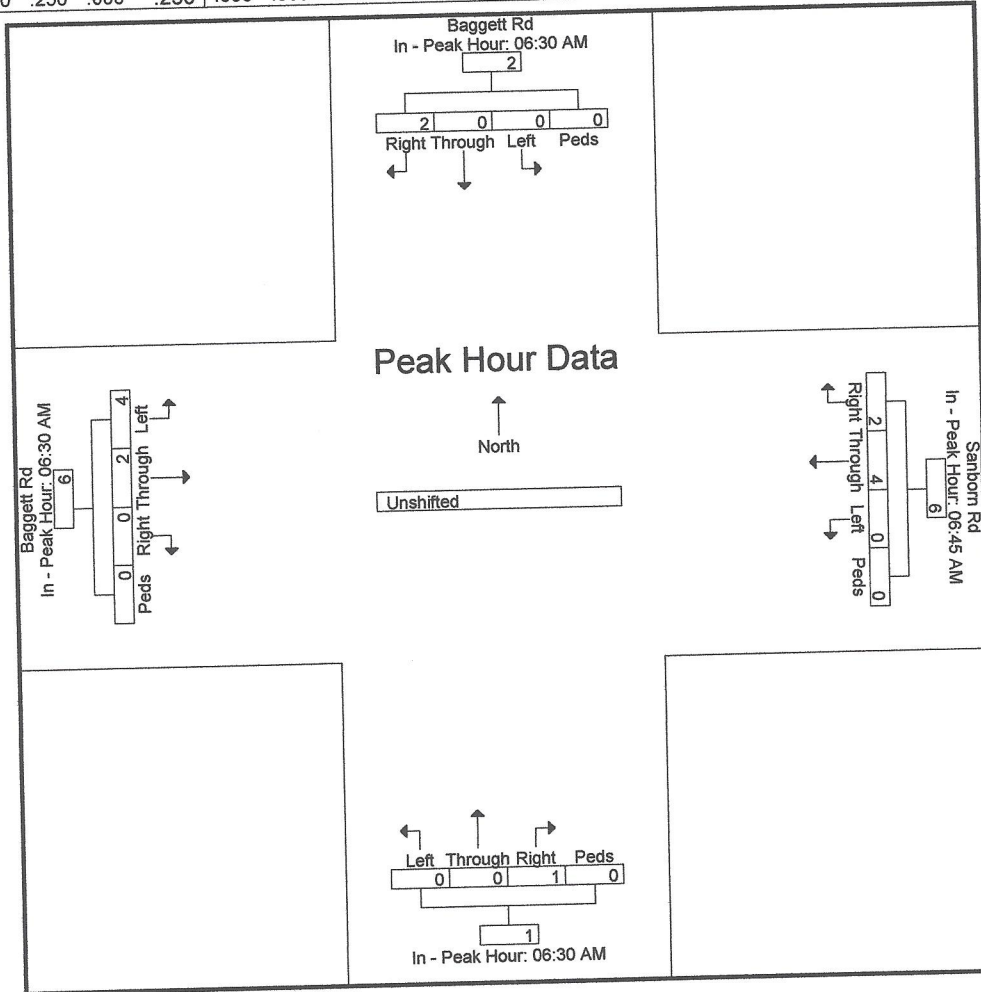



LSC Transportation Consultants, Inc.

545 E Pikes Peak Ave, Suite 210
 Colorado Springs, CO 80905
 719-633-2868

File Name : Baggett Rd - Sanborn Rd PM
 Site Code : 00194980
 Start Date : 12/18/2019
 Page No : 1

Groups Printed- Unshifted

Start Time	Baggett Rd Southbound					Sanborn Rd Westbound					Northbound					Baggett Rd Eastbound					Int. Total	
	Left	Through	Right	Peds	App. Total	Left	Through	Right	Peds	App. Total	Left	Through	Right	Peds	App. Total	Left	Through	Right	Peds	App. Total		
04:00 PM	1	0	1	0	2	0	0	0	0	0	0	0	0	0	0	0	0	0	0	0	0	2
04:15 PM	0	0	1	0	1	0	0	0	0	0	0	0	0	0	0	2	0	0	0	0	2	3
04:30 PM	0	0	2	0	2	0	1	0	0	1	0	0	0	0	0	1	1	0	0	2	2	5
04:45 PM	0	0	0	0	0	0	1	0	0	1	0	0	0	0	0	2	1	0	0	3	3	4
Total	1	0	4	0	5	0	2	0	0	2	0	0	0	0	0	5	2	0	0	7	7	14
05:00 PM	0	0	0	0	0	0	0	0	0	0	0	0	0	0	0	0	2	0	0	2	2	2
05:15 PM	0	0	1	0	1	0	0	0	0	0	0	0	0	0	0	1	0	0	0	1	1	2
05:30 PM	0	0	1	0	1	0	0	0	0	0	0	0	0	0	0	1	0	0	0	1	1	2
05:45 PM	0	0	1	0	1	0	1	0	0	1	0	0	0	0	0	1	1	0	0	2	2	4
Total	0	0	3	0	3	0	1	0	0	1	0	0	0	0	0	3	3	0	0	6	6	10
Grand Total	1	0	7	0	8	0	3	0	0	3	0	0	0	0	0	8	5	0	0	13	13	24
Apprch %	12.5	0	87.5	0		0	100	0	0		0	0	0	0		61.5	38.5	0	0			
Total %	4.2	0	29.2	0	33.3	0	12.5	0	0	12.5	0	0	0	0	0	33.3	20.8	0	0	54.2	54.2	



LSC Transportation Consultants, Inc.

545 E Pikes Peak Ave, Suite 210

Colorado Springs, CO 80905

719-633-2868

File Name : Baggett Rd - Sanborn Rd PM

Site Code : 00194980

Start Date : 12/18/2019

Page No : 2

Start Time	Baggett Rd Southbound					Sanborn Rd Westbound					Northbound					Baggett Rd Eastbound					Int. Total	
	Left	Through	Right	Peds	App. Total	Left	Through	Right	Peds	App. Total	Left	Through	Right	Peds	App. Total	Left	Through	Right	Peds	App. Total		
Peak Hour Analysis From 04:00 PM to 05:45 PM - Peak 1 of 1																						
Peak Hour for Entire Intersection Begins at 04:00 PM																						
04:00 PM	1	0	1	0	2	0	0	0	0	0	0	0	0	0	0	0	0	0	0	0	0	2
04:15 PM	0	0	1	0	1	0	0	0	0	0	0	0	0	0	0	0	1	1	0	0	0	2
04:30 PM	0	0	2	0	2	0	1	0	0	1	0	0	0	0	0	0	2	1	0	0	0	3
04:45 PM	0	0	0	0	0	0	1	0	0	1	0	0	0	0	0	0	5	2	0	0	0	7
Total Volume	1	0	4	0	5	0	2	0	0	2	0	0	0	0	0	0	71.4	28.6	0	0	0	14
% App. Total	20	0	80	0		0	100	0	0		0	0	0	0		.625	.500	.000	.000		.583	.700
PHF	.250	.000	.500	.000	.625	.000	.500	.000	.000	.500	.000	.000	.000	.000	.000	.625	.500	.000	.000	.583		.700

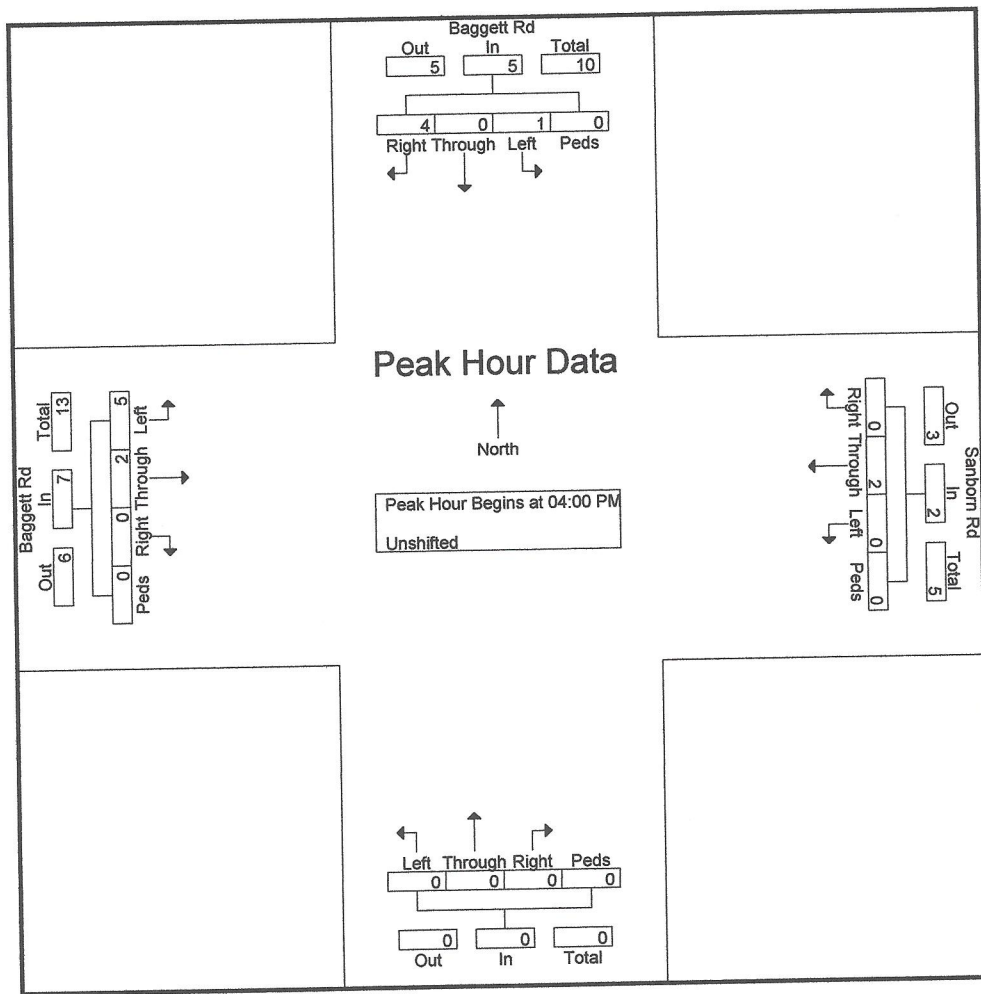



LSC Transportation Consultants, Inc.
 545 E Pikes Peak Ave, Suite 210
 Colorado Springs, CO 80905
 719-633-2868

File Name : Baggett Rd - Sanborn Rd PM
 Site Code : 00194980
 Start Date : 12/18/2019
 Page No : 3

Start Time	Baggett Rd Southbound					Sanborn Rd Westbound					Northbound					Baggett Rd Eastbound					Int. Total	
	Left	Through	Right	Peds	App. Total	Left	Through	Right	Peds	App. Total	Left	Through	Right	Peds	App. Total	Left	Through	Right	Peds	App. Total		
Peak Hour Analysis From 04:00 PM to 05:45 PM - Peak 1 of 1																						
Peak Hour for Each Approach Begins at:																						
	04:00 PM					04:00 PM					04:00 PM					04:15 PM						
+0 mins.	1	0	1	0	2	0	0	0	0	0	0	0	0	0	0	2	0	0	0	0	2	
+15 mins.	0	0	1	0	1	0	0	0	0	0	0	0	0	0	0	1	1	0	0	0	2	
+30 mins.	0	0	2	0	2	0	1	0	0	1	0	0	0	0	0	0	2	0	0	0	3	
+45 mins.	0	0	0	0	0	0	1	0	0	1	0	0	0	0	0	0	2	0	0	0	2	
Total Volume	1	0	4	0	5	0	2	0	0	2	0	0	0	0	0	5	4	0	0	0	9	
% App. Total	20	0	80	0		0	100	0	0		0	0	0	0		55.6	44.4	0	0			
PHF	.250	.000	.500	.000	.625	.000	.500	.000	.000	.500	.000	.000	.000	.000	.000	.625	.500	.000	.000	.750		

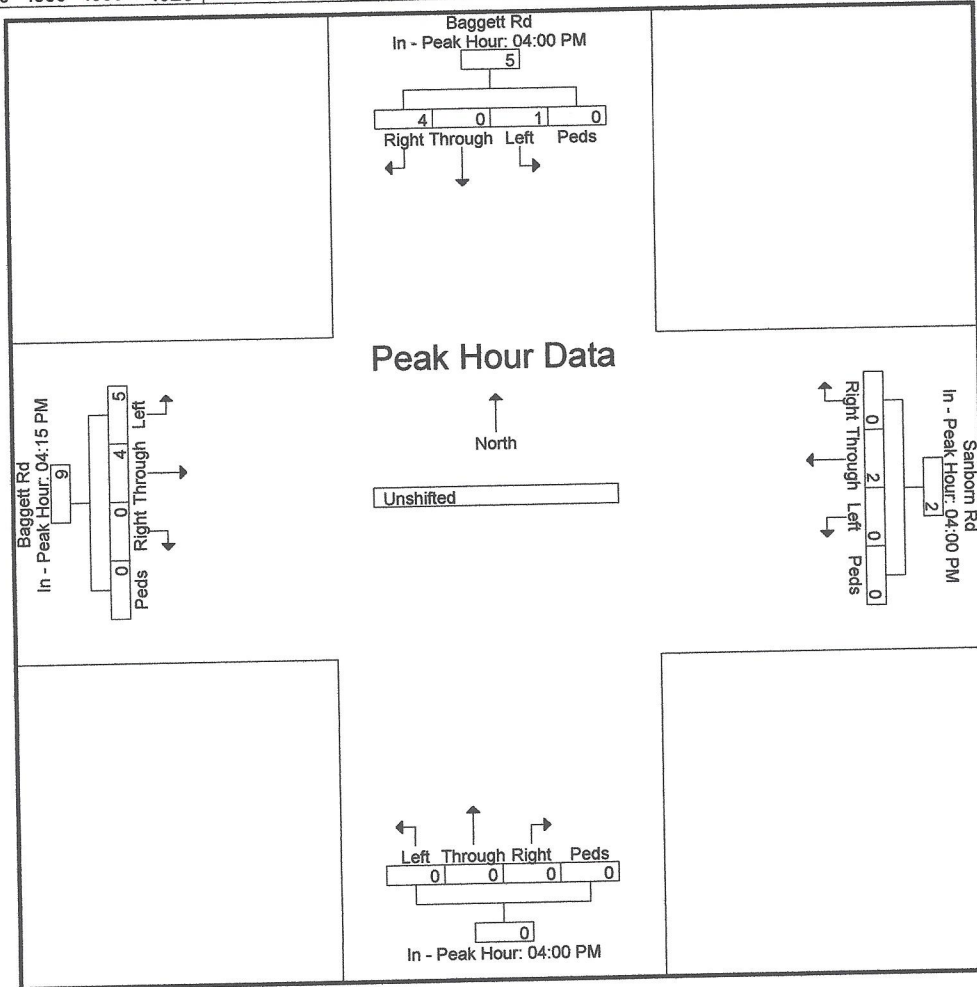

Levels of Service



HCM 6th TWSC
1: Baggett Rd & SH 94

Existing
AM

Intersection

Int Delay, s/veh 2.1

Movement	EBL	EBT	EBR	WBL	WBT	WBR	NBL	NBT	NBR	SBL	SBT	SBR
Lane Configurations		↕			↕			↕			↕	
Traffic Vol, veh/h	4	61	2	0	154	0	15	0	0	0	0	23
Future Vol, veh/h	4	61	2	0	154	0	15	0	0	0	0	23
Conflicting Peds, #/hr	0	0	0	0	0	0	0	0	0	0	0	0
Sign Control	Free	Free	Free	Free	Free	Free	Stop	Stop	Stop	Stop	Stop	Stop
RT Channelized	-	-	None	-	-	None	-	-	None	-	-	None
Storage Length	-	-	-	-	-	-	-	-	-	-	-	-
Veh in Median Storage, #	-	0	-	-	0	-	-	0	-	-	0	-
Grade, %	-	0	-	-	0	-	-	0	-	-	0	-
Peak Hour Factor	77	77	77	100	100	100	100	100	100	47	47	47
Heavy Vehicles, %	2	2	2	2	2	2	2	2	2	2	2	2
Mvmt Flow	5	79	3	0	154	0	15	0	0	0	0	49

Major/Minor	Major1	Major2	Minor1	Minor2
Conflicting Flow All	154	0	0	82
Stage 1	-	-	-	-
Stage 2	-	-	-	-
Critical Hdwy	4.12	-	-	4.12
Critical Hdwy Stg 1	-	-	-	-
Critical Hdwy Stg 2	-	-	-	-
Follow-up Hdwy	2.218	-	-	2.218
Pot Cap-1 Maneuver	1426	-	-	1515
Stage 1	-	-	-	-
Stage 2	-	-	-	-
Platoon blocked, %	-	-	-	-
Mov Cap-1 Maneuver	1426	-	-	1515
Mov Cap-2 Maneuver	-	-	-	-
Stage 1	-	-	-	-
Stage 2	-	-	-	-

Approach	EB	WB	NB	SB
HCM Control Delay, s	0.4	0	10.7	9.3
HCM LOS			B	A

Minor Lane/Major Mvmt	NBLn1	EBL	EBT	EBR	WBL	WBT	WBR	SBLn1
Capacity (veh/h)	643	1426	-	-	1515	-	-	892
HCM Lane V/C Ratio	0.023	0.004	-	-	-	-	-	0.055
HCM Control Delay (s)	10.7	7.5	0	-	0	-	-	9.3
HCM Lane LOS	B	A	A	-	A	-	-	A
HCM 95th %tile Q(veh)	0.1	0	-	-	0	-	-	0.2

HCM 6th TWSC
2: Sanborn Rd & Baggett Rd

Existing
AM

Intersection

Int Delay, s/veh 2.6

Movement	EBL	EBT	WBT	WBR	SBL	SBR
Lane Configurations		↕	↕		↕	
Traffic Vol, veh/h	3	3	4	2	0	2
Future Vol, veh/h	3	3	4	2	0	2
Conflicting Peds, #/hr	0	0	0	0	0	0
Sign Control	Free	Free	Free	Free	Stop	Stop
RT Channelized	-	None	-	None	-	None
Storage Length	-	-	-	-	0	-
Veh in Median Storage, #	-	0	0	-	0	-
Grade, %	-	0	0	-	0	-
Peak Hour Factor	75	75	50	50	50	50
Heavy Vehicles, %	2	2	2	2	2	2
Mvmt Flow	4	4	8	4	0	4

Major/Minor	Major1	Major2	Minor2		
Conflicting Flow All	12	0	-	0	22 10
Stage 1	-	-	-	-	10 -
Stage 2	-	-	-	-	12 -
Critical Hdwy	4.12	-	-	-	6.42 6.22
Critical Hdwy Stg 1	-	-	-	-	5.42 -
Critical Hdwy Stg 2	-	-	-	-	5.42 -
Follow-up Hdwy	2.218	-	-	-	3.518 3.318
Pot Cap-1 Maneuver	1607	-	-	-	995 1071
Stage 1	-	-	-	-	1013 -
Stage 2	-	-	-	-	1011 -
Platoon blocked, %	-	-	-	-	-
Mov Cap-1 Maneuver	1607	-	-	-	993 1071
Mov Cap-2 Maneuver	-	-	-	-	993 -
Stage 1	-	-	-	-	1011 -
Stage 2	-	-	-	-	1011 -

Approach	EB	WB	SB
HCM Control Delay, s	3.6	0	8.4
HCM LOS			A

Minor Lane/Major Mvmt	EBL	EBT	WBT	WBR	SBLn1
Capacity (veh/h)	1607	-	-	-	1071
HCM Lane V/C Ratio	0.002	-	-	-	0.004
HCM Control Delay (s)	7.2	0	-	-	8.4
HCM Lane LOS	A	A	-	-	A
HCM 95th %tile Q(veh)	0	-	-	-	0

HCM 6th TWSC
1: Baggett Rd & SH 94

Existing
PM

Intersection

Int Delay, s/veh 0.7

Movement	EBL	EBT	EBR	WBL	WBT	WBR	NBL	NBT	NBR	SBL	SBT	SBR
Lane Configurations		↕	↗		↕			↕			↕	
Traffic Vol, veh/h	10	152	9	0	87	0	7	0	0	0	0	5
Future Vol, veh/h	10	152	9	0	87	0	7	0	0	0	0	5
Conflicting Peds, #/hr	0	0	0	0	0	0	0	0	0	0	0	0
Sign Control	Free	Free	Free	Free	Free	Free	Stop	Stop	Stop	Stop	Stop	Stop
RT Channelized	-	-	None	-	-	None	-	-	None	-	-	None
Storage Length	-	-	400	-	-	-	-	-	-	-	-	-
Veh in Median Storage, #	-	0	-	-	0	-	-	0	-	-	0	-
Grade, %	-	0	-	-	0	-	-	0	-	-	0	-
Peak Hour Factor	84	84	84	99	99	99	100	100	100	100	100	100
Heavy Vehicles, %	2	2	2	2	2	2	2	2	2	2	2	2
Mvmt Flow	12	181	11	0	88	0	7	0	0	0	0	5

Major/Minor	Major1			Major2			Minor1			Minor2		
Conflicting Flow All	88	0	0	192	0	0	296	293	181	299	304	88
Stage 1	-	-	-	-	-	-	205	205	-	88	88	-
Stage 2	-	-	-	-	-	-	91	88	-	211	216	-
Critical Hdwy	4.12	-	-	4.12	-	-	7.12	6.52	6.22	7.12	6.52	6.22
Critical Hdwy Stg 1	-	-	-	-	-	-	6.12	5.52	-	6.12	5.52	-
Critical Hdwy Stg 2	-	-	-	-	-	-	6.12	5.52	-	6.12	5.52	-
Follow-up Hdwy	2.218	-	-	2.218	-	-	3.518	4.018	3.318	3.518	4.018	3.318
Pot Cap-1 Maneuver	1508	-	-	1381	-	-	656	618	862	653	609	970
Stage 1	-	-	-	-	-	-	797	732	-	920	822	-
Stage 2	-	-	-	-	-	-	916	822	-	791	724	-
Platoon blocked, %	-	-	-	-	-	-	-	-	-	-	-	-
Mov Cap-1 Maneuver	1508	-	-	1381	-	-	648	612	862	648	604	970
Mov Cap-2 Maneuver	-	-	-	-	-	-	648	612	-	648	604	-
Stage 1	-	-	-	-	-	-	790	725	-	912	822	-
Stage 2	-	-	-	-	-	-	911	822	-	784	717	-

Approach	EB	WB	NB	SB
HCM Control Delay, s	0.4	0	10.6	8.7
HCM LOS			B	A

Minor Lane/Major Mvmt	NBLn1	EBL	EBT	EBR	WBL	WBT	WBR	SBLn1
Capacity (veh/h)	648	1508	-	-	1381	-	-	970
HCM Lane V/C Ratio	0.011	0.008	-	-	-	-	-	0.005
HCM Control Delay (s)	10.6	7.4	0	-	0	-	-	8.7
HCM Lane LOS	B	A	A	-	A	-	-	A
HCM 95th %tile Q(veh)	0	0	-	-	0	-	-	0

HCM 6th TWSC
2: Sanborn Rd & Baggett Rd

Existing
PM

Intersection

Int Delay, s/veh 5.4

Movement	EBL	EBT	WBT	WBR	SBL	SBR
Lane Configurations		↕	↕		↕	
Traffic Vol, veh/h	5	2	2	0	1	4
Future Vol, veh/h	5	2	2	0	1	4
Conflicting Peds, #/hr	0	0	0	0	0	0
Sign Control	Free	Free	Free	Free	Stop	Stop
RT Channelized	-	None	-	None	-	None
Storage Length	-	-	-	-	0	-
Veh in Median Storage, #	-	0	0	-	0	-
Grade, %	-	0	0	-	0	-
Peak Hour Factor	88	88	50	50	63	63
Heavy Vehicles, %	2	2	2	2	2	2
Mvmt Flow	6	2	4	0	2	6

Major/Minor	Major1	Major2	Minor2
Conflicting Flow All	4	0	0 18 4
Stage 1	-	-	- 4 -
Stage 2	-	-	- 14 -
Critical Hdwy	4.12	-	- 6.42 6.22
Critical Hdwy Stg 1	-	-	- 5.42 -
Critical Hdwy Stg 2	-	-	- 5.42 -
Follow-up Hdwy	2.218	-	- 3.518 3.318
Pot Cap-1 Maneuver	1618	-	- 1000 1080
Stage 1	-	-	- 1019 -
Stage 2	-	-	- 1009 -
Platoon blocked, %	-	-	-
Mov Cap-1 Maneuver	1618	-	- 996 1080
Mov Cap-2 Maneuver	-	-	- 996 -
Stage 1	-	-	- 1015 -
Stage 2	-	-	- 1009 -

Approach	EB	WB	SB
HCM Control Delay, s	5.2	0	8.4
HCM LOS			A

Minor Lane/Major Mvmt	EBL	EBT	WBT	WBR	SBLn1
Capacity (veh/h)	1618	-	-	-	1062
HCM Lane V/C Ratio	0.004	-	-	-	0.007
HCM Control Delay (s)	7.2	0	-	-	8.4
HCM Lane LOS	A	A	-	-	A
HCM 95th %tile Q(veh)	0	-	-	-	0

HCM 6th TWSC
1: Baggett Rd & SH 94

Existing + Site
AM

Intersection

Int Delay, s/veh 2.3

Movement	EBL	EBT	EBR	WBL	WBT	WBR	NBL	NBT	NBR	SBL	SBT	SBR
Lane Configurations		↕			↕			↕			↕	
Traffic Vol, veh/h	4	61	8	0	154	0	21	0	0	0	0	23
Future Vol, veh/h	4	61	8	0	154	0	21	0	0	0	0	23
Conflicting Peds, #/hr	0	0	0	0	0	0	0	0	0	0	0	0
Sign Control	Free	Free	Free	Free	Free	Free	Stop	Stop	Stop	Stop	Stop	Stop
RT Channelized	-	-	None	-	-	None	-	-	None	-	-	None
Storage Length	-	-	-	-	-	-	-	-	-	-	-	-
Veh in Median Storage, #	-	0	-	-	0	-	-	0	-	-	0	-
Grade, %	-	0	-	-	0	-	-	0	-	-	0	-
Peak Hour Factor	77	77	77	100	100	100	100	100	100	47	47	47
Heavy Vehicles, %	2	2	2	2	2	2	2	2	2	2	2	2
Mvmt Flow	5	79	10	0	154	0	21	0	0	0	0	49

Major/Minor	Major1	Major2	Minor1	Minor2
Conflicting Flow All	154	0	0	89
Stage 1	-	-	-	-
Stage 2	-	-	-	-
Critical Hdwy	4.12	-	-	4.12
Critical Hdwy Stg 1	-	-	-	-
Critical Hdwy Stg 2	-	-	-	-
Follow-up Hdwy	2.218	-	-	2.218
Pot Cap-1 Maneuver	1426	-	-	1506
Stage 1	-	-	-	-
Stage 2	-	-	-	-
Platoon blocked, %	-	-	-	-
Mov Cap-1 Maneuver	1426	-	-	1506
Mov Cap-2 Maneuver	-	-	-	-
Stage 1	-	-	-	-
Stage 2	-	-	-	-

Approach	EB	WB	NB	SB
HCM Control Delay, s	0.4	0	10.8	9.3
HCM LOS			B	A

Minor Lane/Major Mvmt	NBLn1	EBL	EBT	EBR	WBL	WBT	WBR	SBLn1
Capacity (veh/h)	640	1426	-	-	1506	-	-	892
HCM Lane V/C Ratio	0.033	0.004	-	-	-	-	-	0.055
HCM Control Delay (s)	10.8	7.5	0	-	0	-	-	9.3
HCM Lane LOS	B	A	A	-	A	-	-	A
HCM 95th %tile Q(veh)	0.1	0	-	-	0	-	-	0.2

HCM 6th TWSC
2: Sanborn Rd & Baggett Rd

Existing + Site
AM

Intersection

Int Delay, s/veh 5

Movement	EBL	EBT	WBT	WBR	SBL	SBR
Lane Configurations		↕	↕		↕	
Traffic Vol, veh/h	9	3	4	2	0	8
Future Vol, veh/h	9	3	4	2	0	8
Conflicting Peds, #/hr	0	0	0	0	0	0
Sign Control	Free	Free	Free	Free	Stop	Stop
RT Channelized	-	None	-	None	-	None
Storage Length	-	-	-	-	0	-
Veh in Median Storage, #	-	0	0	-	0	-
Grade, %	-	0	0	-	0	-
Peak Hour Factor	75	75	50	50	50	50
Heavy Vehicles, %	2	2	2	2	2	2
Mvmt Flow	12	4	8	4	0	16

Major/Minor	Major1	Major2	Minor2		
Conflicting Flow All	12	0	0	38	10
Stage 1	-	-	-	10	-
Stage 2	-	-	-	28	-
Critical Hdwy	4.12	-	-	6.42	6.22
Critical Hdwy Stg 1	-	-	-	5.42	-
Critical Hdwy Stg 2	-	-	-	5.42	-
Follow-up Hdwy	2.218	-	-	3.518	3.318
Pot Cap-1 Maneuver	1607	-	-	974	1071
Stage 1	-	-	-	1013	-
Stage 2	-	-	-	995	-
Platoon blocked, %	-	-	-	-	-
Mov Cap-1 Maneuver	1607	-	-	967	1071
Mov Cap-2 Maneuver	-	-	-	967	-
Stage 1	-	-	-	1006	-
Stage 2	-	-	-	995	-

Approach	EB	WB	SB
HCM Control Delay, s	5.4	0	8.4
HCM LOS			A

Minor Lane/Major Mvmt	EBL	EBT	WBT	WBR	SBLn1
Capacity (veh/h)	1607	-	-	-	1071
HCM Lane V/C Ratio	0.007	-	-	-	0.015
HCM Control Delay (s)	7.3	0	-	-	8.4
HCM Lane LOS	A	A	-	-	A
HCM 95th %tile Q(veh)	0	-	-	-	0

HCM 6th TWSC
3: Sanborn Rd & Site Access

Existing + Site
AM

Intersection

Int Delay, s/veh 2.5

Movement	EBL	EBT	WBT	WBR	SBL	SBR
Lane Configurations		↕	↕		↕	
Traffic Vol, veh/h	6	6	6	6	6	0
Future Vol, veh/h	6	6	6	6	6	0
Conflicting Peds, #/hr	0	0	0	0	0	0
Sign Control	Free	Free	Free	Free	Stop	Stop
RT Channelized	-	None	-	None	-	None
Storage Length	-	-	-	-	0	-
Veh in Median Storage, #	-	0	0	-	0	-
Grade, %	-	0	0	-	0	-
Peak Hour Factor	75	75	50	50	92	92
Heavy Vehicles, %	2	2	2	2	2	2
Mvmt Flow	8	8	12	12	7	0

Major/Minor	Major1	Major2	Minor2		
Conflicting Flow All	24	0	0	42	18
Stage 1	-	-	-	18	-
Stage 2	-	-	-	24	-
Critical Hdwy	4.12	-	-	6.42	6.22
Critical Hdwy Stg 1	-	-	-	5.42	-
Critical Hdwy Stg 2	-	-	-	5.42	-
Follow-up Hdwy	2.218	-	-	3.518	3.318
Pot Cap-1 Maneuver	1591	-	-	969	1061
Stage 1	-	-	-	1005	-
Stage 2	-	-	-	999	-
Platoon blocked, %	-	-	-	-	-
Mov Cap-1 Maneuver	1591	-	-	964	1061
Mov Cap-2 Maneuver	-	-	-	964	-
Stage 1	-	-	-	1000	-
Stage 2	-	-	-	999	-

Approach	EB	WB	SB
HCM Control Delay, s	3.6	0	8.8
HCM LOS			A

Minor Lane/Major Mvmt	EBL	EBT	WBT	WBR	SBLn1
Capacity (veh/h)	1591	-	-	-	964
HCM Lane V/C Ratio	0.005	-	-	-	0.007
HCM Control Delay (s)	7.3	0	-	-	8.8
HCM Lane LOS	A	A	-	-	A
HCM 95th %tile Q(veh)	0	-	-	-	0

HCM 6th TWSC
1: Baggett Rd & SH 94

Existing + Site
PM

Intersection

Int Delay, s/veh 0.8

Movement	EBL	EBT	EBR	WBL	WBT	WBR	NBL	NBT	NBR	SBL	SBT	SBR
Lane Configurations		↕			↕			↕			↕	
Traffic Vol, veh/h	10	152	12	0	87	0	10	0	0	0	0	5
Future Vol, veh/h	10	152	12	0	87	0	10	0	0	0	0	5
Conflicting Peds, #/hr	0	0	0	0	0	0	0	0	0	0	0	0
Sign Control	Free	Free	Free	Free	Free	Free	Stop	Stop	Stop	Stop	Stop	Stop
RT Channelized	-	-	None	-	-	None	-	-	None	-	-	None
Storage Length	-	-	-	-	-	-	-	-	-	-	-	-
Veh in Median Storage, #	-	0	-	-	0	-	-	0	-	-	0	-
Grade, %	-	0	-	-	0	-	-	0	-	-	0	-
Peak Hour Factor	84	84	84	99	99	99	100	100	100	100	100	100
Heavy Vehicles, %	6	6	6	6	6	6	2	2	2	2	2	2
Mvmt Flow	12	181	14	0	88	0	10	0	0	0	0	5

Major/Minor	Major1			Major2			Minor1			Minor2		
Conflicting Flow All	88	0	0	195	0	0	303	300	188	300	307	88
Stage 1	-	-	-	-	-	-	212	212	-	88	88	-
Stage 2	-	-	-	-	-	-	91	88	-	212	219	-
Critical Hdwy	4.16	-	-	4.16	-	-	7.12	6.52	6.22	7.12	6.52	6.22
Critical Hdwy Stg 1	-	-	-	-	-	-	6.12	5.52	-	6.12	5.52	-
Critical Hdwy Stg 2	-	-	-	-	-	-	6.12	5.52	-	6.12	5.52	-
Follow-up Hdwy	2.254	-	-	2.254	-	-	3.518	4.018	3.318	3.518	4.018	3.318
Pot Cap-1 Maneuver	1483	-	-	1354	-	-	649	612	854	652	607	970
Stage 1	-	-	-	-	-	-	790	727	-	920	822	-
Stage 2	-	-	-	-	-	-	916	822	-	790	722	-
Platoon blocked, %	-	-	-	-	-	-	-	-	-	-	-	-
Mov Cap-1 Maneuver	1483	-	-	1354	-	-	641	606	854	647	602	970
Mov Cap-2 Maneuver	-	-	-	-	-	-	641	606	-	647	602	-
Stage 1	-	-	-	-	-	-	783	720	-	912	822	-
Stage 2	-	-	-	-	-	-	911	822	-	783	716	-

Approach	EB	WB	NB	SB
HCM Control Delay, s	0.4	0	10.7	8.7
HCM LOS			B	A

Minor Lane/Major Mvmt	NBLn1	EBL	EBT	EBR	WBL	WBT	WBR	SBLn1
Capacity (veh/h)	641	1483	-	-	1354	-	-	970
HCM Lane V/C Ratio	0.016	0.008	-	-	-	-	-	0.005
HCM Control Delay (s)	10.7	7.4	0	-	0	-	-	8.7
HCM Lane LOS	B	A	A	-	A	-	-	A
HCM 95th %tile Q(veh)	0	0	-	-	0	-	-	0

HCM 6th TWSC
2: Sanborn Rd & Baggett Rd

Existing + Site
PM

Intersection						
Int Delay, s/veh	6.1					
Movement	EBL	EBT	WBT	WBR	SBL	SBR
Lane Configurations		↖	↗		↘	
Traffic Vol, veh/h	8	2	2	0	1	7
Future Vol, veh/h	8	2	2	0	1	7
Conflicting Peds, #/hr	0	0	0	0	0	0
Sign Control	Free	Free	Free	Free	Stop	Stop
RT Channelized	-	None	-	None	-	None
Storage Length	-	-	-	-	0	-
Veh in Median Storage, #	-	0	0	-	0	-
Grade, %	-	0	0	-	0	-
Peak Hour Factor	88	88	50	50	63	63
Heavy Vehicles, %	2	2	2	2	2	2
Mvmt Flow	9	2	4	0	2	11

Major/Minor	Major1	Major2	Minor2		
Conflicting Flow All	4	0	-	0	24
Stage 1	-	-	-	-	4
Stage 2	-	-	-	-	20
Critical Hdwy	4.12	-	-	-	6.42
Critical Hdwy Stg 1	-	-	-	-	5.42
Critical Hdwy Stg 2	-	-	-	-	5.42
Follow-up Hdwy	2.218	-	-	-	3.518
Pot Cap-1 Maneuver	1618	-	-	-	992
Stage 1	-	-	-	-	1019
Stage 2	-	-	-	-	1003
Platoon blocked, %	-	-	-	-	-
Mov Cap-1 Maneuver	1618	-	-	-	986
Mov Cap-2 Maneuver	-	-	-	-	986
Stage 1	-	-	-	-	1013
Stage 2	-	-	-	-	1003

Approach	EB	WB	SB
HCM Control Delay, s	5.8	0	8.4
HCM LOS			A

Minor Lane/Major Mvmt	EBL	EBT	WBT	WBR	SBLn1
Capacity (veh/h)	1618	-	-	-	1067
HCM Lane V/C Ratio	0.006	-	-	-	0.012
HCM Control Delay (s)	7.2	0	-	-	8.4
HCM Lane LOS	A	A	-	-	A
HCM 95th %tile Q(veh)	0	-	-	-	0

HCM 6th TWSC
3: Sanborn Rd & Site Access

Existing + Site
PM

Intersection						
Int Delay, s/veh	2.6					
Movement	EBL	EBT	WBT	WBR	SBL	SBR
Lane Configurations		↖	↗		↘	↙
Traffic Vol, veh/h	0	5	5	3	3	6
Future Vol, veh/h	0	5	5	3	3	6
Conflicting Peds, #/hr	0	0	0	0	0	0
Sign Control	Free	Free	Free	Free	Stop	Stop
RT Channelized	-	None	-	None	-	None
Storage Length	-	-	-	-	0	-
Veh in Median Storage, #	-	0	0	-	0	-
Grade, %	-	0	0	-	0	-
Peak Hour Factor	88	88	50	50	92	92
Heavy Vehicles, %	2	2	2	2	2	2
Mvmt Flow	0	6	10	6	3	7

Major/Minor	Major1	Major2	Minor2		
Conflicting Flow All	16	0	-	0	19 13
Stage 1	-	-	-	-	13 -
Stage 2	-	-	-	-	6 -
Critical Hdwy	4.12	-	-	-	6.42 6.22
Critical Hdwy Stg 1	-	-	-	-	5.42 -
Critical Hdwy Stg 2	-	-	-	-	5.42 -
Follow-up Hdwy	2.218	-	-	-	3.518 3.318
Pot Cap-1 Maneuver	1602	-	-	-	998 1067
Stage 1	-	-	-	-	1010 -
Stage 2	-	-	-	-	1017 -
Platoon blocked, %		-	-	-	
Mov Cap-1 Maneuver	1602	-	-	-	998 1067
Mov Cap-2 Maneuver	-	-	-	-	998 -
Stage 1	-	-	-	-	1010 -
Stage 2	-	-	-	-	1017 -

Approach	EB	WB	SB
HCM Control Delay, s	0	0	8.5
HCM LOS			A

Minor Lane/Major Mvmt	EBL	EBT	WBT	WBR	SBLn1
Capacity (veh/h)	1602	-	-	-	1043
HCM Lane V/C Ratio	-	-	-	-	0.009
HCM Control Delay (s)	0	-	-	-	8.5
HCM Lane LOS	A	-	-	-	A
HCM 95th %tile Q(veh)	0	-	-	-	0

Intersection

Int Delay, s/veh 3.1

Movement	EBL	EBT	EBR	WBL	WBT	WBR	NBL	NBT	NBR	SBL	SBT	SBR
Lane Configurations	↖	↗		↖	↗			↕			↕	
Traffic Vol, veh/h	5	75	5	5	225	5	20	5	5	5	5	35
Future Vol, veh/h	5	75	5	5	225	5	20	5	5	5	5	35
Conflicting Peds, #/hr	0	0	0	0	0	0	0	0	0	0	0	0
Sign Control	Free	Free	Free	Free	Free	Free	Stop	Stop	Stop	Stop	Stop	Stop
RT Channelized	-	-	None	-	-	None	-	-	None	-	-	None
Storage Length	500	-	-	500	-	-	-	-	-	-	-	-
Veh in Median Storage, #	-	0	-	-	0	-	-	0	-	-	0	-
Grade, %	-	0	-	-	0	-	-	0	-	-	0	-
Peak Hour Factor	77	77	77	100	100	100	100	100	100	47	47	47
Heavy Vehicles, %	2	2	2	2	2	2	2	2	2	2	2	2
Mvmt Flow	6	97	6	5	225	5	20	5	5	11	11	74

Major/Minor	Major1	Major2	Minor1	Minor2
Conflicting Flow All	230	0	0	103
Stage 1	-	-	-	-
Stage 2	-	-	-	-
Critical Hdwy	4.12	-	-	4.12
Critical Hdwy Stg 1	-	-	-	-
Critical Hdwy Stg 2	-	-	-	-
Follow-up Hdwy	2.218	-	-	2.218
Pot Cap-1 Maneuver	1338	-	-	1489
Stage 1	-	-	-	-
Stage 2	-	-	-	-
Platoon blocked, %	-	-	-	-
Mov Cap-1 Maneuver	1338	-	-	1489
Mov Cap-2 Maneuver	-	-	-	-
Stage 1	-	-	-	-
Stage 2	-	-	-	-

Approach	EB	WB	NB	SB
HCM Control Delay, s	0.5	0.2	11.8	10.6
HCM LOS			B	B

Minor Lane/Major Mvmt	NBLn1	EBL	EBT	EBR	WBL	WBT	WBR	SBLn1
Capacity (veh/h)	559	1338	-	-	1489	-	-	744
HCM Lane V/C Ratio	0.054	0.005	-	-	0.003	-	-	0.129
HCM Control Delay (s)	11.8	7.7	-	-	7.4	-	-	10.6
HCM Lane LOS	B	A	-	-	A	-	-	B
HCM 95th %tile Q(veh)	0.2	0	-	-	0	-	-	0.4

HCM 6th TWSC
2: Sanborn Rd & Baggett Rd

2040 Background
AM

Intersection

Int Delay, s/veh 0.6

Movement EBL EBT WBT WBR SBL SBR

Movement	EBL	EBT	WBT	WBR	SBL	SBR
Lane Configurations		↖	↗		↖	↗
Traffic Vol, veh/h	5	65	70	3	2	3
Future Vol, veh/h	5	65	70	3	2	3
Conflicting Peds, #/hr	0	0	0	0	0	0
Sign Control	Free	Free	Free	Free	Stop	Stop
RT Channelized	-	None	-	None	-	None
Storage Length	-	-	-	-	0	-
Veh in Median Storage, #	-	0	0	-	0	-
Grade, %	-	0	0	-	0	-
Peak Hour Factor	75	75	50	50	50	50
Heavy Vehicles, %	2	2	2	2	2	2
Mvmt Flow	7	87	140	6	4	6

Major/Minor Major1 Major2 Minor2

Conflicting Flow All	146	0	-	0	244	143
Stage 1	-	-	-	-	143	-
Stage 2	-	-	-	-	101	-
Critical Hdwy	4.12	-	-	-	6.42	6.22
Critical Hdwy Stg 1	-	-	-	-	5.42	-
Critical Hdwy Stg 2	-	-	-	-	5.42	-
Follow-up Hdwy	2.218	-	-	-	3.518	3.318
Pot Cap-1 Maneuver	1436	-	-	-	744	905
Stage 1	-	-	-	-	884	-
Stage 2	-	-	-	-	923	-
Platoon blocked, %		-	-	-		
Mov Cap-1 Maneuver	1436	-	-	-	740	905
Mov Cap-2 Maneuver	-	-	-	-	740	-
Stage 1	-	-	-	-	880	-
Stage 2	-	-	-	-	923	-

Approach EB WB SB

HCM Control Delay, s	0.5	0	9.4
HCM LOS			A

Minor Lane/Major Mvmt EBL EBT WBT WBR SBLn1

Capacity (veh/h)	1436	-	-	-	831
HCM Lane V/C Ratio	0.005	-	-	-	0.012
HCM Control Delay (s)	7.5	0	-	-	9.4
HCM Lane LOS	A	A	-	-	A
HCM 95th %tile Q(veh)	0	-	-	-	0

HCM 6th TWSC
1: Baggett Rd & SH 94

2040 Background
PM

Intersection

Int Delay, s/veh 1.3

Movement	EBL	EBT	EBR	WBL	WBT	WBR	NBL	NBT	NBR	SBL	SBT	SBR
Lane Configurations	↖	↗		↖	↗			↕			↕	
Traffic Vol, veh/h	15	225	15	5	125	5	10	5	5	5	5	10
Future Vol, veh/h	15	225	15	5	125	5	10	5	5	5	5	10
Conflicting Peds, #/hr	0	0	0	0	0	0	0	0	0	0	0	0
Sign Control	Free	Free	Free	Free	Free	Free	Stop	Stop	Stop	Stop	Stop	Stop
RT Channelized	-	-	None	-	-	None	-	-	None	-	-	None
Storage Length	500	-	-	500	-	-	-	-	-	-	-	-
Veh in Median Storage, #	-	0	-	-	0	-	-	0	-	-	0	-
Grade, %	-	0	-	-	0	-	-	0	-	-	0	-
Peak Hour Factor	84	84	84	99	99	99	100	100	100	100	100	100
Heavy Vehicles, %	6	6	6	6	6	6	2	2	2	2	2	2
Mvmt Flow	18	268	18	5	126	5	10	5	5	5	5	10

Major/Minor	Major1	Major2	Minor1	Minor2
Conflicting Flow All	131	0	0	286
Stage 1	-	-	-	-
Stage 2	-	-	-	-
Critical Hdwy	4.16	-	-	4.16
Critical Hdwy Stg 1	-	-	-	-
Critical Hdwy Stg 2	-	-	-	-
Follow-up Hdwy	2.254	-	-	2.254
Pot Cap-1 Maneuver	1430	-	-	1253
Stage 1	-	-	-	-
Stage 2	-	-	-	-
Platoon blocked, %	-	-	-	-
Mov Cap-1 Maneuver	1430	-	-	1253
Mov Cap-2 Maneuver	-	-	-	-
Stage 1	-	-	-	-
Stage 2	-	-	-	-

Approach	EB	WB	NB	SB
HCM Control Delay, s	0.4	0.3	11.9	10.8
HCM LOS			B	B

Minor Lane/Major Mvmt	NBLn1	EBL	EBT	EBR	WBL	WBT	WBR	SBLn1
Capacity (veh/h)	543	1430	-	-	1253	-	-	643
HCM Lane V/C Ratio	0.037	0.012	-	-	0.004	-	-	0.031
HCM Control Delay (s)	11.9	7.5	-	-	7.9	-	-	10.8
HCM Lane LOS	B	A	-	-	A	-	-	B
HCM 95th %tile Q(veh)	0.1	0	-	-	0	-	-	0.1

Intersection						
Int Delay, s/veh	0.9					
Movement	EBL	EBT	WBT	WBR	SBL	SBR
Lane Configurations		↕	↕		↕	
Traffic Vol, veh/h	7	65	60	1	3	6
Future Vol, veh/h	7	65	60	1	3	6
Conflicting Peds, #/hr	0	0	0	0	0	0
Sign Control	Free	Free	Free	Free	Stop	Stop
RT Channelized	-	None	-	None	-	None
Storage Length	-	-	-	-	0	-
Veh in Median Storage, #	-	0	0	-	0	-
Grade, %	-	0	0	-	0	-
Peak Hour Factor	92	92	92	92	92	92
Heavy Vehicles, %	2	2	2	2	2	2
Mvmt Flow	8	71	65	1	3	7

Major/Minor	Major1	Major2	Minor2		
Conflicting Flow All	66	0	-	0	153
Stage 1	-	-	-	-	66
Stage 2	-	-	-	-	87
Critical Hdwy	4.12	-	-	-	6.42
Critical Hdwy Stg 1	-	-	-	-	5.42
Critical Hdwy Stg 2	-	-	-	-	5.42
Follow-up Hdwy	2.218	-	-	-	3.518
Pot Cap-1 Maneuver	1536	-	-	-	839
Stage 1	-	-	-	-	957
Stage 2	-	-	-	-	936
Platoon blocked, %		-	-	-	
Mov Cap-1 Maneuver	1536	-	-	-	835
Mov Cap-2 Maneuver	-	-	-	-	835
Stage 1	-	-	-	-	952
Stage 2	-	-	-	-	936

Approach	EB	WB	SB
HCM Control Delay, s	0.7	0	8.9
HCM LOS			A

Minor Lane/Major Mvmt	EBL	EBT	WBT	WBR	SBLn1
Capacity (veh/h)	1536	-	-	-	937
HCM Lane V/C Ratio	0.005	-	-	-	0.01
HCM Control Delay (s)	7.4	0	-	-	8.9
HCM Lane LOS	A	A	-	-	A
HCM 95th %tile Q(veh)	0	-	-	-	0

HCM 6th TWSC
1: Baggett Rd & SH 94

Intersection													
Int Delay, s/veh	3.2												
Movement	EBL	EBT	EBR	WBL	WBT	WBR	NBL	NBT	NBR	SBL	SBT	SBR	
Lane Configurations	↖	↗		↖	↗			↕				↕	
Traffic Vol, veh/h	5	75	11	5	225	5	26	5	5	5	5	5	35
Future Vol, veh/h	5	75	11	5	225	5	26	5	5	5	5	5	35
Conflicting Peds, #/hr	0	0	0	0	0	0	0	0	0	0	0	0	0
Sign Control	Free	Free	Free	Free	Free	Free	Stop	Stop	Stop	Stop	Stop	Stop	Stop
RT Channelized	-	-	None	-	-	None	-	-	None	-	-	-	None
Storage Length	500	-	-	500	-	-	-	-	-	-	-	-	-
Veh in Median Storage, #	-	0	-	-	0	-	-	0	-	-	0	-	-
Grade, %	-	0	-	-	0	-	-	0	-	-	0	-	-
Peak Hour Factor	77	77	77	100	100	100	100	100	100	47	47	47	
Heavy Vehicles, %	2	2	2	2	2	2	2	2	2	2	2	2	2
Mvmt Flow	6	97	14	5	225	5	26	5	5	11	11	11	74

Major/Minor	Major1			Major2			Minor1			Minor2		
Conflicting Flow All	230	0	0	111	0	0	396	356	104	359	361	228
Stage 1	-	-	-	-	-	-	116	116	-	238	238	-
Stage 2	-	-	-	-	-	-	280	240	-	121	123	-
Critical Hdwy	4.12	-	-	4.12	-	-	7.12	6.52	6.22	7.12	6.52	6.22
Critical Hdwy Stg 1	-	-	-	-	-	-	6.12	5.52	-	6.12	5.52	-
Critical Hdwy Stg 2	-	-	-	-	-	-	6.12	5.52	-	6.12	5.52	-
Follow-up Hdwy	2.218	-	-	2.218	-	-	3.518	4.018	3.318	3.518	4.018	3.318
Pot Cap-1 Maneuver	1338	-	-	1479	-	-	564	570	951	596	566	811
Stage 1	-	-	-	-	-	-	889	800	-	765	708	-
Stage 2	-	-	-	-	-	-	727	707	-	883	794	-
Platoon blocked, %		-	-		-	-						
Mov Cap-1 Maneuver	1338	-	-	1479	-	-	502	566	951	585	562	811
Mov Cap-2 Maneuver	-	-	-	-	-	-	502	566	-	585	562	-
Stage 1	-	-	-	-	-	-	885	797	-	762	706	-
Stage 2	-	-	-	-	-	-	648	705	-	869	791	-

Approach	EB	WB	NB	SB
HCM Control Delay, s	0.4	0.2	12.1	10.6
HCM LOS			B	B

Minor Lane/Major Mvmt	NBLn1	EBL	EBT	EBR	WBL	WBT	WBR	SBLn1
Capacity (veh/h)	546	1338	-	-	1479	-	-	743
HCM Lane V/C Ratio	0.066	0.005	-	-	0.003	-	-	0.129
HCM Control Delay (s)	12.1	7.7	-	-	7.4	-	-	10.6
HCM Lane LOS	B	A	-	-	A	-	-	B
HCM 95th %tile Q(veh)	0.2	0	-	-	0	-	-	0.4

Intersection						
Int Delay, s/veh	1.2					
Movement	EBL	EBT	WBT	WBR	SBL	SBR
Lane Configurations		↕	↕		↕	
Traffic Vol, veh/h	11	65	70	3	2	9
Future Vol, veh/h	11	65	70	3	2	9
Conflicting Peds, #/hr	0	0	0	0	0	0
Sign Control	Free	Free	Free	Free	Stop	Stop
RT Channelized	-	None	-	None	-	None
Storage Length	-	-	-	-	0	-
Veh in Median Storage, #	-	0	0	-	0	-
Grade, %	-	0	0	-	0	-
Peak Hour Factor	75	75	50	50	50	50
Heavy Vehicles, %	2	2	2	2	2	2
Mvmt Flow	15	87	140	6	4	18

Major/Minor	Major1	Major2	Minor2		
Conflicting Flow All	146	0	-	0	260 143
Stage 1	-	-	-	-	143 -
Stage 2	-	-	-	-	117 -
Critical Hdwy	4.12	-	-	-	6.42 6.22
Critical Hdwy Stg 1	-	-	-	-	5.42 -
Critical Hdwy Stg 2	-	-	-	-	5.42 -
Follow-up Hdwy	2.218	-	-	-	3.518 3.318
Pot Cap-1 Maneuver	1436	-	-	-	729 905
Stage 1	-	-	-	-	884 -
Stage 2	-	-	-	-	908 -
Platoon blocked, %	-	-	-	-	-
Mov Cap-1 Maneuver	1436	-	-	-	721 905
Mov Cap-2 Maneuver	-	-	-	-	721 -
Stage 1	-	-	-	-	874 -
Stage 2	-	-	-	-	908 -

Approach	EB	WB	SB
HCM Control Delay, s	1.1	0	9.3
HCM LOS			A

Minor Lane/Major Mvmt	EBL	EBT	WBT	WBR	SBLn1
Capacity (veh/h)	1436	-	-	-	865
HCM Lane V/C Ratio	0.01	-	-	-	0.025
HCM Control Delay (s)	7.5	0	-	-	9.3
HCM Lane LOS	A	A	-	-	A
HCM 95th %tile Q(veh)	0	-	-	-	0.1

Intersection

Int Delay, s/veh 0.5

Movement	EBL	EBT	WBT	WBR	SBL	SBR
----------	-----	-----	-----	-----	-----	-----

Lane Configurations		↕	↕		↕	
Traffic Vol, veh/h	6	61	73	6	6	0
Future Vol, veh/h	6	61	73	6	6	0
Conflicting Peds, #/hr	0	0	0	0	0	0
Sign Control	Free	Free	Free	Free	Stop	Stop
RT Channelized	-	None	-	None	-	None
Storage Length	-	-	-	-	0	-
Veh in Median Storage, #	-	0	0	-	0	-
Grade, %	-	0	0	-	0	-
Peak Hour Factor	75	75	50	50	92	92
Heavy Vehicles, %	2	2	2	2	2	2
Mvmt Flow	8	81	146	12	7	0

Major/Minor	Major1	Major2	Minor2
-------------	--------	--------	--------

Conflicting Flow All	158	0	0	249	152
Stage 1	-	-	-	152	-
Stage 2	-	-	-	97	-
Critical Hdwy	4.12	-	-	6.42	6.22
Critical Hdwy Stg 1	-	-	-	5.42	-
Critical Hdwy Stg 2	-	-	-	5.42	-
Follow-up Hdwy	2.218	-	-	3.518	3.318
Pot Cap-1 Maneuver	1422	-	-	739	894
Stage 1	-	-	-	876	-
Stage 2	-	-	-	927	-
Platoon blocked, %	-	-	-	-	-
Mov Cap-1 Maneuver	1422	-	-	735	894
Mov Cap-2 Maneuver	-	-	-	735	-
Stage 1	-	-	-	871	-
Stage 2	-	-	-	927	-

Approach	EB	WB	SB
----------	----	----	----

HCM Control Delay, s	0.7	0	9.9
HCM LOS			A

Minor Lane/Major Mvmt	EBL	EBT	WBT	WBR	SBLn1
-----------------------	-----	-----	-----	-----	-------

Capacity (veh/h)	1422	-	-	-	735
HCM Lane V/C Ratio	0.006	-	-	-	0.009
HCM Control Delay (s)	7.5	0	-	-	9.9
HCM Lane LOS	A	A	-	-	A
HCM 95th %tile Q(veh)	0	-	-	-	0

Intersection												
Int Delay, s/veh	1.3											
Movement	EBL	EBT	EBR	WBL	WBT	WBR	NBL	NBT	NBR	SBL	SBT	SBR
Lane Configurations	↖	↗		↖	↗			↕			↕	
Traffic Vol, veh/h	15	225	18	5	125	5	13	5	5	5	5	10
Future Vol, veh/h	15	225	18	5	125	5	13	5	5	5	5	10
Conflicting Peds, #/hr	0	0	0	0	0	0	0	0	0	0	0	0
Sign Control	Free	Free	Free	Free	Free	Free	Stop	Stop	Stop	Stop	Stop	Stop
RT Channelized	-	-	None	-	-	None	-	-	None	-	-	None
Storage Length	500			500								
Veh in Median Storage, #	-	0		-	0		-	0		-	0	
Grade, %	-	0		-	0		-	0		-	0	
Peak Hour Factor	84	84	84	99	99	99	100	100	100	100	100	100
Heavy Vehicles, %	6	6	6	6	6	6	2	2	2	2	2	2
Mvmt Flow	18	268	21	5	126	5	13	5	5	5	5	10

Major/Minor	Major1			Major2			Minor1			Minor2		
Conflicting Flow All	131	0	0	289	0	0	461	456	279	459	464	129
Stage 1	-	-	-	-	-	-	315	315	-	139	139	-
Stage 2	-	-	-	-	-	-	146	141	-	320	325	-
Critical Hdwy	4.16	-	-	4.16	-	-	7.12	6.52	6.22	7.12	6.52	6.22
Critical Hdwy Stg 1	-	-	-	-	-	-	6.12	5.52	-	6.12	5.52	-
Critical Hdwy Stg 2	-	-	-	-	-	-	6.12	5.52	-	6.12	5.52	-
Follow-up Hdwy	2.254	-	-	2.254	-	-	3.518	4.018	3.318	3.518	4.018	3.318
Pot Cap-1 Maneuver	1430	-	-	1250	-	-	511	501	760	512	495	921
Stage 1	-	-	-	-	-	-	696	656	-	864	782	-
Stage 2	-	-	-	-	-	-	857	780	-	692	649	-
Platoon blocked, %												
Mov Cap-1 Maneuver	1430	-	-	1250	-	-	495	492	760	498	487	921
Mov Cap-2 Maneuver	-	-	-	-	-	-	495	492	-	498	487	-
Stage 1	-	-	-	-	-	-	687	647	-	853	779	-
Stage 2	-	-	-	-	-	-	839	777	-	674	641	-

Approach	EB	WB	NB	SB
HCM Control Delay, s	0.4	0.3	12	10.8
HCM LOS			B	B

Minor Lane/Major Mvmt	NBLn1	EBL	EBT	EBR	WBL	WBT	WBR	SBLn1
Capacity (veh/h)	535	1430	-	-	1250	-	-	642
HCM Lane V/C Ratio	0.043	0.012	-	-	0.004	-	-	0.031
HCM Control Delay (s)	12	7.5	-	-	7.9	-	-	10.8
HCM Lane LOS	B	A	-	-	A	-	-	B
HCM 95th %tile Q(veh)	0.1	0	-	-	0	-	-	0.1

Intersection

Int Delay, s/veh 1.4

Movement	EBL	EBT	WBT	WBR	SBL	SBR
----------	-----	-----	-----	-----	-----	-----

Lane Configurations		↑	↑		↑	
Traffic Vol, veh/h	10	65	60	1	3	13
Future Vol, veh/h	10	65	60	1	3	13
Conflicting Peds, #/hr	0	0	0	0	0	0
Sign Control	Free	Free	Free	Free	Stop	Stop
RT Channelized	-	None	-	None	-	None
Storage Length	-	-	-	-	0	-
Veh in Median Storage, #	-	0	0	-	0	-
Grade, %	-	0	0	-	0	-
Peak Hour Factor	92	92	92	92	92	92
Heavy Vehicles, %	2	2	2	2	2	2
Mvmt Flow	11	71	65	1	3	14

Major/Minor	Major1	Major2	Minor2
-------------	--------	--------	--------

Conflicting Flow All	66	0	0	159	66
Stage 1	-	-	-	66	-
Stage 2	-	-	-	93	-
Critical Hdwy	4.12	-	-	6.42	6.22
Critical Hdwy Stg 1	-	-	-	5.42	-
Critical Hdwy Stg 2	-	-	-	5.42	-
Follow-up Hdwy	2.218	-	-	3.518	3.318
Pot Cap-1 Maneuver	1536	-	-	832	998
Stage 1	-	-	-	957	-
Stage 2	-	-	-	931	-
Platoon blocked, %	-	-	-	-	-
Mov Cap-1 Maneuver	1536	-	-	826	998
Mov Cap-2 Maneuver	-	-	-	826	-
Stage 1	-	-	-	950	-
Stage 2	-	-	-	931	-

Approach	EB	WB	SB
----------	----	----	----

HCM Control Delay, s	1	0	8.8
HCM LOS			A

Minor Lane/Major Mvmt	EBL	EBT	WBT	WBR	SBLn1
-----------------------	-----	-----	-----	-----	-------

Capacity (veh/h)	1536	-	-	-	960
HCM Lane V/C Ratio	0.007	-	-	-	0.018
HCM Control Delay (s)	7.4	0	-	-	8.8
HCM Lane LOS	A	A	-	-	A
HCM 95th %tile Q(veh)	0	-	-	-	0.1

Intersection

Int Delay, s/veh 0.6

Movement	EBL	EBT	WBT	WBR	SBL	SBR
Lane Configurations		↕	↕		↕	
Traffic Vol, veh/h	0	68	60	3	3	6
Future Vol, veh/h	0	68	60	3	3	6
Conflicting Peds, #/hr	0	0	0	0	0	0
Sign Control	Free	Free	Free	Free	Stop	Stop
RT Channelized	-	None	-	None	-	None
Storage Length	-	-	-	-	0	-
Veh in Median Storage, #	-	0	0	-	0	-
Grade, %	-	0	0	-	0	-
Peak Hour Factor	92	92	92	92	92	92
Heavy Vehicles, %	2	2	2	2	2	2
Mvmt Flow	0	74	65	3	3	7

Major/Minor	Major1	Major2	Minor2		
Conflicting Flow All	68	0	0	141	67
Stage 1	-	-	-	67	-
Stage 2	-	-	-	74	-
Critical Hdwy	4.12	-	-	6.42	6.22
Critical Hdwy Stg 1	-	-	-	5.42	-
Critical Hdwy Stg 2	-	-	-	5.42	-
Follow-up Hdwy	2.218	-	-	3.518	3.318
Pot Cap-1 Maneuver	1533	-	-	852	997
Stage 1	-	-	-	956	-
Stage 2	-	-	-	949	-
Platoon blocked, %	-	-	-	-	-
Mov Cap-1 Maneuver	1533	-	-	852	997
Mov Cap-2 Maneuver	-	-	-	852	-
Stage 1	-	-	-	956	-
Stage 2	-	-	-	949	-

Approach	EB	WB	SB
HCM Control Delay, s	0	0	8.9
HCM LOS			A

Minor Lane/Major Mvmt	EBL	EBT	WBT	WBR	SBLn1
Capacity (veh/h)	1533	-	-	-	943
HCM Lane V/C Ratio	-	-	-	-	0.01
HCM Control Delay (s)	0	-	-	-	8.9
HCM Lane LOS	A	-	-	-	A
HCM 95th %tile Q(veh)	0	-	-	-	0

Access Exhibit by Stage (from LOI)





RPM, Inc.

Vicinity Map:

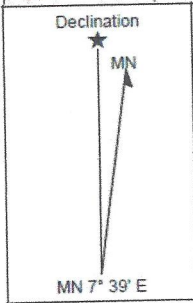
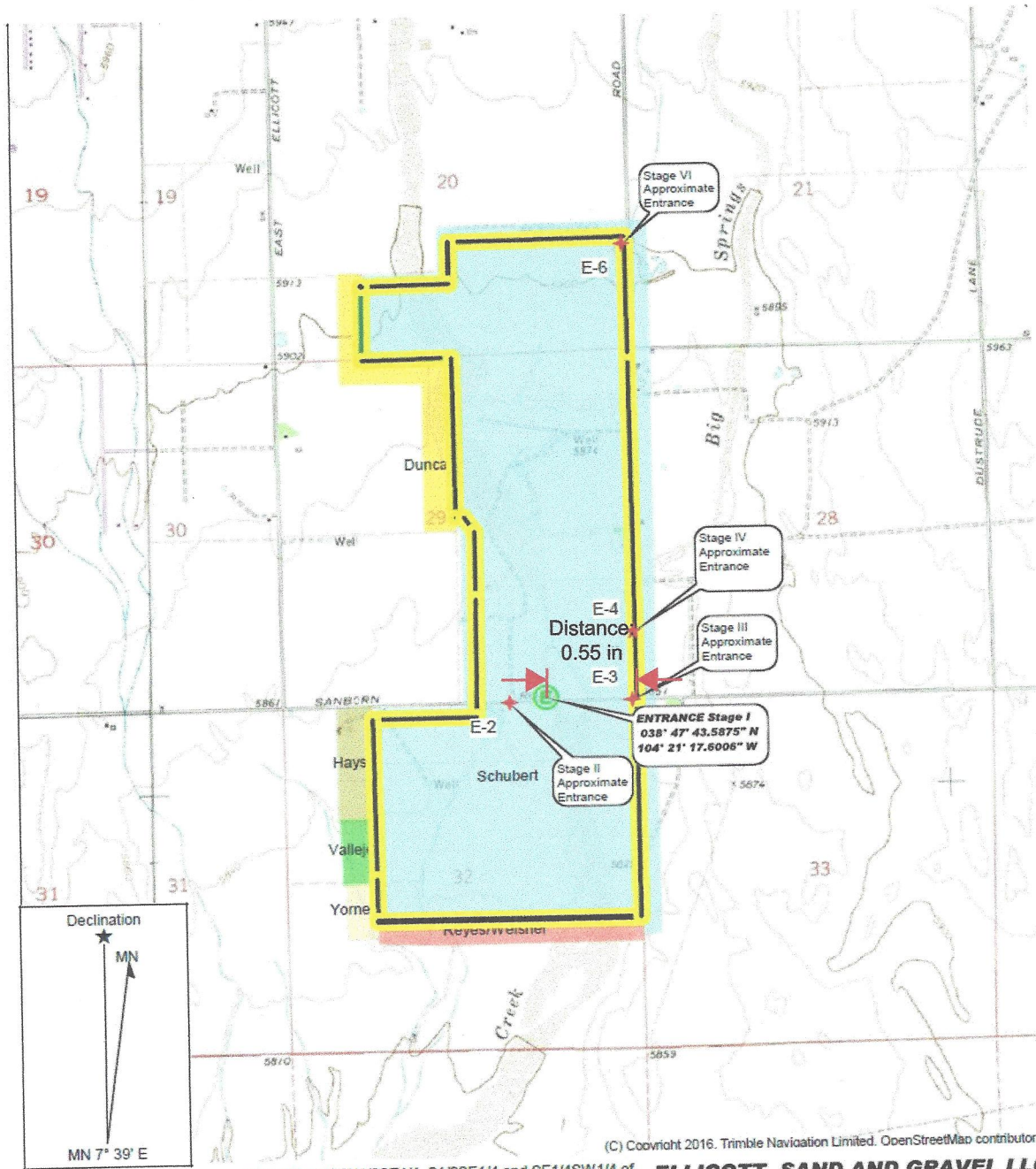

(C) Copyright 2016. Trimble Navigation Limited. OpenStreetMap contributors

Quad. Name: BIG SPRINGS RANCH
 Date: 03/03/20
 Scale: 1 inch = 2,000 ft.

Part of the S1/2N1/2SE1/4, S1/2SE1/4, and SE1/4SW1/4 of Section 20, and The E1/2E1/2 and NW1/4NE1/4 and parts of the SW1/4NE1/4, SW1/4SE1/4, and NW1/4SE1/4 of Section 29 and The E1/2NE1/4, SW1/4NE1/4, & SE1/4NW1/4, and parts of the NW1/4NE1/4 & NE1/4NW1/4, Section 32, Township 14 South, Range 62 West, 6th P.M. El Paso County, Colorado Containing 733.7 acres more or less.

**ELLICOTT SAND AND GRAVEL LLC
 SCHUBERT RANCH SAND
 RESOURCE
 MAP EXHIBIT B - VICINITY MAP**