

**FINAL DRAINAGE REPORT**  
for  
**OWL MARKETPLACE FILNG NO. 1**  
**PRE-SUBDIVISION GRADING**

Falcon, Colorado

**August 2024**

Prepared for:

**Meridian & Owl X, LLC**  
450 N McClintock Drive  
Chandler, AZ 85226  
Contact: Brian Zurek  
(480)-313-2724

Prepared by:

**Drexel, Barrell & Co.**  
3 South 7th Street  
Colorado Springs, CO 80905  
Contact: Tim McConnell, P.E.  
(719) 260-0887

El Paso County File No. CDR247

## TABLE OF CONTENTS

1.0	CERTIFICATION STATEMENTS .....	III
2.0	PURPOSE.....	1
3.0	GENERAL SITE DESCRIPTION .....	1
4.0	DRAINAGE CRITERIA .....	3
5.0	EXISTING CLOMR ANALYSIS .....	3
6.0	EXISTING ONSITE CONDITION .....	4
7.0	PROPOSED CONDITION CLOMR ANALYSIS .....	5
8.0	PRE-SUBDIVISION ONSITE CONDITION.....	5
9.0	DETENTION & WATER QUALITY TREATMENT .....	7
10.0	FOUR-STEP PROCESS .....	7
11.0	DBPS ANALYSIS .....	7
12.0	OWNERSHIP AND MAINTENANCE .....	10
13.0	DRAINAGE/BRIDGE FEES.....	11
14.0	REIMBURSABLE COSTS.....	11
15.0	COST ESTIMATE.....	12
16.0	CONCLUSIONS.....	12
17.0	REFERENCES.....	13

### APPENDICES

VICINITY MAP  
SOILS MAP  
FLOODPLAIN MAP  
HYDROLOGY CALCULATIONS  
HYDRAULIC CALCULATIONS  
REPORT EXCERPTS  
CLOMR APPROVAL  
DRAINAGE MAPS

**FINAL DRAINAGE REPORT**  
for  
**OWL MARKETPLACE FILING NO. 1**  
**PRE-SUBDIVISION GRADING**  
Falcon, Colorado

**1.0 CERTIFICATION STATEMENTS**

**ENGINEER'S STATEMENT**

The attached drainage plan and report were prepared under my direction and supervision and are correct to the best of my knowledge and belief. Said drainage report has been prepared according to the criteria established by El Paso County for drainage reports, and said report is in conformity with the master plan of the drainage basin. I accept responsibility for any liability caused by any negligent acts, errors or omission on my part in preparing this report.

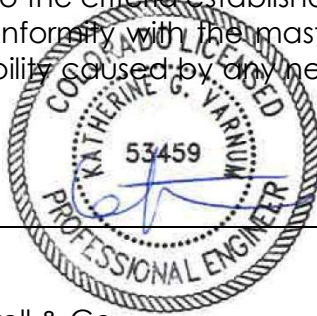

\_\_\_\_\_  
Katherine G. Varnum, P.E.  
Colorado P.E. License No. 53459  
For and on Behalf of Drexel, Barrell & Co.

\_\_\_\_\_  
August 21, 2024  
Date

**DEVELOPER'S STATEMENT**

I, the developer have read and will comply with all the requirements specified in this drainage report and plan.

Business Name: Meridian & Owl X, LLC.

By: \_\_\_\_\_  
Brian Zurek  
Address: 450 N McClintock Drive  
Chandler, AZ 85226

\_\_\_\_\_  
August 21, 2024  
Date

**EL PASO COUNTY**

Filed in accordance with the requirements of the El Paso County Land Development Code, Drainage Criteria Manual Volumes 1 and 2, and the Engineering Criteria Manual, as amended.

9/11/2024

\_\_\_\_\_  
Joshua Palmer, P.E.  
CONDITIONS:

\_\_\_\_\_  
Date

**FINAL DRAINAGE REPORT**  
for  
**OWL MARKETPLACE FILING NO. 1**  
**PRE-SUBDIVISION GRADING**  
Falcon, Colorado

**2.0 PURPOSE**

This report is prepared by Drexel, Barrel & Co in support of the Owl Marketplace Filing No. 1 project. The purpose of this report is to identify onsite and offsite drainage patterns, storm sewer, and areas tributary to the site during the pre-subdivision overlot grading stage, and to safely route adjusted storm water runoff to adequate outfall facilities.

**3.0 GENERAL SITE DESCRIPTION**

**Location and Existing Site Conditions**

The site is located at the southwest corner of Owl Place and Meridian Road at 11745 Owl Pl. Lot 15 Falcon Ranchettes – SE ¼ of the SE ¼ of Section 1, Township 13S, Range 65W of the 6<sup>th</sup> P.M., El Paso County, Colorado. 11685 Owl Place, Lot 14 Falcon Ranchettes is also being replatted as part of this development in order to provide for public right-of-way in alignment with that directly existing to the south and proposed to the north.

There is one small home on the 11745 Owl Place portion of the property as well as a few minor out buildings. The site is bounded to the south by the Falcon Marketplace development, to the east by Meridian Road, and to the north and west by large-lot residential Falcon Ranchettes Subdivision. The lots immediately adjacent have recently been rezoned to commercial service (CS) for future development. The existing house is served by well and septic, that are to be removed/abandoned in accordance with CDPHE regulations. There are no existing irrigation facilities on the project site. The house and outbuildings located on 11685 Owl Place will remain.

The site is approximately 9.6 acres in size and is currently generally covered by native grass and vegetation. The eastern portion of the site gently slopes from the northeast to the southwest corner of the site. The East Branch of the Middle Tributary of Upper Black Squirrel Creek currently discharges flows from the roadside ditch along Meridian Road to the north, southwest across the property before discharging into the sub-regional detention facility SR4 to the south. A CLOMR to contain the floodplain, within a 10'x6' concrete box culvert across this portion of the property has been approved by FEMA (Case No. 22-08-0669R, December 21, 2022). The western portion of the property (11685 Owl Place) generally slopes from north to south. The West Branch of the Middle Tributary of Upper Black Squirrel Creek currently discharges flow from northwest to southeast across the property. The aforementioned CLOMR does not affect this portion of the property, and the floodplain will remain until future development and subsequent CLOMR/LOMR applications occur.

## **Proposed Site Conditions**

Owl Marketplace is a proposed commercial development replatted to provide for four individual pad sites, serviced by an adjacent collector roadway – Meridian Park Drive. As previously mentioned, the adjacent property will also be included in this replat solely to provide for public right-of-way in alignment with adjacent developments. Meridian Park Drive is proposed to be extended from the Eastonville roundabout on the Falcon Marketplace property to Owl Place where future extension to the Bent Grass subdivision will take place by others. Dedication of right-of-way for Meridian Park Drive is proposed to straddle the current property line, by agreement with the adjacent landowner.

In this “Pre-Subdivision” condition, only the overlot grading and installation of the box culvert and wet utilities will be considered. Ultimate final grading and the developed condition will be addressed in the Final Drainage Report for the overall development.

## **Soils**

According to the Soil Survey of El Paso County Area, Colorado, prepared by the U.S. Department of Agriculture Soil Conservation Service, the site is completely underlain by Columbine Gravelly Sandy Loam (Soil No. 19) All soils are type ‘A’ hydrologic soil group. See appendix for map.

## **Climate**

This area of El Paso County can be described as the foothills, with total precipitation amounts typical of a semi-arid region. Winters are generally cold and dry, and summers relatively warm and dry. Precipitation ranges from 12 to 14 inches per year, with the majority of this moisture occurring in the spring and summer in the form of rainfall. Thunderstorms are common during the summer months.

## **Floodplain Statement**

The effective floodplain, Zone A limits, for the Unnamed Tributary to Black Squirrel Creek (UTBSC), in the vicinity of the Owl Marketplace project, are defined on the FIRM for El Paso County, Colorado and Unincorporated Areas, Map Number 8041CO553G, Effective Date December 7, 2018.

A CLOMR to modify the effective floodplain was approved by FEMA, Case No. 22-08-0669R (December 21, 2022).

## **Drainage Basin**

This property is located with the Falcon Drainage Basin, and was studied as part of the following basin planning studies and subsequent reports for neighboring developments.

Falcon Drainage Basin Planning Study, September 2015 **(DPBS – Matrix)**

Bent Grass MDDP Amendment & DBPS Amendment, September 2021  
**(DBPS Amendment – Galloway)**

Request for Conditional Letter of Map Revision, Unnamed Tributary to Black Squirrel Creek, Falcon Owl Place, October 2022 **(CLOMR)**

Request for Letter of Map Revision, Unnamed Tributary to Black Squirrel Creek, Falcon Marketplace, March 2021. **(LOMR)**

Final Drainage Report for Falcon Marketplace, November 2019

Final Drainage Report, Falcon Ranchettes Filing No. 1A Meridian Storage, October 2023.

Relevant excerpts from previous drainage studies and reports and included in the appendix, and further discussed below.

### **Geotechnical Recommendations**

Geologic conditions identified for the property will be those associated with the potentially expansive soils, shallow bedrock, seasonally shallow groundwater, and the currently mapped floodplain. These conditions can be satisfactorily mitigated through proper engineering design and construction practices. Refer to the Soils and Geology Study for the property by Entech Engineering, Inc. June 2023 for more information.

## **4.0 DRAINAGE CRITERIA**

This drainage analysis has been prepared in accordance with the current El Paso County Drainage Criteria Manual. Calculations were performed to determine runoff quantities during the 5-year and 100-year frequency storms for historic and developed conditions using the Rational Method as required for basins containing less than 100-acres.

Hydraflow was utilized to determine the hydraulic capacity of the proposed storm system.

## **5.0 EXISTING CLOMR ANALYSIS**

The Middle Branch of the UTBSC is currently conveyed under Owl Place via two 36" CMP near the northeast corner of the site. The 2-36" CMP culverts are severely undersized and partially filled with sediment. The culverts only convey 86-95 cfs, depending on tailwater depth. The remaining flow (approximately 825-834 cfs) in the 100-year event overtops Owl Place. See excerpts in the appendix.

Under existing and proposed conditions, the East Branch of the UTBSC leaving the Owl Marketplace site discharges to Pond SR4 on the Falcon Marketplace development to the south. The pond was designed for a 100-year discharge of 1,016 cfs, which includes both West and East branches of the UTBSC.

## 6.0 EXISTING ONSITE CONDITION

### Rational Method Existing Runoff Summary

EXISTING				
BASIN	DP	Area (Ac.)	Q <sub>5</sub> (CFS)	Q <sub>100</sub> (CFS)
RMT064	X1		288.5	920.0
OSE1	E1	1.26	0.9	3.1
E2		1.95	0.5	3.7
	E2	3.21	1.4	6.9
E3	E3	2.34	0.6	4.4
E4	E4	0.33	0.1	0.7
MT060	X2		60.1	196.8

Offsite flows reaching Owl Place from the roadside ditch along Meridian Road to the north are represented by **Design Point X1**. These flows are established by the DBPS (Matrix) and subsequent DBPS Amendment (Galloway) studies as DBPS Reach RMT064. The most recent CLOMR study determined rates of Q<sub>5</sub>=288.5 cfs and Q<sub>100</sub>=920 cfs for this section. See further description below.

An offsite basin for adjacent Lot 14 Falcon Ranchettes has not been delineated on the existing conditions map, but excerpts from the Falcon DBPS (Matrix) and DBPS Amendment (Galloway) have been included in the appendix to establish the existing flows entering Pond SR4 at the south of the lot, at **Design Point X2**. These flows are represented by DBPS Reach MT060 and consist of rates of Q<sub>5</sub>=60.1 cfs and Q<sub>100</sub>=196.8 cfs.

**Basin OSE1** represents an offsite 1.26-acre basins to the north of Owl Place. Runoff rates of Q<sub>5</sub>=0.9 cfs and Q<sub>100</sub>=3.1 cfs are generated by this basin, and generally travel to the south towards the low point in Owl Place (**Design Point E1**) before discharging on to the Owl Marketplace property.

**Basin E2** represents a 1.95 acre basin on the north side of the Owl Marketplace property to the south of Owl Place. This basin contains the Upper Black Squirrel Creek Tributary and as such flow generated by this basin (Q<sub>5</sub>=0.5 cfs and Q<sub>100</sub>=3.7 cfs) combine with those from offsite basin OSE1 and travel towards the center of the basin before following the tributary and discharging out the southwest property line at **Design Point E2**.

**Basin E3** represents 2.34-acres at the south of the Owl Marketplace property. Runoff rates of Q<sub>5</sub>=0.6 cfs and Q<sub>100</sub>=4.4 cfs are generated by this basin, and generally travel to the southwest towards the property corner at **Design Point E3** before discharging into the adjacent subregional pond SR4 on the Falcon Marketplace property.

**Basin E4** covers 0.33-acres along Meridian Road at the eastern boundary of the Owl Marketplace property. Runoff rates of Q<sub>5</sub>=0.1 cfs and Q<sub>100</sub>=0.7 cfs are generated by this basin, and generally travel to the east and south towards Meridian Road and **Design Point E4**.

## 7.0 PROPOSED CONDITION CLOMR ANALYSIS

The Middle Branch of the UTBSC flows southwest across the property and is proposed to be contained within a 10'x6' box culvert that will discharge into the Subregional Pond SR4 recently constructed on the Falcon Marketplace property.

Pond SR4 was designed for a 100-year discharge of 1,016 cfs, which includes both West and Middle branches of the UTBSC. The 100-year water surface elevation upstream of the pond as shown in the LOMR is 6902.5 (NAVD88), or 6898.7 (NGVD29). The starting HGL for the box culvert analysis was conservatively placed at the top of pipe elevation of 6895.84 feet (NGVD29) for analyzing flows to the East branch only. However, an additional analysis was performed with a starting HGL of 6898.7, to evaluate the backwater effects from the pond.

The proposed box culvert will convey the entire 100-year event (920 cfs), as established by the Falcon DBPS with an HGL of 6911.31 at the proposed headwall upstream of Owl Place, which is more than one foot below Owl Place and contained within the existing and proposed channel upstream. Channel grading will be required for approximately 30 feet to tie into the existing creek profile upstream. The channel side slopes will be reduced from approximately 5.5H:1V to 1.8H:1V and protected with Type M grouted riprap. A proposed Type VI stilling basin and additional riprap slope protection is proposed at the outfall into Pond SR4. An extension of the existing trickle channel will provide connection to the existing low flow path through the facility.

## 8.0 PRE-SUBDIVISION ONSITE CONDITION

As noted in Section 6.0 of this report, offsite flows reaching Owl Place from the roadside ditch along Meridian Road to the north are represented by **Design Point X1**. These flows are established by the DBPS (Matrix) and subsequent DBPS Amendment (Galloway) studies as DBPS Reach RMT064 and consist of rates of  $Q_5=288.5$  cfs and  $Q_{100}=920$  cfs. As noted above in Section 7.0 a proposed public 10'x6' box culvert will convey the full 100-year event without overtopping Owl Place from this point to Pond SR4 to the south.

Basin X1A was added for the developed condition to represent the area disturbed by the riprap drop installation at the culvert inlet point. The minimal flows generated by this basin, are technically included in the DBPS flows, but are directly added to the upstream DBPS flows at **Design Point X1A** for the purposes of this report.

An offsite basin for adjacent Lot 14 Falcon Ranchettes has not been delineated on the developed conditions map, as no changes - beyond those already incorporated into the following developed condition analysis - are proposed for Lot 14. The lot will remain in its current residential condition and any further development of Lot 14 (or Lot 5 as replatted with Owl Marketplace) will require additional drainage analysis and possible CLOMR to remove portions of the lot from the remaining floodplain. Flows reaching Pond SR4 to the south will remain as described in the existing condition as **Design Point X2** ( $Q_5=60.1$  cfs and  $Q_{100}=196.8$  cfs).

The site is proposed to be overlotted graded as part of the pre-subdivision grading permit, along with the installation of the box culvert, a portion of the public storm sewer and the



water and sanitary sewer utilities. The following basin descriptions represent the overlot graded condition prior to the installation of any pavement or curb and gutter.

### Rational Method Runoff Summary

DEVELOPED				
BASIN	DP	Area (Ac.)	Q <sub>5</sub> (CFS)	Q <sub>100</sub> (CFS)
X1A		0.08	0.03	0.2
	X1A		288.5	920.2
A	1	3.01	1.0	6.9
Offsite	2	0.00	0.6	1.5
B		1.89	1.9	6.6
	3	1.89	1.2	11.0
Offsite 2	4	0.00	1.0	2.1
C		0.29	1.1	2.8
	5	0.29	0.1	0.6
	6	3.05	5.7	12.6
D	7	0.09	0.0	0.2
E	8	0.21	0.1	0.5

**Basin A** represents the eastern portion of the development. This basin will be graded to direct flow to the southwest towards **Design Point 1** and on to a proposed temporary sediment basin at **Design Point 6**.

Due to the concurrent development to the north (Falcon Ranchettes Filing No. 1a – Meridian Storage), the flowrates entering this property from the north are based on those defined in the aforementioned report for Falcon Ranchettes Filing No. 1a, by Galloway & Co., assuming development will occur prior to this development. See appendix for excerpts and further information. **Design Point 2** receives rates of Q<sub>5</sub>=0.6 cfs and Q<sub>100</sub>=1.5 cfs (identified as DP12 in Galloway report) and **Design Point 4** (identified as DP13 in the Galloway report) receives flows of Q<sub>5</sub>=1.0 cfs and Q<sub>100</sub>=2.1 cfs. These design points are located at the north end of Meridian Park Drive at Owl Place. These flows are inclusive of any bypass flow from the proposed upstream at-grade inlets, and are straight added to the downstream design points further described in this report.

**Basin B** represents the western portion of Lot 15. Runoff generated by this area will combine with that from upstream **Design Point 2** and drain towards the rough cut roadway section along the property line between Lots 14 and 15, ultimately heading south towards **Design Point 3**. A temporary diversion swale will direct flows towards the temporary sediment basin at **Design Point 6**.

**Basin C** represent the western portion of the proposed rough cut roadway. This basin will combine with flows from upstream **Design Point 4** and drain to the south towards **Design Point 5**. A temporary diversion swale will direct flows towards the temporary sediment basin at **Design Point 6**.

**Design Point 6** represents the flows reaching the proposed temporary sediment basin. Covering an area of approximately 4.8-acres, the basin is proposed as an 18,000 CF basin designed to allow sediment to settle prior to discharge into the public storm system. A portion of the proposed public 30" storm system designed for the ultimate condition is

proposed to be installed with this phase of development. This section of storm sewer will allow for the temporary sediment basin to be connected to the ultimate system in the interim, and also allow for concurrent disturbance to the downstream detention facility, given the installation of the proposed box culvert.

**Basin D** represents the southern portion of the development that will follow current drainage conditions draining to the south at **Design Point 7** into the Falcon Marketplace development.

**Basin E** represents the western portion of the development that will follow current drainage conditions draining to the southwest at **Design Point 8** into the Falcon Marketplace development and existing sub-regional detention facility SR4.

## **9.0 DETENTION & WATER QUALITY TREATMENT**

Detention and water quality treatment will be addressed for the developed condition for the overall development with the Final Drainage Report.

## **10.0 FOUR-STEP PROCESS**

In the overlot condition, no four step process analysis is required as there is no proposed change in impervious coverage. The four step process will be addressed for the developed condition for the overall development in the Final Drainage Report.

## **11.0 DBPS ANALYSIS**

### **Falcon DPBS (Matrix)**

The Falcon DBPS watershed establishes three major basins, including the "Middle Tributary" which covers this property. The unnamed tributary to Black Squirrel Creek (UTBSC) located in the "Middle Tributary" consists of an "East Branch" and "West Branch". The "East Branch" enters this property at the northeast corner, after passing through existing culverts at Owl Place. The "West Branch" is located on the adjacent property to the west. The two converge just north of the Falcon Marketplace site before discharging into existing sub-regional detention facility SR4. The Falcon DBPS identifies junctions north and south of the project site, JMT050 and JMT060. These are summarized below, and excerpts are provided in the appendix.

The Falcon DBPS specifies reach improvements between junctions JMT050 and JMT060, specifically identified as reach RMT064. These improvements include a recommendation for small drop structures with toe protection.

Future Land Use Condition - Peak Discharge				
Model Location	Physical Location	Branch	Proximity to Owl Place	Future Flow Q100 (cfs)
JMT050	Bent Grass Meadows Drive & Meridian Road	East Branch	Upstream of site	850
JMT060	Eastonville Road & Meridian Road	East and West Convergence	Downstream of site	1000

### **Bent Grass DPBS Amendment (Galloway)**

The Bent Grass DBPS Amendment addresses a drainage diversion took place as part of the Bent Grass Residential Filing No. 1 development, specifically the rerouting of the UTBSC West Tributary to the east towards the intersection of Meridian Road and Bent Grass Meadows Drive. As a result of this diversion, a new junction was created in the Middle Tributary – JMT060a. This junction is located just south of JMT050 from the Falcon DPBS (Matrix) and is summarized below.

Future Land Use Condition - Peak Discharge				
Model Location	Physical Location	Branch	Proximity to Owl Place	Future Flow Q100 (cfs)
JMT060a	Bent Grass Meadows Drive & Meridian Road	East Branch	Upstream of site	909.3

The Bent Grass DBPS Amendment recommends a 15' wide bottom channel with 4:1 side slopes at 6.5' deep with a longitudinal slope of 0.30% for reach RMT064.

### **Falcon Ranchettes Filing No. 1a – Meridian Storage (Galloway)**

The Falcon Ranchettes Filing No. 1a development located directly north of Owl Place, includes regrading a portion of the UTBSC East Branch along Meridian Road with small drop structures with toe protection. The channel has been designed for a 925-cfs design flow as specified in the Bent Grass DBPS Amendment. The improvements are intended to be intercepted by the 10'x6' box culvert proposed with this development. Per discussions with the adjacent developer, construction is expected to run concurrently with the Owl Marketplace project and design has been coordinated accordingly.

### **Owl Place CLOMR Analysis**

This Owl Marketplace development includes regrading and rerouting a portion of the UTBSC East Branch. The improvements intercept the existing creek immediately north of Owl Place and convey is via 10'x6' box culvert to the subregional detention facility SR4 directly to the south. The box culvert is designed to convey the full 100-year discharge.

The Falcon DBPS did not include a junction on the East Branch immediately upstream of the convergence at pond SR4. Therefore, the Owl Place CLOMR modified the HMS model to create a new junction located at the southern boundary of this development. This junction is summarized below.

<b>Future Land Use Condition - Peak Discharge</b>				
<b>Model Location</b>	<b>Physical Location</b>	<b>Branch</b>	<b>Proximity to Owl Place</b>	<b>Future Flow Q100 (cfs)</b>
JMT051	Immediately upstream of Pond SR4	East Branch	Downstream of site	920

As mentioned above, a Conditional Letter of Map Revision (CLOMR) was approved by FEMA (Case No. 22-08-0669R) on December 21, 2022. Referenced portions of the CLOMR are included in the appendix.

Design of the riprap drop into the culvert utilized the simplified design method for grade control structures, as outlined in the USDCM Vol. 2, Chapter 9, Section 2. The table below summarizes the specific design and compliance with the criteria:

<b>Deisgn Parameter</b>	<b>Requirement to Use Simplified Design Procedure</b>	<b>Proposed Design</b>
Maximum Net Drop Height (Hd)	5 feet	5 feet
Maximum Unit Discharge over any Portion of Drop Width	35 cfs per foot of drop width	30.3 cfs (at headwall)
Maximum Longitudinal Slope (Steepest Face Slope)	4(H):1(V)	4(H):1(V)
Minimum Stilling Basin Depression	1 foot	N/A
Minimum Length of Approach Riprap	8 feet	8 feet
Minimum Stilling Basin Length	Figure 9-1	N/A
Minimum Stilling Basin Width	Same as Crest Width	N/A
Minimum Cutoff Wall Depth	6 feet	6 feet
Minimum Length of Riprap Downstream of Stilling Basin	10 feet	N/A
Minimum D50 for Approach and Downstream Riprap	12 inches	12 inches (Type M Riprap)
Minimum Boulder Size for Drop Structures	Figure 9-1	N/A

## **DBPS Analysis conclusions**

Per the Falcon DBPS, channel improvements are required to stabilize RMT064 of the UTBSC East Branch. The table below compares the proposed design flow against previous reports.

<b>Future Land Use Condition - Peak Discharge</b>				
<b>Model Location</b>	<b>Physical Location</b>	<b>Branch</b>	<b>Proximity to Owl Place</b>	<b>Future Flow Q100 (cfs)</b>
RMT064	North of Owl Place, South of Bent Grass Meadows Drive	East Branch	-	925
JMT050 (Falcon DBPS)	Bent Grass Meadows Drive & Meridian Road	East Branch	Upstream of site	850
JMT060a (Bent Grass Amendment)	Bent Grass Meadows Drive & Meridian Road	East Branch	Upstream of site	909.3
JMT051 (Owl Place CLOMR)	Immediately upstream of Pond SR4	East Branch	Downstream of site	920

Due to the added junctions (JMT060a and JMT051), no revisions to the existing HMS models are needed for identifying the proposed design flow for RMT064.

There are no proposed changes to the West Tributary proposed as part of this project. The property encumbered by this tributary and associated floodplain (Lot 14 Falcon Ranchettes – Lot 5, Owl Marketplace as replatted), will be required to undergo additional drainage analysis in the future at time of development.

## **12.0 OWNERSHIP AND MAINTENANCE**

It is anticipated that all public drainage facilities are to be owned and maintained by El Paso County. All private drainage facilities proposed for the developed condition (reference the Final Drainage Report) are to be owned and maintained initially by CD Meridian & Owl X, LLC, until such time that the individual lots transfer ownership upon development.

**13.0 DRAINAGE/BRIDGE FEES**

The project lies within the Falcon Drainage Basin. The property is already platted, but since there will be an increase in impervious acreage payment of additional drainage fees shall be required. Lots 14 and 15 of Falcon Ranchettes were platted as 5-acre residential lots. The Falcon DBPS estimated that 3% of the lot acreage would be considered as impervious acreage. The difference between the existing 3% impervious coverage and the proposed is listed in the table below.

		Existing	Proposed	
Location	Acreage	5-acre residential (3% Impervious) Acres	Commercial area (95% Impervious) Acres	Additional Impervious Acres
Lot 15 (Lots 1-4 Replat)	4.61	0.14	4.38	4.24
Lot 14 (Lot 5 Replat)	5.00	0.15	4.75	4.60

The additional impervious acreage equates to 8.84-acres, and as such the following fees will be required at final plat recording.

**2023 Drainage Fee**

$\$37,256 \times 8.84 \text{ Impervious Acres} = \$329,343.04$

**2023 Bridge Fee**

$\$5,118 \times 8.84 \text{ Impervious Acres} = \$45,243.12$

These fees will be due at recording of the final plat and are subject to change based on the calendar year.

**14.0 REIMBURSABLE COSTS**

The Falcon DBPS – Fee Development categorizes improvements into Developer Costs, County Costs, and Metro District Costs. Items identified as Developer Costs (those incurred by the Developer) are eligible for reimbursement. County Costs and Metro District Costs are not eligible for reimbursement. The applicable reach is classified in the DBPS as follows:

Reach/Feature	Reach Length (ft)	Improvement	Cost Category	Eligible for Reimbursement	Cost As Shown in Falcon DBPS
RMT064	3,358	Small Drop Structures w/Toe Protection	County	No	\$1,231,110 (\$366/LF)

The developer intends to amend the Falcon DBPS to allow for the costs of 1,020-LF of RMT064 to become reimbursable by the process outlined in County criteria.

### 15.0 COST ESTIMATE

An Engineering Opinion of Probably Cost for all drainage improvements for the “pre-subdivision” grading phase of development is provided below:

ITEM	QUANTITY	UNIT	UNIT COST	COST
<b>REIMBURSABLE PUBLIC FACILITIES ESTIMATE</b>				
10'X6' CONCRETE BOX CULVERT	992	LF	\$ 800.00	\$ 793,600.00
10'X6' 45° BEND W/MH ACCESS	3	EA	\$ 12,500.00	\$ 37,500.00
10'X6' 45° BEND	2	EA	\$ 8,500.00	\$ 17,000.00
TYPE L&M GROUTED RIPRAP DROP WITH CUT OFF WALLS	135	CY	\$ 225.00	\$ 30,375.00
HEADWALL WITH HANDRAIL	1	EA	\$ 10,000.00	\$ 10,000.00
GUARD RAIL	75	LF	\$ 150.00	\$ 11,250.00
<b>Improvements within Pond SR4</b>				
TYPE VI STILLING BASIN	1	EA	\$ 15,000.00	\$ 15,000.00
CONCRETE TRICKLE CHANNEL EXTENSION	50	LF	\$ 35.00	\$ 1,750.00
REMOVE AND REPLACE EX. TYPE M GROUTED RIPRAP	1	LS	\$ 10,000.00	\$ 10,000.00
<b>REIMBURSABLE PUBLIC DRAINAGE FACILITIES TOTAL</b>				<b>\$ 926,475.00</b>
<b>NON-REIMBURSABLE PUBLIC DRAINAGE FACILITIES</b>				
30" RCP STORM SEWER	130	LF	\$ 123.00	\$ 15,990.00
24" RCP STORM SEWER	16	LF	\$ 98.00	\$ 1,568.00
30"X45° RC BEND	1	EA	\$ 500.00	\$ 500.00
TYPE II STORM MANHOLE	1	EA	\$ 8,500.00	\$ 8,500.00
FOREBAY BAFFLE MODIFICATIONS	1	LS	\$ 2,500.00	\$ 2,500.00
<b>NON-REIMBURSABLE PRIVATE DRAINAGE FACILITIES TOTAL</b>				<b>\$ 29,058.00</b>

### 16.0 CONCLUSIONS

The Owl Marketplace Filing No. 1 Final Drainage Report for Pre-Subdivision Grading has been prepared in accordance with El Paso County criteria. The downstream facilities are adequate to receive runoff from this development and are functioning as intended. The site runoff will not adversely affect the downstream and surrounding developments. This report is in general conformance with all previously prepared reports for this area.

After grading and the installation of the box culvert is complete, a LOMR will be submitted to FEMA to revise the FIRM map and remove the floodplain from the eastern portion of the site (Lots 1-4 Owl Marketplace, as replatted). The floodplain will remain on Lot 14 Falcon Ranchettes (Lot 5 Owl Marketplace as replatted) until such time that property develops and a separate CLOMR/LOMR process is completed.

## 17.0 REFERENCES

The sources of information used in the development of this study are listed below:

1. City of Colorado Springs/El Paso County Drainage Criteria Manual, May 2014.
2. Urban Storm Drainage Criteria Manuals, Urban Drainage and Flood Control District. June 2001, Revised April 2008.
3. Request for Conditional Letter of Map Revision, Unnamed Tributary to Black Squirrel Creek, Prepared by Drexel, Barrell & Co., October 25, 2022.
5. Natural Resources Conservation Service (NRCS) Web Soil Survey
7. EL Paso County Board Resolution No 15-042: El Paso County adoption of Chapter 6 and Section 3.2.1, Chapter 13 of the City of Colorado Springs Drainage Criteria Manual, May 2014.
8. Falcon Drainage Basin Planning Study. Prepared by Matrix Design Group, September 2015.
9. Final Drainage Report for Falcon Marketplace. Prepared by Drexel, Barrell & Co. November 2019.
10. El Paso County Engineering Criteria Manual , July 18, 2023.
11. MDDP & DBPS Amendment Bent Grass Development. Prepared by Galloway & Co. February 2021.



**APPENDIX**  
VICINITY MAP

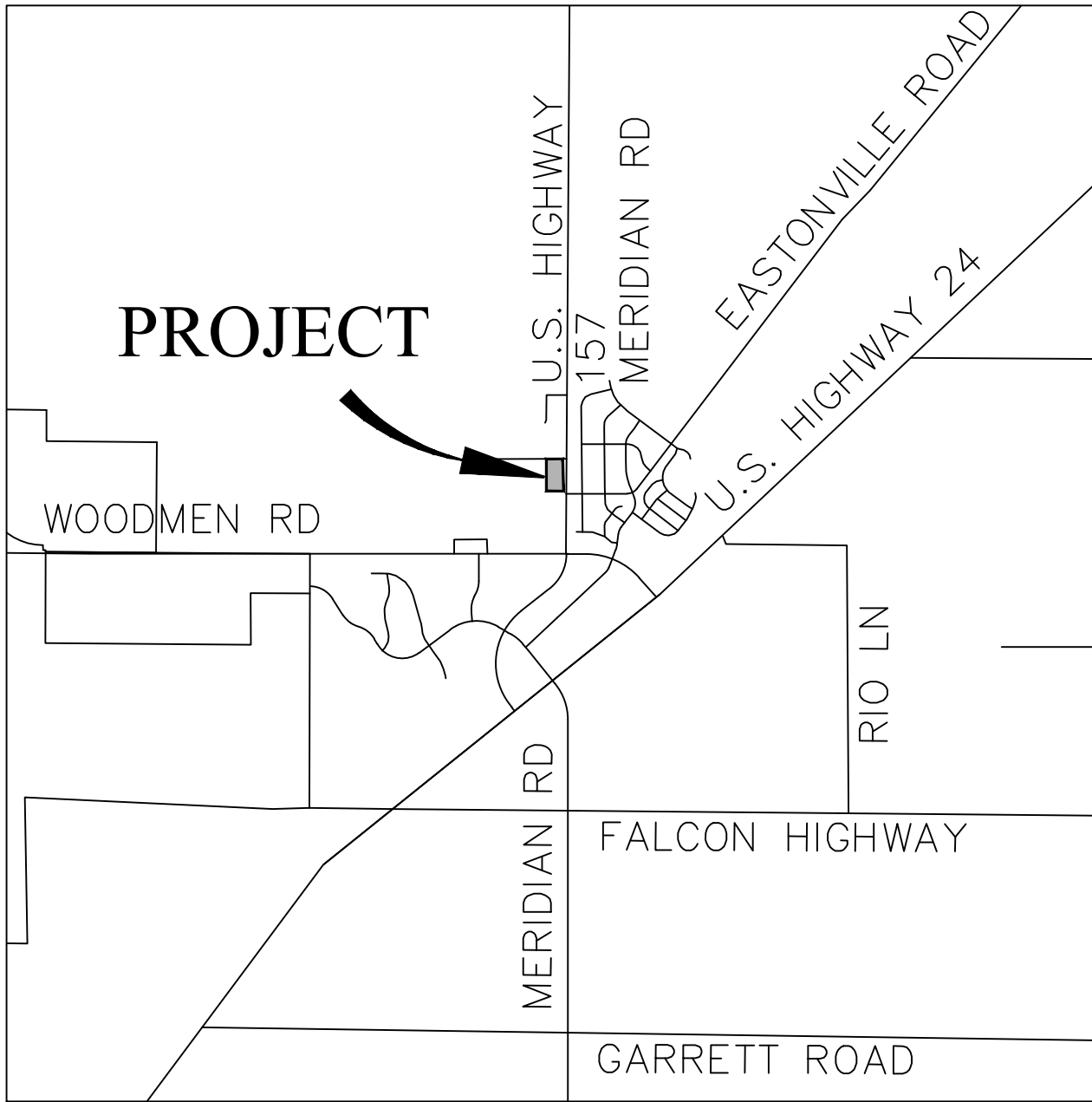

*Vicinity Map*  
Not to scale

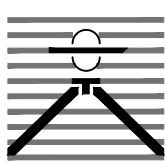

OWL PLACE  
EL PASO COUNTY, CO  
VICINITY MAP

**Drexel, Barrell & Co.**  
Engineers • Surveyors

DATE:  
JOB NO:  
**21611-00CSCV**

DWG. NO.  
**VMAP**  
SHEET 1 OF 1

**APPENDIX**  
SOILS MAP

# Custom Soil Resource Report Soil Map

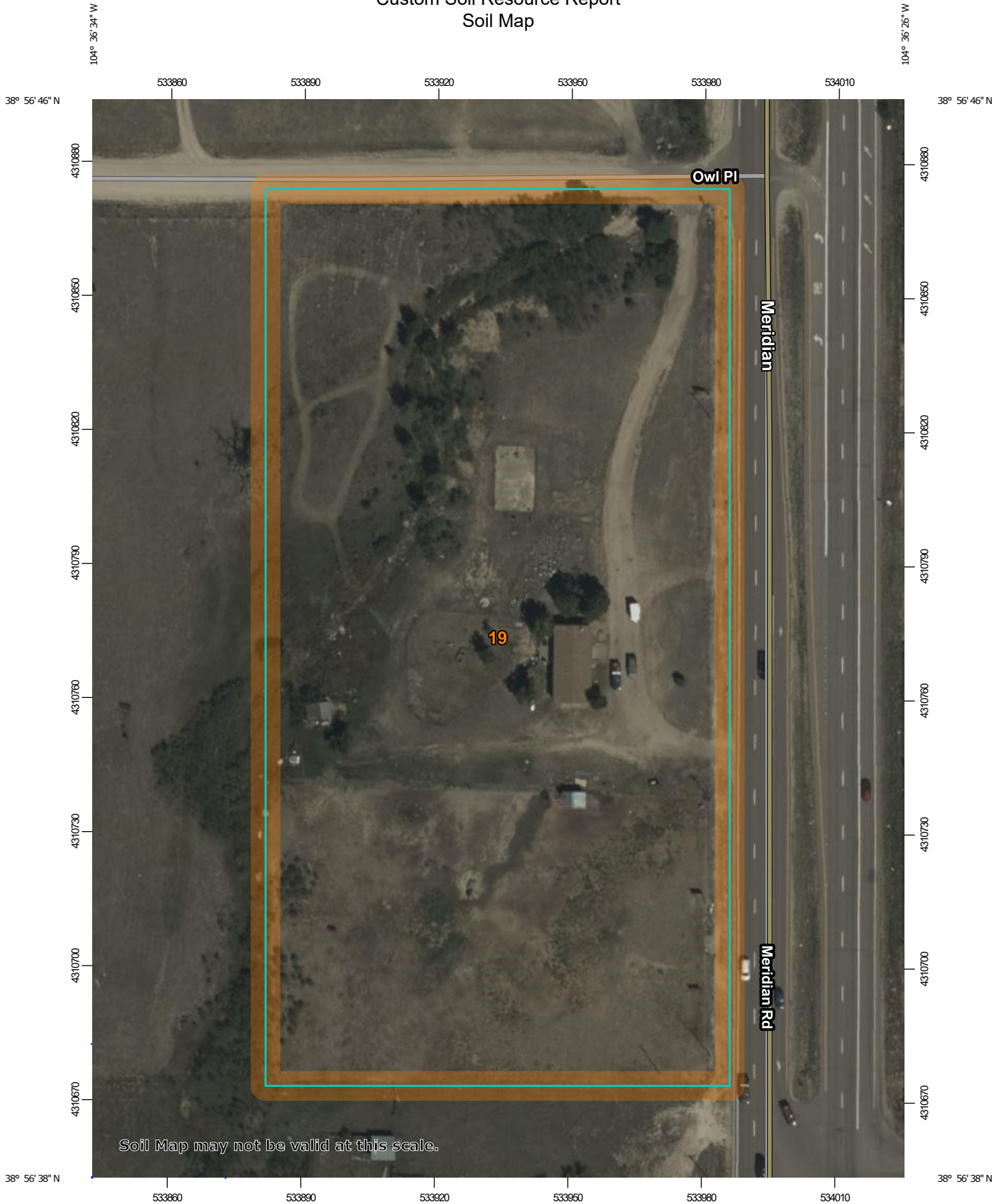

Soil Map may not be valid at this scale.

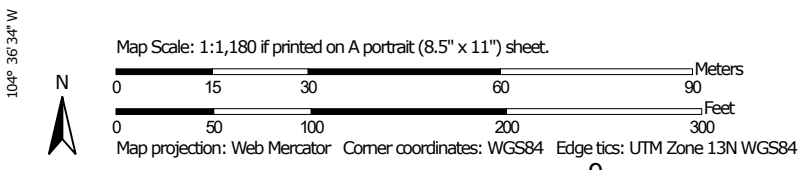

### MAP LEGEND

**Area of Interest (AOI)**

 Area of Interest (AOI)

**Soils**

 Soil Map Unit Polygons

 Soil Map Unit Lines

 Soil Map Unit Points

**Special Point Features**





-  Blowout
-  Borrow Pit
-  Clay Spot
-  Closed Depression
-  Gravel Pit
-  Gravelly Spot
-  Landfill
-  Lava Flow
-  Marsh or swamp
-  Mine or Quarry
-  Miscellaneous Water
-  Perennial Water
-  Rock Outcrop
-  Saline Spot
-  Sandy Spot
-  Severely Eroded Spot
-  Sinkhole
-  Slide or Slip
-  Sodic Spot

-  Spoil Area
-  Stony Spot
-  Very Stony Spot
-  Wet Spot
-  Other
-  Special Line Features

**Water Features**

 Streams and Canals

**Transportation**

-  Rails
-  Interstate Highways
-  US Routes
-  Major Roads
-  Local Roads

**Background**

 Aerial Photography

### MAP INFORMATION

The soil surveys that comprise your AOI were mapped at 1:24,000.

Warning: Soil Map may not be valid at this scale.

Enlargement of maps beyond the scale of mapping can cause misunderstanding of the detail of mapping and accuracy of soil line placement. The maps do not show the small areas of contrasting soils that could have been shown at a more detailed scale.

Please rely on the bar scale on each map sheet for map measurements.

Source of Map: Natural Resources Conservation Service  
 Web Soil Survey URL:  
 Coordinate System: Web Mercator (EPSG:3857)

Maps from the Web Soil Survey are based on the Web Mercator projection, which preserves direction and shape but distorts distance and area. A projection that preserves area, such as the Albers equal-area conic projection, should be used if more accurate calculations of distance or area are required.

This product is generated from the USDA-NRCS certified data as of the version date(s) listed below.

Soil Survey Area: El Paso County Area, Colorado  
 Survey Area Data: Version 20, Sep 2, 2022

Soil map units are labeled (as space allows) for map scales 1:50,000 or larger.

Date(s) aerial images were photographed: Sep 11, 2018—Oct 20, 2018

The orthophoto or other base map on which the soil lines were compiled and digitized probably differs from the background imagery displayed on these maps. As a result, some minor shifting of map unit boundaries may be evident.

## Map Unit Legend

Map Unit Symbol	Map Unit Name	Acres in AOI	Percent of AOI
19	Columbine gravelly sandy loam, 0 to 3 percent slopes	5.2	100.0%
<b>Totals for Area of Interest</b>		<b>5.2</b>	<b>100.0%</b>

## Map Unit Descriptions

The map units delineated on the detailed soil maps in a soil survey represent the soils or miscellaneous areas in the survey area. The map unit descriptions, along with the maps, can be used to determine the composition and properties of a unit.

A map unit delineation on a soil map represents an area dominated by one or more major kinds of soil or miscellaneous areas. A map unit is identified and named according to the taxonomic classification of the dominant soils. Within a taxonomic class there are precisely defined limits for the properties of the soils. On the landscape, however, the soils are natural phenomena, and they have the characteristic variability of all natural phenomena. Thus, the range of some observed properties may extend beyond the limits defined for a taxonomic class. Areas of soils of a single taxonomic class rarely, if ever, can be mapped without including areas of other taxonomic classes. Consequently, every map unit is made up of the soils or miscellaneous areas for which it is named and some minor components that belong to taxonomic classes other than those of the major soils.

Most minor soils have properties similar to those of the dominant soil or soils in the map unit, and thus they do not affect use and management. These are called noncontrasting, or similar, components. They may or may not be mentioned in a particular map unit description. Other minor components, however, have properties and behavioral characteristics divergent enough to affect use or to require different management. These are called contrasting, or dissimilar, components. They generally are in small areas and could not be mapped separately because of the scale used. Some small areas of strongly contrasting soils or miscellaneous areas are identified by a special symbol on the maps. If included in the database for a given area, the contrasting minor components are identified in the map unit descriptions along with some characteristics of each. A few areas of minor components may not have been observed, and consequently they are not mentioned in the descriptions, especially where the pattern was so complex that it was impractical to make enough observations to identify all the soils and miscellaneous areas on the landscape.

The presence of minor components in a map unit in no way diminishes the usefulness or accuracy of the data. The objective of mapping is not to delineate pure taxonomic classes but rather to separate the landscape into landforms or landform segments that have similar use and management requirements. The delineation of such segments on the map provides sufficient information for the development of resource plans. If intensive use of small areas is planned, however, onsite investigation is needed to define and locate the soils and miscellaneous areas.

## Custom Soil Resource Report

An identifying symbol precedes the map unit name in the map unit descriptions. Each description includes general facts about the unit and gives important soil properties and qualities.

Soils that have profiles that are almost alike make up a *soil series*. Except for differences in texture of the surface layer, all the soils of a series have major horizons that are similar in composition, thickness, and arrangement.

Soils of one series can differ in texture of the surface layer, slope, stoniness, salinity, degree of erosion, and other characteristics that affect their use. On the basis of such differences, a soil series is divided into *soil phases*. Most of the areas shown on the detailed soil maps are phases of soil series. The name of a soil phase commonly indicates a feature that affects use or management. For example, Alpha silt loam, 0 to 2 percent slopes, is a phase of the Alpha series.

Some map units are made up of two or more major soils or miscellaneous areas. These map units are complexes, associations, or undifferentiated groups.

A *complex* consists of two or more soils or miscellaneous areas in such an intricate pattern or in such small areas that they cannot be shown separately on the maps. The pattern and proportion of the soils or miscellaneous areas are somewhat similar in all areas. Alpha-Beta complex, 0 to 6 percent slopes, is an example.

An *association* is made up of two or more geographically associated soils or miscellaneous areas that are shown as one unit on the maps. Because of present or anticipated uses of the map units in the survey area, it was not considered practical or necessary to map the soils or miscellaneous areas separately. The pattern and relative proportion of the soils or miscellaneous areas are somewhat similar. Alpha-Beta association, 0 to 2 percent slopes, is an example.

An *undifferentiated group* is made up of two or more soils or miscellaneous areas that could be mapped individually but are mapped as one unit because similar interpretations can be made for use and management. The pattern and proportion of the soils or miscellaneous areas in a mapped area are not uniform. An area can be made up of only one of the major soils or miscellaneous areas, or it can be made up of all of them. Alpha and Beta soils, 0 to 2 percent slopes, is an example.

Some surveys include *miscellaneous areas*. Such areas have little or no soil material and support little or no vegetation. Rock outcrop is an example.

## El Paso County Area, Colorado

### 19—Columbine gravelly sandy loam, 0 to 3 percent slopes

#### Map Unit Setting

*National map unit symbol:* 367p  
*Elevation:* 6,500 to 7,300 feet  
*Mean annual precipitation:* 14 to 16 inches  
*Mean annual air temperature:* 46 to 50 degrees F  
*Frost-free period:* 125 to 145 days  
*Farmland classification:* Not prime farmland

#### Map Unit Composition

*Columbine and similar soils:* 97 percent  
*Minor components:* 3 percent  
*Estimates are based on observations, descriptions, and transects of the mapunit.*

#### Description of Columbine

##### Setting

*Landform:* Fans, fan terraces, flood plains  
*Down-slope shape:* Linear  
*Across-slope shape:* Linear  
*Parent material:* Alluvium

##### Typical profile

*A - 0 to 14 inches:* gravelly sandy loam  
*C - 14 to 60 inches:* very gravelly loamy sand

##### Properties and qualities

*Slope:* 0 to 3 percent  
*Depth to restrictive feature:* More than 80 inches  
*Drainage class:* Well drained  
*Runoff class:* Very low  
*Capacity of the most limiting layer to transmit water (Ksat):* High to very high (5.95 to 19.98 in/hr)  
*Depth to water table:* More than 80 inches  
*Frequency of flooding:* None  
*Frequency of ponding:* None  
*Available water supply, 0 to 60 inches:* Very low (about 2.5 inches)

##### Interpretive groups

*Land capability classification (irrigated):* 4e  
*Land capability classification (nonirrigated):* 6e  
*Hydrologic Soil Group:* A  
*Ecological site:* R049XY214CO - Gravelly Foothill  
*Hydric soil rating:* No

#### Minor Components

##### Fluvaquentic haplaquolls

*Percent of map unit:* 1 percent  
*Landform:* Swales  
*Hydric soil rating:* Yes



## Custom Soil Resource Report

### **Other soils**

*Percent of map unit:* 1 percent

*Hydric soil rating:* No

### **Pleasant**

*Percent of map unit:* 1 percent

*Landform:* Depressions

*Hydric soil rating:* Yes

**APPENDIX**  
FLOODPLAIN MAP

# National Flood Hazard Layer FIRMette



104°36'50"W 38°56'57"N

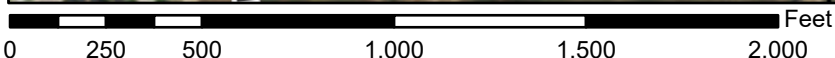

1:6,000

104°36'12"W 38°56'29"N

Basemap: USGS National Map: Orthoimagery: Data refreshed October, 2020

## Legend

SEE FIS REPORT FOR DETAILED LEGEND AND INDEX MAP FOR FIRM PANEL LAYOUT

SPECIAL FLOOD HAZARD AREAS		Without Base Flood Elevation (BFE) Zone A, V, A99
		With BFE or Depth Zone AE, AO, AH, VE, AR
		Regulatory Floodway
OTHER AREAS OF FLOOD HAZARD		0.2% Annual Chance Flood Hazard, Areas of 1% annual chance flood with average depth less than one foot or with drainage areas of less than one square mile Zone X
		Future Conditions 1% Annual Chance Flood Hazard Zone X
		Area with Reduced Flood Risk due to Levee. See Notes. Zone X
		Area with Flood Risk due to Levee Zone D
OTHER AREAS		NO SCREEN Area of Minimal Flood Hazard Zone X
		Effective LOMRs
GENERAL STRUCTURES		Area of Undetermined Flood Hazard Zone D
		Channel, Culvert, or Storm Sewer
OTHER FEATURES		Levee, Dike, or Floodwall
		20.2 Cross Sections with 1% Annual Chance Water Surface Elevation
MAP PANELS		17.5
		8 Coastal Transect
		Base Flood Elevation Line (BFE)
		Limit of Study
		Jurisdiction Boundary
		Coastal Transect Baseline
		Profile Baseline
		Hydrographic Feature
		Digital Data Available
		No Digital Data Available
		Unmapped



The pin displayed on the map is an approximate point selected by the user and does not represent an authoritative property location.

This map complies with FEMA's standards for the use of digital flood maps if it is not void as described below. The basemap shown complies with FEMA's basemap accuracy standards

The flood hazard information is derived directly from the authoritative NFHL web services provided by FEMA. This map was exported on 1/25/2023 at 12:53 PM and does not reflect changes or amendments subsequent to this date and time. The NFHL and effective information may change or become superseded by new data over time.

This map image is void if the one or more of the following map elements do not appear: basemap imagery, flood zone labels, legend, scale bar, map creation date, community identifiers, FIRM panel number, and FIRM effective date. Map images for unmapped and unmodernized areas cannot be used for regulatory purposes.

**APPENDIX**  
HYDROLOGY CALCULATIONS

# PROJECT INFORMATION

**PROJECT:** Owl Marketplace  
**PROJECT NO:** 21611-01CSCV  
**DESIGN BY:** KGV  
**REV. BY:** TDM  
**AGENCY:** El Paso County  
**REPORT TYPE:** Final  
**DATE:** 8/22/2024



Drexel, Barrell & Co.

	C2*	C5*	C10*	C100*	% IMPERV
<b>Business - Commercial Area</b>		0.81		0.88	95
<b>Pasture/Meadow/Lawn</b>		0.08		0.35	0
<b>Streets - Gravel</b>		0.90		0.96	100
<b>Streets - Paved</b>		0.90		0.96	100

\*C-Values and Basin Imperviousness based on Table 6-6, City of Colorado Springs Drainage Criteria Manual

SUB-BASIN	SURFACE DESIGNATION	AREA ACRE	COMPOSITE RUNOFF COEFFICIENTS				% IMPERV
			C2	C5	C10	C100	
<b>EXISTING</b>							
<b>OSE1</b>	Business - Commercial Area	0.00		0.81		0.88	95
	Pasture/Meadow/Lawn	0.94		0.08		0.35	0
	Streets - Gravel	0.20		0.90		0.96	100
	Streets - Paved	0.12		0.90		0.96	100
<b>OSE1 TOTAL</b>	<i>WEIGHTED AVERAGE</i>	1.26		0.20		0.41	16
<b>E2</b>	Business - Commercial Area	0.00		0.81		0.88	95
	Pasture/Meadow/Lawn	1.95		0.08		0.35	0
	Streets - Paved	0.00		0.90		0.96	100
<b>E2 TOTAL</b>	<i>WEIGHTED AVERAGE</i>	1.95		0.08		0.35	0
<b>E3</b>	Business - Commercial Area	0.00		0.81		0.88	95
	Pasture/Meadow/Lawn	2.34		0.08		0.35	0
	Streets - Paved	0.00		0.90		0.96	100
<b>E3 TOTAL</b>	<i>WEIGHTED AVERAGE</i>	2.34		0.08		0.35	0
<b>E4</b>	Business - Commercial Area	0.00		0.81		0.88	95
	Pasture/Meadow/Lawn	0.33		0.08		0.35	0
	Streets - Paved	0.00		0.90		0.96	100
<b>E4 TOTAL</b>	<i>WEIGHTED AVERAGE</i>	0.33		0.08		0.35	0
<b>OVERLOT</b>							
<b>X1A</b>	Pasture/Meadow/Lawn	0.08		0.08		0.35	0
	Streets - Gravel	0.00		0.90		0.96	0
	Streets - Paved	0.00		0.90		0.96	100
<b>X1A TOTAL</b>	<i>WEIGHTED AVERAGE</i>	0.08		0.08		0.35	0
<b>A</b>	Pasture/Meadow/Lawn	2.97		0.08		0.35	0
	Streets - Gravel	0.00		0.90		0.96	0
	Streets - Paved	0.04		0.90		0.96	100
<b>A TOTAL</b>	<i>WEIGHTED AVERAGE</i>	3.01		0.09		0.36	1

# PROJECT INFORMATION

**PROJECT:** Owl Marketplace  
**PROJECT NO:** 21611-01CSCV  
**DESIGN BY:** KGV  
**REV. BY:** TDM  
**AGENCY:** El Paso County  
**REPORT TYPE:** Final  
**DATE:** 8/22/2024



Drexel, Barrell & Co.

	C2*	C5*	C10*	C100*	% IMPERV
<b>Business - Commercial Area</b>		0.81		0.88	95
<b>Pasture/Meadow/Lawn</b>		0.08		0.35	0
<b>Streets - Gravel</b>		0.90		0.96	100
<b>Streets - Paved</b>		0.90		0.96	100

\*C-Values and Basin Imperviousness based on Table 6-6, City of Colorado Springs Drainage Criteria Manual

<b>B</b>	Pasture/Meadow/Lawn	1.66		0.08		0.35	0
	Streets - Gravel	0.16		0.90		0.96	0
	Streets - Paved	0.07		0.90		0.96	100
<b>B TOTAL</b>	<i>WEIGHTED AVERAGE</i>	1.89		0.18		0.42	4
<b>C</b>	Pasture/Meadow/Lawn	0.29		0.08		0.35	0
	Streets - Gravel	0.00		0.90		0.96	0
	Streets - Paved	0.00		0.90		0.96	100
<b>C TOTAL</b>	<i>WEIGHTED AVERAGE</i>	0.29		0.08		0.35	0
<b>D</b>	Pasture/Meadow/Lawn	0.09		0.08		0.35	0
	Streets - Gravel	0.00		0.90		0.96	0
	Streets - Paved	0.00		0.90		0.96	100
<b>D TOTAL</b>	<i>WEIGHTED AVERAGE</i>	0.09		0.08		0.35	0
<b>E</b>	Pasture/Meadow/Lawn	0.21		0.08		0.35	0
	Streets - Gravel	0.00		0.90		0.96	0
	Streets - Paved	0.00		0.90		0.96	100
<b>E TOTAL</b>	<i>WEIGHTED AVERAGE</i>	0.21		0.08		0.35	0

**PROJECT INFORMATION**

PROJECT: Owl Marketplace  
 PROJECT NO: 21611-01CSCV  
 DESIGN BY: KGV  
 REV. BY: TDM  
 AGENCY: El Paso County  
 REPORT TYPE: Final  
 DATE: 8/22/2024



**RATIONAL METHOD CALCULATIONS FOR STORM WATER RUNOFF**  
 DEVELOPED TIME OF CONCENTRATION STANDARD FORM SF-2

SUB-BASIN DATA					INITIAL/OVERLAND TIME (t <sub>i</sub> )			TRAVEL TIME (t <sub>t</sub> )				TIME OF CONC. t <sub>c</sub>		FINAL t <sub>c</sub>
BASIN	DESIGN PT.	C <sub>5</sub>	C <sub>100</sub>	AREA	LENGTH	SLOPE	t <sub>i</sub>	LENGTH	SLOPE	VEL.	t <sub>t</sub>	COMP.	MINIMUM	
				Ac	Ft	%	Min	Ft	%	FPS	Min	t <sub>c</sub>	t <sub>c</sub>	Min
<b>EXISTING</b>														
RMT064	<b>X1</b>	Flow directly added												
OSE1	<b>E1</b>	0.20	0.41	1.26	100	3.0	11.7	150	1.0	1.5	1.7	13.3	5.0	13.3
E2		0.08	0.35	1.95	100	2.0	15.1	340	3.0	4.3	1.3	16.5	5.0	16.5
OS1+E2	<b>E2</b>	0.13	0.37	3.21	From OSE1		13.3	350	3.0	4.3	1.4	14.7	5.0	14.7
E3	<b>E3</b>	0.08	0.35	2.34	100	2.0	15.1	410	3.0	4.3	1.6	16.7	5.0	16.7
E4	<b>E4</b>	0.08	0.35	0.33	50	2.0	10.7	550	2.0	3.8	2.4	13.1	5.0	13.1
MT060	<b>X2</b>	Flow directly added												
<b>OVERLOT</b>														
X1A		0.08	0.35	0.08	50	3.0	9.4					9.4	5.0	9.4
	<b>X1A</b>	Flow directly added from offsite basin X1												
A	<b>1</b>	0.09	0.36	3.01	50	3.0	9.3	600	2.3	4.3	2.3	11.6	5.0	11.6
Offsite	<b>2</b>	Flow directly added from offsite basin - Falcon Ranchettes #1A DP12												
B		0.18	0.42	1.89	50	3.0	8.4	917	2.5	4.3	3.6	12.0	5.0	12.0
DP2+B	<b>3</b>	0.18	0.99	1.89	From Basin B		12.0	550	2.0	4.1	2.2	14.2	5.0	14.2
Offsite 2	<b>4</b>	Flow directly added from offsite basin - Falcon Ranchettes #1A DP13												
C		0.08	0.35	0.29	50	3.0	9.4	550	2.5	4.3	2.1	11.5	5.0	11.5
DP4+C	<b>5</b>	0.08	0.35	0.29	From Basin C		11.5	550	2.0	4.1	2.2	13.7	5.0	13.7
DP1+DP3+DP5	<b>6</b>	0.21	1.00	3.05	From DP5		13.7	50	1.3	3.2	0.3	14.0	5.0	14.0
D	<b>7</b>	0.08	0.35	0.09	50	3.0	9.4	50	2.3	4.3	0.2	9.5	5.0	9.5
E	<b>8</b>	0.08	0.35	0.21	50	2.0	10.7	50	2.0	4.1	0.2	10.9	5.0	10.9

**PROJECT INFORMATION**

PROJECT: Owl Marketplace  
 PROJECT NO: 21611-01CSCV  
 DESIGN BY: KGV  
 REV. BY: TDM  
 AGENCY: El Paso County  
 REPORT TYPE: Final  
 DATE: 8/22/2024



**RATIONAL METHOD CALCULATIONS FOR STORM WATER RUNOFF**

DEVELOPED RUNOFF 5 YR STORM P1= 1.50

BASIN (S)	DIRECT RUNOFF						
	DESIGN POINT	AREA (AC)	RUNOFF COEFF	t <sub>c</sub> (MIN)	C * A	I (IN/HR)	Q (CFS)
<b>EXISTING</b>							
RMT064	X1						288.5
OSE1	E1	1.26	0.20	13.3	0.25	3.60	0.9
E2		1.95	0.08	16.5	0.16	3.26	0.5
	E2	3.21	0.13	14.7	0.41	3.44	1.4
E3	E3	2.34	0.08	16.7	0.19	3.23	0.6
E4	E4	0.33	0.08	13.1	0.03	3.62	0.1
MT060	X2						60.1
<b>OVERLOT</b>							
X1A		0.08	0.08	9.4	0.01	4.16	0.03
	X1A						288.5
A	1	3.01	0.09	11.6	0.27	3.82	1.0
Offsite	2						0.6
B		1.89	0.18	12.0	0.34	3.76	1.9
	3	1.89	0.18	14.2	0.34	3.49	1.2
Offsite 2	4						1.0
C		0.29	0.08	11.5	0.02	3.84	1.1
	5	0.29	0.08	13.7	0.02	3.55	0.1
	6	3.05	0.21	14.0	0.63	3.52	5.7
D	7	0.09	0.08	9.5	0.01	4.13	0.0
E	8	0.21	0.08	10.9	0.02	3.92	0.1



**PROJECT INFORMATION**

PROJECT: Owl Marketplace  
 PROJECT NO: 21611-01CSCV  
 DESIGN BY: KGV  
 REV. BY: TDM  
 AGENCY: El Paso County  
 REPORT TYPE: Final  
 DATE: 8/22/2024



**RATIONAL METHOD CALCULATIONS FOR STORM WATER RUNOFF**

DEVELOPED RUNOFF 100 YR STORM P1= 2.52

BASIN (S)	DIRECT RUNOFF						
	DESIGN POINT	AREA (AC)	RUNOFF COEFF	t <sub>c</sub> (MIN)	C * A	I (IN/HR)	Q (CFS)
<b>EXISTING</b>							
RMT064	X1						920.0
OSE1	E1	1.26	0.41	13.3	0.52	6.04	3.1
E2		1.95	0.35	16.5	0.68	5.47	3.7
	E2	3.21	0.37	14.7	1.20	5.78	6.9
E3	E3	2.34	0.35	16.7	0.82	5.43	4.4
E4	E4	0.33	0.35	13.1	0.12	6.08	0.7
MT060	X2						196.8
<b>OVERLOT</b>							
X1A		0.08	0.35	9.4	0.03	7.00	0.2
	X1A						920.2
A	1	3.01	0.36	11.6	1.07	6.42	6.9
Offsite	2	0.00	0.00	0.0	0.00	11.76	1.5
B		1.89	0.42	12.0	0.80	6.33	6.6
	3	1.89	0.99	14.2	1.87	5.86	11.0
Offsite 2	4	0.00	0.00	0.0	0.00	11.76	2.1
C		0.29	0.35	11.5	0.10	6.44	2.8
	5	0.29	0.35	13.7	0.10	5.96	0.6
	6	3.05	1.00	14.0	3.05	5.91	12.6
D	7	0.09	0.35	9.5	0.03	6.94	0.2
E	8	0.21	0.35	10.9	0.07	6.58	0.5

**APPENDIX**  
HYDRAULIC CALCULATIONS

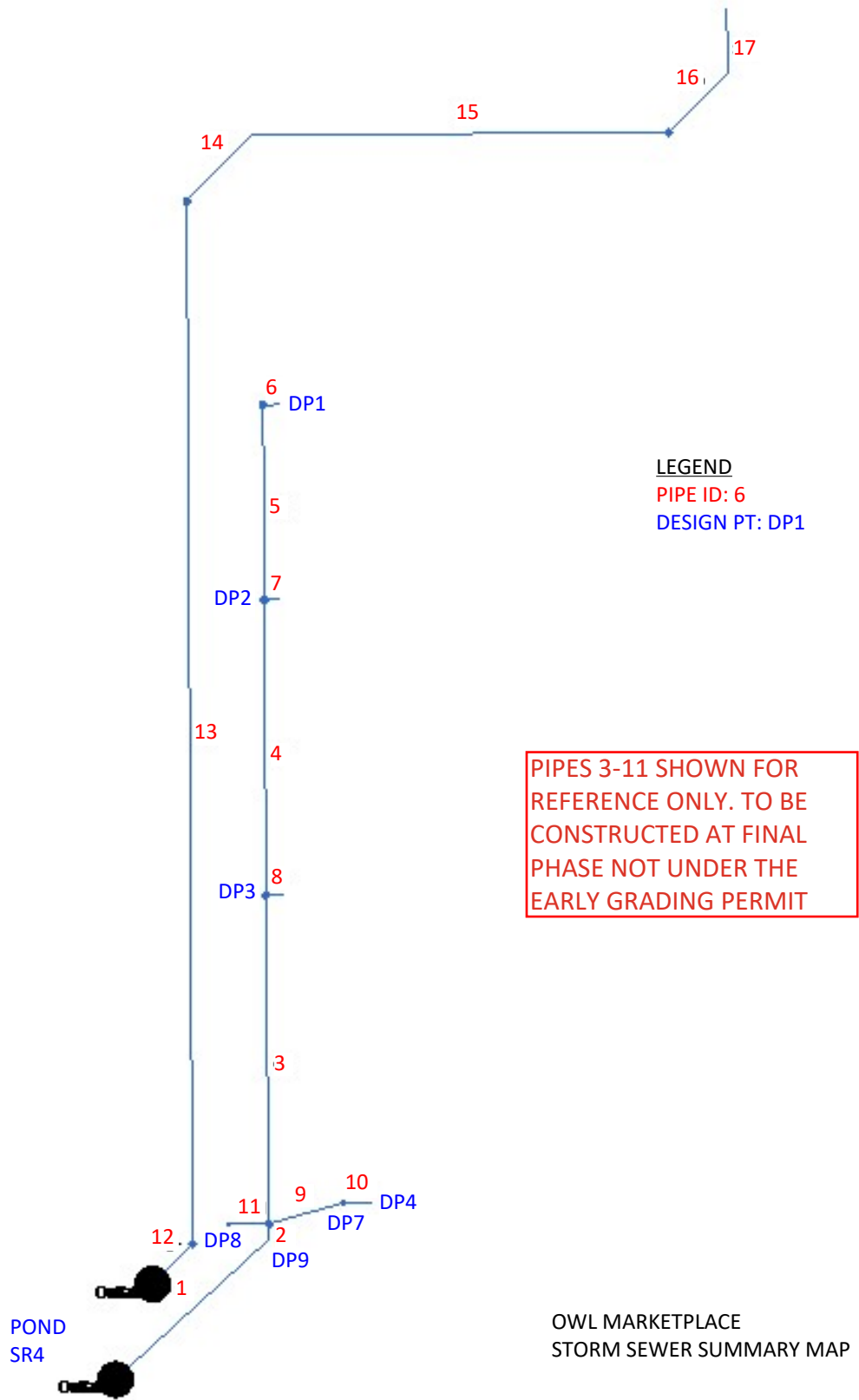

# Hydraulic Grade Line Computations

Line	Size	Q	Downstream								Len	Upstream								Check		JL coeff	Minor loss
			Invert elev (ft)	HGL elev (ft)	Depth (ft)	Area (sqft)	Vel (ft/s)	Vel head (ft)	EGL elev (ft)	Sf (%)		Invert elev (ft)	HGL elev (ft)	Depth (ft)	Area (sqft)	Vel (ft/s)	Vel head (ft)	EGL elev (ft)	Sf (%)	Ave Sf (%)	Enrgy loss (ft)		
(1)	(in) (2)	(cfs) (3)	(4)	(5)	(6)	(7)	(8)	(9)	(10)	(11)	(ft) (12)	(13)	(14)	(15)	(16)	(17)	(18)	(19)	(20)	(21)	(22)	(K) (23)	(ft) (24)
1	30	23.90	6893.94	6895.59	1.65	3.44	6.95	0.74	6896.33	0.000	123.733	6896.36	6898.02	1.66**	3.47	6.89	0.74	6898.76	0.000	0.000	n/a	0.79	0.58
2	30	23.90	6896.36	6898.02	1.66*	3.47	6.89	0.74	6898.76	0.000	6.466	6896.48	6898.14	1.66**	3.47	6.89	0.74	6898.88	0.000	0.000	n/a	1.00	0.74

**PIPES 3-11 REMOVED FROM THIS LIST FOR CLARITY AS THEY ARE NOT COVERED UNDER THE EARLY GRADING PERMIT. REFERENCE THE FINAL DRAINAGE REPORT FOR THE OVERALL DEVELOPMENT FOR CALCULATIONS**

12	72 120 B	288.5	6894.07	6900.07	6.00*	60.00	4.81	0.36	6900.43	0.076	31.966	6894.39	6900.08	5.69	56.91	5.07	0.40	6900.48	0.053	0.065	0.021	0.75	0.30
13	72 120 B	288.5	6894.39	6900.38	5.99	59.91	4.82	1.48	6901.86	0.000	609.769	6900.75	6903.71 j	2.95**	29.55	9.76	1.48	6905.19	0.000	0.000	n/a	0.75	n/a
14	72 120 B	288.5	6900.75	6903.71	2.95*	29.55	9.76	1.48	6905.19	0.000	52.499	6901.76	6904.71	2.95**	29.55	9.76	1.48	6906.20	0.000	0.000	n/a	0.75	n/a
15	72 120 B	288.5	6901.76	6904.71	2.95*	29.55	9.76	1.48	6906.20	0.000	235.000	6906.30	6909.25	2.95**	29.55	9.76	1.48	6910.74	0.000	0.000	n/a	0.75	n/a
16	72 120 B	288.5	6906.30	6909.25	2.95*	29.55	9.76	1.48	6910.74	0.000	47.000	6907.20	6910.16	2.95**	29.55	9.76	1.48	6911.64	0.000	0.000	n/a	0.75	n/a
17	72 120 B	288.5	6907.20	6910.16	2.95*	29.55	9.76	1.48	6911.64	0.000	15.500	6907.50	6910.46	2.95**	29.55	9.76	1.48	6911.94	0.000	0.000	n/a	1.00	n/a

Project File: OP 5-YR REV3.stm

Number of lines: 17

Run Date: 5/23/2024

Notes: \* depth assumed; \*\* Critical depth.; j-Line contains hyd. jump ; c = cir e = ellip b = box

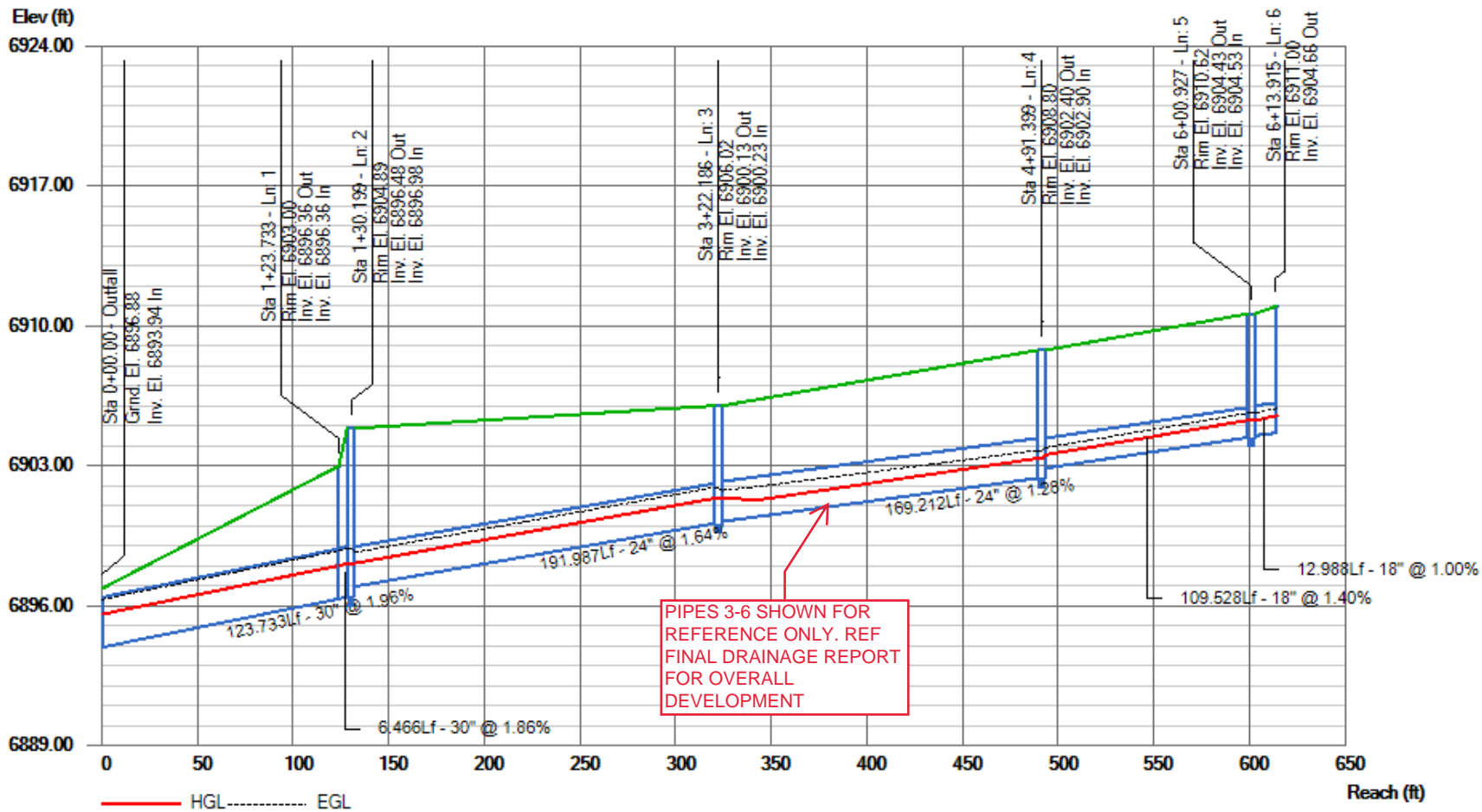

PIPES 3-6 SHOWN FOR REFERENCE ONLY. REF FINAL DRAINAGE REPORT FOR OVERALL DEVELOPMENT

# Storm Sewer Profile

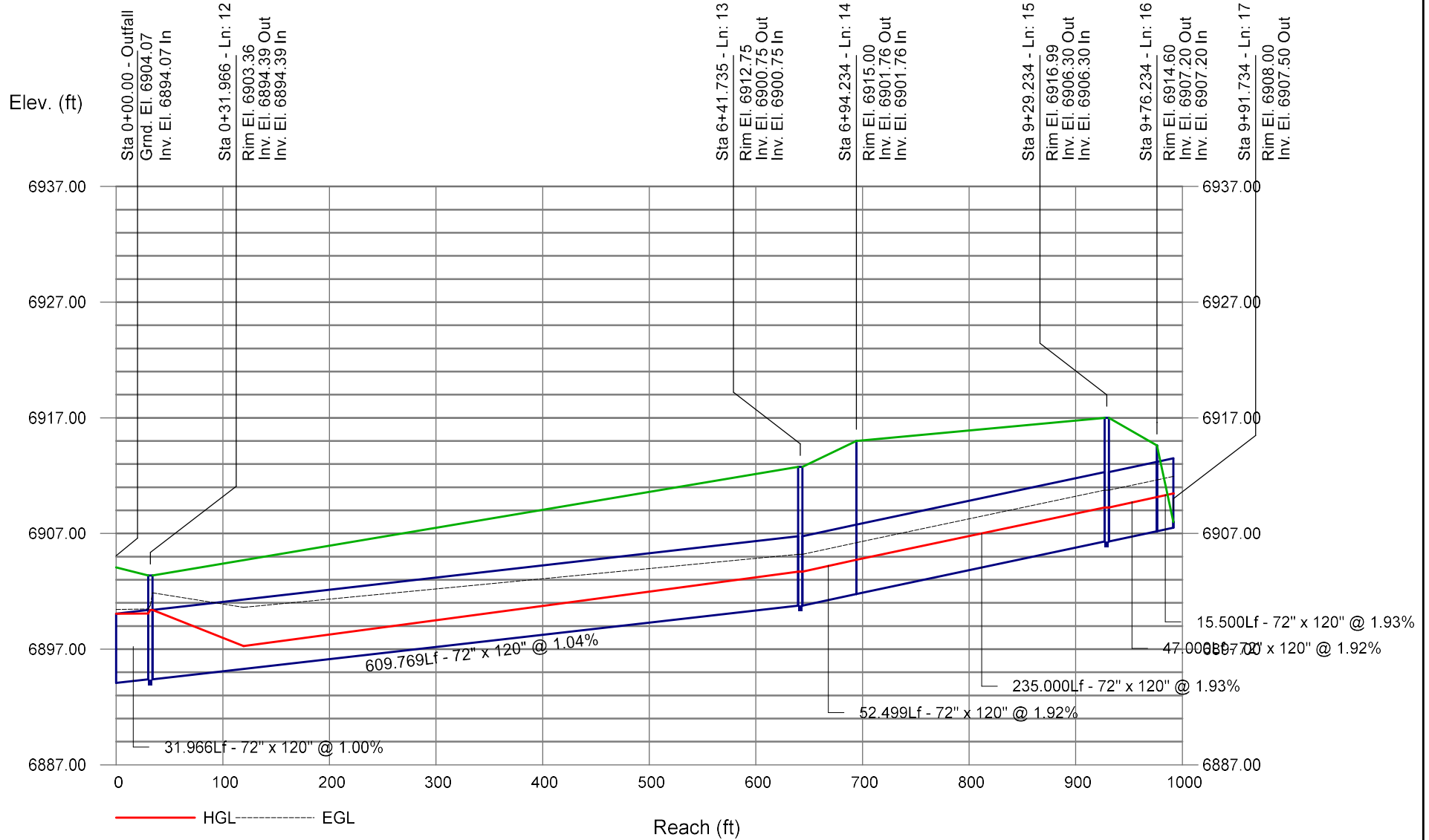

# Hydraulic Grade Line Computations

Line	Size	Q	Downstream								Len	Upstream								Check		JL coeff	Minor loss
			Invert elev (ft)	HGL elev (ft)	Depth (ft)	Area (sqft)	Vel (ft/s)	Vel head (ft)	EGL elev (ft)	Sf (%)		Invert elev (ft)	HGL elev (ft)	Depth (ft)	Area (sqft)	Vel (ft/s)	Vel head (ft)	EGL elev (ft)	Sf (%)	Ave Sf (%)	Enrgy loss (ft)		
(1)	(in) (2)	(cfs) (3)	(4)	(5)	(6)	(7)	(8)	(9)	(10)	(11)	(ft) (12)	(13)	(14)	(15)	(16)	(17)	(18)	(19)	(20)	(21)	(22)	(K) (23)	(ft) (24)
1	30	44.30	6893.94	6895.59	1.65	3.44	12.89	1.45	6897.04	0.000	123.733	6896.36	6898.57	2.21**	4.59	9.64	1.45	6900.02	0.000	0.000	n/a	0.79	n/a
2	30	44.30	6896.36	6898.57	2.21*	4.59	9.64	1.45	6900.02	0.000	6.466	6896.48	6898.69	2.21**	4.59	9.64	1.45	6900.14	0.000	0.000	n/a	1.00	n/a

**PIPES 3-11 REMOVED FROM THIS LIST FOR CLARITY AS THEY ARE NOT COVERED UNDER THE EARLY GRADING PERMIT. REFERENCE THE FINAL DRAINAGE REPORT FOR THE OVERALL DEVELOPMENT FOR CALCULATIONS**

12	72 120 B	920.0	6894.07	6900.07	6.00*	60.00	15.33	3.66	6903.73	0.778	31.966	6894.39	6900.39	6.00**	60.00	15.33	3.66	6904.05	0.778	0.778	n/a	0.75	n/a
13	72 120 B	920.0	6894.39	6900.39	6.00*	60.00	15.33	3.66	6904.05	0.778	609.769	6900.75	6906.75	6.00**	60.00	15.33	3.66	6910.41	0.778	0.778	n/a	0.75	n/a
14	72 120 B	920.0	6900.75	6906.75	6.00*	60.00	15.33	3.66	6910.41	0.778	52.499	6901.76	6907.76	6.00**	60.00	15.33	3.66	6911.42	0.778	0.778	n/a	0.75	n/a
15	72 120 B	920.0	6901.76	6907.76	6.00*	60.00	15.33	3.66	6911.42	0.778	235.000	6906.30	6912.30	6.00**	60.00	15.33	3.66	6915.96	0.778	0.778	n/a	0.75	n/a
16	72 120 B	920.0	6906.30	6912.30	6.00*	60.00	15.33	3.66	6915.96	0.778	47.000	6907.20	6913.20	6.00**	60.00	15.33	3.66	6916.86	0.778	0.778	n/a	0.75	n/a
17	72 120 B	920.0	6907.20	6913.20	6.00*	60.00	15.33	3.66	6916.86	0.778	15.500	6907.50	6913.50	6.00**	60.00	15.33	3.66	6917.16	0.778	0.778	n/a	1.00	n/a

Project File: OP 100-YR REV3.stm

Number of lines: 17

Run Date: 5/23/2024

Notes: \* depth assumed; \*\* Critical depth.; j-Line contains hyd. jump ; c = cir e = ellip b = box

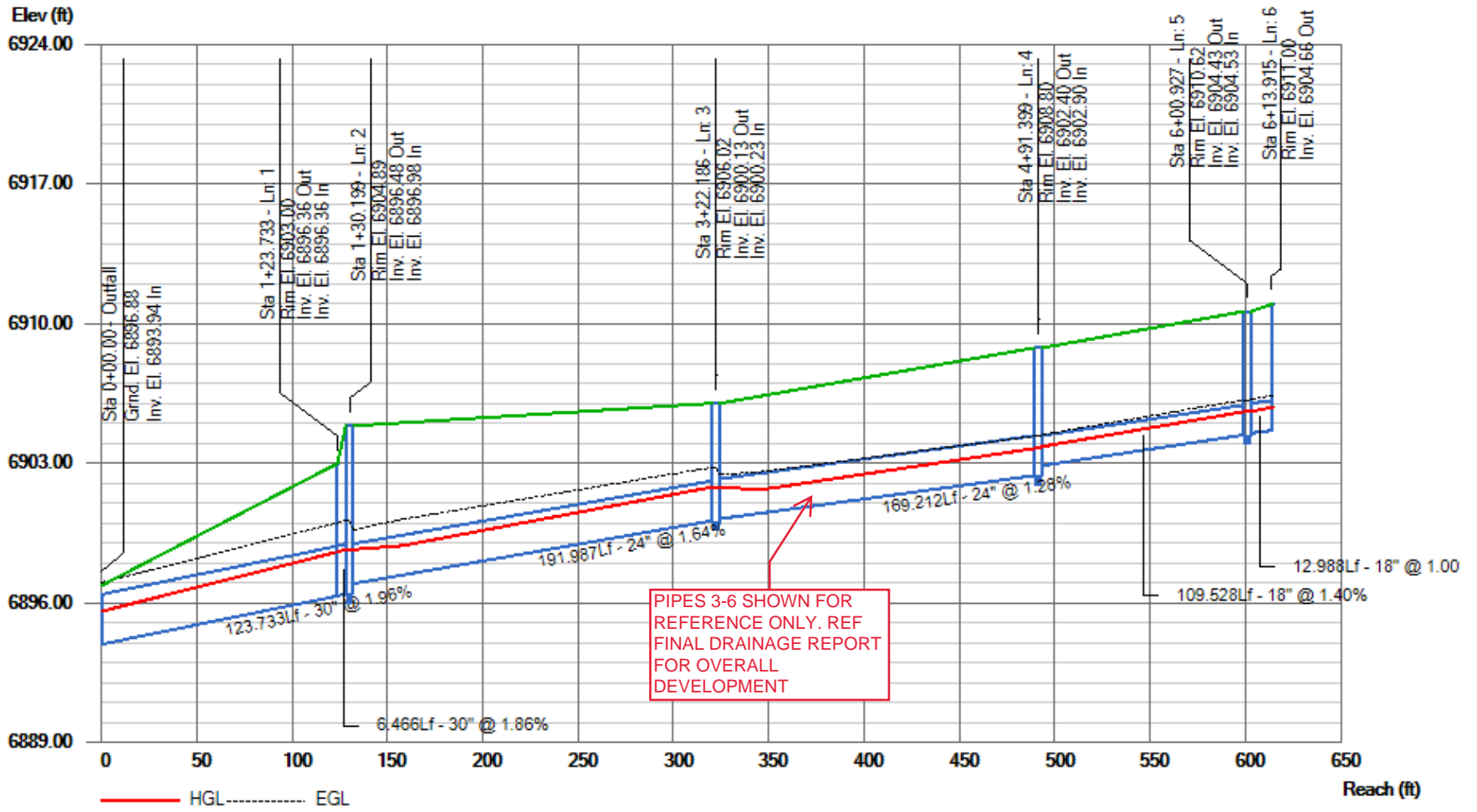



# Storm Sewer Profile

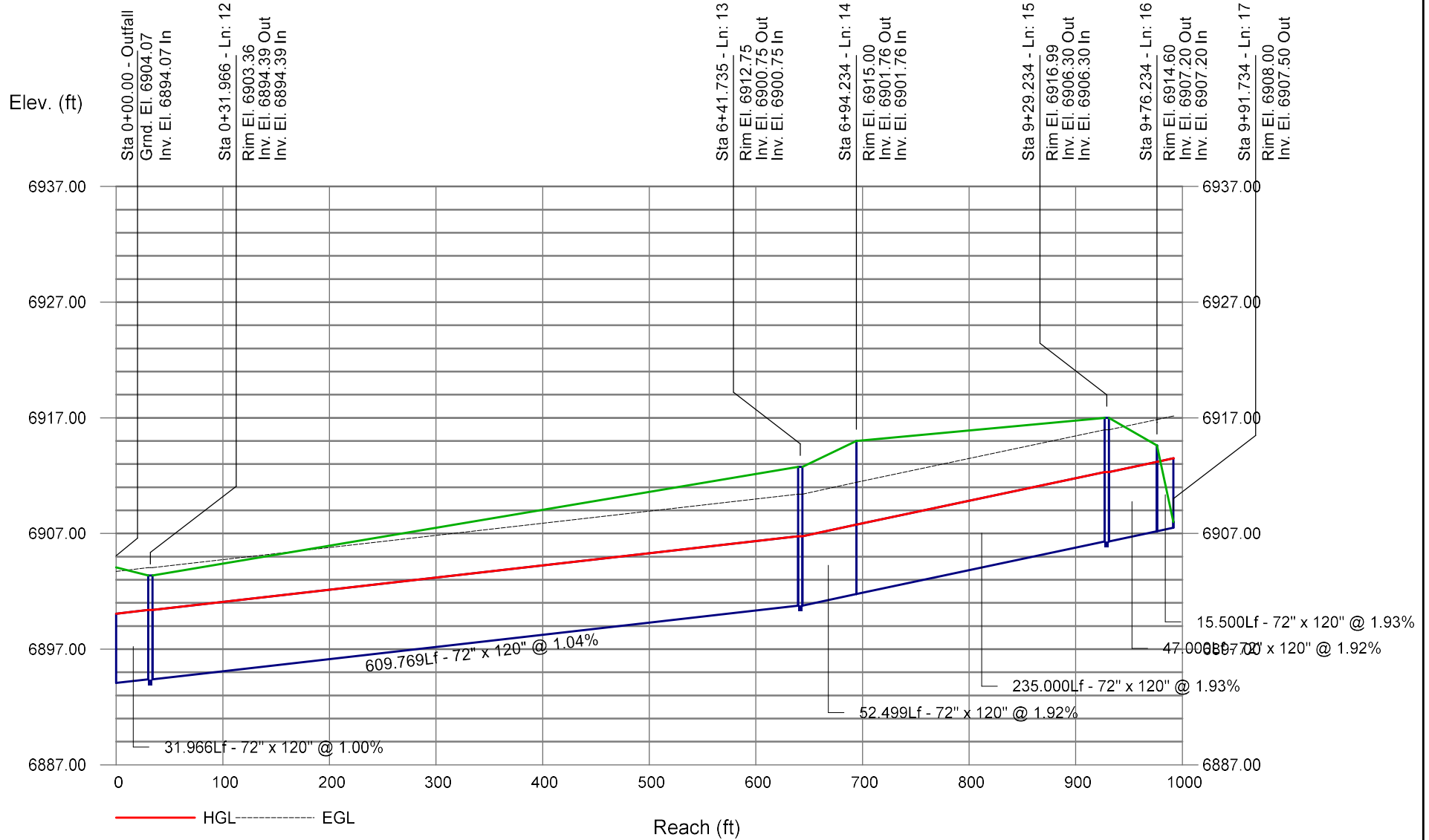

# Channel Report

## Owl Marketplace - Meridian channel at Culvert Headwall

### Trapezoidal

Bottom Width (ft) = 13.00  
Side Slopes (z:1) = 1.80, 1.80  
Total Depth (ft) = 9.00  
Invert Elev (ft) = 6908.00  
Slope (%) = 0.30  
N-Value = 0.020

### Highlighted

Depth (ft) = 4.83  
Q (cfs) = 920.00  
Area (sqft) = 104.78  
Velocity (ft/s) = 8.78  
Wetted Perim (ft) = 32.89  
Crit Depth, Yc (ft) = 4.37  
Top Width (ft) = 30.39  
EGL (ft) = 6.03

### Calculations

Compute by: Known Q  
Known Q (cfs) = 920.00

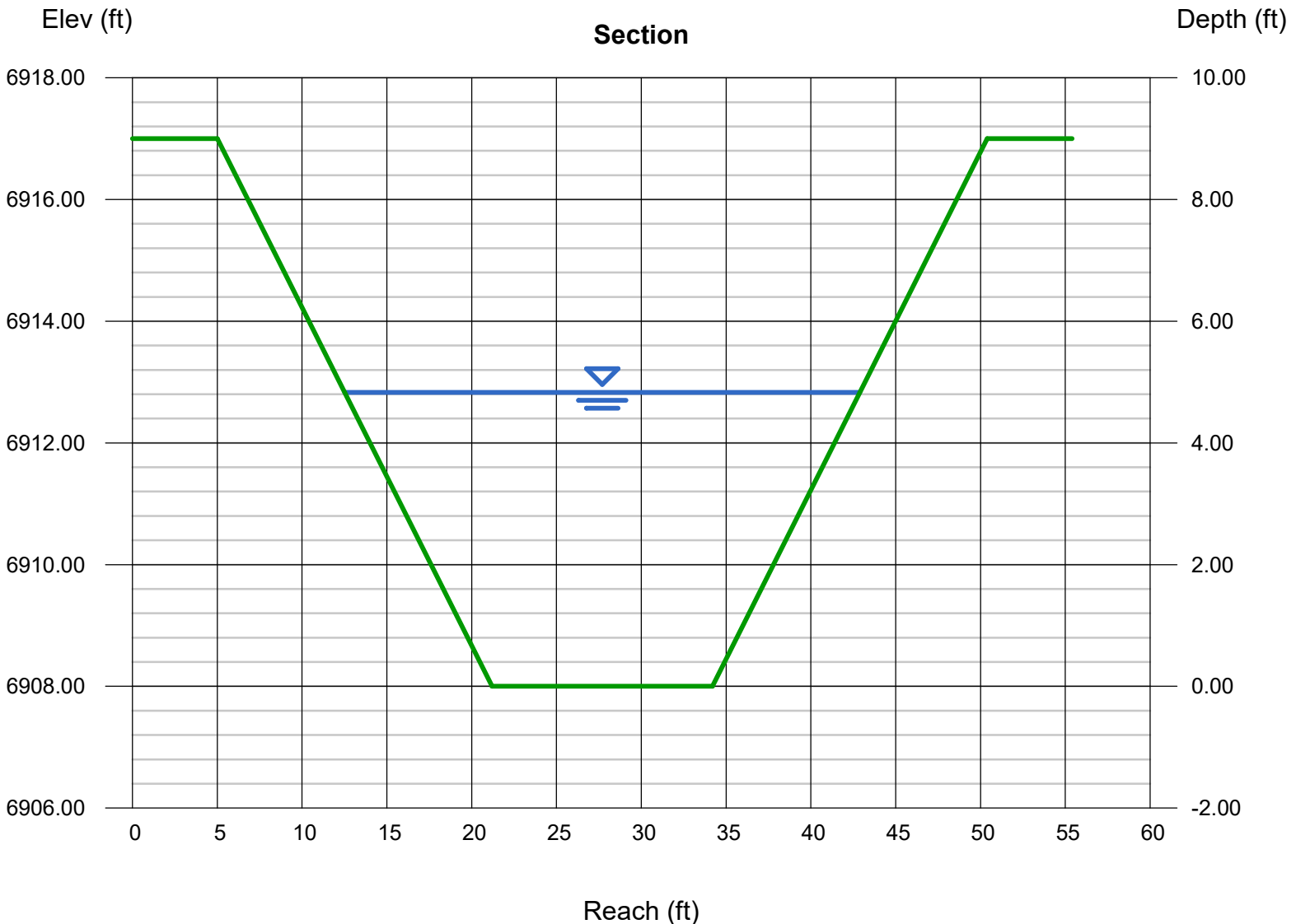

# Channel Report

## Owl Marketplace - Temp. diversion swale

### Triangular

Side Slopes (z:1) = 3.00, 3.00  
Total Depth (ft) = 1.00

Invert Elev (ft) = 1.00  
Slope (%) = 2.00  
N-Value = 0.035

### Calculations

Compute by: Known Q  
Known Q (cfs) = 6.90

### Highlighted

Depth (ft) = 0.85  
Q (cfs) = 6.900  
Area (sqft) = 2.17  
Velocity (ft/s) = 3.18  
Wetted Perim (ft) = 5.38  
Crit Depth, Yc (ft) = 0.81  
Top Width (ft) = 5.10  
EGL (ft) = 1.01

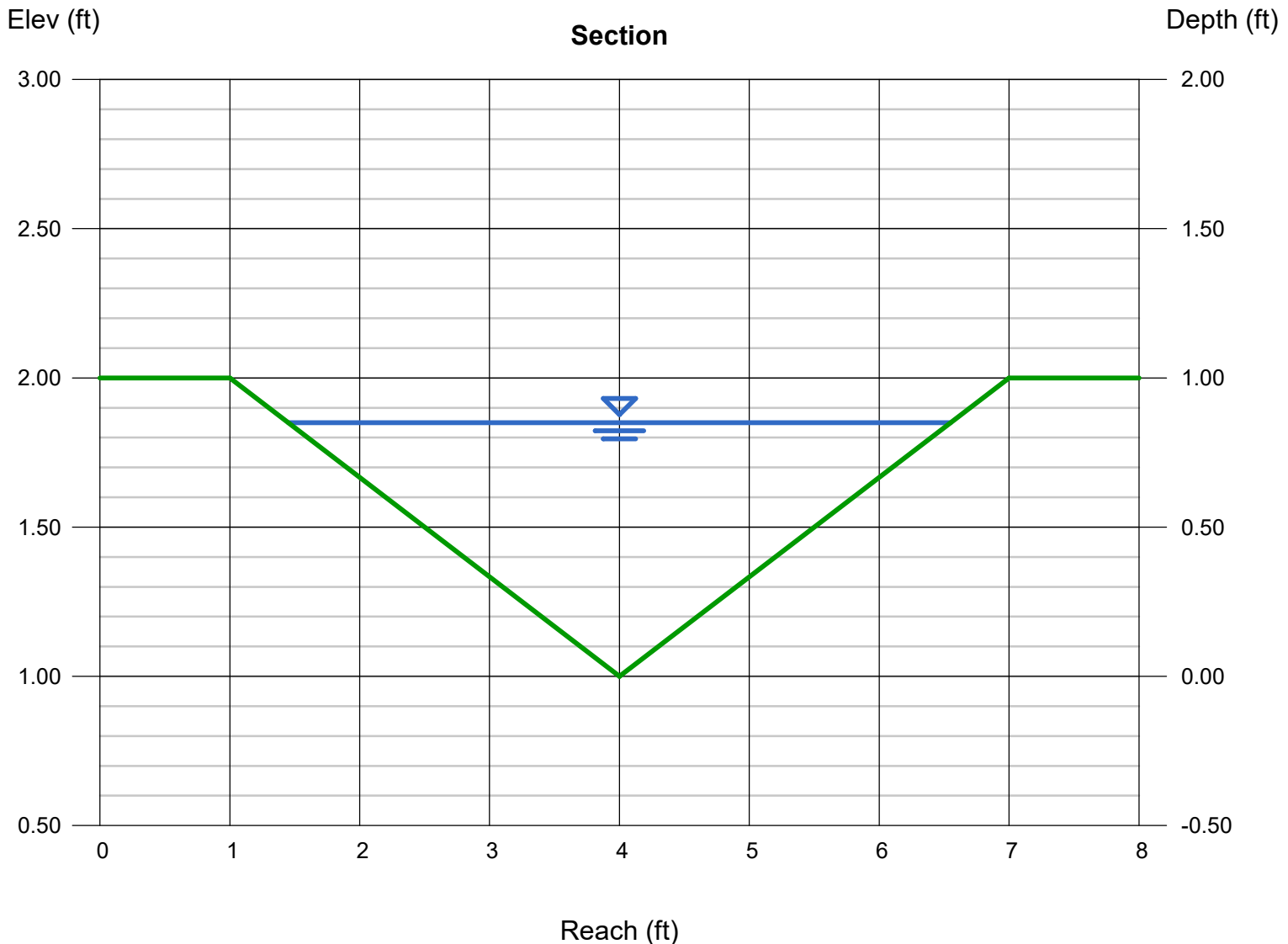

## PROJECT INFORMATION

PROJECT: Owl Marketplace  
PROJECT NO: 21611-01CSCV  
DESIGN BY: KGV  
REV. BY: TDM  
AGENCY: El Paso County  
REPORT TYPE: Final  
DATE: 9/28/2023



## STILLING BASIN

mannings, n	0.013	
Culvert width, W	10	ft
Culvert height, H	6	ft
Culvert slope	1.00	%
Q <sub>100</sub>	920	cfs
Depth of flow	4.5	ft
Velocity	15.33	fps
Froude	1.28	
<i>Reference MHFD Figure 9-45 in appendix</i>		
D	6.71	ft
W	20.22	ft
H	15.17	ft
L	26.97	ft
a	10.11	ft
b	7.58	ft
c	10.11	ft
d	3.37	ft
e	1.69	ft
f	2.53	ft
t	1.69	ft

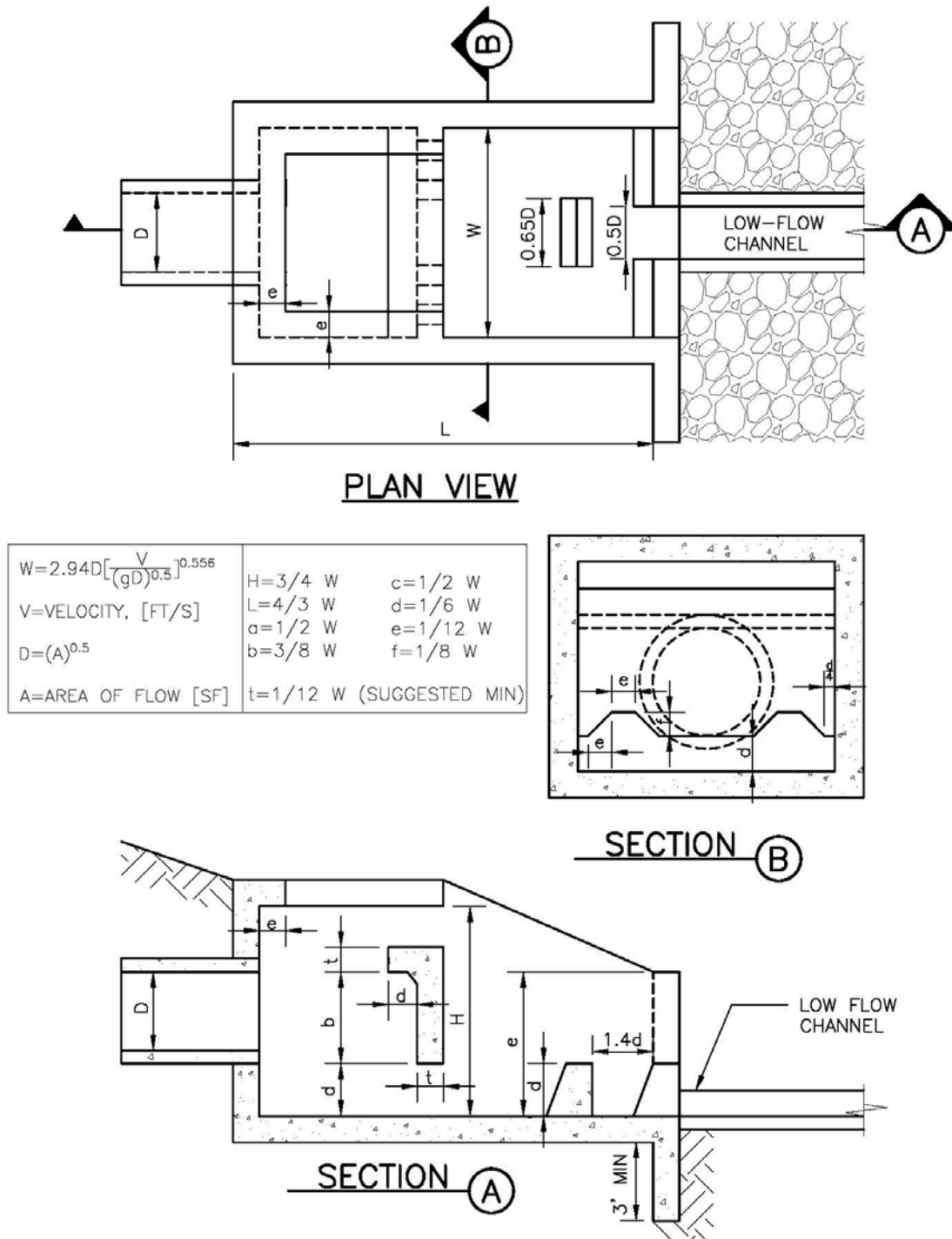
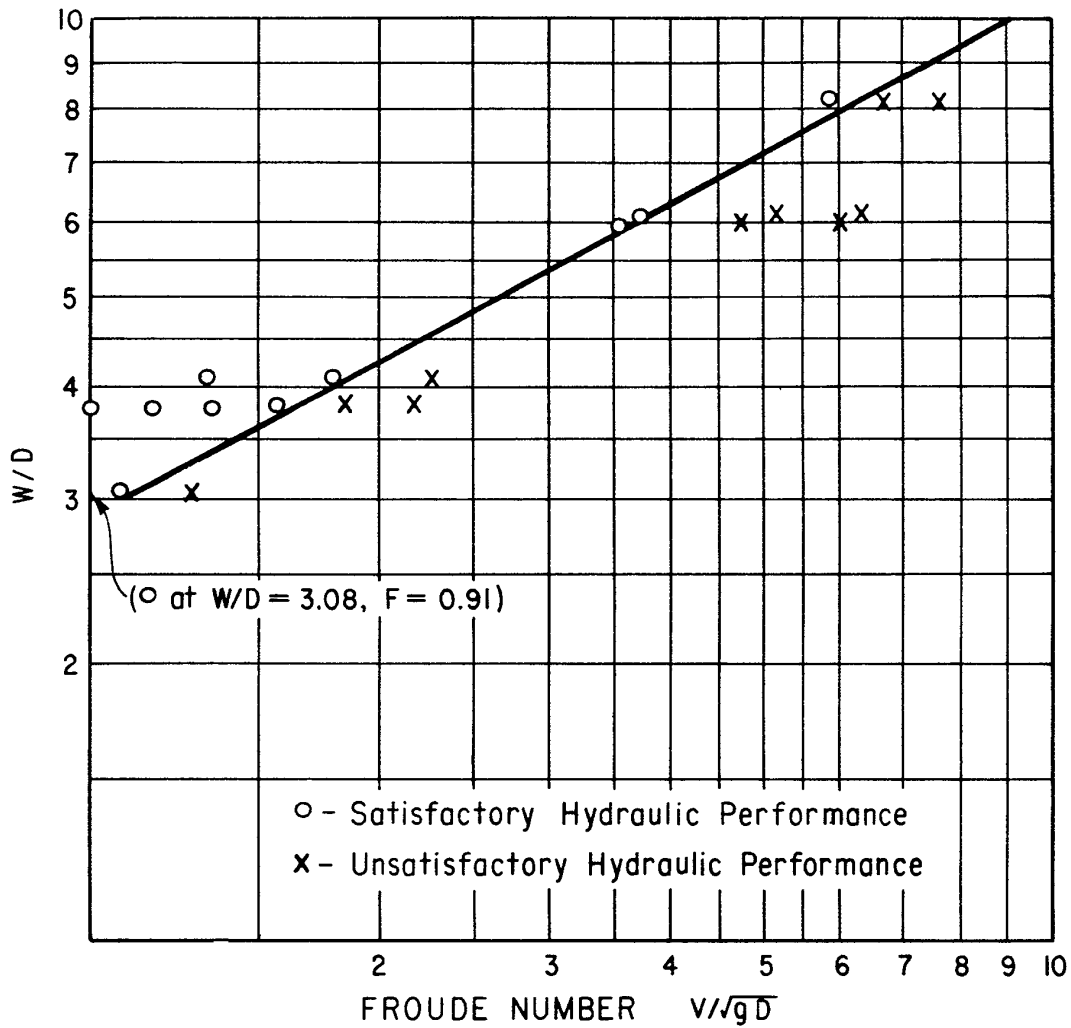

Figure 9-45. UDFCD modified USBR type VI impacts stilling basin (general design dimensions)



"W" is the inside width of the basin.  
 "D" represents the depth of flow entering the basin and is the square root of the flow area at the conduit outlet.  
 "V" is the velocity of the incoming flow.  
 The tailwater depth is uncontrolled.

Figure 9-46. Basin width diagram for the USBR type VI impact stilling basin

**STILLING BASIN FOREBAY VOLUME**

Req'd V=3% x WQCV

WQCV= 1.04 ac-ft  
V= 0.0312 ac-ft  
Actual V 0.0344 ac-ft

**FOREBAY RELEASE NOTCH WIDTH**

$Q=CLH^{3/2}$

$Q_{100}= 920$  cfs  
2% of Q= 18.40 cfs  
C= 2.6  
H (height of forebay wall)= 1.65 ft  
L\*= 3.34 ft  
3 in min.

\* L is dictated by the Type VI low impact basin design. This notch width will allow for 1.65' of ponding in the forebay - less than the 2.5' max for this size of tributary area.

**TRICKLE CHANNEL CAPACITY**

Channel Slope 0.01 ft/ft  
Bottom Width 8 feet  
Curb height 6 inches  
Notch release capacity 18.40 cfs  
Flow capacity, Q 21.64 cfs OK

**EXISTING POND SR4 EAST FOREBAY VOLUME**

Req'd V=3% x WQCV

WQCV= 0.19 ac-ft  
V= 0.0057 ac-ft  
Actual V 0.0115 ac-ft OK

**EXISTING FOREBAY RELEASE NOTCH WIDTH**

$Q=CLH^{3/2}$

$Q_{100}= 48.6$  cfs Owl Marketplace + Falcon Marketplace Flows  
2% of Q= 0.97 cfs  
C= 2.6  
H (height of forebay wall)= 1 ft  
L= 4 in 6" existing  
3 in min.

**TRICKLE CHANNEL CAPACITY**

Channel Slope 0.005 ft/ft  
Bottom Width 6 feet  
Curb height 6 inches  
Notch release capacity x 2, 1.944281 cfs  
Flow capacity, Q 11.2 cfs OK

**APPENDIX**  
REPORT EXCERPTS & UPDATED CALCULATIONS  
FALCON MARKETPLACE FINAL DRAINAGE REPORT



## DETENTION VOLUME BY THE FULL SPECTRUM METHOD

**Project:** FALCON MARKETPLACE POND SR4  
**Basin ID:** \_\_\_\_\_

\* User input data shown in blue.

Area of Watershed (acres)	740.00	
Subwatershed Imperviousness	15.0%	
Level of Minimizing Directly Connected Impervious Area (MDCIA)	0	▼
Effective Imperviousness <sup>1</sup>	15.0%	
Hydrologic Soil Type	Percentage of Area	Area (acres)
Type A	100.0%	740.0
Type B	0.0	0.0
Type C or D	0.0	0.0

Recommended Horton's Equation Parameters for CUHP		
Infiltration (inches per hour)		Decay Coefficient-- $\alpha$
Initial-- $f_i$	Final-- $f_o$	
5	1.0	0.0007
Detention Volumes <sup>2,5</sup>		
(watershed inches)	(acre-feet)	Maximum Allowable Release Rate, cfs <sup>3</sup>
0.22	13.30	Design Outlet to Empty EURV in 72 Hours
0.32	19.72	370.00

Excess Urban Runoff Volume<sup>4</sup>

100-year Detention Volume Including WQCV<sup>5</sup>

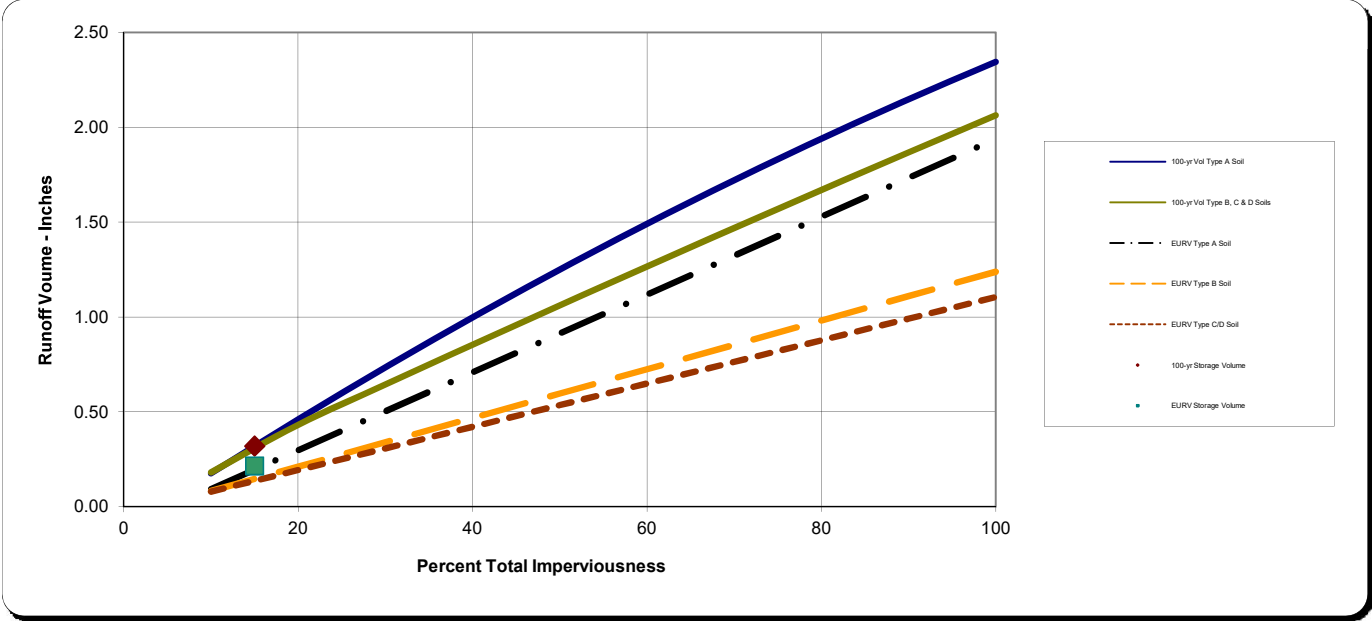

**Notes:**

- 1) Effective imperviousness is based on Figure ND-1 of the Urban Storm Drainage Criteria Manual (USDCM).
- 2) Results shown reflect runoff reduction from Level 1 or 2 MDCIA and are plotted at the watershed's total imperviousness value; the impact of MDCIA is reflected by the results being below the curves.
- 3) Maximum allowable release rates for 100-year event are based on Table SO-1. Outlet for the Excess Urban Runoff Volume (EURV) to be designed to empty out the EURV in 72 hours. Outlet design is similar to one for the WQCV outlet of an extended detention basin (i.e., perforated plate with a micro-pool) and extends to top of EURV water surface elevation.
- 4) EURV approximates the difference between developed and pre-developed runoff volume.
- 5) 100-yr detention volume includes EURV. No need to add more volume for WQCV or EURV



STAGE-STORAGE SIZING FOR DETENTION BASINS

Project: \_\_\_\_\_  
Basin ID: \_\_\_\_\_

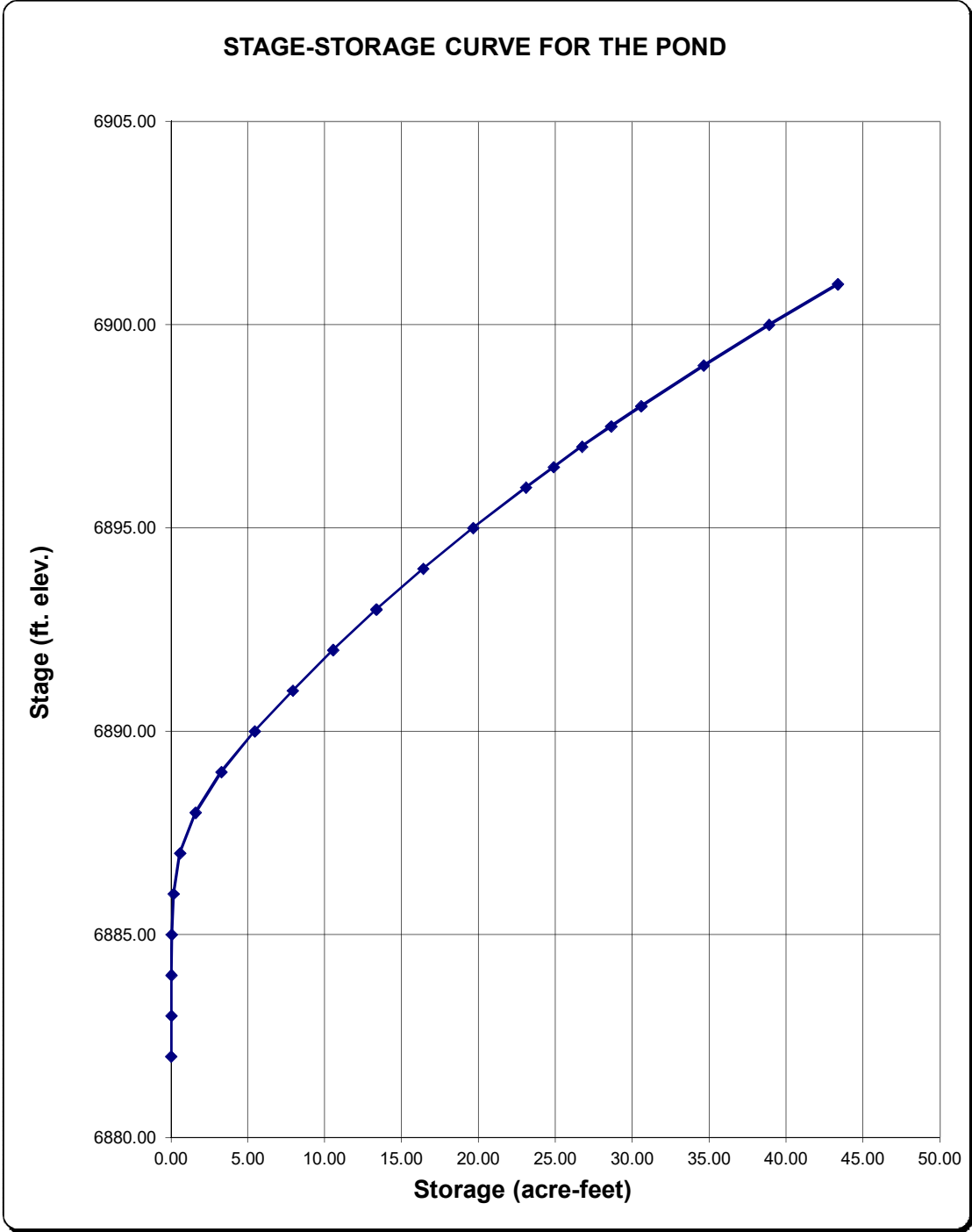



STAGE-DISCHARGE SIZING OF THE WATER QUALITY CAPTURE VOLUME (WQCV) OUTLET

Worksheet Protected

Project: FALCON MARKETPLACE  
Basin ID: NORTH POND #1

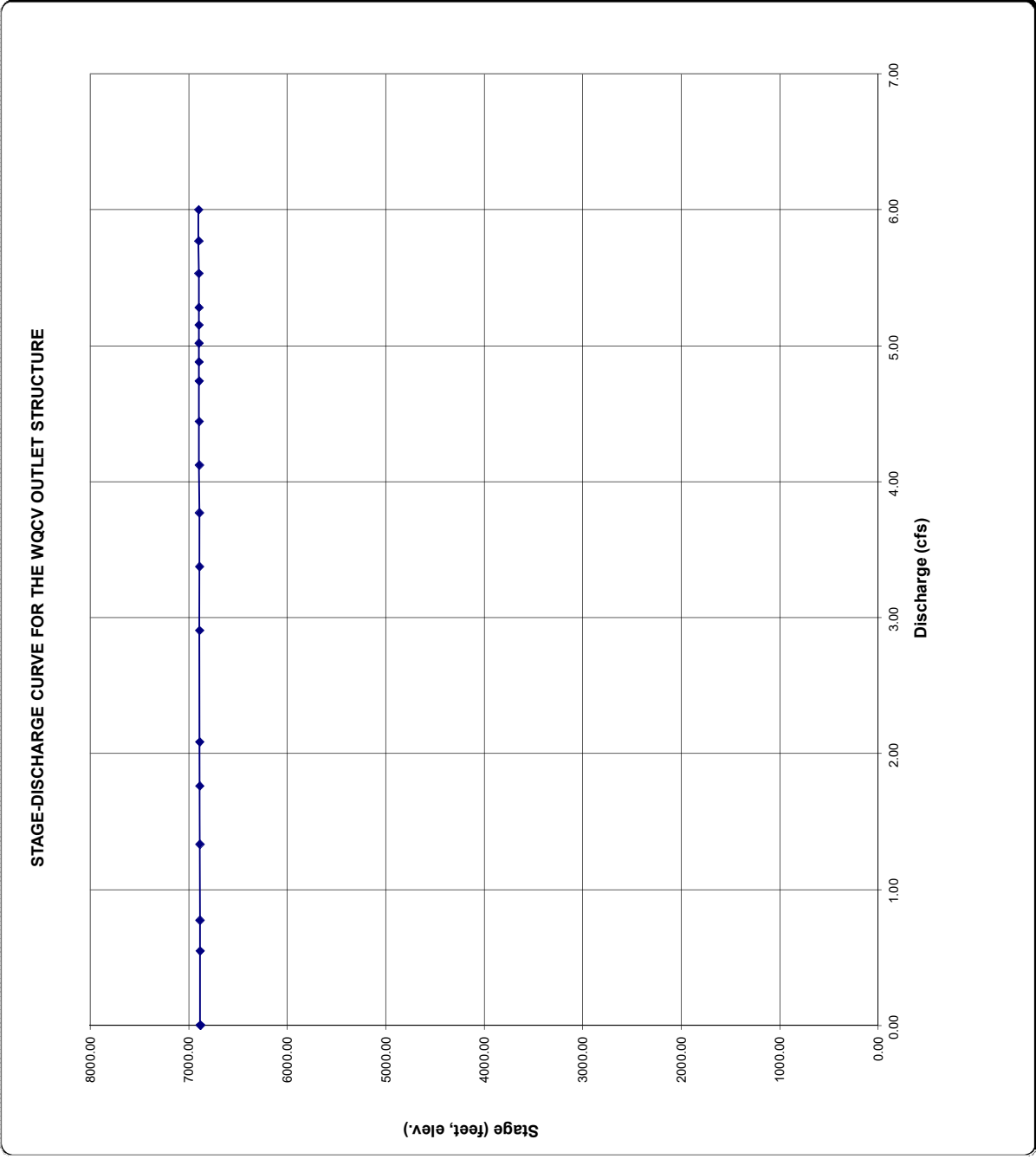



STAGE-DISCHARGE SIZING OF THE WEIRS AND ORIFICES (INLET CONTROL)

Project: Falcon Marketplace #1  
Basin ID: NORTH POND #1

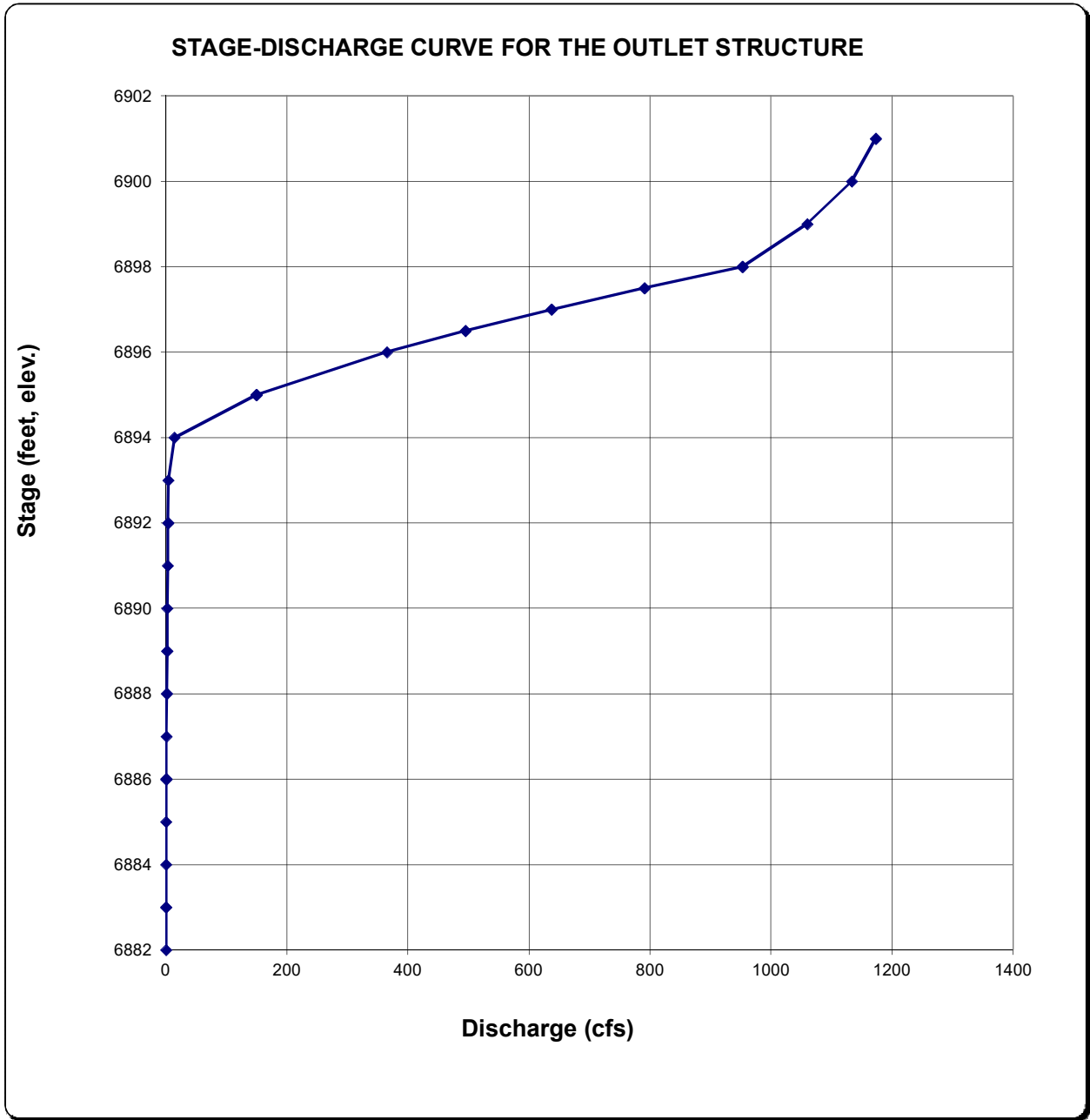

STAGE-DISCHARGE SIZING OF THE WATER QUALITY CAPTURE VOLUME (WQCV) OUTLET

Worksheet Protected

Project: FALCON MARKETPLACE  
Basin ID: NORTH POND #1

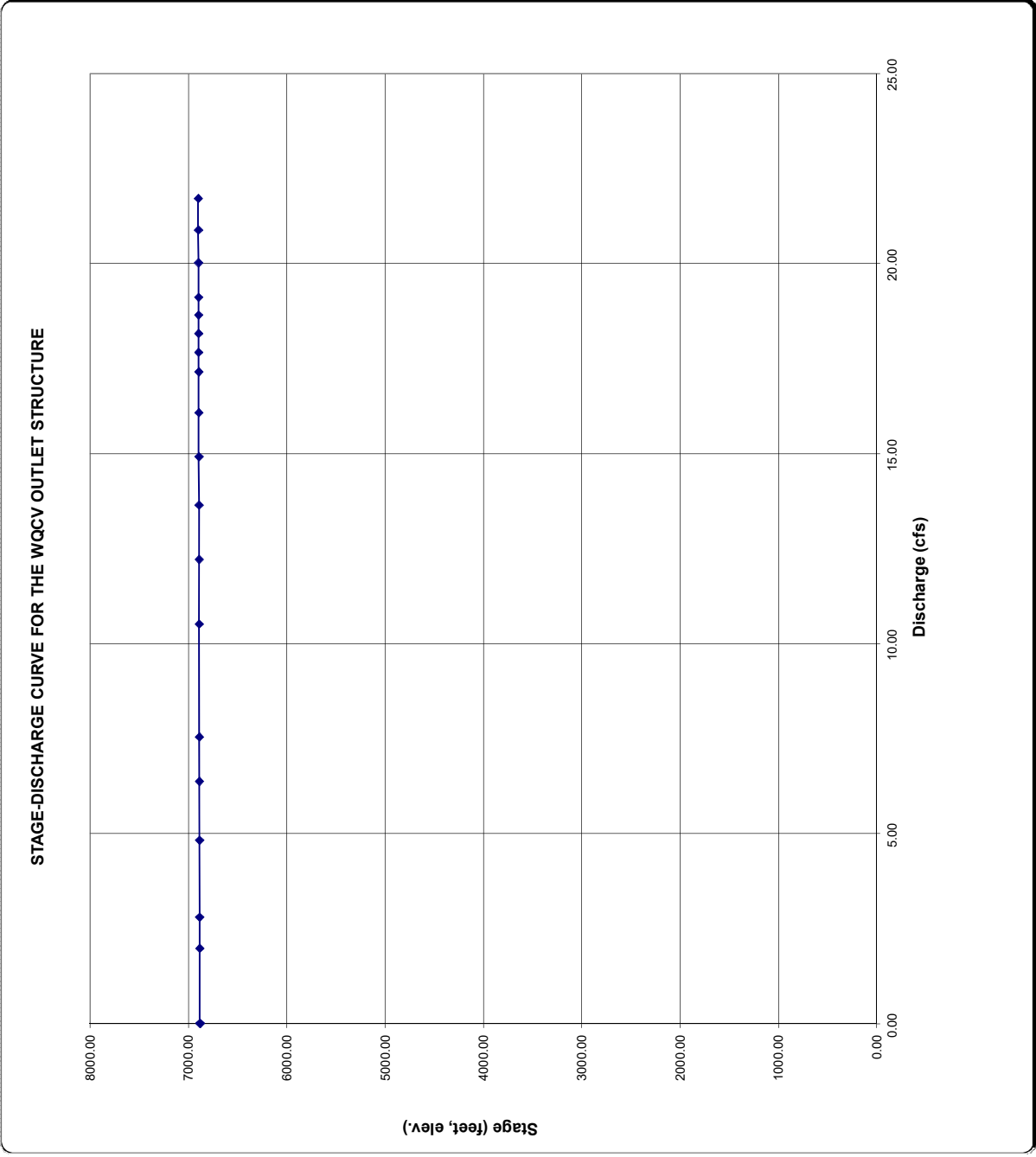





STAGE-DISCHARGE SIZING OF THE OUTLET CULVERT (INLET vs. OUTLET CONTROL WITH TAILWATER EFFECTS)

Project: FALCON MARKETPLACE  
Basin ID: NORTH POND #1

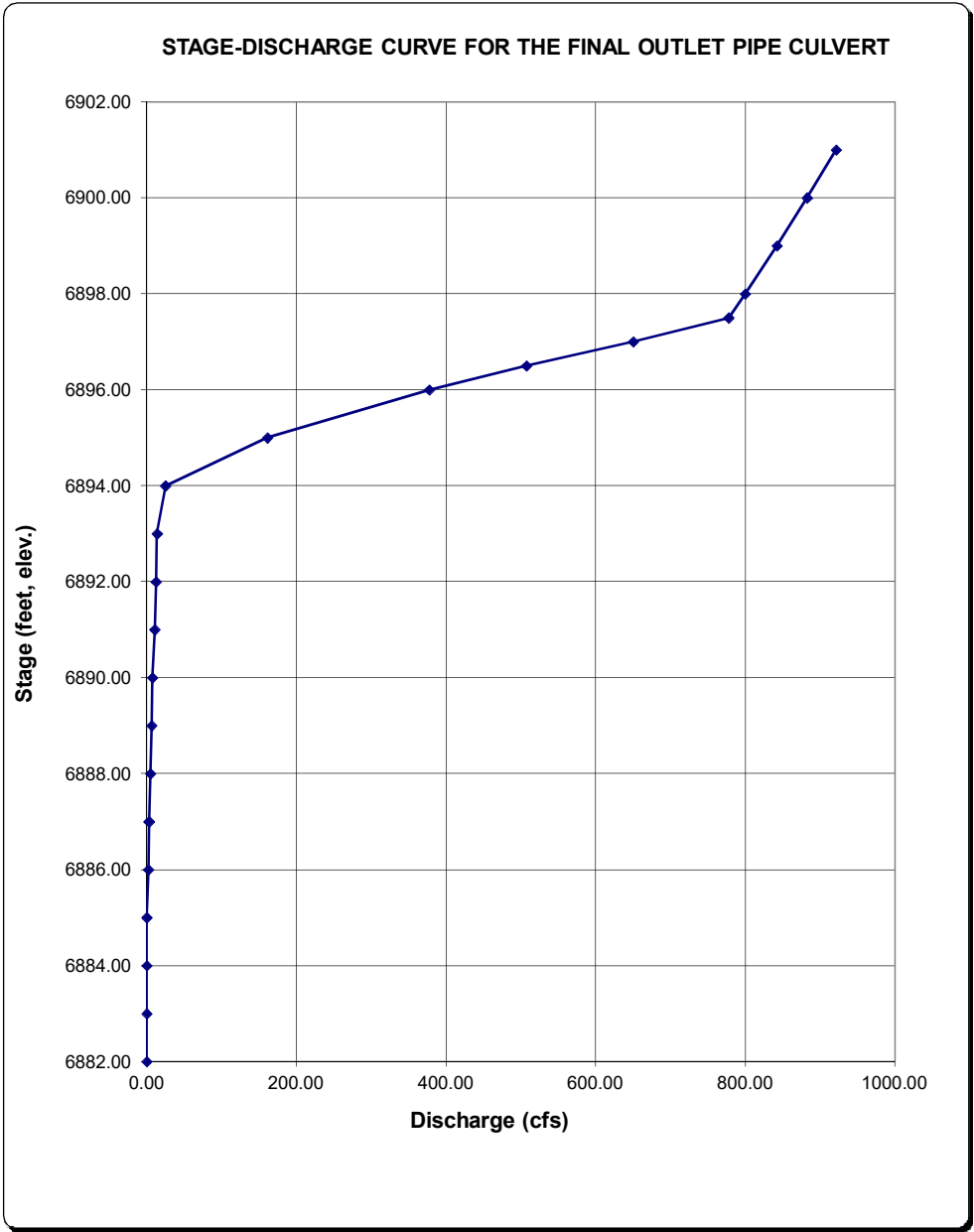



## PROJECT INFORMATION

PROJECT: Falcon Marketplace  
PROJECT NO: 20988-00CSCV  
DESIGN BY: KGV  
REV. BY: TDM  
AGENCY: El Paso County  
REPORT TYPE: Preliminary  
DATE: 6/19/2017



Drexel, Barrell & Co.

## SPILLWAY CALCULATIONS

$$Q=CL(H^{2/3})$$

Weir coefficient C: 3.5  
Depth H, ft: 1.5  
Flowrate Q. cfs: 10.16

**Required L, ft: 158.01**

FALCON MARKETPLACE POND SR4  
ORIGINAL APPROVED DESIGN

6/21/2017  
8:50 AM

**STAGE-DISCHARGE SIZING OF THE SPILLWAY**

Project: FALCON MARKETPLACE  
Basin ID: NORTH POND #1

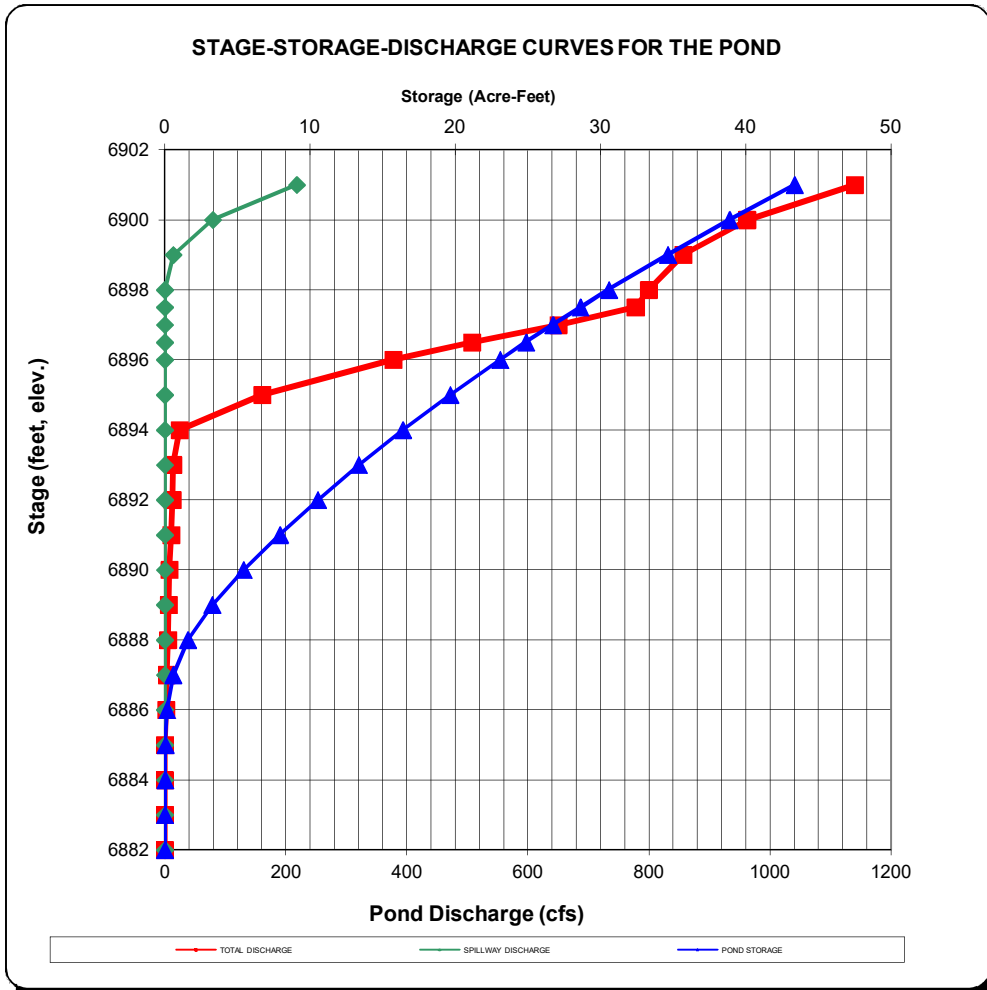

## DETENTION VOLUME BY THE FULL SPECTRUM METHOD

**Project:** FALCON MARKETPLACE POND SR4

**Basin ID:** \_\_\_\_\_

\* User input data shown in blue.

Area of Watershed (acres)	740.00	
Subwatershed Imperviousness	15.5%	
Level of Minimizing Directly Connected Impervious Area (MDCIA)	0	0 ▼
Effective Imperviousness <sup>1</sup>	15.5%	
<b>Hydrologic Soil Type</b>	<b>Percentage of Area</b>	<b>Area (acres)</b>
Type A	100.0%	740.0
Type B	0.0	0.0
Type C or D	0.0	0.0

Recommended Horton's Equation Parameters for CUHP		
Infiltration (inches per hour)		Decay Coefficient-- $\alpha$
Initial-- $f_i$	Final-- $f_o$	
5	1.0	0.0007
Detention Volumes <sup>2,5</sup>		Maximum Allowable Release Rate, cfs <sup>3</sup>
(watershed inches)	(acre-feet)	
0.23	13.99	Design Outlet to Empty EURV in 72 Hours
0.33	20.60	370.00

**Excess Urban Runoff Volume<sup>4</sup>**

**100-year Detention Volume Including WQCV<sup>5</sup>**

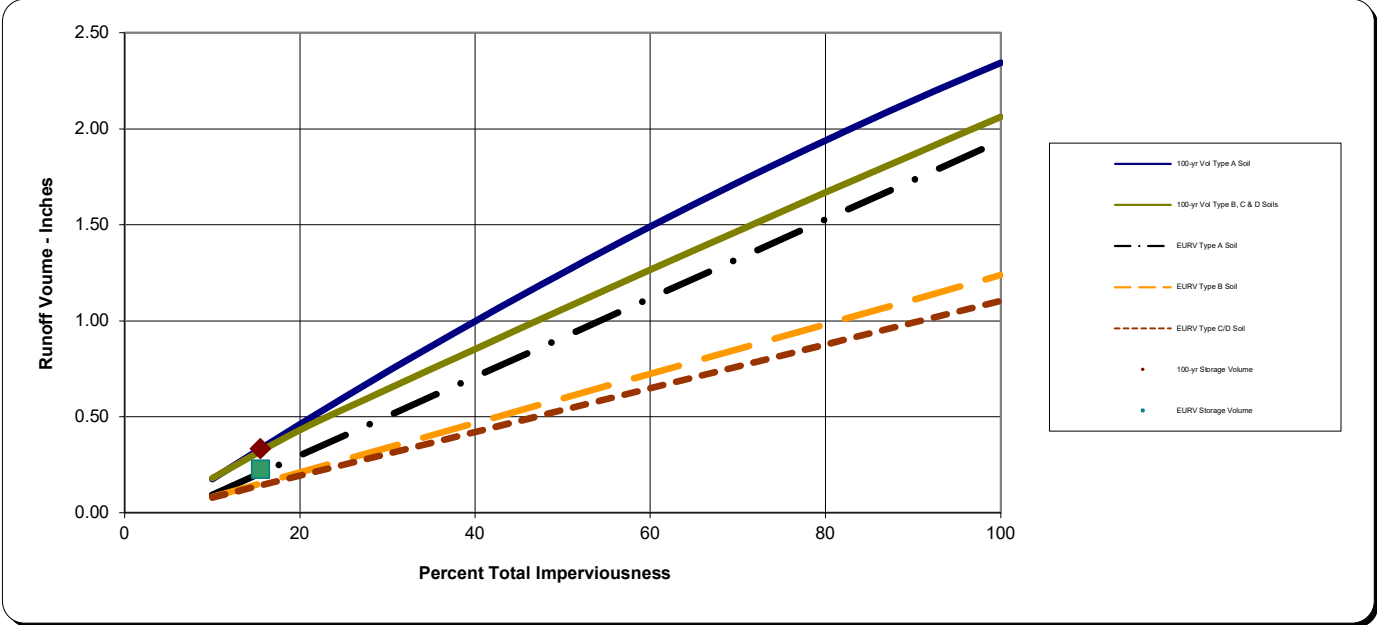

- Notes:**
- 1) Effective imperviousness is based on Figure ND-1 of the Urban Storm Drainage Criteria Manual (USDCM).
  - 2) Results shown reflect runoff reduction from Level 1 or 2 MDCIA and are plotted at the watershed's total imperviousness value; the impact of MDCIA is reflected by the results being below the curves.
  - 3) Maximum allowable release rates for 100-year event are based on Table SO-1. Outlet for the Excess Urban Runoff Volume (EURV) to be designed to empty out the EURV in 72 hours. Outlet design is similar to one for the WQCV outlet of an extended detention basin (i.e., perforated plate with a micro-pool) and extends to top of EURV water surface elevation.
  - 4) EURV approximates the difference between developed and pre-developed runoff volume.
  - 5) 100-yr detention volume includes EURV. No need to add more volume for WQCV or EURV



STAGE-STORAGE SIZING FOR DETENTION BASINS

Project: \_\_\_\_\_  
Basin ID: \_\_\_\_\_

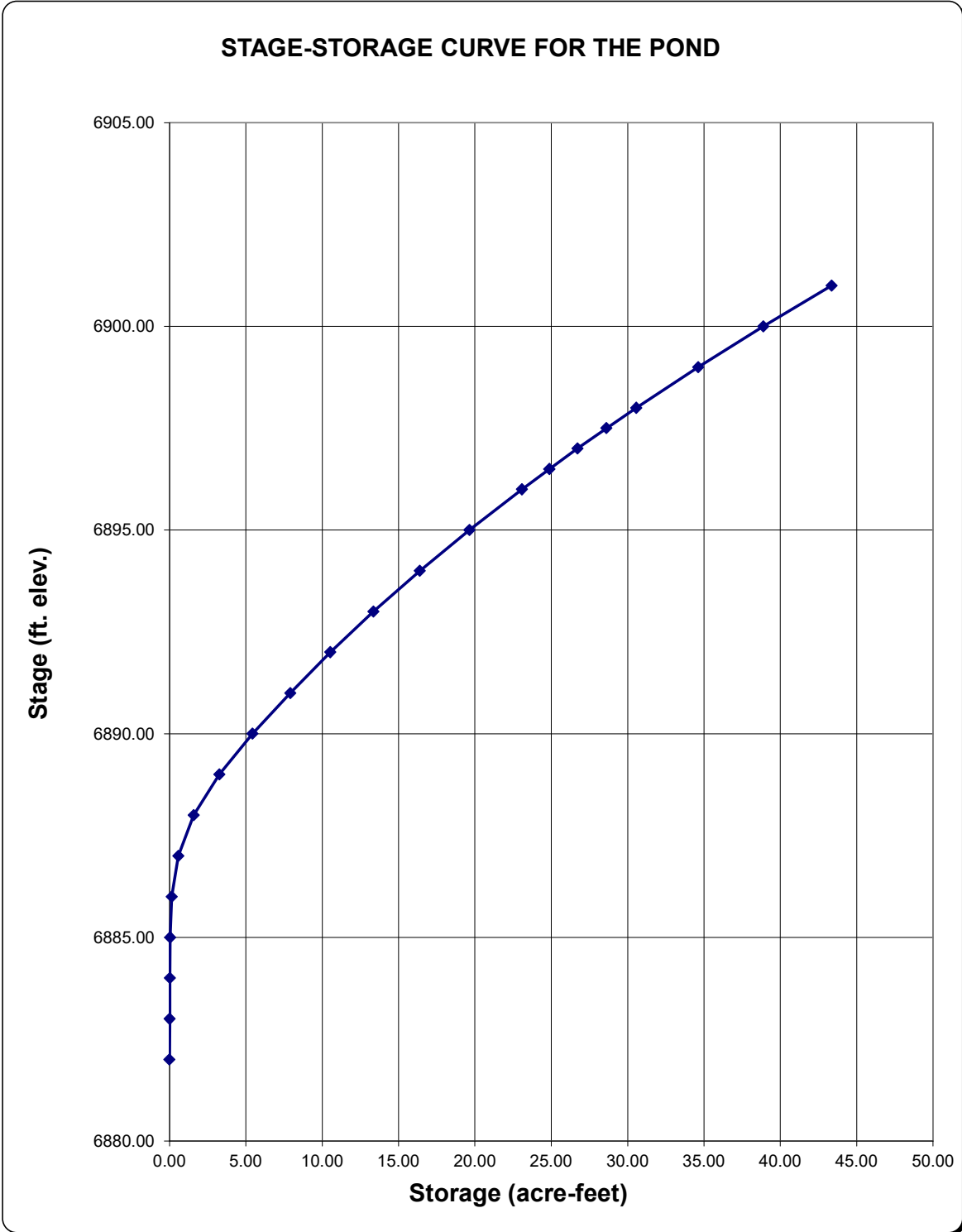





STAGE-DISCHARGE SIZING OF THE WATER QUALITY CAPTURE VOLUME (WQCV) OUTLET

Worksheet Protected

Project: FALCON MARKETPLACE  
Basin ID: NORTH POND #1

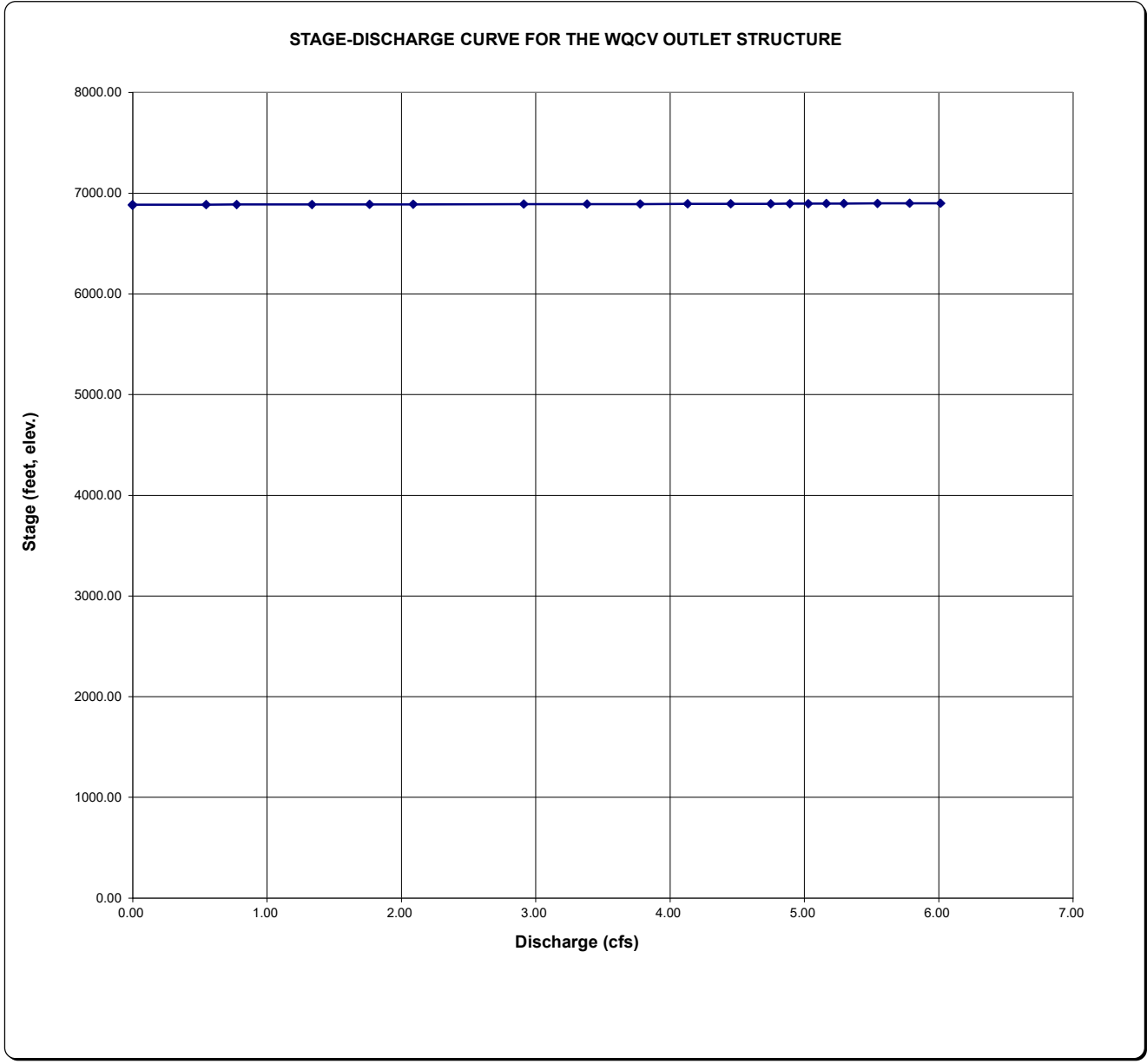



STAGE-DISCHARGE SIZING OF THE WEIRS AND ORIFICES (INLET CONTROL)

Project: Falcon Marketplace #1  
Basin ID: NORTH POND #1

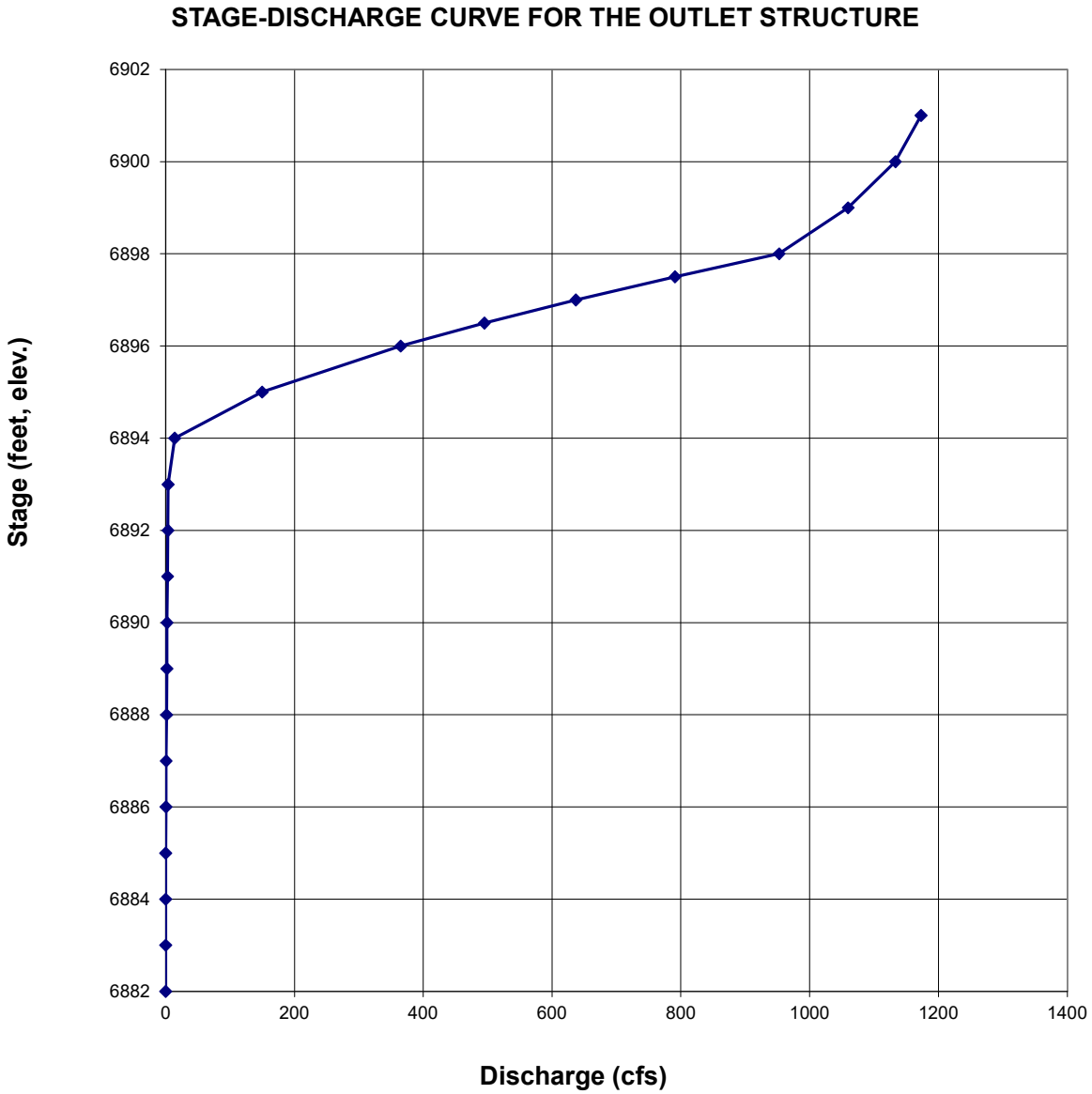



STAGE-DISCHARGE SIZING OF THE OUTLET CULVERT (INLET vs. OUTLET CONTROL WITH TAILWATER EFFECTS)

Project: FALCON MARKETPLACE  
Basin ID: NORTH POND #1

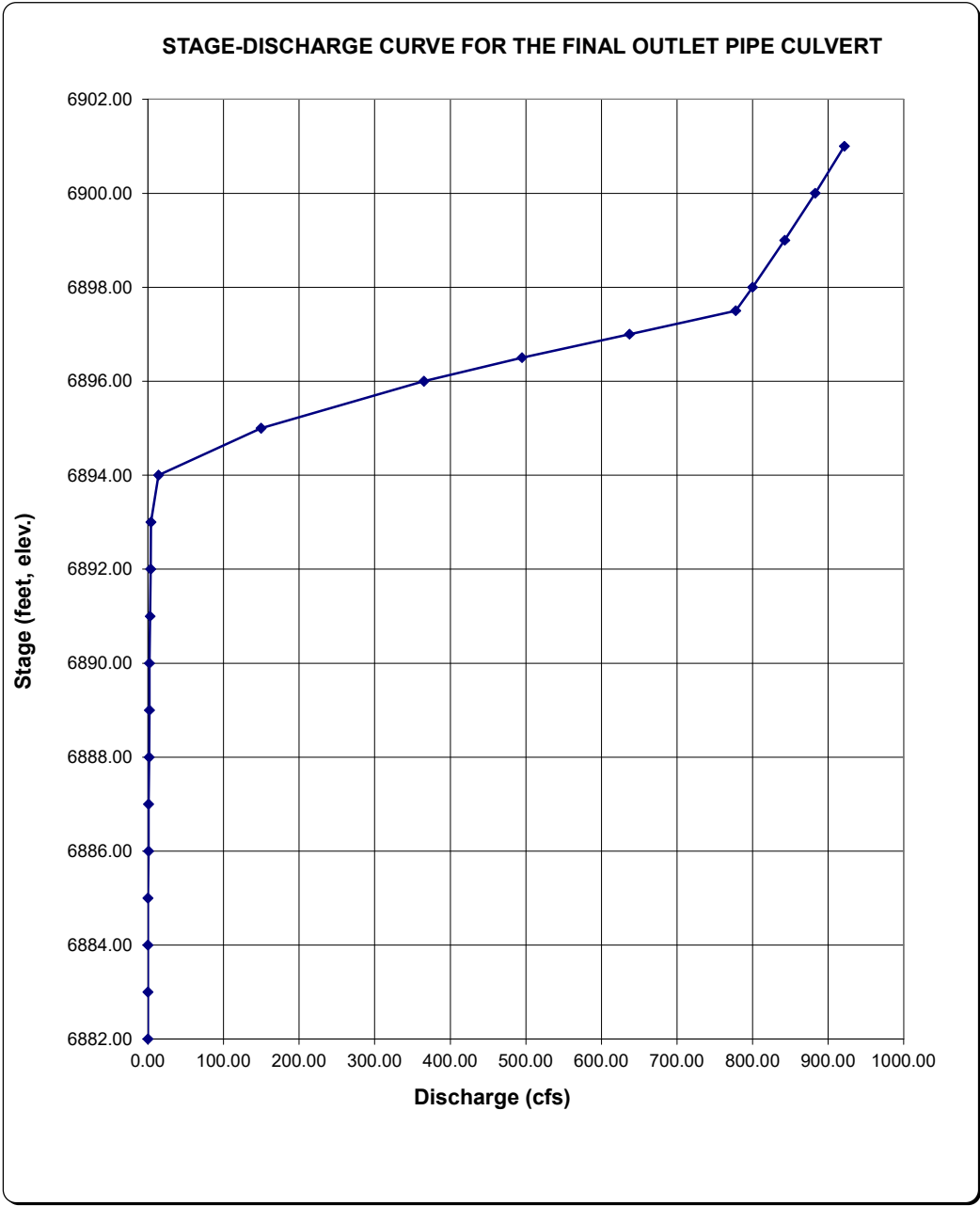



**STAGE-DISCHARGE SIZING OF THE SPILLWAY**

Project: FALCON MARKETPLACE  
 Basin ID: NORTH POND #1

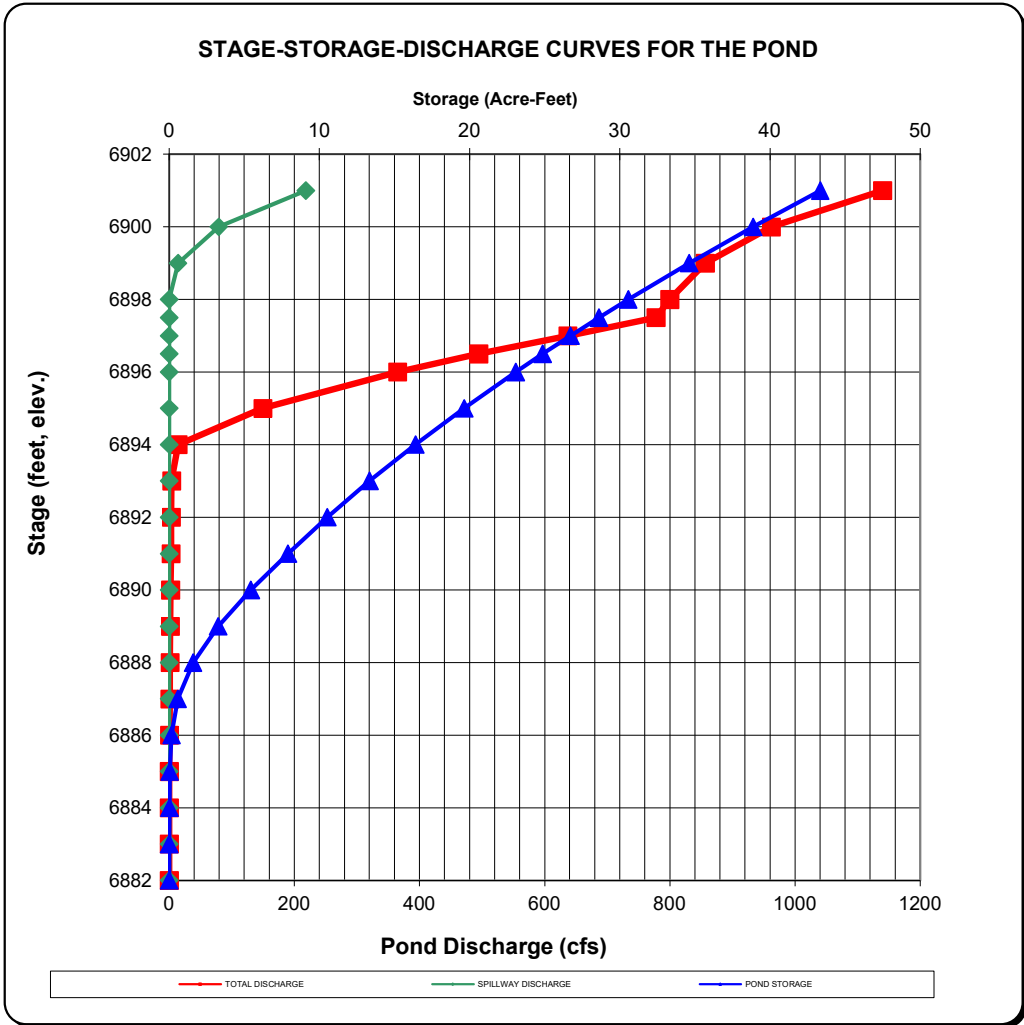



**APPENDIX**  
REPORT EXCERPTS  
FALCON DBPS

**FALCON DRAINAGE BASIN PLANNING STUDY**  
**SELECTED PLAN REPORT**  
**FINAL - SEPTEMBER 2015**

Prepared for:



El Paso County Public Services Department  
3275 Akers Drive  
Colorado Springs, CO 80922

Prepared By:



Matrix Design Group  
2435 Research Parkway, Suite 300  
Colorado Springs, CO 80920

Matrix Project No. 10.122.003

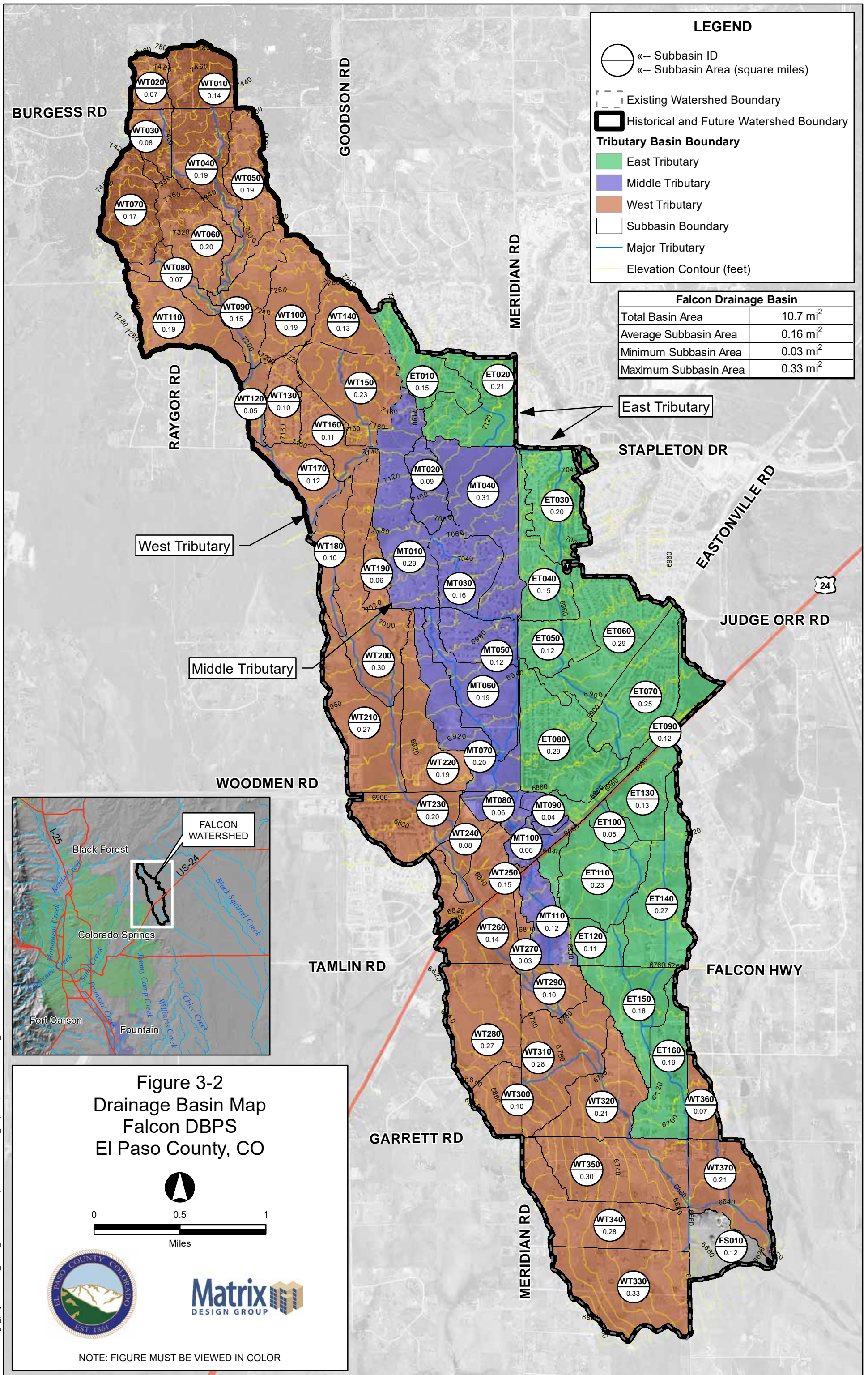

### LEGEND

- Subbasin ID
- Subbasin Area (square miles)
- Existing Watershed Boundary
- Historical and Future Watershed Boundary
- Tributary Basin Boundary**
- East Tributary
- Middle Tributary
- West Tributary
- Subbasin Boundary
- Major Tributary
- Elevation Contour (feet)

Falcon Drainage Basin	
Total Basin Area	10.7 mi <sup>2</sup>
Average Subbasin Area	0.16 mi <sup>2</sup>
Minimum Subbasin Area	0.03 mi <sup>2</sup>
Maximum Subbasin Area	0.33 mi <sup>2</sup>

East Tributary

West Tributary

Middle Tributary

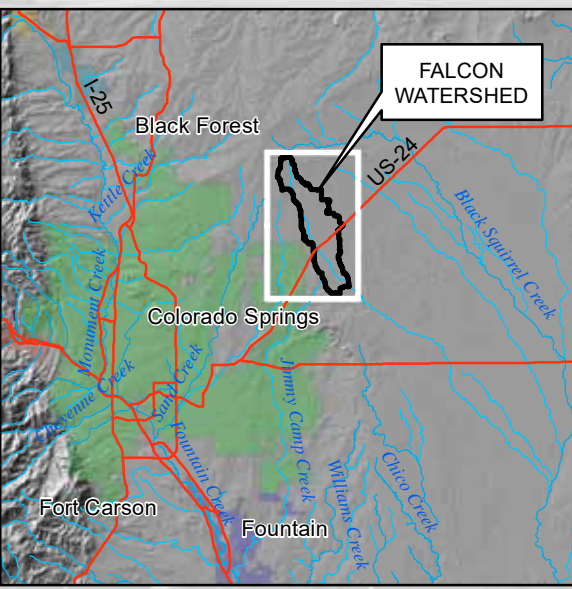

### Figure 3-2 Drainage Basin Map Falcon DBPS El Paso County, CO

0 0.5 1  
Miles

NOTE: FIGURE MUST BE VIEWED IN COLOR

FILE: G:\gis\_projects\Falcon\_Creek\_DBPS\active\apps\20110613\basin\_map.mxd, 8/29/2011, wilson\_wheeler

BURGESS RD

GOODSON RD

MERIDIAN RD

STAPLETON DR

EASTONVILLE RD

JUDGE ORR RD

WOODMEN RD

TAMLIN RD

GARRETT RD

FALCON HWY

LEGEND

- ⊕ ← Subbasin ID
- ⊕ ← 2-yr & 100-yr Flows (cfs)
- ◊ Detention Pond
- △ Junctions
- - - Existing Watershed Boundary
- ▭ Historical and Future Watershed Boundary
- ▭ Tributary Basin Boundary
- ▭ Subbasin Boundary
- Major Tributary

Hydrologic Element	Area (sq mi)	Future Peak Flows (cfs)		Hydrologic Element	Area (sq mi)	Future Peak Flows (cfs)	
		2-year	100-year			2-year	100-year
ET010	0.15	38	200	RET050	0.71	27	570
ET030	0.21	73	360	RET060	0.83	11	530
ET040	0.20	45	240	RET070	1.11	13	430
ET040	0.15	28	170	RET080	1.36	65	420
ET050	0.12	37	200	RET090	1.66	15	350
ET060	0.29	110	530	RET100	1.78	26	390
ET070	0.25	94	460	RET110	1.83	27	390
ET080	0.29	110	520	RET120	2.05	39	430
ET090	0.12	26	130	RET140	0.13	11	85
ET100	0.05	11	72	RET152	2.16	49	450
ET110	0.23	24	200	RET154	0.40	26	200
ET120	0.11	11	89	RET156	2.57	50	650
ET130	0.13	11	85	RET162	2.74	59	680
ET140	0.27	16	120	RET164	2.93	66	710
ET150	0.18	17	140	RMT030	0.09	25	140
ET160	0.19	19	140	RMT040	0.25	49	290
FS010	0.12	6	75	RMT050	0.56	110	750
JET010	0.15	29	150	RMT062	0.29	1	160
JET020	0.36	74	390	RMT064	0.67	120	850
JET030	0.56	97	580	RMT070	1.16	130	1,000
JET040	0.71	27	570	RMT080	1.36	150	1,200
JET050	0.83	11	520	RMT090	0.04	9	32
JET060	1.11	13	430	RMT102	1.42	86	1,200
JET070	1.36	94	480	RMT104	0.04	9	32
JET080	1.66	15	350	RMT106	1.46	91	1,200
JET090	1.78	26	390	RMT112	1.52	92	1,200
JET100	1.83	27	390	RMT114	1.64	94	1,200
JET110	2.05	40	460	RMT030	0.07	4	42
JET120	2.16	49	450	RMT042	0.14	9	85
JET130	0.13	11	85	RMT044	0.14	9	89
JET140	0.40	26	200	RMT046	0.28	15	170
JET152	2.57	51	650	RMT054	0.46	24	260
JET154	2.74	62	680	RMT080	0.17	14	130
JET160	2.93	66	710	RMT092	0.85	43	480
FS010	0.12	6	75	RMT094	1.09	54	610
JMT010	0.29	1	160	RMT122	1.43	68	730
JMT020	0.09	26	140	RMT124	1.63	77	840
JMT030	0.25	50	290	RMT150	0.13	32	180
JMT040	0.56	110	750	RMT160	0.36	15	170
JMT050	0.67	120	850	RMT170	1.77	85	920
JMT060	1.16	130	1,000	RMT176	2.24	98	960
JMT070	1.36	150	1,200	RMT180	2.36	100	990
JMT080	1.42	86	1,200	RMT202	2.46	100	1,000
JMT090	0.04	9	32	RMT204	0.06	4	43
JMT102	1.46	91	1,200	RMT210	2.82	110	1,200
JMT104	0.04	9	32	RMT232	3.09	120	1,300
JMT106	1.52	92	1,200	RMT234	0.19	47	250
JMT110	1.64	94	1,200	RMT236	3.28	120	1,400
JMT110	0.14	9	89	RMT240	3.47	130	1,400
JMT120	0.07	4	42	RMT240			
JMT130	0.14	9	85	Diversion			
JMT142	0.28	15	170	RMT252	3.55	30	39
JMT144	0.46	24	260	RMT250	3.55	83	1,100
JMT150	0.85	43	480	RMT260	3.70	85	1,100
JMT170	0.17	14	130	RMT291	3.84	86	1,100
JMT180	1.09	54	610	RMT292	0.03	11	57
JMT190	1.43	68	730	RMT294	0.27	33	250
JMT210	1.63	77	840	RMT295	3.87	86	1,100
JMT220	1.77	85	920	RMT296	4.13	94	1,100
JMT230	0.13	32	180	RMT312	0.10	12	91
JMT240	0.36	15	170	RMT314	5.88	160	1,700
JMT250	0.47	35	190	RMT320	6.25	160	1,700
JMT272	2.24	99	960	RMT344	0.33	32	250
JMT274	2.36	100	990	RMT352	6.46	160	1,700
JMT280	2.46	100	1,000	RMT354	9.69	210	2,400
JMT290	0.06	4	43	RMT372	10.30	230	2,500
JMT200	2.82	110	1,200	RMT374	0.07	7	55
JMT210	3.09	120	1,300	RMT376	10.36	230	2,500
JMT220	0.19	47	250	M1	0.06	4	43
JMT232	3.28	120	1,400	M2	0.29	1	160
JMT234	3.47	130	1,400	WH North	0.71	28	570
JMT240	3.55	83	1,100	WH South	0.71	27	520
JMT250	3.70	85	1,100	WH2	0.83	11	530
JMT260	3.84	86	1,100	WH3	1.11	13	430
JMT270	0.03	11	57	WH4	1.66	15	350
JMT280	0.27	33	250	WH5	0.04	9	32
JMT292	3.87	86	1,100	WHH	0.56	110	750
JMT294	4.13	96	1,100	WT010	0.14	9	89
JMT296	5.88	160	1,700	WT020	0.07	4	42
JMT300	0.10	12	92	WT030	0.08	9	75
JMT310	6.25	160	1,700	WT040	0.19	9	93
JMT320	6.46	160	1,700	WT050	0.19	17	140
JMT330	0.33	32	250	WT060	0.20	14	120
JMT352	9.69	210	2,400	WT070	0.17	14	130
JMT354	10.30	230	2,500	WT080	0.07	9	67
JMT360	0.07	7	55	WT090	0.15	22	160
JMT372	10.36	230	2,500	WT100	0.19	56	300
JMT374				WT110	0.19	22	170
OUTLET	10.58	230	2,500	WT120	0.05	8	55
RWU	0.29	28	210	WT130	0.10	35	170
MT020	0.09	26	140	WT140	0.13	32	180
MT030	0.16	39	230	WT150	0.23	49	250
MT040	0.31	95	460	WT160	0.11	35	180
MT050	0.12	17	110	WT170	0.12	21	140
MT060	0.19	30	200	WT180	0.10	8	66
MT070	0.20	25	170	WT190	0.06	11	75
MT080	0.06	62	190	WT200	0.30	25	190
MT090	0.04	40	130	WT210	0.27	32	190
MT100	0.06	17	88	WT220	0.19	47	250
MT110	0.12	19	120	WT230	0.20	71	350
PBH4	0.15	29	150	WT240	0.08	36	160
PBH1	0.10	10	130	WT250	0.15	63	290
PBH2	0.36	51	270	WT260	0.14	10	78
PBH3	0.36	51	270	WT270	0.03	11	57
PBHC	0.19	11	160	WT280	0.27	33	250
RMN	1.42	86	1,200	WT290	0.10	15	110
RWU				WT300	0.10	12	92
Diversion	3.55	83	1,100	WT310	0.28	31	250
RWU North	3.55	110	1,400	WT320	0.21	27	200
RWU South	3.55	55	1,000	WT330	0.33	32	250
RET020	0.15	29	150	WT340	0.28	19	150
RET030	0.36	71	380	WT350	0.30	38	280
RET040	0.56	95	580	WT360	0.07	7	55
				WT370	0.21	7	120

Figure 3-13 Future Hydrology Falcon DBPS El Paso County, CO



NOTE: FIGURE MUST BE VIEWED IN COLOR

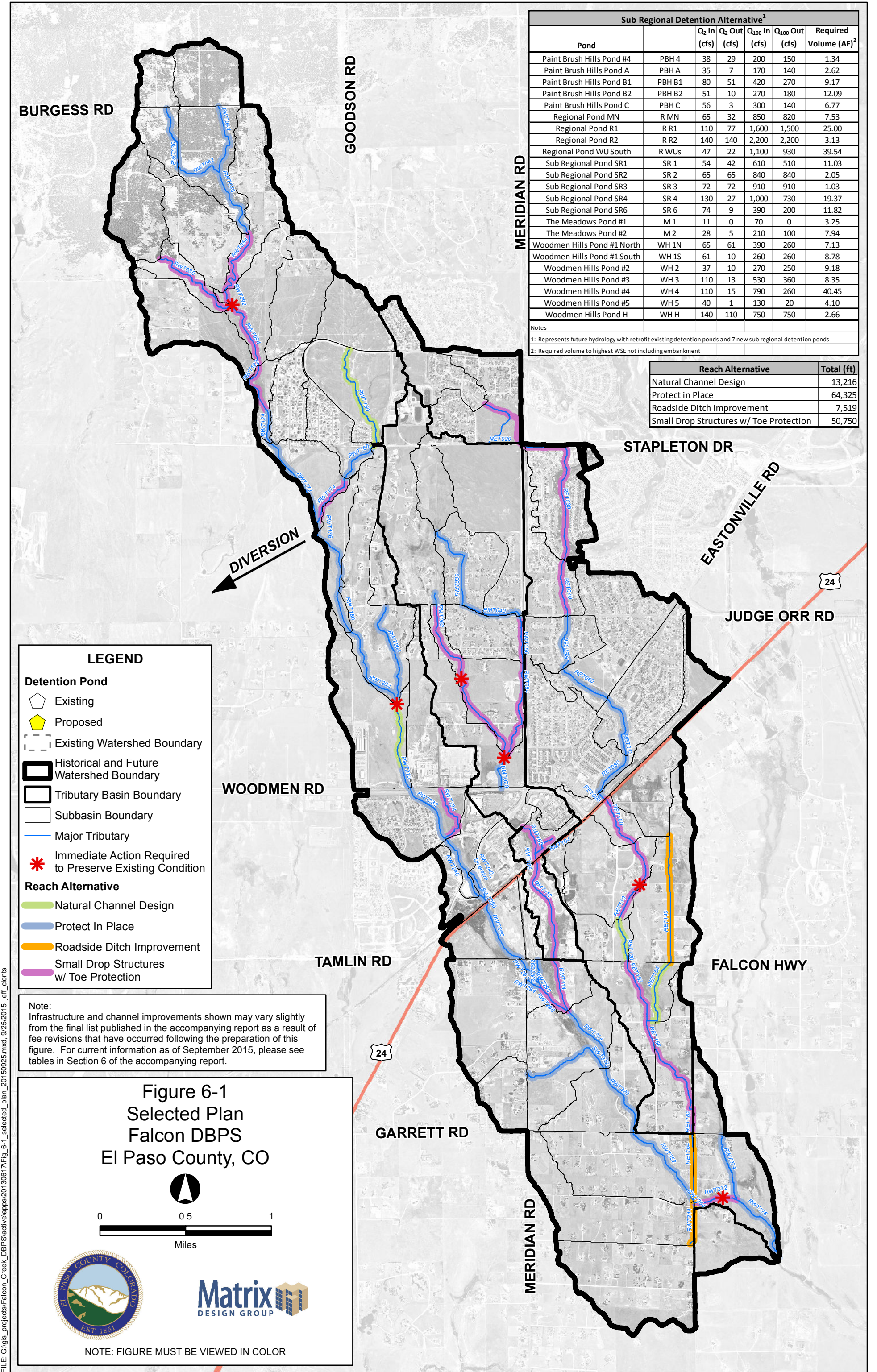

Sub Regional Detention Alternative <sup>1</sup>						
Pond		Q <sub>2</sub> In (cfs)	Q <sub>2</sub> Out (cfs)	Q <sub>100</sub> In (cfs)	Q <sub>100</sub> Out (cfs)	Required Volume (AF) <sup>2</sup>
Paint Brush Hills Pond #4	PBH 4	38	29	200	150	1.34
Paint Brush Hills Pond A	PBH A	35	7	170	140	2.62
Paint Brush Hills Pond B1	PBH B1	80	51	420	270	9.17
Paint Brush Hills Pond B2	PBH B2	51	10	270	180	12.09
Paint Brush Hills Pond C	PBH C	56	3	300	140	6.77
Regional Pond MN	R MN	65	32	850	820	7.53
Regional Pond R1	R R1	110	77	1,600	1,500	25.00
Regional Pond R2	R R2	140	140	2,200	2,200	3.13
Regional Pond WU South	R WUs	47	22	1,100	930	39.54
Sub Regional Pond SR1	SR 1	54	42	610	510	11.03
Sub Regional Pond SR2	SR 2	65	65	840	840	2.05
Sub Regional Pond SR3	SR 3	72	72	910	910	1.03
Sub Regional Pond SR4	SR 4	130	27	1,000	730	19.37
Sub Regional Pond SR6	SR 6	74	9	390	200	11.82
The Meadows Pond #1	M 1	11	0	70	0	3.25
The Meadows Pond #2	M 2	28	5	210	100	7.94
Woodmen Hills Pond #1 North	WH 1N	65	61	390	260	7.13
Woodmen Hills Pond #1 South	WH 1S	61	10	260	260	8.78
Woodmen Hills Pond #2	WH 2	37	10	270	250	9.18
Woodmen Hills Pond #3	WH 3	110	13	530	360	8.35
Woodmen Hills Pond #4	WH 4	110	15	790	260	40.45
Woodmen Hills Pond #5	WH 5	40	1	130	20	4.10
Woodmen Hills Pond H	WH H	140	110	750	750	2.66

Reach Alternative	Total (ft)
Natural Channel Design	13,216
Protect in Place	64,325
Roadside Ditch Improvement	7,519
Small Drop Structures w/ Toe Protection	50,750

Notes  
 1: Represents future hydrology with retrofit existing detention ponds and 7 new sub regional detention ponds  
 2: Required volume to highest WSE not including embankment

**LEGEND**

**Detention Pond**  
 Existing (pentagon symbol)  
 Proposed (yellow pentagon symbol)

Existing Watershed Boundary (dashed line)  
 Historical and Future Watershed Boundary (thick black line)  
 Tributary Basin Boundary (thin black line)  
 Subbasin Boundary (thin grey line)

Major Tributary (blue line)  
 Immediate Action Required to Preserve Existing Condition (red asterisk)

**Reach Alternative**  
 Natural Channel Design (green line)  
 Protect In Place (blue line)  
 Roadside Ditch Improvement (orange line)  
 Small Drop Structures w/ Toe Protection (purple line)

Note:  
 Infrastructure and channel improvements shown may vary slightly from the final list published in the accompanying report as a result of fee revisions that have occurred following the preparation of this figure. For current information as of September 2015, please see tables in Section 6 of the accompanying report.

**Figure 6-1  
 Selected Plan  
 Falcon DBPS  
 El Paso County, CO**

0 0.5 1  
 Miles

NOTE: FIGURE MUST BE VIEWED IN COLOR

# Sheet 6-23 Falcon DBPS Conceptual Plan Middle Tributary El Paso County, CO

- Drainageway Crossing
- Stream Centerline
- Existing Approximate 100-yr Floodplain\*
- Floodplain Study Limit
- Storm Sewer**
  - Inlet
  - Manhole
  - Pipe
- Reach Improvements**
  - Natural Channel Design
  - Protect In Place
  - Roadside Ditch Improvement
  - Small Drop Structures w/ Toe Protection
  - Existing Detention
  - Proposed Detention
  - Proposed Detention Grading
  - Small Drop Structure
  - Cross Vane
  - Immediate Action Required to Preserve Existing Condition

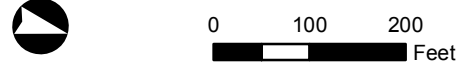

\* These approximate 100-yr floodplain boundaries are for planning purposes only. This information is not intended to replace the information provided on the FEMA Flood Insurance Rate Maps for this area.  
\*\* These are conceptual design drawings and are subject to change. These drawings are not intended for construction purposes.



**MT 6 - Woodmen Rd.**  
EX Size: 4' Circular RCP (x3)  
PR Size: 5' Circular RCP (x3)  
\* Sub-Regional Pond SR4 will be designed to mitigate capacity issues.

Floodplain Enters Underground Storm System

**Sub Regional Pond SR4**  
WQCV = 7.3 AF  
100-yr Volume = 19 AF  
Q<sub>2 in</sub> = 130 cfs  
Q<sub>2 out</sub> = 27 cfs  
Q<sub>100 in</sub> = 1000 cfs  
Q<sub>100 out</sub> = 730 cfs  
See Detail on Sheet 6-55

**MT 7 - Owl Place**  
EX Size: 1.75' (W) x 1.25' (H) CMP Elliptical (x4)  
PR Size: 4' (W) x 2' (H) Concrete Box (x9)  
\* Road profile would need to be raised to implement a feasible solution.

**MT 6-2 - Woodmen Rd.**  
EX Size: 4' Circular RCP (x3)  
PR Size: 5' Circular RCP (x3)  
\* Sub-Regional Pond SR4 will be designed to mitigate capacity issues.

Small Drop Structure  
See Detail on Sheet 6-54

Note:  
Infrastructure and channel improvements shown may vary slightly from the final list published in the accompanying report as a result of fee revisions that have occurred following the preparation of this figure. For current information as of September 2015, please see tables in Section 6 of the accompanying report.

Future conveyance from Meridian Rd roadside ditch TBD

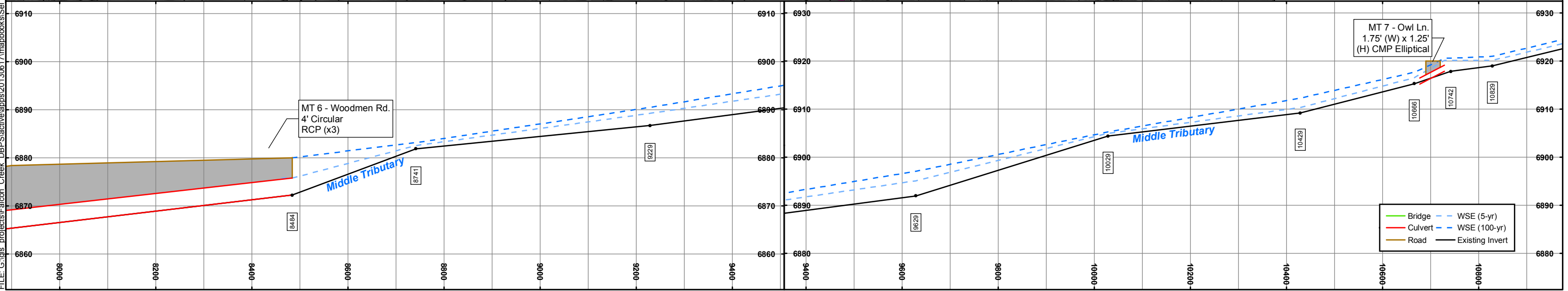
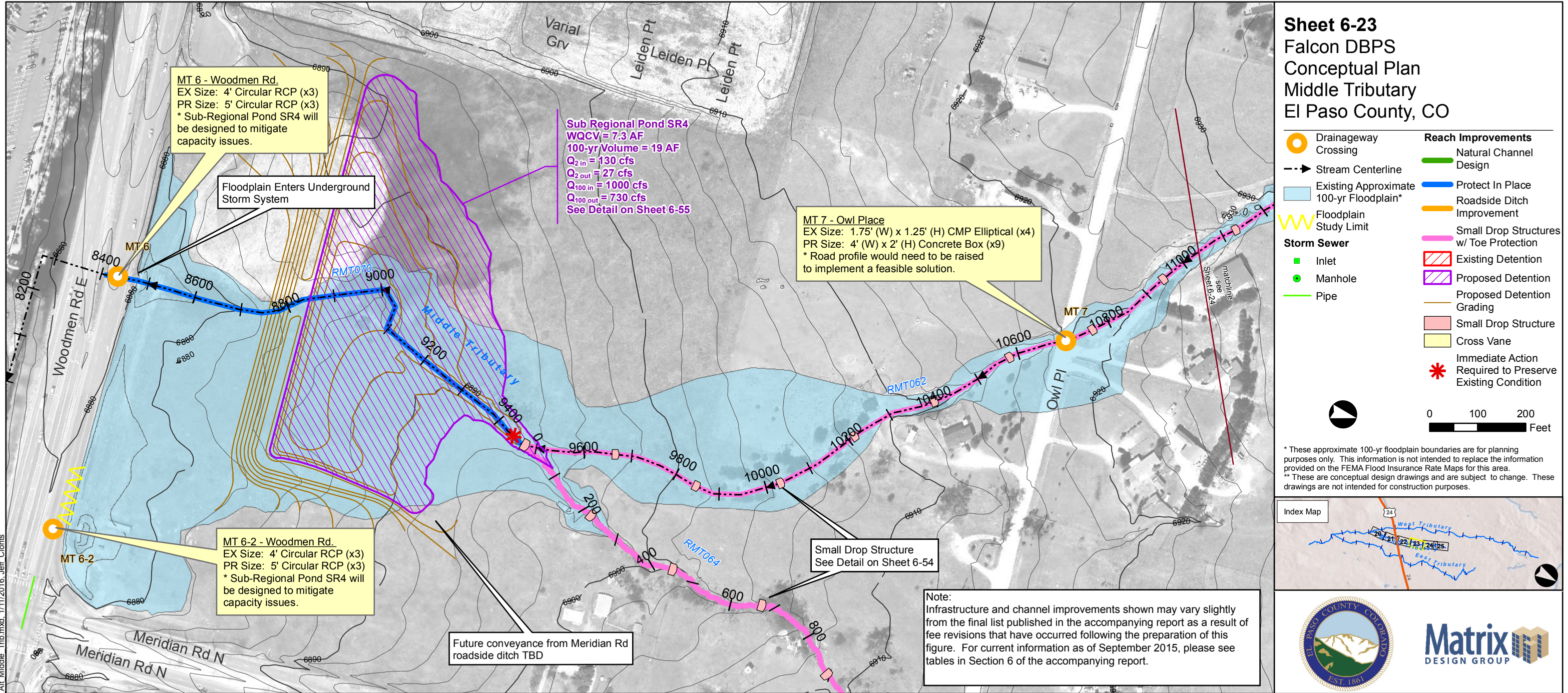

FILE: G:\gis\_projects\Falcon\_Creek\_DBPS\active\ppps20130617\mapbooks\sel Alt Middle Trib.mxd, 1/11/2016, Jeff Clonis

# Sheet 6-24 Falcon DBPS Conceptual Plan Middle Tributary El Paso County, CO

- Drainageway Crossing
- Stream Centerline
- Existing Approximate 100-yr Floodplain\*
- Floodplain Study Limit
- Storm Sewer**
  - Inlet
  - Manhole
  - Pipe
- Reach Improvements**
  - Natural Channel Design
  - Protect In Place
  - Roadside Ditch Improvement
  - Small Drop Structures w/ Toe Protection
  - Existing Detention
  - Proposed Detention
  - Proposed Detention Grading
  - Small Drop Structure
  - Cross Vane
  - Immediate Action Required to Preserve Existing Condition

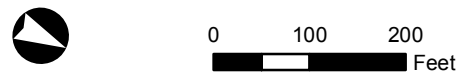

\* These approximate 100-yr floodplain boundaries are for planning purposes only. This information is not intended to replace the information provided on the FEMA Flood Insurance Rate Maps for this area.  
 \*\* These are conceptual design drawings and are subject to change. These drawings are not intended for construction purposes.

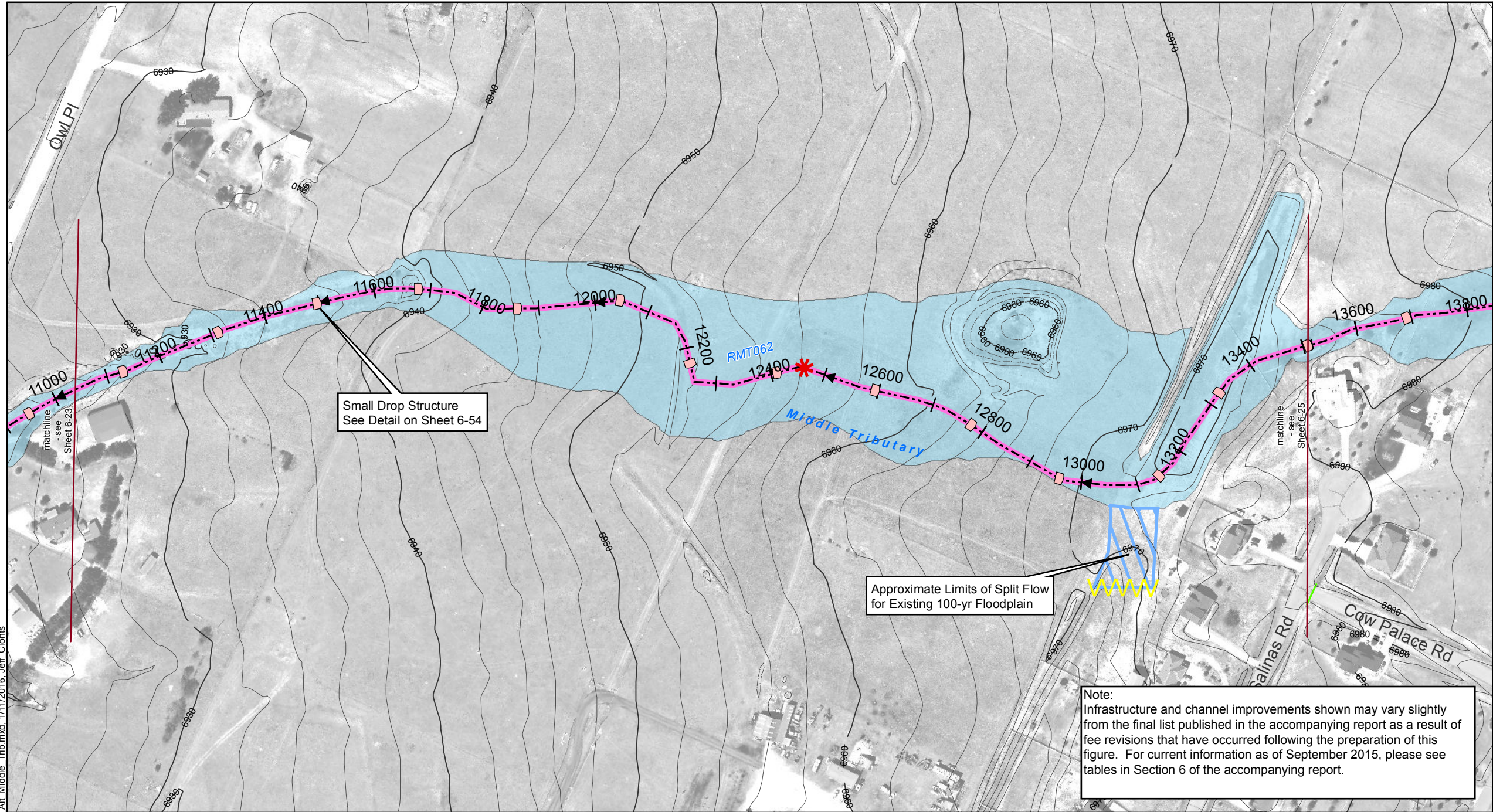
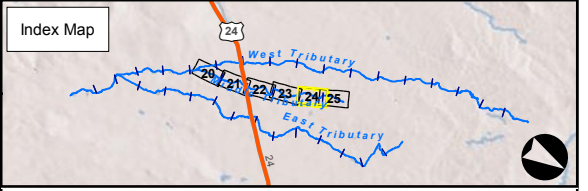

Note:  
 Infrastructure and channel improvements shown may vary slightly from the final list published in the accompanying report as a result of fee revisions that have occurred following the preparation of this figure. For current information as of September 2015, please see tables in Section 6 of the accompanying report.

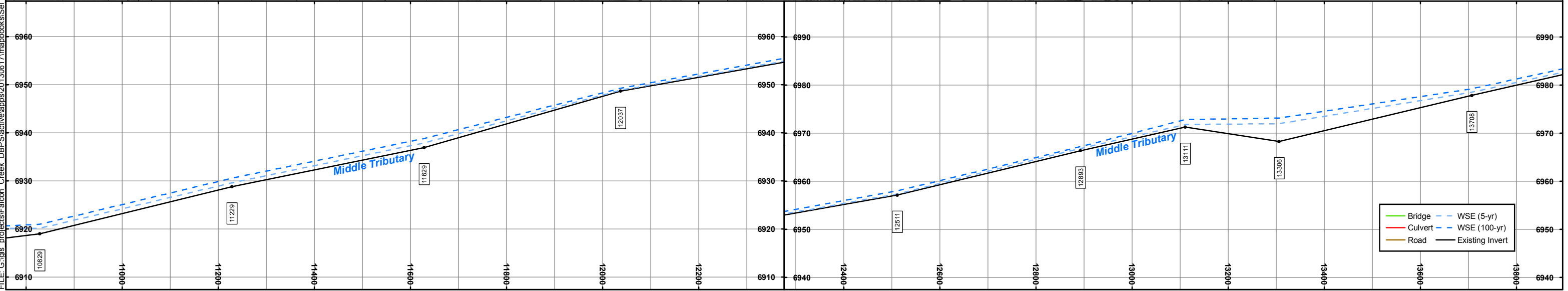

FILE: G:\gis\projects\Falcon\_Creek\_DBPS\active\apps\20130617\mapbooks\sel\Alt Middle Trib.mxd, 1/11/2016, Jeff Clontis

## 7.0 FEE DEVELOPMENT

### 7.1. Introduction

The objective of the fee development exercise was to determine the equitable share of drainage improvement costs that a developer is responsible for paying to El Paso County if they wish to plat a property. This fee is a function of the total cost for the selected plan outlined in Section 6 and will be used by the County to pay for drainage improvements that are necessary as a result of development. The product of this calculation is a unit fee (cost/impervious acre) that is a one-time charge to the developer based on the number of impervious acres within the platted property.

### 7.2. Developable Land

The Falcon Watershed has a total area of 6,847 acres. The entirety of the watershed is within the County with 1,969 acres unplatted, according to the GIS dataset received from the County. This dataset also includes unplatted areas that can't be developed because of specific land use designations. Table 7-1 provides a summary of land classifications in the Falcon Watershed. A complete summary of unplatted area land use is provided in Appendix E.

**Table 7-1. Land Classification**

Classification	Area (acres)
Platted	3,670
Unplatted	1,969
Other	1,208
<b>Total</b>	<b>6,847</b>

The projected impervious acreage within unplatted areas totals 645.58 acres. A summary of land classification within the Falcon Watershed is provided in Figure 7-3.

### 7.3. Fee Calculation & County Cost

The total cost for the Selected Plan was separated into a Development Fee, County Cost, Metropolitan District Cost, and Drainage and Bridge Funds. A description of how the aforementioned were defined is as follows:

- **County Cost** – Drainage improvement costs that are the responsibility of the County as shown in Figure 7-1.
- **Metropolitan District Cost** – Drainage improvement costs that are the responsibility of a metropolitan district as shown in Figure 7-2.
- **Development Fee** – All drainage improvement costs that are directly associated with new development.
- **Drainage and Bridge Funds** – The balance of drainage and bridge funds as of August 2015 was \$584,134 and \$510,777, respectively, with a liability of \$300,000 cost for this DBPS (an additional contract amendment increased the cost of this DBPS to \$339,088).

The anticipated reimbursements due for work completed in the Falcon Watershed are approximately equivalent to the available drainage and bridge funds. As a result, reimbursements were not included in

the fee calculation. Drainage improvements that are required as a result of new development are listed in Appendix E.

The costs apportioned to County and metropolitan district drainage improvements are provided in Table 7-2 and Table 7-3. The bridge improvement fees shown in Table 7-2 and Table 7-3 were determined by classification of the crossing as either a bridge or a culvert. This classification was based on the DCM criteria.

**Table 7-2. County Cost**

Drainage Improvements	\$ 24,051,349
Bridge Improvements	\$ 2,887,437
<b>Total Cost</b>	<b>\$ 26,938,786</b>

**Table 7-3. Metropolitan District Cost**

Drainage Improvements	\$ 3,972,407
Bridge Improvements	\$ 1,855,620
<b>Total Cost</b>	<b>\$ 5,828,027</b>

The development cost and corresponding fee calculations based on impervious acreage are provided in Table 7-4 and 7-5.

**Table 7-4. Development Drainage Cost and Fee**

Drainage Improvements	\$ 14,649,163
DBPS Cost	\$ 339,088
<b>Total Cost</b>	<b>\$ 14,988,251</b>
<b>Drainage Fee (per imp. ac.)</b>	<b>\$ 23,217</b>

**Table 7-5. Development Bridge Cost and Fee**

Bridge Improvements	\$ 2,058,474
<b>Total Cost</b>	<b>\$ 2,058,474</b>
<b>Bridge Fee (per imp. ac.)</b>	<b>\$ 3,189</b>



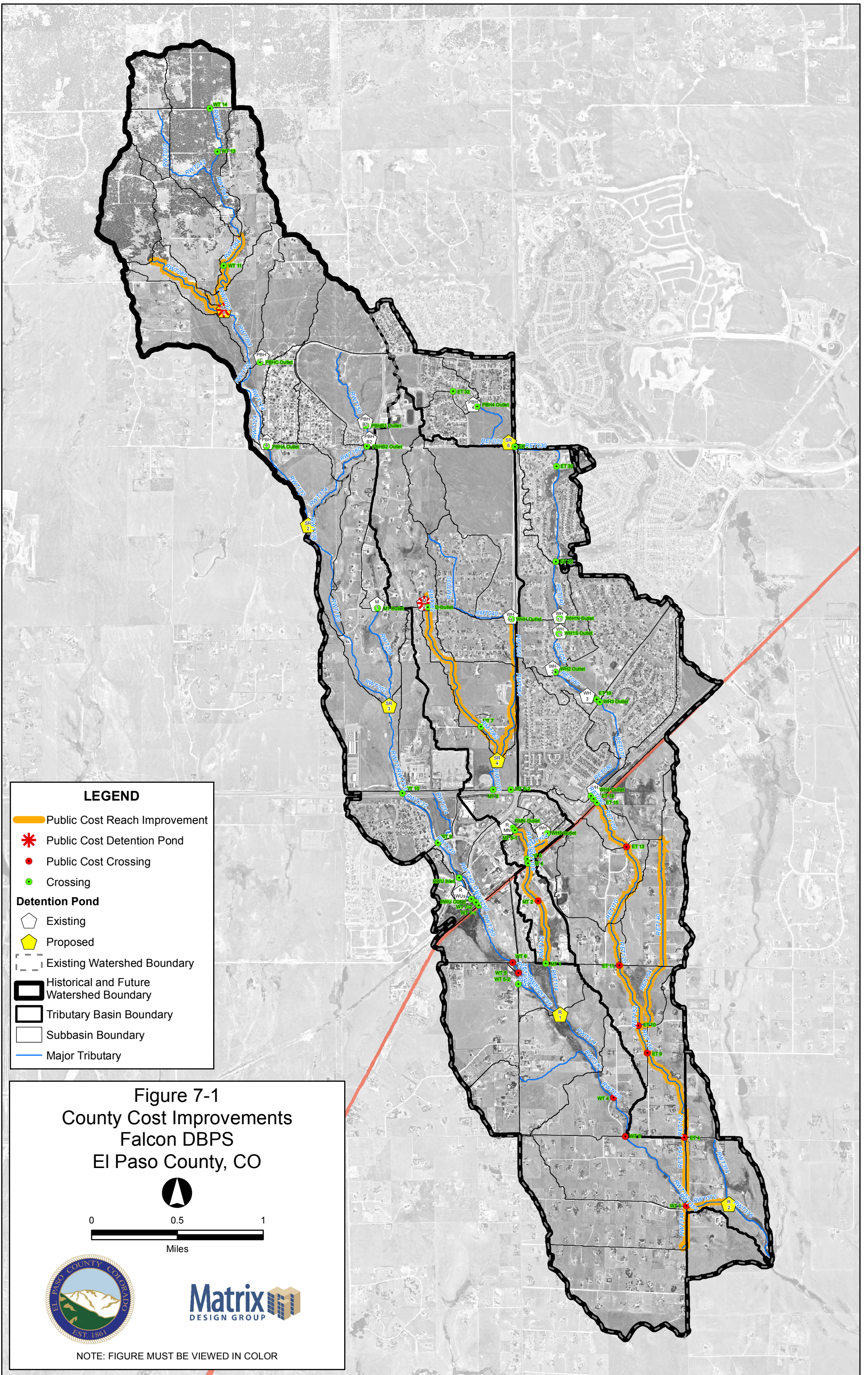

**Falcon DBPS  
County Costs**

<b>Drainage Fees</b>			
<b>Reach/Pond</b>	<b>Reach Length (ft)</b>	<b>Improvement</b>	<b>Cost</b>
RWT344	1,379	Roadside Ditch Improvement	\$ 167,006
RET140	4,052	Roadside Ditch Improvement	\$ 295,914
RET164	2,072	Roadside Ditch Improvement	\$ 132,703
RET100	1,791	Small Drop Structures w/Toe Protection	\$ 1,342,120
RET110	2,751	Small Drop Structures w/Toe Protection	\$ 1,055,516
RET152	2,030	Small Drop Structures w/Toe Protection	\$ 1,081,390
RET120	1,379	Natural Channel Design	\$ 72,798
RET162	3,256	Small Drop Structures w/Toe Protection	\$ 656,460
RMT050	1,568	Small Drop Structures w/Toe Protection	\$ 814,189
RMT062	5,688	Small Drop Structures w/Toe Protection	\$ 2,381,127
RMT064	3,358	Small Drop Structures w/Toe Protection	\$ 1,231,110
RMT112	3,372	Small Drop Structures w/Toe Protection	\$ 1,276,142
RWT054	2,497	Small Drop Structures w/Toe Protection	\$ 1,414,531
RWT080	3,494	Small Drop Structures w/Toe Protection	\$ 2,345,153
RWT092	626	Small Drop Structures w/Toe Protection	\$ 414,434
RWT372	1,377	Small Drop Structures w/Toe Protection	\$ 947,221
RMT102	1,021	Small Drop Structures w/Toe Protection	\$ 636,082
RMT104	874	Small Drop Structures w/Toe Protection	\$ 186,349
RET154	2,357	Natural Channel Design	\$ 468,927
RET156	942	Natural Channel Design	\$ 73,722
WT 5	43	Crossing - Culvert	\$ 8,651
ET 13	50	Crossing - Culvert	\$ 113,991
ET 11	40	Crossing - Culvert	\$ 84,348
ET 9	40	Crossing - Culvert	\$ 84,102
ET 4	61	Crossing - Culvert	\$ 106,060
Sub Regional Pond SR1		Detention Pond	\$ 405,769
The Meadows Pond #2		Detention Pond	\$ 20,000
		Subtotal	\$ 17,815,814
		Engineering/Construction Admin (15%)	\$ 2,672,372
		Contingency (20%)	\$ 3,563,163
		<b>Total</b>	<b>\$ 24,051,349</b>

<b>Bridge Fees</b>			
<b>Reach/Pond</b>	<b>Reach Length (ft)</b>	<b>Improvement</b>	<b>Cost</b>
WT 6	43	Crossing - Bridge	\$ 249,775
WT 4	48	Crossing - Bridge	\$ 528,324
WT 3	46	Crossing - Bridge	\$ 218,292
WT 1	40	Crossing - Bridge	\$ 636,648
MT 2	83	Crossing - Bridge	\$ 343,147
ET 10	44	Crossing - Bridge	\$ 162,656
		Subtotal	\$ 2,138,842
		Engineering/Construction Admin (15%)	\$ 320,826
		Contingency (20%)	\$ 427,768
		<b>Total</b>	<b>\$ 2,887,437</b>



## MDDP & DBPS AMENDMENT

### **BENT GRASS DEVELOPMENT**

El Paso County, Colorado

---

PREPARED FOR:  
**Challenger Communities, LLC**  
8605 Explorer Dr., Suite 250  
Colorado Springs, CO 80920

PREPARED BY:  
**Galloway & Company, Inc.**  
1155 Kelly Johnson Blvd., Suite 305  
Colorado Springs, CO 80920

DATE:  
January 2021  
Revised: March 2021  
Revised: April 2021  
Revised: June 2021  
Revised: August 2021  
Revised: September 2021

PUDSP-20-005



recommendations from the Falcon DBPS, when additional land is obtained to expand the ROW along the southbound portion of Meridian Road.

In the interim condition, it has been proposed to add a temporary lining to the existing channel to handle the excess velocities and depth associated with the DBPS flows and Bent Grass development re-routed flows. This analysis has been included in the Appendix.

The West Tributary Channel will be natural, vegetated facility, helping to ensure that the overall velocities will be reduced, flow depth will not exceed 5' and minimize any potential for scour. If needed, grade control structures may be designed as proposed in the DBPS to ensure these criteria are met.

### **3. Implement BMPs That Provide a Water Quality Capture Volume with Slow Release**

This step utilizes formalized water quality capture volume to slow the release of runoff from the site. The WQCV will release in no less than 40 hours. On-site water quality control volume detention ponds will provide water quality treatment prior to the runoff being released into the channel. WQCV facilities will be designed as Extended Detention Basins.

The Falcon Meadows at Bent Grass development, west of Bent Grass Residential, Filing No. 1 and No. 2, will include several water quality ponds throughout the site to ensure flows will be treated prior to being released into the West Tributary Channel, running through the site. Only a small area, less than 1.0 acres will not be treated prior to releasing into the channel.

Currently, the existing Meridian Road roadside ditch, ultimately conveys runoff to the existing detention and water quality pond MN, as shown and discussed in the Falcon DBPS. The Falcon DBPS also shows a future detention and water quality pond SR-4 that is to receive flows from basin MT060 and discharge into basin MT070, ultimately routing to existing Pond MN. Flows from Bent Grass Meadows Drive are listed in basin MT060 but are being routed to the existing roadside ditch along Meridian Road, which is in basin MT070. The flows from the "School Site" and upstream basins will release into the east side of Pond SR-4 (west of Falcon Market Place). Pond SR-4 is currently under construction. The proposed improvements impact on the existing drainage basin and both Pond MN and Pond SR-4 are discussed later in the report.

### **4. Consider Need for Industrial and Commercial BMPs**

Source control BMPs for homeowners include the use of garages as the primary area where pollutants can be stored. The single-family detached homes provide garages which can act as storage areas. The proposed development does not include outdoor storage or the potential for introduction of contaminants to the Counties' MS4, thus no targeted source control BMPs are necessary. The biggest source control BMP is public education and discuss topics such as: pet waste, car washing, lawn care, fall leaves, and snow melt and deicer.

Bent Grass East Commercial Filing No. 1 contains commercial development. This area will need to consider the need for Industrial & Commercial BMPs. No industrial uses or outside storage is proposed for this area. Drainage will be routed through water quality ponds prior to leaving the site to minimize contaminants into the public system.

## **VII. Future Drainage Conditions**

## MIDDLE TRIBUTARY

Design Point 30 and Basins OS-25 and OS-26 are as described under Existing Drainage Conditions. However, Basins OS-25 and OS-26 now route through proposed “future” detention pond, on what’s been previously referred to as the “School Site”, north of Bent Grass Meadows Drive and just west of Bent Grass Filing No. 2. This “future” pond will replace the current sedimentation pond on the “School Site”. Upon any additional development within the Middle Tributary area of the Bent Grass Development and north of Bent Grass Meadows Drive, this pond will need to be constructed to accommodate the re-routed flows from the Meadows Pond #2 at DP 30.

This future facility will need to provide 2.76 ac-ft of water quality, 6.26 ac-ft for EURV and 11.98 ac-ft for 100-year storage volume. Preliminary release rates for the 5 and 100-year storms are 3.8 cfs and 32.2 cfs. These flows were then routed to Bent Grass Meadows to the south. With the decrease in flows, flows will not overtop Bent Grass Meadows Drive and continue east to the future box culvert under Bent Grass Meadows Drive at DP BG20 (5-year flow=292.5 cfs, 100-year flow=909.3 cfs). Flows were still checked against street capacity on the north and south side of Bent Grass Meadows Drive, as it continues to the east. With the construction of the future pond, Bent Grass Meadows Drive will be able to adequately handle the flows and no additional storm infrastructure would need to be built to carry these future developed flows. Any area north of Bent Grass Meadows Drive that will develop in the future will need to provide its own on-site detention. Should future development not be able to release flows into Bent Grass Meadows Drive, a 42” RCP would be able to convey the flows of DP BG 15n (Q100=40.9 cfs, Q5=8.8 cfs) to the northwest corner of the Bent Grass Meadows Drive and Meridian Road intersection. Analysis for this culvert sizing has been included in the appendix.

At the Bent Grass Meadows Drive/Meridian Road intersection, the elliptical rcp’s will need to be replaced with a double 16’ x 4’ rcbc. The future roadside ditch will have a 15’ wide bottom channel with 4:1 side slope, 6.5’ deep and a longitudinal slope of 0.30%. This will result in a flow depth of 5.15’ and velocity of 5.04 fps. This channel will direct flows to Owl Place where the existing twin cmp’s will be replaced with a 20’ x 4’ rcbc or equivalent. This structure will need to be built when any development west of Meridian Road at the intersection of Owl Place happens. With future development, it is anticipated that the existing channel conveying flows to the south will be removed to accommodate the new development. The new channel will need to be a 35’ wide bottom channel with 4:1 sides, 5’ deep and a longitudinal slope of 0.30%. This will produce a flow depth of 3.7’ and a velocity of 4.6 fps. If the channel option is not viable, twin 78” rcp’s at a minimum 0.50% slope would be able to handle this future flow. Analysis for this design option has been included in the appendix.

Calculations are provided in Appendix C for the future culverts and roadside channel.

## WEST TRIBUTARY

Offsite flows entering the west tributary location of Bent Grass have not changed from what was discussed under Current Conditions. Reach RWT202 at the northwest corner of the development has a 100-year flow of 1000 cfs and Reach RWT204 has a flow of 43 cfs. These were obtained from the DBPS by Matrix. The Flood Insurance Study (FIS) by FEMA does not have flows evaluated this far north. They have a flow of 1482 cfs beginning at RWT210. The 8 undeveloped on-site basins for Bent Grass West have been replaced with 17 developed basins. These basins are found in the Falcon Meadows for Bent Grass PDR. A summary of these basins is provided below and are part of the hydrology analysis provided in Appendix B.

Sub Regional Detention Alternative <sup>1</sup>						
Pond		Q <sub>2</sub> In (cfs)	Q <sub>2</sub> Out (cfs)	Q <sub>100</sub> In (cfs)	Q <sub>100</sub> Out (cfs)	Required Volume (AF) <sup>2</sup>
Paint Brush Hills Pond #4	PBH 4	38	29	200	150	1.34
Paint Brush Hills Pond A	PBH A	35	7	170	140	2.62
Paint Brush Hills Pond B1	PBH B1	80	51	420	270	9.17
Paint Brush Hills Pond B2	PBH B2	51	10	270	180	12.09
Paint Brush Hills Pond C	PBH C	56	3	300	140	6.77
Regional Pond MN	R MN	65	32	850	820	7.53
Regional Pond R1	R R1	110	77	1,600	1,500	25.00
Regional Pond R2	R R2	140	140	2,100	2,100	7.90
Regional Pond WU South	R WU	47	22	1,070	930	39.54
Sub Regional Pond SR1	SR 1	54	42	610	510	11.03
Sub Regional Pond SR2	SR 2	65	65	840	840	2.05
Sub Regional Pond SR3	SR 3	72	72	910	910	1.03
Sub Regional Pond SR4	SR 4	130	27	1,000	730	19.37
Sub Regional Pond SR6	SR 6	74	9	390	200	11.82
The Meadows Pond #1	M 1	11	0	75	2	3.25
The Meadows Pond #2	M 2	28	5	210	99	7.94
Woodmen Hills Pond #1 North	WH 1N	65	61	390	260	7.13
Woodmen Hills Pond #1 South	WH 1S	61	10	260	260	8.78
Woodmen Hills Pond #2	WH 2	37	10	270	250	9.18
Woodmen Hills Pond #3	WH 3	105	13	530	360	8.35
Woodmen Hills Pond #4	WH 4	110	15	790	260	40.45
Woodmen Hills Pond #5	WH 5	40	1	130	19	4.10
Woodmen Hills Pond H	WH H	140	110	750	750	2.66

Notes  
1: Represents future hydrology with retrofit existing detention ponds and 5 new subregional detention ponds  
2: Required volume to highest WSE

Reach Alternative	Total (ft)
Protect In Place	30,066
Natural Channel Design	32,359
Small Drop Structures w/ Toe Protection	76,812
Large Drop Structures w/ Toe Protection	0

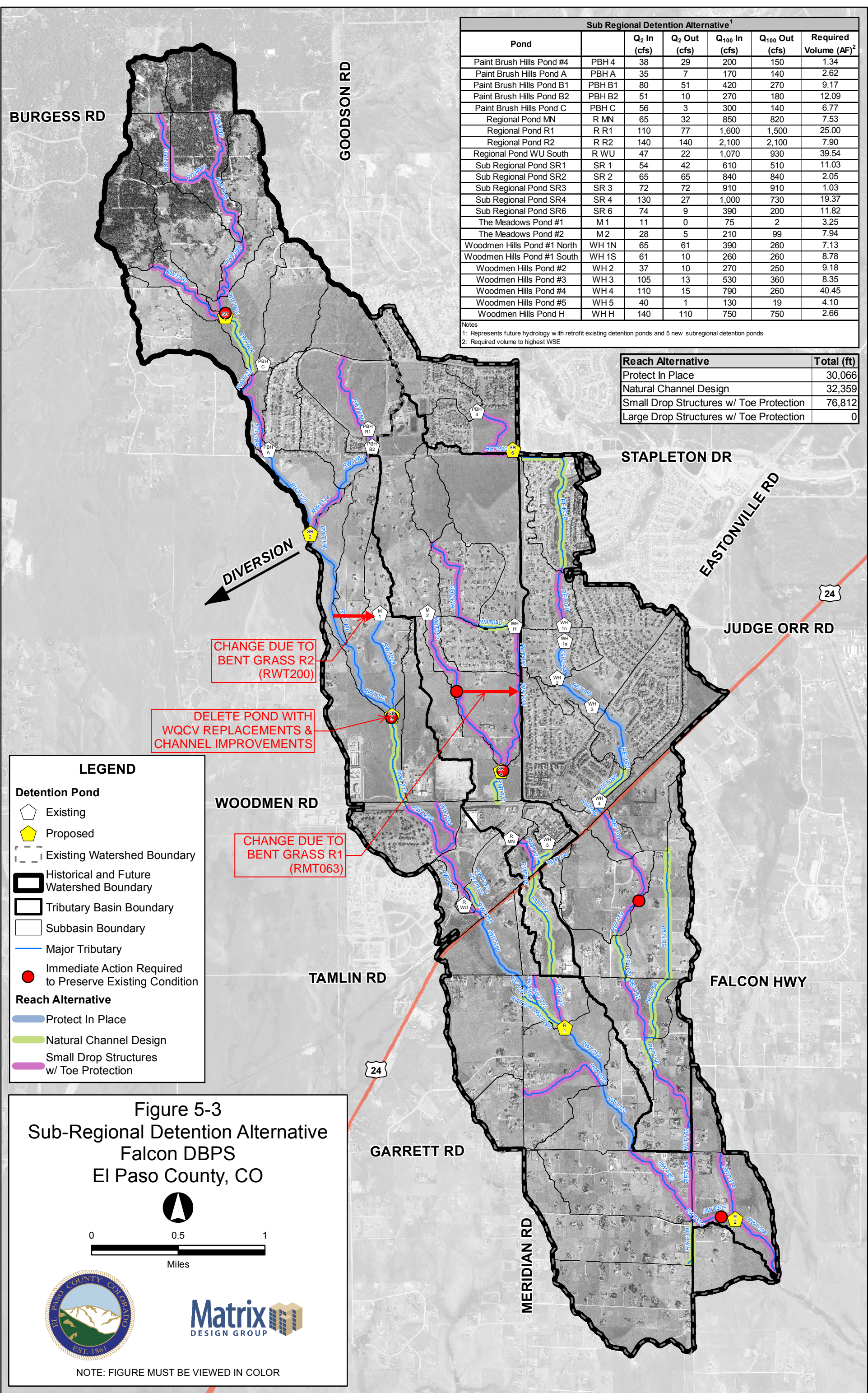

**LEGEND**

**Detention Pond**

- Existing (White pentagon)
- Proposed (Yellow pentagon)

**Boundary**

- Existing Watershed Boundary (Dashed line)
- Historical and Future Watershed Boundary (Thick black line)
- Tributary Basin Boundary (Thin black line)
- Subbasin Boundary (Dashed line)

**Major Tributary**

- Major Tributary (Blue line)

**Immediate Action Required to Preserve Existing Condition**

- Immediate Action Required to Preserve Existing Condition (Red circle)

**Reach Alternative**

- Protect In Place (Blue line)
- Natural Channel Design (Green line)
- Small Drop Structures w/ Toe Protection (Purple line)

**Figure 5-3**  
**Sub-Regional Detention Alternative**  
**Falcon DBPS**  
**El Paso County, CO**

0 0.5 1  
Miles

NOTE: FIGURE MUST BE VIEWED IN COLOR

FILE: G:\gis\_projects\Falcon\_Creek\_DBPStativeapps\20111215\_alternatives\subregional\_detention\_alt.mxd, 12/19/2011, ron\_ramold

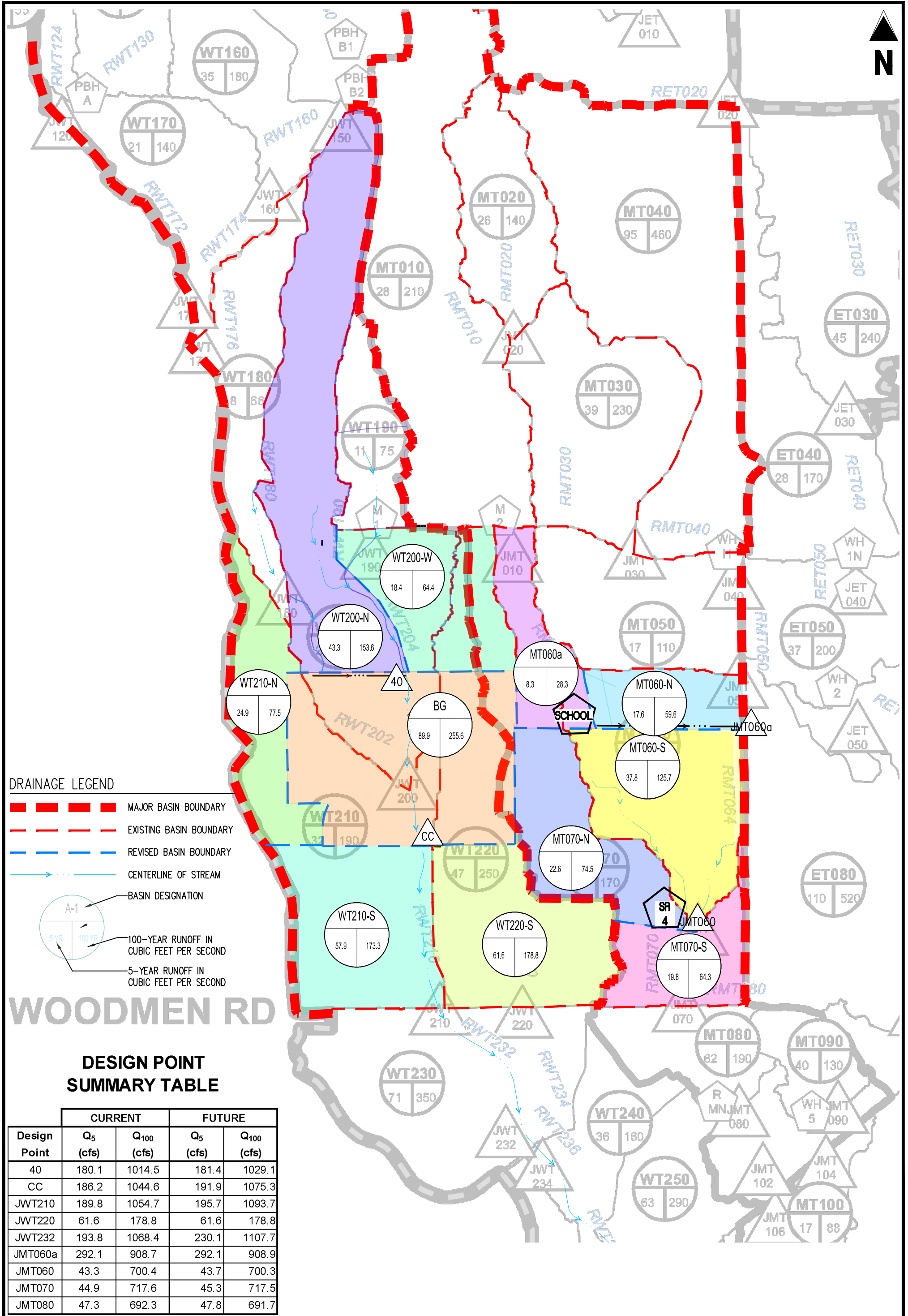

**DRAINAGE LEGEND**

- MAJOR BASIN BOUNDARY
- EXISTING BASIN BOUNDARY
- REVISED BASIN BOUNDARY
- CENTERLINE OF STREAM
- BASIN DESIGNATION
- 100-YEAR RUNOFF IN CUBIC FEET PER SECOND
- 5-YEAR RUNOFF IN CUBIC FEET PER SECOND

**WOODMEN RD**

**DESIGN POINT SUMMARY TABLE**

Design Point	CURRENT		FUTURE	
	Q <sub>5</sub> (cfs)	Q <sub>100</sub> (cfs)	Q <sub>5</sub> (cfs)	Q <sub>100</sub> (cfs)
40	180.1	1014.5	181.4	1029.1
CC	186.2	1044.6	191.9	1075.3
JWT210	189.8	1054.7	195.7	1093.7
JWT220	61.6	178.8	61.6	178.8
JWT232	193.8	1068.4	230.1	1107.7
JMT060a	292.1	908.7	292.1	908.9
JMT060	43.3	700.4	43.7	700.3
JMT070	44.9	717.6	45.3	717.5
JMT080	47.3	692.3	47.8	691.7

FALCON MEADOWS AT BENT GRASS  
MDDP

REVISED BASIN HYDROLOGY - HMS MODEL

Project No: CLH0017  
 Drawn By: CMD  
 Checked By: GD  
 Date: 06/16/21

**Galloway**  
 6162 S. Willow Drive, Suite 320  
 Greenwood Village, CO 80111  
 303.770.8884 • GallowayUS.com

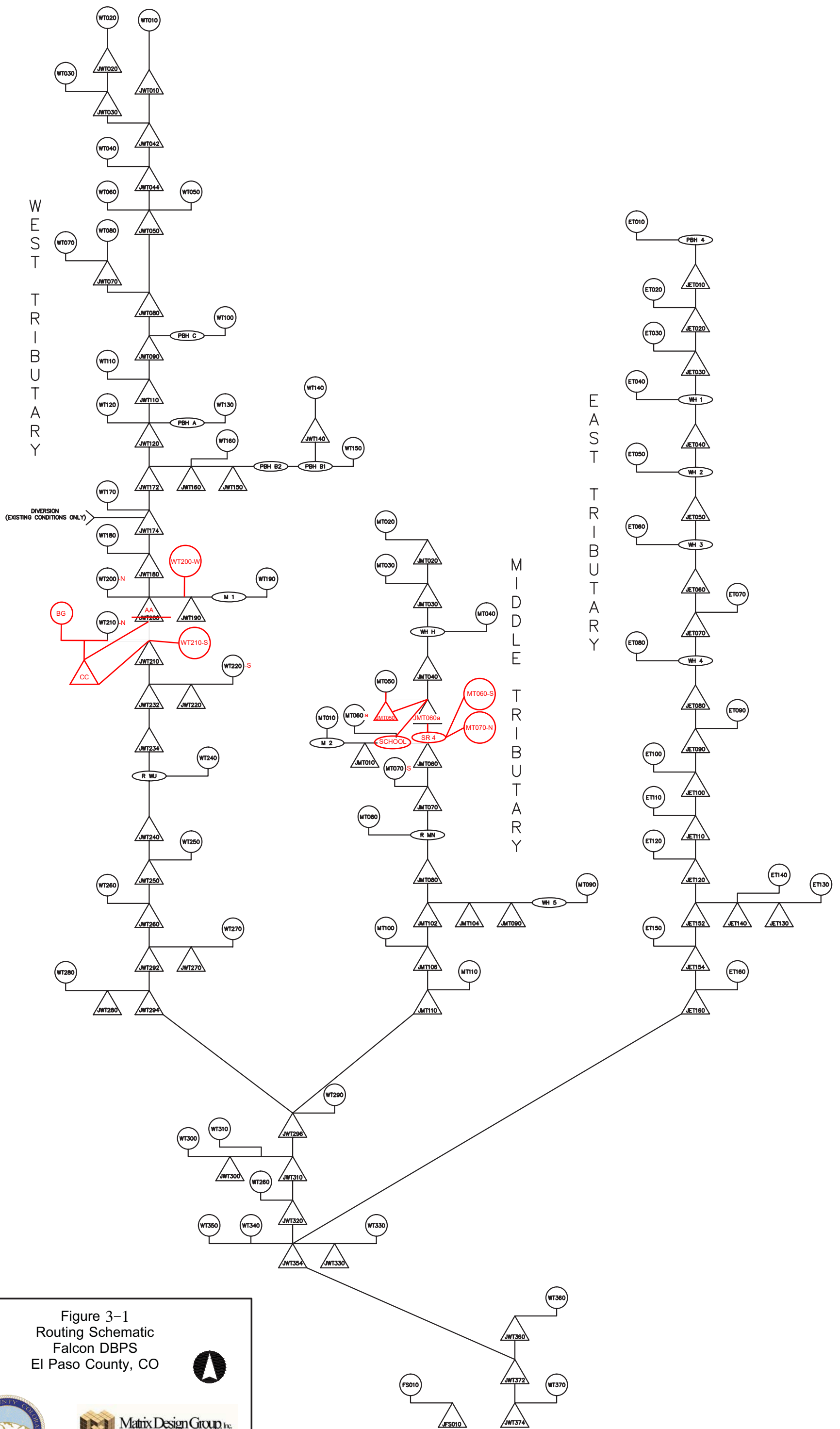

Figure 3-1  
Routing Schematic  
Falcon DBPS  
El Paso County, CO



DRAWING NOT TO SCALE



# MERIDIAN ROAD

## Worksheet for Fut Channel - Pr 100 Yr Flow-MR

### Project Description

Friction Method	Manning Formula
Solve For	Normal Depth

### Input Data

Roughness Coefficient	0.035
Channel Slope	0.30 %
Left Side Slope	4.00 ft/ft (H:V)
Right Side Slope	4.00 ft/ft (H:V)
Bottom Width	15.00 ft
Discharge	925.00 ft <sup>3</sup> /s

### Results

Normal Depth	5.15 ft
Flow Area	183.50 ft <sup>2</sup>
Wetted Perimeter	57.49 ft
Hydraulic Radius	3.19 ft
Top Width	56.22 ft
Critical Depth	3.58 ft
Critical Slope	0.01368 ft/ft
Velocity	5.04 ft/s
Velocity Head	0.39 ft
Specific Energy	5.55 ft
Froude Number	0.49
Flow Type	Subcritical

### GVF Input Data

Downstream Depth	0.00 ft
Length	0.00 ft
Number Of Steps	0

### GVF Output Data

Upstream Depth	0.00 ft
Profile Description	
Profile Headloss	0.00 ft
Downstream Velocity	Infinity ft/s
Upstream Velocity	Infinity ft/s
Normal Depth	5.15 ft
Critical Depth	3.58 ft
Channel Slope	0.30 %



**APPENDIX**  
CLOMR APPROVAL



# Federal Emergency Management Agency

Washington, D.C. 20472

## CONDITIONAL LETTER OF MAP REVISION COMMENT DOCUMENT

COMMUNITY INFORMATION		PROPOSED PROJECT DESCRIPTION	BASIS OF CONDITIONAL REQUEST
COMMUNITY	<b>El Paso County Colorado (Unincorporated Areas)</b>	CULVERT FILL	1D HYDRAULIC ANALYSIS UPDATED TOPOGRAPHIC DATA HYDROLOGIC ANALYSIS
	COMMUNITY NO.: 080059		
IDENTIFIER	Falcon Owl Place	<b>APPROXIMATE LATITUDE AND LONGITUDE:</b> 38.946, -104.609 <b>SOURCE:</b> OTHER <b>DATUM:</b> NAD 83	
<b>AFFECTED MAP PANELS</b>			
TYPE: FIRM*	NO.: 08041C0553G	DATE: December 7, 2018	*FIRM - Flood Insurance Rate Map

### FLOODING SOURCE AND REACH DESCRIPTION

Unnamed Tributary to Black Squirrel Creek (East Branch) – From approximately 890 feet downstream of Owl Place to just upstream of Owl Place

### PROPOSED PROJECT DESCRIPTION

Flooding Source	Proposed Project	Location of Proposed Project
Unnamed Tributary to Black Squirrel Creek (East Branch)	Two New 10' x 6' Box Culverts	From approximately 890 feet downstream of Owl Place to just upstream of Owl Place

### SUMMARY OF IMPACTS TO FLOOD HAZARD DATA

Flooding Source	Effective Flooding	Proposed Flooding	Increases	Decreases
Unnamed Tributary to Black Squirrel Creek (East Branch)	Zone A	Contained	None	Yes

### COMMENT

This document provides the Federal Emergency Management Agency's (FEMA's) comment regarding a request for a CLOMR for the project described above. This document is not a final determination; it only provides our comment on the proposed project in relation to the flood hazard information shown on the effective National Flood Insurance Program (NFIP) map. We reviewed the submitted data and the data used to prepare the effective flood hazard information for your community and determined that the proposed project meets the minimum floodplain management criteria of the NFIP. Your community is responsible for approving all floodplain development and for ensuring that all permits required by Federal or State/Commonwealth law have been received. State/Commonwealth, county, and community officials, based on their knowledge of local conditions and in the interest of safety, may set higher standards for construction in the Special Flood Hazard Area (SFHA), the area subject to inundation by the base flood. If the State/Commonwealth, county, or community has adopted more restrictive or comprehensive floodplain management criteria, these criteria take precedence over the minimum NFIP criteria.

This comment is based on the flood data presently available. If you have any questions about this document, please contact the FEMA Mapping and Insurance eXchange (FMIX) toll free at 1-877-336-2627 (1-877-FEMA MAP) or by letter addressed to the LOMC Clearinghouse, 3601 Eisenhower Avenue, Suite 500, Alexandria, VA 22304. Additional Information about the NFIP is available on the FEMA website at <https://www.fema.gov/flood-insurance>.

Patrick "Rick" F. Sacbbit, P.E., Branch Chief  
Engineering Services Branch  
Federal Insurance and Mitigation Administration



**Federal Emergency Management Agency**  
Washington, D.C. 20472

**CONDITIONAL LETTER OF MAP REVISION  
COMMENT DOCUMENT (CONTINUED)**

**COMMUNITY INFORMATION**

To determine the changes in flood hazards that will be caused by the proposed project, we compared the hydraulic modeling reflecting the proposed project (referred to as the proposed conditions model) to the hydraulic modeling reflecting the existing conditions.

The table below shows the changes in the base flood water-surface elevations (WSELs).

Base Flood WSEL Comparison Table

Flooding Source: Unnamed Tributary to Black Squirrel Creek (East Branch)		Base Flood WSEL Change (feet)	Location of maximum change
Proposed vs.	Maximum increase	None	Not Applicable
Existing	Maximum decrease	None	Not Applicable

NFIP regulations Subparagraph 60.3(b)(7) requires communities to ensure that the flood-carrying capacity within the altered or relocated portion of any watercourse is maintained. This provision is incorporated into your community's existing floodplain management ordinances; therefore, responsibility for maintenance of the altered or relocated watercourse, including any related appurtenances such as bridges, culverts, and other drainage structures, rests with your community. We may request that your community submit a description and schedule of maintenance activities necessary to ensure this requirement.

This comment is based on the flood data presently available. If you have any questions about this document, please contact the FEMA Mapping and Insurance eXchange (FMIX) toll free at 1-877-336-2627 (1-877-FEMA MAP) or by letter addressed to the LOMC Clearinghouse, 3601 Eisenhower Avenue, Suite 500, Alexandria, VA 22304. Additional Information about the NFIP is available on the FEMA website at <https://www.fema.gov/flood-insurance>.

Patrick "Rick" F. Sacbibit, P.E., Branch Chief  
Engineering Services Branch  
Federal Insurance and Mitigation Administration



# Federal Emergency Management Agency

Washington, D.C. 20472

## CONDITIONAL LETTER OF MAP REVISION COMMENT DOCUMENT (CONTINUED)

### COMMUNITY INFORMATION (CONTINUED)

#### DATA REQUIRED FOR FOLLOW-UP LOMR

Upon completion of the project, your community must submit the data listed below and request that we make a final determination on revising the effective FIRM. If the project is built as proposed and the data below are received, a revision to the FIRM would be warranted.

- Detailed application and certification forms must be used for requesting final revisions to the maps. Therefore, when the map revision request for the area covered by this letter is submitted, Form 1, entitled "Overview and Concurrence Form," must be included. A copy of this form may be accessed at <https://www.fema.gov/flood-maps/change-your-flood-zone/paper-application-forms/mt-2>.

- The detailed application and certification forms listed below may be required if as-built conditions differ from the proposed plans. If required, please submit new forms, which may be accessed at <https://www.fema.gov/flood-maps/change-your-flood-zone/paper-application-forms/mt-2>, or annotated copies of the previously submitted forms showing the revised information.

Form 2, entitled "Riverine Hydrology and Hydraulics Form." Hydraulic analyses for as-built conditions of the base flood must be submitted with Form 2.

Form 3, entitled "Riverine Structures Form."

- A certified topographic work map showing the revised and effective base floodplain boundaries. Please ensure that the revised information ties-in with the current effective information at the downstream and upstream ends of the revised reach.

- An annotated copy of the FIRM, at the scale of the effective FIRM, that shows the revised base floodplain boundary delineations shown on the submitted work map and how they tie-in to the base floodplain boundary delineations shown on the current effective FIRM at the downstream and upstream ends of the revised reach.

- As-built plans, certified by a registered Professional Engineer, of all proposed project elements.

This comment is based on the flood data presently available. If you have any questions about this document, please contact the FEMA Mapping and Insurance eXchange (FMIX) toll free at 1-877-336-2627 (1-877-FEMA MAP) or by letter addressed to the LOMC Clearinghouse, 3601 Eisenhower Avenue, Suite 500, Alexandria, VA 22304. Additional Information about the NFIP is available on the FEMA website at <https://www.fema.gov/flood-insurance>.

A handwritten signature in black ink, appearing to read "Rick F. Sacbbit".

Patrick "Rick" F. Sacbbit, P.E., Branch Chief  
Engineering Services Branch  
Federal Insurance and Mitigation Administration



# Federal Emergency Management Agency

Washington, D.C. 20472

## CONDITIONAL LETTER OF MAP REVISION COMMENT DOCUMENT (CONTINUED)

### COMMUNITY INFORMATION (CONTINUED)

#### DATA REQUIRED FOR FOLLOW-UP LOMR (continued)

• FEMA's fee schedule for reviewing and processing requests for conditional and final modifications to published flood information and maps may be accessed at <https://www.fema.gov/flood-maps/change-your-flood-zone/status/flood-map-related-fees>. The fee at the time of the map revision submittal must be received before we can begin processing the request. Payment of this fee can be made through a check or money order, made payable in U.S. funds to the National Flood Insurance Program, or by credit card (Visa or MasterCard only). Please either forward the payment, along with the revision application, to the following address:

Colorado Water Conservation Board  
Attention: Floodplain Mapping Program Manager  
1313 Sherman Street, Rm 718  
Denver, CO 80203

or submit the LOMR using the Online LOMC portal at: <https://hazards.fema.gov/femaportal/onlinelomc/signin>

After receiving appropriate documentation to show that the project has been completed, FEMA will initiate a revision to the FIRM. Because the flood hazard information (i.e., base flood elevations, base flood depths, SFHAs, zone designations, and/or regulatory floodways) will change as a result of the project, a 90-day appeal period will be initiated for the revision, during which community officials and interested persons may appeal the revised flood hazard information based on scientific or technical data.

This comment is based on the flood data presently available. If you have any questions about this document, please contact the FEMA Mapping and Insurance eXchange (FMIX) toll free at 1-877-336-2627 (1-877-FEMA MAP) or by letter addressed to the LOMC Clearinghouse, 3601 Eisenhower Avenue, Suite 500, Alexandria, VA 22304-6426. Additional Information about the NFIP is available on the FEMA website at <https://www.fema.gov/flood-insurance>.

A handwritten signature in black ink, appearing to read "Rick F. Sacbbit".

Patrick "Rick" F. Sacbbit, P.E., Branch Chief  
Engineering Services Branch  
Federal Insurance and Mitigation Administration



Federal Emergency Management Agency  
Washington, D.C. 20472

**CONDITIONAL LETTER OF MAP REVISION  
COMMENT DOCUMENT (CONTINUED)**

**COMMUNITY INFORMATION (CONTINUED)**

**COMMUNITY REMINDERS**

We have designated a Consultation Coordination Officer (CCO) to assist your community. The CCO will be the primary liaison between your community and FEMA. For information regarding your CCO, please contact:

Jeanine P. Petterson  
Director, Mitigation Division  
Federal Emergency Management Agency, Region VIII  
Denver Federal Center, Building 710  
P.O. Box 25267  
Denver, CO 80225-0267  
(303) 235-4830

This comment is based on the flood data presently available. If you have any questions about this document, please contact the FEMA Mapping and Insurance eXchange (FMIX) toll free at 1-877-336-2627 (1-877-FEMA MAP) or by letter addressed to the LOMC Clearinghouse, 3601 Eisenhower Avenue, Suite 500, Alexandria, VA 22304. Additional Information about the NFIP is available on the FEMA website at <https://www.fema.gov/flood-insurance>.

A handwritten signature in black ink, appearing to read "Rick F. Sacibit".

Patrick "Rick" F. Sacibit, P.E., Branch Chief  
Engineering Services Branch  
Federal Insurance and Mitigation Administration



### 3.0 HYDROLOGIC ANALYSIS

#### 3.1 Falcon DBPS

The Falcon DBPS completed hydrologic analysis for the Falcon Basin Watershed, using HEC-HMS v3.5 software, for historical, existing, and future land use conditions by applying a 24-hour storm event with 2-, 5-, 10-, 25-, 50-, and 100-year recurrence intervals and current drainage infrastructure. Chapter 3 and Appendix A of the Falcon DBPS include a detailed discussion of the hydrologic analysis. An electronic copy of the HEC-HMS model (File: Aug15\_Working\_Falcon\_DBPS\_S.hms) is also provided.

The Falcon DBPS identified Subregional Pond SR4 to be installed on the Falcon Marketplace property. Pond SR4 was constructed in early 2021 and the property floodplain mapping was updated in LOMR Case Number 21-08-0534P.

El Paso County requires regional drainage infrastructure to be sized for future land use conditions. Therefore, peak discharges with existing drainage infrastructure and future land use conditions near Owl Place are summarized in Table 3-1.

**Table 3-1. Future Land Use Conditions Peak Discharges near Falcon Owl Place on the Middle Tributary, Falcon DBPS**

Model Location	Physical Location	Branch	Proximity to Owl Place	Q100 (cfs)
JMT050	Bent Grass Meadows Drive	Only East Branch	Upstream of Site	850
JMT060	Eastonville Road (Pond SR4 inflow)	Both East and West Branches	Downstream of Site	1,000

#### 3.2 Falcon Owl Place

The Falcon DBPS HEC-HMS model with existing drainage infrastructure and future land use (Existing Conditions) was used as the basis for the Falcon Owl Place hydrologic analysis. The Existing Conditions model was replicated in HEC-HMS version 4.7.1, due to instabilities and runtime issues with the prior, outdated model version (3.5). The Existing model produced 100-year peak flows of 859 and 1,023 cfs upstream (JMT050) and downstream (JMT060) of the site, which are comparable to and more conservative than the 850 and 1,000 cfs in the DBPS. It should be noted that in Existing Conditions, JMT050 is on the East Branch of the Middle Tributary, whereas JMT060 includes flows from both the West and East Branches, immediately upstream of Pond SR4.

The Falcon watershed did not include a design point on the East Branch immediately upstream of Pond SR4. Therefore, it was necessary to modify the HMS model to obtain a design flow for Owl Place. In the Proposed Conditions basin model, the junction JMT051 was created on the East Branch of the UTBSC at the southern boundary of the Falcon Owl Place property, immediately upstream of Pond SR4.

The lag time and drainage area for Basin MT060 were reduced to 0.077 square miles and 17 minutes, respectively. The length and slope of Routing RMT060 were also updated. The NRCS soils for the proposed basin are Columbine gravelly sandy loam with a Hydrologic Soil Group (HSG) A. The basin is zoned for a combination of 5-acre residential, commercial, and planned unit development (PUD). The nearby PUD (Bent Grass Meadows) is residential with an average lot size of 0.22 acres. Based on TR-55 Table 2-2a, areas with 0.22-acre lots and HSG A have a Curve Number (CN) of 65. However, it is unknown how and when this area will develop in the future. For example, the Owl Place site is currently being rezoned from RR-5 to CS, which would increase the CN from 46 to 89. The future conditions CN of 66 used in the Falcon DBPS is a reasonable representation of the future development potential in the basin and was used in the proposed conditions model.

The hydrologic parameter calculations, base mapping, and select output from the HEC-HMS model is included in **Appendix 4**, and the model files (HEC-HMS file: Falcon\_OwlCLOMR.hms) are provided. Proposed peak discharges used for the Falcon Owl Place development are summarized in Table 3-2.

**Table 3-2. Proposed Peak Discharges at Falcon Owl Place (East Branch of the UTBSC)**

Recurrence Interval	Q100 (cfs)
100-year	920
5-year	288.5

## 4.0 HYDRAULIC ANALYSIS

### 4.1 General

The effective FIRM identifies an approximate Zone A floodplain across the Falcon Owl Place property with no flood profiles, discharges, or BFE's defined. The Falcon Owl Place development includes filling and regrading the site and rerouting the East Branch of the UTBSC through a box culvert across the site.

### 4.2 Vertical Datum

The effective FIRM is on the North American Vertical Datum of 1988 (NAVD88). The ALTA survey completed for the site (Olsson, 2021) and the design and construction

drawings are on the National Geodetic Vertical Datum of 1929 (NGVD29). The Falcon DBPS and the hydraulic analysis for this CLOMR were both completed on the NGVD29. The difference between the NGVD29 and NAVD88 is 3.8 feet on the Falcon Owl Place.

#### **4.3 Horizontal Datum**

The field survey, design, construction drawings and hydraulic modeling for the Falcon Owl Place project were completed on the North American Datum of 1983 (NAD83), Colorado State Plane coordinate system, Central Zone.

#### **4.4 Box Culvert Hydraulic Analysis**

Under existing and proposed conditions, the East Branch of the UTBSC leaving the Falcon Owl Place site discharges to Pond SR4 on the Falcon Marketplace. The pond was designed for a 100-year discharge of 1,016 cfs, which includes both West and East branches of the UTBSC. The 100-year water surface elevation upstream of the pond as shown in the LOMR is 6902.5 (NAVD88), or 6898.7 (NGVD29). The starting HGL for the box culvert analysis was conservatively placed at the top of pipe elevation of 6895.84 feet (NGVD29) for analyzing flows to the East branch only. However, an additional analysis was performed with a starting HGL of 6898.7, to evaluate the backwater effects from the pond.

StormCAD was used to evaluate the hydraulic performance of the 10'x6' box culvert. The profile and output for the 100-year storm event is included in **Appendix 5**, and the model files are provided.

#### **4.5 Existing and Proposed Owl Place Culverts**

The East Branch of the UTBSC is currently conveyed under Owl Place via two 36" CMP near the northeast corner of the site. The HY-8 software was used to analyze the existing culverts for the 100-year storm event.

The 2-36" CMP culverts are severely undersized and partially filled with sediment as shown in the photo below. The culverts only convey 86-95 cfs, depending on tailwater depth. The remaining flow (approximately 825-834 cfs) in the 100-year event overtops Owl Place. The proposed box culvert will convey the entire 100-year event (920 cfs) with an HGL of 6911.31 at the proposed headwall upstream of Owl Place, which is more than one foot below Owl Place and contained within the existing and proposed channel upstream. Channel grading will be required for approximately 30 feet to tie into the existing creek profile upstream. The channel side slopes will be reduced from approximately 5.5H:1V to 1.8H:1V and protected with riprap.

The HY-8 output is included in **Appendix 5** and the model file (Owl Place.hy8) is provided.

REQUEST FOR CONDITIONAL LETTER OF MAP REVISION  
UNNAMED TRIBUTARY TO BLACK SQUIRREL CREEK,  
FALCON OWL PLACE



**Existing 2-36" CMP under Owl Place (Upstream Inlets)**

## **5.0 NFIP REGULATION COMPLIANCE**

### **5.1 Floodplain Work Map and Annotated FIRM**

The effective Zone AE 100-year floodplain delineation for the UTBSC terminates at the boundary between the Falcon Marketplace and Falcon Owl Place properties and represents flows from both West and East branches. No changes are proposed to the Zone AE floodplain. The 100-year flood discharge for the East Branch is contained in the proposed culvert. Therefore, the Zone A floodplain for this branch has been removed, and the split between the Zone A floodplains for the West and East branches is denoted in the Annotated FIRM. The effective and proposed UTBSC floodplains are delineated on the Floodplain Work Map and Annotated FIRM in **Appendix 7**.

### **5.2 Forms and Notifications**

The appropriate FEMA forms are located in **Appendix 6**. Modifications to 100-year floodplain elevations and delineations are limited to the Falcon Owl Place development. Furthermore, there are no proposed increases to the BFE's or floodplain extents. Therefore, individual legal notices are not required for this CLOMR submittal.

### **5.3 Compliance with Section 65.12**

Although there are no increases to BFE's due to the proposed project, an alternatives evaluation was performed to evaluate options for closed conduit and open channel conveyance of the East Branch of the UTBSC. The alternatives evaluation can be provided upon request.

Furthermore, no structures are located in areas that would be impacted by the floodplain modifications proposed by this CLOMR.

### **5.4 Endangered Species Act (ESA)**

ESA Compliance information is provided in **Appendix 8**.

## **6.0 CONCLUSIONS**

The Falcon Owl Place development will relocate a portion of the East Branch of an Unnamed Tributary of Black Squirrel Creek (Middle Tributary). This report and supporting documentation are being submitted to FEMA for the purpose of requesting a CLOMR to conditionally change the floodplain in accordance with NFIP regulations.

**APPENDIX**  
DRAINAGE MAPS

**LEGEND**

- - - - - EX. MINOR CONTOUR
- - - - - 6800 - - - EX. MAJOR CONTOUR
- - - - - PR. MINOR CONTOUR
- - - - - 6800 - - - PR. MAJOR CONTOUR
- - - - - ST - - - EX. STORM DRAIN
- - - - - FLOODPLAIN BOUNDARY
- - - - - BASIN BOUNDARY
- ← - - - FLOW DIRECTION
- △ - - - DESIGN POINT

**BASIN**

AREA (ACRE)

OS-1  
C5  
C100

EXISTING				
BASIN	DP	Area (Ac.)	Q <sub>2</sub> (CFS)	Q <sub>100</sub> (CFS)
RMT064	X1		288.5	920.0
OSE1	E1	1.26	0.9	3.1
E2		1.95	0.5	3.7
E3	E3	2.34	0.6	4.4
E4	E4	0.33	0.1	0.7
MT060	X2		60.1	196.8

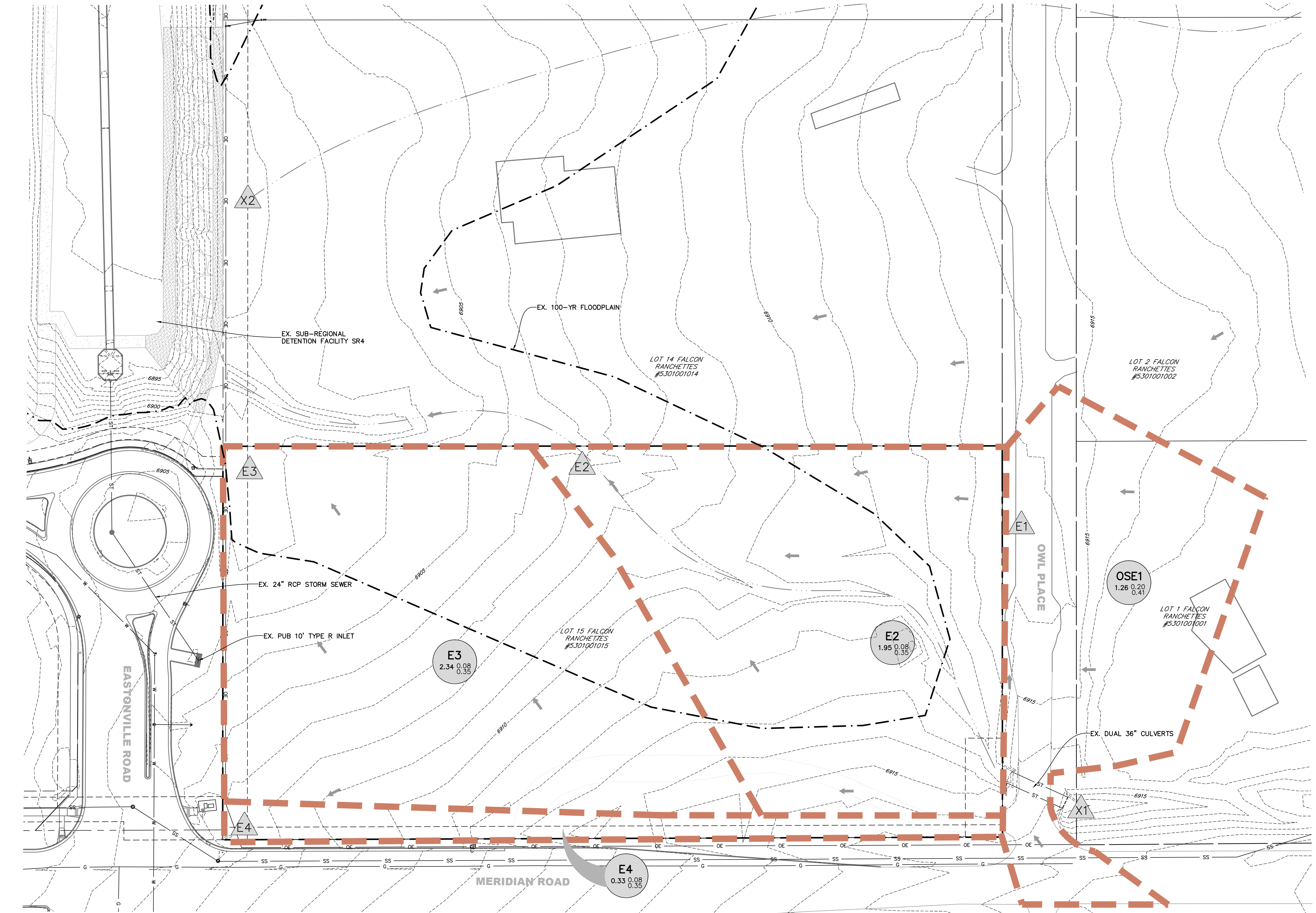
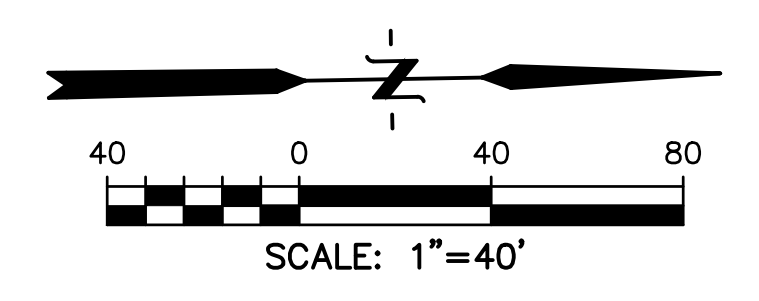

PREPARED BY:

**DREXEL, BARRELL & CO.**  
 Engineers • Surveyors  
 101 SAWATCH ST., STE #100  
 COLORADO SPGS, COLORADO 80903  
 CONTACT: TIM D. MCCONNELL, P.E.  
 (719)260-0887  
 COLORADO SPRINGS • LAFAYETTE

CLIENT:

**BH RE INVESTMENTS, LLC**  
 450 N MCCLINTOCK DRIVE  
 CHANDLER, AZ 85226  
 (480) 313-2724

DRAINAGE PLANS FOR:

# OWL MARKETPLACE

FALCON, COLORADO

ISSUE	DATE
INITIAL ISSUE	9-29-2023
RESUBMITTAL	3-11-2024
DESIGNED BY:	KGV
DRAWN BY:	CGH
CHECKED BY:	TDM
FILE NAME:	21611-DRN-EX

PREPARED UNDER MY DIRECT SUPERVISION FOR AND ON BEHALF OF DREXEL, BARRELL & CO.

DRAWING SCALE:  
 HORIZONTAL: 1" = 40"  
 VERTICAL: N/A

**EXISTING  
DRAINAGE  
MAP**

PROJECT NO. 21611-01CSCV  
 DRAWING NO.

**DRN**

SHEET: 1 OF 2

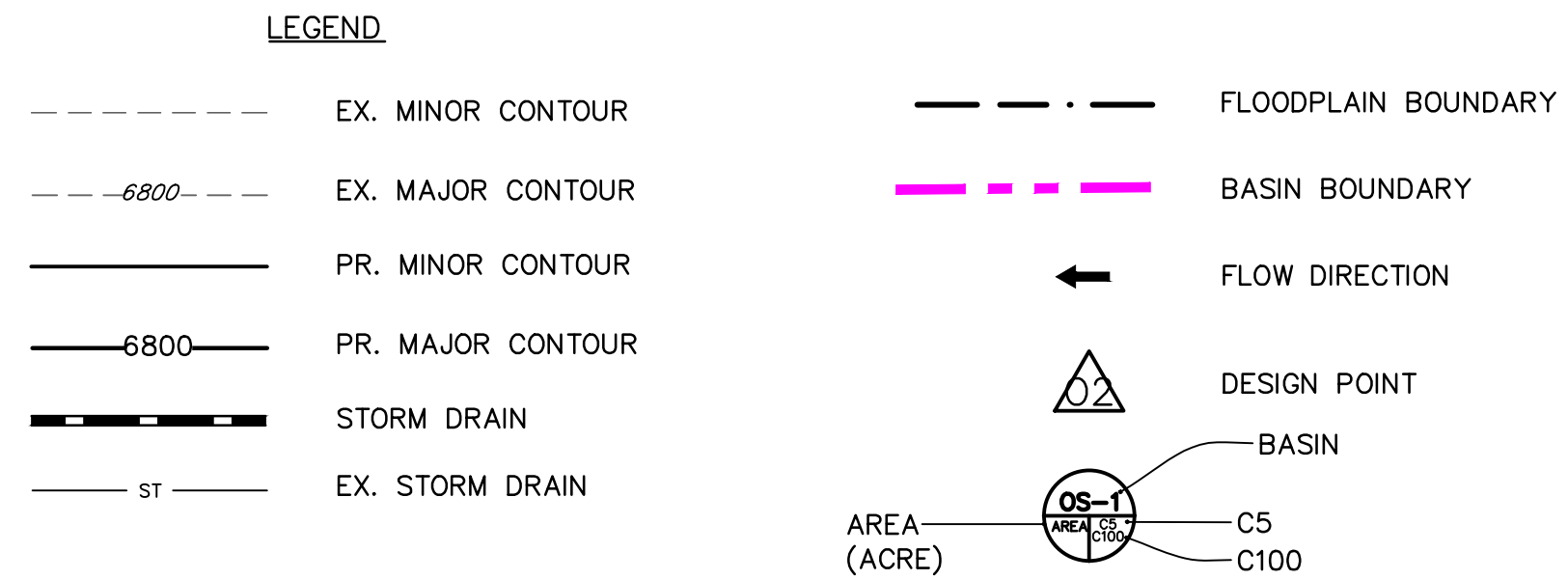

DEVELOPED				
BASIN	DP	Area (Ac.)	Q <sub>2</sub> (CFS)	Q <sub>100</sub> (CFS)
X1A	X1A	0.08	0.0	0.2
A	1	3.01	1.0	6.9
Offsite	2	0.00	0.6	1.5
B	3	1.89	1.9	6.6
Offsite 2	4	0.00	1.2	11.0
C	5	0.29	1.1	2.8
D	6	0.29	0.1	0.6
E	7	3.05	5.7	12.6
	8	0.09	0.0	0.2
		0.21	0.1	0.5

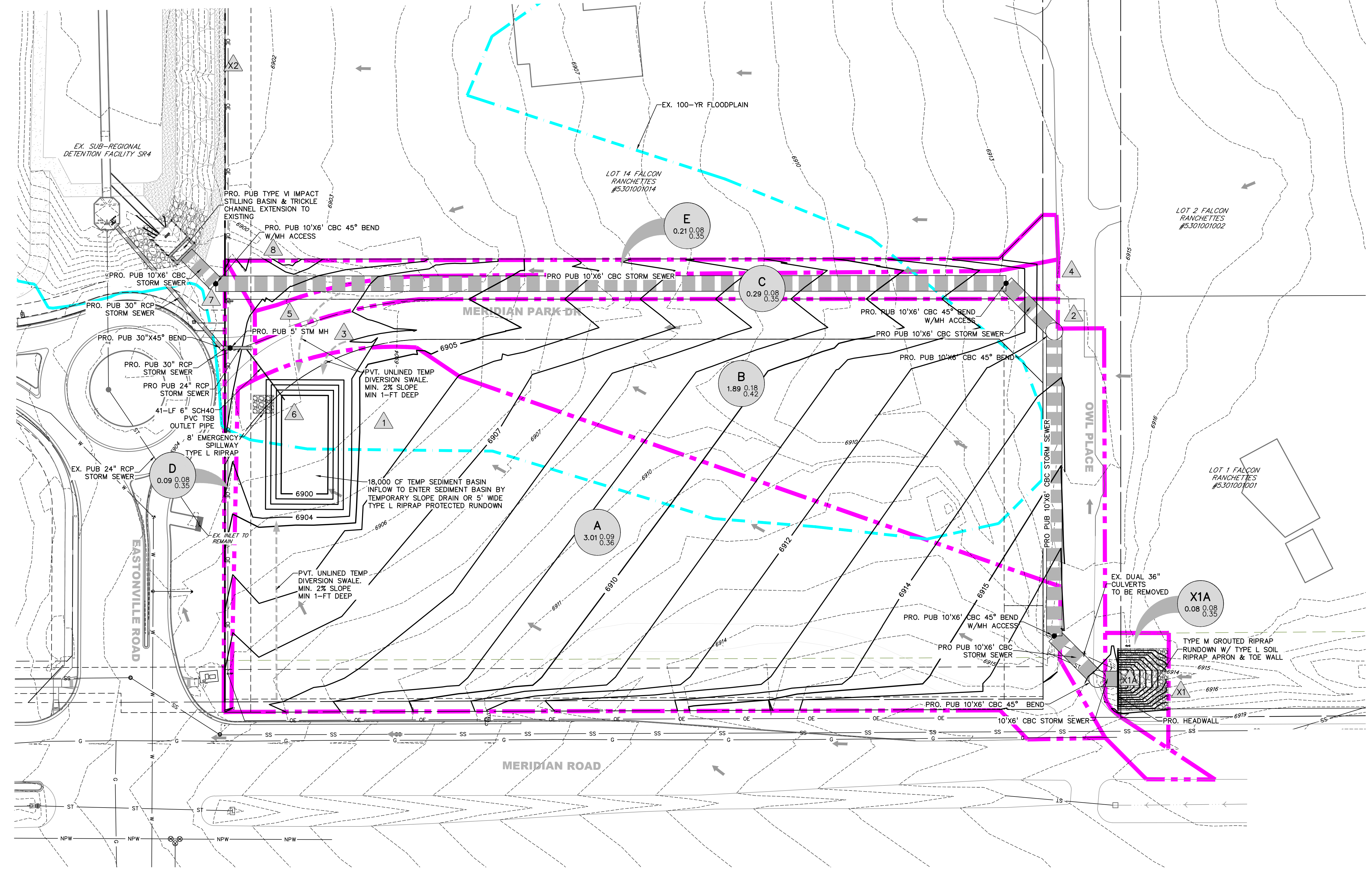
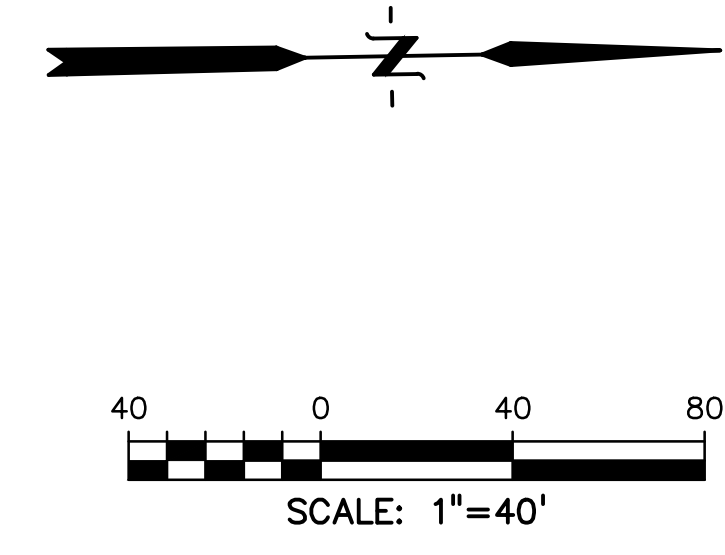

PREPARED BY:



CLIENT:

BH RE INVESTMENTS, LLC  
 450 N MCCLINTOCK DRIVE  
 CHANDLER, AZ 85226  
 (480) 313-2724

DRAINAGE PLANS FOR:  
**OWL MARKETPLACE**  
 FALCON, COLORADO

ISSUE	DATE
INITIAL ISSUE	7/23/2024
RESUBMITTAL	9/5/2024
DESIGNED BY:	KGV
DRAWN BY:	CGH
CHECKED BY:	TDM
FILE NAME:	21611-DRN-OL

PREPARED UNDER MY DIRECT SUPERVISION FOR AND ON BEHALF OF DREXEL, BARRELL & CO.  
 DRAWING SCALE:  
 HORIZONTAL: 1" = 40"  
 VERTICAL: N/A

**OVERLOT DRAINAGE MAP**

PROJECT NO. 21611-01CSCV  
 DRAWING NO.

**DRN**