

**FINAL DRAINAGE REPORT
FOR
STERLING RANCH RECYCLING FACILITY**

Prepared For:

**SR Land, LLC
20 Boulder Crescent, Suite 200
Colorado Springs, CO 80903
(719) 491-3024**

**February 2024
Project No. 25188.14
PCD Filing No: PPR2341 & SF2325**

**Prepared By:
JR Engineering, LLC
5475 Tech Center Drive, Suite 235
Colorado Springs, CO 80919
719-593-2593**

ENGINEER'S STATEMENT:

The attached drainage plan and report were prepared under my direction and supervision and are correct to the best of my knowledge and belief. Said drainage letter has been prepared according to the criteria established by El Paso County for drainage reports and said report is in conformity with the master plan of the drainage basin. I accept responsibility for any liability caused by any negligent acts, errors, or omissions on my part in preparing this report.

Ryan Burns, Colorado P.E. 0054412
For and On Behalf of JR Engineering, LLC

DEVELOPER'S STATEMENT:

I, the developer, have read and will comply with all of the requirements specified in this drainage report and plan.

Business Name: SR Land, LLC

By: _____

Title: _____

Address: 20 Boulder Crescent, Suite 200
Colorado Springs, CO 80903

El Paso County:

Filed in accordance with the requirements of the El Paso County Land Development Code, Drainage Criteria Manual, Volumes 1 and 2 and Engineering Criteria Manual, as amended.

County Engineer/ ECM Administrator



Table of Contents

Purpose.....	1
General Site Description	1
General Location	1
Description of Property	1
Floodplain Statement.....	1
Existing Drainage Conditions	2
Major Basin Descriptions	2
Existing Sub-basin Drainage	2
Proposed Drainage Conditions	4
Proposed Conveyance	4
Proposed Sub-basin Drainage.....	4
Ultimate Sub-basin Drainage	7
Drainage Design Criteria	8
Development Criteria Reference	8
Hydrologic Criteria.....	8
Hydraulic Criteria.....	8
Drainage Facility Design	10
General Concept	10
Four Step Process to Minimize Adverse Impacts of Urbanization	10
Water Quality	11
Erosion Control Plan	13
Operation & Maintenance	13
Drainage and Bridge Fees	13
Construction Cost Opinion	14
Summary	14
References.....	15

APPENDICES

- Appendix A – Vicinity Map, Soil Descriptions, FEMA Floodplain Map
- Appendix B – Hydrologic Calculations
- Appendix C – Hydraulic Calculations
- Appendix D – Reference Material
- Appendix E – Drainage Maps



PURPOSE

This document is the Final Drainage Report for Sterling Ranch Recycling Facility. The purpose of this report is to identify on-site and off-site drainage patterns, areas tributary to the site, and compare existing and proposed drainage conditions.

GENERAL SITE DESCRIPTION

GENERAL LOCATION

Sterling Ranch Recycling Facility (hereby referred to as the “site”) is a proposed development within the Sterling Ranch master planned community with a total area of approximately 32 acres. The site is presently used as a concrete and asphalt recycling facility.

The site is located in the north half of Section 5, Township 13 South, Range 65 West of the Sixth Principal Meridian in El Paso County, State of Colorado. The site is bounded by Marksheffel Road to the east, Pioneer Sand CO land to the west and south, and unplatted land to the north. Refer to the vicinity map in Appendix A for additional information.

DESCRIPTION OF PROPERTY

In the existing condition analysis, the property was analyzed at the time of the parcel sale in 2021. Before the sale of the site in 2021, the parcel had been used as a crushing facility for a nearby mining operation. The crushing business halted operations and vegetation was established on portions of the site prior to the sale. There was an asphalt access road and compacted gravel roads on the site at the time of sale. The site generally slope(s) to the south at 1 to 6% towards an existing 8’ berm on the southern edge of the property. In the proposed interim condition, the property will be used as an asphalt and concrete recycling facility with asphalt drives, a staging area and some existing grasslands. In the ultimate condition, the site and surrounding properties are assumed to be developed per their land use which includes heavy industrial, multi-family residential, and commercial.

Soils located on the project site are Blakeland Loamy Sand (8) and Columbine Gravelly Sandy Loam (19). These soils are classified as Hydrologic Soil Group A. Group A soils exhibit high infiltration rates when thoroughly wet, and consist mainly of deep, well drained to excessively drained sands or gravelly sands. Refer to the soil survey map in Appendix A for additional information.

There are no known irrigation facilities located on the project site.

FLOODPLAIN STATEMENT

Based on the FEMA FIRM Maps number 08041C0533G, dated December 7, 2018, the entire site lies within Zone X. Zone X is defined as area outside the Special Flood Hazard Area (SFHA) and higher



than the elevation of the 0.2-percent-annual-chance (or 500-year) flood. Refer to the FIRM Map in Appendix A for additional information.

EXISTING DRAINAGE CONDITIONS

MAJOR BASIN DESCRIPTIONS

The site lies within the upper Sand Creek Drainage Basin based on the “Sand Creek Drainage Basin Planning Study” (DBPS) completed by Kiowa Engineering Corporation in January 1993, revised March 1996. The Sand Creek Drainage Basin covers approximately 54 square miles and is divided into 7 major sub-basins. The site is within the respective upper basin Sand Creek sub-basin as shown in Appendix D. Sand Creek ultimately enters Fountain Creek about two miles upstream of the Academy Boulevard bridge over Fountain Creek.

The site generally drains from north to southwest. Sand Creek is located to the east of the site and runs from north to south. This reach of drainage conveyance does not currently have any improvements. As of the date of this report, Kiowa is performing studies and plans to address Sand Creek stabilization adjacent to the site.

EXISTING SUB-BASIN DRAINAGE

The existing condition analyzes the parcel at the latest time of sale in 2021. The existing condition of the site was broken into nine sub-basins including six on-site basins and three off-site basins. The basin delineation is shown in the existing drainage map in Appendix E and is described as follows:

Basin EXA ($Q_5=1.1$ cfs, $Q_{100}=5.4$ cfs) is 2.68 acres with an 8 percent impervious and is located on the northwestern portion of the site. This basin is comprised of part of an existing paved access road, existing vegetation and undeveloped area. Runoff from this basin sheet flows southwest onto the adjacent property to the west at design point (DP) 1. Runoff follows historical drainage patterns off-site and outfalls to Sand Creek.

Basin EXB ($Q_5=0.6$ cfs, $Q_{100}=4.3$ cfs) is 2.60 acres with a 2 percent impervious and is located on the western portion of the site. This basin is comprised of existing vegetation and undeveloped area. Runoff from this basin sheet flows southwest onto the adjacent property to the west at DP2. Runoff follows historical drainage patterns off-site and outfalls to Sand Creek.

Basin EXC ($Q_5=1.0$ cfs, $Q_{100}=4.3$ cfs) is 2.11 acres with a 14 percent impervious and is located on the southwest portion of the site. This basin is comprised of several existing gravel roads, existing vegetation and undeveloped area. Runoff from this basin sheet flows southwest to DP3 located along the existing 8' berm. Runoff from DP3 infiltrates the ground along the berm's toe of slope.



Basin EXD ($Q_5=7.6$ cfs, $Q_{100}=28.1$ cfs) is 13.44 acres with a 17 percent impervious and is located on the western central portion of the site. This basin is comprised of part of an existing paved access road, several existing gravel roads, existing vegetation and undeveloped area. Runoff from this basin sheet flows south to DP4 located along the existing 8' berm. Runoff from DP4 flows south across the existing berm via an existing 12" PVC pipe. Runoff follows historical drainage patterns off-site and outfalls to Sand Creek.

Basin OS1 ($Q_5=1.4$ cfs, $Q_{100}=9.2$ cfs) is 8.74 acres with a 2 percent impervious and is located to the north of the site. This basin is comprised of off-site undeveloped area tributary to the site. Runoff from this basin sheet flows south and then east along the existing off-site berm to DP5. Runoff from DP5 flows south entering into Basin EXE. Runoff follows historical drainage patterns within Basin EXE and combines at DP7.1.

Basin OS3 ($Q_5=0.2$ cfs, $Q_{100}=0.9$ cfs) is 0.29 acres with a 2 percent impervious and is located to the south of the site. This basin is comprised of off-site undeveloped area tributary to the proposed pond. Runoff from this basin sheet flows north to DP6 entering into Basin EXE. Runoff follows historical drainage patterns within Basin EXE and combines at DP7.1.

Basin EXE ($Q_5=2.0$ cfs, $Q_{100}=13.4$ cfs) is 8.51 acres with a 2 percent impervious and is located on the eastern central portion of the site. This basin is comprised of part of several existing dirt access roads, existing vegetation and undeveloped area. Runoff from this basin sheet flows south and then east to DP6 located along the existing 8' berm. Runoff from DP5, DP6, and DP7 combine at DP7.1 ($Q_5=2.8$ cfs, $Q_{100}=18.3$ cfs). Runoff from DP7.1 continues to flow southeast through the neighboring property to the south. Flow becomes concentrated off-site in a natural stream section that ultimately follows the historical drainage patterns into Sand Creek.

Basin OS2 ($Q_5=0.2$ cfs, $Q_{100}=1.1$ cfs) is 0.53 acres with a 2 percent impervious and is located to the east of the site. Runoff from this basin sheet flows west to DP8 entering into Basin EXF. Runoff follows historical drainage patterns within Basin EXE and combines at DP9.1.

Basin EXF ($Q_5=0.8$ cfs, $Q_{100}=5.2$ cfs) is 3.09 acres with a 2 percent impervious and is located on the eastern portion of the site. This basin is comprised of part of an existing dirt access road and undeveloped area. Runoff from this basin sheet flows southeast to DP9 located along the eastern side of the site. Runoff from DP8 and DP9 combine at DP9.1 ($Q_5=0.9$ cfs, $Q_{100}=6.1$ cfs). Runoff from DP9.1 continues to flow south through the neighboring sanitary lift station property to the east. Flow becomes concentrated off-site in a natural stream section that ultimately follows the historical drainage patterns into Sand Creek.



PROPOSED DRAINAGE CONDITIONS

PROPOSED CONVEYANCE

In general, developed flows are collected in proposed swales, which convey water to the proposed water quality and detention area. Proposed swale sections were designed to ensure they are stable and have required capacity to satisfy criteria. A swale is considered stable with a velocity of 5 ft/s or less. Where swale Froude numbers exceed 0.8, swales will be reinforced with the specified SC250 VMax TRM (turf reinforcement mat) product (or approved equivalent) shown in Appendix C. Specific locations where the TRM is required in swale sections is shown in the Grading and Erosion Control Construction Documents. To ensure capacity, swales will have a minimum of 1 ft. of freeboard over the water surface for flows anticipated in a 100-year storm event. In addition to the swales, a proposed culvert also conveys flows under the access roadway. The culvert was sized to not overtop the roadways with flows from a 100-year storm event. Detailed swale calculations, sections, and culvert calculations are located in Appendix C.

PROPOSED SUB-BASIN DRAINAGE

The proposed condition analyzes the parcel for the interim use of a recycling facility. The Rational Method produced flows that were used to design the proposed interim swales, culverts, storm sewer, and pond forebays. The proposed site was broken into eight basins including six on-site basins and two off-site basins. The proposed basin delineation is shown on the drainage basin map within Appendix E and is described as follows:

Basin A ($Q_5=0.3$ cfs, $Q_{100}=1.6$ cfs) is 0.50 acres with a 2% impervious and is located on the western and a portion of the southern property line of the site. This basin is comprised of proposed area to remain undeveloped and therefore follows the historic drainage pattern flowing off-site to the west and south undetained or treated. This is in accordance with Section I.7.1.B.7 of the ECM Stormwater Quality Policy and Procedure. Runoff from this basin sheet flows southwest to DP1 and then off-site to the adjacent property to the west. Runoff then follows historical drainage patterns sheet flowing off-site and outfalls to Sand Creek.

Basin B ($Q_5=7.4$ cfs, $Q_{100}=25.1$ cfs) is 14.03 acres with a 19 percent impervious and is located on the western central portion of the site. This basin is comprised of part of a paved roadway, raw concrete stockpile, raw concrete with rebar stockpile, asphalt stockpile, weighing station, mobile crusher, fence, part of temporary gravel road, swales and undeveloped land. Runoff from this basin sheet flows overland south to a proposed swale that directs flows east to DP2. Runoff from DP2 is combined at the proposed 54" FES at DP4.2. Runoff from this basin is captured and treated within proposed Pond A.



Basin OS1 ($Q_5=1.4$ cfs, $Q_{100}=9.2$ cfs) is 8.74 acres with a 2 percent impervious and is located to the north of the site. This basin is comprised of off-site undeveloped area tributary to the site. Runoff from this basin sheet flows south and then east along the existing off-site berm to DP3. Runoff from DP3 flows south entering into Basin C. Runoff follows the drainage patterns within Basin C and combines at the proposed 24" RCP culvert at DP4.1.

Basin C ($Q_5=3.4$ cfs, $Q_{100}=17.7$ cfs) is 10.70 acres with a 6 percent impervious and is located on the eastern central portion of the site. This basin is comprised of a part of proposed Sterling Ranch Road, asphalt access roads, swales and undeveloped land. Runoff from this basin flows along proposed curb and gutter as well as sheet flows overland south to proposed swales that directs flows east to DP4. Runoff from DP4 is combined with flows from DP3 at the proposed 24" RCP culvert at DP4.1 ($Q_5=3.7$ cfs, $Q_{100}=21.1$ cfs). Runoff from DP4.1 enters the proposed culvert into Basin B and a proposed swale directs flows to the proposed 54" FES at DP4.2 ($Q_5=9.3$ cfs, $Q_{100}=40.1$ cfs). DP4.2 flows are piped to the west forebay within the pond and combine at DP9.1. Runoff from this basin is captured and treated within proposed Pond A.

Basin D ($Q_5=0.5$ cfs, $Q_{100}=3.7$ cfs) is 2.16 acres with a 2 percent impervious and is located on the eastern boundary of the site. This basin is comprised of undeveloped land. Runoff from this basin sheet flows overland southeast to a proposed swale that directs flows south to DP5. Runoff from DP5 is combined at the proposed Type C sump inlet at DP7.1 within Basin E. Runoff from this basin is captured and treated within proposed Pond A.

Basin E ($Q_5=2.2$ cfs, $Q_{100}=7.1$ cfs) is 3.10 acres with a 22 percent impervious and is located on the eastern portion of the site. This basin is comprised of a part of proposed Sterling Ranch Road, part of a temporary gravel road, asphalt access road, swale and undeveloped land. Runoff from this basin flows along proposed curb and gutter and then sheet flows overland southeast to a proposed swale that directs flows east to DP6. Runoff from DP6 is combined at the proposed Type C sump inlet at DP7.1. Runoff from this basin is captured and treated within proposed Pond A.

Basin OS2 ($Q_5=0.1$ cfs, $Q_{100}=0.7$ cfs) is 0.36 acres with a 2 percent impervious and is located to the east of the site. This basin is comprised of off-site undeveloped area tributary to the proposed pond. Runoff from this basin sheet flows west and then south along the property boundary to DP7. Runoff from DP7 is combined with DP5 and DP6 flows at the proposed Type C sump inlet at DP7.1 ($Q_5=2.8$ cfs, $Q_{100}=11.2$ cfs). DP7.1 flows are piped to the north forebay within the pond and combine at DP9.1.

Basin OS3 ($Q_5=0.2$ cfs, $Q_{100}=1.0$ cfs) is 0.30 acres with a 2 percent impervious and is located to the south of the site. This basin is comprised of off-site undeveloped area tributary to the proposed pond. Runoff from this basin sheet flows north to DP8. Runoff from DP8 combines with DP4.2, DP7.1, and DP6 flows at the proposed outlet structure at DP9.1.



Basin F ($Q_5=0.6$ cfs, $Q_{100}=4.4$ cfs) is 2.27 acres with a 2 percent impervious and is located on the southeast portion of the site. This basin is comprised of a proposed full-spectrum extended detention basin (EDB) within Tract A and the proposed off-site detention pond easement. Runoff from this basin sheet flows overland to a proposed trickle channel that directs flows east to DP9. Runoff from DP9 is combined with flows from DP4.2, DP7.1, and DP8 at the proposed full-spectrum EDB outlet structure at DP9.1 ($Q_5=11.4$ cfs, $Q_{100}=49.4$ cfs). DP8.1 represents the total proposed flows that will enter the proposed full-spectrum EDB in the interim condition. Flows will be released through the outlet structure at DP9.2 ($Q_5=0.1$ cfs, $Q_{100}=8.3$ cfs) and connect into the existing storm infrastructure sending the flows east where they will eventually follow the historical drainage patterns into Sand Creek.

Basin G ($Q_5=2.2$ cfs, $Q_{100}=7.1$ cfs) is 0.06 acres with a 67 percent impervious and is located on the eastern portion of the site. This basin is comprised of a part of proposed Sterling Ranch Road. Runoff from this basin flows along proposed curb and gutter east to DP10 then flows off-site basin OS4. Flows combine at DP11.1 within Basin OS4. Due to the proposed highpoint in the Sterling Ranch Road it is not practicable to capture runoff from this basin and flows go off-site to the east undetained or treated. This is in accordance with Section I.7.1.C.1a of the ECM Stormwater Quality Policy and Procedure. The total uncaptured area for this site (Basins A and G) total 0.56 acres, which is under the 1 acre maximum threshold.

Basin OS4 ($Q_5=6.7$ cfs, $Q_{100}=12.8$ cfs) is 2.08 acres with an 82 percent impervious and is located to the east of the site. This basin is comprised of off-site area comprised of a portion of Marksheffel Road and an existing Type R on-grade inlet. Runoff from this basin flows southeast to DP11 and flows with DP10 combine at the existing 15' Type R on-grade inlet at DP11.1 ($Q_5=6.9$ cfs, $Q_{100}=13.1$ cfs). Bypass flows from this inlet follow the existing path along Marksheffel Road and are less than existing.

In the interim condition, there are three locations where flows leave the site.

1. Flows from Basin A leave the site uncaptured and untreated at DP1 ($Q_5=0.3$ cfs, $Q_{100}=1.6$ cfs). Flows from existing Basins EXA-EXD travel off-site along the western and southern boundaries at DP1-4 for a total flow of $Q_5=10.3$ cfs, $Q_{100}=42.1$ cfs. Compared to the existing flows, Basin A flows are less than historic and will not adversely affect downstream infrastructure.
1. Released flows from the pond outlet structure at DP9.2 ($Q_5=0.1$ cfs, $Q_{100}=8.3$ cfs) are released into the existing storm infrastructure located adjacent to the site. Flows from existing design points DP7.1 and 9.1 flow off-site to the south for a total flow of $Q_5=3.7$ cfs, $Q_{100}=24.4$ cfs. Compared to the existing flows, DP9.2 flows are less than historic and will not adversely affect downstream infrastructure. See the ultimate section below for more information on the existing downstream infrastructure.
2. Flows from Basin G leave the site uncaptured and untreated at DP10 ($Q_5=0.2$ cfs, $Q_{100}=0.4$ cfs) and combine with OS4 flows at DP11 ($Q_5=6.7$ cfs, $Q_{100}=12.8$ cfs) at the existing 15'



Type R on-grade inlet at DP11.1 ($Q_5=6.9$ cfs, $Q_{100}=13.1$ cfs). The existing inlet was constructed as part of Sterling Ranch Filing No. 2 (see applicable excerpts in Appendix D). The Filing 2 report Basin A10 (Basin OS4) has a total flow to the 15' Type R on-grade inlet of $Q_5=9.2$ cfs, $Q_{100}=17.3$ cfs. Compared to the existing flows, DP11.1 flows are less than historic and will not adversely affect downstream infrastructure.

ULTIMATE SUB-BASIN DRAINAGE

The ultimate condition analyzes the parcel and tributary properties for the future development based on the land use in order to design the ultimate full-spectrum EDB and spillway overflow path. The ultimate site was broken into five land uses. The land uses are shown on the proposed drainage map within Appendix E and is described as follows.

- Lot 1 is 4.74 acres and is zoned as Heavy Industrial Area (90% impervious)
- Urban Non-Residential Collector Roadway (80' R.O.W.) is 1.78 acres (100% impervious for roadway, curb & gutter, and sidewalk width, 2% impervious for other areas)
- Lot 2 is 24.05 acres and is zoned as Residential-1/8 Acre or Less (65% impervious)
- Tract A is 1.85 acres and is used as detention pond area (2% impervious)
- Off-site vacant land to the north is 8.74 acres and is zoned as Commercial Area (95% impervious)
- Off-site Tract/ Lift Station land to the east is 1.87 acres and is zoned as Heavy Industrial Area (90% impervious)
- Off-site land to the east is 0.44 acres and is used as detention pond area (2% impervious)
- Off-site land to the south is 0.30 acres and flows to detention pond area (2% impervious)
- Total Area = 43.77 acres with 71.6% impervious (used 72% for design)

The ultimate condition was used overall to size the full-spectrum EDB and ensure it will operate for future developments.

In the ultimate condition, there is one location where flows leave the site.

2. Ultimate released flows from the pond outlet structure ($Q_5=1.5$ cfs, $Q_{100}=22.2$ cfs) are released into the existing storm infrastructure located adjacent to the site. Flows from existing design points DP7.1 and 9.1 flow off-site to the south for a total flow of $Q_5=3.7$ cfs, $Q_{100}=24.4$ cfs. The existing downstream 66" RCP that the outfall ties into was designed and installed as part of the Sterling Ranch Filing 2 development. The existing 66" RCP was designed for Filing 2 DP4.7 flows ($Q_5=58.4$ cfs, $Q_{100}=248.6$ cfs) and the ultimate condition flows ($Q_5=32.2$ cfs, $Q_{100}=255.6$ cfs) will result in an increase in flows in the major storm. The StormCAD analysis in Appendix C shows that the existing storm system was designed deep enough to have the capacity for the increase in flow. There are also no adverse affects from the increase in flow in the minor storm shown in the MHFD Detention spreadsheet as the existing storm system was designed to handle the peak 100-year flows which greatly surpass



the 5-year flow rates. See Appendix C for the StormCAD analysis and calculations. The existing storm system the proposed site ties continues to travel east and south about 1,800 feet before ultimately releasing directly into Sand Creek.

DRAINAGE DESIGN CRITERIA

DEVELOPMENT CRITERIA REFERENCE

Storm drainage analysis and design criteria for this project were taken from the “*City of Colorado Springs/El Paso County Drainage Criteria Manual*” Volumes 1 and 2 (EPCDCM), dated October 12, 1994, the “*Urban Storm Drainage Criteria Manual*” Volumes 1 to 3 (USDCM) and Chapter 6 and Section 3.2.1 of Chapter 13 of the “*Colorado Springs Drainage Criteria Manual*” (CSDCM), dated May 2014, as adopted by El Paso County.

HYDROLOGIC CRITERIA

All hydrologic data was obtained from the “*El Paso Drainage Criteria Manual*” Volumes 1 and 2, and the “*Urban Drainage and Flood Control District Urban Storm Drainage Criteria Manual*” Volumes 1, 2, and 3. On-site drainage improvements were designed based on the 5-year (minor) storm event and the 100-year (major) storm event. Runoff was calculated using the Rational Method, and rainfall intensities for the 5-year and the 100-year storm return frequencies were obtained from Table 6-2 of the CSDCM. One-hour point rainfall data for the storm events is identified in the chart below. Runoff coefficients were determined based on proposed land use and from data in Table 6-6 from the CSDCM. Time of concentrations were developed using equations from CSDCM. All runoff calculations and applicable charts and graphs are included in the Appendices.

Table 1: 1-hr Point Rainfall Data

Storm	Rainfall (in.)
5-year	1.50
100-year	2.52

HYDRAULIC CRITERIA

The Rational Method and USDCM’s SF-2 and SF-3 forms were used to determine the runoff from the minor and major storms on the site. Autodesk Hydraflow Express was used to size the overflow channel and drainage swales per criteria. The MHFD-Detention_v4.06 spreadsheet was utilized for evaluating proposed detention and water quality for Pond A. Bentley StormCAD v8i was used to analyze the hydraulic grade lines and energy grade lines for the storm sewer network. Manhole and pipe losses for the model were obtained from the *Modeling Hydraulic and Energy Gradients in Storm Sewers: A Comparison of Computation Methods*, by AMEC Earth & Environmental, Inc. The manhole loss coefficients used in the model can be seen in Table 2 (below), this method is accurate



for pipes 42” and smaller for larger pipes the Standard head-loss coefficients as recommended by Bentley were used as shown in Table 3. StormCAD, Autodesk Hydraflow results, along with street and inlet capacities, are presented in Appendix C.

Table 2: Storm Head-loss Coefficients

StormCAD Conversion Table			
Bend Loss	Bend Angle	K coefficient Conversion	
	0	0.05	
	22.5	0.1	
	45	0.4	
	60	0.64	
	90	1.32	
Lateral Loss	1 Lateral K coefficient Conversion		
	Bend Angle	Non Surcharged	Surcharged
	45	0.27	0.47
	60	0.52	0.9
	90	1.02	1.77
	2 Laterals K coefficient Conversion		
	45	0.96	
	60	1.16	
90	1.52		

Table 3 - Storm Head-loss Coefficients

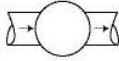
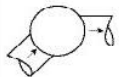
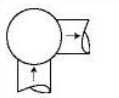
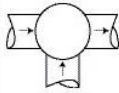
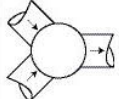
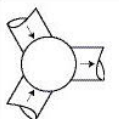
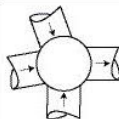
Type of Manhole	Diagram	Headloss Coefficient
Trunkline only with no bend at the junction		0.5
Trunkline only with 45° bend at the junction		0.6
Trunkline only with 90° bend at the junction		0.8
Trunkline with one lateral		Small 0.6 Large 0.7
Two roughly equivalent entrance lines with angle < 90° between lines		0.8
Two roughly equivalent entrance lines with angle > 90° between lines		0.9
Three or more entrance lines		1.0

DRAINAGE FACILITY DESIGN

GENERAL CONCEPT

The project site is anticipated to be developed in phases, beginning with the development of the Sterling Ranch Recycling Facility portion of Lot 2. This is known as the “interim condition”. In the future, it is anticipated that Lot 1 will develop as a heavy industrial area, Lot 2 will develop as multi-family, proposed Sterling Ranch Road R.O.W. will develop as an urban non-residential collector roadway, unplatted land to the north of the site will develop as a commercial area, tract land to the east of the site will develop as heavy industrial, and Tract A will develop as the full-spectrum EDB. The timing and specific site details are largely unknown at this time. The fully developed site and tributary properties is referred to as the “ultimate condition”.

All on-site swales, culverts, and conveyances were designed for the interim phase. The proposed full-spectrum EDB was designed for the interim condition. To limit the amount of required modifications and re-work upon ultimate developed conditions, the outlet pipe, emergency spillway, pond volume, 6-ft trickle channel, and emergency overflow inlet structure, were all sized per the anticipated ultimate conditions. The 2-ft trickle channel, forebays and orifice plate were all designed per the interim condition to ensure the pond will function as required until the site further develops. Upon development of the remaining undeveloped lots, lot specific drainage report(s) must be submitted to ensure the proposed full-spectrum EDB and drainage system designs herein are adequate to accommodate the developed flows. The reports shall identify any proposed modification, if needed, to ensure proposer functionality of the drainage system(s) and compliance with the current EPC criteria. Treated water will outfall to the existing storm infrastructure to the east of the site and will eventually outfall into Sand Creek. A proposed drainage map is provided in Appendix E.

FOUR STEP PROCESS TO MINIMIZE ADVERSE IMPACTS OF URBANIZATION

In accordance with the El Paso County Drainage Criteria Manual Volume 2, this site has implemented the four-step process to minimize adverse impacts of urbanization. The four-step process includes reducing runoff volumes, treating the water quality capture volume (WQCV), stabilizing drainage ways, and implementing long-term source controls.

Step 1 – Reducing Runoff Volumes: In the interim site development, the site will remain largely undeveloped. Runoff is routed by sheet flow and grass-lined swales to promote infiltration and reduce runoff. The ultimate site development partly consists of multi-family homes with open spaces and lawn areas interspersed within the development which helps disconnect impervious areas and reduce runoff volumes. Roof drains from the structures will discharge to lawn areas, where feasible, to allow for infiltration and runoff volume reduction.

Step 2 – Stabilize Drainageways: The site lies within the Sand Creek Drainage Basin. Basin and bridge fees will be due at time of platting. These funds will be used for the future channel stabilization being designed by Kiowa adjacent to the site and on future projects within the basin to



stabilize drainageways. The site does not discharge directly into the open drainageway of Sand Creek, therefore no downstream stabilization will be accomplished with this project.

Step 3 – Treat the WQCV: Water Quality treatment for this site is provided in a proposed full-spectrum extended detention basin (Pond A). It is not practicable to capture runoff from interim Basins A and G due to the grading of those basins. In accordance with Section I.7.1.C.1a of the ECM Stormwater Quality Policy and Procedure, the total uncaptured area for this site total 0.56 acres, which is under the 1 acre maximum threshold. The runoff from this site will be collected within swales to FES and inlets and conveyed to the proposed pond via storm sewer. Upon entrance to the ponds, flows will be captured in forebays designed to promote settlement of suspended solids. A concrete trickle channel is also incorporated into the pond to minimize the amount of standing water. The outlet structure has been designed to detain the water quality capture volume (WQCV) for 40 hours, and the extended urban runoff volume (EURV) for 72 hours. Major flows released from the ponds will be reduced to less than historic rates.

Step 4 –BMPs will be utilized to minimize off-site contaminants and to protect the downstream receiving waters. Site specific temporary source control BMPs that will be implemented include, but are not limited to, silt fencing placed around downstream areas of disturbance, construction vehicle tracking pads at the entrances, designated concrete truck washout basin, designated vehicle fueling areas, covered storage areas, spill containment and control, etc. The permanent erosion control BMPs include asphalt drives, storm inlets, storm pipe, the full-spectrum EDB Pond A and permanent vegetation. Maintenance responsibilities and plans will be defined at the time of final platting.

WATER QUALITY

The “Soils and Geology Study: Lot 1, Sterling Ranch Recycling Facility” prepared by Entech Engineering showed some bore test results with groundwater located within 4 to 5 feet of the surface. The test borings taken (TB-1 and TB-2) were not located in the immediate vicinity of the proposed full-spectrum EDB, which is located to the southeast portion of the site. See excerpts of the soil report in Appendix D. At the time of construction, if shallow groundwater is located where the full-spectrum EDB is proposed, mitigation options such as clay or geomembrane layers shall be utilized.

In accordance with Section 13.3.2.1 of the CCS/EPCDCM, full-spectrum water quality and detention are provided for all developed basins. The ultimate condition was used to size the full-spectrum EDB to ensure the required volume, forebay structures sized per required volumes, outlet structure, trickle channels to ensure capacity for 2% of peak 100-year inflow, and emergency spillway and overflow structure design to ensure freeboard and capacity. The concrete forebays (West and North) were sized per the ultimate tributary areas for each to ensure they had the required volumes and release rates for the ultimate condition. The outlet structure was designed to replace the interim orifice plate with the ultimate orifice plate to ensure drain times were met in both conditions.

The interim condition will utilize the same pond grading design and outlet structure, but will have a different orifice plate design to ensure the interim design meets criteria for drain times. Upon development of the surrounding properties (unplatted land to the north and tract land to the east) and the ultimate site, a lot specific drainage report shall be prepared to confirm the adequacy of Pond A to accept, treat, and detain the developed flows per EPC requirements and acceptable criteria.

Where possible, flows were routed through proposed swales to promote infiltration and reduce runoff. Flows for the interim site are routed through the proposed swales and the proposed storm sewer system to a proposed full-spectrum extended detention basin, Pond A. The proposed ultimate WQCV for the pond shall be released within 40 hours and the ultimate EURV shall be released within 72 hours. Proposed interim Basins B-F, OS1, and OS2 are tributary to the proposed Pond A. It is not practicable to capture runoff from interim Basins A and G due to the grading of those basins. In accordance with Section I.7.1.C.1a of the ECM Stormwater Quality Policy and Procedure, the total uncaptured area for this site total 0.56 acres, which is under the 1 acre maximum threshold. The table below provides the volumes required for the proposed pond, along with the release rates for the 5-year and 100-year storm. The proposed pond will utilize forebays, trickle channels, and an outlet structure to dissipate energy and treat flows. The proposed outlet structure for this pond shall reduce the release rates for the major storm events to less than historic rates to minimize adverse impacts to downstream stormwater facilities. For some minor storm events, the release rate is higher than the existing predevelopment flows. There are no adverse affects from the increase in flow in the minor storm as the existing storm system was designed to handle the peak 100-year flows which greatly surpass the 5-year flow rates. See the proposed sub-basin section above for a comparison of flows leaving the site. The outlet structure was designed to meet drain times for the WQCV, EURV, and 100-year events.

A broad crested weir lined with Type L buried soil riprap is provided as an emergency spillway for Pond A. A concrete cutoff wall is not required as the flows are spread over the 120' wide crest and have sufficient stability with the use of Type L buried soil riprap. The emergency spillway provided will convey flows into a proposed outfall channel that will direct flows to the proposed emergency overflow structure (Double Type D sump inlet) to the south of the existing sanitary lift station. The emergency overflow structure was sized to have the capacity for the ultimate peak undetained 100-year flow for Pond A and connects to the existing storm infrastructure that crosses Marksheffel Rd. This will ensure that emergency flows are captured and are directed away from Aspen Meadows Subdivision Filing No. 2.

The released flows from Pond A discharges into the proposed emergency overflow structure and then connects to an existing 10.33'x10.33' storm junction box. Flows upstream from the north of this junction within the existing 54" RCP storm line are $Q_5=30.7$ cfs and $Q_{100}=233.4$ cfs. The proposed released flows ($Q_5=1.5$ cfs, $Q_{100}=22.2$ cfs) combine with these existing flows and then continues within an existing 66" RCP storm pipe for a total flow of $Q_5=32.2$ cfs and $Q_{100}=255.6$ cfs. The existing 66" RCP was designed for Filing 2 DP4.7 flows ($Q_5=58.4$ cfs, $Q_{100}=248.6$ cfs) and the



ultimate condition flows will result in an increase in flows in the major storm. The StormCAD analysis in Appendix C shows that the existing storm system was designed deep enough to have the capacity for the increase in flow. The existing storm system the proposed site ties continues to travel east and south about 1,800 feet before ultimately releasing directly into Sand Creek.

Pond A will be private and maintained by the property owner. Access shall be granted to the owner and El Paso County for maintenance of the private full-spectrum EDB.

	Required Volume (ac-ft)	Provided Volume (ac-ft)	WQCV (ac-ft)	EURV (ac-ft)	5-year Release (cfs)	100-year Release (cfs)
Interim	1.054	6.110	0.254	0.349	0.1	8.3
Ultimate	5.864	6.110	1.039	4.036	1.5	22.2

EROSION CONTROL PLAN

We respectfully request that the Erosion Control Plan be submitted in conjunction with the Grading and Erosion Control Plan prior to obtaining a grading permit.

OPERATION & MAINTENANCE

In order to ensure the function and effectiveness of the stormwater infrastructure, maintenance activities such as inspection, routine maintenance, restorative maintenance, rehabilitation and repair, are required. The property owner shall be responsible for the inspection, maintenance, rehabilitation and repair of stormwater and erosion control facilities located on the property unless another party accepts such responsibility in writing and responsibility is properly assigned through legal documentation. This includes swales, inlets, and storm sewer that is to be maintained by the property owner. Access is provided from on-site facilities and easements for proposed infrastructure located off-site. The gravel maintenance road access is off future Sterling Ranch Road and wraps around the top of the pond providing access to the 6-foot trickle channel at the bottom of the pond. The trickle channel is 6-foot wide to allow anticipated maintenance vehicles to travel towards required pond structures (forebays and outlet structure) for the proposed pond.

DRAINAGE AND BRIDGE FEES

The site lies within the Sand Creek Drainage Basin. Anticipated drainage and bridge fees are presented below and will be due at time of platting (depending on date of plat submittal):

Sterling Ranch Recycling Facility - Impervious Area Calculation			
Breakdown	Area (acres)	% Impervious	Impervious Acres
R.O.W.	1.7826	100%	1.78
Lot 1	4.7423	90%	4.27
Lot 2	24.0565	65%	15.64
Tracts A - EDB	1.8448	2%	0.04
Total	32.4262		21.72



2024 Drainage and Bridge Fees – Sterling Ranch Recycling Facility				
Impervious Acres (ac.)	Sand Creek Drainage Fee (Per Imp. Acre)	Bridge Fee (Per Imp. Acre)	Sterling Ranch Recycling Facility Drainage Fee	Sterling Ranch Recycling Facility Bridge Fee
21.72	\$25,632	\$10,484	\$556,837.03	\$227,757.47

CONSTRUCTION COST OPINION

A construction cost opinion for the drainage infrastructure has been provided below. The below cost opinion is only an estimate of facility and drainage infrastructure cost and may vary.

Sterling Ranch Recycling Facility (Public Non-Reimbursable)					
Item	Description	Quantity	Unit	Unit Price	Cost
1	18" RCP	18	L.F.	\$ 82	\$ 1,476.00
2	24" RCP	253	L.F.	\$ 98	\$ 24,794.00
3	36" RCP	21	L.F.	\$ 151	\$ 3,171.00
4	48" RCP	52	L.F.	\$ 245	\$ 12,740.00
5	54" RCP	48	L.F.	\$ 320	\$ 15,360.00
6	24" FES	2	Ea.	\$ 588	\$ 1,176.00
7	54" FES	1	Ea.	\$ 1,920	\$ 1,920.00
8	Type C Inlet	1	Ea.	\$ 6,037	\$ 6,037.00
9	Type D Inlet	2	Ea.	\$ 9,000	\$ 18,000.00
10	Storm Sewer Manhole, Box Base	1	Ea.	\$ 15,130	\$ 15,130.00
11	Concrete Pavement (8") Trickle Channel-6' Wide	652	L.F.	\$ 60	\$ 39,120.00
12	Concrete Forebay-North Forebay	1	Ea.	\$ 12,000	\$ 12,000.00
13	Concrete Forebay-West Forebay	1	Ea.	\$ 18,000	\$ 18,000.00
14	Outlet Structure	1	Ea.	\$ 18,000	\$ 18,000.00
15	Type VL Soil Riprap (12" Depth)	3	CY	\$ 50	\$ 150.00
16	Type L Soil Riprap (18" Depth)	756	CY	\$ 70	\$ 52,920.00
17	Aggregate Base Course (Class 6) (8" Thickness)	212	CY	\$ 133	\$ 28,196.00
18	Aggregate Base Course (Class 6) (12" Thickness)	47	CY	\$ 133	\$ 6,251.00
				Sub-Total	\$ 274,441.00

SUMMARY

The proposed Sterling Ranch Recycling Facility drainage improvements were designed to meet or exceed the El Paso County Drainage Criteria. The proposed development will not adversely affect the off-site drainage ways or surrounding development. This report is in conformance and meets the latest El Paso County Storm Drainage Criteria requirements for this site.



REFERENCES

1. "El Paso County and City of Colorado Springs Drainage Criteria Manual, Vol I & II".
 2. Urban Storm Drainage Criteria Manual (Volumes 1, 2, and 3), Urban Drainage and Flood Control District, June 2001.
 3. Sand Creek Drainage Basin Planning Study, prepared Kiowa Engineering Corporation, January 1993, revised March 1996.
 4. "Final Drainage Report for Sterling Ranch Filing No. 2", prepared by JR Engineering, dated August 2021
 5. Soils and Geology Study: Lot 1, Sterling Ranch Recycling Facility, Entech Engineering, Inc., April 2023.
-

Appendix A
Vicinity Map, Soil Descriptions, FEMA Floodplain Map



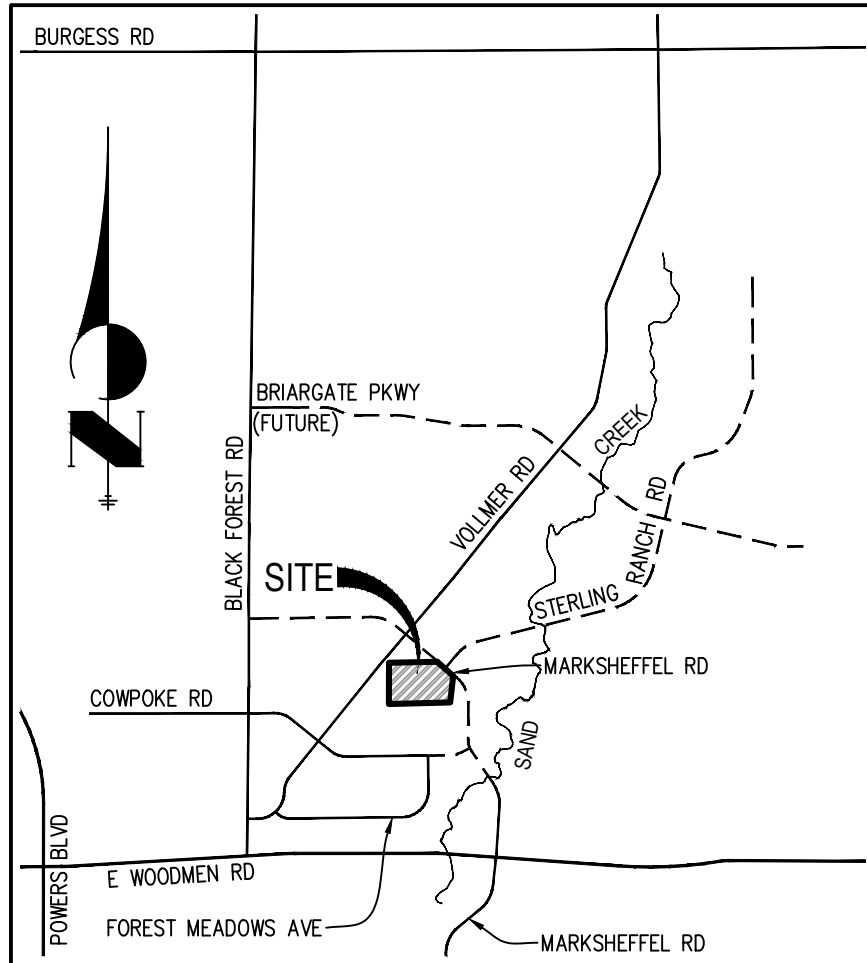

VICINITY MAP

N.T.S.

STERLING RECYCLING FACILITY
 VICINITY MAP
 JOB NO. 25188.00
 6/3/22
 SHEET 1 OF 1



J·R ENGINEERING

A Westrian Company

Centennial 303-740-9393 • Colorado Springs 719-593-2593
 Fort Collins 970-491-9888 • www.jrengineering.com







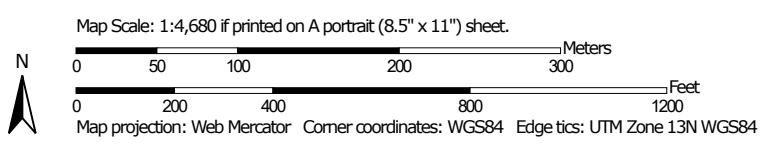

























Hydrologic Soil Group—El Paso County Area, Colorado



Soil Map may not be valid at this scale.



MAP LEGEND

- Area of Interest (AOI)**
 -  Area of Interest (AOI)
- Soils**
 - Soil Rating Polygons**
 -  A
 -  A/D
 -  B
 -  B/D
 -  C
 -  C/D
 -  D
 -  Not rated or not available
 - Soil Rating Lines**
 -  A
 -  A/D
 -  B
 -  B/D
 -  C
 -  C/D
 -  D
 -  Not rated or not available
 - Soil Rating Points**
 -  A
 -  A/D
 -  B
 -  B/D
- Water Features**
 -  Streams and Canals
- Transportation**
 -  Rails
 -  Interstate Highways
 -  US Routes
 -  Major Roads
 -  Local Roads
- Background**
 -  Aerial Photography
- Other**
 -  C
 -  C/D
 -  D
 -  Not rated or not available

MAP INFORMATION

The soil surveys that comprise your AOI were mapped at 1:24,000.

Warning: Soil Map may not be valid at this scale.
 Enlargement of maps beyond the scale of mapping can cause misunderstanding of the detail of mapping and accuracy of soil line placement. The maps do not show the small areas of contrasting soils that could have been shown at a more detailed scale.

Please rely on the bar scale on each map sheet for map measurements.

Source of Map: Natural Resources Conservation Service
 Web Soil Survey URL:
 Coordinate System: Web Mercator (EPSG:3857)

Maps from the Web Soil Survey are based on the Web Mercator projection, which preserves direction and shape but distorts distance and area. A projection that preserves area, such as the Albers equal-area conic projection, should be used if more accurate calculations of distance or area are required.

This product is generated from the USDA-NRCS certified data as of the version date(s) listed below.

Soil Survey Area: El Paso County Area, Colorado
 Survey Area Data: Version 19, Aug 31, 2021

Soil map units are labeled (as space allows) for map scales 1:50,000 or larger.

Date(s) aerial images were photographed: Aug 19, 2018—Sep 23, 2018

The orthophoto or other base map on which the soil lines were compiled and digitized probably differs from the background imagery displayed on these maps. As a result, some minor shifting of map unit boundaries may be evident.

Hydrologic Soil Group

Map unit symbol	Map unit name	Rating	Acres in AOI	Percent of AOI
8	Blakeland loamy sand, 1 to 9 percent slopes	A	46.2	51.5%
19	Columbine gravelly sandy loam, 0 to 3 percent slopes	A	43.6	48.5%
Totals for Area of Interest			89.8	100.0%

Description

Hydrologic soil groups are based on estimates of runoff potential. Soils are assigned to one of four groups according to the rate of water infiltration when the soils are not protected by vegetation, are thoroughly wet, and receive precipitation from long-duration storms.

The soils in the United States are assigned to four groups (A, B, C, and D) and three dual classes (A/D, B/D, and C/D). The groups are defined as follows:

Group A. Soils having a high infiltration rate (low runoff potential) when thoroughly wet. These consist mainly of deep, well drained to excessively drained sands or gravelly sands. These soils have a high rate of water transmission.

Group B. Soils having a moderate infiltration rate when thoroughly wet. These consist chiefly of moderately deep or deep, moderately well drained or well drained soils that have moderately fine texture to moderately coarse texture. These soils have a moderate rate of water transmission.

Group C. Soils having a slow infiltration rate when thoroughly wet. These consist chiefly of soils having a layer that impedes the downward movement of water or soils of moderately fine texture or fine texture. These soils have a slow rate of water transmission.

Group D. Soils having a very slow infiltration rate (high runoff potential) when thoroughly wet. These consist chiefly of clays that have a high shrink-swell potential, soils that have a high water table, soils that have a claypan or clay layer at or near the surface, and soils that are shallow over nearly impervious material. These soils have a very slow rate of water transmission.

If a soil is assigned to a dual hydrologic group (A/D, B/D, or C/D), the first letter is for drained areas and the second is for undrained areas. Only the soils that in their natural condition are in group D are assigned to dual classes.

Rating Options

Aggregation Method: Dominant Condition

Component Percent Cutoff: None Specified

Tie-break Rule: Higher

NOTES TO USERS

This map is for use in administering the National Flood Insurance Program. It does not necessarily identify all areas subject to flooding...

To obtain more detailed information in areas where Base Flood Elevations (BFEs) and/or Floodways have been determined, users are encouraged to consult the Flood Profiles and Floodway Data and/or Summary of Stillwater Elevations tables...

Coastal Base Flood Elevations shown on this map apply only landward of 0.0' North American Vertical Datum of 1988 (NAVD83). Users of this FIRM should be aware that coastal flood elevations are also provided in the Summary of Stillwater Elevations tables...

Boundaries of the floodways were computed at cross sections and interpolated between cross sections. The floodways were based on hydraulic considerations with regard to requirements of the National Flood Insurance Program...

Certain areas not in Special Flood Hazard Areas may be protected by flood control structures. Refer to section 2.4 "Flood Protection Measures" of this Flood Insurance Study report for information on flood control structures for this jurisdiction.

The projection used in the preparation of this map was Universal Transverse Mercator (UTM) zone 13. The horizontal datum was NAD83, GRS80 spheroid. Differences in datum, spheroid projection or UTM zones across users in the production of FIRMs for adjacent jurisdictions may result in slight positional differences in map features across jurisdiction boundaries...

Flood elevations on this map are referenced to the North American Vertical Datum of 1988 (NAVD83). These flood elevations must be compared to structure and ground elevations referenced to the same vertical datum...

NGS Information Services NOAA, NNGS12 National Geodetic Survey SSMC-3, #9222 1315 East-West Highway Silver Spring, MD 20910-3282

To obtain current elevation, description, and/or location information for bench marks shown on this map, please contact the information Services Branch of the National Geodetic Survey at (202) 733-3242 or visit its website at http://www.ngs.noaa.gov/.

Base Map information shown on this FIRM was provided in digital format by El Paso County, Colorado Springs Utilities, and Anderson Consulting Engineers, Inc. These data are current as of 2008.

This map reflects more detailed and up-to-date stream channel configurations and floodplain delineations than those shown on the previous FIRM for this jurisdiction. The floodplains and floodways that were transferred from the previous FIRM may have been adjusted to conform to these new stream channel configurations...

Corporate limits shown on this map are based on the best data available at the time of publication. Because changes due to annexations or de-annexations may have occurred after this map was published, map users should contact appropriate community officials to verify current corporate limit locations.

Please refer to the separately printed Map Index for an overview map of the county showing the layout of map panels; community map repository addresses; and a Listing of Communities table containing National Flood Insurance Program dates for each community as well as a listing of the panels on which each community is located.

Contact FEMA Map Service Center (MSC) via the FEMA Map Information eXchange (FMIX) 1-877-336-2627 for information on available products associated with this FIRM. Available products may include previously issued Letters of Map Change, a Flood Insurance Study Report, and/or digital versions of this map. The MSC may also be reached by Fax at 1-800-368-9620 and its website at http://www.msc.fema.gov/.

If you have questions about this map or questions concerning the National Flood Insurance Program in general, please call 1-877-FEMA MAP (1-877-336-2627) or visit the FEMA website at http://www.fema.gov/business/inf.

El Paso County Vertical Datum Offset Table. Table with 2 columns: Flooding Source, Vertical Datum Offset (ft).

REFER TO SECTION 3.3 OF THE EL PASO COUNTY FLOOD INSURANCE STUDY FOR STREAM/STREAM VERTICAL DATUM CONVERSION INFORMATION.

Panel Location Map

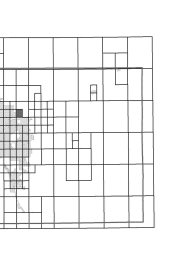

This Digital Flood Insurance Rate Map (DFIRM) was produced through a Cooperating Technical Plan (CTP) agreement between the State of Colorado Water Conservation Board (CWCB) and the Federal Emergency Management Agency (FEMA).

Additional Flood Hazard information and resources are available from local communities and the Colorado Water Conservation Board.

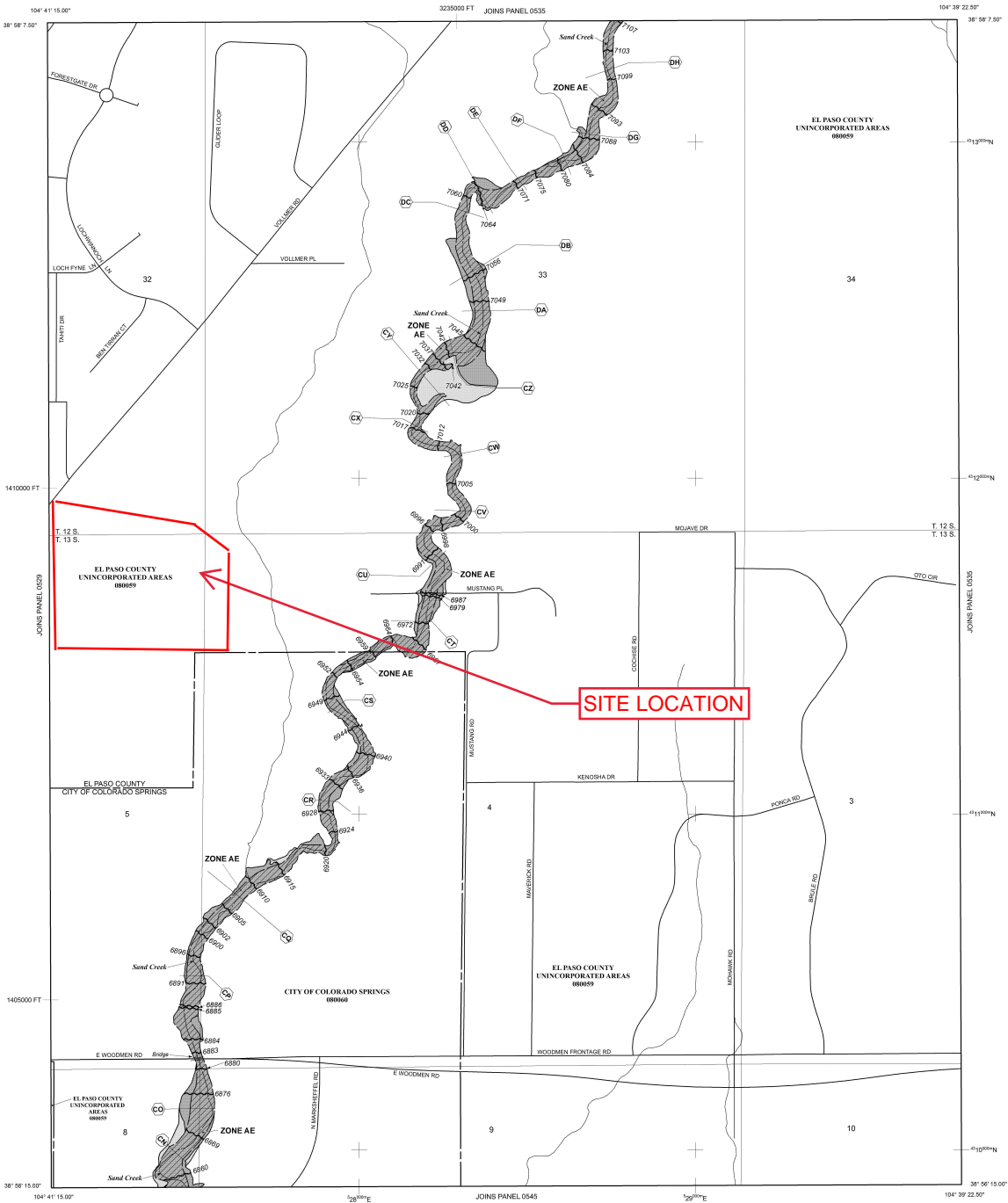

LEGEND

- SPECIAL FLOOD HAZARD AREAS (SFHAS) SUBJECT TO INUNDATION BY THE 1% ANNUAL CHANCE FLOOD. ZONE A: No Base Flood Elevations determined. ZONE AE: Base Flood Elevations determined. ZONE AH: Flood depths of 1 to 3 feet (usually areas of ponding); Base Flood Elevations determined. ZONE AO: Flood depths of 1 to 3 feet (usually sheet flow on steep terrain); average depths determined. For areas of alluvial fan flooding, velocities also determined. ZONE AR: Special Flood Hazard Area Formerly protected from the 1% annual chance flood by a flood control system that was previously decommissioned. Zone AR indicates that the former flood control system is being restored to provide protection from the 1% annual chance or greater flood. ZONE A99: Area to be protected from 1% annual chance flood by a Federal flood protection system under construction; no Base Flood Elevations determined. ZONE V: Coastal flood zone with velocity hazard (wave action); no Base Flood Elevations determined. ZONE VE: Coastal flood zone with velocity hazard (wave action); Base Flood Elevations determined.

- FLOODWAY AREAS IN ZONE AE. OTHER FLOOD AREAS. ZONE X: Areas of 0.2% annual chance flood, areas of 1% annual chance flood with average depths of less than 1 foot or with velocities less than 1 square mile; and areas protected by levees from 1% annual chance flood. OTHER AREAS. ZONE X: Areas determined to be outside the 0.2% annual chance floodplain. ZONE D: Areas in which flood hazards are undetermined, but possible. COASTAL BARRIER PROTECTED SYSTEM (CBRS) AREAS. OTHERWISE PROTECTED AREAS (OPA). CBRS areas and OPAs are normally located within or adjacent to Special Flood Hazard Areas.

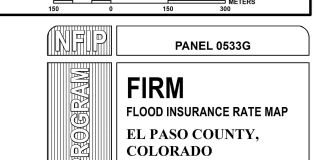
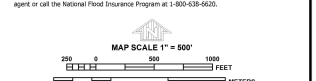

PANEL 0533G. FIRM FLOOD INSURANCE RATE MAP. EL PASO COUNTY, COLORADO AND INCORPORATED AREAS. PANEL 533 OF 1300. (SEE MAP INDEX FOR FIRM PANEL LAYOUT). COORDINATE NUMBER, PANEL, SHEET. MAP NUMBER 08041C0533G. MAP REVISED DECEMBER 7, 2018. Federal Emergency Management Agency.

NOTE: MAP AREA SHOWN ON THIS PANEL IS LOCATED WITHIN TOWNSHIP 12 SOUTH, RANGE 65 WEST, AND TOWNSHIP 13 SOUTH, RANGE 65 WEST.

Appendix B

Hydrologic Calculations

COMPOSITE % IMPERVIOUS & COMPOSITE EXISTING RUNOFF COEFFICIENT CALCULATIONS

Subdivision: Sterling Ranch Recycling Facility
 Location: El Paso County

Project Name: Sterling Ranch
 Project No.: 25188.14
 Calculated By: GAG
 Checked By: _____
 Date: 1/18/24

Basin ID	Total Area (ac)	Streets-Paved (100% Impervious)				Streets-Gravel (80% Impervious)				Historical Analysis (2% Impervious)				Basins Total Weighted C Values		Basins Total Weighted % Imp.
		C ₅	C ₁₀₀	Area (ac)	Weighted % Imp.	C ₅	C ₁₀₀	Area (ac)	Weighted % Imp.	C ₅	C ₁₀₀	Area (ac)	Weighted % Imp.	C ₅	C ₁₀₀	
		EXA	2.68	0.90	0.96	0.16	6.0%	0.59	0.70	0.00	0.0%	0.09	0.36	2.52	1.9%	
EXB	2.60	0.90	0.96	0.00	0.0%	0.59	0.70	0.00	0.0%	0.09	0.36	2.60	2.0%	0.09	0.36	2.0%
EXC	2.11	0.90	0.96	0.00	0.0%	0.59	0.70	0.33	12.5%	0.09	0.36	1.78	1.7%	0.17	0.41	14.2%
EXD	13.44	0.90	0.96	0.86	6.4%	0.59	0.70	1.48	8.8%	0.09	0.36	11.10	1.7%	0.20	0.44	16.9%
EXE	8.51	0.90	0.96	0.00	0.0%	0.59	0.70	0.00	0.0%	0.09	0.36	8.51	2.0%	0.09	0.36	2.0%
EXF	3.09	0.90	0.96	0.00	0.0%	0.59	0.70	0.00	0.0%	0.09	0.36	3.09	2.0%	0.09	0.36	2.0%
OS1	8.74	0.90	0.96	0.00	0.0%	0.59	0.70	0.00	0.0%	0.09	0.36	8.74	2.0%	0.09	0.36	2.0%
OS2	0.53	0.90	0.96	0.00	0.0%	0.59	0.70	0.00	0.0%	0.09	0.36	0.53	2.0%	0.09	0.36	2.0%
OS3	0.29	0.90	0.96	0.00	0.0%	0.59	0.70	0.00	0.0%	0.09	0.36	0.29	2.0%	0.09	0.36	2.0%
TOTAL	41.99															7.7%

EXISTING STANDARD FORM SF-2 TIME OF CONCENTRATION

Subdivision: Sterling Ranch Recycling Facility
Location: El Paso County

Project Name: Sterling Ranch
Project No.: 25188.14
Calculated By: GAG
Checked By: _____
Date: 1/18/24

SUB-BASIN						INITIAL/OVERLAND			TRAVEL TIME					t _c CHECK			FINAL
DATA						(T _i)			(T _i)					(URBANIZED BASINS)			
BASIN ID	D.A. (ac)	Hydrologic Soils Group	Impervious (%)	C ₅	C ₁₀₀	L (ft)	S _o (%)	t _i (min)	L _t (ft)	S _t (%)	K	VEL. (ft/s)	t _t (min)	COMP. t _c (min)	TOTAL LENGTH (ft)	Urbanized t _c (min)	
EXA	2.68	A	8%	0.14	0.40	300	4.0%	19.0	190	2.3%	10.0	1.5	2.1	21.1	490.0	26.7	21.1
EXB	2.60	A	2%	0.09	0.36	300	2.5%	23.3	240	2.5%	10.0	1.6	2.5	25.9	540.0	28.4	25.9
EXC	2.11	A	14%	0.17	0.41	300	2.6%	21.3	135	1.7%	15.0	2.0	1.2	22.4	435.0	25.2	22.4
EXD	13.44	A	17%	0.20	0.44	300	3.6%	18.5	810	3.4%	15.0	2.8	4.9	23.4	1110.0	29.6	23.4
EXE	8.51	A	2%	0.09	0.36	300	4.0%	20.0	800	3.0%	10.0	1.7	7.7	27.7	1100.0	34.0	27.7
EXF	3.09	A	2%	0.09	0.36	300	3.5%	20.9	400	4.3%	10.0	2.1	3.2	24.1	700.0	29.1	24.1
OS1	8.74	A	2%	0.09	0.36	150	2.0%	17.8	850	0.2%	10.0	0.4	31.7	49.4	1000.0	59.8	49.4
OS2	0.53	A	2%	0.09	0.36	155	3.0%	15.8	0	0.0%	10.0	0.0	0.0	15.8	155.0	25.7	15.8
OS3	0.29	A	2%	0.09	0.36	35	15.0%	4.4	0	0.0%	10.0	0.0	0.0	4.4	35.0	25.7	5.0

NOTES:

$$t_c = t_i + t_t$$

Equation 6-2

$$t_t = \frac{0.395(1.1 - C_5)\sqrt{L_t}}{S_o^{0.33}}$$

Equation 6-3

Where:

t_c = computed time of concentration (minutes)

t_i = overland (initial) flow time (minutes)

t_t = channelized flow time (minutes).

Where:

t_i = overland (initial) flow time (minutes)

C₅ = runoff coefficient for 5-year frequency (from Table 6-4)

L_t = length of overland flow (ft)

S_o = average slope along the overland flow path (ft/ft).

Use a minimum t_c value of 5 minutes for urbanized areas and a minimum t_c value of 10 minutes for areas that are not considered urban. Use minimum values even when calculations result in a lesser time of concentration.

$$t_t = \frac{L_t}{60K\sqrt{S_o}} = \frac{L_t}{60V_t}$$

Equation 6-4 $t_t = (26 - 17i) + \frac{L_t}{60(14i + 9)\sqrt{S_o}}$

Equation 6-5

Where:

t_t = channelized flow time (travel time, min)

L_t = waterway length (ft)

S_o = waterway slope (ft/ft)

V_t = travel time velocity (ft/sec) = K√S_o

K = NRCS conveyance factor (see Table 6-2).

Where:

t_c = minimum time of concentration for first design point when less than t_c from Equation 6-1.

L_t = length of channelized flow path (ft)

i = imperviousness (expressed as a decimal)

S_o = slope of the channelized flow path (ft/ft).

Table 6-2. NRCS Conveyance factors, K

Type of Land Surface	Conveyance Factor, K
Heavy meadow	2.5
Tillage/field	5
Short pasture and lawns	7
Nearly bare ground	10
Grassed waterway	15
Paved areas and shallow paved swales	20

STANDARD FORM SF-3 - EXISTING
STORM DRAINAGE SYSTEM DESIGN
(RATIONAL METHOD PROCEDURE)

Subdivision: Sterling Ranch Recycling Facility
Location: El Paso County
Design Storm: 5-Year

Project Name: Sterling Ranch
Project No.: 25188.14
Calculated By: GAG
Checked By:
Date: 1/18/24

STREET	Design Point	DIRECT RUNOFF							TOTAL RUNOFF				STREET/SWALE			PIPE				TRAVEL TIME			REMARKS
		Basin ID	Area (Ac)	Runoff Coeff.	t _c (min)	C*A (Ac)	I (in/hr)	Q (cfs)	t _c (min)	C*A (ac)	I (in/hr)	Q (cfs)	Q _{street/swale} (cfs)	C*A (ac)	Slope (%)	Q _{pipe} (cfs)	C*A (ac)	Slope (%)	Pipe Size (inches)	Length (ft)	Velocity (fps)	t _r (min)	
	1	EXA	2.68	0.14	21.1	0.37	3.01	1.1															Sheet flows overland to DP1 Flows off-site to the west
	2	EXB	2.60	0.09	25.9	0.23	2.70	0.6															Sheet flows overland to DP2 Flows off-site to the west
	3	EXC	2.11	0.17	22.4	0.35	2.92	1.0															Sheet flows overland and along berm to DP3 Flows off-site to the south
	4	EXD	13.44	0.20	23.4	2.65	2.85	7.6															Sheet flows overland and along berm to DP4 Flows off-site to the south
	5	OS1	8.74	0.09	49.4	0.79	1.73	1.4															Sheet flows overland and along berm to DP5 Flows on-site and combines at DP7.1
	6	OS3	0.29	0.09	5.0	0.03	5.17	0.2															Sheet flows overland to DP6 Flows on-site and combines at DP7.1
	7	EXE	8.51	0.09	27.7	0.77	2.60	2.0															Sheet flows overland and along berm to DP7 Combines flows at DP7.1
	7.1								49.4	1.59	1.73	2.8											Combines the flows from DP5, DP6, and DP7 Flows off-site to the south
	8	OS2	0.53	0.09	15.8	0.05	3.44	0.2															Sheet flows overland to DP8 Combines flows at DP9.1
	9	EXF	3.09	0.09	24.1	0.28	2.81	0.8															Sheet flows overland to DP9 Combines flows at DP9.1
	9.1								24.1	0.33	2.81	0.9											Combines the flows from DP8 and DP9 Flows off-site to the east

Notes:
Street and Pipe C*A values are determined by Q/i using the catchment's intensity value.
All pipes are private and RCP unless otherwise noted. Pipe size shown in table column.

STANDARD FORM SF-3 - EXISTING
STORM DRAINAGE SYSTEM DESIGN
(RATIONAL METHOD PROCEDURE)

Subdivision: Sterling Ranch Recycling Facility
Location: El Paso County
Design Storm: 100-Year

Project Name: Sterling Ranch
Project No.: 25188.14
Calculated By: GAG
Checked By: _____
Date: 1/18/24

Description	Design Point	DIRECT RUNOFF							TOTAL RUNOFF				STREET/SWALE			PIPE				TRAVEL TIME			REMARKS
		Basin ID	Area (ac)	Runoff Coeff.	t _c (min)	C*A (ac)	I (in/hr)	Q (cfs)	t _c (min)	C*A (ac)	I (in/hr)	Q (cfs)	Q _{street/swale} (cfs)	C*A (ac)	Slope (%)	Q _{pipe} (cfs)	C*A (ac)	Slope (%)	Pipe Size (inches)	Length (ft)	Velocity (fps)	t _t (min)	
	1	EXA	2.68	0.40	21.1	1.06	5.05	5.4															Sheet flows overland to DP1 Flows off-site to the west
	2	EXB	2.60	0.36	25.9	0.94	4.54	4.3															Sheet flows overland to DP2 Flows off-site to the west
	3	EXC	2.11	0.41	22.4	0.87	4.90	4.3															Sheet flows overland and along berm to DP3 Flows off-site to the south
	4	EXD	13.44	0.44	23.4	5.86	4.79	28.1															Sheet flows overland and along berm to DP4 Flows off-site to the south
	5	OS1	8.74	0.36	49.4	3.15	2.90	9.2															Sheet flows overland and along berm to DP5 Flows on-site and combines at DP7.1
	6	OS3	0.29	0.36	5.0	0.10	8.68	0.9															Sheet flows overland to DP6 Flows on-site and combines at DP7.1
	7	EXE	8.51	0.36	27.7	3.06	4.37	13.4															Sheet flows overland and along berm to DP7 Combines flows at DP7.1
	7.1								49.4	6.31	2.90	18.3											Combines the flows from DP5, DP6, and DP7 Flows off-site to the south
	8	OS2	0.53	0.36	15.8	0.19	5.78	1.1															Sheet flows overland to DP8 Combines flows at DP9.1
	9	EXF	3.09	0.36	24.1	1.11	4.72	5.2															Sheet flows overland to DP9 Combines flows at DP9.1
	9.1								24.1	1.30	4.72	6.1											Combines the flows from DP8 and DP9 Flows off-site to the east

Notes:
Street and Pipe C*A values are determined by Q/i using the catchment's intensity value.
All pipes are private and RCP unless otherwise noted. Pipe size shown in table column.

COMPOSITE % IMPERVIOUS & COMPOSITE PROPOSED RUNOFF COEFFICIENT CALCULATIONS

Subdivision: Sterling Ranch Recycling Facility
 Location: El Paso County

Project Name: Sterling Ranch
 Project No.: 25188.14
 Calculated By: GAG
 Checked By: _____
 Date: 1/24/24

Basin ID	Total Area (ac)	Streets-Paved (100% Impervious)				Streets-Gravel (80% Impervious)				Historical Analysis (2% Impervious)				Basins Total Weighted C Values		Basins Total Weighted % Imp.
		C ₅	C ₁₀₀	Area (ac)	Weighted % Imp.	C ₅	C ₁₀₀	Area (ac)	Weighted % Imp.	C ₅	C ₁₀₀	Area (ac)	Weighted % Imp.	C ₅	C ₁₀₀	
		A	0.50	0.90	0.96	0.00	0.0%	0.59	0.70	0.00	0.0%	0.09	0.36	0.50	2.0%	
B	14.03	0.90	0.96	2.45	17.5%	0.59	0.70	0.00	0.0%	0.09	0.36	11.58	1.7%	0.23	0.46	19.1%
C	10.70	0.90	0.96	0.47	4.4%	0.59	0.70	0.00	0.0%	0.09	0.36	10.23	1.9%	0.13	0.39	6.3%
D	2.16	0.90	0.96	0.00	0.0%	0.59	0.70	0.00	0.0%	0.09	0.36	2.16	2.0%	0.09	0.36	2.0%
E	3.10	0.90	0.96	0.40	12.9%	0.59	0.70	0.31	8.0%	0.09	0.36	2.39	1.5%	0.24	0.47	22.4%
F	2.27	0.90	0.96	0.00	0.0%	0.59	0.70	0.00	0.0%	0.09	0.36	2.27	2.0%	0.09	0.36	2.0%
G	0.06	0.90	0.96	0.04	66.7%	0.59	0.70	0.00	0.0%	0.09	0.36	0.02	0.7%	0.63	0.76	67.3%
OS1	8.74	0.90	0.96	0.00	0.0%	0.59	0.70	0.00	0.0%	0.09	0.36	8.74	2.0%	0.09	0.36	2.0%
OS2	0.36	0.90	0.96	0.00	0.0%	0.59	0.70	0.00	0.0%	0.09	0.36	0.36	2.0%	0.09	0.36	2.0%
OS3	0.30	0.90	0.96	0.00	0.0%	0.59	0.70	0.00	0.0%	0.09	0.36	0.30	2.0%	0.09	0.36	2.0%
OS4	2.08	0.90	0.96	1.70	81.7%	0.59	0.70	0.00	0.0%	0.09	0.36	0.38	0.4%	0.75	0.85	82.1%
Total W. Forebay (Basins B, C, OS1)	33.47															10.5%
Total N. Forebay (Basins D, E, OS2)	5.62															13.3%
Total Pond A (Basins B-F, OS1-3)	41.66															10.4%

PROPOSED STANDARD FORM SF-2 TIME OF CONCENTRATION

Subdivision: Sterling Ranch Recycling Facility
Location: El Paso County

Project Name: Sterling Ranch
Project No.: 25188.14
Calculated By: GAG
Checked By: _____
Date: 1/24/24

SUB-BASIN						INITIAL/OVERLAND			TRAVEL TIME					t _c CHECK			FINAL
DATA						(T _i)			(T _i)					(URBANIZED BASINS)			
BASIN ID	D.A. (ac)	Hydrologic Soils Group	Impervious (%)	C ₅	C ₁₀₀	L (ft)	S _o (%)	t _i (min)	L _t (ft)	S _t (%)	K	VEL. (ft/s)	t _t (min)	COMP. t _c (min)	TOTAL LENGTH (ft)	Urbanized t _c (min)	t _c (min)
A	0.50	A	2%	0.09	0.36	20	33.0%	2.6	0	0.0%	10.0	0.0	0.0	2.6	20.0	25.7	5.0
B	14.03	A	19%	0.23	0.46	300	2.7%	19.6	1600	1.5%	15.0	1.8	14.5	34.1	1900.0	41.4	34.1
C	10.70	A	6%	0.13	0.39	300	2.7%	22.0	735	1.5%	15.0	1.8	6.7	28.6	1035.0	35.0	28.6
D	2.16	A	2%	0.09	0.36	215	3.0%	18.6	400	1.5%	10.0	1.2	5.4	24.1	615.0	31.5	24.1
E	3.10	A	22%	0.24	0.47	100	1.2%	14.5	910	1.5%	15.0	1.8	8.3	22.8	1010.0	32.4	22.8
F	2.27	A	2%	0.09	0.36	40	25.0%	4.0	615	0.5%	10.0	0.7	14.5	18.5	655.0	41.3	18.5
G	0.06	A	67%	0.63	0.76	54	2.0%	5.0	35	1.0%	20.0	2.0	0.3	5.3	89.0	14.9	5.3
OS1	8.74	A	2%	0.09	0.36	150	2.0%	17.8	850	0.2%	10.0	0.4	31.7	49.4	1000.0	59.8	49.4
OS2	0.36	A	2%	0.09	0.36	115	3.0%	13.6	300	3.0%	10.0	1.7	2.9	16.5	415.0	28.8	16.5
OS3	0.30	A	2%	0.09	0.36	35	15.0%	4.4	0	0.0%	10.0	0.0	0.0	4.4	35.0	25.7	5.0
OS4	2.08	A	82%	0.75	0.85	15	2.0%	1.9	1335	2.5%	20.0	3.2	7.0	9.0	1350.0	18.9	9.0

NOTES:

$$t_c = t_i + t_t$$

Equation 6-2

$$t_i = \frac{0.395(1.1 - C_5)\sqrt{L_i}}{S_o^{0.33}}$$

Equation 6-3

Where:

t_c = computed time of concentration (minutes)

t_i = overland (initial) flow time (minutes)

t_t = channelized flow time (minutes).

Where:

t_i = overland (initial) flow time (minutes)

C₅ = runoff coefficient for 5-year frequency (from Table 6-4)

L_i = length of overland flow (ft)

S_o = average slope along the overland flow path (ft/ft).

Use a minimum t_c value of 5 minutes for urbanized areas and a minimum t_c value of 10 minutes for areas that are not considered urban. Use minimum values even when calculations result in a lesser time of concentration.

$$t_t = \frac{L_t}{60K\sqrt{S_o}} = \frac{L_t}{60V_t}$$

Equation 6-4 $t_c = (26 - 17i) + \frac{L_t}{60(14i + 9)\sqrt{S_t}}$

Equation 6-5

Where:

t_t = channelized flow time (travel time, min)

L_t = waterway length (ft)

S_o = waterway slope (ft/ft)

V_t = travel time velocity (ft/sec) = K√S_o

K = NRCS conveyance factor (see Table 6-2).

Where:

t_c = minimum time of concentration for first design point when less than t_c from Equation 6-1.

L_t = length of channelized flow path (ft)

i = imperviousness (expressed as a decimal)

S_t = slope of the channelized flow path (ft/ft).

Table 6-2. NRCS Conveyance factors, K

Type of Land Surface	Conveyance Factor, K
Heavy meadow	2.5
Tillage/field	5
Short pasture and lawns	7
Nearly bare ground	10
Grassed waterway	15
Paved areas and shallow paved swales	20

**STANDARD FORM SF-3 - PROPOSED
STORM DRAINAGE SYSTEM DESIGN
(RATIONAL METHOD PROCEDURE)**

Subdivision: Sterling Ranch Recycling Facility
 Location: El Paso County
 Design Storm: 5-Year

Project Name: Sterling Ranch
 Project No.: 25188.14
 Calculated By: GAG
 Checked By:
 Date: 1/24/24

STREET	Design Point	DIRECT RUNOFF							TOTAL RUNOFF				STREET/SWALE			PIPE				TRAVEL TIME			REMARKS
		Basin ID	Area (Ac)	Runoff Coeff.	t _c (min)	C*A (Ac)	I (in/hr)	Q (cfs)	t _c (min)	C*A (ac)	I (in/hr)	Q (cfs)	Q _{street/swale} (cfs)	C*A (ac)	Slope (%)	Q _{pipe} (cfs)	C*A (ac)	Slope (%)	Pipe Size (inches)	Length (ft)	Velocity (fps)	t _t (min)	
	1	A	0.50	0.09	5.0	0.05	5.17	0.3															Flows overland along the western site boundary to DP1 Flows off-site to the west
	2	B	14.03	0.23	34.1	3.25	2.29	7.4															Sheet flows overland to swale and then to DP2 Combines flow at FES at DP4.2
	3	OS1	8.74	0.09	49.4	0.79	1.73	1.4															Sheet flows overland and along berm to DP3 Flows on-site and combines at culvert at DP4.1
	4	C	10.70	0.13	28.6	1.34	2.55	3.4															Sheet flows overland to swale and then to DP4 Combines flow at culvert at DP4.1
	4.1								49.4	2.13	1.73	3.7											Combined flow of DP3 and DP4 within culvert Swale to FES at DP4.2
	4.2								49.4	5.38	1.73	9.3											Combined flow of DP2 and DP4.1 at sump inlet Piped to pond forebay, combines flow at DP9.1
	5	D	2.16	0.09	24.1	0.19	2.81	0.5															Sheet flows overland to swale and then to DP5 Combines flow at sump inlet at DP7.1
	6	E	3.10	0.24	22.8	0.76	2.89	2.2															Sheet flows overland to swale and then to DP6 Combines flow at sump inlet at DP7.1
	7	OS2	0.36	0.09	16.5	0.03	3.38	0.1															Sheet flows overland to DP7 Combines flow at sump inlet at DP7.1
	7.1								24.1	0.98	2.81	2.8											Combined flow of DP5, DP6, and DP7 at sump inlet Piped to pond forebay, combines flow at DP9.1
	8	OS3	0.30	0.09	5.0	0.03	5.17	0.2															Sheet flows overland to DP8 Combines flow at DP9.1
	9	F	2.27	0.09	18.5	0.20	3.21	0.6															Flows along trickle channel to DP9 at outlet structure Combines flow at DP9.1
	9.1								49.4	6.59	1.73	11.4											Combined flow of DP4.2, DP7.1, DP8 and DP9. Total interim pond inflow. Released though pond outlet structure at DP9.2
	9.2								-	-	-	0.1											Released flow through interim outlet structure from MHFD_Detention Piped to existing junction box and storm infrastructure
	10	G	0.06	0.63	5.3	0.04	5.09	0.2															Flows along prop. Sterling Ranch Rd. c&g to DP10 to Marksheffel Rd. Combines at existing Marksheffel Rd. existing 15' Type R inlet.
	11	OS4	2.08	0.75	9.0	1.56	4.29	6.7															Off-site work along existing Marksheffel Rd. c&g to ex. 15' Type R inlet. Combines at existing Marksheffel Rd. existing 15' Type R inlet.
	11.1								9.0	1.60	4.29	6.9											Combined flow of DP 10 and DP11 within existing 15' Type R inlet. Captured flow continues off-site southeast along Marksheffel Rd. storm

Notes:
 Street and Pipe C*A values are determined by Q/i using the catchment's intensity value.
 All pipes are private and RCP unless otherwise noted. Pipe size shown in table column.

**STANDARD FORM SF-3 - PROPOSED
STORM DRAINAGE SYSTEM DESIGN
(RATIONAL METHOD PROCEDURE)**

Subdivision: Sterling Ranch Recycling Facility
 Location: El Paso County
 Design Storm: 100-Year

Project Name: Sterling Ranch
 Project No.: 25188.14
 Calculated By: GAG
 Checked By: _____
 Date: 1/24/24

Description	Design Point	DIRECT RUNOFF							TOTAL RUNOFF				STREET/SWALE			PIPE				TRAVEL TIME			REMARKS
		Basin ID	Area (ac)	Runoff Coeff.	t _c (min)	C*A (ac)	I (in/hr)	Q (cfs)	t _c (min)	C*A (ac)	I (in/hr)	Q (cfs)	Q _{street/swale} (cfs)	C*A (ac)	Slope (%)	Q _{pipe} (cfs)	C*A (ac)	Slope (%)	Pipe Size (inches)	Length (ft)	Velocity (fps)	t _i (min)	
	1	A	0.50	0.36	5.0	0.18	8.68	1.6															Flows overland along the western site boundary to DP1 Flows off-site to the west
	2	B	14.03	0.46	34.1	6.52	3.84	25.1															Sheet flows overland to swale and then to DP2 Combines flow at FES at DP4.2
	3	OS1	8.74	0.36	49.4	3.15	2.90	9.2															Sheet flows overland and along berm to DP3 Flows on-site and combines at culvert at DP4.1
	4	C	10.70	0.39	28.6	4.13	4.28	17.7															Sheet flows overland to swale and then to DP4 Combines flow at culvert at DP4.1
	4.1								49.4	7.28	2.90	21.1											Combined flow of DP3 and DP4 within culvert Swale to FES at DP4.2
	4.2								49.4	13.80	2.90	40.1											Combined flow of DP2 and DP4.1 at sump inlet Piped to pond forebay, combines flow at DP9.1
	5	D	2.16	0.36	24.1	0.78	4.72	3.7															Sheet flows overland to swale and then to DP5 Combines flow at sump inlet at DP7.1
	6	E	3.10	0.47	22.8	1.46	4.86	7.1															Sheet flows overland to swale and then to DP6 Combines flow at sump inlet at DP7.1
	7	OS2	0.36	0.36	16.5	0.13	5.67	0.7															Sheet flows overland to DP7 Combines flow at sump inlet at DP7.1
	7.1								24.1	2.37	4.72	11.2											Combined flow of DP5, DP6, and DP7 at sump inlet Piped to pond forebay, combines flow at DP9.1
	8	OS3	0.30	0.36	5.0	0.11	8.68	1.0															Sheet flows overland to DP8 Combines flow at DP9.1
	9	F	2.27	0.36	18.5	0.82	5.38	4.4															Flows along trickle channel to DP9 at outlet structure Combines flow at DP9.1
	9.1								49.4	16.99	2.90	49.4											Combined flow of DP4.2, DP7.1, DP8 and DP9. Total interim pond inflow. Released though pond outlet structure at DP9.2
	9.2								-	-	-	8.3											Released flow through interim outlet structure from MHFD_Detention Piped to existing junction box and storm infrastructure
	10	G	0.06	0.76	5.3	0.05	8.56	0.4															Flows along prop. Sterling Ranch Rd. c&g to DP10 to Marksheffel Rd. Combines at existing Marksheffel Rd. existing 15' Type R inlet.
	11	OS4	2.08	0.85	9.0	1.77	7.21	12.8															Off-site work along existing Marksheffel Rd. c&g to ex. 15' Type R inlet. Combines at existing Marksheffel Rd. existing 15' Type R inlet.
	11.1								9.0	1.82	7.21	13.1											Combined flow of DP 10 and DP11 within existing 15' Type R inlet. Captured flow continues off-site southeast along Marksheffel Rd. storm

Notes:
 Street and Pipe C*A values are determined by Q/i using the catchment's intensity value.
 All pipes are private and RCP unless otherwise noted. Pipe size shown in table column.

COMPOSITE % IMPERVIOUS & COMPOSITE ULTIMATE RUNOFF COEFFICIENT CALCULATIONS

Subdivision: Sterling Ranch Recycling Facility
 Location: El Paso County

Project Name: Sterling Ranch
 Project No.: 25188.14
 Calculated By: GAG
 Checked By: _____
 Date: 2/8/24

Basin ID	Total Area (ac)	Industrial-Heavy Areas (90% Impervious)				Business-Commercial Areas (95% Impervious)				Residential-1/8 Acre or Less (65% Impervious)				Streets-Paved (100% Impervious)				Historical Analysis (2% Impervious)				Basins Total Weighted C Values		Basins Total Weighted % Imp.
		C ₅	C ₁₀₀	Area (ac)	Weighted % Imp.	C ₅	C ₁₀₀	Area (ac)	Weighted % Imp.	C ₅	C ₁₀₀	Area (ac)	Weighted % Imp.	C ₅	C ₁₀₀	Area (ac)	Weighted % Imp.	C ₅	C ₁₀₀	Area (ac)	Weighted % Imp.	C ₅	C ₁₀₀	
		Lot 1 Heavy Industrial	4.74	0.73	0.81	4.74	90.0%	0.81	0.88	0.00	0.0%	0.45	0.59	0.00	0.0%	0.90	0.96	0.00	0.0%	0.09	0.36	0.00	0.0%	
Urban Non-Residential Collector Roadway (R.O.W.)	1.78	0.73	0.81	0.00	0.0%	0.81	0.88	0.00	0.0%	0.45	0.59	0.00	0.0%	0.90	0.96	1.40	78.7%	0.09	0.36	0.38	0.4%	0.73	0.83	79.1%
Lot 2 Residential-1/8 Acre or Less	24.05	0.73	0.81	0.00	0.0%	0.81	0.88	0.00	0.0%	0.45	0.59	24.05	65.0%	0.90	0.96	0.00	0.0%	0.09	0.36	0.00	0.0%	0.45	0.59	65.0%
Tract A Detention Pond	1.85	0.73	0.81	0.00	0.0%	0.81	0.88	0.00	0.0%	0.45	0.59	0.00	0.0%	0.90	0.96	0.00	0.0%	0.09	0.36	1.85	2.0%	0.09	0.36	2.0%
Future Commercial (Off-site to north)	8.74	0.73	0.81	0.00	0.0%	0.81	0.88	8.74	95.0%	0.45	0.59	0.00	0.0%	0.90	0.96	0.00	0.0%	0.09	0.36	0.00	0.0%	0.81	0.88	95.0%
Future Heavy Industrial (Off-site to east)	1.87	0.73	0.81	1.87	90.0%	0.81	0.88	0.00	0.0%	0.45	0.59	0.00	0.0%	0.90	0.96	0.00	0.0%	0.09	0.36	0.00	0.0%	0.73	0.81	90.0%
Detention Pond (Off-site to east)	0.44	0.73	0.81	0.00	0.0%	0.81	0.88	0.00	0.0%	0.45	0.59	0.00	0.0%	0.90	0.96	0.00	0.0%	0.09	0.36	0.44	2.0%	0.09	0.36	2.0%
Detention Pond (Off-site to south)	0.30	0.73	0.81	0.00	0.0%	0.81	0.88	0.00	0.0%	0.45	0.59	0.00	0.0%	0.90	0.96	0.00	0.0%	0.09	0.36	0.30	2.0%	0.09	0.36	2.0%
Total Pond A	43.77																							71.6%
Total W. Forebay (North Commercial, Lot 2, R.O.W.)	34.57																					0.56	0.68	73.3%
Total N. Forebay (Lot 1, East Heavy Industrial)	6.61																					0.73	0.81	90.0%

Appendix C

Hydraulic Calculations

Channel Report

Swale DP2

Triangular

Side Slopes (z:1) = 3.00, 3.00
Total Depth (ft) = 2.60

Invert Elev (ft) = 1.00
Slope (%) = 1.00
N-Value = 0.035

Calculations

Compute by: Known Q
Known Q (cfs) = 25.50

Highlighted

Depth (ft) = 1.57
Q (cfs) = 25.50
Area (sqft) = 7.39
Velocity (ft/s) = 3.45
Wetted Perim (ft) = 9.93
Crit Depth, Yc (ft) = 1.36
Top Width (ft) = 9.42
EGL (ft) = 1.75

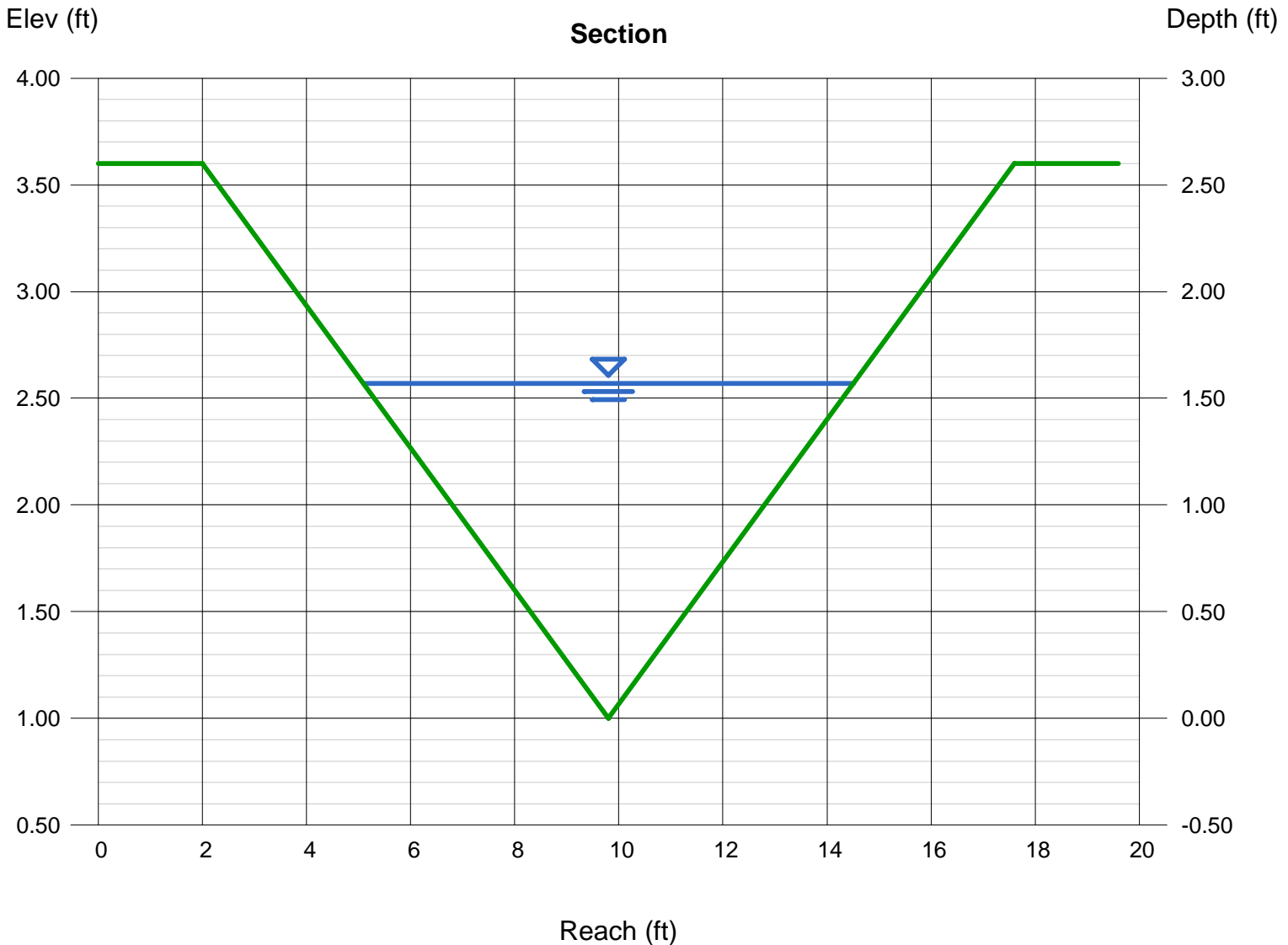

Channel Report

Swale DP4

Triangular

Side Slopes (z:1) = 4.00, 3.00
Total Depth (ft) = 2.50

Invert Elev (ft) = 1.00
Slope (%) = 1.00
N-Value = 0.035

Calculations

Compute by: Known Q
Known Q (cfs) = 18.00

Highlighted

Depth (ft) = 1.30
Q (cfs) = 18.00
Area (sqft) = 5.91
Velocity (ft/s) = 3.04
Wetted Perim (ft) = 9.47
Crit Depth, Yc (ft) = 1.11
Top Width (ft) = 9.10
EGL (ft) = 1.44

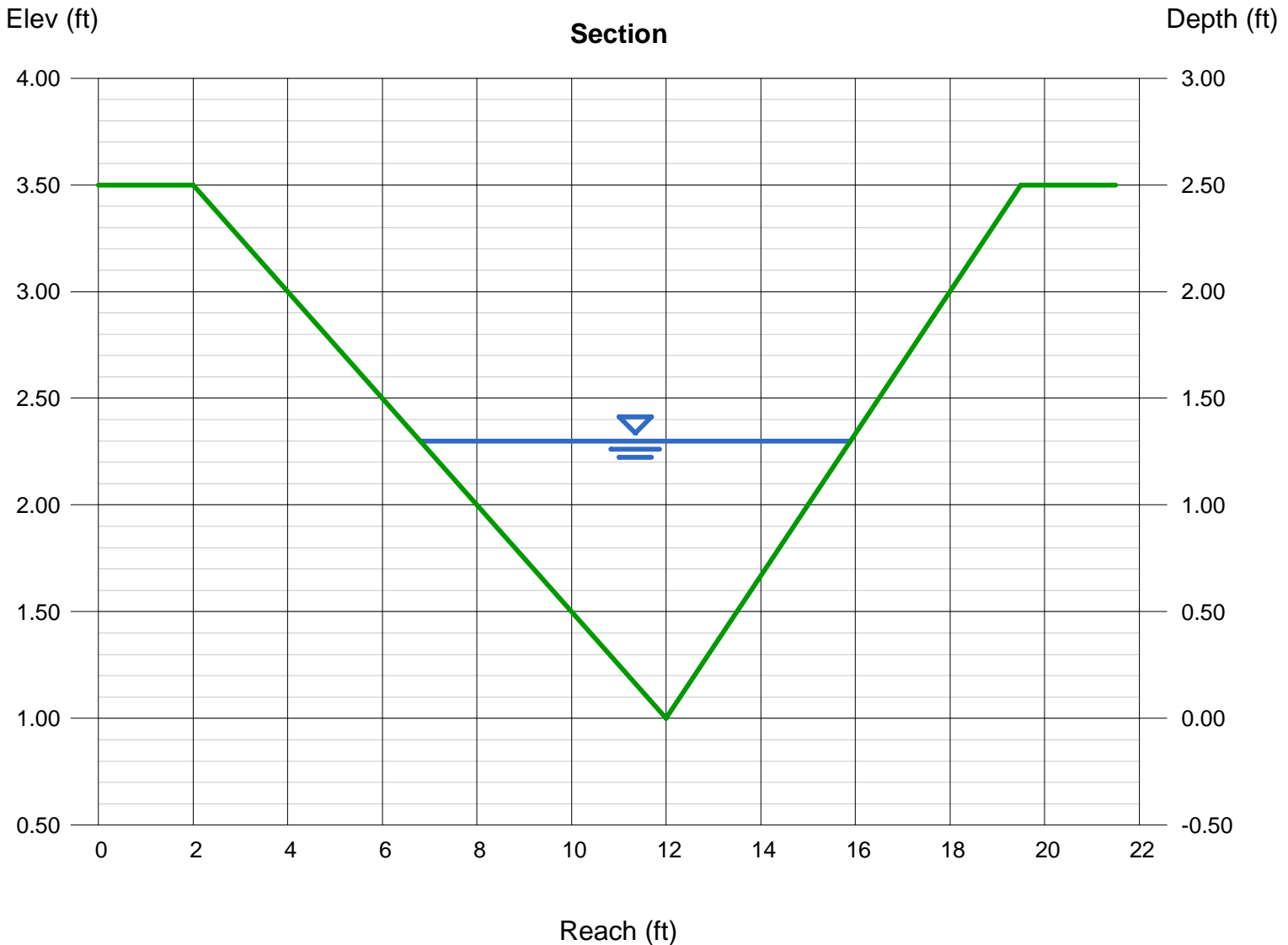

Channel Report

Swale DP4.1

Triangular

Side Slopes (z:1) = 3.00, 3.00
Total Depth (ft) = 2.50

Invert Elev (ft) = 1.00
Slope (%) = 2.00
N-Value = 0.035

Calculations

Compute by: Known Q
Known Q (cfs) = 21.50

Highlighted

Depth (ft) = 1.29
Q (cfs) = 21.50
Area (sqft) = 4.99
Velocity (ft/s) = 4.31
Wetted Perim (ft) = 8.16
Crit Depth, Yc (ft) = 1.27
Top Width (ft) = 7.74
EGL (ft) = 1.58

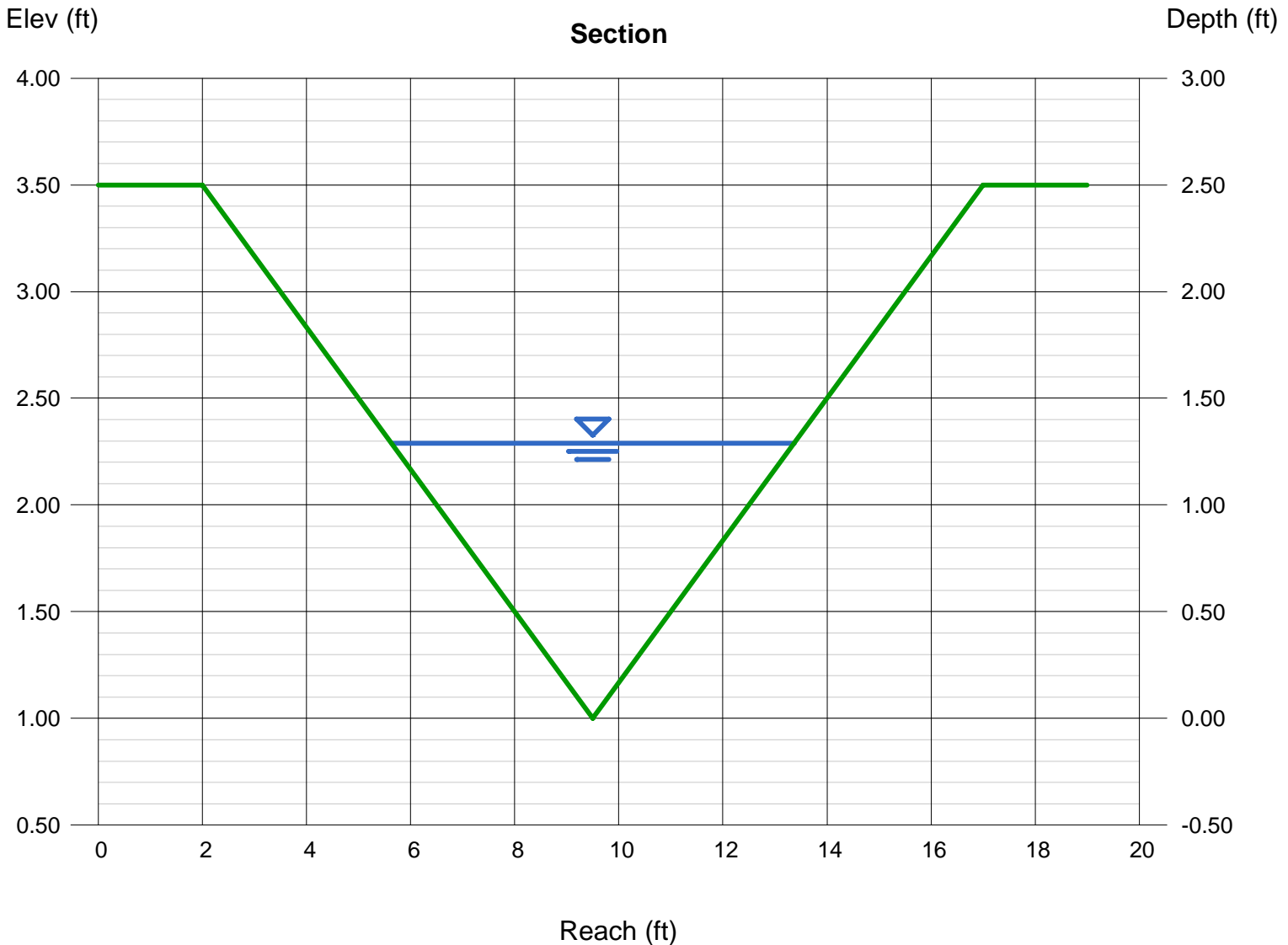

Culvert Report

DP4.1-5 year

Invert Elev Dn (ft)	= 6978.36
Pipe Length (ft)	= 69.60
Slope (%)	= 0.99
Invert Elev Up (ft)	= 6979.05
Rise (in)	= 24.0
Shape	= Circular
Span (in)	= 24.0
No. Barrels	= 1
n-Value	= 0.013
Culvert Type	= Circular Concrete
Culvert Entrance	= Groove end projecting (C)
Coeff. K,M,c,Y,k	= 0.0045, 2, 0.0317, 0.69, 0.2

Embankment	
Top Elevation (ft)	= 6982.04
Top Width (ft)	= 40.00
Crest Width (ft)	= 125.00

Calculations	
Qmin (cfs)	= 4.00
Qmax (cfs)	= 4.00
Tailwater Elev (ft)	= 0.00

Highlighted	
Qtotal (cfs)	= 4.00
Qpipe (cfs)	= 4.00
Qovertop (cfs)	= 0.00
Veloc Dn (ft/s)	= 5.38
Veloc Up (ft/s)	= 4.08
HGL Dn (ft)	= 6978.93
HGL Up (ft)	= 6979.75
Hw Elev (ft)	= 6980.01
Hw/D (ft)	= 0.48
Flow Regime	= Inlet Control

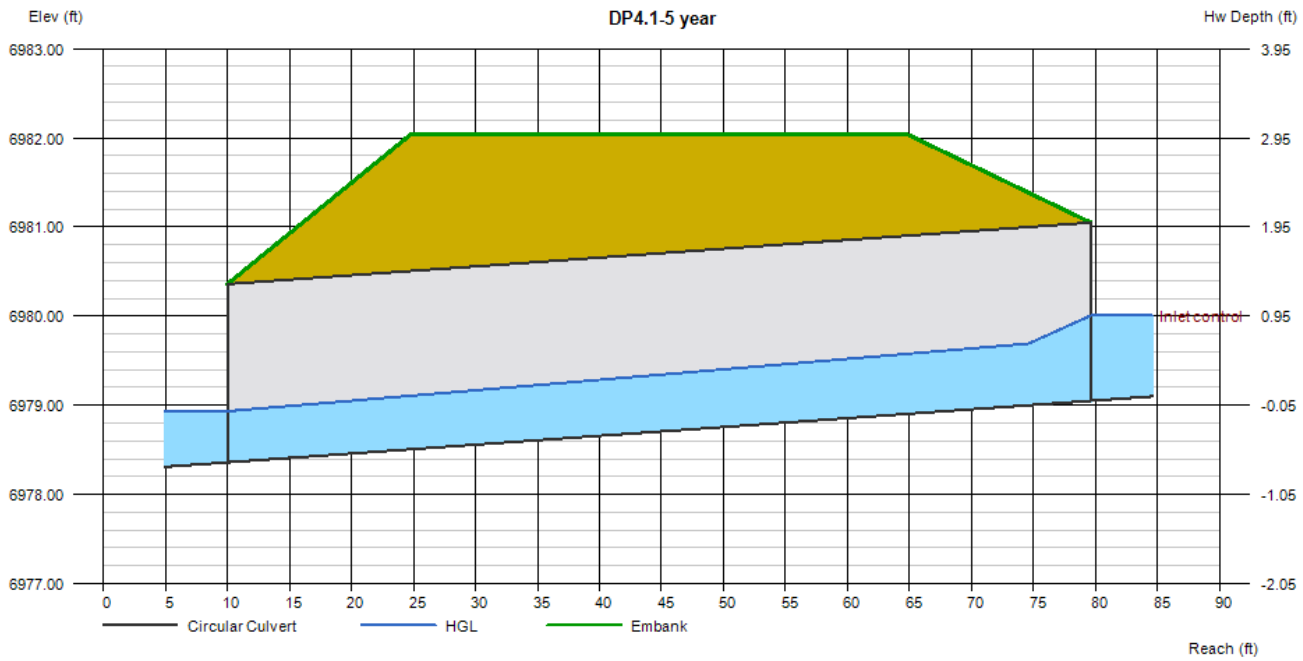

Culvert Report

DP4.1-100 year

Invert Elev Dn (ft)	= 6978.36
Pipe Length (ft)	= 69.60
Slope (%)	= 0.99
Invert Elev Up (ft)	= 6979.05
Rise (in)	= 24.0
Shape	= Circular
Span (in)	= 24.0
No. Barrels	= 1
n-Value	= 0.013
Culvert Type	= Circular Concrete
Culvert Entrance	= Groove end projecting (C)
Coeff. K,M,c,Y,k	= 0.0045, 2, 0.0317, 0.69, 0.2

Embankment	
Top Elevation (ft)	= 6982.04
Top Width (ft)	= 40.00
Crest Width (ft)	= 125.00

Calculations	
Qmin (cfs)	= 21.50
Qmax (cfs)	= 21.50
Tailwater Elev (ft)	= 0.00

Highlighted	
Qtotal (cfs)	= 21.50
Qpipe (cfs)	= 21.50
Qovertop (cfs)	= 0.00
Veloc Dn (ft/s)	= 8.16
Veloc Up (ft/s)	= 7.72
HGL Dn (ft)	= 6979.92
HGL Up (ft)	= 6980.71
Hw Elev (ft)	= 6981.91
Hw/D (ft)	= 1.43
Flow Regime	= Inlet Control

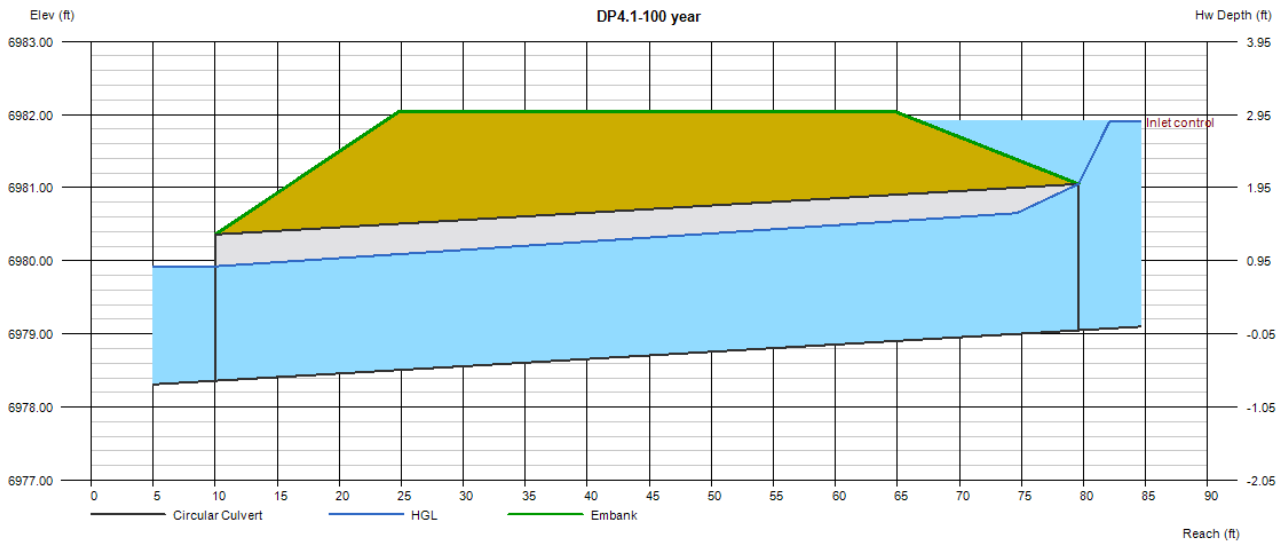

Culvert Report

DP4.2 Culvert to West Forebay-5 year

Invert Elev Dn (ft)	= 6969.30
Pipe Length (ft)	= 47.65
Slope (%)	= 0.99
Invert Elev Up (ft)	= 6969.77
Rise (in)	= 54.0
Shape	= Circular
Span (in)	= 54.0
No. Barrels	= 1
n-Value	= 0.013
Culvert Type	= Circular Concrete
Culvert Entrance	= Groove end projecting (C)
Coeff. K,M,c,Y,k	= 0.0045, 2, 0.0317, 0.69, 0.2

Embankment	
Top Elevation (ft)	= 6975.50
Top Width (ft)	= 12.00
Crest Width (ft)	= 78.00

Calculations	
Qmin (cfs)	= 9.50
Qmax (cfs)	= 9.50
Tailwater Elev (ft)	= 6967.62

Highlighted	
Qtotal (cfs)	= 9.50
Qpipe (cfs)	= 9.50
Qovertop (cfs)	= 0.00
Veloc Dn (ft/s)	= 6.14
Veloc Up (ft/s)	= 4.42
HGL Dn (ft)	= 6969.99
HGL Up (ft)	= 6970.64
Hw Elev (ft)	= 6970.92
Hw/D (ft)	= 0.26
Flow Regime	= Inlet Control

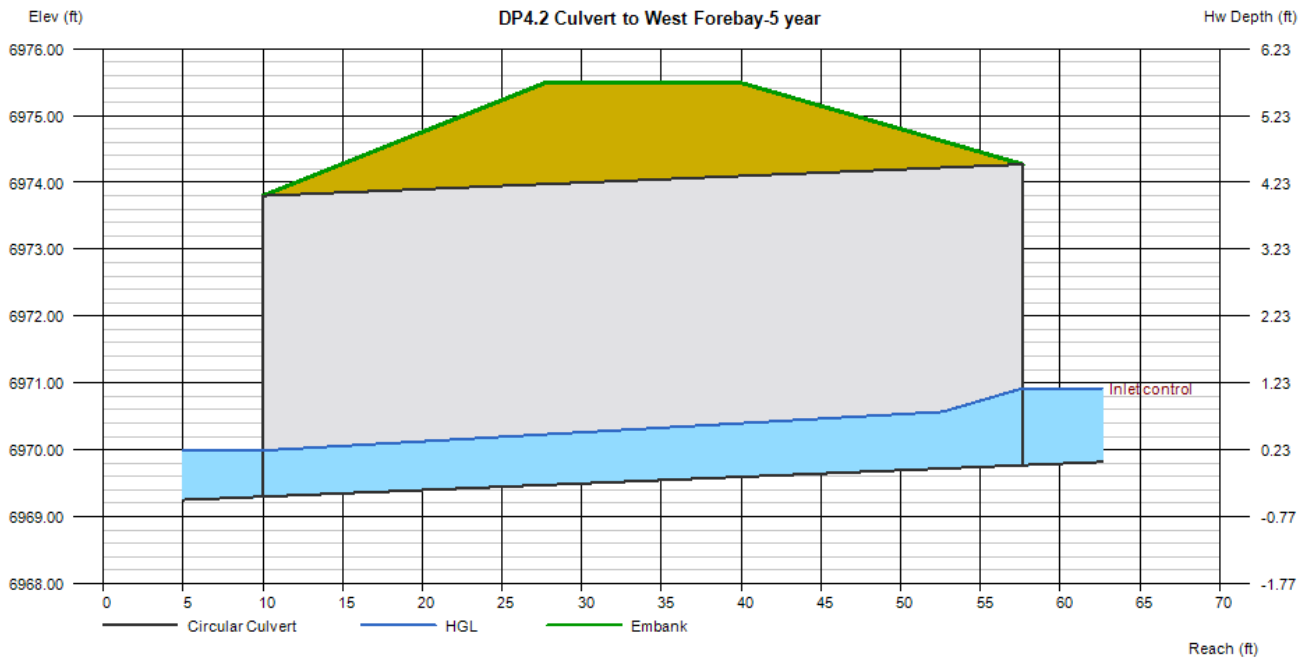

Culvert Report

DP4.2 Culvert to West Forebay-100 year

Invert Elev Dn (ft)	= 6969.30
Pipe Length (ft)	= 47.65
Slope (%)	= 0.99
Invert Elev Up (ft)	= 6969.77
Rise (in)	= 54.0
Shape	= Circular
Span (in)	= 54.0
No. Barrels	= 1
n-Value	= 0.013
Culvert Type	= Circular Concrete
Culvert Entrance	= Groove end projecting (C)
Coeff. K,M,c,Y,k	= 0.0045, 2, 0.0317, 0.69, 0.2

Embankment	
Top Elevation (ft)	= 6975.50
Top Width (ft)	= 12.00
Crest Width (ft)	= 78.00

Calculations	
Qmin (cfs)	= 40.50
Qmax (cfs)	= 40.50
Tailwater Elev (ft)	= 6969.67

Highlighted	
Qtotal (cfs)	= 40.50
Qpipe (cfs)	= 40.50
Qovertop (cfs)	= 0.00
Veloc Dn (ft/s)	= 8.74
Veloc Up (ft/s)	= 6.66
HGL Dn (ft)	= 6970.80
HGL Up (ft)	= 6971.60
Hw Elev (ft)	= 6972.30
Hw/D (ft)	= 0.56
Flow Regime	= Inlet Control

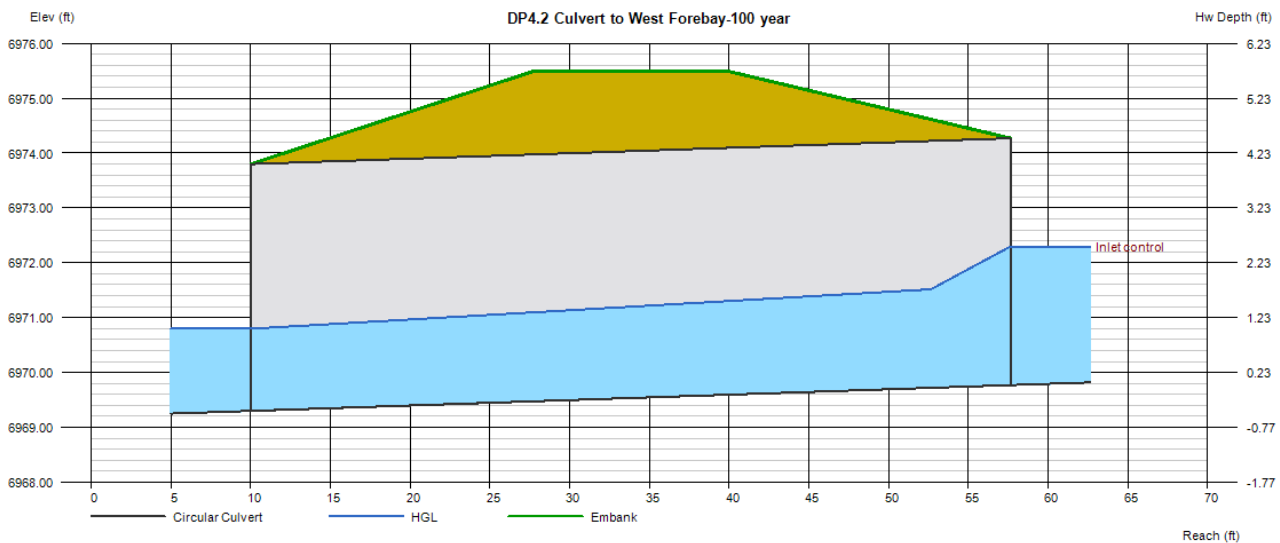

Channel Report

Swale DP5

Triangular

Side Slopes (z:1) = 3.00, 3.00
Total Depth (ft) = 2.00

Invert Elev (ft) = 1.00
Slope (%) = 1.00
N-Value = 0.035

Calculations

Compute by: Known Q
Known Q (cfs) = 4.00

Highlighted

Depth (ft) = 0.79
Q (cfs) = 4.000
Area (sqft) = 1.87
Velocity (ft/s) = 2.14
Wetted Perim (ft) = 5.00
Crit Depth, Yc (ft) = 0.65
Top Width (ft) = 4.74
EGL (ft) = 0.86

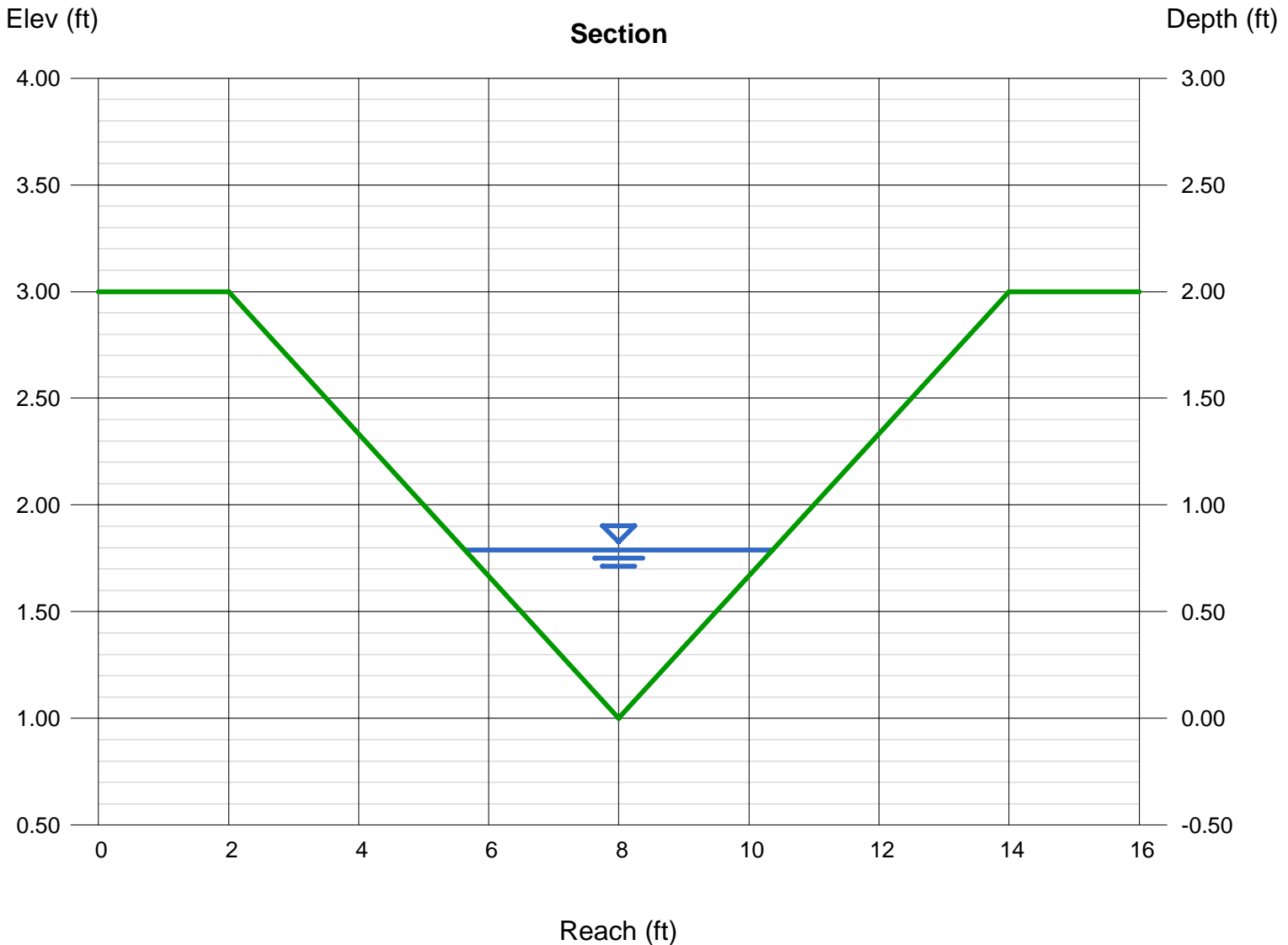

Channel Report

Swale DP6

Triangular

Side Slopes (z:1) = 3.00, 3.00
Total Depth (ft) = 2.00

Invert Elev (ft) = 1.00
Slope (%) = 1.00
N-Value = 0.035

Calculations

Compute by: Known Q
Known Q (cfs) = 7.50

Highlighted

Depth (ft) = 0.99
Q (cfs) = 7.500
Area (sqft) = 2.94
Velocity (ft/s) = 2.55
Wetted Perim (ft) = 6.26
Crit Depth, Yc (ft) = 0.83
Top Width (ft) = 5.94
EGL (ft) = 1.09

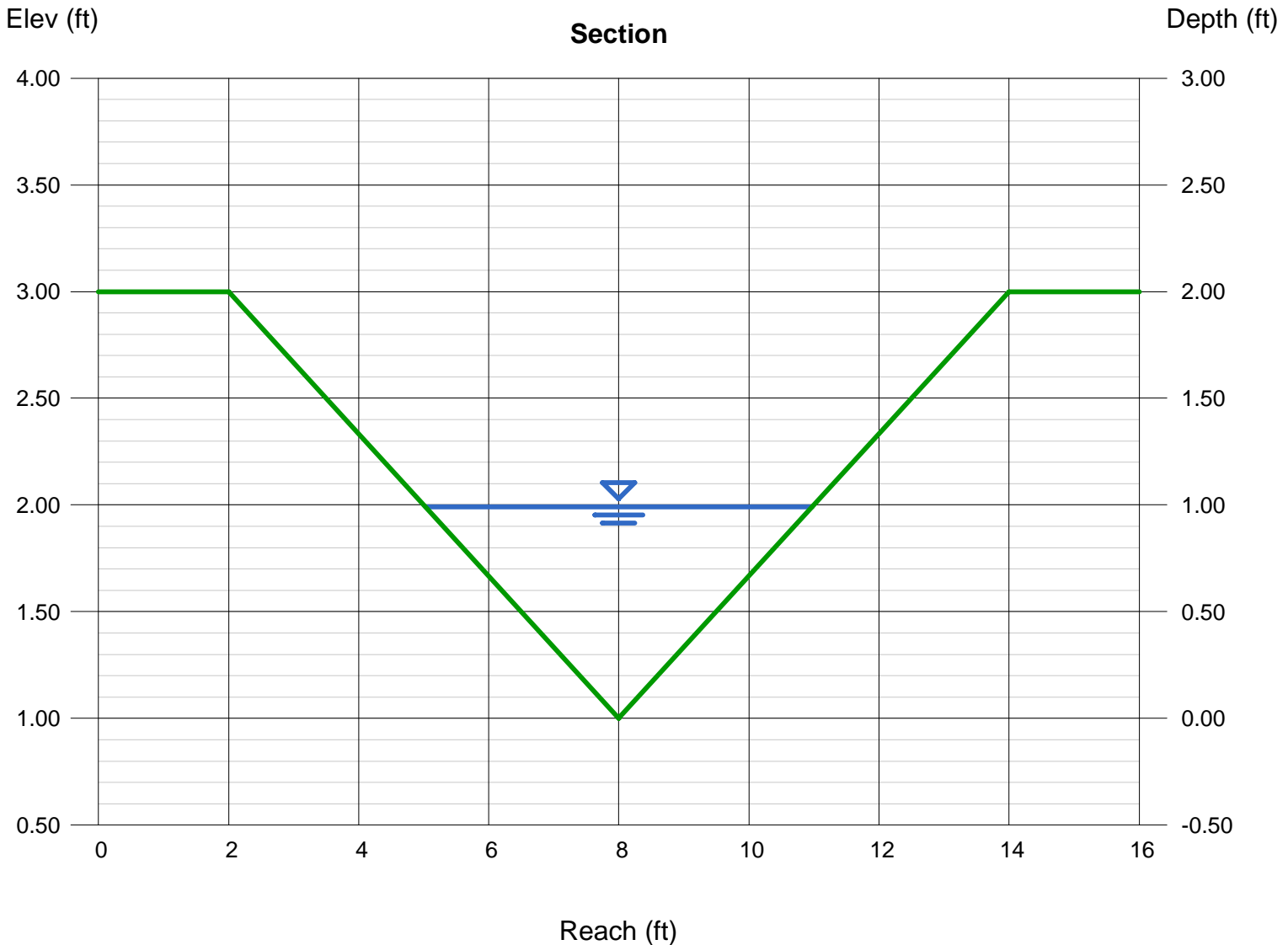

Froude Number Calculations

Sterling Ranch Recycling Facility

Froude Number Equation:

$$Fr = \frac{v}{(gh_m)^{1/2}}$$

Where:

v= velocity (ft/s)

g= acceleration of gravity (32.2ft/s²)

h_m=hydraulic mean depth (ft)

Hydraulic Mean Depth Equation:

$$h_m = \frac{A}{T}$$

Where:

A= cross sectional area of filled flow in channel (ft²)

T= width of channel open to surface (ft)

Swale DP2 Calculations:

Parameters: S= 1.0%, A= 7.39 ft², T= 9.42 ft, v= 3.45 ft/s

Therefore:

$$h_m = \frac{7.39}{9.42} = 0.78 \text{ ft}$$

$$Fr = \frac{3.45}{(32.2 * 0.78)^{1/2}} = 0.69$$

For cohesive soils, maximum Froude Number is 0.80.

Swale DP4 Calculations:

Parameters: S= 1.0%, A= 5.91 ft², T= 9.10 ft, v= 3.04 ft/s

Therefore:

$$h_m = \frac{5.91}{9.10} = 0.65 \text{ ft}$$

$$Fr = \frac{3.04}{(32.2 * 0.65)^{1/2}} = 0.66$$

For cohesive soils, maximum Froude Number is 0.80.

Swale DP4.1 Calculations:

Parameters: S= 2.0%, A= 4.99 ft², T= 7.74 ft, v= 4.31 ft/s

Therefore:
$$h_m = \frac{4.99}{7.74} = 0.64 \text{ ft}$$

$$Fr = \frac{4.31}{(32.2 * 0.64)^{1/2}} = 0.95$$

For cohesive soils, maximum Froude Number is 0.80.

Turf Reinforcement Mat (TRM) used for this swale.

Swale DP5 Calculations:

Parameters: S= 1.0%, A= 1.87 ft², T= 4.74 ft, v= 2.14 ft/s

Therefore:
$$h_m = \frac{1.87}{4.74} = 0.39 \text{ ft}$$

$$Fr = \frac{2.14}{(32.2 * 0.39)^{1/2}} = 0.60$$

For cohesive soils, maximum Froude Number is 0.80.

Swale DP6 Calculations:

Parameters: S= 1.0%, A= 2.94 ft², T= 5.94 ft, v= 2.55 ft/s

Therefore:
$$h_m = \frac{2.94}{5.94} = 0.49 \text{ ft}$$

$$Fr = \frac{2.55}{(32.2 * 0.49)^{1/2}} = 0.64$$

For cohesive soils, maximum Froude Number is 0.80.

VMax[®] TRMs



A Permanent Turf Reinforcement Mat Solution for Every Design

The VMax system of permanent TRMs are ideal for high-flow channels, streambanks, shorelines, and other areas needing permanent vegetation reinforcement and protection from water and wind. Our VMax TRMs combine a three-dimensional matting and a fiber matrix material for all-out erosion protection, vegetation establishment and reinforcement. The VMax TRMs are available with various performance capabilities and support reinforced vegetative lining development from germination to maturity.

VMax[®] Unique Three-Dimensional Design

North American Green VMax TRMs are each designed to maximize performance through all development phases of a reinforced vegetative lining. The corrugated matting structure lends a true reinforcement zone for vegetation entanglement, especially compared to flat net mats. The unique design of the corrugated matting also helps to create a shear plane that deflects flowing water away from the soil surface. And the incorporation of a fiber matrix supplements the 3-D structure by creating a ground cover that blocks soil movement and aids in vegetation establishment.

Four VMax Turf Reinforcement Mats Designed for Every Level of Performance

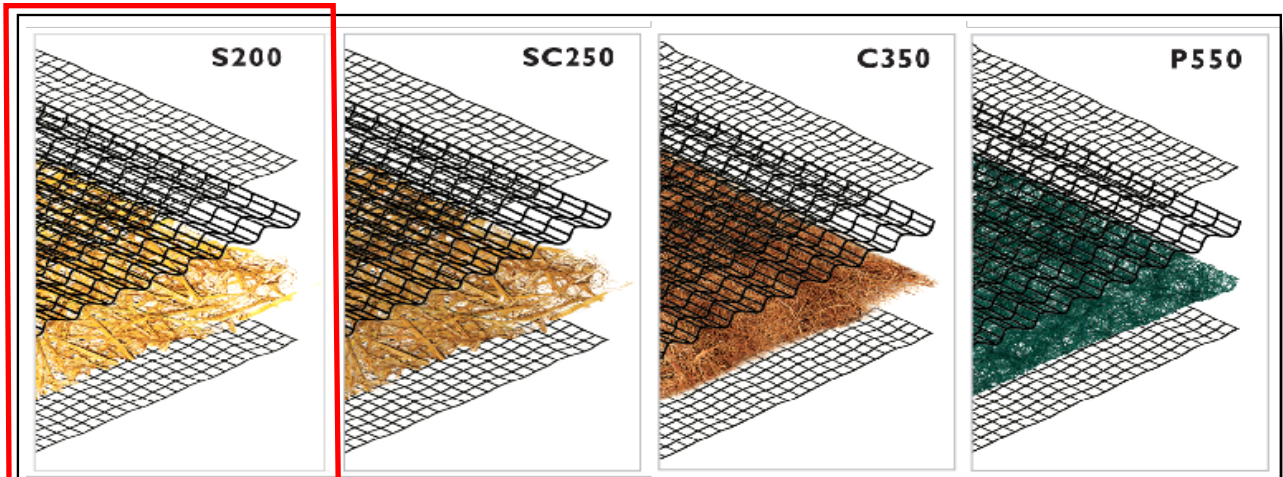

Matrix Fiber	100% Straw	70% Straw / 30% Coconut	100% Coconut	100% Polypropylene
Netting Types	Top and Bottom light-weight UV-stabilized PP, Crimped PP center net	Top and Bottom UV-stabilized PP, Crimped PP center net	Top and Bottom heavy-weight UV-stabilized PP, Crimped PP center net	Top and Bottom ultra heavy-weight UV-stabilized PP, Crimped PP center net
Typical Slope Applications (H:V)	1:1 and greater	1:1 and greater	1:1 and greater	1:1 and greater
Channel Shear Stress Threshold	Unvegetated: 2.3 psf Vegetated: 10.0 psf	Unvegetated: 3.0 psf Vegetated: 10.0 psf	Unvegetated: 3.2 psf Vegetated: 12.0 psf	Unvegetated: 4.0 psf Vegetated: 14.0 psf
Channel Velocity Threshold	Unvegetated: 8.5 fps Vegetated: 18 fps	Unvegetated: 9.5 fps Vegetated: 15 fps	Unvegetated: 10.5 fps Vegetated: 20 fps	Unvegetated: 12.5 fps Vegetated: 25 fps

Selected product that will work for all swales above 5 ft/s. Has maximum channel velocity of 18 ft/s.

Copyright 2021.

North American Green, LLC.
4609 E. Boonville-New Harmony Rd., Evansville, IN
(800) 772-2040 | www.nagreen.com



VMax[®] TRMs cont.

Selecting the Right VMax TRM

Choosing the right VMax TRM can be made easy by utilizing our Erosion Control Materials Design Software (www.ecmds.com), which allows users to input project specific parameters for channels, slopes, spillways, and more and ensures proper evaluation, design, and product selection in return. Our four VMax TRMs offer varying performance values, fiber matrix longevities, and price points, to help you meet your project specific goals.



Twist Pin + VMax TRM - an Ideal Installation

Utilizing the VMax TRMs in conjunction with Twist Pin fastener technology can result in an installed system that pushes TRM performance with increased factors of safety. The combined system has been shown to have superior pullout strength performance up to 200 lbs when compared to installation with traditional wire staples and pins. This is up to 10x the pullout resistance of wire staples and pins. Additionally, the use of the twist pins provides intimate contact between the TRM and the soil, and have been shown to be effective in a wide range of soil types. With a quick and easy installation using an electric drill and custom chuck, the TRM+Twist Pin system can eliminate time and labor costs from day 1 through project release.

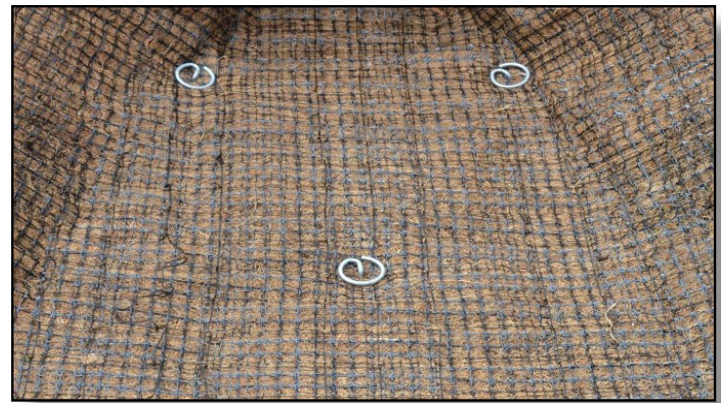

VMax turf reinforcement mat being installed on a channel application (top right), twist pins installed with TRMs can have increased system performance and pullout resistance (middle right), twist pins are available in 8" and 12" lengths and two coil configurations designed for hard or soft soil types (lower right).

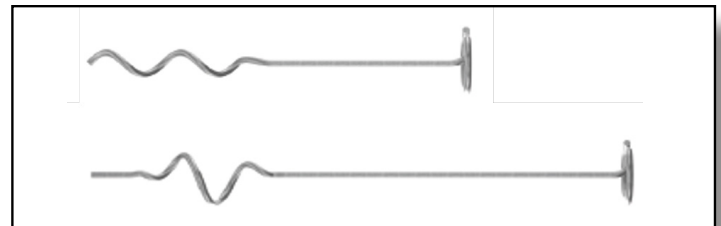

Comparison of common TRM fasteners based on pullout performance and typical application (below).

Fastener	Pullout Resistance (lb)	Comment
6" Round Top Pin	14	Best for hardened soils where other fasteners are damaged during installation.
6" Regular U-staple	42	Standard fastener that develops additional pullout as legs may deflect and add friction during installation.
12" Pin with Washer	35	Standard fastener good for soils where staples can be bent frequently and are too difficult to install.
18" Pin with Washer	27	Standard fastener good for soils where staples are frequently bent and 12" straight pins fail to provide sufficient pullout because surface soil is wet or loose.
Twist Pin	170	Upgraded fastener that provides high pullout and ideal for loose or soft soils.



Copyright 2021.

North American Green, LLC.
4609 E. Boonville-New Harmony Rd., Evansville, IN
(800) 772-2040 | www.nagreen.com

PIPE OUTFALL RIPRAP SIZING CALCULATIONS

Subdivision: Sterling Ranch Recycling Facility
 Location: El Paso County

Project Name: Sterling Ranch
 Project No.: 25188.14
 Calculated By: GAG
 Checked By: _____
 Date: 1/24/24

	STORM DRAIN SYSTEM			Notes
	DP4.1	DESIGN POINT	DESIGN POINT	
Q ₁₀₀ (cfs):	21.5			Flows are the greater of proposed vs. future
Conduit	Pipe			
D _c , Pipe Diameter (in):	24			
W, Box Width (ft):	N/A			
H, Box Height (ft):	N/A			
Y _t , Tailwater Depth (ft):	1.60			If unknown, use Y _t /D _c (or H)=0.4
Y _t /D _c or Y _t /H	0.80			
Q/D ^{2.5} or Q/(WH ^{3/2})	3.80			
Supercritical?	No			
Y _n , Normal Depth (ft) [Supercritical]:				
D _a , H _a (in) [Supercritical]:	N/A			D _a =(D _c +Y _n)/2
Riprap d ₅₀ (in) [Supercritical]:	N/A			
Riprap d ₅₀ (in) [Subcritical]:	2.74			
Required Riprap Size:	L			Fig. 9-38 or Fig. 9-36
d ₅₀ (in):	9			
Expansion Factor, 1/(2 tan θ):	6.80			Read from Fig. 9-35 or 9-36
θ:	0.07			
Erosive Soils?	No			
Area of Flow, A _t (ft ²):	3.07			A _t =Q/V
Length of Protection, L _p (ft):	-0.5			L=(1/(2 tan θ))(A _t /Y _t - D)
Min Length (ft)	6.0			Min L=3D or 3H
Max Length (ft)	20.0			Max L=10D or 10H
Min Bottom Width, T (ft):	1.9			T=2*(L _p *tanθ)+W
Design Length (ft)	6.0			
Design Width (ft)	1.9			
Riprap Depth (in)	18			Depth=2(d ₅₀)
Type II Bedding Depth (in)*	6			*Not used if Soil Riprap
Cutoff Wall	No			
Cutoff Wall Depth (ft)				Depth of Riprap and Base
Cutoff Wall Width (ft)				

Note: No Type II Base to be used if Soil Riprap is specified within the plans
 * For use when the flow in the culvert is supercritical (and less than full).

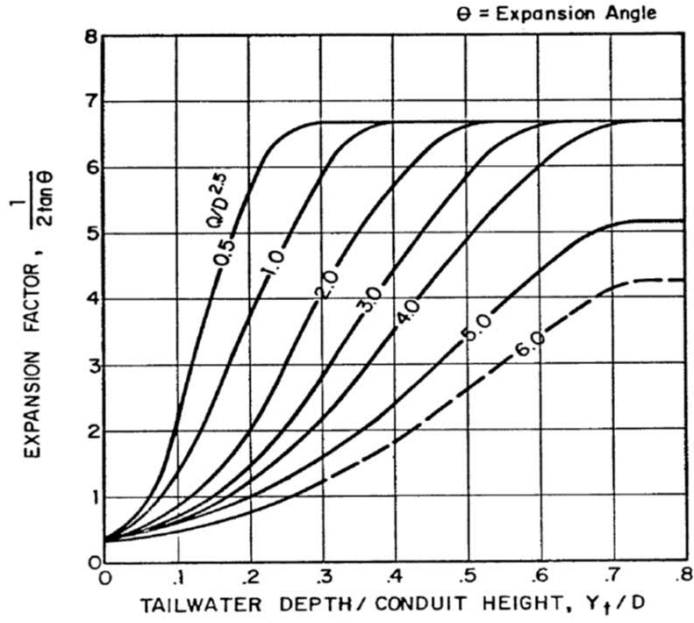

Figure 9-35. Expansion factor for circular conduits

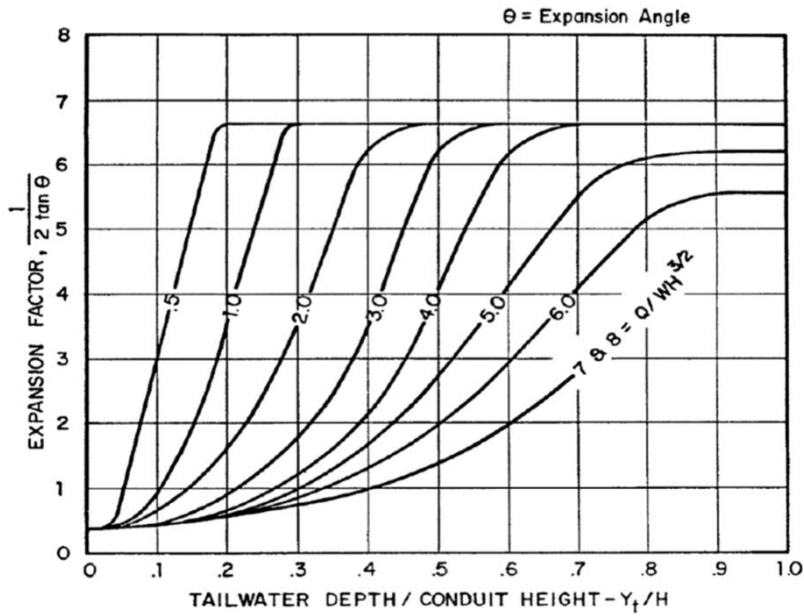

Figure 9-36. Expansion factor for rectangular conduits

INLET MANAGEMENT

Worksheet Protected

INLET NAME	DP7.1
Site Type (Urban or Rural)	URBAN
Inlet Application (Street or Area)	AREA
Hydraulic Condition	Swale
Inlet Type	CDOT Type C

USER-DEFINED INPUT

User-Defined Design Flows	
Minor Q_{Known} (cfs)	2.8
Major Q_{Known} (cfs)	11.2
Bypass (Carry-Over) Flow from Upstream Inlets must be organized from upstream (let	
Receive Bypass Flow from:	No Bypass Flow Received
Minor Bypass Flow Received, Q_b (cfs)	0.0
Major Bypass Flow Received, Q_b (cfs)	0.0
Watershed Characteristics	
Subcatchment Area (acres)	
Percent Impervious	
NRCS Soil Type	
Watershed Profile	
Overland Slope (ft/ft)	
Overland Length (ft)	
Channel Slope (ft/ft)	
Channel Length (ft)	
Minor Storm Rainfall Input	
Design Storm Return Period, T_r (years)	
One-Hour Precipitation, P_1 (inches)	
Major Storm Rainfall Input	
Design Storm Return Period, T_r (years)	
One-Hour Precipitation, P_1 (inches)	

CALCULATED OUTPUT

Minor Total Design Peak Flow, Q (cfs)	2.8
Major Total Design Peak Flow, Q (cfs)	11.2
Minor Flow Bypassed Downstream, Q_b (cfs)	0.0
Major Flow Bypassed Downstream, Q_b (cfs)	0.0

AREA INLET IN A SWALE

Sterling Ranch Recycling Facility

DP7.1

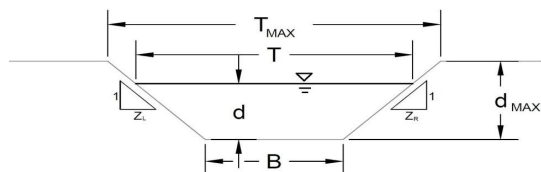

This worksheet uses the NRCS vegetat retardance method to determine Manning's n for grass-lined channels.

An override Manning's n can be entered for other channel materials.

Analysis of Trapezoidal Channel (Grass-Lined uses SCS Method)

NRCS Vegetal Retardance (A, B, C, D, or E)
 Manning's n (Leave cell D16 blank to manually enter an n value)
 Channel Invert Slope
 Bottom Width
 Left Side Slope
 Right Side Slope

Check one of the following soil types:

Soil Type:	Max. Velocity (V _{MAX})	Max Froude No. (F _{MAX})
Non-Cohesive	5.0 fps	0.60
Cohesive	7.0 fps	0.80
Paved	N/A	N/A

A, B, C, D, or E =
 n = 0.030
 S₀ = 0.0100 ft/ft
 B = 0.00 ft
 Z1 = 3.00 ft/ft
 Z2 = 3.00 ft/ft

Choose One:
 Non-Cohesive
 Cohesive
 Paved

Maximum Allowable Top Width of Channel for Minor & Major Storm
 Maximum Allowable Water Depth in Channel for Minor & Major Storm

	Minor Storm	Major Storm	
T _{MAX} =	9.00	12.00	ft
d _{MAX} =	1.50	2.00	ft

Allowable Channel Capacity Based On Channel Geometry

MINOR STORM Allowable Capacity is based on Depth Criterion
 MAJOR STORM Allowable Capacity is based on Depth Criterion

	Minor Storm	Major Storm	
Q _{allow} =	26.7	57.5	cfs
d _{allow} =	1.50	2.00	ft

Water Depth in Channel Based On Design Peak Flow

Design Peak Flow
 Water Depth

Q _o =	2.8	11.2	cfs
d =	0.64	1.08	ft

Minor storm max. allowable capacity GOOD - greater than the design flow given on sheet 'Inlet Management'
 Major storm max. allowable capacity GOOD - greater than the design flow given on sheet 'Inlet Management'

MHFD-Inlet, Version 5.03 (August 2023)
AREA INLET IN A SWALE

Sterling Ranch Recycling Facility
 DP7.1

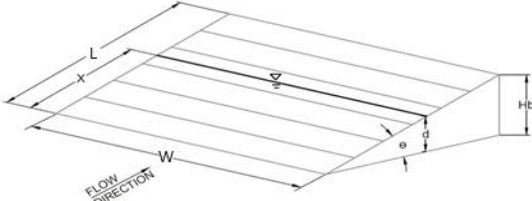
Inlet Design Information (Input)																					
Type of Inlet	CDOT Type C																				
Inlet Type =	CDOT Type C																				
Angle of Inclined Gate (must be ≤ 30 degrees)	$\theta = 0.00$ degrees																				
Width of Gate	$W = 3.00$ ft																				
Length of Gate	$L = 3.00$ ft																				
Open Area Ratio	$A_{RATIO} = 0.70$																				
Height of Inclined Gate	$H_B = 0.00$ ft																				
Clogging Factor	$C_f = 0.50$																				
Grate Discharge Coefficient	$C_d = 0.96$																				
Orifice Coefficient	$C_o = 0.64$																				
Weir Coefficient	$C_w = 2.05$																				
																					
Water Depth at Inlet (for depressed inlets, 1 foot is added for depression)	<table border="1"> <thead> <tr> <th></th> <th>MINOR</th> <th>MAJOR</th> <th></th> </tr> </thead> <tbody> <tr> <td>$d =$</td> <td>0.64</td> <td>1.08</td> <td></td> </tr> <tr> <td>$Q_a =$</td> <td>9.5</td> <td>16.8</td> <td>cfs</td> </tr> <tr> <td>$Q_b =$</td> <td>0.0</td> <td>0.0</td> <td>cfs</td> </tr> <tr> <td>$C\% =$</td> <td>100</td> <td>100</td> <td>%</td> </tr> </tbody> </table>		MINOR	MAJOR		$d =$	0.64	1.08		$Q_a =$	9.5	16.8	cfs	$Q_b =$	0.0	0.0	cfs	$C\% =$	100	100	%
	MINOR	MAJOR																			
$d =$	0.64	1.08																			
$Q_a =$	9.5	16.8	cfs																		
$Q_b =$	0.0	0.0	cfs																		
$C\% =$	100	100	%																		
Total Inlet Interception Capacity (assumes clogged condition)																					
Bypassed Flow																					
Capture Percentage = Q_a/Q_o																					

Warning 03: Velocity exceeds USDCM Volume I recommendation.
 Warning 04: Froude No. exceeds USDCM Volume I recommendation.

Scenario: 100-YEAR

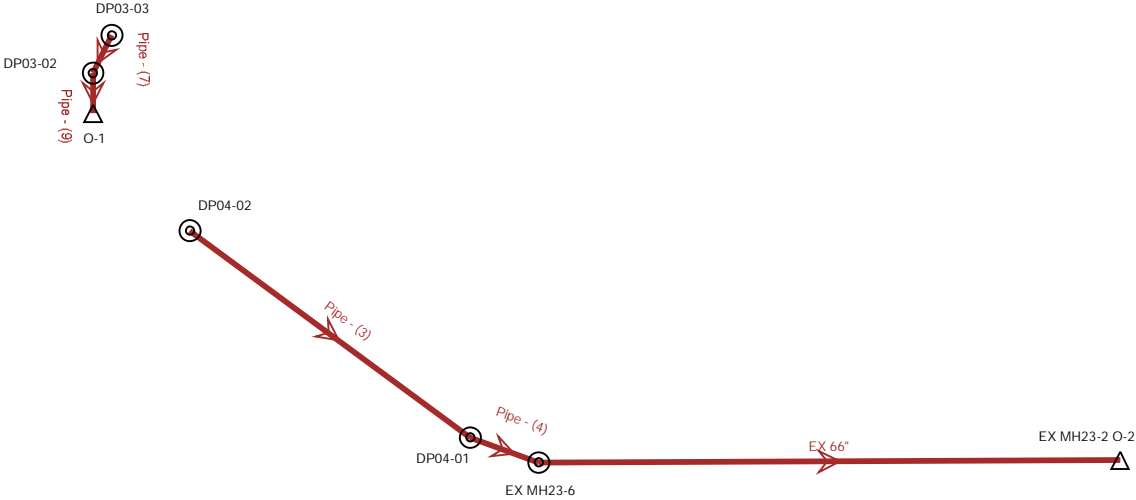

5-year Interim Report																	
Upstream Structure	Label	Flow (cfs)	Capacity (Full Flow) (cfs)	Diameter (in)	Manning's n	Length (User Defined) (ft)	Slope (Calculated) (ft/ft)	Invert (Start) (ft)	Invert (Stop) (ft)	Elevation Ground (Start) (ft)	Elevation Ground (Stop) (ft)	HGL (In) (ft)	HGL (Out) (ft)	Energy Grade Line (In) (ft)	Energy Grade Line (Out) (ft)	Velocity (ft/s)	Upstream Structure Headloss Coefficient
EX MH23-6	EX 66"	30.8	224.37	66	0.013	383	0.004	6,950.94	6,949.23	6,969.69	6,967.11	6,952.44	6,951.02	6,952.98	6,951.35	6.62	0.8
DP04-02	Pipe - (3)	0.1	36.88	24	0.013	182.8	0.027	6,962.50	6,957.64	6,972.90	6,965.69	6,962.61	6,957.72	6,962.64	6,957.82	2.53	0.05
DP04-01	Pipe - (4)	0.1	286.97	48	0.013	47.1	0.04	6,955.32	6,953.44	6,965.69	6,969.69	6,955.41	6,953.50	6,955.44	6,953.61	2.64	0.6
DP03-03	Pipe - (7)	2.8	25.67	18	0.013	17.9	0.06	6,969.54	6,968.47	6,973.50	6,975.50	6,970.18	6,968.84	6,970.42	6,969.93	9.53	0.05
DP03-02	Pipe - (9)	2.8	93.93	36	0.013	20.7	0.02	6,966.97	6,966.56	6,975.50	6,971.23	6,967.49	6,967.62	6,967.67	6,967.64	5.93	0.1
100-year Interim Report																	
Upstream Structure	Label	Flow (cfs)	Capacity (Full Flow) (cfs)	Diameter (in)	Manning's n	Length (User Defined) (ft)	Slope (Calculated) (ft/ft)	Invert (Start) (ft)	Invert (Stop) (ft)	Elevation Ground (Start) (ft)	Elevation Ground (Stop) (ft)	HGL (In) (ft)	HGL (Out) (ft)	Energy Grade Line (In) (ft)	Energy Grade Line (Out) (ft)	Velocity (ft/s)	Upstream Structure Headloss Coefficient
EX MH23-6	EX 66"	241.7	224.37	66	0.013	383	0.004	6,950.94	6,949.23	6,969.69	6,967.11	6,959.37	6,957.39	6,960.98	6,959.00	10.17	0.8
DP04-02	Pipe - (3)	8.3	36.88	24	0.013	182.8	0.027	6,962.50	6,957.64	6,972.90	6,965.69	6,963.53	6,960.67	6,963.93	6,960.77	9.48	0.05
DP04-01	Pipe - (4)	8.3	286.97	48	0.013	47.1	0.04	6,955.32	6,953.44	6,965.69	6,969.69	6,960.66	6,960.66	6,960.67	6,960.67	0.66	0.6
DP03-03	Pipe - (7)	11.2	25.67	18	0.013	17.9	0.06	6,969.54	6,968.47	6,973.50	6,975.50	6,970.82	6,969.31	6,971.58	6,971.17	14.04	0.05
DP03-02	Pipe - (9)	11.2	93.93	36	0.013	20.7	0.02	6,966.97	6,966.56	6,975.50	6,971.23	6,969.67	6,969.67	6,969.71	6,969.71	8.94	0.1

DPO3 - 5-YEAR

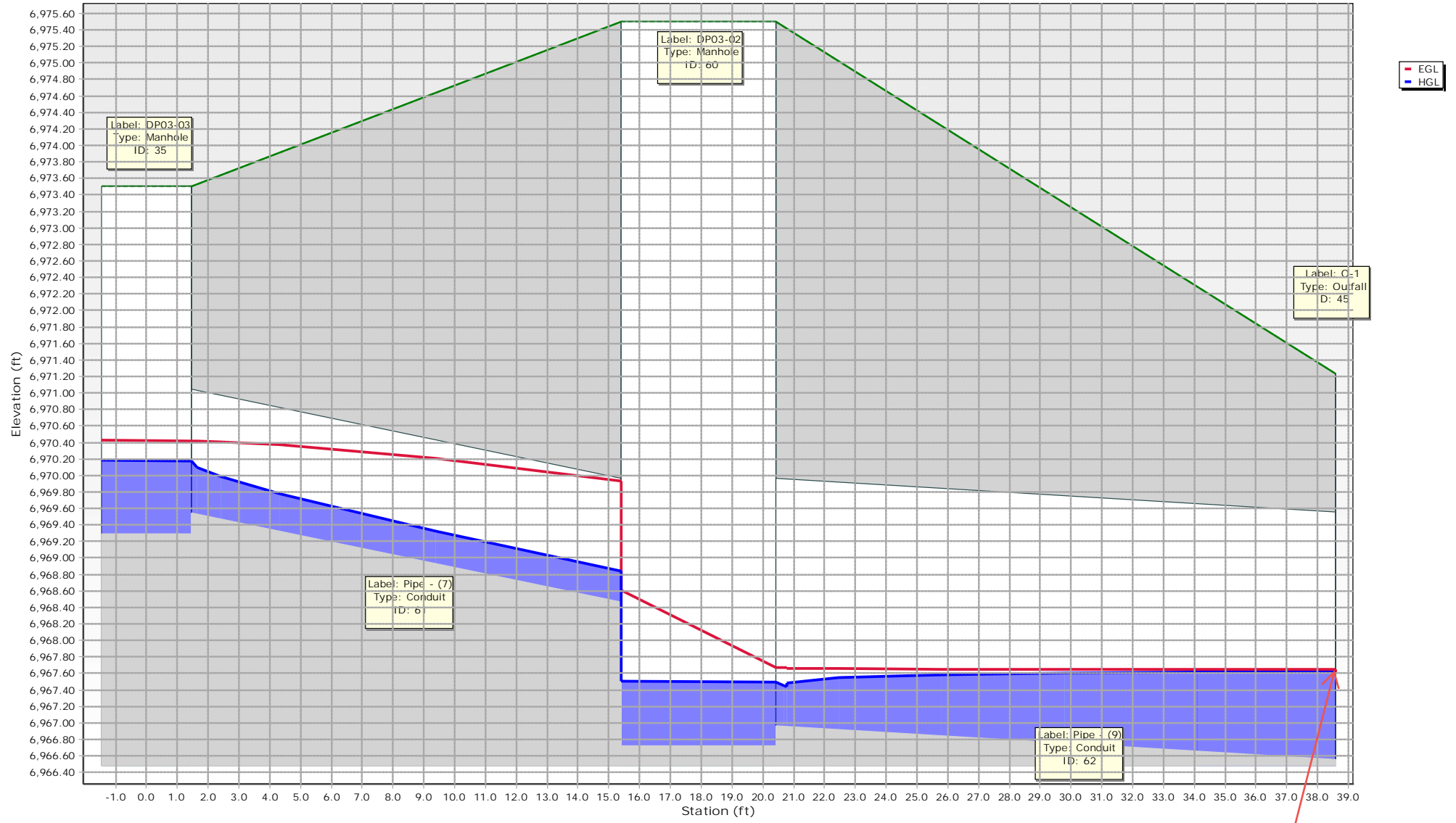

Interim Pond 5-year
Tailwater: 6967.62

DPO4-Interim - 5-YEAR

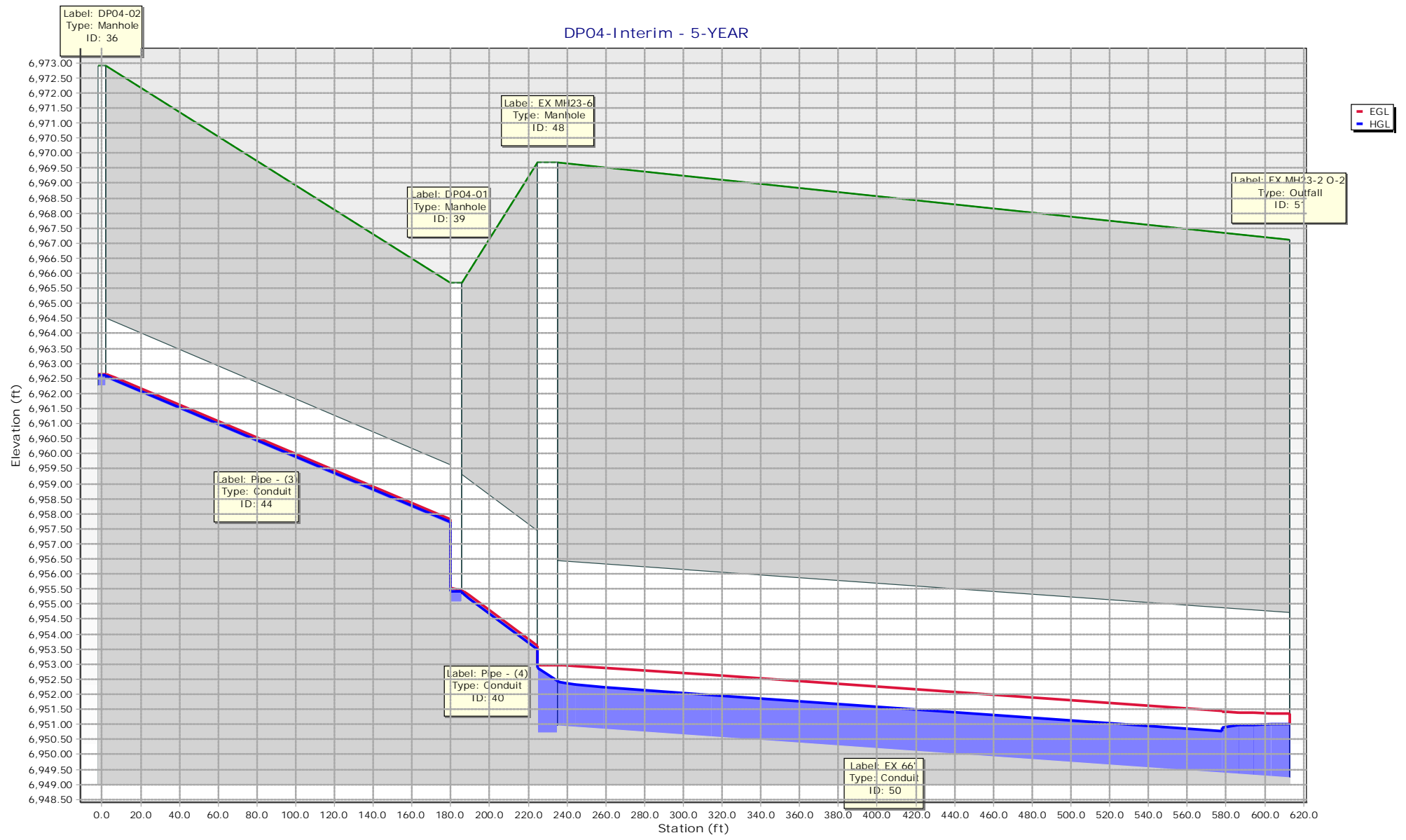

DPO3 - 100-YEAR

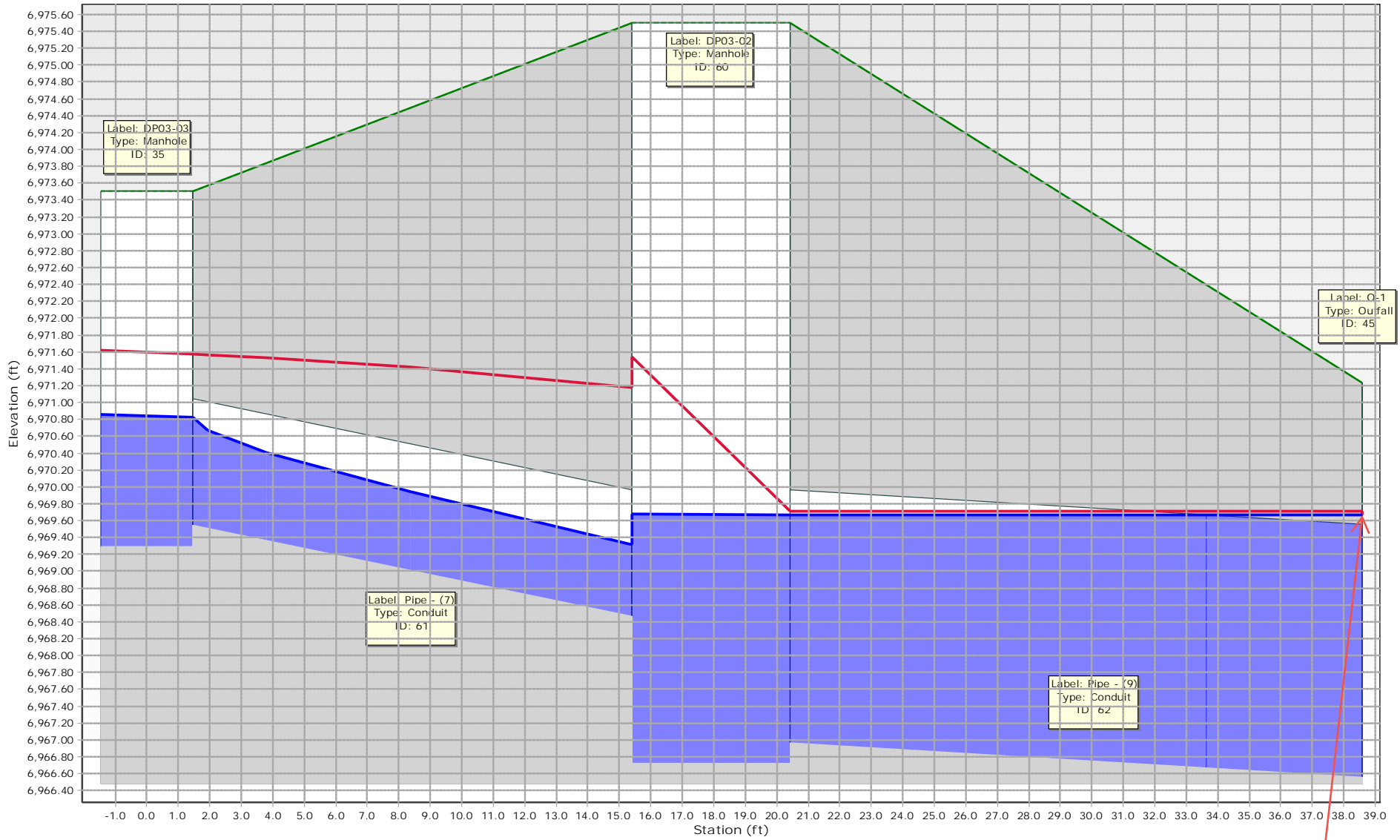

EGL
HGL

Interim Pond 100-year
Tailwater: 6969.67

DPO4-Interim - 100-YEAR

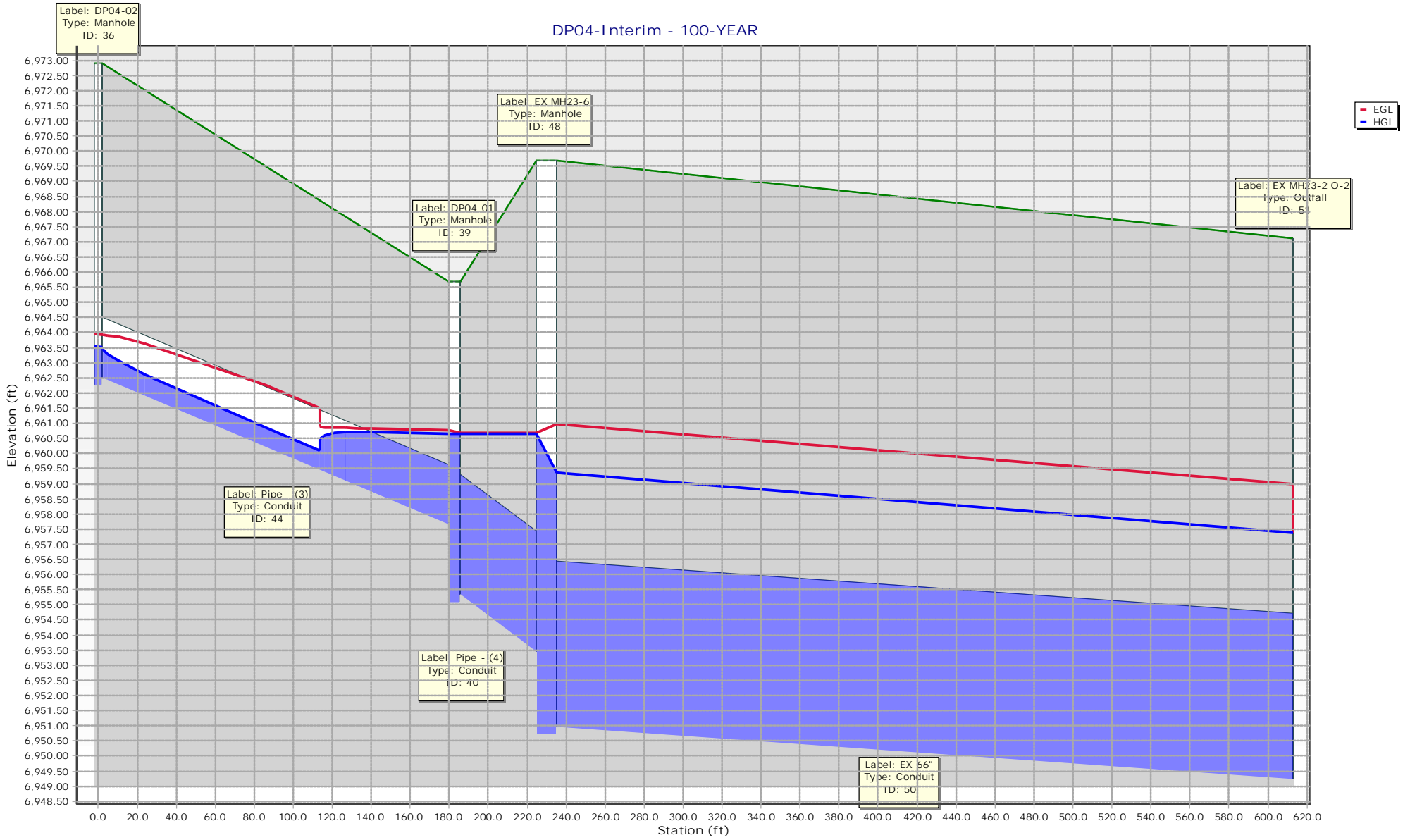

5-year Ultimate Report																	
Upstream Structure	Label	Flow (cfs)	Capacity (Full Flow) (cfs)	Diameter (in)	Manning's n	Length (User Defined) (ft)	Slope (Calculated) (ft/ft)	Invert (Start) (ft)	Invert (Stop) (ft)	Elevation Ground (Start) (ft)	Elevation Ground (Stop) (ft)	HGL (In) (ft)	HGL (Out) (ft)	Energy Grade Line (In) (ft)	Energy Grade Line (Out) (ft)	Velocity (ft/s)	Upstream Structure Headloss Coefficient
EX MH23-6	EX 66"	32.2	224.37	66	0.013	383	0.004	6,950.94	6,949.23	6,969.69	6,967.11	6,952.47	6,951.02	6,953.02	6,951.38	6.71	0.8
DP04-02	Pipe - (3)	1.5	36.88	24	0.013	182.8	0.027	6,962.50	6,957.64	6,972.90	6,965.69	6,962.92	6,957.92	6,963.07	6,958.43	5.75	0.05
DP04-01	Pipe - (4)	1.5	286.97	48	0.013	47.1	0.04	6,955.32	6,953.44	6,965.69	6,969.69	6,955.67	6,953.65	6,955.79	6,954.21	6.01	0.6
100-year Ultimate Report																	
Upstream Structure	Label	Flow (cfs)	Capacity (Full Flow) (cfs)	Diameter (in)	Manning's n	Length (User Defined) (ft)	Slope (Calculated) (ft/ft)	Invert (Start) (ft)	Invert (Stop) (ft)	Elevation Ground (Start) (ft)	Elevation Ground (Stop) (ft)	HGL (In) (ft)	HGL (Out) (ft)	Energy Grade Line (In) (ft)	Energy Grade Line (Out) (ft)	Velocity (ft/s)	Upstream Structure Headloss Coefficient
EX MH23-6	EX 66"	255.6	224.37	66	0.013	383	0.004	6,950.94	6,949.23	6,969.69	6,967.11	6,959.61	6,957.39	6,961.41	6,959.19	10.76	0.8
DP04-02	Pipe - (3)	22.2	36.88	24	0.013	182.8	0.027	6,962.50	6,957.64	6,972.90	6,965.69	6,964.18	6,961.09	6,965.15	6,961.86	12.28	0.05
DP04-01	Pipe - (4)	22.2	286.97	48	0.013	47.1	0.04	6,955.32	6,953.44	6,965.69	6,969.69	6,961.06	6,961.05	6,961.11	6,961.10	1.77	0.6
100-year Ultimate Report- Emergency Overflow																	
Upstream Structure	Label	Flow (cfs)	Capacity (Full Flow) (cfs)	Diameter (in)	Manning's n	Length (User Defined) (ft)	Slope (Calculated) (ft/ft)	Invert (Start) (ft)	Invert (Stop) (ft)	Elevation Ground (Start) (ft)	Elevation Ground (Stop) (ft)	HGL (In) (ft)	HGL (Out) (ft)	Energy Grade Line (In) (ft)	Energy Grade Line (Out) (ft)	Velocity (ft/s)	Upstream Structure Headloss Coefficient
EX MH23-6	EX 66"	358.4	224.37	66	0.013	383	0.004	6,950.94	6,949.23	6,969.69	6,967.11	6,961.75	6,957.39	6,965.29	6,960.93	15.09	0.8
DP04-02	Pipe - (3)	22.2	36.88	24	0.013	182.8	0.027	6,962.50	6,957.64	6,972.90	6,965.69	6,967.45	6,965.69	6,968.23	6,966.47	7.07	0.05
DP04-01	Pipe - (4)	125	286.97	48	0.013	47.1	0.04	6,955.32	6,953.44	6,965.69	6,969.69	6,964.94	6,964.58	6,966.48	6,966.12	9.95	0.6

DP04-Ultimate - 5-YEAR

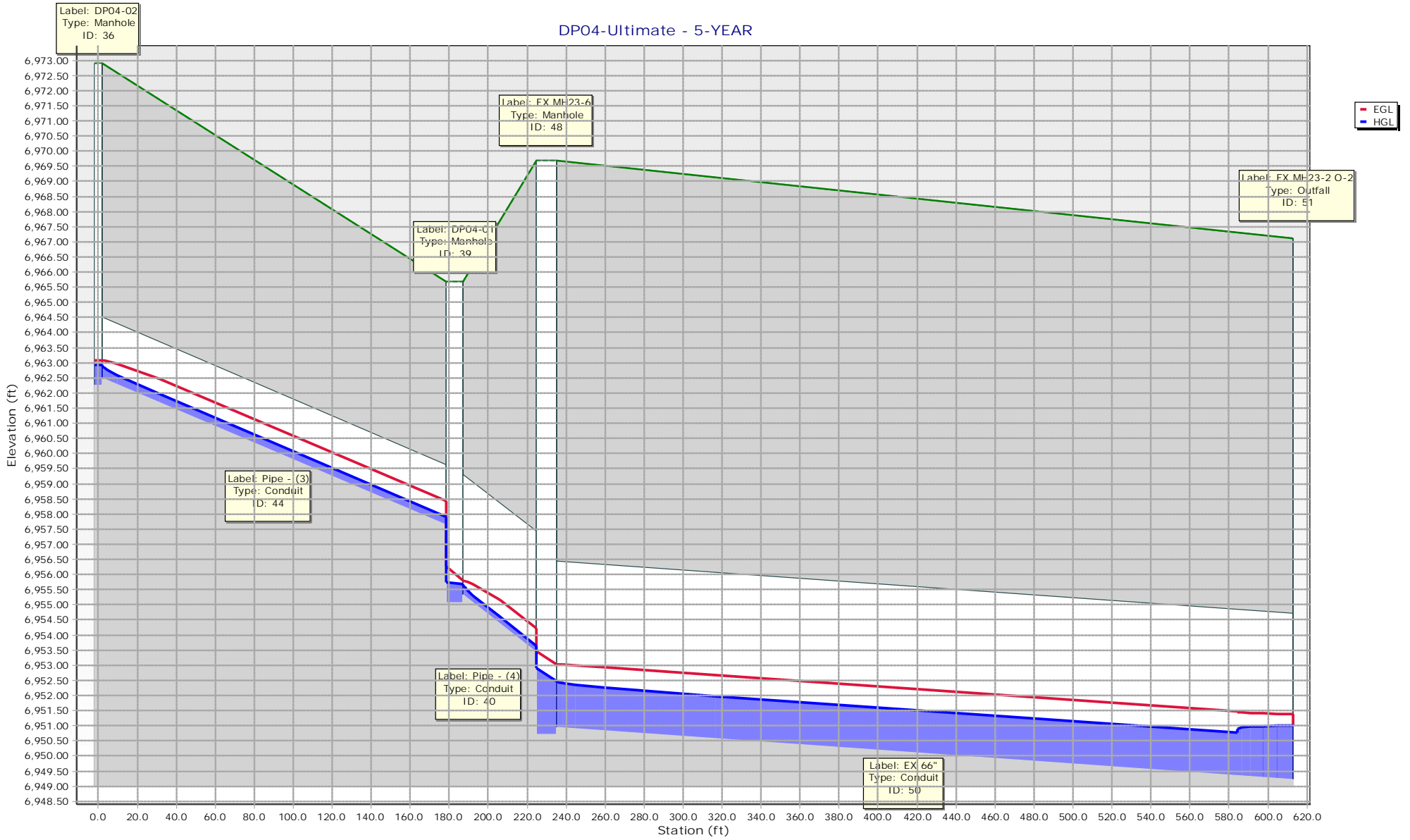

DP04-Ultimate - 100-YEAR

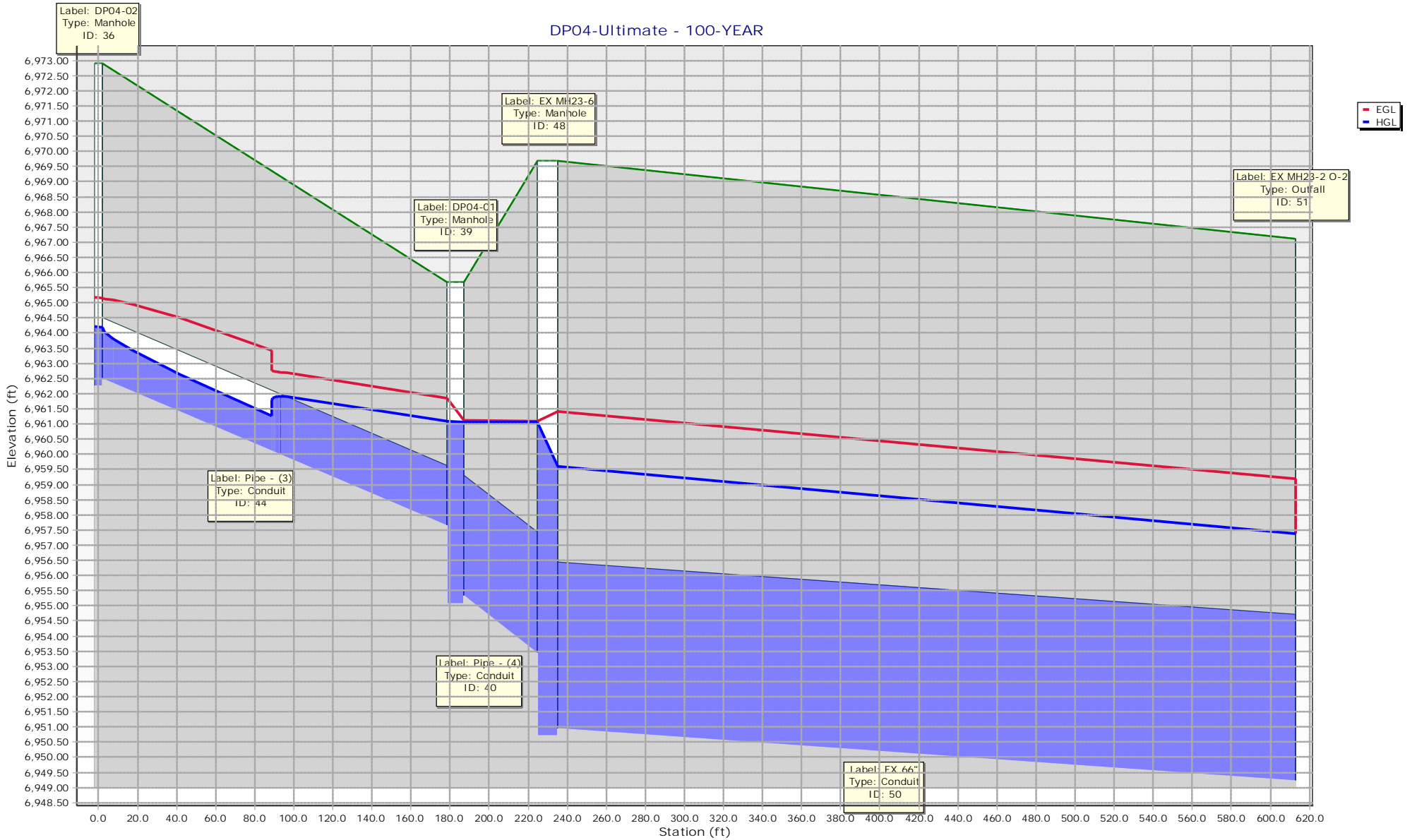

DP04-Ultimate Emergency Overflow - 100-YEAR

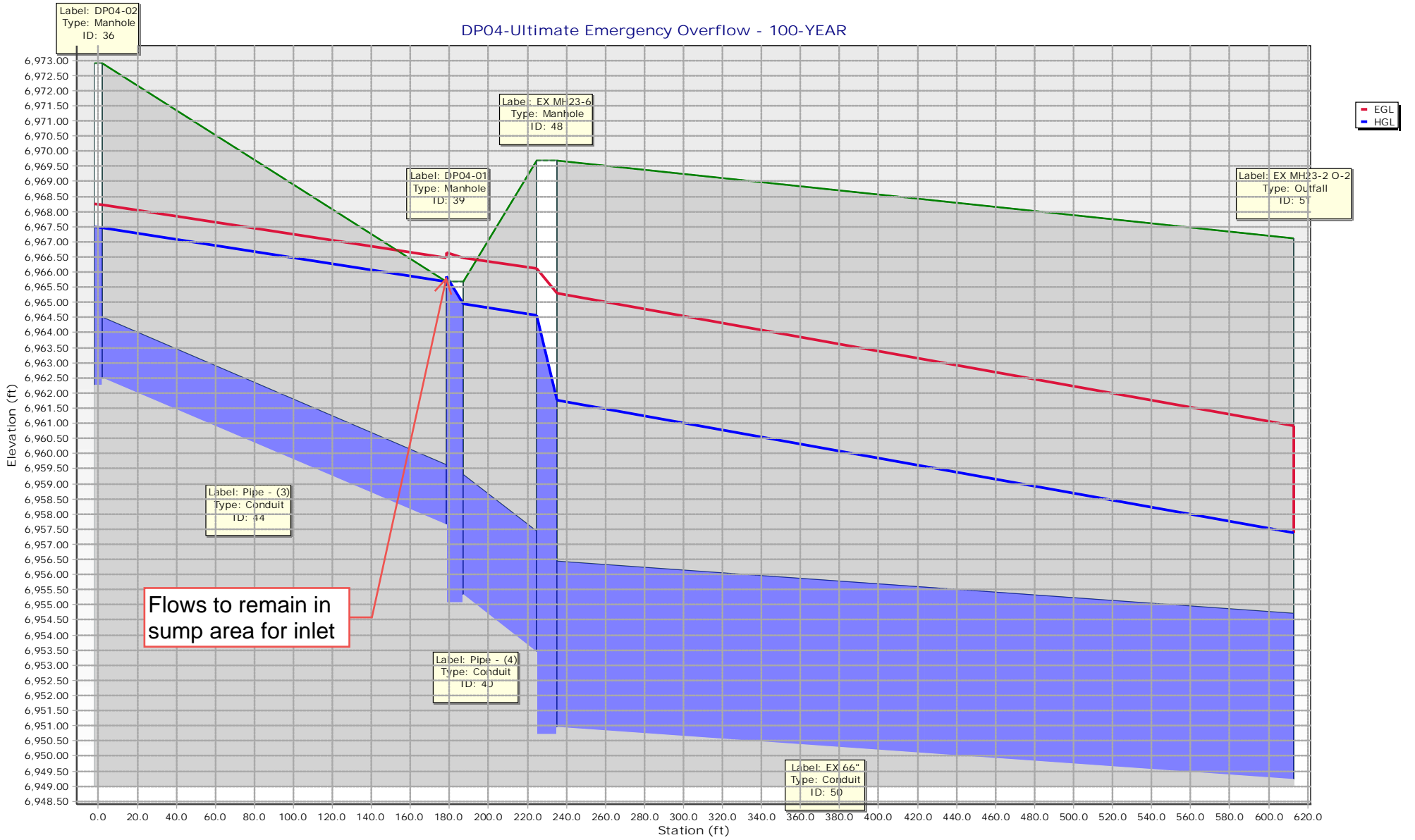

Design Procedure Form: Extended Detention Basin (EDB)

UD-BMP (Version 3.07, March 2018)

Sheet 1 of 3

Designer: Gabe Gonzales
Company: JR Engineering
Date: February 12, 2024
Project: Sterling Ranch Recycling Facility
Location: West Forebay

1. Basin Storage Volume

- A) Effective Imperviousness of Tributary Area, I_a
- B) Tributary Area's Imperviousness Ratio ($i = I_a / 100$)
- C) Contributing Watershed Area
- D) For Watersheds Outside of the Denver Region, Depth of Average Runoff Producing Storm
- E) Design Concept
(Select EURV when also designing for flood control)
- F) Design Volume (WQCV) Based on 40-hour Drain Time
($V_{DESIGN} = (1.0 * (0.91 * i^2 - 1.19 * i^2 + 0.78 * i) / 12 * Area)$)
- G) For Watersheds Outside of the Denver Region, Water Quality Capture Volume (WQCV) Design Volume
($V_{WQCV\ OTHER} = (d_6 * (V_{DESIGN} / 0.43))$)
- H) User Input of Water Quality Capture Volume (WQCV) Design Volume
(Only if a different WQCV Design Volume is desired)
- I) NRCS Hydrologic Soil Groups of Tributary Watershed
 - i) Percentage of Watershed consisting of Type A Soils
 - ii) Percentage of Watershed consisting of Type B Soils
 - iii) Percentage of Watershed consisting of Type C/D Soils
- J) Excess Urban Runoff Volume (EURV) Design Volume
 For HSG A: $EURV_A = 1.68 * i^{1.28}$
 For HSG B: $EURV_B = 1.36 * i^{1.08}$
 For HSG C/D: $EURV_{C/D} = 1.20 * i^{1.08}$
- K) User Input of Excess Urban Runoff Volume (EURV) Design Volume
(Only if a different EURV Design Volume is desired)

$I_a =$ %

$i =$

Area = ac

$d_6 =$ in

Choose One

- Water Quality Capture Volume (WQCV)
- Excess Urban Runoff Volume (EURV)

$V_{DESIGN} =$ ac-ft

$V_{DESIGN\ OTHER} =$ ac-ft

$V_{DESIGN\ USER} =$ ac-ft

HSG _A = %

HSG _B = %

HSG _{C/D} = %

$EURV_{DESIGN} =$ ac-ft

$EURV_{DESIGN\ USER} =$ ac-ft

- 2. Basin Shape: Length to Width Ratio**
(A basin length to width ratio of at least 2:1 will improve TSS reduction.)

L : W = : 1

3. Basin Side Slopes

- A) Basin Maximum Side Slopes
(Horizontal distance per unit vertical, 4:1 or flatter preferred)

Z = ft / ft

4. Inlet

- A) Describe means of providing energy dissipation at concentrated inflow locations:

5. Forebay

- A) Minimum Forebay Volume
($V_{FMN} =$ of the WQCV)
- B) Actual Forebay Volume
- C) Forebay Depth
($D_F =$ inch maximum)
- D) Forebay Discharge
 - i) Undetained 100-year Peak Discharge
 - ii) Forebay Discharge Design Flow
($Q_F = 0.02 * Q_{100}$)
- E) Forebay Discharge Design
- F) Discharge Pipe Size (minimum 8-inches)
- G) Rectangular Notch Width

$V_{FMN} =$ ac-ft

$V_F =$ ac-ft

$D_F =$ in

$Q_{100} =$ cfs

$Q_F =$ cfs

Choose One

- Berm With Pipe
- Wall with Rect. Notch
- Wall with V-Notch Weir

Calculated $D_P =$ in

Calculated $W_N =$ in

Design Procedure Form: Extended Detention Basin (EDB)

UD-BMP (Version 3.07, March 2018)

Sheet 1 of 3

Designer: Gabe Gonzales
Company: JR Engineering
Date: February 8, 2024
Project: Sterling Ranch Recycling Facility
Location: North Forebay

1. Basin Storage Volume

- A) Effective Imperviousness of Tributary Area, I_a
- B) Tributary Area's Imperviousness Ratio ($i = I_a / 100$)
- C) Contributing Watershed Area
- D) For Watersheds Outside of the Denver Region, Depth of Average Runoff Producing Storm
- E) Design Concept
(Select EURV when also designing for flood control)
- F) Design Volume (WQCV) Based on 40-hour Drain Time
($V_{DESIGN} = (1.0 * (0.91 * i^2 - 1.19 * i^2 + 0.78 * i) / 12 * Area)$)
- G) For Watersheds Outside of the Denver Region, Water Quality Capture Volume (WQCV) Design Volume
($V_{WQCV\ OTHER} = (d_6 * (V_{DESIGN} / 0.43))$)
- H) User Input of Water Quality Capture Volume (WQCV) Design Volume
(Only if a different WQCV Design Volume is desired)
- I) NRCS Hydrologic Soil Groups of Tributary Watershed
 - i) Percentage of Watershed consisting of Type A Soils
 - ii) Percentage of Watershed consisting of Type B Soils
 - iii) Percentage of Watershed consisting of Type C/D Soils
- J) Excess Urban Runoff Volume (EURV) Design Volume
 For HSG A: $EURV_A = 1.68 * i^{1.28}$
 For HSG B: $EURV_B = 1.36 * i^{1.08}$
 For HSG C/D: $EURV_{C/D} = 1.20 * i^{1.08}$
- K) User Input of Excess Urban Runoff Volume (EURV) Design Volume
(Only if a different EURV Design Volume is desired)

$I_a =$ %
 $i =$
 Area = ac
 $d_6 =$
 Choose One
 Water Quality Capture Volume (WQCV)
 Excess Urban Runoff Volume (EURV)
 $V_{DESIGN} =$ ac-ft
 $V_{DESIGN\ OTHER} =$
 $V_{DESIGN\ USER} =$
 $HSG_A =$ %
 $HSG_B =$ %
 $HSG_{C/D} =$ %
 $EURV_{DESIGN} =$ ac-ft
 $EURV_{DESIGN\ USER} =$ ac-ft

2. Basin Shape: Length to Width Ratio
(A basin length to width ratio of at least 2:1 will improve TSS reduction.)

$L : W =$: 1

3. Basin Side Slopes

- A) Basin Maximum Side Slopes
(Horizontal distance per unit vertical, 4:1 or flatter preferred)

$Z =$ ft / ft

4. Inlet

- A) Describe means of providing energy dissipation at concentrated inflow locations:

5. Forebay

- A) Minimum Forebay Volume
($V_{FMIN} =$ of the WQCV)
- B) Actual Forebay Volume
- C) Forebay Depth
($D_F =$ inch maximum)
- D) Forebay Discharge
 - i) Undetained 100-year Peak Discharge
 - ii) Forebay Discharge Design Flow
($Q_F = 0.02 * Q_{100}$)
- E) Forebay Discharge Design
- F) Discharge Pipe Size (minimum 8-inches)
- G) Rectangular Notch Width

$V_{FMIN} =$ ac-ft
 $V_F =$ ac-ft
 $D_F =$ in
 $Q_{100} =$ cfs
 $Q_F =$ cfs
 Choose One
 Berm With Pipe
 Wall with Rect. Notch
 Wall with V-Notch Weir
 Calculated $D_P =$ in
 Calculated $W_N =$ in

Flow too small for berm w/ pipe

Weir Report

West Forebay Interim Release Rate

Compound Weir

Crest	= Sharp
Bottom Length (ft)	= 6.00
Total Depth (ft)	= 2.50
Length, x (ft)	= 0.25
Depth, a (ft)	= 2.25

Highlighted

Depth (ft)	= 0.98
Q (cfs)	= 0.810
Area (sqft)	= 0.25
Velocity (ft/s)	= 3.30
Top Width (ft)	= 0.25

Calculations

Weir Coeff. Cw	= 3.33
Compute by:	Known Q
Known Q (cfs)	= 0.81

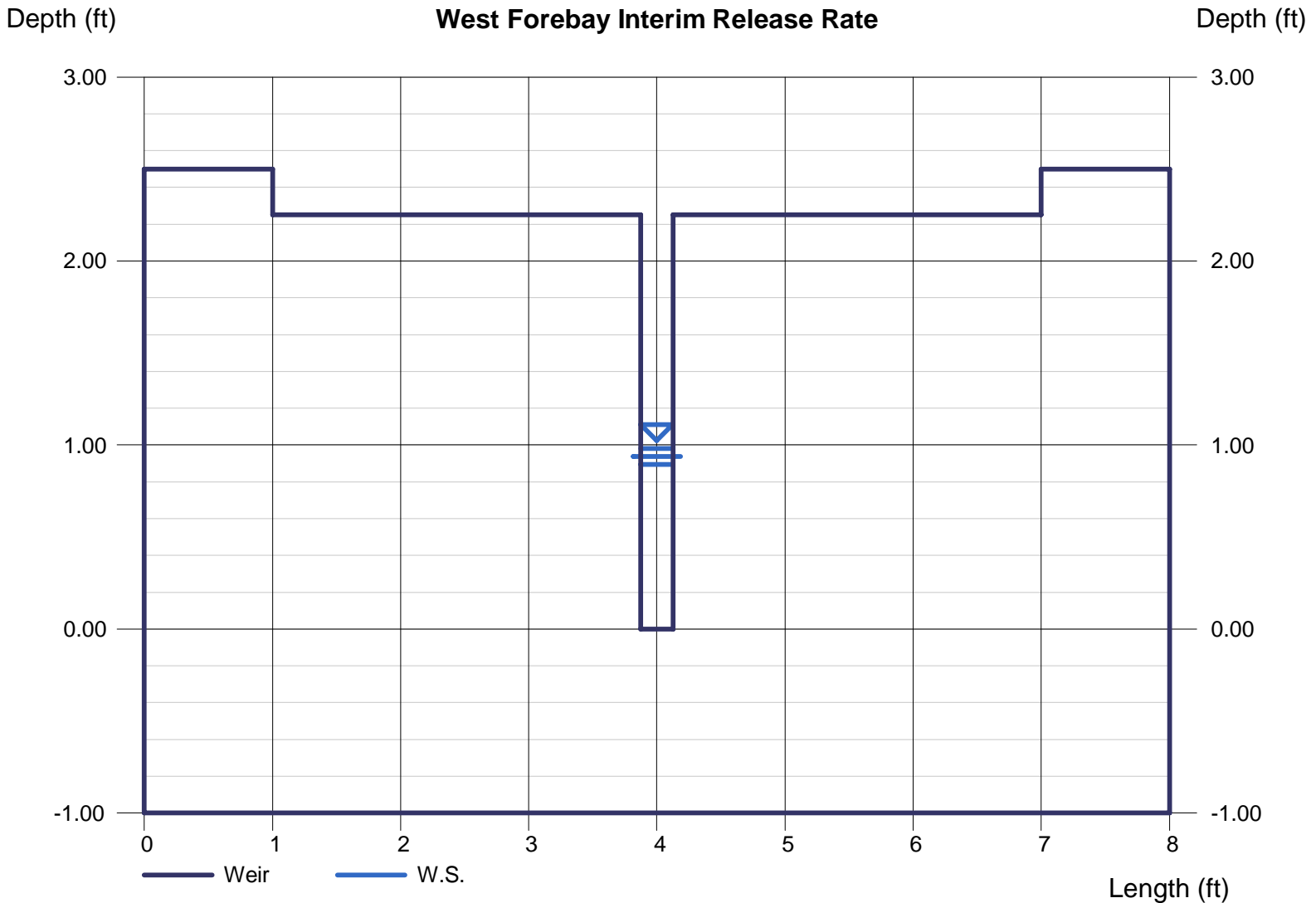

Weir Report

North Forebay Interim Release Rate

Compound Weir

Crest	= Sharp
Bottom Length (ft)	= 6.00
Total Depth (ft)	= 1.50
Length, x (ft)	= 0.25
Depth, a (ft)	= 1.25

Highlighted

Depth (ft)	= 0.42
Q (cfs)	= 0.230
Area (sqft)	= 0.11
Velocity (ft/s)	= 2.17
Top Width (ft)	= 0.25

Calculations

Weir Coeff. Cw	= 3.33
Compute by:	Known Q
Known Q (cfs)	= 0.23

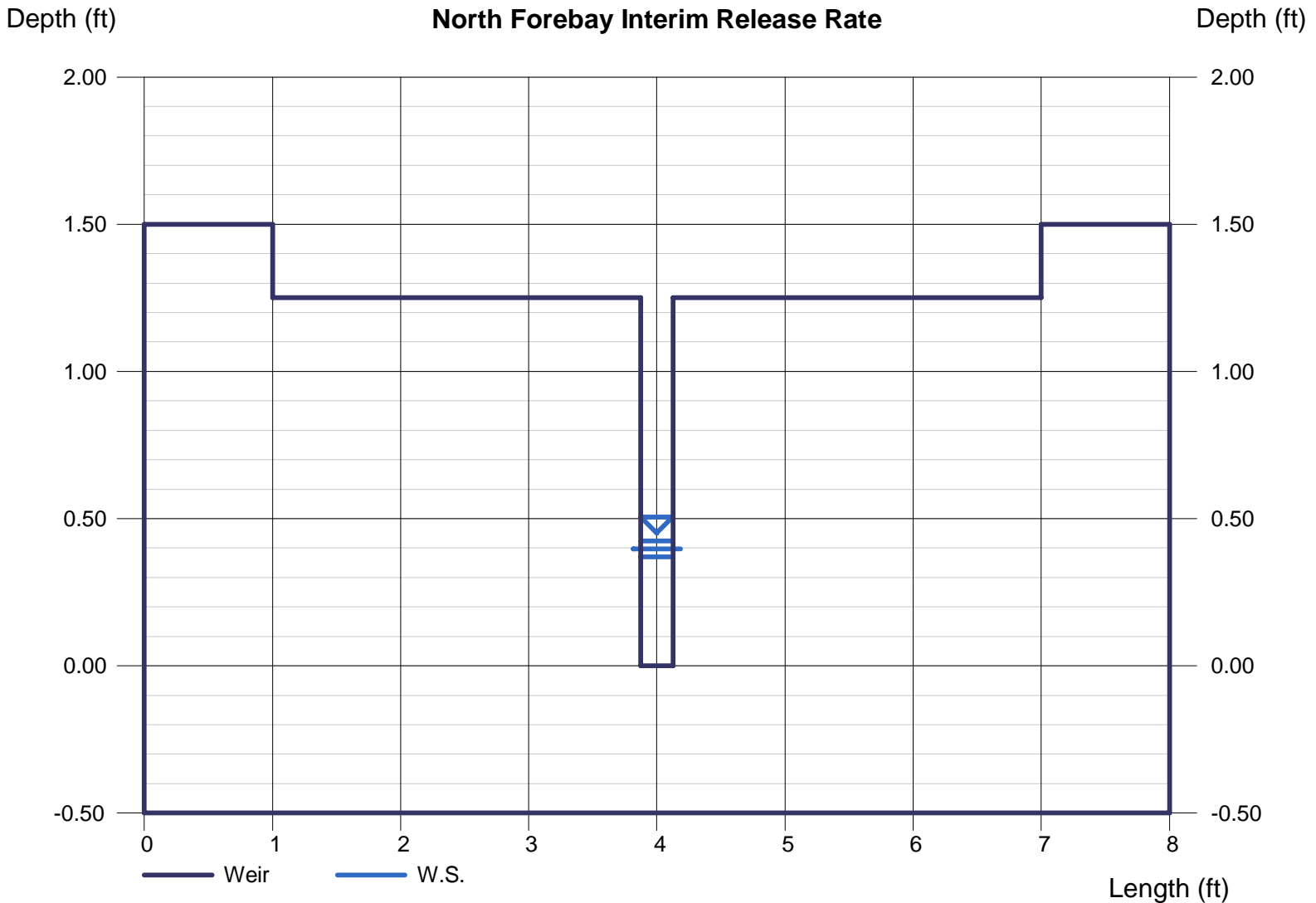

Channel Report

Trickle Channel Capacity-Interim 6 ft

Rectangular

Bottom Width (ft) = 6.00
Total Depth (ft) = 0.50

Invert Elev (ft) = 100.00
Slope (%) = 0.50
N-Value = 0.013

Calculations

Compute by: Known Q
Known Q (cfs) = 1.00

Highlighted

Depth (ft) = 0.10
Q (cfs) = 1.000
Area (sqft) = 0.60
Velocity (ft/s) = 1.67
Wetted Perim (ft) = 6.20
Crit Depth, Yc (ft) = 0.10
Top Width (ft) = 6.00
EGL (ft) = 0.14

Interim Peak Inflow= 49.5 cfs

2% of $Q_{100} = 49.5 * 0.02 = 1.0 \text{ cfs}$

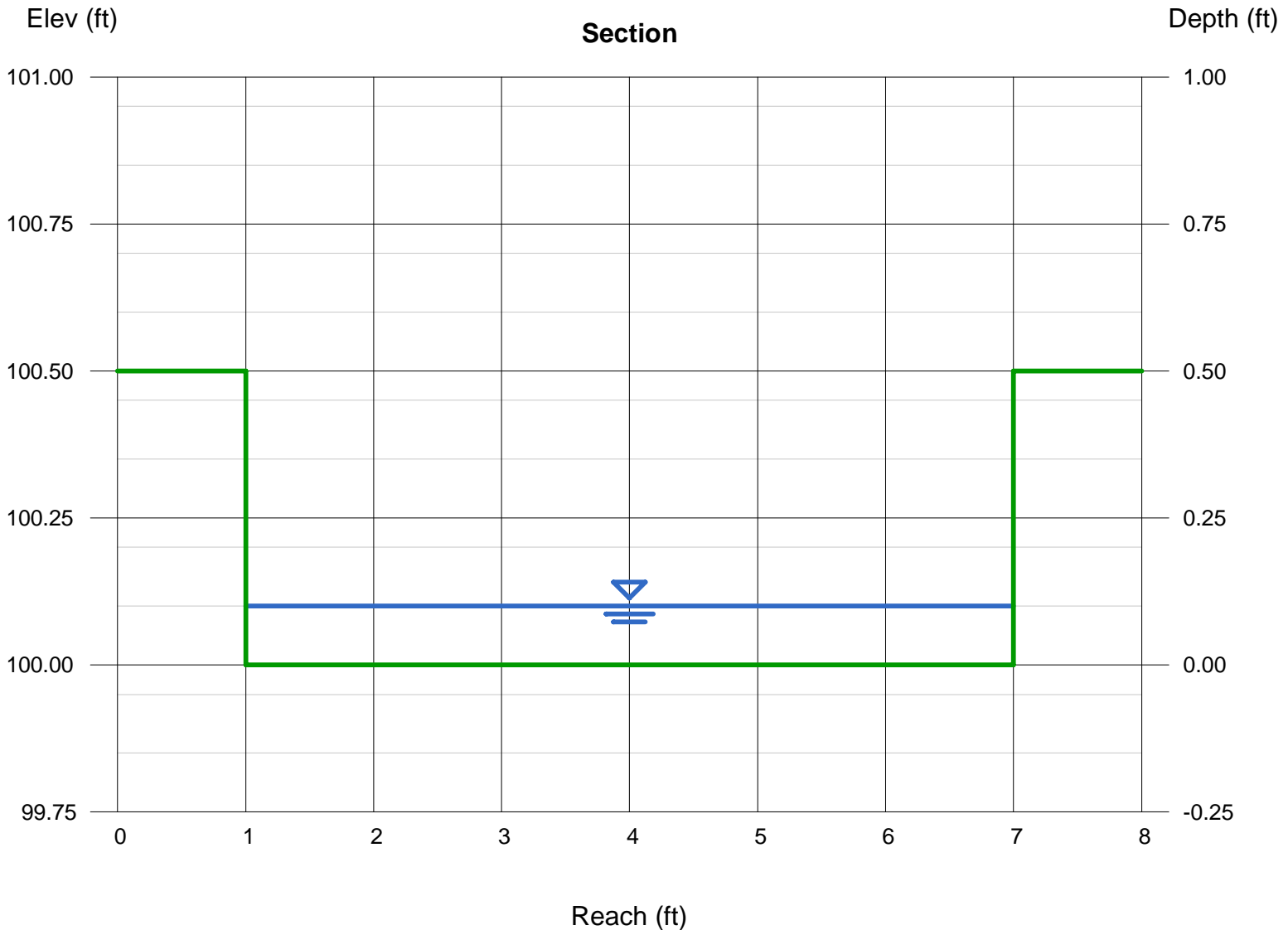

Channel Report

Trickle Channel Capacity-Ultimate

Rectangular

Bottom Width (ft) = 6.00
Total Depth (ft) = 0.50

Invert Elev (ft) = 100.00
Slope (%) = 0.50
N-Value = 0.013

Calculations

Compute by: Known Q
Known Q (cfs) = 2.50

Highlighted

Depth (ft) = 0.18
Q (cfs) = 2.500
Area (sqft) = 1.08
Velocity (ft/s) = 2.31
Wetted Perim (ft) = 6.36
Crit Depth, Yc (ft) = 0.18
Top Width (ft) = 6.00
EGL (ft) = 0.26

Ultimate Peak Inflow= 123.1 cfs
2% of $Q_{100} = 125 * 0.02 = 2.5 \text{ cfs}$

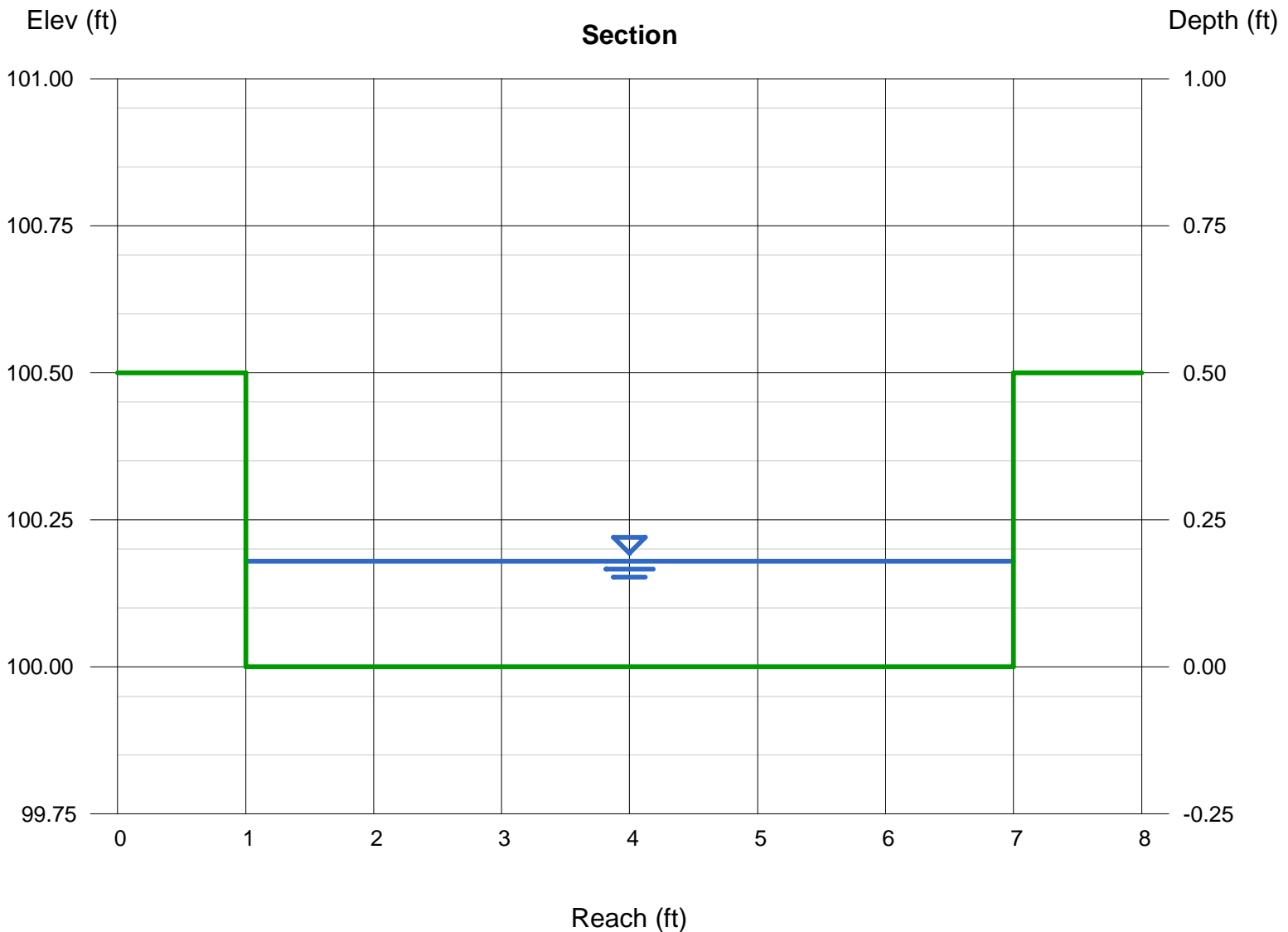

DETENTION BASIN STAGE-STORAGE TABLE BUILDER

MHFD-Defetion, Version 4.06 (July 2022)

Project: Sterling Ranch Recycling Facility
Basin ID: Pond A-Interim

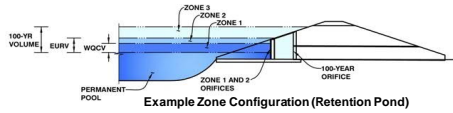

Example Zone Configuration (Retention Pond)

Watershed Information

Selected BMP Type =	EDB
Watershed Area =	42.00 acres
Watershed Length =	2.265 ft
Watershed Length to Centroid =	1.455 ft
Watershed Slope =	0.030 ft/ft
Watershed Imperviousness =	11.00% percent
Percentage Hydrologic Soil Group A =	100.0% percent
Percentage Hydrologic Soil Group B =	0.0% percent
Percentage Hydrologic Soil Groups C/D =	0.0% percent
Target WQC Drain Time =	40.0 hours
Location for 1-hr Rainfall Depths =	User Input

After providing required inputs above including 1-hour rainfall depths, click "Run CUHP" to generate runoff hydrographs using the embedded Colorado Urban Hydrograph Procedure.

Water Quality Capture Volume (WQCV) =	0.254 acre-feet	Optional User Overrides	
Excess Urban Runoff Volume (EURV) =	0.349 acre-feet	acre-feet	
2-yr Runoff Volume (P1 = 1.19 in.) =	0.180 acre-feet	1.19 inches	
5-yr Runoff Volume (P1 = 1.5 in.) =	0.296 acre-feet	1.50 inches	
10-yr Runoff Volume (P1 = 1.75 in.) =	0.395 acre-feet	1.75 inches	
25-yr Runoff Volume (P1 = 2 in.) =	0.972 acre-feet	2.00 inches	
50-yr Runoff Volume (P1 = 2.25 in.) =	1.547 acre-feet	2.25 inches	
100-yr Runoff Volume (P1 = 2.52 in.) =	2.354 acre-feet	2.52 inches	
500-yr Runoff Volume (P1 = 3.14 in.) =	4.129 acre-feet	inches	
Approximate 2-yr Detention Volume =	0.210 acre-feet		
Approximate 5-yr Detention Volume =	0.287 acre-feet		
Approximate 10-yr Detention Volume =	0.376 acre-feet		
Approximate 25-yr Detention Volume =	0.506 acre-feet		
Approximate 50-yr Detention Volume =	0.669 acre-feet		
Approximate 100-yr Detention Volume =	1.054 acre-feet		

Define Zones and Basin Geometry

Zone 1 Volume (WQCV) =	0.254 acre-feet
Zone 2 Volume (EURV - Zone 1) =	0.094 acre-feet
Zone 3 Volume (100-year - Zones 1 & 2) =	0.706 acre-feet
Total Detention Basin Volume =	1.054 acre-feet
Initial Surcharge Volume (ISV) =	user ft ³
Initial Surcharge Depth (ISD) =	user ft
Total Available Detention Depth (H _{total}) =	user ft
Depth of Trickle Channel (H _{TC}) =	user ft
Slope of Trickle Channel (S _{TC}) =	user ft/ft
Slopes of Main Basin Sides (S _{main}) =	user H:V
Basin Length-to-Width Ratio (R _{L/W}) =	user
Initial Surcharge Area (A _{ISV}) =	user ft ²
Surcharge Volume Length (L _{ISV}) =	user ft
Surcharge Volume Width (W _{ISV}) =	user ft
Depth of Basin Floor (H _{FLOOR}) =	user ft
Length of Basin Floor (L _{FLOOR}) =	user ft
Width of Basin Floor (W _{FLOOR}) =	user ft
Area of Basin Floor (A _{FLOOR}) =	user ft ²
Volume of Basin Floor (V _{FLOOR}) =	user ft ³
Depth of Main Basin (H _{MAIN}) =	user ft
Length of Main Basin (L _{MAIN}) =	user ft
Width of Main Basin (W _{MAIN}) =	user ft
Area of Main Basin (A _{MAIN}) =	user ft ²
Volume of Main Basin (V _{MAIN}) =	user ft ³
Calculated Total Basin Volume (V _{total}) =	USER acre-feet

Stage - Storage Description	Stage (ft)	Optional Override Stage (ft)	Length (ft)	Width (ft)	Area (ft ²)	Optional Override Area (ft ²)	Area (acre)	Volume (ft ³)	Volume (ac-ft)
Top of Micropool	--	0.00	--	--	--	10	0.000		
6966	--	1.00	--	--	--	1,164	0.027	587	0.013
6967	--	2.00	--	--	--	7,912	0.182	5,125	0.118
6968	--	3.00	--	--	--	17,659	0.405	17,910	0.411
6969	--	4.00	--	--	--	27,893	0.640	40,686	0.934
6970	--	5.00	--	--	--	36,100	0.829	72,683	1.669
6971	--	6.00	--	--	--	42,123	0.967	111,794	2.566
6972	--	7.00	--	--	--	48,273	1.108	156,992	3.604
6973	--	8.00	--	--	--	54,548	1.252	208,403	4.784
6974 (Crest)	--	9.00	--	--	--	60,948	1.399	266,151	6.110
6975	--	10.00	--	--	--	67,404	1.547	330,327	7.583
6975.5	--	10.50	--	--	--	70,671	1.622	364,846	8.376
--	--	--	--	--	--	--	--	--	--
--	--	--	--	--	--	--	--	--	--

DETENTION BASIN STAGE-STORAGE TABLE BUILDER

MHFD-Defention, Version 4.06 (July 2022)

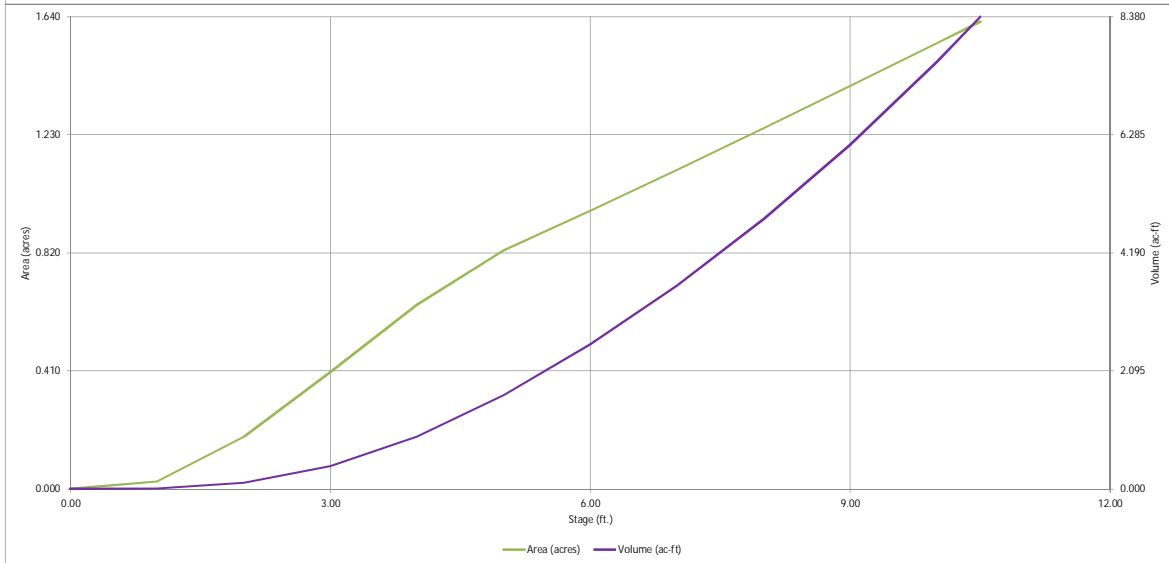
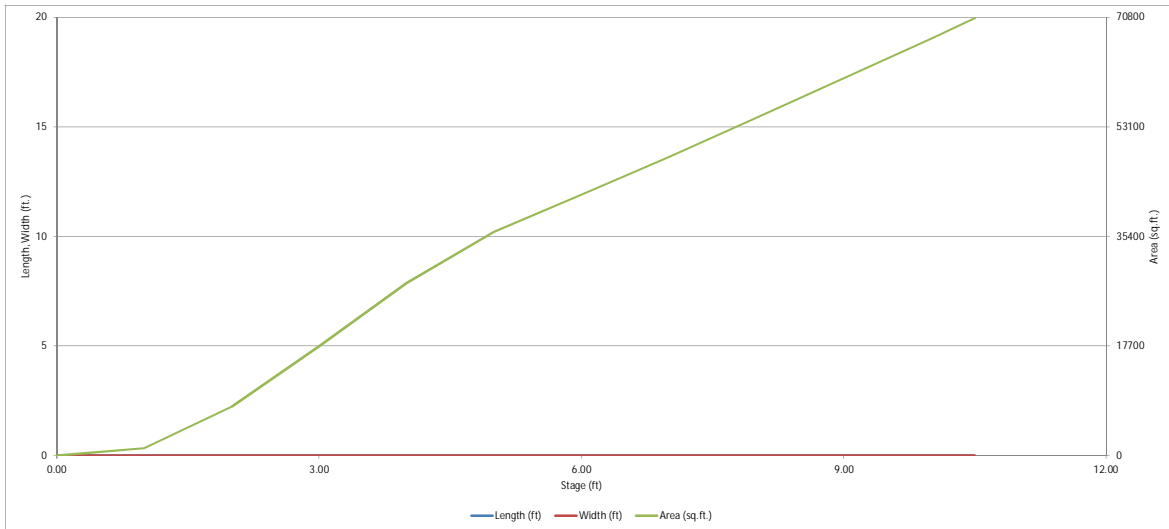

DETENTION BASIN OUTLET STRUCTURE DESIGN

MHFD-Detention, Version 4.06 (July 2022)

Project: Sterling Ranch Recycling Facility
Basin ID: Pond A-Interim

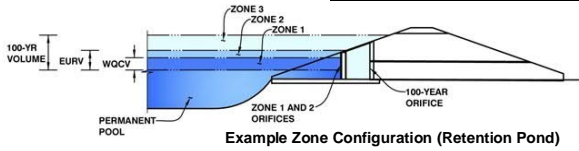

	Estimated Stage (ft)	Estimated Volume (ac-ft)	Outlet Type
Zone 1 (WOCV)	2.56	0.254	Orifice Plate
Zone 2 (EURV)	2.84	0.094	Rectangular Orifice
Zone 3 (100-year)	4.19	0.706	Weir&Pipe (Restrict)
Total (all zones)		1.054	

User Input: Orifice at Underdrain Outlet (typically used to drain WOCV in a Filtration BMP)

Underdrain Orifice Invert Depth =	N/A	ft (distance below the filtration media surface)
Underdrain Orifice Diameter =	N/A	inches

Calculated Parameters for Underdrain

Underdrain Orifice Area =	N/A	ft ²
Underdrain Orifice Centroid =	N/A	feet

User Input: Orifice Plate with one or more orifices or Elliptical Slot Weir (typically used to drain WOCV and/or EURV in a sedimentation BMP)

Centroid of Lowest Orifice =	0.00	ft (relative to basin bottom at Stage = 0 ft)
Depth at top of Zone using Orifice Plate =	2.75	ft (relative to basin bottom at Stage = 0 ft)
Orifice Plate: Orifice Vertical Spacing =	N/A	inches
Orifice Plate: Orifice Area per Row =	N/A	sq. inches

Calculated Parameters for Plate

WO Orifice Area per Row =	N/A	ft ²
Elliptical Half-Width =	N/A	feet
Elliptical Slot Centroid =	N/A	feet
Elliptical Slot Area =	N/A	ft ²

User Input: Stage and Total Area of Each Orifice Row (numbered from lowest to highest)

	Row 1 (required)	Row 2 (optional)	Row 3 (optional)	Row 4 (optional)	Row 5 (optional)	Row 6 (optional)	Row 7 (optional)	Row 8 (optional)
Stage of Orifice Centroid (ft)	0.00	1.00						
Orifice Area (sq. inches)	1.00	1.10						

	Row 9 (optional)	Row 10 (optional)	Row 11 (optional)	Row 12 (optional)	Row 13 (optional)	Row 14 (optional)	Row 15 (optional)	Row 16 (optional)
Stage of Orifice Centroid (ft)								
Orifice Area (sq. inches)								

User Input: Vertical Orifice (Circular or Rectangular)

	Zone 2 Rectangular	Not Selected	
Invert of Vertical Orifice =	2.85	N/A	ft (relative to basin bottom at Stage = 0 ft)
Depth at top of Zone using Vertical Orifice =	4.55	N/A	ft (relative to basin bottom at Stage = 0 ft)
Vertical Orifice Height =	21.00	N/A	inches
Vertical Orifice Width =	12.00		inches

Calculated Parameters for Vertical Orifice

	Zone 2 Rectangular	Not Selected	
Vertical Orifice Area =	1.75	N/A	ft ²
Vertical Orifice Centroid =	0.88	N/A	feet

User Input: Overflow Weir (Dropbox with Flat or Sloped Gate and Outlet Pipe OR Rectangular/Trapezoidal Weir and No Outlet Pipe)

	Zone 3 Weir	Not Selected	
Overflow Weir Front Edge Height, Ho =	7.90	N/A	ft (relative to basin bottom at Stage = 0 ft)
Overflow Weir Front Edge Length =	4.00	N/A	feet
Overflow Weir Gate Slope =	0.00	N/A	H:V
Horiz. Length of Weir Sides =	4.00	N/A	feet
Overflow Gate Type =	Close Mesh Gate	N/A	
Debris Clogging % =	50%	N/A	%

Calculated Parameters for Overflow Weir

	Zone 3 Weir	Not Selected	
Height of Gate Upper Edge, H ₁ =	7.90	N/A	feet
Overflow Weir Slope Length =	4.00	N/A	feet
Gate Open Area / 100-yr Orifice Area =	4.03	N/A	
Overflow Gate Open Area w/o Debris =	12.66	N/A	ft ²
Overflow Gate Open Area w/ Debris =	6.33	N/A	ft ²

User Input: Outlet Pipe w/ Flow Restriction Plate (Circular Orifice, Restrictor Plate, or Rectangular Orifice)

	Zone 3 Restrictor	Not Selected	
Depth to Invert of Outlet Pipe =	2.50	N/A	ft (distance below basin bottom at Stage = 0 ft)
Outlet Pipe Diameter =	24.00	N/A	inches
Restrictor Plate Height Above Pipe Invert =	24.00		inches

Calculated Parameters for Outlet Pipe w/ Flow Restriction Plate

	Zone 3 Restrictor	Not Selected	
Outlet Orifice Area =	3.14	N/A	ft ²
Outlet Orifice Centroid =	1.00	N/A	feet
Half-Central Angle of Restrictor Plate on Pipe =	3.14	N/A	radians

User Input: Emergency Spillway (Rectangular or Trapezoidal)

Spillway Invert Stage =	9.00	ft (relative to basin bottom at Stage = 0 ft)
Spillway Crest Length =	120.00	feet
Spillway End Slopes =	4.00	H:V
Freeboard above Max Water Surface =	1.00	feet

Calculated Parameters for Spillway

Spillway Design Flow Depth =	0.48	feet
Stage at Top of Freeboard =	10.48	feet
Basin Area at Top of Freeboard =	1.62	acres
Basin Volume at Top of Freeboard =	8.34	acre-ft

Routed Hydrograph Results

The user can override the default CUHP hydrographs and runoff volumes by entering new values in the Inflow Hydrographs table (Columns W through AF).

	WOCV	EURV	2 Year	5 Year	10 Year	25 Year	50 Year	100 Year	500 Year
Design Storm Return Period =									
One-Hour Rainfall Depth (in) =	N/A	N/A	1.19	1.50	1.75	2.00	2.25	2.52	3.14
CUHP Runoff Volume (acre-ft) =	0.254	0.349	0.180	0.296	0.395	0.972	1.547	2.354	4.129
Inflow Hydrograph Volume (acre-ft) =	N/A	N/A	0.180	0.296	0.395	0.972	1.547	2.354	4.129
CUHP Predevelopment Peak Q (cfs) =	N/A	N/A	0.3	0.5	0.7	6.3	12.7	21.2	38.6
OPTIONAL Override Predevelopment Peak Q (cfs) =	N/A	N/A							
Predevelopment Unit Peak Flow, q (cfs/acre) =	N/A	N/A	0.01	0.01	0.02	0.15	0.30	0.50	0.92
Peak Inflow Q (cfs) =	N/A	N/A	1.7	3.0	4.1	10.7	17.2	26.1	43.9
Peak Outflow Q (cfs) =	0.1	0.1	0.1	0.1	0.1	2.1	4.6	8.3	12.5
Ratio Peak Outflow to Predevelopment Q =	N/A	N/A	N/A	0.2	0.2	0.3	0.4	0.4	0.3
Structure Controlling Flow =	Plate	Plate	Plate	Plate	Vertical Orifice 1	Vertical Orifice 1	Vertical Orifice 1	Vertical Orifice 1	Vertical Orifice
Max Velocity through Gate 1 (fps) =	N/A	N/A	N/A	N/A	N/A	N/A	N/A	N/A	N/A
Max Velocity through Gate 2 (fps) =	N/A	N/A	N/A	N/A	N/A	N/A	N/A	N/A	N/A
Time to Drain 97% of Inflow Volume (hours) =	39	49	31	44	54	58	55	52	45
Time to Drain 99% of Inflow Volume (hours) =	41	52	33	46	57	63	62	61	58
Maximum Ponding Depth (ft) =	2.56	2.84	2.20	2.62	2.89	3.66	4.13	4.67	5.88
Area at Maximum Ponding Depth (acres) =	0.31	0.37	0.23	0.32	0.38	0.56	0.66	0.76	0.95
Maximum Volume Stored (acre-ft) =	0.254	0.349	0.158	0.270	0.368	0.724	1.012	1.398	2.451

DETENTION BASIN OUTLET STRUCTURE DESIGN

MHFD-Detention, Version 4.06 (July 2022)

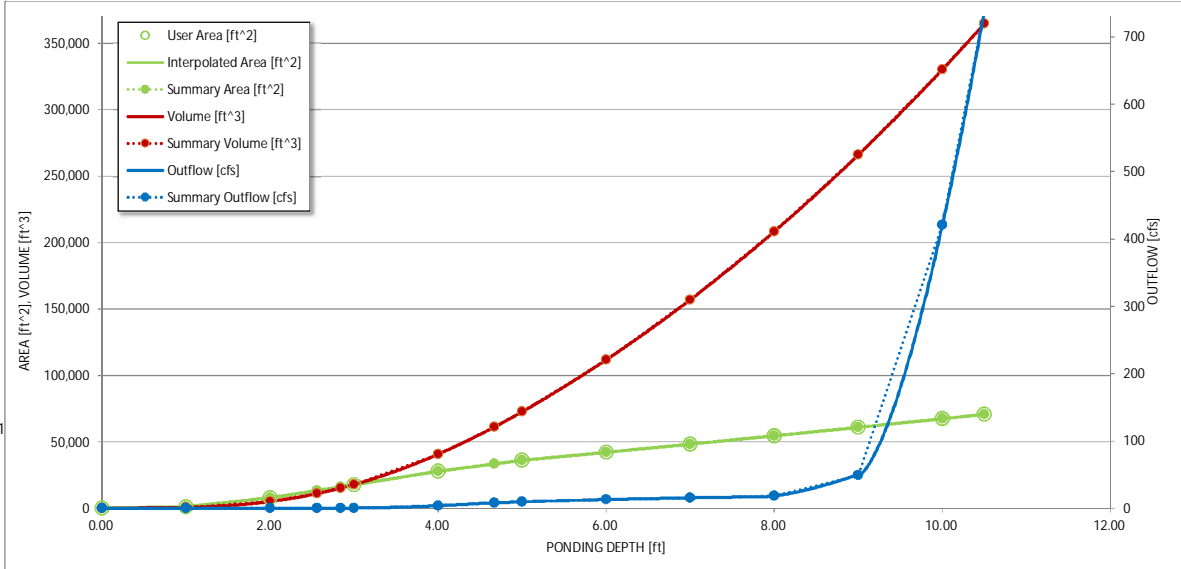
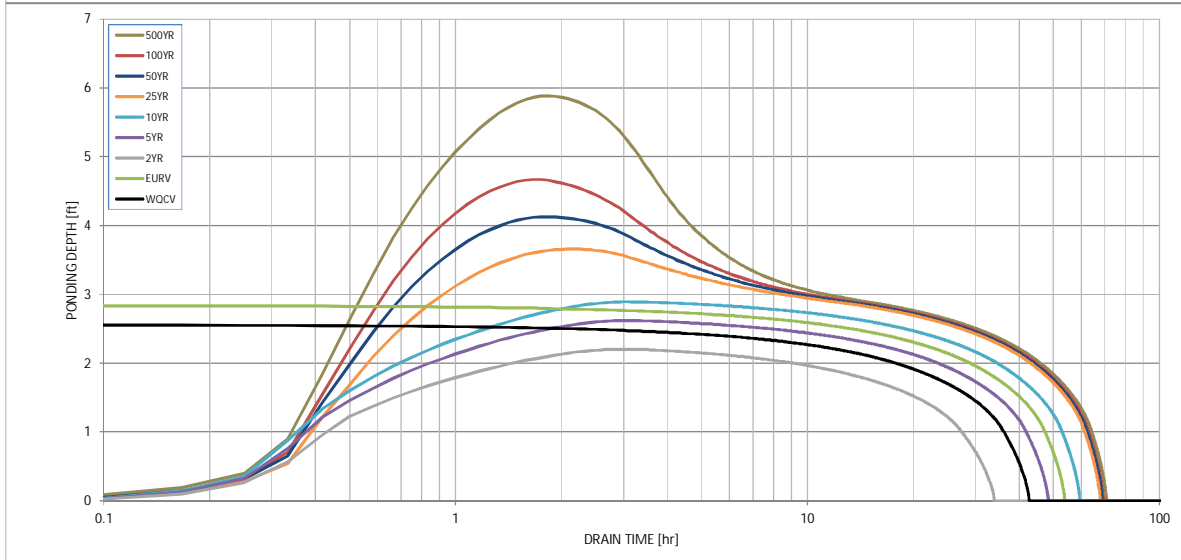
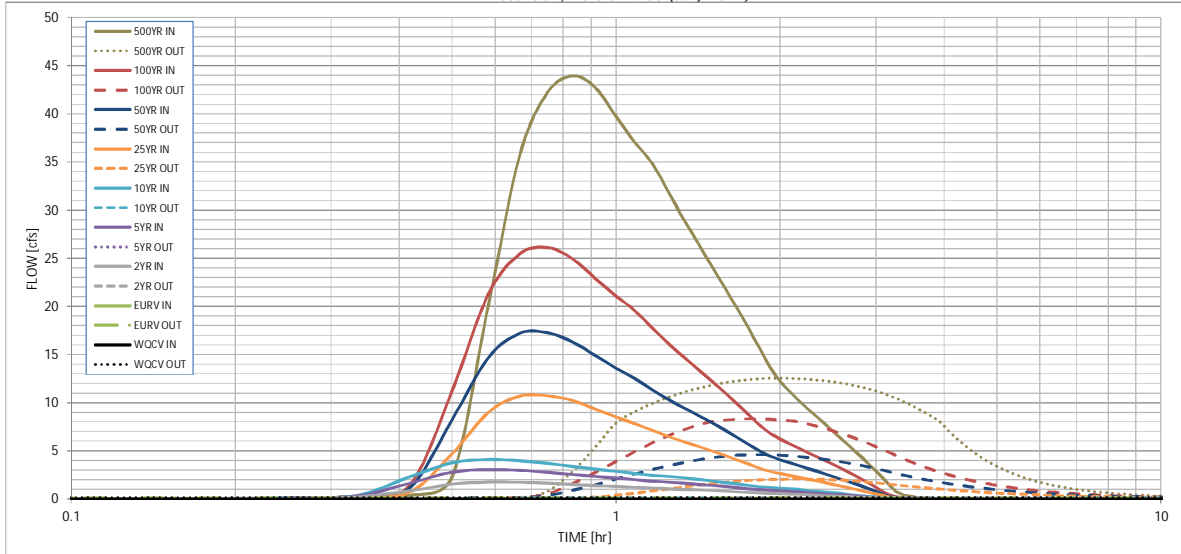

S-A-V-D Chart Axis Override	X-axis	Left Y-Axis	Right Y-Axis
minimum bound			
maximum bound			

DETENTION BASIN OUTLET STRUCTURE DESIGN

Outflow Hydrograph Workbook Filename:

Inflow Hydrographs

The user can override the calculated inflow hydrographs from this workbook with inflow hydrographs developed in a separate program.

Time Interval	SOURCE	WQCV [cfs]	EURV [cfs]	2 Year [cfs]	5 Year [cfs]	10 Year [cfs]	25 Year [cfs]	50 Year [cfs]	100 Year [cfs]	500 Year [cfs]
5.00 min	0:00:00	0.00	0.00	0.00	0.00	0.00	0.00	0.00	0.00	0.00
	0:05:00	0.00	0.00	0.00	0.00	0.00	0.00	0.00	0.00	0.00
	0:10:00	0.00	0.00	0.00	0.00	0.00	0.00	0.01	0.00	0.02
	0:15:00	0.00	0.00	0.05	0.09	0.11	0.07	0.09	0.09	0.14
	0:20:00	0.00	0.00	0.21	0.29	0.34	0.22	0.26	0.27	0.37
	0:25:00	0.00	0.00	0.82	1.61	2.26	0.67	1.07	1.32	2.28
	0:30:00	0.00	0.00	1.53	2.77	3.75	4.67	8.24	11.20	20.13
	0:35:00	0.00	0.00	1.75	3.04	4.08	9.00	14.67	21.30	35.82
	0:40:00	0.00	0.00	1.73	2.96	3.97	10.68	17.22	25.45	42.28
	0:45:00	0.00	0.00	1.63	2.77	3.69	10.70	17.24	26.10	43.93
	0:50:00	0.00	0.00	1.50	2.53	3.36	10.20	16.30	24.90	42.71
	0:55:00	0.00	0.00	1.39	2.33	3.10	9.33	14.88	22.89	39.70
	1:00:00	0.00	0.00	1.30	2.17	2.86	8.50	13.59	21.09	37.02
	1:05:00	0.00	0.00	1.21	2.00	2.64	7.81	12.48	19.53	34.79
	1:10:00	0.00	0.00	1.13	1.86	2.46	7.10	11.32	17.76	31.84
	1:15:00	0.00	0.00	1.05	1.74	2.33	6.46	10.29	16.10	28.98
	1:20:00	0.00	0.00	0.99	1.63	2.19	5.93	9.43	14.70	26.48
	1:25:00	0.00	0.00	0.93	1.52	2.04	5.45	8.65	13.43	24.14
	1:30:00	0.00	0.00	0.86	1.41	1.88	4.99	7.90	12.23	21.93
	1:35:00	0.00	0.00	0.80	1.29	1.71	4.53	7.15	11.07	19.82
	1:40:00	0.00	0.00	0.74	1.18	1.55	4.08	6.42	9.92	17.75
	1:45:00	0.00	0.00	0.68	1.06	1.39	3.63	5.69	8.78	15.70
	1:50:00	0.00	0.00	0.63	0.97	1.28	3.20	4.98	7.68	13.74
	1:55:00	0.00	0.00	0.59	0.91	1.21	2.85	4.44	6.82	12.24
	2:00:00	0.00	0.00	0.56	0.86	1.14	2.62	4.08	6.22	11.14
	2:05:00	0.00	0.00	0.51	0.79	1.05	2.42	3.76	5.72	10.20
	2:10:00	0.00	0.00	0.47	0.73	0.96	2.23	3.46	5.26	9.35
	2:15:00	0.00	0.00	0.43	0.66	0.88	2.04	3.18	4.82	8.55
	2:20:00	0.00	0.00	0.39	0.60	0.79	1.86	2.89	4.39	7.78
	2:25:00	0.00	0.00	0.35	0.53	0.71	1.69	2.62	3.97	7.03
	2:30:00	0.00	0.00	0.31	0.48	0.63	1.52	2.35	3.57	6.33
	2:35:00	0.00	0.00	0.27	0.42	0.55	1.35	2.08	3.18	5.63
	2:40:00	0.00	0.00	0.24	0.36	0.48	1.18	1.82	2.78	4.94
	2:45:00	0.00	0.00	0.20	0.31	0.41	1.01	1.56	2.39	4.25
	2:50:00	0.00	0.00	0.17	0.26	0.34	0.85	1.30	2.00	3.56
	2:55:00	0.00	0.00	0.14	0.20	0.27	0.69	1.04	1.61	2.88
	3:00:00	0.00	0.00	0.11	0.15	0.20	0.52	0.79	1.22	2.20
	3:05:00	0.00	0.00	0.08	0.11	0.14	0.36	0.53	0.83	1.52
	3:10:00	0.00	0.00	0.06	0.08	0.10	0.21	0.29	0.46	0.87
	3:15:00	0.00	0.00	0.05	0.06	0.08	0.12	0.16	0.25	0.52
	3:20:00	0.00	0.00	0.04	0.05	0.07	0.08	0.11	0.16	0.34
	3:25:00	0.00	0.00	0.04	0.05	0.06	0.06	0.08	0.11	0.22
	3:30:00	0.00	0.00	0.03	0.04	0.05	0.05	0.06	0.08	0.15
	3:35:00	0.00	0.00	0.03	0.03	0.04	0.04	0.05	0.06	0.10
	3:40:00	0.00	0.00	0.02	0.03	0.04	0.03	0.04	0.04	0.06
	3:45:00	0.00	0.00	0.02	0.02	0.03	0.03	0.03	0.03	0.04
	3:50:00	0.00	0.00	0.01	0.02	0.02	0.02	0.02	0.02	0.03
	3:55:00	0.00	0.00	0.01	0.02	0.02	0.02	0.02	0.02	0.02
	4:00:00	0.00	0.00	0.01	0.01	0.02	0.01	0.02	0.01	0.02
	4:05:00	0.00	0.00	0.01	0.01	0.01	0.01	0.01	0.01	0.01
	4:10:00	0.00	0.00	0.01	0.01	0.01	0.01	0.01	0.01	0.01
	4:15:00	0.00	0.00	0.00	0.00	0.01	0.01	0.01	0.01	0.01
	4:20:00	0.00	0.00	0.00	0.00	0.00	0.00	0.00	0.00	0.01
	4:25:00	0.00	0.00	0.00	0.00	0.00	0.00	0.00	0.00	0.00
	4:30:00	0.00	0.00	0.00	0.00	0.00	0.00	0.00	0.00	0.00
	4:35:00	0.00	0.00	0.00	0.00	0.00	0.00	0.00	0.00	0.00
	4:40:00	0.00	0.00	0.00	0.00	0.00	0.00	0.00	0.00	0.00
	4:45:00	0.00	0.00	0.00	0.00	0.00	0.00	0.00	0.00	0.00
	4:50:00	0.00	0.00	0.00	0.00	0.00	0.00	0.00	0.00	0.00
	4:55:00	0.00	0.00	0.00	0.00	0.00	0.00	0.00	0.00	0.00
5:00:00	0.00	0.00	0.00	0.00	0.00	0.00	0.00	0.00	0.00	
5:05:00	0.00	0.00	0.00	0.00	0.00	0.00	0.00	0.00	0.00	
5:10:00	0.00	0.00	0.00	0.00	0.00	0.00	0.00	0.00	0.00	
5:15:00	0.00	0.00	0.00	0.00	0.00	0.00	0.00	0.00	0.00	
5:20:00	0.00	0.00	0.00	0.00	0.00	0.00	0.00	0.00	0.00	
5:25:00	0.00	0.00	0.00	0.00	0.00	0.00	0.00	0.00	0.00	
5:30:00	0.00	0.00	0.00	0.00	0.00	0.00	0.00	0.00	0.00	
5:35:00	0.00	0.00	0.00	0.00	0.00	0.00	0.00	0.00	0.00	
5:40:00	0.00	0.00	0.00	0.00	0.00	0.00	0.00	0.00	0.00	
5:45:00	0.00	0.00	0.00	0.00	0.00	0.00	0.00	0.00	0.00	
5:50:00	0.00	0.00	0.00	0.00	0.00	0.00	0.00	0.00	0.00	
5:55:00	0.00	0.00	0.00	0.00	0.00	0.00	0.00	0.00	0.00	
6:00:00	0.00	0.00	0.00	0.00	0.00	0.00	0.00	0.00	0.00	

DETENTION BASIN STAGE-STORAGE TABLE BUILDER

MHFD-Defention, Version 4.06 (July 2022)

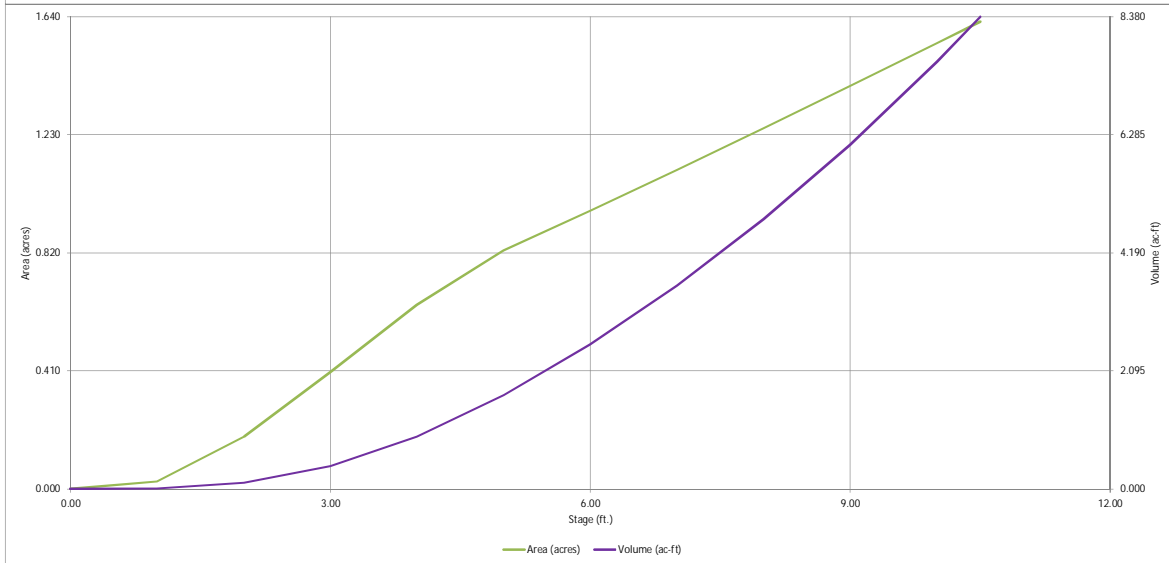
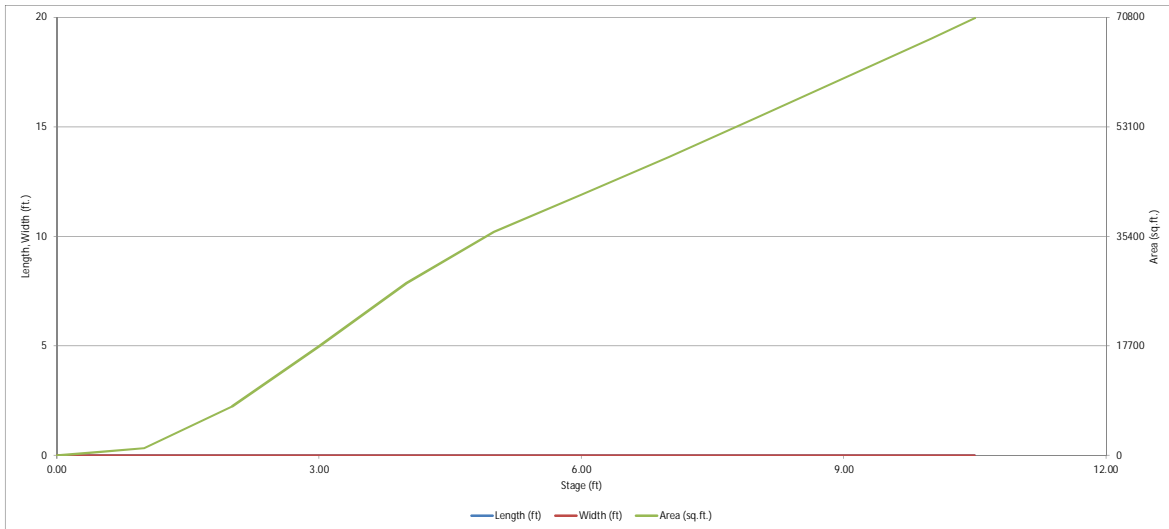

DETENTION BASIN OUTLET STRUCTURE DESIGN

MHFD-*Detention*, Version 4.06 (July 2022)

Project: Sterling Ranch Recycling Facility
Basin ID: Pond A-Ultimate

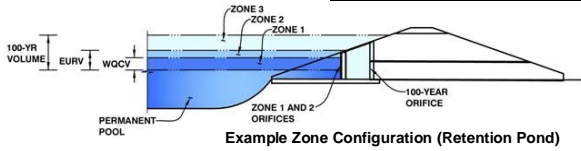

	Estimated Stage (ft)	Estimated Volume (ac-ft)	Outlet Type
Zone 1 (WOCV)	4.16	1.037	Orifice Plate
Zone 2 (EURV)	7.38	2.987	Circular Orifice
Zone 3 (100-year)	8.83	1.839	Weir&Pipe (Restrict)
Total (all zones)		5.864	

User Input: Orifice at Underdrain Outlet (typically used to drain WOCV in a Filtration BMP)

Underdrain Orifice Invert Depth =	N/A	ft (distance below the filtration media surface)
Underdrain Orifice Diameter =	N/A	inches

Calculated Parameters for Underdrain		
Underdrain Orifice Area =	N/A	ft ²
Underdrain Orifice Centroid =	N/A	feet

User Input: Orifice Plate with one or more orifices or Elliptical Slot Weir (typically used to drain WOCV and/or EURV in a sedimentation BMP)

Centroid of Lowest Orifice =	0.00	ft (relative to basin bottom at Stage = 0 ft)
Depth at top of Zone using Orifice Plate =	4.16	ft (relative to basin bottom at Stage = 0 ft)
Orifice Plate: Orifice Vertical Spacing =	N/A	inches
Orifice Plate: Orifice Area per Row =	N/A	sq. inches

Calculated Parameters for Plate		
WO Orifice Area per Row =	N/A	ft ²
Elliptical Half-Width =	N/A	feet
Elliptical Slot Centroid =	N/A	feet
Elliptical Slot Area =	N/A	ft ²

User Input: Stage and Total Area of Each Orifice Row (numbered from lowest to highest)

	Row 1 (required)	Row 2 (optional)	Row 3 (optional)	Row 4 (optional)	Row 5 (optional)	Row 6 (optional)	Row 7 (optional)	Row 8 (optional)
Stage of Orifice Centroid (ft)	0.00	1.35	2.77					
Orifice Area (sq. inches)	2.80	2.80	2.80					

	Row 9 (optional)	Row 10 (optional)	Row 11 (optional)	Row 12 (optional)	Row 13 (optional)	Row 14 (optional)	Row 15 (optional)	Row 16 (optional)
Stage of Orifice Centroid (ft)								
Orifice Area (sq. inches)								

User Input: Vertical Orifice (Circular or Rectangular)

	Zone 2 Circular	Not Selected	
Invert of Vertical Orifice =	4.16	N/A	ft (relative to basin bottom at Stage = 0 ft)
Depth at top of Zone using Vertical Orifice =	7.38	N/A	ft (relative to basin bottom at Stage = 0 ft)
Vertical Orifice Diameter =	4.30	N/A	inches

Calculated Parameters for Vertical Orifice		
Vertical Orifice Area =	0.10	ft ²
Vertical Orifice Centroid =	0.18	feet

User Input: Overflow Weir (Dropbox with Flat or Sloped Gate and Outlet Pipe OR Rectangular/Trapezoidal Weir and No Outlet Pipe)

	Zone 3 Weir	Not Selected	
Overflow Weir Front Edge Height, Ho =	7.90	N/A	ft (relative to basin bottom at Stage = 0 ft)
Overflow Weir Front Edge Length =	4.00	N/A	feet
Overflow Weir Gate Slope =	0.00	N/A	H:V
Horiz. Length of Weir Sides =	4.00	N/A	feet
Overflow Gate Type =	Close Mesh Gate	N/A	
Debris Clogging % =	50%	N/A	%

Calculated Parameters for Overflow Weir		
Height of Gate Upper Edge, H ₁ =	7.90	feet
Overflow Weir Slope Length =	4.00	feet
Gate Open Area / 100-yr Orifice Area =	9.01	
Overflow Gate Open Area w/o Debris =	12.66	ft ²
Overflow Gate Open Area w/ Debris =	6.33	ft ²

User Input: Outlet Pipe w/ Flow Restriction Plate (Circular Orifice, Restrictor Plate, or Rectangular Orifice)

	Zone 3 Restrictor	Not Selected	
Depth to Invert of Outlet Pipe =	2.50	N/A	ft (distance below basin bottom at Stage = 0 ft)
Outlet Pipe Diameter =	24.00	N/A	inches
Restrictor Plate Height Above Pipe Invert =	11.00	N/A	inches

Calculated Parameters for Outlet Pipe w/ Flow Restriction Plate		
Outlet Orifice Area =	1.40	ft ²
Outlet Orifice Centroid =	0.53	feet
Half-Central Angle of Restrictor Plate on Pipe =	1.49	radians

User Input: Emergency Spillway (Rectangular or Trapezoidal)

Spillway Invert Stage =	9.00	ft (relative to basin bottom at Stage = 0 ft)
Spillway Crest Length =	120.00	feet
Spillway End Slopes =	4.00	H:V
Freeboard above Max Water Surface =	1.00	feet

Calculated Parameters for Spillway		
Spillway Design Flow Depth =	0.48	feet
Stage at Top of Freeboard =	10.48	feet
Basin Area at Top of Freeboard =	1.62	acres
Basin Volume at Top of Freeboard =	8.34	acre-ft

Routed Hydrograph Results

The user can override the default CUHP hydrographs and runoff volumes by entering new values in the Inflow Hydrographs table (Columns W through AF).

	WOCV	EURV	2 Year	5 Year	10 Year	25 Year	50 Year	100 Year	500 Year
Design Storm Return Period									
One-Hour Rainfall Depth (in)	N/A	N/A	1.19	1.50	1.75	2.00	2.25	2.52	3.14
CUHP Runoff Volume (acre-ft)	1.037	4.024	2.942	3.836	4.555	5.444	6.314	7.348	9.622
Inflow Hydrograph Volume (acre-ft)	N/A	N/A	2.942	3.836	4.555	5.444	6.314	7.348	9.622
CUHP Predevelopment Peak Q (cfs)	N/A	N/A	0.3	0.5	0.7	6.7	13.4	22.5	40.9
OPTIONAL Override Predevelopment Peak Q (cfs)	N/A	N/A							
Predevelopment Unit Peak Flow, q (cfs/acre)	N/A	N/A	0.01	0.01	0.02	0.15	0.31	0.51	0.93
Peak Inflow Q (cfs)	N/A	N/A	45.5	58.9	68.8	86.3	101.3	120.0	157.6
Peak Outflow Q (cfs)	0.5	1.5	1.3	1.5	1.6	5.6	12.1	22.2	68.5
Ratio Peak Outflow to Predevelopment Q	N/A	N/A	N/A	2.7	2.1	0.8	0.9	1.0	1.7
Structure Controlling Flow	Vertical Orifice 1	Vertical Orifice 1	Vertical Orifice 1	Vertical Orifice 1	Vertical Orifice 1	Overflow Weir 1	Overflow Weir 1	Outlet Plate 1	Spillway
Max Velocity through Gate 1 (fps)	N/A	N/A	N/A	N/A	N/A	0.3	0.8	1.6	1.6
Max Velocity through Gate 2 (fps)	N/A	N/A	N/A	N/A	N/A	N/A	N/A	N/A	N/A
Time to Drain 97% of Inflow Volume (hours)	39	67	60	66	71	73	72	71	68
Time to Drain 99% of Inflow Volume (hours)	41	72	65	71	76	80	79	79	78
Maximum Ponding Depth (ft)	4.16	7.38	6.19	7.00	7.61	8.18	8.43	8.79	9.25
Area at Maximum Ponding Depth (acres)	0.67	1.16	0.99	1.11	1.19	1.28	1.32	1.37	1.44
Maximum Volume Stored (acre-ft)	1.039	4.036	2.743	3.604	4.295	5.012	5.336	5.819	6.464

DETENTION BASIN OUTLET STRUCTURE DESIGN

MHFD-Detention, Version 4.06 (July 2022)

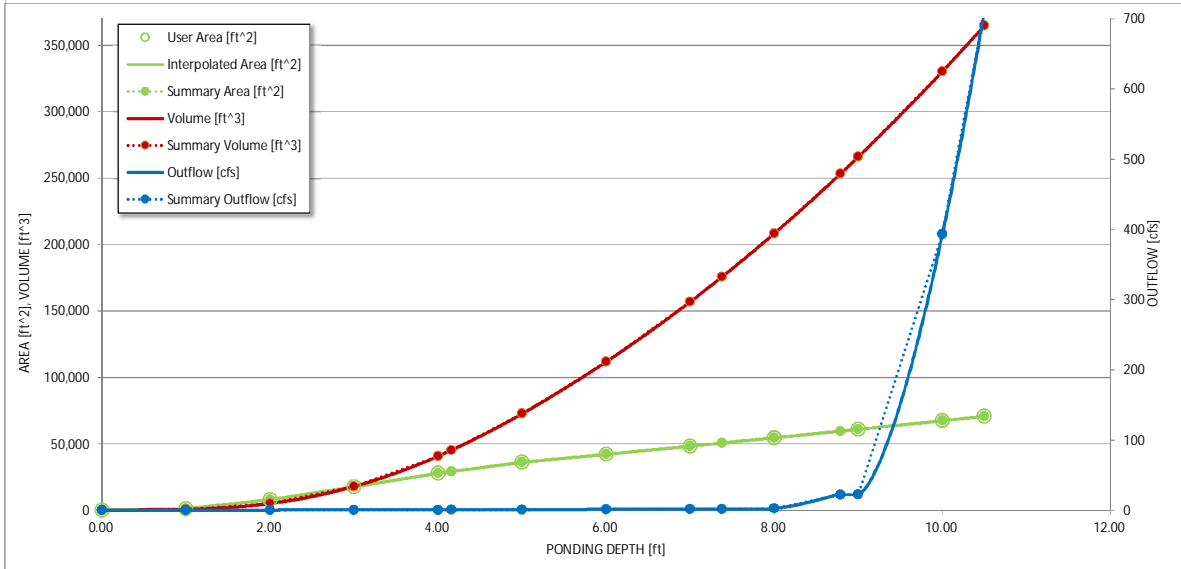
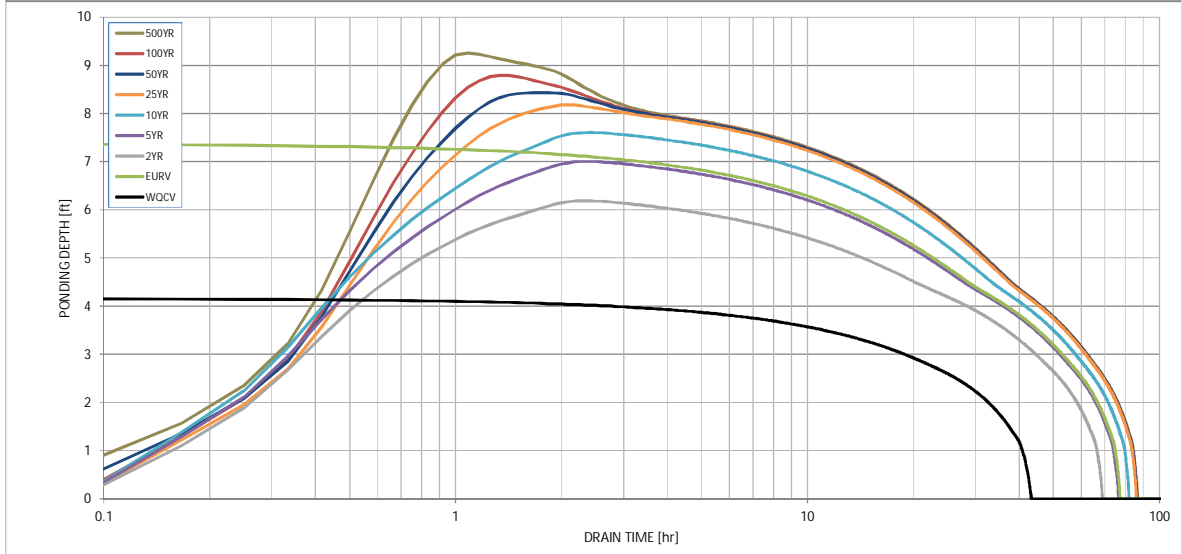
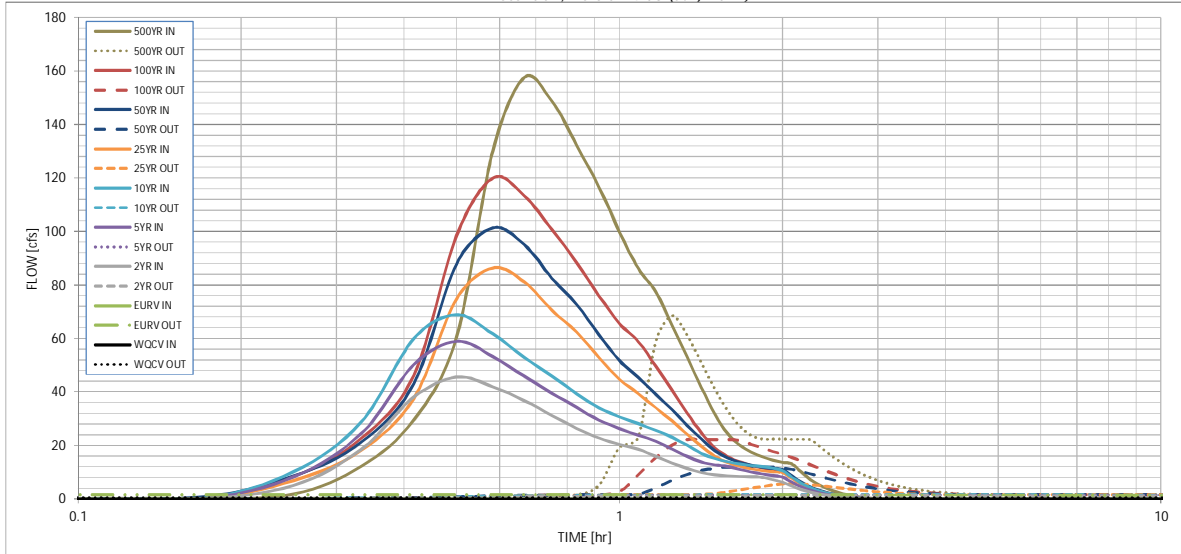

S-A-V-D Chart Axis Override	X-axis	Left Y-Axis	Right Y-Axis
minimum bound			
maximum bound			

DETENTION BASIN OUTLET STRUCTURE DESIGN

Outflow Hydrograph Workbook Filename: _____

Inflow Hydrographs

The user can override the calculated inflow hydrographs from this workbook with inflow hydrographs developed in a separate program.

Time Interval	SOURCE	CUHP	CUHP	CUHP	CUHP	CUHP	CUHP	CUHP	CUHP	CUHP
	TIME	WQCV [cfs]	EURV [cfs]	2 Year [cfs]	5 Year [cfs]	10 Year [cfs]	25 Year [cfs]	50 Year [cfs]	100 Year [cfs]	500 Year [cfs]
5.00 min	0:00:00	0.00	0.00	0.00	0.00	0.00	0.00	0.00	0.00	0.00
	0:05:00	0.00	0.00	0.00	0.00	0.00	0.00	0.00	0.00	0.00
	0:10:00	0.00	0.00	0.00	0.00	0.00	0.00	0.57	0.06	1.83
	0:15:00	0.00	0.00	5.05	8.22	10.18	6.84	8.59	8.34	12.16
	0:20:00	0.00	0.00	18.49	24.39	28.72	18.15	21.18	22.63	29.51
	0:25:00	0.00	0.00	38.05	50.12	59.86	37.51	43.02	46.17	60.49
	0:30:00	0.00	0.00	45.54	58.87	68.83	74.78	87.92	98.38	130.15
	0:35:00	0.00	0.00	41.90	53.26	61.67	86.30	101.33	119.99	157.58
	0:40:00	0.00	0.00	36.74	45.86	52.97	81.13	95.11	113.39	148.64
	0:45:00	0.00	0.00	31.21	39.50	45.91	70.58	82.55	100.68	132.31
	0:50:00	0.00	0.00	26.39	34.22	39.33	62.32	72.70	88.45	116.56
	0:55:00	0.00	0.00	22.70	29.43	33.99	52.82	61.36	75.91	99.84
	1:00:00	0.00	0.00	20.32	26.23	30.69	44.70	51.70	65.52	86.12
	1:05:00	0.00	0.00	18.51	23.80	28.11	39.37	45.45	58.85	77.48
	1:10:00	0.00	0.00	15.95	21.50	25.59	34.05	39.18	49.59	64.99
	1:15:00	0.00	0.00	13.45	18.71	23.09	29.16	33.43	40.80	53.16
	1:20:00	0.00	0.00	11.32	15.89	20.06	24.06	27.48	32.11	41.61
	1:25:00	0.00	0.00	9.80	13.80	16.95	19.69	22.38	24.67	31.79
	1:30:00	0.00	0.00	8.99	12.73	15.05	15.90	17.99	19.07	24.43
	1:35:00	0.00	0.00	8.58	12.15	13.89	13.59	15.33	15.79	20.11
	1:40:00	0.00	0.00	8.35	11.01	13.06	12.15	13.69	13.82	17.52
	1:45:00	0.00	0.00	8.20	10.02	12.46	11.21	12.62	12.47	15.72
	1:50:00	0.00	0.00	8.08	9.31	12.04	10.55	11.88	11.56	14.50
	1:55:00	0.00	0.00	7.16	8.78	11.48	10.11	11.38	10.90	13.63
	2:00:00	0.00	0.00	6.26	8.16	10.49	9.80	11.03	10.45	13.03
	2:05:00	0.00	0.00	4.79	6.27	8.01	7.59	8.53	8.03	10.00
	2:10:00	0.00	0.00	3.51	4.55	5.79	5.49	6.17	5.81	7.23
	2:15:00	0.00	0.00	2.55	3.31	4.20	3.98	4.47	4.23	5.27
	2:20:00	0.00	0.00	1.84	2.38	3.04	2.89	3.25	3.10	3.85
	2:25:00	0.00	0.00	1.31	1.66	2.15	2.04	2.29	2.19	2.72
	2:30:00	0.00	0.00	0.90	1.13	1.50	1.43	1.60	1.53	1.90
	2:35:00	0.00	0.00	0.60	0.78	1.04	1.01	1.13	1.08	1.34
	2:40:00	0.00	0.00	0.37	0.51	0.66	0.66	0.74	0.70	0.87
	2:45:00	0.00	0.00	0.19	0.30	0.37	0.39	0.43	0.41	0.50
	2:50:00	0.00	0.00	0.08	0.14	0.17	0.18	0.20	0.19	0.24
	2:55:00	0.00	0.00	0.03	0.04	0.05	0.06	0.06	0.06	0.07
	3:00:00	0.00	0.00	0.00	0.00	0.00	0.00	0.00	0.00	0.00
	3:05:00	0.00	0.00	0.00	0.00	0.00	0.00	0.00	0.00	0.00
	3:10:00	0.00	0.00	0.00	0.00	0.00	0.00	0.00	0.00	0.00
	3:15:00	0.00	0.00	0.00	0.00	0.00	0.00	0.00	0.00	0.00
	3:20:00	0.00	0.00	0.00	0.00	0.00	0.00	0.00	0.00	0.00
	3:25:00	0.00	0.00	0.00	0.00	0.00	0.00	0.00	0.00	0.00
	3:30:00	0.00	0.00	0.00	0.00	0.00	0.00	0.00	0.00	0.00
	3:35:00	0.00	0.00	0.00	0.00	0.00	0.00	0.00	0.00	0.00
	3:40:00	0.00	0.00	0.00	0.00	0.00	0.00	0.00	0.00	0.00
	3:45:00	0.00	0.00	0.00	0.00	0.00	0.00	0.00	0.00	0.00
	3:50:00	0.00	0.00	0.00	0.00	0.00	0.00	0.00	0.00	0.00
	3:55:00	0.00	0.00	0.00	0.00	0.00	0.00	0.00	0.00	0.00
	4:00:00	0.00	0.00	0.00	0.00	0.00	0.00	0.00	0.00	0.00
	4:05:00	0.00	0.00	0.00	0.00	0.00	0.00	0.00	0.00	0.00
	4:10:00	0.00	0.00	0.00	0.00	0.00	0.00	0.00	0.00	0.00
	4:15:00	0.00	0.00	0.00	0.00	0.00	0.00	0.00	0.00	0.00
	4:20:00	0.00	0.00	0.00	0.00	0.00	0.00	0.00	0.00	0.00
	4:25:00	0.00	0.00	0.00	0.00	0.00	0.00	0.00	0.00	0.00
	4:30:00	0.00	0.00	0.00	0.00	0.00	0.00	0.00	0.00	0.00
	4:35:00	0.00	0.00	0.00	0.00	0.00	0.00	0.00	0.00	0.00
	4:40:00	0.00	0.00	0.00	0.00	0.00	0.00	0.00	0.00	0.00
	4:45:00	0.00	0.00	0.00	0.00	0.00	0.00	0.00	0.00	0.00
	4:50:00	0.00	0.00	0.00	0.00	0.00	0.00	0.00	0.00	0.00
	4:55:00	0.00	0.00	0.00	0.00	0.00	0.00	0.00	0.00	0.00
	5:00:00	0.00	0.00	0.00	0.00	0.00	0.00	0.00	0.00	0.00
	5:05:00	0.00	0.00	0.00	0.00	0.00	0.00	0.00	0.00	0.00
	5:10:00	0.00	0.00	0.00	0.00	0.00	0.00	0.00	0.00	0.00
	5:15:00	0.00	0.00	0.00	0.00	0.00	0.00	0.00	0.00	0.00
	5:20:00	0.00	0.00	0.00	0.00	0.00	0.00	0.00	0.00	0.00
	5:25:00	0.00	0.00	0.00	0.00	0.00	0.00	0.00	0.00	0.00
	5:30:00	0.00	0.00	0.00	0.00	0.00	0.00	0.00	0.00	0.00
	5:35:00	0.00	0.00	0.00	0.00	0.00	0.00	0.00	0.00	0.00
	5:40:00	0.00	0.00	0.00	0.00	0.00	0.00	0.00	0.00	0.00
	5:45:00	0.00	0.00	0.00	0.00	0.00	0.00	0.00	0.00	0.00
	5:50:00	0.00	0.00	0.00	0.00	0.00	0.00	0.00	0.00	0.00
	5:55:00	0.00	0.00	0.00	0.00	0.00	0.00	0.00	0.00	0.00
	6:00:00	0.00	0.00	0.00	0.00	0.00	0.00	0.00	0.00	0.00

DETENTION BASIN OUTLET STRUCTURE DESIGN

MHFD- Detention, Version 4.06 (July 2022)

Summary Stage-Area-Volume-Discharge Relationships

The user can create a summary S-A-V-D by entering the desired stage increments and the remainder of the table will populate automatically. The user should graphically compare the summary S-A-V-D table to the full S-A-V-D table in the chart to confirm it captures all key transition points.

Table with 7 columns: Stage - Storage Description, Stage [ft], Area [ft^2], Area [acres], Volume [ft^3], Volume [ac-ft], Total Outflow [cfs]. Rows include stages like 6965-Top of Micropool, 6966, 6967, 6968, 6969, 6969.16-WOCV WSEL, 6970, 6971, 6972, 6972.38-EURV WSEL, 6973, 6973.79-100 yr WSEL, 6974-Spillway Crest, 6975, and 6975.50-Top of Pond.

For best results, include the stages of all grade slope changes (e.g. ISV and Floor) from the S-A-V table on Sheet 'Basin'. Also include the inverts of all outlets (e.g. vertical orifice, overflow grate, and spillway, where applicable).

SPILLWAY RIPRAP CALCULATION

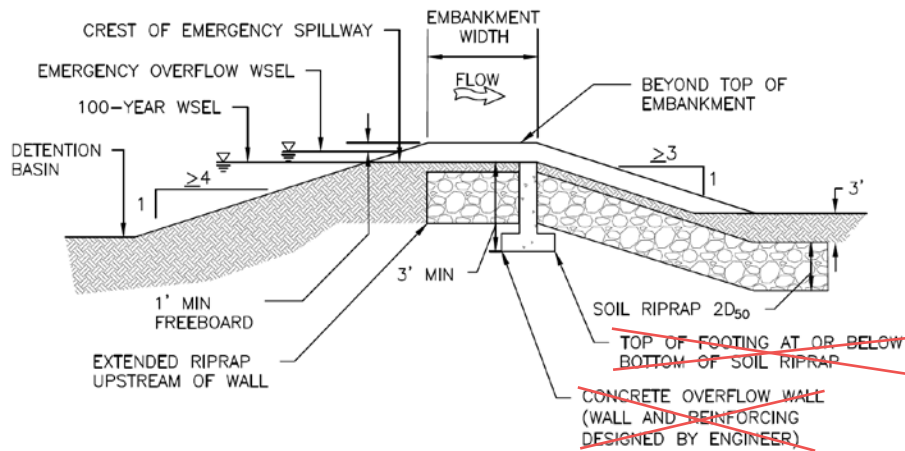

EMERGENCY SPILLWAY PROFILE

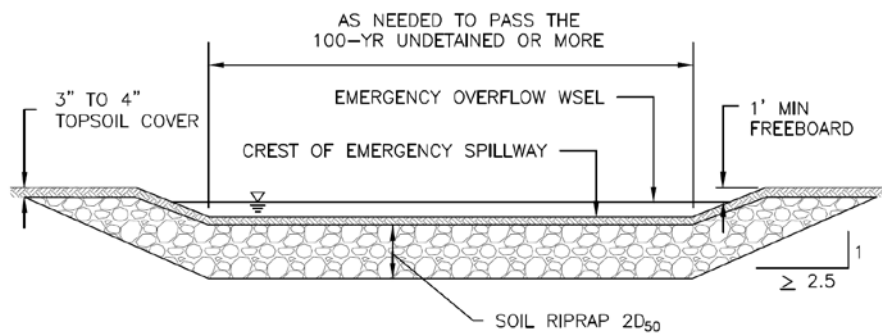

EMERGENCY SPILLWAY SECTION AND SPILLWAY CHANNEL

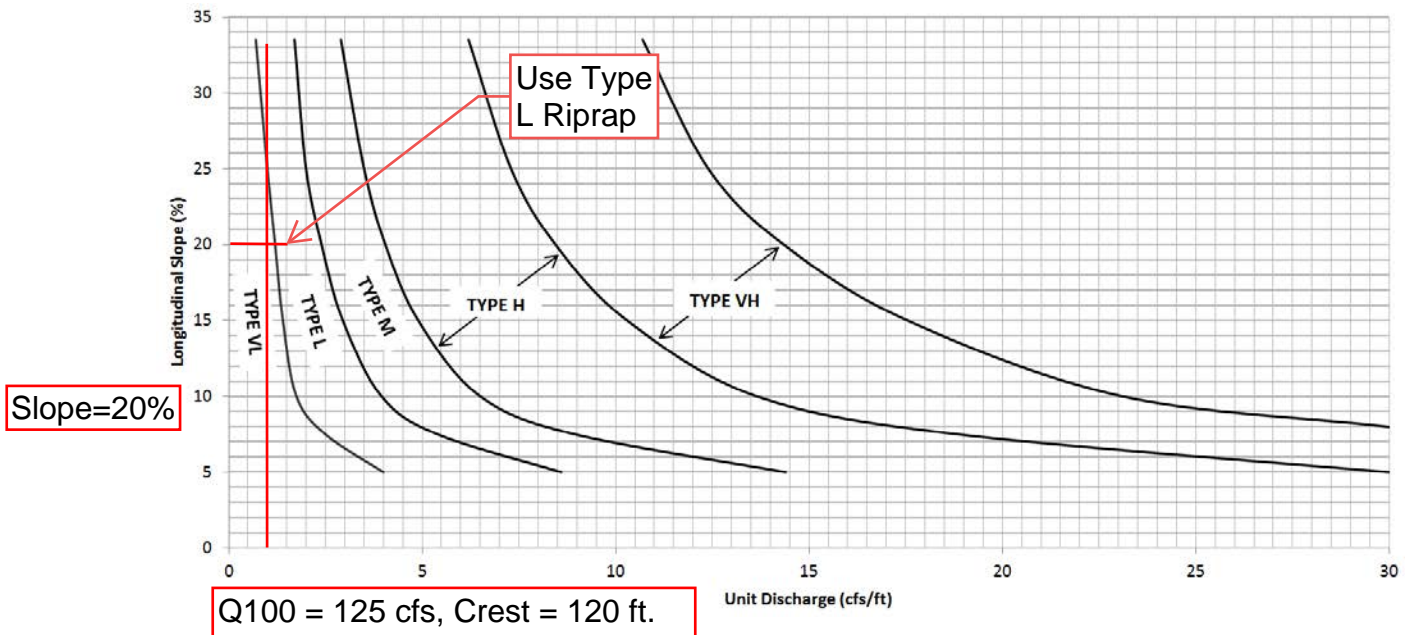

Figure 12-21. Embankment protection details and rock sizing chart (adapted from Arapahoe County)

Channel Report

Spillway Overflow Channel (Wide)

Trapezoidal

Bottom Width (ft) = 6.00
Side Slopes (z:1) = 30.00, 70.00
Total Depth (ft) = 1.50
Invert Elev (ft) = 100.00
Slope (%) = 4.50
N-Value = 0.035

Highlighted

Depth (ft) = 0.68
Q (cfs) = 125.00
Area (sqft) = 27.20
Velocity (ft/s) = 4.60
Wetted Perim (ft) = 74.02
Crit Depth, Yc (ft) = 0.78
Top Width (ft) = 74.00
EGL (ft) = 1.01

Calculations

Compute by: Known Q
Known Q (cfs) = 125.00

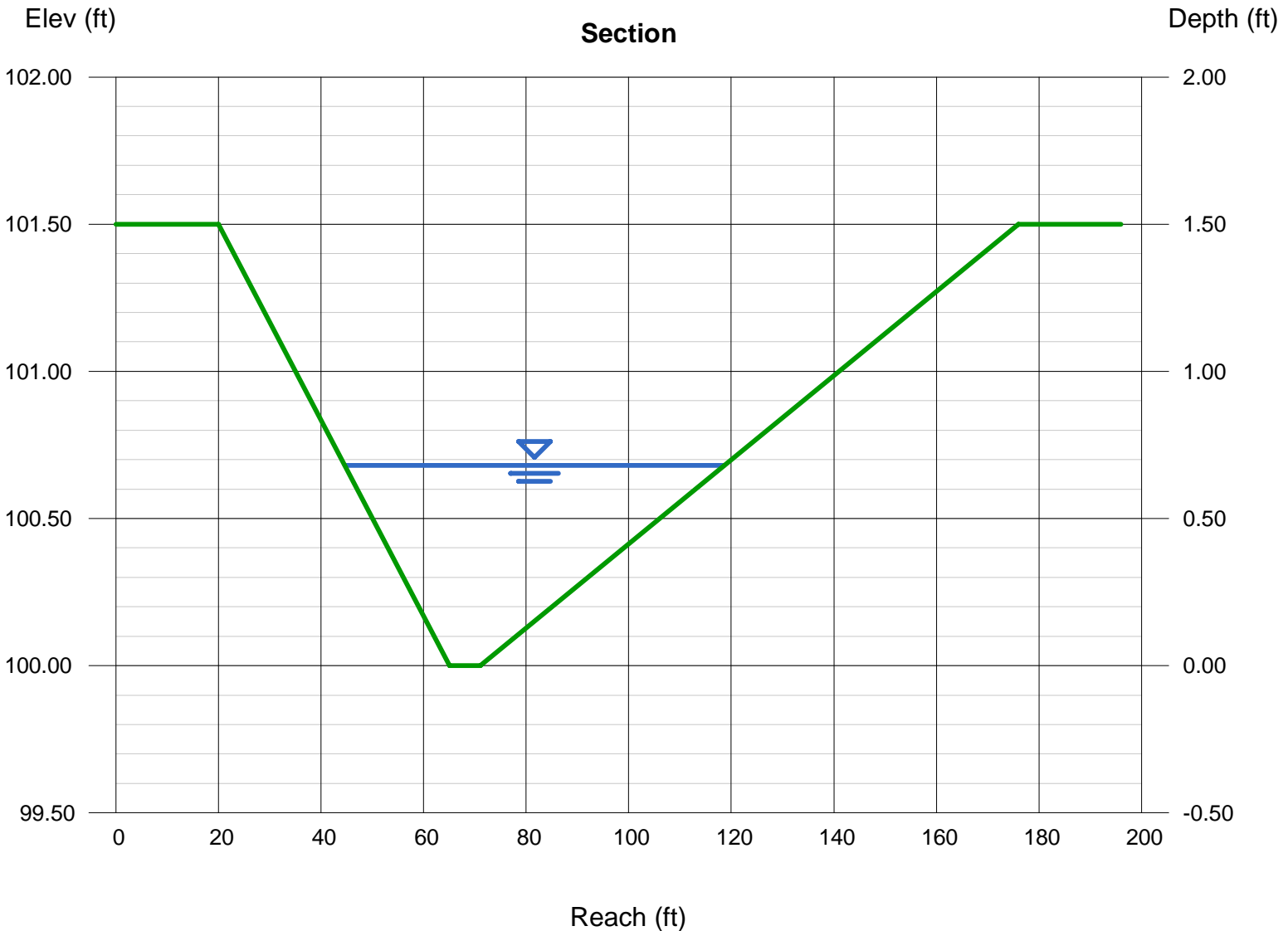

Channel Report

Spillway Overflow Channel (Narrow)

Trapezoidal

Bottom Width (ft) = 6.00
Side Slopes (z:1) = 3.00, 3.00
Total Depth (ft) = 4.00
Invert Elev (ft) = 100.00
Slope (%) = 4.50
N-Value = 0.035

Highlighted

Depth (ft) = 1.40
Q (cfs) = 125.00
Area (sqft) = 14.28
Velocity (ft/s) = 8.75
Wetted Perim (ft) = 14.85
Crit Depth, Y_c (ft) = 1.78
Top Width (ft) = 14.40
EGL (ft) = 2.59

Calculations

Compute by: Known Q
Known Q (cfs) = 125.00

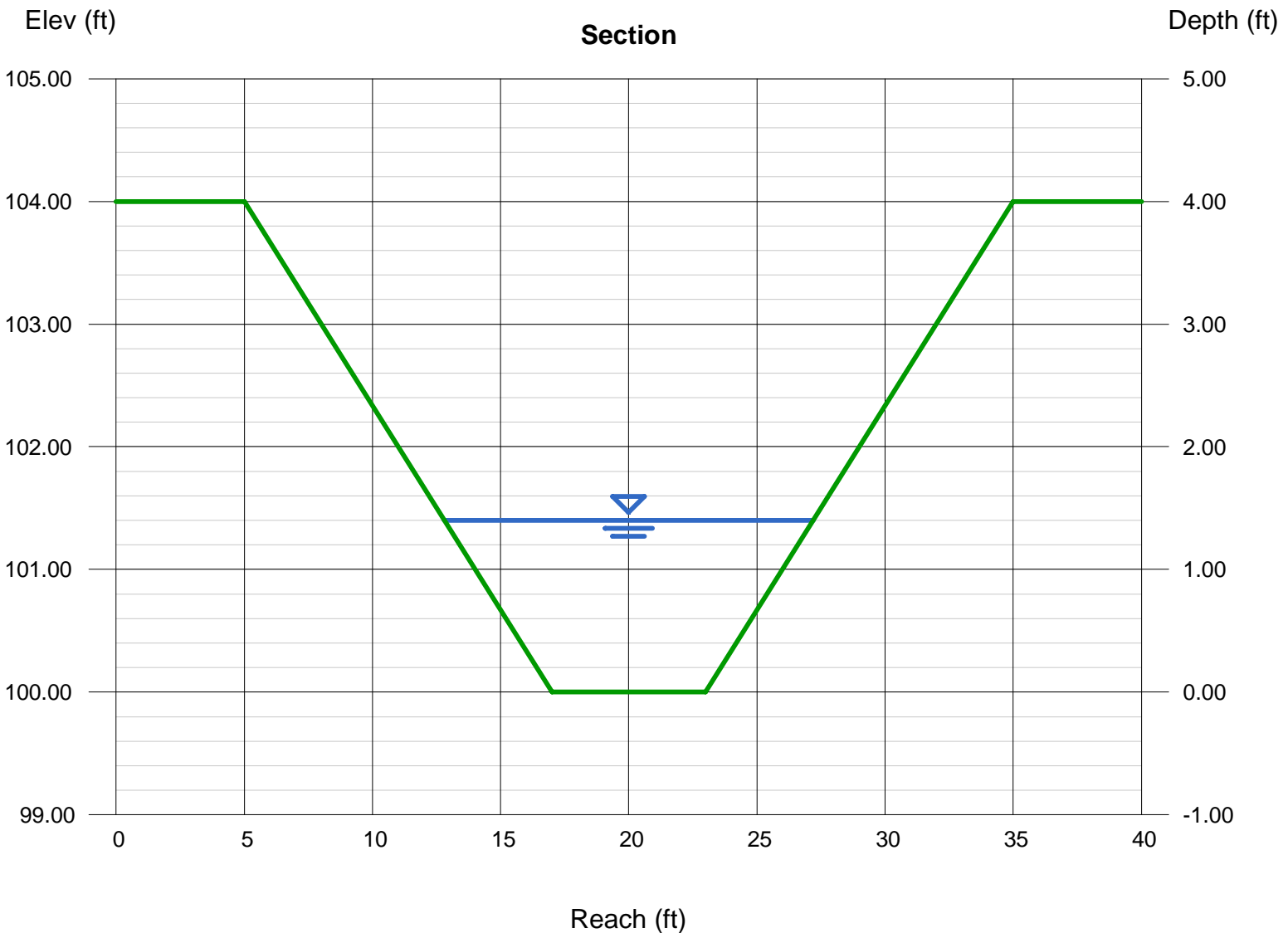

INLET MANAGEMENT

Worksheet Protected

INLET NAME	Pond Emergency Overflow
Site Type (Urban or Rural)	URBAN
Inlet Application (Street or Area)	AREA
Hydraulic Condition	Swale
Inlet Type	User-Defined

USER-DEFINED INPUT

User-Defined Design Flows	
Minor Q_{Known} (cfs)	0.0
Major Q_{Known} (cfs)	125.0
Bypass (Carry-Over) Flow from Upstream Inlets must be organized from upstream (let	
Receive Bypass Flow from:	No Bypass Flow Received
Minor Bypass Flow Received, Q_b (cfs)	0.0
Major Bypass Flow Received, Q_b (cfs)	0.0
Watershed Characteristics	
Subcatchment Area (acres)	
Percent Impervious	
NRCS Soil Type	
Watershed Profile	
Overland Slope (ft/ft)	
Overland Length (ft)	
Channel Slope (ft/ft)	
Channel Length (ft)	
Minor Storm Rainfall Input	
Design Storm Return Period, T_r (years)	
One-Hour Precipitation, P_1 (inches)	
Major Storm Rainfall Input	
Design Storm Return Period, T_r (years)	
One-Hour Precipitation, P_1 (inches)	

CALCULATED OUTPUT

Minor Total Design Peak Flow, Q (cfs)	0.0
Major Total Design Peak Flow, Q (cfs)	125.0
Minor Flow Bypassed Downstream, Q_b (cfs)	0.0
Major Flow Bypassed Downstream, Q_b (cfs)	0.0

AREA INLET IN A SWALE

Sterling Ranch Recycling Facility
Pond Emergency Overflow

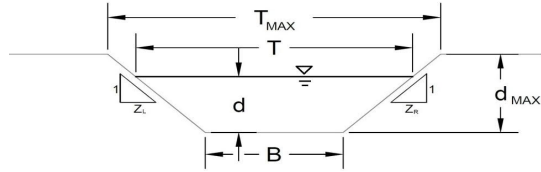

This worksheet uses the NRCS vegetal retardance method to determine Manning's n for grass-lined channels.
An override Manning's n can be entered for other channel materials.

Analysis of Trapezoidal Channel (Grass-Lined uses SCS Method)

NRCS Vegetal Retardance (A, B, C, D, or E) A, B, C, D, or E =

Manning's n (Leave cell D16 blank to manually enter an n value) n = 0.030

Channel Invert Slope S₀ = 0.0005 ft/ft

Bottom Width B = 6.00 ft

Left Side Slope Z1 = 3.00 ft/ft

Right Side Slope Z2 = 3.00 ft/ft

Check one of the following soil types:

Soil Type:	Max. Velocity (V _{max})	Max. Froude No. (F _{max})
Non-Cohesive	5.0 fps	0.60
Cohesive	7.0 fps	0.80
Paved	N/A	N/A

Choose One:

Non-Cohesive

Cohesive

Paved

	Minor Storm	Major Storm	
Maximum Allowable Top Width of Channel for Minor & Major Storm	18.00	30.00	ft
Maximum Allowable Water Depth in Channel for Minor & Major Storm	3.00	4.00	ft

Allowable Channel Capacity Based On Channel Geometry

MINOR STORM Allowable Capacity is based on Top Width Criterion

MAJOR STORM Allowable Capacity is based on Depth Criterion

	Minor Storm	Major Storm	
Q _{allow}	29.9	132.2	cfs
d _{allow}	2.00	4.00	ft

Water Depth in Channel Based On Design Peak Flow

Design Peak Flow

Water Depth

	0.0	125.0	
Q _o	0.0	125.0	cfs
d	0.00	3.90	ft

Minor storm max. allowable capacity GOOD - greater than the design flow given on sheet 'Inlet Management'

Major storm max. allowable capacity GOOD - greater than the design flow given on sheet 'Inlet Management'

MHFD-Inlet, Version 5.03 (August 2023)
AREA INLET IN A SWALE

Sterling Ranch Recycling Facility
 Pond Emergency Overflow

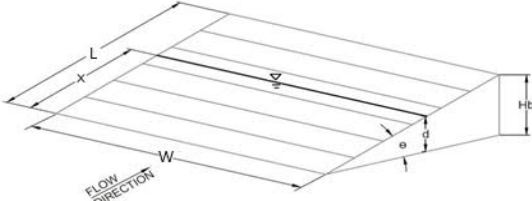
Inlet Design Information (Input)																					
Type of Inlet	User-Defined																				
Inlet Type =	User-Defined																				
Angle of Inclined Grate (must be ≤ 30 degrees)	$\theta = 0.00$ degrees																				
Width of Grate	$W = 6.00$ ft																				
Length of Grate	$L = 6.00$ ft																				
Open Area Ratio	$A_{RATIO} = 0.70$																				
Height of Inclined Grate	$H_B = 0.00$ ft																				
Clogging Factor	$C_f = 0.50$																				
Grate Discharge Coefficient	$C_d = N/A$																				
Orifice Coefficient	$C_o = 0.64$																				
Weir Coefficient	$C_w = 2.05$																				
																					
Water Depth at Inlet (for depressed inlets, 1 foot is added for depression)	<table border="1"> <thead> <tr> <th></th> <th>MINOR</th> <th>MAJOR</th> <th></th> </tr> </thead> <tbody> <tr> <td>$d =$</td> <td>0.00</td> <td>3.90</td> <td></td> </tr> <tr> <td>$Q_a =$</td> <td>0.0</td> <td>127.8</td> <td>cfs</td> </tr> <tr> <td>$Q_b =$</td> <td>0.0</td> <td>0.0</td> <td>cfs</td> </tr> <tr> <td>$C\% =$</td> <td>100</td> <td>100</td> <td>%</td> </tr> </tbody> </table>		MINOR	MAJOR		$d =$	0.00	3.90		$Q_a =$	0.0	127.8	cfs	$Q_b =$	0.0	0.0	cfs	$C\% =$	100	100	%
	MINOR	MAJOR																			
$d =$	0.00	3.90																			
$Q_a =$	0.0	127.8	cfs																		
$Q_b =$	0.0	0.0	cfs																		
$C\% =$	100	100	%																		
Total Inlet Interception Capacity (assumes clogged condition)																					
Bypassed Flow																					
Capture Percentage = Q_a/Q_o																					

Appendix D

Reference Materials



SAND CREEK DRAINAGE BASIN PLANNING STUDY
PRELIMINARY DESIGN REPORT
CITY OF COLORADO SPRINGS, EL PASO COUNTY, COLORADO

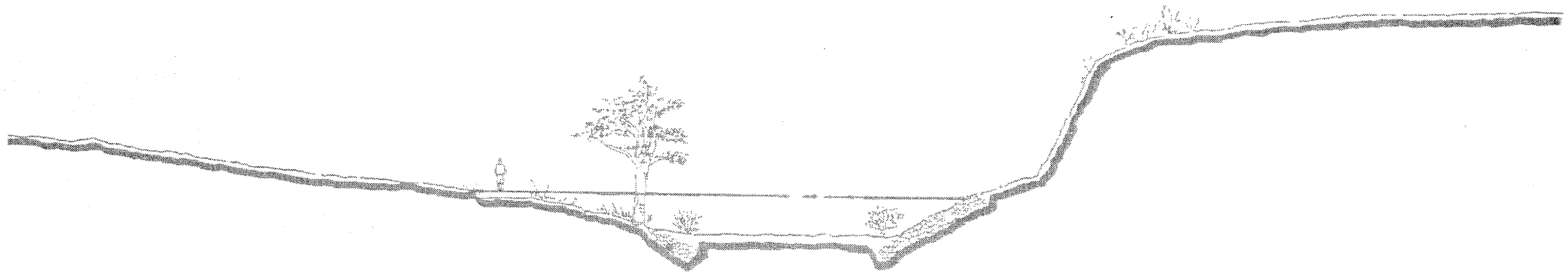

PREPARED FOR:

City of Colorado Springs
Department of Comprehensive Planning, Development and Finance
Engineering Division
30 S. Nevada
Colorado Springs, Colorado 80903

PREPARED BY:

Kiowa Engineering Corporation
1011 North Weber
Colorado Springs, CO 80903

II. STUDY AREA DESCRIPTION

The Sand Creek drainage basin is a left-bank tributary to the Fountain Creek lying in the west-central portions of El Paso County. Sand Creek's drainage area at Fountain Creek is approximately 54 square miles of which approximately 18.8 square miles are inside the City of Colorado Springs corporate limits. The basin is divided into five major sub-basins, the Sand Creek mainstem, the East Fork Sand Creek, the Central Tributary to East Fork, the West Fork, and the East Fork Subtributary. Figure II-1 shows the location of the Sand Creek basin.

Basin Description

The Sand Creek basin covers a total of 54 square miles in unincorporated El Paso County and Colorado Springs, Colorado. Of this total, approximately 28 square miles is encompassed by the Sand Creek basin, and 26 square miles for the East Fork Sand Creek basin. The basin trends in generally a south to southwesterly direction, entering the Fountain Creek approximately two miles upstream of the Academy Boulevard bridge over Fountain Creek. Two main tributaries drain the basin, those being the mainstem of Sand Creek and East Fork Sand Creek. Development presence is most evident along the mainstream. At this time, approximately 25 percent of the basin is developed. This alternative evaluation focuses upon the Sand Creek basin only.

The maximum basin elevation is approximately 7,620 feet above mean sea level, and falls to approximately 5,790 feet at the confluence with Fountain Creek. The headwaters of the basin originate in the conifer covered areas of The Black Forest. The middle eastern portions of the basin are typified by rolling range land with fair to good vegetative cover associated with semi-arid climates.

Climate

This area of El Paso County can be described, in general as high plains, with total precipitation amounts typical of a semi-arid region. Winters are generally cold and dry. Precipitation ranges from 14 to 16 inches per year, with the majority of this precipitation occurring in spring and summer in the form of rainfall. Thunderstorms are common during the summer months, and are typified by quick-moving low pressure cells which draw moisture from the Gulf of Mexico into the region. Average temperatures range from about 30°F in the winter

to 75° in the summer. The relative humidity ranges from about 25 percent in the summer to 45 percent in the winter.

Soils and Geology

Soils within the Sand Creek basin vary between soil types A through D, as identified by the U. S. Department of Agriculture, Soil Conservation Service. The predominant soil groupings are in the Truckton and Bresser soil associations. The soils consist of deep, well drained soils that formed in alluvium and residuum, derived from sedimentary rock. The soils have high to moderate infiltration rates, and are extremely susceptible to wind and water erosion where poor vegetation cover exists. In undeveloped areas, the predominance of Type A and B soils give this basin a lower runoff per unit area as compared to basins with soils dominated by Types C and D. Presented on Figure II-2 is the Hydrologic Soil distribution map for the Sand Creek basin.

Property Ownership and Impervious Land Densities

Property ownership along the major drainageway within the Sand Creek basin vary from public to private. Along the developed reaches, drainage right-of-ways and greenbelts have been dedicated during the development of the adjacent residential and commercial land. Where development has not occurred, the drainageways remain under private ownership with no delineated drainage right-of-way or easements. There are several public parks which abut the mainstem of Sand Creek. Roadway and utility easements abutting or crossing the major drainageways occur most frequently in the developed portions of the basin.

Land use information for the existing and future conditions were reviewed as part of the planning effort. This information is used in the hydrologic analysis to predict runoff rates and volumes for the purposes of facility evaluation. The identification of land uses abutting the drainageways is also useful in the identification of feasible plans for stabilization and aesthetic treatment of the creek. Presented on Figure II-3 is the proposed land use map used in the evaluation of impervious land densities discussed in the hydrologic section of this report. Figure II-3 is not intended to reflect the future zoning or land use policies of the City or the County.

The land use information within the Banning-Lewis Ranch property was obtained from Aries Properties during the time the draft East Fork Sand Creek Drainage Basin Planning Study was being prepared. The land use information was again reviewed with the City of Colorado Springs Department of Planning and was found to be appropriate for use in the estimation of hydrology for the East Fork Basin. The location of future arterial streets and roadways within

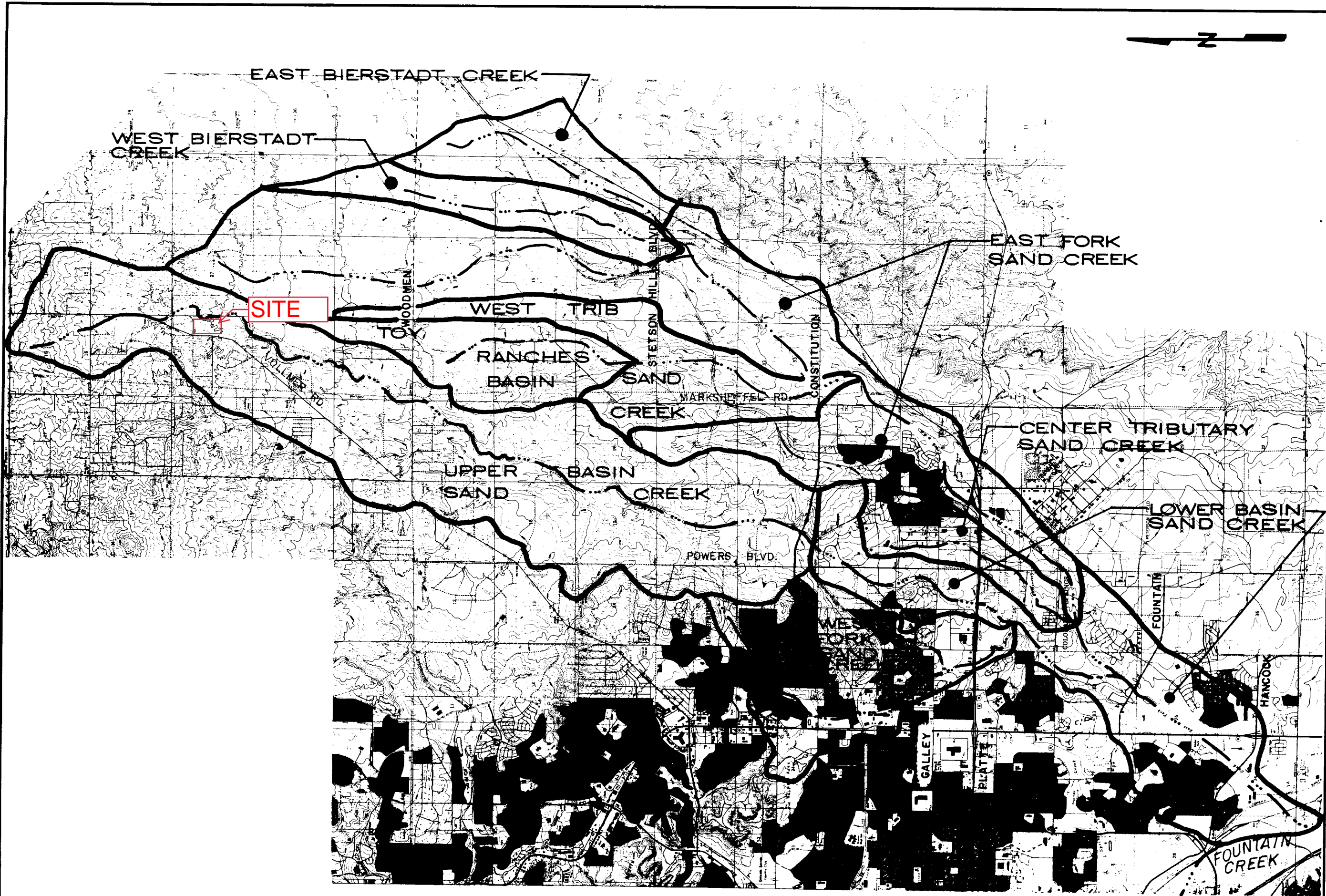

Kiowa Engineering Corporation
 419 W. Bijou Street
 Colorado Springs, Colorado
 80905-1308

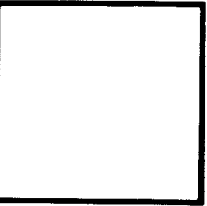

SAND CREEK DRAINAGE
 BASIN PLANNING STUDY
 REGIONAL SUB-BASINS

Project No	90-04-09
Date:	11/90
Design:	
Drawn:	EAK
Check:	
Revisions:	

**FINAL DRAINAGE REPORT
FOR
STERLING RANCH FILING NO. 2**

**Prepared For:
SR Land, LLC
20 Boulder Crescent, Suite 210
Colorado Springs, CO 80903**

**August 2021
Project No. 25188.01**

**Prepared By:
JR Engineering, LLC
5475 Tech Center Drive
Colorado Springs, CO 80919
719-593-2593**

PCD File No. SF-20-015

ALLOWABLE CAPACITY FOR ONE-HALF OF STREET (Minor & Major Storm)

(Based on Regulated Criteria for Maximum Allowable Flow Depth and Spread)

Project: **Sterling Ranch Filing No. 2**
 Inlet ID: **A10**

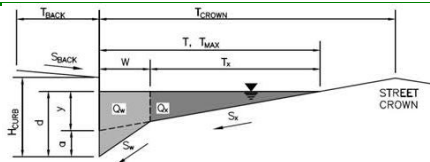

Gutter Geometry (Enter data in the blue cells)													
Maximum Allowable Width for Spread Behind Curb	$T_{BACK} = 15.0$ ft												
Side Slope Behind Curb (leave blank for no conveyance credit behind curb)	$S_{BACK} = 0.020$ ft/ft												
Manning's Roughness Behind Curb (typically between 0.012 and 0.020)	$n_{BACK} = 0.016$												
Height of Curb at Gutter Flow Line	$H_{CURB} = 6.00$ inches												
Distance from Curb Face to Street Crown	$T_{CROWN} = 38.0$ ft												
Gutter Width	$W = 2.00$ ft												
Street Transverse Slope	$S_x = 0.020$ ft/ft												
Gutter Cross Slope (typically 2 inches over 24 inches or 0.083 ft/ft)	$S_w = 0.083$ ft/ft												
Street Longitudinal Slope - Enter 0 for sump condition	$S_o = 0.012$ ft/ft												
Manning's Roughness for Street Section (typically between 0.012 and 0.020)	$n_{STREET} = 0.016$												
Max. Allowable Spread for Minor & Major Storm	<table border="1"> <thead> <tr> <th></th> <th>Minor Storm</th> <th>Major Storm</th> <th></th> </tr> </thead> <tbody> <tr> <td>$T_{MAX} =$</td> <td>33.0</td> <td>38.0</td> <td>ft</td> </tr> <tr> <td>$d_{MAX} =$</td> <td>6.0</td> <td>9.1</td> <td>inches</td> </tr> </tbody> </table>		Minor Storm	Major Storm		$T_{MAX} =$	33.0	38.0	ft	$d_{MAX} =$	6.0	9.1	inches
	Minor Storm	Major Storm											
$T_{MAX} =$	33.0	38.0	ft										
$d_{MAX} =$	6.0	9.1	inches										
Max. Allowable Depth at Gutter Flowline for Minor & Major Storm													
Allow Flow Depth at Street Crown (leave blank for no)	<input type="checkbox"/> <input type="checkbox"/> check = yes												
MINOR STORM Allowable Capacity is based on Depth Criterion													
MAJOR STORM Allowable Capacity is based on Depth Criterion													
Minor storm max. allowable capacity GOOD - greater than the design flow given on sheet 'Inlet Management'													
Major storm max. allowable capacity GOOD - greater than the design flow given on sheet 'Inlet Management'													
$Q_{allow} =$	<table border="1"> <thead> <tr> <th></th> <th>Minor Storm</th> <th>Major Storm</th> <th></th> </tr> </thead> <tbody> <tr> <td></td> <td>15.2</td> <td>63.8</td> <td>cfs</td> </tr> </tbody> </table>		Minor Storm	Major Storm			15.2	63.8	cfs				
	Minor Storm	Major Storm											
	15.2	63.8	cfs										

INLET ON A CONTINUOUS GRADE

Version 4.05 Released March 2017

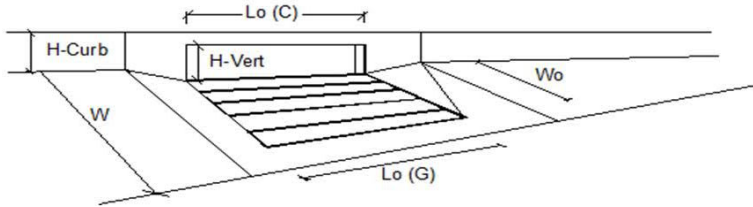

Design Information (Input)	MINOR	MAJOR	
Type of Inlet	CDOT Type R Curb Opening		
Local Depression (additional to continuous gutter depression 'a')	3.0	3.0	inches
Total Number of Units in the Inlet (Grate or Curb Opening)	1	1	
Length of a Single Unit Inlet (Grate or Curb Opening)	15.00	15.00	ft
Width of a Unit Grate (cannot be greater than W, Gutter Width)	N/A	N/A	ft
Clogging Factor for a Single Unit Grate (typical min. value = 0.5)	N/A	N/A	
Clogging Factor for a Single Unit Curb Opening (typical min. value = 0.1)	0.10	0.10	
Street Hydraulics: OK - $Q < Q_{allowable}$ Street Capacity.			
Total Inlet Interception Capacity	8.7	12.8	cfs
Total Inlet Carry-Over Flow (flow bypassing inlet)	0.5	4.5	cfs
Capture Percentage = Q_b/Q_o =	94	74	%

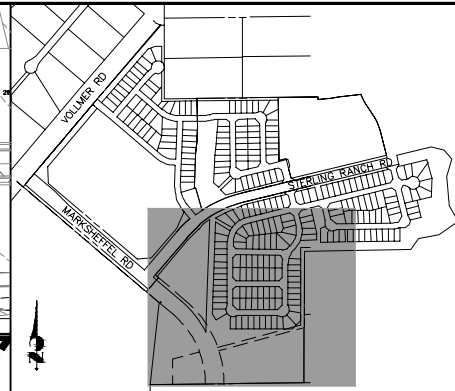
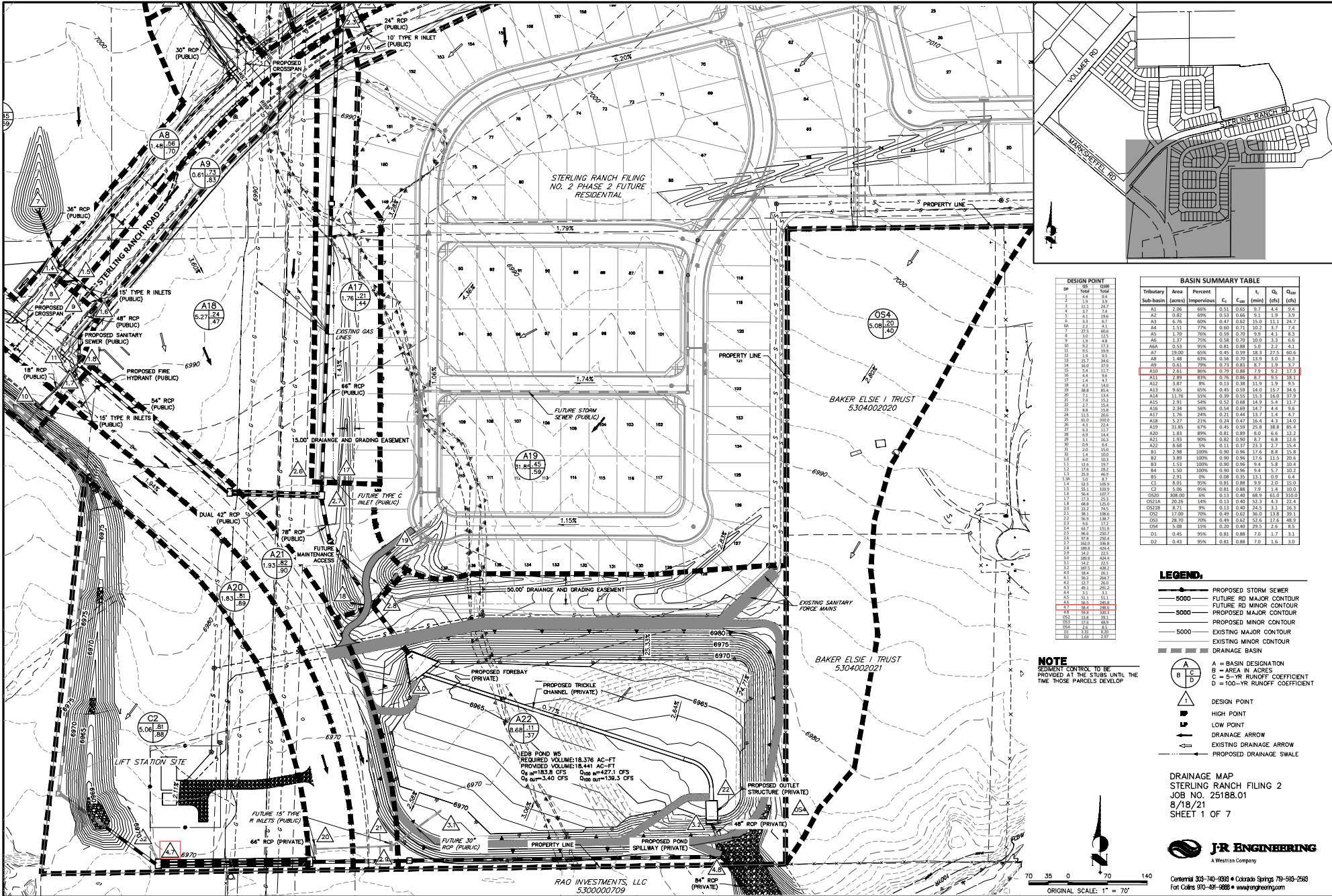

DESIGN POINT	SP	TP	TP	TP
	Year	Year	Year	Year
A1	1.44	1.19		
A2	1.11	0.87		
A3	1.17	1.06		
A4	1.32	1.1		
A5	1.10	1.13		
A6	1.17	1.08		
A7	1.10	1.13		
A8	1.32	1.1		
A9	1.48	1.26		
A10	1.48	1.26		
A11	1.48	1.26		
A12	1.48	1.26		
A13	1.48	1.26		
A14	1.48	1.26		
A15	1.48	1.26		
A16	1.48	1.26		
A17	1.48	1.26		
A18	1.48	1.26		
A19	1.48	1.26		
A20	1.48	1.26		
A21	1.48	1.26		
A22	1.48	1.26		
C1	1.48	1.26		
C2	1.48	1.26		

BASIN SUMMARY TABLE							
Tributary	Area	Percent	C _s	C ₁₀₀	t _r (hrs)	Q ₁₀₀	Q ₅
Sub-basin	(acres)			(ft/min)		(cfs)	(cfs)
A1	0.02	0.02%	0.5	0.66	0.1	1.9	3.9
A2	0.02	0.02%	0.5	0.66	0.1	1.9	3.9
A3	0.76	0.08%	0.47	0.62	0.30	11.1	24.7
A4	0.51	0.06%	0.46	0.61	0.27	9.9	22.1
A5	1.70	0.20%	0.59	0.70	0.59	4.1	8.3
A6	1.07	0.13%	0.58	0.68	0.38	13.7	30.4
A7	0.53	0.06%	0.81	0.88	5.0	2.2	4.1
A8	1.32	0.16%	0.58	0.68	0.38	13.7	30.4
A9	1.48	0.18%	0.56	0.70	13.9	1.0	6.3
A10	0.63	0.08%	0.73	0.83	8.7	1.9	3.7
A11	2.63	0.32%	0.79	0.88	7.9	2.2	3.9
A12	2.89	0.35%	0.76	0.86	8.7	0.5	18.1
A13	3.97	0.48%	0.73	0.81	11.9	1.9	9.9
A14	9.85	1.22%	0.45	0.59	14.0	15.7	34.6
A15	13.76	1.70%	0.52	0.68	14.9	16.0	37.9
A16	2.34	0.29%	0.54	0.69	14.7	4.4	9.6
A17	1.76	0.22%	0.73	0.84	13.7	2.4	4.7
A18	5.27	0.65%	0.24	0.47	16.4	4.3	14.0
A19	31.85	3.97%	0.43	0.59	15.8	38.8	85.4
A20	1.83	0.23%	0.81	0.89	8.0	6.6	12.2
A21	1.92	0.24%	0.82	0.90	8.7	6.8	12.4
A22	6.58	0.82%	0.53	0.71	13.3	2.7	15.4
B1	2.96	0.37%	0.90	0.96	17.6	8.8	15.8
B2	3.89	0.49%	0.90	0.96	17.6	11.5	20.6
B3	1.53	0.19%	0.90	0.96	9.4	5.8	10.4
B4	1.50	0.19%	0.90	0.96	9.4	5.7	10.2
B5	2.91	0.36%	0.98	0.95	13.1	10.9	6.4
C1	8.01	1.00%	0.81	0.88	9.9	2.0	15.0
C2	5.96	0.75%	0.53	0.71	14.9	1.4	10.0
OS10	308.00	3.9%	0.13	0.40	18.9	83.0	103.0
OS11A	79.76	1.01%	0.13	0.40	23.4	4.1	22.4
OS11B	8.71	0.11%	0.13	0.40	24.5	1.1	16.3
OS12	37.00	0.47%	0.13	0.40	23.4	4.1	22.4
OS13	19.70	0.25%	0.49	0.62	25.6	17.6	48.3
OS14	5.98	0.08%	0.20	0.29	29.5	2.8	8.5
OS15	4.95	0.06%	0.20	0.29	29.5	2.8	8.5
OS16	0.43	0.01%	0.81	0.88	7.0	1.6	3.0

- LEGEND:**
- 5000 — PROPOSED STORM SEWER
 - 5000 — FUTURE RD MAJOR CONTOUR
 - 5000 — FUTURE RD MINOR CONTOUR
 - 5000 — PROPOSED MAJOR CONTOUR
 - 5000 — PROPOSED MINOR CONTOUR
 - 5000 — EXISTING MAJOR CONTOUR
 - 5000 — EXISTING MINOR CONTOUR
 - DRAINAGE BASIN
- NOTE:**
 SEDIMENT CONTROL TO BE PROVIDED AT THE STUBS UNTIL THE TIME THOSE PARCELS DEVELOP
- DESIGN POINT**
 A = BASIN DESIGNATION
 B = AREA IN ACRES
 C = 5-YR RUNOFF COEFFICIENT
 D = 100-YR RUNOFF COEFFICIENT
- DESIGN POINT**
 ▲ HIGH POINT
 ▼ LOW POINT
 → DRAINAGE ARROW
 → EXISTING DRAINAGE ARROW
 → PROPOSED DRAINAGE ARROW

DRAINAGE MAP
 STERLING RANCH FILING 2
 JOB NO. 25188.01
 8/18/21
 SHEET 1 OF 7



Located 330-740-9924 • Colorado Springs 703-589-2950
 Fort Collins 970-498-9888 • www.jrengineering.com

RAO INVESTMENTS, LLC
 5300000709



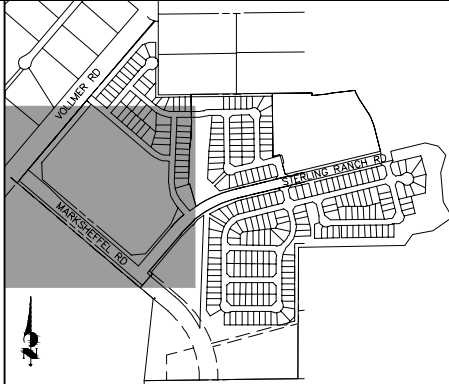
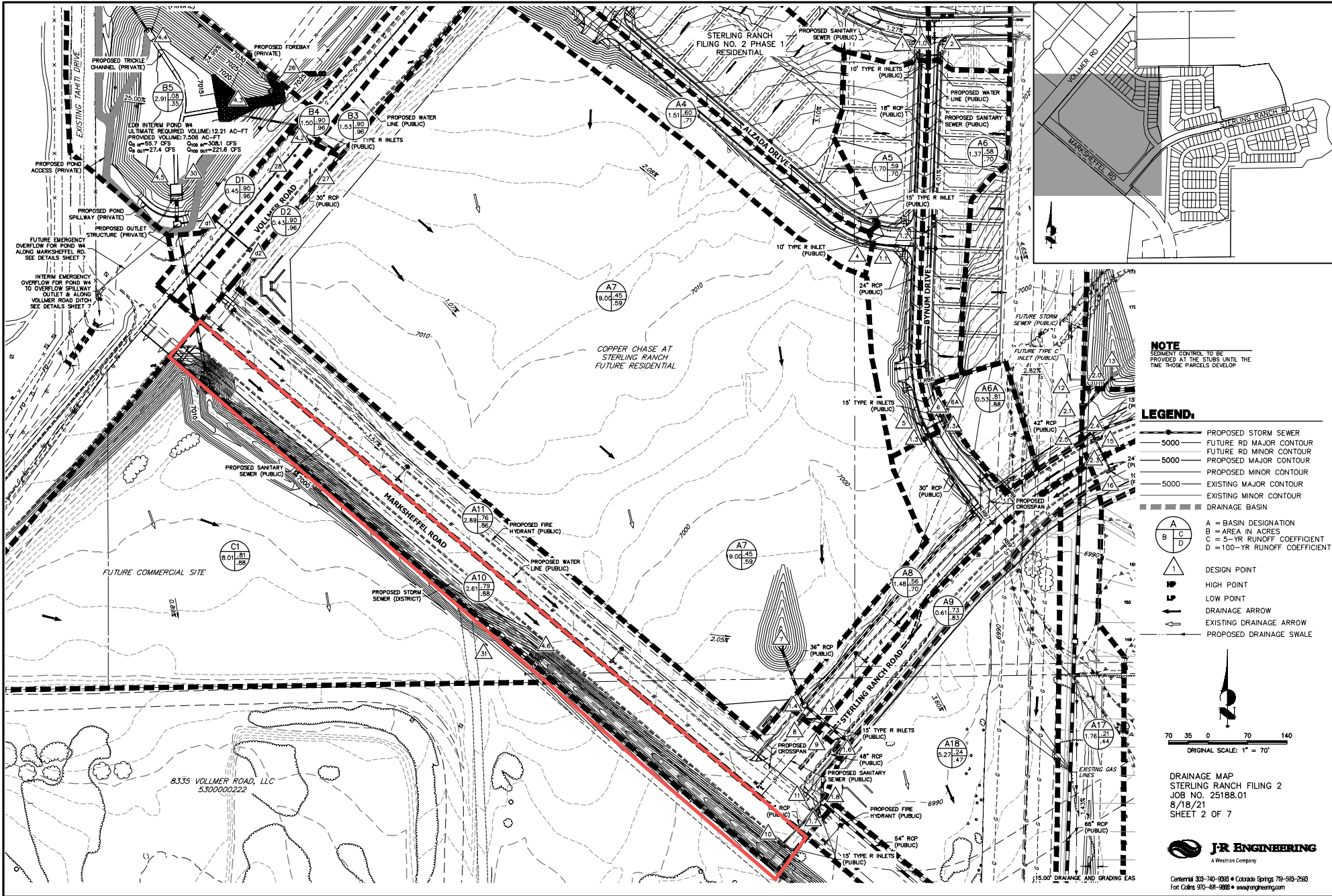

NOTE
 SEDIMENT CONTROL TO BE PROVIDED AT THE STUBS UNTIL THE TIME THOSE PARCELS DEVELOP

- LEGEND:**
- PROPOSED STORM SEWER
 - FUTURE RD MAJOR CONTOUR
 - FUTURE RD MINOR CONTOUR
 - PROPOSED MAJOR CONTOUR
 - PROPOSED MINOR CONTOUR
 - EXISTING MAJOR CONTOUR
 - EXISTING MINOR CONTOUR
 - DRAINAGE BASIN
- | | |
|---|-------------------------------|
| A | A = BASIN DESIGNATION |
| B | B = AREA IN ACRES |
| C | C = 5-YR RUNOFF COEFFICIENT |
| D | D = 100-YR RUNOFF COEFFICIENT |
- △ DESIGN POINT
 - ▽ HIGH POINT
 - ▽ LOW POINT
 - DRAINAGE ARROW
 - EXISTING DRAINAGE ARROW
 - PROPOSED DRAINAGE SWALE

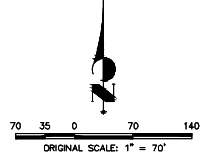

DRAINAGE MAP
 STERLING RANCH FILING 2
 JOB NO. 25188.01
 8/18/21
 SHEET 2 OF 7



Callendar 333-740-9293 • Colorado Springs 719-589-2593
 Fort Collins 970-591-9888 • www.jrengineering.com

EDB INTERM POND W4
 ULTIMATE REQUIRED VOLUME: 12.21 AC-FT
 PROVIDED VOLUME: 7.509 AC-FT
 C₅ = 59.7 CFS
 C₁₀₀ = 27.4 CFS

INTERM EMERGENCY
 OVERFLOW FOR POND W4
 TO OVERFLOW SPILLWAY
 OUTLET & ALONG
 VOLLMER ROAD DITCH
 SEE DETAILS SHEET 7

8335 VOLLMER ROAD, LLC
 5300000222

COPPER CHASE AT
 STERLING RANCH
 FUTURE RESIDENTIAL

STERLING RANCH
 FILING NO. 2 PHASE 1
 RESIDENTIAL

15.00' DRAINAGE AND GRADING EAS



ENTECH
ENGINEERING, INC.

505 ELKTON DRIVE
COLORADO SPRINGS, CO 80907
PHONE (719) 531-5599

**SOILS AND GEOLOGY STUDY
LOT 1, STERLING RECYCLING FACILITY
PARCEL NO. 53000-00-743
COLORADO SPRINGS, COLORADO**

Prepared for:
**Rhetoric LLC
20 Boulder Crescent
Colorado Springs, CO 80903**

Attn: Chaz Collins

August 17, 2023

Respectfully Submitted,

ENTECH ENGINEERING, INC.

Logan L. Langford, P.G.
Geologist

LLL

Reviewed by:



Joseph C. Goode Jr., P.E.
President

5.5 Groundwater

Groundwater was encountered in TB-1 and TB-2 at depths of 4 to 5 feet. TB-3 which was drilled to 20 feet was dry. Fluctuation in groundwater conditions may occur due to variations in rainfall and other factors not readily apparent at this time. It should be noted that in the sandy materials on-site, some groundwater conditions might be encountered due to the variability in the soil profile. Isolated sand and gravel layers within the soils, sometimes only a few feet in thickness and width, can carry water in the subsurface. Groundwater may also flow on top of the underlying bedrock. Builders and planners should be cognizant of the potential for the occurrence of such subsurface water features during construction on-site and deal with each individual problem as necessary at the time of construction.

6 ENGINEERING GEOLOGY – IDENTIFICATION AND MITIGATION OF GEOLOGIC HAZARDS

Geologic mapping has been performed on this site to produce an Engineering Geology Map Figure 7. This map shows the location of various geologic conditions of which the developers should be cognizant during the planning, design and construction stages of the project. These hazards and the recommended mitigation techniques are as follows:

Artificial Fill – Constraint

These are areas of man-made fill associated with past quarry operations and fill dumped across the site, in addition to the asphalt, concrete, and soil piles associated with the Sterling Recycling Facility. Fill was encountered in the test borings at depths of 3 to 5 feet. Fill depths are variable across the site and test pits and or additional test borings in the building areas are recommended once development plans are finalized.

Mitigation: The fill on this site is considered uncontrolled for construction purposes. Any uncontrolled fill encountered beneath foundations will require removal and recompaction at a minimum of 95% of its maximum Modified Proctor Dry Density, ASTM D-1557.

Collapsible Soils – Constraint

The majority of the soils encountered on-site do not exhibit collapsible characteristics, however, areas of loose soils were encountered in the test borings drilled on site. Additionally, areas mapped as Qes (eolian sand) have the potential for hydrocompaction (Reference 7, Figure 5).

Mitigation: Should loose or collapsible soils be encountered beneath foundations, recompaction and moisture conditioning of the upper 2 feet of soil at 95% of its maximum Modified Proctor Dry

LOT 1, STERLING RECYCLING FACILITY

SECTION 5 IN TOWNSHIP 12 SOUTH RANGE 65 WEST OF THE 6TH PRINCIPAL MERIDIAN EL PASO COUNTY, CO
SITE DEVELOPMENT PLAN

REVISION	BY



SITE PLAN/TESTING LOCATION MAP
 LOT 1, STERLING RECYCLING FACILITY
 EL PASO COUNTY, COLORADO
 RHETORIC LLC

JOB NO.
 231252
FIG. 3

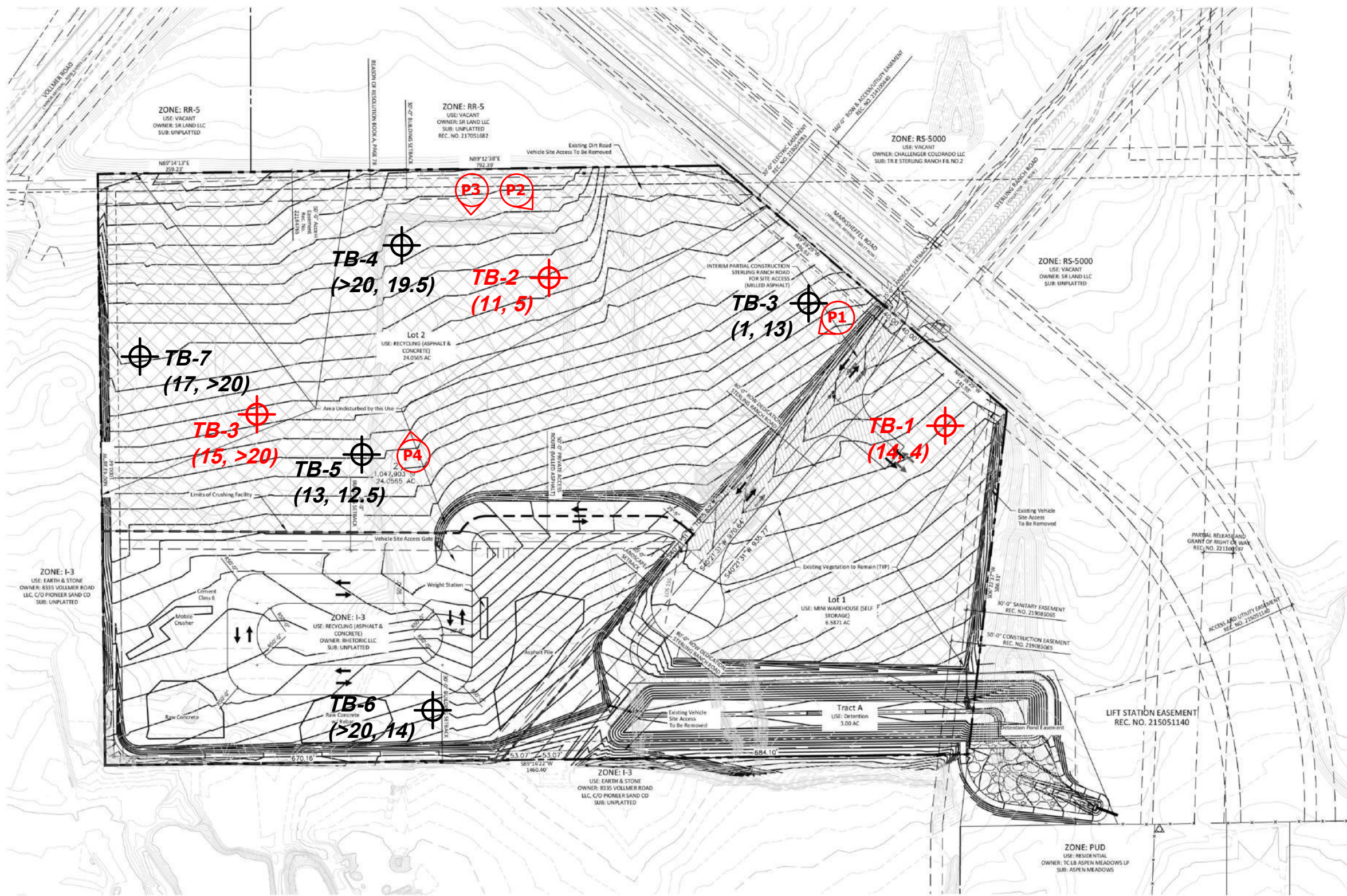

- ⊕ - APPROXIMATE TEST BORING LOCATION AND NUMBER (BEDROCK, GROUNDWATER DEPTHS FT.) EEI JOB NO. 231252
- ⊕ - APPROXIMATE TEST BORING LOCATION AND NUMBER (BEDROCK, GROUNDWATER DEPTHS FT.) EEI JOB NO. 220402
- Ⓚ - APPROXIMATE PHOTOGRAPH LOCATION AND NUMBER

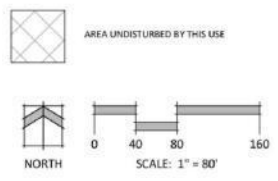

Appendix E

Drainage Maps



STERLING RANCH RECYCLING FACILITY

EXISTING DRAINAGE MAP

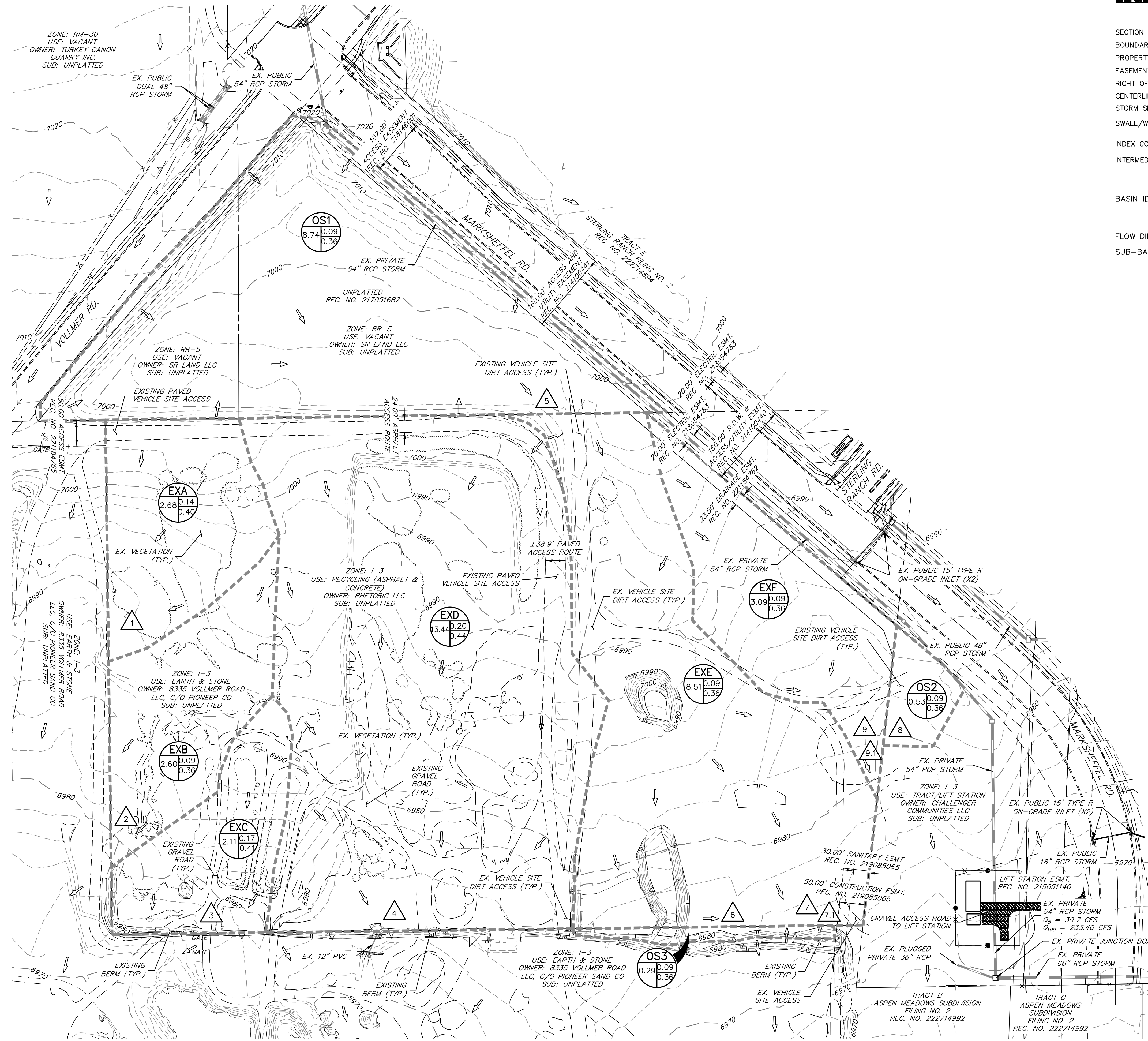

LEGEND

	EXISTING	PROPOSED
SECTION LINE	---	---
BOUNDARY LINE	---	---
PROPERTY LINE	---	---
EASEMENT LINE	---	---
RIGHT OF WAY	---	---
CENTERLINE	---	---
STORM SEWER	---	---
SWALE/WATERWAY FLOWLINE	---	---
INDEX CONTOUR	---	---
INTERMEDIATE CONTOUR	---	---
BASIN ID	⊙ ID AC C5 C100	⊙ ID C5 C100
DESIGN POINT DESIGNATION	△ 1	△ 1
FLOW DIRECTION	→	→
SUB-BASIN DRAINAGE AREA	---	---

BASIN SUMMARY TABLE

Tributary Sub-basin	Area (acres)	Percent Impervious	C _s	C ₁₀₀	t _c (min)	Q _s (cfs)	Q ₁₀₀ (cfs)
EXA	2.68	8%	0.14	0.40	21.1	1.1	5.4
EXB	2.60	2%	0.09	0.36	25.9	0.6	4.3
EXC	2.11	14%	0.17	0.41	22.4	1.0	4.3
EXD	13.44	17%	0.20	0.44	23.4	7.6	28.1
EXE	8.51	2%	0.09	0.36	27.7	2.0	13.4
EXF	3.09	2%	0.09	0.36	24.1	0.8	5.2
OS1	8.74	2%	0.09	0.36	49.4	1.4	9.2
OS2	0.53	2%	0.09	0.36	15.8	0.2	1.1
OS3	0.29	2%	0.09	0.36	5.0	0.2	0.9

DESIGN POINT

DP	Q5		Q100	
	Total	Total	Total	Total
1	1.1	5.4		
2	0.6	4.3		
3	1.0	4.3		
4	7.6	28.1		
5	1.4	9.2		
6	0.2	0.9		
7	2.0	13.4		
7.1	2.8	18.3		
8	0.2	1.1		
9	0.8	5.2		
9.1	0.9	6.1		

PCD FILE NO. PPR2341 & SF2325
 STERLING RANCH RECYCLING FACILITY
 EXISTING DRAINAGE MAP
 JOB NO. 25188.14
 01/19/2024
 SHEET 1 OF 1

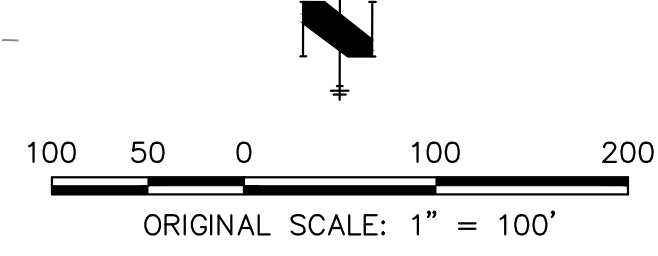

Centennial 303-740-9393 • Colorado Springs 719-593-2593
 Fort Collins 970-491-9888 • www.jrengineering.com

STERLING RANCH RECYCLING FACILITY PROPOSED DRAINAGE MAP

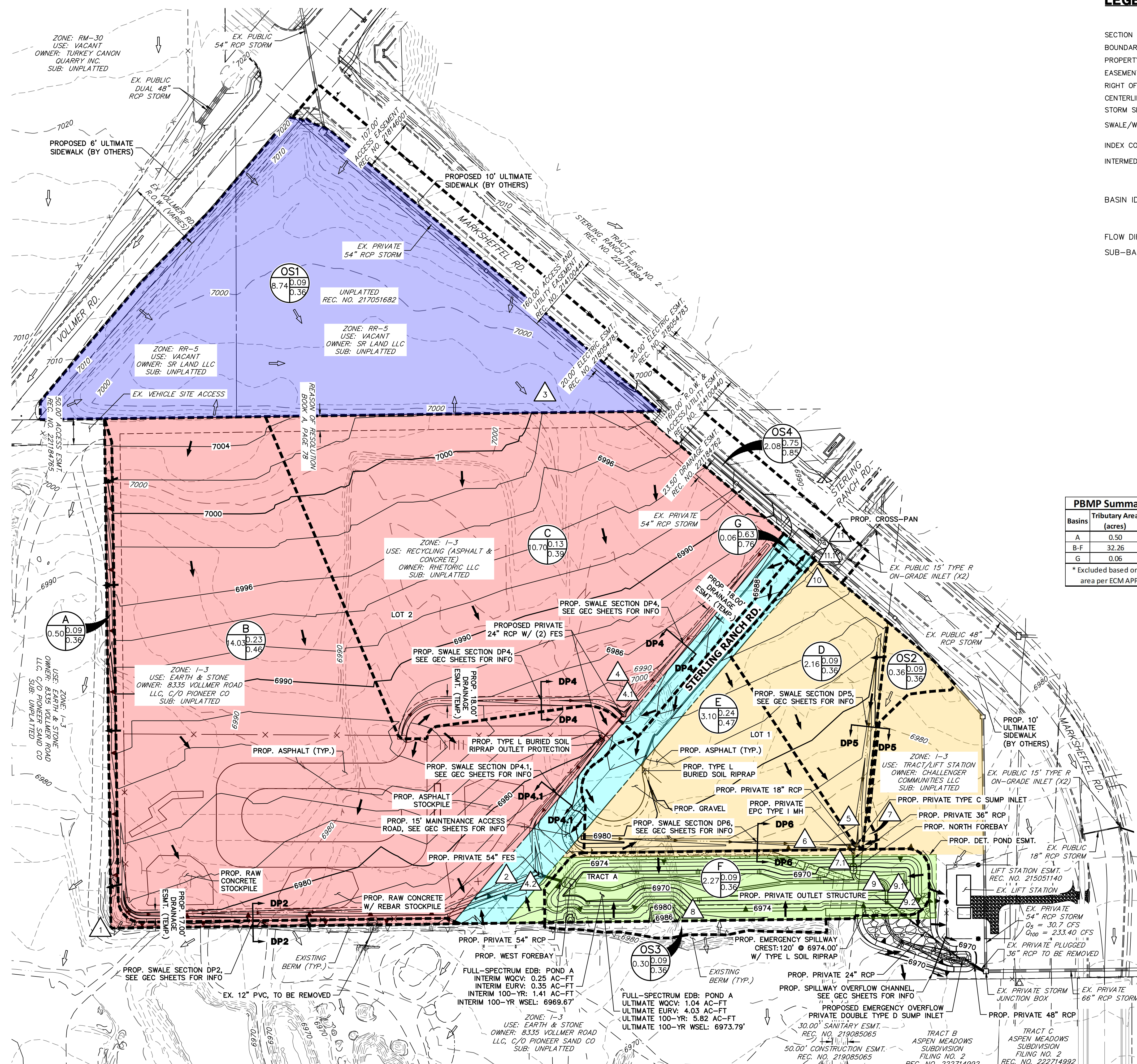

LEGEND

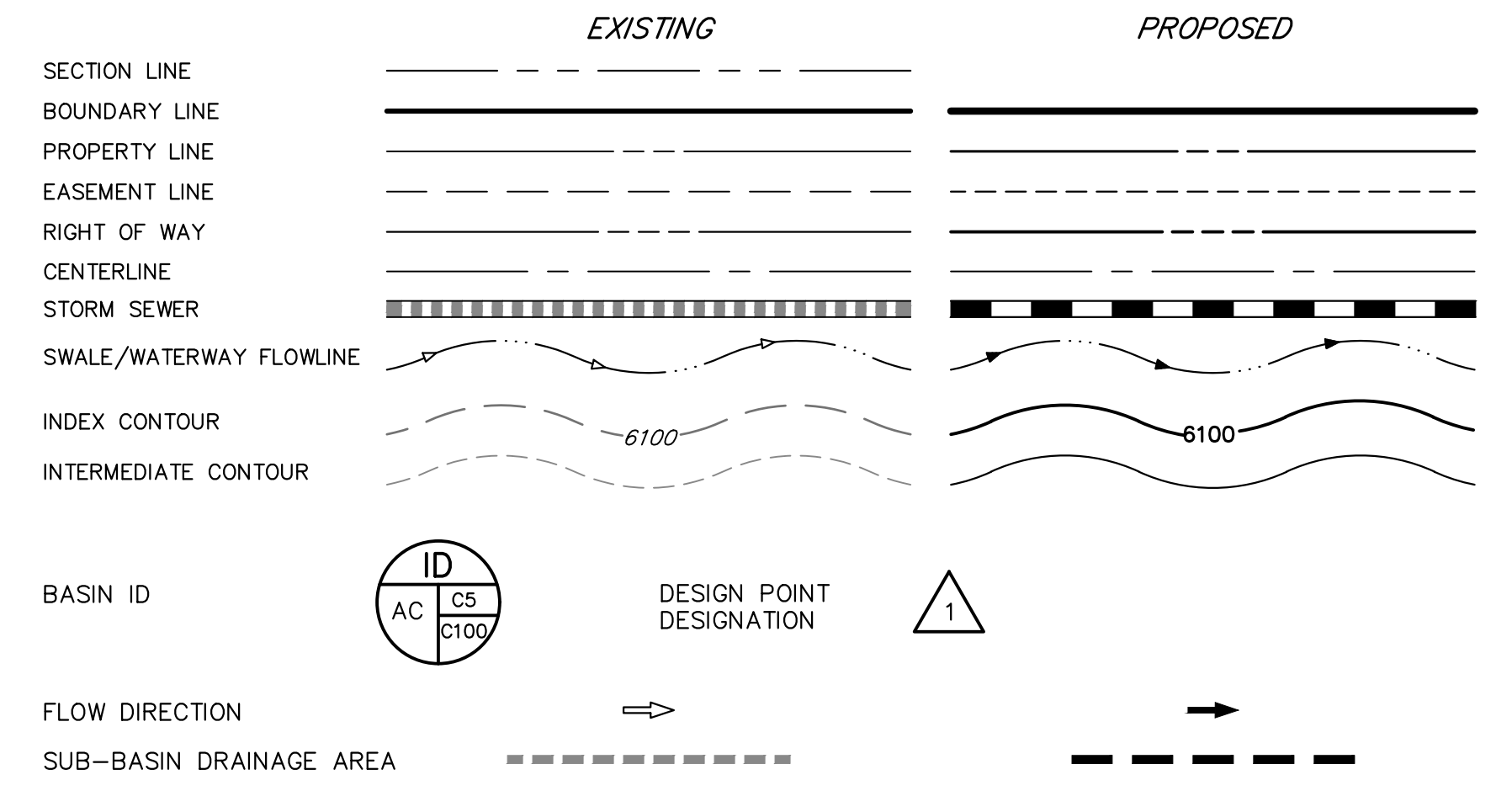

ULTIMATE LAND USE LEGEND

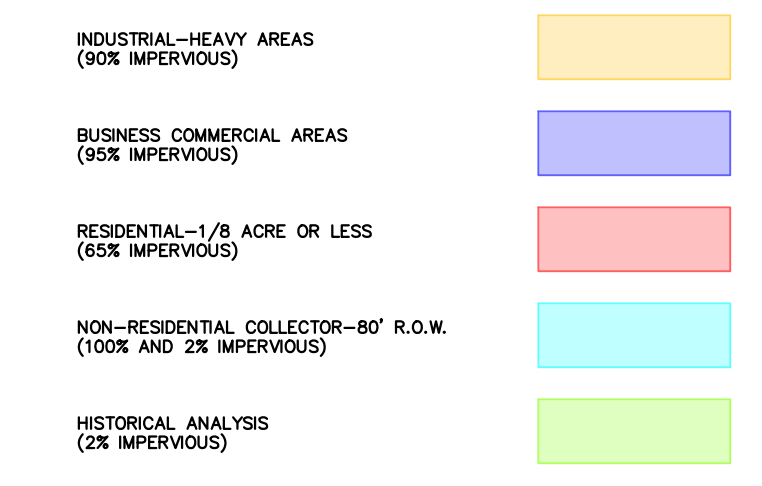

PBMP Summary Table

Basins	Tributary Area (acres)	PBMP
A	0.50	Excluded*
B-F	32.26	Pond A
G	0.06	Excluded*

* Excluded based on < 1 acres of area per ECM APP. I.7.C.1.a

BASIN SUMMARY TABLE

Tributary Sub-basin	Area (acres)	Percent Impervious	C _s	C ₁₀₀	t _c (min)	Q _s (cfs)	Q ₁₀₀ (cfs)
A	0.50	2%	0.09	0.36	5.0	0.3	1.6
B	14.03	19%	0.23	0.46	34.1	7.4	25.1
C	10.70	6%	0.13	0.39	28.6	3.4	17.7
D	2.16	2%	0.09	0.36	24.1	0.5	3.7
E	3.10	22%	0.24	0.47	22.8	2.2	7.1
F	2.27	2%	0.09	0.36	18.5	0.6	4.4
G	0.06	67%	0.63	0.76	5.3	0.2	0.4
OS1	8.74	2%	0.09	0.36	49.4	1.4	9.2
OS2	0.36	2%	0.09	0.36	16.5	0.1	0.7
OS3	0.30	2%	0.09	0.36	5.0	0.2	1.0
OS4	2.08	82%	0.75	0.85	9.0	6.7	12.8

DESIGN POINT

DP	Q5		Q100	
	Total	Total	Total	Total
1	0.3	1.6		
2	7.4	25.1		
3	1.4	9.2		
4	3.4	17.7		
4.1	3.7	21.1		
4.2	9.3	40.1		
5	0.5	3.7		
6	2.2	7.1		
7	0.1	0.7		
7.1	2.8	11.2		
8	0.2	1.0		
9	0.6	4.4		
9.1	11.4	49.4		
9.2	0.1	8.3		
10	0.2	0.4		
11	6.7	12.8		
11.1	6.9	13.1		

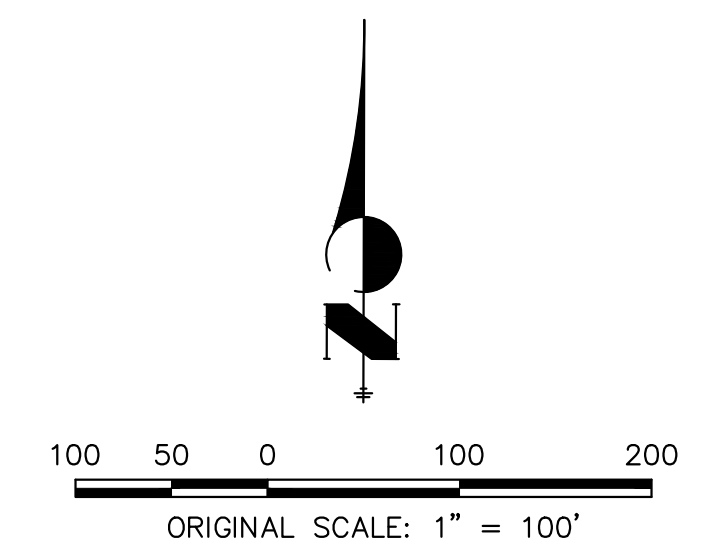

PCD FILE NO. PPR2341 & SF2325
STERLING RANCH RECYCLING FACILITY
PROPOSED DRAINAGE MAP
JOB NO. 25188.14
02/09/2024
SHEET 1 OF 1



Centennial 303-740-9393 • Colorado Springs 719-593-2593
Fort Collins 970-491-9888 • www.jrengineering.com