

DRAINAGE LETTER REPORT

for

**SHOPS AT MERIDIAN RANCH CONVENIENCE STORE
11810 STAPLETON DRIVE
LOT 2, THE SHOPS FILING NO. 1A AT MERIDIAN RANCH**

Prepared for:

Hunjan Gas Stations LLC
12599 Mt. Lindsey Drive
Peyton, CO 80831

May 5, 2023
Revised September 18, 2023
Revised January 8, 2024

Prepared by:

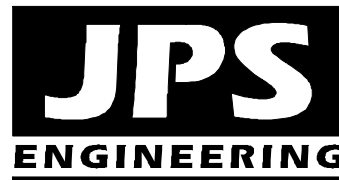

**19 E. Willamette Ave.
Colorado Springs, CO 80903
(719)-477-9429
www.jpsengr.com**

**JPS Project No. 092202
PCD Filing No. PPR2322 and VR2314**

**SHOPS AT MERIDIAN RANCH CONVENIENCE STORE
DRAINAGE LETTER REPORT
TABLE OF CONTENTS**

| | |
|---|-------------|
| | <u>PAGE</u> |
| DRAINAGE STATEMENT | i |
| I. INTRODUCTION | 1 |
| II. EXISTING / PROPOSED DRAINAGE CONDITIONS | 2 |
| III. DRAINAGE PLANNING FOUR STEP PROCESS..... | 6 |
| IV. FLOODPLAIN IMPACTS..... | 6 |
| V. STORMWATER DETENTION AND WATER QUALITY | 7 |
| VI. PUBLIC IMPROVEMENTS / DRAINAGE BASIN FEES | 7 |
| VII. SUMMARY | 8 |

APPENDICES

| | |
|-------------|--|
| APPENDIX A | Excerpts from Subdivision Drainage Reports |
| APPENDIX B | Hydrologic Calculations |
| APPENDIX C1 | Hydraulic Calculations |
| APPENDIX C2 | Hydraulic Calculations – Storm Sewer |
| APPENDIX D | Figures |
| Figure FIRM | Floodplain Map |
| Sheet RR-1 | Runoff Reduction Exhibit |
| Sheet D1 | Developed Drainage Plan |

DRAINAGE STATEMENT

Engineer's Statement:

The attached drainage plan and report were prepared under my direction and supervision and are correct to the best of my knowledge and belief. Said drainage report has been prepared according to the criteria established by the County for drainage reports and said report is in conformity with the master plan of the drainage basin. I accept responsibility for liability caused by negligent acts, errors or omissions on my part in preparing this report.

John P. Schwab, P.E. #29891

Developer's Statement:

I, the developer have read and will comply with all of the requirements specified in this drainage report and plan.

By:

Hunjan Gas Stations LLC
12599 Mt. Lindsey Drive, Peyton, CO 80831

Date

El Paso County's Statement

Filed in accordance with the requirements of the El Paso County Land Development Code, Drainage Criteria Manual, Volumes 1 and 2, and Engineering Criteria Manual as amended.

Joshua Palmer, P.E.
County Engineer / ECM Administrator

Date

Conditions:

I. INTRODUCTION

A. Property Location and Description

Hunjan Gas Stations LLC (Owner) is planning to construct a new Convenience Store on the vacant 1.46-acre property in the Shops at Meridian Ranch commercial area northeast of Stapleton Drive and Meridian Road in the Falcon area of El Paso County, Colorado. The property is currently described as part of Lot 2, The Shops Filing No. 1 at Meridian Ranch (El Paso County Assessor's Parcel Number 42303-19-056).

The project consists of a new 12,000 square-foot, single-story Convenience Store and Gas Station with associated parking and site improvements. The property adjoins Stapleton Drive on the south side, which is a fully improved, asphalt-paved arterial public street. The property is bounded by an existing shared private driveway along the north and east sides. The west boundary of the site adjoins a vacant 1.0-acre commercial tract currently described as the balance of Lot 2, The Shops Filing No. 1 at Meridian Ranch (El Paso County Assessor's Parcel Number 42303-19-055).

The total anticipated land disturbance associated with the project is approximately 1.3 acres.

The property is zoned Commercial Regional District (CR), and the proposed site development is fully consistent with the existing zoning of the site. Access to the site will be provided by new connections to the existing shared private driveways adjoining the north and east boundaries of the site.

The site is located in the Bennett Ranch Drainage Basin, and surface drainage from this site sheet flows southeasterly to an existing private storm sewer system draining easterly across the property, ultimately flowing to the existing Bennett Regional Detention Pond. While the County "Drainage Basin Map" identifies the area at the northeast corner of Meridian Road and Stapleton Road as lying with the "Falcon Drainage Basin," all of the developed area along the north side of Stapleton Road east of Meridian Road drains easterly to the Bennett Detention Pond, and this area is included within the Bennett Ranch Drainage Basin according to all of the previously approved subdivision drainage reports for this area.

This report is intended to meet the requirements of a site-specific "Letter Type" drainage report in accordance with El Paso County subdivision drainage criteria.

B. Drainage Analysis Methods and Criteria

| ITEM | DESCRIPTION | REFERENCE |
|--------------------------------|--|------------|
| Design Storm (initial/major) | 5-year/100-year | CS/EPC DCM |
| Storm Runoff | Rational Method (Area<100acres) | CS/EPC DCM |
| Major Drainage Basin | Bennett Ranch | |
| Floodplain Impacts | Parcel is located outside any delineated FEMA floodplains | FIRM |
| Existing Downstream Facilities | Existing storm sewer system flowing to Bennett Ranch Regional Detention Pond | |

CS/EPC DCM = City of Colorado Springs & El Paso County Drainage Criteria Manual

C. References

Olsson Associates, “Drainage Letter – Lot 3, The Shops at Meridian Ranch Filing 4B,” May 7, 2015 (approved by El Paso County 8/20/15).

Tech Contractors, “Preliminary / Final Drainage Report for Meridian Ranch Filing 4B, The Shops at Meridian Ranch Filing 1,” April 2014 (approved by El Paso County 9/9/14; EPC Project No. SF147).

Tech Contractors Engineering Group, “Drainage Conformance Letter, Building E, Lot 4, the Shops Filing 1 at Meridian Ranch,” April 1, 2022 (approved by El Paso County 4/7/22).

Tech Contractors Engineering Group, “Drainage Conformance Letter, Lot 4, the Shops Filing 1 at Meridian Ranch,” May 3, 2019 (approved by El Paso County 6/5/19; EPC Project No. PPR1833).

URS, “Final Drainage & Erosion Control Report for Woodmen Hills Subdivision Filing 10,” April 3, 2001 (approved by El Paso County 4/24/01; EPC Project No. SF0030).

II. EXISTING / PROPOSED DRAINAGE CONDITIONS

The site slopes downward to the southeast, with average grades of 1-4 percent. Soils within the proposed Convenience Store site are classified by SCS as type 19, “Columbine gravelly sandy loam” soils. These soils have high infiltration rates, rapid permeability, and low runoff potential. The soils are classified as hydrologic soils group A.

Subdivision Drainage Reports

Drainage planning for this site was previously studied in several approved drainage reports for the Meridian Ranch Subdivision (see excerpts in Appendix A), the most relevant of which is the “Drainage Conformance Letter, Lot 4, the Shops Filing 1 at Meridian Ranch” by Tech Contractors Engineering Group, dated May 3, 2019 (EPC’s EDARP File No. PPR1833).

Developed drainage from this commercial site will sheet flow southeasterly to the existing storm sewer system which flows east across The Shops at Meridian Ranch commercial area, ultimately flowing to the existing downstream Bennett Regional Detention Pond.

The existing detention pond and downstream drainage piping / facilities were sized to account for fully developed flows from this commercial area. As detailed in the previously approved subdivision drainage reports for this area, both stormwater detention and water quality treatment is provided in the existing Bennett Ranch Regional Detention Pond. According to the April, 2001 “Final Drainage & Erosion Control Report for Woodmen Hills Subdivision Filing 10,” by URS, “Within the Regional Detention Pond, a Water Quality Capture Volume (WQCV) will be provided.”

The Bennett Ranch Regional Detention Pond provides water quality treatment for this commercial subdivision in accordance with “Design Base Standard E” of the El Paso County MS4 Permit. As detailed in the “Drainage Conformance Letter, Lot 4, the Shops Filing 1 at Meridian Ranch” by Tech Contractors Engineering Group dated May 3, 2019:

“Additional water quality is provided by applying the “Applicable Development Site Draining to a Regional WQCV Facility” rule (20%/10% Rule) found in Part 4.a.IV.A.1 Control Measure Requirements of the El Paso County MS4 Program. The regional WQCV facility is designed to accept drainage from the applicable development site. Stormwater from the site may discharge to a water of the state before being discharged to the regional WQCV facility. Before discharging to a water of the state, 20 percent of the total impervious surface of the applicable development site must first drain to a control measure covering an area equal to 10 percent of the total impervious surface of the applicable development site. The control measure must be designed in accordance with a design manual identified by the permittee. In addition, the stream channel between the discharge point of the applicable development site and the regional WQCV must be stabilized.”

In a similar manner as previously provided and approved for Lot 4, Filing 1, this project site (Filing No. 1A) meets the requirements listed above by providing a pervious landscaped area along the south side of the Lot 2 parking lot (see additional discussion in Section V).

As shown on the enclosed Drainage Plan from the “Drainage Letter – Lot 3, The Shops at Meridian Ranch Filing 4B” by Olsson Associates (OA), dated May 7, 2015, the proposed Convenience Store site lies entirely within Basin C as delineated in the previously approved drainage plans. The previously approved drainage reports for The Shops at Meridian Ranch assumed full commercial development for this basin, which is consistent with the proposed site development.

The previously approved subdivision drainage planning assumed full commercial development within all of Basin C1, with runoff coefficients of $C_5 = 0.78$ and $C_{100} = 0.89$ (equivalent to impervious areas of approximately 90 percent). According to the Rational Method calculations in the original subdivision drainage report, developed peak flows from Basin C (Design Point #3) were calculated as $Q_5 = 8.2$ cfs and $Q_{100} = 15.5$ cfs.

Developed Drainage Plan

Developed drainage flows have been calculated based on the impervious areas associated with the proposed building and parking improvements. Surface drainage swales and a private storm sewer system will convey flows to the existing private storm sewer system that has been designed to convey developed flows from this site to the existing downstream Bennett Ranch Regional Detention Pond. As detailed in the previously approved subdivision drainage reports for this commercial subdivision, the Bennett Ranch Regional Detention Pond provides stormwater detention and water quality treatment for this site.

Site grades will slope to storm inlets and curb openings at selected locations, collecting surface drainage and conveying stormwater to the existing storm sewer system. The proposed building pad will be graded with protective slopes to provide positive drainage away from the building, and the curb, gutter, drainage swales, and private storm sewer improvements will convey developed flows to the existing storm sewer system at the southeast corner of the site.

For consistency with the previously approved subdivision drainage report, the site drainage basins have been delineated as Basins C1.1-C1.3. The proposed Convenience Store site on Lot 2 has been delineated as Basin C1.2, which drains by sheet flow and curb and gutter to the proposed Storm Inlet C1.2 (Private Type C Inlet) at the southeast corner of the property. Runoff reduction will be provided by routing a majority of developed flows from the site through the proposed landscaped Swale C1.2 along the south edge of the property. Developed peak flows from Basin C1.2 are calculated as $Q_5 = 4.3$ cfs and $Q_{100} = 8.0$ cfs. Storm Inlet C1.2 has been sized to accept the full developed flow from Basins C1.2 in addition to the carryover flow from the upstream Inlet C1.1 at the west boundary of Lot 2. In the event of clogging, overflows from Inlet C1.2 would sheet flow easterly into the existing 20' Type R "Inlet #CB-3" located immediately downstream to the east.

Private Storm Sewer C1.2 (15" HDPE) will convey the flow from Inlet C1.2 into the back side of the existing private Storm Inlet #3 at the northwest corner of Stapleton Drive and the shared private access drive along the east side of Lot 2.

The future commercial site development lot to the west of this site has been delineated as Basin C1.1, which will drain southeasterly, contributing to DP-C1. Assuming developed runoff coefficients consistent with the previous subdivision drainage reports, developed peak flows from Basin C1.1 are calculated as $Q_5 = 3.7$ cfs and $Q_{100} = 6.7$ cfs.

Development of the proposed Lot 2 Convenience Store will include construction of the shared access drive between Lots 1 and 2, and the proposed private Storm Inlet C1.1 (10' Type R) will be installed along the east side of Basin C1.1 to accept future developed flows. Proposed Private Storm Sewer SD-C1.1 (12" RCP) will convey the flow from Inlet C1.1 into the existing Storm Manhole (MH-3), connecting to the existing 30" RCP private storm sewer flowing easterly across the site.

Depending on the future site grading scheme for Lot 1, additional private storm sewer improvements may be constructed within Basin C1.1 if necessary.

Developed flows from Basins C1.1 and C1.2 combine at Design Point #C1, with peak flows calculated as $Q_5 = 7.3$ cfs and $Q_{100} = 13.6$ cfs. Proposed Inlet C1.2 and Storm Sewer C1.2 have been sized to accept the full developed flow from Design Point #C1 (combined Basins C1.1 and C1.2).

The existing shared private access drive along the north and east sides of the site has been delineated as Basin C1.3, which drains by curb and gutter to the existing Private Storm Inlet #3 at the northwest corner of Stapleton Drive and the shared driveway. Developed peak flows from Basin C1.3 are calculated as $Q_5 = 1.3$ cfs and $Q_{100} = 2.3$ cfs.

Developed flows from Basins C1.1-C1.3 combine at Design Point #3, with peak flows calculated as $Q_5 = 8.5$ cfs and $Q_{100} = 15.8$ cfs. The calculated flows in this report are fully consistent with the previously approved drainage report by Olsson Associates ($Q_5 = 8.2$ cfs and $Q_{100} = 15.5$ cfs at DP #3). The OA report identifies the combined flow at DP #3 being conveyed easterly through "PIPE-10" (24" RCP) and continuing downstream in the existing 24"-42" RCP storm sewer system flowing to the Bennett Regional Detention Pond.

Storm sewer calculations are provided in Appendix C2, demonstrating acceptable hydraulic grade line conditions for the proposed storm sewer improvements.

The landscaped area along the south boundary of the site has been delineated as Basin OS-1.1, consistent with the previously approved subdivision drainage report. Basin OS-1.1 sheet flows southeasterly into the existing curb and gutter along the north side of Stapleton Drive, flowing to existing downstream storm sewer facilities. Developed peak flows from Basin OS-1.1 are calculated as $Q_5 = 0.06$ cfs and $Q_{100} = 0.4$ cfs.

Stormwater detention and water quality treatment for this site is provided in the existing downstream Bennett Ranch Regional Detention Pond.

Hydrologic and hydraulic calculations for the site are detailed in the appendices (Appendix B and C), and peak flows are identified on Figure D1 (Appendix D).

III. DRAINAGE PLANNING FOUR STEP PROCESS

El Paso County Drainage Criteria require drainage planning to include a Four Step Process for receiving water protection that focuses on reducing runoff volumes, treating the water quality capture volume (WQCV), stabilizing drainageways, and implementing long-term source controls.

As stated in ECM Appendix I.7., the Four Step Process is applicable to all new and re-development projects with construction activities that disturb 1 acre or greater or that disturb less than 1 acre but are part of a larger common plan of development. The Four Step Process has been implemented as follows in the planning of this project:

Step 1: Employ Runoff Reduction Practices

- **Minimize Directly Connected Impervious Areas (MDCIA):** A landscaped drainage swale has been designed along the downstream edge of the parking area, providing for disconnection of the impervious area of the south parking lot from the downstream storm sewer system.
- **Landscaped Swale:** A pervious landscaped swale has been designed along the south edge of the parking lot to help reduce runoff from the site.

Step 2: Stabilize Drainageways

- There are no drainageways directly adjacent to this project site. The on-site private drainage improvements will convey developed flows to the existing downstream storm sewer system and regional detention basin, which has been designed to minimize downstream drainage impacts.
- Drainage basin fees were previously paid during recording of the subdivision plat, and these fees provided the applicable cost contribution towards regional drainage improvements.

Step 3: Provide Water Quality Capture Volume (WQCV)

- Water quality treatment for this site is provided in the existing downstream Bennett Ranch Regional Detention Pond.

Step 4: Consider Need for Industrial and Commercial BMPs

- No industrial uses are proposed for this site.
- The commercial property owner will implement a Stormwater Management Plan including proper housekeeping practices and spill containment procedures.

IV. FLOODPLAIN IMPACTS

According to the FEMA floodplain map for this area, El Paso County FIRM Panel No. 08041C0551G, dated December 7, 2018, the site is located beyond the limits of any delineated 100-year floodplains.

V. STORMWATER DETENTION AND WATER QUALITY

Stormwater detention and Water Quality for this site is provided in the existing Bennett Ranch Regional Detention Pond. According to the previously approved OA drainage report, the “Bennett Regional Pond has been adequately sized such that 100 YR developed flows will be detained and released at (or below) the pre-developed flow rate.”

As detailed in Appendix B, the calculated runoff coefficients for this site ($C_{100} = 0.89$ at DP3) are fully consistent with the impervious area assumptions in the previously approved subdivision drainage reports.

An on-site landscaped swale will be constructed along the south edge of the parking area to help reduce runoff from this site. In the same manner as other previously approved drainage letter reports for this subdivision, the landscaped swale will meet the requirements of the “20%/10% Rule” described in Section I.7.1.C.5. of the El Paso County Engineering Criteria Manual for “Applicable Development Site Draining to a Regional WQCV Facility.” This rule specifies that “at least 20 percent of the applicable development site must be disconnected from the storm drainage system and drain through a receiving pervious area control measure comprising a footprint of at least 10 percent of the upstream disconnected impervious area.”

The drainage design for Basin C1.2 meets or exceeds the requirements listed above by routing the south and west parking areas through the landscaped drainage swale along the south edge of the site. The “Unconnected Impervious Area” (UIA) of the parking lots is 25,847 square feet, which is 66.0 percent of the total basin impervious area. The total landscaped swale area along the south edge of the site is 3,700 square feet, which is 15.4 percent of the disconnected impervious area of the project site.

As discussed in the previously approved drainage reports for this commercial subdivision, an existing downstream “SNOUT” water quality system provides additional stormwater quality enhancement for Meridian Ranch Filing 4B, which includes this commercial area.

VI. PUBLIC IMPROVEMENTS / DRAINAGE BASIN FEES

No public drainage improvements are required or proposed for this project.

The site lies completely within the Bennett Ranch Drainage Basin. Applicable drainage basin fees were paid at the time of original platting, so no drainage basin fees or bridge fees are applicable at this time.

VII. SUMMARY

The developed drainage patterns for the proposed Convenience Store site development on Lot 2, The Shops Filing No. 1 at Meridian Ranch will remain consistent with the established drainage plan for this subdivision. The grading and drainage plan for the proposed convenience store development fully conforms to the approved drainage plan for this subdivision.

Developed flows from the site will drain through a private storm sewer system at the southeast corner of the property, connecting to the existing downstream public drainage system. Stormwater detention and water quality is provided by the existing Bennett Regional Detention Pond, which was designed to accept fully developed flows from the commercial area encompassing this site (including all of The Shops Filing No. 1 at Meridian Ranch Subdivision). The existing downstream Bennett Regional Detention Pond and drainage facilities are functioning as intended.

Construction and proper maintenance of the on-site drainage facilities, in conjunction with proper erosion control practices, will ensure that this developed site has no significant adverse drainage impact on downstream or surrounding areas.

APPENDIX A

EXCERPTS FROM SUBDIVISION DRAINAGE REPORTS

FINAL DRAINAGE &
EROSION CONTROL REPORT FOR
WOODMEN HILLS SUBDIVISION FILING 10,
EL PASO COUNTY, COLORADO

April 3, 2001

PREPARED FOR:

FALCON PROPERTIES AND INVESTMENTS
P.O. Box 62039
11720 Woodmen Hills Drive
Colorado Springs, CO 80962

PREPARED BY:

URS
8415 Explorer Drive, Suite 110
Colorado Springs, CO 80920

URS PROJECT NO. 67-00042446

Rational Method Criteria

The Rational Method was used to estimate stormwater runoff facilities for the 5-year and 100-year design storm. The Rational Method coefficients "C" were selected from Table 5-1 in the Drainage Criteria Manual. Times of concentration were also calculated per Drainage Criteria Manual requirements. Rainfall intensities for each basin were calculated from Figure 5-1 of the Drainage Criteria Manual and based upon the basin's calculated time of concentration. The resulting runoffs were used to size storm systems and pipe sizes. Please see Appendix D : Rational Method Analysis for calculations.

Detention Storage Criteria

Ponds 3 and 4 of Woodmen Hills have been sized with a portion of Filing 10 flows included. Please see Filing 8 FDR and Filing 9 FDR for details. The Bennett Ranch pond was sized within the Bennett Ranch MDDP. Preliminary detention storage requirements for ponds 3 and 4 were estimated graphically using the SCS method for single stage structure routing. The relationship between allowable outflow (Q_o) and inflow (Q_i) from the pond is directly correlated to the volume of direct runoff (V_r) and volume of storage (V_s) to obtain a graphic solution. These estimates were then refined using the HEC-1 model. In continued cooperation with the Bennett Ranch development to the north, the Bennett Ranch Basin pond has been designed to discharge at 80% of historical rates for the 5-year and 100-year storms at release points located on Eastonville Road, along the easterly boundary of both developments. The Regional Detention Pond also has been sized to control the 2-year and 10-year storm to give added control. The downstream areas are prone to flooding and the reduced historical release rates will minimize the impacts of future large storm events.

Water Quality Capture Volumes (WQCV) are added to the above calculated detention volumes for two reasons. First, the purpose of these volumes is for water quality; sediment is allowed to settle out and accumulate over time to improve water quality and to maintain full volume for detention during the life of the facility for a major storm event. Second, the additional detention volumes will be made available from the WQCV in the chance of back to back storm events.

The WQCVs were calculated based on the equations found in Volume 3, Section B of the Urban Drainage Criteria Manual (UDCM) of Denver per proposed El Paso County criteria. Detention of the WQCVs will be used to meet proposed El Paso County criteria for a Regional Pond. The release rates from the WQCVs are generally very small which help minimize downstream impacts. Detaining the WQCVs will also serve to cleanse the "first flush" of runoff from the higher initial concentration of sediment and pollutants by allowing for sedimentation. This greatly improves the quality of runoff leaving the facilities and reduces the potential for erosion. The positive impact on water quality is expected to be significant, particularly during construction.

Tech Contractors
ENGINEERING GROUP

May 3, 2019

Len Kendall
El Paso County Planning and Community Development
2880 International Cir
Colorado Springs, CO 80910

RE: Drainage Conformance Letter
Lot 4, the Shops Filing 1 at Meridian Ranch
PCD File No. PPR-18-033

Dear Mr. Kendall

The attached short form drainage report is to serve as a statement of compliance for the development of Lot 4 of the Shops Filing 1 at Meridian Ranch commercial property with the *Preliminary/Final Drainage Report for Meridian Ranch Filing 4B, The Shops at Meridian Ranch* (the REPORT) prepared by Tech Contractors, dated April 2014, and approved on September 9, 2014. The REPORT provides hydrologic and hydraulic analysis for the development located at the northeast corner of Meridian Road and Stapleton Drive in El Paso County, Colorado.

Sincerely



Thomas A. Kerby, PE
Tech Contractors
11886 Stapleton Drive
Falcon, CO 80831
719.495.7444

PCD File No. PPR-18-033

Telephone No.: 719.495.7444

11886 Stapleton Dr
Falcon CO. 80831

Billing Address
P. O. Box 80036
San Diego, CA 92138

Introduction

This short report was prepared for the commercial Lot 4 of the Shops Filing 1 at Meridian Ranch. The report shows the drainage for developed lot is in substantial conformance with the original calculations established with the *Preliminary/Final Drainage Report for Meridian Ranch Filing 4B, The Shops at Meridian Ranch* (the REPORT) prepared by Tech Contractors, dated April 2014, and approved on September 9, 2014. The REPORT provides hydrologic and hydraulic analysis for the development located at the northeast corner of Meridian Road and Stapleton Drive in El Paso County, Colorado.

Background

Lot 4 approximately 3.4 acres in size and is located near the southeast corner of Tourmaline Dr. and Meridian Rd. The lot was originally graded with development of Meridian Ranch Filing 4B in 2014 and slopes generally in a southeasterly direction toward Fleece Flower Way and the main roadway for the Shops development.

The first phase of commercial construction occurred within Lot 3, which included the utility and private storm drain system and the construction of the main roadway through the commercial center and the development of Lot 3 of The Shops Filing 1 at Meridian Ranch. A drainage letter showing Lot 3's compliance with the REPORT was approved by the County on August 20, 2015.

The REPORT anticipated runoff from the commercial areas, collectively referred to as The Shops (Lots 1-4, The Shops Filing 1 at Meridian Ranch), to be discharged to the storm drain system constructed as a part of Meridian Ranch Filing 4B. Said storm sewer system will ultimately discharge developed flows from Filing 4B, including The Shops, to the main stem of the Bennett Ranch Channel then convey the flow downstream to the Bennett Regional Detention Pond. The Bennett Regional Detention Pond was designed and constructed as a regional facility providing detention and water quality for all areas within the Bennett Ranch Drainage Basin within the Woodmen Hills Filings 10 & 11 and Meridian Ranch including the flows from The Shops Filing 1 at Meridian Ranch. The Bennett Pond has been adequately sized such that 100 YR developed will be detained and released at (or below) the pre-developed flow rate for the same event.

Water Quality

When regional water quality capture volume facilities are present, BMPs are still required onsite to address water quality and channel stability for the reach of the drainageway upstream of the regional facility. In accordance with MS4 permits and regulations, BMPs must be implemented prior to discharges to a State Water from areas of "New Development and Significant Redevelopment." Therefore, if a regional BMP is utilized downstream of a discharge from a development into a State Water, additional BMPs are required to protect the State Water between the development site and the regional facility. However, these BMPs may not have to be as extensive as would normally be required, as long as they are adequate to protect the State Water upstream of the regional BMP.

Additional water quality is provided by applying the 'Applicable Development Site Draining to a Regional WQCV Facility' rule (20%/10% Rule) found in Part 4.a.IV.A.1 Control Measure Requirements of the El Paso County MS4 Program. The regional WQCV facility is designed to accept drainage from the applicable development site. Stormwater from the site may discharge to a water of the state before being discharged to the regional WQCV facility. Before discharging to a water of the state, 20 percent of the total impervious surface of the applicable development site must first drain to a control measure covering an area equal to 10 percent of the total impervious surface of the applicable development site. The control measure must be designed in accordance with a design manual identified by the permittee. In addition, the stream channel between the discharge point of the applicable development site and the regional WQCV facility must be stabilized.

The project site meets or exceeds the requirements listed above in that the roof top areas discharge to grass lined swales prior to entering into the storm drain system. The storm drainage system is then routed through Meridian Ranch Filing 4b and passes through the SNOUT then is discharged into a stabilized stream channel prior to entering the downstream WQCV facility located within the Bennett Ranch Regional Detention Pond.

The total roof top area of the proposed buildings is 34,120 SQ. FT or 25.3% of the total impervious surface area of the project site. The two buildings discharge the storm runoff to grass lined swales via the roof drains. The total grass lined swale area is 16,735 SQ. FT. or 12.4% of the total impervious surface area of the project site. Please see the Water Quality Exhibit A for a graphic representation of the site.

The BMP SNOUT stormwater quality system was installed with the construction of the storm drain system for Meridian Ranch Filing 4b to meet the initial water quality protection prior to releasing the flow to the State Water in the Bennett Channel. The SNOUT reduces gross pollutants such as floatables and trash as well as free oils and sediments. The SNOUT meets or exceeds the requirement to the Maximum Extent Practicable to prevent "pollution of the receiving waters in excess of the pollution permitted by an applicable water quality standard or applicable antidegradation requirement." The SNOUT is an approved BMP by the EPA. The SNOUT is owned and maintained by the Meridian Service Metropolitan District.

By applying the 20%/10% Rule for regional WQCV facilities and with the addition of the BMP SNOUT stormwater quality system, this project meets or exceeds the requirements for water quality.

Drainage Analysis

The anticipated developed flows from The Shops were accounted for in two basins within the REPORT; basin 4 and basin 9. The flows from basin 4 originate from the Shops on-site flows and were expected to discharge directly into the previously- constructed Filing 4B storm drain system via pipe (Design Point X01). The off-site flows are from basin 9 were expected to be captured by an existing 15' Type R inlet located near the intersection of Meridian Ranch Blvd & Stapleton Dr.

The analysis completed for the initial phase of the Shops, Lot 3 along with portions of the adjacent roadways, showed 35 cfs during the 5 YR event and 68 cfs for the 100 YR event for the on-site flows discharged to the pipe connection at design point X01.

The storm drainage analysis for this phase of the Shops Filing 1 at Meridian Ranch yields a 5 YR event flow of 29 cfs and 58 cfs for the 100 YR at the pipe connection at design point X01 entering Meridian Ranch Filing 4B. A comparison of the different flow rates from the various drainage studies can be found in the table below.

Table 1 Design Flow Rates for Design Point X01

| | Minor Storm (5-yr/10-yr) | Major Storm (100-yr) |
|---|-----------------------------|-------------------------|
| Filing 4B/The Shops - FDR, 2014 | 38 | 70 |
| The Shops, Lot 3 - Drainage Letter, 2015 | 35 | 68 |
| The Shops, Lot 4 - Drainage Letter, 2018 | 29 | 58 |

This letter shows the development of Lot 4 of the Shops Filing 1 at Meridian Ranch is in substantial conformance with the original Final Drainage Report for the Shops Filing 1 and will not adversely impact downstream facilities, as those facilities were designed to convey developed flows from all areas within The Shops. Upon full build-out of The Shops (according to the planned layout of Lot 4, the existing layout of Lot 3 & the conceptual layout of Lots 1 & 2) as presented in the attached Developed Drainage Basin map), the resulting developed flows will be less than the REPORT's expected flows at Design Point X01.

Drainage and Bridge Fees

There are no Drainage and Bridge Fees with this project as the fees were paid at the time of the recordation of the Shops Filing 1 at Meridian Ranch on August 12, 2015.

DRAINAGE MAP FROM THE SHOPS AT MERIDIAN RANCH, LOT 3 FINAL DRAINAGE LETTER FROM OLSSSEN ASSOCIATES (DATED MAY 7, 2015)

STORM DRAINAGE SYSTEM DESIGN (RATIONAL METHOD DIRECT RUNOFF)

Calc. by: GSZ
Chk'd by: JE
Date: 5/7/2015

| DESIGN POINT | BASIN | AREA (AC) | To (min.) | COEFF. (C) | | | | C/A | | | | REMARKS |
|--------------|-------|-----------|-----------|------------|---------|-------------|-------------|---------|---------|---------|---------|-----------------------------|
| | | | | 5-YR | 100-YR | 5-YR | 100-YR | 5-YR | 100-YR | 5-YR | 100-YR | |
| | | | | Q (cfs) | Q (cfs) | I (in./hr.) | I (in./hr.) | Q (cfs) | Q (cfs) | Q (cfs) | Q (cfs) | |
| 1 | A | 1.97 | 12.4 | 0.85 | 0.70 | 1.08 | 1.37 | 3.8 | 6.4 | 4.2 | 8.5 | Drains to Grated MH |
| 2 | B | 1.06 | 6.7 | 0.47 | 0.65 | 0.51 | 0.70 | 4.7 | 7.9 | 2.4 | 5.6 | Drains to 20' Type R |
| 3 | C | 2.25 | 7.3 | 0.78 | 0.88 | 1.76 | 1.88 | 4.6 | 7.7 | 8.2 | 15.5 | Drains to 20' Type R |
| 11 | E | 1.29 | 6.3 | 0.78 | 0.80 | 1.01 | 1.14 | 4.8 | 8.1 | 4.0 | 9.3 | Drains to 10' Type R |
| 8 | F | 0.22 | 5.8 | 0.78 | 0.86 | 0.17 | 0.19 | 5.0 | 8.4 | 0.8 | 1.6 | Drains to 10' Type R |
| 7 | G | 0.18 | 10.7 | 0.36 | 0.95 | 0.07 | 0.10 | 4.0 | 6.8 | 0.3 | 0.7 | Drains to 4' Type R |
| 6 | H | 1.85 | 6.5 | 0.61 | 0.75 | 1.13 | 1.39 | 4.4 | 7.3 | 5.0 | 10.3 | Drains to 12' Type R |
| 9 | I | 2.54 | 13.7 | 0.62 | 0.75 | 1.57 | 1.80 | 3.7 | 6.1 | 5.8 | 11.8 | Drains to Future 14' Type R |
| 10 | J | 1.30 | 7.4 | 0.70 | 0.91 | 1.02 | 1.18 | 4.6 | 7.7 | 4.7 | 9.2 | Drains to 10' Type R |
| 6 | K | 0.88 | 7.0 | 0.70 | 0.87 | 0.86 | 0.72 | 4.7 | 7.8 | 8.1 | 5.7 | Drains to 10' Type R |
| 12 | L | 1.19 | 7.8 | 0.78 | 0.84 | 0.87 | 1.01 | 4.5 | 7.6 | 4.0 | 7.7 | Drains to 10' Type R |
| 14 | N | 0.41 | 11.3 | 0.56 | 0.65 | 0.14 | 0.22 | 3.9 | 6.6 | 1.5 | 2.9 | Drains to Grated MH |
| 18 | OS-1 | 8.22 | 11.3 | 0.60 | 0.73 | 3.71 | 4.53 | 3.9 | 6.6 | 14.7 | 30.2 | Drains to Existing Inlet |
| 11 | OS-2 | 0.68 | 20.8 | 0.71 | 0.81 | 0.49 | 0.66 | 3.0 | 6.1 | 1.6 | 2.9 | Drains to 10' Type R |

STORM DRAINAGE SYSTEM DESIGN PIPE FLOW TABLE

Calc. by: GSZ
Chk'd by: JE
Date: 5/7/2015

| Pipe Name | Diameter (in) | Length (ft) | Slope | Time (min) | Invert | | Velocity (ft/s) | | Flow (cfs) | | Hydraulic Grade (ft) | | Hydraulic Grade (Out) | |
|-----------|---------------|-------------|-------|------------|----------|----------|-----------------|--------|------------|--------|----------------------|----------|-----------------------|----------|
| | | | | | In | Out | 5-Yr | 100-Yr | 5-Yr | 100-Yr | 5-Yr | 100-Yr | 5-Yr | 100-Yr |
| | | | | | ft | ft | ft | ft | ft | ft | ft | ft | | |
| P-1 | 42 | 25.30 | 0.40% | 0.06 | 7,055.85 | 7,055.75 | 6.73 | 7.09 | 34.77 | 68.17 | 7,058.42 | 7,058.65 | 7,058.40 | 7,058.40 |
| P-2 | 36 | 171.00 | 0.30% | 0.36 | 7,056.90 | 7,056.34 | 6.08 | 8.61 | 31.57 | 60.89 | 7,058.98 | 7,060.53 | 7,058.42 | 7,058.86 |
| P-3 | 36 | 175.40 | 0.50% | 0.36 | 7,057.79 | 7,056.90 | 7.22 | 8.69 | 31.91 | 61.45 | 7,059.63 | 7,062.02 | 7,058.98 | 7,060.53 |
| P-4 | 30 | 256.50 | 2.10% | 0.30 | 7,063.61 | 7,058.28 | 11.40 | 13.37 | 25.89 | 47.09 | 7,065.27 | 7,065.87 | 7,059.38 | 7,062.02 |
| P-5 | 30 | 210.50 | 2.80% | 0.30 | 7,070.80 | 7,053.61 | 11.99 | 14.44 | 18.82 | 38.19 | 7,073.27 | 7,072.89 | 7,065.27 | 7,065.87 |
| P-6 | 30 | 289.50 | 0.80% | 0.66 | 7,072.82 | 7,070.80 | 5.38 | 6.48 | 18.56 | 33.82 | 7,073.33 | 7,074.54 | 7,072.27 | 7,072.89 |
| P-7 | 24 | 276.10 | 0.40% | 0.72 | 7,073.71 | 7,072.52 | 5.07 | 6.58 | 10.03 | 20.88 | 7,074.91 | 7,075.05 | 7,073.65 | 7,074.34 |
| P-8 | 24 | 176.00 | 0.60% | 0.42 | 7,074.74 | 7,073.71 | 5.74 | 6.67 | 10.19 | 20.95 | 7,075.88 | 7,076.13 | 7,074.51 | 7,075.68 |
| P-9 | 18 | 34.00 | 1.00% | 1.50 | 7,075.58 | 7,075.24 | 2.52 | 3.58 | 0.26 | 0.68 | 7,075.88 | 7,076.19 | 7,075.88 | 7,076.19 |
| P-10 | 24 | 96.70 | 0.50% | 0.24 | 7,059.22 | 7,058.79 | 5.30 | 6.29 | 11.17 | 19.77 | 7,060.49 | 7,062.74 | 7,059.99 | 7,062.02 |
| P-11 | 24 | 40.00 | 0.20% | 0.18 | 7,059.30 | 7,059.22 | 3.54 | 4.71 | 8.92 | 14.80 | 7,060.54 | 7,062.91 | 7,060.49 | 7,062.74 |
| P-13 | 18 | 114.80 | 2.50% | 0.18 | 7,066.49 | 7,063.61 | 8.06 | 10.24 | 6.87 | 11.86 | 7,067.51 | 7,067.81 | 7,065.27 | 7,065.87 |
| P-14 | 18 | 57.30 | 2.40% | 0.12 | 7,068.07 | 7,066.70 | 8.81 | 10.06 | 6.91 | 12.01 | 7,069.09 | 7,069.36 | 7,067.40 | 7,067.69 |
| P-15 | 18 | 32.00 | 1.80% | 0.06 | 7,068.63 | 7,068.07 | 7.13 | 8.38 | 4.71 | 8.95 | 7,069.47 | 7,069.79 | 7,069.09 | 7,069.36 |
| P-16 | 18 | 83.70 | 1.00% | 0.08 | 7,073.35 | 7,073.24 | 6.17 | 6.68 | 5.81 | 11.80 | 7,076.48 | 7,076.57 | 7,076.04 | 7,076.19 |
| P-17 | 18 | 59.10 | 1.00% | 0.06 | 7,068.72 | 7,068.62 | 5.52 | 6.48 | 3.95 | 7.64 | 7,069.58 | 7,069.99 | 7,069.47 | 7,069.79 |
| P-18 | 18 | 65.00 | 1.00% | 0.12 | 7,075.57 | 7,075.02 | 6.81 | 7.53 | 6.75 | 12.85 | 7,074.58 | 7,075.43 | 7,073.50 | 7,074.37 |
| P-20 | 18 | 180.80 | 1.00% | 0.72 | 7,074.88 | 7,073.02 | 5.19 | 4.22 | 0.57 | 1.51 | 7,075.11 | 7,075.29 | 7,073.56 | 7,074.34 |

DRAINAGE LEGEND

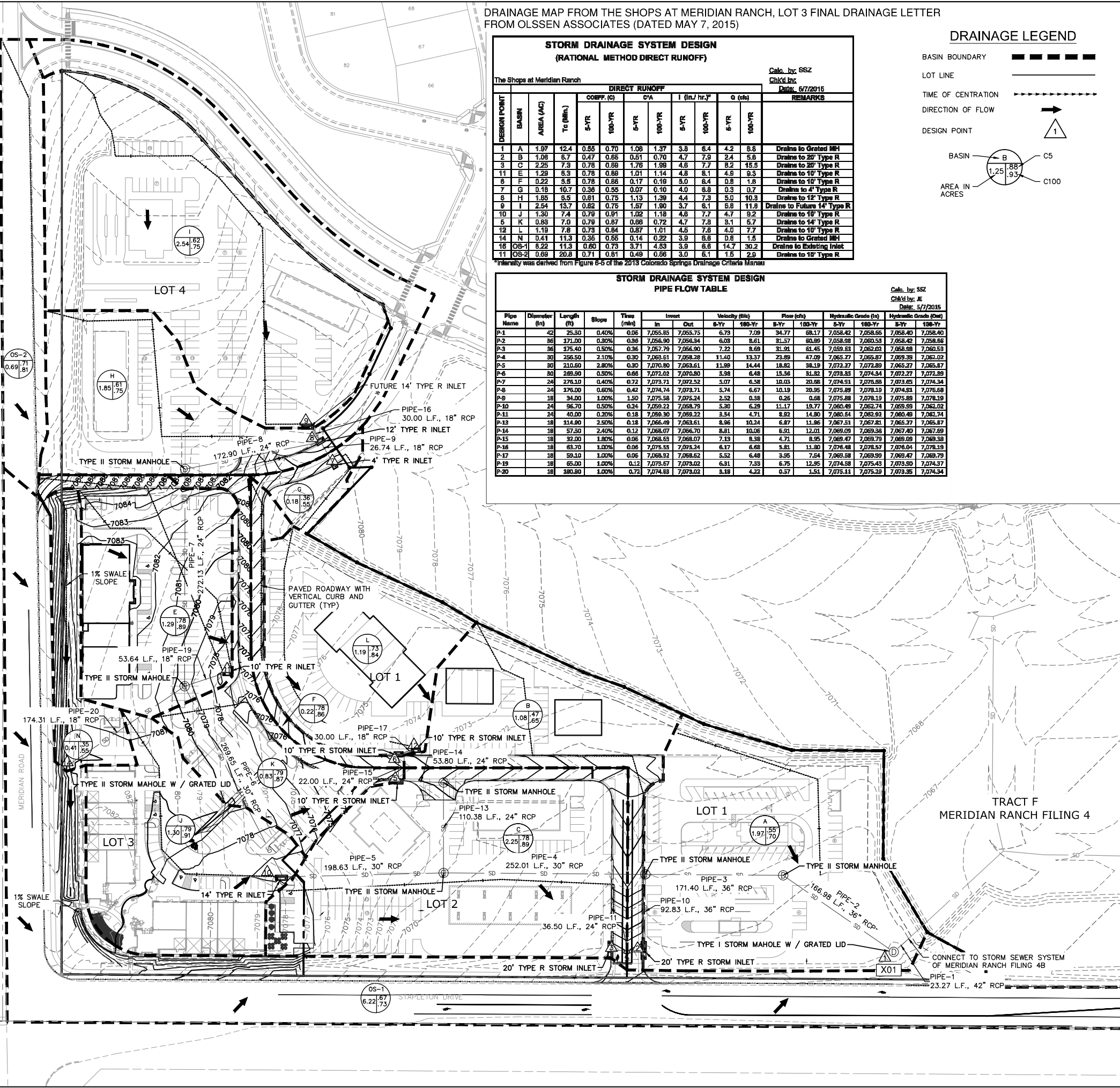
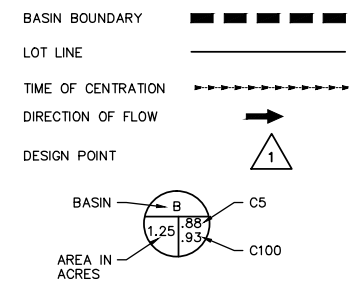

DWG: F:\Projects\014-1030\Documents\Reports\Drawings\141030_PDRN.dwg
 DATE: May 07, 2015 7:44pm
 USER: esay
 141030_PBASE
 141030_PUTIL
 HZ-BASE-FIB-14-04-28
 HZ-BASE-COM
 141030_PBASE

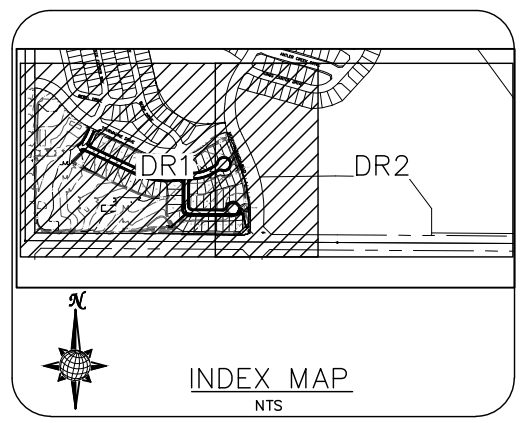
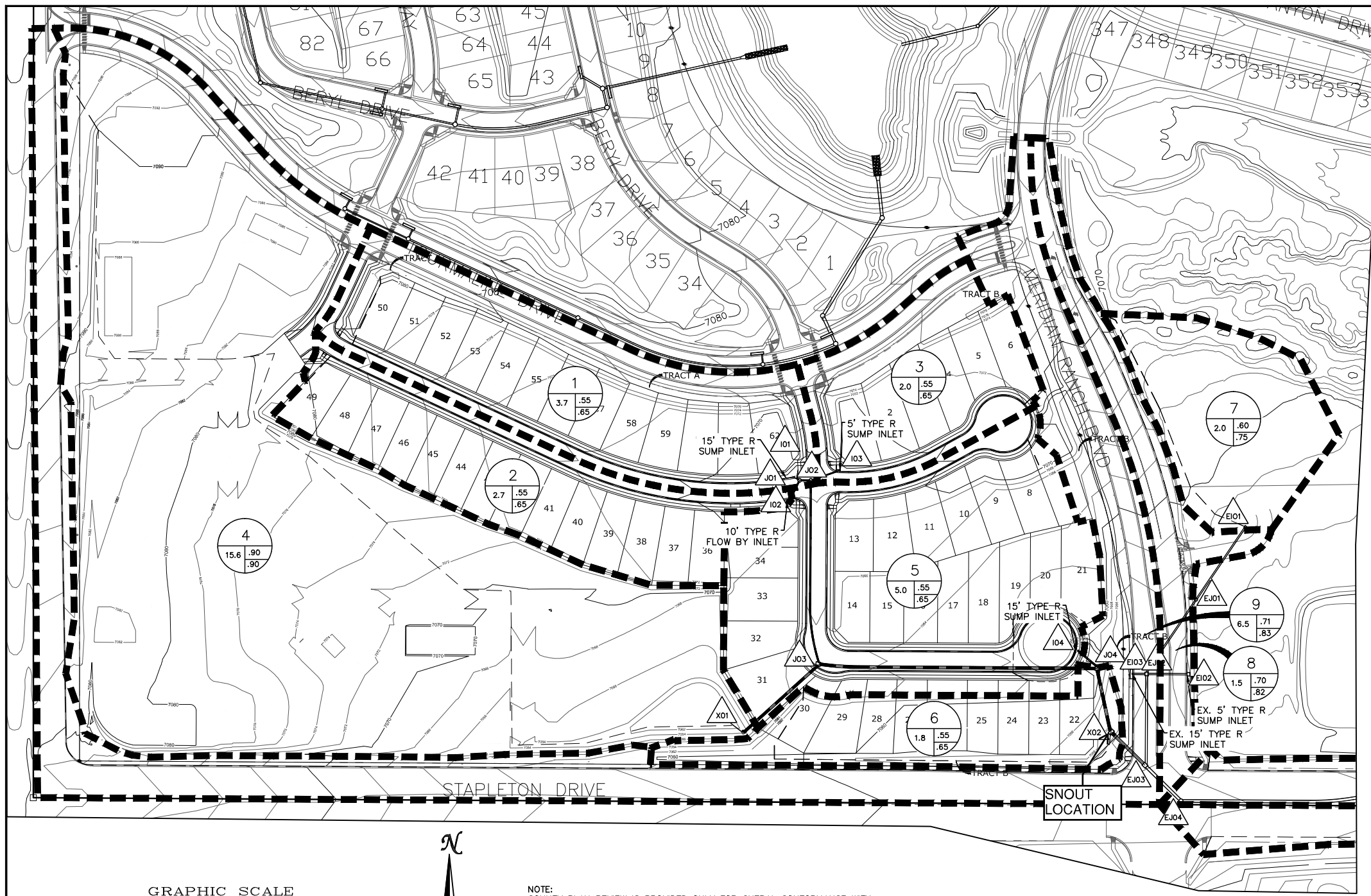

PROJECT BENCHMARK
 INTERSECTION OF WOODMEN RD AND MERIDIAN ROAD AT SW CORNER (BRASS CAP W/ NO. GF-9)
 ELEVATION = 6874.00

WATERSHED DESIGNATION

7 BASIN DESIGNATION
 AC. C_s C₁₀₀ MINOR/MAJOR STORM COEFFICIENT
 BASIN AREA IN ACRES

LEGEND

7 AC. C_s C₁₀₀ SUB-WATERSHED DESIGNATION
 5 DESIGN POINT DESIGNATION
 MAJOR BASIN BOUNDARY
 SUB-BASIN BOUNDARY
 6130 EXISTING CONTOUR
 6130 PROPOSED CONTOUR
 24" RCP PROPOSED STORM SEWER
 INITIAL/OVERLAND TIME (T_i)
 TRAVEL TIME (T_t)

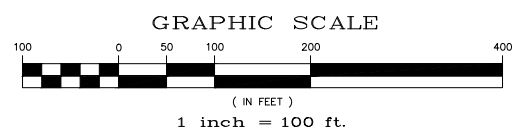

NOTE:
 COUNTY PLAN REVIEW IS PROVIDED ONLY FOR GENERAL CONFORMANCE WITH COUNTY DESIGN CRITERIA. THE COUNTY IS NOT RESPONSIBLE FOR THE ACCURACY AND ADEQUACY OF THE DESIGN, DIMENSIONS, AND/OR ELEVATIONS WHICH SHALL BE CONFIRMED AT THE JOB SITE. THE COUNTY THROUGH THE APPROVAL OF THIS DOCUMENT ASSUMES NO RESPONSIBILITY FOR THE COMPLETENESS AND/OR ACCURACY OF THIS DOCUMENT.

| DESIGN POINT | BASIN | AREA (AC) | DIRECT RUNOFF | | | | TOTAL RUNOFF | | | | OVERLAND TRAVEL TIME | | | | | | |
|--------------|-------|-----------|-----------------------|--------------------|-------------------|-----------|----------------------------------|--------------------|-----------|----------|----------------------|-----------|----------------|---------|-------------|------------|----------------------------|
| | | | T _c (Min.) | I (in./hr.) (5 YR) | COEFF. C (100 YR) | CA (5 YR) | Sum T _c (min.) (5 YR) | I (in./hr.) (5 YR) | CA (5 YR) | Q (5 YR) | DITCH OR BUTTER | ROUGHNESS | DESTINATION DP | SLOPE % | LENGTH (FT) | VEL. (FPS) | TRAVEL TIME T _t |
| I01 | 1 | 3.7 | 18.9 | 2.90 | 0.55 | 0.65 | 2.03 | 2.40 | 5.9 | 13 | | | | | | | |
| I02 | 2 | 2.7 | 20.6 | 2.77 | 0.55 | 0.65 | 1.47 | 1.74 | 4.1 | 9 | | | | | | | |
| I03 | 3 | 2.0 | 18.9 | 2.90 | 0.55 | 0.65 | 1.10 | 1.30 | 3.2 | 7 | | | | | | | |
| X01 | 4 | 15.6 | 21.0 | 2.74 | 0.90 | 0.90 | 14.00 | 14.00 | 38 | 71 | | | | | | | |
| I04 | 5 | 5.0 | 17.8 | 2.99 | 0.55 | 0.65 | 2.75 | 3.25 | 8.2 | 18.0 | 26.6 | 2.41 | 4.48 | 3.2 | 4.0 | 8.2 | 18 |
| X02 | 6 | 1.8 | 17.0 | 3.06 | 0.55 | 0.65 | 0.96 | 1.14 | 2.9 | 6 | | | | | | | |
| E101 | 7 | 1.9 | 15.3 | 3.22 | 0.60 | 0.75 | 1.14 | 1.43 | 3.7 | 9 | | | | | | | |
| E102 | 8 | 1.5 | 10.9 | 3.73 | 0.70 | 0.82 | 1.04 | 1.22 | 3.9 | 8 | | | | | | | |
| E103 | 9 | 6.5 | 23.7 | 2.57 | 0.71 | 0.83 | 4.62 | 5.35 | 11.9 | 25 | | | | | | | |
| E104 | 10 | 1.8 | 14.9 | 3.26 | 0.75 | 0.85 | 1.38 | 1.56 | 4.5 | 9 | | | | | | | |
| E105 | 11 | 2.0 | 15.0 | 3.25 | 0.78 | 0.87 | 1.52 | 1.69 | 4.9 | 10 | | | | | | | |

| UPSTREAM BASIN | UPSTREAM DESIGN POINT | INLET FLOW | | | | | | Sum T _c (min.) | SYSTEM FLOW | | | | | | TRAVEL TIME | | | | | | | | |
|----------------|-----------------------|-----------------------|--------------------|----------------------|-----------|-------------|----------|---------------------------|-------------|--------------------|----------------------|-----------|-------------|----------|-------------|----------|---------------|----------------|---------|-------------|------------|----------------------------|--|
| | | T _c (Min.) | I (in./hr.) (5 YR) | I (in./hr.) (100 YR) | CA (5 YR) | CA (100 YR) | Q (5 YR) | | Q (100 YR) | I (in./hr.) (5 YR) | I (in./hr.) (100 YR) | CA (5 YR) | CA (100 YR) | Q (5 YR) | Q (100 YR) | PIPE DIA | ROUGHNESS (n) | DESTINATION DP | SLOPE % | LENGTH (FT) | VEL. (FPS) | TRAVEL TIME T _t | |
| 1 | I01 | 18.9 | 2.90 | 5.37 | 2.03 | 2.40 | 5.9 | 13 | | | | | | | | | | | | | | | |
| 2 | I02 | 20.6 | 2.77 | 5.13 | 0.98 | 0.98 | 2.7 | 5 | | | | | | | | | | | | | | | |
| 3 | I03 | 18.9 | 2.90 | 5.37 | 1.10 | 1.30 | 3.2 | 7.0 | 20.7 | 2.76 | 5.12 | 3.01 | 3.38 | | | | | | | | | | |
| 4 | X01 | 21.0 | 2.74 | 5.08 | 14.00 | 14.00 | 38 | 71 | 20.7 | 2.76 | 5.12 | 4.11 | 4.68 | | | | | | | | | | |
| 5 | I04 | 17.8 | 2.99 | 5.54 | 2.75 | 3.25 | 8.2 | 18 | 21.2 | 2.73 | 5.06 | 18.12 | 18.68 | | | | | | | | | | |
| 6 | X02 | 17.0 | 3.06 | 5.67 | 0.96 | 1.14 | 2.9 | 6.4 | 22.1 | 2.67 | 4.94 | 20.87 | 21.93 | | | | | | | | | | |
| 7 | E101 | 15.3 | 3.22 | 5.97 | 1.14 | 1.43 | 3.7 | 8.5 | 21.83 | 2.66 | 4.94 | 21.83 | 23.07 | | | | | | | | | | |
| 8 | E102 | 10.9 | 3.73 | 6.92 | 1.04 | 1.22 | 3.9 | 8.4 | 15.7 | 3.17 | 5.98 | 1.14 | 1.43 | | | | | | | | | | |
| 9 | E103 | 23.7 | 2.57 | 4.76 | 4.62 | 5.35 | 11.9 | 25 | | | | | | | | | | | | | | | |
| 10 | E104 | 14.9 | 3.26 | 6.04 | 1.17 | 1.17 | 3.8 | 7.1 | 23.7 | 2.57 | 4.75 | 6.80 | 7.99 | | | | | | | | | | |
| 11 | E105 | 15.0 | 3.25 | 6.02 | 1.27 | 1.25 | 4.1 | 7.6 | 23.9 | 2.56 | 4.73 | 28.63 | 31.05 | | | | | | | | | | |

TECH CONSTRUCTION CORP.
 10305 ANGELES ROAD
 PEYTON, CO 80831
 TELEPHONE: 719.495.7444

MERIDIAN RANCH

MERIDIAN RANCH FLING 4B
 FINAL DRAINAGE PLAN
 FIGURE 6

Scale AS SHOWN
 Drawn by Log
 Checked by TMK
 Sheet Number 1 of 1

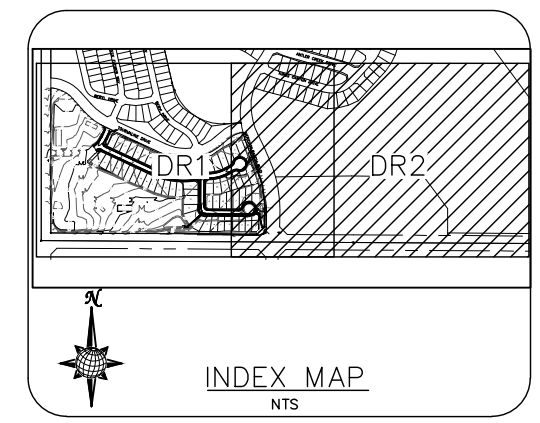
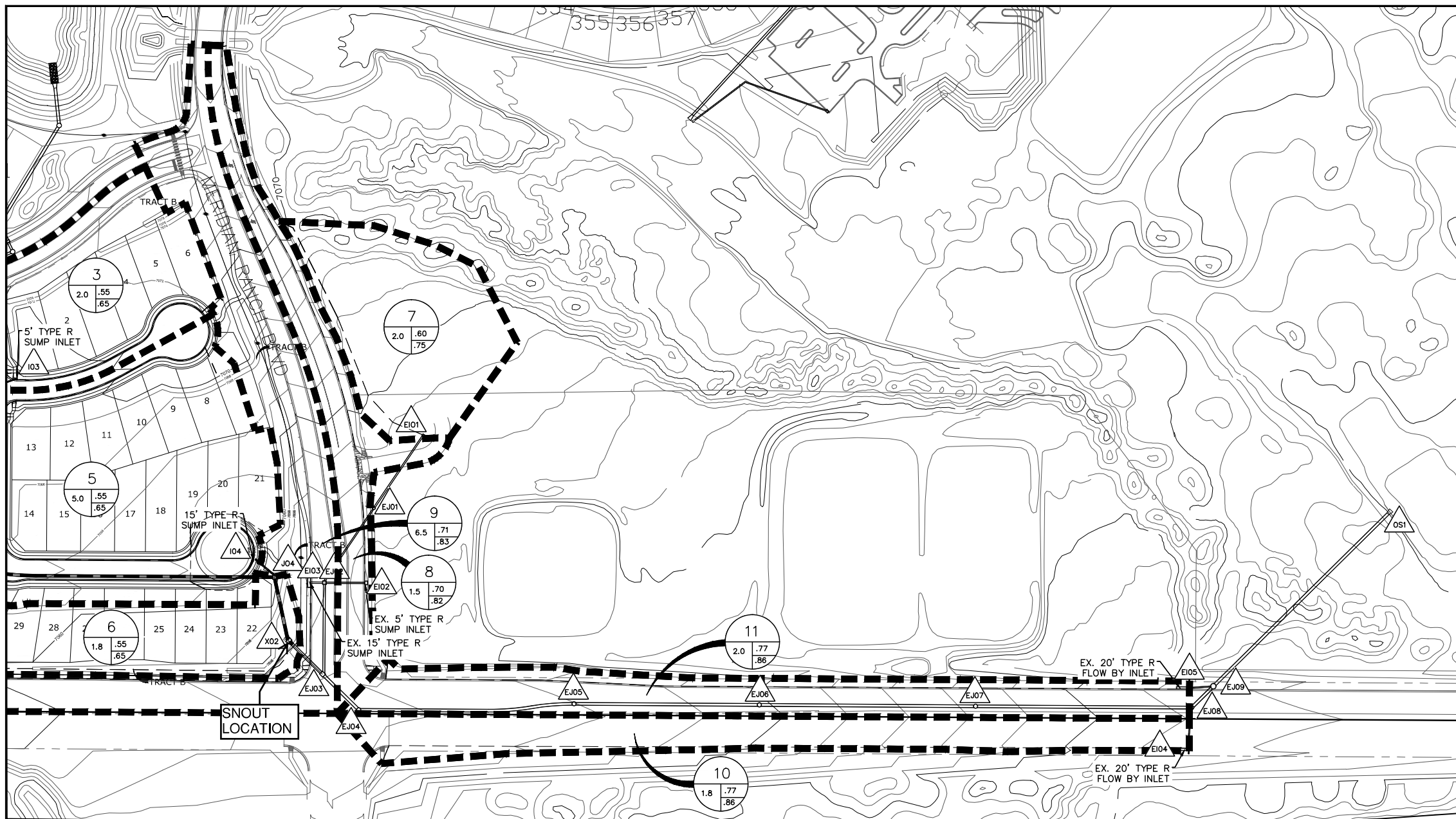

PROJECT BENCHMARK
 INTERSECTION OF WOODMEN RD AND MERIDIAN ROAD AT SW CORNER (BRASS CAP W/ NO. GF-9)
 ELEVATION = 6874.00

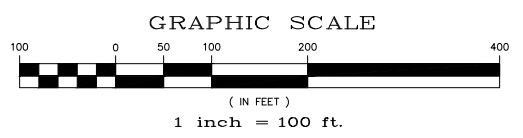
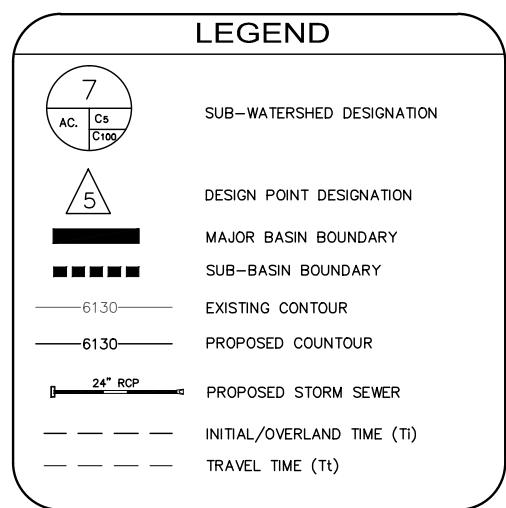
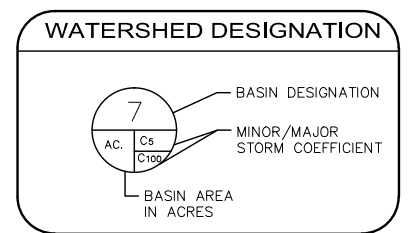

NOTE: COUNTY PLAN REVIEW IS PROVIDED ONLY FOR GENERAL CONFORMANCE WITH COUNTY DESIGN CRITERIA. THE COUNTY IS NOT RESPONSIBLE FOR THE ACCURACY AND ADEQUACY OF THE DESIGN, DIMENSIONS, AND/OR ELEVATIONS WHICH SHALL BE CONFIRMED AT THE JOB SITE. THE COUNTY THROUGH THE APPROVAL OF THIS DOCUMENT ASSUMES NO RESPONSIBILITY FOR THE COMPLETENESS AND/OR ACCURACY OF THIS DOCUMENT.

| DESIGN POINT | BASIN | AREA (AC) | DIRECT RUNOFF | | | | TOTAL RUNOFF | | | | OVERLAND TRAVEL TIME | | | | | | | |
|--------------|-------|-----------|---------------|----------|----------|----------|--------------|----------|--------|----------|----------------------|-----------|----------------|---------|-------------|------------|----------------|--|
| | | | I (in./hr.) | | CDEFF. C | | CA | | Q | | DITCH OR GUTTER | ROUGHNESS | DESTINATION DP | SLOPE % | LENGTH (FT) | VEL. (FPS) | TRAVEL TIME Tt | |
| | | | (5 YR) | (100 YR) | (5 YR) | (100 YR) | (5 YR) | (100 YR) | (5 YR) | (100 YR) | | | | | | | | |
| I01 | 1 | 3.7 | 18.9 | 2.90 | 5.37 | 0.55 | 0.65 | 2.03 | 2.40 | 5.9 | 13 | | | | | | | |
| I02 | 2 | 2.7 | 20.6 | 2.77 | 5.13 | 0.55 | 0.65 | 1.47 | 1.74 | 4.1 | 9 | | | | | | | |
| I03 | 3 | 2.0 | 18.9 | 2.90 | 5.37 | 0.55 | 0.65 | 1.10 | 1.30 | 3.2 | 7 | | | | | | | |
| X01 | 4 | 15.6 | 21.0 | 2.74 | 5.08 | 0.90 | 0.90 | 14.00 | 14.00 | 38 | 71 | | | | | | | |
| I04 | 5 | 5.0 | 17.8 | 2.99 | 5.54 | 0.55 | 0.65 | 2.75 | 3.25 | 8.2 | 18 | | | | | | | |
| X02 | 6 | 1.8 | 17.0 | 3.06 | 5.67 | 0.55 | 0.65 | 0.96 | 1.14 | 2.9 | 6 | | | | | | | |
| EJ01 | 7 | 1.9 | 15.3 | 3.22 | 5.97 | 0.60 | 0.75 | 1.14 | 1.43 | 3.7 | 9 | | | | | | | |
| EJ02 | 8 | 1.5 | 10.9 | 3.73 | 6.92 | 0.70 | 0.82 | 1.04 | 1.22 | 3.9 | 8 | | | | | | | |
| EJ03 | 9 | 6.5 | 23.7 | 2.57 | 4.76 | 0.71 | 0.83 | 4.62 | 5.35 | 11.9 | 25 | | | | | | | |
| EJ04 | 10 | 1.8 | 14.9 | 3.26 | 6.04 | 0.75 | 0.85 | 1.38 | 1.56 | 4.5 | 9 | | | | | | | |
| EJ05 | 11 | 2.0 | 15.0 | 3.25 | 6.02 | 0.78 | 0.87 | 1.52 | 1.69 | 4.9 | 10 | | | | | | | |

| UPSTREAM BASIN | UPSTREAM DESIGN POINT | INLET FLOW | | | | | | Sum Tc (min.) | SYSTEM FLOW | | | | | | TRAVEL TIME | | | | | | |
|----------------|-----------------------|------------|-------------|----------|--------|----------|--------|---------------|-------------|----------|--------|----------|--------|----------|---------------|----------------|---------|-------------|------------|----------------|----------|
| | | Tc (Min.) | I (in./hr.) | | CA | | Q | | I (in./hr.) | CA | | Q | | PIPE DIA | ROUGHNESS (n) | DESTINATION DP | SLOPE % | LENGTH (FT) | VEL. (FPS) | TRAVEL TIME Tt | |
| | | | (5 YR) | (100 YR) | (5 YR) | (100 YR) | (5 YR) | | | (100 YR) | (5 YR) | (100 YR) | (5 YR) | | | | | | | | (100 YR) |
| 1 | I01 | 18.9 | 2.90 | 5.37 | 2.03 | 2.40 | 5.9 | 13 | | | | | | | | | | | | | |
| 2 | I02 | 20.6 | 2.77 | 5.13 | 0.98 | 0.98 | 2.7 | 5 | | | | | | | | | | | | | |
| 3 | J01 | | | | | | | | 20.7 | 2.76 | 5.12 | 3.01 | 3.38 | | | | | | | | |
| 4 | X01 | 21.0 | 2.74 | 5.08 | 14.00 | 14.00 | 38 | 71 | | | | | | | | | | | | | |
| 5 | I04 | 17.8 | 2.99 | 5.54 | 2.75 | 3.25 | 8.2 | 18 | | | | | | | | | | | | | |
| 6 | X02 | 17.0 | 3.06 | 5.67 | 0.96 | 1.14 | 2.9 | 6.4 | | | | | | | | | | | | | |
| 7 | EJ01 | 15.3 | 3.22 | 5.97 | 1.14 | 1.43 | 3.7 | 8.5 | | | | | | | | | | | | | |
| 8 | EJ02 | 10.9 | 3.73 | 6.92 | 1.04 | 1.22 | 3.9 | 8.4 | | | | | | | | | | | | | |
| 9 | EJ03 | 23.7 | 2.57 | 4.76 | 4.62 | 5.35 | 11.9 | 25 | | | | | | | | | | | | | |
| 10 | EJ04 | 14.9 | 3.26 | 6.04 | 1.17 | 1.17 | 3.8 | 7.1 | | | | | | | | | | | | | |
| 11 | EJ05 | 15.0 | 3.25 | 6.02 | 1.27 | 1.25 | 4.1 | 7.6 | | | | | | | | | | | | | |

Scale AS SHOWN Drawn by Log Checked by TMK
 SHEET NUMBER Meridian Ranch Final Drainage Plan Figure 6
 TECH CONSTRUCTION CORP.
 10305 ANGELES ROAD
 PEYTON, CO 80831
 TELEPHONE: 719.495.7444



May 7, 2015

Brandy Williams
El Paso County
2880 International Circle
Colorado Springs, CO 80910

RE: Drainage Letter – Lot 3, The Shops at Meridian Ranch Filing 4B

Ms. Williams:

This letter is to serve as a statement of compliance with the *Preliminary/Final Drainage Report for Meridian Ranch Filing 4B, The Shops at Meridian Ranch* (the REPORT) prepared by Tech Contractors, dated April 2014, and approved on September 9, 2014. The REPORT provides hydrologic and hydraulic analysis for the development located at the northeast corner of Meridian Road and Stapleton Drive in El Paso County, Colorado.

The first phase of commercial construction within Filing 4B will occur within Lot 3, which will include construction of the main roadway through the commercial portion of Filing 4B. While this letter proposes to demonstrate Lot 3's compliance with the REPORT, we are also including conceptual layout/development of Lots 1, 2 & 4 Filing 4B in this analysis for posterity. Development of Lots 1, 2 or 4 Filing 4B must be preceded by a separate drainage letter demonstrating compliance with the REPORT.

The REPORT anticipated runoff from the commercial areas, collectively referred to as The Shops (Lots 1-4, Filing 4B), to be discharged to the previously-constructed storm sewer system within Tract F, Filing 4. Said storm sewer system will ultimately discharge developed flows from Filing 4B, including The Shops, to the Bennett Regional Pond. The Bennett Regional Pond has been adequately sized such that 100 YR developed flows from Filing 4B will be detained and released at (or below) the pre-developed flow rate for the same event.

Anticipated developed flows from The Shops were accounted for in two basins within the REPORT; basin 4 and basin 9. The flows from basin 4 were expected to discharge directly into the previously-constructed Filing 4 storm sewer system via pipe (Design Point X01). The flows from basin 9 were expected to be discharged into the Filing 4 storm sewer system via a 15' Type R inlet located near the intersection of Meridian Ranch Boulevard & Stapleton Drive (Inlet EI03). Anticipated developed flows from the REPORT are summarized in Table 1. Drainage basin maps from the REPORT have also been included with this letter for reference.

Table 1: Anticipated Developed Flows from the REPORT

| Basin Description | 5 YR Flow (cfs) | 100 YR Flow (cfs) |
|-------------------|-----------------|-------------------|
| Basin 4 (X01) | 38.4 | 71.0 |
| Basin 9 (EI03) | 11.9 | 25.4 |

Based upon a detailed analysis of The Shops along with portions of the adjacent roadways, we have determined that 34.7 cfs during the 5 YR event and 68.1 cfs during the 100 YR event will be discharged to the pipe connection at design point X01, while 11.4 cfs during the 5 YR event and 25.4 cfs during the 100 YR event will be conveyed to the inlet at design point EI03. The flows to be collected at design point EI03 are comprised of the direct runoff from Basin OS-1 as well as flows bypassing inlets in the proposed commercial subdivision. The calculated developed flows are summarized in Table 2.

Table 2: Calculated Developed Flows

| DP Description | 5 YR Flow (cfs) | 100 YR Flow (cfs) |
|-----------------------|------------------------|--------------------------|
| Storm Sewer (X01) | 34.7 | 68.1 |
| Inlet (EI03) | 11.4 | 25.4 |

The Shops proposes inlets whose bypass flows will result in additional flow to Stapleton Drive. The routed flows from this bypass are 0.00 cfs during the minor event and 3.76 cfs during the major event. This results in a cumulative expected street flow of approximately 7.2 cfs during the minor event and 18.5 cfs during the major event on Stapleton Drive. Based upon Figure 7-3 of the 2013 Colorado Springs Drainage Criteria Manual the minor storm street capacity for an arterial road is 16 cfs during the minor event and 36 cfs during major event. In both the minor and major event the expected flows are less than the road capacity.

Development of Lot 3 will not adversely impact downstream facilities, as those facilities were designed to convey developed flows from all areas within The Shops. Upon full build-out of The Shops (according to the planned layout of Lot 3 & the conceptual layout of Lots 1, 2 & 4 as presented in the attached Developed Drainage Basin map), the resulting developed flows will be less than the REPORT's expected flows at Design Point X01 and inlet EI03.

Drainage and Bridge Fees:

The 4.11± acre site is the Bennett Drainage Basin. Drainage & Bridge Fees for this basin will be paid to the County at the time of platting. Based on the County's drainage basin maps, the 2015 Drainage & Bridge fees are as follows:

Bennett Drainage Basin Drainage Fee: 4.11 ac*\$9,447/Ac* .867 Imp Area = \$33,663.16
 Bennett Drainage Basin Bridge Fee: 4.11 ac*\$3,624/Ac* 0.867 Imp Area = \$12,913.65

USER: JRM
 FILE: I:\Projects\2015\141030\Drawings\141030_Storm Drainage.dwg
 DATE: MAY 27, 2015 7:47pm
 PLOTTER: HP DesignJet 5000PS
 PLOT SCALE: 1/8" = 1'-0"
 141030_P1.DWG
 HZ-BASE-F48-14-04-25 HZ-BASE-COM 141030_P1.DWG

STORM DRAINAGE SYSTEM DESIGN (RATIONAL METHOD DIRECT RUNOFF)

Calc. by: SSZ
Checked by:
Date: 5/7/2015

The Shops at Meridian Ranch

| DESIGN POINT | BASIN | AREA (AC) | Tc (min.) | DIRECT RUNOFF | | | | | | REMARKS | | |
|--------------|-------|-----------|-----------|---------------|--------|------|------------|--------|---------|---------|--------|--------------------------|
| | | | | COEFF. (C) | | CFA | I (in/hr.) | | Q (cfs) | | | |
| | | | | 5-YR | 100-YR | | 5-YR | 100-YR | 5-YR | | 100-YR | |
| 1 | A | 1.97 | 12.4 | 0.55 | 0.70 | 1.08 | 1.37 | 3.6 | 6.4 | 4.2 | 8.8 | Drains to Grated MH |
| 2 | B | 1.18 | 8.7 | 0.67 | 0.65 | 0.51 | 0.30 | 4.7 | 7.4 | 7.4 | 6.0 | Drains to 20" Type R |
| 3 | C | 2.25 | 7.3 | 0.78 | 0.89 | 1.75 | 1.99 | 4.6 | 7.7 | 8.2 | 15.5 | Drains to 20" Type R |
| 11 | E | 1.29 | 8.3 | 0.78 | 0.89 | 1.01 | 1.14 | 4.0 | 8.1 | 4.9 | 9.3 | Drains to 10" Type R |
| 6 | F | 0.22 | 5.5 | 0.78 | 0.89 | 0.17 | 0.19 | 5.0 | 8.4 | 0.8 | 1.6 | Drains to 10" Type R |
| 7 | G | 0.18 | 10.7 | 0.36 | 0.55 | 0.07 | 0.10 | 4.0 | 6.8 | 0.3 | 0.7 | Drains to 4" Type R |
| 8 | H | 1.85 | 8.5 | 0.51 | 0.75 | 1.13 | 1.39 | 4.4 | 7.5 | 5.0 | 10.5 | Drains to 12" Type R |
| 9 | I | 2.54 | 13.7 | 0.82 | 0.75 | 1.57 | 1.90 | 3.7 | 6.1 | 5.8 | 11.8 | Drains to 14" Type R |
| 10 | J | 1.30 | 7.4 | 0.79 | 0.91 | 1.02 | 1.18 | 4.6 | 7.7 | 4.7 | 9.2 | Drains to 10" Type R |
| 5 | K | 0.83 | 7.0 | 0.79 | 0.87 | 0.86 | 0.72 | 4.7 | 7.8 | 3.1 | 5.7 | Drains to 14" Type R |
| 12 | L | 1.19 | 7.8 | 0.73 | 0.84 | 0.87 | 1.01 | 4.5 | 7.8 | 4.0 | 7.7 | Drains to 10" Type R |
| 14 | N | 0.41 | 11.3 | 0.35 | 0.55 | 0.14 | 0.22 | 3.9 | 6.5 | 0.6 | 1.5 | Drains to Grated MH |
| 15 | OS-1 | 8.22 | 115.1 | 0.63 | 0.72 | 3.71 | 4.53 | 3.9 | 6.8 | 14.7 | 30.2 | Drains to Existing Inlet |
| 11 | OS-2 | 0.69 | 20.8 | 0.71 | 0.81 | 0.49 | 0.56 | 3.0 | 5.1 | 1.5 | 2.9 | Drains to 10" Type R |

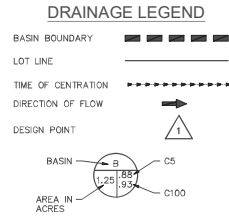

STORM DRAINAGE SYSTEM DESIGN PIPE FLOW TABLE

Calc. by: SSZ
Checked by:
Date: 5/7/2015

| Pipe Name | Diameter (in) | Length (ft) | Slope | Time (min) | Invert | | Velocity (ft/s) | | Flow (cfs) | | Hydraulic Grade (ft) | | Hydraulic Grade (ft) | |
|-----------|---------------|-------------|-------|------------|----------|----------|-----------------|--------|------------|--------|----------------------|----------|----------------------|----------|
| | | | | | In | Out | 5-YR | 100-YR | 5-YR | 100-YR | 5-YR | 100-YR | 5-YR | 100-YR |
| P-1 | 42 | 25.30 | 0.40% | 0.06 | 7,055.85 | 7,055.75 | 6.73 | 7.09 | 34.77 | 68.57 | 7,058.42 | 7,058.56 | 7,058.40 | 7,058.40 |
| P-2 | 24 | 173.00 | 0.39% | 0.46 | 7,046.80 | 7,046.37 | 6.62 | 6.43 | 31.57 | 60.80 | 7,048.98 | 7,049.53 | 7,048.43 | 7,048.86 |
| P-3 | 36 | 175.40 | 0.39% | 0.36 | 7,051.79 | 7,050.91 | 7.22 | 6.69 | 31.93 | 41.45 | 7,053.63 | 7,053.51 | 7,053.86 | 7,053.53 |
| P-4 | 30 | 256.50 | 2.10% | 0.30 | 7,063.61 | 7,058.28 | 11.40 | 13.37 | 23.89 | 47.99 | 7,065.27 | 7,065.87 | 7,059.39 | 7,063.02 |
| P-5 | 30 | 210.60 | 2.88% | 0.30 | 7,070.80 | 7,063.61 | 11.99 | 14.44 | 18.82 | 36.13 | 7,072.37 | 7,072.84 | 7,066.27 | 7,065.87 |
| P-6 | 30 | 260.90 | 0.50% | 0.66 | 7,074.02 | 7,073.81 | 5.98 | 6.48 | 15.56 | 31.42 | 7,074.94 | 7,074.84 | 7,072.27 | 7,072.89 |
| P-7 | 24 | 276.10 | 0.40% | 0.72 | 7,073.71 | 7,073.52 | 5.07 | 6.58 | 10.03 | 20.68 | 7,074.91 | 7,074.68 | 7,073.65 | 7,074.34 |
| P-8 | 24 | 176.00 | 0.60% | 0.43 | 7,074.74 | 7,073.71 | 5.34 | 6.67 | 10.19 | 20.83 | 7,075.89 | 7,075.18 | 7,074.51 | 7,074.68 |
| P-9 | 18 | 34.00 | 1.00% | 1.50 | 7,075.58 | 7,075.24 | 2.52 | 3.38 | 0.26 | 0.88 | 7,075.88 | 7,078.13 | 7,075.89 | 7,078.15 |
| P-10 | 24 | 96.70 | 0.50% | 0.24 | 7,059.22 | 7,058.79 | 5.30 | 6.29 | 11.17 | 19.77 | 7,060.49 | 7,062.24 | 7,059.99 | 7,062.02 |
| P-11 | 34 | 60.00 | 0.39% | 0.18 | 7,060.30 | 7,059.21 | 6.54 | 6.73 | 8.93 | 14.80 | 7,061.64 | 7,061.93 | 7,060.49 | 7,061.74 |
| P-13 | 18 | 114.90 | 2.50% | 0.18 | 7,066.49 | 7,063.61 | 8.96 | 10.24 | 6.87 | 11.96 | 7,067.51 | 7,067.81 | 7,065.27 | 7,065.87 |
| P-14 | 18 | 57.30 | 2.40% | 0.12 | 7,068.07 | 7,066.70 | 8.81 | 10.06 | 6.91 | 12.01 | 7,069.09 | 7,069.38 | 7,067.40 | 7,067.69 |
| P-15 | 18 | 33.00 | 1.80% | 0.06 | 7,068.63 | 7,068.07 | 7.13 | 8.38 | 4.71 | 8.91 | 7,069.47 | 7,069.76 | 7,068.09 | 7,069.38 |
| P-16 | 18 | 63.70 | 1.00% | 0.06 | 7,073.55 | 7,073.24 | 6.17 | 6.88 | 5.81 | 11.80 | 7,074.48 | 7,074.57 | 7,073.04 | 7,073.15 |
| P-17 | 18 | 95.10 | 1.00% | 0.06 | 7,068.92 | 7,068.82 | 5.52 | 6.48 | 3.95 | 7.64 | 7,069.88 | 7,069.78 | 7,069.47 | 7,069.79 |
| P-19 | 18 | 65.00 | 1.00% | 0.12 | 7,074.67 | 7,073.93 | 6.31 | 7.33 | 6.75 | 12.91 | 7,074.68 | 7,074.43 | 7,073.90 | 7,074.13 |
| P-20 | 18 | 180.80 | 1.00% | 0.72 | 7,074.83 | 7,073.92 | 3.18 | 4.22 | 0.57 | 1.51 | 7,075.11 | 7,075.20 | 7,073.35 | 7,074.34 |

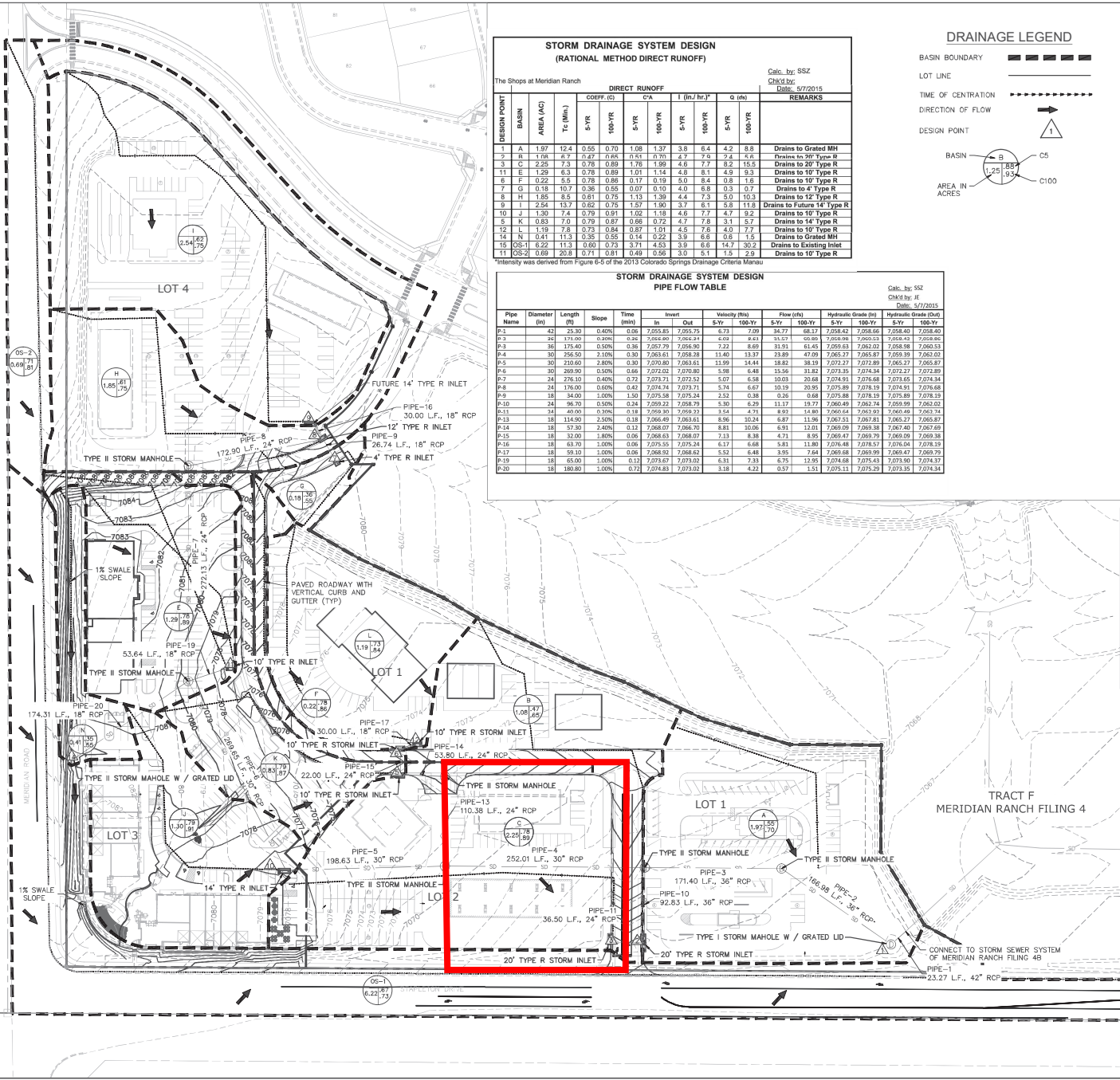

APPENDIX B
HYDROLOGIC CALCULATIONS

Hydrologic Soil Group—El Paso County Area, Colorado
(Lot 2, The Shops Fil. No. 1 at Meridian Ranch)

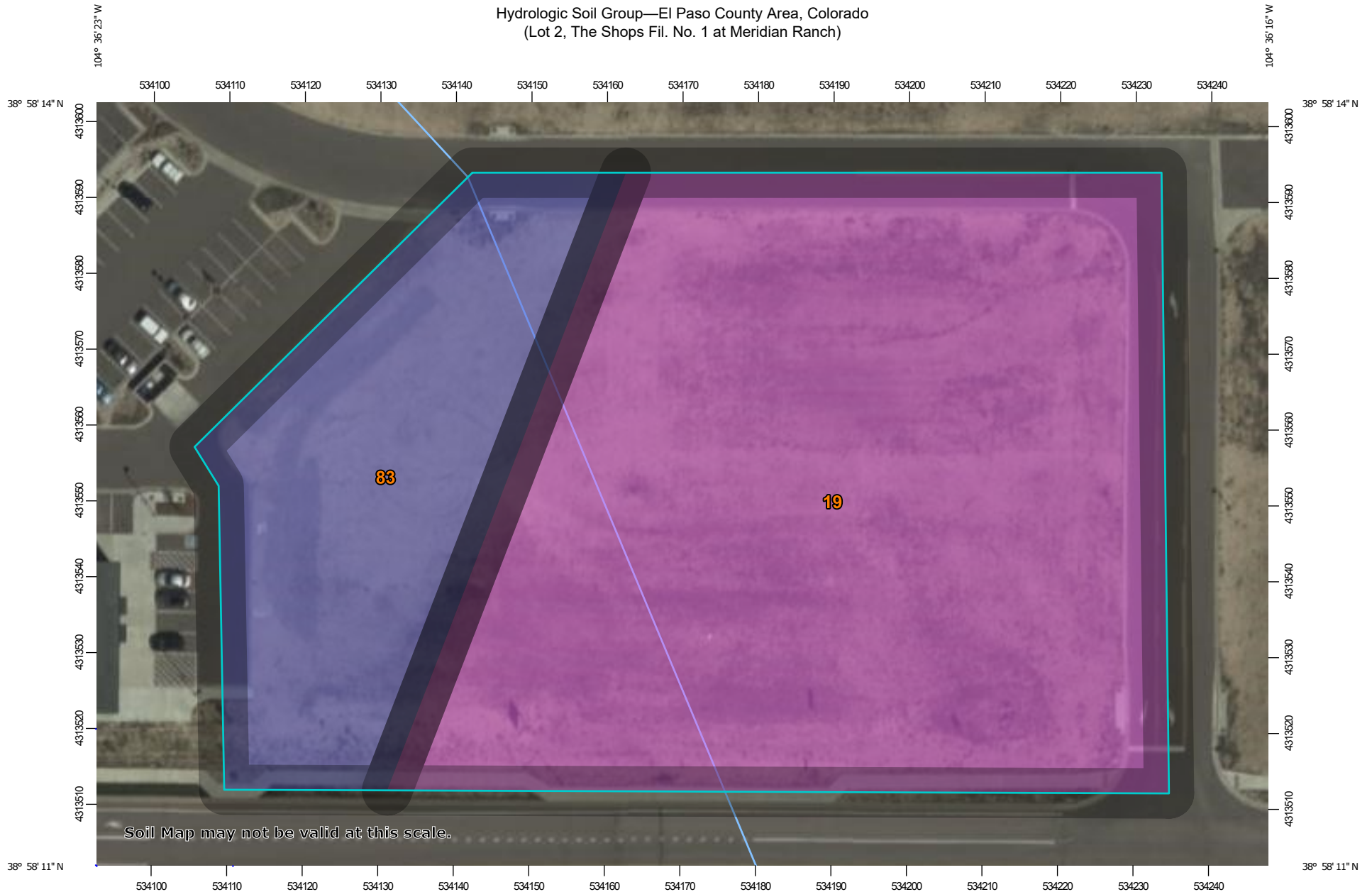

Soil Map may not be valid at this scale.

Map Scale: 1:709 if printed on A landscape (11" x 8.5") sheet.

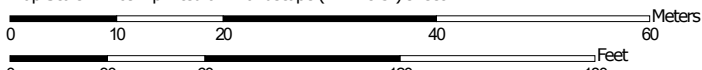

Map projection: Web Mercator Corner coordinates: WGS84 Edge tics: UTM Zone 13N WGS84

Hydrologic Soil Group—El Paso County Area, Colorado
(Lot 2, The Shops Fil. No. 1 at Meridian Ranch)

MAP LEGEND

Area of Interest (AOI)









 Area of Interest (AOI)

Soils

Soil Rating Polygons





-  A
-  A/D
-  B
-  B/D
-  C
-  C/D
-  D
-  Not rated or not available

Soil Rating Lines

-  A
-  A/D
-  B
-  B/D
-  C
-  C/D
-  D
-  Not rated or not available

Soil Rating Points





-  A
-  A/D
-  B
-  B/D

-  C
-  C/D
-  D
-  Not rated or not available

Water Features

 Streams and Canals

Transportation

-  Rails
-  Interstate Highways
-  US Routes
-  Major Roads
-  Local Roads

Background

 Aerial Photography

MAP INFORMATION

The soil surveys that comprise your AOI were mapped at 1:24,000.

Warning: Soil Map may not be valid at this scale.

Enlargement of maps beyond the scale of mapping can cause misunderstanding of the detail of mapping and accuracy of soil line placement. The maps do not show the small areas of contrasting soils that could have been shown at a more detailed scale.

Please rely on the bar scale on each map sheet for map measurements.

Source of Map: Natural Resources Conservation Service
Web Soil Survey URL:
Coordinate System: Web Mercator (EPSG:3857)

Maps from the Web Soil Survey are based on the Web Mercator projection, which preserves direction and shape but distorts distance and area. A projection that preserves area, such as the Albers equal-area conic projection, should be used if more accurate calculations of distance or area are required.

This product is generated from the USDA-NRCS certified data as of the version date(s) listed below.

Soil Survey Area: El Paso County Area, Colorado
Survey Area Data: Version 20, Sep 2, 2022

Soil map units are labeled (as space allows) for map scales 1:50,000 or larger.

Date(s) aerial images were photographed: Sep 11, 2018—Oct 20, 2018

The orthophoto or other base map on which the soil lines were compiled and digitized probably differs from the background imagery displayed on these maps. As a result, some minor shifting of map unit boundaries may be evident.

Hydrologic Soil Group

| Map unit symbol | Map unit name | Rating | Acres in AOI | Percent of AOI |
|------------------------------------|--|--------|--------------|----------------|
| 19 | Columbine gravelly sandy loam, 0 to 3 percent slopes | A | 1.8 | 73.7% |
| 83 | Stapleton sandy loam, 3 to 8 percent slopes | B | 0.6 | 26.3% |
| Totals for Area of Interest | | | 2.4 | 100.0% |

Description

Hydrologic soil groups are based on estimates of runoff potential. Soils are assigned to one of four groups according to the rate of water infiltration when the soils are not protected by vegetation, are thoroughly wet, and receive precipitation from long-duration storms.

The soils in the United States are assigned to four groups (A, B, C, and D) and three dual classes (A/D, B/D, and C/D). The groups are defined as follows:

Group A. Soils having a high infiltration rate (low runoff potential) when thoroughly wet. These consist mainly of deep, well drained to excessively drained sands or gravelly sands. These soils have a high rate of water transmission.

Group B. Soils having a moderate infiltration rate when thoroughly wet. These consist chiefly of moderately deep or deep, moderately well drained or well drained soils that have moderately fine texture to moderately coarse texture. These soils have a moderate rate of water transmission.

Group C. Soils having a slow infiltration rate when thoroughly wet. These consist chiefly of soils having a layer that impedes the downward movement of water or soils of moderately fine texture or fine texture. These soils have a slow rate of water transmission.

Group D. Soils having a very slow infiltration rate (high runoff potential) when thoroughly wet. These consist chiefly of clays that have a high shrink-swell potential, soils that have a high water table, soils that have a claypan or clay layer at or near the surface, and soils that are shallow over nearly impervious material. These soils have a very slow rate of water transmission.

If a soil is assigned to a dual hydrologic group (A/D, B/D, or C/D), the first letter is for drained areas and the second is for undrained areas. Only the soils that in their natural condition are in group D are assigned to dual classes.

Rating Options

Aggregation Method: Dominant Condition

Component Percent Cutoff: None Specified

Tie-break Rule: Higher

Table 6-6. Runoff Coefficients for Rational Method
(Source: UDFCD 2001)

| Land Use or Surface Characteristics | Percent Impervious | Runoff Coefficients | | | | | | | | | | | |
|--|--------------------|---------------------|---------|---------|---------|---------|---------|---------|---------|---------|---------|----------|---------|
| | | 2-year | | 5-year | | 10-year | | 25-year | | 50-year | | 100-year | |
| | | HSG A&B | HSG C&D | HSG A&B | HSG C&D | HSG A&B | HSG C&D | HSG A&B | HSG C&D | HSG A&B | HSG C&D | HSG A&B | HSG C&D |
| Business | | | | | | | | | | | | | |
| Commercial Areas | 95 | 0.79 | 0.80 | 0.81 | 0.82 | 0.83 | 0.84 | 0.85 | 0.87 | 0.87 | 0.88 | 0.88 | 0.89 |
| Neighborhood Areas | 70 | 0.45 | 0.49 | 0.49 | 0.53 | 0.53 | 0.57 | 0.58 | 0.62 | 0.60 | 0.65 | 0.62 | 0.68 |
| Residential | | | | | | | | | | | | | |
| 1/8 Acre or less | 65 | 0.41 | 0.45 | 0.45 | 0.49 | 0.49 | 0.54 | 0.54 | 0.59 | 0.57 | 0.62 | 0.59 | 0.65 |
| 1/4 Acre | 40 | 0.23 | 0.28 | 0.30 | 0.35 | 0.36 | 0.42 | 0.42 | 0.50 | 0.46 | 0.54 | 0.50 | 0.58 |
| 1/3 Acre | 30 | 0.18 | 0.22 | 0.25 | 0.30 | 0.32 | 0.38 | 0.39 | 0.47 | 0.43 | 0.52 | 0.47 | 0.57 |
| 1/2 Acre | 25 | 0.15 | 0.20 | 0.22 | 0.28 | 0.30 | 0.36 | 0.37 | 0.46 | 0.41 | 0.51 | 0.46 | 0.56 |
| 1 Acre | 20 | 0.12 | 0.17 | 0.20 | 0.26 | 0.27 | 0.34 | 0.35 | 0.44 | 0.40 | 0.50 | 0.44 | 0.55 |
| Industrial | | | | | | | | | | | | | |
| Light Areas | 80 | 0.57 | 0.60 | 0.59 | 0.63 | 0.63 | 0.66 | 0.66 | 0.70 | 0.68 | 0.72 | 0.70 | 0.74 |
| Heavy Areas | 90 | 0.71 | 0.73 | 0.73 | 0.75 | 0.75 | 0.77 | 0.78 | 0.80 | 0.80 | 0.82 | 0.81 | 0.83 |
| Parks and Cemeteries | 7 | 0.05 | 0.09 | 0.12 | 0.19 | 0.20 | 0.29 | 0.30 | 0.40 | 0.34 | 0.46 | 0.39 | 0.52 |
| Playgrounds | 13 | 0.07 | 0.13 | 0.16 | 0.23 | 0.24 | 0.31 | 0.32 | 0.42 | 0.37 | 0.48 | 0.41 | 0.54 |
| Railroad Yard Areas | 40 | 0.23 | 0.28 | 0.30 | 0.35 | 0.36 | 0.42 | 0.42 | 0.50 | 0.46 | 0.54 | 0.50 | 0.58 |
| Undeveloped Areas | | | | | | | | | | | | | |
| Historic Flow Analysis-- Greenbelts, Agriculture | 2 | 0.03 | 0.05 | 0.09 | 0.16 | 0.17 | 0.26 | 0.26 | 0.38 | 0.31 | 0.45 | 0.36 | 0.51 |
| Pasture/Meadow | 0 | 0.02 | 0.04 | 0.08 | 0.15 | 0.15 | 0.25 | 0.25 | 0.37 | 0.30 | 0.44 | 0.35 | 0.50 |
| Forest | 0 | 0.02 | 0.04 | 0.08 | 0.15 | 0.15 | 0.25 | 0.25 | 0.37 | 0.30 | 0.44 | 0.35 | 0.50 |
| Exposed Rock | 100 | 0.89 | 0.89 | 0.90 | 0.90 | 0.92 | 0.92 | 0.94 | 0.94 | 0.95 | 0.95 | 0.96 | 0.96 |
| Offsite Flow Analysis (when landuse is undefined) | 45 | 0.26 | 0.31 | 0.32 | 0.37 | 0.38 | 0.44 | 0.44 | 0.51 | 0.48 | 0.55 | 0.51 | 0.59 |
| Streets | | | | | | | | | | | | | |
| Paved | 100 | 0.89 | 0.89 | 0.90 | 0.90 | 0.92 | 0.92 | 0.94 | 0.94 | 0.95 | 0.95 | 0.96 | 0.96 |
| Gravel | 80 | 0.57 | 0.60 | 0.59 | 0.63 | 0.63 | 0.66 | 0.66 | 0.70 | 0.68 | 0.72 | 0.70 | 0.74 |
| Drive and Walks | 100 | 0.89 | 0.89 | 0.90 | 0.90 | 0.92 | 0.92 | 0.94 | 0.94 | 0.95 | 0.95 | 0.96 | 0.96 |
| Roofs | 90 | 0.71 | 0.73 | 0.73 | 0.75 | 0.75 | 0.77 | 0.78 | 0.80 | 0.80 | 0.82 | 0.81 | 0.83 |
| Lawns | 0 | 0.02 | 0.04 | 0.08 | 0.15 | 0.15 | 0.25 | 0.25 | 0.37 | 0.30 | 0.44 | 0.35 | 0.50 |

3.2 Time of Concentration

One of the basic assumptions underlying the Rational Method is that runoff is a function of the average rainfall rate during the time required for water to flow from the hydraulically most remote part of the drainage area under consideration to the design point. However, in practice, the time of concentration can be an empirical value that results in reasonable and acceptable peak flow calculations.

For urban areas, the time of concentration (t_c) consists of an initial time or overland flow time (t_i) plus the travel time (t_r) in the storm sewer, paved gutter, roadside drainage ditch, or drainage channel. For non-urban areas, the time of concentration consists of an overland flow time (t_i) plus the time of travel in a concentrated form, such as a swale or drainageway. The travel portion (t_r) of the time of concentration can be estimated from the hydraulic properties of the storm sewer, gutter, swale, ditch, or drainageway. Initial time, on the other hand, will vary with surface slope, depression storage, surface cover, antecedent rainfall, and infiltration capacity of the soil, as well as distance of surface flow. The time of concentration is represented by Equation 6-7 for both urban and non-urban areas.

$$t_c = t_i + t_t \quad (\text{Eq. 6-7})$$

Where:

t_c = time of concentration (min)

t_i = overland (initial) flow time (min)

t_t = travel time in the ditch, channel, gutter, storm sewer, etc. (min)

3.2.1 Overland (Initial) Flow Time

The overland flow time, t_i , may be calculated using Equation 6-8.

$$t_i = \frac{0.395(1.1 - C_5)\sqrt{L}}{S^{0.33}} \quad (\text{Eq. 6-8})$$

Where:

t_i = overland (initial) flow time (min)

C_5 = runoff coefficient for 5-year frequency (see Table 6-6)

L = length of overland flow (300 ft maximum for non-urban land uses, 100 ft maximum for urban land uses)

S = average basin slope (ft/ft)

Note that in some urban watersheds, the overland flow time may be very small because flows quickly concentrate and channelize.

3.2.2 Travel Time

For catchments with overland and channelized flow, the time of concentration needs to be considered in combination with the travel time, t_t , which is calculated using the hydraulic properties of the swale, ditch, or channel. For preliminary work, the overland travel time, t_t , can be estimated with the help of Figure 6-25 or Equation 6-9 (Guo 1999).

$$V = C_v S_w^{0.5} \quad (\text{Eq. 6-9})$$

Where:

V = velocity (ft/s)

C_v = conveyance coefficient (from Table 6-7)

S_w = watercourse slope (ft/ft)

Table 6-7. Conveyance Coefficient, C_v

| Type of Land Surface | C_v |
|--------------------------------------|-------|
| Heavy meadow | 2.5 |
| Tillage/field | 5 |
| Riprap (not buried)* | 6.5 |
| Short pasture and lawns | 7 |
| Nearly bare ground | 10 |
| Grassed waterway | 15 |
| Paved areas and shallow paved swales | 20 |

* For buried riprap, select C_v value based on type of vegetative cover.

The travel time is calculated by dividing the flow distance (in feet) by the velocity calculated using Equation 6-9 and converting units to minutes.

The time of concentration (t_c) is then the sum of the overland flow time (t_i) and the travel time (t_t) per Equation 6-7.

3.2.3 First Design Point Time of Concentration in Urban Catchments

Using this procedure, the time of concentration at the first design point (typically the first inlet in the system) in an urbanized catchment should not exceed the time of concentration calculated using Equation 6-10. The first design point is defined as the point where runoff first enters the storm sewer system.

$$t_c = \frac{L}{180} + 10 \quad (\text{Eq. 6-10})$$

Where:

t_c = maximum time of concentration at the first design point in an urban watershed (min)

L = waterway length (ft)

Equation 6-10 was developed using the rainfall-runoff data collected in the Denver region and, in essence, represents regional “calibration” of the Rational Method. Normally, Equation 6-10 will result in a lesser time of concentration at the first design point and will govern in an urbanized watershed. For subsequent design points, the time of concentration is calculated by accumulating the travel times in downstream drainageway reaches.

3.2.4 Minimum Time of Concentration

If the calculations result in a t_c of less than 10 minutes for undeveloped conditions, it is recommended that a minimum value of 10 minutes be used. The minimum t_c for urbanized areas is 5 minutes.

3.2.5 Post-Development Time of Concentration

As Equation 6-8 indicates, the time of concentration is a function of the 5-year runoff coefficient for a drainage basin. Typically, higher levels of imperviousness (higher 5-year runoff coefficients) correspond to shorter times of concentration, and lower levels of imperviousness correspond to longer times of

Figure 6-5. Colorado Springs Rainfall Intensity Duration Frequency

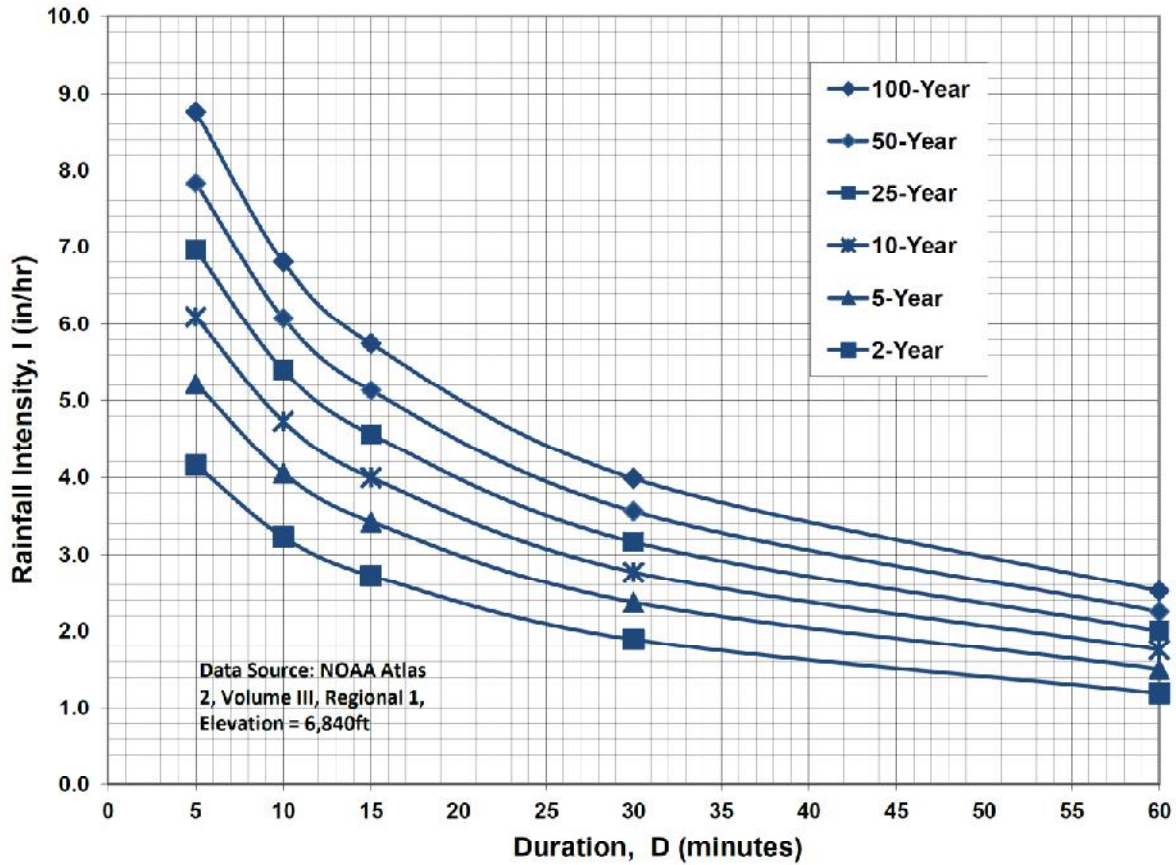

IDF Equations

$I_{100} = -2.52 \ln(D) + 12.735$

$I_{50} = -2.25 \ln(D) + 11.375$

$I_{25} = -2.00 \ln(D) + 10.111$

$I_{10} = -1.75 \ln(D) + 8.847$

$I_5 = -1.50 \ln(D) + 7.583$

$I_2 = -1.19 \ln(D) + 6.035$

Note: Values calculated by equations may not precisely duplicate values read from figure.

SHOPS AT MERIDIAN RANCH CONVENIENCE STORE
COMPOSITE RUNOFF COEFFICIENTS

| DEVELOPED CONDITIONS | | | | | | | | | | | |
|----------------------|-----------------|------|-------------------------------|------|-----------|-------------------------------|------|------|-------------------------------|---|------------------|
| 5-YEAR C VALUES | | | | | | | | | | | |
| BASIN | TOTAL AREA (AC) | (AC) | SUB-AREA 1 DEVELOPMENT/ COVER | C | AREA (AC) | SUB-AREA 2 DEVELOPMENT/ COVER | C | (AC) | SUB-AREA 3 DEVELOPMENT/ COVER | C | WEIGHTED C VALUE |
| C1.1 | 0.86 | 0.80 | PAVED/IMPERVIOUS | 0.9 | 0.06 | LANDSCAPED | 0.08 | | | | 0.843 |
| C1.2 | 1.08 | 0.90 | PAVED/IMPERVIOUS | 0.9 | 0.18 | LANDSCAPED | 0.08 | | | | 0.763 |
| C1.1,C1.2 | 1.94 | | | | | | | | | | 0.799 |
| C1.3 | 0.28 | 0.28 | PAVED/IMPERVIOUS | 0.9 | | | | | | | 0.900 |
| C1.1-C1.3 | 2.22 | | | | | | | | | | 0.811 |
| OS-1.1 | 0.15 | 0.15 | MEADOW | 0.08 | | | | | | | 0.080 |
| 100-YEAR C VALUES | | | | | | | | | | | |
| BASIN | TOTAL AREA (AC) | (AC) | SUB-AREA 1 DEVELOPMENT/ COVER | C | AREA (AC) | SUB-AREA 2 DEVELOPMENT/ COVER | C | (AC) | SUB-AREA 3 DEVELOPMENT/ COVER | C | WEIGHTED C VALUE |
| C1.1 | 0.86 | 0.80 | PAVED/IMPERVIOUS | 0.96 | 0.06 | LANDSCAPED | 0.35 | | | | 0.917 |
| C1.2 | 1.08 | 0.90 | PAVED/IMPERVIOUS | 0.96 | 0.18 | LANDSCAPED | 0.35 | | | | 0.858 |
| C1.1,C1.2 | 1.94 | | | | | | | | | | 0.885 |
| C1.3 | 0.28 | 0.28 | PAVED/IMPERVIOUS | 0.96 | | | | | | | 0.960 |
| C1.1-C1.3 | 2.22 | | | | | | | | | | 0.894 |
| OS-1.1 | 0.15 | 0.15 | MEADOW | 0.35 | | | | | | | 0.350 |

SHOPS AT MERIDIAN RANCH CONVENIENCE STORE
RATIONAL METHOD

DEVELOPED CONDITIONS

| BASIN | DESIGN POINT | AREA (AC) | C | | Overland Flow | | | Channel flow | | | | | TOTAL Tc ⁽⁴⁾ (MIN) | TOTAL Tc ⁽⁴⁾ (MIN) | INTENSITY ⁽⁵⁾ | | PEAK FLOW | |
|--------------|--------------|-----------|--------|----------|---------------|---------------|--------------------------|---------------------|--------------------------|---------------|------------------------------------|-------------------------|-------------------------------|-------------------------------|--------------------------|----------------|-------------------------|---------------------------|
| | | | 5-YEAR | 100-YEAR | LENGTH (FT) | SLOPE (FT/FT) | Tco ⁽¹⁾ (MIN) | CHANNEL LENGTH (FT) | CONVEYANCE COEFFICIENT C | SLOPE (FT/FT) | SCS ⁽²⁾ VELOCITY (FT/S) | Tt ⁽³⁾ (MIN) | | | 5-YR (IN/HR) | 100-YR (IN/HR) | Q5 ⁽⁶⁾ (CFS) | Q100 ⁽⁶⁾ (CFS) |
| | | | | | | | | | | | | | | | | | | |
| C1.1 | C1.1 | 0.86 | 0.843 | 0.917 | 100 | 0.020 | 3.7 | 275 | 20 | 0.018 | 2.68 | 1.7 | 5.4 | 5.4 | 5.04 | 8.47 | 3.65 | 6.68 |
| C1.2 | C1.2 | 1.08 | 0.763 | 0.858 | 70 | 0.036 | 3.4 | 285 | 20 | 0.030 | 3.46 | 1.4 | 4.7 | 5.0 | 5.17 | 8.68 | 4.26 | 8.04 |
| Tt C1.1-C1.2 | | | | | | | | 260 | 20 | 0.029 | 3.41 | 1.3 | | | | | | |
| C1.1,C1.2 | C1 | 1.94 | 0.799 | 0.885 | | | | | | | | | 6.7 | 6.7 | 4.73 | 7.94 | 7.33 | 13.63 |
| C1.3 | C1.3 | 0.28 | 0.900 | 0.960 | 45 | 0.020 | 1.9 | 415 | 20 | 0.019 | 2.76 | 2.5 | 4.5 | 5.0 | 5.17 | 8.68 | 1.30 | 2.33 |
| C1.1-C1.3 | 3 | 2.22 | 0.811 | 0.894 | | | | | | | | | 6.7 | 6.7 | 4.73 | 7.94 | 8.51 | 15.75 |
| OS-1.1 | OS-1.1 | 0.15 | 0.080 | 0.350 | 40 | 0.160 | 4.7 | 350 | 20 | 0.02 | 2.83 | 2.1 | 6.8 | 6.8 | 4.72 | 7.92 | 0.06 | 0.42 |

1) OVERLAND FLOW Tco = (0.395*(1.1-RUNOFF COEFFICIENT)*(OVERLAND FLOW LENGTH^(0.5))/(SLOPE^(0.333))

2) SCS VELOCITY = C * ((SLOPE(FT/FT)^0.5)

C = 2.5 FOR HEAVY MEADOW

C = 5 FOR TILLAGE/FIELD

C = 7 FOR SHORT PASTURE AND LAWNS

C = 10 FOR NEARLY BARE GROUND

C = 15 FOR GRASSED WATERWAY

C = 20 FOR PAVED AREAS AND SHALLOW PAVED SWALES

3) MANNING'S CHANNEL TRAVEL TIME = L/V (WHEN CHANNEL VELOCITY IS KNOWN)

4) Tc = Tco + Tt

*** IF TOTAL TIME OF CONCENTRATION IS LESS THAN 5 MINUTES, THEN 5 MINUTES IS USED

5) INTENSITY BASED ON I-D-F EQUATIONS IN CITY OF COLORADO SPRINGS DRAINAGE CRITERIA MANUAL

$$I_5 = -1.5 * \ln(Tc) + 7.583$$

$$I_{100} = -2.52 * \ln(Tc) + 12.735$$

6) Q = CiA

APPENDIX C1
HYDRAULIC CALCULATIONS

LOT 2, THE SHOPS FIL. NO. 1A AT MERIDIAN RANCH
 CHANNEL CALCULATION SUMMARY - SITE DRAINAGE SWALES

| PROPOSED CHANNEL / SWALE | MAX. SLOPE (%) | MIN. SIDE SLOPE (Z) | MIN. BOT. WIDTH (FT) | MIN. CHANNEL DEPTH (FT) | FRICTION FACTOR (n) | BASIN | Q100 BASIN FLOW (CFS) | CHANNEL FLOW % OF BASIN | Q100 CHANNEL FLOW (CFS) | Q100 DEPTH (FT) | Q100 VELOCITY (FT/S) | TOP WIDTH (FT) | CHANNEL LINING |
|--------------------------|----------------|---------------------|----------------------|-------------------------|---------------------|-------|-----------------------|-------------------------|-------------------------|-----------------|----------------------|----------------|----------------|
| SWALE C1.2 | 1.0 | 4:1 | 4 | 1.0 | 0.030 | C1.2 | 9.4 | 100 | 9.4 | 0.6 | 2.7 | 8.5 | GRASS |
| | | | | | | | | | | | | | |
| | | | | | | | | | | | | | |

ASSUMPTIONS:

- 1) Channel flow calculations based on Manning's Equation
- 2) Channel depth includes 1' minimum freeboard
- 3) n = 0.03 for grass-lined non-irrigated channels (minimum)
- 4) n = 0.035 for riprap-lined channels
- 5) Vmax = 5.0 fps for 100-year flows w/ grass-lined channels
- 6) Vmax = 8.0 fps for 100-year flows w/ Erosion Control Blankets (Tensar Eronet SC150 or equal)
- 7) Vmax = 10.0 fps for 100-year flows w/ Erosion Control Blankets (Tensar Eronet C125 or equal)

Hydraulic Analysis Report

Project Data

Project Title: Lot 2, The Shops Fil. No. 1A at Meridian Ranch
Designer: JPS
Project Date: Thursday, March 16, 2023
Project Units: U.S. Customary Units
Notes:

Channel Analysis: Channel Analysis-Swale C1.2

Notes:

Input Parameters

Channel Type: Trapezoidal
Side Slope 1 (Z1): 4.0000 ft/ft
Side Slope 2 (Z2): 4.0000 ft/ft
Channel Width: 4.0000 ft
Longitudinal Slope: 0.0100 ft/ft
Manning's n: 0.0300
Flow: 9.4000 cfs

Result Parameters

Depth: 0.5575 ft
Area of Flow: 3.4730 ft²
Wetted Perimeter: 8.5970 ft
Hydraulic Radius: 0.4040 ft
Average Velocity: 2.7066 ft/s
Top Width: 8.4598 ft
Froude Number: 0.7444
Critical Depth: 0.4712 ft
Critical Velocity: 3.3901 ft/s
Critical Slope: 0.0189 ft/ft
Critical Top Width: 7.77 ft
Calculated Max Shear Stress: 0.3479 lb/ft²
Calculated Avg Shear Stress: 0.2521 lb/ft²

**SHOPS AT MERIDIAN RANCH CONVENIENCE STORE
STORM INLET SIZING SUMMARY**

| INLET | BASIN FLOW | | | INLET FLOW | | | INLET CONDITION / TYPE | INLET SIZE (FT) | INLET CAPACITY (CFS) |
|-------|------------|---------------------|-----------------------|-----------------------------|---------------------|-----------------------|------------------------------|--------------------|----------------------------|
| | DP | Q5 FLOW (CFS) | Q100 FLOW (CFS) | INLET FLOW % OF BASIN | Q5 FLOW (CFS) | Q100 FLOW (CFS) | | | |
| C1.1 | C1.1 | 3.7 | 6.7 | 100 | 3.7 | 6.7 | TYPE R (GRADE) | 10' | 5.3 |
| | C1.2 | 4.3 | 8.0 | 100 | 4.3 | 8.0 | | | |
| | C1.1 * | | | | 0.1 | 1.4 | | | |
| C1.2 | C1.2A | | | | 4.4 | 9.4 | TYPE C (SUMP) | SGL | 17.7 |
| | | | | | | | | | |

* CARRYOVER FROM INLET C1.1

INLET MANAGEMENT

Worksheet Protected

| | |
|------------------------------------|--------------------------|
| INLET NAME | Inlet C1.1 |
| Site Type (Urban or Rural) | URBAN |
| Inlet Application (Street or Area) | STREET |
| Hydraulic Condition | On Grade |
| Inlet Type | CDOT Type R Curb Opening |

USER-DEFINED INPUT

User-Defined Design Flows

| | |
|-------------------------|-----|
| Minor Q_{Known} (cfs) | 3.7 |
| Major Q_{Known} (cfs) | 6.7 |

Bypass (Carry-Over) Flow from Upstream

| | |
|---|-------------------------|
| Receive Bypass Flow from: | No Bypass Flow Received |
| Minor Bypass Flow Received, Q_b (cfs) | 0.0 |
| Major Bypass Flow Received, Q_b (cfs) | 0.0 |

Watershed Characteristics

| | |
|---------------------------|--|
| Subcatchment Area (acres) | |
| Percent Impervious | |
| NRCS Soil Type | |

Watershed Profile

| | |
|------------------------|--|
| Overland Slope (ft/ft) | |
| Overland Length (ft) | |
| Channel Slope (ft/ft) | |
| Channel Length (ft) | |

Minor Storm Rainfall Input

| | |
|---|--|
| Design Storm Return Period, T_r (years) | |
| One-Hour Precipitation, P_1 (inches) | |

Major Storm Rainfall Input

| | |
|---|--|
| Design Storm Return Period, T_r (years) | |
| One-Hour Precipitation, P_1 (inches) | |

CALCULATED OUTPUT

| | |
|---|------------|
| Minor Total Design Peak Flow, Q (cfs) | 3.7 |
| Major Total Design Peak Flow, Q (cfs) | 6.7 |
| Minor Flow Bypassed Downstream, Q_b (cfs) | 0.1 |
| Major Flow Bypassed Downstream, Q_b (cfs) | 1.4 |

INLET MANAGEMENT

Worksheet Protected

| | |
|------------------------------------|----------------------------|
| INLET NAME | Inlet C1.2 |
| Site Type (Urban or Rural) | URBAN |
| Inlet Application (Street or Area) | AREA |
| Hydraulic Condition | Swale |
| Inlet Type | CDOT Type C (Depressed) |

USER-DEFINED INPUT

User-Defined Design Flows

| | |
|--------------------------------|-----|
| Minor Q_{Known} (cfs) | 4.3 |
| Major Q_{Known} (cfs) | 8.0 |

Bypass (Carry-Over) Flow from Upstream

| | |
|---|--------------|
| Receive Bypass Flow from: | User-Defined |
| Minor Bypass Flow Received, Q_b (cfs) | 0.1 |
| Major Bypass Flow Received, Q_b (cfs) | 1.4 |

Watershed Characteristics

| | |
|---------------------------|--|
| Subcatchment Area (acres) | |
| Percent Impervious | |
| NRCS Soil Type | |

Watershed Profile

| | |
|------------------------|--|
| Overland Slope (ft/ft) | |
| Overland Length (ft) | |
| Channel Slope (ft/ft) | |
| Channel Length (ft) | |

Minor Storm Rainfall Input

| | |
|---|--|
| Design Storm Return Period, T_r (years) | |
| One-Hour Precipitation, P_1 (inches) | |

Major Storm Rainfall Input

| | |
|---|--|
| Design Storm Return Period, T_r (years) | |
| One-Hour Precipitation, P_1 (inches) | |

CALCULATED OUTPUT

| | |
|---|------------|
| Minor Total Design Peak Flow, Q (cfs) | 4.4 |
| Major Total Design Peak Flow, Q (cfs) | 9.4 |
| Minor Flow Bypassed Downstream, Q_b (cfs) | 0.0 |
| Major Flow Bypassed Downstream, Q_b (cfs) | 0.0 |

ALLOWABLE CAPACITY FOR ONE-HALF OF STREET (Minor & Major Storm)

(Based on Regulated Criteria for Maximum Allowable Flow Depth and Spread)

Project: Shops at Meridian Ranch Convenience Store
Inlet ID: Inlet C1.1

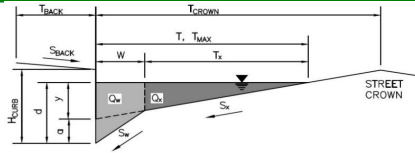

| Gutter Geometry: | | | | | | |
|---|--|-------------|-------------|--------------------------|--------------------------|--------|
| Maximum Allowable Width for Spread Behind Curb | $T_{BACK} = 4.0$ ft | | | | | |
| Side Slope Behind Curb (leave blank for no conveyance credit behind curb) | $S_{BACK} = 0.020$ ft/ft | | | | | |
| Manning's Roughness Behind Curb (typically between 0.012 and 0.020) | $n_{BACK} = 0.020$ | | | | | |
| Height of Curb at Gutter Flow Line | $H_{CURB} = 6.00$ inches | | | | | |
| Distance from Curb Face to Street Crown | $T_{CROWN} = 30.0$ ft | | | | | |
| Gutter Width | $W = 2.00$ ft | | | | | |
| Street Transverse Slope | $S_x = 0.011$ ft/ft | | | | | |
| Gutter Cross Slope (typically 2 inches over 24 inches or 0.083 ft/ft) | $S_w = 0.083$ ft/ft | | | | | |
| Street Longitudinal Slope - Enter 0 for sump condition | $S_o = 0.014$ ft/ft | | | | | |
| Manning's Roughness for Street Section (typically between 0.012 and 0.020) | $n_{STREET} = 0.016$ | | | | | |
| Max. Allowable Spread for Minor & Major Storm | <table border="1" style="display: inline-table; border-collapse: collapse;"> <tr> <td style="text-align: center;">Minor Storm</td> <td style="text-align: center;">Major Storm</td> <td rowspan="2" style="text-align: center;">ft</td> </tr> <tr> <td style="text-align: center;">$T_{MAX} = 30.0$</td> <td style="text-align: center;">30.0</td> </tr> </table> | Minor Storm | Major Storm | ft | $T_{MAX} = 30.0$ | 30.0 |
| Minor Storm | Major Storm | ft | | | | |
| $T_{MAX} = 30.0$ | 30.0 | | | | | |
| Max. Allowable Depth at Gutter Flowline for Minor & Major Storm | <table border="1" style="display: inline-table; border-collapse: collapse;"> <tr> <td style="text-align: center;">Minor Storm</td> <td style="text-align: center;">Major Storm</td> <td rowspan="2" style="text-align: center;">inches</td> </tr> <tr> <td style="text-align: center;">$d_{MAX} = 6.0$</td> <td style="text-align: center;">12.0</td> </tr> </table> | Minor Storm | Major Storm | inches | $d_{MAX} = 6.0$ | 12.0 |
| Minor Storm | Major Storm | inches | | | | |
| $d_{MAX} = 6.0$ | 12.0 | | | | | |
| Allow Flow Depth at Street Crown (check box for yes, leave blank for no) | <table border="1" style="display: inline-table; border-collapse: collapse;"> <tr> <td style="text-align: center;">Minor Storm</td> <td style="text-align: center;">Major Storm</td> </tr> <tr> <td style="text-align: center;"><input type="checkbox"/></td> <td style="text-align: center;"><input type="checkbox"/></td> </tr> </table> | Minor Storm | Major Storm | <input type="checkbox"/> | <input type="checkbox"/> | |
| Minor Storm | Major Storm | | | | | |
| <input type="checkbox"/> | <input type="checkbox"/> | | | | | |
| MINOR STORM Allowable Capacity is based on Spread Criterion | <table border="1" style="display: inline-table; border-collapse: collapse;"> <tr> <td style="text-align: center;">Minor Storm</td> <td style="text-align: center;">Major Storm</td> <td rowspan="2" style="text-align: center;">cfs</td> </tr> <tr> <td style="text-align: center;">$Q_{allow} = 20.9$</td> <td style="text-align: center;">20.9</td> </tr> </table> | Minor Storm | Major Storm | cfs | $Q_{allow} = 20.9$ | 20.9 |
| Minor Storm | Major Storm | cfs | | | | |
| $Q_{allow} = 20.9$ | 20.9 | | | | | |
| MAJOR STORM Allowable Capacity is based on Spread Criterion | | | | | | |
| Minor storm max. allowable capacity GOOD - greater than the design flow given on sheet 'Inlet Management' | | | | | | |
| Major storm max. allowable capacity GOOD - greater than the design flow given on sheet 'Inlet Management' | | | | | | |

INLET ON A CONTINUOUS GRADE

MHFD-Inlet, Version 5.01 (April 2021)

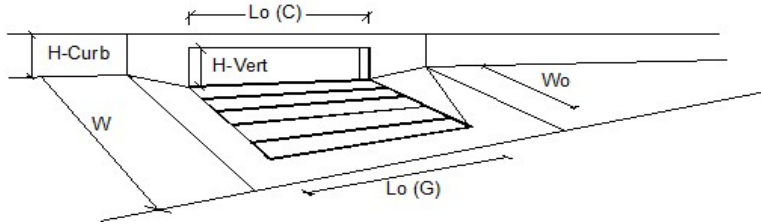

| Design Information (Input) | MINOR | MAJOR | |
|---|--------------------------|-------|--------|
| Type of Inlet | CDOT Type R Curb Opening | | |
| Local Depression (additional to continuous gutter depression 'a') | 3.0 | 3.0 | inches |
| Total Number of Units in the Inlet (Grate or Curb Opening) | 1 | 1 | |
| Length of a Single Unit Inlet (Grate or Curb Opening) | 10.00 | 10.00 | ft |
| Width of a Unit Grate (cannot be greater than W, Gutter Width) | N/A | N/A | ft |
| Clogging Factor for a Single Unit Grate (typical min. value = 0.5) | N/A | N/A | |
| Clogging Factor for a Single Unit Curb Opening (typical min. value = 0.1) | 0.10 | 0.10 | |
| Street Hydraulics: OK - Q < Allowable Street Capacity | | | |
| Total Inlet Interception Capacity | 3.6 | 5.3 | cfs |
| Total Inlet Carry-Over Flow (flow bypassing inlet) | 0.1 | 1.4 | cfs |
| Capture Percentage = Q_i/Q_o = | 98 | 79 | % |

MHFD-Inlet, Version 5.01 (April 2021)
AREA INLET IN A SWALE

Shops at Meridian Ranch Convenience Store
Inlet C1.2

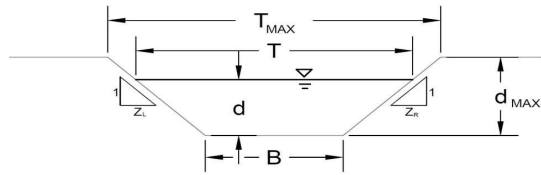

This worksheet uses the NRCS vegetal retardance method to determine Manning's n.
 For more information see Section 7.2.3 of the USDCM.

| Analysis of Trapezoidal Grass-Lined Channel Using SCS Method | | |
|---|-----------------------------|------------------------------|
| NRCS Vegetal Retardance (A, B, C, D, or E) | | |
| Manning's n (Leave cell D16 blank to manually enter an n value) | | |
| Channel Invert Slope | | |
| Bottom Width | | |
| Left Side Slope | | |
| Right Side Slope | | |
| Check one of the following soil types: | | |
| Soil Type: | Max. Velocity (V_{MAX}) | Max Froude No. (F_{MAX}) |
| Non-Cohesive | 5.0 fps | 0.60 |
| Cohesive | 7.0 fps | 0.80 |
| Paved | N/A | N/A |
| A, B, C, D, or E = | | |
| n = 0.030 | | |
| S_0 = 0.0100 ft/ft | | |
| B = 4.00 ft | | |
| Z1 = 4.00 ft/ft | | |
| Z2 = 4.00 ft/ft | | |
| Choose One: | | |
| <input checked="" type="radio"/> Non-Cohesive | | |
| <input type="radio"/> Cohesive | | |
| <input type="radio"/> Paved | | |
| Maximum Allowable Top Width of Channel for Minor & Major Storm | | |
| T_{MAX} = | Minor Storm | Major Storm |
| | 12.00 | 12.00 |
| Maximum Allowable Water Depth in Channel for Minor & Major Storm | | |
| d_{MAX} = | Minor Storm | Major Storm |
| | 0.50 | 1.00 |
| Allowable Channel Capacity Based On Channel Geometry | | |
| MINOR STORM Allowable Capacity is based on Depth Criterion | | |
| MAJOR STORM Allowable Capacity is based on Depth Criterion | | |
| Water Depth in Channel Based On Design Peak Flow | | |
| Design Peak Flow | | |
| Water Depth | | |
| Q_o = | | |
| | Minor Storm | Major Storm |
| | 4.4 | 9.4 |
| d = | | |
| | Minor Storm | Major Storm |
| | 0.37 | 0.56 |
| <p>Minor storm max. allowable capacity GOOD - greater than the design flow given on sheet 'Inlet Management' Major storm max. allowable capacity GOOD - greater than the design flow given on sheet 'Inlet Management'</p> | | |

MHFD-Inlet, Version 5.01 (April 2021)
AREA INLET IN A SWALE

Shops at Meridian Ranch Convenience Store
Inlet C1.2

| Inlet Design Information (Input) | |
|---|-------------------------|
| Type of Inlet | CDOT Type C (Depressed) |
| Inlet Type = | CDOT Type C (Depressed) |
| Angle of Inclined Grate (must be ≤ 30 degrees) | $\theta = 0.00$ degrees |
| Width of Grate | $W = 3.00$ ft |
| Length of Grate | $L = 3.00$ ft |
| Open Area Ratio | $A_{RATIO} = 0.70$ |
| Height of Inclined Grate | $H_B = 0.00$ ft |
| Clogging Factor | $C_f = 0.50$ |
| Grate Discharge Coefficient | $C_d = 0.84$ |
| Orifice Coefficient | $C_o = 0.56$ |
| Weir Coefficient | $C_w = 1.81$ |
| Water Depth at Inlet (for depressed inlets, 1 foot is added for depression) | |
| Total Inlet Interception Capacity (assumes clogged condition) | |
| Bypassed Flow | |
| Capture Percentage = Q_a/Q_o | |

| | MINOR | MAJOR | |
|---------|-------------|-------------|------------|
| $d =$ | 1.37 | 1.56 | |
| $Q_a =$ | 16.7 | 17.7 | cfs |
| $Q_b =$ | 0.0 | 0.0 | cfs |
| $C\% =$ | 100 | 100 | % |

Warning 04: Froude No. exceeds USDCM Volume I recommendation.

ROCK CHECK DAMS PROVIDED FOR CHANNEL STABILITY

APPENDIX C2

HYDRAULIC CALCULATIONS – STORM SEWER

**SHOPS AT MERIDIAN RANCH CONVENIENCE STORE
STORM SEWER SIZING SUMMARY**

| PIPE FLOW | | | | PIPE CAPACITY | | |
|-----------|--------------|---------------|-----------------|---------------|-----------------|---------------------|
| PIPE | DESIGN POINT | Q5 FLOW (CFS) | Q100 FLOW (CFS) | PIPE SIZE | MIN. PIPE SLOPE | PIPE CAPACITY (CFS) |
| C1.1 | C1.1 | 3.7 | 6.7 | 12 | 3.6% | 6.8 |
| | | | | | | |
| C1.2 | C1.2 | 4.4 | 9.4 | 15 | 2.2% | 9.6 |
| | | | | | | |

ASSUMPTIONS:

1. STORM DRAIN PIPE ASSUMED TO BE RCP OR HDPE

Hydraulic Analysis Report

Project Data

Project Title: Project - Shops at Meridian Ranch C-Store

Designer: JPS

Project Date: Tuesday, February 7, 2023

Project Units: U.S. Customary Units

Notes:

Channel Analysis: SD-C1.1

Notes:

Input Parameters

Channel Type: Circular

Pipe Diameter: 1.0000 ft

Longitudinal Slope: 0.0360 ft/ft

Manning's n: 0.0130

Depth: 1.0000 ft

Result Parameters

Flow: 6.7599 cfs

Area of Flow: 0.7854 ft²

Wetted Perimeter: 3.1416 ft

Hydraulic Radius: 0.2500 ft

Average Velocity: 8.6070 ft/s

Top Width: 0.0000 ft

Froude Number: 0.0000

Critical Depth: 0.9714 ft

Critical Velocity: 8.6775 ft/s

Critical Slope: 0.0318 ft/ft

Critical Top Width: 0.33 ft

Calculated Max Shear Stress: 2.2464 lb/ft²

Calculated Avg Shear Stress: 0.5616 lb/ft²

Channel Analysis: SD-C1.2

Notes:

Input Parameters

Channel Type: Circular
Pipe Diameter: 1.2500 ft
Longitudinal Slope: 0.0220 ft/ft
Manning's n: 0.0130
Depth: 1.2500 ft

Result Parameters

Flow: 9.5814 cfs
Area of Flow: 1.2272 ft²
Wetted Perimeter: 3.9270 ft
Hydraulic Radius: 0.3125 ft
Average Velocity: 7.8076 ft/s
Top Width: 0.0000 ft
Froude Number: 0.0000
Critical Depth: 1.1731 ft
Critical Velocity: 8.0113 ft/s
Critical Slope: 0.0190 ft/ft
Critical Top Width: 0.60 ft
Calculated Max Shear Stress: 1.7160 lb/ft²
Calculated Avg Shear Stress: 0.4290 lb/ft²

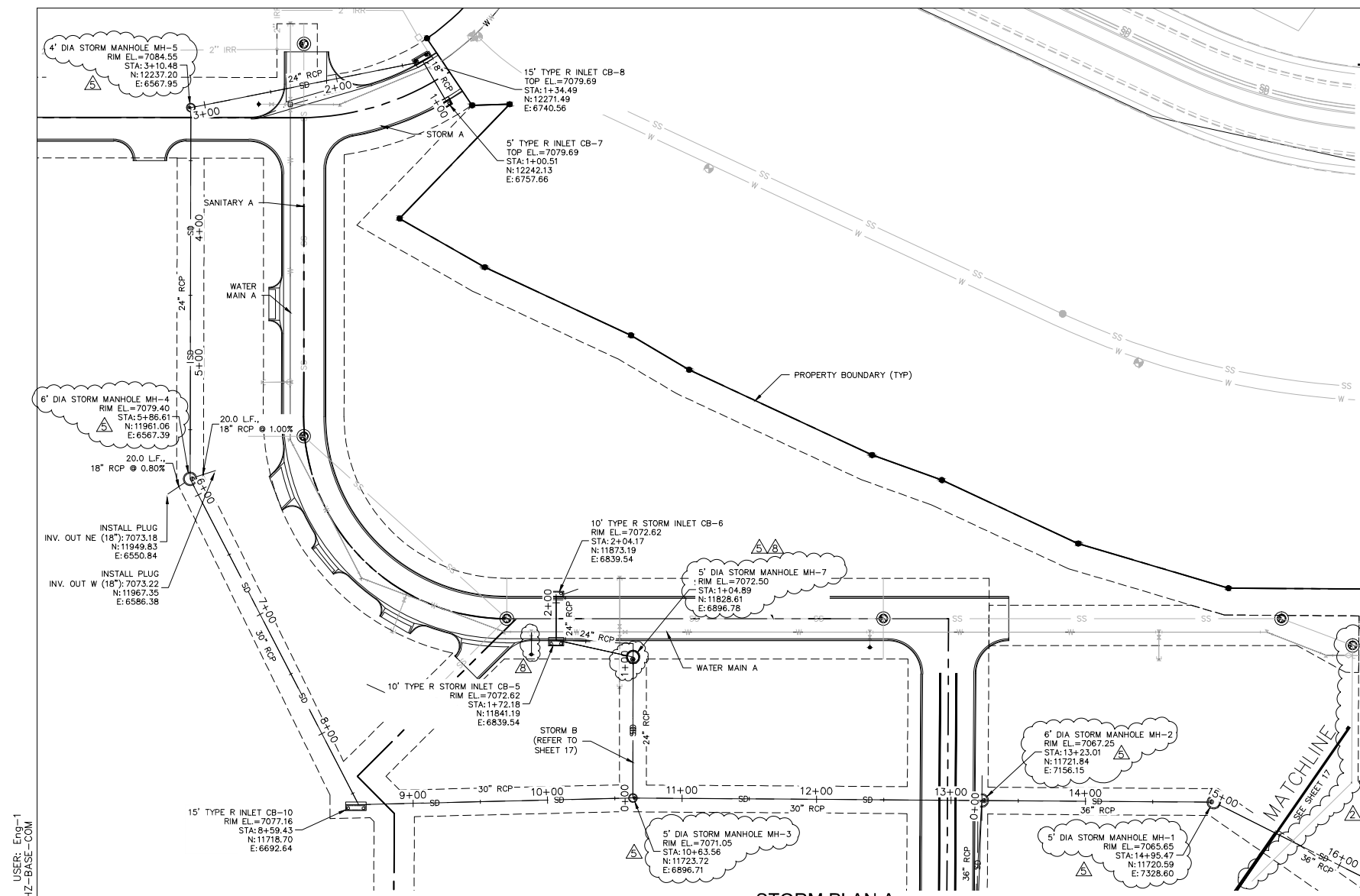

- ### STORM NOTES
- ALL STORM PIPES SHALL BE RCP, SIZED AS SHOWN IN THE PROFILE, UNLESS NOTED OTHERWISE.
 - ALL STATIONING AND DIMENSIONS ARE TO BE CENTERLINE OF VAULT UNLESS OTHERWISE NOTED.
 - REFERENCE SHEETS 2 & 3 FOR UTILITY INSTALLATION NOTES.
 - REFERENCE SHEETS 19-22 FOR UTILITY INSTALLATION DETAILS.
 - CONTRACTOR SHALL FIELD VERIFY ALL CONNECTION LOCATIONS AND ELEVATIONS PRIOR TO CONSTRUCTION. CONTRACTOR SHALL IMMEDIATELY REPORT ANY SIGNIFICANT DEVIATIONS FROM THE PLANS TO THE ENGINEER.
 - ALL STORM WATER INLETS SHALL BE CONSTRUCTED IN ACCORDANCE WITH INLET DETAILS ON SHEET 21.
 - ALL STORM SEWER MANHOLE SHALL BE CONSTRUCTED IN ACCORDANCE WITH DETAILS SD 3-1, AND SD 3-2.
 - CURB INLET LOCATIONS ARE REFERENCED THE CENTER OF BOX AT THE FLOWLINE. THE "TOP ELEV" OF CURB INLETS REFERS TO THE TOP OF THE BOX ELEVATION, WHICH SHALL BE FLUSH WITH THE TOP OF CURB ELEVATION ON EITHER SIDE. PLEASE REFER TO THE HORIZONTAL CONTROL PLAN, FOR ADDITIONAL INLET LOCATION DATA.
 - MANHOLES AND OTHER STRUCTURE LOCATIONS ARE REFERENCED AT THE CENTER OF THE STRUCTURE.
 - FOR DETAILS OF STORM SEWER CONSTRUCTION, SEE THE CITY OF COLORADO SPRINGS CONSTRUCTION SPECIFICATIONS AND STANDARD DRAWINGS. ALL STANDARD SPECIFICATIONS AND ADDENDA SHALL APPLY.
 - MATERIALS, WORKMANSHIP, AND INSTALLATION SHALL MEET OR EXCEED THE SPECIFICATIONS AND INSTALLATION REQUIREMENTS OF THE MANUFACTURER.
 - ALL CAST IN PLACE PORTLAND CEMENT CONCRETE FOR DRAINAGE STRUCTURES SHALL HAVE A MINIMUM 28 DAY COMPRESSIVE STRENGTH OF 4,000 PSI, SHALL HAVE TYPE II CEMENT (UNLESS OTHERWISE SPECIFIED) WITH AIR ENTRAINING ADMIXTURES AND SHALL CONFORM TO ALL THE REQUIREMENTS OF CITY'S SPECIFICATIONS MANUAL.
 - ALL STORM SEWER PIPES SHALL BE CONSTRUCTED WITH WATER TIGHT JOINTS.
 - FOR STORM SEWER PIPE INSTALLATION, THE LIMITS OF BEDDING SHALL BE FROM SIX INCHES (6") BELOW THE BOTTOM OF THE PIPE TO TWELVE INCHES (12") ABOVE THE TOP OF THE PIPE. THE BEDDING MATERIAL SHALL BE COMPACTED TO AT LEAST NINETY FIVE (95%) PERCENT OF MAXIMUM DRY DENSITY AS DETERMINED FROM STANDARD PROCTOR (ASTM D 698) DRY DENSITY AT MOISTURE CONTENTS WITHIN TWO PERCENT (2%) OF OPTIMUM.

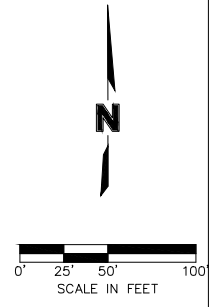

TECH CONTRACTORS
 12311 REX ROAD
 FALCON, CO 80831
 TELEPHONE: 719.495.7444
 FAX: 719.495.2457

REGISTERED PROFESSIONAL ENGINEER
 31429

NOTE:
 THE UNDERGROUND UTILITIES SHOWN HAVE BEEN LOCATED FROM FIELD SURVEY INFORMATION AND EXISTING DRAWINGS. THE ENGINEER/SURVEYOR MAKES NO GUARANTEES THAT THE UTILITIES SHOWN COMPRISE ALL SUCH UTILITIES IN THE AREA, EITHER IN-SERVICE OR ABANDONED. THE ENGINEER/SURVEYOR FURTHER DOES NOT WARRANT THAT THE UTILITIES SHOWN ARE IN THE EXACT LOCATION INDICATED. THE ENGINEER/SURVEYOR HAS NOT PHYSICALLY LOCATED THE UNDERGROUND UTILITIES. THIS INCLUDES PRIVATE AND PUBLIC UTILITIES.

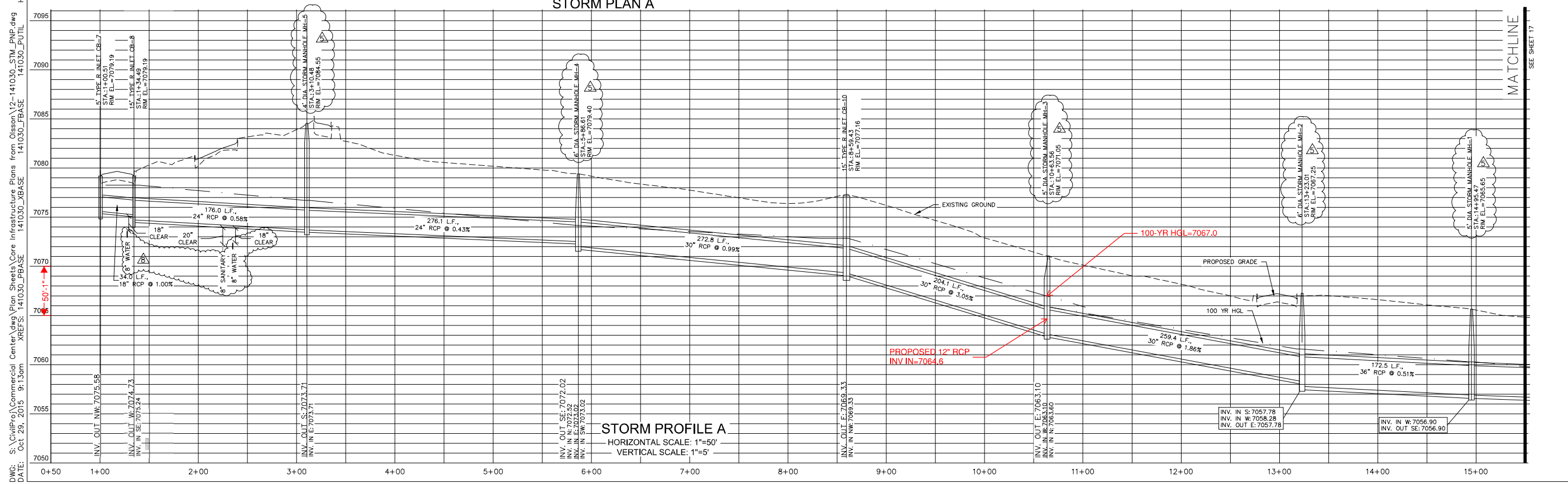

OLSSON ASSOCIATES ASSUMES NO RESPONSIBILITY FOR EXISTING UTILITY LOCATIONS (HORIZONTAL OR VERTICAL). THE EXISTING UTILITIES SHOWN ON THIS DRAWING HAVE BEEN PLOTTED FROM THE BEST AVAILABLE INFORMATION. IT IS HOWEVER THE RESPONSIBILITY OF THE CONTRACTOR TO FIELD VERIFY THE LOCATION OF ALL UTILITIES PRIOR TO THE COMMENCEMENT OF ANY CONSTRUCTION ACTIVITIES.

811
 Know what's below.
 Call before you dig.
 CALL 811 SEVENTY-TWO HOURS PRIOR TO DIGGING, GRADING OR EXCAVATING FOR THE MARKING OF UNDERGROUND MEMBER UTILITIES.

| REV. NO. | DATE | REVISIONS DESCRIPTION |
|----------|------------|-----------------------------------|
| 1 | 10/29/2015 | DEL. 2.1 (CONVERTING & REVISIONS) |
| 2 | 09/30/2015 | VALUE ENGINEERING REVISIONS |
| 3 | 07/30/2015 | VALUE ENGINEERING REVISIONS |
| 4 | 07/30/2015 | VALUE ENGINEERING REVISIONS |
| 5 | 07/30/2015 | VALUE ENGINEERING REVISIONS |
| 6 | 07/30/2015 | VALUE ENGINEERING REVISIONS |

STORM SEWER PLAN AND PROFILE
 THE SHOPS AT MERIDIAN RANCH
 MERIDIAN ROAD AND STAPLETON DRIVE
 SITE CONSTRUCTION DOCUMENTS
 EL PASO, COUNTY

drawn by: BK
 checked by: SZ
 approved by: JE
 QA/QC by: JE
 project no.: 014-1030
 drawing no.: 12-141030_STM_PNP
 date: 07/02/2015

SHEET 16 OF 24

DWG: S:\Civ\Pro\Commercial\Center\dwg\Plan_Sheets\Core Infrastructure\Plans\12-141030_STM_PNP.dwg
 DATE: Oct 29, 2015 9:13am
 USER: Eng-1
 HZ-BASE-COM
 XREFS: 141030_XBASE 141030_PBASE 141030_PUTIL 141030_PBASE

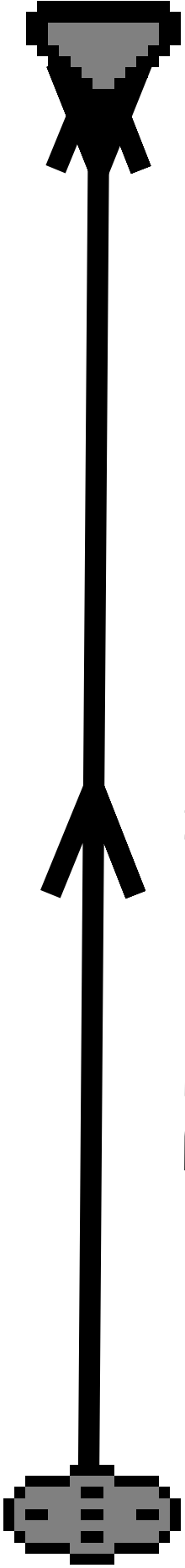

PIPE SD-C1.1

EXISTING STORM

UDSewer Results Summary – SD-C1.1 – 100-Year Analysis

Project Title: New UDSEWER System Module

Project Description: Default system

Table of Contents

[Top](#)

[System Input](#)

[Manhole Input](#)

[Manhole Output](#)

[Sewer Input](#)

[Sewer Flow](#)

[Sewer Sizing](#)

[EGL/HGL Summary](#)

[Excavation Estimate](#)

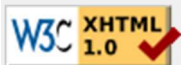

System Input Summary

Rainfall Parameters

Rainfall Return Period: 100

Rainfall Calculation Method: Formula

One Hour Depth (in): 2.52

Rainfall Constant "A": 28.5

Rainfall Constant "B": 10

Rainfall Constant "C": 0.786

Rational Method Constraints

Minimum Urban Runoff Coeff.: 0.20

Maximum Rural Overland Len. (ft): 500

Maximum Urban Overland Len. (ft): 300

Used UDFCD Tc. Maximum: Yes

Sizer Constraints

Minimum Sewer Size (in): 12.00

Maximum Depth to Rise Ratio: 0.90

Maximum Flow Velocity (fps): 18.0

Minimum Flow Velocity (fps): 2.0

Backwater Calculations:

Tailwater Elevation (ft): 7067.00

Sewer Input Summary:

| | | Elevation | | | Loss Coefficients | | | Given Dimensions | | |
|--------------|-------------------|------------------------|-----------|----------------------|-------------------|-----------|--------------|------------------|-----------------|-----------------|
| Element Name | Sewer Length (ft) | Downstream Invert (ft) | Slope (%) | Upstream Invert (ft) | Mannings n | Bend Loss | Lateral Loss | Cross Section | Rise (ft or in) | Span (ft or in) |
| PIPE SD-C1.1 | 30.00 | 7064.59 | 9.7 | 7067.50 | 0.013 | 0.13 | 0.00 | CIRCULAR | 12.00 in | 12.00 in |

Sewer Flow Summary:

| | | Full Flow Capacity | | Critical Flow | | Normal Flow | | | | | |
|--------------|------------|--------------------|------------|----------------|------------|----------------|---------------|--------------------|------------|------------------------|---------|
| Element Name | Flow (cfs) | Velocity (fps) | Depth (in) | Velocity (fps) | Depth (in) | Velocity (fps) | Froude Number | Flow Condition | Flow (cfs) | Surcharged Length (ft) | Comment |
| PIPE SD-C1.1 | 11.13 | 14.17 | 11.65 | 8.60 | 6.71 | 14.82 | 3.87 | Supercritical Jump | 6.70 | 22.81 | |

- A Froude number of 0 indicates that pressurized flow occurs (adverse slope or undersized pipe).
- If the sewer is not pressurized, full flow represents the maximum gravity flow in the sewer.
- If the sewer is pressurized, full flow represents the pressurized flow conditions.

Sewer Sizing Summary:

| | | Existing | | Calculated | | Used | | | | |
|--------------|-----------------|---------------|----------|------------|----------|----------|----------|----------|-------------------------|---------|
| Element Name | Peak Flow (cfs) | Cross Section | Rise | Span | Rise | Span | Rise | Span | Area (ft ²) | Comment |
| PIPE SD-C1.1 | 6.70 | CIRCULAR | 12.00 in | 12.00 in | 12.00 in | 12.00 in | 12.00 in | 12.00 in | 0.79 | |

- Calculated diameter was determined by sewer hydraulic capacity rounded up to the nearest commercially available size.
- Sewer sizes should not decrease downstream.
- All hydraulics were calculated using the 'Used' parameters.

Grade Line Summary:

Tailwater Elevation (ft): 7067.00

| Element Name | Invert Elev. | | Downstream Manhole Losses | | HGL | | EGL | | |
|--------------|-----------------|---------------|---------------------------|-------------------|-----------------|---------------|-----------------|--------------------|---------------|
| | Downstream (ft) | Upstream (ft) | Bend Loss (ft) | Lateral Loss (ft) | Downstream (ft) | Upstream (ft) | Downstream (ft) | Friction Loss (ft) | Upstream (ft) |
| PIPE SD-C1.1 | 7064.59 | 7067.50 | 0.00 | 0.00 | 7067.00 | 7068.47 | 7068.13 | 1.49 | 7069.62 |

- Bend and Lateral losses only apply when there is an outgoing sewer. The system outfall, sewer #0, is not considered a sewer.
- Bend loss = Bend K * V_{fi}² / (2*g)
- Lateral loss = V_{fo}² / (2*g) - Junction Loss K * V_{fi}² / (2*g).
- Friction loss is always Upstream EGL - Downstream EGL.

SD-C1.1-100-Year

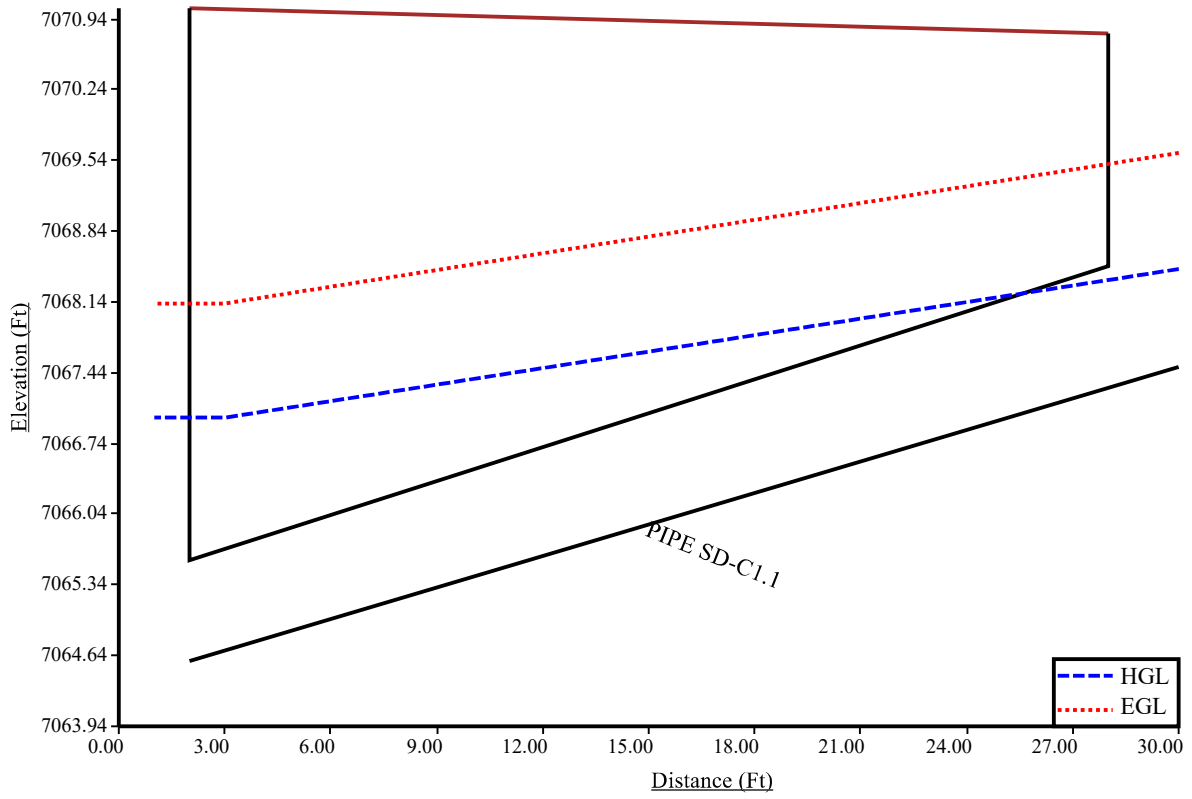

DWG: S:\Civ\Pro\Commercial_Center\dwg\Plan_Sheets\Core_Infrastructure\Plans from Olsson\12-141030_STM_PMP.dwg USER: Eng-1
 DATE: Oct 29, 2015 9:18am XREFS: 141030_XBASE 141030_PBASE 141030_PUTIL 141030_CDM

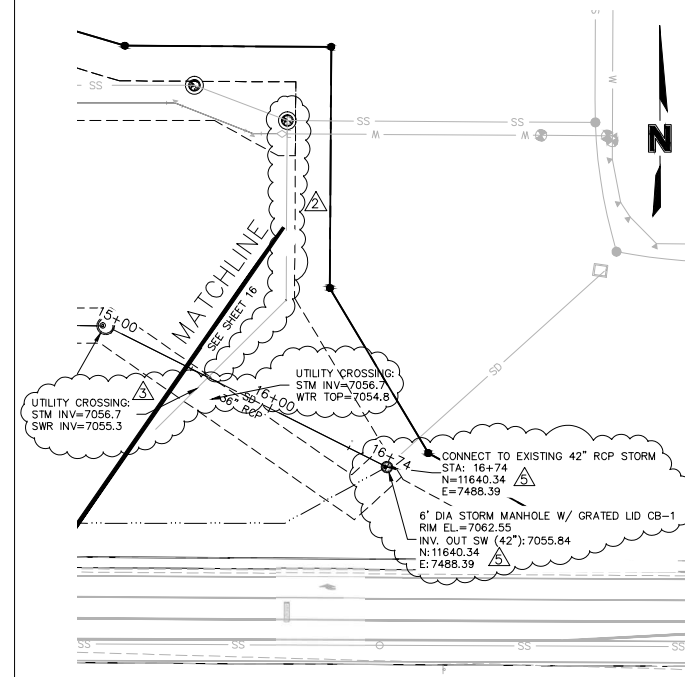

STORM PLAN A

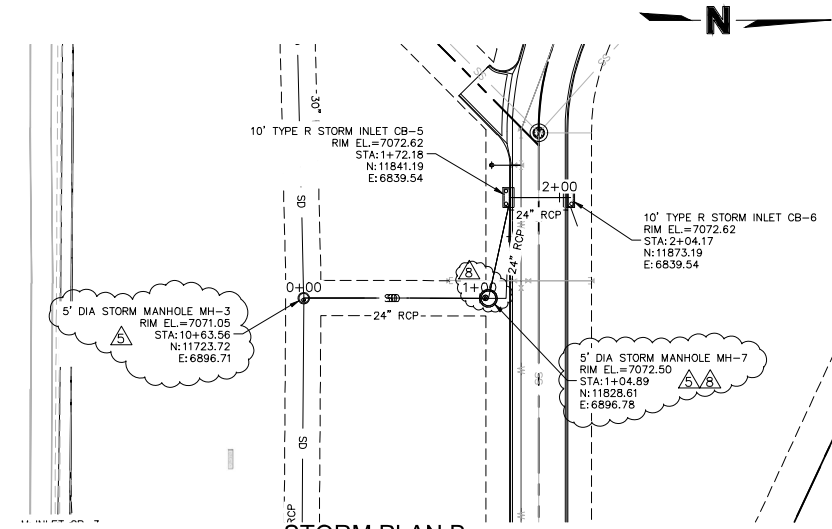

STORM PLAN B

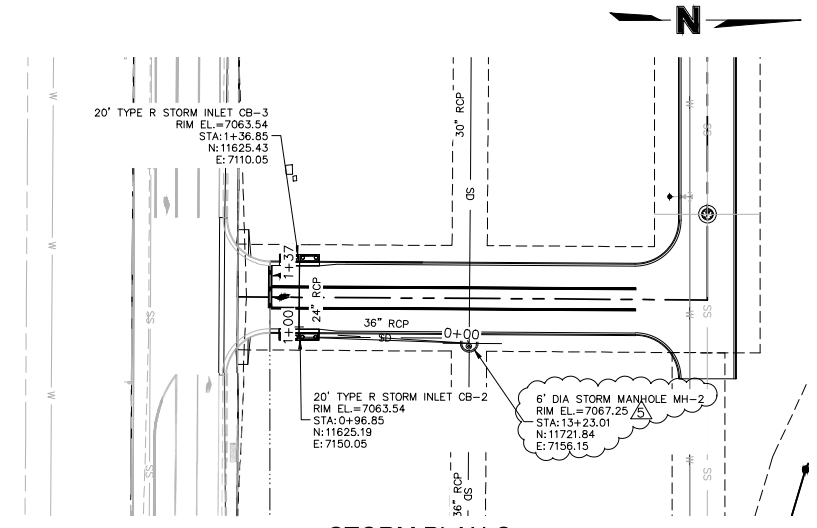

STORM PLAN C

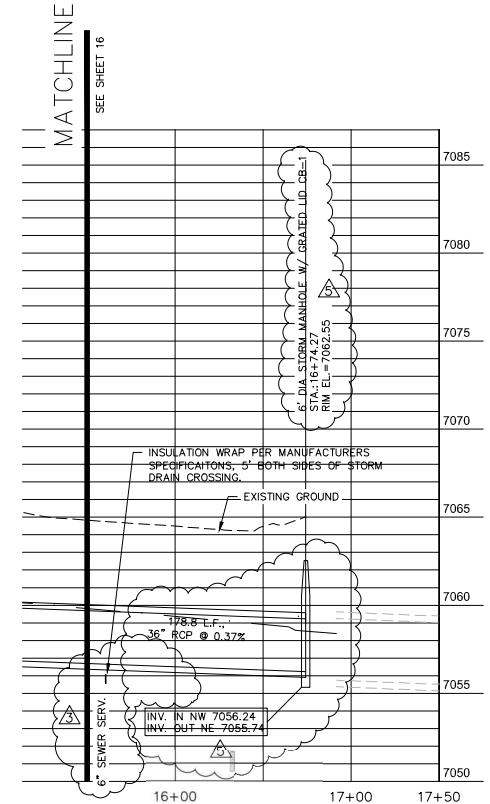

STORM PROFILE A
 HORIZONTAL SCALE: 1"=50'
 VERTICAL SCALE: 1"=5'

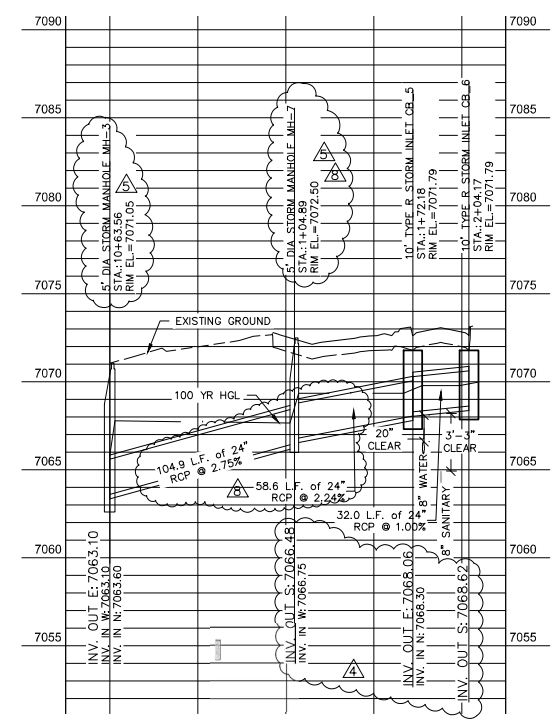

STORM PROFILE B
 HORIZONTAL SCALE: 1"=50'
 VERTICAL SCALE: 1"=5'

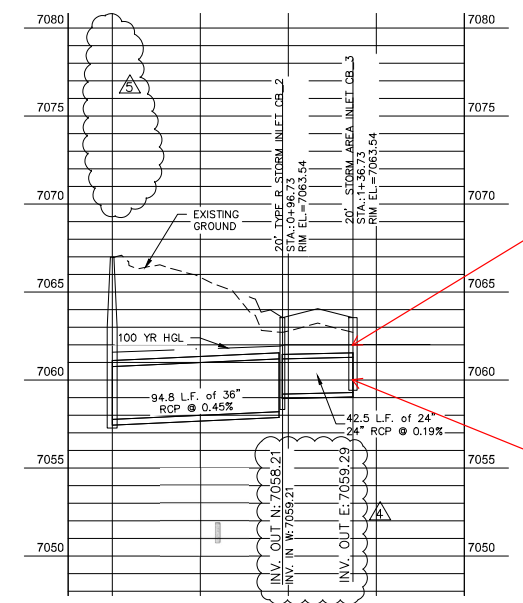

STORM PROFILE C
 HORIZONTAL SCALE: 1"=50'
 VERTICAL SCALE: 1"=5'

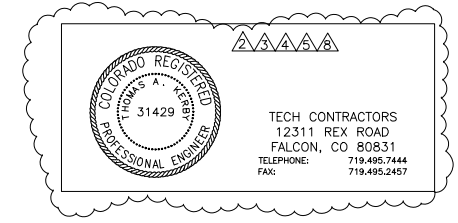

OLSSON ASSOCIATES ASSUMES NO RESPONSIBILITY FOR EXISTING UTILITY LOCATIONS (HORIZONTAL OR VERTICAL). THE EXISTING UTILITIES SHOWN ON THIS DRAWING HAVE BEEN PLOTTED FROM THE BEST AVAILABLE INFORMATION. IT IS HOWEVER THE RESPONSIBILITY OF THE CONTRACTOR TO FIELD VERIFY THE LOCATION OF ALL UTILITIES PRIOR TO THE COMMENCEMENT OF ANY CONSTRUCTION ACTIVITIES.

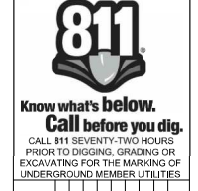

| REV. NO. | DATE | REVISIONS DESCRIPTION |
|----------|------------|-------------------------------------|
| 6 | 10/29/2015 | DEL 2 LOWERING & ABC REVISIONS |
| 5 | 09/02/15 | VALUE ENGINEERING REVISIONS |
| 4 | 09/10/15 | ADDED STORM INVERTS |
| 3 | 07/20/15 | ADDED UTILITY CROSSING AT STM DRAIN |
| 2 | 07/22/15 | ADDED UTILITY CROSSING AT STM DRAIN |

STORM SEWER PLAN AND PROFILE
 THE SHOPS AT MERIDIAN RANCH
 MERIDIAN ROAD AND STAPLETON DRIVE
 SITE CONSTRUCTION DOCUMENTS
 EL PASO, COUNTY 2015

drawn by: BK
 checked by: SZ
 approved by: JE
 QA/QC by: JE
 project no.: 014-1030
 drawing no.: 12-141030_STM_PMP
 date: 07/22/2015

NOTE:
 THE UNDERGROUND UTILITIES SHOWN HAVE BEEN LOCATED FROM FIELD SURVEY INFORMATION AND EXISTING DRAWINGS. THE ENGINEER/SURVEYOR MAKES NO GUARANTEES THAT THE UTILITIES SHOWN COMPRISE ALL SUCH UTILITIES IN THE AREA, EITHER IN-SERVICE OR ABANDONED. THE ENGINEER/SURVEYOR FURTHER DOES NOT WARRANT THAT THE UTILITIES SHOWN ARE IN THE EXACT LOCATION INDICATED, THE ENGINEER/SURVEYOR HAS NOT PHYSICALLY LOCATED THE UNDERGROUND UTILITIES. THIS INCLUDES PRIVATE AND PUBLIC UTILITIES.



UDSewer Results Summary – SD-C1.2 – 100-Year Analysis

Project Title: New UDSEWER System Module

Project Description: Default system

Table of Contents

[Top](#)

[System Input](#)

[Manhole Input](#)

[Manhole Output](#)

[Sewer Input](#)

[Sewer Flow](#)

[Sewer Sizing](#)

[EGL/HGL Summary](#)

[Excavation Estimate](#)

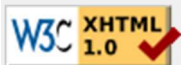

System Input Summary

Rainfall Parameters

Rainfall Return Period: 100

Rainfall Calculation Method: Formula

One Hour Depth (in): 2.52

Rainfall Constant "A": 28.5

Rainfall Constant "B": 10

Rainfall Constant "C": 0.786

Rational Method Constraints

Minimum Urban Runoff Coeff.: 0.20

Maximum Rural Overland Len. (ft): 500

Maximum Urban Overland Len. (ft): 300

Used UDFCD Tc. Maximum: Yes

Sizer Constraints

Minimum Sewer Size (in): 12.00

Maximum Depth to Rise Ratio: 0.90

Maximum Flow Velocity (fps): 18.0

Minimum Flow Velocity (fps): 2.0

Backwater Calculations:

Tailwater Elevation (ft): 7062.00

Sewer Input Summary:

| Element Name | Sewer Length (ft) | Elevation | | | Loss Coefficients | | | Given Dimensions | | |
|--------------|-------------------|------------------------|-----------|----------------------|-------------------|-----------|--------------|------------------|-----------------|-----------------|
| | | Downstream Invert (ft) | Slope (%) | Upstream Invert (ft) | Mannings n | Bend Loss | Lateral Loss | Cross Section | Rise (ft or in) | Span (ft or in) |
| PIPE SD-C1.2 | 32.00 | 7060.04 | 2.2 | 7060.74 | 0.013 | 0.13 | 0.00 | CIRCULAR | 15.00 in | 15.00 in |

Sewer Flow Summary:

| Element Name | Full Flow Capacity | | Critical Flow | | Normal Flow | | | | Flow (cfs) | Surcharged Length (ft) | Comment |
|--------------|--------------------|----------------|---------------|----------------|-------------|----------------|---------------|----------------|------------|------------------------|---------|
| | Flow (cfs) | Velocity (fps) | Depth (in) | Velocity (fps) | Depth (in) | Velocity (fps) | Froude Number | Flow Condition | | | |
| PIPE SD-C1.2 | 9.58 | 7.81 | 14.02 | 7.88 | 12.05 | 8.90 | 1.52 | Pressurized | 9.40 | 32.00 | |

- A Froude number of 0 indicates that pressured flow occurs (adverse slope or undersized pipe).
- If the sewer is not pressurized, full flow represents the maximum gravity flow in the sewer.
- If the sewer is pressurized, full flow represents the pressurized flow conditions.

Sewer Sizing Summary:

| | | Existing | | Calculated | | Used | | | | |
|--------------|-----------------|---------------|----------|------------|----------|----------|----------|----------|-------------------------|---------|
| Element Name | Peak Flow (cfs) | Cross Section | Rise | Span | Rise | Span | Rise | Span | Area (ft ²) | Comment |
| PIPE SD-C1.2 | 9.40 | CIRCULAR | 15.00 in | 15.00 in | 15.00 in | 15.00 in | 15.00 in | 15.00 in | 1.23 | |

- Calculated diameter was determined by sewer hydraulic capacity rounded up to the nearest commercially available size.
- Sewer sizes should not decrease downstream.
- All hydraulics were calculated using the 'Used' parameters.

Grade Line Summary:

Tailwater Elevation (ft): 7062.00

| Element Name | Invert Elev. | | Downstream Manhole Losses | | HGL | | EGL | | |
|--------------|-----------------|---------------|---------------------------|-------------------|-----------------|---------------|-----------------|--------------------|---------------|
| | Downstream (ft) | Upstream (ft) | Bend Loss (ft) | Lateral Loss (ft) | Downstream (ft) | Upstream (ft) | Downstream (ft) | Friction Loss (ft) | Upstream (ft) |
| PIPE SD-C1.2 | 7060.04 | 7060.74 | 0.00 | 0.00 | 7062.00 | 7062.67 | 7062.91 | 0.67 | 7063.59 |

- Bend and Lateral losses only apply when there is an outgoing sewer. The system outfall, sewer #0, is not considered a sewer.
- Bend loss = Bend K * V_{fi}² / (2 * g)
- Lateral loss = V_{fo}² / (2 * g) - Junction Loss K * V_{fi}² / (2 * g).
- Friction loss is always Upstream EGL - Downstream EGL.

SD-C1.2-100-Year

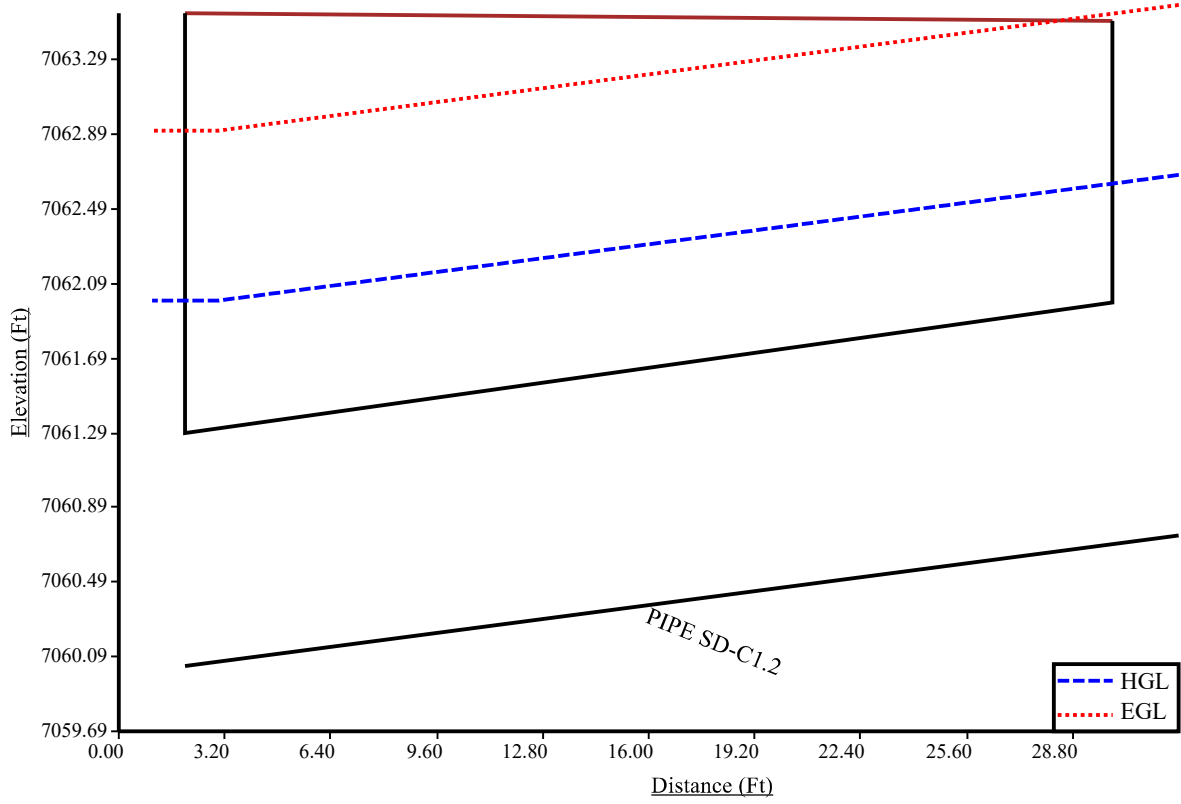

APPENDIX D

FIGURES

National Flood Hazard Layer FIRMette



104°36'38"W 38°58'27"N



Legend

SEE FIS REPORT FOR DETAILED LEGEND AND INDEX MAP FOR FIRM PANEL LAYOUT

- | | | |
|------------------------------------|--|--|
| SPECIAL FLOOD HAZARD AREAS | | Without Base Flood Elevation (BFE) <i>Zone A, V, A99</i> |
| | | With BFE or Depth <i>Zone AE, AO, AH, VE, AR</i> |
| | | Regulatory Floodway |
| OTHER AREAS OF FLOOD HAZARD | | 0.2% Annual Chance Flood Hazard, Areas of 1% annual chance flood with average depth less than one foot or with drainage areas of less than one square mile <i>Zone X</i> |
| | | Future Conditions 1% Annual Chance Flood Hazard <i>Zone X</i> |
| | | Area with Reduced Flood Risk due to Levee. See Notes. <i>Zone X</i> |
| | | Area with Flood Risk due to Levee <i>Zone D</i> |
| OTHER AREAS | | NO SCREEN Area of Minimal Flood Hazard <i>Zone X</i> |
| | | Effective LOMRs |
| GENERAL STRUCTURES | | Area of Undetermined Flood Hazard <i>Zone D</i> |
| | | Channel, Culvert, or Storm Sewer |
| | | Levee, Dike, or Floodwall |
| OTHER FEATURES | | 20.2 Cross Sections with 1% Annual Chance Water Surface Elevation |
| | | 17.5 Cross Sections with 1% Annual Chance Water Surface Elevation |
| | | Coastal Transect |
| | | Base Flood Elevation Line (BFE) |
| | | Limit of Study |
| MAP PANELS | | Jurisdiction Boundary |
| | | Coastal Transect Baseline |
| | | Profile Baseline |
| | | Hydrographic Feature |
| | | Digital Data Available |
| | | No Digital Data Available |
| | | Unmapped |
| | | The pin displayed on the map is an approximate point selected by the user and does not represent an authoritative property location. |



This map complies with FEMA's standards for the use of digital flood maps if it is not void as described below. The basemap shown complies with FEMA's basemap accuracy standards.

The flood hazard information is derived directly from the authoritative NFHL web services provided by FEMA. This map was exported on **2/7/2023 at 1:51 PM** and does not reflect changes or amendments subsequent to this date and time. The NFHL and effective information may change or become superseded by new data over time.

This map image is void if the one or more of the following map elements do not appear: basemap imagery, flood zone labels, legend, scale bar, map creation date, community identifiers, FIRM panel number, and FIRM effective date. Map images for unmapped and unmodernized areas cannot be used for regulatory purposes.

LEGEND

- LIMITS OF DISTURBANCE
- - - FEMA 100-YEAR FLOODWAY
- - - FEMA 100-YR FLOODPLAIN
- - - PROPERTY BOUNDARY
- - - DRAINAGE BASIN BOUNDARY
- - - 7015 PROPOSED CONTOUR
- - - 7015 EXISTING CONTOUR
- - - FLOWLINE
- FLOW DIRECTION ARROW
- DS DOWNSPOUT CONNECTION TO STORM SEWER; INSTALL TRANSITION COUPLINGS & EXTEND 6" PVC (SDR35) AT 1.0% MIN. SLOPE TO SD
- 1 DESIGN POINT
- A BASIN DESIGNATION
- 1.3 AC BASIN AREA (ACRES)
- UNCONNECTED IMPERVIOUS AREA (UIA)
- RECEIVING PERVIOUS AREA (RPA)
- DIRECTLY CONNECTED IMPERVIOUS AREA (DCIA)
- SEPARATE PERVIOUS AREA (SPA)

IMPERVIOUS AREA CALCULATIONS:

BASIN C1.2 = 1.08 AC.

| SURFACE TYPE | AREA |
|-------------------------------|---------------------------|
| BUILDING | 12,000 SF |
| PROP. ASPHALT PARKING & CONC. | 27,172 SF |
| TOTAL IMPERVIOUS AREA | 39,172 SF = 0.9 AC |
| | = 83.3% |

SUMMARY HYDROLOGY TABLE

| DESIGN POINT | Q5 (CFS) | Q100 (CFS) |
|--------------|----------|------------|
| C1 | 7.3 | 13.6 |
| 3 | 8.5 | 15.8 |

PBMP SUMMARY TABLE

| BASINS | PBMP TRIBUTARY AREA (AC) | PBMP |
|-------------------|--------------------------|---------------------------------|
| C1.1-C1.3, OS-1.1 | 2.4 | BENNETT REGIONAL DETENTION POND |

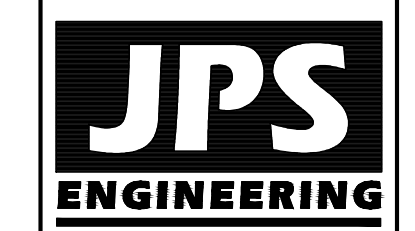
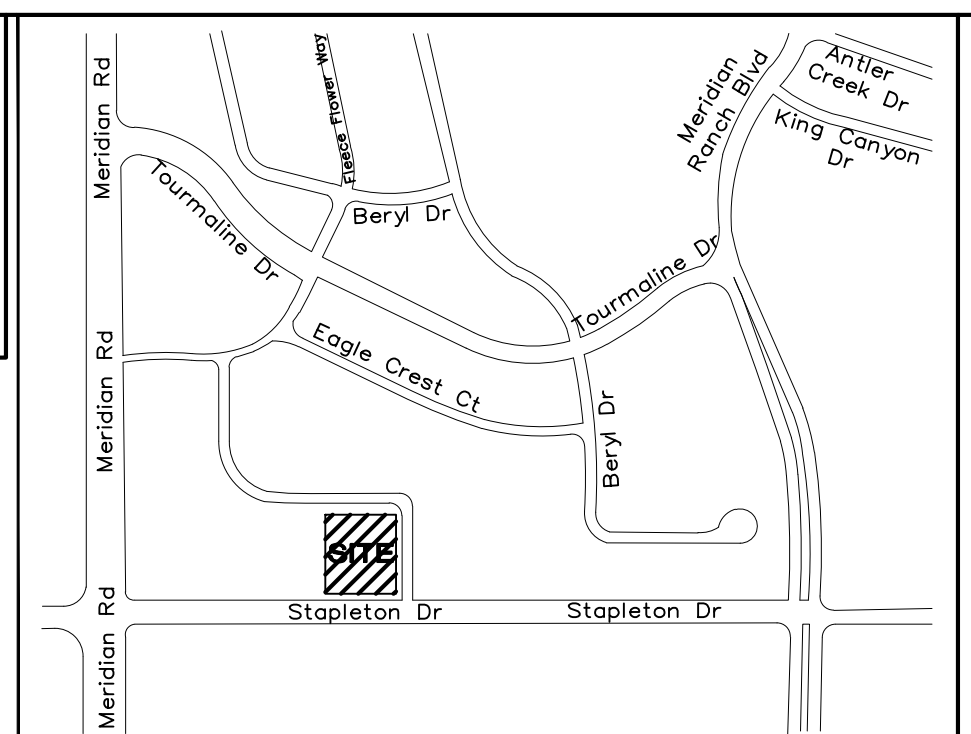

19 E. Wilamette Ave.
Colorado Springs, CO 80903
PH: 719-477-9429
FAX: 719-471-0766
www.jpseng.com



CALL UTILITY NOTIFICATION CENTER OF COLORADO
1-800-922-1987
CALL 2-BUSINESS DAYS IN ADVANCE BEFORE YOU DIG, GRADE, OR EXCAVATE FOR THE MARKING OF UNDERGROUND MEMBER UTILITIES.

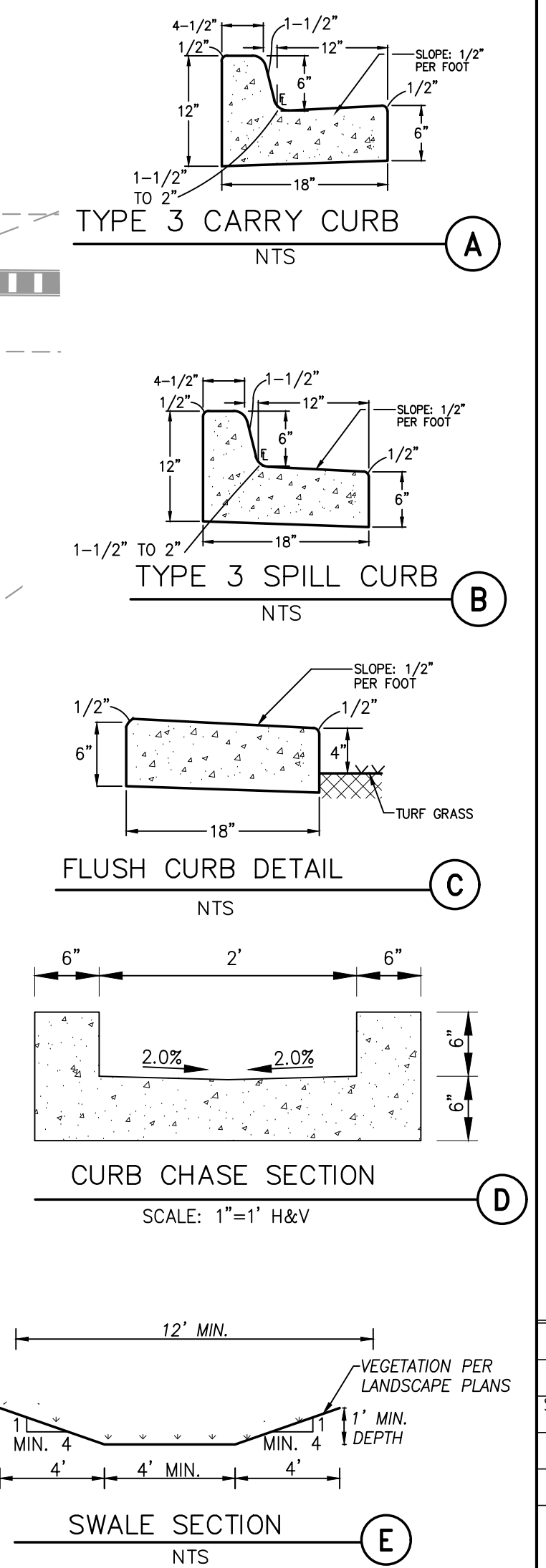
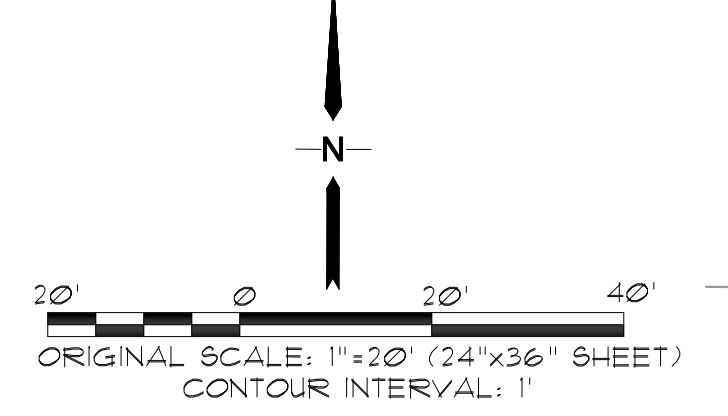
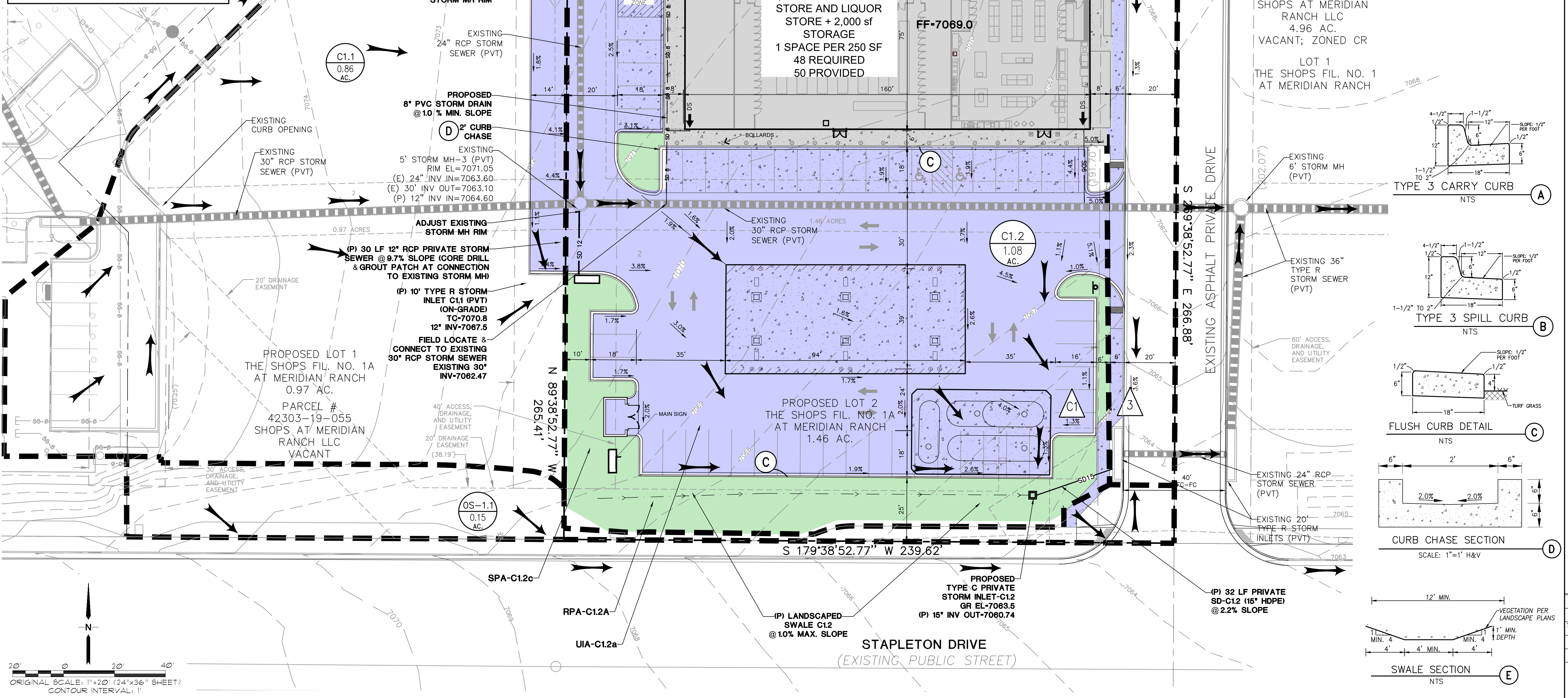

Comment generated due to changes in the document from previous submittal:
The report text above states that WQ treatment will be provided by the existing downstream Bennett Ranch Pond. This map would be required if you were utilizing runoff reduction to achieve water quality treatment. But you're not, so it's a little confusing and contradictory to have it included in this report. It would however be helpful to re-purpose this map to show that you are complying with the 20/10 rule discussed in the report text (PDF pg 8) by showing the 3700sq ft of swale area that meets the req's of that rule. And rename this exhibit's title and update the legend accordingly.

SHOPS AT MERIDIAN RANCH CONVENIENCE STORE LOT 2, THE SHOPS FIL. NO. 1A AT MERIDIAN RANCH

| NO. | REVISION | BY | DATE |
|-----|----------|----|------|
| | | | |
| | | | |
| | | | |
| | | | |

RUNOFF REDUCTION EXHIBIT

| | |
|---------------------|-------------------------|
| HORZ. SCALE: 1"=20' | DRAWN: PV |
| VERT. SCALE: N/A | DESIGNED: JPS |
| SURVEYED: RIDGELINE | CHECKED: JPS |
| CREATED: 08/29/22 | LAST MODIFIED: 01/08/24 |
| PROJECT NO: 092202 | MODIFIED BY: PV |
| SHEET: | RR-1 |

LEGEND

- L00 --- LIMITS OF DISTURBANCE
- - - - FEMA 100-YEAR FLOODWAY
- - - - FEMA 100-YR FLOODPLAIN
- - - - PROPERTY BOUNDARY
- - - - DRAINAGE BASIN BOUNDARY
- 7015 --- PROPOSED CONTOUR
- 7015 --- EXISTING CONTOUR
- > FLOWLINE
- ← FLOW DIRECTION ARROW
- (E) EXISTING
- (P) PROPOSED
- DS → DOWNSPOUT CONNECTION TO STORM SEWER; INSTALL TRANSITION COUPLINGS & EXTEND 6" PVC (SDR35) AT 1.0% MIN. SLOPE TO SD
- △ DESIGN POINT
- BASIN DESIGNATION
- BASIN AREA (ACRES)

IMPERVIOUS AREA CALCULATIONS:

BASIN C1.2 = 1.08 AC.

| SURFACE TYPE | AREA |
|-------------------------------|---------------------------|
| BUILDING | 12,000 SF |
| PROP. ASPHALT PARKING & CONC. | 27,172 SF |
| TOTAL IMPERVIOUS AREA | 39,172 SF = 0.9 AC |
| | = 83.3% |

SUMMARY HYDROLOGY TABLE

| DESIGN POINT | Q5 (CFS) | Q100 (CFS) |
|--------------|----------|------------|
| C1 | 7.3 | 13.6 |
| 3 | 8.5 | 15.8 |

BASIN SUMMARY TABLE

| BASIN | Q5 (CFS) | Q100 (CFS) |
|--------|----------|------------|
| C1.1 | 3.7 | 6.7 |
| C1.2 | 4.3 | 8.0 |
| C1.3 | 1.3 | 2.3 |
| OS-1.1 | 0.06 | 0.4 |

PBMP SUMMARY TABLE

| BASINS | PBMP TRIBUTARY AREA (AC) | PBMP |
|-------------------|--------------------------|---------------------------------|
| C1.1-C1.3, OS-1.1 | 2.4 | BENNETT REGIONAL DETENTION POND |

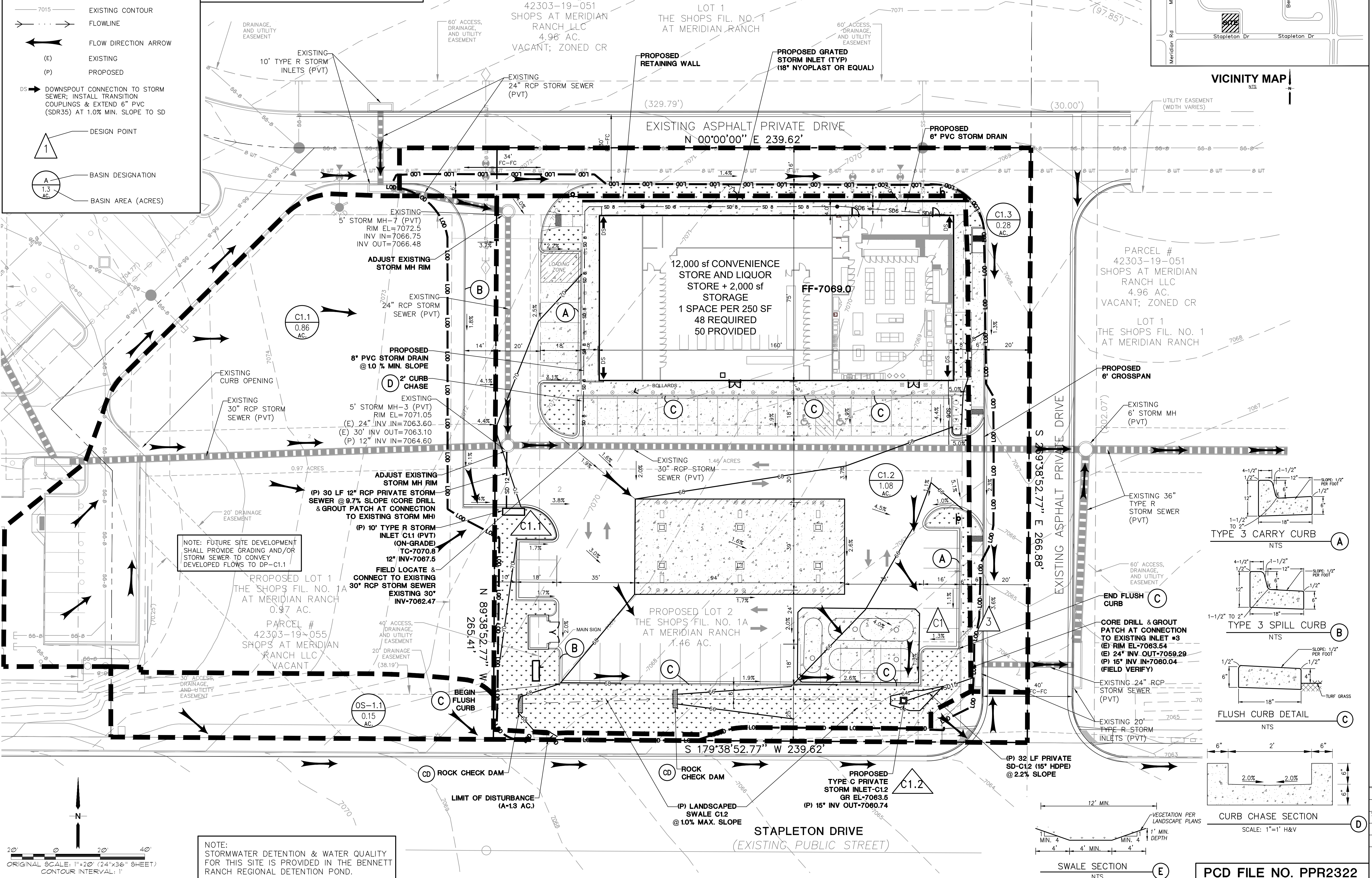
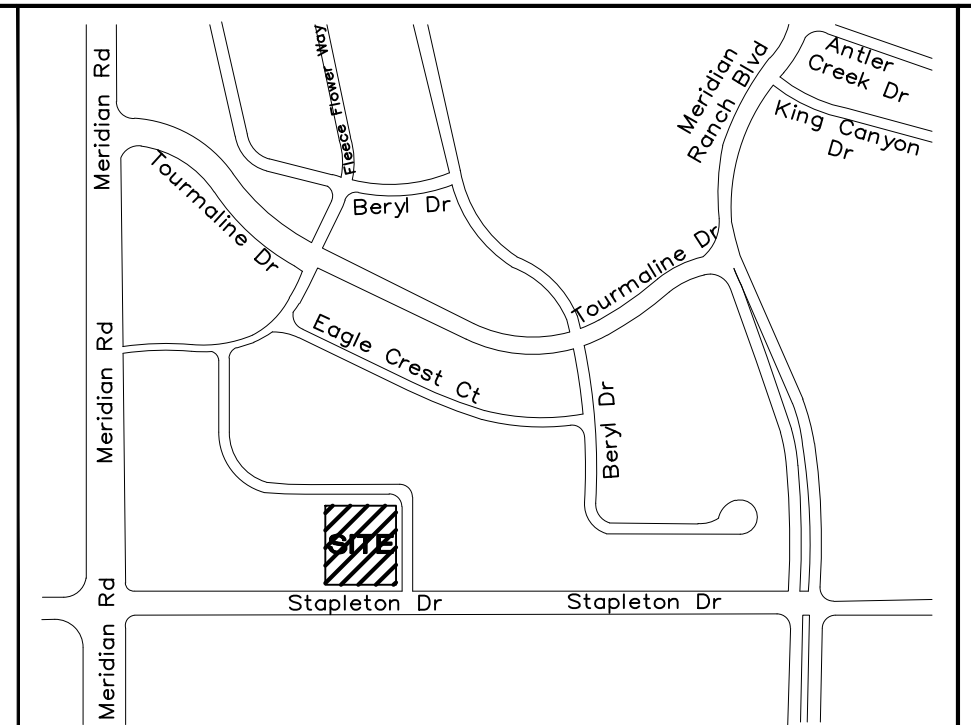

VICINITY MAP

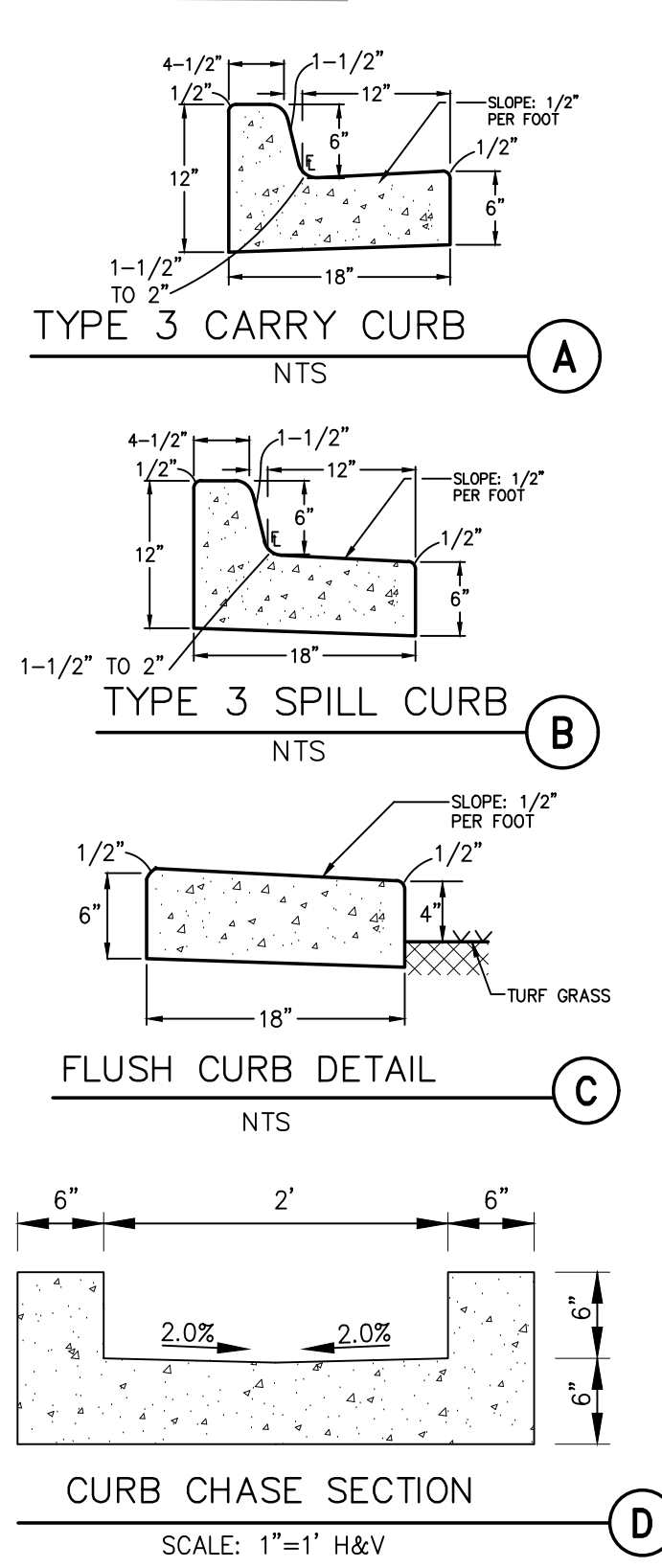

PCD FILE NO. PPR2322

SHOPS AT MERIDIAN RANCH CONVENIENCE STORE LOT 2, THE SHOPS FIL. NO. 1A AT MERIDIAN RANCH

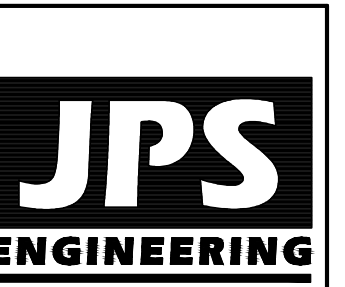

19 E. Wilamette Ave.
Colorado Springs, CO 80903
PH: 719-477-9429
FAX: 719-471-0766
www.jpseng.com

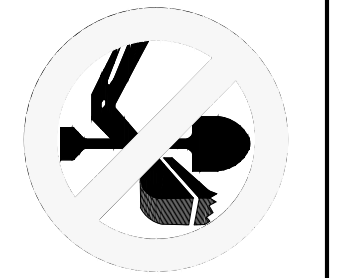

CALL UTILITY NOTIFICATION CENTER OF COLORADO
1-800-922-1987
CALL 2-BUSINESS DAYS IN ADVANCE BEFORE YOU DIG, GRADE, OR EXCAVATE FOR THE MARKING OF UNDERGROUND MEMBER UTILITIES.

| NO. | REVISION | BY | DATE |
|-----|----------|----|------|
| | | | |

DEVELOPED DRAINAGE PLAN

| | |
|---------------------|-------------------------|
| HORZ. SCALE: 1"=20' | DRAWN: PV |
| VERT. SCALE: N/A | DESIGNED: JPS |
| SURVEYED: RIDGELINE | CHECKED: JPS |
| CREATED: 08/29/22 | LAST MODIFIED: 01/08/24 |
| PROJECT NO: 092202 | MODIFIED BY: PV |
| SHEET: | D1 |