



LSC TRANSPORTATION CONSULTANTS, INC.
2504 East Pikes Peak Avenue, Suite 304
Colorado Springs, CO 80909
(719) 633-2868
FAX (719) 633-5430
E-mail: lsc@lsctrans.com
Website: <http://www.lsctrans.com>

Shops at Meridian Ranch
Lot 2, Filing No. 1
Traffic Impact Study
PCD File No. PPR2322
(LSC #S234020)
May 16, 2024
(w/Minor Revision 5/31/2024)

Traffic Engineer's Statement

This traffic report and supporting information were prepared under my responsible charge and they comport with the standard of care. So far as is consistent with the standard of care, said report was prepared in general conformance with the criteria established by the County for traffic reports.



Developer's Statement

I, the Developer, have read and will comply with all commitments made on my behalf within this report.

Eqbal Suif

07/25/2024.

Shops at Meridian Ranch

Lot 2, Filing No.1

Traffic Impact Study

Prepared for:

Hunjan Gas Stations LLC
c/o Brad Nichols
Planner
YOW Architects

MAY 16, 2024 (W/ Minor Revision 5/31/2024)

LSC Transportation Consultants, Inc.

Prepared by: Jeffrey C. Hodsdon, P.E. and Kirstin D. Ferrin, P.E.

LSC #S234020

PCD File No.: [PPR2322](#)



CONTENTS

REPORT CONTENTS 1

PREVIOUS TRAFFIC REPORTS COMPLETED IN THE AREA..... 2

LAND USE AND ACCESS 2

 Land Use 2

 Site Access..... 3

 Pedestrian and Bicycle Analysis 3

ROADWAY AND TRAFFIC CONDITIONS..... 3

 Area Roadways 3

 Existing Traffic Volumes 4

 Existing Levels of Service 4

BACKGROUND TRAFFIC..... 5

TRIP GENERATION..... 5

DIRECTIONAL DISTRIBUTION AND ASSIGNMENT 6

TOTAL TRAFFIC..... 7

PROJECTED LEVELS OF SERVICE 7

 The Shops at Meridian Ranch access to Stapleton Drive..... 7

 Stapleton Drive/Meridian Road 7

 Stapleton Drive/Meridian Ranch Boulevard..... 8

SIGNAL WARRANT ANALYSIS..... 8

 The Shops at Meridian Ranch access to Stapleton Drive..... 8

 Warrant 1: Eight-Hour Vehicular Volume 9

 Warrant 2: Four-Hour Vehicular Volume..... 9

 Warrant 7: Crash Experience 9

RELATIVE TRAFFIC IMPACTS..... 10

ACCESS CONFIGURATION AND CIRCULATION RECOMMENDATIONS..... 10

ROADWAY IMPROVEMENT FEE PROGRAM..... 11

CONCLUSIONS AND RECOMMENDATIONS 11

 Trip Generation..... 11

 Recommendations 11

Enclosures: 12

Tables 2-6

Figures 1-10

Traffic Count Reports

Level of Service Reports

MTCP Maps

Crash History

Appendix Table 1

Stapleton Drive Restriping Exhibit



LSC TRANSPORTATION CONSULTANTS, INC.
2504 East Pikes Peak Avenue, Suite 304
Colorado Springs, CO 80909
(719) 633-2868
FAX (719) 633-5430
E-mail: lsc@lsctrans.com
Website: <http://www.lsctrans.com>

May 16, 2024 (w/ Minor Revision 5/31/2024)

Hunjan Gas Stations LLC
c/o Brad Nichols
Planner
YOW Architects

RE: Shops at Meridian Ranch
Lot 2, Filing No. 1
El Paso County, Colorado
Traffic Impact Study
PCD File No.: [PPR2322](#)
LSC #S234020

Dear Mr. Nichols:

In response to your request, LSC Transportation Consultants, Inc. has prepared this traffic impact study for the currently proposed development of a portion of Lot 2 Filing No. 1 of the Shops at Meridian Ranch. As shown in Figure 1, the site is located northeast of the intersection of Meridian Road and Stapleton Drive in El Paso County, Colorado. LSC completed a traffic technical memorandum for Meridian Ranch Commercial and Residential Filing 4B dated July 11, 2014 as part of the Shops at Meridian Ranch 1 Preliminary Plan ([EPC No. SP147](#)) submittal that included this parcel.

REPORT CONTENTS

This report is being prepared as part of a submittal to El Paso County. It identifies the traffic impacts of the proposed development. The report contains the following:

- The traffic count data and street conditions;
- Short-term and 2044 baseline/background traffic volume estimates;
- The projected average weekday and peak-hour vehicle trips to be generated by the site and a comparison to the trip-generation estimate assumed in the 2014 *Meridian Ranch Commercial and Residential Filing 4B Traffic Technical Memorandum*;
- The assignment of the site's projected traffic volumes to the key area streets and intersections for the short and long term and the resulting total traffic volumes for the short and long term;

- The resulting traffic impacts, including level of service and queueing analysis, at key intersections;
- The project's obligation to the County roadway improvement fee program; and
- Findings and recommendations.

PREVIOUS TRAFFIC REPORTS COMPLETED IN THE AREA

A list of other traffic studies in the area of study completed within the past five years (that LSC is aware of) is attached for reference (Appendix Table 1).

The El Paso County Department of Public Works recently released a draft traffic report prepared by Wilson & Company (December 9, 2021) as part of Briargate-Stapleton Corridor Study. The forecast 2045 total traffic volumes in that study were developed using the PPACG 2045 fiscally constrained RTP model.

LAND USE AND ACCESS

Land Use

The site plan used in the July 22, 2014 traffic technical memorandum for the buildout of the Meridian Ranch Commercial site showed 58,005 square feet of retail floor space, plus a gas station with 20 vehicle fueling positions. However, as at the time most of the site plan was conceptual only, it was decided that the trip-generation estimate and analysis of traffic impacts should be studied for a maximum potential land use of up to 90,000 square feet of retail floor space in addition to the gas station.

Since completion of that report, 58,027 square feet of retail floor space have been constructed within the Shops at Meridian Ranch. About 9,097 square feet of the existing floor area was unoccupied in January 2023 when traffic counts were conducted.

The currently proposed plan is for a commercial building with 14,000 square feet of floor space. The building will include a 4,000-square-foot convenience store, a 7,500-square-foot liquor store, and 2,500 square feet for general retail uses. The proposed plan also includes 12 vehicle fueling positions. The site plan is shown in Figure 2.

If the currently vacant parcels within the Shops at Meridian Ranch (Lots 1 and 2 of the Shops at Meridian Ranch Filing No. 1) are developed as shown on the July 22, 2014 site plan, the resulting buildout land use would total about 76,427 square feet of retail floor space plus the currently proposed gas station. This would be 13,573 square feet below the maximum potential land use of 90,000 square feet used in the July 2014 trip-generation estimate and traffic analysis.

Site Access

There are three existing access points for the greater Shops at Meridian Ranch development, including a full-movement access to Stapleton Drive, a full-movement access to Tourmaline Drive, and a right-in-only access to Meridian Road. Two internal, individual-lot access points are proposed for this convenience store/gas station site development to the Shops at Meridian Ranch internal roadway system. The access to the east/west roadway is planned to be full movement. The access to the north/south roadway (on the east side of the site) is located about 165 feet north of Stapleton Drive (existing centerline spacing). The access to the east-west internal drive is shown about 240 feet west of the north-south entry drive extending south to Stapleton Drive. The access to the east-west internal drive is planned to be restricted to right-in/right-out only.

Pedestrian and Bicycle Analysis

There are currently detached sidewalks along the frontage of the Shops at Meridian Ranch including on the north side of Stapleton Drive between Meridian Road and Meridian Ranch Boulevard and on the east side of Meridian Road between Stapleton Drive and Tourmaline Drive. There are currently no sidewalks on the south side of Stapleton Road, as only the north half of the ultimate cross section has been constructed. Section 3.1 of the draft *Briargate Parkway-Stapleton Road Corridor Study Appendix D: Access Control Plan* dated December 9, 2021, identifies an ultimate hybrid section for Briargate/Stapleton between Black Forest Road and Meridian Road that will resemble the City of Colorado Springs typical section that includes a six-foot outside shoulder to provide a shared facility for bicycles and a six-foot detached sidewalk. Although not included in the corridor study, it is likely that a similar ultimate cross section will be constructed for the section between Meridian Road and US Highway 24.

Sidewalks are planned on the north and south side of the proposed development adjacent to the internal drives.

ROADWAY AND TRAFFIC CONDITIONS

Area Roadways

The major roadways in the site's vicinity are shown in Figure 1 and are described below. Copies of the 2016 El Paso County *Major Transportation Corridors Plan (MTCP) 2040 Roadway Plan*, and 2016 *MTCP 2060 Corridor Preservation Plan (CPP)* with the site location identified on them have been attached to this report.

Stapleton Drive currently extends east from Towner Drive to US Highway (Hwy) 24 and then continues southeast as Curtis Road. It is planned to be ultimately extended west to connect with the Briargate Parkway extension. Adjacent to the site, Stapleton Drive is currently a two-lane roadway with a posted speed limit of 45 miles per hour (mph). It is shown as an Urban four-lane Principal Arterial on the El Paso County *Major Transportation Corridors Plan* and El Paso County *Corridor Preservation Plan (CPP)*.

Meridian Road extends north from South Blaney Road to County Line Road. The posted speed limit on Meridian Road in the vicinity of Stapleton Drive is 55 mph. Meridian Road is shown as a four-lane Principal Arterial south of Rex Road, a four-lane Minor Arterial north of Rex Road, and a two-lane Minor Arterial north of Murphy Road on the El Paso County *MTCP*.

Existing Traffic Volumes

Figure 3 shows the existing morning and afternoon peak-hour traffic volumes at the Shops at Meridian Ranch site access to Stapleton Drive and at the intersections of Meridian Road/Stapleton Drive and Meridian Ranch Boulevard/Stapleton Drive. These volumes are based on manual intersection turning-movement counts conducted by LSC in January 2023, February 2024, and April 2024. The count-data sheets are attached for reference. The data sheets also include counts for off-peak hours utilized in the signal warrant evaluation.

Existing Levels of Service

Level of service (LOS) is a quantitative measure of the level of delay at an intersection. Level of service is indicated on a scale from “A” to “F.” LOS A represents control delay of less than 10 seconds for unsignalized and signalized intersections. LOS F represents control delay of more than 50 seconds for unsignalized intersections and more than 80 seconds for signalized intersections. Table 1 shows the level of service delay ranges.

Table 1: Intersection Levels of Service Delay Ranges

Level of Service	Signalized Intersections	Unsignalized Intersections
	Average Control Delay (seconds per vehicle)	Average Control Delay (seconds per vehicle) ⁽¹⁾
A	10 sec or less	10 sec or less
B	10-20 sec	10-15 sec
C	20-35 sec	15-25 sec
D	35-55 sec	25-35 sec
E	55-80 sec	35-50 sec
F	80 sec or more	50 sec or more

(1) For unsignalized intersections if V/C ratio is greater than 1.0 the level of service is LOS F regardless of the projected average control delay per

Figure 3 presents the results of the existing intersection level of service analysis, based on the unsignalized method of analysis procedures from the *Highway Capacity Manual, 6th Edition* by the Transportation Research Board. The peak-hour factors used for each approach are based on the traffic volumes for the peak fifteen minutes of the entire intersection. If the peak 15 minutes for an approach occurs during an interval other than the peak 15 minutes of the entire

intersection, the suggested peak-hour value based on the total approach volume from Table 9-1 of the *Synchro Studio 10 User Guide* was used instead. The level of service reports are attached. As shown in Figure 3 the southbound left-turn movement currently operates at LOS C during both the morning and afternoon peak hours.

The southbound left-turn movement at the stop-sign-controlled access for the Shops at Meridian Ranch site access to Stapleton Drive is currently operating at LOS C during both the morning and afternoon peak hours. A signal-warrant evaluation of existing conditions is included on page 7 of this report.

The signal-controlled intersection of Meridian Road/Stapleton Drive is currently operating at an overall LOS C during the morning peak hour and LOS B during the afternoon peak hour.

The northbound left-turn movement at the stop-sign-controlled intersection of Meridian Ranch Boulevard/Stapleton Drive is currently operating at LOS F during the morning peak hour and LOS E during the afternoon peak hour. A signal-warrant evaluation of existing conditions is included on page 8 of this report.

BACKGROUND TRAFFIC

Background traffic is the traffic estimated to be on the adjacent roadways without the proposed development's trip generation of site-generated traffic volumes. Background traffic includes the through traffic and the traffic generated by development of other lots within the Shops at Meridian Ranch but assumes zero traffic generated by the currently proposed gas station.

Figure 4 shows the projected short-term background traffic volumes for the year 2028. These volumes are based on the existing traffic volumes from Figure 3 plus about 3 percent per year of growth through traffic on Stapleton Road and Meridian Road plus traffic projected to be generated once the recently constructed building southwest of Tourmaline Drive/Fleece Flower Way is occupied.

Figure 5 shows the projected 20-year background traffic volumes for the year 2044. These volumes assume Stapleton Drive has been extended west (as Briargate Parkway/Stapleton Drive) to connect with the existing section of Briargate Parkway. The 2044 background traffic volumes were based on the volumes shown in the *Briargate-Stapleton Corridor Study (Draft)* by Wilson & Company dated December 9, 2021 and on previous work completed by LSC in the area.

TRIP GENERATION

The site-generated vehicle trips were estimated using the nationally published trip-generation rates from *Trip Generation, 11th Edition, 2021* by the Institute of Transportation Engineers (ITE). Table 2 shows the trip-generation estimates. Also shown in the table, for comparison are the original buildout trip-generation estimates as presented in the July 22, 2014 traffic study.

The total number of vehicle trips generated has been reduced to account for the “pass-by” phenomena. A pass-by trip is made by a motorist who would already be on the adjacent roadways regardless of the proposed development, but who stops in at the site while passing by. The motorist would then continue on his or her way to a final destination in the original direction. The pass-by percentages shown in Table 2 are from the *Trip Generation Handbook - An ITE Proposed Recommended Practice, 3rd Edition, 2017* by ITE.

At buildout, the proposed development is expected to generate about 1,796 new external vehicle trips on the average weekday, with about half entering and half exiting the site during a 24-hour period. During the morning peak hour, about 113 vehicles would enter and 109 vehicles would exit the site. During the afternoon peak hour, about 170 vehicles would enter and 172 vehicles would exit the site.

Assuming the currently vacant parcels within the Shops at Meridian Ranch are developed with about 18,400 additional square feet of retail floor space, the entire Shops at Meridian Ranch development is projected to generate about 5,108 new external vehicle-trips on the average weekday. This is about 323 fewer vehicle trips per day than was estimated in the July 2014 study. During the morning peak hour, about 182 vehicles would enter and 151 vehicles would exit the entire Shops at Meridian Ranch development. This is about 10 more entering vehicles and 6 more exiting vehicles than was estimated in the July 2014 study. During the afternoon peak hour about 359 vehicles would enter and 368 vehicles would exit the entire Shops at Meridian Ranch development. This is about 52 fewer entering vehicles and 54 fewer exiting vehicles than was estimated in the July 2014 study.

The increase in the projected morning peak-hour trip generation despite the decrease in total floor area is due to changes in the trip-generation rates from the 9th edition of Trip Generation which were used in the 2014 report and the rates shown in the 11th edition which were used for the current trip generation estimate.

The minor increase in trip-generation estimate during the average morning peak hour should not present a problem, however, as the access points and adjacent intersections will be designed for the afternoon peak-hour traffic, which is significantly higher than the morning peak hour.

DIRECTIONAL DISTRIBUTION AND ASSIGNMENT

The directional distribution of the site-generated traffic volumes on the area roadways is an important factor in determining the site’s traffic impacts. Figure 6 shows the short-term and long-term directional-distribution estimates for the site-generated traffic volumes. The directional-distribution estimate has been based on the location of the site with respect to area residential, employment, school, commercial, and activity centers; the land use proposed; the access/roadway connections assumed; and the roadway network. The short-term directional-distribution estimate assumes the existing street network. The long-term directional-distribution estimate assumes the Briargate Parkway/Stapleton Drive corridor has been constructed and/or improved to its final Urban Principal cross section between Black Forest Road and US Highway 24.

When the external trip-distribution percentages (from Figure 6) are applied to the trip-generation estimates (from Table 2), the resulting site-generated traffic volumes can be determined. The pass-by trips have been assigned separately, based on the 2028 and 2044 background traffic volumes on Stapleton Drive shown in Figures 4 and 5, respectively. Figure 7 shows the short-term site-generated traffic volumes and Figure 8 shows the long-term site-generated traffic volumes.

TOTAL TRAFFIC

Figure 9 shows the projected 2028 total traffic volumes. The short-term total traffic volumes are the sum of the 2028 background traffic volumes (from Figure 4) plus the short-term site-generated traffic volumes (from Figure 7).

Figure 10 shows the projected 2044 total traffic volumes. The 2044 total traffic volumes are the sum of the 2044 background traffic volumes (from Figure 5) plus the long-term site-generated traffic volumes (from Figure 8).

PROJECTED LEVELS OF SERVICE

The key area intersections and site-access points have been analyzed to determine the projected future levels of service, based on the unsignalized method of analysis procedures from the *Highway Capacity Manual, 6th Edition* by the Transportation Research Board and Synchro signalized intersection procedures. The results of the analysis are contained in Figures 4, 5, 9, and 10. The level of service reports are attached.

The Shops at Meridian Ranch access to Stapleton Drive

The Shops at Meridian Ranch access to Stapleton Drive is currently stop-sign controlled. If this access remains stop-sign controlled, the southbound left-turn movement is projected to operate at LOS E during the morning peak hour and LOS F during the afternoon peak hour, based on the 2028 total traffic volumes. If the east leg of Stapleton Drive is restriped as a two-way, left-turn lane, all movements are projected to operate at LOS D or better during the peak hours through 2028. If this intersection is converted to traffic-signal control, all movements are projected to operate at LOS D or better during the peak hours through 2044. However, traffic-signal warrants may not be met in the short term.

All allowable turning movements at the proposed access to the north/south internal road are projected to operate at LOS B or better through 2044.

Stapleton Drive/Meridian Road

The intersection of Stapleton Drive/Meridian Road is currently traffic-signal controlled with protected/permitted phasing for the northbound and southbound left-turn movements only. All movements at this intersection are projected to operate at LOS D or better during the peak hours,

based on the projected short-term total traffic volumes, if protected/permitted phasing is added for the eastbound and westbound left-turn movements. By 2044, it was assumed that Briargate Parkway would be constructed between Black Forest Road and Towner Avenue and that Stapleton Drive would be improved to its final Principal Arterial cross section. Based on the projected 2044 total peak-hour traffic volumes and the lane geometry shown in Figure 9, this intersection is projected to operate at an overall LOS C or better during the peak hours.

Stapleton Drive/Meridian Ranch Boulevard

The northbound left-turn movement at the stop-sign-controlled intersection of Meridian Ranch Boulevard/Stapleton Drive is currently operating at LOS F during the morning peak hour and LOS E during the afternoon peak hour. The northbound left-turn movement is projected to operate at LOS F during both the morning and afternoon peak hours, based on the projected 2028 background traffic volumes. If this intersection is converted to traffic-signal control, all movements are projected to operate at LOS D or better during the peak hours through 2045.

SIGNAL WARRANT ANALYSIS

The Shops at Meridian Ranch access to Stapleton Drive

The Meridian Ranch Commercial and Residential Filing 4B Traffic Technical Memorandum dated July 22, 2014 included a traffic-signal warrant analysis of the Shops at Meridian Ranch access to Stapleton Drive. That analysis identified that Four-Hour and Eight-Hour Vehicular Volume traffic signal warrants would likely be met when about 55,000 square feet of retail floor space and the gas station are occupied. As currently more than 55,000 square feet of retail floor space have been constructed, besides the currently-proposed filing which includes the planned gas station, these signal warrants have been updated based on the existing traffic conditions. The satisfaction of warrants does not indicate that a signal must be installed. The decision to allow a signal to be installed rests with the County.

Tables 3 and 4 show the results of the analysis of existing conditions, projected existing plus site-generated conditions, 2028 total conditions and 2044 total condition. Table 3 assumes the southbound left-turn movement only as the “minor approach” and all of the eastbound and westbound traffic volumes (left, through, and right-turn movements) as the “major street”. Table 4 assumes the eastbound left-turn movement as the “minor approach” and only the westbound through and right-turn movements as the “major street”. The off-peak existing traffic volumes were based on traffic counts conducted by LSC in January 2023 and the off-peak site-generated future hourly volumes and 2028 background hourly volumes for the balance of the shopping center have been estimated based on vehicle time-of-day distribution data for shopping center, gas station with convenience store, and liquor store land uses published by the Institute of Transportation Engineers.

As shown in Tables 3 and 4, neither a Four-Hour nor an Eight-Hour Vehicular-Volume Traffic-Signal Warrant is projected to be met in the short term. Both the Four-Hour and Eight-

Hour Vehicular-Volume Traffic Signal Warrants are projected to be met by 2044. This traffic-signal warrant analysis should be updated with any future filings submitted within the Shops at Meridian Ranch.

Stapleton Drive/Meridian Ranch Boulevard

The intersection of Stapleton Drive/Meridian Ranch Boulevard was analyzed to determine if the Warrant 1: Eight-Hour Vehicular-Volume, Warrant 2: Four-Hour Vehicular Volume or Warrant 7: Crash Experience are currently met based on the existing, existing plus site-generated, and 2028 total conditions and the criteria contained in the *Manual of Uniform Traffic Control Devices, 11th Edition, December 2023* (MUTCD). Warrants 3, 4, 5, 6, 8, and 9 are not applicable to this intersection.

Warrant 1: Eight-Hour Vehicular Volume

Based on eight hours of traffic-count data collected at the intersection of Meridian Ranch/Stapleton on April 25, 2024, five of the hours analyzed currently meet the thresholds for an Eight-Hour Vehicular-Volume Traffic-Signal Warrant. In order for an Eight-Hour Vehicular-Volume Traffic-Signal Warrant to be satisfied, the volume threshold would need to be met for three additional hours of the day. Note that two additional hours, 11:15 a.m. to 12:15 p.m. and 1:30 p.m. to 2:30 p.m. have traffic volumes that are less than five vehicles below the threshold values. This analysis is based on a single day of data. However, the MUTCD criteria is based on an “average” day. As traffic volumes vary from day to day, it is possible that an Eight-Hour Vehicular-Volume Traffic-Signal Warrant could be shown to be currently met if additional traffic-count data for multiple days were available so that it could be determined if the “average” day is different from the volumes counted April 25, 2024. The thresholds for these two hours will likely be met with the addition of site-generated traffic. However, an eighth and final required hour to complete the total of eight required, will not likely be met without additional growth of background traffic. It is possible that an hour(s) other than the eight hours analyzed could meet or nearly meet the threshold. Based on this analysis an Eight-Hour Vehicular-Volume Traffic-Signal Warrant is either currently met or will likely be met in the short-term future.

Warrant 2: Four-Hour Vehicular Volume

Table 5 shows the results of the Four-Hour Vehicular Volume analysis. Based on eight hours of traffic-count data collected at the intersection of Stapleton Drive/Meridian Ranch Boulevard on April 25 2024, a Four-Hour Vehicular-Volume Traffic-Signal Warrant is currently met.

Warrant 7: Crash Experience

The Colorado State Patrol provided LSC with vehicle-crash data for the intersection of Stapleton Drive/Meridian Ranch Boulevard from March 2021 through March 2024. A copy of these data is attached for reference.

The highest number of reported crashes in the vicinity of this intersection in a 12-month period occurred between July 2023 and March 2024. During this time period, there were three angle crashes, none of which involved injuries or fatalities. There was one crash involving a bicycle during this period; however, the crash occurred 350 feet west of the intersection. Based on the criteria contained in Table 4C-2 of the *MUTCD*, five or more angle and pedestrian crashes of all severity or three or more fatal-and-injury angle and pedestrian crashes need to be reported for the Crash Experience warrant to be met. Based on these criteria, this warrant is not currently met.

During the three-year period four of the eight reported crashes were angle crashes and of those only one was an injury crash. Note that the crash on February 22, 2021 was not included as an “angle” crash because both vehicles were on the minor street. Based on the criteria contained in Table 4C-3 of the *MUTCD*, six or more angle and pedestrian crashes of all severity or four or more fatal-and-injury angle and pedestrian crashes need to be reported for the Crash Experience warrant to be met. Based on these criteria, this warrant is not currently met. A copy of these data is attached for reference.

RELATIVE TRAFFIC IMPACTS

Table 6 shows the impact of site-generated traffic expressed as a percentage of existing-plus-site-generated traffic on the minor approaches at the intersection of Stapleton Drive/Meridian Ranch Boulevard. As shown in Table 6, the site-generated traffic constitutes 5.9 percent of combined morning and afternoon peak-hour existing plus site-generated volumes on the northbound approach and 4.3 percent of the combined morning and afternoon peak-hour volumes affecting the vehicular-volume traffic-signal warrants (northbound left-turn, through and 50 percent of the right-turn volumes and the southbound left-turn and through volumes).

ACCESS CONFIGURATION AND CIRCULATION RECOMMENDATIONS

Figure 11 shows the recommended signing and striping plan for the internal drives.

The north/south entry drive from Stapleton and the intersecting east/west internal drive is planned, by the master developer, to be configured for east/west stop-sign control and a free northbound approach (no stop sign).

- As shown in Figure 11, stop signs should control the eastbound and westbound approaches. Supplemental signs under these stop signs should indicate that northbound (inbound) traffic has an uncontrolled/free movement and does NOT stop. Stop-line markings should be installed on the eastbound and westbound approaches (it appears that the eastbound approach stop bar already exists).

Regarding the proposed lot access to the north/south, internal/private shopping center entry drive/street (on the east side of the site) located about 165 feet north of Stapleton Drive (centerline spacing):

- This access point should be signed and marked for no entering (northbound) left turns and no exiting (eastbound) left turns.
- The north/south, internal/private shopping center entry drive/street (on the east side of the site) should be restriped as shown in Figure 11.

ROADWAY IMPROVEMENT FEE PROGRAM

The property is located in the Woodmen Road Metro District and, therefore, does not pay road impact fees to El Paso County per resolution 13-041. It is our understanding that an agreement to pay any required fees to the Metro District is in process.

CONCLUSIONS AND RECOMMENDATIONS

Trip Generation

- At buildout, the proposed gas station is expected to generate about 1,796 new external vehicle trips on the average weekday, with about half entering and half exiting the site during a 24-hour period. During the morning peak hour, about 113 vehicles would enter and 109 vehicles would exit the site. During the afternoon peak hour, about 170 vehicles would enter and 172 vehicles would exit the site.

Recommendations

- The existing eastbound left-turn lane and westbound right-turn deceleration and acceleration lane at The Shops at Meridian Ranch access to Stapleton Drive meet the criteria contained in the El Paso County *Engineering Criteria Manual*. No additional improvements are anticipated to be required on Stapleton Drive, Meridian Road, or Tourmaline Drive with the construction of the proposed gas station.
- The intersection of Stapleton/Meridian is currently traffic-signal controlled with protected/permitted phasing for the northbound and southbound left-turn movements only. Protected/permitted phasing for the eastbound and westbound left-turn movements will likely be needed in the short term to maintain an acceptable level of service for the westbound left-turn movement.
- Please refer to the section entitled "Access Configuration and Circulation Recommendations."
- The Shops at Meridian Ranch access to Stapleton Drive is **not** projected to meet either an Eight-Hour or a Four-Hour Vehicular-Volume traffic-signal warrant based on the 2028 background traffic plus projected traffic volumes associated with the development of the currently-proposed filing. This intersection is projected to operate at a satisfactory level of service (LOS D or better) during peak hours as a stop-sign-controlled intersection if Stapleton Drive is restriped with a two-way, left-turn center lane east of the access. Please refer to the attached Stapleton Drive Restriping Exhibit for details. Traffic-signal warrant(s) are anticipated to be met with buildout of the remaining vacant parcels within the Shops and

Meridian Ranch and/or growth of through traffic on Stapleton Drive. It is our understanding that the applicant will be party to a cost sharing “agreement” with the overall shopping center, The Shops at Meridian Ranch LLC, and this agreement will be added to the Association CC&Rs that allow for cost sharing of required offsite improvements such as the traffic signal. The Shops at Meridian Ranch LLC will also enter into a development agreement with the County for the installation of the signal when it is warranted.

- The northbound left-turn movement at the stop-sign-controlled intersection of Stapleton Drive/Meridian Ranch Boulevard currently operates at a LOS F during the morning peak hour and LOS E during the morning peak hour. Based on eight hours of traffic-count data collected in April 2024 this intersection is very close to meeting both a Four-Hour and an Eight-Hour Vehicular-Volume Traffic-Signal Warrant. A Four-Hour Warrant will be met with the addition of site-generated traffic and an Eight-Hour Warrant will be met based on the projected 2028 total traffic volumes. As a signal-controlled intersection, all movements at the intersection of Stapleton/Meridian Ranch are projected to operate at LOS D or better through 2045.
- Table 1 presents the relative site-generated traffic impacts at the intersection of Meridian Ranch Boulevard/Stapleton Drive.
- The property is located in the Woodmen Road Metro District and, therefore, does not pay road impact fees to El Paso County per resolution 13-041. It is our understanding that an agreement to pay any required fees to the Metro District is in process.

* * * * *

Please contact me if you have any questions regarding this report.

Respectfully Submitted,

LSC TRANSPORTATION CONSULTANTS, INC.

By: Jeffrey C. Hodsdon, P.E.
Principal

JCH/KDF:jas

Enclosures: Tables 2-6
Figures 1-10
Traffic Count Reports
Level of Service Reports
MTCP Maps
Crash History
Appendix Table 1
Stapleton Drive Restriping Exhibit

Tables 2-4



Table 2
Trip Generation Estimate
The Shops at Meridian Ranch Lot 2, Filing 1

Lot	Land Use Code	Land Use Description	Trip Generation Units	Trip Generation Rates ⁽¹⁾				Total Trips Generated				Internal Trips	Total External Trips Generated					Pass-By Trips ⁽²⁾	New External Trips Generated Average Weekday Traffic			
				Average Weekday Traffic	Morning Peak Hour In	Morning Peak Hour Out	Afternoon Peak Hour In	Afternoon Peak Hour Out	Average Weekday Traffic	Morning Peak Hour In	Morning Peak Hour Out		Afternoon Peak Hour In	Afternoon Peak Hour Out	Average Weekday Traffic	Morning Peak Hour In	Morning Peak Hour Out			Afternoon Peak Hour In	Afternoon Peak Hour Out	
Currently Proposed Land Use																						
2	945	Gasoline/Service Station with Convenience Market (VFP ⁽³⁾ 9-15)	4.0 KSF ⁽⁴⁾	700.43	28.26	28.26	27.26	27.26	2,802	113	113	109	109	5%	2,662	107	107	104	104	56%	1,171	
	899	Liquor Store	7.5 KSF	107.21	0.47	0.12	8.31	8.31	804	3	1	62	63	2.75%	782	3	1	60	61	34%	516	
	821	Shopping Plaza (40-150 KSF With No Supermarket)	2.5 KSF	67.52	1.07	0.66	2.54	2.65	169	3	1	6	7	2.75%	164	3	1	6	7	34%	108	
			14.0 KSF												3,608	113	109	170	172		1,796	
For Reference Only:																						
Existing Land Use																						
3	821	Shopping Plaza (40-150 KSF With No Supermarket)	29.260 KSF	67.52	1.07	0.66	2.54	2.65	1,976	31	19	74	77	2.75%	1,921	31	19	72	75	34%	1,268	
4D	821	Shopping Plaza (40-150 KSF With No Supermarket)	17.352 KSF	67.52	1.07	0.66	2.54	2.65	1,172	19	11	44	46	2.75%	1,139	18	11	43	45	34%	752	
4E	821	Shopping Plaza (40-150 KSF With No Supermarket)	11.415 KSF	67.52	1.07	0.66	2.54	2.65	771	12	8	29	30	2.75%	750	12	7	28	29	34%	495	
		Existing Total	58.027 KSF												3,810	61	37	144	149		2,515	
															Existing Plus Currently Proposed	7,418	174	146	314	321		4,310
Future Land Use																						
1	821	Shopping Plaza (40-150 KSF With No Supermarket)	13 KSF	67.52	1.07	0.66	2.54	2.65	878	14	9	33	34	2.75%	854	14	8	32	33	34%	563	
2	821	Shopping Plaza (40-150 KSF With No Supermarket)	5.4 KSF	67.52	1.07	0.66	2.54	2.65	365	6	4	14	14	2.75%	355	6	3	13	14	34%	234	
		Future Total	18.400 KSF												1,208	19	12	46	47		797	
		Background Total (not including the Lot 2, Filing 1)	76.427 KSF												5,018	80	49	189	197		3,312	
															Buildout Total	8,626	193	158	359	368		5,108
Trip Generation Estimate Shown in the Meridian Ranch Commercial and Residential Filing 4B Traffic Technical Memorandum by LSC, July 11, 2014																						
---	820	Shopping Center	90 KSF	70.46	0.98	0.63	3.23	3.36	6,342	88	56	290	302	2.75%	6,167	86	55	282	294	34%	4,070	
	945	Gasoline/Service Station with Convenience Market	20 VFP	162.78	5.08	5.08	6.76	6.76	3,256	102	102	135	135	5%	3,093	97	97	128	128	56%	1,361	
									9,597	190	158	426	437		9,260	182	151	411	422		5,431	
															Change in Trip Generation Estimate	-634	10	6	-52	-54		-323

Notes:
(1) Source: "Trip Generation, 11th Edition, 2021" by the Institute of Transportation Engineers (ITE)
(2) Source: "Trip Generation Handbook - An ITE Proposed Recommended Practice, 3rd Edition, 2017" by ITE
(3) VFP = vehicle fueling position
(4) KSF = thousand square feet

Table 3
Traffic Signal Warrant Analysis
 Shops at Meridian Ranch Access/Stapleton Drive
 Shops at Meridian Ranch Lot 2 Filing No. 1

Warrant Analysis⁽¹⁾

Hour	Traffic Volumes (vehicles per hour)		Warrant 1: Eight Hour Vehicular Volume Evaluation						Warrant 2: Four Hour Vehicular Volume	
			Warrant Thresholds				Warrant Threshold Met?		70% Warrant Threshold Minimum	Warrant Threshold Met?
	Major ⁽²⁾	Minor Leg ⁽³⁾	Condition A (70%)		Condition B (70%)		North Leg			
			Major	Minor	Major	Minor	Condition A	Condition B	North Leg	

Existing Traffic

6:30 AM	767	6	350	105	525	53	No	No	70	No
7:30 AM	798	11	350	105	525	53	No	No	70	No
8:30 AM	474	12	350	105	525	53	No	No	160	No
11:45 AM	428	21	350	105	525	53	No	No	160	No
12:45 PM	422	26	350	105	525	53	No	No	160	No
1:45 PM	457	17	350	105	525	53	No	No	160	No
3:00 PM	826	19	350	105	525	53	No	No	60	No
4:00 PM	780	36	350	105	525	53	No	No	70	No
5:00 PM	796	27	350	105	525	53	No	No	70	No

Numbers of Hours the Warrant Thresholds Are Met	0	0	0
Warrant Met?	No		No

Existing Plus Site-Generated Traffic

6:30 AM	809	34	350	105	525	53	No	No	60	No
7:30 AM	852	47	350	105	525	53	No	No	60	No
8:30 AM	530	49	350	105	525	53	No	No	125	No
11:45 AM	492	72	350	105	525	53	No	No	160	No
12:45 PM	487	75	350	105	525	53	No	No	160	No
1:45 PM	529	71	350	105	525	53	No	Yes	125	No
3:00 PM	912	83	350	105	525	53	No	Yes	60	Yes
4:00 PM	867	100	350	105	525	53	No	Yes	60	Yes
5:00 PM	899	102	350	105	525	53	No	Yes	60	Yes

Numbers of Hours the Warrant Thresholds Are Met	0	4	3
Warrant Met?	No		No

2028 Total Traffic

6:30 AM	929	34	350	105	525	53	No	No	60	No
7:30 AM	972	47	350	105	525	53	No	No	60	No
8:30 AM	594	49	350	105	525	53	No	No	125	No
11:45 AM	556	76	350	105	525	53	No	Yes	125	No
12:45 PM	548	79	350	105	525	53	No	Yes	125	No
1:45 PM	599	75	350	105	525	53	No	Yes	125	No
3:00 PM	1035	87	350	105	525	53	No	Yes	60	Yes
4:00 PM	981	104	350	105	525	53	No	Yes	60	Yes
5:00 PM	1016	106	350	105	525	53	Yes	Yes	60	Yes

Numbers of Hours the Warrant Thresholds Are Met	1	6	3
Warrant Met?	No		No

2044 Total Traffic

6:30 AM	1150	36	350	105	525	53	No	No	60	No
7:30 AM	1161	53	350	105	525	53	No	Yes	60	No
8:30 AM	706	58	350	105	525	53	No	Yes	70	No
11:45 AM	808	89	350	105	525	53	No	Yes	60	Yes
12:45 PM	792	92	350	105	525	53	No	Yes	70	Yes
1:45 PM	852	88	350	105	525	53	No	Yes	60	Yes
3:00 PM	1474	100	350	105	525	53	No	Yes	60	Yes
4:00 PM	1390	117	350	105	525	53	Yes	Yes	60	Yes
5:00 PM	1414	119	350	105	525	53	Yes	Yes	60	Yes

Numbers of Hours the Warrant Thresholds Are Met	2	8	6
Warrant Met?	Yes		Yes

Notes:

- (1) Thresholds are based on 1 lane on the major approach and 1 lane on the minor approach with the 70% factor applied for a posted speed limit above 40 mph
- (2) The major street traffic includes all movements (left, through, and right) on Stapleton Drive
- (3) The minor street traffic includes left-turn volume only from the Shops at Meridian Ranch access

Table 4
Traffic Signal Warrant Analysis
With The Eastbound Left-Turn as the Minor Approach

Existing and Projected 2028 Total Traffic Conditions
Shops at Meridian Ranch Access/Stapleton Drive
Shops at Meridian Ranch Lot 2 Filing No. 1

Warrant Analysis⁽¹⁾

Hour	Traffic Volumes (vehicles per hour)		Warrant 1: Eight Hour Vehicular Volume Evaluation						Warrant 2: Four Hour Vehicular Volume	
			Warrant Thresholds				Warrant Threshold Met?		70% Warrant Threshold Minimum	Warrant Threshold Met? Minor (EB LT)
	Major ⁽²⁾ (WB Only)	Minor ⁽³⁾ (EB LT)	Condition A (70%)		Condition B (70%)		North Leg			
			Major (WB)	Minor (EB LT)	Major (WB)	Minor (EB LT)	Condition A	Condition B		

Existing Traffic

6:30 AM	543	11	350	105	525	53	No	No	125	No
7:30 AM	436	23	350	105	525	53	No	No	160	No
8:30 AM	254	46	350	105	525	53	No	No	Low Vol	No
11:45 AM	217	31	350	105	525	53	No	No	Low Vol	No
12:45 PM	217	42	350	105	525	53	No	No	Low Vol	No
1:45 PM	199	21	350	105	525	53	No	No	Low Vol	No
3:00 PM	367	42	350	105	525	53	No	No	205	No
4:00 PM	349	46	350	105	525	53	No	No	205	No
5:00 PM	311	44	350	105	525	53	No	No	205	No

Numbers of Hours the Warrant Thresholds Are Met	0	0	0
Warrant Met?	No		No

Existing Plus Site-Generated Traffic

6:30 AM	551	65	350	105	525	53	No	Yes	125	No
7:30 AM	446	92	350	105	525	53	No	No	160	No
8:30 AM	264	117	350	105	525	53	No	No	Low Vol	No
11:45 AM	230	121	350	105	525	53	No	No	Low Vol	No
12:45 PM	230	133	350	105	525	53	No	No	Low Vol	No
1:45 PM	213	120	350	105	525	53	No	No	Low Vol	No
3:00 PM	385	156	350	105	525	53	Yes	No	205	No
4:00 PM	367	161	350	105	525	53	Yes	No	205	No
5:00 PM	332	179	350	105	525	53	No	No	205	No

Numbers of Hours the Warrant Thresholds Are Met	2	1	0
Warrant Met?	No		No

2028 Total Traffic

6:30 AM	637	65	350	105	525	53	No	Yes	90	No
7:30 AM	512	92	350	105	525	53	No	No	125	No
8:30 AM	300	117	350	105	525	53	No	No	205	No
11:45 AM	265	123	350	105	525	53	No	No	Low Vol	No
12:45 PM	265	135	350	105	525	53	No	No	Low Vol	No
1:45 PM	245	122	350	105	525	53	No	No	Low Vol	No
3:00 PM	442	158	350	105	525	53	Yes	No	160	No
4:00 PM	420	163	350	105	525	53	Yes	No	160	Yes
5:00 PM	379	181	350	105	525	53	Yes	No	205	No

Numbers of Hours the Warrant Thresholds Are Met	3	1	1
Warrant Met?	No		No

Notes:

- (1) Thresholds are based on 1 lane on the major approach and 1 lane on the minor approach with the 70% factor applied for a posted speed limit above 40 mph
- (2) The major street traffic includes only the westbound through and right-turn movements on Stapleton Drive
- (3) The minor street traffic includes the eastbound left-turn (EB LT) volume only

Table 5
Traffic Signal Warrant Analysis
 Stapleton Drive/Meridian Ranch Boulevard

Warrant Analysis ⁽¹⁾														
Warrant 1: Eight Hour Vehicular Volume Evaluation											Warrant 2: Four Hour Vehicular Volume Evaluation			
Hour	Major Stapleton ⁽²⁾	Minor 1 Meridian Ranch NB ⁽³⁾	Minor 2 Meridian Ranch SB ⁽⁴⁾	Warrant Thresholds				Warrant Threshold Met?				70% Warrant Threshold Minor Minimum	Warrant Threshold Met?	
				Condition A (70%)		Condition B (70%)		Condition A		Condition B			NB	SB
				Major	Minor	Major	Minor	NB	SB	NB	SB			
Existing Traffic														
6:30 AM	682	102	55	350	140	525	70	No	No	Yes	No	105	---	---
6:55 AM	843	112	52	350	140	525	70	---	---	---	---	80	Yes	No
7:30 AM	675	90	38	350	140	525	70	No	No	Yes	No	108	---	---
11:15 AM	539	65	25	350	140	525	70	No	No	Approaching	Approaching	151	No	No
12:15 PM	489	66	36	350	140	525	70	No	No	No	No	171	No	No
1:30 PM	522	74	74	350	140	525	70	No	No	Approaching	Approaching	157	No	No
2:30 PM	882	91	60	350	140	525	70	No	No	Yes	No	80	Yes	No
4:00 PM	795	92	41	350	140	525	70	No	No	Yes	No	81	Yes	No
5:00 PM	828	94	26	350	140	525	70	No	No	Yes	No	80	Yes	No

0	5	4
No	No	Yes

Existing Plus Site-Generated Traffic														
6:30	692	106	55	350	140	525	70	No	No	Yes	No	102	Yes	No
7:30	688	95	38	350	140	525	70	No	No	Yes	No	104	No	No
11:15	553	72	25	350	140	525	70	No	No	Yes	No	146	No	No
12:15	504	73	36	350	140	525	70	No	No	No	No	164	No	No
13:30	537	81	74	350	140	525	70	No	No	Yes	Yes	152	No	No
14:30	900	99	60	350	140	525	70	No	No	Yes	No	80	Yes	No
16:00	815	101	41	350	140	525	70	No	No	Yes	No	80	Yes	No
17:00	853	105	26	350	140	525	70	No	No	Yes	No	80	Yes	No

0	7	4
No	No	Yes

2028 Total Traffic														
6:30	752	106	55	350	140	525	70	No	No	Yes	No	90	Yes	No
7:30	741	95	38	350	140	525	70	No	No	Yes	No	92	Yes	No
11:15	583	74	25	350	140	525	70	No	No	Yes	No	136	No	No
12:15	538	75	36	350	140	525	70	No	No	Yes	No	152	No	No
13:30	567	83	74	350	140	525	70	No	No	Yes	Yes	142	No	No
14:30	958	101	60	350	140	525	70	No	No	Yes	No	80	Yes	No
16:00	861	103	41	350	140	525	70	No	No	Yes	No	80	Yes	No
17:00	896	107	26	350	140	525	70	No	No	Yes	No	80	Yes	No

0	8	5
No	Yes	Yes

Notes:
 (1) Thresholds are based on 1 lane on the major approach and 2 or more lanes on the minor approach with the 70% factor applied for a posted speed limit above 40 mph
 (2) The major street traffic includes all movements (left, through, and right)
 (3) The minor street traffic for the northbound approach includes left, through, and half of right-turn volumes from the minor street
 (4) The minor street traffic for the southbound approach includes only the left and through volumes from the minor street. The southbound right-turn volumes were excluded as there is an existing exclusive right-turn deceleration lane and an existing southbound to westbound right-turn acceleration lane

Table 6
Percent Impact
Stapleton Drive/Meridian Ranch Boulevard
The Shops at Meridian Ranch Lot 2, Filing 1

	Northbound Approach					Southbound Approach					Traffic Signal Minor Approach Volumes ⁽¹⁾ (vph)
	Left (vph)	Through (vph)	Right (vph)	Total (vph)	Left/Through & 50% of Right (vph)	Left (vph)	Through (vph)	Right (vph)	Total (vph)	Left & Through Only (vph)	
Stapleton Drive/Meridian Ranch Boulevard											
AM Peak Hour											
Existing Volume (vph)	83	16	26	125	112	24	28	104	156	52	164
Site-Generated Volume (vph)	5	0	0	5	5	0	0	3	3	0	5
Existing Plus Site-Generated (vph)	88	16	26	130	117	24	28	107	159	52	169
% of Existing Plus Site-Generated	5.7%	0.0%	0.0%	3.8%	4.3%	0.0%	0.0%	2.8%	1.9%	0.0%	3.0%
PM Peak Hour											
Existing Volume (vph)	68	37	12	117	111	15	22	75	112	37	148
Site-Generated Volume (vph)	9	0	0	9	9	0	0	4	4	0	9
Existing Plus Site-Generated (vph)	77	37	12	126	120	15	22	79	116	37	157
% of Existing Plus Site-Generated	11.7%	0.0%	0.0%	7.1%	7.5%	0.0%	0.0%	5.1%	3.4%	0.0%	5.7%
AM & PM Peak Hour											
Existing Volume (vph)	151	53	38	242	223	39	50	179	268	89	312
Site-Generated Volume (vph)	14	0	0	14	14	0	0	7	7	0	14
Existing Plus Site-Generated (vph)	165	53	38	256	237	39	50	186	275	89	326
% of Existing Plus Site-Generated	8.5%	0.0%	0.0%	5.5%	5.9%	0.0%	0.0%	3.8%	2.5%	0.0%	4.3%

Notes:

(1) The northbound minor approach volume used in the traffic signal warrant analysis included the left turn volume, the through volumes and 50% of the right-turn volume.

The southbound minor approach volume used in the traffic signal warrant analysis included the left turn volume and the through volumes only.

Figures 1-10



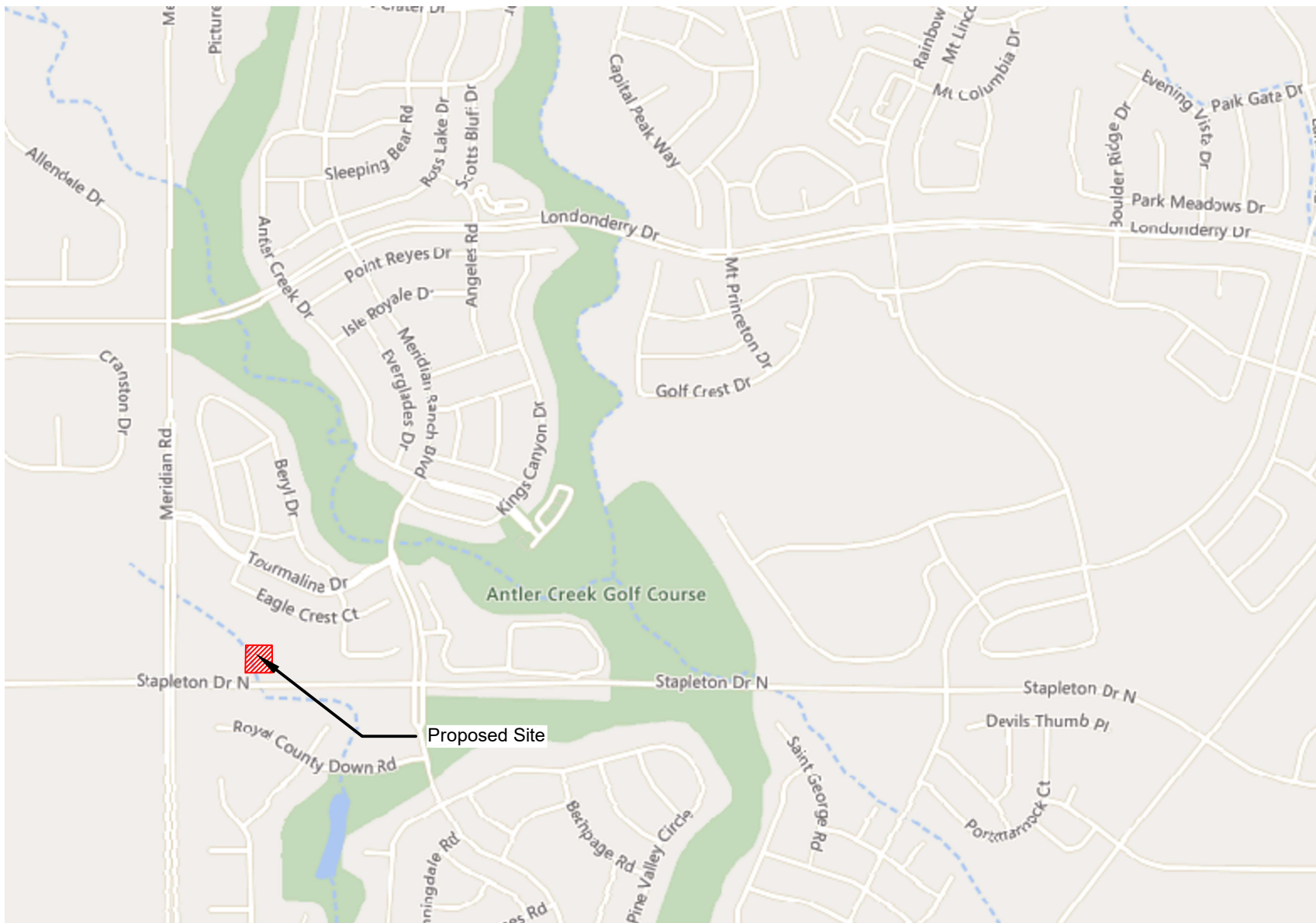

Not to scale



Figure 1
Vicinity Map

The Shops at Meridian Ranch Lot 2 Filing No. 1 (LSC# S234020)



Approximate
Scale
1" = 250'

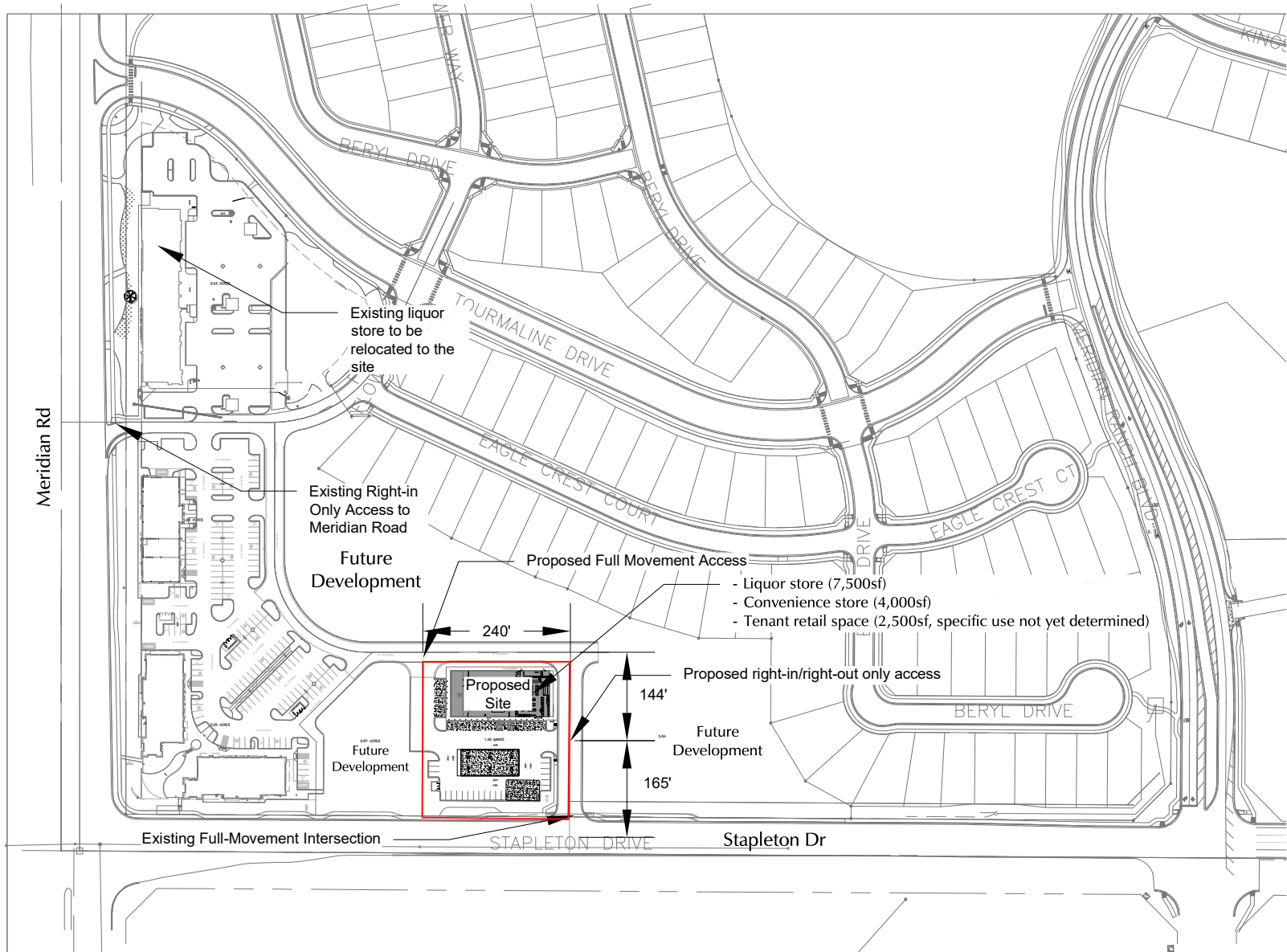
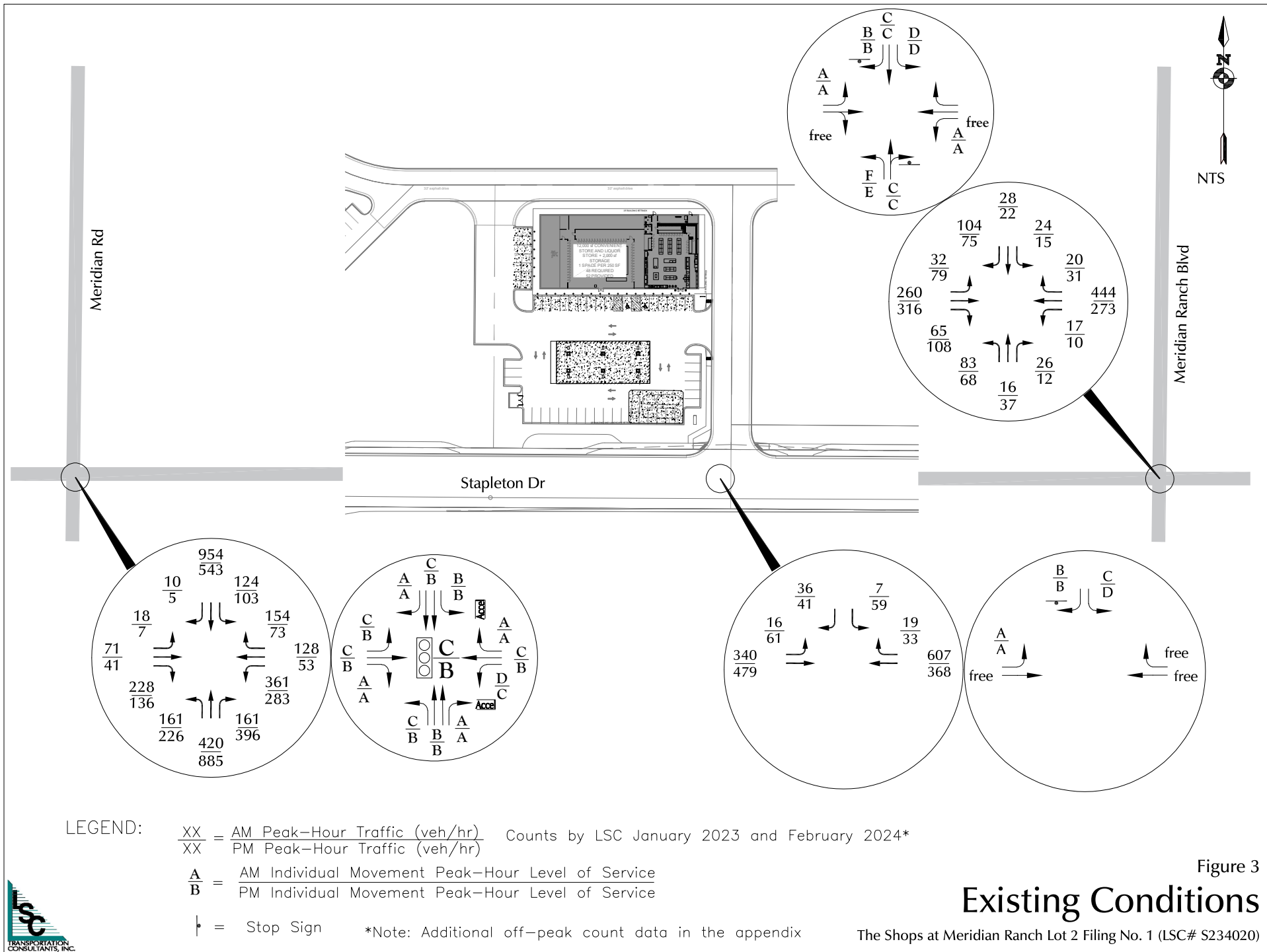
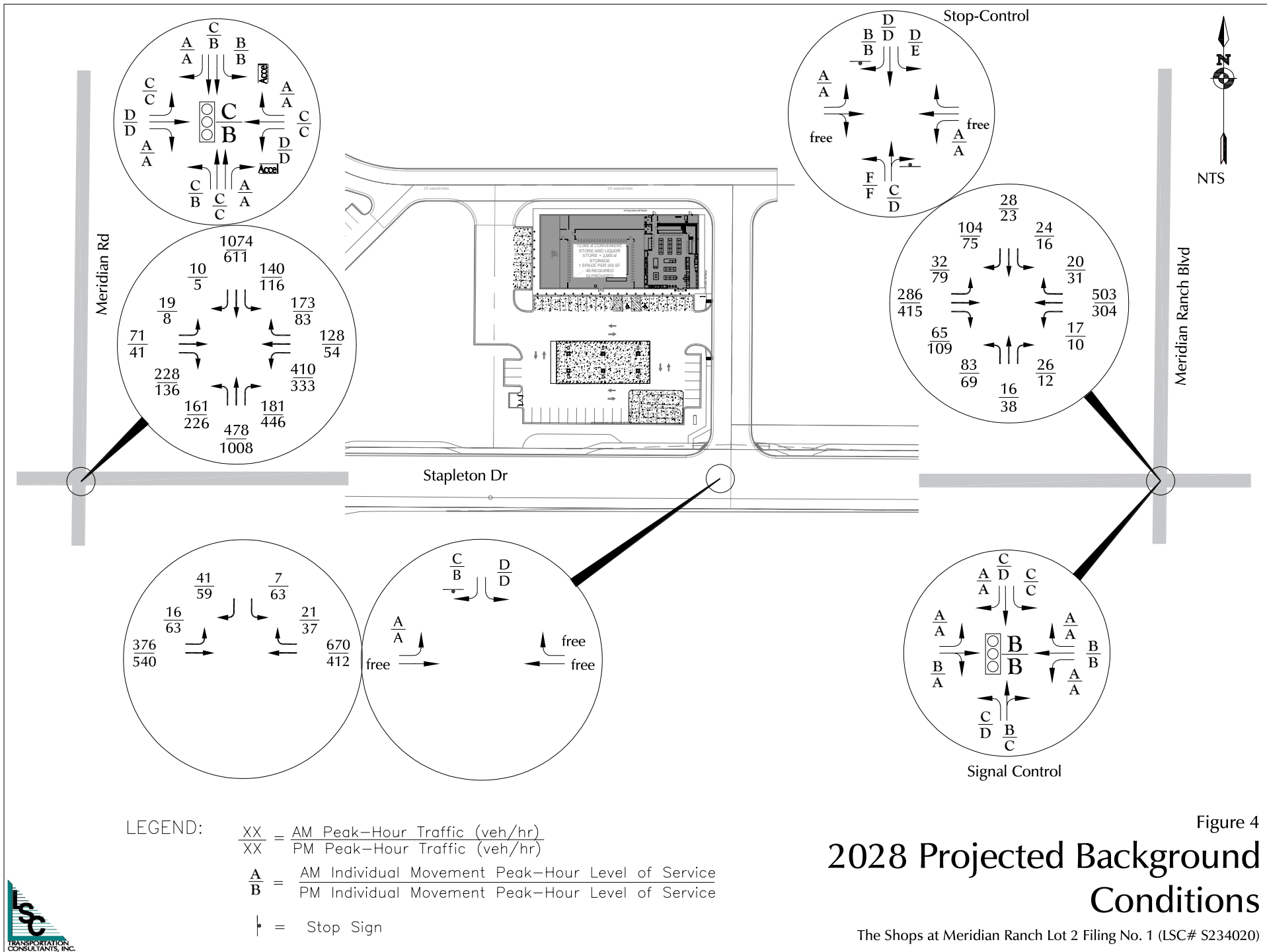
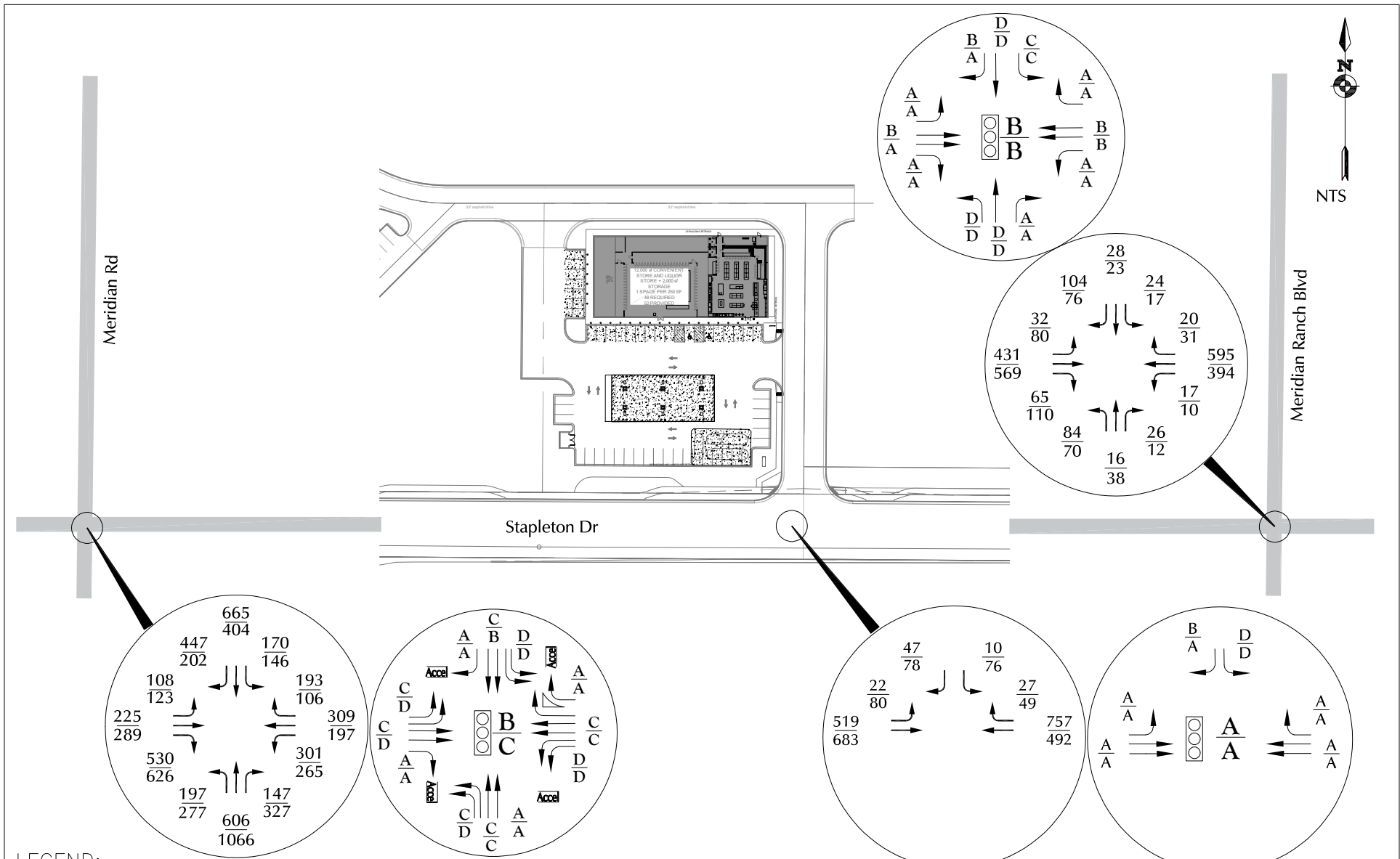

Figure 2
Site Plan

The Shops at Meridian Ranch Lot 2 Filing No. 1 (LSC# S234020)







LEGEND:

$\frac{XX}{XX}$ = AM Peak-Hour Traffic (veh/hr)
 XX = PM Peak-Hour Traffic (veh/hr)

$\frac{A}{B}$ = $\frac{\text{AM Individual Movement Peak-Hour Level of Service}}{\text{PM Individual Movement Peak-Hour Level of Service}}$

$\frac{C}{D}$ = $\frac{\text{AM Entire Intersection Peak-Hour Level of Service}}{\text{PM Entire Intersection Peak-Hour Level of Service}}$



= Stop Sign = Traffic Signal

2044 Background Conditions

The Shops at Meridian Ranch Lot 2 Filing No. 1 (LSC# S234020)

Figure 5

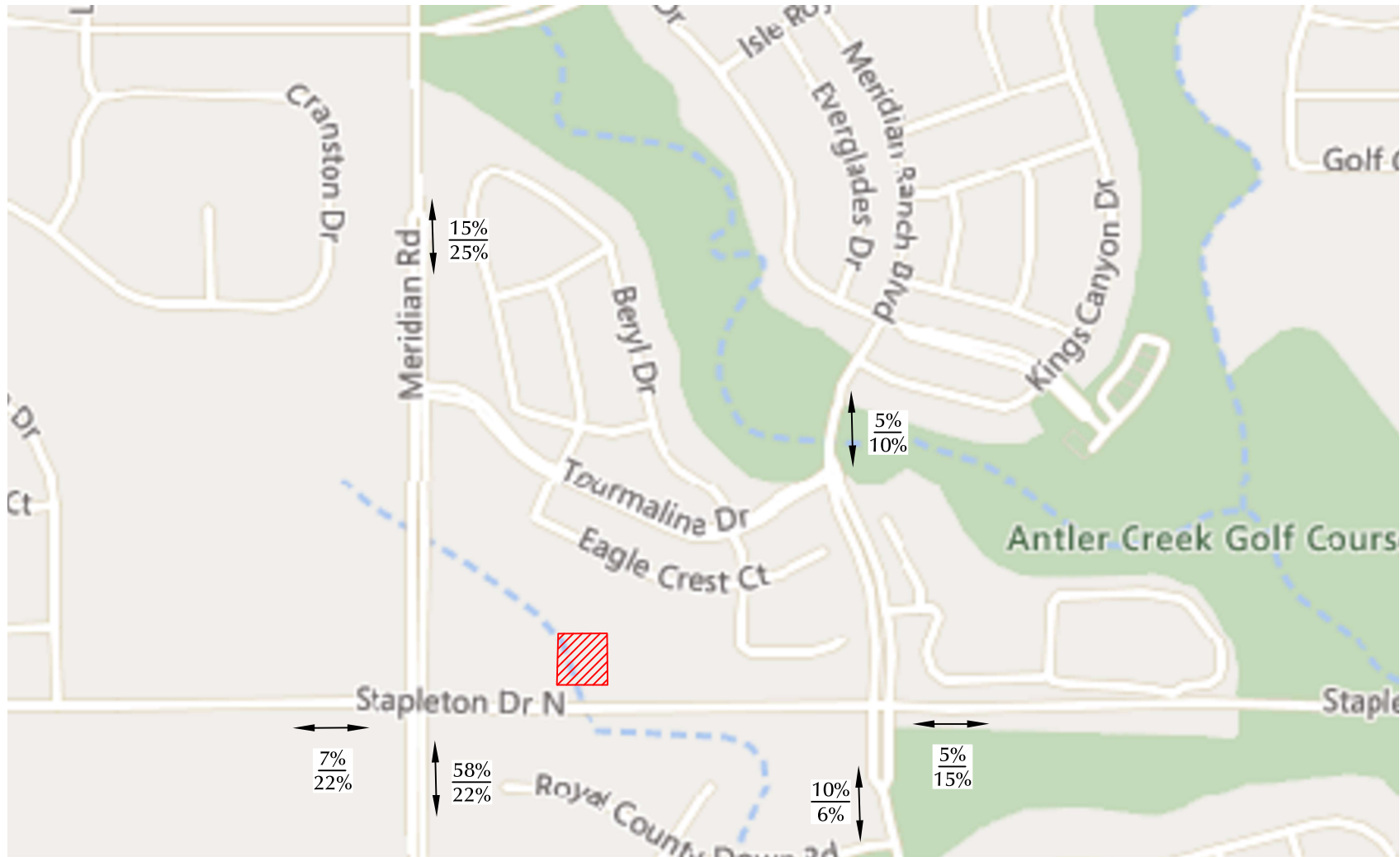

Not to scale



$$\frac{XX\%}{XX\%} = \frac{\text{Short-Term Percent Directional Distribution}}{\text{Long-Term Percent Directional Distribution}}$$

Note: Passby trips have been assigned separately - generally based on the magnitude and direction of traffic on the adjacent Stapleton Drive.

Figure 6
**Estimated Directional Distribution
of Site-Generated Traffic**

The Shops at Meridian Ranch Lot 2 Filing No. 1 (LSC# S234020)



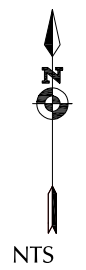
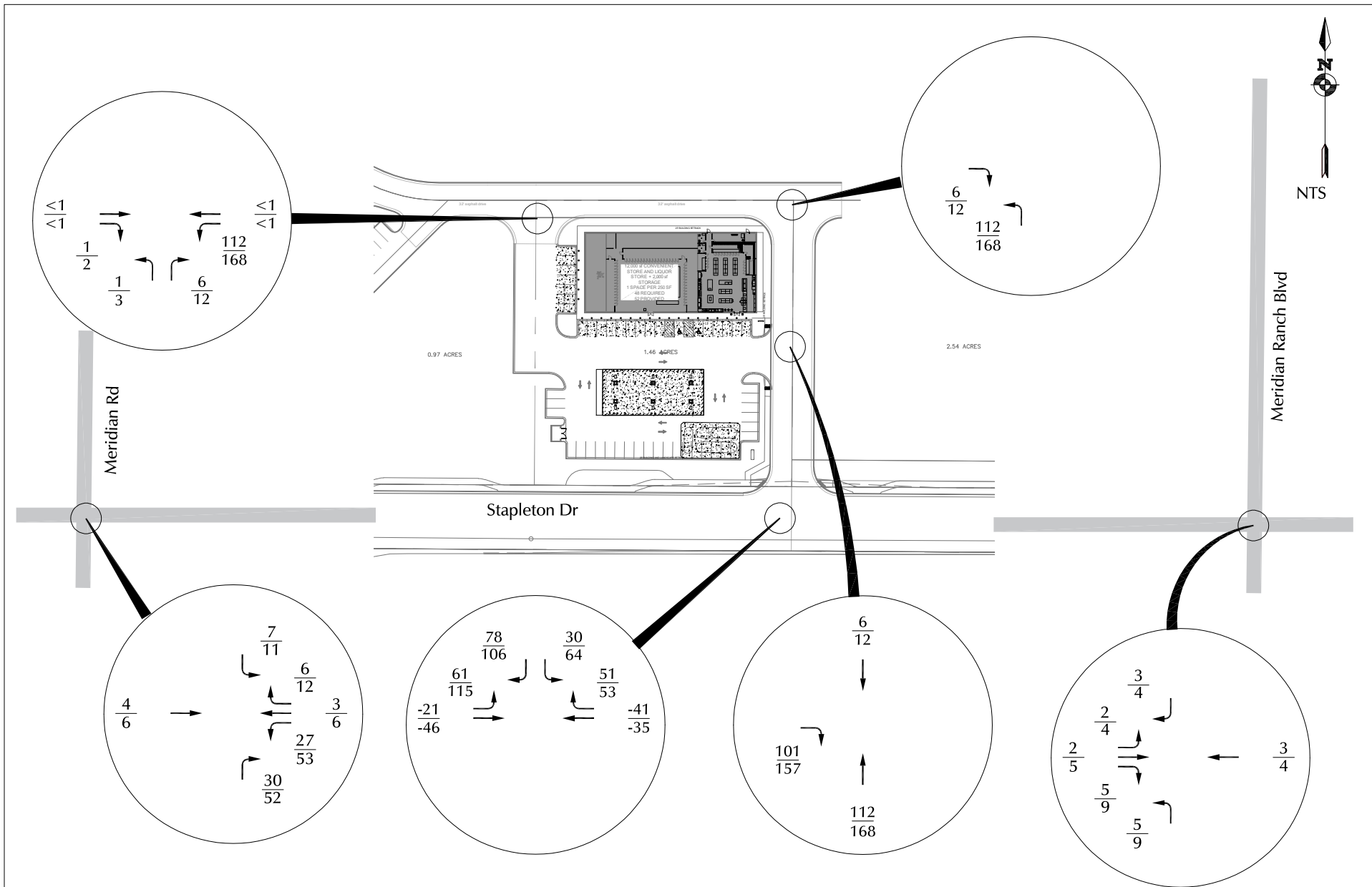

LEGEND: $\frac{XX}{XX}$ = AM Peak-Hour Traffic (veh/hr)
 $\frac{XX}{XX}$ = PM Peak-Hour Traffic (veh/hr)

Figure 7
Short-Term Site-Generated Traffic
 The Shops at Meridian Ranch Lot 2 Filing No. 1 (LSC# S234020)



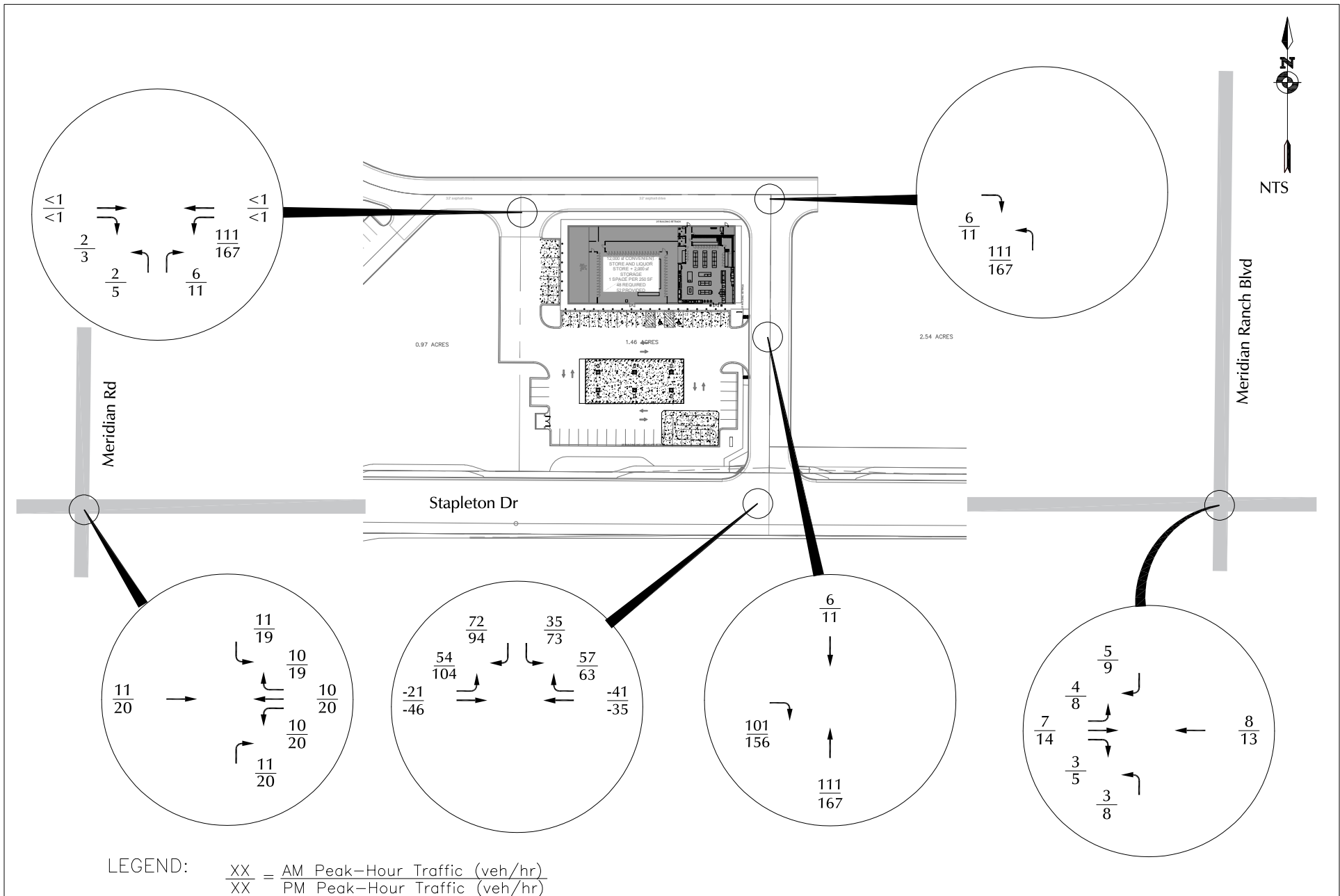

Figure 8
Long-Term Site-Generated Traffic
 The Shops at Meridian Ranch Lot 2 Filing No. 1 (LSC# S234020)

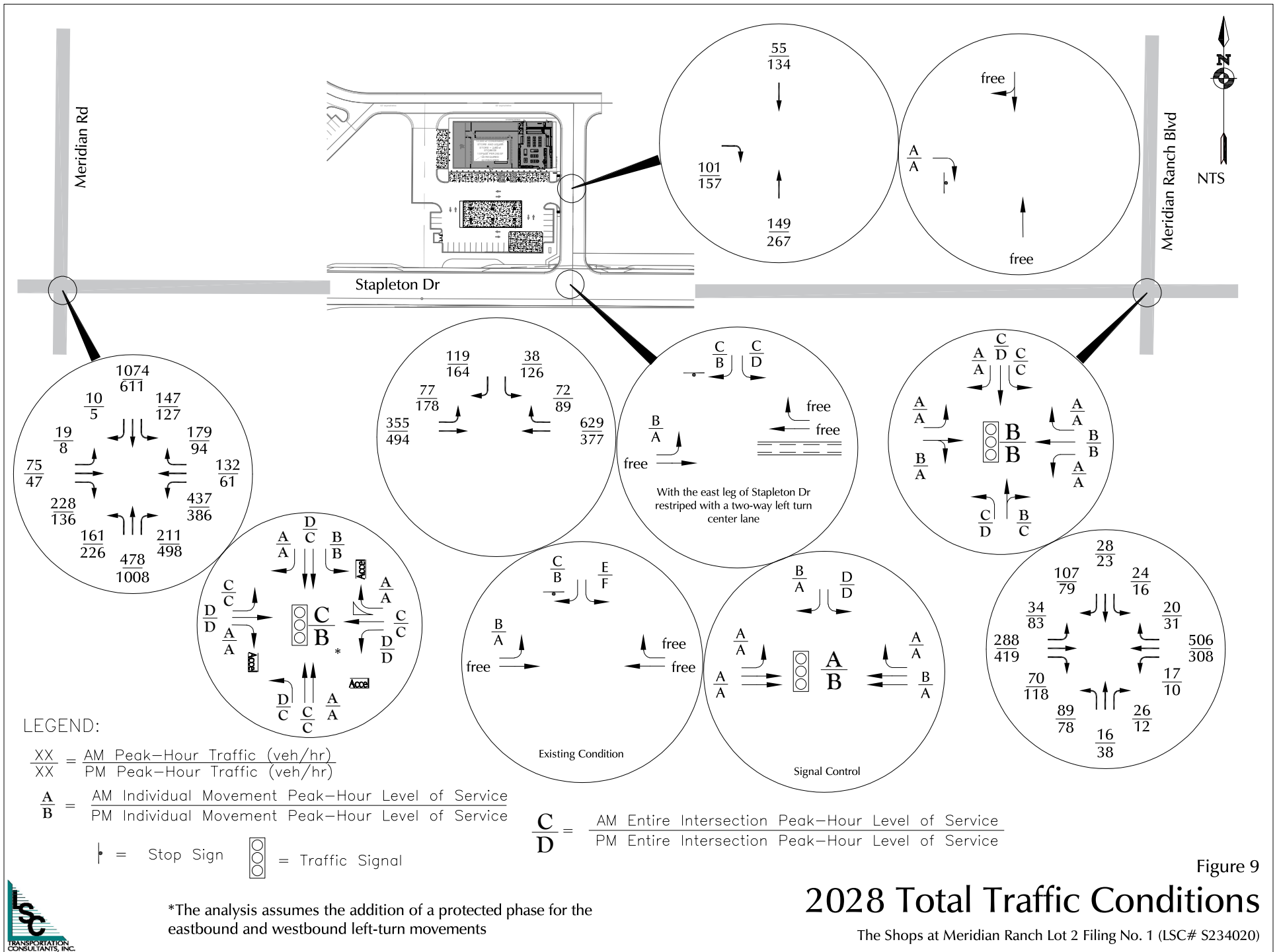

Figure 9

2028 Total Traffic Conditions

The Shops at Meridian Ranch Lot 2 Filing No. 1 (LSC# S234020)

*The analysis assumes the addition of a protected phase for the eastbound and westbound left-turn movements



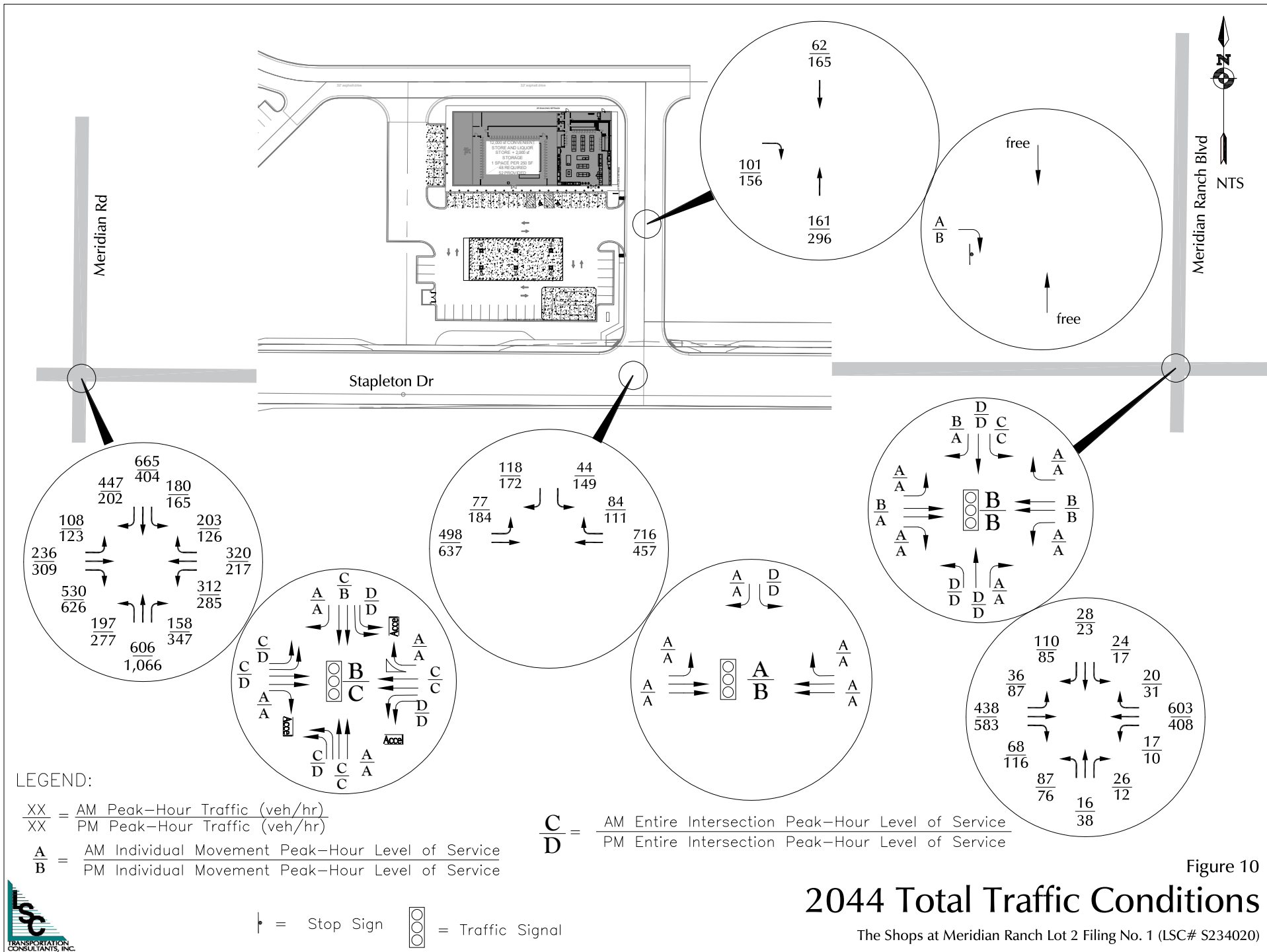

Figure 10
2044 Total Traffic Conditions

The Shops at Meridian Ranch Lot 2 Filing No. 1 (LSC# S234020)

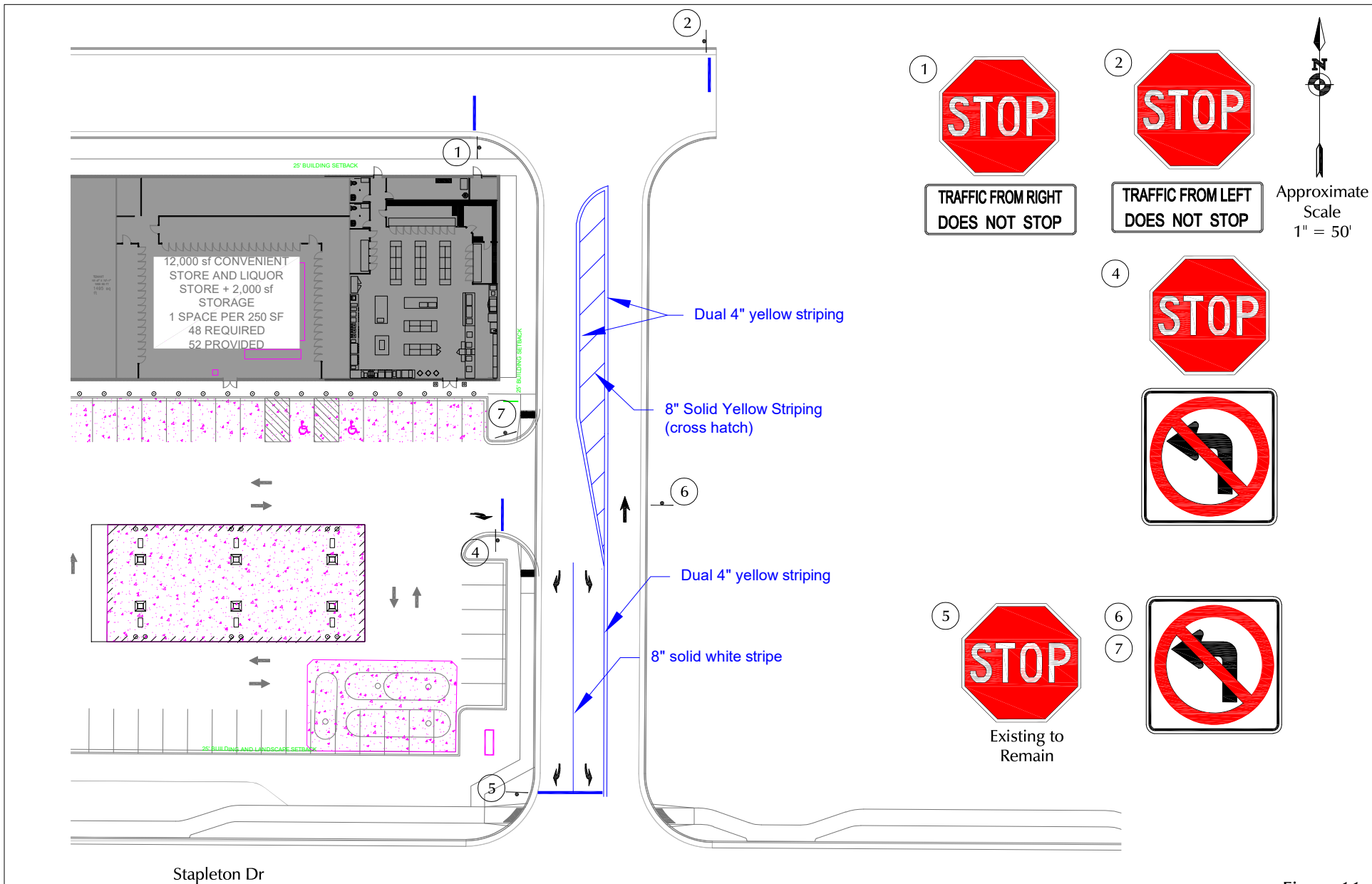

Figure 11
 Access Drive Signing & Pavement
 Markings Recommendations

(Concept only - not
 for construction)

The Shops at Meridian Ranch Lot 2 (LSC# S234020)

Traffic Counts



LSC Transportation Consultants, Inc.

2504 E. Pikes Peak Ave, Suite 304
 Colorado Springs, CO 80909
 719-633-2868

File Name : Meridian Rd - Stapleton Rd AM 2-29-24

Site Code : S234020

Start Date : 2/29/2024

Page No : 1

Groups Printed- Unshifted

Start Time	Meridian Rd Southbound					Stapleton Dr Westbound					Meridian Rd Northbound					Stapleton Dr Eastbound					Int. Total
	Right	Thru	Left	Peds	App. Total	Right	Thru	Left	Peds	App. Total	Right	Thru	Left	Peds	App. Total	Right	Thru	Left	Peds	App. Total	
06:30	0	47	5	0	52	4	1	28	0	33	6	9	6	0	21	16	1	0	0	17	123
06:35	1	63	5	0	69	6	2	23	0	31	7	16	2	0	25	16	2	0	0	18	143
06:40	0	60	2	0	62	3	0	24	0	27	5	17	3	0	25	23	3	0	0	26	140
06:45	0	66	3	0	69	1	2	33	0	36	6	23	9	0	38	13	6	1	0	20	163
06:50	0	65	4	0	69	6	2	39	0	47	13	19	3	0	35	10	6	0	0	16	167
06:55	0	66	5	0	71	9	1	30	0	40	12	15	4	0	31	16	3	0	0	19	161
Total	1	367	24	0	392	29	8	177	0	214	49	99	27	0	175	94	21	1	0	116	897
07:00	1	63	7	0	71	7	3	34	0	44	12	11	12	0	35	21	7	1	0	29	179
07:05	0	83	6	0	89	9	16	39	0	64	16	21	9	0	46	16	3	2	0	21	220
07:10	1	74	12	0	87	8	4	31	0	43	17	29	17	0	63	22	6	0	0	28	221
07:15	0	53	8	0	61	9	15	45	0	69	15	21	14	0	50	17	6	1	0	24	204
07:20	1	100	8	0	109	12	12	22	0	46	11	40	15	0	66	25	9	1	0	35	256
07:25	1	70	7	0	78	15	29	30	0	74	8	28	23	0	59	36	10	2	0	48	259
07:30	1	85	15	0	101	16	17	32	0	65	14	37	25	0	76	9	5	5	0	19	261
07:35	1	88	8	0	97	25	22	29	0	76	9	31	16	0	56	21	7	0	0	28	257
07:40	2	96	7	0	105	18	2	30	0	50	12	50	13	0	75	23	8	1	0	32	262
07:45	2	80	20	0	102	22	7	30	0	59	9	40	6	0	55	19	7	3	0	29	245
07:50	0	76	10	0	86	11	4	29	0	44	16	44	10	0	70	14	6	2	0	22	222
07:55	1	87	15	0	103	6	0	19	0	25	20	37	6	0	63	7	3	1	0	11	202
Total	11	955	123	0	1089	158	131	370	0	659	159	389	166	0	714	230	77	19	0	326	2788
08:00	0	62	8	0	70	3	0	25	0	28	14	42	7	0	63	19	1	0	0	20	181
08:05	0	44	9	0	53	6	3	28	0	37	9	33	6	0	48	5	1	0	0	6	144
08:10	0	59	10	0	69	8	1	16	0	25	16	40	9	0	65	5	0	0	0	5	164
08:15	0	50	3	0	53	9	1	37	0	47	17	30	2	0	49	12	1	1	0	14	163
08:20	1	60	7	0	68	4	1	26	0	31	20	20	8	0	48	13	3	0	0	16	163
08:25	0	67	7	0	74	6	1	23	0	30	16	27	5	0	48	12	0	0	0	12	164
Grand Total	13	1664	191	0	1868	223	146	702	0	1071	300	680	230	0	1210	390	104	21	0	515	4664
Apprch %	0.7	89.1	10.2	0		20.8	13.6	65.5	0		24.8	56.2	19	0		75.7	20.2	4.1	0		
Total %	0.3	35.7	4.1	0	40.1	4.8	3.1	15.1	0	23	6.4	14.6	4.9	0	25.9	8.4	2.2	0.5	0	11	

LSC Transportation Consultants, Inc.

2504 E. Pikes Peak Ave, Suite 304
 Colorado Springs, CO 80909
 719-633-2868

File Name : Meridian Rd - Stapleton Rd AM 2-29-24

Site Code : S234020

Start Date : 2/29/2024

Page No : 2

Start Time	Meridian Rd Southbound					Stapleton Dr Westbound					Meridian Rd Northbound					Stapleton Dr Eastbound					Int. Total
	Right	Thru	Left	Peds	App. Total	Right	Thru	Left	Peds	App. Total	Right	Thru	Left	Peds	App. Total	Right	Thru	Left	Peds	App. Total	
Peak Hour Analysis From 06:30 to 08:25 - Peak 1 of 1																					
Peak Hour for Entire Intersection Begins at 07:05																					
07:05	0	83	6	0	89	9	16	39	0	64	16	21	9	0	46	16	3	2	0	21	220
07:10	1	74	12	0	87	8	4	31	0	43	17	29	17	0	63	22	6	0	0	28	221
07:15	0	53	8	0	61	9	15	45	0	69	15	21	14	0	50	17	6	1	0	24	204
07:20	1	100	8	0	109	12	12	22	0	46	11	40	15	0	66	25	9	1	0	35	256
07:25	1	70	7	0	78	15	29	30	0	74	8	28	23	0	59	36	10	2	0	48	259
07:30	1	85	15	0	101	16	17	32	0	65	14	37	25	0	76	9	5	5	0	19	261
07:35	1	88	8	0	97	25	22	29	0	76	9	31	16	0	56	21	7	0	0	28	257
07:40	2	96	7	0	105	18	2	30	0	50	12	50	13	0	75	23	8	1	0	32	262
07:45	2	80	20	0	102	22	7	30	0	59	9	40	6	0	55	19	7	3	0	29	245
07:50	0	76	10	0	86	11	4	29	0	44	16	44	10	0	70	14	6	2	0	22	222
07:55	1	87	15	0	103	6	0	19	0	25	20	37	6	0	63	7	3	1	0	11	202
08:00	0	62	8	0	70	3	0	25	0	28	14	42	7	0	63	19	1	0	0	20	181
Total Volume	10	954	124	0	1088	154	128	361	0	643	161	420	161	0	742	228	71	18	0	317	2790
% App. Total	0.9	87.7	11.4	0		24	19.9	56.1	0		21.7	56.6	21.7	0		71.9	22.4	5.7	0		
PHF	.417	.795	.517	.000	.832	.513	.368	.669	.000	.705	.671	.700	.537	.000	.814	.528	.592	.300	.000	.550	.887

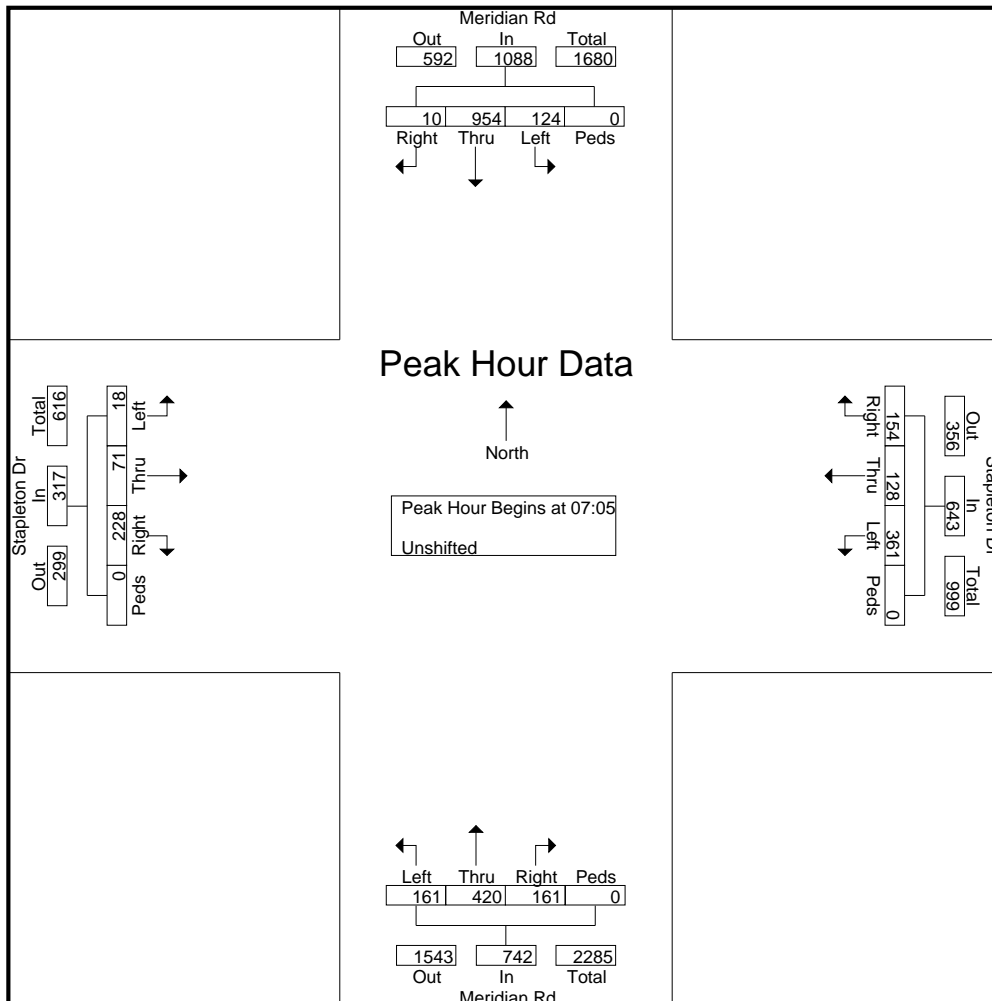

LSC Transportation Consultants, Inc.

2504 E. Pikes Peak Ave, Suite 304
 Colorado Springs, CO 80909
 719-633-2868

File Name : Meridian Rd - Stapleton Rd PM 2-29-24

Site Code : S234020

Start Date : 2/28/2024

Page No : 1

Groups Printed- Unshifted

Start Time	Meridian Rd Southbound					Stapleton Dr Westbound					Meridian Rd Northbound					Stapleton Dr Eastbound					Int. Total
	Right	Thru	Left	Peds	App. Total	Right	Thru	Left	Peds	App. Total	Right	Thru	Left	Peds	App. Total	Right	Thru	Left	Peds	App. Total	
16:00	0	46	8	0	54	9	3	20	0	32	27	82	17	0	126	10	2	1	0	13	225
16:05	1	56	12	0	69	3	4	24	0	31	33	75	15	0	123	11	1	0	0	12	235
16:10	0	48	6	0	54	5	5	31	0	41	29	62	15	0	106	11	1	0	0	12	213
16:15	1	42	4	0	47	11	5	28	0	44	35	75	17	0	127	11	3	1	0	15	233
16:20	0	45	8	0	53	7	2	18	0	27	29	72	10	0	111	11	2	0	0	13	204
16:25	1	46	5	0	52	6	6	12	0	24	37	93	19	0	149	3	3	1	0	7	232
16:30	1	40	4	0	45	8	2	21	0	31	16	58	9	0	83	13	1	2	0	16	175
16:35	1	41	6	0	48	9	4	22	0	35	40	71	12	0	123	12	3	1	0	16	222
16:40	1	56	9	0	66	6	1	23	0	30	30	69	22	0	121	9	3	0	0	12	229
16:45	0	43	8	0	51	9	2	23	0	34	32	67	19	0	118	12	5	1	0	18	221
16:50	0	50	9	0	59	6	2	23	0	31	42	89	12	0	143	6	2	0	0	8	241
16:55	0	50	6	0	56	6	2	24	0	32	31	52	11	0	94	12	0	2	0	14	196
Total	6	563	85	0	654	85	38	269	0	392	381	865	178	0	1424	121	26	9	0	156	2626
17:00	0	35	20	0	55	4	5	19	0	28	28	85	19	0	132	15	3	0	0	18	233
17:05	1	41	3	0	45	4	5	31	0	40	38	78	18	0	134	9	1	0	0	10	229
17:10	0	59	12	0	71	7	5	19	0	31	32	78	16	0	126	12	2	1	0	15	243
17:15	0	36	9	0	45	6	3	36	0	45	33	40	18	0	91	7	5	1	0	13	194
17:20	1	49	4	0	54	7	4	20	0	31	38	101	26	0	165	8	3	0	0	11	261
17:25	0	31	7	0	38	4	10	24	0	38	25	63	17	0	105	20	4	1	0	25	206
17:30	1	48	9	0	58	5	7	19	0	31	34	89	24	0	147	12	6	1	0	19	255
17:35	1	45	7	0	53	9	7	22	0	38	33	74	24	0	131	14	7	0	0	21	243
17:40	0	51	6	0	57	5	4	19	0	28	33	74	20	0	127	6	2	0	0	8	220
17:45	1	41	8	0	50	6	6	19	0	31	39	78	16	0	133	4	3	2	0	9	223
17:50	0	51	10	0	61	6	7	24	0	37	26	51	9	0	86	9	3	1	0	13	197
17:55	0	36	8	0	44	6	4	23	0	33	37	49	16	0	102	9	2	0	0	11	190
Total	5	523	103	0	631	69	67	275	0	411	396	860	223	0	1479	125	41	7	0	173	2694
Grand Total	11	1086	188	0	1285	154	105	544	0	803	777	1725	401	0	2903	246	67	16	0	329	5320
Apprch %	0.9	84.5	14.6	0		19.2	13.1	67.7	0		26.8	59.4	13.8	0		74.8	20.4	4.9	0		
Total %	0.2	20.4	3.5	0	24.2	2.9	2	10.2	0	15.1	14.6	32.4	7.5	0	54.6	4.6	1.3	0.3	0	6.2	

LSC Transportation Consultants, Inc.

2504 E. Pikes Peak Ave, Suite 304
 Colorado Springs, CO 80909
 719-633-2868

File Name : Meridian Rd - Stapleton Rd PM 2-29-24

Site Code : S234020

Start Date : 2/28/2024

Page No : 2

Start Time	Meridian Rd Southbound					Stapleton Dr Westbound					Meridian Rd Northbound					Stapleton Dr Eastbound					Int. Total
	Right	Thru	Left	Peds	App. Total	Right	Thru	Left	Peds	App. Total	Right	Thru	Left	Peds	App. Total	Right	Thru	Left	Peds	App. Total	
Peak Hour Analysis From 16:00 to 17:55 - Peak 1 of 1																					
Peak Hour for Entire Intersection Begins at 16:40																					
16:40	1	56	9	0	66	6	1	23	0	30	30	69	22	0	121	9	3	0	0	12	229
16:45	0	43	8	0	51	9	2	23	0	34	32	67	19	0	118	12	5	1	0	18	221
16:50	0	50	9	0	59	6	2	23	0	31	42	89	12	0	143	6	2	0	0	8	241
16:55	0	50	6	0	56	6	2	24	0	32	31	52	11	0	94	12	0	2	0	14	196
17:00	0	35	20	0	55	4	5	19	0	28	28	85	19	0	132	15	3	0	0	18	233
17:05	1	41	3	0	45	4	5	31	0	40	38	78	18	0	134	9	1	0	0	10	229
17:10	0	59	12	0	71	7	5	19	0	31	32	78	16	0	126	12	2	1	0	15	243
17:15	0	36	9	0	45	6	3	36	0	45	33	40	18	0	91	7	5	1	0	13	194
17:20	1	49	4	0	54	7	4	20	0	31	38	101	26	0	165	8	3	0	0	11	261
17:25	0	31	7	0	38	4	10	24	0	38	25	63	17	0	105	20	4	1	0	25	206
17:30	1	48	9	0	58	5	7	19	0	31	34	89	24	0	147	12	6	1	0	19	255
17:35	1	45	7	0	53	9	7	22	0	38	33	74	24	0	131	14	7	0	0	21	243
Total Volume	5	543	103	0	651	73	53	283	0	409	396	885	226	0	1507	136	41	7	0	184	2751
% App. Total	0.8	83.4	15.8	0		17.8	13	69.2	0		26.3	58.7	15	0		73.9	22.3	3.8	0		
PHF	.417	.767	.429	.000	.764	.676	.442	.655	.000	.757	.786	.730	.724	.000	.761	.567	.488	.292	.000	.613	.878

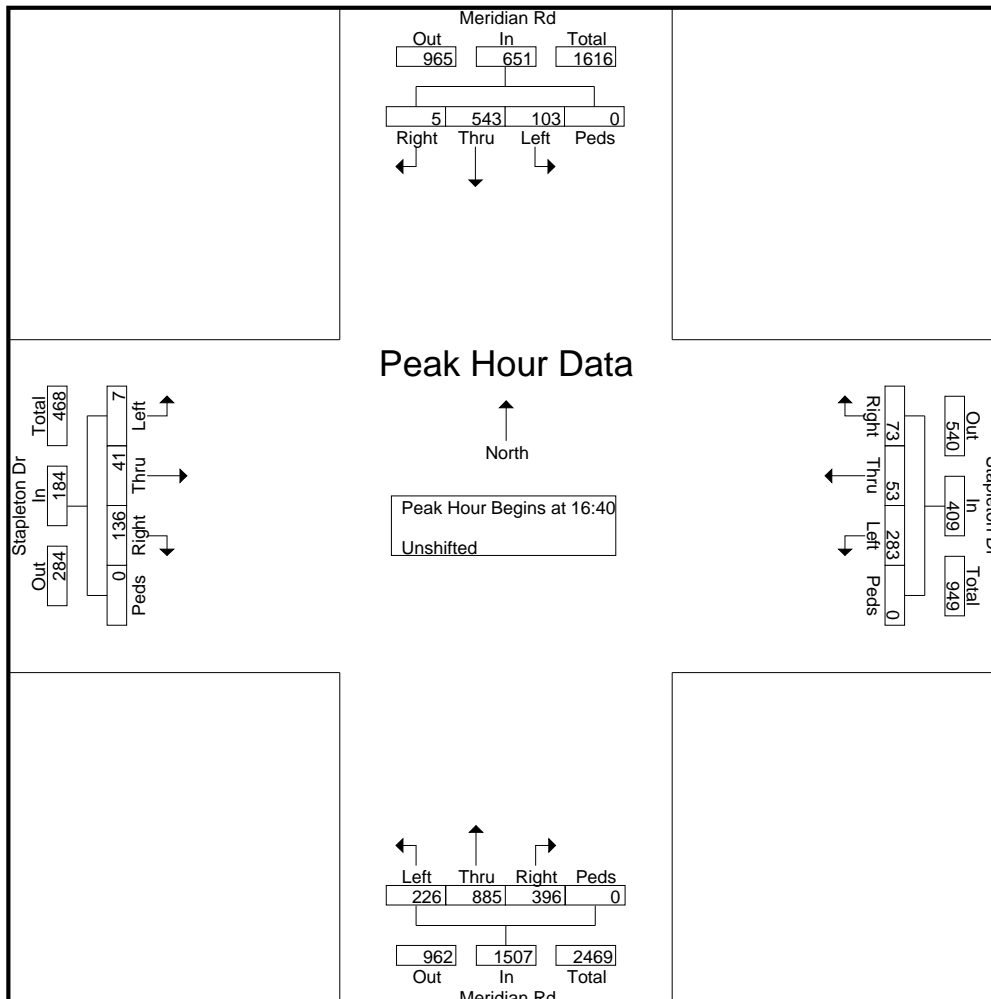

LSC Transportation Consultants, Inc.

2504 E. Pikes Peak Ave, Suite 304
 Colorado Springs, CO 80909
 719-633-2868

File Name : Meridian Ranch Retail Access - Stapelton Dr AM

Site Code : S234020

Start Date : 1/24/2023

Page No : 1

Groups Printed- Unshifted

Start Time	Meridian Ranch Retail Access Southbound					Stapelton Dr Westbound					Northbound					Stapelton Dr Eastbound					Int. Total
	Right	Thru	Left	Peds	App. Total	Right	Thru	Left	Peds	App. Total	Right	Thru	Left	Peds	App. Total	Right	Thru	Left	Peds	App. Total	
06:30	1	0	0	0	1	0	36	0	0	36	0	0	0	0	0	0	12	2	0	14	51
06:35	7	0	0	0	7	1	26	0	0	27	0	0	0	0	0	0	10	1	0	11	45
06:40	0	0	1	0	1	0	24	0	0	24	0	0	0	0	0	0	13	1	0	14	39
06:45	6	0	0	0	6	0	26	0	0	26	0	0	0	0	0	0	15	0	0	15	47
06:50	3	0	1	0	4	0	32	0	0	32	0	0	0	0	0	0	9	0	0	9	45
06:55	5	0	0	0	5	1	42	0	0	43	0	0	0	0	0	0	18	1	0	19	67
Total	22	0	2	0	24	2	186	0	0	188	0	0	0	0	0	0	77	5	0	82	294
07:00	2	0	0	0	2	1	47	0	0	48	0	0	0	0	0	0	20	1	0	21	71
07:05	2	0	0	0	2	3	52	0	0	55	0	0	0	0	0	0	23	2	0	25	82
07:10	6	0	1	0	7	1	54	0	0	55	0	0	0	0	0	0	23	0	0	23	85
07:15	2	0	3	0	5	0	55	0	0	55	0	0	0	0	0	0	25	0	0	25	85
07:20	2	0	0	0	2	2	63	0	0	65	0	0	0	0	0	0	24	1	0	25	92
07:25	3	0	0	0	3	1	76	0	0	77	0	0	0	0	0	0	21	2	0	23	103
07:30	2	0	0	0	2	1	64	0	0	65	0	0	0	0	0	0	27	1	0	28	95
07:35	4	0	1	0	5	1	50	0	0	51	0	0	0	0	0	0	35	2	0	37	93
07:40	3	0	0	0	3	2	54	0	0	56	0	0	0	0	0	0	28	1	0	29	88
07:45	1	0	0	0	1	1	48	0	0	49	0	0	0	0	0	0	36	1	0	37	87
07:50	4	0	2	0	6	5	29	0	0	34	0	0	0	0	0	0	35	4	0	39	79
07:55	3	0	1	0	4	3	21	0	0	24	0	0	0	0	0	0	32	2	0	34	62
Total	34	0	8	0	42	21	613	0	0	634	0	0	0	0	0	0	329	17	0	346	1022
08:00	1	0	0	0	1	0	22	0	0	22	0	0	0	0	0	0	30	1	0	31	54
08:05	4	0	1	0	5	0	23	0	0	23	0	0	0	0	0	0	22	0	0	22	50
08:10	0	0	2	0	2	2	25	0	0	27	0	0	0	0	0	0	26	3	0	29	58
08:15	1	0	1	0	2	5	24	0	0	29	0	0	0	0	0	0	38	6	0	44	75
08:20	2	0	1	0	3	4	26	0	0	30	0	0	0	0	0	0	14	2	0	16	49
08:25	1	0	2	0	3	4	22	0	0	26	0	0	0	0	0	0	16	0	0	16	45
08:30	4	0	1	0	5	0	28	0	0	28	0	0	0	0	0	0	15	4	0	19	52
08:35	3	0	0	0	3	1	13	0	0	14	0	0	0	0	0	0	17	4	0	21	38
08:40	1	0	2	0	3	3	15	0	0	18	0	0	0	0	0	0	12	1	0	13	34
08:45	3	0	0	0	3	1	22	0	0	23	0	0	0	0	0	0	19	2	0	21	47
08:50	4	0	2	0	6	3	17	0	0	20	0	0	0	0	0	0	8	4	0	12	38
08:55	3	0	1	0	4	10	14	0	0	24	0	0	0	0	0	0	16	8	0	24	52
Total	27	0	13	0	40	33	251	0	0	284	0	0	0	0	0	0	233	35	0	268	592
Grand Total	83	0	23	0	106	56	1050	0	0	1106	0	0	0	0	0	0	639	57	0	696	1908
Apprch %	78.3	0	21.7	0		5.1	94.9	0	0		0	0	0	0		0	91.8	8.2	0		
Total %	4.4	0	1.2	0	5.6	2.9	55	0	0	58	0	0	0	0	0	0	33.5	3	0	36.5	

LSC Transportation Consultants, Inc.

2504 E. Pikes Peak Ave, Suite 304
 Colorado Springs, CO 80909
 719-633-2868

File Name : Meridian Ranch Retail Access - Stapleton Dr AM

Site Code : S234020

Start Date : 1/24/2023

Page No : 2

Start Time	Meridian Ranch Retail Access Southbound					Stapleton Dr Westbound					Northbound					Stapleton Dr Eastbound					Int. Total
	Right	Thru	Left	Peds	App. Total	Right	Thru	Left	Peds	App. Total	Right	Thru	Left	Peds	App. Total	Right	Thru	Left	Peds	App. Total	
Peak Hour Analysis From 06:30 to 08:55 - Peak 1 of 1																					
Peak Hour for Entire Intersection Begins at 06:55																					
06:55	5	0	0	0	5	1	42	0	0	43	0	0	0	0	0	0	18	1	0	19	67
07:00	2	0	0	0	2	1	47	0	0	48	0	0	0	0	0	0	20	1	0	21	71
07:05	2	0	0	0	2	3	52	0	0	55	0	0	0	0	0	0	23	2	0	25	82
07:10	6	0	1	0	7	1	54	0	0	55	0	0	0	0	0	0	23	0	0	23	85
07:15	2	0	3	0	5	0	55	0	0	55	0	0	0	0	0	0	25	0	0	25	85
07:20	2	0	0	0	2	2	63	0	0	65	0	0	0	0	0	0	24	1	0	25	92
07:25	3	0	0	0	3	1	76	0	0	77	0	0	0	0	0	0	21	2	0	23	103
07:30	2	0	0	0	2	1	64	0	0	65	0	0	0	0	0	0	27	1	0	28	95
07:35	4	0	1	0	5	1	50	0	0	51	0	0	0	0	0	0	35	2	0	37	93
07:40	3	0	0	0	3	2	54	0	0	56	0	0	0	0	0	0	28	1	0	29	88
07:45	1	0	0	0	1	1	48	0	0	49	0	0	0	0	0	0	36	1	0	37	87
07:50	4	0	2	0	6	5	29	0	0	34	0	0	0	0	0	0	35	4	0	39	79
Total Volume	36	0	7	0	43	19	634	0	0	653	0	0	0	0	0	0	315	16	0	331	1027
% App. Total	83.7	0	16.3	0		2.9	97.1	0	0		0	0	0	0		0	95.2	4.8	0		
PHF	.500	.000	.194	.000	.512	.317	.695	.000	.000	.707	.000	.000	.000	.000	.000	.000	.729	.333	.000	.707	.831

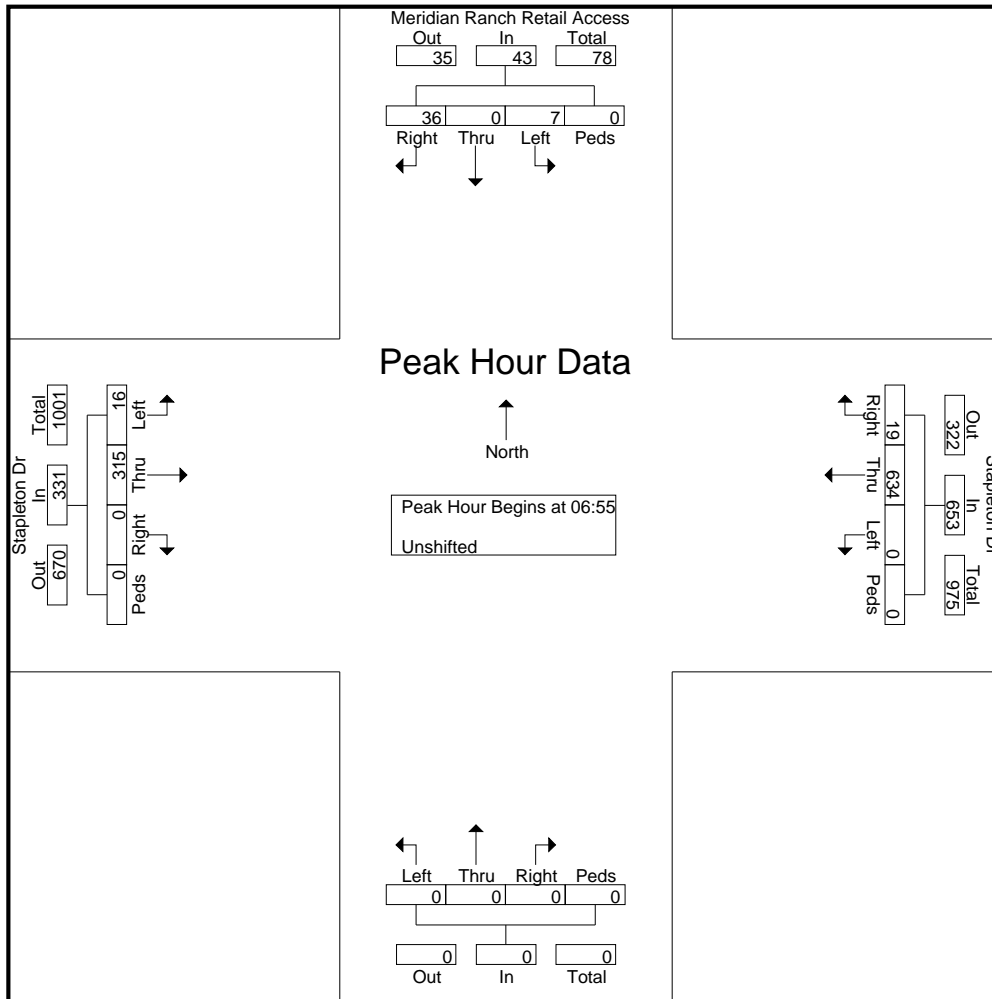

LSC Transportation Consultants, Inc.

2504 E. Pikes Peak Ave, Suite 304
 Colorado Springs, CO 80909
 719-633-2868

File Name : Meridian Ranch Retail Access - Stapelton Dr Mid

Site Code : S234020

Start Date : 1/17/2023

Page No : 1

Groups Printed- Unshifted

Start Time	Meridian Ranch Retail Access Southbound					Stapelton Dr Westbound					Northbound					Stapelton Dr Eastbound					Int. Total
	Right	Thru	Left	Peds	App. Total	Right	Thru	Left	Peds	App. Total	Right	Thru	Left	Peds	App. Total	Right	Thru	Left	Peds	App. Total	
11:45	4	0	2	0	6	1	21	0	0	22	0	0	0	0	0	0	13	4	0	17	45
11:50	4	0	1	0	5	3	15	0	0	18	0	0	0	0	0	0	9	3	0	12	35
11:55	3	0	2	0	5	0	20	0	0	20	0	0	0	0	0	0	20	2	0	22	47
Total	11	0	5	0	16	4	56	0	0	60	0	0	0	0	0	0	42	9	0	51	127
12:00	5	0	4	0	9	1	13	0	0	14	0	0	0	0	0	0	21	3	0	24	47
12:05	6	0	3	0	9	2	7	0	0	9	0	0	0	0	0	0	10	3	0	13	31
12:10	6	0	1	0	7	1	17	0	0	18	0	0	0	0	0	0	20	3	0	23	48
12:15	5	0	1	0	6	4	13	0	0	17	0	0	0	0	0	0	14	0	0	14	37
12:20	3	0	2	0	5	2	21	0	0	23	0	0	0	0	0	0	12	6	0	18	46
12:25	3	0	2	0	5	1	15	0	0	16	0	0	0	0	0	0	15	3	0	18	39
12:30	4	0	2	0	6	1	21	0	0	22	0	0	0	0	0	0	14	0	0	14	42
12:35	3	0	1	0	4	3	20	0	0	23	0	0	0	0	0	0	12	2	0	14	41
12:40	3	0	0	0	3	0	15	0	0	15	0	0	0	0	0	0	20	2	0	22	40
12:45	8	0	1	0	9	3	22	0	0	25	0	0	0	0	0	0	19	5	0	24	58
12:50	3	0	2	0	5	2	21	0	0	23	0	0	0	0	0	0	9	3	0	12	40
12:55	6	0	2	0	8	2	14	0	0	16	0	0	0	0	0	0	12	4	0	16	40
Total	55	0	21	0	76	22	199	0	0	221	0	0	0	0	0	0	178	34	0	212	509
13:00	12	0	3	0	15	1	16	0	0	17	0	0	0	0	0	0	9	5	0	14	46
13:05	9	0	0	0	9	1	15	0	0	16	0	0	0	0	0	0	14	3	0	17	42
13:10	5	0	1	0	6	2	20	0	0	22	0	0	0	0	0	0	12	2	0	14	42
13:15	4	0	5	0	9	1	16	0	0	17	0	0	0	0	0	0	13	3	0	16	42
13:20	5	0	2	0	7	0	21	0	0	21	0	0	0	0	0	0	19	5	0	24	52
13:25	5	0	3	0	8	0	14	0	0	14	0	0	0	0	0	0	15	4	0	19	41
13:30	2	0	3	0	5	1	8	0	0	9	0	0	0	0	0	0	18	3	0	21	35
13:35	2	0	4	0	6	1	12	0	0	13	0	0	0	0	0	0	15	2	0	17	36
13:40	7	0	0	0	7	3	21	0	0	24	0	0	0	0	0	0	8	3	0	11	42
13:45	4	0	4	0	8	3	17	0	0	20	0	0	0	0	0	0	28	5	0	33	61
13:50	2	0	5	0	7	4	19	0	0	23	0	0	0	0	0	0	19	1	0	20	50
13:55	1	0	2	0	3	0	12	0	0	12	0	0	0	0	0	0	28	0	0	28	43
Total	58	0	32	0	90	17	191	0	0	208	0	0	0	0	0	0	198	36	0	234	532
14:00	3	0	0	0	3	2	16	0	0	18	0	0	0	0	0	0	14	3	0	17	38
14:05	6	0	0	0	6	1	16	0	0	17	0	0	0	0	0	0	22	1	0	23	46
14:10	5	0	2	0	7	0	13	0	0	13	0	0	0	0	0	0	18	1	0	19	39
Grand Total	138	0	60	0	198	46	491	0	0	537	0	0	0	0	0	0	472	84	0	556	1291
Apprch %	69.7	0	30.3	0		8.6	91.4	0	0		0	0	0	0		0	84.9	15.1	0		
Total %	10.7	0	4.6	0	15.3	3.6	38	0	0	41.6	0	0	0	0	0	0	36.6	6.5	0	43.1	

LSC Transportation Consultants, Inc.

2504 E. Pikes Peak Ave, Suite 304
 Colorado Springs, CO 80909
 719-633-2868

File Name : Meridian Ranch Retail Access - Stapelton Dr PM

Site Code : S234020

Start Date : 1/17/2023

Page No : 1

Groups Printed- Unshifted

Start Time	Meridian Ranch Retail Access Southbound					Stapelton Dr Westbound					Northbound					Stapelton Dr Eastbound					Int. Total
	Right	Thru	Left	Peds	App. Total	Right	Thru	Left	Peds	App. Total	Right	Thru	Left	Peds	App. Total	Right	Thru	Left	Peds	App. Total	
15:00	4	0	0	0	4	1	34	0	0	35	0	0	0	0	0	0	21	2	0	23	62
15:05	3	0	1	0	4	2	24	0	0	26	0	0	0	0	0	0	43	7	0	50	80
15:10	8	0	1	0	9	3	24	0	0	27	0	0	0	0	0	0	45	4	0	49	85
15:15	2	0	6	0	8	1	33	0	0	34	0	0	0	0	0	0	47	3	0	50	92
15:20	5	0	0	0	5	3	31	0	0	34	0	0	0	0	0	0	33	3	0	36	75
15:25	1	0	1	0	2	1	18	0	0	19	0	0	0	0	0	0	47	4	0	51	72
15:30	8	0	3	0	11	3	37	0	0	40	0	0	0	0	0	0	27	0	0	27	78
15:35	0	0	4	0	4	1	23	0	0	24	0	0	0	0	0	0	28	6	0	34	62
15:40	3	0	0	0	3	2	25	0	0	27	0	0	0	0	0	0	27	2	0	29	59
15:45	0	0	0	0	0	4	32	0	0	36	0	0	0	0	0	0	41	2	0	43	79
15:50	3	0	2	0	5	0	25	0	0	25	0	0	0	0	0	0	25	6	0	31	61
15:55	4	0	1	0	5	4	36	0	0	40	0	0	0	0	0	0	33	3	0	36	81
Total	41	0	19	0	60	25	342	0	0	367	0	0	0	0	0	0	417	42	0	459	886
16:00	2	0	4	0	6	0	39	0	0	39	0	0	0	0	0	0	37	2	0	39	84
16:05	3	0	1	0	4	3	32	0	0	35	0	0	0	0	0	0	30	1	0	31	70
16:10	4	0	5	0	9	6	27	0	0	33	0	0	0	0	0	0	37	2	0	39	81
16:15	2	0	0	0	2	1	32	0	0	33	0	0	0	0	0	0	34	4	0	38	73
16:20	3	0	2	0	5	0	19	0	0	19	0	0	0	0	0	0	37	1	0	38	62
16:25	1	0	1	0	2	1	18	0	0	19	0	0	0	0	0	0	31	5	0	36	57
16:30	6	0	4	0	10	3	21	0	0	24	0	0	0	0	0	0	27	5	0	32	66
16:35	8	0	2	0	10	6	22	0	0	28	0	0	0	0	0	0	39	7	0	46	84
16:40	8	0	5	0	13	2	32	0	0	34	0	0	0	0	0	0	30	4	0	34	81
16:45	5	0	3	0	8	3	19	0	0	22	0	0	0	0	0	0	27	5	0	32	62
16:50	4	0	3	0	7	5	24	0	0	29	0	0	0	0	0	0	24	4	0	28	64
16:55	4	0	6	0	10	4	30	0	0	34	0	0	0	0	0	0	32	6	0	38	82
Total	50	0	36	0	86	34	315	0	0	349	0	0	0	0	0	0	385	46	0	431	866
17:00	4	0	3	0	7	1	28	0	0	29	0	0	0	0	0	0	43	3	0	46	82
17:05	7	0	4	0	11	2	32	0	0	34	0	0	0	0	0	0	44	3	0	47	92
17:10	3	0	0	0	3	2	27	0	0	29	0	0	0	0	0	0	21	10	0	31	63
17:15	4	0	2	0	6	3	30	0	0	33	0	0	0	0	0	0	32	4	0	36	75
17:20	2	0	4	0	6	1	20	0	0	21	0	0	0	0	0	0	37	5	0	42	69
17:25	4	0	5	0	9	1	19	0	0	20	0	0	0	0	0	0	38	5	0	43	72
17:30	4	0	3	0	7	2	12	0	0	14	0	0	0	0	0	0	35	0	0	35	56
17:35	8	0	1	0	9	3	20	0	0	23	0	0	0	0	0	0	31	4	0	35	67
17:40	4	0	2	0	6	3	16	0	0	19	0	0	0	0	0	0	42	7	0	49	74
17:45	4	0	0	0	4	5	25	0	0	30	0	0	0	0	0	0	38	2	0	40	74
17:50	3	0	1	0	4	4	23	0	0	27	0	0	0	0	0	0	39	0	0	39	70
17:55	4	0	2	0	6	5	27	0	0	32	0	0	0	0	0	0	41	1	0	42	80
Total	51	0	27	0	78	32	279	0	0	311	0	0	0	0	0	0	441	44	0	485	874
Grand Total	142	0	82	0	224	91	936	0	0	1027	0	0	0	0	0	0	1243	132	0	1375	2626
Apprch %	63.4	0	36.6	0		8.9	91.1	0	0		0	0	0	0		0	90.4	9.6	0		
Total %	5.4	0	3.1	0	8.5	3.5	35.6	0	0	39.1	0	0	0	0	0	0	47.3	5	0	52.4	

LSC Transportation Consultants, Inc.

2504 E. Pikes Peak Ave, Suite 304
 Colorado Springs, CO 80909
 719-633-2868

File Name : Meridian Ranch Blvd - Stapelton Dr AM SW

Site Code : S234020

Start Date : 4/25/2024

Page No : 1

Groups Printed- Unshifted

Start Time	Meridian Ranch Blvd Southbound					Stapleton Dr Westbound					Meridian Ranch Blvd Northbound					Stapleton Dr Eastbound					Int. Total
	Right	Thru	Left	Peds	App. Total	Right	Thru	Left	Peds	App. Total	Right	Thru	Left	Peds	App. Total	Right	Thru	Left	Peds	App. Total	
06:30	9	1	1	0	11	0	14	1	0	15	0	1	7	0	8	3	9	0	0	12	46
06:35	6	1	2	1	10	1	18	1	1	21	1	0	2	0	3	1	8	3	0	12	46
06:40	2	1	2	0	5	4	23	0	0	27	0	0	6	0	6	3	11	2	0	16	54
06:45	6	2	1	0	9	1	24	0	1	26	0	0	7	0	7	1	10	1	0	12	54
06:50	3	1	3	0	7	2	25	1	0	28	0	2	5	0	7	4	10	1	0	15	57
06:55	7	3	0	0	10	1	29	0	0	30	2	1	4	0	7	2	18	4	0	24	71
Total	33	9	9	1	52	9	133	3	2	147	3	4	31	0	38	14	66	11	0	91	328
07:00	10	1	3	0	14	0	28	0	0	28	1	0	7	0	8	4	14	2	0	20	70
07:05	8	4	2	0	14	0	39	0	1	40	3	3	8	0	14	1	27	4	0	32	100
07:10	6	3	8	0	17	1	44	3	0	48	6	3	9	0	18	4	26	0	0	30	113
07:15	11	3	3	0	17	1	43	1	0	45	6	3	6	0	15	6	29	3	0	38	115
07:20	8	2	2	0	12	6	42	3	0	51	2	1	9	0	12	7	21	2	0	30	105
07:25	7	2	4	0	13	2	48	2	0	52	2	2	4	0	8	4	26	3	0	33	106
07:30	14	2	0	0	16	0	59	3	0	62	1	1	7	0	9	7	19	2	0	28	115
07:35	5	2	1	0	8	2	36	2	0	40	1	0	9	0	10	5	17	2	0	24	82
07:40	13	2	1	0	16	1	34	1	0	36	2	0	8	0	10	9	17	4	0	30	92
07:45	10	1	0	0	11	2	25	1	0	28	0	1	7	0	8	8	29	4	0	41	88
07:50	5	3	0	0	8	4	22	1	0	27	0	1	5	0	6	8	17	2	0	27	68
07:55	8	4	1	0	13	0	23	0	0	23	0	2	5	0	7	2	21	1	0	24	67
Total	105	29	25	0	159	19	443	17	1	480	24	17	84	0	125	65	263	29	0	357	1121
08:00	3	2	0	0	5	0	21	1	0	22	0	1	2	0	3	5	21	1	1	28	58
08:05	1	4	1	0	6	0	21	2	0	23	0	2	8	0	10	3	19	3	0	25	64
08:10	3	1	1	0	5	1	22	2	0	25	1	2	2	0	5	2	10	2	0	14	49
08:15	9	2	0	0	11	1	19	2	0	22	1	4	4	0	9	5	18	2	0	25	67
08:20	6	5	3	0	14	2	27	0	0	29	0	2	5	0	7	4	15	0	0	19	69
08:25	1	1	1	0	3	0	24	0	0	24	1	1	7	0	9	5	19	6	0	30	66
Grand Total	161	53	40	1	255	32	710	27	3	772	30	33	143	0	206	103	431	54	1	589	1822
Apprch %	63.1	20.8	15.7	0.4		4.1	92	3.5	0.4		14.6	16	69.4	0		17.5	73.2	9.2	0.2		
Total %	8.8	2.9	2.2	0.1	14	1.8	39	1.5	0.2	42.4	1.6	1.8	7.8	0	11.3	5.7	23.7	3	0.1	32.3	

LSC Transportation Consultants, Inc.

2504 E. Pikes Peak Ave, Suite 304
 Colorado Springs, CO 80909
 719-633-2868

File Name : Meridian Ranch Blvd - Stapelton Dr AM SW
 Site Code : S234020
 Start Date : 4/25/2024
 Page No : 2

Start Time	Meridian Ranch Blvd Southbound					Stapleton Dr Westbound					Meridian Ranch Blvd Northbound					Stapleton Dr Eastbound					Int. Total
	Right	Thru	Left	Peds	App. Total	Right	Thru	Left	Peds	App. Total	Right	Thru	Left	Peds	App. Total	Right	Thru	Left	Peds	App. Total	
Peak Hour Analysis From 06:30 to 08:25 - Peak 1 of 1																					
Peak Hour for Entire Intersection Begins at 06:55																					
06:55	7	3	0	0	10	1	29	0	0	30	2	1	4	0	7	2	18	4	0	24	71
07:00	10	1	3	0	14	0	28	0	0	28	1	0	7	0	8	4	14	2	0	20	70
07:05	8	4	2	0	14	0	39	0	1	40	3	3	8	0	14	1	27	4	0	32	100
07:10	6	3	8	0	17	1	44	3	0	48	6	3	9	0	18	4	26	0	0	30	113
07:15	11	3	3	0	17	1	43	1	0	45	6	3	6	0	15	6	29	3	0	38	115
07:20	8	2	2	0	12	6	42	3	0	51	2	1	9	0	12	7	21	2	0	30	105
07:25	7	2	4	0	13	2	48	2	0	52	2	2	4	0	8	4	26	3	0	33	106
07:30	14	2	0	0	16	0	59	3	0	62	1	1	7	0	9	7	19	2	0	28	115
07:35	5	2	1	0	8	2	36	2	0	40	1	0	9	0	10	5	17	2	0	24	82
07:40	13	2	1	0	16	1	34	1	0	36	2	0	8	0	10	9	17	4	0	30	92
07:45	10	1	0	0	11	2	25	1	0	28	0	1	7	0	8	8	29	4	0	41	88
07:50	5	3	0	0	8	4	22	1	0	27	0	1	5	0	6	8	17	2	0	27	68
Total Volume	104	28	24	0	156	20	449	17	1	487	26	16	83	0	125	65	260	32	0	357	1125
% App. Total	66.7	17.9	15.4	0		4.1	92.2	3.5	0.2		20.8	12.8	66.4	0		18.2	72.8	9	0		
PHF	.619	.583	.250	.000	.765	.278	.634	.472	.083	.655	.361	.444	.769	.000	.579	.602	.747	.667	.000	.726	.815

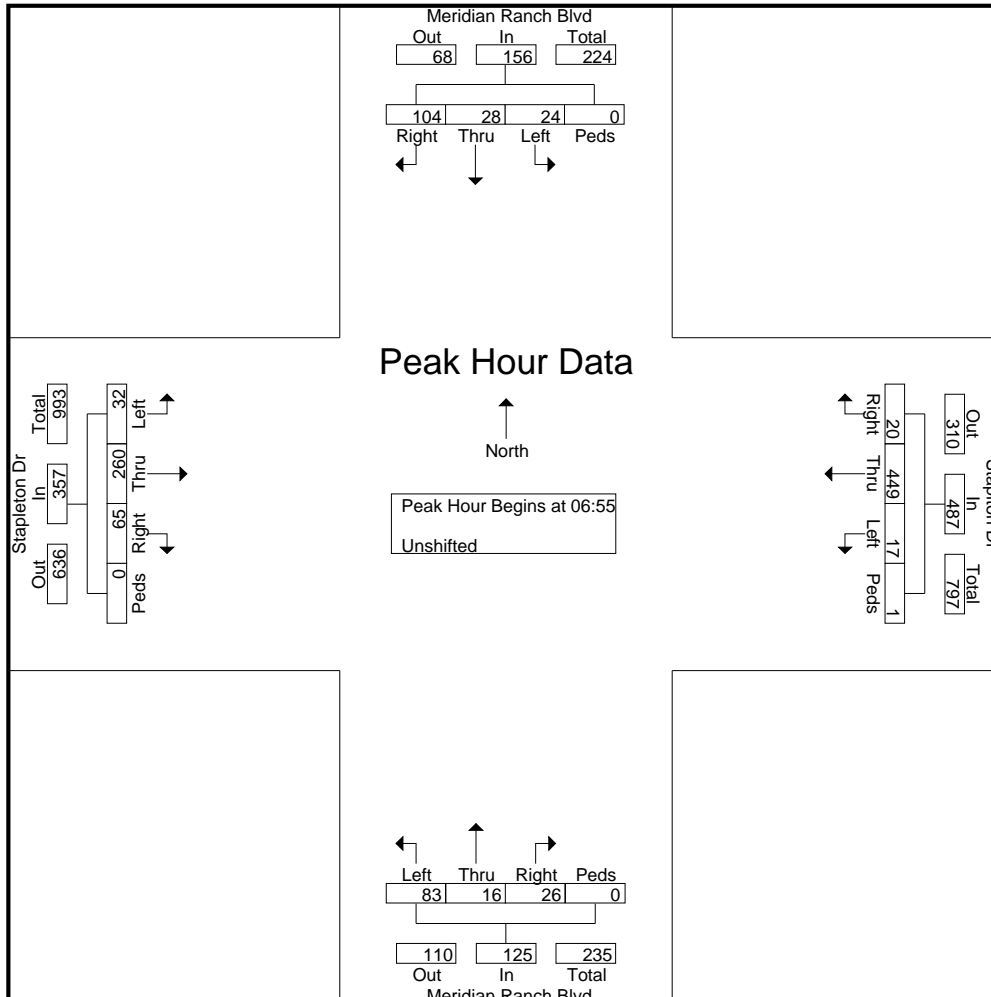

LSC Transportation Consultants, Inc.

2504 E. Pikes Peak Ave, Suite 304
 Colorado Springs, CO 80909
 719-633-2868

File Name : Meridian Ranch Blvd - Stapelton Dr Noon SW
 Site Code : S234020
 Start Date : 4/25/2024
 Page No : 1

Groups Printed- Unshifted

Start Time	Meridian Ranch Blvd Southbound					Westbound					Meridian Ranch Blvd Northbound					Stapelton Dr Eastbound					Int. Total
	Right	Thru	Left	Peds	App. Total	Right	Thru	Left	Peds	App. Total	Right	Thru	Left	Peds	App. Total	Right	Thru	Left	Peds	App. Total	
11:15	1	1	2	0	4	1	14	0	0	15	0	4	8	0	12	9	14	6	0	29	60
11:20	0	3	0	0	3	0	20	0	0	20	2	0	2	0	4	8	17	1	0	26	53
11:25	3	0	1	1	5	1	12	0	0	13	1	2	4	0	7	4	23	3	0	30	55
11:30	4	2	0	0	6	0	10	3	0	13	1	1	3	0	5	2	24	4	0	30	54
11:35	5	2	2	0	9	0	21	1	0	22	1	0	6	0	7	8	21	3	0	32	70
11:40	1	1	1	0	3	0	19	0	0	19	1	1	3	0	5	4	20	4	0	28	55
11:45	8	2	1	0	11	0	13	1	0	14	1	2	1	0	4	3	21	2	0	26	55
11:50	2	1	1	0	4	2	12	1	1	16	0	1	4	0	5	4	21	5	0	30	55
11:55	3	0	1	0	4	2	10	1	0	13	0	0	3	0	3	7	19	4	0	30	50
Total	27	12	9	1	49	6	131	7	1	145	7	11	34	0	52	49	180	32	0	261	507
12:00	2	2	0	0	4	3	16	1	0	20	2	0	9	0	11	7	17	4	0	28	63
12:05	5	1	1	0	7	1	16	0	0	17	0	1	6	0	7	2	23	2	0	27	58
12:10	1	0	0	0	1	3	20	2	0	25	1	3	1	0	5	4	10	3	0	17	48
12:15	3	1	0	0	4	0	14	1	0	15	1	2	4	0	7	2	11	2	0	15	41
12:20	3	2	1	0	6	2	19	0	0	21	0	5	6	0	11	2	10	2	0	14	52
12:25	3	1	3	0	7	2	18	1	1	22	1	0	3	0	4	3	8	4	0	15	48
12:30	2	6	0	0	8	1	27	3	0	31	3	1	5	0	9	4	18	3	0	25	73
12:35	4	2	1	0	7	3	17	0	0	20	0	3	6	0	9	8	13	3	0	24	60
12:40	3	1	0	0	4	2	12	0	0	14	0	2	7	0	9	6	17	4	2	29	56
12:45	5	2	1	0	8	2	11	2	0	15	2	3	0	0	5	2	19	1	0	22	50
12:50	3	4	0	0	7	1	17	1	0	19	1	1	2	0	4	5	12	3	0	20	50
12:55	1	1	0	0	2	1	13	0	0	14	0	4	2	0	6	3	21	3	0	27	49
Total	35	23	7	0	65	21	200	11	1	233	11	25	51	0	87	48	179	34	2	263	648
13:00	2	4	1	0	7	2	12	0	0	14	0	1	1	0	2	5	16	2	0	23	46
13:05	3	2	0	2	7	1	26	1	0	28	0	2	2	0	4	3	14	5	0	22	61
13:10	3	3	0	0	6	1	20	0	0	21	2	1	3	0	6	4	14	4	0	22	55
Grand Total	70	44	17	3	134	31	389	19	2	441	20	40	91	0	151	109	403	77	2	591	1317
Apprch %	52.2	32.8	12.7	2.2		7	88.2	4.3	0.5		13.2	26.5	60.3	0		18.4	68.2	13	0.3		
Total %	5.3	3.3	1.3	0.2	10.2	2.4	29.5	1.4	0.2	33.5	1.5	3	6.9	0	11.5	8.3	30.6	5.8	0.2	44.9	

LSC Transportation Consultants, Inc.

2504 E. Pikes Peak Ave, Suite 304
 Colorado Springs, CO 80909
 719-633-2868

File Name : Meridian Ranch Blvd - Stapelton Dr Noon SW
 Site Code : S234020
 Start Date : 4/25/2024
 Page No : 2

Start Time	Meridian Ranch Blvd Southbound					Westbound					Meridian Ranch Blvd Northbound					Stapelton Dr Eastbound					Int. Total
	Right	Thru	Left	Peds	App. Total	Right	Thru	Left	Peds	App. Total	Right	Thru	Left	Peds	App. Total	Right	Thru	Left	Peds	App. Total	
Peak Hour Analysis From 11:15 to 13:10 - Peak 1 of 1																					
Peak Hour for Entire Intersection Begins at 11:15																					
11:15	1	1	2	0	4	1	14	0	0	15	0	4	8	0	12	9	14	6	0	29	60
11:20	0	3	0	0	3	0	20	0	0	20	2	0	2	0	4	8	17	1	0	26	53
11:25	3	0	1	1	5	1	12	0	0	13	1	2	4	0	7	4	23	3	0	30	55
11:30	4	2	0	0	6	0	10	3	0	13	1	1	3	0	5	2	24	4	0	30	54
11:35	5	2	2	0	9	0	21	1	0	22	1	0	6	0	7	8	21	3	0	32	70
11:40	1	1	1	0	3	0	19	0	0	19	1	1	3	0	5	4	20	4	0	28	55
11:45	8	2	1	0	11	0	13	1	0	14	1	2	1	0	4	3	21	2	0	26	55
11:50	2	1	1	0	4	2	12	1	1	16	0	1	4	0	5	4	21	5	0	30	55
11:55	3	0	1	0	4	2	10	1	0	13	0	0	3	0	3	7	19	4	0	30	50
12:00	2	2	0	0	4	3	16	1	0	20	2	0	9	0	11	7	17	4	0	28	63
12:05	5	1	1	0	7	1	16	0	0	17	0	1	6	0	7	2	23	2	0	27	58
12:10	1	0	0	0	1	3	20	2	0	25	1	3	1	0	5	4	10	3	0	17	48
Total Volume	35	15	10	1	61	13	183	10	1	207	10	15	50	0	75	62	230	41	0	333	676
% App. Total	57.4	24.6	16.4	1.6		6.3	88.4	4.8	0.5		13.3	20	66.7	0		18.6	69.1	12.3	0		
PHF	.365	.417	.417	.083	.462	.361	.726	.278	.083	.690	.417	.313	.463	.000	.521	.574	.799	.569	.000	.867	.805

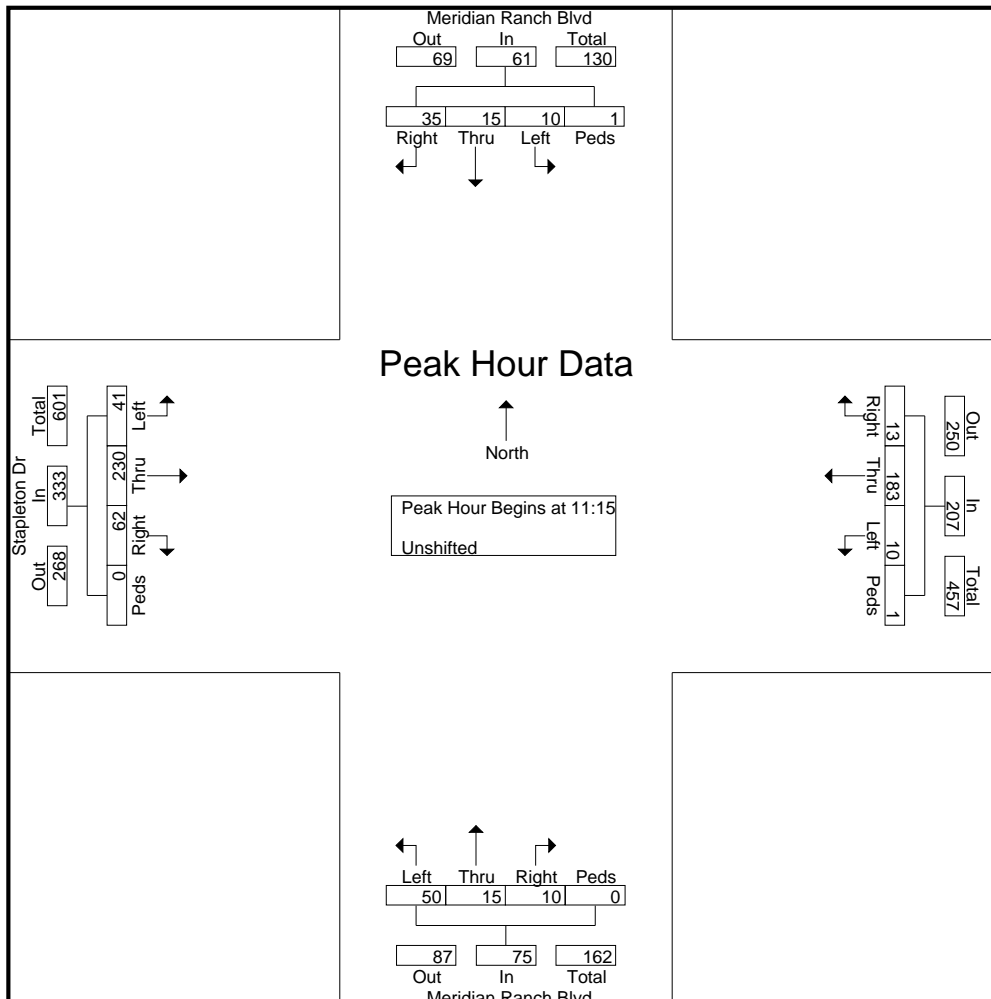

LSC Transportation Consultants, Inc.

2504 E. Pikes Peak Ave, Suite 304
 Colorado Springs, CO 80909
 719-633-2868

File Name : Meridian Ranch Blvd - Stapelton Dr Mid SW
 Site Code : S234020
 Start Date : 4/25/2024
 Page No : 1

Groups Printed- Unshifted

Start Time	Meridian Ranch Blvd Southbound					Stapelton Dr Westbound					Meridian Ranch Blvd Northbound					Stapelton Dr Eastbound					Int. Total
	Right	Thru	Left	Peds	App. Total	Right	Thru	Left	Peds	App. Total	Right	Thru	Left	Peds	App. Total	Right	Thru	Left	Peds	App. Total	
13:30	0	1	6	0	7	0	17	0	2	19	0	0	7	0	7	5	16	1	0	22	55
13:35	4	0	3	0	7	0	11	0	0	11	2	0	5	0	7	4	14	4	0	22	47
13:40	4	1	11	0	16	0	12	0	0	12	0	3	2	0	5	8	14	0	2	24	57
13:45	6	1	4	0	11	0	14	0	0	14	0	1	6	0	7	7	27	3	0	37	69
13:50	4	2	2	0	8	1	16	1	0	18	0	2	4	0	6	3	16	2	0	21	53
13:55	5	1	2	0	8	1	15	1	0	17	0	3	8	0	11	8	18	5	0	31	67
Total	23	6	28	0	57	2	85	2	2	91	2	9	32	0	43	35	105	15	2	157	348
14:00	5	2	3	0	10	0	14	1	0	15	1	0	4	0	5	3	12	3	0	18	48
14:05	2	2	5	0	9	2	16	1	0	19	0	4	4	0	8	4	22	1	0	27	63
14:10	7	2	7	0	16	1	13	0	0	14	2	1	8	0	11	4	17	3	0	24	65
14:15	5	1	6	0	12	1	9	1	0	11	1	0	4	0	5	7	18	7	0	32	60
14:20	4	3	6	0	13	1	20	0	0	21	0	2	5	0	7	6	26	3	0	35	76
14:25	6	1	2	0	9	2	22	1	0	25	1	0	1	0	2	6	29	2	0	37	73
14:30	5	0	3	0	8	1	29	1	0	31	3	2	9	0	14	3	27	4	0	34	87
14:35	6	0	5	0	11	1	19	0	0	20	2	4	7	0	13	6	20	7	0	33	77
14:40	8	2	0	0	10	1	32	2	0	35	2	0	5	0	7	5	20	4	0	29	81
14:45	2	2	7	0	11	3	44	6	0	53	2	1	8	0	11	6	16	4	0	26	101
14:50	3	3	6	0	12	2	56	7	0	65	1	2	1	0	4	5	26	6	0	37	118
14:55	6	2	2	0	10	0	36	3	0	39	0	4	8	0	12	8	24	3	0	35	96
Total	59	20	52	0	131	15	310	23	0	348	15	20	64	0	99	63	257	47	0	367	945
15:00	6	4	1	0	11	2	35	1	0	38	1	2	5	0	8	7	25	2	0	34	91
15:05	4	5	1	0	10	3	21	1	0	25	2	3	7	0	12	14	36	7	0	57	104
15:10	3	2	3	0	8	1	24	2	0	27	1	0	0	0	1	13	39	6	0	58	94
15:15	8	1	3	1	13	0	17	1	1	19	1	1	5	0	7	8	40	5	0	53	92
15:20	4	4	1	0	9	2	18	0	0	20	1	6	4	0	11	8	28	7	0	43	83
15:25	7	2	1	0	10	3	26	2	0	31	2	4	3	0	9	11	26	4	0	41	91
Grand Total	114	44	90	1	249	28	536	32	3	599	25	45	120	0	190	159	556	93	2	810	1848
Apprch %	45.8	17.7	36.1	0.4		4.7	89.5	5.3	0.5		13.2	23.7	63.2	0		19.6	68.6	11.5	0.2		
Total %	6.2	2.4	4.9	0.1	13.5	1.5	29	1.7	0.2	32.4	1.4	2.4	6.5	0	10.3	8.6	30.1	5	0.1	43.8	

LSC Transportation Consultants, Inc.

2504 E. Pikes Peak Ave, Suite 304
 Colorado Springs, CO 80909
 719-633-2868

File Name : Meridian Ranch Blvd - Stapelton Dr Mid SW
 Site Code : S234020
 Start Date : 4/25/2024
 Page No : 2

Start Time	Meridian Ranch Blvd Southbound					Stapelton Dr Westbound					Meridian Ranch Blvd Northbound					Stapelton Dr Eastbound					Int. Total
	Right	Thru	Left	Peds	App. Total	Right	Thru	Left	Peds	App. Total	Right	Thru	Left	Peds	App. Total	Right	Thru	Left	Peds	App. Total	
Peak Hour Analysis From 13:30 to 15:25 - Peak 1 of 1																					
Peak Hour for Entire Intersection Begins at 14:30																					
14:30	5	0	3	0	8	1	29	1	0	31	3	2	9	0	14	3	27	4	0	34	87
14:35	6	0	5	0	11	1	19	0	0	20	2	4	7	0	13	6	20	7	0	33	77
14:40	8	2	0	0	10	1	32	2	0	35	2	0	5	0	7	5	20	4	0	29	81
14:45	2	2	7	0	11	3	44	6	0	53	2	1	8	0	11	6	16	4	0	26	101
14:50	3	3	6	0	12	2	56	7	0	65	1	2	1	0	4	5	26	6	0	37	118
14:55	6	2	2	0	10	0	36	3	0	39	0	4	8	0	12	8	24	3	0	35	96
15:00	6	4	1	0	11	2	35	1	0	38	1	2	5	0	8	7	25	2	0	34	91
15:05	4	5	1	0	10	3	21	1	0	25	2	3	7	0	12	14	36	7	0	57	104
15:10	3	2	3	0	8	1	24	2	0	27	1	0	0	0	1	13	39	6	0	58	94
15:15	8	1	3	1	13	0	17	1	1	19	1	1	5	0	7	8	40	5	0	53	92
15:20	4	4	1	0	9	2	18	0	0	20	1	6	4	0	11	8	28	7	0	43	83
15:25	7	2	1	0	10	3	26	2	0	31	2	4	3	0	9	11	26	4	0	41	91
Total Volume	62	27	33	1	123	19	357	26	1	403	18	29	62	0	109	94	327	59	0	480	1115
% App. Total	50.4	22	26.8	0.8		4.7	88.6	6.5	0.2		16.5	26.6	56.9	0		19.6	68.1	12.3	0		
PHF	.646	.450	.393	.083	.788	.528	.531	.310	.083	.517	.500	.403	.574	.000	.649	.560	.681	.702	.000	.690	.787

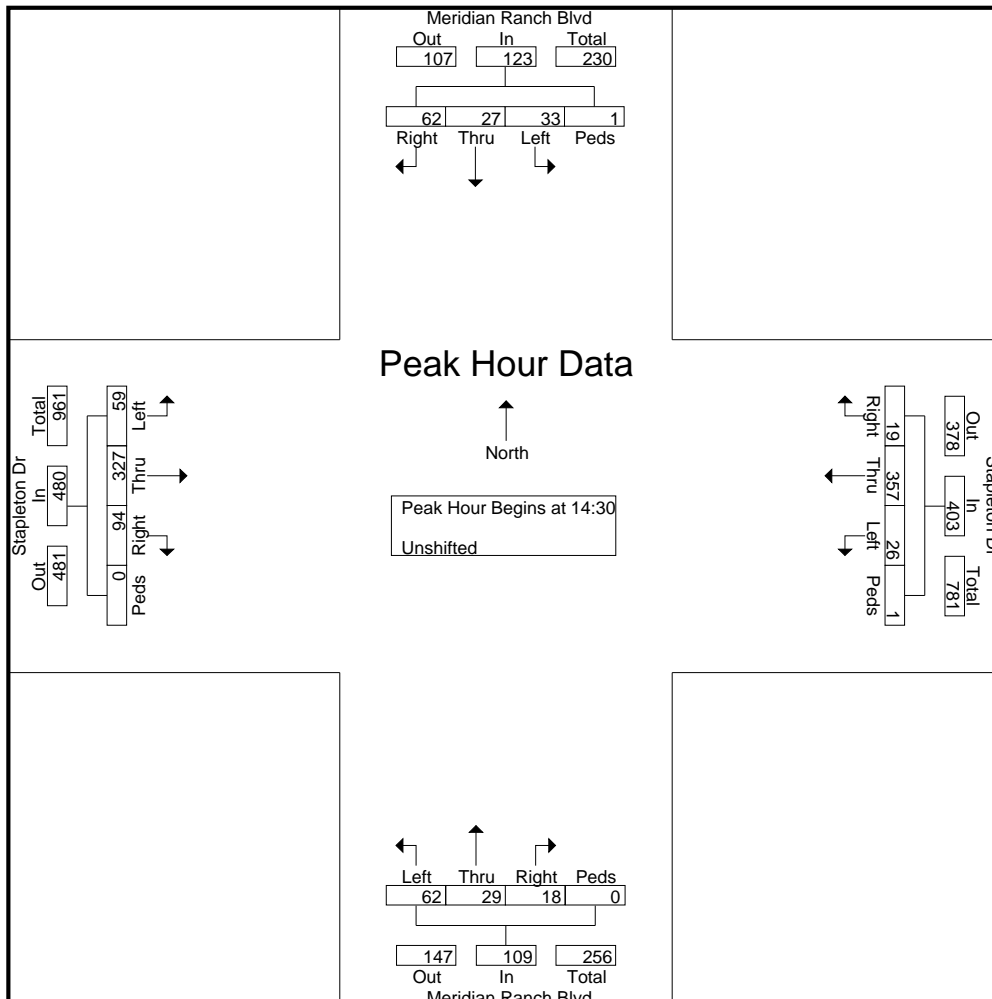

LSC Transportation Consultants, Inc.

2504 E. Pikes Peak Ave, Suite 304
 Colorado Springs, CO 80909
 719-633-2868

File Name : Meridian Ranch Blvd - Stapleton Dr PM SW
 Site Code : S234020
 Start Date : 4/24/2024
 Page No : 1

Groups Printed- Unshifted

Start Time	Meridian Ranch Blvd Southbound					Stapleton Dr Westbound					Meridian Ranch Blvd Northbound					Stapleton Dr Eastbound					Int. Total
	Right	Thru	Left	Peds	App. Total	Right	Thru	Left	Peds	App. Total	Right	Thru	Left	Peds	App. Total	Right	Thru	Left	Peds	App. Total	
16:00	2	0	1	1	4	5	27	0	1	33	1	1	4	0	6	9	26	8	1	44	87
16:05	7	2	1	2	12	2	28	2	0	32	0	4	7	0	11	7	22	11	0	40	95
16:10	8	3	0	0	11	1	19	0	0	20	2	2	3	0	7	14	38	3	0	55	93
16:15	7	3	2	0	12	1	19	1	0	21	1	1	6	0	8	8	20	8	1	37	78
16:20	9	0	1	0	10	2	25	2	0	29	3	1	4	0	8	10	35	8	0	53	100
16:25	3	4	3	0	10	2	24	0	0	26	3	2	6	0	11	8	24	7	0	39	86
16:30	3	2	1	0	6	2	29	3	0	34	0	3	5	0	8	5	16	3	2	26	74
16:35	6	0	2	0	8	3	19	1	0	23	2	5	4	0	11	7	22	6	0	35	77
16:40	6	2	2	1	11	3	24	0	0	27	1	1	3	0	5	9	15	4	0	28	71
16:45	4	2	3	0	9	2	19	1	0	22	2	2	10	0	14	6	25	6	1	38	83
16:50	6	1	2	0	9	4	23	0	0	27	0	5	5	0	10	7	26	6	0	39	85
16:55	3	1	3	0	7	7	25	1	0	33	0	3	5	0	8	10	24	6	0	40	88
Total	64	20	21	4	109	34	281	11	1	327	15	30	62	0	107	100	293	76	5	474	1017
17:00	6	0	1	0	7	2	32	0	0	34	0	1	10	0	11	8	29	12	0	49	101
17:05	6	2	0	0	8	0	18	2	0	20	2	4	5	0	11	15	25	6	1	47	86
17:10	5	2	0	0	7	2	24	0	0	26	3	4	9	0	16	9	26	9	0	44	93
17:15	7	3	0	0	10	2	17	2	0	21	1	2	6	0	9	5	35	3	0	43	83
17:20	12	3	2	2	19	2	31	2	0	35	0	5	4	0	9	10	28	9	0	47	110
17:25	9	3	0	0	12	3	22	0	0	25	0	2	3	0	5	14	33	7	0	54	96
17:30	5	3	0	2	10	1	19	1	0	21	1	3	4	0	8	8	28	5	0	41	80
17:35	5	2	0	0	7	2	13	0	0	15	2	4	1	0	7	8	28	6	0	42	71
17:40	4	1	0	0	5	1	21	2	0	24	1	0	6	0	7	6	25	5	1	37	73
17:45	5	1	0	0	6	3	25	0	0	28	0	2	2	0	4	4	38	7	0	49	87
17:50	1	1	0	0	2	1	24	1	0	26	3	1	9	0	13	3	26	6	0	35	76
17:55	1	2	0	2	5	3	20	0	0	23	1	1	6	0	8	15	25	4	0	44	80
Total	66	23	3	6	98	22	266	10	0	298	14	29	65	0	108	105	346	79	2	532	1036
Grand Total	130	43	24	10	207	56	547	21	1	625	29	59	127	0	215	205	639	155	7	1006	2053
Apprch %	62.8	20.8	11.6	4.8		9	87.5	3.4	0.2		13.5	27.4	59.1	0		20.4	63.5	15.4	0.7		
Total %	6.3	2.1	1.2	0.5	10.1	2.7	26.6	1	0	30.4	1.4	2.9	6.2	0	10.5	10	31.1	7.5	0.3	49	

LSC Transportation Consultants, Inc.

2504 E. Pikes Peak Ave, Suite 304
 Colorado Springs, CO 80909
 719-633-2868

File Name : Meridian Ranch Blvd - Stapelton Dr PM SW
 Site Code : S234020
 Start Date : 4/24/2024
 Page No : 2

Start Time	Meridian Ranch Blvd Southbound					Stapelton Dr Westbound					Meridian Ranch Blvd Northbound					Stapelton Dr Eastbound					Int. Total
	Right	Thru	Left	Peds	App. Total	Right	Thru	Left	Peds	App. Total	Right	Thru	Left	Peds	App. Total	Right	Thru	Left	Peds	App. Total	
Peak Hour Analysis From 16:00 to 17:55 - Peak 1 of 1																					
Peak Hour for Entire Intersection Begins at 16:35																					
16:35	6	0	2	0	8	3	19	1	0	23	2	5	4	0	11	7	22	6	0	35	77
16:40	6	2	2	1	11	3	24	0	0	27	1	1	3	0	5	9	15	4	0	28	71
16:45	4	2	3	0	9	2	19	1	0	22	2	2	10	0	14	6	25	6	1	38	83
16:50	6	1	2	0	9	4	23	0	0	27	0	5	5	0	10	7	26	6	0	39	85
16:55	3	1	3	0	7	7	25	1	0	33	0	3	5	0	8	10	24	6	0	40	88
17:00	6	0	1	0	7	2	32	0	0	34	0	1	10	0	11	8	29	12	0	49	101
17:05	6	2	0	0	8	0	18	2	0	20	2	4	5	0	11	15	25	6	1	47	86
17:10	5	2	0	0	7	2	24	0	0	26	3	4	9	0	16	9	26	9	0	44	93
17:15	7	3	0	0	10	2	17	2	0	21	1	2	6	0	9	5	35	3	0	43	83
17:20	12	3	2	2	19	2	31	2	0	35	0	5	4	0	9	10	28	9	0	47	110
17:25	9	3	0	0	12	3	22	0	0	25	0	2	3	0	5	14	33	7	0	54	96
17:30	5	3	0	2	10	1	19	1	0	21	1	3	4	0	8	8	28	5	0	41	80
Total Volume	75	22	15	5	117	31	273	10	0	314	12	37	68	0	117	108	316	79	2	505	1053
% App. Total	64.1	18.8	12.8	4.3		9.9	86.9	3.2	0		10.3	31.6	58.1	0		21.4	62.6	15.6	0.4		
PHF	.521	.611	.417	.208	.513	.369	.711	.417	.000	.748	.333	.617	.567	.000	.609	.600	.752	.549	.167	.779	.798

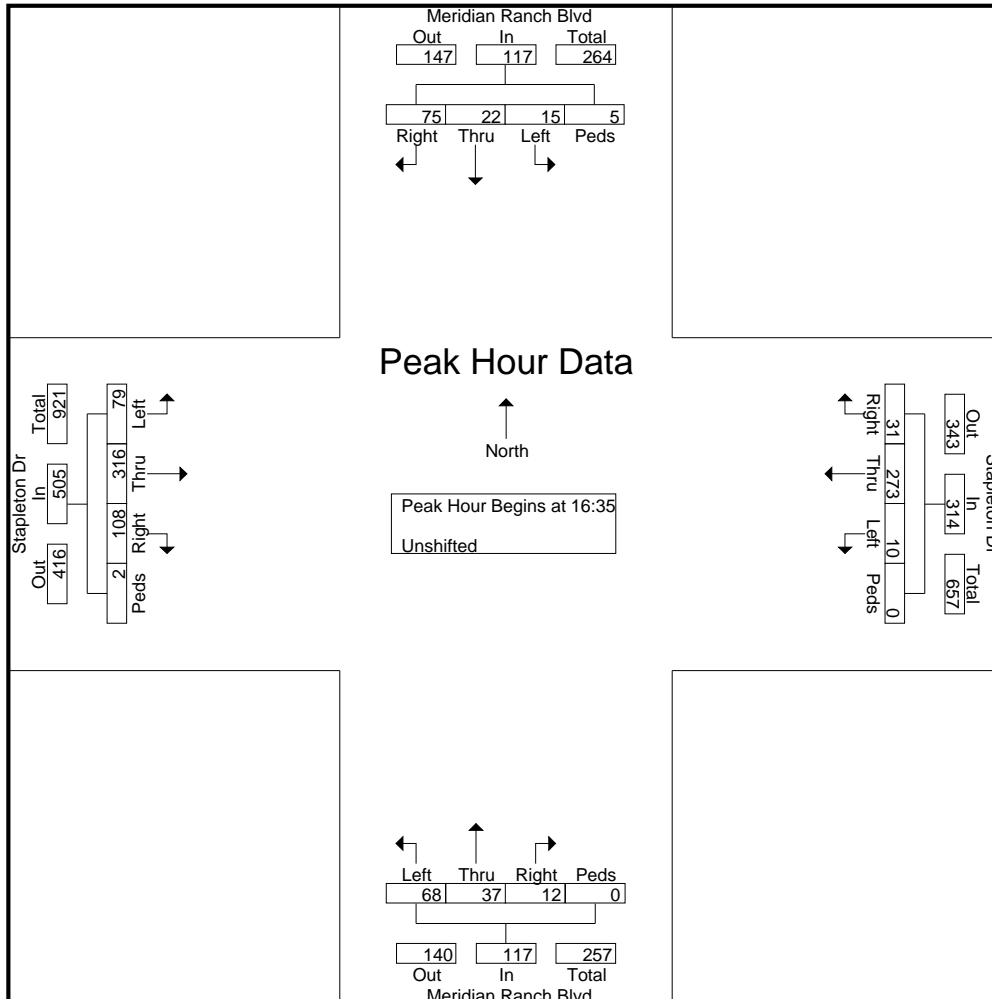

Level of Service Reports



Timings
7: Meridian Rd & Stapleton Dr

Existing Traffic
AM Peak Hour

Lane Group	EBL	EBT	EBR	WBL	WBT	WBR	NBL	NBT	NBR	SBL	SBT	SBR
Lane Configurations												
Traffic Volume (vph)	18	71	228	361	128	154	161	420	161	124	954	10
Future Volume (vph)	18	71	228	361	128	154	161	420	161	124	954	10
Turn Type	Perm	NA	Free	Perm	NA	Free	pm+pt	NA	Free	pm+pt	NA	Free
Protected Phases		4			8		5	2		1	6	
Permitted Phases	4		Free	8		Free	2		Free	6		Free
Detector Phase	4	4		8	8		5	2		1	6	
Switch Phase												
Minimum Initial (s)	5.0	5.0		5.0	5.0		5.0	5.0		5.0	5.0	
Minimum Split (s)	10.0	10.0		10.0	10.0		10.0	10.0		10.0	10.0	
Total Split (s)	33.0	33.0		33.0	33.0		12.0	45.0		12.0	45.0	
Total Split (%)	36.7%	36.7%		36.7%	36.7%		13.3%	50.0%		13.3%	50.0%	
Yellow Time (s)	3.0	3.0		3.0	3.0		3.0	3.0		3.0	3.0	
All-Red Time (s)	2.0	2.0		2.0	2.0		2.0	2.0		2.0	2.0	
Lost Time Adjust (s)	0.0	0.0		0.0	0.0		0.0	0.0		0.0	0.0	
Total Lost Time (s)	5.0	5.0		5.0	5.0		5.0	5.0		5.0	5.0	
Lead/Lag							Lead	Lag		Lead	Lag	
Lead-Lag Optimize?							Yes	Yes		Yes	Yes	
Recall Mode	None	None		None	None		None	None		None	None	
Act Effct Green (s)	28.2	28.2	80.0	28.2	28.2	80.0	36.9	29.8	80.0	36.6	29.7	80.0
Actuated g/C Ratio	0.35	0.35	1.00	0.35	0.35	1.00	0.46	0.37	1.00	0.46	0.37	1.00
v/c Ratio	0.05	0.14	0.18	0.91	0.22	0.11	0.71	0.35	0.11	0.29	0.78	0.01
Control Delay	20.3	20.5	0.3	53.0	21.2	0.1	29.2	18.5	0.1	11.4	26.7	0.0
Queue Delay	0.0	0.0	0.0	0.0	0.0	0.0	0.0	0.0	0.0	0.0	0.0	0.0
Total Delay	20.3	20.5	0.3	53.0	21.2	0.1	29.2	18.5	0.1	11.4	26.7	0.0
LOS	C	C	A	D	C	A	C	B	A	B	C	A
Approach Delay		5.9			34.0			16.8			24.7	
Approach LOS		A			C			B			C	

Intersection Summary

Cycle Length: 90
 Actuated Cycle Length: 80
 Natural Cycle: 70
 Control Type: Actuated-Uncoordinated
 Maximum v/c Ratio: 0.91
 Intersection Signal Delay: 22.4
 Intersection LOS: C
 Intersection Capacity Utilization 74.5%
 ICU Level of Service D
 Analysis Period (min) 15

Splits and Phases: 7: Meridian Rd & Stapleton Dr



HCM 6th TWSC
8: Stapleton Dr & Shops at Meridian Ranch

Existing Traffic
AM Peak Hour

Intersection						
Int Delay, s/veh	0.9					
Movement	EBL	EBT	WBT	WBR	SBL	SBR
Lane Configurations	↘	↗	↗	↘	↘	↘
Traffic Vol, veh/h	16	340	607	19	7	36
Future Vol, veh/h	16	340	607	19	7	36
Conflicting Peds, #/hr	0	0	0	0	0	0
Sign Control	Free	Free	Free	Free	Stop	Stop
RT Channelized	-	None	-	None	-	None
Storage Length	155	-	-	-	60	0
Veh in Median Storage, #	-	0	0	-	0	-
Grade, %	-	0	0	-	0	-
Peak Hour Factor	87	87	85	85	78	78
Heavy Vehicles, %	2	2	2	2	2	2
Mvmt Flow	18	391	714	22	9	46

Major/Minor	Major1	Major2	Minor2		
Conflicting Flow All	736	0	-	0	1141 714
Stage 1	-	-	-	-	714 -
Stage 2	-	-	-	-	427 -
Critical Hdwy	4.12	-	-	-	6.42 6.22
Critical Hdwy Stg 1	-	-	-	-	5.42 -
Critical Hdwy Stg 2	-	-	-	-	5.42 -
Follow-up Hdwy	2.218	-	-	-	3.518 3.318
Pot Cap-1 Maneuver	870	-	-	-	222 431
Stage 1	-	-	-	-	485 -
Stage 2	-	-	-	-	658 -
Platoon blocked, %		-	-	-	
Mov Cap-1 Maneuver	870	-	-	-	217 431
Mov Cap-2 Maneuver	-	-	-	-	217 -
Stage 1	-	-	-	-	475 -
Stage 2	-	-	-	-	658 -

Approach	EB	WB	SB
HCM Control Delay, s	0.4	0	15.7
HCM LOS			C

Minor Lane/Major Mvmt	EBL	EBT	WBT	WBR	SBLn1	SBLn2
Capacity (veh/h)	870	-	-	-	217	431
HCM Lane V/C Ratio	0.021	-	-	-	0.041	0.107
HCM Control Delay (s)	9.2	-	-	-	22.3	14.4
HCM Lane LOS	A	-	-	-	C	B
HCM 95th %tile Q(veh)	0.1	-	-	-	0.1	0.4

HCM 6th TWSC
 9: Meridian Ranch Rd & Stapleton Dr

Existing Traffic
 AM Peak Hour

Intersection												
Int Delay, s/veh	13.7											
Movement	EBL	EBT	EBR	WBL	WBT	WBR	NBL	NBT	NBR	SBL	SBT	SBR
Lane Configurations	↖	↗		↖	↗	↖	↖	↗		↖	↗	↖
Traffic Vol, veh/h	32	260	65	17	449	20	83	16	26	24	28	104
Future Vol, veh/h	32	260	65	17	449	20	83	16	26	24	28	104
Conflicting Peds, #/hr	0	0	0	0	0	0	0	0	0	0	0	0
Sign Control	Free	Free	Free	Free	Free	Free	Stop	Stop	Stop	Stop	Stop	Stop
RT Channelized	-	-	None	-	-	None	-	-	None	-	-	None
Storage Length	300	-	-	235	-	250	285	-	-	170	-	0
Veh in Median Storage, #	-	0	-	-	0	-	-	0	-	-	0	-
Grade, %	-	0	-	-	0	-	-	0	-	-	0	-
Peak Hour Factor	91	91	91	84	84	84	69	69	69	85	85	85
Heavy Vehicles, %	2	2	2	2	2	2	2	2	2	2	2	2
Mvmt Flow	35	286	71	20	535	24	120	23	38	28	33	122

Major/Minor	Major1			Major2			Minor1			Minor2		
Conflicting Flow All	559	0	0	357	0	0	1057	991	322	997	1002	535
Stage 1	-	-	-	-	-	-	392	392	-	575	575	-
Stage 2	-	-	-	-	-	-	665	599	-	422	427	-
Critical Hdwy	4.12	-	-	4.12	-	-	7.12	6.52	6.22	7.12	6.52	6.22
Critical Hdwy Stg 1	-	-	-	-	-	-	6.12	5.52	-	6.12	5.52	-
Critical Hdwy Stg 2	-	-	-	-	-	-	6.12	5.52	-	6.12	5.52	-
Follow-up Hdwy	2.218	-	-	2.218	-	-	3.518	4.018	3.318	3.518	4.018	3.318
Pot Cap-1 Maneuver	1012	-	-	1202	-	-	203	246	719	223	242	545
Stage 1	-	-	-	-	-	-	633	606	-	503	503	-
Stage 2	-	-	-	-	-	-	449	490	-	609	585	-
Platoon blocked, %	-	-	-	-	-	-	-	-	-	-	-	-
Mov Cap-1 Maneuver	1012	-	-	1202	-	-	135	233	719	188	230	545
Mov Cap-2 Maneuver	-	-	-	-	-	-	135	233	-	188	230	-
Stage 1	-	-	-	-	-	-	611	585	-	485	494	-
Stage 2	-	-	-	-	-	-	320	482	-	535	565	-

Approach	EB			WB			NB			SB		
HCM Control Delay, s	0.8			0.3			80.5			17.4		
HCM LOS							F			C		

Minor Lane/Major Mvmt	NBLn1	NBLn2	EBL	EBT	EBR	WBL	WBT	WBR	SBLn1	SBLn2	SBLn3
Capacity (veh/h)	135	401	1012	-	-	1202	-	-	188	230	545
HCM Lane V/C Ratio	0.891	0.152	0.035	-	-	0.017	-	-	0.15	0.143	0.225
HCM Control Delay (s)	113.4	15.6	8.7	-	-	8	-	-	27.5	23.3	13.5
HCM Lane LOS	F	C	A	-	-	A	-	-	D	C	B
HCM 95th %tile Q(veh)	5.9	0.5	0.1	-	-	0.1	-	-	0.5	0.5	0.9

Timings
7: Meridian Rd & Stapleton Dr

Existing Traffic
PM Peak Hour

Lane Group	EBL	EBT	EBR	WBL	WBT	WBR	NBL	NBT	NBR	SBL	SBT	SBR
Lane Configurations												
Traffic Volume (vph)	7	41	136	283	53	73	226	885	396	103	543	5
Future Volume (vph)	7	41	136	283	53	73	226	885	396	103	543	5
Turn Type	Perm	NA	Free	Perm	NA	Free	pm+pt	NA	Free	pm+pt	NA	Free
Protected Phases		4			8		5	2		1	6	
Permitted Phases	4		Free	8		Free	2		Free	6		Free
Detector Phase	4	4		8	8		5	2		1	6	
Switch Phase												
Minimum Initial (s)	5.0	5.0		5.0	5.0		5.0	5.0		5.0	5.0	
Minimum Split (s)	10.0	10.0		10.0	10.0		10.0	10.0		10.0	10.0	
Total Split (s)	30.0	30.0		30.0	30.0		12.0	48.0		12.0	48.0	
Total Split (%)	33.3%	33.3%		33.3%	33.3%		13.3%	53.3%		13.3%	53.3%	
Yellow Time (s)	3.0	3.0		3.0	3.0		3.0	3.0		3.0	3.0	
All-Red Time (s)	2.0	2.0		2.0	2.0		2.0	2.0		2.0	2.0	
Lost Time Adjust (s)	0.0	0.0		0.0	0.0		0.0	0.0		0.0	0.0	
Total Lost Time (s)	5.0	5.0		5.0	5.0		5.0	5.0		5.0	5.0	
Lead/Lag							Lead	Lag		Lead	Lag	
Lead-Lag Optimize?							Yes	Yes		Yes	Yes	
Recall Mode	None	None		None	None		None	None		None	None	
Act Effct Green (s)	19.4	19.4	64.7	19.4	19.4	64.7	31.1	25.8	64.7	29.2	22.3	64.7
Actuated g/C Ratio	0.30	0.30	1.00	0.30	0.30	1.00	0.48	0.40	1.00	0.45	0.34	1.00
v/c Ratio	0.02	0.10	0.12	0.74	0.10	0.05	0.54	0.64	0.26	0.34	0.48	0.00
Control Delay	18.1	18.4	0.2	34.1	18.4	0.1	14.4	19.8	0.4	11.2	18.1	0.0
Queue Delay	0.0	0.0	0.0	0.0	0.0	0.0	0.0	0.0	0.0	0.0	0.0	0.0
Total Delay	18.1	18.4	0.2	34.1	18.4	0.1	14.4	19.8	0.4	11.2	18.1	0.0
LOS	B	B	A	C	B	A	B	B	A	B	B	A
Approach Delay		4.9			26.0			13.9			16.9	
Approach LOS		A			C			B			B	

Intersection Summary

Cycle Length: 90
 Actuated Cycle Length: 64.7
 Natural Cycle: 60
 Control Type: Actuated-Uncoordinated
 Maximum v/c Ratio: 0.74
 Intersection Signal Delay: 15.6
 Intersection Capacity Utilization 65.0%
 Analysis Period (min) 15
 Intersection LOS: B
 ICU Level of Service C

Splits and Phases: 7: Meridian Rd & Stapleton Dr

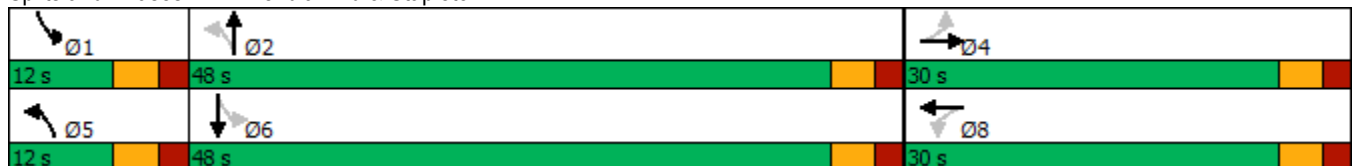

HCM 6th TWSC
8: Stapleton Dr & Shops at Meridian Ranch

Existing Traffic
PM Peak Hour

Intersection						
Int Delay, s/veh	2.6					
Movement	EBL	EBT	WBT	WBR	SBL	SBR
Lane Configurations	↘	↗	↗	↘	↘	↘
Traffic Vol, veh/h	61	479	368	33	59	41
Future Vol, veh/h	61	479	368	33	59	41
Conflicting Peds, #/hr	0	0	0	0	0	0
Sign Control	Free	Free	Free	Free	Stop	Stop
RT Channelized	-	None	-	None	-	None
Storage Length	155	-	-	-	60	0
Veh in Median Storage, #	-	0	0	-	0	-
Grade, %	-	0	0	-	0	-
Peak Hour Factor	92	92	92	92	83	83
Heavy Vehicles, %	2	2	2	2	2	2
Mvmt Flow	66	521	400	36	71	49

Major/Minor	Major1	Major2	Minor2		
Conflicting Flow All	436	0	-	0	1053
Stage 1	-	-	-	-	400
Stage 2	-	-	-	-	653
Critical Hdwy	4.12	-	-	-	6.42
Critical Hdwy Stg 1	-	-	-	-	5.42
Critical Hdwy Stg 2	-	-	-	-	5.42
Follow-up Hdwy	2.218	-	-	-	3.518
Pot Cap-1 Maneuver	1124	-	-	-	251
Stage 1	-	-	-	-	677
Stage 2	-	-	-	-	518
Platoon blocked, %	-	-	-	-	-
Mov Cap-1 Maneuver	1124	-	-	-	236
Mov Cap-2 Maneuver	-	-	-	-	236
Stage 1	-	-	-	-	637
Stage 2	-	-	-	-	518

Approach	EB	WB	SB
HCM Control Delay, s	0.9	0	20.3
HCM LOS			C

Minor Lane/Major Mvmt	EBL	EBT	WBT	WBR	SBLn1	SBLn2
Capacity (veh/h)	1124	-	-	-	236	650
HCM Lane V/C Ratio	0.059	-	-	-	0.301	0.076
HCM Control Delay (s)	8.4	-	-	-	26.7	11
HCM Lane LOS	A	-	-	-	D	B
HCM 95th %tile Q(veh)	0.2	-	-	-	1.2	0.2

HCM 6th TWSC
 9: Meridian Ranch Rd & Stapleton Dr

Existing Traffic
 PM Peak Hour

Intersection												
Int Delay, s/veh	6.9											
Movement	EBL	EBT	EBR	WBL	WBT	WBR	NBL	NBT	NBR	SBL	SBT	SBR
Lane Configurations	↖	↗		↖	↗	↖	↖	↗		↖	↗	↖
Traffic Vol, veh/h	79	316	108	10	273	31	68	37	12	15	22	75
Future Vol, veh/h	79	316	108	10	273	31	68	37	12	15	22	75
Conflicting Peds, #/hr	0	0	0	0	0	0	0	0	0	0	0	0
Sign Control	Free	Free	Free	Free	Free	Free	Stop	Stop	Stop	Stop	Stop	Stop
RT Channelized	-	-	None	-	-	None	-	-	None	-	-	None
Storage Length	300	-	-	235	-	250	285	-	-	170	-	0
Veh in Median Storage, #	-	0	-	-	0	-	-	0	-	-	0	-
Grade, %	-	0	-	-	0	-	-	0	-	-	0	-
Peak Hour Factor	89	89	89	87	87	87	83	83	83	76	76	76
Heavy Vehicles, %	2	2	2	2	2	2	2	2	2	2	2	2
Mvmt Flow	89	355	121	11	314	36	82	45	14	20	29	99

Major/Minor	Major1			Major2			Minor1			Minor2		
Conflicting Flow All	350	0	0	476	0	0	1012	966	416	959	990	314
Stage 1	-	-	-	-	-	-	594	594	-	336	336	-
Stage 2	-	-	-	-	-	-	418	372	-	623	654	-
Critical Hdwy	4.12	-	-	4.12	-	-	7.12	6.52	6.22	7.12	6.52	6.22
Critical Hdwy Stg 1	-	-	-	-	-	-	6.12	5.52	-	6.12	5.52	-
Critical Hdwy Stg 2	-	-	-	-	-	-	6.12	5.52	-	6.12	5.52	-
Follow-up Hdwy	2.218	-	-	2.218	-	-	3.518	4.018	3.318	3.518	4.018	3.318
Pot Cap-1 Maneuver	1209	-	-	1086	-	-	218	255	637	237	246	726
Stage 1	-	-	-	-	-	-	491	493	-	678	642	-
Stage 2	-	-	-	-	-	-	612	619	-	474	463	-
Platoon blocked, %	-	-	-	-	-	-	-	-	-	-	-	-
Mov Cap-1 Maneuver	1209	-	-	1086	-	-	159	234	637	186	226	726
Mov Cap-2 Maneuver	-	-	-	-	-	-	159	234	-	186	226	-
Stage 1	-	-	-	-	-	-	455	457	-	628	636	-
Stage 2	-	-	-	-	-	-	500	613	-	387	429	-

Approach	EB			WB			NB			SB		
HCM Control Delay, s	1.3			0.3			37.8			15.3		
HCM LOS							E			C		

Minor Lane/Major Mvmt	NBLn1	NBLn2	EBL	EBT	EBR	WBL	WBT	WBR	SBLn1	SBLn2	SBLn3
Capacity (veh/h)	159	277	1209	-	-	1086	-	-	186	226	726
HCM Lane V/C Ratio	0.515	0.213	0.073	-	-	0.011	-	-	0.106	0.128	0.136
HCM Control Delay (s)	49.5	21.5	8.2	-	-	8.3	-	-	26.6	23.3	10.7
HCM Lane LOS	E	C	A	-	-	A	-	-	D	C	B
HCM 95th %tile Q(veh)	2.5	0.8	0.2	-	-	0	-	-	0.3	0.4	0.5

Timings
7: Meridian Rd & Stapleton Dr

2028 Background Traffic
AM Peak Hour

Lane Group	EBL	EBT	EBR	WBL	WBT	WBR	NBL	NBT	NBR	SBL	SBT	SBR
Lane Configurations												
Traffic Volume (vph)	19	71	228	410	128	173	161	478	181	140	1074	10
Future Volume (vph)	19	71	228	410	128	173	161	478	181	140	1074	10
Turn Type	pm+pt	NA	Free	pm+pt	NA	Free	pm+pt	NA	Free	pm+pt	NA	Free
Protected Phases	7	4		3	8		5	2		1	6	
Permitted Phases	4		Free	8		Free	2		Free	6		Free
Detector Phase	7	4		3	8		5	2		1	6	
Switch Phase												
Minimum Initial (s)	5.0	5.0		5.0	5.0		5.0	5.0		5.0	5.0	
Minimum Split (s)	10.0	10.0		10.0	10.0		10.0	10.0		10.0	10.0	
Total Split (s)	12.0	15.0		25.0	28.0		12.0	38.0		12.0	38.0	
Total Split (%)	13.3%	16.7%		27.8%	31.1%		13.3%	42.2%		13.3%	42.2%	
Yellow Time (s)	3.0	3.0		3.0	3.0		3.0	3.0		3.0	3.0	
All-Red Time (s)	2.0	2.0		2.0	2.0		2.0	2.0		2.0	2.0	
Lost Time Adjust (s)	0.0	0.0		0.0	0.0		0.0	0.0		0.0	0.0	
Total Lost Time (s)	5.0	5.0		5.0	5.0		5.0	5.0		5.0	5.0	
Lead/Lag	Lead	Lag		Lead	Lag		Lead	Lag		Lead	Lag	
Lead-Lag Optimize?	Yes	Yes		Yes	Yes		Yes	Yes		Yes	Yes	
Recall Mode	None	None		None	None		None	None		None	None	
Act Effct Green (s)	13.4	8.7	83.8	30.4	26.0	83.8	38.3	31.1	83.8	37.9	30.9	83.8
Actuated g/C Ratio	0.16	0.10	1.00	0.36	0.31	1.00	0.46	0.37	1.00	0.45	0.37	1.00
v/c Ratio	0.10	0.47	0.18	0.90	0.25	0.13	0.73	0.40	0.12	0.36	0.89	0.01
Control Delay	20.1	46.3	0.3	46.9	25.2	0.2	34.6	21.3	0.2	14.9	35.2	0.0
Queue Delay	0.0	0.0	0.0	0.0	0.0	0.0	0.0	0.0	0.0	0.0	0.0	0.0
Total Delay	20.1	46.3	0.3	46.9	25.2	0.2	34.6	21.3	0.2	14.9	35.2	0.0
LOS	C	D	A	D	C	A	C	C	A	B	D	A
Approach Delay		11.7			31.6			19.2			32.6	
Approach LOS		B			C			B			C	

Intersection Summary

Cycle Length: 90
 Actuated Cycle Length: 83.8
 Natural Cycle: 90
 Control Type: Actuated-Uncoordinated
 Maximum v/c Ratio: 0.90
 Intersection Signal Delay: 26.4
 Intersection LOS: C
 Intersection Capacity Utilization 80.5%
 ICU Level of Service D
 Analysis Period (min) 15

Splits and Phases: 7: Meridian Rd & Stapleton Dr

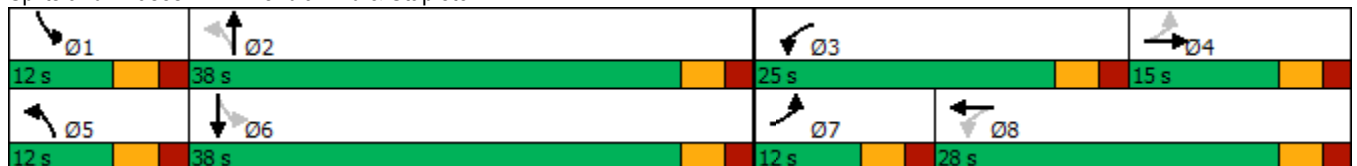

Intersection						
Int Delay, s/veh	0.9					
Movement	EBL	EBT	WBT	WBR	SBL	SBR
Lane Configurations	↘	↗	↗	↘	↘	↘
Traffic Vol, veh/h	16	376	670	21	7	41
Future Vol, veh/h	16	376	670	21	7	41
Conflicting Peds, #/hr	0	0	0	0	0	0
Sign Control	Free	Free	Free	Free	Stop	Stop
RT Channelized	-	None	-	None	-	None
Storage Length	155	-	-	-	60	0
Veh in Median Storage, #	-	0	0	-	0	-
Grade, %	-	0	0	-	0	-
Peak Hour Factor	87	87	85	85	78	78
Heavy Vehicles, %	2	2	2	2	2	2
Mvmt Flow	18	432	788	25	9	53

Major/Minor	Major1	Major2	Minor2		
Conflicting Flow All	813	0	-	0	1256 788
Stage 1	-	-	-	-	788 -
Stage 2	-	-	-	-	468 -
Critical Hdwy	4.12	-	-	-	6.42 6.22
Critical Hdwy Stg 1	-	-	-	-	5.42 -
Critical Hdwy Stg 2	-	-	-	-	5.42 -
Follow-up Hdwy	2.218	-	-	-	3.518 3.318
Pot Cap-1 Maneuver	814	-	-	-	189 391
Stage 1	-	-	-	-	448 -
Stage 2	-	-	-	-	630 -
Platoon blocked, %		-	-	-	
Mov Cap-1 Maneuver	814	-	-	-	185 391
Mov Cap-2 Maneuver	-	-	-	-	185 -
Stage 1	-	-	-	-	438 -
Stage 2	-	-	-	-	630 -

Approach	EB	WB	SB
HCM Control Delay, s	0.4	0	17
HCM LOS			C

Minor Lane/Major Mvmt	EBL	EBT	WBT	WBR	SBLn1	SBLn2
Capacity (veh/h)	814	-	-	-	185	391
HCM Lane V/C Ratio	0.023	-	-	-	0.049	0.134
HCM Control Delay (s)	9.5	-	-	-	25.4	15.6
HCM Lane LOS	A	-	-	-	D	C
HCM 95th %tile Q(veh)	0.1	-	-	-	0.2	0.5

Intersection												
Int Delay, s/veh	18.7											
Movement	EBL	EBT	EBR	WBL	WBT	WBR	NBL	NBT	NBR	SBL	SBT	SBR
Lane Configurations	↖	↗		↖	↗	↖	↖	↗		↖	↗	↖
Traffic Vol, veh/h	32	286	65	17	503	20	83	16	26	24	28	104
Future Vol, veh/h	32	286	65	17	503	20	83	16	26	24	28	104
Conflicting Peds, #/hr	0	0	0	0	0	0	0	0	0	0	0	0
Sign Control	Free	Free	Free	Free	Free	Free	Stop	Stop	Stop	Stop	Stop	Stop
RT Channelized	-	-	None	-	-	None	-	-	None	-	-	None
Storage Length	300	-	-	235	-	250	285	-	-	170	-	0
Veh in Median Storage, #	-	0	-	-	0	-	-	0	-	-	0	-
Grade, %	-	0	-	-	0	-	-	0	-	-	0	-
Peak Hour Factor	91	91	91	84	84	84	69	69	69	85	85	85
Heavy Vehicles, %	2	2	2	2	2	2	2	2	2	2	2	2
Mvmt Flow	35	314	71	20	599	24	120	23	38	28	33	122

Major/Minor	Major1			Major2			Minor1			Minor2		
Conflicting Flow All	623	0	0	385	0	0	1149	1083	350	1089	1094	599
Stage 1	-	-	-	-	-	-	420	420	-	639	639	-
Stage 2	-	-	-	-	-	-	729	663	-	450	455	-
Critical Hdwy	4.12	-	-	4.12	-	-	7.12	6.52	6.22	7.12	6.52	6.22
Critical Hdwy Stg 1	-	-	-	-	-	-	6.12	5.52	-	6.12	5.52	-
Critical Hdwy Stg 2	-	-	-	-	-	-	6.12	5.52	-	6.12	5.52	-
Follow-up Hdwy	2.218	-	-	2.218	-	-	3.518	4.018	3.318	3.518	4.018	3.318
Pot Cap-1 Maneuver	958	-	-	1173	-	-	176	217	693	193	214	502
Stage 1	-	-	-	-	-	-	611	589	-	464	470	-
Stage 2	-	-	-	-	-	-	414	459	-	589	569	-
Platoon blocked, %	-	-	-	-	-	-	-	-	-	-	-	-
Mov Cap-1 Maneuver	958	-	-	1173	-	-	~ 112	205	693	160	203	502
Mov Cap-2 Maneuver	-	-	-	-	-	-	~ 112	205	-	160	203	-
Stage 1	-	-	-	-	-	-	588	567	-	447	462	-
Stage 2	-	-	-	-	-	-	286	451	-	515	548	-

Approach	EB			WB			NB			SB		
HCM Control Delay, s	0.7			0.3			124.9			19.3		
HCM LOS							F			C		

Minor Lane/Major Mvmt	NBLn1	NBLn2	EBL	EBT	EBR	WBL	WBT	WBR	SBLn1	SBLn2	SBLn3
Capacity (veh/h)	112	363	958	-	-	1173	-	-	160	203	502
HCM Lane V/C Ratio	1.074	0.168	0.037	-	-	0.017	-	-	0.176	0.162	0.244
HCM Control Delay (s)	179.5	16.9	8.9	-	-	8.1	-	-	32.3	26.1	14.5
HCM Lane LOS	F	C	A	-	-	A	-	-	D	D	B
HCM 95th %tile Q(veh)	7.3	0.6	0.1	-	-	0.1	-	-	0.6	0.6	0.9

Notes
 ~: Volume exceeds capacity \$: Delay exceeds 300s +: Computation Not Defined *: All major volume in platoon

Timings
9: Meridian Ranch Rd & Stapleton Dr

2028 Background Traffic
AM Peak Hour



Lane Group	EBL	EBT	WBL	WBT	WBR	NBL	NBT	SBL	SBT	SBR
Lane Configurations										
Traffic Volume (vph)	32	286	17	503	20	83	16	24	28	104
Future Volume (vph)	32	286	17	503	20	83	16	24	28	104
Turn Type	pm+pt	NA	pm+pt	NA	Perm	pm+pt	NA	pm+pt	NA	Perm
Protected Phases	5	2	1	6		3	8	7	4	
Permitted Phases	2		6		6	8		4		4
Detector Phase	5	2	1	6	6	3	8	7	4	4
Switch Phase										
Minimum Initial (s)	5.0	5.0	5.0	5.0	5.0	5.0	5.0	5.0	5.0	5.0
Minimum Split (s)	10.0	20.0	10.0	20.0	20.0	10.0	20.0	10.0	20.0	20.0
Total Split (s)	10.0	45.0	10.0	45.0	45.0	10.0	25.0	10.0	25.0	25.0
Total Split (%)	11.1%	50.0%	11.1%	50.0%	50.0%	11.1%	27.8%	11.1%	27.8%	27.8%
Yellow Time (s)	3.0	3.0	3.0	3.0	3.0	3.0	3.0	3.0	3.0	3.0
All-Red Time (s)	2.0	2.0	2.0	2.0	2.0	2.0	2.0	2.0	2.0	2.0
Lost Time Adjust (s)	0.0	0.0	0.0	0.0	0.0	0.0	0.0	0.0	0.0	0.0
Total Lost Time (s)	5.0	5.0	5.0	5.0	5.0	5.0	5.0	5.0	5.0	5.0
Lead/Lag	Lead	Lag	Lead	Lag	Lag	Lead	Lag	Lead	Lag	Lag
Lead-Lag Optimize?	Yes	Yes	Yes	Yes	Yes	Yes	Yes	Yes	Yes	Yes
Recall Mode	None	Min	None	Min	Min	None	None	None	None	None
Act Effct Green (s)	30.8	31.9	30.0	30.3	30.3	13.3	12.0	11.0	7.3	7.3
Actuated g/C Ratio	0.57	0.59	0.56	0.56	0.56	0.25	0.22	0.20	0.14	0.14
v/c Ratio	0.09	0.36	0.03	0.57	0.03	0.36	0.15	0.09	0.13	0.36
Control Delay	6.6	10.0	6.2	15.1	0.1	23.1	16.0	20.2	28.7	7.9
Queue Delay	0.0	0.0	0.0	0.0	0.0	0.0	0.0	0.0	0.0	0.0
Total Delay	6.6	10.0	6.2	15.1	0.1	23.1	16.0	20.2	28.7	7.9
LOS	A	B	A	B	A	C	B	C	C	A
Approach Delay		9.7		14.3			20.7		13.5	
Approach LOS		A		B			C		B	

Intersection Summary

Cycle Length: 90
 Actuated Cycle Length: 53.9
 Natural Cycle: 70
 Control Type: Actuated-Uncoordinated
 Maximum v/c Ratio: 0.57
 Intersection Signal Delay: 13.7
 Intersection LOS: B
 Intersection Capacity Utilization 50.0%
 ICU Level of Service A
 Analysis Period (min) 15

Splits and Phases: 9: Meridian Ranch Rd & Stapleton Dr

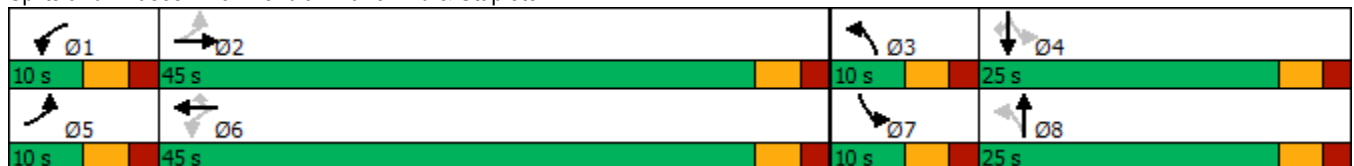

Timings
7: Meridian Rd & Stapleton Dr

2028 Background Traffic
PM Peak Hour

Lane Group	EBL	EBT	EBR	WBL	WBT	WBR	NBL	NBT	NBR	SBL	SBT	SBR
Lane Configurations												
Traffic Volume (vph)	8	41	136	333	54	83	226	1008	446	116	611	5
Future Volume (vph)	8	41	136	333	54	83	226	1008	446	116	611	5
Turn Type	pm+pt	NA	Free	pm+pt	NA	Free	pm+pt	NA	Free	pm+pt	NA	Free
Protected Phases	7	4		3	8		5	2		1	6	
Permitted Phases	4		Free	8		Free	2		Free	6		Free
Detector Phase	7	4		3	8		5	2		1	6	
Switch Phase												
Minimum Initial (s)	5.0	5.0		5.0	5.0		5.0	5.0		5.0	5.0	
Minimum Split (s)	10.0	10.0		10.0	10.0		10.0	10.0		10.0	10.0	
Total Split (s)	12.0	15.0		22.0	25.0		12.0	41.0		12.0	41.0	
Total Split (%)	13.3%	16.7%		24.4%	27.8%		13.3%	45.6%		13.3%	45.6%	
Yellow Time (s)	3.0	3.0		3.0	3.0		3.0	3.0		3.0	3.0	
All-Red Time (s)	2.0	2.0		2.0	2.0		2.0	2.0		2.0	2.0	
Lost Time Adjust (s)	0.0	0.0		0.0	0.0		0.0	0.0		0.0	0.0	
Total Lost Time (s)	5.0	5.0		5.0	5.0		5.0	5.0		5.0	5.0	
Lead/Lag	Lead	Lag		Lead	Lag		Lead	Lag		Lead	Lag	
Lead-Lag Optimize?	Yes	Yes		Yes	Yes		Yes	Yes		Yes	Yes	
Recall Mode	None	None		None	None		None	None		None	None	
Act Effct Green (s)	10.9	8.1	73.1	22.5	20.6	73.1	36.1	30.9	73.1	34.0	26.7	73.1
Actuated g/C Ratio	0.15	0.11	1.00	0.31	0.28	1.00	0.49	0.42	1.00	0.47	0.37	1.00
v/c Ratio	0.05	0.28	0.12	0.78	0.11	0.05	0.60	0.69	0.29	0.45	0.51	0.00
Control Delay	20.4	39.2	0.2	36.2	23.1	0.1	19.2	22.6	0.5	15.6	20.0	0.0
Queue Delay	0.0	0.0	0.0	0.0	0.0	0.0	0.0	0.0	0.0	0.0	0.0	0.0
Total Delay	20.4	39.2	0.2	36.2	23.1	0.1	19.2	22.6	0.5	15.6	20.0	0.0
LOS	C	D	A	D	C	A	B	C	A	B	B	A
Approach Delay		9.7			28.4			16.3			19.2	
Approach LOS		A			C			B			B	

Intersection Summary

Cycle Length: 90
 Actuated Cycle Length: 73.1
 Natural Cycle: 60
 Control Type: Actuated-Uncoordinated
 Maximum v/c Ratio: 0.78
 Intersection Signal Delay: 18.3
 Intersection LOS: B
 Intersection Capacity Utilization 71.9%
 ICU Level of Service C
 Analysis Period (min) 15

Splits and Phases: 7: Meridian Rd & Stapleton Dr

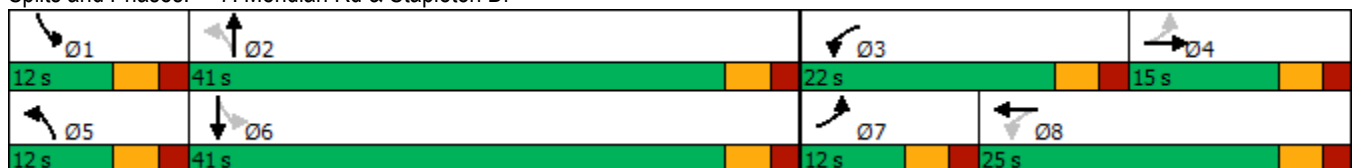

Intersection						
Int Delay, s/veh	3.1					
Movement	EBL	EBT	WBT	WBR	SBL	SBR
Lane Configurations	↘	↗	↗	↘	↘	↘
Traffic Vol, veh/h	63	540	412	37	63	59
Future Vol, veh/h	63	540	412	37	63	59
Conflicting Peds, #/hr	0	0	0	0	0	0
Sign Control	Free	Free	Free	Free	Stop	Stop
RT Channelized	-	None	-	None	-	None
Storage Length	155	-	-	-	60	0
Veh in Median Storage, #	-	0	0	-	0	-
Grade, %	-	0	0	-	0	-
Peak Hour Factor	92	92	92	92	83	83
Heavy Vehicles, %	2	2	2	2	2	2
Mvmt Flow	68	587	448	40	76	71

Major/Minor	Major1	Major2	Minor2		
Conflicting Flow All	488	0	-	0	1171 448
Stage 1	-	-	-	-	448 -
Stage 2	-	-	-	-	723 -
Critical Hdwy	4.12	-	-	-	6.42 6.22
Critical Hdwy Stg 1	-	-	-	-	5.42 -
Critical Hdwy Stg 2	-	-	-	-	5.42 -
Follow-up Hdwy	2.218	-	-	-	3.518 3.318
Pot Cap-1 Maneuver	1075	-	-	-	213 611
Stage 1	-	-	-	-	644 -
Stage 2	-	-	-	-	481 -
Platoon blocked, %		-	-	-	
Mov Cap-1 Maneuver	1075	-	-	-	200 611
Mov Cap-2 Maneuver	-	-	-	-	200 -
Stage 1	-	-	-	-	603 -
Stage 2	-	-	-	-	481 -

Approach	EB	WB	SB
HCM Control Delay, s	0.9	0	23
HCM LOS			C

Minor Lane/Major Mvmt	EBL	EBT	WBT	WBR	SBLn1	SBLn2
Capacity (veh/h)	1075	-	-	-	200	611
HCM Lane V/C Ratio	0.064	-	-	-	0.38	0.116
HCM Control Delay (s)	8.6	-	-	-	33.6	11.7
HCM Lane LOS	A	-	-	-	D	B
HCM 95th %tile Q(veh)	0.2	-	-	-	1.7	0.4

Intersection												
Int Delay, s/veh	8.8											
Movement	EBL	EBT	EBR	WBL	WBT	WBR	NBL	NBT	NBR	SBL	SBT	SBR
Lane Configurations	↖	↗		↖	↗	↖	↖	↗		↖	↗	↖
Traffic Vol, veh/h	79	415	109	10	304	31	69	38	12	16	23	75
Future Vol, veh/h	79	415	109	10	304	31	69	38	12	16	23	75
Conflicting Peds, #/hr	0	0	0	0	0	0	0	0	0	0	0	0
Sign Control	Free	Free	Free	Free	Free	Free	Stop	Stop	Stop	Stop	Stop	Stop
RT Channelized	-	-	None	-	-	None	-	-	None	-	-	None
Storage Length	300	-	-	235	-	250	285	-	-	170	-	0
Veh in Median Storage, #	-	0	-	-	0	-	-	0	-	-	0	-
Grade, %	-	0	-	-	0	-	-	0	-	-	0	-
Peak Hour Factor	89	89	89	87	87	87	83	83	83	76	76	76
Heavy Vehicles, %	2	2	2	2	2	2	2	2	2	2	2	2
Mvmt Flow	89	466	122	11	349	36	83	46	14	21	30	99

Major/Minor	Major1			Major2			Minor1			Minor2		
Conflicting Flow All	385	0	0	588	0	0	1159	1112	527	1106	1137	349
Stage 1	-	-	-	-	-	-	705	705	-	371	371	-
Stage 2	-	-	-	-	-	-	454	407	-	735	766	-
Critical Hdwy	4.12	-	-	4.12	-	-	7.12	6.52	6.22	7.12	6.52	6.22
Critical Hdwy Stg 1	-	-	-	-	-	-	6.12	5.52	-	6.12	5.52	-
Critical Hdwy Stg 2	-	-	-	-	-	-	6.12	5.52	-	6.12	5.52	-
Follow-up Hdwy	2.218	-	-	2.218	-	-	3.518	4.018	3.318	3.518	4.018	3.318
Pot Cap-1 Maneuver	1173	-	-	987	-	-	173	209	551	188	202	694
Stage 1	-	-	-	-	-	-	427	439	-	649	620	-
Stage 2	-	-	-	-	-	-	586	597	-	411	412	-
Platoon blocked, %	-	-	-	-	-	-	-	-	-	-	-	-
Mov Cap-1 Maneuver	1173	-	-	987	-	-	121	191	551	140	185	694
Mov Cap-2 Maneuver	-	-	-	-	-	-	121	191	-	140	185	-
Stage 1	-	-	-	-	-	-	395	406	-	600	613	-
Stage 2	-	-	-	-	-	-	473	590	-	328	381	-

Approach	EB			WB			NB			SB		
HCM Control Delay, s	1.1			0.3			59.4			17.9		
HCM LOS							F			C		

Minor Lane/Major Mvmt	NBLn1	NBLn2	EBL	EBT	EBR	WBL	WBT	WBR	SBLn1	SBLn2	SBLn3
Capacity (veh/h)	121	227	1173	-	-	987	-	-	140	185	694
HCM Lane V/C Ratio	0.687	0.265	0.076	-	-	0.012	-	-	0.15	0.164	0.142
HCM Control Delay (s)	83.3	26.5	8.3	-	-	8.7	-	-	35.2	28.2	11
HCM Lane LOS	F	D	A	-	-	A	-	-	E	D	B
HCM 95th %tile Q(veh)	3.7	1	0.2	-	-	0	-	-	0.5	0.6	0.5

Timings
9: Meridian Ranch Rd & Stapleton Dr

2028 Background Traffic
PM Peak Hour



Lane Group	EBL	EBT	WBL	WBT	WBR	NBL	NBT	SBL	SBT	SBR
Lane Configurations										
Traffic Volume (vph)	79	415	10	304	31	69	38	16	23	75
Future Volume (vph)	79	415	10	304	31	69	38	16	23	75
Turn Type	pm+pt	NA	pm+pt	NA	Perm	pm+pt	NA	pm+pt	NA	Perm
Protected Phases	5	2	1	6		3	8	7	4	
Permitted Phases	2		6		6	8		4		4
Detector Phase	5	2	1	6	6	3	8	7	4	4
Switch Phase										
Minimum Initial (s)	5.0	5.0	5.0	5.0	5.0	5.0	5.0	5.0	5.0	5.0
Minimum Split (s)	10.0	23.0	10.0	23.0	23.0	10.0	23.0	10.0	23.0	23.0
Total Split (s)	10.0	45.0	10.0	45.0	45.0	10.0	25.0	10.0	25.0	25.0
Total Split (%)	11.1%	50.0%	11.1%	50.0%	50.0%	11.1%	27.8%	11.1%	27.8%	27.8%
Yellow Time (s)	3.0	3.0	3.0	3.0	3.0	3.0	3.0	3.0	3.0	3.0
All-Red Time (s)	2.0	2.0	2.0	2.0	2.0	2.0	2.0	2.0	2.0	2.0
Lost Time Adjust (s)	0.0	0.0	0.0	0.0	0.0	0.0	0.0	0.0	0.0	0.0
Total Lost Time (s)	5.0	5.0	5.0	5.0	5.0	5.0	5.0	5.0	5.0	5.0
Lead/Lag	Lead	Lag	Lead	Lag	Lag	Lead	Lag	Lead	Lag	Lag
Lead-Lag Optimize?	Yes	Yes	Yes	Yes	Yes	Yes	Yes	Yes	Yes	Yes
Recall Mode	None	C-Max	None	C-Max	C-Max	None	Min	None	Min	Min
Act Effct Green (s)	63.9	62.1	59.1	54.5	54.5	13.6	11.6	11.6	7.6	7.6
Actuated g/C Ratio	0.71	0.69	0.66	0.61	0.61	0.15	0.13	0.13	0.08	0.08
v/c Ratio	0.13	0.47	0.02	0.31	0.04	0.40	0.25	0.11	0.19	0.37
Control Delay	4.7	7.7	5.3	11.6	0.1	36.6	31.4	29.6	40.0	6.5
Queue Delay	0.0	0.0	0.0	0.0	0.0	0.0	0.0	0.0	0.0	0.0
Total Delay	4.7	7.7	5.3	11.6	0.1	36.6	31.4	29.6	40.0	6.5
LOS	A	A	A	B	A	D	C	C	D	A
Approach Delay		7.3		10.4			34.4		16.4	
Approach LOS		A		B			C		B	

Intersection Summary

Cycle Length: 90
 Actuated Cycle Length: 90
 Offset: 0 (0%), Referenced to phase 2:EBTL and 6:WBTL, Start of Green
 Natural Cycle: 75
 Control Type: Actuated-Coordinated
 Maximum v/c Ratio: 0.47
 Intersection Signal Delay: 12.1
 Intersection LOS: B
 Intersection Capacity Utilization 55.6%
 ICU Level of Service B
 Analysis Period (min) 15

Splits and Phases: 9: Meridian Ranch Rd & Stapleton Dr

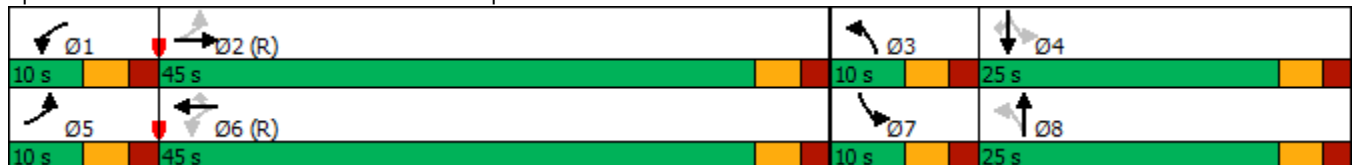

Timings
7: Meridian Rd & Stapleton Dr

2028 Total Traffic
AM Peak Hour

Lane Group	EBL	EBT	EBR	WBL	WBT	WBR	NBL	NBT	NBR	SBL	SBT	SBR
Lane Configurations												
Traffic Volume (vph)	19	75	228	437	132	179	161	478	211	147	1074	10
Future Volume (vph)	19	75	228	437	132	179	161	478	211	147	1074	10
Turn Type	pm+pt	NA	Free	pm+pt	NA	Free	pm+pt	NA	Free	pm+pt	NA	Free
Protected Phases	7	4		3	8		5	2		1	6	
Permitted Phases	4		Free	8		Free	2		Free	6		Free
Detector Phase	7	4		3	8		5	2		1	6	
Switch Phase												
Minimum Initial (s)	5.0	5.0		5.0	5.0		5.0	5.0		5.0	5.0	
Minimum Split (s)	10.0	10.0		10.0	10.0		10.0	10.0		10.0	10.0	
Total Split (s)	12.0	15.0		25.0	28.0		12.0	38.0		12.0	38.0	
Total Split (%)	13.3%	16.7%		27.8%	31.1%		13.3%	42.2%		13.3%	42.2%	
Yellow Time (s)	3.0	3.0		3.0	3.0		3.0	3.0		3.0	3.0	
All-Red Time (s)	2.0	2.0		2.0	2.0		2.0	2.0		2.0	2.0	
Lost Time Adjust (s)	0.0	0.0		0.0	0.0		0.0	0.0		0.0	0.0	
Total Lost Time (s)	5.0	5.0		5.0	5.0		5.0	5.0		5.0	5.0	
Lead/Lag	Lead	Lag		Lead	Lag		Lead	Lag		Lead	Lag	
Lead-Lag Optimize?	Yes	Yes		Yes	Yes		Yes	Yes		Yes	Yes	
Recall Mode	None	None		None	None		None	None		None	None	
Act Effct Green (s)	13.5	8.8	84.7	31.3	26.9	84.7	38.3	31.2	84.7	38.0	31.0	84.7
Actuated g/C Ratio	0.16	0.10	1.00	0.37	0.32	1.00	0.45	0.37	1.00	0.45	0.37	1.00
v/c Ratio	0.10	0.49	0.18	0.94	0.26	0.13	0.74	0.40	0.14	0.39	0.89	0.01
Control Delay	20.1	47.1	0.3	52.9	25.2	0.2	36.1	21.5	0.2	15.4	36.0	0.0
Queue Delay	0.0	0.0	0.0	0.0	0.0	0.0	0.0	0.0	0.0	0.0	0.0	0.0
Total Delay	20.1	47.1	0.3	52.9	25.2	0.2	36.1	21.5	0.2	15.4	36.0	0.0
LOS	C	D	A	D	C	A	D	C	A	B	D	A
Approach Delay		12.3			35.4			19.0			33.3	
Approach LOS		B			D			B			C	

Intersection Summary

Cycle Length: 90
 Actuated Cycle Length: 84.7
 Natural Cycle: 80
 Control Type: Actuated-Uncoordinated
 Maximum v/c Ratio: 0.94
 Intersection Signal Delay: 27.6
 Intersection LOS: C
 Intersection Capacity Utilization 82.0%
 ICU Level of Service D
 Analysis Period (min) 15

Splits and Phases: 7: Meridian Rd & Stapleton Dr

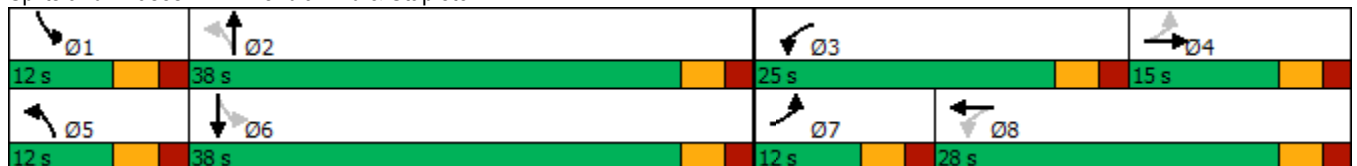

Intersection						
Int Delay, s/veh	3.7					
Movement	EBL	EBT	WBT	WBR	SBL	SBR
Lane Configurations	↘	↗	↗	↘	↘	↘
Traffic Vol, veh/h	77	355	629	72	37	119
Future Vol, veh/h	77	355	629	72	37	119
Conflicting Peds, #/hr	0	0	0	0	0	0
Sign Control	Free	Free	Free	Free	Stop	Stop
RT Channelized	-	None	-	None	-	None
Storage Length	155	-	-	-	60	0
Veh in Median Storage, #	-	0	0	-	0	-
Grade, %	-	0	0	-	0	-
Peak Hour Factor	87	87	85	85	78	78
Heavy Vehicles, %	2	2	2	2	2	2
Mvmt Flow	89	408	740	85	47	153

Major/Minor	Major1	Major2	Minor2		
Conflicting Flow All	825	0	-	0	1326 740
Stage 1	-	-	-	-	740 -
Stage 2	-	-	-	-	586 -
Critical Hdwy	4.12	-	-	-	6.42 6.22
Critical Hdwy Stg 1	-	-	-	-	5.42 -
Critical Hdwy Stg 2	-	-	-	-	5.42 -
Follow-up Hdwy	2.218	-	-	-	3.518 3.318
Pot Cap-1 Maneuver	805	-	-	-	172 417
Stage 1	-	-	-	-	472 -
Stage 2	-	-	-	-	556 -
Platoon blocked, %		-	-	-	
Mov Cap-1 Maneuver	805	-	-	-	153 417
Mov Cap-2 Maneuver	-	-	-	-	153 -
Stage 1	-	-	-	-	420 -
Stage 2	-	-	-	-	556 -

Approach	EB	WB	SB
HCM Control Delay, s	1.8	0	23.3
HCM LOS			C

Minor Lane/Major Mvmt	EBL	EBT	WBT	WBR	SBLn1	SBLn2
Capacity (veh/h)	805	-	-	-	153	417
HCM Lane V/C Ratio	0.11	-	-	-	0.31	0.366
HCM Control Delay (s)	10	-	-	-	38.8	18.5
HCM Lane LOS	B	-	-	-	E	C
HCM 95th %tile Q(veh)	0.4	-	-	-	1.2	1.6

Intersection						
Int Delay, s/veh	3.1					
Movement	EBL	EBT	WBT	WBR	SBL	SBR
Lane Configurations	↘	↗	↗	↘	↘	↘
Traffic Vol, veh/h	77	355	629	72	37	119
Future Vol, veh/h	77	355	629	72	37	119
Conflicting Peds, #/hr	0	0	0	0	0	0
Sign Control	Free	Free	Free	Free	Stop	Stop
RT Channelized	-	None	-	None	-	None
Storage Length	155	-	-	-	60	0
Veh in Median Storage, #	-	0	0	-	0	-
Grade, %	-	0	0	-	0	-
Peak Hour Factor	87	87	85	85	78	78
Heavy Vehicles, %	2	2	2	2	2	2
Mvmt Flow	89	408	740	85	47	153

Major/Minor	Major1	Major2	Minor2		
Conflicting Flow All	825	0	-	0	1326 740
Stage 1	-	-	-	-	740 -
Stage 2	-	-	-	-	586 -
Critical Hdwy	4.12	-	-	-	6.42 6.22
Critical Hdwy Stg 1	-	-	-	-	5.42 -
Critical Hdwy Stg 2	-	-	-	-	5.42 -
Follow-up Hdwy	2.218	-	-	-	3.518 3.318
Pot Cap-1 Maneuver	805	-	-	-	172 417
Stage 1	-	-	-	-	472 -
Stage 2	-	-	-	-	556 -
Platoon blocked, %		-	-	-	
Mov Cap-1 Maneuver	805	-	-	-	153 417
Mov Cap-2 Maneuver	-	-	-	-	286 -
Stage 1	-	-	-	-	420 -
Stage 2	-	-	-	-	556 -

Approach	EB	WB	SB
HCM Control Delay, s	1.8	0	18.9
HCM LOS			C

Minor Lane/Major Mvmt	EBL	EBT	WBT	WBR	SBLn1	SBLn2
Capacity (veh/h)	805	-	-	-	286	417
HCM Lane V/C Ratio	0.11	-	-	-	0.166	0.366
HCM Control Delay (s)	10	-	-	-	20.1	18.5
HCM Lane LOS	B	-	-	-	C	C
HCM 95th %tile Q(veh)	0.4	-	-	-	0.6	1.6

Timings
8: Stapleton Dr & Shops at Meridian Ranch

2028 Total Traffic
AM Peak Hour

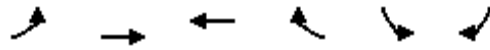

Lane Group	EBL	EBT	WBT	WBR	SBL	SBR
Lane Configurations	↶	↷	↶	↷	↶	↷
Traffic Volume (vph)	77	355	629	72	37	119
Future Volume (vph)	77	355	629	72	37	119
Turn Type	pm+pt	NA	NA	Perm	Prot	Perm
Protected Phases	5	2	6		4	
Permitted Phases	2			6		4
Detector Phase	5	2	6	6	4	4
Switch Phase						
Minimum Initial (s)	5.0	5.0	5.0	5.0	5.0	5.0
Minimum Split (s)	10.0	20.0	20.0	20.0	20.0	20.0
Total Split (s)	10.0	65.0	55.0	55.0	25.0	25.0
Total Split (%)	11.1%	72.2%	61.1%	61.1%	27.8%	27.8%
Yellow Time (s)	3.0	3.0	3.0	3.0	3.0	3.0
All-Red Time (s)	2.0	2.0	2.0	2.0	2.0	2.0
Lost Time Adjust (s)	0.0	0.0	0.0	0.0	0.0	0.0
Total Lost Time (s)	5.0	5.0	5.0	5.0	5.0	5.0
Lead/Lag	Lead		Lag	Lag		
Lead-Lag Optimize?	Yes		Yes	Yes		
Recall Mode	None	C-Max	C-Max	C-Max	None	None
Act Effct Green (s)	71.9	71.9	62.5	62.5	8.1	8.1
Actuated g/C Ratio	0.80	0.80	0.69	0.69	0.09	0.09
v/c Ratio	0.18	0.27	0.57	0.08	0.30	0.54
Control Delay	3.1	3.1	10.4	1.7	42.2	14.2
Queue Delay	0.0	0.0	0.0	0.0	0.0	0.0
Total Delay	3.1	3.1	10.4	1.7	42.2	14.2
LOS	A	A	B	A	D	B
Approach Delay		3.1	9.5		20.8	
Approach LOS		A	A		C	

Intersection Summary

Cycle Length: 90
 Actuated Cycle Length: 90
 Offset: 0 (0%), Referenced to phase 2:EBTL and 6:WBT, Start of Green
 Natural Cycle: 60
 Control Type: Actuated-Coordinated
 Maximum v/c Ratio: 0.57
 Intersection Signal Delay: 8.9
 Intersection LOS: A
 Intersection Capacity Utilization 54.0%
 ICU Level of Service A
 Analysis Period (min) 15

Splits and Phases: 8: Stapleton Dr & Shops at Meridian Ranch

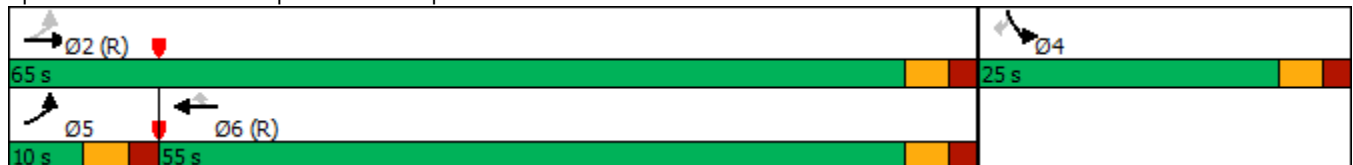

Intersection												
Int Delay, s/veh	23.4											
Movement	EBL	EBT	EBR	WBL	WBT	WBR	NBL	NBT	NBR	SBL	SBT	SBR
Lane Configurations	↖	↗		↖	↗	↖	↖	↗		↖	↗	↖
Traffic Vol, veh/h	34	288	70	17	506	20	89	16	26	24	28	107
Future Vol, veh/h	34	288	70	17	506	20	89	16	26	24	28	107
Conflicting Peds, #/hr	0	0	0	0	0	0	0	0	0	0	0	0
Sign Control	Free	Free	Free	Free	Free	Free	Stop	Stop	Stop	Stop	Stop	Stop
RT Channelized	-	-	None	-	-	None	-	-	None	-	-	None
Storage Length	300	-	-	235	-	250	285	-	-	170	-	0
Veh in Median Storage, #	-	0	-	-	0	-	-	0	-	-	0	-
Grade, %	-	0	-	-	0	-	-	0	-	-	0	-
Peak Hour Factor	91	91	91	84	84	84	69	69	69	85	85	85
Heavy Vehicles, %	2	2	2	2	2	2	2	2	2	2	2	2
Mvmt Flow	37	316	77	20	602	24	129	23	38	28	33	126

Major/Minor	Major1			Major2			Minor1			Minor2		
Conflicting Flow All	626	0	0	393	0	0	1163	1095	355	1101	1109	602
Stage 1	-	-	-	-	-	-	429	429	-	642	642	-
Stage 2	-	-	-	-	-	-	734	666	-	459	467	-
Critical Hdwy	4.12	-	-	4.12	-	-	7.12	6.52	6.22	7.12	6.52	6.22
Critical Hdwy Stg 1	-	-	-	-	-	-	6.12	5.52	-	6.12	5.52	-
Critical Hdwy Stg 2	-	-	-	-	-	-	6.12	5.52	-	6.12	5.52	-
Follow-up Hdwy	2.218	-	-	2.218	-	-	3.518	4.018	3.318	3.518	4.018	3.318
Pot Cap-1 Maneuver	956	-	-	1166	-	-	172	214	689	189	210	500
Stage 1	-	-	-	-	-	-	604	584	-	463	469	-
Stage 2	-	-	-	-	-	-	412	457	-	582	562	-
Platoon blocked, %	-	-	-	-	-	-	-	-	-	-	-	-
Mov Cap-1 Maneuver	956	-	-	1166	-	-	~ 108	202	689	156	198	500
Mov Cap-2 Maneuver	-	-	-	-	-	-	~ 108	202	-	156	198	-
Stage 1	-	-	-	-	-	-	580	561	-	445	461	-
Stage 2	-	-	-	-	-	-	281	449	-	507	540	-

Approach	EB	WB	NB	SB
HCM Control Delay, s	0.8	0.3	156.9	19.5
HCM LOS			F	C

Minor Lane/Major Mvmt	NBLn1	NBLn2	EBL	EBT	EBR	WBL	WBT	WBR	SBLn1	SBLn2	SBLn3
Capacity (veh/h)	108	359	956	-	-	1166	-	-	156	198	500
HCM Lane V/C Ratio	1.194	0.17	0.039	-	-	0.017	-	-	0.181	0.166	0.252
HCM Control Delay (s)	222.9	17.1	8.9	-	-	8.1	-	-	33.1	26.8	14.6
HCM Lane LOS	F	C	A	-	-	A	-	-	D	D	B
HCM 95th %tile Q(veh)	8.4	0.6	0.1	-	-	0.1	-	-	0.6	0.6	1

Notes
 ~: Volume exceeds capacity \$: Delay exceeds 300s +: Computation Not Defined *: All major volume in platoon

Timings
9: Meridian Ranch Rd & Stapleton Dr

2028 Total Traffic
AM Peak Hour



Lane Group	EBL	EBT	WBL	WBT	WBR	NBL	NBT	SBL	SBT	SBR
Lane Configurations										
Traffic Volume (vph)	34	288	17	506	20	89	16	24	28	107
Future Volume (vph)	34	288	17	506	20	89	16	24	28	107
Turn Type	pm+pt	NA	pm+pt	NA	Perm	pm+pt	NA	pm+pt	NA	Perm
Protected Phases	5	2	1	6		3	8	7	4	
Permitted Phases	2		6		6	8		4		4
Detector Phase	5	2	1	6	6	3	8	7	4	4
Switch Phase										
Minimum Initial (s)	5.0	5.0	5.0	5.0	5.0	5.0	5.0	5.0	5.0	5.0
Minimum Split (s)	10.0	20.0	10.0	20.0	20.0	10.0	20.0	10.0	20.0	20.0
Total Split (s)	10.0	45.0	10.0	45.0	45.0	10.0	25.0	10.0	25.0	25.0
Total Split (%)	11.1%	50.0%	11.1%	50.0%	50.0%	11.1%	27.8%	11.1%	27.8%	27.8%
Yellow Time (s)	3.0	3.0	3.0	3.0	3.0	3.0	3.0	3.0	3.0	3.0
All-Red Time (s)	2.0	2.0	2.0	2.0	2.0	2.0	2.0	2.0	2.0	2.0
Lost Time Adjust (s)	0.0	0.0	0.0	0.0	0.0	0.0	0.0	0.0	0.0	0.0
Total Lost Time (s)	5.0	5.0	5.0	5.0	5.0	5.0	5.0	5.0	5.0	5.0
Lead/Lag	Lead	Lag	Lead	Lag	Lag	Lead	Lag	Lead	Lag	Lag
Lead-Lag Optimize?	Yes	Yes	Yes	Yes	Yes	Yes	Yes	Yes	Yes	Yes
Recall Mode	None	Min	None	Min	Min	None	None	None	None	None
Act Effct Green (s)	31.4	32.4	30.6	30.8	30.8	13.3	11.9	10.9	7.2	7.2
Actuated g/C Ratio	0.58	0.59	0.56	0.56	0.56	0.24	0.22	0.20	0.13	0.13
v/c Ratio	0.09	0.36	0.03	0.57	0.03	0.40	0.15	0.09	0.13	0.38
Control Delay	6.6	10.0	6.2	15.1	0.1	24.0	16.1	20.3	28.9	8.5
Queue Delay	0.0	0.0	0.0	0.0	0.0	0.0	0.0	0.0	0.0	0.0
Total Delay	6.6	10.0	6.2	15.1	0.1	24.0	16.1	20.3	28.9	8.5
LOS	A	B	A	B	A	C	B	C	C	A
Approach Delay		9.7		14.3			21.5		13.9	
Approach LOS		A		B			C		B	

Intersection Summary

Cycle Length: 90
 Actuated Cycle Length: 54.6
 Natural Cycle: 70
 Control Type: Actuated-Uncoordinated
 Maximum v/c Ratio: 0.57
 Intersection Signal Delay: 13.8
 Intersection LOS: B
 Intersection Capacity Utilization 50.7%
 ICU Level of Service A
 Analysis Period (min) 15

Splits and Phases: 9: Meridian Ranch Rd & Stapleton Dr

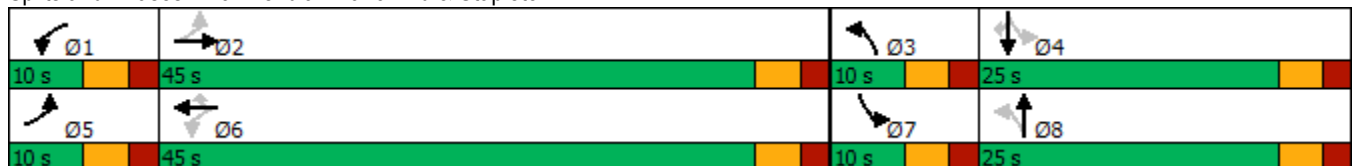

Intersection						
Int Delay, s/veh	3					
Movement	EBL	EBR	NBL	NBT	SBT	SBR
Lane Configurations		↗		↑	↘	
Traffic Vol, veh/h	0	101	0	149	55	0
Future Vol, veh/h	0	101	0	149	55	0
Conflicting Peds, #/hr	0	0	0	0	0	0
Sign Control	Stop	Stop	Free	Free	Free	Free
RT Channelized	-	None	-	None	-	None
Storage Length	-	0	-	-	-	-
Veh in Median Storage, #	0	-	-	0	0	-
Grade, %	0	-	-	0	0	-
Peak Hour Factor	95	95	95	95	95	95
Heavy Vehicles, %	2	2	2	2	2	2
Mvmt Flow	0	106	0	157	58	0

Major/Minor	Minor2	Major1	Major2		
Conflicting Flow All	-	58	-	0	-
Stage 1	-	-	-	-	-
Stage 2	-	-	-	-	-
Critical Hdwy	-	6.22	-	-	-
Critical Hdwy Stg 1	-	-	-	-	-
Critical Hdwy Stg 2	-	-	-	-	-
Follow-up Hdwy	-	3.318	-	-	-
Pot Cap-1 Maneuver	0	1008	0	-	-
Stage 1	0	-	0	-	-
Stage 2	0	-	0	-	-
Platoon blocked, %				-	-
Mov Cap-1 Maneuver	-	1008	-	-	-
Mov Cap-2 Maneuver	-	-	-	-	-
Stage 1	-	-	-	-	-
Stage 2	-	-	-	-	-

Approach	EB	NB	SB
HCM Control Delay, s	9	0	0
HCM LOS	A		

Minor Lane/Major Mvmt	NBT EBLn1	SBT	SBR
Capacity (veh/h)	- 1008	-	-
HCM Lane V/C Ratio	- 0.105	-	-
HCM Control Delay (s)	- 9	-	-
HCM Lane LOS	- A	-	-
HCM 95th %tile Q(veh)	- 0.4	-	-

Timings
7: Meridian Rd & Stapleton Dr

2028 Total Traffic
PM Peak Hour

Lane Group	EBL	EBT	EBR	WBL	WBT	WBR	NBL	NBT	NBR	SBL	SBT	SBR
Lane Configurations												
Traffic Volume (vph)	8	47	136	386	61	94	226	1008	498	127	611	5
Future Volume (vph)	8	47	136	386	61	94	226	1008	498	127	611	5
Turn Type	pm+pt	NA	Free	pm+pt	NA	Free	pm+pt	NA	Free	pm+pt	NA	Free
Protected Phases	7	4		3	8		5	2		1	6	
Permitted Phases	4		Free	8		Free	2		Free	6		Free
Detector Phase	7	4		3	8		5	2		1	6	
Switch Phase												
Minimum Initial (s)	5.0	5.0		5.0	5.0		5.0	5.0		5.0	5.0	
Minimum Split (s)	10.0	10.0		10.0	10.0		10.0	10.0		10.0	10.0	
Total Split (s)	12.0	15.0		22.0	25.0		12.0	41.0		12.0	41.0	
Total Split (%)	13.3%	16.7%		24.4%	27.8%		13.3%	45.6%		13.3%	45.6%	
Yellow Time (s)	3.0	3.0		3.0	3.0		3.0	3.0		3.0	3.0	
All-Red Time (s)	2.0	2.0		2.0	2.0		2.0	2.0		2.0	2.0	
Lost Time Adjust (s)	0.0	0.0		0.0	0.0		0.0	0.0		0.0	0.0	
Total Lost Time (s)	5.0	5.0		5.0	5.0		5.0	5.0		5.0	5.0	
Lead/Lag	Lead	Lag		Lead	Lag		Lead	Lag		Lead	Lag	
Lead-Lag Optimize?	Yes	Yes		Yes	Yes		Yes	Yes		Yes	Yes	
Recall Mode	None	None		None	None		None	None		None	None	
Act Effct Green (s)	12.6	8.2	76.9	26.4	24.4	76.9	36.2	31.1	76.9	34.1	27.0	76.9
Actuated g/C Ratio	0.16	0.11	1.00	0.34	0.32	1.00	0.47	0.40	1.00	0.44	0.35	1.00
v/c Ratio	0.04	0.33	0.12	0.82	0.11	0.06	0.64	0.72	0.32	0.54	0.53	0.00
Control Delay	20.4	41.1	0.2	38.7	22.8	0.1	22.2	24.8	0.5	19.8	21.6	0.0
Queue Delay	0.0	0.0	0.0	0.0	0.0	0.0	0.0	0.0	0.0	0.0	0.0	0.0
Total Delay	20.4	41.1	0.2	38.7	22.8	0.1	22.2	24.8	0.5	19.8	21.6	0.0
LOS	C	D	A	D	C	A	C	C	A	B	C	A
Approach Delay		11.0			30.2			17.5			21.1	
Approach LOS		B			C			B			C	

Intersection Summary

Cycle Length: 90
 Actuated Cycle Length: 76.9
 Natural Cycle: 60
 Control Type: Actuated-Uncoordinated
 Maximum v/c Ratio: 0.82
 Intersection Signal Delay: 19.9
 Intersection LOS: B
 Intersection Capacity Utilization 75.5%
 ICU Level of Service D
 Analysis Period (min) 15

Splits and Phases: 7: Meridian Rd & Stapleton Dr

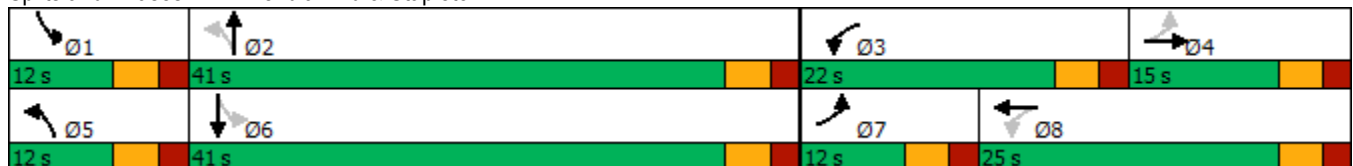

Intersection						
Int Delay, s/veh	18.7					
Movement	EBL	EBT	WBT	WBR	SBL	SBR
Lane Configurations	↖	↗	↗	↖	↖	↖
Traffic Vol, veh/h	178	494	377	89	126	164
Future Vol, veh/h	178	494	377	89	126	164
Conflicting Peds, #/hr	0	0	0	0	0	0
Sign Control	Free	Free	Free	Free	Stop	Stop
RT Channelized	-	None	-	None	-	None
Storage Length	155	-	-	-	60	0
Veh in Median Storage, #	-	0	0	-	0	-
Grade, %	-	0	0	-	0	-
Peak Hour Factor	92	92	92	92	83	83
Heavy Vehicles, %	2	2	2	2	2	2
Mvmt Flow	193	537	410	97	152	198

Major/Minor	Major1	Major2	Minor2		
Conflicting Flow All	507	0	-	0	1333 410
Stage 1	-	-	-	-	410 -
Stage 2	-	-	-	-	923 -
Critical Hdwy	4.12	-	-	-	6.42 6.22
Critical Hdwy Stg 1	-	-	-	-	5.42 -
Critical Hdwy Stg 2	-	-	-	-	5.42 -
Follow-up Hdwy	2.218	-	-	-	3.518 3.318
Pot Cap-1 Maneuver	1058	-	-	-	170 642
Stage 1	-	-	-	-	670 -
Stage 2	-	-	-	-	387 -
Platoon blocked, %		-	-	-	
Mov Cap-1 Maneuver	1058	-	-	-	~ 139 642
Mov Cap-2 Maneuver	-	-	-	-	~ 139 -
Stage 1	-	-	-	-	548 -
Stage 2	-	-	-	-	387 -

Approach	EB	WB	SB
HCM Control Delay, s	2.4	0	79.7
HCM LOS			F

Minor Lane/Major Mvmt	EBL	EBT	WBT	WBR	SBLn1	SBLn2
Capacity (veh/h)	1058	-	-	-	139	642
HCM Lane V/C Ratio	0.183	-	-	-	1.092	0.308
HCM Control Delay (s)	9.2	-	-	-	166.3	13.1
HCM Lane LOS	A	-	-	-	F	B
HCM 95th %tile Q(veh)	0.7	-	-	-	8.4	1.3

Notes
 ~: Volume exceeds capacity \$: Delay exceeds 300s +: Computation Not Defined *: All major volume in platoon

Intersection						
Int Delay, s/veh	6					
Movement	EBL	EBT	WBT	WBR	SBL	SBR
Lane Configurations	↖	↗	↗	↖	↖	↖
Traffic Vol, veh/h	178	494	377	89	126	164
Future Vol, veh/h	178	494	377	89	126	164
Conflicting Peds, #/hr	0	0	0	0	0	0
Sign Control	Free	Free	Free	Free	Stop	Stop
RT Channelized	-	None	-	None	-	None
Storage Length	155	-	-	-	60	0
Veh in Median Storage, #	-	0	0	-	0	-
Grade, %	-	0	0	-	0	-
Peak Hour Factor	92	92	92	92	83	83
Heavy Vehicles, %	2	2	2	2	2	2
Mvmt Flow	193	537	410	97	152	198

Major/Minor	Major1	Major2	Minor2		
Conflicting Flow All	507	0	-	0	1333 410
Stage 1	-	-	-	-	410 -
Stage 2	-	-	-	-	923 -
Critical Hdwy	4.12	-	-	-	6.42 6.22
Critical Hdwy Stg 1	-	-	-	-	5.42 -
Critical Hdwy Stg 2	-	-	-	-	5.42 -
Follow-up Hdwy	2.218	-	-	-	3.518 3.318
Pot Cap-1 Maneuver	1058	-	-	-	170 642
Stage 1	-	-	-	-	670 -
Stage 2	-	-	-	-	387 -
Platoon blocked, %		-	-	-	
Mov Cap-1 Maneuver	1058	-	-	-	~ 139 642
Mov Cap-2 Maneuver	-	-	-	-	268 -
Stage 1	-	-	-	-	548 -
Stage 2	-	-	-	-	387 -

Approach	EB	WB	SB
HCM Control Delay, s	2.4	0	22.4
HCM LOS			C

Minor Lane/Major Mvmt	EBL	EBT	WBT	WBR	SBLn1	SBLn2
Capacity (veh/h)	1058	-	-	-	268	642
HCM Lane V/C Ratio	0.183	-	-	-	0.566	0.308
HCM Control Delay (s)	9.2	-	-	-	34.6	13.1
HCM Lane LOS	A	-	-	-	D	B
HCM 95th %tile Q(veh)	0.7	-	-	-	3.2	1.3

Notes
 ~: Volume exceeds capacity \$: Delay exceeds 300s +: Computation Not Defined *: All major volume in platoon

Timings
8: Stapleton Dr & Shops at Meridian Ranch

2028 Total Traffic
PM Peak Hour



Lane Group	EBL	EBT	WBT	WBR	SBL	SBR
Lane Configurations	↗	↗	↗	↗	↘	↘
Traffic Volume (vph)	178	494	377	89	126	164
Future Volume (vph)	178	494	377	89	126	164
Turn Type	pm+pt	NA	NA	Perm	Prot	Perm
Protected Phases	5	2	6		4	
Permitted Phases	2			6		4
Detector Phase	5	2	6	6	4	4
Switch Phase						
Minimum Initial (s)	5.0	5.0	5.0	5.0	5.0	5.0
Minimum Split (s)	10.0	20.0	20.0	20.0	20.0	20.0
Total Split (s)	10.0	65.0	55.0	55.0	25.0	25.0
Total Split (%)	11.1%	72.2%	61.1%	61.1%	27.8%	27.8%
Yellow Time (s)	3.0	3.0	3.0	3.0	3.0	3.0
All-Red Time (s)	2.0	2.0	2.0	2.0	2.0	2.0
Lost Time Adjust (s)	0.0	0.0	0.0	0.0	0.0	0.0
Total Lost Time (s)	5.0	5.0	5.0	5.0	5.0	5.0
Lead/Lag	Lead		Lag	Lag		
Lead-Lag Optimize?	Yes		Yes	Yes		
Recall Mode	None	C-Max	C-Max	C-Max	None	None
Act Effct Green (s)	67.0	67.0	54.4	54.4	13.0	13.0
Actuated g/C Ratio	0.74	0.74	0.60	0.60	0.14	0.14
v/c Ratio	0.28	0.39	0.36	0.10	0.60	0.50
Control Delay	4.9	5.6	9.1	1.8	45.2	9.6
Queue Delay	0.0	0.0	0.0	0.0	0.0	0.0
Total Delay	4.9	5.6	9.1	1.8	45.2	9.6
LOS	A	A	A	A	D	A
Approach Delay		5.4	7.7		25.1	
Approach LOS		A	A		C	

Intersection Summary

Cycle Length: 90
 Actuated Cycle Length: 90
 Offset: 0 (0%), Referenced to phase 2:EBTL and 6:WBT, Start of Green
 Natural Cycle: 50
 Control Type: Actuated-Coordinated
 Maximum v/c Ratio: 0.60
 Intersection Signal Delay: 10.5
 Intersection LOS: B
 Intersection Capacity Utilization 49.2%
 ICU Level of Service A
 Analysis Period (min) 15

Splits and Phases: 8: Stapleton Dr & Shops at Meridian Ranch



Intersection												
Int Delay, s/veh	11.3											
Movement	EBL	EBT	EBR	WBL	WBT	WBR	NBL	NBT	NBR	SBL	SBT	SBR
Lane Configurations	↖	↗		↖	↗	↖	↖	↗		↖	↗	↖
Traffic Vol, veh/h	83	419	118	10	308	31	78	38	12	16	23	79
Future Vol, veh/h	83	419	118	10	308	31	78	38	12	16	23	79
Conflicting Peds, #/hr	0	0	0	0	0	0	0	0	0	0	0	0
Sign Control	Free	Free	Free	Free	Free	Free	Stop	Stop	Stop	Stop	Stop	Stop
RT Channelized	-	-	None	-	-	None	-	-	None	-	-	None
Storage Length	300	-	-	235	-	250	285	-	-	170	-	0
Veh in Median Storage, #	-	0	-	-	0	-	-	0	-	-	0	-
Grade, %	-	0	-	-	0	-	-	0	-	-	0	-
Peak Hour Factor	89	89	89	87	87	87	83	83	83	76	76	76
Heavy Vehicles, %	2	2	2	2	2	2	2	2	2	2	2	2
Mvmt Flow	93	471	133	11	354	36	94	46	14	21	30	104

Major/Minor	Major1			Major2			Minor1			Minor2		
Conflicting Flow All	390	0	0	604	0	0	1185	1136	538	1130	1166	354
Stage 1	-	-	-	-	-	-	724	724	-	376	376	-
Stage 2	-	-	-	-	-	-	461	412	-	754	790	-
Critical Hdwy	4.12	-	-	4.12	-	-	7.12	6.52	6.22	7.12	6.52	6.22
Critical Hdwy Stg 1	-	-	-	-	-	-	6.12	5.52	-	6.12	5.52	-
Critical Hdwy Stg 2	-	-	-	-	-	-	6.12	5.52	-	6.12	5.52	-
Follow-up Hdwy	2.218	-	-	2.218	-	-	3.518	4.018	3.318	3.518	4.018	3.318
Pot Cap-1 Maneuver	1169	-	-	974	-	-	166	202	543	181	194	690
Stage 1	-	-	-	-	-	-	417	430	-	645	616	-
Stage 2	-	-	-	-	-	-	581	594	-	401	402	-
Platoon blocked, %	-	-	-	-	-	-	-	-	-	-	-	-
Mov Cap-1 Maneuver	1169	-	-	974	-	-	114	184	543	133	177	690
Mov Cap-2 Maneuver	-	-	-	-	-	-	114	184	-	133	177	-
Stage 1	-	-	-	-	-	-	384	396	-	593	609	-
Stage 2	-	-	-	-	-	-	464	587	-	318	370	-

Approach	EB			WB			NB			SB		
HCM Control Delay, s	1.1			0.3			79.2			18.2		
HCM LOS							F			C		

Minor Lane/Major Mvmt	NBLn1	NBLn2	EBL	EBT	EBR	WBL	WBT	WBR	SBLn1	SBLn2	SBLn3
Capacity (veh/h)	114	219	1169	-	-	974	-	-	133	177	690
HCM Lane V/C Ratio	0.824	0.275	0.08	-	-	0.012	-	-	0.158	0.171	0.151
HCM Control Delay (s)	112.3	27.6	8.3	-	-	8.7	-	-	37.1	29.5	11.1
HCM Lane LOS	F	D	A	-	-	A	-	-	E	D	B
HCM 95th %tile Q(veh)	4.8	1.1	0.3	-	-	0	-	-	0.5	0.6	0.5

Timings
9: Meridian Ranch Rd & Stapleton Dr

2028 Total Traffic
PM Peak Hour



Lane Group	EBL	EBT	WBL	WBT	WBR	NBL	NBT	SBL	SBT	SBR
Lane Configurations										
Traffic Volume (vph)	83	419	10	308	31	78	38	16	23	79
Future Volume (vph)	83	419	10	308	31	78	38	16	23	79
Turn Type	pm+pt	NA	pm+pt	NA	Perm	pm+pt	NA	pm+pt	NA	Perm
Protected Phases	5	2	1	6		3	8	7	4	
Permitted Phases	2		6		6	8		4		4
Detector Phase	5	2	1	6	6	3	8	7	4	4
Switch Phase										
Minimum Initial (s)	5.0	5.0	5.0	5.0	5.0	5.0	5.0	5.0	5.0	5.0
Minimum Split (s)	10.0	23.0	10.0	23.0	23.0	10.0	23.0	10.0	23.0	23.0
Total Split (s)	10.0	45.0	10.0	45.0	45.0	10.0	25.0	10.0	25.0	25.0
Total Split (%)	11.1%	50.0%	11.1%	50.0%	50.0%	11.1%	27.8%	11.1%	27.8%	27.8%
Yellow Time (s)	3.0	3.0	3.0	3.0	3.0	3.0	3.0	3.0	3.0	3.0
All-Red Time (s)	2.0	2.0	2.0	2.0	2.0	2.0	2.0	2.0	2.0	2.0
Lost Time Adjust (s)	0.0	0.0	0.0	0.0	0.0	0.0	0.0	0.0	0.0	0.0
Total Lost Time (s)	5.0	5.0	5.0	5.0	5.0	5.0	5.0	5.0	5.0	5.0
Lead/Lag	Lead	Lag	Lead	Lag	Lag	Lead	Lag	Lead	Lag	Lag
Lead-Lag Optimize?	Yes	Yes	Yes	Yes	Yes	Yes	Yes	Yes	Yes	Yes
Recall Mode	None	C-Max	None	C-Max	C-Max	None	Min	None	Min	Min
Act Effct Green (s)	63.9	62.1	59.0	54.4	54.4	13.6	11.6	11.6	7.6	7.6
Actuated g/C Ratio	0.71	0.69	0.66	0.60	0.60	0.15	0.13	0.13	0.08	0.08
v/c Ratio	0.14	0.48	0.02	0.31	0.04	0.45	0.25	0.11	0.19	0.39
Control Delay	4.2	7.0	5.3	11.7	0.1	38.5	31.4	29.6	40.0	7.2
Queue Delay	0.0	0.0	0.0	0.0	0.0	0.0	0.0	0.0	0.0	0.0
Total Delay	4.2	7.0	5.3	11.7	0.1	38.5	31.4	29.6	40.0	7.2
LOS	A	A	A	B	A	D	C	C	D	A
Approach Delay		6.6		10.5			35.7		16.6	
Approach LOS		A		B			D		B	

Intersection Summary

Cycle Length: 90
 Actuated Cycle Length: 90
 Offset: 0 (0%), Referenced to phase 2:EBTL and 6:WBTL, Start of Green
 Natural Cycle: 75
 Control Type: Actuated-Coordinated
 Maximum v/c Ratio: 0.48
 Intersection Signal Delay: 12.0
 Intersection LOS: B
 Intersection Capacity Utilization 56.9%
 ICU Level of Service B
 Analysis Period (min) 15

Splits and Phases: 9: Meridian Ranch Rd & Stapleton Dr

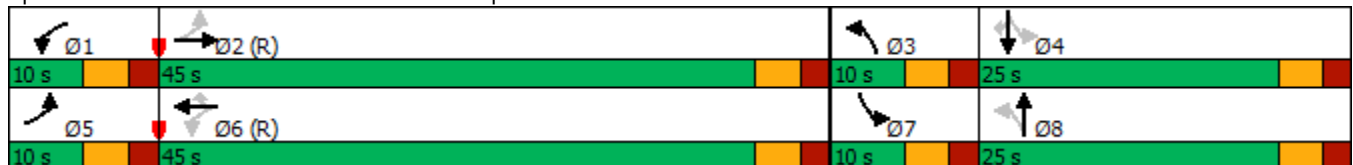

Intersection						
Int Delay, s/veh	2.8					
Movement	EBL	EBR	NBL	NBT	SBT	SBR
Lane Configurations		↗		↑	↘	
Traffic Vol, veh/h	0	157	0	267	134	0
Future Vol, veh/h	0	157	0	267	134	0
Conflicting Peds, #/hr	0	0	0	0	0	0
Sign Control	Stop	Stop	Free	Free	Free	Free
RT Channelized	-	None	-	None	-	None
Storage Length	-	0	-	-	-	-
Veh in Median Storage, #	0	-	-	0	0	-
Grade, %	0	-	-	0	0	-
Peak Hour Factor	95	95	95	95	95	95
Heavy Vehicles, %	2	2	2	2	2	2
Mvmt Flow	0	165	0	281	141	0

Major/Minor	Minor2	Major1	Major2		
Conflicting Flow All	-	141	-	0	-
Stage 1	-	-	-	-	-
Stage 2	-	-	-	-	-
Critical Hdwy	-	6.22	-	-	-
Critical Hdwy Stg 1	-	-	-	-	-
Critical Hdwy Stg 2	-	-	-	-	-
Follow-up Hdwy	-	3.318	-	-	-
Pot Cap-1 Maneuver	0	907	0	-	-
Stage 1	0	-	0	-	-
Stage 2	0	-	0	-	-
Platoon blocked, %				-	-
Mov Cap-1 Maneuver	-	907	-	-	-
Mov Cap-2 Maneuver	-	-	-	-	-
Stage 1	-	-	-	-	-
Stage 2	-	-	-	-	-

Approach	EB	NB	SB
HCM Control Delay, s	9.9	0	0
HCM LOS	A		

Minor Lane/Major Mvmt	NBT EBLn1	SBT	SBR
Capacity (veh/h)	- 907	-	-
HCM Lane V/C Ratio	- 0.182	-	-
HCM Control Delay (s)	- 9.9	-	-
HCM Lane LOS	- A	-	-
HCM 95th %tile Q(veh)	- 0.7	-	-

Timings
7: Meridian Rd & Stapleton Dr

2044 Background Traffic
AM Peak Hour

Lane Group	EBL	EBT	EBR	WBL	WBT	WBR	NBL	NBT	NBR	SBL	SBT	SBR
Lane Configurations												
Traffic Volume (vph)	108	225	530	301	309	193	197	606	147	170	665	447
Future Volume (vph)	108	225	530	301	309	193	197	606	147	170	665	447
Turn Type	Prot	NA	Free	Prot	NA	Free	Prot	NA	Free	Prot	NA	Free
Protected Phases	7	4		3	8		5	2		1	6	
Permitted Phases			Free			Free			Free			Free
Detector Phase	7	4		3	8		5	2		1	6	
Switch Phase												
Minimum Initial (s)	5.0	5.0		5.0	5.0		5.0	5.0		5.0	5.0	
Minimum Split (s)	10.0	10.0		10.0	10.0		10.0	10.0		10.0	10.0	
Total Split (s)	15.0	30.0		15.0	30.0		15.0	63.0		12.0	60.0	
Total Split (%)	12.5%	25.0%		12.5%	25.0%		12.5%	52.5%		10.0%	50.0%	
Yellow Time (s)	3.0	3.0		3.0	3.0		3.0	3.0		3.0	3.0	
All-Red Time (s)	2.0	2.0		2.0	2.0		2.0	2.0		2.0	2.0	
Lost Time Adjust (s)	0.0	0.0		0.0	0.0		0.0	0.0		0.0	0.0	
Total Lost Time (s)	5.0	5.0		5.0	5.0		5.0	5.0		5.0	5.0	
Lead/Lag	Lead	Lag		Lead	Lag		Lead	Lag		Lead	Lag	
Lead-Lag Optimize?	Yes	Yes		Yes	Yes		Yes	Yes		Yes	Yes	
Recall Mode	None	None		None	None		None	None		None	None	
Act Effct Green (s)	8.0	10.9	71.2	10.1	15.8	71.2	9.3	22.8	71.2	7.1	20.5	71.2
Actuated g/C Ratio	0.11	0.15	1.00	0.14	0.22	1.00	0.13	0.32	1.00	0.10	0.29	1.00
v/c Ratio	0.30	0.44	0.35	0.65	0.42	0.13	0.46	0.56	0.10	0.52	0.69	0.30
Control Delay	33.2	30.9	0.6	38.3	28.5	0.2	34.0	22.2	0.1	38.8	26.5	0.5
Queue Delay	0.0	0.0	0.0	0.0	0.0	0.0	0.0	0.0	0.0	0.0	0.0	0.0
Total Delay	33.2	30.9	0.6	38.3	28.5	0.2	34.0	22.2	0.1	38.8	26.5	0.5
LOS	C	C	A	D	C	A	C	C	A	D	C	A
Approach Delay		12.6			25.4			21.2			19.1	
Approach LOS		B			C			C			B	

Intersection Summary

Cycle Length: 120
 Actuated Cycle Length: 71.2
 Natural Cycle: 55
 Control Type: Actuated-Uncoordinated
 Maximum v/c Ratio: 0.69
 Intersection Signal Delay: 19.4
 Intersection Capacity Utilization 55.5%
 Analysis Period (min) 15
 Intersection LOS: B
 ICU Level of Service B

Splits and Phases: 7: Meridian Rd & Stapleton Dr



Timings
8: Stapleton Dr & Shops at Meridian Ranch

2044 Background Traffic
AM Peak Hour



Lane Group	EBL	EBT	WBT	WBR	SBL	SBR
Lane Configurations	↖	↑↑	↑↑	↗	↖	↗
Traffic Volume (vph)	22	519	757	27	10	47
Future Volume (vph)	22	519	757	27	10	47
Turn Type	pm+pt	NA	NA	Perm	Prot	Perm
Protected Phases	5	2	6		4	
Permitted Phases	2			6		4
Detector Phase	5	2	6	6	4	4
Switch Phase						
Minimum Initial (s)	5.0	5.0	5.0	5.0	5.0	5.0
Minimum Split (s)	10.0	20.0	20.0	20.0	20.0	20.0
Total Split (s)	12.0	90.0	78.0	78.0	30.0	30.0
Total Split (%)	10.0%	75.0%	65.0%	65.0%	25.0%	25.0%
Yellow Time (s)	3.0	3.0	3.0	3.0	3.0	3.0
All-Red Time (s)	2.0	2.0	2.0	2.0	2.0	2.0
Lost Time Adjust (s)	0.0	0.0	0.0	0.0	0.0	0.0
Total Lost Time (s)	5.0	5.0	5.0	5.0	5.0	5.0
Lead/Lag	Lead		Lag	Lag		
Lead-Lag Optimize?	Yes		Yes	Yes		
Recall Mode	None	C-Max	C-Max	C-Max	Max	Max
Act Effct Green (s)	85.0	85.0	78.3	78.3	25.0	25.0
Actuated g/C Ratio	0.71	0.71	0.65	0.65	0.21	0.21
v/c Ratio	0.05	0.22	0.35	0.03	0.03	0.13
Control Delay	5.5	6.3	6.9	1.4	38.3	11.6
Queue Delay	0.0	0.0	0.0	0.0	0.0	0.0
Total Delay	5.5	6.3	6.9	1.4	38.3	11.6
LOS	A	A	A	A	D	B
Approach Delay		6.2	6.7		16.5	
Approach LOS		A	A		B	

Intersection Summary

Cycle Length: 120
 Actuated Cycle Length: 120
 Offset: 14 (12%), Referenced to phase 2:EBTL and 6:WBT, Start of Green
 Natural Cycle: 50
 Control Type: Actuated-Coordinated
 Maximum v/c Ratio: 0.35
 Intersection Signal Delay: 6.9
 Intersection Capacity Utilization 33.4%
 Analysis Period (min) 15
 Intersection LOS: A
 ICU Level of Service A

Splits and Phases: 8: Stapleton Dr & Shops at Meridian Ranch

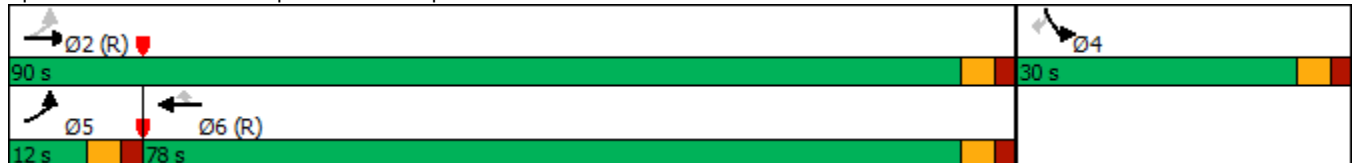

Timings
9: Meridian Ranch Rd & Stapleton Dr

2044 Background Traffic
AM Peak Hour

Lane Group	EBL	EBT	EBR	WBL	WBT	WBR	NBL	NBT	NBR	SBL	SBT	SBR
Lane Configurations												
Traffic Volume (vph)	32	431	65	17	595	20	84	16	26	24	28	104
Future Volume (vph)	32	431	65	17	595	20	84	16	26	24	28	104
Turn Type	pm+pt	NA	Perm	pm+pt	NA	Perm	pm+pt	NA	Perm	pm+pt	NA	Perm
Protected Phases	5	2		1	6		3	8		7	4	
Permitted Phases	2		2	6		6	8		8	4		4
Detector Phase	5	2	2	1	6	6	3	8	8	7	4	4
Switch Phase												
Minimum Initial (s)	5.0	5.0	5.0	5.0	5.0	5.0	5.0	5.0	5.0	5.0	5.0	5.0
Minimum Split (s)	10.0	20.0	20.0	10.0	20.0	20.0	10.0	20.0	20.0	10.0	20.0	20.0
Total Split (s)	12.0	71.0	71.0	12.0	71.0	71.0	12.0	25.0	25.0	12.0	25.0	25.0
Total Split (%)	10.0%	59.2%	59.2%	10.0%	59.2%	59.2%	10.0%	20.8%	20.8%	10.0%	20.8%	20.8%
Yellow Time (s)	3.0	3.0	3.0	3.0	3.0	3.0	3.0	3.0	3.0	3.0	3.0	3.0
All-Red Time (s)	2.0	2.0	2.0	2.0	2.0	2.0	2.0	2.0	2.0	2.0	2.0	2.0
Lost Time Adjust (s)	0.0	0.0	0.0	0.0	0.0	0.0	0.0	0.0	0.0	0.0	0.0	0.0
Total Lost Time (s)	5.0	5.0	5.0	5.0	5.0	5.0	5.0	5.0	5.0	5.0	5.0	5.0
Lead/Lag	Lead	Lag	Lag	Lead	Lag	Lag	Lead	Lag	Lag	Lead	Lag	Lag
Lead-Lag Optimize?	Yes	Yes	Yes	Yes	Yes	Yes	Yes	Yes	Yes	Yes	Yes	Yes
Recall Mode	None	C-Max	C-Max	None	C-Max	C-Max	None	Max	Max	None	Max	Max
Act Effct Green (s)	76.2	73.4	73.4	74.7	71.0	71.0	29.1	24.9	24.9	26.5	20.1	20.1
Actuated g/C Ratio	0.64	0.61	0.61	0.62	0.59	0.59	0.24	0.21	0.21	0.22	0.17	0.17
v/c Ratio	0.07	0.21	0.07	0.03	0.30	0.02	0.27	0.04	0.07	0.08	0.09	0.31
Control Delay	7.9	11.0	0.7	7.7	13.3	0.1	36.8	42.1	0.3	33.6	43.4	10.4
Queue Delay	0.0	0.0	0.0	0.0	0.0	0.0	0.0	0.0	0.0	0.0	0.0	0.0
Total Delay	7.9	11.0	0.7	7.7	13.3	0.1	36.8	42.1	0.3	33.6	43.4	10.4
LOS	A	B	A	A	B	A	D	D	A	C	D	B
Approach Delay		9.6			12.8			30.0			19.9	
Approach LOS		A			B			C			B	

Intersection Summary

Cycle Length: 120
 Actuated Cycle Length: 120
 Offset: 112 (93%), Referenced to phase 2:EBTL and 6:WBTL, Start of Green
 Natural Cycle: 60
 Control Type: Actuated-Coordinated
 Maximum v/c Ratio: 0.31
 Intersection Signal Delay: 13.9
 Intersection LOS: B
 Intersection Capacity Utilization 44.4%
 ICU Level of Service A
 Analysis Period (min) 15

Splits and Phases: 9: Meridian Ranch Rd & Stapleton Dr



Timings
7: Meridian Rd & Stapleton Dr

2044 Background Traffic
PM Peak Hour

Lane Group	EBL	EBT	EBR	WBL	WBT	WBR	NBL	NBT	NBR	SBL	SBT	SBR
Lane Configurations												
Traffic Volume (vph)	123	289	626	265	197	106	277	1066	327	146	404	202
Future Volume (vph)	123	289	626	265	197	106	277	1066	327	146	404	202
Turn Type	Prot	NA	Free	Prot	NA	Free	Prot	NA	Free	Prot	NA	Free
Protected Phases	7	4		3	8		5	2		1	6	
Permitted Phases			Free			Free			Free			Free
Detector Phase	7	4		3	8		5	2		1	6	
Switch Phase												
Minimum Initial (s)	5.0	5.0		5.0	5.0		5.0	5.0		5.0	5.0	
Minimum Split (s)	10.0	10.0		10.0	10.0		10.0	10.0		10.0	10.0	
Total Split (s)	15.0	30.0		15.0	30.0		15.0	63.0		12.0	60.0	
Total Split (%)	12.5%	25.0%		12.5%	25.0%		12.5%	52.5%		10.0%	50.0%	
Yellow Time (s)	3.0	3.0		3.0	3.0		3.0	3.0		3.0	3.0	
All-Red Time (s)	2.0	2.0		2.0	2.0		2.0	2.0		2.0	2.0	
Lost Time Adjust (s)	0.0	0.0		0.0	0.0		0.0	0.0		0.0	0.0	
Total Lost Time (s)	5.0	5.0		5.0	5.0		5.0	5.0		5.0	5.0	
Lead/Lag	Lead	Lag		Lead	Lag		Lead	Lag		Lead	Lag	
Lead-Lag Optimize?	Yes	Yes		Yes	Yes		Yes	Yes		Yes	Yes	
Recall Mode	None	None		None	None		None	None		None	None	
Act Effct Green (s)	8.5	13.0	84.8	10.2	14.6	84.8	10.2	34.2	84.8	7.1	31.2	84.8
Actuated g/C Ratio	0.10	0.15	1.00	0.12	0.17	1.00	0.12	0.40	1.00	0.08	0.37	1.00
v/c Ratio	0.37	0.56	0.42	0.68	0.34	0.07	0.71	0.79	0.22	0.54	0.33	0.13
Control Delay	41.3	38.6	0.8	47.5	34.4	0.1	48.9	26.5	0.3	47.6	19.8	0.2
Queue Delay	0.0	0.0	0.0	0.0	0.0	0.0	0.0	0.0	0.0	0.0	0.0	0.0
Total Delay	41.3	38.6	0.8	47.5	34.4	0.1	48.9	26.5	0.3	47.6	19.8	0.2
LOS	D	D	A	D	C	A	D	C	A	D	B	A
Approach Delay		16.1			34.1			25.1			19.9	
Approach LOS		B			C			C			B	

Intersection Summary

Cycle Length: 120
 Actuated Cycle Length: 84.8
 Natural Cycle: 60
 Control Type: Actuated-Uncoordinated
 Maximum v/c Ratio: 0.79
 Intersection Signal Delay: 23.1
 Intersection LOS: C
 Intersection Capacity Utilization 65.8%
 ICU Level of Service C
 Analysis Period (min) 15

Splits and Phases: 7: Meridian Rd & Stapleton Dr



Timings
8: Stapleton Dr & Shops at Meridian Ranch

2044 Background Traffic
PM Peak Hour



Lane Group	EBL	EBT	WBT	WBR	SBL	SBR
Lane Configurations	↶	↷↷	↷↷	↷	↶	↷
Traffic Volume (vph)	80	683	492	49	76	78
Future Volume (vph)	80	683	492	49	76	78
Turn Type	pm+pt	NA	NA	Perm	Prot	Prot
Protected Phases	5	2	6		4	4
Permitted Phases	2			6		
Detector Phase	5	2	6	6	4	4
Switch Phase						
Minimum Initial (s)	5.0	5.0	5.0	5.0	5.0	5.0
Minimum Split (s)	10.0	20.0	20.0	20.0	20.0	20.0
Total Split (s)	12.0	85.0	73.0	73.0	35.0	35.0
Total Split (%)	10.0%	70.8%	60.8%	60.8%	29.2%	29.2%
Yellow Time (s)	3.0	3.0	3.0	3.0	3.0	3.0
All-Red Time (s)	2.0	2.0	2.0	2.0	2.0	2.0
Lost Time Adjust (s)	0.0	0.0	0.0	0.0	0.0	0.0
Total Lost Time (s)	5.0	5.0	5.0	5.0	5.0	5.0
Lead/Lag	Lead		Lag	Lag		
Lead-Lag Optimize?	Yes		Yes	Yes		
Recall Mode	None	C-Max	C-Max	C-Max	Max	Max
Act Effct Green (s)	80.0	80.0	70.4	70.4	30.0	30.0
Actuated g/C Ratio	0.67	0.67	0.59	0.59	0.25	0.25
v/c Ratio	0.15	0.30	0.25	0.05	0.18	0.18
Control Delay	7.7	8.8	7.8	1.6	36.7	8.5
Queue Delay	0.0	0.0	0.0	0.0	0.0	0.0
Total Delay	7.7	8.8	7.8	1.6	36.7	8.5
LOS	A	A	A	A	D	A
Approach Delay		8.7	7.2		22.5	
Approach LOS		A	A		C	

Intersection Summary

Cycle Length: 120
 Actuated Cycle Length: 120
 Offset: 14 (12%), Referenced to phase 2:EBTL and 6:WBT, Start of Green
 Natural Cycle: 50
 Control Type: Actuated-Coordinated
 Maximum v/c Ratio: 0.30
 Intersection Signal Delay: 9.6
 Intersection Capacity Utilization 34.7%
 Analysis Period (min) 15

Intersection LOS: A
 ICU Level of Service A

Splits and Phases: 8: Stapleton Dr & Shops at Meridian Ranch



Timings
9: Meridian Ranch Rd & Stapleton Dr

2044 Background Traffic
PM Peak Hour

Lane Group	EBL	EBT	EBR	WBL	WBT	WBR	NBL	NBT	NBR	SBL	SBT	SBR
Lane Configurations												
Traffic Volume (vph)	80	569	110	10	394	31	70	38	12	17	23	76
Future Volume (vph)	80	569	110	10	394	31	70	38	12	17	23	76
Turn Type	pm+pt	NA	Perm	pm+pt	NA	Perm	pm+pt	NA	Perm	pm+pt	NA	Perm
Protected Phases	5	2		1	6		3	8		7	4	
Permitted Phases	2		2	6		6	8		8	4		4
Detector Phase	5	2	2	1	6	6	3	8	8	7	4	4
Switch Phase												
Minimum Initial (s)	5.0	5.0	5.0	5.0	5.0	5.0	5.0	5.0	5.0	5.0	5.0	5.0
Minimum Split (s)	10.0	20.0	20.0	10.0	20.0	20.0	10.0	20.0	20.0	10.0	20.0	20.0
Total Split (s)	12.0	71.0	71.0	12.0	71.0	71.0	12.0	25.0	25.0	12.0	25.0	25.0
Total Split (%)	10.0%	59.2%	59.2%	10.0%	59.2%	59.2%	10.0%	20.8%	20.8%	10.0%	20.8%	20.8%
Yellow Time (s)	3.0	3.0	3.0	3.0	3.0	3.0	3.0	3.0	3.0	3.0	3.0	3.0
All-Red Time (s)	2.0	2.0	2.0	2.0	2.0	2.0	2.0	2.0	2.0	2.0	2.0	2.0
Lost Time Adjust (s)	0.0	0.0	0.0	0.0	0.0	0.0	0.0	0.0	0.0	0.0	0.0	0.0
Total Lost Time (s)	5.0	5.0	5.0	5.0	5.0	5.0	5.0	5.0	5.0	5.0	5.0	5.0
Lead/Lag	Lead	Lag	Lag	Lead	Lag	Lag	Lead	Lag	Lag	Lead	Lag	Lag
Lead-Lag Optimize?	Yes	Yes	Yes	Yes	Yes	Yes	Yes	Yes	Yes	Yes	Yes	Yes
Recall Mode	None	C-Max	C-Max	None	C-Max	C-Max	None	Max	Max	None	Max	Max
Act Effct Green (s)	77.1	75.7	75.7	73.1	68.4	68.4	30.0	27.2	27.2	27.6	22.4	22.4
Actuated g/C Ratio	0.64	0.63	0.63	0.61	0.57	0.57	0.25	0.23	0.23	0.23	0.19	0.19
v/c Ratio	0.14	0.27	0.11	0.02	0.21	0.03	0.22	0.09	0.03	0.05	0.07	0.21
Control Delay	7.5	9.1	1.5	7.7	13.4	0.1	35.7	40.6	0.1	33.4	43.0	4.9
Queue Delay	0.0	0.0	0.0	0.0	0.0	0.0	0.0	0.0	0.0	0.0	0.0	0.0
Total Delay	7.5	9.1	1.5	7.7	13.4	0.1	35.7	40.6	0.1	33.4	43.0	4.9
LOS	A	A	A	A	B	A	D	D	A	C	D	A
Approach Delay		7.8			12.3			33.6			16.6	
Approach LOS		A			B			C			B	

Intersection Summary

Cycle Length: 120
 Actuated Cycle Length: 120
 Offset: 112 (93%), Referenced to phase 2:EBTL and 6:WBTL, Start of Green
 Natural Cycle: 60
 Control Type: Actuated-Coordinated
 Maximum v/c Ratio: 0.27
 Intersection Signal Delay: 12.1
 Intersection LOS: B
 Intersection Capacity Utilization 42.9%
 ICU Level of Service A
 Analysis Period (min) 15

Splits and Phases: 9: Meridian Ranch Rd & Stapleton Dr

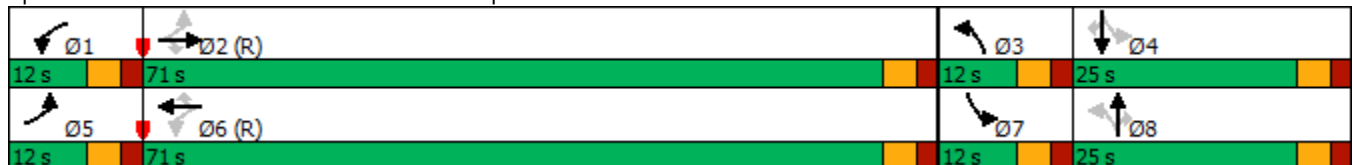

Timings
7: Meridian Rd & Stapleton Dr

2044 Total Traffic
AM Peak Hour

Lane Group	EBL	EBT	EBR	WBL	WBT	WBR	NBL	NBT	NBR	SBL	SBT	SBR
Lane Configurations												
Traffic Volume (vph)	108	236	530	312	320	203	197	606	158	180	665	447
Future Volume (vph)	108	236	530	312	320	203	197	606	158	180	665	447
Turn Type	Prot	NA	Free	Prot	NA	Free	Prot	NA	Free	Prot	NA	Free
Protected Phases	7	4		3	8		5	2		1	6	
Permitted Phases			Free			Free			Free			Free
Detector Phase	7	4		3	8		5	2		1	6	
Switch Phase												
Minimum Initial (s)	5.0	5.0		5.0	5.0		5.0	5.0		5.0	5.0	
Minimum Split (s)	10.0	10.0		10.0	10.0		10.0	10.0		10.0	10.0	
Total Split (s)	15.0	30.0		15.0	30.0		15.0	63.0		12.0	60.0	
Total Split (%)	12.5%	25.0%		12.5%	25.0%		12.5%	52.5%		10.0%	50.0%	
Yellow Time (s)	3.0	3.0		3.0	3.0		3.0	3.0		3.0	3.0	
All-Red Time (s)	2.0	2.0		2.0	2.0		2.0	2.0		2.0	2.0	
Lost Time Adjust (s)	0.0	0.0		0.0	0.0		0.0	0.0		0.0	0.0	
Total Lost Time (s)	5.0	5.0		5.0	5.0		5.0	5.0		5.0	5.0	
Lead/Lag	Lead	Lag		Lead	Lag		Lead	Lag		Lead	Lag	
Lead-Lag Optimize?	Yes	Yes		Yes	Yes		Yes	Yes		Yes	Yes	
Recall Mode	None	None		None	None		None	None		None	None	
Act Effct Green (s)	8.0	11.1	71.5	10.1	16.0	71.5	9.3	22.9	71.5	7.1	20.6	71.5
Actuated g/C Ratio	0.11	0.16	1.00	0.14	0.22	1.00	0.13	0.32	1.00	0.10	0.29	1.00
v/c Ratio	0.30	0.45	0.35	0.67	0.43	0.14	0.46	0.56	0.10	0.56	0.69	0.30
Control Delay	33.5	31.0	0.6	39.5	28.6	0.2	34.3	22.3	0.1	40.1	26.6	0.5
Queue Delay	0.0	0.0	0.0	0.0	0.0	0.0	0.0	0.0	0.0	0.0	0.0	0.0
Total Delay	33.5	31.0	0.6	39.5	28.6	0.2	34.3	22.3	0.1	40.1	26.6	0.5
LOS	C	C	A	D	C	A	C	C	A	D	C	A
Approach Delay		12.9			25.7			21.1			19.4	
Approach LOS		B			C			C			B	

Intersection Summary

Cycle Length: 120	
Actuated Cycle Length: 71.5	
Natural Cycle: 55	
Control Type: Actuated-Uncoordinated	
Maximum v/c Ratio: 0.69	
Intersection Signal Delay: 19.7	Intersection LOS: B
Intersection Capacity Utilization 56.1%	ICU Level of Service B
Analysis Period (min) 15	

Splits and Phases: 7: Meridian Rd & Stapleton Dr



Timings
8: Stapleton Dr & Shops at Meridian Ranch

2044 Total Traffic
AM Peak Hour



Lane Group	EBL	EBT	WBT	WBR	SBL	SBR
Lane Configurations	↶	↶↶	↶↶	↷	↶	↷
Traffic Volume (vph)	77	498	716	84	44	118
Future Volume (vph)	77	498	716	84	44	118
Turn Type	pm+pt	NA	NA	Perm	Prot	Perm
Protected Phases	5	2	6		4	
Permitted Phases	2			6		4
Detector Phase	5	2	6	6	4	4
Switch Phase						
Minimum Initial (s)	5.0	5.0	5.0	5.0	5.0	5.0
Minimum Split (s)	10.0	20.0	20.0	20.0	20.0	20.0
Total Split (s)	12.0	90.0	78.0	78.0	30.0	30.0
Total Split (%)	10.0%	75.0%	65.0%	65.0%	25.0%	25.0%
Yellow Time (s)	3.0	3.0	3.0	3.0	3.0	3.0
All-Red Time (s)	2.0	2.0	2.0	2.0	2.0	2.0
Lost Time Adjust (s)	0.0	0.0	0.0	0.0	0.0	0.0
Total Lost Time (s)	5.0	5.0	5.0	5.0	5.0	5.0
Lead/Lag	Lead		Lag	Lag		
Lead-Lag Optimize?	Yes		Yes	Yes		
Recall Mode	None	C-Max	C-Max	C-Max	Max	Max
Act Effct Green (s)	85.0	85.0	75.5	75.5	25.0	25.0
Actuated g/C Ratio	0.71	0.71	0.63	0.63	0.21	0.21
v/c Ratio	0.17	0.21	0.34	0.09	0.12	0.29
Control Delay	6.2	6.2	8.1	1.1	39.8	8.7
Queue Delay	0.0	0.0	0.0	0.0	0.0	0.0
Total Delay	6.2	6.2	8.1	1.1	39.8	8.7
LOS	A	A	A	A	D	A
Approach Delay		6.2	7.4		17.1	
Approach LOS		A	A		B	

Intersection Summary

Cycle Length: 120
 Actuated Cycle Length: 120
 Offset: 14 (12%), Referenced to phase 2:EBTL and 6:WBT, Start of Green
 Natural Cycle: 50
 Control Type: Actuated-Coordinated
 Maximum v/c Ratio: 0.34
 Intersection Signal Delay: 8.0
 Intersection Capacity Utilization 40.7%
 Analysis Period (min) 15
 Intersection LOS: A
 ICU Level of Service A

Splits and Phases: 8: Stapleton Dr & Shops at Meridian Ranch

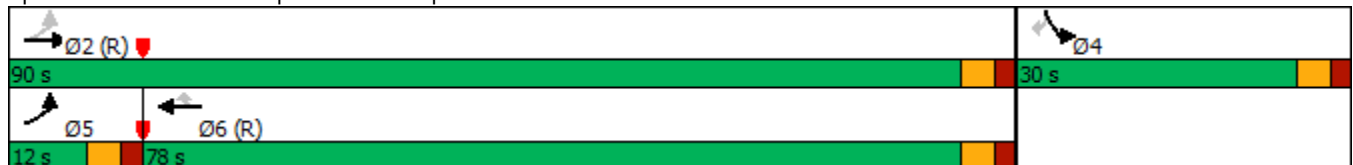

Timings
9: Meridian Ranch Rd & Stapleton Dr

2044 Total Traffic
AM Peak Hour

Lane Group	EBL	EBT	EBR	WBL	WBT	WBR	NBL	NBT	NBR	SBL	SBT	SBR
Lane Configurations												
Traffic Volume (vph)	36	438	68	17	603	20	87	16	26	24	28	109
Future Volume (vph)	36	438	68	17	603	20	87	16	26	24	28	109
Turn Type	pm+pt	NA	Perm	pm+pt	NA	Perm	pm+pt	NA	Perm	pm+pt	NA	Perm
Protected Phases	5	2		1	6		3	8		7	4	
Permitted Phases	2		2	6		6	8		8	4		4
Detector Phase	5	2	2	1	6	6	3	8	8	7	4	4
Switch Phase												
Minimum Initial (s)	5.0	5.0	5.0	5.0	5.0	5.0	5.0	5.0	5.0	5.0	5.0	5.0
Minimum Split (s)	10.0	20.0	20.0	10.0	20.0	20.0	10.0	20.0	20.0	10.0	20.0	20.0
Total Split (s)	12.0	71.0	71.0	12.0	71.0	71.0	12.0	25.0	25.0	12.0	25.0	25.0
Total Split (%)	10.0%	59.2%	59.2%	10.0%	59.2%	59.2%	10.0%	20.8%	20.8%	10.0%	20.8%	20.8%
Yellow Time (s)	3.0	3.0	3.0	3.0	3.0	3.0	3.0	3.0	3.0	3.0	3.0	3.0
All-Red Time (s)	2.0	2.0	2.0	2.0	2.0	2.0	2.0	2.0	2.0	2.0	2.0	2.0
Lost Time Adjust (s)	0.0	0.0	0.0	0.0	0.0	0.0	0.0	0.0	0.0	0.0	0.0	0.0
Total Lost Time (s)	5.0	5.0	5.0	5.0	5.0	5.0	5.0	5.0	5.0	5.0	5.0	5.0
Lead/Lag	Lead	Lag	Lag	Lead	Lag	Lag	Lead	Lag	Lag	Lead	Lag	Lag
Lead-Lag Optimize?	Yes	Yes	Yes	Yes	Yes	Yes	Yes	Yes	Yes	Yes	Yes	Yes
Recall Mode	None	C-Max	C-Max	None	C-Max	C-Max	None	Max	Max	None	Max	Max
Act Effct Green (s)	76.2	73.4	73.4	74.7	71.0	71.0	29.1	24.9	24.9	26.5	20.1	20.1
Actuated g/C Ratio	0.64	0.61	0.61	0.62	0.59	0.59	0.24	0.21	0.21	0.22	0.17	0.17
v/c Ratio	0.08	0.21	0.07	0.03	0.30	0.02	0.28	0.04	0.07	0.08	0.09	0.32
Control Delay	7.4	10.4	0.5	7.7	13.4	0.1	37.1	42.1	0.3	33.6	43.4	10.3
Queue Delay	0.0	0.0	0.0	0.0	0.0	0.0	0.0	0.0	0.0	0.0	0.0	0.0
Total Delay	7.4	10.4	0.5	7.7	13.4	0.1	37.1	42.1	0.3	33.6	43.4	10.3
LOS	A	B	A	A	B	A	D	D	A	C	D	B
Approach Delay		8.9			12.8			30.4			19.5	
Approach LOS		A			B			C			B	

Intersection Summary

Cycle Length: 120
 Actuated Cycle Length: 120
 Offset: 112 (93%), Referenced to phase 2:EBTL and 6:WBTL, Start of Green
 Natural Cycle: 60
 Control Type: Actuated-Coordinated
 Maximum v/c Ratio: 0.32
 Intersection Signal Delay: 13.7
 Intersection LOS: B
 Intersection Capacity Utilization 44.8%
 ICU Level of Service A
 Analysis Period (min) 15

Splits and Phases: 9: Meridian Ranch Rd & Stapleton Dr

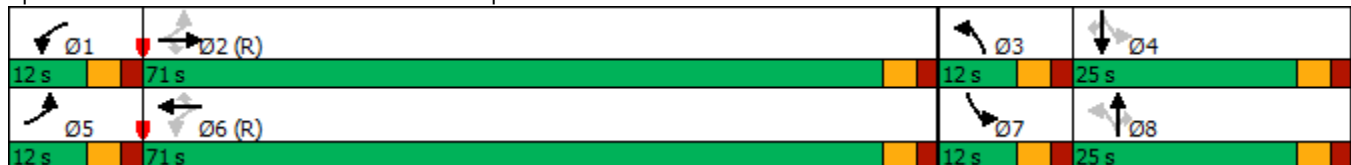

Intersection						
Int Delay, s/veh	2.8					
Movement	EBL	EBR	NBL	NBT	SBT	SBR
Lane Configurations		↗		↑	↘	
Traffic Vol, veh/h	0	101	0	160	61	0
Future Vol, veh/h	0	101	0	160	61	0
Conflicting Peds, #/hr	0	0	0	0	0	0
Sign Control	Stop	Stop	Free	Free	Free	Free
RT Channelized	-	None	-	None	-	None
Storage Length	-	0	-	-	-	-
Veh in Median Storage, #	0	-	-	0	0	-
Grade, %	0	-	-	0	0	-
Peak Hour Factor	95	95	95	95	95	95
Heavy Vehicles, %	2	2	2	2	2	2
Mvmt Flow	0	106	0	168	64	0

Major/Minor	Minor2	Major1	Major2		
Conflicting Flow All	-	64	-	0	-
Stage 1	-	-	-	-	-
Stage 2	-	-	-	-	-
Critical Hdwy	-	6.22	-	-	-
Critical Hdwy Stg 1	-	-	-	-	-
Critical Hdwy Stg 2	-	-	-	-	-
Follow-up Hdwy	-	3.318	-	-	-
Pot Cap-1 Maneuver	0	1000	0	-	-
Stage 1	0	-	0	-	-
Stage 2	0	-	0	-	-
Platoon blocked, %				-	-
Mov Cap-1 Maneuver	-	1000	-	-	-
Mov Cap-2 Maneuver	-	-	-	-	-
Stage 1	-	-	-	-	-
Stage 2	-	-	-	-	-

Approach	EB	NB	SB
HCM Control Delay, s	9	0	0
HCM LOS	A		

Minor Lane/Major Mvmt	NBT EBLn1	SBT	SBR
Capacity (veh/h)	- 1000	-	-
HCM Lane V/C Ratio	- 0.106	-	-
HCM Control Delay (s)	- 9	-	-
HCM Lane LOS	- A	-	-
HCM 95th %tile Q(veh)	- 0.4	-	-

Timings
7: Meridian Rd & Stapleton Dr

2044 Total Traffic
PM Peak Hour

Lane Group	EBL	EBT	EBR	WBL	WBT	WBR	NBL	NBT	NBR	SBL	SBT	SBR
Lane Configurations												
Traffic Volume (vph)	123	309	626	285	217	126	277	1066	347	165	404	202
Future Volume (vph)	123	309	626	285	217	126	277	1066	347	165	404	202
Turn Type	Prot	NA	Free	Prot	NA	Free	Prot	NA	Free	Prot	NA	Free
Protected Phases	7	4		3	8		5	2		1	6	
Permitted Phases			Free			Free			Free			Free
Detector Phase	7	4		3	8		5	2		1	6	
Switch Phase												
Minimum Initial (s)	5.0	5.0		5.0	5.0		5.0	5.0		5.0	5.0	
Minimum Split (s)	10.0	10.0		10.0	10.0		10.0	10.0		10.0	10.0	
Total Split (s)	15.0	30.0		15.0	30.0		15.0	63.0		12.0	60.0	
Total Split (%)	12.5%	25.0%		12.5%	25.0%		12.5%	52.5%		10.0%	50.0%	
Yellow Time (s)	3.0	3.0		3.0	3.0		3.0	3.0		3.0	3.0	
All-Red Time (s)	2.0	2.0		2.0	2.0		2.0	2.0		2.0	2.0	
Lost Time Adjust (s)	0.0	0.0		0.0	0.0		0.0	0.0		0.0	0.0	
Total Lost Time (s)	5.0	5.0		5.0	5.0		5.0	5.0		5.0	5.0	
Lead/Lag	Lead	Lag		Lead	Lag		Lead	Lag		Lead	Lag	
Lead-Lag Optimize?	Yes	Yes		Yes	Yes		Yes	Yes		Yes	Yes	
Recall Mode	None	None		None	None		None	None		None	None	
Act Effct Green (s)	8.5	13.5	85.7	10.2	15.1	85.7	10.2	34.6	85.7	7.1	31.5	85.7
Actuated g/C Ratio	0.10	0.16	1.00	0.12	0.18	1.00	0.12	0.40	1.00	0.08	0.37	1.00
v/c Ratio	0.38	0.58	0.42	0.74	0.36	0.08	0.72	0.79	0.23	0.61	0.33	0.13
Control Delay	41.9	39.1	0.8	50.9	34.6	0.1	49.9	26.8	0.3	50.9	20.0	0.2
Queue Delay	0.0	0.0	0.0	0.0	0.0	0.0	0.0	0.0	0.0	0.0	0.0	0.0
Total Delay	41.9	39.1	0.8	50.9	34.6	0.1	49.9	26.8	0.3	50.9	20.0	0.2
LOS	D	D	A	D	C	A	D	C	A	D	B	A
Approach Delay		16.7			35.1			25.1			21.4	
Approach LOS		B			D			C			C	

Intersection Summary

Cycle Length: 120
 Actuated Cycle Length: 85.7
 Natural Cycle: 60
 Control Type: Actuated-Uncoordinated
 Maximum v/c Ratio: 0.79
 Intersection Signal Delay: 23.8
 Intersection LOS: C
 Intersection Capacity Utilization 67.5%
 ICU Level of Service C
 Analysis Period (min) 15

Splits and Phases: 7: Meridian Rd & Stapleton Dr



Timings
8: Stapleton Dr & Shops at Meridian Ranch

2044 Total Traffic
PM Peak Hour



Lane Group	EBL	EBT	WBT	WBR	SBL	SBR
Lane Configurations	↖	↗↗	↖↖	↖	↘	↘
Traffic Volume (vph)	184	637	457	111	149	172
Future Volume (vph)	184	637	457	111	149	172
Turn Type	pm+pt	NA	NA	Perm	Prot	Prot
Protected Phases	5	2	6		4	4
Permitted Phases	2			6		
Detector Phase	5	2	6	6	4	4
Switch Phase						
Minimum Initial (s)	5.0	5.0	5.0	5.0	5.0	5.0
Minimum Split (s)	10.0	20.0	20.0	20.0	20.0	20.0
Total Split (s)	12.0	85.0	73.0	73.0	35.0	35.0
Total Split (%)	10.0%	70.8%	60.8%	60.8%	29.2%	29.2%
Yellow Time (s)	3.0	3.0	3.0	3.0	3.0	3.0
All-Red Time (s)	2.0	2.0	2.0	2.0	2.0	2.0
Lost Time Adjust (s)	0.0	0.0	0.0	0.0	0.0	0.0
Total Lost Time (s)	5.0	5.0	5.0	5.0	5.0	5.0
Lead/Lag	Lead		Lag	Lag		
Lead-Lag Optimize?	Yes		Yes	Yes		
Recall Mode	None	C-Max	C-Max	C-Max	Max	Max
Act Effct Green (s)	80.0	80.0	68.0	68.0	30.0	30.0
Actuated g/C Ratio	0.67	0.67	0.57	0.57	0.25	0.25
v/c Ratio	0.33	0.28	0.24	0.12	0.36	0.34
Control Delay	9.2	8.6	8.3	1.9	39.8	7.0
Queue Delay	0.0	0.0	0.0	0.0	0.0	0.0
Total Delay	9.2	8.6	8.3	1.9	39.8	7.0
LOS	A	A	A	A	D	A
Approach Delay		8.7	7.1		22.2	
Approach LOS		A	A		C	

Intersection Summary

Cycle Length: 120
 Actuated Cycle Length: 120
 Offset: 14 (12%), Referenced to phase 2:EBTL and 6:WBT, Start of Green
 Natural Cycle: 50
 Control Type: Actuated-Coordinated
 Maximum v/c Ratio: 0.36
 Intersection Signal Delay: 10.7
 Intersection Capacity Utilization 43.6%
 Analysis Period (min) 15
 Intersection LOS: B
 ICU Level of Service A

Splits and Phases: 8: Stapleton Dr & Shops at Meridian Ranch

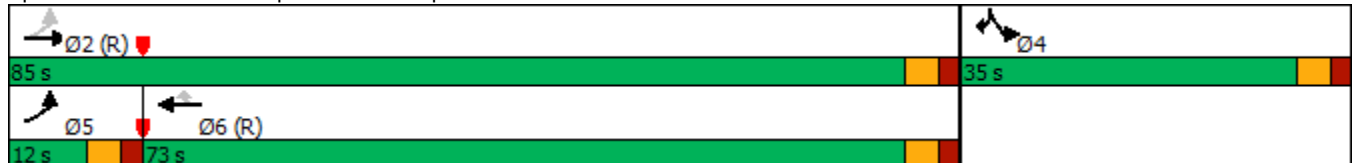

Timings
9: Meridian Ranch Rd & Stapleton Dr

2044 Total Traffic
PM Peak Hour

Lane Group	EBL	EBT	EBR	WBL	WBT	WBR	NBL	NBT	NBR	SBL	SBT	SBR
Lane Configurations												
Traffic Volume (vph)	87	583	116	10	408	31	76	38	12	17	23	85
Future Volume (vph)	87	583	116	10	408	31	76	38	12	17	23	85
Turn Type	pm+pt	NA	Perm	pm+pt	NA	Perm	pm+pt	NA	Perm	pm+pt	NA	Perm
Protected Phases	5	2		1	6		3	8		7	4	
Permitted Phases	2		2	6		6	8		8	4		4
Detector Phase	5	2	2	1	6	6	3	8	8	7	4	4
Switch Phase												
Minimum Initial (s)	5.0	5.0	5.0	5.0	5.0	5.0	5.0	5.0	5.0	5.0	5.0	5.0
Minimum Split (s)	10.0	20.0	20.0	10.0	20.0	20.0	10.0	20.0	20.0	10.0	20.0	20.0
Total Split (s)	12.0	71.0	71.0	12.0	71.0	71.0	12.0	25.0	25.0	12.0	25.0	25.0
Total Split (%)	10.0%	59.2%	59.2%	10.0%	59.2%	59.2%	10.0%	20.8%	20.8%	10.0%	20.8%	20.8%
Yellow Time (s)	3.0	3.0	3.0	3.0	3.0	3.0	3.0	3.0	3.0	3.0	3.0	3.0
All-Red Time (s)	2.0	2.0	2.0	2.0	2.0	2.0	2.0	2.0	2.0	2.0	2.0	2.0
Lost Time Adjust (s)	0.0	0.0	0.0	0.0	0.0	0.0	0.0	0.0	0.0	0.0	0.0	0.0
Total Lost Time (s)	5.0	5.0	5.0	5.0	5.0	5.0	5.0	5.0	5.0	5.0	5.0	5.0
Lead/Lag	Lead	Lag	Lag	Lead	Lag	Lag	Lead	Lag	Lag	Lead	Lag	Lag
Lead-Lag Optimize?	Yes	Yes	Yes	Yes	Yes	Yes	Yes	Yes	Yes	Yes	Yes	Yes
Recall Mode	None	C-Max	C-Max	None	C-Max	C-Max	None	Max	Max	None	Max	Max
Act Effct Green (s)	77.1	75.7	75.7	72.0	66.2	66.2	30.0	27.2	27.2	27.6	22.4	22.4
Actuated g/C Ratio	0.64	0.63	0.63	0.60	0.55	0.55	0.25	0.23	0.23	0.23	0.19	0.19
v/c Ratio	0.16	0.27	0.12	0.02	0.22	0.04	0.24	0.09	0.03	0.05	0.07	0.23
Control Delay	6.9	8.3	1.0	7.7	14.1	0.1	36.1	40.6	0.1	33.4	43.0	6.5
Queue Delay	0.0	0.0	0.0	0.0	0.0	0.0	0.0	0.0	0.0	0.0	0.0	0.0
Total Delay	6.9	8.3	1.0	7.7	14.1	0.1	36.1	40.6	0.1	33.4	43.0	6.5
LOS	A	A	A	A	B	A	D	D	A	C	D	A
Approach Delay		7.1			13.0			34.0			16.9	
Approach LOS		A			B			C			B	

Intersection Summary

Cycle Length: 120
 Actuated Cycle Length: 120
 Offset: 112 (93%), Referenced to phase 2:EBTL and 6:WBTL, Start of Green
 Natural Cycle: 60
 Control Type: Actuated-Coordinated
 Maximum v/c Ratio: 0.27
 Intersection Signal Delay: 12.0
 Intersection LOS: B
 Intersection Capacity Utilization 43.7%
 ICU Level of Service A
 Analysis Period (min) 15

Splits and Phases: 9: Meridian Ranch Rd & Stapleton Dr

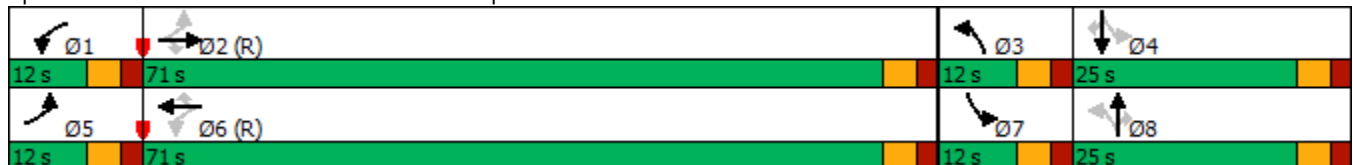

Intersection						
Int Delay, s/veh	2.6					
Movement	EBL	EBR	NBL	NBT	SBT	SBR
Lane Configurations		↗		↑	↘	
Traffic Vol, veh/h	0	156	0	293	163	0
Future Vol, veh/h	0	156	0	293	163	0
Conflicting Peds, #/hr	0	0	0	0	0	0
Sign Control	Stop	Stop	Free	Free	Free	Free
RT Channelized	-	None	-	None	-	None
Storage Length	-	0	-	-	-	-
Veh in Median Storage, #	0	-	-	0	0	-
Grade, %	0	-	-	0	0	-
Peak Hour Factor	95	95	95	95	95	95
Heavy Vehicles, %	2	2	2	2	2	2
Mvmt Flow	0	164	0	308	172	0

Major/Minor	Minor2	Major1	Major2		
Conflicting Flow All	-	172	-	0	-
Stage 1	-	-	-	-	-
Stage 2	-	-	-	-	-
Critical Hdwy	-	6.22	-	-	-
Critical Hdwy Stg 1	-	-	-	-	-
Critical Hdwy Stg 2	-	-	-	-	-
Follow-up Hdwy	-	3.318	-	-	-
Pot Cap-1 Maneuver	0	872	0	-	-
Stage 1	0	-	0	-	-
Stage 2	0	-	0	-	-
Platoon blocked, %				-	-
Mov Cap-1 Maneuver	-	872	-	-	-
Mov Cap-2 Maneuver	-	-	-	-	-
Stage 1	-	-	-	-	-
Stage 2	-	-	-	-	-

Approach	EB	NB	SB
HCM Control Delay, s	10.1	0	0
HCM LOS	B		

Minor Lane/Major Mvmt	NBT	EBLn1	SBT	SBR
Capacity (veh/h)	-	872	-	-
HCM Lane V/C Ratio	-	0.188	-	-
HCM Control Delay (s)	-	10.1	-	-
HCM Lane LOS	-	B	-	-
HCM 95th %tile Q(veh)	-	0.7	-	-

MTCP Maps



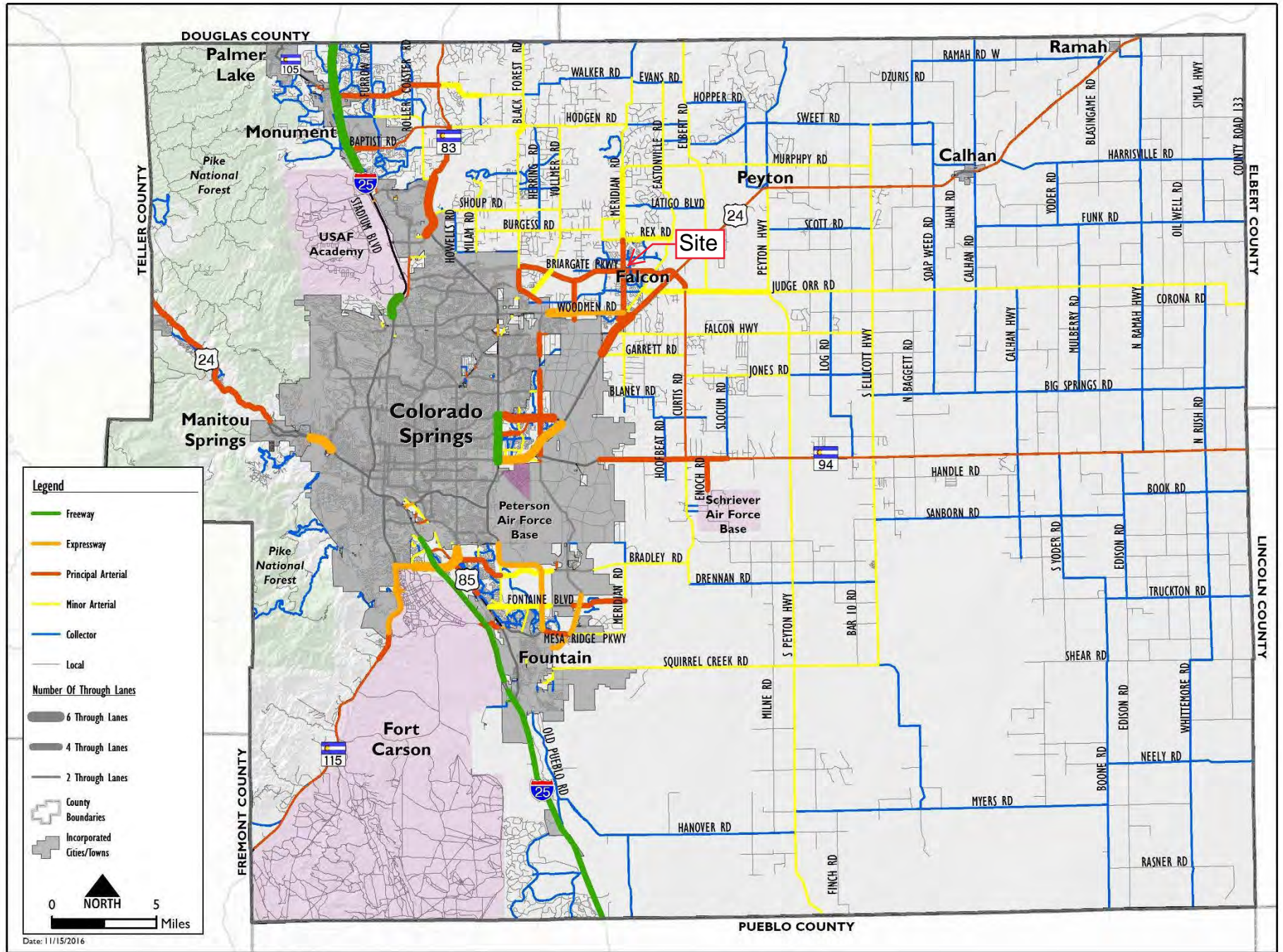

Map 14: 2040 Roadway Plan (Classification and Lanes)

Map 17: 2060 Corridor Preservation

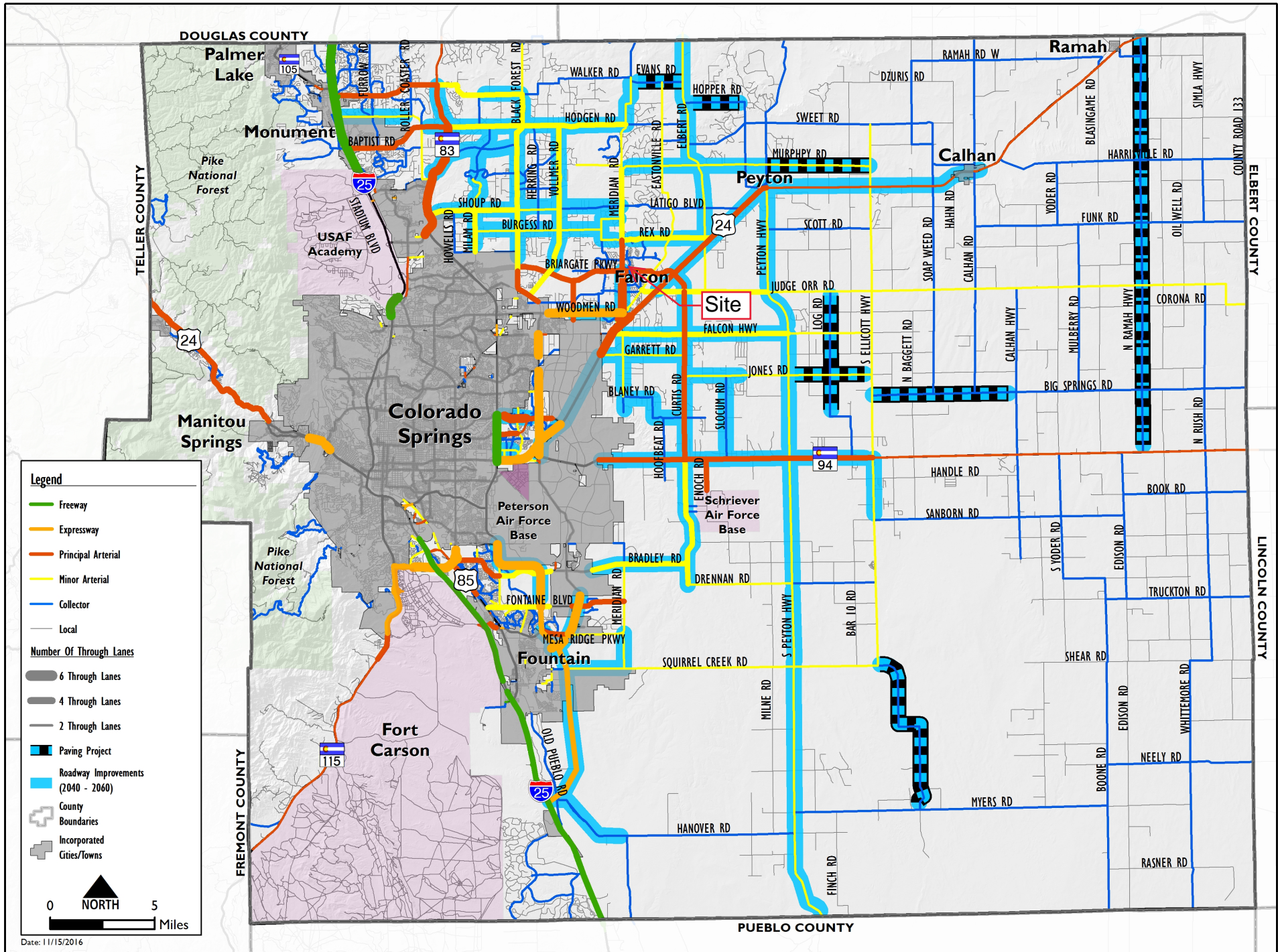

Legend

- Freeway
- Expressway
- Principal Arterial
- Minor Arterial
- Collector
- Local

Number Of Through Lanes

- 6 Through Lanes
- 4 Through Lanes
- 2 Through Lanes

- Paving Project
- Roadway Improvements (2040 - 2060)
- County Boundaries
- Incorporated Cities/Towns

0 **NORTH** 5
Miles

Date: 11/15/2016

Crash History



LocationRoadName	FIP	ReferencePointName	ReferencePointAtName	FeetFromReferencePoint	DirectionCode	AccidentNarrative
STAPLETON	Property	STAPLETON DR	MERIDIAN RANCH BLVD			Vehicle #1 was proceeding from a stop sign, turning left from southbound Meridian Ranch Blvd onto eastbound Stapleton Drive. Vehicle #2 was proceeding from a stop sign, northbound on Meridian Ranch Blvd at the intersection to Stapleton Drive. Vehicle #2 collided with the right rear of Vehicle #1 with its front. After impact, both vehicles were moved prior to investigation.
STAPLETON	Injury	STAPLETON DR	MERIDIAN RANCH BLVD			Vehicle #1 was south bound on Meridian Ranch Blvd, stopped at the stop sign for Stapleton Dr. Vehicle #2 was east bound on Stapleton Drive. Stapleton east bound / west bound have right-of-way. Meridian Ranch Blvd north bound / south bound had temporary stop signs erected. As vehicle #2 was passing through the intersection, vehicle #1 pulled out, into the lane of travel. The front of vehicle #1 crashed into the front of the driver side of vehicle #2. Vehicle #1 came to rest in the intersection, on all four wheels, facing east. Vehicle #2 came to rest in the intersection, on all four wheels, facing south east.
STAPLETON	Property	STAPLETON DR	MERIDIAN RANCH BLVD			Vehicle #2 was traveling eastbound on Stapleton Dr. Vehicle #1 was northbound on Meridian Ranch Blvd. The driver of Vehicle #1 drove into the intersection while Vehicle #2 was driving through the intersection. The front passenger side of Vehicle #2 struck the front driver's side of Vehicle #1. Vehicle #1 rotated clockwise after impact and came to final rest in the eastbound lane of Stapleton Dr. Vehicle #2 rotated clockwise while traveling off the right side of the road.
STAPLETON	Property	STAPLETON DR	MERIDIAN RANCH BLVD	150	N	Vehicle 1 was traveling northbound on Meridian Ranch Blvd north of Stapleton Dr. The left side of Vehicle 1 impacted a curb approximately 150 feet north of Stapleton Dr and continued traveling northbound. Vehicle 1 came to final rest on Meridian Ranch Blvd approximately 300 feet north of Stapleton Dr facing north on its wheels with disabling damage. The driver of Vehicle 1 fled the scene and failed to notify law enforcement that crash occurred.
STAPLETON	Property	STAPLETON DR	MERIDIAN RANCH BLVD	370	W	Traffic Unit 1 (TU1) is a bicycle, travelling westbound on Stapleton Dr, east of Meridian Rd. Traffic Unit 2/Vehicle 2 was travelling westbound on Stapleton Dr, east of Meridian Rd and was behind TU1. Vehicle 2 swerved to the right to avoid TU1. Vehicle 2 travelled off the right side of the roadway and collided with an above-ground manhole cover. TU1 left the scene. Vehicle 2 came to final rest high centered on the above-ground manhole cover, facing northwest.
STAPLETON	Property	STAPLETON DR	MERIDIAN RANCH BLVD			Vehicle #1 was stopped at the stop sign northbound on Meridian Ranch Blvd and Stapleton Rd. Vehicle #2 was traveling westbound on Stapleton Rd. approaching Meridian Ranch Blvd. (no stop sign) .Vehicle #3 was stopped at the stop sign southbound on Meridian Ranch Blvd. and Stapleton Rd. Vehicle #1 attempted to make a left turn onto Stapleton Rd as vehicle #2 entered the intersection and collided its right front with the left rear of vehicle #2. Vehicle #2 lost control and rotated counterclockwise before colliding its right side with the left side of vehicle #3. Vehicle #1 was moved prior to investigation. Vehicle #2 came to rest on its wheels facing south in the intersection of Meridian Ranch Blvd and Stapleton rd. Vehicle #3 came to rest on its wheels facing southwest on Meridian Ranch Blvd in the southbound lane.
STAPLETON	Property	STAPLETON DR	MERIDIAN RANCH BLVD			Vehicle 1 was on northbound Meridian Ranch Boulevard at the stop sign at Stapleton Drive. Vehicle 2 was traveling westbound on Stapleton Drive, approaching Meridian Ranch Boulevard. Vehicle 3 was stopped on southbound Meridian Ranch Boulevard in the left turn lane to turn left onto Stapleton Drive. Vehicle 1 proceeded from the stop sign and collided with the front left corner of Vehicle 2 in the middle of the intersection. After impact with Vehicle 2, Vehicle 1 rotated counterclockwise and its front bumper collided with the left side of Vehicle 3. Vehicle 1 came to final rest with it's front end against the left driver's door of Vehicle 3, facing west. Vehicle 2 came to final rest blocking northbound Meridian Ranch Boulevard facing north. Vehicle 3 came to final rest blocking the left turn lane and the through lane on southbound Meridian Ranch Boulevard, facing south.
STAPLETON	Property	STAPLETON DR	MERIDIAN RANCH BLVD			Vehicle 1 and Vehicle 2 were traveling southbound on Meridian Ranch Boulevard, just north of Stapleton Drive. Vehicle 2 stopped at the stop sign in the right turn lane on Meridian Ranch Boulevard at Stapleton Drive. Vehicle 1 did not stop and collided with the rear of Vehicle 2. Vehicle 1 fled from the scene. Vehicle 2 came to final rest blocking the right turn lane, facing south.

Appendix Table 1



Appendix Table 1
Area Traffic Impact Studies
Shops at Meridian Ranch Lot 2

Study	PCD File No⁽¹⁾	Consultant	Date
Meridian Ranch Commercial and Residential Filing 4B Traffic Technical Memorandum	SP147	LSC Transportation Consultants, Inc	July 11, 2014
The Shops at Meridian Ranch Lot 4 Traffic Technical Memorandum	PPR223	LSC Transportation Consultants, Inc	May 15, 2019
Autumn Acres Master Traffic Impact Analysis	SKP231	LSC Transportation Consultants, Inc	December 23, 2022
Briargate-Stapleton Corridor Study (DRAFT)	briargate-stapleton.com	Wilson & Company	December 9, 2021
Notes:			
(1) Follow the links listed below to obtain the most recent version of each listed study. To obtain a copy of the version of each study used in preparing this report please contact LSC			
<i>Source: LSC Transportation Consultants, Inc.</i>			<i>Feb-23</i>

Stapleton Drive Restriping Exhibit



Shops at Meridian Ranch Access Drive (See Figure 11)

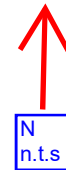
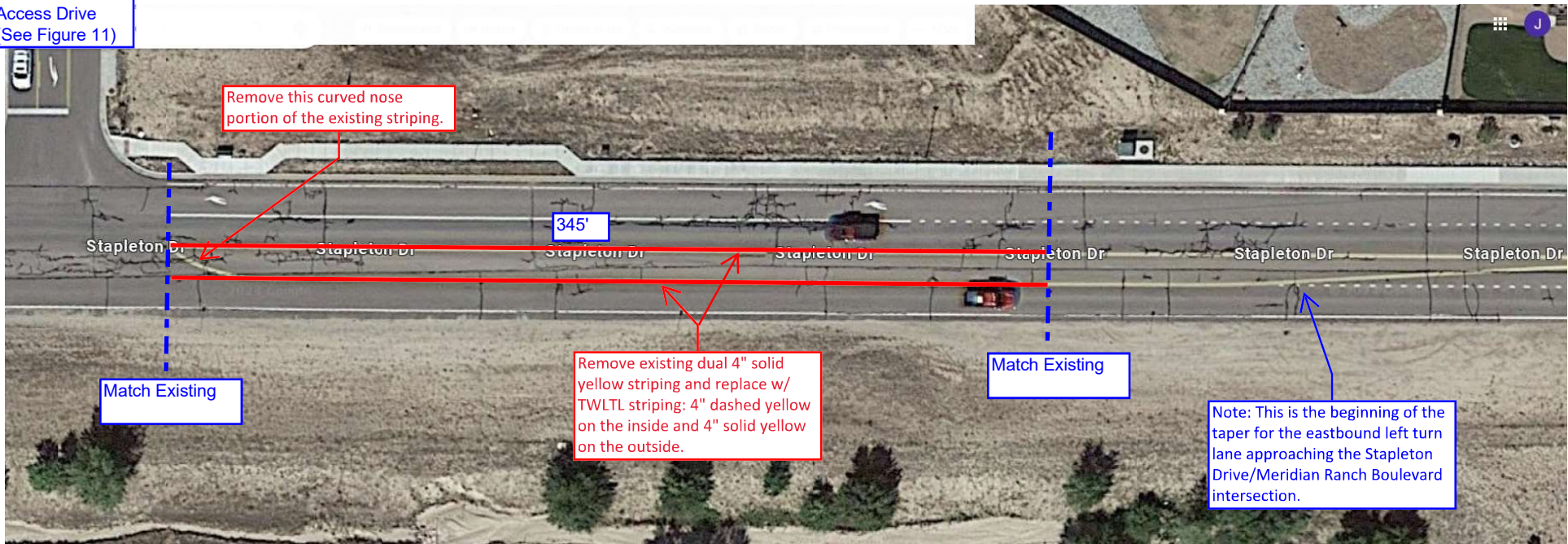

Stapleton Drive Restriping Exhibit