

Final Channel Design Report
East Fork Jimmy Camp Creek
Creekside at Lorson Ranch Filing No. 1
CDR 192
El Paso County, Colorado

Prepared for:
Lorson Development
212 North Wahsatch Suite 301
Colorado Springs, Colorado 80903

Prepared by:
Kiowa
Engineering Corporation

1604 South 21st Street
Colorado Springs, Colorado 80904
(719) 630-7342

Kiowa Project No. 18020
May 14, 2020

	<u>Page</u>
Table of Contents	i
Engineer’s Statement	ii
I. General Location and Description	1
II. Project Background	5
III. Previous Reports and References	5
IV. Site Description	6
V. Hydrology	6
VI. Hydraulics	7
VII. Design Elements	8
VIII. Construction Permitting	9
IX. Drainage and Bridge Fees	9
X. Phasing	9
XI. Conclusions	9

List of Figures

Figure 1	Vicinity Map.....	2
Figure 2	FIRM Panel 957G.....	3
Figure 3	Annotated FIRM Panel 957G LOMR Case Number19-08-0605P	4

Appendix A – Hydrologic and Hydraulic Calculations

Appendix B – Lorson Ranch 404 Permit

Appendix C – Geotechnical Report-Creekside at Lorson Ranch Filing 1
NRCS Soil Survey

Appendix D – East Fork Jimmy Camp Creek LOMR Case No. 19-08-0605P and No Rise Calculations

Appendix E - Correspondence with Colorado Parks and Wildlife, Department of Natural Resources

Engineer's Statement:

The attached drainage plan and report were prepared under my direction and supervision and are correct to the best of my knowledge and belief. Said drainage report has been prepared according to the criteria established by the County for drainage reports and said report is in conformity with the master plan of the drainage basin. I accept responsibility for any liability caused by any negligent acts, errors or omissions on my part in preparing this report.

Kiowa Engineering Corporation, 1604 South 21st Street, Colorado Springs, Colorado 80904

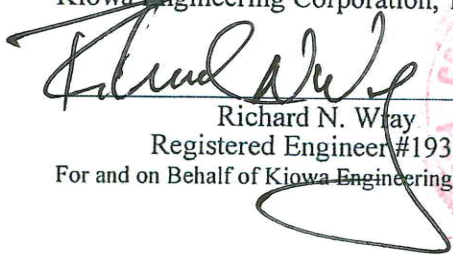

Richard N. Wray
Registered Engineer #19310
For and on Behalf of Kiowa Engineering Corporation



3/25/2020
Date

Developer's Statement:

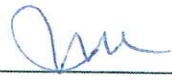
I, the Developer, have read and will comply with all of the requirements specified in this drainage report and plan.

BY: 
JEFF MARK
Printed

3/25/20
Date

ADDRESS: Lorson Development, LLC
212 North Wahsatch Suite 300
Colorado Springs, Colorado 80903

El Paso County:

Filed in accordance with the requirements of the Drainage Criteria Manual Volumes 1 and 2, El Paso County Engineering Criteria Manual and Land Development Code, as amended.

Jennifer Irvine, P.E.
County Engineer/ECM Administrator



I. General Location and Description

This report serves to summarize the design of the East Fork Jimmy Camp Creek (EFJCC), drainageway associated with the Creekside at Lorson Ranch Filing No. 1 subdivision. This design proposes to construct low flow boulder linings and soil/riprap banks at selective locations along a segment of EFJCC that begins at the south property line of Lorson Ranch and extends 3,900 feet upstream. At the upstream limit of the project an existing trapezoidal channel exists that was built as part of previous subdivision filings. The location of the site is shown on Figure 1.

Upon the completion of the drainageway facilities and acceptance by El Paso County and Lorson Ranch Metropolitan District, easements and or tracts will be dedicated within Creekside at Lorson Ranch Filing No. 1 for the purposes of maintenance access. Currently, the work will be completed within an un-plated parcel of land that encompasses the 100-year floodplain that commences at the south property line and extending north to Lorson Boulevard. Ownership, operation and maintenance of the drainageway will be the responsibility of the Lorson Ranch Metropolitan District.

Letter of Map Revision (LOMR), Case Number 19-08-0605P was approved in December 2019. The results of the LOMR become effective in April 2020. This LOMR reflects the post project condition of the channel improvements between Fontaine Boulevard to the north property line of Lorson Ranch, and new bridges at Fontaine Boulevard and Lorson Boulevard. The 100-year floodplain from the LOMR is shown on the design drawings and on the grading and erosion control plan. For the East Fork Jimmy Camp improvements south of Lorson Boulevard, encroachments of fill into the floodway have been avoided, and at a few locations the channel cross-section has been widened as compared to existing conditions. In this case, a no-rise determination has been prepared and the results included in Appendix D. Prior to commencing with the construction, a floodplain development permit will be processed through the Regional Administrator's office and the no-rise determination submitted. A Conditional Letter of Map Revision is therefore not required for the issuance of a floodplain development permit. The effective FIRM panel number 957G has been included within this report as Figure 2. The revised floodplain from the LOMR has been included as well and is presented as Figure 3.

A 404 permit has been issued for Lorson Ranch and covers all work proposed for East Fork Jimmy Camp Creek. This permit has been included within Appendix B of this report. As with the construction for the bridges at Lorson Boulevard and Fontaine Boulevard, and the previous channel stabilization measures constructed for East Fork Jimmy Camp Creek, the condition of the permit require that the Corps of Engineers be notified when work authorized by the permit is anticipated to begin. Specifically, for the reach of East Fork Jimmy Camp Creek south of Lorson Boulevard, special condition 2 requires that that a stream preservation concept be advanced. The design as submitted with his report reflects the channel preservation concept whereby a "bankfull" low flow channel be constructed using un-grouted rock and channel benches stabilized with native vegetation. Once the initial review by El Paso County has been completed and the general design for the East Fork approved, a pre-construction meeting will be held with the Corps so that authorization under the Lorson Ranch 404 can proceed. This is the same process that was followed for the East Fork Jimmy Camp Creek north of Fontaine Boulevard. Based upon the initial review by El Paso County and a general acceptance of the proposed design, a wetland delineation will be updated in advance of a preconstruction notification.

Coordination with the Colorado Division of Parks and Wildlife, Department of Natural Resources (DNR), has been carried out as part of the design development. The proposed channel concept, specifically the low flow channel and overbank benched areas above the low flow, have been designed to address the concerns raised by the DNR during the review of the Creekside at Lorson

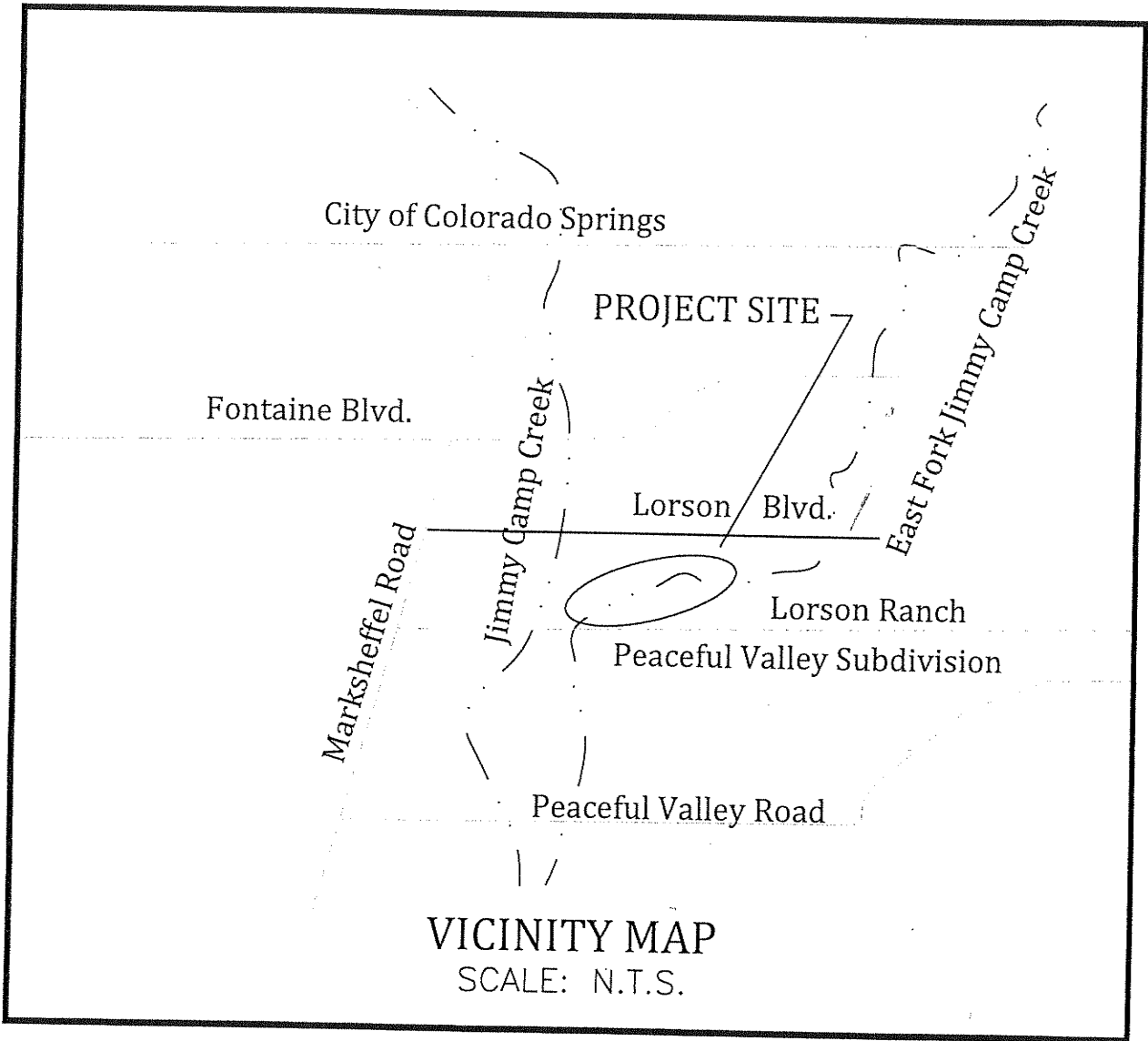

National Flood Hazard Layer FIRMette



Legend

SEE FIS REPORT FOR DETAILED LEGEND AND INDEX MAP FOR FIRM PANEL LAYOUT

SPECIAL FLOOD HAZARD AREAS

- Without Base Flood Elevation (BFE) Zone AE, AH, VE, AR
- With BFE or Depth Zone AE, AO, AH, VE, AR
- Regulatory Floodway

OTHER AREAS OF FLOOD HAZARD

- 0.2% Annual Chance Flood Hazard, Area of 1% annual chance flood with average depth less than one foot or with drainage areas of less than one square mile Zone X
- Future Conditions 1% Annual Chance Flood Hazard Zone X
- Area with Reduced Flood Risk due to Levee. See Notes. Zone X
- Area with Flood Risk due to Levee Zone X

OTHER AREAS

- Area of Minimal Flood Hazard Zone X
- Effective LOMRS
- Area of Undetermined Flood Hazard Zone X

GENERAL STRUCTURES

- Channel, Culvert, or Storm Sewer
- Levee, Dike, or Floodwall

OTHER FEATURES

- Cross Sections with 1% Annual Chance Water Surface Elevation
- Coastal Transect
- Base Flood Elevation Line (BFE)
- Limit of Study
- Jurisdiction Boundary
- Coastal Transect Baseline
- Profile Baseline
- Hydrographic Feature

MAP PANELS

- Digital Data Available
- No Digital Data Available
- Unmapped

The pin displayed on the map is an approximate point selected by the user and does not represent an authoritative property location.

This map complies with FEMA's standards for the use of digital flood maps if it is not void as described below. The basemap shown complies with FEMA's basemap accuracy standards

The flood hazard information is derived directly from the authoritative NFHL web services provided by FEMA. This map was exported on 7/9/2019 at 12:54:29 PM and does not reflect changes or amendments subsequent to this date and time. The NFHL and effective information may change or become superseded by new data over time.

This map image is void if the one or more of the following map elements do not appear: basemap imagery, flood zone labels, legend, scale bar, map creation date, community identifiers, FIRM panel number, and FIRM effective date. Map images for unmapped and unmodernized areas cannot be used for regulatory purposes.



FIGURE 2.

USGS The National Map: The Imagery, Data refreshed April, 2019.

Scale: 1:6,000
 0 250 500 1,000 1,500 2,000 Feet
 104°38'4.71"W
 38°43'40.80"N

JOINS PANEL 0769

104° 37' 30.00"
38° 45' 0.00"
42 89 000mN

NOTE: MAP AREA SHOWN ON THIS PANEL IS LOCATED WITHIN TOWNSHIP 15 SOUTH, RANGE 65 WEST.

City of Colorado Springs
080060

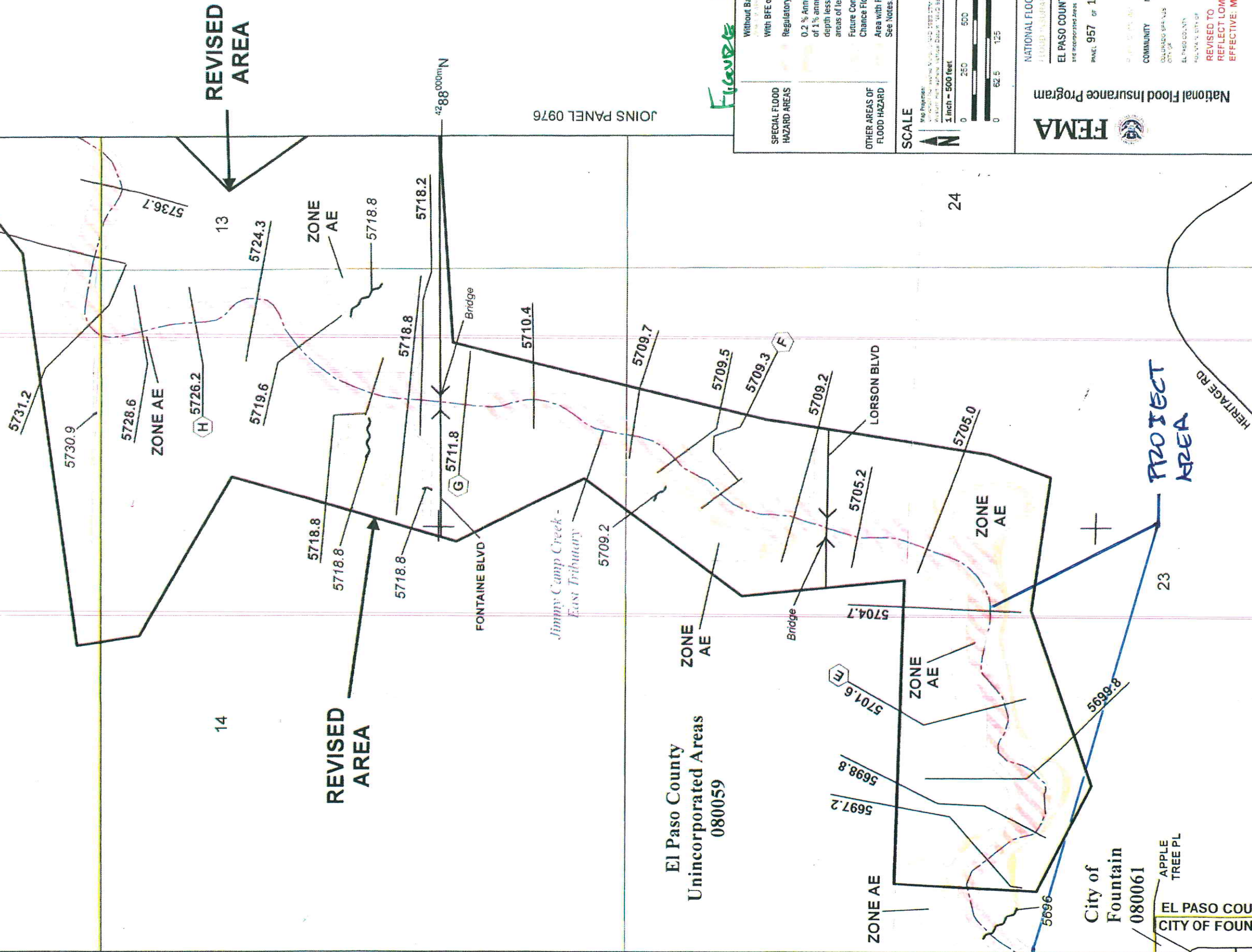

JOINS PANEL 0976

Figure 3

SPECIAL FLOOD HAZARD AREAS	Without Base Flood Elevation (BFE)
	With BFE or Depth Regulatory Floodway
OTHER AREAS OF FLOOD HAZARD	0.2 % Annual Chance Flood Hazard, Areas of 1 % annual chance flood with average depth less than one foot or with drainage areas of less than one square mile Future Conditions 1 % Annual Chance Flood Hazard Area with Reduced Flood Risk due to Levee See Notes.

SCALE

Map Prepared: [illegible]
1 inch = 500 feet
1:6,000

0 250 500 1,000
0 62.5 125 250
Feet
Meters

FEMA

NATIONAL FLOOD INSURANCE PROGRAM

EL PASO COUNTY, COLORADO
REGULATED AREA

PANEL 957 OF 1300

COMMUNITY	NUMBER	PANEL	SUFFIX
COLORADO SPRINGS	080059	0957	0
EL PASO COUNTY	080059	0957	0
CITY OF	080059	0957	0

REVISED TO REFLECT LOMR
EFFECTIVE: May 4, 2020

MAP NUMBER: 1.1.1.0
MAP SHEET: 08041C0957G
MAP FILE: 08041C0957G
DECEMBER 7, 2018

City of Fountain
080061
APPLE TREE PL
EL PASO COUNTY
CITY OF FOUNTAIN

ROLLING RIDGE RD

HERITAGE RD

PROJECT AREA

REVISED AREA

REVISED AREA

14

13

24

23

El Paso County
Unincorporated Areas
080059

Jimmy Camp Creek -
East Tributary

FONTAINE BLVD

LORSON BLVD

Bridge

Bridge

ZONE AE

ZONE AE

ZONE AE

ZONE AE

ZONE AE

5733.0

5731.2

5730.9

5728.6

5726.2

5719.6

5718.8

5718.8

5718.8

5718.8

5718.8

5718.8

5718.2

5710.4

5709.7

5709.5

5709.3

5709.2

5704.7

5705.0

5701.6

5698.8

5697.2

5699.8

5696

Ranch Filing No. 1 subdivision application. The documents related to the design coordination with the DNR has been included within Appendix E of this report.

The developer intends to request reimbursement for the cost to construct drainageway facilities, or request credit against future drainage and bridge fees. Reimbursement will be processed in accordance with sections 1.7 and 3.3 of the Drainage Criteria Manual (DCM). The drainageway facilities will be owned, operated and maintained by the Lorson Ranch Metropolitan District.

II. Project Background

EFJCC is a natural drainageway that was shown to be stabilized in the Lorson Ranch Master Development Drainage Plan (MDDP). The MDDP as last updated showed the EFJCC drainageway to be reconfigured into a benched channel section capable of conveying the 100-year discharge as defined in the Reference 6. The bankfull flow for this segment of East Fork Jimmy Camp Creek which typically has a recurrence interval of around the 1-3/4- to 2-year runoff event, was estimated at 110 cubic feet per second in Reference 2. The segment subject to design begins at the south property line and terminates at the existing trapezoidal channel that was constructed in 2015

In April 2015, the City of Colorado Springs adopted an update to the 1987 Jimmy Camp Creek DBPS. The primary findings and recommendations summarized in the updated 2015 DBPS regarding hydrology and the recommendation for implementation of full spectrum detention (FSD) within the overall Jimmy Camp Creek watershed. The long-term stable slope estimated in the Reference 2 was 0.09 percent. The segment subject to design presently has an average longitudinal slope of 0.25 percent. The segment subject to design will need vertical stabilization by means of grade controls. The 100-year discharge used in the design was obtained from References 6 and 7. The 100-year hydrology used for design reflects existing development conditions within the tributary watershed.

Another finding of the 2015 DBPS was that with the assumption of the maintenance of existing basin condition flow rates through the implementation of FSD, the low flow channel would still be needing stabilization because of the anticipation of continuous low flow once the basin develops into an urban watershed. The 2015 DBPS also called for the 100-year floodplain to be preserved for many segments of the natural drainageways within the Jimmy Camp Creek watershed, including the EFJCC drainageway subject to this design. Low flow stabilization was called for in the 2015 DBPS for the EFJCC, along with selective bank lining and the preservation of the 100-year floodplain.

Though the 2015 DBPS was never adopted by El Paso County, the County is now requiring development to provide for FSD, as in the City of Colorado Springs. The implementation of FSD is being accomplished in the County through the adoption of Chapter 6 and Section 3.2.1 of Chapter 13 of the City of Colorado Springs Drainage Criteria Manual, Volume 1.

III. Previous Reports and References

The basis for the development of the design has been developed from referencing the following reports:

- 1. *Lorson Ranch Master Development Drainage Plan (MDDP), prepared by Core Engineering, latest version (not approved by El Paso County).***
- 2. *Jimmy Camp Creek Drainage Basin Planning Study (DBPS), prepared by Kiowa Engineering, 2015 (not approved by El Paso County).***
- 3. *City of Colorado Springs and El Paso County Drainage Criteria Manual, 1987.***
- 4. *El Paso County Engineering Criteria Manual, most current version.***

5. *City of Colorado Springs Drainage Criteria Manual, Chapters 6 and 12, May 2014.*
6. *The City of Colorado Springs and El Paso County Flood Insurance Study (FIS), prepared by the Federal Emergency Management Agency, effective December 7, 2018.*
7. *East Fork Jimmy Camp Creek Letter of Map Revision, Case Number 19-08-0605P, Lorson Ranch Development, dated May 2019.*
8. *Design of Roadside Channels with Flexible Linings, Hydraulic Engineering Circular 15, October 1985.*

Reference 7 provides for the existing condition floodplain and floodway for the segment of EFJCC subject to this design. The 100-year existing condition floodplain has been shown on the design drawings. Construction of the channel improvements shown on the design plans will not alter the limits of the 100-year floodplain and floodway from those shown in Reference 7. Reference 7 is the post-project condition LOMR that reflects the bridges at Lorson Boulevard, Fontaine Boulevard and the drainageway stabilization measures from Fontaine Boulevard to the north property line of Lorson Ranch, all constructed as part of the Lorson East Subdivision. Reference 7 has been included in the Appendix. The LOMR is contained within Appendix D.

Chapter 6 and Section 3.2.1 of Chapter 12 of the City of Colorado Springs DCM (Reference 5), was made part of Reference 3 by El Paso County Board of County Commissioners Resolution 15-042.

IV. Site Description

The EFJCC floodplain within the design reach is vegetated with native and non-native grasses, herbs and shrubs that are in fair to good condition. The channel overbank is vegetated with trees and shrubs. There is very little evidence of active invert degradation or bank sloughing however there are some portions of the existing low flow channel that have formed nearly vertical banks. Current longitudinal slope along the project is ranges from 0.18 to 0.32 percent. There is presently a base flow in this segment. Where a low flow channel has formed, top widths range from 10 to 20-foot wide and ranges in depth from 2 to 3 feet. Topography used in the design was compiled at a two-foot contour interval and is dated 2015. The grading for the drainageway has been tied into the proposed grading for Creekside at Lorson Ranch Filing 1 as developed by Core Engineering. There are presently no encroachments into the floodplain or channel thread associated with man-made structures. There is presently an existing sanitary sewer outfall owned by Widefield Water and Sanitation that is aligned at the west bank of the floodplain. The Fountain Mutual Irrigation Company siphon crosses under the proposed drainageway near the south property line.

V. Hydrology

Hydrology for use in determining the typical channel sections shown on the plans were obtained from References 6 and 7. The 100-year discharge shown in Reference 7 (5,500 cubic feet per second), has been used in the hydraulic design of the channel banks and associated armoring. The HEC-RAS model developed for References 6 and 7 is contained within Appendix B. The 100-year water surface, depths and velocity were used in sizing the soil riprap bench and bank linings. Watershed area for the southern limit of the project is approximately 9.2 square miles (Reference 6). The watershed north of the Lorson Ranch development is presently undeveloped. Table 4 from Reference 6 has been included within Appendix A.

The assumption that FSD will be required for all future development is reflected in the use of the FIS discharges in this design. There is a good correlation between the FIS and DBPS 100-year discharges for the segment of EFJCC subject to this design. Use of the existing basin condition flow

rates is consistent with the requirements set forth in the annexation agreement between the owners of Banning-Lewis Ranch and the City of Colorado Springs. The future FSDs within Banning-Lewis Ranch will be publicly operated and maintained facilities.

VI. Hydraulics

The hydraulic design of the drainageway and bridge as presented on the plans was carried out using the US Army Corps of Engineers HEC-RAS model compiled for References 6 and 7. The summary output for this model has been included within Appendix A. The results from the HEC-RAS model was used to determine the 100-year hydraulic grade line shown on the design profile. The 100-year flood profile from Reference 6 has been included in the Appendix A as well. The limits of the 100-year floodplain from Reference 7 has been presented on the design plans as well as on the grading and erosion control plan. The location for selected HEC-RAS cross-sections are shown on the design profile. The LOMR floodplain work maps from Reference 7 have been included within Appendix D.

The proposed drainageway design concepts put forth on the plans are 100-year selective bank lining with low flow stabilization. The bankfull channel will be constructed using un-grouted boulders. Above the bankfull channel will be soil and riprap benches that will be revegetated using native grasses and shrubs. At outside bends, soil and riprap bank linings with maximum side slopes of 3 to 1 is proposed that will extend to the height of the 100-year hydraulic grade line. The soil riprap benches were sized using the tractive force that would be developed during a 100-year flood event. Permissible shear stresses were obtained from Reference 8.

The effect of development within the watershed will be to increase the frequency and duration of base flows. Base flows will increase with the development because of discharges from future FSDs and irrigation return flows. Natural drainageways will eventually degrade along the invert in turn causing bank sloughing to occur. The bank full capacity as estimated in the DBPS represents rate of runoff that would form the low flow channel over time. The bank full capacity for most natural watersheds represents a flow rate usually between the 2- to 5-year recurrence intervals. In order to comply with DBPS criteria, the low flow channel capacity for this design was set at 110 cubic feet per second per Reference 2. The current DCM requires that the low flow channel be design for the 10-year discharge or 10 percent of the 100-year discharge. Using current County criteria, the low flow would be required to be sized to convey 550 cubic feet per second. Assuming a 2-foot depth the required top width would be 38 feet. As providing for this flow rate of conveyance would cause a significant reconfiguration of the existing low flow channel with resulting negative impacts upon the existing wetland vegetation and fish habitat. A deviation request will be submitted to allow for the sizing of the low flow channel to 110 cubic feet per second as determined in Reference 2.

A qualitative channel stability analysis was carried as part of developing the design for EFJCC. The analysis consisted of a field inspection, historic topographic mapping comparisons and the determination of existing channel slopes. Field observations revealed no indication of invert degradation along the entire length of the design reach. The long-term stable slope for this segment the East Fork Jimmy Camp Creek was estimated at 0.09 percent (Reference 2). The current slope ranges from 0.18 to 0.32 percent through the project reach. The design plans have been developed to address the potential for invert degradation should the channel seek the 0.09 percent long-term equilibrium slope of slope estimated in Reference 2. Should the invert reach a slope of 0.09 percent the bottom of the boulders as designed will not become exposed and therefore undermining of the low flow channel will be prevented. The boulders along the low flow channel will be situated so that the bottom of the boulder is at least two feet below the design invert shown on the profiles. Where the long-term invert would cause the channel to degrade to the bottom of the boulder lining, a grade control structure has been proposed. Five grade control structures have been designed and shown on the plan and profiles

Based upon the field observations regarding channel stability, the EFJCC low flow channel was designed to operate at normal depths of flow, thereby eliminating channel instability associated

with super-critical flow conditions. The low flow channel lining is proposed to be a combination of soil/riprap bank and turf reinforcement mats depending upon velocity. The locations where selective 100-year soil/riprap lining are proposed was based upon the velocities returned by the HEC-RAS model. Velocities for the 100-year discharge range from 5.3 to 10.5 feet per second. The F100-year Froude Number ranges from .37 to .73 which confirms that subcritical flow conditions exist even for the 100-year event. Calculations related to the sizing of the soil riprap banks, for the overbanks and low flow channel section are contained within the Appendix A of the report. The low flow is in normal depth conditions for the entire reach. Velocity within the low flow channel is ranges from 4.0 to 4.4 feet per second assuming a two-foot depth of flow and bottom widths ranging from 12 to 20-feet. The Froude Number for the low flow channel ranges from .52 to .54 which confirms the presence of normal flow conditions. At the outside channel bends of the floodplain, soil riprap is proposed as the bank lining material. Soil riprap is also specified for the channel bench above the low for channel

There was also an effort to realign portions of the low flow channel away the toe of outside bends of the drainageway. The intent of the repositioning of the low flow in these locations was to minimize disturbance to the vegetation on the benches of the 100-year floodplain that could occur during construction. Finally, shear stress calculations were carried out for the 100-year flow condition at each segment of the drainageway. Maximum 100-year shear stress on the bench was calculated at 1.4 pounds per square foot. Permissible shear stress for native vegetation with Class B retardance is 2.1 pounds per square foot for the vegetation that is present at the site. Channel design calculations are included in the Appendix A of this report. memorandum.

VII. Design Elements

Presented on the design plans associated with this report are the proposed drainageway conditions. Design criteria for the project are summarized as follows:

Channel design slope:	0.18-0.32 percent
Outside bend slopes- riprap	3 to 1 maximum
Low flow channel side slopes- riprap lined	vertical
Low flow channel depth	3 feet
Manning's n-values:	.025-.04
Minimum low flow channel radius	100 feet
Design shear stress: low flow channel	
Boulder linings	1.4 psf
Design shear stress: soil/riprap linings at outside bends and benches	
Type VL riprap	2.5 psf

The construction of the improvements shown on the plans will result in a long-term stable drainageway corridor and prevent damages that could arise from bank sloughing related to the erosion of the drainageway's invert. Because the low flow channel will be stabilized both horizontally and vertically the potential for negative impacts upon the existing vegetative habitat will be minimized. The preservation of the low flow channel and floodplain is consistent with the special condition 2 of the East Fork Jimmy Camp Creek 404 permit and with Reference 2. A stabilized floodplain corridor will result from the construction of the proposed drainageway structures and over the long term, the environmental quality of the corridor will be enhanced and preserved.

Maintenance access to the low flow channel and benches be provided via platted tracts within Creekside at Lorson Ranch Filing 1. The maintenance road will follow the existing outfall sewer that is shown on the design plans. The benches of the channel are relatively flat and will allow for access to the low flow channel, however an access trail to the benches is not recommended in order to limit disturbance to existing vegetation or that will be revegetated in the future. Maintenance access will have an all-weather surface and be a minimum of 12-feet in width.

VIII. Construction Permitting

The following permits are anticipated to allow for the construction of the project as shown on the design plans. A copy of the Lorson Ranch 404 Permit is included within the Appendix.

Notification of project in conformance with existing 404 permit - USACOE

Floodplain Development Permit – Regional Building Department

Grading and Erosion Control Permit (ESQCP) – El Paso County

Construction Stormwater Discharge Permit – CDPHE

IX. Drainage and Bridge Fees

The Lorson Ranch Development and specifically Lorson Ranch East lies wholly within the Jimmy Camp Creek drainage basin. Drainage and bridge fees have been established by the County for the Jimmy Camp Creek drainage basin for assessment against platted land within the watershed. The drainageway structures will be public and will be maintained by the Lorson Ranch Metropolitan District and are considered reimbursable or creditable, if a DBPS is approved, against drainage fees owed when land within Creekside at Lorson Ranch Filing 1 is platted pending approval through the DCM reimbursement process.

The current 2020 drainage and bridge fees for the Jimmy Camp Creek drainage basin are as follows:

Drainage Fee:	\$19,084 per all impervious acres
Drainage Fee Escrow (BOCC Reas.18-470)	<u>\$7,285 per acre</u>
Total Drainage Fee	\$26,369 per acre
Bridge Fee:	\$893 per acre

X. Phasing

Construction of the drainageway stabilization measures shown on the plans is to be completed all at once and no phasing of the construction is proposed. The construction will commence prior to or concurrent with the development of Creekside at Lorson Ranch Filing 1. Plans are to commence with construction in Summer 2020 with substantial completion in late Fall 2020.

XI. Conclusions

The development of the Creekside at Lorson Ranch Filing No. 1 requires that drainageway stabilization be implemented along East Fork Jimmy Camp Creek. The stabilization measures are intended to provide protection to the residential lots from long term erosion of the banks and invert

of East Fork Jimmy Camp Creek. Stabilization of the drainageway to convey 100-year peak discharges will also promote better water quality to downstream reaches of East Fork Jimmy Camp Creek, Jimmy Camp Creek and Fountain Creek as the potential for sediment from bank sloughing to be conveyed downstream will be eliminated. Upon construction of the drainageway stabilization measures as shown on the design plans, adjacent and downstream properties will not be adversely impacted by the runoff from Creekside Filing No. 1 and upstream drainage basins that will be conveyed by East Fork Jimmy Camp Creek.

Appendix A
Hydrologic and Hydraulic Calculations

Table 4. Summary of Discharges (cont.)

<u>Flooding Source and Location</u>	<u>Drainage Area (Square Miles)</u>	<u>Peak Discharges (Cubic Feet Per Second)</u>			
		<u>10-Year</u>	<u>50-Year</u>	<u>100-Year</u>	<u>500-Year</u>
Jimmy Camp Creek At confluence with Fountain Creek	66.4	8,500	12,400	16,000	20,500
Jimmy Camp Creek – East Tributary At confluence with Jimmy Camp Creek	9.2	2,800	4,600	5,500	6,900
Jimmy Camp Creek – West Tributary At confluence with Jimmy Camp Creek	3.93	1,160	2,280	2,780	4,500
Kettle Creek At State Highway 83	16.3	2,600	6,600	9,300	19,300
Lower Big Springs At confluence with Black Squirrel Creek	-- ¹	-- ¹	-- ¹	4,820	-- ¹
Mesa Basin At confluence with Monument Creek	2.2	1,260	1,880	2,250	3,470
Mines Subtributary to Corral Tributary At confluence with Corral Tributary	9.4	2,200	2,500	4,300	5,400
Monument Creek At confluence with Fountain Creek	238.0	11,500	23,500	32,000	57,000
Upstream of City of Colorado Springs corporate limits At northern boundary of U.S. Air Force Academy	196.5	10,200	20,700	27,200	49,000
	74.7	7,400	15,300	19,900	37,200
Monument Creek Tributary At Cross Section C	1.4	890	1,620	1,880	2,880
190 feet downstream of Cross Section A	1.4	890	1,620	1,880	5,020 ²
North Beaver Creek At Confluence with Beaver Creek	3.5	-- ¹	-- ¹	1,932	-- ¹

¹Data not available

²Includes Monument Creek Bypass, only 500-year flood

Normal Flow Analysis - Trapezoidal Channel

Project: 18020 East Fork Sand Creek south of Lorson Blvd
 Channel ID: Bankfull low flow Q=110 cfs 12-foot BW s=0.32%

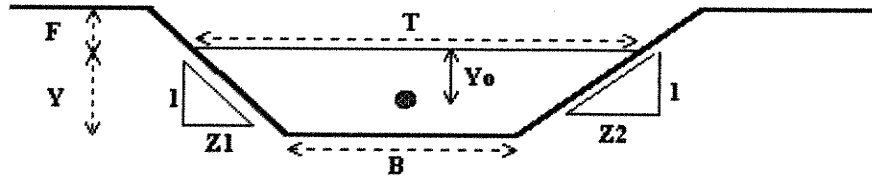

Design Information (Input)

Channel Invert Slope	$S_o =$	<u>0.0032</u> ft/ft
Manning's n	$n =$	<u>0.025</u>
Bottom Width	$B =$	<u>12.00</u> ft
Left Side Slope	$Z_1 =$	<u>0.10</u> ft/ft
Right Side Slope	$Z_2 =$	<u>0.10</u> ft/ft
Freeboard Height	$F =$	<u>0.00</u> ft
Design Water Depth	$Y =$	<u>2.00</u> ft

Normal Flow Condition (Calculated)

Discharge	$Q =$	<u>108.90</u> cfs
Froude Number	$Fr =$	<u>0.56</u>
Flow Velocity	$V =$	<u>4.46</u> fps
Flow Area	$A =$	<u>24.40</u> sq ft
Top Width	$T =$	<u>12.40</u> ft
Wetted Perimeter	$P =$	<u>16.02</u> ft
Hydraulic Radius	$R =$	<u>1.52</u> ft
Hydraulic Depth	$D =$	<u>1.97</u> ft
Specific Energy	$E_s =$	<u>2.31</u> ft
Centroid of Flow Area	$Y_o =$	<u>0.99</u> ft
Specific Force	$F_s =$	<u>2.46</u> kip

Critical Flow Analysis - Trapezoidal Channel

Project: 16031 East Fork Jimmy Camp Creek
 Channel ID: Bankfull low flow Q=110 cfs 12-foot BW s=0.32%

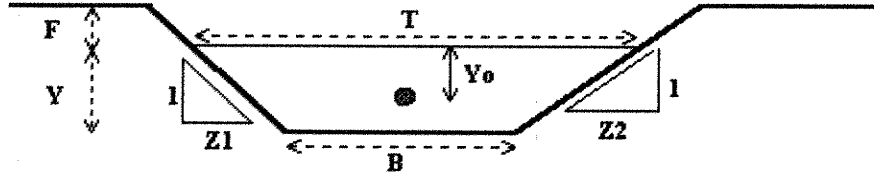

Design Information (Input)	
Bottom Width	B = <u>12.00</u> ft
Left Side Slope	Z1 = <u>0.10</u> ft/ft
Right Side Slope	Z2 = <u>0.10</u> ft/ft
Design Discharge	Q = <u>110.00</u> cfs
Critical Flow Condition (Calculated)	
Critical Flow Depth	Y = <u>1.37</u> ft
Critical Flow Area	A = <u>16.63</u> sq ft
Critical Top Width	T = <u>12.27</u> ft
Critical Hydraulic Depth	D = <u>1.35</u> ft
Critical Flow Velocity	V = <u>6.62</u> fps
Froude Number	Fr = <u>1.00</u>
Critical Wetted Perimeter	P = <u>14.75</u> ft
Critical Hydraulic Radius	R = <u>1.13</u> ft
Critical (min) Specific Energy	Esc = <u>2.05</u> ft
Centroid on the Critical Flow Area	Yoc = <u>0.68</u> ft
Critical (min) Specific Force	Fsc = <u>2.12</u> kip

Normal Flow Analysis - Trapezoidal Channel

Project: 18020 East Fork Sand Creek south of Lorson Blvd
 Channel ID: Bankfull low flow Q=110 cfs 20-foot BW S=0.18%

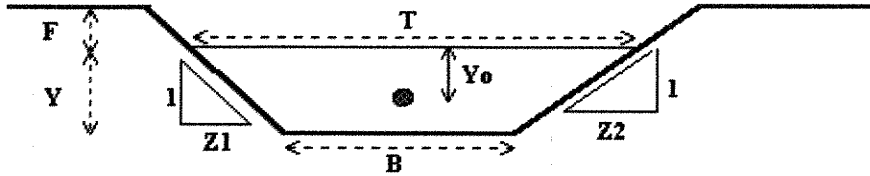

Design Information (Input)	
Channel Invert Slope	So = <u>0.0018</u> ft/ft
Manning's n	n = <u>0.025</u>
Bottom Width	B = <u>20.00</u> ft
Left Side Slope	Z1 = <u>0.10</u> ft/ft
Right Side Slope	Z2 = <u>0.10</u> ft/ft
Freeboard Height	F = <u>0.00</u> ft
Design Water Depth	Y = <u>2.00</u> ft
Normal Flow Condition (Calculated)	
Discharge	Q = <u>144.48</u> cfs
Froude Number	Fr = <u>0.45</u>
Flow Velocity	V = <u>3.58</u> fps
Flow Area	A = <u>40.40</u> sq ft
Top Width	T = <u>20.40</u> ft
Wetted Perimeter	P = <u>24.02</u> ft
Hydraulic Radius	R = <u>1.68</u> ft
Hydraulic Depth	D = <u>1.98</u> ft
Specific Energy	Es = <u>2.20</u> ft
Centroid of Flow Area	Yo = <u>1.00</u> ft
Specific Force	Fs = <u>3.51</u> kip

Critical Flow Analysis - Trapezoidal Channel

Project: 16031 East Fork Jimmy Camp Creek
 Channel ID: Bankfull low flow Q=110 cfs 20-foot BW S=0.18%

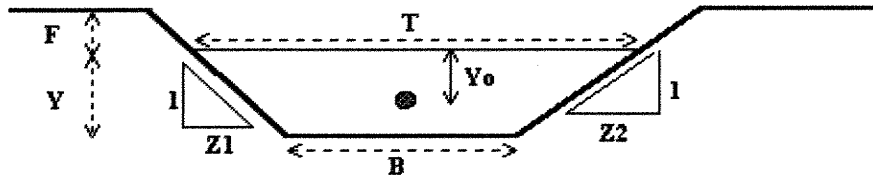

Design Information (Input)	
Bottom Width	B = <u>20.00</u> ft
Left Side Slope	Z1 = <u>0.10</u> ft/ft
Right Side Slope	Z2 = <u>0.10</u> ft/ft
Design Discharge	Q = <u>100.00</u> cfs
Critical Flow Condition (Calculated)	
Critical Flow Depth	Y = <u>0.92</u> ft
Critical Flow Area	A = <u>18.38</u> sq ft
Critical Top Width	T = <u>20.18</u> ft
Critical Hydraulic Depth	D = <u>0.91</u> ft
Critical Flow Velocity	V = <u>5.44</u> fps
Froude Number	Fr = <u>1.00</u>
Critical Wetted Perimeter	P = <u>21.84</u> ft
Critical Hydraulic Radius	R = <u>0.84</u> ft
Critical (min) Specific Energy	Esc = <u>1.37</u> ft
Centroid on the Critical Flow Area	Yoc = <u>0.46</u> ft
Critical (min) Specific Force	Fsc = <u>1.58</u> kip

Normal Flow Analysis - Trapezoidal Channel

Project: 18020 East Fork Sand Creek south of Lorson Blvd
 Channel ID: Q=550 cfs 12-foot BW s=0.18%

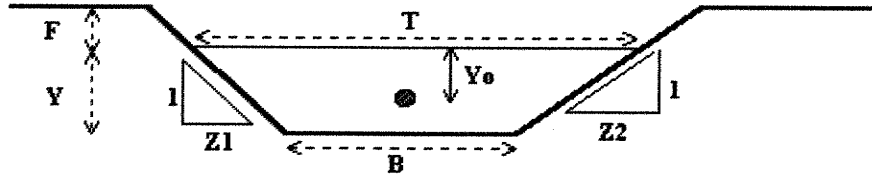

Design Information (Input)	
Channel Invert Slope	So = <u>0.0018</u> ft/ft
Manning's n	n = <u>0.025</u>
Bottom Width	B = <u>38.00</u> ft
Left Side Slope	Z1 = <u>0.10</u> ft/ft
Right Side Slope	Z2 = <u>0.10</u> ft/ft
Freeboard Height	F = <u>0.00</u> ft
Design Water Depth	Y = <u>3.00</u> ft
Normal Flow Condition (Calculated)	
Discharge	Q = <u>550.70</u> cfs
Froude Number	Fr = <u>0.49</u>
Flow Velocity	V = <u>4.79</u> fps
Flow Area	A = <u>114.90</u> sq ft
Top Width	T = <u>38.60</u> ft
Wetted Perimeter	P = <u>44.03</u> ft
Hydraulic Radius	R = <u>2.61</u> ft
Hydraulic Depth	D = <u>2.98</u> ft
Specific Energy	Es = <u>3.36</u> ft
Centroid of Flow Area	Yo = <u>1.50</u> ft
Specific Force	Fs = <u>15.85</u> kip

Critical Flow Analysis - Trapezoidal Channel

Project: 16031 East Fork Jimmy Camp Creek
 Channel ID: Q=550 cfs 12-foot BW s=0.18%

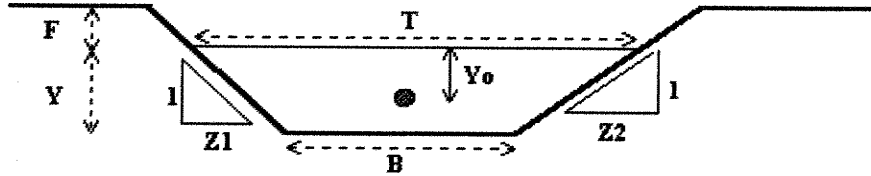

Design Information (Input)	
Bottom Width	B = <u>38.00</u> ft
Left Side Slope	Z1 = <u>0.50</u> ft/ft
Right Side Slope	Z2 = <u>0.50</u> ft/ft
Design Discharge	Q = <u>550.00</u> cfs
Critical Flow Condition (Calculated)	
Critical Flow Depth	Y = <u>1.85</u> ft
Critical Flow Area	A = <u>72.01</u> sq ft
Critical Top Width	T = <u>39.85</u> ft
Critical Hydraulic Depth	D = <u>1.81</u> ft
Critical Flow Velocity	V = <u>7.64</u> fps
Froude Number	Fr = <u>1.00</u>
Critical Wetted Perimeter	P = <u>42.14</u> ft
Critical Hydraulic Radius	R = <u>1.71</u> ft
Critical (min) Specific Energy	Esc = <u>2.76</u> ft
Centroid on the Critical Flow Area	Yoc = <u>0.91</u> ft
Critical (min) Specific Force	Fsc = <u>12.24</u> kip

Piping Sizing:

Allow Velocity in orcale

$$10.4 \text{ fps} \times 5500$$

$$S = .0032 \text{ in} \quad S_s = 2.4$$

$$\frac{V_s^{1.7}}{(2.6-1).66} = \frac{V_s^{1.7}}{1.36} = \frac{4.02}{1.36} = 2.96$$

High end of VL

∴ Per table 10-6 DCM Type L

$D_{50} = 9''$; min thickness = 18"

TABLE 10-6

RIPRAP REQUIREMENTS FOR CHANNEL LININGS **

$V S^{0.17} / (S_s - 1)^{0.66} *$ (ft ^{1/2} /sec)	Rock Type ***
1.4 to 3.2	VL
3.3 to 3.9	L ←
4.0 to 4.5	M
4.6 to 5.5	H
5.6 to 6.4	VH

* where:

V = mean channel flow velocity, in fps;

S = longitudinal channel slope, in feet per foot (ft/ft); and

S_s = specific gravity of stone (minimum $S_s = 2.50$)

** Table valid only for Froude number of 0.8 or less and side slopes no steeper than 2h:1v.

*** Type VL and L riprap may be buried after placement to reduce vandalism.

Traction Force on channel benches.

Typical depth over bench $\approx 9'$

Typical slope = $S = .25\%$

$$\tau = \gamma d S = 62.4(9)(.0025) = 1.4 \text{ psf}$$

Permissible traction force (Des. of Roadside channels)

Class 'B' Vegetation = 2.1

Riprap: 6" D50 = 2.5 psf

Riprap: 12" D50 = 5.0 psf.

Use Type VL : D50 = 6" ; 18" thick.

BARRETS

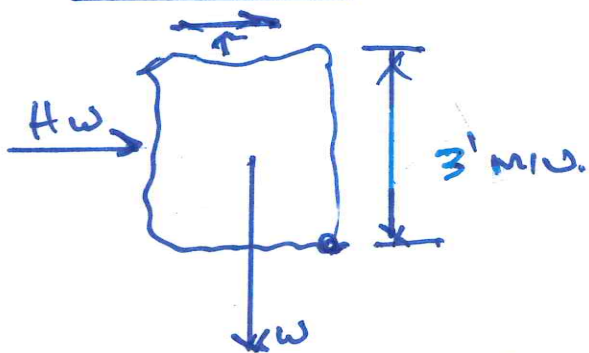

$$W = 130 \text{ psf} : q < F(F_t)'$$

$$W = 1170 \text{ #/ft}$$

$$\tau = 62.4(10')(0.0025) = 1.75 \text{ #/ft}$$

$$H_w = \gamma h = 62.4(10' - 1.5) = 530 \text{ psf/ft}$$

Overturning $530(1.5) + 1.75(3) = 800 \text{ #/ft}$

Resisting $1170(1.5) = 1755 \text{ #/ft}$

$$FS = 1755/800 = 2.2 \text{ } \underline{ok}$$

**DESIGN OF ROADSIDE CHANNELS
WITH FLEXIBLE LININGS**

Hydraulic Engineering Circular No. 15

Prepared By

Simons, Li & Associates, Inc.
3555 Stanford Road
P.O. Box 1816
Fort Collins, Colorado 80522

For

U.S. Department of Transportation
Federal Highway Administration

October 25, 1985

Table 4.1. Permissible Shear Stresses for Lining Materials.

Lining Category	Lining Type	Permissible Unit Shear Stress (lb/ft ²)
Temporary	Woven Paper Net	0.15
	Jute Net	0.45
	Fiberglass Roving*	0.75
	Straw and Erosion Net	1.45
	Curled Wood Mat	1.55
	Nylon Mat	2.00
Vegetative	Class A	3.70
	Class B	2.10
	Class C	1.00
	Class D	0.60
	Class E	0.35
Gravel Riprap	1-inch	0.40
	2-inch	0.80
Rock Riprap	6-inch	2.50
	12-inch	5.00

* single and double applications

HEC-RAS Plan: Proposed No Rise Floodway River: East Tributary Reach: Main Reach (Continued)

Reach	River Sta	Profile	Q Total (cfs)	Min Ch El (ft)	W.S. Elev (ft)	Crit W.S. (ft)	E.G. Elev (ft)	E.G. Slope (ft/ft)	Vel Chnl (ft/s)	Flow Area (sq ft)	Top Width (ft)	Froude # Chl
Main Reach	6150	100yr	5500.00	5680.80	5690.22	5687.75	5691.11	0.003312	7.62	782.43	279.49	0.51
Main Reach	6150	550 cfs	550.00	5680.80	5684.59	5683.10	5684.73	0.002132	3.07	179.22	141.96	0.35
Main Reach	6150	110 cfs	110.00	5680.80	5682.69	5681.83	5682.74	0.002104	1.89	58.26	49.74	0.31
Main Reach	6000	100yr	5500.00	5680.20	5689.86	5687.31	5690.62	0.002729	7.58	958.89	199.31	0.47
Main Reach	6000	550 cfs	550.00	5680.20	5684.31	5682.22	5684.43	0.001780	2.85	195.87	84.31	0.31
Main Reach	6000	110 cfs	110.00	5680.20	5682.55	5680.89	5682.58	0.000636	1.35	81.32	42.86	0.17
Main Reach	5865	100yr	5500.00	5679.90	5688.91	5687.45	5690.09	0.004942	9.26	744.18	166.85	0.61
Main Reach	5865	550 cfs	550.00	5679.90	5683.86	5682.87	5684.08	0.004060	3.70	148.54	71.57	0.45
Main Reach	5865	110 cfs	110.00	5679.90	5682.32	5681.09	5682.39	0.004308	2.18	50.36	55.33	0.40
Main Reach	5710	100yr	5500.00	5679.40	5688.33	5686.36	5689.34	0.004148	8.25	757.46	193.68	0.56
Main Reach	5710	550 cfs	550.00	5679.40	5683.30	5682.33	5683.47	0.003589	3.35	164.35	84.91	0.42
Main Reach	5710	110 cfs	110.00	5679.40	5681.66	5680.41	5681.75	0.004053	2.40	45.81	40.76	0.40
Main Reach	5436	100yr	5500.00	5678.40	5687.69	5685.11	5688.34	0.002671	6.59	913.11	181.17	0.45
Main Reach	5436	550 cfs	550.00	5678.40	5682.39	5681.27	5682.54	0.003179	3.09	177.91	95.04	0.40
Main Reach	5436	110 cfs	110.00	5678.40	5680.91	5679.38	5680.95	0.002134	1.76	62.62	56.43	0.29
Main Reach	5236	100yr	5500.00	5677.70	5686.92	5684.65	5687.74	0.003345	7.37	818.51	160.27	0.51
Main Reach	5236	550 cfs	550.00	5677.70	5681.71	5680.73	5681.87	0.003500	3.28	167.53	87.46	0.42
Main Reach	5236	110 cfs	110.00	5677.70	5680.20	5679.08	5680.28	0.006083	2.23	49.43	69.39	0.46
Main Reach	5032	100yr	5500.00	5677.10	5686.58	5683.78	5687.19	0.001768	6.85	1057.87	202.01	0.45
Main Reach	5032	550 cfs	550.00	5677.10	5681.22	5680.10	5681.35	0.001840	2.98	206.22	113.63	0.37
Main Reach	5032	110 cfs	110.00	5677.10	5679.46	5678.11	5679.53	0.002426	2.23	49.38	45.05	0.38
Main Reach	4836	100yr	5500.00	5676.60	5686.67	5682.36	5686.90	0.000546	3.96	1644.01	311.71	0.26
Main Reach	4836	550 cfs	550.00	5676.60	5681.13	5679.33	5681.17	0.000455	1.60	342.68	154.32	0.19
Main Reach	4836	110 cfs	110.00	5676.60	5679.10	5677.61	5679.13	0.001671	1.44	76.43	106.49	0.30
Main Reach	4500	100yr	5500.00	5676.10	5686.60	5682.49	5686.69	0.000494	3.01	2650.83	482.65	0.20
Main Reach	4500	550 cfs	550.00	5676.10	5680.66	5679.11	5680.81	0.004107	3.23	205.50	217.10	0.45
Main Reach	4500	110 cfs	110.00	5676.10	5678.16	5677.43	5678.29	0.004099	2.87	38.31	27.64	0.43

Jimmy Camp Ck East Trib 2019 DS No Rise Plan: Proposed DS for No Rise Floodway 7/1/2020

River = East Tributary Reach = Main Reach RS = 9000

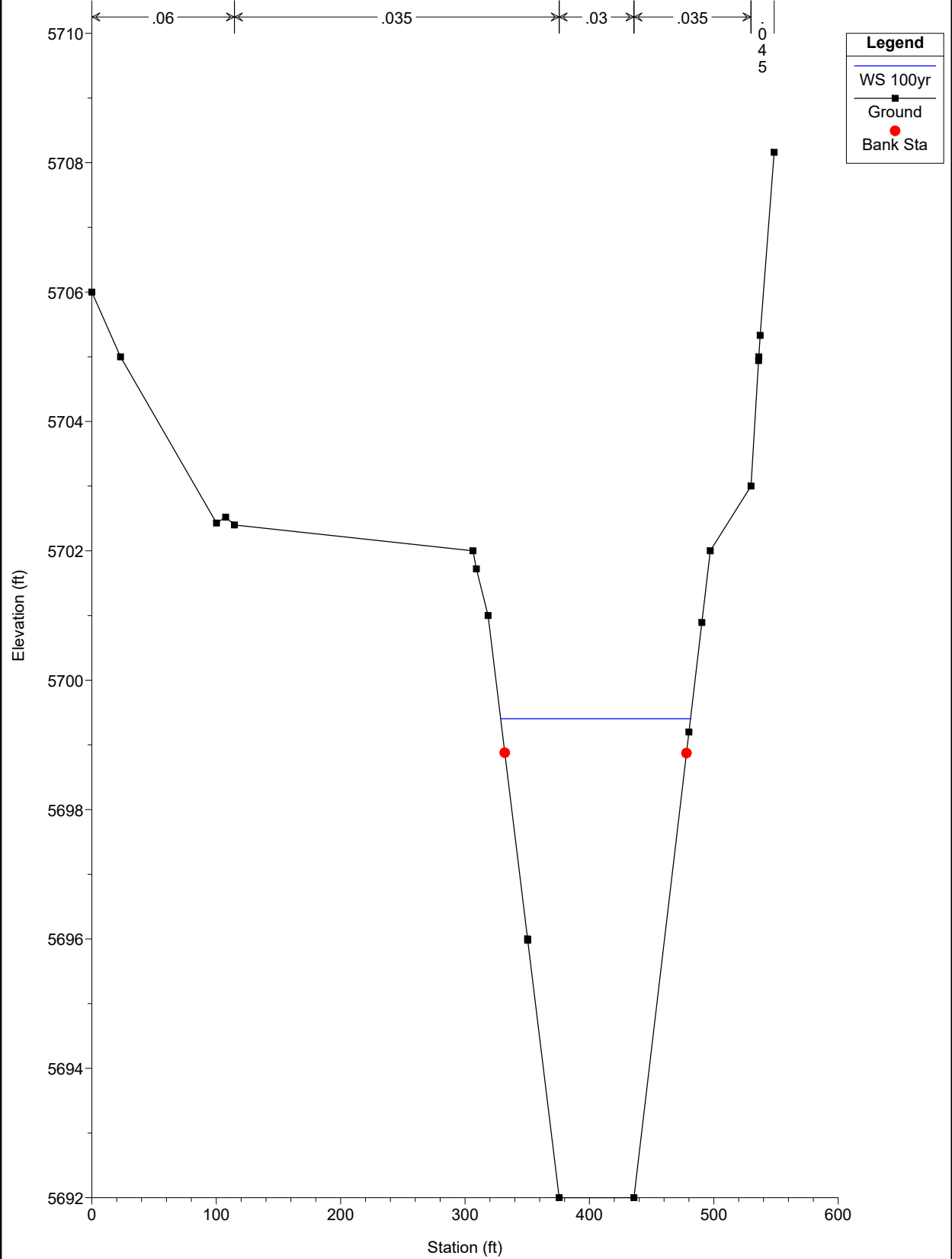

Jimmy Camp Ck East Trib 2019 DS No Rise Plan: Proposed DS for No Rise Floodway 7/1/2020

River = East Tributary Reach = Main Reach RS = 8850

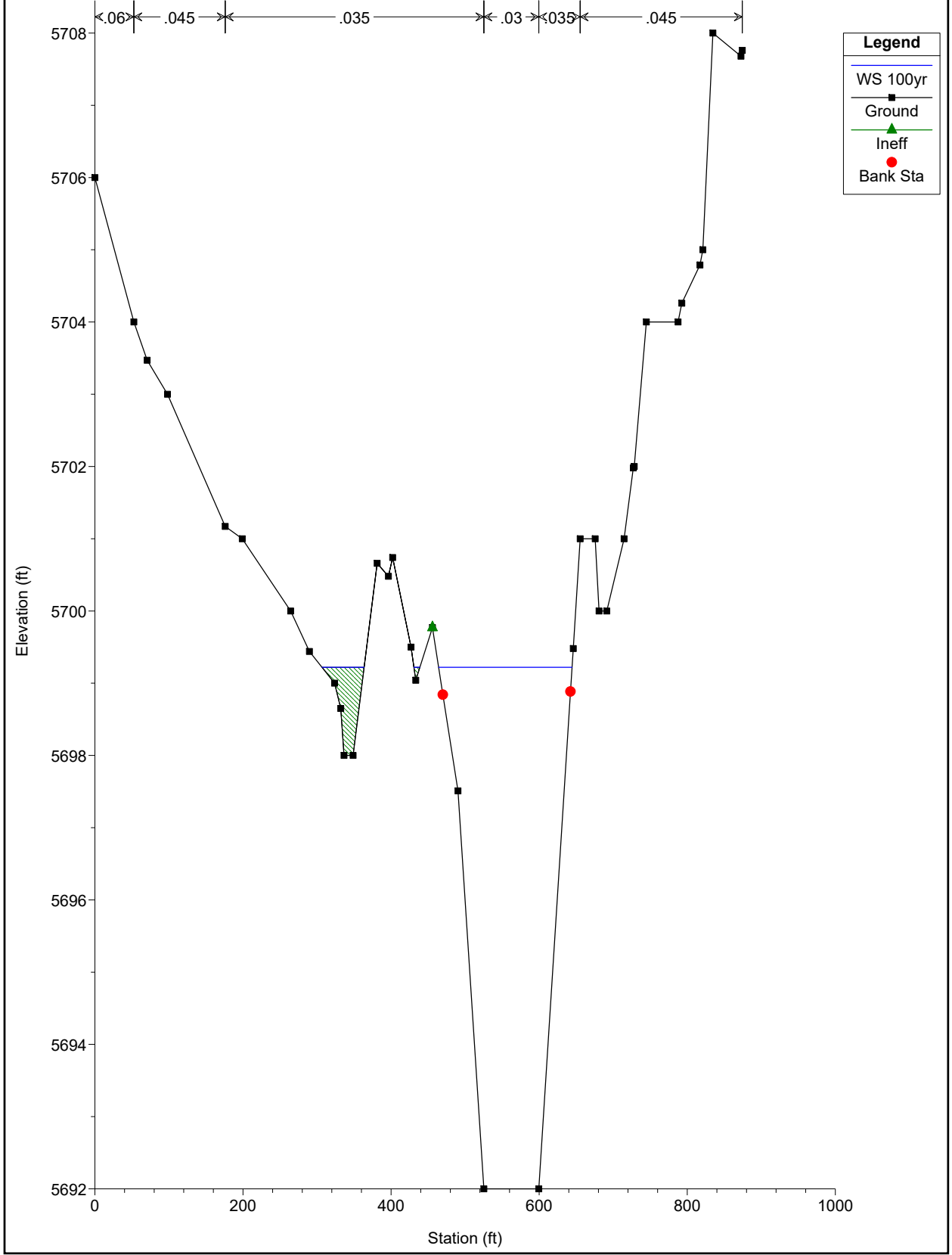

Jimmy Camp Ck East Trib 2019 DS No Rise Plan: Proposed DS for No Rise Floodway 7/1/2020

River = East Tributary Reach = Main Reach RS = 8650

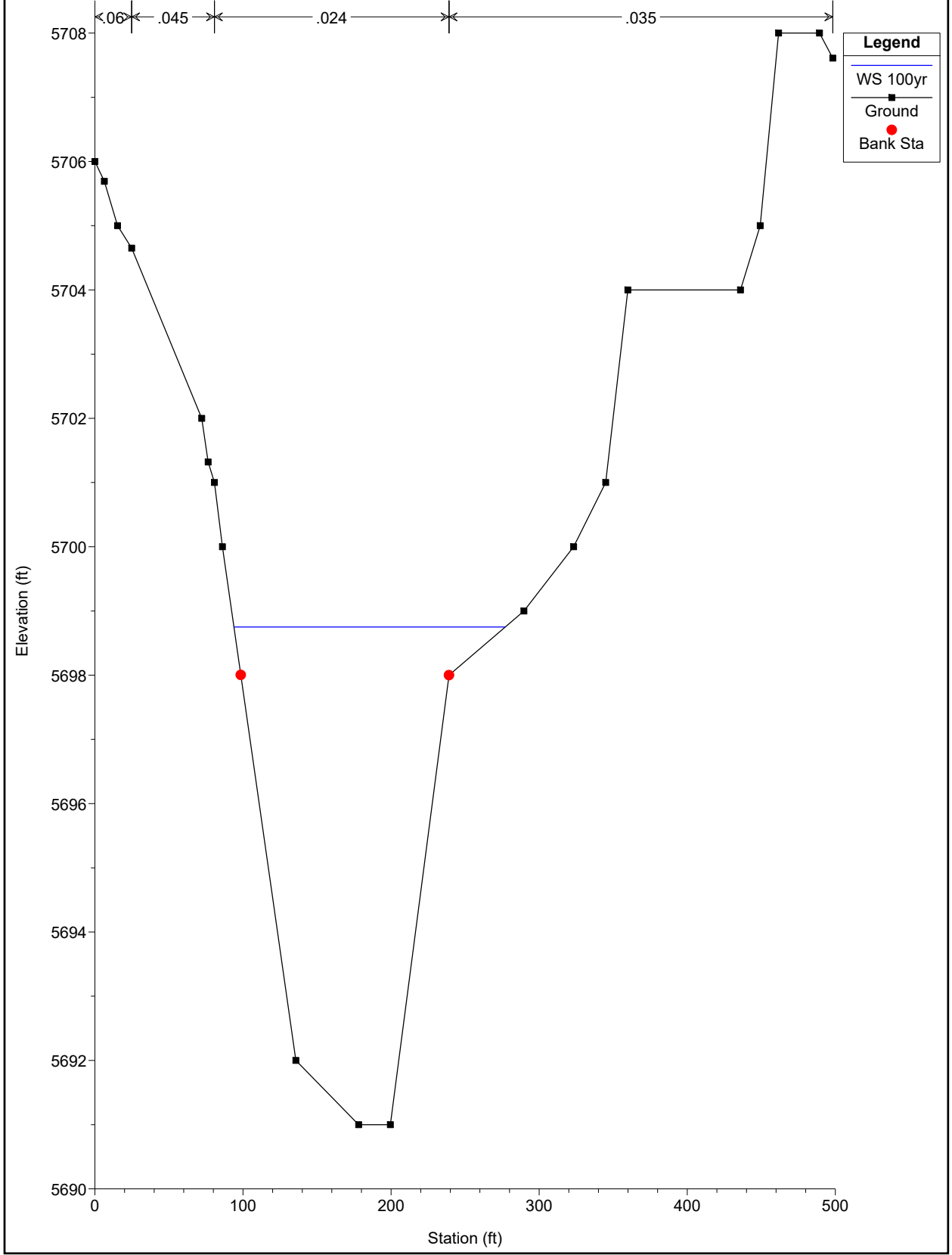

Jimmy Camp Ck East Trib 2019 DS No Rise Plan: Proposed DS for No Rise Floodway 7/1/2020

River = East Tributary Reach = Main Reach RS = 8521.53

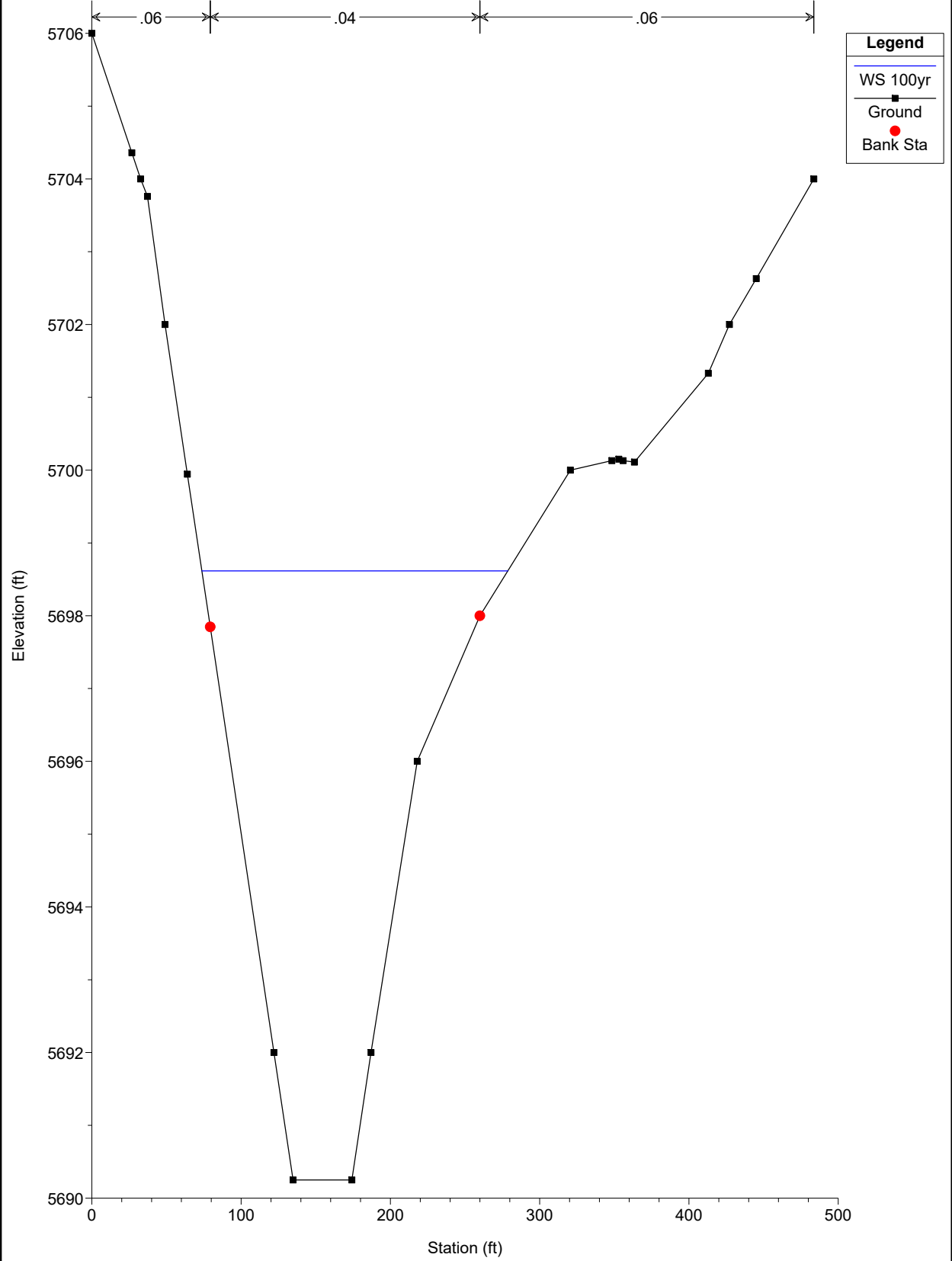

Jimmy Camp Ck East Trib 2019 DS No Rise Plan: Proposed DS for No Rise Floodway 7/1/2020

River = East Tributary Reach = Main Reach RS = 8470 Bottom Sheet Pile Check

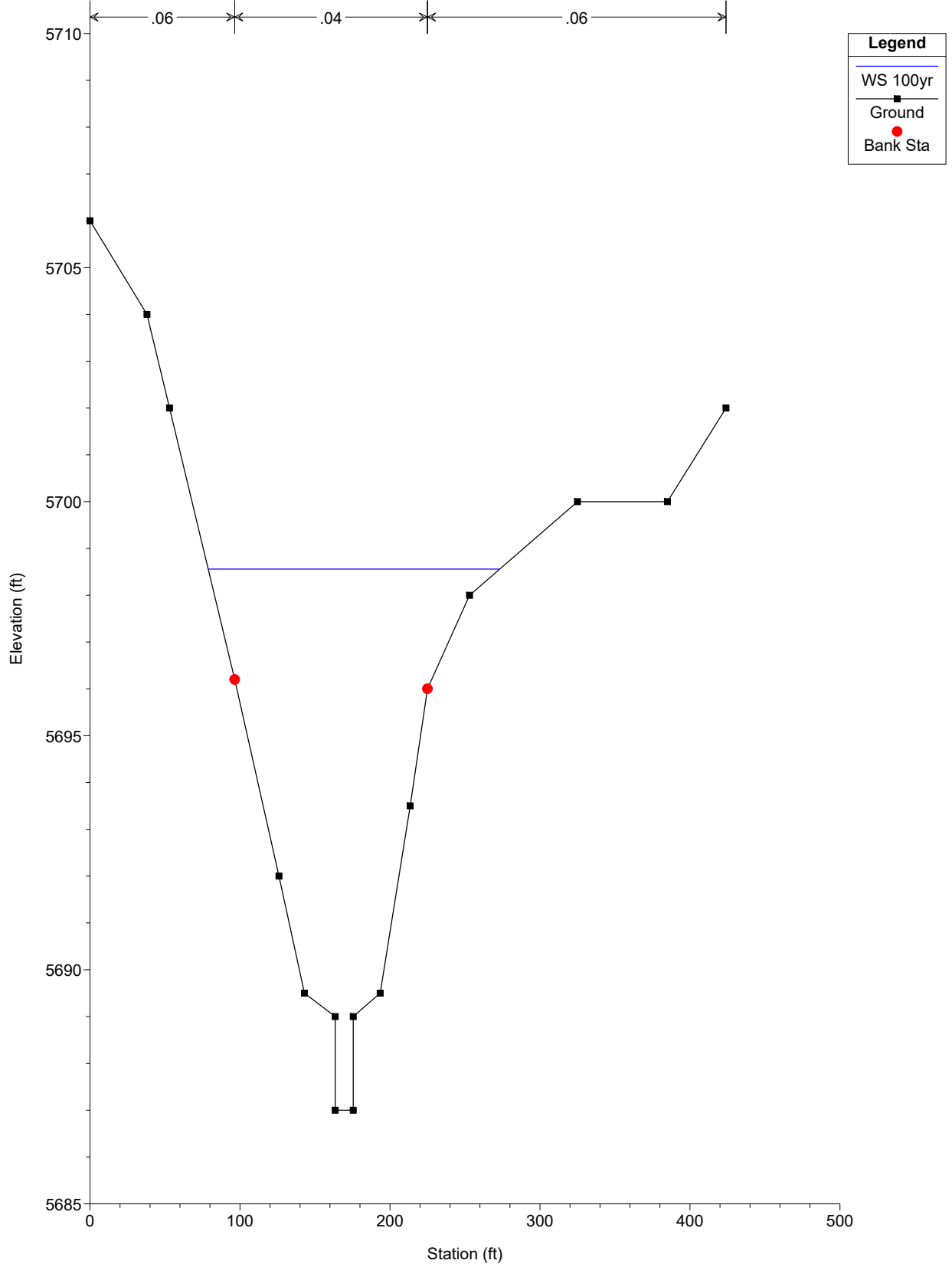

Jimmy Camp Ck East Trib 2019 DS No Rise Plan: Proposed DS for No Rise Floodway 7/1/2020

River = East Tributary Reach = Main Reach RS = 8430

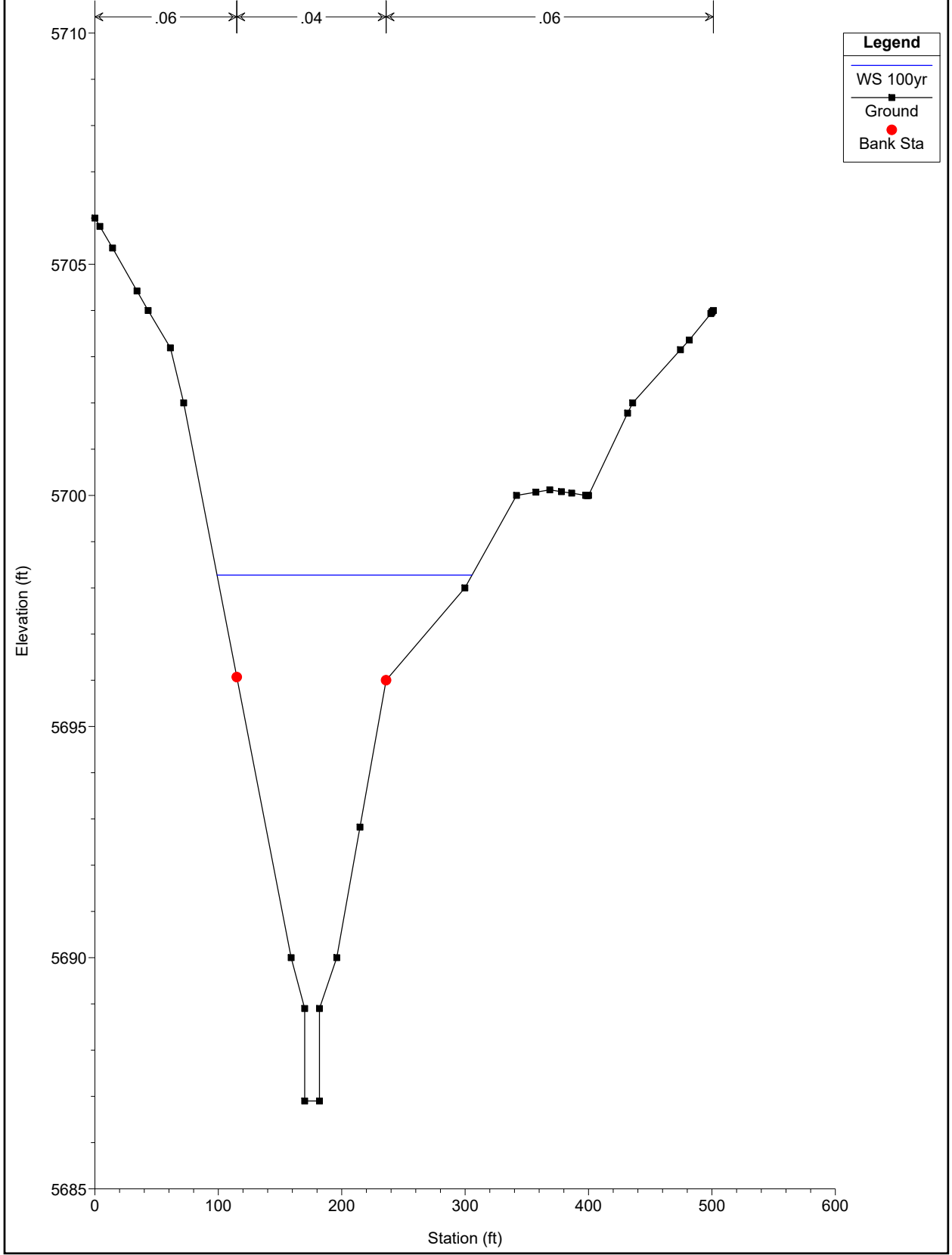

Jimmy Camp Ck East Trib 2019 DS No Rise Plan: Proposed DS for No Rise Floodway 7/1/2020

River = East Tributary Reach = Main Reach RS = 8350

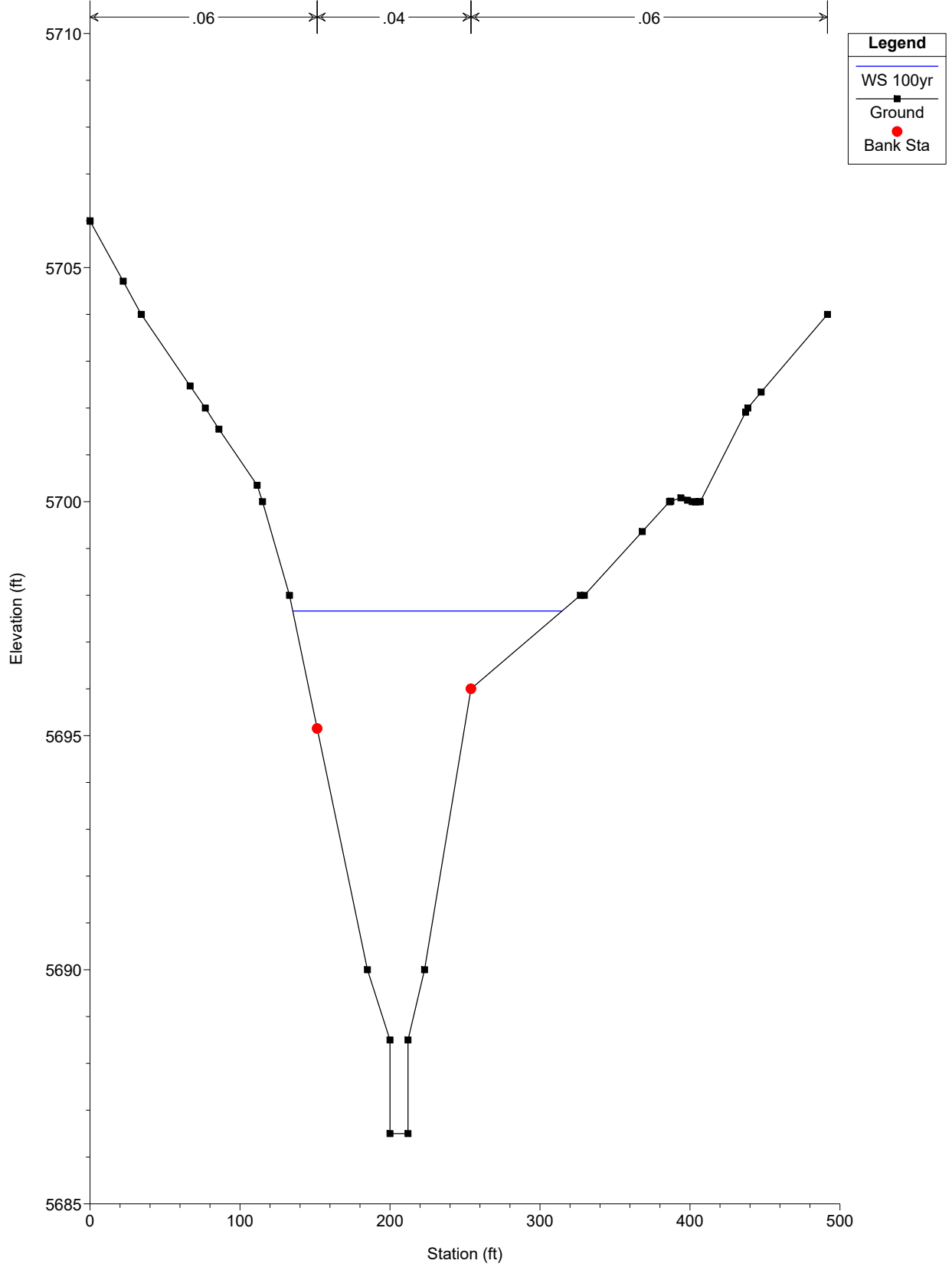

Jimmy Camp Ck East Trib 2019 DS No Rise Plan: Proposed DS for No Rise Floodway 7/1/2020

River = East Tributary Reach = Main Reach RS = 8200

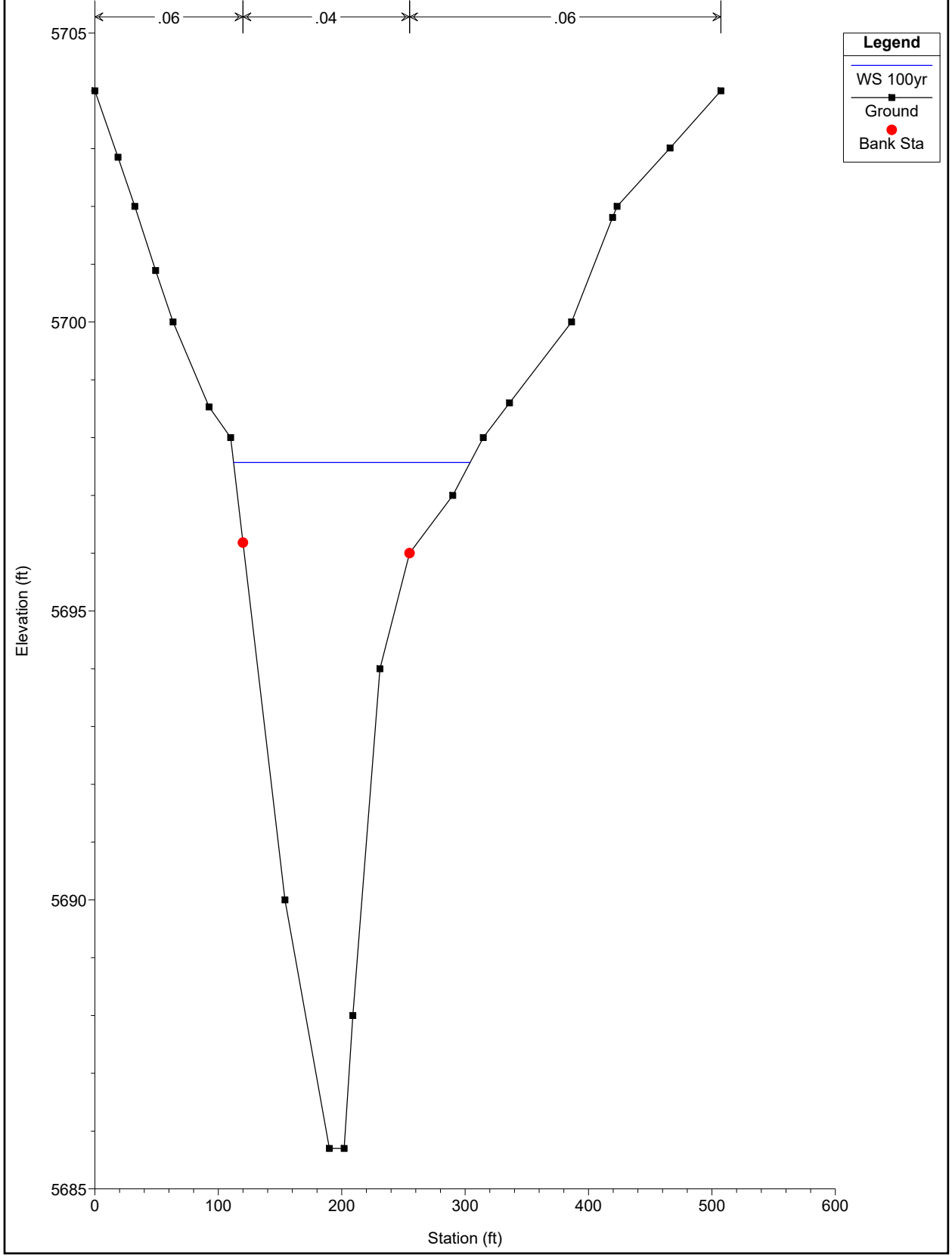

Jimmy Camp Ck East Trib 2019 DS No Rise Plan: Proposed DS for No Rise Floodway 7/1/2020

River = East Tributary Reach = Main Reach RS = 8000

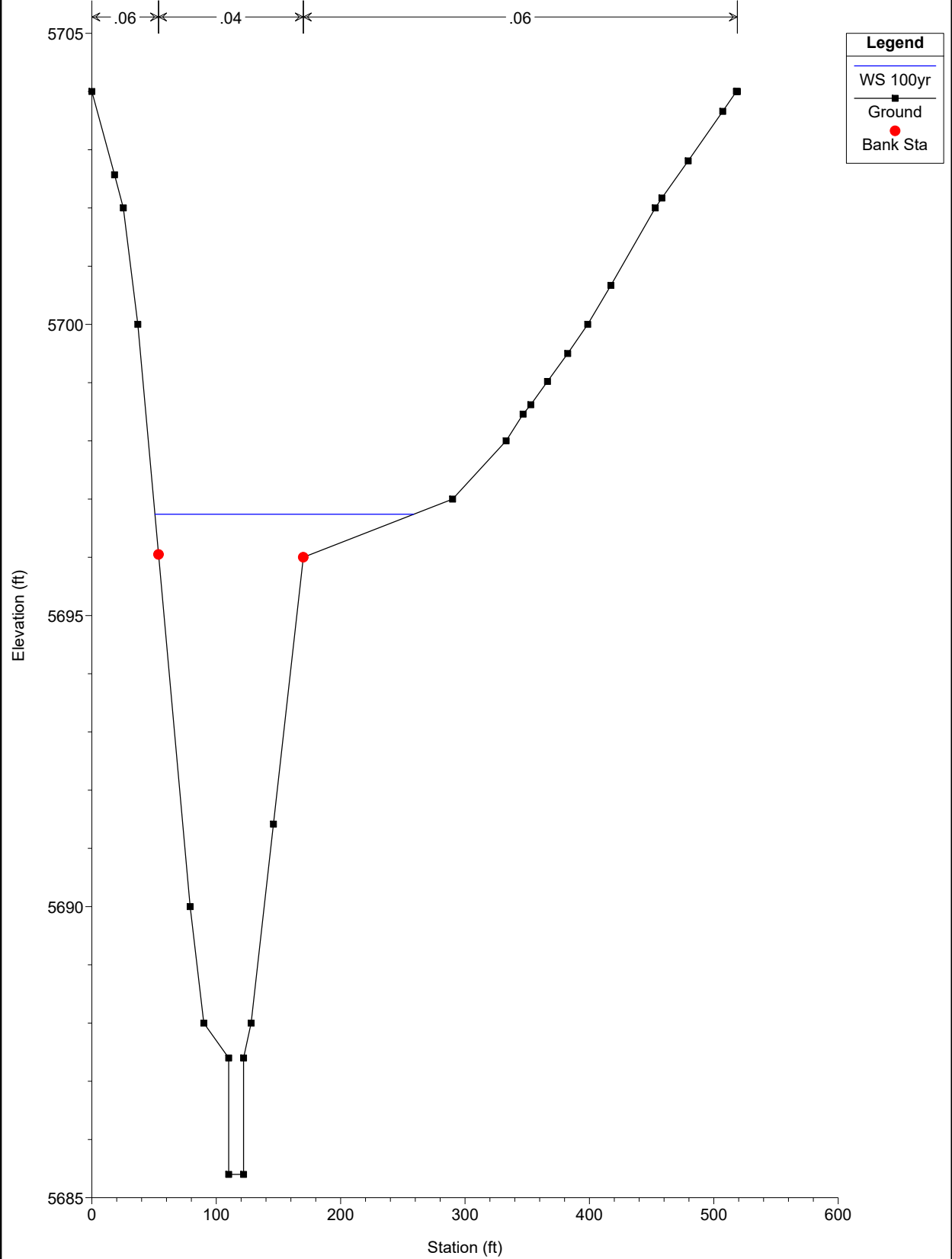

Jimmy Camp Ck East Trib 2019 DS No Rise Plan: Proposed DS for No Rise Floodway 7/1/2020

River = East Tributary Reach = Main Reach RS = 7924

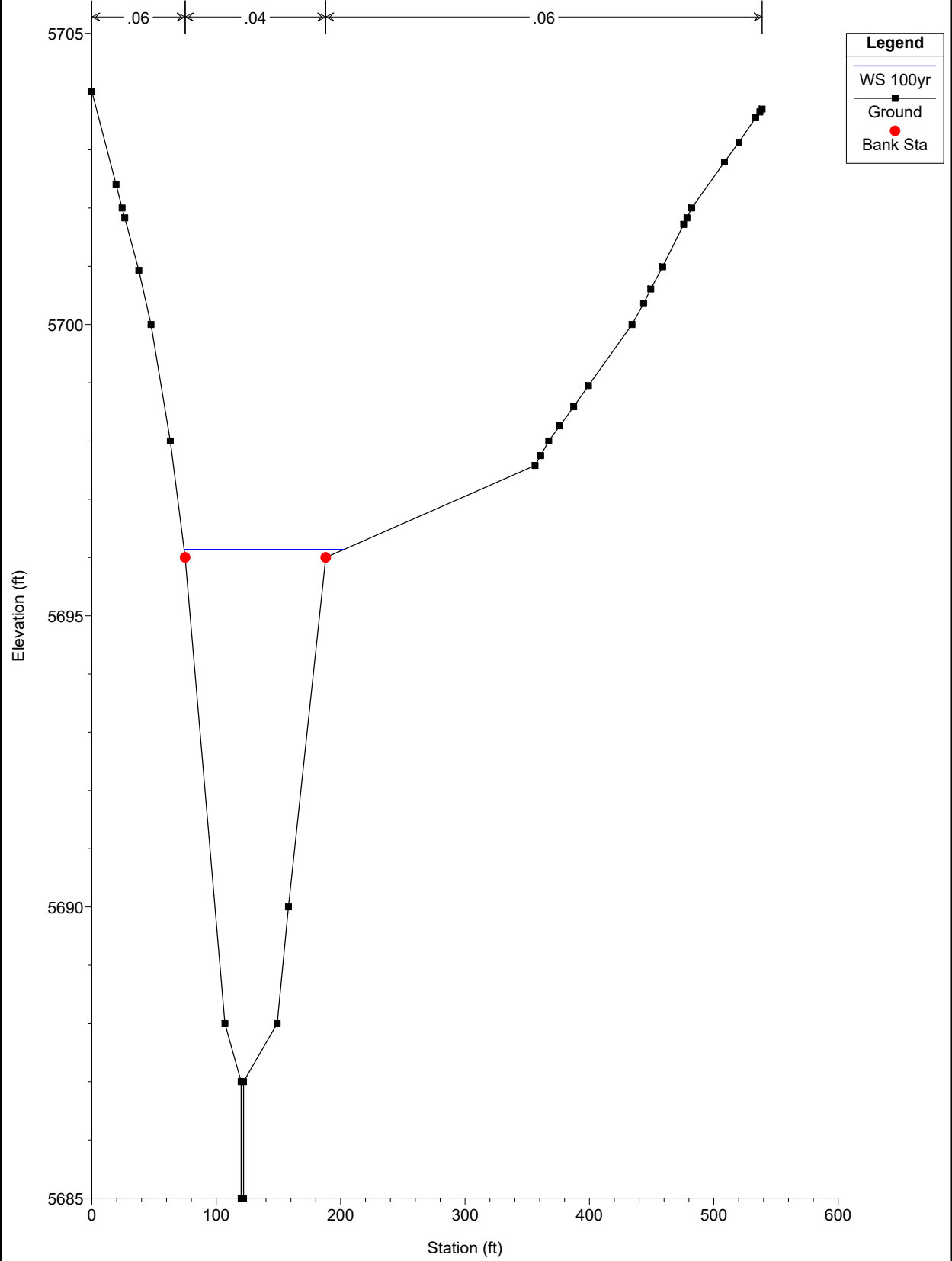

Jimmy Camp Ck East Trib 2019 DS No Rise Plan: Proposed DS for No Rise Floodway 7/1/2020

River = East Tributary Reach = Main Reach RS = 7750

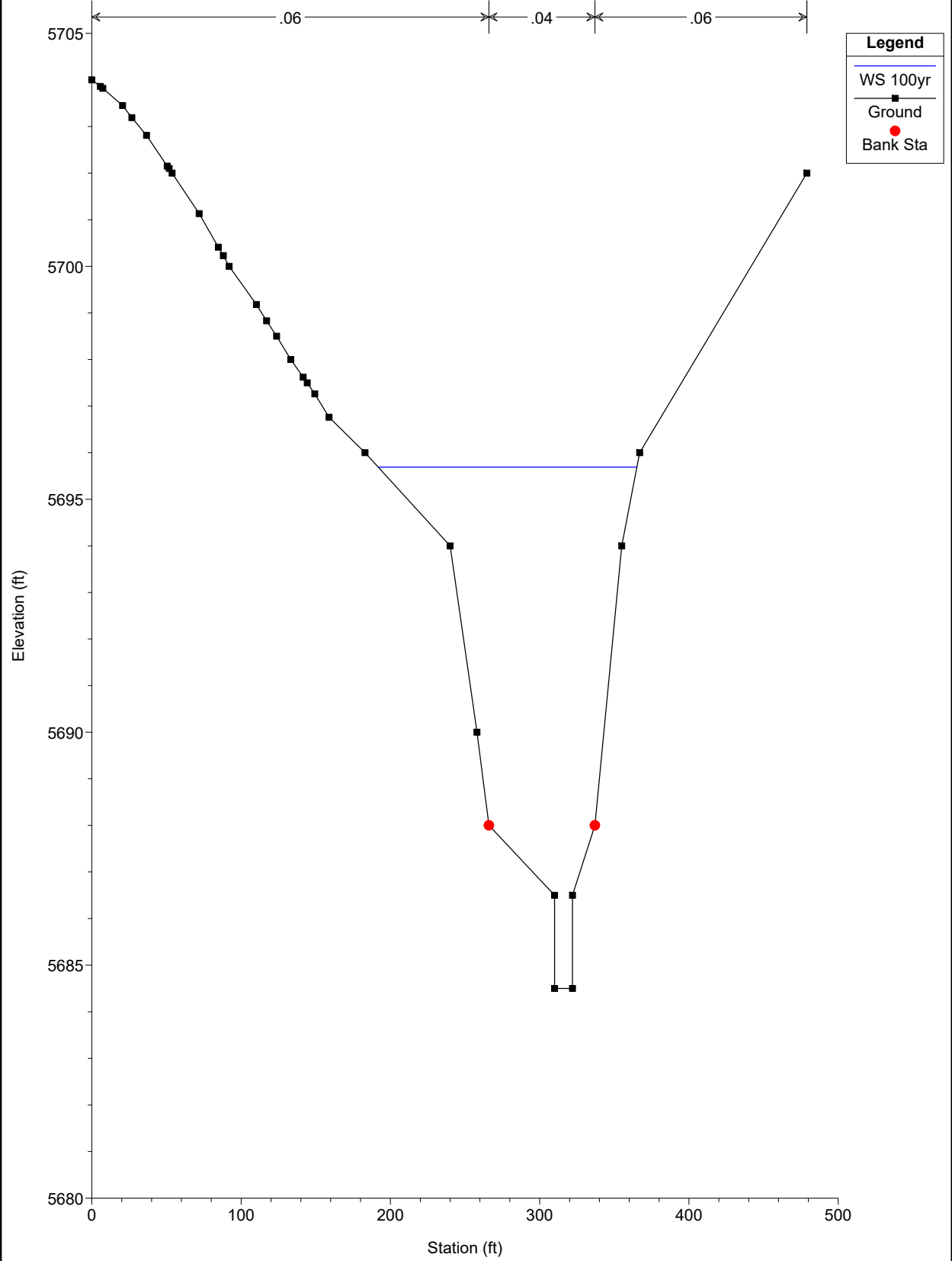

Jimmy Camp Ck East Trib 2019 DS No Rise Plan: Proposed DS for No Rise Floodway 7/1/2020

River = East Tributary Reach = Main Reach RS = 7525

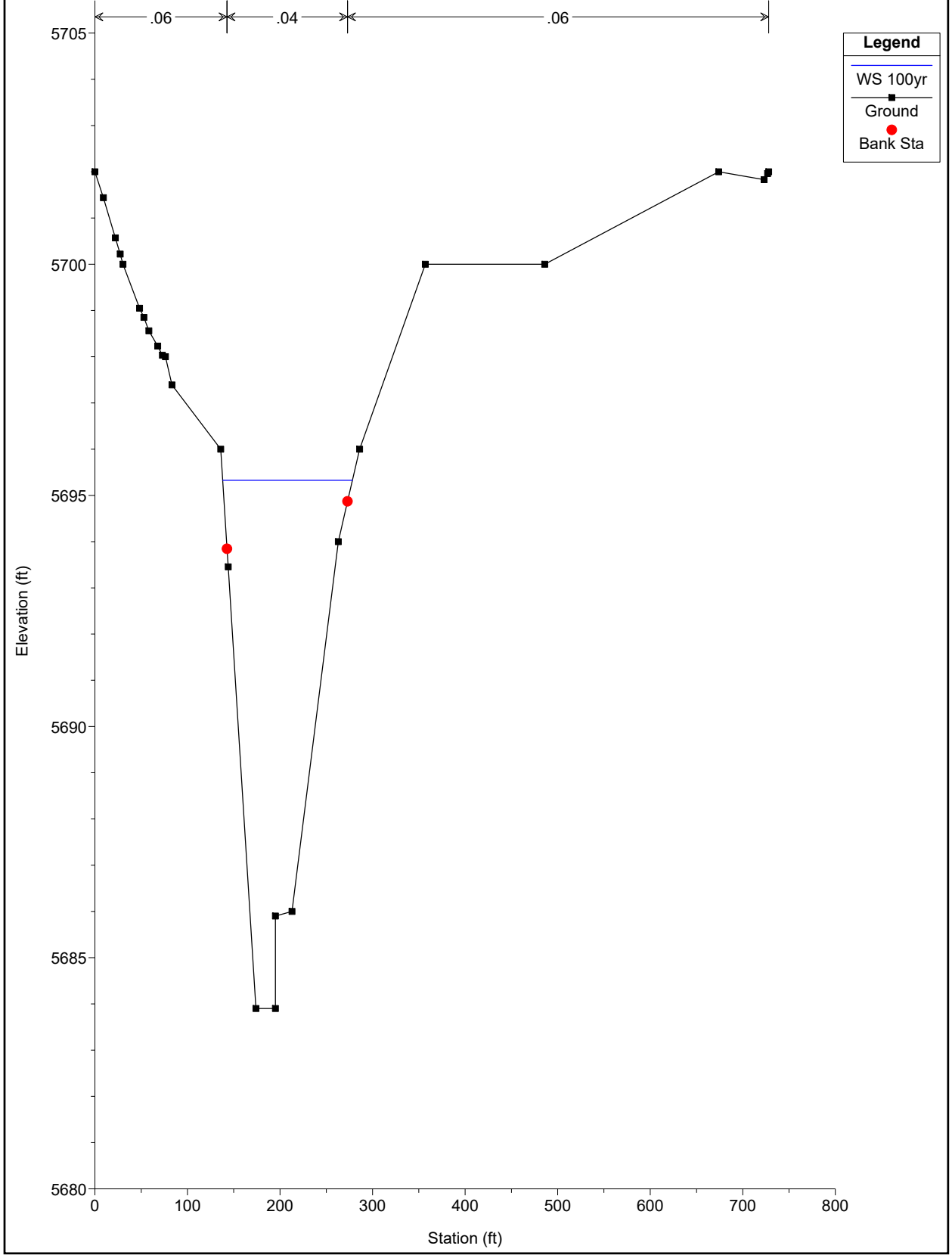

Jimmy Camp Ck East Trib 2019 DS No Rise Plan: Proposed DS for No Rise Floodway 7/1/2020

River = East Tributary Reach = Main Reach RS = 7375

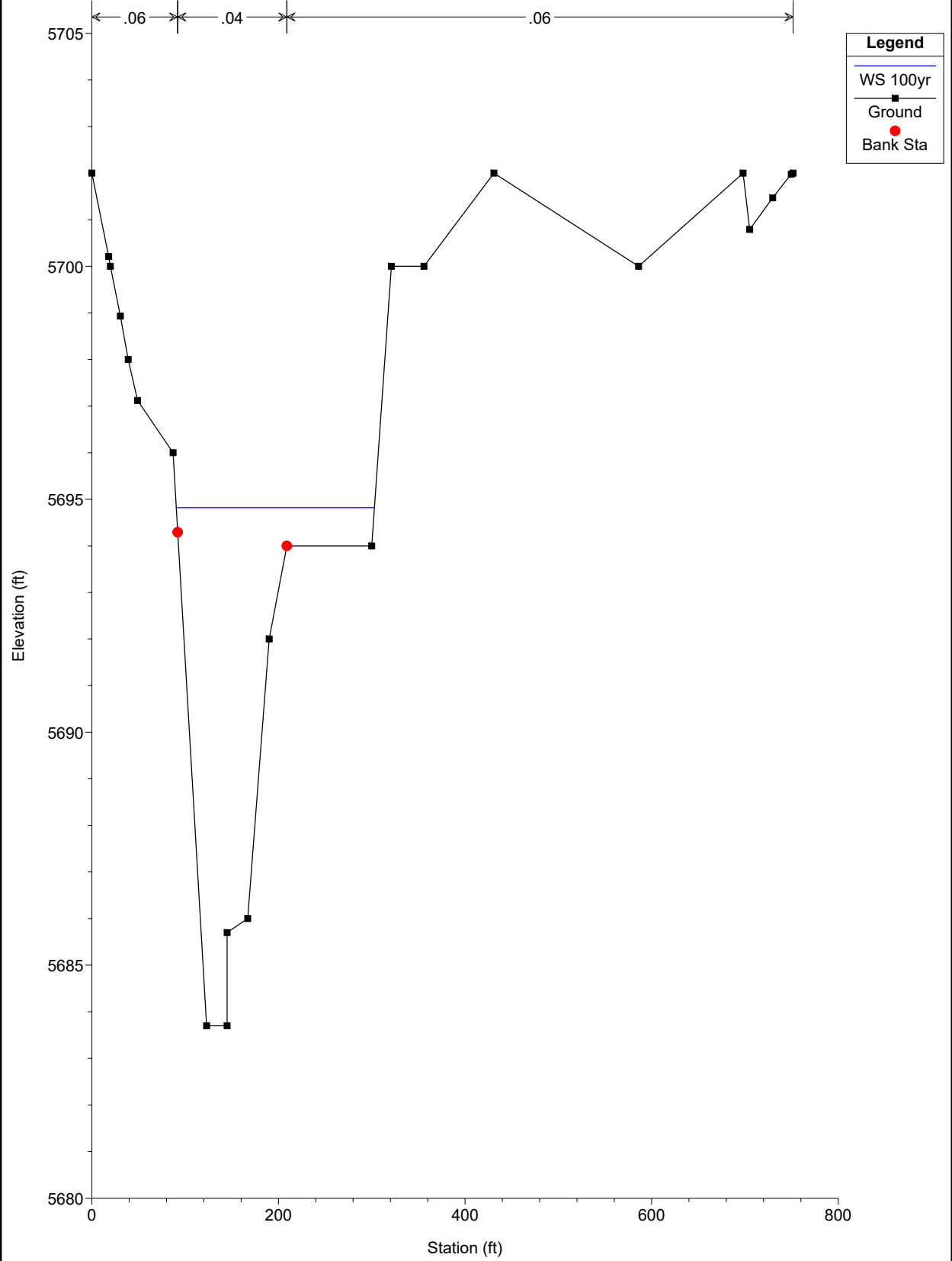

Jimmy Camp Ck East Trib 2019 DS No Rise Plan: Proposed DS for No Rise Floodway 7/1/2020

River = East Tributary Reach = Main Reach RS = 7200

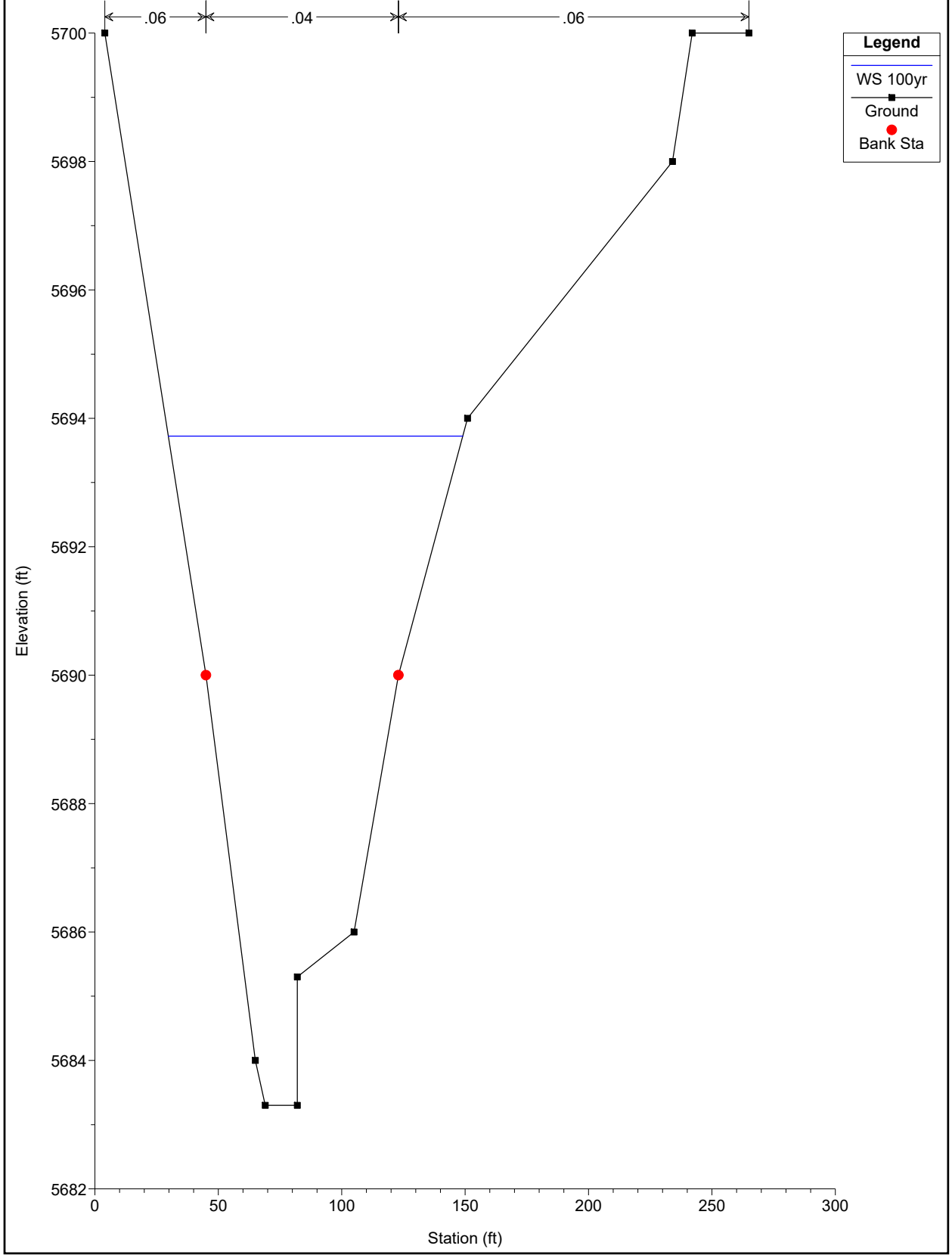

Jimmy Camp Ck East Trib 2019 DS No Rise Plan: Proposed DS for No Rise Floodway 7/1/2020

River = East Tributary Reach = Main Reach RS = 7075

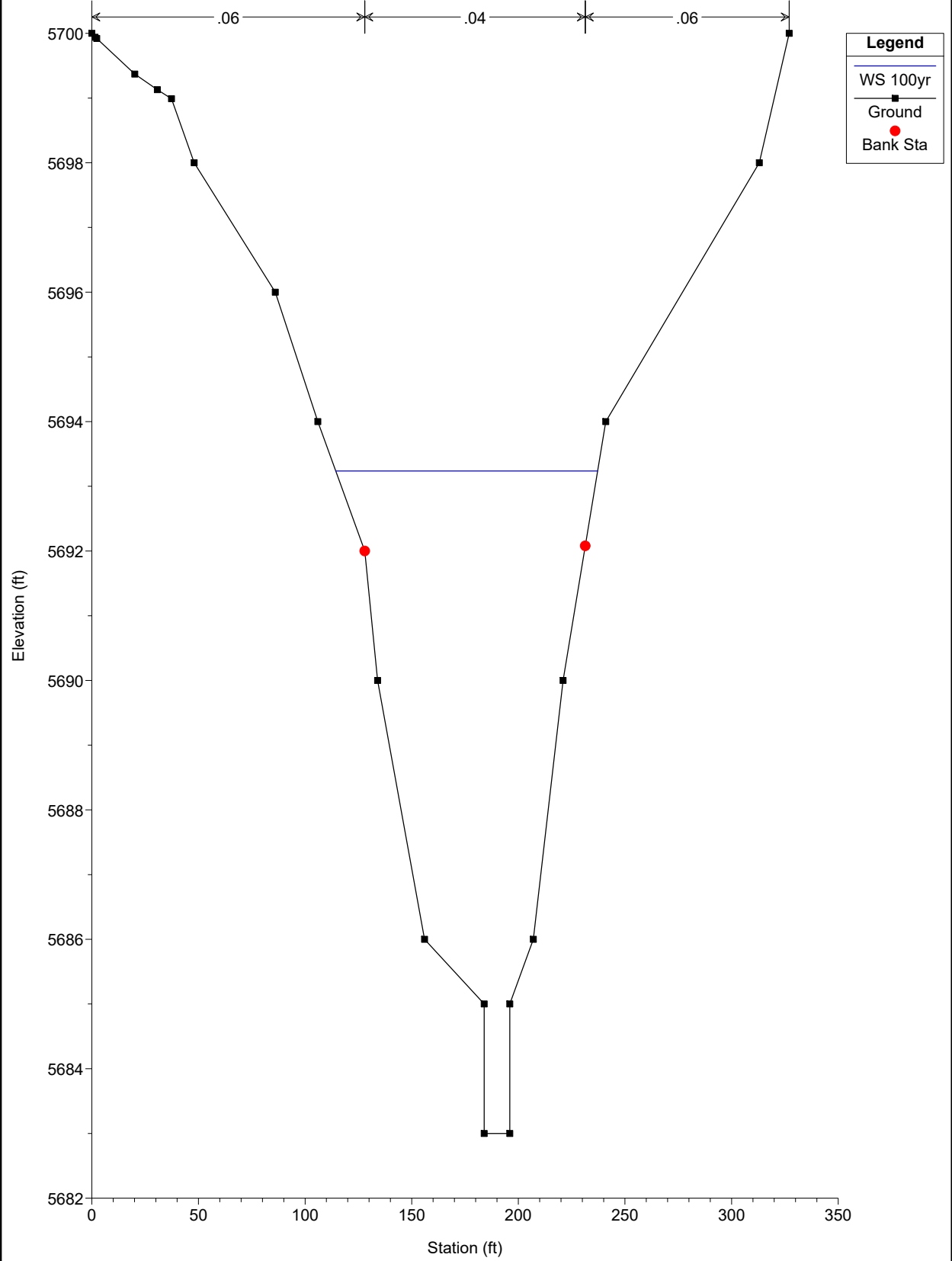

Jimmy Camp Ck East Trib 2019 DS No Rise Plan: Proposed DS for No Rise Floodway 7/1/2020

River = East Tributary Reach = Main Reach RS = 6925

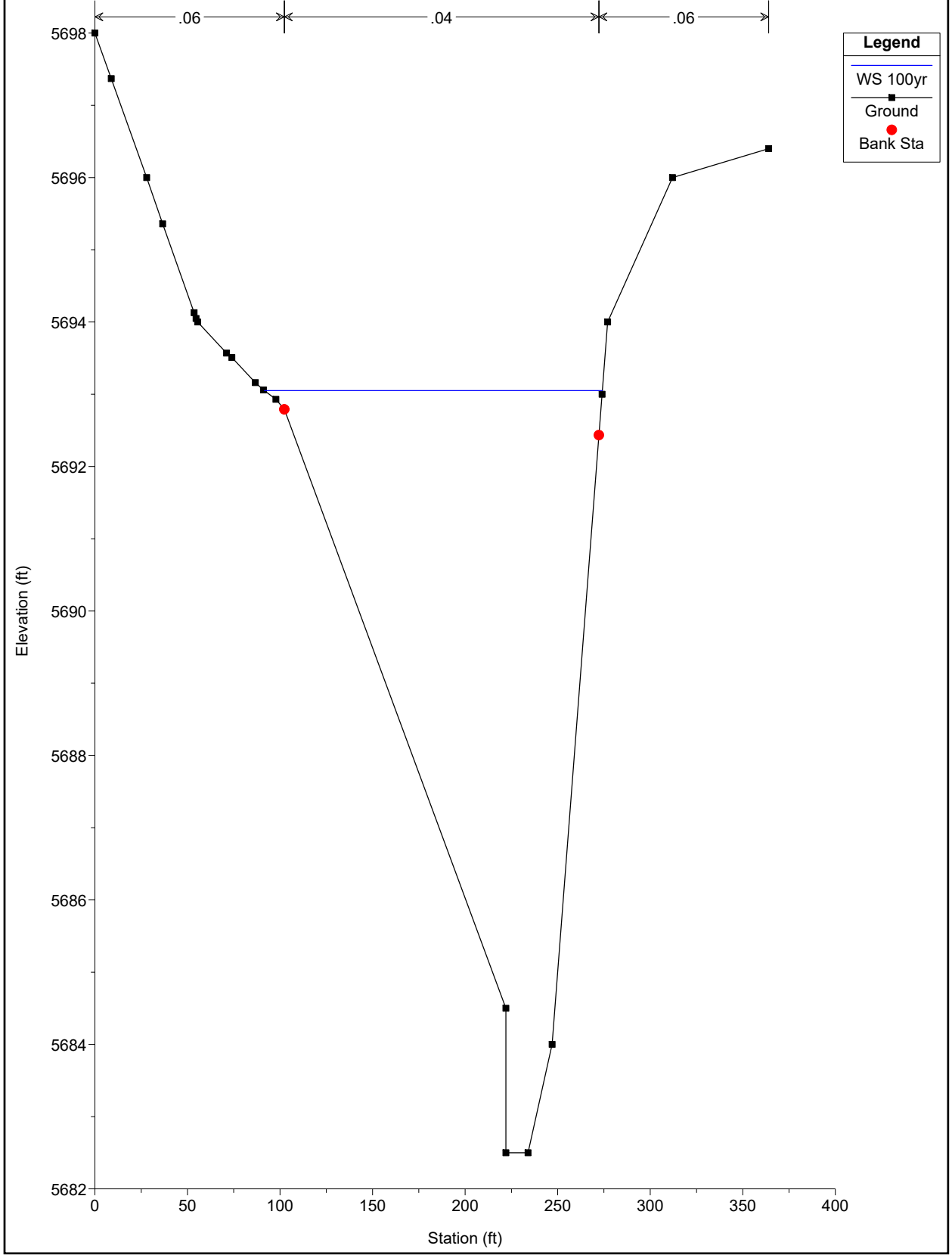

Jimmy Camp Ck East Trib 2019 DS No Rise Plan: Proposed DS for No Rise Floodway 7/1/2020

River = East Tributary Reach = Main Reach RS = 6746

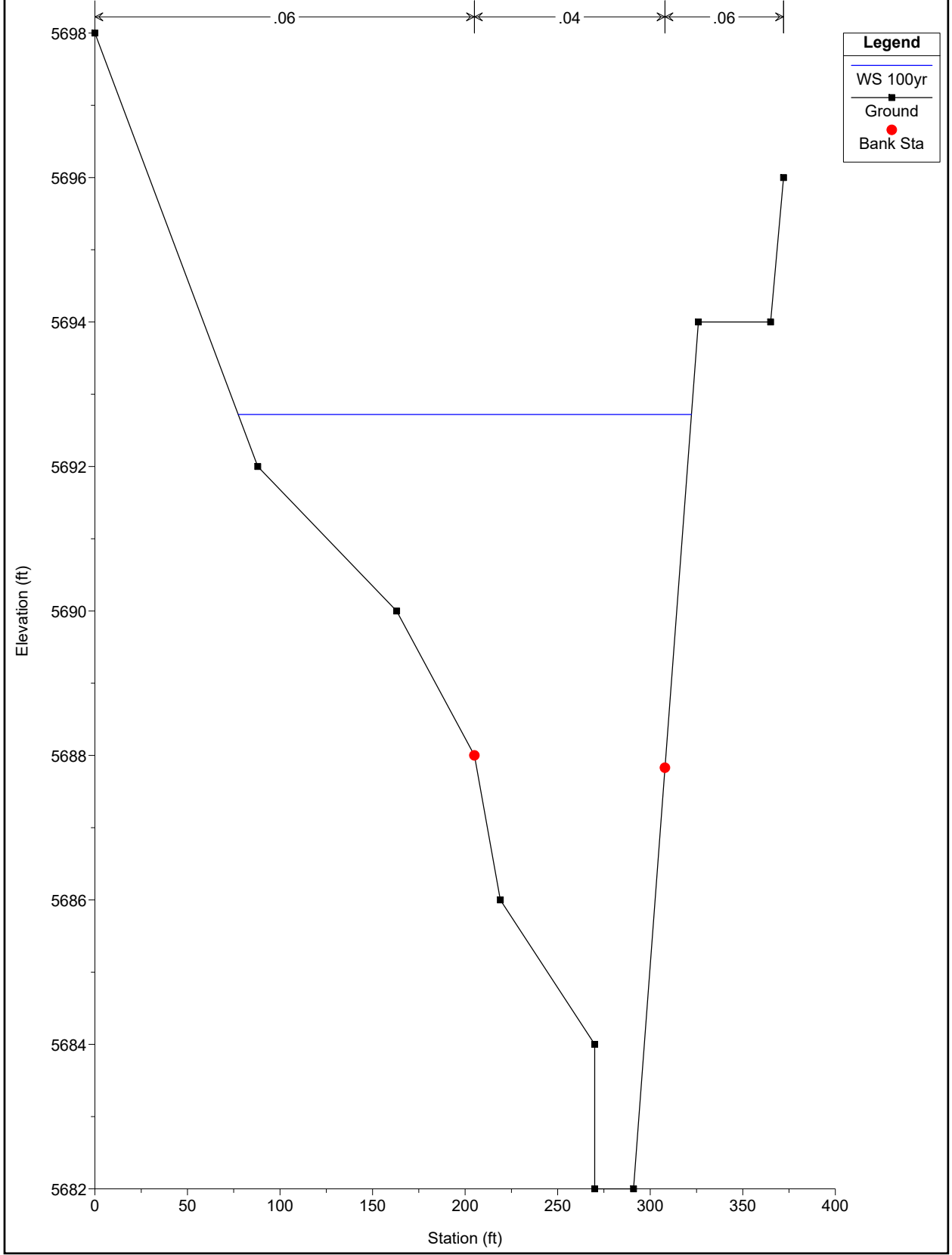

Legend

- WS 100yr
- Ground
- Bank Sta

Jimmy Camp Ck East Trib 2019 DS No Rise Plan: Proposed DS for No Rise Floodway 7/1/2020

River = East Tributary Reach = Main Reach RS = 6561

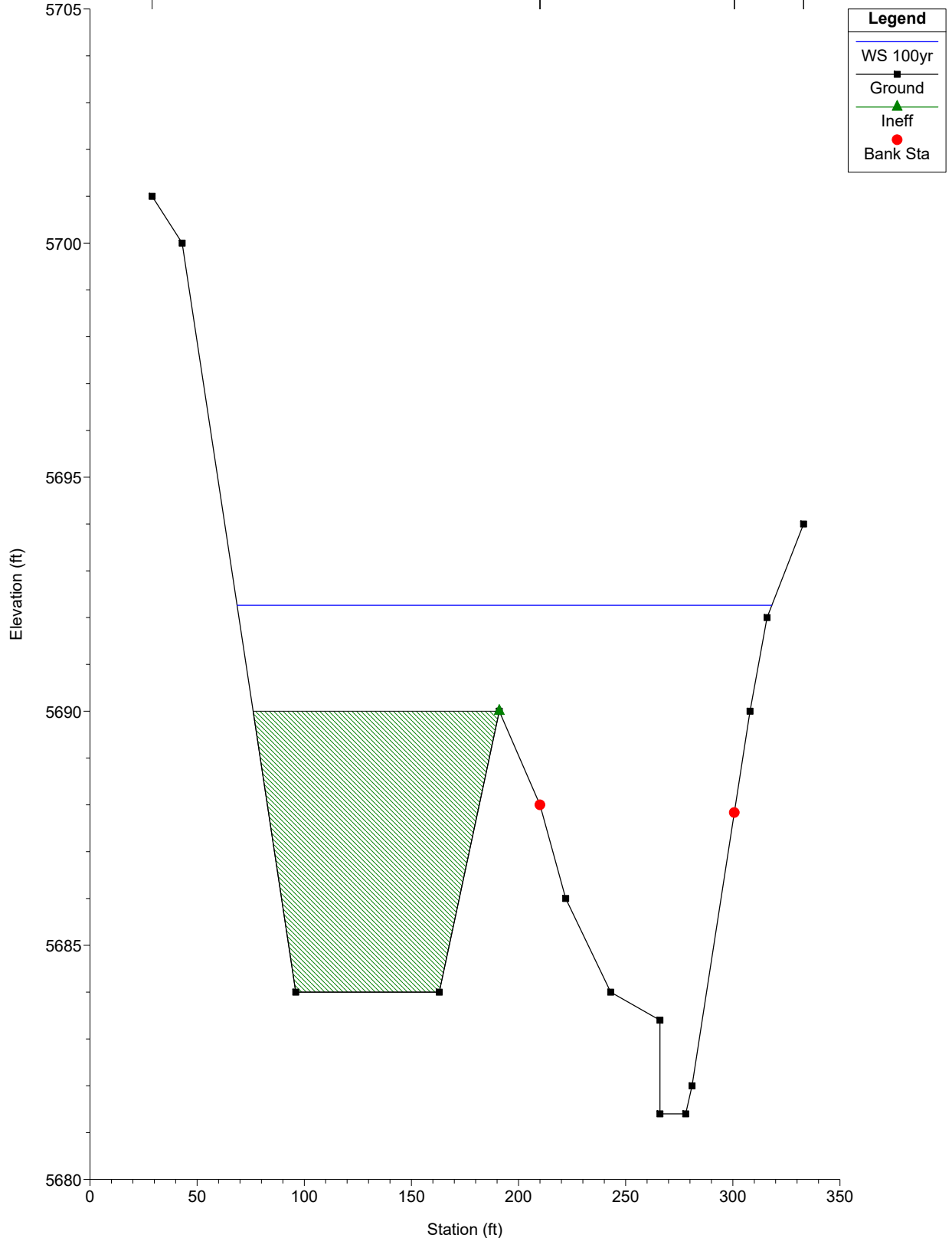

Jimmy Camp Ck East Trib 2019 DS No Rise Plan: Proposed DS for No Rise Floodway 7/1/2020

River = East Tributary Reach = Main Reach RS = 6448

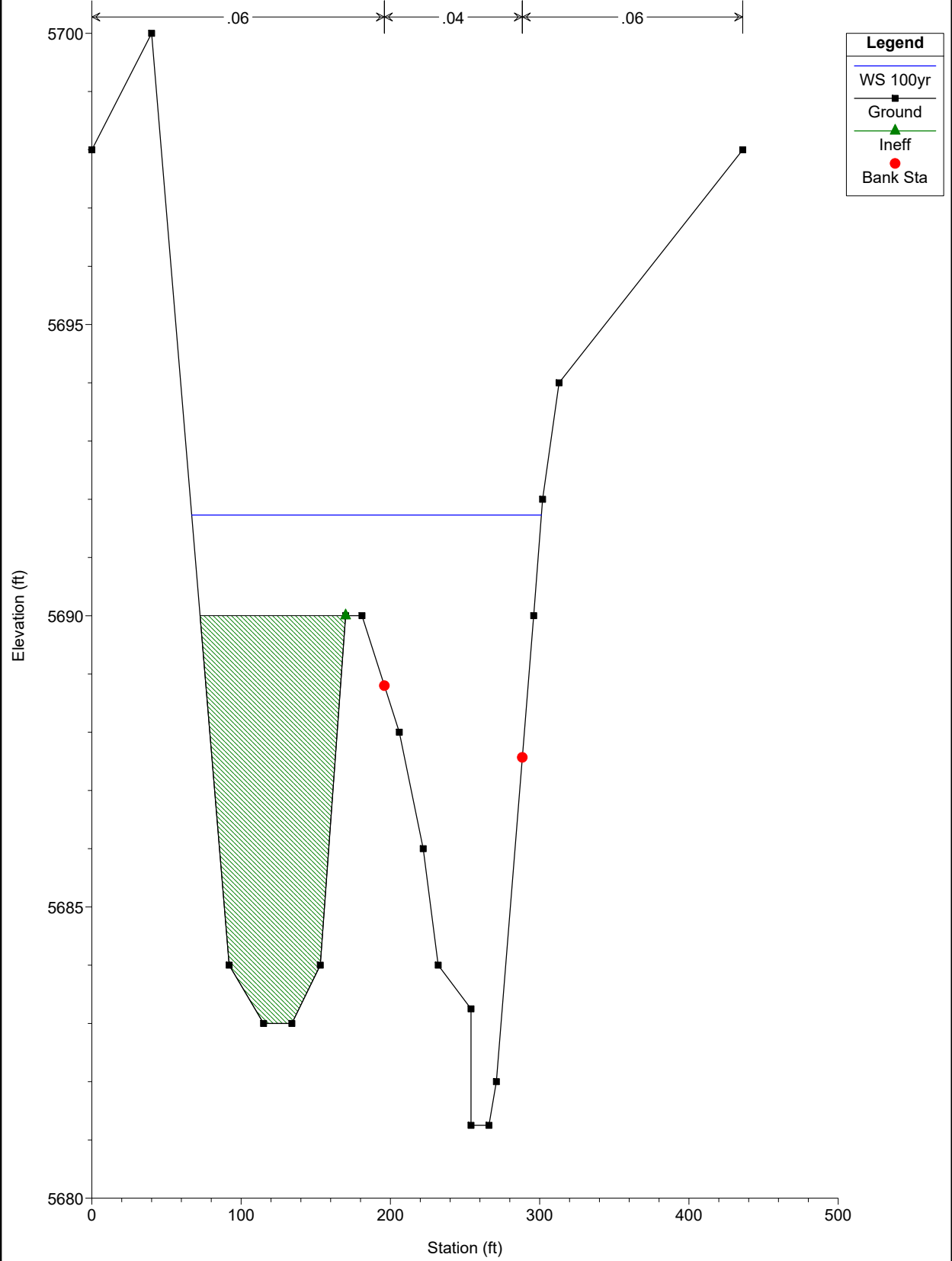

Jimmy Camp Ck East Trib 2019 DS No Rise Plan: Proposed DS for No Rise Floodway 7/1/2020

River = East Tributary Reach = Main Reach RS = 6259

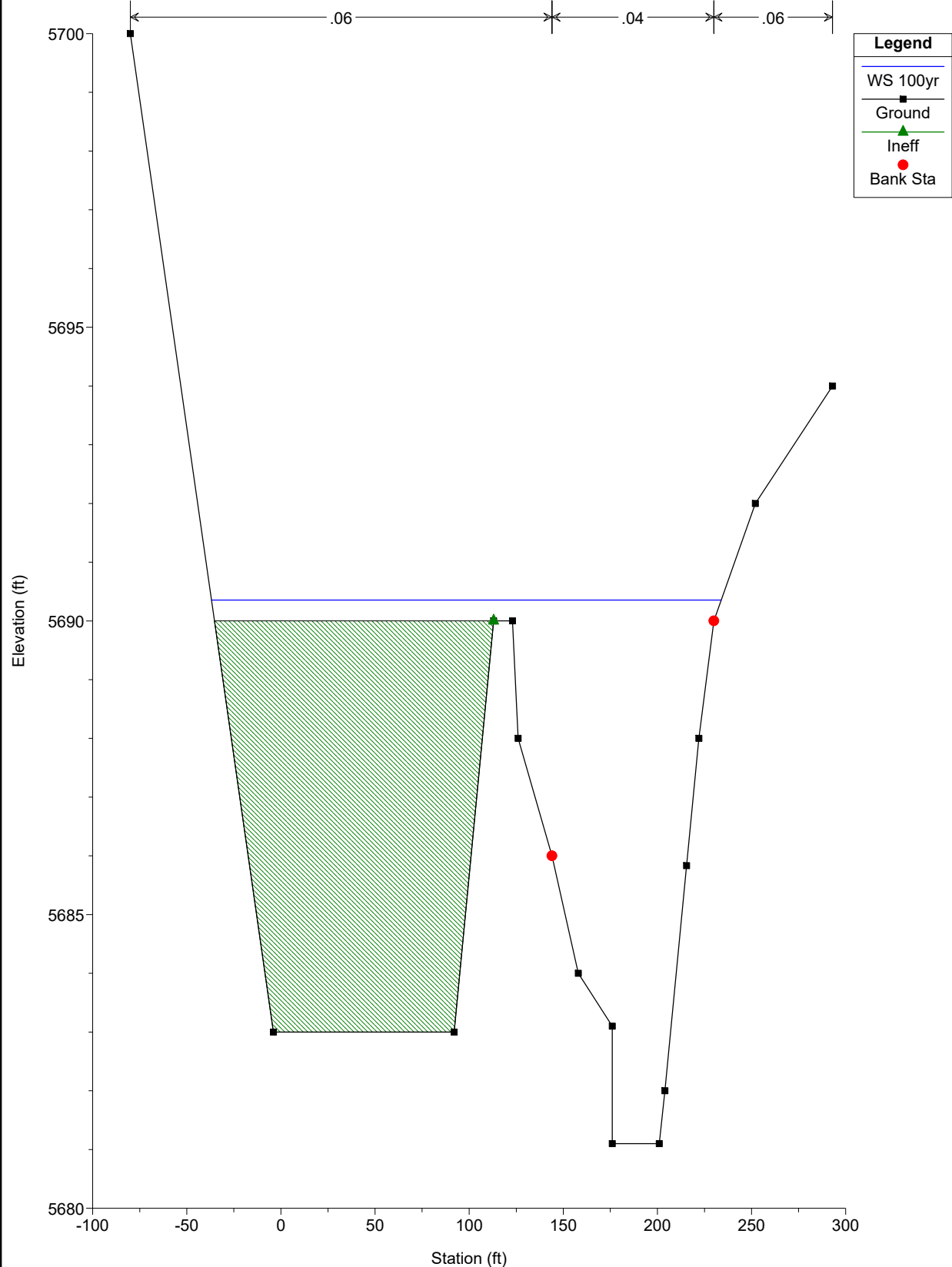

Jimmy Camp Ck East Trib 2019 DS No Rise Plan: Proposed DS for No Rise Floodway 7/1/2020

River = East Tributary Reach = Main Reach RS = 6150

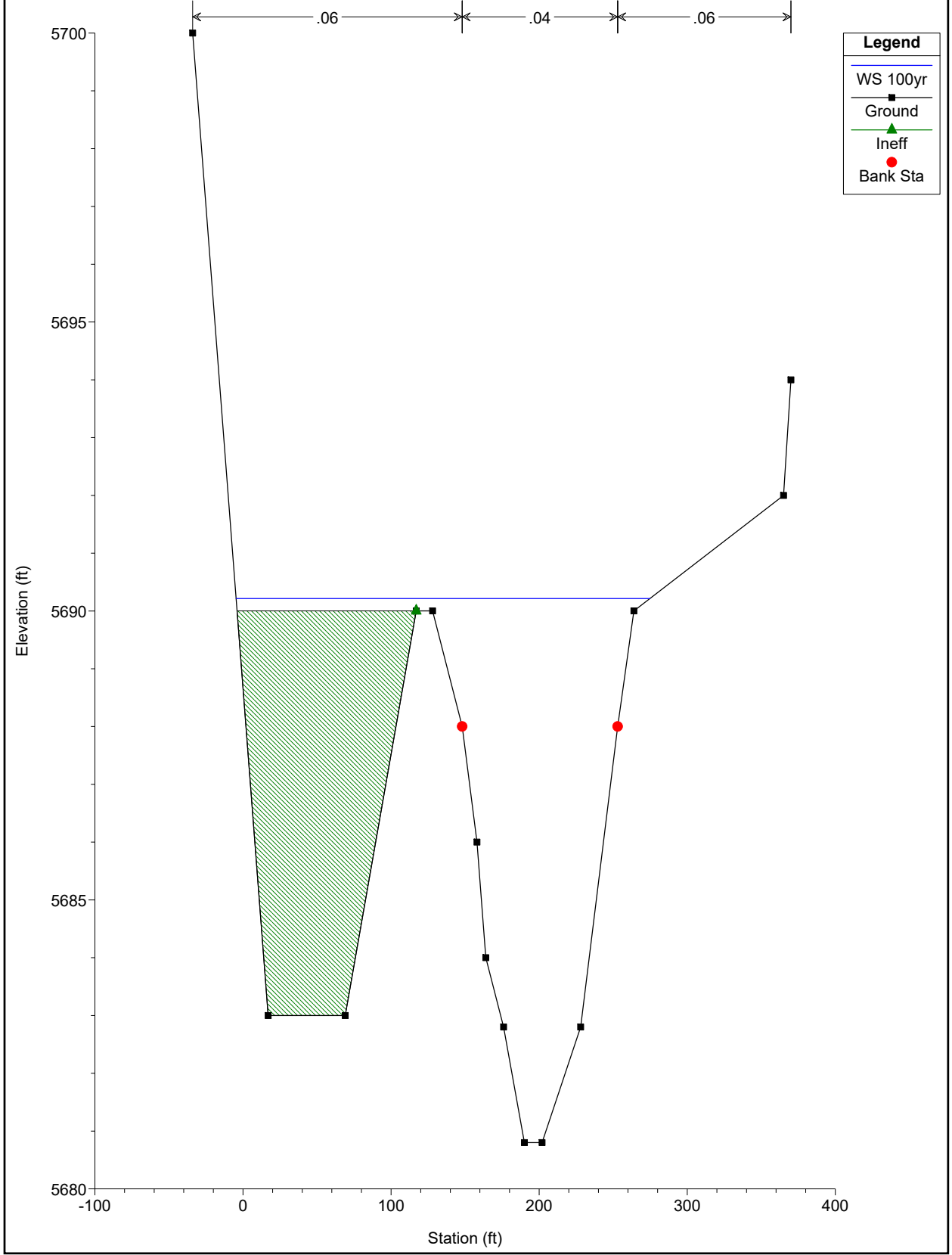

Jimmy Camp Ck East Trib 2019 DS No Rise Plan: Proposed DS for No Rise Floodway 7/1/2020

River = East Tributary Reach = Main Reach RS = 6000

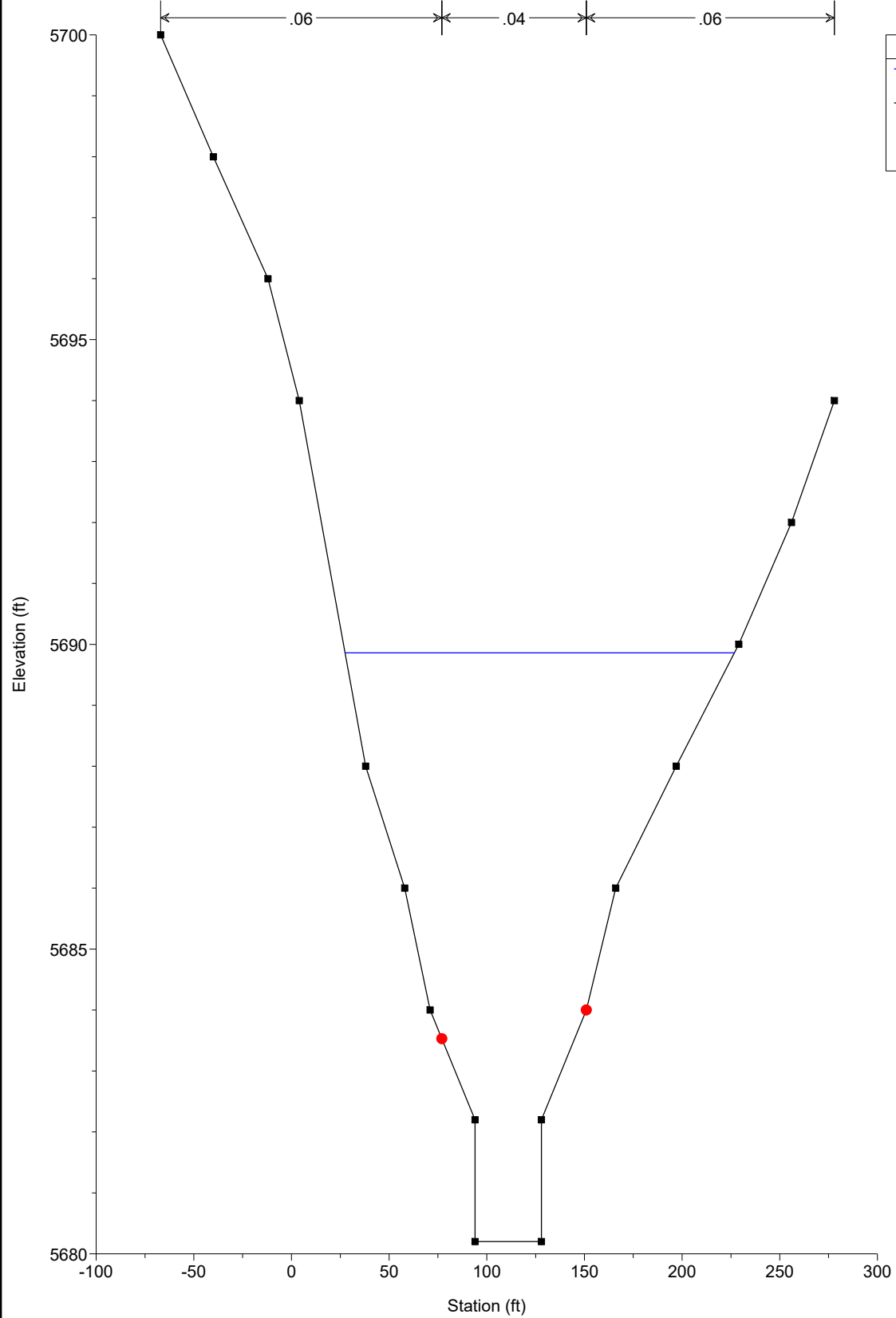

Legend

- WS 100yr
- Ground
- Bank Sta

Jimmy Camp Ck East Trib 2019 DS No Rise Plan: Proposed DS for No Rise Floodway 7/1/2020

River = East Tributary Reach = Main Reach RS = 5865

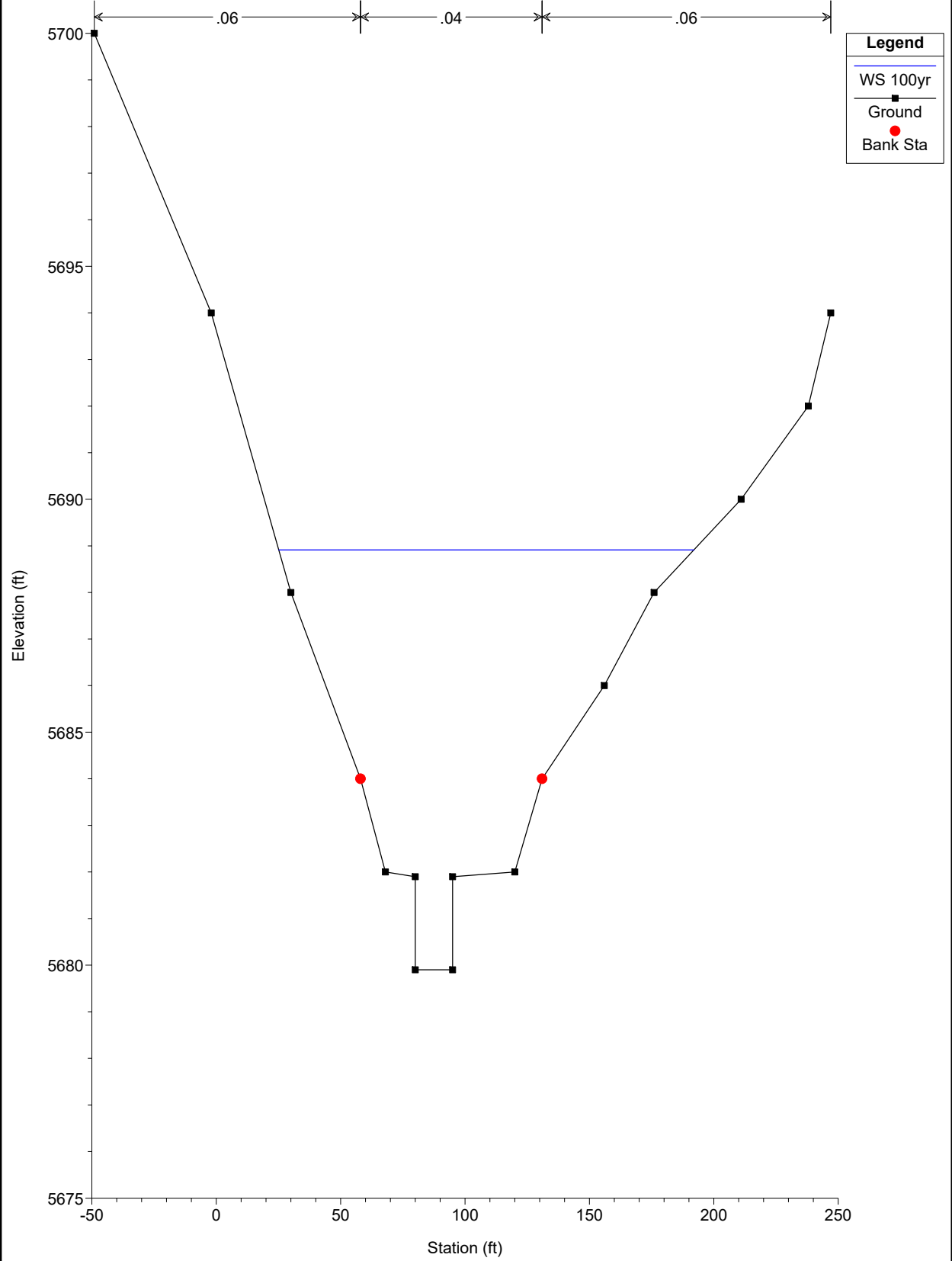

Jimmy Camp Ck East Trib 2019 DS No Rise Plan: Proposed DS for No Rise Floodway 7/1/2020

River = East Tributary Reach = Main Reach RS = 5710

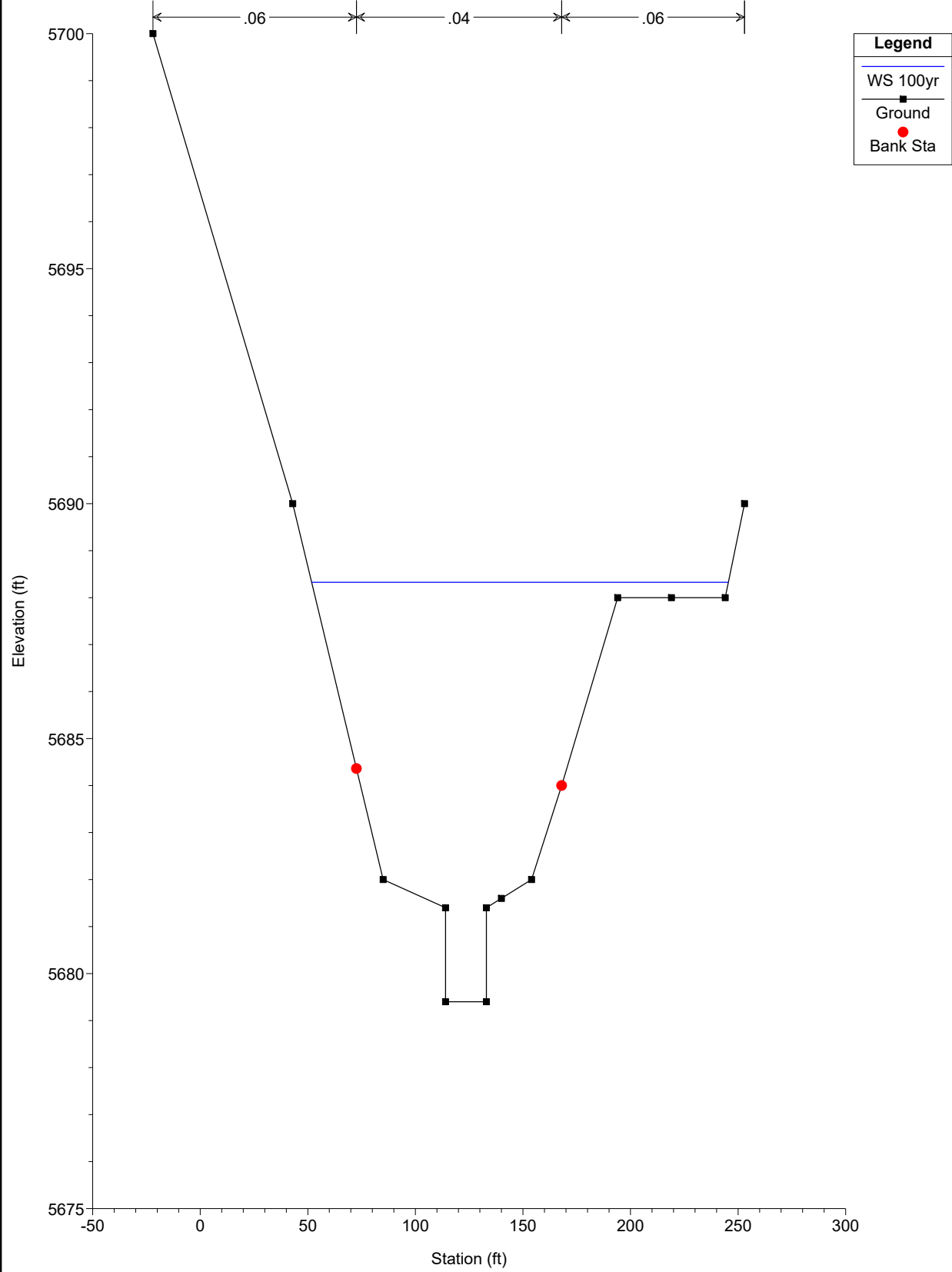

Jimmy Camp Ck East Trib 2019 DS No Rise Plan: Proposed DS for No Rise Floodway 7/1/2020

River = East Tributary Reach = Main Reach RS = 5436

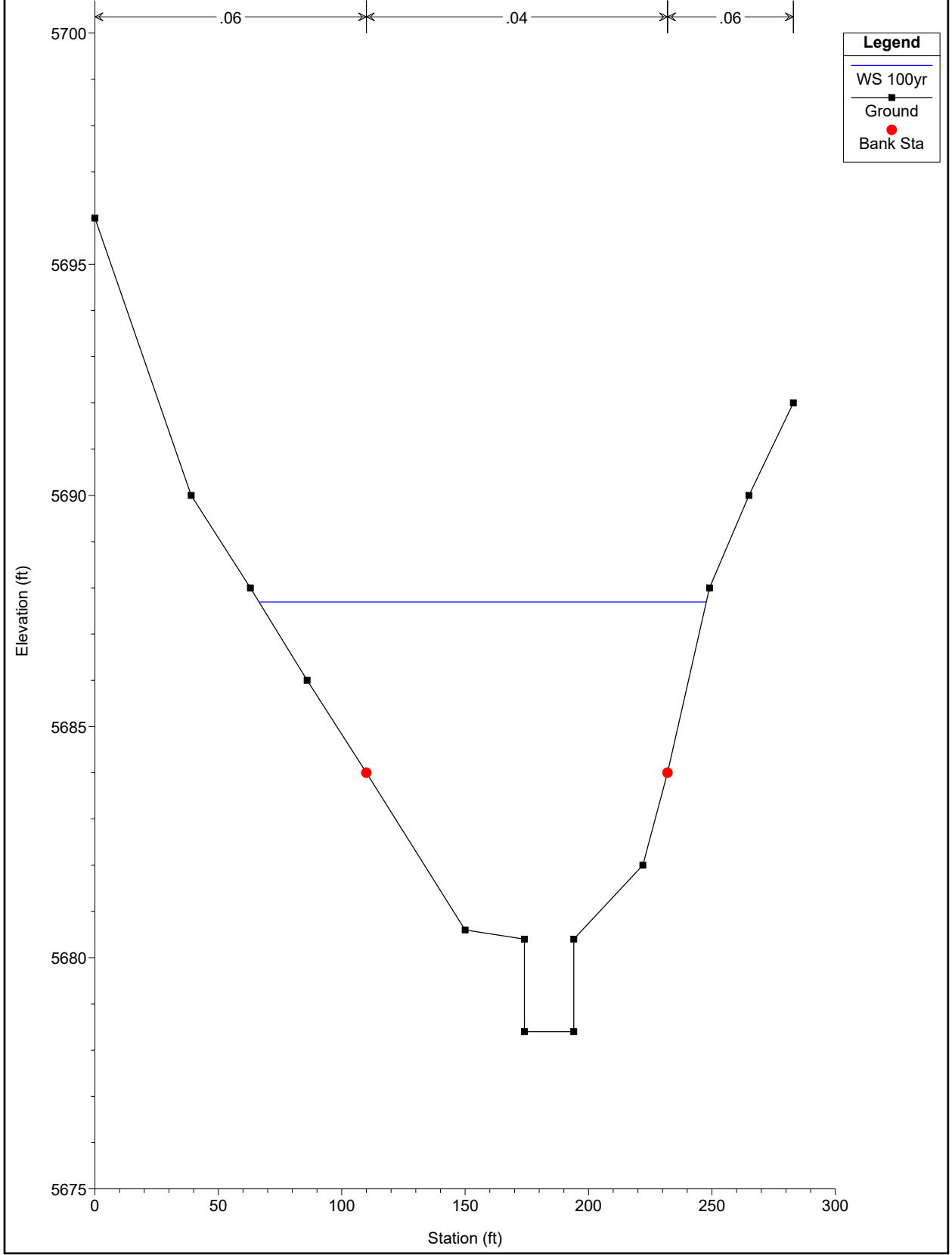

Jimmy Camp Ck East Trib 2019 DS No Rise Plan: Proposed DS for No Rise Floodway 7/1/2020

River = East Tributary Reach = Main Reach RS = 5236

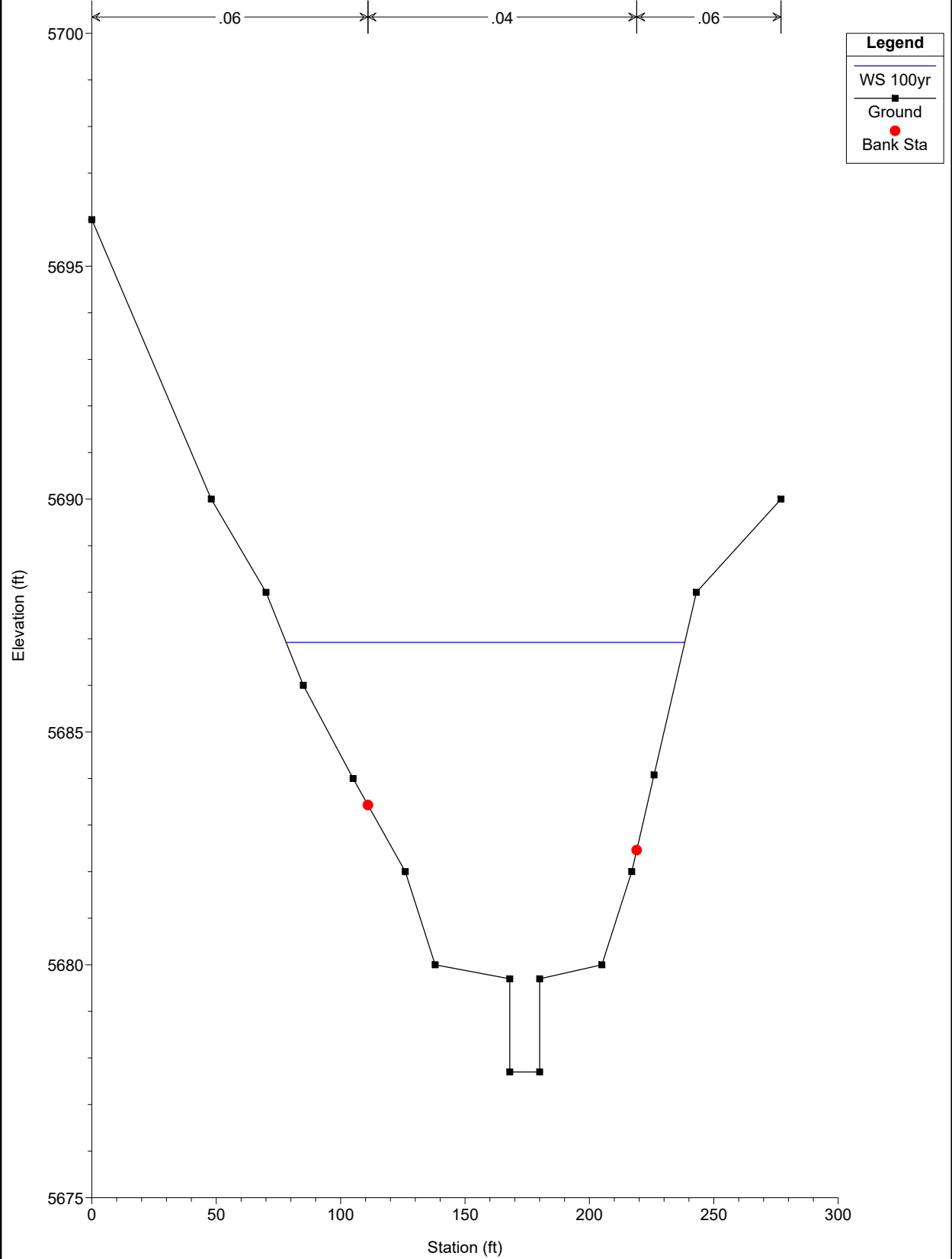

Jimmy Camp Ck East Trib 2019 DS No Rise Plan: Proposed DS for No Rise Floodway 7/1/2020

River = East Tributary Reach = Main Reach RS = 5032

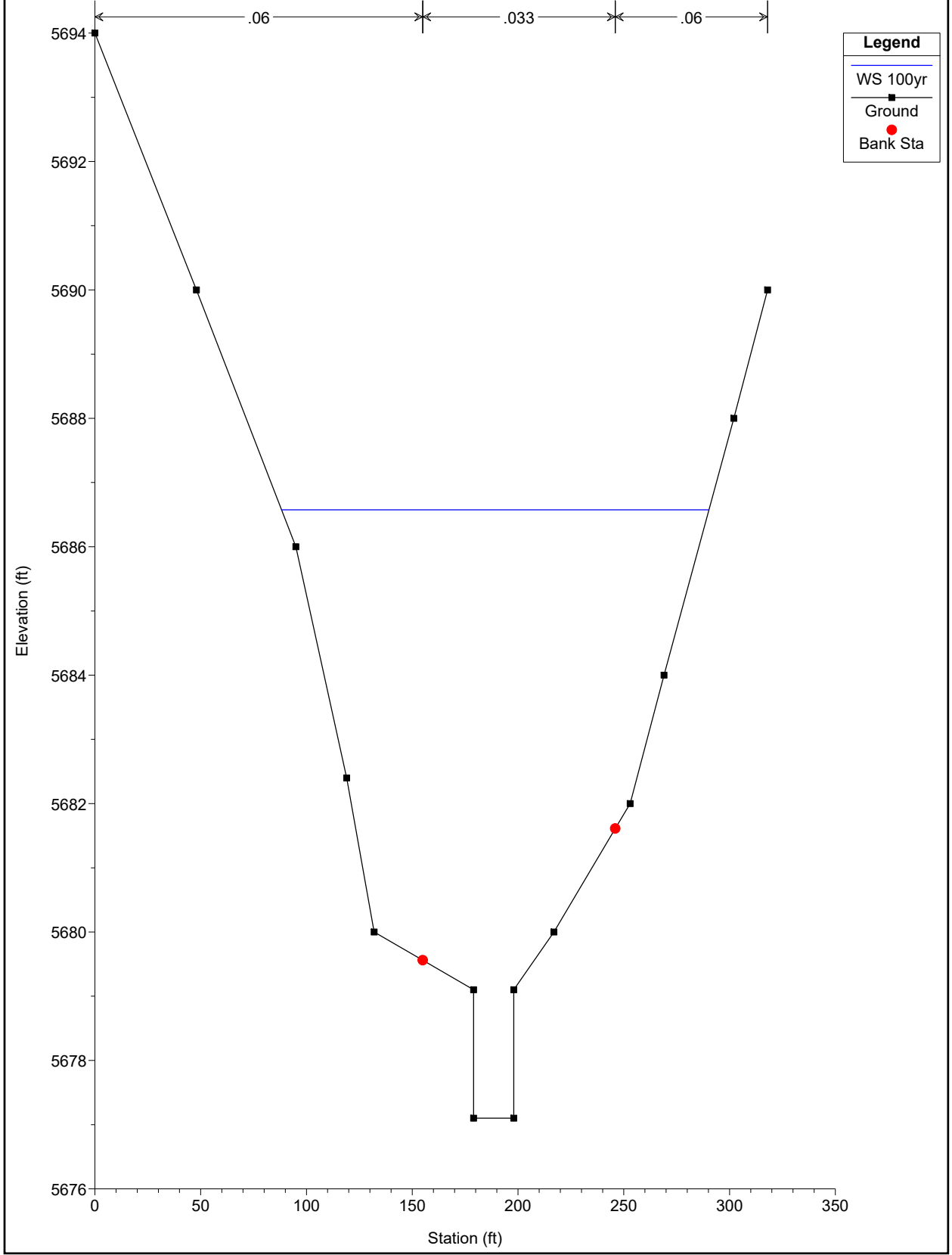

Jimmy Camp Ck East Trib 2019 DS No Rise Plan: Proposed DS for No Rise Floodway 7/1/2020

River = East Tributary Reach = Main Reach RS = 4836

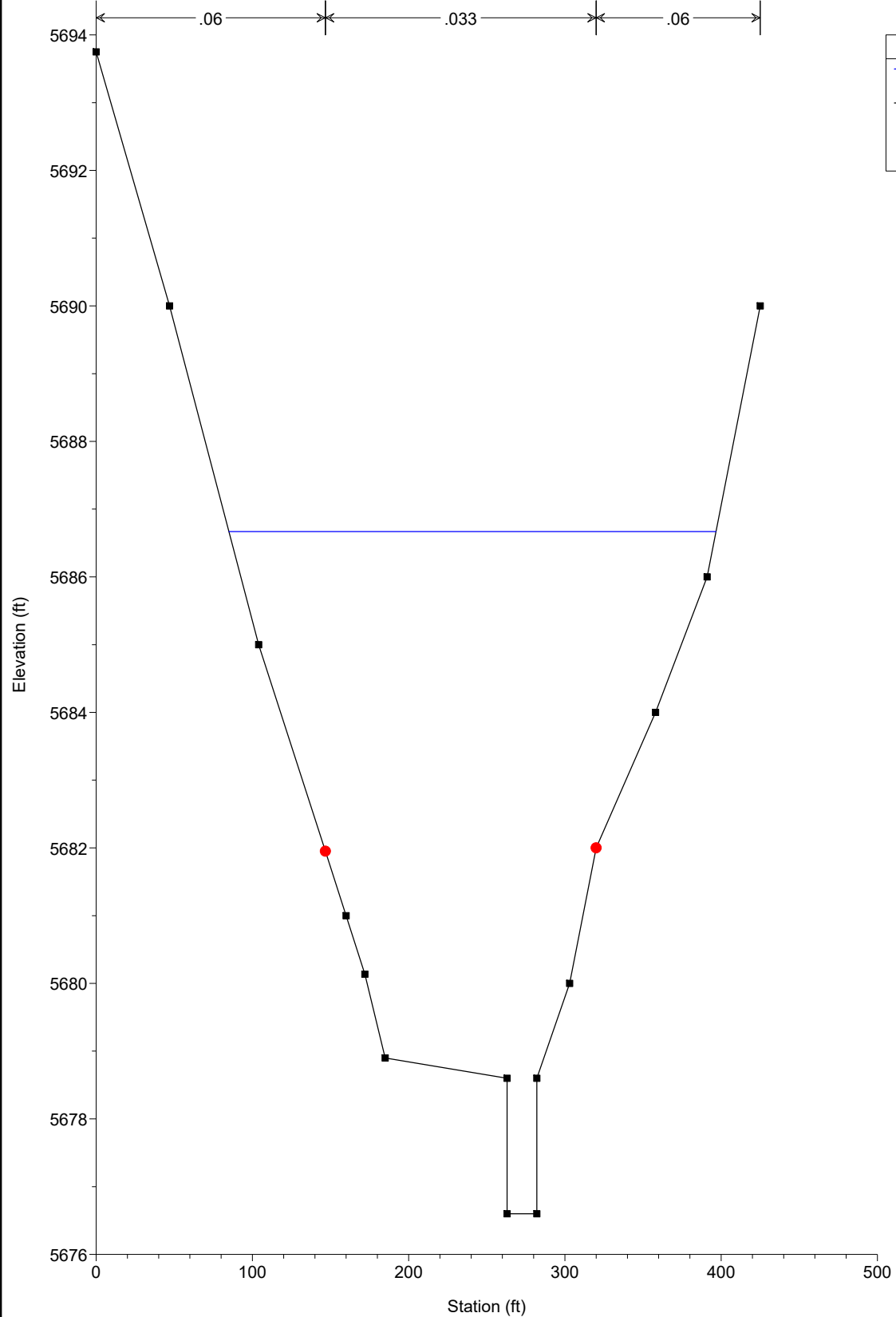

Legend

- WS 100yr
- Ground
- Bank Sta

Jimmy Camp Ck East Trib 2019 DS No Rise Plan: Proposed DS for No Rise Floodway 7/1/2020

River = East Tributary Reach = Main Reach RS = 4500

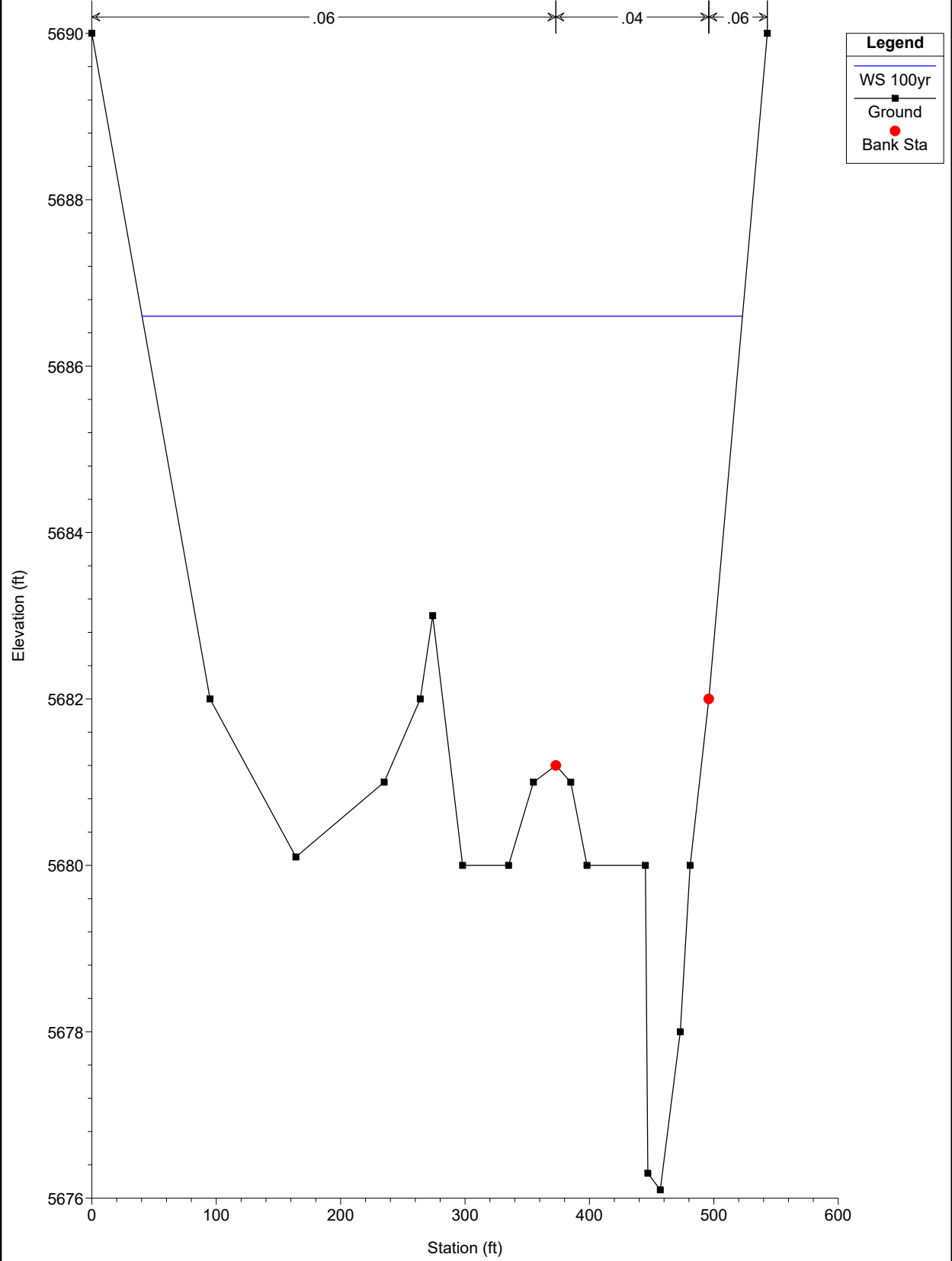

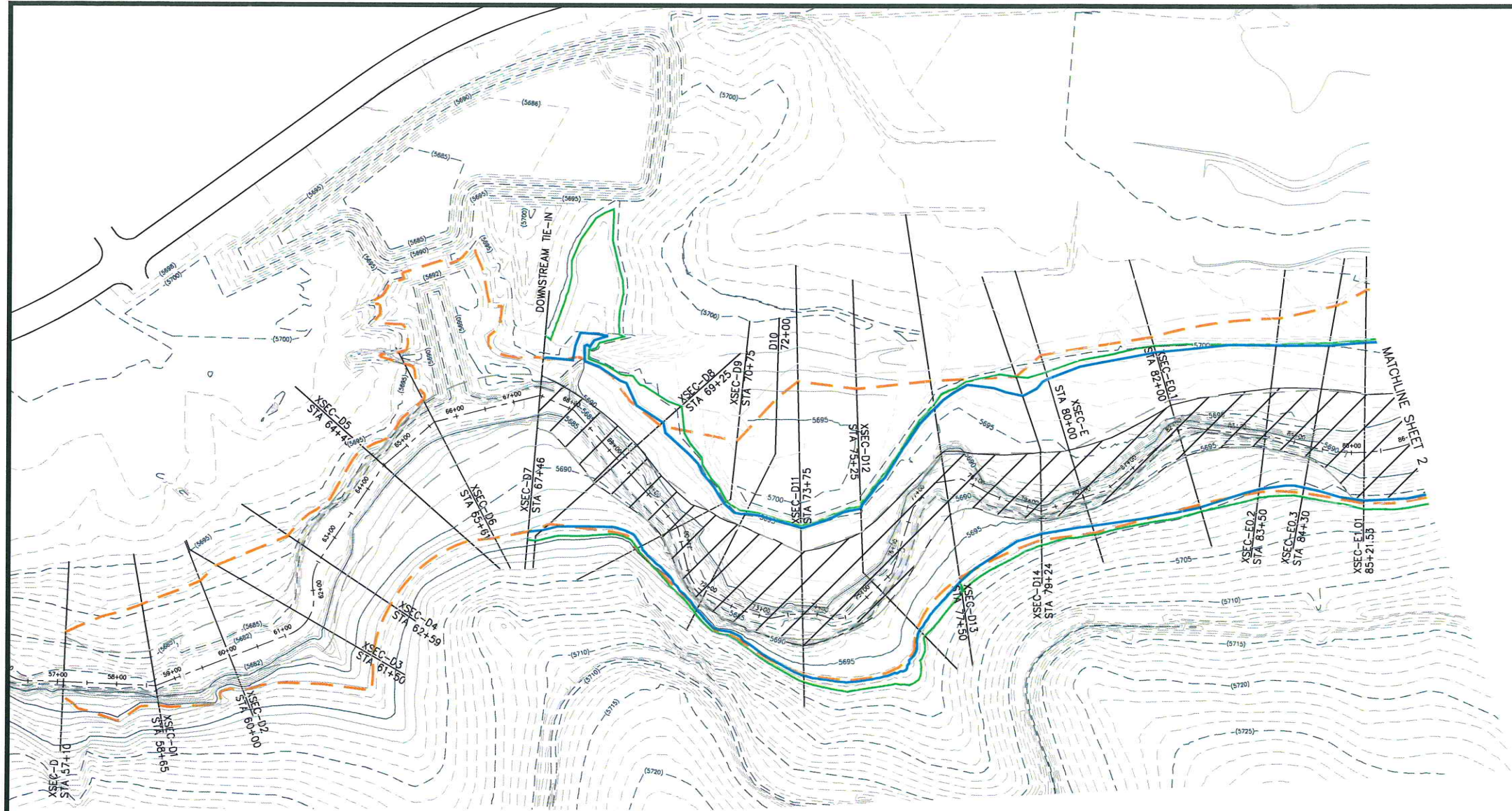

LEGEND

- EFFECTIVE 100-YEAR FLOODPLAIN
- EFFECTIVE 500-YEAR FLOODPLAIN
- EFFECTIVE FLOODWAY
- POST PROJECT 100-YEAR FLOODPLAIN
- POST PROJECT 500-YEAR FLOODPLAIN
- POST PROJECT FLOODWAY
- EXISTING CONTOURS

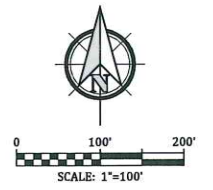

TOPOGRAPHY DOWNSTREAM OF SECTION 84+30 IS BASED UPON AERIAL MAPPING PROVIDED BY CORE ENGINEERING INC, COLORADO STATE PLANE COORDINATES 1983, AND NATIONAL GEODETIC VERTICAL DATUM OF 1929.

THE TOPOGRAPHY WAS COMPILED IN ACCORDANCE WITH NATIONAL MAPPING STANDARDS FOR 1"=200' & 2' CONTOUR INTERVAL DETAIL.

TOPOGRAPHIC MAPPING UPSTREAM OF SECTION 84+30 IS BASED ON FIELD SURVEY BY M & S CIVIL CONSULTANTS, COLORADO STATE PLANE COORDINATES 1983, AND NATIONAL GEODETIC VERTICAL DATUM OF 1929.

SITE BENCHMARK: FIMS MONUMENT NO. F204



STEPHEN A. BROWN
COLORADO LIC. 40190

7/31/19
DATED

Kiowa
Engineering Corporation
1604 South 21st Street
Colorado Springs, Colorado 80904
(719) 630-7342

**EAST TRIBUTARY JIMMY CAMP CREEK LOMR
LORSON RANCH
POST PROJECT CONDITIONS FLOODPLAIN MAP
EL PASO COUNTY, COLORADO**

Project No.	19001
Date:	JULY 31, 2019
Design:	SAB
Drawn:	SAB
Check:	RNW
Revisions:	

SHEET
1
OF 4 SHEETS

10001 LOMR - Worksheet - FLOODPLAIN MAP - July 31, 2019

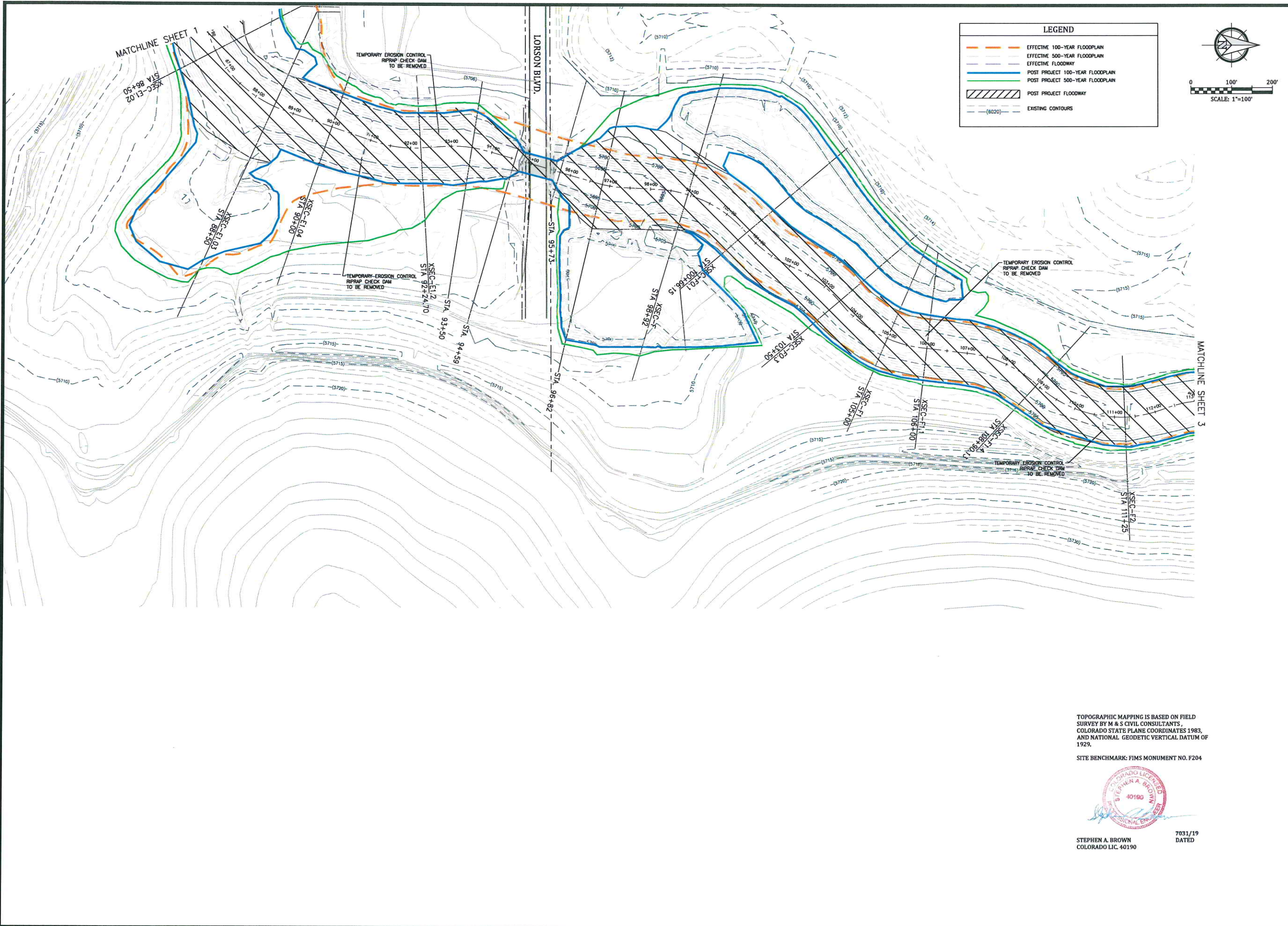

LEGEND

- EFFECTIVE 100-YEAR FLOODPLAIN
- EFFECTIVE 500-YEAR FLOODPLAIN
- POST PROJECT 100-YEAR FLOODPLAIN
- POST PROJECT 500-YEAR FLOODPLAIN
- POST PROJECT FLOODWAY
- EXISTING CONTOURS

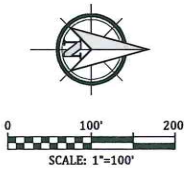

Celebrating 30 years
Kiowa
Engineering Corporation

1604 South 21st Street
Colorado Springs, Colorado 80904
(719) 630-7342

EAST TRIBUTARY JIMMY CAMP CREEK LOMR
LORSON RANCH
POST PROJECT CONDITIONS FLOODPLAIN MAP
EL PASO COUNTY, COLORADO

TOPOGRAPHIC MAPPING IS BASED ON FIELD SURVEY BY M & S CIVIL CONSULTANTS, COLORADO STATE PLANE COORDINATES 1983, AND NATIONAL GEODETIC VERTICAL DATUM OF 1929.
SITE BENCHMARK: FIMS MONUMENT NO. F204



STEPHEN A. BROWN
COLORADO LIC. 40190

7031/19
DATED

Project No:	19001
Date:	JULY 31, 2019
Design:	SAB
Drawn:	SAB
Check:	RNW
Revisions:	

SHEET

2

OF 4 SHEETS

19001 LOMR - Jimmy Camp Creek LOMR - July 31, 2019

Appendix B

Lorson Ranch 404 Permit



April 1, 2020

Mr. Van Truan
U. S. Army Corps of Engineers
200 South Santa Fe Avenue Suite 301
Pueblo, Colorado 81003

Re: SPA Action No. 2005 00757 Modification Amendment No. 2 Concurrence Request
Lorson Ranch East Fork Jimmy Camp Creek Creekside Development
El Paso County, Colorado
(Kiowa Project No. 18020)

Dear Van:

Following Permit Modification No. 1 of August 2017, we are submitting a Permit Modification Amendment No. 2 for the above-mentioned project on behalf of Lorson Development and are requesting your concurrence at this time. Your office issued concurrence of Permit Modification No. 1 on September 7, 2017.

The purpose of this Modification Amendment is to address Special Condition 2 in the permit and will complete all activities that were originally authorized. Construction is proposed to commence in June 2020.

Permit Summary

Project impacts for the East Fork Jimmy Camp Creek on the Lorson Ranch were originally authorized under the above-mentioned permit by the Pueblo Regulatory Office on September 22, 2006. The permit authorized channel bank linings, grade control structures and two roadway crossings for three segments for the entire length of the East Fork Jimmy Camp Creek on the Lorson Ranch. See Figure 2, Permit Modification Amendment No. 2 Map (included in Wetland Delineation) for location of existing and proposed activities discussed here.

The central stream segment, designed as a reconfigured reach (Item#1 on Figure 2) was completed in about 2007 or 2008. Subsequently, a construction standstill in 2009 occurred and activity lapsed for about ten years. At that time, about 3,600 linear feet of reconfigured trapezoidal channel consisting of 100-Year riprap bank linings and grouted grade control structures were completed. The bottom width was designed at about 60-feet wide and the top width was about 180-feet wide. Currently, the reconfigured channel is vegetated with upland vegetation with areas of exposed rock on the bank linings and grouted drops structures.

Items 2, 3, and 4, the upper reach of the East Fork of Jimmy Camp Creek, the Fontaine Boulevard and Lorson Boulevard Bridges were completed between 2017 and 2018 and have been restored according to the Erosion Control Plan. No mitigation was required as these improvements had no loss to wetland or waters of the U.S.

Special Condition 2 applies to the lower stream preservation reach (Item #5 on Figure 2) and is addressed in this Permit Modification No. 2. The Lorson Ranch has been delineated twice, first by Savage and Savage in 2002 for the overall project for both the Mainstem and the East Fork under

18020COEPerModAmend_2.docx

1604 South 21st Street, Colorado Springs, Colorado 80904-4208
Ph: [719] 630-7342 Fax: [719] 630-0406 www.kiowaengineering.com

Action No. SPA-2002-00701. The East Fork Jimmy Camp Creek on the Lorson Ranch was again delineated in March 7, 2006 by AG Environmental Services, Inc. under Action No. SPA-2005-00757. The existing delineations for this reach were reviewed and verified for current conditions and are submitted within the Wetland Delineation (enclosed).

Lower Lorson East Fork Jimmy Camp Creek Stream Preservation Plan

This reach will be about 3,640 linear feet of discontinuous stream improvements in the Creekside Development on the Lorson Ranch. The design concept for this reach is to retain the stream alignment and sinuosity, to maintain the channel invert and bottom width, and to lay back the steep banks to three-to-one or four-to one with as minimal modifications as possible. An ungrouted boulder lining in selective locations will be placed along the low flow channel to prevent bank degradation.

Project Impacts

Project impacts within the ordinary high water are ungrouted boulder low flow channel linings in selective locations. A shallow overbank terrace of varying widths will be formed and revegetated to allow for riparian restoration. The lower terrace will be about three vertical feet. Stabilized outer banks, also in select locations, will be three-to-one revegetated rock/soil bank linings. The remainder of the outer banks will be regraded to four-to-one and will be revegetated. The outer banks will be outside of the Waters of the U.S. Two sheet pile grade control structures will ensure invert stability of this low gradient waterway. The bottom width of the channel will be about 12- to 20-feet.

The existing Waters of the U.S. measure 1.4 acres and will be replaced with approximately 1.5 acres of Waters of the U.S. All wetlands found to be present in 2020 are included within the Waters of the U.S. We anticipate that the pools and intermittent wetland channel vegetation replace in situ with no net fill to Waters of the U.S. and disturbance to be of a temporary impact.

Please let us know if you need more information.

Sincerely,
KIOWA ENGINEERING CORPORATION

Elizabeth Klein

Encs. Wetland Delineation and 404 Permitting Update East Fork Jimmy Camp Creek Channel Design Creekside at Lorson Filing No.1

East Fork Jimmy Camp Creek Channel Design Creekside at Lorson Filing No 1. Final Design Plans

cc: Jeff Mark, Lorson Development
Richard Schindler, Core Engineering

**Wetland Delineation and 404 Permitting Update
East Fork Jimmy Camp Creek Channel Design
Creekside at Lorson Filing No.1**

U.S.A.C.E. Action No. SPA-2005-00757
Colorado Springs, Colorado

Prepared for:
Lorson Development
212 N. Wahsatch Ave., Ste 301
Colorado Springs, CO 80903

Prepared by:
Kiowa
Engineering Corporation

1604 South 21st Street
Colorado Springs, Colorado 80904
(719) 630-7342

Kiowa Project No. 18020

March 30, 2020

Introduction and Project History

The proposed East Fork Jimmy Camp Creek Channel Design Project is located on the East Fork of Jimmy Camp Creek in El Paso County Colorado, in Section 24 Township 15 South and Range 65 West of the 6th Principal Meridian (see Vicinity Map on Figure 1). GPS coordinates for the center of the project are approximately 38.732° Lat. and -104.637° Long.

Project impacts for the East Fork Jimmy Camp Creek on the Lorson Ranch were originally authorized by the Pueblo Regulatory Office of the U.S. Army Corps of Engineers on September 22, 2006 under USACE Action No. 2005-00757 with an expiration date of December 31, 2009. The permit authorized channel bank linings, grade control structures and two roadway crossings for three segments for the entire length of the East Fork Jimmy Camp Creek on the Lorson Ranch from the north boundary to the south boundary.

Attached Figure 2, Permit Modification Amendment No. 1 Map (Revised 2020) shows locations of jurisdictional activities authorized under this permit. The central stream segment, designed as a reconfigured reach (Item#1 on Figure 2), was completed in about 2007 or 2008. Subsequently, a construction standstill in 2009 occurred with no further activity for a number of years. It appears that the permit was extended twice, first to September 2001 and then to September 2021.

In August 2017, Kiowa Engineering consulted with the USACE to update the existing permit per Modification Amendment No. 1. The purpose of this Modification Amendment was to address and clarify Special Conditions in the permit and summarize all future activities that were originally authorized in this permit. The agency concurred with Modification Amendment No. 1 in September 2017 (see Appendix).

Following Modification Amendment No. 1, Item 2 (Upper Reach Channel Improvements), Item 3 (Fontaine Boulevard Bridge) and Item 4 (Lorson Boulevard Bridge) have been completed.

Item 5, the lower reach of the East Fork Jimmy Camp Creek from the existing trapezoidal channel to the south property line is proposed to be completed in the near future. The East Fork Jimmy Camp Creek Channel Design Creekside at Lorson Filing No 1 Final Design Plans are included in the Appendix.

Per Special Condition 2 of the Permit Modification, the lower stream preservation reach (Item #5 on Figure 2) will be about 3,600 linear feet of revegetated three-to-one soil/riprap bank linings in selective locations on the overbanks with two steel sheet pile grade control structures. The low flow channel will be lined with boulders in selective locations to prevent over bank degradation and retain a bottom width similar to the existing channel width. The design concept for this

reach retains the stream sinuosity and alignment as much as possible, avoids future channel incision and lays back steep over banks to three-to-one and four-to-one. The proposed invert remains similar the same as the existing.

This Wetland Delineation Update is being submitted to satisfy Permit Modification #1 of August 2017 to review the current Waters of the U.S. and adjacent wetlands. This will be the last phase of the East Fork Jimmy Camp Creek IP-SPA-2005-00757 and will finalize the above-mentioned permit.

Wetland Assessments

The Lorson Ranch has been delineated twice during the permitting process. The original delineation by Savage and Savage in 2002 for the overall project delineated both the Mainstem Jimmy Camp Creek and the East Fork Jimmy Camp Creek. Subsequently, the Mainstem Jimmy Camp Creek was permitted and completed under Action No. 2002 00701. The East Fork Jimmy Camp Creek in the Lorson Ranch was again delineated in March 7, 2006 by AG Environmental Services, Inc. under Action No. 2005 00757.

The existing delineations for this reach were verified for current conditions in March 2020 and are presented in this document.

Vegetation

The dominant upland vegetation community in the project area is short grass prairie dominated by smooth brome grass where disturbed and blue grama in undisturbed areas. A poorly developed riparian forest/shrubland is present along the waterway. Small pockets of wetland vegetation are present within the Ordinary High Water Mark. As the project site had been historically used for grazing to the extent it was overgrazed, large areas of weedy species are present.

Wetland plant species found were soft stemmed bulrush (*Scirpus sp.* OBL), American three Square (*Schoenoplectus pungens.* FACW), sandbar willow (*Salix exigua* OBL), and cattails (*Typhus angustifolia* and *latifolia* OBL). On the whole, wetland species were sparse and interspersed with communities of upland species.

Riparian forest/shrubland species present on the site are dominated by non-native Russian olive trees (*Eleagnus angustifolia*, FACU), snowberry (*Symphoricarpos occidentalis* UPL), wildrose (*Rosa woodsii* FACU) and elm (*Ulmus pumila* NI). In general, the riparian species present along the waterway were non-native undesirable native species that may shade the water but not promote water quality. Only a few native cottonwoods were found and one peachleaf willow. Fortunately, no tamarisk was found.

Upland herb species encountered include smooth broom (*Bromus inermis* NI), blue grama (*Bouteloua gracilis* NI), filaree (*Erodium cicutarium* NI), licorice (*Glycerrhiza*

lepidota, FACU), milkweed (*Asclepias speciosa* FAC), annual brome grass (*Bromus tectorum* FACU), mullein (*Verbascum thaspus* NI), and Canada thistle (*Cirsium arvense* FACU). Other weedy species present were blue mustard (*Chorispora tenuella* NI), kochia (*Kochia sp* UPL), and flaxweed (*Descurainia sp.* NI).

Hydrology

The East Fork Jimmy Camp Creek is a 'blue-line' drainageway as depicted on the Fountain Quadrangle Map (1994) and appears to have an intermittent flow and as such is an assumed jurisdictional waterway. Channel banks are nearly vertical fairly shallow and range from 2- to over 10-feet of height. The channel varies from vegetated to unvegetated. The channel has very shallow slopes of less than 0.5% to nearly flat.

The Fountain Mutual Irrigation Canal (FMIC) formerly traversed around the East Fork Jimmy Camp Creek channel and contributed to the historic hydrology. More than 15 years ago, the FMIC was realigned and subsequently caused adjacent wetlands to dry out. A large area of former wetland body downgradient of the FMIC was decommissioned by the U.S.A.C.E. in the delineation of 2006.

Seasonal snowfall for this location is 149% of normal per Colorado Springs climate data for October 2019 through March 30, 2020. The flow at the time of delineation is substantially higher than usual with standing water of three-to four inches present on the channel bottom in many locations. During the average growing season, this stream segment is often dry with only small pools remaining. The hydrology present during this field review is much greater than can be expected during the average growing season due to high seasonal snows.

Soils

The native soils within the project area per the Soil Survey of El Paso County are the Blendon sandy loam and the Ellicott loamy coarse sand. Neither of these soils is considered hydric, although both could have pockets of hydric soil inclusions.

The Blendon sandy loam, 0-3% slopes, is a deep well drained soil with a depth of the water table anticipated to be greater than 6.5 feet, run-off is anticipated to be low, frequency of flooding and/or ponding is none. This upland soil was formed in alluvium and residuum and is derived from arkosic sedimentary rock.

The Ellicott loamy coarse sand, 0-5% slopes are somewhat excessively drained soils, with an expected depth to the water table to be greater than 6.5 feet. Runoff is anticipated to be very low, frequency of flooding is frequent, but ponding is none. This soil is formed on floodplains and terraces.

Hydric soils were only found on the bottom of the channel bed.

Wetland Resources and Jurisdictional Waters of the U.S.

Waters of the U.S. were found within the existing low flow channel with a depth of about two vertical feet and are presented on Exhibit 1. Small pockets of mixed emergent wetlands were found within the existing channel bottom, but rapidly transitioned to upland vegetation with where a clear boundary between wetland vegetation and upland vegetation shows on the bank. The wetland vegetation is contained within the Waters of the U.S. and measures approximately 1.4 acres.

Summary

Existing Waters of the U.S. and adjacent wetlands (1.4 acres) will be replaced with an intermittent wetland/pool channel of similar area (1.5 acres). Channel width, length, and invert will remain the same as the existing condition allowing intermittent pools to exist. Sinuosity will also be preserved and overbanks will be stabilized compatible with the stream preservation design concept.

References

El Paso County, Colorado, Comprehensive Hydric Soils List. U.S. Department of Agriculture, Soil Conservation Survey.

Regional Supplement to the Corps of Engineers Wetland Delineation Manual: Great Plains Region ver 2.0, March 2010, ERDC/EL TR-10-1.

Munsell Color Charts. Macbeth: a Division of Kollmorgan Corporation.

National Wetland Inventory, Fountain Quadrangle, 1975. U. S. Department of the Interior, U.S. Fish and Wildlife Service.

National Wetland Inventory Wetlands Mapper August, 2019. U. S. Department of the Interior, U.S. Fish and Wildlife Service.

Reed, P.B. 1996. National List of Plants That Occur in Wetlands: Colorado. U.S. Fish and Wildlife Service, Washington D.C. NERC-88/18.06.

Rocky Mountain Group Engineers, August 2018. Geology and Soils Report Creekside at Lorson Ranch, Filing No. 1, El Paso County CO.

Custom Soils Report for Lower Lorson East Fork Jimmy Camp Creek, of El Paso County, Colorado. July 25, 2019. U.S. Department of Agriculture, Natural Resource Conservation Service.

Weber, W. A. 1996. Flora of Colorado: East Slope. University Press of Colorado, Boulder, Colorado.

U.S.G.S. 7.5-minute Fountain Quadrangle Map. El Paso County, Colorado. 1994. U. S. Department of the Interior.

Appendix

Photographs

USACE Concurrence Letter

Figure 1 Vicinity Map

Figure 2 Permit Modification Map – Revised in 2020

Exhibit 1 Waters of the U.S. Map 2020 Update

East Fork Jimmy Camp Creek Channel Design Creekside at Lorson Filing No 1. Final Design Plans



Photograph 1: DP 1 Near downstream property line near FMIC siphon.



Photograph 2: DP2 Near old ranch road crossings.



Photograph 1: DP 3 Standing water in channel bed.



Photograph 2: DP4 Located downstream of existing trapezoidal channel.

WETLAND DETERMINATION DATA FORM – Great Plains Region

Project/Site: Lower Lurson Ranch City/County: EL PASO Sampling Date: 3/24/20
 Applicant/Owner: LURSON DEVELOPMENT State: CO Sampling Point: DA1
 Investigator(s): Liz Klein Section, Township, Range: S 24 T 15 S R 105 W
 Landform (hillslope, terrace, etc.): Plain Local relief (concave, convex, none): Elevated Slope (%): 0-5%
 Subregion (LRR): LRRG1 Lat: 38.731 Long: -104.034 Datum: _____
 Soil Map Unit Name: MANZANOLA Clay loam NWI classification: Pem1c

Are climatic / hydrologic conditions on the site typical for this time of year? Yes _____ No (If no, explain in Remarks.)
 Are Vegetation _____, Soil _____, or Hydrology _____ significantly disturbed? Are "Normal Circumstances" present? Yes No _____
 Are Vegetation _____, Soil _____, or Hydrology _____ naturally problematic? (If needed, explain any answers in Remarks.)

SUMMARY OF FINDINGS – Attach site map showing sampling point locations, transects, important features, etc.

Hydrophytic Vegetation Present? Yes <input checked="" type="checkbox"/> No _____ Hydric Soil Present? Yes <input checked="" type="checkbox"/> No _____ Wetland Hydrology Present? Yes <input checked="" type="checkbox"/> No _____	Is the Sampled Area within a Wetland? Yes <input checked="" type="checkbox"/> No _____ ABRUT 20' WIDE
Remarks: <u>SEASONAL SNOWFALL AT 149%</u> <u>LOCATED DOWNSTREAM OF FMIC SIPHON</u>	

VEGETATION – Use scientific names of plants.

Tree Stratum (Plot size: <u>30'</u>)	Absolute % Cover	Dominant Species?	Indicator Status	Dominance Test worksheet:
1. <u>ALNUS pyramida</u>	<u>20</u>	<input checked="" type="checkbox"/>	<u>NI</u>	Number of Dominant Species That Are OBL, FACW, or FAC (excluding FAC-): <u>1</u> (A) Total Number of Dominant Species Across All Strata: <u>1</u> (B) Percent of Dominant Species That Are OBL, FACW, or FAC: <u>100</u> (AVB)
2. <u>CELANDES ANAUSTRIACA</u>	<u>20</u>	<input checked="" type="checkbox"/>	<u>FACW</u>	
3. _____	_____	_____	_____	
4. _____	_____	_____	_____	
<u>40</u> = Total Cover				
Sapling/Shrub Stratum (Plot size: <u>15'</u>)	Absolute % Cover	Dominant Species?	Indicator Status	Prevalence Index worksheet:
1. <u>SUMMITRIS CAROLUS</u>	<u>40</u>	<input checked="" type="checkbox"/>	<u>UPL</u>	Total % Cover of: _____ Multiply by: _____ OBL species _____ x 1 = _____ FACW species _____ x 2 = _____ FAC species _____ x 3 = _____ FACU species _____ x 4 = _____ UPL species _____ x 5 = _____ Column Totals: _____ (A) _____ (B) Prevalence Index = B/A = _____
2. <u>SALIX pygmaea</u>	<u>5</u>	<input checked="" type="checkbox"/>	<u>FACW</u>	
3. _____	_____	_____	_____	
4. _____	_____	_____	_____	
5. _____	_____	_____	_____	
<u>45</u> = Total Cover				
Herb Stratum (Plot size: <u>5'</u>)	Absolute % Cover	Dominant Species?	Indicator Status	Hydrophytic Vegetation Indicators:
1. <u>BROMUS inermis</u>	<u>30</u>	<input checked="" type="checkbox"/>	<u>NI</u>	<input type="checkbox"/> 1 - Rapid Test for Hydrophytic Vegetation <input checked="" type="checkbox"/> 2 - Dominance Test is >50% <input type="checkbox"/> 3 - Prevalence Index is ≤3.0 ¹ <input type="checkbox"/> 4 - Morphological Adaptations ¹ (Provide supporting data in Remarks or on a separate sheet) <input type="checkbox"/> Problematic Hydrophytic Vegetation ¹ (Explain) ¹ Indicators of hydric soil and wetland hydrology must be present, unless disturbed or problematic.
2. <u>RUMEX crispus</u>	<u>2</u>	<input checked="" type="checkbox"/>	<u>FAC</u>	
3. <u>SCHOENOPLECTHUS pumilus</u>	<u>30</u>	<input checked="" type="checkbox"/>	<u>OBL</u>	
4. _____	_____	_____	_____	
5. _____	_____	_____	_____	
6. _____	_____	_____	_____	
7. <u>* INDICATIVE OF LOW FLOW AREA *</u>	_____	_____	_____	
8. <u>THIS USED FOR RAPID DOMINANCE TEST</u>	_____	_____	_____	
9. _____	_____	_____	_____	
10. _____	_____	_____	_____	
_____ = Total Cover				
Woody Vine Stratum (Plot size: _____)	Absolute % Cover	Dominant Species?	Indicator Status	Hydrophytic Vegetation Present?
1. _____	_____	_____	_____	Yes <input checked="" type="checkbox"/> No _____
2. _____	_____	_____	_____	
_____ = Total Cover				
% Bare Ground in Herb Stratum _____ = Total Cover				
Remarks: <u>ALL WETLAND VEGETATION LOCATED WITHIN WAS IN A NARROW BAND, TRANSITIONS TO UPLAND AT 2' ELEVATION</u>				

SOIL

Sampling Point: 144

Profile Description: (Describe to the depth needed to document the indicator or confirm the absence of indicators.)

Depth (inches)	Matrix		Redox Features				Texture	Remarks
	Color (moist)	%	Color (moist)	%	Type ¹	Loc ²		
0-12"	10YR 2/2		—					

¹Type: C=Concentration, D=Depletion, RM=Reduced Matrix, CS=Covered or Coated Sand Grains. ²Location: PL=Pore Lining, M=Matrix.

Hydric Soil Indicators: (Applicable to all LRRs, unless otherwise noted.)		Indicators for Problematic Hydric Soils ³ :
<input type="checkbox"/> Histosol (A1)	<input type="checkbox"/> Sandy Gleyed Matrix (S4)	<input type="checkbox"/> 1 cm Muck (A9) (LRR I, J)
<input type="checkbox"/> Histic Epipedon (A2)	<input type="checkbox"/> Sandy Redox (S5)	<input type="checkbox"/> Coast Prairie Redox (A16) (LRR F, G, H)
<input type="checkbox"/> Black Histic (A3)	<input type="checkbox"/> Stripped Matrix (S6)	<input type="checkbox"/> Dark Surface (S7) (LRR G)
<input type="checkbox"/> Hydrogen Sulfide (A4)	<input type="checkbox"/> Loamy Mucky Mineral (F1)	<input type="checkbox"/> High Plains Depressions (F16)
<input type="checkbox"/> Stratified Layers (A5) (LRR F)	<input type="checkbox"/> Loamy Gleyed Matrix (F2)	(LRR H outside of MLRA 72 & 73)
<input type="checkbox"/> 1 cm Muck (A9) (LRR F, G, H)	<input type="checkbox"/> Depleted Matrix (F3)	<input type="checkbox"/> Reduced Vertic (F18)
<input type="checkbox"/> Depleted Below Dark Surface (A11)	<input type="checkbox"/> Redox Dark Surface (F6)	<input type="checkbox"/> Red Parent Material (TF2)
<input checked="" type="checkbox"/> Thick Dark Surface (A12)	<input type="checkbox"/> Depleted Dark Surface (F7)	<input type="checkbox"/> Very Shallow Dark Surface (TF12)
<input type="checkbox"/> Sandy Mucky Mineral (S1)	<input type="checkbox"/> Redox Depressions (F8)	<input type="checkbox"/> Other (Explain in Remarks)
<input type="checkbox"/> 2.5 cm Mucky Peat or Peat (S2) (LRR G, H)	<input checked="" type="checkbox"/> High Plains Depressions (F16)	³ Indicators of hydrophytic vegetation and wetland hydrology must be present, unless disturbed or problematic.
<input type="checkbox"/> 5 cm Mucky Peat or Peat (S3) (LRR F)	(MLRA 72 & 73 of LRR H)	

Restrictive Layer (if present):
 Type: _____
 Depth (inches): _____

Hydric Soil Present? Yes No

Remarks: * wetland soils on IN CHANNEL BOTTOM, upland soil on bank 10YR 4/2

HYDROLOGY

Wetland Hydrology Indicators:	
<p>Primary Indicators (minimum of one required; check all that apply)</p> <input checked="" type="checkbox"/> Surface Water (A1) <input type="checkbox"/> Salt Crust (B11) <input type="checkbox"/> High Water Table (A2) <input type="checkbox"/> Aquatic Invertebrates (B13) <input type="checkbox"/> Saturation (A3) <input type="checkbox"/> Hydrogen Sulfide Odor (C1) <input type="checkbox"/> Water Marks (B1) <input type="checkbox"/> Dry-Season Water Table (C2) <input type="checkbox"/> Sediment Deposits (B2) <input type="checkbox"/> Oxidized Rhizospheres on Living Roots (C3) (where not tilled) <input type="checkbox"/> Drift Deposits (B3) <input type="checkbox"/> Presence of Reduced Iron (C4) <input type="checkbox"/> Algal Mat or Crust (B4) <input type="checkbox"/> Thin Muck Surface (C7) <input type="checkbox"/> Iron Deposits (B5) <input type="checkbox"/> Other (Explain in Remarks) <input type="checkbox"/> Inundation Visible on Aerial Imagery (B7) <input type="checkbox"/> Water-Stained Leaves (B9)	<p>Secondary Indicators (minimum of two required)</p> <input type="checkbox"/> Surface Soil Cracks (B6) <input type="checkbox"/> Sparsely Vegetated Concave Surface (B8) <input type="checkbox"/> Drainage Patterns (B10) <input type="checkbox"/> Oxidized Rhizospheres on Living Roots (C3) (where tilled) <input type="checkbox"/> Crayfish Burrows (C8) <input type="checkbox"/> Saturation Visible on Aerial Imagery (C9) <input type="checkbox"/> Geomorphic Position (D2) <input type="checkbox"/> FAC-Neutral Test (D5) <input type="checkbox"/> Frost-Heave Hummocks (D7) (LRR F)
<p>Field Observations:</p> Surface Water Present? Yes <input checked="" type="checkbox"/> No <input type="checkbox"/> Depth (inches): 0-3" Water Table Present? Yes <input type="checkbox"/> No <input type="checkbox"/> Depth (inches): _____ Saturation Present? Yes <input type="checkbox"/> No <input type="checkbox"/> Depth (inches): _____ (includes capillary fringe)	Wetland Hydrology Present? Yes <input checked="" type="checkbox"/> No <input type="checkbox"/>
Describe Recorded Data (stream gauge, monitoring well, aerial photos, previous inspections), if available:	
Remarks: CHANNEL VARIES FROM 2' TO 12'	

WETLAND DETERMINATION DATA FORM – Great Plains Region

Project/Site: LOWES LUESMA RANCH City/County: EL PASO Sampling Date: 3/24/00
 Applicant/Owner: LOESON DEVELOPMENT State: CO Sampling Point: SP 2
 Investigator(s): LIZ KLEIN Section, Township, Range: S 24 T 15 S R 65 W
 Landform (hillslope, terrace, etc.): plains Local relief (concave, convex, none): ENTRENCHED Slope (%): 0-5%
 Subregion (LRR): LR2G1 Lat: 38.732 Long: -104.641 Datum: _____
 Soil Map Unit Name: BLENDON sandy loam NWI classification: P6M1C

Are climatic / hydrologic conditions on the site typical for this time of year? Yes _____ No (If no, explain in Remarks.)
 Are Vegetation _____, Soil _____, or Hydrology _____ significantly disturbed? Are "Normal Circumstances" present? Yes No _____
 Are Vegetation _____, Soil _____, or Hydrology _____ naturally problematic? (If needed, explain any answers in Remarks.)

SUMMARY OF FINDINGS – Attach site map showing sampling point locations, transects, important features, etc.

Hydrophytic Vegetation Present? Yes <input checked="" type="checkbox"/> No _____ Hydric Soil Present? Yes _____ No _____ Wetland Hydrology Present? Yes <input checked="" type="checkbox"/> No _____	Is the Sampled Area within a Wetland? Yes <input checked="" type="checkbox"/> No _____ BUT ONLY IN CHANNEL
Remarks: SEASONAL SNOWFALL AT 14900 LOCATED NEAR OLD RANCH ROAD CROSSING	

VEGETATION – Use scientific names of plants.

Tree Stratum (Plot size: <u>30'</u>)	Absolute % Cover	Dominant Species?	Indicator Status	Dominance Test worksheet:
1. <u>E. FAGUS AUGUSTA</u>	<u>30</u>	<u>Y</u>	<u>FACW</u>	Number of Dominant Species That Are OBL, FACW, or FAC (excluding FAC-): <u>1</u> (A)
2. _____	_____	_____	_____	Total Number of Dominant Species Across All Strata: <u>1</u> (B)
3. _____	_____	_____	_____	Percent of Dominant Species That Are OBL, FACW, or FAC: <u>100%</u> (A/B)
4. _____	_____	_____	_____	Prevalence Index worksheet: Total % Cover of: _____ Multiply by: _____ OBL species _____ x 1 = _____ FACW species _____ x 2 = _____ FAC species _____ x 3 = _____ FACU species _____ x 4 = _____ UPL species _____ x 5 = _____ Column Totals: _____ (A) _____ (B) Prevalence Index = B/A = _____
= Total Cover				
Sapling/Shrub Stratum (Plot size: <u>15'</u>)				
1. <u>SUMMARIOPARPUS OCCIDENTALIS</u>	<u>15</u>	<u>Y</u>	<u>UPL</u>	
2. _____	_____	_____	_____	
3. _____	_____	_____	_____	
4. _____	_____	_____	_____	
5. _____	_____	_____	_____	
= Total Cover				
Herb Stratum (Plot size: <u>5'</u>)				
1. <u>TYNHA LATIFOLIA</u>	<u>50</u>	<u>Y</u>	<u>OBL</u>	
2. <u>BABYUS INERMIS</u>	<u>50</u>	<u>Y</u>	<u>UPL</u>	
3. <u>SCIRPUS SP</u>	<u>5</u>	<u>N</u>	<u>OBL</u>	
4. _____	_____	_____	_____	
5. _____	_____	_____	_____	
6. _____	_____	_____	_____	
7. _____	_____	_____	_____	
8. _____	_____	_____	_____	
9. _____	_____	_____	_____	
10. _____	_____	_____	_____	
= Total Cover				
Woody Vine Stratum (Plot size: _____)				
1. _____	_____	_____	_____	
2. _____	_____	_____	_____	
= Total Cover				
% Bare Ground in Herb Stratum _____				
= Total Cover				

Hydrophytic Vegetation Indicators:
 ___ 1 - Rapid Test for Hydrophytic Vegetation
 ___ 2 - Dominance Test is >50%
 ___ 3 - Prevalence Index is ≤3.0¹
 ___ 4 - Morphological Adaptations¹ (Provide supporting data in Remarks or on a separate sheet)
 ___ Problematic Hydrophytic Vegetation¹ (Explain)
¹Indicators of hydric soil and wetland hydrology must be present, unless disturbed or problematic.

Hydrophytic Vegetation Present? Yes No _____

Remarks: WETLAND VEG. FOUND IN CHANNEL BOTTOM
DETERMINATION BASED ON CHANNEL AREA ONLY

SOIL

Sampling Point: 105

Profile Description: (Describe to the depth needed to document the indicator or confirm the absence of indicators.)

Depth (inches)	Matrix		Redox Features				Texture	Remarks
	Color (moist)	%	Color (moist)	%	Type ¹	Loc ²		
0-6"	10YR 4/2							
6-9"	10YR 3/2							

¹Type: C=Concentration, D=Depletion, RM=Reduced Matrix, CS=Covered or Coated Sand Grains. ²Location: PL=Pore Lining, M=Matrix.

Hydric Soil Indicators: (Applicable to all LRRs, unless otherwise noted.)		Indicators for Problematic Hydric Soils ³ :
<input type="checkbox"/> Histosol (A1)	<input type="checkbox"/> Sandy Gleyed Matrix (S4)	<input type="checkbox"/> 1 cm Muck (A9) (LRR I, J)
<input type="checkbox"/> Histic Epipedon (A2)	<input type="checkbox"/> Sandy Redox (S5)	<input type="checkbox"/> Coast Prairie Redox (A16) (LRR F, G, H)
<input type="checkbox"/> Black Histic (A3)	<input type="checkbox"/> Stripped Matrix (S6)	<input type="checkbox"/> Dark Surface (S7) (LRR G)
<input type="checkbox"/> Hydrogen Sulfide (A4)	<input type="checkbox"/> Loamy Mucky Mineral (F1)	<input type="checkbox"/> High Plains Depressions (F16)
<input type="checkbox"/> Stratified Layers (A5) (LRR F)	<input type="checkbox"/> Loamy Gleyed Matrix (F2)	<input type="checkbox"/> (LRR H outside of MLRA 72 & 73)
<input type="checkbox"/> 1 cm Muck (A9) (LRR F, G, H)	<input type="checkbox"/> Depleted Matrix (F3)	<input type="checkbox"/> Reduced Vertic (F18)
<input type="checkbox"/> Depleted Below Dark Surface (A11)	<input type="checkbox"/> Redox Dark Surface (F6)	<input type="checkbox"/> Red Parent Material (TF2)
<input type="checkbox"/> Thick Dark Surface (A12)	<input type="checkbox"/> Depleted Dark Surface (F7)	<input type="checkbox"/> Very Shallow Dark Surface (TF12)
<input type="checkbox"/> Sandy Mucky Mineral (S1)	<input type="checkbox"/> Redox Depressions (F8)	<input type="checkbox"/> Other (Explain in Remarks)
<input type="checkbox"/> 2.5 cm Mucky Peat or Peat (S2) (LRR G, H)	<input type="checkbox"/> High Plains Depressions (F16)	³ Indicators of hydrophytic vegetation and wetland hydrology must be present, unless disturbed or problematic.
<input type="checkbox"/> 5 cm Mucky Peat or Peat (S3) (LRR F)	<input type="checkbox"/> (MLRA 72 & 73 of LRR H)	

Restrictive Layer (if present):
 Type: _____
 Depth (inches): _____

Hydric Soil Present? Yes _____ No

Remarks: Immediate overbank NOT hydric soil, BUT ASSUMED in channel

HYDROLOGY

Wetland Hydrology Indicators:

Primary Indicators (minimum of one required; check all that apply)	Secondary Indicators (minimum of two required)
<input checked="" type="checkbox"/> Surface Water (A1)	<input type="checkbox"/> Surface Soil Cracks (B6)
<input type="checkbox"/> High Water Table (A2)	<input type="checkbox"/> Sparsely Vegetated Concave Surface (B8)
<input type="checkbox"/> Saturation (A3)	<input type="checkbox"/> Drainage Patterns (B10)
<input type="checkbox"/> Water Marks (B1)	<input type="checkbox"/> Oxidized Rhizospheres on Living Roots (C3)
<input type="checkbox"/> Sediment Deposits (B2)	<input type="checkbox"/> (where tilled)
<input type="checkbox"/> Drift Deposits (B3)	<input type="checkbox"/> Crayfish Burrows (C8)
<input type="checkbox"/> Algal Mat or Crust (B4)	<input type="checkbox"/> Saturation Visible on Aerial Imagery (C9)
<input type="checkbox"/> Iron Deposits (B5)	<input type="checkbox"/> Geomorphic Position (D2)
<input type="checkbox"/> Inundation Visible on Aerial Imagery (B7)	<input type="checkbox"/> FAC-Neutral Test (D5)
<input type="checkbox"/> Water-Stained Leaves (B9)	<input type="checkbox"/> Frost-Heave Hummocks (D7) (LRR F)
<input type="checkbox"/> Salt Crust (B11)	
<input type="checkbox"/> Aquatic Invertebrates (B13)	
<input type="checkbox"/> Hydrogen Sulfide Odor (C1)	
<input type="checkbox"/> Dry-Season Water Table (C2)	
<input type="checkbox"/> Oxidized Rhizospheres on Living Roots (C3) (where not tilled)	
<input type="checkbox"/> Presence of Reduced Iron (C4)	
<input type="checkbox"/> Thin Muck Surface (C7)	
<input type="checkbox"/> Other (Explain in Remarks)	

Field Observations:

Surface Water Present? Yes No _____ Depth (inches): _____

Water Table Present? Yes _____ No _____ Depth (inches): _____

Saturation Present? Yes _____ No _____ Depth (inches): _____ (includes capillary fringe)

Wetland Hydrology Present? Yes No _____

Describe Recorded Data (stream gauge, monitoring well, aerial photos, previous inspections), if available:

Remarks: standing water

WETLAND DETERMINATION DATA FORM – Great Plains Region

Project/Site: LOWES LOESON RANCH City/County: EL PASO Sampling Date: 3/24/20
 Applicant/Owner: LOESON DEVELOPMENT State: CO Sampling Point: DP3
 Investigator(s): LIZ KLEIN Section, Township, Range: S 24 T 15 R 054
 Landform (hillslope, terrace, etc.): PLAINS Local relief (concave, convex, none): ENTRENCHED Slope (%): 0-5%
 Subregion (LRR): L REG Lat: 38.732 Long: -104.637 Datum: _____
 Soil Map Unit Name: MANZANOLA MOY LOAM NWI classification: PEM1C

Are climatic / hydrologic conditions on the site typical for this time of year? Yes _____ No (If no, explain in Remarks.)
 Are Vegetation _____, Soil _____, or Hydrology _____ significantly disturbed? Are "Normal Circumstances" present? Yes No _____
 Are Vegetation _____, Soil _____, or Hydrology _____ naturally problematic? (If needed, explain any answers in Remarks.)

SUMMARY OF FINDINGS – Attach site map showing sampling point locations, transects, important features, etc.

Hydrophytic Vegetation Present?	Yes _____	No <input checked="" type="checkbox"/>	Is the Sampled Area within a Wetland? Yes _____ No <input checked="" type="checkbox"/>
Hydric Soil Present?	Yes _____	No <input checked="" type="checkbox"/>	
Wetland Hydrology Present?	Yes <input checked="" type="checkbox"/>	No _____	
Remarks: <u>SEASONAL SNOWFALL AT 149%</u>			

VEGETATION – Use scientific names of plants.

Tree Stratum (Plot size: <u>30'</u>)	Absolute % Cover	Dominant Species?	Indicator Status	Dominance Test worksheet:
1. <u>ERIOGONUM AEGAGRIUM</u>	<u>30</u>	<u>Y</u>	<u>NI</u>	Number of Dominant Species That Are OBL, FACW, or FAC (excluding FAC-): <u>0</u> (A)
2. _____				Total Number of Dominant Species Across All Strata: <u>2</u> (B)
3. _____				Percent of Dominant Species That Are OBL, FACW, or FAC: <u>0</u> (A/B)
4. _____				Prevalence Index worksheet: Total % Cover of: _____ Multiply by: _____ OBL species _____ x 1 = _____ FACW species _____ x 2 = _____ FAC species _____ x 3 = _____ FACU species _____ x 4 = _____ UPL species _____ x 5 = _____ Column Totals: _____ (A) _____ (B) Prevalence Index = B/A = _____
= Total Cover				
Sapling/Shrub Stratum (Plot size: <u>15'</u>)				
1. _____				
2. _____				
= Total Cover				
Herb Stratum (Plot size: <u>5'</u>)				
1. <u>BRASSICA HIRSUTA</u>	<u>40</u>	<u>Y</u>	<u>NI</u>	Hydrophytic Vegetation Indicators: <input checked="" type="checkbox"/> 1 - Rapid Test for Hydrophytic Vegetation _____ 2 - Dominance Test is >50% _____ 3 - Prevalence Index is ≤3.0 ¹ _____ 4 - Morphological Adaptations ¹ (Provide supporting data in Remarks or on a separate sheet) _____ Problematic Hydrophytic Vegetation ¹ (Explain) ¹ Indicators of hydric soil and wetland hydrology must be present, unless disturbed or problematic. Hydrophytic Vegetation Present? Yes _____ No <input checked="" type="checkbox"/>
2. <u>LEONTOPODIUM</u>	<u>30</u>	<u>Y</u>	<u>NI</u>	
3. _____				
4. _____				
5. _____				
6. _____				
7. _____				
8. _____				
9. _____				
10. _____				
= Total Cover				
Woody Vine Stratum (Plot size: _____)				
1. _____				
2. _____				
= Total Cover				
% Bare Ground in Herb Stratum _____ = Total Cover				
Remarks: <u>Upland veg. TO WATER</u>				

SOIL

Sampling Point: DC

Profile Description: (Describe to the depth needed to document the indicator or confirm the absence of indicators.)

Depth (inches)	Matrix		Redox Features				Texture	Remarks
	Color (moist)	%	Color (moist)	%	Type ¹	Loc ²		
0-3'	10YR 5/2							
3-12'	10YR 5/3							

¹Type: C=Concentration, D=Depletion, RM=Reduced Matrix, CS=Covered or Coated Sand Grains. ²Location: PL=Pore Lining, M=Matrix.

Hydric Soil Indicators: (Applicable to all LRRs, unless otherwise noted.)

<input type="checkbox"/> Histosol (A1)	<input type="checkbox"/> Sandy Gleyed Matrix (S4)	<input type="checkbox"/> 1 cm Muck (A9) (LRR I, J)
<input type="checkbox"/> Histic Epipedon (A2)	<input type="checkbox"/> Sandy Redox (S5)	<input type="checkbox"/> Coast Prairie Redox (A16) (LRR F, G, H)
<input type="checkbox"/> Black Histic (A3)	<input type="checkbox"/> Stripped Matrix (S6)	<input type="checkbox"/> Dark Surface (S7) (LRR G)
<input type="checkbox"/> Hydrogen Sulfide (A4)	<input type="checkbox"/> Loamy Mucky Mineral (F1)	<input type="checkbox"/> High Plains Depressions (F16)
<input type="checkbox"/> Stratified Layers (A5) (LRR F)	<input type="checkbox"/> Loamy Gleyed Matrix (F2)	<input type="checkbox"/> (LRR H outside of MLRA 72 & 73)
<input type="checkbox"/> 1 cm Muck (A9) (LRR F, G, H)	<input type="checkbox"/> Depleted Matrix (F3)	<input type="checkbox"/> Reduced Vertic (F18)
<input type="checkbox"/> Depleted Below Dark Surface (A11)	<input type="checkbox"/> Redox Dark Surface (F6)	<input type="checkbox"/> Red Parent Material (TF2)
<input type="checkbox"/> Thick Dark Surface (A12)	<input type="checkbox"/> Depleted Dark Surface (F7)	<input type="checkbox"/> Very Shallow Dark Surface (TF12)
<input type="checkbox"/> Sandy Mucky Mineral (S1)	<input type="checkbox"/> Redox Depressions (F8)	<input type="checkbox"/> Other (Explain in Remarks)
<input type="checkbox"/> 2.5 cm Mucky Peat or Peat (S2) (LRR G, H)	<input type="checkbox"/> High Plains Depressions (F16)	³ Indicators of hydrophytic vegetation and wetland hydrology must be present, unless disturbed or problematic.
<input type="checkbox"/> 5 cm Mucky Peat or Peat (S3) (LRR F)	<input type="checkbox"/> (MLRA 72 & 73 of LRR H)	

Restrictive Layer (if present):
 Type: _____
 Depth (inches): _____

Hydric Soil Present? Yes _____ No ✓

Remarks: SOIL DRY ON BANK

HYDROLOGY

Wetland Hydrology Indicators:

<u>Primary Indicators (minimum of one required; check all that apply)</u>		<u>Secondary Indicators (minimum of two required)</u>
<input checked="" type="checkbox"/> Surface Water (A1)	<input type="checkbox"/> Salt Crust (B11)	<input type="checkbox"/> Surface Soil Cracks (B6)
<input type="checkbox"/> High Water Table (A2)	<input type="checkbox"/> Aquatic Invertebrates (B13)	<input type="checkbox"/> Sparsely Vegetated Concave Surface (B8)
<input type="checkbox"/> Saturation (A3)	<input type="checkbox"/> Hydrogen Sulfide Odor (C1)	<input type="checkbox"/> Drainage Patterns (B10)
<input type="checkbox"/> Water Marks (B1)	<input type="checkbox"/> Dry-Season Water Table (C2)	<input type="checkbox"/> Oxidized Rhizospheres on Living Roots (C3)
<input type="checkbox"/> Sediment Deposits (B2)	<input type="checkbox"/> Oxidized Rhizospheres on Living Roots (C3)	<input type="checkbox"/> (where tilled)
<input type="checkbox"/> Drift Deposits (B3)	<input type="checkbox"/> (where not tilled)	<input type="checkbox"/> Crayfish Burrows (C8)
<input type="checkbox"/> Algal Mat or Crust (B4)	<input type="checkbox"/> Presence of Reduced Iron (C4)	<input type="checkbox"/> Saturation Visible on Aerial Imagery (C9)
<input type="checkbox"/> Iron Deposits (B5)	<input type="checkbox"/> Thin Muck Surface (C7)	<input type="checkbox"/> Geomorphic Position (D2)
<input type="checkbox"/> Inundation Visible on Aerial Imagery (B7)	<input type="checkbox"/> Other (Explain in Remarks)	<input type="checkbox"/> FAC-Neutral Test (D5)
<input type="checkbox"/> Water-Stained Leaves (B9)		<input type="checkbox"/> Frost-Heave Hummocks (D7) (LRR F)

Field Observations:

Surface Water Present?	Yes <input checked="" type="checkbox"/> No _____	Depth (inches): <u>3"</u>	ON CHANNEL BOTTOM ONLY Wetland Hydrology Present? Yes <input checked="" type="checkbox"/> No _____
Water Table Present?	Yes _____ No _____	Depth (inches): _____	
Saturation Present? (includes capillary fringe)	Yes _____ No _____	Depth (inches): _____	

Describe Recorded Data (stream gauge, monitoring well, aerial photos, previous inspections), if available:

Remarks: STANDING WATER BANK TO BANK

WETLAND DETERMINATION DATA FORM – Great Plains Region

Project/Site: LOWER LORSON RANCH City/County: EL PASO Sampling Date: 3/24/20
 Applicant/Owner: LORSON DEVELOPMENT State: CO Sampling Point: DP4
 Investigator(s): LIZ KLEIN Section, Township, Range: S 24 T 75 S R 65 W
 Landform (hillslope, terrace, etc.): PLAINS Local relief (concave, convex, none): _____ Slope (%): _____
 Subregion (LRR): LRRG Lat: 38.733 Long: -104.634 Datum: _____
 Soil Map Unit Name: MANZANUA clay loam NWI classification: PEM1C

Are climatic / hydrologic conditions on the site typical for this time of year? Yes _____ No (If no, explain in Remarks.)
 Are Vegetation _____, Soil _____, or Hydrology _____ significantly disturbed? Are "Normal Circumstances" present? Yes No _____
 Are Vegetation _____, Soil _____, or Hydrology _____ naturally problematic? (If needed, explain any answers in Remarks.)

SUMMARY OF FINDINGS – Attach site map showing sampling point locations, transects, important features, etc.

Hydrophytic Vegetation Present? Yes <input checked="" type="checkbox"/> No _____ Hydric Soil Present? Yes <input checked="" type="checkbox"/> No _____ Wetland Hydrology Present? Yes <input checked="" type="checkbox"/> No _____	Is the Sampled Area <u>NARROW CHANNEL</u> within a Wetland? Yes <input checked="" type="checkbox"/> No _____
Remarks: <p align="center"><u>SEASONAL SNOWFALL at 14990</u> <u>DOWNSTREAM OF TRAPEZOIDAL CHANNEL</u></p>	

VEGETATION – Use scientific names of plants.

Tree Stratum (Plot size: <u>30'</u>)	Absolute % Cover	Dominant Species?	Indicator Status	Dominance Test worksheet:
1. _____	_____	_____	_____	Number of Dominant Species That Are OBL, FACW, or FAC (excluding FAC-): <u>2</u> (A) Total Number of Dominant Species Across All Strata: <u>2</u> (B) Percent of Dominant Species That Are OBL, FACW, or FAC: <u>100%</u> (A/B)
2. _____	_____	_____	_____	
3. _____	_____	_____	_____	
4. _____	_____	_____	_____	
= Total Cover				Prevalence Index worksheet: Total % Cover of: _____ Multiply by: OBL species _____ x 1 = _____ FACW species _____ x 2 = _____ FAC species _____ x 3 = _____ FACU species _____ x 4 = _____ UPL species _____ x 5 = _____ Column Totals: _____ (A) _____ (B) Prevalence Index = B/A = _____
Sapling/Shrub Stratum (Plot size: <u>15'</u>)				
1. <u>ELAEAGNUS ARGENTIFOLIA</u>	<u>15</u>	<u>Y</u>	<u>N1</u>	
2. <u>SUMMERRIS ALBA</u>	<u>50</u>	<u>Y</u>	<u>UPL</u>	
3. _____	_____	_____	_____	
= Total Cover				
Herb Stratum (Plot size: <u>5'</u>)				
1. <u>SCIRPUS SP</u>	<u>50</u>	<u>Y</u>	<u>OBL</u>	
2. <u>GLYCYRRHIZA LEPIDOTA</u>	<u>10</u>	<u>N</u>	<u>FACU</u>	
3. <u>SCHNAPPELII</u>	<u>50</u>	<u>Y</u>	<u>FACU</u>	
4. _____	_____	_____	_____	
= Total Cover				
Woody Vine Stratum (Plot size: _____)				
1. _____	_____	_____	_____	
2. _____	_____	_____	_____	
= Total Cover				
% Bare Ground in Herb Stratum _____ = Total Cover				
Remarks: <p align="center"><u>VEGETATION OUTSIDE OF CHANNEL DISREGARDED</u></p>				

SOIL

Sampling Point: 104

Profile Description: (Describe to the depth needed to document the indicator or confirm the absence of indicators.)

Depth (inches)	Matrix		Redox Features				Texture	Remarks
	Color (moist)	%	Color (moist)	%	Type ¹	Loc ²		
0-5	10YR 5/2		10YR 5/2					
5-9	10YR 5/3							

¹Type: C=Concentration, D=Depletion, RM=Reduced Matrix, CS=Covered or Coated Sand Grains. ²Location: PL=Pore Lining, M=Matrix.

Hydric Soil Indicators: (Applicable to all LRRs, unless otherwise noted.)		Indicators for Problematic Hydric Soils ³ :
<input type="checkbox"/> Histosol (A1)	<input type="checkbox"/> Sandy Gleyed Matrix (S4)	<input type="checkbox"/> 1 cm Muck (A9) (LRR I, J)
<input type="checkbox"/> Histic Epipedon (A2)	<input type="checkbox"/> Sandy Redox (S5)	<input type="checkbox"/> Coast Prairie Redox (A16) (LRR F, G, H)
<input type="checkbox"/> Black Histic (A3)	<input type="checkbox"/> Stripped Matrix (S6)	<input type="checkbox"/> Dark Surface (S7) (LRR G)
<input type="checkbox"/> Hydrogen Sulfide (A4)	<input type="checkbox"/> Loamy Mucky Mineral (F1)	<input type="checkbox"/> High Plains Depressions (F16)
<input type="checkbox"/> Stratified Layers (A5) (LRR F)	<input type="checkbox"/> Loamy Gleyed Matrix (F2)	(LRR H outside of MLRA 72 & 73)
<input type="checkbox"/> 1 cm Muck (A9) (LRR F, G, H)	<input type="checkbox"/> Depleted Matrix (F3)	<input type="checkbox"/> Reduced Vertic (F18)
<input type="checkbox"/> Depleted Below Dark Surface (A11)	<input type="checkbox"/> Redox Dark Surface (F6)	<input type="checkbox"/> Red Parent Material (TF2)
<input type="checkbox"/> Thick Dark Surface (A12)	<input type="checkbox"/> Depleted Dark Surface (F7)	<input type="checkbox"/> Very Shallow Dark Surface (TF12)
<input type="checkbox"/> Sandy Mucky Mineral (S1)	<input type="checkbox"/> Redox Depressions (F8)	<input type="checkbox"/> Other (Explain in Remarks)
<input type="checkbox"/> 2.5 cm Mucky Peat or Peat (S2) (LRR G, H)	<input type="checkbox"/> High Plains Depressions (F16)	³ Indicators of hydrophytic vegetation and wetland hydrology must be present, unless disturbed or problematic.
<input type="checkbox"/> 5 cm Mucky Peat or Peat (S3) (LRR F)	(MLRA 72 & 73 of LRR H)	

Restrictive Layer (if present):
 Type: _____
 Depth (inches): _____

Hydric Soil Present? Yes No

Remarks: ASSUMED wetland soil in channel only
 QUICKLY TRANSITIONS TO upland

HYDROLOGY

Wetland Hydrology Indicators:		
<u>Primary Indicators (minimum of one required; check all that apply)</u>		<u>Secondary Indicators (minimum of two required)</u>
<input checked="" type="checkbox"/> Surface Water (A1)	<input type="checkbox"/> Salt Crust (B11)	<input type="checkbox"/> Surface Soil Cracks (B6)
<input type="checkbox"/> High Water Table (A2)	<input type="checkbox"/> Aquatic Invertebrates (B13)	<input type="checkbox"/> Sparsely Vegetated Concave Surface (B8)
<input checked="" type="checkbox"/> Saturation (A3)	<input type="checkbox"/> Hydrogen Sulfide Odor (C1)	<input type="checkbox"/> Drainage Patterns (B10)
<input type="checkbox"/> Water Marks (B1)	<input type="checkbox"/> Dry-Season Water Table (C2)	<input type="checkbox"/> Oxidized Rhizospheres on Living Roots (C3)
<input type="checkbox"/> Sediment Deposits (B2)	<input type="checkbox"/> Oxidized Rhizospheres on Living Roots (C3)	(where tilled)
<input type="checkbox"/> Drift Deposits (B3)	(where not tilled)	<input type="checkbox"/> Crayfish Burrows (C8)
<input type="checkbox"/> Algal Mat or Crust (B4)	<input type="checkbox"/> Presence of Reduced Iron (C4)	<input type="checkbox"/> Saturation Visible on Aerial Imagery (C9)
<input type="checkbox"/> Iron Deposits (B5)	<input type="checkbox"/> Thin Muck Surface (C7)	<input type="checkbox"/> Geomorphic Position (D2)
<input type="checkbox"/> Inundation Visible on Aerial Imagery (B7)	<input type="checkbox"/> Other (Explain in Remarks)	<input type="checkbox"/> FAC-Neutral Test (D5)
<input type="checkbox"/> Water-Stained Leaves (B9)		<input type="checkbox"/> Frost-Heave Hummocks (D7) (LRR F)
Field Observations:		
Surface Water Present? Yes <input checked="" type="checkbox"/> No <input type="checkbox"/>	Depth (inches): <u>2"</u>	Wetland Hydrology Present? Yes <input checked="" type="checkbox"/> No <input type="checkbox"/>
Water Table Present? Yes <input type="checkbox"/> No <input type="checkbox"/>	Depth (inches): _____	
Saturation Present? Yes <input type="checkbox"/> No <input type="checkbox"/>	Depth (inches): _____	
(includes capillary fringe)		

Describe Recorded Data (stream gauge, monitoring well, aerial photos, previous inspections), if available:

Remarks: saturation present in a narrow band
 AT TOE OF SLOPE



REPLY TO
ATTENTION OF

DEPARTMENT OF THE ARMY
ALBUQUERQUE DISTRICT, U.S. ARMY CORPS OF ENGINEERS
SOUTHERN COLORADO REGULATORY OFFICE
200 S. SANTA FE AVENUE, SUITE 301
PUEBLO, COLORADO 81003

September 7, 2017

Regulatory Division

SUBJECT: Action No. SPA-2005-00757; Modification to the Lorson Ranch Permit in El Paso County, Colorado

Elizabeth Klein
Kiowa Engineering
1604 South 21st Street
Colorado Springs, CO 80904

Ms. Klein:

The U.S. Army Corps of Engineers (Corps) is in receipt of your letter dated August 3, 2017, requesting a modification to the Department of the Army permit for the discharge of dredged and fill material into waters of the United States associated with Lorson Ranch. This includes the bridge construction and stream configurations and updating delineation for upland swale in the Lorson ranch development, Fountain, El Paso County, Colorado.

We have reviewed and hereby approve your request. Action Number SPA-2005-00757 is modified as follows: This includes approval of the Special Condition 1 - Lorson Blvd. & Fontaine Blvd. bridge design and stream configuration, Special Condition 2 - no action required; and Upper Reach Item #2 Stabilization - No permit required.

Replace the project description on page one of your permit with: Insert the approved designs into the Permit as an attachment to the Special Condition 1.

The expiration date of your is still September 30, 2021.

This modification is effective immediately. All other terms and conditions of the original permit remain in full force and effect.

If you have any questions concerning this letter, please contact me at (719) 543-6915 or by e-mail at Van.A.Truan@usace.army.mil.

Sincerely,

TRUAN.VAN.A
LLAN.123142
2150
Van Truan
Chief, Southern Colorado
Regulatory Branch

Digitally signed by
TRUAN.VAN.ALLAN.1231422150
DN: c=US, o=U.S. Government,
ou=DoD, ou=PKI, ou=USA,
cn=TRUAN.VAN.ALLAN.12314221
50
Date: 2017.09.07 09:15:45 -06'00'

DEPARTMENT OF THE ARMY PERMIT

Permittee Lorson LLC nominee for Lorson Conservation Investment 1, LLLP

Permit No. 2005 00757

Issuing Office Albuquerque District Corps of Engineers

NOTE: The term "you" and its derivatives, as used in this permit, means the permittee or any future transferee. The term "this office" refers to the appropriate district or division office of the Corps of Engineers having jurisdiction over the permitted activity or the appropriate official of that office acting under the authority of the commanding officer.

You are authorized to perform work in accordance with the terms and conditions specified below.

Project Description: The work includes modifying the lower 3,110 linear feet of stream with bank protection while preserving the stream alignment (stream preservation reach), and reconfiguring the upper 5,825 linear feet of the stream (reconfiguration reach). Specifically:

In the lower stream preservation reach, about 3,110 linear feet will be treated on one or both banks by regrading the overbank to 3H:1V and treating with concrete or synthetic matting with seeded topsoil beneath the mat. About 350 linear feet will be treated with stone toe protection with soil coir lifts. One or two grade control structures may be built to provide protection from future channel incision.

In the upper reconfiguration reach, a breached stock pond dam will be removed. About 4,025 linear feet of the upper channel will be reconstructed with a bottom width of about 40 feet, side slopes no steeper than 5H:1V, and a natural channel bottom. The new channel side slopes will be protected with a mat material that will provide stability while allowing establishment of vegetation. Eleven boulder grade control structures will be built.

The upper 1,800 linear feet of the channel is actually an upland swale and is not a water of the U.S. However, it's channel design is included in the permit for clarity.

Two road crossings will be built in the upper reach for Lorson Boulevard and Fontaine Boulevard. These structures will be two or three concrete arch, natural bottom spans. A temporary construction crossing may be built in the upper stream portion.

The project will be constructed in accordance with the attached drawings, entitled, "Lorson Ranch channel modification in East Tributary of Jimmy Camp Creek near Fountain, El Paso County, Colorado, Application by: Lorson LLC, Application No. 2005 00757," sheets 1 through 16, dated May 17, 2006.

Project Location: In the East Tributary of Jimmy Camp Creek and adjacent wetlands in the east portion of the Lorson Ranch development located east of the intersection of Fontaine Boulevard and Marksheffel Road near Fountain, El Paso County, Colorado, Sections 13, 14 and 23, Township 15S, Range 65W (38° 44.1' N Latitude, 104° 37.9' W Longitude).

Permit Conditions:

General Conditions:

1. The time limit for completing the work authorized ends on December 31, 2009. If you find that you need more time to complete the authorized activity, submit your request for a time extension to this office for consideration at least one month before the above date is reached.
2. You must maintain the activity authorized by this permit in good condition and in conformance with the terms and conditions of this permit. You are not relieved of this requirement if you abandon the permitted activity, although you may make a good faith transfer to a third party in compliance with General Condition 4 below. Should you wish to cease to maintain the authorized activity or should you desire to abandon it without a good faith transfer, you must obtain a modification of this permit from this office, which may require restoration of the area.
3. If you discover any previously unknown historic or archeological remains while accomplishing the activity authorized by this permit, you must immediately notify this office of what you have found. We will initiate the Federal and state coordination required to determine if the remains warrant a recovery effort or if the site is eligible for listing in the National Register of Historic Places.
4. If you sell the property associated with this permit, you must obtain the signature of the new owner in the space provided and forward a copy of the permit to this office to validate the transfer of this authorization.
5. If a conditioned water quality certification has been issued for your project, you must comply with the conditions specified in the certification as special conditions to this permit. For your convenience, a copy of the certification is attached if it contains such conditions.
6. You must allow representatives from this office to inspect the authorized activity at any time deemed necessary to ensure that it is being or has been accomplished in accordance with the terms and conditions of your permit.

Special Conditions:

After a detailed and careful review of all of the conditions contained in this permit, the permittee acknowledges that, although said conditions were required by the Corps of Engineers, nonetheless the permittee agreed to those conditions voluntarily to facilitate issuance of the permit; the permittee will comply fully with all the terms of all the permit conditions.

1. Final bridge designs for Fontaine Boulevard and Lorson Boulevard will be submitted to the Corps of Engineers for review and approval 60 days prior to start of each bridge construction. Project construction of each structure may begin upon the Corps of Engineers' issuance of a start-of-work authorization.
2. The bank armoring for the stream preservation (lower) reach will be ungrouted stone toe with coir fabric lifts or similar materials. A final design for the stream preservation reach, including vegetation species list, will be submitted to the Corps of Engineers for review and

approval 60 days prior to start of bank armoring construction. Project construction may begin upon the Corps of Engineers' issuance of a start-of-work authorization.

3. The bank armoring for the reconfiguration (upper) reach will be armorflex, geogrid, or similar materials. The bank armoring will be covered with at least 6 inches of topsoil and seeded with grasses. The boulder grade control structures will be ungrouted. A final design for the reconfigured channel reach, including vegetation species list, will be submitted to the Corps of Engineers for review and approval 60 days prior to start of channel construction. Project construction may begin upon the Corps of Engineers' issuance of a start-of-work authorization.

4. Sloping boulder grade control structures will be ungrouted and designed to allow passage of small fish. For the stream preservation (lower) reach, the location of grade control structures and their design will be submitted to the Corps of Engineers for review and approval 60 days prior to the start of grade control structure construction.

* 5. Erosion control measures will be implemented to prevent upland erosion into the East Tributary of Jimmy Camp Creek. All upland areas disturbed by the permittee or their (sub)contractors located within 200 feet of the stream will be treated with erosion control measures including placing topsoil, seeding, and mulching within 21 calendar days after final grading or final earth disturbance or in accordance with the erosion control plan required by El Paso County. An erosion control plan or a summary of the County's approved plan will be provided to the Corps of Engineers within 60 days of permit issuance.

6. Noxious weeds will be controlled in all project-disturbed areas within 200 feet of the stream during the 5-year maintenance period. A plan for such control will be provided to the Corps of Engineers within 60 days of permit issuance, for review and approval.

7. A detailed mitigation plan will be provided to the Corps of Engineers within 60 days of permit issuance, for review and approval prior to start of project construction. Project construction may begin upon the Corps of Engineers' issuance of a start-of-work authorization. The plan will provide for the mitigation of the loss of 4.56 acres of wetland shrubs and the loss of riparian trees. The mitigation work will begin in the spring following winter construction (or in the fall following summer construction) and be completed within 6 months of project construction. The plan will include, but is not limited to, the following items:

- A typical cross section showing the area to be planted with shrubs and trees,
- Planting densities and number and species of trees,
- Methods and times of year for planting. (If willow stakes are used, they must be planted with no more than 6 inches of the stake exposed above the ground.) And,
- A plan for short and long term management and maintenance of the mitigation sites, including supplemental tree watering if needed,

replacement of failed plantings before the end of the 5-year monitoring period, and other contingency needs.

5. The mitigation efforts must be maintained for at least 5 years including 5 growing seasons or until the Corps of Engineers has determined that the mitigation efforts have been successful. Tree plantings will be deemed successful when 80% of the planted trees are alive at the end of the 5-year period. Willow shrub plantings will be deemed successful when 50% of the planted shrubs are alive at the end of the 5-year period.

9. An annual monitoring report of mitigation activities is required and will be sent to the Corps of Engineers by October 31 of each year. The monitoring report will include as a minimum:

- A drawing or sketch showing photographic monitoring points,
- Before and after photographs from fixed photographic location(s),
- A brief discussion of the overall success, any bare or problem areas, and a plan to remedy any problem areas.

10. A letter of intent from the local governing authority will be provided as financial assurances for construction, and for contingency and monitoring of the mitigation for the 5-year monitoring period. The assurances of the mitigation effort will be provided sufficient to hire an independent contractor to complete the proposed mitigation should the permittee default. The financial assurance for construction of the mitigation project will in an amount equal to 115 percent of the estimated cost of construction. The financial assurance for contingency and monitoring of the mitigation for the 5-year monitoring period will be in an amount equal to 25% of the construction costs and will be to assure the success of the mitigation. The letter of intent will be submitted to the Corps of Engineers, for approval, within 90 days of permit issuance.

11. Any changes to the project must be approved by the Corps of Engineers through a permit modification prior to the changes being implemented.

Further information:

1. Congressional Authorities: You have been authorized to undertake the activity described above pursuant to:

() Section 10 of the Rivers and Harbors Act of 1899 (33 U.S.C. 403).

(XX) Section 404 of the Clean Water Act (33 U.S.C. 1344).

() Section 103 of the Marine Protection, Research and Sanctuaries Act of 1972 (33 U.S.C. 1413).

2. Limits of this authorization.

- a. This permit does not obviate the need to obtain other Federal, state, or local authorizations required by law.

- b. This permit does not grant any property rights or exclusive privileges.
 - c. This permit does not authorize any injury to the property or rights of others.
 - d. This permit does not authorize interference with any existing or proposed Federal project.
3. Limits of Federal Liability. In issuing this permit, the Federal Government does not assume any liability for the following:
- a. Damages to the permitted project or uses thereof as a result of other permitted or unpermitted activities or from natural causes.
 - b. Damages to the permitted project or uses thereof as a result of current or future activities undertaken by or on behalf of the United States in the public interest.
 - c. Damages to persons, property, or to other permitted or unpermitted activities or structures caused by the activity authorized by this permit.
 - d. Design or construction deficiencies associated with the permitted work.
 - e. Damage claims associated with any future modification, suspension, or revocation of this permit.
4. Reliance on Applicant's Data: The determination of this office that issuance of this permit is not contrary to the public interest was made in reliance on the information you provided.
5. Reevaluation of Permit Decision. This office may reevaluate its decision on this permit at any time the circumstances warrant. Circumstances that could require a reevaluation include, but are not limited to, the following:
- a. You fail to comply with the terms and conditions of this permit.
 - b. The information provided by you in support of your permit application proves to have been false, incomplete, or inaccurate (See 4 above).
 - c. Significant new information surfaces which this office did not consider in reaching the original public interest decision.
- Such a reevaluation may result in a determination that it is appropriate to use the suspension, modification, and revocation procedures contained in 33 CFR 325.7 or enforcement procedures such as those contained in 33 CFR 326.4 and 326.5. The referenced enforcement procedures provide for the issuance of an administrative order requiring you to comply with the terms and conditions of your permit and for the initiation of legal action where appropriate. You will be required to pay for any corrective measures ordered by this office, and if you fail to comply with such directive, this office may in certain situations (such as those specified in 33 CFR 209.170) accomplish the corrective measures by contract or otherwise and bill you for the cost.
6. Extensions. General condition 1 establishes a time limit for the completion of the activity authorized by this permit. Unless there are circumstances requiring either a prompt completion of the authorized activity or a reevaluation of the public interest decision, the Corps will normally give favorable consideration to a request for an extension of this time limit.
- Your signature below, as permittee, indicates that you accept and agree to comply with the terms and conditions of this permit.

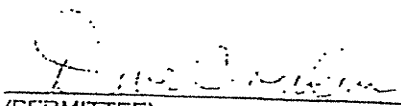
 (PERMITTEE)

11 September 2007
 (DATE)

This permit becomes effective when the Federal official, designated to act for the Secretary of the Army, has signed below.



Van A. Truan
Chief, Southern Colorado Regulatory Office
(for the DISTRICT ENGINEER)

22 September 2006

(DATE)

When the structures or work authorized by this permit are still in existence at the time the property is transferred, the terms and conditions of this permit will continue to be binding on the new owner(s) of the property. To validate the transfer of this permit and the associated liabilities associated with compliance with its terms and conditions, have the transferee sign and date below.

(TRANSFERREE)

(DATE)

City of Colorado Springs/North Lorson Ranch Boundary

PROPOSED
PROJECT SITE

Existing Fontaine Blvd.

Ex, Lorson Blvd.

East Fork Jimmy Camp Creek

Lorson Ranch South Boundary

Peaceful Valley Subdivision

Marksheffel Road

Jimmy Camp Creek

Peaceful Valley Road

FIG. 1 VICINITY MAP

SCALE: N.T.S.

STATUS OF CONSTRUCTION ACTIVITIES IN 2020 PERMITTED UNDER ACTION NO. 2005 00757

- ① MIDDLE REACH 3,600 LF RECONFIGURED CHANNEL EXISTING-COMPLETED IN 2007 PER PERMIT
- ② UPPER REACH 3,100 LF STABILIZED CHANNEL WITH FLOODPLAIN PRESERVATION COMPLETED PER PERMIT MOCIFICAITON #1
- ③ EXISTING FONTAINE BLVD BRIDGE COMPLETED PER PERMIT MODIFICATION #1
- ④ EXISTING LORSON BLVD BRIDGE COMPLETED PER PERMIT MODIFICATION #1
- ⑤ LOWER REACH 3,640± LF STREAM PRESERVATION PROPOSED PER THIS PERMIT MODIFICATION #2

ITEM #1 WAS COMPLETED IN 2007

ITEMS #2, #3 AND #4 COMPLETED PROJECTS PER PERMIT MODIFICATION NO. 1 IN 2017 TO 2018.

ITEM #5 ADDRESSED IN MODIFICATION AMENDMENT #2.

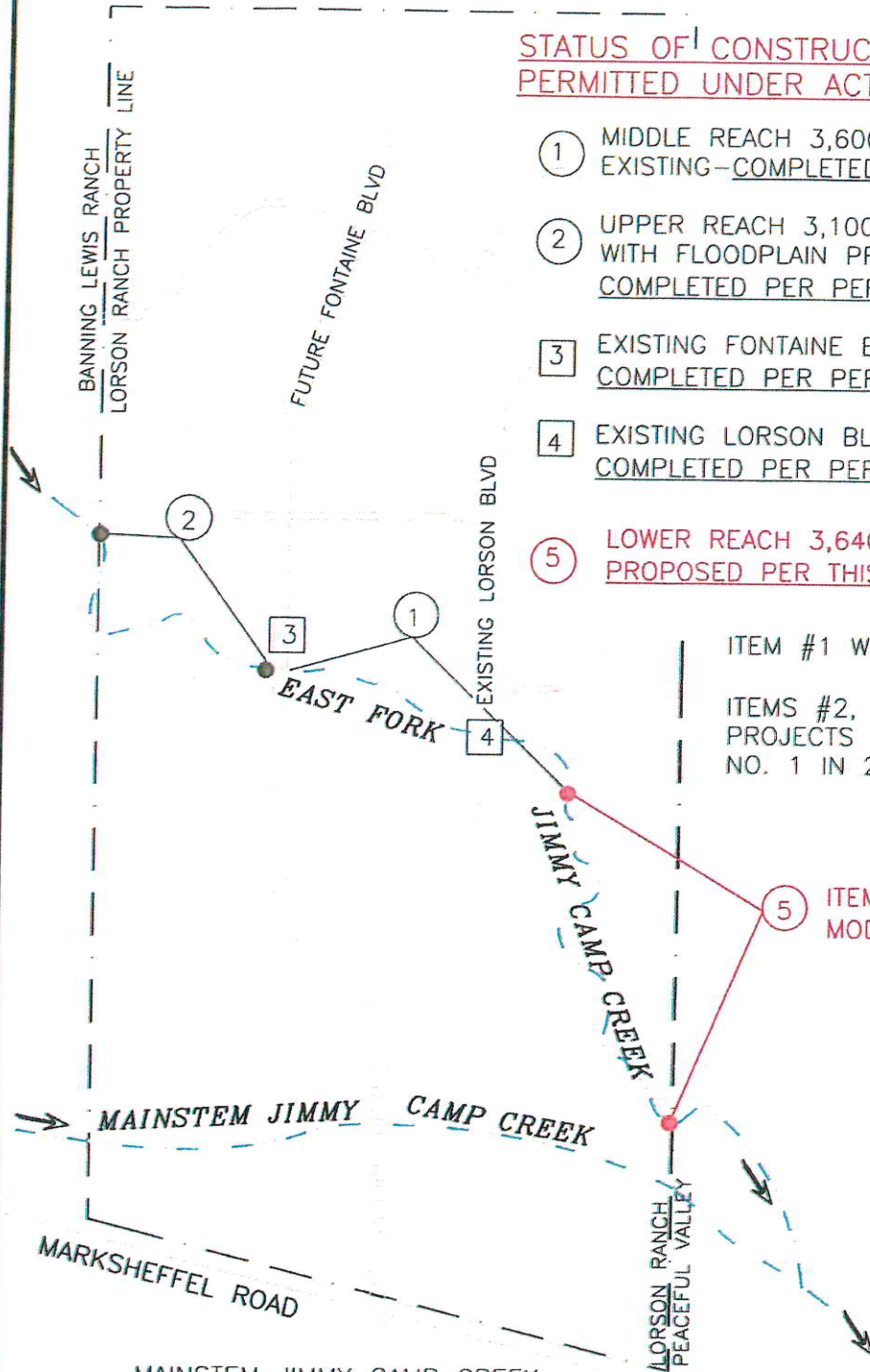

MAINSTEM JIMMY CAMP CREEK
PERMITTED UNDER ACTION NO.
2002 00701
CONSTRUCTION COMPLETED

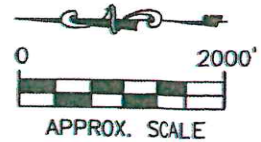

LORSON RANCH
PERMIT MODIFICATION AMENDMENT NO. 2 MAP
ACTION NO. 2005 00757
EL PASO COUNTY, COLORADO

FIGURE 2

DATE: 04/1/20
PROJECT NO. 18020

Kiowa
Engineering Corporation

1804 South 21st Street
Colorado Springs, Colorado 80904
(719) 530-7342

Project No.	18821
Date	7/2009
Design	EAK
Drawn	DAK
Checked	
Reviewed	

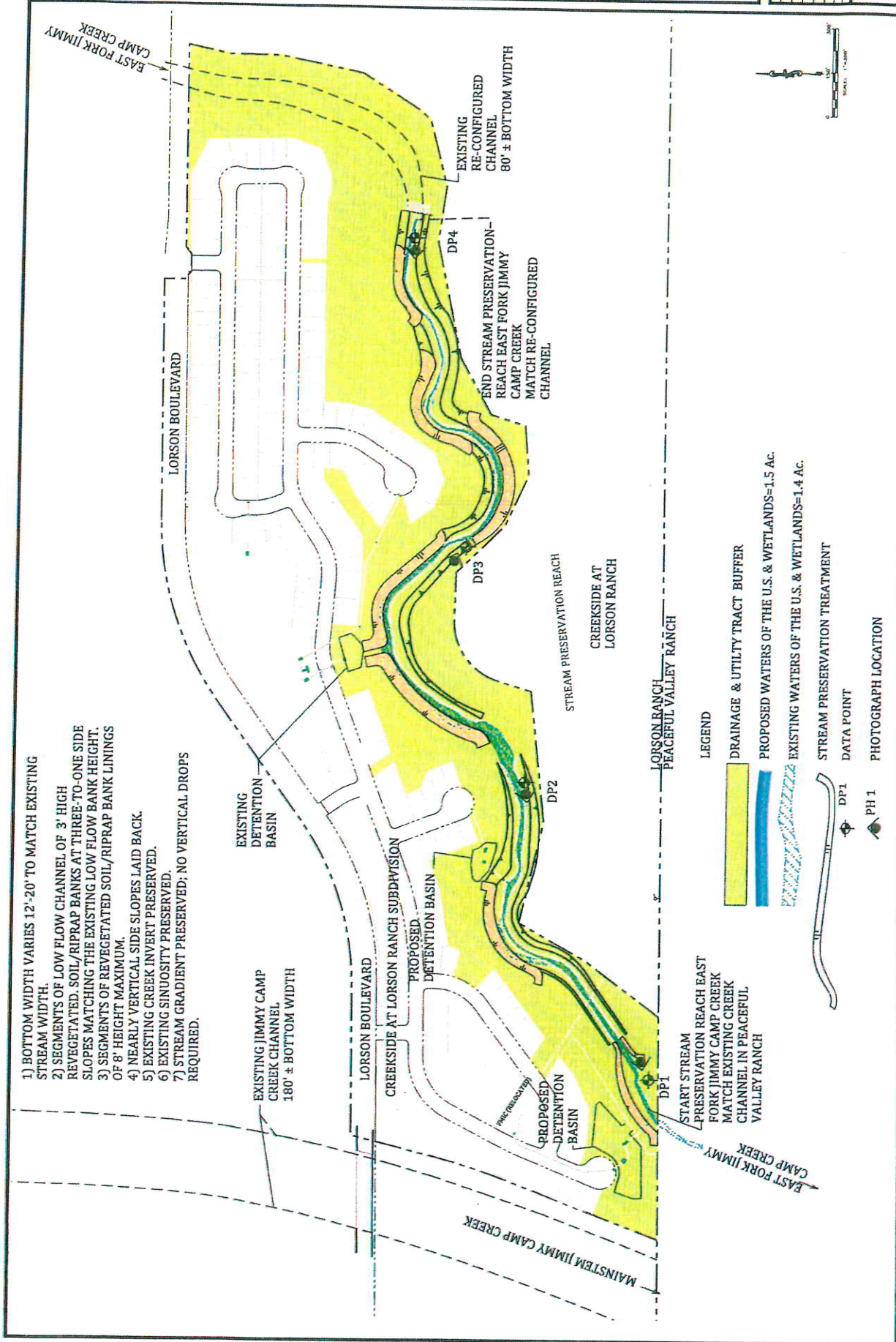

- 1) BOTTOM WIDTH VARIES 12'-20' TO MATCH EXISTING STREAM WIDTH.
- 2) SEGMENTS OF LOW FLOW CHANNEL OF 3' HIGH REVEGETATED SOIL/RIPRAP BANKS AT THREE-TO-ONE SIDE SLOPES MATCHING THE EXISTING LOW FLOW BANK HEIGHT.
- 3) SEGMENTS OF REVEGETATED SOIL/RIPRAP BANK LININGS OF 8' HEIGHT MAXIMUM.
- 4) NEARLY VERTICAL SIDE SLOPES LAID BACK.
- 5) EXISTING CREEK INVERT PRESERVED.
- 6) EXISTING SINUOSITY PRESERVED.
- 7) STREAM GRADIENT PRESERVED; NO VERTICAL DROPS REQUIRED.

- LEGEND**
- DRAINAGE & UTILITY TRACT BUFFER
 - PROPOSED WATERS OF THE U.S. & WETLANDS=1.5 AC.
 - EXISTING WATERS OF THE U.S. & WETLANDS=1.4 AC.
 - STREAM PRESERVATION TREATMENT
 - DATA POINT
 - PH 1
 - PHOTOGRAPH LOCATION

DATE PLOTTED: 7/2009

Appendix C
Creekside at Lorson Ranch Filing No., 1- Geotechnical Report
NCRS Soil Survey



ROCKY MOUNTAIN GROUP

GEOLOGY AND SOILS REPORT

**Creekside at Lorson Ranch, Filing No. 1
El Paso County, Colorado**

PREPARED FOR:

**Lorson Ranch Metropolitan District No.1
212 N. Wahsatch Ave, Ste. 301
Colorado Springs, CO 80903**

JOB NO. 164808

August 10, 2018

Respectfully Submitted,

RMG – Rocky Mountain Group

Reviewed by,

RMG – Rocky Mountain Group

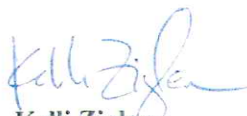
Kelli Zigler
Project Geologist

Geoff Webster, P.E.
Sr. Geotechnical Project Manager



TABLE OF CONTENTS

1.0 GENERAL SITE AND PROJECT DESCRIPTION.....	4
1.2 Existing and Proposed Land Use.....	4
1.3 Project Description.....	4
2.0 QUALIFICATIONS OF PREPARERS.....	4
3.0 STUDY OVERVIEW.....	5
3.1 Scope and Objective.....	5
3.2 Site Evaluation Techniques.....	5
3.3 Previous Studies and Filed Investigation.....	6
4.0 SITE CONDITIONS.....	6
4.1 Land Use.....	6
4.2 Topography.....	6
4.3 Vegetation.....	6
5.0 FIELD INVESTIGATION.....	7
5.1 Drilling.....	7
5.2 Laboratory Testing.....	7
6.0 GEOLOGIC AND SUBSURFACE CONDITIONS.....	7
6.1 General Physiographic Setting.....	7
6.2 General Geology.....	7
6.3 Soil Conservation Service.....	8
6.4 Subsurface Materials.....	8
6.5 Bedrock Conditions.....	8
6.6 Structural Features.....	9
6.7 Surficial (Unconsolidated) Deposits.....	9
6.8 Drainage of Water and Groundwater.....	9
6.9 Features of Special Significance.....	9
6.10 Engineering Geology.....	9
6.11 Mineral Resources.....	9
6.12 Permeability.....	10
7.0 POTENTIAL GEOLOGIC CONDITIONS.....	10
7.1 Landslides.....	10
7.2 Rockfall.....	10
7.3 Debris Flow and Debris Fans.....	11
7.4 Faults and Seismicity.....	11
7.5 Steeply Dipping Bedrock.....	12
7.6 Unstable or Potentially Unstable Slopes.....	12
7.7 Ground Subsidence.....	13
7.8 Hydrocompactive and Potentially Expansive Soils (Moisture Sensitive Soils).....	13
7.9 Radon.....	13
7.10 Flooding and Surface Drainage.....	14
7.11 Springs and High Groundwater.....	14
7.12 Erosion and Corrosion.....	15
7.13 Surface Grading and Drainage.....	15
7.14 Fill Soils.....	15
7.15 Proposed Grading, Erosion Control, Cuts and Masses of Fill.....	16
7.16 Onsite Waste Water Treatment Systems.....	16
7.17 Special Recommendations.....	16
8.0 BEARING OF GEOLOGIC CONDITIONS UPON PROPOSED DEVELOPMENT.....	17
9.0 BURIED UTILITIES.....	17
10.0 PAVEMENTS.....	18
11.0 ANTICIPATED FOUNDATION SYSTEMS.....	18

11.1 Subexcavation and Moisture Conditioned Fill	18
11.2 Foundation Stabilization.....	19
11.3 Foundation Drains	19
11.4 Structural Fill.....	19
11.5 Design Parameters.....	20
12.0 DETENTION STORAGE CRITERIA.....	20
2.1 Detention Storage Criteria.....	20
12.2 Embankment Recommendations.....	21
13.0 ADDITIONAL STUDIES.....	21
14.0 CONCLUSIONS.....	21
15.0 CLOSING.....	22
16.0 REFERENCES.....	23

FIGURES

Site Vicinity Map	1
Aerial Photograph	2
Preliminary Concept Plan	3
Preliminary Concept Plan with Test Boring Locations	4
Explanation of Test Boring Logs	5
Test Boring Logs.....	6-11
Summary of Laboratory Test Results	12
Soil Classification Data.....	13-17
Swell/Consolidation Test Results	16-18
USDA Soils Survey Map	19
Geologic Conditions Map	20
FEMA Map	21
Active Drain in Sewer Utility Trench.....	22
Passive Drain in Sewer Utility Trench	23

APPENDIX A – Guideline Site Grading Specifications

APPENDIX B – USGS Seismic Output

1.0 GENERAL SITE AND PROJECT DESCRIPTION

1.1 Project Location

The project lies in the northeast portion of Section 23, Township 15 South, Range 65 West of the 6th Principal Meridian in El Paso County, Colorado. The approximate location of the site is shown on the Site Vicinity Map, Figure 1.

1.2 Existing Land Use

The site currently consists of portions of ree parcels. The combined total area of the proposed site is to be 83.085 acres. The three parcels included are:

- Schedule No. 5500000265 which consists of 48.88 acres and is located on the northern portion of the site. The parcel is currently not developed.
- Schedule No. 5500000267 which consists of 18.87 acres and is located along the northern portion of Jimmy Camp Creek “east tributary”. The parcel is currently not developed.
- A portion of Schedule No. 5500000406 which consists of 15.335 acres and is located along the southern bank of Jimmy Camp Creek “east tributary”. The parcel is currently not developed.

The parcels are zoned "PUD" (Planned Unit Development).

The Jimmy Camp Creek “east tributary” is included in this development, but is to be platted outside of the buildable lots.

1.3 Project Description

The majority of the site is to be developed as a single-family residential subdivision and is proposed to contain 235 single family lots. The proposed development will consist of the replat of portions of the three existing parcels into one parcel with 83.085 acres.

Rocky Mountain Group - RMG was retained to explore the subsurface conditions at the site and develop geotechnical engineering recommendations for the proposed land development operations.

2.0 QUALIFICATIONS OF PREPARERS

This Geology and Soils report was prepared by a professional geologist as defined by Colorado Revised Statutes section 34-1-201(3) and by a qualified geotechnical engineer as defined by policy statement 15, "Engineering in Designated Natural Hazards Areas" of the Colorado State Board of Registration for Professional Engineers and Professional Land Surveyors. (Ord. 96-74; Ord. 01-42)

The principle investigators for this study are Kelli Zigler, P.G. and Geoff G. Webster, P.E. Ms. Zigler is a Professional Geologist as defined by State Statute (C.R.S 34-1-201) with over 18 years of experience in the geological and geotechnical engineering field. Ms. Kelli Zigler holds a B.S. in Geology from the University of Tulsa. Ms. Zigler has supervised and performed numerous geological and geotechnical field investigations in Colorado.

Geoff Webster, P.E. is a licensed Professional Engineer with over 33 years of experience in the structural and geotechnical engineering fields. Mr. Webster is a professional engineer and holds a Master's degree from the University of Central Florida. Mr. Webster has supervised and performed numerous geological and geotechnical field investigation programs in Colorado and other states.

3.0 STUDY OVERVIEW

The purpose of this investigation is to characterize the general geotechnical and geologic site conditions, and present our opinions of the potential effect of these conditions on the proposed development of single-family residences within the referenced site. As such, our services exclude evaluation of the environmental and/or human, health-related work products or recommendations previously prepared, by others, for this project.

Revisions to the conclusions presented in this report may be issued based upon submission of the development plan. This study has been prepared in accordance with the requirements outlined in the El Paso County Land Development Code (LDC) specifically Chapter 8 last updated 01/06/2015 applicable sections include 8.4.9. and the Engineering Criteria Manual (ECM), specifically Appendix C last updated July 29, 2015.

This report presents the findings of the study performed by RMG relating to the geotechnical and geologic conditions of the above-referenced site. Revisions and modifications to the conclusions and recommendations presented in this report may be issued subsequently by RMG based upon additional observations made during grading and construction which may indicate conditions that require re-evaluation of some of the criteria presented in this report.

3.1 Scope and Objective

This report presents the findings of our Geology and Soils Investigation for the Creekside at Lorson Ranch, Filing No. 1 development located in southern El Paso County, Colorado.

The purpose of our report is to adhere to the guidelines outlined in Appendix C of the ECM and Chapter 8.4.9 of the LDC. The occurrences of potential geologic hazards were evaluated and our opinions of the observed conditions on the proposed development with the respect to the intended usage are outlined in this report.

This report presents the findings of the study performed by RMG-Rocky Mountain Group (RMG) relating to the geology and soil conditions of the above-referenced site.

3.2 Site Evaluation Techniques

The information included in this report has been compiled from:

- Field reconnaissance
- Geologic and topographic maps
- Review of selected publicly available, pertinent reports
- Available aerial photographs
- Exploratory borings
- Laboratory testing of representative site soil and rock samples

- Geologic research and analysis
- Site development plans prepared by others

Geophysical investigations were not considered necessary for characterization of the site geology. Monitoring programs, which typically include instrumentation and/or observations for changes in groundwater, surface water flows, slope stability, subsidence, and similar conditions, are not known to exist and were not considered applicable for the scope of this report.

3.3 Previous Studies and Field Investigation

Reports of previous geotechnical engineering/geologic investigations for this site were available for our review and are listed below:

1. *Preliminary Site Grading and Erosion Control plans for Creekside at Lorson Ranch, Filing No. 1, El Paso County, Colorado*, prepared by Core Engineering Group, LLC, Project No. 100.045 dated August, 2018.
2. *FIRM, Flood Insurance Rate Map, El Paso County, Colorado and Incorporated Areas, Parcel 957 of 1300, Map No. 08041CO957F and 08041C1000F* dated March 17, 1997, modified per LOMR Case No. 14-08-0534P.
3. *Preliminary Drainage Plan for Creekside at Lorson Ranch, Filing No. 1, El Paso County, Colorado*, prepared by Core Engineering Group, LLC, Project No. 100.045, August, 2018.
4. *PUD and Preliminary Plan, Creekside at Lorson Ranch, Filing No. 1, El Paso County, Colorado*, prepared by Thomas and Thomas.

4.0 SITE CONDITIONS

4.1 Proposed Land Use and Zoning

It is our understanding that the project is to consist of single-family residential construction on 235 lots at the Creekside at Lorson Ranch, Filing No. 1 subdivision. The residential structures are anticipated to be one to two-stories in height with multi-car garages. The homes may be constructed with or without basements.

Figure 2 presents the general boundaries of our investigation.

4.2 Topography

Based on our site observations, the ground surface generally slopes gently down to the south and southwest across the entire site. The elevation difference across the site from northeast to southwest is approximately 16 to 20 feet. The Jimmy Camp Creek "east tributary" runs along the southern property line and Jimmy Camp Creek runs parallel to the western property line. The Jimmy Camp Creek "east tributary" was dry at the time of the site reconnaissance on July 23, 2018.

4.3 Vegetation

The majority of the site consists of tall native grasses and weeds. Deciduous trees and vegetation are denser along the Jimmy Camp Creek "east tributary".

5.0 FIELD INVESTIGATION

5.1 Drilling

The subsurface conditions within the property were explored by drilling twelve exploratory borings on June 25, 2018 extending to depths of approximately 25 to 30 feet below the existing ground surface. The test borings were performed to explore the subsurface soils underlying the site. The number of borings is in excess of the minimum one test boring per 10 acres of development up to 100 acres and one additional boring for every 25 acres of development above 100 acres as required by the ECM, Section C.3.3.

The test borings were drilled with a power-driven, continuous-flight auger drill rig. Samples were obtained during drilling of the test borings in general accordance with ASTM D-1586 utilizing a 2-inch O.D. Split Barrel sampler. Results of the penetration tests are shown on the drilling logs. The Test Boring are presented in Figures 6 through 11.

5.2 Laboratory Testing

Soil laboratory testing was performed as part of this investigation. The laboratory tests included moisture content, dry density, grain-size analyses, Atterberg Limits and Swell/Consolidation tests. A Summary of Laboratory Test Results is presented in Figure 12. Soils Classification Data is presented in Figures 13 and 15. Swell/Consolidation Test Results are presented in Figures 16 through 18.

6.0 GEOLOGIC AND SUBSURFACE CONDITIONS

6.1 Geologic Conditions

Based upon review of the *Geologic Map of the Fountain Quadrangle, El Paso County, Colorado* the site reconnaissance and exploratory drilling, the site and surrounding area generally consists of a silty to clayey sand and sandy clay overlying the Pierre Shale Formation. The Pierre Shale was not encountered in the Test Borings at the time of drilling.

6.2 General Geology

Our field investigation included a site reconnaissance with consideration given to geologic features and significant surficial deposits. The general geology of the area is typically stream terrace deposits and alluvium soils overlying the Pierre Shale. Three general geology units were mapped in the vicinity of the site and are identified (Morgan, et al., 2003) as:

- af: Man-placed fill – associated with the removal of the existing structures after the Black Forest fire.
- al: alluvium is loose, unconsolidated (not cemented together into a solid rock) soil or sediments, which has been eroded, reshaped by water in some form, and redeposited in a non-marine setting. Alluvium is typically made up of a variety of materials, including fine particles of silt and clay and larger particles of sand and gravel.

- Kp: Pierre Shale – (Upper Cretaceous) Underlain by the Piney Creek Alluvium. Permeability is generally low, excavation and compaction generally easy. Foundation stability is less than fair. The majority of the formation has low to high swell potential. Slope stability is generally poor and slopes steeper than 5 degrees may slide, if the toe of the slope is removed.

The General Geology is presented in the Geologic Conditions Map, Figure 21.

6.3 U.S. Soil Conservation Service

The U.S. Soil Conservation Service along with United States Department of Agriculture (USDA) has identified the soils on the property as:

- 10 – Blendon sandy loam, 0 to 3% slopes. Properties of the sandy loam include, well-drained soils, depth of the water table is anticipated to be greater than 6.5 feet, run-off is anticipated to be low, frequency of flooding and/or ponding is none, and landforms include alluvial fans and terraces.
- 40 – Ellicott loamy coarse sand, 0 to 5% slopes. Properties of the loamy sand include, somewhat excessively drained soils, depth of the water table is anticipated to be greater than 6.5 feet, run-off is anticipated to be very low, frequency of flooding is frequent and ponding is none, and landforms include flood plains and stream terraces.
- 52 – Manzanst clay loam, 0 to 3 percent slopes. Properties of the clay loam include, well-drained soils, depth of the water table is anticipated to be greater than 6.5 feet, runoff is anticipated to be low, frequency of flooding and/or ponding is none, and landforms include terraces and drainage-ways.

The USDA Soil Survey Map is presented in Figure 19.

6.4 Subsurface Materials

The subsurface materials encountered in the test borings were classified using the Unified Soils Classification System (USCS) and the materials were grouped into the general categories of silty to clayey sand (SM and SC), sandy silt (ML) and sandy clay (CL and CH).

Additional descriptions and the interpreted distribution (approximate depths) of the subsurface materials are presented on the Test Boring Logs presented in Figures 6 through 11. The classifications shown on the logs are based upon the engineer's classification of the samples at the depths indicated. Stratification lines shown on the logs represent the approximate boundaries between material types and the actual transitions may be gradual and vary with location.

6.5 Bedrock Conditions

Bedrock was not encountered in the test borings for this investigation. The bedrock beneath the site is considered to be part of the Pierre Shale Formation and consists of sandy claystone, silty sandstone and shale.

6.6 Structural Features

Structural features such as schistosity, folds, zones of contortion or crushing, joints, shear zones or faults were not observed on the site, surrounding the site or in the soil samples collected for laboratory testing.

6.7 Surficial (Unconsolidated) Deposits

Various lake and pond sediments, swamp accumulations, sand dunes, marine and non-marine terrace deposits, talus accumulations, creep or slope wash were not observed along the Jimmy Camp Creek "east tributary" or elsewhere on the site. Slump and slide debris were not observed on the site.

6.8 Drainage of Water and Groundwater

The overall topography of the site slopes down to the south and west towards Jimmy Camp Creek "east tributary". Groundwater was encountered in all twelve of the test borings at depths ranging from approximately 14 to 26 feet at the time of drilling. When checked 29 days subsequent to drilling groundwater was encountered in at depths ranging from approximately 12 to 23 feet below the existing ground surface.

The Jimmy Camp Creek "east tributary" is currently a defined drainage way located along the southern property line of the property. Review of the historical photos provided by Google Earth depict that the Jimmy Camp Creek "east tributary" adjacent to the site has remained in its native state since at least 1999.

6.9 Features of Special Significance

Features of special significance such as accelerated erosion, (advancing gully head, badlands or cliff reentrants) were not observed on the property. Features indicating settlement or subsidence such as fissures, scarplets and offset reference features were also not observed on the property.

Features indicating creep, slump or slide masses in bedrock and surficial deposits were also not observed on the property.

6.10 Engineering Geology

The Engineering Geology is presented below. Charles Robinson and Associates have mapped two environmental engineering units the site as:

- 2A: Stable alluvium, colluvium and bedrock on gentle to moderate slopes (5-12%).
- 7A: Physiographic floodplain where erosion and deposition presently occur and is generally subject to recurrent flooding. Includes 100-year along major streams where floodplain studies have been conducted and Base Flood Elevations have been determined.

The Engineering Geology is presented in the Geologic Conditions Map in Figure 20.

6.11 Mineral Resources

Under the provision of House Bill 1529, it was made a policy by the State of Colorado to preserve for extraction commercial mineral resources located in a populous county. Review of the *Master Plan for*

Mineral Extraction, Map 2 indicates the site is not identified as an aggregate resource. Extraction of the sand and sandstone resources are not considered to be economical compared to materials available elsewhere within the county.

6.12 Permeability

The permeability of a soil measures how well air and water can flow within the soil. Soil permeability varies according to the type of soil and other factors.

The infiltration rate of a soil refers to how much water a type of soil can absorb over a specific time period. Infiltration rates are determined by soil permeability and surface conditions, and usually are measured in inches per hour.

The soils encountered in the test borings, at the time of drilling were silty to clayey sand and sandy clay. The permeability of the sands is anticipated to be moderate to high. The permeability of the clay is anticipated to be low.

7.0 POTENTIAL GEOLOGIC CONDITIONS

The El Paso County Engineering Criteria Manual recognizes and delineates the difference between hazards and constraints. A geologic hazard is one of several types of adverse geologic conditions capable of causing significant damage or loss of property and life. Geologic hazards are defined in Section C.2.2 Sub-section E.1 of the ECM. A geologic constraint is one of several types of adverse geologic conditions capable of limiting or restricting construction on a particular site. Geologic constraints are defined in Section C.2.2 Sub-section E.2 of the ECM. The following sections discuss potential geologic conditions that commonly exist within El Paso County, Colorado.

7.1 Landslides

Landslides are a form of mass wasting slope failure that consists of relatively rapid downward sliding, falling, or flowing of a mass of soil, rock, or a mixture of the two. Landslides typically have one or more distinct failure surfaces. They typically occur on slope sides where the shear strength of a material is exceeded by the driving mass or weight of the material and may be induced by the presence of groundwater, heavy precipitation, and seismic events.

The entire area appears to lie outside the mapped areas of previous landslide and/or unstable slopes according to the electronic (online) version of the Colorado Landslide Inventory map prepared by the Colorado Geological Survey (CGS) located at:

<https://cologeosurvey.maps.arcgis.com/apps/webappviewer/index.html?id=9dd73db7fbc34139abe51599396e2648>

Neither unstable slopes nor apparent signs of ongoing slope movement were observed on the property.

7.2 Rockfall

Rockfall is the falling of a newly detached mass of rock from a cliff or down a very steep slope, and is considered to be a type of landslide with a very rapid rate of down-slope movement. It usually occurs on

mountainsides or other steep slopes during periods of abundant moisture and frequent freeze-thaw cycles, and is caused by the loss of support from underneath or detachment from a larger rock mass. Ice wedging, root growth, or ground shaking, erosion or chemical weathering may start the fall. The rocks may freefall, bounce, tumble, roll, or slide down slope and can vary considerably in size.

The subject site does not have steep slopes with large boulders above or around it to generate rockfall. The subject property is not considered to be prone to rockfall.

7.3 Debris Flow and Debris Fans

Debris flows consist of water with a high sediment load of sand, cobbles and boulders flowing down a stream, ravine, canyon, arroyo or gully, and are typically activated by heavy or long-term rains or snowmelts which cause rapid erosion and transport of surficial materials down slope of drainages. Debris fans are created when debris flows reach a valley with a much lower gradient. As the energy level drops, the sediment load is deposited creating the fan shape.

The potential for the development of significant debris flows was not observed on the surface of the property.

7.4 Faults and Seismicity

Review of the *Geologic Map of the Colorado Springs Quadrangle* and *Map of Areas Susceptible to Differential Heave in Expansive, Steeply Dipping Bedrock, City of Colorado Springs, Colorado* indicates the Ute Pass Fault lies approximately 10 miles to the west of the proposed residential development. According to the CGS, these faults are not considered to be recently active. However, they have been active during geologic times and could affect the site if they did rupture.

Information presented by the CGS indicates that several recent earthquakes have occurred in the vicinity of the Ute Pass Fault near Colorado Springs and Woodland Park. The earthquakes, with magnitudes in the range of 3.0 to 3.9, occurred approximately from 1962 to 2007.

Earthquakes felt at this site will most likely result from minor shifting of the granite mass within the Pikes Peak Batholith which includes pull from minor movements along faults found in the Denver basin. Ground motions resulting from small earthquakes are more likely to affect structures at this site and will likely only affect slopes stability to a minimal degree.

In accordance with the International Building Code, 2012/2015, seismic design parameters have been determined for this site. The Seismic Site Class has been interpreted from the results of the soil test boring drilled within the project site. The USGS seismic design tool has been used to determine the seismic response acceleration parameters. USGS output is presented in Appendix B. The soil on this site is not considered susceptible to liquefaction. The following recommended Seismic Design Parameters are based upon Seismic Site Class D, and a 2 percent probability of exceedance in 50 years. The Seismic Design Category is "B".

Period (sec)	Mapped MCE Spectral Response Acceleration (g)		Site Coefficients		Adjusted MCE Spectral Response Acceleration (g)		Design Spectral Response Acceleration (g)	
	S _s	0.168	F _a	1.6	S _{ms}	0.268	S _{ds}	0.179
1.0	S _l	0.059	F _v	2.4	S _{ml}	0.142	S _{d1}	0.095

Notes: MCE = Maximum Considered Earthquake
g = acceleration due to gravity

The USGS Seismic Output is presented in Appendix B.

7.5 Steeply Dipping Bedrock

Steeply dipping bedrock is a geological hazard common along the Rocky Mountain Front Range piedmont where uplifted sedimentary formations containing thin layers of moderately to highly expansive shale are encountered near the ground surface e.g., Noe and Dodson 1995; Noe 1997. Problematic formations in the region, most notably the Pierre Shale, are characterized by relatively thin vertically oriented beds that can exhibit dissimilar swelling characteristics from one particular bed to the next.

The site lies outside of the mapped zone of areas susceptible to differential heave in expansive steeply dipping bedrock. Bedrock was not encountered in the test borings drilled for this investigation. Indications of dipping bedrock were not observed in the soil samples collected. The site is generally not considered to be prone to steeply dipping bedrock.

7.6 Unstable or Potentially Unstable Slopes

Slope stability is the potential of soil covered slopes to withstand and undergo movement. The stability of a slope is determined by the balance of shear stress and shear strength. Previously stable slopes may initially be affected by preparatory factors, making the slope conditionally unstable. Factors that may trigger a slope failure may be climatic events that can make a slope actively unstable, leading to mass movements. Mass movements can be caused by an increase in shear stress, such as loading, lateral pressure, and transient forces. Alternatively, shear strength may be decreased by weathering, changes in pore water pressure, and organic material.

According to the LDC, Chapter 8.4.2 Section B.3 Unsuitable Building Areas, areas that are identified as having certain characteristics "... shall be deemed unsuitable for building and shall be identified as no build areas on the plat." One such characteristic is "Areas where slopes are greater than 30%." These areas have typically been designated as "No Build" areas in the recent past.

Unstable slopes greater than 30 percent or apparent signs of ongoing slope movement were not observed around or on the property. The subject site is also not in an area identified as containing unstable slopes in the Colorado Landslide Inventory map referenced in section 7.1 of this report.

Mitigation

Long term fill slopes should be limited to areas supported by foundation walls or other engineered components, unless adequately benched into the bedrock. Long term cut slopes in the upper soil should be limited to no steeper than 3:1 (horizontal:vertical).

We believe the surficial soils will classify as Type C materials as defined by OSHA in 29CFR Part 1926, date January 2, 1990. OSHA requires temporary slopes made in Type C materials be laid back at ratios no steeper than 1.5:1 (horizontal to vertical) unless the excavation is shored or braced. Flatter slopes will likely be necessary should groundwater conditions occur.

7.7 Ground Subsidence

Subsidence is the motion of the ground surface (usually, the Earth's surface) as it shifts downward relative to a datum such as sea-level.

Common causes of land subsidence from human activity are pumping water, oil, and gas from underground reservoirs; dissolution of limestone aquifers (sinkholes); collapse of underground mines; drainage of organic soils; and initial wetting of dry soils (hydrocompaction).

The presence of sinkholes and collapse were not observed on the site. The site lies outside of the Colorado Springs Subsidence Investigation report (Dames and Moore, 1985). Evidence of underground mining in the presence of coal was not encountered in the test boring samples. The site is generally not considered to be prone to ground subsidence.

7.8 Hydrocompactive and Potentially Expansive Soils (Moisture Sensitive Soils)

The subsurface materials at the site generally consist of silty to clayey sand and sandy clay. Based on the test borings performed on site, the silty to clayey sand and sandy clay generally possess low swell potential. Expansive bedrock was not identified on this site. It is anticipated that if these materials are encountered can readily be mitigated with typical construction practices common to this region of El Paso County, Colorado.

Mitigation

Shallow foundations are anticipated for structures within this development. Foundation design and construction are typically adjusted for expansive soils. Mitigation of expansive soils are typically accomplished by overexcavation and replacement with structural fill, subexcavation and/or replacement with on-site moisture-conditioned soils. If loose sands are encountered, mitigation of hydrocompactive soils can be accomplished by overexcavation and replacement with structural fill, subexcavation and replacement with on-site moisture-conditioned soils, and/or the use of a geogrid reinforced fill.

7.9 Radon

"Radon Act 51 passed by Congress set the natural outdoor level of radon gas (0.4 pCi/L) as the target radon level for indoor radon levels.

The 80925 zip code located in El Paso County, has an EPA assigned Radon Zone of 1. A radon zone of 1 predicts an average indoor radon screening level greater than 4 pCi/L, which is above the recommended levels assigned by the EPA. Black Forest is located in a high risk area of the country. *The EPA recommends you take corrective measures to reduce your exposure to radon gas.*

Most of Colorado is generally considered to have the potential of high levels of radon gas, based on the information provided at: http://county-radon.info/CO/El_Paso.html. There is not believed to be unusually hazardous levels of radon from naturally occurring sources at this site.

Mitigation

Radon hazards are best mitigated at the building design and construction phases. Providing increased ventilation of basements, crawlspaces, creating slightly positive pressures within structures, and sealing of joints and cracks in the foundations and below-grade walls can help mitigate radon hazards.

7.10 Flooding and Surface Drainage

The Jimmy Camp Creek "east tributary" resides along the southern property boundary. The Flood Insurance Study report and Flood Insurance Rate Map for FEMA Map Number 08041C0957 dated March 17, 1997, has been modified per LOMR Case No. 14-08-0534P.

The Jimmy Camp Creek "east tributary" resides in Zone AE, which is defined by FEMA as areas subject to inundation by the 1-percent-annual chance-flood event determined by detailed methods. This area is shown hatched on the Geologic Conditions Map, Figure 21

The remainder of the site now lies in the Zone X. Zone X is defined by FEMA as an area of minimal flood hazard that is determined to be outside the Special Flood Hazard Area and higher than the elevation of the 0.2-percent-annual-chance (or 500-year) flood.

7.11 Springs and High Groundwater

Based on the site observations, review of the Fountain Quadrangle of El Paso County, 7.5 minute series (Topographic) dated 2000, and Google Earth images dating back to September 1999, springs do not appear to originate on the subject site. Groundwater was encountered at depths ranging from 12 to 23 feet in the test borings for this investigation at the time of drilling and when checked 29 days subsequent to drilling.

Fluctuations in groundwater and subsurface moisture conditions may occur due to variations in rainfall and other factors not readily apparent at this time. Development of the property and adjacent properties may also affect groundwater levels.

Mitigation:

If shallow groundwater conditions are encountered during the Site Specific Soils Investigations and Open Excavation Observations, mitigations can include a combination of surface and subsurface drainage systems, vertical drainboard, etc.

In general, if groundwater was encountered within 4 to 6 feet of the proposed basement slab elevation, an underslab drain should be anticipated in conjunction with the perimeter drain. Perimeter drains are anticipated for each individual lot to prevent the infiltration of water and to help control wetting of potentially expansive and hydrocompactive soils in the immediate vicinity of foundation elements. It must be understood that the drain is designed to intercept some types of subsurface moisture and not others. Therefore, the drain could operate properly and not mitigate all moisture problems relating to foundation performance or moisture intrusion into the basement area.

7.12 Erosion and Corrosion

The upper sands encountered at the site are susceptible to erosion by wind and flowing water. The sandstone at this site typically has low resistivity values (less than 2,000 ohm-cm) and is likely to be potentially corrosive to buried, ferrous metal piping and other structures.

Mitigation:

Due to the nature of the soils on the site it is anticipated that the majority of the surficial soils (silty to clayey sand) is subject to erosion by wind or water. The majority of the site has low lying vegetation that is reducing the potential for erosion. During construction disturbance of the site most likely will occur around the buildings site and may require regrading and revegetation. Further recommendations for Erosion Control are discussed in section 7.15

7.13 Surface Grading and Drainage

The ground surface should be sloped from the buildings with a minimum gradient of 10 percent for the first 10 feet. This is equivalent to 12 inches of fall across this 10-foot zone. If a 10-foot zone is not possible on the upslope side of the structure, then a well-defined swale should be created a minimum 5 feet from the foundation and sloped parallel with the wall with a minimum slope of 2 percent to intercept the surface water and transport it around and away from the structure. Roof drains should extend across backfill zones and landscaped areas to a region that is graded to direct flow away from the structure. Homeowners should maintain the surface grading and drainage recommended in this report to help prevent water from being directed toward and/or ponding near the foundations.

Landscaping should be selected to reduce irrigation requirements. Plants used close to foundation walls should be limited to those with low moisture requirements and irrigated grass should not be located within 5 feet of the foundation. To help control weed growth, geotextiles should be used below landscaped areas adjacent to foundations. Impervious plastic membranes are not recommended.

Irrigation devices should not be placed within 5 feet of the foundation. Irrigation should be limited to the amount sufficient to maintain vegetation. Application of more water will increase the likelihood of slab and foundation movements.

The recommendations listed in this report are intended to address normal surface drainage conditions, assuming the presence of groundcover (established vegetation, paved surfaces, and/or structures) throughout the regions upslope from this structure. However, groundcover may not be present due to a variety of factors (ongoing construction/development, wildfires, etc.). During periods when groundcover is not present in the "upslope" regions, higher than normal surface drainage conditions may occur, resulting in perched water tables, excess runoff, flash floods, etc. In these cases, the surface drainage recommendations presented herein (even if properly maintained) may not mitigate all groundwater problems or moisture intrusion into the structure. We recommend that the site plan be prepared with consideration of increased runoff during periods when groundcover is not present on the upslope areas.

7.14 Fill Soils

Fill soils were not encountered at the time of drilling. Fill soils could include (but are not limited to) non-engineered fills, fill soils containing trash or debris, contaminated, fill soils that appear to have been improperly placed and/or compacted, etc. If unsuitable soils are encountered during the Site Specific

Soils Investigation and/or the Open Excavation Observation, they may require removal (overexcavation) and replacement with compacted structural fill. The anticipated fill areas (af) are hatched on the Geologic Condition Map, Figure 20.

Mitigation

If any man-placed fill is encountered, it is considered unsuitable for support of foundations. If unsuitable fill soils are encountered during construction, they should be removed (overexcavated) and replaced with compacted structural fill. If contaminated soils from the septic fields are encountered all soils should be removed and disposed of properly. The zone of overexcavation shall extend to the bottom of the unsuitable fill zone and shall extend at least that same distance beyond the building perimeter (or lateral extent of any fill, if encountered first). Provided that this recommendation is implemented, the presence of this fill is not considered to pose a risk to the proposed new structures.

7.15 Proposed Grading, Erosion Control, Cuts and Masses of Fill

Preliminary grading plans were provided (referenced above) and reviewed at the time the report was issued. It is assumed based on the test borings for this investigation that the excavations will encounter silty to clayey sands and/or sandy clay. The on-site soils can be used as site grading fill.

The on-site soils are mildly susceptible to wind and water erosion. Minor wind erosion and dust may be an issue for a short time during and immediately after construction. Should the problem be considered severe during construction, watering of the cut areas may be required. Once construction is complete, vegetation should be re-established.

Prior to placement of overlot fill or removal and recompaction of the existing materials, topsoil, low-density native soil, fill and organic matter should be removed from the fill area. The subgrade should be scarified, moisture conditioned to within 2% of the optimum moisture content, and recompacted to the same degree as the overlying fill to be placed. The placement and compaction of fill should be periodically observed and tested by a representative of RMG during construction.

7.16 Onsite Wastewater Treatment Systems

It is our understanding that on-site wastewater treatment systems are not proposed. Based on the Preliminary Plan by Thomas and Thomas, sewer services will be dedicated to Widefield Water and Sanitation District.

7.17 Special Recommendations

The Jimmy Camp Creek "east tributary" extends along the southern boundary of the site. Based on the relative elevation of these water features to the proposed structures and the conditions encountered in the subsurface soil investigation and the open excavation observation for each lot, additional drainage features may be recommended. It appears the current Jimmy Camp Creek "east tributary" alignment and existing detention pond (C1-R) will remain undisturbed during construction.

8.0 BEARING OF GEOLOGIC CONDITIONS UPON PROPOSED DEVELOPMENT

Geologic hazards (as described in section 7.0 of this report) and geologic constraints (also as described in section 7.0 of this report) were found to be present at this site.

The geologic hazards anticipated to affect this site are Faults/Seismicity and Radioactivity/Radon Gas.

The most significant geologic constraints to development recognized at this site are *potential for expansive and hydrocompactive soils*. It may be necessary to design and implement mitigation alternatives at the site.

The geologic conditions encountered at this site are relatively common to the immediate area and mitigation can be accomplished by implementing common engineering and construction practices.

9.0 BURIED UTILITIES

Based upon the conditions encountered in the exploratory test borings, we anticipate that the soils encountered in the utility trench excavations will consist of silty to clayey sands, (SM and SC) sandy silt (ML) and sandy clay (CL and CH). It is anticipated that the sands will be encountered at loose to medium dense relative densities, the clays at medium stiff to very stiff consistencies. Depending on the depth of excavations, temporary shoring and hydraulic water pumps may be required to prevent the collapse of trenches and the accumulation of water at the bottom of the excavation.

We believe the sand and clays will classify as Type C materials as defined by OSHA in 29 CFR Part 1926. OSHA requires that temporary excavations made in Type B and C materials be laid back at ratios no steeper than 1:1 (horizontal to vertical) and 1½:1 (horizontal to vertical), respectively, unless the excavation is shored and braced. Excavations deeper than 20 feet, or when water is present, should always be braced or the slope designed by a professional engineer.

Utility mains such as water and sanitary sewer lines are typically placed beneath paved roadways. The settlement of the utility trench backfill can have a detrimental effect on pavements and roadway surfaces. We recommend that utility trench backfill be placed in thin loose lifts, moisture conditioned as required and compacted to the recommendations outlined in the **Backfill** section of this report. The placement and compaction of utility trench backfill should be observed and tested by a representative of RMG Engineers during construction.

It is a common local practice for underdrains to be placed at the bottom of sanitary sewer trenches within drive lanes. Underdrains placed in the sanitary sewer trenches in areas where groundwater is anticipated will likely be the "active" type, which uses a perforated drain pipe. In areas where groundwater is not anticipated, "passive" type underdrains may be used. Typical underdrain details are presented in Figures 22 and 23. If an underdrain system is used, it will likely necessitate construction and maintenance of a pumping station to collect and redirect the discharge from the underdrain system. At this time an underdrain system is not anticipated. One potential alternative to this approach would be to provide individual sump pits and pumps for each residence to collect and redirect discharge water from all recommended subsurface foundation drains. If this option is selected, care should be taken to

ensure that the sump pumps have outfall to a location that is graded to direct the discharge water away from the surrounding structures and to a suitable collection or drainage area.

10.0 PAVEMENTS

Preliminary Roadway Layout plans were provided prior to the report issue date. Roadways throughout the proposed development are anticipated to be classified as Urban/Residential, Local and Residential Collectors and 2-lane Minor Arterials in accordance with Appendix D of the ECM. ***The actual pavement section design for individual streets will be completed following overlot grading and rough cutting of the street subgrade.***

For preliminary planning purposes, estimated full-depth pavement sections have been evaluated based on current design criteria. For purposes of this report, we anticipate the subgrade soils will primarily have an American Association of State Highway and Transportation Officials (AASHTO) Soil Classification of A-2-4, A-4, A-6, A-7-5, and A-7-6 with an estimated California Bearing Ratio (CBR) value of approximately 3 to 10.

The above value is for preliminary planning purposes and may vary upon final design, dependent upon the soil material used for subgrade construction.

11.0 ANTICIPATED FOUNDATION SYSTEMS

Based on the information presented previously, conventional shallow foundation systems consisting of standard spread footings/stemwalls are anticipated to be suitable for the proposed residential structures. It is assumed that the deepest excavation cuts will be approximately 6 to 8 feet below the final ground surface not including overexcavation which may be required on a lot-by-lot basis.

Due to its swell potential, the sandy clay is generally not suitable for support of spread footing foundations or floor slabs. Where expansive soils are encountered near spread footing foundation or floor slab levels, they should be removed and replaced with granular, non-expansive structural fill. Foundation systems which may reduce or eliminate the need for overexcavation include (but are not limited to) post-tension slabs-on-grade, integral stiffened (ribbed) slab foundations, driller pier (caisson) foundations with or without a structural floor, etc.

If loose or hydrocompactive sands are encountered, they may require additional compaction. In some cases, removal and recompaction may be required for loose soils. Similarly, if shallow groundwater conditions result in unstable soils, unsuitable for bearing of residential foundations, these soils may require stabilization or overexcavation and replacement prior to construction of foundation components.

The foundation system for each lot should be designed and constructed based upon recommendations developed in a detailed Subsurface Soil Investigation completed after site development activities are complete. The recommendations presented in the Subsurface Soil Investigation should be verified by an Open Excavation Observation following the excavation on each lot.

11.1 Subexcavation and Moisture-Conditioned Fill

Based upon the field exploration and laboratory testing, subexcavation and replacement is not anticipated. However, prior to performing excavation and/or filling operations, vegetation, organic and

deleterious material shall be cleared and disposed of in accordance with applicable requirements. The excavation should extend to a minimum depth below and laterally beyond the bottom of foundations as determined based on final grading plans.

11.2 Foundation Stabilization

Groundwater and loose soils were encountered at the time of drilling, if moisture conditions encountered at the time of the foundation excavation result in water flow into the excavation and/or destabilization of the foundation bearing soils, stabilization techniques should be implemented. Various stabilization methods can be employed, and can be discussed at the time of construction. However, a method that affords potentially a reduced amount of overexcavation (versus other methods) and provides increased performance under moderately to severely unstable conditions is the use of a layered geogrid and structural fill system.

Additionally, dependent upon the rate of groundwater flow into the excavation, a geosynthetic vertical drain and an overexcavation perimeter drain may be required around the lower portions of the excavation to allow for installation of the layered geogrid and structural fill system.

11.3 Foundations Drains

A subsurface perimeter drain is recommended around portions of the structure which will have habitable or storage space located below the finished ground surface. This includes crawlspace areas but not the walkout trench, if applicable.

Groundwater conditions were encountered in the test borings at the time of field exploration. The proposed detention ponds appear to be located at proposed basement foundation elevations. Depending on the conditions encountered during the lot specific Subsurface Soil Investigation and the conditions observed at the time of the Open Excavation Observation, additional subsurface drainage systems may be recommended.

One such system is an underslab drainage layer to help intercept groundwater before it enters the slab area should the groundwater levels rise. In general, if groundwater was encountered within 4 to 6 feet of the proposed basement slab elevation, an underslab drain should be anticipated. Another such system would consist of a subsurface drain and/or vertical drain board placed around the perimeter of the overexcavation to help intercept groundwater and allow for proper placement and compaction of the replacement structural fill. Careful attention should be paid to grade and discharge of the drain pipes of these systems.

It must be understood that the drain systems are designed to intercept some types of subsurface moisture and not others. Therefore, the drains could operate properly and not mitigate all moisture problems relating to foundation performance or moisture intrusion into the basement area.

11.4 Structural Fill

Areas to receive structural fill should have topsoil, organic material, or debris removed. The upper 6 inches of the exposed surface soils should be scarified and moisture conditioned to facilitate compaction (usually within 2 percent of the optimum moisture content) and compacted to a minimum of 95 percent of the maximum dry density as determined by the Standard Proctor test (ASTM D-698) or to a minimum

of 92 percent of the maximum dry density as determined by the Modified Proctor test (ASTM D-1557) prior to placing structural fill.

Structural fill placed on slopes should be benched into the slope. Maximum bench heights should not exceed 4 feet, and bench widths should be wide enough to accommodate compaction equipment.

Structural fill shall consist of granular, non-expansive material. It should be placed in loose lifts not exceeding 8 to 12 inches, moisture conditioned to facilitate compaction (usually within 2 percent of the optimum moisture content) and compacted to a minimum of 92 percent of the maximum dry density as determined by the Modified Proctor test, ASTM D-1557. The materials should be compacted by mechanical means.

Materials used for structural fill should be approved by RMG prior to use. Structural fill should not be placed on frozen subgrade or allowed to freeze during moisture conditioning and placement.

11.5 Design Parameters

The allowable bearing pressure of the subsurface soils should be determined by a detailed site specific Subsurface Soil Investigation and verified by and Open Excavation Observation, as noted above.

12.0 DETENTION STORAGE CRITERIA

The purpose of this investigation is to characterize the subsurface soils pertinent to embankment construction, and to provide recommendations regarding embankment construction. This report has been prepared in accordance with the requirements outlined in the El Paso County Land Development Code (LDC), the Engineering Criteria Manual (ECM) Section 2.2.6 and Appendix C.3.2.B, and the El Paso County (EPC) Drainage Criteria Manual, Volume 1 Section 11.3.3.

2.1 Detention Storage Criteria

Detention pond embankments that impound water above the natural grade of the land are considered dams under rules and regulation promulgated by the State of Colorado Department of Natural Resources. Rules and Regulations for Dam Safety and Dam Construction have been developed to provide guidance to design engineers and constructors. Dams are regulated as jurisdictional dams or non-jurisdictional dams. In accordance with El Paso County Drainage Criteria Manual, Volume 1, Section 6.6, embankments associated with Creekside at Lorson Ranch, Filing No. 1 detention ponds CR2 and CR3 **do not** include features that can be considered dams and are not subject to the State dam rules and regulations. Based upon the Creekside at Lorson Ranch Filing No. 1 Early Grading and Erosion Plans, these ponds will be cut into the existing natural terrain and will not impound water above the natural ground level.

The purpose of our report is to comply with the referenced guidelines and provide pertinent geotechnical information upon which to base the design and construction of pond embankments. This report presents the findings of the investigation performed by RMG and our recommendations regarding detention pond construction.

12.2 Embankment Recommendations

In the event that embankments become necessary the following general construction recommendations are applicable. Embankments should be constructed in accordance with applicable sections of the El Paso County Engineering Criteria Manual, the El Paso County Drainage Criteria Manual, and the El Paso County Land Development Manual. The following recommendations are in accordance with the El Paso county DCM Volume 2, Extended Detention Basin (EDB), Design Procedure and Criteria, paragraph 8.

The ground area to receive embankments should be cleared and grubbed to a minimum depth of two-feet to remove grass, shrubs, trees, roots, stumps, and other organic material. The exposed soil should be moisture conditioned to facilitate compaction (usually within 2 percent of the optimum moisture content) and compacted to a minimum of 95 percent of the maximum dry density as determined by the Modified Proctor test (ASTM D-1557). The prepared surface should present a firm and stable condition.

Embankment should be constructed as structural fill on a prepared stable base. On-site native soil when screened of all deleterious material and cobbles greater than 6-inches in any dimension is suitable for embankment construction. Structural fill should be placed in 10-inch loose lifts and moisture conditioned to facilitate compaction (usually within 2 percent of the optimum moisture content) and compacted to a minimum of 95 percent of the maximum dry density as determined by the Modified Proctor test (ASTM D-1557).

Structural fill placed on slopes should be benched into the slope. Maximum bench heights should not exceed 4 feet, and bench widths should be wide enough to accommodate compaction equipment. Structural fill should not be placed on frozen subgrade or allowed to freeze during moisture conditioning and placement. To verify the condition of the compacted soils, density tests should be performed during placement. The first density tests should be conducted when 24 inches of fill have been placed.

13.0 ADDITIONAL STUDIES

The findings, conclusions and recommendations presented in this report were provided to evaluate the suitability of the site for future development. Unless indicated otherwise, the test borings, laboratory test results, conclusions and recommendations presented in this report are not intended for use for design and construction. ***A site specific Subsurface Soil Investigation will be required for all proposed structures including (but not limited to) residences, retaining walls and pumphouses, commercial buildings, etc.***

To develop recommendations for construction of the proposed roadways, a pavement design investigation should be performed. This investigation should consist of additional test borings, soil laboratory testing and specific recommendations for the design and construction of roadway pavement sections.

14.0 CONCLUSIONS

Based upon our evaluation of the geologic conditions, it is our opinion that the proposed development is feasible. The potential for hydrocompactive and expansive soils and flooding, the geologic hazards identified are not considered unusual for the Front Range region of Colorado. Mitigation of geologic

hazards is most effectively accomplished by avoidance. However, where avoidance is not a practical or acceptable alternative, geologic hazards should be mitigated by implementing appropriate planning, engineering, and local construction practices.

Potential mitigation alternatives include (but are not limited to) overexcavation and replacement of unsuitable soils and the design and construction of surface and subsurface drainage systems which are commonly used in the El Paso County vicinity.

Revisions and modifications to the conclusions and recommendations presented in this report may be issued subsequently by RMG based upon additional observations made during grading and construction which may indicate conditions that require re-evaluation of some of the criteria presented in this report.

15.0 CLOSING

This report is for the exclusive purpose of providing geologic hazards information and preliminary geotechnical engineering recommendations. The scope of services did not include, either specifically or by implication, evaluation of wild fire hazards, environmental assessment of the site, or identification of contaminated or hazardous materials or conditions. Development of recommendations for the mitigation of environmentally related conditions, including but not limited to, biological or toxicological issues, are beyond the scope of this report. If the owner is concerned about the potential for such contamination or conditions, other studies should be undertaken.

This report has been prepared for **Lorson Ranch Metro District No. 1** in accordance with generally accepted geotechnical engineering and engineering geology practices. The conclusions and recommendations in this report are based in part upon data obtained from review of available topographic and geologic maps, review of available reports of previous studies conducted in the site vicinity, a site reconnaissance, and research of available published information, soil test borings, soil laboratory testing, and engineering analyses. The nature and extent of variations may not become evident until construction activities begin. If variations then become evident, RMG should be retained to re-evaluate the recommendations of this report, if necessary.

Our professional services were performed using that degree of care and skill ordinarily exercised, under similar circumstances, by geotechnical engineers and engineering geologists practicing in this or similar localities. RMG does not warrant the work of regulatory agencies or other third parties supplying information which may have been used during the preparation of this report. No warranty, express or implied, is made by the preparation of this report. Third parties reviewing this report should draw their own conclusions regarding site conditions and specific construction techniques to be used on this project.

If we can be of further assistance in discussing the contents of this report or analysis of the proposed development, from a geotechnical engineering and/or geologic hazards point-of-view, please feel free to contact us.

16.0 REFERENCES

1. Bing, Street Map, downloaded June 18, 2018.
1. El Paso County, updated thru January 1, 2015, Section 8.4.9, *El Paso County Land Development Code*.
2. El Paso County, revise July 29, 2015, *Appendix C, Soils Investigation Reports and Mitigation, Engineering Criteria Manual*.
3. Google Maps, Aerial Photograph, downloaded June 18, 2018.
4. El Paso County, February 8, 1996, *Master Plan for Mineral Extraction, Map 2*.
5. Kirkham, R.M. and Rogers, W.P., 1981, *Earthquake Potential in Colorado, A Preliminary Evaluation*, Colorado Geological Survey, Bulletin 43.
6. Colorado Geological Survey, 1991, *Results of the 1987-88 EPA Supported Radon Study in Colorado, with a discussion on Geology*, Open file Report 91-4.
7. Dames and Moore, 1985, *Colorado Springs Subsidence Investigation, State of Colorado Mined Land Reclamation*. (Reviewed to verify project location)
8. Federal Emergency Management Agency (FEMA), dated March 17, 1997, *Flood Insurance Rate Map, El Paso County, Colorado and Unincorporated Areas, Community Panel No. 08041C0957*.
9. United States Department of Agriculture Soils Conservation Service, 1980, *Soil Survey of El Paso County Area, Colorado*.
<http://websoilsurvey.sc.egov.usda.gov/App/WebSoilSurvey.aspx>
10. On-site Wastewater Treatment Systems (OWTS) Regulations, El Paso County, Colorado, Chapter 8, effective April 10, 2014 ammended July 7, 2018.
11. Wait, T.C. & White, J.L., 2006. *Rockfall Hazard Susceptibility in Colorado Springs*, El Paso County, Colorado. Colorado Geological Survey, Open-File Report 06-3
12. Colorado Geologic Survey, Colorado Landslide Inventory:
13. <https://cologeosurvey.maps.arcgis.com/apps/webappviewer/index.html?id=5e7484a637c4432e84f4f16d0af306d3>
14. Himmelreich, J.W. & Noe, D.C., 1999, *Map of Areas Susceptible to Differential Heave in Expansive, Steeply Dipping Bedrock*, City of Colorado Springs, Colorado. Colorado Geological Survey, Map Series 32. (Reviewed to verify project location)
15. Charles S. Robinson and Associates, Inc., 1977, El Paso County, Colorado – *Potential Geologic Hazards and Surficial Deposits, Environmental and Engineering Geologic Maps and Tales for Land Use*.
16. Carroll, C.J. & Crawford, T.A., 2000, Geologic Map of the Monument Quadrangle, El Paso County, Colorado, Colorado Geological Survey, Open File Report 00-3.

FIGURES



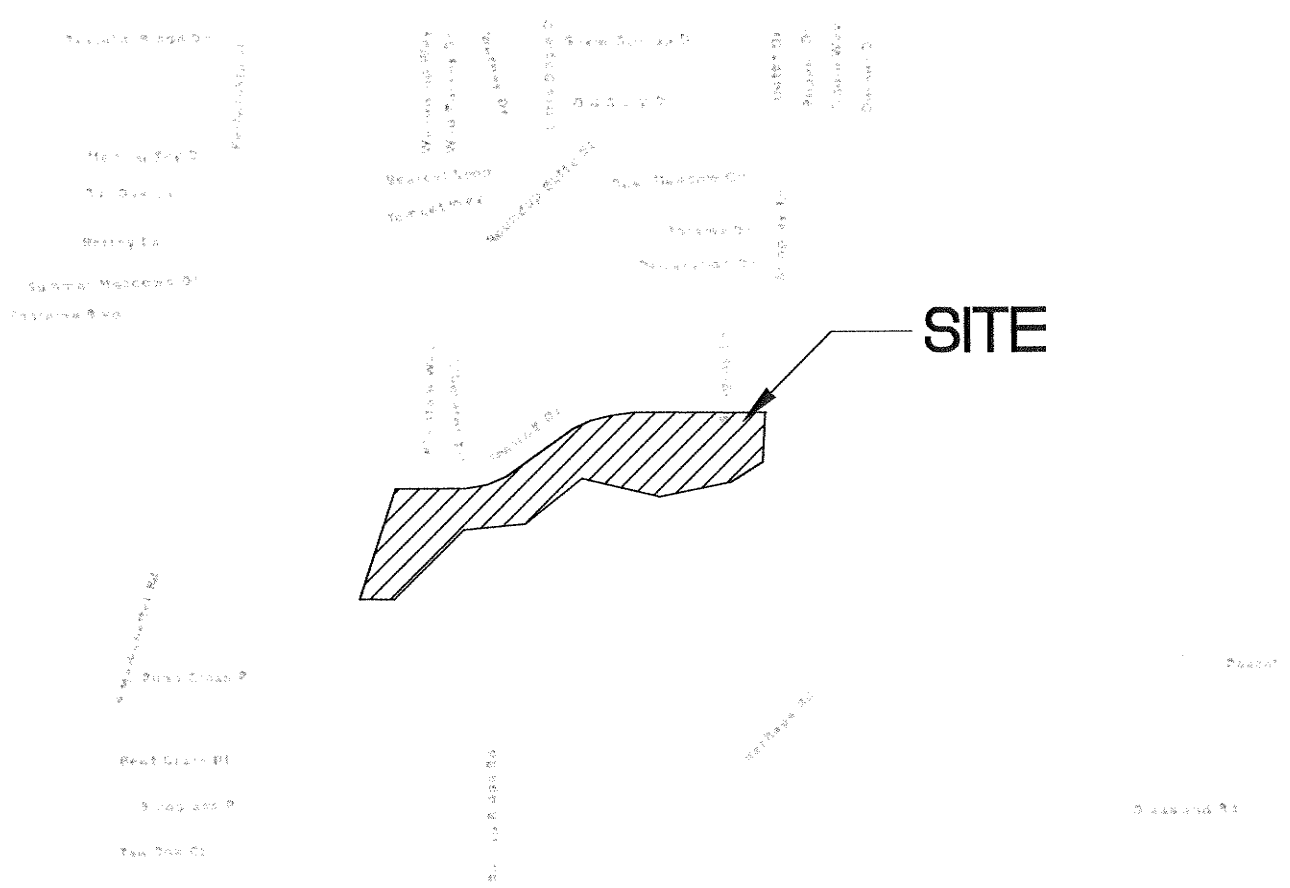

SITE



NOT TO SCALE



ROCKY MOUNTAIN GROUP

Southern Office
 Colorado Springs, CO
 80918
 (719) 548-0600
Central Office:
 Englewood, CO 80112
 (303) 688-9475
Northern Office:
 Greeley / Evans, CO 80620
 (970) 330-1071

SITE VICINITY MAP

**CREEKSIDE AT LORSON RANCH
 FILING NO. 1
 EL PASO COUNTY, COLORADO
 LORSON RANCH METRO DISTRICT NO. 1**

JOB No. 164808

FIG No. 1

DATE 8-10-2018



NOT TO SCALE

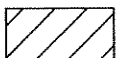

INDICATES THE APPROXIMATE LIMITS OF THIS INVESTIGATION

BASE MAP PROVIDED BY: GOOGLE 2018



ROCKY MOUNTAIN GROUP

Southern Office
 Colorado Springs, CO
 80918
 (719) 548-0600
Central Office:
 Englewood, CO 80112
 (303) 688-9475
Northern Office:
 Greeley / Evans, CO 80620
 (970) 330-1071

**2018 AERIAL
 PHOTOGRAPH**
 CREEKSIDE AT LORSON RANCH
 FILING NO. 1
 EL PASO COUNTY, COLORADO
 LORSON RANCH METRO DISTRICT NO. 1

JOB No. 164808

FIG No. 2

DATE 8-10-2018

JOB No. 164808



ROCKY MOUNTAIN GROUP
Southern Office
Colorado Springs, CO
80918
(719) 548-0800
Central Office
Englewood, CO 80112
(303) 686-9475
Northern Office
Greeley / Evans, CO 80620
(970) 330-1071
Woodland Park Office
(719) 887-6077
Mountain Office
(719) 488-2145
Pueblo / Canon City
(719) 544-7750

CREEKSIDE AT
LORSON, FILING NO. 1
EL PASO COUNTY, CO
LORSON RANCH METRO
DISTRICT, NO. 1

ENGINEER	GW
DRAWN BY	ISZ
CHECKED BY	GW
ISSUED	8-10-2008
DATE	
REVISION	
JOB #	

PRELIMINARY
CONCEPT PLAN

SHEET NO.
FIG-3

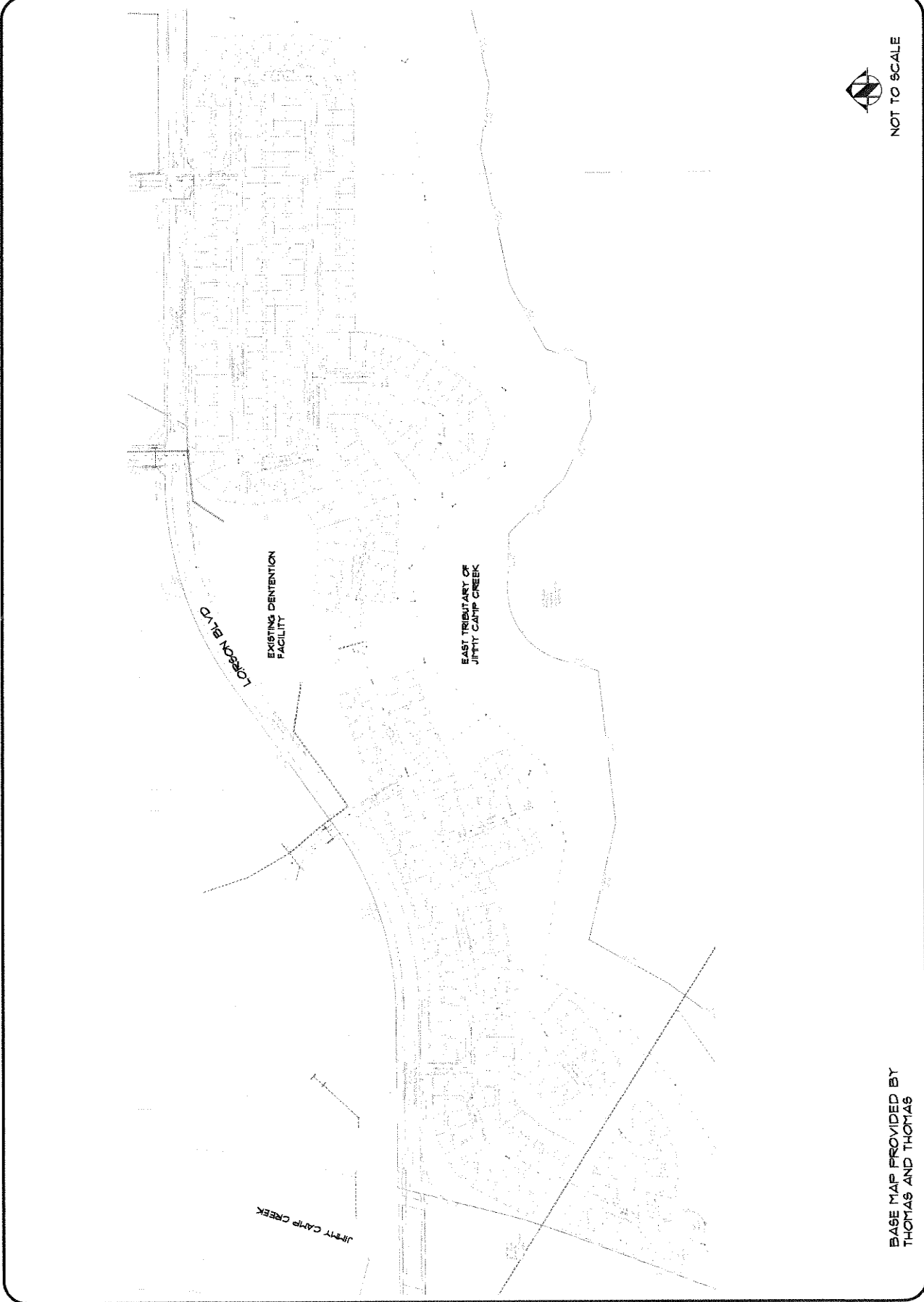

BASE MAP PROVIDED BY
THOMAS AND THOMAS

JOB No. 164808



ROCKY MOUNTAIN GROUP

Southern Office:
 Colorado Springs, CO
 80918
 (719) 548-0600

Central Office:
 Englewood, CO 80112
 (303) 686-9475

Northern Office:
 Greeley / Evans, CO 80620
 (970) 330-1071

Woodland Park Office:
 (719) 687-6077

Monument Office:
 (719) 488-2145

Pueblo / Canon City:
 (719) 544-7750

CREEKSIDE AT
 LORSON, FILING NO. 1

EL PASO COUNTY, CO
 LORSON RANCH METRO
 DISTRICT, NO. 1

ENGINEER:	GM
DRAWN BY:	SK
CHECKED BY:	GM
ISSUED:	8-10-2018
DATE:	
REVISION:	
JOB #:	

PRELIMINARY
 CONCEPT PLAN WITH
 TEST BORING LOCATIONS

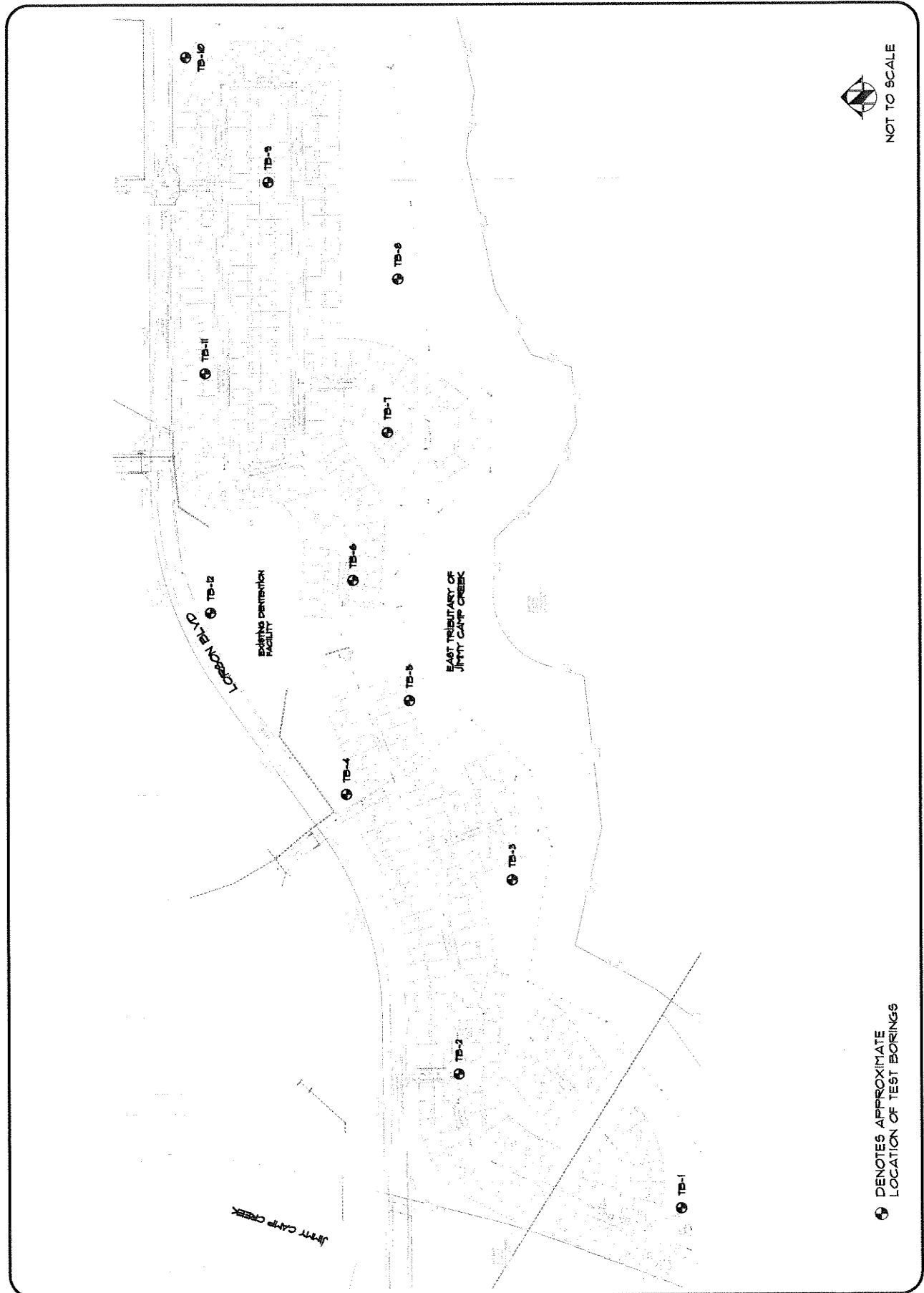

SHEET NO.
FIG-4



NOT TO SCALE







⊕ DENOTES APPROXIMATE
 LOCATION OF TEST BORINGS

SOILS DESCRIPTION

-  CLAYEY SAND
-  SANDY CLAY
-  SILTY SAND

UNLESS NOTED OTHERWISE, ALL LABORATORY TESTS PRESENTED HEREIN WERE PERFORMED BY:
 RMG - ROCKY MOUNTAIN GROUP
 2910 AUSTIN BLUFFS PARKWAY
 COLORADO SPRINGS, COLORADO

SYMBOLS AND NOTES

-  XX STANDARD PENETRATION TEST - MADE BY DRIVING A SPLIT-BARREL SAMPLER INTO THE SOIL BY DROPPING A 140 LB. HAMMER 30", IN GENERAL ACCORDANCE WITH ASTM D-1586. NUMBER INDICATES NUMBER OF HAMMER BLOWS PER FOOT (UNLESS OTHERWISE INDICATED).
-  XX UNDISTURBED CALIFORNIA SAMPLE - MADE BY DRIVING A RING-LINED SAMPLER INTO THE SOIL BY DROPPING A 140 LB. HAMMER 30", IN GENERAL ACCORDANCE WITH ASTM D-3550. NUMBER INDICATES NUMBER OF HAMMER BLOWS PER FOOT (UNLESS OTHERWISE INDICATED).
-  FREE WATER TABLE
-  DEPTH AT WHICH BORING CAVED
-  BULK DISTURBED BULK SAMPLE
-  AUG AUGER "CUTTINGS"
- 4.5 WATER CONTENT (%)

ROCKY MOUNTAIN GROUP

Architectural
Structural
Forensics



Geotechnical
Materials Testing
Civil Planning

Colorado Springs - Corporate Office
2910 Austin Bluffs Parkway
Colorado Springs, CO 80918
(719) 548-0800

SOUTHERN COLORADO, DENVER METRO, NORTHERN COLORADO

EXPLANATION OF TEST BORING LOGS

JOB No. 164808

FIGURE No. 5

DATE 8/10/18

TEST BORING: 1 DATE DRILLED: 6/25/18 ELEVATION (FT): GROUNDWATER @ 23.0' 7/24/18	DEPTH (FT)	SYMBOL	SAMPLES	BLOWS PER FT.	WATER CONTENT %	TEST BORING: 2 DATE DRILLED: 6/25/18 ELEVATION (FT): GROUNDWATER @ 20.0' 7/24/18	DEPTH (FT)	SYMBOL	SAMPLES	BLOWS PER FT.	WATER CONTENT %		
CLAY, SANDY, with clayey sand seams, light brown, medium stiff to stiff, moist to wet	5		7	7	14.1	SAND, SILTY, tan, loose to medium dense, moist	5		8	8	4.6		
	10		17	17	16.9		10		10	10	8.8		
	15		15	15	15.3		15		10	10	4.3		
	20		10	10	33.4		CLAY, SANDY, brown, stiff, moist to wet		20		7	7	29.2
	25		10	10	-		25						
30		10	10	-									

ROCKY MOUNTAIN GROUP

Architectural
Structural
Forensics



Colorado Springs - Corporate Office
2910 Austin Bluffs Parkway
Colorado Springs, CO 80918
(719) 548-0800

SOUTHERN COLORADO, DENVER METRO, NORTHERN COLORADO













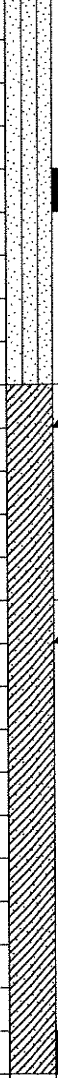







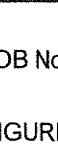

Geotechnical
Materials Testing
Civil, Planning

TEST BORING LOG

JOB No. 164808

FIGURE No. 6

DATE 8/10/18

TEST BORING: 3 DATE DRILLED: 6/25/18 ELEVATION (FT): GROUNDWATER @ 20.0' 7/24/18	DEPTH (FT)	SYMBOL	SAMPLES	BLOWS PER FT.	WATER CONTENT %	TEST BORING: 4 DATE DRILLED: 6/25/18 ELEVATION (FT): GROUNDWATER @ 19.0' 7/24/18	DEPTH (FT)	SYMBOL	SAMPLES	BLOWS PER FT.	WATER CONTENT %
CLAY, SANDY, with sandy silt seams, light brown, stiff to very stiff, moist to wet	5			10	17.1	SAND, SILTY, tan, medium dense, moist	5			10	7.6
	10			15	26.3	CLAY, SANDY, light brown, medium stiff to stiff, moist to wet	10			11	28.7
	15			21	15.3		15			7	20.1
	20			14	31.8					7	32.4
	25			11	34.8		25			7	32.4

ROCKY MOUNTAIN GROUP

Architectural
Structural
Forensics



Geotechnical
Materials Testing
Civil, Planning

Colorado Springs - Corporate Office
2910 Austin Bluffs Parkway
Colorado Springs, CO 80918
(719) 549-0600
SOUTHERN COLORADO, DENVER METRO, NORTHERN COLORADO

TEST BORING LOG

JOB No. 164808

FIGURE No. 7

DATE 8/10/18

TEST BORING: 5 DATE DRILLED: 6/25/18 ELEVATION (FT): GROUNDWATER @ 18.0' 7/24/18	DEPTH (FT)	SYMBOL	SAMPLES	BLOWS PER FT.	WATER CONTENT %	TEST BORING: 6 DATE DRILLED: 6/25/18 ELEVATION (FT): GROUNDWATER @ 15.0' 7/24/18	DEPTH (FT)	SYMBOL	SAMPLES	BLOWS PER FT.	WATER CONTENT %
SAND, SILTY, light brown, medium dense, moist	5			11	10.3	SAND, SILTY, light brown, medium dense, moist	5			6	5.8
CLAY, SANDY, brown, very stiff, moist	10			20	26.2	CLAY, SANDY, brown, stiff, moist	10			7	5.5
SAND, SILTY, TO CLAYEY, light brown, very loose to loose, moist to wet	15			14	11.4	SAND, CLAYEY, brown, loose, moist to wet	15	▽		11	--
CLAY, SANDY, brown, very stiff, moist to wet	20			3	24.6		20			7	26.6
	25			7	23.7	CLAY, SANDY, brown, moist to wet to wet	25				
							30				

ROCKY MOUNTAIN GROUP

Architectural
Structural
Forensics



Geotechnical
Materials Testing
Civil, Planning

Colorado Springs (Corporate Office)
2910 Austin Bluffs Parkway
Colorado Springs, CO 80918
(719) 548-0600

















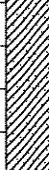



SOUTHERN COLORADO, DENVER METRO, NORTHERN COLORADO

TEST BORING LOG

JOB No. 164808

FIGURE No. 8

DATE 8/10/18

TEST BORING: 7 DATE DRILLED: 6/25/18 ELEVATION (FT): GROUNDWATER @ 14.0' 7/24/18	DEPTH (FT)	SYMBOL	SAMPLES	BLOWS PER FT.	WATER CONTENT %	TEST BORING: 8 DATE DRILLED: 6/25/18 ELEVATION (FT): GROUNDWATER @ 14.0' 7/24/18	DEPTH (FT)	SYMBOL	SAMPLES	BLOWS PER FT.	WATER CONTENT %
CLAY, SANDY, dark brown, medium stiff to very stiff, moist to wet	5			27	20.8	CLAY, SANDY, light brown, medium stiff to stiff, moist to wet	5			17	11.4
	10			7	17.7		10			15	17.9
	15			7	25.6		15				
	20						20			7	28.1
	25			6	27.9		25			7	29.5

ROCKY MOUNTAIN GROUP

Architectural
Structural
Forensics



Geotechnical
Materials Testing
Civil, Planning

Colorado Springs, (Corporate Office)
2910 Austin Bluffs Parkway
Colorado Springs, CO 80918
(719) 548-0900

SOUTHERN COLORADO, DENVER METRO, NORTHERN COLORADO

TEST BORING LOG

JOB No. 164808

FIGURE No. 9

DATE 8/10/18

TEST BORING: 9 DATE DRILLED: 6/25/18 ELEVATION (FT): GROUNDWATER @ 16.0' 7/24/18					TEST BORING: 10 DATE DRILLED: 6/25/18 ELEVATION (FT): GROUNDWATER @ 18.0' 7/24/18				
DEPTH (FT)	SYMBOL	SAMPLES	BLOWS PER FT.	WATER CONTENT %	DEPTH (FT)	SYMBOL	SAMPLES	BLOWS PER FT.	WATER CONTENT %
5			8	15.7	5			9	9.7
10			12	5.9	10			11	7.8
15			8	6.5	15			18	20.9
20					20			12	23.6
25			7	24.8	25				
					30			6	25.0

ROCKY MOUNTAIN GROUP

Architectural
Structural
Forensics



Geotechnical
Materials Testing
Civil, Planning

Colorado Springs - Corporate Office
2910 Austin Bluffs Parkway
Colorado Springs, CO 80918
(719) 546-0600
SOUTHERN COLORADO, DENVER METRO, NORTHERN COLORADO

TEST BORING LOG

JOB No. 164808

FIGURE No. 10

DATE 8/10/18

TEST BORING: 11 DATE DRILLED: 6/25/18 ELEVATION (FT): GROUNDWATER @ 17.0' 7/24/18	DEPTH (FT)	SYMBOL	SAMPLES	BLOWS PER FT.	WATER CONTENT %	TEST BORING: 12 DATE DRILLED: 6/25/18 ELEVATION (FT): GROUNDWATER @ 12.0' 7/24/18	DEPTH (FT)	SYMBOL	SAMPLES	BLOWS PER FT.	WATER CONTENT %
SAND, SILTY, light brown, loose, moist	5			11	13.0	SAND, SILTY, brown, loose, moist	5			6	10.4
CLAY, SANDY, light brown, medium stiff, moist to wet	10			9	6.6	CLAY, SANDY, with sandy silt seams, medium stiff to stiff, moist to wet	10			8	34.9
	15			6	14.0		15			10	32.9
	25			6	20.5		25			8	25.3

ROCKY MOUNTAIN GROUP

Architectural
Structural
Forensics

**ARCHITECTS
RMG
ENGINEERS**

Colorado Springs, CO Corporate Office
2910 Austin Bluffs Parkway
Colorado Springs, CO 80918
(719) 548-0800
SOUTHERN COLORADO, DENVER METRO, NORTHERN COLORADO

Geotechnical
Materials Testing
Civil, Planning

TEST BORING LOG

JOB No. 164808

FIGURE No. 11

DATE 8/10/18

Test Boring No.	Depth	Water Content (%)	Dry Density (pcf)	Liquid Limit	Plasticity Index	% Retained No.4 Sieve	% Passing No. 200 Sieve	FHA Expansion Pressure (psf)	% Swell/ Collapse	USCS Classification
1	4.0	14.1								
1	9.0	16.9	90.3	42	17		38.9		0.5	SC
1	14.0	15.3								
1	19.0	33.4								
2	4.0	4.6								
2	9.0	8.8								
2	14.0	4.3	106.7	NP	NP		30.5		- 2.0	SM
2	24.0	29.2								
3	4.0	17.1		39	12		93.0			ML
3	9.0	26.3								
3	14.0	15.3	108.4						3.2	
3	19.0	31.8								
3	24.0	34.8								
4	4.0	7.6								
4	9.0	28.7		59	29		99.0			CH
4	14.0	20.1								
4	24.0	32.4								
5	4.0	10.3								
5	9.0	26.2								
5	14.0	11.4	93.9	NP	NP		35.1		- 1.5	SM
5	19.0	24.6								
5	24.0	23.7								
6	4.0	5.8								
6	9.0	5.5		NP	NP	0.0	18.1			SM
6	19.0	26.6								
6	24.0	26.0								
6	29.0	22.2								
7	4.0	20.8								
7	9.0	17.7		32	13		65.3			CL
7	14.0	25.6								
7	24.0	27.9								
8	4.0	11.4								
8	9.0	17.9								
8	19.0	28.1		35	19		94.3			CL

ROCKY MOUNTAIN GROUP

Architectural
Structural
Forensics



Geotechnical
Materials Testing
Civil, Planning

Colorado Springs, (Corporate Office)
2910 Austin Bluffs Parkway
Colorado Springs, CO 80918

(719) 548-0600

SOUTHERN COLORADO, DENVER METRO, NORTHERN COLORADO

SUMMARY OF LABORATORY TEST RESULTS

JOB No. 164808
FIGURE No. 12
PAGE 1 OF 2
DATE 8/10/18

Test Boring No.	Depth	Water Content (%)	Dry Density (pcf)	Liquid Limit	Plasticity Index	% Retained No.4 Sieve	% Passing No. 200 Sieve	FHA Expansion Pressure (psf)	% Swell/ Collapse	USCS Classification
8	24.0	29.5								
9	4.0	15.7		NP	NP	0.0	82.5			ML
9	9.0	5.9								
9	14.0	6.5								
9	24.0	24.8								
10	4.0	9.7								
10	9.0	7.8								
10	14.0	20.9	77.4	46	24		62.5		0.0	CL
10	19.0	23.6								
10	29.0	25.0								
11	4.0	13.0								
11	9.0	6.6		NP	NP	0.0	24.1			SM
11	14.0	14.0								
11	24.0	20.5								
12	4.0	10.4								
12	9.0	34.9	85.0	NP	NP		95.3		0.7	ML
12	14.0	32.9								
12	24.0	25.3								

ROCKY MOUNTAIN GROUP

Architectural
Structural
Forensics



Geotechnical
Materials Testing
Civil, Planning

Colorado Springs, (Corporate Office)
2910 Austin Bluffs Parkway
Colorado Springs, CO 80918
(719) 548-0600

SOUTHERN COLORADO, DENVER METRO, NORTHERN COLORADO

SUMMARY OF LABORATORY TEST RESULTS

JOB No. 164808
FIGURE No. 12
PAGE 2 OF 2
DATE 8/10/18

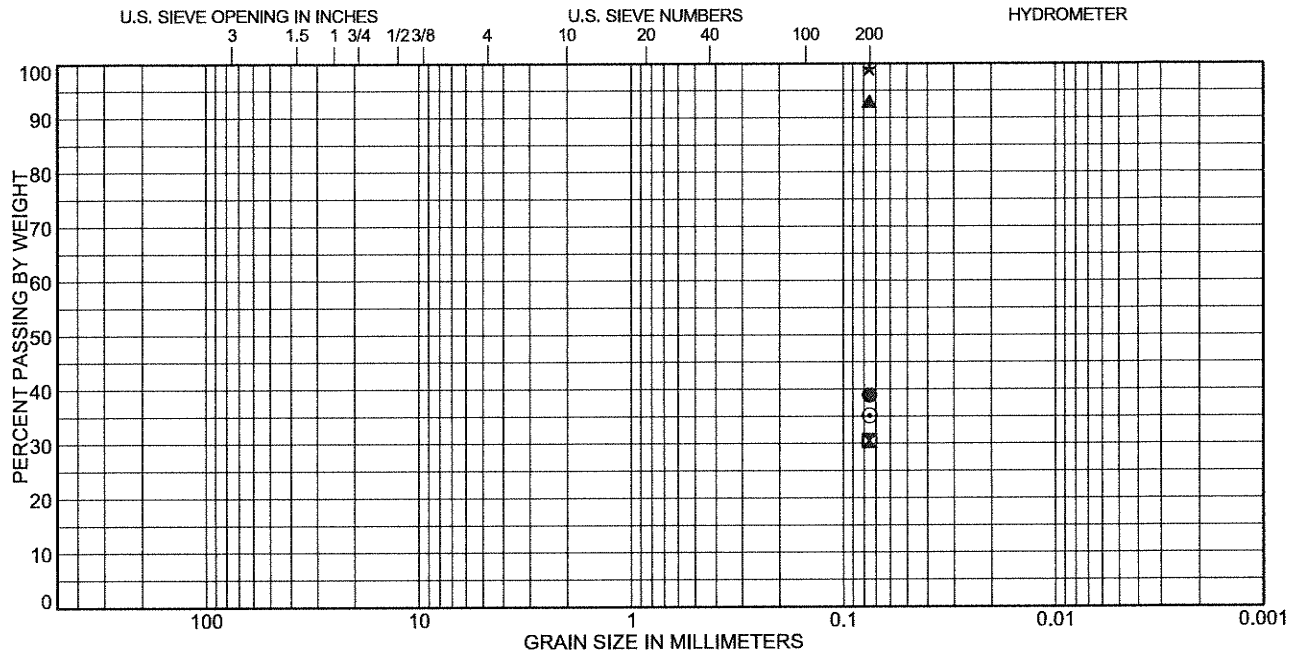

COBBLES	GRAVEL		SAND			SILT OR CLAY
	coarse	fine	coarse	medium	fine	

Test Boring	Depth (ft)	Classification	LL	PL	PI
● 1	9.0	CLAYEY SAND(SC)	42	25	17
☒ 2	14.0	SILTY SAND(SM)	NP	NP	NP
▲ 3	4.0	SILT(ML)	39	27	12
★ 4	9.0	FAT CLAY(CH)	59	30	29
⊙ 5	14.0	SILTY SAND(SM)	NP	NP	NP

Test Boring	Depth (ft)	%Gravel	%Sand	%Silt	%Clay
● 1	9.0			38.9	
☒ 2	14.0			30.5	
▲ 3	4.0			93.0	
★ 4	9.0			99.0	
⊙ 5	14.0			35.1	

ROCKY MOUNTAIN GROUP

Architectural
Structural
Forensics



Geotechnical
Materials Testing
Civil Planning

Colorado Springs (Corporate Office)
2910 Austin Bluffs Parkway
Colorado Springs, CO 80918
(719) 548-0800

SOUTHERN COLORADO, DENVER METRO, NORTHERN COLORADO

SOIL CLASSIFICATION DATA

JOB No. 164808

FIGURE No. 13

DATE 8/10/18

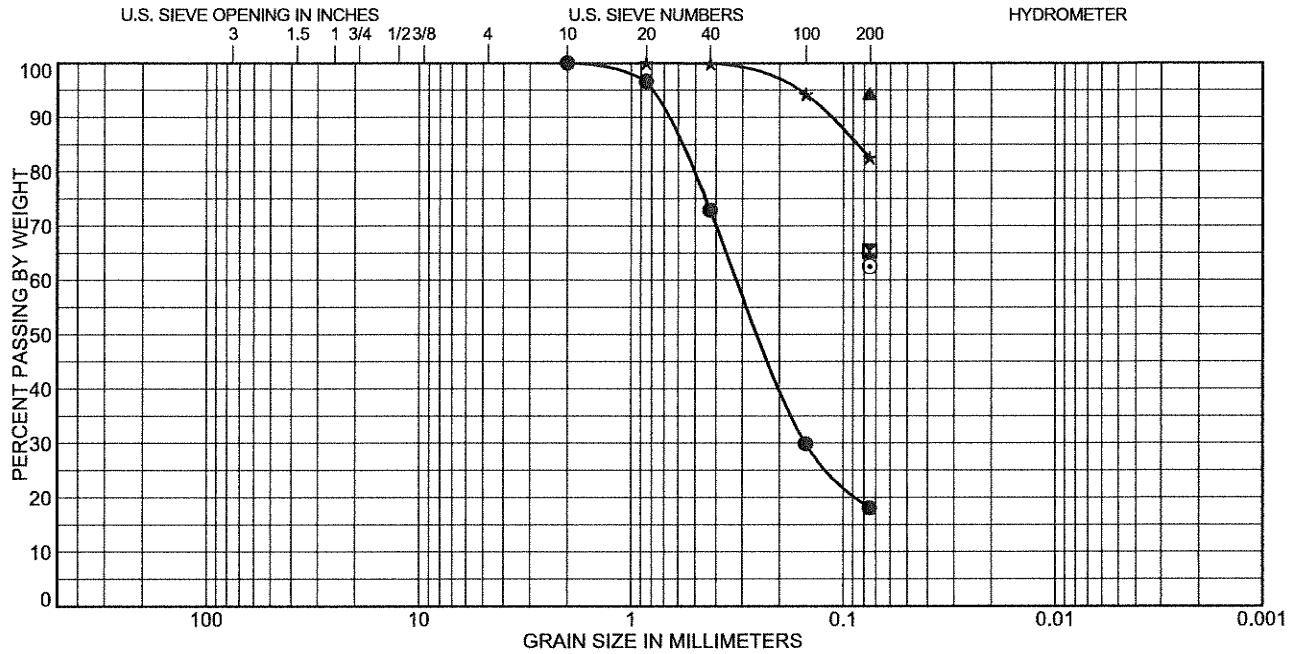

COBBLES	GRAVEL		SAND			SILT OR CLAY
	coarse	fine	coarse	medium	fine	

Test Boring	Depth (ft)	Classification	LL	PL	PI
● 6	9.0	SILTY SAND(SM)	NP	NP	NP
⊗ 7	9.0	SANDY LEAN CLAY(CL)	32	19	13
▲ 8	19.0	LEAN CLAY(CL)	35	16	19
★ 9	4.0	SILT with SAND(ML)	NP	NP	NP
⊙ 10	14.0	SANDY LEAN CLAY(CL)	46	22	24

Test Boring	Depth (ft)	%Gravel	%Sand	%Silt	%Clay
● 6	9.0	0.0	81.9	18.1	
⊗ 7	9.0			65.3	
▲ 8	19.0			94.3	
★ 9	4.0	0.0	17.5	82.5	
⊙ 10	14.0			62.5	

ROCKY MOUNTAIN GROUP

Architectural
Structural
Forensics



Geotechnical
Materials Testing
Civil, Planning

Colorado Springs: (Corporate Office)
2910 Austin Bluffs Parkway
Colorado Springs, CO 80918
(719) 548-0600

SOUTHERN COLORADO, DENVER METRO, NORTHERN COLORADO

SOIL CLASSIFICATION DATA

JOB No. 164808

FIGURE No. 14

DATE 8/10/18

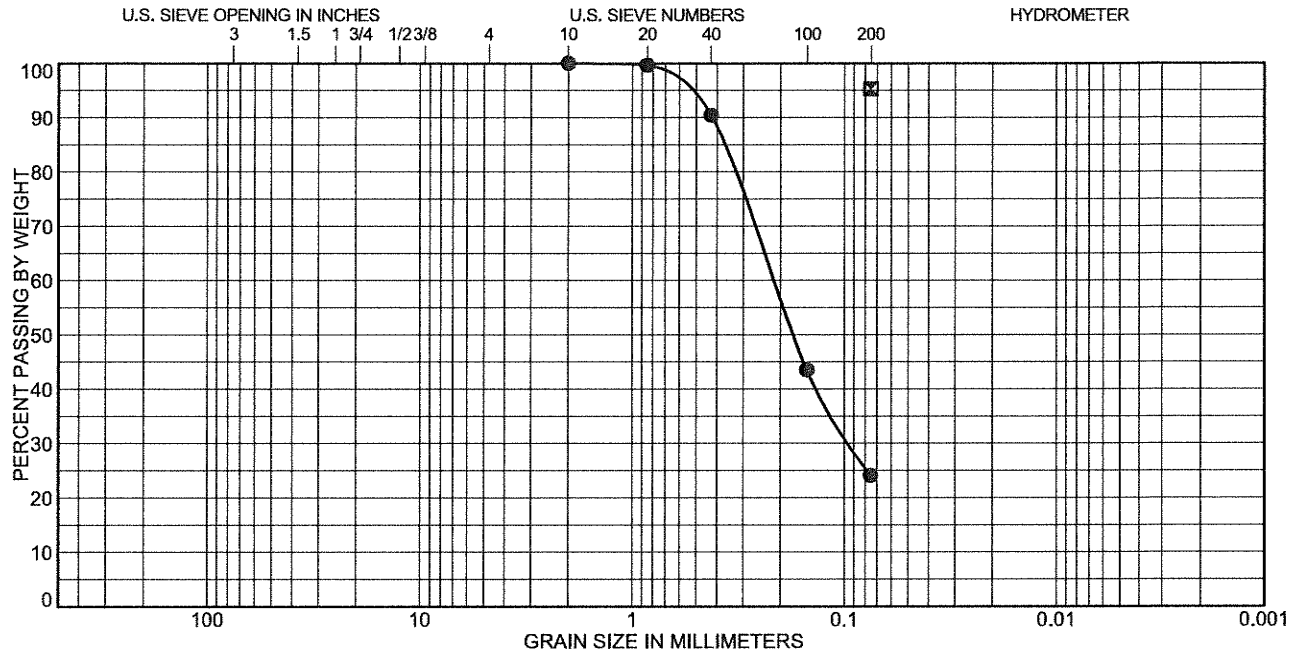

COBBLES	GRAVEL		SAND			SILT OR CLAY
	coarse	fine	coarse	medium	fine	

Test Boring	Depth (ft)	Classification	LL	PL	PI
● 11	9.0	SILTY SAND(SM)	NP	NP	NP
☒ 12	9.0	SILT(ML)	NP	NP	NP

Test Boring	Depth (ft)	%Gravel	%Sand	%Silt	%Clay
● 11	9.0	0.0	75.9	24.1	
☒ 12	9.0			95.3	

ROCKY MOUNTAIN GROUP

Architectural
Structural
Forensics



Geotechnical
Materials Testing
Civil Planning

Colorado Springs (Corporate Office)
2910 Austin Bluffs Parkway
Colorado Springs, CO 80918
(719) 549-0600

SOUTHERN COLORADO, DENVER METRO, NORTHERN COLORADO

SOIL CLASSIFICATION DATA

JOB No. 164808

FIGURE No. 15

DATE 8/10/18

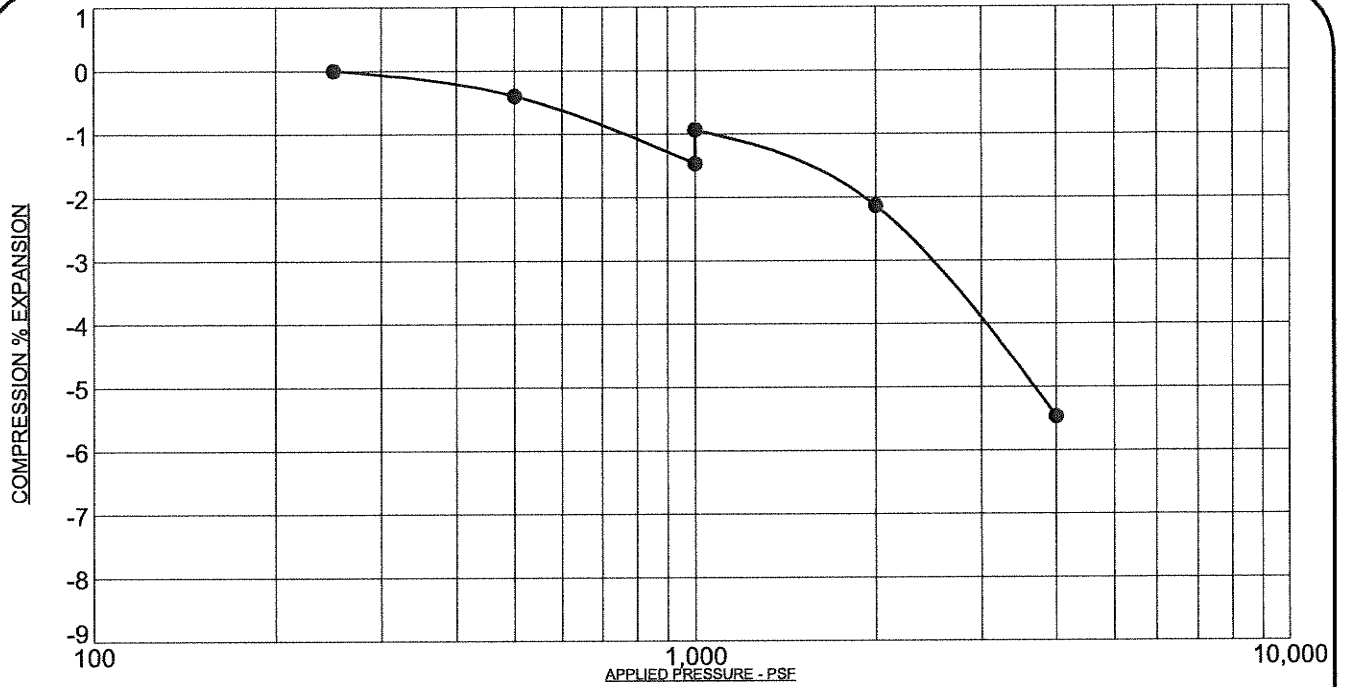

PROJECT: Creekside at Lorson Ranch, Filing No. 1 El Paso County, Colorado
 SAMPLE DESCRIPTION: SAND, CLAYEY
 NOTE: SAMPLE WAS INUNDATED WITH WATER AT 1,000 PSF

SAMPLE LOCATION: 1 @ 9 FT
 NATURAL DRY UNIT WEIGHT: 90.3 PCF
 NATURAL MOISTURE CONTENT: 16.8%
 PERCENT SWELL/COMPRESSION: 0.5

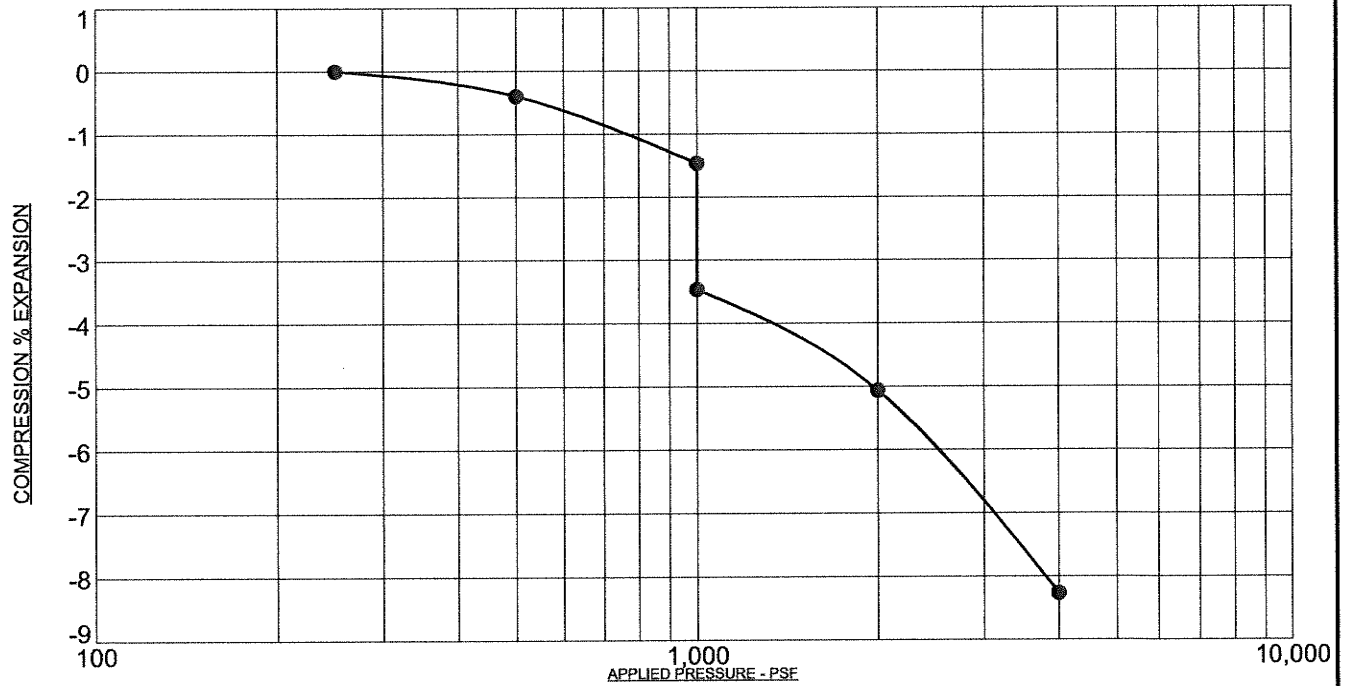

PROJECT: Creekside at Lorson Ranch, Filing No. 1 El Paso County, Colorado
 SAMPLE DESCRIPTION: SAND, SILTY
 NOTE: SAMPLE WAS INUNDATED WITH WATER AT 1,000 PSF

SAMPLE LOCATION: 2 @ 14 FT
 NATURAL DRY UNIT WEIGHT: 106.7 PCF
 NATURAL MOISTURE CONTENT: 4.3%
 PERCENT SWELL/COMPRESSION: -2.0

ROCKY MOUNTAIN GROUP

Architectural
Structural
Forensics



Geotechnical
Materials Testing
Cvt. Planning

Colorado Springs (Corporate Office)
2910 Austin Bluffs Parkway
Colorado Springs, CO 80916
(719) 548-0690

SOUTHERN COLORADO, DENVER METRO, NORTHERN COLORADO

SWELL/CONSOLIDATION TEST RESULTS

JOB No. 164808

FIGURE No. 16

DATE 8/10/18

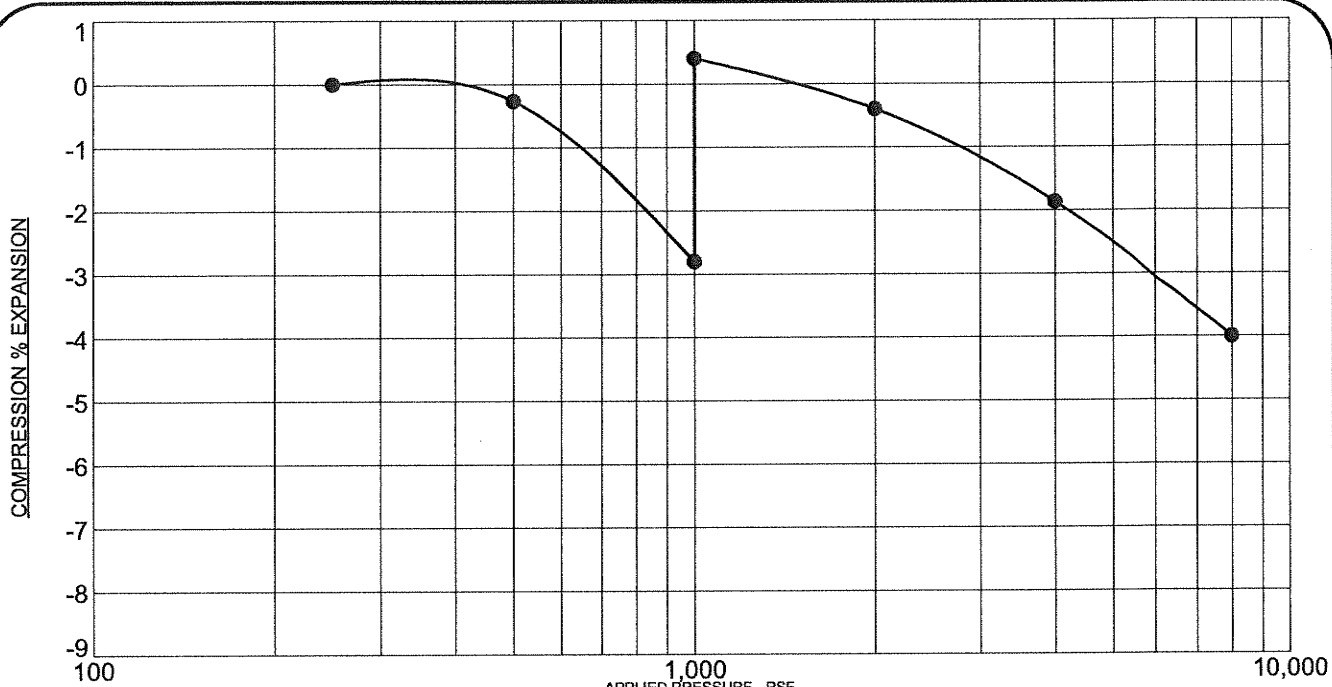

PROJECT: Creekside at Lorson Ranch, Filing No. 1 El Paso County, Colorado
 SAMPLE DESCRIPTION: CLAY, SANDY
 NOTE: SAMPLE WAS INUNDATED WITH WATER AT 1,000 PSF

SAMPLE LOCATION: 3 @ 14 FT
 NATURAL DRY UNIT WEIGHT: 108.4 PCF
 NATURAL MOISTURE CONTENT: 15.3%
 PERCENT SWELL/COMPRESSION: 3.2

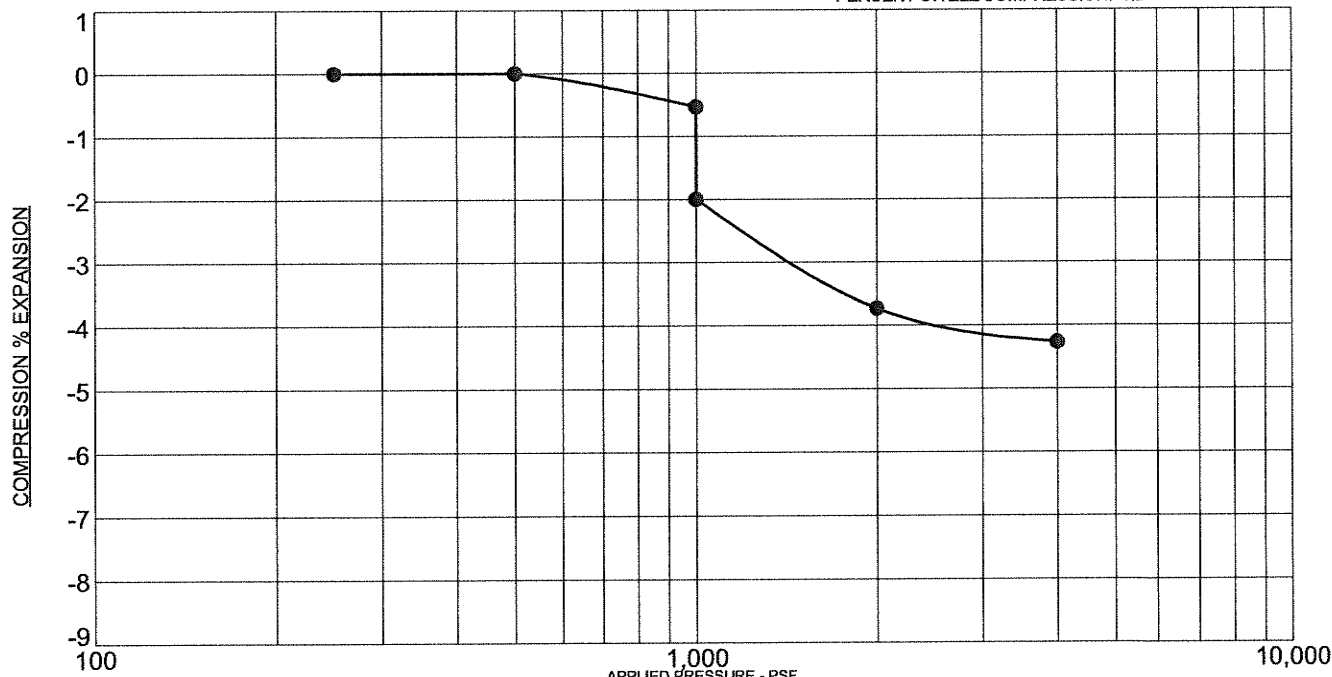

PROJECT: Creekside at Lorson Ranch, Filing No. 1 El Paso County, Colorado
 SAMPLE DESCRIPTION: SAND, SILTY
 NOTE: SAMPLE WAS INUNDATED WITH WATER AT 1,000 PSF

SAMPLE LOCATION: 5 @ 14 FT
 NATURAL DRY UNIT WEIGHT: 93.9 PCF
 NATURAL MOISTURE CONTENT: 11.4%
 PERCENT SWELL/COMPRESSION: -1.5

ROCKY MOUNTAIN GROUP

Architectural
Structural
Forensics

Geotechnical
Materials Testing
Civil, Planning

Colorado Springs - (Corporate Office)
 2910 Austin Bluffs Parkway
 Colorado Springs, CO 80918
 (719) 548-0600
 SOUTHERN COLORADO, DENVER METRO, NORTHERN COLORADO

SWELL/CONSOLIDATION TEST RESULTS

JOB No. 164808
 FIGURE No. 17
 DATE 8/10/18

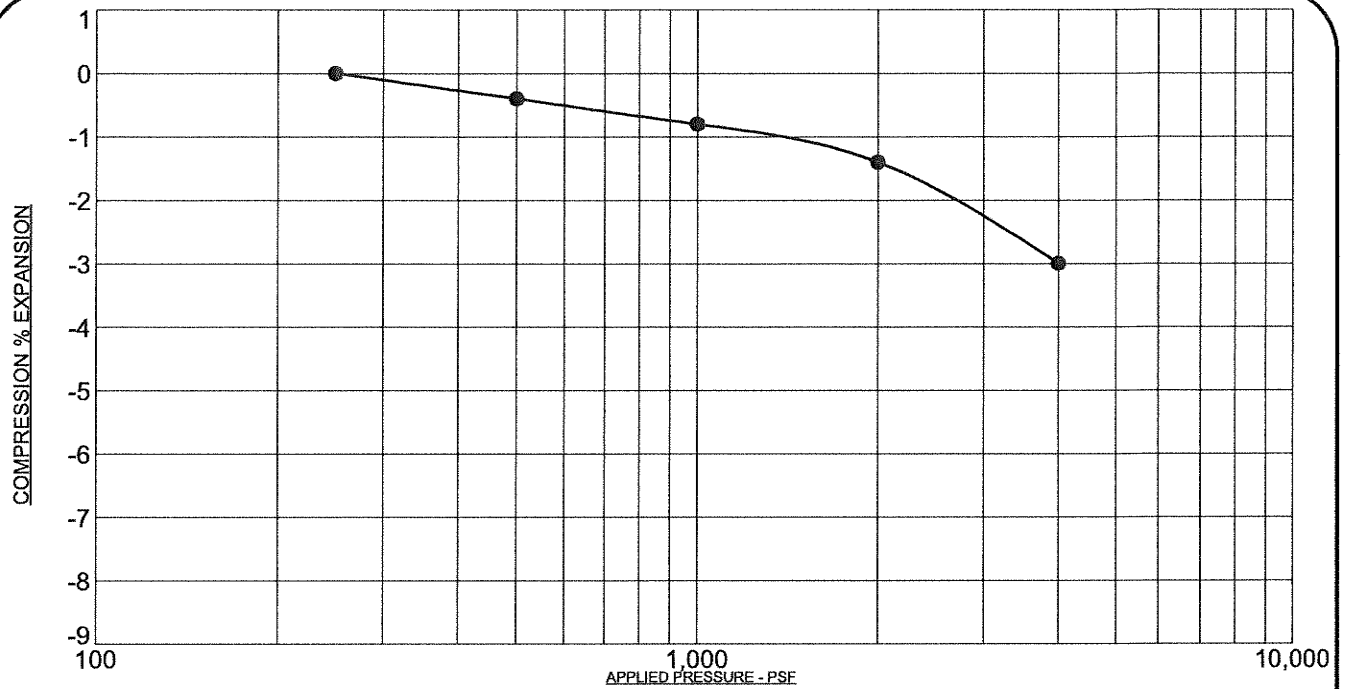

PROJECT: Creekside at Lorson Ranch, Filing No. 1 El Paso County, Colorado
 SAMPLE DESCRIPTION: CLAY, SANDY
 NOTE: SAMPLE WAS INUNDATED WITH WATER AT 1,000 PSF

SAMPLE LOCATION: 10 @ 14 FT
 NATURAL DRY UNIT WEIGHT: 77.4 PCF
 NATURAL MOISTURE CONTENT: 20.9%
 PERCENT SWELL/COMPRESSION: 0.0

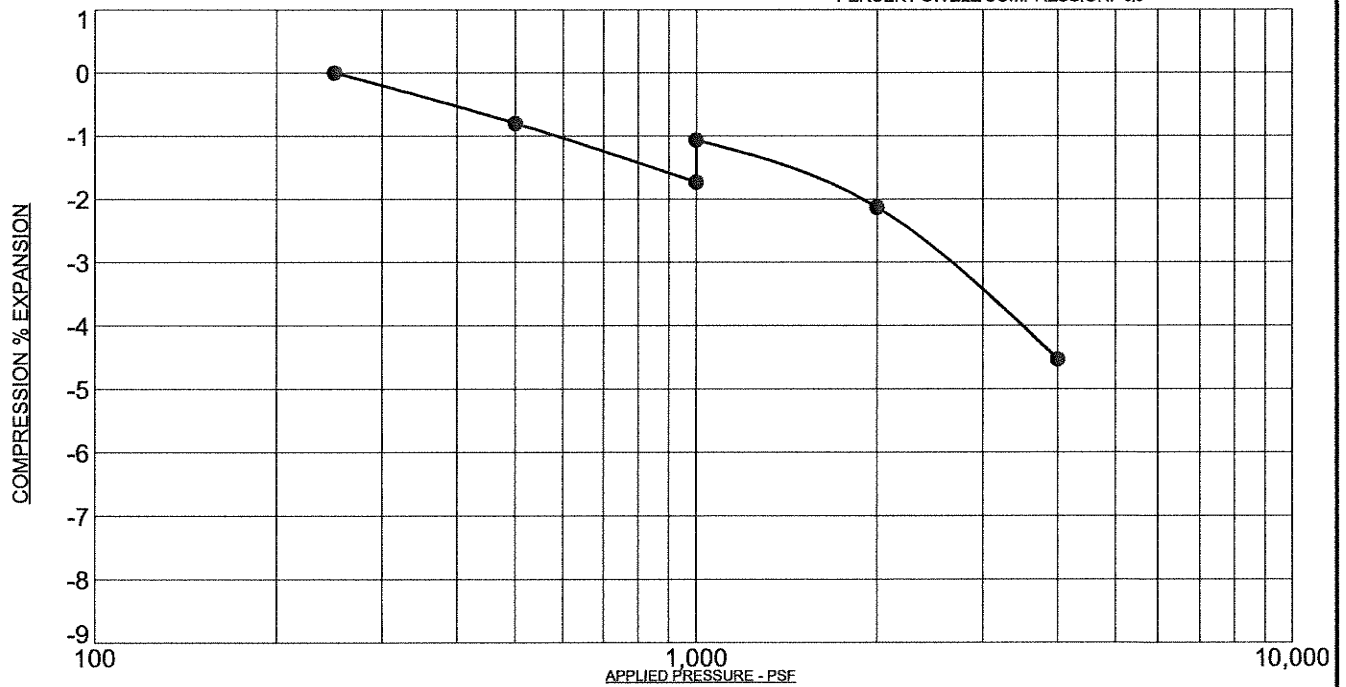

PROJECT: Creekside at Lorson Ranch, Filing No. 1 El Paso County, Colorado
 SAMPLE DESCRIPTION: CLAY, SANDY
 NOTE: SAMPLE WAS INUNDATED WITH WATER AT 1,000 PSF

SAMPLE LOCATION: 12 @ 9 FT
 NATURAL DRY UNIT WEIGHT: 85.0 PCF
 NATURAL MOISTURE CONTENT: 34.8%
 PERCENT SWELL/COMPRESSION: 0.7

ROCKY MOUNTAIN GROUP

Architectural
Structural
Forensics



Geotechnical
Materials Testing
Civil, Planning

Colorado Springs: (Corporate Office)
2910 Austin Bluffs Parkway
Colorado Springs, CO 80918
(719) 548-0900

SOUTHERN COLORADO, DENVER METRO, NORTHERN COLORADO

SWELL/CONSOLIDATION TEST RESULTS

JOB No. 164808

FIGURE No. 18

DATE 8/10/18

JOB No. 164808
FIG No. 19
DATE 8-10-2018

USDA SOIL TYPES

CREEKSIDE AT LORSON RANCH
PLING NO. 1
EL PASO COUNTY, COLORADO
LORSON RANCH METRO DISTRICT NO. 1

Southern Office
Colorado Springs, CO
80918
(719) 548-0600
Central Office:
Englewood, CO 80112
(303) 688-9475
Northern Office:
Grealey / Evans, CO 80620
(970) 330-1071

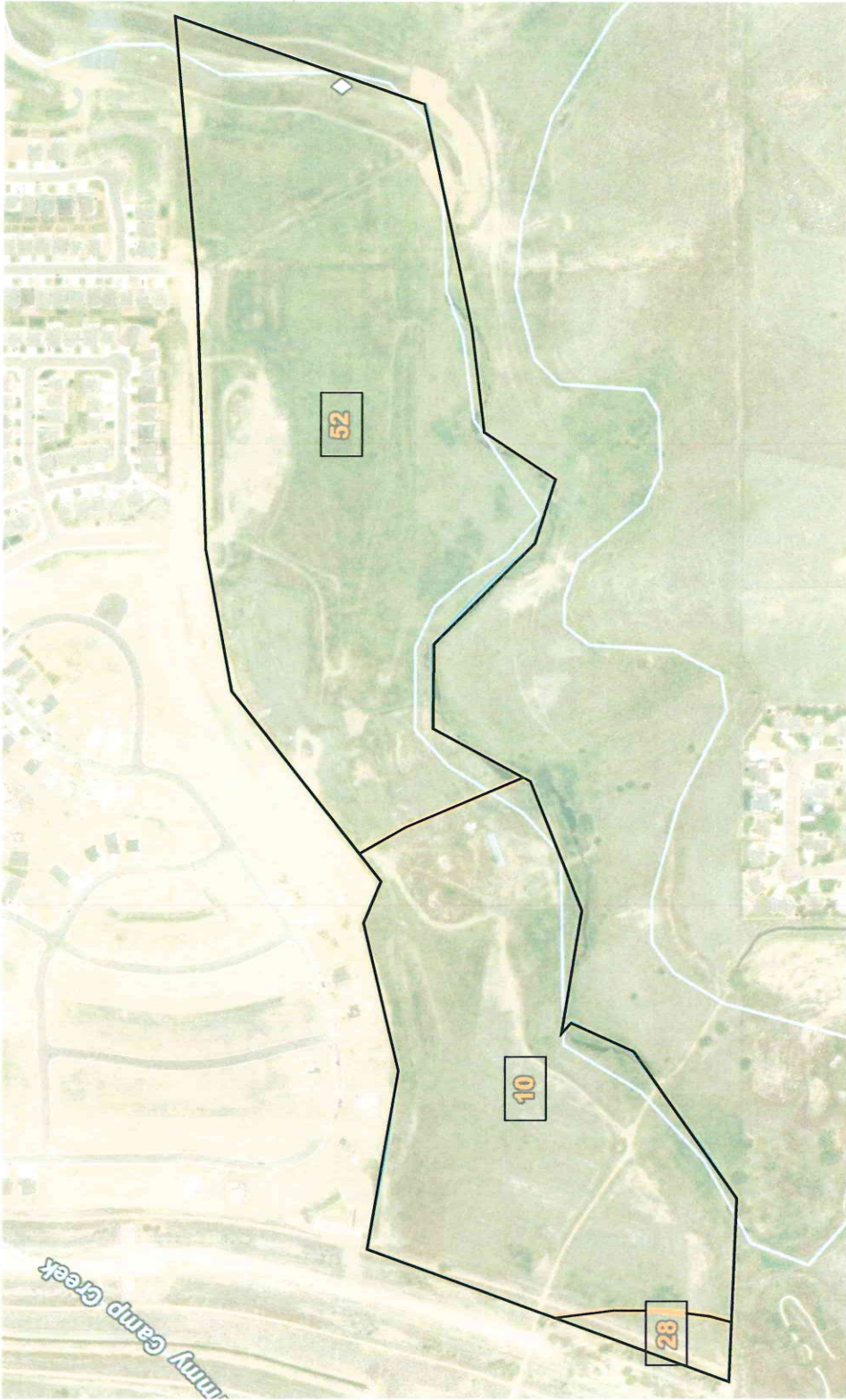

REFER TO SECTION 6.3, PAGE 8 OF THE
GEOLOGY AND SOILS REPORT
FOR SOIL EXPLANATIONS



NOT TO SCALE

BASE MAP PROVIDED BY: U.S. SOIL CONSERVATION SERVICE

JOB No. 164808



ROCKY MOUNTAIN GROUP
Southern Office
Colorado Springs, CO
80918
(719) 548-0600
Central Office
Englewood, CO 80112
(303) 888-9475
Northern Office
Greeley / Evans, CO 80620
(970) 330-1071
Woodland Park Office
(719) 687-6077
Monument Office
(719) 488-2145
Pueblo / Canon City
(719) 544-7750

EL PASO COUNTY, CO
LORSON RANCH METRO
DISTRICT, NO. 1
**CREEKSIDE AT
LORSON, FILING NO. 1**

ENGINEER	CU
DRAWN BY	KZ
CHECKED BY	CU
ISSUED	8-10-2018
REVISION	
DATE	
JOB #	

GENERAL GEOLOGIC
CONDITIONS MAP

SHEET No.
FIG-20

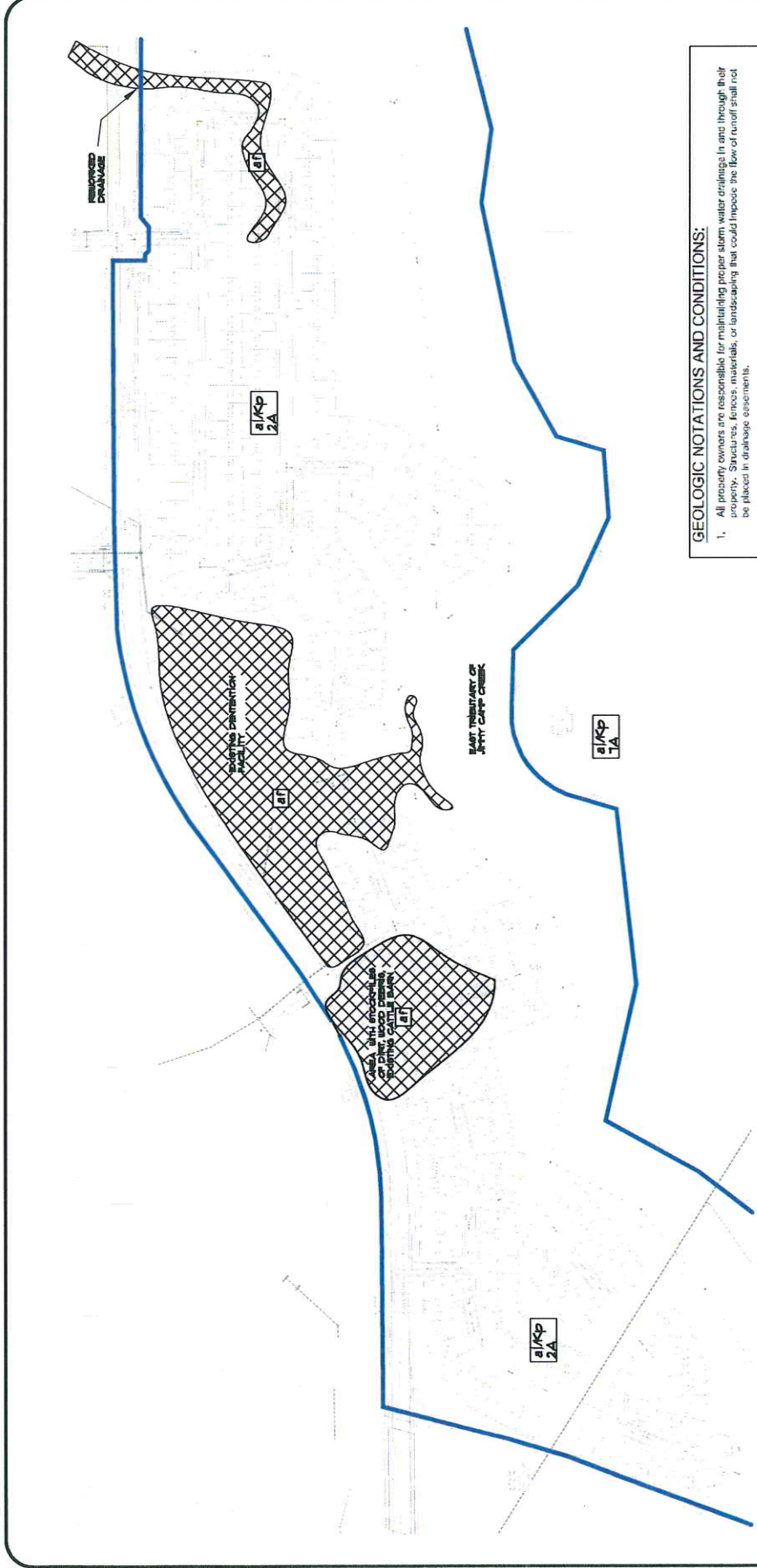

ENGINEERING GEOLOGY
 2A - Stable alluvium, colluvium and bedrock on gentle to moderate slopes (5-12%)
 7A - Physiographic floodplain

GENERAL GEOLOGY
 af - artificial fill
 al - Stable alluvium
 kp - Pierre shale

GEOLOGIC NOTATIONS AND CONDITIONS:

1. All property owners are responsible for maintaining proper storm water drainage in and through their property. Structures, fences, materials, or landscaping that could impede the flow of runoff shall not be placed in drainage easements.
2. Developers shall comply with local, federal, and state laws, regulations, ordinances, rules and permit requirements, and other agency requirements, if any, of applicable agencies including, but not limited to, the Colorado Division of Wildlife, Colorado Department of Transportation, U.S. Army Corps of Engineers and the U.S. Fish and Wildlife Service regarding the Endangered Species Act.
3. A Soils and Geology Report for Lorson Ranch, East, El Paso County, Colorado was completed by Rocky Mountain Group (RMG). There are no significant geological hazards; however, the potential for geologic hazards or constraints do exist related to the potential for expansive or hydrocompressive soils. The geologic conditions are considered relatively common to the immediate area and mitigation can be accomplished by implementing common engineering and construction practices.
4. Site specific subsurface soil investigations shall be conducted prior to construction on all lots. In addition to providing anticipated foundation design recommendations, these investigations should also consider lot-specific recommendations relating to the following geologic conditions:
 - a. Mitigation for loose and/or compressive soil conditions (if encountered); and
 - b. Potential shallow groundwater conditions and feasibility of below-grade construction.
5. At a minimum, separate subsurface perimeter drains should be provided around the below-grade (habitable portions of user) foundation. Additional drainage measures may also be required as determined by the lot-specific subsurface soil investigation and/or the lot-specific excavation observation performed at the time of construction.



NOT TO SCALE

JOB NO. 164808



ROCKY MOUNTAIN GROUP
Southern Office
Colorado Springs, CO
80918
(719) 548-0600
Central Office:
Englewood, CO 80112
(303) 688-9475
Northern Office:
Greeley / Evans, CO 80620
(970) 330-1071
Woodland Park Office:
(719) 687-6077
Monument Office:
(719) 488-2145
Pueblo / Canon City:
(719) 544-7760

CREEKSIDE AT
LORSON, FILING NO. 1
EL PASO COUNTY, CO
LORSON RANCH METRO
DISTRICT, NO. 1

ENGINEER	GW
DRAWN BY	KZ
CHECKED BY	GW
ISSUED	8-16-2018
DATE	
REVISION	
JOB #	

REVISED FEMA MAP
TO REFLECT LOMR

SHEET NO.
FIG-21

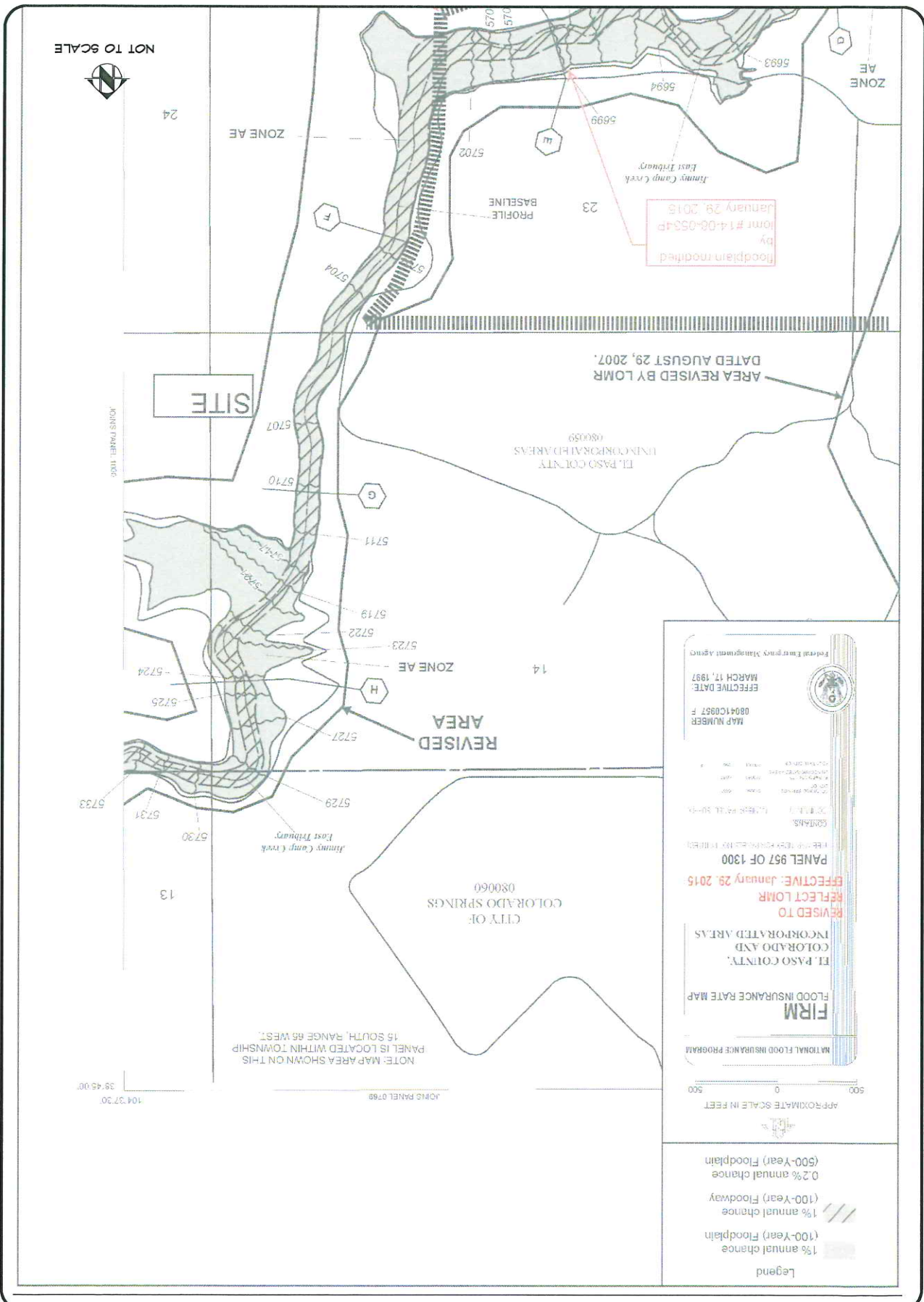

NOTE: TO BE USED IN CASES WHERE GROUNDWATER IS FOUND DURING TRENCHING OR WHERE SHALLOW GROUNDWATER IS KNOWN TO EXIST

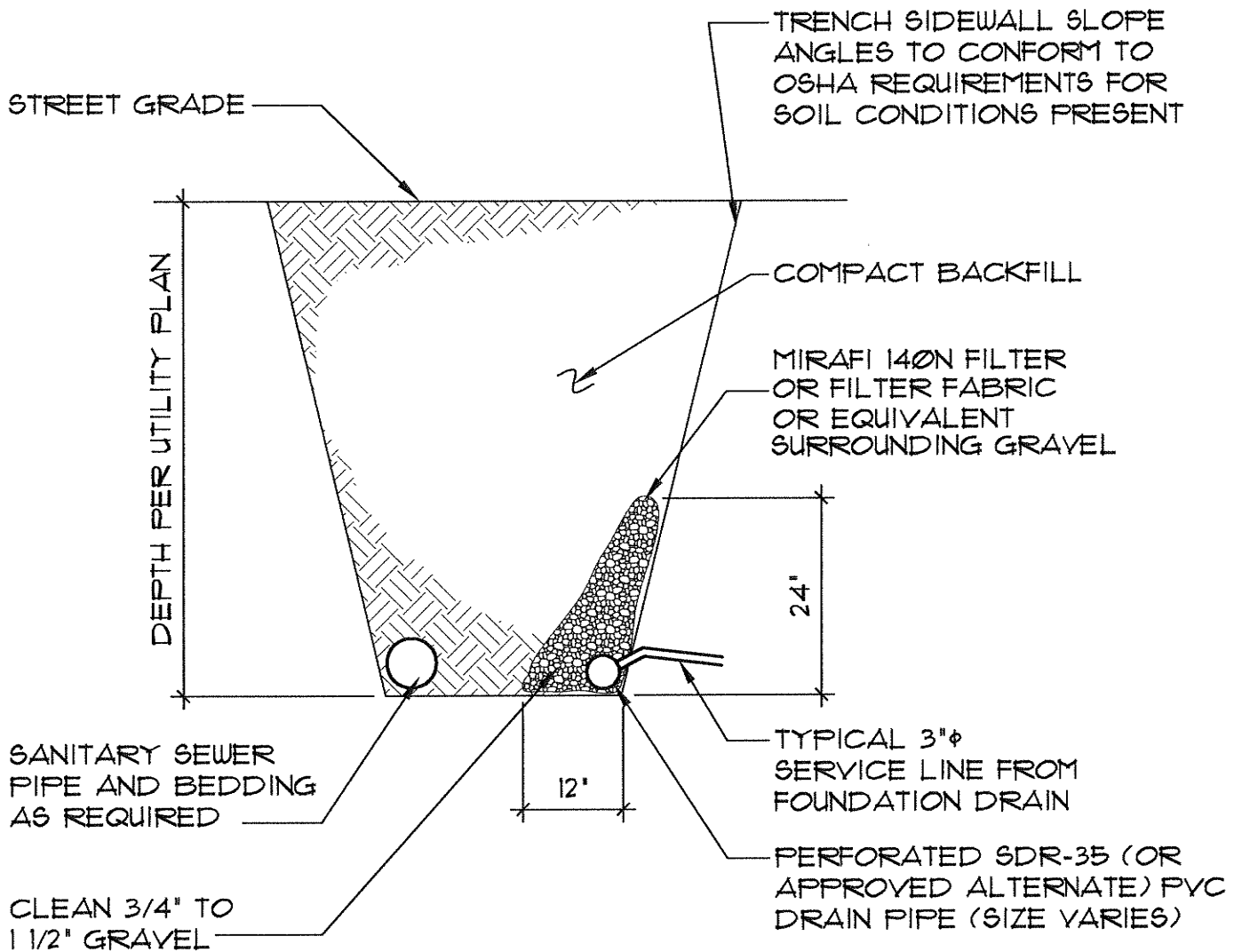

ROCKY MOUNTAIN GROUP

Southern Office:
 Colorado Springs, CO
 80918
 (719) 548-0600
Central Office:
 Englewood, CO 80112
 (303) 688-9475
Northern Office:
 Greeley / Evans, CO 80620
 (970) 330-1071

ACTIVE UNDERDRAIN IN SANITARY SEWER TRENCH

JOB. No. 164808

FIG. No. 22

DATE 8-7-18

NOTE: TO BE USED WHERE NO SHALLOW GROUNDWATER IS KNOWN TO EXIST

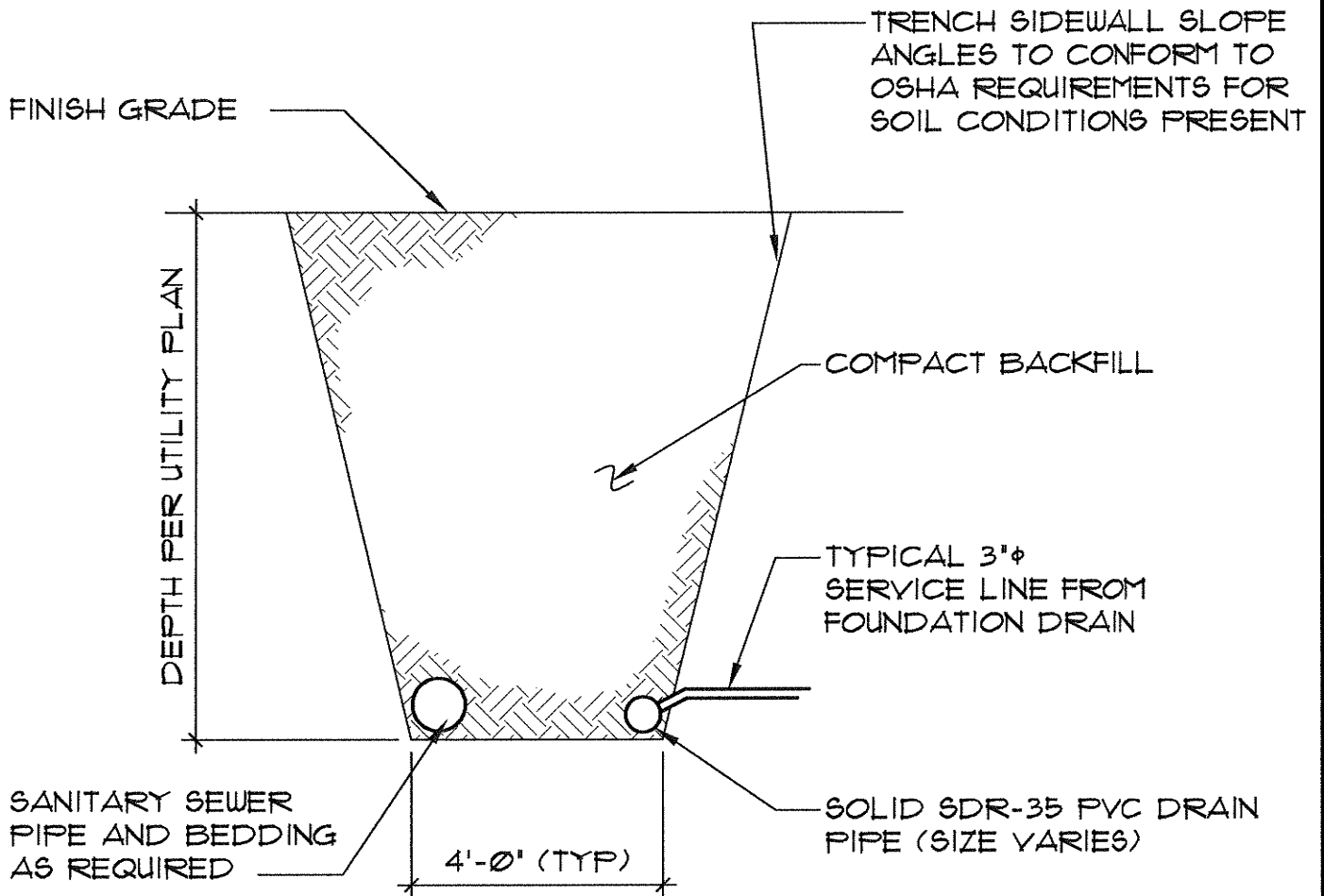

ROCKY MOUNTAIN GROUP

Southern Office
Colorado Springs, CO
80918
(719) 548-0600
Central Office:
Englewood, CO 80112
(303) 688-9475
Northern Office:
Greeley / Evans, CO 80620
(970) 330-1071

PASSIVE UNDERDRAIN IN SANITARY SEWER TRENCH

JOB. No. 164808

FIG. No. 23

DATE 8-7-18

APPENDIX A

GUIDELINE SITE GRADING SPECIFICATIONS

Guideline Site Grading Specifications

Description: Unless specified otherwise by local or state regulatory agencies, these guideline specifications are for the excavation, placement and compaction of material from locations indicated on the plans, or staked by the Engineer, as necessary to achieve the required elevations. These specifications shall also apply to compaction of materials that may be placed outside of the project.

General: The Geotechnical Engineer shall approve fill materials, method of placement, moisture contents and percent compactions, and shall give written approval of the compacted fill.

Clearing Site: The Contractor shall remove trees, brush, rubbish, vegetation, topsoil and existing structures before excavation or fill placement is commenced. The Contractor shall dispose of the cleared material to provide the Owner with a clean job site. Cleared material shall not be placed in areas to receive fill or where the material will support structures. Clearing shall also include removal of existing fills that do not meet the requirements of this specification and existing structures.

Preparation of Slopes or Drainage Areas to Receive Fill: Natural slopes or slopes of drainage gullies where grades are 20 percent (5:1, horizontal to vertical) or steeper shall be benched prior to fill placement. Benches shall be at least 10 feet wide. Benches may require additional width to accommodate excavation or compaction equipment. At least one bench shall be provided for each 5 feet or less of vertical elevation difference. The bench surface shall be essentially horizontal perpendicular to the slope or at a slight incline into the slope.

Scarifying: Topsoil and vegetation shall be removed from the ground surface in areas to receive fill. The surface shall be plowed or scarified a minimum of 12 inches until the surface is free from ruts, hummocks or other uneven features which would prevent uniform compaction by the equipment to be used.

Compacting Area to Receive Fill: After the area to receive fill has been cleared and scarified, it shall be disked or bladed until it is free from large clods, moisture conditioned to a proper moisture content and compacted to the maximum density as specified for the overlying fill. Areas to receive fill shall be worked, stabilized, or removed and replaced, if necessary, in accordance with the Geotechnical Engineer's recommendations in preparation for fill.

Fill Materials: Fill material shall be free from organic material or other deleterious substances, and shall not contain rocks or lumps having a diameter greater than six inches. Fill materials shall be obtained from cut areas shown on the plans or staked in the field by the Engineer or imported to the site and shall be approved by the Geotechnical Engineer prior to placement. It is recommended that the fill materials have nil to low expansion potential, i.e., consist of silty to slightly clayey sand.

- The moisture-conditioned materials should be placed in maximum 6" compacted lifts. These materials should be compacted to a minimum of 92 percent of the maximum Modified Proctor dry density or 95 percent of the maximum Standard Proctor dry density. Material not meeting the above requirements shall be reprocessed.
-

Materials used for moisture-conditioned structural fill should be approved by RMG prior to use. Moisture-conditioned structural fill should not be placed on frozen subgrade or allowed to freeze during moisture conditioning and placement.

Moisture Content: Fill materials shall be moisture conditioned to within limits of optimum moisture content specified. Sufficient laboratory compaction tests shall be made to determine the optimum moisture content for the various soils encountered in borrow areas or imported to the site.

The contractor may be required to add moisture to the excavation materials in the borrow area if, in the opinion of the Geotechnical Engineer, it is not possible to obtain uniform moisture content by adding water to the fill material during placement. The Contractor may be required to rake or disk the fill soils to provide uniform moisture content through the soils.

The application of water to embankment materials shall be made with watering equipment, approved by the Geotechnical Engineer, which will give the desired results. Water jets from the spreader shall not be directed at the embankment with such force that fill materials are eroded.

Should too much water be added to the fill, such that the material is too wet to permit the desired compaction to be obtained, compacting and work on that section of the fill shall be delayed until the material has been allowed to dry to the required moisture content. The Contractor will be permitted to rework the wet material in an approved manner to hasten its drying.

Compaction of Fill Areas: Selected fill material shall be placed and mixed in evenly spread layers. After each fill layer has been placed, it shall be uniformly compacted to not less than the specified percentage of maximum density. Fill materials shall be placed such that the thickness of loose material does not exceed 10 inches and the compacted lift thickness does not exceed 6 inches.

Compaction, as specified above, shall be obtained by the use of sheepsfoot rollers, multiple-wheel pneumatic-tired rollers, or other equipment approved by the Geotechnical Engineer. Granular fill shall be compacted using vibratory equipment or other equipment approved by the Geotechnical Engineer. Compaction shall be accomplished while the fill material is at the specified moisture content. Compaction of each layer shall be continuous over the entire area.

Moisture Content and Density Criteria:

- A. Fill placed in roadways and utility trenches should be moisture conditioned and compacted in accordance with El Paso County Specifications.
- B. Fill placed outside of roadways and utility trenches should be compacted to at least 92% of the maximum Modified Proctor density (ASTM D-1557) or at least 95% of the maximum Standard Proctor density (ASTM D-698) at a moisture content within 2% of optimum.

Compaction of Slopes: Fill slopes shall be compacted by means of sheepsfoot rollers or other suitable equipment. Compaction operations shall be continued until slopes are stable, but not too dense for planting, and such that there is no appreciable amount of loose soil on the slopes. Compaction of slopes may be done progressively in increments of three to five feet in height or after the fill is brought to its total height. Permanent fill slopes shall not exceed 3:1 (horizontal to vertical).

Density Testing: Field density testing shall be performed by the Geotechnical Engineer at locations and depths of his choosing. Where sheepsfoot rollers are used, the soil may be disturbed to a depth of several inches. Density tests shall be taken in compacted material below the disturbed surface. When density tests indicate the density or moisture content of any layer of fill or portion thereof is below that required, the particular layer or portion shall be reworked until the required density or moisture content has been achieved.

Observation and Testing of Fill: Observation by the Geotechnical Engineer shall be sufficient during the placement of fill and compaction operations so that he can declare the fill was placed in general conformance with Specifications. All observations necessary to test the placement of fill and observe compaction operations will be at the expense of the Owner.

Seasonal Limits: No fill material shall be placed, spread or rolled while it is frozen, thawing, or during unfavorable weather conditions. When work is interrupted by heavy precipitation, fill operations shall not be resumed until the Geotechnical Engineer indicates the moisture content and density of previously placed materials are as specified.

Reporting of Field Density Tests: Density tests made by the Geotechnical Engineer shall be submitted progressively to the Owner. Dry density, moisture content, percent compaction, and approximate location shall be reported for each test taken.

APPENDIX B
USGS Seismic Data

USGS Design Maps Summary Report

User-Specified Input

Report Title Creekside at Lorson Ranch, Filing No. 1
Tue August 7, 2018 21:05:46 UTC

Building Code Reference Document 2012/2015 International Building Code
(which utilizes USGS hazard data available in 2008)

Site Coordinates 38.73373°N, 104.64357°W

Site Soil Classification Site Class D - "Stiff Soil"

Risk Category I/II/III

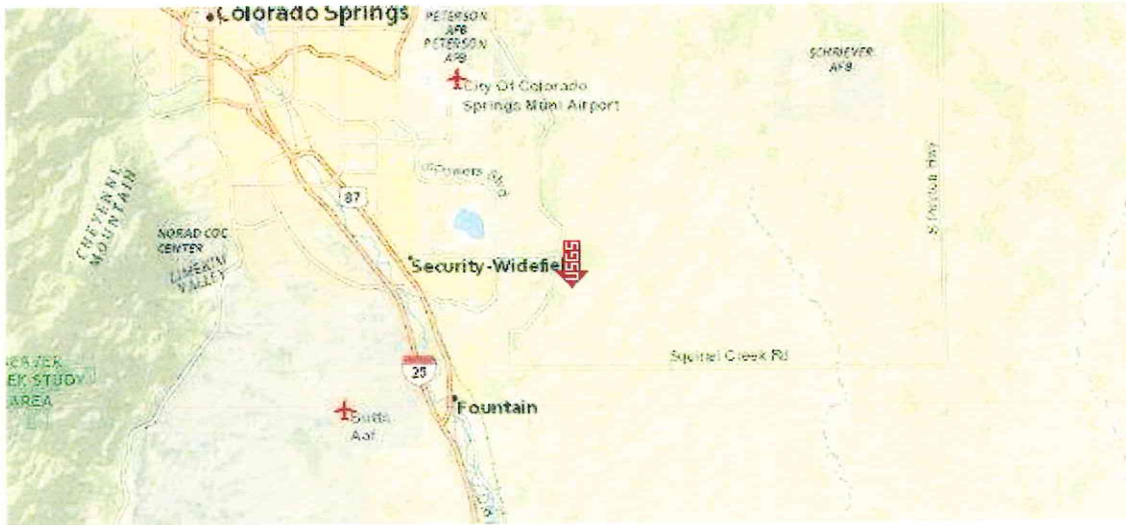

USGS-Provided Output

$S_s = 0.168 \text{ g}$	$S_{MS} = 0.268 \text{ g}$	$S_{DS} = 0.179 \text{ g}$
$S_1 = 0.059 \text{ g}$	$S_{M1} = 0.142 \text{ g}$	$S_{D1} = 0.095 \text{ g}$

For information on how the S_s and S_1 values above have been calculated from probabilistic (risk-targeted) and deterministic ground motions in the direction of maximum horizontal response, please return to the application and select the "2009 NEHRP" building code reference document.

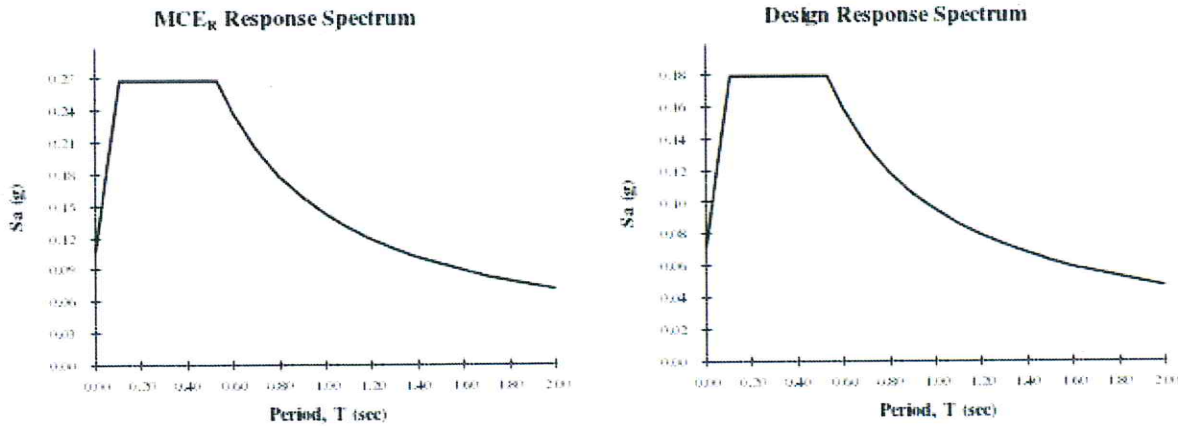

Although this information is a product of the U.S. Geological Survey, we provide no warranty, expressed or implied, as to the accuracy of the data contained therein. This tool is not a substitute for technical subject-matter knowledge.

USDA United States
Department of
Agriculture
NRCS
Natural
Resources
Conservation
Service

A product of the National
Cooperative Soil Survey,
a joint effort of the United
States Department of
Agriculture and other
Federal agencies, State
agencies including the
Agricultural Experiment
Stations, and local
participants

Custom Soil Resource Report for El Paso County Area, Colorado

Lorson Ranch



Preface

Soil surveys contain information that affects land use planning in survey areas. They highlight soil limitations that affect various land uses and provide information about the properties of the soils in the survey areas. Soil surveys are designed for many different users, including farmers, ranchers, foresters, agronomists, urban planners, community officials, engineers, developers, builders, and home buyers. Also, conservationists, teachers, students, and specialists in recreation, waste disposal, and pollution control can use the surveys to help them understand, protect, or enhance the environment.

Various land use regulations of Federal, State, and local governments may impose special restrictions on land use or land treatment. Soil surveys identify soil properties that are used in making various land use or land treatment decisions. The information is intended to help the land users identify and reduce the effects of soil limitations on various land uses. The landowner or user is responsible for identifying and complying with existing laws and regulations.

Although soil survey information can be used for general farm, local, and wider area planning, onsite investigation is needed to supplement this information in some cases. Examples include soil quality assessments (<http://www.nrcs.usda.gov/wps/portal/nrcs/main/soils/health/>) and certain conservation and engineering applications. For more detailed information, contact your local USDA Service Center (<https://offices.sc.egov.usda.gov/locator/app?agency=nrcs>) or your NRCS State Soil Scientist (http://www.nrcs.usda.gov/wps/portal/nrcs/detail/soils/contactus/?cid=nrcs142p2_053951).

Great differences in soil properties can occur within short distances. Some soils are seasonally wet or subject to flooding. Some are too unstable to be used as a foundation for buildings or roads. Clayey or wet soils are poorly suited to use as septic tank absorption fields. A high water table makes a soil poorly suited to basements or underground installations.

The National Cooperative Soil Survey is a joint effort of the United States Department of Agriculture and other Federal agencies, State agencies including the Agricultural Experiment Stations, and local agencies. The Natural Resources Conservation Service (NRCS) has leadership for the Federal part of the National Cooperative Soil Survey.

Information about soils is updated periodically. Updated information is available through the NRCS Web Soil Survey, the site for official soil survey information.

The U.S. Department of Agriculture (USDA) prohibits discrimination in all its programs and activities on the basis of race, color, national origin, age, disability, and where applicable, sex, marital status, familial status, parental status, religion, sexual orientation, genetic information, political beliefs, reprisal, or because all or a part of an individual's income is derived from any public assistance program. (Not all prohibited bases apply to all programs.) Persons with disabilities who require

alternative means for communication of program information (Braille, large print, audiotape, etc.) should contact USDA's TARGET Center at (202) 720-2600 (voice and TDD). To file a complaint of discrimination, write to USDA, Director, Office of Civil Rights, 1400 Independence Avenue, S.W., Washington, D.C. 20250-9410 or call (800) 795-3272 (voice) or (202) 720-6382 (TDD). USDA is an equal opportunity provider and employer.

Contents

Preface.....	2
How Soil Surveys Are Made.....	5
Soil Map.....	8
Soil Map.....	9
Legend.....	10
Map Unit Legend.....	11
Map Unit Descriptions.....	11
El Paso County Area, Colorado.....	14
2—Ascalon sandy loam, 1 to 3 percent slopes.....	14
3—Ascalon sandy loam, 3 to 9 percent slopes.....	15
10—Blendon sandy loam, 0 to 3 percent slopes.....	16
28—Ellicott loamy coarse sand, 0 to 5 percent slopes.....	17
30—Fort Collins loam, 0 to 3 percent slopes.....	19
52—Manzanst clay loam, 0 to 3 percent slopes.....	20
54—Midway clay loam, 3 to 25 percent slopes.....	21
56—Nelson-Tassel fine sandy loams, 3 to 18 percent slopes.....	23
59—Nunn clay loam, 0 to 3 percent slopes.....	25
75—Razor-Midway complex.....	26
104—Vona sandy loam, warm, 0 to 3 percent slopes.....	28
108—Wiley silt loam, 3 to 9 percent slopes.....	30
References.....	32

How Soil Surveys Are Made

Soil surveys are made to provide information about the soils and miscellaneous areas in a specific area. They include a description of the soils and miscellaneous areas and their location on the landscape and tables that show soil properties and limitations affecting various uses. Soil scientists observed the steepness, length, and shape of the slopes; the general pattern of drainage; the kinds of crops and native plants; and the kinds of bedrock. They observed and described many soil profiles. A soil profile is the sequence of natural layers, or horizons, in a soil. The profile extends from the surface down into the unconsolidated material in which the soil formed or from the surface down to bedrock. The unconsolidated material is devoid of roots and other living organisms and has not been changed by other biological activity.

Currently, soils are mapped according to the boundaries of major land resource areas (MLRAs). MLRAs are geographically associated land resource units that share common characteristics related to physiography, geology, climate, water resources, soils, biological resources, and land uses (USDA, 2006). Soil survey areas typically consist of parts of one or more MLRA.

The soils and miscellaneous areas in a survey area occur in an orderly pattern that is related to the geology, landforms, relief, climate, and natural vegetation of the area. Each kind of soil and miscellaneous area is associated with a particular kind of landform or with a segment of the landform. By observing the soils and miscellaneous areas in the survey area and relating their position to specific segments of the landform, a soil scientist develops a concept, or model, of how they were formed. Thus, during mapping, this model enables the soil scientist to predict with a considerable degree of accuracy the kind of soil or miscellaneous area at a specific location on the landscape.

Commonly, individual soils on the landscape merge into one another as their characteristics gradually change. To construct an accurate soil map, however, soil scientists must determine the boundaries between the soils. They can observe only a limited number of soil profiles. Nevertheless, these observations, supplemented by an understanding of the soil-vegetation-landscape relationship, are sufficient to verify predictions of the kinds of soil in an area and to determine the boundaries.

Soil scientists recorded the characteristics of the soil profiles that they studied. They noted soil color, texture, size and shape of soil aggregates, kind and amount of rock fragments, distribution of plant roots, reaction, and other features that enable them to identify soils. After describing the soils in the survey area and determining their properties, the soil scientists assigned the soils to taxonomic classes (units). Taxonomic classes are concepts. Each taxonomic class has a set of soil characteristics with precisely defined limits. The classes are used as a basis for comparison to classify soils systematically. Soil taxonomy, the system of taxonomic classification used in the United States, is based mainly on the kind and character of soil properties and the arrangement of horizons within the profile. After the soil

Custom Soil Resource Report

scientists classified and named the soils in the survey area, they compared the individual soils with similar soils in the same taxonomic class in other areas so that they could confirm data and assemble additional data based on experience and research.

The objective of soil mapping is not to delineate pure map unit components; the objective is to separate the landscape into landforms or landform segments that have similar use and management requirements. Each map unit is defined by a unique combination of soil components and/or miscellaneous areas in predictable proportions. Some components may be highly contrasting to the other components of the map unit. The presence of minor components in a map unit in no way diminishes the usefulness or accuracy of the data. The delineation of such landforms and landform segments on the map provides sufficient information for the development of resource plans. If intensive use of small areas is planned, onsite investigation is needed to define and locate the soils and miscellaneous areas.

Soil scientists make many field observations in the process of producing a soil map. The frequency of observation is dependent upon several factors, including scale of mapping, intensity of mapping, design of map units, complexity of the landscape, and experience of the soil scientist. Observations are made to test and refine the soil-landscape model and predictions and to verify the classification of the soils at specific locations. Once the soil-landscape model is refined, a significantly smaller number of measurements of individual soil properties are made and recorded. These measurements may include field measurements, such as those for color, depth to bedrock, and texture, and laboratory measurements, such as those for content of sand, silt, clay, salt, and other components. Properties of each soil typically vary from one point to another across the landscape.

Observations for map unit components are aggregated to develop ranges of characteristics for the components. The aggregated values are presented. Direct measurements do not exist for every property presented for every map unit component. Values for some properties are estimated from combinations of other properties.

While a soil survey is in progress, samples of some of the soils in the area generally are collected for laboratory analyses and for engineering tests. Soil scientists interpret the data from these analyses and tests as well as the field-observed characteristics and the soil properties to determine the expected behavior of the soils under different uses. Interpretations for all of the soils are field tested through observation of the soils in different uses and under different levels of management. Some interpretations are modified to fit local conditions, and some new interpretations are developed to meet local needs. Data are assembled from other sources, such as research information, production records, and field experience of specialists. For example, data on crop yields under defined levels of management are assembled from farm records and from field or plot experiments on the same kinds of soil.

Predictions about soil behavior are based not only on soil properties but also on such variables as climate and biological activity. Soil conditions are predictable over long periods of time, but they are not predictable from year to year. For example, soil scientists can predict with a fairly high degree of accuracy that a given soil will have a high water table within certain depths in most years, but they cannot predict that a high water table will always be at a specific level in the soil on a specific date.

After soil scientists located and identified the significant natural bodies of soil in the survey area, they drew the boundaries of these bodies on aerial photographs and

Custom Soil Resource Report

identified each as a specific map unit. Aerial photographs show trees, buildings, fields, roads, and rivers, all of which help in locating boundaries accurately.

Soil Map

The soil map section includes the soil map for the defined area of interest, a list of soil map units on the map and extent of each map unit, and cartographic symbols displayed on the map. Also presented are various metadata about data used to produce the map, and a description of each soil map unit.

Custom Soil Resource Report Soil Map

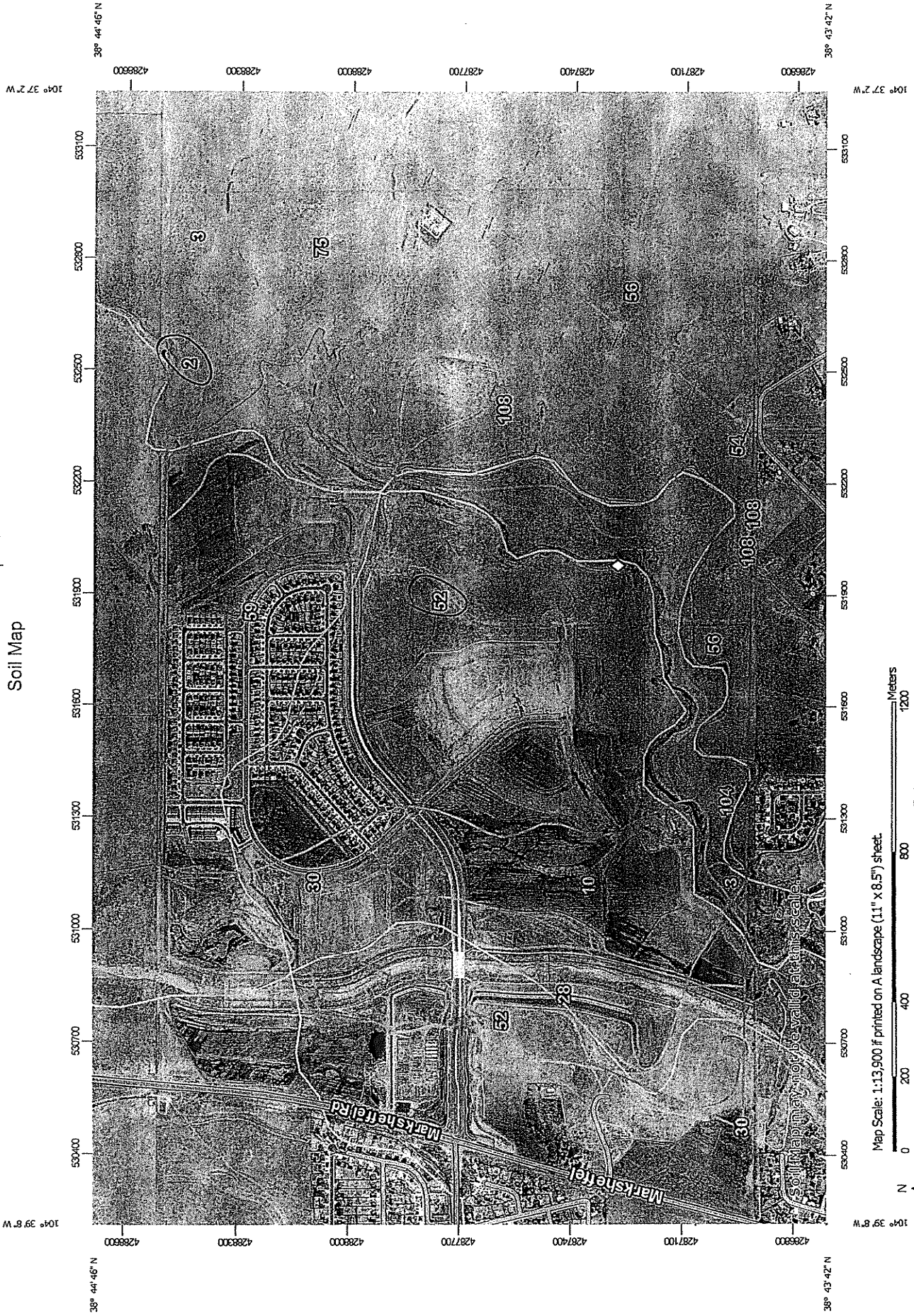

Map Scale: 1:13,900 if printed on A landscape (11" x 8.5") sheet.

Map projection: Web Mercator Corner coordinates: WGS84 Edge tics: UTM Zone 13N WGS84

MAP LEGEND

- Area of Interest (AOI)
 - Area of Interest (AOI)
 - Soils
 - Soil Map Unit Polygons
 - Soil Map Unit Lines
 - Soil Map Unit Points
- Special Point Features
 - Blowout
 - Borrow Pit
 - Clay Spot
 - Closed Depression
 - Gravel Pit
 - Gravelly Spot
 - Landfill
 - Lava Flow
 - Marsh or swamp
 - Mine or Quarry
 - Miscellaneous Water
 - Perennial Water
 - Rock Outcrop
 - Saline Spot
 - Sandy Spot
 - Severely Eroded Spot
 - Sinkhole
 - Slide or Slip
 - Sodic Spot
- Water Features
 - Streams and Canals
- Transportation
 - Rails
 - Interstate Highways
 - US Routes
 - Major Roads
 - Local Roads
- Background
 - Aerial Photography
- Soil Area
 - Stony Spot
 - Very Stony Spot
 - Wet Spot
 - Other
- Special Line Features

MAP INFORMATION

The soil surveys that comprise your AOI were mapped at 1:24,000.

Warning: Soil Map may not be valid at this scale.

Enlargement of maps beyond the scale of mapping can cause misunderstanding of the detail of mapping and accuracy of soil line placement. The maps do not show the small areas of contrasting soils that could have been shown at a more detailed scale.

Please rely on the bar scale on each map sheet for map measurements.

Source of Map: Natural Resources Conservation Service
 Web Soil Survey URL:
 Coordinate System: Web Mercator (EPSG:3857)

Maps from the Web Soil Survey are based on the Web Mercator projection, which preserves direction and shape but distorts distance and area. A projection that preserves area, such as the Albers equal-area conic projection, should be used if more accurate calculations of distance or area are required.

This product is generated from the USDA-NRCS certified data as of the version date(s) listed below.

Soil Survey Area: El Paso County Area, Colorado
 Survey Area Data: Version 14, Sep 23, 2016

Soil map units are labeled (as space allows) for map scales 1:50,000 or larger.

Date(s) aerial images were photographed: Apr 15, 2011—Sep 22, 2011

The orthophoto or other base map on which the soil lines were compiled and digitized probably differs from the background imagery displayed on these maps. As a result, some minor shifting of map unit boundaries may be evident.

Map Unit Legend

El Paso County Area, Colorado (CO625)			
Map Unit Symbol	Map Unit Name	Acres in AOI	Percent of AOI
2	Ascalon sandy loam, 1 to 3 percent slopes	12.5	1.5%
3	Ascalon sandy loam, 3 to 9 percent slopes	11.0	1.3%
10	Blendon sandy loam, 0 to 3 percent slopes	70.2	8.2%
28	Ellicott loamy coarse sand, 0 to 5 percent slopes	75.7	8.9%
30	Fort Collins loam, 0 to 3 percent slopes	24.8	2.9%
52	Manzanst clay loam, 0 to 3 percent slopes	315.6	37.0%
54	Midway clay loam, 3 to 25 percent slopes	3.7	0.4%
56	Nelson-Tassel fine sandy loams, 3 to 18 percent slopes	129.4	15.2%
59	Nunn clay loam, 0 to 3 percent slopes	85.4	10.0%
75	Razor-Midway complex	25.8	3.0%
104	Vona sandy loam, warm, 0 to 3 percent slopes	9.7	1.1%
108	Wiley silt loam, 3 to 9 percent slopes	89.2	10.5%
Totals for Area of Interest		852.7	100.0%

Map Unit Descriptions

The map units delineated on the detailed soil maps in a soil survey represent the soils or miscellaneous areas in the survey area. The map unit descriptions, along with the maps, can be used to determine the composition and properties of a unit.

A map unit delineation on a soil map represents an area dominated by one or more major kinds of soil or miscellaneous areas. A map unit is identified and named according to the taxonomic classification of the dominant soils. Within a taxonomic class there are precisely defined limits for the properties of the soils. On the landscape, however, the soils are natural phenomena, and they have the characteristic variability of all natural phenomena. Thus, the range of some observed properties may extend beyond the limits defined for a taxonomic class. Areas of soils of a single taxonomic class rarely, if ever, can be mapped without including areas of other taxonomic classes. Consequently, every map unit is made up of the soils or miscellaneous areas for which it is named and some minor components that belong to taxonomic classes other than those of the major soils.

Custom Soil Resource Report

Most minor soils have properties similar to those of the dominant soil or soils in the map unit, and thus they do not affect use and management. These are called noncontrasting, or similar, components. They may or may not be mentioned in a particular map unit description. Other minor components, however, have properties and behavioral characteristics divergent enough to affect use or to require different management. These are called contrasting, or dissimilar, components. They generally are in small areas and could not be mapped separately because of the scale used. Some small areas of strongly contrasting soils or miscellaneous areas are identified by a special symbol on the maps. If included in the database for a given area, the contrasting minor components are identified in the map unit descriptions along with some characteristics of each. A few areas of minor components may not have been observed, and consequently they are not mentioned in the descriptions, especially where the pattern was so complex that it was impractical to make enough observations to identify all the soils and miscellaneous areas on the landscape.

The presence of minor components in a map unit in no way diminishes the usefulness or accuracy of the data. The objective of mapping is not to delineate pure taxonomic classes but rather to separate the landscape into landforms or landform segments that have similar use and management requirements. The delineation of such segments on the map provides sufficient information for the development of resource plans. If intensive use of small areas is planned, however, onsite investigation is needed to define and locate the soils and miscellaneous areas.

An identifying symbol precedes the map unit name in the map unit descriptions. Each description includes general facts about the unit and gives important soil properties and qualities.

Soils that have profiles that are almost alike make up a *soil series*. Except for differences in texture of the surface layer, all the soils of a series have major horizons that are similar in composition, thickness, and arrangement.

Soils of one series can differ in texture of the surface layer, slope, stoniness, salinity, degree of erosion, and other characteristics that affect their use. On the basis of such differences, a soil series is divided into *soil phases*. Most of the areas shown on the detailed soil maps are phases of soil series. The name of a soil phase commonly indicates a feature that affects use or management. For example, Alpha silt loam, 0 to 2 percent slopes, is a phase of the Alpha series.

Some map units are made up of two or more major soils or miscellaneous areas. These map units are complexes, associations, or undifferentiated groups.

A *complex* consists of two or more soils or miscellaneous areas in such an intricate pattern or in such small areas that they cannot be shown separately on the maps. The pattern and proportion of the soils or miscellaneous areas are somewhat similar in all areas. Alpha-Beta complex, 0 to 6 percent slopes, is an example.

An *association* is made up of two or more geographically associated soils or miscellaneous areas that are shown as one unit on the maps. Because of present or anticipated uses of the map units in the survey area, it was not considered practical or necessary to map the soils or miscellaneous areas separately. The pattern and relative proportion of the soils or miscellaneous areas are somewhat similar. Alpha-Beta association, 0 to 2 percent slopes, is an example.

An *undifferentiated group* is made up of two or more soils or miscellaneous areas that could be mapped individually but are mapped as one unit because similar interpretations can be made for use and management. The pattern and proportion

Custom Soil Resource Report

of the soils or miscellaneous areas in a mapped area are not uniform. An area can be made up of only one of the major soils or miscellaneous areas, or it can be made up of all of them. Alpha and Beta soils, 0 to 2 percent slopes, is an example.

Some surveys include *miscellaneous areas*. Such areas have little or no soil material and support little or no vegetation. Rock outcrop is an example.

El Paso County Area, Colorado

2—Ascalon sandy loam, 1 to 3 percent slopes

Map Unit Setting

National map unit symbol: 367q
Elevation: 5,500 to 6,500 feet
Mean annual precipitation: 14 to 16 inches
Mean annual air temperature: 47 to 50 degrees F
Frost-free period: 130 to 150 days
Farmland classification: Prime farmland if irrigated

Map Unit Composition

Ascalon and similar soils: 85 percent
Estimates are based on observations, descriptions, and transects of the mapunit.

Description of Ascalon

Setting

Landform: Flats
Landform position (three-dimensional): Talf
Down-slope shape: Linear
Across-slope shape: Linear
Parent material: Mixed alluvium and/or eolian deposits

Typical profile

A - 0 to 8 inches: sandy loam
Bt - 8 to 21 inches: sandy clay loam
BC - 21 to 27 inches: sandy loam
Ck1 - 27 to 48 inches: sandy loam
Ck2 - 48 to 60 inches: loamy sand

Properties and qualities

Slope: 1 to 3 percent
Depth to restrictive feature: More than 80 inches
Natural drainage class: Well drained
Runoff class: Low
Capacity of the most limiting layer to transmit water (Ksat): Moderately high to high (0.60 to 2.00 in/hr)
Depth to water table: More than 80 inches
Frequency of flooding: None
Frequency of ponding: None
Calcium carbonate, maximum in profile: 10 percent
Salinity, maximum in profile: Nonsaline to very slightly saline (0.0 to 2.0 mmhos/cm)
Available water storage in profile: Moderate (about 7.1 inches)

Interpretive groups

Land capability classification (irrigated): 3e
Land capability classification (nonirrigated): 4e
Hydrologic Soil Group: B
Ecological site: Sandy Plains LRU's A & B (R069XY026CO)
Other vegetative classification: SANDY PLAINS (069BY026CO)
Hydric soil rating: No

Minor Components

Other soils

Percent of map unit:
Hydric soil rating: No

Pleasant

Percent of map unit:
Landform: Depressions
Hydric soil rating: Yes

3—Ascalon sandy loam, 3 to 9 percent slopes

Map Unit Setting

National map unit symbol: 2tlny
Elevation: 3,870 to 5,960 feet
Mean annual precipitation: 13 to 18 inches
Mean annual air temperature: 46 to 54 degrees F
Frost-free period: 95 to 155 days
Farmland classification: Not prime farmland

Map Unit Composition

Ascalon and similar soils: 85 percent
Minor components: 15 percent
Estimates are based on observations, descriptions, and transects of the mapunit.

Description of Ascalon

Setting

Landform: Interfluves
Landform position (two-dimensional): Backslope
Landform position (three-dimensional): Side slope
Down-slope shape: Linear
Across-slope shape: Linear
Parent material: Wind-reworked alluvium and/or calcareous sandy eolian deposits

Typical profile

Ap - 0 to 6 inches: sandy loam
Bt1 - 6 to 12 inches: sandy clay loam
Bt2 - 12 to 19 inches: sandy clay loam
Bk1 - 19 to 35 inches: fine sandy loam
Bk2 - 35 to 80 inches: fine sandy loam

Properties and qualities

Slope: 3 to 9 percent
Depth to restrictive feature: More than 80 inches
Natural drainage class: Well drained
Runoff class: Medium
Capacity of the most limiting layer to transmit water (Ksat): Moderately high to high (0.60 to 5.98 in/hr)

Custom Soil Resource Report

Depth to water table: More than 80 inches
Frequency of flooding: None
Frequency of ponding: None
Calcium carbonate, maximum in profile: 10 percent
Salinity, maximum in profile: Nonsaline (0.1 to 1.9 mmhos/cm)
Sodium adsorption ratio, maximum in profile: 1.0
Available water storage in profile: Moderate (about 7.1 inches)

Interpretive groups

Land capability classification (irrigated): 6e
Land capability classification (nonirrigated): 6e
Hydrologic Soil Group: B
Ecological site: Sandy Plains (R067BY024CO)
Hydric soil rating: No

Minor Components

Olnešt

Percent of map unit: 10 percent
Landform: Interfluves
Landform position (two-dimensional): Backslope
Landform position (three-dimensional): Side slope
Down-slope shape: Linear
Across-slope shape: Linear
Ecological site: Sandy Plains (R067BY024CO)
Hydric soil rating: No

Vona

Percent of map unit: 5 percent
Landform: Interfluves
Landform position (two-dimensional): Backslope
Landform position (three-dimensional): Side slope
Down-slope shape: Linear
Across-slope shape: Linear
Ecological site: Sandy Plains (R067BY024CO)
Hydric soil rating: No

10—Blendon sandy loam, 0 to 3 percent slopes

Map Unit Setting

National map unit symbol: 3671
Elevation: 6,000 to 6,800 feet
Mean annual precipitation: 14 to 16 inches
Mean annual air temperature: 46 to 48 degrees F
Frost-free period: 125 to 145 days
Farmland classification: Not prime farmland

Map Unit Composition

Blendon and similar soils: 85 percent
Estimates are based on observations, descriptions, and transects of the mapunit.

Custom Soil Resource Report

Description of Blendon

Setting

Landform: Alluvial fans, terraces
Down-slope shape: Linear
Across-slope shape: Linear
Parent material: Sandy alluvium derived from arkose

Typical profile

A - 0 to 10 inches: sandy loam
Bw - 10 to 36 inches: sandy loam
C - 36 to 60 inches: gravelly sandy loam

Properties and qualities

Slope: 0 to 3 percent
Depth to restrictive feature: More than 80 inches
Natural drainage class: Well drained
Runoff class: Low
Capacity of the most limiting layer to transmit water (Ksat): Moderately high to high (0.60 to 2.00 in/hr)
Depth to water table: More than 80 inches
Frequency of flooding: None
Frequency of ponding: None
Calcium carbonate, maximum in profile: 2 percent
Available water storage in profile: Moderate (about 6.2 inches)

Interpretive groups

Land capability classification (irrigated): None specified
Land capability classification (nonirrigated): 3e
Hydrologic Soil Group: B
Ecological site: Sandy Foothill (R049BY210CO)
Hydric soil rating: No

Minor Components

Other soils

Percent of map unit:
Hydric soil rating: No

Pleasant

Percent of map unit:
Landform: Depressions
Hydric soil rating: Yes

28—Ellicott loamy coarse sand, 0 to 5 percent slopes

Map Unit Setting

National map unit symbol: 3680
Elevation: 5,500 to 6,500 feet
Mean annual precipitation: 13 to 15 inches
Mean annual air temperature: 47 to 50 degrees F

Custom Soil Resource Report

Frost-free period: 125 to 145 days

Farmland classification: Not prime farmland

Map Unit Composition

Ellicott and similar soils: 85 percent

Estimates are based on observations, descriptions, and transects of the mapunit.

Description of Ellicott

Setting

Landform: Flood plains, stream terraces

Landform position (three-dimensional): Tread

Down-slope shape: Linear

Across-slope shape: Linear

Parent material: Sandy alluvium

Typical profile

A - 0 to 4 inches: loamy coarse sand

C - 4 to 60 inches: stratified coarse sand to sandy loam

Properties and qualities

Slope: 0 to 5 percent

Depth to restrictive feature: More than 80 inches

Natural drainage class: Somewhat excessively drained

Runoff class: Very low

Capacity of the most limiting layer to transmit water (Ksat): High to very high (5.95 to 19.98 in/hr)

Depth to water table: More than 80 inches

Frequency of flooding: Frequent

Frequency of ponding: None

Available water storage in profile: Low (about 4.1 inches)

Interpretive groups

Land capability classification (irrigated): None specified

Land capability classification (nonirrigated): 7w

Hydrologic Soil Group: A

Ecological site: Sandy Bottomland LRU's A & B (R069XY031CO)

Other vegetative classification: SANDY BOTTOMLAND (069AY031CO)

Hydric soil rating: No

Minor Components

Fluvaquentic haplaquoll

Percent of map unit:

Landform: Swales

Hydric soil rating: Yes

Other soils

Percent of map unit:

Hydric soil rating: No

Pleasant

Percent of map unit:

Landform: Depressions

Hydric soil rating: Yes

30—Fort Collins loam, 0 to 3 percent slopes

Map Unit Setting

National map unit symbol: 3683
Elevation: 5,200 to 6,500 feet
Mean annual precipitation: 14 to 16 inches
Mean annual air temperature: 48 to 52 degrees F
Frost-free period: 135 to 155 days
Farmland classification: Prime farmland if irrigated

Map Unit Composition

Fort collins and similar soils: 85 percent
Estimates are based on observations, descriptions, and transects of the mapunit.

Description of Fort Collins

Setting

Landform: Flats
Landform position (three-dimensional): Talf
Down-slope shape: Linear
Across-slope shape: Linear
Parent material: Loamy alluvium

Typical profile

A - 0 to 9 inches: loam
Bt - 9 to 16 inches: clay loam
Bk - 16 to 21 inches: clay loam
Ck - 21 to 60 inches: loam

Properties and qualities

Slope: 0 to 3 percent
Depth to restrictive feature: More than 80 inches
Natural drainage class: Well drained
Runoff class: Low
Capacity of the most limiting layer to transmit water (Ksat): Moderately high to high (0.57 to 2.00 in/hr)
Depth to water table: More than 80 inches
Frequency of flooding: None
Frequency of ponding: None
Calcium carbonate, maximum in profile: 15 percent
Salinity, maximum in profile: Nonsaline to very slightly saline (0.0 to 2.0 mmhos/cm)
Available water storage in profile: High (about 10.1 inches)

Interpretive groups

Land capability classification (irrigated): 2e
Land capability classification (nonirrigated): 4e
Hydrologic Soil Group: B
Ecological site: Loamy Plains (R067BY002CO)
Other vegetative classification: LOAMY PLAINS (069AY006CO)

Custom Soil Resource Report

Hydric soil rating: No

Minor Components

Pleasant

Percent of map unit:
Landform: Depressions
Hydric soil rating: Yes

Other soils

Percent of map unit:
Hydric soil rating: No

52—Manzanst clay loam, 0 to 3 percent slopes

Map Unit Setting

National map unit symbol: 2w4nr
Elevation: 4,060 to 6,660 feet
Mean annual precipitation: 14 to 16 inches
Mean annual air temperature: 50 to 54 degrees F
Frost-free period: 130 to 170 days
Farmland classification: Prime farmland if irrigated

Map Unit Composition

Manzanst and similar soils: 85 percent
Minor components: 15 percent
Estimates are based on observations, descriptions, and transects of the mapunit.

Description of Manzanst

Setting

Landform: Terraces, drainageways
Landform position (three-dimensional): Tread
Down-slope shape: Linear
Across-slope shape: Linear, concave
Parent material: Clayey alluvium derived from shale

Typical profile

A - 0 to 3 inches: clay loam
Bt - 3 to 12 inches: clay
Btk - 12 to 37 inches: clay
Bk1 - 37 to 52 inches: clay
Bk2 - 52 to 79 inches: clay

Properties and qualities

Slope: 0 to 3 percent
Depth to restrictive feature: More than 80 inches
Natural drainage class: Well drained
Capacity of the most limiting layer to transmit water (Ksat): Moderately low to moderately high (0.06 to 0.20 in/hr)
Depth to water table: More than 80 inches

Custom Soil Resource Report

Frequency of flooding: None
Frequency of ponding: None
Calcium carbonate, maximum in profile: 15 percent
Gypsum, maximum in profile: 3 percent
Salinity, maximum in profile: Slightly saline (4.0 to 7.0 mmhos/cm)
Sodium adsorption ratio, maximum in profile: 10.0
Available water storage in profile: High (about 9.0 inches)

Interpretive groups

Land capability classification (irrigated): 3e
Land capability classification (nonirrigated): 4c
Hydrologic Soil Group: C
Ecological site: Saline Overflow (R067BY037CO)
Hydric soil rating: No

Minor Components

Ritoazul

Percent of map unit: 7 percent
Landform: Drainageways, interfluves
Landform position (three-dimensional): Rise
Down-slope shape: Linear
Across-slope shape: Linear
Ecological site: Clayey Plains (R067BY042CO)
Hydric soil rating: No

Arvada

Percent of map unit: 6 percent
Landform: Drainageways, interfluves
Down-slope shape: Linear
Across-slope shape: Linear
Ecological site: Salt Flat (R067XY033CO)
Hydric soil rating: No

Wiley

Percent of map unit: 2 percent
Landform: Interfluves
Down-slope shape: Linear
Across-slope shape: Linear
Ecological site: Loamy Plains (R067BY002CO)
Hydric soil rating: No

54—Midway clay loam, 3 to 25 percent slopes

Map Unit Setting

National map unit symbol: 368y
Elevation: 5,200 to 6,200 feet
Mean annual precipitation: 12 to 14 inches
Mean annual air temperature: 48 to 52 degrees F
Frost-free period: 135 to 155 days
Farmland classification: Not prime farmland

Custom Soil Resource Report

Map Unit Composition

Midway and similar soils: 85 percent

Estimates are based on observations, descriptions, and transects of the mapunit.

Description of Midway

Setting

Landform: Hills

Landform position (three-dimensional): Side slope

Down-slope shape: Linear

Across-slope shape: Linear

Parent material: Slope alluvium over residuum weathered from shale

Typical profile

A - 0 to 4 inches: clay loam

C - 4 to 13 inches: clay

Cr - 13 to 17 inches: weathered bedrock

Properties and qualities

Slope: 3 to 25 percent

Depth to restrictive feature: 6 to 20 inches to paralithic bedrock

Natural drainage class: Well drained

Runoff class: Medium

Capacity of the most limiting layer to transmit water (Ksat): Moderately low to moderately high (0.06 to 0.20 in/hr)

Depth to water table: More than 80 inches

Frequency of flooding: None

Frequency of ponding: None

Calcium carbonate, maximum in profile: 15 percent

Gypsum, maximum in profile: 15 percent

Salinity, maximum in profile: Very slightly saline to moderately saline (2.0 to 8.0 mmhos/cm)

Sodium adsorption ratio, maximum in profile: 15.0

Available water storage in profile: Very low (about 2.2 inches)

Interpretive groups

Land capability classification (irrigated): None specified

Land capability classification (nonirrigated): 7e

Hydrologic Soil Group: D

Ecological site: Shaly Plains LRU's A & B (R069XY046CO)

Other vegetative classification: SHALY PLAINS (069AY046CO)

Hydric soil rating: No

Minor Components

Other soils

Percent of map unit:

Hydric soil rating: No

Pleasant

Percent of map unit:

Landform: Depressions

Hydric soil rating: Yes

56—Nelson-Tassel fine sandy loams, 3 to 18 percent slopes

Map Unit Setting

National map unit symbol: 3690
Elevation: 5,600 to 6,400 feet
Mean annual precipitation: 12 to 14 inches
Mean annual air temperature: 48 to 52 degrees F
Frost-free period: 135 to 155 days
Farmland classification: Not prime farmland

Map Unit Composition

Nelson and similar soils: 45 percent
Tassel and similar soils: 30 percent
Estimates are based on observations, descriptions, and transects of the mapunit.

Description of Nelson

Setting

Landform: Hills
Landform position (three-dimensional): Crest, side slope
Down-slope shape: Linear
Across-slope shape: Linear
Parent material: Calcareous residuum weathered from interbedded sedimentary rock

Typical profile

A - 0 to 5 inches: fine sandy loam
Ck - 5 to 23 inches: fine sandy loam
Cr - 23 to 27 inches: weathered bedrock

Properties and qualities

Slope: 3 to 12 percent
Depth to restrictive feature: 20 to 40 inches to paralithic bedrock
Natural drainage class: Well drained
Runoff class: Medium
Capacity of the most limiting layer to transmit water (Ksat): Moderately low to high (0.06 to 2.00 in/hr)
Depth to water table: More than 80 inches
Frequency of flooding: None
Frequency of ponding: None
Calcium carbonate, maximum in profile: 10 percent
Salinity, maximum in profile: Nonsaline to very slightly saline (0.0 to 2.0 mmhos/cm)
Available water storage in profile: Very low (about 2.8 inches)

Interpretive groups

Land capability classification (irrigated): 4e
Land capability classification (nonirrigated): 6e
Hydrologic Soil Group: B
Ecological site: Shaly Plains (R067BY045CO)

Custom Soil Resource Report

Other vegetative classification: SHALY PLAINS (069AY046CO)

Hydric soil rating: No

Description of Tassel

Setting

Landform: Hills

Landform position (three-dimensional): Crest, side slope

Down-slope shape: Linear

Across-slope shape: Linear

Parent material: Calcareous slope alluvium over residuum weathered from sandstone

Typical profile

A - 0 to 4 inches: fine sandy loam

C - 4 to 10 inches: fine sandy loam

Cr - 10 to 14 inches: weathered bedrock

Properties and qualities

Slope: 3 to 18 percent

Depth to restrictive feature: 6 to 20 inches to paralithic bedrock

Natural drainage class: Well drained

Runoff class: Medium

Capacity of the most limiting layer to transmit water (Ksat): Moderately high (0.20 to 0.60 in/hr)

Depth to water table: More than 80 inches

Frequency of flooding: None

Frequency of ponding: None

Calcium carbonate, maximum in profile: 10 percent

Available water storage in profile: Very low (about 1.2 inches)

Interpretive groups

Land capability classification (irrigated): None specified

Land capability classification (nonirrigated): 6s

Hydrologic Soil Group: D

Ecological site: Shaly Plains (R067BY045CO)

Other vegetative classification: SHALY PLAINS (069AY046CO)

Hydric soil rating: No

Minor Components

Other soils

Percent of map unit:

Hydric soil rating: No

Pleasant

Percent of map unit:

Landform: Depressions

Hydric soil rating: Yes

59—Nunn clay loam, 0 to 3 percent slopes

Map Unit Setting

National map unit symbol: 3693
Elevation: 5,400 to 6,500 feet
Mean annual precipitation: 13 to 15 inches
Mean annual air temperature: 46 to 50 degrees F
Frost-free period: 135 to 155 days
Farmland classification: Prime farmland if irrigated

Map Unit Composition

Nunn and similar soils: 85 percent
Estimates are based on observations, descriptions, and transects of the mapunit.

Description of Nunn

Setting

Landform: Terraces, fans
Down-slope shape: Linear
Across-slope shape: Linear
Parent material: Mixed alluvium

Typical profile

A - 0 to 12 inches: clay loam
Bt - 12 to 26 inches: clay loam
BC - 26 to 30 inches: clay loam
Bk - 30 to 58 inches: sandy clay loam
C - 58 to 72 inches: clay

Properties and qualities

Slope: 0 to 3 percent
Depth to restrictive feature: More than 80 inches
Natural drainage class: Well drained
Runoff class: Low
Capacity of the most limiting layer to transmit water (Ksat): Moderately low to moderately high (0.06 to 0.20 in/hr)
Depth to water table: More than 80 inches
Frequency of flooding: None
Frequency of ponding: None
Calcium carbonate, maximum in profile: 15 percent
Gypsum, maximum in profile: 2 percent
Salinity, maximum in profile: Nonsaline to very slightly saline (0.0 to 2.0 mmhos/cm)
Available water storage in profile: High (about 9.8 inches)

Interpretive groups

Land capability classification (irrigated): 2e
Land capability classification (nonirrigated): 3c
Hydrologic Soil Group: C

Custom Soil Resource Report

Ecological site: Clayey Plains LRU's A & B (R069XY042CO)
Other vegetative classification: CLAYEY PLAINS (069AY042CO)
Hydric soil rating: No

Minor Components

Other soils

Percent of map unit:
Hydric soil rating: No

Pleasant

Percent of map unit:
Landform: Depressions
Hydric soil rating: Yes

75—Razor-Midway complex

Map Unit Setting

National map unit symbol: 369p
Elevation: 5,300 to 6,100 feet
Mean annual precipitation: 12 to 14 inches
Mean annual air temperature: 48 to 52 degrees F
Frost-free period: 135 to 155 days
Farmland classification: Not prime farmland

Map Unit Composition

Razor and similar soils: 50 percent
Midway and similar soils: 30 percent
Estimates are based on observations, descriptions, and transects of the mapunit.

Description of Razor

Setting

Landform: Hills
Landform position (three-dimensional): Side slope
Down-slope shape: Concave, linear
Across-slope shape: Linear
Parent material: Clayey slope alluvium over residuum weathered from shale

Typical profile

A - 0 to 4 inches: stony clay loam
Bw - 4 to 22 inches: cobbly clay loam
Bk - 22 to 29 inches: cobbly clay
Cr - 29 to 33 inches: weathered bedrock

Properties and qualities

Slope: 3 to 15 percent
Depth to restrictive feature: 20 to 40 inches to paralithic bedrock
Natural drainage class: Well drained
Runoff class: Medium

Custom Soil Resource Report

Capacity of the most limiting layer to transmit water (Ksat): Moderately low to moderately high (0.06 to 0.20 in/hr)
Depth to water table: More than 80 inches
Frequency of flooding: None
Frequency of ponding: None
Calcium carbonate, maximum in profile: 15 percent
Gypsum, maximum in profile: 5 percent
Salinity, maximum in profile: Moderately saline to strongly saline (8.0 to 16.0 mmhos/cm)
Sodium adsorption ratio, maximum in profile: 15.0
Available water storage in profile: Low (about 4.7 inches)

Interpretive groups

Land capability classification (irrigated): 6e
Land capability classification (nonirrigated): 6e
Hydrologic Soil Group: D
Ecological site: Alkaline Plains LRU's A & B (R069XY047CO)
Other vegetative classification: ALKALINE PLAINS (069AY047CO)
Hydric soil rating: No

Description of Midway

Setting

Landform: Hills
Landform position (three-dimensional): Side slope
Down-slope shape: Linear
Across-slope shape: Linear
Parent material: Slope alluvium over residuum weathered from shale

Typical profile

A - 0 to 4 inches: clay loam
C - 4 to 13 inches: clay
Cr - 13 to 17 inches: weathered bedrock

Properties and qualities

Slope: 3 to 25 percent
Depth to restrictive feature: 6 to 20 inches to paralithic bedrock
Natural drainage class: Well drained
Runoff class: Medium
Capacity of the most limiting layer to transmit water (Ksat): Moderately low to moderately high (0.06 to 0.20 in/hr)
Depth to water table: More than 80 inches
Frequency of flooding: None
Frequency of ponding: None
Calcium carbonate, maximum in profile: 15 percent
Gypsum, maximum in profile: 15 percent
Salinity, maximum in profile: Very slightly saline to moderately saline (2.0 to 8.0 mmhos/cm)
Sodium adsorption ratio, maximum in profile: 15.0
Available water storage in profile: Very low (about 2.2 inches)

Interpretive groups

Land capability classification (irrigated): None specified
Land capability classification (nonirrigated): 7e
Hydrologic Soil Group: D
Ecological site: Shaly Plains LRU's A & B (R069XY046CO)
Other vegetative classification: SHALY PLAINS (069AY045CO)

Custom Soil Resource Report

Hydric soil rating: No

Minor Components

Pleasant

Percent of map unit:
Landform: Depressions
Hydric soil rating: Yes

Other soils

Percent of map unit:
Hydric soil rating: No

104—Vona sandy loam, warm, 0 to 3 percent slopes

Map Unit Setting

National map unit symbol: 2t516
Elevation: 3,590 to 6,000 feet
Mean annual precipitation: 14 to 16 inches
Mean annual air temperature: 50 to 54 degrees F
Frost-free period: 130 to 170 days
Farmland classification: Not prime farmland

Map Unit Composition

Vona, warm, and similar soils: 85 percent
Minor components: 15 percent
Estimates are based on observations, descriptions, and transects of the mapunit.

Description of Vona, Warm

Setting

Landform: Sand sheets
Landform position (two-dimensional): Backslope
Landform position (three-dimensional): Side slope
Down-slope shape: Linear
Across-slope shape: Linear
Parent material: Eolian sands

Typical profile

A - 0 to 5 inches: sandy loam
Bt1 - 5 to 12 inches: sandy loam
Bt2 - 12 to 17 inches: sandy loam
Bk - 17 to 41 inches: sandy loam
BCK - 41 to 79 inches: loamy sand

Properties and qualities

Slope: 0 to 3 percent
Depth to restrictive feature: More than 80 inches
Natural drainage class: Somewhat excessively drained

Custom Soil Resource Report

Capacity of the most limiting layer to transmit water (Ksat): High (2.00 to 6.00 in/hr)

Depth to water table: More than 80 inches

Frequency of flooding: None

Frequency of ponding: None

Calcium carbonate, maximum in profile: 15 percent

Gypsum, maximum in profile: 2 percent

Salinity, maximum in profile: Nonsaline to slightly saline (0.5 to 4.0 mmhos/cm)

Sodium adsorption ratio, maximum in profile: 2.0

Available water storage in profile: Moderate (about 7.2 inches)

Interpretive groups

Land capability classification (irrigated): 4e

Land capability classification (nonirrigated): 4e

Hydrologic Soil Group: A

Ecological site: Sandy Plains (R067BY024CO)

Other vegetative classification: Loamy, Dry (G067BW019CO), Sandy Plains #24 (067XY024CO_2)

Hydric soil rating: No

Minor Components

Valent, warm

Percent of map unit: 5 percent

Landform: Sand sheets

Landform position (two-dimensional): Shoulder, backslope

Landform position (three-dimensional): Crest, side slope

Down-slope shape: Convex

Across-slope shape: Convex

Ecological site: Deep Sand (R067BY015CO)

Other vegetative classification: Sandy, Dry (G067BW026CO), Deep Sands #15 (067XY015CO_3)

Hydric soil rating: No

Olnešt, warm

Percent of map unit: 5 percent

Landform: Hillslopes

Landform position (two-dimensional): Summit, backslope

Landform position (three-dimensional): Crest, side slope

Down-slope shape: Linear

Across-slope shape: Linear

Ecological site: Sandy Plains (R067BY024CO)

Other vegetative classification: Loamy, Dry (G067BW019CO)

Hydric soil rating: No

Otero

Percent of map unit: 5 percent

Landform: Hillslopes

Landform position (two-dimensional): Shoulder, backslope

Landform position (three-dimensional): Side slope, head slope

Down-slope shape: Linear

Across-slope shape: Linear

Ecological site: Sandy Plains (R067BY024CO)

Other vegetative classification: Loamy, Dry (G067BW019CO), SANDY PLAINS (067XY024CO_1)

Hydric soil rating: No

108—Wiley silt loam, 3 to 9 percent slopes

Map Unit Setting

National map unit symbol: 367b
Elevation: 5,200 to 6,200 feet
Mean annual precipitation: 12 to 14 inches
Mean annual air temperature: 48 to 52 degrees F
Frost-free period: 135 to 155 days
Farmland classification: Not prime farmland

Map Unit Composition

Wiley and similar soils: 85 percent
Estimates are based on observations, descriptions, and transects of the mapunit.

Description of Wiley

Setting

Landform: Hills
Landform position (three-dimensional): Side slope
Down-slope shape: Linear
Across-slope shape: Linear
Parent material: Calcareous silty eolian deposits

Typical profile

A - 0 to 4 inches: silt loam
Bt - 4 to 16 inches: silt loam
Bk - 16 to 60 inches: silt loam

Properties and qualities

Slope: 3 to 9 percent
Depth to restrictive feature: More than 80 inches
Natural drainage class: Well drained
Runoff class: Medium
Capacity of the most limiting layer to transmit water (Ksat): Moderately high to high (0.60 to 2.00 in/hr)
Depth to water table: More than 80 inches
Frequency of flooding: None
Frequency of ponding: None
Calcium carbonate, maximum in profile: 15 percent
Salinity, maximum in profile: Nonsaline to very slightly saline (0.0 to 2.0 mmhos/cm)
Available water storage in profile: High (about 11.5 inches)

Interpretive groups

Land capability classification (irrigated): 4e
Land capability classification (nonirrigated): 6e
Hydrologic Soil Group: B
Ecological site: Loamy Plains (R067BY002CO)
Other vegetative classification: LOAMY PLAINS (069AY006CO)
Hydric soil rating: No

Custom Soil Resource Report

Minor Components

Pleasant

Percent of map unit:
Landform: Depressions
Hydric soil rating: Yes

Other soils

Percent of map unit:
Hydric soil rating: No

References

- American Association of State Highway and Transportation Officials (AASHTO). 2004. Standard specifications for transportation materials and methods of sampling and testing. 24th edition.
- American Society for Testing and Materials (ASTM). 2005. Standard classification of soils for engineering purposes. ASTM Standard D2487-00.
- Cowardin, L.M., V. Carter, F.C. Golet, and E.T. LaRoe. 1979. Classification of wetlands and deep-water habitats of the United States. U.S. Fish and Wildlife Service FWS/OBS-79/31.
- Federal Register. July 13, 1994. Changes in hydric soils of the United States.
- Federal Register. September 18, 2002. Hydric soils of the United States.
- Hurt, G.W., and L.M. Vasilas, editors. Version 6.0, 2006. Field indicators of hydric soils in the United States.
- National Research Council. 1995. Wetlands: Characteristics and boundaries.
- Soil Survey Division Staff. 1993. Soil survey manual. Soil Conservation Service. U.S. Department of Agriculture Handbook 18. http://www.nrcs.usda.gov/wps/portal/nrcs/detail/national/soils/?cid=nrcs142p2_054262
- Soil Survey Staff. 1999. Soil taxonomy: A basic system of soil classification for making and interpreting soil surveys. 2nd edition. Natural Resources Conservation Service, U.S. Department of Agriculture Handbook 436. http://www.nrcs.usda.gov/wps/portal/nrcs/detail/national/soils/?cid=nrcs142p2_053577
- Soil Survey Staff. 2010. Keys to soil taxonomy. 11th edition. U.S. Department of Agriculture, Natural Resources Conservation Service. http://www.nrcs.usda.gov/wps/portal/nrcs/detail/national/soils/?cid=nrcs142p2_053580
- Tiner, R.W., Jr. 1985. Wetlands of Delaware. U.S. Fish and Wildlife Service and Delaware Department of Natural Resources and Environmental Control, Wetlands Section.
- United States Army Corps of Engineers, Environmental Laboratory. 1987. Corps of Engineers wetlands delineation manual. Waterways Experiment Station Technical Report Y-87-1.
- United States Department of Agriculture, Natural Resources Conservation Service. National forestry manual. http://www.nrcs.usda.gov/wps/portal/nrcs/detail/soils/home/?cid=nrcs142p2_053374
- United States Department of Agriculture, Natural Resources Conservation Service. National range and pasture handbook. <http://www.nrcs.usda.gov/wps/portal/nrcs/detail/national/landuse/rangepasture/?cid=stelp20101043084>

Custom Soil Resource Report

United States Department of Agriculture, Natural Resources Conservation Service. National soil survey handbook, title 430-VI. http://www.nrcs.usda.gov/wps/portal/nrcs/detail/soils/scientists/?cid=nrcs142p2_054242

United States Department of Agriculture, Natural Resources Conservation Service. 2006. Land resource regions and major land resource areas of the United States, the Caribbean, and the Pacific Basin. U.S. Department of Agriculture Handbook 296. http://www.nrcs.usda.gov/wps/portal/nrcs/detail/national/soils/?cid=nrcs142p2_053624

United States Department of Agriculture, Soil Conservation Service. 1961. Land capability classification. U.S. Department of Agriculture Handbook 210. http://www.nrcs.usda.gov/Internet/FSE_DOCUMENTS/nrcs142p2_052290.pdf

Appendix D
East Fork Jimmy Camp Creek Letter of Map Revision
Case No. 19-08-0605P
No Rise Determination Calculations



Federal Emergency Management Agency

Washington, D.C. 20472

December 18, 2019

CERTIFIED MAIL
RETURN RECEIPT REQUESTED

The Honorable John Suthers
Mayor, City of Colorado Springs
30 South Nevada Avenue, Suite 601
Colorado Springs, CO 80903

IN REPLY REFER TO:

Case No.: 19-08-0605P
Follows Conditional
Case No.: 17-08-1043R
Community Name: City of Colorado Springs, CO
Community No.: 080060
Effective Date of
This Revision: May 4, 2020

Dear Mayor Suthers:

The Flood Insurance Study (FIS) Report and Flood Insurance Rate Map (FIRM) for your community have been revised by this Letter of Map Revision (LOMR). Please use the enclosed annotated map panel(s) revised by this LOMR for floodplain management purposes and for all flood insurance policies and renewals issued in your community.

Additional documents are enclosed that provide information regarding this LOMR. Please see the List of Enclosures below to determine which documents are included. Other enclosures specific to this request may be included as referenced in the Determination Document. If you have any questions regarding floodplain management regulations for your community or the National Flood Insurance Program (NFIP) in general, please contact the Consultation Coordination Officer for your community. If you have any technical questions regarding this LOMR, please contact the Director, Mitigation Division of the Department of Homeland Security's Federal Emergency Management Agency (FEMA) in Denver, Colorado, at (303) 235-4830, or the FEMA Map Information eXchange (FMIX) toll free at 1-877-336-2627 (1-877-FEMA MAP). Additional information about the NFIP is available on our website at <https://www.fema.gov/national-flood-insurance-program>.

Sincerely,

Patrick "Rick" F. Sacbibit, P.E., Branch Chief
Engineering Services Branch
Federal Insurance and Mitigation Administration

List of Enclosures:

Letter of Map Revision Determination Document
Annotated Flood Insurance Rate Map
Annotated Flood Insurance Study Report

cc: The Honorable Mark Waller
President, El Paso County
Board of Commissioners

Mr. Keith Curtis, P.E., CFM
Floodplain Administrator
City of Colorado Springs and El Paso County

Mr. Stephen A. Brown, P.E.
Principal
Kiowa Engineering Corp.

Follows Conditional Case No.: 17-08-1043R



Federal Emergency Management Agency
Washington, D.C. 20472

**LETTER OF MAP REVISION
DETERMINATION DOCUMENT**

COMMUNITY AND REVISION INFORMATION		PROJECT DESCRIPTION	BASIS OF REQUEST
COMMUNITY	City of Colorado Springs El Paso County Colorado	BRIDGE CHANNELIZATION EXCAVATION FILL	BASE MAP CHANGES FLOODWAY HYDRAULIC ANALYSIS UPDATED TOPOGRAPHIC DATA
	COMMUNITY NO.: 080060		
IDENTIFIER	Jimmy Camp Creek East Tributary	APPROXIMATE LATITUDE & LONGITUDE: 38.732, -104.636 SOURCE: USGS QUADRANGLE DATUM: NAD 83	
ANNOTATED MAPPING ENCLOSURES		ANNOTATED STUDY ENCLOSURES	
TYPE: FIRM* NO.: 08041C0976G DATE: December 7, 2018 TYPE: FIRM* NO.: 08041C0957G DATE: December 7, 2018		DATE OF EFFECTIVE FLOOD INSURANCE STUDY: December 7, 2018 PROFILE: 213P FLOODWAY DATA TABLE: 8	

Enclosures reflect changes to flooding sources affected by this revision.
* FIRM - Flood Insurance Rate Map

FLOODING SOURCE AND REVISED REACH

Jimmy Camp Creek East Tributary - From approximately 2,760 feet downstream of Lorson Boulevard to approximately 4,260 feet upstream of Fontaine Boulevard

SUMMARY OF REVISIONS

Flooding Source	Effective Flooding	Revised Flooding	Increases	Decreases
Jimmy Camp Creek East Tributary	Zone AE	Zone AE	YES	YES
	Zone X (shaded)	Zone X (shaded)	YES	YES
	BFEs*	BFEs	YES	YES
	Floodway	Floodway	YES	YES

* BFEs - Base Flood Elevations

DETERMINATION

This document provides the determination from the Department of Homeland Security's Federal Emergency Management Agency (FEMA) regarding a request for a Letter of Map Revision (LOMR) for the area described above. Using the information submitted, we have determined that a revision to the flood hazards depicted in the Flood Insurance Study (FIS) report and/or National Flood Insurance Program (NFIP) map is warranted. This document revises the effective NFIP map, as indicated in the attached documentation. Please use the enclosed annotated map panels revised by this LOMR for floodplain management purposes and for all flood insurance policies and renewals in your community.

This determination is based on the flood data presently available. The enclosed documents provide additional information regarding this determination. If you have any questions about this document, please contact the FEMA Map Information eXchange toll free at 1-877-336-2627 (1-877-FEMA MAP) or by letter addressed to the LOMC Clearinghouse, 3601 Eisenhower Avenue, Suite 500, Alexandria, VA 22304-6426. Additional information about the NFIP is available on our website at <https://www.fema.gov/national-flood-insurance-program>.

Patrick "Rick" F. Sacbibit, P.E., Branch Chief
Engineering Services Branch
Federal Insurance and Mitigation Administration



Federal Emergency Management Agency
Washington, D.C. 20472

LETTER OF MAP REVISION
DETERMINATION DOCUMENT (CONTINUED)

OTHER COMMUNITIES AFFECTED BY THIS REVISION

CID Number: 080059

Name: El Paso County, Colorado

AFFECTED MAP PANELS

AFFECTED PORTIONS OF THE FLOOD INSURANCE STUDY REPORT

TYPE: FIRM* NO.: 08041C0957G
TYPE: FIRM* NO.: 08041C0976G

DATE: December 7, 2018
DATE: December 7, 2018

DATE OF EFFECTIVE FLOOD INSURANCE STUDY: December 7, 2018
PROFILE(S): 210P, 211P, 212P, and 213P
FLOODWAY DATA TABLE: 8

This determination is based on the flood data presently available. The enclosed documents provide additional information regarding this determination. If you have any questions about this document, please contact the FEMA Map Information eXchange toll free at 1-877-336-2627 (1-877-FEMA MAP) or by letter addressed to the LOMC Clearinghouse, 3601 Eisenhower Avenue, Suite 500, Alexandria, VA 22304-6426. Additional information about the NFIP is available on our website at <https://www.fema.gov/national-flood-insurance-program>.

Patrick "Rick" F. Sachbit, P.E., Branch Chief
Engineering Services Branch
Federal Insurance and Mitigation Administration



Federal Emergency Management Agency
Washington, D.C. 20472

LETTER OF MAP REVISION
DETERMINATION DOCUMENT (CONTINUED)

COMMUNITY INFORMATION

APPLICABLE NFIP REGULATIONS/COMMUNITY OBLIGATION

We have made this determination pursuant to Section 206 of the Flood Disaster Protection Act of 1973 (P.L. 93-234) and in accordance with the National Flood Insurance Act of 1968, as amended (Title XIII of the Housing and Urban Development Act of 1968, P.L. 90-448), 42 U.S.C. 4001-4128, and 44 CFR Part 65. Pursuant to Section 1361 of the National Flood Insurance Act of 1968, as amended, communities participating in the NFIP are required to adopt and enforce floodplain management regulations that meet or exceed NFIP criteria. These criteria, including adoption of the FIS report and FIRM, and the modifications made by this LOMR, are the minimum requirements for continued NFIP participation and do not supersede more stringent State/Commonwealth or local requirements to which the regulations apply.

We provide the floodway designation to your community as a tool to regulate floodplain development. Therefore, the floodway revision we have described in this letter, while acceptable to us, must also be acceptable to your community and adopted by appropriate community action, as specified in Paragraph 60.3(d) of the NFIP regulations.

NFIP regulations Subparagraph 60.3(b)(7) requires communities to ensure that the flood-carrying capacity within the altered or relocated portion of any watercourse is maintained. This provision is incorporated into your community's existing floodplain management ordinances; therefore, responsibility for maintenance of the altered or relocated watercourse, including any related appurtenances such as bridges, culverts, and other drainage structures, rests with your community. We may request that your community submit a description and schedule of maintenance activities necessary to ensure this requirement.

COMMUNITY REMINDERS

We based this determination on the 1-percent-annual-chance flood discharges computed in the FIS for your community without considering subsequent changes in watershed characteristics that could increase flood discharges. Future development of projects upstream could cause increased flood discharges, which could cause increased flood hazards. A comprehensive restudy of your community's flood hazards would consider the cumulative effects of development on flood discharges subsequent to the publication of the FIS report for your community and could, therefore, establish greater flood hazards in this area.

Your community must regulate all proposed floodplain development and ensure that permits required by Federal and/or State/Commonwealth law have been obtained. State/Commonwealth or community officials, based on knowledge of local conditions and in the interest of safety, may set higher standards for construction or may limit development in floodplain areas. If your State/Commonwealth or community has adopted more restrictive or comprehensive floodplain management criteria, those criteria take precedence over the minimum NFIP requirements.

This determination is based on the flood data presently available. The enclosed documents provide additional information regarding this determination. If you have any questions about this document, please contact the FEMA Map Information eXchange toll free at 1-877-336-2627 (1-877-FEMA MAP) or by letter addressed to the LOMC Clearinghouse, 3601 Eisenhower Avenue, Suite 500, Alexandria, VA 22304-6426. Additional information about the NFIP is available on our website at <https://www.fema.gov/national-flood-insurance-program>.

Patrick "Rick" F. Sacbibit, P.E., Branch Chief
Engineering Services Branch
Federal Insurance and Mitigation Administration



Federal Emergency Management Agency
Washington, D.C. 20472

**LETTER OF MAP REVISION
DETERMINATION DOCUMENT (CONTINUED)**

We will not print and distribute this LOMR to primary users, such as local insurance agents or mortgage lenders; instead, the community will serve as a repository for the new data. We encourage you to disseminate the information in this LOMR by preparing a news release for publication in your community's newspaper that describes the revision and explains how your community will provide the data and help interpret the NFIP maps. In that way, interested persons, such as property owners, insurance agents, and mortgage lenders, can benefit from the information.

This revision has met our criteria for removing an area from the 1-percent-annual-chance floodplain to reflect the placement of fill. However, we encourage you to require that the lowest adjacent grade and lowest floor (including basement) of any structure placed within the subject area be elevated to or above the Base (1-percent-annual-chance) Flood Elevation.

We have designated a Consultation Coordination Officer (CCO) to assist your community. The CCO will be the primary liaison between your community and FEMA. For information regarding your CCO, please contact:

Ms. Jeanine D. Petterson
Director, Mitigation Division
Federal Emergency Management Agency, Region VIII
Denver Federal Center, Building 710
P.O. Box 25267
Denver, CO 80225-0267
(303) 235-4830

STATUS OF THE COMMUNITY NFIP MAPS

We will not physically revise and republish the FIRM and FIS report for your community to reflect the modifications made by this LOMR at this time. When changes to the previously cited FIRM panel(s) and FIS report warrant physical revision and republication in the future, we will incorporate the modifications made by this LOMR at that time.

This determination is based on the flood data presently available. The enclosed documents provide additional information regarding this determination. If you have any questions about this document, please contact the FEMA Map Information eXchange toll free at 1-877-336-2627 (1-877-FEMA MAP) or by letter addressed to the LOMC Clearinghouse, 3601 Eisenhower Avenue, Suite 500, Alexandria, VA 22304-6426. Additional information about the NFIP is available on our website at <https://www.fema.gov/national-flood-insurance-program>.

Patrick "Rick" F. Sacbibit, P.E., Branch Chief
Engineering Services Branch
Federal Insurance and Mitigation Administration



Federal Emergency Management Agency
Washington, D.C. 20472

LETTER OF MAP REVISION
DETERMINATION DOCUMENT (CONTINUED)

PUBLIC NOTIFICATION OF REVISION

A notice of changes will be published in the *Federal Register*. This information also will be published in your local newspaper on or about the dates listed below, and through FEMA's Flood Hazard Mapping website at https://www.floodmaps.fema.gov/thm/bfe_status/bfe_main.asp

LOCAL NEWSPAPER

Name: *The Colorado Springs Gazette*

Dates: December 27, 2019 and January 3, 2020

Within 90 days of the second publication in the local newspaper, any interested party may request that we reconsider this determination. Any request for reconsideration must be based on scientific or technical data. Therefore, this letter will be effective only after the 90-day appeal period has elapsed and we have resolved any appeals that we receive during this appeal period. Until this LOMR is effective, the revised flood hazard determination presented in this LOMR may be changed.

This determination is based on the flood data presently available. The enclosed documents provide additional information regarding this determination. If you have any questions about this document, please contact the FEMA Map Information eXchange toll free at 1-877-336-2627 (1-877-FEMA MAP) or by letter addressed to the LOMC Clearinghouse, 3601 Eisenhower Avenue, Suite 500, Alexandria, VA 22304-6426. Additional information about the NFIP is available on our website at <https://www.fema.gov/national-flood-insurance-program>.

Patrick "Rick" F. Sacbbit, P.E., Branch Chief
Engineering Services Branch
Federal Insurance and Mitigation Administration



Federal Emergency Management Agency

Washington, D.C. 20472

December 18, 2019

CERTIFIED MAIL
RETURN RECEIPT REQUESTED

The Honorable Mark Waller
President, El Paso County
Board of Commissioners
200 South Cascade Avenue, Suite 100
Colorado Springs, CO 80903

IN REPLY REFER TO:

Case No.: 19-08-0605P
Follows Conditional
Case No.: 17-08-1043R
Community Name: El Paso County, CO
Community No.: 080059
Effective Date of
This Revision: May 4, 2020

Dear Mr. Waller:

The Flood Insurance Study (FIS) Report and Flood Insurance Rate Map (FIRM) for your community have been revised by this Letter of Map Revision (LOMR). Please use the enclosed annotated map panel(s) revised by this LOMR for floodplain management purposes and for all flood insurance policies and renewals issued in your community.

Additional documents are enclosed that provide information regarding this LOMR. Please see the List of Enclosures below to determine which documents are included. Other enclosures specific to this request may be included as referenced in the Determination Document. If you have any questions regarding floodplain management regulations for your community or the National Flood Insurance Program (NFIP) in general, please contact the Consultation Coordination Officer for your community. If you have any technical questions regarding this LOMR, please contact the Director, Mitigation Division of the Department of Homeland Security's Federal Emergency Management Agency (FEMA) in Denver, Colorado, at (303) 235-4830, or the FEMA Map Information eXchange (FMIX) toll free at 1-877-336-2627 (1-877-FEMA MAP). Additional information about the NFIP is available on our website at <https://www.fema.gov/national-flood-insurance-program>.

Sincerely,

Patrick "Rick" F. Sacbibit, P.E., Branch Chief
Engineering Services Branch
Federal Insurance and Mitigation Administration

List of Enclosures:

Letter of Map Revision Determination Document
Annotated Flood Insurance Rate Map
Annotated Flood Insurance Study Report

cc: The Honorable John Suthers
Mayor, City of Colorado Springs

Mr. Keith Curtis, P.E., CFM
Floodplain Administrator
El Paso County and City of Colorado Springs

Mr. Stephen A. Brown, P.E.
Principal
Kiowa Engineering Corp.

Follows Conditional Case No.: 17-08-1043R



Federal Emergency Management Agency

Washington, D.C. 20472

LETTER OF MAP REVISION DETERMINATION DOCUMENT

COMMUNITY AND REVISION INFORMATION		PROJECT DESCRIPTION	BASIS OF REQUEST
COMMUNITY	El Paso County Colorado (Unincorporated Areas)	BRIDGE CHANNELIZATION EXCAVATION FILL	BASE MAP CHANGES FLOODWAY HYDRAULIC ANALYSIS UPDATED TOPOGRAPHIC DATA
	COMMUNITY NO.: 080059		
IDENTIFIER	Jimmy Camp Creek East Tributary	APPROXIMATE LATITUDE & LONGITUDE: 38.732, -104.636 SOURCE: USGS QUADRANGLE DATUM: NAD 83	
ANNOTATED MAPPING ENCLOSURES		ANNOTATED STUDY ENCLOSURES	
TYPE: FIRM*	NO.: 08041C0957G DATE: December 7, 2018	DATE OF EFFECTIVE FLOOD INSURANCE STUDY: December 7, 2018	
TYPE: FIRM*	NO.: 08041C0976G DATE: December 7, 2018	PROFILE(S): 210P, 211P, 212P, and 213P FLOODWAY DATA TABLE: 8	

Enclosures reflect changes to flooding sources affected by this revision.

* FIRM - Flood Insurance Rate Map

FLOODING SOURCE AND REVISED REACH

Jimmy Camp Creek East Tributary - From approximately 2,760 feet downstream of Lorson Boulevard to approximately 4,260 feet upstream of Fontaine Boulevard

SUMMARY OF REVISIONS

Flooding Source	Effective Flooding	Revised Flooding	Increases	Decreases
Jimmy Camp Creek East Tributary	Zone AE	Zone AE	YES	YES
	Zone X (shaded)	Zone X (shaded)	YES	YES
	BFES*	BFES	YES	YES
	Floodway	Floodway	YES	YES

* BFES - Base Flood Elevations

DETERMINATION

This document provides the determination from the Department of Homeland Security's Federal Emergency Management Agency (FEMA) regarding a request for a Letter of Map Revision (LOMR) for the area described above. Using the information submitted, we have determined that a revision to the flood hazards depicted in the Flood Insurance Study (FIS) report and/or National Flood Insurance Program (NFIP) map is warranted. This document revises the effective NFIP map, as indicated in the attached documentation. Please use the enclosed annotated map panels revised by this LOMR for floodplain management purposes and for all flood insurance policies and renewals in your community.

This determination is based on the flood data presently available. The enclosed documents provide additional information regarding this determination. If you have any questions about this document, please contact the FEMA Map Information eXchange toll free at 1-877-336-2627 (1-877-FEMA MAP) or by letter addressed to the LOMC Clearinghouse, 3601 Eisenhower Avenue, Suite 500, Alexandria, VA 22304-6426. Additional information about the NFIP is available on our website at <https://www.fema.gov/national-flood-insurance-program>.

Patrick "Rick" F. Sacibit, P.E., Branch Chief
Engineering Services Branch
Federal Insurance and Mitigation Administration



Federal Emergency Management Agency
Washington, D.C. 20472

LETTER OF MAP REVISION
DETERMINATION DOCUMENT (CONTINUED)

OTHER COMMUNITIES AFFECTED BY THIS REVISION

CID Number: 080060 Name: City of Colorado Springs, Colorado

AFFECTED MAP PANELS

AFFECTED PORTIONS OF THE FLOOD INSURANCE STUDY REPORT

TYPE: FIRM* NO.: 08041C0976G DATE: December 7, 2018
TYPE: FIRM* NO.: 08041C0957G DATE: December 7, 2018

DATE OF EFFECTIVE FLOOD INSURANCE STUDY: December 7, 2018
PROFILE(S): 213P
FLOODWAY DATA TABLE: 8

This determination is based on the flood data presently available. The enclosed documents provide additional information regarding this determination. If you have any questions about this document, please contact the FEMA Map Information eXchange toll free at 1-877-336-2627 (1-877-FEMA MAP) or by letter addressed to the LOMC Clearinghouse, 3601 Eisenhower Avenue, Suite 500, Alexandria, VA 22304-6426. Additional information about the NFIP is available on our website at <https://www.fema.gov/national-flood-insurance-program>.

Patrick "Rick" F. Sacibit, P.E., Branch Chief
Engineering Services Branch
Federal Insurance and Mitigation Administration



Federal Emergency Management Agency
Washington, D.C. 20472

**LETTER OF MAP REVISION
DETERMINATION DOCUMENT (CONTINUED)**

COMMUNITY INFORMATION

APPLICABLE NFIP REGULATIONS/COMMUNITY OBLIGATION

We have made this determination pursuant to Section 206 of the Flood Disaster Protection Act of 1973 (P.L. 93-234) and in accordance with the National Flood Insurance Act of 1968, as amended (Title XIII of the Housing and Urban Development Act of 1968, P.L. 90-448), 42 U.S.C. 4001-4128, and 44 CFR Part 65. Pursuant to Section 1361 of the National Flood Insurance Act of 1968, as amended, communities participating in the NFIP are required to adopt and enforce floodplain management regulations that meet or exceed NFIP criteria. These criteria, including adoption of the FIS report and FIRM, and the modifications made by this LOMR, are the minimum requirements for continued NFIP participation and do not supersede more stringent State/Commonwealth or local requirements to which the regulations apply.

We provide the floodway designation to your community as a tool to regulate floodplain development. Therefore, the floodway revision we have described in this letter, while acceptable to us, must also be acceptable to your community and adopted by appropriate community action, as specified in Paragraph 60.3(d) of the NFIP regulations.

NFIP regulations Subparagraph 60.3(b)(7) requires communities to ensure that the flood-carrying capacity within the altered or relocated portion of any watercourse is maintained. This provision is incorporated into your community's existing floodplain management ordinances; therefore, responsibility for maintenance of the altered or relocated watercourse, including any related appurtenances such as bridges, culverts, and other drainage structures, rests with your community. We may request that your community submit a description and schedule of maintenance activities necessary to ensure this requirement.

COMMUNITY REMINDERS

We based this determination on the 1-percent-annual-chance flood discharges computed in the FIS for your community without considering subsequent changes in watershed characteristics that could increase flood discharges. Future development of projects upstream could cause increased flood discharges, which could cause increased flood hazards. A comprehensive restudy of your community's flood hazards would consider the cumulative effects of development on flood discharges subsequent to the publication of the FIS report for your community and could, therefore, establish greater flood hazards in this area.

Your community must regulate all proposed floodplain development and ensure that permits required by Federal and/or State/Commonwealth law have been obtained. State/Commonwealth or community officials, based on knowledge of local conditions and in the interest of safety, may set higher standards for construction or may limit development in floodplain areas. If your State/Commonwealth or community has adopted more restrictive or comprehensive floodplain management criteria, those criteria take precedence over the minimum NFIP requirements.

This determination is based on the flood data presently available. The enclosed documents provide additional information regarding this determination. If you have any questions about this document, please contact the FEMA Map Information eXchange toll free at 1-877-336-2627 (1-877-FEMA MAP) or by letter addressed to the LOMC Clearinghouse, 3601 Eisenhower Avenue, Suite 500, Alexandria, VA 22304-6426. Additional information about the NFIP is available on our website at <https://www.fema.gov/national-flood-insurance-program>.

Patrick "Rick" F. Sacbibit, P.E., Branch Chief
Engineering Services Branch
Federal Insurance and Mitigation Administration



Federal Emergency Management Agency
Washington, D.C. 20472

**LETTER OF MAP REVISION
DETERMINATION DOCUMENT (CONTINUED)**

We will not print and distribute this LOMR to primary users, such as local insurance agents or mortgage lenders; instead, the community will serve as a repository for the new data. We encourage you to disseminate the information in this LOMR by preparing a news release for publication in your community's newspaper that describes the revision and explains how your community will provide the data and help interpret the NFIP maps. In that way, interested persons, such as property owners, insurance agents, and mortgage lenders, can benefit from the information.

This revision has met our criteria for removing an area from the 1-percent-annual-chance floodplain to reflect the placement of fill. However, we encourage you to require that the lowest adjacent grade and lowest floor (including basement) of any structure placed within the subject area be elevated to or above the Base (1-percent-annual-chance) Flood Elevation.

We have designated a Consultation Coordination Officer (CCO) to assist your community. The CCO will be the primary liaison between your community and FEMA. For information regarding your CCO, please contact:

Ms. Jeanine D. Petterson
Director, Mitigation Division
Federal Emergency Management Agency, Region VIII
Denver Federal Center, Building 710
P.O. Box 25267
Denver, CO 80225-0267
(303) 235-4830

STATUS OF THE COMMUNITY NFIP MAPS

We will not physically revise and republish the FIRM and FIS report for your community to reflect the modifications made by this LOMR at this time. When changes to the previously cited FIRM panel(s) and FIS report warrant physical revision and republication in the future, we will incorporate the modifications made by this LOMR at that time.

This determination is based on the flood data presently available. The enclosed documents provide additional information regarding this determination. If you have any questions about this document, please contact the FEMA Map Information eXchange toll free at 1-877-336-2627 (1-877-FEMA MAP) or by letter addressed to the LOMC Clearinghouse, 3601 Eisenhower Avenue, Suite 500, Alexandria, VA 22304-6426. Additional information about the NFIP is available on our website at <https://www.fema.gov/national-flood-insurance-program>.

A handwritten signature in black ink, appearing to read "Rick Sacibit".

Patrick "Rick" F. Sacibit, P.E., Branch Chief
Engineering Services Branch
Federal Insurance and Mitigation Administration



Federal Emergency Management Agency
Washington, D.C. 20472

LETTER OF MAP REVISION
DETERMINATION DOCUMENT (CONTINUED)

PUBLIC NOTIFICATION OF REVISION

A notice of changes will be published in the *Federal Register*. This information also will be published in your local newspaper on or about the dates listed below, and through FEMA's Flood Hazard Mapping website at https://www.floodmaps.fema.gov/flm/bfe_status/bfe_main.asp

LOCAL NEWSPAPER

Name: *The Colorado Springs Gazette*

Dates: December 27, 2019 and January 3, 2020

Within 90 days of the second publication in the local newspaper, any interested party may request that we reconsider this determination. Any request for reconsideration must be based on scientific or technical data. Therefore, this letter will be effective only after the 90-day appeal period has elapsed and we have resolved any appeals that we receive during this appeal period. Until this LOMR is effective, the revised flood hazard determination presented in this LOMR may be changed.

This determination is based on the flood data presently available. The enclosed documents provide additional information regarding this determination. If you have any questions about this document, please contact the FEMA Map Information eXchange toll free at 1-877-336-2627 (1-877-FEMA MAP) or by letter addressed to the LOMC Clearinghouse, 3601 Eisenhower Avenue, Suite 500, Alexandria, VA 22304-6426. Additional information about the NFIP is available on our website at <https://www.fema.gov/national-flood-insurance-program>.

A handwritten signature in black ink, appearing to read "Rick Sacibit".

Patrick "Rick" F. Sacibit, P.E., Branch Chief
Engineering Services Branch
Federal Insurance and Mitigation Administration

FLOODING SOURCE		FLOODWAY			BASE FLOOD WATER-SURFACE ELEVATION (FEET NAVD88)			
CROSS SECTION	DISTANCE ¹	WIDTH (FEET)	SECTION AREA (SQUARE FEET)	MEAN VELOCITY (FEET PER SECOND)	REGULATORY	WITHOUT FLOODWAY	WITH FLOODWAY	INCREASE
Jimmy Camp Creek - East Tributary								
A	1,672	240	1,535	3.6	5679.4	5678.2 ²	5679.0 ²	0.8
B	1,962	700	862	6.4	5684.7	5684.7	5685.7	1.0
C	4,362	340	2,188	2.5	5690.0	5690.0	5690.7	0.7
D	5,693	80	660	8.3	5692.9	5692.9	5693.4	0.5
E	7,983	111	672	10.1	5701.6	5701.6	5701.8	0.2
F	10,049	172	1090	4.8	5709.3	5709.3	5709.3	0.0
G	11,455	90	443	11.8	5711.8	5711.8	5711.8	0.0
H	13,024	158	513	10.5	5726.2	5726.2	5726.2	0.0
I	13,933	148	511	8.8	5733.0	5733.0	5733.0	0.0
J	17,377	220	518	8.5	5763.6	5763.6	5763.6	0.0
K	18,757	260	735	5.0	5775.4	5775.4	5775.9	0.5
L	20,057	670	647	5.6	5789.1	5789.1	5789.2	0.1
M	23,137	600	1,259	2.9	5816.4	5816.4	5816.4	0.0
N	24,867	450	596	6.1	5831.5	5831.5	5832.2	0.7
O	26,127	400	900	3.7	5847.0	5847.0	5848.0	1.0
P	28,097	195	346	7.8	5870.0	5870.0	5870.0	0.0
Q	30,037	190	550	4.9	5886.2	5886.2	5886.5	0.3
R	30,257	200	613	4.4	5888.1	5888.1	5888.1	0.0
S	30,299	200	580	4.7	5890.6	5890.6	5890.6	0.0
T	30,399	280	996	2.7	5890.6	5890.6	5890.6	0.0
U	31,759	230	435	5.5	5901.7	5901.7	5902.4	0.7
V	32,839	350	518	4.6	5913.8	5913.8	5914.0	0.2
W	33,919	150	318	7.6	5925.1	5925.1	5925.1	0.0
X	35,939	130	255	7.9	5957.7	5957.7	5957.7	0.0

REVISED DATA

¹Feet Above Confluence with Jimmy Camp Creek.
² Elevation Computed without Consideration of Backwater Effects from Jimmy Camp Creek.

FEDERAL EMERGENCY MANAGEMENT AGENCY

EL PASO COUNTY, CO
AND INCORPORATED AREAS

FLOODWAY DATA

REVISED TO REFLECT LOMR EFFECTIVE: May 4, 2020

JIMMY CAMP CREEK - EAST TRIBUTARY

TABLE 8

FLOODING SOURCE		FLOODWAY			BASE FLOOD WATER-SURFACE ELEVATION (FEET NAVD88)			
CROSS SECTION	DISTANCE ¹	WIDTH (FEET)	SECTION AREA (SQUARE FEET)	MEAN VELOCITY (FEET PER SECOND)	REGULATORY	WITHOUT FLOODWAY	WITH FLOODWAY	INCREASE
Jimmy Camp Creek - East Tributary								
Y	38,039	70	221	9.0	5989.9	5989.9	5989.9	0.0
Z	40,529	110	187	7.2	6028.7	6028.7	6028.8	0.1
AA	41,739	198	240	5.6	6062.4	6062.4	6062.4	0.0
AB	42,659	100	178	7.6	6084.3	6084.3	6084.3	0.0

¹ Feet Above Confluence with Jimmy Camp Creek.

FEDERAL EMERGENCY MANAGEMENT AGENCY
EL PASO COUNTY, CO
AND INCORPORATED AREAS

FLOODWAY DATA

REVISED TO REFLECT LOMR EFFECTIVE: May 4, 2020

JIMMY CAMP CREEK - EAST TRIBUTARY

TABLE 8

JOINS PANEL 0769

104° 37' 30.00"

38° 45' 0.00"

4289000mN

NOTE: MAP AREA SHOWN ON THIS PANEL IS LOCATED WITHIN TOWNSHIP 15 SOUTH, RANGE 65 WEST.

City of Colorado Springs
080060

14

13

REVISED AREA

REVISED AREA

FONTAINE BLVD

Jimmy Camp Creek -
East Tributary

Bridge

JOINS PANEL 0976

4288000mN

El Paso County
Unincorporated Areas
080059

ZONE AE

24

ZONE AE

ZONE AE

ZONE AE

City of
Fountain
080061

APPLE
TREE PL

EL PASO COUNTY
CITY OF FOUNTAIN

ROLLING RIDGE RD

HERITAGE RD

PROJECT
AREA

Without Base Flood Elevation (BFE)
Special Flood Hazard Areas
Regulatory Floodway

0.2% Annual Chance Flood Hazard, Areas of 1% annual chance flood with average depth less than one foot or with drainage areas of less than one square mile.
Future Conditions 1% Annual Chance Flood Hazard
Area with Reduced Flood Risk due to Levee
See Notes.

OTHER AREAS OF FLOOD HAZARD

SCALE

Map Projection: NAD 83 UTM Zone 18Q
Datum: North American Vertical Datum of 1988
Units: Meter

1 inch = 500 Feet

0 250 500 1,000 Feet

0 50 100 200 Meters

NATIONAL FLOOD INSURANCE PROGRAM
EL PASO COUNTY, COLORADO
UNINCORPORATED AREAS
Panel: 957 of 1300

FEMA
National Flood Insurance Program

COMMUNITY	NUMBER	PANEL	SUFFIX
COLORADO SPRINGS	58000	0957	0
EL PASO COUNTY	080059	0957	0
FOUNTAIN	080061	0957	0

REVISED TO REFLECT LOMR EFFECTIVE May 4, 2020

VERSION NUMBER: 1.1.1.0
MAP NUMBER: 08041C0957G
MAP PREPARED: DECEMBER 7, 2018

NOTE: MAP AREA SHOWN ON THIS PANEL IS LOCATED WITHIN TOWNSHIP 15 SOUTH, RANGE 64 WEST AND TOWNSHIP 15 SOUTH, RANGE 65 WEST.

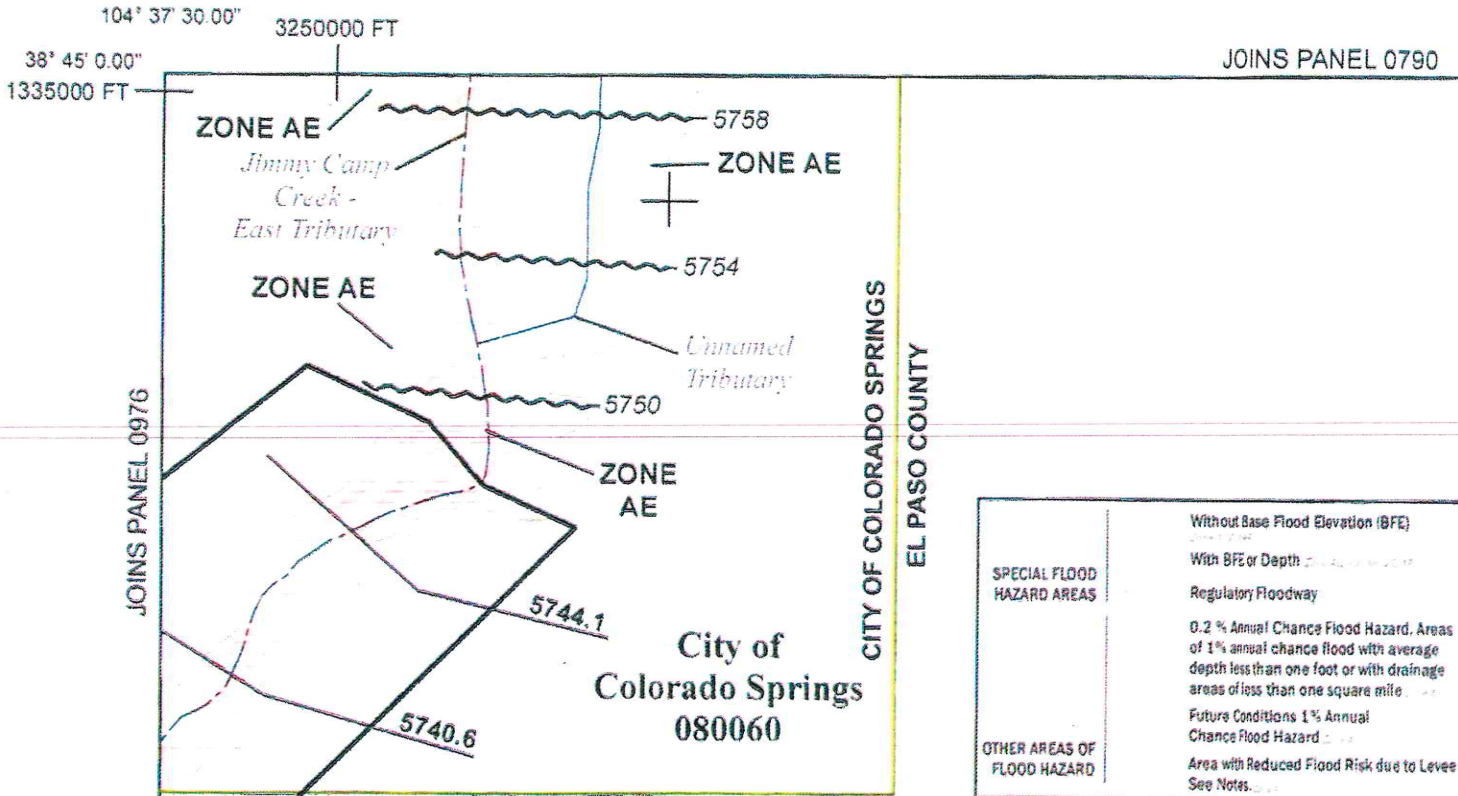

JOINS PANEL 0976

JOINS PANEL 0790

CITY OF COLORADO SPRINGS
EL PASO COUNTY

City of Colorado Springs
080060

13

REVISED AREA

El Paso County
Unincorporated Areas
080059

SPECIAL FLOOD HAZARD AREAS	Without Base Flood Elevation (BFE)
	With BFE or Depth
OTHER AREAS OF FLOOD HAZARD	Regulatory Floodway
	0.2% Annual Chance Flood Hazard, Areas of 1% annual chance flood with average depth less than one foot or with drainage areas of less than one square mile
	Future Conditions 1% Annual Chance Flood Hazard
	Area with Reduced Flood Risk due to Levee See Notes

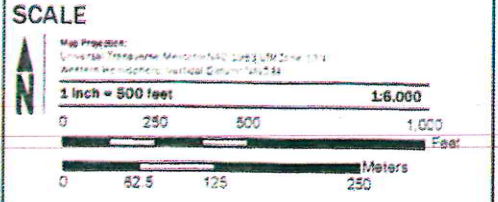

FEMA
National Flood Insurance Program

NATIONAL FLOOD INSURANCE PROGRAM
FLOOD INSURANCE RATE MAP

EL PASO COUNTY, COLORADO
and Incorporated Areas

PANEL 976 of 1300

COMMUNITY	NUMBER	PANEL	SUFFIX
COLORADO SPRINGS OTM OF	080060	0976	0
EL PASO COUNTY	080059	0976	0

REVISED TO REFLECT LOMR
EFFECTIVE: May 4, 2020

VERSION NUMBER
1.1.1.0

MAP NUMBER
08041C0976G

MAP REVISED
DECEMBER 7, 2018

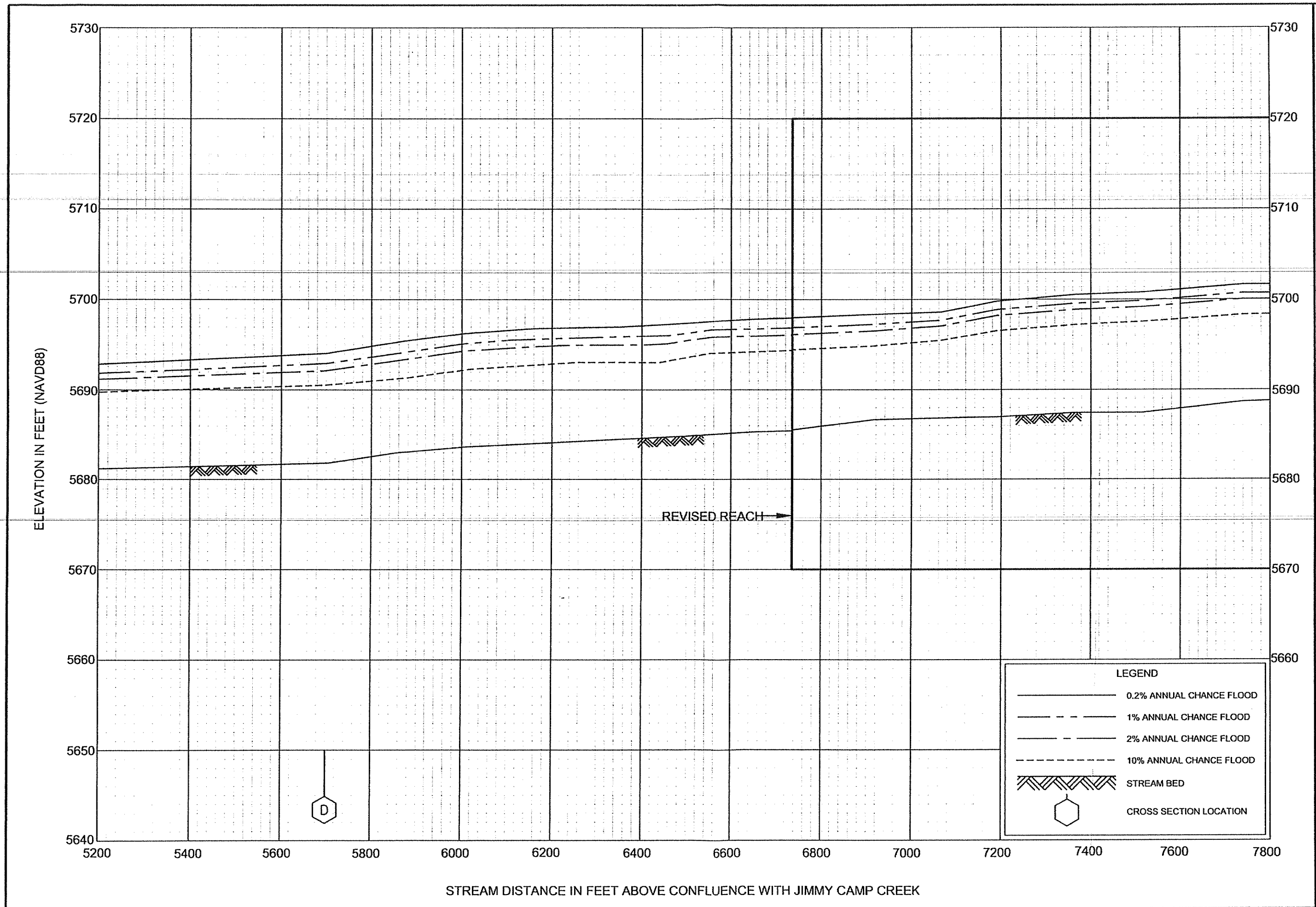

REVISED TO
 REFLECT LOMR
 EFFECTIVE: May 4, 2020

FLOOD PROFILES

JIMMY CAMP CREEK - EAST TRIBUTARY

FEDERAL EMERGENCY MANAGEMENT AGENCY
EL PASO COUNTY, CO
 (AND INCORPORATED AREAS)

210P

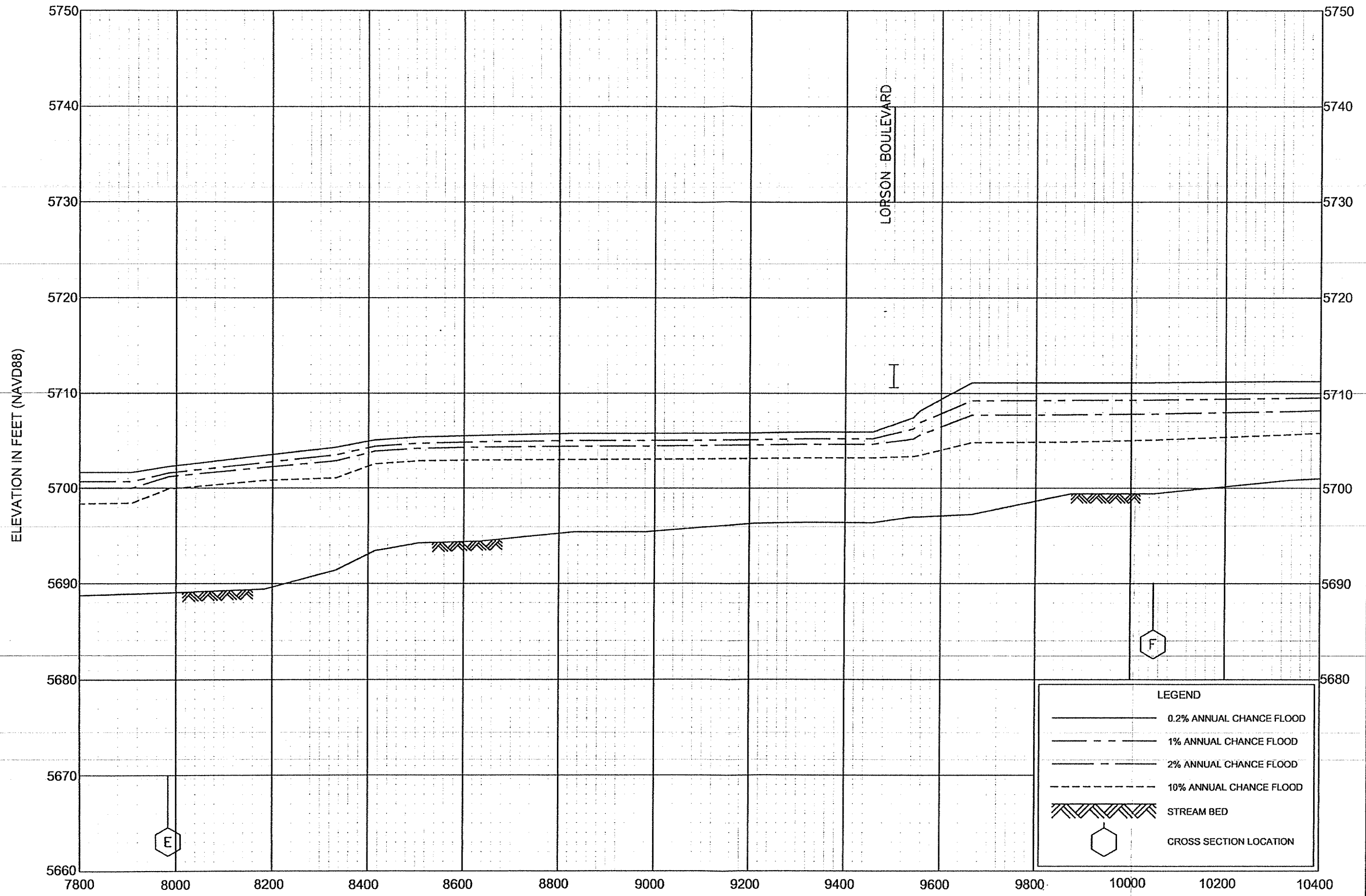

LEGEND	
	0.2% ANNUAL CHANCE FLOOD
	1% ANNUAL CHANCE FLOOD
	2% ANNUAL CHANCE FLOOD
	10% ANNUAL CHANCE FLOOD
	STREAM BED
	CROSS SECTION LOCATION

REVISED TO
REFLECT LOMR
EFFECTIVE: MAY 4, 2020

FLOOD PROFILES

JIMMY CAMP CREEK - EAST TRIBUTARY

FEDERAL EMERGENCY MANAGEMENT AGENCY

EL PASO COUNTY, CO
(AND INCORPORATED AREAS)

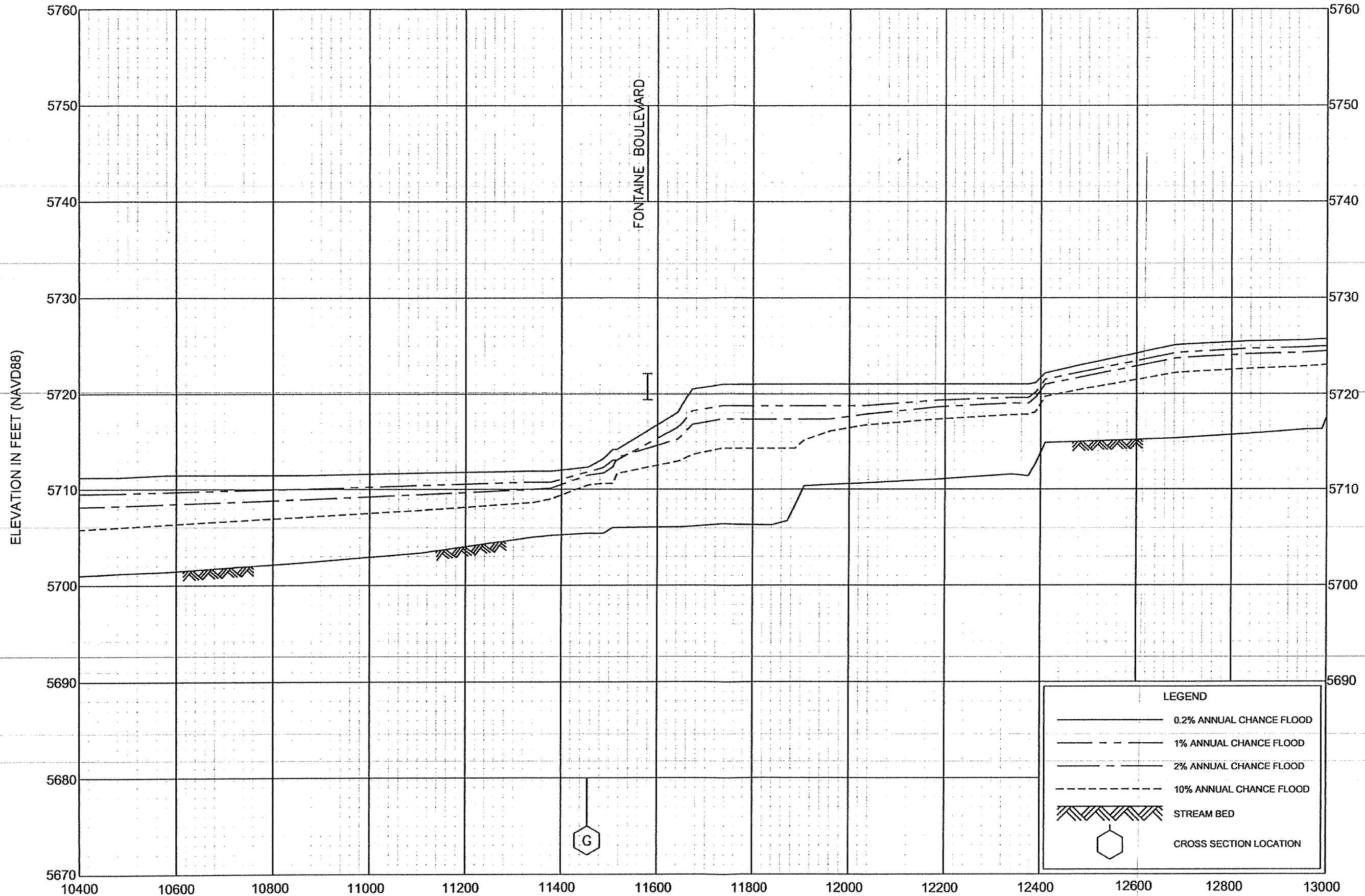

STREAM DISTANCE IN FEET ABOVE CONFLUENCE WITH JIMMY CAMP CREEK

REVISED TO
REFLECT LOWR
EFFECTIVE: May 4, 2020

FLOOD PROFILES

JIMMY CAMP CREEK - EAST TRIBUTARY

FEDERAL EMERGENCY MANAGEMENT AGENCY

EL PASO COUNTY, CO
(AND INCORPORATED AREAS)

212P

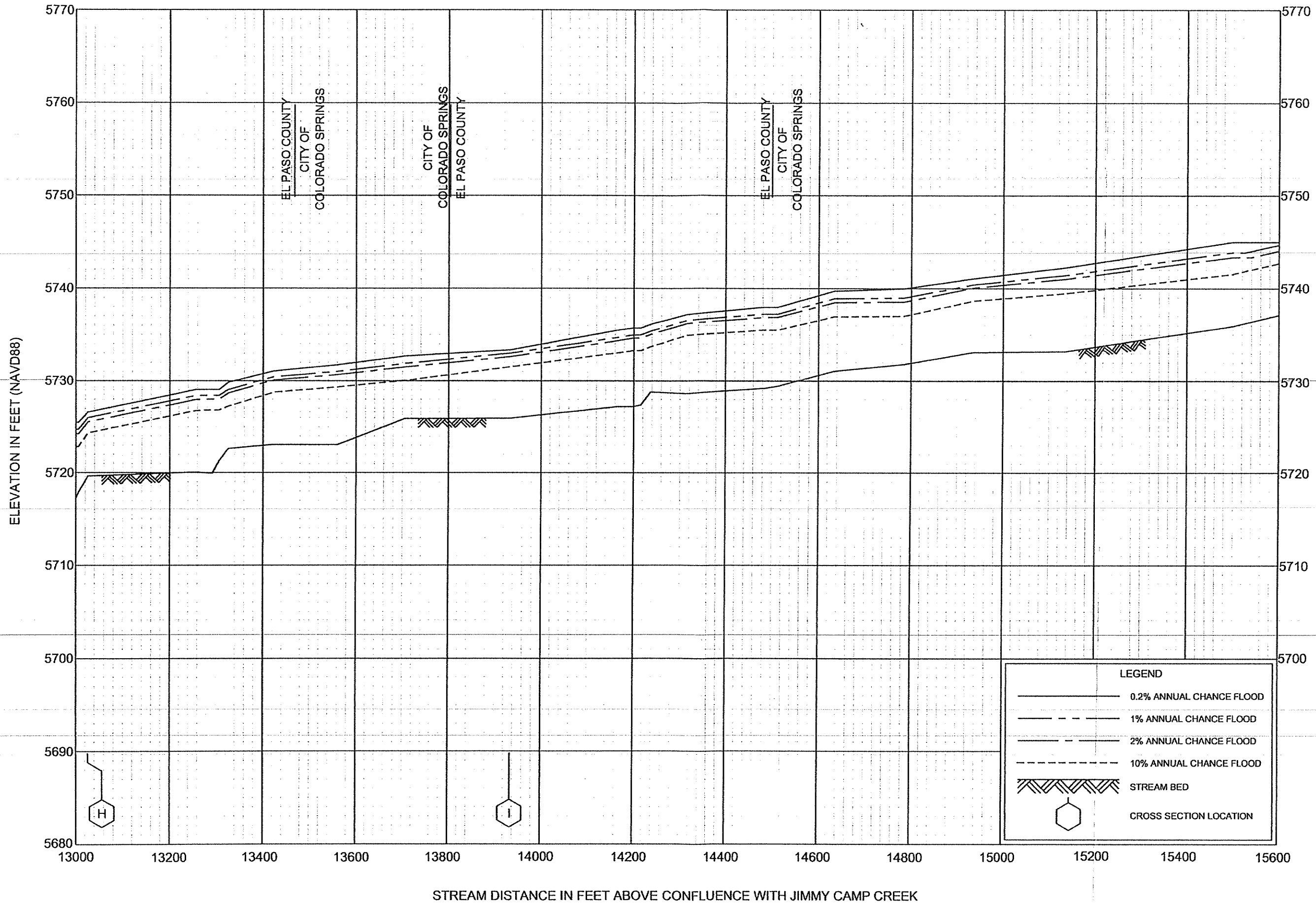

REVISED TO
REFLECT LOMR
EFFECTIVE: May 4, 2020

FLOOD PROFILES

JIMMY CAMP CREEK - EAST TRIBUTARY

FEDERAL EMERGENCY MANAGEMENT AGENCY

EL PASO COUNTY, CO
(AND INCORPORATED AREAS)

17-Mar
SAB

River Sta	Proposed Revised			Effective 100yr W.S. Elev (ft)	PP Rev-Eff 100yr Difference (ft)
	100yr W.S. Elev (ft)	550 cfs	110 cfs		
9000	5699.47	5694.15	5692.96	5702.15	-2.7
8850	5699.43	5693.85	5692.70	5702.21	-2.8
8650	5698.74	5693.14	5692.08	5702.03	-3.3
8521.53	5698.59	5691.88	5690.85	5701.88	-3.3
8470	5698.58	5691.92	5689.72	5701.62	-3.0
8430	5698.27	5691.64	5689.42	5701.29	-3.0
8350	5697.69	5690.88	5688.82	5699.93	-2.2
8200	5697.56	5690.74	5688.79	5699.08	-1.5
8000	5696.73	5690.28	5688.62	5698.13	-1.4
7924	5696.13	5689.71	5688.33	5697.13	-1.0
7750	5695.67	5688.95	5686.85	5696.44	-0.8
7525	5695.29	5688.51	5686.40	5695.39	-0.1
7375	5694.81	5688.29	5686.23	5695.42	-0.6
7200	5693.63	5687.91	5685.94	5695.02	-1.4
7075	5693.09	5687.42	5685.25	5693.97	-0.9
6925	5692.84	5686.86	5684.64	5693.69	-0.8
6746	5692.44	5686.46	5684.31	5693.47	-1.0
6561	5691.95	5685.98	5683.86	5693.18	-1.2
6448	5691.70	5685.55	5683.38	5692.57	-0.9
6259	5690.49	5684.85	5682.90	5692.37	-1.9
6150	5690.22	5684.61	5682.69	5692.25	-2.0
6000	5689.88	5684.33	5682.55	5691.69	-1.8
5865	5689.19	5683.87	5682.32	5690.77	-1.6
5710	5688.21	5683.30	5681.66	5688.58	-0.4
5436	5687.49	5682.43	5680.89	5687.83	-0.3
5236	5686.65	5681.85	5680.34	5687.18	-0.5
5032	5684.84	5681.29	5679.62	5684.85	0.0
4836	5684.65	5681.16	5679.16	5684.75	-0.1
4500	5683.70	5680.62	5678.16	5683.70	0.0

Appendix E
Correspondence with Colorado Parks and Wildlife
Department of Natural Resources

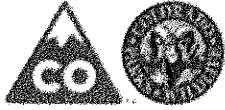

COLORADO
Parks and Wildlife

Department of Natural Resources

Area 14
4255 Sinton Road
Colorado Springs, CO 80907
P 719.227.5200 | F 719.227.5297

September 17, 2018

Thomas and Thomas Planning Group
ATTN: Jason Alwine
702 N. Tejon Street
Colorado Springs, CO

Re: Creekside at Lorson Ranch PUDSP Plan/ PUDSP- Combined PUD/Preliminary Plan

Dear Mr. Alwine:

Thank you for the opportunity to comment on the Creekside at Lorson Ranch PUDSP Plan. Colorado Parks and Wildlife (CPW) has reviewed the project materials and visited the site. CPW has commented on previous phases of this development, and offers the following comments on this phase.

The vegetation is comprised of short grass prairie species. This habitat type will sustain numerous wildlife species including antelope, deer, coyote, fox, raptors, songbirds and numerous small mammals.

Construction even near riparian habitats can have downstream effects, such as increased sedimentation and erosion. If bank stabilization is not completely necessary in an area, we recommend leaving it in its natural state. Disturbance to soil can lead to introduction of invasive plant species which, among other things, can reduce the amount of quality forage for wildlife and cattle as well as possibly create an increased fire hazard. CPW recommends the development and implementation of a noxious weed control plan for the site. CPW recommends that in places where vegetation is removed, a native seed blend is used that matches the surrounding vegetation types as accurately as possible. All disturbed soils should be monitored for noxious weeds and noxious weeds should be actively controlled until native plant re-vegetation and reclamation is achieved. All landscaping in the developed area should be comprised of native species, and CPW recommends against using non-native plants or noxious weeds. Some care should be taken with species choice to prevent the attraction of unwanted wildlife into the development area. Information on plant species consumption by specific wildlife species is available through CPW.

By using native species with high food and cover values in an open space area large enough to maintain a viable movement corridor, and native plants with little food and cover value in the



developed area, wildlife will be concentrated in areas that minimize conflict and optimize wildlife watching opportunities. Native species provide an aesthetically pleasing landscape that requires little maintenance and are frequently more drought-tolerant than non-native species.

CPW has identified current and past raptor nesting in the area. CPW recommends the use of preconstruction surveys, as well as continuation of those surveys during construction, to identify raptor nests within the project area and implement appropriate restrictions. CPW recommends adherence to the recommended buffer distances and timing stipulations identified in the attached document "**Recommended Buffer Zones and Seasonal Restrictions for Colorado Raptors**". Removal or relocation of any active raptor nests will require consultation with CPW and US Fish and Wildlife Service prior to moving. Both active and potential nest sites, winter night roosts should be considered when evaluating disturbance during construction.

Jimmy Camp Creek contains a population of Arkansas darters, a state threatened and federal candidate species. The Jimmy Camp Creek population of Arkansas darters is an important population in the Arkansas Basin. Arkansas darters are a high priority Tier 1 species in the CPW State Wildlife Action Plan. One of the conservation actions of CPW is securing habitat quality for existing populations. Although no Arkansas Darters were located during a stream survey conducted in 2005, the East Tributary of Jimmy Camp Creek (ETJC) does provide potential darter habitat.

In 2006, then, Colorado Division of Wildlife (CDOW) wrote a comment letter advising against straightening the ETJC. Reduction in sinuosity (the way a stream channel bends) can cause negative impacts to the riparian wildlife habitat associated with this stream. As streams are straightened, the slope of the channel tends to steepen, thus increasing water flows and sedimentation. Riparian areas and flood plains slow flood waters, provide habitat for wildlife, and decreases potential damage to any structures that end up being built near the creek channel. A stream with higher sinuosity allows for willows and other plants to establish along the banks and create a complex root system, thus strengthening the integrity of the stream channel. Although some sinuosity was left, the channel has undergone a drastic change and is **for the most part straight; the channel is perfectly "U" shaped which further increases water velocity during high flow/flood events.** ETJC also no longer has a riparian/flood plain as it goes through the development. Since 2006, several hundred acres of short grass prairie have been developed creating a large amount of impervious surface. The proposed addition will add an additional approximate 83.08 acres of impervious surface. This increase in impervious surface combined with the new straightened and channelized nature of the creek will increase erosion, siltation and water velocity during heavy rain events which could have a negative impact on the surrounding environment as well as manmade structures. Jimmy Camp Creek's **hydrograph** already has a flow pattern dominated by flood pulse events that is sharply amplified by the **already constructed developments both up stream and down from the development's future location.** CPW is concerned about the possible addition to the amplitude of flows that could result from the impacts listed above.

Conflicts may arise between homeowners and wildlife. The following is a list of general recommendations that CPW would also like to be taken into consideration in order to avoid

nuisance conflicts with wildlife. Coyotes, foxes, cottontail rabbits, and raccoons are several species that have adapted well to living within city limits. Open space, as well as developed areas, may become suitable habitat for many wildlife species. Coyote sightings are common within the city and few interactions are negative for the coyote. While coyotes will not usually approach people, in places where they see us often, they become less fearful. Coyotes feed near homes, yards, trails, and roads in order to survive in urban areas. Homeowners can do their part by *not* inviting wildlife into their yard. Many times these conditions can be enforced **through the local Homeowner's Association or through covenants.**

1. Pets should not be allowed to roam free and fences should be installed to decrease or eliminate this problem. Dogs and cats chase or prey on various wildlife species. One benefit to keeping animals under control is that they are less likely to bother other people, be in roadways or become prey for coyotes, foxes or owls.
2. Trash should be kept indoors until the morning of trash pickup. CPW recommends using bear resistant trash containers. Skunks, raccoons, bears, and neighborhood dogs are attracted to garbage and do become habituated.
3. Feeding of all wildlife should be prohibited, with the exception of songbirds. The use of bird feeders, suet feeders, and hummingbird feeders are discouraged. However, if feeders are used, they should be placed so they are inaccessible to raccoons or skunks and other wildlife species that might cause damage or threaten human safety. It is illegal to feed big game including deer, elk, antelope, moose, bear and lion as well as coyote and fox.
4. Pets should be fed inside or if pets are fed outside, feeding should occur only for a specified period of time and food bowls returned afterwards to a secure site for storage. Pet food left outside attracts various wildlife species which in turn attracts predators.
5. When landscaping lots, it is strongly recommended that native vegetation be used that wildlife is less likely to be attracted to. Planting of trees and shrubs that are attractive to native ungulates should incorporate the use of materials that will prevent access and damage (fencing, tree guards, trunk guards, etc.).
6. Fences, other than those around the immediate domicile and serving to protect landscaped trees and shrubs, should be designed so as not to impair wildlife movements. Ornamental fences with sharp vertical points or projections extending beyond the top rail should be strongly discouraged. Wildlife friendly design recommendations can be provided upon request.

CPW has further resources available to developers and residents on our website at [CPW's homepage](#).

CPW believes that the development as proposed will lead to increased nuisance wildlife conflicts as well as erosion concerns on the East Tributary of Jimmy Camp Creek similar to those seen in many other Colorado Springs streams. The proximity of human development on both sides of the ETJC as well as the main channel limits the effectiveness of these streams as

wildlife corridors. To preserve the ETJC as outlined in the 2003 Highway 94 Comprehensive plan CPW recommends increasing the size of the open space surrounding the creek.

We appreciate being given the opportunity to comment. Please feel free to contact District Wildlife Manager Philip Gurule, should you have any questions or require additional information at 719-227-5283 or via email at Philip.gurule@state.co.us.

Sincerely,



Frank McGee
Area Wildlife Manager

Cc: Philip Gurule DWM
SE Regional File
Area 14 File

Rich Wray

From: Rich Wray
Sent: Monday, March 11, 2019 11:11 AM
To: Philip Gurule - DNR
Subject: Creekside/east fork jimmy camp creek
Attachments: 18020 rev efcc cross-sections.pdf

Philip: I am following up on our recent channel design drawings submitted to your office last January. Having not heard from your office regarding the latest channel sections we are proceeding with our submittal to the County Planning office using the attached low flow detail. If you can provide any further comments it would be appreciated.

Thanks for your help on this.

Rich Wray

Richard Wray, PE
Principal



1604 South 21st Street
Colorado Springs, Colorado 80904-4208
Phone: (719) 630-7342
Email: rwray@kiowaengineering.com

Rich Wray

From: Rich Wray
Sent: Friday, January 11, 2019 12:49 PM
To: Philip Gurule - DNR
Cc: 'Jason Alwine'
Subject: creek side at lorson ranch
Attachments: 18020 rev efjcc cross-sections.pdf

Phillip: sorry it has taken so long to get back to you. Regarding your email dated November 28th, I have revised the typical peal sections transmitted previously for your review. The new low flow section accommodates a 2-foot deep bankfull channel created out of boulders and a 2-foot deep overbank channel. Combined the bankfull channel and overbank channel can carry the required low flow capacity of 560 cfs per county criteria. The bankfull flow of 110 cfs (2yr frequency +/-), was derived by Kiowa when the Jimmy Camp Creek drainage basin planning study was completed in 2014. The bankfull channel as shown carries 113 cfs. This two stage approach is I believe what you were explaining in your email. Velocities are around 6 feet per second well within the erosive tolerance of the proposed vegetated bench.

Let me know your thoughts as if this appears to meet the goals of DNR than I will take this concept to the County and begin the design review process.

Rich

Richard N. Wray, PE
Kiowa Engineering
Principal

(719) 630-7342 Work
rwray@kiowaengineering.com

1604 South 21st
Colorado Springs, Colorado 80904

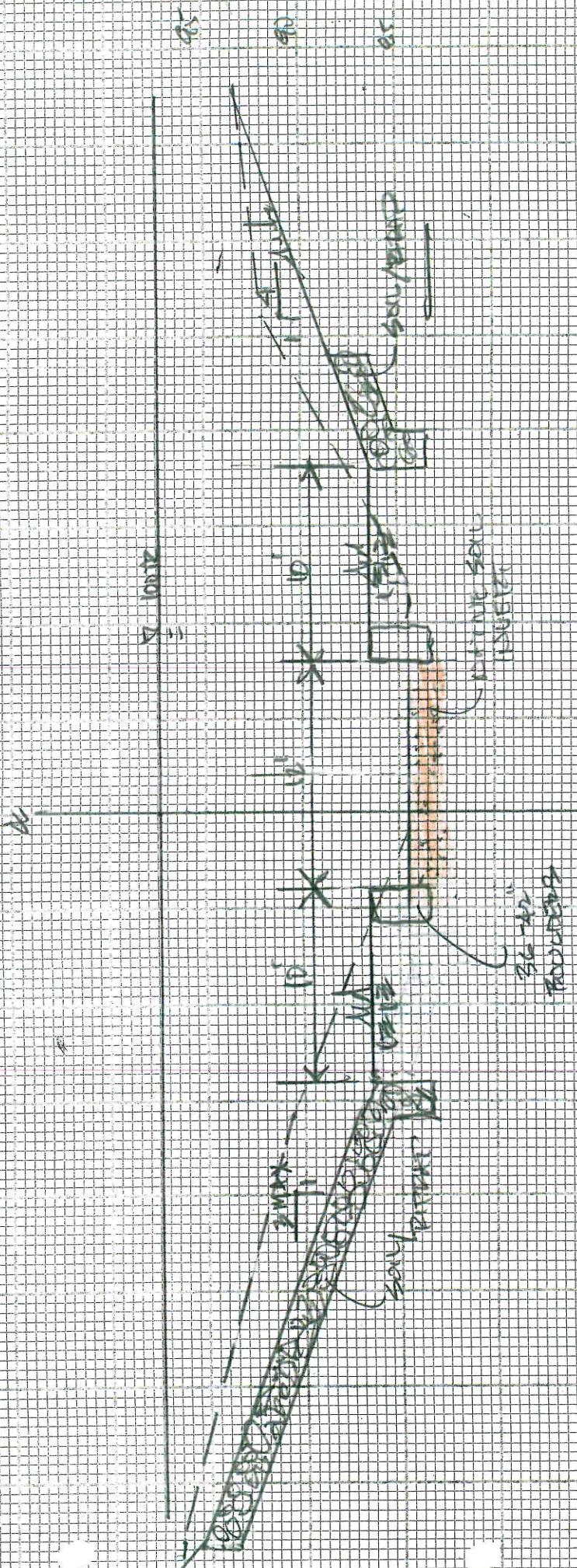

XSEL 41150
 15-5 HLY

Rev. 1/10/19

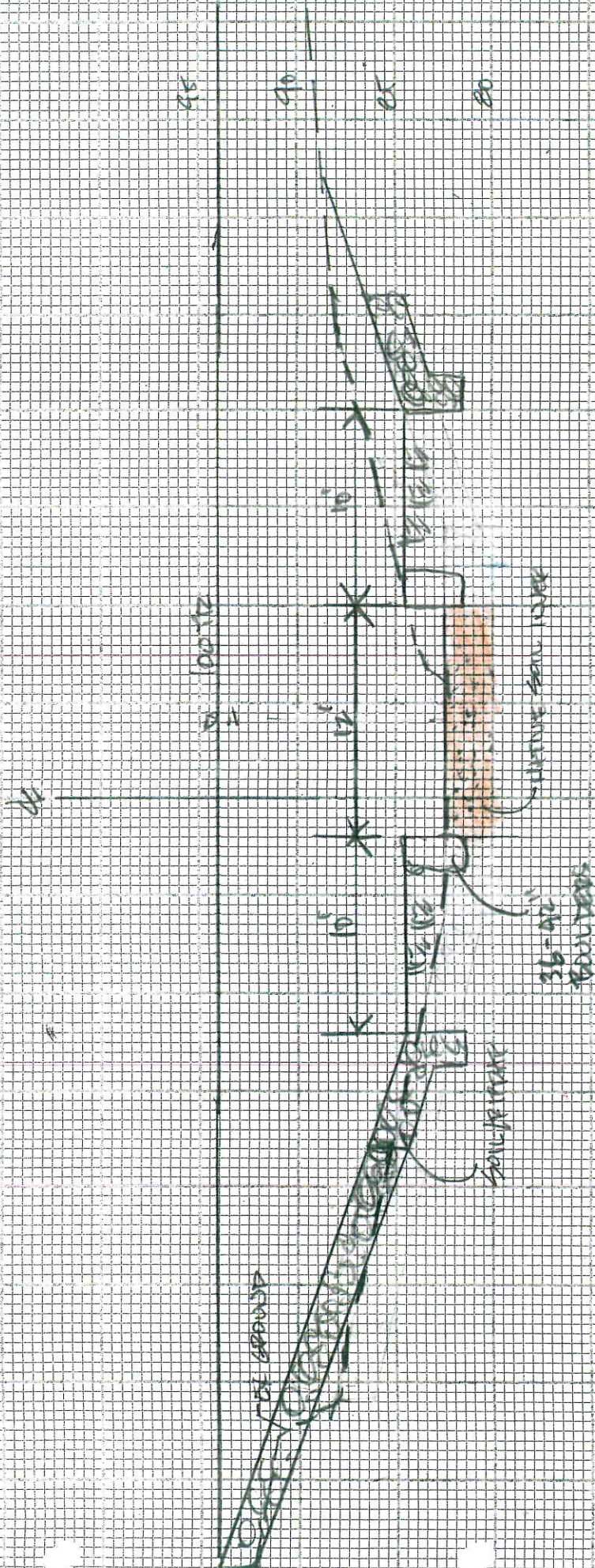

X-501 33000

1" = 5' H.F.V

Rev 1/10/19

Rich Wray

From: Jason Alwine <jalwine@ttplan.net>
Sent: Thursday, December 6, 2018 12:19 PM
To: Rich Wray; Liz Klein
Subject: FW: Creekside at Lorson Ranch
Attachments: image001.jpg

Rich,

Did you response to Philip about his question? Seems like this is getting deeper than it needs to be but then again what do I know 😊

Jason

From: Gurule - DNR, Philip <philip.gurule@state.co.us>
Sent: Wednesday, November 28, 2018 11:14 AM
To: Jason Alwine <jalwine@ttplan.net>; eklein@kiowaengineering.com; Rich Wray <rwrap@kiowaengineering.com>
Cc: Paul Foutz - DNR <paul.foutz@state.co.us>; Cory Noble - DNR <cory.noble@state.co.us>
Subject: Re: Creekside at Lorson Ranch

Good afternoon everyone,

Thank you so much for getting those cross sections sent over! We really appreciate the willingness to work with us. Very seldom do we find folks who will sit down with us and discuss the project more in depth. As we looked at the cross section, we saw some areas where we feel that enhancements could be made. Such as, adding a two stage channel design that would have a stabilized lower stage channel which can hold and carry a bankfull flow and the incorporation of native woody vegetation. This would be beneficial to the stabilization of the creek as well as enhance the area for wildlife. I will be typing up a formal letter for the addition of these elements. If you have any questions in the meantime, don't hesitate to reach out to me! Thanks!

On Mon, Nov 26, 2018 at 1:29 PM Jason Alwine <jalwine@ttplan.net> wrote:

Philip,

Attached are some cross sections that indicate the minimal improvements to the existing channel for the Creekside at LR project. Please let us know of any questions, thank you.

Jason

Jason Alwine, PLA

Rich Wray

From: Rich Wray
Sent: Monday, November 26, 2018 12:50 PM
To: 'Jason Alwine'
Subject: efjcc cross-sections
Attachments: 18020 efjcc cross-sections.pdf

Jason: attached are cross-sections per our meeting with USFW.

Rich

Richard N. Wray, PE
Kiowa Engineering
Principal

(719) 630-7342 Work
rwray@kiowaengineering.com

1604 South 21st
Colorado Springs, Colorado 80904

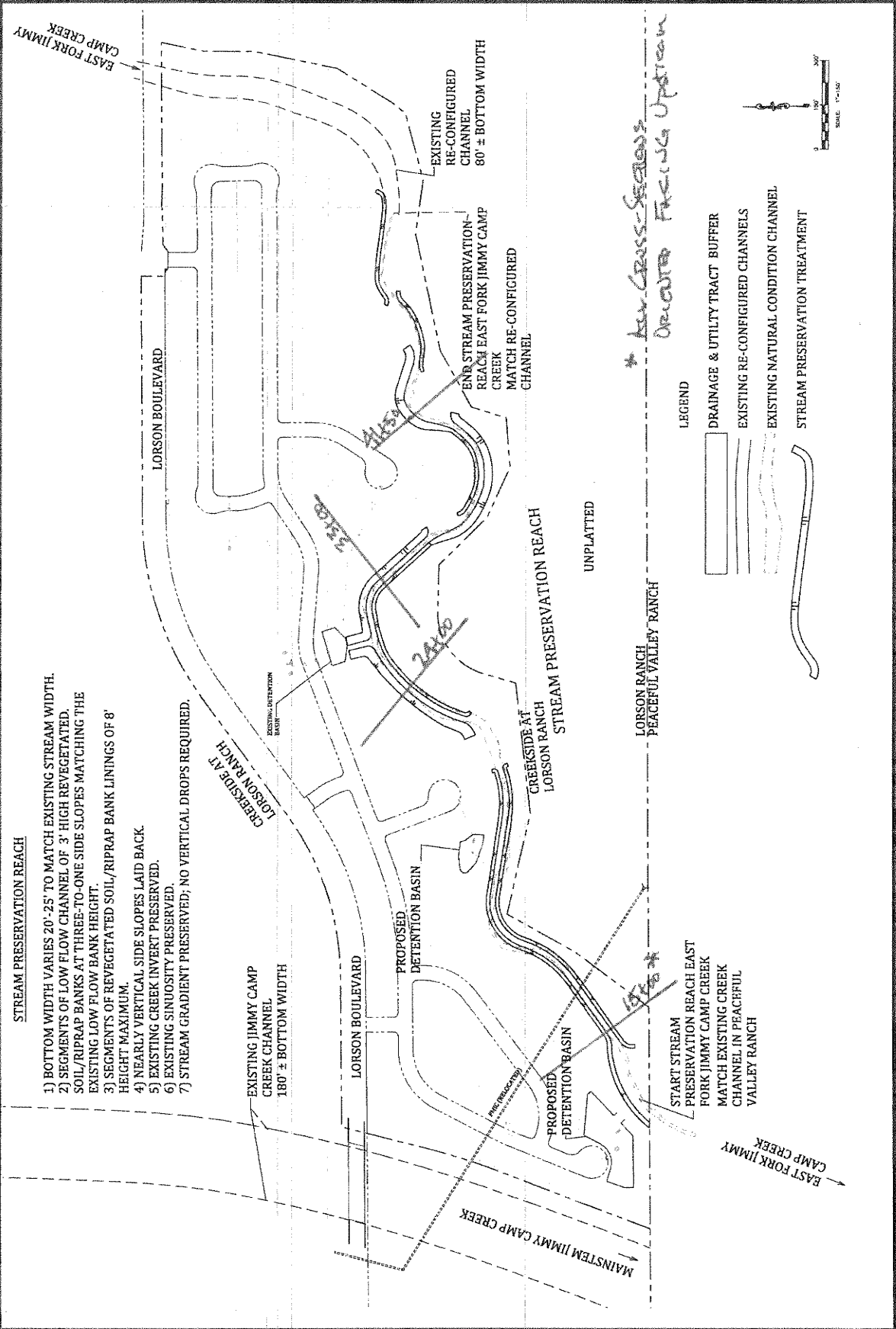

3

100
100
100
100

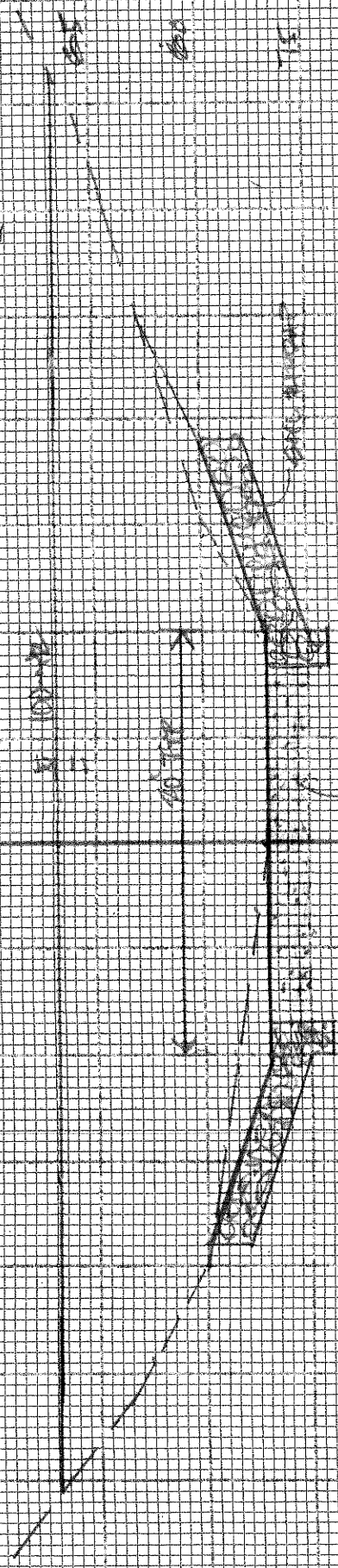

YSEC 10702
 100' DIV

ENTRANCE OF INVERT

ENTRANCE OF INVERT

200

100



X SEC 28+00
1" = 5' H&V

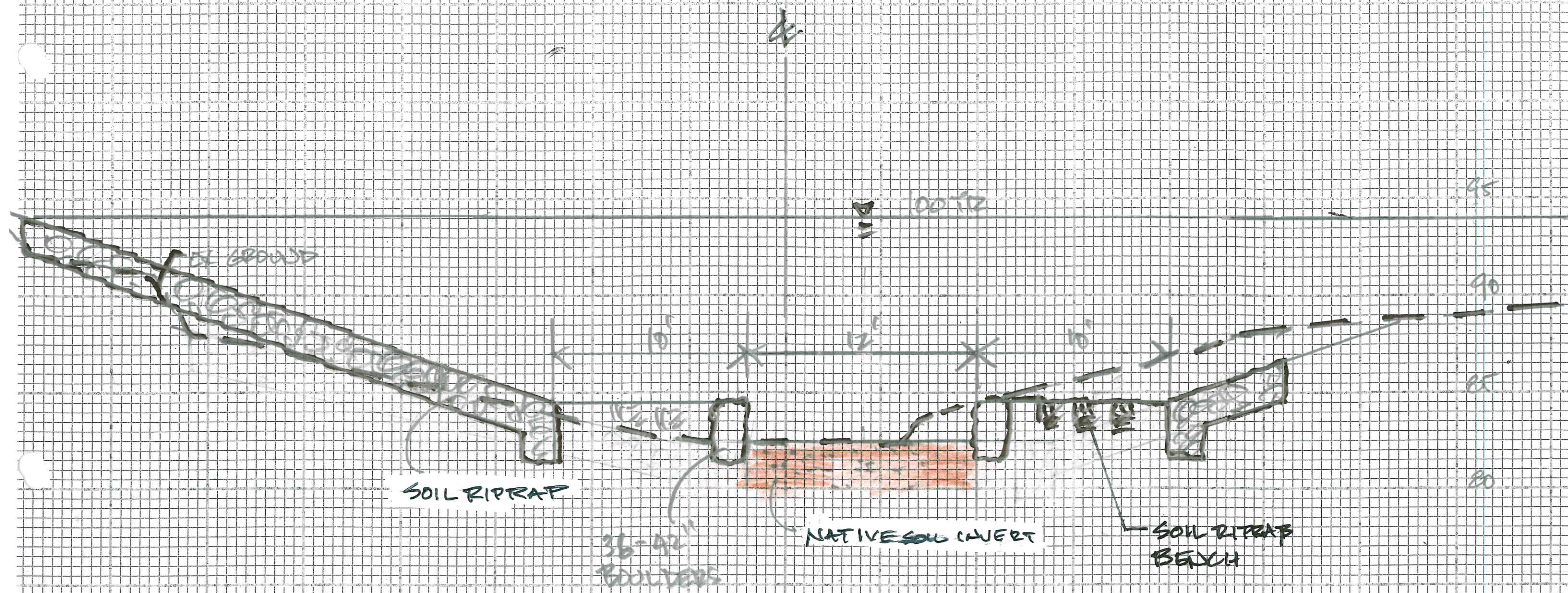

X SEC 33+00

1" = 5' H+V

10/19

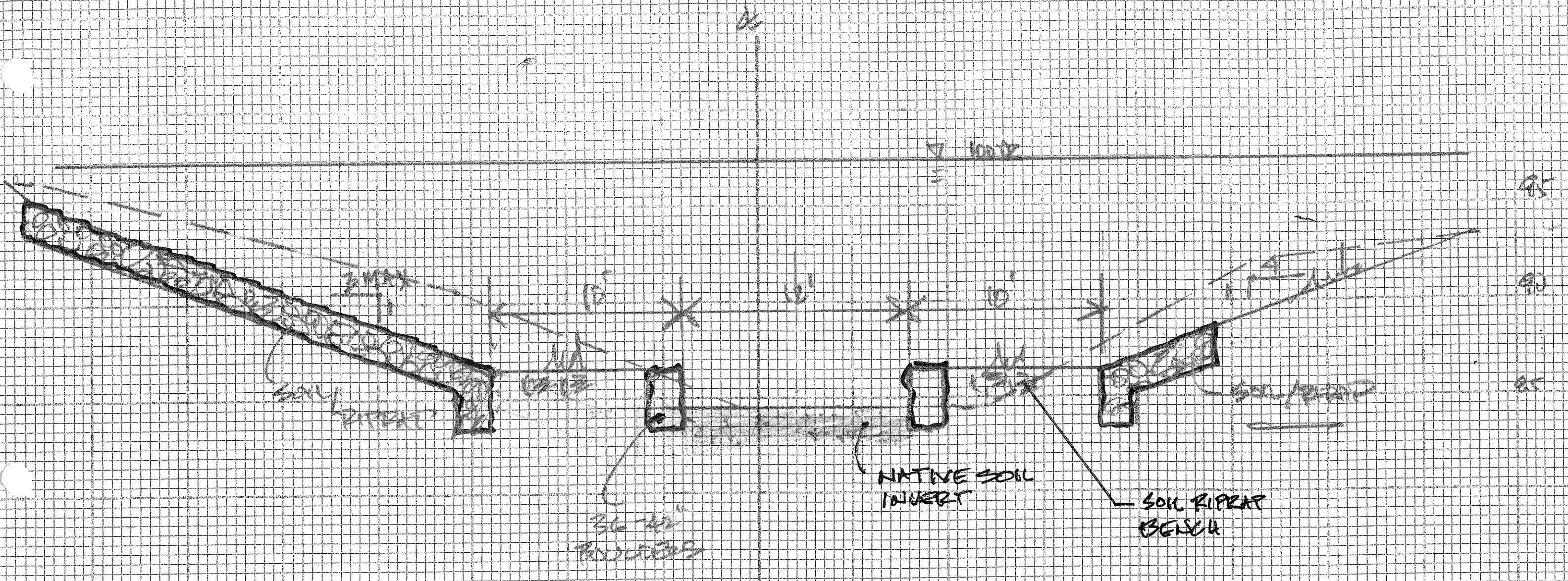

XSEC 41+50

1" = 5' HAY

Rev. 1/10/19