

ACCEPTED for FILE
Engineering Review

01/04/2023 8:24:06 AM
dsdnijkamp

EPC Planning & Community
Development Department



LSC TRANSPORTATION CONSULTANTS, INC.
2504 East Pikes Peak Avenue, Suite 304
Colorado Springs, CO 80909
(719) 633-2868
FAX (719) 633-5430
E-mail: lsc@lscctrans.com
Website: <http://www.lscctrans.com>

ARACO Concrete
Transportation Memorandum
(LSC #194560)
PCD File No.: PPR1950
February 21, 2022
(w/minor rev. 4/27/22)

Traffic Engineer's Statement

This traffic report and supporting information were prepared under my responsible charge and they comport with the standard of care. So far as is consistent with the standard of care, said report was prepared in general conformance with the criteria established by the County for traffic reports.



Developer's Statement

I, the Developer, have read and will comply with all commitments made on my behalf within this report.

A handwritten signature in blue ink, written over a horizontal line.

Date _____



LSC TRANSPORTATION CONSULTANTS, INC.
2504 East Pikes Peak Avenue, Suite 304
Colorado Springs, CO 80909
(719) 633-2868
FAX (719) 633-5430
E-mail: lsc@lsctrans.com
Website: <http://www.lsctrans.com>

February 21, 2022
(w/minor rev. 4/27/22)

Arturo Acosta
ARACO Enterprises
7470 Southmoor Drive
Fountain, CO 80817

RE: ARACO Concrete
El Paso County, CO
Transportation Memorandum
LSC # 194560
PCD File No. PPR1950

Dear Mr. Acosta,

LSC Transportation Consultants, Inc. has prepared this Transportation Memorandum for the ARACO Concrete site. The site is located at 7470 Southmoor Drive in unincorporated El Paso County, Colorado. Access is proposed to Southmoor Drive. This report has been prepared as part of a Site Development Plan submittal to the El Paso County Planning and Community Development Department.

This memorandum has been prepared primarily to address the existing roadway and traffic conditions, the existing trip generation, and the projected trip generation following the completion of the proposed site improvements, as well as to evaluate the access plan with respect to the criteria in the *Engineering Criteria Manual*.

REPORT CONTENTS

The preparation of this report included the following:

- An inventory of existing roadway and traffic conditions on the adjacent and nearby roadway system, including surface conditions, functional classification, jurisdictional control, widths, pavement markings, traffic control signs, posted speed limits, intersection and access spacing, roadway and intersection alignments, roadway grades, and auxiliary turn lanes;
- The proposed site improvement plan and access plan;
- Estimated peak-hour and average daily traffic (ADT) volumes adjacent to the proposed ARACO Concrete site on Southmoor Drive;

- Evaluation of access sight distances and comparison to El Paso County *Engineering Criteria Manual (ECM)* criteria for stopping sight distance and entering/intersection sight distance;
- Evaluation of the access points with respect to the *ECM* Criteria contained in Section 2.4.1.; and
- Pedestrian & bicycle facilities.

LAND USE AND ACCESS

The 4.2-acre ARACO Concrete site is located at 7470 Southmoor Drive in unincorporated El Paso County, Colorado. The site location is shown in Figure 1. Access is to the adjacent Southmoor Drive. The proposed site improvements plan showing the proposed building, on-site circulation, and proposed access points is attached.

The current concrete services business operates out of the 2,000-square-foot building on the site. The company employs eight office staff members and approximately 10-16 field employees who will travel to/from the site for work via private vehicle. Crews then travel to job sites in company vehicles. This site is not a concrete batch plant and no concrete mixer trucks are dispatched from this site. **However**, occasionally concrete mixer trucks will travel to the site to pour concrete into prefabricated forms, then leave. Also, periodically concrete pumper trucks may be stored on-site. The applicant will require all concrete mixer trucks and similar heavy/large vehicles such as pumper trucks, dump trucks, and RVs, to enter from and exit to the south via Southmoor Drive south of the site only and the intersection of Southmoor Drive/Highway 85. The applicant will require use of this route so that they are not going through the residential development to the north per the city of Fountain directive:

"Truck traffic shall be limited to Southmoor Drive south to Hwy 85 as the primary ingress/egress. Truck traffic is not permitted through the residential developments".

The proposed site plan shows the addition of a 6,000-square-foot building. Although this will increase the building square footage on-site from 2,000 to 8,000 square feet, the new building is planned to be used for storage and as a shop. It will not contain business offices. There is also outside storage for contractor equipment, which will remain. The parking area south of the building will be formalized and access to this lot will be better defined. The three spaces in front of the existing building are proposed to remain. The site plan shows three ninety-degree parking spaces. A proposed 40-foot-wide driveway (curb cut) is proposed for access to these parking spaces. The remainder of the site frontage to Southmoor Drive near these parking spaces will be closed off with new curb so that only the 40-foot-wide access opening can be used. A deviation has been prepared (and is included with this submittal).

A 114-space RV & vehicle storage lot is also proposed on the north side of the site.

ROAD AND TRAFFIC CONDITIONS

The attached site plan shows the streets adjacent to and in the vicinity of the site. Adjacent streets serving the site are identified below, followed by a brief description of each:

US Highway 85/87 (US Hwy 85/87) is classified as NR-A (Non-Rural Principal Highway) extending north from I-25 in Fountain to the City of Colorado Springs. In the vicinity of the site, US Hwy 85/87 has a posted speed limit of 50 miles per hour (mph) and is a four-lane urban section with curb and gutter. The T-intersection of US Hwy 85-87/Southmoor Drive is stop-sign-controlled with auxiliary turn lanes.

Southmoor Drive is classified as a two-lane Collector roadway adjacent to the site by the El Paso County road inventory. The County section only extends between 425 feet south of River Drive to the point where the street turns to the east (from which point it extends east to US Highway 85). The posted speed limit on Southmoor Drive is 25 mph, and the paved roadway width is about 22 feet. The section north of the County portion is in the City of Fountain. The City of Fountain Traffic Master Plan shows the “Collector” portion of Southmoor Drive beginning at Carson Boulevard and extending north. There is another County-owned/maintained section north of Lovitt Lane.

Existing Traffic Volumes

Vehicular turning-movement counts were conducted at the intersection of Southmoor Drive/Araco Concrete parking access/Southmoor Lane on Wednesday, August 14, 2019, from 6:30-8:30 a.m. and from 4:00-6:00 p.m. Count data is attached in Appendix Table 2 and is shown in Figure 2. The current volumes on the adjacent section of Southmoor Drive are light.

TRIP GENERATION

Estimates of the existing vehicle-trip generation and trip generation following the implementation of the site plan have been made using the nationally published trip generation rates from *Trip Generation, 10th Edition, 2017* by the Institute of Transportation Engineers (ITE). Corresponding trip-generation rates from ITE Land Use Category “180 – Specialty Trade Contractor” have been used to develop the trip-generation estimates for the exiting business and are based on the Site Development Plan. Table 2 shows estimates of the trip generation. The estimates are based on ITE rates with “building square footage” as the predictor variable.

Regarding the proposed RV Storage lot, ITE’s Trip Generation does not include trip-generation rates specifically for RV/boat storage businesses. For this report "RV/Vehicle Storage" rates (shown in the attached Table 2) are based on the results of a trip-generation study consisting of trip-generation data collection by LSC at several RV storage facilities in El Paso County (2018). Please refer to Appendix A for details.

Table 2 and Figure 3 (attached) present estimates of projected site trip generation. Existing count data have also been used in the trip estimate. The table shows estimates of the existing trip generation of the business, based on traffic count data and ITE rates with “building square footage” as the predictor variable.

The entire site is expected to generate about 105 vehicle trips on the average weekday (one half entering and one half exiting in a 24-hour period) following expansion. During the morning peak hour, 12 vehicles are projected to enter the site while 5 are projected to exit. Approximately 7 vehicles would enter and 14 vehicles would exit the site during the evening peak hour.

TRIP DISTRIBUTION AND ASSIGNMENT

Directional Distribution

An estimate of the proportion of site-generated vehicle trips to/from the north and south on Southmoor Drive and other key study-area streets that will provide access to the site is a necessary component in determining the site’s traffic impacts on these study-area streets. Figure 3 shows the estimated distribution/proportion of site-generated trips on the area roadway network.

Estimates were based on the following factors: existing traffic-count data, the proposed land use, the site-access plan, existing and planned area street and roadway system that will provide access to the site, the site’s geographic location, and adjacent existing land uses.

It is our understanding that the intersection of US Hwy 85/87 with Carson Avenue has been identified as a future signalized intersection (Destination 2025 Priority Project #186) on the City of Fountain’s *Major Thoroughfare Plan*. As such, northbound vehicles exiting the site may decide to travel north via Southmoor Drive to access US Hwy 85/87 via the future signal at Carson Avenue rather than turning from the stop-sign-controlled Southmoor Drive intersection with US Hwy 85/87.

Existing Plus Site-Generated Traffic Volumes

Figure 4 shows the sum of existing traffic volumes (from Figure 2) and site-generated peak-hour traffic volumes (shown in Figure 3). These volumes represent the projected short-term total traffic.

Estimated Future 2041 Background Traffic Volumes

Figure 5 shows the projected 20-year background traffic volumes for the year 2041. Estimated 2041 background traffic volumes on adjacent roadways and at the study-area intersections are based on projected additional development (background traffic) in the vicinity of the site and minor northbound-/southbound-through volume increases on Southmoor Drive. Estimated 2040

background northbound and southbound through traffic volumes on SH 115 are based on the CDOT 20-year growth factor of 1.25. The 2041 background volumes assume that Southmoor Drive/US 85/87 would remain a stop-sign-controlled intersection. Traffic from the site is **not** included in the **background** traffic volumes.

Future 2041 Total Traffic Volumes

Figure 6 shows the projected 2041 total traffic volumes, which are the sum of 2041 background traffic volumes (from Figure 5) plus long-term site-generated traffic volumes (from Figure 3).

LEVEL OF SERVICE ANALYSIS

Level of service (LOS) is a quantitative measure of the level of congestion or delay at an intersection and is indicated on a scale from “A” to “F.” LOS A is indicative of little congestion or delay. LOS F indicates a high level of congestion or delay. Table 1 shows the level of service delay ranges for signalized and unsignalized intersections.

Table 1: Intersection Levels of Service Delay Ranges

Level of Service	Signalized Intersections	Unsignalized Intersections
	Average Control Delay (seconds per vehicle)	Average Control Delay (seconds per vehicle) ⁽¹⁾
A	10.0 sec or less	10.0 sec or less
B	10.1-20.0 sec	10.1-15.0 sec
C	20.1-35.0 sec	15.1-25.0 sec
D	35.1-55.0 sec	25.1-35.0 sec
E	55.1-80.0 sec	35.1-50.0 sec
F	80.1 sec or more	50.1 sec or more

(1) For unsignalized intersections, if V/C ratio is greater than 1.0 the level of service is LOS F, regardless of the projected average control delay per vehicle.

Detailed Synchro reports are attached. A summary of LOS during the weekday morning and evening peak hours for the following unsignalized intersections is shown in the following figures:

- Figure 2: Existing Traffic, Lane Geometry, Traffic Control, and LOS
- Figure 4: Existing + Site Traffic, Lane Geometry, Traffic Control, and LOS
- Figure 5: 2041 Background Traffic, Lane Geometry, Traffic Control, and LOS
- Figure 6: 2041 Background + Site Traffic, Lane Geometry, Traffic Control, and LOS

Site Access Intersections

All approaches at both the north and south site-access points currently operate at and are projected to remain at LOS A or better following site buildout. Please refer to the detailed Synchro reports (attached) for additional details.

Southmoor Drive/US 85-87

The northeast-bound left-turn at the intersection of US Hwy 85-87/Southmoor Drive currently operates at LOS F and is projected to remain LOS F during the afternoon peak hour through the 20-year horizon. However, analysis results show a volume-to-capacity (v/c) ratio to be well below 1.00 for the eastbound-through turning movement during all short-term traffic scenarios. This is not uncommon for minor street approaches on arterial streets to operate at levels of service E or even F during peak periods, as signal timings would be adjusted to favor heavier northbound and southbound through volumes on US Hwy 85-87. Despite Synchro's reported LOS F (HCM methodology) for the northeast-bound left-turning movement during the afternoon peak hour, gaps created from the nearby signal at US Hwy 85-87/Mesa Ridge Parkway would allow side street vehicles to turn left onto US Hwy 85-87.

SITE-ACCESS PLAN

ECM Criteria for Access Design

The north and south site-access points will be allowed from the adjacent Southmoor Drive (Collector roadway). County staff has also indicated that a defined, single, 40-foot-wide driveway on Southmoor Drive will also be allowed for vehicular access to the three parking spaces in front of the building. Conditions of approval apply. Note: the head-in parking spaces on Southmoor Drive are addressed separately in the deviation request. The following summarizes *Engineering Criteria Manual* Section 2.4.1 access criteria, which states the following five access design guidelines:

- Adequate spacing
- Proper alignments
- Clear sight distances
- Coordinated widths with its intended use
- Clearances from intersections

The following sections address each of these criteria for access-point design throughout the site.

Adequate Spacing

Southmoor Drive is a Collector roadway. The *ECM* indicates that accesses shall be separated by a distance equal to the entering sight-distance values in Table 2-35. Based on a posted speed limit of 25 mph, the prescribed spacing would be 425 feet. The distance between the two site-access points is 480 feet, which meets *ECM* criteria.

Access Alignment

All proposed site-access points should be aligned at 90 degrees to the adjacent roadway centerline. The adjacent roadway grades are essentially level. The vertical alignment criteria in *ECM* Section 2.4.1.C.2 shall be met for the driveways. The access points are shown to intersect Southmoor Drive at 90 degrees.

Access Sight Distances

The access sight distance criteria in section 2.4.1.D would apply:

“Any potentially obstructing objects, such as but not limited to advertising signs, structures, trees, and bushes, shall be designed, placed, and maintained at a height not to interfere with the sight distance needed by any vehicle using the access.”

Southmoor Drive has a straight horizontal alignment with no significant vertical curvature that would limit access sight distance. Site improvements, such as signs, on-street angled parking, and landscaping, should not impede the required sight-distance lines of sight. The sight distance from the south access to the 90-degree corner to the southeast would be acceptable, given the design speed of that corner and the distance from the driver’s eye at the access.

Based on a 25-mph posted speed limit, sight distances for both approaches from both proposed site-access locations exceed the required 425-foot requirement for multi-unit trucks, per *ECM* Table 2-35, with one exception – the sight distance to the south from the south access point. The following analysis corresponds to sight distances for the proposed site-access intersections with Southmoor Drive.

Proposed Southmoor Drive/North Site-Access Intersection

Sight distances are as follows:

- To the northwest: greater than 1/4-mile
- To the southeast: 730 feet (unobstructed to L-corner turn on Southmoor Drive)

Proposed Southmoor Drive/South Site-Access Intersection

Sight distances are as follows:

- To the northwest: greater than 1/4-mile
- To the southeast: 290 feet (unobstructed to L-corner turn on Southmoor Drive). Although this is short of the 425-foot *ECM* minimum criteria, the design speed for traffic arriving from the south around the tight horizontal curve in Southmoor Drive is about 13 to 14 mph (the curve-warning sign indicates an advisory speed of 10 mph). Based on the speed of the approaching vehicle as it turns the corner and is seen by possible, but infrequent, multi-unit trucks, the intersection sight distance, based on the AASHTO formula, is 236 feet. As 290 feet is available, the sight distance is acceptable.

Access Width

The *ECM* requires a minimum of 25-foot width (and maximum of 40 feet) for a commercial access point on a Non-Residential Collector roadway. The south access drive (30 feet wide) would meet this criterion, while the north (gated) access drive (24 feet wide) would be just short of *ECM* criterion. The middle access, which will provide access to the three parking spaces in front of the existing building, will be 40 feet wide.

For the north access, LSC recommends a 65-foot stacking distance between the entry gate and the west edge of Southmoor Drive. This would allow for a Class A RV, 30-foot-long single-unit truck or a 35-foot-long U-Haul truck (largest size) plus an additional 30 feet to allow for a towed utility trailer, moving trailer, or following passenger vehicle.

Clearances from Intersections

Regarding access clearance from intersection criteria outlined in Section 2.4.1.F of the *ECM*:

Access to commercial or industrial properties fronting collector or local roads shall be located a minimum of 50 feet from the point of curvature or point of tangency of the curb line at the intersection. Access to commercial or industrial parcels fronting Nonresidential Collector roadways shall be located a minimum of 115 – 480 feet from the point of curvature or point of tangency of the curb line at the intersection, depending on the sight distance and location with respect to the intersection, intersection control, and posted speed.

*In all cases, a minimum corner clearance of 50 feet shall be provided. If the minimum corner clearance cannot be attained, the *ECM* Administrator may require investigation to determine if left turns should be prohibited into or out of the access point. For proposed access points near stop or signalized intersections, the *ECM* Administrator will require studies to determine if stopping queues will block the access point and if left turns should be prohibited into or out of the access point.*

Based on the proposed driveway locations shown in the site plan, the south access point would have a centerline offset of about 100 feet from the nearest intersection (Southmoor Drive/Southmoor Lane), which meets the aforementioned *ECM* criteria. This is a minor intersection with low through volumes and low turning volumes to/from Southmoor Lane.

PEDESTRIAN & BICYCLE FACILITIES

Sidewalks exist within the City of Fountain just to the north of the site (at the River Drive/Southmoor intersection). The existing drainage structure just to the north appears to have limited width and future sidewalk installation may not be feasible. There is an existing trail located just north of the site – the Crews Gulch Trail. The section of Southmoor connecting to US Hwy 85/87 has curb & gutter, but no sidewalk. Sidewalk exists along the west side of US Hwy 85/87. Southmoor

Lane, which exists directly across from this site, extends east to US Hwy 85. Although Southmoor adjacent to the site frontage does not have sidewalks on either side, the traffic volumes are light and there are paved areas and gravel shoulder areas along the site frontage which can be utilized by the few pedestrians who may walk through this generally industrial area at the south end of Southmoor Drive. Pedestrians would have the option to utilize Southmoor Lane, which is a slower speed, narrow street, to connect to sidewalks along Highway 85/87.

ACCESS AUTOTURN VEHICLE-TURNING ANALYSIS

AutoTurn analysis was run at the request of staff and to assist with the planning and design of the proposed north site access. Detailed AutoTurn analysis exhibits depicting entering and exiting B-40 (simulating a Class A RV) vehicle-movement wheel paths are attached as "AutoTurn Exhibits 1-4."

DEVIATION REQUEST FORM

A deviation request form is included with this submittal. This deviation is for the request for the three parking spaces in front of the existing main building. The deviation is specifically a request for access to a Collector street, as access to a Collector is not permitted by *ECM* criteria.

CONCLUSIONS/RECOMMENDATIONS

Access Evaluation

- The site-access points meet *ECM* Criteria, or the intent of the *ECM* Criteria (in the case of the sight distance to the south at the south access point). Please refer to this section of the report for details.
- No improvements would be required to the existing auxiliary turn lanes at the intersection of US 85-87/Southmoor Drive due to this development's impact.

Level of Service Analysis

- The site-access points would operate at an acceptable LOS. The intersection of Southmoor Drive/US Hwy 85 has been analyzed and results indicate a LOS F for side street left-turn movements during peak hours. This is not likely to be signalized or converted to a right-in/right-out intersection. Alternatives to the eastbound left-turn movement at this intersection are available. Please refer to this section of the report for details.

County Road Impact Fee Program

South Portion of the Site

This project will be required to participate in the El Paso County Road Improvement Fee Program. The preliminary indication from the applicant is to opt out of the PID option. The applicable fee program land use is "Industrial" and the corresponding building permit "Full Fee" is \$3,651 per

thousand square feet. Based on 6,000 additional square feet, the fee amount would be \$21,906, **plus** the amount for the RV storage.

North Portion of the site (RV Storage)

Per our understanding of recent correspondence received from the County Principal Transportation Planner on another proposed RV Storage use, the roadway impact fee shall be calculated based on:

- The total square footage of RV storage parking spaces (not including drive aisles, landscaping islands, etc.) and
- The mini warehouse fee rate of \$725 per 1,000 square feet.
- The latest site plan indicates that the RV storage parking spaces would cover about 26,250 square feet. (26.25 KSF)
- Therefore, the calculated County Roadway Impact Fee for the RV storage use is \$19,031.
- This amount paid should be taken into account in the future upon any redevelopment of the RV storage area, so fees are not paid twice for the same lot.

CDOT ACCESS PERMIT

A Colorado State Highway Access Permit will be required. This application will be for the Southmoor Drive (public street) connection to US Highway 85/87 located east of the site. Please refer to CDOT comments and LSC Responses to comments for additional details.

* * * * *

Please contact me if you have any questions regarding this report.

Respectfully Submitted,

LSC TRANSPORTATION CONSULTANTS, INC.

By: Jeffrey C. Hodsdon, P.E.
Principal

JCH/JAB:jas

Enclosures: Table 2
Figures 1-6
Appendix Table: Traffic Count Data
Traffic Counts
Levels of Service
AutoTurn Exhibits 1-4
Site Plan Exhibit
Appendix A - Trip Generation Study for RV Storage

Trip Generation Table

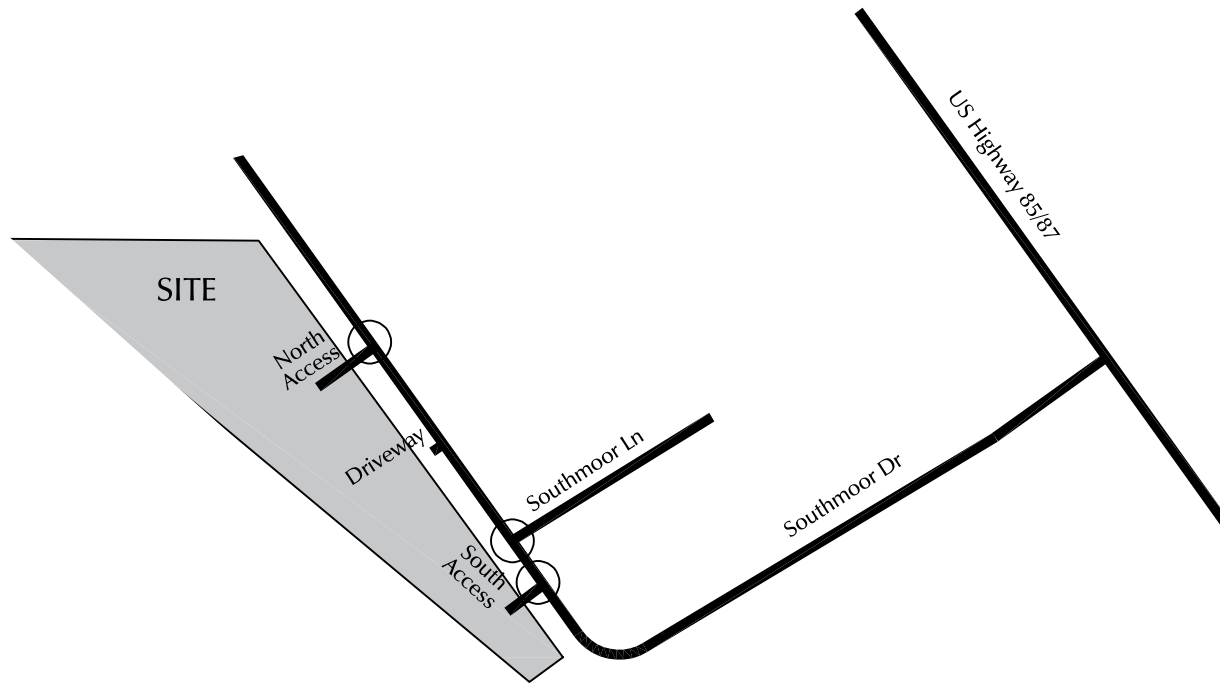

Table 2: Trip Generation Estimate

ITE		Value	Units ¹	Trip Generation Rates ²					Total Trips Generated				
Code	Description			Average Weekday	A.M.		P.M.		Average Weekday	A.M.		P.M.	
				In	Out	In	Out		In	Out	In	Out	
Existing Trip Generation "Snapshot" (from an Actual Count)													
180	Specialty Trade Contractor	2.062	KSF	-	-	-	-	-	N/A	5	3	5	7
Estimate Based on Building Square Footage (Based on ITE Rates)													
180	Specialty Trade Contractor	2.062	KSF	10.22	1.21	0.45	0.63	1.34	21	2	1	1	3
Difference: Existing (Based on Counts) Minus Existing (Based on ITE Rates)									-	3	2	4	4
Estimate of Trips Following Site Improvements (Based on ITE Fitted Rates)													
180	Specialty Trade Contractor	8.062	KSF	10.22	1.21	0.45	0.63	1.34	82	10	4	5	11
-	RV/Vehicle Storage	1.14	HOC	20.00	2.28	1.37	1.98	2.81	23	2	1	2	3
								Total	105	12	5	7	14
¹ KSF = 1,000 square feet of gross floor area, HOC = hundred occupied spaces ² Source: <i>Trip Generation</i> , 10th Edition, 2017, by the Institute of Transportation Engineers (ITE) Note: "RV/Vehicle Storage" rates based on RV storage facility turning movement counts conducted by LSC in El Paso County (2018)													

Figures





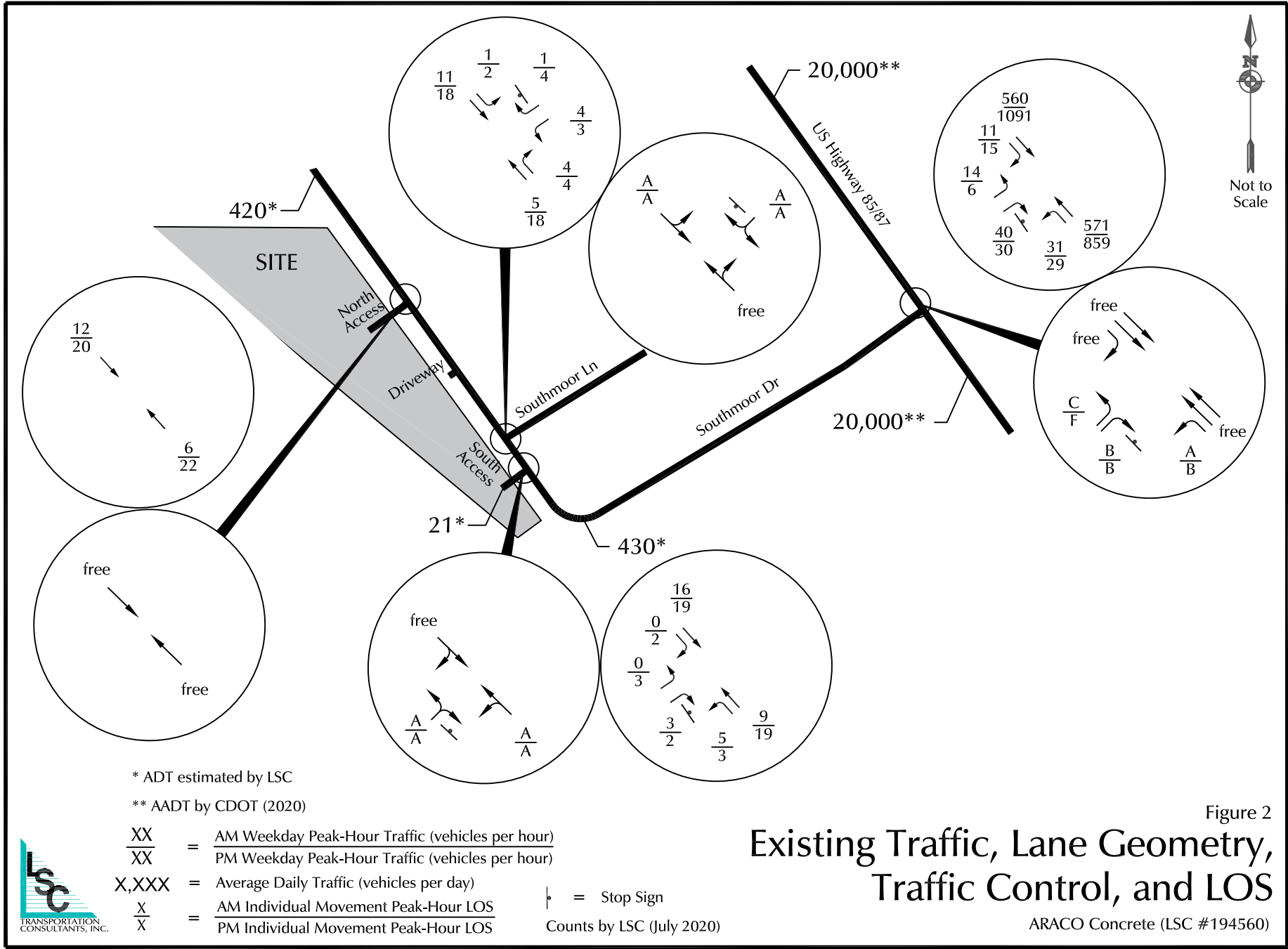

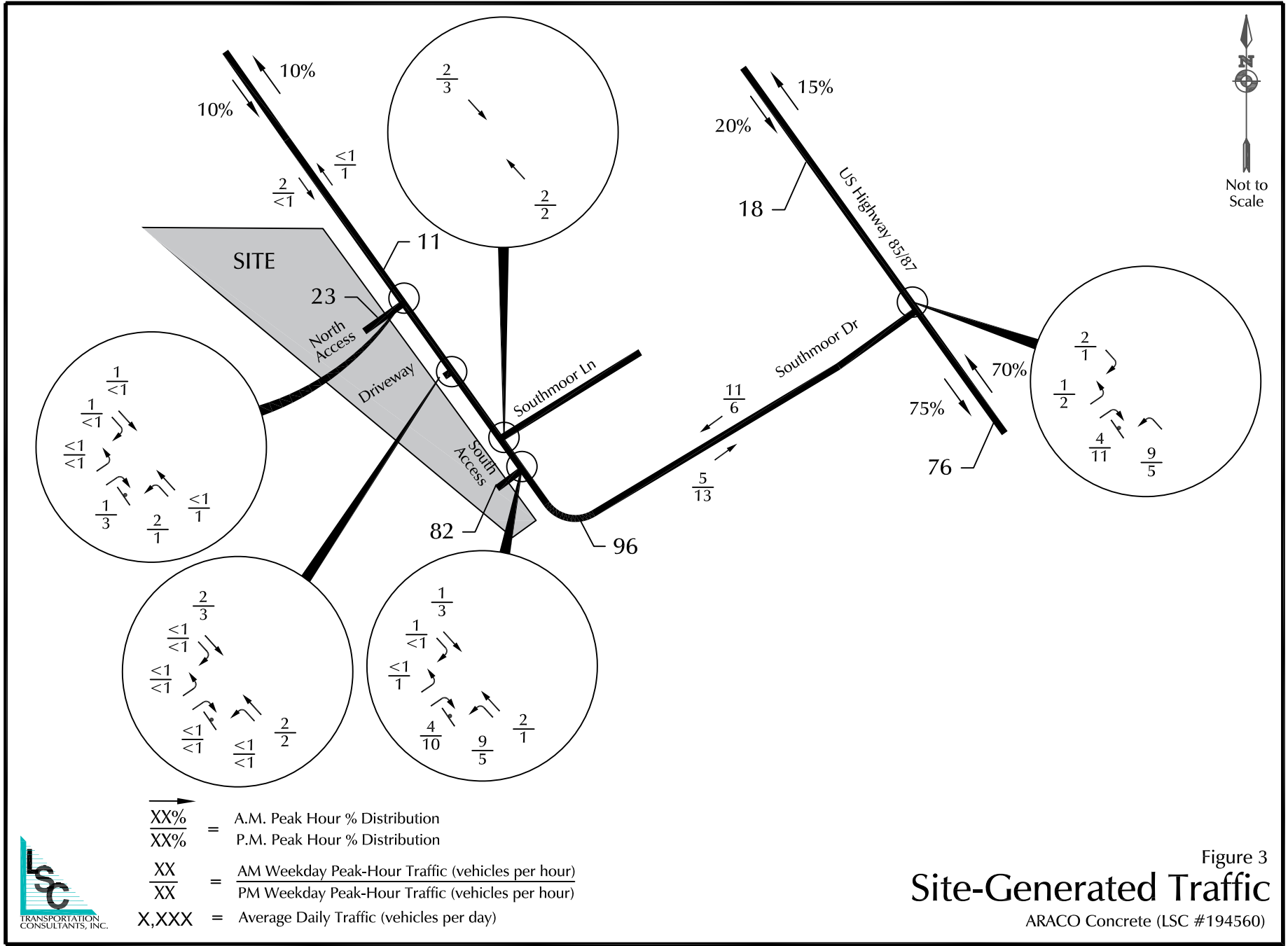

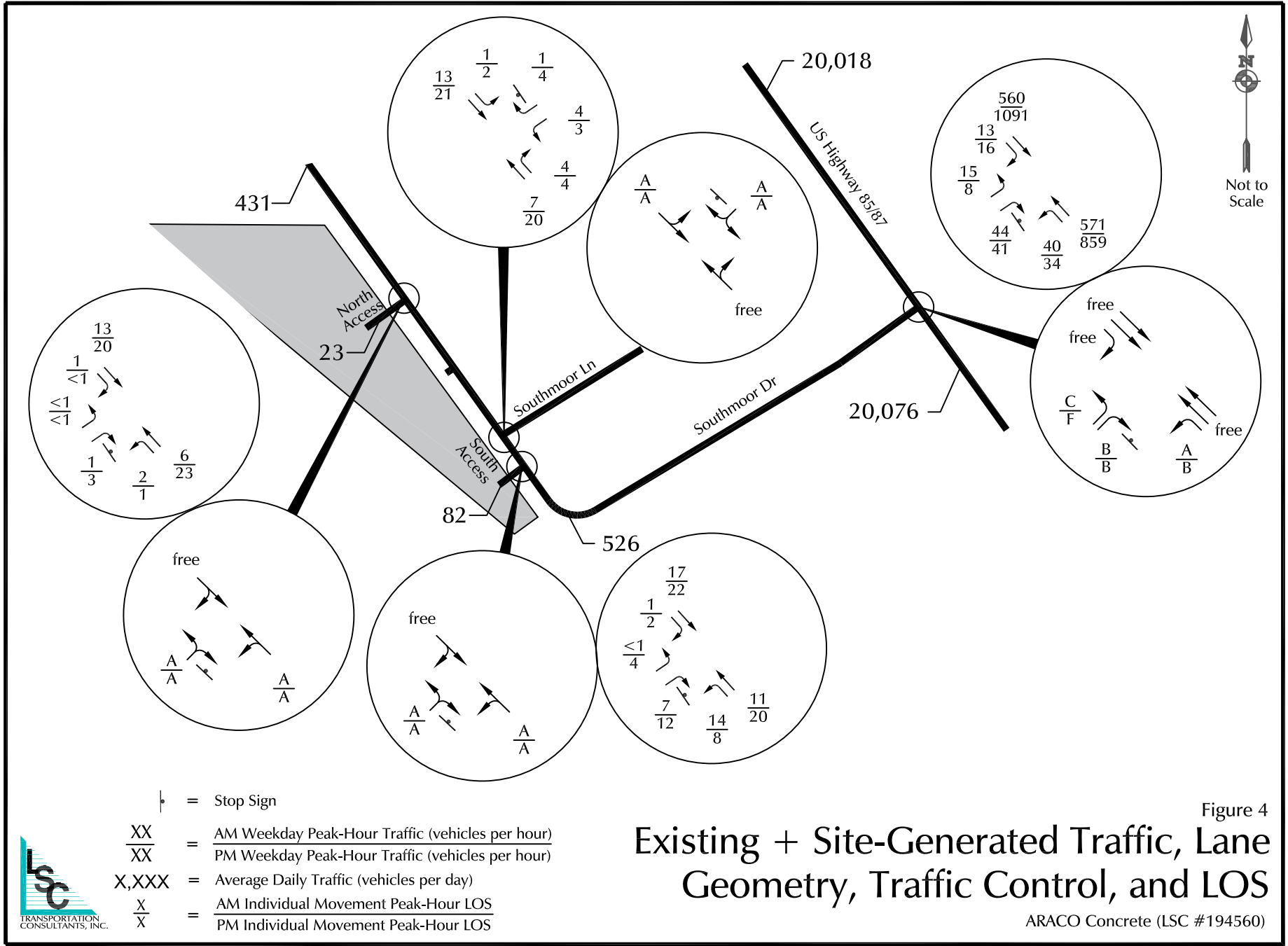

- ┆ = Stop Sign
- $\frac{XX}{XX}$ = $\frac{\text{AM Weekday Peak-Hour Traffic (vehicles per hour)}}{\text{PM Weekday Peak-Hour Traffic (vehicles per hour)}}$
- X,XXX = Average Daily Traffic (vehicles per day)
- $\frac{X}{X}$ = $\frac{\text{AM Individual Movement Peak-Hour LOS}}{\text{PM Individual Movement Peak-Hour LOS}}$



Figure 4
**Existing + Site-Generated Traffic, Lane
 Geometry, Traffic Control, and LOS**

ARACO Concrete (LSC #194560)

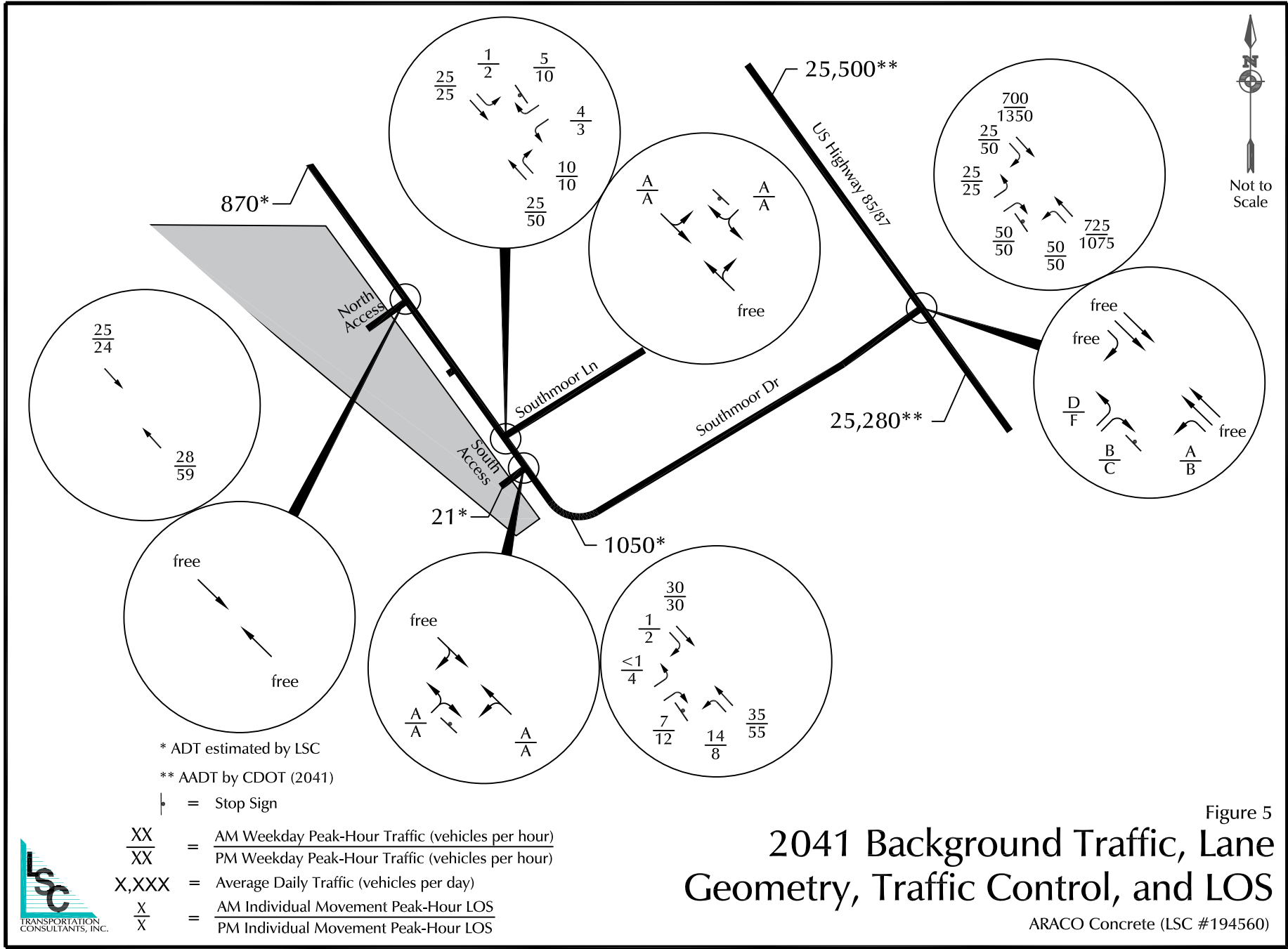
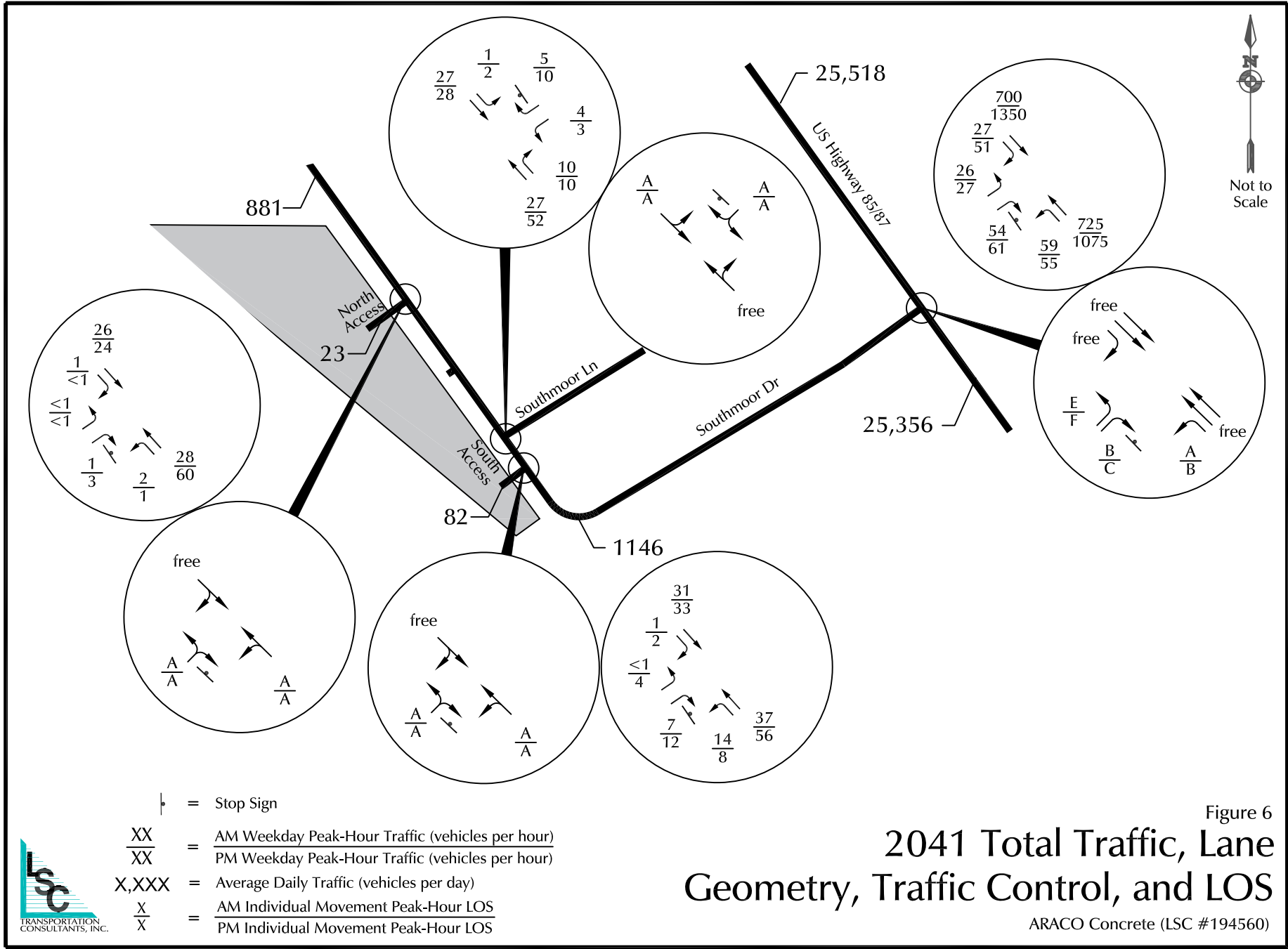



Figure 5
 2041 Background Traffic, Lane
 Geometry, Traffic Control, and LOS

ARACO Concrete (LSC #194560)





Note: Refer to text for sign distance looking to/from the north

-  AASHTO-required sight distance for vehicles traveling at 13-14 mph approaching from the south around horizontal corner on Southmoor Dr
-  Unobstructed sight distance to vehicles right-turning from the horizontal corner on Southmoor Dr

Sight Distance to the South from the Shifted Proposed Access Location

ARACO Concrete (LSC #194560)

Exhibit 1



Appendix Tables



Appendix Table: Traffic Count Data
Southmoor Drive/Southmoor Lane/Existing Araco Access

Volume	SBR	SBT	SBL	WBR	WBT	WBL	NBR	NBT	NBL	EBR	EBT	EBL											
AM/PM	0/2	11/16	1/2	1/4	0/0	4/3	4/4	5/15	5/3	3/2	0/2	0/3											
PHF	1.00/1.00		0.63/0.58			0.7/0.55			0.75/1.00														
AM																							
Time	SB					WB					NB					EB					Total		
	SBL	SBT	SBR	SBU	SB Total	WBL	WBT	WBR	WBU	WB Total	NBL	NBT	NBR	NBU	NB Total	EBL	EBT	EBR	EBU	EB Total			
7:00	AM	0	3	0	0	3	0	0	0	0	3	0	2	0	5	0	0	0	0	0	0	8	
7:15	AM	1	1	0	0	2	1	0	1	2	2	1	0	0	3	0	0	0	0	0	0	7	
7:30	AM	0	5	0	0	5	1	0	0	1	0	0	1	0	1	0	0	2	0	2	9		
7:45	AM	0	2	0	0	2	2	0	0	2	0	4	1	0	5	0	0	1	0	1	10		
TOTAL		1	11	0	0	12	4	0	1	5	5	5	4	0	14	0	0	3	0	3	34		
Peak-15			2			4		2				5						1					
4x Peak-15			8					8				20						4					
60 Total			12					5				14						3					
PHF			1.50					0.63				0.70						0.75					
Approach			SB					WB				NB						EB					
PHF -- USE			1.00					0.63				0.70						0.75					
PM																							
Time	SB					WB					NB					EB					Total		
	SBL	SBT	SBR	SBU	SB Total	WBL	WBT	WBR	WBU	WB Total	NBL	NBT	NBR	NBU	NB Total	EBL	EBT	EBR	EBU	EB Total			
4:45	PM	0	5	2	0	7	0	0	1	1	0	3	0	0	3	1	1	0	0	2	13		
5:00	PM	1	2	0	0	3	0	0	2	2	0	4	0	0	4	1	0	0	0	1	10		
5:15	PM	0	6	0	0	6	0	0	1	1	2	2	1	0	5	0	1	2	0	3	15		
5:30	PM	1	3	0	0	4	3	0	0	3	1	6	3	0	10	1	0	0	0	1	18		
TOTAL		2	16	2	0	20	3	0	4	7	3	15	4	0	22	3	2	2	0	7	56		
Peak-15			4					3				10						1					
4x Peak-15			16					12				40						4					
60 Total			20					7				22						7					
PHF			1.25					0.58				0.55						1.75					
Approach			SB					WB				NB						EB					
PHF -- USE			1.00					0.58				0.55						1.00					
AM			1.00					0.63				0.70						0.75					
PM			1.00					0.58				0.55						1.00					

Traffic Counts



LSC Transportation Consultants, Inc.

545 E Pikes Peak Ave, Suite 210
 Colorado Springs, CO 80905
 719-633-2868

File Name : Hwy 85-87 - Southmoor Dr AM
 Site Code : 194560
 Start Date : 7/16/2020
 Page No : 1

Groups Printed- Unshifted

Start Time	Hwy 85/87 Southbound					Westbound					Hwy 85/87 Northbound					Southmoor Dr Eastbound					Int. Total
	L	T	R	U	App. Total	L	T	R	U	App. Total	L	T	R	U	App. Total	L	T	R	U	App. Total	
07:00 AM	0	88	0	0	88	0	0	0	0	0	6	131	0	0	137	0	0	9	0	9	234
07:15 AM	0	119	0	0	119	0	0	0	0	0	7	124	0	0	131	2	0	7	0	9	259
07:30 AM	0	144	4	0	148	0	0	0	0	0	8	186	0	1	195	3	0	8	0	11	354
07:45 AM	0	138	1	0	139	0	0	0	0	0	6	154	0	2	162	3	0	5	0	8	309
Total	0	489	5	0	494	0	0	0	0	0	27	595	0	3	625	8	0	29	0	37	1156
08:00 AM	0	136	4	0	140	0	0	0	0	0	6	111	0	1	118	3	0	8	0	11	269
08:15 AM	0	142	2	0	144	0	0	0	0	0	7	120	0	0	127	5	0	19	0	24	295
08:30 AM	0	148	2	0	150	0	0	0	0	0	6	140	0	0	146	2	0	17	0	19	315
08:45 AM	0	121	4	0	125	0	0	0	0	0	7	120	0	0	127	3	0	7	0	10	262
Total	0	547	12	0	559	0	0	0	0	0	26	491	0	1	518	13	0	51	0	64	1141
Grand Total	0	1036	17	0	1053	0	0	0	0	0	53	1086	0	4	1143	21	0	80	0	101	2297
Apprch %	0	98.4	1.6	0		0	0	0	0	0	4.6	95	0	0.3		20.8	0	79.2	0		
Total %	0	45.1	0.7	0	45.8	0	0	0	0	0	2.3	47.3	0	0.2	49.8	0.9	0	3.5	0	4.4	

LSC Transportation Consultants, Inc.

545 E Pikes Peak Ave, Suite 210
 Colorado Springs, CO 80905
 719-633-2868

File Name : Hwy 85-87 - Southmoor Dr AM
 Site Code : 194560
 Start Date : 7/16/2020
 Page No : 2

Start Time	Hwy 85/87 Southbound					Westbound					Hwy 85/87 Northbound					Southmoor Dr Eastbound					Int. Total
	L	T	R	U	App. Total	L	T	R	U	App. Total	L	T	R	U	App. Total	L	T	R	U	App. Total	
Peak Hour Analysis From 7:00:00 AM to 8:45:00 AM - Peak 1 of 1																					
Peak Hour for Entire Intersection Begins at 7:30:00 AM																					
7:30:00 AM	0	144	4	0	148	0	0	0	0	0	8	186	0	1	195	3	0	8	0	11	354
7:45:00 AM	0	138	1	0	139	0	0	0	0	0	6	154	0	2	162	3	0	5	0	8	309
8:00:00 AM	0	136	4	0	140	0	0	0	0	0	6	111	0	1	118	3	0	8	0	11	269
8:15:00 AM	0	142	2	0	144	0	0	0	0	0	7	120	0	0	127	5	0	19	0	24	295
Total Volume	0	560	11	0	571	0	0	0	0	0	27	571	0	4	602	14	0	40	0	54	1227
% App. Total	0	98.1	1.9	0		0	0	0	0		4.5	94.9	0	0.7		25.9	0	74.1	0		
PHF	.000	.972	.688	.000	.965	.000	.000	.000	.000	.000	.844	.767	.000	.500	.772	.700	.000	.526	.000	.563	.867

LSC Transportation Consultants, Inc.

545 E Pikes Peak Ave, Suite 210
 Colorado Springs, CO 80905
 719-633-2868

File Name : Hwy 85-87 - Southmoor Dr AM
 Site Code : 194560
 Start Date : 7/16/2020
 Page No : 3

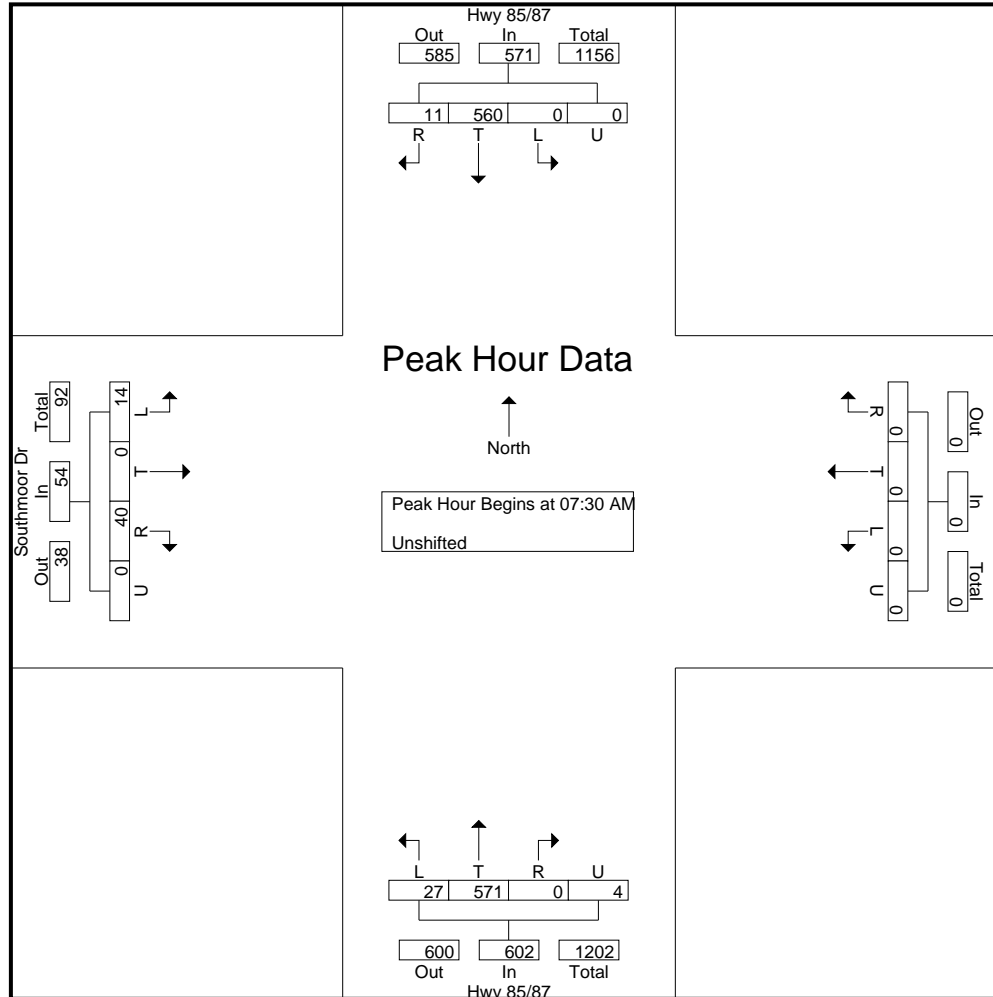

LSC Transportation Consultants, Inc.

545 E Pikes Peak Ave, Suite 210
 Colorado Springs, CO 80905
 719-633-2868

File Name : Hwy 85-87 - Southmoor Dr AM
 Site Code : 194560
 Start Date : 7/16/2020
 Page No : 4

Start Time	Hwy 85/87 Southbound					Westbound					Hwy 85/87 Northbound					Southmoor Dr Eastbound					Int. Total
	L	T	R	U	App. Total	L	T	R	U	App. Total	L	T	R	U	App. Total	L	T	R	U	App. Total	
Peak Hour Analysis From 7:00:00 AM to 8:45:00 AM - Peak 1 of 1																					
Peak Hour for Each Approach Begins at:																					
	7:45:00 AM					7:00:00 AM					7:00:00 AM					8:00:00 AM					
+0 mins.	0	138	1	0	139	0	0	0	0	0	6	131	0	0	137	3	0	8	0	11	
+5 mins.	0	136	4	0	140	0	0	0	0	0	7	124	0	0	131	5	0	19	0	24	
+10 mins.	0	142	2	0	144	0	0	0	0	0	8	186	0	1	195	2	0	17	0	19	
+15 mins.	0	148	2	0	150	0	0	0	0	0	6	154	0	2	162	3	0	7	0	10	
Total Volume	0	564	9	0	573	0	0	0	0	0	27	595	0	3	625	13	0	51	0	64	
% App. Total	0	98.4	1.6	0		0	0	0	0		4.3	95.2	0	0.5		20.3	0	79.7	0		
PHF	.000	.953	.563	.000	.955	.000	.000	.000	.000	.000	.844	.800	.000	.375	.801	.650	.000	.671	.000	.667	

LSC Transportation Consultants, Inc.

545 E Pikes Peak Ave, Suite 210
 Colorado Springs, CO 80905
 719-633-2868

File Name : Hwy 85-87 - Southmoor Dr AM
 Site Code : 194560
 Start Date : 7/16/2020
 Page No : 5

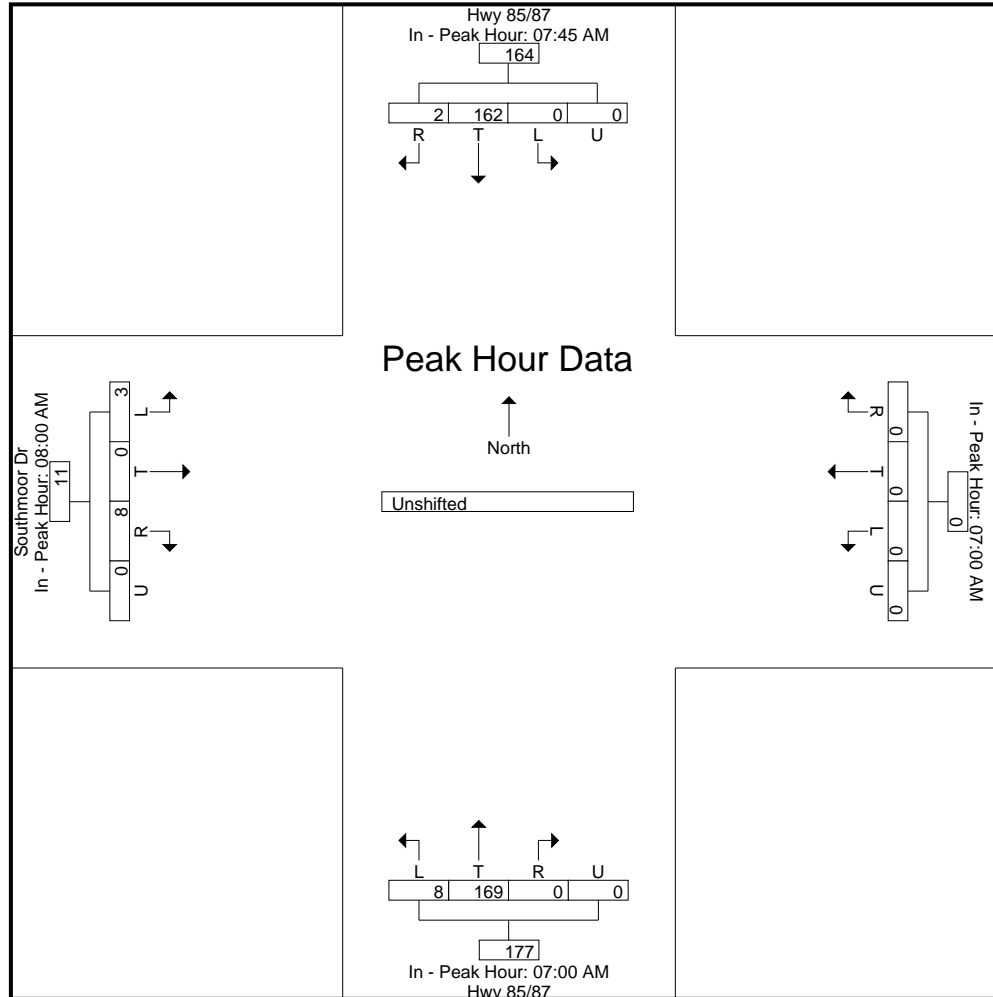

LSC Transportation Consultants, Inc.

545 E Pikes Peak Ave, Suite 210
 Colorado Springs, CO 80905
 719-633-2868

File Name : Hwy 85-87 - Southmoor Dr PM
 Site Code : 194560
 Start Date : 7/16/2020
 Page No : 1

Groups Printed- Unshifted

Start Time	Hwy 85-87 Southbound					Westbound					Hwy 85-87 Northbound					Southmoor Dr Eastbound					Int. Total
	L	T	R	U	App. Total	L	T	R	U	App. Total	L	T	R	U	App. Total	L	T	R	U	App. Total	
04:00 PM	0	223	5	0	228	0	0	0	0	0	6	215	0	0	221	2	0	5	0	7	456
04:15 PM	0	251	1	0	252	0	0	0	0	0	10	203	0	1	214	4	0	14	0	18	484
04:30 PM	0	240	4	0	244	0	0	0	0	0	6	207	0	0	213	3	0	10	0	13	470
04:45 PM	0	286	2	0	288	0	0	0	0	0	6	231	0	0	237	1	0	2	0	3	528
Total	0	1000	12	0	1012	0	0	0	0	0	28	856	0	1	885	10	0	31	0	41	1938
05:00 PM	0	247	3	0	250	0	0	0	0	0	8	214	0	0	222	1	0	4	0	5	477
05:15 PM	0	298	7	0	305	0	0	0	0	0	7	217	0	0	224	4	0	16	0	20	549
05:30 PM	0	260	3	0	263	0	0	0	0	0	7	197	0	1	205	0	0	8	0	8	476
05:45 PM	0	247	5	0	252	0	0	0	0	0	6	198	0	0	204	4	0	12	0	16	472
Total	0	1052	18	0	1070	0	0	0	0	0	28	826	0	1	855	9	0	40	0	49	1974
Grand Total	0	2052	30	0	2082	0	0	0	0	0	56	1682	0	2	1740	19	0	71	0	90	3912
Apprch %	0	98.6	1.4	0		0	0	0	0		3.2	96.7	0	0.1		21.1	0	78.9	0		
Total %	0	52.5	0.8	0	53.2	0	0	0	0	0	1.4	43	0	0.1	44.5	0.5	0	1.8	0	2.3	

LSC Transportation Consultants, Inc.

545 E Pikes Peak Ave, Suite 210
 Colorado Springs, CO 80905
 719-633-2868

File Name : Hwy 85-87 - Southmoor Dr PM
 Site Code : 194560
 Start Date : 7/16/2020
 Page No : 2

Start Time	Hwy 85-87 Southbound					Westbound					Hwy 85-87 Northbound					Southmoor Dr Eastbound					Int. Total
	L	T	R	U	App. Total	L	T	R	U	App. Total	L	T	R	U	App. Total	L	T	R	U	App. Total	
Peak Hour Analysis From 4:00:00 PM to 5:45:00 PM - Peak 1 of 1																					
Peak Hour for Entire Intersection Begins at 4:45:00 PM																					
4:45:00 PM	0	286	2	0	288	0	0	0	0	0	6	231	0	0	237	1	0	2	0	3	528
5:00:00 PM	0	247	3	0	250	0	0	0	0	0	8	214	0	0	222	1	0	4	0	5	477
5:15:00 PM	0	298	7	0	305	0	0	0	0	0	7	217	0	0	224	4	0	16	0	20	549
5:30:00 PM	0	260	3	0	263	0	0	0	0	0	7	197	0	1	205	0	0	8	0	8	476
Total Volume	0	1091	15	0	1106	0	0	0	0	0	28	859	0	1	888	6	0	30	0	36	2030
% App. Total	0	98.6	1.4	0		0	0	0	0		3.2	96.7	0	0.1		16.7	0	83.3	0		
PHF	.000	.915	.536	.000	.907	.000	.000	.000	.000	.000	.875	.930	.000	.250	.937	.375	.000	.469	.000	.450	.924

LSC Transportation Consultants, Inc.

545 E Pikes Peak Ave, Suite 210
 Colorado Springs, CO 80905
 719-633-2868

File Name : Hwy 85-87 - Southmoor Dr PM
 Site Code : 194560
 Start Date : 7/16/2020
 Page No : 3

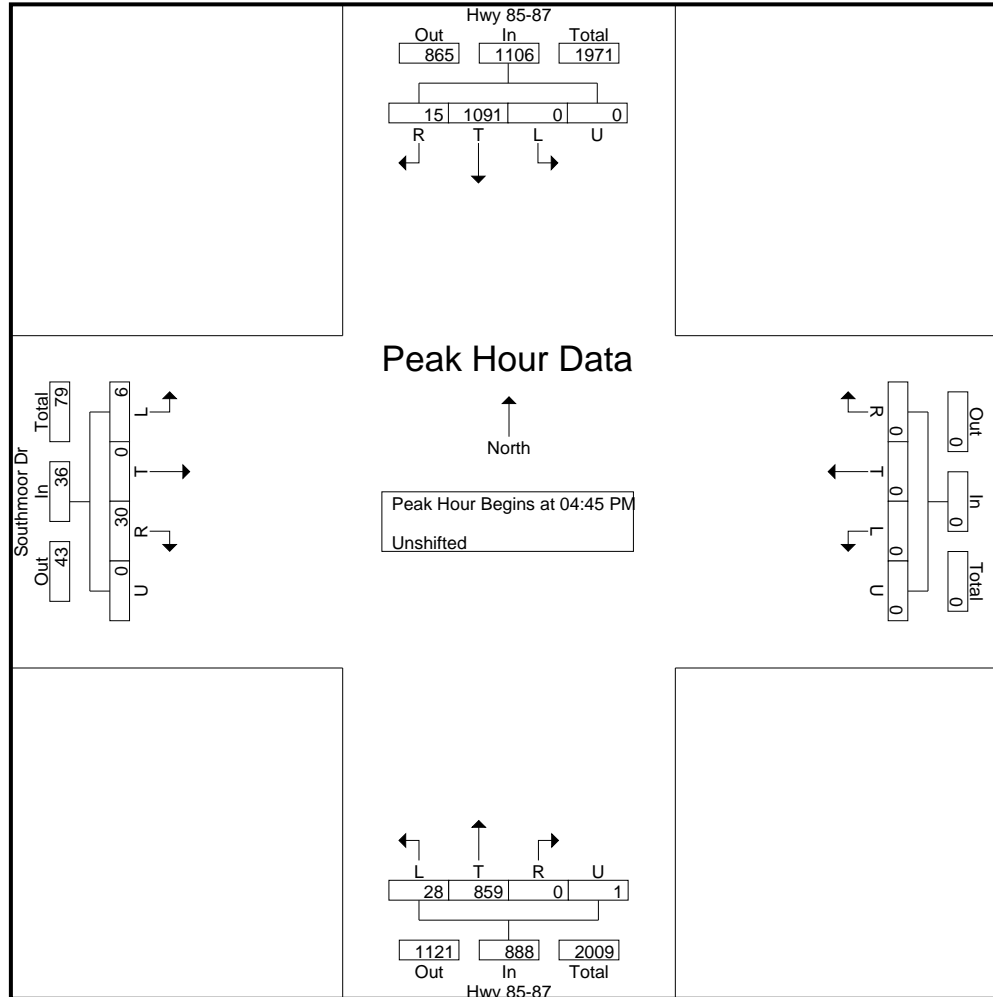

LSC Transportation Consultants, Inc.

545 E Pikes Peak Ave, Suite 210
 Colorado Springs, CO 80905
 719-633-2868

File Name : Hwy 85-87 - Southmoor Dr PM
 Site Code : 194560
 Start Date : 7/16/2020
 Page No : 4

Start Time	Hwy 85-87 Southbound					Westbound					Hwy 85-87 Northbound					Southmoor Dr Eastbound					Int. Total
	L	T	R	U	App. Total	L	T	R	U	App. Total	L	T	R	U	App. Total	L	T	R	U	App. Total	
Peak Hour Analysis From 4:00:00 PM to 5:45:00 PM - Peak 1 of 1																					
Peak Hour for Each Approach Begins at:																					
	4:45:00 PM					4:00:00 PM					4:30:00 PM					5:00:00 PM					
+0 mins.	0	286	2	0	288	0	0	0	0	0	6	207	0	0	213	1	0	4	0	5	
+5 mins.	0	247	3	0	250	0	0	0	0	0	6	231	0	0	237	4	0	16	0	20	
+10 mins.	0	298	7	0	305	0	0	0	0	0	8	214	0	0	222	0	0	8	0	8	
+15 mins.	0	260	3	0	263	0	0	0	0	0	7	217	0	0	224	4	0	12	0	16	
Total Volume	0	1091	15	0	1106	0	0	0	0	0	27	869	0	0	896	9	0	40	0	49	
% App. Total	0	98.6	1.4	0		0	0	0	0		3	97	0	0		18.4	0	81.6	0		
PHF	.000	.915	.536	.000	.907	.000	.000	.000	.000	.000	.844	.940	.000	.000	.945	.563	.000	.625	.000	.613	

LSC Transportation Consultants, Inc.

545 E Pikes Peak Ave, Suite 210
 Colorado Springs, CO 80905
 719-633-2868

File Name : Hwy 85-87 - Southmoor Dr PM
 Site Code : 194560
 Start Date : 7/16/2020
 Page No : 5

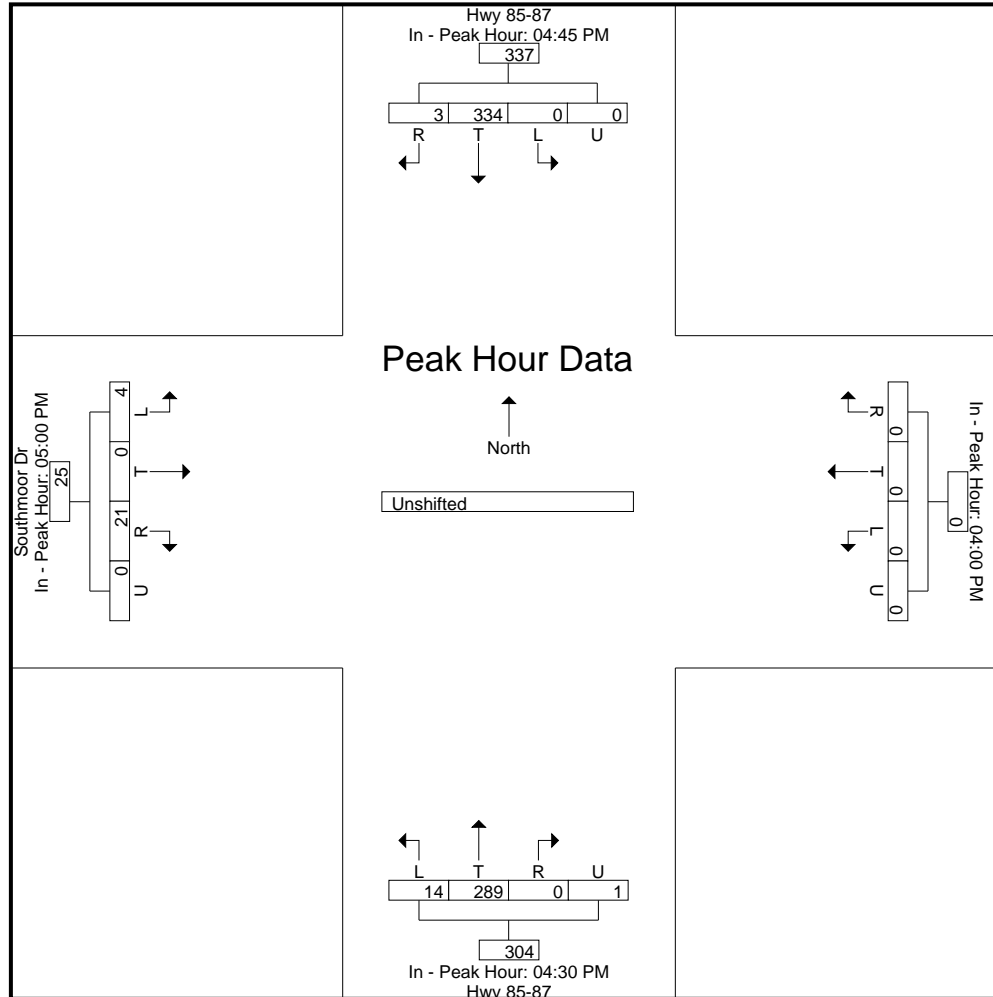



LSC Transportation Consultants, Inc.

545 E Pikes Peak Ave, Suite 210
 Colorado Springs, CO 80905
 719-633-2868

File Name : Southmoor Dr - Araco Concrete Access AM
 Site Code : 00000000
 Start Date : 8/14/2019
 Page No : 1

Groups Printed- Unshifted

Start Time	Southmoor Dr Southbound					Araco Access Westbound					Southmoor Dr Northbound					Araco Annex Eastbound					Int. Total
	Left	Through	Right	Peds	App. Total	Left	Through	Right	Peds	App. Total	Left	Through	Right	Peds	App. Total	Left	Through	Right	Peds	App. Total	
06:30 AM	0	4	0	0	4	0	0	0	0	0	0	1	0	0	1	0	0	1	0	1	6
06:45 AM	1	6	0	0	7	0	0	0	0	0	0	0	0	0	0	0	0	0	0	0	7
Total	1	10	0	0	11	0	0	0	0	0	0	1	0	0	1	0	0	1	0	1	13
07:00 AM	0	3	0	0	3	0	0	0	0	0	3	0	2	0	5	0	0	0	0	0	8
07:15 AM	1	1	0	0	2	1	0	1	0	2	2	1	0	0	3	0	0	0	0	0	7
07:30 AM	0	5	0	0	5	1	0	0	0	1	0	0	1	0	1	0	0	2	0	2	9
07:45 AM	0	2	0	0	2	2	0	0	0	2	0	4	1	0	5	0	0	1	0	1	10
Total	1	11	0	0	12	4	0	1	0	5	5	5	4	0	14	0	0	3	0	3	34
08:00 AM	0	4	0	0	4	1	0	0	0	1	0	0	0	0	0	0	0	0	0	0	5
08:15 AM	0	3	0	0	3	1	0	1	0	2	1	3	0	0	4	0	0	0	0	0	9
Grand Total	2	28	0	0	30	6	0	2	0	8	6	9	4	0	19	0	0	4	0	4	61
Apprch %	6.7	93.3	0	0		75	0	25	0		31.6	47.4	21.1	0		0	0	100	0		
Total %	3.3	45.9	0	0	49.2	9.8	0	3.3	0	13.1	9.8	14.8	6.6	0	31.1	0	0	6.6	0	6.6	



LSC Transportation Consultants, Inc.

545 E Pikes Peak Ave, Suite 210
 Colorado Springs, CO 80905
 719-633-2868

File Name : Southmoor Dr - Araco Concrete Access AM
 Site Code : 00000000
 Start Date : 8/14/2019
 Page No : 2

Start Time	Southmoor Dr Southbound					Araco Access Westbound					Southmoor Dr Northbound					Araco Annex Eastbound					Int. Total	
	Left	Through	Right	Peds	App. Total	Left	Through	Right	Peds	App. Total	Left	Through	Right	Peds	App. Total	Left	Through	Right	Peds	App. Total		
Peak Hour Analysis From 06:30 AM to 08:15 AM - Peak 1 of 1																						
Peak Hour for Entire Intersection Begins at 07:00 AM																						
07:00 AM	0	3	0	0	3	0	0	0	0	0	3	0	2	0	5	0	0	0	0	0	0	8
07:15 AM	1	1	0	0	2	1	0	1	0	2	2	1	0	0	3	0	0	0	0	0	0	7
07:30 AM	0	5	0	0	5	1	0	0	0	1	0	0	1	0	1	0	0	2	0	2	0	9
07:45 AM	0	2	0	0	2	2	0	0	0	2	0	4	1	0	5	0	0	1	0	1	0	10
Total Volume	1	11	0	0	12	4	0	1	0	5	5	5	4	0	14	0	0	3	0	3	0	34
% App. Total	8.3	91.7	0	0		80	0	20	0		35.7	35.7	28.6	0		0	0	100	0			
PHF	.250	.550	.000	.000	.600	.500	.000	.250	.000	.625	.417	.313	.500	.000	.700	.000	.000	.375	.000	.375		.850

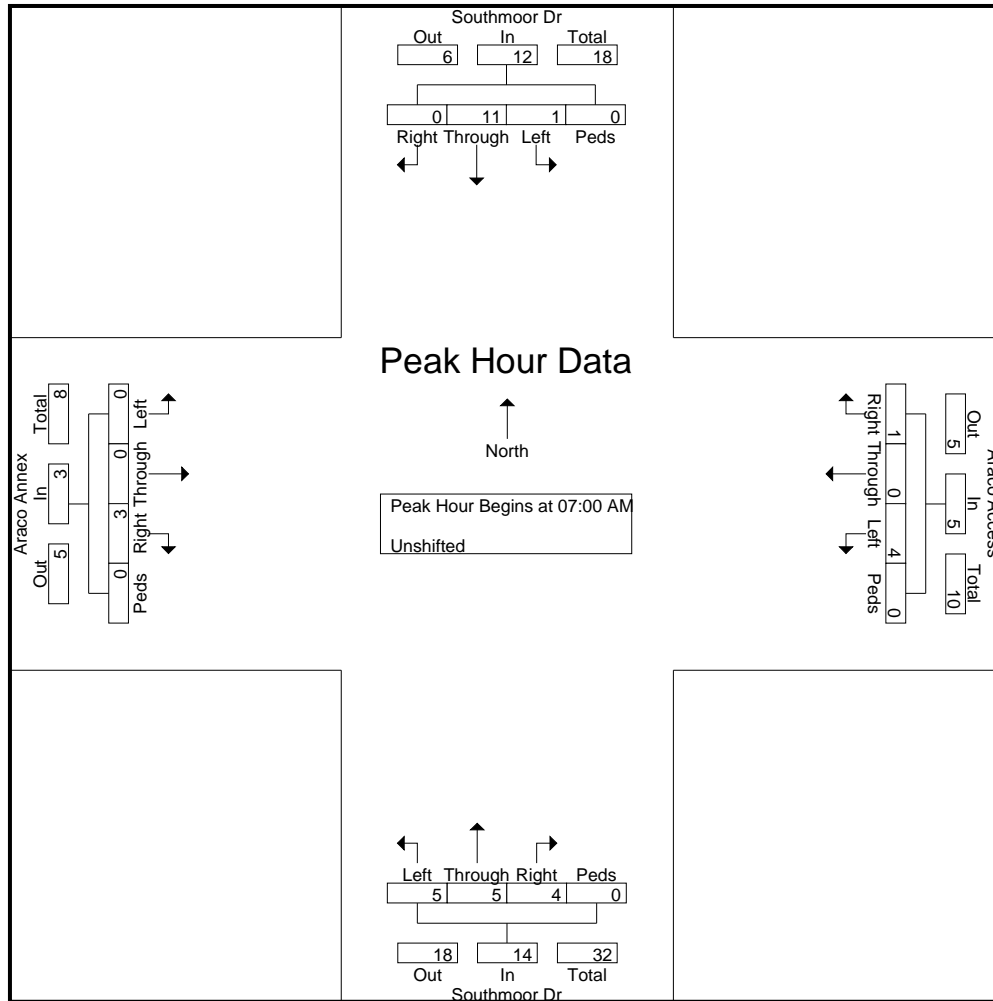



LSC Transportation Consultants, Inc.

545 E Pikes Peak Ave, Suite 210
 Colorado Springs, CO 80905
 719-633-2868

File Name : Southmoor Dr - Araco Concrete Access AM
 Site Code : 00000000
 Start Date : 8/14/2019
 Page No : 3

Start Time	Southmoor Dr Southbound					Araco Access Westbound					Southmoor Dr Northbound					Araco Annex Eastbound					Int. Total				
	Left	Through	Right	Peds	App. Total	Left	Through	Right	Peds	App. Total	Left	Through	Right	Peds	App. Total	Left	Through	Right	Peds	App. Total					
Peak Hour Analysis From 06:30 AM to 08:15 AM - Peak 1 of 1																									
Peak Hour for Each Approach Begins at:																									
	06:45 AM					07:15 AM					07:00 AM					07:00 AM									
+0 mins.	1	6	0	0	7	1	0	1	0	2	3	0	2	0	5	0	0	0	0	0	0	0	0	0	0
+15 mins.	0	3	0	0	3	1	0	0	0	1	2	1	0	0	3	0	0	0	0	0	0	0	0	0	0
+30 mins.	1	1	0	0	2	2	0	0	0	2	0	0	1	0	1	0	0	2	0	2	0	0	0	0	0
+45 mins.	0	5	0	0	5	1	0	0	0	1	0	4	1	0	5	0	0	1	0	1	0	0	0	0	0
Total Volume	2	15	0	0	17	5	0	1	0	6	5	5	4	0	14	0	0	3	0	3	0	0	0	0	0
% App. Total	11.8	88.2	0	0		83.3	0	16.7	0		35.7	35.7	28.6	0		0	0	100	0		0	0	0	0	0
PHF	.500	.625	.000	.000	.607	.625	.000	.250	.000	.750	.417	.313	.500	.000	.700	.000	.000	.375	.000	.375					

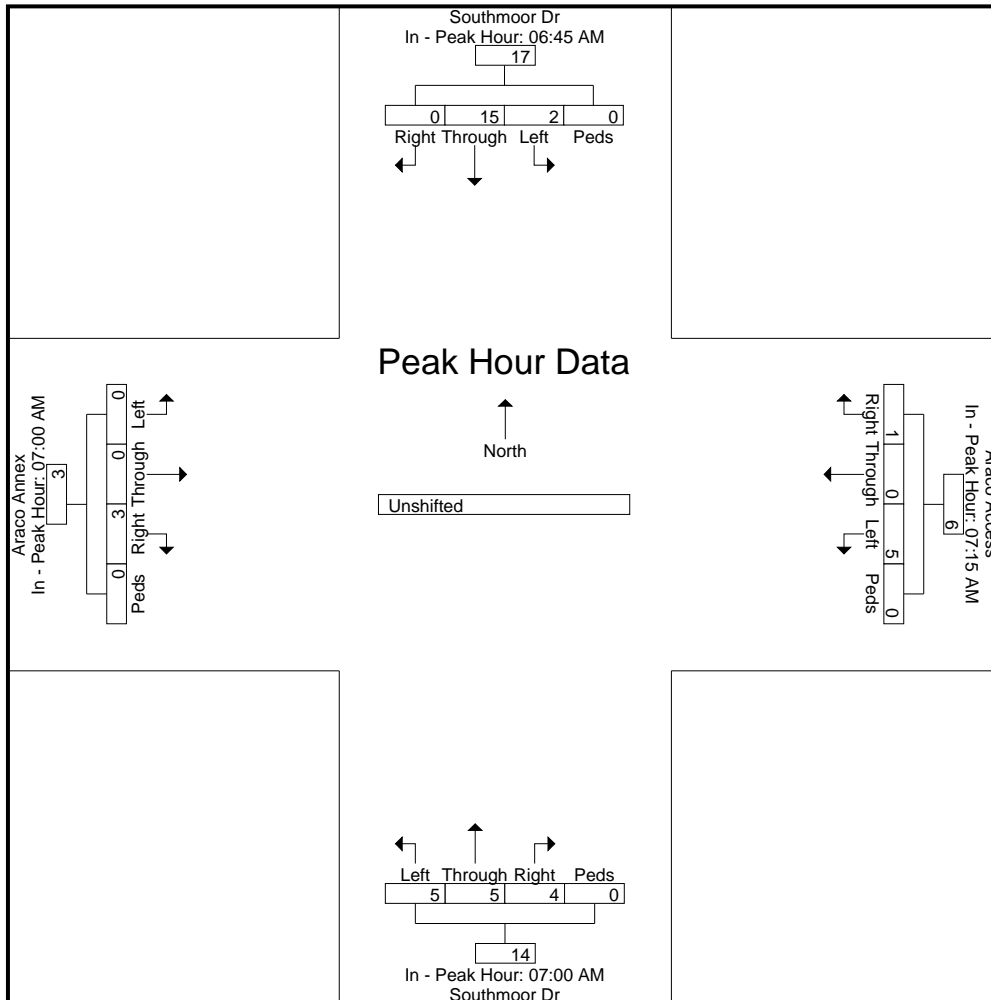



LSC Transportation Consultants, Inc.

545 E Pikes Peak Ave, Suite 210
 Colorado Springs, CO 80905
 719-633-2868

File Name : Southmoor Dr - Araco Concrete Access PM
 Site Code : 00194560
 Start Date : 8/15/2019
 Page No : 1

Groups Printed- Unshifted

Start Time	Southmoor Dr Southbound					Araco Access Westbound					Southmoor Dr Northbound					Araco Annex Eastbound					Int. Total
	Left	Through	Right	Peds	App. Total	Left	Through	Right	Peds	App. Total	Left	Through	Right	Peds	App. Total	Left	Through	Right	Peds	App. Total	
04:00 PM	1	3	0	0	4	0	0	1	0	1	0	2	2	0	4	0	0	0	0	0	9
04:15 PM	0	2	0	0	2	1	0	3	0	4	0	4	3	0	7	1	0	2	0	3	16
04:30 PM	0	4	0	0	4	1	0	0	0	1	0	1	1	0	2	0	0	1	0	1	8
04:45 PM	0	5	2	0	7	0	0	1	0	1	0	3	0	0	3	1	1	0	0	2	13
Total	1	14	2	0	17	2	0	5	0	7	0	10	6	0	16	2	1	3	0	6	46
05:00 PM	1	2	0	0	3	0	0	2	0	2	0	4	0	0	4	1	0	0	0	1	10
05:15 PM	0	6	0	0	6	0	0	1	0	1	2	2	1	0	5	0	1	2	0	3	15
05:30 PM	1	3	0	0	4	3	0	0	0	3	1	6	3	0	10	1	0	0	0	1	18
05:45 PM	1	2	0	0	3	0	0	1	0	1	1	4	2	0	7	0	1	1	0	2	13
Total	3	13	0	0	16	3	0	4	0	7	4	16	6	0	26	2	2	3	0	7	56
Grand Total	4	27	2	0	33	5	0	9	0	14	4	26	12	0	42	4	3	6	0	13	102
Apprch %	12.1	81.8	6.1	0		35.7	0	64.3	0		9.5	61.9	28.6	0		30.8	23.1	46.2	0		
Total %	3.9	26.5	2	0	32.4	4.9	0	8.8	0	13.7	3.9	25.5	11.8	0	41.2	3.9	2.9	5.9	0	12.7	



LSC Transportation Consultants, Inc.

545 E Pikes Peak Ave, Suite 210
 Colorado Springs, CO 80905
 719-633-2868

File Name : Southmoor Dr - Araco Concrete Access PM
 Site Code : 00194560
 Start Date : 8/15/2019
 Page No : 2

Start Time	Southmoor Dr Southbound					Araco Access Westbound					Southmoor Dr Northbound					Araco Annex Eastbound					Int. Total
	Left	Through	Right	Peds	App. Total	Left	Through	Right	Peds	App. Total	Left	Through	Right	Peds	App. Total	Left	Through	Right	Peds	App. Total	
Peak Hour Analysis From 04:00 PM to 05:30 PM - Peak 1 of 1																					
Peak Hour for Entire Intersection Begins at 04:45 PM																					
04:45 PM	0	5	2	0	7	0	0	1	0	1	0	3	0	0	3	1	1	0	0	2	13
05:00 PM	1	2	0	0	3	0	0	2	0	2	0	4	0	0	4	1	0	0	0	1	10
05:15 PM	0	6	0	0	6	0	0	1	0	1	2	2	1	0	5	0	1	2	0	3	15
05:30 PM	1	3	0	0	4	3	0	0	0	3	1	6	3	0	10	1	0	0	0	1	18
Total Volume	2	16	2	0	20	3	0	4	0	7	3	15	4	0	22	3	2	2	0	7	56
% App. Total	10	80	10	0		42.9	0	57.1	0		13.6	68.2	18.2	0		42.9	28.6	28.6	0		
PHF	.500	.667	.250	.000	.714	.250	.000	.500	.000	.583	.375	.625	.333	.000	.550	.750	.500	.250	.000	.583	.778

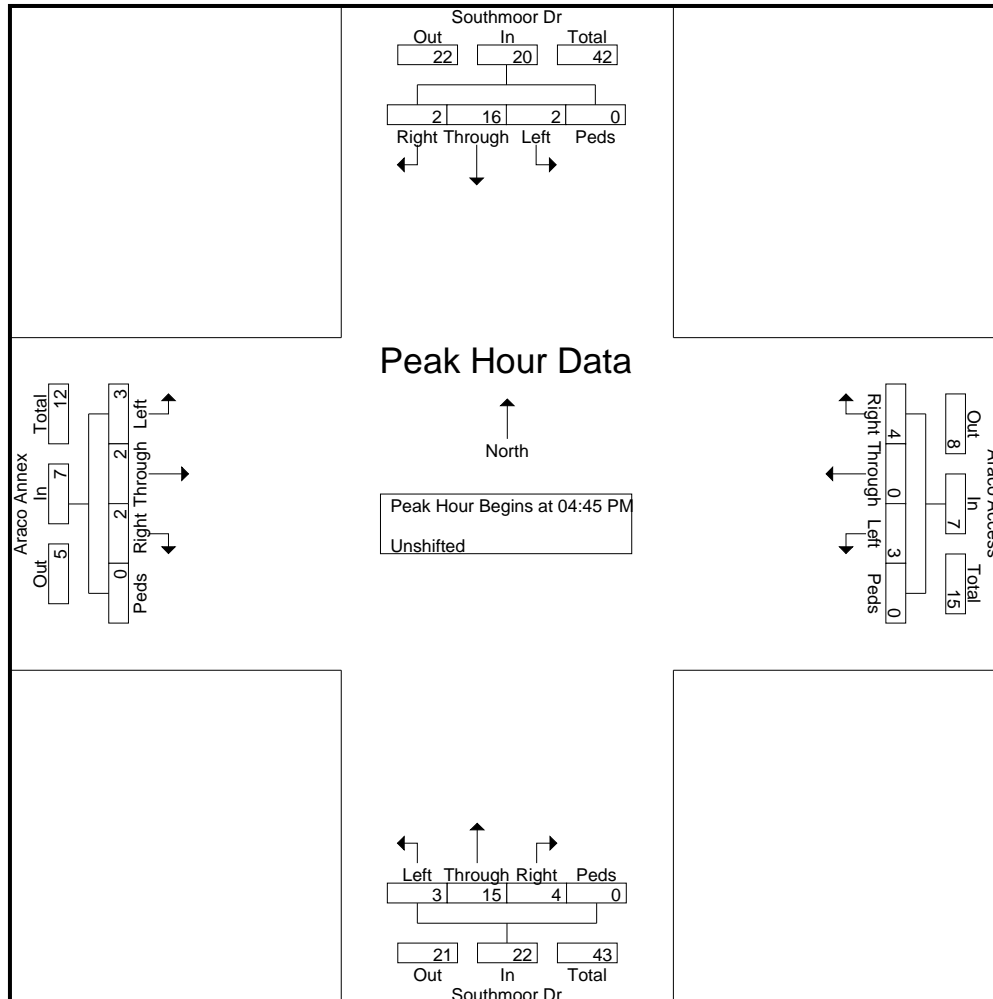



LSC Transportation Consultants, Inc.

545 E Pikes Peak Ave, Suite 210
 Colorado Springs, CO 80905
 719-633-2868

File Name : Southmoor Dr - Araco Concrete Access PM
 Site Code : 00194560
 Start Date : 8/15/2019
 Page No : 3

Start Time	Southmoor Dr Southbound					Araco Access Westbound					Southmoor Dr Northbound					Araco Annex Eastbound					Int. Total
	Left	Through	Right	Peds	App. Total	Left	Through	Right	Peds	App. Total	Left	Through	Right	Peds	App. Total	Left	Through	Right	Peds	App. Total	
Peak Hour Analysis From 04:00 PM to 05:30 PM - Peak 1 of 1																					
Peak Hour for Each Approach Begins at:																					
	04:30 PM					04:15 PM					04:45 PM					04:15 PM					
+0 mins.	0	4	0	0	4	1	0	3	0	4	0	3	0	0	3	1	0	2	0	3	
+15 mins.	0	5	2	0	7	1	0	0	0	1	0	4	0	0	4	0	0	1	0	1	
+30 mins.	1	2	0	0	3	0	0	1	0	1	2	2	1	0	5	1	1	0	0	2	
+45 mins.	0	6	0	0	6	0	0	2	0	2	1	6	3	0	10	1	0	0	0	1	
Total Volume	1	17	2	0	20	2	0	6	0	8	3	15	4	0	22	3	1	3	0	7	
% App. Total	5	85	10	0		25	0	75	0		13.6	68.2	18.2	0		42.9	14.3	42.9	0		
PHF	.250	.708	.250	.000	.714	.500	.000	.500	.000	.500	.375	.625	.333	.000	.550	.750	.250	.375	.000	.583	

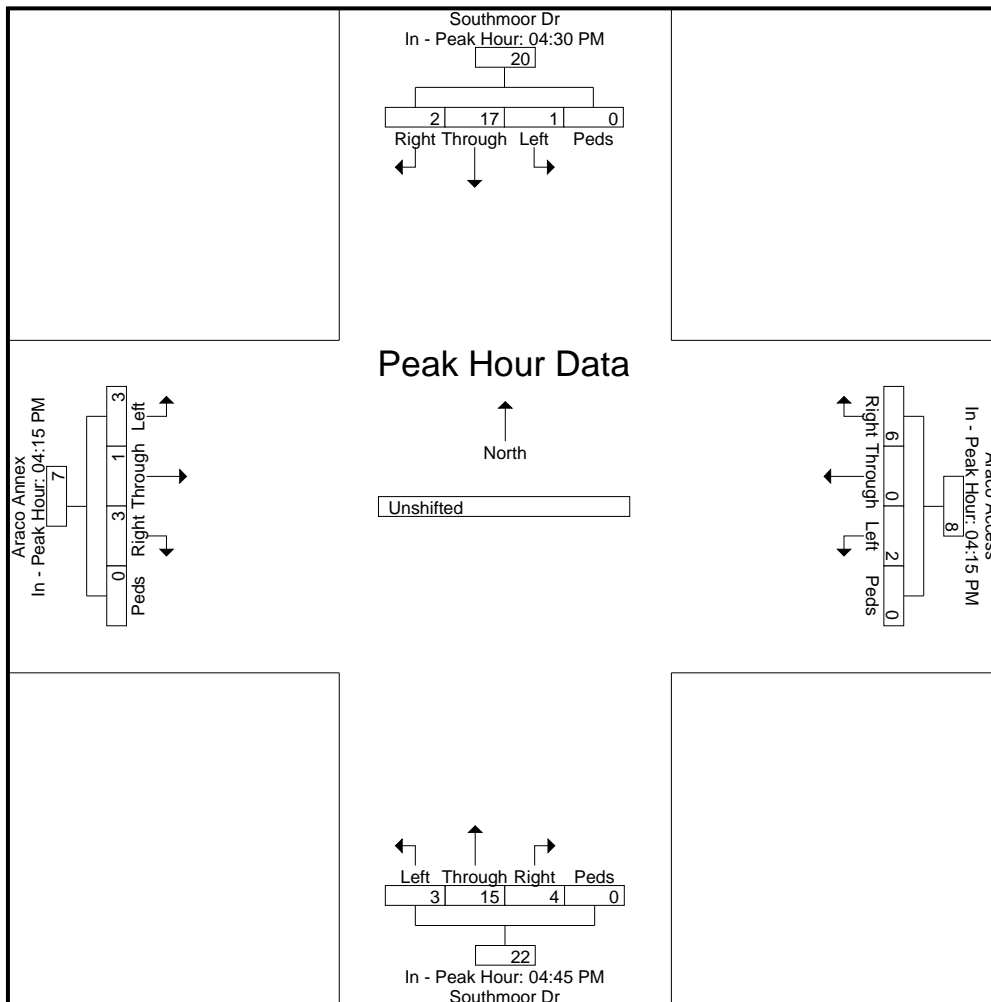

Levels of Service



HCM 6th TWSC
1: Southmoor Ln & US 85/87



Existing
AM

Intersection							
Int Delay, s/veh	0.9						
Movement	SET	SER	NWU	NWL	NWT	NEL	NER
Lane Configurations	↑↑	↑		↓	↑↑	↑	↑
Traffic Vol, veh/h	560	11	4	27	571	14	40
Future Vol, veh/h	560	11	4	27	571	14	40
Conflicting Peds, #/hr	0	0	0	0	0	0	0
Sign Control	Free	Free	Free	Free	Free	Stop	Stop
RT Channelized	-	None	-	-	None	-	Signal
Storage Length	-	0	-	250	-	100	0
Veh in Median Storage, #	0	-	-	-	0	0	-
Grade, %	0	-	-	-	0	0	-
Peak Hour Factor	93	93	93	93	93	83	83
Heavy Vehicles, %	2	2	2	2	2	2	2
Mvmt Flow	602	12	4	29	614	17	48

Major/Minor	Major1	Major2	Minor1				
Conflicting Flow All	0	0	602	614	0	975	301
Stage 1	-	-	-	-	-	602	-
Stage 2	-	-	-	-	-	373	-
Critical Hdwy	-	-	6.44	4.14	-	6.84	6.94
Critical Hdwy Stg 1	-	-	-	-	-	5.84	-
Critical Hdwy Stg 2	-	-	-	-	-	5.84	-
Follow-up Hdwy	-	-	2.52	2.22	-	3.52	3.32
Pot Cap-1 Maneuver	-	-	596	961	-	249	695
Stage 1	-	-	-	-	-	510	-
Stage 2	-	-	-	-	-	666	-
Platoon blocked, %	-	-	-	-	-	-	-
Mov Cap-1 Maneuver	-	-	880	880	-	240	695
Mov Cap-2 Maneuver	-	-	-	-	-	240	-
Stage 1	-	-	-	-	-	510	-
Stage 2	-	-	-	-	-	641	-

Approach	SE	NW	NE
HCM Control Delay, s	0	0.5	13.3
HCM LOS			B

Minor Lane/Major Mvmt	NELn1	NELn2	NWL	NWT	SET	SER
Capacity (veh/h)	240	695	880	-	-	-
HCM Lane V/C Ratio	0.07	0.069	0.038	-	-	-
HCM Control Delay (s)	21.1	10.6	9.2	-	-	-
HCM Lane LOS	C	B	A	-	-	-
HCM 95th %tile Q(veh)	0.2	0.2	0.1	-	-	-

Intersection						
Int Delay, s/veh	1.9					
Movement	SET	SER	NWL	NWT	NEL	NER
Lane Configurations						
Traffic Vol, veh/h	15	0	5	9	0	3
Future Vol, veh/h	15	0	5	9	0	3
Conflicting Peds, #/hr	0	0	0	0	0	0
Sign Control	Free	Free	Free	Free	Stop	Stop
RT Channelized	-	None	-	None	-	None
Storage Length	-	-	-	-	0	-
Veh in Median Storage, #	0	-	-	0	0	-
Grade, %	0	-	-	0	0	-
Peak Hour Factor	78	78	78	78	78	78
Heavy Vehicles, %	2	2	2	2	2	2
Mvmt Flow	19	0	6	12	0	4
Major/Minor	Major1	Major2	Minor1			
Conflicting Flow All	0	0	19	0	43	19
Stage 1	-	-	-	-	19	-
Stage 2	-	-	-	-	24	-
Critical Hdwy	-	-	4.12	-	6.42	6.22
Critical Hdwy Stg 1	-	-	-	-	5.42	-
Critical Hdwy Stg 2	-	-	-	-	5.42	-
Follow-up Hdwy	-	-	2.218	-	3.518	3.318
Pot Cap-1 Maneuver	-	-	1597	-	968	1059
Stage 1	-	-	-	-	1004	-
Stage 2	-	-	-	-	999	-
Platoon blocked, %	-	-	-	-	-	-
Mov Cap-1 Maneuver	-	-	1597	-	964	1059
Mov Cap-2 Maneuver	-	-	-	-	964	-
Stage 1	-	-	-	-	1004	-
Stage 2	-	-	-	-	995	-
Approach	SE	NW	NE			
HCM Control Delay, s	0	2.6	8.4			
HCM LOS				A		
Minor Lane/Major Mvmt	NELn1	NWL	NWT	SET	SER	
Capacity (veh/h)	1059	1597	-	-	-	
HCM Lane V/C Ratio	0.004	0.004	-	-	-	
HCM Control Delay (s)	8.4	7.3	0	-	-	
HCM Lane LOS	A	A	A	-	-	
HCM 95th %tile Q(veh)	0	0	-	-	-	

Intersection

Int Delay, s/veh 2.4

Movement SEL SET NWT NWR SWL SWR

Lane Configurations		↶	↷		↶	
Traffic Vol, veh/h	1	11	5	4	1	6
Future Vol, veh/h	1	11	5	4	1	6
Conflicting Peds, #/hr	0	0	0	0	0	0
Sign Control	Free	Free	Free	Free	Stop	Stop
RT Channelized	-	None	-	None	-	None
Storage Length	-	-	-	-	0	-
Veh in Median Storage, #	-	0	0	-	0	-
Grade, %	-	0	0	-	0	-
Peak Hour Factor	78	78	78	78	78	78
Heavy Vehicles, %	2	2	2	2	2	2
Mvmt Flow	1	14	6	5	1	8

Major/Minor Major1 Major2 Minor2

Conflicting Flow All	11	0	-	0	25	9
Stage 1	-	-	-	-	9	-
Stage 2	-	-	-	-	16	-
Critical Hdwy	4.12	-	-	-	6.42	6.22
Critical Hdwy Stg 1	-	-	-	-	5.42	-
Critical Hdwy Stg 2	-	-	-	-	5.42	-
Follow-up Hdwy	2.218	-	-	-	3.518	3.318
Pot Cap-1 Maneuver	1608	-	-	-	991	1073
Stage 1	-	-	-	-	1014	-
Stage 2	-	-	-	-	1007	-
Platoon blocked, %		-	-	-		
Mov Cap-1 Maneuver	1608	-	-	-	990	1073
Mov Cap-2 Maneuver	-	-	-	-	990	-
Stage 1	-	-	-	-	1013	-
Stage 2	-	-	-	-	1007	-

Approach SE NW SW

HCM Control Delay, s	0.6	0	8.4
HCM LOS			A

Minor Lane/Major Mvmt NWT NWR SEL SETSWLn1

Capacity (veh/h)	-	-	1608	-	1060
HCM Lane V/C Ratio	-	-	0.001	-	0.008
HCM Control Delay (s)	-	-	7.2	0	8.4
HCM Lane LOS	-	-	A	A	A
HCM 95th %tile Q(veh)	-	-	0	-	0

HCM 6th TWSC
1: Southmoor Ln & US 85/87

Existing
PM

Intersection							
Int Delay, s/veh	0.6						
Movement	SET	SER	NWU	NWL	NWT	NEL	NER
Lane Configurations	↑↑	↗		↘	↑↑	↖	↗
Traffic Vol, veh/h	1091	15	1	28	859	6	30
Future Vol, veh/h	1091	15	1	28	859	6	30
Conflicting Peds, #/hr	0	0	0	0	0	0	0
Sign Control	Free	Free	Free	Free	Free	Stop	Stop
RT Channelized	-	None	-	-	None	-	Signal
Storage Length	-	0	-	250	-	100	0
Veh in Median Storage, #	0	-	-	-	0	0	-
Grade, %	0	-	-	-	0	0	-
Peak Hour Factor	95	95	93	93	93	83	83
Heavy Vehicles, %	2	2	2	2	2	2	2
Mvmt Flow	1148	16	1	30	924	7	36

Major/Minor	Major1	Major2	Minor1				
Conflicting Flow All	0	0	1148	1164	0	1672	574
Stage 1	-	-	-	-	-	1148	-
Stage 2	-	-	-	-	-	524	-
Critical Hdwy	-	-	6.44	4.14	-	6.84	6.94
Critical Hdwy Stg 1	-	-	-	-	-	5.84	-
Critical Hdwy Stg 2	-	-	-	-	-	5.84	-
Follow-up Hdwy	-	-	2.52	2.22	-	3.52	3.32
Pot Cap-1 Maneuver	-	-	267	596	-	87	462
Stage 1	-	-	-	-	-	264	-
Stage 2	-	-	-	-	-	559	-
Platoon blocked, %	-	-	-	-	-	-	-
Mov Cap-1 Maneuver	-	-	569	569	-	82	462
Mov Cap-2 Maneuver	-	-	-	-	-	82	-
Stage 1	-	-	-	-	-	264	-
Stage 2	-	-	-	-	-	529	-

Approach	SE	NW	NE
HCM Control Delay, s	0	0.4	20.1
HCM LOS			C

Minor Lane/Major Mvmt	NELn1	NELn2	NWL	NWT	SET	SER
Capacity (veh/h)	82	462	569	-	-	-
HCM Lane V/C Ratio	0.088	0.078	0.055	-	-	-
HCM Control Delay (s)	53.1	13.5	11.7	-	-	-
HCM Lane LOS	F	B	B	-	-	-
HCM 95th %tile Q(veh)	0.3	0.3	0.2	-	-	-

Intersection						
Int Delay, s/veh	1.4					
Movement	SET	SER	NWL	NWT	NEL	NER
Lane Configurations						
Traffic Vol, veh/h	19	2	3	19	3	2
Future Vol, veh/h	19	2	3	19	3	2
Conflicting Peds, #/hr	0	0	0	0	0	0
Sign Control	Free	Free	Free	Free	Stop	Stop
RT Channelized	-	None	-	None	-	None
Storage Length	-	-	-	-	0	-
Veh in Median Storage, #	0	-	-	0	0	-
Grade, %	0	-	-	0	0	-
Peak Hour Factor	78	78	78	78	78	78
Heavy Vehicles, %	2	2	2	2	2	2
Mvmt Flow	24	3	4	24	4	3

Major/Minor	Major1	Major2	Minor1		
Conflicting Flow All	0	0	27	0	58
Stage 1	-	-	-	-	26
Stage 2	-	-	-	-	32
Critical Hdwy	-	-	4.12	-	6.42
Critical Hdwy Stg 1	-	-	-	-	5.42
Critical Hdwy Stg 2	-	-	-	-	5.42
Follow-up Hdwy	-	-	2.218	-	3.518
Pot Cap-1 Maneuver	-	-	1587	-	949
Stage 1	-	-	-	-	997
Stage 2	-	-	-	-	991
Platoon blocked, %	-	-	-	-	-
Mov Cap-1 Maneuver	-	-	1587	-	946
Mov Cap-2 Maneuver	-	-	-	-	946
Stage 1	-	-	-	-	997
Stage 2	-	-	-	-	988

Approach	SE	NW	NE
HCM Control Delay, s	0	1	8.7
HCM LOS			A

Minor Lane/Major Mvmt	NELn1	NWL	NWT	SET	SER
Capacity (veh/h)	985	1587	-	-	-
HCM Lane V/C Ratio	0.007	0.002	-	-	-
HCM Control Delay (s)	8.7	7.3	0	-	-
HCM Lane LOS	A	A	A	-	-
HCM 95th %tile Q(veh)	0	0	-	-	-

Intersection						
Int Delay, s/veh	1.5					
Movement	SEL	SET	NWT	NWR	SWL	SWR
Lane Configurations		↶	↷		↶	↷
Traffic Vol, veh/h	2	18	18	4	3	4
Future Vol, veh/h	2	18	18	4	3	4
Conflicting Peds, #/hr	0	0	0	0	0	0
Sign Control	Free	Free	Free	Free	Stop	Stop
RT Channelized	-	None	-	None	-	None
Storage Length	-	-	-	-	0	-
Veh in Median Storage, #	-	0	0	-	0	-
Grade, %	-	0	0	-	0	-
Peak Hour Factor	78	78	78	78	78	78
Heavy Vehicles, %	2	2	2	2	2	2
Mvmt Flow	3	23	23	5	4	5
Major/Minor	Major1	Major2	Minor2			
Conflicting Flow All	28	0	-	0	55	26
Stage 1	-	-	-	-	26	-
Stage 2	-	-	-	-	29	-
Critical Hdwy	4.12	-	-	-	6.42	6.22
Critical Hdwy Stg 1	-	-	-	-	5.42	-
Critical Hdwy Stg 2	-	-	-	-	5.42	-
Follow-up Hdwy	2.218	-	-	-	3.518	3.318
Pot Cap-1 Maneuver	1585	-	-	-	953	1050
Stage 1	-	-	-	-	997	-
Stage 2	-	-	-	-	994	-
Platoon blocked, %		-	-	-		
Mov Cap-1 Maneuver	1585	-	-	-	951	1050
Mov Cap-2 Maneuver	-	-	-	-	951	-
Stage 1	-	-	-	-	995	-
Stage 2	-	-	-	-	994	-
Approach	SE	NW	SW			
HCM Control Delay, s	0.7	0	8.6			
HCM LOS			A			
Minor Lane/Major Mvmt	NWT	NWR	SEL	SETSWLn1		
Capacity (veh/h)	-	-	1585	-	1005	
HCM Lane V/C Ratio	-	-	0.002	-	0.009	
HCM Control Delay (s)	-	-	7.3	0	8.6	
HCM Lane LOS	-	-	A	A	A	
HCM 95th %tile Q(veh)	-	-	0	-	0	

Intersection							
Int Delay, s/veh	1.1						
Movement	SET	SER	NWU	NWL	NWT	NEL	NER
Lane Configurations	↑↑	↑		↓	↑↑	↑	↑
Traffic Vol, veh/h	560	13	4	40	571	15	44
Future Vol, veh/h	560	13	4	40	571	15	44
Conflicting Peds, #/hr	0	0	0	0	0	0	0
Sign Control	Free	Free	Free	Free	Free	Stop	Stop
RT Channelized	-	None	-	-	None	-	Signal
Storage Length	-	0	-	250	-	100	0
Veh in Median Storage, #	0	-	-	-	0	0	-
Grade, %	0	-	-	-	0	0	-
Peak Hour Factor	93	93	93	93	93	83	83
Heavy Vehicles, %	2	2	2	2	2	2	2
Mvmt Flow	602	14	4	43	614	18	53

Major/Minor	Major1	Major2	Minor1				
Conflicting Flow All	0	0	602	616	0	1003	301
Stage 1	-	-	-	-	-	602	-
Stage 2	-	-	-	-	-	401	-
Critical Hdwy	-	-	6.44	4.14	-	6.84	6.94
Critical Hdwy Stg 1	-	-	-	-	-	5.84	-
Critical Hdwy Stg 2	-	-	-	-	-	5.84	-
Follow-up Hdwy	-	-	2.52	2.22	-	3.52	3.32
Pot Cap-1 Maneuver	-	-	596	960	-	239	695
Stage 1	-	-	-	-	-	510	-
Stage 2	-	-	-	-	-	645	-
Platoon blocked, %	-	-	-	-	-	-	-
Mov Cap-1 Maneuver	-	-	901	901	-	227	695
Mov Cap-2 Maneuver	-	-	-	-	-	227	-
Stage 1	-	-	-	-	-	510	-
Stage 2	-	-	-	-	-	611	-

Approach	SE	NW	NE
HCM Control Delay, s	0	0.7	13.5
HCM LOS			B

Minor Lane/Major Mvmt	NELn1	NELn2	NWL	NWT	SET	SER
Capacity (veh/h)	227	695	901	-	-	-
HCM Lane V/C Ratio	0.08	0.076	0.053	-	-	-
HCM Control Delay (s)	22.2	10.6	9.2	-	-	-
HCM Lane LOS	C	B	A	-	-	-
HCM 95th %tile Q(veh)	0.3	0.2	0.2	-	-	-

Intersection

Int Delay, s/veh 3.3

Movement SET SER NWL NWT NEL NER

Lane Configurations						
Traffic Vol, veh/h	17	1	14	11	1	7
Future Vol, veh/h	17	1	14	11	1	7
Conflicting Peds, #/hr	0	0	0	0	0	0
Sign Control	Free	Free	Free	Free	Stop	Stop
RT Channelized	-	None	-	None	-	None
Storage Length	-	-	-	-	0	-
Veh in Median Storage, #	0	-	-	0	0	-
Grade, %	0	-	-	0	0	-
Peak Hour Factor	78	78	78	78	78	78
Heavy Vehicles, %	2	2	2	2	2	2
Mvmt Flow	22	1	18	14	1	9

Major/Minor Major1 Major2 Minor1

Conflicting Flow All	0	0	23	0	73	23
Stage 1	-	-	-	-	23	-
Stage 2	-	-	-	-	50	-
Critical Hdwy	-	-	4.12	-	6.42	6.22
Critical Hdwy Stg 1	-	-	-	-	5.42	-
Critical Hdwy Stg 2	-	-	-	-	5.42	-
Follow-up Hdwy	-	-	2.218	-	3.518	3.318
Pot Cap-1 Maneuver	-	-	1592	-	931	1054
Stage 1	-	-	-	-	1000	-
Stage 2	-	-	-	-	972	-
Platoon blocked, %	-	-	-	-	-	-
Mov Cap-1 Maneuver	-	-	1592	-	921	1054
Mov Cap-2 Maneuver	-	-	-	-	921	-
Stage 1	-	-	-	-	1000	-
Stage 2	-	-	-	-	961	-

Approach SE NW NE

HCM Control Delay, s 0 4.1 8.5
HCM LOS A

Minor Lane/Major Mvmt NELn1 NWL NWT SET SER

Capacity (veh/h)	1035	1592	-	-	-
HCM Lane V/C Ratio	0.01	0.011	-	-	-
HCM Control Delay (s)	8.5	7.3	0	-	-
HCM Lane LOS	A	A	A	-	-
HCM 95th %tile Q(veh)	0	0	-	-	-

Intersection						
Int Delay, s/veh	1.7					
Movement	SEL	SET	NWT	NWR	SWL	SWR
Lane Configurations		↶	↷		↶	↷
Traffic Vol, veh/h	1	13	7	4	4	1
Future Vol, veh/h	1	13	7	4	4	1
Conflicting Peds, #/hr	0	0	0	0	0	0
Sign Control	Free	Free	Free	Free	Stop	Stop
RT Channelized	-	None	-	None	-	None
Storage Length	-	-	-	-	0	-
Veh in Median Storage, #	-	0	0	-	0	-
Grade, %	-	0	0	-	0	-
Peak Hour Factor	78	78	78	78	78	78
Heavy Vehicles, %	2	2	2	2	2	2
Mvmt Flow	1	17	9	5	5	1
Major/Minor	Major1	Major2	Minor2			
Conflicting Flow All	14	0	-	0	31	12
Stage 1	-	-	-	-	12	-
Stage 2	-	-	-	-	19	-
Critical Hdwy	4.12	-	-	-	6.42	6.22
Critical Hdwy Stg 1	-	-	-	-	5.42	-
Critical Hdwy Stg 2	-	-	-	-	5.42	-
Follow-up Hdwy	2.218	-	-	-	3.518	3.318
Pot Cap-1 Maneuver	1604	-	-	-	983	1069
Stage 1	-	-	-	-	1011	-
Stage 2	-	-	-	-	1004	-
Platoon blocked, %		-	-	-		
Mov Cap-1 Maneuver	1604	-	-	-	982	1069
Mov Cap-2 Maneuver	-	-	-	-	982	-
Stage 1	-	-	-	-	1010	-
Stage 2	-	-	-	-	1004	-
Approach	SE	NW	SW			
HCM Control Delay, s	0.5	0	8.6			
HCM LOS			A			
Minor Lane/Major Mvmt	NWT	NWR	SEL	SETSWLn1		
Capacity (veh/h)	-	-	1604	-	998	
HCM Lane V/C Ratio	-	-	0.001	-	0.006	
HCM Control Delay (s)	-	-	7.2	0	8.6	
HCM Lane LOS	-	-	A	A	A	
HCM 95th %tile Q(veh)	-	-	0	-	0	

HCM 6th TWSC
1: Southmoor Ln & US 85/87

Existing + Site
PM

Intersection							
Int Delay, s/veh	0.8						
Movement	SET	SER	NWU	NWL	NWT	NEL	NER
Lane Configurations	↑↑	↗		↘	↑↑	↖	↗
Traffic Vol, veh/h	1091	16	1	34	859	8	41
Future Vol, veh/h	1091	16	1	34	859	8	41
Conflicting Peds, #/hr	0	0	0	0	0	0	0
Sign Control	Free	Free	Free	Free	Free	Stop	Stop
RT Channelized	-	None	-	-	None	-	Signal
Storage Length	-	0	-	250	-	100	0
Veh in Median Storage, #	0	-	-	-	0	0	-
Grade, %	0	-	-	-	0	0	-
Peak Hour Factor	95	95	93	93	93	83	83
Heavy Vehicles, %	2	2	2	2	2	2	2
Mvmt Flow	1148	17	1	37	924	10	49

Major/Minor	Major1	Major2	Minor1				
Conflicting Flow All	0	0	1148	1165	0	1686	574
Stage 1	-	-	-	-	-	1148	-
Stage 2	-	-	-	-	-	538	-
Critical Hdwy	-	-	6.44	4.14	-	6.84	6.94
Critical Hdwy Stg 1	-	-	-	-	-	5.84	-
Critical Hdwy Stg 2	-	-	-	-	-	5.84	-
Follow-up Hdwy	-	-	2.52	2.22	-	3.52	3.32
Pot Cap-1 Maneuver	-	-	267	595	-	85	462
Stage 1	-	-	-	-	-	264	-
Stage 2	-	-	-	-	-	549	-
Platoon blocked, %	-	-	-	-	-	-	-
Mov Cap-1 Maneuver	-	-	571	571	-	79	462
Mov Cap-2 Maneuver	-	-	-	-	-	79	-
Stage 1	-	-	-	-	-	264	-
Stage 2	-	-	-	-	-	512	-

Approach	SE	NW	NE
HCM Control Delay, s	0	0.5	20.7
HCM LOS			C

Minor Lane/Major Mvmt	NELn1	NELn2	NWL	NWT	SET	SER
Capacity (veh/h)	79	462	571	-	-	-
HCM Lane V/C Ratio	0.122	0.107	0.066	-	-	-
HCM Control Delay (s)	56.8	13.7	11.7	-	-	-
HCM Lane LOS	F	B	B	-	-	-
HCM 95th %tile Q(veh)	0.4	0.4	0.2	-	-	-

Intersection						
Int Delay, s/veh	2.9					
Movement	SET	SER	NWL	NWT	NEL	NER
Lane Configurations						
Traffic Vol, veh/h	22	2	8	20	4	12
Future Vol, veh/h	22	2	8	20	4	12
Conflicting Peds, #/hr	0	0	0	0	0	0
Sign Control	Free	Free	Free	Free	Stop	Stop
RT Channelized	-	None	-	None	-	None
Storage Length	-	-	-	-	0	-
Veh in Median Storage, #	0	-	-	0	0	-
Grade, %	0	-	-	0	0	-
Peak Hour Factor	78	78	78	78	78	78
Heavy Vehicles, %	2	2	2	2	2	2
Mvmt Flow	28	3	10	26	5	15

Major/Minor	Major1	Major2	Minor1			
Conflicting Flow All	0	0	31	0	76	30
Stage 1	-	-	-	-	30	-
Stage 2	-	-	-	-	46	-
Critical Hdwy	-	-	4.12	-	6.42	6.22
Critical Hdwy Stg 1	-	-	-	-	5.42	-
Critical Hdwy Stg 2	-	-	-	-	5.42	-
Follow-up Hdwy	-	-	2.218	-	3.518	3.318
Pot Cap-1 Maneuver	-	-	1582	-	927	1044
Stage 1	-	-	-	-	993	-
Stage 2	-	-	-	-	976	-
Platoon blocked, %	-	-	-	-	-	-
Mov Cap-1 Maneuver	-	-	1582	-	921	1044
Mov Cap-2 Maneuver	-	-	-	-	921	-
Stage 1	-	-	-	-	993	-
Stage 2	-	-	-	-	970	-

Approach	SE	NW	NE
HCM Control Delay, s	0	2.1	8.6
HCM LOS			A

Minor Lane/Major Mvmt	NELn1	NWL	NWT	SET	SER
Capacity (veh/h)	1010	1582	-	-	-
HCM Lane V/C Ratio	0.02	0.006	-	-	-
HCM Control Delay (s)	8.6	7.3	0	-	-
HCM Lane LOS	A	A	A	-	-
HCM 95th %tile Q(veh)	0.1	0	-	-	-

Intersection						
Int Delay, s/veh	0.9					
Movement	SET	SER	NWL	NWT	NEL	NER
Lane Configurations						
Traffic Vol, veh/h	20	1	1	23	1	3
Future Vol, veh/h	20	1	1	23	1	3
Conflicting Peds, #/hr	0	0	0	0	0	0
Sign Control	Free	Free	Free	Free	Stop	Stop
RT Channelized	-	None	-	None	-	None
Storage Length	-	-	-	-	0	-
Veh in Median Storage, #	0	-	-	0	0	-
Grade, %	0	-	-	0	0	-
Peak Hour Factor	78	78	78	78	78	78
Heavy Vehicles, %	10	50	50	10	50	50
Mvmt Flow	26	1	1	29	1	4

Major/Minor	Major1	Major2	Minor1		
Conflicting Flow All	0	0	27	0	58
Stage 1	-	-	-	-	27
Stage 2	-	-	-	-	31
Critical Hdwy	-	-	4.6	-	6.9
Critical Hdwy Stg 1	-	-	-	-	5.9
Critical Hdwy Stg 2	-	-	-	-	5.9
Follow-up Hdwy	-	-	2.65	-	3.95
Pot Cap-1 Maneuver	-	-	1326	-	842
Stage 1	-	-	-	-	885
Stage 2	-	-	-	-	881
Platoon blocked, %	-	-	-	-	-
Mov Cap-1 Maneuver	-	-	1326	-	841
Mov Cap-2 Maneuver	-	-	-	-	841
Stage 1	-	-	-	-	885
Stage 2	-	-	-	-	880

Approach	SE	NW	NE
HCM Control Delay, s	0	0.3	9
HCM LOS			A

Minor Lane/Major Mvmt	NELn1	NWL	NWT	SET	SER
Capacity (veh/h)	903	1326	-	-	-
HCM Lane V/C Ratio	0.006	0.001	-	-	-
HCM Control Delay (s)	9	7.7	0	-	-
HCM Lane LOS	A	A	A	-	-
HCM 95th %tile Q(veh)	0	0	-	-	-

Intersection						
Int Delay, s/veh	1.3					
Movement	SET	SER	NWL	NWT	NEL	NER
Lane Configurations	↑↑	↗	↘	↑↑	↖	↗
Traffic Vol, veh/h	700	25	50	725	25	54
Future Vol, veh/h	700	25	50	725	25	54
Conflicting Peds, #/hr	0	0	0	0	0	0
Sign Control	Free	Free	Free	Free	Stop	Stop
RT Channelized	-	None	-	None	-	Signal
Storage Length	-	0	250	-	100	0
Veh in Median Storage, #	0	-	-	0	0	-
Grade, %	0	-	-	0	0	-
Peak Hour Factor	93	93	93	93	83	83
Heavy Vehicles, %	2	2	2	2	2	2
Mvmt Flow	753	27	54	780	30	65

Major/Minor	Major1	Major2	Minor1	Minor2
Conflicting Flow All	0	0	780	1251
Stage 1	-	-	-	753
Stage 2	-	-	-	498
Critical Hdwy	-	-	4.14	6.84
Critical Hdwy Stg 1	-	-	-	5.84
Critical Hdwy Stg 2	-	-	-	5.84
Follow-up Hdwy	-	-	2.22	3.52
Pot Cap-1 Maneuver	-	-	833	621
Stage 1	-	-	-	426
Stage 2	-	-	-	576
Platoon blocked, %	-	-	-	-
Mov Cap-1 Maneuver	-	-	833	154
Mov Cap-2 Maneuver	-	-	-	154
Stage 1	-	-	-	426
Stage 2	-	-	-	539

Approach	SE	NW	NE
HCM Control Delay, s	0	0.6	18.6
HCM LOS			C

Minor Lane/Major Mvmt	NELn1	NELn2	NWL	NWT	SET	SER
Capacity (veh/h)	154	621	833	-	-	-
HCM Lane V/C Ratio	0.196	0.105	0.065	-	-	-
HCM Control Delay (s)	34	11.5	9.6	-	-	-
HCM Lane LOS	D	B	A	-	-	-
HCM 95th %tile Q(veh)	0.7	0.3	0.2	-	-	-

Intersection						
Int Delay, s/veh	1.9					
Movement	SET	SER	NWL	NWT	NEL	NER
Lane Configurations						
Traffic Vol, veh/h	30	1	14	35	1	7
Future Vol, veh/h	30	1	14	35	1	7
Conflicting Peds, #/hr	0	0	0	0	0	0
Sign Control	Free	Free	Free	Free	Stop	Stop
RT Channelized	-	None	-	None	-	None
Storage Length	-	-	-	-	0	-
Veh in Median Storage, #	0	-	-	0	0	-
Grade, %	0	-	-	0	0	-
Peak Hour Factor	78	78	83	83	78	78
Heavy Vehicles, %	2	2	2	2	2	2
Mvmt Flow	38	1	17	42	1	9
Major/Minor	Major1	Major2	Minor1			
Conflicting Flow All	0	0	39	0	115	39
Stage 1	-	-	-	-	39	-
Stage 2	-	-	-	-	76	-
Critical Hdwy	-	-	4.12	-	6.42	6.22
Critical Hdwy Stg 1	-	-	-	-	5.42	-
Critical Hdwy Stg 2	-	-	-	-	5.42	-
Follow-up Hdwy	-	-	2.218	-	3.518	3.318
Pot Cap-1 Maneuver	-	-	1571	-	881	1033
Stage 1	-	-	-	-	983	-
Stage 2	-	-	-	-	947	-
Platoon blocked, %	-	-	-	-	-	-
Mov Cap-1 Maneuver	-	-	1571	-	871	1033
Mov Cap-2 Maneuver	-	-	-	-	871	-
Stage 1	-	-	-	-	983	-
Stage 2	-	-	-	-	937	-
Approach	SE	NW	NE			
HCM Control Delay, s	0	2.1	8.6			
HCM LOS			A			
Minor Lane/Major Mvmt	NELn1	NWL	NWT	SET	SER	
Capacity (veh/h)	1010	1571	-	-	-	
HCM Lane V/C Ratio	0.01	0.011	-	-	-	
HCM Control Delay (s)	8.6	7.3	0	-	-	
HCM Lane LOS	A	A	A	-	-	
HCM 95th %tile Q(veh)	0	0	-	-	-	

Intersection						
Int Delay, s/veh	1.2					
Movement	SEL	SET	NWT	NWR	SWL	SWR
Lane Configurations		↶	↷		↶	↷
Traffic Vol, veh/h	1	25	25	10	4	5
Future Vol, veh/h	1	25	25	10	4	5
Conflicting Peds, #/hr	0	0	0	0	0	0
Sign Control	Free	Free	Free	Free	Stop	Stop
RT Channelized	-	None	-	None	-	None
Storage Length	-	-	-	-	0	-
Veh in Median Storage, #	-	0	0	-	0	-
Grade, %	-	0	0	-	0	-
Peak Hour Factor	78	78	78	78	78	78
Heavy Vehicles, %	2	2	2	2	2	2
Mvmt Flow	1	32	32	13	5	6
Major/Minor	Major1	Major2	Minor2			
Conflicting Flow All	45	0	-	0	73	39
Stage 1	-	-	-	-	39	-
Stage 2	-	-	-	-	34	-
Critical Hdwy	4.12	-	-	-	6.42	6.22
Critical Hdwy Stg 1	-	-	-	-	5.42	-
Critical Hdwy Stg 2	-	-	-	-	5.42	-
Follow-up Hdwy	2.218	-	-	-	3.518	3.318
Pot Cap-1 Maneuver	1563	-	-	-	931	1033
Stage 1	-	-	-	-	983	-
Stage 2	-	-	-	-	988	-
Platoon blocked, %		-	-	-		
Mov Cap-1 Maneuver	1563	-	-	-	930	1033
Mov Cap-2 Maneuver	-	-	-	-	930	-
Stage 1	-	-	-	-	982	-
Stage 2	-	-	-	-	988	-
Approach	SE	NW	SW			
HCM Control Delay, s	0.3	0	8.7			
HCM LOS			A			
Minor Lane/Major Mvmt	NWT	NWR	SEL	SETSWLn1		
Capacity (veh/h)	-	-	1563	-	985	
HCM Lane V/C Ratio	-	-	0.001	-	0.012	
HCM Control Delay (s)	-	-	7.3	0	8.7	
HCM Lane LOS	-	-	A	A	A	
HCM 95th %tile Q(veh)	-	-	0	-	0	

Intersection						
Int Delay, s/veh	3.3					
Movement	SET	SER	NWL	NWT	NEL	NER
Lane Configurations	↑↑	↗	↘	↑↑	↖	↗
Traffic Vol, veh/h	1350	50	50	1075	25	50
Future Vol, veh/h	1350	50	50	1075	25	50
Conflicting Peds, #/hr	0	0	0	0	0	0
Sign Control	Free	Free	Free	Free	Stop	Stop
RT Channelized	-	None	-	None	-	Signal
Storage Length	-	0	250	-	100	0
Veh in Median Storage, #	0	-	-	0	0	-
Grade, %	0	-	-	0	0	-
Peak Hour Factor	93	93	93	93	83	83
Heavy Vehicles, %	2	2	2	2	2	2
Mvmt Flow	1452	54	54	1156	30	60

Major/Minor	Major1	Major2	Minor1	Minor2	Minor3
Conflicting Flow All	0	0	1506	0	2138
Stage 1	-	-	-	-	1452
Stage 2	-	-	-	-	686
Critical Hdwy	-	-	4.14	-	6.84
Critical Hdwy Stg 1	-	-	-	-	5.84
Critical Hdwy Stg 2	-	-	-	-	5.84
Follow-up Hdwy	-	-	2.22	-	3.52
Pot Cap-1 Maneuver	-	-	441	-	42
Stage 1	-	-	-	-	182
Stage 2	-	-	-	-	461
Platoon blocked, %	-	-	-	-	-
Mov Cap-1 Maneuver	-	-	441	-	37
Mov Cap-2 Maneuver	-	-	-	-	37
Stage 1	-	-	-	-	182
Stage 2	-	-	-	-	405

Approach	SE	NW	NE
HCM Control Delay, s	0	0.6	95.7
HCM LOS			F

Minor Lane/Major Mvmt	NELn1	NELn2	NWL	NWT	SET	SER
Capacity (veh/h)	37	367	441	-	-	-
HCM Lane V/C Ratio	0.814	0.164	0.122	-	-	-
HCM Control Delay (s)	253.8	16.7	14.3	-	-	-
HCM Lane LOS	F	C	B	-	-	-
HCM 95th %tile Q(veh)	3	0.6	0.4	-	-	-

Intersection						
Int Delay, s/veh	1.8					
Movement	SET	SER	NWL	NWT	NEL	NER
Lane Configurations						
Traffic Vol, veh/h	30	2	8	55	4	12
Future Vol, veh/h	30	2	8	55	4	12
Conflicting Peds, #/hr	0	0	0	0	0	0
Sign Control	Free	Free	Free	Free	Stop	Stop
RT Channelized	-	None	-	None	-	None
Storage Length	-	-	-	-	0	-
Veh in Median Storage, #	0	-	-	0	0	-
Grade, %	0	-	-	0	0	-
Peak Hour Factor	78	78	83	83	78	78
Heavy Vehicles, %	2	2	2	2	2	2
Mvmt Flow	38	3	10	66	5	15

Major/Minor	Major1	Major2	Minor1		
Conflicting Flow All	0	0	41	0	126 40
Stage 1	-	-	-	-	40 -
Stage 2	-	-	-	-	86 -
Critical Hdwy	-	-	4.12	-	6.42 6.22
Critical Hdwy Stg 1	-	-	-	-	5.42 -
Critical Hdwy Stg 2	-	-	-	-	5.42 -
Follow-up Hdwy	-	-	2.218	-	3.518 3.318
Pot Cap-1 Maneuver	-	-	1568	-	869 1031
Stage 1	-	-	-	-	982 -
Stage 2	-	-	-	-	937 -
Platoon blocked, %	-	-	-	-	-
Mov Cap-1 Maneuver	-	-	1568	-	863 1031
Mov Cap-2 Maneuver	-	-	-	-	863 -
Stage 1	-	-	-	-	982 -
Stage 2	-	-	-	-	930 -

Approach	SE	NW	NE
HCM Control Delay, s	0	0.9	8.7
HCM LOS			A

Minor Lane/Major Mvmt	NELn1	NWL	NWT	SET	SER
Capacity (veh/h)	983	1568	-	-	-
HCM Lane V/C Ratio	0.021	0.006	-	-	-
HCM Control Delay (s)	8.7	7.3	0	-	-
HCM Lane LOS	A	A	A	-	-
HCM 95th %tile Q(veh)	0.1	0	-	-	-

Intersection						
Int Delay, s/veh	1.3					
Movement	SEL	SET	NWT	NWR	SWL	SWR
Lane Configurations		4	1		3	
Traffic Vol, veh/h	2	25	50	10	3	10
Future Vol, veh/h	2	25	50	10	3	10
Conflicting Peds, #/hr	0	0	0	0	0	0
Sign Control	Free	Free	Free	Free	Stop	Stop
RT Channelized	-	None	-	None	-	None
Storage Length	-	-	-	-	0	-
Veh in Median Storage, #	-	0	0	-	0	-
Grade, %	-	0	0	-	0	-
Peak Hour Factor	78	78	78	78	78	78
Heavy Vehicles, %	2	2	2	2	2	2
Mvmt Flow	3	32	64	13	4	13
Major/Minor	Major1	Major2	Minor2			
Conflicting Flow All	77	0	-	0	109	71
Stage 1	-	-	-	-	71	-
Stage 2	-	-	-	-	38	-
Critical Hdwy	4.12	-	-	-	6.42	6.22
Critical Hdwy Stg 1	-	-	-	-	5.42	-
Critical Hdwy Stg 2	-	-	-	-	5.42	-
Follow-up Hdwy	2.218	-	-	-	3.518	3.318
Pot Cap-1 Maneuver	1522	-	-	-	888	991
Stage 1	-	-	-	-	952	-
Stage 2	-	-	-	-	984	-
Platoon blocked, %		-	-	-		
Mov Cap-1 Maneuver	1522	-	-	-	886	991
Mov Cap-2 Maneuver	-	-	-	-	886	-
Stage 1	-	-	-	-	950	-
Stage 2	-	-	-	-	984	-
Approach	SE	NW	SW			
HCM Control Delay, s	0.5	0	8.8			
HCM LOS			A			
Minor Lane/Major Mvmt	NWT	NWR	SEL	SETSWLn1		
Capacity (veh/h)	-	-	1522	-	965	
HCM Lane V/C Ratio	-	-	0.002	-	0.017	
HCM Control Delay (s)	-	-	7.4	0	8.8	
HCM Lane LOS	-	-	A	A	A	
HCM 95th %tile Q(veh)	-	-	0	-	0.1	

Intersection						
Int Delay, s/veh	1.4					
Movement	SET	SER	NWL	NWT	NEL	NER
Lane Configurations	↑↑	↑	↓	↑↑	↑	↑
Traffic Vol, veh/h	700	27	59	725	26	54
Future Vol, veh/h	700	27	59	725	26	54
Conflicting Peds, #/hr	0	0	0	0	0	0
Sign Control	Free	Free	Free	Free	Stop	Stop
RT Channelized	-	None	-	None	-	Signal
Storage Length	-	0	250	-	100	0
Veh in Median Storage, #	0	-	-	0	0	-
Grade, %	0	-	-	0	0	-
Peak Hour Factor	93	93	93	93	83	83
Heavy Vehicles, %	2	2	2	2	2	2
Mvmt Flow	753	29	63	780	31	65

Major/Minor	Major1	Major2	Minor1	Minor2
Conflicting Flow All	0	0	782	0 1269 377
Stage 1	-	-	-	- 753 -
Stage 2	-	-	-	- 516 -
Critical Hdwy	-	-	4.14	- 6.84 6.94
Critical Hdwy Stg 1	-	-	-	- 5.84 -
Critical Hdwy Stg 2	-	-	-	- 5.84 -
Follow-up Hdwy	-	-	2.22	- 3.52 3.32
Pot Cap-1 Maneuver	-	-	832	- 160 621
Stage 1	-	-	-	- 426 -
Stage 2	-	-	-	- 564 -
Platoon blocked, %	-	-	-	-
Mov Cap-1 Maneuver	-	-	832	- 148 621
Mov Cap-2 Maneuver	-	-	-	- 148 -
Stage 1	-	-	-	- 426 -
Stage 2	-	-	-	- 521 -

Approach	SE	NW	NE
HCM Control Delay, s	0	0.7	19.4
HCM LOS			C

Minor Lane/Major Mvmt	NELn1	NELn2	NWL	NWT	SET	SER
Capacity (veh/h)	148	621	832	-	-	-
HCM Lane V/C Ratio	0.212	0.105	0.076	-	-	-
HCM Control Delay (s)	35.7	11.5	9.7	-	-	-
HCM Lane LOS	E	B	A	-	-	-
HCM 95th %tile Q(veh)	0.8	0.3	0.2	-	-	-

Intersection						
Int Delay, s/veh	1.9					
Movement	SET	SER	NWL	NWT	NEL	NER
Lane Configurations						
Traffic Vol, veh/h	31	1	14	37	1	7
Future Vol, veh/h	31	1	14	37	1	7
Conflicting Peds, #/hr	0	0	0	0	0	0
Sign Control	Free	Free	Free	Free	Stop	Stop
RT Channelized	-	None	-	None	-	None
Storage Length	-	-	-	-	0	-
Veh in Median Storage, #	0	-	-	0	0	-
Grade, %	0	-	-	0	0	-
Peak Hour Factor	78	78	83	83	78	78
Heavy Vehicles, %	2	2	2	2	2	2
Mvmt Flow	40	1	17	45	1	9

Major/Minor	Major1	Major2	Minor1	Minor2	Minor3
Conflicting Flow All	0	0	41	0	120
Stage 1	-	-	-	-	41
Stage 2	-	-	-	-	79
Critical Hdwy	-	-	4.12	-	6.42
Critical Hdwy Stg 1	-	-	-	-	5.42
Critical Hdwy Stg 2	-	-	-	-	5.42
Follow-up Hdwy	-	-	2.218	-	3.518
Pot Cap-1 Maneuver	-	-	1568	-	876
Stage 1	-	-	-	-	981
Stage 2	-	-	-	-	944
Platoon blocked, %	-	-	-	-	-
Mov Cap-1 Maneuver	-	-	1568	-	866
Mov Cap-2 Maneuver	-	-	-	-	866
Stage 1	-	-	-	-	981
Stage 2	-	-	-	-	934

Approach	SE	NW	NE
HCM Control Delay, s	0	2	8.6
HCM LOS			A

Minor Lane/Major Mvmt	NELn1	NWL	NWT	SET	SER
Capacity (veh/h)	1006	1568	-	-	-
HCM Lane V/C Ratio	0.01	0.011	-	-	-
HCM Control Delay (s)	8.6	7.3	0	-	-
HCM Lane LOS	A	A	A	-	-
HCM 95th %tile Q(veh)	0	0	-	-	-

Intersection						
Int Delay, s/veh	0.6					
Movement	SET	SER	NWL	NWT	NEL	NER
Lane Configurations						
Traffic Vol, veh/h	26	1	2	28	1	1
Future Vol, veh/h	26	1	2	28	1	1
Conflicting Peds, #/hr	0	0	0	0	0	0
Sign Control	Free	Free	Free	Free	Stop	Stop
RT Channelized	-	None	-	None	-	None
Storage Length	-	-	-	-	0	-
Veh in Median Storage, #	0	-	-	0	0	-
Grade, %	0	-	-	0	0	-
Peak Hour Factor	78	78	83	83	78	78
Heavy Vehicles, %	10	50	50	10	50	50
Mvmt Flow	33	1	2	34	1	1

Major/Minor	Major1	Major2	Minor1	Minor2	Minor3
Conflicting Flow All	0	0	34	0	72
Stage 1	-	-	-	-	34
Stage 2	-	-	-	-	38
Critical Hdwy	-	-	4.6	-	6.9
Critical Hdwy Stg 1	-	-	-	-	5.9
Critical Hdwy Stg 2	-	-	-	-	5.9
Follow-up Hdwy	-	-	2.65	-	3.95
Pot Cap-1 Maneuver	-	-	1317	-	826
Stage 1	-	-	-	-	878
Stage 2	-	-	-	-	874
Platoon blocked, %	-	-	-	-	-
Mov Cap-1 Maneuver	-	-	1317	-	824
Mov Cap-2 Maneuver	-	-	-	-	824
Stage 1	-	-	-	-	878
Stage 2	-	-	-	-	872

Approach	SE	NW	NE
HCM Control Delay, s	0	0.5	9.2
HCM LOS			A

Minor Lane/Major Mvmt	NELn1	NWL	NWT	SET	SER
Capacity (veh/h)	868	1317	-	-	-
HCM Lane V/C Ratio	0.003	0.002	-	-	-
HCM Control Delay (s)	9.2	7.7	0	-	-
HCM Lane LOS	A	A	A	-	-
HCM 95th %tile Q(veh)	0	0	-	-	-

Intersection						
Int Delay, s/veh	1.2					
Movement	SEL	SET	NWT	NWR	SWL	SWR
Lane Configurations		↶	↷		↶	↷
Traffic Vol, veh/h	1	27	27	10	4	5
Future Vol, veh/h	1	27	27	10	4	5
Conflicting Peds, #/hr	0	0	0	0	0	0
Sign Control	Free	Free	Free	Free	Stop	Stop
RT Channelized	-	None	-	None	-	None
Storage Length	-	-	-	-	0	-
Veh in Median Storage, #	-	0	0	-	0	-
Grade, %	-	0	0	-	0	-
Peak Hour Factor	78	78	78	78	78	78
Heavy Vehicles, %	2	2	2	2	2	2
Mvmt Flow	1	35	35	13	5	6
Major/Minor	Major1	Major2	Minor2			
Conflicting Flow All	48	0	-	0	79	42
Stage 1	-	-	-	-	42	-
Stage 2	-	-	-	-	37	-
Critical Hdwy	4.12	-	-	-	6.42	6.22
Critical Hdwy Stg 1	-	-	-	-	5.42	-
Critical Hdwy Stg 2	-	-	-	-	5.42	-
Follow-up Hdwy	2.218	-	-	-	3.518	3.318
Pot Cap-1 Maneuver	1559	-	-	-	924	1029
Stage 1	-	-	-	-	980	-
Stage 2	-	-	-	-	985	-
Platoon blocked, %		-	-	-		
Mov Cap-1 Maneuver	1559	-	-	-	923	1029
Mov Cap-2 Maneuver	-	-	-	-	923	-
Stage 1	-	-	-	-	979	-
Stage 2	-	-	-	-	985	-
Approach	SE	NW	SW			
HCM Control Delay, s	0.3	0	8.7			
HCM LOS			A			
Minor Lane/Major Mvmt	NWT	NWR	SEL	SETSWLn1		
Capacity (veh/h)	-	-	1559	-	979	
HCM Lane V/C Ratio	-	-	0.001	-	0.012	
HCM Control Delay (s)	-	-	7.3	0	8.7	
HCM Lane LOS	-	-	A	A	A	
HCM 95th %tile Q(veh)	-	-	0	-	0	

Intersection						
Int Delay, s/veh	4					
Movement	SET	SER	NWL	NWT	NEL	NER
Lane Configurations	↑↑	↑	↓	↑↑	↓	↑
Traffic Vol, veh/h	1350	51	55	1075	27	61
Future Vol, veh/h	1350	51	55	1075	27	61
Conflicting Peds, #/hr	0	0	0	0	0	0
Sign Control	Free	Free	Free	Free	Stop	Stop
RT Channelized	-	None	-	None	-	Signal
Storage Length	-	0	250	-	100	0
Veh in Median Storage, #	0	-	-	0	0	-
Grade, %	0	-	-	0	0	-
Peak Hour Factor	93	93	93	93	83	83
Heavy Vehicles, %	2	2	2	2	2	2
Mvmt Flow	1452	55	59	1156	33	73

Major/Minor	Major1	Major2	Minor1	Minor2	Minor3
Conflicting Flow All	0	0	1507	0	2148
Stage 1	-	-	-	-	1452
Stage 2	-	-	-	-	696
Critical Hdwy	-	-	4.14	-	6.84
Critical Hdwy Stg 1	-	-	-	-	5.84
Critical Hdwy Stg 2	-	-	-	-	5.84
Follow-up Hdwy	-	-	2.22	-	3.52
Pot Cap-1 Maneuver	-	-	440	-	41
Stage 1	-	-	-	-	182
Stage 2	-	-	-	-	456
Platoon blocked, %	-	-	-	-	-
Mov Cap-1 Maneuver	-	-	440	-	36
Mov Cap-2 Maneuver	-	-	-	-	36
Stage 1	-	-	-	-	182
Stage 2	-	-	-	-	395

Approach	SE	NW	NE
HCM Control Delay, s	0	0.7	99.7
HCM LOS			F

Minor Lane/Major Mvmt	NELn1	NELn2	NWL	NWT	SET	SER
Capacity (veh/h)	36	367	440	-	-	-
HCM Lane V/C Ratio	0.904	0.2	0.134	-	-	-
HCM Control Delay (s)	286.1	17.2	14.4	-	-	-
HCM Lane LOS	F	C	B	-	-	-
HCM 95th %tile Q(veh)	3.3	0.7	0.5	-	-	-

Intersection						
Int Delay, s/veh	1.8					
Movement	SET	SER	NWL	NWT	NEL	NER
Lane Configurations						
Traffic Vol, veh/h	33	2	8	56	4	12
Future Vol, veh/h	33	2	8	56	4	12
Conflicting Peds, #/hr	0	0	0	0	0	0
Sign Control	Free	Free	Free	Free	Stop	Stop
RT Channelized	-	None	-	None	-	None
Storage Length	-	-	-	-	0	-
Veh in Median Storage, #	0	-	-	0	0	-
Grade, %	0	-	-	0	0	-
Peak Hour Factor	78	78	83	83	78	78
Heavy Vehicles, %	2	2	2	2	2	2
Mvmt Flow	42	3	10	67	5	15

Major/Minor	Major1	Major2	Minor1		
Conflicting Flow All	0	0	45	0	131 44
Stage 1	-	-	-	-	44 -
Stage 2	-	-	-	-	87 -
Critical Hdwy	-	-	4.12	-	6.42 6.22
Critical Hdwy Stg 1	-	-	-	-	5.42 -
Critical Hdwy Stg 2	-	-	-	-	5.42 -
Follow-up Hdwy	-	-	2.218	-	3.518 3.318
Pot Cap-1 Maneuver	-	-	1563	-	863 1026
Stage 1	-	-	-	-	978 -
Stage 2	-	-	-	-	936 -
Platoon blocked, %	-	-	-	-	-
Mov Cap-1 Maneuver	-	-	1563	-	857 1026
Mov Cap-2 Maneuver	-	-	-	-	857 -
Stage 1	-	-	-	-	978 -
Stage 2	-	-	-	-	929 -

Approach	SE	NW	NE
HCM Control Delay, s	0	0.9	8.8
HCM LOS			A

Minor Lane/Major Mvmt	NELn1	NWL	NWT	SET	SER
Capacity (veh/h)	978	1563	-	-	-
HCM Lane V/C Ratio	0.021	0.006	-	-	-
HCM Control Delay (s)	8.8	7.3	0	-	-
HCM Lane LOS	A	A	A	-	-
HCM 95th %tile Q(veh)	0.1	0	-	-	-

Intersection						
Int Delay, s/veh	0.5					
Movement	SET	SER	NWL	NWT	NEL	NER
Lane Configurations						
Traffic Vol, veh/h	24	1	1	60	1	3
Future Vol, veh/h	24	1	1	60	1	3
Conflicting Peds, #/hr	0	0	0	0	0	0
Sign Control	Free	Free	Free	Free	Stop	Stop
RT Channelized	-	None	-	None	-	None
Storage Length	-	-	-	-	0	-
Veh in Median Storage, #	0	-	-	0	0	-
Grade, %	0	-	-	0	0	-
Peak Hour Factor	78	78	83	83	78	78
Heavy Vehicles, %	10	50	50	10	50	50
Mvmt Flow	31	1	1	72	1	4

Major/Minor	Major1	Major2	Minor1		
Conflicting Flow All	0	0	32	0	106 32
Stage 1	-	-	-	-	32 -
Stage 2	-	-	-	-	74 -
Critical Hdwy	-	-	4.6	-	6.9 6.7
Critical Hdwy Stg 1	-	-	-	-	5.9 -
Critical Hdwy Stg 2	-	-	-	-	5.9 -
Follow-up Hdwy	-	-	2.65	-	3.95 3.75
Pot Cap-1 Maneuver	-	-	1319	-	788 920
Stage 1	-	-	-	-	880 -
Stage 2	-	-	-	-	841 -
Platoon blocked, %	-	-	-	-	-
Mov Cap-1 Maneuver	-	-	1319	-	787 920
Mov Cap-2 Maneuver	-	-	-	-	787 -
Stage 1	-	-	-	-	880 -
Stage 2	-	-	-	-	840 -

Approach	SE	NW	NE
HCM Control Delay, s	0	0.1	9.1
HCM LOS			A

Minor Lane/Major Mvmt	NELn1	NWL	NWT	SET	SER
Capacity (veh/h)	883	1319	-	-	-
HCM Lane V/C Ratio	0.006	0.001	-	-	-
HCM Control Delay (s)	9.1	7.7	0	-	-
HCM Lane LOS	A	A	A	-	-
HCM 95th %tile Q(veh)	0	0	-	-	-

Intersection						
Int Delay, s/veh	1.2					
Movement	SEL	SET	NWT	NWR	SWL	SWR
Lane Configurations		4	1		3	
Traffic Vol, veh/h	2	28	52	10	3	10
Future Vol, veh/h	2	28	52	10	3	10
Conflicting Peds, #/hr	0	0	0	0	0	0
Sign Control	Free	Free	Free	Free	Stop	Stop
RT Channelized	-	None	-	None	-	None
Storage Length	-	-	-	-	0	-
Veh in Median Storage, #	-	0	0	-	0	-
Grade, %	-	0	0	-	0	-
Peak Hour Factor	78	78	78	78	78	78
Heavy Vehicles, %	2	2	2	2	2	2
Mvmt Flow	3	36	67	13	4	13
Major/Minor	Major1	Major2	Minor2			
Conflicting Flow All	80	0	-	0	116	74
Stage 1	-	-	-	-	74	-
Stage 2	-	-	-	-	42	-
Critical Hdwy	4.12	-	-	-	6.42	6.22
Critical Hdwy Stg 1	-	-	-	-	5.42	-
Critical Hdwy Stg 2	-	-	-	-	5.42	-
Follow-up Hdwy	2.218	-	-	-	3.518	3.318
Pot Cap-1 Maneuver	1518	-	-	-	880	988
Stage 1	-	-	-	-	949	-
Stage 2	-	-	-	-	980	-
Platoon blocked, %		-	-	-		
Mov Cap-1 Maneuver	1518	-	-	-	878	988
Mov Cap-2 Maneuver	-	-	-	-	878	-
Stage 1	-	-	-	-	947	-
Stage 2	-	-	-	-	980	-
Approach	SE	NW	SW			
HCM Control Delay, s	0.5	0	8.8			
HCM LOS			A			
Minor Lane/Major Mvmt	NWT	NWR	SEL	SETSWLn1		
Capacity (veh/h)	-	-	1518	-	960	
HCM Lane V/C Ratio	-	-	0.002	-	0.017	
HCM Control Delay (s)	-	-	7.4	0	8.8	
HCM Lane LOS	-	-	A	A	A	
HCM 95th %tile Q(veh)	-	-	0	-	0.1	

AutoTurn Exhibits



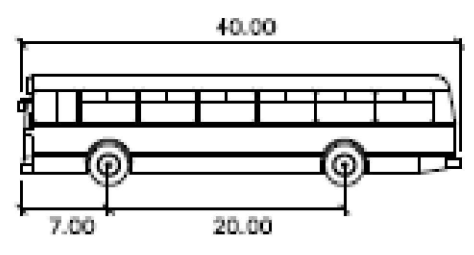
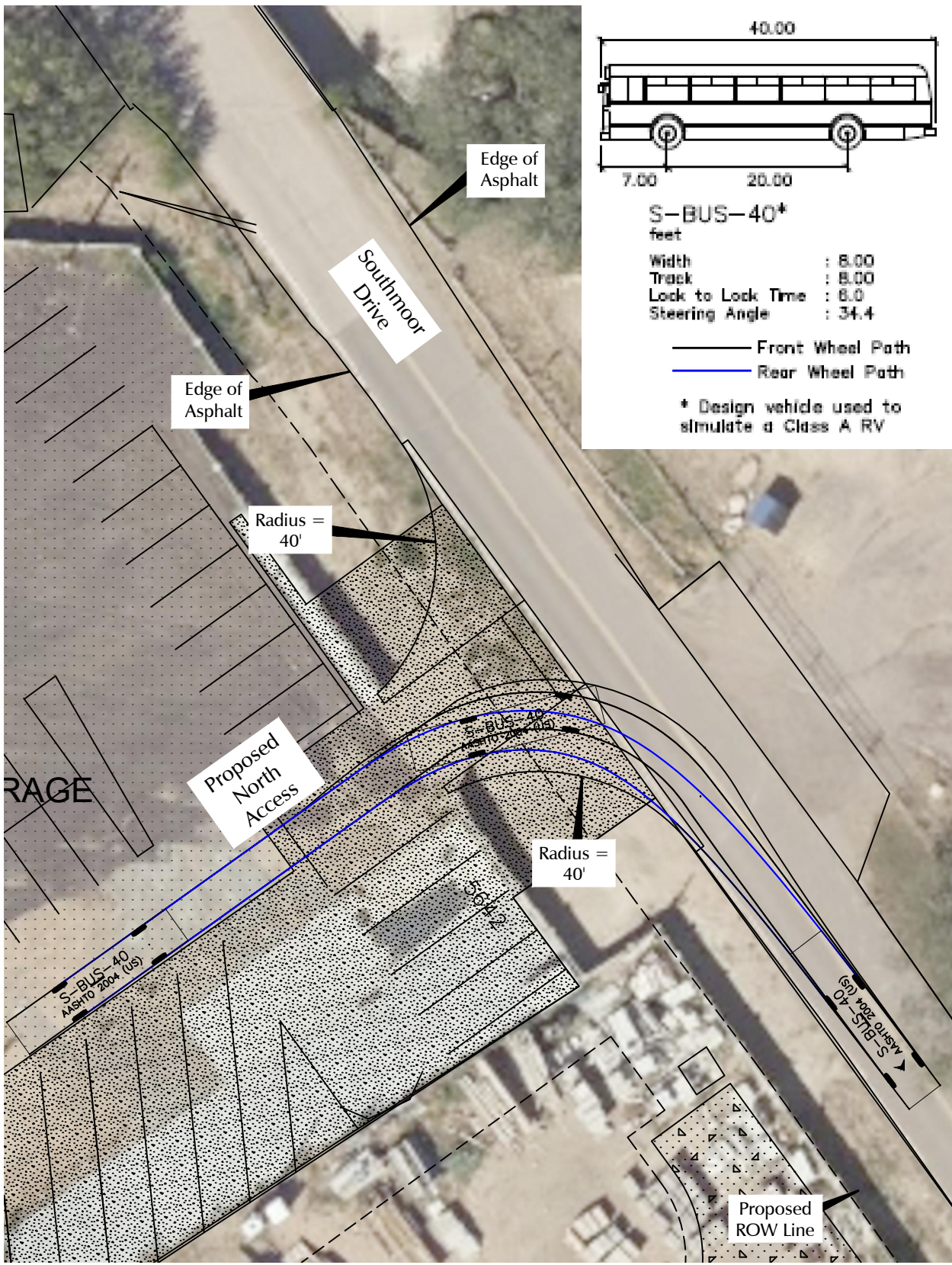

S-BUS-40*
 feet

Width	: 8.00
Track	: 8.00
Lock to Lock Time	: 8.0
Steering Angle	: 34.4

— Front Wheel Path
 — Rear Wheel Path

* Design vehicle used to simulate a Class A RV

RAGE

Proposed North Access

Radius = 40'

Radius = 40'

S-BUS-40
 Asphalt 2004 (US)

S-BUS-40
 Asphalt 2004 (US)

Proposed ROW Line

AutoTurn Exhibit 1

AutoTurn Analysis

North Access - RV Storage (Exiting to South)

Araco Concrete (LSC # 194560)



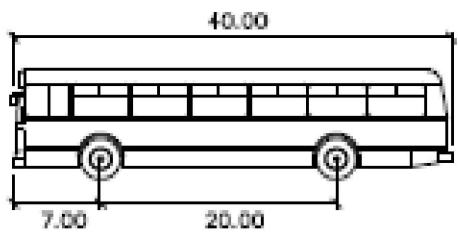
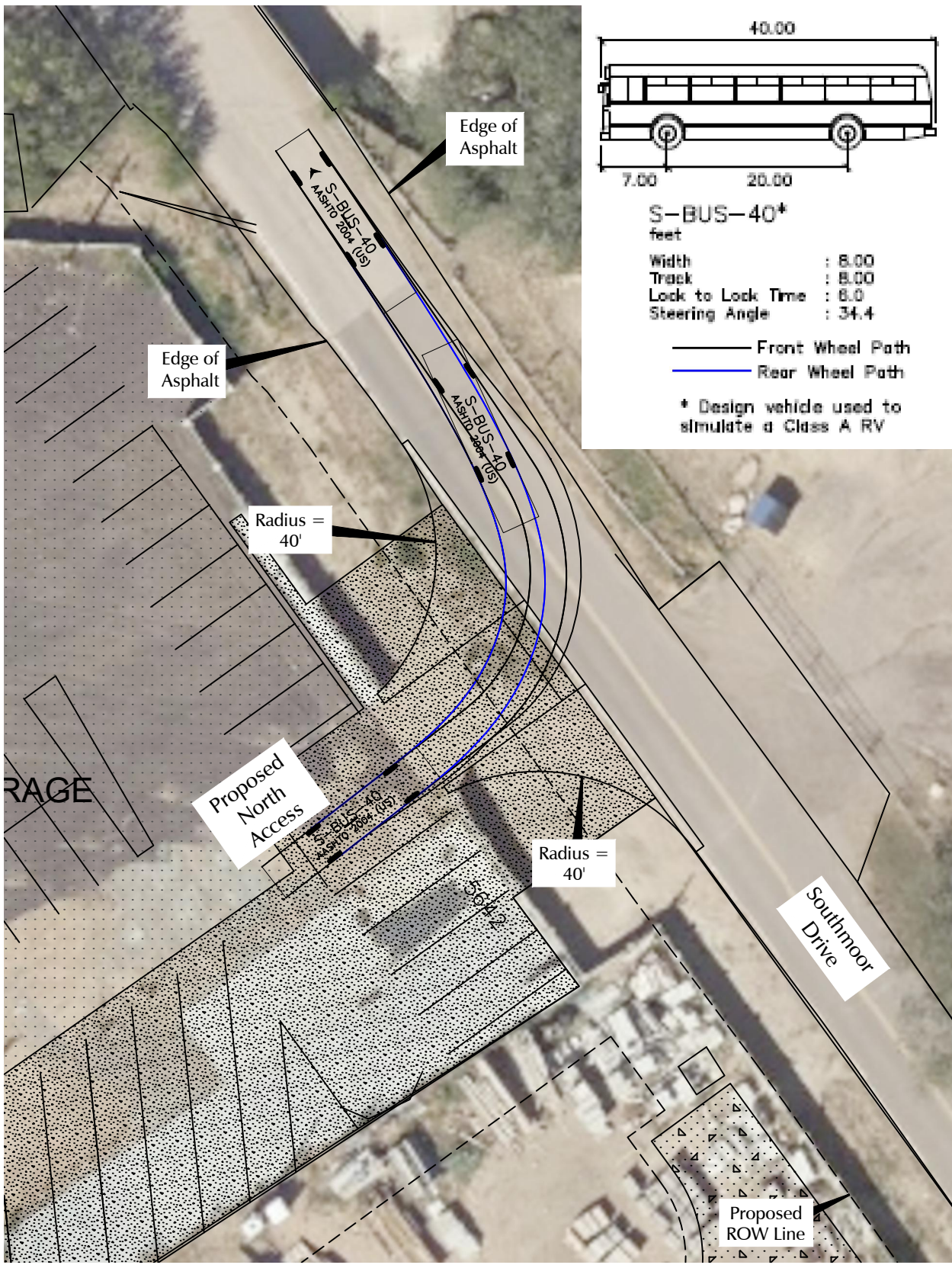

1" = 30' scale

S-BUS-40*
 feet
 Width : 8.00
 Track : 8.00
 Lock to Lock Time : 8.0
 Steering Angle : 34.4

— Front Wheel Path
 — Rear Wheel Path

* Design vehicle used to simulate a Class A RV

AutoTurn Exhibit 2

AutoTurn Analysis

North Access - RV Storage (Exiting to North)



Araco Concrete (LSC # 194560)

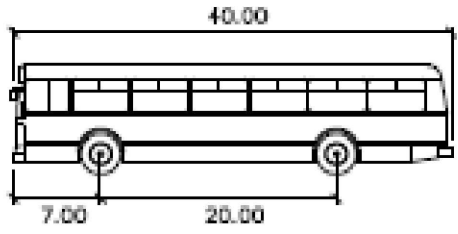
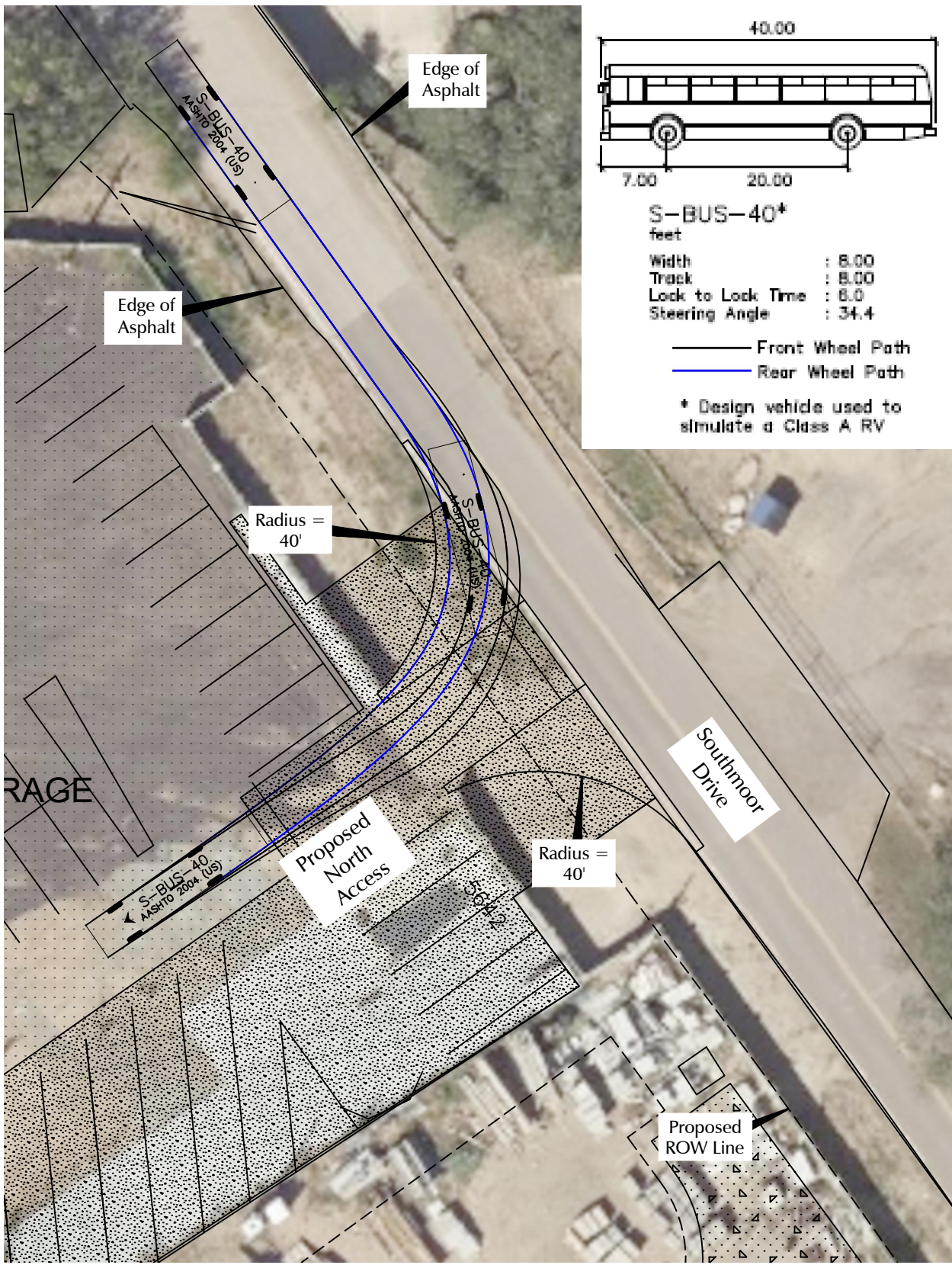

1" = 30'
scale

S-BUS-40*
feet
 Width : 8.00
 Track : 8.00
 Lock to Lock Time : 8.0
 Steering Angle : 34.4

— Front Wheel Path
 — Rear Wheel Path

* Design vehicle used to simulate a Class A RV

AutoTurn Exhibit 3

AutoTurn Analysis

North Access - RV Storage (Entering from North)



Araco Concrete (LSC # 194560)

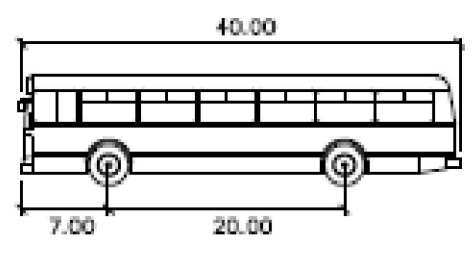
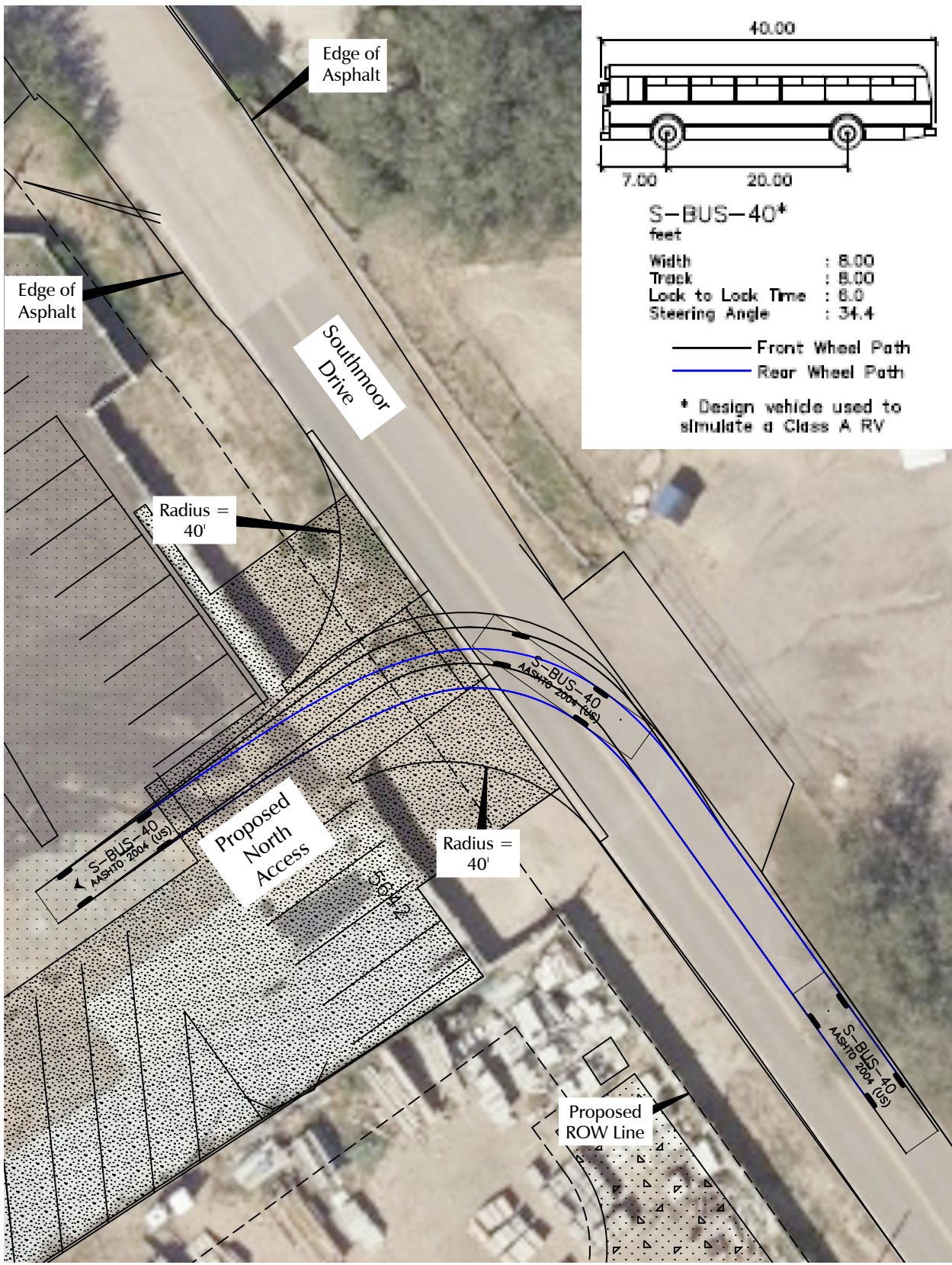

S-BUS-40*
 feet

Width	: 8.00
Track	: 8.00
Lock to Lock Time	: 6.0
Steering Angle	: 34.4

— Front Wheel Path
 — Rear Wheel Path

* Design vehicle used to simulate a Class A RV



AutoTurn Exhibit 4

AutoTurn Analysis

North Access - RV Storage (Entering from South)

Araco Concrete (LSC # 194560)

Site Plan



ARACO CONCRETE

SITE DEVELOPMENT PLAN
EL PASO COUNTY, COLORADO

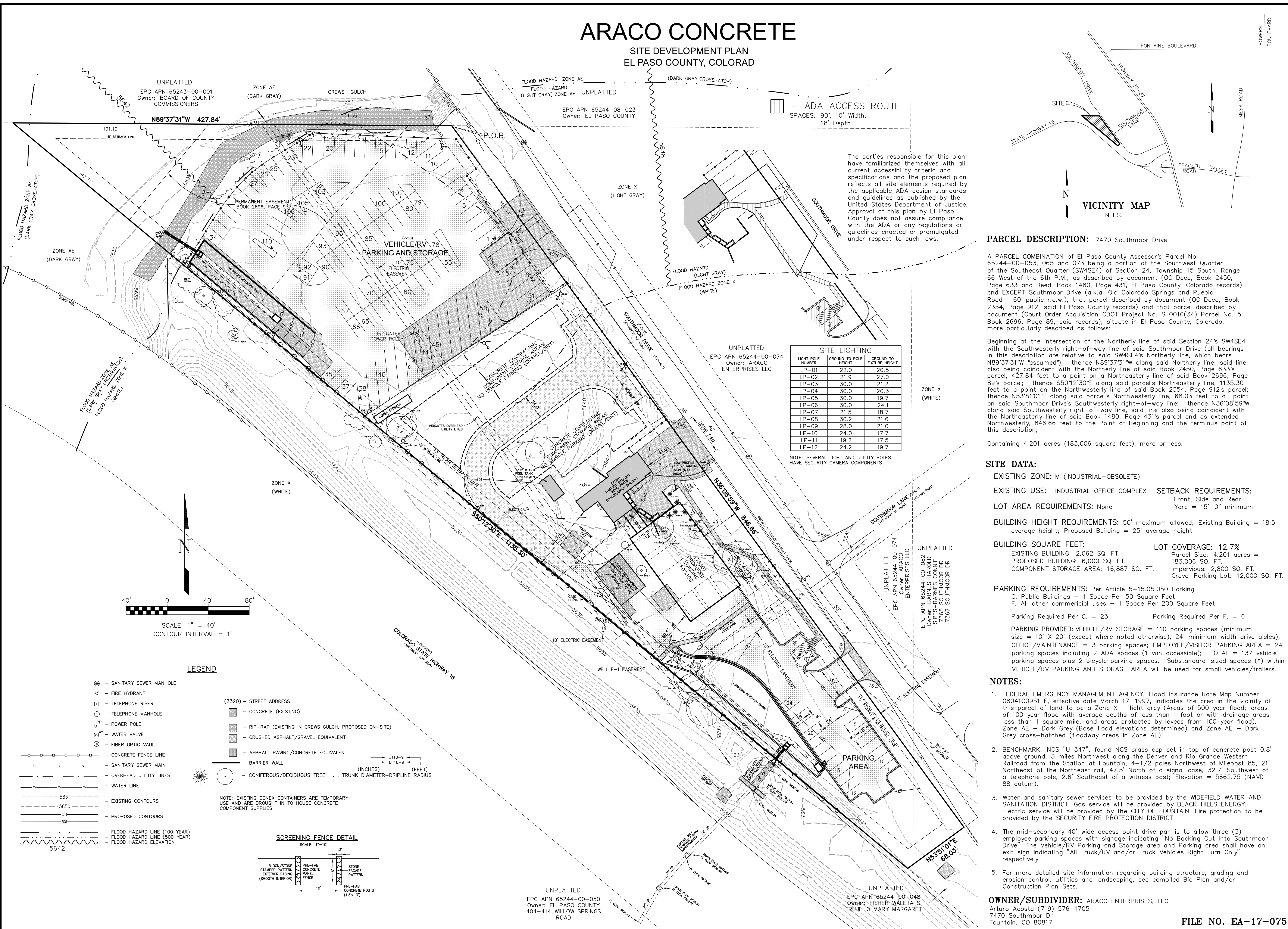

SITE LIGHTING

LIGHT POLE NUMBER	GROUND TO POLE HEIGHT	GROUND TO FIXTURE HEIGHT
LP-01	22.0	20.5
LP-02	21.9	27.0
LP-03	30.0	21.2
LP-04	30.0	20.3
LP-05	30.0	19.7
LP-06	30.0	24.1
LP-07	21.5	18.7
LP-08	30.2	21.6
LP-09	28.0	21.0
LP-10	24.0	17.7
LP-11	19.2	17.5
LP-12	24.2	19.7

NOTE: SEVERAL LIGHT AND UTILITY POLES HAVE SECURITY CAMERA COMPONENTS

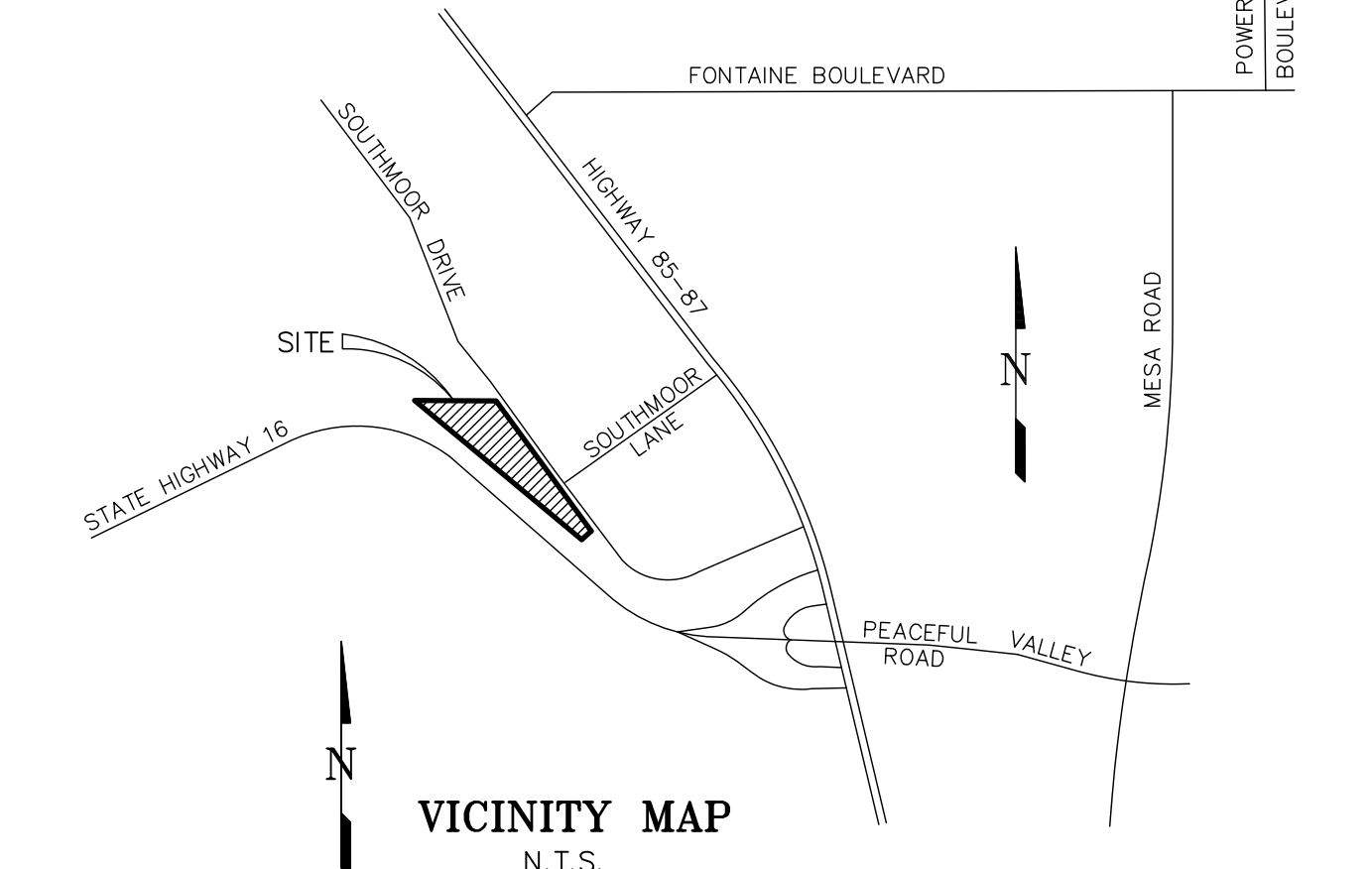

PARCEL DESCRIPTION: 7470 Southmoor Drive

A PARCEL COMBINATION of El Paso County Assessor's Parcel No. 65244-00-053, 065 and 073 being a portion of the Southwest Quarter of the Southeast Quarter (SW4SE4) of Section 24, Township 15 South, Range 66 West of the 6th P.M., as described by document (QC Deed, Book 2450, Page 633 and Deed, Book 1480, Page 431, El Paso County, Colorado records) and EXCEPT Southmoor Drive (a.k.a. Old Colorado Springs and Pueblo Road - 60' public r.o.w.), that parcel described by document (QC Deed, Book 2354, Page 912, said El Paso County records) and that parcel described by document (Court Order Acquisition CDDT Project No. S 0016(34) Parcel No. 5, Book 2696, Page 89, said records), situate in El Paso County, Colorado, more particularly described as follows:

Beginning at the intersection of the Northerly line of said Section 24's SW4SE4 with the Southwesterly right-of-way line of said Southmoor Drive (all bearings in this description are relative to said SW4SE4's Northerly line, which bears N89°37'31"W assumed); thence N89°37'31"W along said Northerly line, said line also being coincident with the Northerly line of said Book 2450, Page 633's parcel; 427.84 feet to a point on a Northeasterly line of said Book 2696, Page 89's parcel; thence S50°12'30"E along said parcel's Northeasterly line, 1135.30 feet to a point on the Northwesterly line of said Book 2354, Page 912's parcel; thence N53°51'01"E along said parcel's Northwesterly line, 68.03 feet to a point on said Southmoor Drive's Southwesterly right-of-way line; thence N36°08'59"W along said Southwesterly right-of-way line, said line also being coincident with the Northeasterly line of said Book 1480, Page 431's parcel and as extended Northwesterly, 846.66 feet to the Point of Beginning and the terminus point of this description;

Containing 4.201 acres (183,006 square feet), more or less.

SITE DATA:

EXISTING ZONE: M (INDUSTRIAL-OBSOLETE)

EXISTING USE: INDUSTRIAL OFFICE COMPLEX SETBACK REQUIREMENTS: Front, Side and Rear
Yard = 15'-0" minimum

LOT AREA REQUIREMENTS: None

BUILDING HEIGHT REQUIREMENTS: 50' maximum allowed; Existing Building = 18.5' average height; Proposed Building = 25' average height

BUILDING SQUARE FEET: EXISTING BUILDING: 2,062 SQ. FT. LOT COVERAGE: 12.7%
PROPOSED BUILDING: 6,000 SQ. FT. Parcel Size: 4.201 acres = 183,006 SQ. FT.
COMPONENT STORAGE AREA: 16,887 SQ. FT. Impervious: 2,800 SQ. FT. Gravel Parking Lot: 12,000 SQ. FT.

PARKING REQUIREMENTS: Per Article 5-15.05.050 Parking
C. Public Buildings - 1 Space Per 50 Square Feet
F. All other commercial uses - 1 Space Per 200 Square Feet

Parking Required Per C. = 23 Parking Required Per F. = 6

NOTES:

- FEDERAL EMERGENCY MANAGEMENT AGENCY, Flood Insurance Rate Map Number 08041C0951 F, effective date March 17, 1997, indicates the area in the vicinity of this parcel of land to be a Zone X - light grey (Areas of 500 year flood; areas of 100 year flood with average depths of less than 1 foot or with drainage areas less than 1 square mile; and areas protected by levees from 100 year flood), Zone AE - Dark Grey (Base flood elevations determined) and Zone AE - Dark Grey cross-hatched (floodway areas in Zone AE).
- BENCHMARK: NGS "U 347", found NGS brass cap set in top of concrete post 0.8' above ground, 3 miles Northwest along the Denver and Rio Grande Western Railroad from the Station at Fountain, 4-1/2 poles Northwest of Milepost 85, 21' Northeast of the Northeast rail, 47.5' North of a signal case, 32.7' Southwest of a telephone pole, 2.6' Southeast of a witness post; Elevation = 5662.75 (NAVD 88 datum).
- Water and sanitary sewer services to be provided by the WIDEFIELD WATER AND SANITATION DISTRICT. Gas service will be provided by BLACK HILLS ENERGY. Electric service will be provided by the CITY OF FOUNTAIN. Fire protection to be provided by the SECURITY FIRE PROTECTION DISTRICT.
- The mid-secondary 40' wide access point drive pan is to allow three (3) employee parking spaces with signage indicating "No Backing Out into Southmoor Drive". The Vehicle/RV Parking and Storage area and Parking area shall have an exit sign indicating "All Truck/RV and/or Truck Vehicles Right Turn Only" respectively.
- For more detailed site information regarding building structure, grading and erosion control, utilities and landscaping, see compiled Bid Plan and/or Construction Plan Sets.

OWNER/SUBDIVIDER: ARACO ENTERPRISES, LLC
Arturo Acosta (719) 576-1705
7470 Southmoor Dr
Fountain, CO 80817

FILE NO. EA-17-075

CALL BEFORE YOU DIG ...
811
DIAL 811
48 HOURS BEFORE YOU DIG, CALL UTILITY LOCATORS FOR LOCATING GAS, ELECTRIC, WATER AND WASTEWATER

REVISIONS

No.	Description	By	Date
1	DATA CLARIFICATION	BRH	02/27/18
2	LANDSCAPE DATA	BRH	03/05/18
3	UPDATE	BRH	10/24/19
4	COUNTY COMMENTS	BRH	06/24/20
5	COUNTY COMMENTS	DVH	04/07,10/01/21
6	COUNTY COMMENTS	DVH	12/08,2021

H Scale: 1" = 40'
V Scale: N/A
Designed By: N/A
Drawn By: SLG
Checked By: DVH
Date: 08/14/17

Land Development Consultants, Inc.
PLANNING SURVEYING
www.ldc-inc.com TEL: (719) 528-6133 FAX: (719) 528-8646
3888 MAZELAND ROAD COLORADO SPRINGS, CO 80909

ARACO CONCRETE
SITE DEVELOPMENT PLAN
A PORTION OF THE SOUTHEAST QUARTER OF SECTION 24,
TOWNSHIP 15 SOUTH, RANGE 66 WEST OF THE 6TH P.M.,
EL PASO COUNTY, COLORADO

Project No.: 17033
Sheet: 1 of 1

Appendix A - Trip Generation Study for RV Storage



APPENDIX A – TRIP GENERATION STUDY FOR RV STORAGE

For this report "RV/Vehicle Storage" rates (shown in Table 2) are based on the results of a trip-generation study consisting of trip-generation data collection by LSC at several RV storage facilities in El Paso County (2018). These counts were conducted specifically to estimate a trip-generation rate for this land use, as ITE's *Trip Generation* does not include trip-generation rates specifically for RV/boat storage businesses. These rates have been used within TIS reports for other RV storage projects in El Paso County within the past couple of years. The following list contains dates and location data for these sample RV storage facility counts in El Paso County. Raw count data is attached:

- Dalby Drive, LLC RV Storage – July 20, 2018
- 6850 Dalby Drive, Colorado Springs, CO 80923
- All About Outdoor Storage – July 24-25, 2018
- 16140 Old Denver Road, Monument, CO 80312
- All Outside Storage – July 23, 2018
- 835 N Washington Street, Monument, CO 80132
- Falcon Meadow Campground (2 site accesses) – July 2018
- 11150 US 24, Peyton, CO 80831