

Traffic Impact Study

Crossroads North

Colorado Springs and El Paso County, Colorado

PCD File No. SP-20-7

Prepared for:

Pikes Peak Investments LLC

c/o The Equity Group

Kimley»Horn

T R A F F I C I M P A C T S T U D Y

Traffic Engineer's Statement

The attached traffic report and supporting information were prepared under my responsible charge and they comport with the standard of care. So far as is consistent with the standard of care, said report was prepared in general conformance with the criteria established by the County for traffic reports.



Jeffrey R. Planck, P.E., PE #53006

March 23, 2023
Date

Developer's Statement

I, the Developer, have read and will comply with all commitments made on my behalf within this report.

Ms. Kelly Nelson
Pikes Peak Investments LLC
c/o The Equity Group
90 South Cascade Avenue, Suite 1500
Colorado Springs, CO 80903

Date

Crossroads North

PCD File No. SP-20-7

Colorado Springs and El Paso County, Colorado

Prepared for
Pikes Peak Investments LLC
c/o The Equity Group
90 South Cascade Avenue
Suite 1500
Colorado Springs, Colorado 80903

Prepared by
Kimley-Horn and Associates, Inc.
2 North Nevada Avenue
Suite 300
Colorado Springs, Colorado 80903
(719) 453-0180



March 2023

This document, together with the concepts and designs presented herein, as an instrument of service, is intended only for the specific purpose and client for which it was prepared. Reuse of and improper reliance on this document without written authorization and adaptation by Kimley-Horn and Associates, Inc. shall be without liability to Kimley-Horn and Associates, Inc.

TABLE OF CONTENTS

TABLE OF CONTENTS	i
LIST OF TABLES	ii
LIST OF FIGURES	iii
1.0 EXECUTIVE SUMMARY	1
2.0 INTRODUCTION	6
3.0 EXISTING AND FUTURE CONDITIONS	8
3.1 Existing and Future Study Area	8
3.2 Existing and Future Roadway Network	8
3.3 Existing Traffic Volumes	10
3.4 Unspecified Development Traffic Growth	11
4.0 PROJECT TRAFFIC CHARACTERISTICS	17
4.1 Trip Generation	17
4.2 Trip Distribution	19
4.3 Traffic Assignment and Total (Background Plus Project) Traffic	19
5.0 TRAFFIC OPERATIONS ANALYSIS	25
5.1 Analysis Methodology	25
5.2 Key Intersection Operational Analysis	26
5.3 Project Access Operational Analysis	31
5.4 Sight Distance Evaluation	35
5.5 Bicycle and Pedestrian Access	35
5.6 CDOT Turn Lane Evaluation	36
5.7 Queuing Analysis	41
5.8 Crossroads North: North Access Sensitivity Analysis	44
5.9 Safety Analysis	48
5.10 Road Impact Fees	50
5.11 Deviations from El Paso County Standards	51
5.12 Improvement Summary	51
6.0 CONCLUSIONS AND RECOMMENDATIONS	55

APPENDICES

- Appendix A – Intersection Count Sheets / COVID Adjustment Calculations
- Appendix B – CDOT Annual Traffic Data / 2040 PPACOG Model
- Appendix C – Trip Generation Worksheets
- Appendix D – Intersection Analysis Worksheets
- Appendix E – Signal Warrant Analysis / Signal Clearance Intervals
- Appendix F – Queueing Analysis Worksheets
- Appendix G – Time-Space Diagrams
- Appendix H – Crash Data
- Appendix I – Conceptual Site Plans

LIST OF TABLES

Table 1 – Phase 1 Project Traffic Generation.....	18
Table 2 – Full Buildout Project Traffic Generation	18
Table 3 – Level of Service Definitions	25
Table 4 – US-24 and Marksheffel Road (#1) LOS Results	27
Table 5 – SH-94/Newt Drive and US-24 (#2) LOS Results.....	29
Table 6 – SH-94 and Marksheffel Road (#3) LOS Results	30
Table 7 – Project Access LOS Results.....	33
Table 8 – Turn Lane Storage Length Analysis Results.....	42
Table 9 – Crossroads North Access Scenarios LOS Results	44
Table 10 – Crossroads North Access Scenarios Vehicle Queueing Results.....	45
Table 11 – Signal Progression Comparison	47
Table 12 – Road Impact Fees.....	51
Table 13 – Crossroads North Improvement Summary.....	52

LIST OF FIGURES

Figure 1 – Vicinity Map.....7
Figure 2 – Site Area9
Figure 3 – Existing Lane Configurations.....12
Figure 4 – 2020 Existing Traffic Volumes13
Figure 5 – 2020 Adjusted Existing Traffic Volumes14
Figure 6 – 2026 Background Traffic Volumes.....15
Figure 7 – 2040 Background Traffic Volumes.....16
Figure 8 – Project Trip Distribution20
Figure 9 – 2026 Project Traffic Assignment.....21
Figure 10 – 2040 Project Traffic Assignment.....22
Figure 11 – 2026 Background Plus Project Traffic Volumes.....23
Figure 12 – 2040 Background Plus Project Traffic Volumes.....24
Figure 13 – Crossroads North Street Classification Map34
Figure 14 – 2026 Recommended Lane Configurations53
Figure 15 – 2040 Recommended Lane Configurations54

1.0 EXECUTIVE SUMMARY

Crossroads North is a mixed-use development proposed to be located on the northwest corner of the SH-94 and Marksheffel Road intersection in El Paso County and Colorado Springs, Colorado. Marksheffel Road within the project limits is anticipated to be annexed into the City of Colorado Springs. Crossroads North proposes to contain retail uses and a park/sports complex. Crossroads North is expected to be a 10-year build. As such, an initial phase of development was evaluated in a 2026 horizon while full buildout was evaluated in the long-term 2040 horizon.

The purpose of this study is to identify project traffic generation characteristics, to identify potential project traffic related impacts on the local street system, and to develop mitigation measures required for identified impacts. The following intersections were incorporated into this traffic study in accordance with the City of Colorado Springs, El Paso County, and Colorado Department of Transportation (CDOT) standards and requirements:

- US-24 and Marksheffel Road (#1)
- SH-94/Newt Drive and US-24 (#2)
- SH-94 and Marksheffel Road (#3)

In addition, two project accesses (#4 and #5) proposed along Marksheffel Road were included for evaluation. Further four (4) internal intersections (#6-9) along public roadways proposed within Crossroads North were also included for evaluation.

Regional access to the project is provided by Interstate 25 (I-25) and US-24. Primary access to the project will be provided by SH-94 and Marksheffel Road. Direct access to the proposed project is to be provided by two project accesses located along Marksheffel Road.

Phase 1 development of the project in 2026 is expected to generate approximately 11,246 daily weekday external vehicle trips with 927 of these trips occurring during the morning peak hour and 899 trips occurring during the afternoon peak hour. With full buildout of the development by 2040, the project is expected to generate approximately 16,066 daily weekday external vehicle trips with 1,037 of these trips occurring during the morning peak hour and 1,269 trips occurring during the afternoon peak hour.

Distribution of site traffic on the street system was based on the area street system characteristics, existing traffic patterns and volumes, anticipated surrounding development areas, expected roadway improvements, and the proposed access system for the project. Assignment of project traffic was based upon the trip generation described previously and the distribution developed for the project area. Assigned traffic was added to future traffic volumes projected at the study area intersections to conduct a traffic analysis for the determination of possible improvements needed to surrounding street system.

Based on the complete analysis of the project area including existing and background traffic volumes from other sources and developments presented in this report, Kimley-Horn believes the Crossroads North development will be successfully incorporated into the existing and future roadway network. All of the area traffic combined including the proposed background traffic volume growth, project development, and expected future traffic volumes in the 2026 and 2040 full buildout horizons resulted in the following conclusions and recommendations:

2026 Recommendations:

- CDOT will likely require Access Permits for the intersections of SH-94/US-24 (#2) and SH-94/Marksheffel Road (#3) in association with the project.
- The intersection of SH-94/US-24 (#2) currently operates poorly during the peak hours in the existing condition. As a regional capacity improvement, it was found that US-24 may need to provide three through lanes in each direction from the Peterson Road interchange through this intersection with SH-94 in the near-term horizon. The additional through lanes should be considered by CDOT in the near future. If and when US-24 is improved to provide three through lanes in each direction, it is recommended that a separate 600-foot plus 225-foot taper right turn deceleration lane be constructed to maintain free right turn movements to eastbound SH-94. For southwestbound US-24 at SH-94 (#2), the existing acceleration lane along US-24 will need to be reconstructed with 960 feet of length plus a 225-foot taper if and when US-24 is improved to provide three through lanes along westbound US-24. For northeastbound US-24 at SH-94, it is recommended that this acceleration lane be converted to the third northbound through lane as the acceleration lane is not warranted. Further, the

northeastbound US-24 third through lane needs to continue for 1,200 feet plus provide a 660-foot taper based on MUTCD standards. In addition to these regional improvements, it is recommended that the existing single 900-foot left turn lane be changed to 850-feet plus 225-foot taper with dual left turn lanes on the northeastbound US-24 approach for the left turn to Newt Drive. The area for these dual lefts is presently available (mostly); however, the lane is striped out which will require restriping with a slight extension that may also need to be constructed. Also, at the intersection of US-24 and SH-94 (#2), the existing dual westbound left turn lanes on SH-94 should be converted to triple left turn lanes by restriping the inside westbound through lane to a left turn lane. The inside two westbound left turn lanes should be extended to a length of 760 feet plus a 225-foot taper per CDOT requirements. Three receiving lanes will be available with the expansion of US-24 to three westbound lanes to the Peterson Road interchange off-ramp. A traffic signal modification will be required at the intersection to incorporate all of these improvements. As requested by CDOT, an additional analysis was performed with an interchange grade separation including a westbound left turn flyover ramp condition. With this westbound left turn flyover ramp and the existing two through lanes in each direction along US-24, the intersection of SH-94 and US-24 (#2) is expected to operate acceptably with LOS D during the peak hours in 2026 and LOS E during the peak hours in 2040. With three through lanes in each direction along US-24 and the implementation of the westbound left turn flyover ramp, this intersection is expected to operate acceptably during the peak hours in 2040.

- At SH-94 and Marksheffel Road (#3), it was found that the eastbound and westbound right turns should operate with overlap phasing, while the northbound and southbound right turns should operate with free movements with acceleration lanes constructed in accordance with the CDOT State Highway Access Code. The acceleration lane along westbound SH-94 is recommended to tie into the outside through lane on the approach to US-24. The eastbound left turn lane shall be extended to a length of 750 feet with a 225-foot taper while the westbound left turn lane should be extended to a length of 650 feet with a 225-foot taper. The eastbound and westbound right turn lanes should be extended to 600 feet. The eastbound acceleration lane from the Marksheffel Road northbound right turn should be constructed to 1,380 feet with a 300-foot taper. These improvements at this intersection may already be identified with the SH-94 improvements already being planned by CDOT.

- A traffic signal is anticipated to be needed and warranted at the south full movement access intersection (#5) along Marksheffel Road for Crossroads North. Therefore, a traffic signal is recommended for installation at this access intersection with development of Crossroads North. To meet Colorado Springs standards, the northbound left turn at the Marksheffel Road South Access (#5) should provide a turn lane length of 340 feet plus a 200-foot taper, whereas the southbound right turn lane should provide a lane length of 235 feet plus a 200-foot taper. Lastly, separate eastbound left turn and right turn lanes are recommended to serve exiting traffic out of Crossroads North at this access.
- The Marksheffel Road North Access (#4) should operate as a three-quarter intersection with a R1-1 “STOP” sign installed on the eastbound approach. Based on Colorado Springs standards, the northbound left turn at the Marksheffel Road North Access (#4) should provide a turn lane length of 270 feet plus a 200-foot taper, whereas the southbound right turn lane should provide a lane length of 235 feet plus a 200-foot taper. A sensitivity analysis has been prepared later in Section 5.8 comparing the north access along Marksheffel Road as a full movement signalized intersection and a three-quarter movement unsignalized intersection.
- An internal street evaluation was conducted for the Crossroads North development area. The south access to Crossroads North along Marksheffel Road is proposed to be named Air Lane and is expected to be classified as an El Paso County Urban Non-Residential Collector roadway with a 60-foot right-of-way (ROW). Air Lane extends east/west and is proposed to connect with a north/south extending Non-Residential Collector Street (#7). Intersection #7 (collector to collector) is proposed to be located approximately 525 feet west of Marksheffel Road. The north/south extending Non-Residential Collector Street also connects with an east/west collector street (#6) that extends from the north access to Marksheffel Road. The north access street connecting with Marksheffel Road is proposed to be classified as an El Paso County Urban Non-Residential Collector roadway. To meet El Paso County standards for a design speed of 35 mph, the recommended left-turn lanes and right turn lanes internal to Crossroads North should provide 135 feet of deceleration length plus 140-foot tapers while all left turn lanes and right turn lanes that require a stop will also provide a storage length (determined from ECM Table 2-30 for each location).

- To meet El Paso County standards, it is recommended that a 335-foot eastbound right turn lane be designated at south access along Marksheffel Road (#5). It is recommended that a 235-foot westbound right turn lane be designated at the Crossroads North internal intersection #6. A 135-foot westbound right turn lane is recommended to be designated at the Air Lane Intersection (#7).

2040 Recommendations:

- If future traffic volume projections are realized, US-24 may need to provide three through lanes in each direction through the Marksheffel Road intersection. Likewise, Marksheffel Road between US-24 and Peterson Air Force Base East Gate may need to provide three through lanes in each direction. It is recommended that traffic volumes continue to be monitored by CDOT and the City of Colorado Springs, as applicable, to determine if and when these regional improvements will be needed. It is understood that US-24 and Marksheffel Road are identified with four-lane cross-sections. If future traffic projections are realized, additional right-of-way may need to be dedicated to account for six-lane cross sections along both US-24 and Marksheffel Road within the study limits.
- Several extensions of auxiliary turn lanes may be needed by 2040 and should be monitored by CDOT and the City of Colorado Springs, as applicable, to determine if and when the recommended turn lane lengths will be needed.

General Recommendations:

- Any on-site and off-site roadway, signing, striping, and signal improvements should be incorporated into the Civil Drawings, and conform to City of Colorado Springs and/or CDOT standards as applicable, as well as the Manual on Uniform Traffic Control Devices – 2009 Edition (MUTCD).

2.0 INTRODUCTION

Kimley-Horn and Associates, Inc. (Kimley-Horn) has prepared this report to document the results of a Traffic Impact Study of future traffic conditions associated with the Crossroads North development to be located on the northwest corner of the SH-94 and Marksheffel Road intersection in El Paso County and Colorado Springs, Colorado. Marksheffel Road within the project limits is anticipated to be annexed into the City of Colorado Springs. Crossroads North proposes to contain retail uses and a park/sports complex. A vicinity map illustrating the location of the development area is shown in **Figure 1**. A conceptual site plan for the development area is attached in **Appendix I**.

Crossroads North is proposed to be located on the northwest corner of the SH-94 and Marksheffel Road intersection. Crossroads North is expected to be a 10-year build. As such, an initial phase of development was evaluated in a five-year 2026 horizon while full buildout was evaluated in the long-term twenty-year 2040 horizon.

The purpose of this study is to identify project traffic generation characteristics, to identify potential project traffic related impacts on the local street system, and to develop mitigation measures required for identified impacts. The following intersections were incorporated into this traffic study in accordance with the City of Colorado Springs, El Paso County, and Colorado Department of Transportation (CDOT) standards and requirements:

- US-24 and Marksheffel Road (#1)
- SH-94/Newt Drive and US-24 (#2)
- SH-94 and Marksheffel Road (#3)

In addition, two project accesses (#4 and #5) proposed along Marksheffel Road were included for evaluation. Further two (2) internal intersections (#6 and #7) along public roadways proposed within Crossroads North were also included for evaluation.

Regional access to the project is provided by Interstate 25 (I-25) and US-24. Primary access to the project will be provided by SH-94 and Marksheffel Road. Direct access to the proposed project is to be provided by two project accesses located along Marksheffel Road.

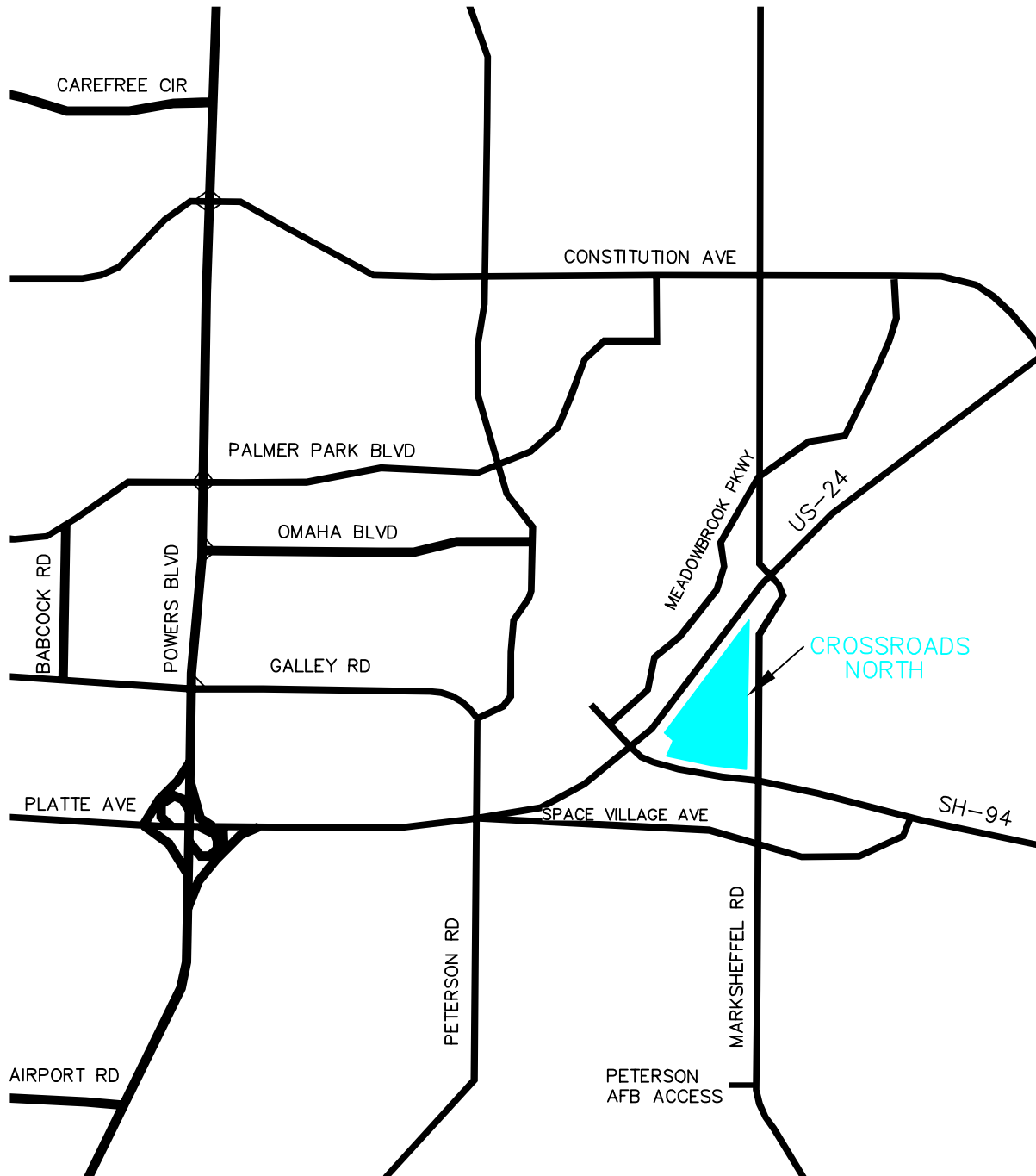

CROSSROADS NORTH
COLORADO SPRING, CO
VICINITY MAP

FIGURE 1

3.0 EXISTING AND FUTURE CONDITIONS

3.1 Existing and Future Study Area

The existing site area is comprised of vacant land. The surrounding area contains a mix of uses. Directly east of Crossroads North is an existing water treatment plant. The surrounding area to the east and south is vacant land. Directly to the west is mainly residential neighborhoods. Other industrial uses are proposed to the north. Outside of these uses, Peterson Air Force Base and the Colorado Springs Airport exists to the south and southwest. The site area is shown in the aerial of **Figure 2**.

3.2 Existing and Future Roadway Network

Regional access to the project is provided by Interstate 25 (I-25) and US-24. Primary access to the project will be provided by SH-94 and Marksheffel Road. Direct access to Crossroads North is proposed from the northern three-quarter access (#4) and the southern full movement access (#5) along Marksheffel Road approximately 2,000 feet and 1,000 feet north of SH-94.

SH-94 is a CDOT Highway, categorized E-X: Expressway, Major Bypass that provides one through lane of travel both eastbound and westbound in the vicinity of the site. SH-94 has a 40 mile per hour speed limit at US-24, a 55-mph speed limit through the Marksheffel Road intersection and a 65-mph speed limit east of Marksheffel Road. US-24 is a CDOT Highway, categorized E-X: Expressway, Major Bypass that provides two through lanes of travel with a 55 mile per hour speed limit through the study area. Marksheffel Road provides two through lanes of travel in each direction, northbound and southbound, with a 55 mile per hour speed limit through the study area.



CROSSROADS NORTH
COLORADO SPRINGS, CO
SITE AREA

FIGURE 2

The US-24 and Marksheffel Road (#1) intersection is a four-leg signalized intersection. The eastbound and westbound US-24 approaches consist of dual left turn lanes, two through lanes, and a right turn lane with free movements while the northbound and southbound Marksheffel Road approaches consist of a left turn lane, two through lanes, and separate right turn lanes operating with free right turn movements.

The intersection of SH-94 and US-24 (#2) is signalized with four-legs. Both state highways run east-west, however the traffic software for this intersection assigned SH-94 as east-west and US-24 as north-south. The eastbound Newt Drive approach consists of dual left turn lanes, one through lane, and a free right turn lane. The westbound SH-94 approach consists of dual left turn lanes, two through lanes, and a free right turn lane. The US-24 approaches each consist of a left turn lane, two through lanes, and a right turn lane.

The SH-94 and Marksheffel Road (#3) intersection is a four-leg signalized intersection. The eastbound and westbound approaches consist of a left turn lane, one through lane, and one right turn lane. The northbound and southbound approaches consist of a left turn lane, two through lanes, and a right turn lane. Existing intersection lane configurations and control for the study area are shown in **Figure 3**.

3.3 Existing Traffic Volumes

Due to the effects on traffic from COVID-19, traffic counts at each intersection were derived by different methodologies. Existing peak hour turning movement counts, pedestrian counts, heavy vehicle percentages, and bicycle counts were conducted at the intersection of US-24/Marksheffel Road (#1) on Thursday, June 4, 2020, and at the intersections of SH-94/US-24 (#2) and SH-94/Marksheffel Road (#3) on Tuesday, June 2, 2020. The weekday counts were conducted in 15-minute intervals during the AM and PM peak hours of adjacent street traffic from 7:00 AM to 9:00 AM and 4:00 PM to 6:00 PM. The turning movement counts were grown based on data obtained from hourly counts from the CDOT OTIS database and additional historical CDOT traffic information provided to Kimley-Horn to account for a COVID-19 adjustment for this area. Based on this information and through coordination with CDOT, the morning and afternoon peak hour counts were adjusted by 35 percent except for the counts at the intersection of SH-94 and

Marksheffel Road (#3) which were not adjusted in the morning peak hour but were adjusted by 44 percent for the afternoon peak hour.

Existing turning movement counts are shown in **Figure 4** while the adjusted turning movement counts are shown in **Figure 5** with count sheets and COVID-19 count adjustment data provided in **Appendix A**. It should be noted that heavy vehicle percentages are documented in the count sheets and these percentages were used in the intersection operational analysis.

3.4 Unspecified Development Traffic Growth

According to information provided on the website for the Colorado Department of Transportation (CDOT), the average 20-year growth factor along SH-94 in the vicinity of the site is 1.29. This value equates to an annual growth rate of 1.16 percent. SH-94 traffic information from the CDOT Online Transportation Information System (OTIS) website is included in **Appendix B**. Based on this, an annual growth rate of 1.16 percent was used to calculate future traffic volumes within the project study area. This annual growth rate was used to estimate near term 2026 and long term 2040 traffic volume projections at the key intersections.

In addition to the applied annual traffic growth rates, project traffic volumes from Meadowbrook Park, Crossroads Mixed Use, and Reagan Ranch developments were included as background traffic volumes. Along with the annual growth and other background development studies, calculated trips from an additional 1,123 single family detached housing units, located in the parcels east of the southeast area of Reagan Ranch, were added to the 2040 background volumes. Further, project traffic from the single-family housing development to the west at Newt Drive were estimated based on the number of homes yet to be occupied and added to the background traffic volumes. The Pikes Peak Area Council of Governments (PPACOG) 2040 traffic volume projections were used as a comparison to future traffic volume projections with this study. All future average daily traffic volume projections in this study exceed the PPACOG projections; therefore, the annual growth rate of 1.16 percent should be conservative. It should be noted that all known development traffic studies have been included in this study and this includes the Kimley-Horn traffic studies of Meadowbrook Park, Crossroads Mixed Use, and Reagan Ranch completed in the immediate area in the last five years. Background traffic volumes for 2026 and 2040 are shown in **Figures 6** and **7**, respectively.

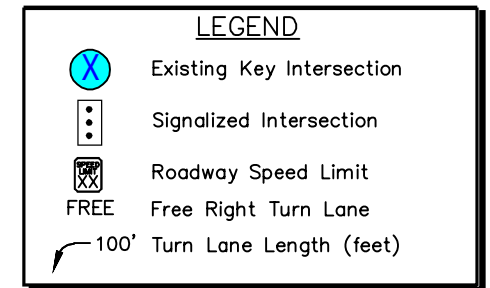
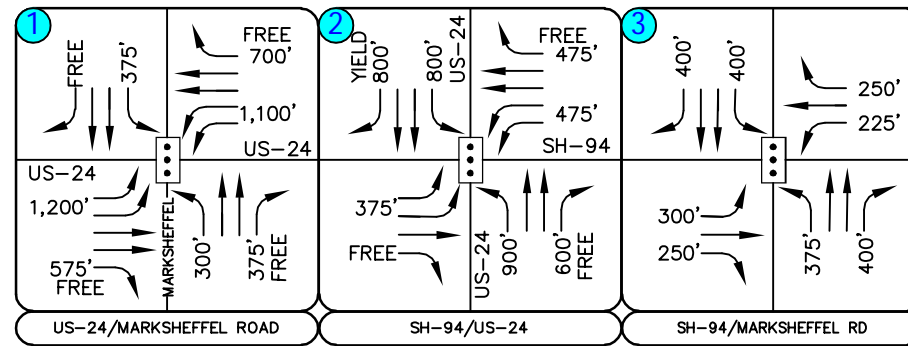
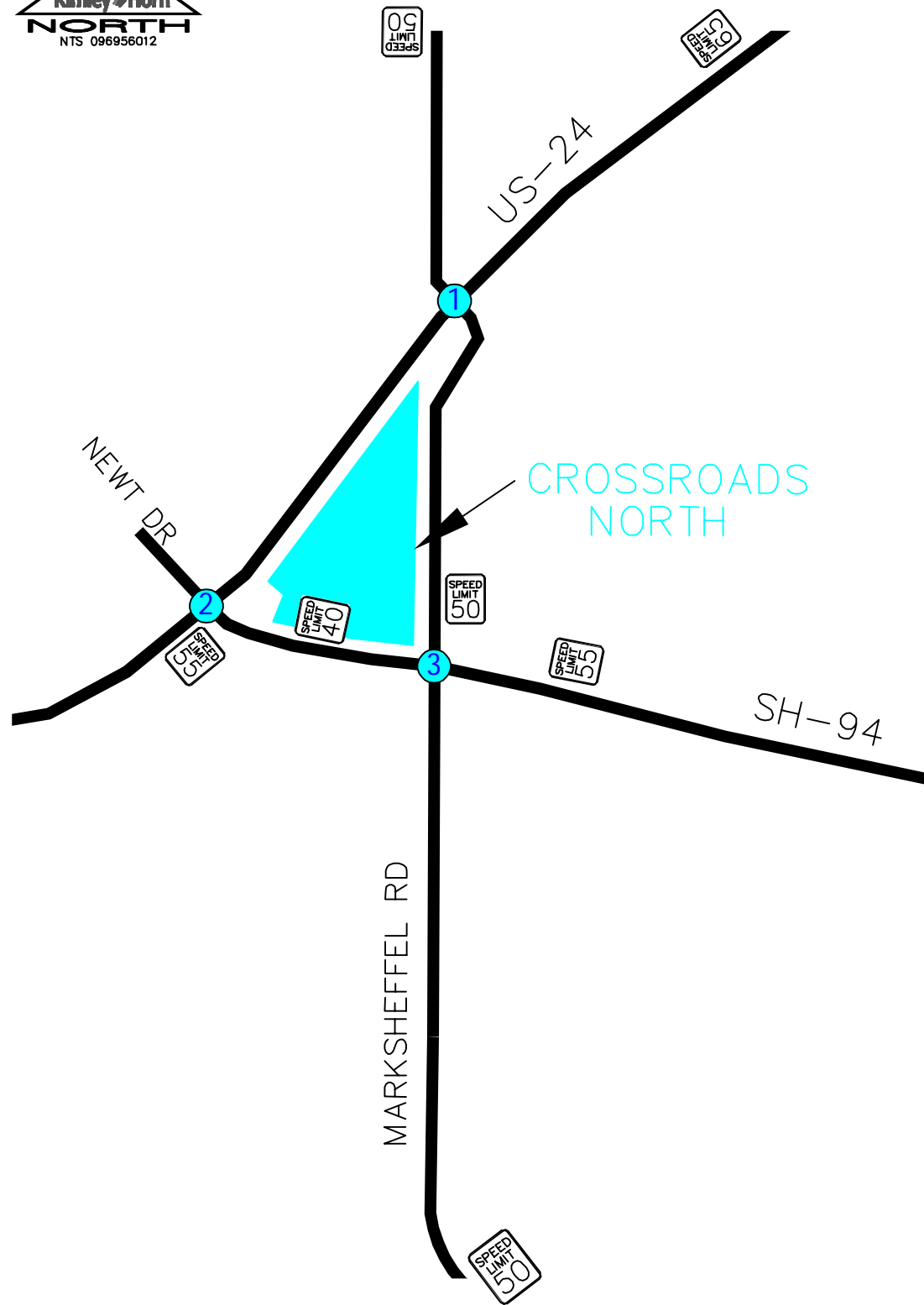

CROSSROADS NORTH
COLORADO SPRINGS, CO
EXISTING LANE CONFIGURATIONS AND CONTROL

FIGURE 3

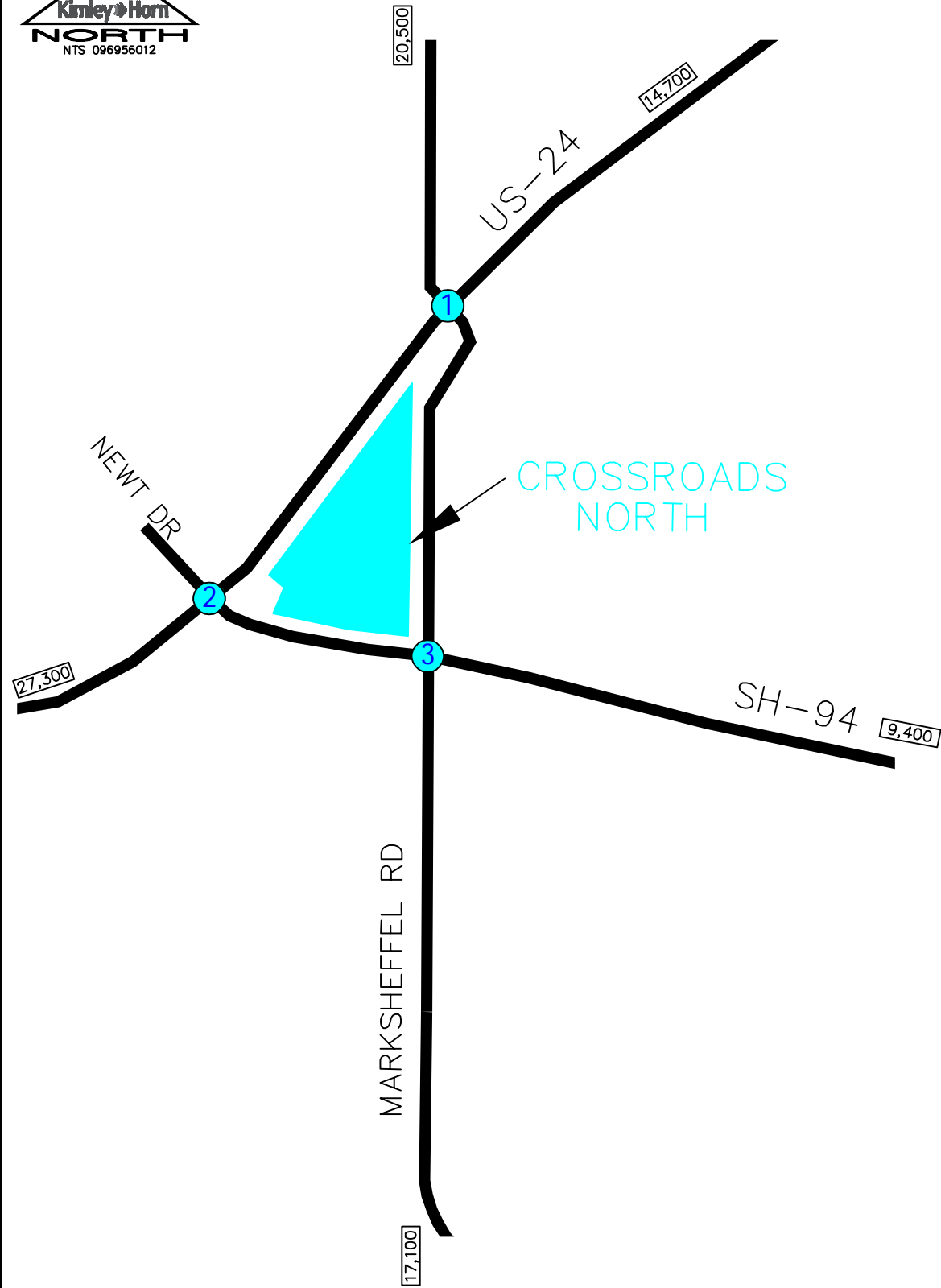

<p>1</p> <p>MARKSHEFFEL</p> <p>522(350) 524(410) 7(12)</p> <p>13(11) 820(389) 209(104)</p> <p>248(461) 360(815) 0(5)</p> <p>1(9) 336(615) 40(132)</p> <p>US-24</p> <p>US-24/MARKSHEFFEL ROAD</p>	<p>2</p> <p>US-24</p> <p>27(27) 1285(691) 3(3)</p> <p>12(21) 21(29) 145(176)</p> <p>107(117) 591(1250) 281(237)</p> <p>SH-94</p> <p>SH-94/US-24</p>	<p>3</p> <p>SH-94</p> <p>3(5) 501(398) 256(110)</p> <p>77(238) 297(247) 28(27)</p> <p>254(204) 54(65)</p> <p>54(53) 270(569) 18(16)</p> <p>SH-94/MARKSHEFFEL RD</p>
---	--	--

CROSSROADS NORTH
COLORADO SPRINGS, CO
2020 EXISTING TRAFFIC VOLUMES

LEGEND

- Existing Key Intersection
- XXX(XXX) Weekday AM(PM) Peak Hour Traffic Volumes
- Estimated Daily Traffic Volume

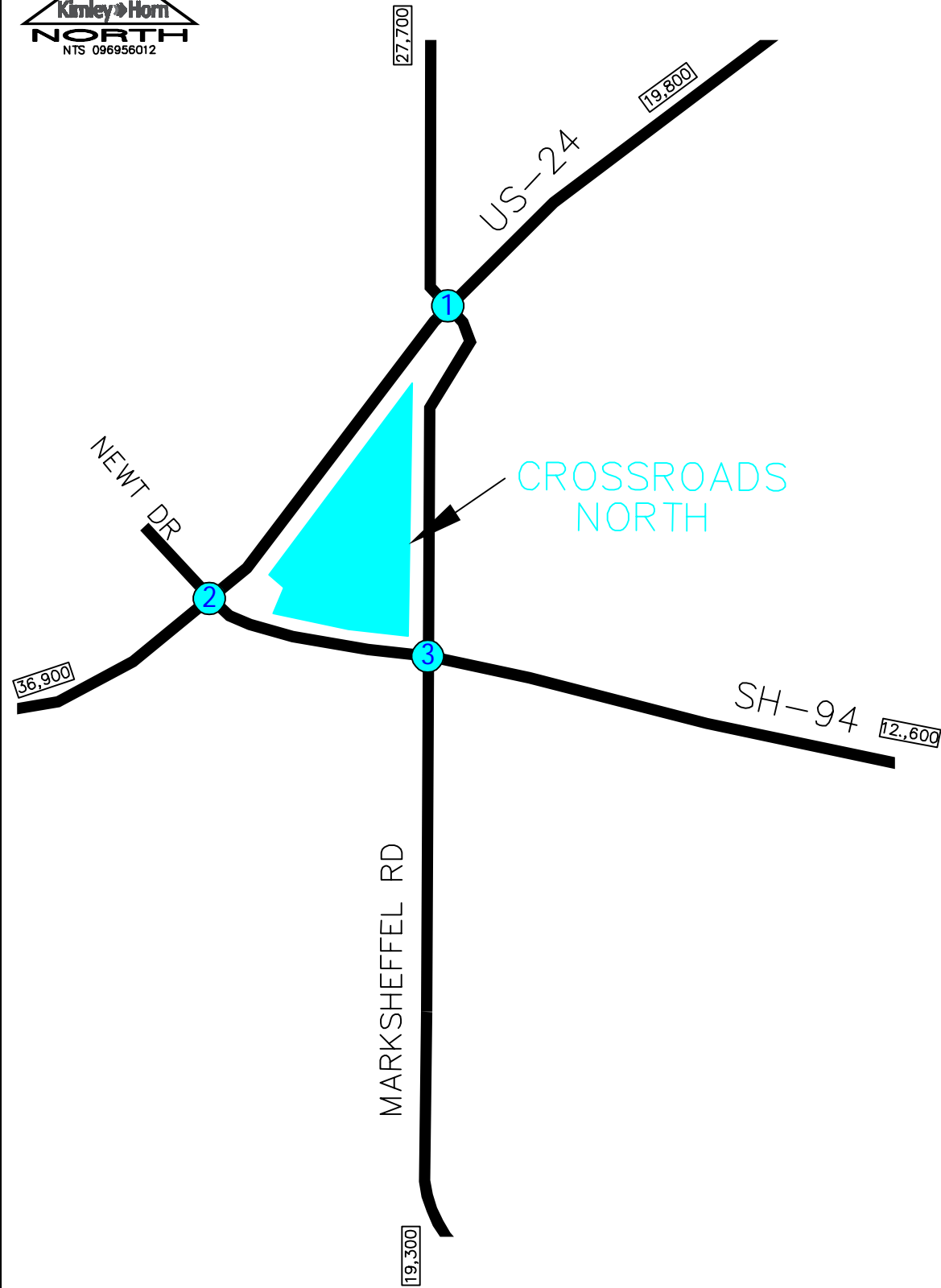

CROSSROADS NORTH
COLORADO SPRINGS, CO
2020 ADJUSTED EXISTING TRAFFIC VOLUMES

1	MARKSHEFFEL	2	US-24	3	SH-94
	705(473) ↘ ↙ 707(554) 9(16) ↖ ↗ 18(15) ↘ 1107(525) ↙ 282(140)		36(36) ↘ ↙ 1735(933) 4(4) ↖ ↗ 1(7) ↘ 39(23) ↙ 440(350)		3(7) ↘ ↙ 501(573) 256(158) ↖ ↗ 77(343) ↘ 297(356) ↙ 28(39)
	335(622) ↘ ↙ 486(1100) 0(7) ↖ ↗ 1(12) ↘ 454(830) ↙ 54(178)		16(28) ↘ ↙ 28(39) 196(238) ↖ ↗ 144(158) ↘ 798(1688) ↙ 379(320)		254(294) ↘ ↙ 54(94) 54(76) ↖ ↗ 270(819) ↘ 18(23)
	US-24		US-24		SH-94
	US-24/MARKSHEFFEL ROAD		SH-94/US-24		SH-94/MARKSHEFFEL RD

LEGEND

- Existing Key Intersection
- XXX(XXX) Weekday AM(PM) Peak Hour Traffic Volumes
- Estimated Daily Traffic Volume

FIGURE 5

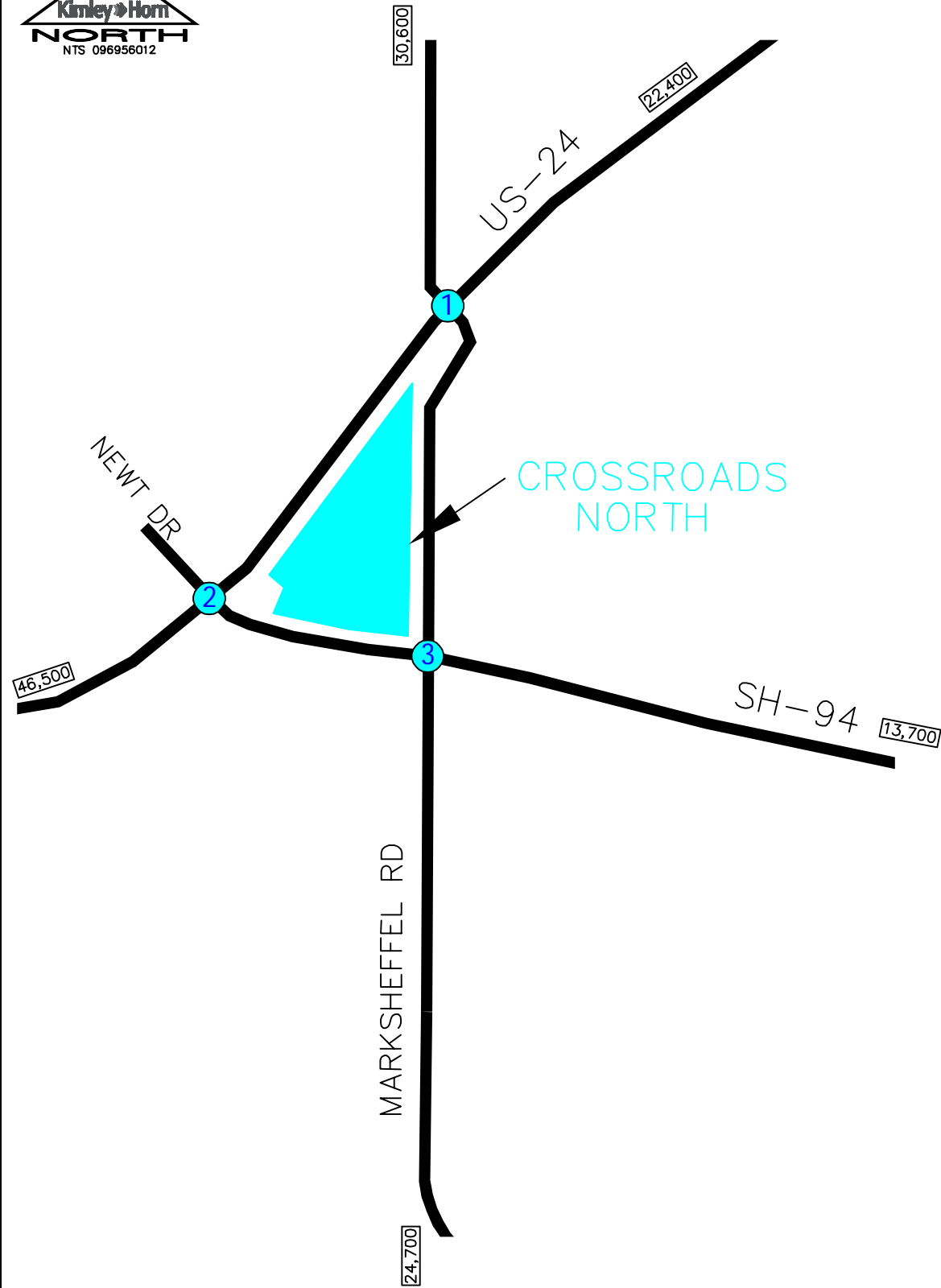

1	2	3
MARKSHEFFEL	US-24	SH-94
<p>760(510) ↘</p> <p>875(780) ↘</p> <p>10(20) ↘</p> <p>20(20) ↗</p> <p>1215(585) ↗</p> <p>325(190) ↗</p>	<p>65(60) ↘</p> <p>1860(1000) ↘</p> <p>5(5) ↘</p> <p>5(10) ↗</p> <p>95(65) ↗</p> <p>580(500) ↗</p>	<p>5(10) ↘</p> <p>675(825) ↘</p> <p>280(175) ↘</p> <p>90(375) ↗</p> <p>345(405) ↗</p> <p>35(45) ↗</p>
<p>360(670) ↗</p> <p>550(1200) ↗</p> <p>0(10) ↗</p> <p>5(15) ↘</p> <p>625(1060) ↘</p> <p>85(225) ↘</p>	<p>45(55) ↗</p> <p>90(80) ↗</p> <p>495(450) ↗</p> <p>425(395) ↘</p> <p>860(1810) ↘</p> <p>485(490) ↘</p>	<p>300(340) ↗</p> <p>160(265) ↗</p> <p>190(225) ↘</p> <p>445(1075) ↘</p> <p>25(30) ↘</p>
US-24	US-24	SH-94
US-24/MARKSHEFFEL ROAD	SH-94/US-24	SH-94/MARKSHEFFEL RD

CROSSROADS NORTH
COLORADO SPRINGS, CO
2026 BACKGROUND TRAFFIC VOLUMES

LEGEND	
(X)	Existing Key Intersection
XXX(XXX)	Weekday AM(PM) Peak Hour Traffic Volumes
XX,X00	Estimated Daily Traffic Volume

FIGURE 6

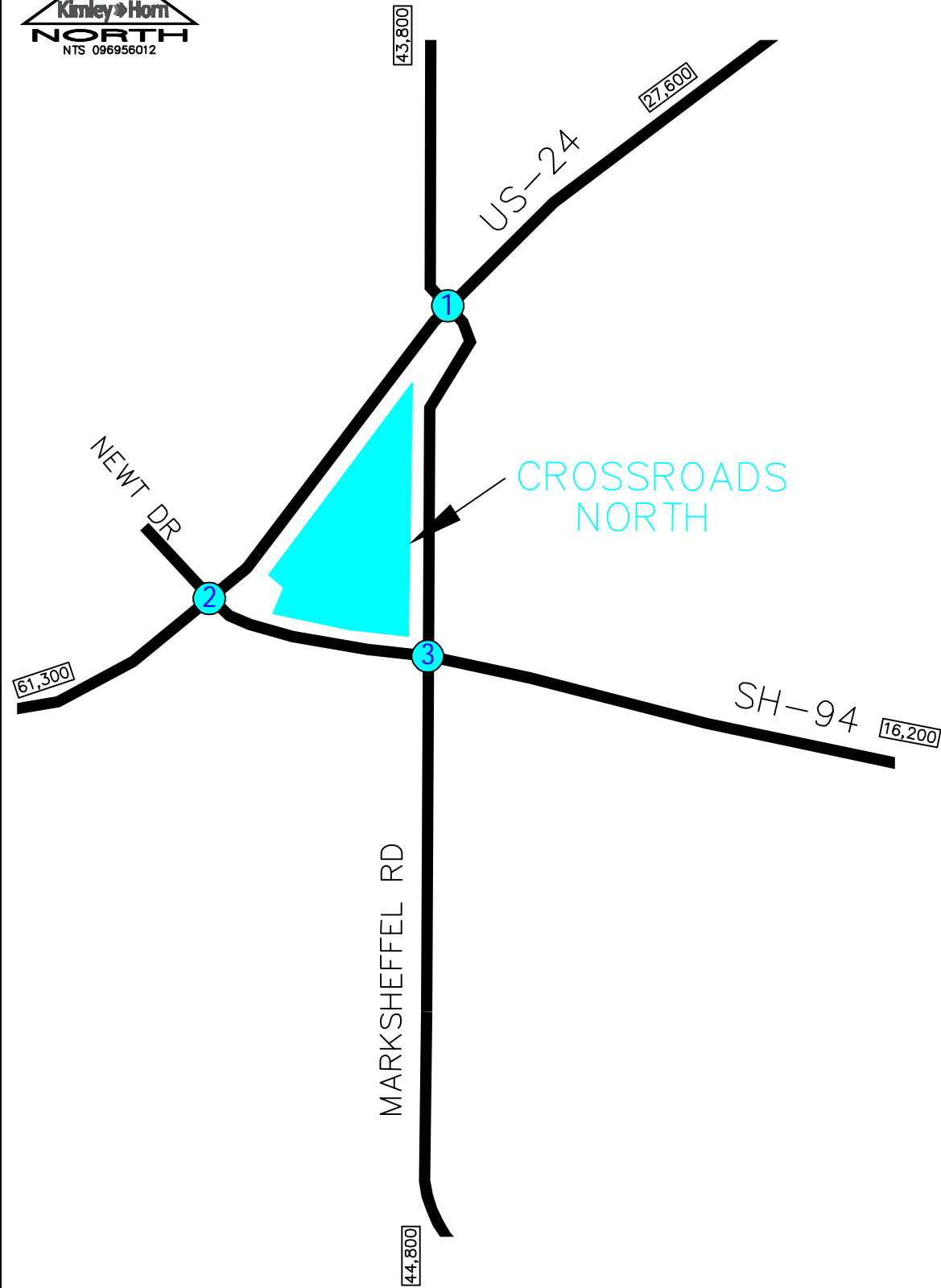

1	MARKSHEFFEL	2	US-24	SH-94	3	SH-94
890(600)	25(20)	80(75)	5(10)	5(10)	950(1455)	105(440)
1165(1330)	1425(690)	2190(1180)	105(80)	330(205)	405(475)	405(475)
15(25)	405(285)	10(10)	885(885)	40(50)		
425(785)	5(20)	55(65)	480(470)	350(400)	430(565)	780(1695)
645(1415)	955(1620)	95(95)	1010(2130)	310(665)	780(1695)	30(50)
0(10)	135(320)	555(535)	695(930)			
US-24						
US-24/MARKSHEFFEL ROAD		SH-94/US-24		SH-94/MARKSHEFFEL RD		

CROSSROADS NORTH
COLORADO SPRINGS, CO
2040 BACKGROUND TRAFFIC VOLUMES

LEGEND

- Existing Key Intersection
- XXX(XXX) Weekday AM(PM) Peak Hour Traffic Volumes
- Estimated Daily Traffic Volume

4.0 PROJECT TRAFFIC CHARACTERISTICS

4.1 Trip Generation

Site-generated traffic estimates are determined through a process known as trip generation. Rates and equations are applied to the proposed land use to estimate traffic generated by the development during a specific time interval. The acknowledged source for trip generation rates is the *Trip Generation Manual*¹ published by the Institute of Transportation Engineers (ITE). ITE has established trip rates in nationwide studies of similar land uses.

As mentioned previously, the project was evaluated with a 2026 horizon and a full buildout 2040 horizon. For this study, Kimley-Horn used the ITE Trip Generation Manual average rates and fitted curve equations that apply to Public Park (ITE 411), Movie Theater (ITE 444), Tire Superstore (ITE 849), Home Improvement Superstore (ITE 862), Furniture Store (ITE 890), Sit-Down Restaurant (ITE 932), Fast-Food Restaurant with Drive Through (ITE 934), and Gasoline Station with Convenience Market (ITE 960) for traffic associated with the development area of the project.

Since the project is proposed to contain a mix of uses, internal capture trips are expected to occur on site as well. These internal capture trips are shared trips from vehicles already within the internal street network. These shared trips reduce the number of total external trips and were calculated directly per the ITE procedure but were capped based on thresholds set forth by CDOT. Based on the CDOT access code, internal trip reductions cannot not exceed two percent for the AM peak or eight percent for PM peaks unless clearly justified and documented by actual studies. As such, an internal capture rate of two (2) percent was used during the morning peak hour and a rate of eight (8) percent during the afternoon peak. Phase 1 development of the project in 2026 is expected to generate approximately 11,246 daily weekday external vehicle trips with 927 of these trips occurring during the morning peak hour and 899 trips occurring during the afternoon peak hour. Calculations were based on the procedure and information provided in the ITE *Trip Generation Manual, 10th Edition – Volume 1: User's Guide and Handbook*, 2017. **Table 1** provides

¹ Institute of Transportation Engineers, *Trip Generation Manual*, Tenth Edition, Washington DC, 2017.

the estimated trip generation for Phase 1 of the project. The trip generation calculations are included in **Appendix C**.

Table 1 – Phase 1 Project Traffic Generation

Use	Quantity	Daily	Weekday Vehicle Trips					
			AM Peak Hour			PM Peak Hour		
			In	Out	Total	In	Out	Total
Crossroads North								
Public Park (ITE 411)	20 Acres	16	0	0	0	1	1	2
Tire Superstore (ITE 849)	7,000 SF	144	6	3	9	7	8	15
Home Improvement Superstore (ITE 862)	127,000 SF	3,904	113	86	199	145	151	296
Furniture Store (ITE 890)	114,000 SF	720	21	9	30	28	31	59
Sit Down Restaurant (ITE 932)	11,000 SF	1,234	60	49	109	66	41	107
Fast-Food Restaurant (ITE 934)	2,500 SF	1,178	51	49	100	43	39	82
Gas Station Super Convenience (ITE 960)	6,000 SF	5,026	249	250	499	208	208	416
Total Crossroads North Trips		12,222	500	446	946	498	479	977
Crossroads North Trips after Internal Capture		11,246	490	437	927	458	441	899

With full project buildout by 2040, the development area is expected to generate approximately 16,066 daily weekday external vehicle trips with 1,037 of these trips occurring during the morning peak hour and 1,269 trips occurring during the afternoon peak hour. **Table 2** provides the estimated trip generation for full buildout of the project.

Table 2 – Full Buildout Project Traffic Generation

Use	Quantity	Daily	Weekday Vehicle Trips					
			AM Peak Hour			PM Peak Hour		
			In	Out	Total	In	Out	Total
Crossroads North								
Public Park (ITE 411)	20 Acres	16	0	0	0	1	1	2
Movie Theatre (ITE 444)	52,000 SF	4,062	5	6	11	302	19	321
Tire Superstore (ITE 849)	7,000 SF	144	6	3	9	7	8	15
Home Improvement Superstore (ITE 862)	127,000 SF	3,904	113	86	199	145	151	296
Furniture Store (ITE 890)	114,000 SF	720	21	9	30	28	31	59
Sit Down Restaurant (ITE 932)	11,000 SF	1,234	60	49	109	66	41	107
Fast-Food Restaurant (ITE 934)	5,000 SF	2,356	103	98	201	85	78	163
Gas Station Super Convenience (ITE 960)	6,000 SF	5,026	249	250	499	208	208	416
Total Crossroads North Trips		17,462	557	501	1,058	842	537	1,379
Crossroads North Trips after Internal Capture		16,066	546	491	1,037	775	494	1,269

4.2 Trip Distribution

Distribution of site traffic on the street system was based on the area street system characteristics, existing traffic patterns, existing and anticipated surrounding demographic information, expected roadway improvements, and the proposed access system for the project. Assignment of project traffic was based upon the trip generation described previously and the distributions developed for the project area. The directional distribution of traffic is a means to quantify the percentage of site-generated traffic that approaches the site from a given direction and departs the site back to the original source. The project trip distribution is illustrated in **Figure 8**.

4.3 Traffic Assignment and Total (Background Plus Project) Traffic

Traffic assignment was obtained by applying the project trip distribution to the estimated traffic generation of the development shown in **Table 1** and **Table 2**. Phase 1 project traffic assignment for the development area is shown in **Figure 9** while full buildout traffic assignment is shown in **Figure 10**. Project traffic volumes were added to the background volumes to represent estimated traffic conditions for the short term 2026 horizon and long term 2040 horizon. These background plus project (total) traffic volumes for the project are illustrated for the 2026 and 2040 horizon years in **Figures 11** and **12**, respectively.

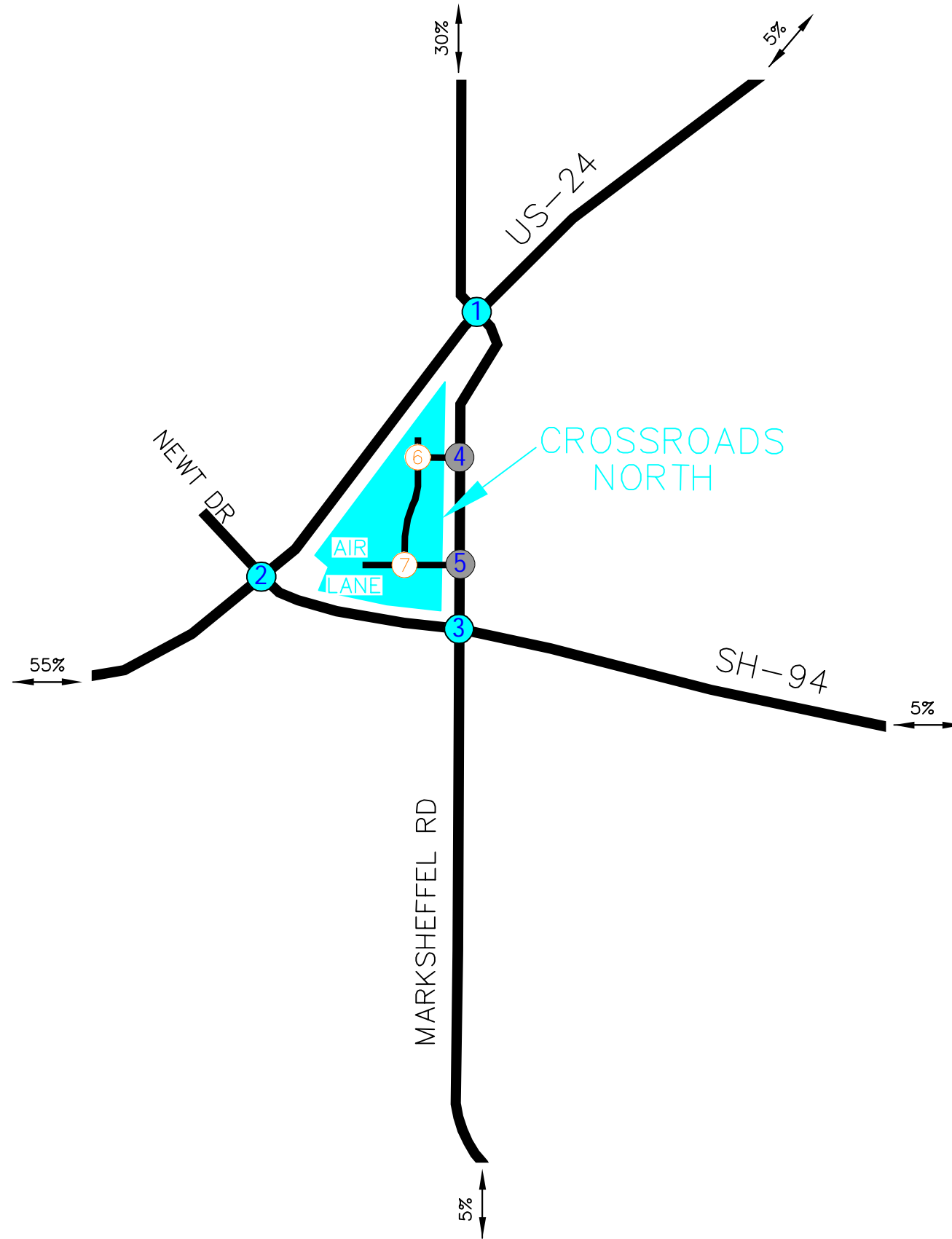

LEGEND

- Existing Key Intersection
- Proposed Access Intersection
- Proposed Internal Intersection
- External Trip Distribution

CROSSROADS NORTH
 COLORADO SPRINGS, CO
 PROJECT TRIP DISTRIBUTION

FIGURE 8

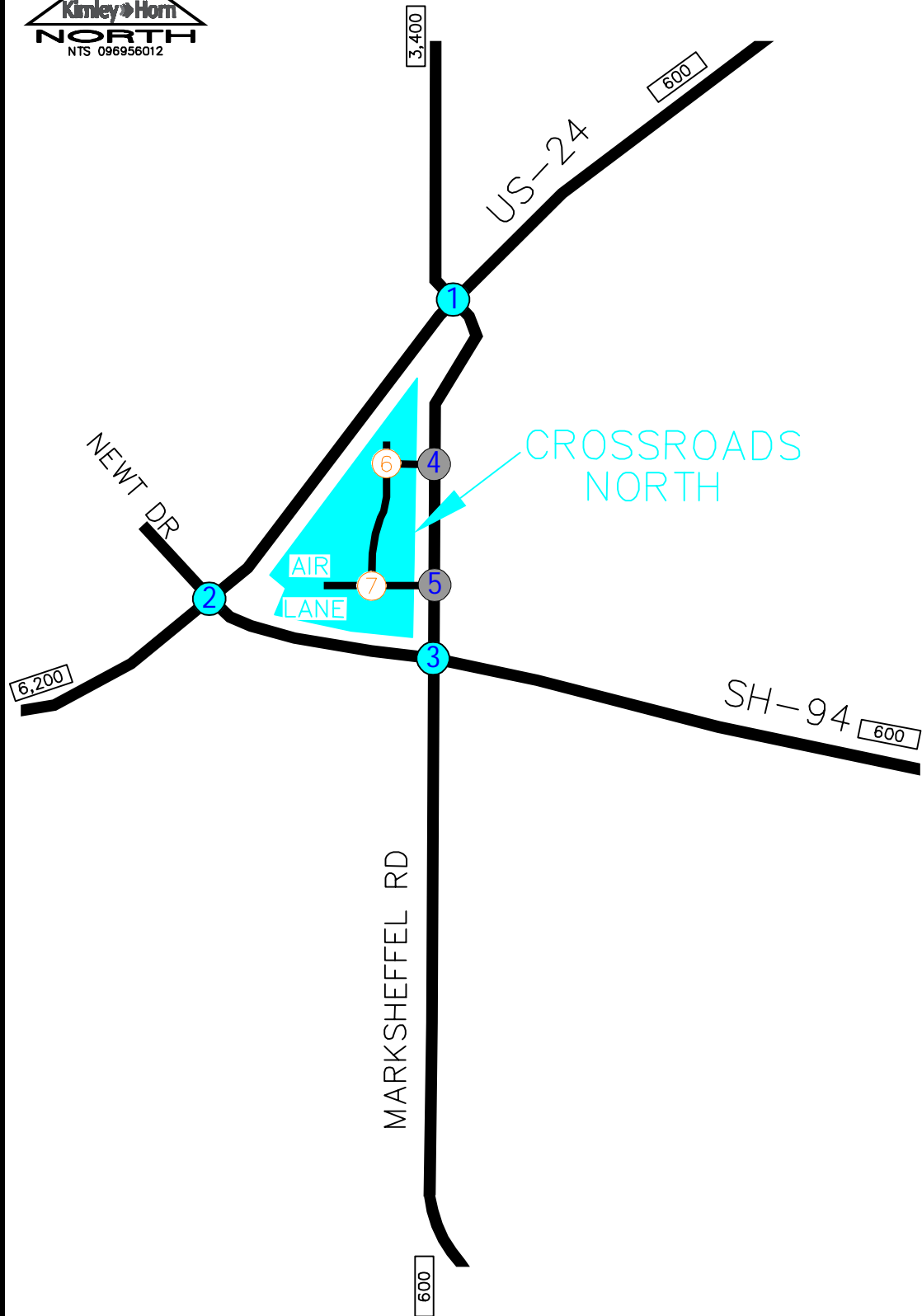

<p>1 MARKSHEFFEL</p> <p>← 147(137)</p> <p>← 25(23)</p> <p>123(115) →</p> <p>131(132) ↑</p> <p>22(22) ↑</p> <p>US-24</p> <p>US-24/MARKSHEFFEL ROAD</p>	<p>2 US-24</p> <p>SH-94</p> <p>← 240(243)</p> <p>123(115) ↑</p> <p>147(137) ↑</p> <p>SH-94/US-24</p>	<p>3 SH-94</p> <p>← 240(243)</p> <p>22(22) ↓</p> <p>22(22) ↓</p> <p>25(23) ↖</p> <p>147(137) →</p> <p>25(23) ↑</p> <p>SH-94/MARKSHEFFEL RD</p>
<p>4 MARKSHEFFEL RD NORTH ACCESS</p> <p>← 196(183)</p> <p>← 98(92)</p> <p>87(88) →</p> <p>49(46) ↑</p> <p>153(154) ↑</p> <p>MARKSHEFFEL RD NORTH ACCESS</p>	<p>5 MARKSHEFFEL RD/AIR LANE ACCESS</p> <p>← 98(92)</p> <p>← 87(88)</p> <p>153(154) →</p> <p>197(198) →</p> <p>147(137) ↑</p> <p>49(46) ↑</p> <p>MARKSHEFFEL RD/AIR LANE ACCESS</p>	<p>6 CROSSROADS NORTH INT #6</p> <p>← 22(22)</p> <p>← 22(22)</p> <p>49(46) ↖</p> <p>196(183) ↖</p> <p>66(66) ↖</p> <p>CROSSROADS NORTH INT #6</p>
<p>7 AIR LANE INTERSECTION</p> <p>← 306(309)</p> <p>← 196(183)</p> <p>← 49(46)</p> <p>44(44) →</p> <p>AIR LANE INTERSECTION</p>		

LEGEND

- ⊗ Existing Key Intersection
- ⊗ Proposed Access Intersection
- ⊗ Proposed Internal Intersection
- XXX(XXX) Weekday AM(PM)
Peak Hour Traffic Volumes
- XX,X00 Estimated Daily Traffic Volume

CROSSROADS NORTH
COLORADO SPRINGS, CO
2026 PROJECT TRAFFIC ASSIGNMENT

FIGURE 9

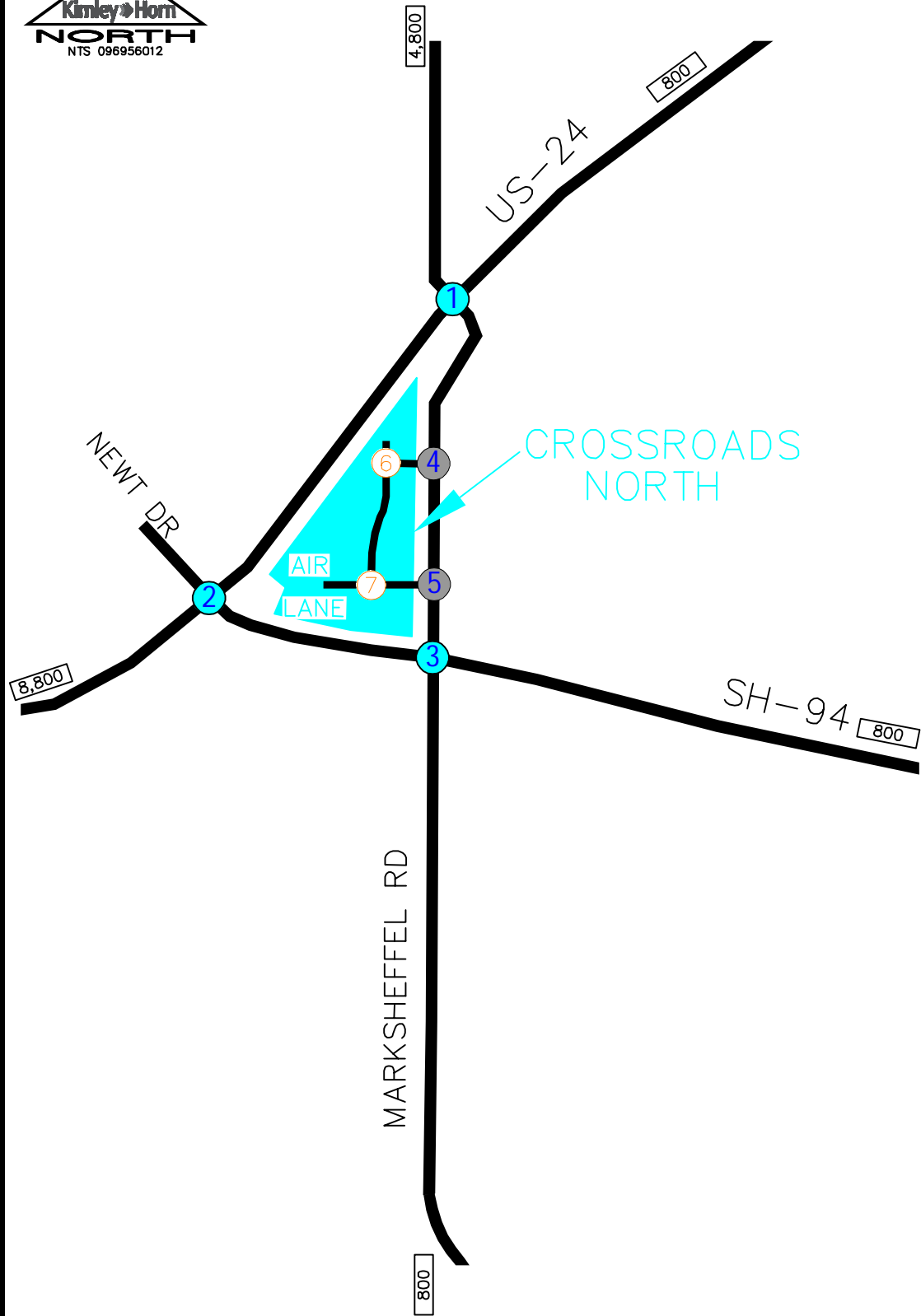

<p>1 MARKSHEFFEL</p> <p>← 164(233)</p> <p>← 27(39)</p> <p>137(194) →</p> <p>US-24</p> <p>US-24/MARKSHEFFEL ROAD</p>	<p>2 US-24</p> <p>← 27(39)</p> <p>147(148) ↑</p> <p>25(25) ↑</p> <p>270(272)</p> <p>137(194) ↑</p> <p>164(233) ↑</p> <p>SH-94/US-24</p>	<p>3 SH-94</p> <p>← 270(272)</p> <p>← 25(25)</p> <p>← 25(25)</p> <p>← 27(39)</p> <p>164(233) →</p> <p>27(39) ↑</p> <p>SH-94/MARKSHEFFEL RD</p>
<p>4 MARKSHEFFEL RD NORTH ACCESS</p> <p>← 218(310)</p> <p>← 109(155)</p> <p>98(99) →</p> <p>55(78) ↑</p> <p>172(173) ↑</p> <p>MARKSHEFFEL RD NORTH ACCESS</p>	<p>5 MARKSHEFFEL RD/AIR LANE ACCESS</p> <p>← 109(155)</p> <p>← 98(99)</p> <p>172(173) →</p> <p>221(222) →</p> <p>164(233) ↑</p> <p>55(78) ↑</p> <p>MARKSHEFFEL RD/AIR LANE ACCESS</p>	<p>6 CROSSROADS NORTH INT #6</p> <p>← 25(25)</p> <p>← 25(25)</p> <p>← 55(78)</p> <p>← 218(310)</p> <p>74(74) →</p> <p>CROSSROADS NORTH INT #6</p>
<p>7 AIR LANE INTERSECTION</p> <p>← 344(346)</p> <p>← 218(310)</p> <p>← 55(78)</p> <p>49(49) →</p> <p>AIR LANE INTERSECTION</p>		

LEGEND

- ⊗ Existing Key Intersection
- ⊗ Proposed Access Intersection
- ⊗ Proposed Internal Intersection
- XXX(XXX) Weekday AM(PM)
Peak Hour Traffic Volumes
- XX,X00 Estimated Daily Traffic Volume

CROSSROADS NORTH
COLORADO SPRINGS, CO
2040 PROJECT TRAFFIC ASSIGNMENT

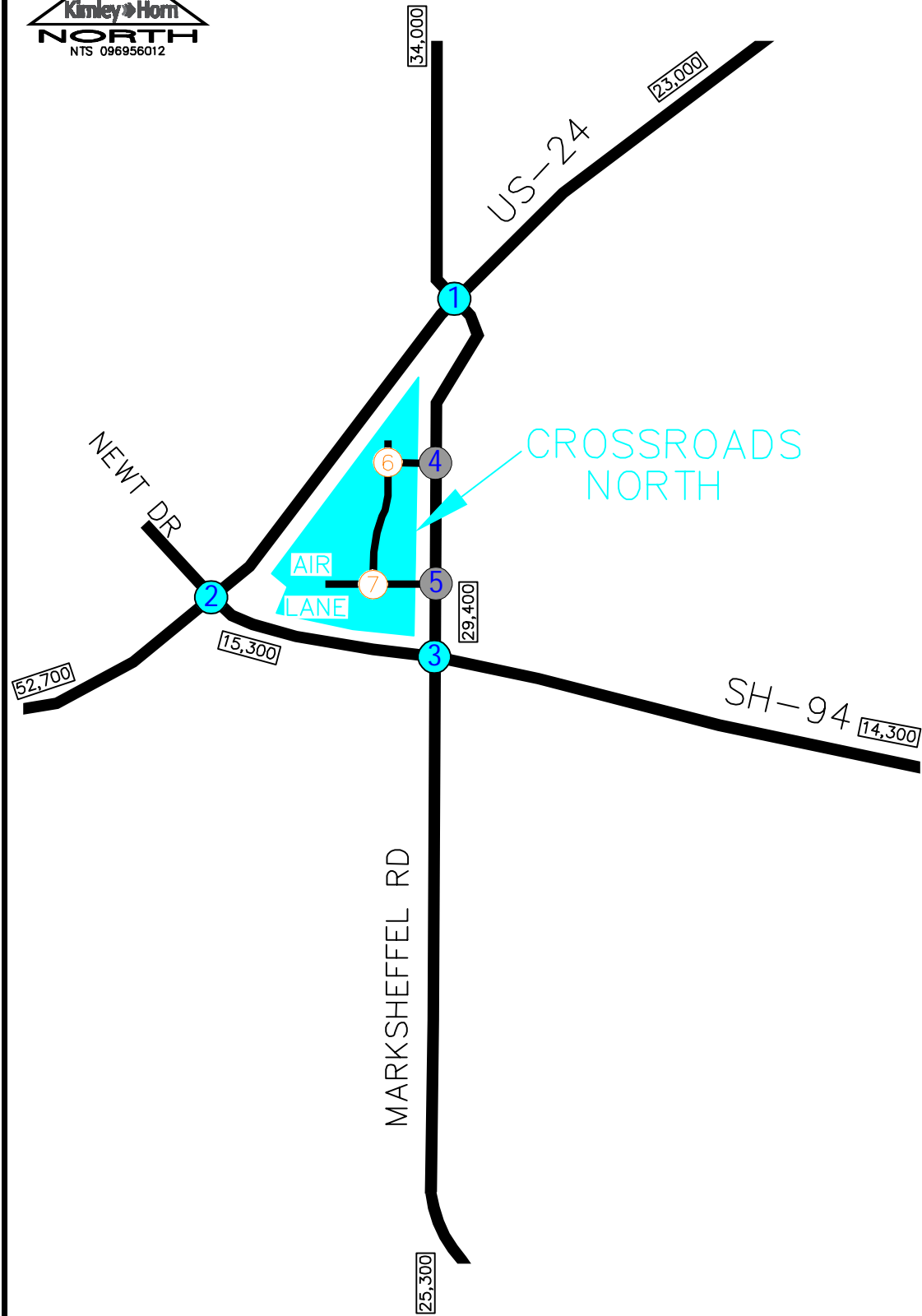

<p>1</p> <p>MARKSHEFFEL</p> <p>760(510) ← 1025(915) ↓ 10(20) →</p> <p>← 1215(585) 350(210) ←</p> <p>20(20) ↗ 5(10) ↘</p> <p>5(15) ↖ 755(1190) ↗ 105(245) ↘</p> <p>US-24</p>	<p>2</p> <p>US-24</p> <p>65(60) ↖ 1860(1000) ↓ 5(5) ↘</p> <p>45(55) ↖ 90(80) ↘ 495(450) ↘</p> <p>425(395) ↖ 985(1925) ↓ 635(625) ↘</p> <p>SH-94</p>	<p>3</p> <p>SH-94</p> <p>245(255) ↖ 695(845) ↓ 300(200) ↘</p> <p>115(395) ↖ 345(405) ↓ 35(45) ↘</p> <p>150(140) ↖ 300(340) ↓ 160(265) ↘</p> <p>190(225) ↖ 470(1100) ↓ 25(30) ↘</p> <p>SH-94/MARKSHEFFEL RD</p>
<p>4</p> <p>MARKSHEFFEL RD NORTH ACCESS</p> <p>200(185) ↖ 1300(1045) ↓</p> <p>90(90) ↖</p> <p>50(50) ↖ 860(1450) ↓</p>	<p>5</p> <p>MARKSHEFFEL RD/AIR LANE ACCESS</p> <p>100(95) ↖ 1290(1040) ↓</p> <p>155(155) ↖ 200(200) ↘</p> <p>150(140) ↖ 755(1345) ↓</p>	<p>6</p> <p>CROSSROADS NORTH INT #6</p> <p>22(22) ↖ 25(25) ↓</p> <p>50(50) ↖ 200(185) ↓</p> <p>2(2) ↖ 70(70) ↓</p>
<p>7</p> <p>AIR LANE INTERSECTION</p> <p>2(2) ↖ 310(310) ↓</p> <p>200(185) ↖ 50(50) ↓</p> <p>2(2) ↖ 45(45) ↓</p>		

LEGEND

- ⊗ Existing Key Intersection
- ⊗ Proposed Access Intersection
- ⊗ Proposed Internal Intersection
- XXX(XXX) Weekday AM(PM)
Peak Hour Traffic Volumes
- XX,X00 Estimated Daily Traffic Volume

CROSSROADS NORTH
COLORADO SPRINGS, CO
2026 TOTAL TRAFFIC VOLUMES

FIGURE 11

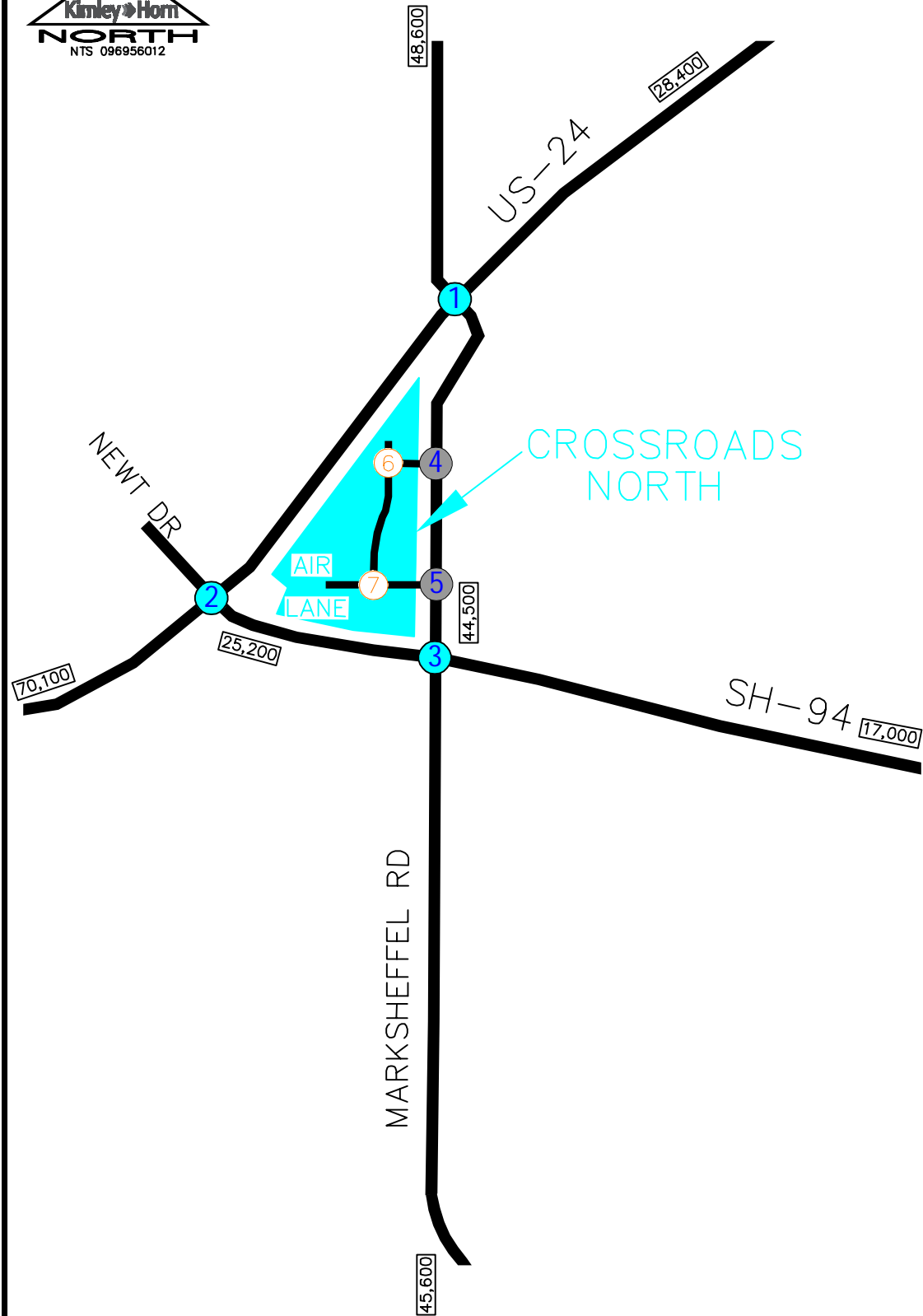

<p>1 MARKSHEFFEL</p> <p>890(600) ← 1330(1560) ↓ 15(25) ↘</p> <p>25(20) ↖ 1425(690) ← 435(325) ↖</p> <p>425(785) → 645(1415) → 140(205) →</p> <p>5(20) ↖ 1100(1765) ↖ 160(345) ↖</p> <p>US-24</p>	<p>2 US-24</p> <p>80(75) ↖ 2190(1180) ↓ 10(10) ↘</p> <p>5(10) ↖ 105(80) ← 1155(1160) ↖</p> <p>55(65) ↖ 95(95) → 555(535) ↖</p> <p>480(470) ↖ 1150(2325) ↖ 855(1165) ↖</p> <p>SH-94</p>	<p>3 SH-94</p> <p>275(285) ↖ 975(1480) ↓ 355(230) ↘</p> <p>135(480) ↖ 405(475) ← 40(50) ↖</p> <p>165(235) → 350(400) → 310(665) →</p> <p>430(565) ↖ 810(1735) ↖ 30(50) ↖</p> <p>SH-94/MARKSHEFFEL RD</p>
<p>4 MARKSHEFFEL RD NORTH ACCESS</p> <p>220(310) ↖ 1675(1760) ↓</p> <p>100(100) ↖</p> <p>55(80) ↖ 1260(2125) ↖</p>	<p>5 MARKSHEFFEL RD/AIR LANE ACCESS</p> <p>110(155) ↖ 1665(1705) ↓</p> <p>175(175) ↖ 225(225) ↖</p> <p>165(235) ↖ 1145(2030) ↖</p>	<p>6 CROSSROADS NORTH INT #6</p> <p>25(25) ↖ 25(25) ↖</p> <p>55(80) ↖ 220(310) ↖</p> <p>2(2) ↖ 75(75) ↖</p>
<p>7 AIR LANE INTERSECTION</p> <p>2(2) ↖ 345(350) ↖</p> <p>220(310) ↖ 55(80) ↖</p> <p>2(2) ↖ 50(50) ↖</p>		

LEGEND

- ⊗ Existing Key Intersection
- ⊗ Proposed Access Intersection
- ⊗ Proposed Internal Intersection
- XXX(XXX) Weekday AM(PM)
Peak Hour Traffic Volumes
- XX,X00 Estimated Daily Traffic Volume

CROSSROADS NORTH
COLORADO SPRINGS, CO
2040 TOTAL TRAFFIC VOLUMES

FIGURE 12

5.0 TRAFFIC OPERATIONS ANALYSIS

Kimley-Horn's analysis of traffic operations in the site vicinity was conducted to determine potential capacity deficiencies in the 2026 and 2040 development horizons at the identified key intersections. The acknowledged source for determining overall capacity is the *Highway Capacity Manual*².

5.1 Analysis Methodology

Capacity analysis results are listed in terms of Level of Service (LOS). LOS is a qualitative term describing operating conditions a driver will experience while traveling on a particular street or highway during a specific time interval. It ranges from A (very little delay) to F (long delays and congestion). For intersections and roadways in this study area, standard traffic engineering practice recommends overall intersection LOS D and movement/approach LOS E as the minimum desirable thresholds for acceptable operations. **Table 3** shows the definition of level of service for signalized and unsignalized intersections.

Table 3 – Level of Service Definitions

Level of Service	Signalized Intersection Average Total Control Delay (sec/veh)	Unsignalized Intersection Average Total Control Delay (sec/veh)
A	≤ 10	≤ 10
B	> 10 and ≤ 20	> 10 and ≤ 15
C	> 20 and ≤ 35	> 15 and ≤ 25
D	> 35 and ≤ 55	> 25 and ≤ 35
E	> 55 and ≤ 80	> 35 and ≤ 50
F	> 80	> 50

Study area intersections were analyzed based on average total control delay analysis for signalized and unsignalized intersections. Under the unsignalized analysis, the level of service (LOS) for a two-way stop-controlled intersection is determined by the computed or measured control delay and is defined for each minor movement. Level of service for a two-way stop-controlled intersection is not defined for the intersection as a whole. Level of service for a signalized and four-way stop controlled intersection is defined for the overall intersection.

² Transportation Research Board, *Highway Capacity Manual*, Sixth Edition, Washington DC, 2016.

5.2 Key Intersection Operational Analysis

Calculations for the level of service at the key intersections identified for study are provided in **Appendix D**. The existing and background traffic analyses are based on the lane geometry and intersection control shown in **Figure 3**. The signalized intersection analysis utilizes the observed cycle lengths with existing phasing and timing. Based on increased national attention given to setting appropriate yellow and all-red clearance intervals to improve intersection safety, these have been calculated and are applied for the approaches to the signalized intersections. The increase in the yellow and all red time sacrifices intersection capacity for improved safety. These yellow and all red time calculations are also included in **Appendix E**. Existing peak hour factors were used for all horizons while the recommended HCM urban area peak hour factor of 0.92 was used for the project accesses. Synchro traffic analysis software was used to analyze the study area intersections and access drives for level of service. The Synchro Highway Capacity Manual (HCM) methodology reports were used to analyze intersection control delay and level of service.

US-24 and Marksheffel Road (#1)

US-24 and Marksheffel Road (#1) is a four-leg signalized intersection. This intersection currently operates with a LOS D during the morning and afternoon peak hours under the existing lane configuration and signal control. With the existing lane configurations and control, this intersection is expected to continue to operate acceptably with LOS D during both peak hours in the 2026 total condition.

By 2040, it is anticipated that the intersection will operate with long delays during the peak hours without the addition of project traffic. To improve operations at this intersection, both US-24 and Marksheffel Road may need to provide three through lanes on all approaches. With these improvements, the intersection is anticipated to operate at LOS D during the peak hours in 2040.

Table 4 provides the results of the level of service at this intersection.

Table 4 – US-24 and Marksheffel Road (#1) LOS Results

Scenario	AM Peak Hour		PM Peak Hour	
	Control Delay (sec/veh)	LOS	Control Delay (sec/veh)	LOS
2020 Adjusted Existing	44.3	D	43.2	D
2026 Background	50.9	D	52.6	D
2026 Background Plus Project	53.7	D	54.2	D
2040 Background	101.5	F	135.9	F
2040 Background Plus Project #	42.4	D	51.5	D

= Three through lanes on all approaches

SH-94/Newt Drive and US-24 (#2)

SH-94/Newt Drive and US-24 (#2) is a four-leg signalized intersection. Although both highways are east-west, the traffic software at this intersection assigned US-24 as north-south based on cardinal direction of existing roadway alignments. This intersection currently operates with LOS E during the morning and afternoon peak hours under the existing lane configuration and signal control. With or without the completion of the development in 2026, the intersection is anticipated to operate with LOS F during the morning and afternoon peak hours. If future project volumes are realized, it is recommended that an additional through lane be considered as a regional improvement on the US-24 approaches. The US-24 right turn to eastbound SH-94 is recommended to include a separate right turn lane operating with free movements. Acceleration lanes currently exist in both directions along US-24 from both Newt Drive and SH-94. For southwestbound US-24 at SH-94 (#2), the existing acceleration lane along US-24 will need to be reconstructed with 960 feet of length plus a 225-foot taper if and when US-24 is improved to provide three through lanes along northbound US-24. For northeastbound US-24 at SH-94, it is recommended that this acceleration lane be converted to the third northbound through lane as the acceleration lane is not warranted. Further, the northeastbound US-24 third through lane needs to continue for 1,200 feet plus provide a 660-foot taper based on MUTCD standards. Also, it is recommended that triple westbound left turns be designated by converting the inside westbound through lane to a left turn lane. It is believed that with these improvements, the intersection is at its ultimate at-grade configuration. With the ultimate configuration the intersection improves significantly and operates acceptably in 2026, but long delays may still occur during the peak hours in 2040. As such, and as requested by CDOT, an additional analysis was performed with an interchange grade separation including a westbound left turn flyover ramp condition. With this westbound left turn flyover ramp and the existing two through lanes in each direction along US-24, this intersection is expected to operate acceptably with LOS D during the peak hours in 2026 and LOS E during the peak hours in 2040. With three through lanes in each direction along US-24 and the implementation of the westbound left turn flyover ramp, this intersection is expected to operate acceptably during the peak hours in 2040. **Table 5** provides the results of the level of service at this intersection.

Table 5 – SH-94/Newt Drive and US-24 (#2) LOS Results

Scenario	AM Peak Hour		PM Peak Hour	
	Control Delay (sec/veh)	LOS	Control Delay (sec/veh)	LOS
2020 Adjusted Existing	76.6	E	58.3	E
2026 Background	145.4	F	98.0	F
2026 Background Plus Project	207.1	F	153.3	F
2026 Background Plus Project #	54.7	D	46.0	D
2026 Background Plus Project ## (WBL Flyover)	48.5	D	52.9	D
2040 Background #	88.9	F	84.9	F
2040 Background Plus Project #	133.2	F	118.3	F
2040 Background Plus Project ## (WBL Flyover)	63.2	E	62.1	E
2040 Background Plus Project ### (WBL Flyover)	44.7	D	32.0	C

= Three northbound and southbound through lanes, dual northbound left turn lanes, triple westbound left turn lanes.

= Dual northbound left turn lanes and westbound left flyover ramp

= Three northbound and southbound through lanes, dual northbound left turn lanes and westbound left flyover ramp

SH-94 and Marksheffel Road (#3)

The existing intersection of SH-94 and Marksheffel Road (#3) is currently a four-leg signalized intersection. This intersection currently operates with LOS C during the morning and afternoon peaks hours with existing traffic volumes and lane configurations. With the completion of development in 2026, the northbound and southbound right turns at this intersection are anticipated to be a free southbound right turn due to CDOT State Highway Access Code guidelines. By completion of development in 2026, this intersection is expected to continue to operate acceptably during the peak hours with existing lane configurations and control.

By 2040, the following improvements are recommended: eastbound and westbound right turn movements to implement permissive/overlap phasing, two eastbound and westbound through lanes, and three northbound and southbound through lanes. With these improvements, this intersection is anticipated to operate acceptable with LOS D or better during the peak hours in 2040. **Table 6** provides the results of the level of service at this intersection.

Table 6 – SH-94 and Marksheffel Road (#3) LOS Results

Scenario	AM Peak Hour		PM Peak Hour	
	Control Delay (sec/veh)	LOS	Control Delay (sec/veh)	LOS
2020 Adjusted Existing	24.8	C	25.9	C
2026 Background	24.3	C	27.6	C
2026 Background Plus Project #	26.3	C	31.6	C
2040 Background	45.3	D	202.9	F
2040 Background Plus Project ##	31.6	C	49.3	D

= NB to EB right turn acceleration lane, and SB to WB right turn acceleration lane
 ## = Two eastbound and westbound through lanes, three northbound and southbound through lanes, NB to EB right turn acceleration lane, and SB to WB right turn acceleration lane

5.3 Project Access Operational Analysis

Direct access to Crossroads North is proposed from the northern three-quarter access (#4) and the southern full movement access (#5) along Marksheffel Road located approximately 2,000 feet and 1,000 feet north of SH-94, respectively. The south access is currently proposed to be named Air Lane which will provide east-west collector roadway connectivity to Crossroads North. A sensitivity analysis has been prepared later in Section 5.8 comparing the north access along Marksheffel Road as a full movement signalized intersection and a three-quarter movement unsignalized intersection.

Based on Colorado Springs standards, a right turn lane is required for any access with a projected peak hour right ingress turning volume of 25 vehicles per hour or greater for principal arterials, therefore it is recommended that a southbound right turn lane be constructed at both intersections due to the volumes being 200 vehicles per hour at the north access and 100 vehicles per hour at the south access in 2026. Northbound left turn lanes will also be required at both of these accesses (#4 and #5) along Marksheffel Road. Based on Colorado Springs standards, the northbound left turn at the Marksheffel Road North Access (#4) should provide a turn lane length of 270 feet plus a 200-foot taper, whereas the southbound right turn lane should provide a lane length of 235 feet plus a 200-foot taper. Additionally, an R1-1 "STOP" sign should be installed on the exiting eastbound approach of the Marksheffel Road North Access (#4). To meet Colorado Springs standards, the northbound left turn at the Marksheffel Road South Access (#5) should provide a turn lane length of 340 feet plus a 200-foot taper, whereas the southbound right turn lane should provide a lane length of 235 feet plus a 200-foot taper.

An internal street evaluation was conducted for the Crossroads North development area. The south access to Crossroads North along Marksheffel Road is proposed to be named Air Lane and is expected to be classified as an El Paso County Urban Non-Residential Collector roadway with a 60-foot right-of-way (ROW). Air Lane extends east/west and is proposed to connect with a north/south extending Non-Residential Collector Street (#7). Intersection #7 (collector to collector) is proposed to be located approximately 525 feet west of Marksheffel Road. The north/south extending Non-Residential Collector Street also connects with an east/west collector street (#6) that extends from the north access to Marksheffel Road. The north access street connecting with Marksheffel Road is proposed to be classified as an El Paso County Urban Non-Residential

Collector roadway. To meet El Paso County standards for a design speed of 35 mph, the recommended left-turn lanes and right turn lanes internal to Crossroads North should provide 135 feet of deceleration length plus 140-foot tapers while all left turn lanes and right turn lanes that require a stop will also provide a storage length (determined from ECM Table 2-30 for each location).

The eastbound left turn movement at the proposed Marksheffel Road South Access (#5) is expected to operate with LOS F during the peak hours in 2026 under stop control. As such, a signal warrant evaluation was performed, and warrants are expected to be met at this access based on 2026 traffic volume projections. The signal warrant analysis is attached in **Appendix E**. With signal control, the Marksheffel Road South Access (#5) intersection is expected to operate acceptably with LOS A during the peak hours throughout the 2040 horizon.

With the recommended lane configurations and control, all movements at the two internal intersections (#6 and #7) to Crossroads North are expected to operate acceptably with LOS B or better during the peak hours throughout the 2040 horizon. **Figure 13** illustrates the street classification map for roadways internal to Crossroads North. The operational analysis at the proposed project driveways as well as the internal intersections to Crossroads North is summarized in **Table 7** for development in 2026 and for the long-term 2040 horizon. Detailed results of the operational analysis are also provided in **Appendix D**.

Table 7 – Project Access LOS Results

	2026 Total Traffic				2040 Total Traffic			
	AM Peak Hour		PM Peak Hour		AM Peak Hour		PM Peak Hour	
	Control Delay (sec/veh)	LOS	Control Delay (sec/veh)	LOS	Control Delay (sec/veh)	LOS	Control Delay (sec/veh)	LOS
Access and Movement								
Crossroads North: Marksheffel Road North Access (#4) (3/4 Movements – Unsignalized)					#	#	#	#
Northbound Left	15.6	C	12.9	B	12.3	B	14.9	B
Eastbound Right	17.8	C	14.8	B	13.9	B	14.4	B
Crossroads North: Marksheffel Road South Access (#5)								
Northbound Left	18.0	C	13.8	B	-	-	-	-
Eastbound Left	108.3	F	74.1	F				
Eastbound Right	26.3	D	19.2	C				
Crossroads North: Marksheffel Rd South Access (#5 - Signal)	8.2	A	9.4	A	#	#	#	#
					8.7	A	7.6	A
Crossroads North Internal Intersections: North Intersection (#6)								
Westbound Left	10.6	B	10.4	B	10.8	B	11.9	B
Westbound Right	8.7	A	8.7	A	8.7	A	8.8	A
Southbound Left	7.4	A	7.4	A	7.4	A	7.4	A
Crossroads North Internal Intersections: Air Lane Intersection (#7)								
Eastbound Left	7.8	A	7.8	A	7.9	A	8.2	A
Southbound Approach	12.0	B	12.0	B	12.7	B	13.2	B

= Three northbound and southbound through lanes

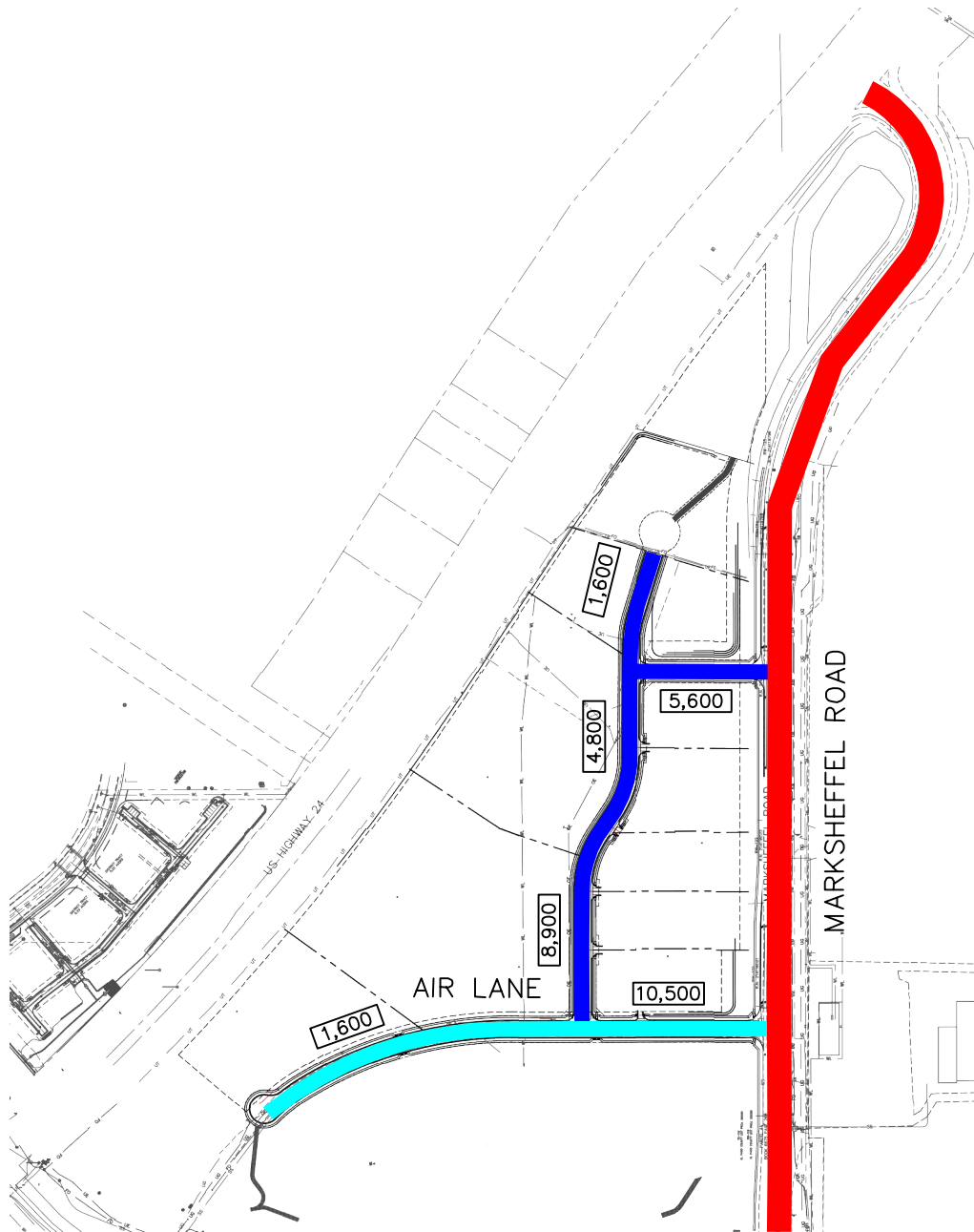

LEGEND

- URBAN 4-LANE PRINCIPAL ARTERIAL
- URBAN NON-RESIDENTIAL COLLECTOR
- MODIFIED URBAN NON-RES. COLLECTOR
- XX,X00 ESTIMATED 2040 DAILY TRAFFIC VOLUME

NOTE: EL PASO COUNTY STREET CLASSIFICATIONS

CROSSROADS NORTH
 EL PASO COUNTY, CO
 CROSSROADS NORTH SITE CIRCULATION

FIGURE 13

5.4 Sight Distance Evaluation

It is recommended that appropriate sight distance triangles be provided at all site access points to give drivers exiting the development area a clear view of oncoming traffic. Landscaping and objects within sight triangles must not obstruct drivers' views of the adjacent travel lanes. Intersection sight distances for left turn from stop and right turn from stop were analyzed for the proposed project accesses along Marksheffel Road.

With AASHTO standards and a design speed of 55 miles per hour along Marksheffel Road, the intersection sight distance for a vehicle turning left from stop is 610 feet, while the sight distance for a vehicle turning right from stop is 530 feet. Therefore, all obstructions for left turning vehicles from stop should be clear to the right within the triangle created with a vertex point located 14.5 feet from the edge of the major road traveled way (typical position of the minor road driver's eye when stopped) and a line-of-sight distance of 610 feet located in the middle of the nearest lane opposite of the center median for both accesses along Marksheffel Road. Likewise, all obstructions for right turning vehicles from stop should be clear to the left within the triangle created with a vertex point located 14.5 feet from the edge of the major road traveled way and a line-of-sight distance of 530 feet located in the middle of the nearest lane for all accesses along Marksheffel Road.

5.5 Bicycle and Pedestrian Access

Bicycle and pedestrian access evaluations were conducted for the Crossroads North project. This focused on the areas of Marksheffel Road, US-24, and SH-94 adjacent to the site development area. The following provides a description of the assessment.

Existing Bicycle, Pedestrian, and Transit Access

There are currently not any sidewalks or bicycle lanes provided along Marksheffel Road, US-24, and SH-94 within the project limits. Transit within the area is provided by Mountain Metropolitan Transit. From review of the most recent route map from August 1, 2019, there are not any transit routes that extend through the project limits.

Future Bicycle, Pedestrian, and Transit Access

Sidewalks will be provided internal to the development area along both sides of all local and collector streets and connections will be made to Marksheffel Road. Additionally, a pedestrian amenity connection will be provided to the secondary regional trail along SH-94. Sidewalk will be provided along Marksheffel Road adjacent to the project frontage; however, bicycle lanes are not proposed along Marksheffel Road or SH-94 adjacent to the project.

5.6 CDOT Turn Lane Evaluation

CDOT Access Permits will be required for the intersections of SH-94/US-24 (#2) and SH-94/Marksheffel Road (#3) in association with the project.

Since US-24 and SH-94 are state owned and maintained facilities, it is recommended that auxiliary turn lanes along US-24 and SH-94 be constructed in accordance with the current CDOT State Highway Access Code. CDOT categorizes the segments of US-24 and SH-94 through the study area as E-X: Expressway, Major Bypass. According to the State Highway Access Code for category E-X roadways, the following thresholds apply:

- A left turn deceleration lane is required for any access with a projected average daily left turn ingress volume greater than 10 with the transition taper included within the required deceleration length. If the projected peak hour left ingress turning volume is greater than 10 vehicles per hour (vph), a left turn deceleration, storage, and taper lane is required for any access.
- A right turn lane with deceleration and taper lengths is required for any access with a projected peak hour right ingress turning volume greater than 10 vph.
- A right turn lane with acceleration and taper lengths is required for any access with a project peak hour turning volume greater than 10 vph.

Based on traffic projections and the above thresholds, auxiliary turn lane requirements were calculated for the key intersections along SH-94. SH-94 provides one lane of travel in each direction and has a posted speed limit of 40 miles per hour at US-24, 55 miles per hour west of Marksheffel Road and 65 miles per hour east of Marksheffel Road. US-24 provides two lanes of travel in each direction and has a posted speed limit of 55 miles per hour through the SH-94

intersection. As such, turn lane requirements at the study area intersections along SH-94 to be impacted by project traffic are as follows:

SH-94 and US-24 (#2)

Left Turn Deceleration Lanes:

- A westbound left turn deceleration lane exists and **is** warranted today and based on projected 2026 background plus project traffic being 820 westbound left turns during the peak hour. Since SH-94 has a category of E-X the left turn lane requirement is deceleration, storage, and taper lengths. Currently there are westbound dual left-turn lanes of approximately a 475-foot length with a 525-foot taper. Based on the 40-mile per hour speed limit, the deceleration lane length is 370 feet, plus a 150-foot taper. Since triple left turn lanes are recommended here with conversion of the inside westbound through lane to a left turn lane, the storage requirement is 275 feet per lane. Therefore, it is recommended that these two left turn lanes be constructed and designated to 645 feet plus a 200-foot taper, with the outside third left turn lane being continuous. By 2040, this turn lane may need to be 760 feet plus a 200-foot taper.
- A northbound left turn deceleration lane exists and **is** warranted along US-24 approach to Newt Drive/SH-94 today and based on projected 2026 background plus project traffic being 225 left turns during the peak hour. Since US-24 has a category of E-X the left turn lane requirement is deceleration, storage, and taper lengths. Currently the northbound left-turn lane is approximately 900 feet long and the taper is approximately 150 feet. Based on the 55-mile per hour speed limit, the deceleration lane length is 600 feet, plus a 225-foot taper, and 480 feet of storage for a total length of 1,080 feet plus 225-foot taper. However, by 2026 it is recommended that dual northbound US-24 left turn lanes be designated at this intersection. Dividing the storage in half results in 850-foot plus 225-foot taper northbound dual left turn lanes.
- A southbound US-24 left turn deceleration lane exists and **is** warranted based on existing traffic volumes. However, the storage component to the left turn lane is not required based on projected 2026 background plus project traffic being 5 southbound left turns during the peak hour and the threshold being greater than 10 vph. This southbound left turn lane

along US-24 at SH-94 currently provides approximately 800 feet of length plus a 200-foot taper. Based on the 65-mile per hour speed limit along southwestbound US-24, the required deceleration length is 500 feet plus a 300-foot taper (25:1) for this left turn lane. Therefore, no improvements are needed for this lane.

Right Turn Deceleration Lanes:

- A northbound right turn deceleration lane along US-24 exists and **is** warranted today and based on projected 2026 background plus project traffic being 635 northbound right turns during the peak hour and the threshold being 10 vph. Since US-24 has a category of E-X the right turn lane requirement is deceleration and taper lengths. The northbound right turn lane is currently 600 feet with a 225-foot taper. Based on the 55-mile per hour speed limit, the deceleration lane length is 600 feet plus a 225-foot taper. Therefore, the existing northbound right turn lane meets current CDOT requirements.
- A southbound US-24 right turn deceleration lane exists and **is** warranted today and based on projected 2026 background plus project traffic being 65 southbound right turns during the peak hour and the threshold being 10 vph. Since US-24 has a category of E-X the right turn lane requirement is deceleration, and taper lengths. The southbound right turn lane is currently 800 feet long with a 200-foot taper. Based on the 55-mile per hour speed limit, the deceleration lane length is 600 feet plus a 225-foot taper. Therefore, the existing southbound right turn lane meets current CDOT requirements.
- A westbound right turn deceleration lane exists but **is not** warranted based on projected 2026 background plus project traffic being 10 westbound right turns during the peak hour and the threshold being greater than 10 vph. Since US-24 has a category of E-X the right turn lane requirement is deceleration, and taper lengths. The westbound right turn lane is currently 475 feet long with a 750-foot taper. Based on the 40-mile per hour speed limit, the deceleration lane length is 370 feet, plus a 150-foot taper. Therefore, the existing westbound right turn lane meets current CDOT requirements.

Acceleration Lanes:

- An eastbound acceleration lane along SH-94 from the US-24 northbound right turn exists and **is** warranted today and based on projected 2026 background plus project traffic being 635 northbound right turns during the peak hour and the threshold being 10 vph. Since SH-94 has a category of E-X the right turn lane requirement is acceleration and taper length. Currently the eastbound acceleration lane is approximately 425 feet long with a 175-foot taper. Based on the 40-mile per hour speed limit, the acceleration lane length requirement is 380 feet plus a 145-foot taper. Therefore, no improvements are needed for this lane.
- A southwestbound right turn acceleration lane along US-24 from the Newt Drive right turn exists and **is** warranted today and based on projected 2026 background plus project traffic being 495 eastbound right turns during the peak hour and the threshold being 10 vph. Since US-24 has a category of E-X and a speed limit of 55 mph the right turn lane requirement is acceleration, and taper lengths. Based on the 55-mile per hour speed limit, the acceleration lane length requirement is 960 feet plus a 225-foot taper. This acceleration lane exists today for a length of 760 feet plus 225-foot taper; therefore, this lane should be extended from 760 feet to 960 feet.
- A northeastbound acceleration lane along US-24 from the SH-94 westbound right turn exists but **is not** warranted based on projected 2026 background plus project traffic being 10 westbound right turns during the peak hour and the threshold being greater than 10 vph. Since SH-94 has a category of E-X the right turn lane requirement is acceleration and taper length. Currently the eastbound acceleration lane is approximately 1,425 feet long with a 300-foot taper. Based on the 55-mile per hour speed limit, the acceleration lane length requirement is 960 feet plus a 225-foot taper. Therefore, no improvements are needed for this lane. However, if and when a third northbound through lane is provided along US-24 at SH-94, it is recommended that this acceleration lane be converted to the third northbound through lane as the acceleration lane is not warranted.

SH-94 and Marksheffel Road (#3)

Left Turn Deceleration Lanes:

- An eastbound left turn deceleration lane exists and **is** warranted based on projected 2026 background plus project traffic being 150 eastbound left turns during the peak hour. Since SH-94 has a category of E-X the left turn lane requirement is deceleration, storage, and taper lengths. Currently the eastbound left-turn lanes are approximately 300 feet long with a 100-foot taper. Based on the 55-mile per hour speed limit, the deceleration lane length is 600 feet, plus a 225-foot taper. The storage requirement is 150 feet in 2026 and 235 feet in 2040 based on the projected left turning volume. Therefore, it is recommended that this left turn lane be constructed and designated to 750 feet plus a 225-foot taper in 2026 and 835 feet plus a 225-foot taper in 2040.
- A westbound left turn deceleration lane exists and **is** warranted today and based on projected 2026 background plus project traffic being 45 westbound left turns during the peak hour. Since SH-94 has a category of E-X the left turn lane requirement is deceleration, storage, and taper lengths. Currently the westbound left-turn lanes are approximately 225 feet long with a 200-foot taper. Based on the 55-mile per hour speed limit, the deceleration lane length is 600 feet, plus a 225-foot taper. The storage requirement is 50 feet based on the projected left turning volume. Therefore, it is recommended that this lane be constructed to 650 feet with a 225-foot taper.

Right Turn Deceleration Lanes:

- An eastbound right turn deceleration lane exists and **is** warranted today and based on projected 2026 background plus project traffic being 265 eastbound right turns during the peak hour and the threshold being 10 vph. Since SH-94 has a category of E-X the right turn lane requirement is deceleration plus taper length. The eastbound right turn lane is currently 250 feet long with a 200-foot taper. Based on the 55-mile per hour speed limit, the deceleration lane length requirement is 600 feet plus a 225-foot taper. Therefore, the existing eastbound right turn lane does not meet current CDOT requirements. It is recommended that this lane be constructed to 600 feet plus a 225-foot taper.

- A westbound right turn deceleration lane exists and **is** warranted today and based on projected 2026 background plus project traffic being 395 westbound right turns during the peak hour and the threshold being 10 vph. Since SH-94 has a category of E-X the right turn lane requirement is deceleration plus taper length. The westbound right turn lane is currently 250 feet long with a 275-foot taper. Based on the 55-mile per hour speed limit, the deceleration lane length requirement is 600 feet plus a 225-foot taper. Therefore, the existing westbound right turn lane does not meet current CDOT requirements. It is recommended that this lane be constructed to 600 feet plus a 225-foot taper.

Acceleration Lanes:

- An eastbound acceleration lane along SH-94 from the Marksheffel Road northbound right turn **is** warranted today and based on projected 2026 background plus project traffic being 30 northbound right turns during the peak hour and the threshold being 10 vph. Since SH-94 has a category of E-X the right turn lane requirement is acceleration, and taper lengths. The right turn lane currently has no acceleration lane. Based on the 65-mile per hour speed limit, a 1,380-foot acceleration lane with 300-foot taper is recommended.
- A westbound acceleration lane along SH-94 from the Marksheffel Road southbound right turn **is** warranted based on projected 2026 background plus project traffic being 255 westbound right turns during the peak hour and the threshold being 10 vph. Since SH-94 has a category of E-X the right turn lane requirement is acceleration, and taper lengths. The right turn lane currently has no acceleration lane. Based on the 40-mile per hour speed limit, a 380-foot acceleration lane with a 145-foot taper is required; however, it is recommended that this acceleration lane be a continuous lane to tie into the outside westbound through lane on the approach to US-24.

5.7 Queuing Analysis

A vehicle queuing analysis was conducted for the study area intersections. The queuing analysis was performed using Synchro presenting the results of the 95th percentile queue lengths. Results are shown in the following **Table 8** with calculations provided within the level of service operational sheets of **Appendix D** for the unsignalized intersections and **Appendix F** for signalized intersections.

Table 8 – Turn Lane Storage Length Analysis Results

Intersection Turn Lane	Existing Turn Lane Length (feet)	2026 Calculated Queue Length (feet)	2026 Recommended Turn Lane Length (feet)	2040 Calculated Queue Length (feet)	2040 Recommended Turn Lane Length (feet)
US-24 (EB/WB) & Marksheffel Road (NB/SB) (#1)					
Eastbound Left	1200' DL	355' DL	1200' DL	423' DL	1200' DL
Eastbound Right	575'	FREE	575'	139'	575'
Westbound Left	1100'	184' DL	1,100' DL (CDOT)	235' DL	1,100' DL (CDOT)
Westbound Right	700'	FREE	700'	25'	700'
Northbound Left	300'	25'	300'	29'	300'
Northbound Right	375'	FREE	375'	FREE	375'
Southbound Left	375'	29'	375'	25'	375'
Southbound Right	C	FREE	C	FREE	C
SH-94 & US-24 (#2)					
Eastbound Newt Drive Left	375' DL	45'	375' DL	51'	375' DL
Eastbound Newt Drive Right	C	FREE	C	FREE	C
Westbound SH-94 Left	475' DL	314'	645' (CDOT) TL	587' TL	760' (CDOT) TL
Westbound SH-94 Right	475'	FREE	475'	FREE	475'
Northbound US-24 Left	900'	391' DL	900' DL	442'	900' DL
Northbound US-24 Right	600'	FREE	600'	FREE	600'
Southbound US-24 Left	800'	25'	800'	25'	800'
Southbound US-24 Right	800'	25'	800'	25'	800'
SH-94 & Marksheffel Road (#3)					
Eastbound Left	300'	256'	750' (CDOT)	239'	835' (CDOT)
Eastbound Right	250'	90'	600' (CDOT)	439'	600' (CDOT)
Westbound Left	225'	60'	650' (CDOT)	56'	650' (CDOT)
Westbound Right	250'	275'	600' (CDOT)	371'	600' (CDOT)
Northbound Left	375'	157'	375'	260' DL	375' DL
Northbound Right	400'	FREE	400'	-	-
Southbound Left	400'	210'	400'	338'	400'
Southbound Right	400'	FREE	400'	FREE	400'
Marksheffel Rd North Access (#4)					
Eastbound Right	DNE	25'	C	25'	C
Northbound Left	DNE	25'	270'+200' T (CS)	25'	295'+200' T (CS)
Southbound Right	DNE	25'	235'+200' T (CS)	25'	235'+200' T (CS)
Marksheffel Rd South Access (#5)					
Eastbound Left	DNE	105'	C	111'	C
Eastbound Right	DNE	78'	335'+140' T (EPC)	77'	335'+140' T (EPC)
Northbound Left	DNE	106'	340'+200' T (CS)	152'	390'+200' T (CS)
Southbound Right	DNE	25'	235'+200' T (CS)	25'	235'+200' T (CS)
Internal Access Intersection (#6)					
Westbound Left	DNE	25'	C	50'	C
Westbound Right	DNE	25'	235' (EPC)	25'	235'(EPC)
Internal Air Lane Intersection (#7)					
Westbound Right	DNE	25'	135' (EPC)	25'	135'(EPC)

* = Maximum Possible Length, DL = Dual Left Turn Lanes, TL = Triple Left Turn Lanes, DNE = Does Not Exist, C = Continuous Lane, FREE = Free Right Turn Movement, NA = Not Applicable, (CDOT) = CDOT Standard, (CS) = Colorado Springs Standard, (EPC) = El Paso County Standard, **Blue text = Improvement or New Turn Lane**

Turn lane lengths along Marksheffel Road were recommended based on City of Colorado Springs standards, whereas internal turn lane lengths are based on El Paso County Standards. It should be noted that 95th percentile vehicle queue lengths were recommended if they were reporting lengths longer than design standards.

Left turn lanes are warranted along El Paso County roadways when the left turning volume is greater than 25 vehicles per hour while right turn lanes are warranted when the right turning volumes is greater than 50 vehicles per hour. According to Section 3.5: Auxiliary Turn Lanes of the CDOT Access Code which the El Paso County Standards are based on, the auxiliary lanes required in the category design standards may be waived when the 20-year horizon predicted roadway volumes conflicting with the turning vehicle are below the following minimum volume thresholds. The right turn lane may be dropped if the volume if the travel lane is predicted to be below 150 directional hourly volumes (DHV). The left turn lane may be dropped if the opposing traffic is predicted to be below 100 DHV. This waiver was applied to the internal street intersections.

Based on El Paso County standards for a design speed of 35 mph, the recommended left-turn lanes and right turn lanes internal to Crossroads North should provide 135 feet of deceleration length plus 140-foot tapers while all left turn lanes and right turn lanes that require a stop will also provide a storage length (determined from ECM Table 2-30 for each location).

To meet El Paso County standards, it is recommended that a 335-foot eastbound right turn lane be designated at south access along Marksheffel Road (#5). It is recommended that a 235-foot westbound right turn lane be designated at the Crossroads North internal intersection #6. A 135-foot westbound right turn lane is recommended to be designated at the Air Lane Intersection (#7).

5.8 Crossroads North: North Access Sensitivity Analysis

A sensitivity analysis within Crossroads North has been prepared comparing the north access along Marksheffel Road as a full movement signalized intersection and a three-quarter movement unsignalized intersection. As such, an intersection operational, vehicle queuing, signal progression, and safety evaluation has been analyzed and prepared comparing both access scenarios.

Intersection Operational Analysis

A traffic operational analysis comparing the north access along Marksheffel Road as a full movement signalized intersection and as a three-quarter movement unsignalized intersection has been evaluated to determine operational differences. **Table 9** provides the results of the level of service at the two control access intersections (#4 and #5) for both access scenarios to Crossroads North.

Table 9 – Crossroads North Access Scenarios LOS Results

Access and Movement	2026 Total Traffic				2040 Total Traffic			
	AM Peak Hour		PM Peak Hour		AM Peak Hour		PM Peak Hour	
	Control Delay (sec/veh)	LOS	Control Delay (sec/veh)	LOS	Control Delay (sec/veh)	LOS	Control Delay (sec/veh)	LOS
Crossroads North: Marksheffel Road North Access (#4) (3/4 Movements – Unsignalized)					#	#	#	#
Northbound Left	15.6	C	12.9	B	12.3	B	14.9	B
Eastbound Right	17.8	C	14.8	B	13.9	B	14.4	B
Crossroads North: Marksheffel Rd North Access (#4) (Full Movements - Signal)	8.6	A	6.7	A	3.9	A	3.1	A
Crossroads North: Marksheffel Rd South Access (#5) (Signal w/ North Access 3/4 Movements)	15.6	B	14.4	B	29.2	C	25.5	C
Crossroads North: Marksheffel Rd South Access (#5) (Signal w/ North Access Signalized)	8.2	A	9.4	A	8.7	A	7.6	A

= Three northbound and southbound through lanes

As shown in **Table 9**, both proposed access intersections (#4 and #5) to Crossroads North along Marksheffel Road are expected to operate acceptably with LOS C or better during the peak hours

under both access scenarios. It should be noted that the south access (#5) along Marksheffel Road is expected to have delays increase by approximately 20 seconds (from LOS A to LOS C) during the peak hours in 2040 if the north access is unsignalized.

Vehicle Queuing Analysis

A vehicle queuing analysis comparing the north access along Marksheffel Road as a full movement signalized intersection and as a three-quarter movement unsignalized intersection has been evaluated to determine potential vehicle queuing deficiencies. **Table 10** provides the results of the 95th percentile vehicle queues at the two control access intersections (#4 and #5) for both access scenarios to Crossroads North.

Table 10 – Crossroads North Access Scenarios Vehicle Queuing Results

Intersection Turn Lane	2026 Calculated Queue Length (feet)	2040 Calculated Queue Length (feet)
Crossroads North: Marksheffel Rd North Access (#4) (3/4 Movements – Unsignalized)		#
Eastbound Right	25'	25'
Northbound Left	25'	25'
Crossroads North: Marksheffel Rd North Access (#4) (Full Movements - Signal)		#
Eastbound Left	126'	137'
Eastbound Right	50'	52'
Northbound Left	35'	57'
Southbound Right	83'	120'
Crossroads North: Marksheffel Rd North Access (#5) (Signal w/ North Access 3/4 Mvmts)		#
Eastbound Left	192'	218'
Eastbound Right	70'	71'
Northbound Left	120'	171'
Southbound Right	41'	79'
Crossroads North: Marksheffel Rd North Access (#5) (Signal w/ North Access Signalized)		#
Eastbound Left	105'	111'
Eastbound Right	78'	77'
Northbound Left	106'	152'
Southbound Right	25'	25'

= Three northbound and southbound through lanes

As shown in **Table 10**, vehicle queues are relatively uniform between the two access intersections when both are signalized. Eastbound left exiting vehicle queues are longer at the south access intersection when the north access intersection is stop control controlled as all traffic with destinations to the north are routed through the south access.

Signal Progression Analysis

A traffic signal progression analysis was conducted along the approximate 1.6-mile-long segment of Marksheffel Road from Meadowbrook Parkway to the north to the proposed Reagan Ranch full access to the south due to the proposed signalization of the south access intersections (#5) to Crossroads North, the Space Village Avenue intersection as well as one of the proposed Reagan Ranch accesses. Although the Marksheffel Road North Access (#4) is recommended as a three-quarter movement for purposes of this signal progression analysis it was included as a signalized intersection to be conservative. As such, four (4) new signalized intersections and three (3) existing signalizations for a total of seven (7) signalized intersections were evaluated for progression along this corridor. Further, a comparison evaluation was conducted with the north access (#4) to Crossroads North along Marksheffel Road operating with stop control. In the second scenario, six (6) signalized intersections were evaluated for progression along the Marksheffel Road corridor.

The signal progression analysis was conducted to determine if the four traffic signals proposed along Marksheffel Road would interrupt the northbound and southbound bandwidth and platooning of vehicles along Marksheffel Road. Bandwidth is the window of time within the cycle length of a traffic signal that allows vehicles to travel through coordinated intersections without stopping. The goal of signal coordination is to provide sufficient bandwidth to allow for the progression of traffic along a corridor. Intersection coordination bandwidths for the study area were estimated using *Synchro 10* and were evaluated under full buildout 2040 total traffic conditions during the weekday morning and afternoon peak hours.

With the intersection of Space Village Avenue/Marksheffel Road and three proposed access intersections (#4 and #5) along Marksheffel Road (two accesses to Crossroads North and one access to Reagan Ranch) as signalized intersections and coordinated with the intersections of Meadowbrook Parkway/Marksheffel Road, US-24/Marksheffel Road, and SH-94/Marksheffel

Road, the available vehicle bandwidth through the studied Marksheffel Road corridor is anticipated to be 43 seconds northbound and 44 seconds southbound during the morning peak hour in 2040. Likewise, the bandwidth during the afternoon peak hour is anticipated to be 36 seconds northbound and 37 seconds southbound in 2040. These bandwidths equate to a platoon efficiency of approximately 36/37 percent and 30/31 percent in the morning and afternoon peak hours, respectively.

With the north access (#4) to Crossroads North along Marksheffel Road operating with stop control, the six (6) studied signalized intersections along the Marksheffel Road corridor are expected to have an available bandwidth of 45 seconds northbound and 49 seconds southbound during the morning peak hour in 2040. Likewise, the bandwidth during the afternoon peak hour is anticipated to be 36 seconds both northbound and southbound in 2040. These bandwidths equate to a platoon efficiency of approximately 38/41 percent and 30 percent in the morning and afternoon peak hours, respectively. The following **Table 11** summarizes the available bandwidths and platoon efficiencies for both access scenarios withing Crossroads North.

Table 11 – Signal Progression Comparison

Analysis Year and Peak	Bandwidth (seconds)		Platoon Efficiency (%)	
	Northbound	Southbound	Northbound	Southbound
Crossroads North: Signalized North Access (7 studied signalized intersections)				
2040 Total AM	43 sec.	44 sec.	36%	37%
2040 Total PM	36 sec.	37 sec.	30%	31%
Crossroads North: Unsignalized North Access (6 studied signalized intersections)				
2040 Total AM	45 sec.	49 sec.	38%	41%
2040 Total PM	36 sec.	36 sec.	30%	30%

Marksheffel Road is comparable to a NR-B: Non-Rural Arterial as defined in the State of Colorado State Highway Access Code. A goal platoon efficiency for an NR-B corridor is typically 30 percent or better, which has been achieved in 2040 for both directions of travel under both access scenarios. Therefore, it is believed that traffic signals at the intersections of Space Village Avenue/Marksheffel Road, two Crossroads North accesses (#4 and #5) and Marksheffel Road, and Reagan Ranch Full Movement Access/Marksheffel Road would maintain an acceptable

platoon efficiency along the Marksheffel Road corridor if coordinated with the adjacent traffic signals. Time-space diagrams for the corridor are attached in **Appendix G**.

Safety Evaluation

The north access to Crossroads North along Marksheffel Road meets standards for capacity operations, vehicle queues, and signal progression under a signal control. Further, national standards are met for signal warrants, sight distance, and intersection spacing at this access.

5.9 Safety Analysis

As requested by the State of Colorado Department of Transportation (CDOT) a Safety Analysis was performed for the state highway intersections in association with this project. Crash data was obtained for the most recent three-year timeframe available from January 2017 through December 2019, as provided in **Appendix H**. The following provides a discussion of the crash data and projections on an intersection-by-intersection basis.

US-24 and Marksheffel Road (#1)

A total of 35 crashes were reported at the intersection of US-24 and Marksheffel Road in the three-year study timer period. These 35 crashes resulted in 36 injuries and no fatalities. Most of the crashes occurred between two vehicles (29 crashes), with four crashes being single vehicle and two crashes including three or more vehicles. Of the 35 crashes, 24 occurred during daylight conditions, one at dawn or dusk, and 10 under dark conditions. The highest proportion of crashes were rear end (10 crashes) and approach turn (10 crashes). Additional crash types were broadside (6 crashes), sideswipe same (4 crashes), overturning (2 crashes), fixed objects (2 crashes), and sideswipe opposite (1 crash). Weather conditions were predominately nice with 31 crashes reported during no weather condition, one with rain, one with snow, one with fog, and one with wind. The crash rate is 83.79 per million vehicle miles traveled. In 2019, there were a total of 16 crashes at this intersection. With traffic volumes at this intersection anticipated to increase by 28 percent to 2026, the number of crashes at this intersection may increase to 20 per year. Recent improvements at this intersection (incorporated after the 2019 crash data) include dual left turn lanes from US-24 to southbound Marksheffel Road, which may improve intersection operations and safety. By 2040, traffic volumes are anticipated to increase by 73 percent. Therefore, crashes may be on the order of magnitude of 28 per year in the twenty-year planning

horizon. In the 2040 horizon, three through lanes are anticipated on all four approaches to this intersection.

US-24 and SH-94 (#2)

A total of 24 crashes were reported at the US-24 and SH-94 intersection in the three-year study timer period. These 24 crashes resulted in 19 injuries and no fatalities. Most of the crashes occurred between two vehicles (17 crashes), with one crash being a single vehicle and six crashes including three or more vehicles. Of the 24 crashes, 16 occurred during daylight conditions, two at dawn or dusk, and six under dark conditions. The highest proportion of crashes were rear end (12 crashes). Additional crash types were broadside (6 crashes), approach turn (4 crashes), sideswipe same (1 crash), and fixed objects (1 crash). Weather conditions were predominately nice with 22 crashes reported during no weather condition, one with rain, and one with snow. The crash rate is 38.45 per million vehicle miles traveled. In 2019, there were a total of 10 crashes at this intersection. With traffic volumes at this intersection anticipated to increase by 41 percent to 2026, the number of crashes at this intersection may increase to 14 per year. Improvements proposed by 2026 include triple westbound left turn lanes, dual northbound left turn lanes, and three through lanes on US-24. By 2040, traffic volumes are anticipated to increase by 87 percent. Therefore, crashes may be on the order of magnitude of 19 per year in the twenty-year planning horizon. Grade separated features of this intersection are anticipated sometime in the future to include possibly a grade separated westbound left turn.

SH-94 and Marksheffel Road (#3)

A total of 15 crashes were reported at the intersection of SH-94 and Marksheffel Road in the three-year study timer period. These 15 crashes resulted in 10 injuries and one (1) fatality. The fatal crash occurred in June of 2018 where a bus carrying 15 people turned left and collided with an eastbound through passenger car on eastbound SH-94. There was no weather, it was daylight, and the roadway was dry. No impairment was suspected for either driver and no apparent contributing factor was identified. It was noted that the both the eastbound and westbound left turns operate under permissive-only phasing. Safety could be improved of this intersection to implement protected/permitted or protected-only eastbound and westbound left turn phasing.

Most of the crashes occurred between two vehicles (13 crashes), with one crash being a single vehicle and one crash including three or more vehicles. Of the 15 crashes, 11 occurred during daylight conditions, one at dawn or dusk, and 3 under dark conditions. The highest proportion of crashes were rear end (6 crashes) and approach turn (5 crashes). Additional crash types were broadside (3 crashes) and domestic animal (1 crash). Weather conditions were predominately nice with 14 crashes reported during no weather condition and one with wind. The crash rate is 62.75 per million vehicle miles traveled due to the fatality. In 2019, there were a total of 7 crashes at this intersection. With traffic volumes at this intersection anticipated to increase by 53 percent to 2026, the number of crashes at this intersection may increase to 11 per year. The improvements proposed by this horizon include extending the eastbound and westbound left and right turn deceleration lanes along SH-94 to meet CDOT standards. In addition, acceleration lanes are proposed. These auxiliary turn lane improvements are anticipated to improve safety of the intersection. By 2040, traffic volumes are anticipated to increase by 139 percent. Therefore, crashes may be on the order of magnitude of 17 per year in the twenty-year planning horizon. Improvements anticipated at this horizon include two eastbound and westbound through lanes along SH-94 and three northbound and southbound through lanes along Marksheffel Road. The eastbound and westbound left turns should operate with protected/permitted left turn phasing.

Although these calculate possible future crashes at the key study intersections, vehicle technology is expected to continue to evolve with connected vehicles and autonomous safety features, which is anticipated to improve roadway safety. Therefore, the number of crashes may not increase at the same rate of the traffic volume increases as identified herein.

5.10 Road Impact Fees

Road impact fees were evaluated based on the El Paso County Road Impact Fee Schedule. The road impact fee for the proposed Crossroads North project is expected to be \$1,807,338. Road impact fee calculations are shown in **Table 12**. During the final plat process, the project team will determine if the impact fees are paid up front or if the property will be included in one of the available public improvement districts with reduced upfront costs. The project team will determine payment methods with the final plat. The improvements along CDOT highways will be appropriately coordinated with CDOT while Marksheffel Road will be controlled by the City of Colorado Springs. The internal roadways to the project are not identified in the MTCP; therefore,

it is believed that improvements identified in this study are not reimbursable under the current MTCP.

Table 12 – Road Impact Fees

Use	Units	Per 1,000 SF or DU	Fee / Unit	Per Use Fee
Crossroads North				
Public Park (ITE 411)	50,000	50	3,372.00	\$168,600.00
Movie Theatre (ITE 444)	52,000	52	4,958.00	\$257,816.00
Tire Superstore (ITE 849)	7,000	7	4,958.00	\$34,706.00
Home Improvement Superstore (ITE 862)	127,000	127	4,958.00	\$629,666.00
Furniture Store (ITE 890)	114,000	114	4,958.00	\$565,212.00
Sit Down Restaurant (ITE 932)	11,000	11	4,958.00	\$54,538.00
Fast-Food Restaurant (ITE 934)	5,000	5	8,800.00	\$44,000.00
Gas Station Super Convenience (ITE 960)	6,000	6	8,800.00	\$52,800.00
Crossroads North Road Impact Fee				\$1,807,338.00

5.11 Deviations from El Paso County Standards

Traffic volume projections along Air Lane meet the characteristics of an Urban Non-Residential Collector Street. Air Lane is designed with a modified cross section within the existing 60-foot ROW. The standard cross section includes two 18-foot travel lanes, a 12-foot median within 48 feet of pavement width, two 5-foot sidewalks, two 2.5-foot curb and gutters, two 8-foot tree lawns, with two 1-foot easements on both sides. The modified Air Lane cross section includes two 11-foot eastbound egress lanes at Marksheffel Road, and a 12-foot receiving lane, two 2.5-foot curb and gutters, and 23 feet of public improvements easements (11 feet on southern side and 12 feet on northern side of modified cross section). A deviation will need to be provided for this modified urban non-residential cross section along Air Lane for the County to consider for approval.

5.12 Improvement Summary

Based on the results of the level of service operational and turn lane analysis for the study area in the 2026 short term and 2040 long-term twenty-year horizons, anticipated improvements are identified as shown in **Figures 14** and **15**, respectively. Likewise, a recommended improvements summary table is provided in **Table 13**. The recommended improvements are based on the analysis provided for this area of Colorado Springs considering existing traffic volumes, background traffic volume growth from other development projects, and the project area. The improvements identified are not solely needed to accommodate Crossroads North, as it is the existing and background traffic volume growth that contribute to the improvement needs as well.

Table 13 – Crossroads North Improvement Summary

Intersection	Improvements	Horizon Year Needed	Associated Development Area
US-24 & Marksheffel Road (#1)	Three through lanes on all four approaches	2040	Regional
SH-94 & US-24 (#2)	Designate northbound dual left turn lanes with 850-feet plus 225-foot taper	Full Buildout	Crossroads Mixed Use
	Provide triple westbound left turn lanes with 645 feet plus 145-foot taper	Full Buildout	Reagan Ranch
	Extend eastbound to southwestbound right turn acceleration lane from 760 feet to 960 feet	Full Buildout	Crossroads Mixed Use
	Three US-24 northbound and southbound through lanes	Full Buildout	Regional
SH-94 & Marksheffel Road (#3)	Extend the 300-foot eastbound left turn lane to 750 feet with a 225-foot taper	Full Buildout	Crossroads North
	Extend the 250-foot eastbound right turn lane to 600 feet with a 225-foot taper	Full Buildout	Reagan Ranch
	Extend the 225-foot westbound left turn lane to 650 feet with a 225-foot taper	Full Buildout	Reagan Ranch
	Extend the 250-foot westbound right turn lane to 600 feet with a 225-foot taper	Full Buildout	Crossroads North
	Provide northbound to eastbound right turn acceleration lane	Full Buildout	Reagan Ranch
	Provide southbound to westbound right turn acceleration lane	Full Buildout	Crossroads North
	Provide northbound dual left turn lanes	2040	Reagan Ranch
	Provide two through lanes both eastbound and westbound and three through lanes both northbound and southbound	2040	Regional
All Development Accesses and Internal Intersections (#4-7)	All Access and Internal Intersections	Full Buildout	Crossroads North

Revise to detail aux lanes and tapers for internal roads.

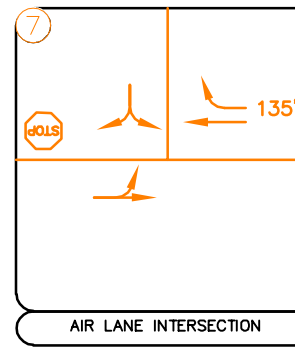
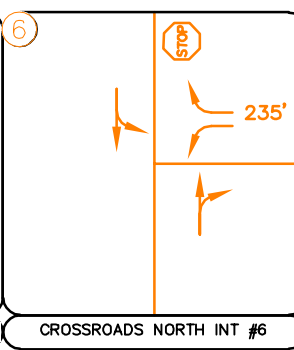
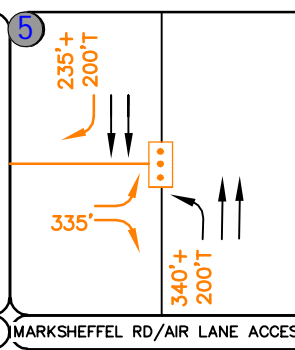
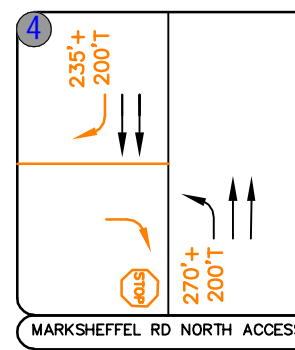
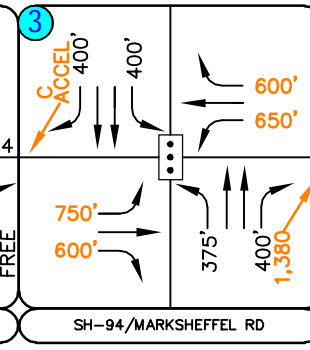
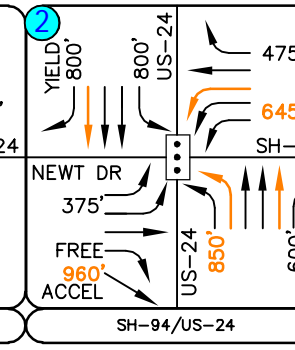
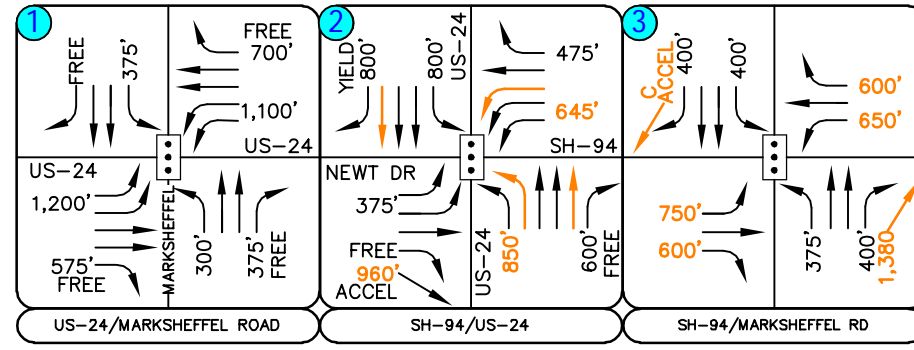
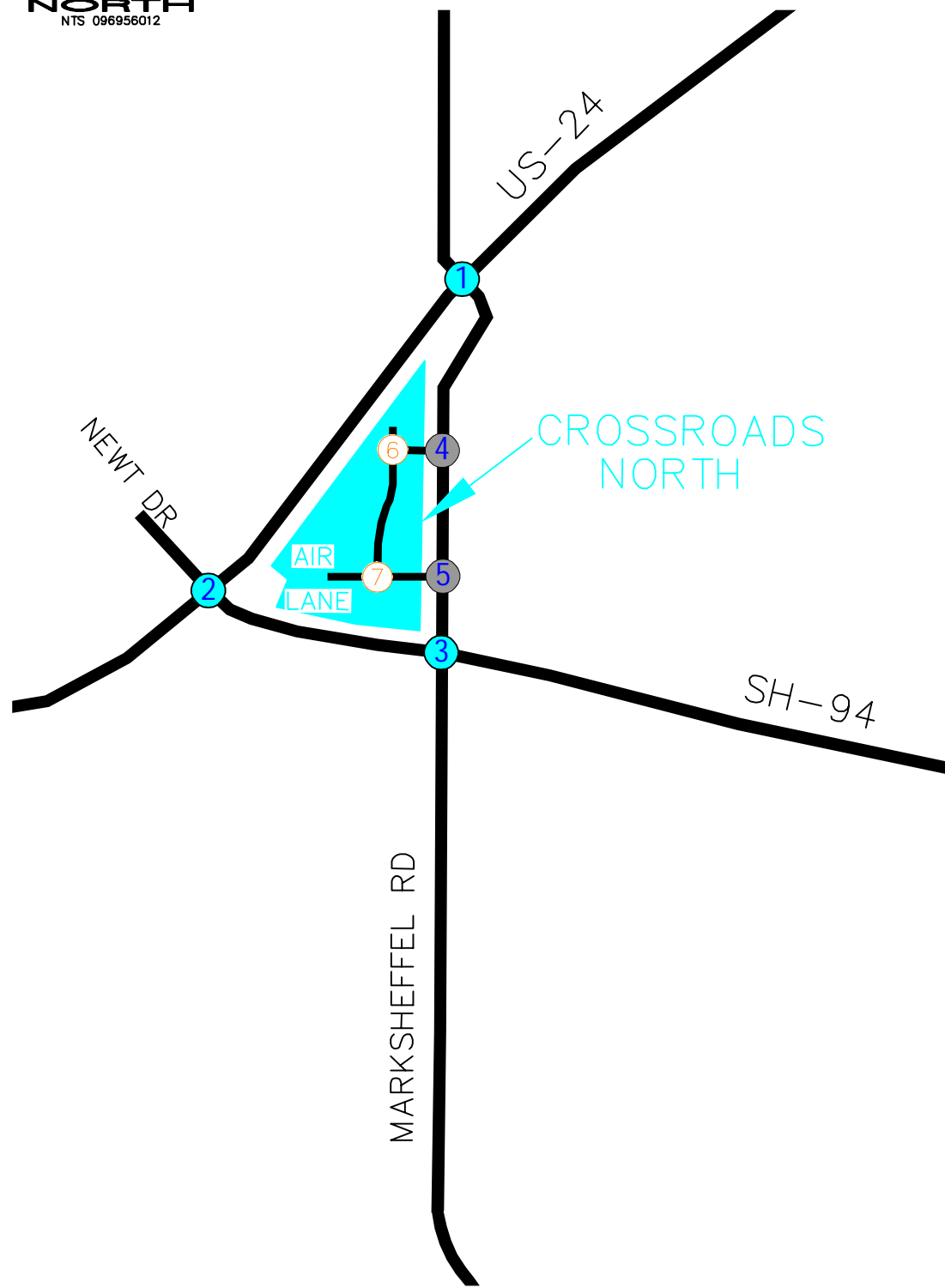

LEGEND

Existing Key Intersection	Signalized Intersection
Proposed Access Intersection	Stop Controlled Approach
Proposed Internal Intersection	Continuous Lane
Improvement	ACCEL Acceleration Lane
Taper	100' Turn Lane Length (feet)
FREE Free Right Turn Lane	

CROSSROADS NORTH
COLORADO SPRINGS, CO
2026 RECOMMENDED LANE CONFIGURATIONS

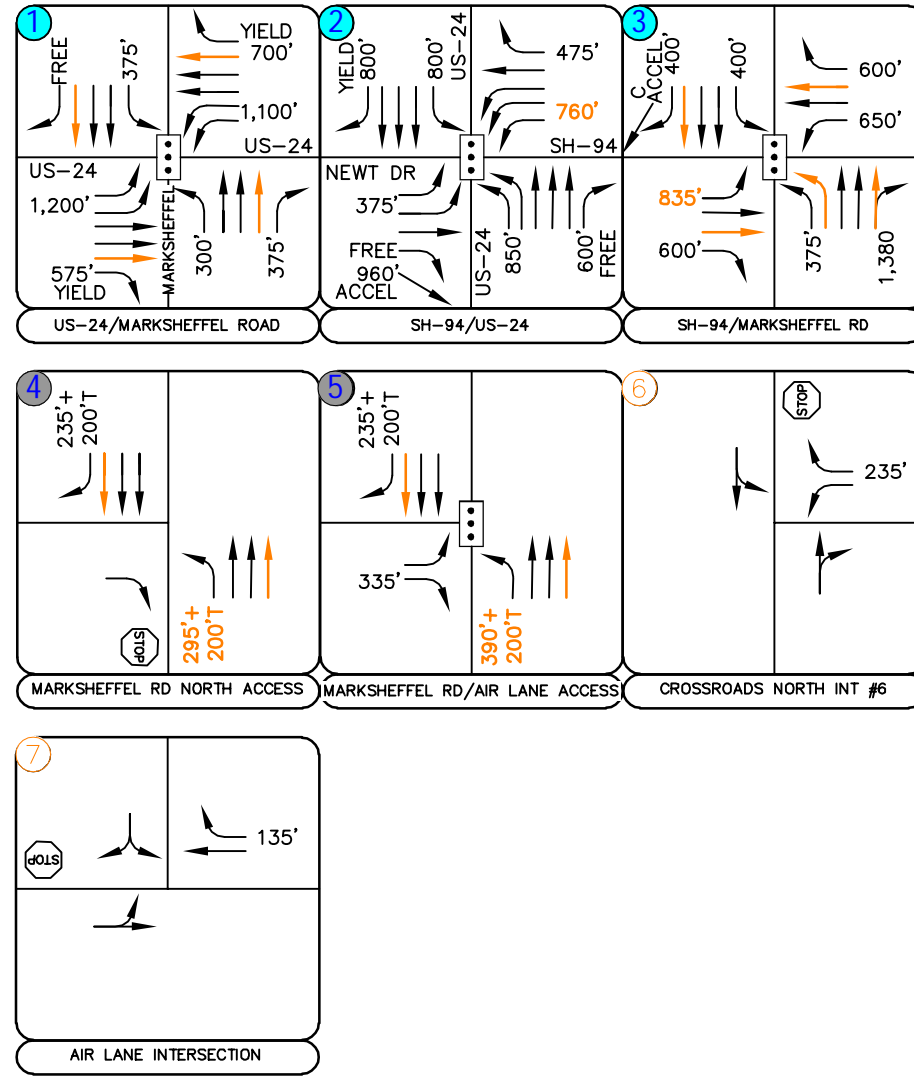
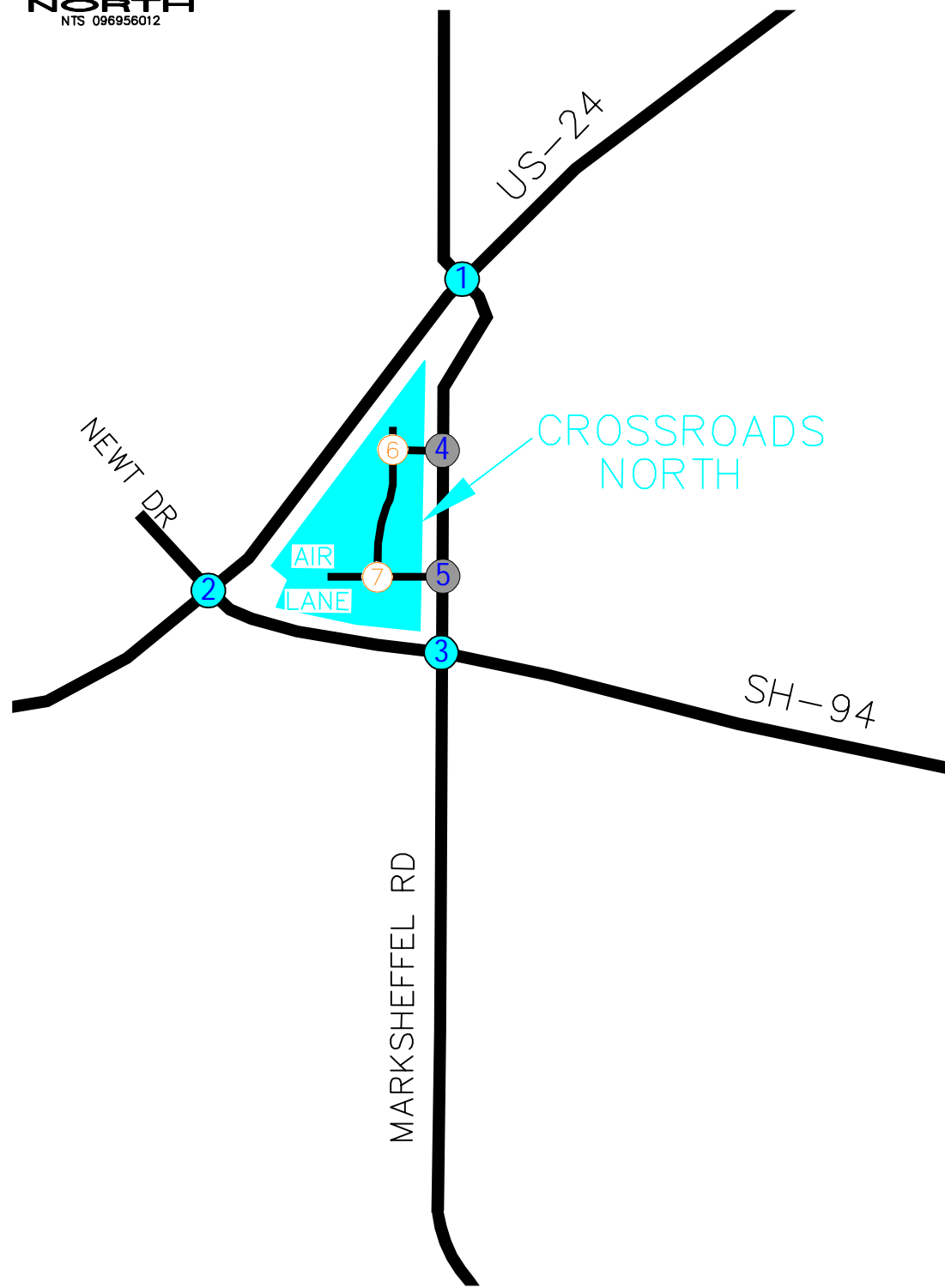

LEGEND			
	Existing Key Intersection		Signalized Intersection
	Proposed Access Intersection		Stop Controlled Approach
	Proposed Internal Intersection		Continuous Lane
	Improvement		ACCEL Acceleration Lane
	Taper		100' Turn Lane Length (feet)
	Free Right Turn Lane		

CROSSROADS NORTH
COLORADO SPRINGS, CO
2040 RECOMMENDED LANE CONFIGURATIONS

6.0 CONCLUSIONS AND RECOMMENDATIONS

Based on the complete analysis of the project area including existing and background traffic volumes from other sources and developments presented in this report, Kimley-Horn believes the Crossroads North development will be successfully incorporated into the existing and future roadway network. All of the area traffic combined including the proposed background traffic volume growth, project development, and expected future traffic volumes in the 2026 and 2040 full buildout horizons resulted in the following conclusions and recommendations:

2026 Recommendations:

- CDOT will likely require Access Permits for the intersections of SH-94/US-24 (#2) and SH-94/Marksheffel Road (#3) in association with the project.
- The intersection of SH-94/US-24 (#2) currently operates poorly during the peak hours in the existing condition. As a regional capacity improvement, it was found that US-24 may need to provide three through lanes in each direction from the Peterson Road interchange through this intersection with SH-94 in the near-term horizon. The additional through lanes should be considered by CDOT in the near future. If and when US-24 is improved to provide three through lanes in each direction, it is recommended that a separate 600-foot plus 225-foot taper right turn deceleration lane be constructed to maintain free right turn movements to eastbound SH-94. For southwestbound US-24 at SH-94 (#2), the existing acceleration lane along US-24 will need to be reconstructed with 960 feet of length plus a 225-foot taper if and when US-24 is improved to provide three through lanes along westbound US-24. For northeastbound US-24 at SH-94, it is recommended that this acceleration lane be converted to the third northbound through lane as the acceleration lane is not warranted. Further, the northeastbound US-24 third through lane needs to continue for 1,200 feet plus provide a 660-foot taper based on MUTCD standards. In addition to these regional improvements, it is recommended that the existing single 900-foot left turn lane be changed to 850-foot plus 225-foot taper with dual left turn lanes on the northeastbound US-24 approach for the left turn to Newt Drive. The area for these dual lefts is presently available (mostly); however, the lane is striped out which will require restriping with a slight extension that may also need to be constructed. Also, at the intersection of US-24 and SH-94 (#2), the existing dual westbound

left turn lanes on SH-94 should be converted to triple left turn lanes by restriping the inside westbound through lane to a left turn lane. The inside two westbound left turn lanes should be extended to a length of 760 feet plus a 225-foot taper per CDOT requirements. Three receiving lanes will be available with the expansion of US-24 to three westbound lanes to the Peterson Road interchange off-ramp. A traffic signal modification will be required at the intersection to incorporate all of these improvements. As requested by CDOT, an additional analysis was performed with an interchange grade separation including a westbound left turn flyover ramp condition. With this westbound left turn flyover ramp and the existing two through lanes in each direction along US-24, the intersection of SH-94 and US-24 (#2) is expected to operate acceptably with LOS D during the peak hours in 2026 and LOS E during the peak hours in 2040. With three through lanes in each direction along US-24 and the implementation of the westbound left turn flyover ramp, this intersection is expected to operate acceptably during the peak hours in 2040.

- At SH-94 and Marksheffel Road (#3), it was found that the eastbound and westbound right turns should operate with overlap phasing, while the northbound and southbound right turns should operate with free movements with acceleration lanes constructed in accordance with the CDOT State Highway Access Code. The acceleration lane along westbound SH-94 is recommended to tie into the outside through lane on the approach to US-24. The eastbound left turn lane shall be extended to a length of 750 feet with a 225-foot taper while the westbound left turn lane should be extended to a length of 650 feet with a 225-foot taper. The eastbound and westbound right turn lanes should be extended to 600 feet. The eastbound acceleration lane from the Marksheffel Road northbound right turn should be constructed to 1,380 feet with a 300-foot taper. These improvements at this intersection may already be identified with the SH-94 improvements already being planned by CDOT.
- A traffic signal is anticipated to be needed and warranted at the south full movement access intersection (#5) along Marksheffel Road for Crossroads North. Therefore, a traffic signal is recommended for installation at this access intersection with development of Crossroads North. To meet Colorado Springs standards, the northbound left turn at the Marksheffel Road South Access (#5) should provide a turn lane length of 340 feet plus a 200-foot taper, whereas the southbound right turn lane should provide a lane length of 235 feet plus a 200-foot taper.

Lastly, separate eastbound left turn and right turn lanes are recommended to serve exiting traffic out of Crossroads North at this access.

- The Marksheffel Road North Access (#4) should operate as a three-quarter intersection with a R1-1 “STOP” sign installed on the eastbound approach. Based on Colorado Springs standards, the northbound left turn at the Marksheffel Road North Access (#4) should provide a turn lane length of 270 feet plus a 200-foot taper, whereas the southbound right turn lane should provide a lane length of 235 feet plus a 200-foot taper. A sensitivity analysis has been prepared later in Section 5.8 comparing the north access along Marksheffel Road as a full movement signalized intersection and a three-quarter movement unsignalized intersection.
- An internal street evaluation was conducted for the Crossroads North development area. The south access to Crossroads North along Marksheffel Road is proposed to be named Air Lane and is expected to be classified as an El Paso County Urban Non-Residential Collector roadway with a 60-foot right-of-way (ROW). Air Lane extends east/west and is proposed to connect with a north/south extending Non-Residential Collector Street (#7). Intersection #7 (collector to collector) is proposed to be located approximately 525 feet west of Marksheffel Road. The north/south extending Non-Residential Collector Street also connects with an east/west collector street (#6) that extends from the north access to Marksheffel Road. The north access street connecting with Marksheffel Road is proposed to be classified as an El Paso County Urban Non-Residential Collector roadway. To meet El Paso County standards for a design speed of 35 mph, the recommended left-turn lanes and right turn lanes internal to Crossroads North should provide 135 feet of deceleration length plus 140-foot tapers while all left turn lanes and right turn lanes that require a stop will also provide a storage length (determined from ECM Table 2-30 for each location).
- To meet El Paso County standards, it is recommended that a 335-foot eastbound right turn lane be designated at south access along Marksheffel Road (#5). It is recommended that a 235-foot westbound right turn lane be designated at the Crossroads North internal intersection #6. A 135-foot westbound right turn lane is recommended to be designated at the Air Lane Intersection (#7).

2040 Recommendations:

- If future traffic volume projections are realized, US-24 may need to provide three through lanes in each direction through the Marksheffel Road intersection. Likewise, Marksheffel Road between US-24 and Peterson Air Force Base East Gate may need to provide three through lanes in each direction. It is recommended that traffic volumes continue to be monitored by CDOT and the City of Colorado Springs, as applicable, to determine if and when these regional improvements will be needed. It is understood that US-24 and Marksheffel Road are identified with four-lane cross-sections. If future traffic projections are realized, additional right-of-way may need to be dedicated to account for six-lane cross sections along both US-24 and Marksheffel Road within the study limits.
- Several extensions of auxiliary turn lanes may be needed by 2040 and should be monitored by CDOT and the City of Colorado Springs, as applicable, to determine if and when the recommended turn lane lengths will be needed.

General Recommendations:

- Any on-site and off-site roadway, signing, striping, and signal improvements should be incorporated into the Civil Drawings, and conform to City of Colorado Springs and/or CDOT standards as applicable, as well as the Manual on Uniform Traffic Control Devices – 2009 Edition (MUTCD).

APPENDICES

APPENDIX A

Intersection Count Sheets

COVID-19 Count Adjustment Data



US 24 Marksheffel Rd

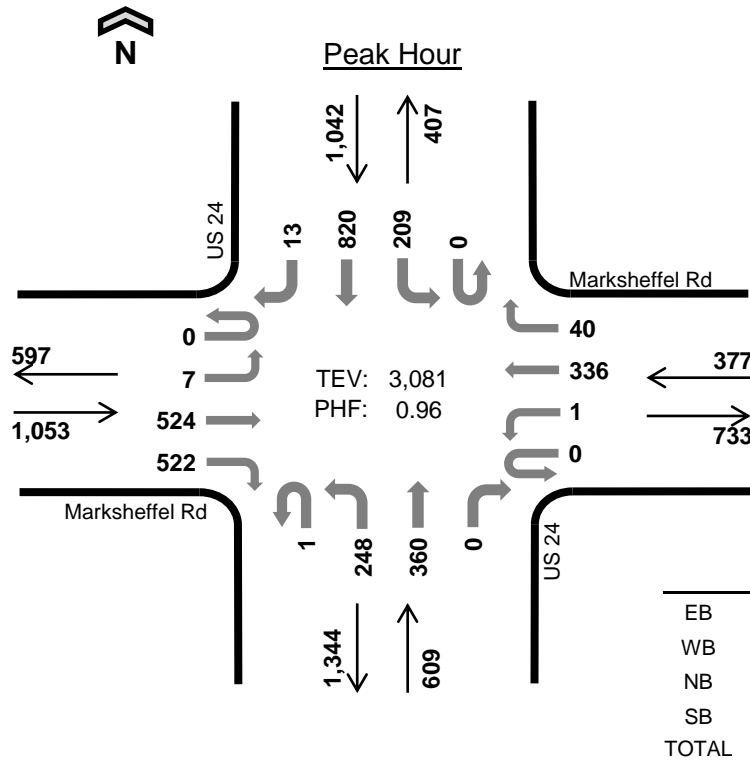

Date: Thu, Jun 04, 2020
Count Period: 7:00 AM to 9:00 AM
Peak Hour: 7:00 AM to 8:00 AM

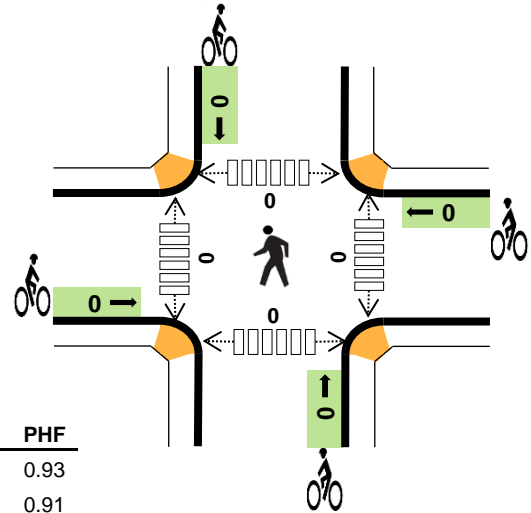

	HV %:	PHF
EB	5.5%	0.93
WB	3.2%	0.91
NB	10.5%	0.93
SB	3.9%	0.94
TOTAL	5.7%	0.96

Two-Hour Count Summaries

Interval Start	Marksheffel Rd				Marksheffel Rd				US 24				US 24				15-min Total	Rolling One Hour
	Eastbound				Westbound				Northbound				Southbound					
	UT	LT	TH	RT	UT	LT	TH	RT	UT	LT	TH	RT	UT	LT	TH	RT		
7:00 AM	0	0	122	138	0	0	94	6	0	68	96	0	0	50	203	1	778	0
7:15 AM	0	0	155	127	0	0	96	8	1	59	96	0	0	43	213	3	801	0
7:30 AM	0	3	123	142	0	1	80	14	0	62	78	0	0	59	214	5	781	0
7:45 AM	0	4	124	115	0	0	66	12	0	59	90	0	0	57	190	4	721	3,081
8:00 AM	0	8	106	109	0	2	57	17	0	50	75	0	0	37	125	7	593	2,896
8:15 AM	0	1	87	90	0	0	48	16	0	50	73	1	0	42	138	1	547	2,642
8:30 AM	0	3	83	105	0	1	84	13	0	48	71	0	0	30	155	1	594	2,455
8:45 AM	0	0	92	85	0	2	58	8	0	52	91	0	0	39	162	5	594	2,328
Count Total	0	19	892	911	0	6	583	94	1	448	670	1	0	357	1,400	27	5,409	0
Peak Hour	0	7	524	522	0	1	336	40	1	248	360	0	0	209	820	13	3,081	0

Note: Two-hour count summary volumes include heavy vehicles but exclude bicycles in overall count.

Interval Start	Heavy Vehicle Totals					Bicycles					Pedestrians (Crossing Leg)				
	EB	WB	NB	SB	Total	EB	WB	NB	SB	Total	East	West	North	South	Total
7:00 AM	18	3	10	8	39	0	0	0	0	0	0	0	0	0	0
7:15 AM	12	3	17	10	42	0	0	0	0	0	0	0	0	0	0
7:30 AM	14	4	21	13	52	0	0	0	0	0	0	0	0	0	0
7:45 AM	14	2	16	10	42	0	0	0	0	0	0	0	0	0	0
8:00 AM	9	3	18	11	41	0	0	0	0	0	0	0	0	0	0
8:15 AM	9	1	12	7	29	0	0	0	0	0	0	0	0	0	0
8:30 AM	9	2	10	9	30	0	0	0	0	0	0	0	0	0	0
8:45 AM	11	4	22	21	58	0	0	0	0	0	0	0	0	0	0
Count Total	96	22	126	89	333	0	0	0	0	0	0	0	0	0	0
Peak Hour	58	12	64	41	175	0	0	0	0	0	0	0	0	0	0



US 24 Marksheffel Rd

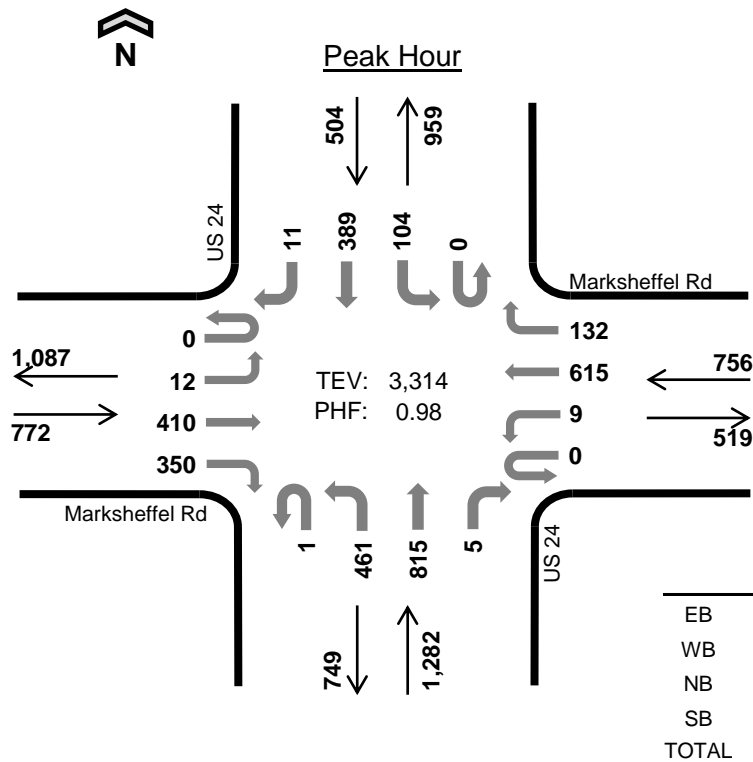

Date: Thu, Jun 04, 2020
 Count Period: 4:00 PM to 6:00 PM
 Peak Hour: 4:30 PM to 5:30 PM

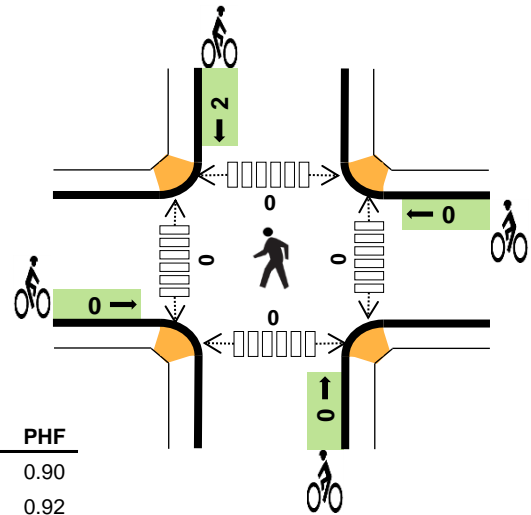

	HV %:	PHF
EB	2.8%	0.90
WB	1.3%	0.92
NB	1.7%	0.97
SB	2.8%	0.91
TOTAL	2.1%	0.98

Two-Hour Count Summaries

Interval Start	Marksheffel Rd				Marksheffel Rd				US 24				US 24				15-min Total	Rolling One Hour
	Eastbound				Westbound				Northbound				Southbound					
	UT	LT	TH	RT	UT	LT	TH	RT	UT	LT	TH	RT	UT	LT	TH	RT		
4:00 PM	0	2	102	84	0	3	163	33	0	78	159	0	1	21	132	0	778	0
4:15 PM	0	7	82	73	0	1	172	39	2	131	166	1	0	32	121	4	831	0
4:30 PM	0	4	92	73	0	4	165	37	0	119	207	0	0	23	100	2	826	0
4:45 PM	0	5	117	92	0	1	162	34	0	128	185	4	0	17	90	5	840	3,275
5:00 PM	0	3	96	92	0	2	140	34	1	96	210	1	0	27	101	1	804	3,301
5:15 PM	0	0	105	93	0	2	148	27	0	118	213	0	0	37	98	3	844	3,314
5:30 PM	0	3	111	87	0	1	115	29	0	108	178	1	0	15	109	2	759	3,247
5:45 PM	0	3	78	62	0	6	110	20	0	96	122	0	0	24	91	1	613	3,020
Count Total	0	27	783	656	0	20	1,175	253	3	874	1,440	7	1	196	842	18	6,295	0
Peak Hour	0	12	410	350	0	9	615	132	1	461	815	5	0	104	389	11	3,314	0

Note: Two-hour count summary volumes include heavy vehicles but exclude bicycles in overall count.

Interval Start	Heavy Vehicle Totals					Bicycles					Pedestrians (Crossing Leg)				
	EB	WB	NB	SB	Total	EB	WB	NB	SB	Total	East	West	North	South	Total
4:00 PM	12	3	7	8	30	0	0	0	0	0	0	0	0	0	0
4:15 PM	6	2	10	5	23	0	0	0	0	0	0	0	0	0	0
4:30 PM	4	4	6	6	20	0	0	0	1	1	0	0	0	0	0
4:45 PM	6	2	6	1	15	0	0	0	0	0	0	0	0	0	0
5:00 PM	7	2	6	3	18	0	0	0	0	0	0	0	0	0	0
5:15 PM	5	2	4	4	15	0	0	0	1	1	0	0	0	0	0
5:30 PM	6	0	5	5	16	0	0	0	0	0	0	0	0	0	0
5:45 PM	2	2	3	2	9	0	0	0	1	1	0	0	0	0	0
Count Total	48	17	47	34	146	0	0	0	3	3	0	0	0	0	0
Peak Hour	22	10	22	14	68	0	0	0	2	2	0	0	0	0	0



**US 24
SH 94**

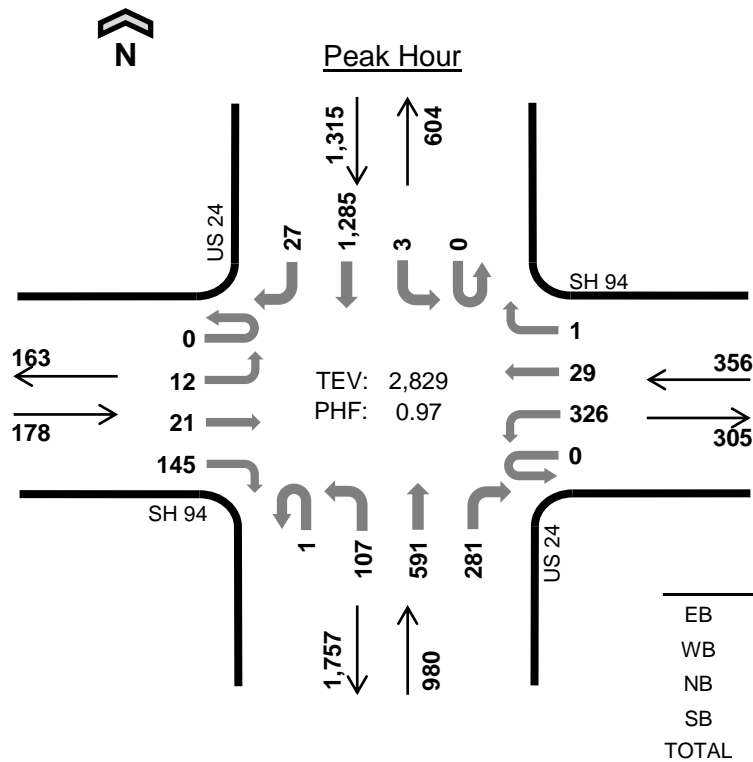

Date: Tue, Jun 02, 2020
 Count Period: 7:00 AM to 9:00 AM
 Peak Hour: 7:00 AM to 8:00 AM

	HV %:	PHF
EB	5.1%	0.77
WB	3.9%	0.88
NB	10.4%	0.97
SB	5.5%	0.96
TOTAL	7.0%	0.97

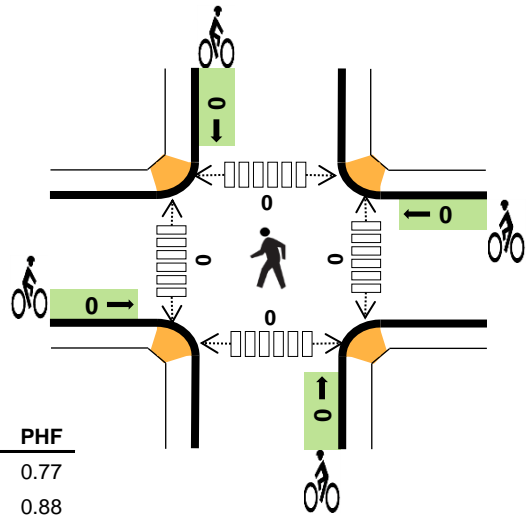

Two-Hour Count Summaries

Interval Start	SH 94 Eastbound				SH 94 Westbound				US 24 Northbound				US 24 Southbound				15-min Total	Rolling One Hour
	UT	LT	TH	RT	UT	LT	TH	RT	UT	LT	TH	RT	UT	LT	TH	RT		
	7:00 AM	0	1	6	45	0	81	10	0	0	27	147	65	0	1	319		
7:15 AM	0	6	7	21	0	90	10	1	0	25	145	79	0	0	336	8	728	0
7:30 AM	0	5	6	47	0	85	5	0	0	20	152	80	0	0	310	6	716	0
7:45 AM	0	0	2	32	0	70	4	0	1	35	147	57	0	2	320	6	676	2,829
8:00 AM	0	4	4	25	0	51	7	1	0	28	120	54	0	3	230	5	532	2,652
8:15 AM	0	4	4	34	0	51	6	0	1	17	107	64	0	1	207	10	506	2,430
8:30 AM	0	1	4	26	0	66	2	0	0	25	128	55	0	0	223	4	534	2,248
8:45 AM	0	3	7	29	0	48	6	1	1	23	131	44	0	1	197	9	500	2,072
Count Total	0	24	40	259	0	542	50	3	3	200	1,077	498	0	8	2,142	55	4,901	0
Peak Hour	0	12	21	145	0	326	29	1	1	107	591	281	0	3	1,285	27	2,829	0

Note: Two-hour count summary volumes include heavy vehicles but exclude bicycles in overall count.

Interval Start	Heavy Vehicle Totals					Bicycles					Pedestrians (Crossing Leg)				
	EB	WB	NB	SB	Total	EB	WB	NB	SB	Total	East	West	North	South	Total
7:00 AM	4	1	19	20	44	0	0	0	0	0	0	0	0	0	0
7:15 AM	0	5	27	16	48	0	0	0	0	0	0	0	0	0	0
7:30 AM	4	3	31	15	53	0	0	0	0	0	0	0	0	0	0
7:45 AM	1	5	25	21	52	0	0	0	0	0	0	0	0	0	0
8:00 AM	1	8	20	15	44	0	0	0	0	0	0	0	0	0	0
8:15 AM	3	2	24	9	38	0	0	0	0	0	0	0	0	0	0
8:30 AM	0	7	27	13	47	0	0	0	0	0	0	0	0	0	0
8:45 AM	2	5	15	18	40	0	0	0	0	0	0	0	0	0	0
Count Total	15	36	188	127	366	0	0	0	0	0	0	0	0	0	0
Peak Hour	9	14	102	72	197	0	0	0	0	0	0	0	0	0	0



**US 24
SH 94**

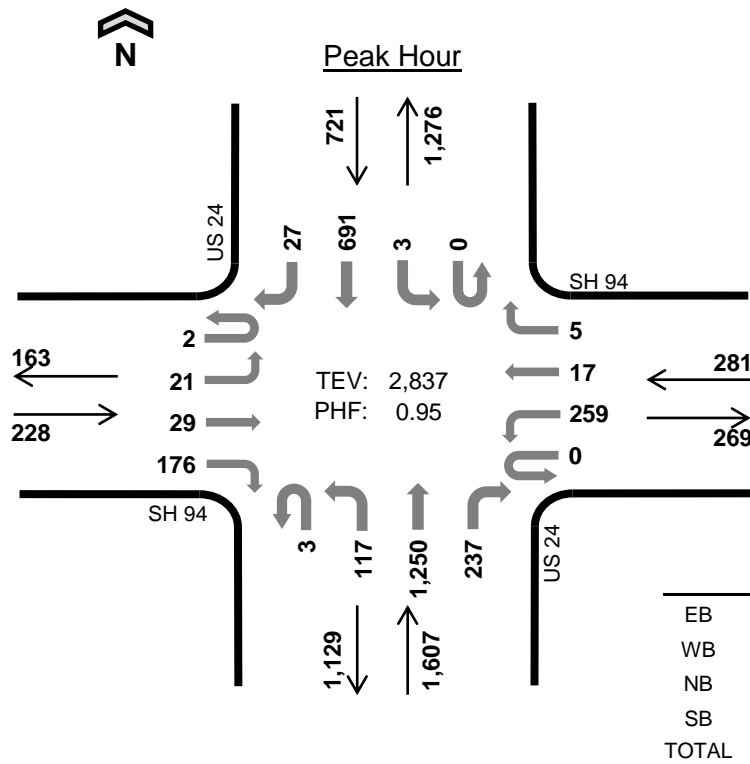

Date: Tue, Jun 02, 2020
Count Period: 4:00 PM to 6:00 PM
Peak Hour: 4:15 PM to 5:15 PM

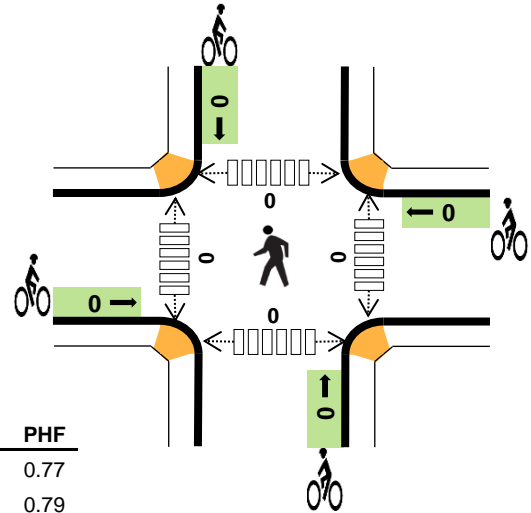

Two-Hour Count Summaries

Interval Start	SH 94				SH 94				US 24				US 24				15-min Total	Rolling One Hour
	Eastbound				Westbound				Northbound				Southbound					
	UT	LT	TH	RT	UT	LT	TH	RT	UT	LT	TH	RT	UT	LT	TH	RT		
4:00 PM	0	5	4	32	0	73	7	0	1	31	284	80	1	2	177	7	704	0
4:15 PM	0	5	4	45	0	51	2	2	1	30	327	62	0	3	153	7	692	0
4:30 PM	0	4	13	33	0	66	7	0	1	29	300	46	0	0	194	7	700	0
4:45 PM	0	9	1	40	0	83	5	1	0	31	307	53	0	0	158	7	695	2,791
5:00 PM	2	3	11	58	0	59	3	2	1	27	316	76	0	0	186	6	750	2,837
5:15 PM	0	8	7	36	0	49	8	0	0	19	299	80	0	0	170	8	684	2,829
5:30 PM	0	5	4	29	0	44	7	1	0	19	267	85	0	0	183	4	648	2,777
5:45 PM	0	3	8	24	0	38	4	1	0	12	252	62	0	0	142	10	556	2,638
Count Total	2	42	52	297	0	463	43	7	4	198	2,352	544	1	5	1,363	56	5,429	0
Peak Hour	2	21	29	176	0	259	17	5	3	117	1,250	237	0	3	691	27	2,837	0

Note: Two-hour count summary volumes include heavy vehicles but exclude bicycles in overall count.

Interval Start	Heavy Vehicle Totals					Bicycles					Pedestrians (Crossing Leg)				
	EB	WB	NB	SB	Total	EB	WB	NB	SB	Total	East	West	North	South	Total
4:00 PM	0	4	16	12	32	0	0	0	0	0	0	0	0	0	0
4:15 PM	0	3	11	12	26	0	0	0	0	0	0	0	0	0	0
4:30 PM	1	1	20	12	34	0	0	0	0	0	0	0	0	0	0
4:45 PM	1	1	14	5	21	0	0	0	0	0	0	0	0	0	0
5:00 PM	0	3	4	7	14	0	0	0	0	0	0	0	0	0	0
5:15 PM	1	2	10	6	19	0	0	0	0	0	0	0	0	0	0
5:30 PM	2	1	7	11	21	0	0	0	0	0	0	0	0	0	0
5:45 PM	1	2	3	7	13	0	0	0	0	0	0	0	0	0	0
Count Total	6	17	85	72	180	0	0	0	0	0	0	0	0	0	0
Peak Hour	2	8	49	36	95	0	0	0	0	0	0	0	0	0	0



Marksheffel Rd SH 94

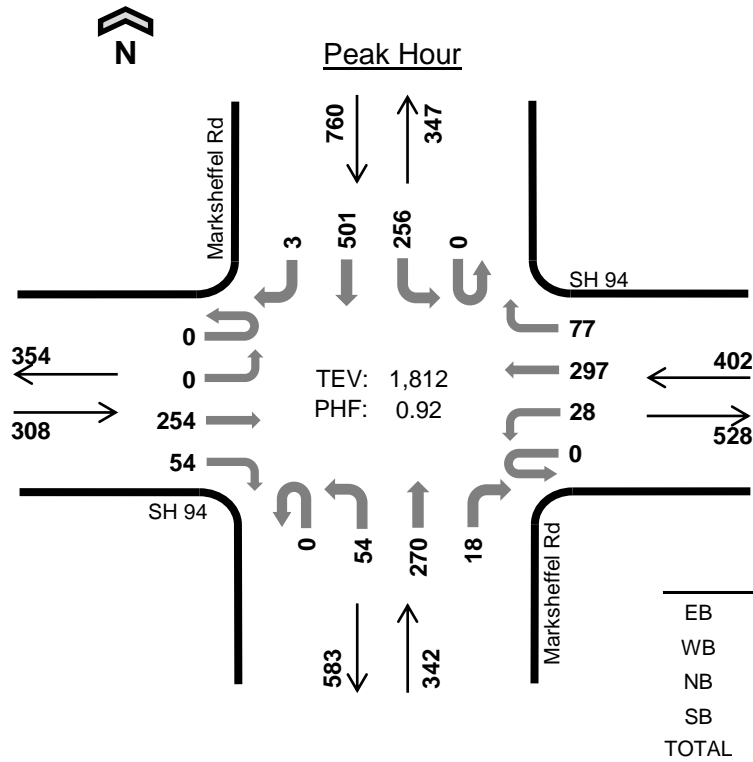

Date: Tue, Jun 02, 2020
Count Period: 7:00 AM to 9:00 AM
Peak Hour: 7:00 AM to 8:00 AM

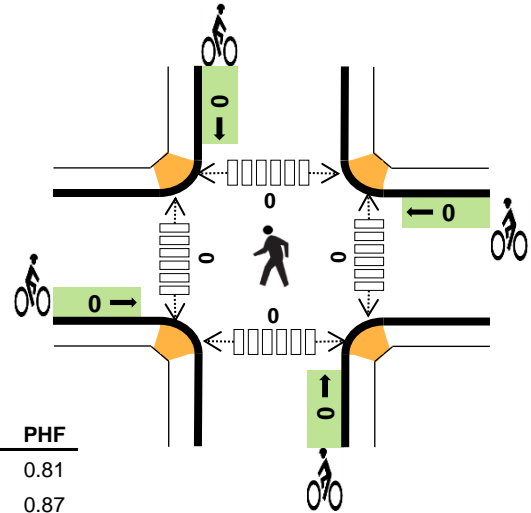

	HV %:	PHF
EB	8.1%	0.81
WB	5.5%	0.87
NB	4.7%	0.82
SB	2.6%	0.87
TOTAL	4.6%	0.92

Two-Hour Count Summaries

Interval Start	SH 94				SH 94				Marksheffel Rd				Marksheffel Rd				15-min Total	Rolling One Hour
	Eastbound				Westbound				Northbound				Southbound					
	UT	LT	TH	RT	UT	LT	TH	RT	UT	LT	TH	RT	UT	LT	TH	RT		
7:00 AM	0	0	57	8	0	2	73	22	0	11	71	7	0	79	110	0	440	0
7:15 AM	0	0	79	16	0	7	87	21	0	10	51	3	0	74	143	1	492	0
7:30 AM	0	0	61	21	0	8	69	13	0	24	76	4	0	67	133	1	477	0
7:45 AM	0	0	57	9	0	11	68	21	0	9	72	4	0	36	115	1	403	1,812
8:00 AM	0	4	39	14	0	2	43	12	0	10	50	2	0	47	115	1	339	1,711
8:15 AM	0	0	61	11	0	2	49	21	0	8	59	2	0	32	89	0	334	1,553
8:30 AM	0	1	50	15	0	6	67	25	0	9	52	4	0	32	85	1	347	1,423
8:45 AM	0	0	36	14	0	4	44	17	0	14	49	1	0	21	85	2	287	1,307
Count Total	0	5	440	108	0	42	500	152	0	95	480	27	0	388	875	7	3,119	0
Peak Hour	0	0	254	54	0	28	297	77	0	54	270	18	0	256	501	3	1,812	0

Note: Two-hour count summary volumes include heavy vehicles but exclude bicycles in overall count.

Interval Start	Heavy Vehicle Totals					Bicycles					Pedestrians (Crossing Leg)				
	EB	WB	NB	SB	Total	EB	WB	NB	SB	Total	East	West	North	South	Total
7:00 AM	4	2	5	5	16	0	0	0	0	0	0	0	0	0	0
7:15 AM	6	4	4	4	18	0	0	0	0	0	0	0	0	0	0
7:30 AM	9	6	4	8	27	0	0	0	0	0	0	0	0	0	0
7:45 AM	6	10	3	3	22	0	0	0	0	0	0	0	0	0	0
8:00 AM	3	7	2	9	21	0	0	0	0	0	0	0	0	0	0
8:15 AM	10	5	2	4	21	0	0	0	0	0	0	0	0	0	0
8:30 AM	8	5	8	7	28	0	0	0	0	0	0	0	0	0	0
8:45 AM	8	6	1	5	20	0	0	0	0	0	0	0	0	0	0
Count Total	54	45	29	45	173	0	0	0	0	0	0	0	0	0	0
Peak Hour	25	22	16	20	83	0	0	0	0	0	0	0	0	0	0



Marksheffel Rd SH 94

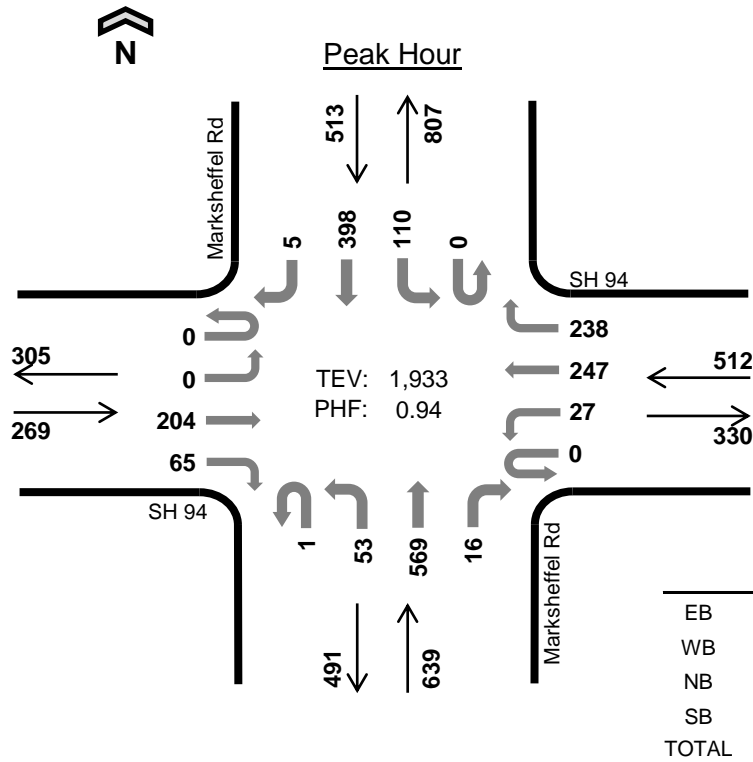

Date: Tue, Jun 02, 2020
Count Period: 4:00 PM to 6:00 PM
Peak Hour: 4:00 PM to 5:00 PM

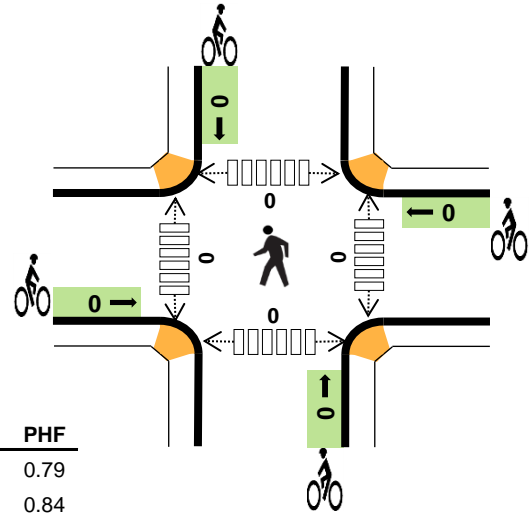

	HV %:	PHF
EB	3.3%	0.79
WB	2.7%	0.84
NB	2.3%	0.92
SB	3.9%	0.97
TOTAL	3.0%	0.94

Two-Hour Count Summaries

Interval Start	SH 94 Eastbound				SH 94 Westbound				Marksheffel Rd Northbound				Marksheffel Rd Southbound				15-min Total	Rolling One Hour
	UT	LT	TH	RT	UT	LT	TH	RT	UT	LT	TH	RT	UT	LT	TH	RT		
	4:00 PM	0	0	58	27	0	7	63	49	0	14	140	2	0	24	94		
4:15 PM	0	0	57	15	0	10	65	78	1	10	142	6	0	28	102	1	515	0
4:30 PM	0	0	42	13	0	6	47	62	0	12	159	2	0	25	105	1	474	0
4:45 PM	0	0	47	10	0	4	72	49	0	17	128	6	0	33	97	2	465	1,933
5:00 PM	1	1	72	14	0	5	52	48	0	8	107	2	0	20	84	2	416	1,870
5:15 PM	1	0	73	13	0	5	37	44	0	18	112	3	0	29	110	0	445	1,800
5:30 PM	0	0	69	19	0	1	40	31	0	12	75	3	0	28	115	0	393	1,719
5:45 PM	0	0	47	21	0	0	32	31	0	7	122	2	0	28	110	0	400	1,654
Count Total	2	1	465	132	0	38	408	392	1	98	985	26	0	215	817	7	3,587	0
Peak Hour	0	0	204	65	0	27	247	238	1	53	569	16	0	110	398	5	1,933	0

Note: Two-hour count summary volumes include heavy vehicles but exclude bicycles in overall count.

Interval Start	Heavy Vehicle Totals					Bicycles					Pedestrians (Crossing Leg)				
	EB	WB	NB	SB	Total	EB	WB	NB	SB	Total	East	West	North	South	Total
4:00 PM	1	5	4	7	17	0	0	0	0	0	0	0	0	0	0
4:15 PM	2	3	4	4	13	0	0	0	0	0	0	0	0	0	0
4:30 PM	2	4	5	8	19	0	0	0	0	0	0	0	0	0	0
4:45 PM	4	2	2	1	9	0	0	0	0	0	0	0	0	0	0
5:00 PM	1	2	2	4	9	0	0	0	0	0	0	0	0	0	0
5:15 PM	2	1	3	2	8	0	0	1	0	1	0	0	0	0	0
5:30 PM	3	0	2	1	6	0	0	0	0	0	0	0	0	0	0
5:45 PM	1	1	3	4	9	0	0	0	0	0	0	0	0	0	0
Count Total	16	18	25	31	90	0	0	1	0	1	0	0	0	0	0
Peak Hour	9	14	15	20	58	0	0	0	0	0	0	0	0	0	0

Station ID: 103943
 Date: 7/11/2019
 Route: 094A

Description: SH 94 E/O Marksheffel Rd, Colorado Springs

COUNTDIR	12:00 AM	1:00 AM	2:00 AM	3:00 AM	4:00 AM	5:00 AM	6:00 AM	7:00 AM	8:00 AM	9:00 AM	10:00 AM	11:00 AM	12:00 PM	1:00 PM	2:00 PM	3:00 PM	4:00 PM	5:00 PM	6:00 PM	7:00 PM	8:00 PM	9:00 PM	10:00 PM	11:00 PM			
P	21	16	9	23	82	299	705	500	366	246	211	243	253	246	252	271	391	383	282	193	178	120	99	54			
S	17	6	10	14	45	141	322	359	287	278	237	292	270	272	395	606	824	541	282	153	90	54	40	51			
								Marsheffel and SH 94		Peak Hour Counts		528	95%									Marsheffel and SH 94		Peak Hour Counts		330	118%
										Percent Difference		402	89%											Percent Difference		512	161%
												92%														144%	

Station ID: 100851
 Date: 2/20/2020
 Route: 024G

Description: SH 24 NE/O SH 94, Colorado Springs

COUNTDIR	12:00 AM	1:00 AM	2:00 AM	3:00 AM	4:00 AM	5:00 AM	6:00 AM	7:00 AM	8:00 AM	9:00 AM	10:00 AM	11:00 AM	12:00 PM	1:00 PM	2:00 PM	3:00 PM	4:00 PM	5:00 PM	6:00 PM	7:00 PM	8:00 PM	9:00 PM	10:00 PM	11:00 PM			
P	55	33	24	26	94	150	465	601	503	409	468	614	622	633	920	1088	1495	1289	704	712	452	268	159	82			
S	36	17	38	95	301	818	1863	1716	1023	715	636	665	609	577	613	655	693	685	369	224	183	124	79	53			
								US 24 and SH 94		Peak Hour Counts		604	100%									US 24 and SH 94		Peak Hour Counts		1276	117%
										Percent Difference		1315	130%											Percent Difference		721	96%
										121%												110%					
								US 24 and Marksheffel		Peak Hour Counts		609	99%									US 24 and Marksheffel		Peak Hour Counts		1282	117%
										Percent Difference		1344	128%											Percent Difference		749	93%
										119%												108%					



US 24 Marksheffel Rd

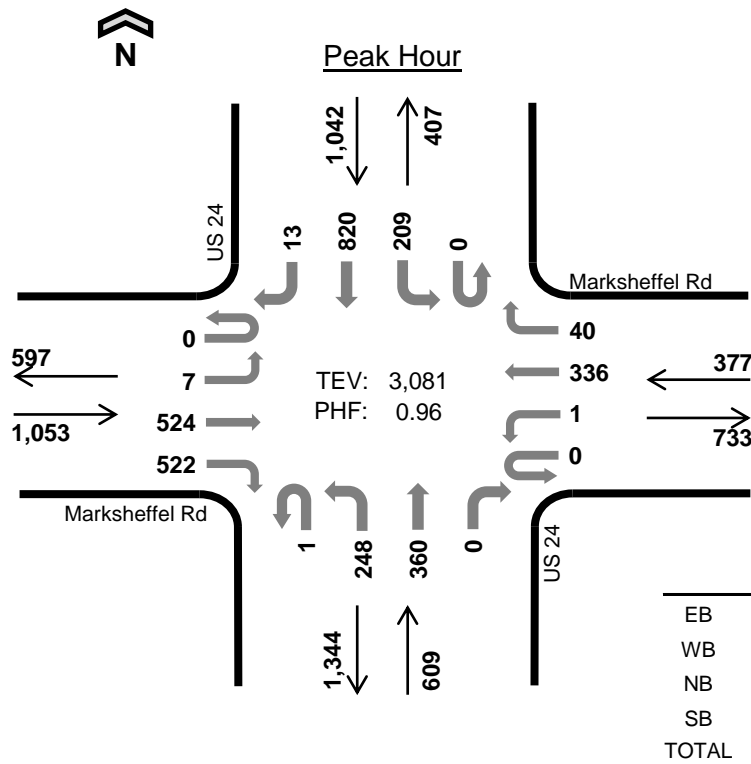

Date: Thu, Jun 04, 2020
Count Period: 7:00 AM to 9:00 AM
Peak Hour: 7:00 AM to 8:00 AM

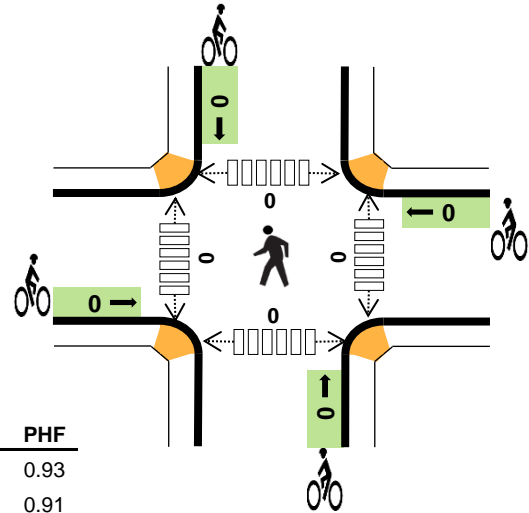

	HV %:	PHF
EB	5.5%	0.93
WB	3.2%	0.91
NB	10.5%	0.93
SB	3.9%	0.94
TOTAL	5.7%	0.96

Two-Hour Count Summaries

Interval Start	Marksheffel Rd Eastbound				Marksheffel Rd Westbound				US 24 Northbound				US 24 Southbound				15-min Total	Rolling One Hour
	UT	LT	TH	RT	UT	LT	TH	RT	UT	LT	TH	RT	UT	LT	TH	RT		
	7:00 AM	0	0	122	138	0	0	94	6	0	68	96	0	0	50	203		
7:15 AM	0	0	155	127	0	0	96	8	1	59	96	0	0	43	213	3	801	0
7:30 AM	0	3	123	142	0	1	80	14	0	62	78	0	0	59	214	5	781	0
7:45 AM	0	4	124	115	0	0	66	12	0	59	90	0	0	57	190	4	721	3,081
8:00 AM	0	8	106	109	0	2	57	17	0	50	75	0	0	37	125	7	593	2,896
8:15 AM	0	1	87	90	0	0	48	16	0	50	73	1	0	42	138	1	547	2,642
8:30 AM	0	3	83	105	0	1	84	13	0	48	71	0	0	30	155	1	594	2,455
8:45 AM	0	0	92	85	0	2	58	8	0	52	91	0	0	39	162	5	594	2,328
Count Total	0	19	892	911	0	6	583	94	1	448	670	1	0	357	1,400	27	5,409	0
Peak Hour	0	7	524	522	0	1	336	40	1	248	360	0	0	209	820	13	3,081	0

Note: Two-hour count summary volumes include heavy vehicles but exclude bicycles in overall count.

Interval Start	Heavy Vehicle Totals					Bicycles					Pedestrians (Crossing Leg)				
	EB	WB	NB	SB	Total	EB	WB	NB	SB	Total	East	West	North	South	Total
7:00 AM	18	3	10	8	39	0	0	0	0	0	0	0	0	0	0
7:15 AM	12	3	17	10	42	0	0	0	0	0	0	0	0	0	0
7:30 AM	14	4	21	13	52	0	0	0	0	0	0	0	0	0	0
7:45 AM	14	2	16	10	42	0	0	0	0	0	0	0	0	0	0
8:00 AM	9	3	18	11	41	0	0	0	0	0	0	0	0	0	0
8:15 AM	9	1	12	7	29	0	0	0	0	0	0	0	0	0	0
8:30 AM	9	2	10	9	30	0	0	0	0	0	0	0	0	0	0
8:45 AM	11	4	22	21	58	0	0	0	0	0	0	0	0	0	0
Count Total	96	22	126	89	333	0	0	0	0	0	0	0	0	0	0
Peak Hour	58	12	64	41	175	0	0	0	0	0	0	0	0	0	0



US 24 Marksheffel Rd

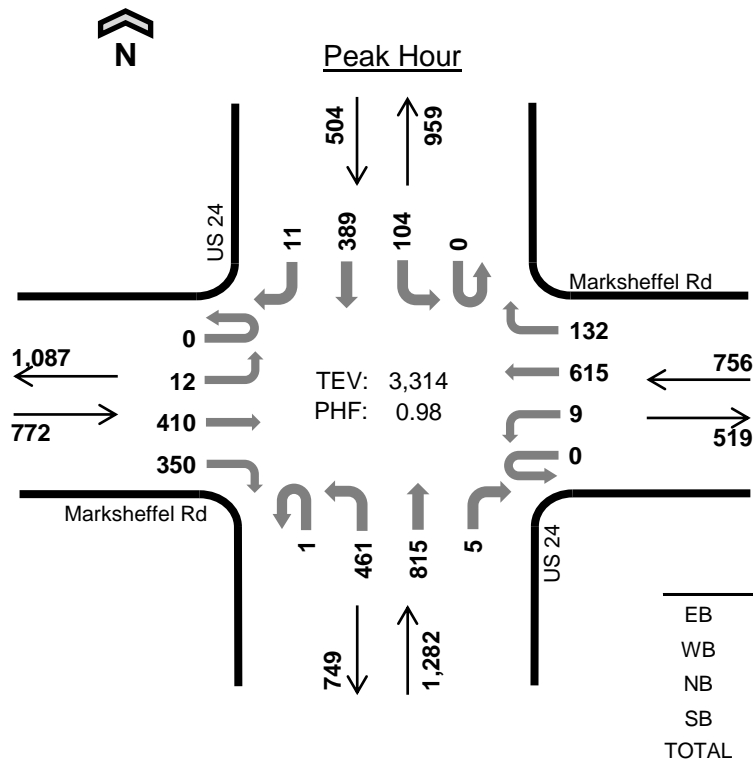

Date: Thu, Jun 04, 2020
 Count Period: 4:00 PM to 6:00 PM
 Peak Hour: 4:30 PM to 5:30 PM

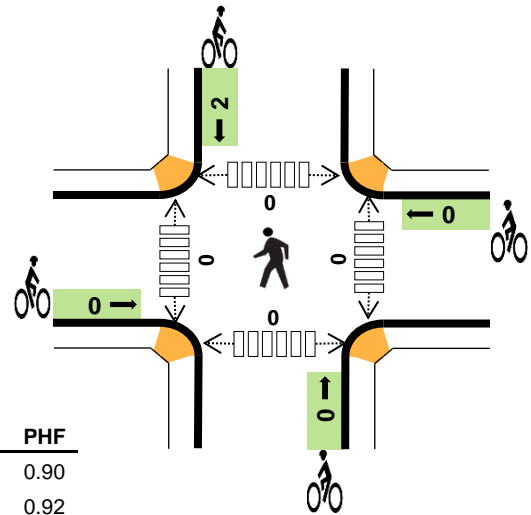

Two-Hour Count Summaries

Interval Start	Marksheffel Rd				Marksheffel Rd				US 24				US 24				15-min Total	Rolling One Hour
	Eastbound				Westbound				Northbound				Southbound					
	UT	LT	TH	RT	UT	LT	TH	RT	UT	LT	TH	RT	UT	LT	TH	RT		
4:00 PM	0	2	102	84	0	3	163	33	0	78	159	0	1	21	132	0	778	0
4:15 PM	0	7	82	73	0	1	172	39	2	131	166	1	0	32	121	4	831	0
4:30 PM	0	4	92	73	0	4	165	37	0	119	207	0	0	23	100	2	826	0
4:45 PM	0	5	117	92	0	1	162	34	0	128	185	4	0	17	90	5	840	3,275
5:00 PM	0	3	96	92	0	2	140	34	1	96	210	1	0	27	101	1	804	3,301
5:15 PM	0	0	105	93	0	2	148	27	0	118	213	0	0	37	98	3	844	3,314
5:30 PM	0	3	111	87	0	1	115	29	0	108	178	1	0	15	109	2	759	3,247
5:45 PM	0	3	78	62	0	6	110	20	0	96	122	0	0	24	91	1	613	3,020
Count Total	0	27	783	656	0	20	1,175	253	3	874	1,440	7	1	196	842	18	6,295	0
Peak Hour	0	12	410	350	0	9	615	132	1	461	815	5	0	104	389	11	3,314	0

Note: Two-hour count summary volumes include heavy vehicles but exclude bicycles in overall count.

Interval Start	Heavy Vehicle Totals					Bicycles					Pedestrians (Crossing Leg)				
	EB	WB	NB	SB	Total	EB	WB	NB	SB	Total	East	West	North	South	Total
4:00 PM	12	3	7	8	30	0	0	0	0	0	0	0	0	0	0
4:15 PM	6	2	10	5	23	0	0	0	0	0	0	0	0	0	0
4:30 PM	4	4	6	6	20	0	0	0	1	1	0	0	0	0	0
4:45 PM	6	2	6	1	15	0	0	0	0	0	0	0	0	0	0
5:00 PM	7	2	6	3	18	0	0	0	0	0	0	0	0	0	0
5:15 PM	5	2	4	4	15	0	0	0	1	1	0	0	0	0	0
5:30 PM	6	0	5	5	16	0	0	0	0	0	0	0	0	0	0
5:45 PM	2	2	3	2	9	0	0	0	1	1	0	0	0	0	0
Count Total	48	17	47	34	146	0	0	0	3	3	0	0	0	0	0
Peak Hour	22	10	22	14	68	0	0	0	2	2	0	0	0	0	0



**US 24
SH 94**

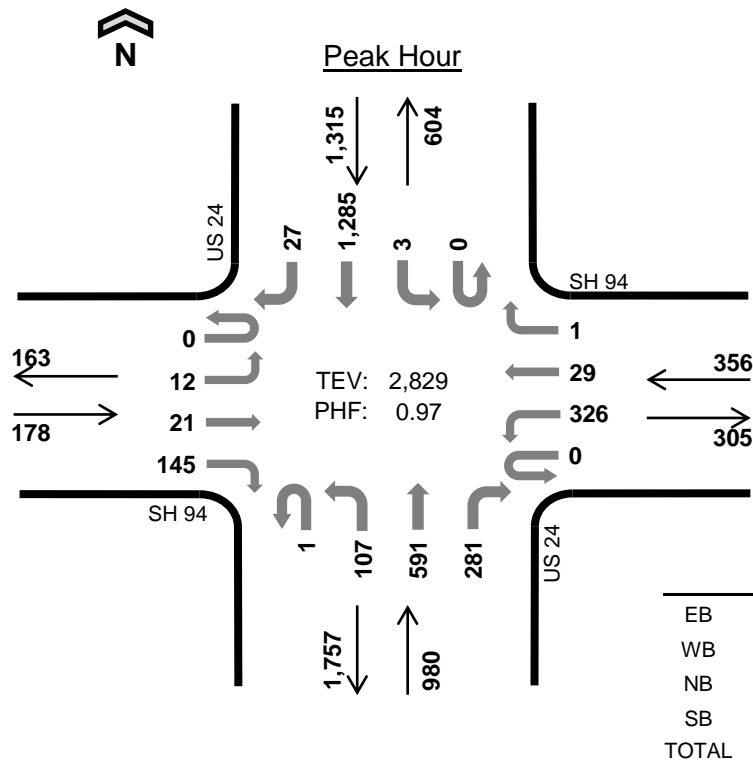

Date: Tue, Jun 02, 2020
Count Period: 7:00 AM to 9:00 AM
Peak Hour: 7:00 AM to 8:00 AM

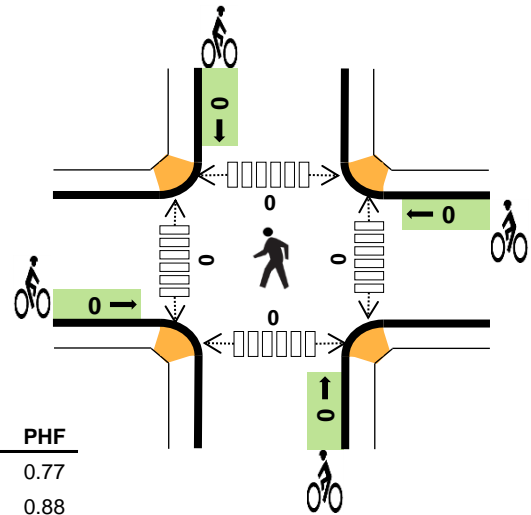

Two-Hour Count Summaries

Interval Start	SH 94				SH 94				US 24				US 24				15-min Total	Rolling One Hour
	Eastbound				Westbound				Northbound				Southbound					
	UT	LT	TH	RT	UT	LT	TH	RT	UT	LT	TH	RT	UT	LT	TH	RT		
7:00 AM	0	1	6	45	0	81	10	0	0	27	147	65	0	1	319	7	709	0
7:15 AM	0	6	7	21	0	90	10	1	0	25	145	79	0	0	336	8	728	0
7:30 AM	0	5	6	47	0	85	5	0	0	20	152	80	0	0	310	6	716	0
7:45 AM	0	0	2	32	0	70	4	0	1	35	147	57	0	2	320	6	676	2,829
8:00 AM	0	4	4	25	0	51	7	1	0	28	120	54	0	3	230	5	532	2,652
8:15 AM	0	4	4	34	0	51	6	0	1	17	107	64	0	1	207	10	506	2,430
8:30 AM	0	1	4	26	0	66	2	0	0	25	128	55	0	0	223	4	534	2,248
8:45 AM	0	3	7	29	0	48	6	1	1	23	131	44	0	1	197	9	500	2,072
Count Total	0	24	40	259	0	542	50	3	3	200	1,077	498	0	8	2,142	55	4,901	0
Peak Hour	0	12	21	145	0	326	29	1	1	107	591	281	0	3	1,285	27	2,829	0

Note: Two-hour count summary volumes include heavy vehicles but exclude bicycles in overall count.

Interval Start	Heavy Vehicle Totals					Bicycles					Pedestrians (Crossing Leg)				
	EB	WB	NB	SB	Total	EB	WB	NB	SB	Total	East	West	North	South	Total
7:00 AM	4	1	19	20	44	0	0	0	0	0	0	0	0	0	0
7:15 AM	0	5	27	16	48	0	0	0	0	0	0	0	0	0	0
7:30 AM	4	3	31	15	53	0	0	0	0	0	0	0	0	0	0
7:45 AM	1	5	25	21	52	0	0	0	0	0	0	0	0	0	0
8:00 AM	1	8	20	15	44	0	0	0	0	0	0	0	0	0	0
8:15 AM	3	2	24	9	38	0	0	0	0	0	0	0	0	0	0
8:30 AM	0	7	27	13	47	0	0	0	0	0	0	0	0	0	0
8:45 AM	2	5	15	18	40	0	0	0	0	0	0	0	0	0	0
Count Total	15	36	188	127	366	0	0	0	0	0	0	0	0	0	0
Peak Hour	9	14	102	72	197	0	0	0	0	0	0	0	0	0	0



**US 24
SH 94**

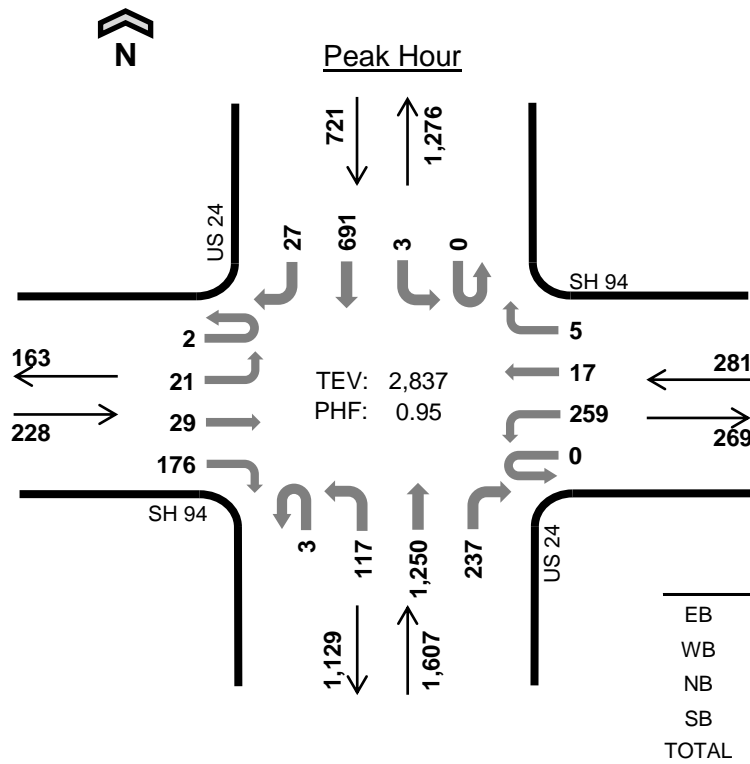

Date: Tue, Jun 02, 2020
Count Period: 4:00 PM to 6:00 PM
Peak Hour: 4:15 PM to 5:15 PM

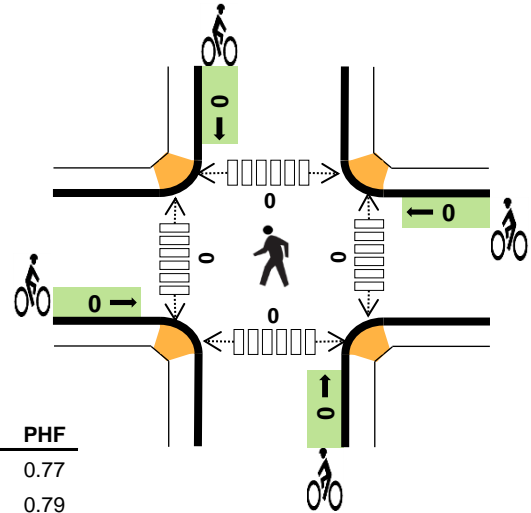

Two-Hour Count Summaries

Interval Start	SH 94 Eastbound				SH 94 Westbound				US 24 Northbound				US 24 Southbound				15-min Total	Rolling One Hour
	UT	LT	TH	RT	UT	LT	TH	RT	UT	LT	TH	RT	UT	LT	TH	RT		
	4:00 PM	0	5	4	32	0	73	7	0	1	31	284	80	1	2	177		
4:15 PM	0	5	4	45	0	51	2	2	1	30	327	62	0	3	153	7	692	0
4:30 PM	0	4	13	33	0	66	7	0	1	29	300	46	0	0	194	7	700	0
4:45 PM	0	9	1	40	0	83	5	1	0	31	307	53	0	0	158	7	695	2,791
5:00 PM	2	3	11	58	0	59	3	2	1	27	316	76	0	0	186	6	750	2,837
5:15 PM	0	8	7	36	0	49	8	0	0	19	299	80	0	0	170	8	684	2,829
5:30 PM	0	5	4	29	0	44	7	1	0	19	267	85	0	0	183	4	648	2,777
5:45 PM	0	3	8	24	0	38	4	1	0	12	252	62	0	0	142	10	556	2,638
Count Total	2	42	52	297	0	463	43	7	4	198	2,352	544	1	5	1,363	56	5,429	0
Peak Hour	2	21	29	176	0	259	17	5	3	117	1,250	237	0	3	691	27	2,837	0

Note: Two-hour count summary volumes include heavy vehicles but exclude bicycles in overall count.

Interval Start	Heavy Vehicle Totals					Bicycles					Pedestrians (Crossing Leg)				
	EB	WB	NB	SB	Total	EB	WB	NB	SB	Total	East	West	North	South	Total
4:00 PM	0	4	16	12	32	0	0	0	0	0	0	0	0	0	0
4:15 PM	0	3	11	12	26	0	0	0	0	0	0	0	0	0	0
4:30 PM	1	1	20	12	34	0	0	0	0	0	0	0	0	0	0
4:45 PM	1	1	14	5	21	0	0	0	0	0	0	0	0	0	0
5:00 PM	0	3	4	7	14	0	0	0	0	0	0	0	0	0	0
5:15 PM	1	2	10	6	19	0	0	0	0	0	0	0	0	0	0
5:30 PM	2	1	7	11	21	0	0	0	0	0	0	0	0	0	0
5:45 PM	1	2	3	7	13	0	0	0	0	0	0	0	0	0	0
Count Total	6	17	85	72	180	0	0	0	0	0	0	0	0	0	0
Peak Hour	2	8	49	36	95	0	0	0	0	0	0	0	0	0	0



Marksheffel Rd SH 94

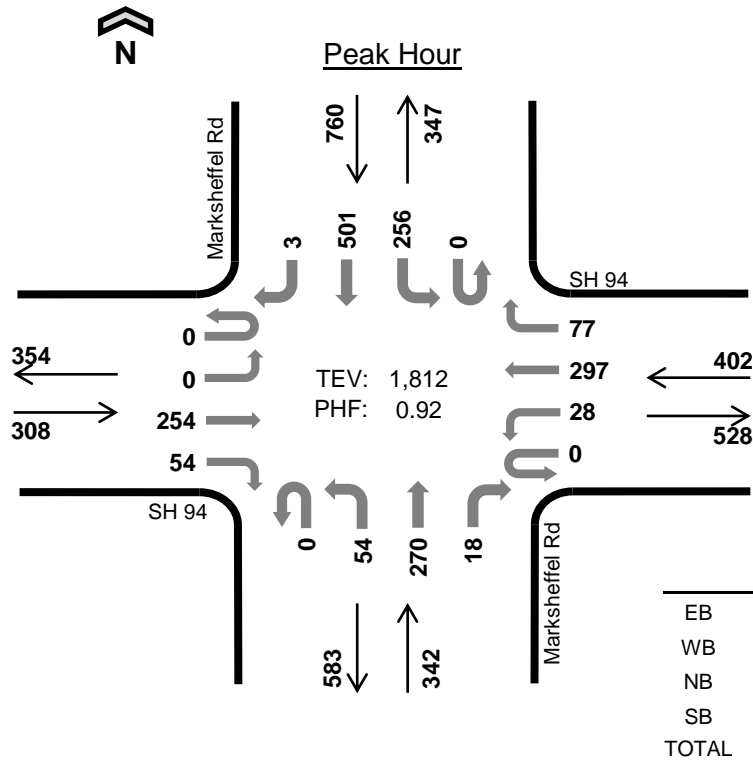

Date: Tue, Jun 02, 2020
Count Period: 7:00 AM to 9:00 AM
Peak Hour: 7:00 AM to 8:00 AM

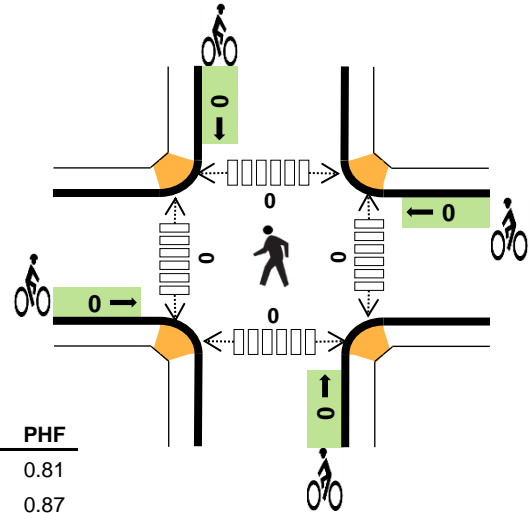

	HV %:	PHF
EB	8.1%	0.81
WB	5.5%	0.87
NB	4.7%	0.82
SB	2.6%	0.87
TOTAL	4.6%	0.92

Two-Hour Count Summaries

Interval Start	SH 94 Eastbound				SH 94 Westbound				Marksheffel Rd Northbound				Marksheffel Rd Southbound				15-min Total	Rolling One Hour
	UT	LT	TH	RT	UT	LT	TH	RT	UT	LT	TH	RT	UT	LT	TH	RT		
	7:00 AM	0	0	57	8	0	2	73	22	0	11	71	7	0	79	110		
7:15 AM	0	0	79	16	0	7	87	21	0	10	51	3	0	74	143	1	492	0
7:30 AM	0	0	61	21	0	8	69	13	0	24	76	4	0	67	133	1	477	0
7:45 AM	0	0	57	9	0	11	68	21	0	9	72	4	0	36	115	1	403	1,812
8:00 AM	0	4	39	14	0	2	43	12	0	10	50	2	0	47	115	1	339	1,711
8:15 AM	0	0	61	11	0	2	49	21	0	8	59	2	0	32	89	0	334	1,553
8:30 AM	0	1	50	15	0	6	67	25	0	9	52	4	0	32	85	1	347	1,423
8:45 AM	0	0	36	14	0	4	44	17	0	14	49	1	0	21	85	2	287	1,307
Count Total	0	5	440	108	0	42	500	152	0	95	480	27	0	388	875	7	3,119	0
Peak Hour	0	0	254	54	0	28	297	77	0	54	270	18	0	256	501	3	1,812	0

Note: Two-hour count summary volumes include heavy vehicles but exclude bicycles in overall count.

Interval Start	Heavy Vehicle Totals					Bicycles					Pedestrians (Crossing Leg)				
	EB	WB	NB	SB	Total	EB	WB	NB	SB	Total	East	West	North	South	Total
7:00 AM	4	2	5	5	16	0	0	0	0	0	0	0	0	0	0
7:15 AM	6	4	4	4	18	0	0	0	0	0	0	0	0	0	0
7:30 AM	9	6	4	8	27	0	0	0	0	0	0	0	0	0	0
7:45 AM	6	10	3	3	22	0	0	0	0	0	0	0	0	0	0
8:00 AM	3	7	2	9	21	0	0	0	0	0	0	0	0	0	0
8:15 AM	10	5	2	4	21	0	0	0	0	0	0	0	0	0	0
8:30 AM	8	5	8	7	28	0	0	0	0	0	0	0	0	0	0
8:45 AM	8	6	1	5	20	0	0	0	0	0	0	0	0	0	0
Count Total	54	45	29	45	173	0	0	0	0	0	0	0	0	0	0
Peak Hour	25	22	16	20	83	0	0	0	0	0	0	0	0	0	0



Marksheffel Rd SH 94

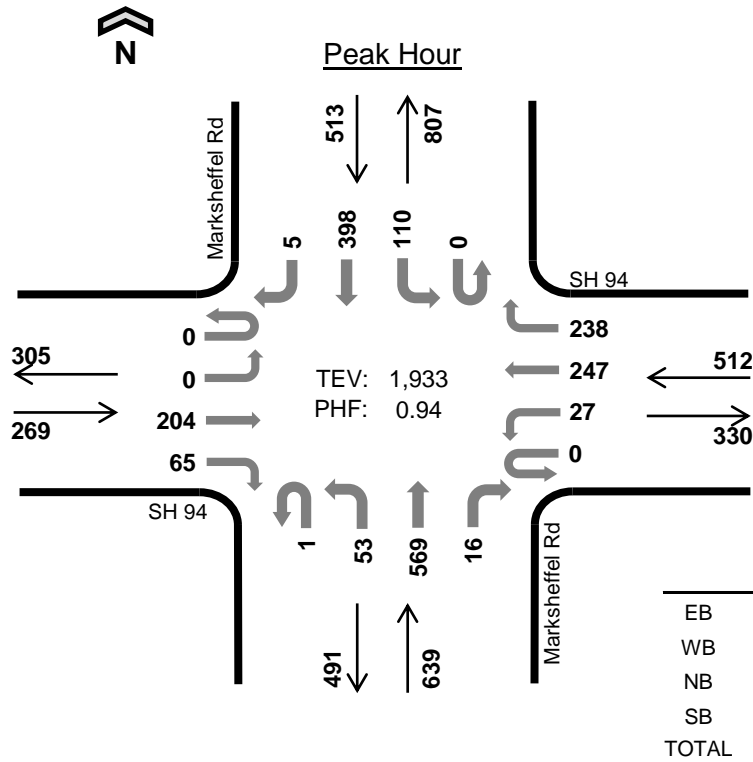

Date: Tue, Jun 02, 2020
Count Period: 4:00 PM to 6:00 PM
Peak Hour: 4:00 PM to 5:00 PM

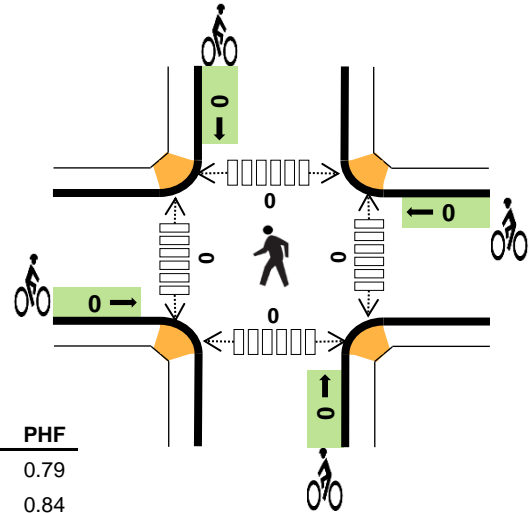

	HV %:	PHF
EB	3.3%	0.79
WB	2.7%	0.84
NB	2.3%	0.92
SB	3.9%	0.97
TOTAL	3.0%	0.94

Two-Hour Count Summaries

Interval Start	SH 94 Eastbound				SH 94 Westbound				Marksheffel Rd Northbound				Marksheffel Rd Southbound				15-min Total	Rolling One Hour
	UT	LT	TH	RT	UT	LT	TH	RT	UT	LT	TH	RT	UT	LT	TH	RT		
	4:00 PM	0	0	58	27	0	7	63	49	0	14	140	2	0	24	94		
4:15 PM	0	0	57	15	0	10	65	78	1	10	142	6	0	28	102	1	515	0
4:30 PM	0	0	42	13	0	6	47	62	0	12	159	2	0	25	105	1	474	0
4:45 PM	0	0	47	10	0	4	72	49	0	17	128	6	0	33	97	2	465	1,933
5:00 PM	1	1	72	14	0	5	52	48	0	8	107	2	0	20	84	2	416	1,870
5:15 PM	1	0	73	13	0	5	37	44	0	18	112	3	0	29	110	0	445	1,800
5:30 PM	0	0	69	19	0	1	40	31	0	12	75	3	0	28	115	0	393	1,719
5:45 PM	0	0	47	21	0	0	32	31	0	7	122	2	0	28	110	0	400	1,654
Count Total	2	1	465	132	0	38	408	392	1	98	985	26	0	215	817	7	3,587	0
Peak Hour	0	0	204	65	0	27	247	238	1	53	569	16	0	110	398	5	1,933	0

Note: Two-hour count summary volumes include heavy vehicles but exclude bicycles in overall count.

Interval Start	Heavy Vehicle Totals					Bicycles					Pedestrians (Crossing Leg)				
	EB	WB	NB	SB	Total	EB	WB	NB	SB	Total	East	West	North	South	Total
4:00 PM	1	5	4	7	17	0	0	0	0	0	0	0	0	0	0
4:15 PM	2	3	4	4	13	0	0	0	0	0	0	0	0	0	0
4:30 PM	2	4	5	8	19	0	0	0	0	0	0	0	0	0	0
4:45 PM	4	2	2	1	9	0	0	0	0	0	0	0	0	0	0
5:00 PM	1	2	2	4	9	0	0	0	0	0	0	0	0	0	0
5:15 PM	2	1	3	2	8	0	0	1	0	1	0	0	0	0	0
5:30 PM	3	0	2	1	6	0	0	0	0	0	0	0	0	0	0
5:45 PM	1	1	3	4	9	0	0	0	0	0	0	0	0	0	0
Count Total	16	18	25	31	90	0	0	1	0	1	0	0	0	0	0
Peak Hour	9	14	15	20	58	0	0	0	0	0	0	0	0	0	0

APPENDIX B

CDOT Annual Traffic Data

2040 PPACOG Traffic Model

Reagan Ranch Traffic Projection

ROUTE	REFPT	ENDREFPT	LENGTH	YR20FACTOR	DHV	LOCATION
094A	0.548	1	0.47	1.33	13.5	ON SH 94 E/O MARKSHEFFEL RD COLORADO SPRINGS
094A	1	8.085	7.077	1.25	12.5	ON SH 94 E/O SPACE VILLAGE AVE CR 2804

Station ID	2018 AADT	2040 AADT	Growth Factor	Yearly Growth Rate
103943	10000	13630	1.33	1.30%
103944	11000	14025	1.25	1.02%
		Avg Growth Rate		1.16%

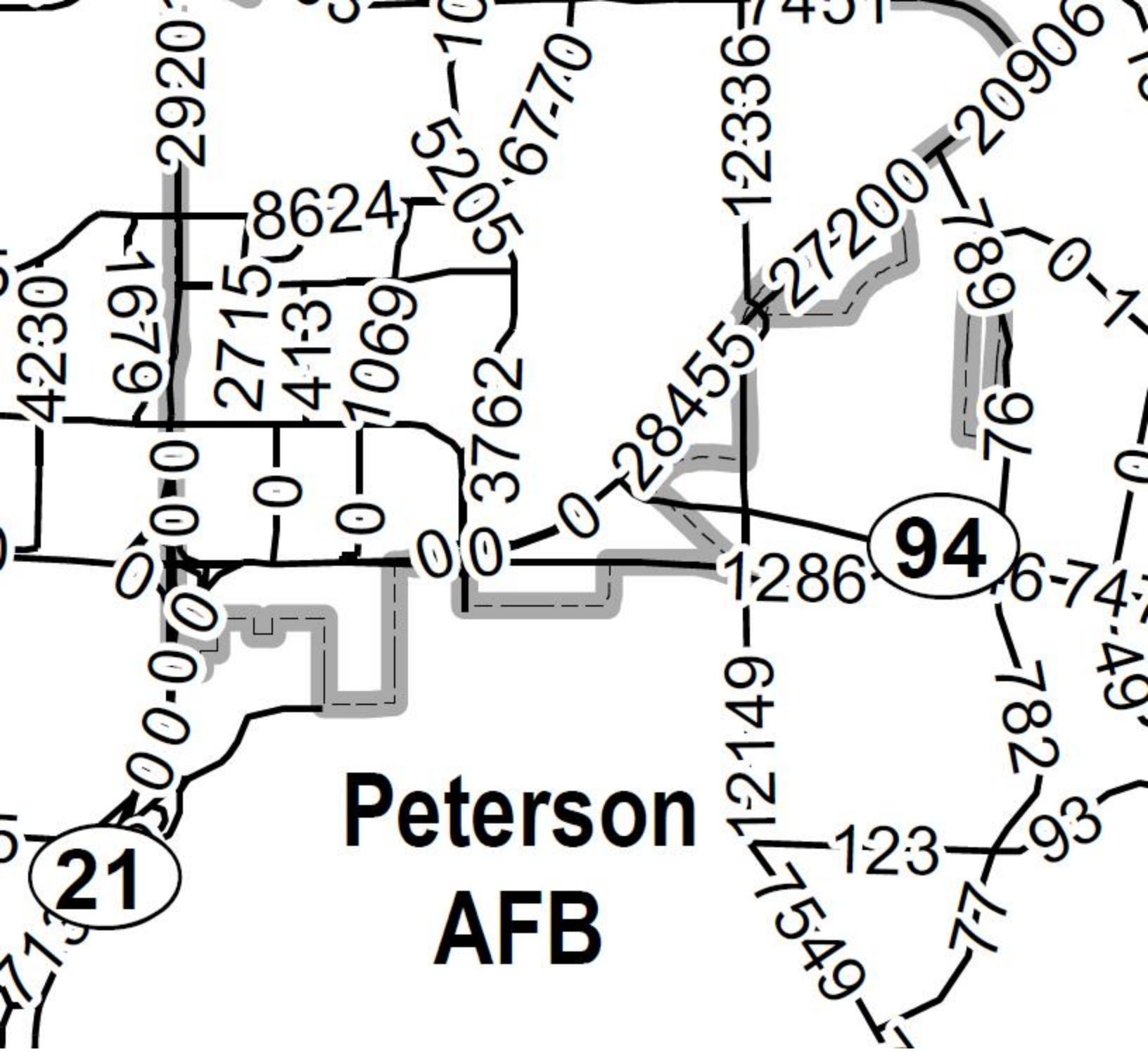

2040 PPACOG MODEL

APPENDIX C

Trip Generation Worksheets

Crossroads North Phase 1 Trip Generation Summary

Use	Quantity	Daily	Weekday Vehicle Trips					
			AM Peak Hour			PM Peak Hour		
			In	Out	Total	In	Out	Total
Crossroads North								
Public Park (ITE 411)	20 Acres	16	0	0	0	1	1	2
Tire Superstore (ITE 849)	7,000 SF	144	6	3	9	7	8	15
Home Improvement Superstore (ITE 862)	127,000 SF	3,904	113	86	199	145	151	296
Furniture Store (ITE 890)	114,000 SF	720	21	9	30	28	31	59
Sit Down Restaurant (ITE 932)	11,000 SF	1,234	60	49	109	66	41	107
Fast-Food Restaurant (ITE 934)	2,500 SF	1,178	51	49	100	43	39	82
Gas Station Super Convenience (ITE 960)	6,000 SF	5,026	249	250	499	208	208	416
Total Crossroads North Trips		12,222	500	446	946	498	479	977
Crossroads North Trips after Internal Capture		11,246	490	437	927	458	441	899

Crossroads North Full Buildout Trip Generation Summary

Use	Quantity	Daily	Weekday Vehicle Trips					
			AM Peak Hour			PM Peak Hour		
			In	Out	Total	In	Out	Total
Crossroads North								
Public Park (ITE 411)	20 Acres	16	0	0	0	1	1	2
Movie Theatre (ITE 444)	52,000 SF	4,062	5	6	11	302	19	321
Tire Superstore (ITE 849)	7,000 SF	144	6	3	9	7	8	15
Home Improvement Superstore (ITE 862)	127,000 SF	3,904	113	86	199	145	151	296
Furniture Store (ITE 890)	114,000 SF	720	21	9	30	28	31	59
Sit Down Restaurant (ITE 932)	11,000 SF	1,234	60	49	109	66	41	107
Fast-Food Restaurant (ITE 934)	5,000 SF	2,356	103	98	201	85	78	163
Gas Station Super Convenience (ITE 960)	6,000 SF	5,026	249	250	499	208	208	416
Total Crossroads North Trips		17,462	557	501	1,058	842	537	1,379
Crossroads North Trips after Internal Capture		16,066	546	491	1,037	775	494	1,269

Project Crossroads-Meadowbrook-Reagan Ranch (Crossroads North - Phase 1)
 Subject Trip Generation - Public Park
 Designed by JRP Date February 08, 2021 Job No. 096956015
 Checked by _____ Date _____ Sheet No. 1 of 1

TRIP GENERATION MANUAL TECHNIQUES

ITE Trip Generation Manual 10th Edition, Average Rate Equations
 Land Use Code - Public Park (411)
 Independent Variable - Acres (X)

Acres 20
 $X = 20$
 T = Average Vehicle Trip Ends

Peak Hour of Adjacent Street Traffic, One Hour Between 7 and 9 a.m. (400 Series Page 3)

Directional Distribution: 59% ent. 41% exit.
 $(T) = 0.02 (X)$
 $(T) = 0.02^* (20.0)$
 $T = 0$ Average Vehicle Trip Ends
 0 entering 0 exiting
 0 + 0 = 0

Peak Hour of Adjacent Street Traffic, One Hour Between 4 and 6 p.m. (400 Series Page 4)

Directional Distribution: 55% ent. 45% exit.
 $(T) = 0.11 (X)$
 $(T) = 0.11^* (20.0)$
 $T = 2$ Average Vehicle Trip Ends
 1 entering 1 exiting
 1 + 1 = 2

Weekday (400 Series page 2)

Average Weekday
 $T = 0.78^* (X)$
 $T = 0.78^* 20$
 Directional Distribution: 50% entering, 50% exiting
 $T = 16$ Average Vehicle Trip Ends
 8 entering 8 exiting
 8 + 8 = 16

Project Crossroads-Meadowbrook-Reagan Ranch (Crossroads North Phase 1)
 Subject Trip Generation for Tire Superstore
 Designed by JRP Date February 08, 2021 Job No. 096956015
 Checked by _____ Date _____ Sheet No. _____ of _____

TRIP GENERATION MANUAL TECHNIQUES

ITE Trip Generation Manual 10th Edition, Average Rate Equations

Land Use Code - Tire Superstore (849)

Independant Variable - 1000 Square Feet Gross Floor Area (X)

Gross Floor Area = **7,000** Square Feet

X = 7.000

T = Average Vehicle Trip Ends

Peak Hour of Adjacent Street Traffic, One Hour Between 7 and 9 a.m. (800 Series Page 262)

		Directional Distribution:	65% ent.	35% exit.
T = 1.34 (X)		T =	9	Average Vehicle Trip Ends
T = 1.34 *	7.000	6	entering	3 exiting
		6	+	3 = 9

Peak Hour of Adjacent Street Traffic, One Hour Between 4 and 6 p.m. (800 Series Page 263)

		Directional Distribution:	47% ent.	53% exit.
T = 2.11 (X)		T =	15	Average Vehicle Trip Ends
T = 2.11 *	7.000	7	entering	8 exiting
		7	+	8 = 15

Weekday (800 Series Page 261)

Average Weekday		Directional Distribution:	50% entering,	50% exiting
T = 20.37 (X)		T =	144	Average Vehicle Trip Ends
T = 20.37*	7.000	72	entering	72 exiting
		72	+	72 = 144

Project Crossroads-Meadowbrook-Reagan Ranch (Crossroads North Phase 1)
 Subject Trip Generation for Home Improvements Superstore
 Designed by JRP Date February 08, 2021 Job No. 096956015
 Checked by _____ Date _____ Sheet No. _____ of _____

TRIP GENERATION MANUAL TECHNIQUES

ITE Trip Generation Manual 10th Edition, Average Rate Equations

Land Use Code - Home Improvement Superstore (862)

Independant Variable - 1000 Square Feet Gross Floor Area (X)

Gross Floor Area = **127,000** Square Feet

X = 127.000

T = Average Vehicle Trip Ends

Peak Hour of Adjacent Street Traffic, One Hour Between 7 and 9 a.m. (800 Series Page 437)

		Directional Distribution:	57% ent.	43% exit.
T = 1.57 (X)		T =	199	Average Vehicle Trip Ends
T = 1.57 *	127.000	113 entering	86 exiting	
		113 (*) · 86 =	199	

Peak Hour of Adjacent Street Traffic, One Hour Between 4 and 6 p.m. (800 Series Page 438)

		Directional Distribution:	49% ent.	51% exit.
T = 2.33 (X)		T =	296	Average Vehicle Trip Ends
T = 2.33 *	127.000	145 entering	151 exiting	
		145 + 151 =	296	

Weekday (800 Series Page 436)

Average Weekday		Directional Distribution:	50% entering,	50% exiting
T = 30.74 (X)		T =	3904	Average Vehicle Trip Ends
T = 30.74* 127.000		1952 entering	1952 exiting	
		1952 + 1952 =	3904	

Project Crossroads-Meadowbrook-Reagan Ranch (Crossroads North Phase 1)
 Subject Trip Generation for Furniture Store
 Designed by JRP Date February 08, 2021 Job No. 096956015
 Checked by _____ Date _____ Sheet No. _____ of _____

TRIP GENERATION MANUAL TECHNIQUES

ITE Trip Generation Manual 10th Edition, Average Rates

Land Use Code - Furniture Store (890)

Independent Variable - 1000 Square Feet (X)

SF = **114,000**

X = 114.000

T = Average Vehicle Trip Ends

Peak Hour of Adjacent Street Traffic, One Hour Between 7 and 9 a.m. (800 Series Page 585)

(T) = 0.26 (X)		Directional Distribution:	71% ent.	29% exit.
(T) = 0.26 *	(114.0)	T = 30	Average Vehicle Trip Ends	
		21 entering	9	exiting
		21 + 9	=	30

Peak Hour of Adjacent Street Traffic, One Hour Between 4 and 6 p.m. (800 Series Page 586)

(T) = 0.52 (X)		Directional Distribution:	47% ent.	53% exit.
(T) = 0.52 *	(114.0)	T = 59	Average Vehicle Trip Ends	
		28 entering	31	exiting
		28 + 31	=	59

Weekday (800 Series Page 584)

Average Weekday		Directional Distribution:	50% ent.	50% exit.
(T) = 6.30 (X)		T = 720	Average Vehicle Trip Ends	
(T) = 6.30 *	(114.0)	360 entering	360	exiting
		360 + 360	=	720

Saturday, Peak Hour of Generator (800 Series Page 590)

Daily Weekday		Directional Distribution:	54% ent.	46% exit.
(T) = 1.10 (X)		T = 125	Average Vehicle Trip Ends	
(T) = 1.10 *	(114.0)	68 entering	58	exiting
		68 + 57	=	125

Project Crossroads-Meadowbrook-Reagan Ranch (Crossroads North Phase 1)
 Subject Trip Generation for High-Turnover (Sit-Down) Restaurant
 Designed by TES Date June 24, 2020 Job No. 096956015
 Checked by _____ Date _____ Sheet No. _____ of _____

TRIP GENERATION MANUAL TECHNIQUES

ITE Trip Generation Manual 10th Edition, Average Rate Equations

Land Use Code - High Turnover Sit-Down Restaurant (932)

Independant Variable - 1000 Square Feet Gross Floor Area (X)

Gross Floor Area = **11,000** Square Feet

X = 11.000

T = Average Vehicle Trip Ends

Peak Hour of Adjacent Street Traffic, One Hour Between 7 and 9 a.m. (900 Series Page 97)

Average Weekday	Directional Distribution:	55% ent.	45% exit.
T = 9.94 (X)	T =	109	Average Vehicle Trip Ends
T = 9.94 * 11.000	60 entering	49	exiting

Peak Hour of Adjacent Street Traffic, One Hour Between 4 and 6 p.m. (900 Series Page 98)

Average Weekday	Directional Distribution:	62% ent.	38% exit.
T = 9.77 (X)	T =	107	Average Vehicle Trip Ends
T = 9.77 * 11.000	66 entering	41	exiting

Weekday (900 Series Page 96)

Average Weekday	Directional Distribution:	50% entering, 50% exiting
T = 112.18 (X)	T =	1234 Average Vehicle Trip Ends
T = 112.18 * 11.000	617 entering	617 exiting

P.M. Peak Hour of Generator (900 Series Page 100)

Average Weekday	Directional Distribution:	52% ent.	48% exit.
T = 17.41 (X)	T =	192	Average Vehicle Trip Ends
T = 17.41 * 11.000	100 entering	92	exiting

Saturday Peak Hour of Generator (900 Series Page 105)

Average Saturday	Directional Distribution:	51% ent.	49% exit.
T = 11.19 (X)	T =	124	Average Vehicle Trip Ends
T = 11.19 * 11.000	63 entering	61	exiting

Non Pass-By Trip Volumes (Per ITE Trip Generation Handbook, 3rd Edition September 2017-Page 207)

AM Peak Hour =	57%	Non-Pass By	PM Peak Hour =	57%	Non-Pass By
	IN	Out	Total		
AM Peak	34	28	62		
PM Peak	38	23	61		
Daily	352	352	704		PM Peak Hour Rate Applied to Daily

Pass-By Trip Volumes (Per ITE Trip Generation Handbook, 3rd Edition September 2017 -Page 207)

AM Peak Hour =	43%	Pass By	PM Peak Hour =	43%	Pass By
	IN	Out	Total		
AM Peak	26	21	48		
PM Peak	28	18	46		
Daily	265	265	530		PM Peak Hour Rate Applied to Daily

Project Crossroads-Meadowbrook-Reagan Ranch (Crossroads North Phase 1)
 Subject Trip Generation for Fast-Food Restaurant with Drive-Through Window
 Designed by JRP Date February 08, 2021 Job No. 096956015
 Checked by _____ Date _____ Sheet No. _____ of _____

TRIP GENERATION MANUAL TECHNIQUES

ITE Trip Generation Manual 10th Edition, Average Rate Equations

Land Use Code - Fast Food Restaurant With Drive-Through Window (934)

Independant Variable - 1000 Square Feet Gross Floor Area (X)

Gross Floor Area = **2,500** Square Feet

X = 2.500

T = Average Vehicle Trip Ends

Peak Hour of Adjacent Street Traffic, One Hour Between 7 and 9 a.m. (900 Series page 158)

Average Weekday
 T = 40.19 (X)
 T = 40.19 * 2.500

Directional Distribution: 51% ent. 49% exit.
 T = 100 Average Vehicle Trip Ends
 51 entering 49 exiting
 51 + 49 = 100

Peak Hour of Adjacent Street Traffic, One Hour Between 4 and 6 p.m. (900 Series page 159)

Average Weekday
 T = 32.67 (X)
 T = 32.67 * 2.500

Directional Distribution: 52% ent. 48% exit.
 T = 82 Average Vehicle Trip Ends
 43 entering 39 exiting
 43 + 39 (*) = 82

Weekday (900 Series page 157)

Average Weekday
 T = 470.95 (X)
 T = 470.95 * 2.500

Directional Distribution: 50% entering, 50% exiting
 T = 1178 Average Vehicle Trip Ends
 589 entering 589 exiting
 589 + 589 = 1178

Saturday Peak Hour of Generator (900 Series page 163)

T = 54.86 (X)
 T = 54.86 * 2.500

Directional Distribution: 51% ent. 49% exit.
 T = 137 Average Vehicle Trip Ends
 70 entering 67 exiting
 70 + 67 = 137

Non Pass-By Trip Volumes (Per ITE Trip Generation Handbook, 3rd Edition September 2017)

AM Peak Hour =	51%	Non-Pass By	PM Peak Hour =	50%	Non-Pass By
	IN	Out	Total		
AM Peak	26	25	51		
PM Peak	22	20	41		
Daily	295	295	590	PM Peak Hour Rate Applied to Daily	

Pass-By Trip Volumes (Per ITE Trip Generation Handbook, 3rd Edition September 2017)

AM Peak Hour =	49%	Pass By	PM Peak Hour =	50%	Pass By
	IN	Out	Total		
AM Peak	25	24	49		
PM Peak	22	20	41		
Daily	294	294	588	PM Peak Hour Rate Applied to Daily	

Project Crossroads-Meadowbrook-Reagan Ranch (Crossroads North Phase 1)
 Subject Trip Generation for Super Convenience Market/Gas Station
 Designed by JRP Date February 08, 2021 Job No. 096956015
 Checked by _____ Date _____ Sheet No. _____ of _____

TRIP GENERATION MANUAL TECHNIQUES

ITE Trip Generation Manual 10th Edition, Average Rate Equations

Land Use Code - Super Convenience Market/Gas Station (960)

Independant Variable - 1000 Square Feet Gross Leasable Area (X)

Gross Leasable Area = **6,000** Square Feet

X = 6.000

T = Average Vehicle Trip Ends

Peak Hour of Adjacent Street Traffic, One Hour Between 7 and 9 a.m. (900 Series Page 404)

		Directional Distribution:	50% ent.	50% exit.
T = 83.14 (X)		T = 499	Average Vehicle Trip Ends	
T = 83.14 *	6.000	249 entering	250	exiting
		249 + 250 =	499	

Peak Hour of Adjacent Street Traffic, One Hour Between 4 and 6 p.m. (900 Series page 405)

		Directional Distribution:	50% ent.	50% exit.
T = 69.28 (X)		T = 416	Average Vehicle Trip Ends	
T = 69.28 *	6.000	208 entering	208	exiting
		208 + 208 =	416	

Weekday (800 Series page 335)

		Directional Distribution:	50% entering,	50% exiting
Average Weekday		T = 5026	Average Vehicle Trip Ends	
T = 837.58 (X)		2513 entering	2513	exiting
T = 837.58 *	6.000	2513 + 2513 =	5026	

Non Pass-By Trip Volumes (Per ITE Trip Generation Handbook, 3rd Edition September 2017)

PM Peak Hour =	44%	Non-Pass By	AM Peak Hour =	38%	Non-Pass By
	IN	Out	Total	* Utilized ITE 945 pass-by calculations	
AM Peak	95	95	190		
PM Peak	92	92	183		
Daily	1106	1106	2212	PM Peak Hour Rate Applied to Daily	

Pass-By Trip Volumes (Per ITE Trip Generation Handbook, 3rd Edition September 2017)

PM Peak Hour =	56%	Pass By	AM Peak Hour =	62%	Pass By
	IN	Out	Total		
AM Peak	154	155	309		
PM Peak	116	116	233		
Daily	1407	1407	2814	PM Peak Hour Rate Applied to Daily	

Project Crossroads-Meadowbrook-Reagan Ranch (Crossroads North)
 Subject Trip Generation - Public Park
 Designed by JRP Date February 08, 2021 Job No. 096956015
 Checked by _____ Date _____ Sheet No. 1 of 1

TRIP GENERATION MANUAL TECHNIQUES

P

ITE Trip Generation Manual 10th Edition, Average Rate Equations
 Land Use Code - Public Park (411)
 Independant Variable - Acres (X)

Acres 20
 X = 20
 T = Average Vehicle Trip Ends

Peak Hour of Adjacent Street Traffic, One Hour Between 7 and 9 a.m. (400 Series Page 3)

(T) = 0.02 (X)		Directional Distribution:	59% ent.	41% exit.
(T) = 0.02 *	(20.0)	T = 0	Average Vehicle Trip Ends	
		0 entering	0 exiting	
		0 + 0	=	0

Peak Hour of Adjacent Street Traffic, One Hour Between 4 and 6 p.m. (400 Series Page 4)

(T) = 0.11 (X)		Directional Distribution:	55% ent.	45% exit.
(T) = 0.11 *	(20.0)	T = 2	Average Vehicle Trip Ends	
		1 entering	1 exiting	
		1 + 1	=	2

Weekday (400 Series page 2)

Average Weekday		Directional Distribution:	50% entering, 50% exiting	
T = 0.78* (X)		T = 16	Average Vehicle Trip Ends	
T = 0.78 *	20	8 entering	8 exiting	
		8 + 8	=	16

Project Crossroads-Meadowbrook-Reagan Ranch (Crossroads North)
 Subject Trip Generation for Movie Theater
 Designed by JRP Date February 08, 2021 Job No. 096956015
 Checked by _____ Date _____ Sheet No. _____ of _____

TRIP GENERATION MANUAL TECHNIQUES

ITE Trip Generation Manual 10th Edition, Average Rate Equations

Land Use Code - Movie Theater (444)

Independent Variable - Gross Floor Area

Gross Floor Area = **52,000** Square Feet

X = 52.0

T = Average Vehicle Trip Ends

Peak Hour of Adjacent Street Traffic, One Hour Between 7 and 9 a.m. (400 Series Page 111)

		Directional Distribution:	50% ent.	50% exit.
T = 0.22 (X)		T = 11	Average Vehicle Trip Ends	
T = 0.22 *	52	5 entering	6	exiting
		5 (*) + 6 =	11	

Peak Hour of Adjacent Street Traffic, One Hour Between 4 and 6 p.m. (400 Series Page 112)

		Directional Distribution:	94% ent.	6% exit.
T = 6.17 (X)		T = 321	Average Vehicle Trip Ends	
T = 6.17 *	52	302 entering	19	exiting
		302 + 19 =	321	

Weekday (400 Series Page 110)

Average Weekday		Directional Distribution:	50% entering, 50% exiting	
T = 78.09 (X)		T = 4062	Average Vehicle Trip Ends	
T = 78.09*	52	2031 entering	2031	exiting
		2031 + 2031 =	4062	

Project Crossroads-Meadowbrook-Reagan Ranch (Crossroads North)
 Subject Trip Generation for Tire Superstore
 Designed by JRP Date February 08, 2021 Job No. 096956015
 Checked by _____ Date _____ Sheet No. _____ of _____

TRIP GENERATION MANUAL TECHNIQUES

ITE Trip Generation Manual 10th Edition, Average Rate Equations

Land Use Code - Tire Superstore (849)

Independant Variable - 1000 Square Feet Gross Floor Area (X)

Gross Floor Area = **7,000** Square Feet

X = 7.000

T = Average Vehicle Trip Ends

Peak Hour of Adjacent Street Traffic, One Hour Between 7 and 9 a.m. (800 Series Page 262)

		Directional Distribution:	65% ent.	35% exit.
T = 1.34 (X)		T =	9	Average Vehicle Trip Ends
T = 1.34 *	7.000	6 entering	3 exiting	
		6 + 3 =	9	

Peak Hour of Adjacent Street Traffic, One Hour Between 4 and 6 p.m. (800 Series Page 263)

		Directional Distribution:	47% ent.	53% exit.
T = 2.11 (X)		T =	15	Average Vehicle Trip Ends
T = 2.11 *	7.000	7 entering	8 exiting	
		7 + 8 =	15	

Weekday (800 Series Page 261)

Average Weekday		Directional Distribution:	50% entering,	50% exiting
T = 20.37 (X)		T =	144	Average Vehicle Trip Ends
T = 20.37*	7.000	72 entering	72 exiting	
		72 + 72 =	144	

Project Crossroads-Meadowbrook-Reagan Ranch (Crossroads North)
 Subject Trip Generation for Home Improvements Superstore
 Designed by JRP Date February 08, 2021 Job No. 096956015
 Checked by _____ Date _____ Sheet No. _____ of _____

TRIP GENERATION MANUAL TECHNIQUES

ITE Trip Generation Manual 10th Edition, Average Rate Equations

Land Use Code - Home Improvement Superstore (862)

Independant Variable - 1000 Square Feet Gross Floor Area (X)

Gross Floor Area = **127,000** Square Feet

X = 127.000

T = Average Vehicle Trip Ends

Peak Hour of Adjacent Street Traffic, One Hour Between 7 and 9 a.m. (800 Series Page 437)

		Directional Distribution:	57% ent.	43% exit.
T = 1.57 (X)		T =	199	Average Vehicle Trip Ends
T = 1.57 *	127.000	113 entering	86 exiting	
		113 (*) · 86 =	199	

Peak Hour of Adjacent Street Traffic, One Hour Between 4 and 6 p.m. (800 Series Page 438)

		Directional Distribution:	49% ent.	51% exit.
T = 2.33 (X)		T =	296	Average Vehicle Trip Ends
T = 2.33 *	127.000	145 entering	151 exiting	
		145 + 151 =	296	

Weekday (800 Series Page 436)

Average Weekday		Directional Distribution:	50% entering,	50% exiting
T = 30.74 (X)		T =	3904	Average Vehicle Trip Ends
T = 30.74*	127.000	1952 entering	1952 exiting	
		1952 + 1952 =	3904	

Project Crossroads-Meadowbrook-Reagan Ranch (Crossroads North)
 Subject Trip Generation for Furniture Store
 Designed by JRP Date ### February 08, 2021 Job No. 096956015
 Checked by _____ Date _____ Sheet No. _____ of _____

TRIP GENERATION MANUAL TECHNIQUES

ITE Trip Generation Manual 10th Edition, Average Rates

Land Use Code - Furniture Store (890)

Independent Variable - 1000 Square Feet (X)

SF = **114,000**

X = 114.000

T = Average Vehicle Trip Ends

Peak Hour of Adjacent Street Traffic, One Hour Between 7 and 9 a.m. (800 Series Page 585)

(T) = 0.26 (X)		Directional Distribution:	71% ent.	29% exit.
(T) = 0.26 *	(114.0)	T = 30	Average Vehicle Trip Ends	
		21 entering	9	exiting
		21 + 9	=	30

Peak Hour of Adjacent Street Traffic, One Hour Between 4 and 6 p.m. (800 Series Page 586)

(T) = 0.52 (X)		Directional Distribution:	47% ent.	53% exit.
(T) = 0.52 *	(114.0)	T = 59	Average Vehicle Trip Ends	
		28 entering	31	exiting
		28 + 31	=	59

Weekday (800 Series Page 584)

Average Weekday		Directional Distribution:	50% ent.	50% exit.
(T) = 6.30 (X)		T = 720	Average Vehicle Trip Ends	
(T) = 6.30 *	(114.0)	360 entering	360	exiting
		360 + 360	=	720

Saturday, Peak Hour of Generator (800 Series Page 590)

Daily Weekday		Directional Distribution:	54% ent.	46% exit.
(T) = 1.10 (X)		T = 125	Average Vehicle Trip Ends	
(T) = 1.10 *	(114.0)	68 entering	58	exiting
		68 + 57	=	125

Project Crossroads-Meadowbrook-Reagan Ranch (Crossroads North)
 Subject Trip Generation for High-Turnover (Sit-Down) Restaurant
 Designed by TES Date June 24, 2020 Job No. 096956015
 Checked by _____ Date _____ Sheet No. _____ of _____

TRIP GENERATION MANUAL TECHNIQUES

ITE Trip Generation Manual 10th Edition, Average Rate Equations

Land Use Code - High Turnover Sit-Down Restaurant (932)

Independant Variable - 1000 Square Feet Gross Floor Area (X)

Gross Floor Area = **11,000** Square Feet

X = 11.000

T = Average Vehicle Trip Ends

Peak Hour of Adjacent Street Traffic, One Hour Between 7 and 9 a.m. (900 Series Page 97)

Average Weekday	Directional Distribution:	55% ent.	45% exit.
T = 9.94 (X)	T = 109	Average Vehicle Trip Ends	
T = 9.94 * 11.000	60 entering	49	exiting

Peak Hour of Adjacent Street Traffic, One Hour Between 4 and 6 p.m. (900 Series Page 98)

Average Weekday	Directional Distribution:	62% ent.	38% exit.
T = 9.77 (X)	T = 107	Average Vehicle Trip Ends	
T = 9.77 * 11.000	66 entering	41	exiting

Weekday (900 Series Page 96)

Average Weekday	Directional Distribution:	50% entering, 50% exiting	
T = 112.18 (X)	T = 1234	Average Vehicle Trip Ends	
T = 112.18 * 11.000	617 entering	617	exiting

P.M. Peak Hour of Generator (900 Series Page 100)

Average Weekday	Directional Distribution:	52% ent.	48% exit.
T = 17.41 (X)	T = 192	Average Vehicle Trip Ends	
T = 17.41 * 11.000	100 entering	92	exiting

Saturday Peak Hour of Generator (900 Series Page 105)

Average Saturday	Directional Distribution:	51% ent.	49% exit.
T = 11.19 (X)	T = 124	Average Vehicle Trip Ends	
T = 11.19 * 11.000	63 entering	61	exiting

Non Pass-By Trip Volumes (Per ITE Trip Generation Handbook, 3rd Edition September 2017-Page 207)

AM Peak Hour = 57% Non-Pass By	PM Peak Hour = 57% Non-Pass By
IN Out Total	
AM Peak 34 28 62	
PM Peak 38 23 61	
Daily 352 352 704	PM Peak Hour Rate Applied to Daily

Pass-By Trip Volumes (Per ITE Trip Generation Handbook, 3rd Edition September 2017 -Page 207)

AM Peak Hour = 43% Pass By	PM Peak Hour = 43% Pass By
IN Out Total	
AM Peak 26 21 48	
PM Peak 28 18 46	
Daily 265 265 530	PM Peak Hour Rate Applied to Daily

Project Crossroads-Meadowbrook-Reagan Ranch (Crossroads North)
 Subject Trip Generation for Fast-Food Restaurant with Drive-Through Window
 Designed by JRP Date February 08, 2021 Job No. 096956015
 Checked by _____ Date _____ Sheet No. _____ of _____

TRIP GENERATION MANUAL TECHNIQUES

ITE Trip Generation Manual 10th Edition, Average Rate Equations

Land Use Code - Fast Food Restaurant With Drive-Through Window (934)

Independant Variable - 1000 Square Feet Gross Floor Area (X)

Gross Floor Area = **5,000** Square Feet

X = 5.000

T = Average Vehicle Trip Ends

Peak Hour of Adjacent Street Traffic, One Hour Between 7 and 9 a.m. (900 Series page 158)

Average Weekday
 T = 40.19 (X)
 T = 40.19 * 5.000

Directional Distribution: 51% ent. 49% exit.
 T = 201 Average Vehicle Trip Ends
 103 entering 98 exiting
 103 + 98 (*) = 201

Peak Hour of Adjacent Street Traffic, One Hour Between 4 and 6 p.m. (900 Series page 159)

Average Weekday
 T = 32.67 (X)
 T = 32.67 * 5.000

Directional Distribution: 52% ent. 48% exit.
 T = 163 Average Vehicle Trip Ends
 85 entering 78 exiting
 85 + 78 = 163

Weekday (900 Series page 157)

Average Weekday
 T = 470.95 (X)
 T = 470.95 * 5.000

Directional Distribution: 50% entering, 50% exiting
 T = 2356 Average Vehicle Trip Ends
 1178 entering 1178 exiting
 1178 + 1178 = 2356

Saturday Peak Hour of Generator (900 Series page 163)

T = 54.86 (X)
 T = 54.86 * 5.000

Directional Distribution: 51% ent. 49% exit.
 T = 274 Average Vehicle Trip Ends
 140 entering 134 exiting
 140 + 134 = 274

Non Pass-By Trip Volumes (Per ITE Trip Generation Handbook, 3rd Edition September 2017)

AM Peak Hour =	51%	Non-Pass By	PM Peak Hour =	50%	Non-Pass By
	IN	Out	Total		
AM Peak	53	50	103		
PM Peak	43	39	82		
Daily	589	589	1178	PM Peak Hour Rate Applied to Daily	

Pass-By Trip Volumes (Per ITE Trip Generation Handbook, 3rd Edition September 2017)

AM Peak Hour =	49%	Pass By	PM Peak Hour =	50%	Pass By
	IN	Out	Total		
AM Peak	50	48	98		
PM Peak	43	39	82		
Daily	589	589	1178	PM Peak Hour Rate Applied to Daily	

Project Crossroads-Meadowbrook-Reagan Ranch (Crossroads North)
 Subject Trip Generation for Super Convenience Market/Gas Station
 Designed by JRP Date February 08, 2021 Job No. 096956015
 Checked by _____ Date _____ Sheet No. _____ of _____

TRIP GENERATION MANUAL TECHNIQUES

ITE Trip Generation Manual 10th Edition, Average Rate Equations

Land Use Code - Super Convenience Market/Gas Station (960)

Independant Variable - 1000 Square Feet Gross Leasable Area (X)

Gross Leasable Area = **6,000** Square Feet

X = 6.000

T = Average Vehicle Trip Ends

Peak Hour of Adjacent Street Traffic, One Hour Between 7 and 9 a.m. (900 Series Page 404)

		Directional Distribution:	50% ent.	50% exit.
T = 83.14 (X)		T = 499	Average Vehicle Trip Ends	
T = 83.14 *	6.000	249 entering	250	exiting
		249 + 250 =	499	

Peak Hour of Adjacent Street Traffic, One Hour Between 4 and 6 p.m. (900 Series page 405)

		Directional Distribution:	50% ent.	50% exit.
T = 69.28 (X)		T = 416	Average Vehicle Trip Ends	
T = 69.28 *	6.000	208 entering	208	exiting
		208 + 208 =	416	

Weekday (800 Series page 335)

		Directional Distribution:	50% entering,	50% exiting
Average Weekday		T = 5026	Average Vehicle Trip Ends	
T = 837.58 (X)		2513 entering	2513	exiting
T = 837.58 *	6.000	2513 + 2513 =	5026	

Non Pass-By Trip Volumes (Per ITE Trip Generation Handbook, 3rd Edition September 2017)

PM Peak Hour =	44%	Non-Pass By	AM Peak Hour =	38%	Non-Pass By
	IN	Out	Total	* Utilized ITE 945 pass-by calculations	
AM Peak	95	95	190		
PM Peak	92	92	183		
Daily	1106	1106	2212	PM Peak Hour Rate Applied to Daily	

Pass-By Trip Volumes (Per ITE Trip Generation Handbook, 3rd Edition September 2017)

PM Peak Hour =	56%	Pass By	AM Peak Hour =	62%	Pass By
	IN	Out	Total		
AM Peak	154	155	309		
PM Peak	116	116	233		
Daily	1407	1407	2814	PM Peak Hour Rate Applied to Daily	

APPENDIX D

Intersection Analysis Worksheets

Timings

2: Marksheffel Rd & US-24



Lane Group	EBL	EBT	WBL	WBT	WBR	NBL	NBT	NBR	SBL	SBT	SBR
Lane Configurations	↖↗	↕	↖↗	↕	↖	↖	↕	↖	↖	↕	↖
Traffic Volume (vph)	335	486	282	1107	18	1	454	54	9	707	705
Future Volume (vph)	335	486	282	1107	18	1	454	54	9	707	705
Turn Type	Prot	NA	Prot	NA	Free	Prot	NA	Free	Prot	NA	Free
Protected Phases	5	2	1	6		3	8		7	4	
Permitted Phases					Free			Free			Free
Detector Phase	5	2	1	6		3	8		7	4	
Switch Phase											
Minimum Initial (s)	5.0	5.0	5.0	5.0		5.0	5.0		5.0	5.0	
Minimum Split (s)	12.0	12.0	12.0	12.0		11.5	11.5		10.5	10.5	
Total Split (s)	21.0	50.5	23.0	52.5		11.5	36.0		10.5	35.0	
Total Split (%)	17.5%	42.1%	19.2%	43.8%		9.6%	30.0%		8.8%	29.2%	
Yellow Time (s)	5.0	5.0	5.0	5.0		5.0	5.0		4.5	4.5	
All-Red Time (s)	1.5	1.5	1.5	1.5		1.5	1.5		1.0	1.0	
Lost Time Adjust (s)	0.0	0.0	0.0	0.0		0.0	0.0		0.0	0.0	
Total Lost Time (s)	6.5	6.5	6.5	6.5		6.5	6.5		5.5	5.5	
Lead/Lag	Lead	Lag	Lead	Lag		Lag	Lead		Lag	Lead	
Lead-Lag Optimize?	Yes	Yes	Yes	Yes		Yes	Yes		Yes	Yes	
Recall Mode	None	C-Max	None	C-Max		None	None		None	None	
Act Effct Green (s)	17.7	55.4	15.0	52.7	120.0	5.1	27.6	120.0	6.2	28.8	120.0
Actuated g/C Ratio	0.15	0.46	0.12	0.44	1.00	0.04	0.23	1.00	0.05	0.24	1.00
v/c Ratio	0.75	0.34	0.70	0.76	0.01	0.01	0.59	0.04	0.10	0.90	0.48
Control Delay	51.7	39.9	59.5	33.2	0.0	72.0	51.3	0.0	51.4	53.2	1.6
Queue Delay	0.0	0.0	0.0	0.0	0.0	0.0	0.0	0.0	0.0	0.0	0.0
Total Delay	51.7	39.9	59.5	33.2	0.0	72.0	51.3	0.0	51.4	53.2	1.6
LOS	D	D	E	C	A	E	D	A	D	D	A
Approach Delay		44.7		38.0			45.9			27.6	
Approach LOS		D		D			D			C	

Intersection Summary

Cycle Length: 120
 Actuated Cycle Length: 120
 Offset: 105 (88%), Referenced to phase 2:EBT and 6:WBT, Start of Green
 Natural Cycle: 90
 Control Type: Actuated-Coordinated
 Maximum v/c Ratio: 0.90
 Intersection Signal Delay: 36.8
 Intersection LOS: D
 Intersection Capacity Utilization 75.1%
 ICU Level of Service D
 Analysis Period (min) 15

Splits and Phases: 2: Marksheffel Rd & US-24

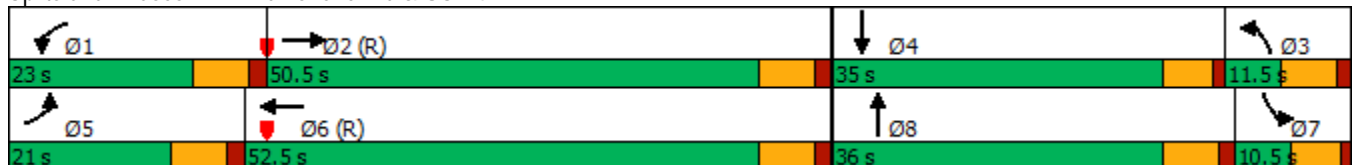

HCM 6th Signalized Intersection Summary
 2: Marksheffel Rd & US-24

2020 Adjusted Existing AM.syn
 01/11/2022



Movement	EBL	EBT	EBR	WBL	WBT	WBR	NBL	NBT	NBR	SBL	SBT	SBR
Lane Configurations	↖↗	↖↖	↗	↖↗	↖↖	↗	↖	↖↖	↗	↖	↖↖	↗
Traffic Volume (veh/h)	335	486	0	282	1107	18	1	454	54	9	707	705
Future Volume (veh/h)	335	486	0	282	1107	18	1	454	54	9	707	705
Initial Q (Qb), veh	0	0	0	0	0	0	0	0	0	0	0	0
Ped-Bike Adj(A_pbT)	1.00		1.00	1.00		1.00	1.00		1.00	1.00		1.00
Parking Bus, Adj	1.00	1.00	1.00	1.00	1.00	1.00	1.00	1.00	1.00	1.00	1.00	1.00
Work Zone On Approach		No			No			No			No	
Adj Sat Flow, veh/h/ln	1737	1737	1737	1841	1841	1841	1856	1856	1856	1811	1811	1811
Adj Flow Rate, veh/h	349	506	0	294	1153	0	1	473	0	9	736	0
Peak Hour Factor	0.96	0.96	0.96	0.96	0.96	0.96	0.96	0.96	0.96	0.96	0.96	0.96
Percent Heavy Veh, %	11	11	11	4	4	4	3	3	3	6	6	6
Cap, veh/h	388	1491		357	1524		2	586		104	804	
Arrive On Green	0.12	0.45	0.00	0.10	0.44	0.00	0.00	0.17	0.00	0.08	0.31	0.00
Sat Flow, veh/h	3209	3300	1472	3401	3497	1560	1767	3526	1572	1725	3441	1535
Grp Volume(v), veh/h	349	506	0	294	1153	0	1	473	0	9	736	0
Grp Sat Flow(s),veh/h/ln	1605	1650	1472	1700	1749	1560	1767	1763	1572	1725	1721	1535
Q Serve(g_s), s	12.9	11.9	0.0	10.2	33.3	0.0	0.1	15.5	0.0	0.6	24.7	0.0
Cycle Q Clear(g_c), s	12.9	11.9	0.0	10.2	33.3	0.0	0.1	15.5	0.0	0.6	24.7	0.0
Prop In Lane	1.00		1.00	1.00		1.00	1.00		1.00	1.00		1.00
Lane Grp Cap(c), veh/h	388	1491		357	1524		2	586		104	804	
V/C Ratio(X)	0.90	0.34		0.82	0.76		0.41	0.81		0.09	0.92	
Avail Cap(c_a), veh/h	388	1491		468	1524		74	867		104	846	
HCM Platoon Ratio	1.00	1.00	1.00	1.00	1.00	1.00	1.00	1.00	1.00	1.33	1.33	1.33
Upstream Filter(l)	1.00	1.00	0.00	1.00	1.00	0.00	1.00	1.00	0.00	0.84	0.84	0.00
Uniform Delay (d), s/veh	52.0	21.3	0.0	52.6	28.5	0.0	59.9	48.2	0.0	52.1	40.2	0.0
Incr Delay (d2), s/veh	23.2	0.6	0.0	8.9	3.6	0.0	85.9	3.6	0.0	0.3	12.2	0.0
Initial Q Delay(d3),s/veh	0.0	0.0	0.0	0.0	0.0	0.0	0.0	0.0	0.0	0.0	0.0	0.0
%ile BackOfQ(50%),veh/ln	6.4	4.7	0.0	4.8	14.5	0.0	0.1	7.1	0.0	0.3	11.2	0.0
Unsig. Movement Delay, s/veh												
LnGrp Delay(d),s/veh	75.3	21.9	0.0	61.5	32.0	0.0	145.8	51.7	0.0	52.4	52.5	0.0
LnGrp LOS	E	C		E	C		F	D		D	D	
Approach Vol, veh/h		855	A		1447	A		474	A		745	A
Approach Delay, s/veh		43.7			38.0			51.9			52.5	
Approach LOS		D			D			D			D	
Timer - Assigned Phs	1	2	3	4	5	6	7	8				
Phs Duration (G+Y+Rc), s	19.1	60.7	6.7	33.5	21.0	58.8	13.8	26.5				
Change Period (Y+Rc), s	6.5	6.5	6.5	5.5	6.5	6.5	6.5	* 6.5				
Max Green Setting (Gmax), s	16.5	44.0	5.0	29.5	14.5	46.0	5.0	* 30				
Max Q Clear Time (g_c+l1), s	12.2	13.9	2.1	26.7	14.9	35.3	2.6	17.5				
Green Ext Time (p_c), s	0.4	3.7	0.0	1.3	0.0	5.9	0.0	2.4				

Intersection Summary

HCM 6th Ctrl Delay	44.3
HCM 6th LOS	D

Notes

* HCM 6th computational engine requires equal clearance times for the phases crossing the barrier.
 Unsignalized Delay for [NBR, EBR, WBR, SBR] is excluded from calculations of the approach delay and intersection delay.

Timings

2: Marksheffel Rd & US-24

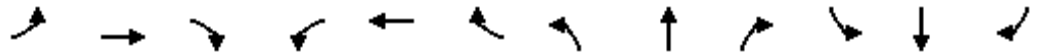

Lane Group	EBL	EBT	EBR	WBL	WBT	WBR	NBL	NBT	NBR	SBL	SBT	SBR
Lane Configurations	↖↗	↖↖	↖	↖↗	↖↖	↖	↖	↖↖	↖	↖	↖↖	↖
Traffic Volume (vph)	622	1100	7	140	525	15	12	830	178	16	554	473
Future Volume (vph)	622	1100	7	140	525	15	12	830	178	16	554	473
Turn Type	Prot	NA	Free	Prot	NA	Free	Prot	NA	Free	Prot	NA	Free
Protected Phases	5	2		1	6		3	8		7	4	
Permitted Phases			Free			Free			Free			Free
Detector Phase	5	2		1	6		3	8		7	4	
Switch Phase												
Minimum Initial (s)	5.0	5.0		5.0	5.0		5.0	5.0		5.0	5.0	
Minimum Split (s)	12.0	12.0		12.0	12.0		11.5	11.5		10.5	10.5	
Total Split (s)	34.0	53.5		14.0	33.5		11.5	42.0		10.5	41.0	
Total Split (%)	28.3%	44.6%		11.7%	27.9%		9.6%	35.0%		8.8%	34.2%	
Yellow Time (s)	5.0	5.0		5.0	5.0		5.0	5.0		4.5	4.5	
All-Red Time (s)	1.5	1.5		1.5	1.5		1.5	1.5		1.0	1.0	
Lost Time Adjust (s)	0.0	0.0		0.0	0.0		0.0	0.0		0.0	0.0	
Total Lost Time (s)	6.5	6.5		6.5	6.5		6.5	6.5		5.5	5.5	
Lead/Lag	Lead	Lag		Lead	Lag		Lag	Lead		Lag	Lead	
Lead-Lag Optimize?	Yes	Yes		Yes	Yes		Yes	Yes		Yes	Yes	
Recall Mode	None	C-Max		None	C-Max		None	None		None	None	
Act Effct Green (s)	25.7	54.3	120.0	8.5	37.0	120.0	6.6	33.6	120.0	5.2	35.7	120.0
Actuated g/C Ratio	0.21	0.45	1.00	0.07	0.31	1.00	0.06	0.28	1.00	0.04	0.30	1.00
v/c Ratio	0.86	0.70	0.00	0.60	0.50	0.01	0.12	0.86	0.11	0.21	0.54	0.31
Control Delay	36.7	37.8	0.0	65.0	38.0	0.0	49.3	40.6	0.1	58.2	32.8	0.6
Queue Delay	0.0	0.0	0.0	0.0	0.0	0.0	0.0	0.0	0.0	0.0	0.0	0.0
Total Delay	36.7	37.8	0.0	65.0	38.0	0.0	49.3	40.6	0.1	58.2	32.8	0.6
LOS	D	D	A	E	D	A	D	D	A	E	C	A
Approach Delay		37.3			42.7			33.7			18.6	
Approach LOS		D			D			C			B	

Intersection Summary

Cycle Length: 120
 Actuated Cycle Length: 120
 Offset: 105 (88%), Referenced to phase 2:EBT and 6:WBT, Start of Green
 Natural Cycle: 90
 Control Type: Actuated-Coordinated
 Maximum v/c Ratio: 0.86
 Intersection Signal Delay: 32.9
 Intersection Capacity Utilization 73.8%
 Analysis Period (min) 15
 Intersection LOS: C
 ICU Level of Service D

Splits and Phases: 2: Marksheffel Rd & US-24

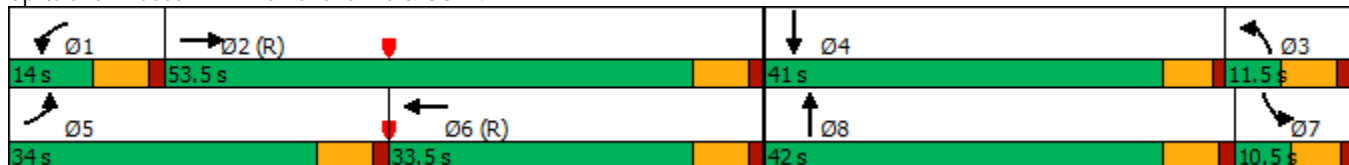

HCM 6th Signalized Intersection Summary

2020 Adjusted Existing PM.syn

2: Marksheffel Rd & US-24

01/11/2022



Movement	EBL	EBT	EBR	WBL	WBT	WBR	NBL	NBT	NBR	SBL	SBT	SBR
Lane Configurations	↖↗	↑↑	↖	↖↗	↑↑	↖	↖	↑↑	↖	↖	↑↑	↖
Traffic Volume (veh/h)	622	1100	7	140	525	15	12	830	178	16	554	473
Future Volume (veh/h)	622	1100	7	140	525	15	12	830	178	16	554	473
Initial Q (Qb), veh	0	0	0	0	0	0	0	0	0	0	0	0
Ped-Bike Adj(A_pbT)	1.00		1.00	1.00		1.00	1.00		1.00	1.00		1.00
Parking Bus, Adj	1.00	1.00	1.00	1.00	1.00	1.00	1.00	1.00	1.00	1.00	1.00	1.00
Work Zone On Approach		No			No			No			No	
Adj Sat Flow, veh/h/ln	1870	1870	1870	1856	1856	1856	1870	1870	1870	1856	1856	1856
Adj Flow Rate, veh/h	635	1122	0	143	536	0	12	847	0	16	565	0
Peak Hour Factor	0.98	0.98	0.98	0.98	0.98	0.98	0.98	0.98	0.98	0.98	0.98	0.98
Percent Heavy Veh, %	2	2	2	3	3	3	2	2	2	3	3	3
Cap, veh/h	706	1561		197	1031		185	957		30	674	
Arrive On Green	0.20	0.44	0.00	0.06	0.29	0.00	0.10	0.27	0.00	0.03	0.38	0.00
Sat Flow, veh/h	3456	3554	1585	3428	3526	1572	1781	3554	1585	1767	3526	1572
Grp Volume(v), veh/h	635	1122	0	143	536	0	12	847	0	16	565	0
Grp Sat Flow(s),veh/h/ln	1728	1777	1585	1714	1763	1572	1781	1777	1585	1767	1763	1572
Q Serve(g_s), s	21.5	31.0	0.0	4.9	15.2	0.0	0.7	27.4	0.0	1.1	17.5	0.0
Cycle Q Clear(g_c), s	21.5	31.0	0.0	4.9	15.2	0.0	0.7	27.4	0.0	1.1	17.5	0.0
Prop In Lane	1.00		1.00	1.00		1.00	1.00		1.00	1.00		1.00
Lane Grp Cap(c), veh/h	706	1561		197	1031		185	957		30	674	
V/C Ratio(X)	0.90	0.72		0.73	0.52		0.06	0.88		0.53	0.84	
Avail Cap(c_a), veh/h	792	1561		214	1031		185	1051		74	1043	
HCM Platoon Ratio	1.00	1.00	1.00	1.00	1.00	1.00	1.00	1.00	1.00	2.00	2.00	2.00
Upstream Filter(l)	1.00	1.00	0.00	1.00	1.00	0.00	1.00	1.00	0.00	0.94	0.94	0.00
Uniform Delay (d), s/veh	46.5	27.6	0.0	55.6	35.4	0.0	48.5	42.1	0.0	57.5	35.4	0.0
Incr Delay (d2), s/veh	12.3	2.9	0.0	10.7	1.9	0.0	0.1	8.6	0.0	12.6	3.5	0.0
Initial Q Delay(d3),s/veh	0.0	0.0	0.0	0.0	0.0	0.0	0.0	0.0	0.0	0.0	0.0	0.0
%ile BackOfQ(50%),veh/ln	10.4	13.6	0.0	2.4	6.8	0.0	0.3	13.1	0.0	0.6	6.5	0.0
Unsig. Movement Delay, s/veh												
LnGrp Delay(d),s/veh	58.9	30.4	0.0	66.3	37.3	0.0	48.7	50.7	0.0	70.0	38.9	0.0
LnGrp LOS	E	C		E	D		D	D		E	D	
Approach Vol, veh/h		1757	A		679	A		859	A		581	A
Approach Delay, s/veh		40.7			43.4			50.6			39.7	
Approach LOS		D			D			D			D	
Timer - Assigned Phs	1	2	3	4	5	6	7	8				
Phs Duration (G+Y+Rc), s	13.4	59.2	19.0	28.4	31.0	41.6	8.6	38.8				
Change Period (Y+Rc), s	6.5	6.5	6.5	5.5	6.5	6.5	6.5	* 6.5				
Max Green Setting (Gmax), s	7.5	47.0	5.0	35.5	27.5	27.0	5.0	* 36				
Max Q Clear Time (g_c+I1), s	6.9	33.0	2.7	19.5	23.5	17.2	3.1	29.4				
Green Ext Time (p_c), s	0.0	6.8	0.0	3.5	1.0	2.5	0.0	2.9				

Intersection Summary

HCM 6th Ctrl Delay	43.2
HCM 6th LOS	D

Notes

* HCM 6th computational engine requires equal clearance times for the phases crossing the barrier.

Unsignalized Delay for [NBR, EBR, WBR, SBR] is excluded from calculations of the approach delay and intersection delay.

Timings
2: Marksheffel Rd & US-24



Lane Group	EBL	EBT	WBL	WBT	WBR	NBL	NBT	NBR	SBL	SBT	SBR
Lane Configurations	↔↔	↑↑	↔↔	↑↑	↔	↔	↑↑	↔	↔	↑↑	↔
Traffic Volume (vph)	360	550	325	1215	20	5	625	85	10	875	760
Future Volume (vph)	360	550	325	1215	20	5	625	85	10	875	760
Turn Type	Prot	NA	Prot	NA	Free	Prot	NA	Free	Prot	NA	Free
Protected Phases	5	2	1	6		3	8		7	4	
Permitted Phases					Free			Free			Free
Detector Phase	5	2	1	6		3	8		7	4	
Switch Phase											
Minimum Initial (s)	5.0	5.0	5.0	5.0		5.0	5.0		5.0	5.0	
Minimum Split (s)	12.0	12.0	12.0	12.0		11.5	11.5		10.5	10.5	
Total Split (s)	21.0	46.5	25.0	50.5		11.5	38.0		10.5	37.0	
Total Split (%)	17.5%	38.8%	20.8%	42.1%		9.6%	31.7%		8.8%	30.8%	
Yellow Time (s)	5.0	5.0	5.0	5.0		5.0	5.0		4.5	4.5	
All-Red Time (s)	1.5	1.5	1.5	1.5		1.5	1.5		1.0	1.0	
Lost Time Adjust (s)	0.0	0.0	0.0	0.0		0.0	0.0		0.0	0.0	
Total Lost Time (s)	6.5	6.5	6.5	6.5		6.5	6.5		5.5	5.5	
Lead/Lag	Lead	Lag	Lead	Lag		Lag	Lead		Lag	Lead	
Lead-Lag Optimize?	Yes	Yes	Yes	Yes		Yes	Yes		Yes	Yes	
Recall Mode	None	C-Max	None	C-Max		None	None		None	None	
Act Effect Green (s)	19.5	50.9	16.6	48.0	120.0	5.0	30.8	120.0	5.5	31.6	120.0
Actuated g/C Ratio	0.16	0.42	0.14	0.40	1.00	0.04	0.26	1.00	0.05	0.26	1.00
v/c Ratio	0.73	0.42	0.73	0.91	0.01	0.07	0.72	0.06	0.13	1.01	0.52
Control Delay	46.2	44.7	58.9	45.3	0.0	68.0	50.7	0.1	52.3	68.6	1.5
Queue Delay	0.0	0.0	0.0	0.0	0.0	0.0	0.0	0.0	0.0	0.0	0.0
Total Delay	46.2	44.7	58.9	45.3	0.0	68.0	50.7	0.1	52.3	68.6	1.5
LOS	D	D	E	D	A	E	D	A	D	E	A
Approach Delay		45.3		47.6			44.7			37.5	
Approach LOS		D		D			D			D	

Intersection Summary

Cycle Length: 120
 Actuated Cycle Length: 120
 Offset: 105 (88%), Referenced to phase 2:EBT and 6:WBT, Start of Green
 Natural Cycle: 120
 Control Type: Actuated-Coordinated
 Maximum v/c Ratio: 1.01
 Intersection Signal Delay: 43.3
 Intersection Capacity Utilization 83.5%
 Analysis Period (min) 15
 Intersection LOS: D
 ICU Level of Service E

Splits and Phases: 2: Marksheffel Rd & US-24



HCM 6th Signalized Intersection Summary
2: Marksheffel Rd & US-24

2026 Background AM.syn

01/11/2022



Movement	EBL	EBT	EBR	WBL	WBT	WBR	NBL	NBT	NBR	SBL	SBT	SBR
Lane Configurations	↖↗	↕	↖	↖↗	↕	↖	↖	↕	↖	↖	↕	↖
Traffic Volume (veh/h)	360	550	0	325	1215	20	5	625	85	10	875	760
Future Volume (veh/h)	360	550	0	325	1215	20	5	625	85	10	875	760
Initial Q (Qb), veh	0	0	0	0	0	0	0	0	0	0	0	0
Ped-Bike Adj(A_pbT)	1.00		1.00	1.00		1.00	1.00		1.00	1.00		1.00
Parking Bus, Adj	1.00	1.00	1.00	1.00	1.00	1.00	1.00	1.00	1.00	1.00	1.00	1.00
Work Zone On Approach		No			No			No			No	
Adj Sat Flow, veh/h/ln	1737	1737	1737	1841	1841	1841	1856	1856	1856	1811	1811	1811
Adj Flow Rate, veh/h	375	573	0	339	1266	0	5	651	0	10	911	0
Peak Hour Factor	0.96	0.96	0.96	0.96	0.96	0.96	0.96	0.96	0.96	0.96	0.96	0.96
Percent Heavy Veh, %	11	11	11	4	4	4	3	3	3	6	6	6
Cap, veh/h	388	1333		404	1406		11	765		75	903	
Arrive On Green	0.12	0.40	0.00	0.12	0.40	0.00	0.01	0.22	0.00	0.09	0.52	0.00
Sat Flow, veh/h	3209	3300	1472	3401	3497	1560	1767	3526	1572	1725	3441	1535
Grp Volume(v), veh/h	375	573	0	339	1266	0	5	651	0	10	911	0
Grp Sat Flow(s),veh/h/ln	1605	1650	1472	1700	1749	1560	1767	1763	1572	1725	1721	1535
Q Serve(g_s), s	14.0	15.0	0.0	11.7	40.7	0.0	0.3	21.3	0.0	0.6	31.5	0.0
Cycle Q Clear(g_c), s	14.0	15.0	0.0	11.7	40.7	0.0	0.3	21.3	0.0	0.6	31.5	0.0
Prop In Lane	1.00		1.00	1.00		1.00	1.00		1.00	1.00		1.00
Lane Grp Cap(c), veh/h	388	1333		404	1406		11	765		75	903	
V/C Ratio(X)	0.97	0.43		0.84	0.90		0.44	0.85		0.13	1.01	
Avail Cap(c_a), veh/h	388	1333		524	1406		74	925		75	903	
HCM Platoon Ratio	1.00	1.00	1.00	1.00	1.00	1.00	1.00	1.00	1.00	2.00	2.00	2.00
Upstream Filter(I)	1.00	1.00	0.00	1.00	1.00	0.00	1.00	1.00	0.00	0.74	0.74	0.00
Uniform Delay (d), s/veh	52.5	25.8	0.0	51.8	33.6	0.0	59.4	45.1	0.0	52.7	28.5	0.0
Incr Delay (d2), s/veh	37.0	1.0	0.0	9.2	9.6	0.0	24.8	6.5	0.0	0.6	27.9	0.0
Initial Q Delay(d3),s/veh	0.0	0.0	0.0	0.0	0.0	0.0	0.0	0.0	0.0	0.0	0.0	0.0
%ile BackOfQ(50%),veh/ln	7.6	6.1	0.0	5.5	18.8	0.0	0.2	10.0	0.0	0.3	13.1	0.0
Unsig. Movement Delay, s/veh												
LnGrp Delay(d),s/veh	89.5	26.8	0.0	61.0	43.2	0.0	84.2	51.7	0.0	53.3	56.4	0.0
LnGrp LOS	F	C		E	D		F	D		D	F	
Approach Vol, veh/h		948	A		1605	A		656	A		921	A
Approach Delay, s/veh		51.6			47.0			51.9			56.3	
Approach LOS		D			D			D			E	
Timer - Assigned Phs	1	2	3	4	5	6	7	8				
Phs Duration (G+Y+Rc), s	20.7	55.0	7.3	37.0	21.0	54.7	11.7	32.5				
Change Period (Y+Rc), s	6.5	6.5	6.5	5.5	6.5	6.5	6.5	* 6.5				
Max Green Setting (Gmax), s	18.5	40.0	5.0	31.5	14.5	44.0	5.0	* 32				
Max Q Clear Time (g_c+I1), s	13.7	17.0	2.3	33.5	16.0	42.7	2.6	23.3				
Green Ext Time (p_c), s	0.5	4.0	0.0	0.0	0.0	1.0	0.0	2.8				

Intersection Summary

HCM 6th Ctrl Delay	50.9
HCM 6th LOS	D

Notes

* HCM 6th computational engine requires equal clearance times for the phases crossing the barrier.

Unsignalized Delay for [NBR, EBR, WBR, SBR] is excluded from calculations of the approach delay and intersection delay.

Timings

2: Marksheffel Rd & US-24

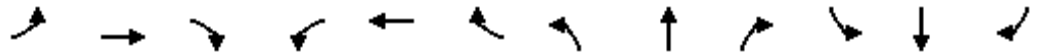

Lane Group	EBL	EBT	EBR	WBL	WBT	WBR	NBL	NBT	NBR	SBL	SBT	SBR
Lane Configurations	↖↖	↗↗	↘	↖↖	↗↗	↘	↖	↗↗	↘	↖	↗↗	↘
Traffic Volume (vph)	670	1200	10	190	585	20	15	1060	225	20	780	510
Future Volume (vph)	670	1200	10	190	585	20	15	1060	225	20	780	510
Turn Type	Prot	NA	Free	Prot	NA	Free	Prot	NA	Free	Prot	NA	Free
Protected Phases	5	2		1	6		3	8		7	4	
Permitted Phases			Free			Free			Free			Free
Detector Phase	5	2		1	6		3	8		7	4	
Switch Phase												
Minimum Initial (s)	5.0	5.0		5.0	5.0		5.0	5.0		5.0	5.0	
Minimum Split (s)	12.0	12.0		12.0	12.0		11.5	11.5		10.5	10.5	
Total Split (s)	31.0	50.5		14.0	33.5		11.8	45.0		10.5	43.7	
Total Split (%)	25.8%	42.1%		11.7%	27.9%		9.8%	37.5%		8.8%	36.4%	
Yellow Time (s)	5.0	5.0		5.0	5.0		5.0	5.0		4.5	4.5	
All-Red Time (s)	1.5	1.5		1.5	1.5		1.5	1.5		1.0	1.0	
Lost Time Adjust (s)	0.0	0.0		0.0	0.0		0.0	0.0		0.0	0.0	
Total Lost Time (s)	6.5	6.5		6.5	6.5		6.5	6.5		5.5	5.5	
Lead/Lag	Lead	Lag		Lead	Lag		Lag	Lead		Lag	Lead	
Lead-Lag Optimize?	Yes	Yes		Yes	Yes		Yes	Yes		Yes	Yes	
Recall Mode	None	C-Max		None	C-Max		None	None		None	None	
Act Effect Green (s)	27.2	47.7	120.0	10.1	30.6	120.0	5.9	38.5	120.0	5.0	38.8	120.0
Actuated g/C Ratio	0.23	0.40	1.00	0.08	0.26	1.00	0.05	0.32	1.00	0.04	0.32	1.00
v/c Ratio	0.88	0.87	0.01	0.68	0.67	0.01	0.17	0.95	0.15	0.27	0.70	0.33
Control Delay	39.3	43.5	0.0	66.2	45.2	0.0	47.1	44.7	0.1	59.1	33.9	0.5
Queue Delay	0.0	0.0	0.0	0.0	0.0	0.0	0.0	0.0	0.0	0.0	0.0	0.0
Total Delay	39.3	43.5	0.0	66.2	45.2	0.0	47.1	44.7	0.1	59.1	33.9	0.5
LOS	D	D	A	E	D	A	D	D	A	E	C	A
Approach Delay		41.8			49.1			37.0			21.3	
Approach LOS		D			D			D			C	

Intersection Summary

Cycle Length: 120	
Actuated Cycle Length: 120	
Offset: 105 (88%), Referenced to phase 2:EBT and 6:WBT, Start of Green	
Natural Cycle: 100	
Control Type: Actuated-Coordinated	
Maximum v/c Ratio: 0.95	
Intersection Signal Delay: 36.6	Intersection LOS: D
Intersection Capacity Utilization 84.1%	ICU Level of Service E
Analysis Period (min) 15	

Splits and Phases: 2: Marksheffel Rd & US-24

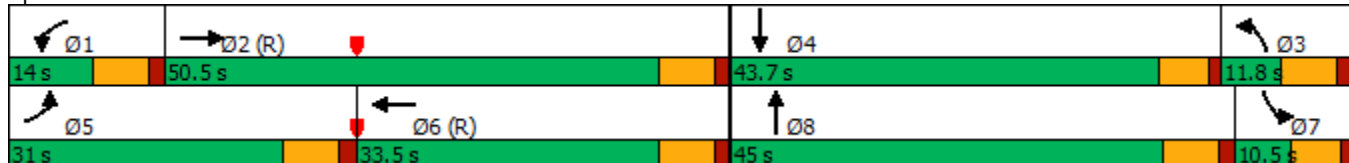

HCM 6th Signalized Intersection Summary
 2: Marksheffel Rd & US-24

2026 Background PM.syn

01/11/2022

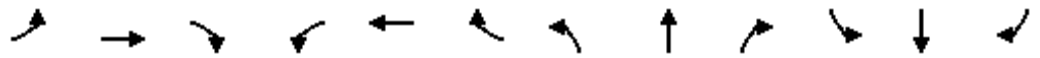

Movement	EBL	EBT	EBR	WBL	WBT	WBR	NBL	NBT	NBR	SBL	SBT	SBR
Lane Configurations	↖↗	↑↑	↖	↖↗	↑↑	↖	↖	↑↑	↖	↖	↑↑	↖
Traffic Volume (veh/h)	670	1200	10	190	585	20	15	1060	225	20	780	510
Future Volume (veh/h)	670	1200	10	190	585	20	15	1060	225	20	780	510
Initial Q (Qb), veh	0	0	0	0	0	0	0	0	0	0	0	0
Ped-Bike Adj(A_pbT)	1.00		1.00	1.00		1.00	1.00		1.00	1.00		1.00
Parking Bus, Adj	1.00	1.00	1.00	1.00	1.00	1.00	1.00	1.00	1.00	1.00	1.00	1.00
Work Zone On Approach		No			No			No			No	
Adj Sat Flow, veh/h/ln	1870	1870	1870	1856	1856	1856	1870	1870	1870	1856	1856	1856
Adj Flow Rate, veh/h	684	1224	0	194	597	0	15	1082	0	20	796	0
Peak Hour Factor	0.98	0.98	0.98	0.98	0.98	0.98	0.98	0.98	0.98	0.98	0.98	0.98
Percent Heavy Veh, %	2	2	2	3	3	3	2	2	2	3	3	3
Cap, veh/h	706	1356		214	846		165	1134		36	898	
Arrive On Green	0.20	0.38	0.00	0.06	0.24	0.00	0.09	0.32	0.00	0.04	0.51	0.00
Sat Flow, veh/h	3456	3554	1585	3428	3526	1572	1781	3554	1585	1767	3526	1572
Grp Volume(v), veh/h	684	1224	0	194	597	0	15	1082	0	20	796	0
Grp Sat Flow(s),veh/h/ln	1728	1777	1585	1714	1763	1572	1781	1777	1585	1767	1763	1572
Q Serve(g_s), s	23.6	39.0	0.0	6.7	18.6	0.0	0.9	35.8	0.0	1.3	24.2	0.0
Cycle Q Clear(g_c), s	23.6	39.0	0.0	6.7	18.6	0.0	0.9	35.8	0.0	1.3	24.2	0.0
Prop In Lane	1.00		1.00	1.00		1.00	1.00		1.00	1.00		1.00
Lane Grp Cap(c), veh/h	706	1356		214	846		165	1134		36	898	
V/C Ratio(X)	0.97	0.90		0.91	0.71		0.09	0.95		0.56	0.89	
Avail Cap(c_a), veh/h	706	1356		214	846		165	1140		74	1122	
HCM Platoon Ratio	1.00	1.00	1.00	1.00	1.00	1.00	1.00	1.00	1.00	2.00	2.00	2.00
Upstream Filter(I)	1.00	1.00	0.00	1.00	1.00	0.00	1.00	1.00	0.00	0.87	0.87	0.00
Uniform Delay (d), s/veh	47.4	35.0	0.0	55.9	41.7	0.0	49.8	40.0	0.0	57.0	27.9	0.0
Incr Delay (d2), s/veh	26.4	10.0	0.0	36.7	4.9	0.0	0.2	16.8	0.0	11.3	6.5	0.0
Initial Q Delay(d3),s/veh	0.0	0.0	0.0	0.0	0.0	0.0	0.0	0.0	0.0	0.0	0.0	0.0
%ile BackOfQ(50%),veh/ln	12.7	18.4	0.0	4.0	8.6	0.0	0.4	18.1	0.0	0.7	8.5	0.0
Unsig. Movement Delay, s/veh												
LnGrp Delay(d),s/veh	73.8	45.0	0.0	92.6	46.7	0.0	50.0	56.8	0.0	68.3	34.4	0.0
LnGrp LOS	E	D		F	D		D	E		E	C	
Approach Vol, veh/h		1908	A		791	A		1097	A		816	A
Approach Delay, s/veh		55.3			57.9			56.7			35.3	
Approach LOS		E			E			E			D	
Timer - Assigned Phs	1	2	3	4	5	6	7	8				
Phs Duration (G+Y+Rc), s	14.0	52.3	17.6	36.1	31.0	35.3	8.9	44.8				
Change Period (Y+Rc), s	6.5	6.5	6.5	5.5	6.5	6.5	6.5	* 6.5				
Max Green Setting (Gmax), s	7.5	44.0	5.3	38.2	24.5	27.0	5.0	* 39				
Max Q Clear Time (g_c+I1), s	8.7	41.0	2.9	26.2	25.6	20.6	3.3	37.8				
Green Ext Time (p_c), s	0.0	2.1	0.0	4.3	0.0	2.1	0.0	0.5				

Intersection Summary

HCM 6th Ctrl Delay	52.6
HCM 6th LOS	D

Notes

* HCM 6th computational engine requires equal clearance times for the phases crossing the barrier.
 Unsignalized Delay for [NBR, EBR, WBR, SBR] is excluded from calculations of the approach delay and intersection delay.

Timings

2: Marksheffel Rd & US-24

Lane Group	EBL	EBT	EBR	WBL	WBT	WBR	NBL	NBT	NBR	SBL	SBT	SBR
Lane Configurations												
Traffic Volume (vph)	360	550	125	350	1215	20	5	755	105	10	1025	760
Future Volume (vph)	360	550	125	350	1215	20	5	755	105	10	1025	760
Turn Type	Prot	NA	Free	Prot	NA	Free	Prot	NA	Free	Prot	NA	Free
Protected Phases	5	2		1	6		3	8		7	4	
Permitted Phases			Free			Free			Free			Free
Detector Phase	5	2		1	6		3	8		7	4	
Switch Phase												
Minimum Initial (s)	5.0	5.0		5.0	5.0		5.0	5.0		5.0	5.0	
Minimum Split (s)	12.0	12.0		12.0	12.0		11.5	11.5		10.5	10.5	
Total Split (s)	20.0	35.0		30.0	45.0		12.0	44.5		10.5	43.0	
Total Split (%)	16.7%	29.2%		25.0%	37.5%		10.0%	37.1%		8.8%	35.8%	
Yellow Time (s)	4.5	5.0		4.5	5.0		4.5	5.0		4.5	4.5	
All-Red Time (s)	1.5	1.5		1.5	1.5		1.5	1.5		1.0	1.0	
Lost Time Adjust (s)	0.0	0.0		0.0	0.0		0.0	0.0		0.0	0.0	
Total Lost Time (s)	6.0	6.5		6.0	6.5		6.0	6.5		5.5	5.5	
Lead/Lag	Lead	Lag		Lead	Lag		Lag	Lead		Lag	Lead	
Lead-Lag Optimize?	Yes	Yes		Yes	Yes		Yes	Yes		Yes	Yes	
Recall Mode	None	C-Max		None	C-Max		None	None		None	None	
Act Effct Green (s)	20.0	43.9	120.0	18.2	42.0	120.0	5.8	36.8	120.0	5.7	37.5	120.0
Actuated g/C Ratio	0.17	0.37	1.00	0.15	0.35	1.00	0.05	0.31	1.00	0.05	0.31	1.00
v/c Ratio	0.71	0.48	0.09	0.72	1.04	0.01	0.06	0.73	0.07	0.12	1.00	0.52
Control Delay	41.8	42.2	0.1	56.4	75.7	0.0	55.0	39.4	0.1	48.7	57.6	0.9
Queue Delay	0.0	0.0	0.0	0.0	0.0	0.0	0.0	0.0	0.0	0.0	0.0	0.0
Total Delay	41.8	42.2	0.1	56.4	75.7	0.0	55.0	39.4	0.1	48.7	57.6	0.9
LOS	D	D	A	E	E	A	D	D	A	D	E	A
Approach Delay		37.0			70.5			34.8			33.6	
Approach LOS		D			E			C			C	

Intersection Summary

Cycle Length: 120
 Actuated Cycle Length: 120
 Offset: 105 (88%), Referenced to phase 2:EBT and 6:WBT, Start of Green
 Natural Cycle: 140
 Control Type: Actuated-Coordinated
 Maximum v/c Ratio: 1.04
 Intersection Signal Delay: 45.5
 Intersection LOS: D
 Intersection Capacity Utilization 87.2%
 ICU Level of Service E
 Analysis Period (min) 15

Splits and Phases: 2: Marksheffel Rd & US-24

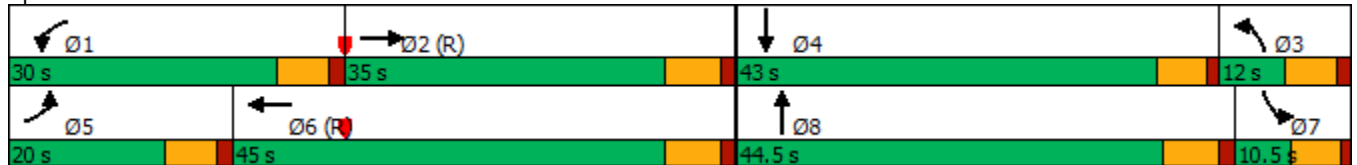

HCM 6th Signalized Intersection Summary

2026 Total AM.syn

01/11/2022

2: Marksheffel Rd & US-24

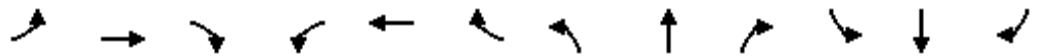

Movement	EBL	EBT	EBR	WBL	WBT	WBR	NBL	NBT	NBR	SBL	SBT	SBR
Lane Configurations	↔↔	↑↑	↗	↔↔	↑↑	↗	↗	↑↑	↗	↗	↑↑	↗
Traffic Volume (veh/h)	360	550	125	350	1215	20	5	755	105	10	1025	760
Future Volume (veh/h)	360	550	125	350	1215	20	5	755	105	10	1025	760
Initial Q (Qb), veh	0	0	0	0	0	0	0	0	0	0	0	0
Ped-Bike Adj(A_pbT)	1.00		1.00	1.00		1.00	1.00		1.00	1.00		1.00
Parking Bus, Adj	1.00	1.00	1.00	1.00	1.00	1.00	1.00	1.00	1.00	1.00	1.00	1.00
Work Zone On Approach		No			No			No			No	
Adj Sat Flow, veh/h/ln	1737	1737	1737	1841	1841	1841	1856	1856	1856	1811	1811	1811
Adj Flow Rate, veh/h	375	573	0	365	1266	0	5	786	0	10	1068	0
Peak Hour Factor	0.96	0.96	0.96	0.96	0.96	0.96	0.96	0.96	0.96	0.96	0.96	0.96
Percent Heavy Veh, %	11	11	11	4	4	4	3	3	3	6	6	6
Cap, veh/h	374	1162		439	1275		11	922		84	1075	
Arrive On Green	0.12	0.35	0.00	0.13	0.36	0.00	0.01	0.26	0.00	0.10	0.63	0.00
Sat Flow, veh/h	3209	3300	1472	3401	3497	1560	1767	3526	1572	1725	3441	1535
Grp Volume(v), veh/h	375	573	0	365	1266	0	5	786	0	10	1068	0
Grp Sat Flow(s),veh/h/ln	1605	1650	1472	1700	1749	1560	1767	1763	1572	1725	1721	1535
Q Serve(g_s), s	14.0	16.3	0.0	12.6	43.3	0.0	0.3	25.4	0.0	0.6	36.8	0.0
Cycle Q Clear(g_c), s	14.0	16.3	0.0	12.6	43.3	0.0	0.3	25.4	0.0	0.6	36.8	0.0
Prop In Lane	1.00		1.00	1.00		1.00	1.00		1.00	1.00		1.00
Lane Grp Cap(c), veh/h	374	1162		439	1275		11	922		84	1075	
V/C Ratio(X)	1.00	0.49		0.83	0.99		0.44	0.85		0.12	0.99	
Avail Cap(c_a), veh/h	374	1162		680	1275		88	1116		84	1075	
HCM Platoon Ratio	1.00	1.00	1.00	1.00	1.00	1.00	1.00	1.00	1.00	2.00	2.00	2.00
Upstream Filter(I)	1.00	1.00	0.00	1.00	1.00	0.00	1.00	1.00	0.00	0.66	0.66	0.00
Uniform Delay (d), s/veh	53.0	30.5	0.0	51.0	38.0	0.0	59.4	42.1	0.0	51.8	22.4	0.0
Incr Delay (d2), s/veh	46.9	1.5	0.0	5.2	23.7	0.0	24.8	5.6	0.0	0.4	20.6	0.0
Initial Q Delay(d3),s/veh	0.0	0.0	0.0	0.0	0.0	0.0	0.0	0.0	0.0	0.0	0.0	0.0
%ile BackOfQ(50%),veh/ln	8.1	6.7	0.0	5.7	22.3	0.0	0.2	11.7	0.0	0.3	12.5	0.0
Unsig. Movement Delay, s/veh												
LnGrp Delay(d),s/veh	99.9	32.0	0.0	56.2	61.6	0.0	84.2	47.7	0.0	52.2	43.0	0.0
LnGrp LOS	F	C		E	E		F	D		D	D	
Approach Vol, veh/h		948	A		1631	A		791	A		1078	A
Approach Delay, s/veh		58.8			60.4			47.9			43.1	
Approach LOS		E			E			D			D	
Timer - Assigned Phs	1	2	3	4	5	6	7	8				
Phs Duration (G+Y+Rc), s	21.5	48.7	6.8	43.0	20.0	50.2	11.9	37.9				
Change Period (Y+Rc), s	6.0	6.5	6.0	5.5	6.0	6.5	6.0	* 6.5				
Max Green Setting (Gmax), s	24.0	28.5	6.0	37.5	14.0	38.5	5.0	* 38				
Max Q Clear Time (g_c+l1), s	14.6	18.3	2.3	38.8	16.0	45.3	2.6	27.4				
Green Ext Time (p_c), s	0.9	2.8	0.0	0.0	0.0	0.0	0.0	4.0				

Intersection Summary

HCM 6th Ctrl Delay	53.7
HCM 6th LOS	D

Notes

* HCM 6th computational engine requires equal clearance times for the phases crossing the barrier.
 Unsignalized Delay for [NBR, EBR, WBR, SBR] is excluded from calculations of the approach delay and intersection delay.

Timings
2: Marksheffel Rd & US-24

2026 Total PM.syn
01/11/2022

Lane Group	EBL	EBT	EBR	WBL	WBT	WBR	NBL	NBT	NBR	SBL	SBT	SBR
Lane Configurations												
Traffic Volume (vph)	670	1200	125	210	585	20	15	1190	245	20	915	510
Future Volume (vph)	670	1200	125	210	585	20	15	1190	245	20	915	510
Turn Type	Prot	NA	Free	Prot	NA	Free	Prot	NA	Free	Prot	NA	Free
Protected Phases	5	2		1	6		3	8		7	4	
Permitted Phases			Free			Free			Free			Free
Detector Phase	5	2		1	6		3	8		7	4	
Switch Phase												
Minimum Initial (s)	5.0	5.0		5.0	5.0		5.0	5.0		5.0	5.0	
Minimum Split (s)	12.0	12.0		12.0	12.0		11.5	11.5		10.5	10.5	
Total Split (s)	37.0	47.0		14.0	24.0		11.5	48.5		10.5	47.5	
Total Split (%)	30.8%	39.2%		11.7%	20.0%		9.6%	40.4%		8.8%	39.6%	
Yellow Time (s)	4.5	5.0		4.5	5.0		4.5	5.0		4.5	4.5	
All-Red Time (s)	1.5	1.5		1.5	1.5		1.5	1.5		1.0	1.0	
Lost Time Adjust (s)	0.0	0.0		0.0	0.0		0.0	0.0		0.0	0.0	
Total Lost Time (s)	6.0	6.5		6.0	6.5		6.0	6.5		5.5	5.5	
Lead/Lag	Lead	Lag		Lead	Lag		Lag	Lead		Lag	Lead	
Lead-Lag Optimize?	Yes	Yes		Yes	Yes		Yes	Yes		Yes	Yes	
Recall Mode	None	C-Max		None	C-Max		None	None		None	None	
Act Effct Green (s)	28.0	43.9	120.0	10.9	26.8	120.0	5.7	42.0	120.0	5.0	42.6	120.0
Actuated g/C Ratio	0.23	0.37	1.00	0.09	0.22	1.00	0.05	0.35	1.00	0.04	0.36	1.00
v/c Ratio	0.85	0.95	0.08	0.69	0.76	0.01	0.18	0.98	0.16	0.27	0.75	0.33
Control Delay	31.4	41.7	0.0	65.7	52.3	0.0	51.1	46.2	0.2	57.6	31.6	0.5
Queue Delay	0.0	0.0	0.0	0.0	0.0	0.0	0.0	0.0	0.0	0.0	0.0	0.0
Total Delay	31.4	41.7	0.0	65.7	52.3	0.0	51.1	46.2	0.2	57.6	31.6	0.5
LOS	C	D	A	E	D	A	D	D	A	E	C	A
Approach Delay		35.6			54.5			38.5			21.0	
Approach LOS		D			D			D			C	

Intersection Summary

Cycle Length: 120
 Actuated Cycle Length: 120
 Offset: 105 (88%), Referenced to phase 2:EBT and 6:WBT, Start of Green
 Natural Cycle: 120
 Control Type: Actuated-Coordinated
 Maximum v/c Ratio: 0.98
 Intersection Signal Delay: 35.3
 Intersection LOS: D
 Intersection Capacity Utilization 87.9%
 ICU Level of Service E
 Analysis Period (min) 15

Splits and Phases: 2: Marksheffel Rd & US-24

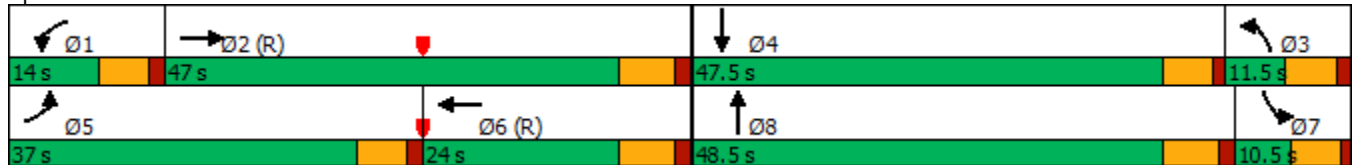

HCM 6th Signalized Intersection Summary
 2: Marksheffel Rd & US-24

2026 Total PM.syn
 01/11/2022



Movement	EBL	EBT	EBR	WBL	WBT	WBR	NBL	NBT	NBR	SBL	SBT	SBR
Lane Configurations	↖↗	↑↑	↖	↖↗	↑↑	↖	↖	↑↑	↖	↖	↑↑	↖
Traffic Volume (veh/h)	670	1200	125	210	585	20	15	1190	245	20	915	510
Future Volume (veh/h)	670	1200	125	210	585	20	15	1190	245	20	915	510
Initial Q (Qb), veh	0	0	0	0	0	0	0	0	0	0	0	0
Ped-Bike Adj(A_pbT)	1.00		1.00	1.00		1.00	1.00		1.00	1.00		1.00
Parking Bus, Adj	1.00	1.00	1.00	1.00	1.00	1.00	1.00	1.00	1.00	1.00	1.00	1.00
Work Zone On Approach		No			No			No			No	
Adj Sat Flow, veh/h/ln	1870	1870	1870	1856	1856	1856	1870	1870	1870	1856	1856	1856
Adj Flow Rate, veh/h	684	1224	0	214	597	0	15	1214	0	20	934	0
Peak Hour Factor	0.98	0.98	0.98	0.98	0.98	0.98	0.98	0.98	0.98	0.98	0.98	0.98
Percent Heavy Veh, %	2	2	2	3	3	3	2	2	2	3	3	3
Cap, veh/h	764	1261		229	706		153	1244		36	1033	
Arrive On Green	0.22	0.35	0.00	0.07	0.20	0.00	0.09	0.35	0.00	0.04	0.59	0.00
Sat Flow, veh/h	3456	3554	1585	3428	3526	1572	1781	3554	1585	1767	3526	1572
Grp Volume(v), veh/h	684	1224	0	214	597	0	15	1214	0	20	934	0
Grp Sat Flow(s),veh/h/ln	1728	1777	1585	1714	1763	1572	1781	1777	1585	1767	1763	1572
Q Serve(g_s), s	23.1	40.7	0.0	7.5	19.6	0.0	0.9	40.5	0.0	1.3	28.0	0.0
Cycle Q Clear(g_c), s	23.1	40.7	0.0	7.5	19.6	0.0	0.9	40.5	0.0	1.3	28.0	0.0
Prop In Lane	1.00		1.00	1.00		1.00	1.00		1.00	1.00		1.00
Lane Grp Cap(c), veh/h	764	1261		229	706		153	1244		36	1033	
V/C Ratio(X)	0.89	0.97		0.94	0.85		0.10	0.98		0.56	0.90	
Avail Cap(c_a), veh/h	893	1261		229	706		153	1244		74	1234	
HCM Platoon Ratio	1.00	1.00	1.00	1.00	1.00	1.00	1.00	1.00	1.00	2.00	2.00	2.00
Upstream Filter(I)	1.00	1.00	0.00	1.00	1.00	0.00	1.00	1.00	0.00	0.83	0.83	0.00
Uniform Delay (d), s/veh	45.4	38.1	0.0	55.7	46.2	0.0	50.6	38.5	0.0	57.0	23.4	0.0
Incr Delay (d2), s/veh	10.4	19.3	0.0	42.2	11.9	0.0	0.3	19.9	0.0	10.8	7.2	0.0
Initial Q Delay(d3),s/veh	0.0	0.0	0.0	0.0	0.0	0.0	0.0	0.0	0.0	0.0	0.0	0.0
%ile BackOfQ(50%),veh/ln	10.9	20.8	0.0	4.6	9.7	0.0	0.4	20.7	0.0	0.7	9.0	0.0
Unsig. Movement Delay, s/veh												
LnGrp Delay(d),s/veh	55.8	57.4	0.0	97.9	58.1	0.0	50.9	58.4	0.0	67.8	30.6	0.0
LnGrp LOS	E	E		F	E		D	E		E	C	
Approach Vol, veh/h		1908	A		811	A		1229	A		954	A
Approach Delay, s/veh		56.8			68.6			58.3			31.4	
Approach LOS		E			E			E			C	
Timer - Assigned Phs	1	2	3	4	5	6	7	8				
Phs Duration (G+Y+Rc), s	14.0	49.1	16.3	40.7	32.5	30.5	8.4	48.5				
Change Period (Y+Rc), s	6.0	6.5	6.0	5.5	6.0	6.5	6.0	* 6.5				
Max Green Setting (Gmax), s	8.0	40.5	5.5	42.0	31.0	17.5	5.0	* 42				
Max Q Clear Time (g_c+I1), s	9.5	42.7	2.9	30.0	25.1	21.6	3.3	42.5				
Green Ext Time (p_c), s	0.0	0.0	0.0	5.2	1.5	0.0	0.0	0.0				

Intersection Summary

HCM 6th Ctrl Delay	54.2
HCM 6th LOS	D

Notes

* HCM 6th computational engine requires equal clearance times for the phases crossing the barrier.
 Unsignalized Delay for [NBR, EBR, WBR, SBR] is excluded from calculations of the approach delay and intersection delay.

Timings
2: Marksheffel Rd & US-24



Lane Group	EBL	EBT	WBL	WBT	WBR	NBL	NBT	NBR	SBL	SBT	SBR
Lane Configurations	↔↔	↑↑	↔↔	↑↑	↔	↔	↑↑	↔	↔	↑↑	↔
Traffic Volume (vph)	425	645	405	1425	25	5	955	135	15	1165	890
Future Volume (vph)	425	645	405	1425	25	5	955	135	15	1165	890
Turn Type	Prot	NA	Prot	NA	Free	Prot	NA	Free	Prot	NA	Free
Protected Phases	5	2	1	6		3	8		7	4	
Permitted Phases					Free			Free			Free
Detector Phase	5	2	1	6		3	8		7	4	
Switch Phase											
Minimum Initial (s)	5.0	5.0	5.0	5.0		5.0	5.0		5.0	5.0	
Minimum Split (s)	12.0	12.0	12.0	12.0		11.5	11.5		10.5	10.5	
Total Split (s)	20.0	41.5	27.0	48.5		11.5	41.0		10.5	40.0	
Total Split (%)	16.7%	34.6%	22.5%	40.4%		9.6%	34.2%		8.8%	33.3%	
Yellow Time (s)	5.0	5.0	5.0	5.0		5.0	5.0		4.5	4.5	
All-Red Time (s)	1.5	1.5	1.5	1.5		1.5	1.5		1.0	1.0	
Lost Time Adjust (s)	0.0	0.0	0.0	0.0		0.0	0.0		0.0	0.0	
Total Lost Time (s)	6.5	6.5	6.5	6.5		6.5	6.5		5.5	5.5	
Lead/Lag	Lead	Lag	Lead	Lag		Lag	Lead		Lag	Lead	
Lead-Lag Optimize?	Yes	Yes	Yes	Yes		Yes	Yes		Yes	Yes	
Recall Mode	None	C-Max	None	C-Max		None	None		None	None	
Act Effect Green (s)	19.8	42.9	18.9	42.0	120.0	5.0	34.5	120.0	5.0	37.4	120.0
Actuated g/C Ratio	0.16	0.36	0.16	0.35	1.00	0.04	0.29	1.00	0.04	0.31	1.00
v/c Ratio	0.85	0.58	0.80	1.22	0.02	0.07	0.99	0.09	0.23	1.14	0.61
Control Delay	56.0	52.4	60.5	142.7	0.0	53.8	62.7	0.1	50.3	103.6	1.2
Queue Delay	0.0	0.0	0.0	0.0	0.0	0.0	0.0	0.0	0.0	0.0	0.0
Total Delay	56.0	52.4	60.5	142.7	0.0	53.8	62.7	0.1	50.3	103.6	1.2
LOS	E	D	E	F	A	D	E	A	D	F	A
Approach Delay		53.8		122.8			54.9			59.2	
Approach LOS		D		F			D			E	

Intersection Summary

Cycle Length: 120
 Actuated Cycle Length: 120
 Offset: 105 (88%), Referenced to phase 2:EBT and 6:WBT, Start of Green
 Natural Cycle: 150
 Control Type: Actuated-Coordinated
 Maximum v/c Ratio: 1.22
 Intersection Signal Delay: 76.8
 Intersection LOS: E
 Intersection Capacity Utilization 99.1%
 ICU Level of Service F
 Analysis Period (min) 15

Splits and Phases: 2: Marksheffel Rd & US-24

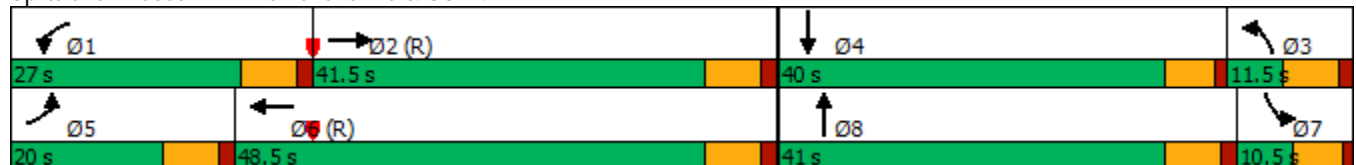

HCM 6th Signalized Intersection Summary
 2: Marksheffel Rd & US-24

2040 Background AM.syn

01/11/2022



Movement	EBL	EBT	EBR	WBL	WBT	WBR	NBL	NBT	NBR	SBL	SBT	SBR
Lane Configurations	↖↗	↕	↖	↖↗	↕	↖	↖	↕	↖	↖	↕	↖
Traffic Volume (veh/h)	425	645	0	405	1425	25	5	955	135	15	1165	890
Future Volume (veh/h)	425	645	0	405	1425	25	5	955	135	15	1165	890
Initial Q (Qb), veh	0	0	0	0	0	0	0	0	0	0	0	0
Ped-Bike Adj(A_pbT)	1.00		1.00	1.00		1.00	1.00		1.00	1.00		1.00
Parking Bus, Adj	1.00	1.00	1.00	1.00	1.00	1.00	1.00	1.00	1.00	1.00	1.00	1.00
Work Zone On Approach		No			No			No			No	
Adj Sat Flow, veh/h/ln	1737	1737	1737	1841	1841	1841	1856	1856	1856	1811	1811	1811
Adj Flow Rate, veh/h	443	672	0	422	1484	0	5	995	0	16	1214	0
Peak Hour Factor	0.96	0.96	0.96	0.96	0.96	0.96	0.96	0.96	0.96	0.96	0.96	0.96
Percent Heavy Veh, %	11	11	11	4	4	4	3	3	3	6	6	6
Cap, veh/h	361	1107		487	1280		45	1014		30	989	
Arrive On Green	0.11	0.34	0.00	0.14	0.37	0.00	0.03	0.29	0.00	0.03	0.57	0.00
Sat Flow, veh/h	3209	3300	1472	3401	3497	1560	1767	3526	1572	1725	3441	1535
Grp Volume(v), veh/h	443	672	0	422	1484	0	5	995	0	16	1214	0
Grp Sat Flow(s),veh/h/ln	1605	1650	1472	1700	1749	1560	1767	1763	1572	1725	1721	1535
Q Serve(g_s), s	13.5	20.4	0.0	14.6	43.9	0.0	0.3	33.6	0.0	1.1	34.5	0.0
Cycle Q Clear(g_c), s	13.5	20.4	0.0	14.6	43.9	0.0	0.3	33.6	0.0	1.1	34.5	0.0
Prop In Lane	1.00		1.00	1.00		1.00	1.00		1.00	1.00		1.00
Lane Grp Cap(c), veh/h	361	1107		487	1280		45	1014		30	989	
V/C Ratio(X)	1.23	0.61		0.87	1.16		0.11	0.98		0.54	1.23	
Avail Cap(c_a), veh/h	361	1107		581	1280		74	1014		72	989	
HCM Platoon Ratio	1.00	1.00	1.00	1.00	1.00	1.00	1.00	1.00	1.00	2.00	2.00	2.00
Upstream Filter(I)	1.00	1.00	0.00	1.00	1.00	0.00	1.00	1.00	0.00	0.50	0.50	0.00
Uniform Delay (d), s/veh	53.3	33.3	0.0	50.3	38.0	0.0	57.1	42.4	0.0	57.5	25.5	0.0
Incr Delay (d2), s/veh	124.3	2.5	0.0	11.5	80.6	0.0	1.1	23.8	0.0	7.4	106.9	0.0
Initial Q Delay(d3),s/veh	0.0	0.0	0.0	0.0	0.0	0.0	0.0	0.0	0.0	0.0	0.0	0.0
%ile BackOfQ(50%),veh/ln	11.7	8.5	0.0	7.0	32.8	0.0	0.2	17.8	0.0	0.5	24.4	0.0
Unsig. Movement Delay, s/veh												
LnGrp Delay(d),s/veh	177.5	35.8	0.0	61.8	118.7	0.0	58.2	66.2	0.0	64.8	132.4	0.0
LnGrp LOS	F	D		E	F		E	E		E	F	
Approach Vol, veh/h		1115	A		1906	A		1000	A		1230	A
Approach Delay, s/veh		92.1			106.1			66.2			131.5	
Approach LOS		F			F			E			F	
Timer - Assigned Phs	1	2	3	4	5	6	7	8				
Phs Duration (G+Y+Rc), s	23.7	46.8	9.6	40.0	20.0	50.4	8.6	41.0				
Change Period (Y+Rc), s	6.5	6.5	6.5	5.5	6.5	6.5	6.5	* 6.5				
Max Green Setting (Gmax), s	20.5	35.0	5.0	34.5	13.5	42.0	5.0	* 35				
Max Q Clear Time (g_c+I1), s	16.6	22.4	2.3	36.5	15.5	45.9	3.1	35.6				
Green Ext Time (p_c), s	0.6	3.8	0.0	0.0	0.0	0.0	0.0	0.0				

Intersection Summary

HCM 6th Ctrl Delay	101.5
HCM 6th LOS	F

Notes

* HCM 6th computational engine requires equal clearance times for the phases crossing the barrier.
 Unsignalized Delay for [NBR, EBR, WBR, SBR] is excluded from calculations of the approach delay and intersection delay.

Timings
2: Marksheffel Rd & US-24

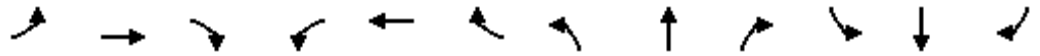

Lane Group	EBL	EBT	EBR	WBL	WBT	WBR	NBL	NBT	NBR	SBL	SBT	SBR
Lane Configurations	↖↗	↑↑	↖	↖↗	↑↑	↖	↖	↑↑	↖	↖	↑↑	↖
Traffic Volume (vph)	785	1415	10	285	690	20	20	1620	320	25	1330	600
Future Volume (vph)	785	1415	10	285	690	20	20	1620	320	25	1330	600
Turn Type	Prot	NA	Free	Prot	NA	Free	Prot	NA	Free	Prot	NA	Free
Protected Phases	5	2		1	6		3	8		7	4	
Permitted Phases			Free			Free			Free			Free
Detector Phase	5	2		1	6		3	8		7	4	
Switch Phase												
Minimum Initial (s)	5.0	5.0		5.0	5.0		5.0	5.0		5.0	5.0	
Minimum Split (s)	12.0	12.0		12.0	12.0		11.5	11.5		10.5	10.5	
Total Split (s)	28.0	46.5		14.0	32.5		11.5	49.0		10.5	48.0	
Total Split (%)	23.3%	38.8%		11.7%	27.1%		9.6%	40.8%		8.8%	40.0%	
Yellow Time (s)	5.0	5.0		5.0	5.0		5.0	5.0		4.5	4.5	
All-Red Time (s)	1.5	1.5		1.5	1.5		1.5	1.5		1.0	1.0	
Lost Time Adjust (s)	0.0	0.0		0.0	0.0		0.0	0.0		0.0	0.0	
Total Lost Time (s)	6.5	6.5		6.5	6.5		6.5	6.5		5.5	5.5	
Lead/Lag	Lead	Lag		Lead	Lag		Lag	Lead		Lag	Lead	
Lead-Lag Optimize?	Yes	Yes		Yes	Yes		Yes	Yes		Yes	Yes	
Recall Mode	None	C-Max		None	C-Max		None	None		None	None	
Act Effct Green (s)	25.7	40.0	120.0	11.7	26.0	120.0	5.0	42.5	120.0	5.0	45.2	120.0
Actuated g/C Ratio	0.21	0.33	1.00	0.10	0.22	1.00	0.04	0.35	1.00	0.04	0.38	1.00
v/c Ratio	1.09	1.22	0.01	0.88	0.93	0.01	0.27	1.32	0.21	0.36	1.03	0.39
Control Delay	88.5	146.3	0.0	80.9	65.5	0.0	50.0	173.9	0.2	54.7	57.1	0.5
Queue Delay	0.0	0.0	0.0	0.0	0.0	0.0	0.0	0.0	0.0	0.0	0.0	0.0
Total Delay	88.5	146.3	0.0	80.9	65.5	0.0	50.0	173.9	0.2	54.7	57.1	0.5
LOS	F	F	A	F	E	A	D	F	A	D	E	A
Approach Delay		125.1			68.7			144.3			39.7	
Approach LOS		F			E			F			D	

Intersection Summary

Cycle Length: 120
 Actuated Cycle Length: 120
 Offset: 105 (88%), Referenced to phase 2:EBT and 6:WBT, Start of Green
 Natural Cycle: 150
 Control Type: Actuated-Coordinated
 Maximum v/c Ratio: 1.32
 Intersection Signal Delay: 99.0
 Intersection LOS: F
 Intersection Capacity Utilization 108.3%
 ICU Level of Service G
 Analysis Period (min) 15

Splits and Phases: 2: Marksheffel Rd & US-24

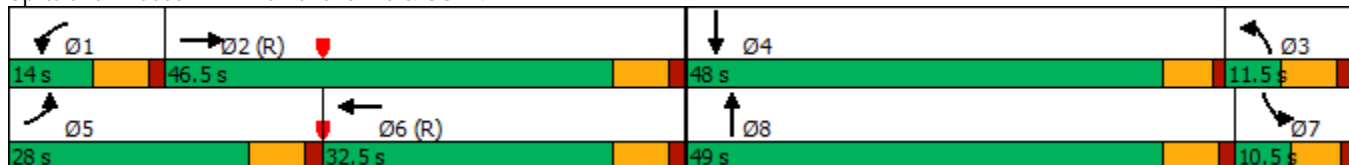



Movement	EBL	EBT	EBR	WBL	WBT	WBR	NBL	NBT	NBR	SBL	SBT	SBR
Lane Configurations	↖↗	↕	↖	↖↗	↕	↖	↖	↕	↖	↖	↕	↖
Traffic Volume (veh/h)	785	1415	10	285	690	20	20	1620	320	25	1330	600
Future Volume (veh/h)	785	1415	10	285	690	20	20	1620	320	25	1330	600
Initial Q (Qb), veh	0	0	0	0	0	0	0	0	0	0	0	0
Ped-Bike Adj(A_pbT)	1.00		1.00	1.00		1.00	1.00		1.00	1.00		1.00
Parking Bus, Adj	1.00	1.00	1.00	1.00	1.00	1.00	1.00	1.00	1.00	1.00	1.00	1.00
Work Zone On Approach		No			No			No			No	
Adj Sat Flow, veh/h/ln	1870	1870	1870	1856	1856	1856	1870	1870	1870	1856	1856	1856
Adj Flow Rate, veh/h	801	1444	0	291	704	0	20	1653	0	26	1357	0
Peak Hour Factor	0.98	0.98	0.98	0.98	0.98	0.98	0.98	0.98	0.98	0.98	0.98	0.98
Percent Heavy Veh, %	2	2	2	3	3	3	2	2	2	3	3	3
Cap, veh/h	619	1217		214	796		58	1259		43	1249	
Arrive On Green	0.18	0.34	0.00	0.06	0.23	0.00	0.03	0.35	0.00	0.05	0.71	0.00
Sat Flow, veh/h	3456	3554	1585	3428	3526	1572	1781	3554	1585	1767	3526	1572
Grp Volume(v), veh/h	801	1444	0	291	704	0	20	1653	0	26	1357	0
Grp Sat Flow(s),veh/h/ln	1728	1777	1585	1714	1763	1572	1781	1777	1585	1767	1763	1572
Q Serve(g_s), s	21.5	41.1	0.0	7.5	23.2	0.0	1.3	42.5	0.0	1.7	42.5	0.0
Cycle Q Clear(g_c), s	21.5	41.1	0.0	7.5	23.2	0.0	1.3	42.5	0.0	1.7	42.5	0.0
Prop In Lane	1.00		1.00	1.00		1.00	1.00		1.00	1.00		1.00
Lane Grp Cap(c), veh/h	619	1217		214	796		58	1259		43	1249	
V/C Ratio(X)	1.29	1.19		1.36	0.88		0.35	1.31		0.61	1.09	
Avail Cap(c_a), veh/h	619	1217		214	796		74	1259		74	1249	
HCM Platoon Ratio	1.00	1.00	1.00	1.00	1.00	1.00	1.00	1.00	1.00	2.00	2.00	2.00
Upstream Filter(I)	1.00	1.00	0.00	1.00	1.00	0.00	1.00	1.00	0.00	0.60	0.60	0.00
Uniform Delay (d), s/veh	49.3	39.4	0.0	56.3	44.9	0.0	56.8	38.8	0.0	56.5	17.5	0.0
Incr Delay (d2), s/veh	143.9	92.4	0.0	188.4	13.7	0.0	3.5	146.8	0.0	8.1	47.9	0.0
Initial Q Delay(d3),s/veh	0.0	0.0	0.0	0.0	0.0	0.0	0.0	0.0	0.0	0.0	0.0	0.0
%ile BackOfQ(50%),veh/ln	21.6	33.2	0.0	8.8	11.6	0.0	0.7	43.8	0.0	0.9	16.7	0.0
Unsig. Movement Delay, s/veh												
LnGrp Delay(d),s/veh	193.2	131.8	0.0	244.6	58.6	0.0	60.3	185.5	0.0	64.7	65.4	0.0
LnGrp LOS	F	F		F	E		E	F		E	F	
Approach Vol, veh/h		2245	A		995	A		1673	A		1383	A
Approach Delay, s/veh		153.7			113.0			184.0			65.4	
Approach LOS		F			F			F			E	
Timer - Assigned Phs	1	2	3	4	5	6	7	8				
Phs Duration (G+Y+Rc), s	14.0	47.6	10.4	48.0	28.0	33.6	9.4	49.0				
Change Period (Y+Rc), s	6.5	6.5	6.5	5.5	6.5	6.5	6.5	* 6.5				
Max Green Setting (Gmax), s	7.5	40.0	5.0	42.5	21.5	26.0	5.0	* 43				
Max Q Clear Time (g_c+I1), s	9.5	43.1	3.3	44.5	23.5	25.2	3.7	44.5				
Green Ext Time (p_c), s	0.0	0.0	0.0	0.0	0.0	0.4	0.0	0.0				

Intersection Summary

HCM 6th Ctrl Delay	135.9
HCM 6th LOS	F

Notes

* HCM 6th computational engine requires equal clearance times for the phases crossing the barrier.
 Unsignalized Delay for [NBR, EBR, WBR, SBR] is excluded from calculations of the approach delay and intersection delay.

Timings
2: Marksheffel Rd & US-24

2040 Total AM.syn
02/15/2021

Lane Group	EBL	EBT	EBR	WBL	WBT	WBR	NBL	NBT	NBR	SBL	SBT	SBR
Lane Configurations												
Traffic Volume (vph)	425	645	140	435	1425	25	5	1100	160	15	1330	890
Future Volume (vph)	425	645	140	435	1425	25	5	1100	160	15	1330	890
Turn Type	Prot	NA	Perm	Prot	NA	Perm	Prot	NA	Free	Prot	NA	Free
Protected Phases	5	2		1	6		3	8		7	4	
Permitted Phases			2			6			Free			Free
Detector Phase	5	2	2	1	6	6	3	8		7	4	
Switch Phase												
Minimum Initial (s)	5.0	5.0	5.0	5.0	5.0	5.0	5.0	5.0		5.0	5.0	
Minimum Split (s)	12.0	12.0	12.0	12.0	12.0	12.0	11.5	11.5		10.5	10.5	
Total Split (s)	24.0	38.0	38.0	30.0	44.0	44.0	11.5	41.5		10.5	40.5	
Total Split (%)	20.0%	31.7%	31.7%	25.0%	36.7%	36.7%	9.6%	34.6%		8.8%	33.8%	
Yellow Time (s)	5.0	5.0	5.0	5.0	5.0	5.0	5.0	5.0		4.5	4.5	
All-Red Time (s)	1.5	1.5	1.5	1.5	1.5	1.5	1.5	1.5		1.0	1.0	
Lost Time Adjust (s)	0.0	0.0	0.0	0.0	0.0	0.0	0.0	0.0		0.0	0.0	
Total Lost Time (s)	6.5	6.5	6.5	6.5	6.5	6.5	6.5	6.5		5.5	5.5	
Lead/Lag	Lead	Lag	Lag	Lead	Lag	Lag	Lag	Lead		Lag	Lead	
Lead-Lag Optimize?	Yes	Yes	Yes	Yes	Yes	Yes	Yes	Yes		Yes	Yes	
Recall Mode	None	C-Max	C-Max	None	C-Max	C-Max	None	None		None	None	
Act Effct Green (s)	20.2	41.0	41.0	20.7	41.5	41.5	5.0	34.6	120.0	5.2	37.5	120.0
Actuated g/C Ratio	0.17	0.34	0.34	0.17	0.35	0.35	0.04	0.29	1.00	0.04	0.31	1.00
v/c Ratio	0.84	0.42	0.25	0.78	0.86	0.04	0.07	0.79	0.11	0.22	0.91	0.61
Control Delay	51.2	45.9	25.9	57.4	43.3	0.1	37.6	25.3	0.1	49.5	36.1	1.2
Queue Delay	0.0	0.0	0.0	0.0	0.0	0.0	0.0	0.0	0.0	0.0	0.0	0.0
Total Delay	51.2	45.9	25.9	57.4	43.3	0.1	37.6	25.3	0.1	49.5	36.1	1.2
LOS	D	D	C	E	D	A	D	C	A	D	D	A
Approach Delay		45.5			45.9			22.2			22.3	
Approach LOS		D			D			C			C	

Intersection Summary

Cycle Length: 120
 Actuated Cycle Length: 120
 Offset: 105 (88%), Referenced to phase 2:EBT and 6:WBT, Start of Green
 Natural Cycle: 110
 Control Type: Actuated-Coordinated
 Maximum v/c Ratio: 0.91
 Intersection Signal Delay: 33.3
 Intersection LOS: C
 Intersection Capacity Utilization 80.8%
 ICU Level of Service D
 Analysis Period (min) 15

Splits and Phases: 2: Marksheffel Rd & US-24

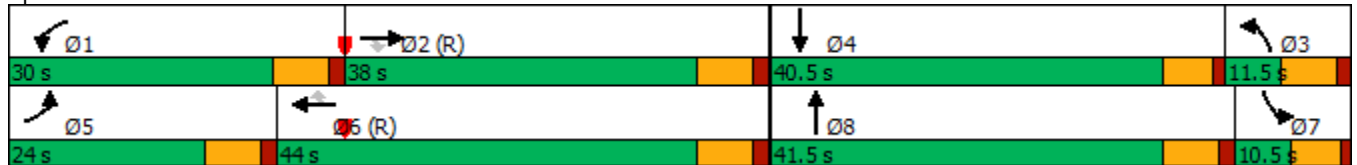

HCM 6th Signalized Intersection Summary

2040 Total AM.syn

02/15/2021

2: Marksheffel Rd & US-24



Movement	EBL	EBT	EBR	WBL	WBT	WBR	NBL	NBT	NBR	SBL	SBT	SBR
Lane Configurations	↔↔	↑↑↑	↗	↔↔	↑↑↑	↗	↔	↑↑↑	↗	↔	↑↑↑	↗
Traffic Volume (veh/h)	425	645	140	435	1425	25	5	1100	160	15	1330	890
Future Volume (veh/h)	425	645	140	435	1425	25	5	1100	160	15	1330	890
Initial Q (Qb), veh	0	0	0	0	0	0	0	0	0	0	0	0
Ped-Bike Adj(A_pbT)	1.00		1.00	1.00		1.00	1.00		1.00	1.00		1.00
Parking Bus, Adj	1.00	1.00	1.00	1.00	1.00	1.00	1.00	1.00	1.00	1.00	1.00	1.00
Work Zone On Approach		No			No			No			No	
Adj Sat Flow, veh/h/ln	1737	1737	1737	1841	1841	1841	1856	1856	1856	1811	1811	1811
Adj Flow Rate, veh/h	443	672	0	453	1484	0	5	1146	0	16	1385	0
Peak Hour Factor	0.96	0.96	0.96	0.96	0.96	0.96	0.96	0.96	0.96	0.96	0.96	0.96
Percent Heavy Veh, %	11	11	11	4	4	4	3	3	3	6	6	6
Cap, veh/h	468	1617		524	1755		11	1340		41	1435	
Arrive On Green	0.15	0.34	0.00	0.15	0.35	0.00	0.01	0.35	0.00	0.05	0.58	0.00
Sat Flow, veh/h	3209	4742	1472	3401	5025	1560	1767	5066	1572	1725	4944	1535
Grp Volume(v), veh/h	443	672	0	453	1484	0	5	1146	0	16	1385	0
Grp Sat Flow(s),veh/h/ln	1605	1581	1472	1700	1675	1560	1767	1689	1572	1725	1648	1535
Q Serve(g_s), s	16.4	13.1	0.0	15.6	32.7	0.0	0.3	25.2	0.0	1.1	32.1	0.0
Cycle Q Clear(g_c), s	16.4	13.1	0.0	15.6	32.7	0.0	0.3	25.2	0.0	1.1	32.1	0.0
Prop In Lane	1.00		1.00	1.00		1.00	1.00		1.00	1.00		1.00
Lane Grp Cap(c), veh/h	468	1617		524	1755		11	1340		41	1435	
V/C Ratio(X)	0.95	0.42		0.86	0.85		0.44	0.86		0.39	0.97	
Avail Cap(c_a), veh/h	468	1617		666	1755		74	1477		72	1442	
HCM Platoon Ratio	1.00	1.00	1.00	1.00	1.00	1.00	1.33	1.33	1.33	2.00	2.00	2.00
Upstream Filter(l)	1.00	1.00	0.00	1.00	1.00	0.00	0.95	0.95	0.00	0.36	0.36	0.00
Uniform Delay (d), s/veh	50.8	30.4	0.0	49.5	36.1	0.0	59.3	36.8	0.0	56.3	24.6	0.0
Incr Delay (d2), s/veh	28.5	0.8	0.0	9.4	5.2	0.0	23.7	4.6	0.0	2.2	7.9	0.0
Initial Q Delay(d3),s/veh	0.0	0.0	0.0	0.0	0.0	0.0	0.0	0.0	0.0	0.0	0.0	0.0
%ile BackOfQ(50%),veh/ln	8.4	5.1	0.0	7.3	14.0	0.0	0.2	10.3	0.0	0.5	9.7	0.0
Unsig. Movement Delay, s/veh												
LnGrp Delay(d),s/veh	79.3	31.2	0.0	58.9	41.3	0.0	83.0	41.3	0.0	58.5	32.5	0.0
LnGrp LOS	E	C		E	D		F	D		E	C	
Approach Vol, veh/h		1115	A		1937	A		1151	A		1401	A
Approach Delay, s/veh		50.3			45.4			41.5			32.8	
Approach LOS		D			D			D			C	
Timer - Assigned Phs	1	2	3	4	5	6	7	8				
Phs Duration (G+Y+Rc), s	25.0	47.4	7.3	40.3	24.0	48.4	9.4	38.2				
Change Period (Y+Rc), s	6.5	6.5	6.5	5.5	6.5	6.5	6.5	* 6.5				
Max Green Setting (Gmax), s	23.5	31.5	5.0	35.0	17.5	37.5	5.0	* 35				
Max Q Clear Time (g_c+l1), s	17.6	15.1	2.3	34.1	18.4	34.7	3.1	27.2				
Green Ext Time (p_c), s	0.9	4.3	0.0	0.7	0.0	2.2	0.0	4.6				

Intersection Summary

HCM 6th Ctrl Delay	42.4
HCM 6th LOS	D

Notes

* HCM 6th computational engine requires equal clearance times for the phases crossing the barrier.

Unsignalized Delay for [NBR, EBR, WBR, SBR] is excluded from calculations of the approach delay and intersection delay.

Timings
2: Marksheffel Rd & US-24

2040 Total PM.syn
02/15/2021

Lane Group	EBL	EBT	EBR	WBL	WBT	WBR	NBL	NBT	NBR	SBL	SBT	SBR
Lane Configurations												
Traffic Volume (vph)	785	1415	205	325	690	20	20	1765	345	25	1560	600
Future Volume (vph)	785	1415	205	325	690	20	20	1765	345	25	1560	600
Turn Type	Prot	NA	Perm	Prot	NA	Perm	Prot	NA	Free	Prot	NA	Free
Protected Phases	5	2		1	6		3	8		7	4	
Permitted Phases			2			6			Free			Free
Detector Phase	5	2	2	1	6	6	3	8		7	4	
Switch Phase												
Minimum Initial (s)	5.0	5.0	5.0	5.0	5.0	5.0	5.0	5.0		5.0	5.0	
Minimum Split (s)	12.0	12.0	12.0	12.0	12.0	12.0	11.5	11.5		10.5	10.5	
Total Split (s)	34.0	41.5	41.5	18.0	25.5	25.5	11.5	50.0		10.5	49.0	
Total Split (%)	28.3%	34.6%	34.6%	15.0%	21.3%	21.3%	9.6%	41.7%		8.8%	40.8%	
Yellow Time (s)	5.0	5.0	5.0	5.0	5.0	5.0	5.0	5.0		4.5	4.5	
All-Red Time (s)	1.5	1.5	1.5	1.5	1.5	1.5	1.5	1.5		1.0	1.0	
Lost Time Adjust (s)	0.0	0.0	0.0	0.0	0.0	0.0	0.0	0.0		0.0	0.0	
Total Lost Time (s)	6.5	6.5	6.5	6.5	6.5	6.5	6.5	6.5		5.5	5.5	
Lead/Lag	Lead	Lag	Lag	Lead	Lag	Lag	Lag	Lead		Lag	Lead	
Lead-Lag Optimize?	Yes	Yes	Yes	Yes	Yes	Yes	Yes	Yes		Yes	Yes	
Recall Mode	None	C-Max	C-Max	None	C-Max	C-Max	None	None		None	None	
Act Effct Green (s)	30.7	36.5	36.5	14.2	20.0	20.0	5.1	43.5	120.0	5.0	46.2	120.0
Actuated g/C Ratio	0.26	0.30	0.30	0.12	0.17	0.17	0.04	0.36	1.00	0.04	0.38	1.00
v/c Ratio	0.91	0.93	0.36	0.83	0.84	0.05	0.27	0.98	0.22	0.36	0.82	0.39
Control Delay	33.5	47.7	21.8	69.9	58.6	0.2	59.9	45.3	0.3	53.6	28.5	0.4
Queue Delay	0.0	0.0	0.0	0.0	0.0	0.0	0.0	0.0	0.0	0.0	0.0	0.0
Total Delay	33.5	47.7	21.8	69.9	58.6	0.2	59.9	45.3	0.3	53.6	28.5	0.4
LOS	C	D	C	E	E	A	E	D	A	D	C	A
Approach Delay		40.8			61.1			38.2			21.1	
Approach LOS		D			E			D			C	

Intersection Summary

Cycle Length: 120
 Actuated Cycle Length: 120
 Offset: 105 (88%), Referenced to phase 2:EBT and 6:WBT, Start of Green
 Natural Cycle: 110
 Control Type: Actuated-Coordinated
 Maximum v/c Ratio: 0.98
 Intersection Signal Delay: 37.3
 Intersection LOS: D
 Intersection Capacity Utilization 87.0%
 ICU Level of Service E
 Analysis Period (min) 15

Splits and Phases: 2: Marksheffel Rd & US-24

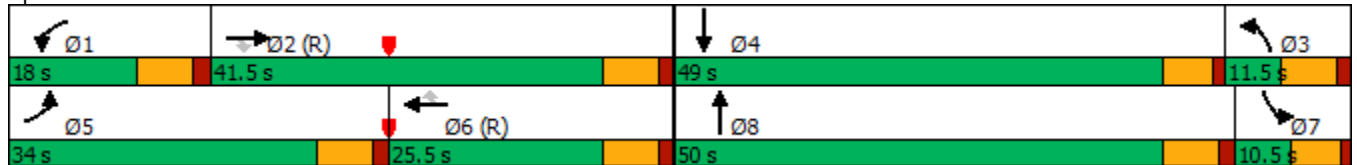

HCM 6th Signalized Intersection Summary

2040 Total PM.syn

2: Marksheffel Rd & US-24

02/15/2021



Movement	EBL	EBT	EBR	WBL	WBT	WBR	NBL	NBT	NBR	SBL	SBT	SBR
Lane Configurations	↔↔	↑↑↑	↗	↔↔	↑↑↑	↗	↔	↑↑↑	↗	↔	↑↑↑	↗
Traffic Volume (veh/h)	785	1415	205	325	690	20	20	1765	345	25	1560	600
Future Volume (veh/h)	785	1415	205	325	690	20	20	1765	345	25	1560	600
Initial Q (Qb), veh	0	0	0	0	0	0	0	0	0	0	0	0
Ped-Bike Adj(A_pbT)	1.00		1.00	1.00		1.00	1.00		1.00	1.00		1.00
Parking Bus, Adj	1.00	1.00	1.00	1.00	1.00	1.00	1.00	1.00	1.00	1.00	1.00	1.00
Work Zone On Approach		No			No			No			No	
Adj Sat Flow, veh/h/ln	1870	1870	1870	1856	1856	1856	1870	1870	1870	1856	1856	1856
Adj Flow Rate, veh/h	801	1444	0	332	704	0	20	1801	0	26	1592	0
Peak Hour Factor	0.98	0.98	0.98	0.98	0.98	0.98	0.98	0.98	0.98	0.98	0.98	0.98
Percent Heavy Veh, %	2	2	2	3	3	3	2	2	2	3	3	3
Cap, veh/h	792	1536		329	849		96	1851		43	1729	
Arrive On Green	0.23	0.30	0.00	0.10	0.17	0.00	0.05	0.36	0.00	0.05	0.68	0.00
Sat Flow, veh/h	3456	5106	1585	3428	5066	1572	1781	5106	1585	1767	5066	1572
Grp Volume(v), veh/h	801	1444	0	332	704	0	20	1801	0	26	1592	0
Grp Sat Flow(s),veh/h/ln	1728	1702	1585	1714	1689	1572	1781	1702	1585	1767	1689	1572
Q Serve(g_s), s	27.5	33.1	0.0	11.5	16.1	0.0	1.3	41.7	0.0	1.7	32.2	0.0
Cycle Q Clear(g_c), s	27.5	33.1	0.0	11.5	16.1	0.0	1.3	41.7	0.0	1.7	32.2	0.0
Prop In Lane	1.00		1.00	1.00		1.00	1.00		1.00	1.00		1.00
Lane Grp Cap(c), veh/h	792	1536		329	849		96	1851		43	1729	
V/C Ratio(X)	1.01	0.94		1.01	0.83		0.21	0.97		0.61	0.92	
Avail Cap(c_a), veh/h	792	1536		329	849		96	1851		74	1836	
HCM Platoon Ratio	1.00	1.00	1.00	1.00	1.00	1.00	1.00	1.00	1.00	2.00	2.00	2.00
Upstream Filter(I)	1.00	1.00	0.00	1.00	1.00	0.00	0.81	0.81	0.00	0.44	0.44	0.00
Uniform Delay (d), s/veh	46.3	40.9	0.0	54.2	48.3	0.0	54.3	37.7	0.0	56.5	17.7	0.0
Incr Delay (d2), s/veh	34.8	12.5	0.0	52.3	9.2	0.0	0.9	13.1	0.0	6.0	3.8	0.0
Initial Q Delay(d3),s/veh	0.0	0.0	0.0	0.0	0.0	0.0	0.0	0.0	0.0	0.0	0.0	0.0
%ile BackOfQ(50%),veh/ln	15.5	15.5	0.0	7.3	7.5	0.0	0.6	19.3	0.0	0.8	7.5	0.0
Unsig. Movement Delay, s/veh												
LnGrp Delay(d),s/veh	81.1	53.4	0.0	106.6	57.5	0.0	55.2	50.8	0.0	62.6	21.5	0.0
LnGrp LOS	F	D		F	E		E	D		E	C	
Approach Vol, veh/h		2245	A		1036	A		1821	A		1618	A
Approach Delay, s/veh		63.3			73.2			50.8			22.1	
Approach LOS		E			E			D			C	
Timer - Assigned Phs	1	2	3	4	5	6	7	8				
Phs Duration (G+Y+Rc), s	18.0	42.6	12.9	46.5	34.0	26.6	9.4	50.0				
Change Period (Y+Rc), s	6.5	6.5	6.5	5.5	6.5	6.5	6.5	* 6.5				
Max Green Setting (Gmax), s	11.5	35.0	5.0	43.5	27.5	19.0	5.0	* 44				
Max Q Clear Time (g_c+I1), s	13.5	35.1	3.3	34.2	29.5	18.1	3.7	43.7				
Green Ext Time (p_c), s	0.0	0.0	0.0	6.7	0.0	0.4	0.0	0.0				

Intersection Summary

HCM 6th Ctrl Delay	51.5
HCM 6th LOS	D

Notes

* HCM 6th computational engine requires equal clearance times for the phases crossing the barrier.

Unsignalized Delay for [NBR, EBR, WBR, SBR] is excluded from calculations of the approach delay and intersection delay.

Timings
4: US-24 & Newt Dr/SH-94

2020 Adjusted Existing AM.syn
02/15/2021

Lane Group	EBL	EBT	EBR	WBL	WBT	WBR	NBL	NBT	NBR	SBL	SBT	SBR
Lane Configurations												
Traffic Volume (vph)	16	28	196	440	39	1	144	798	379	4	1735	36
Future Volume (vph)	16	28	196	440	39	1	144	798	379	4	1735	36
Turn Type	Prot	NA	Free	Prot	NA	Free	pm+pt	NA	Free	pm+pt	NA	Perm
Protected Phases	7	4		3	8		5	2		1	6	
Permitted Phases			Free			Free	2		Free	6		6
Detector Phase	7	4		3	8		5	2		1	6	6
Switch Phase												
Minimum Initial (s)	5.0	5.0		5.0	5.0		5.0	5.0		5.0	5.0	5.0
Minimum Split (s)	11.5	24.5		11.0	24.0		12.0	25.0		12.5	25.5	25.5
Total Split (s)	11.5	24.5		19.0	32.0		12.0	64.0		12.5	64.5	64.5
Total Split (%)	9.6%	20.4%		15.8%	26.7%		10.0%	53.3%		10.4%	53.8%	53.8%
Yellow Time (s)	3.5	3.5		4.0	4.0		5.0	5.0		5.0	5.0	5.0
All-Red Time (s)	2.0	2.0		2.0	2.0		2.0	2.0		2.0	2.0	2.0
Lost Time Adjust (s)	0.0	0.0		0.0	0.0		0.0	0.0		0.0	0.0	0.0
Total Lost Time (s)	5.5	5.5		6.0	6.0		7.0	7.0		7.0	7.0	7.0
Lead/Lag	Lead	Lag		Lead	Lag		Lag	Lead		Lag	Lead	Lead
Lead-Lag Optimize?	Yes	Yes		Yes	Yes		Yes	Yes		Yes	Yes	Yes
Recall Mode	None	None		None	None		None	C-Max		None	C-Max	C-Max
Act Effct Green (s)	5.8	7.5	120.0	13.0	16.8	120.0	84.1	83.1	120.0	79.1	73.6	73.6
Actuated g/C Ratio	0.05	0.06	1.00	0.11	0.14	1.00	0.70	0.69	1.00	0.66	0.61	0.61
v/c Ratio	0.10	0.26	0.13	1.25	0.08	0.00	1.12	0.36	0.27	0.01	0.86	0.04
Control Delay	55.9	58.6	0.2	160.8	24.1	0.0	150.4	9.7	0.4	6.8	24.2	0.1
Queue Delay	0.0	0.0	0.0	0.0	0.0	0.0	0.0	0.0	0.0	0.0	0.0	0.0
Total Delay	55.9	58.6	0.2	160.8	24.1	0.0	150.4	9.7	0.4	6.8	24.2	0.1
LOS	E	E	A	F	C	A	F	A	A	A	C	A
Approach Delay		10.7			149.5			22.3			23.7	
Approach LOS		B			F			C			C	

Intersection Summary

Cycle Length: 120
 Actuated Cycle Length: 120
 Offset: 55.9 (47%), Referenced to phase 2:NBTL and 6:SBTL, Start of Green
 Natural Cycle: 150
 Control Type: Actuated-Coordinated
 Maximum v/c Ratio: 1.25
 Intersection Signal Delay: 38.2
 Intersection Capacity Utilization 91.8%
 Analysis Period (min) 15
 Intersection LOS: D
 ICU Level of Service F

Splits and Phases: 4: US-24 & Newt Dr/SH-94

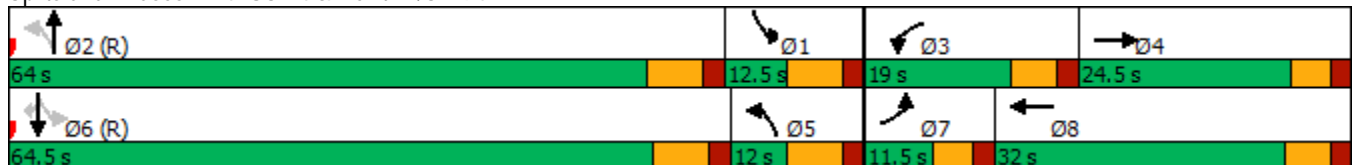

HCM 6th Signalized Intersection Summary
 4: US-24 & Newt Dr/SH-94

2020 Adjusted Existing AM.syn
 02/15/2021



Movement	EBL	EBT	EBR	WBL	WBT	WBR	NBL	NBT	NBR	SBL	SBT	SBR
Lane Configurations	↖↗	↑	↖	↖↗	↑↑	↖	↖	↑↑	↖	↖	↑↑	↖
Traffic Volume (veh/h)	16	28	196	440	39	1	144	798	379	4	1735	36
Future Volume (veh/h)	16	28	196	440	39	1	144	798	379	4	1735	36
Initial Q (Qb), veh	0	0	0	0	0	0	0	0	0	0	0	0
Ped-Bike Adj(A_pbT)	1.00		1.00	1.00		1.00	1.00		1.00	1.00		1.00
Parking Bus, Adj	1.00	1.00	1.00	1.00	1.00	1.00	1.00	1.00	1.00	1.00	1.00	1.00
Work Zone On Approach		No			No			No			No	
Adj Sat Flow, veh/h/ln	1826	1826	1826	1841	1841	1841	1752	1752	1752	1811	1811	1811
Adj Flow Rate, veh/h	16	29	0	454	40	0	148	823	0	4	1789	0
Peak Hour Factor	0.97	0.97	0.97	0.97	0.97	0.97	0.97	0.97	0.97	0.97	0.97	0.97
Percent Heavy Veh, %	5	5	5	4	4	4	10	10	10	6	6	6
Cap, veh/h	58	72		368	470		321	1581		532	1649	
Arrive On Green	0.02	0.04	0.00	0.11	0.13	0.00	0.16	0.47	0.00	0.16	0.48	0.00
Sat Flow, veh/h	3374	1826	1547	3401	3497	1560	1668	3328	1485	1725	3441	1535
Grp Volume(v), veh/h	16	29	0	454	40	0	148	823	0	4	1789	0
Grp Sat Flow(s),veh/h/ln	1687	1826	1547	1700	1749	1560	1668	1664	1485	1725	1721	1535
Q Serve(g_s), s	0.6	1.9	0.0	13.0	1.2	0.0	5.1	20.7	0.0	0.0	57.5	0.0
Cycle Q Clear(g_c), s	0.6	1.9	0.0	13.0	1.2	0.0	5.1	20.7	0.0	0.0	57.5	0.0
Prop In Lane	1.00		1.00	1.00		1.00	1.00		1.00	1.00		1.00
Lane Grp Cap(c), veh/h	58	72		368	470		321	1581		532	1649	
V/C Ratio(X)	0.28	0.41		1.23	0.09		0.46	0.52		0.01	1.09	
Avail Cap(c_a), veh/h	169	289		368	758		321	1581		532	1649	
HCM Platoon Ratio	1.00	1.00	1.00	1.00	1.00	1.00	1.00	1.00	1.00	1.00	1.00	1.00
Upstream Filter(l)	1.00	1.00	0.00	0.69	0.69	0.00	1.00	1.00	0.00	1.00	1.00	0.00
Uniform Delay (d), s/veh	58.2	56.3	0.0	53.5	45.5	0.0	43.8	22.0	0.0	17.4	31.3	0.0
Incr Delay (d2), s/veh	2.5	3.6	0.0	120.1	0.1	0.0	1.0	1.2	0.0	0.0	49.1	0.0
Initial Q Delay(d3),s/veh	0.0	0.0	0.0	0.0	0.0	0.0	0.0	0.0	0.0	0.0	0.0	0.0
%ile BackOfQ(50%),veh/ln	0.3	0.9	0.0	11.7	0.5	0.0	4.0	8.2	0.0	0.1	34.1	0.0
Unsig. Movement Delay, s/veh												
LnGrp Delay(d),s/veh	60.8	59.9	0.0	173.6	45.5	0.0	44.8	23.2	0.0	17.4	80.4	0.0
LnGrp LOS	E	E		F	D		D	C		B	F	
Approach Vol, veh/h		45	A		494	A		971	A		1793	A
Approach Delay, s/veh		60.2			163.2			26.5			80.2	
Approach LOS		E			F			C			F	
Timer - Assigned Phs	1	2	3	4	5	6	7	8				
Phs Duration (G+Y+Rc), s	26.3	64.0	19.0	10.7	25.8	64.5	7.6	22.1				
Change Period (Y+Rc), s	7.0	7.0	6.0	* 6	7.0	7.0	5.5	6.0				
Max Green Setting (Gmax), s	5.5	57.0	13.0	* 19	5.0	57.5	6.0	26.0				
Max Q Clear Time (g_c+I1), s	2.0	22.7	15.0	3.9	7.1	59.5	2.6	3.2				
Green Ext Time (p_c), s	0.0	6.9	0.0	0.1	0.0	0.0	0.0	0.1				

Intersection Summary

HCM 6th Ctrl Delay	76.6
HCM 6th LOS	E

Notes

* HCM 6th computational engine requires equal clearance times for the phases crossing the barrier.
 Unsignalized Delay for [NBR, EBR, WBR, SBR] is excluded from calculations of the approach delay and intersection delay.

Timings
4: US-24 & Newt Dr/SH-94

2020 Adjusted Existing PM.syn

02/15/2021

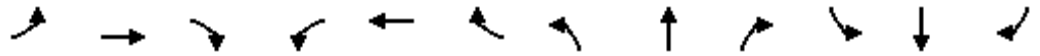

Lane Group	EBL	EBT	EBR	WBL	WBT	WBR	NBL	NBT	NBR	SBL	SBT	SBR
Lane Configurations	↖↖	↑	↗	↖↖	↑↑	↗	↖	↑↑	↗	↖	↑↑	↗
Traffic Volume (vph)	28	39	238	350	23	7	158	1688	320	4	933	36
Future Volume (vph)	28	39	238	350	23	7	158	1688	320	4	933	36
Turn Type	Prot	NA	Free	Prot	NA	Free	pm+pt	NA	Free	pm+pt	NA	Perm
Protected Phases	7	4		3	8		5	2		1	6	
Permitted Phases			Free			Free	2		Free	6		6
Detector Phase	7	4		3	8		5	2		1	6	6
Switch Phase												
Minimum Initial (s)	5.0	5.0		5.0	5.0		5.0	5.0		5.0	5.0	5.0
Minimum Split (s)	11.5	24.5		11.0	24.0		12.0	25.0		12.5	25.5	25.5
Total Split (s)	11.5	24.5		18.0	31.0		19.0	65.0		12.5	58.5	58.5
Total Split (%)	9.6%	20.4%		15.0%	25.8%		15.8%	54.2%		10.4%	48.8%	48.8%
Yellow Time (s)	3.5	3.5		4.0	4.0		5.0	5.0		5.0	5.0	5.0
All-Red Time (s)	2.0	2.0		2.0	2.0		2.0	2.0		2.0	2.0	2.0
Lost Time Adjust (s)	0.0	0.0		0.0	0.0		0.0	0.0		0.0	0.0	0.0
Total Lost Time (s)	5.5	5.5		6.0	6.0		7.0	7.0		7.0	7.0	7.0
Lead/Lag	Lead	Lag		Lead	Lag		Lag	Lead		Lag	Lead	Lead
Lead-Lag Optimize?	Yes	Yes		Yes	Yes		Yes	Yes		Yes	Yes	Yes
Recall Mode	None	None		None	None		None	C-Max		None	C-Max	C-Max
Act Effct Green (s)	6.1	8.1	120.0	16.8	21.1	120.0	78.7	76.3	120.0	70.1	64.6	64.6
Actuated g/C Ratio	0.05	0.07	1.00	0.14	0.18	1.00	0.66	0.64	1.00	0.58	0.54	0.54
v/c Ratio	0.17	0.33	0.16	0.77	0.04	0.00	0.50	0.80	0.21	0.03	0.53	0.04
Control Delay	56.7	59.5	0.2	82.0	35.7	0.0	21.3	21.1	0.3	5.8	18.5	0.2
Queue Delay	0.0	0.0	0.0	0.0	0.0	0.0	0.0	0.0	0.0	0.0	0.0	0.0
Total Delay	56.7	59.5	0.2	82.0	35.7	0.0	21.3	21.1	0.3	5.8	18.5	0.2
LOS	E	E	A	F	D	A	C	C	A	A	B	A
Approach Delay		12.9			77.7			18.1			17.8	
Approach LOS		B			E			B			B	

Intersection Summary

Cycle Length: 120
 Actuated Cycle Length: 120
 Offset: 55.9 (47%), Referenced to phase 2:NBTL and 6:SBTL, Start of Green
 Natural Cycle: 120
 Control Type: Actuated-Coordinated
 Maximum v/c Ratio: 0.80
 Intersection Signal Delay: 23.5
 Intersection LOS: C
 Intersection Capacity Utilization 84.1%
 ICU Level of Service E
 Analysis Period (min) 15

Splits and Phases: 4: US-24 & Newt Dr/SH-94

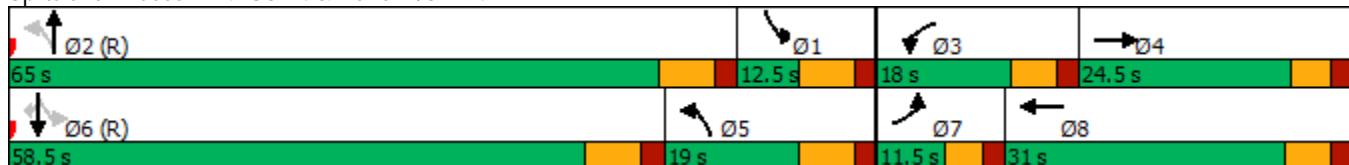

HCM 6th Signalized Intersection Summary
4: US-24 & Newt Dr/SH-94

2020 Adjusted Existing PM.syn
02/15/2021



Movement	EBL	EBT	EBR	WBL	WBT	WBR	NBL	NBT	NBR	SBL	SBT	SBR
Lane Configurations	↖↗	↑	↖	↖↗	↑↑	↖	↖	↑↑	↖	↖	↑↑	↖
Traffic Volume (veh/h)	28	39	238	350	23	7	158	1688	320	4	933	36
Future Volume (veh/h)	28	39	238	350	23	7	158	1688	320	4	933	36
Initial Q (Qb), veh	0	0	0	0	0	0	0	0	0	0	0	0
Ped-Bike Adj(A_pbT)	1.00		1.00	1.00		1.00	1.00		1.00	1.00		1.00
Parking Bus, Adj	1.00	1.00	1.00	1.00	1.00	1.00	1.00	1.00	1.00	1.00	1.00	1.00
Work Zone On Approach		No			No			No			No	
Adj Sat Flow, veh/h/ln	1870	1870	1870	1856	1856	1856	1856	1856	1856	1826	1826	1826
Adj Flow Rate, veh/h	29	41	0	368	24	0	166	1777	0	4	982	0
Peak Hour Factor	0.95	0.95	0.95	0.95	0.95	0.95	0.95	0.95	0.95	0.95	0.95	0.95
Percent Heavy Veh, %	2	2	2	3	3	3	3	3	3	5	5	5
Cap, veh/h	89	75		343	417		547	1704		338	1489	
Arrive On Green	0.03	0.04	0.00	0.10	0.12	0.00	0.21	0.48	0.00	0.16	0.43	0.00
Sat Flow, veh/h	3456	1870	1585	3428	3526	1572	1767	3526	1572	1739	3469	1547
Grp Volume(v), veh/h	29	41	0	368	24	0	166	1777	0	4	982	0
Grp Sat Flow(s),veh/h/ln	1728	1870	1585	1714	1763	1572	1767	1763	1572	1739	1735	1547
Q Serve(g_s), s	1.0	2.6	0.0	12.0	0.7	0.0	0.0	58.0	0.0	0.0	27.0	0.0
Cycle Q Clear(g_c), s	1.0	2.6	0.0	12.0	0.7	0.0	0.0	58.0	0.0	0.0	27.0	0.0
Prop In Lane	1.00		1.00	1.00		1.00	1.00		1.00	1.00		1.00
Lane Grp Cap(c), veh/h	89	75		343	417		547	1704		338	1489	
V/C Ratio(X)	0.33	0.55		1.07	0.06		0.30	1.04		0.01	0.66	
Avail Cap(c_a), veh/h	173	296		343	734		547	1704		338	1489	
HCM Platoon Ratio	1.00	1.00	1.00	1.00	1.00	1.00	1.00	1.00	1.00	1.00	1.00	1.00
Upstream Filter(l)	1.00	1.00	0.00	0.71	0.71	0.00	1.00	1.00	0.00	1.00	1.00	0.00
Uniform Delay (d), s/veh	57.4	56.6	0.0	54.0	47.0	0.0	29.5	31.0	0.0	42.3	27.3	0.0
Incr Delay (d2), s/veh	2.1	6.2	0.0	62.1	0.0	0.0	0.3	33.9	0.0	0.0	2.3	0.0
Initial Q Delay(d3),s/veh	0.0	0.0	0.0	0.0	0.0	0.0	0.0	0.0	0.0	0.0	0.0	0.0
%ile BackOfQ(50%),veh/ln	0.5	1.3	0.0	8.1	0.3	0.0	3.9	31.6	0.0	0.1	11.5	0.0
Unsig. Movement Delay, s/veh												
LnGrp Delay(d),s/veh	59.5	62.7	0.0	116.1	47.0	0.0	29.8	64.9	0.0	42.3	29.6	0.0
LnGrp LOS	E	E		F	D		C	F		D	C	
Approach Vol, veh/h		70	A		392	A		1943	A		986	A
Approach Delay, s/veh		61.4			111.8			61.9			29.6	
Approach LOS		E			F			E			C	
Timer - Assigned Phs	1	2	3	4	5	6	7	8				
Phs Duration (G+Y+Rc), s	26.2	65.0	18.0	10.8	32.7	58.5	8.6	20.2				
Change Period (Y+Rc), s	7.0	7.0	6.0	* 6	7.0	7.0	5.5	6.0				
Max Green Setting (Gmax), s	5.5	58.0	12.0	* 19	12.0	51.5	6.0	25.0				
Max Q Clear Time (g_c+I1), s	2.0	60.0	14.0	4.6	2.0	29.0	3.0	2.7				
Green Ext Time (p_c), s	0.0	0.0	0.0	0.1	0.3	7.5	0.0	0.1				

Intersection Summary

HCM 6th Ctrl Delay	58.3
HCM 6th LOS	E

Notes

* HCM 6th computational engine requires equal clearance times for the phases crossing the barrier.
Unsignalized Delay for [NBR, EBR, WBR, SBR] is excluded from calculations of the approach delay and intersection delay.

Timings
4: US-24 & Newt Dr/SH-94

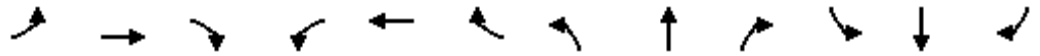

Lane Group	EBL	EBT	EBR	WBL	WBT	WBR	NBL	NBT	NBR	SBL	SBT	SBR
Lane Configurations	↖↗	↑	↖	↖↗	↑↑	↖	↖	↑↑	↖	↖	↑↑	↖
Traffic Volume (vph)	45	90	495	580	95	5	425	860	485	5	1860	65
Future Volume (vph)	45	90	495	580	95	5	425	860	485	5	1860	65
Turn Type	Prot	NA	Free	Prot	NA	Free	pm+pt	NA	Free	pm+pt	NA	Perm
Protected Phases	7	4		3	8		5	2		1	6	
Permitted Phases			Free			Free	2		Free	6		6
Detector Phase	7	4		3	8		5	2		1	6	6
Switch Phase												
Minimum Initial (s)	5.0	5.0		5.0	5.0		5.0	5.0		5.0	5.0	5.0
Minimum Split (s)	11.5	24.5		11.0	24.0		12.0	25.0		12.5	25.5	25.5
Total Split (s)	11.5	24.5		20.0	33.0		12.0	63.0		12.5	63.5	63.5
Total Split (%)	9.6%	20.4%		16.7%	27.5%		10.0%	52.5%		10.4%	52.9%	52.9%
Yellow Time (s)	3.5	3.5		4.0	4.0		5.0	5.0		5.0	5.0	5.0
All-Red Time (s)	2.0	2.0		2.0	2.0		2.0	2.0		2.0	2.0	2.0
Lost Time Adjust (s)	0.0	0.0		0.0	0.0		0.0	0.0		0.0	0.0	0.0
Total Lost Time (s)	5.5	5.5		6.0	6.0		7.0	7.0		7.0	7.0	7.0
Lead/Lag	Lead	Lag		Lead	Lag		Lag	Lead		Lag	Lead	Lead
Lead-Lag Optimize?	Yes	Yes		Yes	Yes		Yes	Yes		Yes	Yes	Yes
Recall Mode	None	None		None	None		None	C-Max		None	C-Max	C-Max
Act Effct Green (s)	5.9	11.5	120.0	14.0	21.8	120.0	74.5	73.5	120.0	69.5	64.0	64.0
Actuated g/C Ratio	0.05	0.10	1.00	0.12	0.18	1.00	0.62	0.61	1.00	0.58	0.53	0.53
v/c Ratio	0.28	0.54	0.33	1.53	0.16	0.00	3.37	0.44	0.34	0.02	1.06	0.07
Control Delay	59.6	62.4	0.6	278.8	31.0	0.0	1101.5	14.4	0.6	9.4	61.5	0.6
Queue Delay	0.0	0.0	0.0	0.0	0.0	0.0	0.0	0.0	0.0	0.0	0.0	0.0
Total Delay	59.6	62.4	0.6	278.8	31.0	0.0	1101.5	14.4	0.6	9.4	61.5	0.6
LOS	E	E	A	F	C	A	F	B	A	A	E	A
Approach Delay		13.6			242.2			271.5			59.3	
Approach LOS		B			F			F			E	

Intersection Summary

Cycle Length: 120
 Actuated Cycle Length: 120
 Offset: 55.9 (47%), Referenced to phase 2:NBTL and 6:SBTL, Start of Green
 Natural Cycle: 150
 Control Type: Actuated-Coordinated
 Maximum v/c Ratio: 3.37
 Intersection Signal Delay: 153.4
 Intersection LOS: F
 Intersection Capacity Utilization 114.8%
 ICU Level of Service H
 Analysis Period (min) 15

Splits and Phases: 4: US-24 & Newt Dr/SH-94

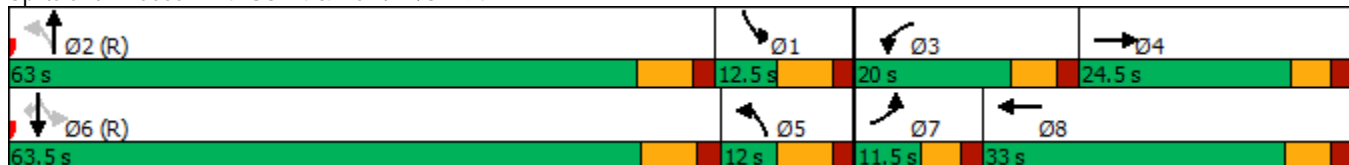

HCM 6th Signalized Intersection Summary
 4: US-24 & Newt Dr/SH-94

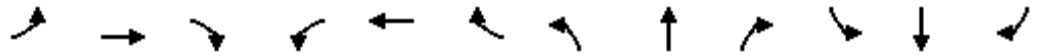

Movement	EBL	EBT	EBR	WBL	WBT	WBR	NBL	NBT	NBR	SBL	SBT	SBR
Lane Configurations	↖↗	↑	↖	↖↗	↑↑	↖	↖	↑↑	↖	↖	↑↑	↖
Traffic Volume (veh/h)	45	90	495	580	95	5	425	860	485	5	1860	65
Future Volume (veh/h)	45	90	495	580	95	5	425	860	485	5	1860	65
Initial Q (Qb), veh	0	0	0	0	0	0	0	0	0	0	0	0
Ped-Bike Adj(A_pbT)	1.00		1.00	1.00		1.00	1.00		1.00	1.00		1.00
Parking Bus, Adj	1.00	1.00	1.00	1.00	1.00	1.00	1.00	1.00	1.00	1.00	1.00	1.00
Work Zone On Approach		No			No			No			No	
Adj Sat Flow, veh/h/ln	1826	1826	1826	1841	1841	1841	1752	1752	1752	1811	1811	1811
Adj Flow Rate, veh/h	46	93	0	598	98	0	438	887	0	5	1918	0
Peak Hour Factor	0.97	0.97	0.97	0.97	0.97	0.97	0.97	0.97	0.97	0.97	0.97	0.97
Percent Heavy Veh, %	5	5	5	4	4	4	10	10	10	6	6	6
Cap, veh/h	110	126		397	549		272	1553		452	1620	
Arrive On Green	0.03	0.07	0.00	0.04	0.05	0.00	0.13	0.47	0.00	0.13	0.47	0.00
Sat Flow, veh/h	3374	1826	1547	3401	3497	1560	1668	3328	1485	1725	3441	1535
Grp Volume(v), veh/h	46	93	0	598	98	0	438	887	0	5	1918	0
Grp Sat Flow(s),veh/h/ln	1687	1826	1547	1700	1749	1560	1668	1664	1485	1725	1721	1535
Q Serve(g_s), s	1.6	6.0	0.0	14.0	3.2	0.0	15.2	23.3	0.0	0.0	56.5	0.0
Cycle Q Clear(g_c), s	1.6	6.0	0.0	14.0	3.2	0.0	15.2	23.3	0.0	0.0	56.5	0.0
Prop In Lane	1.00		1.00	1.00		1.00	1.00		1.00	1.00		1.00
Lane Grp Cap(c), veh/h	110	126		397	549		272	1553		452	1620	
V/C Ratio(X)	0.42	0.74		1.51	0.18		1.61	0.57		0.01	1.18	
Avail Cap(c_a), veh/h	169	289		397	787		272	1553		452	1620	
HCM Platoon Ratio	1.00	1.00	1.00	0.33	0.33	0.33	1.00	1.00	1.00	1.00	1.00	1.00
Upstream Filter(l)	1.00	1.00	0.00	0.67	0.67	0.00	1.00	1.00	0.00	1.00	1.00	0.00
Uniform Delay (d), s/veh	56.9	54.8	0.0	57.7	49.5	0.0	50.7	23.3	0.0	21.5	31.7	0.0
Incr Delay (d2), s/veh	2.5	8.2	0.0	236.9	0.1	0.0	291.3	1.5	0.0	0.0	89.3	0.0
Initial Q Delay(d3),s/veh	0.0	0.0	0.0	0.0	0.0	0.0	0.0	0.0	0.0	0.0	0.0	0.0
%ile BackOfQ(50%),veh/ln	0.7	3.0	0.0	19.5	1.4	0.0	30.1	9.3	0.0	0.1	42.7	0.0
Unsig. Movement Delay, s/veh												
LnGrp Delay(d),s/veh	59.4	63.1	0.0	294.6	49.6	0.0	342.0	24.8	0.0	21.5	121.1	0.0
LnGrp LOS	E	E		F	D		F	C		C	F	
Approach Vol, veh/h		139	A		696	A		1325	A		1923	A
Approach Delay, s/veh		61.9			260.1			129.7			120.8	
Approach LOS		E			F			F			F	
Timer - Assigned Phs	1	2	3	4	5	6	7	8				
Phs Duration (G+Y+Rc), s	22.7	63.0	20.0	14.3	22.2	63.5	9.4	24.8				
Change Period (Y+Rc), s	7.0	7.0	6.0	* 6	7.0	7.0	5.5	6.0				
Max Green Setting (Gmax), s	5.5	56.0	14.0	* 19	5.0	56.5	6.0	27.0				
Max Q Clear Time (g_c+I1), s	2.0	25.3	16.0	8.0	17.2	58.5	3.6	5.2				
Green Ext Time (p_c), s	0.0	7.4	0.0	0.3	0.0	0.0	0.0	0.5				

Intersection Summary

HCM 6th Ctrl Delay	145.4
HCM 6th LOS	F

Notes

* HCM 6th computational engine requires equal clearance times for the phases crossing the barrier.
 Unsignalized Delay for [NBR, EBR, WBR, SBR] is excluded from calculations of the approach delay and intersection delay.

Timings
4: US-24 & Newt Dr/SH-94

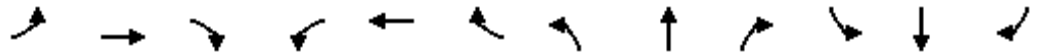

Lane Group	EBL	EBT	EBR	WBL	WBT	WBR	NBL	NBT	NBR	SBL	SBT	SBR
Lane Configurations	↖↗	↑	↖	↖↗	↑↑	↖	↖	↑↑	↖	↖	↑↑	↖
Traffic Volume (vph)	55	80	450	500	65	10	395	1810	490	5	1000	60
Future Volume (vph)	55	80	450	500	65	10	395	1810	490	5	1000	60
Turn Type	Prot	NA	Free	Prot	NA	Free	pm+pt	NA	Free	pm+pt	NA	Perm
Protected Phases	7	4		3	8		5	2		1	6	
Permitted Phases			Free			Free	2		Free	6		6
Detector Phase	7	4		3	8		5	2		1	6	6
Switch Phase												
Minimum Initial (s)	5.0	5.0		5.0	5.0		5.0	5.0		5.0	5.0	5.0
Minimum Split (s)	11.5	24.5		11.0	24.0		12.0	25.0		12.5	25.5	25.5
Total Split (s)	11.5	24.5		18.0	31.0		19.0	65.0		12.5	58.5	58.5
Total Split (%)	9.6%	20.4%		15.0%	25.8%		15.8%	54.2%		10.4%	48.8%	48.8%
Yellow Time (s)	3.5	3.5		4.0	4.0		5.0	5.0		5.0	5.0	5.0
All-Red Time (s)	2.0	2.0		2.0	2.0		2.0	2.0		2.0	2.0	2.0
Lost Time Adjust (s)	0.0	0.0		0.0	0.0		0.0	0.0		0.0	0.0	0.0
Total Lost Time (s)	5.5	5.5		6.0	6.0		7.0	7.0		7.0	7.0	7.0
Lead/Lag	Lead	Lag		Lead	Lag		Lag	Lead		Lag	Lead	Lead
Lead-Lag Optimize?	Yes	Yes		Yes	Yes		Yes	Yes		Yes	Yes	Yes
Recall Mode	None	None		None	None		None	C-Max		None	C-Max	C-Max
Act Effct Green (s)	5.9	10.7	120.0	12.0	16.6	120.0	81.1	78.7	120.0	67.7	62.2	62.2
Actuated g/C Ratio	0.05	0.09	1.00	0.10	0.14	1.00	0.68	0.66	1.00	0.56	0.52	0.52
v/c Ratio	0.34	0.51	0.30	1.55	0.14	0.01	1.14	0.83	0.33	0.03	0.59	0.07
Control Delay	60.9	61.9	0.5	300.0	38.9	0.0	124.1	21.9	0.6	7.0	22.0	0.9
Queue Delay	0.0	0.0	0.0	0.0	0.0	0.0	0.0	0.0	0.0	0.0	0.0	0.0
Total Delay	60.9	61.9	0.5	300.0	38.9	0.0	124.1	21.9	0.6	7.0	22.0	0.9
LOS	E	E	A	F	D	A	F	C	A	A	C	A
Approach Delay		14.5			265.2			33.0			20.7	
Approach LOS		B			F			C			C	

Intersection Summary

Cycle Length: 120
 Actuated Cycle Length: 120
 Offset: 55.9 (47%), Referenced to phase 2:NBTL and 6:SBTL, Start of Green
 Natural Cycle: 150
 Control Type: Actuated-Coordinated
 Maximum v/c Ratio: 1.55
 Intersection Signal Delay: 55.3
 Intersection LOS: E
 Intersection Capacity Utilization 91.8%
 ICU Level of Service F
 Analysis Period (min) 15

Splits and Phases: 4: US-24 & Newt Dr/SH-94

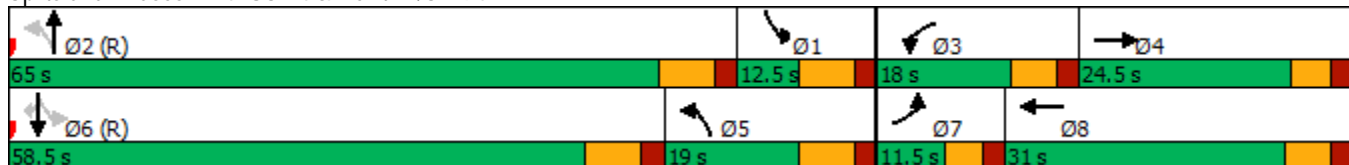



Movement	EBL	EBT	EBR	WBL	WBT	WBR	NBL	NBT	NBR	SBL	SBT	SBR
Lane Configurations	↔↔	↑	↗	↔↔	↑↑	↗	↖	↑↑	↗	↖	↑↑	↗
Traffic Volume (veh/h)	55	80	450	500	65	10	395	1810	490	5	1000	60
Future Volume (veh/h)	55	80	450	500	65	10	395	1810	490	5	1000	60
Initial Q (Qb), veh	0	0	0	0	0	0	0	0	0	0	0	0
Ped-Bike Adj(A_pbT)	1.00		1.00	1.00		1.00	1.00		1.00	1.00		1.00
Parking Bus, Adj	1.00	1.00	1.00	1.00	1.00	1.00	1.00	1.00	1.00	1.00	1.00	1.00
Work Zone On Approach		No			No			No			No	
Adj Sat Flow, veh/h/ln	1870	1870	1870	1856	1856	1856	1856	1856	1856	1826	1826	1826
Adj Flow Rate, veh/h	58	84	0	526	68	0	416	1905	0	5	1053	0
Peak Hour Factor	0.95	0.95	0.95	0.95	0.95	0.95	0.95	0.95	0.95	0.95	0.95	0.95
Percent Heavy Veh, %	2	2	2	3	3	3	3	3	3	5	5	5
Cap, veh/h	123	117		343	463		488	1704		299	1489	
Arrive On Green	0.04	0.06	0.00	0.10	0.13	0.00	0.19	0.48	0.00	0.14	0.43	0.00
Sat Flow, veh/h	3456	1870	1585	3428	3526	1572	1767	3526	1572	1739	3469	1547
Grp Volume(v), veh/h	58	84	0	526	68	0	416	1905	0	5	1053	0
Grp Sat Flow(s),veh/h/ln	1728	1870	1585	1714	1763	1572	1767	1763	1572	1739	1735	1547
Q Serve(g_s), s	2.0	5.3	0.0	12.0	2.1	0.0	16.6	58.0	0.0	0.0	29.9	0.0
Cycle Q Clear(g_c), s	2.0	5.3	0.0	12.0	2.1	0.0	16.6	58.0	0.0	0.0	29.9	0.0
Prop In Lane	1.00		1.00	1.00		1.00	1.00		1.00	1.00		1.00
Lane Grp Cap(c), veh/h	123	117		343	463		488	1704		299	1489	
V/C Ratio(X)	0.47	0.72		1.53	0.15		0.85	1.12		0.02	0.71	
Avail Cap(c_a), veh/h	173	296		343	734		488	1704		299	1489	
HCM Platoon Ratio	1.00	1.00	1.00	1.00	1.00	1.00	1.00	1.00	1.00	1.00	1.00	1.00
Upstream Filter(l)	1.00	1.00	0.00	0.57	0.57	0.00	1.00	1.00	0.00	1.00	1.00	0.00
Uniform Delay (d), s/veh	56.8	55.2	0.0	54.0	46.2	0.0	40.8	31.0	0.0	44.7	28.1	0.0
Incr Delay (d2), s/veh	2.8	7.9	0.0	248.7	0.1	0.0	13.7	61.7	0.0	0.0	2.9	0.0
Initial Q Delay(d3),s/veh	0.0	0.0	0.0	0.0	0.0	0.0	0.0	0.0	0.0	0.0	0.0	0.0
%ile BackOfQ(50%),veh/ln	0.9	2.8	0.0	17.0	0.9	0.0	13.4	38.2	0.0	0.1	12.8	0.0
Unsig. Movement Delay, s/veh												
LnGrp Delay(d),s/veh	59.5	63.1	0.0	302.7	46.3	0.0	54.5	92.7	0.0	44.7	30.9	0.0
LnGrp LOS	E	E		F	D		D	F		D	C	
Approach Vol, veh/h		142	A		594	A		2321	A		1058	A
Approach Delay, s/veh		61.6			273.4			85.8			31.0	
Approach LOS		E			F			F			C	
Timer - Assigned Phs	1	2	3	4	5	6	7	8				
Phs Duration (G+Y+Rc), s	23.5	65.0	18.0	13.5	30.0	58.5	9.8	21.7				
Change Period (Y+Rc), s	7.0	7.0	6.0	* 6	7.0	7.0	5.5	6.0				
Max Green Setting (Gmax), s	5.5	58.0	12.0	* 19	12.0	51.5	6.0	25.0				
Max Q Clear Time (g_c+I1), s	2.0	60.0	14.0	7.3	18.6	31.9	4.0	4.1				
Green Ext Time (p_c), s	0.0	0.0	0.0	0.2	0.0	7.7	0.0	0.3				

Intersection Summary

HCM 6th Ctrl Delay	98.0
HCM 6th LOS	F

Notes

* HCM 6th computational engine requires equal clearance times for the phases crossing the barrier.

Unsignalized Delay for [NBR, EBR, WBR, SBR] is excluded from calculations of the approach delay and intersection delay.

Timings
4: US-24 & Newt Dr/SH-94

2026 Total AM.syn
02/15/2021

Lane Group	EBL	EBT	EBR	WBL	WBT	WBR	NBL	NBT	NBR	SBL	SBT	SBR
Lane Configurations												
Traffic Volume (vph)	45	90	495	820	95	5	425	985	635	5	1860	65
Future Volume (vph)	45	90	495	820	95	5	425	985	635	5	1860	65
Turn Type	Prot	NA	Free	Prot	NA	Free	pm+pt	NA	Free	pm+pt	NA	Perm
Protected Phases	7	4		3	8		5	2		1	6	
Permitted Phases			Free			Free	2		Free	6		6
Detector Phase	7	4		3	8		5	2		1	6	6
Switch Phase												
Minimum Initial (s)	5.0	5.0		5.0	5.0		5.0	5.0		5.0	5.0	5.0
Minimum Split (s)	11.5	24.5		11.0	24.0		12.0	25.0		12.5	25.5	25.5
Total Split (s)	11.5	24.5		24.0	37.0		20.0	59.0		12.5	51.5	51.5
Total Split (%)	9.6%	20.4%		20.0%	30.8%		16.7%	49.2%		10.4%	42.9%	42.9%
Yellow Time (s)	3.5	3.5		4.0	4.0		5.0	5.0		5.0	5.0	5.0
All-Red Time (s)	2.0	2.0		2.0	2.0		2.0	2.0		2.0	2.0	2.0
Lost Time Adjust (s)	0.0	0.0		0.0	0.0		0.0	0.0		0.0	0.0	0.0
Total Lost Time (s)	5.5	5.5		6.0	6.0		7.0	7.0		7.0	7.0	7.0
Lead/Lag	Lead	Lag		Lead	Lag		Lag	Lead		Lag	Lead	Lead
Lead-Lag Optimize?	Yes	Yes		Yes	Yes		Yes	Yes		Yes	Yes	Yes
Recall Mode	None	None		None	None		None	C-Max		None	C-Max	C-Max
Act Effct Green (s)	5.9	11.5	120.0	18.0	25.8	120.0	72.0	69.5	120.0	57.5	52.0	52.0
Actuated g/C Ratio	0.05	0.10	1.00	0.15	0.22	1.00	0.60	0.58	1.00	0.48	0.43	0.43
v/c Ratio	0.28	0.54	0.33	1.67	0.13	0.00	1.81	0.53	0.45	0.02	1.30	0.08
Control Delay	59.6	62.4	0.6	340.6	35.1	0.0	409.3	18.0	1.0	9.6	172.2	0.3
Queue Delay	0.0	0.0	0.0	0.0	0.0	0.0	0.0	0.0	0.0	0.0	0.0	0.0
Total Delay	59.6	62.4	0.6	340.6	35.1	0.0	409.3	18.0	1.0	9.6	172.2	0.3
LOS	E	E	A	F	D	A	F	B	A	A	F	A
Approach Delay		13.6			307.2			94.0			166.0	
Approach LOS		B			F			F			F	

Intersection Summary

Cycle Length: 120
 Actuated Cycle Length: 120
 Offset: 55.9 (47%), Referenced to phase 2:NBTL and 6:SBTL, Start of Green
 Natural Cycle: 150
 Control Type: Actuated-Coordinated
 Maximum v/c Ratio: 1.81
 Intersection Signal Delay: 145.5
 Intersection LOS: F
 Intersection Capacity Utilization 121.7%
 ICU Level of Service H
 Analysis Period (min) 15

Splits and Phases: 4: US-24 & Newt Dr/SH-94

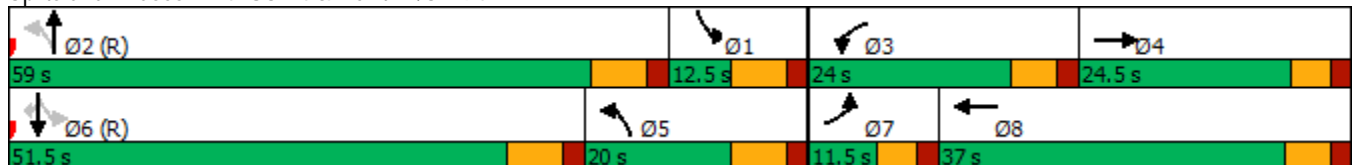

HCM 6th Signalized Intersection Summary
 4: US-24 & Newt Dr/SH-94

2026 Total AM.syn
 02/15/2021



Movement	EBL	EBT	EBR	WBL	WBT	WBR	NBL	NBT	NBR	SBL	SBT	SBR
Lane Configurations	↖↗	↑	↖	↖↗	↑↑	↖	↖	↑↑	↖	↖	↑↑	↖
Traffic Volume (veh/h)	45	90	495	820	95	5	425	985	635	5	1860	65
Future Volume (veh/h)	45	90	495	820	95	5	425	985	635	5	1860	65
Initial Q (Qb), veh	0	0	0	0	0	0	0	0	0	0	0	0
Ped-Bike Adj(A_pbT)	1.00		1.00	1.00		1.00	1.00		1.00	1.00		1.00
Parking Bus, Adj	1.00	1.00	1.00	1.00	1.00	1.00	1.00	1.00	1.00	1.00	1.00	1.00
Work Zone On Approach		No			No			No			No	
Adj Sat Flow, veh/h/ln	1826	1826	1826	1841	1841	1841	1752	1752	1752	1811	1811	1811
Adj Flow Rate, veh/h	46	93	0	845	98	0	438	1015	0	5	1918	0
Peak Hour Factor	0.97	0.97	0.97	0.97	0.97	0.97	0.97	0.97	0.97	0.97	0.97	0.97
Percent Heavy Veh, %	5	5	5	4	4	4	10	10	10	6	6	6
Cap, veh/h	110	126		510	666		383	1442		352	1276	
Arrive On Green	0.03	0.07	0.00	0.05	0.06	0.00	0.19	0.43	0.00	0.13	0.37	0.00
Sat Flow, veh/h	3374	1826	1547	3401	3497	1560	1668	3328	1485	1725	3441	1535
Grp Volume(v), veh/h	46	93	0	845	98	0	438	1015	0	5	1918	0
Grp Sat Flow(s),veh/h/ln	1687	1826	1547	1700	1749	1560	1668	1664	1485	1725	1721	1535
Q Serve(g_s), s	1.6	6.0	0.0	18.0	3.2	0.0	23.2	29.8	0.0	0.0	44.5	0.0
Cycle Q Clear(g_c), s	1.6	6.0	0.0	18.0	3.2	0.0	23.2	29.8	0.0	0.0	44.5	0.0
Prop In Lane	1.00		1.00	1.00		1.00	1.00		1.00	1.00		1.00
Lane Grp Cap(c), veh/h	110	126		510	666		383	1442		352	1276	
V/C Ratio(X)	0.42	0.74		1.66	0.15		1.14	0.70		0.01	1.50	
Avail Cap(c_a), veh/h	169	289		510	903		383	1442		352	1276	
HCM Platoon Ratio	1.00	1.00	1.00	0.33	0.33	0.33	1.00	1.00	1.00	1.00	1.00	1.00
Upstream Filter(l)	1.00	1.00	0.00	0.82	0.82	0.00	1.00	1.00	0.00	1.00	1.00	0.00
Uniform Delay (d), s/veh	56.9	54.8	0.0	57.0	47.0	0.0	46.6	27.7	0.0	33.8	37.8	0.0
Incr Delay (d2), s/veh	2.5	8.2	0.0	302.5	0.1	0.0	91.0	2.9	0.0	0.0	230.5	0.0
Initial Q Delay(d3),s/veh	0.0	0.0	0.0	0.0	0.0	0.0	0.0	0.0	0.0	0.0	0.0	0.0
%ile BackOfQ(50%),veh/ln	0.7	3.0	0.0	29.7	1.4	0.0	21.0	12.3	0.0	0.1	59.2	0.0
Unsig. Movement Delay, s/veh												
LnGrp Delay(d),s/veh	59.4	63.1	0.0	359.5	47.1	0.0	137.6	30.6	0.0	33.8	268.3	0.0
LnGrp LOS	E	E		F	D		F	C		C	F	
Approach Vol, veh/h		139	A		943	A		1453	A		1923	A
Approach Delay, s/veh		61.9			327.1			62.9			267.7	
Approach LOS		E			F			E			F	
Timer - Assigned Phs	1	2	3	4	5	6	7	8				
Phs Duration (G+Y+Rc), s	22.7	59.0	24.0	14.3	30.2	51.5	9.4	28.8				
Change Period (Y+Rc), s	7.0	7.0	6.0	* 6	7.0	7.0	5.5	6.0				
Max Green Setting (Gmax), s	5.5	52.0	18.0	* 19	13.0	44.5	6.0	31.0				
Max Q Clear Time (g_c+I1), s	2.0	31.8	20.0	8.0	25.2	46.5	3.6	5.2				
Green Ext Time (p_c), s	0.0	7.5	0.0	0.3	0.0	0.0	0.0	0.5				

Intersection Summary

HCM 6th Ctrl Delay	207.1
HCM 6th LOS	F

Notes

* HCM 6th computational engine requires equal clearance times for the phases crossing the barrier.
 Unsignalized Delay for [NBR, EBR, WBR, SBR] is excluded from calculations of the approach delay and intersection delay.

Timings
4: US-24 & Newt Dr/SH-94

2026 Total PM.syn
02/15/2021

Lane Group	EBL	EBT	EBR	WBL	WBT	WBR	NBL	NBT	NBR	SBL	SBT	SBR
Lane Configurations												
Traffic Volume (vph)	55	80	450	740	65	10	395	1925	625	5	1000	60
Future Volume (vph)	55	80	450	740	65	10	395	1925	625	5	1000	60
Turn Type	Prot	NA	Free	Prot	NA	Free	pm+pt	NA	Free	pm+pt	NA	Perm
Protected Phases	7	4		3	8		5	2		1	6	
Permitted Phases			Free			Free	2		Free	6		6
Detector Phase	7	4		3	8		5	2		1	6	6
Switch Phase												
Minimum Initial (s)	5.0	5.0		5.0	5.0		5.0	5.0		5.0	5.0	5.0
Minimum Split (s)	11.5	24.5		11.0	24.0		12.0	25.0		12.5	25.5	25.5
Total Split (s)	11.5	24.5		25.0	38.0		24.0	58.0		12.5	46.5	46.5
Total Split (%)	9.6%	20.4%		20.8%	31.7%		20.0%	48.3%		10.4%	38.8%	38.8%
Yellow Time (s)	3.5	3.5		4.0	4.0		5.0	5.0		5.0	5.0	5.0
All-Red Time (s)	2.0	2.0		2.0	2.0		2.0	2.0		2.0	2.0	2.0
Lost Time Adjust (s)	0.0	0.0		0.0	0.0		0.0	0.0		0.0	0.0	0.0
Total Lost Time (s)	5.5	5.5		6.0	6.0		7.0	7.0		7.0	7.0	7.0
Lead/Lag	Lead	Lag		Lead	Lag		Lag	Lead		Lag	Lead	Lead
Lead-Lag Optimize?	Yes	Yes		Yes	Yes		Yes	Yes		Yes	Yes	Yes
Recall Mode	None	None		None	None		None	C-Max		None	C-Max	C-Max
Act Effct Green (s)	5.9	10.7	120.0	19.0	23.6	120.0	74.2	71.7	120.0	55.7	50.2	50.2
Actuated g/C Ratio	0.05	0.09	1.00	0.16	0.20	1.00	0.62	0.60	1.00	0.46	0.42	0.42
v/c Ratio	0.34	0.51	0.30	1.45	0.10	0.01	1.16	0.97	0.42	0.03	0.73	0.08
Control Delay	60.9	61.9	0.5	252.5	36.8	0.0	135.8	38.2	0.8	13.2	40.9	1.3
Queue Delay	0.0	0.0	0.0	0.0	0.0	0.0	0.0	0.0	0.0	0.0	0.0	0.0
Total Delay	60.9	61.9	0.5	252.5	36.8	0.0	135.8	38.2	0.8	13.2	40.9	1.3
LOS	E	E	A	F	D	A	F	D	A	B	D	A
Approach Delay		14.5			232.2			43.4			38.6	
Approach LOS		B			F			D			D	

Intersection Summary

Cycle Length: 120
 Actuated Cycle Length: 120
 Offset: 55.9 (47%), Referenced to phase 2:NBTL and 6:SBTL, Start of Green
 Natural Cycle: 150
 Control Type: Actuated-Coordinated
 Maximum v/c Ratio: 1.45
 Intersection Signal Delay: 67.8
 Intersection LOS: E
 Intersection Capacity Utilization 101.8%
 ICU Level of Service G
 Analysis Period (min) 15

Splits and Phases: 4: US-24 & Newt Dr/SH-94

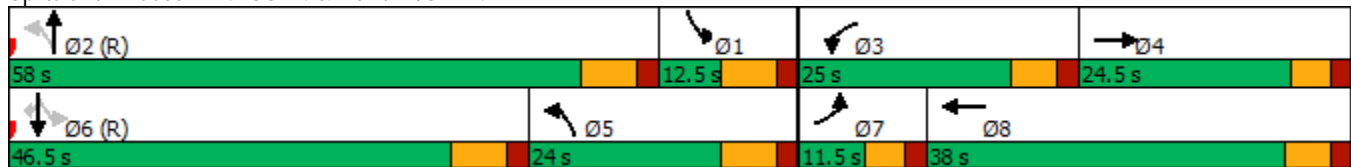

HCM 6th Signalized Intersection Summary
 4: US-24 & Newt Dr/SH-94

2026 Total PM.syn
 02/15/2021



Movement	EBL	EBT	EBR	WBL	WBT	WBR	NBL	NBT	NBR	SBL	SBT	SBR
Lane Configurations	↖↗	↑	↖	↖↗	↑↑	↖	↖	↑↑	↖	↖	↑↑	↖
Traffic Volume (veh/h)	55	80	450	740	65	10	395	1925	625	5	1000	60
Future Volume (veh/h)	55	80	450	740	65	10	395	1925	625	5	1000	60
Initial Q (Qb), veh	0	0	0	0	0	0	0	0	0	0	0	0
Ped-Bike Adj(A_pbT)	1.00		1.00	1.00		1.00	1.00		1.00	1.00		1.00
Parking Bus, Adj	1.00	1.00	1.00	1.00	1.00	1.00	1.00	1.00	1.00	1.00	1.00	1.00
Work Zone On Approach		No			No			No			No	
Adj Sat Flow, veh/h/ln	1870	1870	1870	1856	1856	1856	1856	1856	1856	1826	1826	1826
Adj Flow Rate, veh/h	58	84	0	779	68	0	416	2026	0	5	1053	0
Peak Hour Factor	0.95	0.95	0.95	0.95	0.95	0.95	0.95	0.95	0.95	0.95	0.95	0.95
Percent Heavy Veh, %	2	2	2	3	3	3	3	3	3	5	5	5
Cap, veh/h	123	117		543	668		483	1498		299	1142	
Arrive On Green	0.04	0.06	0.00	0.16	0.19	0.00	0.23	0.43	0.00	0.14	0.33	0.00
Sat Flow, veh/h	3456	1870	1585	3428	3526	1572	1767	3526	1572	1739	3469	1547
Grp Volume(v), veh/h	58	84	0	779	68	0	416	2026	0	5	1053	0
Grp Sat Flow(s),veh/h/ln	1728	1870	1585	1714	1763	1572	1767	1763	1572	1739	1735	1547
Q Serve(g_s), s	2.0	5.3	0.0	19.0	1.9	0.0	22.1	51.0	0.0	0.0	35.1	0.0
Cycle Q Clear(g_c), s	2.0	5.3	0.0	19.0	1.9	0.0	22.1	51.0	0.0	0.0	35.1	0.0
Prop In Lane	1.00		1.00	1.00		1.00	1.00		1.00	1.00		1.00
Lane Grp Cap(c), veh/h	123	117		543	668		483	1498		299	1142	
V/C Ratio(X)	0.47	0.72		1.44	0.10		0.86	1.35		0.02	0.92	
Avail Cap(c_a), veh/h	173	296		543	940		483	1498		299	1142	
HCM Platoon Ratio	1.00	1.00	1.00	1.00	1.00	1.00	1.00	1.00	1.00	1.00	1.00	1.00
Upstream Filter(I)	1.00	1.00	0.00	0.73	0.73	0.00	1.00	1.00	0.00	1.00	1.00	0.00
Uniform Delay (d), s/veh	56.8	55.2	0.0	50.5	40.2	0.0	41.8	34.5	0.0	44.7	38.8	0.0
Incr Delay (d2), s/veh	2.8	7.9	0.0	203.5	0.0	0.0	14.7	163.0	0.0	0.0	13.5	0.0
Initial Q Delay(d3),s/veh	0.0	0.0	0.0	0.0	0.0	0.0	0.0	0.0	0.0	0.0	0.0	0.0
%ile BackOfQ(50%),veh/ln	0.9	2.8	0.0	23.5	0.8	0.0	13.6	55.1	0.0	0.1	16.9	0.0
Unsig. Movement Delay, s/veh												
LnGrp Delay(d),s/veh	59.5	63.1	0.0	254.0	40.2	0.0	56.5	197.5	0.0	44.7	52.2	0.0
LnGrp LOS	E	E		F	D		E	F		D	D	
Approach Vol, veh/h		142	A		847	A		2442	A		1058	A
Approach Delay, s/veh		61.6			236.8			173.5			52.2	
Approach LOS		E			F			F			D	
Timer - Assigned Phs	1	2	3	4	5	6	7	8				
Phs Duration (G+Y+Rc), s	23.5	58.0	25.0	13.5	35.0	46.5	9.8	28.7				
Change Period (Y+Rc), s	7.0	7.0	6.0	* 6	7.0	7.0	5.5	6.0				
Max Green Setting (Gmax), s	5.5	51.0	19.0	* 19	17.0	39.5	6.0	32.0				
Max Q Clear Time (g_c+I1), s	2.0	53.0	21.0	7.3	24.1	37.1	4.0	3.9				
Green Ext Time (p_c), s	0.0	0.0	0.0	0.2	0.0	1.6	0.0	0.3				

Intersection Summary

HCM 6th Ctrl Delay	153.3
HCM 6th LOS	F

Notes

* HCM 6th computational engine requires equal clearance times for the phases crossing the barrier.
 Unsignalized Delay for [NBR, EBR, WBR, SBR] is excluded from calculations of the approach delay and intersection delay.

Timings

4: US-24 & Newt Dr/SH-94

02/18/2021

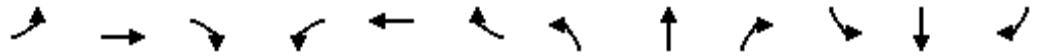

Lane Group	EBL	EBT	EBR	WBL	WBT	WBR	NBL	NBT	NBR	SBL	SBT	SBR
Lane Configurations	↖↗	↑	↖	↖↗↘	↑	↖	↖↗	↖↗↘	↖	↖	↖↗↘	↖
Traffic Volume (vph)	45	90	495	820	95	5	425	985	635	5	1860	65
Future Volume (vph)	45	90	495	820	95	5	425	985	635	5	1860	65
Turn Type	Prot	NA	Free	Prot	NA	Free	Prot	NA	Free	pm+pt	NA	Perm
Protected Phases	7	4		3	8		5	2		1	6	
Permitted Phases			Free			Free			Free	6		6
Detector Phase	7	4		3	8		5	2		1	6	6
Switch Phase												
Minimum Initial (s)	5.0	5.0		5.0	5.0		5.0	5.0		5.0	5.0	5.0
Minimum Split (s)	10.5	23.5		11.0	24.0		12.0	25.0		12.0	25.0	25.0
Total Split (s)	12.0	24.5		27.5	40.0		14.0	55.0		13.0	54.0	54.0
Total Split (%)	10.0%	20.4%		22.9%	33.3%		11.7%	45.8%		10.8%	45.0%	45.0%
Yellow Time (s)	3.5	3.5		4.0	4.0		5.0	5.0		5.0	5.0	5.0
All-Red Time (s)	2.0	2.0		2.0	2.0		2.0	2.0		2.0	2.0	2.0
Lost Time Adjust (s)	0.0	0.0		0.0	0.0		0.0	0.0		0.0	0.0	0.0
Total Lost Time (s)	5.5	5.5		6.0	6.0		7.0	7.0		7.0	7.0	7.0
Lead/Lag	Lead	Lag		Lead	Lag		Lag	Lead		Lag	Lead	Lead
Lead-Lag Optimize?	Yes	Yes		Yes	Yes		Yes	Yes		Yes	Yes	Yes
Recall Mode	None	None		None	None		None	C-Max		None	C-Max	C-Max
Act Effct Green (s)	6.3	11.5	120.0	21.5	28.9	120.0	7.0	65.9	120.0	60.1	54.5	54.5
Actuated g/C Ratio	0.05	0.10	1.00	0.18	0.24	1.00	0.06	0.55	1.00	0.50	0.45	0.45
v/c Ratio	0.26	0.54	0.33	0.96	0.22	0.00	2.37	0.39	0.45	0.02	0.86	0.08
Control Delay	58.5	62.4	0.6	58.1	29.8	0.0	656.5	17.2	1.0	9.4	32.3	0.8
Queue Delay	0.0	0.0	0.0	0.0	0.0	0.0	0.0	0.0	0.0	0.0	0.0	0.0
Total Delay	58.5	62.4	0.6	58.1	29.8	0.0	656.5	17.2	1.0	9.4	32.3	0.8
LOS	E	E	A	E	C	A	F	B	A	A	C	A
Approach Delay		13.5			54.9			145.0			31.2	
Approach LOS		B			D			F			C	

Intersection Summary

Cycle Length: 120
 Actuated Cycle Length: 120
 Offset: 55.9 (47%), Referenced to phase 2:NBT and 6:SBTL, Start of Green
 Natural Cycle: 140
 Control Type: Actuated-Coordinated
 Maximum v/c Ratio: 2.37
 Intersection Signal Delay: 75.3
 Intersection Capacity Utilization 87.0%
 Analysis Period (min) 15
 Intersection LOS: E
 ICU Level of Service E

Splits and Phases: 4: US-24 & Newt Dr/SH-94

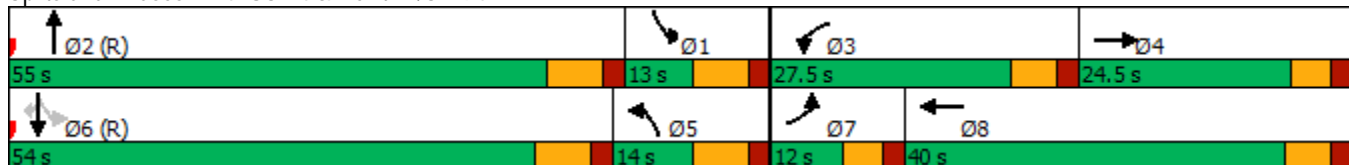

HCM 6th Signalized Intersection Summary
 4: US-24 & Newt Dr/SH-94

2026 Total AM Improved.syn
 02/18/2021



Movement	EBL	EBT	EBR	WBL	WBT	WBR	NBL	NBT	NBR	SBL	SBT	SBR
Lane Configurations	↖↗	↑	↖	↖↗↘	↑	↖	↖↗	↑↑↑	↖	↖	↑↑↑	↖
Traffic Volume (veh/h)	45	90	495	820	95	5	425	985	635	5	1860	65
Future Volume (veh/h)	45	90	495	820	95	5	425	985	635	5	1860	65
Initial Q (Qb), veh	0	0	0	0	0	0	0	0	0	0	0	0
Ped-Bike Adj(A_pbT)	1.00		1.00	1.00		1.00	1.00		1.00	1.00		1.00
Parking Bus, Adj	1.00	1.00	1.00	1.00	1.00	1.00	1.00	1.00	1.00	1.00	1.00	1.00
Work Zone On Approach		No			No			No			No	
Adj Sat Flow, veh/h/ln	1826	1826	1826	1841	1841	1841	1752	1752	1752	1811	1811	1811
Adj Flow Rate, veh/h	46	93	0	845	98	0	438	1015	0	5	1918	0
Peak Hour Factor	0.97	0.97	0.97	0.97	0.97	0.97	0.97	0.97	0.97	0.97	0.97	0.97
Percent Heavy Veh, %	5	5	5	4	4	4	10	10	10	6	6	6
Cap, veh/h	110	126		886	404		465	1913		417	1936	
Arrive On Green	0.03	0.07	0.00	0.06	0.07	0.00	0.14	0.40	0.00	0.14	0.39	0.00
Sat Flow, veh/h	3374	1826	1547	4944	1841	1560	3237	4782	1485	1725	4944	1535
Grp Volume(v), veh/h	46	93	0	845	98	0	438	1015	0	5	1918	0
Grp Sat Flow(s),veh/h/ln	1687	1826	1547	1648	1841	1560	1618	1594	1485	1725	1648	1535
Q Serve(g_s), s	1.6	6.0	0.0	20.5	6.0	0.0	16.1	19.4	0.0	0.0	46.3	0.0
Cycle Q Clear(g_c), s	1.6	6.0	0.0	20.5	6.0	0.0	16.1	19.4	0.0	0.0	46.3	0.0
Prop In Lane	1.00		1.00	1.00		1.00	1.00		1.00	1.00		1.00
Lane Grp Cap(c), veh/h	110	126		886	404		465	1913		417	1936	
V/C Ratio(X)	0.42	0.74		0.95	0.24		0.94	0.53		0.01	0.99	
Avail Cap(c_a), veh/h	183	289		886	522		465	1913		417	1936	
HCM Platoon Ratio	1.00	1.00	1.00	0.33	0.33	0.33	1.00	1.00	1.00	1.00	1.00	1.00
Upstream Filter(I)	1.00	1.00	0.00	0.86	0.86	0.00	1.00	1.00	0.00	1.00	1.00	0.00
Uniform Delay (d), s/veh	56.9	54.8	0.0	56.0	46.2	0.0	50.9	27.4	0.0	24.4	36.3	0.0
Incr Delay (d2), s/veh	2.5	8.2	0.0	18.0	0.3	0.0	27.7	1.1	0.0	0.0	18.3	0.0
Initial Q Delay(d3),s/veh	0.0	0.0	0.0	0.0	0.0	0.0	0.0	0.0	0.0	0.0	0.0	0.0
%ile BackOfQ(50%),veh/ln	0.7	3.0	0.0	10.6	2.9	0.0	8.3	7.5	0.0	0.1	21.4	0.0
Unsig. Movement Delay, s/veh												
LnGrp Delay(d),s/veh	59.4	63.1	0.0	74.0	46.5	0.0	78.6	28.5	0.0	24.4	54.6	0.0
LnGrp LOS	E	E		E	D		E	C		C	D	
Approach Vol, veh/h		139	A		943	A		1453	A		1923	A
Approach Delay, s/veh		61.9			71.1			43.6			54.5	
Approach LOS		E			E			D			D	
Timer - Assigned Phs	1	2	3	4	5	6	7	8				
Phs Duration (G+Y+Rc), s	23.2	55.0	27.5	14.3	24.2	54.0	9.4	32.3				
Change Period (Y+Rc), s	7.0	7.0	6.0	* 6	7.0	7.0	5.5	6.0				
Max Green Setting (Gmax), s	6.0	48.0	21.5	* 19	7.0	47.0	6.5	34.0				
Max Q Clear Time (g_c+I1), s	2.0	21.4	22.5	8.0	18.1	48.3	3.6	8.0				
Green Ext Time (p_c), s	0.0	8.3	0.0	0.3	0.0	0.0	0.0	0.5				

Intersection Summary

HCM 6th Ctrl Delay	54.7
HCM 6th LOS	D

Notes

* HCM 6th computational engine requires equal clearance times for the phases crossing the barrier.
 Unsignalized Delay for [NBR, EBR, WBR, SBR] is excluded from calculations of the approach delay and intersection delay.

Timings
4: US-24 & Newt Dr/SH-94

2026 Total PM Improved.syn
02/18/2021

Lane Group	EBL	EBT	EBR	WBL	WBT	WBR	NBL	NBT	NBR	SBL	SBT	SBR
Lane Configurations												
Traffic Volume (vph)	55	80	450	740	65	10	395	1925	625	5	1000	60
Future Volume (vph)	55	80	450	740	65	10	395	1925	625	5	1000	60
Turn Type	Prot	NA	Free	Prot	NA	Free	Prot	NA	Free	pm+pt	NA	Perm
Protected Phases	7	4		3	8		5	2		1	6	
Permitted Phases			Free			Free			Free			6
Detector Phase	7	4		3	8		5	2		1	6	6
Switch Phase												
Minimum Initial (s)	5.0	5.0		5.0	5.0		5.0	5.0		5.0	5.0	5.0
Minimum Split (s)	11.5	24.5		11.0	24.0		12.0	25.0		12.5	25.5	25.5
Total Split (s)	11.5	24.5		26.0	39.0		25.0	57.0		12.5	44.5	44.5
Total Split (%)	9.6%	20.4%		21.7%	32.5%		20.8%	47.5%		10.4%	37.1%	37.1%
Yellow Time (s)	3.5	3.5		4.0	4.0		5.0	5.0		5.0	5.0	5.0
All-Red Time (s)	2.0	2.0		2.0	2.0		2.0	2.0		2.0	2.0	2.0
Lost Time Adjust (s)	0.0	0.0		0.0	0.0		0.0	0.0		0.0	0.0	0.0
Total Lost Time (s)	5.5	5.5		6.0	6.0		7.0	7.0		7.0	7.0	7.0
Lead/Lag	Lead	Lag		Lead	Lag		Lag	Lead		Lag	Lead	Lead
Lead-Lag Optimize?	Yes	Yes		Yes	Yes		Yes	Yes		Yes	Yes	Yes
Recall Mode	None	None		None	None		None	C-Max		None	C-Max	C-Max
Act Effct Green (s)	5.9	10.7	120.0	20.2	24.8	120.0	17.5	70.5	120.0	54.0	48.5	48.5
Actuated g/C Ratio	0.05	0.09	1.00	0.17	0.21	1.00	0.15	0.59	1.00	0.45	0.40	0.40
v/c Ratio	0.34	0.51	0.30	0.94	0.18	0.01	0.84	0.68	0.42	0.03	0.53	0.08
Control Delay	60.9	61.9	0.5	77.8	37.5	0.0	65.9	20.5	0.8	14.8	37.3	1.7
Queue Delay	0.0	0.0	0.0	0.0	0.0	0.0	0.0	0.0	0.0	0.0	0.0	0.0
Total Delay	60.9	61.9	0.5	77.8	37.5	0.0	65.9	20.5	0.8	14.8	37.3	1.7
LOS	E	E	A	E	D	A	E	C	A	B	D	A
Approach Delay		14.5			73.6			22.4			35.2	
Approach LOS		B			E			C			D	

Intersection Summary

Cycle Length: 120
 Actuated Cycle Length: 120
 Offset: 55.9 (47%), Referenced to phase 2:NBT and 6:SBTL, Start of Green
 Natural Cycle: 110
 Control Type: Actuated-Coordinated
 Maximum v/c Ratio: 0.94
 Intersection Signal Delay: 31.8
 Intersection Capacity Utilization 78.8%
 Analysis Period (min) 15
 Intersection LOS: C
 ICU Level of Service D

Splits and Phases: 4: US-24 & Newt Dr/SH-94

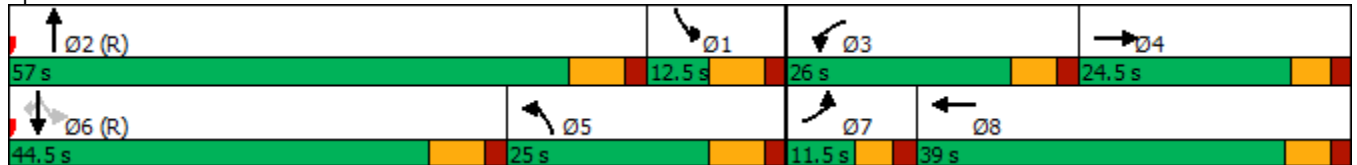

HCM 6th Signalized Intersection Summary
 4: US-24 & Newt Dr/SH-94

2026 Total PM Improved.syn
 02/18/2021



Movement	EBL	EBT	EBR	WBL	WBT	WBR	NBL	NBT	NBR	SBL	SBT	SBR
Lane Configurations	↖↗	↑	↖	↖↗↘	↑	↖	↖↗	↖↗↘	↖	↖	↖↗↘	↖
Traffic Volume (veh/h)	55	80	450	740	65	10	395	1925	625	5	1000	60
Future Volume (veh/h)	55	80	450	740	65	10	395	1925	625	5	1000	60
Initial Q (Qb), veh	0	0	0	0	0	0	0	0	0	0	0	0
Ped-Bike Adj(A_pbT)	1.00		1.00	1.00		1.00	1.00		1.00	1.00		1.00
Parking Bus, Adj	1.00	1.00	1.00	1.00	1.00	1.00	1.00	1.00	1.00	1.00	1.00	1.00
Work Zone On Approach		No			No			No			No	
Adj Sat Flow, veh/h/ln	1870	1870	1870	1856	1856	1856	1856	1856	1856	1826	1826	1826
Adj Flow Rate, veh/h	58	84	0	779	68	0	416	2026	0	5	1053	0
Peak Hour Factor	0.95	0.95	0.95	0.95	0.95	0.95	0.95	0.95	0.95	0.95	0.95	0.95
Percent Heavy Veh, %	2	2	2	3	3	3	3	3	3	5	5	5
Cap, veh/h	123	117		831	367		828	2111		299	1558	
Arrive On Green	0.04	0.06	0.00	0.28	0.33	0.00	0.24	0.42	0.00	0.14	0.31	0.00
Sat Flow, veh/h	3456	1870	1585	4983	1856	1572	3428	5066	1572	1739	4985	1547
Grp Volume(v), veh/h	58	84	0	779	68	0	416	2026	0	5	1053	0
Grp Sat Flow(s),veh/h/ln	1728	1870	1585	1661	1856	1572	1714	1689	1572	1739	1662	1547
Q Serve(g_s), s	2.0	5.3	0.0	18.3	3.1	0.0	12.6	46.7	0.0	0.0	22.1	0.0
Cycle Q Clear(g_c), s	2.0	5.3	0.0	18.3	3.1	0.0	12.6	46.7	0.0	0.0	22.1	0.0
Prop In Lane	1.00		1.00	1.00		1.00	1.00		1.00	1.00		1.00
Lane Grp Cap(c), veh/h	123	117		831	367		828	2111		299	1558	
V/C Ratio(X)	0.47	0.72		0.94	0.19		0.50	0.96		0.02	0.68	
Avail Cap(c_a), veh/h	173	296		831	510		828	2111		299	1558	
HCM Platoon Ratio	1.00	1.00	1.00	1.67	1.67	1.67	1.00	1.00	1.00	1.00	1.00	1.00
Upstream Filter(I)	1.00	1.00	0.00	0.78	0.78	0.00	1.00	1.00	0.00	1.00	1.00	0.00
Uniform Delay (d), s/veh	56.8	55.2	0.0	42.7	33.3	0.0	39.3	34.0	0.0	44.7	36.0	0.0
Incr Delay (d2), s/veh	2.8	7.9	0.0	15.0	0.2	0.0	0.5	12.2	0.0	0.0	2.4	0.0
Initial Q Delay(d3),s/veh	0.0	0.0	0.0	0.0	0.0	0.0	0.0	0.0	0.0	0.0	0.0	0.0
%ile BackOfQ(50%),veh/ln	0.9	2.8	0.0	7.9	1.4	0.0	5.4	21.0	0.0	0.1	9.3	0.0
Unsig. Movement Delay, s/veh												
LnGrp Delay(d),s/veh	59.5	63.1	0.0	57.7	33.5	0.0	39.8	46.2	0.0	44.7	38.3	0.0
LnGrp LOS	E	E		E	C		D	D		D	D	
Approach Vol, veh/h		142	A		847	A		2442	A		1058	A
Approach Delay, s/veh		61.6			55.7			45.1			38.4	
Approach LOS		E			E			D			D	
Timer - Assigned Phs	1	2	3	4	5	6	7	8				
Phs Duration (G+Y+Rc), s	23.5	57.0	26.0	13.5	36.0	44.5	9.8	29.7				
Change Period (Y+Rc), s	7.0	7.0	6.0	* 6	7.0	7.0	5.5	6.0				
Max Green Setting (Gmax), s	5.5	50.0	20.0	* 19	18.0	37.5	6.0	33.0				
Max Q Clear Time (g_c+I1), s	2.0	48.7	20.3	7.3	14.6	24.1	4.0	5.1				
Green Ext Time (p_c), s	0.0	1.2	0.0	0.2	0.5	6.2	0.0	0.3				

Intersection Summary

HCM 6th Ctrl Delay	46.0
HCM 6th LOS	D

Notes

* HCM 6th computational engine requires equal clearance times for the phases crossing the barrier.
 Unsignalized Delay for [NBR, EBR, WBR, SBR] is excluded from calculations of the approach delay and intersection delay.

Timings
4: US-24 & Newt Dr/SH-94



Lane Group	EBL	EBT	EBR	WBT	WBR	NBL	NBT	NBR	SBL	SBT	SBR
Lane Configurations	↖↗	↑	↖	↖↗	↖	↖↗	↖↗	↖	↖	↖↗	↖
Traffic Volume (vph)	45	90	495	95	5	425	985	635	5	1860	65
Future Volume (vph)	45	90	495	95	5	425	985	635	5	1860	65
Turn Type	Prot	NA	Free	NA	Free	Prot	NA	Free	pm+pt	NA	Perm
Protected Phases	7	4		8		5	2		1	6	
Permitted Phases			Free		Free			Free	6		6
Detector Phase	7	4		8		5	2		1	6	6
Switch Phase											
Minimum Initial (s)	5.0	5.0		5.0		5.0	5.0		5.0	5.0	5.0
Minimum Split (s)	11.5	24.5		24.0		12.0	25.0		12.5	25.5	25.5
Total Split (s)	11.5	35.5		24.0		26.0	102.0		12.5	88.5	88.5
Total Split (%)	7.7%	23.7%		16.0%		17.3%	68.0%		8.3%	59.0%	59.0%
Yellow Time (s)	3.5	3.5		4.0		5.0	5.0		5.0	5.0	5.0
All-Red Time (s)	2.0	2.0		2.0		2.0	2.0		2.0	2.0	2.0
Lost Time Adjust (s)	0.0	0.0		0.0		0.0	0.0		0.0	0.0	0.0
Total Lost Time (s)	5.5	5.5		6.0		7.0	7.0		7.0	7.0	7.0
Lead/Lag	Lead			Lag		Lag	Lead		Lag	Lead	Lead
Lead-Lag Optimize?	Yes			Yes		Yes	Yes		Yes	Yes	Yes
Recall Mode	None	None		None		None	C-Max		None	C-Max	C-Max
Act Effect Green (s)	5.9	19.4	150.0	9.7	150.0	19.0	115.6	150.0	97.6	92.1	92.1
Actuated g/C Ratio	0.04	0.13	1.00	0.06	1.00	0.13	0.77	1.00	0.65	0.61	0.61
v/c Ratio	0.35	0.40	0.33	0.44	0.00	1.09	0.40	0.45	0.01	0.92	0.07
Control Delay	77.7	63.5	0.6	73.2	0.0	129.4	7.2	1.0	6.0	34.8	0.1
Queue Delay	0.0	0.0	0.0	0.0	0.0	0.0	0.0	0.0	0.0	0.0	0.0
Total Delay	77.7	63.5	0.6	73.2	0.0	129.4	7.2	1.0	6.0	34.8	0.1
LOS	E	E	A	E	A	F	A	A	A	C	A
Approach Delay		15.1		69.7			30.7			33.5	
Approach LOS		B		E			C			C	

Intersection Summary

Cycle Length: 150
 Actuated Cycle Length: 150
 Offset: 0 (0%), Referenced to phase 2:NBT and 6:SBTL, Start of Green
 Natural Cycle: 150
 Control Type: Actuated-Coordinated
 Maximum v/c Ratio: 1.09
 Intersection Signal Delay: 30.6
 Intersection Capacity Utilization 87.7%
 Analysis Period (min) 15
 Intersection LOS: C
 ICU Level of Service E

Splits and Phases: 4: US-24 & Newt Dr/SH-94



HCM 6th Signalized Intersection Summary
 4: US-24 & Newt Dr/SH-94

2026 Total AM Improved_4 WBL Flyover.syn

03/31/2021

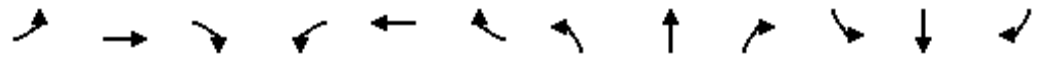

Movement	EBL	EBT	EBR	WBL	WBT	WBR	NBL	NBT	NBR	SBL	SBT	SBR
Lane Configurations	↖↗	↑	↖		↑↑	↖	↖↗	↑↑	↖	↖	↑↑	↖
Traffic Volume (veh/h)	45	90	495	0	95	5	425	985	635	5	1860	65
Future Volume (veh/h)	45	90	495	0	95	5	425	985	635	5	1860	65
Initial Q (Qb), veh	0	0	0	0	0	0	0	0	0	0	0	0
Ped-Bike Adj(A_pbT)	1.00		1.00	1.00		1.00	1.00		1.00	1.00		1.00
Parking Bus, Adj	1.00	1.00	1.00	1.00	1.00	1.00	1.00	1.00	1.00	1.00	1.00	1.00
Work Zone On Approach		No			No			No			No	
Adj Sat Flow, veh/h/ln	1826	1826	1826	0	1841	1841	1752	1752	1752	1811	1811	1811
Adj Flow Rate, veh/h	46	93	0	0	98	0	438	1015	0	5	1918	0
Peak Hour Factor	0.97	0.97	0.97	0.97	0.97	0.97	0.97	0.97	0.97	0.97	0.97	0.97
Percent Heavy Veh, %	5	5	5	0	4	4	10	10	10	6	6	6
Cap, veh/h	96	198		0	151		696	2108		469	1870	
Arrive On Green	0.03	0.11	0.00	0.00	0.04	0.00	0.22	0.63	0.00	0.13	0.54	0.00
Sat Flow, veh/h	3374	1826	1547	0	3589	1560	3237	3328	1485	1725	3441	1535
Grp Volume(v), veh/h	46	93	0	0	98	0	438	1015	0	5	1918	0
Grp Sat Flow(s),veh/h/ln	1687	1826	1547	0	1749	1560	1618	1664	1485	1725	1721	1535
Q Serve(g_s), s	2.0	7.2	0.0	0.0	4.1	0.0	18.4	24.1	0.0	0.0	81.5	0.0
Cycle Q Clear(g_c), s	2.0	7.2	0.0	0.0	4.1	0.0	18.4	24.1	0.0	0.0	81.5	0.0
Prop In Lane	1.00		1.00	0.00		1.00	1.00		1.00	1.00		1.00
Lane Grp Cap(c), veh/h	96	198		0	151		696	2108		469	1870	
V/C Ratio(X)	0.48	0.47		0.00	0.65		0.63	0.48		0.01	1.03	
Avail Cap(c_a), veh/h	135	365		0	420		696	2108		469	1870	
HCM Platoon Ratio	1.00	1.00	1.00	1.00	1.00	1.00	1.00	1.00	1.00	1.00	1.00	1.00
Upstream Filter(l)	1.00	1.00	0.00	0.00	0.82	0.00	1.00	1.00	0.00	1.00	1.00	0.00
Uniform Delay (d), s/veh	71.8	62.8	0.0	0.0	70.6	0.0	53.4	14.5	0.0	18.4	34.3	0.0
Incr Delay (d2), s/veh	3.7	1.7	0.0	0.0	3.8	0.0	1.8	0.8	0.0	0.0	27.7	0.0
Initial Q Delay(d3),s/veh	0.0	0.0	0.0	0.0	0.0	0.0	0.0	0.0	0.0	0.0	0.0	0.0
%ile BackOfQ(50%),veh/ln	0.9	3.5	0.0	0.0	1.9	0.0	7.7	9.3	0.0	0.1	40.2	0.0
Unsig. Movement Delay, s/veh												
LnGrp Delay(d),s/veh	75.5	64.6	0.0	0.0	74.5	0.0	55.3	15.3	0.0	18.4	61.9	0.0
LnGrp LOS	E	E		A	E		E	B		B	F	
Approach Vol, veh/h		139	A		98	A		1453	A		1923	A
Approach Delay, s/veh		68.2			74.5			27.3			61.8	
Approach LOS		E			E			C			E	
Timer - Assigned Phs	1	2		4	5	6	7	8				
Phs Duration (G+Y+Rc), s	25.8	102.0		22.2	39.3	88.5	9.8	12.5				
Change Period (Y+Rc), s	7.0	7.0		* 6	7.0	7.0	5.5	6.0				
Max Green Setting (Gmax), s	5.5	95.0		* 30	19.0	81.5	6.0	18.0				
Max Q Clear Time (g_c+I1), s	2.0	26.1		9.2	20.4	83.5	4.0	6.1				
Green Ext Time (p_c), s	0.0	10.0		0.4	0.0	0.0	0.0	0.3				

Intersection Summary

HCM 6th Ctrl Delay	48.5
HCM 6th LOS	D

Notes

* HCM 6th computational engine requires equal clearance times for the phases crossing the barrier.
 Unsignalized Delay for [NBR, EBR, WBR, SBR] is excluded from calculations of the approach delay and intersection delay.

Timings
4: US-24 & Newt Dr/SH-94



Lane Group	EBL	EBT	EBR	WBT	WBR	NBL	NBT	NBR	SBL	SBT	SBR
Lane Configurations	↖↖	↑	↗	↖↖	↗	↖↖	↖↖	↗	↖	↖↖	↗
Traffic Volume (vph)	55	80	450	65	10	395	1925	625	5	1000	60
Future Volume (vph)	55	80	450	65	10	395	1925	625	5	1000	60
Turn Type	Prot	NA	Free	NA	Free	Prot	NA	Free	pm+pt	NA	Perm
Protected Phases	7	4		8		5	2		1	6	
Permitted Phases			Free		Free			Free	6		6
Detector Phase	7	4		8		5	2		1	6	6
Switch Phase											
Minimum Initial (s)	5.0	5.0		5.0		5.0	5.0		5.0	5.0	5.0
Minimum Split (s)	11.5	24.5		24.0		12.0	25.0		12.5	25.5	25.5
Total Split (s)	11.5	35.5		24.0		29.0	72.0		12.5	55.5	55.5
Total Split (%)	9.6%	29.6%		20.0%		24.2%	60.0%		10.4%	46.3%	46.3%
Yellow Time (s)	3.5	3.5		4.0		5.0	5.0		5.0	5.0	5.0
All-Red Time (s)	2.0	2.0		2.0		2.0	2.0		2.0	2.0	2.0
Lost Time Adjust (s)	0.0	0.0		0.0		0.0	0.0		0.0	0.0	0.0
Total Lost Time (s)	5.5	5.5		6.0		7.0	7.0		7.0	7.0	7.0
Lead/Lag	Lead			Lag		Lag	Lead		Lag	Lead	Lead
Lead-Lag Optimize?	Yes			Yes		Yes	Yes		Yes	Yes	Yes
Recall Mode	None	None		None		None	C-Max		None	C-Max	C-Max
Act Effect Green (s)	6.4	18.0	120.0	7.7	120.0	19.3	90.9	120.0	71.2	65.7	65.7
Actuated g/C Ratio	0.05	0.15	1.00	0.06	1.00	0.16	0.76	1.00	0.59	0.55	0.55
v/c Ratio	0.32	0.30	0.30	0.30	0.01	0.76	0.76	0.42	0.03	0.56	0.07
Control Delay	59.6	46.7	0.5	54.0	0.0	57.7	14.8	0.8	8.4	22.5	0.8
Queue Delay	0.0	0.0	0.0	0.0	0.0	0.0	0.0	0.0	0.0	0.0	0.0
Total Delay	59.6	46.7	0.5	54.0	0.0	57.7	14.8	0.8	8.4	22.5	0.8
LOS	E	D	A	D	A	E	B	A	A	C	A
Approach Delay		12.4		46.5			17.6			21.2	
Approach LOS		B		D			B			C	

Intersection Summary

Cycle Length: 120
 Actuated Cycle Length: 120
 Offset: 55.9 (47%), Referenced to phase 2:NBT and 6:SBTL, Start of Green
 Natural Cycle: 120
 Control Type: Actuated-Coordinated
 Maximum v/c Ratio: 0.76
 Intersection Signal Delay: 18.2
 Intersection Capacity Utilization 81.9%
 Analysis Period (min) 15
 Intersection LOS: B
 ICU Level of Service D

Splits and Phases: 4: US-24 & Newt Dr/SH-94

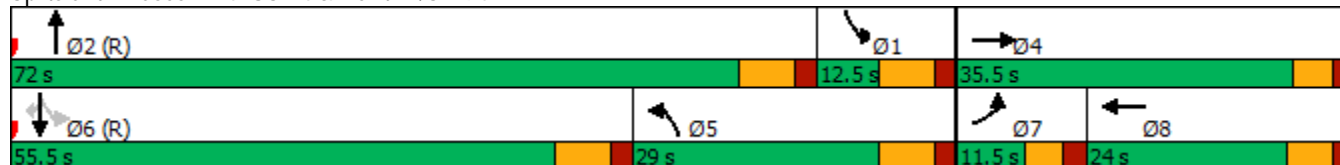

HCM 6th Signalized Intersection Summary
 4: US-24 & Newt Dr/SH-94

2026 Total PM Improved_4 WBL Flyover.syn

03/31/2021

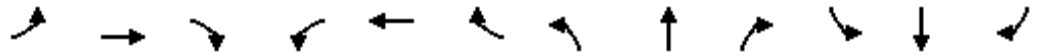

Movement	EBL	EBT	EBR	WBL	WBT	WBR	NBL	NBT	NBR	SBL	SBT	SBR
Lane Configurations	↖↗	↑	↖		↑↑	↖	↖↗	↑↑	↖	↖	↑↑	↖
Traffic Volume (veh/h)	55	80	450	0	65	10	395	1925	625	5	1000	60
Future Volume (veh/h)	55	80	450	0	65	10	395	1925	625	5	1000	60
Initial Q (Qb), veh	0	0	0	0	0	0	0	0	0	0	0	0
Ped-Bike Adj(A_pbT)	1.00		1.00	1.00		1.00	1.00		1.00	1.00		1.00
Parking Bus, Adj	1.00	1.00	1.00	1.00	1.00	1.00	1.00	1.00	1.00	1.00	1.00	1.00
Work Zone On Approach		No			No			No			No	
Adj Sat Flow, veh/h/ln	1870	1870	1870	0	1856	1856	1856	1856	1856	1826	1826	1826
Adj Flow Rate, veh/h	58	84	0	0	68	0	416	2026	0	5	1053	0
Peak Hour Factor	0.95	0.95	0.95	0.95	0.95	0.95	0.95	0.95	0.95	0.95	0.95	0.95
Percent Heavy Veh, %	2	2	2	0	3	3	3	3	3	5	5	5
Cap, veh/h	123	230		0	146		1050	1910		354	1402	
Arrive On Green	0.04	0.12	0.00	0.00	0.04	0.00	0.31	0.54	0.00	0.17	0.40	0.00
Sat Flow, veh/h	3456	1870	1585	0	3618	1572	3428	3526	1572	1739	3469	1547
Grp Volume(v), veh/h	58	84	0	0	68	0	416	2026	0	5	1053	0
Grp Sat Flow(s),veh/h/ln	1728	1870	1585	0	1763	1572	1714	1763	1572	1739	1735	1547
Q Serve(g_s), s	2.0	4.9	0.0	0.0	2.3	0.0	11.5	65.0	0.0	0.0	31.2	0.0
Cycle Q Clear(g_c), s	2.0	4.9	0.0	0.0	2.3	0.0	11.5	65.0	0.0	0.0	31.2	0.0
Prop In Lane	1.00		1.00	0.00		1.00	1.00		1.00	1.00		1.00
Lane Grp Cap(c), veh/h	123	230		0	146		1050	1910		354	1402	
V/C Ratio(X)	0.47	0.37		0.00	0.47		0.40	1.06		0.01	0.75	
Avail Cap(c_a), veh/h	173	468		0	529		1050	1910		354	1402	
HCM Platoon Ratio	1.00	1.00	1.00	1.00	1.00	1.00	1.00	1.00	1.00	1.00	1.00	1.00
Upstream Filter(I)	1.00	1.00	0.00	0.00	0.73	0.00	1.00	1.00	0.00	1.00	1.00	0.00
Uniform Delay (d), s/veh	56.8	48.3	0.0	0.0	56.2	0.0	32.9	27.5	0.0	41.5	30.6	0.0
Incr Delay (d2), s/veh	2.8	1.0	0.0	0.0	1.7	0.0	0.2	39.0	0.0	0.0	3.7	0.0
Initial Q Delay(d3),s/veh	0.0	0.0	0.0	0.0	0.0	0.0	0.0	0.0	0.0	0.0	0.0	0.0
%ile BackOfQ(50%),veh/ln	0.9	2.4	0.0	0.0	1.0	0.0	4.8	36.1	0.0	0.1	13.6	0.0
Unsig. Movement Delay, s/veh												
LnGrp Delay(d),s/veh	59.5	49.3	0.0	0.0	57.9	0.0	33.1	66.5	0.0	41.5	34.3	0.0
LnGrp LOS	E	D		A	E		C	F		D	C	
Approach Vol, veh/h		142	A		68	A		2442	A		1058	A
Approach Delay, s/veh		53.5			57.9			60.8			34.4	
Approach LOS		D			E			E			C	
Timer - Assigned Phs	1	2		4	5	6	7	8				
Phs Duration (G+Y+Rc), s	27.3	72.0		20.7	43.8	55.5	9.8	11.0				
Change Period (Y+Rc), s	7.0	7.0		* 6	7.0	7.0	5.5	6.0				
Max Green Setting (Gmax), s	5.5	65.0		* 30	22.0	48.5	6.0	18.0				
Max Q Clear Time (g_c+I1), s	2.0	67.0		6.9	13.5	33.2	4.0	4.3				
Green Ext Time (p_c), s	0.0	0.0		0.4	1.0	6.8	0.0	0.2				

Intersection Summary

HCM 6th Ctrl Delay	52.9
HCM 6th LOS	D

Notes

* HCM 6th computational engine requires equal clearance times for the phases crossing the barrier.
 Unsignalized Delay for [NBR, EBR, WBR, SBR] is excluded from calculations of the approach delay and intersection delay.

Timings
4: US-24 & Newt Dr/SH-94

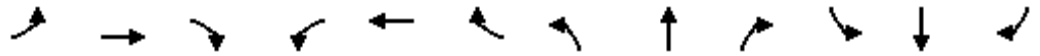

Lane Group	EBL	EBT	EBR	WBL	WBT	WBR	NBL	NBT	NBR	SBL	SBT	SBR
Lane Configurations	↖↗	↑	↖	↖↗↘	↑	↖	↖↗	↑↑↑	↖	↖	↑↑↑	↖
Traffic Volume (vph)	55	95	555	885	105	5	480	1010	695	10	2190	80
Future Volume (vph)	55	95	555	885	105	5	480	1010	695	10	2190	80
Turn Type	Prot	NA	Free	Prot	NA	Free	Prot	NA	Free	pm+pt	NA	Perm
Protected Phases	7	4		3	8		5	2		1	6	
Permitted Phases			Free			Free			Free	6		6
Detector Phase	7	4		3	8		5	2		1	6	6
Switch Phase												
Minimum Initial (s)	5.0	5.0		5.0	5.0		5.0	5.0		5.0	5.0	5.0
Minimum Split (s)	11.5	24.5		11.0	24.0		12.0	25.0		12.5	25.5	25.5
Total Split (s)	11.5	24.5		23.0	36.0		14.0	60.0		12.5	58.5	58.5
Total Split (%)	9.6%	20.4%		19.2%	30.0%		11.7%	50.0%		10.4%	48.8%	48.8%
Yellow Time (s)	3.5	3.5		4.0	4.0		5.0	5.0		5.0	5.0	5.0
All-Red Time (s)	2.0	2.0		2.0	2.0		2.0	2.0		2.0	2.0	2.0
Lost Time Adjust (s)	0.0	0.0		0.0	0.0		0.0	0.0		0.0	0.0	0.0
Total Lost Time (s)	5.5	5.5		6.0	6.0		7.0	7.0		7.0	7.0	7.0
Lead/Lag	Lead	Lag		Lead	Lag		Lag	Lead		Lag	Lead	Lead
Lead-Lag Optimize?	Yes	Yes		Yes	Yes		Yes	Yes		Yes	Yes	Yes
Recall Mode	None	None		None	None		None	C-Max		None	C-Max	C-Max
Act Effct Green (s)	5.9	11.8	120.0	17.0	25.1	120.0	7.0	70.2	120.0	64.2	58.7	58.7
Actuated g/C Ratio	0.05	0.10	1.00	0.14	0.21	1.00	0.06	0.58	1.00	0.54	0.49	0.49
v/c Ratio	0.35	0.55	0.37	1.32	0.28	0.00	2.68	0.38	0.49	0.04	0.94	0.10
Control Delay	61.2	62.7	0.7	186.1	43.0	0.0	791.2	14.8	1.2	6.8	31.0	0.9
Queue Delay	0.0	0.0	0.0	0.0	0.0	0.0	0.0	0.0	0.0	0.0	0.0	0.0
Total Delay	61.2	62.7	0.7	186.1	43.0	0.0	791.2	14.8	1.2	6.8	31.0	0.9
LOS	E	E	A	F	D	A	F	B	A	A	C	A
Approach Delay		13.8			170.1			181.1			29.9	
Approach LOS		B			F			F			C	

Intersection Summary

Cycle Length: 120
 Actuated Cycle Length: 120
 Offset: 55.9 (47%), Referenced to phase 2:NBT and 6:SBTL, Start of Green
 Natural Cycle: 150
 Control Type: Actuated-Coordinated
 Maximum v/c Ratio: 2.68
 Intersection Signal Delay: 104.3
 Intersection Capacity Utilization 96.2%
 Analysis Period (min) 15
 Intersection LOS: F
 ICU Level of Service F

Splits and Phases: 4: US-24 & Newt Dr/SH-94

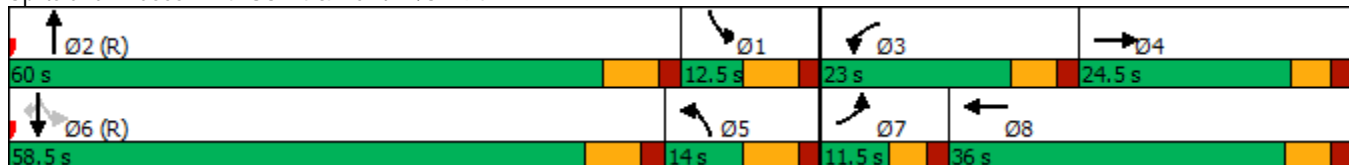

HCM 6th Signalized Intersection Summary
 4: US-24 & Newt Dr/SH-94

2040 Background AM.syn

01/05/2022

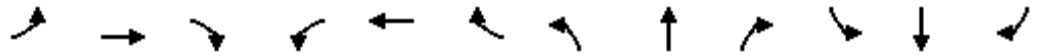

Movement	EBL	EBT	EBR	WBL	WBT	WBR	NBL	NBT	NBR	SBL	SBT	SBR
Lane Configurations	↖↗	↑	↖	↖↗↘	↑	↖	↖↗	↖↗↘	↖	↖	↖↗↘	↖
Traffic Volume (veh/h)	55	95	555	885	105	5	480	1010	695	10	2190	80
Future Volume (veh/h)	55	95	555	885	105	5	480	1010	695	10	2190	80
Initial Q (Qb), veh	0	0	0	0	0	0	0	0	0	0	0	0
Ped-Bike Adj(A_pbT)	1.00		1.00	1.00		1.00	1.00		1.00	1.00		1.00
Parking Bus, Adj	1.00	1.00	1.00	1.00	1.00	1.00	1.00	1.00	1.00	1.00	1.00	1.00
Work Zone On Approach		No			No			No			No	
Adj Sat Flow, veh/h/ln	1826	1826	1826	1841	1841	1841	1752	1752	1752	1811	1811	1811
Adj Flow Rate, veh/h	57	98	0	912	108	0	495	1041	0	10	2258	0
Peak Hour Factor	0.97	0.97	0.97	0.97	0.97	0.97	0.97	0.97	0.97	0.97	0.97	0.97
Percent Heavy Veh, %	5	5	5	4	4	4	10	10	10	6	6	6
Cap, veh/h	120	131		700	335		456	2112		425	2122	
Arrive On Green	0.04	0.07	0.00	0.05	0.06	0.00	0.14	0.44	0.00	0.13	0.43	0.00
Sat Flow, veh/h	3374	1826	1547	4944	1841	1560	3237	4782	1485	1725	4944	1535
Grp Volume(v), veh/h	57	98	0	912	108	0	495	1041	0	10	2258	0
Grp Sat Flow(s),veh/h/ln	1687	1826	1547	1648	1841	1560	1618	1594	1485	1725	1648	1535
Q Serve(g_s), s	2.0	6.3	0.0	17.0	6.7	0.0	16.9	18.6	0.0	0.0	51.5	0.0
Cycle Q Clear(g_c), s	2.0	6.3	0.0	17.0	6.7	0.0	16.9	18.6	0.0	0.0	51.5	0.0
Prop In Lane	1.00		1.00	1.00		1.00	1.00		1.00	1.00		1.00
Lane Grp Cap(c), veh/h	120	131		700	335		456	2112		425	2122	
V/C Ratio(X)	0.48	0.75		1.30	0.32		1.09	0.49		0.02	1.06	
Avail Cap(c_a), veh/h	169	289		700	460		456	2112		425	2122	
HCM Platoon Ratio	1.00	1.00	1.00	0.33	0.33	0.33	1.00	1.00	1.00	1.00	1.00	1.00
Upstream Filter(l)	1.00	1.00	0.00	0.09	0.09	0.00	1.00	1.00	0.00	1.00	1.00	0.00
Uniform Delay (d), s/veh	56.8	54.6	0.0	57.2	49.3	0.0	51.5	23.9	0.0	21.9	34.2	0.0
Incr Delay (d2), s/veh	2.9	8.3	0.0	137.0	0.0	0.0	67.2	0.8	0.0	0.0	39.2	0.0
Initial Q Delay(d3),s/veh	0.0	0.0	0.0	0.0	0.0	0.0	0.0	0.0	0.0	0.0	0.0	0.0
%ile BackOfQ(50%),veh/ln	0.9	3.2	0.0	16.4	3.2	0.0	11.1	7.1	0.0	0.2	27.7	0.0
Unsig. Movement Delay, s/veh												
LnGrp Delay(d),s/veh	59.7	62.9	0.0	194.2	49.4	0.0	118.8	24.7	0.0	21.9	73.5	0.0
LnGrp LOS	E	E		F	D		F	C		C	F	
Approach Vol, veh/h		155	A		1020	A		1536	A		2268	A
Approach Delay, s/veh		61.7			178.8			55.0			73.2	
Approach LOS		E			F			E			E	
Timer - Assigned Phs	1	2	3	4	5	6	7	8				
Phs Duration (G+Y+Rc), s	22.4	60.0	23.0	14.6	23.9	58.5	9.8	27.8				
Change Period (Y+Rc), s	7.0	7.0	6.0	* 6	7.0	7.0	5.5	6.0				
Max Green Setting (Gmax), s	5.5	53.0	17.0	* 19	7.0	51.5	6.0	30.0				
Max Q Clear Time (g_c+I1), s	2.0	20.6	19.0	8.3	18.9	53.5	4.0	8.7				
Green Ext Time (p_c), s	0.0	9.1	0.0	0.3	0.0	0.0	0.0	0.5				

Intersection Summary

HCM 6th Ctrl Delay	88.9
HCM 6th LOS	F

Notes

* HCM 6th computational engine requires equal clearance times for the phases crossing the barrier.
 Unsignalized Delay for [NBR, EBR, WBR, SBR] is excluded from calculations of the approach delay and intersection delay.

Timings
4: US-24 & Newt Dr/SH-94

Lane Group	EBL	EBT	EBR	WBL	WBT	WBR	NBL	NBT	NBR	SBL	SBT	SBR
Lane Configurations												
Traffic Volume (vph)	65	95	535	885	80	10	470	2130	930	10	1180	75
Future Volume (vph)	65	95	535	885	80	10	470	2130	930	10	1180	75
Turn Type	Prot	NA	Free	Prot	NA	Free	Prot	NA	Free	pm+pt	NA	Perm
Protected Phases	7	4		3	8		5	2		1	6	
Permitted Phases			Free			Free			Free			6
Detector Phase	7	4		3	8		5	2		1	6	6
Switch Phase												
Minimum Initial (s)	5.0	5.0		5.0	5.0		5.0	5.0		5.0	5.0	5.0
Minimum Split (s)	11.5	24.5		11.0	24.0		12.0	25.0		12.5	25.5	25.5
Total Split (s)	11.5	24.5		21.0	34.0		19.0	62.0		12.5	55.5	55.5
Total Split (%)	9.6%	20.4%		17.5%	28.3%		15.8%	51.7%		10.4%	46.3%	46.3%
Yellow Time (s)	3.5	3.5		4.0	4.0		5.0	5.0		5.0	5.0	5.0
All-Red Time (s)	2.0	2.0		2.0	2.0		2.0	2.0		2.0	2.0	2.0
Lost Time Adjust (s)	0.0	0.0		0.0	0.0		0.0	0.0		0.0	0.0	0.0
Total Lost Time (s)	5.5	5.5		6.0	6.0		7.0	7.0		7.0	7.0	7.0
Lead/Lag	Lead	Lag		Lead	Lag		Lag	Lead		Lag	Lead	Lead
Lead-Lag Optimize?	Yes	Yes		Yes	Yes		Yes	Yes		Yes	Yes	Yes
Recall Mode	None	None		None	None		None	C-Max		None	C-Max	C-Max
Act Effct Green (s)	6.0	11.8	120.0	15.0	23.1	120.0	12.0	72.2	120.0	61.2	55.7	55.7
Actuated g/C Ratio	0.05	0.10	1.00	0.12	0.19	1.00	0.10	0.60	1.00	0.51	0.46	0.46
v/c Ratio	0.40	0.55	0.36	1.51	0.24	0.01	1.46	0.74	0.62	0.07	0.54	0.10
Control Delay	62.5	62.2	0.6	272.5	45.8	0.0	259.2	20.4	1.9	10.9	28.2	1.7
Queue Delay	0.0	0.0	0.0	0.0	0.0	0.0	0.0	0.0	0.0	0.0	0.0	0.0
Total Delay	62.5	62.2	0.6	272.5	45.8	0.0	259.2	20.4	1.9	10.9	28.2	1.7
LOS	E	E	A	F	D	A	F	C	A	B	C	A
Approach Delay		14.8			251.0			47.3			26.4	
Approach LOS		B			F			D			C	

Intersection Summary

Cycle Length: 120
 Actuated Cycle Length: 120
 Offset: 55.9 (47%), Referenced to phase 2:NBT and 6:SBTL, Start of Green
 Natural Cycle: 130
 Control Type: Actuated-Coordinated
 Maximum v/c Ratio: 1.51
 Intersection Signal Delay: 70.5
 Intersection Capacity Utilization 85.5%
 Analysis Period (min) 15
 Intersection LOS: E
 ICU Level of Service E

Splits and Phases: 4: US-24 & Newt Dr/SH-94

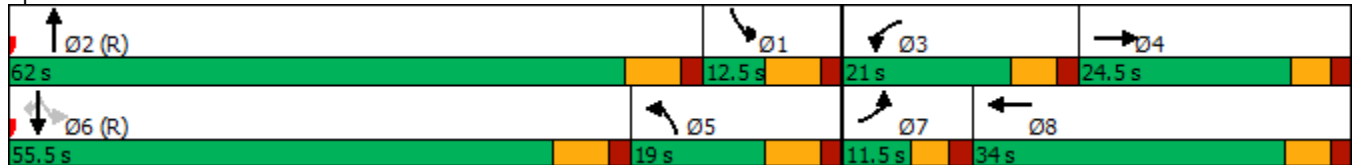

HCM 6th Signalized Intersection Summary
 4: US-24 & Newt Dr/SH-94

2040 Background PM.syn

01/05/2022

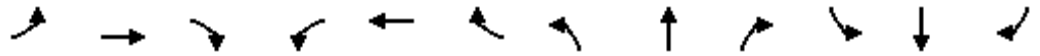

Movement	EBL	EBT	EBR	WBL	WBT	WBR	NBL	NBT	NBR	SBL	SBT	SBR
Lane Configurations												
Traffic Volume (veh/h)	65	95	535	885	80	10	470	2130	930	10	1180	75
Future Volume (veh/h)	65	95	535	885	80	10	470	2130	930	10	1180	75
Initial Q (Qb), veh	0	0	0	0	0	0	0	0	0	0	0	0
Ped-Bike Adj(A_pbT)	1.00		1.00	1.00		1.00	1.00		1.00	1.00		1.00
Parking Bus, Adj	1.00	1.00	1.00	1.00	1.00	1.00	1.00	1.00	1.00	1.00	1.00	1.00
Work Zone On Approach		No			No			No			No	
Adj Sat Flow, veh/h/ln	1870	1870	1870	1856	1856	1856	1856	1856	1856	1826	1826	1826
Adj Flow Rate, veh/h	68	100	0	932	84	0	495	2242	0	11	1242	0
Peak Hour Factor	0.95	0.95	0.95	0.95	0.95	0.95	0.95	0.95	0.95	0.95	0.95	0.95
Percent Heavy Veh, %	2	2	2	3	3	3	3	3	3	5	5	5
Cap, veh/h	129	134		623	303		626	2322		283	2015	
Arrive On Green	0.04	0.07	0.00	0.04	0.05	0.00	0.18	0.46	0.00	0.13	0.40	0.00
Sat Flow, veh/h	3456	1870	1585	4983	1856	1572	3428	5066	1572	1739	4985	1547
Grp Volume(v), veh/h	68	100	0	932	84	0	495	2242	0	11	1242	0
Grp Sat Flow(s),veh/h/ln	1728	1870	1585	1661	1856	1572	1714	1689	1572	1739	1662	1547
Q Serve(g_s), s	2.3	6.3	0.0	15.0	5.2	0.0	16.6	51.6	0.0	0.0	23.7	0.0
Cycle Q Clear(g_c), s	2.3	6.3	0.0	15.0	5.2	0.0	16.6	51.6	0.0	0.0	23.7	0.0
Prop In Lane	1.00		1.00	1.00		1.00	1.00		1.00	1.00		1.00
Lane Grp Cap(c), veh/h	129	134		623	303		626	2322		283	2015	
V/C Ratio(X)	0.53	0.75		1.50	0.28		0.79	0.97		0.04	0.62	
Avail Cap(c_a), veh/h	173	296		623	433		626	2322		283	2015	
HCM Platoon Ratio	1.00	1.00	1.00	0.33	0.33	0.33	1.00	1.00	1.00	1.00	1.00	1.00
Upstream Filter(l)	1.00	1.00	0.00	0.09	0.09	0.00	1.00	1.00	0.00	1.00	1.00	0.00
Uniform Delay (d), s/veh	56.7	54.7	0.0	57.5	50.0	0.0	46.8	31.6	0.0	45.6	28.4	0.0
Incr Delay (d2), s/veh	3.3	8.1	0.0	224.0	0.0	0.0	6.8	12.2	0.0	0.1	1.4	0.0
Initial Q Delay(d3),s/veh	0.0	0.0	0.0	0.0	0.0	0.0	0.0	0.0	0.0	0.0	0.0	0.0
%ile BackOfQ(50%),veh/ln	1.1	3.3	0.0	19.6	2.5	0.0	7.6	22.9	0.0	0.3	9.6	0.0
Unsig. Movement Delay, s/veh												
LnGrp Delay(d),s/veh	60.0	62.7	0.0	281.6	50.0	0.0	53.6	43.8	0.0	45.6	29.8	0.0
LnGrp LOS	E	E		F	D		D	D		D	C	
Approach Vol, veh/h		168	A		1016	A		2737	A		1253	A
Approach Delay, s/veh		61.6			262.4			45.6			29.9	
Approach LOS		E			F			D			C	
Timer - Assigned Phs	1	2	3	4	5	6	7	8				
Phs Duration (G+Y+Rc), s	22.4	62.0	21.0	14.6	28.9	55.5	10.0	25.6				
Change Period (Y+Rc), s	7.0	7.0	6.0	* 6	7.0	7.0	5.5	6.0				
Max Green Setting (Gmax), s	5.5	55.0	15.0	* 19	12.0	48.5	6.0	28.0				
Max Q Clear Time (g_c+I1), s	2.0	53.6	17.0	8.3	18.6	25.7	4.3	7.2				
Green Ext Time (p_c), s	0.0	1.3	0.0	0.3	0.0	9.8	0.0	0.3				

Intersection Summary

HCM 6th Ctrl Delay	84.9
HCM 6th LOS	F

Notes

* HCM 6th computational engine requires equal clearance times for the phases crossing the barrier.
 Unsignalized Delay for [NBR, EBR, WBR, SBR] is excluded from calculations of the approach delay and intersection delay.

Timings
4: US-24 & Newt Dr/SH-94

2040 Total AM.syn
02/18/2021

Lane Group	EBL	EBT	EBR	WBL	WBT	WBR	NBL	NBT	NBR	SBL	SBT	SBR
Lane Configurations												
Traffic Volume (vph)	55	95	555	1155	105	5	480	1150	855	10	2190	80
Future Volume (vph)	55	95	555	1155	105	5	480	1150	855	10	2190	80
Turn Type	Prot	NA	Free	Prot	NA	Free	Prot	NA	Free	pm+pt	NA	Perm
Protected Phases	7	4		3	8		5	2		1	6	
Permitted Phases			Free			Free			Free	6		6
Detector Phase	7	4		3	8		5	2		1	6	6
Switch Phase												
Minimum Initial (s)	5.0	5.0		5.0	5.0		5.0	5.0		5.0	5.0	5.0
Minimum Split (s)	11.5	24.5		11.0	24.0		12.0	25.0		12.5	25.5	25.5
Total Split (s)	11.5	24.5		23.0	36.0		14.0	60.0		12.5	58.5	58.5
Total Split (%)	9.6%	20.4%		19.2%	30.0%		11.7%	50.0%		10.4%	48.8%	48.8%
Yellow Time (s)	3.5	3.5		4.0	4.0		5.0	5.0		5.0	5.0	5.0
All-Red Time (s)	2.0	2.0		2.0	2.0		2.0	2.0		2.0	2.0	2.0
Lost Time Adjust (s)	0.0	0.0		0.0	0.0		0.0	0.0		0.0	0.0	0.0
Total Lost Time (s)	5.5	5.5		6.0	6.0		7.0	7.0		7.0	7.0	7.0
Lead/Lag	Lead	Lag		Lead	Lag		Lag	Lead		Lag	Lead	Lead
Lead-Lag Optimize?	Yes	Yes		Yes	Yes		Yes	Yes		Yes	Yes	Yes
Recall Mode	None	None		None	None		None	C-Max		None	C-Max	C-Max
Act Effct Green (s)	5.9	11.8	120.0	17.0	25.1	120.0	7.0	70.2	120.0	64.2	58.7	58.7
Actuated g/C Ratio	0.05	0.10	1.00	0.14	0.21	1.00	0.06	0.58	1.00	0.54	0.49	0.49
v/c Ratio	0.35	0.55	0.37	1.72	0.28	0.00	2.68	0.43	0.60	0.04	0.94	0.10
Control Delay	61.2	62.7	0.7	359.8	45.7	0.0	791.2	15.5	1.8	6.9	31.8	1.1
Queue Delay	0.0	0.0	0.0	0.0	0.0	0.0	0.0	0.0	0.0	0.0	0.0	0.0
Total Delay	61.2	62.7	0.7	359.8	45.7	0.0	791.2	15.5	1.8	6.9	31.8	1.1
LOS	E	E	A	F	D	A	F	B	A	A	C	A
Approach Delay		13.8			332.4			160.7			30.6	
Approach LOS		B			F			F			C	

Intersection Summary

Cycle Length: 120
 Actuated Cycle Length: 120
 Offset: 55.9 (47%), Referenced to phase 2:NBT and 6:SBTL, Start of Green
 Natural Cycle: 150
 Control Type: Actuated-Coordinated
 Maximum v/c Ratio: 2.68
 Intersection Signal Delay: 133.5
 Intersection LOS: F
 Intersection Capacity Utilization 101.3%
 ICU Level of Service G
 Analysis Period (min) 15

Splits and Phases: 4: US-24 & Newt Dr/SH-94

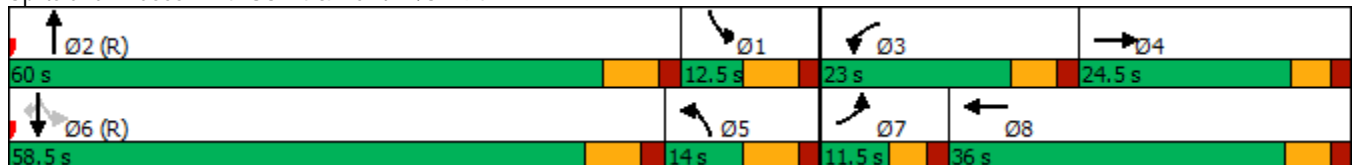

HCM 6th Signalized Intersection Summary

2040 Total AM.syn

4: US-24 & Newt Dr/SH-94

02/18/2021



Movement	EBL	EBT	EBR	WBL	WBT	WBR	NBL	NBT	NBR	SBL	SBT	SBR
Lane Configurations	↖↗	↑	↖	↖↗↘	↑	↖	↖↗	↖↗↘	↖	↖	↖↗↘	↖
Traffic Volume (veh/h)	55	95	555	1155	105	5	480	1150	855	10	2190	80
Future Volume (veh/h)	55	95	555	1155	105	5	480	1150	855	10	2190	80
Initial Q (Qb), veh	0	0	0	0	0	0	0	0	0	0	0	0
Ped-Bike Adj(A_pbT)	1.00		1.00	1.00		1.00	1.00		1.00	1.00		1.00
Parking Bus, Adj	1.00	1.00	1.00	1.00	1.00	1.00	1.00	1.00	1.00	1.00	1.00	1.00
Work Zone On Approach		No			No			No			No	
Adj Sat Flow, veh/h/ln	1826	1826	1826	1841	1841	1841	1752	1752	1752	1811	1811	1811
Adj Flow Rate, veh/h	57	98	0	1191	108	0	495	1186	0	10	2258	0
Peak Hour Factor	0.97	0.97	0.97	0.97	0.97	0.97	0.97	0.97	0.97	0.97	0.97	0.97
Percent Heavy Veh, %	5	5	5	4	4	4	10	10	10	6	6	6
Cap, veh/h	120	131		700	335		456	2112		394	2122	
Arrive On Green	0.04	0.07	0.00	0.14	0.18	0.00	0.14	0.44	0.00	0.13	0.43	0.00
Sat Flow, veh/h	3374	1826	1547	4944	1841	1560	3237	4782	1485	1725	4944	1535
Grp Volume(v), veh/h	57	98	0	1191	108	0	495	1186	0	10	2258	0
Grp Sat Flow(s),veh/h/ln	1687	1826	1547	1648	1841	1560	1618	1594	1485	1725	1648	1535
Q Serve(g_s), s	2.0	6.3	0.0	17.0	6.1	0.0	16.9	22.1	0.0	0.0	51.5	0.0
Cycle Q Clear(g_c), s	2.0	6.3	0.0	17.0	6.1	0.0	16.9	22.1	0.0	0.0	51.5	0.0
Prop In Lane	1.00		1.00	1.00		1.00	1.00		1.00	1.00		1.00
Lane Grp Cap(c), veh/h	120	131		700	335		456	2112		394	2122	
V/C Ratio(X)	0.48	0.75		1.70	0.32		1.09	0.56		0.03	1.06	
Avail Cap(c_a), veh/h	169	289		700	460		456	2112		394	2122	
HCM Platoon Ratio	1.00	1.00	1.00	1.00	1.00	1.00	1.00	1.00	1.00	1.00	1.00	1.00
Upstream Filter(l)	1.00	1.00	0.00	0.84	0.84	0.00	1.00	1.00	0.00	1.00	1.00	0.00
Uniform Delay (d), s/veh	56.8	54.6	0.0	51.5	42.6	0.0	51.5	24.9	0.0	24.1	34.2	0.0
Incr Delay (d2), s/veh	2.9	8.3	0.0	320.4	0.5	0.0	67.2	1.1	0.0	0.0	39.2	0.0
Initial Q Delay(d3),s/veh	0.0	0.0	0.0	0.0	0.0	0.0	0.0	0.0	0.0	0.0	0.0	0.0
%ile BackOfQ(50%),veh/ln	0.9	3.2	0.0	27.8	2.8	0.0	11.1	8.5	0.0	0.2	27.7	0.0
Unsig. Movement Delay, s/veh												
LnGrp Delay(d),s/veh	59.7	62.9	0.0	371.9	43.1	0.0	118.8	26.0	0.0	24.1	73.5	0.0
LnGrp LOS	E	E		F	D		F	C		C	F	
Approach Vol, veh/h		155	A		1299	A		1681	A		2268	A
Approach Delay, s/veh		61.7			344.6			53.3			73.3	
Approach LOS		E			F			D			E	
Timer - Assigned Phs	1	2	3	4	5	6	7	8				
Phs Duration (G+Y+Rc), s	22.4	60.0	23.0	14.6	23.9	58.5	9.8	27.8				
Change Period (Y+Rc), s	7.0	7.0	6.0	* 6	7.0	7.0	5.5	6.0				
Max Green Setting (Gmax), s	5.5	53.0	17.0	* 19	7.0	51.5	6.0	30.0				
Max Q Clear Time (g_c+I1), s	2.0	24.1	19.0	8.3	18.9	53.5	4.0	8.1				
Green Ext Time (p_c), s	0.0	10.3	0.0	0.3	0.0	0.0	0.0	0.5				

Intersection Summary

HCM 6th Ctrl Delay	131.9
HCM 6th LOS	F

Notes

* HCM 6th computational engine requires equal clearance times for the phases crossing the barrier.
 Unsignalized Delay for [NBR, EBR, WBR, SBR] is excluded from calculations of the approach delay and intersection delay.

Timings
4: US-24 & Newt Dr/SH-94

2040 Total PM.syn
02/18/2021

Lane Group	EBL	EBT	EBR	WBL	WBT	WBR	NBL	NBT	NBR	SBL	SBT	SBR
Lane Configurations												
Traffic Volume (vph)	65	95	535	1160	80	10	470	2325	1165	10	1180	75
Future Volume (vph)	65	95	535	1160	80	10	470	2325	1165	10	1180	75
Turn Type	Prot	NA	Free	Prot	NA	Free	Prot	NA	Free	pm+pt	NA	Perm
Protected Phases	7	4		3	8		5	2		1	6	
Permitted Phases			Free			Free			Free			6
Detector Phase	7	4		3	8		5	2		1	6	6
Switch Phase												
Minimum Initial (s)	5.0	5.0		5.0	5.0		5.0	5.0		5.0	5.0	5.0
Minimum Split (s)	11.5	24.5		11.0	24.0		12.0	25.0		12.5	25.5	25.5
Total Split (s)	11.5	24.5		29.0	42.0		24.5	54.0		12.5	42.0	42.0
Total Split (%)	9.6%	20.4%		24.2%	35.0%		20.4%	45.0%		10.4%	35.0%	35.0%
Yellow Time (s)	3.5	3.5		4.0	4.0		5.0	5.0		5.0	5.0	5.0
All-Red Time (s)	2.0	2.0		2.0	2.0		2.0	2.0		2.0	2.0	2.0
Lost Time Adjust (s)	0.0	0.0		0.0	0.0		0.0	0.0		0.0	0.0	0.0
Total Lost Time (s)	5.5	5.5		6.0	6.0		7.0	7.0		7.0	7.0	7.0
Lead/Lag	Lead	Lag		Lead	Lag		Lag	Lead		Lag	Lead	Lead
Lead-Lag Optimize?	Yes	Yes		Yes	Yes		Yes	Yes		Yes	Yes	Yes
Recall Mode	None	None		None	None		None	C-Max		None	C-Max	C-Max
Act Effct Green (s)	6.0	11.8	120.0	23.0	31.1	120.0	17.5	64.2	120.0	47.7	42.2	42.2
Actuated g/C Ratio	0.05	0.10	1.00	0.19	0.26	1.00	0.15	0.54	1.00	0.40	0.35	0.35
v/c Ratio	0.40	0.55	0.36	1.29	0.18	0.01	1.00	0.91	0.78	0.07	0.71	0.11
Control Delay	62.5	62.2	0.6	168.2	15.2	0.0	91.9	32.1	4.0	16.2	60.1	2.9
Queue Delay	0.0	0.0	0.0	0.0	0.0	0.0	0.0	0.0	0.0	0.0	0.0	0.0
Total Delay	62.5	62.2	0.6	168.2	15.2	0.0	91.9	32.1	4.0	16.2	60.1	2.9
LOS	E	E	A	F	B	A	F	C	A	B	E	A
Approach Delay		14.8			157.0			30.9			56.3	
Approach LOS		B			F			C			E	

Intersection Summary

Cycle Length: 120
 Actuated Cycle Length: 120
 Offset: 55.9 (47%), Referenced to phase 2:NBT and 6:SBTL, Start of Green
 Natural Cycle: 150
 Control Type: Actuated-Coordinated
 Maximum v/c Ratio: 1.29
 Intersection Signal Delay: 55.8
 Intersection LOS: E
 Intersection Capacity Utilization 94.5%
 ICU Level of Service F
 Analysis Period (min) 15

Splits and Phases: 4: US-24 & Newt Dr/SH-94

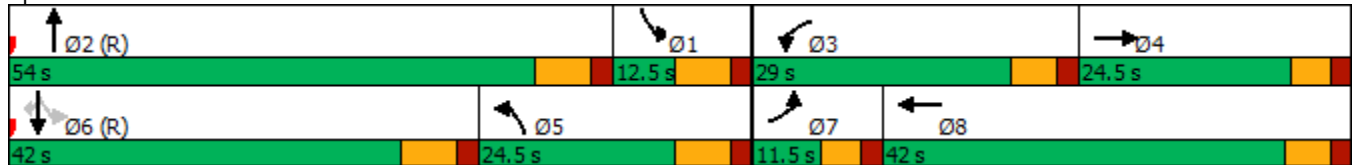

HCM 6th Signalized Intersection Summary

2040 Total PM.syn

4: US-24 & Newt Dr/SH-94

02/18/2021



Movement	EBL	EBT	EBR	WBL	WBT	WBR	NBL	NBT	NBR	SBL	SBT	SBR
Lane Configurations	↖↗	↑	↖	↖↗↘	↑	↖	↖↗	↖↗↘	↖	↖	↖↗↘	↖
Traffic Volume (veh/h)	65	95	535	1160	80	10	470	2325	1165	10	1180	75
Future Volume (veh/h)	65	95	535	1160	80	10	470	2325	1165	10	1180	75
Initial Q (Qb), veh	0	0	0	0	0	0	0	0	0	0	0	0
Ped-Bike Adj(A_pbT)	1.00		1.00	1.00		1.00	1.00		1.00	1.00		1.00
Parking Bus, Adj	1.00	1.00	1.00	1.00	1.00	1.00	1.00	1.00	1.00	1.00	1.00	1.00
Work Zone On Approach		No			No			No			No	
Adj Sat Flow, veh/h/ln	1870	1870	1870	1856	1856	1856	1856	1856	1856	1826	1826	1826
Adj Flow Rate, veh/h	68	100	0	1221	84	0	495	2447	0	11	1242	0
Peak Hour Factor	0.95	0.95	0.95	0.95	0.95	0.95	0.95	0.95	0.95	0.95	0.95	0.95
Percent Heavy Veh, %	2	2	2	3	3	3	3	3	3	5	5	5
Cap, veh/h	129	134		955	427		783	1984		283	1454	
Arrive On Green	0.04	0.07	0.00	0.19	0.23	0.00	0.23	0.39	0.00	0.13	0.29	0.00
Sat Flow, veh/h	3456	1870	1585	4983	1856	1572	3428	5066	1572	1739	4985	1547
Grp Volume(v), veh/h	68	100	0	1221	84	0	495	2447	0	11	1242	0
Grp Sat Flow(s),veh/h/ln	1728	1870	1585	1661	1856	1572	1714	1689	1572	1739	1662	1547
Q Serve(g_s), s	2.3	6.3	0.0	23.0	4.4	0.0	15.6	47.0	0.0	0.0	28.2	0.0
Cycle Q Clear(g_c), s	2.3	6.3	0.0	23.0	4.4	0.0	15.6	47.0	0.0	0.0	28.2	0.0
Prop In Lane	1.00		1.00	1.00		1.00	1.00		1.00	1.00		1.00
Lane Grp Cap(c), veh/h	129	134		955	427		783	1984		283	1454	
V/C Ratio(X)	0.53	0.75		1.28	0.20		0.63	1.23		0.04	0.85	
Avail Cap(c_a), veh/h	173	296		955	557		783	1984		283	1454	
HCM Platoon Ratio	1.00	1.00	1.00	1.00	1.00	1.00	1.00	1.00	1.00	1.00	1.00	1.00
Upstream Filter(l)	1.00	1.00	0.00	0.71	0.71	0.00	1.00	1.00	0.00	1.00	1.00	0.00
Uniform Delay (d), s/veh	56.7	54.7	0.0	48.5	37.3	0.0	41.7	36.5	0.0	45.6	40.1	0.0
Incr Delay (d2), s/veh	3.3	8.1	0.0	131.1	0.2	0.0	1.7	109.6	0.0	0.1	6.6	0.0
Initial Q Delay(d3),s/veh	0.0	0.0	0.0	0.0	0.0	0.0	0.0	0.0	0.0	0.0	0.0	0.0
%ile BackOfQ(50%),veh/ln	1.1	3.3	0.0	21.1	2.0	0.0	6.8	39.0	0.0	0.3	12.3	0.0
Unsig. Movement Delay, s/veh												
LnGrp Delay(d),s/veh	60.0	62.7	0.0	179.6	37.4	0.0	43.4	146.1	0.0	45.6	46.7	0.0
LnGrp LOS	E	E		F	D		D	F		D	D	
Approach Vol, veh/h		168	A		1305	A		2942	A		1253	A
Approach Delay, s/veh		61.6			170.5			128.8			46.7	
Approach LOS		E			F			F			D	
Timer - Assigned Phs	1	2	3	4	5	6	7	8				
Phs Duration (G+Y+Rc), s	22.4	54.0	29.0	14.6	34.4	42.0	10.0	33.6				
Change Period (Y+Rc), s	7.0	7.0	6.0	* 6	7.0	7.0	5.5	6.0				
Max Green Setting (Gmax), s	5.5	47.0	23.0	* 19	17.5	35.0	6.0	36.0				
Max Q Clear Time (g_c+I1), s	2.0	49.0	25.0	8.3	17.6	30.2	4.3	6.4				
Green Ext Time (p_c), s	0.0	0.0	0.0	0.3	0.0	3.2	0.0	0.4				

Intersection Summary

HCM 6th Ctrl Delay 118.3

HCM 6th LOS F

Notes

* HCM 6th computational engine requires equal clearance times for the phases crossing the barrier.

Unsignalized Delay for [NBR, EBR, WBR, SBR] is excluded from calculations of the approach delay and intersection delay.

Timings
4: US-24 & Newt Dr/SH-94



Lane Group	EBL	EBT	EBR	WBT	WBR	NBL	NBT	NBR	SBL	SBT	SBR
Lane Configurations	↖↖	↑	↗	↑↑	↗	↖↖	↑↑	↗	↖	↑↑	↗
Traffic Volume (vph)	55	95	555	105	5	480	1150	855	10	2190	80
Future Volume (vph)	55	95	555	105	5	480	1150	855	10	2190	80
Turn Type	Prot	NA	Free	NA	Free	Prot	NA	Free	pm+pt	NA	Perm
Protected Phases	7	4		8		5	2		1	6	
Permitted Phases			Free		Free			Free	6		6
Detector Phase	7	4		8		5	2		1	6	6
Switch Phase											
Minimum Initial (s)	5.0	5.0		5.0		5.0	5.0		5.0	5.0	5.0
Minimum Split (s)	11.5	24.5		24.0		12.0	25.0		12.5	25.5	25.5
Total Split (s)	11.5	35.5		24.0		16.5	102.0		12.5	98.0	98.0
Total Split (%)	7.7%	23.7%		16.0%		11.0%	68.0%		8.3%	65.3%	65.3%
Yellow Time (s)	3.5	3.5		4.0		5.0	5.0		5.0	5.0	5.0
All-Red Time (s)	2.0	2.0		2.0		2.0	2.0		2.0	2.0	2.0
Lost Time Adjust (s)	0.0	0.0		0.0		0.0	0.0		0.0	0.0	0.0
Total Lost Time (s)	5.5	5.5		6.0		7.0	7.0		7.0	7.0	7.0
Lead/Lag	Lead			Lag		Lag	Lead		Lag	Lead	Lead
Lead-Lag Optimize?	Yes			Yes		Yes	Yes		Yes	Yes	Yes
Recall Mode	None	None		None		None	C-Max		None	C-Max	C-Max
Act Effct Green (s)	6.0	19.9	150.0	10.2	150.0	9.5	112.6	150.0	106.6	101.1	101.1
Actuated g/C Ratio	0.04	0.13	1.00	0.07	1.00	0.06	0.75	1.00	0.71	0.67	0.67
v/c Ratio	0.43	0.41	0.37	0.46	0.00	2.46	0.48	0.60	0.03	0.98	0.08
Control Delay	80.6	63.4	0.7	73.3	0.0	699.0	9.4	1.8	5.3	39.7	0.8
Queue Delay	0.0	0.0	0.0	0.0	0.0	0.0	0.0	0.0	0.0	0.0	0.0
Total Delay	80.6	63.4	0.7	73.3	0.0	699.0	9.4	1.8	5.3	39.7	0.8
LOS	F	E	A	E	A	F	A	A	A	D	A
Approach Delay		15.4		70.1			140.0			38.2	
Approach LOS		B		E			F			D	

Intersection Summary

Cycle Length: 150
 Actuated Cycle Length: 150
 Offset: 0 (0%), Referenced to phase 2:NBT and 6:SBTL, Start of Green
 Natural Cycle: 150
 Control Type: Actuated-Coordinated
 Maximum v/c Ratio: 2.46
 Intersection Signal Delay: 81.3
 Intersection Capacity Utilization 98.7%
 Analysis Period (min) 15
 Intersection LOS: F
 ICU Level of Service F

Splits and Phases: 4: US-24 & Newt Dr/SH-94



HCM 6th Signalized Intersection Summary

2040 Total AM_4 WBL Flyover.syn

4: US-24 & Newt Dr/SH-94

03/31/2021



Movement	EBL	EBT	EBR	WBL	WBT	WBR	NBL	NBT	NBR	SBL	SBT	SBR
Lane Configurations	↖↗	↑	↖		↑↑	↖	↖↗	↑↑	↖	↖	↑↑	↖
Traffic Volume (veh/h)	55	95	555	0	105	5	480	1150	855	10	2190	80
Future Volume (veh/h)	55	95	555	0	105	5	480	1150	855	10	2190	80
Initial Q (Qb), veh	0	0	0	0	0	0	0	0	0	0	0	0
Ped-Bike Adj(A_pbT)	1.00		1.00	1.00		1.00	1.00		1.00	1.00		1.00
Parking Bus, Adj	1.00	1.00	1.00	1.00	1.00	1.00	1.00	1.00	1.00	1.00	1.00	1.00
Work Zone On Approach		No			No			No			No	
Adj Sat Flow, veh/h/ln	1826	1826	1826	0	1841	1841	1752	1752	1752	1811	1811	1811
Adj Flow Rate, veh/h	57	98	0	0	108	0	495	1186	0	10	2258	0
Peak Hour Factor	0.97	0.97	0.97	0.97	0.97	0.97	0.97	0.97	0.97	0.97	0.97	0.97
Percent Heavy Veh, %	5	5	5	0	4	4	10	10	10	6	6	6
Cap, veh/h	102	207		0	162		475	2108		440	2088	
Arrive On Green	0.03	0.11	0.00	0.00	0.05	0.00	0.15	0.63	0.00	0.12	0.61	0.00
Sat Flow, veh/h	3374	1826	1547	0	3589	1560	3237	3328	1485	1725	3441	1535
Grp Volume(v), veh/h	57	98	0	0	108	0	495	1186	0	10	2258	0
Grp Sat Flow(s),veh/h/ln	1687	1826	1547	0	1749	1560	1618	1664	1485	1725	1721	1535
Q Serve(g_s), s	2.5	7.5	0.0	0.0	4.6	0.0	22.0	30.4	0.0	0.0	91.0	0.0
Cycle Q Clear(g_c), s	2.5	7.5	0.0	0.0	4.6	0.0	22.0	30.4	0.0	0.0	91.0	0.0
Prop In Lane	1.00		1.00	0.00		1.00	1.00		1.00	1.00		1.00
Lane Grp Cap(c), veh/h	102	207		0	162		475	2108		440	2088	
V/C Ratio(X)	0.56	0.47		0.00	0.67		1.04	0.56		0.02	1.08	
Avail Cap(c_a), veh/h	135	365		0	420		475	2108		440	2088	
HCM Platoon Ratio	1.00	1.00	1.00	1.00	1.00	1.00	1.00	1.00	1.00	1.00	1.00	1.00
Upstream Filter(I)	1.00	1.00	0.00	0.00	0.09	0.00	1.00	1.00	0.00	1.00	1.00	0.00
Uniform Delay (d), s/veh	71.7	62.3	0.0	0.0	70.4	0.0	64.0	15.7	0.0	17.4	29.5	0.0
Incr Delay (d2), s/veh	4.7	1.7	0.0	0.0	0.4	0.0	52.4	1.1	0.0	0.0	45.9	0.0
Initial Q Delay(d3),s/veh	0.0	0.0	0.0	0.0	0.0	0.0	0.0	0.0	0.0	0.0	0.0	0.0
%ile BackOfQ(50%),veh/ln	1.2	3.6	0.0	0.0	2.1	0.0	12.6	11.7	0.0	0.2	49.1	0.0
Unsig. Movement Delay, s/veh												
LnGrp Delay(d),s/veh	76.5	64.0	0.0	0.0	70.8	0.0	116.4	16.8	0.0	17.4	75.4	0.0
LnGrp LOS	E	E		A	E		F	B		B	F	
Approach Vol, veh/h		155	A		108	A		1681	A		2268	A
Approach Delay, s/veh		68.6			70.8			46.1			75.1	
Approach LOS		E			E			D			E	
Timer - Assigned Phs	1	2		4	5	6	7	8				
Phs Duration (G+Y+Rc), s	25.0	102.0		23.0	29.0	98.0	10.0	12.9				
Change Period (Y+Rc), s	7.0	7.0		* 6	7.0	7.0	5.5	6.0				
Max Green Setting (Gmax), s	5.5	95.0		* 30	9.5	91.0	6.0	18.0				
Max Q Clear Time (g_c+I1), s	2.0	32.4		9.5	24.0	93.0	4.5	6.6				
Green Ext Time (p_c), s	0.0	12.7		0.4	0.0	0.0	0.0	0.4				

Intersection Summary

HCM 6th Ctrl Delay	63.2
HCM 6th LOS	E

Notes

* HCM 6th computational engine requires equal clearance times for the phases crossing the barrier.
 Unsignalized Delay for [NBR, EBR, WBR, SBR] is excluded from calculations of the approach delay and intersection delay.

Timings
4: US-24 & Newt Dr/SH-94



Lane Group	EBL	EBT	EBR	WBT	WBR	NBL	NBT	NBR	SBL	SBT	SBR
Lane Configurations	↖↗	↑	↖	↑↑	↖	↖↗	↑↑	↖	↖	↑↑	↖
Traffic Volume (vph)	65	95	535	80	10	470	2325	1165	10	1180	75
Future Volume (vph)	65	95	535	80	10	470	2325	1165	10	1180	75
Turn Type	Prot	NA	Free	NA	Free	Prot	NA	Free	pm+pt	NA	Perm
Protected Phases	7	4		8		5	2		1	6	
Permitted Phases			Free		Free			Free	6		6
Detector Phase	7	4		8		5	2		1	6	6
Switch Phase											
Minimum Initial (s)	5.0	5.0		5.0		5.0	5.0		5.0	5.0	5.0
Minimum Split (s)	11.5	24.5		24.0		12.0	25.0		12.5	25.5	25.5
Total Split (s)	11.5	35.5		24.0		35.5	102.0		12.5	79.0	79.0
Total Split (%)	7.7%	23.7%		16.0%		23.7%	68.0%		8.3%	52.7%	52.7%
Yellow Time (s)	3.5	3.5		4.0		5.0	5.0		5.0	5.0	5.0
All-Red Time (s)	2.0	2.0		2.0		2.0	2.0		2.0	2.0	2.0
Lost Time Adjust (s)	0.0	0.0		0.0		0.0	0.0		0.0	0.0	0.0
Total Lost Time (s)	5.5	5.5		6.0		7.0	7.0		7.0	7.0	7.0
Lead/Lag	Lead			Lag		Lag	Lead		Lag	Lead	Lead
Lead-Lag Optimize?	Yes			Yes		Yes	Yes		Yes	Yes	Yes
Recall Mode	None	None		None		None	C-Max		None	C-Max	C-Max
Act Effect Green (s)	6.6	19.6	150.0	9.3	150.0	25.9	112.9	150.0	90.6	85.1	85.1
Actuated g/C Ratio	0.04	0.13	1.00	0.06	1.00	0.17	0.75	1.00	0.60	0.57	0.57
v/c Ratio	0.45	0.41	0.36	0.39	0.01	0.84	0.93	0.78	0.10	0.64	0.08
Control Delay	79.7	63.9	0.6	72.6	0.0	74.0	24.7	4.0	10.4	25.1	0.2
Queue Delay	0.0	0.0	0.0	0.0	0.0	0.0	0.0	0.0	0.0	0.0	0.0
Total Delay	79.7	63.9	0.6	72.6	0.0	74.0	24.7	4.0	10.4	25.1	0.2
LOS	E	E	A	E	A	E	C	A	B	C	A
Approach Delay		16.6		64.2			24.5			23.5	
Approach LOS		B		E			C			C	

Intersection Summary

Cycle Length: 150
 Actuated Cycle Length: 150
 Offset: 0 (0%), Referenced to phase 2:NBT and 6:SBTL, Start of Green
 Natural Cycle: 150
 Control Type: Actuated-Coordinated
 Maximum v/c Ratio: 0.93
 Intersection Signal Delay: 23.9
 Intersection Capacity Utilization 93.2%
 Analysis Period (min) 15
 Intersection LOS: C
 ICU Level of Service F

Splits and Phases: 4: US-24 & Newt Dr/SH-94

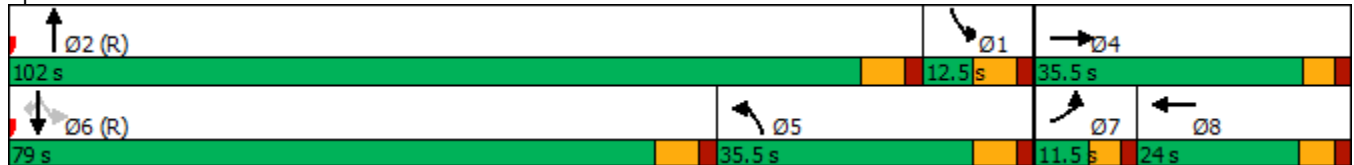

HCM 6th Signalized Intersection Summary

2040 Total PM_4 WBL Flyover.syn

4: US-24 & Newt Dr/SH-94

03/31/2021



Movement	EBL	EBT	EBR	WBL	WBT	WBR	NBL	NBT	NBR	SBL	SBT	SBR
Lane Configurations	↖↗	↑	↖		↑↑	↖	↖↗	↑↑	↖	↖	↑↑	↖
Traffic Volume (veh/h)	65	95	535	0	80	10	470	2325	1165	10	1180	75
Future Volume (veh/h)	65	95	535	0	80	10	470	2325	1165	10	1180	75
Initial Q (Qb), veh	0	0	0	0	0	0	0	0	0	0	0	0
Ped-Bike Adj(A_pbT)	1.00		1.00	1.00		1.00	1.00		1.00	1.00		1.00
Parking Bus, Adj	1.00	1.00	1.00	1.00	1.00	1.00	1.00	1.00	1.00	1.00	1.00	1.00
Work Zone On Approach		No			No			No			No	
Adj Sat Flow, veh/h/ln	1870	1870	1870	0	1856	1856	1856	1856	1856	1826	1826	1826
Adj Flow Rate, veh/h	68	100	0	0	84	0	495	2447	0	11	1242	0
Peak Hour Factor	0.95	0.95	0.95	0.95	0.95	0.95	0.95	0.95	0.95	0.95	0.95	0.95
Percent Heavy Veh, %	2	2	2	0	3	3	3	3	3	5	5	5
Cap, veh/h	108	200		0	136		960	2233		268	1665	
Arrive On Green	0.03	0.11	0.00	0.00	0.04	0.00	0.28	0.63	0.00	0.13	0.48	0.00
Sat Flow, veh/h	3456	1870	1585	0	3618	1572	3428	3526	1572	1739	3469	1547
Grp Volume(v), veh/h	68	100	0	0	84	0	495	2447	0	11	1242	0
Grp Sat Flow(s),veh/h/ln	1728	1870	1585	0	1763	1572	1714	1763	1572	1739	1735	1547
Q Serve(g_s), s	2.9	7.6	0.0	0.0	3.5	0.0	18.2	95.0	0.0	0.0	43.5	0.0
Cycle Q Clear(g_c), s	2.9	7.6	0.0	0.0	3.5	0.0	18.2	95.0	0.0	0.0	43.5	0.0
Prop In Lane	1.00		1.00	0.00		1.00	1.00		1.00	1.00		1.00
Lane Grp Cap(c), veh/h	108	200		0	136		960	2233		268	1665	
V/C Ratio(X)	0.63	0.50		0.00	0.62		0.52	1.10		0.04	0.75	
Avail Cap(c_a), veh/h	138	374		0	423		960	2233		268	1665	
HCM Platoon Ratio	1.00	1.00	1.00	1.00	1.00	1.00	1.00	1.00	1.00	1.00	1.00	1.00
Upstream Filter(l)	1.00	1.00	0.00	0.00	0.09	0.00	1.00	1.00	0.00	1.00	1.00	0.00
Uniform Delay (d), s/veh	71.8	63.2	0.0	0.0	71.0	0.0	45.4	27.5	0.0	57.2	31.6	0.0
Incr Delay (d2), s/veh	5.8	1.9	0.0	0.0	0.4	0.0	0.5	51.0	0.0	0.1	3.1	0.0
Initial Q Delay(d3),s/veh	0.0	0.0	0.0	0.0	0.0	0.0	0.0	0.0	0.0	0.0	0.0	0.0
%ile BackOfQ(50%),veh/ln	1.4	3.7	0.0	0.0	1.6	0.0	7.9	53.5	0.0	0.4	18.9	0.0
Unsig. Movement Delay, s/veh												
LnGrp Delay(d),s/veh	77.6	65.2	0.0	0.0	71.4	0.0	45.9	78.5	0.0	57.3	34.7	0.0
LnGrp LOS	E	E		A	E		D	F		E	C	
Approach Vol, veh/h		168	A		84	A		2942	A		1253	A
Approach Delay, s/veh		70.2			71.4			73.0			34.9	
Approach LOS		E			E			E			C	
Timer - Assigned Phs	1	2		4	5	6	7	8				
Phs Duration (G+Y+Rc), s	26.0	102.0		22.0	49.0	79.0	10.2	11.8				
Change Period (Y+Rc), s	7.0	7.0		* 6	7.0	7.0	5.5	6.0				
Max Green Setting (Gmax), s	5.5	95.0		* 30	28.5	72.0	6.0	18.0				
Max Q Clear Time (g_c+I1), s	2.0	97.0		9.6	20.2	45.5	4.9	5.5				
Green Ext Time (p_c), s	0.0	0.0		0.4	1.2	10.9	0.0	0.3				

Intersection Summary

HCM 6th Ctrl Delay	62.1
HCM 6th LOS	E

Notes

* HCM 6th computational engine requires equal clearance times for the phases crossing the barrier.
 Unsignalized Delay for [NBR, EBR, WBR, SBR] is excluded from calculations of the approach delay and intersection delay.

Timings
4: US-24 & Newt Dr/SH-94



Lane Group	EBL	EBT	EBR	WBT	WBR	NBL	NBT	NBR	SBL	SBT	SBR
Lane Configurations	↔↔	↑	↔	↑↑	↔	↔↔	↑↑↑	↔	↔	↑↑↑	↔
Traffic Volume (vph)	55	95	555	105	5	480	1150	855	10	2190	80
Future Volume (vph)	55	95	555	105	5	480	1150	855	10	2190	80
Turn Type	Prot	NA	Free	NA	Free	Prot	NA	Free	pm+pt	NA	Perm
Protected Phases	7	4		8		5	2		1	6	
Permitted Phases			Free		Free			Free	6		6
Detector Phase	7	4		8		5	2		1	6	6
Switch Phase											
Minimum Initial (s)	5.0	5.0		5.0		5.0	5.0		5.0	5.0	5.0
Minimum Split (s)	11.5	24.5		24.0		12.0	25.0		12.5	25.5	25.5
Total Split (s)	11.5	35.5		24.0		24.0	72.0		12.5	60.5	60.5
Total Split (%)	9.6%	29.6%		20.0%		20.0%	60.0%		10.4%	50.4%	50.4%
Yellow Time (s)	3.5	3.5		4.0		5.0	5.0		5.0	5.0	5.0
All-Red Time (s)	2.0	2.0		2.0		2.0	2.0		2.0	2.0	2.0
Lost Time Adjust (s)	0.0	0.0		0.0		0.0	0.0		0.0	0.0	0.0
Total Lost Time (s)	5.5	5.5		6.0		7.0	7.0		7.0	7.0	7.0
Lead/Lag	Lead			Lag		Lag	Lead		Lag	Lead	Lead
Lead-Lag Optimize?	Yes			Yes		Yes	Yes		Yes	Yes	Yes
Recall Mode	None	None		None		None	C-Max		None	C-Max	C-Max
Act Effct Green (s)	5.9	18.8	120.0	9.1	120.0	17.0	86.2	120.0	70.2	64.7	64.7
Actuated g/C Ratio	0.05	0.16	1.00	0.08	1.00	0.14	0.72	1.00	0.58	0.54	0.54
v/c Ratio	0.35	0.35	0.37	0.41	0.00	1.10	0.35	0.60	0.04	0.86	0.09
Control Delay	61.2	46.8	0.7	54.0	0.0	120.0	7.8	1.8	6.1	24.5	0.5
Queue Delay	0.0	0.0	0.0	0.0	0.0	0.0	0.0	0.0	0.0	0.0	0.0
Total Delay	61.2	46.8	0.7	54.0	0.0	120.0	7.8	1.8	6.1	24.5	0.5
LOS	E	D	A	D	A	F	A	A	A	C	A
Approach Delay		11.7		51.6			27.4			23.6	
Approach LOS		B		D			C			C	

Intersection Summary

Cycle Length: 120
 Actuated Cycle Length: 120
 Offset: 55.9 (47%), Referenced to phase 2:NBT and 6:SBTL, Start of Green
 Natural Cycle: 130
 Control Type: Actuated-Coordinated
 Maximum v/c Ratio: 1.10
 Intersection Signal Delay: 24.3
 Intersection Capacity Utilization 80.5%
 Analysis Period (min) 15
 Intersection LOS: C
 ICU Level of Service D

Splits and Phases: 4: US-24 & Newt Dr/SH-94

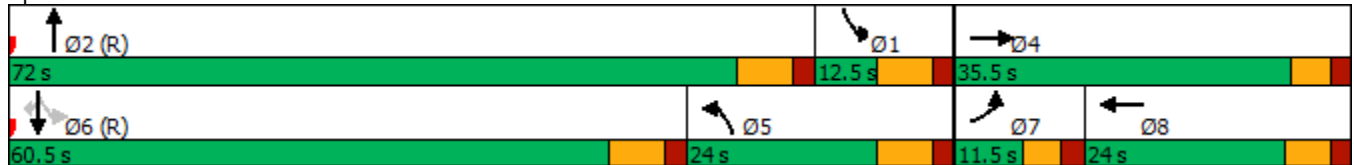

HCM 6th Signalized Intersection Summary
4: US-24 & Newt Dr/SH-94

2040 Total AM_4 WBL Flyover_Imp.syn
03/31/2021

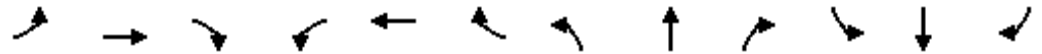

Movement	EBL	EBT	EBR	WBL	WBT	WBR	NBL	NBT	NBR	SBL	SBT	SBR
Lane Configurations	↖↗	↑	↖		↑↑	↖	↖↗	↑↑↑	↖	↖	↑↑↑	↖
Traffic Volume (veh/h)	55	95	555	0	105	5	480	1150	855	10	2190	80
Future Volume (veh/h)	55	95	555	0	105	5	480	1150	855	10	2190	80
Initial Q (Qb), veh	0	0	0	0	0	0	0	0	0	0	0	0
Ped-Bike Adj(A_pbT)	1.00		1.00	1.00		1.00	1.00		1.00	1.00		1.00
Parking Bus, Adj	1.00	1.00	1.00	1.00	1.00	1.00	1.00	1.00	1.00	1.00	1.00	1.00
Work Zone On Approach		No			No			No			No	
Adj Sat Flow, veh/h/ln	1826	1826	1826	0	1841	1841	1752	1752	1752	1811	1811	1811
Adj Flow Rate, veh/h	57	98	0	0	108	0	495	1186	0	10	2258	0
Peak Hour Factor	0.97	0.97	0.97	0.97	0.97	0.97	0.97	0.97	0.97	0.97	0.97	0.97
Percent Heavy Veh, %	5	5	5	0	4	4	10	10	10	6	6	6
Cap, veh/h	120	241		0	177		827	2590		470	2204	
Arrive On Green	0.04	0.13	0.00	0.00	0.02	0.00	0.26	0.54	0.00	0.16	0.45	0.00
Sat Flow, veh/h	3374	1826	1547	0	3589	1560	3237	4782	1485	1725	4944	1535
Grp Volume(v), veh/h	57	98	0	0	108	0	495	1186	0	10	2258	0
Grp Sat Flow(s),veh/h/ln	1687	1826	1547	0	1749	1560	1618	1594	1485	1725	1648	1535
Q Serve(g_s), s	2.0	5.9	0.0	0.0	3.7	0.0	16.1	18.1	0.0	0.0	53.5	0.0
Cycle Q Clear(g_c), s	2.0	5.9	0.0	0.0	3.7	0.0	16.1	18.1	0.0	0.0	53.5	0.0
Prop In Lane	1.00		1.00	0.00		1.00	1.00		1.00	1.00		1.00
Lane Grp Cap(c), veh/h	120	241		0	177		827	2590		470	2204	
V/C Ratio(X)	0.48	0.41		0.00	0.61		0.60	0.46		0.02	1.02	
Avail Cap(c_a), veh/h	169	456		0	525		827	2590		470	2204	
HCM Platoon Ratio	1.00	1.00	1.00	1.00	0.33	0.33	1.00	1.00	1.00	1.00	1.00	1.00
Upstream Filter(I)	1.00	1.00	0.00	0.00	0.09	0.00	1.00	1.00	0.00	1.00	1.00	0.00
Uniform Delay (d), s/veh	56.8	47.8	0.0	0.0	57.8	0.0	39.2	16.8	0.0	18.3	33.3	0.0
Incr Delay (d2), s/veh	2.9	1.1	0.0	0.0	0.3	0.0	1.2	0.6	0.0	0.0	25.6	0.0
Initial Q Delay(d3),s/veh	0.0	0.0	0.0	0.0	0.0	0.0	0.0	0.0	0.0	0.0	0.0	0.0
%ile BackOfQ(50%),veh/ln	0.9	2.8	0.0	0.0	1.7	0.0	6.5	6.7	0.0	0.2	25.9	0.0
Unsig. Movement Delay, s/veh												
LnGrp Delay(d),s/veh	59.7	48.9	0.0	0.0	58.1	0.0	40.4	17.3	0.0	18.3	58.9	0.0
LnGrp LOS	E	D		A	E		D	B		B	F	
Approach Vol, veh/h		155	A		108	A		1681	A		2268	A
Approach Delay, s/veh		52.9			58.1			24.1			58.7	
Approach LOS		D			E			C			E	
Timer - Assigned Phs	1	2		4	5	6	7	8				
Phs Duration (G+Y+Rc), s	26.2	72.0		21.8	37.7	60.5	9.8	12.1				
Change Period (Y+Rc), s	7.0	7.0		* 6	7.0	7.0	5.5	6.0				
Max Green Setting (Gmax), s	5.5	65.0		* 30	17.0	53.5	6.0	18.0				
Max Q Clear Time (g_c+I1), s	2.0	20.1		7.9	18.1	55.5	4.0	5.7				
Green Ext Time (p_c), s	0.0	11.6		0.4	0.0	0.0	0.0	0.4				

Intersection Summary

HCM 6th Ctrl Delay	44.7
HCM 6th LOS	D

Notes

* HCM 6th computational engine requires equal clearance times for the phases crossing the barrier.
Unsignalized Delay for [NBR, EBR, WBR, SBR] is excluded from calculations of the approach delay and intersection delay.

Timings
4: US-24 & Newt Dr/SH-94



Lane Group	EBL	EBT	EBR	WBT	WBR	NBL	NBT	NBR	SBL	SBT	SBR
Lane Configurations	↖↖	↑	↗	↑↑	↗	↖↖	↑↑↑	↗	↖	↑↑↑	↗
Traffic Volume (vph)	65	95	535	80	10	470	2325	1165	10	1180	75
Future Volume (vph)	65	95	535	80	10	470	2325	1165	10	1180	75
Turn Type	Prot	NA	Free	NA	Free	Prot	NA	Free	pm+pt	NA	Perm
Protected Phases	7	4		8		5	2		1	6	
Permitted Phases			Free		Free			Free	6		6
Detector Phase	7	4		8		5	2		1	6	6
Switch Phase											
Minimum Initial (s)	5.0	5.0		5.0		5.0	5.0		5.0	5.0	5.0
Minimum Split (s)	11.5	24.5		24.0		12.0	25.0		12.5	25.5	25.5
Total Split (s)	11.5	35.5		24.0		32.0	72.0		12.5	52.5	52.5
Total Split (%)	9.6%	29.6%		20.0%		26.7%	60.0%		10.4%	43.8%	43.8%
Yellow Time (s)	3.5	3.5		4.0		5.0	5.0		5.0	5.0	5.0
All-Red Time (s)	2.0	2.0		2.0		2.0	2.0		2.0	2.0	2.0
Lost Time Adjust (s)	0.0	0.0		0.0		0.0	0.0		0.0	0.0	0.0
Total Lost Time (s)	5.5	5.5		6.0		7.0	7.0		7.0	7.0	7.0
Lead/Lag	Lead			Lag		Lag	Lead		Lag	Lead	Lead
Lead-Lag Optimize?	Yes			Yes		Yes	Yes		Yes	Yes	Yes
Recall Mode	None	None		None		None	C-Max		None	C-Max	C-Max
Act Effct Green (s)	6.6	18.7	120.0	8.4	120.0	22.0	86.3	120.0	65.3	59.8	59.8
Actuated g/C Ratio	0.06	0.16	1.00	0.07	1.00	0.18	0.72	1.00	0.54	0.50	0.50
v/c Ratio	0.36	0.34	0.36	0.34	0.01	0.80	0.68	0.78	0.08	0.50	0.09
Control Delay	60.5	47.1	0.6	57.5	0.0	56.7	11.9	4.0	11.9	27.5	1.6
Queue Delay	0.0	0.0	0.0	0.0	0.0	0.0	0.0	0.0	0.0	0.0	0.0
Total Delay	60.5	47.1	0.6	57.5	0.0	56.7	11.9	4.0	11.9	27.5	1.6
LOS	E	D	A	E	A	E	B	A	B	C	A
Approach Delay		12.5		50.8			14.9			25.8	
Approach LOS		B		D			B			C	

Intersection Summary

Cycle Length: 120
 Actuated Cycle Length: 120
 Offset: 55.9 (47%), Referenced to phase 2:NBT and 6:SBTL, Start of Green
 Natural Cycle: 100
 Control Type: Actuated-Coordinated
 Maximum v/c Ratio: 0.80
 Intersection Signal Delay: 17.5
 Intersection Capacity Utilization 73.9%
 Analysis Period (min) 15
 Intersection LOS: B
 ICU Level of Service D

Splits and Phases: 4: US-24 & Newt Dr/SH-94

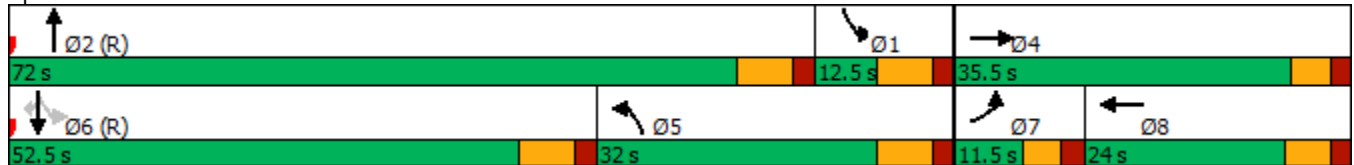

HCM 6th Signalized Intersection Summary
4: US-24 & Newt Dr/SH-94

2040 Total PM_4 WBL Flyover_Imp.syn
03/31/2021



Movement	EBL	EBT	EBR	WBL	WBT	WBR	NBL	NBT	NBR	SBL	SBT	SBR
Lane Configurations	↖↗	↑	↖		↑↑	↖	↖↗	↑↑↑	↖	↖	↑↑↑	↖
Traffic Volume (veh/h)	65	95	535	0	80	10	470	2325	1165	10	1180	75
Future Volume (veh/h)	65	95	535	0	80	10	470	2325	1165	10	1180	75
Initial Q (Qb), veh	0	0	0	0	0	0	0	0	0	0	0	0
Ped-Bike Adj(A_pbT)	1.00		1.00	1.00		1.00	1.00		1.00	1.00		1.00
Parking Bus, Adj	1.00	1.00	1.00	1.00	1.00	1.00	1.00	1.00	1.00	1.00	1.00	1.00
Work Zone On Approach		No			No			No			No	
Adj Sat Flow, veh/h/ln	1870	1870	1870	0	1856	1856	1856	1856	1856	1826	1826	1826
Adj Flow Rate, veh/h	68	100	0	0	84	0	495	2447	0	11	1242	0
Peak Hour Factor	0.95	0.95	0.95	0.95	0.95	0.95	0.95	0.95	0.95	0.95	0.95	0.95
Percent Heavy Veh, %	2	2	2	0	3	3	3	3	3	5	5	5
Cap, veh/h	129	235		0	149		1127	2744		349	1890	
Arrive On Green	0.04	0.13	0.00	0.00	0.04	0.00	0.33	0.54	0.00	0.17	0.38	0.00
Sat Flow, veh/h	3456	1870	1585	0	3618	1572	3428	5066	1572	1739	4985	1547
Grp Volume(v), veh/h	68	100	0	0	84	0	495	2447	0	11	1242	0
Grp Sat Flow(s),veh/h/ln	1728	1870	1585	0	1763	1572	1714	1689	1572	1739	1662	1547
Q Serve(g_s), s	2.3	5.9	0.0	0.0	2.8	0.0	13.6	51.4	0.0	0.0	24.7	0.0
Cycle Q Clear(g_c), s	2.3	5.9	0.0	0.0	2.8	0.0	13.6	51.4	0.0	0.0	24.7	0.0
Prop In Lane	1.00		1.00	0.00		1.00	1.00		1.00	1.00		1.00
Lane Grp Cap(c), veh/h	129	235		0	149		1127	2744		349	1890	
V/C Ratio(X)	0.53	0.43		0.00	0.56		0.44	0.89		0.03	0.66	
Avail Cap(c_a), veh/h	173	468		0	529		1127	2744		349	1890	
HCM Platoon Ratio	1.00	1.00	1.00	1.00	1.00	1.00	1.00	1.00	1.00	1.00	1.00	1.00
Upstream Filter(l)	1.00	1.00	0.00	0.00	0.09	0.00	1.00	1.00	0.00	1.00	1.00	0.00
Uniform Delay (d), s/veh	56.7	48.5	0.0	0.0	56.4	0.0	31.6	24.4	0.0	41.7	30.8	0.0
Incr Delay (d2), s/veh	3.3	1.2	0.0	0.0	0.3	0.0	0.3	4.9	0.0	0.0	1.8	0.0
Initial Q Delay(d3),s/veh	0.0	0.0	0.0	0.0	0.0	0.0	0.0	0.0	0.0	0.0	0.0	0.0
%ile BackOfQ(50%),veh/ln	1.1	2.9	0.0	0.0	1.3	0.0	5.7	20.8	0.0	0.3	10.1	0.0
Unsig. Movement Delay, s/veh												
LnGrp Delay(d),s/veh	60.0	49.7	0.0	0.0	56.7	0.0	31.9	29.3	0.0	41.8	32.6	0.0
LnGrp LOS	E	D		A	E		C	C		D	C	
Approach Vol, veh/h		168	A		84	A		2942	A		1253	A
Approach Delay, s/veh		53.9			56.7			29.7			32.7	
Approach LOS		D			E			C			C	
Timer - Assigned Phs	1	2		4	5	6	7	8				
Phs Duration (G+Y+Rc), s	26.9	72.0		21.1	46.4	52.5	10.0	11.1				
Change Period (Y+Rc), s	7.0	7.0		* 6	7.0	7.0	5.5	6.0				
Max Green Setting (Gmax), s	5.5	65.0		* 30	25.0	45.5	6.0	18.0				
Max Q Clear Time (g_c+I1), s	2.0	53.4		7.9	15.6	26.7	4.3	4.8				
Green Ext Time (p_c), s	0.0	10.5		0.4	1.3	8.9	0.0	0.3				

Intersection Summary

HCM 6th Ctrl Delay	32.0
HCM 6th LOS	C

Notes

* HCM 6th computational engine requires equal clearance times for the phases crossing the barrier.
Unsignalized Delay for [NBR, EBR, WBR, SBR] is excluded from calculations of the approach delay and intersection delay.

Timings
5: Marksheffel Rd & SH-94

2020 Adjusted Existing AM.syn
02/15/2021



Lane Group	EBT	EBR	WBL	WBT	WBR	NBL	NBT	NBR	SBL	SBT	SBR
Lane Configurations	↑	↗	↖	↑	↗	↖	↑↑	↗	↖	↑↑	↗
Traffic Volume (vph)	254	54	28	297	77	54	270	18	256	501	3
Future Volume (vph)	254	54	28	297	77	54	270	18	256	501	3
Turn Type	NA	Perm	Perm	NA	Perm	pm+pt	NA	Perm	pm+pt	NA	Perm
Protected Phases	4			8		5	2		1	6	
Permitted Phases		4	8		8	2		2	6		6
Detector Phase	4	4	8	8	8	5	2	2	1	6	6
Switch Phase											
Minimum Initial (s)	5.0	5.0	5.0	5.0	5.0	5.0	5.0	5.0	5.0	5.0	5.0
Minimum Split (s)	11.0	11.0	11.0	11.0	11.0	11.5	11.5	11.5	11.5	11.5	11.5
Total Split (s)	51.0	51.0	51.0	51.0	51.0	16.0	33.0	33.0	36.0	53.0	53.0
Total Split (%)	42.5%	42.5%	42.5%	42.5%	42.5%	13.3%	27.5%	27.5%	30.0%	44.2%	44.2%
Yellow Time (s)	5.0	5.0	5.0	5.0	5.0	5.0	5.0	5.0	5.0	5.0	5.0
All-Red Time (s)	1.0	1.0	1.0	1.0	1.0	1.5	1.5	1.5	1.5	1.5	1.5
Lost Time Adjust (s)	0.0	0.0	0.0	0.0	0.0	0.0	0.0	0.0	0.0	0.0	0.0
Total Lost Time (s)	6.0	6.0	6.0	6.0	6.0	6.5	6.5	6.5	6.5	6.5	6.5
Lead/Lag						Lead	Lag	Lag	Lead	Lag	Lag
Lead-Lag Optimize?						Yes	Yes	Yes	Yes	Yes	Yes
Recall Mode	None	None	None	None	None	None	C-Max	C-Max	None	C-Max	C-Max
Act Effect Green (s)	27.8	27.8	27.8	27.8	27.8	66.7	59.6	59.6	79.3	68.6	68.6
Actuated g/C Ratio	0.23	0.23	0.23	0.23	0.23	0.56	0.50	0.50	0.66	0.57	0.57
v/c Ratio	0.68	0.13	0.20	0.78	0.18	0.12	0.17	0.02	0.39	0.27	0.00
Control Delay	46.8	0.6	37.5	55.9	0.8	10.2	19.2	0.1	5.1	5.9	0.0
Queue Delay	0.0	0.0	0.0	0.0	0.0	0.0	0.0	0.0	0.0	0.0	0.0
Total Delay	46.8	0.6	37.5	55.9	0.8	10.2	19.2	0.1	5.1	5.9	0.0
LOS	D	A	D	E	A	B	B	A	A	A	A
Approach Delay	38.7			44.0			16.7			5.6	
Approach LOS	D			D			B			A	

Intersection Summary

Cycle Length: 120
 Actuated Cycle Length: 120
 Offset: 33 (28%), Referenced to phase 2:NBTL and 6:SBTL, Start of Green
 Natural Cycle: 55
 Control Type: Actuated-Coordinated
 Maximum v/c Ratio: 0.78
 Intersection Signal Delay: 21.9
 Intersection Capacity Utilization 60.7%
 Analysis Period (min) 15
 Intersection LOS: C
 ICU Level of Service B

Splits and Phases: 5: Marksheffel Rd & SH-94

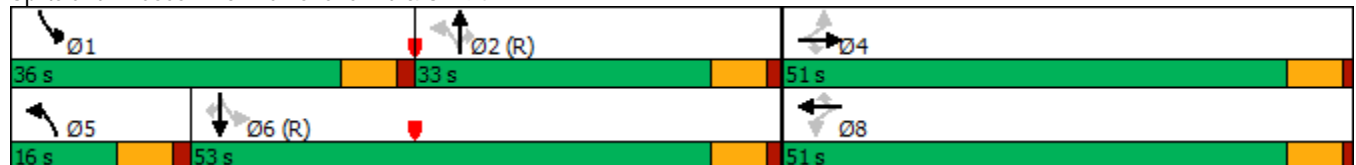

HCM 6th Signalized Intersection Summary

2020 Adjusted Existing AM.syn

5: Marksheffel Rd & SH-94

02/15/2021

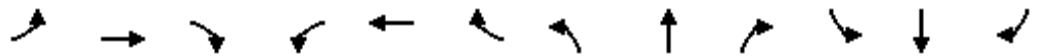

Movement	EBL	EBT	EBR	WBL	WBT	WBR	NBL	NBT	NBR	SBL	SBT	SBR
Lane Configurations	↖	↗	↘	↖	↗	↘	↖	↕	↗	↘	↕	↘
Traffic Volume (veh/h)	0	254	54	28	297	77	54	270	18	256	501	3
Future Volume (veh/h)	0	254	54	28	297	77	54	270	18	256	501	3
Initial Q (Qb), veh	0	0	0	0	0	0	0	0	0	0	0	0
Ped-Bike Adj(A_pbT)	1.00		1.00	1.00		1.00	1.00		1.00	1.00		1.00
Parking Bus, Adj	1.00	1.00	1.00	1.00	1.00	1.00	1.00	1.00	1.00	1.00	1.00	1.00
Work Zone On Approach		No			No			No			No	
Adj Sat Flow, veh/h/ln	1781	1781	1781	1811	1811	1811	1826	1826	1826	1856	1856	1856
Adj Flow Rate, veh/h	0	276	-104	30	323	-25	59	293	20	278	545	3
Peak Hour Factor	0.92	0.92	0.92	0.92	0.92	0.92	0.92	0.92	0.92	0.92	0.92	0.92
Percent Heavy Veh, %	8	8	8	6	6	6	5	5	5	3	3	3
Cap, veh/h	60	367	311	147	373	316	564	1899	847	751	2115	943
Arrive On Green	0.00	0.41	0.00	0.21	0.21	0.00	0.04	0.55	0.55	0.09	0.60	0.60
Sat Flow, veh/h	1030	1781	1510	1174	1811	1535	1739	3469	1547	1767	3526	1572
Grp Volume(v), veh/h	0	276	-104	30	323	-25	59	293	20	278	545	3
Grp Sat Flow(s),veh/h/ln	1030	1781	1510	1174	1811	1535	1739	1735	1547	1767	1763	1572
Q Serve(g_s), s	0.0	15.8	0.0	2.9	20.7	0.0	1.8	5.0	0.7	7.8	8.8	0.1
Cycle Q Clear(g_c), s	0.0	15.8	0.0	18.8	20.7	0.0	1.8	5.0	0.7	7.8	8.8	0.1
Prop In Lane	1.00		1.00	1.00		1.00	1.00		1.00	1.00		1.00
Lane Grp Cap(c), veh/h	60	367	311	147	373	316	564	1899	847	751	2115	943
V/C Ratio(X)	0.00	0.75	-0.33	0.20	0.87	-0.08	0.10	0.15	0.02	0.37	0.26	0.00
Avail Cap(c_a), veh/h	234	668	566	345	679	576	639	1899	847	1029	2115	943
HCM Platoon Ratio	2.00	2.00	2.00	1.00	1.00	1.00	1.00	1.00	1.00	1.00	1.00	1.00
Upstream Filter(l)	0.00	0.97	0.00	1.00	1.00	0.00	1.00	1.00	1.00	1.00	1.00	1.00
Uniform Delay (d), s/veh	0.0	32.7	0.0	52.8	46.0	0.0	10.8	13.4	12.5	8.9	11.4	9.6
Incr Delay (d2), s/veh	0.0	3.0	0.0	0.7	6.1	0.0	0.1	0.2	0.1	0.3	0.3	0.0
Initial Q Delay(d3),s/veh	0.0	0.0	0.0	0.0	0.0	0.0	0.0	0.0	0.0	0.0	0.0	0.0
%ile BackOfQ(50%),veh/ln	0.0	5.8	0.0	0.9	9.9	0.0	0.7	2.0	0.3	2.9	3.5	0.0
Unsig. Movement Delay, s/veh												
LnGrp Delay(d),s/veh	0.0	35.7	0.0	53.5	52.2	0.0	10.9	13.6	12.5	9.3	11.7	9.6
LnGrp LOS	A	D	A	D	D	A	B	B	B	A	B	A
Approach Vol, veh/h		172			328			372			826	
Approach Delay, s/veh		57.3			56.3			13.1			10.8	
Approach LOS		E			E			B			B	
Timer - Assigned Phs	1	2		4	5	6		8				
Phs Duration (G+Y+Rc), s	17.1	72.2		30.7	10.8	78.5		30.7				
Change Period (Y+Rc), s	6.5	6.5		6.0	6.5	6.5		6.0				
Max Green Setting (Gmax), s	29.5	26.5		45.0	9.5	46.5		45.0				
Max Q Clear Time (g_c+I1), s	9.8	7.0		17.8	3.8	10.8		22.7				
Green Ext Time (p_c), s	0.8	1.8		1.7	0.0	4.1		2.0				

Intersection Summary

HCM 6th Ctrl Delay	24.8
HCM 6th LOS	C

Timings

5: Marksheffel Rd & SH-94

	→	↘	↙	←	↖	↗	↑	↘	↙	↓	↖
Lane Group	EBT	EBR	WBL	WBT	WBR	NBL	NBT	NBR	SBL	SBT	SBR
Lane Configurations	↑	↗	↙	↑	↗	↙	↑↑	↗	↙	↑↑	↗
Traffic Volume (vph)	294	94	39	356	343	76	819	23	158	573	7
Future Volume (vph)	294	94	39	356	343	76	819	23	158	573	7
Turn Type	NA	Perm	Perm	NA	Perm	pm+pt	NA	Perm	pm+pt	NA	Perm
Protected Phases	4			8		5	2		1	6	
Permitted Phases		4	8		8	2		2	6		6
Detector Phase	4	4	8	8	8	5	2	2	1	6	6
Switch Phase											
Minimum Initial (s)	5.0	5.0	5.0	5.0	5.0	5.0	5.0	5.0	5.0	5.0	5.0
Minimum Split (s)	11.0	11.0	11.0	11.0	11.0	11.5	11.5	11.5	11.5	11.5	11.5
Total Split (s)	47.0	47.0	47.0	47.0	47.0	13.0	52.0	52.0	21.0	60.0	60.0
Total Split (%)	39.2%	39.2%	39.2%	39.2%	39.2%	10.8%	43.3%	43.3%	17.5%	50.0%	50.0%
Yellow Time (s)	5.0	5.0	5.0	5.0	5.0	5.0	5.0	5.0	5.0	5.0	5.0
All-Red Time (s)	1.0	1.0	1.0	1.0	1.0	1.5	1.5	1.5	1.5	1.5	1.5
Lost Time Adjust (s)	0.0	0.0	0.0	0.0	0.0	0.0	0.0	0.0	0.0	0.0	0.0
Total Lost Time (s)	6.0	6.0	6.0	6.0	6.0	6.5	6.5	6.5	6.5	6.5	6.5
Lead/Lag						Lead	Lag	Lag	Lead	Lag	Lag
Lead-Lag Optimize?						Yes	Yes	Yes	Yes	Yes	Yes
Recall Mode	None	None	None	None	None	None	C-Max	C-Max	None	C-Max	C-Max
Act Effect Green (s)	32.1	32.1	32.1	32.1	32.1	65.4	58.4	58.4	73.1	64.3	64.3
Actuated g/C Ratio	0.27	0.27	0.27	0.27	0.27	0.54	0.49	0.49	0.61	0.54	0.54
v/c Ratio	0.63	0.19	0.24	0.77	0.64	0.17	0.51	0.03	0.46	0.33	0.01
Control Delay	41.4	0.9	35.3	50.7	20.7	11.8	24.1	0.0	13.2	21.4	0.4
Queue Delay	0.0	0.0	0.0	0.0	0.0	0.0	0.0	0.0	0.0	0.0	0.0
Total Delay	41.4	0.9	35.3	50.7	20.7	11.8	24.1	0.0	13.2	21.4	0.4
LOS	D	A	D	D	C	B	C	A	B	C	A
Approach Delay	31.6			35.9			22.5			19.4	
Approach LOS	C			D			C			B	

Intersection Summary

Cycle Length: 120
 Actuated Cycle Length: 120
 Offset: 33 (28%), Referenced to phase 2:NBTL and 6:SBTL, Start of Green
 Natural Cycle: 60
 Control Type: Actuated-Coordinated
 Maximum v/c Ratio: 0.77
 Intersection Signal Delay: 26.5
 Intersection LOS: C
 Intersection Capacity Utilization 75.1%
 ICU Level of Service D
 Analysis Period (min) 15

Splits and Phases: 5: Marksheffel Rd & SH-94

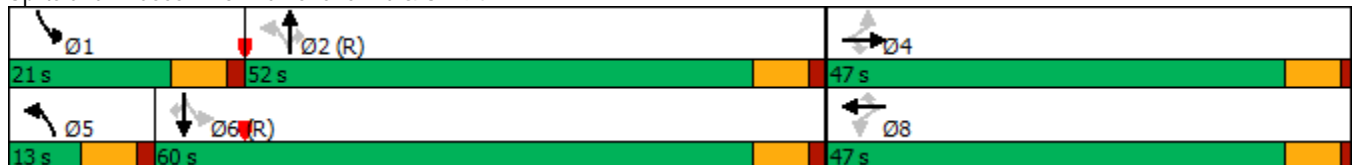

HCM 6th Signalized Intersection Summary

2020 Adjusted Existing PM.syn

5: Marksheffel Rd & SH-94

02/15/2021



Movement	EBL	EBT	EBR	WBL	WBT	WBR	NBL	NBT	NBR	SBL	SBT	SBR
Lane Configurations												
Traffic Volume (veh/h)	0	294	94	39	356	343	76	819	23	158	573	7
Future Volume (veh/h)	0	294	94	39	356	343	76	819	23	158	573	7
Initial Q (Qb), veh	0	0	0	0	0	0	0	0	0	0	0	0
Ped-Bike Adj(A_pbT)	1.00		1.00	1.00		1.00	1.00		1.00	1.00		1.00
Parking Bus, Adj	1.00	1.00	1.00	1.00	1.00	1.00	1.00	1.00	1.00	1.00	1.00	1.00
Work Zone On Approach		No			No			No			No	
Adj Sat Flow, veh/h/ln	1856	1856	1856	1856	1856	1856	1870	1870	1870	1841	1841	1841
Adj Flow Rate, veh/h	0	313	-60	41	379	259	81	871	24	168	610	7
Peak Hour Factor	0.94	0.94	0.94	0.94	0.94	0.94	0.94	0.94	0.94	0.94	0.94	0.94
Percent Heavy Veh, %	3	3	3	3	3	3	2	2	2	4	4	4
Cap, veh/h	60	442	374	177	442	374	510	1930	861	408	1975	881
Arrive On Green	0.00	0.48	0.00	0.24	0.24	0.24	0.04	0.54	0.54	0.06	0.56	0.56
Sat Flow, veh/h	784	1856	1572	1118	1856	1572	1781	3554	1585	1753	3497	1560
Grp Volume(v), veh/h	0	313	-60	41	379	259	81	871	24	168	610	7
Grp Sat Flow(s),veh/h/ln	784	1856	1572	1118	1856	1572	1781	1777	1585	1753	1749	1560
Q Serve(g_s), s	0.0	16.0	0.0	4.1	23.5	18.0	2.4	17.8	0.8	5.0	11.0	0.2
Cycle Q Clear(g_c), s	0.0	16.0	0.0	20.1	23.5	18.0	2.4	17.8	0.8	5.0	11.0	0.2
Prop In Lane	1.00		1.00	1.00		1.00	1.00		1.00	1.00		1.00
Lane Grp Cap(c), veh/h	60	442	374	177	442	374	510	1930	861	408	1975	881
V/C Ratio(X)	0.00	0.71	-0.16	0.23	0.86	0.69	0.16	0.45	0.03	0.41	0.31	0.01
Avail Cap(c_a), veh/h	141	634	537	293	634	537	538	1930	861	513	1975	881
HCM Platoon Ratio	2.00	2.00	2.00	1.00	1.00	1.00	1.00	1.00	1.00	1.00	1.00	1.00
Upstream Filter(l)	0.00	0.98	0.00	1.00	1.00	1.00	1.00	1.00	1.00	1.00	1.00	1.00
Uniform Delay (d), s/veh	0.0	28.1	0.0	49.9	43.8	41.7	11.3	16.6	12.7	12.2	13.8	11.4
Incr Delay (d2), s/veh	0.0	2.1	0.0	0.7	8.1	2.3	0.1	0.8	0.1	0.7	0.4	0.0
Initial Q Delay(d3),s/veh	0.0	0.0	0.0	0.0	0.0	0.0	0.0	0.0	0.0	0.0	0.0	0.0
%ile BackOfQ(50%),veh/ln	0.0	5.8	0.0	1.2	11.7	7.2	1.0	7.3	0.3	2.0	4.4	0.1
Unsig. Movement Delay, s/veh												
LnGrp Delay(d),s/veh	0.0	30.2	0.0	50.6	51.8	44.0	11.5	17.4	12.8	12.9	14.2	11.4
LnGrp LOS	A	C	A	D	D	D	B	B	B	B	B	B
Approach Vol, veh/h		253			679			976			785	
Approach Delay, s/veh		37.4			48.8			16.8			13.9	
Approach LOS		D			D			B			B	
Timer - Assigned Phs	1	2		4	5	6		8				
Phs Duration (G+Y+Rc), s	13.8	71.7		34.6	11.2	74.3		34.6				
Change Period (Y+Rc), s	6.5	6.5		6.0	6.5	6.5		6.0				
Max Green Setting (Gmax), s	14.5	45.5		41.0	6.5	53.5		41.0				
Max Q Clear Time (g_c+I1), s	7.0	19.8		18.0	4.4	13.0		25.5				
Green Ext Time (p_c), s	0.2	6.9		1.9	0.0	4.8		3.1				

Intersection Summary

HCM 6th Ctrl Delay	25.9
HCM 6th LOS	C

Timings
5: Marksheffel Rd & SH-94



Lane Group	EBT	EBR	WBL	WBT	WBR	NBL	NBT	NBR	SBL	SBT	SBR
Lane Configurations	↑	↗	↖	↑	↗	↖	↑↑	↗	↖	↑↑	↗
Traffic Volume (vph)	300	160	35	345	90	190	445	25	280	675	5
Future Volume (vph)	300	160	35	345	90	190	445	25	280	675	5
Turn Type	NA	Perm	Perm	NA	Perm	pm+pt	NA	Perm	pm+pt	NA	Perm
Protected Phases	4			8		5	2		1	6	
Permitted Phases		4	8		8	2		2	6		6
Detector Phase	4	4	8	8	8	5	2	2	1	6	6
Switch Phase											
Minimum Initial (s)	5.0	5.0	5.0	5.0	5.0	5.0	5.0	5.0	5.0	5.0	5.0
Minimum Split (s)	11.0	11.0	11.0	11.0	11.0	11.5	11.5	11.5	11.5	11.5	11.5
Total Split (s)	51.0	51.0	51.0	51.0	51.0	16.0	33.0	33.0	36.0	53.0	53.0
Total Split (%)	42.5%	42.5%	42.5%	42.5%	42.5%	13.3%	27.5%	27.5%	30.0%	44.2%	44.2%
Yellow Time (s)	5.0	5.0	5.0	5.0	5.0	5.0	5.0	5.0	5.0	5.0	5.0
All-Red Time (s)	1.0	1.0	1.0	1.0	1.0	1.5	1.5	1.5	1.5	1.5	1.5
Lost Time Adjust (s)	0.0	0.0	0.0	0.0	0.0	0.0	0.0	0.0	0.0	0.0	0.0
Total Lost Time (s)	6.0	6.0	6.0	6.0	6.0	6.5	6.5	6.5	6.5	6.5	6.5
Lead/Lag						Lead	Lag	Lag	Lead	Lag	Lag
Lead-Lag Optimize?						Yes	Yes	Yes	Yes	Yes	Yes
Recall Mode	None	None	None	None	None	None	C-Max	C-Max	None	C-Max	C-Max
Act Effct Green (s)	31.4	31.4	31.4	31.4	31.4	65.5	54.3	54.3	73.2	58.4	58.4
Actuated g/C Ratio	0.26	0.26	0.26	0.26	0.26	0.55	0.45	0.45	0.61	0.49	0.49
v/c Ratio	0.71	0.34	0.26	0.80	0.19	0.48	0.31	0.03	0.52	0.43	0.01
Control Delay	42.1	3.5	36.7	53.9	1.8	15.4	24.1	0.1	7.6	9.6	0.0
Queue Delay	0.0	0.0	0.0	0.0	0.0	0.0	0.0	0.0	0.0	0.0	0.0
Total Delay	42.1	3.5	36.7	53.9	1.8	15.4	24.1	0.1	7.6	9.6	0.0
LOS	D	A	D	D	A	B	C	A	A	A	A
Approach Delay	28.7			42.7			20.7			9.0	
Approach LOS	C			D			C			A	

Intersection Summary

Cycle Length: 120
 Actuated Cycle Length: 120
 Offset: 33 (28%), Referenced to phase 2:NBTL and 6:SBTL, Start of Green
 Natural Cycle: 60
 Control Type: Actuated-Coordinated
 Maximum v/c Ratio: 0.80
 Intersection Signal Delay: 21.8
 Intersection Capacity Utilization 72.3%
 Analysis Period (min) 15
 Intersection LOS: C
 ICU Level of Service C

Splits and Phases: 5: Marksheffel Rd & SH-94

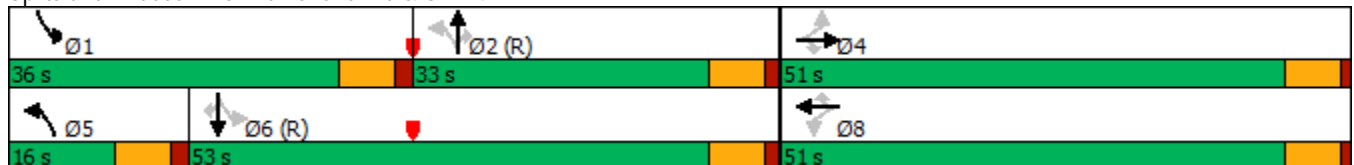

5: Marksheffel Rd & SH-94

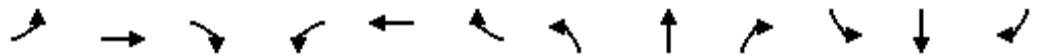

Movement	EBL	EBT	EBR	WBL	WBT	WBR	NBL	NBT	NBR	SBL	SBT	SBR
Lane Configurations	↖	↗	↘	↖	↗	↘	↖	↗↗	↘	↖	↗↗	↘
Traffic Volume (veh/h)	0	300	160	35	345	90	190	445	25	280	675	5
Future Volume (veh/h)	0	300	160	35	345	90	190	445	25	280	675	5
Initial Q (Qb), veh	0	0	0	0	0	0	0	0	0	0	0	0
Ped-Bike Adj(A_pbT)	1.00		1.00	1.00		1.00	1.00		1.00	1.00		1.00
Parking Bus, Adj	1.00	1.00	1.00	1.00	1.00	1.00	1.00	1.00	1.00	1.00	1.00	1.00
Work Zone On Approach		No			No			No			No	
Adj Sat Flow, veh/h/ln	1781	1781	1781	1811	1811	1811	1826	1826	1826	1856	1856	1856
Adj Flow Rate, veh/h	0	326	11	38	375	-11	207	484	27	304	734	5
Peak Hour Factor	0.92	0.92	0.92	0.92	0.92	0.92	0.92	0.92	0.92	0.92	0.92	0.92
Percent Heavy Veh, %	8	8	8	6	6	6	5	5	5	3	3	3
Cap, veh/h	60	420	356	144	427	362	476	1735	774	616	1873	836
Arrive On Green	0.00	0.47	0.47	0.24	0.24	0.00	0.07	0.50	0.50	0.11	0.53	0.53
Sat Flow, veh/h	969	1781	1510	1010	1811	1535	1739	3469	1547	1767	3526	1572
Grp Volume(v), veh/h	0	326	11	38	375	-11	207	484	27	304	734	5
Grp Sat Flow(s),veh/h/ln	969	1781	1510	1010	1811	1535	1739	1735	1547	1767	1763	1572
Q Serve(g_s), s	0.0	18.3	0.5	4.3	23.9	0.0	6.9	9.7	1.1	9.8	14.8	0.2
Cycle Q Clear(g_c), s	0.0	18.3	0.5	22.6	23.9	0.0	6.9	9.7	1.1	9.8	14.8	0.2
Prop In Lane	1.00		1.00	1.00		1.00	1.00		1.00	1.00		1.00
Lane Grp Cap(c), veh/h	60	420	356	144	427	362	476	1735	774	616	1873	836
V/C Ratio(X)	0.00	0.78	0.03	0.26	0.88	-0.03	0.43	0.28	0.03	0.49	0.39	0.01
Avail Cap(c_a), veh/h	195	668	566	285	679	576	484	1735	774	864	1873	836
HCM Platoon Ratio	2.00	2.00	2.00	1.00	1.00	1.00	1.00	1.00	1.00	1.00	1.00	1.00
Upstream Filter(l)	0.00	0.94	0.94	1.00	1.00	0.00	1.00	1.00	1.00	1.00	1.00	1.00
Uniform Delay (d), s/veh	0.0	29.0	24.3	52.4	44.2	0.0	13.0	17.4	15.3	11.9	16.6	13.2
Incr Delay (d2), s/veh	0.0	2.9	0.0	1.0	7.9	0.0	0.6	0.4	0.1	0.6	0.6	0.0
Initial Q Delay(d3),s/veh	0.0	0.0	0.0	0.0	0.0	0.0	0.0	0.0	0.0	0.0	0.0	0.0
%ile BackOfQ(50%),veh/ln	0.0	6.4	0.2	1.1	11.6	0.0	2.7	4.0	0.4	3.9	6.1	0.1
Unsig. Movement Delay, s/veh												
LnGrp Delay(d),s/veh	0.0	32.0	24.4	53.3	52.1	0.0	13.7	17.8	15.3	12.5	17.3	13.2
LnGrp LOS	A	C	C	D	D	A	B	B	B	B	B	B
Approach Vol, veh/h		337			402			718			1043	
Approach Delay, s/veh		31.7			53.6			16.5			15.8	
Approach LOS		C			D			B			B	
Timer - Assigned Phs	1	2		4	5	6		8				
Phs Duration (G+Y+Rc), s	19.2	66.5		34.3	15.4	70.3		34.3				
Change Period (Y+Rc), s	6.5	6.5		6.0	6.5	6.5		6.0				
Max Green Setting (Gmax), s	29.5	26.5		45.0	9.5	46.5		45.0				
Max Q Clear Time (g_c+l1), s	11.8	11.7		20.3	8.9	16.8		25.9				
Green Ext Time (p_c), s	0.8	2.9		2.0	0.0	5.8		2.4				

Intersection Summary

HCM 6th Ctrl Delay	24.3
HCM 6th LOS	C

Timings
5: Marksheffel Rd & SH-94

	→	↘	↙	←	↖	↗	↑	↘	↙	↓	↖
Lane Group	EBT	EBR	WBL	WBT	WBR	NBL	NBT	NBR	SBL	SBT	SBR
Lane Configurations	↑	↗	↙	↑	↗	↙	↑↑	↗	↙	↑↑	↗
Traffic Volume (vph)	340	265	45	405	375	225	1075	30	175	825	10
Future Volume (vph)	340	265	45	405	375	225	1075	30	175	825	10
Turn Type	NA	Perm	Perm	NA	Perm	pm+pt	NA	Perm	pm+pt	NA	Perm
Protected Phases	4			8		5	2		1	6	
Permitted Phases		4	8		8	2		2	6		6
Detector Phase	4	4	8	8	8	5	2	2	1	6	6
Switch Phase											
Minimum Initial (s)	5.0	5.0	5.0	5.0	5.0	5.0	5.0	5.0	5.0	5.0	5.0
Minimum Split (s)	11.0	11.0	11.0	11.0	11.0	11.5	11.5	11.5	11.5	11.5	11.5
Total Split (s)	47.0	47.0	47.0	47.0	47.0	13.0	52.0	52.0	21.0	60.0	60.0
Total Split (%)	39.2%	39.2%	39.2%	39.2%	39.2%	10.8%	43.3%	43.3%	17.5%	50.0%	50.0%
Yellow Time (s)	5.0	5.0	5.0	5.0	5.0	5.0	5.0	5.0	5.0	5.0	5.0
All-Red Time (s)	1.0	1.0	1.0	1.0	1.0	1.5	1.5	1.5	1.5	1.5	1.5
Lost Time Adjust (s)	0.0	0.0	0.0	0.0	0.0	0.0	0.0	0.0	0.0	0.0	0.0
Total Lost Time (s)	6.0	6.0	6.0	6.0	6.0	6.5	6.5	6.5	6.5	6.5	6.5
Lead/Lag						Lead	Lag	Lag	Lead	Lag	Lag
Lead-Lag Optimize?						Yes	Yes	Yes	Yes	Yes	Yes
Recall Mode	None	None	None	None	None	None	C-Max	C-Max	None	C-Max	C-Max
Act Effct Green (s)	34.6	34.6	34.6	34.6	34.6	62.8	53.9	53.9	69.3	57.4	57.4
Actuated g/C Ratio	0.29	0.29	0.29	0.29	0.29	0.52	0.45	0.45	0.58	0.48	0.48
v/c Ratio	0.68	0.47	0.30	0.81	0.69	0.69	0.72	0.04	0.66	0.53	0.01
Control Delay	39.9	8.5	36.4	51.6	26.2	29.8	32.0	0.1	18.0	28.2	0.4
Queue Delay	0.0	0.0	0.0	0.0	0.0	0.0	0.0	0.0	0.0	0.0	0.0
Total Delay	39.9	8.5	36.4	51.6	26.2	29.8	32.0	0.1	18.0	28.2	0.4
LOS	D	A	D	D	C	C	C	A	B	C	A
Approach Delay	26.2			39.2			30.9			26.2	
Approach LOS	C			D			C			C	

Intersection Summary

Cycle Length: 120
 Actuated Cycle Length: 120
 Offset: 33 (28%), Referenced to phase 2:NBTL and 6:SBTL, Start of Green
 Natural Cycle: 75
 Control Type: Actuated-Coordinated
 Maximum v/c Ratio: 0.81
 Intersection Signal Delay: 30.7
 Intersection Capacity Utilization 85.7%
 Analysis Period (min) 15
 Intersection LOS: C
 ICU Level of Service E

Splits and Phases: 5: Marksheffel Rd & SH-94

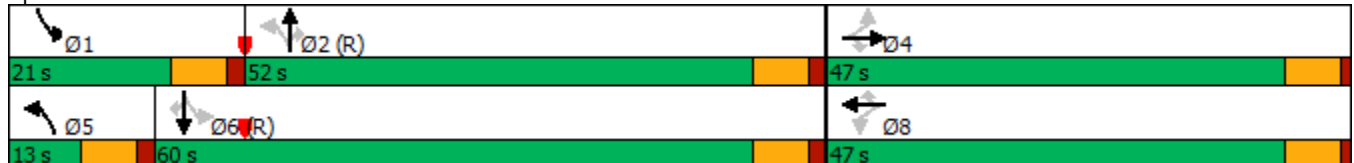



Movement	EBL	EBT	EBR	WBL	WBT	WBR	NBL	NBT	NBR	SBL	SBT	SBR
Lane Configurations	↖	↗	↘	↖	↗	↘	↖	↗↘	↗	↖	↗↘	↖
Traffic Volume (veh/h)	0	340	265	45	405	375	225	1075	30	175	825	10
Future Volume (veh/h)	0	340	265	45	405	375	225	1075	30	175	825	10
Initial Q (Qb), veh	0	0	0	0	0	0	0	0	0	0	0	0
Ped-Bike Adj(A_pbT)	1.00		1.00	1.00		1.00	1.00		1.00	1.00		1.00
Parking Bus, Adj	1.00	1.00	1.00	1.00	1.00	1.00	1.00	1.00	1.00	1.00	1.00	1.00
Work Zone On Approach		No			No			No			No	
Adj Sat Flow, veh/h/ln	1856	1856	1856	1856	1856	1856	1870	1870	1870	1841	1841	1841
Adj Flow Rate, veh/h	0	362	122	48	431	293	239	1144	32	186	878	11
Peak Hour Factor	0.94	0.94	0.94	0.94	0.94	0.94	0.94	0.94	0.94	0.94	0.94	0.94
Percent Heavy Veh, %	3	3	3	3	3	3	2	2	2	4	4	4
Cap, veh/h	60	494	419	166	494	419	382	1799	803	309	1823	813
Arrive On Green	0.00	0.53	0.53	0.27	0.27	0.27	0.05	0.51	0.51	0.07	0.52	0.52
Sat Flow, veh/h	724	1856	1572	904	1856	1572	1781	3554	1585	1753	3497	1560
Grp Volume(v), veh/h	0	362	122	48	431	293	239	1144	32	186	878	11
Grp Sat Flow(s),veh/h/ln	724	1856	1572	904	1856	1572	1781	1777	1585	1753	1749	1560
Q Serve(g_s), s	0.0	17.9	5.2	5.9	26.6	20.2	6.5	28.1	1.2	6.0	19.3	0.4
Cycle Q Clear(g_c), s	0.0	17.9	5.2	23.9	26.6	20.2	6.5	28.1	1.2	6.0	19.3	0.4
Prop In Lane	1.00		1.00	1.00		1.00	1.00		1.00	1.00		1.00
Lane Grp Cap(c), veh/h	60	494	419	166	494	419	382	1799	803	309	1823	813
V/C Ratio(X)	0.00	0.73	0.29	0.29	0.87	0.70	0.63	0.64	0.04	0.60	0.48	0.01
Avail Cap(c_a), veh/h	115	634	537	234	634	537	382	1799	803	399	1823	813
HCM Platoon Ratio	2.00	2.00	2.00	1.00	1.00	1.00	1.00	1.00	1.00	1.00	1.00	1.00
Upstream Filter(l)	0.00	0.94	0.94	1.00	1.00	1.00	1.00	1.00	1.00	1.00	1.00	1.00
Uniform Delay (d), s/veh	0.0	24.8	21.8	49.4	42.1	39.7	18.2	21.6	14.9	17.6	18.4	13.9
Incr Delay (d2), s/veh	0.0	3.0	0.4	1.0	10.5	2.8	3.2	1.7	0.1	1.9	0.9	0.0
Initial Q Delay(d3),s/veh	0.0	0.0	0.0	0.0	0.0	0.0	0.0	0.0	0.0	0.0	0.0	0.0
%ile BackOfQ(50%),veh/ln	0.0	6.2	1.8	1.4	13.6	8.1	2.3	11.9	0.5	2.5	7.9	0.2
Unsig. Movement Delay, s/veh												
LnGrp Delay(d),s/veh	0.0	27.8	22.1	50.4	52.6	42.5	21.4	23.3	15.0	19.4	19.3	13.9
LnGrp LOS	A	C	C	D	D	D	C	C	B	B	B	B
Approach Vol, veh/h		484			772			1415			1075	
Approach Delay, s/veh		26.4			48.6			22.8			19.3	
Approach LOS		C			D			C			B	
Timer - Assigned Phs	1	2		4	5	6		8				
Phs Duration (G+Y+Rc), s	14.8	67.3		38.0	13.0	69.0		38.0				
Change Period (Y+Rc), s	6.5	6.5		6.0	6.5	6.5		6.0				
Max Green Setting (Gmax), s	14.5	45.5		41.0	6.5	53.5		41.0				
Max Q Clear Time (g_c+I1), s	8.0	30.1		19.9	8.5	21.3		28.6				
Green Ext Time (p_c), s	0.3	7.5		2.6	0.0	7.4		3.3				

Intersection Summary

HCM 6th Ctrl Delay	27.6
HCM 6th LOS	C

Timings

5: Marksheffel Rd & SH-94

02/18/2021

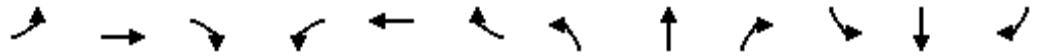

Lane Group	EBL	EBT	EBR	WBL	WBT	WBR	NBL	NBT	NBR	SBL	SBT	SBR
Lane Configurations	↖	↑	↗	↖	↑	↗	↖	↑↑	↗	↖	↑↑	↗
Traffic Volume (vph)	150	300	160	35	345	115	190	470	25	300	695	245
Future Volume (vph)	150	300	160	35	345	115	190	470	25	300	695	245
Turn Type	Perm	NA	Perm	Perm	NA	Perm	pm+pt	NA	Free	pm+pt	NA	Free
Protected Phases		4			8		5	2		1	6	
Permitted Phases	4		4	8		8	2		Free	6		Free
Detector Phase	4	4	4	8	8	8	5	2		1	6	
Switch Phase												
Minimum Initial (s)	5.0	5.0	5.0	5.0	5.0	5.0	5.0	5.0		5.0	5.0	
Minimum Split (s)	11.0	11.0	11.0	11.0	11.0	11.0	11.5	11.5		11.5	11.5	
Total Split (s)	51.0	51.0	51.0	51.0	51.0	51.0	16.0	33.0		36.0	53.0	
Total Split (%)	42.5%	42.5%	42.5%	42.5%	42.5%	42.5%	13.3%	27.5%		30.0%	44.2%	
Yellow Time (s)	5.0	5.0	5.0	5.0	5.0	5.0	5.0	5.0		5.0	5.0	
All-Red Time (s)	1.0	1.0	1.0	1.0	1.0	1.0	1.5	1.5		1.5	1.5	
Lost Time Adjust (s)	0.0	0.0	0.0	0.0	0.0	0.0	0.0	0.0		0.0	0.0	
Total Lost Time (s)	6.0	6.0	6.0	6.0	6.0	6.0	6.5	6.5		6.5	6.5	
Lead/Lag							Lead	Lag		Lead	Lag	
Lead-Lag Optimize?							Yes	Yes		Yes	Yes	
Recall Mode	None	None	None	None	None	None	None	C-Max		None	C-Max	
Act Effct Green (s)	35.5	35.5	35.5	35.5	35.5	35.5	58.5	48.1	120.0	69.8	55.2	120.0
Actuated g/C Ratio	0.30	0.30	0.30	0.30	0.30	0.30	0.49	0.40	1.00	0.58	0.46	1.00
v/c Ratio	1.07	0.63	0.31	0.20	0.71	0.22	0.54	0.37	0.02	0.60	0.47	0.17
Control Delay	127.2	36.3	3.3	30.5	44.2	3.3	22.8	24.9	0.0	22.6	23.3	0.2
Queue Delay	0.0	0.0	0.0	0.0	0.0	0.0	0.0	0.0	0.0	0.0	0.0	0.0
Total Delay	127.2	36.3	3.3	30.5	44.2	3.3	22.8	24.9	0.0	22.6	23.3	0.2
LOS	F	D	A	C	D	A	C	C	A	C	C	A
Approach Delay		50.0			33.8			23.4			18.6	
Approach LOS		D			C			C			B	

Intersection Summary

Cycle Length: 120
 Actuated Cycle Length: 120
 Offset: 33 (28%), Referenced to phase 2:NBTL and 6:SBTL, Start of Green
 Natural Cycle: 65
 Control Type: Actuated-Coordinated
 Maximum v/c Ratio: 1.07
 Intersection Signal Delay: 28.5
 Intersection Capacity Utilization 77.0%
 Analysis Period (min) 15
 Intersection LOS: C
 ICU Level of Service D

Splits and Phases: 5: Marksheffel Rd & SH-94

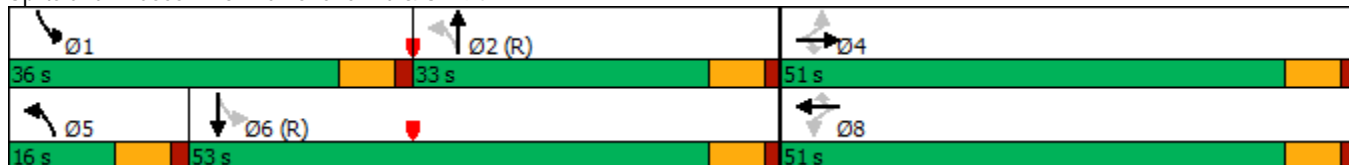

HCM 6th Signalized Intersection Summary

2026 Total AM Improved.syn

5: Marksheffel Rd & SH-94

02/18/2021



Movement	EBL	EBT	EBR	WBL	WBT	WBR	NBL	NBT	NBR	SBL	SBT	SBR
Lane Configurations	↖	↗	↘	↖	↗	↘	↖	↗	↘	↖	↗	↘
Traffic Volume (veh/h)	150	300	160	35	345	115	190	470	25	300	695	245
Future Volume (veh/h)	150	300	160	35	345	115	190	470	25	300	695	245
Initial Q (Qb), veh	0	0	0	0	0	0	0	0	0	0	0	0
Ped-Bike Adj(A_pbT)	1.00		1.00	1.00		1.00	1.00		1.00	1.00		1.00
Parking Bus, Adj	1.00	1.00	1.00	1.00	1.00	1.00	1.00	1.00	1.00	1.00	1.00	1.00
Work Zone On Approach		No			No			No			No	
Adj Sat Flow, veh/h/ln	1781	1781	1781	1811	1811	1811	1826	1826	1826	1856	1856	1856
Adj Flow Rate, veh/h	163	326	11	38	375	16	207	511	0	326	755	0
Peak Hour Factor	0.92	0.92	0.92	0.92	0.92	0.92	0.92	0.92	0.92	0.92	0.92	0.92
Percent Heavy Veh, %	8	8	8	6	6	6	5	5	5	3	3	3
Cap, veh/h	239	636	539	313	647	548	352	1216		551	1429	
Arrive On Green	0.60	0.60	0.60	0.36	0.36	0.36	0.16	0.70	0.00	0.09	0.27	0.00
Sat Flow, veh/h	946	1781	1510	1010	1811	1535	1739	3469	1547	1767	3526	1572
Grp Volume(v), veh/h	163	326	11	38	375	16	207	511	0	326	755	0
Grp Sat Flow(s),veh/h/ln	946	1781	1510	1010	1811	1535	1739	1735	1547	1767	1763	1572
Q Serve(g_s), s	19.9	12.8	0.4	3.5	20.1	0.8	9.5	7.5	0.0	13.2	21.9	0.0
Cycle Q Clear(g_c), s	40.0	12.8	0.4	16.3	20.1	0.8	9.5	7.5	0.0	13.2	21.9	0.0
Prop In Lane	1.00		1.00	1.00		1.00	1.00		1.00	1.00		1.00
Lane Grp Cap(c), veh/h	239	636	539	313	647	548	352	1216		551	1429	
V/C Ratio(X)	0.68	0.51	0.02	0.12	0.58	0.03	0.59	0.42		0.59	0.53	
Avail Cap(c_a), veh/h	256	668	566	331	679	576	352	1216		748	1429	
HCM Platoon Ratio	1.67	1.67	1.67	1.00	1.00	1.00	2.00	2.00	2.00	0.67	0.67	0.67
Upstream Filter(l)	0.89	0.89	0.89	1.00	1.00	1.00	1.00	1.00	0.00	0.78	0.78	0.00
Uniform Delay (d), s/veh	33.3	18.1	15.6	35.0	31.3	25.1	21.9	12.8	0.0	19.8	33.9	0.0
Incr Delay (d2), s/veh	5.9	0.6	0.0	0.2	1.1	0.0	2.5	1.1	0.0	0.8	1.1	0.0
Initial Q Delay(d3),s/veh	0.0	0.0	0.0	0.0	0.0	0.0	0.0	0.0	0.0	0.0	0.0	0.0
%ile BackOfQ(50%),veh/ln	4.5	4.4	0.1	0.9	9.0	0.3	3.7	2.6	0.0	5.9	10.1	0.0
Unsig. Movement Delay, s/veh												
LnGrp Delay(d),s/veh	39.3	18.7	15.7	35.2	32.4	25.1	24.5	13.9	0.0	20.6	35.0	0.0
LnGrp LOS	D	B	B	D	C	C	C	B		C	D	
Approach Vol, veh/h		500			429			718	A		1081	A
Approach Delay, s/veh		25.3			32.4			16.9			30.7	
Approach LOS		C			C			B			C	
Timer - Assigned Phs	1	2		4	5	6		8				
Phs Duration (G+Y+Rc), s	22.6	48.5		48.9	16.0	55.1		48.9				
Change Period (Y+Rc), s	6.5	6.5		6.0	6.5	6.5		6.0				
Max Green Setting (Gmax), s	29.5	26.5		45.0	9.5	46.5		45.0				
Max Q Clear Time (g_c+I1), s	15.2	9.5		42.0	11.5	23.9		22.1				
Green Ext Time (p_c), s	0.8	3.2		0.9	0.0	5.5		2.6				

Intersection Summary

HCM 6th Ctrl Delay	26.3
HCM 6th LOS	C

Notes

Unsignalized Delay for [NBR, SBR] is excluded from calculations of the approach delay and intersection delay.

Timings

5: Marksheffel Rd & SH-94

Lane Group	EBL	EBT	EBR	WBL	WBT	WBR	NBL	NBT	NBR	SBL	SBT	SBR
Lane Configurations												
Traffic Volume (vph)	140	340	265	45	405	395	225	1100	30	200	845	255
Future Volume (vph)	140	340	265	45	405	395	225	1100	30	200	845	255
Turn Type	Perm	NA	Perm	Perm	NA	Perm	pm+pt	NA	Free	pm+pt	NA	Free
Protected Phases		4			8		5	2		1	6	
Permitted Phases	4		4	8		8	2		Free	6		Free
Detector Phase	4	4	4	8	8	8	5	2		1	6	
Switch Phase												
Minimum Initial (s)	5.0	5.0	5.0	5.0	5.0	5.0	5.0	5.0		5.0	5.0	
Minimum Split (s)	11.0	11.0	11.0	11.0	11.0	11.0	11.5	11.5		11.5	11.5	
Total Split (s)	47.0	47.0	47.0	47.0	47.0	47.0	13.0	52.0		21.0	60.0	
Total Split (%)	39.2%	39.2%	39.2%	39.2%	39.2%	39.2%	10.8%	43.3%		17.5%	50.0%	
Yellow Time (s)	5.0	5.0	5.0	5.0	5.0	5.0	5.0	5.0		5.0	5.0	
All-Red Time (s)	1.0	1.0	1.0	1.0	1.0	1.0	1.5	1.5		1.5	1.5	
Lost Time Adjust (s)	0.0	0.0	0.0	0.0	0.0	0.0	0.0	0.0		0.0	0.0	
Total Lost Time (s)	6.0	6.0	6.0	6.0	6.0	6.0	6.5	6.5		6.5	6.5	
Lead/Lag							Lead	Lag		Lead	Lag	
Lead-Lag Optimize?							Yes	Yes		Yes	Yes	
Recall Mode	None	None	None	None	None	None	None	C-Max		None	C-Max	
Act Effct Green (s)	37.6	37.6	37.6	37.6	37.6	37.6	57.8	50.1	120.0	68.1	55.7	120.0
Actuated g/C Ratio	0.31	0.31	0.31	0.31	0.31	0.31	0.48	0.42	1.00	0.57	0.46	1.00
v/c Ratio	1.08	0.63	0.45	0.25	0.75	0.69	0.78	0.79	0.02	0.80	0.56	0.17
Control Delay	133.6	36.7	9.0	32.8	45.1	25.8	32.9	28.1	0.0	50.5	14.3	0.2
Queue Delay	0.0	0.0	0.0	0.0	0.0	0.0	0.0	0.0	0.0	0.0	0.0	0.0
Total Delay	133.6	36.7	9.0	32.8	45.1	25.8	32.9	28.1	0.0	50.5	14.3	0.2
LOS	F	D	A	C	D	C	C	C	A	D	B	A
Approach Delay		45.0			35.4			28.3			17.1	
Approach LOS		D			D			C			B	

Intersection Summary

Cycle Length: 120
 Actuated Cycle Length: 120
 Offset: 33 (28%), Referenced to phase 2:NBTL and 6:SBTL, Start of Green
 Natural Cycle: 80
 Control Type: Actuated-Coordinated
 Maximum v/c Ratio: 1.08
 Intersection Signal Delay: 29.2
 Intersection Capacity Utilization 91.4%
 Analysis Period (min) 15
 Intersection LOS: C
 ICU Level of Service F

Splits and Phases: 5: Marksheffel Rd & SH-94





Movement	EBL	EBT	EBR	WBL	WBT	WBR	NBL	NBT	NBR	SBL	SBT	SBR
Lane Configurations	↖	↗	↘	↖	↗	↘	↖	↗	↘	↖	↗	↘
Traffic Volume (veh/h)	140	340	265	45	405	395	225	1100	30	200	845	255
Future Volume (veh/h)	140	340	265	45	405	395	225	1100	30	200	845	255
Initial Q (Qb), veh	0	0	0	0	0	0	0	0	0	0	0	0
Ped-Bike Adj(A_pbT)	1.00		1.00	1.00		1.00	1.00		1.00	1.00		1.00
Parking Bus, Adj	1.00	1.00	1.00	1.00	1.00	1.00	1.00	1.00	1.00	1.00	1.00	1.00
Work Zone On Approach		No			No			No			No	
Adj Sat Flow, veh/h/ln	1856	1856	1856	1856	1856	1856	1870	1870	1870	1841	1841	1841
Adj Flow Rate, veh/h	149	362	122	48	431	314	239	1170	0	213	899	0
Peak Hour Factor	0.94	0.94	0.94	0.94	0.94	0.94	0.94	0.94	0.94	0.94	0.94	0.94
Percent Heavy Veh, %	3	3	3	3	3	3	2	2	2	4	4	4
Cap, veh/h	161	634	537	239	634	537	284	1472		328	1559	
Arrive On Green	0.45	0.45	0.45	0.34	0.34	0.34	0.11	0.83	0.00	0.03	0.15	0.00
Sat Flow, veh/h	710	1856	1572	904	1856	1572	1781	3554	1585	1753	3497	1560
Grp Volume(v), veh/h	149	362	122	48	431	314	239	1170	0	213	899	0
Grp Sat Flow(s),veh/h/ln	710	1856	1572	904	1856	1572	1781	1777	1585	1753	1749	1560
Q Serve(g_s), s	17.1	17.2	5.7	5.4	23.9	19.7	6.5	19.9	0.0	8.1	28.7	0.0
Cycle Q Clear(g_c), s	41.0	17.2	5.7	22.6	23.9	19.7	6.5	19.9	0.0	8.1	28.7	0.0
Prop In Lane	1.00		1.00	1.00		1.00	1.00		1.00	1.00		1.00
Lane Grp Cap(c), veh/h	161	634	537	239	634	537	284	1472		328	1559	
V/C Ratio(X)	0.92	0.57	0.23	0.20	0.68	0.58	0.84	0.79		0.65	0.58	
Avail Cap(c_a), veh/h	161	634	537	239	634	537	284	1472		389	1559	
HCM Platoon Ratio	1.33	1.33	1.33	1.00	1.00	1.00	2.00	2.00	2.00	0.33	0.33	0.33
Upstream Filter(I)	0.91	0.91	0.91	1.00	1.00	1.00	1.00	1.00	0.00	0.87	0.87	0.00
Uniform Delay (d), s/veh	47.4	26.3	23.1	40.8	33.9	32.5	31.6	7.7	0.0	21.4	40.6	0.0
Incr Delay (d2), s/veh	46.4	1.1	0.2	0.4	2.9	1.6	19.7	4.5	0.0	2.5	1.4	0.0
Initial Q Delay(d3),s/veh	0.0	0.0	0.0	0.0	0.0	0.0	0.0	0.0	0.0	0.0	0.0	0.0
%ile BackOfQ(50%),veh/ln	6.5	7.2	2.1	1.2	11.2	7.7	5.6	4.1	0.0	3.8	13.8	0.0
Unsig. Movement Delay, s/veh												
LnGrp Delay(d),s/veh	93.9	27.4	23.3	41.2	36.8	34.1	51.3	12.3	0.0	24.0	42.0	0.0
LnGrp LOS	F	C	C	D	D	C	D	B		C	D	
Approach Vol, veh/h		633			793			1409	A		1112	A
Approach Delay, s/veh		42.2			36.0			18.9			38.5	
Approach LOS		D			D			B			D	
Timer - Assigned Phs	1	2		4	5	6		8				
Phs Duration (G+Y+Rc), s	16.8	56.2		47.0	13.0	60.0		47.0				
Change Period (Y+Rc), s	6.5	6.5		6.0	6.5	6.5		6.0				
Max Green Setting (Gmax), s	14.5	45.5		41.0	6.5	53.5		41.0				
Max Q Clear Time (g_c+I1), s	10.1	21.9		43.0	8.5	30.7		25.9				
Green Ext Time (p_c), s	0.2	9.5		0.0	0.0	6.8		3.7				

Intersection Summary

HCM 6th Ctrl Delay	31.6
HCM 6th LOS	C

Notes

Unsignalized Delay for [NBR, SBR] is excluded from calculations of the approach delay and intersection delay.

Timings
5: Marksheffel Rd & SH-94



Lane Group	EBT	EBR	WBL	WBT	WBR	NBL	NBT	NBR	SBL	SBT	SBR
Lane Configurations	↑	↗	↖	↑	↗	↖	↑↑	↗	↖	↑↑	↗
Traffic Volume (vph)	350	310	40	405	105	430	780	30	330	950	5
Future Volume (vph)	350	310	40	405	105	430	780	30	330	950	5
Turn Type	NA	Perm	Perm	NA	Perm	pm+pt	NA	Perm	pm+pt	NA	Perm
Protected Phases	4			8		5	2		1	6	
Permitted Phases		4	8		8	2		2	6		6
Detector Phase	4	4	8	8	8	5	2	2	1	6	6
Switch Phase											
Minimum Initial (s)	5.0	5.0	5.0	5.0	5.0	5.0	5.0	5.0	5.0	5.0	5.0
Minimum Split (s)	11.0	11.0	11.0	11.0	11.0	11.5	11.5	11.5	11.5	11.5	11.5
Total Split (s)	51.0	51.0	51.0	51.0	51.0	16.0	33.0	33.0	36.0	53.0	53.0
Total Split (%)	42.5%	42.5%	42.5%	42.5%	42.5%	13.3%	27.5%	27.5%	30.0%	44.2%	44.2%
Yellow Time (s)	5.0	5.0	5.0	5.0	5.0	5.0	5.0	5.0	5.0	5.0	5.0
All-Red Time (s)	1.0	1.0	1.0	1.0	1.0	1.5	1.5	1.5	1.5	1.5	1.5
Lost Time Adjust (s)	0.0	0.0	0.0	0.0	0.0	0.0	0.0	0.0	0.0	0.0	0.0
Total Lost Time (s)	6.0	6.0	6.0	6.0	6.0	6.5	6.5	6.5	6.5	6.5	6.5
Lead/Lag						Lead	Lag	Lag	Lead	Lag	Lag
Lead-Lag Optimize?						Yes	Yes	Yes	Yes	Yes	Yes
Recall Mode	None	None	None	None	None	None	C-Max	C-Max	None	C-Max	C-Max
Act Effct Green (s)	35.8	35.8	35.8	35.8	35.8	59.1	41.9	41.9	65.7	46.5	46.5
Actuated g/C Ratio	0.30	0.30	0.30	0.30	0.30	0.49	0.35	0.35	0.55	0.39	0.39
v/c Ratio	0.73	0.55	0.28	0.82	0.20	1.32	0.71	0.05	0.81	0.76	0.01
Control Delay	39.3	9.6	34.6	51.9	2.5	196.0	32.1	0.1	43.7	21.2	0.0
Queue Delay	0.0	0.0	0.0	0.0	0.0	0.0	0.0	0.0	0.0	0.0	0.0
Total Delay	39.3	9.6	34.6	51.9	2.5	196.0	32.1	0.1	43.7	21.2	0.0
LOS	D	A	C	D	A	F	C	A	D	C	A
Approach Delay	25.3			41.2			88.1			26.9	
Approach LOS	C			D			F			C	

Intersection Summary

Cycle Length: 120
 Actuated Cycle Length: 120
 Offset: 33 (28%), Referenced to phase 2:NBTL and 6:SBTL, Start of Green
 Natural Cycle: 90
 Control Type: Actuated-Coordinated
 Maximum v/c Ratio: 1.32
 Intersection Signal Delay: 49.1
 Intersection LOS: D
 Intersection Capacity Utilization 96.4%
 ICU Level of Service F
 Analysis Period (min) 15

Splits and Phases: 5: Marksheffel Rd & SH-94

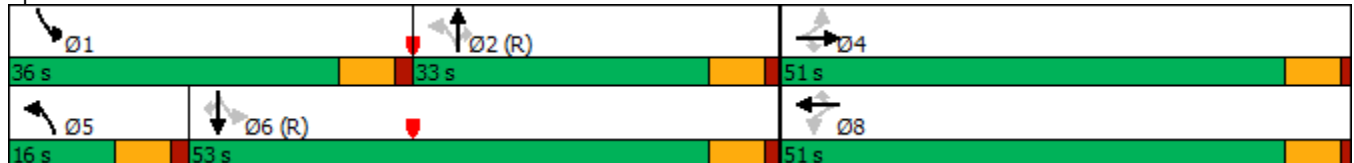

HCM 6th Signalized Intersection Summary
 5: Marksheffel Rd & SH-94

2040 Background AM.syn

01/05/2022

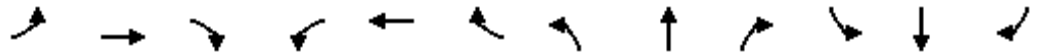

Movement	EBL	EBT	EBR	WBL	WBT	WBR	NBL	NBT	NBR	SBL	SBT	SBR
Lane Configurations												
Traffic Volume (veh/h)	0	350	310	40	405	105	430	780	30	330	950	5
Future Volume (veh/h)	0	350	310	40	405	105	430	780	30	330	950	5
Initial Q (Qb), veh	0	0	0	0	0	0	0	0	0	0	0	0
Ped-Bike Adj(A_pbT)	1.00		1.00	1.00		1.00	1.00		1.00	1.00		1.00
Parking Bus, Adj	1.00	1.00	1.00	1.00	1.00	1.00	1.00	1.00	1.00	1.00	1.00	1.00
Work Zone On Approach		No			No			No			No	
Adj Sat Flow, veh/h/ln	1781	1781	1781	1811	1811	1811	1826	1826	1826	1856	1856	1856
Adj Flow Rate, veh/h	0	380	174	43	440	5	467	848	33	359	1033	5
Peak Hour Factor	0.92	0.92	0.92	0.92	0.92	0.92	0.92	0.92	0.92	0.92	0.92	0.92
Percent Heavy Veh, %	8	8	8	6	6	6	5	5	5	3	3	3
Cap, veh/h	60	485	411	145	494	418	345	1520	678	528	1727	770
Arrive On Green	0.00	0.55	0.55	0.27	0.27	0.27	0.16	0.88	0.88	0.13	0.49	0.49
Sat Flow, veh/h	900	1781	1510	827	1811	1535	1739	3469	1547	1767	3526	1572
Grp Volume(v), veh/h	0	380	174	43	440	5	467	848	33	359	1033	5
Grp Sat Flow(s),veh/h/ln	900	1781	1510	827	1811	1535	1739	1735	1547	1767	1763	1572
Q Serve(g_s), s	0.0	20.3	8.2	5.9	28.0	0.3	9.5	7.1	0.3	12.7	25.4	0.2
Cycle Q Clear(g_c), s	0.0	20.3	8.2	26.2	28.0	0.3	9.5	7.1	0.3	12.7	25.4	0.2
Prop In Lane	1.00		1.00	1.00		1.00	1.00		1.00	1.00		1.00
Lane Grp Cap(c), veh/h	60	485	411	145	494	418	345	1520	678	528	1727	770
V/C Ratio(X)	0.00	0.78	0.42	0.30	0.89	0.01	1.35	0.56	0.05	0.68	0.60	0.01
Avail Cap(c_a), veh/h	152	668	566	230	679	576	345	1520	678	731	1727	770
HCM Platoon Ratio	2.00	2.00	2.00	1.00	1.00	1.00	2.00	2.00	2.00	1.00	1.00	1.00
Upstream Filter(l)	0.00	0.87	0.87	1.00	1.00	1.00	1.00	1.00	1.00	0.86	0.86	0.86
Uniform Delay (d), s/veh	0.0	24.5	21.7	50.9	41.9	31.9	29.8	4.6	4.2	13.8	22.1	15.7
Incr Delay (d2), s/veh	0.0	3.6	0.6	1.1	11.0	0.0	176.3	1.5	0.1	1.3	1.3	0.0
Initial Q Delay(d3),s/veh	0.0	0.0	0.0	0.0	0.0	0.0	0.0	0.0	0.0	0.0	0.0	0.0
%ile BackOfQ(50%),veh/ln	0.0	6.7	2.6	1.3	13.9	0.1	22.9	1.9	0.1	5.1	10.6	0.1
Unsig. Movement Delay, s/veh												
LnGrp Delay(d),s/veh	0.0	28.1	22.3	52.0	52.9	31.9	206.0	6.1	4.3	15.2	23.4	15.7
LnGrp LOS	A	C	C	D	D	C	F	A	A	B	C	B
Approach Vol, veh/h		554			488			1348			1397	
Approach Delay, s/veh		26.3			52.6			75.3			21.3	
Approach LOS		C			D			E			C	
Timer - Assigned Phs	1	2		4	5	6		8				
Phs Duration (G+Y+Rc), s	22.2	59.1		38.7	16.0	65.3		38.7				
Change Period (Y+Rc), s	6.5	6.5		6.0	6.5	6.5		6.0				
Max Green Setting (Gmax), s	29.5	26.5		45.0	9.5	46.5		45.0				
Max Q Clear Time (g_c+l1), s	14.7	9.1		22.3	11.5	27.4		30.0				
Green Ext Time (p_c), s	1.0	5.8		3.0	0.0	7.5		2.7				

Intersection Summary

HCM 6th Ctrl Delay	45.3
HCM 6th LOS	D

Timings
5: Marksheffel Rd & SH-94

	→	↘	↙	←	↖	↗	↑	↘	↙	↓	↖
Lane Group	EBT	EBR	WBL	WBT	WBR	NBL	NBT	NBR	SBL	SBT	SBR
Lane Configurations	↑	↗	↙	↑	↗	↙	↑↑	↗	↙	↑↑	↗
Traffic Volume (vph)	400	665	50	475	440	565	1695	50	205	1455	10
Future Volume (vph)	400	665	50	475	440	565	1695	50	205	1455	10
Turn Type	NA	Perm	Perm	NA	Perm	pm+pt	NA	Perm	pm+pt	NA	Perm
Protected Phases	4			8		5	2		1	6	
Permitted Phases		4	8		8	2		2	6		6
Detector Phase	4	4	8	8	8	5	2	2	1	6	6
Switch Phase											
Minimum Initial (s)	5.0	5.0	5.0	5.0	5.0	5.0	5.0	5.0	5.0	5.0	5.0
Minimum Split (s)	11.0	11.0	11.0	11.0	11.0	11.5	11.5	11.5	11.5	11.5	11.5
Total Split (s)	47.0	47.0	47.0	47.0	47.0	13.0	52.0	52.0	21.0	60.0	60.0
Total Split (%)	39.2%	39.2%	39.2%	39.2%	39.2%	10.8%	43.3%	43.3%	17.5%	50.0%	50.0%
Yellow Time (s)	5.0	5.0	5.0	5.0	5.0	5.0	5.0	5.0	5.0	5.0	5.0
All-Red Time (s)	1.0	1.0	1.0	1.0	1.0	1.5	1.5	1.5	1.5	1.5	1.5
Lost Time Adjust (s)	0.0	0.0	0.0	0.0	0.0	0.0	0.0	0.0	0.0	0.0	0.0
Total Lost Time (s)	6.0	6.0	6.0	6.0	6.0	6.5	6.5	6.5	6.5	6.5	6.5
Lead/Lag						Lead	Lag	Lag	Lead	Lag	Lag
Lead-Lag Optimize?						Yes	Yes	Yes	Yes	Yes	Yes
Recall Mode	None	None	None	None	None	None	C-Max	C-Max	None	C-Max	C-Max
Act Effct Green (s)	41.0	41.0	41.0	41.0	41.0	53.0	46.5	46.5	65.9	53.5	53.5
Actuated g/C Ratio	0.34	0.34	0.34	0.34	0.34	0.44	0.39	0.39	0.55	0.45	0.45
v/c Ratio	0.68	1.12	0.30	0.80	0.73	3.83	1.32	0.08	0.85	1.00	0.01
Control Delay	37.1	97.2	34.8	47.0	29.5	1287.5	166.5	0.2	48.4	58.8	0.0
Queue Delay	0.0	0.0	0.0	0.0	0.0	0.0	0.0	0.0	0.0	0.0	0.0
Total Delay	37.1	97.2	34.8	47.0	29.5	1287.5	166.5	0.2	48.4	58.8	0.0
LOS	D	F	C	D	C	F	F	A	D	E	A
Approach Delay	74.6			38.4			437.1			57.2	
Approach LOS	E			D			F			E	

Intersection Summary

Cycle Length: 120
 Actuated Cycle Length: 120
 Offset: 33 (28%), Referenced to phase 2:NBTL and 6:SBTL, Start of Green
 Natural Cycle: 150
 Control Type: Actuated-Coordinated
 Maximum v/c Ratio: 3.83
 Intersection Signal Delay: 203.3
 Intersection Capacity Utilization 121.5%
 Analysis Period (min) 15
 Intersection LOS: F
 ICU Level of Service H

Splits and Phases: 5: Marksheffel Rd & SH-94

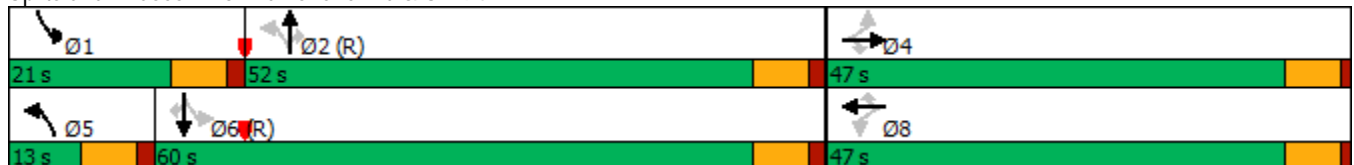

HCM 6th Signalized Intersection Summary
 5: Marksheffel Rd & SH-94

2040 Background PM.syn

01/05/2022

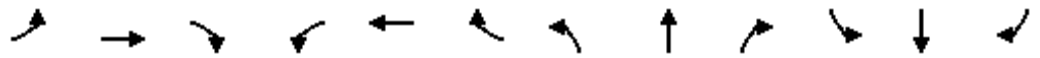

Movement	EBL	EBT	EBR	WBL	WBT	WBR	NBL	NBT	NBR	SBL	SBT	SBR
Lane Configurations	↖	↑	↗	↖	↑	↗	↖	↑↑	↗	↖	↑↑	↗
Traffic Volume (veh/h)	0	400	665	50	475	440	565	1695	50	205	1455	10
Future Volume (veh/h)	0	400	665	50	475	440	565	1695	50	205	1455	10
Initial Q (Qb), veh	0	0	0	0	0	0	0	0	0	0	0	0
Ped-Bike Adj(A_pbT)	1.00		1.00	1.00		1.00	1.00		1.00	1.00		1.00
Parking Bus, Adj	1.00	1.00	1.00	1.00	1.00	1.00	1.00	1.00	1.00	1.00	1.00	1.00
Work Zone On Approach		No			No			No			No	
Adj Sat Flow, veh/h/ln	1856	1856	1856	1856	1856	1856	1870	1870	1870	1841	1841	1841
Adj Flow Rate, veh/h	0	426	547	53	505	362	601	1803	53	218	1548	11
Peak Hour Factor	0.94	0.94	0.94	0.94	0.94	0.94	0.94	0.94	0.94	0.94	0.94	0.94
Percent Heavy Veh, %	3	3	3	3	3	3	2	2	2	4	4	4
Cap, veh/h	60	634	537	164	634	537	158	1399	624	246	1559	695
Arrive On Green	0.00	0.57	0.57	0.34	0.34	0.34	0.11	0.79	0.79	0.07	0.30	0.30
Sat Flow, veh/h	633	1856	1572	573	1856	1572	1781	3554	1585	1753	3497	1560
Grp Volume(v), veh/h	0	426	547	53	505	362	601	1803	53	218	1548	11
Grp Sat Flow(s),veh/h/ln	633	1856	1572	573	1856	1572	1781	1777	1585	1753	1749	1560
Q Serve(g_s), s	0.0	19.2	41.0	10.0	29.5	23.6	6.5	47.3	0.9	10.6	53.0	0.6
Cycle Q Clear(g_c), s	0.0	19.2	41.0	29.2	29.5	23.6	6.5	47.3	0.9	10.6	53.0	0.6
Prop In Lane	1.00		1.00	1.00		1.00	1.00		1.00	1.00		1.00
Lane Grp Cap(c), veh/h	60	634	537	164	634	537	158	1399	624	246	1559	695
V/C Ratio(X)	0.00	0.67	1.02	0.32	0.80	0.67	3.80	1.29	0.08	0.89	0.99	0.02
Avail Cap(c_a), veh/h	60	634	537	164	634	537	158	1399	624	272	1559	695
HCM Platoon Ratio	1.67	1.67	1.67	1.00	1.00	1.00	2.00	2.00	2.00	0.67	0.67	0.67
Upstream Filter(l)	0.00	0.76	0.76	1.00	1.00	1.00	1.00	1.00	1.00	0.86	0.86	0.86
Uniform Delay (d), s/veh	0.0	21.1	25.8	44.3	35.7	33.8	28.6	12.7	7.8	37.3	41.9	23.5
Incr Delay (d2), s/veh	0.0	2.1	38.5	1.1	7.0	3.3	1277.0	135.3	0.3	23.1	19.5	0.0
Initial Q Delay(d3),s/veh	0.0	0.0	0.0	0.0	0.0	0.0	0.0	0.0	0.0	0.0	0.0	0.0
%ile BackOfQ(50%),veh/ln	0.0	6.9	17.6	1.5	14.5	9.5	58.6	31.2	0.4	8.3	27.8	0.2
Unsig. Movement Delay, s/veh												
LnGrp Delay(d),s/veh	0.0	23.2	64.2	45.4	42.8	37.1	1305.6	148.1	8.1	60.4	61.4	23.6
LnGrp LOS	A	C	F	D	D	D	F	F	A	E	E	C
Approach Vol, veh/h		973			920			2457			1777	
Approach Delay, s/veh		46.3			40.7			428.2			61.0	
Approach LOS		D			D			F			E	
Timer - Assigned Phs	1	2		4	5	6		8				
Phs Duration (G+Y+Rc), s	19.2	53.8		47.0	13.0	60.0		47.0				
Change Period (Y+Rc), s	6.5	6.5		6.0	6.5	6.5		6.0				
Max Green Setting (Gmax), s	14.5	45.5		41.0	6.5	53.5		41.0				
Max Q Clear Time (g_c+l1), s	12.6	49.3		43.0	8.5	55.0		31.5				
Green Ext Time (p_c), s	0.1	0.0		0.0	0.0	0.0		3.6				
Intersection Summary												
HCM 6th Ctrl Delay			202.9									
HCM 6th LOS			F									

Timings
5: Marksheffel Rd & SH-94

2040 Total AM.syn
02/18/2021



Lane Group	EBL	EBT	EBR	WBL	WBT	WBR	NBL	NBT	SBL	SBT	SBR
Lane Configurations	↘	↑↑	↗	↘	↑↑	↗	↘↗	↑↑↗	↘	↑↑↑	↗
Traffic Volume (vph)	165	350	310	40	405	135	430	810	355	975	275
Future Volume (vph)	165	350	310	40	405	135	430	810	355	975	275
Turn Type	Perm	NA	Perm	Perm	NA	Perm	Prot	NA	pm+pt	NA	Free
Protected Phases		4			8		5	2	1	6	
Permitted Phases	4		4	8		8			6		Free
Detector Phase	4	4	4	8	8	8	5	2	1	6	
Switch Phase											
Minimum Initial (s)	5.0	5.0	5.0	5.0	5.0	5.0	5.0	5.0	5.0	5.0	5.0
Minimum Split (s)	11.0	11.0	11.0	11.0	11.0	11.0	11.5	11.5	11.5	11.5	11.5
Total Split (s)	48.0	48.0	48.0	48.0	48.0	48.0	29.0	36.0	36.0	43.0	43.0
Total Split (%)	40.0%	40.0%	40.0%	40.0%	40.0%	40.0%	24.2%	30.0%	30.0%	35.8%	35.8%
Yellow Time (s)	5.0	5.0	5.0	5.0	5.0	5.0	5.0	5.0	5.0	5.0	5.0
All-Red Time (s)	1.0	1.0	1.0	1.0	1.0	1.0	1.5	1.5	1.5	1.5	1.5
Lost Time Adjust (s)	0.0	0.0	0.0	0.0	0.0	0.0	0.0	0.0	0.0	0.0	0.0
Total Lost Time (s)	6.0	6.0	6.0	6.0	6.0	6.0	6.5	6.5	6.5	6.5	6.5
Lead/Lag							Lead	Lag	Lead	Lag	
Lead-Lag Optimize?							Yes	Yes	Yes	Yes	
Recall Mode	None	None	None	None	None	None	None	C-Max	None	C-Max	
Act Effct Green (s)	34.1	34.1	34.1	34.1	34.1	34.1	20.6	41.5	71.4	46.2	120.0
Actuated g/C Ratio	0.28	0.28	0.28	0.28	0.28	0.28	0.17	0.35	0.60	0.38	1.00
v/c Ratio	0.90	0.40	0.51	0.19	0.45	0.27	0.82	0.54	0.76	0.55	0.19
Control Delay	73.2	30.9	3.8	31.1	35.7	5.4	65.3	29.3	47.5	24.6	0.2
Queue Delay	0.0	0.0	0.0	0.0	0.0	0.0	0.0	0.0	0.0	0.0	0.0
Total Delay	73.2	30.9	3.8	31.1	35.7	5.4	65.3	29.3	47.5	24.6	0.2
LOS	E	C	A	C	D	A	E	C	D	C	A
Approach Delay		29.2			28.3			41.5		25.5	
Approach LOS		C			C			D		C	

Intersection Summary

Cycle Length: 120
 Actuated Cycle Length: 120
 Offset: 33 (28%), Referenced to phase 2:NBT and 6:SBTL, Start of Green
 Natural Cycle: 55
 Control Type: Actuated-Coordinated
 Maximum v/c Ratio: 0.90
 Intersection Signal Delay: 31.3
 Intersection Capacity Utilization 77.2%
 Analysis Period (min) 15
 Intersection LOS: C
 ICU Level of Service D

Splits and Phases: 5: Marksheffel Rd & SH-94

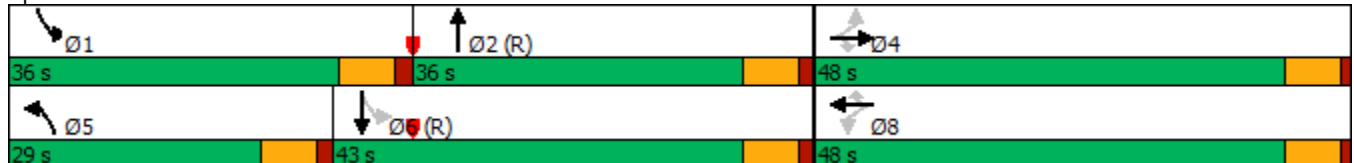

HCM 6th Signalized Intersection Summary

2040 Total AM.syn

02/18/2021

5: Marksheffel Rd & SH-94

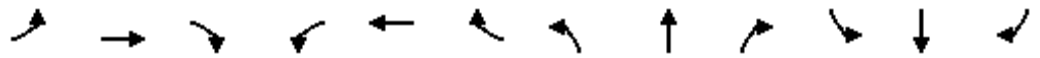

Movement	EBL	EBT	EBR	WBL	WBT	WBR	NBL	NBT	NBR	SBL	SBT	SBR
Lane Configurations												
Traffic Volume (veh/h)	165	350	310	40	405	135	430	810	30	355	975	275
Future Volume (veh/h)	165	350	310	40	405	135	430	810	30	355	975	275
Initial Q (Qb), veh	0	0	0	0	0	0	0	0	0	0	0	0
Ped-Bike Adj(A_pbT)	1.00		1.00	1.00		1.00	1.00		1.00	1.00		1.00
Parking Bus, Adj	1.00	1.00	1.00	1.00	1.00	1.00	1.00	1.00	1.00	1.00	1.00	1.00
Work Zone On Approach		No			No			No			No	
Adj Sat Flow, veh/h/ln	1781	1781	1781	1811	1811	1811	1826	1826	1826	1856	1856	1856
Adj Flow Rate, veh/h	179	380	174	43	440	38	467	880	0	386	1060	0
Peak Hour Factor	0.92	0.92	0.92	0.92	0.92	0.92	0.92	0.92	0.92	0.92	0.92	0.92
Percent Heavy Veh, %	8	8	8	6	6	6	5	5	5	3	3	3
Cap, veh/h	257	1100	491	277	1119	499	524	1812		511	1830	
Arrive On Green	0.54	0.54	0.54	0.33	0.33	0.33	0.31	0.73	0.00	0.05	0.12	0.00
Sat Flow, veh/h	873	3385	1510	827	3441	1535	3374	5149	0	1767	5066	1572
Grp Volume(v), veh/h	179	380	174	43	440	38	467	880	0	386	1060	0
Grp Sat Flow(s),veh/h/ln	873	1692	1510	827	1721	1535	1687	1662	0	1767	1689	1572
Q Serve(g_s), s	23.3	7.6	7.8	4.9	11.9	2.1	15.8	8.9	0.0	15.4	23.8	0.0
Cycle Q Clear(g_c), s	35.2	7.6	7.8	12.4	11.9	2.1	15.8	8.9	0.0	15.4	23.8	0.0
Prop In Lane	1.00		1.00	1.00		1.00	1.00		0.00	1.00		1.00
Lane Grp Cap(c), veh/h	257	1100	491	277	1119	499	524	1812		511	1830	
V/C Ratio(X)	0.70	0.35	0.35	0.16	0.39	0.08	0.89	0.49		0.75	0.58	
Avail Cap(c_a), veh/h	279	1185	528	297	1204	537	633	1812		675	1830	
HCM Platoon Ratio	1.67	1.67	1.67	1.00	1.00	1.00	2.00	2.00	2.00	0.33	0.33	0.33
Upstream Filter(I)	0.78	0.78	0.78	1.00	1.00	1.00	1.00	1.00	0.00	0.81	0.81	0.00
Uniform Delay (d), s/veh	32.2	20.2	20.3	34.5	31.3	28.0	40.4	11.6	0.0	21.2	44.2	0.0
Incr Delay (d2), s/veh	5.2	0.1	0.3	0.3	0.2	0.1	13.1	0.9	0.0	2.8	1.1	0.0
Initial Q Delay(d3),s/veh	0.0	0.0	0.0	0.0	0.0	0.0	0.0	0.0	0.0	0.0	0.0	0.0
%ile BackOfQ(50%),veh/ln	4.7	2.8	2.6	1.0	5.0	0.8	6.5	2.7	0.0	7.5	11.0	0.0
Unsig. Movement Delay, s/veh												
LnGrp Delay(d),s/veh	37.4	20.4	20.6	34.7	31.6	28.1	53.5	12.6	0.0	24.0	45.3	0.0
LnGrp LOS	D	C	C	C	C	C	D	B		C	D	
Approach Vol, veh/h		733			521			1347	A		1446	A
Approach Delay, s/veh		24.6			31.6			26.8			39.6	
Approach LOS		C			C			C			D	
Timer - Assigned Phs	1	2		4	5	6		8				
Phs Duration (G+Y+Rc), s	24.9	50.1		45.0	25.1	49.9		45.0				
Change Period (Y+Rc), s	6.5	6.5		6.0	6.5	6.5		6.0				
Max Green Setting (Gmax), s	29.5	29.5		42.0	22.5	36.5		42.0				
Max Q Clear Time (g_c+l1), s	17.4	10.9		37.2	17.8	25.8		14.4				
Green Ext Time (p_c), s	1.0	6.1		1.8	0.8	5.4		3.5				

Intersection Summary

HCM 6th Ctrl Delay	31.6
HCM 6th LOS	C

Notes

Unsignalized Delay for [NBR, SBR] is excluded from calculations of the approach delay and intersection delay.

Timings
5: Marksheffel Rd & SH-94

2040 Total PM.syn
02/18/2021



Lane Group	EBL	EBT	EBR	WBL	WBT	WBR	NBL	NBT	SBL	SBT	SBR
Lane Configurations	↘	↑↑	↗	↘	↑↑	↗	↘↗	↑↑↗	↘	↑↑↑	↗
Traffic Volume (vph)	235	400	665	50	475	480	565	1735	230	1480	285
Future Volume (vph)	235	400	665	50	475	480	565	1735	230	1480	285
Turn Type	pm+pt	NA	pm+ov	pm+pt	NA	pm+ov	Prot	NA	pm+pt	NA	Free
Protected Phases	7	4	5	3	8	1	5	2	1	6	
Permitted Phases	4		4	8		8			6		Free
Detector Phase	7	4	5	3	8	1	5	2	1	6	
Switch Phase											
Minimum Initial (s)	5.0	5.0	5.0	5.0	5.0	5.0	5.0	5.0	5.0	5.0	5.0
Minimum Split (s)	9.5	11.0	11.5	9.5	11.0	11.5	11.5	11.5	11.5	11.5	11.5
Total Split (s)	15.0	38.0	36.0	9.5	32.5	19.0	36.0	53.5	19.0	36.5	
Total Split (%)	12.5%	31.7%	30.0%	7.9%	27.1%	15.8%	30.0%	44.6%	15.8%	30.4%	
Yellow Time (s)	3.5	5.0	5.0	3.5	5.0	5.0	5.0	5.0	5.0	5.0	5.0
All-Red Time (s)	1.0	1.0	1.5	1.0	1.0	1.5	1.5	1.5	1.5	1.5	1.5
Lost Time Adjust (s)	0.0	0.0	0.0	0.0	0.0	0.0	0.0	0.0	0.0	0.0	0.0
Total Lost Time (s)	4.5	6.0	6.5	4.5	6.0	6.5	6.5	6.5	6.5	6.5	6.5
Lead/Lag	Lead	Lag	Lead	Lead	Lag	Lead	Lead	Lag	Lead	Lag	
Lead-Lag Optimize?	Yes	Yes	Yes	Yes	Yes	Yes	Yes	Yes	Yes	Yes	Yes
Recall Mode	None	None	None	None	None	None	None	C-Max	None	C-Max	
Act Effct Green (s)	39.0	29.9	63.0	29.0	22.5	44.4	27.0	47.6	52.3	36.4	120.0
Actuated g/C Ratio	0.32	0.25	0.52	0.24	0.19	0.37	0.22	0.40	0.44	0.30	1.00
v/c Ratio	1.02	0.49	0.81	0.21	0.77	0.74	0.78	0.94	0.84	1.04	0.20
Control Delay	89.7	43.2	23.0	29.3	54.3	28.6	45.7	57.6	58.2	84.7	0.2
Queue Delay	0.0	0.0	0.0	0.0	0.0	0.0	0.0	0.0	0.0	0.0	0.0
Total Delay	89.7	43.2	23.0	29.3	54.3	28.6	45.7	57.6	58.2	84.7	0.2
LOS	F	D	C	C	D	C	D	E	E	F	A
Approach Delay		41.3			40.7			54.7		69.6	
Approach LOS		D			D			D		E	

Intersection Summary

Cycle Length: 120
 Actuated Cycle Length: 120
 Offset: 0 (0%), Referenced to phase 2:NBT and 6:SBTL, Start of Green
 Natural Cycle: 100
 Control Type: Actuated-Coordinated
 Maximum v/c Ratio: 1.04
 Intersection Signal Delay: 54.4
 Intersection LOS: D
 Intersection Capacity Utilization 93.1%
 ICU Level of Service F
 Analysis Period (min) 15

Splits and Phases: 5: Marksheffel Rd & SH-94

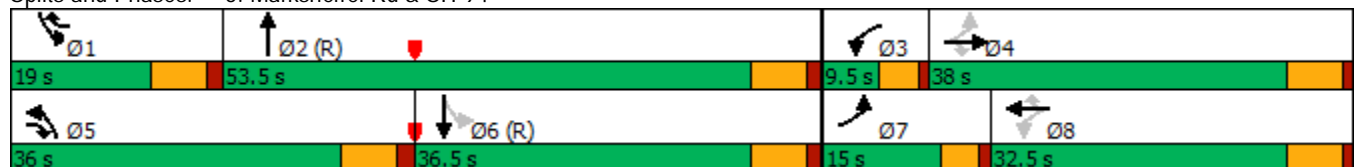



Movement	EBL	EBT	EBR	WBL	WBT	WBR	NBL	NBT	NBR	SBL	SBT	SBR
Lane Configurations	↖	↗	↘	↖	↗	↘	↖	↗	↘	↖	↗	↘
Traffic Volume (veh/h)	235	400	665	50	475	480	565	1735	50	230	1480	285
Future Volume (veh/h)	235	400	665	50	475	480	565	1735	50	230	1480	285
Initial Q (Qb), veh	0	0	0	0	0	0	0	0	0	0	0	0
Ped-Bike Adj(A_pbT)	1.00		1.00	1.00		1.00	1.00		1.00	1.00		1.00
Parking Bus, Adj	1.00	1.00	1.00	1.00	1.00	1.00	1.00	1.00	1.00	1.00	1.00	1.00
Work Zone On Approach		No			No			No			No	
Adj Sat Flow, veh/h/ln	1856	1856	1856	1856	1856	1856	1870	1870	1870	1841	1841	1841
Adj Flow Rate, veh/h	250	426	361	53	505	245	601	1846	0	245	1574	0
Peak Hour Factor	0.94	0.94	0.94	0.94	0.94	0.94	0.94	0.94	0.94	0.94	0.94	0.94
Percent Heavy Veh, %	3	3	3	3	3	3	2	2	2	4	4	4
Cap, veh/h	242	809	676	214	623	441	693	2226		263	1706	
Arrive On Green	0.15	0.38	0.38	0.03	0.18	0.18	0.07	0.14	0.00	0.10	0.34	0.00
Sat Flow, veh/h	1767	3526	1572	1767	3526	1572	3456	5274	0	1753	5025	1560
Grp Volume(v), veh/h	250	426	361	53	505	245	601	1846	0	245	1574	0
Grp Sat Flow(s),veh/h/ln	1767	1763	1572	1767	1763	1572	1728	1702	0	1753	1675	1560
Q Serve(g_s), s	10.5	11.2	20.4	2.9	16.5	15.9	20.7	42.2	0.0	11.0	36.1	0.0
Cycle Q Clear(g_c), s	10.5	11.2	20.4	2.9	16.5	15.9	20.7	42.2	0.0	11.0	36.1	0.0
Prop In Lane	1.00		1.00	1.00		1.00	1.00		0.00	1.00		1.00
Lane Grp Cap(c), veh/h	242	809	676	214	623	441	693	2226		263	1706	
V/C Ratio(X)	1.03	0.53	0.53	0.25	0.81	0.55	0.87	0.83		0.93	0.92	
Avail Cap(c_a), veh/h	242	940	735	227	779	511	850	2226		263	1706	
HCM Platoon Ratio	1.67	1.67	1.67	1.00	1.00	1.00	0.33	0.33	0.33	1.00	1.00	1.00
Upstream Filter(I)	0.57	0.57	0.57	1.00	1.00	1.00	1.00	1.00	0.00	0.78	0.78	0.00
Uniform Delay (d), s/veh	39.5	32.0	20.2	38.6	47.5	36.8	54.4	47.0	0.0	28.8	38.1	0.0
Incr Delay (d2), s/veh	52.3	0.3	0.4	0.6	5.3	1.1	8.1	3.7	0.0	31.5	8.0	0.0
Initial Q Delay(d3),s/veh	0.0	0.0	0.0	0.0	0.0	0.0	0.0	0.0	0.0	0.0	0.0	0.0
%ile BackOfQ(50%),veh/ln	5.8	4.3	6.1	1.3	7.7	6.3	10.4	20.0	0.0	6.9	15.9	0.0
Unsig. Movement Delay, s/veh												
LnGrp Delay(d),s/veh	91.8	32.3	20.6	39.2	52.7	37.9	62.5	50.8	0.0	60.4	46.1	0.0
LnGrp LOS	F	C	C	D	D	D	E	D		E	D	
Approach Vol, veh/h		1037			803			2447	A		1819	A
Approach Delay, s/veh		42.6			47.3			53.7			48.0	
Approach LOS		D			D			D			D	
Timer - Assigned Phs	1	2	3	4	5	6	7	8				
Phs Duration (G+Y+Rc), s	19.0	58.8	8.6	33.5	30.6	47.2	15.0	27.2				
Change Period (Y+Rc), s	6.5	6.5	4.5	6.0	6.5	6.5	4.5	6.0				
Max Green Setting (Gmax), s	12.5	47.0	5.0	32.0	29.5	30.0	10.5	26.5				
Max Q Clear Time (g_c+I1), s	13.0	44.2	4.9	22.4	22.7	38.1	12.5	18.5				
Green Ext Time (p_c), s	0.0	2.5	0.0	3.0	1.4	0.0	0.0	2.7				

Intersection Summary

HCM 6th Ctrl Delay	49.3
HCM 6th LOS	D

Notes

Unsignalized Delay for [NBR, SBR] is excluded from calculations of the approach delay and intersection delay.

Intersection						
Int Delay, s/veh	3.7					
Movement	EBL	EBR	NBL	NBT	SBT	SBR
Lane Configurations	↖	↗	↖	↕↕	↕↕	↗
Traffic Vol, veh/h	90	90	50	775	1300	200
Future Vol, veh/h	90	90	50	775	1300	200
Conflicting Peds, #/hr	0	0	0	0	0	0
Sign Control	Stop	Stop	Free	Free	Free	Free
RT Channelized	-	None	-	None	-	None
Storage Length	200	0	300	-	-	250
Veh in Median Storage, #	1	-	-	0	0	-
Grade, %	0	-	-	0	0	-
Peak Hour Factor	92	92	92	92	92	92
Heavy Vehicles, %	2	2	2	5	5	2
Mvmt Flow	98	98	54	842	1413	217

Major/Minor	Minor2	Major1	Major2			
Conflicting Flow All	1942	707	1630	0	-	0
Stage 1	1413	-	-	-	-	-
Stage 2	529	-	-	-	-	-
Critical Hdwy	6.84	6.94	4.14	-	-	-
Critical Hdwy Stg 1	5.84	-	-	-	-	-
Critical Hdwy Stg 2	5.84	-	-	-	-	-
Follow-up Hdwy	3.52	3.32	2.22	-	-	-
Pot Cap-1 Maneuver	*~ 80	378	394	-	-	-
Stage 1	*191	-	-	-	-	-
Stage 2	*720	-	-	-	-	-
Platoon blocked, %	1			-	-	-
Mov Cap-1 Maneuver	*~ 69	378	394	-	-	-
Mov Cap-2 Maneuver	*139	-	-	-	-	-
Stage 1	*165	-	-	-	-	-
Stage 2	*720	-	-	-	-	-

Approach	EB	NB	SB
HCM Control Delay, s	47.3	0.9	0
HCM LOS	E		

Minor Lane/Major Mvmt	NBL	NBT	EBLn1	EBLn2	SBT	SBR
Capacity (veh/h)	394	-	139	378	-	-
HCM Lane V/C Ratio	0.138	-	0.704	0.259	-	-
HCM Control Delay (s)	15.6	-	76.7	17.8	-	-
HCM Lane LOS	C	-	F	C	-	-
HCM 95th %tile Q(veh)	0.5	-	4	1	-	-

Notes
 -: Volume exceeds capacity \$: Delay exceeds 300s +: Computation Not Defined *: All major volume in platoon

Intersection						
Int Delay, s/veh	2.7					
Movement	EBL	EBR	NBL	NBT	SBT	SBR
Lane Configurations	↖	↗	↖	↕	↕	↗
Traffic Vol, veh/h	90	90	50	1365	1045	185
Future Vol, veh/h	90	90	50	1365	1045	185
Conflicting Peds, #/hr	0	0	0	0	0	0
Sign Control	Stop	Stop	Free	Free	Free	Free
RT Channelized	-	None	-	None	-	None
Storage Length	200	0	300	-	-	250
Veh in Median Storage, #	1	-	-	0	0	-
Grade, %	0	-	-	0	0	-
Peak Hour Factor	92	92	92	92	92	92
Heavy Vehicles, %	2	2	2	3	3	2
Mvmt Flow	98	98	54	1484	1136	201

Major/Minor	Minor2	Major1	Major2			
Conflicting Flow All	1986	568	1337	0	-	0
Stage 1	1136	-	-	-	-	-
Stage 2	850	-	-	-	-	-
Critical Hdwy	6.84	6.94	4.14	-	-	-
Critical Hdwy Stg 1	5.84	-	-	-	-	-
Critical Hdwy Stg 2	5.84	-	-	-	-	-
Follow-up Hdwy	3.52	3.32	2.22	-	-	-
Pot Cap-1 Maneuver	~ 53	466	512	-	-	-
Stage 1	268	-	-	-	-	-
Stage 2	379	-	-	-	-	-
Platoon blocked, %				-	-	-
Mov Cap-1 Maneuver	~ 47	466	512	-	-	-
Mov Cap-2 Maneuver	154	-	-	-	-	-
Stage 1	240	-	-	-	-	-
Stage 2	379	-	-	-	-	-

Approach	EB	NB	SB
HCM Control Delay, s	38.5	0.5	0
HCM LOS	E		

Minor Lane/Major Mvmt	NBL	NBT	EBLn1	EBLn2	SBT	SBR
Capacity (veh/h)	512	-	154	466	-	-
HCM Lane V/C Ratio	0.106	-	0.635	0.21	-	-
HCM Control Delay (s)	12.9	-	62.1	14.8	-	-
HCM Lane LOS	B	-	F	B	-	-
HCM 95th %tile Q(veh)	0.4	-	3.5	0.8	-	-

Notes
 -: Volume exceeds capacity \$: Delay exceeds 300s +: Computation Not Defined *: All major volume in platoon

Timings
 9: Marksheffel Rd & CRN North Full Access



Lane Group	EBL	EBR	NBL	NBT	SBT	SBR
Lane Configurations	↖	↗	↖	↑↑	↑↑	↗
Traffic Volume (vph)	90	90	50	775	1300	200
Future Volume (vph)	90	90	50	775	1300	200
Turn Type	Prot	Perm	pm+pt	NA	NA	Perm
Protected Phases	4		5	2	6	
Permitted Phases		4	2			6
Detector Phase	4	4	5	2	6	6
Switch Phase						
Minimum Initial (s)	5.0	5.0	5.0	5.0	5.0	5.0
Minimum Split (s)	24.0	24.0	11.0	24.0	24.0	24.0
Total Split (s)	30.0	30.0	11.0	90.0	79.0	79.0
Total Split (%)	25.0%	25.0%	9.2%	75.0%	65.8%	65.8%
Yellow Time (s)	3.5	3.5	4.5	4.5	4.5	4.5
All-Red Time (s)	1.5	1.5	1.0	1.0	1.0	1.0
Lost Time Adjust (s)	0.0	0.0	0.0	0.0	0.0	0.0
Total Lost Time (s)	5.0	5.0	5.5	5.5	5.5	5.5
Lead/Lag			Lead		Lag	Lag
Lead-Lag Optimize?			Yes		Yes	Yes
Recall Mode	None	None	None	C-Max	C-Max	C-Max
Act Effect Green (s)	12.0	12.0	97.5	97.5	88.0	88.0
Actuated g/C Ratio	0.10	0.10	0.81	0.81	0.73	0.73
v/c Ratio	0.55	0.40	0.18	0.30	0.56	0.18
Control Delay	62.7	14.2	6.6	5.7	25.0	8.9
Queue Delay	0.0	0.0	0.0	0.0	0.0	0.0
Total Delay	62.7	14.2	6.6	5.7	25.0	8.9
LOS	E	B	A	A	C	A
Approach Delay	38.4			5.7	22.8	
Approach LOS	D			A	C	

Intersection Summary

Cycle Length: 120
 Actuated Cycle Length: 120
 Offset: 0 (0%), Referenced to phase 2:NBTL and 6:SBT, Start of Green
 Natural Cycle: 70
 Control Type: Actuated-Coordinated
 Maximum v/c Ratio: 0.56
 Intersection Signal Delay: 18.3
 Intersection Capacity Utilization 55.3%
 Analysis Period (min) 15
 Intersection LOS: B
 ICU Level of Service B

Splits and Phases: 9: Marksheffel Rd & CRN North Full Access

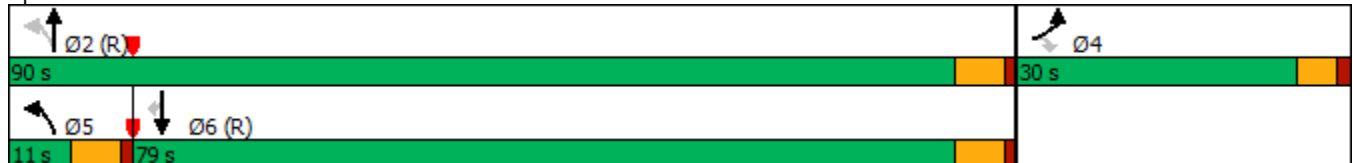

HCM 6th Signalized Intersection Summary
 9: Marksheffel Rd & CRN North Full Access

2026 Total AM Improved.syn
 02/16/2021



Movement	EBL	EBR	NBL	NBT	SBT	SBR
Lane Configurations						
Traffic Volume (veh/h)	90	90	50	775	1300	200
Future Volume (veh/h)	90	90	50	775	1300	200
Initial Q (Qb), veh	0	0	0	0	0	0
Ped-Bike Adj(A_pbT)	1.00	1.00	1.00			1.00
Parking Bus, Adj	1.00	1.00	1.00	1.00	1.00	1.00
Work Zone On Approach	No			No	No	
Adj Sat Flow, veh/h/ln	1870	1870	1870	1826	1826	1870
Adj Flow Rate, veh/h	98	98	54	842	1413	217
Peak Hour Factor	0.92	0.92	0.92	0.92	0.92	0.92
Percent Heavy Veh, %	2	2	2	5	5	2
Cap, veh/h	145	129	301	2884	2604	1190
Arrive On Green	0.08	0.08	0.07	1.00	0.75	0.75
Sat Flow, veh/h	1781	1585	1781	3561	3561	1585
Grp Volume(v), veh/h	98	98	54	842	1413	217
Grp Sat Flow(s),veh/h/ln	1781	1585	1781	1735	1735	1585
Q Serve(g_s), s	6.4	7.3	0.7	0.0	20.6	4.7
Cycle Q Clear(g_c), s	6.4	7.3	0.7	0.0	20.6	4.7
Prop In Lane	1.00	1.00	1.00			1.00
Lane Grp Cap(c), veh/h	145	129	301	2884	2604	1190
V/C Ratio(X)	0.68	0.76	0.18	0.29	0.54	0.18
Avail Cap(c_a), veh/h	371	330	321	2884	2604	1190
HCM Platoon Ratio	1.00	1.00	2.00	2.00	1.00	1.00
Upstream Filter(l)	1.00	1.00	0.96	0.96	1.00	1.00
Uniform Delay (d), s/veh	53.6	54.0	4.8	0.0	6.3	4.3
Incr Delay (d2), s/veh	5.5	8.9	0.3	0.2	0.8	0.3
Initial Q Delay(d3),s/veh	0.0	0.0	0.0	0.0	0.0	0.0
%ile BackOfQ(50%),veh/ln	3.1	6.6	0.2	0.1	6.8	1.5
Unsig. Movement Delay, s/veh						
LnGrp Delay(d),s/veh	59.1	62.9	5.1	0.2	7.1	4.7
LnGrp LOS	E	E	A	A	A	A
Approach Vol, veh/h	196			896	1630	
Approach Delay, s/veh	61.0			0.5	6.8	
Approach LOS	E			A	A	
Timer - Assigned Phs		2		4	5	6
Phs Duration (G+Y+Rc), s		105.3		14.7	9.7	95.6
Change Period (Y+Rc), s		5.5		5.0	5.5	5.5
Max Green Setting (Gmax), s		84.5		25.0	5.5	73.5
Max Q Clear Time (g_c+I1), s		2.0		9.3	2.7	22.6
Green Ext Time (p_c), s		7.5		0.5	0.0	18.2
Intersection Summary						
HCM 6th Ctrl Delay			8.6			
HCM 6th LOS			A			

Timings

9: Marksheffel Rd & CRN North Full Access



Lane Group	EBL	EBR	NBL	NBT	SBT	SBR
Lane Configurations	↖	↗	↖	↑↑	↑↑	↗
Traffic Volume (vph)	90	90	50	1365	1045	185
Future Volume (vph)	90	90	50	1365	1045	185
Turn Type	Prot	Perm	pm+pt	NA	NA	Perm
Protected Phases	4		5	2	6	
Permitted Phases		4	2			6
Detector Phase	4	4	5	2	6	6
Switch Phase						
Minimum Initial (s)	5.0	5.0	5.0	5.0	5.0	5.0
Minimum Split (s)	24.0	24.0	11.0	24.0	24.0	24.0
Total Split (s)	28.0	28.0	13.0	92.0	79.0	79.0
Total Split (%)	23.3%	23.3%	10.8%	76.7%	65.8%	65.8%
Yellow Time (s)	3.5	3.5	4.5	4.5	4.5	4.5
All-Red Time (s)	1.5	1.5	1.0	1.0	1.0	1.0
Lost Time Adjust (s)	0.0	0.0	0.0	0.0	0.0	0.0
Total Lost Time (s)	5.0	5.0	5.5	5.5	5.5	5.5
Lead/Lag			Lead		Lag	Lag
Lead-Lag Optimize?			Yes		Yes	Yes
Recall Mode	None	None	None	C-Max	C-Max	C-Max
Act Effect Green (s)	12.0	12.0	97.5	97.5	88.0	88.0
Actuated g/C Ratio	0.10	0.10	0.81	0.81	0.73	0.73
v/c Ratio	0.56	0.40	0.14	0.52	0.44	0.17
Control Delay	62.9	14.2	3.0	4.0	15.9	6.7
Queue Delay	0.0	0.0	0.0	0.0	0.0	0.0
Total Delay	62.9	14.2	3.0	4.0	15.9	6.7
LOS	E	B	A	A	B	A
Approach Delay	38.5			3.9	14.5	
Approach LOS	D			A	B	

Intersection Summary

Cycle Length: 120
 Actuated Cycle Length: 120
 Offset: 0 (0%), Referenced to phase 2:NBTL and 6:SBT, Start of Green
 Natural Cycle: 60
 Control Type: Actuated-Coordinated
 Maximum v/c Ratio: 0.56
 Intersection Signal Delay: 10.8
 Intersection Capacity Utilization 51.5%
 Analysis Period (min) 15
 Intersection LOS: B
 ICU Level of Service A

Splits and Phases: 9: Marksheffel Rd & CRN North Full Access



HCM 6th Signalized Intersection Summary
 9: Marksheffel Rd & CRN North Full Access

2026 Total PM Improved.syn
 02/16/2021



Movement	EBL	EBR	NBL	NBT	SBT	SBR
Lane Configurations						
Traffic Volume (veh/h)	90	90	50	1365	1045	185
Future Volume (veh/h)	90	90	50	1365	1045	185
Initial Q (Qb), veh	0	0	0	0	0	0
Ped-Bike Adj(A_pbT)	1.00	1.00	1.00			1.00
Parking Bus, Adj	1.00	1.00	1.00	1.00	1.00	1.00
Work Zone On Approach	No			No	No	
Adj Sat Flow, veh/h/ln	1870	1870	1870	1856	1856	1870
Adj Flow Rate, veh/h	98	98	54	1484	1136	201
Peak Hour Factor	0.92	0.92	0.92	0.92	0.92	0.92
Percent Heavy Veh, %	2	2	2	3	3	2
Cap, veh/h	144	128	381	2932	2648	1190
Arrive On Green	0.08	0.08	0.07	1.00	0.75	0.75
Sat Flow, veh/h	1781	1585	1781	3618	3618	1585
Grp Volume(v), veh/h	98	98	54	1484	1136	201
Grp Sat Flow(s),veh/h/ln	1781	1585	1781	1763	1763	1585
Q Serve(g_s), s	6.4	7.3	0.7	0.0	14.2	4.3
Cycle Q Clear(g_c), s	6.4	7.3	0.7	0.0	14.2	4.3
Prop In Lane	1.00	1.00	1.00			1.00
Lane Grp Cap(c), veh/h	144	128	381	2932	2648	1190
V/C Ratio(X)	0.68	0.76	0.14	0.51	0.43	0.17
Avail Cap(c_a), veh/h	341	304	430	2932	2648	1190
HCM Platoon Ratio	1.00	1.00	2.00	2.00	1.00	1.00
Upstream Filter(l)	1.00	1.00	0.85	0.85	1.00	1.00
Uniform Delay (d), s/veh	53.6	54.0	3.5	0.0	5.5	4.3
Incr Delay (d2), s/veh	5.5	9.0	0.1	0.5	0.5	0.3
Initial Q Delay(d3),s/veh	0.0	0.0	0.0	0.0	0.0	0.0
%ile BackOfQ(50%),veh/ln	3.1	6.6	0.2	0.2	4.7	1.3
Unsig. Movement Delay, s/veh						
LnGrp Delay(d),s/veh	59.1	63.1	3.7	0.5	6.0	4.6
LnGrp LOS	E	E	A	A	A	A
Approach Vol, veh/h	196			1538	1337	
Approach Delay, s/veh	61.1			0.6	5.8	
Approach LOS	E			A	A	
Timer - Assigned Phs		2		4	5	6
Phs Duration (G+Y+Rc), s		105.3		14.7	9.7	95.6
Change Period (Y+Rc), s		5.5		5.0	5.5	5.5
Max Green Setting (Gmax), s		86.5		23.0	7.5	73.5
Max Q Clear Time (g_c+I1), s		2.0		9.3	2.7	16.2
Green Ext Time (p_c), s		19.6		0.5	0.0	12.9
Intersection Summary						
HCM 6th Ctrl Delay			6.7			
HCM 6th LOS			A			

HCM 6th Signalized Intersection Summary
 9: Marksheffel Rd & CRN North Full Access

2040 Total AM.syn
 02/16/2021



Movement	EBL	EBR	NBL	NBT	SBT	SBR
Lane Configurations						
Traffic Volume (veh/h)	100	100	55	1160	1675	220
Future Volume (veh/h)	100	100	55	1160	1675	220
Initial Q (Qb), veh	0	0	0	0	0	0
Ped-Bike Adj(A_pbT)	1.00	1.00	1.00			1.00
Parking Bus, Adj	1.00	1.00	1.00	1.00	1.00	1.00
Work Zone On Approach	No			No	No	
Adj Sat Flow, veh/h/ln	1870	1870	1870	1826	1826	1870
Adj Flow Rate, veh/h	109	109	60	1261	1821	239
Peak Hour Factor	0.92	0.92	0.92	0.92	0.92	0.92
Percent Heavy Veh, %	2	2	2	5	5	2
Cap, veh/h	157	140	275	4109	3701	1177
Arrive On Green	0.09	0.09	0.07	1.00	1.00	1.00
Sat Flow, veh/h	1781	1585	1781	5149	5149	1585
Grp Volume(v), veh/h	109	109	60	1261	1821	239
Grp Sat Flow(s),veh/h/ln	1781	1585	1781	1662	1662	1585
Q Serve(g_s), s	7.1	8.1	0.9	0.0	0.0	0.0
Cycle Q Clear(g_c), s	7.1	8.1	0.9	0.0	0.0	0.0
Prop In Lane	1.00	1.00	1.00			1.00
Lane Grp Cap(c), veh/h	157	140	275	4109	3701	1177
V/C Ratio(X)	0.69	0.78	0.22	0.31	0.49	0.20
Avail Cap(c_a), veh/h	341	304	337	4109	3701	1177
HCM Platoon Ratio	1.00	1.00	2.00	2.00	2.00	2.00
Upstream Filter(l)	1.00	1.00	0.96	0.96	0.45	0.45
Uniform Delay (d), s/veh	53.1	53.6	2.5	0.0	0.0	0.0
Incr Delay (d2), s/veh	5.4	9.0	0.4	0.2	0.2	0.2
Initial Q Delay(d3),s/veh	0.0	0.0	0.0	0.0	0.0	0.0
%ile BackOfQ(50%),veh/ln	3.4	7.3	0.3	0.1	0.1	0.1
Unsig. Movement Delay, s/veh						
LnGrp Delay(d),s/veh	58.5	62.6	2.9	0.2	0.2	0.2
LnGrp LOS	E	E	A	A	A	A
Approach Vol, veh/h	218			1321	2060	
Approach Delay, s/veh	60.6			0.3	0.2	
Approach LOS	E			A	A	
Timer - Assigned Phs		2		4	5	6
Phs Duration (G+Y+Rc), s		104.4		15.6	9.8	94.6
Change Period (Y+Rc), s		5.5		5.0	5.5	5.5
Max Green Setting (Gmax), s		86.5		23.0	8.5	72.5
Max Q Clear Time (g_c+I1), s		2.0		10.1	2.9	2.0
Green Ext Time (p_c), s		13.6		0.5	0.0	29.1
Intersection Summary						
HCM 6th Ctrl Delay			3.9			
HCM 6th LOS			A			

Timings
 9: Marksheffel Rd & CRN North Full Access



Lane Group	EBL	EBR	NBL	NBT	SBT	SBR
Lane Configurations	↖	↗	↖	↑↑↑	↑↑↑	↗
Traffic Volume (vph)	100	100	80	2025	1760	310
Future Volume (vph)	100	100	80	2025	1760	310
Turn Type	Prot	Perm	pm+pt	NA	NA	Perm
Protected Phases	4		5	2	6	
Permitted Phases		4	2			6
Detector Phase	4	4	5	2	6	6
Switch Phase						
Minimum Initial (s)	5.0	5.0	5.0	5.0	5.0	5.0
Minimum Split (s)	24.0	24.0	11.0	24.0	24.0	24.0
Total Split (s)	34.0	34.0	15.0	86.0	71.0	71.0
Total Split (%)	28.3%	28.3%	12.5%	71.7%	59.2%	59.2%
Yellow Time (s)	3.5	3.5	4.5	4.5	4.5	4.5
All-Red Time (s)	1.5	1.5	1.0	1.0	1.0	1.0
Lost Time Adjust (s)	0.0	0.0	0.0	0.0	0.0	0.0
Total Lost Time (s)	5.0	5.0	5.5	5.5	5.5	5.5
Lead/Lag			Lead		Lag	Lag
Lead-Lag Optimize?			Yes		Yes	Yes
Recall Mode	None	None	None	C-Max	C-Max	C-Max
Act Effect Green (s)	12.7	12.7	96.8	96.8	83.9	83.9
Actuated g/C Ratio	0.11	0.11	0.81	0.81	0.70	0.70
v/c Ratio	0.58	0.41	0.40	0.54	0.54	0.28
Control Delay	63.0	13.4	15.8	4.1	22.0	8.1
Queue Delay	0.0	0.0	0.0	0.0	0.0	0.0
Total Delay	63.0	13.4	15.8	4.1	22.0	8.1
LOS	E	B	B	A	C	A
Approach Delay	38.2			4.5	19.9	
Approach LOS	D			A	B	

Intersection Summary

Cycle Length: 120
 Actuated Cycle Length: 120
 Offset: 0 (0%), Referenced to phase 2:NBTL and 6:SBT, Start of Green
 Natural Cycle: 65
 Control Type: Actuated-Coordinated
 Maximum v/c Ratio: 0.58
 Intersection Signal Delay: 13.3
 Intersection LOS: B
 Intersection Capacity Utilization 57.3%
 ICU Level of Service B
 Analysis Period (min) 15

Splits and Phases: 9: Marksheffel Rd & CRN North Full Access



HCM 6th Signalized Intersection Summary
 9: Marksheffel Rd & CRN North Full Access

2040 Total PM.syn
 02/16/2021



Movement	EBL	EBR	NBL	NBT	SBT	SBR
Lane Configurations						
Traffic Volume (veh/h)	100	100	80	2025	1760	310
Future Volume (veh/h)	100	100	80	2025	1760	310
Initial Q (Qb), veh	0	0	0	0	0	0
Ped-Bike Adj(A_pbT)	1.00	1.00	1.00			1.00
Parking Bus, Adj	1.00	1.00	1.00	1.00	1.00	1.00
Work Zone On Approach	No			No	No	
Adj Sat Flow, veh/h/ln	1870	1870	1870	1856	1856	1870
Adj Flow Rate, veh/h	109	109	87	2201	1913	337
Peak Hour Factor	0.92	0.92	0.92	0.92	0.92	0.92
Percent Heavy Veh, %	2	2	2	3	3	2
Cap, veh/h	158	141	254	4172	3741	1170
Arrive On Green	0.09	0.09	0.08	1.00	1.00	1.00
Sat Flow, veh/h	1781	1585	1781	5233	5233	1585
Grp Volume(v), veh/h	109	109	87	2201	1913	337
Grp Sat Flow(s),veh/h/ln	1781	1585	1781	1689	1689	1585
Q Serve(g_s), s	7.1	8.1	1.3	0.0	0.0	0.0
Cycle Q Clear(g_c), s	7.1	8.1	1.3	0.0	0.0	0.0
Prop In Lane	1.00	1.00	1.00			1.00
Lane Grp Cap(c), veh/h	158	141	254	4172	3741	1170
V/C Ratio(X)	0.69	0.77	0.34	0.53	0.51	0.29
Avail Cap(c_a), veh/h	430	383	325	4172	3741	1170
HCM Platoon Ratio	1.00	1.00	2.00	2.00	2.00	2.00
Upstream Filter(l)	1.00	1.00	0.83	0.83	0.54	0.54
Uniform Delay (d), s/veh	53.1	53.5	2.6	0.0	0.0	0.0
Incr Delay (d2), s/veh	5.2	8.7	0.7	0.4	0.3	0.3
Initial Q Delay(d3),s/veh	0.0	0.0	0.0	0.0	0.0	0.0
%ile BackOfQ(50%),veh/ln	3.4	7.3	0.4	0.2	0.1	0.1
Unsig. Movement Delay, s/veh						
LnGrp Delay(d),s/veh	58.3	62.2	3.2	0.4	0.3	0.3
LnGrp LOS	E	E	A	A	A	A
Approach Vol, veh/h				2288	2250	
Approach Delay, s/veh	60.3			0.5	0.3	
Approach LOS	E			A	A	
Timer - Assigned Phs		2		4	5	6
Phs Duration (G+Y+Rc), s		104.3		15.7	10.2	94.1
Change Period (Y+Rc), s		5.5		5.0	5.5	5.5
Max Green Setting (Gmax), s		80.5		29.0	9.5	65.5
Max Q Clear Time (g_c+l1), s		2.0		10.1	3.3	2.0
Green Ext Time (p_c), s		39.6		0.6	0.1	31.7
Intersection Summary						
HCM 6th Ctrl Delay			3.1			
HCM 6th LOS			A			

Intersection						
Int Delay, s/veh	6.1					
Movement	EBL	EBR	NBL	NBT	SBT	SBR
Lane Configurations	↖	↗	↖	↕	↕	↗
Traffic Vol, veh/h	70	200	150	755	1290	100
Future Vol, veh/h	70	200	150	755	1290	100
Conflicting Peds, #/hr	0	0	0	0	0	0
Sign Control	Stop	Stop	Free	Free	Free	Free
RT Channelized	-	None	-	None	-	None
Storage Length	200	0	300	-	-	250
Veh in Median Storage, #	1	-	-	0	0	-
Grade, %	0	-	-	0	0	-
Peak Hour Factor	92	92	92	92	92	92
Heavy Vehicles, %	2	2	2	5	5	2
Mvmt Flow	76	217	163	821	1402	109

Major/Minor	Minor2	Major1	Major2			
Conflicting Flow All	2139	701	1511	0	-	0
Stage 1	1402	-	-	-	-	-
Stage 2	737	-	-	-	-	-
Critical Hdwy	6.84	6.94	4.14	-	-	-
Critical Hdwy Stg 1	5.84	-	-	-	-	-
Critical Hdwy Stg 2	5.84	-	-	-	-	-
Follow-up Hdwy	3.52	3.32	2.22	-	-	-
Pot Cap-1 Maneuver	*~ 52	381	439	-	-	-
Stage 1	*193	-	-	-	-	-
Stage 2	*720	-	-	-	-	-
Platoon blocked, %	1			-	-	-
Mov Cap-1 Maneuver	*~ 33	381	439	-	-	-
Mov Cap-2 Maneuver	*101	-	-	-	-	-
Stage 1	*121	-	-	-	-	-
Stage 2	*720	-	-	-	-	-

Approach	EB	NB	SB
HCM Control Delay, s	47.6	3	0
HCM LOS	E		

Minor Lane/Major Mvmt	NBL	NBT	EBLn1	EBLn2	SBT	SBR
Capacity (veh/h)	439	-	101	381	-	-
HCM Lane V/C Ratio	0.371	-	0.753	0.571	-	-
HCM Control Delay (s)	18	-	108.3	26.3	-	-
HCM Lane LOS	C	-	F	D	-	-
HCM 95th %tile Q(veh)	1.7	-	4	3.4	-	-

Notes
 -: Volume exceeds capacity \$: Delay exceeds 300s +: Computation Not Defined *: All major volume in platoon

Intersection						
Int Delay, s/veh	3.8					
Movement	EBL	EBR	NBL	NBT	SBT	SBR
Lane Configurations	↖	↗	↖	↕	↕	↗
Traffic Vol, veh/h	70	200	140	1345	1040	95
Future Vol, veh/h	70	200	140	1345	1040	95
Conflicting Peds, #/hr	0	0	0	0	0	0
Sign Control	Stop	Stop	Free	Free	Free	Free
RT Channelized	-	None	-	None	-	None
Storage Length	200	0	300	-	-	250
Veh in Median Storage, #	1	-	-	0	0	-
Grade, %	0	-	-	0	0	-
Peak Hour Factor	92	92	92	92	92	92
Heavy Vehicles, %	2	2	2	3	3	2
Mvmt Flow	76	217	152	1462	1130	103

Major/Minor	Minor2	Major1	Major2			
Conflicting Flow All	2165	565	1233	0	-	0
Stage 1	1130	-	-	-	-	-
Stage 2	1035	-	-	-	-	-
Critical Hdwy	6.84	6.94	4.14	-	-	-
Critical Hdwy Stg 1	5.84	-	-	-	-	-
Critical Hdwy Stg 2	5.84	-	-	-	-	-
Follow-up Hdwy	3.52	3.32	2.22	-	-	-
Pot Cap-1 Maneuver	~ 40	468	561	-	-	-
Stage 1	270	-	-	-	-	-
Stage 2	303	-	-	-	-	-
Platoon blocked, %				-	-	-
Mov Cap-1 Maneuver	~ 29	468	561	-	-	-
Mov Cap-2 Maneuver	122	-	-	-	-	-
Stage 1	197	-	-	-	-	-
Stage 2	303	-	-	-	-	-

Approach	EB	NB	SB
HCM Control Delay, s	33.4	1.3	0
HCM LOS	D		

Minor Lane/Major Mvmt	NBL	NBT	EBLn1	EBLn2	SBT	SBR
Capacity (veh/h)	561	-	122	468	-	-
HCM Lane V/C Ratio	0.271	-	0.624	0.465	-	-
HCM Control Delay (s)	13.8	-	74.1	19.2	-	-
HCM Lane LOS	B	-	F	C	-	-
HCM 95th %tile Q(veh)	1.1	-	3.2	2.4	-	-

Notes
 -: Volume exceeds capacity \$: Delay exceeds 300s +: Computation Not Defined *: All major volume in platoon

Timings

10: Marksheffel Rd & Airl Lane (CRN South Full Access)



Lane Group	EBL	EBR	NBL	NBT	SBT	SBR
Lane Configurations	↖	↗	↖	↑↑	↑↑	↗
Traffic Volume (vph)	70	200	150	755	1290	100
Future Volume (vph)	70	200	150	755	1290	100
Turn Type	Prot	Perm	pm+pt	NA	NA	Perm
Protected Phases	4		5	2	6	
Permitted Phases		4	2			6
Detector Phase	4	4	5	2	6	6
Switch Phase						
Minimum Initial (s)	5.0	5.0	5.0	5.0	5.0	5.0
Minimum Split (s)	23.0	23.0	10.5	23.5	23.5	23.5
Total Split (s)	25.0	25.0	19.0	95.0	76.0	76.0
Total Split (%)	20.8%	20.8%	15.8%	79.2%	63.3%	63.3%
Yellow Time (s)	3.5	3.5	4.5	4.5	4.5	4.5
All-Red Time (s)	1.5	1.5	1.0	1.0	1.0	1.0
Lost Time Adjust (s)	0.0	0.0	0.0	0.0	0.0	0.0
Total Lost Time (s)	5.0	5.0	5.5	5.5	5.5	5.5
Lead/Lag			Lead		Lag	Lag
Lead-Lag Optimize?			Yes		Yes	Yes
Recall Mode	None	None	None	C-Max	C-Max	C-Max
Act Effect Green (s)	10.5	10.5	99.0	99.0	85.1	85.1
Actuated g/C Ratio	0.09	0.09	0.82	0.82	0.71	0.71
v/c Ratio	0.49	0.65	0.51	0.29	0.58	0.09
Control Delay	62.2	17.1	16.0	2.7	4.7	0.7
Queue Delay	0.0	0.0	0.0	0.0	0.0	0.0
Total Delay	62.2	17.1	16.0	2.7	4.7	0.7
LOS	E	B	B	A	A	A
Approach Delay	28.8			4.9	4.4	
Approach LOS	C			A	A	

Intersection Summary

Cycle Length: 120
 Actuated Cycle Length: 120
 Offset: 0 (0%), Referenced to phase 2:NBTL and 6:SBT, Start of Green
 Natural Cycle: 75
 Control Type: Actuated-Coordinated
 Maximum v/c Ratio: 0.65
 Intersection Signal Delay: 7.1
 Intersection Capacity Utilization 61.5%
 Analysis Period (min) 15

Intersection LOS: A
 ICU Level of Service B

Splits and Phases: 10: Marksheffel Rd & Airl Lane (CRN South Full Access)

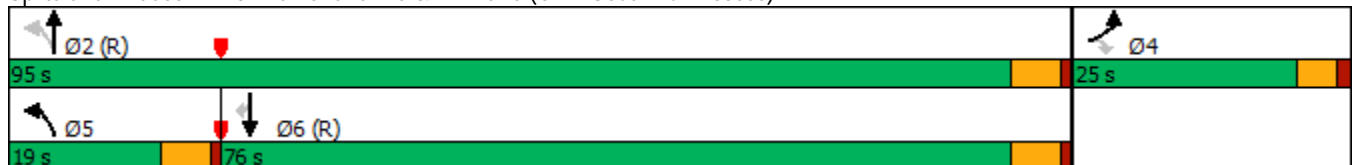

HCM 6th Signalized Intersection Summary
 10: Marksheffel Rd & Airl Lane (CRN South Full Access)

2026 Total AM Improved.syn

02/15/2021



Movement	EBL	EBR	NBL	NBT	SBT	SBR
Lane Configurations						
Traffic Volume (veh/h)	70	200	150	755	1290	100
Future Volume (veh/h)	70	200	150	755	1290	100
Initial Q (Qb), veh	0	0	0	0	0	0
Ped-Bike Adj(A_pbT)	1.00	1.00	1.00			1.00
Parking Bus, Adj	1.00	1.00	1.00	1.00	1.00	1.00
Work Zone On Approach	No			No	No	
Adj Sat Flow, veh/h/ln	1870	1870	1870	1826	1826	1870
Adj Flow Rate, veh/h	76	217	163	821	1402	109
Peak Hour Factor	0.92	0.92	0.92	0.92	0.92	0.92
Percent Heavy Veh, %	2	2	2	5	5	2
Cap, veh/h	272	242	375	2636	2313	1057
Arrive On Green	0.15	0.15	0.09	1.00	1.00	1.00
Sat Flow, veh/h	1781	1585	1781	3561	3561	1585
Grp Volume(v), veh/h	76	217	163	821	1402	109
Grp Sat Flow(s),veh/h/ln	1781	1585	1781	1735	1735	1585
Q Serve(g_s), s	4.5	16.1	3.4	0.0	0.0	0.0
Cycle Q Clear(g_c), s	4.5	16.1	3.4	0.0	0.0	0.0
Prop In Lane	1.00	1.00	1.00			1.00
Lane Grp Cap(c), veh/h	272	242	375	2636	2313	1057
V/C Ratio(X)	0.28	0.90	0.43	0.31	0.61	0.10
Avail Cap(c_a), veh/h	297	264	491	2636	2313	1057
HCM Platoon Ratio	1.00	1.00	2.00	2.00	2.00	2.00
Upstream Filter(l)	1.00	1.00	0.86	0.86	0.76	0.76
Uniform Delay (d), s/veh	45.0	49.9	4.6	0.0	0.0	0.0
Incr Delay (d2), s/veh	0.6	28.8	0.7	0.3	0.9	0.1
Initial Q Delay(d3),s/veh	0.0	0.0	0.0	0.0	0.0	0.0
%ile BackOfQ(50%),veh/ln	2.1	15.3	1.1	0.1	0.3	0.0
Unsig. Movement Delay, s/veh						
LnGrp Delay(d),s/veh	45.6	78.7	5.3	0.3	0.9	0.1
LnGrp LOS	D	E	A	A	A	A
Approach Vol, veh/h				984	1511	
Approach Delay, s/veh				1.1	0.9	
Approach LOS				A	A	
Timer - Assigned Phs		2		4	5	6
Phs Duration (G+Y+Rc), s		96.7		23.3	11.2	85.5
Change Period (Y+Rc), s		5.5		5.0	5.5	5.5
Max Green Setting (Gmax), s		89.5		20.0	13.5	70.5
Max Q Clear Time (g_c+l1), s		2.0		18.1	5.4	2.0
Green Ext Time (p_c), s		7.3		0.2	0.3	18.1
Intersection Summary						
HCM 6th Ctrl Delay			8.2			
HCM 6th LOS			A			

Timings

10: Marksheffel Rd & Airl Lane (CRN South Full Access)



Lane Group	EBL	EBR	NBL	NBT	SBT	SBR
Lane Configurations	↖	↗	↖	↑↑	↑↑	↗
Traffic Volume (vph)	70	200	140	1345	1040	95
Future Volume (vph)	70	200	140	1345	1040	95
Turn Type	Prot	Perm	pm+pt	NA	NA	Perm
Protected Phases	4		5	2	6	
Permitted Phases		4	2			6
Detector Phase	4	4	5	2	6	6
Switch Phase						
Minimum Initial (s)	5.0	5.0	5.0	5.0	5.0	5.0
Minimum Split (s)	23.0	23.0	10.5	23.5	23.5	23.5
Total Split (s)	29.0	29.0	20.0	91.0	71.0	71.0
Total Split (%)	24.2%	24.2%	16.7%	75.8%	59.2%	59.2%
Yellow Time (s)	3.5	3.5	4.5	4.5	4.5	4.5
All-Red Time (s)	1.5	1.5	1.0	1.0	1.0	1.0
Lost Time Adjust (s)	0.0	0.0	0.0	0.0	0.0	0.0
Total Lost Time (s)	5.0	5.0	5.5	5.5	5.5	5.5
Lead/Lag			Lead		Lag	Lag
Lead-Lag Optimize?			Yes		Yes	Yes
Recall Mode	None	None	None	C-Max	C-Max	C-Max
Act Effect Green (s)	10.5	10.5	99.0	99.0	85.9	85.9
Actuated g/C Ratio	0.09	0.09	0.82	0.82	0.72	0.72
v/c Ratio	0.49	0.65	0.38	0.51	0.45	0.09
Control Delay	62.2	15.9	6.9	10.6	5.7	1.5
Queue Delay	0.0	0.0	0.0	0.0	0.0	0.0
Total Delay	62.2	15.9	6.9	10.6	5.7	1.5
LOS	E	B	A	B	A	A
Approach Delay	27.9			10.3	5.4	
Approach LOS	C			B	A	

Intersection Summary

Cycle Length: 120
 Actuated Cycle Length: 120
 Offset: 0 (0%), Referenced to phase 2:NBTL and 6:SBT, Start of Green
 Natural Cycle: 60
 Control Type: Actuated-Coordinated
 Maximum v/c Ratio: 0.65
 Intersection Signal Delay: 10.0
 Intersection Capacity Utilization 54.0%
 Analysis Period (min) 15
 Intersection LOS: A
 ICU Level of Service A

Splits and Phases: 10: Marksheffel Rd & Airl Lane (CRN South Full Access)



HCM 6th Signalized Intersection Summary
 10: Marksheffel Rd & Airl Lane (CRN South Full Access)

2026 Total PM Improved.syn

02/15/2021



Movement	EBL	EBR	NBL	NBT	SBT	SBR
Lane Configurations						
Traffic Volume (veh/h)	70	200	140	1345	1040	95
Future Volume (veh/h)	70	200	140	1345	1040	95
Initial Q (Qb), veh	0	0	0	0	0	0
Ped-Bike Adj(A_pbT)	1.00	1.00	1.00			1.00
Parking Bus, Adj	1.00	1.00	1.00	1.00	1.00	1.00
Work Zone On Approach	No			No	No	
Adj Sat Flow, veh/h/ln	1870	1870	1870	1856	1856	1870
Adj Flow Rate, veh/h	76	217	152	1462	1130	103
Peak Hour Factor	0.92	0.92	0.92	0.92	0.92	0.92
Percent Heavy Veh, %	2	2	2	3	3	2
Cap, veh/h	276	245	440	2671	2355	1059
Arrive On Green	0.15	0.15	0.04	0.76	1.00	1.00
Sat Flow, veh/h	1781	1585	1781	3618	3618	1585
Grp Volume(v), veh/h	76	217	152	1462	1130	103
Grp Sat Flow(s),veh/h/ln	1781	1585	1781	1763	1763	1585
Q Serve(g_s), s	4.5	16.1	3.0	20.6	0.0	0.0
Cycle Q Clear(g_c), s	4.5	16.1	3.0	20.6	0.0	0.0
Prop In Lane	1.00	1.00	1.00			1.00
Lane Grp Cap(c), veh/h	276	245	440	2671	2355	1059
V/C Ratio(X)	0.28	0.88	0.35	0.55	0.48	0.10
Avail Cap(c_a), veh/h	356	317	577	2671	2355	1059
HCM Platoon Ratio	1.00	1.00	1.00	1.00	2.00	2.00
Upstream Filter(l)	1.00	1.00	0.51	0.51	0.86	0.86
Uniform Delay (d), s/veh	44.8	49.7	4.9	6.0	0.0	0.0
Incr Delay (d2), s/veh	0.5	20.4	0.2	0.4	0.6	0.2
Initial Q Delay(d3),s/veh	0.0	0.0	0.0	0.0	0.0	0.0
%ile BackOfQ(50%),veh/ln	2.0	14.7	1.0	6.6	0.2	0.0
Unsig. Movement Delay, s/veh						
LnGrp Delay(d),s/veh	45.3	70.1	5.1	6.4	0.6	0.2
LnGrp LOS	D	E	A	A	A	A
Approach Vol, veh/h				1614	1233	
Approach Delay, s/veh				6.3	0.6	
Approach LOS				A	A	
Timer - Assigned Phs		2		4	5	6
Phs Duration (G+Y+Rc), s		96.4		23.6	10.8	85.7
Change Period (Y+Rc), s		5.5		5.0	5.5	5.5
Max Green Setting (Gmax), s		85.5		24.0	14.5	65.5
Max Q Clear Time (g_c+l1), s		22.6		18.1	5.0	2.0
Green Ext Time (p_c), s		18.3		0.5	0.3	12.2
Intersection Summary						
HCM 6th Ctrl Delay			9.4			
HCM 6th LOS			A			

Timings
 10: Marksheffel Rd & Airl Lane (CRN South Full Access)



Lane Group	EBL	EBR	NBL	NBT	SBT	SBR
Lane Configurations	↖	↗	↖	↑↑↑	↑↑↑	↗
Traffic Volume (vph)	75	225	165	1145	1665	110
Future Volume (vph)	75	225	165	1145	1665	110
Turn Type	Prot	Perm	pm+pt	NA	NA	Perm
Protected Phases	4		5	2	6	
Permitted Phases		4	2			6
Detector Phase	4	4	5	2	6	6
Switch Phase						
Minimum Initial (s)	5.0	5.0	5.0	5.0	5.0	5.0
Minimum Split (s)	23.0	23.0	10.5	23.5	23.5	23.5
Total Split (s)	27.0	27.0	25.0	93.0	68.0	68.0
Total Split (%)	22.5%	22.5%	20.8%	77.5%	56.7%	56.7%
Yellow Time (s)	3.5	3.5	4.5	4.5	4.5	4.5
All-Red Time (s)	1.5	1.5	1.0	1.0	1.0	1.0
Lost Time Adjust (s)	0.0	0.0	0.0	0.0	0.0	0.0
Total Lost Time (s)	5.0	5.0	5.5	5.5	5.5	5.5
Lead/Lag			Lead		Lag	Lag
Lead-Lag Optimize?			Yes		Yes	Yes
Recall Mode	None	None	None	C-Max	C-Max	C-Max
Act Effect Green (s)	10.9	10.9	98.6	98.6	81.1	81.1
Actuated g/C Ratio	0.09	0.09	0.82	0.82	0.68	0.68
v/c Ratio	0.51	0.67	0.61	0.31	0.54	0.11
Control Delay	62.4	15.7	22.1	7.6	3.1	0.5
Queue Delay	0.0	0.0	0.0	0.0	0.0	0.0
Total Delay	62.4	15.7	22.1	7.6	3.1	0.5
LOS	E	B	C	A	A	A
Approach Delay	27.4			9.4	2.9	
Approach LOS	C			A	A	

Intersection Summary

Cycle Length: 120
 Actuated Cycle Length: 120
 Offset: 0 (0%), Referenced to phase 2:NBTL and 6:SBT, Start of Green
 Natural Cycle: 65
 Control Type: Actuated-Coordinated
 Maximum v/c Ratio: 0.67
 Intersection Signal Delay: 7.6
 Intersection Capacity Utilization 58.8%
 Analysis Period (min) 15
 Intersection LOS: A
 ICU Level of Service B

Splits and Phases: 10: Marksheffel Rd & Airl Lane (CRN South Full Access)

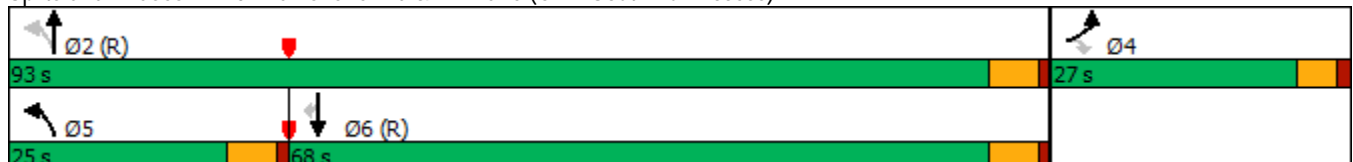

HCM 6th Signalized Intersection Summary
 10: Marksheffel Rd & Airl Lane (CRN South Full Access)

2040 Total AM.syn
 02/15/2021



Movement	EBL	EBR	NBL	NBT	SBT	SBR
Lane Configurations						
Traffic Volume (veh/h)	75	225	165	1145	1665	110
Future Volume (veh/h)	75	225	165	1145	1665	110
Initial Q (Qb), veh	0	0	0	0	0	0
Ped-Bike Adj(A_pbT)	1.00	1.00	1.00			1.00
Parking Bus, Adj	1.00	1.00	1.00	1.00	1.00	1.00
Work Zone On Approach	No			No	No	
Adj Sat Flow, veh/h/ln	1870	1870	1870	1826	1826	1870
Adj Flow Rate, veh/h	82	245	179	1245	1810	120
Peak Hour Factor	0.92	0.92	0.92	0.92	0.92	0.92
Percent Heavy Veh, %	2	2	2	5	5	2
Cap, veh/h	303	270	301	3700	3214	1022
Arrive On Green	0.17	0.17	0.05	0.74	1.00	1.00
Sat Flow, veh/h	1781	1585	1781	5149	5149	1585
Grp Volume(v), veh/h	82	245	179	1245	1810	120
Grp Sat Flow(s),veh/h/ln	1781	1585	1781	1662	1662	1585
Q Serve(g_s), s	4.8	18.2	3.8	10.3	0.0	0.0
Cycle Q Clear(g_c), s	4.8	18.2	3.8	10.3	0.0	0.0
Prop In Lane	1.00	1.00	1.00			1.00
Lane Grp Cap(c), veh/h	303	270	301	3700	3214	1022
V/C Ratio(X)	0.27	0.91	0.59	0.34	0.56	0.12
Avail Cap(c_a), veh/h	327	291	498	3700	3214	1022
HCM Platoon Ratio	1.00	1.00	1.00	1.00	2.00	2.00
Upstream Filter(l)	1.00	1.00	0.81	0.81	0.80	0.80
Uniform Delay (d), s/veh	43.3	48.9	5.6	5.3	0.0	0.0
Incr Delay (d2), s/veh	0.5	29.2	1.5	0.2	0.6	0.2
Initial Q Delay(d3),s/veh	0.0	0.0	0.0	0.0	0.0	0.0
%ile BackOfQ(50%),veh/ln	2.2	17.1	1.4	3.2	0.2	0.1
Unsig. Movement Delay, s/veh						
LnGrp Delay(d),s/veh	43.8	78.1	7.1	5.5	0.6	0.2
LnGrp LOS	D	E	A	A	A	A
Approach Vol, veh/h				1424	1930	
Approach Delay, s/veh				5.7	0.6	
Approach LOS				A	A	
Timer - Assigned Phs		2		4	5	6
Phs Duration (G+Y+Rc), s		94.6		25.4	11.7	82.9
Change Period (Y+Rc), s		5.5		5.0	5.5	5.5
Max Green Setting (Gmax), s		87.5		22.0	19.5	62.5
Max Q Clear Time (g_c+I1), s		12.3		20.2	5.8	2.0
Green Ext Time (p_c), s		13.2		0.2	0.4	26.0
Intersection Summary						
HCM 6th Ctrl Delay			8.7			
HCM 6th LOS			A			

Timings
 10: Marksheffel Rd & Airl Lane (CRN South Full Access)



Lane Group	EBL	EBR	NBL	NBT	SBT	SBR
Lane Configurations	↖	↗	↖	↑↑↑	↑↑↑	↗
Traffic Volume (vph)	75	225	235	2030	1705	155
Future Volume (vph)	75	225	235	2030	1705	155
Turn Type	Prot	Perm	pm+pt	NA	NA	Perm
Protected Phases	4		5	2	6	
Permitted Phases		4	2			6
Detector Phase	4	4	5	2	6	6
Switch Phase						
Minimum Initial (s)	5.0	5.0	5.0	5.0	5.0	5.0
Minimum Split (s)	23.0	23.0	10.5	23.5	23.5	23.5
Total Split (s)	23.0	23.0	30.0	97.0	67.0	67.0
Total Split (%)	19.2%	19.2%	25.0%	80.8%	55.8%	55.8%
Yellow Time (s)	3.5	3.5	4.5	4.5	4.5	4.5
All-Red Time (s)	1.5	1.5	1.0	1.0	1.0	1.0
Lost Time Adjust (s)	0.0	0.0	0.0	0.0	0.0	0.0
Total Lost Time (s)	5.0	5.0	5.5	5.5	5.5	5.5
Lead/Lag			Lead		Lag	Lag
Lead-Lag Optimize?			Yes		Yes	Yes
Recall Mode	None	None	None	C-Max	C-Max	C-Max
Act Effect Green (s)	10.9	10.9	98.6	98.6	76.1	76.1
Actuated g/C Ratio	0.09	0.09	0.82	0.82	0.63	0.63
v/c Ratio	0.51	0.67	0.74	0.53	0.58	0.16
Control Delay	62.5	15.7	35.3	1.4	7.7	1.7
Queue Delay	0.0	0.0	0.0	0.0	0.0	0.0
Total Delay	62.5	15.7	35.3	1.4	7.7	1.7
LOS	E	B	D	A	A	A
Approach Delay	27.4			4.9	7.2	
Approach LOS	C			A	A	

Intersection Summary

Cycle Length: 120
 Actuated Cycle Length: 120
 Offset: 0 (0%), Referenced to phase 2:NBTL and 6:SBT, Start of Green
 Natural Cycle: 75
 Control Type: Actuated-Coordinated
 Maximum v/c Ratio: 0.74
 Intersection Signal Delay: 7.4
 Intersection Capacity Utilization 63.5%
 Analysis Period (min) 15
 Intersection LOS: A
 ICU Level of Service B

Splits and Phases: 10: Marksheffel Rd & Airl Lane (CRN South Full Access)



HCM 6th Signalized Intersection Summary
 10: Marksheffel Rd & Airl Lane (CRN South Full Access)

2040 Total PM.syn
 02/15/2021



Movement	EBL	EBR	NBL	NBT	SBT	SBR
Lane Configurations						
Traffic Volume (veh/h)	75	225	235	2030	1705	155
Future Volume (veh/h)	75	225	235	2030	1705	155
Initial Q (Qb), veh	0	0	0	0	0	0
Ped-Bike Adj(A_pbT)	1.00	1.00	1.00			1.00
Parking Bus, Adj	1.00	1.00	1.00	1.00	1.00	1.00
Work Zone On Approach	No			No	No	
Adj Sat Flow, veh/h/ln	1870	1870	1870	1856	1856	1870
Adj Flow Rate, veh/h	82	245	255	2207	1853	168
Peak Hour Factor	0.92	0.92	0.92	0.92	0.92	0.92
Percent Heavy Veh, %	2	2	2	3	3	2
Cap, veh/h	267	238	318	3863	3285	1028
Arrive On Green	0.15	0.15	0.09	1.00	1.00	1.00
Sat Flow, veh/h	1781	1585	1781	5233	5233	1585
Grp Volume(v), veh/h	82	245	255	2207	1853	168
Grp Sat Flow(s),veh/h/ln	1781	1585	1781	1689	1689	1585
Q Serve(g_s), s	4.9	18.0	5.5	0.0	0.0	0.0
Cycle Q Clear(g_c), s	4.9	18.0	5.5	0.0	0.0	0.0
Prop In Lane	1.00	1.00	1.00			1.00
Lane Grp Cap(c), veh/h	267	238	318	3863	3285	1028
V/C Ratio(X)	0.31	1.03	0.80	0.57	0.56	0.16
Avail Cap(c_a), veh/h	267	238	560	3863	3285	1028
HCM Platoon Ratio	1.00	1.00	1.33	1.33	2.00	2.00
Upstream Filter(l)	1.00	1.00	0.21	0.21	0.77	0.77
Uniform Delay (d), s/veh	45.4	51.0	9.9	0.0	0.0	0.0
Incr Delay (d2), s/veh	0.6	66.5	1.0	0.1	0.5	0.3
Initial Q Delay(d3),s/veh	0.0	0.0	0.0	0.0	0.0	0.0
%ile BackOfQ(50%),veh/ln	2.2	19.0	1.8	0.0	0.2	0.1
Unsig. Movement Delay, s/veh						
LnGrp Delay(d),s/veh	46.1	117.5	10.9	0.1	0.5	0.3
LnGrp LOS	D	F	B	A	A	A
Approach Vol, veh/h	327			2462	2021	
Approach Delay, s/veh	99.6			1.2	0.5	
Approach LOS	F			A	A	
Timer - Assigned Phs		2		4	5	6
Phs Duration (G+Y+Rc), s		97.0		23.0	13.7	83.3
Change Period (Y+Rc), s		5.5		5.0	5.5	5.5
Max Green Setting (Gmax), s		91.5		18.0	24.5	61.5
Max Q Clear Time (g_c+I1), s		2.0		20.0	7.5	2.0
Green Ext Time (p_c), s		42.1		0.0	0.7	27.3
Intersection Summary						
HCM 6th Ctrl Delay			7.6			
HCM 6th LOS			A			

Intersection						
Int Delay, s/veh	7.4					
Movement	WBL	WBR	NBT	NBR	SBL	SBT
Lane Configurations						
Traffic Vol, veh/h	200	50	2	70	25	22
Future Vol, veh/h	200	50	2	70	25	22
Conflicting Peds, #/hr	0	0	0	0	0	0
Sign Control	Stop	Stop	Free	Free	Free	Free
RT Channelized	-	None	-	None	-	None
Storage Length	0	185	-	-	-	-
Veh in Median Storage, #	0	-	1	-	-	1
Grade, %	0	-	0	-	-	0
Peak Hour Factor	92	92	92	92	92	92
Heavy Vehicles, %	2	2	2	2	2	2
Mvmt Flow	217	54	2	76	27	24

Major/Minor	Minor1	Major1	Major2			
Conflicting Flow All	118	40	0	0	78	0
Stage 1	40	-	-	-	-	-
Stage 2	78	-	-	-	-	-
Critical Hdwy	6.42	6.22	-	-	4.12	-
Critical Hdwy Stg 1	5.42	-	-	-	-	-
Critical Hdwy Stg 2	5.42	-	-	-	-	-
Follow-up Hdwy	3.518	3.318	-	-	2.218	-
Pot Cap-1 Maneuver	878	1031	-	-	1520	-
Stage 1	982	-	-	-	-	-
Stage 2	945	-	-	-	-	-
Platoon blocked, %			-	-		
Mov Cap-1 Maneuver	862	1031	-	-	1520	-
Mov Cap-2 Maneuver	862	-	-	-	-	-
Stage 1	982	-	-	-	-	-
Stage 2	928	-	-	-	-	-

Approach	WB	NB	SB
HCM Control Delay, s	10.2	0	3.9
HCM LOS	B		

Minor Lane/Major Mvmt	NBT	NBRWBLn1	WBLn2	SBL	SBT	
Capacity (veh/h)	-	-	862	1031	1520	-
HCM Lane V/C Ratio	-	-	0.252	0.053	0.018	-
HCM Control Delay (s)	-	-	10.6	8.7	7.4	0
HCM Lane LOS	-	-	B	A	A	A
HCM 95th %tile Q(veh)	-	-	1	0.2	0.1	-

Intersection						
Int Delay, s/veh	7.2					
Movement	WBL	WBR	NBT	NBR	SBL	SBT
Lane Configurations						
Traffic Vol, veh/h	185	50	2	70	25	22
Future Vol, veh/h	185	50	2	70	25	22
Conflicting Peds, #/hr	0	0	0	0	0	0
Sign Control	Stop	Stop	Free	Free	Free	Free
RT Channelized	-	None	-	None	-	None
Storage Length	0	235	-	-	-	-
Veh in Median Storage, #	0	-	1	-	-	1
Grade, %	0	-	0	-	-	0
Peak Hour Factor	92	92	92	92	92	92
Heavy Vehicles, %	2	2	2	2	2	2
Mvmt Flow	201	54	2	76	27	24

Major/Minor	Minor1	Major1	Major2			
Conflicting Flow All	118	40	0	0	78	0
Stage 1	40	-	-	-	-	-
Stage 2	78	-	-	-	-	-
Critical Hdwy	6.42	6.22	-	-	4.12	-
Critical Hdwy Stg 1	5.42	-	-	-	-	-
Critical Hdwy Stg 2	5.42	-	-	-	-	-
Follow-up Hdwy	3.518	3.318	-	-	2.218	-
Pot Cap-1 Maneuver	878	1031	-	-	1520	-
Stage 1	982	-	-	-	-	-
Stage 2	945	-	-	-	-	-
Platoon blocked, %			-	-		
Mov Cap-1 Maneuver	862	1031	-	-	1520	-
Mov Cap-2 Maneuver	862	-	-	-	-	-
Stage 1	982	-	-	-	-	-
Stage 2	928	-	-	-	-	-

Approach	WB	NB	SB
HCM Control Delay, s	10	0	3.9
HCM LOS	B		

Minor Lane/Major Mvmt	NBT	NBRWBLn1	WBLn2	SBL	SBT	
Capacity (veh/h)	-	-	862	1031	1520	-
HCM Lane V/C Ratio	-	-	0.233	0.053	0.018	-
HCM Control Delay (s)	-	-	10.4	8.7	7.4	0
HCM Lane LOS	-	-	B	A	A	A
HCM 95th %tile Q(veh)	-	-	0.9	0.2	0.1	-

Intersection						
Int Delay, s/veh	7.6					
Movement	WBL	WBR	NBT	NBR	SBL	SBT
Lane Configurations						
Traffic Vol, veh/h	220	55	2	75	25	25
Future Vol, veh/h	220	55	2	75	25	25
Conflicting Peds, #/hr	0	0	0	0	0	0
Sign Control	Stop	Stop	Free	Free	Free	Free
RT Channelized	-	None	-	None	-	None
Storage Length	0	235	-	-	-	-
Veh in Median Storage, #	0	-	1	-	-	1
Grade, %	0	-	0	-	-	0
Peak Hour Factor	92	92	92	92	92	92
Heavy Vehicles, %	2	2	2	2	2	2
Mvmt Flow	239	60	2	82	27	27

Major/Minor	Minor1	Major1	Major2			
Conflicting Flow All	124	43	0	0	84	0
Stage 1	43	-	-	-	-	-
Stage 2	81	-	-	-	-	-
Critical Hdwy	6.42	6.22	-	-	4.12	-
Critical Hdwy Stg 1	5.42	-	-	-	-	-
Critical Hdwy Stg 2	5.42	-	-	-	-	-
Follow-up Hdwy	3.518	3.318	-	-	2.218	-
Pot Cap-1 Maneuver	871	1027	-	-	1513	-
Stage 1	979	-	-	-	-	-
Stage 2	942	-	-	-	-	-
Platoon blocked, %			-	-		-
Mov Cap-1 Maneuver	855	1027	-	-	1513	-
Mov Cap-2 Maneuver	855	-	-	-	-	-
Stage 1	979	-	-	-	-	-
Stage 2	925	-	-	-	-	-

Approach	WB	NB	SB
HCM Control Delay, s	10.4	0	3.7
HCM LOS	B		

Minor Lane/Major Mvmt	NBT	NBRWBLn1	WBLn2	SBL	SBT
Capacity (veh/h)	-	-	855	1027	1513
HCM Lane V/C Ratio	-	-	0.28	0.058	0.018
HCM Control Delay (s)	-	-	10.8	8.7	7.4
HCM Lane LOS	-	-	B	A	A
HCM 95th %tile Q(veh)	-	-	1.1	0.2	0.1

Intersection						
Int Delay, s/veh	8.9					
Movement	WBL	WBR	NBT	NBR	SBL	SBT
Lane Configurations						
Traffic Vol, veh/h	310	80	2	75	25	25
Future Vol, veh/h	310	80	2	75	25	25
Conflicting Peds, #/hr	0	0	0	0	0	0
Sign Control	Stop	Stop	Free	Free	Free	Free
RT Channelized	-	None	-	None	-	None
Storage Length	0	235	-	-	-	-
Veh in Median Storage, #	0	-	1	-	-	1
Grade, %	0	-	0	-	-	0
Peak Hour Factor	92	92	92	92	92	92
Heavy Vehicles, %	2	2	2	2	2	2
Mvmt Flow	337	87	2	82	27	27

Major/Minor	Minor1	Major1	Major2			
Conflicting Flow All	124	43	0	0	84	0
Stage 1	43	-	-	-	-	-
Stage 2	81	-	-	-	-	-
Critical Hdwy	6.42	6.22	-	-	4.12	-
Critical Hdwy Stg 1	5.42	-	-	-	-	-
Critical Hdwy Stg 2	5.42	-	-	-	-	-
Follow-up Hdwy	3.518	3.318	-	-	2.218	-
Pot Cap-1 Maneuver	871	1027	-	-	1513	-
Stage 1	979	-	-	-	-	-
Stage 2	942	-	-	-	-	-
Platoon blocked, %			-	-		
Mov Cap-1 Maneuver	855	1027	-	-	1513	-
Mov Cap-2 Maneuver	855	-	-	-	-	-
Stage 1	979	-	-	-	-	-
Stage 2	925	-	-	-	-	-

Approach	WB	NB	SB
HCM Control Delay, s	11.3	0	3.7
HCM LOS	B		

Minor Lane/Major Mvmt	NBT	NBRWBLn1	WBLn2	SBL	SBT	
Capacity (veh/h)	-	-	855	1027	1513	-
HCM Lane V/C Ratio	-	-	0.394	0.085	0.018	-
HCM Control Delay (s)	-	-	11.9	8.8	7.4	0
HCM Lane LOS	-	-	B	A	A	A
HCM 95th %tile Q(veh)	-	-	1.9	0.3	0.1	-

Intersection						
Int Delay, s/veh	6.2					
Movement	EBL	EBT	WBT	WBR	SBL	SBR
Lane Configurations		↕	↑	↗	↘	
Traffic Vol, veh/h	2	45	50	200	310	2
Future Vol, veh/h	2	45	50	200	310	2
Conflicting Peds, #/hr	0	0	0	0	0	0
Sign Control	Free	Free	Free	Free	Stop	Stop
RT Channelized	-	None	-	None	-	None
Storage Length	-	-	-	150	-	-
Veh in Median Storage, #	-	0	0	-	1	-
Grade, %	-	0	0	-	0	-
Peak Hour Factor	92	92	92	92	92	92
Heavy Vehicles, %	2	2	2	2	2	2
Mvmt Flow	2	49	54	217	337	2
Major/Minor	Major1	Major2	Minor2			
Conflicting Flow All	271	0	-	0	107	54
Stage 1	-	-	-	-	54	-
Stage 2	-	-	-	-	53	-
Critical Hdwy	4.12	-	-	-	6.42	6.22
Critical Hdwy Stg 1	-	-	-	-	5.42	-
Critical Hdwy Stg 2	-	-	-	-	5.42	-
Follow-up Hdwy	2.218	-	-	-	3.518	3.318
Pot Cap-1 Maneuver	1292	-	-	-	891	1013
Stage 1	-	-	-	-	969	-
Stage 2	-	-	-	-	970	-
Platoon blocked, %	-	-	-	-	-	-
Mov Cap-1 Maneuver	1292	-	-	-	889	1013
Mov Cap-2 Maneuver	-	-	-	-	848	-
Stage 1	-	-	-	-	967	-
Stage 2	-	-	-	-	970	-
Approach	EB	WB	SB			
HCM Control Delay, s	0.3	0	12			
HCM LOS			B			
Minor Lane/Major Mvmt	EBL	EBT	WBT	WBR	SBLn1	
Capacity (veh/h)	1292	-	-	-	849	
HCM Lane V/C Ratio	0.002	-	-	-	0.399	
HCM Control Delay (s)	7.8	0	-	-	12	
HCM Lane LOS	A	A	-	-	B	
HCM 95th %tile Q(veh)	0	-	-	-	1.9	

Intersection						
Int Delay, s/veh	6.3					
Movement	EBL	EBT	WBT	WBR	SBL	SBR
Lane Configurations		↕	↑	↗	↘	
Traffic Vol, veh/h	2	45	50	185	310	2
Future Vol, veh/h	2	45	50	185	310	2
Conflicting Peds, #/hr	0	0	0	0	0	0
Sign Control	Free	Free	Free	Free	Stop	Stop
RT Channelized	-	None	-	None	-	None
Storage Length	-	-	-	135	-	-
Veh in Median Storage, #	-	0	0	-	1	-
Grade, %	-	0	0	-	0	-
Peak Hour Factor	92	92	92	92	92	92
Heavy Vehicles, %	2	2	2	2	2	2
Mvmt Flow	2	49	54	201	337	2

Major/Minor	Major1	Major2	Minor2		
Conflicting Flow All	255	0	0	107	54
Stage 1	-	-	-	54	-
Stage 2	-	-	-	53	-
Critical Hdwy	4.12	-	-	6.42	6.22
Critical Hdwy Stg 1	-	-	-	5.42	-
Critical Hdwy Stg 2	-	-	-	5.42	-
Follow-up Hdwy	2.218	-	-	3.518	3.318
Pot Cap-1 Maneuver	1310	-	-	891	1013
Stage 1	-	-	-	969	-
Stage 2	-	-	-	970	-
Platoon blocked, %	-	-	-	-	-
Mov Cap-1 Maneuver	1310	-	-	889	1013
Mov Cap-2 Maneuver	-	-	-	848	-
Stage 1	-	-	-	967	-
Stage 2	-	-	-	970	-

Approach	EB	WB	SB
HCM Control Delay, s	0.3	0	12
HCM LOS			B

Minor Lane/Major Mvmt	EBL	EBT	WBT	WBR	SBLn1
Capacity (veh/h)	1310	-	-	-	849
HCM Lane V/C Ratio	0.002	-	-	-	0.399
HCM Control Delay (s)	7.8	0	-	-	12
HCM Lane LOS	A	A	-	-	B
HCM 95th %tile Q(veh)	0	-	-	-	1.9

Intersection

Int Delay, s/veh 6.6

Movement	EBL	EBT	WBT	WBR	SBL	SBR
Lane Configurations		↕	↑	↗	↘	
Traffic Vol, veh/h	2	50	55	220	345	2
Future Vol, veh/h	2	50	55	220	345	2
Conflicting Peds, #/hr	0	0	0	0	0	0
Sign Control	Free	Free	Free	Free	Stop	Stop
RT Channelized	-	None	-	None	-	None
Storage Length	-	-	-	135	-	-
Veh in Median Storage, #	-	0	0	-	1	-
Grade, %	-	0	0	-	0	-
Peak Hour Factor	92	92	92	92	92	92
Heavy Vehicles, %	2	2	2	2	2	2
Mvmt Flow	2	54	60	239	375	2

Major/Minor	Major1	Major2	Minor2		
Conflicting Flow All	299	0	0	118	60
Stage 1	-	-	-	60	-
Stage 2	-	-	-	58	-
Critical Hdwy	4.12	-	-	6.42	6.22
Critical Hdwy Stg 1	-	-	-	5.42	-
Critical Hdwy Stg 2	-	-	-	5.42	-
Follow-up Hdwy	2.218	-	-	3.518	3.318
Pot Cap-1 Maneuver	1262	-	-	878	1005
Stage 1	-	-	-	963	-
Stage 2	-	-	-	965	-
Platoon blocked, %	-	-	-	-	-
Mov Cap-1 Maneuver	1262	-	-	876	1005
Mov Cap-2 Maneuver	-	-	-	839	-
Stage 1	-	-	-	961	-
Stage 2	-	-	-	965	-

Approach	EB	WB	SB
HCM Control Delay, s	0.3	0	12.7
HCM LOS			B

Minor Lane/Major Mvmt	EBL	EBT	WBT	WBR	SBLn1
Capacity (veh/h)	1262	-	-	-	840
HCM Lane V/C Ratio	0.002	-	-	-	0.449
HCM Control Delay (s)	7.9	0	-	-	12.7
HCM Lane LOS	A	A	-	-	B
HCM 95th %tile Q(veh)	0	-	-	-	2.3

Intersection						
Int Delay, s/veh	5.9					
Movement	EBL	EBT	WBT	WBR	SBL	SBR
Lane Configurations		↕	↑	↗	↘	
Traffic Vol, veh/h	2	50	80	310	350	2
Future Vol, veh/h	2	50	80	310	350	2
Conflicting Peds, #/hr	0	0	0	0	0	0
Sign Control	Free	Free	Free	Free	Stop	Stop
RT Channelized	-	None	-	None	-	None
Storage Length	-	-	-	135	-	-
Veh in Median Storage, #	-	0	0	-	1	-
Grade, %	-	0	0	-	0	-
Peak Hour Factor	92	92	92	92	92	92
Heavy Vehicles, %	2	2	2	2	2	2
Mvmt Flow	2	54	87	337	380	2

Major/Minor	Major1	Major2	Minor2		
Conflicting Flow All	424	0	0	145	87
Stage 1	-	-	-	87	-
Stage 2	-	-	-	58	-
Critical Hdwy	4.12	-	-	6.42	6.22
Critical Hdwy Stg 1	-	-	-	5.42	-
Critical Hdwy Stg 2	-	-	-	5.42	-
Follow-up Hdwy	2.218	-	-	3.518	3.318
Pot Cap-1 Maneuver	1135	-	-	847	971
Stage 1	-	-	-	936	-
Stage 2	-	-	-	965	-
Platoon blocked, %	-	-	-	-	-
Mov Cap-1 Maneuver	1135	-	-	845	971
Mov Cap-2 Maneuver	-	-	-	818	-
Stage 1	-	-	-	934	-
Stage 2	-	-	-	965	-

Approach	EB	WB	SB
HCM Control Delay, s	0.3	0	13.2
HCM LOS			B

Minor Lane/Major Mvmt	EBL	EBT	WBT	WBR	SBLn1
Capacity (veh/h)	1135	-	-	-	819
HCM Lane V/C Ratio	0.002	-	-	-	0.467
HCM Control Delay (s)	8.2	0	-	-	13.2
HCM Lane LOS	A	A	-	-	B
HCM 95th %tile Q(veh)	0	-	-	-	2.5

4: Marksheffel Rd & CRN North Full Access

02/16/2021

Intersection						
Int Delay, s/veh	1					
Movement	EBL	EBR	NBL	NBT	SBT	SBR
Lane Configurations		↗	↘	↕	↕	↗
Traffic Vol, veh/h	0	90	50	860	1300	200
Future Vol, veh/h	0	90	50	860	1300	200
Conflicting Peds, #/hr	0	0	0	0	0	0
Sign Control	Stop	Stop	Free	Free	Free	Free
RT Channelized	-	None	-	None	-	None
Storage Length	-	0	300	-	-	250
Veh in Median Storage, #	1	-	-	0	0	-
Grade, %	0	-	-	0	0	-
Peak Hour Factor	92	92	92	92	92	92
Heavy Vehicles, %	2	2	2	5	5	2
Mvmt Flow	0	98	54	935	1413	217

Major/Minor	Minor2	Major1	Major2		
Conflicting Flow All	-	707	1630	0	0
Stage 1	-	-	-	-	-
Stage 2	-	-	-	-	-
Critical Hdwy	-	6.94	4.14	-	-
Critical Hdwy Stg 1	-	-	-	-	-
Critical Hdwy Stg 2	-	-	-	-	-
Follow-up Hdwy	-	3.32	2.22	-	-
Pot Cap-1 Maneuver	0	378	394	-	-
Stage 1	0	-	-	-	-
Stage 2	0	-	-	-	-
Platoon blocked, %				-	-
Mov Cap-1 Maneuver	-	378	394	-	-
Mov Cap-2 Maneuver	-	-	-	-	-
Stage 1	-	-	-	-	-
Stage 2	-	-	-	-	-

Approach	EB	NB	SB
HCM Control Delay, s	17.8	0.9	0
HCM LOS	C		

Minor Lane/Major Mvmt	NBL	NBT	EBLn1	SBT	SBR
Capacity (veh/h)	394	-	378	-	-
HCM Lane V/C Ratio	0.138	-	0.259	-	-
HCM Control Delay (s)	15.6	-	17.8	-	-
HCM Lane LOS	C	-	C	-	-
HCM 95th %tile Q(veh)	0.5	-	1	-	-

4: Marksheffel Rd & CRN North Full Access

02/16/2021

Intersection						
Int Delay, s/veh	0.7					
Movement	EBL	EBR	NBL	NBT	SBT	SBR
Lane Configurations		↗	↘	↕	↕	↗
Traffic Vol, veh/h	0	90	50	1450	1045	185
Future Vol, veh/h	0	90	50	1450	1045	185
Conflicting Peds, #/hr	0	0	0	0	0	0
Sign Control	Stop	Stop	Free	Free	Free	Free
RT Channelized	-	None	-	None	-	None
Storage Length	-	0	300	-	-	250
Veh in Median Storage, #	1	-	-	0	0	-
Grade, %	0	-	-	0	0	-
Peak Hour Factor	92	92	92	92	92	92
Heavy Vehicles, %	2	2	2	3	3	2
Mvmt Flow	0	98	54	1576	1136	201

Major/Minor	Minor2	Major1	Major2		
Conflicting Flow All	-	568	1337	0	0
Stage 1	-	-	-	-	-
Stage 2	-	-	-	-	-
Critical Hdwy	-	6.94	4.14	-	-
Critical Hdwy Stg 1	-	-	-	-	-
Critical Hdwy Stg 2	-	-	-	-	-
Follow-up Hdwy	-	3.32	2.22	-	-
Pot Cap-1 Maneuver	0	466	512	-	-
Stage 1	0	-	-	-	-
Stage 2	0	-	-	-	-
Platoon blocked, %				-	-
Mov Cap-1 Maneuver	-	466	512	-	-
Mov Cap-2 Maneuver	-	-	-	-	-
Stage 1	-	-	-	-	-
Stage 2	-	-	-	-	-

Approach	EB	NB	SB
HCM Control Delay, s	14.8	0.4	0
HCM LOS	B		

Minor Lane/Major Mvmt	NBL	NBT	EBLn1	SBT	SBR
Capacity (veh/h)	512	-	466	-	-
HCM Lane V/C Ratio	0.106	-	0.21	-	-
HCM Control Delay (s)	12.9	-	14.8	-	-
HCM Lane LOS	B	-	B	-	-
HCM 95th %tile Q(veh)	0.4	-	0.8	-	-

4: Marksheffel Rd & CRN North Full Access

02/16/2021

Intersection

Int Delay, s/veh 0.6

Movement	EBL	EBR	NBL	NBT	SBT	SBR
Lane Configurations		↗	↘	↑↑↑	↑↑↑	↗
Traffic Vol, veh/h	0	100	55	1260	1675	220
Future Vol, veh/h	0	100	55	1260	1675	220
Conflicting Peds, #/hr	0	0	0	0	0	0
Sign Control	Stop	Stop	Free	Free	Free	Free
RT Channelized	-	None	-	None	-	None
Storage Length	-	0	300	-	-	250
Veh in Median Storage, #	1	-	-	0	0	-
Grade, %	0	-	-	0	0	-
Peak Hour Factor	92	92	92	92	92	92
Heavy Vehicles, %	2	2	2	5	5	2
Mvmt Flow	0	109	60	1370	1821	239

Major/Minor

	Minor2	Major1	Major2		
Conflicting Flow All	-	911	2060	0	-
Stage 1	-	-	-	-	-
Stage 2	-	-	-	-	-
Critical Hdwy	-	7.14	5.34	-	-
Critical Hdwy Stg 1	-	-	-	-	-
Critical Hdwy Stg 2	-	-	-	-	-
Follow-up Hdwy	-	3.92	3.12	-	-
Pot Cap-1 Maneuver	0	*514	556	-	-
Stage 1	0	-	-	-	-
Stage 2	0	-	-	-	-
Platoon blocked, %		1	1	-	-
Mov Cap-1 Maneuver	-	*514	556	-	-
Mov Cap-2 Maneuver	-	-	-	-	-
Stage 1	-	-	-	-	-
Stage 2	-	-	-	-	-

Approach

	EB	NB	SB
HCM Control Delay, s	13.9	0.5	0
HCM LOS	B		

Minor Lane/Major Mvmt

	NBL	NBT	EBLn1	SBT	SBR
Capacity (veh/h)	556	-	514	-	-
HCM Lane V/C Ratio	0.108	-	0.211	-	-
HCM Control Delay (s)	12.3	-	13.9	-	-
HCM Lane LOS	B	-	B	-	-
HCM 95th %tile Q(veh)	0.4	-	0.8	-	-

Notes

-: Volume exceeds capacity \$: Delay exceeds 300s +: Computation Not Defined *: All major volume in platoon

4: Marksheffel Rd & CRN North Full Access

02/16/2021

Intersection						
Int Delay, s/veh	0.6					
Movement	EBL	EBR	NBL	NBT	SBT	SBR
Lane Configurations		↗	↘	↑↑↑	↑↑↑	↗
Traffic Vol, veh/h	0	100	80	2125	1760	310
Future Vol, veh/h	0	100	80	2125	1760	310
Conflicting Peds, #/hr	0	0	0	0	0	0
Sign Control	Stop	Stop	Free	Free	Free	Free
RT Channelized	-	None	-	None	-	None
Storage Length	-	0	300	-	-	250
Veh in Median Storage, #	1	-	-	0	0	-
Grade, %	0	-	-	0	0	-
Peak Hour Factor	92	92	92	92	92	92
Heavy Vehicles, %	2	2	2	3	3	2
Mvmt Flow	0	109	87	2310	1913	337

Major/Minor	Minor2	Major1	Major2		
Conflicting Flow All	-	957	2250	0	0
Stage 1	-	-	-	-	-
Stage 2	-	-	-	-	-
Critical Hdwy	-	7.14	5.34	-	-
Critical Hdwy Stg 1	-	-	-	-	-
Critical Hdwy Stg 2	-	-	-	-	-
Follow-up Hdwy	-	3.92	3.12	-	-
Pot Cap-1 Maneuver	0	*492	449	-	-
Stage 1	0	-	-	-	-
Stage 2	0	-	-	-	-
Platoon blocked, %		1	1	-	-
Mov Cap-1 Maneuver	-	*492	449	-	-
Mov Cap-2 Maneuver	-	-	-	-	-
Stage 1	-	-	-	-	-
Stage 2	-	-	-	-	-

Approach	EB	NB	SB
HCM Control Delay, s	14.4	0.5	0
HCM LOS	B		

Minor Lane/Major Mvmt	NBL	NBT	EBLn1	SBT	SBR
Capacity (veh/h)	449	-	492	-	-
HCM Lane V/C Ratio	0.194	-	0.221	-	-
HCM Control Delay (s)	14.9	-	14.4	-	-
HCM Lane LOS	B	-	B	-	-
HCM 95th %tile Q(veh)	0.7	-	0.8	-	-

Notes
 -: Volume exceeds capacity \$: Delay exceeds 300s +: Computation Not Defined *: All major volume in platoon

Timings

5: Marksheffel Rd & Airl Lane (CRN South Full Access)

02/16/2021



Lane Group	EBL	EBR	NBL	NBT	SBT	SBR
Lane Configurations	↖	↗	↖	↑↑	↑↑	↗
Traffic Volume (vph)	155	200	150	755	1290	100
Future Volume (vph)	155	200	150	755	1290	100
Turn Type	Prot	Perm	pm+pt	NA	NA	Perm
Protected Phases	4		5	2	6	
Permitted Phases		4	2			6
Detector Phase	4	4	5	2	6	6
Switch Phase						
Minimum Initial (s)	5.0	5.0	5.0	5.0	5.0	5.0
Minimum Split (s)	23.0	23.0	10.5	23.5	23.5	23.5
Total Split (s)	27.0	27.0	19.0	93.0	74.0	74.0
Total Split (%)	22.5%	22.5%	15.8%	77.5%	61.7%	61.7%
Yellow Time (s)	3.5	3.5	4.5	4.5	4.5	4.5
All-Red Time (s)	1.5	1.5	1.0	1.0	1.0	1.0
Lost Time Adjust (s)	0.0	0.0	0.0	0.0	0.0	0.0
Total Lost Time (s)	5.0	5.0	5.5	5.5	5.5	5.5
Lead/Lag			Lead		Lag	Lag
Lead-Lag Optimize?			Yes		Yes	Yes
Recall Mode	None	None	None	C-Max	C-Max	C-Max
Act Effect Green (s)	16.5	16.5	93.0	93.0	78.4	78.4
Actuated g/C Ratio	0.14	0.14	0.78	0.78	0.65	0.65
v/c Ratio	0.69	0.54	0.55	0.31	0.62	0.10
Control Delay	63.6	11.5	20.8	4.5	19.1	3.8
Queue Delay	0.0	0.0	0.0	0.0	0.0	0.0
Total Delay	63.6	11.5	20.8	4.5	19.1	3.8
LOS	E	B	C	A	B	A
Approach Delay	34.2			7.2	18.0	
Approach LOS	C			A	B	

Intersection Summary

Cycle Length: 120
 Actuated Cycle Length: 120
 Offset: 0 (0%), Referenced to phase 2:NBTL and 6:SBT, Start of Green
 Natural Cycle: 75
 Control Type: Actuated-Coordinated
 Maximum v/c Ratio: 0.69
 Intersection Signal Delay: 16.5
 Intersection LOS: B
 Intersection Capacity Utilization 65.9%
 ICU Level of Service C
 Analysis Period (min) 15

Splits and Phases: 10: Marksheffel Rd & Airl Lane (CRN South Full Access)

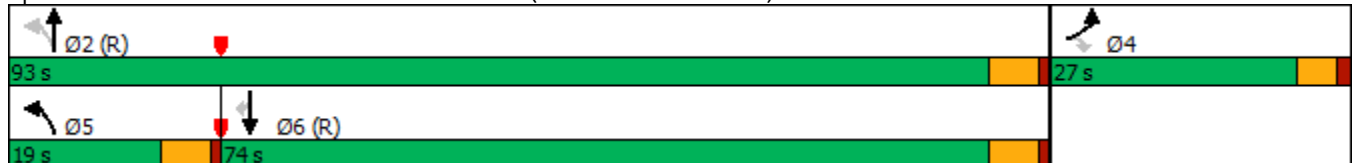

HCM 6th Signalized Intersection Summary

2026 Total AM Improved.syn

5: Marksheffel Rd & Airl Lane (CRN South Full Access)

02/16/2021



Movement	EBL	EBR	NBL	NBT	SBT	SBR
Lane Configurations						
Traffic Volume (veh/h)	155	200	150	755	1290	100
Future Volume (veh/h)	155	200	150	755	1290	100
Initial Q (Qb), veh	0	0	0	0	0	0
Ped-Bike Adj(A_pbT)	1.00	1.00	1.00			1.00
Parking Bus, Adj	1.00	1.00	1.00	1.00	1.00	1.00
Work Zone On Approach	No			No	No	
Adj Sat Flow, veh/h/ln	1870	1870	1870	1826	1826	1870
Adj Flow Rate, veh/h	168	217	163	821	1402	109
Peak Hour Factor	0.92	0.92	0.92	0.92	0.92	0.92
Percent Heavy Veh, %	2	2	2	5	5	2
Cap, veh/h	276	245	296	2628	2305	1053
Arrive On Green	0.15	0.15	0.09	1.00	0.66	0.66
Sat Flow, veh/h	1781	1585	1781	3561	3561	1585
Grp Volume(v), veh/h	168	217	163	821	1402	109
Grp Sat Flow(s),veh/h/ln	1781	1585	1781	1735	1735	1585
Q Serve(g_s), s	10.6	16.1	3.5	0.0	27.3	3.0
Cycle Q Clear(g_c), s	10.6	16.1	3.5	0.0	27.3	3.0
Prop In Lane	1.00	1.00	1.00			1.00
Lane Grp Cap(c), veh/h	276	245	296	2628	2305	1053
V/C Ratio(X)	0.61	0.88	0.55	0.31	0.61	0.10
Avail Cap(c_a), veh/h	327	291	412	2628	2305	1053
HCM Platoon Ratio	1.00	1.00	2.00	2.00	1.00	1.00
Upstream Filter(l)	1.00	1.00	0.86	0.86	1.00	1.00
Uniform Delay (d), s/veh	47.3	49.7	10.8	0.0	11.3	7.3
Incr Delay (d2), s/veh	2.4	23.3	1.4	0.3	1.2	0.2
Initial Q Delay(d3),s/veh	0.0	0.0	0.0	0.0	0.0	0.0
%ile BackOfQ(50%),veh/ln	4.9	14.9	1.6	0.1	10.1	1.0
Unsig. Movement Delay, s/veh						
LnGrp Delay(d),s/veh	49.7	72.9	12.2	0.3	12.5	7.5
LnGrp LOS	D	E	B	A	B	A
Approach Vol, veh/h	385			984	1511	
Approach Delay, s/veh	62.8			2.2	12.2	
Approach LOS	E			A	B	
Timer - Assigned Phs		2		4	5	6
Phs Duration (G+Y+Rc), s		96.4		23.6	11.2	85.2
Change Period (Y+Rc), s		5.5		5.0	5.5	5.5
Max Green Setting (Gmax), s		87.5		22.0	13.5	68.5
Max Q Clear Time (g_c+I1), s		2.0		18.1	5.5	29.3
Green Ext Time (p_c), s		7.3		0.5	0.3	15.7
Intersection Summary						
HCM 6th Ctrl Delay			15.6			
HCM 6th LOS			B			

5: Marksheffel Rd & Airl Lane (CRN South Full Access)

02/16/2021



Lane Group	EBL	EBR	NBL	NBT	SBT	SBR
Lane Configurations	↖	↗	↖	↑↑	↑↑	↗
Traffic Volume (vph)	155	200	140	1345	1040	95
Future Volume (vph)	155	200	140	1345	1040	95
Turn Type	Prot	Perm	pm+pt	NA	NA	Perm
Protected Phases	4		5	2	6	
Permitted Phases		4	2			6
Detector Phase	4	4	5	2	6	6
Switch Phase						
Minimum Initial (s)	5.0	5.0	5.0	5.0	5.0	5.0
Minimum Split (s)	23.0	23.0	10.5	23.5	23.5	23.5
Total Split (s)	29.0	29.0	21.0	91.0	70.0	70.0
Total Split (%)	24.2%	24.2%	17.5%	75.8%	58.3%	58.3%
Yellow Time (s)	3.5	3.5	4.5	4.5	4.5	4.5
All-Red Time (s)	1.5	1.5	1.0	1.0	1.0	1.0
Lost Time Adjust (s)	0.0	0.0	0.0	0.0	0.0	0.0
Total Lost Time (s)	5.0	5.0	5.5	5.5	5.5	5.5
Lead/Lag			Lead		Lag	Lag
Lead-Lag Optimize?			Yes		Yes	Yes
Recall Mode	None	None	None	C-Max	C-Max	C-Max
Act Effect Green (s)	16.6	16.6	92.9	92.9	79.2	79.2
Actuated g/C Ratio	0.14	0.14	0.77	0.77	0.66	0.66
v/c Ratio	0.69	0.53	0.41	0.54	0.49	0.10
Control Delay	63.1	10.7	10.8	15.3	19.5	5.7
Queue Delay	0.0	0.0	0.0	0.0	0.0	0.0
Total Delay	63.1	10.7	10.8	15.3	19.5	5.7
LOS	E	B	B	B	B	A
Approach Delay	33.6			14.9	18.4	
Approach LOS	C			B	B	

Intersection Summary

Cycle Length: 120
 Actuated Cycle Length: 120
 Offset: 0 (0%), Referenced to phase 2:NBTL and 6:SBT, Start of Green
 Natural Cycle: 60
 Control Type: Actuated-Coordinated
 Maximum v/c Ratio: 0.69
 Intersection Signal Delay: 18.4
 Intersection Capacity Utilization 58.4%
 Analysis Period (min) 15
 Intersection LOS: B
 ICU Level of Service B

Splits and Phases: 10: Marksheffel Rd & Airl Lane (CRN South Full Access)

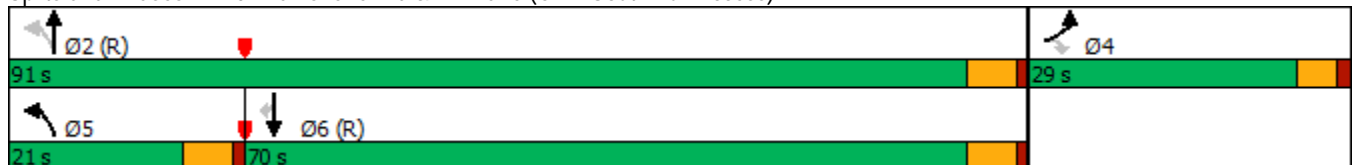

HCM 6th Signalized Intersection Summary

2026 Total PM Improved.syn

5: Marksheffel Rd & Airl Lane (CRN South Full Access)

02/16/2021



Movement	EBL	EBR	NBL	NBT	SBT	SBR
Lane Configurations						
Traffic Volume (veh/h)	155	200	140	1345	1040	95
Future Volume (veh/h)	155	200	140	1345	1040	95
Initial Q (Qb), veh	0	0	0	0	0	0
Ped-Bike Adj(A_pbT)	1.00	1.00	1.00			1.00
Parking Bus, Adj	1.00	1.00	1.00	1.00	1.00	1.00
Work Zone On Approach	No			No	No	
Adj Sat Flow, veh/h/ln	1870	1870	1870	1856	1856	1870
Adj Flow Rate, veh/h	168	217	152	1462	1130	103
Peak Hour Factor	0.92	0.92	0.92	0.92	0.92	0.92
Percent Heavy Veh, %	2	2	2	3	3	2
Cap, veh/h	278	247	369	2667	2350	1056
Arrive On Green	0.16	0.16	0.04	0.76	0.67	0.67
Sat Flow, veh/h	1781	1585	1781	3618	3618	1585
Grp Volume(v), veh/h	168	217	152	1462	1130	103
Grp Sat Flow(s),veh/h/ln	1781	1585	1781	1763	1763	1585
Q Serve(g_s), s	10.5	16.1	3.1	20.7	18.9	2.8
Cycle Q Clear(g_c), s	10.5	16.1	3.1	20.7	18.9	2.8
Prop In Lane	1.00	1.00	1.00			1.00
Lane Grp Cap(c), veh/h	278	247	369	2667	2350	1056
V/C Ratio(X)	0.60	0.88	0.41	0.55	0.48	0.10
Avail Cap(c_a), veh/h	356	317	520	2667	2350	1056
HCM Platoon Ratio	1.00	1.00	1.00	1.00	1.00	1.00
Upstream Filter(l)	1.00	1.00	0.51	0.51	1.00	1.00
Uniform Delay (d), s/veh	47.2	49.5	7.6	6.1	9.8	7.1
Incr Delay (d2), s/veh	2.1	19.4	0.4	0.4	0.7	0.2
Initial Q Delay(d3),s/veh	0.0	0.0	0.0	0.0	0.0	0.0
%ile BackOfQ(50%),veh/ln	4.8	14.7	1.1	6.7	7.1	1.0
Unsig. Movement Delay, s/veh						
LnGrp Delay(d),s/veh	49.3	68.9	8.0	6.5	10.5	7.3
LnGrp LOS	D	E	A	A	B	A
Approach Vol, veh/h	385			1614	1233	
Approach Delay, s/veh	60.3			6.6	10.3	
Approach LOS	E			A	B	
Timer - Assigned Phs		2		4	5	6
Phs Duration (G+Y+Rc), s		96.3		23.7	10.8	85.5
Change Period (Y+Rc), s		5.5		5.0	5.5	5.5
Max Green Setting (Gmax), s		85.5		24.0	15.5	64.5
Max Q Clear Time (g_c+l1), s		22.7		18.1	5.1	20.9
Green Ext Time (p_c), s		18.3		0.7	0.3	11.6
Intersection Summary						
HCM 6th Ctrl Delay			14.4			
HCM 6th LOS			B			

5: Marksheffel Rd & Airl Lane (CRN South Full Access)

02/16/2021



Lane Group	EBL	EBR	NBL	NBT	SBT	SBR
Lane Configurations	↖	↗	↖	↑↑↑	↑↑↑	↗
Traffic Volume (vph)	175	225	165	1145	1665	110
Future Volume (vph)	175	225	165	1145	1665	110
Turn Type	Prot	Perm	pm+pt	NA	NA	Perm
Protected Phases	4		5	2	6	
Permitted Phases		4	2			6
Detector Phase	4	4	5	2	6	6
Switch Phase						
Minimum Initial (s)	5.0	5.0	5.0	5.0	5.0	5.0
Minimum Split (s)	23.0	23.0	10.5	23.5	23.5	23.5
Total Split (s)	28.0	28.0	24.0	92.0	68.0	68.0
Total Split (%)	23.3%	23.3%	20.0%	76.7%	56.7%	56.7%
Yellow Time (s)	3.5	3.5	4.5	4.5	4.5	4.5
All-Red Time (s)	1.5	1.5	1.0	1.0	1.0	1.0
Lost Time Adjust (s)	0.0	0.0	0.0	0.0	0.0	0.0
Total Lost Time (s)	5.0	5.0	5.5	5.5	5.5	5.5
Lead/Lag			Lead		Lag	Lag
Lead-Lag Optimize?			Yes		Yes	Yes
Recall Mode	None	None	None	C-Max	C-Max	C-Max
Act Effect Green (s)	17.8	17.8	91.7	91.7	73.9	73.9
Actuated g/C Ratio	0.15	0.15	0.76	0.76	0.62	0.62
v/c Ratio	0.73	0.55	0.65	0.33	0.60	0.12
Control Delay	64.3	10.3	29.0	10.9	14.4	4.1
Queue Delay	0.0	0.0	0.0	0.0	0.0	0.0
Total Delay	64.3	10.3	29.0	10.9	14.4	4.1
LOS	E	B	C	B	B	A
Approach Delay	33.9			13.2	13.7	
Approach LOS	C			B	B	

Intersection Summary

Cycle Length: 120
 Actuated Cycle Length: 120
 Offset: 0 (0%), Referenced to phase 2:NBTL and 6:SBT, Start of Green
 Natural Cycle: 65
 Control Type: Actuated-Coordinated
 Maximum v/c Ratio: 0.73
 Intersection Signal Delay: 15.8
 Intersection LOS: B
 Intersection Capacity Utilization 64.3%
 ICU Level of Service C
 Analysis Period (min) 15

Splits and Phases: 10: Marksheffel Rd & Airl Lane (CRN South Full Access)



5: Marksheffel Rd & Airl Lane (CRN South Full Access)

02/16/2021



Movement	EBL	EBR	NBL	NBT	SBT	SBR
Lane Configurations						
Traffic Volume (veh/h)	175	225	165	1145	1665	110
Future Volume (veh/h)	175	225	165	1145	1665	110
Initial Q (Qb), veh	0	0	0	0	0	0
Ped-Bike Adj(A_pbT)	1.00	1.00	1.00			1.00
Parking Bus, Adj	1.00	1.00	1.00	1.00	1.00	1.00
Work Zone On Approach	No			No	No	
Adj Sat Flow, veh/h/ln	1870	1870	1870	1826	1826	1870
Adj Flow Rate, veh/h	190	245	179	1245	1810	120
Peak Hour Factor	0.92	0.92	0.92	0.92	0.92	0.92
Percent Heavy Veh, %	2	2	2	5	5	2
Cap, veh/h	306	272	225	3692	3208	1020
Arrive On Green	0.17	0.17	0.03	0.50	0.21	0.21
Sat Flow, veh/h	1781	1585	1781	5149	5149	1585
Grp Volume(v), veh/h	190	245	179	1245	1810	120
Grp Sat Flow(s),veh/h/ln	1781	1585	1781	1662	1662	1585
Q Serve(g_s), s	11.9	18.2	3.8	18.1	39.0	7.3
Cycle Q Clear(g_c), s	11.9	18.2	3.8	18.1	39.0	7.3
Prop In Lane	1.00	1.00	1.00			1.00
Lane Grp Cap(c), veh/h	306	272	225	3692	3208	1020
V/C Ratio(X)	0.62	0.90	0.80	0.34	0.56	0.12
Avail Cap(c_a), veh/h	341	304	408	3692	3208	1020
HCM Platoon Ratio	1.00	1.00	0.67	0.67	0.33	0.33
Upstream Filter(l)	1.00	1.00	0.81	0.81	1.00	1.00
Uniform Delay (d), s/veh	46.1	48.7	24.4	12.4	32.2	19.7
Incr Delay (d2), s/veh	2.9	26.1	5.2	0.2	0.7	0.2
Initial Q Delay(d3),s/veh	0.0	0.0	0.0	0.0	0.0	0.0
%ile BackOfQ(50%),veh/ln	5.5	16.9	3.8	7.5	17.6	2.9
Unsig. Movement Delay, s/veh						
LnGrp Delay(d),s/veh	48.9	74.8	29.6	12.6	32.9	20.0
LnGrp LOS	D	E	C	B	C	B
Approach Vol, veh/h	435			1424	1930	
Approach Delay, s/veh	63.5			14.7	32.1	
Approach LOS	E			B	C	
Timer - Assigned Phs		2		4	5	6
Phs Duration (G+Y+Rc), s		94.4		25.6	11.7	82.7
Change Period (Y+Rc), s		5.5		5.0	5.5	5.5
Max Green Setting (Gmax), s		86.5		23.0	18.5	62.5
Max Q Clear Time (g_c+l1), s		20.1		20.2	5.8	41.0
Green Ext Time (p_c), s		13.1		0.4	0.4	14.7
Intersection Summary						
HCM 6th Ctrl Delay			29.2			
HCM 6th LOS			C			

5: Marksheffel Rd & Airl Lane (CRN South Full Access)

02/16/2021



Lane Group	EBL	EBR	NBL	NBT	SBT	SBR
Lane Configurations	↖	↗	↖	↑↑↑	↑↑↑	↗
Traffic Volume (vph)	175	225	235	2030	1705	155
Future Volume (vph)	175	225	235	2030	1705	155
Turn Type	Prot	Perm	pm+pt	NA	NA	Perm
Protected Phases	4		5	2	6	
Permitted Phases		4	2			6
Detector Phase	4	4	5	2	6	6
Switch Phase						
Minimum Initial (s)	5.0	5.0	5.0	5.0	5.0	5.0
Minimum Split (s)	23.0	23.0	10.5	23.5	23.5	23.5
Total Split (s)	26.0	26.0	29.3	94.0	64.7	64.7
Total Split (%)	21.7%	21.7%	24.4%	78.3%	53.9%	53.9%
Yellow Time (s)	3.5	3.5	4.5	4.5	4.5	4.5
All-Red Time (s)	1.5	1.5	1.0	1.0	1.0	1.0
Lost Time Adjust (s)	0.0	0.0	0.0	0.0	0.0	0.0
Total Lost Time (s)	5.0	5.0	5.5	5.5	5.5	5.5
Lead/Lag			Lead		Lag	Lag
Lead-Lag Optimize?			Yes		Yes	Yes
Recall Mode	None	None	None	C-Max	C-Max	C-Max
Act Effect Green (s)	17.4	17.4	92.1	92.1	69.7	69.7
Actuated g/C Ratio	0.14	0.14	0.77	0.77	0.58	0.58
v/c Ratio	0.74	0.56	0.78	0.57	0.63	0.17
Control Delay	66.4	10.6	46.2	3.2	23.7	8.1
Queue Delay	0.0	0.0	0.0	0.0	0.0	0.0
Total Delay	66.4	10.6	46.2	3.2	23.7	8.1
LOS	E	B	D	A	C	A
Approach Delay	35.0			7.7	22.4	
Approach LOS	D			A	C	

Intersection Summary

Cycle Length: 120
 Actuated Cycle Length: 120
 Offset: 0 (0%), Referenced to phase 2:NBT and 6:SBT, Start of Green
 Natural Cycle: 75
 Control Type: Actuated-Coordinated
 Maximum v/c Ratio: 0.78
 Intersection Signal Delay: 16.2
 Intersection LOS: B
 Intersection Capacity Utilization 69.0%
 ICU Level of Service C
 Analysis Period (min) 15

Splits and Phases: 10: Marksheffel Rd & Airl Lane (CRN South Full Access)



HCM 6th Signalized Intersection Summary

2040 Total PM.syn

5: Marksheffel Rd & Airl Lane (CRN South Full Access)

02/16/2021



Movement	EBL	EBR	NBL	NBT	SBT	SBR
Lane Configurations						
Traffic Volume (veh/h)	175	225	235	2030	1705	155
Future Volume (veh/h)	175	225	235	2030	1705	155
Initial Q (Qb), veh	0	0	0	0	0	0
Ped-Bike Adj(A_pbT)	1.00	1.00	1.00			1.00
Parking Bus, Adj	1.00	1.00	1.00	1.00	1.00	1.00
Work Zone On Approach	No			No	No	
Adj Sat Flow, veh/h/ln	1870	1870	1870	1856	1856	1870
Adj Flow Rate, veh/h	190	245	255	2207	1853	168
Peak Hour Factor	0.92	0.92	0.92	0.92	0.92	0.92
Percent Heavy Veh, %	2	2	2	3	3	2
Cap, veh/h	302	269	288	3763	3043	952
Arrive On Green	0.17	0.17	0.10	0.74	0.20	0.20
Sat Flow, veh/h	1781	1585	1781	5233	5233	1585
Grp Volume(v), veh/h	190	245	255	2207	1853	168
Grp Sat Flow(s),veh/h/ln	1781	1585	1781	1689	1689	1585
Q Serve(g_s), s	11.9	18.2	9.0	23.8	40.0	10.6
Cycle Q Clear(g_c), s	11.9	18.2	9.0	23.8	40.0	10.6
Prop In Lane	1.00	1.00	1.00			1.00
Lane Grp Cap(c), veh/h	302	269	288	3763	3043	952
V/C Ratio(X)	0.63	0.91	0.89	0.59	0.61	0.18
Avail Cap(c_a), veh/h	312	277	470	3763	3043	952
HCM Platoon Ratio	1.00	1.00	1.00	1.00	0.33	0.33
Upstream Filter(l)	1.00	1.00	0.29	0.29	1.00	1.00
Uniform Delay (d), s/veh	46.3	48.9	31.8	7.0	35.3	23.4
Incr Delay (d2), s/veh	3.8	31.4	3.7	0.2	0.9	0.4
Initial Q Delay(d3),s/veh	0.0	0.0	0.0	0.0	0.0	0.0
%ile BackOfQ(50%),veh/ln	5.6	17.3	7.8	7.5	18.4	4.6
Unsig. Movement Delay, s/veh						
LnGrp Delay(d),s/veh	50.1	80.3	35.5	7.2	36.2	23.9
LnGrp LOS	D	F	D	A	D	C
Approach Vol, veh/h	435			2462	2021	
Approach Delay, s/veh	67.1			10.2	35.2	
Approach LOS	E			B	D	
Timer - Assigned Phs		2		4	5	6
Phs Duration (G+Y+Rc), s		94.6		25.4	17.1	77.6
Change Period (Y+Rc), s		5.5		5.0	5.5	5.5
Max Green Setting (Gmax), s		88.5		21.0	23.8	59.2
Max Q Clear Time (g_c+l1), s		25.8		20.2	11.0	42.0
Green Ext Time (p_c), s		35.7		0.1	0.6	12.7
Intersection Summary						
HCM 6th Ctrl Delay			25.5			
HCM 6th LOS			C			

APPENDIX E

Signal Warrant Analysis

Signal Clearance Intervals

WARRANT 2 - FOUR HOUR VEHICULAR VOLUME (70% FACTOR)

(COMMUNITY LESS THAN 10,000 POPULATION OR ABOVE 70 km/h (40 mph) ON MAJOR STREET)

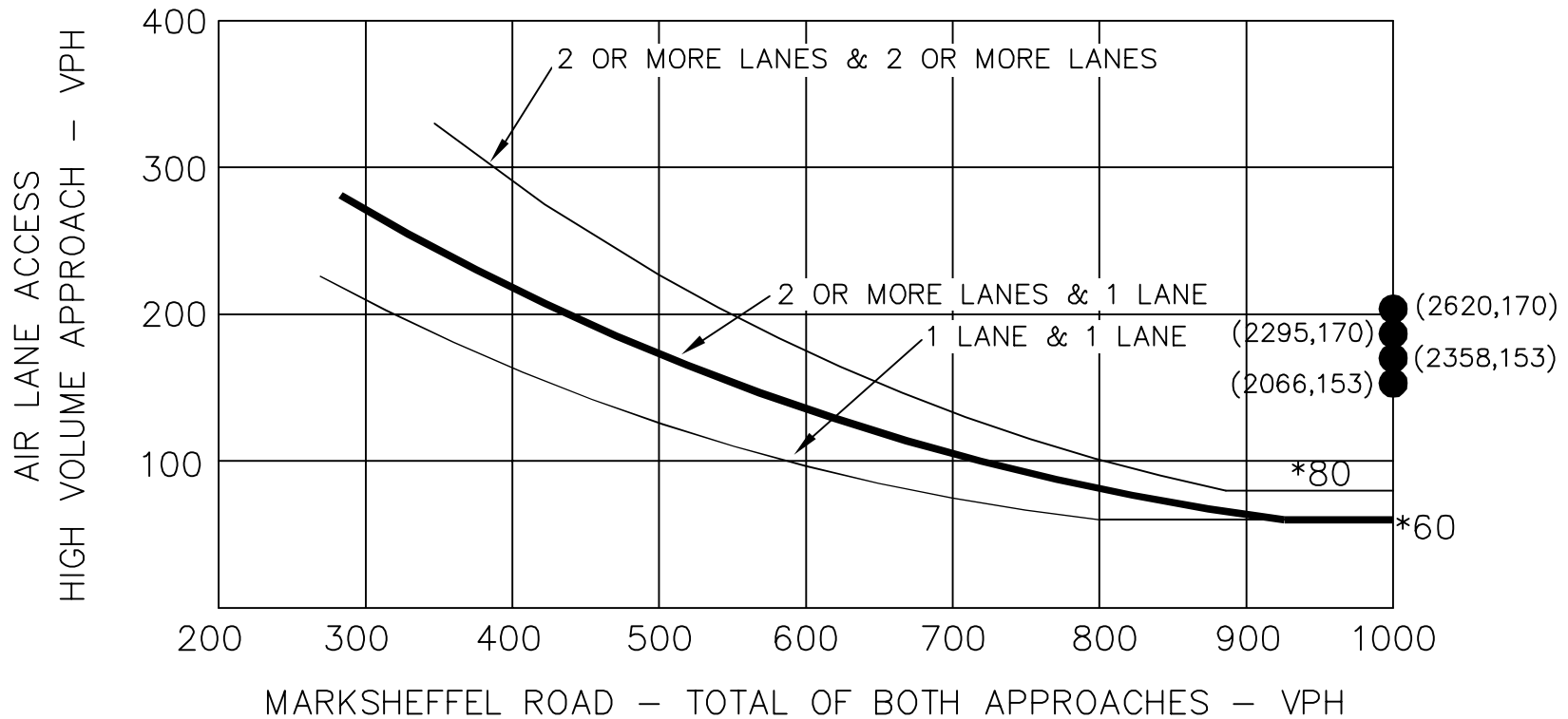

MARKSHEFFEL ROAD
AND AIR LANE ACCESS
SIGNAL WARRANT ANALYSIS
FOUR HOUR VOLUME WARRANT

* NOTE: 80 VPH APPLIES AS THE LOWER THRESHOLD VOLUME FOR A MINOR STREET APPROACH WITH TWO OR MORE LANES AND 60 VPH APPLIES AS THE LOWER THRESHOLD VOLUME FOR A MINOR STREET APPROACHING WITH ONE LANE.

● 2026 TOTAL TRAFFIC DATA POINT WITH PROJECT

Source: Manual of Uniform Traffic Control Devices 2009



Crossroads North Signal Clearance Calculations

Signal Clearance Intervals				
Approach	Intersection	Yellow Time	All Red Time	Total
EB	US-24 and Marksheffel Rd (#1)	4.675	1.265	5.940
WB		5.043	1.707	6.749
NB		5.778	1.528	7.305
SB		5.778	1.706	7.483
EB	SH-94 and US-24 (#2)	2.838	3.020	5.858
WB		3.940	2.245	6.185
NB		5.043	1.868	6.910
SB		5.778	2.009	7.787
EB	SH-94 and Marksheffel Rd (#3)	5.043	1.237	6.279
WB		5.043	1.237	6.279
NB		5.043	1.459	6.502
SB		4.675	1.578	6.253

Input Parameters	
Speed Limit (mph)	Intersection Width (feet)
50	73
55	118
65	126
65	143
25	91
40	112
55	131
65	172
55	80
55	80
55	98
50	96

APPENDIX F

Queueing Analysis Worksheets

1: Marksheffel Rd & US-24

02/17/2021

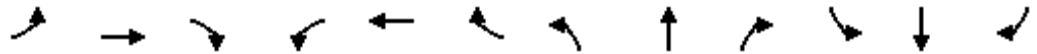

Lane Group	EBL	EBT	EBR	WBL	WBT	WBR	NBL	NBT	NBR	SBL	SBT	SBR
Lane Group Flow (vph)	375	573	130	365	1266	21	5	786	109	10	1068	792
v/c Ratio	0.71	0.48	0.09	0.72	1.04	0.01	0.06	0.73	0.07	0.12	1.00	0.52
Control Delay	42.6	45.9	0.1	56.4	75.7	0.0	43.0	29.1	0.1	48.7	57.6	0.9
Queue Delay	0.0	0.0	0.0	0.0	0.0	0.0	0.0	0.0	0.0	0.0	0.0	0.0
Total Delay	42.6	45.9	0.1	56.4	75.7	0.0	43.0	29.1	0.1	48.7	57.6	0.9
Queue Length 50th (ft)	141	239	0	140	-550	0	4	278	0	8	-438	0
Queue Length 95th (ft)	#260	311	0	184	#738	0	m13	124	0	m11	#585	0
Internal Link Dist (ft)		1511			2597			1201			1023	
Turn Bay Length (ft)	1000		575	1000		700	300		375	375		
Base Capacity (vph)	526	1189	1455	673	1216	1553	87	1109	1568	80	1065	1524
Starvation Cap Reductn	0	0	0	0	0	0	0	0	0	0	0	0
Spillback Cap Reductn	0	0	0	0	0	0	0	0	0	0	0	0
Storage Cap Reductn	0	0	0	0	0	0	0	0	0	0	0	0
Reduced v/c Ratio	0.71	0.48	0.09	0.54	1.04	0.01	0.06	0.71	0.07	0.13	1.00	0.52

Intersection Summary

~ Volume exceeds capacity, queue is theoretically infinite.

Queue shown is maximum after two cycles.

95th percentile volume exceeds capacity, queue may be longer.

Queue shown is maximum after two cycles.

m Volume for 95th percentile queue is metered by upstream signal.

1: Marksheffel Rd & US-24

02/17/2021



Lane Group	EBL	EBT	EBR	WBL	WBT	WBR	NBL	NBT	NBR	SBL	SBT	SBR
Lane Group Flow (vph)	684	1224	128	214	597	20	15	1214	250	20	934	520
v/c Ratio	0.85	0.95	0.08	0.69	0.76	0.01	0.18	0.98	0.16	0.27	0.75	0.33
Control Delay	36.7	51.8	0.1	65.7	52.3	0.0	52.9	55.6	0.2	57.6	31.6	0.5
Queue Delay	0.0	0.0	0.0	0.0	0.0	0.0	0.0	0.0	0.0	0.0	0.0	0.0
Total Delay	36.7	51.8	0.1	65.7	52.3	0.0	52.9	55.6	0.2	57.6	31.6	0.5
Queue Length 50th (ft)	261	536	0	81	220	0	10	375	0	16	333	0
Queue Length 95th (ft)	355	#690	m0	#164	#406	0	m21	#627	0	m29	418	0
Internal Link Dist (ft)		1511			2597			1201			1023	
Turn Bay Length (ft)	1000		575	1000		700	300		375	375		
Base Capacity (vph)	886	1293	1583	309	782	1568	84	1238	1583	73	1243	1568
Starvation Cap Reductn	0	0	0	0	0	0	0	0	0	0	0	0
Spillback Cap Reductn	0	0	0	0	0	0	0	0	0	0	0	0
Storage Cap Reductn	0	0	0	0	0	0	0	0	0	0	0	0
Reduced v/c Ratio	0.77	0.95	0.08	0.69	0.76	0.01	0.18	0.98	0.16	0.27	0.75	0.33

Intersection Summary

- # 95th percentile volume exceeds capacity, queue may be longer.
Queue shown is maximum after two cycles.
- m Volume for 95th percentile queue is metered by upstream signal.

1: Marksheffel Rd & US-24

02/15/2021



Lane Group	EBL	EBT	EBR	WBL	WBT	WBR	NBL	NBT	NBR	SBL	SBT	SBR
Lane Group Flow (vph)	443	672	146	453	1484	26	5	1146	167	16	1385	927
v/c Ratio	0.84	0.42	0.25	0.78	0.86	0.04	0.07	0.79	0.11	0.22	0.91	0.61
Control Delay	51.2	45.9	25.9	57.4	43.3	0.1	37.6	25.3	0.1	49.5	36.1	1.2
Queue Delay	0.0	0.0	0.0	0.0	0.0	0.0	0.0	0.0	0.0	0.0	0.0	0.0
Total Delay	51.2	45.9	25.9	57.4	43.3	0.1	37.6	25.3	0.1	49.5	36.1	1.2
Queue Length 50th (ft)	167	189	39	173	389	0	4	319	0	12	352	0
Queue Length 95th (ft)	#284	248	126	227	#512	0	m12	111	0	m14	m#482	m0
Internal Link Dist (ft)		1511			2597			1917			1023	
Turn Bay Length (ft)	1000		575	1000		700	300		375	375		
Base Capacity (vph)	530	1597	589	659	1726	629	73	1468	1568	74	1529	1524
Starvation Cap Reductn	0	0	0	0	0	0	0	0	0	0	0	0
Spillback Cap Reductn	0	0	0	0	0	0	0	0	0	0	0	0
Storage Cap Reductn	0	0	0	0	0	0	0	0	0	0	0	0
Reduced v/c Ratio	0.84	0.42	0.25	0.69	0.86	0.04	0.07	0.78	0.11	0.22	0.91	0.61

Intersection Summary

95th percentile volume exceeds capacity, queue may be longer.

Queue shown is maximum after two cycles.

m Volume for 95th percentile queue is metered by upstream signal.

1: Marksheffel Rd & US-24

02/15/2021



Lane Group	EBL	EBT	EBR	WBL	WBT	WBR	NBL	NBT	NBR	SBL	SBT	SBR
Lane Group Flow (vph)	801	1444	209	332	704	20	20	1801	352	26	1592	612
v/c Ratio	0.91	0.93	0.36	0.83	0.84	0.05	0.27	0.98	0.22	0.36	0.82	0.39
Control Delay	33.5	47.7	21.8	69.9	58.6	0.2	59.9	45.3	0.3	53.6	28.5	0.4
Queue Delay	0.0	0.0	0.0	0.0	0.0	0.0	0.0	0.0	0.0	0.0	0.0	0.0
Total Delay	33.5	47.7	21.8	69.9	58.6	0.2	59.9	45.3	0.3	53.6	28.5	0.4
Queue Length 50th (ft)	~339	440	104	~140	197	0	16	523	0	20	259	0
Queue Length 95th (ft)	m#423	m#519	m139	#235	#265	0	m29	#599	0	m24	447	m0
Internal Link Dist (ft)		1511			2597			1917			1023	
Turn Bay Length (ft)	1000		575	1000		700	300		375	375		
Base Capacity (vph)	876	1546	579	402	841	428	75	1843	1583	73	1938	1568
Starvation Cap Reductn	0	0	0	0	0	0	0	0	0	0	0	0
Spillback Cap Reductn	0	0	0	0	0	0	0	0	0	0	0	0
Storage Cap Reductn	0	0	0	0	0	0	0	0	0	0	0	0
Reduced v/c Ratio	0.91	0.93	0.36	0.83	0.84	0.05	0.27	0.98	0.22	0.36	0.82	0.39

Intersection Summary

- ~ Volume exceeds capacity, queue is theoretically infinite.
Queue shown is maximum after two cycles.
- # 95th percentile volume exceeds capacity, queue may be longer.
Queue shown is maximum after two cycles.
- m Volume for 95th percentile queue is metered by upstream signal.

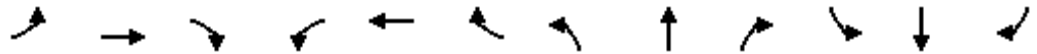

Lane Group	EBL	EBT	EBR	WBL	WBT	WBR	NBL	NBT	NBR	SBL	SBT	SBR
Lane Group Flow (vph)	46	93	510	845	98	5	438	1015	655	5	1918	67
v/c Ratio	0.26	0.54	0.33	0.96	0.12	0.00	2.37	0.39	0.45	0.02	0.86	0.08
Control Delay	58.5	62.4	0.6	60.1	29.2	0.0	656.5	17.2	1.0	12.4	36.4	1.1
Queue Delay	0.0	0.0	0.0	0.0	0.0	0.0	0.0	0.0	0.0	0.0	0.0	0.0
Total Delay	58.5	62.4	0.6	60.1	29.2	0.0	656.5	17.2	1.0	12.4	36.4	1.1
Queue Length 50th (ft)	18	70	0	207	29	0	-286	149	0	1	366	0
Queue Length 95th (ft)	38	121	0	#314	48	m0	#391	249	0	m2	m387	m2
Internal Link Dist (ft)		543			2360			1172			881	
Turn Bay Length (ft)	375			475		475	900		600	800		800
Base Capacity (vph)	180	286	1538	876	984	1553	185	2589	1468	264	2222	798
Starvation Cap Reductn	0	0	0	0	0	0	0	0	0	0	0	0
Spillback Cap Reductn	0	0	0	0	0	0	0	0	0	0	0	0
Storage Cap Reductn	0	0	0	0	0	0	0	0	0	0	0	0
Reduced v/c Ratio	0.26	0.33	0.33	0.96	0.10	0.00	2.37	0.39	0.45	0.02	0.86	0.08

Intersection Summary

- ~ Volume exceeds capacity, queue is theoretically infinite.
Queue shown is maximum after two cycles.
- # 95th percentile volume exceeds capacity, queue may be longer.
Queue shown is maximum after two cycles.
- m Volume for 95th percentile queue is metered by upstream signal.

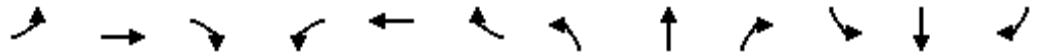

Lane Group	EBL	EBT	EBR	WBL	WBT	WBR	NBL	NBT	NBR	SBL	SBT	SBR
Lane Group Flow (vph)	58	84	474	779	68	11	416	2026	658	5	1053	63
v/c Ratio	0.34	0.51	0.30	0.94	0.09	0.01	0.84	0.68	0.42	0.03	0.53	0.08
Control Delay	60.9	61.9	0.5	75.6	34.4	0.0	65.9	20.5	0.8	14.2	39.4	1.4
Queue Delay	0.0	0.0	0.0	0.0	0.0	0.0	0.0	0.0	0.0	0.0	0.0	0.0
Total Delay	60.9	61.9	0.5	75.6	34.4	0.0	65.9	20.5	0.8	14.2	39.4	1.4
Queue Length 50th (ft)	22	63	0	209	18	0	162	372	0	1	191	0
Queue Length 95th (ft)	45	112	0	#290	m30	m0	#236	589	0	m3	329	m7
Internal Link Dist (ft)		543			2360			1172			881	
Turn Bay Length (ft)	375			475		475	900		600	800		800
Base Capacity (vph)	171	294	1583	831	963	1568	510	2958	1568	149	1998	776
Starvation Cap Reductn	0	0	0	0	0	0	0	0	0	0	0	0
Spillback Cap Reductn	0	0	0	0	0	0	0	0	0	0	0	0
Storage Cap Reductn	0	0	0	0	0	0	0	0	0	0	0	0
Reduced v/c Ratio	0.34	0.29	0.30	0.94	0.07	0.01	0.82	0.68	0.42	0.03	0.53	0.08

Intersection Summary

95th percentile volume exceeds capacity, queue may be longer.

Queue shown is maximum after two cycles.

m Volume for 95th percentile queue is metered by upstream signal.



Lane Group	EBL	EBT	EBR	WBL	WBT	WBR	NBL	NBT	NBR	SBL	SBT	SBR
Lane Group Flow (vph)	57	98	572	1191	108	5	495	1186	881	10	2258	82
v/c Ratio	0.35	0.55	0.37	1.72	0.15	0.00	2.68	0.43	0.60	0.04	0.94	0.10
Control Delay	61.2	62.7	0.7	360.2	44.2	0.0	791.2	15.5	1.8	6.9	31.8	1.1
Queue Delay	0.0	0.0	0.0	0.0	0.0	0.0	0.0	0.0	0.0	0.0	0.0	0.0
Total Delay	61.2	62.7	0.7	360.2	44.2	0.0	791.2	15.5	1.8	6.9	31.8	1.1
Queue Length 50th (ft)	22	74	0	~493	42	0	~334	166	0	2	346	1
Queue Length 95th (ft)	45	126	0	#587	m64	m0	#442	279	0	m2	#741	m4
Internal Link Dist (ft)		543			2360			1172			881	
Turn Bay Length (ft)	375			475		475	900		600	800		800
Base Capacity (vph)	166	286	1538	693	867	1553	185	2758	1468	234	2393	845
Starvation Cap Reductn	0	0	0	0	0	0	0	0	0	0	0	0
Spillback Cap Reductn	0	0	0	0	0	0	0	0	0	0	0	0
Storage Cap Reductn	0	0	0	0	0	0	0	0	0	0	0	0
Reduced v/c Ratio	0.34	0.34	0.37	1.72	0.12	0.00	2.68	0.43	0.60	0.04	0.94	0.10

Intersection Summary

- ~ Volume exceeds capacity, queue is theoretically infinite.
Queue shown is maximum after two cycles.
- # 95th percentile volume exceeds capacity, queue may be longer.
Queue shown is maximum after two cycles.
- m Volume for 95th percentile queue is metered by upstream signal.

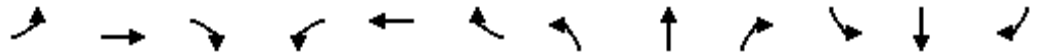

Lane Group	EBL	EBT	EBR	WBL	WBT	WBR	NBL	NBT	NBR	SBL	SBT	SBR
Lane Group Flow (vph)	68	100	563	1221	84	11	495	2447	1226	11	1242	79
v/c Ratio	0.40	0.55	0.36	1.29	0.09	0.01	1.00	0.91	0.78	0.07	0.71	0.11
Control Delay	62.5	62.2	0.6	180.0	20.0	0.0	91.9	32.1	4.0	16.2	60.1	2.9
Queue Delay	0.0	0.0	0.0	0.0	0.0	0.0	0.0	0.0	0.0	0.0	0.0	0.0
Total Delay	62.5	62.2	0.6	180.0	20.0	0.0	91.9	32.1	4.0	16.2	60.1	2.9
Queue Length 50th (ft)	26	75	0	~440	21	0	200	572	0	4	360	3
Queue Length 95th (ft)	51	128	0	m#517	m23	m0	#313	#920	0	m7	409	m13
Internal Link Dist (ft)		543			2360			1172			881	
Turn Bay Length (ft)	375			475		475	900		600	800		800
Base Capacity (vph)	171	294	1583	947	1051	1568	495	2695	1568	150	1739	709
Starvation Cap Reductn	0	0	0	0	0	0	0	0	0	0	0	0
Spillback Cap Reductn	0	0	0	0	0	0	0	0	0	0	0	0
Storage Cap Reductn	0	0	0	0	0	0	0	0	0	0	0	0
Reduced v/c Ratio	0.40	0.34	0.36	1.29	0.08	0.01	1.00	0.91	0.78	0.07	0.71	0.11

Intersection Summary

- ~ Volume exceeds capacity, queue is theoretically infinite.
Queue shown is maximum after two cycles.
- # 95th percentile volume exceeds capacity, queue may be longer.
Queue shown is maximum after two cycles.
- m Volume for 95th percentile queue is metered by upstream signal.

3: Marksheffel Rd & SH-94

02/18/2021



Lane Group	EBL	EBT	EBR	WBL	WBT	WBR	NBL	NBT	NBR	SBL	SBT	SBR
Lane Group Flow (vph)	163	326	174	38	375	125	207	511	27	326	755	266
v/c Ratio	1.07	0.63	0.31	0.20	0.71	0.22	0.54	0.37	0.02	0.60	0.47	0.17
Control Delay	127.2	36.3	3.3	30.5	44.2	3.3	22.8	24.9	0.0	22.6	23.3	0.2
Queue Delay	0.0	0.0	0.0	0.0	0.0	0.0	0.0	0.0	0.0	0.0	0.0	0.0
Total Delay	127.2	36.3	3.3	30.5	44.2	3.3	22.8	24.9	0.0	22.6	23.3	0.2
Queue Length 50th (ft)	~136	182	0	22	253	0	41	151	0	103	162	0
Queue Length 95th (ft)	#250	237	29	47	327	26	#127	246	0	210	275	0
Internal Link Dist (ft)		2360			2852			463			968	
Turn Bay Length (ft)	300		250	225		250	375		400	400		400
Base Capacity (vph)	192	659	669	243	672	665	390	1378	1538	663	1611	1568
Starvation Cap Reductn	0	0	0	0	0	0	0	0	0	0	0	0
Spillback Cap Reductn	0	0	0	0	0	0	0	0	0	0	0	0
Storage Cap Reductn	0	0	0	0	0	0	0	0	0	0	0	0
Reduced v/c Ratio	0.85	0.49	0.26	0.16	0.56	0.19	0.53	0.37	0.02	0.49	0.47	0.17

Intersection Summary

- ~ Volume exceeds capacity, queue is theoretically infinite.
Queue shown is maximum after two cycles.
- # 95th percentile volume exceeds capacity, queue may be longer.
Queue shown is maximum after two cycles.

3: Marksheffel Rd & SH-94

02/18/2021

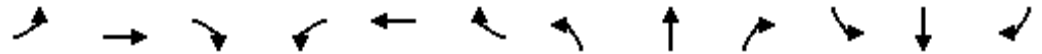

Lane Group	EBL	EBT	EBR	WBL	WBT	WBR	NBL	NBT	NBR	SBL	SBT	SBR
Lane Group Flow (vph)	149	362	282	48	431	420	239	1170	32	213	899	271
v/c Ratio	1.08	0.63	0.45	0.25	0.75	0.69	0.78	0.79	0.02	0.80	0.56	0.17
Control Delay	133.6	36.7	9.0	32.8	45.1	25.8	32.9	28.1	0.0	50.5	14.3	0.2
Queue Delay	0.0	0.0	0.0	0.0	0.0	0.0	0.0	0.0	0.0	0.0	0.0	0.0
Total Delay	133.6	36.7	9.0	32.8	45.1	25.8	32.9	28.1	0.0	50.5	14.3	0.2
Queue Length 50th (ft)	116	237	28	26	285	158	51	442	0	101	191	0
Queue Length 95th (ft)	#256	339	90	60	404	275	#157	538	m0	#207	210	0
Internal Link Dist (ft)		2360			2852			463			968	
Turn Bay Length (ft)	300		250	225		250	375		400	400		400
Base Capacity (vph)	151	630	666	208	630	652	306	1477	1583	283	1611	1553
Starvation Cap Reductn	0	0	0	0	0	0	0	0	0	0	0	0
Spillback Cap Reductn	0	0	0	0	0	0	0	0	0	0	0	0
Storage Cap Reductn	0	0	0	0	0	0	0	0	0	0	0	0
Reduced v/c Ratio	0.99	0.57	0.42	0.23	0.68	0.64	0.78	0.79	0.02	0.75	0.56	0.17

Intersection Summary

95th percentile volume exceeds capacity, queue may be longer.

Queue shown is maximum after two cycles.

m Volume for 95th percentile queue is metered by upstream signal.

3: Marksheffel Rd & SH-94

Lane Group	EBL	EBT	EBR	WBL	WBT	WBR	NBL	NBT	SBL	SBT	SBR
Lane Group Flow (vph)	179	380	337	43	440	147	467	913	386	1060	299
v/c Ratio	0.90	0.40	0.51	0.19	0.45	0.27	0.82	0.54	0.76	0.55	0.19
Control Delay	73.2	30.9	3.8	31.1	35.7	5.4	65.3	29.3	47.5	24.6	0.2
Queue Delay	0.0	0.0	0.0	0.0	0.0	0.0	0.0	0.0	0.0	0.0	0.0
Total Delay	73.2	30.9	3.8	31.1	35.7	5.4	65.3	29.3	47.5	24.6	0.2
Queue Length 50th (ft)	112	107	0	24	142	0	139	258	206	131	0
Queue Length 95th (ft)	#239	137	38	52	178	42	188	319	314	226	0
Internal Link Dist (ft)		2360			2852			463		968	
Turn Bay Length (ft)	300		250	225		250	375		400		400
Base Capacity (vph)	245	1170	742	284	1192	630	625	1700	562	1939	1568
Starvation Cap Reductn	0	0	0	0	0	0	0	0	0	0	0
Spillback Cap Reductn	0	0	0	0	0	0	0	0	0	0	0
Storage Cap Reductn	0	0	0	0	0	0	0	0	0	0	0
Reduced v/c Ratio	0.73	0.32	0.45	0.15	0.37	0.23	0.75	0.54	0.69	0.55	0.19

Intersection Summary

95th percentile volume exceeds capacity, queue may be longer.
Queue shown is maximum after two cycles.

3: Marksheffel Rd & SH-94

Lane Group	EBL	EBT	EBR	WBL	WBT	WBR	NBL	NBT	SBL	SBT	SBR
Lane Group Flow (vph)	250	426	707	53	505	511	601	1899	245	1574	303
v/c Ratio	1.02	0.49	0.81	0.21	0.77	0.74	0.78	0.94	0.84	1.04	0.20
Control Delay	89.7	43.2	23.0	29.3	54.3	28.6	45.7	57.6	58.2	84.7	0.2
Queue Delay	0.0	0.0	0.0	0.0	0.0	0.0	0.0	0.0	0.0	0.0	0.0
Total Delay	89.7	43.2	23.0	29.3	54.3	28.6	45.7	57.6	58.2	84.7	0.2
Queue Length 50th (ft)	~157	154	327	28	195	229	249	489	166	-499	0
Queue Length 95th (ft)	m#227	m197	439	56	248	371	m260	m500	#338	#643	0
Internal Link Dist (ft)		2360			2852			463		968	
Turn Bay Length (ft)	300		250	225		250	375		400		400
Base Capacity (vph)	246	935	904	256	774	689	849	2010	292	1514	1553
Starvation Cap Reductn	0	0	0	0	0	0	0	0	0	0	0
Spillback Cap Reductn	0	0	0	0	0	0	0	0	0	0	0
Storage Cap Reductn	0	0	0	0	0	0	0	0	0	0	0
Reduced v/c Ratio	1.02	0.46	0.78	0.21	0.65	0.74	0.71	0.94	0.84	1.04	0.20

Intersection Summary

- ~ Volume exceeds capacity, queue is theoretically infinite.
Queue shown is maximum after two cycles.
- # 95th percentile volume exceeds capacity, queue may be longer.
Queue shown is maximum after two cycles.
- m Volume for 95th percentile queue is metered by upstream signal.

4: Marksheffel Rd & CRN North Full Access

02/16/2021



Lane Group	EBL	EBR	NBL	NBT	SBT	SBR
Lane Group Flow (vph)	98	98	54	842	1413	217
v/c Ratio	0.55	0.40	0.18	0.30	0.56	0.18
Control Delay	62.7	14.2	6.6	5.7	25.0	8.9
Queue Delay	0.0	0.0	0.0	0.0	0.0	0.0
Total Delay	62.7	14.2	6.6	5.7	25.0	8.9
Queue Length 50th (ft)	74	0	5	44	493	65
Queue Length 95th (ft)	125	50	35	205	m523	m83
Internal Link Dist (ft)	495			910	636	
Turn Bay Length (ft)	200		300			250
Base Capacity (vph)	368	407	293	2793	2520	1218
Starvation Cap Reductn	0	0	0	0	0	0
Spillback Cap Reductn	0	0	0	0	0	0
Storage Cap Reductn	0	0	0	0	0	0
Reduced v/c Ratio	0.27	0.24	0.18	0.30	0.56	0.18

Intersection Summary

m Volume for 95th percentile queue is metered by upstream signal.

4: Marksheffel Rd & CRN North Full Access

02/16/2021



Lane Group	EBL	EBR	NBL	NBT	SBT	SBR
Lane Group Flow (vph)	98	98	54	1484	1136	201
v/c Ratio	0.56	0.40	0.14	0.52	0.44	0.17
Control Delay	62.9	14.2	3.0	4.0	15.9	6.7
Queue Delay	0.0	0.0	0.0	0.0	0.0	0.0
Total Delay	62.9	14.2	3.0	4.0	15.9	6.7
Queue Length 50th (ft)	74	0	7	130	281	25
Queue Length 95th (ft)	126	50	m13	130	372	m67
Internal Link Dist (ft)	495			910	636	
Turn Bay Length (ft)	200		300			250
Base Capacity (vph)	339	382	398	2849	2570	1214
Starvation Cap Reductn	0	0	0	0	0	0
Spillback Cap Reductn	0	0	0	0	0	0
Storage Cap Reductn	0	0	0	0	0	0
Reduced v/c Ratio	0.29	0.26	0.14	0.52	0.44	0.17

Intersection Summary

m Volume for 95th percentile queue is metered by upstream signal.

4: Marksheffel Rd & CRN North Full Access

02/16/2021



Lane Group	EBL	EBR	NBL	NBT	SBT	SBR
Lane Group Flow (vph)	109	109	60	1261	1821	239
v/c Ratio	0.58	0.41	0.27	0.32	0.51	0.20
Control Delay	63.0	13.4	12.2	4.6	24.6	9.0
Queue Delay	0.0	0.0	0.0	0.0	0.0	0.0
Total Delay	63.0	13.4	12.2	4.6	24.6	9.0
Queue Length 50th (ft)	82	0	18	158	491	70
Queue Length 95th (ft)	137	52	28	87	521	m96
Internal Link Dist (ft)	495			910	1917	
Turn Bay Length (ft)	200		300			250
Base Capacity (vph)	339	391	248	3984	3587	1215
Starvation Cap Reductn	0	0	0	0	0	0
Spillback Cap Reductn	0	0	0	0	0	0
Storage Cap Reductn	0	0	0	0	0	0
Reduced v/c Ratio	0.32	0.28	0.24	0.32	0.51	0.20

Intersection Summary

m Volume for 95th percentile queue is metered by upstream signal.

4: Marksheffel Rd & CRN North Full Access

02/16/2021



Lane Group	EBL	EBR	NBL	NBT	SBT	SBR
Lane Group Flow (vph)	109	109	87	2201	1913	337
v/c Ratio	0.58	0.41	0.40	0.54	0.54	0.28
Control Delay	63.0	13.4	15.8	4.1	22.0	8.1
Queue Delay	0.0	0.0	0.0	0.0	0.0	0.0
Total Delay	63.0	13.4	15.8	4.1	22.0	8.1
Queue Length 50th (ft)	82	0	16	107	426	57
Queue Length 95th (ft)	137	52	57	147	495	m120
Internal Link Dist (ft)	495			910	1917	
Turn Bay Length (ft)	200		300			250
Base Capacity (vph)	427	465	247	4062	3522	1208
Starvation Cap Reductn	0	0	0	0	0	0
Spillback Cap Reductn	0	0	0	0	0	0
Storage Cap Reductn	0	0	0	0	0	0
Reduced v/c Ratio	0.26	0.23	0.35	0.54	0.54	0.28

Intersection Summary

m Volume for 95th percentile queue is metered by upstream signal.

5: Marksheffel Rd & Airl Lane (CRN South Full Access)

02/15/2021



Lane Group	EBL	EBR	NBL	NBT	SBT	SBR
Lane Group Flow (vph)	76	217	163	821	1402	109
v/c Ratio	0.49	0.65	0.51	0.29	0.58	0.09
Control Delay	62.2	17.1	16.0	2.7	4.7	0.7
Queue Delay	0.0	0.0	0.0	0.0	0.0	0.0
Total Delay	62.2	17.1	16.0	2.7	4.7	0.7
Queue Length 50th (ft)	57	4	27	35	105	0
Queue Length 95th (ft)	105	78	m106	112	184	3
Internal Link Dist (ft)	358			968	910	
Turn Bay Length (ft)	200		300			250
Base Capacity (vph)	295	440	385	2835	2436	1153
Starvation Cap Reductn	0	0	0	0	0	0
Spillback Cap Reductn	0	0	0	0	0	0
Storage Cap Reductn	0	0	0	0	0	0
Reduced v/c Ratio	0.26	0.49	0.42	0.29	0.58	0.09

Intersection Summary

m Volume for 95th percentile queue is metered by upstream signal.

5: Marksheffel Rd & Airl Lane (CRN South Full Access)

02/15/2021



Lane Group	EBL	EBR	NBL	NBT	SBT	SBR
Lane Group Flow (vph)	76	217	152	1462	1130	103
v/c Ratio	0.49	0.65	0.38	0.51	0.45	0.09
Control Delay	62.2	15.9	6.9	10.6	5.7	1.5
Queue Delay	0.0	0.0	0.0	0.0	0.0	0.0
Total Delay	62.2	15.9	6.9	10.6	5.7	1.5
Queue Length 50th (ft)	57	0	42	360	135	3
Queue Length 95th (ft)	105	73	m62	m475	157	6
Internal Link Dist (ft)	358			968	910	
Turn Bay Length (ft)	200		300			250
Base Capacity (vph)	354	490	482	2891	2510	1162
Starvation Cap Reductn	0	0	0	0	0	0
Spillback Cap Reductn	0	0	0	0	0	0
Storage Cap Reductn	0	0	0	0	0	0
Reduced v/c Ratio	0.21	0.44	0.32	0.51	0.45	0.09

Intersection Summary

m Volume for 95th percentile queue is metered by upstream signal.

5: Marksheffel Rd & Airl Lane (CRN South Full Access)

02/15/2021



Lane Group	EBL	EBR	NBL	NBT	SBT	SBR
Lane Group Flow (vph)	82	245	179	1245	1810	120
v/c Ratio	0.51	0.67	0.61	0.31	0.54	0.11
Control Delay	62.4	15.7	22.1	7.6	3.1	0.5
Queue Delay	0.0	0.0	0.0	0.0	0.0	0.0
Total Delay	62.4	15.7	22.1	7.6	3.1	0.5
Queue Length 50th (ft)	62	0	86	112	26	0
Queue Length 95th (ft)	111	77	m149	267	134	2
Internal Link Dist (ft)	358			968	910	
Turn Bay Length (ft)	200		300			250
Base Capacity (vph)	324	490	393	4059	3336	1108
Starvation Cap Reductn	0	0	0	0	0	0
Spillback Cap Reductn	0	0	0	0	0	0
Storage Cap Reductn	0	0	0	0	0	0
Reduced v/c Ratio	0.25	0.50	0.46	0.31	0.54	0.11

Intersection Summary

m Volume for 95th percentile queue is metered by upstream signal.

5: Marksheffel Rd & Airl Lane (CRN South Full Access)

02/15/2021



Lane Group	EBL	EBR	NBL	NBT	SBT	SBR
Lane Group Flow (vph)	82	245	255	2207	1853	168
v/c Ratio	0.51	0.67	0.74	0.53	0.58	0.16
Control Delay	62.5	15.7	35.3	1.4	7.7	1.7
Queue Delay	0.0	0.0	0.0	0.0	0.0	0.0
Total Delay	62.5	15.7	35.3	1.4	7.7	1.7
Queue Length 50th (ft)	62	0	137	53	143	5
Queue Length 95th (ft)	111	77	m152	m71	183	9
Internal Link Dist (ft)	358			968	910	
Turn Bay Length (ft)	200		300			250
Base Capacity (vph)	265	445	449	4138	3192	1064
Starvation Cap Reductn	0	0	0	0	0	0
Spillback Cap Reductn	0	0	0	0	0	0
Storage Cap Reductn	0	0	0	0	0	0
Reduced v/c Ratio	0.31	0.55	0.57	0.53	0.58	0.16

Intersection Summary

m Volume for 95th percentile queue is metered by upstream signal.

5: Marksheffel Rd & Airl Lane (CRN South Full Access)

02/16/2021



Lane Group	EBL	EBR	NBL	NBT	SBT	SBR
Lane Group Flow (vph)	168	217	163	821	1402	109
v/c Ratio	0.69	0.54	0.55	0.31	0.62	0.10
Control Delay	63.6	11.5	20.8	4.5	19.1	3.8
Queue Delay	0.0	0.0	0.0	0.0	0.0	0.0
Total Delay	63.6	11.5	20.8	4.5	19.1	3.8
Queue Length 50th (ft)	126	3	41	52	534	12
Queue Length 95th (ft)	192	70	m120	157	m560	m33
Internal Link Dist (ft)	358			968	910	
Turn Bay Length (ft)	200		300			250
Base Capacity (vph)	324	464	354	2664	2246	1071
Starvation Cap Reductn	0	0	0	0	0	0
Spillback Cap Reductn	0	0	0	0	0	0
Storage Cap Reductn	0	0	0	0	0	0
Reduced v/c Ratio	0.52	0.47	0.46	0.31	0.62	0.10

Intersection Summary

m Volume for 95th percentile queue is metered by upstream signal.

5: Marksheffel Rd & Airl Lane (CRN South Full Access)

02/16/2021



Lane Group	EBL	EBR	NBL	NBT	SBT	SBR
Lane Group Flow (vph)	168	217	152	1462	1130	103
v/c Ratio	0.69	0.53	0.41	0.54	0.49	0.10
Control Delay	63.1	10.7	10.8	15.3	19.5	5.7
Queue Delay	0.0	0.0	0.0	0.0	0.0	0.0
Total Delay	63.1	10.7	10.8	15.3	19.5	5.7
Queue Length 50th (ft)	126	0	59	442	403	23
Queue Length 95th (ft)	191	66	m89	m561	521	m41
Internal Link Dist (ft)	358			968	910	
Turn Bay Length (ft)	200		300			250
Base Capacity (vph)	354	490	459	2712	2312	1079
Starvation Cap Reductn	0	0	0	0	0	0
Spillback Cap Reductn	0	0	0	0	0	0
Storage Cap Reductn	0	0	0	0	0	0
Reduced v/c Ratio	0.47	0.44	0.33	0.54	0.49	0.10

Intersection Summary

m Volume for 95th percentile queue is metered by upstream signal.

5: Marksheffel Rd & Airl Lane (CRN South Full Access)

02/16/2021



Lane Group	EBL	EBR	NBL	NBT	SBT	SBR
Lane Group Flow (vph)	190	245	179	1245	1810	120
v/c Ratio	0.73	0.55	0.65	0.33	0.60	0.12
Control Delay	64.3	10.3	29.0	10.9	14.4	4.1
Queue Delay	0.0	0.0	0.0	0.0	0.0	0.0
Total Delay	64.3	10.3	29.0	10.9	14.4	4.1
Queue Length 50th (ft)	142	0	92	122	420	15
Queue Length 95th (ft)	213	70	m164	288	508	m42
Internal Link Dist (ft)	358			968	910	
Turn Bay Length (ft)	200		300			250
Base Capacity (vph)	339	501	359	3776	3041	1020
Starvation Cap Reductn	0	0	0	0	0	0
Spillback Cap Reductn	0	0	0	0	0	0
Storage Cap Reductn	0	0	0	0	0	0
Reduced v/c Ratio	0.56	0.49	0.50	0.33	0.60	0.12

Intersection Summary

m Volume for 95th percentile queue is metered by upstream signal.

5: Marksheffel Rd & Airl Lane (CRN South Full Access)

02/16/2021



Lane Group	EBL	EBR	NBL	NBT	SBT	SBR
Lane Group Flow (vph)	190	245	255	2207	1853	168
v/c Ratio	0.74	0.56	0.78	0.57	0.63	0.17
Control Delay	66.4	10.6	46.2	3.2	23.7	8.1
Queue Delay	0.0	0.0	0.0	0.0	0.0	0.0
Total Delay	66.4	10.6	46.2	3.2	23.7	8.1
Queue Length 50th (ft)	142	0	153	115	427	39
Queue Length 95th (ft)	218	71	m171	m115	564	m79
Internal Link Dist (ft)	358			968	910	
Turn Bay Length (ft)	200		300			250
Base Capacity (vph)	309	479	421	3866	2923	986
Starvation Cap Reductn	0	0	0	0	0	0
Spillback Cap Reductn	0	0	0	0	0	0
Storage Cap Reductn	0	0	0	0	0	0
Reduced v/c Ratio	0.61	0.51	0.61	0.57	0.63	0.17

Intersection Summary

m Volume for 95th percentile queue is metered by upstream signal.

APPENDIX G

Time-Space Diagrams

Time-Space Diagram 2040 Total AM_Signal_Int 9 Signal.syn

Arterial Bandwidths, 90th Percentile Green Times

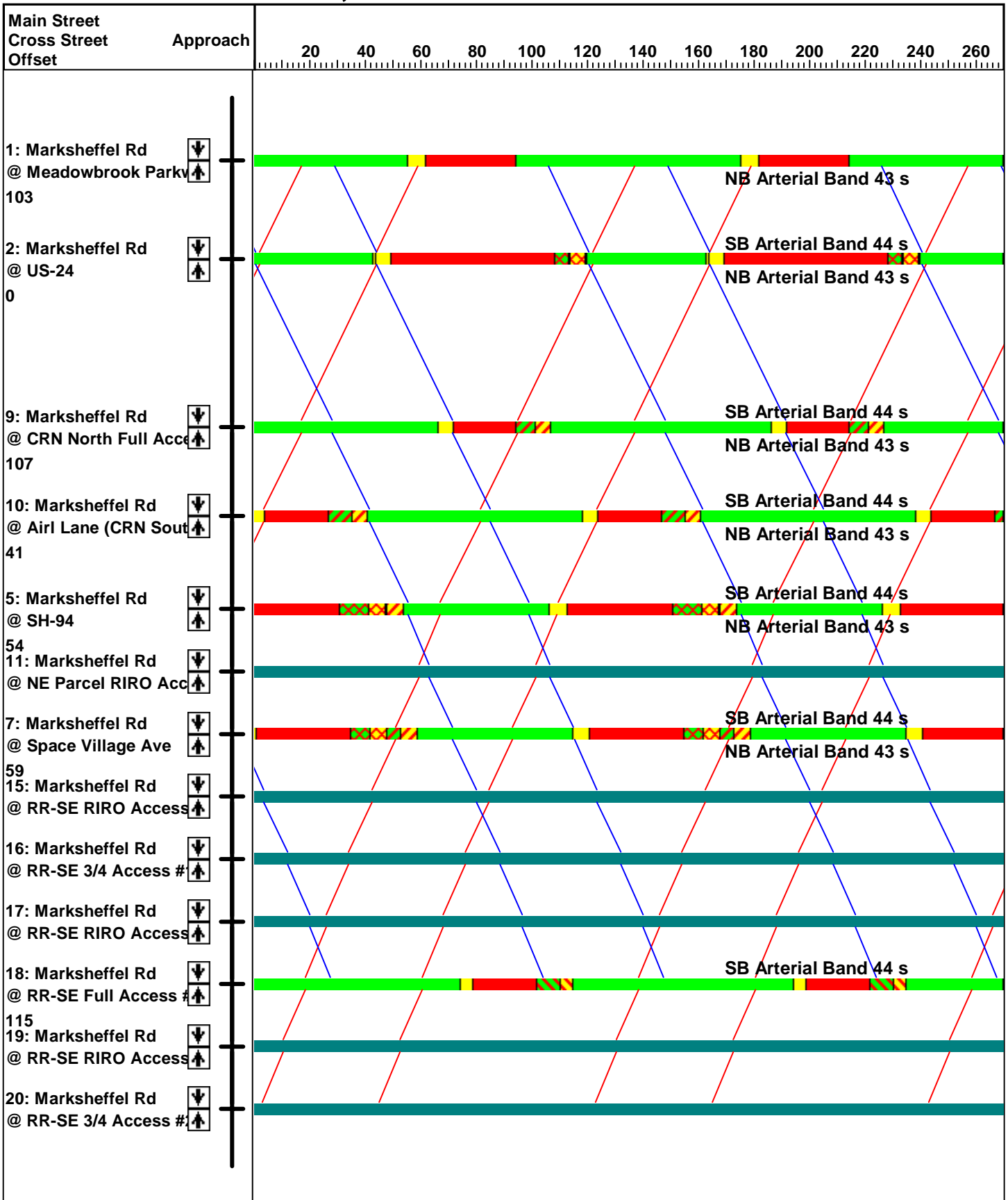

Time-Space Diagram 2040 Total PM_Signal_Int 9 Signal.syn

Arterial Bandwidths, 90th Percentile Green Times

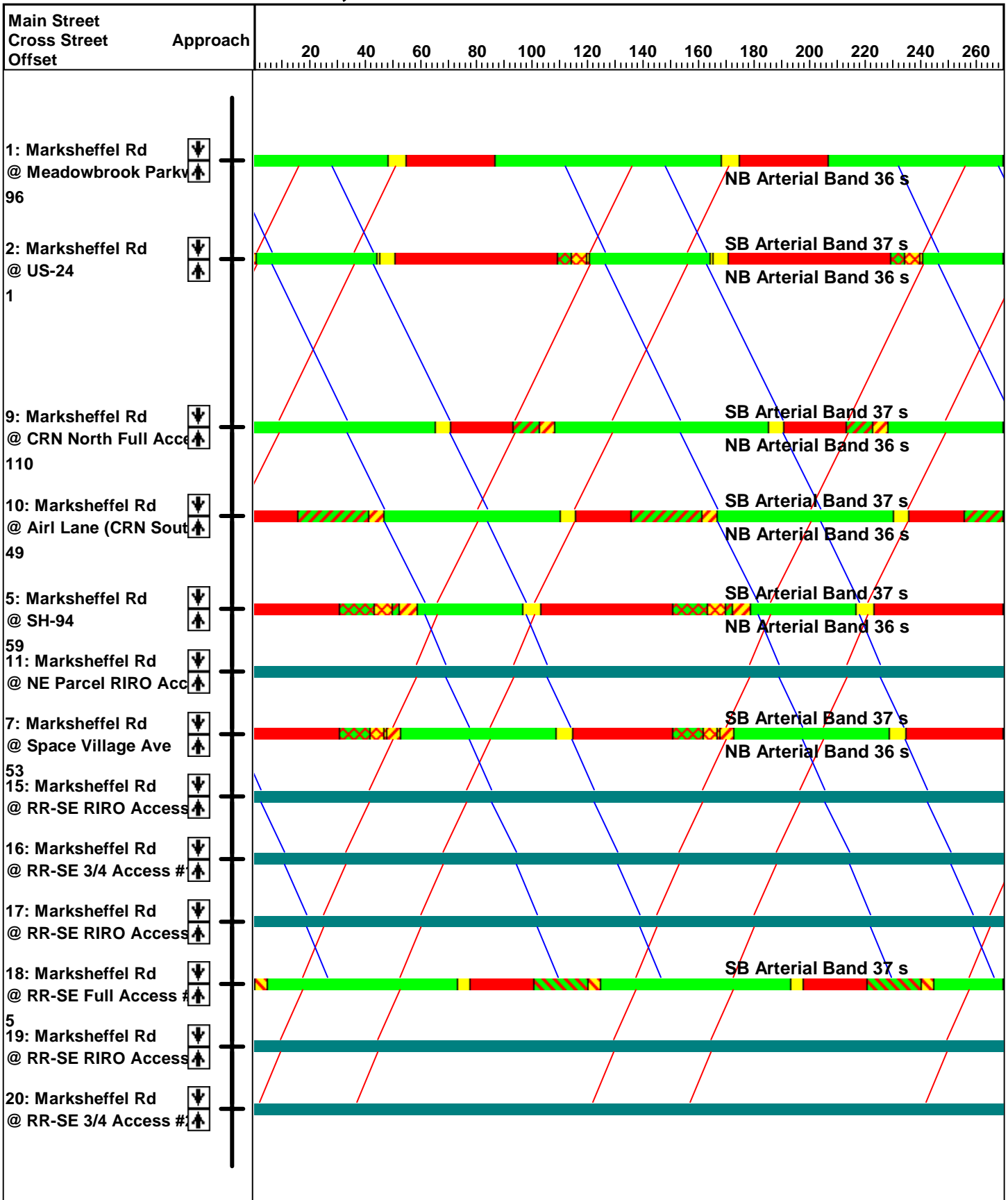

Time-Space Diagram 2040 Total AM_Signal_Int 9 TWSC.syn

Arterial Bandwidths, 90th Percentile Green Times

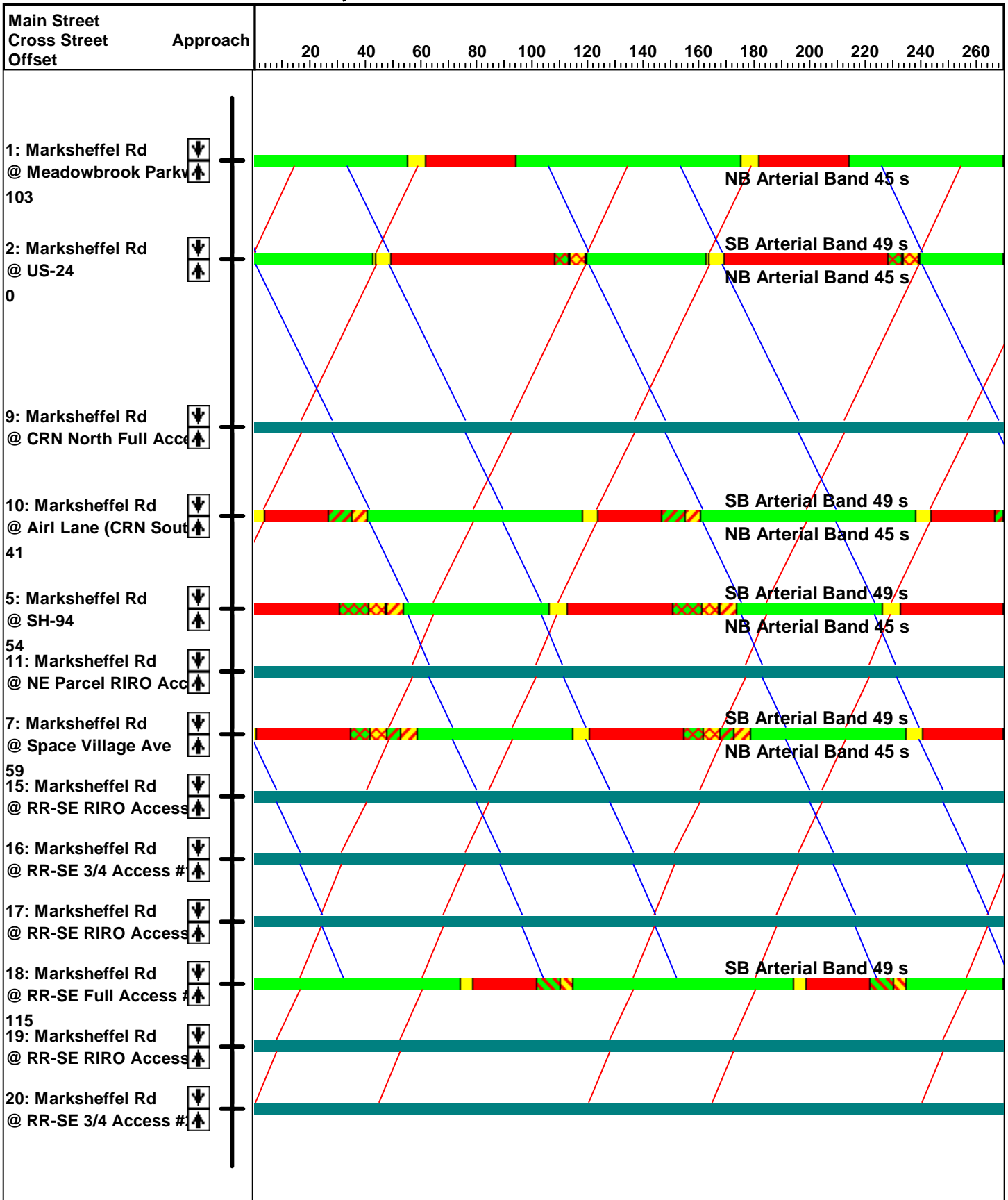

Time-Space Diagram 2040 Total PM_Signal_Int 9 TWSC.syn

Arterial Bandwidths, 90th Percentile Green Times

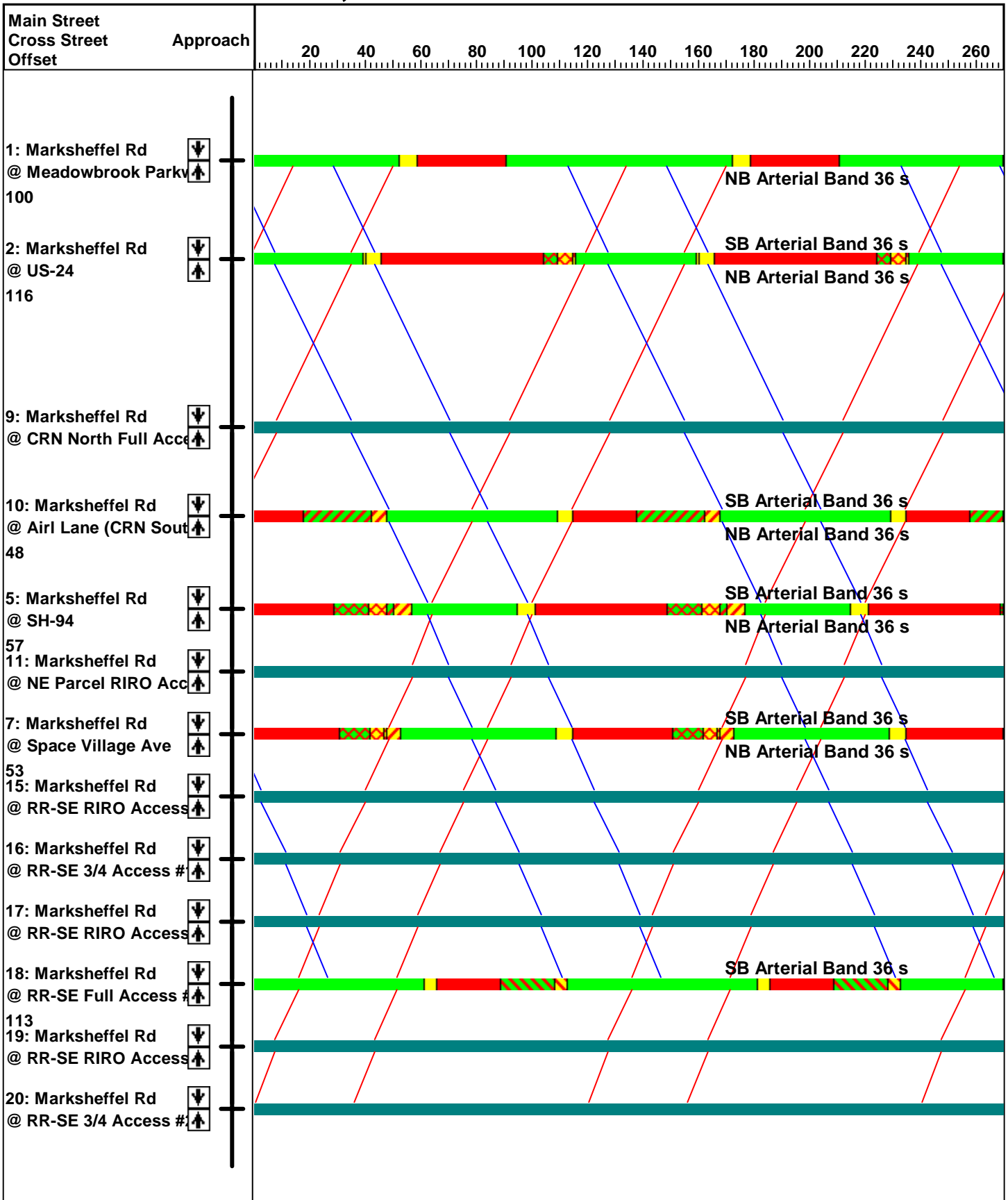

APPENDIX H

Crash Data



**Colorado Department of Transportation
DiExSys™ Roadway Safety Systems
General Summary of Crashes Report**

12/08/2021

Job #: 20211208130629

Location: 24 G Begin: 313.17 End:313.19 From:01/01/2017 To:12/31/2019

Severity	
PDO:	17
INJ:	18 36 :Injured
FAT:	0 0 :Killed
Total:	35

Number of Vehicles	
One Vehicle:	4
Two Vehicles:	29
Three or More:	2
Unknown:	0
Total:	35

Location	
On Road:	31
Off Road:	4
Unknown:	0
Total:	35

Mainline/Ramps/Frontage Rds	
Mainline:	35
Ramps:	0
Frontage/Ramp Intsx:	0
Frontage Roads:	0
HOV Lanes:	0
Unknown:	0
Total:	35

Lighting Conditions	
Daylight:	24
Dawn or Dusk:	1
Dark - Lighted:	7
Dark - Unlighted:	3
Unknown:	0
Total:	35

Crash Rates	
PDO:	40.70 * * Per MVMT
INJ:	43.09 * ** Per 100 MVMT
FAT:	0.00 **
Total:	83.79 *

Crash Type	
Overtuning:	2
Other Non Collision:	0
Pedestrians:	0
Broadside:	6
Head On:	0
Rear End:	10
Sideswipe Same:	4
Sideswipe Opposite:	1
Approach Turn:	10
Overtaking Turn:	0
Parked Motor Vehicle:	0
Railway Vehicle:	0
Bicycles:	0
Domestic Animal:	0
Wild Animal:	0
Fixed Objects:	2
Other Objects:	0
Unknown:	0
Total:	35

Weather Conditions	
None:	31
Rain:	1
Snow/Sleet/Hail:	1
Fog:	1
Dust:	0
Wind:	1
Unknown:	0
Total:	35

Road Conditions	
Dry:	30
Wet:	2
Muddy:	0
Snowy:	0
Icy:	0
Slushy:	0
Foreign Material:	0
With Road Treatment:	3
Unknown:	0
Total:	35

Vehicle Types	Vehicle 1	Vehicle 2	Vehicle 3
Passenger Car/Van:	12	13	1
Passenger Car/Van w/Trailer:	0	0	0
Pickup Truck/Utility Van:	6	5	0
Pickup Truck/Utility Van w/Trailer:	1	1	0
SUV:	8	11	1
SUV w/Trailer:	0	0	0
Truck 10k lbs or Less:	0	0	0
Trucks > 10k lbs/Busses > 15 People:	4	1	0
School Bus < 15 People:	0	0	0
Non School Bus < 15 People:	0	0	0
Motorhome:	0	0	0
Motorcycle:	2	0	0
Bicycle:	0	0	0
Motorized Bicycle:	0	0	0
Farm Equipment:	0	0	0
Hit and Run - Unknown:	2	0	0
Other:	0	0	0
Unknown:	0	0	0
Total:	35	31	2

ADT: 19,073 Length: 0.02

US-24 and Marksheffel Road (MP 313.18) Crash Data

date	time	severity	location	vehicles	condition	lighting	weather	acctype	dir_1	vehicle_1	driver_1	factor_1	speed_1	veh_move_1	dir_2	vehicle_2	driver_2	factor_2	speed_2	veh_move_2
12/31/2019	1835	INJ	ON	2	DRY	DARK-LIGHTED	NONE	APPROACH TURN	W	PICKUP TRUCK/UTILITY VAN	NO IMPAIRMENT SUSPECTED	UNKNOWN	20	MAKING LEFT TURN	E	PICKUP TRUCK/UTILITY VAN	NO IMPAIRMENT SUSPECTED	NO APPARENT CONTRIBUTING FACTOR	65	GOING STRAIGHT
12/13/2019	2150	PDO	ON	2	DRY	DARK-LIGHTED	NONE	REAR-END	S	PICKUP TRUCK/UTILITY VAN	NO IMPAIRMENT SUSPECTED	NO APPARENT CONTRIBUTING FACTOR	10	GOING STRAIGHT	S	PASSENGER CAR/VAN	NO IMPAIRMENT SUSPECTED	NO APPARENT CONTRIBUTING FACTOR	0	STOPPED IN TRAFFIC
12/13/2019	1605	PDO	ON	2	DRY	DAYLIGHT	NONE	REAR-END	E	PICKUP TRUCK/UTILITY VAN	NO IMPAIRMENT SUSPECTED	NO APPARENT CONTRIBUTING FACTOR	5	GOING STRAIGHT	E	SUV	NO IMPAIRMENT SUSPECTED	NO APPARENT CONTRIBUTING FACTOR	0	STOPPED IN TRAFFIC
12/10/2019	1840	PDO	ON	2	DRY	DARK-UNLIGHTED	NONE	REAR-END	E	PICKUP TRUCK/UTILITY VAN	NO IMPAIRMENT SUSPECTED	UNKNOWN	5	GOING STRAIGHT	E	PASSENGER CAR/VAN	NO IMPAIRMENT SUSPECTED	NO APPARENT CONTRIBUTING FACTOR	0	STOPPED IN TRAFFIC
12/7/2019	2020	INJ	ON	2	DRY	DARK-LIGHTED	NONE	APPROACH TURN	W	PASSENGER CAR/VAN	NO IMPAIRMENT SUSPECTED	NO APPARENT CONTRIBUTING FACTOR	15	MAKING LEFT TURN	E	SUV	NO IMPAIRMENT SUSPECTED	NO APPARENT CONTRIBUTING FACTOR	65	GOING STRAIGHT
10/2/2019	1015	PDO	ON	2	DRY	DAYLIGHT	NONE	REAR-END	S	SUV	NO IMPAIRMENT SUSPECTED	DRIVER PREOCCUPIED	5	MAKING RIGHT TURN	S	PASSENGER CAR/VAN	NO IMPAIRMENT SUSPECTED	NO APPARENT CONTRIBUTING FACTOR	1	MAKING RIGHT TURN
8/12/2019	1233	PDO	ON	2	DRY	DAYLIGHT	NONE	SIDESWIPE (SAME DIRECTION)	E	TRUCK GVW > 10K/BUSSES > 15 PEOPLE	NO IMPAIRMENT SUSPECTED	NO APPARENT CONTRIBUTING FACTOR	15	MAKING LEFT TURN	E	PICKUP TRUCK/UTILITY VAN W/TRAILER	NO IMPAIRMENT SUSPECTED	NO APPARENT CONTRIBUTING FACTOR	5	MAKING LEFT TURN
7/25/2019	1840	INJ	ON	2	DRY	DAYLIGHT	NONE	APPROACH TURN	W	PASSENGER CAR/VAN	NO IMPAIRMENT SUSPECTED	DRIVER UNFAMILIAR WITH AREA	15	MAKING LEFT TURN	E	PASSENGER CAR/VAN	NO IMPAIRMENT SUSPECTED	NO APPARENT CONTRIBUTING FACTOR	50	GOING STRAIGHT
7/15/2019	1738	INJ	OFF RIGHT	1	DRY	DAYLIGHT	NONE	SIGN	S	MOTORCYCLE	ALCOHOL INVOLVED	UNKNOWN	50	MAKING RIGHT TURN			NO IMPAIRMENT SUSPECTED	NO APPARENT CONTRIBUTING FACTOR		
7/12/2019	1500	PDO	ON	2	DRY	DAYLIGHT	NONE	REAR-END	N	HIT & RUN - UNKNOWN	NO IMPAIRMENT SUSPECTED	NO APPARENT CONTRIBUTING FACTOR	1	OTHER	N	SUV	NO IMPAIRMENT SUSPECTED	NO APPARENT CONTRIBUTING FACTOR	0	STOPPED IN TRAFFIC
6/5/2019	1800	PDO	ON	2	WET	DAYLIGHT	RAIN	SIDESWIPE (SAME DIRECTION)	S	PASSENGER CAR/VAN	NO IMPAIRMENT SUSPECTED	DRIVER PREOCCUPIED	10	CHANGING LANES	S	SUV	NO IMPAIRMENT SUSPECTED	NO APPARENT CONTRIBUTING FACTOR		MAKING RIGHT TURN
5/14/2019	950	PDO	ON	2	DRY	DAYLIGHT	NONE	REAR-END	E	PASSENGER CAR/VAN	NO IMPAIRMENT SUSPECTED	DRIVER PREOCCUPIED	10	MAKING RIGHT TURN	E	PASSENGER CAR/VAN	NO IMPAIRMENT SUSPECTED	NO APPARENT CONTRIBUTING FACTOR	UK	5 SLOWING
4/14/2019	318	INJ	OFF RIGHT	1	ICY W/VIS ICY ROAD TREATMENT	DARK-LIGHTED	NONE	OVERTURNING	E	PICKUP TRUCK/UTILITY VAN	ALCOHOL/DRUGS	UNKNOWN	55	GOING STRAIGHT			NO IMPAIRMENT SUSPECTED	NO APPARENT CONTRIBUTING FACTOR		
3/6/2019	2105	INJ	ON	2	DRY	DARK-LIGHTED	NONE	BROADSIDE	S	PASSENGER CAR/VAN	NO IMPAIRMENT SUSPECTED	DRIVER PREOCCUPIED	5	GOING STRAIGHT	W	PASSENGER CAR/VAN	NO IMPAIRMENT SUSPECTED	NO APPARENT CONTRIBUTING FACTOR	65	GOING STRAIGHT
1/16/2019	2050	INJ	ON	2	DRY	DARK-UNLIGHTED	NONE	APPROACH TURN	W	SUV	NO IMPAIRMENT SUSPECTED	NO APPARENT CONTRIBUTING FACTOR	30	MAKING LEFT TURN	E	PASSENGER CAR/VAN	NO IMPAIRMENT SUSPECTED	NO APPARENT CONTRIBUTING FACTOR	65	GOING STRAIGHT
1/7/2019	1806	INJ	ON	2	DRY	DARK-LIGHTED	WIND	APPROACH TURN	W	SUV	NO IMPAIRMENT SUSPECTED	NO APPARENT CONTRIBUTING FACTOR	20	MAKING LEFT TURN	E	SUV	NO IMPAIRMENT SUSPECTED	NO APPARENT CONTRIBUTING FACTOR	65	GOING STRAIGHT
12/29/2018	821	INJ	ON	2	SNOWY W/VIS ICY ROAD TREATMENT	DAYLIGHT	NONE	BROADSIDE	S	PASSENGER CAR/VAN	NO IMPAIRMENT SUSPECTED	DRIVER INEXPERIENCE	30	MAKING RIGHT TURN	W	PASSENGER CAR/VAN	NO IMPAIRMENT SUSPECTED	NO APPARENT CONTRIBUTING FACTOR	60	GOING STRAIGHT
11/1/2018	1200	PDO	ON	2	DRY	DAYLIGHT	NONE	BROADSIDE	S	PASSENGER CAR/VAN	NO IMPAIRMENT SUSPECTED	DRIVER PREOCCUPIED	20	GOING STRAIGHT	E	PASSENGER CAR/VAN	NO IMPAIRMENT SUSPECTED	NO APPARENT CONTRIBUTING FACTOR	20	GOING STRAIGHT
9/27/2018	710	INJ	ON	2	DRY	DAYLIGHT	NONE	REAR-END	W	PASSENGER CAR/VAN	NO IMPAIRMENT SUSPECTED	DRIVER PREOCCUPIED	60	GOING STRAIGHT	W	SUV	NO IMPAIRMENT SUSPECTED	NO APPARENT CONTRIBUTING FACTOR	UK	SLOWING
8/10/2018	1845	INJ	ON	2	DRY	DAYLIGHT	NONE	BROADSIDE	S	SUV	NO IMPAIRMENT SUSPECTED	DRIVER INEXPERIENCE	15	MAKING LEFT TURN	E	PICKUP TRUCK/UTILITY VAN	NO IMPAIRMENT SUSPECTED	NO APPARENT CONTRIBUTING FACTOR	60	GOING STRAIGHT
6/5/2018	1415	PDO	ON	2	DRY	DAYLIGHT	NONE	APPROACH TURN	W	PICKUP TRUCK/UTILITY VAN W/TRAILER	NO IMPAIRMENT SUSPECTED	DRIVER UNFAMILIAR WITH AREA	15	MAKING LEFT TURN	E	PICKUP TRUCK/UTILITY VAN	NO IMPAIRMENT SUSPECTED	NO APPARENT CONTRIBUTING FACTOR	65	GOING STRAIGHT
4/26/2018	1600	PDO	ON	2	DRY	DAYLIGHT	NONE	REAR-END	N	PASSENGER CAR/VAN	NO IMPAIRMENT SUSPECTED	NO APPARENT CONTRIBUTING FACTOR	10	MAKING LEFT TURN	N	PASSENGER CAR/VAN	NO IMPAIRMENT SUSPECTED	NO APPARENT CONTRIBUTING FACTOR	0	STOPPED IN TRAFFIC
4/21/2018	1820	PDO	ON	2	DRY	DAYLIGHT	NONE	SIDESWIPE (SAME DIRECTION)	N	SUV	NO IMPAIRMENT SUSPECTED	NO APPARENT CONTRIBUTING FACTOR	30	MAKING RIGHT TURN	N	PICKUP TRUCK/UTILITY VAN	NO IMPAIRMENT SUSPECTED	NO APPARENT CONTRIBUTING FACTOR	30	MAKING RIGHT TURN
4/4/2018	1310	INJ	ON	2	DRY	DAYLIGHT	NONE	APPROACH TURN	W	TRUCK GVW > 10K/BUSSES > 15 PEOPLE	NO IMPAIRMENT SUSPECTED	UNKNOWN	15	MAKING LEFT TURN	E	PICKUP TRUCK/UTILITY VAN	NO IMPAIRMENT SUSPECTED	NO APPARENT CONTRIBUTING FACTOR	55	GOING STRAIGHT
3/14/2018	1617	PDO	ON	2	DRY	DAYLIGHT	NONE	APPROACH TURN	W	PASSENGER CAR/VAN	NO IMPAIRMENT SUSPECTED	UNKNOWN	20	MAKING LEFT TURN	E	SUV	NO IMPAIRMENT SUSPECTED	NO APPARENT CONTRIBUTING FACTOR	60	GOING STRAIGHT
1/21/2018	1255	INJ	ON	3	ICY W/VIS ICY ROAD TREATMENT	DAYLIGHT	SNOW/SLEET/HAIL	BROADSIDE	S	SUV	NO IMPAIRMENT SUSPECTED	DISTRACTED BY PASSENGER	UK	GOING STRAIGHT	E	SUV	NO IMPAIRMENT SUSPECTED	NO APPARENT CONTRIBUTING FACTOR	40	GOING STRAIGHT
9/6/2017	632	INJ	ON	2	DRY	DAYLIGHT	NONE	APPROACH TURN	W	PICKUP TRUCK/UTILITY VAN	NO IMPAIRMENT SUSPECTED	UNKNOWN	30	MAKING LEFT TURN	E	TRUCK GVW > 10K/BUSSES > 15 PEOPLE	NO IMPAIRMENT SUSPECTED	NO APPARENT CONTRIBUTING FACTOR	65	GOING STRAIGHT
8/16/2017	615	INJ	ON	1	DRY	DAWN OR DUSK	NONE	OVERTURNING	NE	MOTORCYCLE	NO IMPAIRMENT SUSPECTED	DRIVER INEXPERIENCE	10	MAKING RIGHT TURN			NO IMPAIRMENT SUSPECTED	NO APPARENT CONTRIBUTING FACTOR		
8/2/2017	1130	PDO	ON	2	DRY	DAYLIGHT	NONE	BROADSIDE	NE	TRUCK GVW > 10K/BUSSES > 15 PEOPLE	NO IMPAIRMENT SUSPECTED	UNKNOWN	40	GOING STRAIGHT	N	SUV	NO IMPAIRMENT SUSPECTED	NO APPARENT CONTRIBUTING FACTOR	30	GOING STRAIGHT
7/12/2017	930	INJ	ON	2	DRY	DAYLIGHT	NONE	REAR-END	E	TRUCK GVW > 10K/BUSSES > 15 PEOPLE	NO IMPAIRMENT SUSPECTED	DRIVER PREOCCUPIED	2	GOING STRAIGHT	E	SUV	NO IMPAIRMENT SUSPECTED	NO APPARENT CONTRIBUTING FACTOR	0	STOPPED IN TRAFFIC
6/28/2017	1643	PDO	ON	2	DRY	DAYLIGHT	NONE	REAR-END	W	PASSENGER CAR/VAN	NO IMPAIRMENT SUSPECTED	NO APPARENT CONTRIBUTING FACTOR	30	GOING STRAIGHT	W	PASSENGER CAR/VAN	NO IMPAIRMENT SUSPECTED	NO APPARENT CONTRIBUTING FACTOR	0	STOPPED IN TRAFFIC
6/9/2017	1400	INJ	OFF IN MEDIAN	2	DRY	DAYLIGHT	NONE	SIDESWIPE (OPPOSITE DIRECTION)	S	SUV	ALCOHOL INVOLVED	UNKNOWN	45	WRONG WAY	N	PASSENGER CAR/VAN	NO IMPAIRMENT SUSPECTED	NO APPARENT CONTRIBUTING FACTOR	30	GOING STRAIGHT
2/2/2017	1915	INJ	ON	2	WET	DARK-LIGHTED	FOG	APPROACH TURN	W	PASSENGER CAR/VAN	NO IMPAIRMENT SUSPECTED	DRIVER UNFAMILIAR WITH AREA	40	MAKING LEFT TURN	E	SUV	NO IMPAIRMENT SUSPECTED	NO APPARENT CONTRIBUTING FACTOR	49	GOING STRAIGHT



Colorado Department of Transportation
DiExSys™ Roadway Safety Systems
General Summary of Crashes Report

12/08/2021

Job #: 20211208123416

Location: 24 G Begin: 312.42 End: 312.44 From: 01/01/2017 To: 12/31/2019

Severity	
PDO:	14
INJ:	10 19 :Injured
FAT:	0 0 :Killed
Total:	24

Number of Vehicles	
One Vehicle:	1
Two Vehicles:	17
Three or More:	6
Unknown:	0
Total:	24

Location	
On Road:	23
Off Road:	1
Unknown:	0
Total:	24

Mainline/Ramps/Frontage Rds	
Mainline:	24
Ramps:	0
Frontage/Ramp Intsx:	0
Frontage Roads:	0
HOV Lanes:	0
Unknown:	0
Total:	24

Lighting Conditions	
Daylight:	16
Dawn or Dusk:	2
Dark - Lighted:	3
Dark - Unlighted:	3
Unknown:	0
Total:	24

Crash Rates	
PDO:	22.43 * * Per MVMT
INJ:	16.02 * ** Per 100 MVMT
FAT:	0.00 **
Total:	38.45 *

Crash Type	
Overtuning:	0
Other Non Collision:	0
Pedestrians:	0
Broadside:	6
Head On:	0
Rear End:	12
Sideswipe Same:	1
Sideswipe Opposite:	0
Approach Turn:	4
Overtaking Turn:	0
Parked Motor Vehicle:	0
Railway Vehicle:	0
Bicycles:	0
Domestic Animal:	0
Wild Animal:	0
Fixed Objects:	1
Other Objects:	0
Unknown:	0
Total:	24

Weather Conditions	
None:	22
Rain:	1
Snow/Sleet/Hail:	1
Fog:	0
Dust:	0
Wind:	0
Unknown:	0
Total:	24

Road Conditions	
Dry:	21
Wet:	1
Muddy:	0
Snowy:	1
Icy:	0
Slushy:	0
Foreign Material:	0
With Road Treatment:	1
Unknown:	0
Total:	24

Vehicle Types	Vehicle 1	Vehicle 2	Vehicle 3
Passenger Car/Van:	12	8	2
Passenger Car/Van w/Trailer:	0	0	0
Pickup Truck/Utility Van:	3	5	2
Pickup Truck/Utility Van w/Trailer:	0	0	0
SUV:	4	9	2
SUV w/Trailer:	0	0	0
Truck 10k lbs or Less:	0	0	0
Trucks > 10k lbs/Busses > 15 People:	4	0	0
School Bus < 15 People:	0	0	0
Non School Bus < 15 People:	0	0	0
Motorhome:	0	0	0
Motorcycle:	0	1	0
Bicycle:	0	0	0
Motorized Bicycle:	0	0	0
Farm Equipment:	0	0	0
Hit and Run - Unknown:	1	0	0
Other:	0	0	0
Unknown:	0	0	0
Total:	24	23	6

ADT: 28,500 Length: 0.02

US-24 and SH-94 (MP 312.42) Crash Data

date	time	severity	location	vehicles	condition	lighting	weather	acctype	dir_1	vehicle_1	driver_1	factor_1	speed_1	veh_move_1	dir_2	vehicle_2	driver_2	factor_2	speed_2	veh_move_2
11/19/2019	1911	INJ	ON	3	DRY	DARK-LIGHTED	NONE	BROADSIDE	E	PICKUP TRUCK/UTILITY VAN	NO IMPAIRMENT SUSPECTED	NO APPARENT CONTRIBUTING FACTOR	15	MAKING LEFT TURN	S	SUV	NO IMPAIRMENT SUSPECTED	NO APPARENT CONTRIBUTING FACTOR	40	GOING STRAIGHT
11/4/2019	1530	PDO	ON	2	DRY	DAYLIGHT	NONE	REAR-END	SE	TRUCK GVW > 10K/BUSSES > 15 PEOPLE	NO IMPAIRMENT SUSPECTED	DRIVER PREOCCUPIED	5	BACKING	SE	SUV	NO IMPAIRMENT SUSPECTED	NO APPARENT CONTRIBUTING FACTOR	0	STOPPED IN TRAFFIC
11/3/2019	1745	PDO	ON	2	DRY	DARK-LIGHTED	NONE	REAR-END	E	PASSENGER CAR/VAN	NO IMPAIRMENT SUSPECTED	DRIVER PREOCCUPIED	45	GOING STRAIGHT	E	PICKUP TRUCK/UTILITY VAN	NO IMPAIRMENT SUSPECTED	NO APPARENT CONTRIBUTING FACTOR	10	SLOWING
7/23/2019	1715	PDO	ON	2	DRY	DAYLIGHT	NONE	BROADSIDE	E	PASSENGER CAR/VAN	NO IMPAIRMENT SUSPECTED	DRIVER INEXPERIENCE	30	MAKING LEFT TURN	S	SUV	NO IMPAIRMENT SUSPECTED	NO APPARENT CONTRIBUTING FACTOR	5	MAKING LEFT TURN
6/14/2019	1524	PDO	ON	2	WET	DAYLIGHT	RAIN	REAR-END	W	PASSENGER CAR/VAN	NO IMPAIRMENT SUSPECTED	NO APPARENT CONTRIBUTING FACTOR	35	GOING STRAIGHT	W	PICKUP TRUCK/UTILITY VAN	NO IMPAIRMENT SUSPECTED	NO APPARENT CONTRIBUTING FACTOR	25	SLOWING
6/12/2019	1240	PDO	ON	2	DRY	DAYLIGHT	NONE	REAR-END	E	PICKUP TRUCK/UTILITY VAN	NO IMPAIRMENT SUSPECTED	DRIVER INEXPERIENCE	45	GOING STRAIGHT	E	PASSENGER CAR/VAN	NO IMPAIRMENT SUSPECTED	NO APPARENT CONTRIBUTING FACTOR	0	STOPPED IN TRAFFIC
6/6/2019	1720	PDO	ON	2	DRY	DAYLIGHT	NONE	REAR-END	W	PASSENGER CAR/VAN	NO IMPAIRMENT SUSPECTED	UNKNOWN	5	SLOWING	W	SUV	NO IMPAIRMENT SUSPECTED	NO APPARENT CONTRIBUTING FACTOR	0	STOPPED IN TRAFFIC
2/20/2019	2002	PDO	ON	3	DRY	DARK-LIGHTED	NONE	REAR-END	E	HIT & RUN - UNKNOWN	NO IMPAIRMENT SUSPECTED	NO APPARENT CONTRIBUTING FACTOR	UK	GOING STRAIGHT	E	SUV	NO IMPAIRMENT SUSPECTED	NO APPARENT CONTRIBUTING FACTOR	3	STOPPED IN TRAFFIC
2/16/2019	1310	INJ	ON	2	DRY	DAYLIGHT	NONE	BROADSIDE	E	PASSENGER CAR/VAN	NO IMPAIRMENT SUSPECTED	DRIVER PREOCCUPIED	65	GOING STRAIGHT	N	PASSENGER CAR/VAN	NO IMPAIRMENT SUSPECTED	NO APPARENT CONTRIBUTING FACTOR	25	GOING STRAIGHT
2/11/2019	1615	PDO	ON	2	DRY	DAYLIGHT	NONE	REAR-END	W	SUV	NO IMPAIRMENT SUSPECTED	DRIVER PREOCCUPIED	65	GOING STRAIGHT	W	PASSENGER CAR/VAN	NO IMPAIRMENT SUSPECTED	NO APPARENT CONTRIBUTING FACTOR	0	STOPPED IN TRAFFIC
12/12/2018	1815	INJ	ON	3	DRY	DARK-UNLIGHTED	NONE	REAR-END	E	PASSENGER CAR/VAN	NO IMPAIRMENT SUSPECTED	DRIVER PREOCCUPIED	45	SLOWING	E	PASSENGER CAR/VAN	NO IMPAIRMENT SUSPECTED	NO APPARENT CONTRIBUTING FACTOR	0	STOPPED IN TRAFFIC
11/27/2018	657	PDO	ON	2	WET W/VIS ICY ROAD TREATMENT	DAYLIGHT	NONE	BROADSIDE	E	SUV	NO IMPAIRMENT SUSPECTED	NO APPARENT CONTRIBUTING FACTOR	50	OTHER	N	SUV	NO IMPAIRMENT SUSPECTED	NO APPARENT CONTRIBUTING FACTOR	0	STOPPED IN TRAFFIC
11/5/2018	648	INJ	ON	2	DRY	DAYLIGHT	NONE	APPROACH TURN	E	PICKUP TRUCK/UTILITY VAN	NO IMPAIRMENT SUSPECTED	UNKNOWN	15	MAKING LEFT TURN	W	PASSENGER CAR/VAN	NO IMPAIRMENT SUSPECTED	UNKNOWN	60	SLOWING
9/24/2018	1614	PDO	ON	3	DRY	DAYLIGHT	NONE	REAR-END	E	SUV	NO IMPAIRMENT SUSPECTED	DRIVER PREOCCUPIED	25	GOING STRAIGHT	E	PICKUP TRUCK/UTILITY VAN	NO IMPAIRMENT SUSPECTED	NO APPARENT CONTRIBUTING FACTOR	0	STOPPED IN TRAFFIC
5/7/2018	1600	PDO	ON	2	DRY	DAYLIGHT	NONE	APPROACH TURN	E	TRUCK GVW > 10K/BUSSES > 15 PEOPLE	NO IMPAIRMENT SUSPECTED	NO APPARENT CONTRIBUTING FACTOR	5	MAKING LEFT TURN	W	MOTORCYCLE	NO IMPAIRMENT SUSPECTED	NO APPARENT CONTRIBUTING FACTOR	55	GOING STRAIGHT
5/4/2018	1355	PDO	ON	2	DRY	DAYLIGHT	NONE	REAR-END	E	PASSENGER CAR/VAN	NO IMPAIRMENT SUSPECTED	DRIVER PREOCCUPIED	3	GOING STRAIGHT	E	PICKUP TRUCK/UTILITY VAN	NO IMPAIRMENT SUSPECTED	NO APPARENT CONTRIBUTING FACTOR	0	STOPPED IN TRAFFIC
3/18/2018	2140	INJ	ON	2	SNOWY	DARK-UNLIGHTED	SNOW/SLEET/HAIL	REAR-END	W	TRUCK GVW > 10K/BUSSES > 15 PEOPLE	NO IMPAIRMENT SUSPECTED	UNKNOWN	15	GOING STRAIGHT	W	SUV	NO IMPAIRMENT SUSPECTED	NO APPARENT CONTRIBUTING FACTOR	0	STOPPED IN TRAFFIC
3/8/2018	730	INJ	ON	2	DRY	DAYLIGHT	NONE	APPROACH TURN	E	PASSENGER CAR/VAN	NO IMPAIRMENT SUSPECTED	NO APPARENT CONTRIBUTING FACTOR	55	MAKING LEFT TURN	W	PICKUP TRUCK/UTILITY VAN	NO IMPAIRMENT SUSPECTED	NO APPARENT CONTRIBUTING FACTOR	65	GOING STRAIGHT
12/30/2017	1230	INJ	ON	5	DRY	DAYLIGHT	NONE	REAR-END	W	PASSENGER CAR/VAN	NO IMPAIRMENT SUSPECTED	UNKNOWN	65	GOING STRAIGHT	W	PASSENGER CAR/VAN	NO IMPAIRMENT SUSPECTED	NO APPARENT CONTRIBUTING FACTOR	0	STOPPED IN TRAFFIC
3/9/2017	1625	INJ	ON	2	DRY	DAYLIGHT	NONE	BROADSIDE	N	PASSENGER CAR/VAN	NO IMPAIRMENT SUSPECTED	DRIVER PREOCCUPIED	15	MAKING LEFT TURN	W	PASSENGER CAR/VAN	NO IMPAIRMENT SUSPECTED	NO APPARENT CONTRIBUTING FACTOR	55	GOING STRAIGHT
8/1/2017	640	PDO	ON	2	DRY	DAYLIGHT	NONE	BROADSIDE	W	TRUCK GVW > 10K/BUSSES > 15 PEOPLE	NO IMPAIRMENT SUSPECTED	NO APPARENT CONTRIBUTING FACTOR	35	MAKING RIGHT TURN	N	SUV	NO IMPAIRMENT SUSPECTED	NO APPARENT CONTRIBUTING FACTOR	15	GOING STRAIGHT
3/9/2017	1745	INJ	ON	2	DRY	DAWN OR DUSK	NONE	APPROACH TURN	NE	PASSENGER CAR/VAN	NO IMPAIRMENT SUSPECTED	DRIVER UNFAMILIAR WITH AREA	10	MAKING LEFT TURN	SW	PASSENGER CAR/VAN	NO IMPAIRMENT SUSPECTED	NO APPARENT CONTRIBUTING FACTOR	70	GOING STRAIGHT
2/5/2017	2030	PDO	OFF AT TEE	1	DRY	DARK-UNLIGHTED	NONE	EMBANKMENT CUT/FILL SLOPE	N	SUV	NO IMPAIRMENT SUSPECTED	DRIVER UNFAMILIAR WITH AREA	35	GOING STRAIGHT			NO IMPAIRMENT SUSPECTED	NO APPARENT CONTRIBUTING FACTOR		



Colorado Department of Transportation
DiExSys™ Roadway Safety Systems
General Summary of Crashes Report

12/08/2021

Job #: 20211208125823

Location: 94 A Begin: 0.99 End: 1.01 From:01/01/2017 To:12/31/2019

Severity	
PDO:	8
INJ:	6 10 :Injured
FAT:	1 1 :Killed
Total:	15

Number of Vehicles	
One Vehicle:	1
Two Vehicles:	13
Three or More:	1
Unknown:	0
Total:	15

Location	
On Road:	15
Off Road:	0
Unknown:	0
Total:	15

Mainline/Ramps/Frontage Rds	
Mainline:	15
Ramps:	0
Frontage/Ramp Intsx:	0
Frontage Roads:	0
HOV Lanes:	0
Unknown:	0
Total:	15

Lighting Conditions	
Daylight:	11
Dawn or Dusk:	1
Dark - Lighted:	1
Dark - Unlighted:	2
Unknown:	0
Total:	15

Crash Rates	
PDO:	33.46 * * Per MVMT
INJ:	25.10 * ** Per 100 MVMT
FAT:	418.31 **
Total:	62.75 *

Crash Type	
Overtuning:	0
Other Non Collision:	0
Pedestrians:	0
Broadside:	3
Head On:	0
Rear End:	6
Sideswipe Same:	0
Sideswipe Opposite:	0
Approach Turn:	5
Overtaking Turn:	0
Parked Motor Vehicle:	0
Railway Vehicle:	0
Bicycles:	0
Domestic Animal:	1
Wild Animal:	0
Fixed Objects:	0
Other Objects:	0
Unknown:	0
Total:	15

Weather Conditions	
None:	14
Rain:	0
Snow/Sleet/Hail:	0
Fog:	0
Dust:	0
Wind:	1
Unknown:	0
Total:	15

Road Conditions	
Dry:	15
Wet:	0
Muddy:	0
Snowy:	0
Icy:	0
Slushy:	0
Foreign Material:	0
With Road Treatment:	0
Unknown:	0
Total:	15

Vehicle Types	Vehicle 1	Vehicle 2	Vehicle 3
Passenger Car/Van:	6	6	0
Passenger Car/Van w/Trailer:	0	0	0
Pickup Truck/Utility Van:	3	3	1
Pickup Truck/Utility Van w/Trailer:	0	0	0
SUV:	5	3	0
SUV w/Trailer:	0	0	0
Truck 10k lbs or Less:	0	0	0
Trucks > 10k lbs/Busses > 15 People:	1	2	0
School Bus < 15 People:	0	0	0
Non School Bus < 15 People:	0	0	0
Motorhome:	0	0	0
Motorcycle:	0	0	0
Bicycle:	0	0	0
Motorized Bicycle:	0	0	0
Farm Equipment:	0	0	0
Hit and Run - Unknown:	0	0	0
Other:	0	0	0
Unknown:	0	0	0
Total:	15	14	1

ADT: 10,396 Length: 0.02

SH-94 and Marksheffel Road (MP 1) Crash Data

date	time	severity	location	vehicles	condition	lighting	weather	acctype	dir_1	vehicle_1	driver_1	factor_1	speed_1	veh_move_1	dir_2	vehicle_2	driver_2	factor_2	speed_2	veh_move_2
12/2/2019	640	INJ	ON	2	DRY	DAWN OR DUSK	NONE	APPROACH TURN	S	SUV	NO IMPAIRMENT SUSPECTED	NO APPARENT CONTRIBUTING FACTOR	20	MAKING LEFT TURN	N	PASSENGER CAR/VAN	NO IMPAIRMENT SUSPECTED	NO APPARENT CONTRIBUTING FACTOR	50	GOING STRAIGHT
10/16/2019	950	INJ	ON	2	DRY	DAYLIGHT	NONE	REAR-END	S	PICKUP TRUCK/UTILITY VAN	NO IMPAIRMENT SUSPECTED	DRIVER PREOCCUPIED	55	GOING STRAIGHT	S	TRUCK GVW > 10K/BUSSES > 15 PEOPLE	NO IMPAIRMENT SUSPECTED	NO APPARENT CONTRIBUTING FACTOR	0	STOPPED IN TRAFFIC
10/11/2019	1323	PDO	ON	2	DRY	DAYLIGHT	NONE	REAR-END	W	PICKUP TRUCK/UTILITY VAN	NO IMPAIRMENT SUSPECTED	NO APPARENT CONTRIBUTING FACTOR	10	MAKING RIGHT TURN	W	PASSENGER CAR/VAN	NO IMPAIRMENT SUSPECTED	NO APPARENT CONTRIBUTING FACTOR	0	STOPPED IN TRAFFIC
8/13/2019	1700	PDO	ON	2	DRY	DAYLIGHT	NONE	REAR-END	W	PASSENGER CAR/VAN	NO IMPAIRMENT SUSPECTED	NO APPARENT CONTRIBUTING FACTOR	30	SLOWING	W	SUV	NO IMPAIRMENT SUSPECTED	NO APPARENT CONTRIBUTING FACTOR	0	STOPPED IN TRAFFIC
7/9/2019	845	PDO	ON	2	DRY	DAYLIGHT	NONE	BROADSIDE	W	PASSENGER CAR/VAN	NO IMPAIRMENT SUSPECTED	NO APPARENT CONTRIBUTING FACTOR	5	MAKING RIGHT TURN	N	PICKUP TRUCK/UTILITY VAN	NO IMPAIRMENT SUSPECTED	NO APPARENT CONTRIBUTING FACTOR	45	GOING STRAIGHT
6/27/2019	720	PDO	ON	2	DRY	DAYLIGHT	NONE	APPROACH TURN	S	SUV	NO IMPAIRMENT SUSPECTED	DRIVER PREOCCUPIED	15	MAKING LEFT TURN	N	PASSENGER CAR/VAN	NO IMPAIRMENT SUSPECTED	NO APPARENT CONTRIBUTING FACTOR	50	GOING STRAIGHT
1/9/2019	555	PDO	ON	2	DRY	DARK-UNLIGHTED	NONE	REAR-END	S	PASSENGER CAR/VAN	NO IMPAIRMENT SUSPECTED	DRIVER PREOCCUPIED	15	SLOWING	S	SUV	NO IMPAIRMENT SUSPECTED	NO APPARENT CONTRIBUTING FACTOR	0	STOPPED IN TRAFFIC
9/14/2018	1545	INJ	ON	2	DRY	DAYLIGHT	NONE	APPROACH TURN	S	PASSENGER CAR/VAN	NO IMPAIRMENT SUSPECTED	UNKNOWN	15	MAKING LEFT TURN	N	TRUCK GVW > 10K/BUSSES > 15 PEOPLE	NO IMPAIRMENT SUSPECTED	NO APPARENT CONTRIBUTING FACTOR	50	GOING STRAIGHT
9/2/2018	1435	PDO	ON	2	DRY	DAYLIGHT	NONE	REAR-END	W	PASSENGER CAR/VAN	ALCOHOL INVOLVED	UNKNOWN	55	GOING STRAIGHT	W	PICKUP TRUCK/UTILITY VAN	NO IMPAIRMENT SUSPECTED	NO APPARENT CONTRIBUTING FACTOR	35	GOING STRAIGHT
6/4/2018	1055	FAT	ON	2	DRY	DAYLIGHT	NONE	APPROACH TURN	W	TRUCK GVW > 10K/BUSSES > 15 PEOPLE	NO IMPAIRMENT SUSPECTED	NO APPARENT CONTRIBUTING FACTOR	15	MAKING LEFT TURN	E	PASSENGER CAR/VAN	NO IMPAIRMENT SUSPECTED	NO APPARENT CONTRIBUTING FACTOR	45	GOING STRAIGHT
4/2/2018	1435	INJ	ON	3	DRY	DAYLIGHT	NONE	BROADSIDE	W	PICKUP TRUCK/UTILITY VAN	NO IMPAIRMENT SUSPECTED	UNKNOWN	65	GOING STRAIGHT	S	SUV	NO IMPAIRMENT SUSPECTED	NO APPARENT CONTRIBUTING FACTOR	45	GOING STRAIGHT
12/28/2017	740	INJ	ON	2	DRY	DAYLIGHT	NONE	BROADSIDE	S	SUV	NO IMPAIRMENT SUSPECTED	NO APPARENT CONTRIBUTING FACTOR	50	GOING STRAIGHT	W	PASSENGER CAR/VAN	NO IMPAIRMENT SUSPECTED	NO APPARENT CONTRIBUTING FACTOR	50	GOING STRAIGHT
11/30/2017	545	PDO	ON	2	DRY	DARK-LIGHTED	NONE	APPROACH TURN	S	PASSENGER CAR/VAN	NO IMPAIRMENT SUSPECTED	NO APPARENT CONTRIBUTING FACTOR	20	MAKING LEFT TURN	N	PICKUP TRUCK/UTILITY VAN	NO IMPAIRMENT SUSPECTED	NO APPARENT CONTRIBUTING FACTOR	50	GOING STRAIGHT
1/9/2017	955	INJ	ON	2	DRY	DAYLIGHT	WIND	REAR-END	W	SUV	NO IMPAIRMENT SUSPECTED	UNKNOWN	15	GOING STRAIGHT	W	PASSENGER CAR/VAN	NO IMPAIRMENT SUSPECTED	NO APPARENT CONTRIBUTING FACTOR	0	STOPPED IN TRAFFIC

APPENDIX I

Conceptual Site Plans

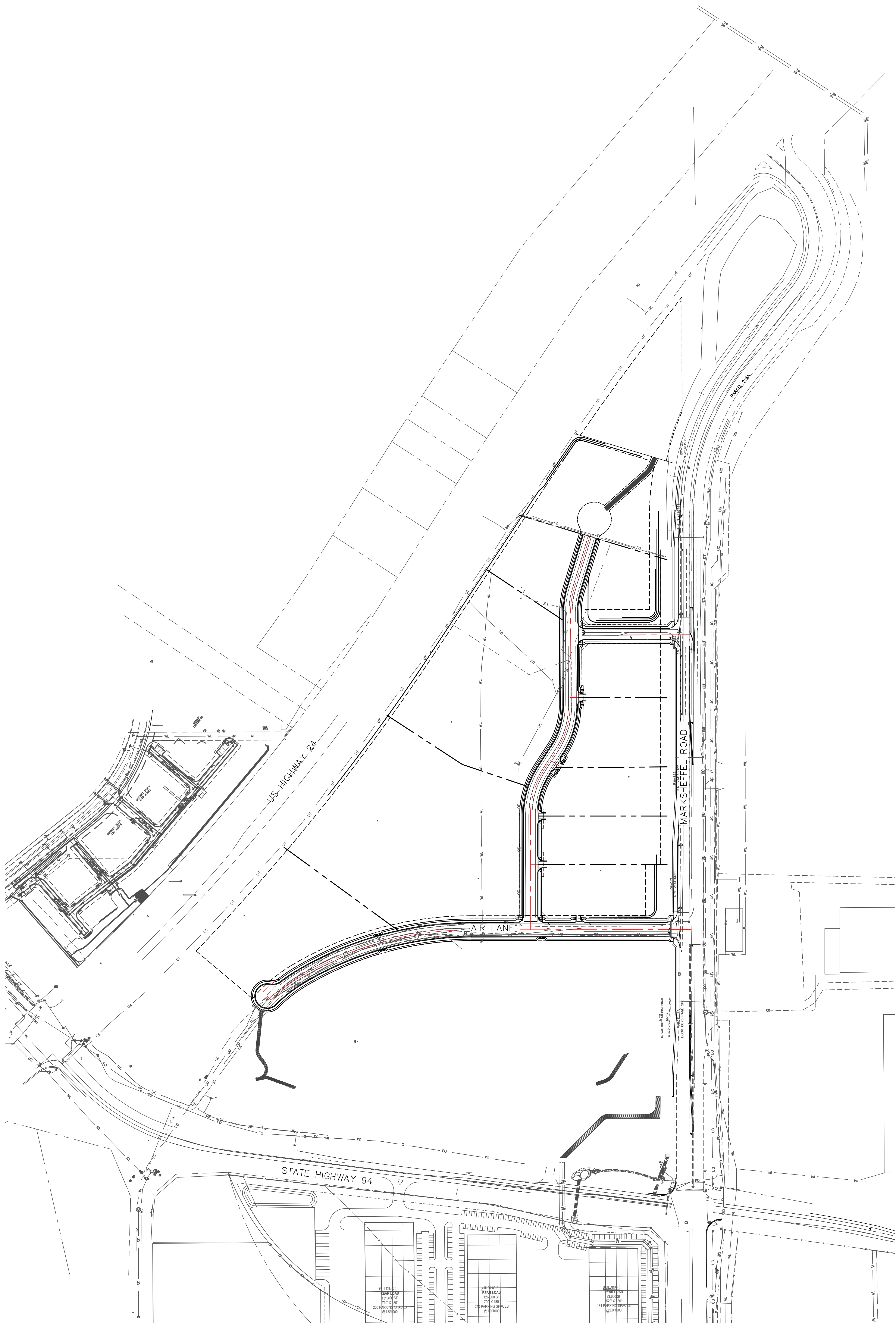

US HIGHWAY 24

AIR LANE

MARKSHEFFEL ROAD

STATE HIGHWAY 94

BUILDING 1
REAR LOAD
131,400 SF
720' X 80'
200' PARKING SPACES
@ 1:511000

BUILDING 2
REAR LOAD
120,000 SF
700' X 80'
240' PARKING SPACES
@ 1:511000

BUILDING 3
REAR LOAD
83,600 SF
520' X 80'
180' PARKING SPACES
@ 2:011000

SEE PLAN SHEET 24-1000
FOR EXACT SPACING AND
LOCATION OF ALL UTILITIES
AND STRUCTURES

v4_TIS_Comments.pdf Markup Summary

Callout (1)

sections | All Access and Internal Intersections

Revise to detail aux lanes and tapers for internal roads.

Subject: Callout
Page Label: 57
Author: lpackman
Date: 11/15/2023 4:56:34 PM
Status:
Color: ■
Layer:
Space:

Revise to detail aux lanes and tapers for internal roads.