



**MVE, INC.**  
ENGINEERS, SURVEYORS

1903 kelaray street, suite 200  
colorado springs, co 80909  
719.635.5736

# Drainage Letter

## **Meadow Ranch II & III**

**Project No. 61209**

**July 23, 2024**

PCD File No. CDR243

# **Drainage Letter**

for

**Meadow Ranch II & III**

**Project No. 61209**

**July 23, 2024**

prepared for

**Mountain View Ranches, LLC**

277 Locust Street, Suite A

Dover, NH 03820

prepared by

**MVE, Inc.**

1903 Lelaray Street, Suite 200

Colorado Springs, CO 80909

719.635.5736

Copyright © MVE, Inc., 2024

61209 Drainage Letter.odt

# Statements and Acknowledgments

## Engineer's Statement

The attached drainage plan and report were prepared under my direction and supervision and are correct to the best of my knowledge and belief. Said drainage report has been prepared according to the criteria established by the County for drainage reports and said report is in conformity with the applicable master plan of the drainage basin. I accept responsibility for any liability caused by any negligent acts, errors or omissions on my part in preparing this report.

David R. Gorman, P.E.  
Colorado No. 31672  
For and on Behalf of MVE, Inc.

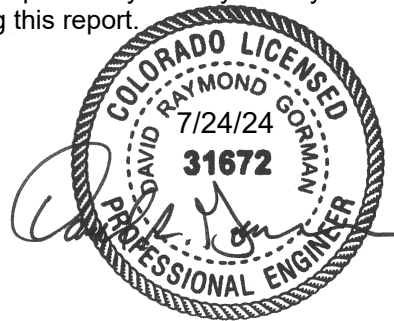

## Developer's Statement

I, the owner/developer have read and will comply with all of the requirements specified in this drainage report and plan.

\_\_\_\_\_  
Aleksander Bologna, as Principal  
Mountain View Ranches LLC

7/24/24

\_\_\_\_\_  
Date

## El Paso County

Filed in accordance with the requirements of the Drainage Criteria Manual, Volumes 1 and 2, El Paso County Engineering Criteria Manual and Land Development Code as amended.

9/4/2024

\_\_\_\_\_  
Joshua Palmer  
County Engineer/ECM Administrator

\_\_\_\_\_  
Date

Conditions:

# Contents

Statements and Acknowledgments.....	iii
Contents.....	v
Drainage Letter.....	1
<b>1 General Location and Description.....</b>	<b>1</b>
1.1 Location.....	1
1.2 Description of Property.....	1
1.3 Soil Description.....	1
<b>2 Drainage Basins and Sub-Basins.....</b>	<b>2</b>
2.1 Major Basin Descriptions.....	2
<b>3 Drainage Facility Design.....</b>	<b>2</b>
3.1 Reseeding and Allowable Ditch Flow Velocities.....	2
3.2 Water Quality Enhancement Best Management Practices.....	2
<b>4 Drainage Fees.....</b>	<b>3</b>
<b>5 Conclusion.....</b>	<b>3</b>
References.....	5
Appendices.....	7
<b>1 General Maps and Supporting Data.....</b>	<b>7</b>
<b>2 Hydrologic Calculations.....</b>	<b>24</b>
<b>3 Hydraulic Calculations.....</b>	<b>71</b>

# Drainage Letter

The purpose of this Drainage Letter is to address the Four-Step Process in the construction of the private access easements for Meadow Ranch II & III, a proposed rural residential 35 acre land division, El Paso County, Colorado. The report presents the stormwater management issues specific to this site and discusses the aspects of the drainage design that addresses those issues. The report and included maps present results of the final hydrologic analyses. The report recommends that no additional drainage improvements are needed for the site. This report has been prepared and submitted in accordance with the requirements of the El Paso County Drainage Criteria Manual approval process. An **Appendix** is included with this report with pertinent calculations and data used in the drainage analysis.

## 1 General Location and Description

### 1.1 Location

The Meadow Ranch II & III site is located within portions of Sections 3, 4, 10, 11 & 14, Township 17 South, Range 61 West, of the 6<sup>th</sup> Principal Meridian in El Paso County, Colorado. The site is situated along Myers Road and west of Boone Road. The site is made up of several unplatted parcels having El Paso County Tax Assessor's Schedule Numbers: 1700000021, 1700000029, 1700000023, 1700000024, 1700000025, 1700000026 & 1700000027. A Vicinity Map is included in the **Appendix**.

### 1.2 Description of Property

The Meadow Ranch II & III site encompasses approximately 2,083 ± acres existing as unplatted parcels. The site is to be divided by Land Survey Plat into 55 Tracts as Meadow Ranch II & III.

This parcel is mostly undeveloped grazing land with minor grading around one residence. The storm runoff from the site generally drains from the north to the south.

Access for this developed area is via Myers Road. The owners intend to divide the 2,083 ± acres parcel into 55 Tracts with with at least 35 acres each. Additionally, a private access easement will be added to the north half of the property and three private access easements will be added to the south portion and connect the proposed Tracts.

### 1.3 Soil Description

According to the National Resource Conservation Service, there are two primary soil types identified at the Meadow Ranch II & III site within the areas of the access easements. Olney sandy loam, 0 to 3 percent slopes (map unit 60) makes up about 56% of the site and which is contained in Hydrologic Soil Group B. This soil is deep and is well drained, permeability is moderate, and the hazard of erosion is moderate.

The secondary soil group is: Olneysandy loam, 3 to 8 percent slopes (map unit 61) which is primarily the southwest portion of the site makes up about 18%. This soil is contained in Hydrologic Soil Group B. This soil is deep and well drained, permeability is moderate, and the hazard of erosion is slight to moderate. A portion of the Soil Map and data tables from the National Cooperative Soil Survey and relevant Official Soil Series Descriptions (OSD) are included in the **Appendix**.<sup>1 2</sup>

A portion of the Soil Map and data tables from the National Cooperative Soil Survey and relevant Official Soil Series Descriptions (OSD) are included in the **Appendix**.<sup>3 4</sup>

---

1 WSS  
2 OSD  
3 WSS  
4 OSD

## 2 Drainage Basins and Sub-Basins

### 2.1 Major Basin Descriptions

The Meadow Ranch II & III site is located in the eastern portion of the East Haynes (HAHA0400) and the northern portion of the West Kramer (KRKR0200) Drainage Basins.

Discharge from the western portion of the site flows southwesterly into an unnamed tributary of Haynes Creek in the East Haynes drainage basin. Flows from the eastern portion of the site flow generally southeast into an unnamed tributary of Kramer Creek in the West Kramer drainage basin.

According to the Federal Emergency Management Agency's Flood Insurance Rate Map (FIRM) Community Panel Number(s) 08041C1275G, effective December 7, 2018, for El Paso County, Colorado, a portion of the site is located within a Federal Emergency Management Agency (FEMA) designated Special Flood Hazard Area (SFHA), Zone A<sup>5</sup>. No portion of the area to be disturbed lies in this Floodplain. An excerpt of the current FEMA Flood Insurance Rate Maps with the site delineated is included in the **Appendix**.

## 3 Drainage Facility Design

### 3.1 Reseeding and Allowable Ditch Flow Velocities

All disturbed areas that are not access easement surfaces or otherwise protected by riprap shall be reseeded using the El Paso Low Grow Grass Seed Mix suggested by the El Paso County Conservation District. A copy of this recommendation is included in the **Appendix** of this report and on the Grading and Erosion Control Plan for this project. The seed mix contains a mixture of about 24% Western Wheatgrass, about 20% Blue Grama, Native, about 18% Buffalograss, about 13% Sideoats Grama, about 6% Green Needlegrass, and about 1.5% Sand Dropseed. These specific species of native seed are selected for erosion control properties, suitability to the local climate, growth potential and hardiness. Each of the seed species provides good soil holding capabilities ground coverage. The characteristics of the predominate seed species are shown on the Plant Guides also included in the **Appendix**. The El Paso County Drainage Criteria Manual Table 10-4 is intended to provide guidance on allowable flow velocities for various types of open channel grass linings. However, Table 10-4 does not address the predominate species contained in the suggested Seed Mix and is not useful for determining allowable flow velocities with these types of linings. Therefore, a supplemental data table from the "Stability Thresholds for Stream Materials" prepared by U.S. Army Engineer Research and Development Center is included in the appendix which contains better descriptions along with testing and research references that indicate the native grass types in the reseed mix are able to withstand flow velocities ranging from 4 ft/sec to 6 ft/sec or more. Flow velocities on all reseeded areas remain below 5 ft/sec and the native grasses are adequate to withstand to flows. Maximum ditch velocity calculation is included in the **Appendix**.

### 3.2 Access Easement Culverts

Culverts shall be installed where grading crosses low points in the existing terrain to allow water to continue along historic routes. The tributary area of each proposed access grading culvert was determined and runoff calculated for each location. Runoff calculations as well as Drainage Maps showing the tributary areas are included in the **Appendix**. Culverts were sized to allow the 5 year runoff to pass under the access easement grading and the 100 year runoff of some of the culverts may overtop the access easements. A culvert design report calculated for 9.2 cfs (10% greater than the maximum 5 year flows) is included in the **Appendix**. Calculations for the culvert outlet protection are also included and outlet protection shall be detailed in the GEC Plans.

## 4 Water Quality Enhancement Best Management Practices

The El Paso County Engineering Criteria Manual (Appendix I, Section I.7.2) requires the consideration of a “Four Step Process for receiving water protection that focuses on reducing runoff volumes, treating the water quality capture volume (WQCV), stabilizing drainage ways, and implementing long term source controls”. The Four Step Process is incorporated in this project and the elements are discussed below.

**1) Step 1: Employ Runoff Reduction Practices:** Runoff Reduction Practices are employed in this project. Impervious surfaces have been reduced as much as practically possible. There is only minimal impervious surfaces proposed. Minimized Directly Connected Impervious Areas (MDCIA) is employed on the project because runoff passes through a Receiving Pervious Area (RPA) vegetated buffer adjacent to the proposed travel ways and an open space meadow area before leaving the site.

These private access easements are edged with Receiving Pervious Areas (RPAs) as detailed in the **BMP Area ID** map attached in the **Appendix**. The RPA has established vegetation. The slope at the UIA/RPA interface prevents any accumulation of sediment from interfering with runoff entering the proposed RPAs. No step is provided at this interface for vehicle safety. The runoff generated from the impervious areas of the access easement will be treated for water quality by the RPA's.

Areas being used as RPA constitute vegetated areas down-gradient of impervious areas as specified in Water Quality Control Volume reduction procedure detailed in Chapter 4, Fact Sheet T-00 “Quantifying Runoff Reduction” of the Urban Storm Drainage Criteria Manual, Volume 3. Permanent seeding will follow the proposed construction, and temporary irrigation will establish a grass cover. The volume reduction calculation was made with the aid of the “UD-BMP\_v3.07” spreadsheet developed by Mile High Flood District and is attached in the **Appendix** showing a WQCV reduction more than 60%.

**2) Step 2: Stabilize Drainageways:** There are no drainage paths on the site that are required to be stabilized as they are well vegetated with no visual erosion. The mild drainage paths have shallow side slopes of >10:1 with 1-3' fescue grass within the existing drainage paths. Culverts shall be installed where grading crosses low points in the existing terrain to allow water to continue along historic routes. Culverts were sized to allow the 5 year runoff to pass under the access easement grading and the 100 year runoff of some of the culverts may overtop the access easements. Downstream ends of the culverts shall be protected with 6' wide by 8' long Type VL riprap as shown in the GEC Plan. In some places it is necessary to extend a swale from the end of the culvert to daylight to the existing drainage paths These “Ditch Out” swale are shown on the GEC Plan where necessary. Calculations for the culverts, riprap protection and “Ditch Out” swales are included in the **Appendix**.

**3) Step 3: Provide Water Quality Capture Volume (WQCV):** The runoff generated from the impervious areas of the access easements will be treated for water quality by utilizing the runoff reduction standard. Stormwater runoff from the proposed access easements will pass through a strip of RPA edging the impervious areas and will infiltrate into the ground, evaporate, or evapotranspire a quantity of water equal to at least 60% of what the calculated WQCV would be if all impervious area for the applicable development site discharged without infiltration. A uniform strip of at least 4 feet in width along the access easements and 8 foot in width around the cul-de-sacs adjacent to the proposed impervious areas is sufficient to accomplish the necessary 60% reduction minimum and provide for a consistent and manageable shape to the RPA. Runoff Reduction calculations are included in the **Appendix** that demonstrate the effectiveness of the uniform strip of RPA. The proposed RPAs are considered permanent BMPs and a signed PCM Maintenance Agreement and O&M Manual will be prepared and executed.

**4) Step 4: Consider Need for Industrial and Commercial BMPs:** This project is the construction of private roadways for large 35 acre plus rural residential Tracts. There is no anticipated industrial or commercial use of these roadways. No site specific or other source control BMPs are required.

## **5 Drainage Fees**

This project is the construction of private roadways for large 35 acre plus rural residential Tracts. No Site Development Plan is required and no Subdivision Plat is being submitted for the roadways. The East Haynes (HAHA0400) and West Kramer (KRKR0200) Drainage Basins are no fee basins. No Drainage or Bridge Fees are due.

## **6 Conclusion**

This Drainage Letter presents the compliance with the Four-Step Process for the Meadow Ranch II & III project. The development will have negligible and inconsequential effects on the existing site drainage and drainage conditions downstream. With such a negligible increase in stormwater flows from the site, detention will not be necessary for the proposed development and will not be provided. The proposed project will not, with respect to stormwater runoff, negatively impact the adjacent properties and downstream properties.



# References

*NRCS Official Soil Series Descriptions*. United States Department of Agriculture, Natural Resources Conservation Service (["http://soils.usda.gov/technical/classification/osd/index.html"](http://soils.usda.gov/technical/classification/osd/index.html), accessed October 2016).

*NRCS Web Soil Survey*. United States Department of Agriculture, Natural Resources Conservation Service (["http://websoilsurvey.nrcs.usda.gov/app/WebSoilSurvey.aspx"](http://websoilsurvey.nrcs.usda.gov/app/WebSoilSurvey.aspx), accessed October 2016).

*NRCS Official Soil Series Descriptions*. United States Department of Agriculture, Natural Resources Conservation Service (["http://soils.usda.gov/technical/classification/osd/index.html"](http://soils.usda.gov/technical/classification/osd/index.html), accessed March, 2018).

*NRCS Web Soil Survey*. United States Department of Agriculture, Natural Resources Conservation Service (["http://websoilsurvey.nrcs.usda.gov/app/WebSoilSurvey.aspx"](http://websoilsurvey.nrcs.usda.gov/app/WebSoilSurvey.aspx), accessed March, 2018).

*Flood Insurance Rate Map (FIRM)*. Federal Emergency Management Agency, National Flood Insurance Program (Washington D.C.: , March 17, 1997).

# Appendices

## **1 General Maps and Supporting Data**

- Vicinity Map
- Portion of Flood Insurance Rate Map
- Soil Type map and Tables
- Official Soil Series Descriptions
- Hydrologic Soil Group Map and Tables

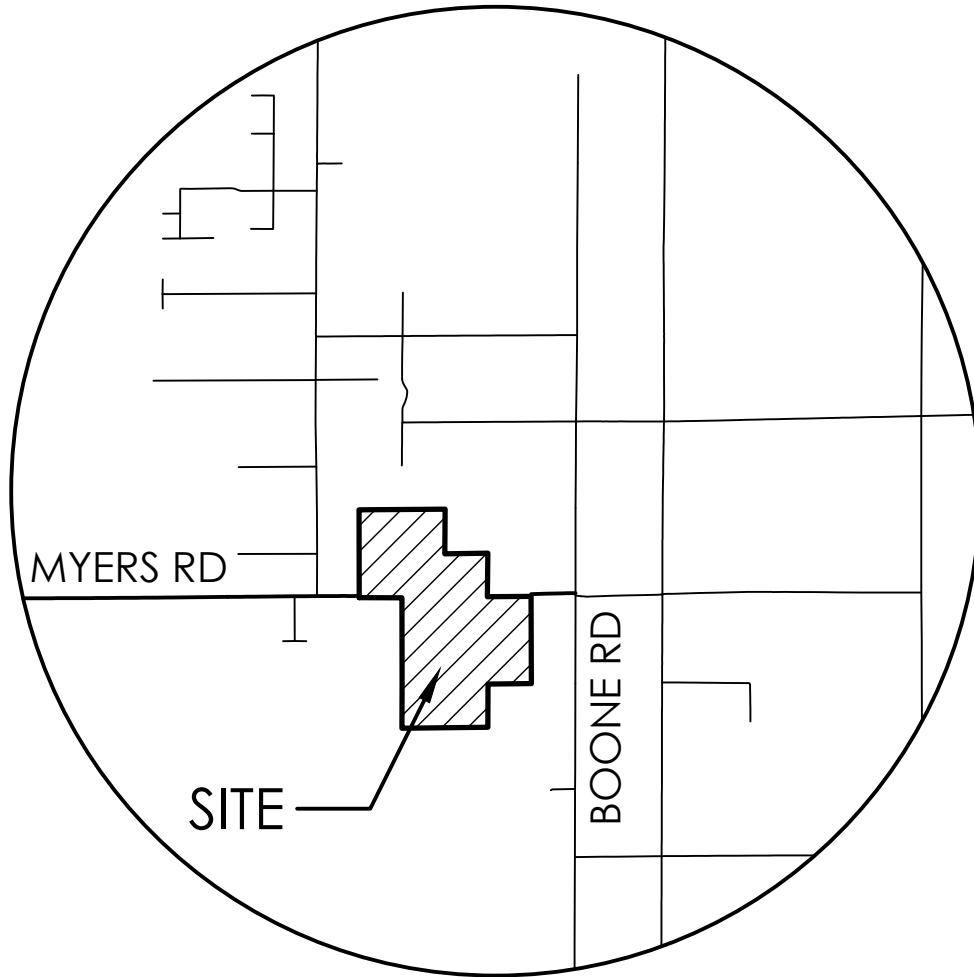

# VICINITY MAP

NOT TO SCALE

**NOTES TO USERS**

This map is for use in administering the National Flood Insurance Program. It does not necessarily identify all areas subject to flooding, particularly from local drainage sources of small size. The community map repository should be consulted for possible updated or additional flood hazard information.

To obtain more detailed information in areas where **Base Flood Elevations (BFEs)** and/or **floodways** have been determined, users are encouraged to consult the Flood Profiles and Floodway Data and/or Summary of Stillwater Elevations tables contained within the Flood Insurance Study (FIS) report that accompanies this FIRM. Users should be aware that BFEs shown on the FIRM represent rounded whole-foot elevations. These BFEs are intended for flood insurance rating purposes only and should not be used as the sole source of flood elevation information. Accordingly, flood elevation data presented in the FIS report should be utilized in conjunction with the FIRM for purposes of construction and/or floodplain management.

**Coastal Base Flood Elevations** shown on this map apply only landward of 0.0' North American Vertical Datum of 1988 (NAVD88). Users of this FIRM should be aware that coastal flood elevations are also provided in the Summary of Stillwater Elevations table in the Flood Insurance Study report for this jurisdiction. Elevations shown in the Summary of Stillwater Elevations table should be used for construction and/or floodplain management purposes when they are higher than the elevations shown on this FIRM.

Boundaries of the **floodways** were computed at cross sections and interpolated between cross sections. The floodways were based on hydraulic considerations with regard to requirements of the National Flood Insurance Program. Floodway widths and other pertinent floodway data are provided in the Flood Insurance Study report for this jurisdiction.

Certain areas not in Special Flood Hazard Areas may be protected by **flood control structures**. Refer to section 2.4 "Flood Protection Measures" of the Flood Insurance Study report for information on flood control structures for this jurisdiction.

The **projection** used in the preparation of this map was Universal Transverse Mercator (UTM) zone 13. The **horizontal datum** was NAD83, GRS80 spheroid. Differences in datum, spheroid, projection or UTM zones zones used in the production of FIRMs for adjacent jurisdictions may result in slight positional differences in map features across jurisdiction boundaries. These differences do not affect the accuracy of this FIRM.

Flood elevations on this map are referenced to the **North American Vertical Datum of 1988 (NAVD88)**. These flood elevations must be compared to structure and ground elevations referenced to the same **vertical datum**. For information regarding conversion between the National Geodetic Vertical Datum of 1929 and the North American Vertical Datum of 1988, visit the National Geodetic Survey website at <http://www.ngs.noaa.gov/> or contact the National Geodetic Survey at the following address:

NGS Information Services  
NOAA, NINGS12  
National Geodetic Survey  
SSMC-3, #9202  
1315 East-West Highway  
Silver Spring, MD 20910-3282

To obtain current elevation, description, and/or location information for **bench marks** shown on this map, please contact the Information Services Branch of the National Geodetic Survey at (301) 713-3242 or visit its website at <http://www.ngs.noaa.gov/>.

**Base Map** information shown on this FIRM was provided in digital format by El Paso County, Colorado Springs Utilities, and Anderson Consulting Engineers, Inc. These data are current as of 2008.

This map reflects more detailed and up-to-date **stream channel configurations and floodplain delineations** than those shown on the previous FIRM for this jurisdiction. The floodplains and floodways that were transferred from the previous FIRM may have been adjusted to conform to these new stream channel configurations. As a result, the Flood Profiles and Floodway Data tables in the Flood Insurance Study Report (which contains authoritative hydraulic data) may reflect stream channel distances that differ from what is shown on this map. The profile baselines depicted on this map represent the hydraulic modeling baselines that match the flood profiles and Floodway Data Tables if applicable, in the FIS report. As a result, the profile baselines may deviate significantly from the new base map channel representation and may appear outside of the floodplain.

**Corporate limits** shown on this map are based on the best data available at the time of publication. Because changes due to annexations or de-annexations may have occurred after this map was published, map users should contact appropriate community officials to verify current corporate limit locations.

Please refer to the separately printed **Map Index** for an overview map of the county showing the layout of map panels; community map repository addresses; and a Listing of Communities table containing National Flood Insurance Program dates for each community as well as a listing of the panels on which each community is located.

Contact **FEMA Map Service Center (MSC)** via the FEMA Map Information eXchange (FIMX) 1-877-336-2627 for information on available products associated with this FIRM. Available products may include previously issued Letters of Map Change, a Flood Insurance Study Report, and/or digital versions of this map. The MSC may also be reached by Fax at 1-800-358-9620 and its website at <http://www.msc.fema.gov/>.

If you have **questions about this map** or questions concerning the National Flood Insurance Program in general, please call 1-877-FEMA MAP (1-877-336-2627) or visit the FEMA website at <http://www.fema.gov/business/nfp>.

El Paso County Vertical Datum Offset Table

Flooding Source	Vertical Datum Offset (ft)

REFER TO SECTION 3.3 OF THE EL PASO COUNTY FLOOD INSURANCE STUDY FOR STREAM BY STREAM VERTICAL DATUM CONVERSION INFORMATION

Panel Location Map

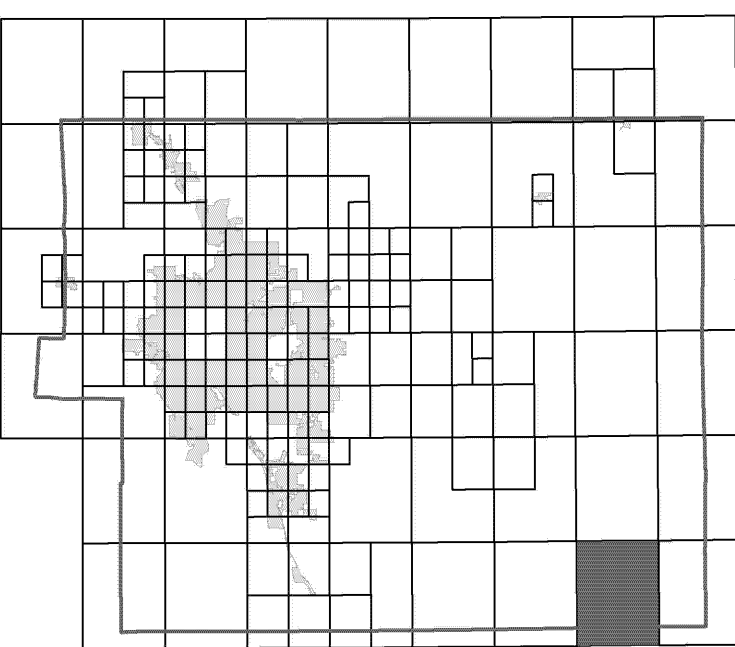

This Digital Flood Insurance Rate Map (DFIRM) was produced through a Cooperating Technical Partner (CTP) agreement between the State of Colorado Water Conservation Board (CWCB) and the Federal Emergency Management Agency (FEMA).



Additional Flood Hazard information and resources are available from local communities and the Colorado Water Conservation Board.

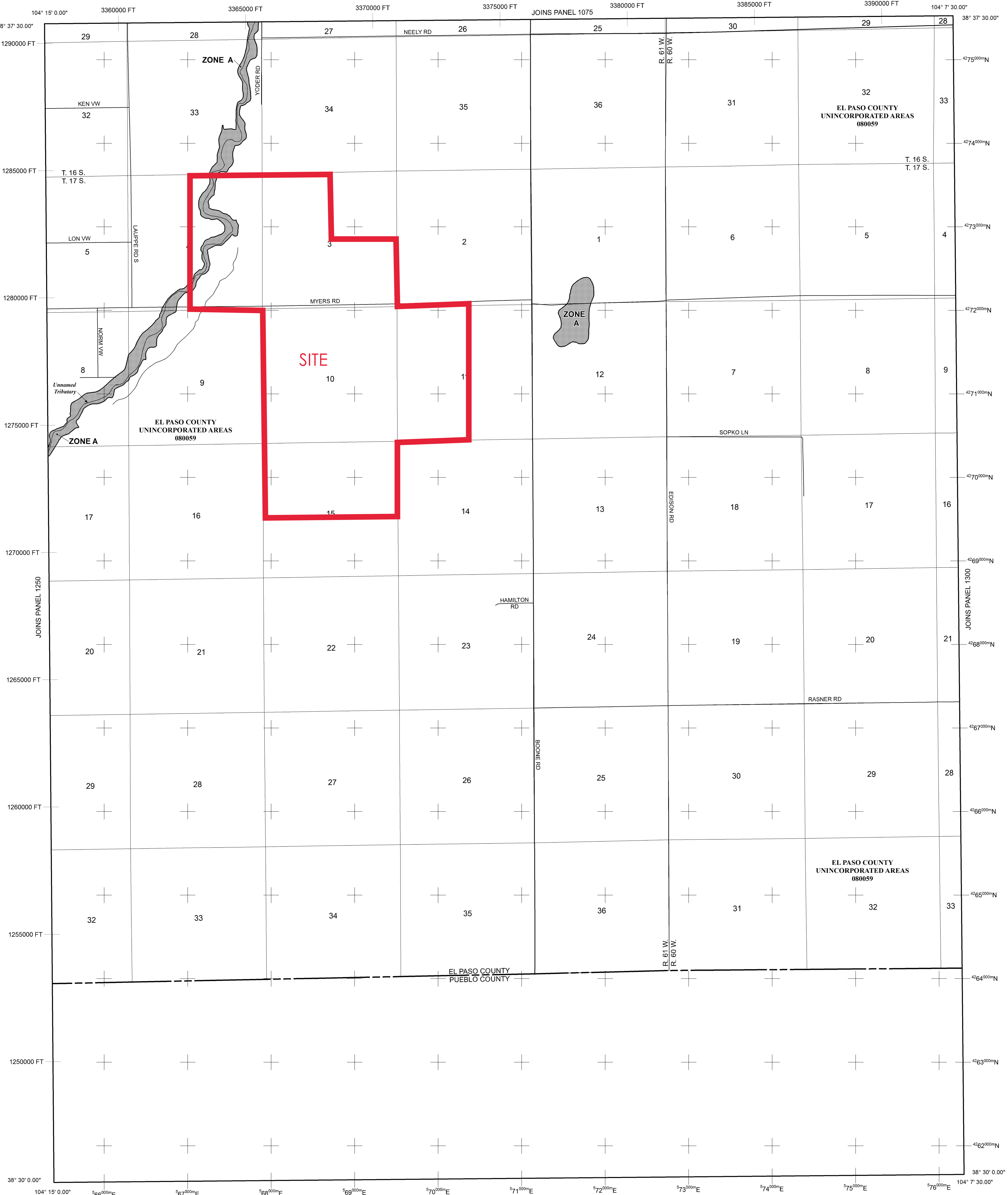

**LEGEND**

- SPECIAL FLOOD HAZARD AREAS (SFHAs) SUBJECT TO INUNDATION BY THE 1% ANNUAL CHANCE FLOOD
- The 1% annual chance flood (100-year flood), also known as the base flood, is the flood that has a 1% chance of being equalled or exceeded in any given year. The Special Flood Hazard Area is the area subject to flooding by the 1% annual chance flood. Areas of Special Flood Hazard include Zones A, AE, AH, AO, AR, A99, V, and VE. The Base Flood Elevation is the water-surface elevation of the 1% annual chance flood.
- ZONE A** No Base Flood Elevations determined.
- ZONE AE** Base Flood Elevations determined.
- ZONE AH** Flood depths of 1 to 3 feet (usually areas of ponding); Base Flood Elevations determined.
- ZONE AO** Flood depths of 1 to 3 feet (usually sheet flow on sloping terrain); average depths determined. For areas of alluvial fan flooding, velocities also determined.
- ZONE AR** Special Flood Hazard Area Formerly protected from the 1% annual chance flood by a flood control system that was subsequently decertified. Zone AR indicates that the former flood control system is being restored to provide protection from the 1% annual chance or greater flood.
- ZONE A99** Area to be protected from 1% annual chance flood by a Federal flood protection system under construction; no Base Flood Elevations determined.
- ZONE V** Coastal flood zone with velocity hazard (wave action); no Base Flood Elevations determined.
- ZONE VE** Coastal flood zone with velocity hazard (wave action); Base Flood Elevations determined.
- FLOODWAY AREAS IN ZONE AE
- The floodway is the channel of a stream plus any adjacent floodplain areas that must be kept free of encroachment so that the 1% annual chance flood can be carried without substantial increases in flood heights.
- OTHER FLOOD AREAS
- ZONE X** Areas of 0.2% annual chance flood; areas of 1% annual chance flood with average depths of less than 1 foot or with drainage areas less than 1 square mile; and areas protected by levees from 1% annual chance flood.
- OTHER AREAS
- ZONE X** Areas determined to be outside the 0.2% annual chance floodplain.
- ZONE D** Areas in which flood hazards are undetermined, but possible.
- COASTAL BARRIER RESOURCES SYSTEM (CBRS) AREAS
- OTHERWISE PROTECTED AREAS (OPAs)
- CBRS areas and OPAs are normally located within or adjacent to Special Flood Hazard Areas.
- Floodplain boundary
- Floodway boundary
- Zone D boundary
- CBRS and OPA boundary
- Boundary dividing Special Flood Hazard Areas of different Base Flood Elevations, flood depths or flood velocities.
- Base Flood Elevation line and value; elevation in feet\* (EL 987)
- \* Referenced to the North American Vertical Datum of 1988 (NAVD 88)
- Cross section line
- Transect line
- Geographic coordinates referenced to the North American Datum of 1983 (NAD 83)
- 1000-meter Universal Transverse Mercator grid ticks, zone 13
- 5000-foot grid ticks; Colorado State Plane coordinate system, central zone (FIPSZONE 0502), Lambert Conformal Conic Projection
- Bench mark (see explanation in Notes to Users section of this FIRM panel)
- River Mile
- MAP REPOSITORIES
- Refer to Map Repositories list on Map Index
- EFFECTIVE DATE OF COUNTYWIDE FLOOD INSURANCE RATE MAP  
**MARCH 17, 1997**
- EFFECTIVE DATE(S) OF REVISION(S) TO THIS PANEL  
**DECEMBER 7, 2018** to update corporate limits, to change Base Flood Elevations and Special Flood Hazard Areas, to update map format, to add roads and road names, and to incorporate previously issued Letters of Map Revision.
- For community map revision history prior to countywide mapping, refer to the Community Map History Table located in the Flood Insurance Study report for this jurisdiction.
- To determine if flood insurance is available in this community, contact your insurance agent or call the National Flood Insurance Program at 1-800-638-6620.

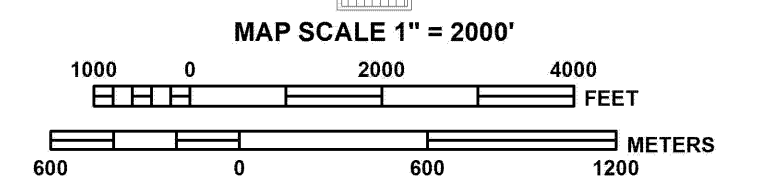

**NFIP**

**PANEL 1275G**

---

**FIRM**

**FLOOD INSURANCE RATE MAP**

**EL PASO COUNTY, COLORADO AND INCORPORATED AREAS**

**PANEL 1275 OF 1300**

(SEE MAP INDEX FOR FIRM PANEL LAYOUT)

CONTAINS:

COMMUNITY	NUMBER	PANEL	SUFFIX
EL PASO COUNTY	080059	1275	G

Notice to User: The Map Number shown below should be used when placing map orders. The Community Number shown above should be used on insurance applications for the subject community.

**MAP NUMBER**  
**08041C1275G**

**MAP REVISED**  
**DECEMBER 7, 2018**

Federal Emergency Management Agency



A product of the National Cooperative Soil Survey, a joint effort of the United States Department of Agriculture and other Federal agencies, State agencies including the Agricultural Experiment Stations, and local participants

# Custom Soil Resource Report for El Paso County Area, Colorado

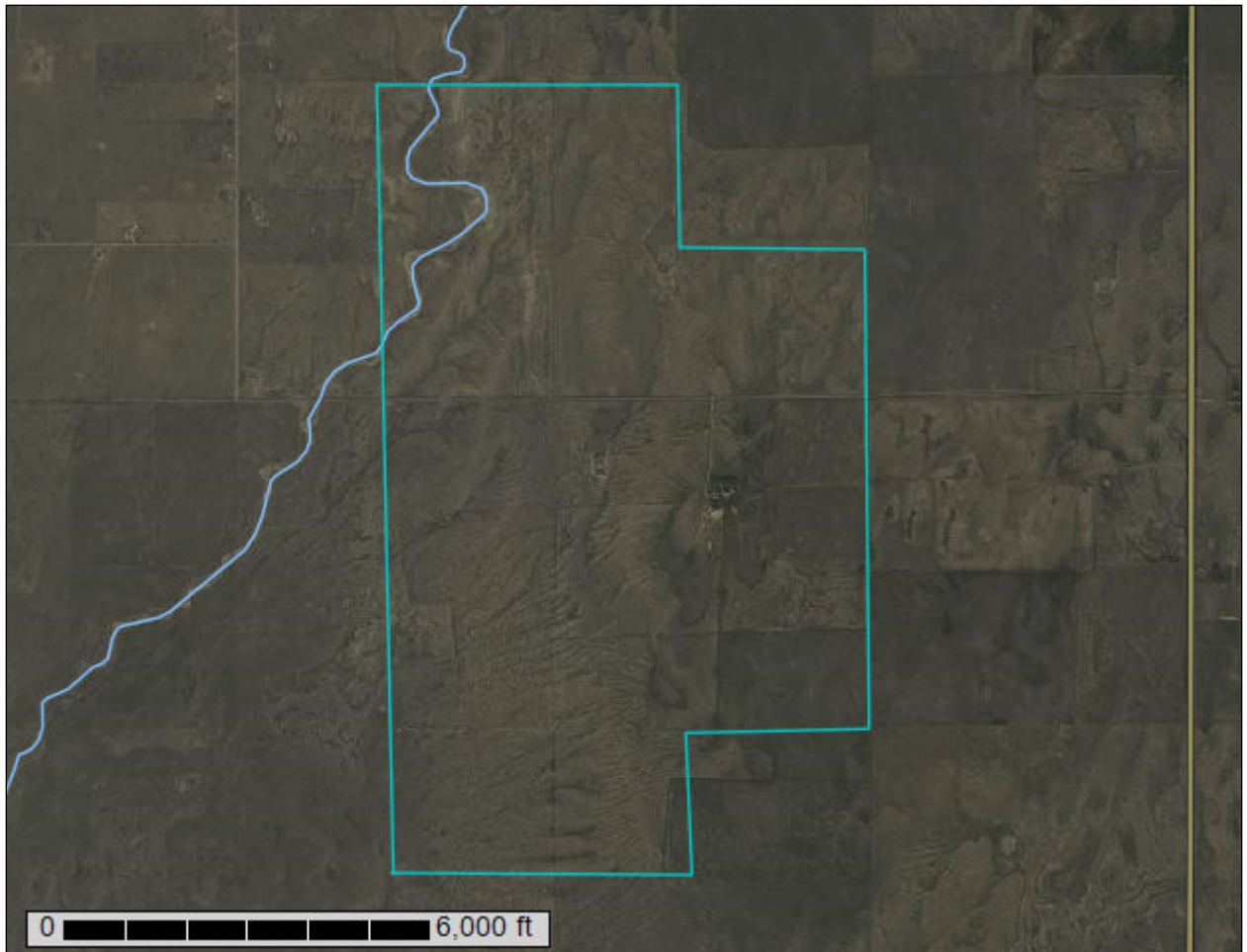

# Preface

---

Soil surveys contain information that affects land use planning in survey areas. They highlight soil limitations that affect various land uses and provide information about the properties of the soils in the survey areas. Soil surveys are designed for many different users, including farmers, ranchers, foresters, agronomists, urban planners, community officials, engineers, developers, builders, and home buyers. Also, conservationists, teachers, students, and specialists in recreation, waste disposal, and pollution control can use the surveys to help them understand, protect, or enhance the environment.

Various land use regulations of Federal, State, and local governments may impose special restrictions on land use or land treatment. Soil surveys identify soil properties that are used in making various land use or land treatment decisions. The information is intended to help the land users identify and reduce the effects of soil limitations on various land uses. The landowner or user is responsible for identifying and complying with existing laws and regulations.

Although soil survey information can be used for general farm, local, and wider area planning, onsite investigation is needed to supplement this information in some cases. Examples include soil quality assessments (<http://www.nrcs.usda.gov/wps/portal/nrcs/main/soils/health/>) and certain conservation and engineering applications. For more detailed information, contact your local USDA Service Center (<https://offices.sc.egov.usda.gov/locator/app?agency=nrcs>) or your NRCS State Soil Scientist ([http://www.nrcs.usda.gov/wps/portal/nrcs/detail/soils/contactus/?cid=nrcs142p2\\_053951](http://www.nrcs.usda.gov/wps/portal/nrcs/detail/soils/contactus/?cid=nrcs142p2_053951)).

Great differences in soil properties can occur within short distances. Some soils are seasonally wet or subject to flooding. Some are too unstable to be used as a foundation for buildings or roads. Clayey or wet soils are poorly suited to use as septic tank absorption fields. A high water table makes a soil poorly suited to basements or underground installations.

The National Cooperative Soil Survey is a joint effort of the United States Department of Agriculture and other Federal agencies, State agencies including the Agricultural Experiment Stations, and local agencies. The Natural Resources Conservation Service (NRCS) has leadership for the Federal part of the National Cooperative Soil Survey.

Information about soils is updated periodically. Updated information is available through the NRCS Web Soil Survey, the site for official soil survey information.

The U.S. Department of Agriculture (USDA) prohibits discrimination in all its programs and activities on the basis of race, color, national origin, age, disability, and where applicable, sex, marital status, familial status, parental status, religion, sexual orientation, genetic information, political beliefs, reprisal, or because all or a part of an individual's income is derived from any public assistance program. (Not all prohibited bases apply to all programs.) Persons with disabilities who require

alternative means for communication of program information (Braille, large print, audiotape, etc.) should contact USDA's TARGET Center at (202) 720-2600 (voice and TDD). To file a complaint of discrimination, write to USDA, Director, Office of Civil Rights, 1400 Independence Avenue, S.W., Washington, D.C. 20250-9410 or call (800) 795-3272 (voice) or (202) 720-6382 (TDD). USDA is an equal opportunity provider and employer.

# Contents

---

<b>Preface</b> .....	2
<b>Soil Map</b> .....	5
Soil Map.....	6
Legend.....	7
Map Unit Legend.....	8
Map Unit Descriptions.....	8
El Paso County Area, Colorado.....	10
7—Bijou sandy loam, 3 to 8 percent slopes.....	10
28—Ellicott loamy coarse sand, 0 to 5 percent slopes.....	11
60—Olney sandy loam, 0 to 3 percent slopes.....	12
61—Olney sandy loam, 3 to 8 percent slopes.....	14
78—Sampson loam, 0 to 3 percent slopes.....	16
102—Valent sand, 1 to 12 percent slopes, dry.....	17
103—Valent sand, 9 to 20 percent slopes, dry.....	18
117—Vonid sandy loam, 0 to 5 percent slopes.....	20
123—Olney-Vonid soils, 1 to 6 percent slopes, eroded.....	21



# Soil Map

---

The soil map section includes the soil map for the defined area of interest, a list of soil map units on the map and extent of each map unit, and cartographic symbols displayed on the map. Also presented are various metadata about data used to produce the map, and a description of each soil map unit.

# Custom Soil Resource Report Soil Map

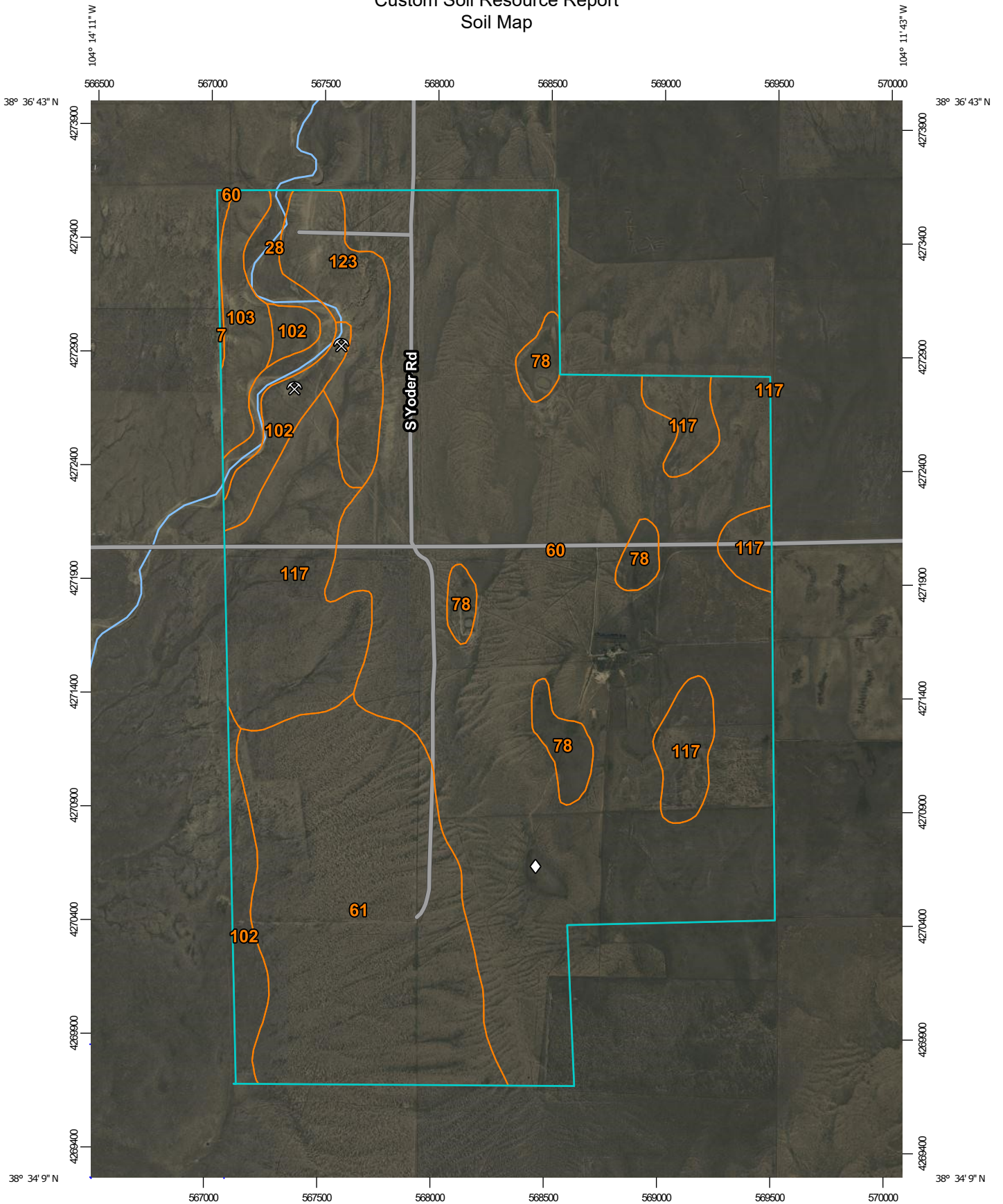

Map Scale: 1:23,100 if printed on A portrait (8.5" x 11") sheet.



Map projection: Web Mercator Corner coordinates: WGS84 Edge tics: UTM Zone 13N WGS84

### MAP LEGEND

**Area of Interest (AOI)**

 Area of Interest (AOI)



















**Soils**

 Soil Map Unit Polygons

 Soil Map Unit Lines

 Soil Map Unit Points

**Special Point Features**





-  Blowout
-  Borrow Pit
-  Clay Spot
-  Closed Depression
-  Gravel Pit
-  Gravelly Spot
-  Landfill
-  Lava Flow
-  Marsh or swamp
-  Mine or Quarry
-  Miscellaneous Water
-  Perennial Water
-  Rock Outcrop
-  Saline Spot
-  Sandy Spot
-  Severely Eroded Spot
-  Sinkhole
-  Slide or Slip
-  Sodic Spot

-  Spoil Area
-  Stony Spot
-  Very Stony Spot
-  Wet Spot
-  Other
-  Special Line Features

**Water Features**

 Streams and Canals

**Transportation**

-  Rails
-  Interstate Highways
-  US Routes
-  Major Roads
-  Local Roads

**Background**

 Aerial Photography

### MAP INFORMATION

The soil surveys that comprise your AOI were mapped at 1:24,000.

Please rely on the bar scale on each map sheet for map measurements.

Source of Map: Natural Resources Conservation Service  
 Web Soil Survey URL:  
 Coordinate System: Web Mercator (EPSG:3857)

Maps from the Web Soil Survey are based on the Web Mercator projection, which preserves direction and shape but distorts distance and area. A projection that preserves area, such as the Albers equal-area conic projection, should be used if more accurate calculations of distance or area are required.

This product is generated from the USDA-NRCS certified data as of the version date(s) listed below.

Soil Survey Area: El Paso County Area, Colorado  
 Survey Area Data: Version 21, Aug 24, 2023

Soil map units are labeled (as space allows) for map scales 1:50,000 or larger.

Date(s) aerial images were photographed: Sep 11, 2018—Oct 20, 2018

The orthophoto or other base map on which the soil lines were compiled and digitized probably differs from the background imagery displayed on these maps. As a result, some minor shifting of map unit boundaries may be evident.

## Map Unit Legend

Map Unit Symbol	Map Unit Name	Acres in AOI	Percent of AOI
7	Bijou sandy loam, 3 to 8 percent slopes	3.8	0.2%
28	Ellicott loamy coarse sand, 0 to 5 percent slopes	36.3	1.8%
60	Olney sandy loam, 0 to 3 percent slopes	1,116.3	55.7%
61	Olney sandy loam, 3 to 8 percent slopes	367.5	18.3%
78	Sampson loam, 0 to 3 percent slopes	51.1	2.6%
102	Valent sand, 1 to 12 percent slopes, dry	79.8	4.0%
103	Valent sand, 9 to 20 percent slopes, dry	43.4	2.2%
117	Vonid sandy loam, 0 to 5 percent slopes	226.9	11.3%
123	Olney-Vonid soils, 1 to 6 percent slopes, eroded	78.8	3.9%
<b>Totals for Area of Interest</b>		<b>2,003.9</b>	<b>100.0%</b>

## Map Unit Descriptions

The map units delineated on the detailed soil maps in a soil survey represent the soils or miscellaneous areas in the survey area. The map unit descriptions, along with the maps, can be used to determine the composition and properties of a unit.

A map unit delineation on a soil map represents an area dominated by one or more major kinds of soil or miscellaneous areas. A map unit is identified and named according to the taxonomic classification of the dominant soils. Within a taxonomic class there are precisely defined limits for the properties of the soils. On the landscape, however, the soils are natural phenomena, and they have the characteristic variability of all natural phenomena. Thus, the range of some observed properties may extend beyond the limits defined for a taxonomic class. Areas of soils of a single taxonomic class rarely, if ever, can be mapped without including areas of other taxonomic classes. Consequently, every map unit is made up of the soils or miscellaneous areas for which it is named and some minor components that belong to taxonomic classes other than those of the major soils.

Most minor soils have properties similar to those of the dominant soil or soils in the map unit, and thus they do not affect use and management. These are called noncontrasting, or similar, components. They may or may not be mentioned in a particular map unit description. Other minor components, however, have properties and behavioral characteristics divergent enough to affect use or to require different management. These are called contrasting, or dissimilar, components. They

## Custom Soil Resource Report

generally are in small areas and could not be mapped separately because of the scale used. Some small areas of strongly contrasting soils or miscellaneous areas are identified by a special symbol on the maps. If included in the database for a given area, the contrasting minor components are identified in the map unit descriptions along with some characteristics of each. A few areas of minor components may not have been observed, and consequently they are not mentioned in the descriptions, especially where the pattern was so complex that it was impractical to make enough observations to identify all the soils and miscellaneous areas on the landscape.

The presence of minor components in a map unit in no way diminishes the usefulness or accuracy of the data. The objective of mapping is not to delineate pure taxonomic classes but rather to separate the landscape into landforms or landform segments that have similar use and management requirements. The delineation of such segments on the map provides sufficient information for the development of resource plans. If intensive use of small areas is planned, however, onsite investigation is needed to define and locate the soils and miscellaneous areas.

An identifying symbol precedes the map unit name in the map unit descriptions. Each description includes general facts about the unit and gives important soil properties and qualities.

Soils that have profiles that are almost alike make up a *soil series*. Except for differences in texture of the surface layer, all the soils of a series have major horizons that are similar in composition, thickness, and arrangement.

Soils of one series can differ in texture of the surface layer, slope, stoniness, salinity, degree of erosion, and other characteristics that affect their use. On the basis of such differences, a soil series is divided into *soil phases*. Most of the areas shown on the detailed soil maps are phases of soil series. The name of a soil phase commonly indicates a feature that affects use or management. For example, Alpha silt loam, 0 to 2 percent slopes, is a phase of the Alpha series.

Some map units are made up of two or more major soils or miscellaneous areas. These map units are complexes, associations, or undifferentiated groups.

A *complex* consists of two or more soils or miscellaneous areas in such an intricate pattern or in such small areas that they cannot be shown separately on the maps. The pattern and proportion of the soils or miscellaneous areas are somewhat similar in all areas. Alpha-Beta complex, 0 to 6 percent slopes, is an example.

An *association* is made up of two or more geographically associated soils or miscellaneous areas that are shown as one unit on the maps. Because of present or anticipated uses of the map units in the survey area, it was not considered practical or necessary to map the soils or miscellaneous areas separately. The pattern and relative proportion of the soils or miscellaneous areas are somewhat similar. Alpha-Beta association, 0 to 2 percent slopes, is an example.

An *undifferentiated group* is made up of two or more soils or miscellaneous areas that could be mapped individually but are mapped as one unit because similar interpretations can be made for use and management. The pattern and proportion of the soils or miscellaneous areas in a mapped area are not uniform. An area can be made up of only one of the major soils or miscellaneous areas, or it can be made up of all of them. Alpha and Beta soils, 0 to 2 percent slopes, is an example.

Some surveys include *miscellaneous areas*. Such areas have little or no soil material and support little or no vegetation. Rock outcrop is an example.

## El Paso County Area, Colorado

### 7—Bijou sandy loam, 3 to 8 percent slopes

#### Map Unit Setting

*National map unit symbol:* 2tqxs  
*Elevation:* 5,700 to 6,200 feet  
*Mean annual precipitation:* 14 to 16 inches  
*Mean annual air temperature:* 50 to 54 degrees F  
*Frost-free period:* 130 to 170 days  
*Farmland classification:* Not prime farmland

#### Map Unit Composition

*Bijou and similar soils:* 85 percent  
*Minor components:* 15 percent  
*Estimates are based on observations, descriptions, and transects of the mapunit.*

#### Description of Bijou

##### Setting

*Landform:* Sand sheets  
*Landform position (two-dimensional):* Backslope  
*Landform position (three-dimensional):* Side slope  
*Down-slope shape:* Linear  
*Across-slope shape:* Linear  
*Parent material:* Eolian sands

##### Typical profile

*A - 0 to 4 inches:* sandy loam  
*Bt1 - 4 to 8 inches:* sandy loam  
*Bt2 - 8 to 21 inches:* sandy loam  
*Bw - 21 to 28 inches:* sandy loam  
*C - 28 to 79 inches:* loamy coarse sand

##### Properties and qualities

*Slope:* 3 to 8 percent  
*Depth to restrictive feature:* More than 80 inches  
*Drainage class:* Somewhat excessively drained  
*Capacity of the most limiting layer to transmit water (Ksat):* High (2.00 to 6.00 in/hr)  
*Depth to water table:* More than 80 inches  
*Frequency of flooding:* None  
*Frequency of ponding:* None  
*Maximum salinity:* Nonsaline (0.1 to 0.2 mmhos/cm)  
*Available water supply, 0 to 60 inches:* Low (about 5.0 inches)

##### Interpretive groups

*Land capability classification (irrigated):* 6e  
*Land capability classification (nonirrigated):* 6e  
*Hydrologic Soil Group:* A  
*Ecological site:* R067BY024CO - Sandy Plains  
*Hydric soil rating:* No

**Minor Components**

**Valent**

*Percent of map unit:* 10 percent  
*Landform:* Sand sheets  
*Landform position (two-dimensional):* Backslope  
*Landform position (three-dimensional):* Side slope  
*Down-slope shape:* Linear  
*Across-slope shape:* Linear  
*Ecological site:* R067BY015CO - Deep Sand  
*Hydric soil rating:* No

**Olnest**

*Percent of map unit:* 5 percent  
*Landform:* Hillslopes  
*Landform position (two-dimensional):* Backslope  
*Landform position (three-dimensional):* Side slope  
*Down-slope shape:* Linear  
*Across-slope shape:* Linear  
*Ecological site:* R067BY024CO - Sandy Plains  
*Hydric soil rating:* No

**28—Ellicott loamy coarse sand, 0 to 5 percent slopes**

**Map Unit Setting**

*National map unit symbol:* 3680  
*Elevation:* 5,500 to 6,500 feet  
*Mean annual precipitation:* 13 to 15 inches  
*Mean annual air temperature:* 47 to 50 degrees F  
*Frost-free period:* 125 to 145 days  
*Farmland classification:* Not prime farmland

**Map Unit Composition**

*Ellicott and similar soils:* 97 percent  
*Minor components:* 3 percent  
*Estimates are based on observations, descriptions, and transects of the mapunit.*

**Description of Ellicott**

**Setting**

*Landform:* Flood plains, stream terraces  
*Landform position (three-dimensional):* Tread  
*Down-slope shape:* Linear  
*Across-slope shape:* Linear  
*Parent material:* Sandy alluvium

**Typical profile**

*A - 0 to 4 inches:* loamy coarse sand  
*C - 4 to 60 inches:* stratified coarse sand to sandy loam

## Custom Soil Resource Report

### Properties and qualities

*Slope:* 0 to 5 percent  
*Depth to restrictive feature:* More than 80 inches  
*Drainage class:* Somewhat excessively drained  
*Runoff class:* Very low  
*Capacity of the most limiting layer to transmit water (Ksat):* High to very high (5.95 to 19.98 in/hr)  
*Depth to water table:* More than 80 inches  
*Frequency of flooding:* Frequent  
*Frequency of ponding:* None  
*Available water supply, 0 to 60 inches:* Low (about 4.1 inches)

### Interpretive groups

*Land capability classification (irrigated):* None specified  
*Land capability classification (nonirrigated):* 7w  
*Hydrologic Soil Group:* A  
*Ecological site:* R069XY031CO - Sandy Bottomland  
*Other vegetative classification:* SANDY BOTTOMLAND (069AY031CO)  
*Hydric soil rating:* No

### Minor Components

#### Fluvaquentic haplaquoll

*Percent of map unit:* 1 percent  
*Landform:* Swales  
*Hydric soil rating:* Yes

#### Other soils

*Percent of map unit:* 1 percent  
*Hydric soil rating:* No

#### Pleasant

*Percent of map unit:* 1 percent  
*Landform:* Depressions  
*Hydric soil rating:* Yes

## 60—Olney sandy loam, 0 to 3 percent slopes

### Map Unit Setting

*National map unit symbol:* 2qnms  
*Elevation:* 3,800 to 6,200 feet  
*Mean annual precipitation:* 12 to 14 inches  
*Mean annual air temperature:* 48 to 54 degrees F  
*Frost-free period:* 130 to 170 days  
*Farmland classification:* Prime farmland if irrigated

### Map Unit Composition

*Olney and similar soils:* 85 percent  
*Minor components:* 15 percent  
*Estimates are based on observations, descriptions, and transects of the mapunit.*



## Description of Olney

### Setting

*Landform:* Sand sheets

*Parent material:* Eolian sands

### Typical profile

*A - 0 to 3 inches:* sandy loam

*BA - 3 to 12 inches:* sandy loam

*Bt - 12 to 24 inches:* sandy clay loam

*Btk - 24 to 36 inches:* sandy loam

*Bk1 - 36 to 46 inches:* sandy loam

*Bk2 - 46 to 79 inches:* fine sandy loam

### Properties and qualities

*Slope:* 0 to 3 percent

*Depth to restrictive feature:* More than 80 inches

*Drainage class:* Well drained

*Runoff class:* Low

*Capacity of the most limiting layer to transmit water (Ksat):* Moderately high to high  
(0.20 to 2.00 in/hr)

*Depth to water table:* More than 80 inches

*Frequency of flooding:* None

*Frequency of ponding:* None

*Calcium carbonate, maximum content:* 25 percent

*Maximum salinity:* Very slightly saline (2.0 to 3.9 mmhos/cm)

*Sodium adsorption ratio, maximum:* 2.0

*Available water supply, 0 to 60 inches:* Moderate (about 7.0 inches)

### Interpretive groups

*Land capability classification (irrigated):* 3e

*Land capability classification (nonirrigated):* 4c

*Hydrologic Soil Group:* B

*Ecological site:* R069XY026CO - Sandy Plains

*Forage suitability group:* Loamy (G069XW017CO)

*Other vegetative classification:* Loamy (G069XW017CO)

*Hydric soil rating:* No

## Minor Components

### Vonid

*Percent of map unit:* 9 percent

*Landform:* Sand sheets

*Ecological site:* R069XY026CO - Sandy Plains

*Other vegetative classification:* Loamy, Dry (G069XW019CO), Sandy Plains  
(069XY026CO\_1)

*Hydric soil rating:* No

### Oterodry

*Percent of map unit:* 4 percent

*Landform:* Hillslopes

*Landform position (two-dimensional):* Shoulder

*Landform position (three-dimensional):* Side slope

*Down-slope shape:* Convex

*Across-slope shape:* Convex

*Ecological site:* R069XY026CO - Sandy Plains

## Custom Soil Resource Report

*Other vegetative classification:* Loamy, Dry (G069XW019CO), Sandy Plains  
(069XY026CO\_1)  
*Hydric soil rating:* No

### **Ustertic haplargids, ponded**

*Percent of map unit:* 2 percent  
*Landform:* Closed depressions  
*Landform position (two-dimensional):* Toeslope  
*Landform position (three-dimensional):* Base slope  
*Down-slope shape:* Linear  
*Across-slope shape:* Concave  
*Ecological site:* R069XY011CO - Closed Depression  
*Other vegetative classification:* Clayey (G069XW001CO)  
*Hydric soil rating:* No

## **61—Olney sandy loam, 3 to 8 percent slopes**

### **Map Unit Setting**

*National map unit symbol:* 2qnmv  
*Elevation:* 3,800 to 6,200 feet  
*Mean annual precipitation:* 12 to 14 inches  
*Mean annual air temperature:* 48 to 54 degrees F  
*Frost-free period:* 130 to 170 days  
*Farmland classification:* Not prime farmland

### **Map Unit Composition**

*Olney and similar soils:* 85 percent  
*Minor components:* 15 percent  
*Estimates are based on observations, descriptions, and transects of the mapunit.*

### **Description of Olney**

#### **Setting**

*Landform:* Sand sheets  
*Parent material:* Eolian sands

#### **Typical profile**

*A - 0 to 3 inches:* sandy loam  
*BA - 3 to 12 inches:* sandy loam  
*Bt - 12 to 24 inches:* sandy clay loam  
*Btk - 24 to 36 inches:* sandy loam  
*Bk1 - 36 to 46 inches:* sandy loam  
*Bk2 - 46 to 79 inches:* fine sandy loam

#### **Properties and qualities**

*Slope:* 3 to 8 percent  
*Depth to restrictive feature:* More than 80 inches  
*Drainage class:* Well drained  
*Runoff class:* Medium  
*Capacity of the most limiting layer to transmit water (Ksat):* Moderately high to high  
(0.20 to 2.00 in/hr)

## Custom Soil Resource Report

*Depth to water table:* More than 80 inches  
*Frequency of flooding:* None  
*Frequency of ponding:* None  
*Calcium carbonate, maximum content:* 25 percent  
*Maximum salinity:* Very slightly saline (2.0 to 3.9 mmhos/cm)  
*Sodium adsorption ratio, maximum:* 2.0  
*Available water supply, 0 to 60 inches:* Moderate (about 7.0 inches)

### Interpretive groups

*Land capability classification (irrigated):* 4e  
*Land capability classification (nonirrigated):* 4e  
*Hydrologic Soil Group:* B  
*Ecological site:* R069XY026CO - Sandy Plains  
*Forage suitability group:* Loamy (G069XW017CO)  
*Other vegetative classification:* Loamy (G069XW017CO)  
*Hydric soil rating:* No

### Minor Components

#### Vonid

*Percent of map unit:* 9 percent  
*Landform:* Sand sheets  
*Ecological site:* R069XY026CO - Sandy Plains  
*Other vegetative classification:* Loamy, Dry (G069XW019CO), Sandy Plains  
(069XY026CO\_1)  
*Hydric soil rating:* No

#### Oterodry

*Percent of map unit:* 4 percent  
*Landform:* Hillslopes  
*Landform position (two-dimensional):* Shoulder  
*Landform position (three-dimensional):* Side slope  
*Down-slope shape:* Convex  
*Across-slope shape:* Convex  
*Ecological site:* R069XY026CO - Sandy Plains  
*Other vegetative classification:* Loamy, Dry (G069XW019CO), Sandy Plains  
(069XY026CO\_1)  
*Hydric soil rating:* No

#### Ustertic haplargids, ponded

*Percent of map unit:* 2 percent  
*Landform:* Closed depressions  
*Landform position (two-dimensional):* Toeslope  
*Landform position (three-dimensional):* Base slope  
*Down-slope shape:* Linear  
*Across-slope shape:* Concave  
*Ecological site:* R069XY011CO - Closed Depression  
*Other vegetative classification:* Clayey (G069XW001CO)  
*Hydric soil rating:* No

## 78—Sampson loam, 0 to 3 percent slopes

### Map Unit Setting

*National map unit symbol:* 369s  
*Elevation:* 5,500 to 6,500 feet  
*Mean annual precipitation:* 13 to 15 inches  
*Mean annual air temperature:* 47 to 50 degrees F  
*Frost-free period:* 135 to 155 days  
*Farmland classification:* Prime farmland if irrigated

### Map Unit Composition

*Sampson and similar soils:* 95 percent  
*Minor components:* 5 percent  
*Estimates are based on observations, descriptions, and transects of the mapunit.*

### Description of Sampson

#### Setting

*Landform:* Depressions, alluvial fans, terraces  
*Down-slope shape:* Linear  
*Across-slope shape:* Linear  
*Parent material:* Alluvium

#### Typical profile

*A - 0 to 15 inches:* loam  
*Bt - 15 to 34 inches:* clay loam  
*Bk - 34 to 60 inches:* sandy clay loam

#### Properties and qualities

*Slope:* 0 to 3 percent  
*Depth to restrictive feature:* More than 80 inches  
*Drainage class:* Well drained  
*Runoff class:* Low  
*Capacity of the most limiting layer to transmit water (Ksat):* Moderately high to high  
(0.60 to 2.00 in/hr)  
*Depth to water table:* More than 80 inches  
*Frequency of flooding:* None  
*Frequency of ponding:* None  
*Calcium carbonate, maximum content:* 15 percent  
*Maximum salinity:* Nonsaline to very slightly saline (0.0 to 2.0 mmhos/cm)  
*Available water supply, 0 to 60 inches:* High (about 9.2 inches)

#### Interpretive groups

*Land capability classification (irrigated):* 2e  
*Land capability classification (nonirrigated):* 3c  
*Hydrologic Soil Group:* B  
*Ecological site:* R049XB202CO - Loamy Foothill  
*Hydric soil rating:* No

**Minor Components**

**Other soils**

*Percent of map unit:* 4 percent  
*Hydric soil rating:* No

**Pleasant**

*Percent of map unit:* 1 percent  
*Landform:* Depressions  
*Hydric soil rating:* Yes

**102—Valent sand, 1 to 12 percent slopes, dry**

**Map Unit Setting**

*National map unit symbol:* 2rgs5  
*Elevation:* 4,000 to 6,200 feet  
*Mean annual precipitation:* 10 to 14 inches  
*Mean annual air temperature:* 50 to 54 degrees F  
*Frost-free period:* 130 to 170 days  
*Farmland classification:* Not prime farmland

**Map Unit Composition**

*Valent, dry, and similar soils:* 85 percent  
*Minor components:* 15 percent  
*Estimates are based on observations, descriptions, and transects of the mapunit.*

**Description of Valent, Dry**

**Setting**

*Landform:* Dunes  
*Parent material:* Eolian sands

**Typical profile**

*A - 0 to 6 inches:* sand  
*AC - 6 to 21 inches:* sand  
*C1 - 21 to 36 inches:* sand  
*C2 - 36 to 79 inches:* sand

**Properties and qualities**

*Slope:* 1 to 12 percent  
*Depth to restrictive feature:* More than 80 inches  
*Drainage class:* Excessively drained  
*Capacity of the most limiting layer to transmit water (Ksat):* Very high (19.99 to 42.51 in/hr)  
*Depth to water table:* More than 80 inches  
*Frequency of flooding:* None  
*Frequency of ponding:* None  
*Maximum salinity:* Nonsaline (0.1 to 0.2 mmhos/cm)  
*Sodium adsorption ratio, maximum:* 0.1  
*Available water supply, 0 to 60 inches:* Very low (about 2.4 inches)

## Custom Soil Resource Report

### Interpretive groups

*Land capability classification (irrigated):* 6e  
*Land capability classification (nonirrigated):* 6e  
*Hydrologic Soil Group:* A  
*Ecological site:* R069XY019CO - Deep Sand  
*Forage suitability group:* Not Suited (G069XW000CO)  
*Other vegetative classification:* Not Suited (G069XW000CO)  
*Hydric soil rating:* No

### Minor Components

#### Vonid

*Percent of map unit:* 10 percent  
*Landform:* Sand sheets  
*Ecological site:* R069XY026CO - Sandy Plains  
*Other vegetative classification:* Not Suited (G069XW000CO), Sandy Plains  
(069XY026CO\_1)  
*Hydric soil rating:* No

#### Olney

*Percent of map unit:* 5 percent  
*Landform:* Sand sheets  
*Ecological site:* R069XY026CO - Sandy Plains  
*Other vegetative classification:* Not Suited (G069XW000CO), Sandy Plains  
(069XY026CO\_1)  
*Hydric soil rating:* No

## 103—Valent sand, 9 to 20 percent slopes, dry

### Map Unit Setting

*National map unit symbol:* 2rgs7  
*Elevation:* 4,000 to 6,200 feet  
*Mean annual precipitation:* 10 to 14 inches  
*Mean annual air temperature:* 50 to 54 degrees F  
*Frost-free period:* 130 to 170 days  
*Farmland classification:* Not prime farmland

### Map Unit Composition

*Valent, dry, and similar soils:* 85 percent  
*Minor components:* 15 percent  
*Estimates are based on observations, descriptions, and transects of the mapunit.*

### Description of Valent, Dry

#### Setting

*Landform:* Hills, ridges  
*Landform position (two-dimensional):* Backslope, summit  
*Landform position (three-dimensional):* Side slope, crest  
*Down-slope shape:* Convex  
*Across-slope shape:* Convex

## Custom Soil Resource Report

*Parent material:* Eolian sands derived from sedimentary rock

### Typical profile

*A - 0 to 6 inches:* sand  
*AC - 6 to 21 inches:* sand  
*C1 - 21 to 36 inches:* sand  
*C2 - 36 to 79 inches:* sand

### Properties and qualities

*Slope:* 9 to 20 percent  
*Depth to restrictive feature:* More than 80 inches  
*Drainage class:* Excessively drained  
*Capacity of the most limiting layer to transmit water (Ksat):* Very high (19.99 to 42.51 in/hr)  
*Depth to water table:* More than 80 inches  
*Frequency of flooding:* None  
*Frequency of ponding:* None  
*Maximum salinity:* Nonsaline (0.1 to 0.2 mmhos/cm)  
*Sodium adsorption ratio, maximum:* 0.1  
*Available water supply, 0 to 60 inches:* Low (about 3.6 inches)

### Interpretive groups

*Land capability classification (irrigated):* 6e  
*Land capability classification (nonirrigated):* 6e  
*Hydrologic Soil Group:* A  
*Ecological site:* R069XY021CO - Choppy Sands  
*Forage suitability group:* Not Suited (G069XW000CO)  
*Other vegetative classification:* Not Suited (G069XW000CO)  
*Hydric soil rating:* No

### Minor Components

#### Vonid

*Percent of map unit:* 10 percent  
*Landform:* Hills  
*Landform position (two-dimensional):* Backslope  
*Landform position (three-dimensional):* Side slope  
*Down-slope shape:* Convex  
*Across-slope shape:* Convex  
*Ecological site:* R069XY026CO - Sandy Plains  
*Other vegetative classification:* Sandy Plains (069XY026CO\_1), Not Suited (G069XW000CO)  
*Hydric soil rating:* No

#### Olney

*Percent of map unit:* 5 percent  
*Landform:* Interfluves  
*Landform position (two-dimensional):* Summit, footslope  
*Landform position (three-dimensional):* Interfluve  
*Down-slope shape:* Convex  
*Across-slope shape:* Linear  
*Ecological site:* R069XY026CO - Sandy Plains  
*Other vegetative classification:* Not Suited (G069XW000CO), Sandy Plains (069XY026CO\_1)  
*Hydric soil rating:* No

## 117—Vonid sandy loam, 0 to 5 percent slopes

### Map Unit Setting

*National map unit symbol:* 2rgqc  
*Elevation:* 4,000 to 6,200 feet  
*Mean annual precipitation:* 12 to 14 inches  
*Mean annual air temperature:* 48 to 54 degrees F  
*Frost-free period:* 130 to 170 days  
*Farmland classification:* Not prime farmland

### Map Unit Composition

*Vonid and similar soils:* 85 percent  
*Minor components:* 15 percent  
*Estimates are based on observations, descriptions, and transects of the mapunit.*

### Description of Vonid

#### Setting

*Landform:* Sand sheets  
*Landform position (two-dimensional):* Backslope  
*Landform position (three-dimensional):* Side slope  
*Down-slope shape:* Linear  
*Across-slope shape:* Linear  
*Parent material:* Eolian sands

#### Typical profile

*A - 0 to 6 inches:* sandy loam  
*Bt - 6 to 29 inches:* sandy loam  
*Bk - 29 to 52 inches:* sandy loam  
*C - 52 to 79 inches:* loamy sand

#### Properties and qualities

*Slope:* 0 to 5 percent  
*Depth to restrictive feature:* More than 80 inches  
*Drainage class:* Somewhat excessively drained  
*Capacity of the most limiting layer to transmit water (Ksat):* High (2.00 to 6.00 in/hr)  
*Depth to water table:* More than 80 inches  
*Frequency of flooding:* None  
*Frequency of ponding:* None  
*Calcium carbonate, maximum content:* 15 percent  
*Maximum salinity:* Nonsaline to very slightly saline (0.0 to 2.0 mmhos/cm)  
*Sodium adsorption ratio, maximum:* 2.0  
*Available water supply, 0 to 60 inches:* Moderate (about 6.3 inches)

#### Interpretive groups

*Land capability classification (irrigated):* 3e  
*Land capability classification (nonirrigated):* 4c  
*Hydrologic Soil Group:* A  
*Ecological site:* R069XY026CO - Sandy Plains



## Custom Soil Resource Report

*Forage suitability group:* Loamy, Dry (G019XW019CO)  
*Other vegetative classification:* Loamy, Dry (G019XW019CO)  
*Hydric soil rating:* No

### Minor Components

#### Olney

*Percent of map unit:* 10 percent  
*Landform:* Interfluves  
*Landform position (two-dimensional):* Summit  
*Down-slope shape:* Linear  
*Across-slope shape:* Linear  
*Ecological site:* R069XY026CO - Sandy Plains  
*Other vegetative classification:* Loamy (G069XW017CO)  
*Hydric soil rating:* No

#### Valent

*Percent of map unit:* 4 percent  
*Landform:* Sand sheets  
*Landform position (two-dimensional):* Shoulder, backslope  
*Landform position (three-dimensional):* Side slope, crest  
*Down-slope shape:* Convex  
*Across-slope shape:* Convex  
*Ecological site:* R067BY015CO - Deep Sand  
*Other vegetative classification:* DEEP SANDS (067XY015CO\_2), Loamy, Dry (G069XW019CO)  
*Hydric soil rating:* No

#### Ustertic haplargids, ponded

*Percent of map unit:* 1 percent  
*Landform:* Closed depressions  
*Down-slope shape:* Concave  
*Across-slope shape:* Concave  
*Ecological site:* R067BY010CO - Closed Depression  
*Other vegetative classification:* Clayey (G069XW001CO)  
*Hydric soil rating:* No

## 123—Olney-Vonid soils, 1 to 6 percent slopes, eroded

### Map Unit Setting

*National map unit symbol:* 2t51d  
*Elevation:* 4,000 to 6,200 feet  
*Mean annual precipitation:* 12 to 14 inches  
*Mean annual air temperature:* 48 to 54 degrees F  
*Frost-free period:* 130 to 170 days  
*Farmland classification:* Not prime farmland

### Map Unit Composition

*Olney, eroded, and similar soils:* 50 percent  
*Vonid, eroded, and similar soils:* 40 percent

## Custom Soil Resource Report

*Minor components: 10 percent*  
*Estimates are based on observations, descriptions, and transects of the mapunit.*

### Description of Olney, Eroded

#### Setting

*Landform: Interfluves*  
*Landform position (two-dimensional): Summit*  
*Down-slope shape: Linear*  
*Across-slope shape: Linear*  
*Parent material: Eolian deposits*

#### Typical profile

*A - 0 to 2 inches: sandy loam*  
*Bt - 2 to 14 inches: sandy clay loam*  
*Bk1 - 14 to 36 inches: sandy loam*  
*Bk2 - 36 to 79 inches: fine sandy loam*

#### Properties and qualities

*Slope: 1 to 4 percent*  
*Depth to restrictive feature: More than 80 inches*  
*Drainage class: Well drained*  
*Capacity of the most limiting layer to transmit water (Ksat): Moderately high to high*  
*(0.20 to 2.00 in/hr)*  
*Depth to water table: More than 80 inches*  
*Frequency of flooding: None*  
*Frequency of ponding: None*  
*Calcium carbonate, maximum content: 25 percent*  
*Maximum salinity: Nonsaline to very slightly saline (0.5 to 2.0 mmhos/cm)*  
*Sodium adsorption ratio, maximum: 2.0*  
*Available water supply, 0 to 60 inches: Moderate (about 7.8 inches)*

#### Interpretive groups

*Land capability classification (irrigated): 3e*  
*Land capability classification (nonirrigated): 4e*  
*Hydrologic Soil Group: B*  
*Ecological site: R069XY026CO - Sandy Plains*  
*Forage suitability group: Loamy (G069XW017CO)*  
*Other vegetative classification: Loamy (G069XW017CO)*  
*Hydric soil rating: No*

### Description of Vonid, Eroded

#### Setting

*Landform: Sand sheets*  
*Landform position (two-dimensional): Backslope*  
*Landform position (three-dimensional): Side slope*  
*Down-slope shape: Linear*  
*Across-slope shape: Linear*  
*Parent material: Eolian sands*

#### Typical profile

*A - 0 to 2 inches: sandy loam*  
*Bt - 2 to 29 inches: sandy loam*  
*Bk - 29 to 52 inches: sandy loam*  
*C - 52 to 79 inches: loamy sand*

## Custom Soil Resource Report

### Properties and qualities

*Slope:* 1 to 6 percent  
*Depth to restrictive feature:* More than 80 inches  
*Drainage class:* Somewhat excessively drained  
*Capacity of the most limiting layer to transmit water (Ksat):* High (2.00 to 6.00 in/hr)  
*Depth to water table:* More than 80 inches  
*Frequency of flooding:* None  
*Frequency of ponding:* None  
*Calcium carbonate, maximum content:* 15 percent  
*Maximum salinity:* Nonsaline to very slightly saline (0.5 to 2.0 mmhos/cm)  
*Sodium adsorption ratio, maximum:* 2.0  
*Available water supply, 0 to 60 inches:* Moderate (about 6.3 inches)

### Interpretive groups

*Land capability classification (irrigated):* 3e  
*Land capability classification (nonirrigated):* 4e  
*Hydrologic Soil Group:* A  
*Ecological site:* R069XY026CO - Sandy Plains  
*Forage suitability group:* Loamy, Dry (G019XW019CO)  
*Other vegetative classification:* Loamy, Dry (G019XW019CO)  
*Hydric soil rating:* No

### Minor Components

#### Vonid

*Percent of map unit:* 5 percent  
*Landform:* Sand sheets  
*Landform position (two-dimensional):* Backslope  
*Landform position (three-dimensional):* Side slope  
*Down-slope shape:* Linear  
*Across-slope shape:* Linear  
*Ecological site:* R069XY026CO - Sandy Plains  
*Other vegetative classification:* Loamy, Dry (G019XW019CO)  
*Hydric soil rating:* No

#### Olney

*Percent of map unit:* 5 percent  
*Landform:* Hillslopes  
*Landform position (two-dimensional):* Summit  
*Landform position (three-dimensional):* Interfluve  
*Down-slope shape:* Linear  
*Across-slope shape:* Linear  
*Ecological site:* R069XY026CO - Sandy Plains  
*Other vegetative classification:* Loamy (G069XW017CO)  
*Hydric soil rating:* No

tices help to maintain vigor and growth of plants. Fencing and properly locating livestock watering facilities also help to control grazing.

Windbreaks and environmental plantings generally are well suited to these soils. Summer fallow a year prior to planting and continued cultivation for weed control are needed to insure establishment and survival. Trees that are best suited to these soils are Rocky Mountain juniper, eastern redcedar, ponderosa pine, Siberian elm, Russian-olive, and hackberry. Shrubs that are best suited to these soils are skunkbush sumac, lilac, Siberian peashrub, and American plum.

These soils are best suited to habitat for openland and rangeland wildlife. In cropland areas, habitat favorable for ring-necked pheasant, mourning dove, and many nongame species can be developed by establishing areas for nesting and escape cover. Rangeland wildlife, such as pronghorn antelope, can be encouraged by developing livestock watering facilities, properly managing livestock grazing, and reseeding range where needed.

The main limitations of the Neville soil for urban use are its limited ability to support a load, moderate shrink-swell potential, and frost action potential. The main limitations of the Rednun soil are slow permeability, shrink-swell potential, and frost action potential. Special designs for buildings and roads are needed to overcome these limitations. Community sewage systems may be required because septic tank absorption fields do not function properly where permeability is slow. Capability subclass IVe.

**59—Nunn clay loam, 0 to 3 percent slopes.** This deep, well drained soil is on terraces, fans, and uplands. It formed in mixed alluvium. Elevation ranges from about 5,400 to 6,500 feet. The average annual precipitation is about 14 inches, the average annual air temperature is about 47 degrees F, and the average frost-free period is about 145 days.

Typically, the surface layer is grayish brown clay loam about 12 inches thick. The subsoil is grayish brown heavy clay loam about 18 inches thick. The substratum to a depth of 72 inches is light olive brown sandy clay loam in the upper part and light brownish gray clay in the lower part. Visible lime occurs as soft masses and streaks throughout the substratum.

Included with this soil in mapping are small areas of Manzanola clay loam, 0 to 1 percent slopes; Manzanola clay loam, 1 to 3 percent slopes; Sampson loam, 0 to 3 percent slopes; and Ustic Torrifluvents, loamy.

Permeability of this Nunn soil is moderately slow. Effective rooting depth is 60 inches or more. Available water capacity is high. Surface runoff is slow to medium, and the hazard of erosion is slight.

About 70 percent of the acreage of this soil is in dryland and irrigated crops. Wheat is the main dryland crop, and corn and alfalfa are the main irrigated crops. The remaining acreage is used as rangeland.

This soil is suited to the production of native vegetation suitable for grazing. The native vegetation is mainly

western wheatgrass, blue grama, alkali sacaton, needle-and-thread, and side-oats grama. Galleta and fourwing saltbush are also present where this soil occurs in the southern part of the survey area. The presence of princesplume, two-groove milkvetch, and Fremont goldenweed indicates that selenium-bearing plants are in the stand.

Good grazing management is essential to maintain the desirable grasses. Deferment of grazing early in spring helps to maintain the vigor of cool-season grasses. Properly locating livestock watering facilities helps to control grazing.

Windbreaks and environmental plantings generally are well suited to this soil. Summer fallow a year prior to planting and continued cultivation for weed control are needed to insure the establishment and survival of plantings. Trees that are best suited and have good survival are Rocky Mountain juniper, eastern redcedar, ponderosa pine, Siberian elm, Russian-olive, and hackberry. Shrubs that are best suited are skunkbush sumac, lilac, Siberian peashrub, and American plum.

This soil is best suited to habitat for openland and rangeland wildlife. In cropland areas, habitat favorable for ring-necked pheasant, mourning dove, and many nongame species can be developed by providing nesting areas and escape cover. For pheasant, undisturbed nesting cover is vital and should be provided for in plans for habitat development; this is especially true for intensively farmed areas. Rangeland wildlife, such as pronghorn antelope, can be encouraged by developing livestock watering facilities, properly managing livestock grazing, and reseeding range where needed.

The main limitations of this soil for urban use are slow permeability, low strength, and shrink-swell potential. Buildings and roads must be designed to overcome the limitations of low bearing strength and shrink-swell potential. Septic tank absorption fields do not function properly because of the slow permeability. Capability subclasses IIc, nonirrigated, and IIe, irrigated.

**60—Olney sandy loam, 0 to 3 percent slopes.** This deep, well drained soil formed in calcareous sandy sediment on uplands. Elevation ranges from 5,200 to 6,000 feet. The average annual precipitation is about 13 inches, the average annual air temperature is about 49 degrees F, and the average frost-free period is about 145 days.

Typically, the surface layer is grayish brown sandy loam about 6 inches thick. The subsoil, about 21 inches thick, is brown sandy clay loam in the upper 7 inches and pale brown sandy clay loam grading to sandy loam in the lower 14 inches. The substratum to a depth of 60 inches is very pale brown sandy loam that grades to loamy sand. The lower part of the subsoil and the substratum have visible lime in the form of soft masses and seams.

Included with this soil in mapping are small areas of Olney and Vona soils, eroded; Vona sandy loam, 1 to 3 percent slopes; and soils that are similar to this Olney soil in the upper 40 inches but that are very dark brown and loamy below a depth of 40 inches. Also included are

several wet-weather lakes, usually less than 2 acres in size.

Permeability of this Olney soil is moderate. Effective rooting depth is 60 inches or more. Available water capacity is moderate. Surface runoff is slow. The hazard of erosion generally is moderate, but it is high where this soil is under dryland cultivation.

This soil is used for nonirrigated crops and for range.

Sorghum, sudangrass, and millet grown for forage and hay are the main crops. Pinto beans and grain sorghums are also grown. All of these crops except pinto beans respond to nitrogen fertilizer. This soil is very susceptible to soil blowing. Use of crop residue, stripcropping, and emergency tillage helps to control soil blowing.

This soil is suited to the production of native vegetation suitable for grazing. The native vegetation is mainly blue grama, which has a typical bunchgrass growth form and makes up one-third to one-half of the cover. Other species are sand dropseed, needleandthread, side-oats grama, and buckwheat.

Seeding is a suitable practice if the range has deteriorated. Seeding of native grasses is a good practice. If the range is severely eroded and blowouts have developed, fertilizing the new seeding is a good practice. Brush control may be needed, and grazing management may help to improve the depleted range. Grazing should be managed so that enough forage is left standing to protect the soil from blowing, to increase infiltration of water, and to catch and hold snow.

Windbreaks and environmental plantings generally are suited to this soil. Soil blowing is the main limitation to the establishment of trees and shrubs. This limitation can be overcome by cultivating only in the tree rows and leaving a strip of vegetation between the rows. Supplemental irrigation may be needed when planting and during dry periods. Trees that are best suited and have good survival are Rocky Mountain juniper, eastern redcedar, ponderosa pine, Siberian elm, Russian-olive, and hackberry. Shrubs that are best suited are skunkbush sumac, lilac, and Siberian peashrub.

This soil is suited to wildlife habitat. It is best suited to habitat for openland and rangeland wildlife. In cropland areas, habitat favorable for ring-necked pheasant, mourning dove, and many nongame species can be developed by providing nesting areas and escape cover. For pheasant, undisturbed nesting cover is vital and should be provided for in plans for habitat development, especially in areas of intensive farming. Rangeland wildlife, such as pronghorn antelope, can be encouraged by developing livestock watering facilities, properly managing livestock grazing, and reseeding range where needed.

The main limitations for urban development on this soil are the frost-action potential, the shrink-swell potential of the subsoil, and the hazard of soil blowing. Roads, streets, and buildings need to be designed to minimize the effects of the shrink-swell potential and frost-heave damage. Erosion control practices are needed to reduce soil blowing when the soil surface is bare during construction. Capability subclass IVe.

**61—Olney sandy loam, 3 to 5 percent slopes.** This deep, well drained, sandy soil formed in calcareous sandy sediment on uplands. Elevation ranges from 5,200 to 6,000 feet. The average annual precipitation is about 13 inches, the average annual air temperature is about 49 degrees F, and the average frost-free period is about 145 days.

Typically, the surface layer is grayish brown sandy loam about 6 inches thick. The subsoil, about 21 inches thick, is brown sandy clay loam in the upper 7 inches and pale brown sandy clay loam that grades to sandy loam in the lower 14 inches. The substratum to a depth of 60 inches is very pale brown sandy loam that grades to loamy sand. The lower part of the subsoil and the substratum have visible lime in the form of soft masses and seams.

Included with this soil in mapping are small areas of Olney and Vona soils, eroded; Vona sandy loam, 3 to 9 percent slopes; and soils that are similar to this Olney soil but are very dark brown loam below a depth of 40 inches. Also included are a few wet-weather lakes, usually less than 2 acres in size.

Permeability of this Olney soil is moderate. Effective rooting depth is 60 inches or more. Available water capacity is moderate. Surface runoff is medium. The hazard of erosion generally is moderate, but it is high where this soil is dryfarmed. The soil is very susceptible to soil blowing.

Most of the acreage is used as rangeland. Some of the acreage is dryfarmed, and a small acreage is farmed under sprinkler irrigation.

This soil is suited to the production of native vegetation suitable for grazing. The native vegetation is mainly blue grama, which has a typical bunchgrass growth form and makes up one-third to one-half of the cover. Other species are sand dropseed, needleandthread, side-oats grama, and buckwheat.

Seeding is advisable if the range has deteriorated. Seeding the native grasses is a good practice. If the range is severely eroded and blowouts have developed, fertilizing the new seeding is a good practice. Brush control may be needed, and grazing management may help to improve the depleted range. Grazing should be managed so that enough forage is left standing to protect the soil from blowing, to increase the infiltration of water, and to catch and hold snow.

Windbreaks and environmental plantings generally are suited to this soil. Soil blowing is the main limitation to the establishment of trees and shrubs. This limitation can be overcome by cultivating only in the tree rows and leaving a strip of vegetation between the rows. Supplemental irrigation may be needed when planting and during dry periods. Trees that are best suited and have good survival are Rocky Mountain juniper, eastern redcedar, ponderosa pine, Siberian elm, Russian-olive, and hackberry. Shrubs that are best suited are skunkbush sumac, lilac, and Siberian peashrub.

This soil is best suited to habitat for openland and rangeland wildlife. In cropland areas, habitat favorable for

ring-necked pheasant, mourning dove, and many nongame species can be developed by providing nesting areas and escape cover. For pheasant, undisturbed nesting cover is vital and should be provided for in plans for habitat development. Rangeland wildlife, such as pronghorn antelope, can be encouraged by developing livestock watering facilities, properly managing livestock grazing, and reseeding range where needed.

The main limitations for urban development are the shrink-swell potential of the subsoil, frost-action potential, and the hazard of soil blowing. Roads and streets and buildings need to be designed to minimize the effects of the shrink-swell potential and frost-heave damage. Practices that reduce the hazard of soil blowing are needed when the soil surface is bare during construction. Capability subclass IVe.

**62—Olney and Vona soils, eroded.** This undifferentiated group is on uplands. Slopes range from 0 to 9 percent but average about 3 percent. Elevation ranges from 5,200 to 6,000 feet. The average annual precipitation is about 13 inches, the average annual air temperature is about 49 degrees F, and the frost-free period is about 145 days.

Both the Olney soil and the Vona soil may occur in each delineated area, or each soil may occur separately.

Included with these soils in mapping are small areas of Olney sandy loam, 0 to 3 percent slopes; Olney sandy loam, 3 to 5 percent slopes; Vona sandy loam, 1 to 3 percent slopes; and Vona sandy loam, 3 to 9 percent slopes.

The Olney soil is deep and well drained. It formed in calcareous sandy sediment. The sandy loam surface layer in most areas has been lost, primarily as a result of soil blowing, exposing the subsoil and in some places the substratum. In some places the surface has a choppy, or dunelike, appearance because of the accumulation of wind-deposited soil material. The subsoil, where present, is about 21 inches thick. It is brown sandy clay loam in the upper 7 inches and pale brown sandy clay loam that grades to sandy loam in the lower 14 inches. The substratum extends to a depth of 60 inches or more. It is very pale brown sandy loam that grades to loamy sand. The lower part of the subsoil and the substratum have visible lime in the form of soft masses and seams.

Permeability of the Olney soil is moderate. Effective rooting depth is 60 inches or more. Available water capacity is moderate. Surface runoff is slow to medium, and the hazard of erosion is high. Erosion is mainly a result of soil blowing (fig. 4), but in places rills and gullies have been produced by water erosion.

The Vona soil is deep and well drained. It formed in sandy, calcareous, eolian material. The sandy loam surface layer in most areas of this soil has been lost mainly as a result of soil blowing, exposing the subsoil and in some places the substratum. In some places the surface has a choppy, or dunelike, appearance because of the accumulation of wind-deposited soil material. The subsoil is brown sandy loam about 8 inches thick where it has not been eroded. The substratum extends to a depth of 60 inches

or more. It is pale brown to very pale brown sandy loam in the upper part and grades to light yellowish brown fine sandy loam in the lower part.

Permeability of the Vona soil is moderately rapid. Effective rooting depth is 60 inches or more. Available water capacity is moderate. Surface runoff is slow, and the hazard of erosion is high. Erosion is mainly a result of soil blowing, but in places some rills and gullies have been produced by water erosion.

These soils are used mostly as rangeland.

These soils are not suited to dryland farming. Most of the acreage was previously cultivated, but the major part of this has been seeded to grass or abandoned.

These soils are suited to the production of native vegetation suitable for grazing. The native vegetation is mainly blue grama, which has a typical bunchgrass growth form and makes up one-third to one-half of the cover. Other species are sand dropseed, needleandthread, side-oats grama, and buckwheat.

Seeding is advisable if the range has deteriorated. Seeding the native grasses is a good practice. If the range is severely eroded and blowouts have developed, fertilizing the new seeding is a good practice. Brush control may be needed, and grazing management may improve the depleted range. Grazing should be managed so that enough forage is left standing to protect the soil from blowing, to increase infiltration of water, and to catch and hold snow.

These soils are generally suited to windbreaks and environmental plantings. Soil blowing is the main limitation to the establishment of trees and shrubs. This limitation can be overcome by cultivating only in the tree rows and leaving a strip of vegetation between the rows. Supplemental irrigation may be needed when planting and during dry periods. Trees that are best suited and have good survival are Rocky Mountain juniper, eastern redcedar, ponderosa pine, Siberian elm, Russian-olive, and hackberry. Shrubs that are best suited are skunkbush sumac, lilac, and Siberian peashrub.

These soils are best suited to habitat for openland and rangeland wildlife. Rangeland wildlife, such as pronghorn antelope, can be encouraged by developing livestock watering facilities, properly managing livestock grazing, and reseeding range where needed.

The main limitations of these soils for urban development are frost-action potential and the hazard of soil blowing. Roads and streets need to be designed to minimize frost-heave damage. Practices are needed to reduce soil blowing when the soil surface is bare during construction. Capability subclass VIe.

**63—Paunsaugunt-Rock outcrop complex, 15 to 65 percent slopes.** This moderately steep to very steep complex is on mountains. Elevation ranges from 7,200 to 8,000 feet. The average annual precipitation is about 15 inches, and the average annual air temperature is about 43 degrees F.

The Paunsaugunt soil makes up about 50 percent of the complex and Rock outcrop about 40 percent. About 10

## **2 Hydrologic Calculations**

Runoff Reduction Worksheets & Maps  
Culvert Tributary Area Sub-Basin Calculations

**Design Procedure Form: Runoff Reduction**

UD-BMP (Version 3.07, March 2018)

Sheet 1 of 1

**Designer:** TJW  
**Company:** M.V.E., Inc.  
**Date:** July 10, 2024  
**Project:** Meadow Ranch  
**Location:** Typical Roadside RPA (100' Long Section of 1/2 Roadway UIA + 4' Wide RPA allowing for a 20' wide driveway)

**SITE INFORMATION (User Input in Blue Cells)**

WQCV Rainfall Depth = 0.60 inches  
 Depth of Average Runoff Producing Storm,  $d_6$  = 0.43 inches (for Watersheds Outside of the Denver Region, Figure 3-1 in USDCM Vol. 3)

Area Type	UIA:RPA														
Area ID	Slope														
Downstream Design Point ID	None														
Downstream BMP Type	None														
DCIA (ft <sup>2</sup> )	--														
UIA (ft <sup>2</sup> )	1,100														
RPA (ft <sup>2</sup> )	320														
SPA (ft <sup>2</sup> )	--														
HSG A (%)	0%														
HSG B (%)	100%														
HSG C/D (%)	0%														
Average Slope of RPA (ft/ft)	0.250														
UIA:RPA Interface Width (ft)	80.00														

**WORST CASE CALCULATED.  
 FLATTER SLOPES PROVIDE  
 ADDITIONAL WQCV REDUCTION**

**CALCULATED RUNOFF RESULTS**

Area ID	Slope														
UIA:RPA Area (ft <sup>2</sup> )	1,420														
L / W Ratio	0.22														
UIA / Area	0.7746														
Runoff (in)	0.15														
Runoff (ft <sup>3</sup> )	18														
Runoff Reduction (ft <sup>3</sup> )	28														

**CALCULATED WQCV RESULTS**

Area ID	Slope														
WQCV (ft <sup>3</sup> )	46														
WQCV Reduction (ft <sup>3</sup> )	28														
WQCV Reduction (%)	60%														
Untreated WQCV (ft <sup>3</sup> )	18														

**CALCULATED DESIGN POINT RESULTS (sums results from all columns with the same Downstream Design Point ID)**

Downstream Design Point ID	None														
DCIA (ft <sup>2</sup> )	0														
UIA (ft <sup>2</sup> )	1,100														
RPA (ft <sup>2</sup> )	320														
SPA (ft <sup>2</sup> )	0														
Total Area (ft <sup>2</sup> )	1,420														
Total Impervious Area (ft <sup>2</sup> )	1,100														
WQCV (ft <sup>3</sup> )	46														
WQCV Reduction (ft <sup>3</sup> )	28														
WQCV Reduction (%)	60%														
Untreated WQCV (ft <sup>3</sup> )	18														

**CALCULATED SITE RESULTS (sums results from all columns in worksheet)**

Total Area (ft <sup>2</sup> )	1,420
Total Impervious Area (ft <sup>2</sup> )	1,100
WQCV (ft <sup>3</sup> )	46
WQCV Reduction (ft <sup>3</sup> )	28
WQCV Reduction (%)	60%
Untreated WQCV (ft <sup>3</sup> )	18



**Design Procedure Form: Runoff Reduction**

UD-BMP (Version 3.07, March 2018)

Sheet 1 of 1

**Designer:** TJW  
**Company:** M.V.E., Inc.  
**Date:** July 10, 2024  
**Project:** Meadow Ranch  
**Location:** Typical Cul-de-sac Bulb Roadside RPA (1/2 Bulb UIA + 8' Wide RPA allowing for a 20' wide driveway)

**SITE INFORMATION (User Input in Blue Cells)**

WQCV Rainfall Depth 0.60 inches  
 Depth of Average Runoff Producing Storm,  $d_6$  = 0.43 inches (for Watersheds Outside of the Denver Region, Figure 3-1 in USDCM Vol. 3)

Area Type	UIA:RPA																			
Area ID	Slope																			
Downstream Design Point ID	None																			
Downstream BMP Type	None																			
DCIA (ft <sup>2</sup> )	--																			
UIA (ft <sup>2</sup> )	2,903																			
RPA (ft <sup>2</sup> )	864																			
SPA (ft <sup>2</sup> )	--																			
HSG A (%)	0%																			
HSG B (%)	100%																			
HSG C/D (%)	0%																			
Average Slope of RPA (ft/ft)	0.250																			
UIA:RPA Interface Width (ft)	104.00																			

**WORST CASE CALCULATED.  
 FLATTER SLOPES PROVIDE  
 ADDITIONAL WQCV REDUCTION**

**CALCULATED RUNOFF RESULTS**

Area ID	Slope																			
UIA:RPA Area (ft <sup>2</sup> )	3,767																			
L / W Ratio	0.35																			
UIA / Area	0.7706																			
Runoff (in)	0.15																			
Runoff (ft <sup>3</sup> )	46																			
Runoff Reduction (ft <sup>3</sup> )	75																			

**CALCULATED WQCV RESULTS**

Area ID	Slope																			
WQCV (ft <sup>3</sup> )	121																			
WQCV Reduction (ft <sup>3</sup> )	75																			
WQCV Reduction (%)	62%																			
Untreated WQCV (ft <sup>3</sup> )	46																			

**CALCULATED DESIGN POINT RESULTS (sums results from all columns with the same Downstream Design Point ID)**

Downstream Design Point ID	None																			
DCIA (ft <sup>2</sup> )	0																			
UIA (ft <sup>2</sup> )	2,903																			
RPA (ft <sup>2</sup> )	864																			
SPA (ft <sup>2</sup> )	0																			
Total Area (ft <sup>2</sup> )	3,767																			
Total Impervious Area (ft <sup>2</sup> )	2,903																			
WQCV (ft <sup>3</sup> )	121																			
WQCV Reduction (ft <sup>3</sup> )	75																			
WQCV Reduction (%)	62%																			
Untreated WQCV (ft <sup>3</sup> )	46																			

**CALCULATED SITE RESULTS (sums results from all columns in worksheet)**

Total Area (ft <sup>2</sup> )	3,767
Total Impervious Area (ft <sup>2</sup> )	2,903
WQCV (ft <sup>3</sup> )	121
WQCV Reduction (ft <sup>3</sup> )	75
WQCV Reduction (%)	62%
Untreated WQCV (ft <sup>3</sup> )	46

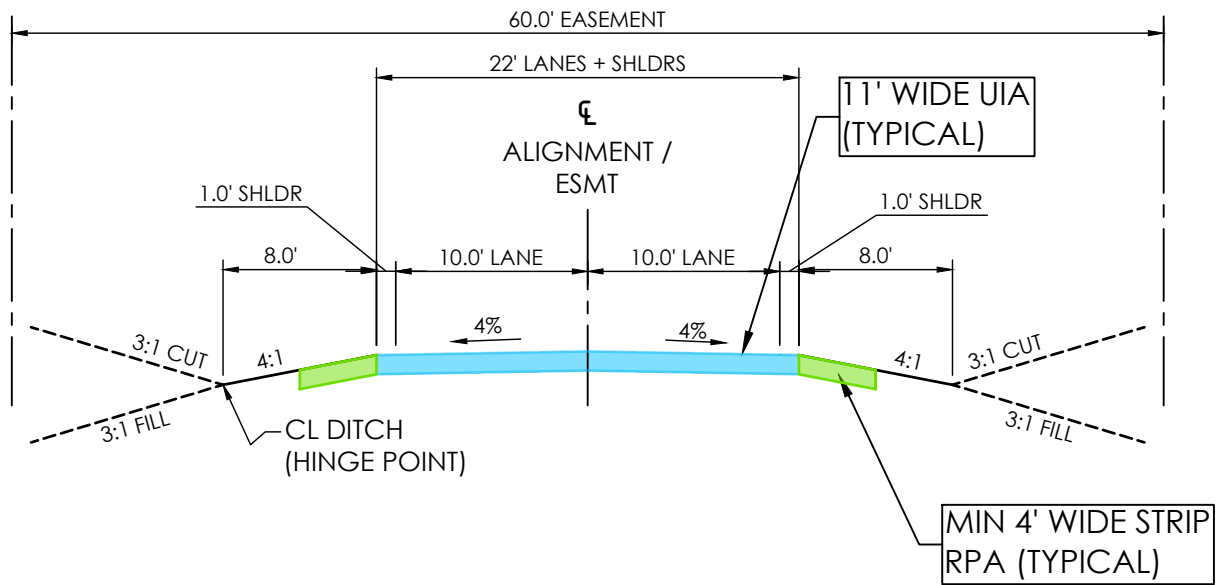

## ACCESS EASEMENT GRADING

SCALE: 1" = 10'

### RPA REQUIREMENTS:

4' OF RPA MINIMUM ALONG EACH SIDE OF THE ENTIRE LENGTH OF ACCESS EASEMENT TRAVEL WAY.

8' OF RPA MINIMUM AROUND PERIMETER OF CUL-DE-SAC BULB GRADING.

NO DROP AT THE UIA / RPA INTERFACE FOR SAFETY.

RPA SHALL VEGETATED AND HAVE A UNIFORM DENSITY OF AT LEAST 80%.

RPA'S SHALL BE MAINTAINED PER THE APPROVED O&M MANUAL AND ADMINISTERED PER THE PCM MAINTENANCE AGREEMENT.

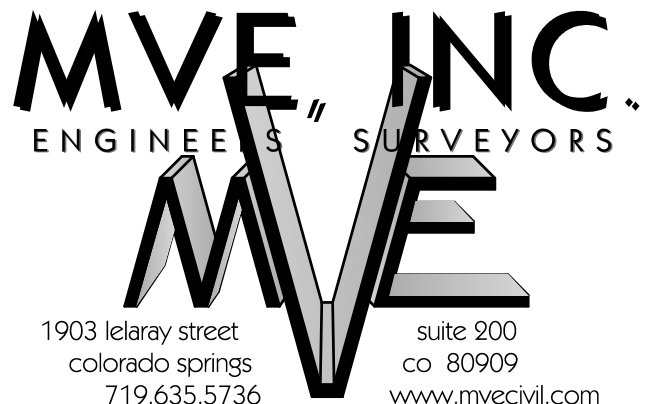

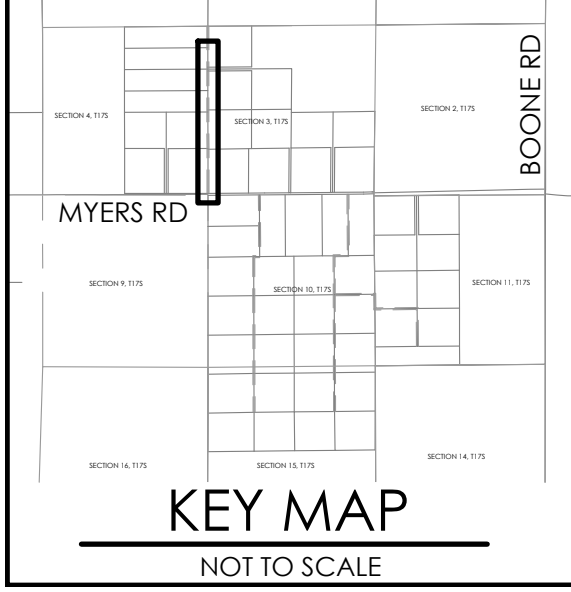
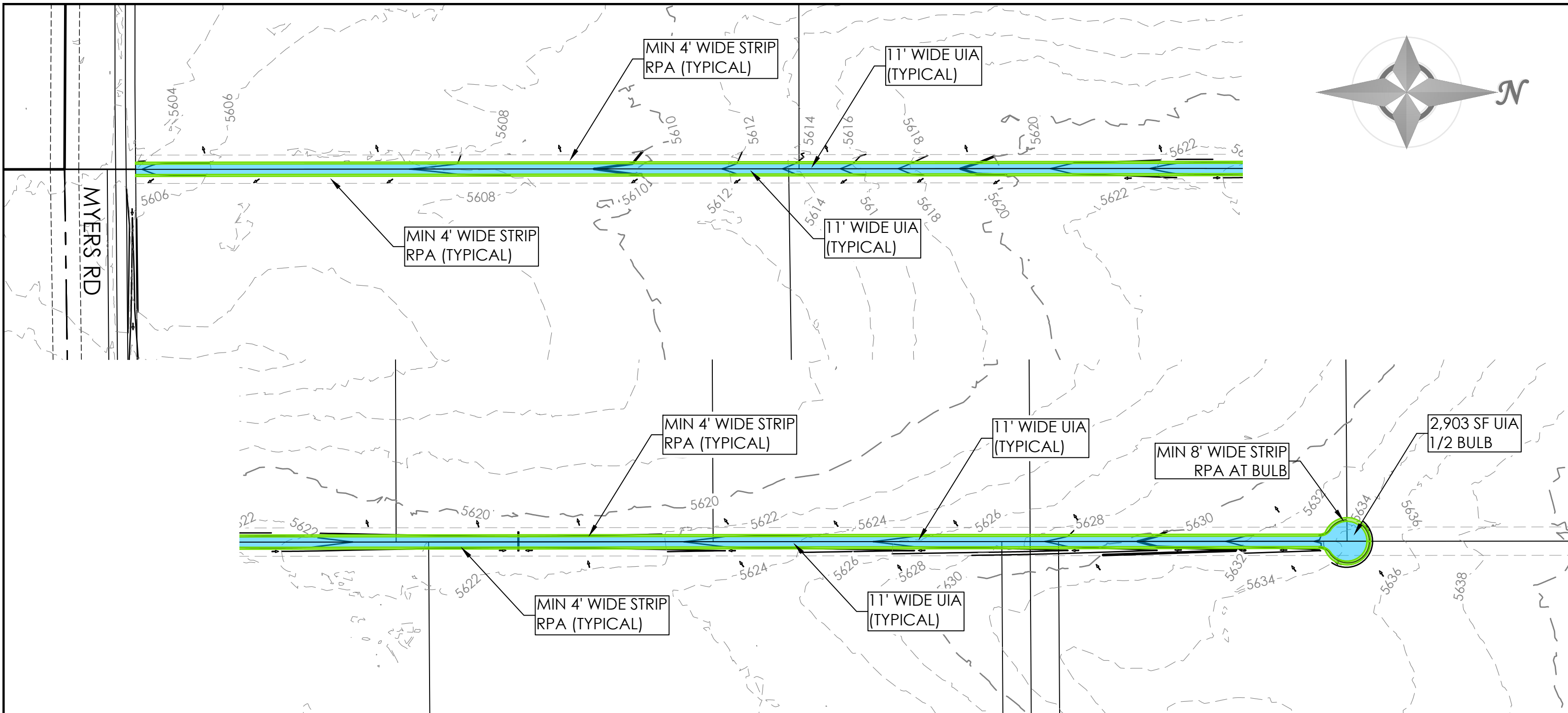
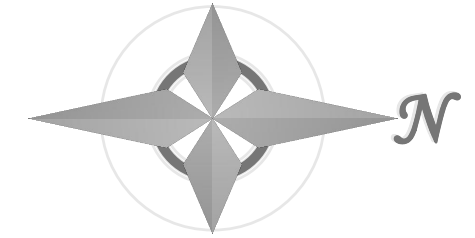

**LEGEND**

	PROPERTY LINE
	EASEMENT LINE
<b>EXISTING</b>	
	INDEX CONTOUR
	INTERMEDIATE CONTOUR
<b>PROPOSED</b>	
	INDEX CONTOUR
	INTERMEDIATE CONTOUR
	AREA BOUNDARY

**SURFACE TYPES**

UNCONNECTED IMPERVIOUS AREA (UIA)	
RECEIVING PERVIOUS AREA (RPA)	

**MVE, INC.**  
ENGINEERS SURVEYORS

1903 lelaray street  
colorado springs  
719.635.5736

suite 200  
co 80909  
www.mvecivil.com

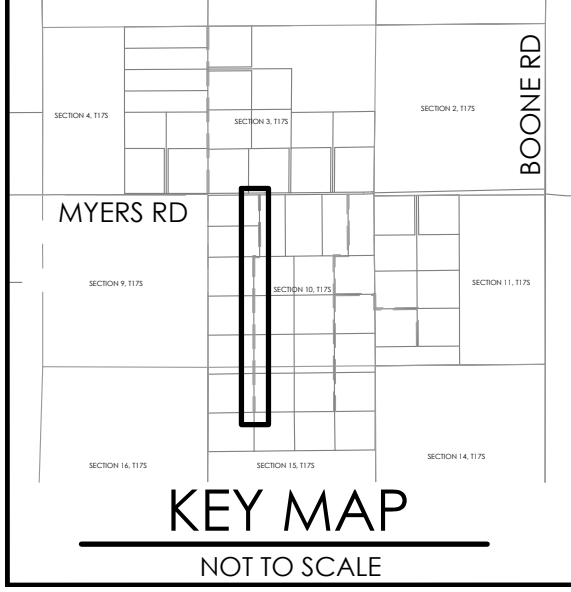
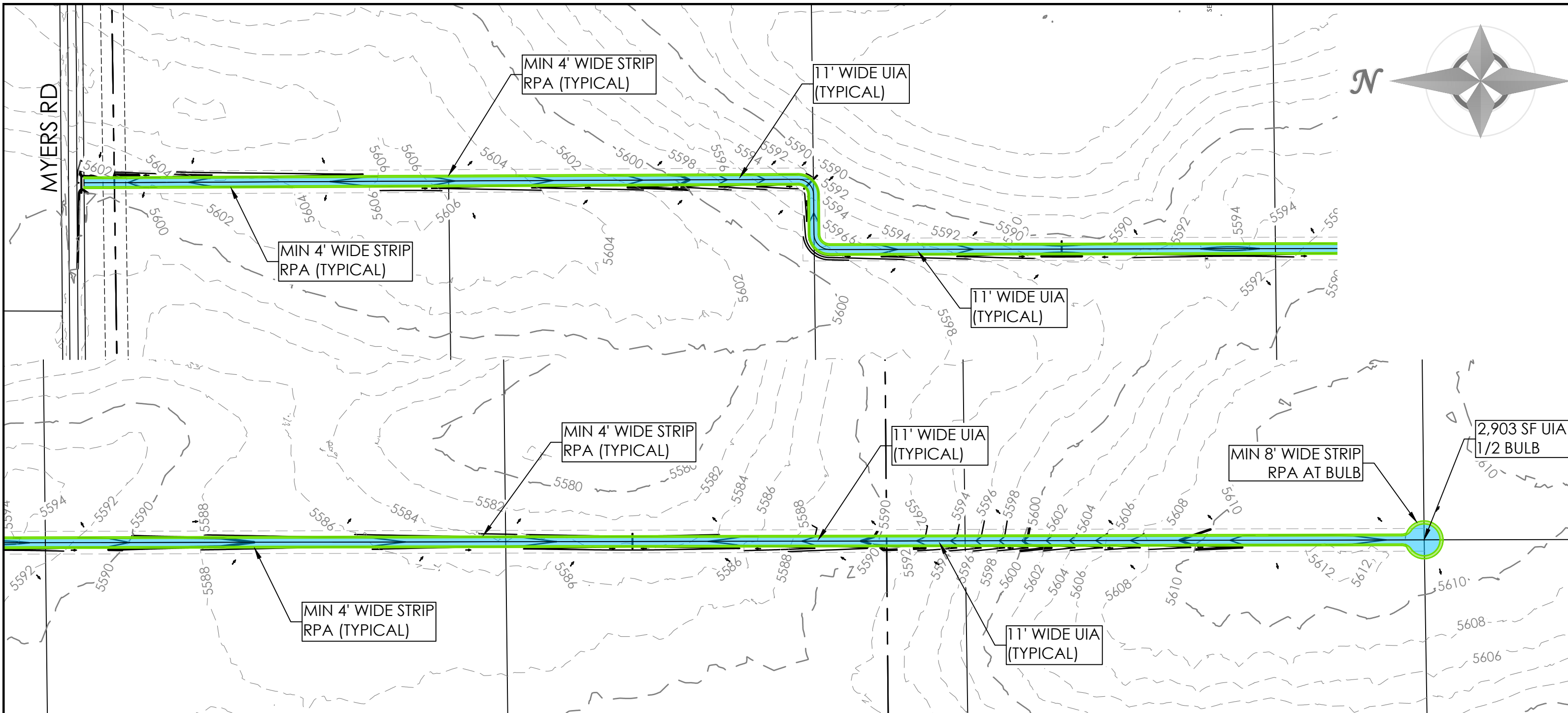
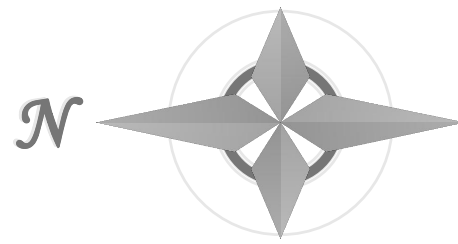

- LEGEND**
- PROPERTY LINE
  - - - EASEMENT LINE
  - EXISTING**
  - - - 5985 - - - INDEX CONTOUR
  - - - 84 - - - INTERMEDIATE CONTOUR
  - PROPOSED**
  - 5985 — INDEX CONTOUR
  - 84 — INTERMEDIATE CONTOUR
  - AREA BOUNDARY

SURFACE TYPES		
UNCONNECTED IMPERVIOUS AREA (UIA)		
RECEIVING PERVIOUS AREA (RPA)		

**MVE, INC.**  
ENGINEERS SURVEYORS

1903 lelaray street  
colorado springs  
719.635.5736

suite 200  
co 80909  
www.mvecivil.com

2,903 SF UIA  
1/2 BULB

MIN 8' WIDE STRIP  
RPA AT BULB

11' WIDE UIA  
(TYPICAL)

MIN 4' WIDE STRIP  
RPA (TYPICAL)

11' WIDE UIA  
(TYPICAL)

MIN 4' WIDE STRIP  
RPA (TYPICAL)

11' WIDE UIA  
(TYPICAL)

MIN 4' WIDE STRIP  
RPA (TYPICAL)

11' WIDE UIA  
(TYPICAL)

MIN 4' WIDE STRIP  
RPA (TYPICAL)

MYERS RD

BOONE RD

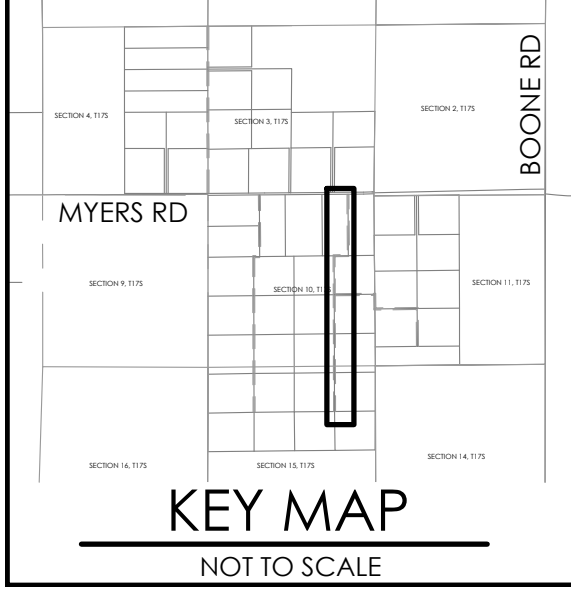
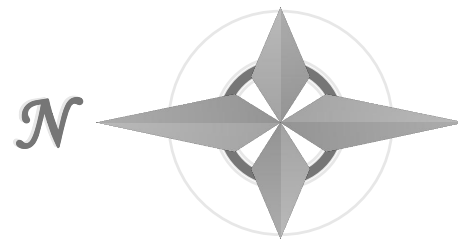
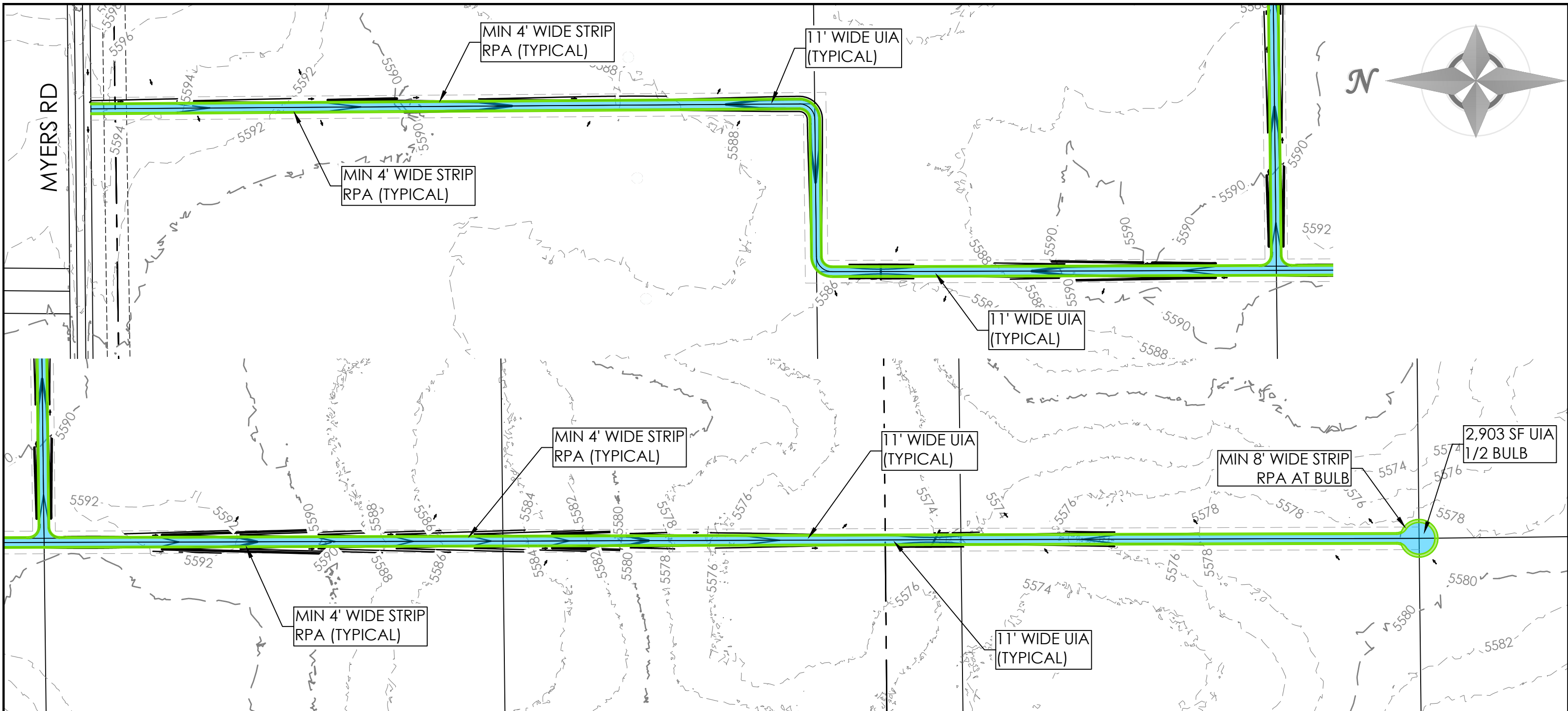

- LEGEND**
- PROPERTY LINE
  - - - EASEMENT LINE
  - EXISTING**
  - - - 5985 - - - INDEX CONTOUR
  - - - 84 - - - INTERMEDIATE CONTOUR
  - PROPOSED**
  - 5985 — INDEX CONTOUR
  - 84 — INTERMEDIATE CONTOUR
  - AREA BOUNDARY

SURFACE TYPES		
UNCONNECTED IMPERVIOUS AREA (UIA)		
RECEIVING PERVIOUS AREA (RPA)		

**MVE, INC.**  
 ENGINEERS SURVEYORS  
  
 1903 lelaray street  
 colorado springs  
 719.635.5736  
 suite 200  
 co 80909  
 www.mvecivil.com

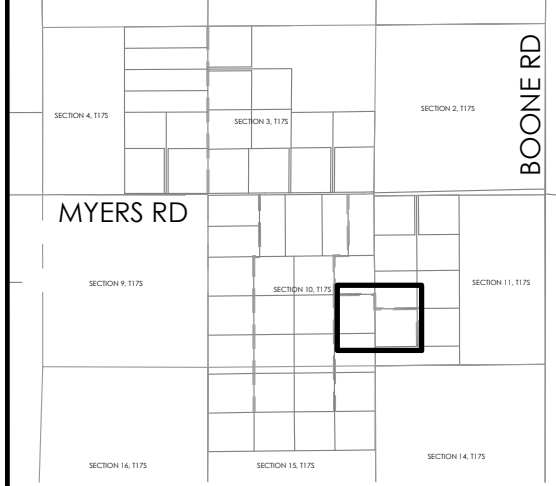
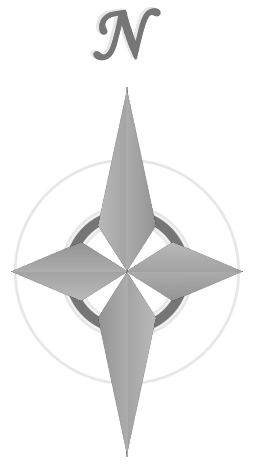
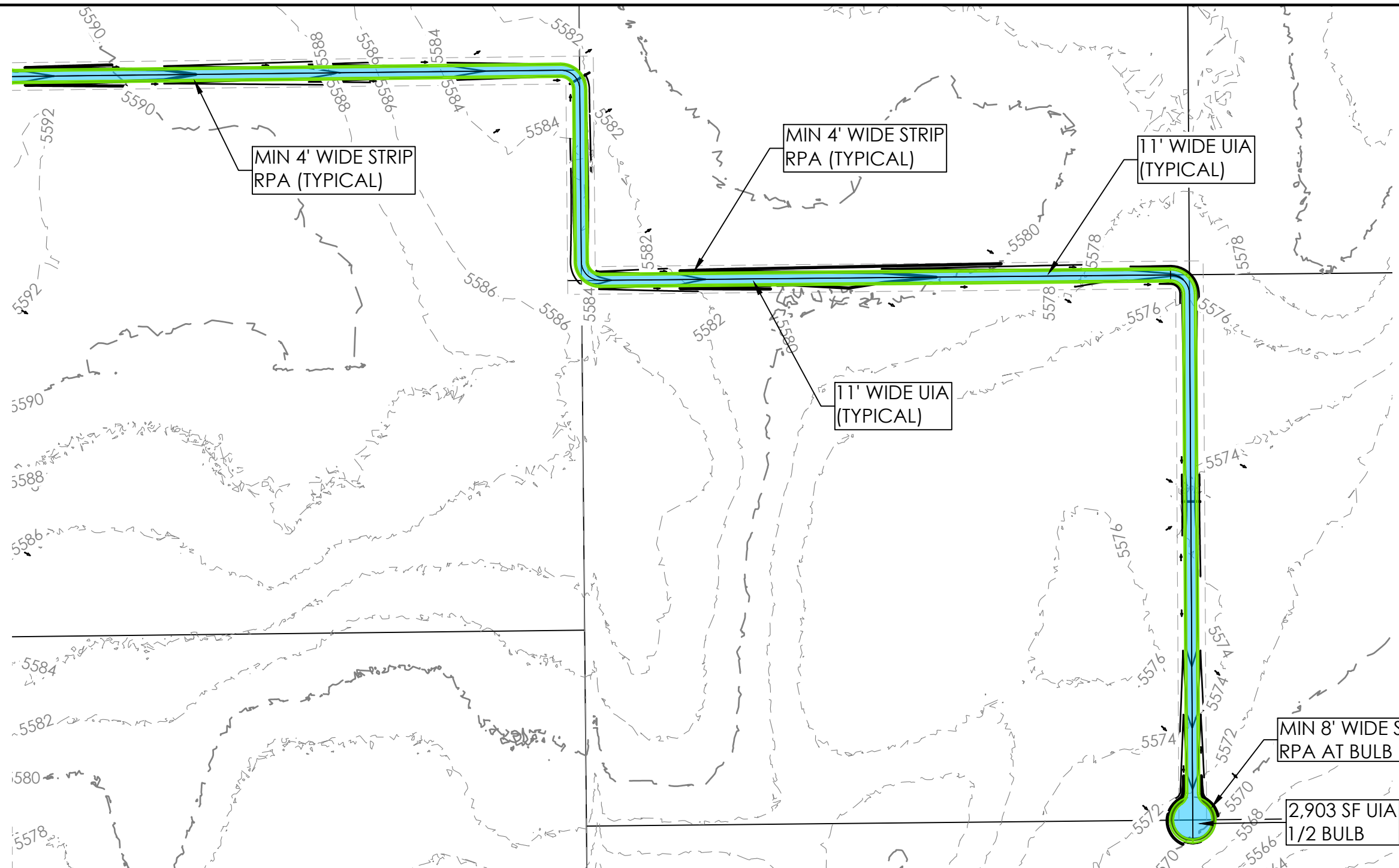

**KEY MAP**  
NOT TO SCALE

**LEGEND**

- PROPERTY LINE
- - - - - EASEMENT LINE
- EXISTING**
- - - - - 5985 - - - INDEX CONTOUR
- - - - - 84 - - - INTERMEDIATE CONTOUR
- PROPOSED**
- 5985 — INDEX CONTOUR
- 84 — INTERMEDIATE CONTOUR
- AREA BOUNDARY

SURFACE TYPES		
UNCONNECTED IMPERVIOUS AREA (UIA)		
RECEIVING PERVIOUS AREA (RPA)		

**MVE, INC.**  
ENGINEERS SURVEYORS

1903 lelaray street  
colorado springs  
719.635.5736

suite 200  
co 80909  
www.mvecivil.com

## Sub-Basin N1 Runoff Calculations

Job No.: 61209  
 Project: Mountain Ranches  
 Jurisdiction: DCM  
 Runoff Coefficient: Surface Type

Date: 7/23/2024 10:00  
 Calcs by: TJW  
 Checked by: \_\_\_\_\_  
 Soil Type: B  
 Urbanization: Non-Urban

### Basin Land Use Characteristics

Surface	Area		Runoff Coefficient						% Imperv.
	(SF)	(Acres)	C2	C5	C10	C25	C50	C100	
Pasture/Meadow	220,517	5.06	0.02	0.08	0.15	0.25	0.3	0.35	0%
Gravel	27,346	0.63	0.57	0.59	0.63	0.66	0.68	0.7	80%
<b>Combined</b>	<b>247,863</b>	<b>5.69</b>	<b>0.08</b>	<b>0.14</b>	<b>0.20</b>	<b>0.30</b>	<b>0.34</b>	<b>0.39</b>	<b>8.8%</b>

247863

### Basin Travel Time

	Shallow Channel	Ground Cover	Short Pasture/Lawns				
$L_{max,Overland}$	300	ft	$C_v$	7			
$L$ (ft)	$\Delta Z_0$ (ft)	$S_0$ (ft/ft)	$v$ (ft/s)	$t$ (min)	$t_{Alt}$ (min)		
Total	2,274	20	-	-	-		
Initial Time	124	2	0.016	-	16.5	N/A DCM Eq. 6-8	
Shallow Channel			0.000	0.0	0.0	- DCM Eq. 6-9	
Channelized	2,150	18	0.008	3.1	11.5	- V-Ditch	
				$t_c$	<b>28.1 min.</b>		

### Rainfall Intensity & Runoff

	2-Yr	5-Yr	10-Yr	25-Yr	50-Yr	100-Yr
Intensity (in/hr)	2.07	2.58	3.01	3.44	3.87	4.33
Runoff (cfs)	0.9	<b>2.0</b>	3.5	5.8	7.5	<b>9.6</b>
Release Rates (cfs/ac)	-	-	-	-	-	-
Allowed Release (cfs)	0.9	<b>2.0</b>	3.5	5.8	7.5	<b>9.6</b>

DCM:  $I = C1 * \ln(tc) + C2$

C1	1.19	1.5	1.75	2	2.25	2.52
C2	6.035	7.583	8.847	10.111	11.375	12.735

### Notes

## Sub-Basin S1-1 Runoff Calculations

Job No.: 61209  
 Project: Mountain Ranches  
 Jurisdiction: DCM  
 Runoff Coefficient: Surface Type

Date: 7/23/2024 10:00  
 Calcs by: TJW  
 Checked by: \_\_\_\_\_  
 Soil Type: B  
 Urbanization: Non-Urban

### Basin Land Use Characteristics

Surface	Area		Runoff Coefficient						% Imperv.
	(SF)	(Acres)	C2	C5	C10	C25	C50	C100	
Pasture/Meadow	194,587	4.47	0.02	0.08	0.15	0.25	0.3	0.35	0%
Gravel	13,530	0.31	0.57	0.59	0.63	0.66	0.68	0.7	80%
<b>Combined</b>	<b>208,117</b>	<b>4.78</b>	<b>0.06</b>	<b>0.11</b>	<b>0.18</b>	<b>0.28</b>	<b>0.32</b>	<b>0.37</b>	<b>5.2%</b>

208117

### Basin Travel Time

	Shallow Channel	Ground Cover	Short Pasture/Lawns			
$L_{max,Overland}$	300	ft			$C_v$	7
$L$ (ft)		$\Delta Z_0$ (ft)	$S_0$ (ft/ft)	$v$ (ft/s)	$t$ (min)	$t_{Alt}$ (min)
Total	1,076	12	-	-	-	-
Initial Time	40	0	0.010	-	11.3	N/A DCM Eq. 6-8
Shallow Channel			0.000	0.0	0.0	- DCM Eq. 6-9
Channelized	1,036	12	0.012	3.5	4.9	- V-Ditch
				$t_c$	<b>16.2 min.</b>	

### Rainfall Intensity & Runoff

	2-Yr	5-Yr	10-Yr	25-Yr	50-Yr	100-Yr
<b>Intensity (in/hr)</b>	2.72	3.41	3.97	4.54	5.11	5.72
<b>Runoff (cfs)</b>	0.7	1.8	3.4	6.0	7.9	10.2
<b>Release Rates (cfs/ac)</b>	-	-	-	-	-	-
<b>Allowed Release (cfs)</b>	0.7	1.8	3.4	6.0	7.9	10.2

DCM:  $I = C1 * \ln(tc) + C2$

C1	1.19	1.5	1.75	2	2.25	2.52
C2	6.035	7.583	8.847	10.111	11.375	12.735

### Notes



## Sub-Basin S1-2 Runoff Calculations

Job No.: 61209  
 Project: Mountain Ranches  
 Jurisdiction: DCM  
 Runoff Coefficient: Surface Type

Date: 7/23/2024 10:00  
 Calcs by: TJW  
 Checked by: \_\_\_\_\_  
 Soil Type: B  
 Urbanization: Non-Urban

### Basin Land Use Characteristics

Surface	Area		Runoff Coefficient						% Imperv.
	(SF)	(Acres)	C2	C5	C10	C25	C50	C100	
Pasture/Meadow	187,799	4.31	0.02	0.08	0.15	0.25	0.3	0.35	0%
Gravel	11,308	0.26	0.57	0.59	0.63	0.66	0.68	0.7	80%
<b>Combined</b>	<b>199,107</b>	<b>4.57</b>	<b>0.05</b>	<b>0.11</b>	<b>0.18</b>	<b>0.27</b>	<b>0.32</b>	<b>0.37</b>	<b>4.5%</b>

199107

### Basin Travel Time

	Shallow Channel	Ground Cover	Short Pasture/Lawns				
$L_{max,Overland}$	300	ft	$C_v$	7			
$L$ (ft)		$\Delta Z_0$ (ft)	$S_0$ (ft/ft)	$v$ (ft/s)	$t$ (min)	$t_{Alt}$ (min)	
Total	777	6	-	-	-	-	
Initial Time	137	2	0.015	-	18.5	N/A DCM Eq. 6-8	
Shallow Channel			0.000	0.0	0.0	- DCM Eq. 6-9	
Channelized	640	4	0.006	2.8	3.8	- V-Ditch	
				$t_c$	<b>22.3 min.</b>		

### Rainfall Intensity & Runoff

	2-Yr	5-Yr	10-Yr	25-Yr	50-Yr	100-Yr
Intensity (in/hr)	2.34	2.93	3.41	3.90	4.39	4.91
Runoff (cfs)	0.5	1.5	2.8	4.9	6.5	8.3
Release Rates (cfs/ac)	-	-	-	-	-	-
Allowed Release (cfs)	0.5	1.5	2.8	4.9	6.5	8.3

DCM:  $I = C1 * \ln(tc) + C2$

C1      1.19      1.5      1.75      2      2.25      2.52

C2      6.035      7.583      8.847      10.111      11.375      12.735

### Notes

## Sub-Basin S1-3 Runoff Calculations

Job No.: 61209  
 Project: Mountain Ranches  
 Jurisdiction: DCM  
 Runoff Coefficient: Surface Type

Date: 7/23/2024 10:00  
 Calcs by: TJW  
 Checked by: \_\_\_\_\_  
 Soil Type: B  
 Urbanization: Non-Urban

### Basin Land Use Characteristics

Surface	Area		Runoff Coefficient						% Imperv.
	(SF)	(Acres)	C2	C5	C10	C25	C50	C100	
Pasture/Meadow	1,287,685	29.56	0.02	0.08	0.15	0.25	0.3	0.35	0%
Gravel	38,500	0.88	0.57	0.59	0.63	0.66	0.68	0.7	80%
<b>Combined</b>	<b>1,326,185</b>	<b>30.45</b>	<b>0.04</b>	<b>0.09</b>	<b>0.16</b>	<b>0.26</b>	<b>0.31</b>	<b>0.36</b>	<b>2.3%</b>

1326185

### Basin Travel Time

	Shallow Channel	Ground Cover	Short Pasture/Lawns				
$L_{max,Overland}$	300	ft	$C_v$	7			
$L$ (ft)	$\Delta Z_0$ (ft)	$S_0$ (ft/ft)	$v$ (ft/s)	$t$ (min)	$t_{Alt}$ (min)		
Total	1,775	27	-	-	-		
Initial Time	80	1	0.010	-	16.2	N/A DCM Eq. 6-8	
Shallow Channel			0.000	0.0	0.0	- DCM Eq. 6-9	
Channelized	1,695	26	0.015	3.9	7.2	- V-Ditch	
				$t_c$	<b>23.5 min.</b>		

### Rainfall Intensity & Runoff

	2-Yr	5-Yr	10-Yr	25-Yr	50-Yr	100-Yr
Intensity (in/hr)	2.28	2.85	3.32	3.80	4.27	4.78
Runoff (cfs)	2.5	<b>8.2</b>	16.6	30.3	40.5	<b>52.4</b>
Release Rates (cfs/ac)	-	-	-	-	-	-
Allowed Release (cfs)	2.5	<b>8.2</b>	16.6	30.3	40.5	<b>52.4</b>

DCM:  $I = C1 * \ln(tc) + C2$

C1      1.19      1.5      1.75      2      2.25      2.52  
 C2      6.035      7.583      8.847      10.111      11.375      12.735

### Notes

## Sub-Basin S2-1 Runoff Calculations

Job No.: 61209  
 Project: Mountain Ranches  
 Jurisdiction: DCM  
 Runoff Coefficient: Surface Type

Date: 7/23/2024 10:00  
 Calcs by: TJW  
 Checked by: \_\_\_\_\_  
 Soil Type: B  
 Urbanization: Non-Urban

### Basin Land Use Characteristics

Surface	Area		Runoff Coefficient						% Imperv.
	(SF)	(Acres)	C2	C5	C10	C25	C50	C100	
Pasture/Meadow	89,154	2.05	0.02	0.08	0.15	0.25	0.3	0.35	0%
Gravel	17,666	0.41	0.57	0.59	0.63	0.66	0.68	0.7	80%
<b>Combined</b>	<b>106,820</b>	<b>2.45</b>	<b>0.11</b>	<b>0.16</b>	<b>0.23</b>	<b>0.32</b>	<b>0.36</b>	<b>0.41</b>	<b>13.2%</b>

116820

### Basin Travel Time

	Shallow Channel	Ground Cover	Short Pasture/Lawns				
$L_{max,Overland}$	300	ft	$C_v$	7			
$L$ (ft)	$\Delta Z_0$ (ft)	$S_0$ (ft/ft)	$v$ (ft/s)	$t$ (min)	$t_{Alt}$ (min)		
Total	1,023	7	-	-	-		
Initial Time	16	3	0.188	-	2.6	N/A	DCM Eq. 6-8
Shallow Channel			0.000	0.0	0.0	-	DCM Eq. 6-9
Channelized	1,007	4	0.004	2.3	7.1	-	V-Ditch
				$t_c$	<b>9.7 min.</b>		

### Rainfall Intensity & Runoff

	2-Yr	5-Yr	10-Yr	25-Yr	50-Yr	100-Yr
Intensity (in/hr)	3.33	4.17	4.87	5.56	6.26	7.01
Runoff (cfs)	0.9	1.7	2.7	4.3	5.6	7.0
Release Rates (cfs/ac)	-	-	-	-	-	-
Allowed Release (cfs)	0.9	1.7	2.7	4.3	5.6	7.0

DCM:  $I = C1 * \ln(tc) + C2$

C1      1.19      1.5      1.75      2      2.25      2.52  
 C2      6.035      7.583      8.847      10.111      11.375      12.735

### Notes

## Sub-Basin S2-2 Runoff Calculations

Job No.: 61209  
 Project: Mountain Ranches  
 Jurisdiction: DCM  
 Runoff Coefficient: Surface Type

Date: 7/23/2024 10:00  
 Calcs by: TJW  
 Checked by: \_\_\_\_\_  
 Soil Type: B  
 Urbanization: Non-Urban

### Basin Land Use Characteristics

Surface	Area		Runoff Coefficient						% Imperv.
	(SF)	(Acres)	C2	C5	C10	C25	C50	C100	
Pasture/Meadow	614,065	14.10	0.02	0.08	0.15	0.25	0.3	0.35	0%
Gravel	2,904	0.07	0.57	0.59	0.63	0.66	0.68	0.7	80%
<b>Combined</b>	<b>616,969</b>	<b>14.16</b>	<b>0.02</b>	<b>0.08</b>	<b>0.15</b>	<b>0.25</b>	<b>0.30</b>	<b>0.35</b>	<b>0.4%</b>

643105

### Basin Travel Time

	Shallow Channel	Ground Cover	Short Pasture/Lawns				
$L_{max,Overland}$	300	ft	$C_v$	7			
$L$ (ft)	$\Delta Z_0$ (ft)	$S_0$ (ft/ft)	$v$ (ft/s)	$t$ (min)	$t_{Alt}$ (min)		
Total	1,460	10	-	-	-		
Initial Time	190	2	0.011	-	24.9	N/A DCM Eq. 6-8	
Shallow Channel			0.000	0.0	0.0	- DCM Eq. 6-9	
Channelized	1,270	8	0.006	2.8	7.6	- V-Ditch	
				$t_c$	<b>32.5 min.</b>		

### Rainfall Intensity & Runoff

	2-Yr	5-Yr	10-Yr	25-Yr	50-Yr	100-Yr
Intensity (in/hr)	1.89	2.36	2.76	3.15	3.54	3.96
Runoff (cfs)	0.6	2.8	5.9	11.2	15.1	19.7
Release Rates (cfs/ac)	-	-	-	-	-	-
Allowed Release (cfs)	0.6	2.8	5.9	11.2	15.1	19.7

DCM:  $I = C1 * \ln(tc) + C2$

C1	1.19	1.5	1.75	2	2.25	2.52
C2	6.035	7.583	8.847	10.111	11.375	12.735

### Notes

## Sub-Basin S2A-1 Runoff Calculations

Job No.: 61209  
 Project: Mountain Ranches  
 Jurisdiction: DCM  
 Runoff Coefficient: Surface Type

Date: 7/23/2024 10:00  
 Calcs by: TJW  
 Checked by: \_\_\_\_\_  
 Soil Type: B  
 Urbanization: Non-Urban

### Basin Land Use Characteristics

Surface	Area		Runoff Coefficient						% Imperv.
	(SF)	(Acres)	C2	C5	C10	C25	C50	C100	
Pasture/Meadow	613,981	14.10	0.02	0.08	0.15	0.25	0.3	0.35	0%
Gravel	23,430	0.54	0.57	0.59	0.63	0.66	0.68	0.7	80%
<b>Combined</b>	<b>637,411</b>	<b>14.63</b>	<b>0.04</b>	<b>0.10</b>	<b>0.17</b>	<b>0.27</b>	<b>0.31</b>	<b>0.36</b>	<b>2.9%</b>

637411

### Basin Travel Time

	Shallow Channel	Ground Cover	Short Pasture/Lawns				
$L_{max,Overland}$	300	ft	$C_v$	7			
$L$ (ft)	$\Delta Z_0$ (ft)	$S_0$ (ft/ft)	$v$ (ft/s)	$t$ (min)	$t_{Alt}$ (min)		
Total	1,102	9	-	-	-		
Initial Time	300	2	0.005	-	39.4	N/A DCM Eq. 6-8	
Shallow Channel	82	1	0.012	0.8	1.8	- DCM Eq. 6-9	
Channelized	720	6	0.008	3.1	3.9	- V-Ditch	
				$t_c$	<b>45.0 min.</b>		

### Rainfall Intensity & Runoff

	2-Yr	5-Yr	10-Yr	25-Yr	50-Yr	100-Yr
Intensity (in/hr)	1.51	1.87	2.19	2.50	2.81	3.14
Runoff (cfs)	0.9	2.7	5.4	9.7	12.9	16.7
Release Rates (cfs/ac)	-	-	-	-	-	-
Allowed Release (cfs)	0.9	2.7	5.4	9.7	12.9	16.7

DCM:  $I = C1 * \ln(tc) + C2$

C1      1.19      1.5      1.75      2      2.25      2.52  
 C2      6.035      7.583      8.847      10.111      11.375      12.735

### Notes

## Sub-Basin S2A-2 Runoff Calculations

Job No.: 61209  
 Project: Mountain Ranches  
 Jurisdiction: DCM  
 Runoff Coefficient: Surface Type

Date: 7/23/2024 10:00  
 Calcs by: TJW  
 Checked by: \_\_\_\_\_  
 Soil Type: B  
 Urbanization: Non-Urban

### Basin Land Use Characteristics

Surface	Area		Runoff Coefficient						% Imperv.
	(SF)	(Acres)	C2	C5	C10	C25	C50	C100	
Pasture/Meadow	1,249,485	28.68	0.02	0.08	0.15	0.25	0.3	0.35	0%
Gravel	23,210	0.53	0.57	0.59	0.63	0.66	0.68	0.7	80%
<b>Combined</b>	<b>1,272,695</b>	<b>29.22</b>	<b>0.03</b>	<b>0.09</b>	<b>0.16</b>	<b>0.26</b>	<b>0.31</b>	<b>0.36</b>	<b>1.5%</b>

1272695

### Basin Travel Time

	Shallow Channel	Ground Cover	Short Pasture/Lawns				
$L_{max,Overland}$	300	ft	$C_v$	7			
$L$ (ft)	1,420	$\Delta Z_0$ (ft)	$S_0$ (ft/ft)	$v$ (ft/s)	$t$ (min)	$t_{Alt}$ (min)	
Total	1,420	11	-	-	-	-	
Initial Time	300	4	0.013	-	28.7	N/A DCM Eq. 6-8	
Shallow Channel	1,120	7	0.006	0.6	33.7	- DCM Eq. 6-9	
Channelized			0.000	0.0	0.0	- V-Ditch	
				$t_c$	<b>62.5 min.</b>		

### Rainfall Intensity & Runoff

	2-Yr	5-Yr	10-Yr	25-Yr	50-Yr	100-Yr
<b>Intensity (in/hr)</b>	1.11	1.38	1.61	1.84	2.07	2.32
<b>Runoff (cfs)</b>	1.0	<b>3.6</b>	7.5	13.9	18.6	<b>24.1</b>
<b>Release Rates (cfs/ac)</b>	-	-	-	-	-	-
<b>Allowed Release (cfs)</b>	1.0	<b>3.6</b>	7.5	13.9	18.6	<b>24.1</b>

DCM:  $I = C1 * \ln(tc) + C2$

C1	1.19	1.5	1.75	2	2.25	2.52
C2	6.035	7.583	8.847	10.111	11.375	12.735

### Notes

### **3 Hydraulic Calculations**

Typical Roadside Ditch Velocity Calculation

Culvert Calculations

Ditch Out Swale Calculations

Reseeding Mix, Grass Characteristics and Allowable Velocities

# Channel Report

## Maximum Velocity for Roadway Ditch

### Triangular

Side Slopes (z:1) = 4.00, 3.00  
Total Depth (ft) = 2.00

Invert Elev (ft) = 100.00  
Slope (%) = 3.23  
N-Value = 0.040

### Calculations

Compute by: Known Q  
Known Q (cfs) = 26.20 (1/2 100 YEAR)

### Highlighted

Depth (ft) = 1.26  
Q (cfs) = 26.20  
Area (sqft) = 5.56  
Velocity (ft/s) = 4.72  
Wetted Perim (ft) = 9.18  
Crit Depth, Yc (ft) = 1.29  
Top Width (ft) = 8.82  
EGL (ft) = 1.61

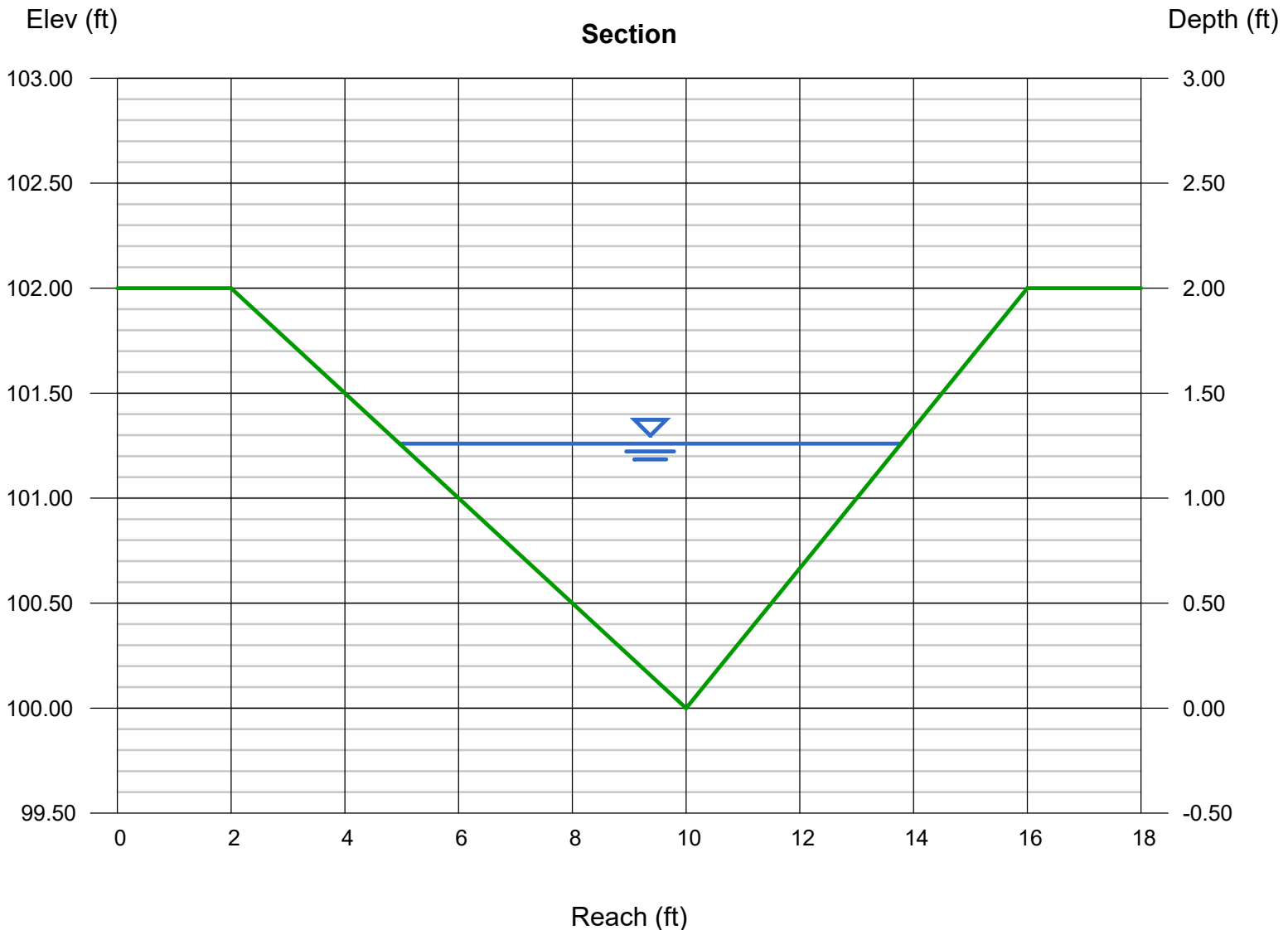



# Culvert Report

## 61209 - Meadow Ranch Typical Culvert (18in CMP) - 5yr Flows

Invert Elev Dn (ft)	= 5619.26
Pipe Length (ft)	= 40.00
Slope (%)	= 2.00
Invert Elev Up (ft)	= 5620.06
Rise (in)	= 18.0
Shape	= Circular
Span (in)	= 18.0
No. Barrels	= 1
n-Value	= 0.023
Culvert Type	= Circular Corrugate Metal Pipe
Culvert Entrance	= Mitered to slope (C)
Coeff. K,M,c,Y,k	= 0.021, 1.33, 0.0463, 0.75, 0.7

<b>Embankment</b>	
Top Elevation (ft)	= 5622.50
Top Width (ft)	= 22.00
Crest Width (ft)	= 400.00

<b>Calculations</b>	
Qmin (cfs)	= 9.20
Qmax (cfs)	= 9.20
Tailwater Elev (ft)	= (dc+D)/2

<b>Highlighted</b>	
Qtotal (cfs)	= 9.20
Qpipe (cfs)	= 9.20
Qovertop (cfs)	= 0.00
Veloc Dn (ft/s)	= 5.53
Veloc Up (ft/s)	= 6.21
HGL Dn (ft)	= 5620.60
HGL Up (ft)	= 5621.23
Hw Elev (ft)	= 5622.46
Hw/D (ft)	= 1.60
Flow Regime	= Inlet Control

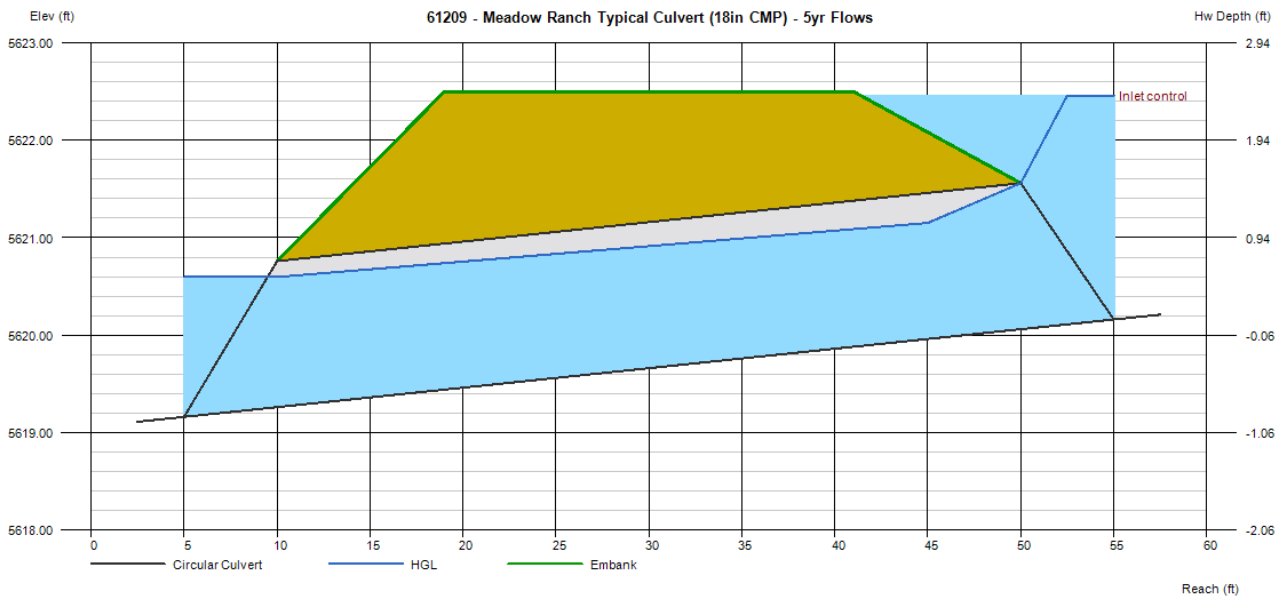

## Determination of Culvert Headwater and Outlet Protection

Project: **Meadow Ranches**  
 Basin ID: **Typical 18" CMP (Max 5yr Flows)**

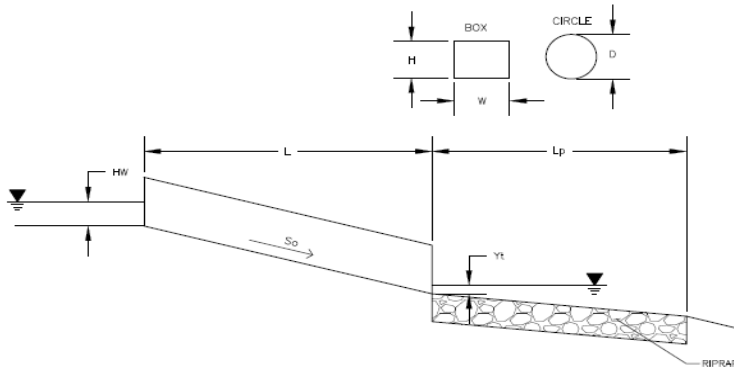

**Soil Type:**

Choose One:

- Sandy  
 Non-Sandy

**Design Information (Input):**

Design Discharge	Q = <input type="text" value="9.2"/> cfs
<b>Circular Culvert:</b>	
Barrel Diameter in Inches	D = <input type="text" value="18"/> inches
Inlet Edge Type (Choose from pull-down list)	<input type="text" value="1.5 : 1 Beveled Edge"/>
<b>Box Culvert:</b>	<b>OR</b>
Barrel Height (Rise) in Feet	Height (Rise) = <input type="text"/>
Barrel Width (Span) in Feet	Width (Span) = <input type="text"/>
Inlet Edge Type (Choose from pull-down list)	<input type="text"/>
Number of Barrels	No = <input type="text" value="1"/>
Inlet Elevation	Elev IN = <input type="text" value="100"/> ft
Outlet Elevation <b>OR</b> Slope	Elev OUT = <input type="text" value="99.2"/> ft
Culvert Length	L = <input type="text" value="40"/> ft
Manning's Roughness	n = <input type="text" value="0.022"/>
Bend Loss Coefficient	$k_b$ = <input type="text" value="0"/>
Exit Loss Coefficient	$k_x$ = <input type="text" value="1"/>
Tailwater Surface Elevation	Elev $Y_t$ = <input type="text"/>
Max Allowable Channel Velocity	V = <input type="text" value="5"/> ft/s

**Required Protection (Output):**

Tailwater Surface Height	$Y_t$ = <input type="text" value="0.60"/> ft
Flow Area at Max Channel Velocity	$A_t$ = <input type="text" value="1.84"/> ft <sup>2</sup>
Culvert Cross Sectional Area Available	A = <input type="text" value="1.77"/> ft <sup>2</sup>
Entrance Loss Coefficient	$k_e$ = <input type="text" value="0.20"/>
Friction Loss Coefficient	$k_f$ = <input type="text" value="2.08"/>
Sum of All Losses Coefficients	$k_s$ = <input type="text" value="3.28"/> ft
Culvert Normal Depth	$Y_n$ = <input type="text" value="1.30"/> ft
Culvert Critical Depth	$Y_c$ = <input type="text" value="1.17"/> ft
Tailwater Depth for Design	d = <input type="text" value="1.34"/> ft
Adjusted Diameter <b>OR</b> Adjusted Rise	$D_a$ = <input type="text" value="-"/> ft
Expansion Factor	$1/(2*\tan(\theta))$ = <input type="text" value="4.11"/>
Flow/Diameter <sup>2.5</sup> <b>OR</b> Flow/(Span * Rise <sup>1.5</sup> )	$Q/D^{2.5}$ = <input type="text" value="3.34"/> ft <sup>0.5</sup> /s
Froude Number	Fr = <input type="text" value="0.79"/>
Tailwater/Adjusted Diameter <b>OR</b> Tailwater/Adjusted Rise	$Y_t/D$ = <input type="text" value="0.40"/>
Inlet Control Headwater	$HW_i$ = <input type="text" value="1.85"/> ft
Outlet Control Headwater	$HW_o$ = <input type="text" value="1.92"/> ft
<b>Design Headwater Elevation</b>	<b>HW</b> = <input type="text" value="101.92"/> ft
<b>Headwater/Diameter <b>OR</b> Headwater/Rise Ratio</b>	<b>HW/D</b> = <input type="text" value="1.28"/>
Minimum Theoretical Riprap Size	$d_{50}$ = <input type="text" value="4"/> in
Nominal Riprap Size	$d_{50}$ = <input type="text" value="6"/> in
<b>UDFCD Riprap Type</b>	<b>Type</b> = <input type="text" value="VL"/>
<b>Length of Protection</b>	$L_p$ = <input type="text" value="7"/> ft
<b>Width of Protection</b>	T = <input type="text" value="4"/> ft

# Channel Report

## Maximum Velocity for Ditch Out swale (100yr)

### Trapezoidal

Bottom Width (ft) = 6.00  
Side Slopes (z:1) = 4.00, 4.00  
Total Depth (ft) = 2.00  
Invert Elev (ft) = 100.00  
Slope (%) = 0.50  
N-Value = 0.034

### Highlighted

Depth (ft) = 1.47  
Q (cfs) = 52.40  
Area (sqft) = 17.46  
Velocity (ft/s) = 3.00  
Wetted Perim (ft) = 18.12  
Crit Depth, Yc (ft) = 1.06  
Top Width (ft) = 17.76  
EGL (ft) = 1.61

### Calculations

Compute by: Known Q  
Known Q (cfs) = 52.40

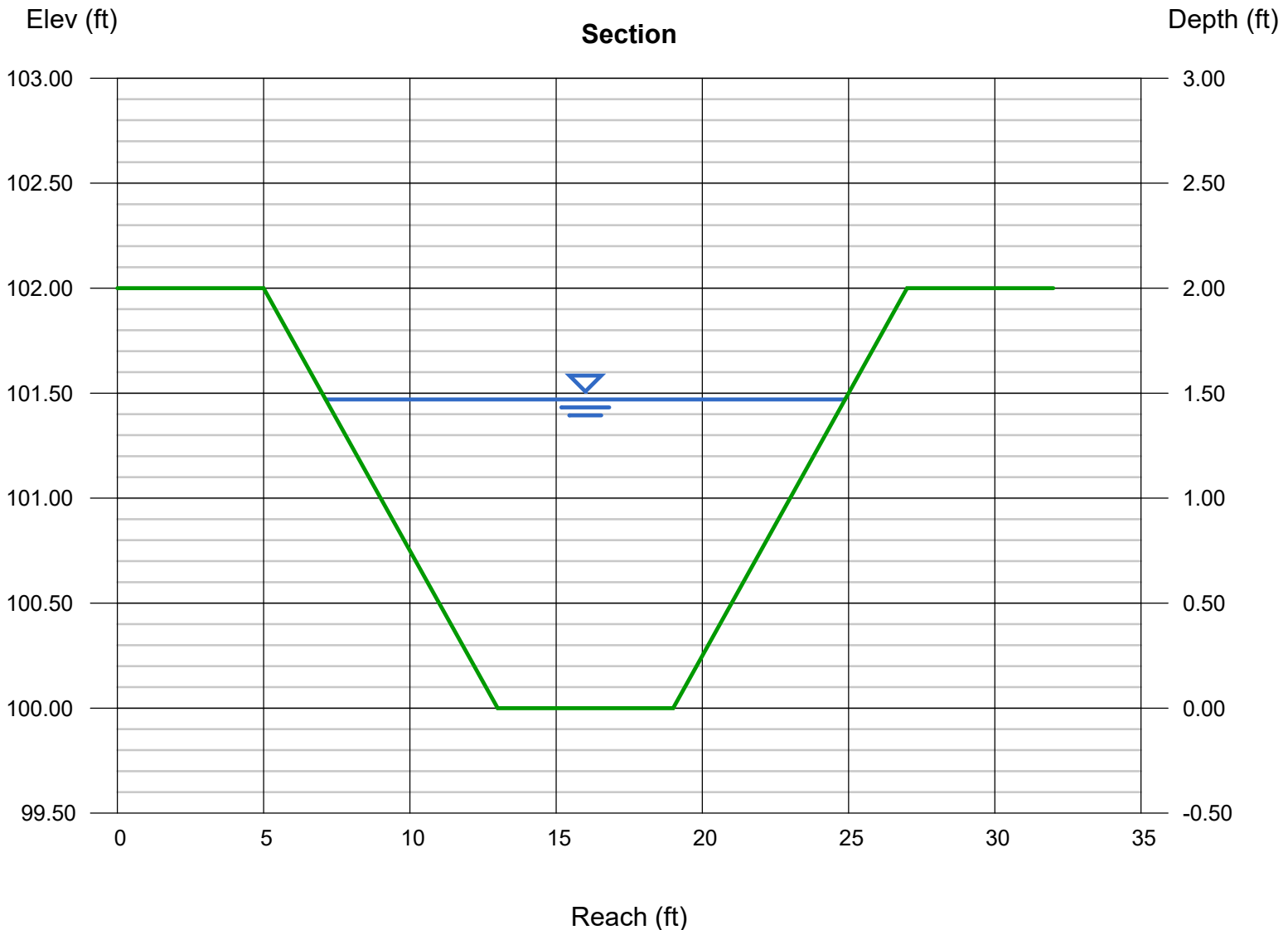



## EL PASO COUNTY CONSERVATION DISTRICT

5610 Industrial Pl #100  
Colorado Springs, CO 80916

719-600-4706

[districtmanager@epccd.org](mailto:districtmanager@epccd.org)

<https://epccd.org>

### BOARD OF SUPERVISORS

Ken Barker, President  
Katie Miller  
Roger Rasner  
Erica Carter  
Billy Richard  
Cassie Olgren

### DISTRICT MANAGER

Mariah Hudson

The El Paso County Conservation District serves landowners, land users, and partners to champion the responsible management and conservation of our finite natural resources.

To Whom It May Concern,

The El Paso County Conservation District (EPCCD) Board of Supervisors recommendations are as follows:

**Ground Disturbance:** If the ground is disturbed, it should be mulched or revegetated within **45 days of disturbance**. It is generally important that some type of native grass should be planted for the protection of natural resources, erosion control, native vegetation preservation, sedimentation prevention, habitat protection, stormwater management, and soil health. Please make sure the “native” grasses and plants already in place are in fact native to the area. The EPCCD store inventory generally includes both our Shotgun Native Grass Seed Mix as well as the El Paso Low Grow Grass Seed Mix; these are our recommendations should grass seed need to be implemented.

- Our **Shotgun Native Grass Seed Mix** is formulated specifically for the Pikes Peak Front Range by our NRCS District Conservationist and Rangeland Management partners. It is drought-tolerant and includes: about 20% each of Big Bluestem Native and Wheatgrass, Western Native, and about 10% each of Grama, Sideoats Native, Green Needlegrass Native, Little Bluestem Native, Prairie Sandreed Native, Switchgrass Native, and Yellow Indiangrass Native.
- The **El Paso Low Grow Grass Seed Mix** is a great drought-tolerant and low-grow grass seed mix designed for the Pikes Peak Front Range; it includes: about 24% Western Wheatgrass, about 20% Blue Grama, Native, about 18% Buffalograss, about 13% Sideoats Grama, about 6% Green Needlegrass, and about 1.5% Sand Dropseed.

More information about these grass seed mixes, as well as clover, cover crop, and wildflower seeds, and many waterwise/Coloradoscape plants, is available on our website at <https://epccd.org/>

**Integrated Noxious Weed Management:** Early intervention and integrated control measures are generally important, especially in areas where the ground is disturbed or undergoing development for: preservation of native vegetation, protection of land and soil, fire risk reduction, maintenance of water quality, cost savings, and long-term health and sustainability. An integrated noxious weed control plan typically includes a combination of prevention, mechanical, biological, and/or chemical control, and ongoing assessment and monitoring. It is a proactive approach to address the threat posed by invasive weeds and protect the ecological and economic health of the region. If there is no integrated noxious weed control plan in place, we recommend a weed program be reviewed and approved by the NRCS, Colorado Department of Agriculture, Colorado State University Extension - El Paso County, El Paso County Environmental Services Department, or a qualified weed management professional *prior* to the land use authority approval.

If you have any questions regarding these remarks please call us at 719-600-4706 or email [districtmanager@epccd.org](mailto:districtmanager@epccd.org)

Thank you,

*Kenneth Barker*

Kenneth Barker, Board President  
El Paso County Conservation District

**Table 2. Permissible Shear and Velocity for Selected Lining Materials<sup>1</sup>**

Boundary Category	Boundary Type	Permissible Shear Stress (lb/sq ft)	Permissible Velocity (ft/sec)	Citation(s)
<u>Soils</u>	Fine colloidal sand	0.02 - 0.03	1.5	A
	Sandy loam (noncolloidal)	0.03 - 0.04	1.75	A
	Alluvial silt (noncolloidal)	0.045 - 0.05	2	A
	Silty loam (noncolloidal)	0.045 - 0.05	1.75 – 2.25	A
	Firm loam	0.075	2.5	A
	Fine gravels	0.075	2.5	A
	Stiff clay	0.26	3 – 4.5	A, F
	Alluvial silt (colloidal)	0.26	3.75	A
	Graded loam to cobbles	0.38	3.75	A
	Graded silts to cobbles	0.43	4	A
	Shales and hardpan	0.67	6	A
<u>Gravel/Cobble</u>	1-in.	0.33	2.5 – 5	A
	2-in.	0.67	3 – 6	A
	6-in.	2.0	4 – 7.5	A
	12-in.	4.0	5.5 – 12	A
<u>Vegetation</u>	Class A turf	3.7	6 – 8	E, N
	Class B turf	2.1	4 - 7	E, N
	Class C turf	1.0	3.5	E, N
	Long native grasses	1.2 – 1.7	4 – 6	G, H, L, N
	Short native and bunch grass	0.7 - 0.95	3 – 4	G, H, L, N
<u>Temporary Degradable RECPS</u>	Reed plantings	0.1-0.6	N/A	E, N
	Hardwood tree plantings	0.41-2.5	N/A	E, N
	Jute net	0.45	1 – 2.5	E, H, M
	Straw with net	1.5 – 1.65	1 – 3	E, H, M
	Coconut fiber with net	2.25	3 – 4	E, M
<u>Non-Degradable RECPS</u>	Fiberglass roving	2.00	2.5 – 7	E, H, M
	Unvegetated	3.00	5 – 7	E, G, M
	Partially established	4.0-6.0	7.5 – 15	E, G, M
	Fully vegetated	8.00	8 – 21	F, L, M
<u>Riprap</u>	6 – in. d <sub>50</sub>	2.5	5 – 10	H
	9 – in. d <sub>50</sub>	3.8	7 – 11	H
	12 – in. d <sub>50</sub>	5.1	10 – 13	H
	18 – in. d <sub>50</sub>	7.6	12 – 16	H
	24 – in. d <sub>50</sub>	10.1	14 – 18	E
	<u>Soil Bioengineering</u>	Wattles	0.2 – 1.0	3
Reed fascine		0.6-1.25	5	E
Coir roll		3 - 5	8	E, M, N
Vegetated coir mat		4 - 8	9.5	E, M, N
Live brush mattress (initial)		0.4 – 4.1	4	B, E, I
Live brush mattress (grown)		3.90-8.2	12	B, C, E, I, N
Brush layering (initial/grown)		0.4 – 6.25	12	E, I, N
Live fascine		1.25-3.10	6 – 8	C, E, I, J
Live willow stakes		2.10-3.10	3 – 10	E, N, O
<u>Hard Surfacing</u>		Gabions	10	14 – 19
	Concrete	12.5	>18	H

<sup>1</sup> Ranges of values generally reflect multiple sources of data or different testing conditions.

A. Chang, H.H. (1988).	F. Julien, P.Y. (1995).	K. Sprague, C.J. (1999).
B. Florineth. (1982)	G. Kouwen, N.; Li, R. M.; and Simons, D.B., (1980).	L. Temple, D.M. (1980).
C. Gerstgraser, C. (1998).	H. Norman, J. N. (1975).	M. TXDOT (1999)
D. Goff, K. (1999).	I. Schiechl, H. M. and R. Stern. (1996).	N. Data from Author (2001)
E. Gray, D.H., and Sotir, R.B. (1996).	J. Schoklitsch, A. (1937).	O. USACE (1997).

Fischenich, C. (2001). "Stability Thresholds for Stream Restoration Materials," EMRRP Technical Notes Collection (ERDC TN-EMRRP-SR-29), U.S. Army Engineer Research and Development Center, Vicksburg, MS.  
[www.wes.army.mil/el/emrrp](http://www.wes.army.mil/el/emrrp)

## REFERENCES

Chang, H.H. (1988). *Fluvial Processes in River Engineering*, John Wiley and Sons, New York and other cities, citing Fortier, S., and Scobey, F.C. (1926). "Permissible canal velocities," *Transactions of the ASCE*, 89:940-984.

Fischenich and Allen (2000). "Stream management," Water Operations Technical Support Program Special Report ERDC/EL SR-W-00-1, Vicksburg, MS.

Florineth, F., (1982). Begrünungen von Erosionszonen im Bereich über der Waldgrenze. *Zeitschrift für Vegetationstechnik* 5, S. 20-24 (In German).

Gerstgraser, C. (1998). "Bioengineering methods of bank stabilization," *GARTEN & LANDSCHAFT*, Vol. 9, September 1998, 35-37.

Goff, K. (1999). "Designer linings," *Erosion Control*, Vol. 6, No. 5.

Gray, D.H., and Sotir, R.B. (1996). *Biotechnical and soil bioengineering: a practical guide for erosion control*. John Wiley and Sons, New York.

Julien, P.Y. (1995). *Erosion and sedimentation*. Cambridge University Press, New York.

Kouwen, N.; Li, R.-M.; and Simons, D.B. (1980). "A stability criteria for vegetated Waterways." *Proceedings, International Symposium on Urban Storm Runoff*. University of Kentucky, Lexington, KY, 28-31 July 1980, 203-210.

Norman, J. N. (1975). "Design of stable channels with flexible linings," Hydraulic Engineering Circular 15, U.S. Dept. of Transportation, Federal Highway Adm., Washington, DC.

Schiechl, H. M., and Stern, R. (1996). *Water Bioengineering Techniques for Watercourse Bank and Shoreline Protection*. Blackwell Science, Inc. 224 pp.

Schoklitsch, A. (1937). *Hydraulic structures; a text and handbook*. Translated by Samuel Shulits. The American Society of Mechanical Engineers, New York.

Shields, A. (1936). "Anwendung der ähnlichkeits-mechanik und der turbulenz-forschung auf die geschiebebewegung," *Mitt. Preuss. Versuchsanst. Wasser. Schiffsbau*, 26, 1-26 (in German).

Sprague, C.J. (1999). "Green engineering: Design principles and applications using rolled erosion control products," *CE News Online*, downloaded from <http://www.cenews.com/edecp0399.html>.

Temple, D.M. (1980). "Tractive force design of vegetated channels," *Transactions of the ASAE*, 23:884-890.

TXDOT (1999). "Field Performance Testing of Selected Erosion Control Products," TXDOT / TTI Hydraulics and Erosion Control Laboratory, Bryan, TX.

USACE TR EL 97-8

## WESTERN WHEATGRASS

*Pascopyrum smithii* (Rydb.) A.  
Love  
Plant Symbol = PASM

Contributed by: USDA NRCS Plant Materials  
Program



Robert H. Mohlenbrock  
USDA NRCS 1989.  
Midwestern Wetland Flora  
@ USDA NRCS PLANTS

**Alternate Names**  
*Agropyron smithii* Rydb.

### Uses

**Erosion control:** Western wheatgrass is an excellent erosion control plant because of its spreading rhizomes. It is widely used in seed mixtures for range seeding, revegetation of saline and alkaline areas, and in critical areas for erosion control in the central and northern Great Plains region. This grass protected watershed dams in Kansas from damage when they were overtopped during a 14-inch rainfall event.

**Reclamation:** Western wheatgrass is frequently used in the northern Great Plains for surface mine revegetation. Because of its strong rhizomes and

adaptation to a variety of soils, it performs well as part of a reclamation mixture.

**Livestock:** Forage quality is high for pasture or range seedings.

### Status

Please consult the PLANTS Web site and your State Department of Natural Resources for this plant's current status (e.g. threatened or endangered species, state noxious status, and wetland indicator values).

### Description

*Pascopyrum smithii* (Rydb.) A. Love, western wheatgrass, is perhaps one of the best known and most commonly used native grasses. It is a long-lived, cool season species that has coarse blue-green leaves with prominent veins. Because of this bluish appearance it has sometimes been called bluestem wheatgrass or bluejoint. It is a sod former with very strong, spreading rhizomes. Stems arise singly or in clusters of a few and reach heights of 1 to 3 feet. The sheaths are hairy and the purplish auricles typically clasp the stem. The seed spike is erect and about 2 to 6 inches long.

### Adaptation and Distribution

Western wheatgrass is adapted to fine and very fine soils and is replaced by thickspike wheatgrass on coarser soils. Although it is able to grow on a wide variety of soils it prefers the heavier but well drained soils. It requires moderate to high soil moisture content and is most common in the 10 to 14 inch annual precipitation zones. Above 20 inches per year it behaves as an increaser on rangelands, below 20 inches it is a decreaser. Its elevational range is 1,000 to 9,000 feet.

Western wheatgrass tolerates saline and saline-sodic soils, poor drainage and moderately severe drought. It will tolerate spring flooding, high water tables, and considerable silt deposition. It is very cold hardy and can grow in partial shade. It is grazing resistant and can survive fires if in the dormant stage; recovery from fire, however, is slow.

Western wheatgrass grows in association with many species, the more common being blue grama, buffalograss, needlegrasses, bluebunch wheatgrass, rough fescue, Idaho fescue, and prairie junegrass. It begins growth about 2 to 3 weeks before blue grama

and does not mature until much later in the growing season.

Western wheatgrass performs poorly in the East and is not recommended for any use in the region.

Western wheatgrass is distributed throughout the west and midwest portions of the United States. For a current distribution map, please consult the Plant Profile page for this species on the PLANTS Website.

### **Establishment**

Seed of western wheatgrass should be planted 1/2 to 1 inch deep in fine to medium soil. Seeding rates should be 5 to 15 pounds PLS per acre drilled or 20 to 25 PLS per row foot. If seed is broadcast or used on harsh sites, the rate should be doubled. This species should be seeded in early spring, late fall or in the period of late summer, early fall. It can be sodded.

Seedling vigor is fair and stands may be slow to establish. It has stronger rooting abilities than does thickspike wheatgrass but spreads more slowly and may take several years to become firmly established. Once established, it is very hardy and enduring. It is moderately compatible with other species and is moderately aggressive.

### **Management**

Western wheatgrass greens up in March or early April and matures in August. If moisture is adequate, it will make fair summer or fall regrowth. If nitrogen is applied it will compete with warm season grasses.

Western wheatgrass is moderately palatable to elk and cattle all year although this quality diminishes in late summer. It is palatable to deer only in spring. It is preferred by cattle more than by sheep. It can be grazed if 50 to 60 percent of the annual growth is allowed to remain (3 or 4 inch stubble). Rest rotation of western wheatgrass is advised. In areas where it is dense, it makes an excellent hay as well as pasture.

Irrigation will improve western wheatgrass stands and aid establishment. Weed control and fertilization will also help. Pitting, chiseling, disking, and interseeding can be used to stimulate stands of western wheatgrass.

### **Pests and Potential Problems**

The primary pests to western wheatgrass are grasshoppers, ergot, and stem and leaf rusts.

### **Cultivars, Improved, and Selected Materials (and area of origin)**

'Ariba' western wheatgrass was released for dry land hay production, grazing, and conservation seedings in the western part of the Central Plains and in the southwestern United States. 'Flintlock' is a broad-based cultivar. It is recommended for conservation seeding, dry land hay production, and grazing in the Central Plains. 'Barton' is a strongly rhizomatous, leafy ecotype, intermediate in growth between northern and southern types. 'Barton' is relatively disease free and high in forage and seed production. 'Rosana' is a northern type western wheatgrass. Plants are blue-green, leafy, with moderately fine stems. Rhizomes produce a tight sod. 'Rosana' is recommended for reseeding depleted range lands and the reclamation of disturbed lands in the Northern Great Plains. 'Rodan' northern type western wheatgrass is moderately rhizomatous and forms a dense blue-green sward. Leaves are thinner and less heavily veined than other western wheatgrasses. Western wheatgrass seed is available at most farm seed stores.

### **Prepared By & Species Coordinator: USDA NRCS Plant Materials Program**

Edited: 05Feb2002 JLK; 060802 jsp

For more information about this and other plants, please contact your local NRCS field office or Conservation District, and visit the PLANTS Web site <<http://plants.usda.gov>> or the Plant Materials Program Web site <<http://Plant-Materials.nrcs.usda.gov>>

*The U.S. Department of Agriculture (USDA) prohibits discrimination in all its programs and activities on the basis of race, color, national origin, sex, religion, age, disability, political beliefs, sexual orientation, and marital or family status. (Not all prohibited bases apply to all programs.) Persons with disabilities who require alternative means for communication of program information (Braille, large print, audiotape, etc.) should contact USDA's TARGET Center at 202-720-2600 (voice and TDD).*

*To file a complaint of discrimination write USDA, Director, Office of Civil Rights, Room 326-W, Whitten Building, 14th and Independence Avenue, SW, Washington, DC 20250-9410 or call 202-720-5964 (voice or TDD). USDA is an equal opportunity provider and employer.*

*Read about [Civil Rights at the Natural Resources Conservation Service](#).*



## BLUE GRAMA

*Bouteloua gracilis* (Willd. ex  
Kunth.) Lag. ex Griffiths  
Plant Symbol = BOGR2

Contributed by: USDA NRCS Plant Materials  
Program



© W. L. Wagner  
Smithsonian Institution  
@USDA NRCS PLANTS

### Uses

**Livestock:** In southern states, blue grama grows as a bunchgrass; in northern states or areas of heavy grazing pressure, it is a sod former.

**Erosion control:** Blue grama is suitable for mixtures of grasses used in erosion control, low maintenance turf plantings, and surface mine revegetation.

### Status

Please consult the PLANTS Web site and your State Department of Natural Resources for this plant's current status (e.g. threatened or endangered species, state noxious status, and wetland indicator values).

### Description

*Bouteloua gracilis*, blue grama, is a major warm season grass found throughout the Great Plains. The plant is fairly short, reaching 10 to 20 inches with narrow basal leaves of 3 to 6 inches. Blue grama grows in definite bunches and reproduces by tillering and by seed. Mature seed heads are curved, resembling a human eyebrow. Blue grama can be found growing in association with buffalograss, western wheatgrass, needlegrasses and in some areas the bluegrasses.

### Adaptation and Distribution

Blue grama demonstrates good drought, fair salinity, and moderate alkalinity tolerances. In its dormant state, it will also tolerate burning. Blue grama will not tolerate dense shade, flooding, a high water table, or acid soils.

Blue grama is distributed throughout the western United States. For a current distribution map, please consult the Plant Profile page for this species on the PLANTS Website.

### Establishment

As with all native grasses, proper ground preparation is one of the most important considerations. The seedbed should be firm but not solid; cultivation to kill the roots of cool-season grasses is essential. Planting may be done by either drilling or broadcasting, with the seed being sown no more than 1/4 to 1/2 inches deep at a rate of 1 to 3 pounds PLS/acre. Seeding in late spring is recommended in the Great Plains; earlier seeding is recommended in areas further south. In the Southwest, seeding should be done during the period from June 15 to July 15. Mulching and irrigation is recommended on harsh sites. Soil tests should be made to test the soils for deficiencies. Blue grama will tolerate low-nutrient soils better than acidic conditions. Planting should be done by a native grass seed drill. In western areas plant blue grama in a sorghum cover crop, stubble, or in with the crop itself.

### Management

Once the grass is established, it is very palatable to livestock all year long. Since growing points are at or near the ground surface, the grass withstands fairly close grazing. For best yields, defer grazing during the growing season every 2 to 3 years. Blue grama cures well on stem, making it a good grass for grazing during the dormant season. Renovation of sodbound stands is also recommended. Weeds can be controlled by use of herbicides, mowing or controlled grazing.

### Pests and Potential Problems

There are no known serious pests of blue grama grass.

**Cultivars, Improved, and Selected Materials (and area of origin)**

Improved materials include the cultivars 'Lovington' (NM), 'Hachita' (NM), and 'Alma' (NM) and the selected class release Bad River Ecotype (SD). Seeds are available at most commercial seed sources.

**Prepared By & Species Coordinator:**  
*USDA NRCS Plant Materials Program*

Edited: 01Feb2002 JLK; 31may06jsp

For more information about this and other plants, please contact your local NRCS field office or Conservation District, and visit the PLANTS Web site <<http://plants.usda.gov>> or the Plant Materials Program Web site <<http://Plant-Materials.nrcs.usda.gov>>

*The U.S. Department of Agriculture (USDA) prohibits discrimination in all its programs and activities on the basis of race, color, national origin, sex, religion, age, disability, political beliefs, sexual orientation, and marital or family status. (Not all prohibited bases apply to all programs.) Persons with disabilities who require alternative means for communication of program information (Braille, large print, audiotape, etc.) should contact USDA's TARGET Center at 202-720-2600 (voice and TDD).*

*To file a complaint of discrimination write USDA, Director, Office of Civil Rights, Room 326-W, Whitten Building, 14th and Independence Avenue, SW, Washington, DC 20250-9410 or call 202-720-5964 (voice or TDD). USDA is an equal opportunity provider and employer.*

*Read about Civil Rights at the Natural Resources Conservation Service.*

## **BUFFALOGRASS** *Buchloe dactyloides* (Nutt.) Engelm. Plant Symbol = BUDA

Contributed by: USDA NRCS Plant Materials  
Program



Hitchcock 1950  
Manual of the Grasses of the U.S.

### **Alternate Names**

*Bouteloua dactyloides* (Nutt.) J.T. Columbus

### **Uses**

**Erosion control:** Buffalograss can be used on areas that do not receive a lot of rain but are affected by wind erosion, such as roadside cuts.

**Recreation and beautification:** This grass can be used in parks and on school grounds, golf course roughs, and open lawns.

**Livestock:** This is an important pasture grass for native and introduced animals.

### **Status**

Please consult the PLANTS Web site and your State Department of Natural Resources for this plant's current status (e.g. threatened or endangered species, state noxious status, and wetland indicator values).

### **Description**

*Buchloe dactyloides* (Nutt.) Engelm., buffalograss, is a perennial, native, low-growing, warm-season grass. Leaf blades are 10 to 12 inches long, but they fall over and give the turf a short appearance. Staminate plants have 2 to 3 flag-like, one-sided spikes on a seedstalk 4 to 6 inches long. Spikelets, usually 10, are 1/8 inch long in two rows on one side of the rachis. Pistillate spikelets are in a short spike or head and included in the inflated sheaths of the upper leaves. Both male and female plants have stolons from several inches to several feet in length, internodes 2 to 3 inches long, and nodes with tufts of short leaves.

### **Adaptation and Distribution**

This grass occurs naturally and grows best on clay loam to clay soils. It requires little mowing to achieve a uniform appearance. It has a low fertility requirement and it often will maintain good density without supplemental fertilization. Buffalograss is well suited for sites with 10 to 25 inches of annual precipitation. It is not adapted to shaded sites.

Buffalograss is distributed throughout the Midwest. For a current distribution map, please consult the Plant Profile page for this species on the PLANTS Website.

### **Establishment**

Buffalograss is propagated by seed and vegetatively. Establishment can be accomplished by seeding, solid sodding, or sprigging rooted and unrooted plugs. If seeds are used, drill at 1/2 inch deep and provide firm contact between the seed and moist soil. The seed may also be broadcast. When broadcasting seed, harrow or rake the area in two directions immediately after seeding to work the seeds into the soil. Broadcast seed must be covered with soil for the seeding to be successful. With any method, the soil must be firmed against the seed. Seedlings begin to appear 14 to 21 days after planting when moisture is available for germination. The amount of seed needed to ensure a stand at the end of the first year will depend on the method of seeding, the quality of seedbed preparation, the availability of water for

establishment, and certain climatic uncertainties. All planting should be delayed until the danger of frost has past. The time of planting depends upon the latitude of the location, and may extend to August 1 in lower latitudes.

Buffalograss can be established from pieces of sod or sod plugs. Sod should be planted on a well prepared seedbed in 18-inch rows. Sod should be spaced from 6 inches to 2 feet apart; plugs should be planted on 12 to 24 inch centers depending on how quickly a complete cover is desired. When planting, dig a hole deep enough to set a plant in with the grass blades above the ground. Pack soil around the sod making sure not to cover with soil because the plant will die. Once planted, the sod should be watered for about 3 weeks to ensure root establishment.

Sprigs should be planted into soil that has been tilled to a depth of 4 to 6 inches. Sprigging rate should be approximately 240 bushels of sprigs per acre, planted to a depth of 1 inch or less. A planted site should be rolled to ensure good sprig-soil contact and irrigated within 3 hours after planting. Newly planted areas will also require irrigation for several weeks to maintain a moist environment for root establishment.

Proper seedbed preparation for planting a home lawn is essential. Buffalograss will grow on heavy and compacted soils, but it is easier to start and maintain on good loam soils. Heavy soils may be improved by applying good quality organic matter such as peat moss, aged manure, or compost. Applying a phosphorus fertilizer stimulates seedling root growth, even on soils testing high in phosphorus. Work the soil to a depth of 4 to 6 inches. This may require plowing, discing, or tilling. The seedbed should be uniform, friable, and well-packed. Use tillage methods to control any weeds that may develop before seeding.

### **Management**

Buffalograss is only recommended for low maintenance and low use turfgrass areas. Mowing height and frequency depend on grass use, amount of irrigation, and time of year. Care must be taken when mowing not to cut shorter than 2 to 3 inches to avoid other grasses from out-competing the buffalograss. Buffalograss responds well to light applications of nitrogen. Over-fertilization will promote undesirable grasses within the planted area. Buffalograss is excellent for people who want a large, attractive lawn during the summer with a minimum of work involved. Other advantages of buffalograss for lawns is that it withstands heavy usage and has good drought tolerance. However, potential lawn

growers should note that buffalograss is a warm-season grass, it turns brown with fall's first freezing weather, and will not green-up until warm weather returns; it will be brown and unattractive when the neighbor's Kentucky Bluegrass is brilliant green. During extended dry periods in the summer months, buffalograss will go brown and become dormant if no supplemental water is provided. Because of aggressive runners, buffalograss can require edging along walks, driveway, and flower beds.

### **Pests and Potential Problems**

Buffalograss has no serious pests.

### **Cultivars, Improved, and Selected Materials (and area of origin)**

'Bison', 'Plains', 'Texoka', and 'Topgun' (cultivars); Bismarck Ecotype (selected class release). Seeds are available at most Midwestern commercial seed sources. Sod, sod plugs, and sprigs can be obtained from sod farms.

### **Prepared By & Species Coordinator:**

*USDA NRCS Plant Materials Program*

Edited: 01Feb2002 JLK; 31may06jsp

For more information about this and other plants, please contact your local NRCS field office or Conservation District, and visit the PLANTS Web site <<http://plants.usda.gov>> or the Plant Materials Program Web site <<http://Plant-Materials.nrcs.usda.gov>>

*The U.S. Department of Agriculture (USDA) prohibits discrimination in all its programs and activities on the basis of race, color, national origin, sex, religion, age, disability, political beliefs, sexual orientation, and marital or family status. (Not all prohibited bases apply to all programs.) Persons with disabilities who require alternative means for communication of program information (Braille, large print, audiotape, etc.) should contact USDA's TARGET Center at 202-720-2600 (voice and TDD).*

*To file a complaint of discrimination write USDA, Director, Office of Civil Rights, Room 326-W, Whitten Building, 14th and Independence Avenue, SW, Washington, DC 20250-9410 or call 202-720-5964 (voice or TDD). USDA is an equal opportunity provider and employer.*

*Read about [Civil Rights at the Natural Resources Conservation Service](#).*

## SIDEOATS GRAMA

### *Bouteloua curtipendula*

(Michx.) Torr.

Plant Symbol = BOCU

Contributed by: USDA NRCS Plant Materials Program



© W. L. Wagner  
Smithsonian Institution  
@USDA NRCS PLANTS

#### Uses

**Erosion Control:** This grass is adapted to most soil conditions. Successful seedings are obtained in rocky, stony, or shallow soils. It is a fair to good erosion control plant when mixed with the other plants naturally associated with it.

**Grazing:** This is one of the most important range grasses. Although not as palatable as some of the smaller gramas, e.g. blue grama, it is more palatable than many of the other grass species. It produces a much greater volume of forage than blue grama, and this tends to make up for its slightly lower palatability. It remains green later in the fall and usually begins growth in the spring before other gramas. It cures well, and maintains a fairly high feeding value throughout the year.

**Wildlife:** Furnishes some forage for deer and antelope when green. Elk use this plant throughout the year.

#### Status

Please consult the PLANTS Web site and your State Department of Natural Resources for this plant's current status (e.g. threatened or endangered species, state noxious status, and wetland indicator values). It is considered threatened in several states.

#### Description

*Bouteloua curtipendula*, sideoats grama, is a medium-size perennial bunchgrass, 15 to 30 inches tall or occasionally taller. This is the largest and most coarse of the grama grasses. It has a bluish-green color, sometimes with a purplish cast (especially in the spring), and cures to a reddish-brown or straw color. Leaves are coarser than other species of gramas, straight, comparatively stiff, and mostly basal. Ten to thirty small, non-comb-like spikes are borne mostly along one side of each central seed stalk. These spikes drop when mature, leaving a long zigzag stalk.

#### Adaptation and Distribution

Sideoats grama is found on rocky open slopes, woodlands, and forest openings up to an elevation of about 7,000 feet.

Sideoats grama is distributed throughout most of the United States. For a current distribution map, please consult the Plant Profile page for this species on the PLANTS Website.

#### Establishment

Seeding of improved strains of this grass is accomplished by drilling in firm, weed-free seedbeds at the rate of 2-1/2 to 5 pounds (or more) pure live seed per acre. Protect from grazing from date of seeding through the second growing season. Seedings should be delayed until good soil moisture is present.

#### Management

Sideoats grama is not as resistant to grazing as blue grama because of its taller growth habit, but sideoats grama stays green longer and can be grazed for a longer period. Reduced forage production, carrying capacity, and loss in cattle weight is a direct result of overgrazing. Sideoats grama is a normal component of a large number of range sites. The grass lengthens

the grazing season and increases forage production, in addition to providing variety in the feed. Sideoats grama will return to most ranges under good management. Practices that will bring the grass back include proper grazing use, planned grazing systems, and brush control.

### **Pests and Potential Problems**

There are no serious pests of sideoats grama.

### **Cultivars, Improved, and Selected Materials (and area of origin)**

Released cultivars include 'Butte' (NE), 'El Reno' (OK), 'Haskell' (TX), 'Niner' (NM), 'Premier' (Mexico), 'Trailway' (NE), and 'Vaughn' (NM); informal releases include Killdeer (ND) and Pierre (SD); and source identified releases include Northern Iowa Germplasm, Central Iowa Germplasm, Southern Iowa Germplasm (all from IA). Seeds are available at most western commercial seed sources.

### **Prepared By & Species Coordinator:**

*USDA NRCS Plant Materials Program*

Edited: 01Feb2002 JLK: 31may06jsp

For more information about this and other plants, please contact your local NRCS field office or Conservation District, and visit the PLANTS Web site <<http://plants.usda.gov>> or the Plant Materials Program Web site <<http://Plant-Materials.nrcs.usda.gov>>

*The U.S. Department of Agriculture (USDA) prohibits discrimination in all its programs and activities on the basis of race, color, national origin, sex, religion, age, disability, political beliefs, sexual orientation, and marital or family status. (Not all prohibited bases apply to all programs.) Persons with disabilities who require alternative means for communication of program information (Braille, large print, audiotape, etc.) should contact USDA's [TARGET Center](#) at 202-720-2600 (voice and TDD).*

*To file a complaint of discrimination write USDA, Director, Office of Civil Rights, Room 326-W, Whitten Building, 14th and Independence Avenue, SW, Washington, DC 20250-9410 or call 202-720-5964 (voice or TDD). USDA is an equal opportunity provider and employer.*

*Read about [Civil Rights at the Natural Resources Conservation Service](#).*

## **4 Maps**

Culvert Tributary Area Map (Meadow Ranch III)  
Culvert Tributary Area Map (Meadow Ranch II)

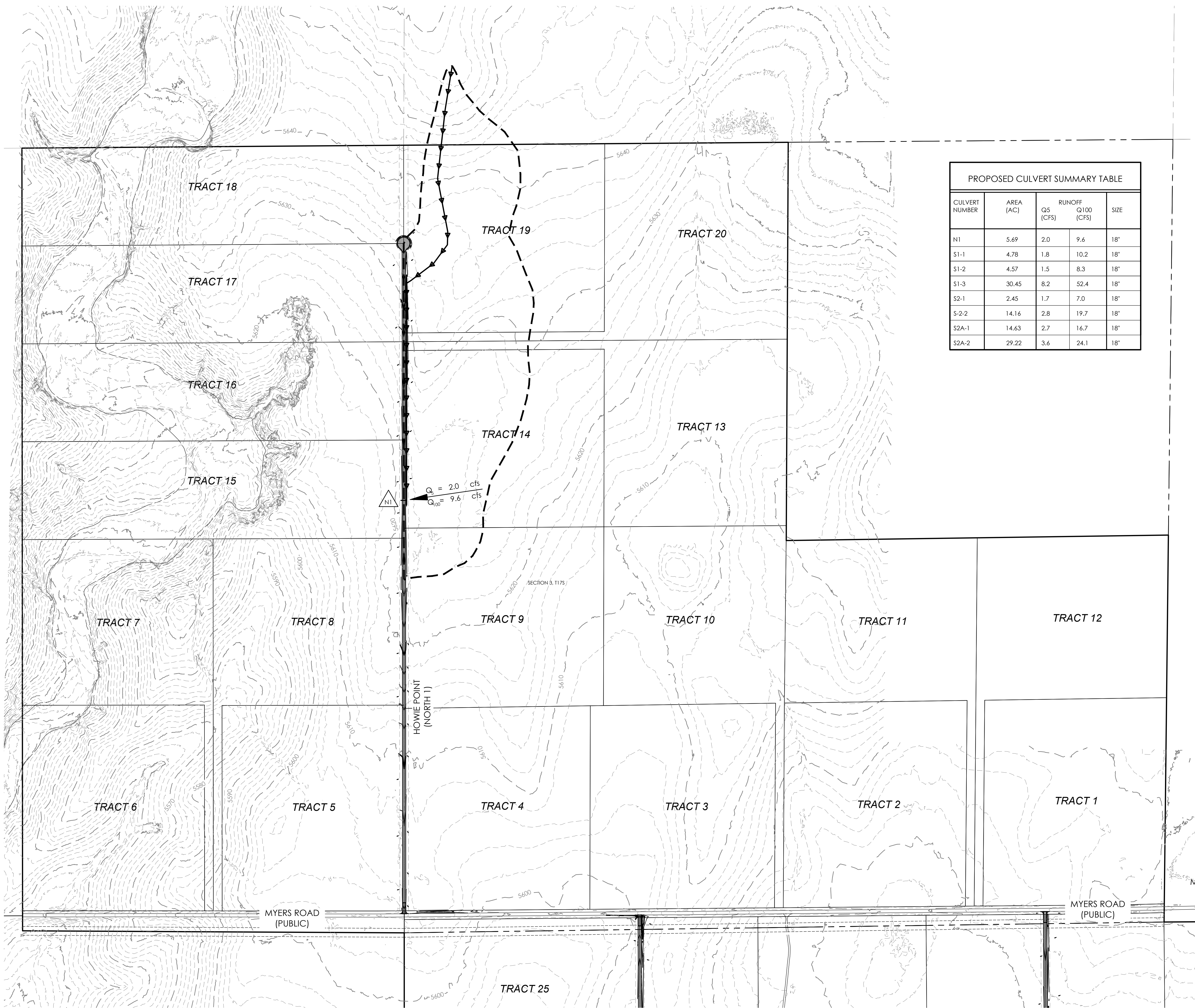

**PROPOSED CULVERT SUMMARY TABLE**

CULVERT NUMBER	AREA (AC)	RUNOFF		SIZE
		Q5 (CFS)	Q100 (CFS)	
N1	5.69	2.0	9.6	18"
S1-1	4.78	1.8	10.2	18"
S1-2	4.57	1.5	8.3	18"
S1-3	30.45	8.2	52.4	18"
S2-1	2.45	1.7	7.0	18"
S-2-2	14.16	2.8	19.7	18"
S2A-1	14.63	2.7	16.7	18"
S2A-2	29.22	3.6	24.1	18"

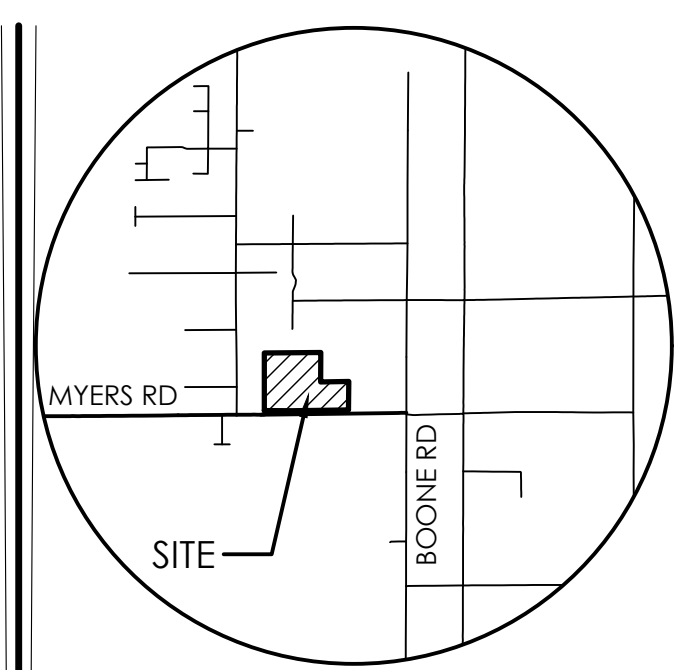

**VICINITY MAP**  
NOT TO SCALE

BENCHMARK

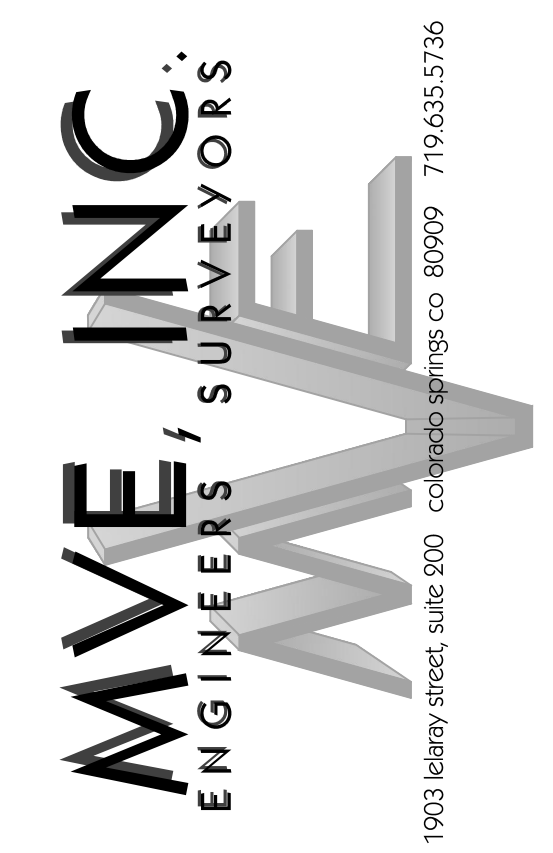
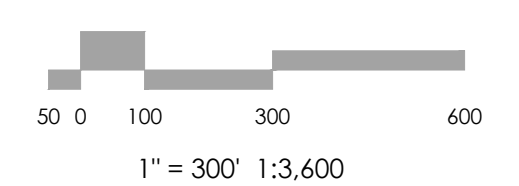
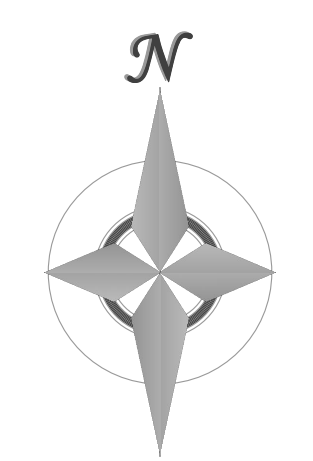

REVISIONS

DESIGNED BY \_\_\_\_\_  
 DRAWN BY \_\_\_\_\_  
 CHECKED BY \_\_\_\_\_  
 AS-BUILTS BY \_\_\_\_\_  
 CHECKED BY \_\_\_\_\_

**MEADOW RANCH II & III**

**DRAINAGE MAP**  
MEADOW RANCH III

MVE PROJECT 61209  
MVE DRAWING **DRAIN-MAP**

**JULY 22, 2024**  
**SHEET 1 OF 1**



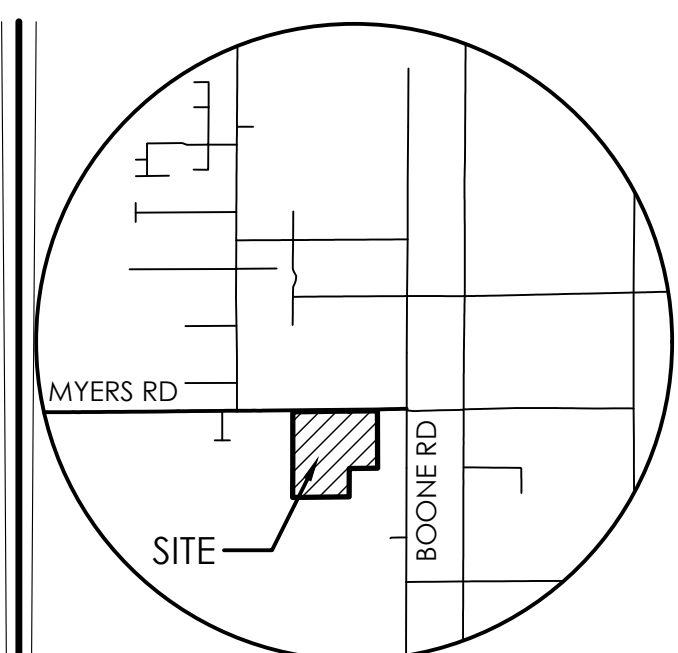
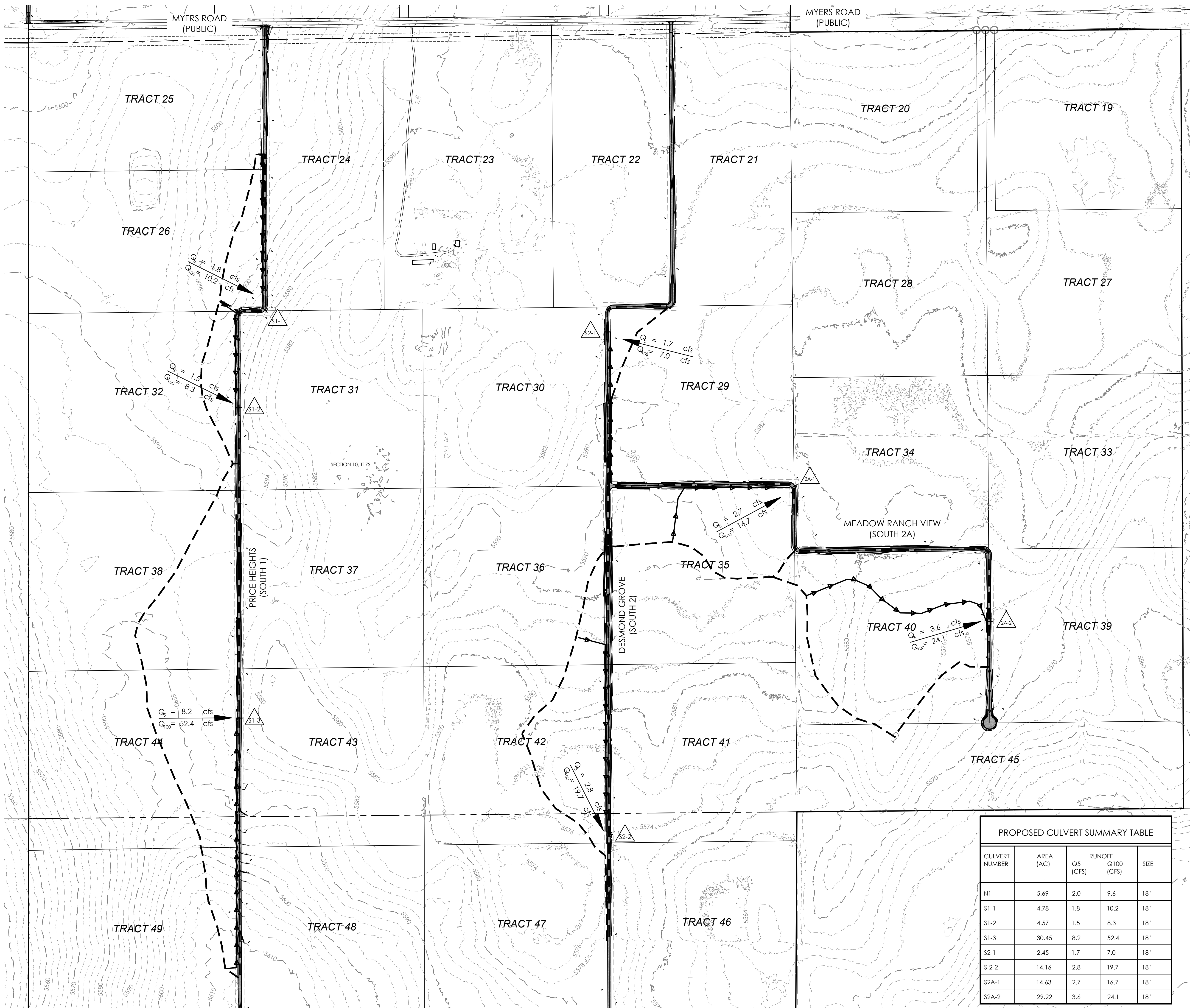

VICINITY MAP

NOT TO SCALE

BENCHMARK

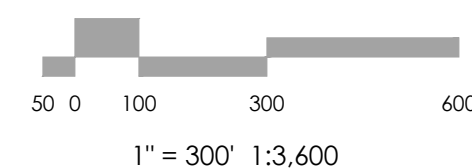
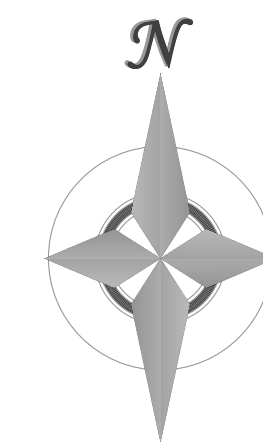

1" = 300' 1:3,600



REVISIONS

DESIGNED BY \_\_\_\_\_  
 DRAWN BY \_\_\_\_\_  
 CHECKED BY \_\_\_\_\_  
 AS-BUILTS BY \_\_\_\_\_  
 CHECKED BY \_\_\_\_\_

MEADOW RANCH II & III

DRAINAGE MAP  
 MEADOW RANCH II

MVE PROJECT 61209  
 MVE DRAWING DRAIN-MAP

JULY 22, 2024  
 SHEET 2 OF 2

PROPOSED CULVERT SUMMARY TABLE				
CULVERT NUMBER	AREA (AC)	Q5 (CFS)	Q100 (CFS)	SIZE
N1	5.69	2.0	9.6	18"
S1-1	4.78	1.8	10.2	18"
S1-2	4.57	1.5	8.3	18"
S1-3	30.45	8.2	52.4	18"
S2-1	2.45	1.7	7.0	18"
S-2-2	14.16	2.8	19.7	18"
S2A-1	14.63	2.7	16.7	18"
S2A-2	29.22	3.6	24.1	18"