



Traffic Impact Study

Please see unresolved
comments from V2.
Please confirm most
current TIS has been
submitted.

Circle K – US-24 & Meridian
PCD File No. CS-21-003
El Paso County, Colorado

Prepared for:

Land Development Consultants

Kimley»»Horn

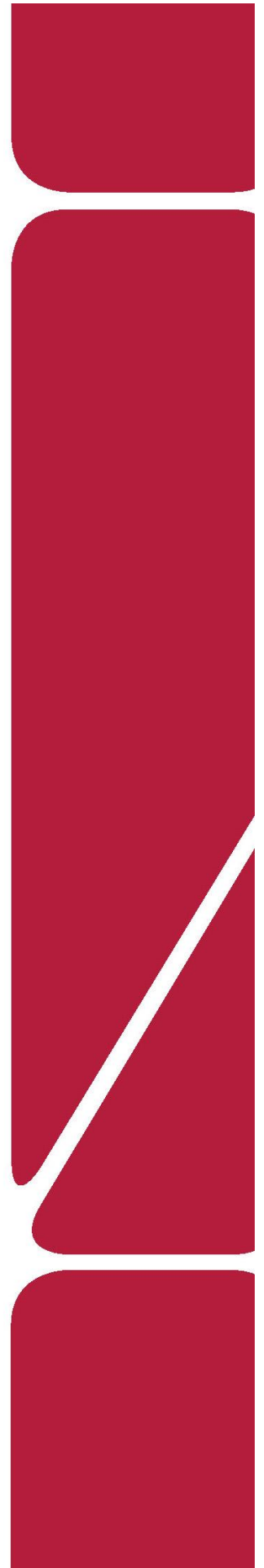

T R A F F I C I M P A C T S T U D Y

Traffic Engineer's Statement

The attached traffic report and supporting information were prepared under my responsible charge and they comport with the standard of care. So far as is consistent with the standard of care, said report was prepared in general conformance with the criteria established by the County for traffic reports.



Jeffrey R. Planck, P.E., PE #53006

December 16, 2021
Date

Developer's Statement

I, the Developer, have read and will comply with all commitments made on my behalf within this report.

Ms. Sofia Hernandez
Land Development Consultants
100 Filmore Street
Suite 500
Denver, Colorado 80206

Date

**Circle K – US-24 & Meridian
PCD File No. CS-21-003**

El Paso County, Colorado

Prepared for
Land Development Consultants
100 Filmore Street
Suite 500
Denver, Colorado 80206

Prepared by
Kimley-Horn and Associates, Inc.
4582 South Ulster Street
Suite 1500
Denver, Colorado 80237
(303) 228-2300

December 2021



This document, together with the concepts and designs presented herein, as an instrument of service, is intended only for the specific purpose and client for which it was prepared. Reuse of and improper reliance on this document without written authorization and adaptation by Kimley-Horn and Associates, Inc. shall be without liability to Kimley-Horn and Associates, Inc.

TABLE OF CONTENTS

TABLE OF CONTENTS	i
APPENDICES	ii
LIST OF TABLES	ii
LIST OF FIGURES.....	ii
1.0 EXECUTIVE SUMMARY.....	1
2.0 INTRODUCTION.....	7
3.0 EXISTING AND FUTURE CONDITIONS.....	10
3.1 Surrounding Land Use.....	10
3.2 Existing and Future Roadway Network.....	10
3.3 Existing Traffic Volumes	12
3.4 Unspecified Development Traffic Growth.....	12
4.0 PROJECT TRAFFIC CHARACTERISTICS.....	19
4.1 Trip Generation.....	19
4.2 Trip Distribution	20
4.3 Traffic Assignment.....	20
4.4 Total (Background Plus Project) Traffic.....	23
5.0 TRAFFIC OPERATIONS ANALYSIS	26
5.1 Analysis Methodology.....	26
5.2 Key Intersection Operational Analysis	27
5.3 Future Intersections.....	30
5.4 El Paso County and CDOT Turn Lane Requirement Analysis.....	32
5.5 Queuing Analysis.....	35
5.6 Access Spacing and Sight Distance Evaluation	37
5.7 Bicycle and Pedestrian Access.....	41
5.8 Road Impact Fees	41
5.9 Improvement Summary	41
6.0 CONCLUSIONS AND RECOMMENDATIONS	44

APPENDICES

Appendix A – Intersection Count Sheets
Appendix B – Future Traffic Projections Data
Appendix C – Trip Generation Worksheets
Appendix D – Intersection Analysis Worksheets
Appendix E – Queuing Analysis Worksheets
Appendix F – Conceptual Site Plan

LIST OF TABLES

Table 1 – Project Traffic Generation.....	20
Table 2 – Level of Service Definitions	26
Table 3 – US-24 and (Old) Meridian Road LOS Results	28
Table 4 – US-24 and (New) Meridian Road LOS Results.....	29
Table 5 – Project Accesses and Future Intersections LOS Results	31
Table 6 – Turn Lane Length Analysis Results	36
Table 7 – Road Impact Fees	41

LIST OF FIGURES

Figure 1 – Vicinity Map.....	8
Figure 2 – Site Area	11
Figure 3 – Existing Lanes and Control	13
Figure 4 – 2021 Existing Traffic Volumes.....	14
Figure 5 – 2021 Existing Adjusted Traffic Volumes	15
Figure 6 – 2023 Background Traffic Volumes.....	17
Figure 7 – 2040 Background Traffic Volumes.....	18
Figure 8 – Project Trip Distribution	21
Figure 9 – Project Traffic Assignment	22
Figure 10 – 2023 Background Plus Project Traffic Volumes.....	24
Figure 11 – 2040 Background Plus Project Traffic Volumes.....	25
Figure 12 – Site Circulation and Roadway Classification.....	40
Figure 13 – 2023 Recommended Lane Configurations and Control	42
Figure 14 – 2040 Recommended Lane Configurations and Control	43

1.0 EXECUTIVE SUMMARY

A Circle K gas station is proposed to redevelop an existing gas station located on the southwest corner of US-24 and (Old) Meridian Road intersection in El Paso County, Colorado. The project is proposing 16 fueling positions with a 5,200 square foot convenience market to replace the existing gas station to be located on the southeast corner of the US-24 and New Meridian Road intersection. It should be noted that the existing gas station on site currently provides eight (8) fueling positions. In addition, this traffic study has been prepared for the entire redevelopment area bounded by New Meridian Road, Old Meridian Road, US-24, and Swingline Road. The remaining development was studied to include 20,000 square feet of retail space, 7,000 square feet of fast casual restaurant space, and a 4,500 square foot fast food restaurant with drive thru. It is expected that the project will be completed by 2023; therefore, analysis was conducted for the 2023 short term horizon as well as the 2040 long-term horizon per El Paso County requirements.

The purpose of this study is to identify project traffic generation characteristics and potential project traffic related impacts on the local street system, as well as to develop mitigation measures required for identified impacts. The following intersections were incorporated into this traffic study in accordance with El Paso County and Colorado Department of Transportation (CDOT) standards and requirements:

- US-24 and (Old) Meridian Road
- US-24 and (New) Meridian Road (future)
- Swingline Road and (New) Meridian Road (future)
- Swingline Road and (Old) Meridian Road (future realignment)
- Pacific Avenue and (New) Meridian Road (future)
- Pacific Avenue and (Old) Meridian Road (future)

Regional access will be provided by Woodmen Road and United States Highway 24 (US-24). Primary and direct access to the site will be provided from (New) Meridian Road and (Old) Meridian Road. A proposed three-quarter turning movement future intersection of Pacific Avenue and (New) Meridian Road and a full movement access along the west side of (Old) Meridian Road at the future Pacific Avenue will provide direct access. Two full movement driveways will be provided along the proposed Pacific Avenue roadway extending between

(Old) Meridian Road and (New) Meridian Road, as well as an access anticipated along Old Meridian Road assumed for the development area to the south between Pacific Avenue and Swingline Road.

The redeveloped Circle K project is expected to generate approximately 4,356 weekday daily trips with 432 of these trips occurring during the morning peak hour and 360 trips occurring during the afternoon peak hour. Based on traffic volume counts conducted and driveways of the existing gas station, the existing gas station on site is currently generating 110 trips during the weekday morning peak hour and 146 trips during the afternoon peak hour. To account for a COVID-19 adjustment, the existing gas station driveway volumes were increased by approximately 46 percent and would be expected to generate approximately 160 trips during the weekday morning peak hour and 213 trips during the afternoon peak hour. Therefore, the redeveloped Circle K project would be expected to generate 272 morning peak hour trips and 214 afternoon peak hour trips. The entire project with the net increase of Circle K trips plus adjacent retail and restaurant space with ITE procedure internal capture trips calculated is expected to generate a net additional 405 morning peak hour trips and 309 trips afternoon peak hour trips than the existing adjusted site traffic volume level.

Distribution of site traffic on the street system was based on the area street system characteristics, existing traffic patterns, anticipated surrounding development in the area, and the proposed access system for the project. Assignment of project traffic was based upon the trip generation described previously and the distributions developed.

Based on the analysis presented in this report, Kimley-Horn believes the redeveloped Circle K project with the adjacent retail and restaurant space will be successfully incorporated into the existing and future roadway network. The proposed project development and expected traffic volumes resulted in the following recommendations and conclusions:

2023 Recommendations:

- The following improvements are recommended in association with the project:
 - Pacific Avenue will be constructed as a public right-of-way within the development area with a Urban Non-Residential Collector classification between New Meridian Road and Old Meridian Road. The future intersections of Pacific Avenue/(New)

Meridian Road and Pacific Avenue/(Old Meridian Avenue will provide primary access for the project. The intersection of Pacific Avenue/(New) Meridian Road is proposed to allow three quarter turning movements with westbound left turns being prohibited. The intersection of Pacific Avenue/(Old) Meridian Road is proposed to allow full turning movements. Direct access to the project will be provided from two driveways located along the proposed Pacific Avenue roadway extending between (Old) Meridian Road and (New) Meridian Road.

- The driveway accesses along Pacific Avenue and (Old) Meridian Road, and the two future access intersections of Pacific Avenue/Meridian Road (New) and Pacific Avenue/Meridian Road (Old) are recommended to provide R1-1 “STOP” signs on the exiting approaches. It is anticipated that single shared movement lanes are sufficient for the exiting approaches of all these access intersections. A raised “pork-chop” median may be required in the exiting throat of the three-quarter movement access intersection of Pacific Avenue and (New) Meridian Road to prevent left turns onto (New) Meridian Road. A R3-2 “No Left Turn” sign should be installed under the STOP sign of this future intersection. A northbound right turn lane should be provided at the proposed Pacific Avenue and (New) Meridian Road intersection.

- There is approximately 340 feet of spacing along (New) Meridian Road between US-24 and the proposed Pacific Avenue (measured edge to edge). With the future intersection of Pacific Avenue and (New) Meridian Road being proposed to allow three-quarter turning movements, it is recommended that the northbound left turn lane at the US-24 and (New) Meridian Road intersection be restriped from 400 feet to 150 feet of length to accommodate back-to-back left turn lanes with the future intersection of Pacific Avenue and (New) Meridian Road. Further, the southbound left turn lane at the future Pacific Avenue and (New) Meridian Road intersection should provide 100 feet of length with a reduced shared taper length of 75 feet. A deviation request will need to be provided to allow these substandard left turn lane lengths; however, calculated vehicle queues are expected to be accommodated within the proposed left turn lane lengths.

- It is recommended that the existing 400-foot northbound right turn lane at the US-24 and (New) Meridian Road intersection be shortened to 155 feet of length plus a 160-foot taper to accommodate the future intersection of Pacific Avenue and (New) Meridian Road. This new length meets El Paso County standards for a design speed of 40 miles per hour and vehicle queues will be accommodated in this lane as the northbound to eastbound right turn acceleration lane will provide free movements at this intersection.
- It is understood that El Paso County may require a 10-foot additional right-of-way dedication along Old Meridian Road to bring the roadway up to the Urban Non-Residential Collector standard from US-24 to Swingline Road adjacent to the project development. A request of the Advisory Committee will be provided to obtain possible credits from the Road Impact Fee associated with this improvement.
- The following improvements along US-24 were completed by CDOT in association with the ongoing realignment of Meridian Road:
 - CDOT will convert the signalized intersection of US-24 and (Old) Meridian Road to an unsignalized intersection. Further, this intersection will be restricted to right-in/right-out only movements with stop control along the northbound and southbound (Old) Meridian Road approaches.
 - With completion of the new alignment of Meridian Road, it is anticipated that CDOT will construct a combination right turn acceleration to deceleration lane that will extend eastbound along US-24 from (New) Meridian Road to (Old) Meridian Road. Likewise, a combination right turn acceleration to deceleration lane will extend westbound along US-24 from (Old) Meridian Road to (New) Meridian Road.
 - A 600-foot eastbound right turn deceleration lane with a 225-foot taper is recommended at the intersection of US-24 and (New) Meridian Road. A 1,125-foot left turn lane with a 225-foot taper is also recommended along the eastbound approach of this intersection. Likewise, a westbound left turn lane with a length of 855 feet is recommended at the US-24 and (New) Meridian Road intersection. Lastly, a southbound Meridian Road to westbound US-24 right turn acceleration is

recommended with a length of 960 feet plus a 225-foot taper. All these improvements meet CDOT SHAC standards.

- Required Access Deviations

- The intersection of Pacific Avenue will be approximately 390 feet south of the (New) Meridian Road and US-24 intersection (measured center to center). The intersection spacing is not located a quarter mile (1,320 feet) from an arterial roadway. Therefore, the proposed intersection does not meet ECM standards. The intersection is expected to meet operational, vehicle queue, and sign distance standards; therefore, it is believed that this intersection should be granted to restrict left-out movements. A deviation will be provided in support of allowing a restricted three-quarter intersection.
- Pacific Avenue is expected to be classified as a local street with lower volumes and no intentions of having cut-through traffic. Therefore, Pacific Avenue can follow driveway spacing of a local roadway of 330 feet from an arterial roadway and 150 feet between local intersections. The west access will be approximately 215 feet (measured center to center) east of (New) Meridian Road. The intersection is expected to meet operational and vehicle queue standards; therefore, a deviation will be provided in support of allowing this access. The west access and the east access along Pacific Avenue are offset approximately 515 feet. Therefore, the accesses meet the 150 feet spacing standards. The east access will be approximately 125 feet (measured center to center) west of (Old) Meridian Road. The intersection is expected to meet operational and vehicle queue standards; therefore, a deviation will be provided in support of allowing this access to be spaced less than 175 feet.
- The proposed intersection access will be approximately 500 feet (measured center to center) south of (Old) Meridian Road and US-24 intersection. The access spacing requirement of a collector roadway to a local roadway intersection is 330 feet. Therefore, it is believed this access meets the access spacing criteria in the ECM.

2040 Recommendations:

- If future traffic volume projections materialize, US-24 will need to be improved to provide at least two through lanes in each direction throughout the study area.
- The westbound left turn lane at the US-24 and Meridian Road intersection may need to be extended from 855 feet to 935 feet of length.
- The eastbound approach of the US-24 and Meridian Road intersection may need to provide dual left turn lanes with 965 feet of length per lane.

General Recommendations:

- All on-site and off-site signing and striping improvements should be incorporated into the Civil Drawings and conform to El Paso County Standards as well as the Manual on Uniform Traffic Control Devices – 2009 Edition (MUTCD).

2.0 INTRODUCTION

Kimley-Horn and Associates, Inc. has prepared this report to document the results of a Traffic Impact Study of future traffic conditions associated with a Circle K redevelopment located on the southwest corner of US-24 and (Old) Meridian Road intersection in El Paso County, Colorado. A vicinity map illustrating the project location is shown in **Figure 1**. The project is proposing 16 fueling positions with a 5,200 square foot convenience market to replace the existing gas station to be located on the southeast corner of the US-24 and New Meridian Road intersection. It should be noted that the existing gas station on site currently provides eight (8) fueling positions. In addition, this traffic study has been prepared for the entire redevelopment area bounded by New Meridian Road, Old Meridian Road, US-24, and Swingline Road. The remaining development was studied to include 20,000 square feet of retail space, 7,000 square feet of fast casual restaurant space, and a 4,500 square foot fast food restaurant with drive thru. A conceptual site plan illustrating the development is shown in **Appendix F**. It is expected that the project will be completed by 2023; therefore, analysis was conducted for the 2023 short term horizon as well as the 2040 long-term horizon per El Paso County and CDOT requirements.

The purpose of this study is to identify project traffic generation characteristics and potential project traffic related impacts on the local street system, as well as to develop mitigation measures required for identified impacts. The following intersections were incorporated into this traffic study in accordance with El Paso County and Colorado Department of Transportation (CDOT) standards and requirements:

- US-24 and (Old) Meridian Road
- US-24 and (New) Meridian Road (future)
- Swingline Road and (New) Meridian Road (future)
- Swingline Road and (Old) Meridian Road (future realignment)
- Pacific Avenue and (New) Meridian Road (future)
- Pacific Avenue and (Old) Meridian Road (future)

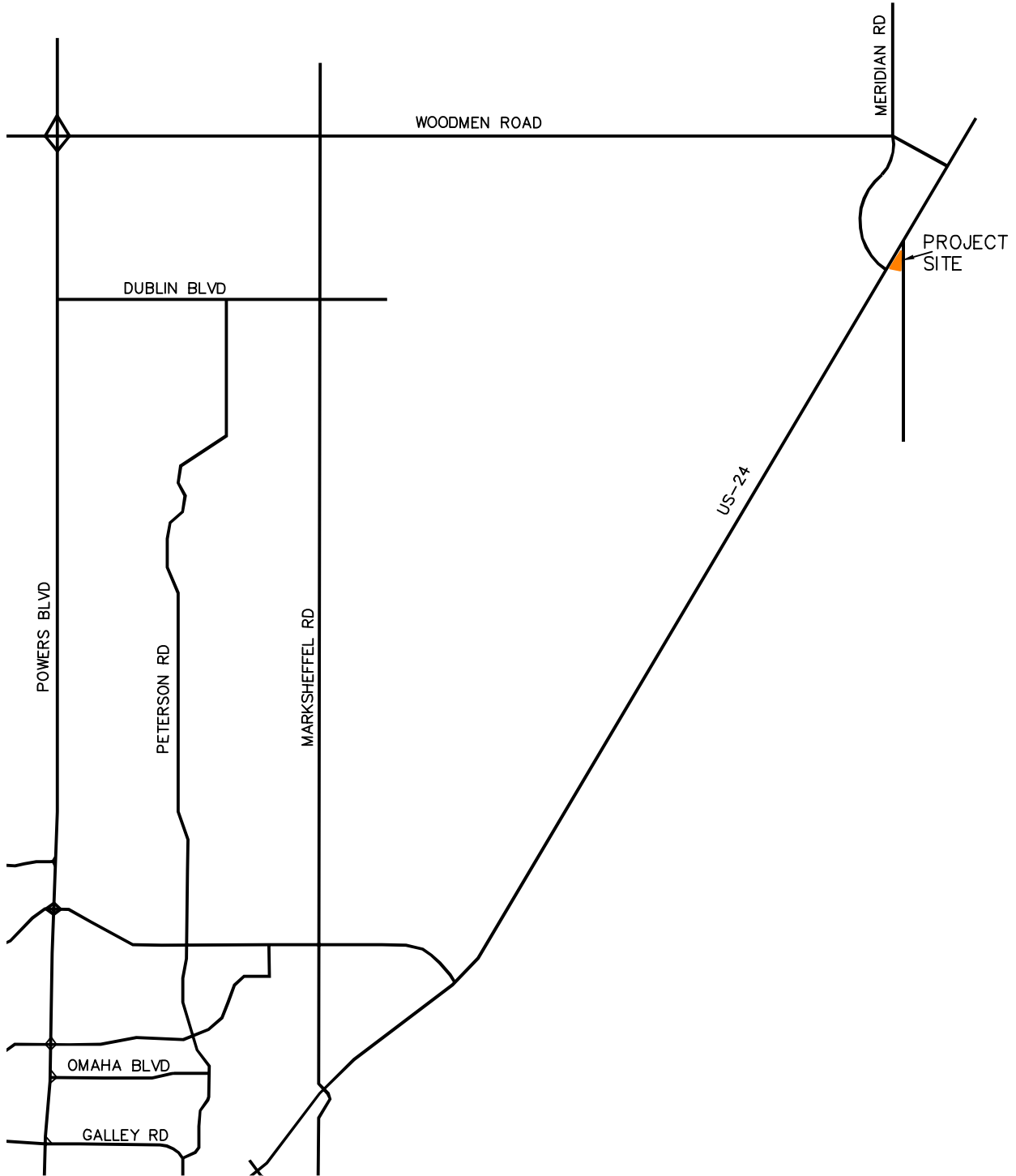

CIRCLE K – US-24 & MERIDIAN
EL PASO COUNTY, COLORADO
VICINITY MAP

FIGURE 1

Regional access will be provided by Woodmen Road and United States Highway 24 (US-24). Primary and direct access to the site will be provided from (New) Meridian Road and (Old) Meridian Road. A proposed three-quarter turning movement future intersection of Pacific Avenue and (New) Meridian Road and a full movement access along the west side of (Old) Meridian Road at the future Pacific Avenue will provide direct access. Two full movement driveways will be provided along the proposed Pacific Avenue roadway extending between (Old) Meridian Road and (New) Meridian Road, as well as an access anticipated along Old Meridian Road assumed for the development area to the south between Pacific Avenue and Swingline Road.

3.0 EXISTING AND FUTURE CONDITIONS

3.1 Surrounding Land Use

The project site is comprised of an existing gas station, two single-family residential homes, and vacant land. The south half of the project area will be for future development. The area to the southwest is primarily vacant while the surrounding area in direction includes residential neighborhoods. The area and roadway network surrounding the project site are shown in the aerial of **Figure 2**.

3.2 Existing and Future Roadway Network

US-24 provides one through lane in each direction adjacent to the project site with a posted speed limit of 55 miles per hour. US-24 is classified as a “principal arterial” per El Paso County roadway classification map while being categorized as E-X: Expressway, Major Bypass by CDOT. The March 2018 PEL for this roadway identifies a possible six-lane roadway for US-24. (Old) Meridian Road provides one through lane in each direction with a posted speed limit of 40 miles per hour. The (New) Meridian Road is currently under construction and is located approximately 1,000 feet west of the (Old) Meridian Road. El Paso County classifies Meridian Road as a principal arterial north of US-24 and a minor arterial roadway south of US-24.

At the time of the counts, the existing intersection of US-24 and (Old) Meridian Road was signalized with protective-permissive left turn signal phasing on the eastbound westbound approaches of US-24. The north-south approaches of (Old) Meridian Road operated with split phasing. The eastbound and westbound approaches of this intersection provided a left turn lane, a through lane, and a right turn lane while the northbound and southbound approaches provided a shared through/left turn lane and a right turn lane. It is believed, this intersection will operate under stop control on the north-south approach of (Old) Meridian Road and be restricted to right-in/right-out only movements when construction is completed.

At the time of the counts, the intersection of US-24 and (New) Meridian Road was currently under construction. The US-24 and (New) Meridian Road intersection has recently been signalized with protected-permitted left turn phasing on all four approaches. The northbound and southbound approaches provide a left turn lane, two through lanes, and a right turn lane.



CIRCLE K – US-24 & MERIDIAN
EL PASO COUNTY, COLORADO
SITE AREA

FIGURE 2

The eastbound and westbound approaches provide a left turn lane, a through lane, and a right turn lane. The existing intersection lane configuration and control for these study area key intersections are shown in **Figure 3**.

3.3 Existing Traffic Volumes

Existing PM peak hour turning movement counts were collected on Wednesday, April 14, 2021 while AM peak hour turning movement counts were conducted on Thursday, April 15, 2021. The counts were conducted in 15-minute intervals during the morning and afternoon peak hours of adjacent street traffic from 7:00 AM to 9:00 AM and 4:00 PM to 6:00 PM. Existing turning movement counts are shown in **Figure 4** with count sheets provided in **Appendix A**.

Due to the counts being collected during the COVID-19 Pandemic, an adjustment factor was determined in order to grow the counts to non-COVID conditions to represent normal condition traffic volumes. Peak hour through volumes conducted in 2019 that were provided by the Colorado Department of Transportation along US-24 were grown to year 2021. These volumes were compared to the approach volumes collected in 2021 at the intersection of US-24 and (Old) Meridian Road. It was determined the morning peak hour traffic volumes needed to be increase by 46 percent while the afternoon peak hour traffic volumes needed to be increased by 47 percent to identify normal existing conditions traffic volumes. The adjusted peak hour turning movement counts are shown in **Figure 5**.

3.4 Unspecified Development Traffic Growth

Based on information provided on the website for the Colorado Department of Transportation, the 20-year average growth factor along US-24 within the study area between 1.4 and 1.5. The average value equates to an annual growth rate of approximately 1.8 percent per year. Traffic information from the CDOT Online Transportation Information System (OTIS) is included in **Appendix B**. Based on the above information, a 2.0 percent annual growth rate was used to calculate future traffic volumes at the study area intersection and adjacent roadways. This annual growth rate was used to estimated short-term 2023 and long-term 2040 traffic volumes at the key intersections. Existing traffic counts at the intersection of US-24 and (Old) Meridian Road were redistributed to the intersection of US-24 and (New) Meridian Road due to the realignment of Meridian Road and (Old) Meridian Road being restricted to right-in/right-out movements in the future.

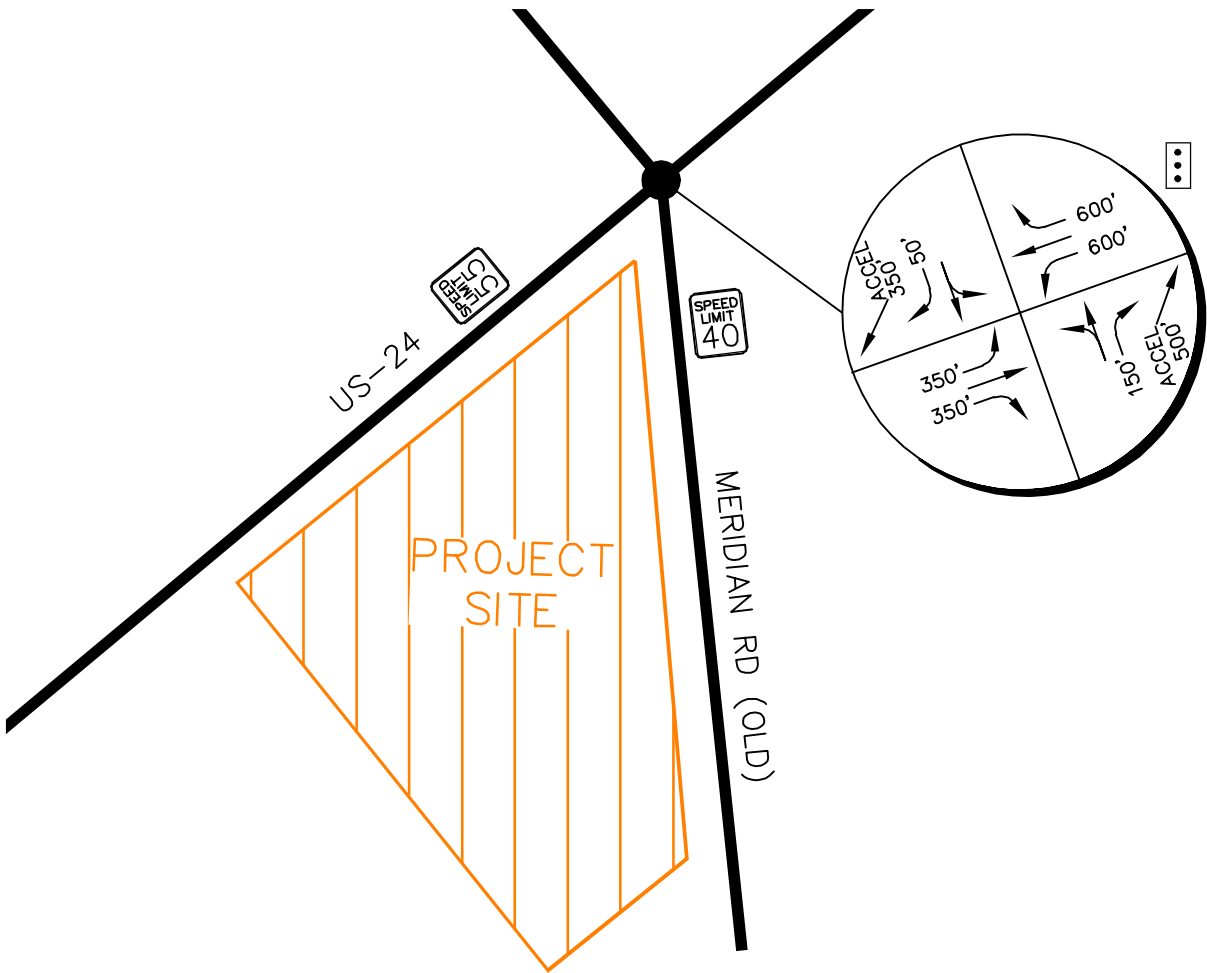

LEGEND	
	Study Area Key Intersection
	Signalized Intersection
	Stop Controlled Approach
	Roadway Speed Limit
C	Continuous Lane
	100' Turn Lane Length (feet)

CIRCLE K – US-24 & MERIDIAN
 EL PASO COUNTY, COLORADO
 EXISTING LANE CONFIGURATIONS

FIGURE 3

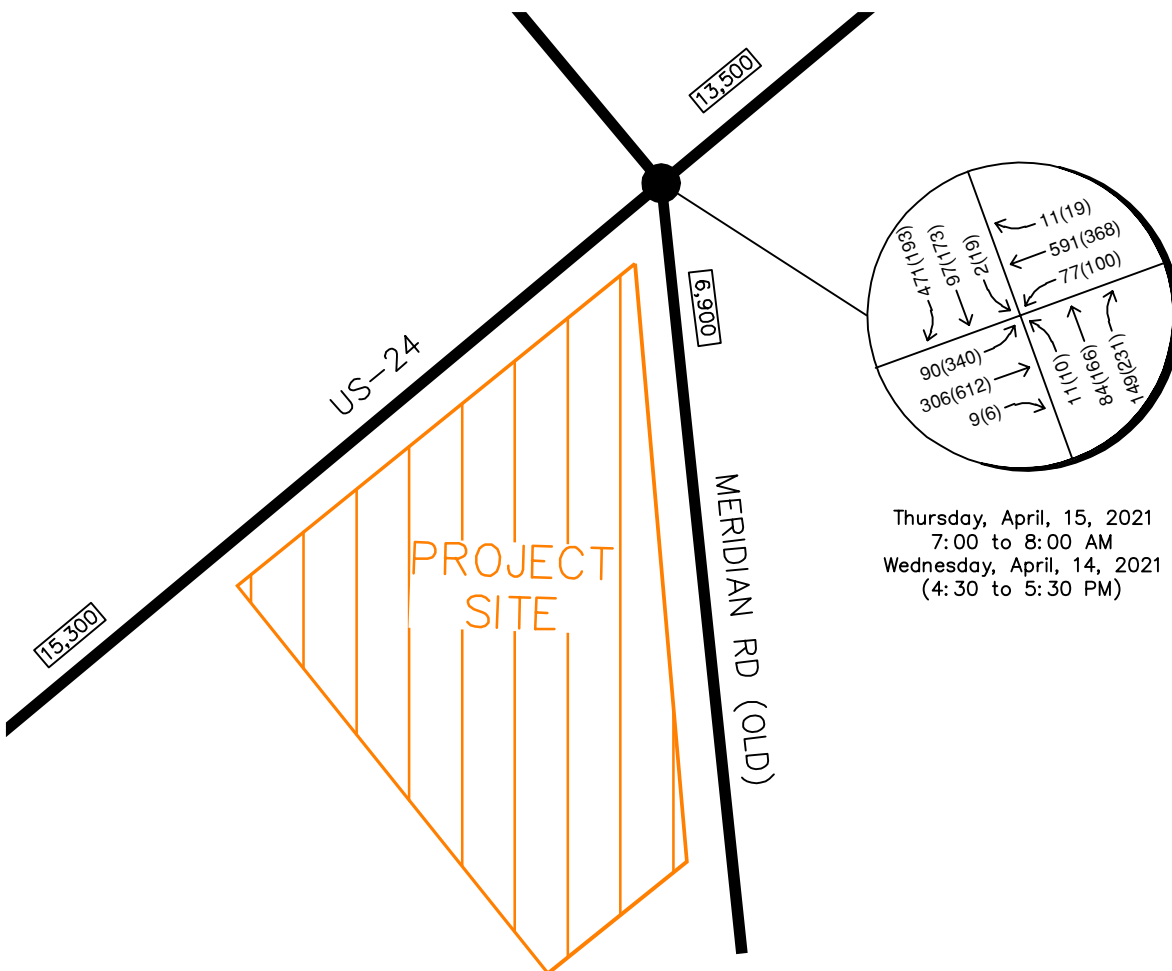

Thursday, April, 15, 2021
 7:00 to 8:00 AM
 Wednesday, April, 14, 2021
 (4:30 to 5:30 PM)

LEGEND

- Study Area Key Intersection
- xxx(xxx) Weekday AM(PM)
Peak Hour Traffic Volumes
- xx,x00 Estimated Daily Traffic Volume

CIRCLE K – US-24 & MERIDIAN
 EL PASO COUNTY, COLORADO
 2021 EXISTING TRAFFIC VOLUMES

FIGURE 4

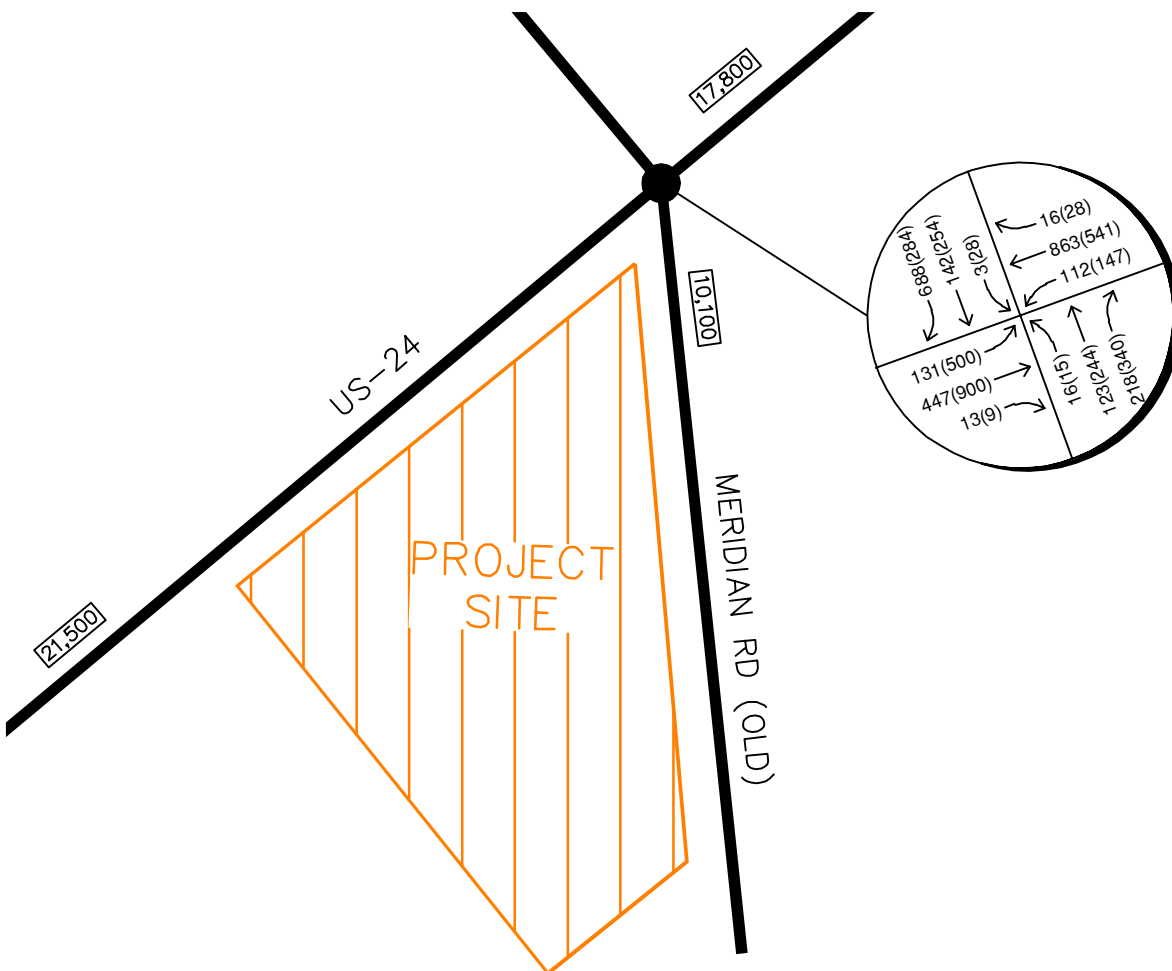

LEGEND

- Study Area Key Intersection
- xxx(xxx) Weekday AM(PM)
Peak Hour Traffic Volumes
- xx,x00 Estimated Daily Traffic Volume

CIRCLE K – US-24 & MERIDIAN
 EL PASO COUNTY, COLORADO
 EXISTING ADJUSTED TRAFFIC VOLUMES

FIGURE 5

In addition, traffic volumes associated with the Meridian Road/Falcon Park and Ride were included in the short-term and long-term horizon. The volumes included in the Traffic Operations/Access Assessment: Meridian Road/Falcon Park and Ride prepared by HDR Engineering, Inc in June 2019 is included in **Appendix B**. The calculated background traffic volumes for 2023 and 2040 are shown in **Figure 6** and **Figure 7**, respectively.

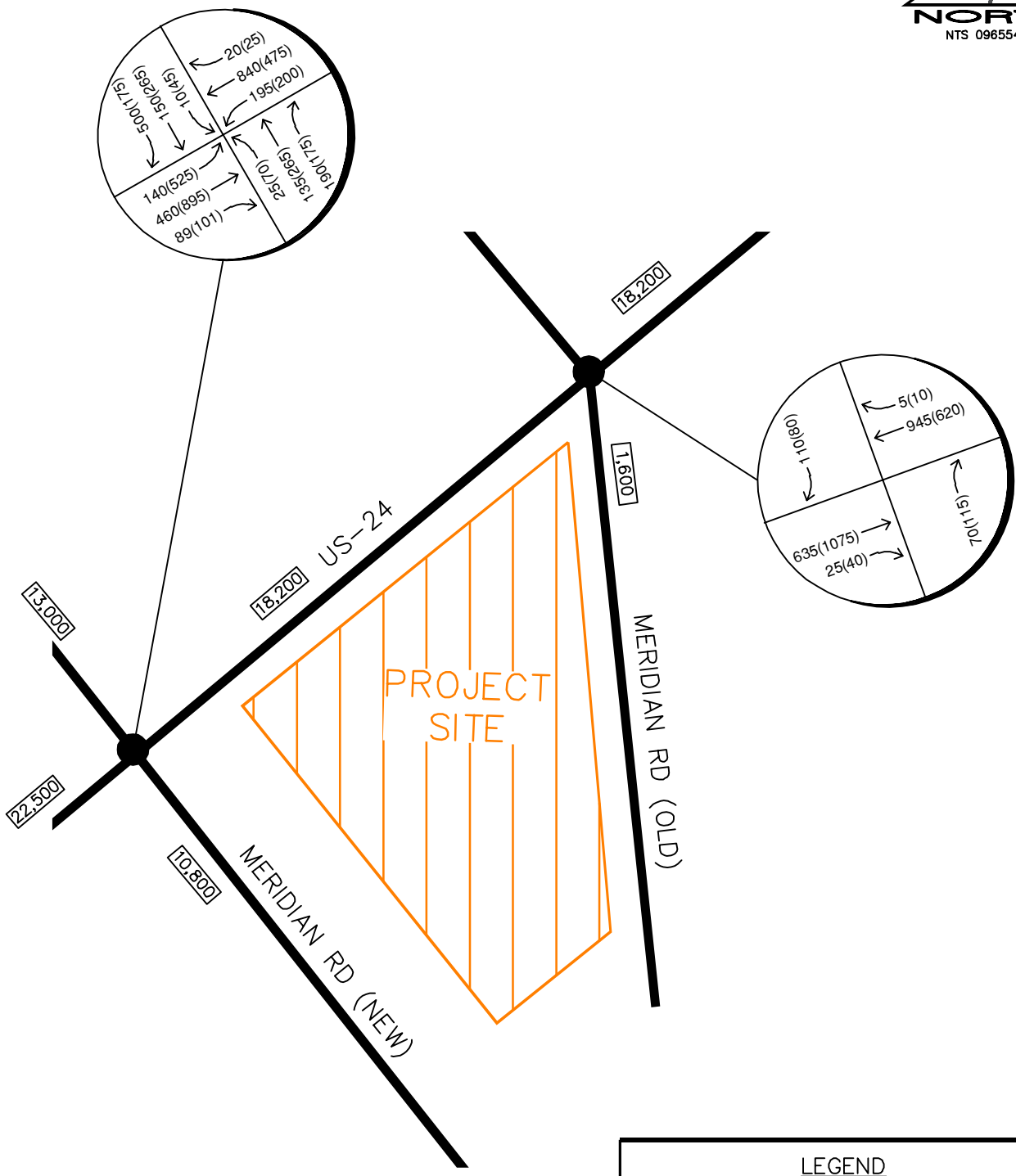

LEGEND

- Study Area Key Intersection
- xxx(xxx) Weekday AM(PM) Peak Hour Traffic Volumes
- xx,x00 Estimated Daily Traffic Volume

CIRCLE K – US-24 & MERIDIAN
 EL PASO COUNTY, COLORADO
 2023 BACKGROUND VOLUMES

FIGURE 6

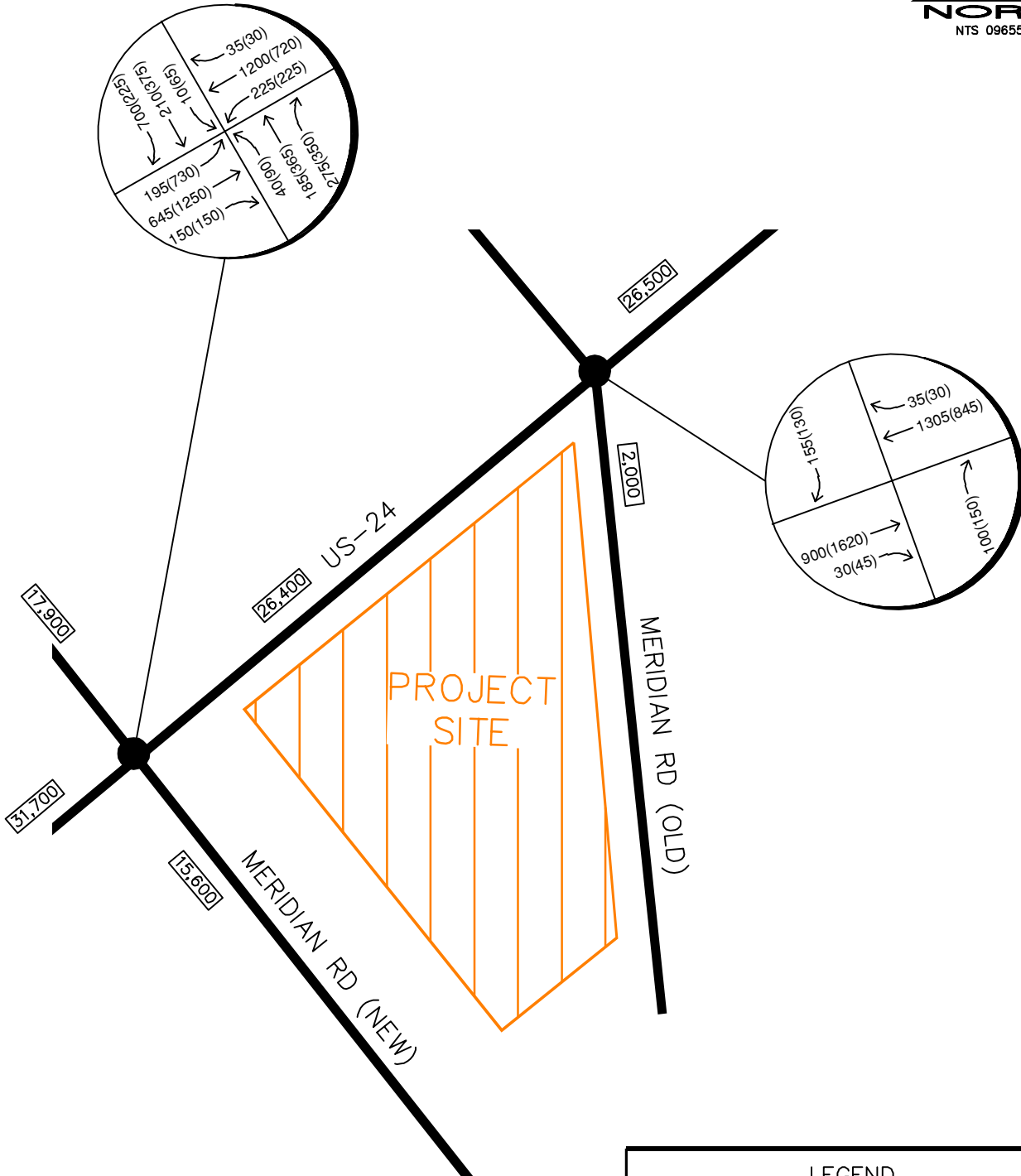

LEGEND

- Study Area Key Intersection
- xxx(xxx) Weekday AM(PM) Peak Hour Traffic Volumes
- xx,x00 Estimated Daily Traffic Volume

CIRCLE K – US-24 & MERIDIAN
 EL PASO COUNTY, COLORADO
 2040 BACKGROUND VOLUMES

FIGURE 7

4.0 PROJECT TRAFFIC CHARACTERISTICS

4.1 Trip Generation

Site-generated traffic estimates are determined through a process known as trip generation. Rates and equations are applied to the proposed land uses to estimate traffic generated by the development during a specific time interval. The acknowledged source for trip generation rates is the *Trip Generation Report*¹ published by the Institute of Transportation Engineers (ITE). ITE has established trip rates in nationwide studies of similar land uses. For this study, Kimley-Horn used the ITE Trip Generation Report average rate equations that apply to Shopping Center (ITE Code 820), Fast Casual Restaurant (ITE 930), Fast-Food Restaurant with Drive-Thru (ITE 934), and Super Convenience Market/Gas Station (ITE 960) for traffic associated with the development.

Since the full buildout of the Circle K Redevelopment is proposed to contain a mix of uses, internal capture trips are expected to occur on site as well. These internal capture trips are shared trips from vehicles already within the internal street network. These shared trips reduce the number of total external trips and were calculated directly per the ITE procedure.

Existing peak hour traffic volumes were collected at the site driveways of the existing gas station on site. Based on the data from these counts, it is determined that the existing site generates 110 morning peak hour trips (59 in and 51 out) and 146 afternoon peak hour trips (70 in and 76 out). To account for a COVID-19 adjustment, the existing gas station driveway volumes were increased by approximately 46 percent and would be expected to generate approximately 160 trips during the weekday morning peak hour and 213 trips during the afternoon peak hour during normal traffic conditions. Therefore, the redeveloped Circle K project would be expected to generate 272 morning peak hour trips and 214 afternoon peak hour trips. The entire project with the net increase of Circle K trips plus adjacent retail and restaurant space with ITE procedure internal capture trips calculated is expected to generate a net additional 405 morning peak hour trips and 309 trips afternoon peak hour trips than the existing adjusted site traffic volume level. Calculations were based on the procedure and information provided in the ITE *Trip Generation Manual, 10th Edition – Volume 2: Data*, 2017. **Table 1** summarizes the

¹ Institute of Transportation Engineers, *Trip Generation: An Information Report*, Tenth Edition, Washington DC, 2017.

estimated trip generation for the proposed development. The trip generation worksheets are included in **Appendix C**.

Table 1 – Project Traffic Generation

Land Use and Quantity	Weekday Vehicle Trips						
	Daily	AM Peak Hour			PM Peak Hour		
		In	Out	Total	In	Out	Total
Shopping Center – (ITE 820) 23,000 Square Feet	870	14	8	22	42	46	88
Fast Casual Restaurant – (ITE 930) 7,000 Square Feet	990	9	5	14	54	45	99
Fast-Food w/ Drive-Thru – (ITE 934) 4,500 Square Feet	2,120	92	89	181	76	71	147
Redeveloped Circle K – (ITE 960) 16 Fueling Positions	4,356	216	216	432	180	180	360
Total Project Trips w/ Internal Capture	6,720	289	276	565	266	256	522
Existing Gas Station Trips – Existing Counts: 8 Fueling Positions	*1,826	59	51	110	70	76	146
Existing Adjusted Gas Station Trips – 8 Fueling Positions	*2,662	86	74	160	102	111	213
Net Site Generated Trips	4,058	203	202	405	164	145	309

*Assuming PM peak hour is 8% of the Daily

4.2 Trip Distribution

Distribution of site traffic on the street system was based on the area street system characteristics, existing traffic patterns, existing and anticipated surrounding demographic information, and the proposed access system for the project. The directional distribution of traffic is a means to quantify the percentage of site-generated traffic that approaches the site from a given direction and departs the site back to the original source. The project trip distribution is illustrated in **Figure 8**.

4.3 Traffic Assignment

Traffic assignment was obtained by applying the project trip distribution to the estimated traffic generation of the development shown in **Table 1**. Project traffic assignment for the Circle K project is shown in **Figure 9**.

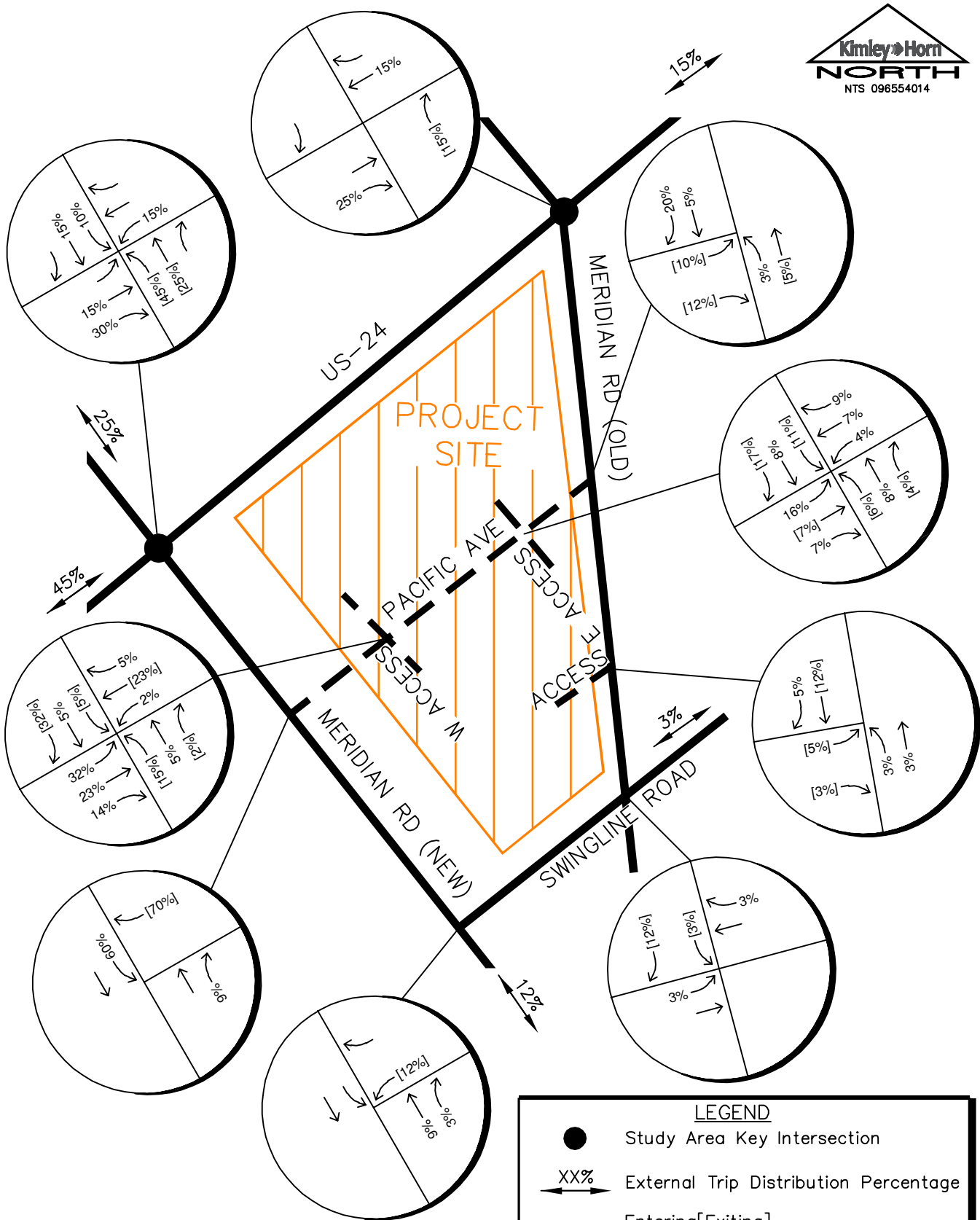

CIRCLE K – US-24 & MERIDIAN
 EL PASO COUNTY, COLORADO
 TRIP DISTRIBUTION

FIGURE 8

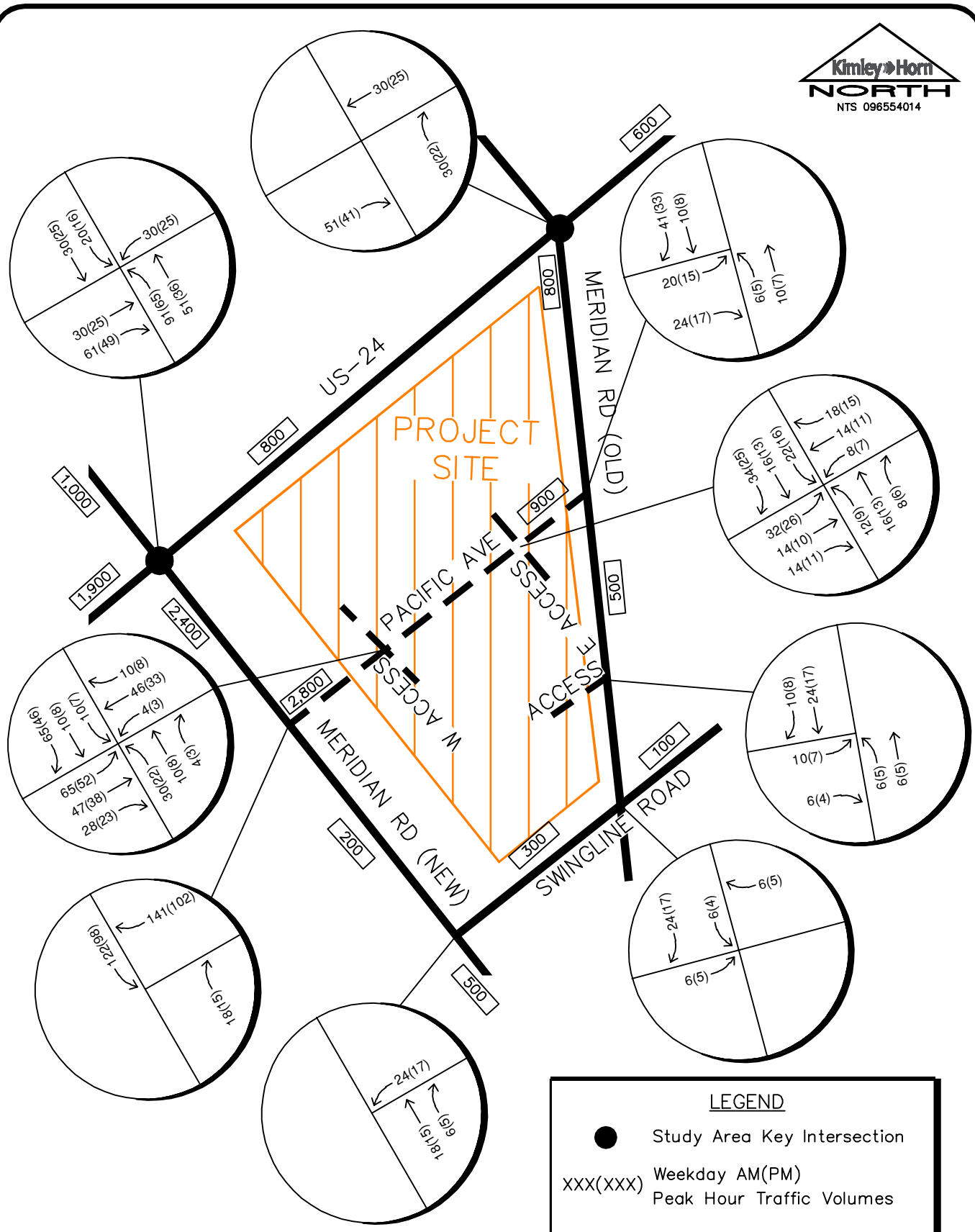

CIRCLE K – US-24 & MERIDIAN
 EL PASO COUNTY, COLORADO
 TRAFFIC ASSIGNMENT

FIGURE 9

4.4 Total (Background Plus Project) Traffic

Site traffic volumes were added to the background volumes to represent estimated traffic conditions for the short term 2023 horizon and long term 2040 horizon. These total traffic volumes for the site are illustrated for the 2023 and 2040 horizon years in **Figure 10** and **Figure 11**, respectively.

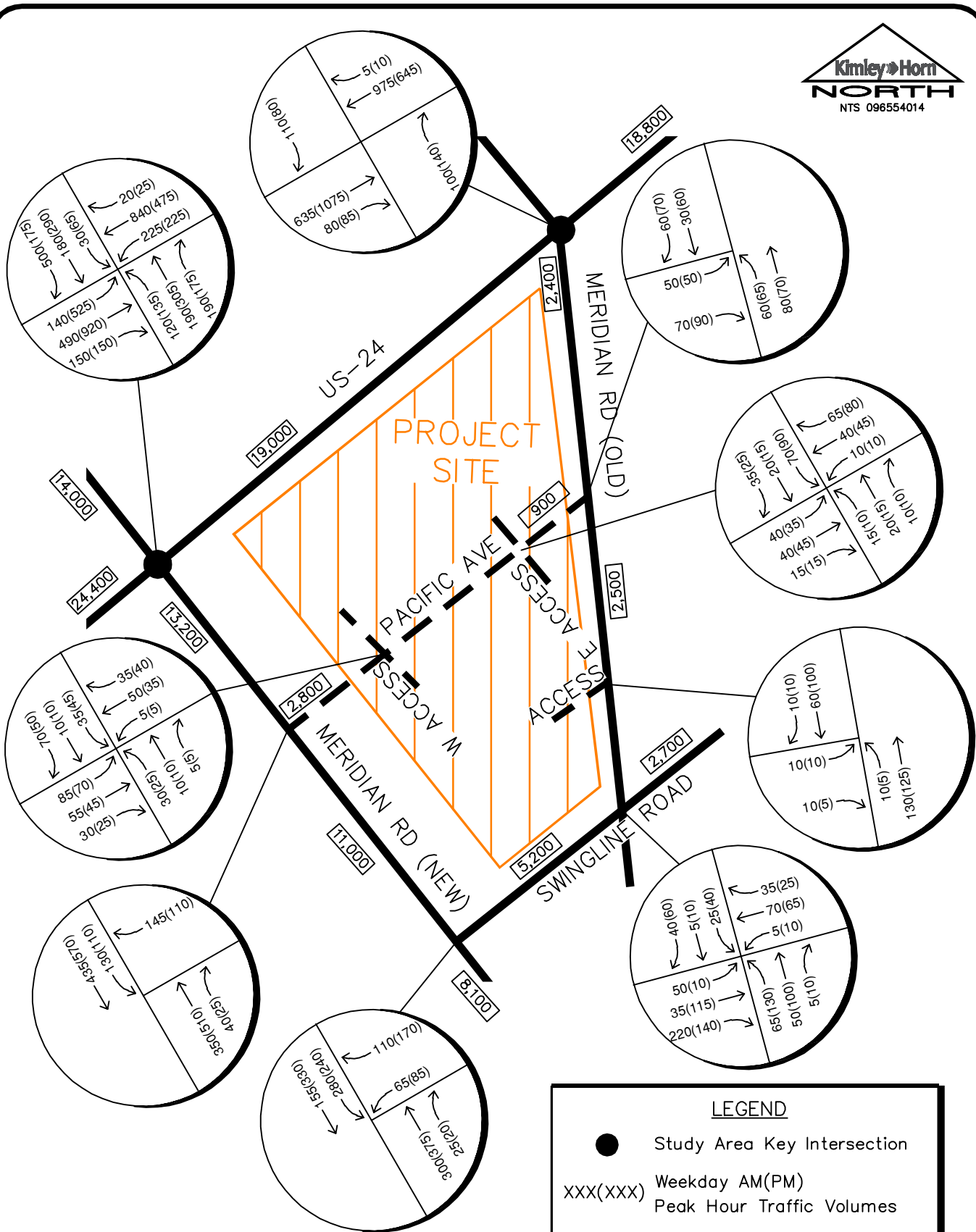

CIRCLE K – US-24 & MERIDIAN
 EL PASO COUNTY, COLORADO
 2023 TOTAL TRAFFIC VOLUMES

FIGURE 10

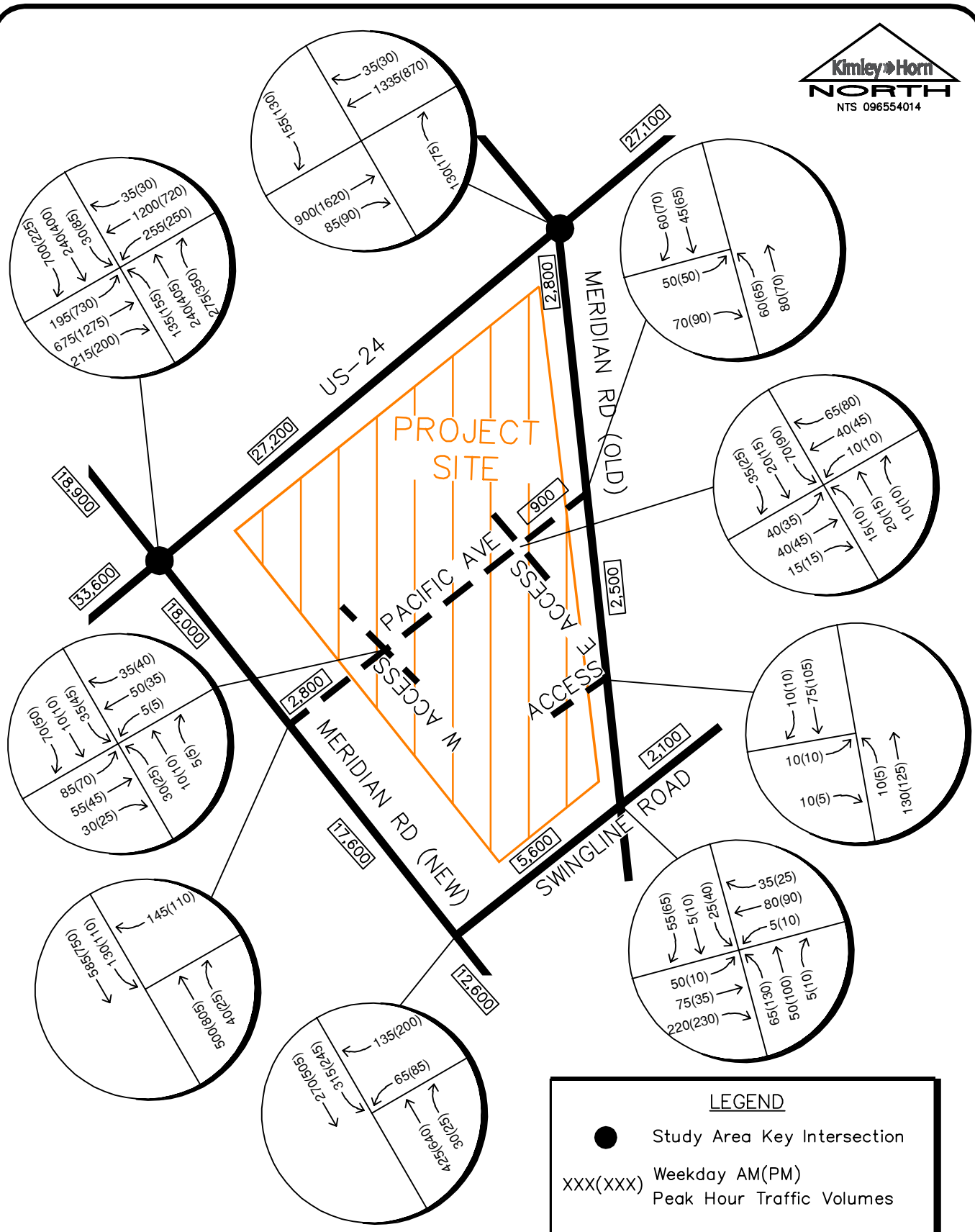

CIRCLE K – US-24 & MERIDIAN
 EL PASO COUNTY, COLORADO
 2040 TOTAL TRAFFIC VOLUMES

FIGURE 11

5.0 TRAFFIC OPERATIONS ANALYSIS

Kimley-Horn’s analysis of traffic operations in the site vicinity was conducted to determine potential capacity deficiencies in the 2023 and 2040 development horizons at the identified key intersections and access driveway. The acknowledged source for determining overall capacity is the current edition of the *Highway Capacity Manual (HCM)*².

5.1 Analysis Methodology

Capacity analysis results are listed in terms of Level of Service (LOS). LOS is a qualitative term describing operating conditions a driver will experience while traveling on a particular street or highway during a specific time interval. It ranges from A (very little delay) to F (long delays and congestion). Typical standard traffic engineering practice recommends LOS D for overall intersections and LOS E for movements or approaches as the minimum thresholds for acceptable operations at intersections. **Table 2** shows the definition of level of service for signalized and unsignalized intersections.

Table 2 – Level of Service Definitions

Level of Service	Signalized Intersection Average Total Delay (sec/veh)	Unsignalized Intersection Average Total Delay (sec/veh)
A	≤ 10	≤ 10
B	> 10 and ≤ 20	> 10 and ≤ 15
C	> 20 and ≤ 35	> 15 and ≤ 25
D	> 35 and ≤ 55	> 25 and ≤ 35
E	> 55 and ≤ 80	> 35 and ≤ 50
F	> 80	> 50

Definitions provided from the Highway Capacity Manual, Special Report 209, Transportation Research Board, 2010.

Study area intersections were analyzed based on average total delay analysis for signalized and unsignalized intersections. Under the unsignalized analysis, the LOS for a two-way stop-controlled intersection is determined by the computed or measured control delay and is defined for each minor movement. LOS for a two-way stop-controlled intersection is not defined for the intersection as a whole. LOS for signalized, roundabout, and all-way stop controlled intersections are defined for each approach and for the overall intersection.

² Transportation Research Board, *Highway Capacity Manual*, Special Report 209, Washington DC, 2010.

5.2 Key Intersection Operational Analysis

Calculations for the level of service at the key intersection and project access driveways for the study area are provided in **Appendix D**. The existing year analysis is based on the lane geometry and intersection control shown in **Figure 3**. Synchro traffic analysis software was used to analyze the study area intersection and access driveway. The Synchro Highway Capacity Manual (HCM) methodology reports were used to analyze intersection delay and level of service.

US-24 and (Old) Meridian Road

The intersection of US-24 and (Old) Meridian Road currently operates as a signalized intersection with protected-permissive left turn phasing on the east-west approaches. This intersection currently operates with LOS C during the morning peak hour and LOS E during the afternoon peak hour. By 2023 and coinciding with the realignment of Meridian Road to the west, the intersection will convert to an unsignalized intersection with stop-control on the north and south approaches and be restricted to right-in/right-out movements on (Old) Meridian Road. With this configuration and control, the intersection movements are anticipated to operate at LOS A during the morning and afternoon peak hours throughout the 2040 horizon. Acceleration lanes will be provided along US-24 at (Old) Meridian Road; therefore, there will not be any movements at this intersection that report vehicular delays. By 2040, the El Paso County Major Transportation Corridors Plan (MTCP) and CDOT PEL both identify US-24 to be widened to six-lanes. It was determined based on the projected through volumes that the roadway would only need to be widened to a four-lane roadway (two through lanes in each direction) and was analyzed as such at the studied intersections along US-24. **Table 3** provides the results of the level of service at this intersection.

Table 3 – US-24 and (Old) Meridian Road LOS Results

Scenario	AM Peak Hour		PM Peak Hour	
	Delay (sec/veh)	LOS	Delay (sec/veh)	LOS
2021 Existing (Adjusted)	33.3	C	65.4	E
2023 Background				
Northbound Right	0.0 *	A	0.0 *	A
Southbound Right	0.0 *	A	0.0 *	A
2023 Background Plus Project				
Northbound Right	0.0 *	A	0.0 *	A
Southbound Right	0.0 *	A	0.0 *	A
2040 Background				
Northbound Right	0.0 *	A	0.0 *	A
Southbound Right	0.0 *	A	0.0 *	A
2040 Background Plus Project #				
Northbound Right	0.0 *	A	0.0 *	A
Southbound Right	0.0 *	A	0.0 *	A

* = Acceleration Lane with Free Movement; # = Includes Two Eastbound and Westbound Through Lanes

US-24 and (New) Meridian Road

The intersection of US-24 and (New) Meridian Road is currently under construction and is anticipated to be complete by the short-term horizon buildout year. The northbound and southbound Meridian Road approaches are anticipated to provide a left turn lane, two through lanes, and a channelized free right turn lane. The eastbound and westbound US-24 approaches are anticipated to provide a left turn lane, a through lane, and a right turn lane. Therefore, under the proposed configuration and control, the intersection is anticipated to operate at LOS C during the morning peak hour and LOS D during the afternoon peak hour with the addition of project traffic and re-routed traffic from the US-24 and (Old) Meridian Road intersection. By 2040, US-24 was identified as needing to provide two through lanes in each direction. In addition, if 2040 volumes are realized, eastbound dual left turn lanes are likely to be needed due to high volumes of left turns projected at this intersection in the future. With these improvements, this intersection is anticipated to operate acceptably during the peak hours in 2040. **Table 4** provides the results of the level of service at this intersection.

Table 4 – US-24 and (New) Meridian Road LOS Results

Scenario	AM Peak Hour		PM Peak Hour	
	Delay (sec)	LOS	Delay (sec)	LOS
2023 Background	31.9	C	41.8	D
2023 Background Plus Project	31.9	C	41.3	D
2040 Background	74.3	E	131.0	F
2040 Background Plus Project #	32.6	C	42.4	D

= Includes Two Eastbound and Westbound Through Lanes and Eastbound Dual Left Turn Lanes

5.3 Future Intersections

The future intersections of Pacific Avenue/(New) Meridian Road and Pacific Avenue/(Old) Meridian Avenue will provide primary access for the project. The intersection of Pacific Avenue/(New) Meridian Road is proposed to allow three quarter turning movements with westbound left turns being prohibited. The intersection of Pacific Avenue/(Old) Meridian Road is proposed to allow full turning movements. Direct access to the project will be provided from two driveways located along proposed Pacific Avenue extending between (Old) Meridian Road and (New) Meridian Road.

The driveways along Pacific Avenue and (Old) Meridian Road, and the two future access intersections of Pacific Avenue/Meridian Road (New) and Pacific Avenue/Meridian Road (Old) are recommended to provide R1-1 "STOP" signs on the exiting approaches. It is anticipated that single shared movement lanes are sufficient for the exiting approaches of all these access intersections.

A raised "pork-chop" median may be required in the exiting throat of the three-quarter movement access intersection of Pacific Avenue and (New) Meridian Road to prevent left turns onto (New) Meridian Road. A R3-2 "No Left Turn" sign should be installed under the STOP sign of this future intersection.

The future intersection of Swingline Road and (New) Meridian Road is currently being constructed and will open with the completion of (New) Meridian Road in the surrounding area. (New) Meridian Road will provide two through lanes in each direction and separate left and right turn lanes onto Swingline Road. The westbound approach of Swingline Road will operate under stop control and will provide separate left and right turn lanes.

In addition, Swingline Road and (Old) Meridian Road will become a single-lane roundabout. The south leg will provide access to the future Meridian Road/Falcon Park and Ride and terminate approximate 500 feet from the roundabout.

With the recommended lane configurations and control, all the movements at the project accesses and proposed new intersections to the south are anticipated to operate at LOS C or

better during the morning and afternoon peak hour throughout the 2040 horizon. **Table 5** provides the results of the level of service at these intersections.

Table 5 – Project Accesses and Future Intersections LOS Results

Scenario	2023 Total Traffic				2040 Total Traffic			
	AM Peak Hour		PM Peak Hour		AM Peak Hour		PM Peak Hour	
	Delay (sec/veh)	LOS	Delay (sec/veh)	LOS	Delay (sec/veh)	LOS	Delay (sec/veh)	LOS
Pacific Avenue & (New) Meridian Rd (3/4 Mvmts)								
Westbound Right	10.4	B	11.0	B	11.3	B	13.0	B
Southbound Left	8.6	A	9.1	A	9.3	A	10.7	B
Swingline Road & (New) Meridian Road								
Westbound Left	19.8	C	21.3	C	26.3	D	30.1	D
Westbound Right	9.9	A	10.8	B	10.8	B	13.3	B
Southbound Left	9.0	A	9.2	A	10.0	A	10.9	B
Swingline Road & (Old) Meridian Road								
Eastbound Approach	4.5	A	4.8	A	4.7	A	4.8	A
Westbound Approach	5.0	A	4.4	A	5.3	A	4.9	A
Northbound Approach	4.1	A	5.3	A	4.2	A	4.7	A
Southbound Approach	3.9	A	4.3	A	4.1	A	4.8	A
	3.7	A	4.9	A	3.8	A	4.5	A
Pacific Avenue & (Old) Meridian Road								
Northbound Left	7.5	A	7.6	A	7.6	A	7.6	A
Eastbound Approach	10.1	B	10.5	B	10.3	B	10.5	B
Pacific Avenue West Access								
Northbound Approach	12.5	B	11.4	B	12.5	B	11.4	B
Eastbound Left	7.6	A	7.5	A	7.6	A	7.5	A
Westbound Left	7.4	A	7.4	A	7.4	A	7.4	A
Southbound Approach	10.7	B	10.6	B	10.7	B	10.6	B
Pacific Avenue East Access								
Northbound Approach	10.8	B	10.5	B	10.8	B	10.5	B
Eastbound Left	7.5	A	7.6	A	7.5	A	7.6	A
Westbound Left	7.3	A	7.4	A	7.3	A	7.4	A
Southbound Approach	11.2	B	11.5	B	11.2	B	11.5	B
(Old) Meridian Road Access								
Northbound Left	7.4	A	7.5	A	7.4	A	7.5	A
Eastbound Approach	9.3	A	9.7	A	9.4	A	9.7	A

5.4 El Paso County and CDOT Turn Lane Requirement Analysis

El Paso County

The El Paso County ECM was used to determine if left and right turn lanes are warranted along (New) Meridian Road, (Old) Meridian Road, and Pacific Avenue. El Paso County classifies (New) Meridian Road as a minor arterial roadway. According to El Paso County ECM guidelines for Minor Arterials, a left turn lane is required for any access with a project peak hour left turning volume of 25 vehicle per hour or greater whereas a right turn lane is required for any access with a projected peak hour right turning volume of 50 vehicles per hour or greater. (Old). Of note, right turn deceleration lanes may be dropped if the approach volumes is below 150 directional hourly vehicles and left turn deceleration lanes may be dropped if the opposing volumes is predicted to be less than 100 directional hourly vehicles based on the CDOT State Highway Access Code, which is adopted by many jurisdictions for supplementary turn lane guidelines.

Based on 2040 traffic volume projections, a northbound right turn lane is not warranted for the future Pacific Avenue and (New) Meridian Road based on projected 2040 total traffic volumes being 40 northbound right turns during the peak hour and the threshold being 50 vehicles per hour. A southbound left turn lane is warranted for the future Pacific Avenue and (New) Meridian Road based on projected 2040 total traffic volumes being 130 southbound left turns during the peak hour and the threshold being 25 vehicles per hour. In addition, neither right nor left turn lanes are warranted at the project accesses along Pacific Avenue or along (Old) Meridian Road based on turn volumes not meeting the threshold or the opposing/advancing volumes being low.

CDOT

Since US-24 is a state owned and maintained facility, it is recommended that auxiliary turn lanes along US-24 be constructed in accordance with the current CDOT State Highway Access Code (SHAC). CDOT categorizes the segment of US-24 through the study area as E-X: Expressway. According to the State Highway Access Code for category E-X roadways, the following thresholds apply:

- A left turn deceleration lane is required for any access with a projected average daily left turn ingress volume greater than 10 with the transition taper included within the required deceleration length. If the projected peak hour left ingress turning volume is greater than

10 vehicles per hour (vph), a left turn deceleration, storage, and taper lane is required for any access.

- A right turn deceleration lane and taper is required for any access with a projected peak hour right ingress turning volume greater than 10 vph.
- A right turn acceleration lane and taper is required for any access with a project peak hour right turning volume greater than 10 vph.

Based on traffic projections and the above thresholds, auxiliary turn lanes requirements along US-24 with a posted speed limit of 55 miles per hour are as follows:

US-24 and (Old) Meridian Road

- An eastbound right turn deceleration lane exists and **is** warranted based on the projected 2023 background plus project traffic being 85 eastbound right turns during the peak hour and the threshold being 10 vph. The existing right turn lane length is continuous from the eastbound acceleration lane at the (New) Meridian Road and US-24 intersection. The right turn deceleration lane length per SHAC requirements is 600 feet with a 225-foot taper (18.5:1 ratio). Therefore, the 600-foot deceleration lane is not accommodated in the existing combination acceleration to deceleration lane along US-24 from (New) Meridian Road to (Old) Meridian Road.
- A westbound right turn deceleration lane exists and **is** warranted based on the projected 2023 background plus project traffic being 10 westbound right turns during the peak hour and the threshold being 10 vph. The existing right turn lane length is intended to be continuous from the acceleration lane at the driveway to the east.
- An acceleration lane for the northbound right to eastbound through exists and **is** warranted based on the projected 2023 background plus project traffic being 140 northbound right turns during the peak hour and the threshold being 10 vph. The existing acceleration lane length is 500 feet long with a 225-foot taper. The acceleration lane length per SHAC requirements is 960 feet with a 225-foot taper (18.5:1 ratio). A design waiver was likely granted previously by CDOT for the existing substandard acceleration lane length due to the bridge located east of this intersection. It is believed that the existing northbound to eastbound acceleration lane along US-24 should remain at the current length and no mitigation is recommended.

- An acceleration lane for the southbound right to westbound through exists and **is** warranted based on the projected 2023 background plus project traffic being 110 southbound right turns during the peak hour and the threshold being 10 vph. The acceleration lane length per SHAC requirements is 960 feet with a 225-taper (18.5:1 ratio). It is anticipated that with completion of the (New) Meridian Road intersection to the west, a combination acceleration to deceleration lane will extend westbound along US-24 from (Old) Meridian Road to (New) Meridian Road.

US-24 and (New) Meridian Road

The intersection of US-24 and (New) Meridian Road is currently under construction and some turn lanes cannot be determined from the aerials. Therefore, only recommendations based on CDOT standards have been provided for the future auxiliary turn lanes.

- An eastbound right turn deceleration lane **is** warranted based on the projected 2023 background plus project traffic being 215 eastbound right turns during the peak hour and the threshold being 10 vph. The right turn deceleration lane length per SHAC requirements is 600 feet with a 225-foot taper (18.5:1 ratio). The right turn lane is constructed as a continuous lane. By 2040, when two through lanes are recommended, then the right turn lane is recommended to be constructed to SHAC requirements.
- A westbound right turn deceleration lane **is** warranted based on the projected 2023 background plus project traffic being 25 westbound right turns during the peak hour and the threshold being 10 vph. The eastbound right turn lane is anticipated to be continuous from the southbound right acceleration lane at the intersection of US-24 and (Old) Meridian Road.
- An eastbound left turn deceleration **is** warranted based on the projected 2023 background plus project traffic being 525 eastbound left turns during the peak hour and the threshold being 10 vph. The left turn deceleration lane per SHAC requirements is 525 feet of storage plus 600 feet of deceleration length plus a 225-foot taper (18.5:1 ratio). Therefore, the left turn deceleration lane should provide 1,125 feet of length plus a 225-foot taper. If 2040 volumes are realized, eastbound dual left turn lanes will likely be needed at this intersection should provide 965 feet of length per lane plus a 225-foot taper.
- A westbound left turn deceleration **is** warranted based on the projected 2023 background plus project traffic being 255 westbound left turns during the peak hour and

the threshold being 10 vph. The left turn deceleration lane per SHAC requirements is 255 feet of storage plus 600 feet of deceleration length plus a 225-foot taper (18.5:1 ratio). Therefore, the left turn deceleration lane should provide 855 feet of length plus a 225-foot taper. By 2040, the turn lane may need to be extended to 935 feet of length.

- An acceleration lane for the northbound right to eastbound through **is** warranted based on the projected 2023 background plus project traffic being 250 northbound right turns during the peak hour and the threshold being 10 vph. The acceleration lane length per SHAC requirements is 960 feet with a 225-foot taper (18.5:1 ratio). However, it is anticipated that a combination acceleration to deceleration lane will extend eastbound along US-24 from (New) Meridian Road to (Old) Meridian Road.
- An acceleration lane for the southbound right to westbound through **is** warranted based on the projected 2023 background plus project traffic being 500 southbound right turns during the peak hour and the threshold being 10 vph. An acceleration lane has been recently constructed to provide 900 feet in length.

5.5 Queuing Analysis

A queuing analysis was conducted for turn lanes at the study intersections. The queuing analysis was performed using the Synchro analysis software presenting the results of the 95th percentile queue length. Results are shown in the following **Table 6** with calculations provided in **Appendix D** for the unsignalized intersections and **Appendix E** for the signalized intersections.

Table 6 – Turn Lane Length Analysis Results

Intersection Turn Lane	Existing Turn Lane Length (feet)	2023 Total Queue Length (feet)	2023 Recommended Turn Lane Length (feet)	2040 Total Queue Length (feet)	2040 Recommended Turn Lane Length (feet)
US-24 & (New) Meridian					
Eastbound Left	DNE	572'	1125'+225'T	481' DL	965'+225'T DL
Eastbound Right	DNE	38'	C	48'	600'+225'T DL
Westbound Left	DNE	305'	855'+225'T	309'	935'+225'T
Westbound Right	DNE	0'	C	0'	C
Northbound Left	400'	147'	150'	149'	150'
Northbound Right	DNE	0'	155'+160'T	0'	155'+160'T
Southbound Left	150'	79'	150'	87'	150'
Southbound Right	300'	0'	300'	0'	300'
Pacific Ave & (New) Meridian Rd					
Westbound Approach	DNE	25'	C	25'	C
Southbound Left	DNE	25'	100'	25'	100'
Swingline Rd & (New) Meridian					
Westbound Left	DNE	50'	100'	50'	100'
Westbound Right	DNE	25'	C	50'	C
Southbound Left	125'	25'	125'	50'	125'
Swingline Rd & (Old) Meridian					
Eastbound Approach	DNE	25'	C	25'	C
Westbound Approach	DNE	25'	C	25'	C
Northbound Approach	DNE	25'	C	25'	C
Southbound Approach	DNE	25'	C	25'	C
Pacific Ave & (Old) Meridian Rd					
Northbound Left	DNE	25'	C	25'	C
Eastbound Approach	DNE	25'	C	25'	C
Pacific Avenue West Access					
Northbound Approach	DNE	25'	C	25'	C
Eastbound Left	DNE	25'	C	25'	C
Westbound Left	DNE	25'	C	25'	C
Southbound Approach	DNE	25'	C	25'	C
Pacific Avenue East Access					
Northbound Approach	DNE	25'	C	25'	C
Eastbound Left	DNE	25'	C	25'	C
Westbound Left	DNE	25'	C	25'	C
Southbound Approach	DNE	25'	C	25'	C
(Old) Meridian Road Access					
Northbound Left	DNE	25'	C	25'	C
Eastbound Approach	DNE	25'	C	25'	C

DNE = Does Not Exist; T = Taper; DL = Dual Left Turn Lanes; C = Continuous Lane

Results of the queuing analysis indicate that vehicle queues are expected to remain within the provided turn lanes of the studied intersections. In addition, the turn lanes for the eastbound left, eastbound right, westbound left, and westbound right at the intersection of US-24 and (New) Meridian Road have been designed per SHAC requirements.

There is approximately 340 feet of spacing along (New) Meridian Road between US-24 and the proposed Pacific Avenue (measured edge to edge). With the future intersection of Pacific Avenue and (New) Meridian Road being proposed to allow three-quarter turning movements, it is recommended that the northbound left turn lane at the US-24 and (New) Meridian Road intersection be restriped from 400 feet to 150 feet of length to accommodate back-to-back left turn lanes with the future intersection of Pacific Avenue and (New) Meridian Road. Further, the southbound left turn lane at the future Pacific Avenue and (New) Meridian Road intersection should provide 100 feet of length with a reduced shared taper length of 75 feet. A deviation request will need to be provided to allow these substandard left turn lane lengths; however, calculated vehicles are expected to be accommodated within the proposed turn lane lengths.

It is recommended that the existing 400-foot northbound right turn lane at the US-24 and (New) Meridian Road intersection be shortened to 155 feet of length plus a 160-foot taper to accommodate the future intersection of Pacific Avenue and (New) Meridian Road. This new length meets El Paso County standards for a design speed of 40 miles per hour and vehicle queues will be accommodated in this lane as the northbound to eastbound right turn acceleration lane will provide free movements at this intersection.

5.6 Access Spacing and Sight Distance Evaluation

Access Spacing Evaluation

The future Pacific Avenue access along (New) Meridian Road will be located approximately 390 feet south of US-24 (measured centerline to centerline) while the access along (Old) Meridian Road will be located approximately 410 feet south of US-24. According to El Paso County 2016 Major Transportation Corridors Plan Update, Meridian Road to the south of US-24 is classified as a Minor Arterial while (Old) Meridian Road is classified as a collector roadway (although meet the volume threshold for a local roadway) once the (New) Meridian Road realignment is complete. In addition, the proposed Pacific Avenue is classified as a local roadway.

According to the El Paso Engineering Criteria Manual (ECM), spacing of roads accessing an urban minor arterial that will result in a full movement intersection shall be planned at one-quarter mile. It is believed that the new public roadway of Pacific Avenue along (New) Meridian Road should be granted to allow for access to the development area. This Pacific Avenue intersection along (New) Meridian Road is proposed with three-quarter movements with the

exiting left turn movements being restricted. The back-to-back left turn configuration with this proposed access along (New) Meridian Road and the intersection of US-24 and Meridian Road (New) has been discussed in detail above in Section 5.5. According to the El Paso ECM, spacing of intersections along urban arterial roadways a quarter mile whereas intersection spacing along urban collector roadways is 660 feet with 330 feet being acceptable when intersecting local roadways. The spacing of intersections along urban local roadway is 175 feet.

(New) Meridian Road & Pacific Avenue

The intersection access will be approximately 390 feet south of the (New) Meridian Road and US-24 intersection (measured center to center). The intersection spacing is not located a quarter mile (1,320 feet) from an arterial roadway. Therefore, the proposed intersection does not meet ECM standards. The intersection is expected to meet operational, vehicle queue, and sign distance standards; therefore, it is believed that this intersection should be granted to restrict left-out movements. A deviation will be provided in support of allowing a restricted three-quarter intersection.

Pacific Avenue Accesses

Pacific Avenue is expected to be classified as a local street with lower volumes and no intentions of having cut-through traffic. Therefore, Pacific Avenue can follow driveway spacing of a local roadway of 330 feet from an arterial roadway and 150 feet between local intersections. The west access will be approximately 215 feet (measured center to center) east of (New) Meridian Road. The intersection is expected to meet operational and vehicle queue standards; therefore, a deviation will be provided in support of allowing this access. The west access and the east access along Pacific Avenue are offset approximately 515 feet. Therefore, the accesses meet the 150 feet spacing standards. The east access will be approximately 125 feet (measured center to center) west of (Old) Meridian Road. The intersection is expected to meet operational and vehicle queue standards; therefore, a deviation will be provided in support of allowing this access to be spaced less than 175 feet.

(Old) Meridian Road & Pacific Avenue

The proposed intersection access will be approximately 500 feet (measured center to center) south of (Old) Meridian Road and US-24 intersection. The access spacing requirement of a

collector roadway to a local roadway intersection is 330 feet. Therefore, it is believed this access meets the access spacing criteria in the ECM.

The future segment of US-24 near the project site meets El Paso County average daily traffic (ADT) threshold of 40,000 vehicles per day (vpd) for a principal arterial. US-24 is expected to have 24,400 to 18,800 vpd. (New) Meridian Road also meets the ADT for an urban principal arterial with an expected 8,100 to 14,000 vpd. Pacific Road is expected to have approximately 900 to 2,800 vpd which meets the volumes thresholds for an urban local roadway. Swingline Road aligns with the El Paso County roadway threshold of 20,000 vpd for a non-residential urban collector roadway. Swingline Road is expected to have 2,700 to 5,200 vpd. (Old) Meridian Road is classified as a non-residential collector but with an ADT below 3,000 vpd, the roadway aligns meet the volume characteristics of a local urban roadway. **Figure 12** illustrates the circulation plan and street classification map for roadways internal and external to the project.

Sight Distance Evaluation

With AASHTO standards for a roadway design speed of 40 miles per hour along (New) Meridian Road, the intersection sight distance for a vehicle turning right from stop is 390 feet, while the sight distance for a vehicle turning right from stop is 385 feet. Therefore, all obstructions for right turning vehicles from stop should be clear to the left within the triangle created with a vertex point located 14.5 feet from the edge of the major road and a line-of-sight distance of 385 feet located in the middle of the nearest northbound through lane along (New) Meridian Road.

Likewise, with AASHTO standards and a future collector roadway design speed of 35 miles per hour along (Old) Meridian Road, the intersection sight distance for a vehicle turning left from stop is 390 feet, while the sight distance for a vehicle turning right from stop is 335 feet. Therefore, all obstructions for left turning vehicles from stop should be clear to the right within the triangle created with a vertex point located 14.5 feet from the edge of the major road traveled way (typical position of the minor road driver's eye when stopped) and a line-of-sight distance of 390 feet located in the middle of the northbound through lane along (Old) Meridian Road. Likewise, all obstructions for right turning vehicles from stop should be clear to the left within the triangle created with a vertex point located 14.5 feet from the edge of the major road traveled way and a line-of-sight distance of 335 feet located in the middle of the southbound through lane along (Old) Meridian Road.

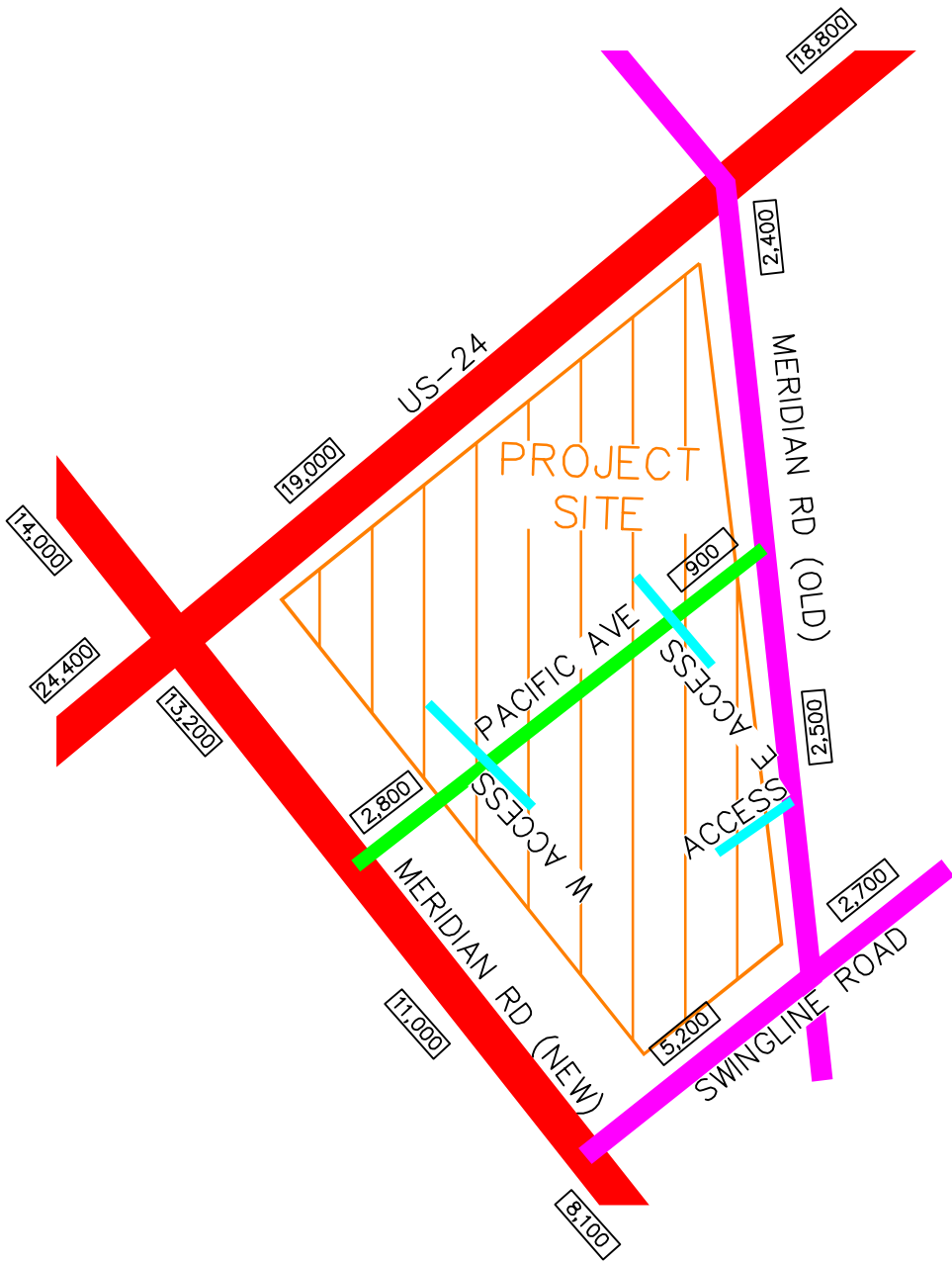

LEGEND

- URBAN PRINCIPAL ARTERIAL
- NON-RESIDENTIAL COLLECTOR
- URBAN LOCAL
- PRIVATE ACCESS
- XX,X00 ESTIMATED 2023 DAILY TRAFFIC VOLUME

CIRCLE K – US-24 & MERIDIAN
 EL PASO COUNTY, COLORADO
 SITE CIRCULATION AND
 ROADWAY CLASSIFICATION

FIGURE 12

It is believed that both accesses are appropriately located to provide the necessary sight distance needed. It is recommended that appropriate sight distance triangles be provided at all site access points to give drivers exiting the development areas a clear view of oncoming traffic. Landscaping and objects within sight triangles must not obstruct drivers' views of the adjacent travel lanes.

5.7 Bicycle and Pedestrian Access

Bicycle lanes and sidewalks are provided along both sides of the recently constructed (New) Meridian Road. Sidewalks are provided on both side of Swingline Road. Adjacent to the site, there are no bicycle lanes or sidewalks along US-24 and (Old) Meridian Road.

5.8 Road Impact Fees

Road impact fees were evaluated based on the El Paso County Road Impact Fee Schedule. Based on these fee schedule guidelines, the fee per general commercial use is \$4,958 per 1,000 square feet and convenience commercial (restaurants and convenience market) is \$8,800 per 1,000 square feet. Therefore, the road impact fee for the proposed Circle K redevelopment is expected to be \$273,314. During the final plat process, the project team will determine if the impact fees are paid up front or if the property will be included in one of the available public improvement districts with reduced upfront costs. The project team will determine payment methods with the final plat. Of note, the applicant petitions to credit the (Old) Meridian Road improvements as an eligible improvement towards the road impact fee.

Table 7 – Road Impact Fees

Use	KSF	Fee / Unit	Total Fee
General Commercial	23	\$4,958	\$114,034
Restaurants & Gas Station	18.1	\$8,800	\$159,280

5.9 Improvement Summary

Based on the results of the intersection operational and queuing analysis, the recommended lane configurations and control at the study key intersection and project access in 2023 and 2040 are shown in **Figure 13** and **Figure 14**, respectively.

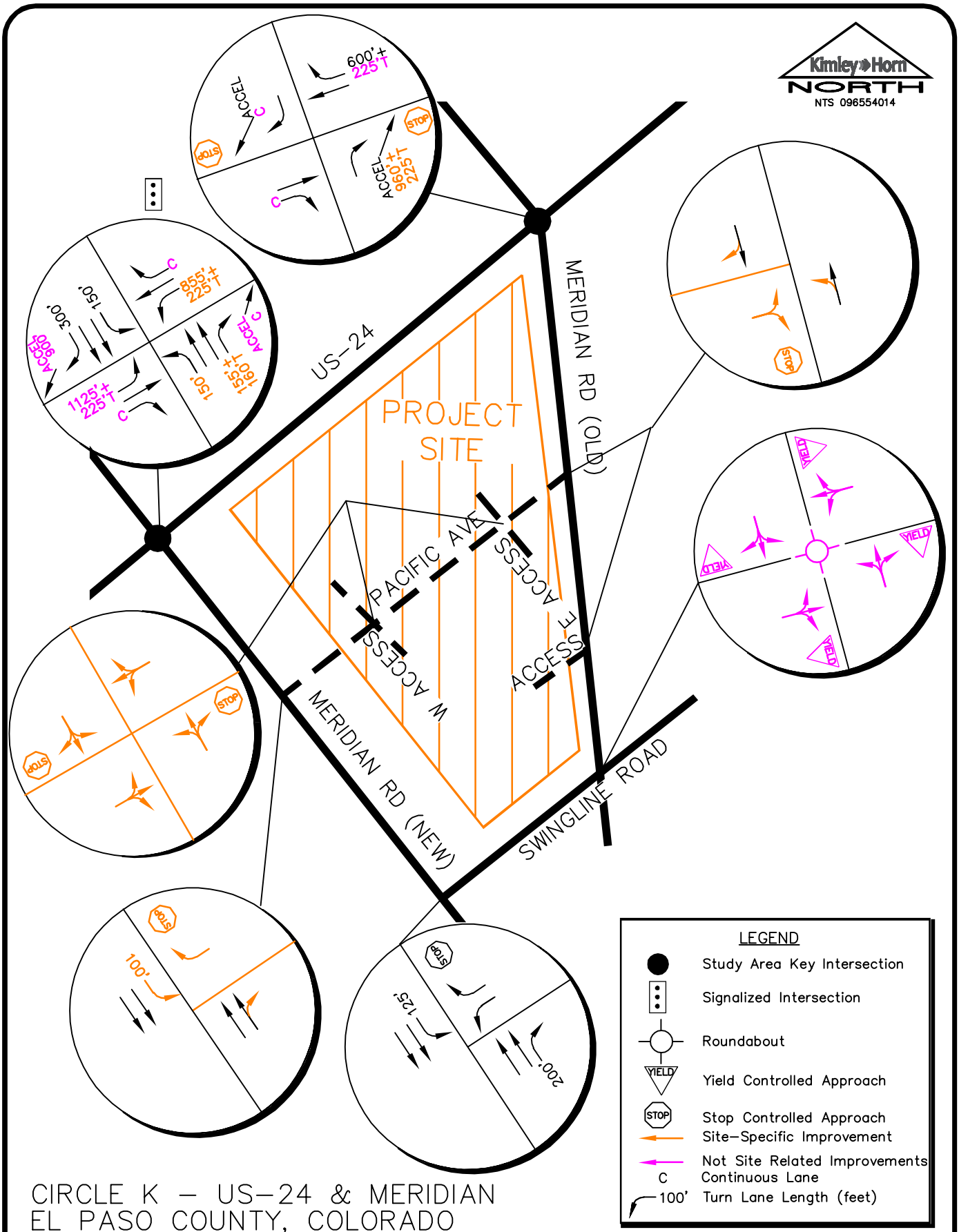

CIRCLE K – US-24 & MERIDIAN
 EL PASO COUNTY, COLORADO
 2023 RECOMMENDED LANE
 CONFIGURATIONS AND CONTROL

FIGURE 13

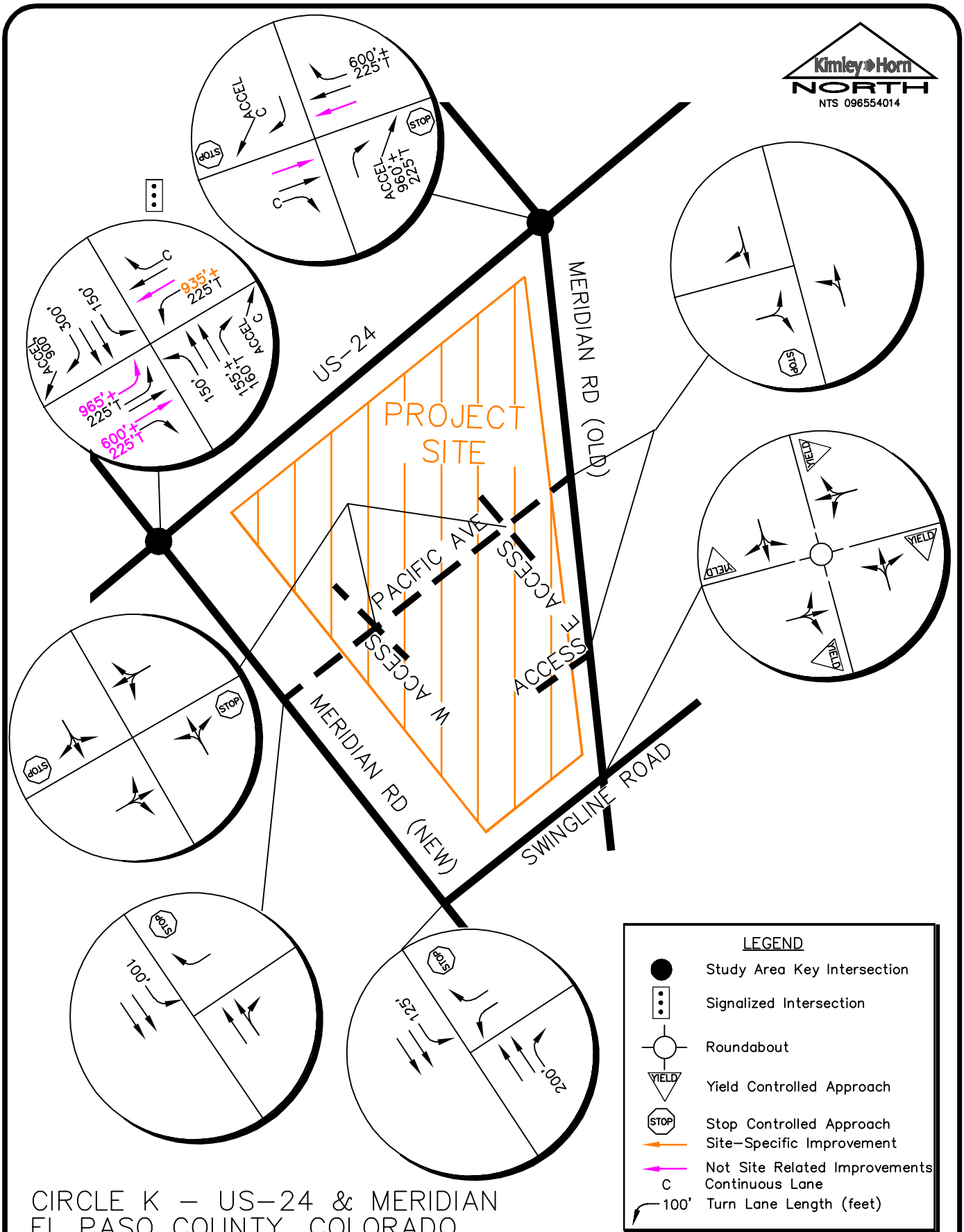

CIRCLE K – US-24 & MERIDIAN
 EL PASO COUNTY, COLORADO
 2040 RECOMMENDED LANE
 CONFIGURATIONS AND CONTROL

FIGURE 14

6.0 CONCLUSIONS AND RECOMMENDATIONS

Based on the analysis presented in this report, Kimley-Horn believes the redeveloped Circle K project with the adjacent retail and restaurant space will be successfully incorporated into the existing and future roadway network. The proposed project development and expected traffic volumes resulted in the following recommendations and conclusions:

2023 Recommendations:

- The following improvements are recommended in association with the project:
 - Pacific Avenue will be constructed as a public right-of-way within the development area with a Urban Non-Residential Collector classification between New Meridian Road and Old Meridian Road. The future intersections of Pacific Avenue/(New) Meridian Road and Pacific Avenue/(Old Meridian Avenue will provide primary access for the project. The intersection of Pacific Avenue/(New) Meridian Road is proposed to allow three quarter turning movements with westbound left turns being prohibited. The intersection of Pacific Avenue/(Old) Meridian Road is proposed to allow full turning movements. Direct access to the project will be provided from two driveways located along the proposed Pacific Avenue roadway extending between (Old) Meridian Road and (New) Meridian Road.
 - The driveway accesses along Pacific Avenue and (Old) Meridian Road, and the two future access intersections of Pacific Avenue/Meridian Road (New) and Pacific Avenue/Meridian Road (Old) are recommended to provide R1-1 “STOP” signs on the exiting approaches. It is anticipated that single shared movement lanes are sufficient for the exiting approaches of all these access intersections. A raised “pork-chop” median may be required in the exiting throat of the three-quarter movement access intersection of Pacific Avenue and (New) Meridian Road to prevent left turns onto (New) Meridian Road. A R3-2 “No Left Turn” sign should be installed under the STOP sign of this future intersection. A northbound right turn lane should be provided at the proposed Pacific Avenue and (New) Meridian Road intersection.
 - There is approximately 340 feet of spacing along (New) Meridian Road between US-24 and the proposed Pacific Avenue (measured edge to edge). With the future

- intersection of Pacific Avenue and (New) Meridian Road being proposed to allow three-quarter turning movements, it is recommended that the northbound left turn lane at the US-24 and (New) Meridian Road intersection be restriped from 400 feet to 150 feet of length to accommodate back-to-back left turn lanes with the future intersection of Pacific Avenue and (New) Meridian Road. Further, the southbound left turn lane at the future Pacific Avenue and (New) Meridian Road intersection should provide 100 feet of length with a reduced shared taper length of 75 feet. A deviation request will need to be provided to allow these substandard left turn lane lengths; however, calculated vehicle queues are expected to be accommodated within the proposed left turn lane lengths.
- It is recommended that the existing 400-foot northbound right turn lane at the US-24 and (New) Meridian Road intersection be shortened to 155 feet of length plus a 160-foot taper to accommodate the future intersection of Pacific Avenue and (New) Meridian Road. This new length meets El Paso County standards for a design speed of 40 miles per hour and vehicle queues will be accommodated in this lane as the northbound to eastbound right turn acceleration lane will provide free movements at this intersection.
 - It is understood that El Paso County may require a 10-foot additional right-of-way dedication along Old Meridian Road to bring the roadway up to the Urban Non-Residential Collector standard from US-24 to Swingline Road adjacent to the project development. A request of the Advisory Committee will be provided to obtain possible credits from the Road Impact Fee associated with this improvement.
- The following improvements along US-24 were completed by CDOT in association with the ongoing realignment of Meridian Road:
 - CDOT will convert the signalized intersection of US-24 and (Old) Meridian Road to an unsignalized intersection. Further, this intersection will be restricted to right-in/right-out only movements with stop control along the northbound and southbound (Old) Meridian Road approaches.

- With completion of the new alignment of Meridian Road, it is anticipated that CDOT will construct a combination right turn acceleration to deceleration lane that will extend eastbound along US-24 from (New) Meridian Road to (Old) Meridian Road. Likewise, a combination right turn acceleration to deceleration lane will extend westbound along US-24 from (Old) Meridian Road to (New) Meridian Road.
- A 600-foot eastbound right turn deceleration lane with a 225-foot taper is recommended at the intersection of US-24 and (New) Meridian Road. A 1,125-foot left turn lane with a 225-foot taper is also recommended along the eastbound approach of this intersection. Likewise, a westbound left turn lane with a length of 855 feet is recommended at the US-24 and (New) Meridian Road intersection. Lastly, a southbound Meridian Road to westbound US-24 right turn acceleration is recommended with a length of 960 feet plus a 225-foot taper. All these improvements meet CDOT SHAC standards.
- Required Access Deviations
 - The intersection of Pacific Avenue will be approximately 390 feet south of the (New) Meridian Road and US-24 intersection (measured center to center). The intersection spacing is not located a quarter mile (1,320 feet) from an arterial roadway. Therefore, the proposed intersection does not meet ECM standards. The intersection is expected to meet operational, vehicle queue, and sign distance standards; therefore, it is believed that this intersection should be granted to restrict left-out movements. A deviation will be provided in support of allowing a restricted three-quarter intersection.
 - Pacific Avenue is expected to be classified as a local street with lower volumes and no intentions of having cut-through traffic. Therefore, Pacific Avenue can follow driveway spacing of a local roadway of 330 feet from an arterial roadway and 150 feet between local intersections. The west access will be approximately 215 feet (measured center to center) east of (New) Meridian Road. The intersection is expected to meet operational and vehicle queue standards; therefore, a deviation will be provided in support of allowing this access. The west access and the east access along Pacific Avenue are offset approximately 515 feet. Therefore, the accesses

meet the 150 feet spacing standards. The east access will be approximately 125 feet (measured center to center) west of (Old) Meridian Road. The intersection is expected to meet operational and vehicle queue standards; therefore, a deviation will be provided in support of allowing this access to be spaced less than 175 feet.

- The proposed intersection access will be approximately 500 feet (measured center to center) south of (Old) Meridian Road and US-24 intersection. The access spacing requirement of a collector roadway to a local roadway intersection is 330 feet. Therefore, it is believed this access meets the access spacing criteria in the ECM.

2040 Recommendations:

- If future traffic volume projections materialize, US-24 will need to be improved to provide at least two through lanes in each direction throughout the study area.
- The westbound left turn lane at the US-24 and Meridian Road intersection may need to be extended from 855 feet to 935 feet of length.
- The eastbound approach of the US-24 and Meridian Road intersection may need to provide dual left turn lanes with 965 feet of length per lane.

General Recommendations:

- All on-site and off-site signing and striping improvements should be incorporated into the Civil Drawings and conform to El Paso County Standards as well as the Manual on Uniform Traffic Control Devices – 2009 Edition (MUTCD).

APPENDICES

APPENDIX A

Intersection Count Sheets



Ridgeview Data
Collection

Falcon, CO
Circle K - US24 & Meridian
AM Peak
US-24 & Meridian Rd

File Name : US24 and Meridian AM
Site Code : IPO 538
Start Date : 4/15/2021
Page No : 2

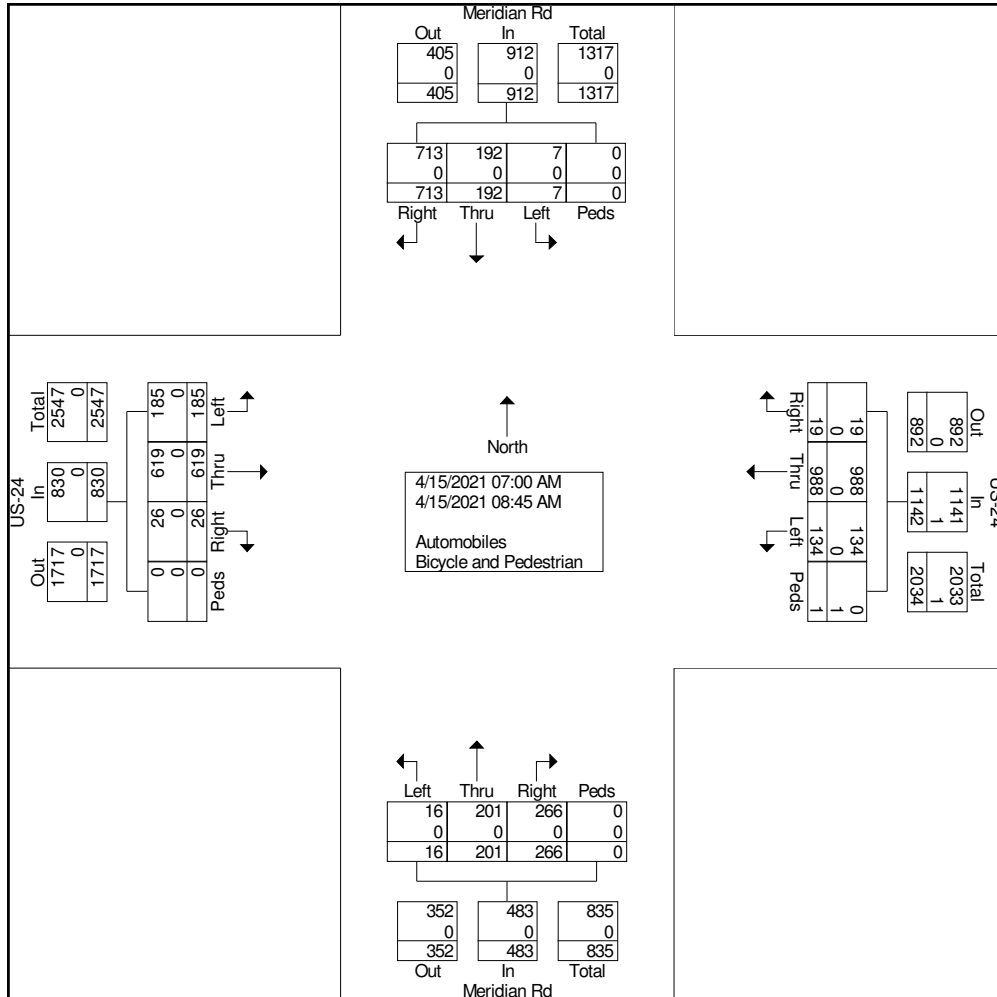



Ridgeview Data
Collection

Falcon, CO
Circle K - US24 & Meridian
AM Peak
US-24 & Meridian Rd

File Name : US24 and Meridian AM
Site Code : IPO 538
Start Date : 4/15/2021
Page No : 3

Start Time	US-24 Eastbound					US-24 Westbound					Meridian Rd Northbound					Meridian Rd Southbound					Int. Total
	Left	Thru	Right	Peds	App. Total	Left	Thru	Right	Peds	App. Total	Left	Thru	Right	Peds	App. Total	Left	Thru	Right	Peds	App. Total	
Peak Hour Analysis From 07:00 AM to 08:45 AM - Peak 1 of 1																					
Peak Hour for Entire Intersection Begins at 07:00 AM																					
07:00 AM	20	70	3	0	93	16	166	2	0	184	3	25	37	0	65	1	18	127	0	146	488
07:15 AM	26	85	0	0	111	11	164	3	0	178	2	15	42	0	59	0	25	114	0	139	487
07:30 AM	22	78	3	0	103	24	151	2	0	177	5	20	25	0	50	0	31	135	0	166	496
07:45 AM	22	73	3	0	98	26	110	4	0	140	1	24	45	0	70	1	23	95	0	119	427
Total Volume	90	306	9	0	405	77	591	11	0	679	11	84	149	0	244	2	97	471	0	570	1898
% App. Total	22.2	75.6	2.2	0		11.3	87	1.6	0		4.5	34.4	61.1	0		0.4	17	82.6	0		
PHF	.865	.900	.750	.000	.912	.740	.890	.688	.000	.923	.550	.840	.828	.000	.871	.500	.782	.872	.000	.858	.957

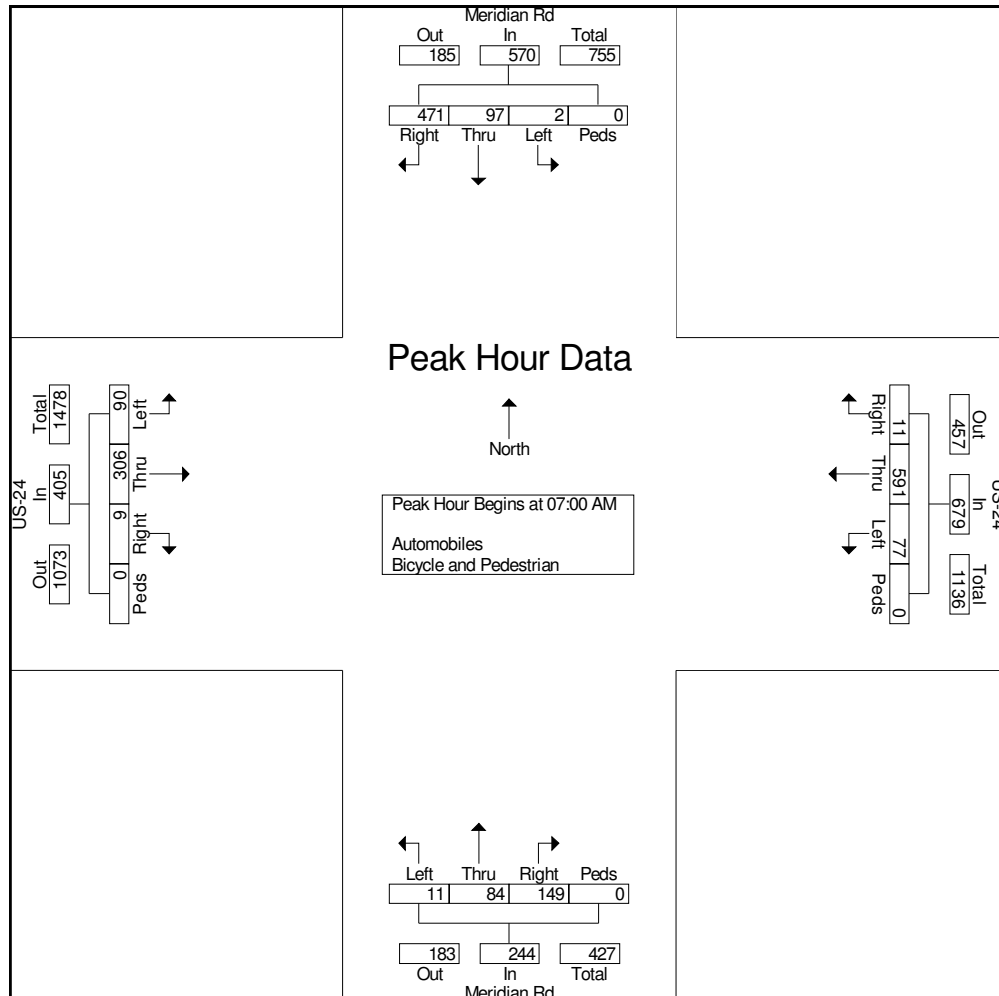



Ridgeview Data Collection

Falcon, CO
Circle K - US24 & Meridian
PM Peak
US-24 & Meridian Rd

File Name : US24 and Meridian PM
Site Code : IPO 538
Start Date : 4/14/2021
Page No : 2

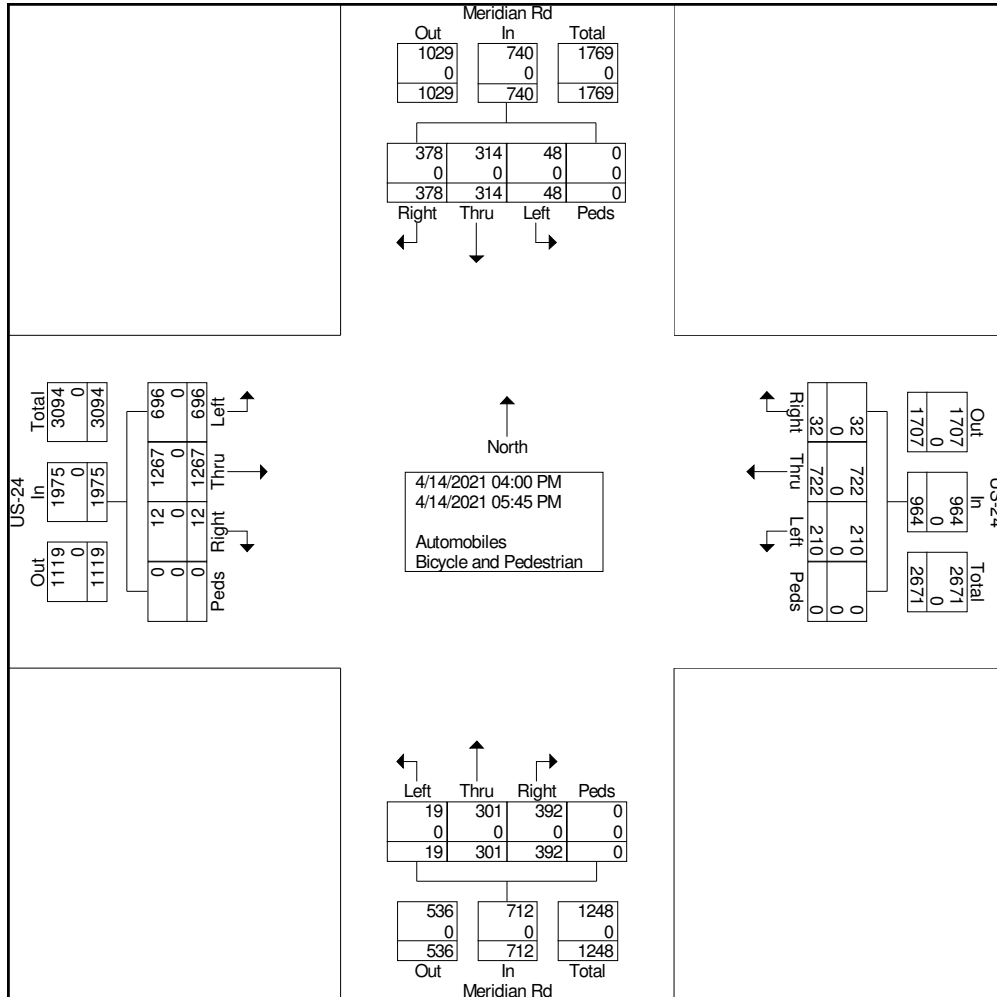



Ridgeview Data
Collection

Falcon, CO
Circle K - US24 & Meridian
PM Peak
US-24 & Meridian Rd

File Name : US24 and Meridian PM
Site Code : IPO 538
Start Date : 4/14/2021
Page No : 3

Start Time	US-24 Eastbound					US-24 Westbound					Meridian Rd Northbound					Meridian Rd Southbound					Int. Total
	Left	Thru	Right	Peds	App. Total	Left	Thru	Right	Peds	App. Total	Left	Thru	Right	Peds	App. Total	Left	Thru	Right	Peds	App. Total	
Peak Hour Analysis From 04:00 PM to 05:45 PM - Peak 1 of 1																					
Peak Hour for Entire Intersection Begins at 04:30 PM																					
04:30 PM	74	159	1	0	234	18	101	4	0	123	0	47	53	0	100	6	38	56	0	100	557
04:45 PM	88	150	1	0	239	27	89	9	0	125	5	39	62	0	106	6	39	40	0	85	555
05:00 PM	87	149	3	0	239	32	90	2	0	124	3	41	62	0	106	3	53	41	0	97	566
05:15 PM	91	154	1	0	246	23	88	4	0	115	2	39	54	0	95	4	43	56	0	103	559
Total Volume	340	612	6	0	958	100	368	19	0	487	10	166	231	0	407	19	173	193	0	385	2237
% App. Total	35.5	63.9	0.6	0		20.5	75.6	3.9	0		2.5	40.8	56.8	0		4.9	44.9	50.1	0		
PHF	.934	.962	.500	.000	.974	.781	.911	.528	.000	.974	.500	.883	.931	.000	.960	.792	.816	.862	.000	.934	.988

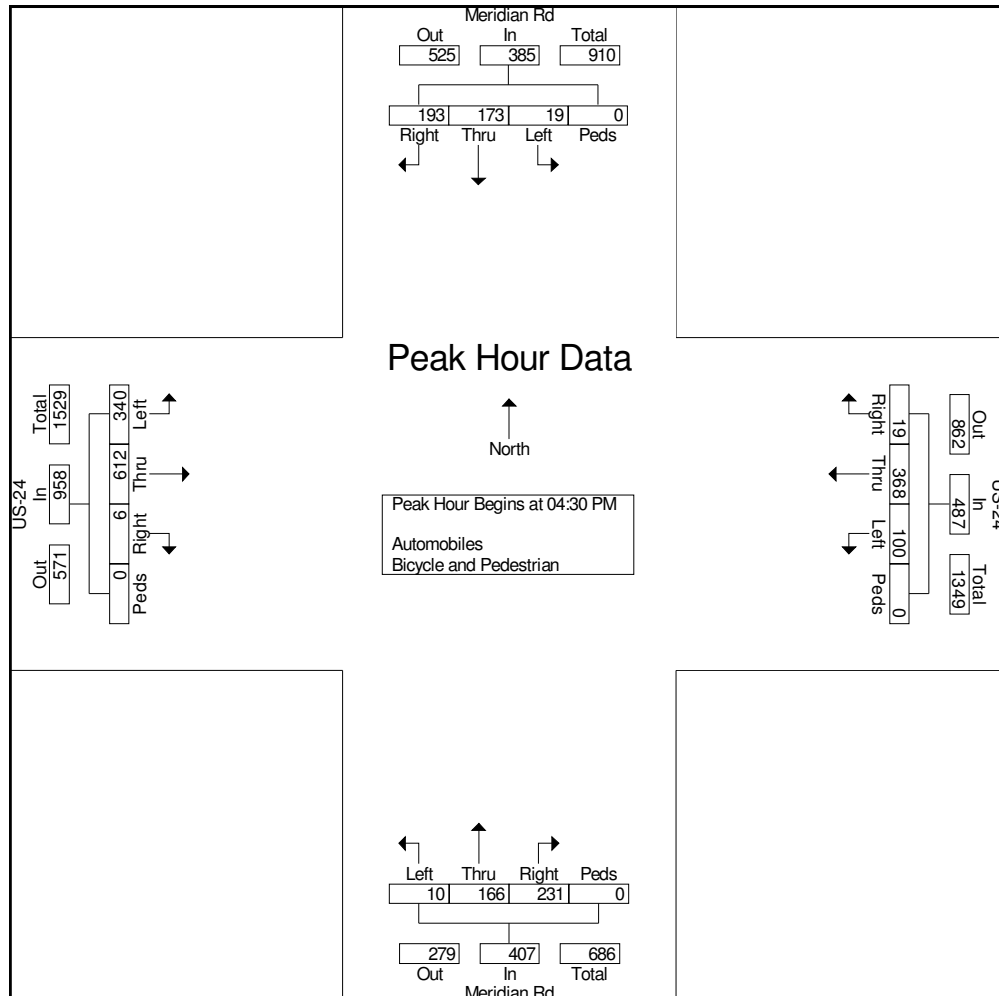



Ridgeview Data
Collection

Falcon, CO
Circle K - US24 & Meridian
AM Peak
Meridian Circle K Access

File Name : Meridian CircleK Access AM
Site Code : IPO 538
Start Date : 4/15/2021
Page No : 2

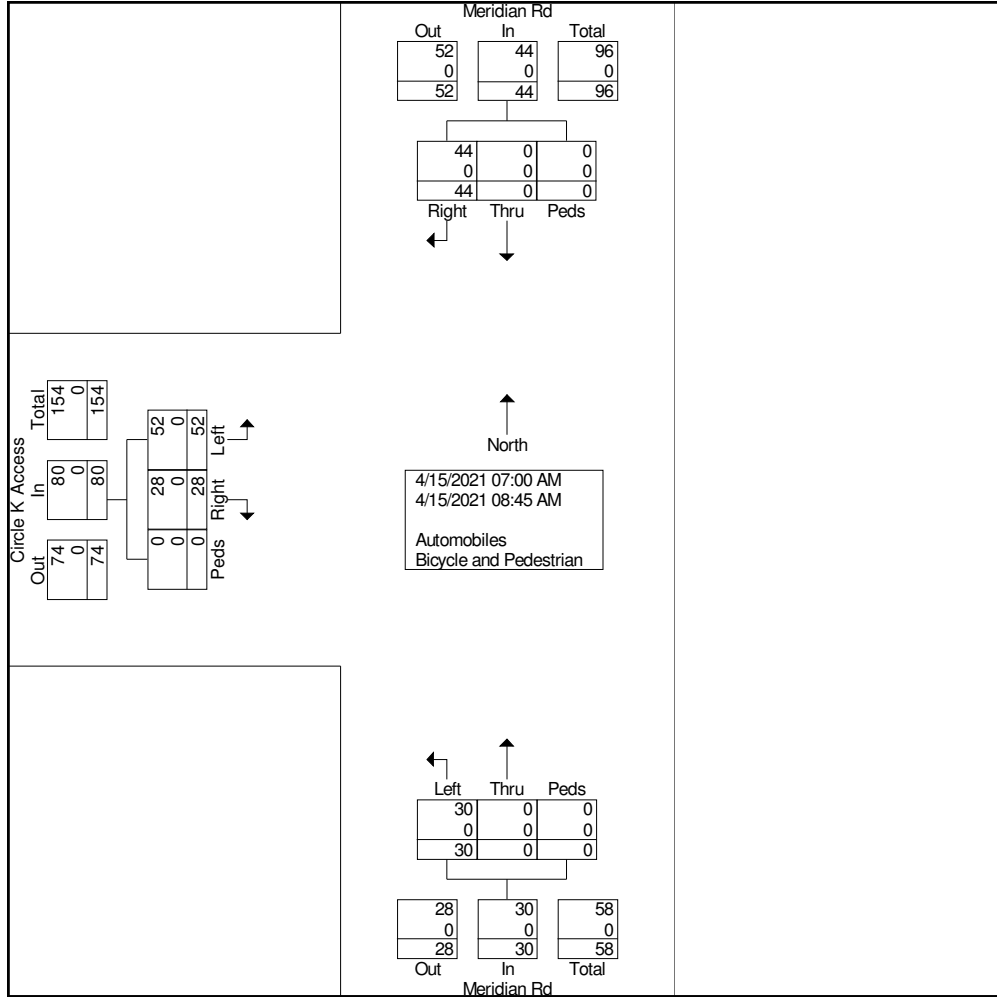



Ridgeview Data
Collection

Falcon, CO
Circle K - US24 & Meridian
AM Peak
Meridian Circle K Access

File Name : Meridian CircleK Access AM
Site Code : IPO 538
Start Date : 4/15/2021
Page No : 3

Start Time	Circle K Access Eastbound				Meridian Rd Northbound				Meridian Rd Southbound				Int. Total
	Left	Right	Peds	App. Total	Left	Thru	Peds	App. Total	Thru	Right	Peds	App. Total	
Peak Hour Analysis From 07:00 AM to 08:45 AM - Peak 1 of 1													
Peak Hour for Entire Intersection Begins at 07:30 AM													
07:30 AM	4	8	0	12	5	0	0	5	0	9	0	9	26
07:45 AM	7	3	0	10	6	0	0	6	0	3	0	3	19
08:00 AM	6	4	0	10	2	0	0	2	0	10	0	10	22
08:15 AM	5	4	0	9	5	0	0	5	0	4	0	4	18
Total Volume	22	19	0	41	18	0	0	18	0	26	0	26	85
% App. Total	53.7	46.3	0		100	0	0		0	100	0		
PHF	.786	.594	.000	.854	.750	.000	.000	.750	.000	.650	.000	.650	.817

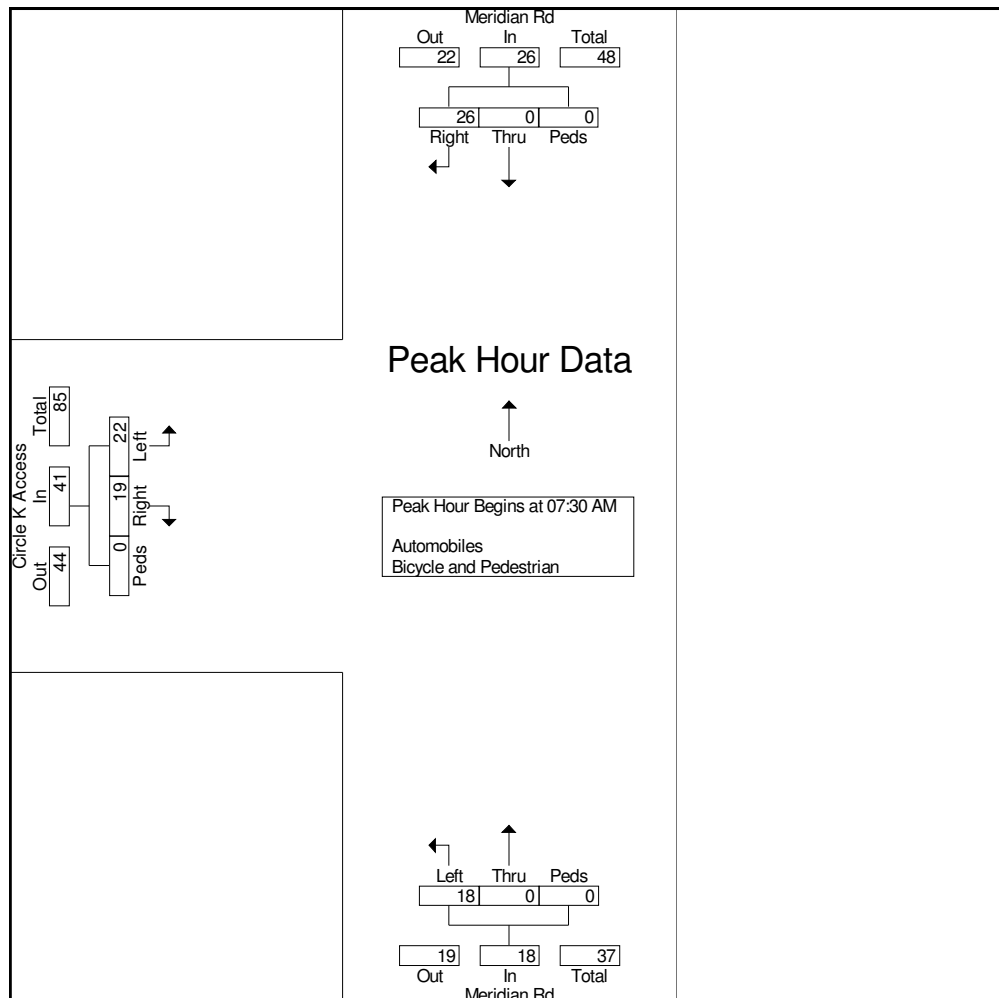



Ridgeview Data
Collection

Falcon, CO
Circle K - US24 & Meridian
PM Peak
Meridian Circle K Access

File Name : Meridian CircleK Access PM
Site Code : IPO 538
Start Date : 4/14/2021
Page No : 2

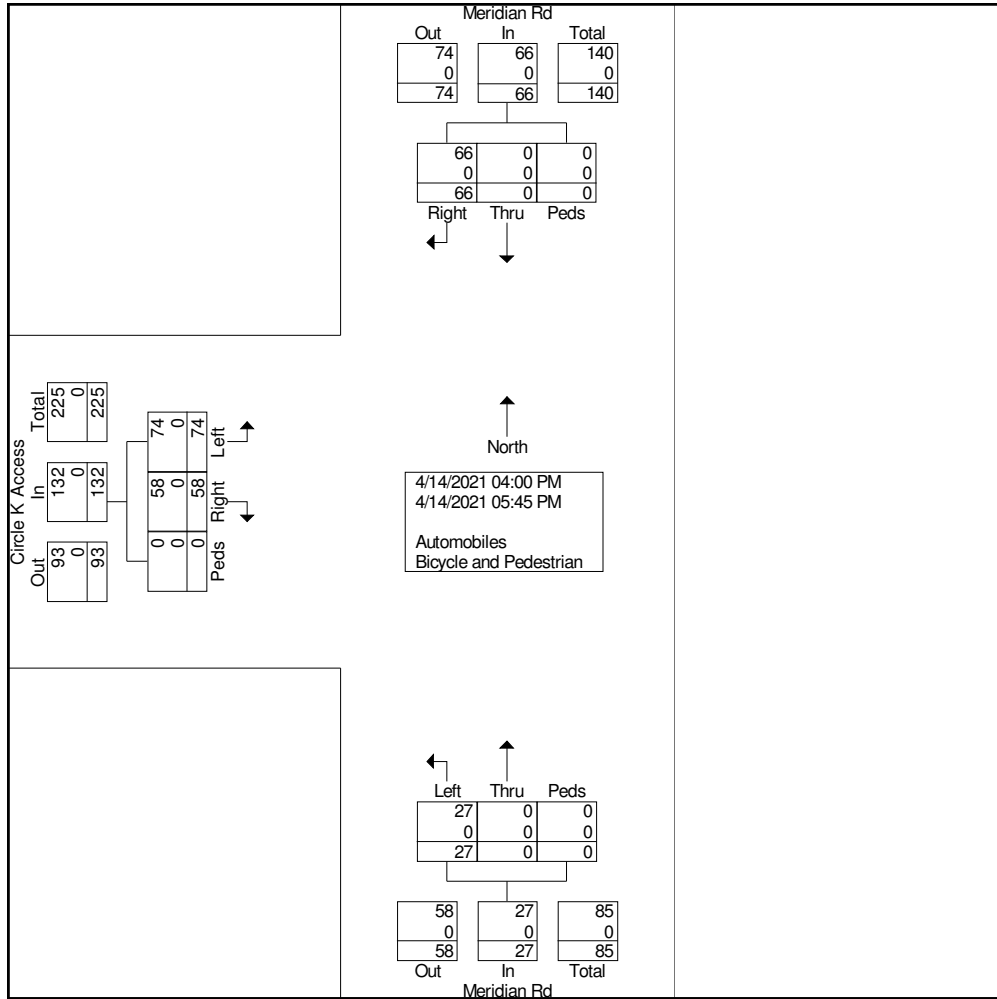



Ridgeview Data
Collection

Falcon, CO
Circle K - US24 & Meridian
PM Peak
Meridian Circle K Access

File Name : Meridian CircleK Access PM
Site Code : IPO 538
Start Date : 4/14/2021
Page No : 3

Start Time	Circle K Access Eastbound				Meridian Rd Northbound				Meridian Rd Southbound				Int. Total
	Left	Right	Peds	App. Total	Left	Thru	Peds	App. Total	Thru	Right	Peds	App. Total	
Peak Hour Analysis From 04:00 PM to 05:45 PM - Peak 1 of 1													
Peak Hour for Entire Intersection Begins at 05:00 PM													
05:00 PM	12	10	0	22	2	0	0	2	0	8	0	8	32
05:15 PM	10	7	0	17	1	0	0	1	0	7	0	7	25
05:30 PM	10	8	0	18	3	0	0	3	0	14	0	14	35
05:45 PM	9	4	0	13	3	0	0	3	0	8	0	8	24
Total Volume	41	29	0	70	9	0	0	9	0	37	0	37	116
% App. Total	58.6	41.4	0		100	0	0		0	100	0		
PHF	.854	.725	.000	.795	.750	.000	.000	.750	.000	.661	.000	.661	.829

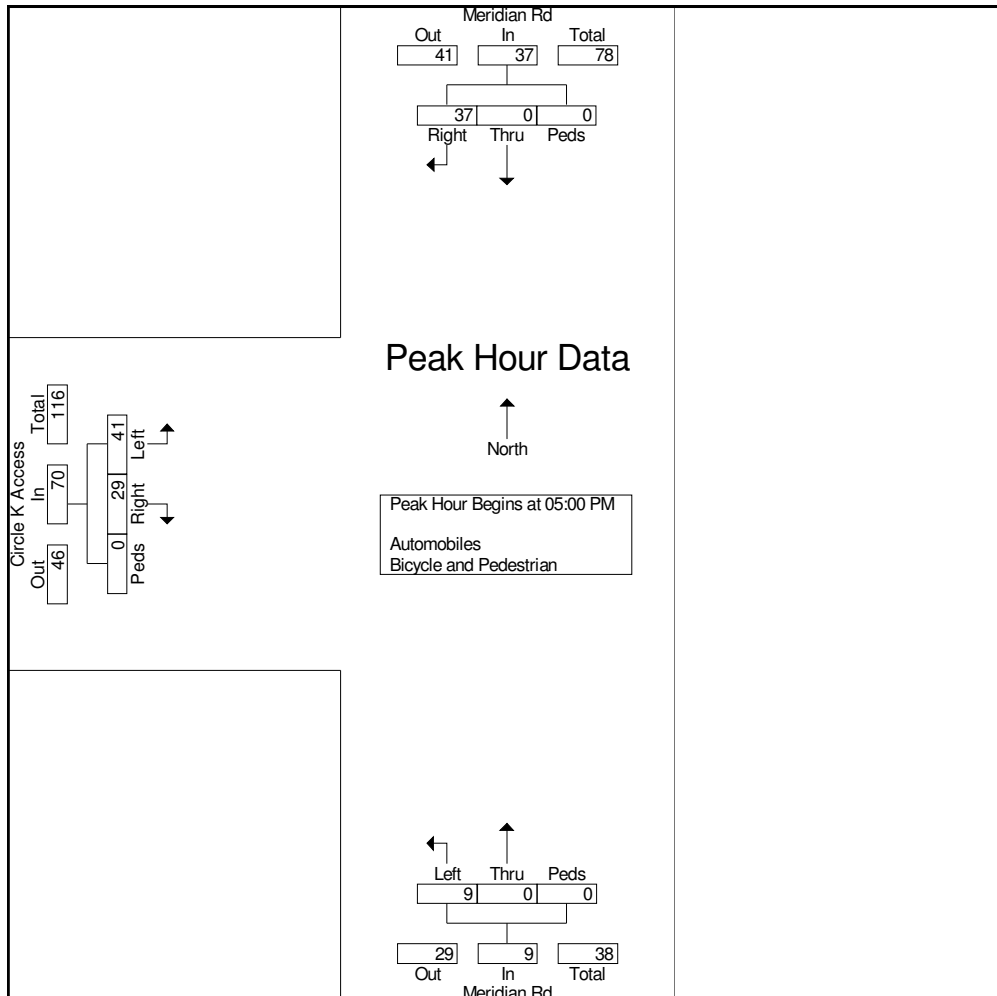



Ridgeview Data
Collection

Falcon, CO
Circle K - US24 & Meridian
AM Peak
US-24 Circle K Access

File Name : US24 CircleK Access AM
Site Code : IPO 538
Start Date : 4/15/2021
Page No : 2

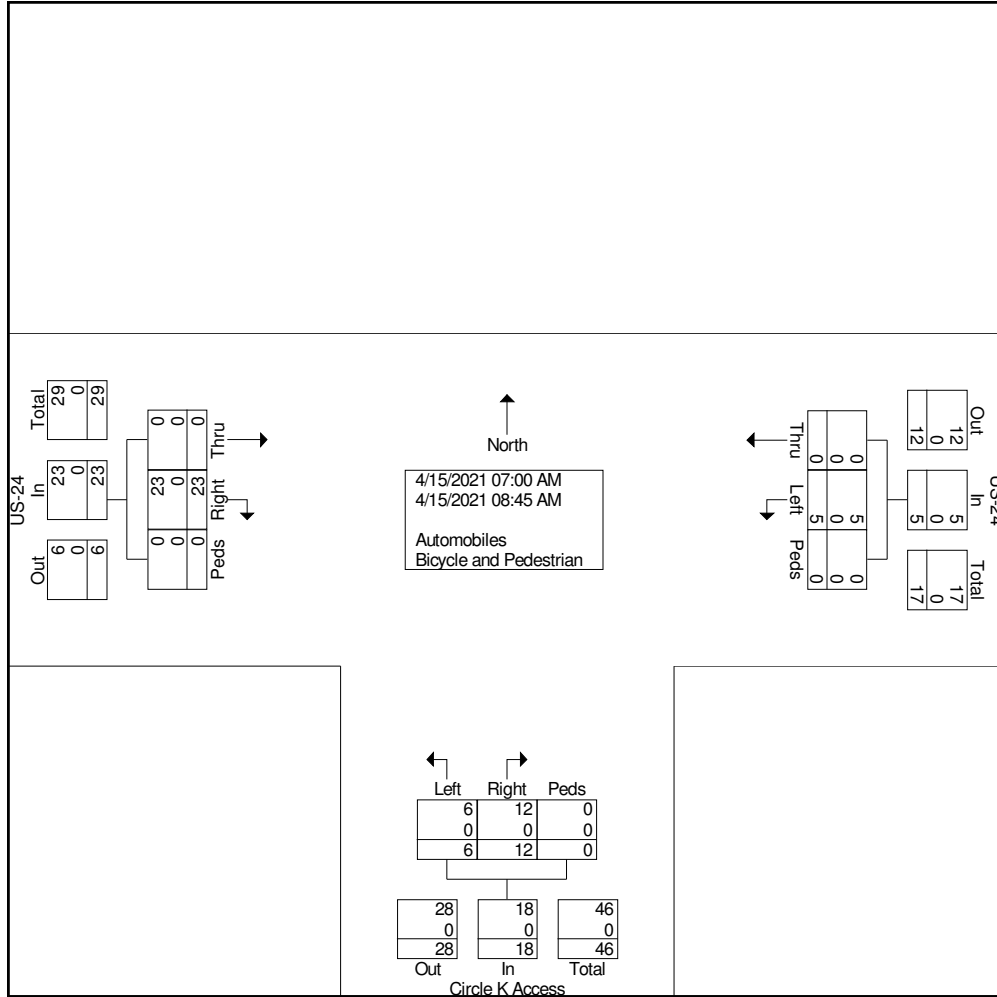



Ridgeview Data
Collection

Falcon, CO
Circle K - US24 & Meridian
AM Peak
US-24 Circle K Access

File Name : US24 CircleK Access AM
Site Code : IPO 538
Start Date : 4/15/2021
Page No : 3

Start Time	US-24 Eastbound				US-24 Westbound				Circle K Access Northbound				Int. Total
	Thru	Right	Peds	App. Total	Left	Thru	Peds	App. Total	Left	Right	Peds	App. Total	
Peak Hour Analysis From 07:00 AM to 08:45 AM - Peak 1 of 1													
Peak Hour for Entire Intersection Begins at 07:15 AM													
07:15 AM	0	6	0	6	0	0	0	0	0	2	0	2	8
07:30 AM	0	3	0	3	2	0	0	2	1	0	0	1	6
07:45 AM	0	0	0	0	2	0	0	2	0	2	0	2	4
08:00 AM	0	2	0	2	0	0	0	0	2	3	0	5	7
Total Volume	0	11	0	11	4	0	0	4	3	7	0	10	25
% App. Total	0	100	0		100	0	0		30	70	0		
PHF	.000	.458	.000	.458	.500	.000	.000	.500	.375	.583	.000	.500	.781

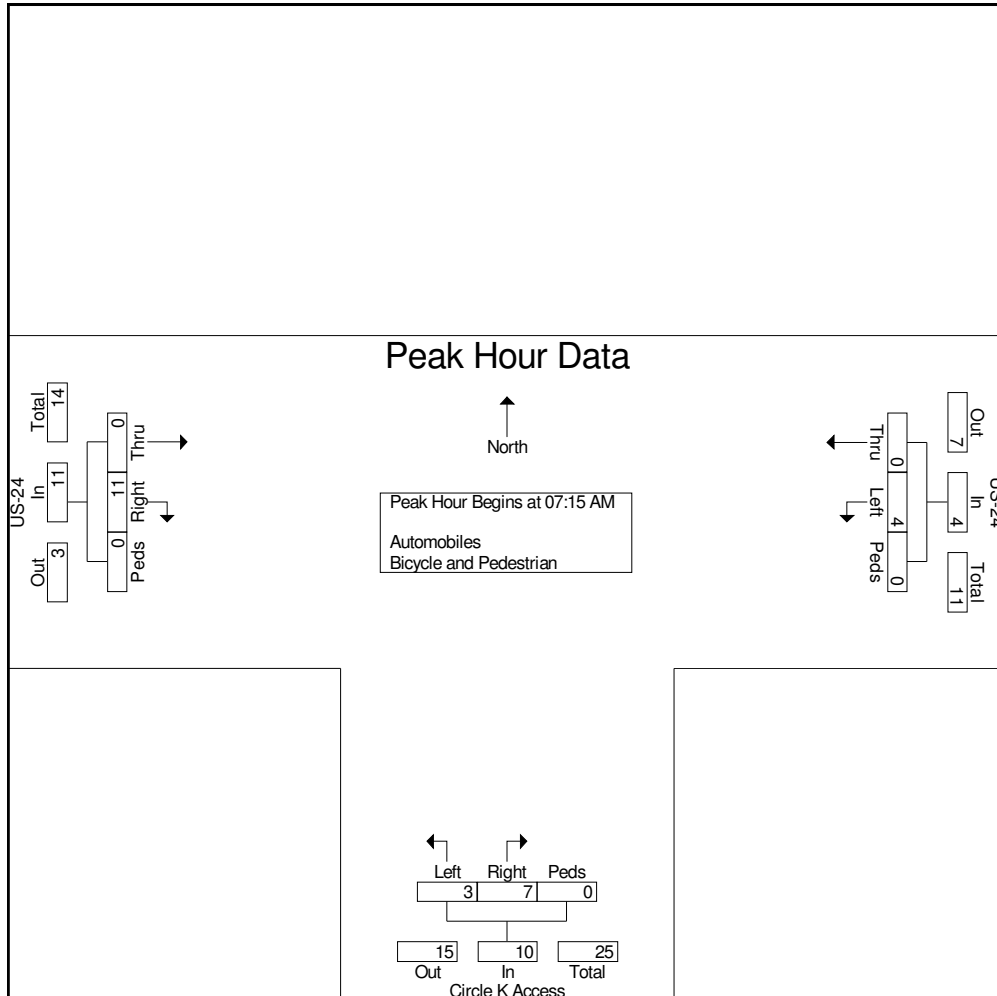



Ridgeview Data Collection

Falcon, CO
Circle K - US24 & Meridian
PM Peak
US-24 Circle K Access

File Name : US24 CircleK Access PM
Site Code : IPO 538
Start Date : 4/14/2021
Page No : 2

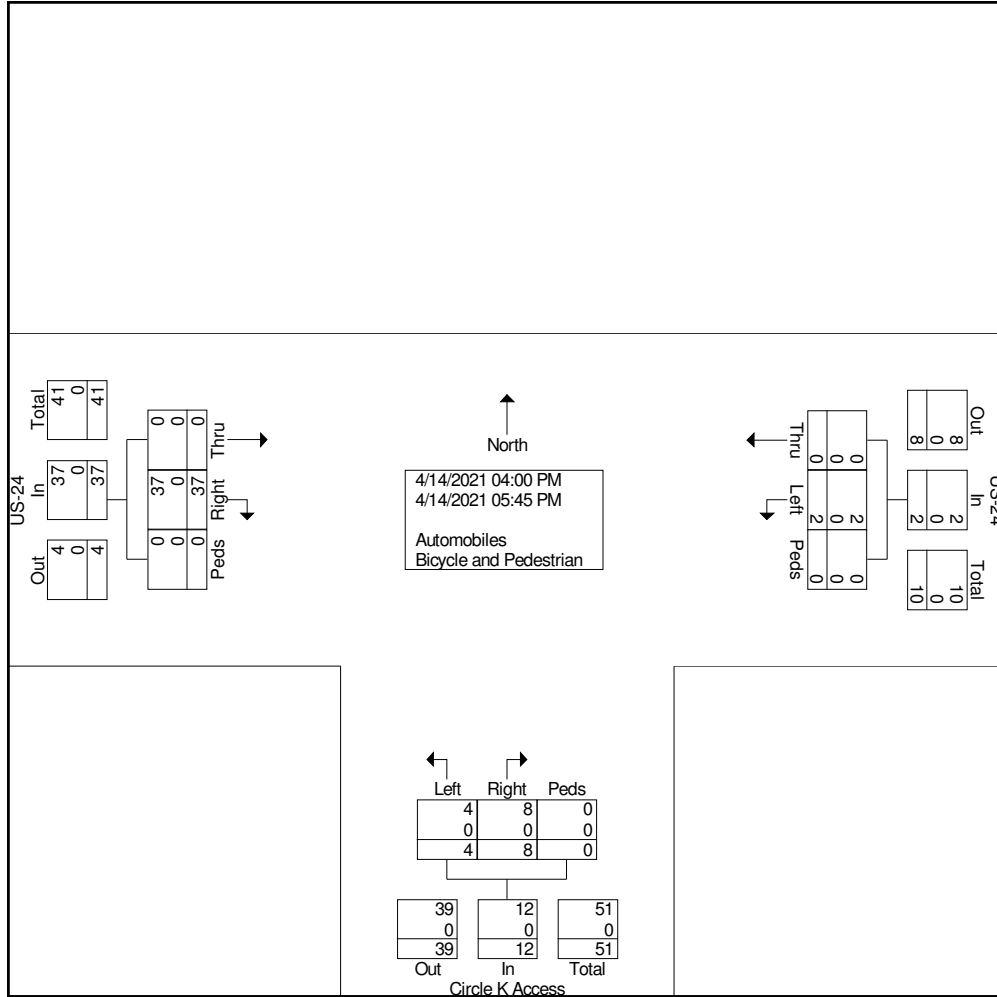



Ridgeview Data
Collection

Falcon, CO
Circle K - US24 & Meridian
PM Peak
US-24 Circle K Access

File Name : US24 CircleK Access PM
Site Code : IPO 538
Start Date : 4/14/2021
Page No : 3

Start Time	US-24 Eastbound				US-24 Westbound				Circle K Access Northbound				Int. Total
	Thru	Right	Peds	App. Total	Left	Thru	Peds	App. Total	Left	Right	Peds	App. Total	
Peak Hour Analysis From 04:00 PM to 05:45 PM - Peak 1 of 1													
Peak Hour for Entire Intersection Begins at 04:45 PM													
04:45 PM	0	4	0	4	0	0	0	0	1	2	0	3	7
05:00 PM	0	5	0	5	0	0	0	0	0	0	0	0	5
05:15 PM	0	9	0	9	0	0	0	0	0	1	0	1	10
05:30 PM	0	5	0	5	1	0	0	1	2	0	0	2	8
Total Volume	0	23	0	23	1	0	0	1	3	3	0	6	30
% App. Total	0	100	0		100	0	0		50	50	0		
PHF	.000	.639	.000	.639	.250	.000	.000	.250	.375	.375	.000	.500	.750

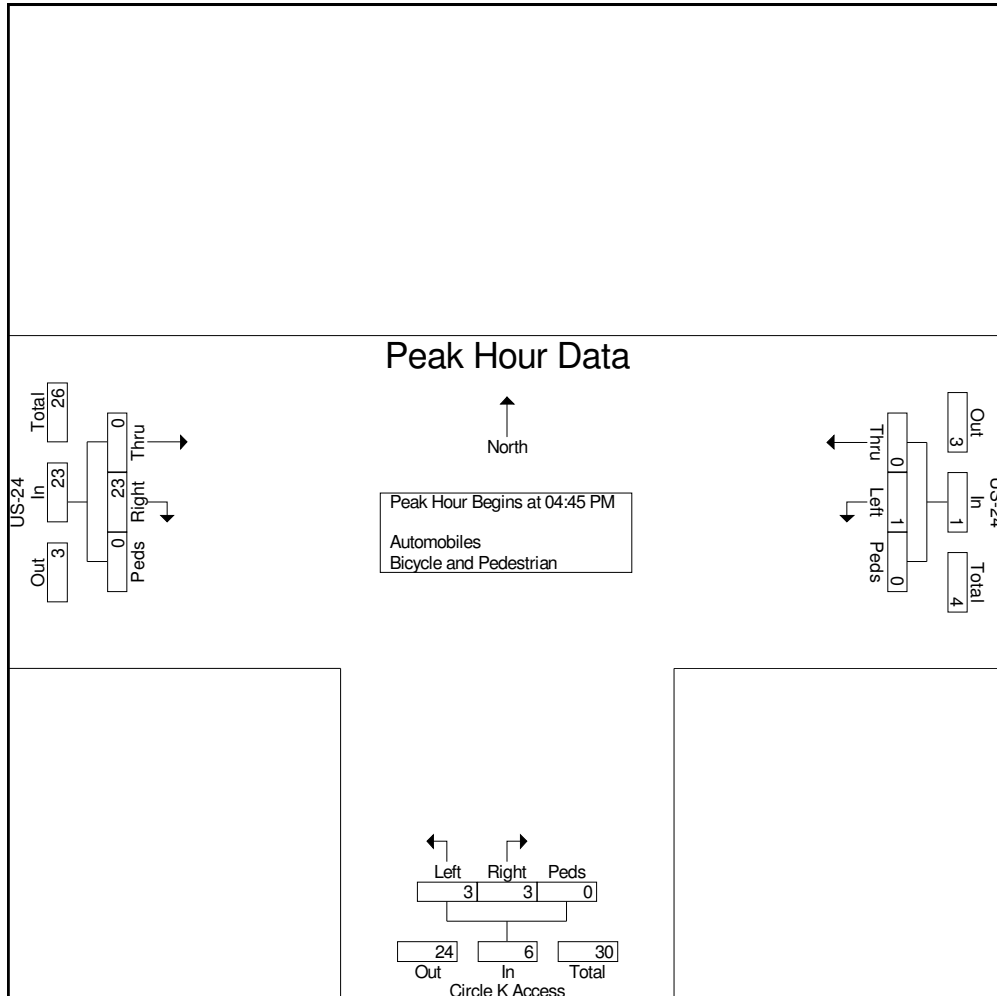

APPENDIX B

Future Traffic Projections Data

Circle K US-24 & Meridian Counts Adjustment

Traffic Counts		
Scenario	AM Peak	PM Peak
2019 Existing (Pre-COVID - 2019-04-16)	2,076	2,161
2019 Grown to 2021	2,160	2,248
2021 Counts (During COVID - 2021-04-15)	1,478	1,529
Percent Change	-31.57%	-31.99%
Growth Adjustment	46.13%	47.04%
Adjustment Factor	1.46	1.47

CDOT OTIS Count Station 107900: SH-24 S/O Woodman Road

COUNTDIR	HOUR7	HOUR8	HOUR16	HOUR17
Primary	535	476	1464	1346
Secondary	1541	1023	697	607
Total	2076	1499	2161	1953

OTIS Growth Rate for Circle K @ US-24 & Meridian Road

ROUTE	UPDATEYR	AADT	AADTYR	COUNTYEAR	OFFPKTRK	YR20FACTOR	Growth Rate	DHV	DD	LOCATION	
024G	2019	20000	2019	2019	5.9	1.5	1.950%	10.5	75	ON SH 24 0.5MI NE/O CONSTITUTION AVE COLORADO SPRINGS	
024G	2019	17000	2019	2017	4.1	1.4	1.615%	9.5	69	ON SH 24 NE/O FALCON HIGHWAY FALCON	
024G	2019	14000	2019	2017	3.8	1.49	1.917%	11	57	ON SH 24 NE/O WOODMAN RD FALCON	
024G	2019	11000	2019	2017	4.7	1.45	1.785%	11	57	ON SH 24 NE/O JUDGE ORR RD FALCON	
							Average	1.817%			



TRAFFIC OPERATIONS/ACCESS ASSESSMENT
Meridian Road/Falcon Park and Ride

Submitted by:

HDR
5555 Tech Center Drive, Suite 310
Colorado Springs, CO 80919
(719) 272-8800

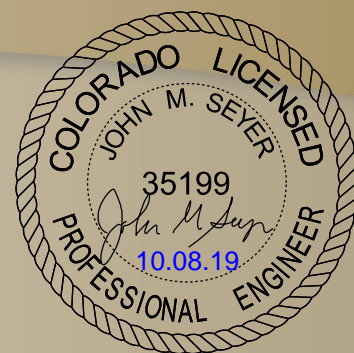

Traffic Operations/Access Assessment - Meridian Road/Falcon Park and Ride

Figure 4-3. 2020 Interim Build Weekday Peak Hour Traffic Volumes

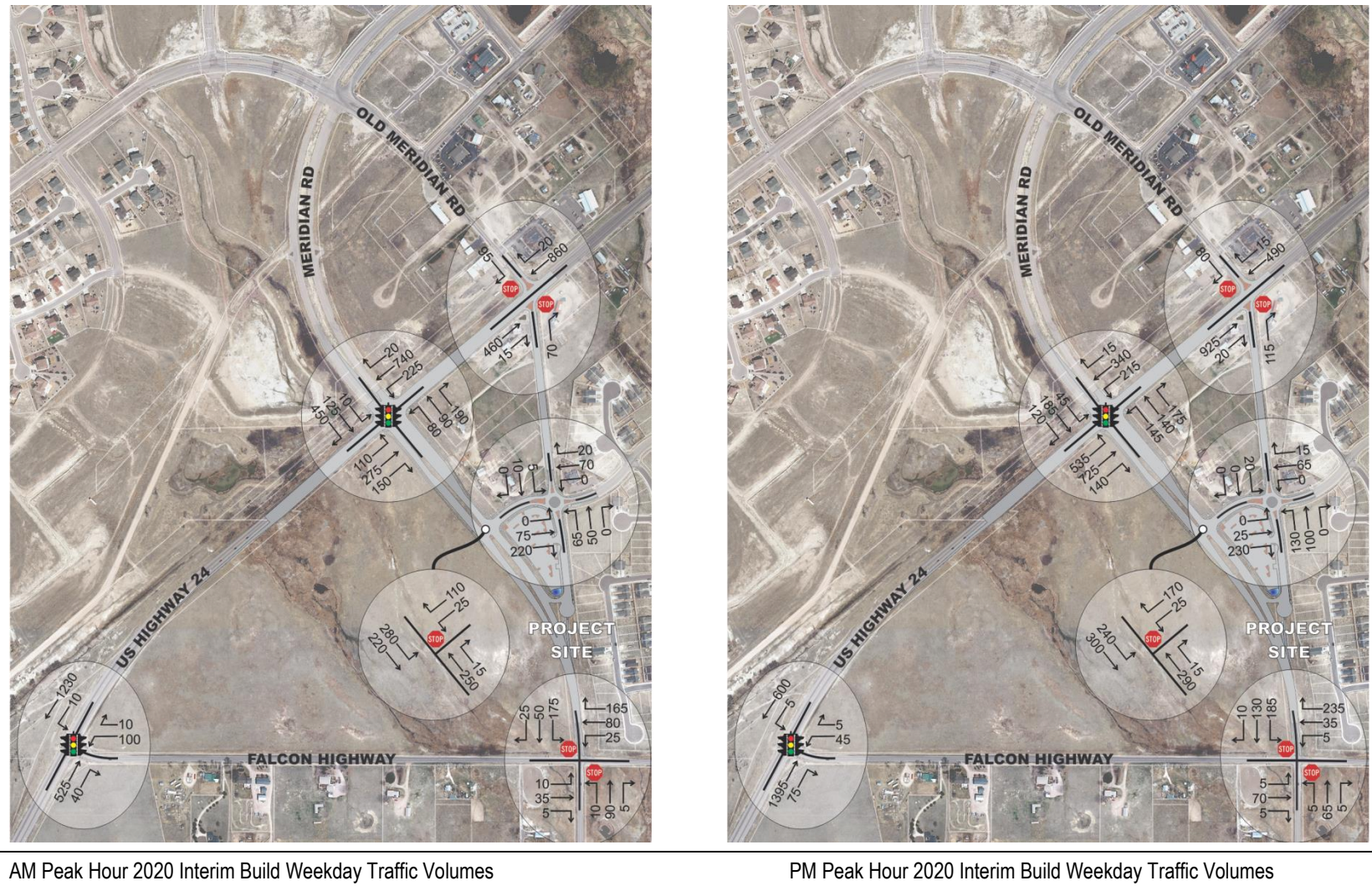

Traffic Operations/Access Assessment - Meridian Road/Falcon Park and Ride

Figure 4-4. 2040 Ultimate Build Weekday Peak Hour Traffic Volumes



AM Peak Hour 2040 Ultimate Build Weekday Traffic Volumes

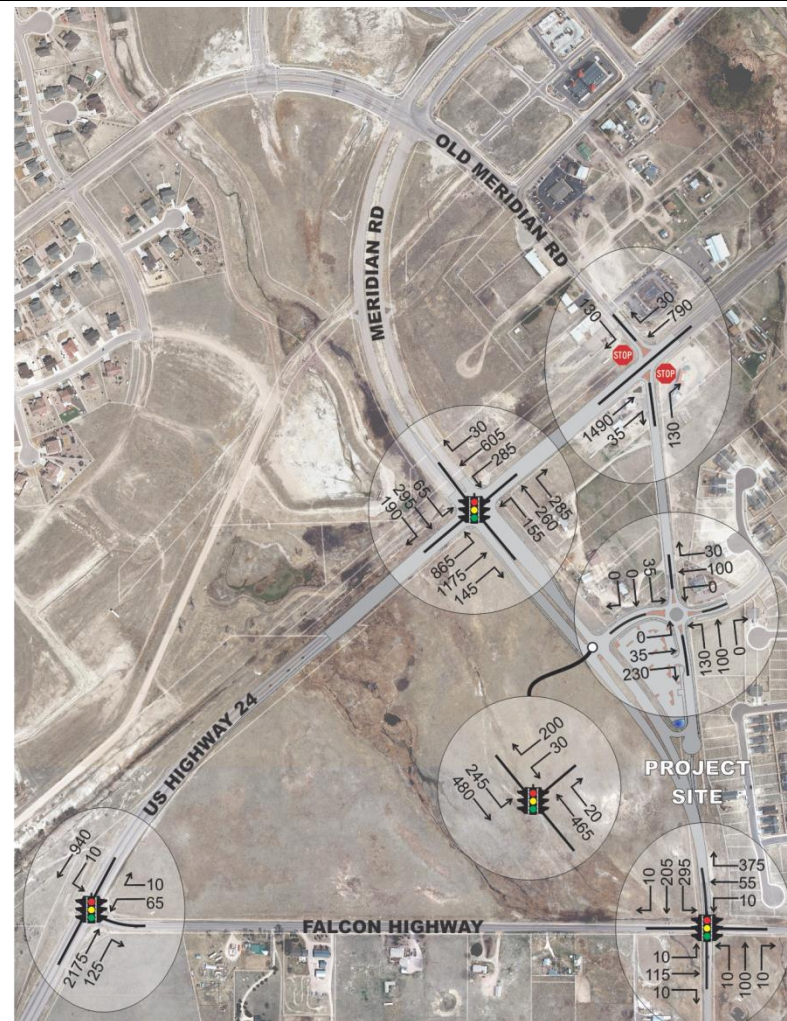

PM Peak Hour 2040 Ultimate Build Weekday Traffic Volumes

APPENDIX C

Trip Generation Worksheets

Project Circle K & US-24 & Meridian Road
 Subject Trip Generation for Shopping Center
 Designed by MAG Date December 14, 2021 Job No. 096554014
 Checked by _____ Date _____ Sheet No. 1 of 1

TRIP GENERATION MANUAL TECHNIQUES

ITE Trip Generation Manual 10th Edition, Average Rate Equations

Land Use Code - Shopping Center (820)

Independant Variable - 1000 Square Feet Gross Leasable Area (X)

Gross Leasable Area = 23,000 Square Feet
 X = 23.000
 T = Average Vehicle Trip Ends

Peak Hour of Adjacent Street Traffic, One Hour Between 7 and 9 a.m. (800 Series Page 139)

Average Weekday		Directional Distribution:	62% ent.	38% exit.
T = 0.94 * (X)		T = 22	Average Vehicle Trip Ends	
T = 0.94 *	23	14 entering	8	exiting
		14 + 8	=	22

Peak Hour of Adjacent Street Traffic, One Hour Between 4 and 6 p.m. (800 Series page 140)

Average Weekday		Directional Distribution:	48% ent.	52% exit.
T = 3.81 * (X)		T = 88	Average Vehicle Trip Ends	
T = 3.81 *	23	42 entering	46	exiting
		42 + 46	=	88

Weekday (800 Series page 138)

Average Weekday		Directional Distribution:	50% entering, 50% exiting	
T = 37.75 * (X)		T = 868	Average Vehicle Trip Ends	
T = 37.75 *	23	434 entering	434	exiting
		434 + 434	=	868

Non Pass-By Trip Volumes (Per ITE Trip Generation Handbook, 3rd Edition September 2017-Page 190)

AM Peak Hour =	66%	Non-Pass By	PM Peak Hour =	66%	Non-Pass By
	IN	Out	Total		
AM Peak	9	5	15		
PM Peak	28	30	59		
Daily	286	286	572		PM Peak Hour Rate Applied to Daily

Pass-By Trip Volumes (Per ITE Trip Generation Handbook, 3rd Edition September 2017 -Page 190)

AM Peak Hour =	34%	Pass By	PM Peak Hour =	34%	Pass By
	IN	Out	Total		
AM Peak	5	3	8		
PM Peak	14	16	30		
Daily	148	148	296		PM Peak Hour Rate Applied to Daily

Project Circle K & US-24 & Meridian Road
 Subject Trip Generation for Fast Casual Restaurant
 Designed by MAG Date December 14, 2021 Job No. 096554014
 Checked by _____ Date _____ Sheet No. 1 of 1

TRIP GENERATION MANUAL TECHNIQUES

ITE Trip Generation Manual 10th Edition, Average Rate Equations

Land Use Code - Fast Casual Restaurant (930)

Independant Variable - 1000 Square Feet Gross Floor Area (X)

Gross Floor Area = 7,000 Square Feet

X = 7.000

T = Average Vehicle Trip Ends

Peak Hour of Adjacent Street Traffic, One Hour Between 7 and 9 a.m. (900 Series Page 62)

Average Weekday

T = 2.07 (X)

T = 2.07 * 7.000

Directional Distribution: 67% ent. 33% exit.

T = 14 Average Vehicle Trip Ends

9 entering 5 exiting

9 (*) + 5 = 14

Peak Hour of Adjacent Street Traffic, One Hour Between 4 and 6 p.m. (900 Series Page 63)

Average Weekday

T = 14.13(X)

T = 14.13 * 7.000

Directional Distribution: 55% ent. 45% exit.

T = 99 Average Vehicle Trip Ends

54 entering 45 exiting

54 + 45 = 99

Weekday (10% K-Factor from PM Peak Hour)

Average Weekday

(T) = PM Peak Total / K Factor 0.1

Directional Distribution: 50% entering, 50% exiting

T = 990 Average Vehicle Trip Ends

495 entering 495 exiting

495 + 495 = 990

Saturday Peak Hour of Generator (900 Series Page 67)

T = 34.02 (X)

T = 34.02 * 7.000

Directional Distribution: 55% ent. 45% exit.

T = 238 Average Vehicle Trip Ends

131 entering 107 exiting

131 + 107 = 238

Project Circle K & US-24 & Meridian Road
 Subject Trip Generation for Fast-Food Restaurant with Drive-Through Window
 Designed by MAG Date December 14, 2021 Job No. 096554014
 Checked by _____ Date _____ Sheet No. 1 of 1

TRIP GENERATION MANUAL TECHNIQUES

ITE Trip Generation Manual 10th Edition, Average Rate Equations

Land Use Code - Fast Food Restaurant With Drive-Through Window (934)

Independant Variable - 1000 Square Feet Gross Floor Area (X)

Gross Floor Area = 4,500 Square Feet

X = 4.500

T = Average Vehicle Trip Ends

Peak Hour of Adjacent Street Traffic, One Hour Between 7 and 9 a.m. (900 Series page 158)

Average Weekday
 T = 40.19 (X)
 T = 40.19 * 4.500

Directional Distribution: 51% ent. 49% exit.
 T = 181 Average Vehicle Trip Ends
 92 entering 89 exiting
 92 + 89 = 181

Peak Hour of Adjacent Street Traffic, One Hour Between 4 and 6 p.m. (900 Series page 159)

Average Weekday
 T = 32.67 (X)
 T = 32.67 * 4.500

Directional Distribution: 52% ent. 48% exit.
 T = 147 Average Vehicle Trip Ends
 76 entering 71 exiting
 76 + 71 = 147

Weekday (900 Series page 157)

Average Weekday
 T = 470.95 (X)
 T = 470.95 * 4.500

Directional Distribution: 50% entering, 50% exiting
 T = 2120 Average Vehicle Trip Ends
 1060 entering 1060 exiting
 1060 + 1060 = 2120

Saturday Peak Hour of Generator (900 Series page 163)

T = 54.86 (X)
 T = 54.86 * 4.500

Directional Distribution: 51% ent. 49% exit.
 T = 247 Average Vehicle Trip Ends
 126 entering 121 exiting
 126 + 121 = 247

Non Pass-By Trip Volumes (Per ITE Trip Generation Handbook, 3rd Edition September 2017)

AM Peak Hour =	51%	Non-Pass By	PM Peak Hour =	50%	Non-Pass By
	IN	Out	Total		
AM Peak	47	45	92		
PM Peak	38	36	74		
Daily	530	530	1060	PM Peak Hour Rate Applied to Daily	

Pass-By Trip Volumes (Per ITE Trip Generation Handbook, 3rd Edition September 2017)

AM Peak Hour =	49%	Pass By	PM Peak Hour =	50%	Pass By
	IN	Out	Total		
AM Peak	45	44	89		
PM Peak	38	36	74		
Daily	530	530	1060	PM Peak Hour Rate Applied to Daily	

Project Circle K @ US-24 & Meridian Road
 Subject Trip Generation for Super Convenience Market/Gas Station
 Designed by MAG Date 5/4/2021 Job No. 096554014
 Checked by _____ Date _____ Sheet No. _____ of _____

TRIP GENERATION MANUAL TECHNIQUES

ITE Trip Generation Manual 10th Edition, Average Rate Equations

Land Use Code - Super Convenience Market/Gas Station (960)

Independent Variable - 1000 Square Feet Gross Leasable Area (X)

Gross Leasable Area = 5,200 Square Feet
 X = 5.200
 T = Average Vehicle Trip Ends

Peak Hour of Adjacent Street Traffic, One Hour Between 7 and 9 a.m. (900 Series Page 404)

T = 83.14 (X)		Directional Distribution:	50%	ent.	50%	exit.
T = 83.14 *	5.200	T =	432	Average Vehicle Trip Ends		
			216	entering	216	exiting
			216	+	216	= 432

Peak Hour of Adjacent Street Traffic, One Hour Between 4 and 6 p.m. (900 Series page 405)

T = 69.28 (X)		Directional Distribution:	50%	ent.	50%	exit.
T = 69.28 *	5.200	T =	360	Average Vehicle Trip Ends		
			180	entering	180	exiting
			180	+	180	= 360

Weekday (800 Series page 335)

Average Weekday		Directional Distribution:	50%	entering,	50%	exiting
T = 837.58 (X)		T =	4356	Average Vehicle Trip Ends		
T = 837.58 *	5.200		2178	entering	2178	exiting
			2178	+	2178	= 4356

Non Pass-By Trip Volumes (Per ITE Trip Generation Handbook, 3rd Edition September 2017)

PM Peak Hour =	44%	Non-Pass By	AM Peak Hour =	38%	Non-Pass By
	IN	Out	Total	* Utilized ITE 945 pass-by calculations	
AM Peak	82	82	164		
PM Peak	79	79	158		
Daily	958	958	1916	PM Peak Hour Rate Applied to Daily	

Pass-By Trip Volumes (Per ITE Trip Generation Handbook, 3rd Edition September 2017)

PM Peak Hour =	56%	Pass By	AM Peak Hour =	62%	Pass By
	IN	Out	Total		
AM Peak	134	134	268		
PM Peak	101	101	202		
Daily	1220	1220	2440	PM Peak Hour Rate Applied to Daily	

NCHRP 684 Internal Trip Capture Estimation Tool			
Project Name:	Circle K US-24 & Meridian	Organization:	Kimley-Horn and Associates, Inc.
Project Location:	El Paso County, Colorado	Performed By:	MAG
Scenario Description:		Date:	12/16/2021
Analysis Year:		Checked By:	
Analysis Period:	AM Street Peak Hour	Date:	

Table 1-A: Base Vehicle-Trip Generation Estimates (Single-Use Site Estimate)						
Land Use	Development Data (For Information Only)			Estimated Vehicle-Trips ³		
	ITE LUCs ¹	Quantity	Units	Total	Entering	Exiting
Office		-	1,000 Sq Ft	0	0	0
Retail		28	1,000 Sq Ft	454	230	224
Restaurant		12	1,000 Sq Ft	195	101	94
Cinema/Entertainment		-	Screen(s)	0	0	0
Residential		-	Dwelling Unit(s)	0	0	0
Hotel		-	Room(s)	0	0	0
All Other Land Uses ²		-	0	0	0	0
				649	331	318

Table 2-A: Mode Split and Vehicle Occupancy Estimates						
Land Use	Entering Trips			Exiting Trips		
	Veh. Occ. ⁴	% Transit	% Non-Motorized	Veh. Occ. ⁴	% Transit	% Non-Motorized
Office	1.00	0%	0%	1.00	0%	0%
Retail	1.00	0%	0%	1.00	0%	0%
Restaurant	1.00	0%	0%	1.00	0%	0%
Cinema/Entertainment	1.00	0%	0%	1.00	0%	0%
Residential	1.00	0%	0%	1.00	0%	0%
Hotel	1.00	0%	0%	1.00	0%	0%
All Other Land Uses ²	1.00	0%	0%	1.00	0%	0%

Table 3-A: Average Land Use Interchange Distances (Feet Walking Distance)						
Origin (From)	Destination (To)					
	Office	Retail	Restaurant	Cinema/Entertainment	Residential	Hotel
Office						
Retail						
Restaurant						
Cinema/Entertainment						
Residential						
Hotel						

Table 4-A: Internal Person-Trip Origin-Destination Matrix*						
Origin (From)	Destination (To)					
	Office	Retail	Restaurant	Cinema/Entertainment	Residential	Hotel
Office		0	0	0	0	0
Retail	0		29	0	0	0
Restaurant	0	13		0	0	0
Cinema/Entertainment	0	0	0		0	0
Residential	0	0	0	0		0
Hotel	0	0	0	0	0	

Table 5-A: Computations Summary			
	Total	Entering	Exiting
All Person-Trips	649	331	318
Internal Capture Percentage	13%	13%	13%
External Vehicle-Trips ⁵	565	289	276
External Transit-Trips ⁶	0	0	0
External Non-Motorized Trips ⁶	0	0	0

Table 6-A: Internal Trip Capture Percentages by Land Use		
Land Use	Entering Trips	Exiting Trips
Office	N/A	N/A
Retail	6%	13%
Restaurant	29%	14%
Cinema/Entertainment	N/A	N/A
Residential	N/A	N/A
Hotel	N/A	N/A

¹Land Use Codes (LUCs) from *Trip Generation Manual*, published by the Institute of Transportation Engineers.

²Total estimate for all other land uses at mixed-use development site is not subject to internal trip capture computations in this estimator.

³Enter trips assuming no transit or non-motorized trips (as assumed in ITE *Trip Generation Manual*).

⁴Enter vehicle occupancy assumed in Table 1-A vehicle trips. If vehicle occupancy changes for proposed mixed-use project, manual adjustments must be made to Tables 5-A, 9-A (O and D). Enter transit, non-motorized percentages that will result with proposed mixed-use project complete.

⁵Vehicle-trips computed using the mode split and vehicle occupancy values provided in Table 2-A.

⁶Person-Trips

*Indicates computation that has been rounded to the nearest whole number.

Estimation Tool Developed by the Texas A&M Transportation Institute - Version 2013.1

Project Name:	Circle K US-24 & Meridian
Analysis Period:	AM Street Peak Hour

Land Use	Table 7-A (D): Entering Trips			Table 7-A (O): Exiting Trips		
	Veh. Occ.	Vehicle-Trips	Person-Trips*	Veh. Occ.	Vehicle-Trips	Person-Trips*
Office	1.00	0	0	1.00	0	0
Retail	1.00	230	230	1.00	224	224
Restaurant	1.00	101	101	1.00	94	94
Cinema/Entertainment	1.00	0	0	1.00	0	0
Residential	1.00	0	0	1.00	0	0
Hotel	1.00	0	0	1.00	0	0

Origin (From)	Destination (To)					
	Office	Retail	Restaurant	Cinema/Entertainment	Residential	Hotel
Office		0	0	0	0	0
Retail	65		29	0	31	0
Restaurant	29	13		0	4	3
Cinema/Entertainment	0	0	0		0	0
Residential	0	0	0	0		0
Hotel	0	0	0	0	0	

Origin (From)	Destination (To)					
	Office	Retail	Restaurant	Cinema/Entertainment	Residential	Hotel
Office		74	23	0	0	0
Retail	0		51	0	0	0
Restaurant	0	18		0	0	0
Cinema/Entertainment	0	0	0		0	0
Residential	0	39	20	0		0
Hotel	0	9	6	0	0	

Destination Land Use	Person-Trip Estimates			External Trips by Mode*		
	Internal	External	Total	Vehicles ¹	Transit ²	Non-Motorized ²
Office	0	0	0	0	0	0
Retail	13	217	230	217	0	0
Restaurant	29	72	101	72	0	0
Cinema/Entertainment	0	0	0	0	0	0
Residential	0	0	0	0	0	0
Hotel	0	0	0	0	0	0
All Other Land Uses ³	0	0	0	0	0	0

Origin Land Use	Person-Trip Estimates			External Trips by Mode*		
	Internal	External	Total	Vehicles ¹	Transit ²	Non-Motorized ²
Office	0	0	0	0	0	0
Retail	29	195	224	195	0	0
Restaurant	13	81	94	81	0	0
Cinema/Entertainment	0	0	0	0	0	0
Residential	0	0	0	0	0	0
Hotel	0	0	0	0	0	0
All Other Land Uses ³	0	0	0	0	0	0

¹Vehicle-trips computed using the mode split and vehicle occupancy values provided in Table 2-A
²Person-Trips
³Total estimate for all other land uses at mixed-use development site is not subject to internal trip capture computations in this estimator
*Indicates computation that has been rounded to the nearest whole number.

NCHRP 684 Internal Trip Capture Estimation Tool			
Project Name:	Circle K US-24 & Meridian	Organization:	Kimley-Horn and Associates, Inc.
Project Location:	El Paso County, Colorado	Performed By:	MAG
Scenario Description:		Date:	12/16/2021
Analysis Year:		Checked By:	
Analysis Period:	PM Street Peak Hour	Date:	

Table 1-P: Base Vehicle-Trip Generation Estimates (Single-Use Site Estimate)						
Land Use	Development Data (For Information Only)			Estimated Vehicle-Trips ³		
	ITE LUCs ¹	Quantity	Units	Total	Entering	Exiting
Office		-	1,000 Sq Ft	0	0	0
Retail		28	1,000 Sq Ft	448	222	226
Restaurant		12	1,000 Sq Ft	246	130	116
Cinema/Entertainment		-	Screen(s)	0	0	0
Residential		-	Dwelling Unit(s)	0	0	0
Hotel		-	Room(s)	0	0	0
All Other Land Uses ²		-	0	0	0	0
				694	352	342

Table 2-P: Mode Split and Vehicle Occupancy Estimates						
Land Use	Entering Trips			Exiting Trips		
	Veh. Occ. ⁴	% Transit	% Non-Motorized	Veh. Occ. ⁴	% Transit	% Non-Motorized
Office	1.00	0%	0%	1.00	0%	0%
Retail	1.00	0%	0%	1.00	0%	0%
Restaurant	1.00	0%	0%	1.00	0%	0%
Cinema/Entertainment	1.00	0%	0%	1.00	0%	0%
Residential	1.00	0%	0%	1.00	0%	0%
Hotel	1.00	0%	0%	1.00	0%	0%
All Other Land Uses ²	1.00	0%	0%	1.00	0%	0%

Table 3-P: Average Land Use Interchange Distances (Feet Walking Distance)						
Origin (From)	Destination (To)					
	Office	Retail	Restaurant	Cinema/Entertainment	Residential	Hotel
Office						
Retail						
Restaurant						
Cinema/Entertainment						
Residential						
Hotel						

Table 4-P: Internal Person-Trip Origin-Destination Matrix*						
Origin (From)	Destination (To)					
	Office	Retail	Restaurant	Cinema/Entertainment	Residential	Hotel
Office		0	0	0	0	0
Retail	0		38	0	0	0
Restaurant	0	48		0	0	0
Cinema/Entertainment	0	0	0		0	0
Residential	0	0	0	0		0
Hotel	0	0	0	0	0	

Table 5-P: Computations Summary			
	Total	Entering	Exiting
All Person-Trips	694	352	342
Internal Capture Percentage	25%	24%	25%
External Vehicle-Trips ⁵	522	266	256
External Transit-Trips ⁶	0	0	0
External Non-Motorized Trips ⁶	0	0	0

Table 6-P: Internal Trip Capture Percentages by Land Use		
Land Use	Entering Trips	Exiting Trips
Office	N/A	N/A
Retail	22%	17%
Restaurant	29%	41%
Cinema/Entertainment	N/A	N/A
Residential	N/A	N/A
Hotel	N/A	N/A

¹Land Use Codes (LUCs) from *Trip Generation Manual*, published by the Institute of Transportation Engineers.

²Total estimate for all other land uses at mixed-use development site is not subject to internal trip capture computations in this estimator.

³Enter trips assuming no transit or non-motorized trips (as assumed in ITE *Trip Generation Manual*).

⁴Enter vehicle occupancy assumed in Table 1-P vehicle trips. If vehicle occupancy changes for proposed mixed-use project, manual adjustments must be made.

⁵Vehicle-trips computed using the mode split and vehicle occupancy values provided in Table 2-P.

⁶Person-Trips

*Indicates computation that has been rounded to the nearest whole number.

Project Name:	Circle K US-24 & Meridian
Analysis Period:	PM Street Peak Hour

Table 7-P: Conversion of Vehicle-Trip Ends to Person-Trip Ends						
Land Use	Table 7-P (D): Entering Trips			Table 7-P (O): Exiting Trips		
	Veh. Occ.	Vehicle-Trips	Person-Trips*	Veh. Occ.	Vehicle-Trips	Person-Trips*
Office	1.00	0	0	1.00	0	0
Retail	1.00	222	222	1.00	226	226
Restaurant	1.00	130	130	1.00	116	116
Cinema/Entertainment	1.00	0	0	1.00	0	0
Residential	1.00	0	0	1.00	0	0
Hotel	1.00	0	0	1.00	0	0

Table 8-P (O): Internal Person-Trip Origin-Destination Matrix (Computed at Origin)						
Origin (From)	Destination (To)					
	Office	Retail	Restaurant	Cinema/Entertainment	Residential	Hotel
Office		0	0	0	0	0
Retail	5		66	9	59	11
Restaurant	3	48		9	21	8
Cinema/Entertainment	0	0	0		0	0
Residential	0	0	0	0		0
Hotel	0	0	0	0	0	

Table 8-P (D): Internal Person-Trip Origin-Destination Matrix (Computed at Destination)						
Origin (From)	Destination (To)					
	Office	Retail	Restaurant	Cinema/Entertainment	Residential	Hotel
Office		18	3	0	0	0
Retail	0		38	0	0	0
Restaurant	0	111		0	0	0
Cinema/Entertainment	0	9	4		0	0
Residential	0	22	18	0		0
Hotel	0	4	7	0	0	

Table 9-P (D): Internal and External Trips Summary (Entering Trips)						
Destination Land Use	Person-Trip Estimates			External Trips by Mode*		
	Internal	External	Total	Vehicles ¹	Transit ²	Non-Motorized ²
Office	0	0	0	0	0	0
Retail	48	174	222	174	0	0
Restaurant	38	92	130	92	0	0
Cinema/Entertainment	0	0	0	0	0	0
Residential	0	0	0	0	0	0
Hotel	0	0	0	0	0	0
All Other Land Uses ³	0	0	0	0	0	0

Table 9-P (O): Internal and External Trips Summary (Exiting Trips)						
Origin Land Use	Person-Trip Estimates			External Trips by Mode*		
	Internal	External	Total	Vehicles ¹	Transit ²	Non-Motorized ²
Office	0	0	0	0	0	0
Retail	38	188	226	188	0	0
Restaurant	48	68	116	68	0	0
Cinema/Entertainment	0	0	0	0	0	0
Residential	0	0	0	0	0	0
Hotel	0	0	0	0	0	0
All Other Land Uses ³	0	0	0	0	0	0

¹Vehicle-trips computed using the mode split and vehicle occupancy values provided in Table 2-P

²Person-Trips

³Total estimate for all other land uses at mixed-use development site is not subject to internal trip capture computations in this estimator

*Indicates computation that has been rounded to the nearest whole number.

APPENDIX D

Intersection Analysis Worksheets

Timings
1: (Old) Meridian Road & US-24

2021 Existing AM.syn
05/06/2021

Lane Group	EBL	EBT	EBR	WBL	WBT	WBR	NBL	NBT	NBR	SBL	SBT	SBR
Lane Configurations												
Traffic Volume (vph)	131	447	13	112	863	16	16	123	218	3	142	688
Future Volume (vph)	131	447	13	112	863	16	16	123	218	3	142	688
Turn Type	pm+pt	NA	Perm	pm+pt	NA	Perm	Perm	NA	Free	Perm	NA	Free
Protected Phases	7	4		3	8			2				1
Permitted Phases	4		4	8		8	2		Free	1		Free
Detector Phase	7	4	4	3	8	8	2	2		1		1
Switch Phase												
Minimum Initial (s)	5.0	5.0	5.0	5.0	5.0	5.0	5.0	5.0		5.0		5.0
Minimum Split (s)	9.5	22.5	22.5	9.5	22.5	22.5	22.5	22.5		22.5		22.5
Total Split (s)	10.9	63.4	63.4	10.9	63.4	63.4	23.1	23.1		22.6		22.6
Total Split (%)	9.1%	52.8%	52.8%	9.1%	52.8%	52.8%	19.3%	19.3%		18.8%		18.8%
Yellow Time (s)	3.5	3.5	3.5	3.5	3.5	3.5	3.5	3.5		3.5		3.5
All-Red Time (s)	1.0	1.0	1.0	1.0	1.0	1.0	1.0	1.0		1.0		1.0
Lost Time Adjust (s)	0.0	0.0	0.0	0.0	0.0	0.0		0.0				0.0
Total Lost Time (s)	4.5	4.5	4.5	4.5	4.5	4.5		4.5				4.5
Lead/Lag	Lead	Lag	Lag	Lead	Lag	Lag	Lag	Lag		Lead		Lead
Lead-Lag Optimize?	Yes	Yes	Yes	Yes	Yes	Yes	Yes	Yes		Yes		Yes
Recall Mode	None	None	None	None	None	None	C-Max	C-Max		Max		Max
Act Effct Green (s)	65.3	58.9	58.9	65.3	58.9	58.9		18.6	120.0			18.1
Actuated g/C Ratio	0.54	0.49	0.49	0.54	0.49	0.49		0.16	1.00			0.15
v/c Ratio	0.87	0.51	0.02	0.28	0.98	0.02		0.53	0.14			0.95
Control Delay	68.2	23.2	0.0	13.2	56.8	0.1		54.4	0.2			110.5
Queue Delay	0.0	0.0	0.0	0.0	0.0	0.0		0.0	0.0			0.0
Total Delay	68.2	23.2	0.0	13.2	56.8	0.1		54.4	0.2			110.5
LOS	E	C	A	B	E	A		D	A			F
Approach Delay		32.6			50.9			21.3				20.0
Approach LOS		C			D			C				B

Intersection Summary

Cycle Length: 120
 Actuated Cycle Length: 120
 Offset: 0 (0%), Referenced to phase 2:NBTL and 6:, Start of Green
 Natural Cycle: 110
 Control Type: Actuated-Coordinated
 Maximum v/c Ratio: 0.98
 Intersection Signal Delay: 33.9
 Intersection LOS: C
 Intersection Capacity Utilization 82.7%
 ICU Level of Service E
 Analysis Period (min) 15

Splits and Phases: 1: (Old) Meridian Road & US-24

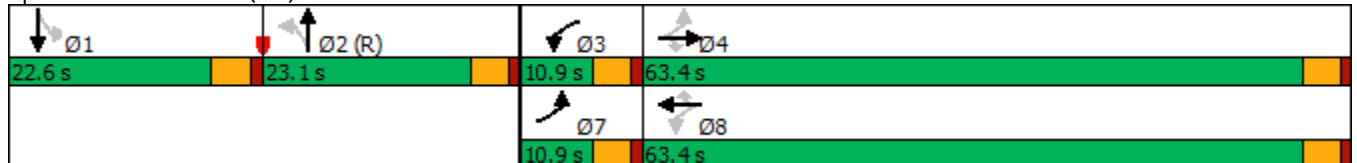

HCM Signalized Intersection Capacity Analysis
1: (Old) Meridian Road & US-24

2021 Existing AM.syn
05/06/2021



Movement	EBL	EBT	EBR	WBL	WBT	WBR	NBL	NBT	NBR	SBL	SBT	SBR
Lane Configurations												
Traffic Volume (vph)	131	447	13	112	863	16	16	123	218	3	142	688
Future Volume (vph)	131	447	13	112	863	16	16	123	218	3	142	688
Ideal Flow (vphpl)	1900	1900	1900	1900	1900	1900	1900	1900	1900	1900	1900	1900
Total Lost time (s)	4.5	4.5	4.5	4.5	4.5	4.5		4.5	4.0		4.5	4.0
Lane Util. Factor	1.00	1.00	1.00	1.00	1.00	1.00		1.00	1.00		1.00	1.00
Frt	1.00	1.00	0.85	1.00	1.00	0.85		1.00	0.85		1.00	0.85
Flt Protected	0.95	1.00	1.00	0.95	1.00	1.00		0.99	1.00		1.00	1.00
Satd. Flow (prot)	1770	1863	1583	1770	1863	1583		1852	1583		1861	1583
Flt Permitted	0.07	1.00	1.00	0.35	1.00	1.00		0.95	1.00		0.57	1.00
Satd. Flow (perm)	127	1863	1583	659	1863	1583		1776	1583		1059	1583
Peak-hour factor, PHF	0.96	0.96	0.96	0.96	0.96	0.96	0.96	0.96	0.96	0.96	0.96	0.96
Adj. Flow (vph)	136	466	14	117	899	17	17	128	227	3	148	717
RTOR Reduction (vph)	0	0	7	0	0	9	0	0	0	0	0	0
Lane Group Flow (vph)	136	466	7	117	899	8	0	145	227	0	151	717
Turn Type	pm+pt	NA	Perm	pm+pt	NA	Perm	Perm	NA	Free	Perm	NA	Free
Protected Phases	7	4		3	8			2			1	
Permitted Phases	4		4	8		8	2		Free	1		Free
Actuated Green, G (s)	65.3	58.9	58.9	65.3	58.9	58.9		18.6	120.0		18.1	120.0
Effective Green, g (s)	65.3	58.9	58.9	65.3	58.9	58.9		18.6	120.0		18.1	120.0
Actuated g/C Ratio	0.54	0.49	0.49	0.54	0.49	0.49		0.16	1.00		0.15	1.00
Clearance Time (s)	4.5	4.5	4.5	4.5	4.5	4.5		4.5			4.5	
Vehicle Extension (s)	3.0	3.0	3.0	3.0	3.0	3.0		3.0			3.0	
Lane Grp Cap (vph)	156	914	776	417	914	776		275	1583		159	1583
v/s Ratio Prot	c0.05	0.25		0.01	c0.48							
v/s Ratio Perm	0.43		0.00	0.14		0.01		0.08	0.14		c0.14	c0.45
v/c Ratio	0.87	0.51	0.01	0.28	0.98	0.01		0.53	0.14		0.95	0.45
Uniform Delay, d1	29.1	20.7	15.6	14.7	30.1	15.6		46.7	0.0		50.5	0.0
Progression Factor	1.00	1.00	1.00	1.00	1.00	1.00		1.00	1.00		1.00	1.00
Incremental Delay, d2	37.6	0.4	0.0	0.4	25.6	0.0		7.1	0.2		59.2	0.9
Delay (s)	66.7	21.2	15.6	15.1	55.7	15.6		53.7	0.2		109.6	0.9
Level of Service	E	C	B	B	E	B		D	A		F	A
Approach Delay (s)		31.1			50.4			21.1			19.8	
Approach LOS		C			D			C			B	

Intersection Summary

HCM 2000 Control Delay	33.3	HCM 2000 Level of Service	C
HCM 2000 Volume to Capacity ratio	0.89		
Actuated Cycle Length (s)	120.0	Sum of lost time (s)	18.0
Intersection Capacity Utilization	82.7%	ICU Level of Service	E
Analysis Period (min)	15		

c Critical Lane Group

Timings
1: (Old) Meridian Road & US-24

2021 Existing PM.syn
05/06/2021

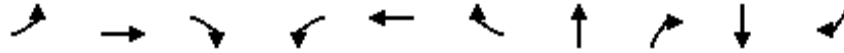

Lane Group	EBL	EBT	EBR	WBL	WBT	WBR	NBT	NBR	SBT	SBR
Lane Configurations										
Traffic Volume (vph)	500	900	9	147	541	28	244	340	254	284
Future Volume (vph)	500	900	9	147	541	28	244	340	254	284
Turn Type	pm+pt	NA	Perm	pm+pt	NA	Perm	NA	Free	NA	Free
Protected Phases	7	4		3	8		2		1	
Permitted Phases	4		4	8		8		Free		Free
Detector Phase	7	4	4	3	8	8	2		1	
Switch Phase										
Minimum Initial (s)	5.0	5.0	5.0	5.0	5.0	5.0	5.0		5.0	
Minimum Split (s)	9.5	22.5	22.5	9.5	22.5	22.5	22.5		22.5	
Total Split (s)	33.2	62.0	62.0	11.3	40.1	40.1	23.5		23.2	
Total Split (%)	27.7%	51.7%	51.7%	9.4%	33.4%	33.4%	19.6%		19.3%	
Yellow Time (s)	3.5	3.5	3.5	3.5	3.5	3.5	3.5		3.5	
All-Red Time (s)	1.0	1.0	1.0	1.0	1.0	1.0	1.0		1.0	
Lost Time Adjust (s)	0.0	0.0	0.0	0.0	0.0	0.0	0.0		0.0	
Total Lost Time (s)	4.5	4.5	4.5	4.5	4.5	4.5	4.5		4.5	
Lead/Lag	Lead	Lag	Lag	Lead	Lag	Lag	Lag		Lead	
Lead-Lag Optimize?	Yes	Yes	Yes	Yes	Yes	Yes	Yes		Yes	
Recall Mode	None	None	None	None	None	None	C-Max		Max	
Act Effct Green (s)	68.8	57.5	57.5	42.4	35.6	35.6	19.0	120.0	18.7	120.0
Actuated g/C Ratio	0.57	0.48	0.48	0.35	0.30	0.30	0.16	1.00	0.16	1.00
v/c Ratio	1.05	1.03	0.01	0.93	1.00	0.05	0.90	0.22	1.00	0.18
Control Delay	89.5	69.4	0.0	83.0	81.0	0.2	82.0	0.3	104.1	0.3
Queue Delay	0.0	0.0	0.0	0.0	0.0	0.0	0.0	0.0	0.0	0.0
Total Delay	89.5	69.4	0.0	83.0	81.0	0.2	82.0	0.3	104.1	0.3
LOS	F	E	A	F	F	A	F	A	F	A
Approach Delay		76.1			78.2		35.6		52.0	
Approach LOS		E			E		D		D	

Intersection Summary





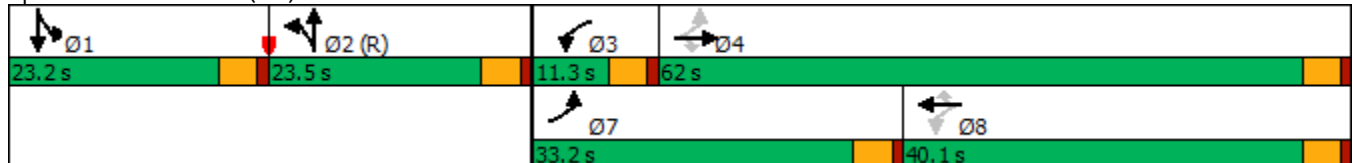

















Cycle Length: 120
 Actuated Cycle Length: 120
 Offset: 0 (0%), Referenced to phase 2:NBTL and 6:, Start of Green
 Natural Cycle: 130
 Control Type: Actuated-Coordinated
 Maximum v/c Ratio: 1.05
 Intersection Signal Delay: 65.0
 Intersection LOS: E
 Intersection Capacity Utilization 99.8%
 ICU Level of Service F
 Analysis Period (min) 15

Splits and Phases: 1: (Old) Meridian Road & US-24



HCM Signalized Intersection Capacity Analysis
 1: (Old) Meridian Road & US-24

2021 Existing PM.syn
 05/06/2021

													
Movement	EBL	EBT	EBR	WBL	WBT	WBR	NBL	NBT	NBR	SBL	SBT	SBR	
Lane Configurations													
Traffic Volume (vph)	500	900	9	147	541	28	15	244	340	28	254	284	
Future Volume (vph)	500	900	9	147	541	28	15	244	340	28	254	284	
Ideal Flow (vphpl)	1900	1900	1900	1900	1900	1900	1900	1900	1900	1900	1900	1900	
Total Lost time (s)	4.5	4.5	4.5	4.5	4.5	4.5		4.5	4.0		4.5	4.0	
Lane Util. Factor	1.00	1.00	1.00	1.00	1.00	1.00		1.00	1.00		1.00	1.00	
Frt	1.00	1.00	0.85	1.00	1.00	0.85		1.00	0.85		1.00	0.85	
Flt Protected	0.95	1.00	1.00	0.95	1.00	1.00		1.00	1.00		0.99	1.00	
Satd. Flow (prot)	1770	1863	1583	1770	1863	1583		1857	1583		1853	1583	
Flt Permitted	0.10	1.00	1.00	0.11	1.00	1.00		1.00	1.00		0.99	1.00	
Satd. Flow (perm)	186	1863	1583	209	1863	1583		1857	1583		1853	1583	
Peak-hour factor, PHF	0.98	0.98	0.98	0.98	0.98	0.98	0.98	0.98	0.98	0.98	0.98	0.98	
Adj. Flow (vph)	510	918	9	150	552	29	15	249	347	29	259	290	
RTOR Reduction (vph)	0	0	5	0	0	20	0	0	0	0	0	0	
Lane Group Flow (vph)	510	918	4	150	552	9	0	264	347	0	288	290	
Turn Type	pm+pt	NA	Perm	pm+pt	NA	Perm	Split	NA	Free	Split	NA	Free	
Protected Phases	7	4		3	8		2	2		1	1		
Permitted Phases	4		4	8		8			Free			Free	
Actuated Green, G (s)	68.8	57.5	57.5	42.4	35.6	35.6		19.0	120.0		18.7	120.0	
Effective Green, g (s)	68.8	57.5	57.5	42.4	35.6	35.6		19.0	120.0		18.7	120.0	
Actuated g/C Ratio	0.57	0.48	0.48	0.35	0.30	0.30		0.16	1.00		0.16	1.00	
Clearance Time (s)	4.5	4.5	4.5	4.5	4.5	4.5		4.5			4.5		
Vehicle Extension (s)	3.0	3.0	3.0	3.0	3.0	3.0		3.0			3.0		
Lane Grp Cap (vph)	485	892	758	162	552	469		294	1583		288	1583	
v/s Ratio Prot	c0.25	0.49		0.05	0.30			c0.14			c0.16		
v/s Ratio Perm	c0.35		0.00	0.27		0.01			0.22			0.18	
v/c Ratio	1.05	1.03	0.01	0.93	1.00	0.02		0.90	0.22		1.00	0.18	
Uniform Delay, d1	37.0	31.2	16.3	33.1	42.2	29.8		49.5	0.0		50.6	0.0	
Progression Factor	1.00	1.00	1.00	1.00	1.00	1.00		1.00	1.00		1.00	1.00	
Incremental Delay, d2	55.1	37.8	0.0	49.0	38.3	0.0		31.8	0.3		53.0	0.3	
Delay (s)	92.1	69.1	16.3	82.2	80.5	29.9		81.4	0.3		103.7	0.3	
Level of Service	F	E	B	F	F	C		F	A		F	A	
Approach Delay (s)		76.9			78.8			35.3			51.8		
Approach LOS		E			E			D			D		
Intersection Summary													
HCM 2000 Control Delay			65.4									HCM 2000 Level of Service	E
HCM 2000 Volume to Capacity ratio			1.04										
Actuated Cycle Length (s)			120.0									Sum of lost time (s)	18.0
Intersection Capacity Utilization			99.8%									ICU Level of Service	F
Analysis Period (min)			15										
c Critical Lane Group													

Intersection												
Int Delay, s/veh	0											
Movement	EBL	EBT	EBR	WBL	WBT	WBR	NBL	NBT	NBR	SBL	SBT	SBR
Lane Configurations		↑	↗		↑	↗			↗			↗
Traffic Vol, veh/h	0	635	25	0	945	5	0	0	70	0	0	110
Future Vol, veh/h	0	635	25	0	945	5	0	0	70	0	0	110
Conflicting Peds, #/hr	0	0	0	0	0	0	0	0	0	0	0	0
Sign Control	Free	Free	Free	Free	Free	Free	Stop	Stop	Stop	Stop	Stop	Stop
RT Channelized	-	-	None	-	-	None	-	-	Free	-	-	Free
Storage Length	-	-	350	-	-	375	-	-	-	-	-	-
Veh in Median Storage, #	-	0	-	-	0	-	-	0	-	-	0	-
Grade, %	-	0	-	-	0	-	-	0	-	-	0	-
Peak Hour Factor	96	96	96	96	96	96	96	96	96	96	96	96
Heavy Vehicles, %	2	2	2	2	2	2	2	2	2	2	2	2
Mvmt Flow	0	661	26	0	984	5	0	0	73	0	0	115

Major/Minor	Major1		Major2		Minor1		Minor2	
Conflicting Flow All	-	0	0	-	-	0	-	-
Stage 1	-	-	-	-	-	-	-	-
Stage 2	-	-	-	-	-	-	-	-
Critical Hdwy	-	-	-	-	-	-	-	-
Critical Hdwy Stg 1	-	-	-	-	-	-	-	-
Critical Hdwy Stg 2	-	-	-	-	-	-	-	-
Follow-up Hdwy	-	-	-	-	-	-	-	-
Pot Cap-1 Maneuver	0	-	-	0	-	-	0	0
Stage 1	0	-	-	0	-	-	0	0
Stage 2	0	-	-	0	-	-	0	0
Platoon blocked, %	-	-	-	-	-	-	-	-
Mov Cap-1 Maneuver	-	-	-	-	-	-	-	-
Mov Cap-2 Maneuver	-	-	-	-	-	-	-	-
Stage 1	-	-	-	-	-	-	-	-
Stage 2	-	-	-	-	-	-	-	-

Approach	EB	WB	NB	SB
HCM Control Delay, s	0	0	0	0
HCM LOS			A	A

Minor Lane/Major Mvmt	NBLn1	EBT	EBR	WBT	WBR	SBLn1
Capacity (veh/h)	-	-	-	-	-	-
HCM Lane V/C Ratio	-	-	-	-	-	-
HCM Control Delay (s)	0	-	-	-	-	0
HCM Lane LOS	A	-	-	-	-	A
HCM 95th %tile Q(veh)	-	-	-	-	-	-

Intersection												
Int Delay, s/veh	0											
Movement	EBL	EBT	EBR	WBL	WBT	WBR	NBL	NBT	NBR	SBL	SBT	SBR
Lane Configurations		↑	↗		↑	↗			↗			↗
Traffic Vol, veh/h	0	1075	40	0	620	10	0	0	115	0	0	80
Future Vol, veh/h	0	1075	40	0	620	10	0	0	115	0	0	80
Conflicting Peds, #/hr	0	0	0	0	0	0	0	0	0	0	0	0
Sign Control	Free	Free	Free	Free	Free	Free	Stop	Stop	Stop	Stop	Stop	Stop
RT Channelized	-	-	None	-	-	None	-	-	Free	-	-	Free
Storage Length	-	-	350	-	-	375	-	-	-	-	-	-
Veh in Median Storage, #	-	0	-	-	0	-	-	0	-	-	0	-
Grade, %	-	0	-	-	0	-	-	0	-	-	0	-
Peak Hour Factor	98	98	98	98	98	98	98	98	98	98	98	98
Heavy Vehicles, %	2	2	2	2	2	2	2	2	2	2	2	2
Mvmt Flow	0	1097	41	0	633	10	0	0	117	0	0	82

Major/Minor	Major1		Major2		Minor1		Minor2	
Conflicting Flow All	-	0	0	-	-	0	-	-
Stage 1	-	-	-	-	-	-	-	-
Stage 2	-	-	-	-	-	-	-	-
Critical Hdwy	-	-	-	-	-	-	-	-
Critical Hdwy Stg 1	-	-	-	-	-	-	-	-
Critical Hdwy Stg 2	-	-	-	-	-	-	-	-
Follow-up Hdwy	-	-	-	-	-	-	-	-
Pot Cap-1 Maneuver	0	-	-	0	-	-	0	0
Stage 1	0	-	-	0	-	-	0	0
Stage 2	0	-	-	0	-	-	0	0
Platoon blocked, %	-	-	-	-	-	-	-	-
Mov Cap-1 Maneuver	-	-	-	-	-	-	-	-
Mov Cap-2 Maneuver	-	-	-	-	-	-	-	-
Stage 1	-	-	-	-	-	-	-	-
Stage 2	-	-	-	-	-	-	-	-

Approach	EB	WB	NB	SB
HCM Control Delay, s	0	0	0	0
HCM LOS			A	A

Minor Lane/Major Mvmt	NBLn1	EBT	EBR	WBT	WBR	SBLn1
Capacity (veh/h)	-	-	-	-	-	-
HCM Lane V/C Ratio	-	-	-	-	-	-
HCM Control Delay (s)	0	-	-	-	-	0
HCM Lane LOS	A	-	-	-	-	A
HCM 95th %tile Q(veh)	-	-	-	-	-	-

Intersection												
Int Delay, s/veh	0											
Movement	EBL	EBT	EBR	WBL	WBT	WBR	NBL	NBT	NBR	SBL	SBT	SBR
Lane Configurations		↑	↗		↑	↗			↗			↗
Traffic Vol, veh/h	0	635	80	0	975	5	0	0	100	0	0	110
Future Vol, veh/h	0	635	80	0	975	5	0	0	100	0	0	110
Conflicting Peds, #/hr	0	0	0	0	0	0	0	0	0	0	0	0
Sign Control	Free	Free	Free	Free	Free	Free	Stop	Stop	Stop	Stop	Stop	Stop
RT Channelized	-	-	None	-	-	None	-	-	Free	-	-	Free
Storage Length	-	-	0	-	-	375	-	-	-	-	-	-
Veh in Median Storage, #	-	0	-	-	0	-	-	0	-	-	0	-
Grade, %	-	0	-	-	0	-	-	0	-	-	0	-
Peak Hour Factor	96	96	96	96	96	96	96	96	96	96	96	96
Heavy Vehicles, %	2	2	2	2	2	2	2	2	2	2	2	2
Mvmt Flow	0	661	83	0	1016	5	0	0	104	0	0	115

Major/Minor	Major1		Major2		Minor1		Minor2	
Conflicting Flow All	-	0	0	-	-	0	-	-
Stage 1	-	-	-	-	-	-	-	-
Stage 2	-	-	-	-	-	-	-	-
Critical Hdwy	-	-	-	-	-	-	-	-
Critical Hdwy Stg 1	-	-	-	-	-	-	-	-
Critical Hdwy Stg 2	-	-	-	-	-	-	-	-
Follow-up Hdwy	-	-	-	-	-	-	-	-
Pot Cap-1 Maneuver	0	-	-	0	-	-	0	0
Stage 1	0	-	-	0	-	-	0	0
Stage 2	0	-	-	0	-	-	0	0
Platoon blocked, %	-	-	-	-	-	-	-	-
Mov Cap-1 Maneuver	-	-	-	-	-	-	-	-
Mov Cap-2 Maneuver	-	-	-	-	-	-	-	-
Stage 1	-	-	-	-	-	-	-	-
Stage 2	-	-	-	-	-	-	-	-

Approach	EB	WB	NB	SB
HCM Control Delay, s	0	0	0	0
HCM LOS			A	A

Minor Lane/Major Mvmt	NBLn1	EBT	EBR	WBT	WBR	SBLn1
Capacity (veh/h)	-	-	-	-	-	-
HCM Lane V/C Ratio	-	-	-	-	-	-
HCM Control Delay (s)	0	-	-	-	-	0
HCM Lane LOS	A	-	-	-	-	A
HCM 95th %tile Q(veh)	-	-	-	-	-	-

Intersection												
Int Delay, s/veh	0											
Movement	EBL	EBT	EBR	WBL	WBT	WBR	NBL	NBT	NBR	SBL	SBT	SBR
Lane Configurations		↑	↗		↑	↗			↗			↗
Traffic Vol, veh/h	0	1075	85	0	645	10	0	0	140	0	0	80
Future Vol, veh/h	0	1075	85	0	645	10	0	0	140	0	0	80
Conflicting Peds, #/hr	0	0	0	0	0	0	0	0	0	0	0	0
Sign Control	Free	Free	Free	Free	Free	Free	Stop	Stop	Stop	Stop	Stop	Stop
RT Channelized	-	-	None	-	-	None	-	-	Free	-	-	Free
Storage Length	-	-	0	-	-	375	-	-	-	-	-	-
Veh in Median Storage, #	-	0	-	-	0	-	-	0	-	-	0	-
Grade, %	-	0	-	-	0	-	-	0	-	-	0	-
Peak Hour Factor	98	98	98	98	98	98	98	98	98	98	98	98
Heavy Vehicles, %	2	2	2	2	2	2	2	2	2	2	2	2
Mvmt Flow	0	1097	87	0	658	10	0	0	143	0	0	82

Major/Minor	Major1		Major2		Minor1		Minor2	
Conflicting Flow All	-	0	0	-	-	0	-	-
Stage 1	-	-	-	-	-	-	-	-
Stage 2	-	-	-	-	-	-	-	-
Critical Hdwy	-	-	-	-	-	-	-	-
Critical Hdwy Stg 1	-	-	-	-	-	-	-	-
Critical Hdwy Stg 2	-	-	-	-	-	-	-	-
Follow-up Hdwy	-	-	-	-	-	-	-	-
Pot Cap-1 Maneuver	0	-	-	0	-	-	0	0
Stage 1	0	-	-	0	-	-	0	0
Stage 2	0	-	-	0	-	-	0	0
Platoon blocked, %	-	-	-	-	-	-	-	-
Mov Cap-1 Maneuver	-	-	-	-	-	-	-	-
Mov Cap-2 Maneuver	-	-	-	-	-	-	-	-
Stage 1	-	-	-	-	-	-	-	-
Stage 2	-	-	-	-	-	-	-	-

Approach	EB	WB	NB	SB
HCM Control Delay, s	0	0	0	0
HCM LOS			A	A

Minor Lane/Major Mvmt	NBLn1	EBT	EBR	WBT	WBR	SBLn1
Capacity (veh/h)	-	-	-	-	-	-
HCM Lane V/C Ratio	-	-	-	-	-	-
HCM Control Delay (s)	0	-	-	-	-	0
HCM Lane LOS	A	-	-	-	-	A
HCM 95th %tile Q(veh)	-	-	-	-	-	-

Intersection												
Int Delay, s/veh	0											
Movement	EBL	EBT	EBR	WBL	WBT	WBR	NBL	NBT	NBR	SBL	SBT	SBR
Lane Configurations		↑	↗		↑	↗			↗			↗
Traffic Vol, veh/h	0	900	30	0	1305	35	0	0	100	0	0	155
Future Vol, veh/h	0	900	30	0	1305	35	0	0	100	0	0	155
Conflicting Peds, #/hr	0	0	0	0	0	0	0	0	0	0	0	0
Sign Control	Free	Free	Free	Free	Free	Free	Stop	Stop	Stop	Stop	Stop	Stop
RT Channelized	-	-	None	-	-	None	-	-	Free	-	-	Free
Storage Length	-	-	350	-	-	-	-	-	-	-	-	-
Veh in Median Storage, #	-	0	-	-	0	-	-	0	-	-	0	-
Grade, %	-	0	-	-	0	-	-	0	-	-	0	-
Peak Hour Factor	96	96	96	96	96	96	96	96	96	96	96	96
Heavy Vehicles, %	2	2	2	2	2	2	2	2	2	2	2	2
Mvmt Flow	0	938	31	0	1359	36	0	0	104	0	0	161

Major/Minor	Major1			Major2			Minor1			Minor2		
Conflicting Flow All	-	0	0	-	-	0	-	-	-	-	-	-
Stage 1	-	-	-	-	-	-	-	-	-	-	-	-
Stage 2	-	-	-	-	-	-	-	-	-	-	-	-
Critical Hdwy	-	-	-	-	-	-	-	-	-	-	-	-
Critical Hdwy Stg 1	-	-	-	-	-	-	-	-	-	-	-	-
Critical Hdwy Stg 2	-	-	-	-	-	-	-	-	-	-	-	-
Follow-up Hdwy	-	-	-	-	-	-	-	-	-	-	-	-
Pot Cap-1 Maneuver	0	-	-	0	-	-	0	0	0	0	0	0
Stage 1	0	-	-	0	-	-	0	0	0	0	0	0
Stage 2	0	-	-	0	-	-	0	0	0	0	0	0
Platoon blocked, %	-	-	-	-	-	-	-	-	-	-	-	-
Mov Cap-1 Maneuver	-	-	-	-	-	-	-	-	-	-	-	-
Mov Cap-2 Maneuver	-	-	-	-	-	-	-	-	-	-	-	-
Stage 1	-	-	-	-	-	-	-	-	-	-	-	-
Stage 2	-	-	-	-	-	-	-	-	-	-	-	-

Approach	EB	WB	NB	SB
HCM Control Delay, s	0	0	0	0
HCM LOS			A	A

Minor Lane/Major Mvmt	NBLn1	EBT	EBR	WBT	WBR	SBLn1
Capacity (veh/h)	-	-	-	-	-	-
HCM Lane V/C Ratio	-	-	-	-	-	-
HCM Control Delay (s)	0	-	-	-	-	0
HCM Lane LOS	A	-	-	-	-	A
HCM 95th %tile Q(veh)	-	-	-	-	-	-

Intersection												
Int Delay, s/veh	0											
Movement	EBL	EBT	EBR	WBL	WBT	WBR	NBL	NBT	NBR	SBL	SBT	SBR
Lane Configurations		↑	↗		↑	↗			↗			↗
Traffic Vol, veh/h	0	1620	45	0	845	30	0	0	150	0	0	130
Future Vol, veh/h	0	1620	45	0	845	30	0	0	150	0	0	130
Conflicting Peds, #/hr	0	0	0	0	0	0	0	0	0	0	0	0
Sign Control	Free	Free	Free	Free	Free	Free	Stop	Stop	Stop	Stop	Stop	Stop
RT Channelized	-	-	None	-	-	None	-	-	Free	-	-	Free
Storage Length	-	-	350	-	-	375	-	-	-	-	-	-
Veh in Median Storage, #	-	0	-	-	0	-	-	0	-	-	0	-
Grade, %	-	0	-	-	0	-	-	0	-	-	0	-
Peak Hour Factor	98	98	98	98	98	98	98	98	98	98	98	98
Heavy Vehicles, %	2	2	2	2	2	2	2	2	2	2	2	2
Mvmt Flow	0	1653	46	0	862	31	0	0	153	0	0	133

Major/Minor	Major1		Major2		Minor1		Minor2	
Conflicting Flow All	-	0	0	-	-	0	-	-
Stage 1	-	-	-	-	-	-	-	-
Stage 2	-	-	-	-	-	-	-	-
Critical Hdwy	-	-	-	-	-	-	-	-
Critical Hdwy Stg 1	-	-	-	-	-	-	-	-
Critical Hdwy Stg 2	-	-	-	-	-	-	-	-
Follow-up Hdwy	-	-	-	-	-	-	-	-
Pot Cap-1 Maneuver	0	-	-	0	-	-	0	0
Stage 1	0	-	-	0	-	-	0	0
Stage 2	0	-	-	0	-	-	0	0
Platoon blocked, %	-	-	-	-	-	-	-	-
Mov Cap-1 Maneuver	-	-	-	-	-	-	-	-
Mov Cap-2 Maneuver	-	-	-	-	-	-	-	-
Stage 1	-	-	-	-	-	-	-	-
Stage 2	-	-	-	-	-	-	-	-

Approach	EB	WB	NB	SB
HCM Control Delay, s	0	0	0	0
HCM LOS			A	A

Minor Lane/Major Mvmt	NBLn1	EBT	EBR	WBT	WBR	SBLn1
Capacity (veh/h)	-	-	-	-	-	-
HCM Lane V/C Ratio	-	-	-	-	-	-
HCM Control Delay (s)	0	-	-	-	-	0
HCM Lane LOS	A	-	-	-	-	A
HCM 95th %tile Q(veh)	-	-	-	-	-	-

Intersection												
Int Delay, s/veh	0											
Movement	EBL	EBT	EBR	WBL	WBT	WBR	NBL	NBT	NBR	SBL	SBT	SBR
Lane Configurations		↑↑	↑		↑↑	↑			↑			↑
Traffic Vol, veh/h	0	900	85	0	1335	35	0	0	130	0	0	155
Future Vol, veh/h	0	900	85	0	1335	35	0	0	130	0	0	155
Conflicting Peds, #/hr	0	0	0	0	0	0	0	0	0	0	0	0
Sign Control	Free	Free	Free	Free	Free	Free	Stop	Stop	Stop	Stop	Stop	Stop
RT Channelized	-	-	None	-	-	None	-	-	Free	-	-	Free
Storage Length	-	-	0	-	-	375	-	-	-	-	-	-
Veh in Median Storage, #	-	0	-	-	0	-	-	0	-	-	0	-
Grade, %	-	0	-	-	0	-	-	0	-	-	0	-
Peak Hour Factor	96	96	96	96	96	96	96	96	96	96	96	96
Heavy Vehicles, %	2	2	2	2	2	2	2	2	2	2	2	2
Mvmt Flow	0	938	89	0	1391	36	0	0	135	0	0	161

Major/Minor	Major1			Major2			Minor1			Minor2		
Conflicting Flow All	-	0	0	-	-	0	-	-	-	-	-	-
Stage 1	-	-	-	-	-	-	-	-	-	-	-	-
Stage 2	-	-	-	-	-	-	-	-	-	-	-	-
Critical Hdwy	-	-	-	-	-	-	-	-	-	-	-	-
Critical Hdwy Stg 1	-	-	-	-	-	-	-	-	-	-	-	-
Critical Hdwy Stg 2	-	-	-	-	-	-	-	-	-	-	-	-
Follow-up Hdwy	-	-	-	-	-	-	-	-	-	-	-	-
Pot Cap-1 Maneuver	0	-	-	0	-	-	0	0	0	0	0	0
Stage 1	0	-	-	0	-	-	0	0	0	0	0	0
Stage 2	0	-	-	0	-	-	0	0	0	0	0	0
Platoon blocked, %	-	-	-	-	-	-	-	-	-	-	-	-
Mov Cap-1 Maneuver	-	-	-	-	-	-	-	-	-	-	-	-
Mov Cap-2 Maneuver	-	-	-	-	-	-	-	-	-	-	-	-
Stage 1	-	-	-	-	-	-	-	-	-	-	-	-
Stage 2	-	-	-	-	-	-	-	-	-	-	-	-

Approach	EB			WB			NB			SB		
HCM Control Delay, s	0			0			0			0		
HCM LOS							A			A		

Minor Lane/Major Mvmt	NBLn1	EBT	EBR	WBT	WBR	SBLn1
Capacity (veh/h)	-	-	-	-	-	-
HCM Lane V/C Ratio	-	-	-	-	-	-
HCM Control Delay (s)	0	-	-	-	-	0
HCM Lane LOS	A	-	-	-	-	A
HCM 95th %tile Q(veh)	-	-	-	-	-	-

Intersection												
Int Delay, s/veh	0											
Movement	EBL	EBT	EBR	WBL	WBT	WBR	NBL	NBT	NBR	SBL	SBT	SBR
Lane Configurations		↑↑	↑		↑↑	↑			↑			↑
Traffic Vol, veh/h	0	1620	90	0	870	30	0	0	175	0	0	130
Future Vol, veh/h	0	1620	90	0	870	30	0	0	175	0	0	130
Conflicting Peds, #/hr	0	0	0	0	0	0	0	0	0	0	0	0
Sign Control	Free	Free	Free	Free	Free	Free	Stop	Stop	Stop	Stop	Stop	Stop
RT Channelized	-	-	None	-	-	None	-	-	Free	-	-	Free
Storage Length	-	-	0	-	-	375	-	-	-	-	-	-
Veh in Median Storage, #	-	0	-	-	0	-	-	0	-	-	0	-
Grade, %	-	0	-	-	0	-	-	0	-	-	0	-
Peak Hour Factor	98	98	98	98	98	98	98	98	98	98	98	98
Heavy Vehicles, %	2	2	2	2	2	2	2	2	2	2	2	2
Mvmt Flow	0	1653	92	0	888	31	0	0	179	0	0	133

Major/Minor	Major1			Major2			Minor1			Minor2		
Conflicting Flow All	-	0	0	-	-	0	-	-	-	-	-	-
Stage 1	-	-	-	-	-	-	-	-	-	-	-	-
Stage 2	-	-	-	-	-	-	-	-	-	-	-	-
Critical Hdwy	-	-	-	-	-	-	-	-	-	-	-	-
Critical Hdwy Stg 1	-	-	-	-	-	-	-	-	-	-	-	-
Critical Hdwy Stg 2	-	-	-	-	-	-	-	-	-	-	-	-
Follow-up Hdwy	-	-	-	-	-	-	-	-	-	-	-	-
Pot Cap-1 Maneuver	0	-	-	0	-	-	0	0	0	0	0	0
Stage 1	0	-	-	0	-	-	0	0	0	0	0	0
Stage 2	0	-	-	0	-	-	0	0	0	0	0	0
Platoon blocked, %	-	-	-	-	-	-	-	-	-	-	-	-
Mov Cap-1 Maneuver	-	-	-	-	-	-	-	-	-	-	-	-
Mov Cap-2 Maneuver	-	-	-	-	-	-	-	-	-	-	-	-
Stage 1	-	-	-	-	-	-	-	-	-	-	-	-
Stage 2	-	-	-	-	-	-	-	-	-	-	-	-

Approach	EB	WB	NB	SB
HCM Control Delay, s	0	0	0	0
HCM LOS			A	A

Minor Lane/Major Mvmt	NBLn1	EBT	EBR	WBT	WBR	SBLn1
Capacity (veh/h)	-	-	-	-	-	-
HCM Lane V/C Ratio	-	-	-	-	-	-
HCM Control Delay (s)	0	-	-	-	-	0
HCM Lane LOS	A	-	-	-	-	A
HCM 95th %tile Q(veh)	-	-	-	-	-	-

Timings
2: (New) Meridian Road & US-24

Lane Group	EBL	EBT	EBR	WBL	WBT	WBR	NBL	NBT	NBR	SBL	SBT	SBR
Lane Configurations												
Traffic Volume (vph)	140	460	89	195	840	20	25	135	190	10	150	500
Future Volume (vph)	140	460	89	195	840	20	25	135	190	10	150	500
Turn Type	pm+pt	NA	Perm	pm+pt	NA	Perm	pm+pt	NA	Free	pm+pt	NA	Free
Protected Phases	7	4		3	8		5	2		1	6	
Permitted Phases	4		4	8		8	2		Free	6		Free
Detector Phase	7	4	4	3	8	8	5	2		1	6	
Switch Phase												
Minimum Initial (s)	5.0	5.0	5.0	5.0	5.0	5.0	5.0	5.0		5.0	5.0	
Minimum Split (s)	9.5	22.5	22.5	9.5	22.5	22.5	9.5	22.5		9.5	22.5	
Total Split (s)	13.3	71.1	71.1	15.2	73.0	73.0	9.5	24.2		9.5	24.2	
Total Split (%)	11.1%	59.3%	59.3%	12.7%	60.8%	60.8%	7.9%	20.2%		7.9%	20.2%	
Yellow Time (s)	3.5	3.5	3.5	3.5	3.5	3.5	3.5	3.5		3.5	3.5	
All-Red Time (s)	1.0	1.0	1.0	1.0	1.0	1.0	1.0	1.0		1.0	1.0	
Lost Time Adjust (s)	0.0	0.0	0.0	0.0	0.0	0.0	0.0	0.0		0.0	0.0	
Total Lost Time (s)	4.5	4.5	4.5	4.5	4.5	4.5	4.5	4.5		4.5	4.5	
Lead/Lag	Lead	Lag	Lag	Lead	Lag	Lag	Lead	Lag		Lead	Lag	
Lead-Lag Optimize?	Yes	Yes	Yes	Yes	Yes	Yes	Yes	Yes		Yes	Yes	
Recall Mode	None	None	None	None	None	None	None	C-Max		None	C-Max	
Act Effct Green (s)	72.7	64.0	64.0	76.3	65.7	65.7	31.1	30.1	120.0	29.3	26.3	120.0
Actuated g/C Ratio	0.61	0.53	0.53	0.64	0.55	0.55	0.26	0.25	1.00	0.24	0.22	1.00
v/c Ratio	0.75	0.50	0.11	0.42	0.90	0.02	0.09	0.17	0.13	0.03	0.21	0.34
Control Delay	44.6	19.6	2.7	10.2	36.4	0.1	35.6	38.0	0.2	35.0	41.9	0.6
Queue Delay	0.0	0.0	0.0	0.0	0.0	0.0	0.0	0.0	0.0	0.0	0.0	0.0
Total Delay	44.6	19.6	2.7	10.2	36.4	0.1	35.6	38.0	0.2	35.0	41.9	0.6
LOS	D	B	A	B	D	A	D	D	A	C	D	A
Approach Delay		22.5			30.9			17.3			10.5	
Approach LOS		C			C			B			B	

Intersection Summary

Cycle Length: 120
 Actuated Cycle Length: 120
 Offset: 0 (0%), Referenced to phase 2:NBTL and 6:SBTL, Start of Green
 Natural Cycle: 90
 Control Type: Actuated-Coordinated
 Maximum v/c Ratio: 0.90
 Intersection Signal Delay: 22.2
 Intersection LOS: C
 Intersection Capacity Utilization 75.3%
 ICU Level of Service D
 Analysis Period (min) 15

Splits and Phases: 2: (New) Meridian Road & US-24

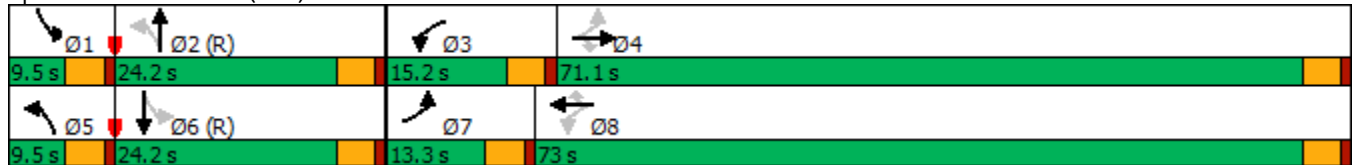

HCM 6th Signalized Intersection Summary
2: (New) Meridian Road & US-24

2023 Background AM.syn

12/15/2021



Movement	EBL	EBT	EBR	WBL	WBT	WBR	NBL	NBT	NBR	SBL	SBT	SBR
Lane Configurations	↖	↗	↘	↖	↗	↘	↖	↗	↘	↖	↗	↘
Traffic Volume (veh/h)	140	460	89	195	840	20	25	135	190	10	150	500
Future Volume (veh/h)	140	460	89	195	840	20	25	135	190	10	150	500
Initial Q (Qb), veh	0	0	0	0	0	0	0	0	0	0	0	0
Ped-Bike Adj(A_pbT)	1.00		1.00	1.00		1.00	1.00		1.00	1.00		1.00
Parking Bus, Adj	1.00	1.00	1.00	1.00	1.00	1.00	1.00	1.00	1.00	1.00	1.00	1.00
Work Zone On Approach		No			No			No			No	
Adj Sat Flow, veh/h/ln	1870	1870	1870	1870	1870	1870	1870	1870	1870	1870	1870	1870
Adj Flow Rate, veh/h	152	500	97	212	913	22	27	147	0	11	163	0
Peak Hour Factor	0.92	0.92	0.92	0.92	0.92	0.92	0.92	0.92	0.92	0.92	0.92	0.92
Percent Heavy Veh, %	2	2	2	2	2	2	2	2	2	2	2	2
Cap, veh/h	200	941	797	457	972	824	363	923		365	881	
Arrive On Green	0.06	0.50	0.50	0.07	0.52	0.52	0.02	0.26	0.00	0.01	0.25	0.00
Sat Flow, veh/h	1781	1870	1585	1781	1870	1585	1781	3554	1585	1781	3554	1585
Grp Volume(v), veh/h	152	500	97	212	913	22	27	147	0	11	163	0
Grp Sat Flow(s),veh/h/ln	1781	1870	1585	1781	1870	1585	1781	1777	1585	1781	1777	1585
Q Serve(g_s), s	4.9	21.8	3.9	6.8	55.0	0.8	1.3	3.8	0.0	0.6	4.3	0.0
Cycle Q Clear(g_c), s	4.9	21.8	3.9	6.8	55.0	0.8	1.3	3.8	0.0	0.6	4.3	0.0
Prop In Lane	1.00		1.00	1.00		1.00	1.00		1.00	1.00		1.00
Lane Grp Cap(c), veh/h	200	941	797	457	972	824	363	923		365	881	
V/C Ratio(X)	0.76	0.53	0.12	0.46	0.94	0.03	0.07	0.16		0.03	0.19	
Avail Cap(c_a), veh/h	227	1038	880	483	1068	905	393	923		417	881	
HCM Platoon Ratio	1.00	1.00	1.00	1.00	1.00	1.00	1.00	1.00	1.00	1.00	1.00	1.00
Upstream Filter(l)	1.00	1.00	1.00	1.00	1.00	1.00	1.00	1.00	0.00	1.00	1.00	0.00
Uniform Delay (d), s/veh	26.9	20.2	15.8	14.8	27.1	14.0	32.3	34.3	0.0	33.0	35.6	0.0
Incr Delay (d2), s/veh	12.3	0.5	0.1	0.7	14.5	0.0	0.1	0.4	0.0	0.0	0.5	0.0
Initial Q Delay(d3),s/veh	0.0	0.0	0.0	0.0	0.0	0.0	0.0	0.0	0.0	0.0	0.0	0.0
%ile BackOfQ(50%),veh/ln	2.8	9.5	1.4	2.8	27.3	0.3	0.6	1.7	0.0	0.2	2.0	0.0
Unsig. Movement Delay, s/veh												
LnGrp Delay(d),s/veh	39.3	20.7	15.9	15.6	41.5	14.1	32.4	34.7	0.0	33.1	36.0	0.0
LnGrp LOS	D	C	B	B	D	B	C	C		C	D	
Approach Vol, veh/h		749			1147			174	A		174	A
Approach Delay, s/veh		23.8			36.2			34.3			35.9	
Approach LOS		C			D			C			D	
Timer - Assigned Phs	1	2	3	4	5	6	7	8				
Phs Duration (G+Y+Rc), s	6.0	35.7	13.5	64.8	7.5	34.2	11.4	66.9				
Change Period (Y+Rc), s	4.5	4.5	4.5	4.5	4.5	4.5	4.5	4.5				
Max Green Setting (Gmax), s	5.0	19.7	10.7	66.6	5.0	19.7	8.8	68.5				
Max Q Clear Time (g_c+I1), s	2.6	5.8	8.8	23.8	3.3	6.3	6.9	57.0				
Green Ext Time (p_c), s	0.0	0.6	0.1	4.0	0.0	0.7	0.1	5.4				

Intersection Summary

HCM 6th Ctrl Delay	31.9
HCM 6th LOS	C

Notes

Unsignalized Delay for [NBR, SBR] is excluded from calculations of the approach delay and intersection delay.

Timings
2: (New) Meridian Road & US-24

Lane Group	EBL	EBT	EBR	WBL	WBT	WBR	NBL	NBT	NBR	SBL	SBT	SBR
Lane Configurations												
Traffic Volume (vph)	525	895	101	200	475	25	70	265	175	45	265	175
Future Volume (vph)	525	895	101	200	475	25	70	265	175	45	265	175
Turn Type	pm+pt	NA	Perm	pm+pt	NA	Perm	pm+pt	NA	Free	pm+pt	NA	Free
Protected Phases	7	4		3	8		5	2		1	6	
Permitted Phases	4		4	8		8	2		Free	6		Free
Detector Phase	7	4	4	3	8	8	5	2		1	6	
Switch Phase												
Minimum Initial (s)	5.0	5.0	5.0	5.0	5.0	5.0	5.0	5.0		5.0	5.0	
Minimum Split (s)	9.5	22.5	22.5	9.5	22.5	22.5	9.5	22.5		9.5	22.5	
Total Split (s)	40.9	70.0	70.0	16.2	45.3	45.3	9.5	24.3		9.5	24.3	
Total Split (%)	34.1%	58.3%	58.3%	13.5%	37.8%	37.8%	7.9%	20.3%		7.9%	20.3%	
Yellow Time (s)	3.5	3.5	3.5	3.5	3.5	3.5	3.5	3.5		3.5	3.5	
All-Red Time (s)	1.0	1.0	1.0	1.0	1.0	1.0	1.0	1.0		1.0	1.0	
Lost Time Adjust (s)	0.0	0.0	0.0	0.0	0.0	0.0	0.0	0.0		0.0	0.0	
Total Lost Time (s)	4.5	4.5	4.5	4.5	4.5	4.5	4.5	4.5		4.5	4.5	
Lead/Lag	Lead	Lag	Lag	Lead	Lag	Lag	Lead	Lag		Lead	Lag	
Lead-Lag Optimize?	Yes	Yes	Yes	Yes	Yes	Yes	Yes	Yes		Yes	Yes	
Recall Mode	None	None	None	None	None	None	None	C-Max		None	C-Max	
Act Effect Green (s)	81.2	65.0	65.0	54.5	42.8	42.8	26.2	22.2	120.0	26.2	22.2	120.0
Actuated g/C Ratio	0.68	0.54	0.54	0.45	0.36	0.36	0.22	0.18	1.00	0.22	0.18	1.00
v/c Ratio	0.92	0.97	0.12	0.93	0.78	0.04	0.34	0.44	0.12	0.22	0.44	0.12
Control Delay	46.9	48.3	3.8	78.5	44.5	0.1	41.2	46.8	0.2	38.2	46.8	0.2
Queue Delay	0.0	0.0	0.0	0.0	0.0	0.0	0.0	0.0	0.0	0.0	0.0	0.0
Total Delay	46.9	48.3	3.8	78.5	44.5	0.1	41.2	46.8	0.2	38.2	46.8	0.2
LOS	D	D	A	E	D	A	D	D	A	D	D	A
Approach Delay		44.8			52.6			30.0			29.2	
Approach LOS		D			D			C			C	

Intersection Summary

Cycle Length: 120
 Actuated Cycle Length: 120
 Offset: 0 (0%), Referenced to phase 2:NBTL and 6:SBTL, Start of Green
 Natural Cycle: 100
 Control Type: Actuated-Coordinated
 Maximum v/c Ratio: 0.97
 Intersection Signal Delay: 41.8 Intersection LOS: D
 Intersection Capacity Utilization 84.7% ICU Level of Service E
 Analysis Period (min) 15

Splits and Phases: 2: (New) Meridian Road & US-24

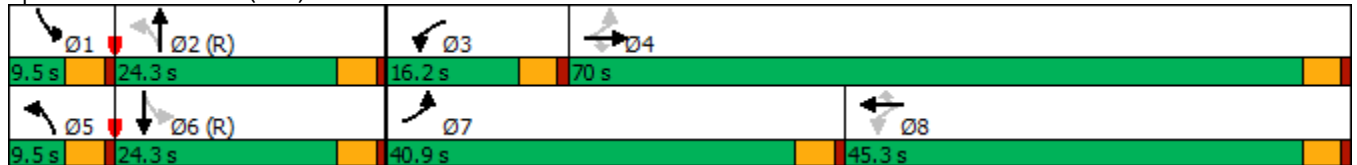

HCM 6th Signalized Intersection Summary
2: (New) Meridian Road & US-24

2023 Background PM.syn

12/15/2021



Movement	EBL	EBT	EBR	WBL	WBT	WBR	NBL	NBT	NBR	SBL	SBT	SBR
Lane Configurations	↖	↑	↗	↖	↑	↗	↖	↑↑	↗	↖	↑↑	↗
Traffic Volume (veh/h)	525	895	101	200	475	25	70	265	175	45	265	175
Future Volume (veh/h)	525	895	101	200	475	25	70	265	175	45	265	175
Initial Q (Qb), veh	0	0	0	0	0	0	0	0	0	0	0	0
Ped-Bike Adj(A_pbT)	1.00		1.00	1.00		1.00	1.00		1.00	1.00		1.00
Parking Bus, Adj	1.00	1.00	1.00	1.00	1.00	1.00	1.00	1.00	1.00	1.00	1.00	1.00
Work Zone On Approach		No			No			No			No	
Adj Sat Flow, veh/h/ln	1870	1870	1870	1870	1870	1870	1870	1870	1870	1870	1870	1870
Adj Flow Rate, veh/h	571	973	110	217	516	27	76	288	0	49	288	0
Peak Hour Factor	0.92	0.92	0.92	0.92	0.92	0.92	0.92	0.92	0.92	0.92	0.92	0.92
Percent Heavy Veh, %	2	2	2	2	2	2	2	2	2	2	2	2
Cap, veh/h	608	1004	851	243	778	659	250	664		245	635	
Arrive On Green	0.21	0.54	0.54	0.09	0.42	0.42	0.04	0.19	0.00	0.03	0.18	0.00
Sat Flow, veh/h	1781	1870	1585	1781	1870	1585	1781	3554	1585	1781	3554	1585
Grp Volume(v), veh/h	571	973	110	217	516	27	76	288	0	49	288	0
Grp Sat Flow(s),veh/h/ln	1781	1870	1585	1781	1870	1585	1781	1777	1585	1781	1777	1585
Q Serve(g_s), s	22.0	60.3	4.1	9.1	26.7	1.2	4.2	8.6	0.0	2.7	8.7	0.0
Cycle Q Clear(g_c), s	22.0	60.3	4.1	9.1	26.7	1.2	4.2	8.6	0.0	2.7	8.7	0.0
Prop In Lane	1.00		1.00	1.00		1.00	1.00		1.00	1.00		1.00
Lane Grp Cap(c), veh/h	608	1004	851	243	778	659	250	664		245	635	
V/C Ratio(X)	0.94	0.97	0.13	0.89	0.66	0.04	0.30	0.43		0.20	0.45	
Avail Cap(c_a), veh/h	767	1021	865	252	778	659	250	664		260	635	
HCM Platoon Ratio	1.00	1.00	1.00	1.00	1.00	1.00	1.00	1.00	1.00	1.00	1.00	1.00
Upstream Filter(I)	1.00	1.00	1.00	1.00	1.00	1.00	1.00	1.00	0.00	1.00	1.00	0.00
Uniform Delay (d), s/veh	21.1	26.8	13.8	30.5	28.3	20.8	38.4	43.2	0.0	38.5	44.0	0.0
Incr Delay (d2), s/veh	17.0	20.8	0.1	29.6	2.1	0.0	0.7	2.1	0.0	0.4	2.3	0.0
Initial Q Delay(d3),s/veh	0.0	0.0	0.0	0.0	0.0	0.0	0.0	0.0	0.0	0.0	0.0	0.0
%ile BackOfQ(50%),veh/ln	11.4	31.3	1.5	5.8	12.3	0.5	1.9	4.0	0.0	1.2	4.0	0.0
Unsig. Movement Delay, s/veh												
LnGrp Delay(d),s/veh	38.1	47.7	13.9	60.1	30.4	20.9	39.1	45.2	0.0	38.9	46.4	0.0
LnGrp LOS	D	D	B	E	C	C	D	D		D	D	
Approach Vol, veh/h		1654			760			364	A		337	A
Approach Delay, s/veh		42.1			38.5			44.0			45.3	
Approach LOS		D			D			D			D	
Timer - Assigned Phs	1	2	3	4	5	6	7	8				
Phs Duration (G+Y+Rc), s	8.5	26.9	15.6	68.9	9.5	25.9	30.2	54.4				
Change Period (Y+Rc), s	4.5	4.5	4.5	4.5	4.5	4.5	4.5	4.5				
Max Green Setting (Gmax), s	5.0	19.8	11.7	65.5	5.0	19.8	36.4	40.8				
Max Q Clear Time (g_c+I1), s	4.7	10.6	11.1	62.3	6.2	10.7	24.0	28.7				
Green Ext Time (p_c), s	0.0	1.2	0.0	2.1	0.0	1.2	1.6	2.7				

Intersection Summary

HCM 6th Ctrl Delay	41.8
HCM 6th LOS	D

Notes

User approved pedestrian interval to be less than phase max green.
Unsignalized Delay for [NBR, SBR] is excluded from calculations of the approach delay and intersection delay.

HCM 6th Signalized Intersection Summary
2: (New) Meridian Road & US-24

2023 Total AM
12/15/2021



Movement	EBL	EBT	EBR	WBL	WBT	WBR	NBL	NBT	NBR	SBL	SBT	SBR
Lane Configurations	↖	↑	↗	↖	↑	↗	↖	↑↑	↗	↖	↑↑	↗
Traffic Volume (veh/h)	140	490	150	225	840	20	120	190	190	30	180	500
Future Volume (veh/h)	140	490	150	225	840	20	120	190	190	30	180	500
Initial Q (Qb), veh	0	0	0	0	0	0	0	0	0	0	0	0
Ped-Bike Adj(A_pbT)	1.00		1.00	1.00		1.00	1.00		1.00	1.00		1.00
Parking Bus, Adj	1.00	1.00	1.00	1.00	1.00	1.00	1.00	1.00	1.00	1.00	1.00	1.00
Work Zone On Approach		No			No			No			No	
Adj Sat Flow, veh/h/ln	1870	1870	1870	1870	1870	1870	1870	1870	1870	1870	1870	1870
Adj Flow Rate, veh/h	152	533	163	245	913	22	130	207	0	33	196	0
Peak Hour Factor	0.92	0.92	0.92	0.92	0.92	0.92	0.92	0.92	0.92	0.92	0.92	0.92
Percent Heavy Veh, %	2	2	2	2	2	2	2	2	2	2	2	2
Cap, veh/h	209	926	784	436	974	825	374	895		359	831	
Arrive On Green	0.06	0.49	0.49	0.09	0.52	0.52	0.05	0.25	0.00	0.03	0.23	0.00
Sat Flow, veh/h	1781	1870	1585	1781	1870	1585	1781	3554	1585	1781	3554	1585
Grp Volume(v), veh/h	152	533	163	245	913	22	130	207	0	33	196	0
Grp Sat Flow(s),veh/h/ln	1781	1870	1585	1781	1870	1585	1781	1777	1585	1781	1777	1585
Q Serve(g_s), s	5.0	24.2	6.9	7.8	54.9	0.8	6.0	5.6	0.0	1.7	5.4	0.0
Cycle Q Clear(g_c), s	5.0	24.2	6.9	7.8	54.9	0.8	6.0	5.6	0.0	1.7	5.4	0.0
Prop In Lane	1.00		1.00	1.00		1.00	1.00		1.00	1.00		1.00
Lane Grp Cap(c), veh/h	209	926	784	436	974	825	374	895		359	831	
V/C Ratio(X)	0.73	0.58	0.21	0.56	0.94	0.03	0.35	0.23		0.09	0.24	
Avail Cap(c_a), veh/h	232	987	836	483	1060	898	374	895		383	831	
HCM Platoon Ratio	1.00	1.00	1.00	1.00	1.00	1.00	1.00	1.00	1.00	1.00	1.00	1.00
Upstream Filter(I)	1.00	1.00	1.00	1.00	1.00	1.00	1.00	1.00	0.00	1.00	1.00	0.00
Uniform Delay (d), s/veh	26.6	21.4	17.1	15.5	26.9	14.0	33.7	35.7	0.0	33.0	37.3	0.0
Incr Delay (d2), s/veh	9.9	0.7	0.1	1.2	14.4	0.0	0.6	0.6	0.0	0.1	0.7	0.0
Initial Q Delay(d3),s/veh	0.0	0.0	0.0	0.0	0.0	0.0	0.0	0.0	0.0	0.0	0.0	0.0
%ile BackOfQ(50%),veh/ln	2.6	10.6	2.6	3.2	27.3	0.3	3.0	2.5	0.0	0.7	2.4	0.0
Unsig. Movement Delay, s/veh												
LnGrp Delay(d),s/veh	36.5	22.1	17.2	16.7	41.3	14.0	34.3	36.3	0.0	33.1	37.9	0.0
LnGrp LOS	D	C	B	B	D	B	C	D		C	D	
Approach Vol, veh/h		848			1180			337	A		229	A
Approach Delay, s/veh		23.8			35.7			35.5			37.2	
Approach LOS		C			D			D			D	
Timer - Assigned Phs	1	2	3	4	5	6	7	8				
Phs Duration (G+Y+Rc), s	7.8	34.2	14.5	63.4	10.0	32.1	11.5	66.5				
Change Period (Y+Rc), s	4.5	4.5	4.5	4.5	4.5	4.5	4.5	4.5				
Max Green Setting (Gmax), s	5.0	21.0	13.2	62.8	5.5	20.5	8.5	67.5				
Max Q Clear Time (g_c+I1), s	3.7	7.6	9.8	26.2	8.0	7.4	7.0	56.9				
Green Ext Time (p_c), s	0.0	1.0	0.2	4.5	0.0	0.9	0.1	5.1				

Intersection Summary

HCM 6th Ctrl Delay	31.9
HCM 6th LOS	C

Notes

Unsignalized Delay for [NBR, SBR] is excluded from calculations of the approach delay and intersection delay.

Timings
2: (New) Meridian Road & US-24

2023 Total PM
12/15/2021

Lane Group	EBL	EBT	EBR	WBL	WBT	WBR	NBL	NBT	NBR	SBL	SBT	SBR
Lane Configurations	↘	↑	↗	↘	↑	↗	↘	↑↑	↗	↘	↑↑	↗
Traffic Volume (vph)	525	920	150	225	475	25	135	305	175	65	290	175
Future Volume (vph)	525	920	150	225	475	25	135	305	175	65	290	175
Turn Type	pm+pt	NA	Perm	pm+pt	NA	Perm	pm+pt	NA	Free	pm+pt	NA	Free
Protected Phases	7	4		3	8		5	2		1	6	
Permitted Phases	4		4	8		8	2		Free	6		Free
Detector Phase	7	4	4	3	8	8	5	2		1	6	
Switch Phase												
Minimum Initial (s)	5.0	5.0	5.0	5.0	5.0	5.0	5.0	5.0		5.0	5.0	
Minimum Split (s)	9.5	22.5	22.5	9.5	22.5	22.5	9.5	22.5		9.5	22.5	
Total Split (s)	39.9	70.0	70.0	17.2	47.3	47.3	9.6	23.3		9.5	23.2	
Total Split (%)	33.3%	58.3%	58.3%	14.3%	39.4%	39.4%	8.0%	19.4%		7.9%	19.3%	
Yellow Time (s)	3.5	3.5	3.5	3.5	3.5	3.5	3.5	3.5		3.5	3.5	
All-Red Time (s)	1.0	1.0	1.0	1.0	1.0	1.0	1.0	1.0		1.0	1.0	
Lost Time Adjust (s)	-0.5	-0.5	-0.5	-0.5	-0.5	-0.5	-0.5	-0.5		-0.5	-0.5	
Total Lost Time (s)	4.0	4.0	4.0	4.0	4.0	4.0	4.0	4.0		4.0	4.0	
Lead/Lag	Lead	Lag	Lag	Lead	Lag	Lag	Lead	Lag		Lead	Lag	
Lead-Lag Optimize?	Yes	Yes	Yes	Yes	Yes	Yes	Yes	Yes		Yes	Yes	
Recall Mode	None	None	None	None	None	None	None	C-Max		None	C-Max	
Act Effct Green (s)	83.1	65.9	65.9	59.7	46.5	46.5	25.8	21.3	120.0	24.8	19.2	120.0
Actuated g/C Ratio	0.69	0.55	0.55	0.50	0.39	0.39	0.22	0.18	1.00	0.21	0.16	1.00
v/c Ratio	0.90	0.98	0.17	0.96	0.72	0.04	0.75	0.53	0.12	0.35	0.56	0.12
Control Delay	39.6	50.6	2.4	82.8	38.9	0.1	65.0	49.1	0.2	42.0	50.7	0.2
Queue Delay	0.0	0.0	0.0	0.0	0.0	0.0	0.0	0.0	0.0	0.0	0.0	0.0
Total Delay	39.6	50.6	2.4	82.8	38.9	0.1	65.0	49.1	0.2	42.0	50.7	0.2
LOS	D	D	A	F	D	A	E	D	A	D	D	A
Approach Delay		42.4			51.2			38.7			33.0	
Approach LOS		D			D			D			C	

Intersection Summary

Cycle Length: 120
 Actuated Cycle Length: 120
 Offset: 0 (0%), Referenced to phase 2:NBTL and 6:SBTL, Start of Green
 Natural Cycle: 110
 Control Type: Actuated-Coordinated
 Maximum v/c Ratio: 0.98
 Intersection Signal Delay: 42.2 Intersection LOS: D
 Intersection Capacity Utilization 89.7% ICU Level of Service E
 Analysis Period (min) 15

Splits and Phases: 2: (New) Meridian Road & US-24

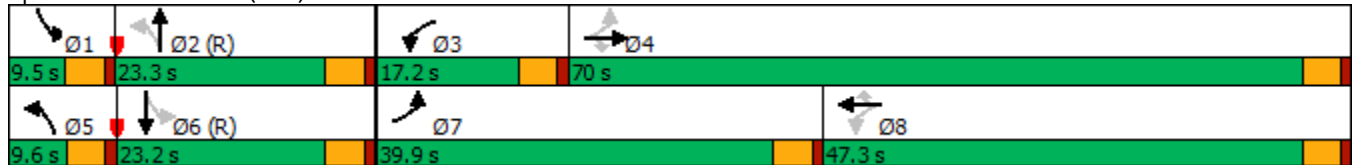

HCM 6th Signalized Intersection Summary
2: (New) Meridian Road & US-24

2023 Total PM
12/15/2021



Movement	EBL	EBT	EBR	WBL	WBT	WBR	NBL	NBT	NBR	SBL	SBT	SBR
Lane Configurations	↖	↗	↘	↖	↗	↘	↖	↗	↘	↖	↗	↘
Traffic Volume (veh/h)	525	920	150	225	475	25	135	305	175	65	290	175
Future Volume (veh/h)	525	920	150	225	475	25	135	305	175	65	290	175
Initial Q (Qb), veh	0	0	0	0	0	0	0	0	0	0	0	0
Ped-Bike Adj(A_pbT)	1.00		1.00	1.00		1.00	1.00		1.00	1.00		1.00
Parking Bus, Adj	1.00	1.00	1.00	1.00	1.00	1.00	1.00	1.00	1.00	1.00	1.00	1.00
Work Zone On Approach		No			No			No			No	
Adj Sat Flow, veh/h/ln	1870	1870	1870	1870	1870	1870	1870	1870	1870	1870	1870	1870
Adj Flow Rate, veh/h	571	1000	163	245	516	27	147	332	0	71	315	0
Peak Hour Factor	0.92	0.92	0.92	0.92	0.92	0.92	0.92	0.92	0.92	0.92	0.92	0.92
Percent Heavy Veh, %	2	2	2	2	2	2	2	2	2	2	2	2
Cap, veh/h	626	1024	868	269	876	742	229	580		222	577	
Arrive On Green	0.19	0.55	0.55	0.11	0.47	0.47	0.05	0.16	0.00	0.05	0.16	0.00
Sat Flow, veh/h	1781	1870	1585	1781	1870	1585	1781	3554	1585	1781	3554	1585
Grp Volume(v), veh/h	571	1000	163	245	516	27	147	332	0	71	315	0
Grp Sat Flow(s),veh/h/ln	1781	1870	1585	1781	1870	1585	1781	1777	1585	1781	1777	1585
Q Serve(g_s), s	18.4	62.4	6.2	11.3	24.3	1.1	5.6	10.3	0.0	3.9	9.8	0.0
Cycle Q Clear(g_c), s	18.4	62.4	6.2	11.3	24.3	1.1	5.6	10.3	0.0	3.9	9.8	0.0
Prop In Lane	1.00		1.00	1.00		1.00	1.00		1.00	1.00		1.00
Lane Grp Cap(c), veh/h	626	1024	868	269	876	742	229	580		222	577	
V/C Ratio(X)	0.91	0.98	0.19	0.91	0.59	0.04	0.64	0.57		0.32	0.55	
Avail Cap(c_a), veh/h	822	1029	872	269	876	742	229	580		222	577	
HCM Platoon Ratio	1.00	1.00	1.00	1.00	1.00	1.00	1.00	1.00	1.00	1.00	1.00	1.00
Upstream Filter(I)	1.00	1.00	1.00	1.00	1.00	1.00	1.00	1.00	0.00	1.00	1.00	0.00
Uniform Delay (d), s/veh	17.1	26.4	13.7	35.6	23.4	17.2	44.8	46.3	0.0	39.6	46.2	0.0
Incr Delay (d2), s/veh	11.9	22.4	0.1	32.2	1.0	0.0	5.9	4.1	0.0	0.8	3.7	0.0
Initial Q Delay(d3),s/veh	0.0	0.0	0.0	0.0	0.0	0.0	0.0	0.0	0.0	0.0	0.0	0.0
%ile BackOfQ(50%),veh/ln	9.6	32.6	2.2	9.6	10.8	0.4	1.9	4.9	0.0	1.8	4.6	0.0
Unsig. Movement Delay, s/veh												
LnGrp Delay(d),s/veh	29.0	48.8	13.8	67.9	24.5	17.3	50.7	50.4	0.0	40.5	49.9	0.0
LnGrp LOS	C	D	B	E	C	B	D	D		D	D	
Approach Vol, veh/h		1734			788			479	A		386	A
Approach Delay, s/veh		39.0			37.7			50.5			48.1	
Approach LOS		D			D			D			D	
Timer - Assigned Phs	1	2	3	4	5	6	7	8				
Phs Duration (G+Y+Rc), s	9.5	23.6	17.2	69.7	9.6	23.5	26.7	60.2				
Change Period (Y+Rc), s	4.5	4.5	4.5	4.5	4.5	4.5	4.5	4.5				
Max Green Setting (Gmax), s	5.0	18.8	12.7	65.5	5.1	18.7	35.4	42.8				
Max Q Clear Time (g_c+I1), s	5.9	12.3	13.3	64.4	7.6	11.8	20.4	26.3				
Green Ext Time (p_c), s	0.0	1.1	0.0	0.8	0.0	1.1	1.8	3.1				

Intersection Summary

HCM 6th Ctrl Delay	41.3
HCM 6th LOS	D

Notes

Unsignalized Delay for [NBR, SBR] is excluded from calculations of the approach delay and intersection delay.

Timings
2: (New) Meridian Road & US-24

Lane Group	EBL	EBT	EBR	WBL	WBT	WBR	NBL	NBT	NBR	SBL	SBT	SBR
Lane Configurations												
Traffic Volume (vph)	195	645	150	225	1200	35	40	185	275	10	210	700
Future Volume (vph)	195	645	150	225	1200	35	40	185	275	10	210	700
Turn Type	pm+pt	NA	Perm	pm+pt	NA	Perm	pm+pt	NA	Free	pm+pt	NA	Free
Protected Phases	7	4		3	8		5	2		1	6	
Permitted Phases	4		4	8		8	2		Free	6		Free
Detector Phase	7	4	4	3	8	8	5	2		1	6	
Switch Phase												
Minimum Initial (s)	5.0	5.0	5.0	5.0	5.0	5.0	5.0	5.0		5.0	5.0	
Minimum Split (s)	9.5	22.5	22.5	9.5	22.5	22.5	9.5	22.5		9.5	22.5	
Total Split (s)	11.0	67.6	67.6	18.4	75.0	75.0	9.5	24.5		9.5	24.5	
Total Split (%)	9.2%	56.3%	56.3%	15.3%	62.5%	62.5%	7.9%	20.4%		7.9%	20.4%	
Yellow Time (s)	3.5	3.5	3.5	3.5	3.5	3.5	3.5	3.5		3.5	3.5	
All-Red Time (s)	1.0	1.0	1.0	1.0	1.0	1.0	1.0	1.0		1.0	1.0	
Lost Time Adjust (s)	-0.5	-0.5	-0.5	-0.5	-0.5	-0.5	-0.5	-0.5		-0.5	-0.5	
Total Lost Time (s)	4.0	4.0	4.0	4.0	4.0	4.0	4.0	4.0		4.0	4.0	
Lead/Lag	Lead	Lag	Lag	Lead	Lag	Lag	Lead	Lag		Lead	Lag	
Lead-Lag Optimize?	Yes	Yes	Yes	Yes	Yes	Yes	Yes	Yes		Yes	Yes	
Recall Mode	None	None	None	None	None	None	None	C-Max		None	C-Max	
Act Effct Green (s)	73.0	66.0	66.0	81.6	71.0	71.0	29.2	28.1	120.0	26.8	22.4	120.0
Actuated g/C Ratio	0.61	0.55	0.55	0.68	0.59	0.59	0.24	0.23	1.00	0.22	0.19	1.00
v/c Ratio	1.28	0.68	0.17	0.62	1.18	0.04	0.17	0.24	0.19	0.04	0.35	0.48
Control Delay	192.4	24.2	2.6	14.3	117.3	0.1	36.5	39.2	0.3	34.5	45.0	1.0
Queue Delay	0.0	0.0	0.0	0.0	0.0	0.0	0.0	0.0	0.0	0.0	0.0	0.0
Total Delay	192.4	24.2	2.6	14.3	117.3	0.1	36.5	39.2	0.3	34.5	45.0	1.0
LOS	F	C	A	B	F	A	D	D	A	C	D	A
Approach Delay		54.1			98.6			17.5			11.4	
Approach LOS		D			F			B			B	

Intersection Summary

Cycle Length: 120
 Actuated Cycle Length: 120
 Offset: 0 (0%), Referenced to phase 2:NBTL and 6:SBTL, Start of Green
 Natural Cycle: 150
 Control Type: Actuated-Coordinated
 Maximum v/c Ratio: 1.28
 Intersection Signal Delay: 56.0
 Intersection Capacity Utilization 97.3%
 Analysis Period (min) 15
 Intersection LOS: E
 ICU Level of Service F

Splits and Phases: 2: (New) Meridian Road & US-24

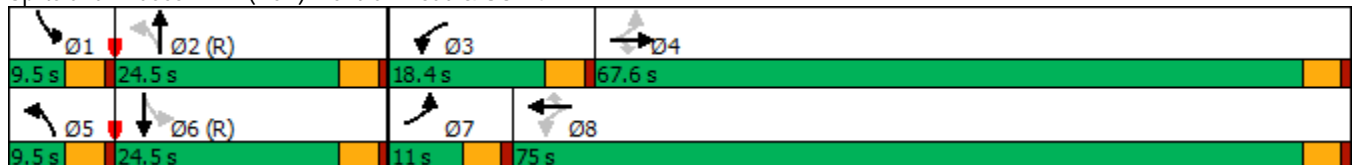

HCM 6th Signalized Intersection Summary
2: (New) Meridian Road & US-24

2040 Background AM.syn

12/15/2021



Movement	EBL	EBT	EBR	WBL	WBT	WBR	NBL	NBT	NBR	SBL	SBT	SBR
Lane Configurations	↖	↑	↗	↖	↑	↗	↖	↑↑	↗	↖	↑↑	↗
Traffic Volume (veh/h)	195	645	150	225	1200	35	40	185	275	10	210	700
Future Volume (veh/h)	195	645	150	225	1200	35	40	185	275	10	210	700
Initial Q (Qb), veh	0	0	0	0	0	0	0	0	0	0	0	0
Ped-Bike Adj(A_pbT)	1.00		1.00	1.00		1.00	1.00		1.00	1.00		1.00
Parking Bus, Adj	1.00	1.00	1.00	1.00	1.00	1.00	1.00	1.00	1.00	1.00	1.00	1.00
Work Zone On Approach		No			No			No			No	
Adj Sat Flow, veh/h/ln	1870	1870	1870	1870	1870	1870	1870	1870	1870	1870	1870	1870
Adj Flow Rate, veh/h	212	701	163	245	1304	38	43	201	0	11	228	0
Peak Hour Factor	0.92	0.92	0.92	0.92	0.92	0.92	0.92	0.92	0.92	0.92	0.92	0.92
Percent Heavy Veh, %	2	2	2	2	2	2	2	2	2	2	2	2
Cap, veh/h	164	1068	905	401	1107	938	268	710		269	642	
Arrive On Green	0.06	0.57	0.57	0.08	0.59	0.59	0.04	0.20	0.00	0.02	0.18	0.00
Sat Flow, veh/h	1781	1870	1585	1781	1870	1585	1781	3554	1585	1781	3554	1585
Grp Volume(v), veh/h	212	701	163	245	1304	38	43	201	0	11	228	0
Grp Sat Flow(s),veh/h/ln	1781	1870	1585	1781	1870	1585	1781	1777	1585	1781	1777	1585
Q Serve(g_s), s	7.0	30.8	5.9	6.6	71.0	1.2	2.3	5.8	0.0	0.6	6.7	0.0
Cycle Q Clear(g_c), s	7.0	30.8	5.9	6.6	71.0	1.2	2.3	5.8	0.0	0.6	6.7	0.0
Prop In Lane	1.00		1.00	1.00		1.00	1.00		1.00	1.00		1.00
Lane Grp Cap(c), veh/h	164	1068	905	401	1107	938	268	710		269	642	
V/C Ratio(X)	1.29	0.66	0.18	0.61	1.18	0.04	0.16	0.28		0.04	0.35	
Avail Cap(c_a), veh/h	164	1068	905	475	1107	938	285	710		321	642	
HCM Platoon Ratio	1.00	1.00	1.00	1.00	1.00	1.00	1.00	1.00	1.00	1.00	1.00	1.00
Upstream Filter(I)	1.00	1.00	1.00	1.00	1.00	1.00	1.00	1.00	0.00	1.00	1.00	0.00
Uniform Delay (d), s/veh	38.9	17.6	12.3	15.0	24.5	10.2	37.7	40.7	0.0	38.9	43.0	0.0
Incr Delay (d2), s/veh	169.7	1.5	0.1	1.7	89.9	0.0	0.3	1.0	0.0	0.1	1.5	0.0
Initial Q Delay(d3),s/veh	0.0	0.0	0.0	0.0	0.0	0.0	0.0	0.0	0.0	0.0	0.0	0.0
%ile BackOfQ(50%),veh/ln	12.7	13.2	2.1	2.6	56.7	0.4	1.0	2.6	0.0	0.3	3.1	0.0
Unsig. Movement Delay, s/veh												
LnGrp Delay(d),s/veh	208.6	19.1	12.4	16.6	114.4	10.3	38.0	41.7	0.0	39.0	44.6	0.0
LnGrp LOS	F	B	B	B	F	B	D	D		D	D	
Approach Vol, veh/h		1076			1587			244	A		239	A
Approach Delay, s/veh		55.4			96.8			41.1			44.3	
Approach LOS		E			F			D			D	
Timer - Assigned Phs	1	2	3	4	5	6	7	8				
Phs Duration (G+Y+Rc), s	6.0	28.0	13.5	72.5	8.3	25.7	11.0	75.0				
Change Period (Y+Rc), s	4.5	4.5	4.5	4.5	4.5	4.5	4.5	4.5				
Max Green Setting (Gmax), s	5.0	20.0	13.9	63.1	5.0	20.0	6.5	70.5				
Max Q Clear Time (g_c+I1), s	2.6	7.8	8.6	32.8	4.3	8.7	9.0	73.0				
Green Ext Time (p_c), s	0.0	0.9	0.3	6.2	0.0	1.0	0.0	0.0				

Intersection Summary

HCM 6th Ctrl Delay	74.3
HCM 6th LOS	E

Notes

Unsignalized Delay for [NBR, SBR] is excluded from calculations of the approach delay and intersection delay.

Timings
2: (New) Meridian Road & US-24

Lane Group	EBL	EBT	EBR	WBL	WBT	WBR	NBL	NBT	NBR	SBL	SBT	SBR
Lane Configurations												
Traffic Volume (vph)	730	1250	150	225	720	30	90	365	350	65	375	225
Future Volume (vph)	730	1250	150	225	720	30	90	365	350	65	375	225
Turn Type	pm+pt	NA	Perm	pm+pt	NA	Perm	pm+pt	NA	Free	pm+pt	NA	Free
Protected Phases	7	4		3	8		5	2		1	6	
Permitted Phases	4		4	8		8	2		Free	6		Free
Detector Phase	7	4	4	3	8	8	5	2		1	6	
Switch Phase												
Minimum Initial (s)	5.0	5.0	5.0	5.0	5.0	5.0	5.0	5.0		5.0	5.0	
Minimum Split (s)	9.5	22.5	22.5	9.5	22.5	22.5	9.5	22.5		9.5	22.5	
Total Split (s)	41.0	73.0	73.0	13.0	45.0	45.0	9.5	24.5		9.5	24.5	
Total Split (%)	34.2%	60.8%	60.8%	10.8%	37.5%	37.5%	7.9%	20.4%		7.9%	20.4%	
Yellow Time (s)	3.5	3.5	3.5	3.5	3.5	3.5	3.5	3.5		3.5	3.5	
All-Red Time (s)	1.0	1.0	1.0	1.0	1.0	1.0	1.0	1.0		1.0	1.0	
Lost Time Adjust (s)	-0.5	-0.5	-0.5	-0.5	-0.5	-0.5	-0.5	-0.5		-0.5	-0.5	
Total Lost Time (s)	4.0	4.0	4.0	4.0	4.0	4.0	4.0	4.0		4.0	4.0	
Lead/Lag	Lead	Lag	Lag	Lead	Lag	Lag	Lead	Lag		Lead	Lag	
Lead-Lag Optimize?	Yes	Yes	Yes	Yes	Yes	Yes	Yes	Yes		Yes	Yes	
Recall Mode	None	None	None	None	None	None	None	C-Max		None	C-Max	
Act Effct Green (s)	82.0	69.0	69.0	50.0	41.0	41.0	26.8	22.4	120.0	26.0	20.5	120.0
Actuated g/C Ratio	0.68	0.58	0.58	0.42	0.34	0.34	0.22	0.19	1.00	0.22	0.17	1.00
v/c Ratio	1.30	1.27	0.17	1.26	1.23	0.05	0.59	0.60	0.24	0.39	0.68	0.15
Control Delay	179.0	154.3	5.6	182.3	152.6	0.2	52.2	49.8	0.4	42.4	53.0	0.2
Queue Delay	0.0	0.0	0.0	0.0	0.0	0.0	0.0	0.0	0.0	0.0	0.0	0.0
Total Delay	179.0	154.3	5.6	182.3	152.6	0.2	52.2	49.8	0.4	42.4	53.0	0.2
LOS	F	F	A	F	F	A	D	D	A	D	D	A
Approach Delay		152.3			154.7			28.6			34.1	
Approach LOS		F			F			C			C	

Intersection Summary

Cycle Length: 120
 Actuated Cycle Length: 120
 Offset: 0 (0%), Referenced to phase 2:NBTL and 6:SBTL, Start of Green
 Natural Cycle: 150
 Control Type: Actuated-Coordinated
 Maximum v/c Ratio: 1.30
 Intersection Signal Delay: 113.9
 Intersection LOS: F
 Intersection Capacity Utilization 107.0%
 ICU Level of Service G
 Analysis Period (min) 15

Splits and Phases: 2: (New) Meridian Road & US-24

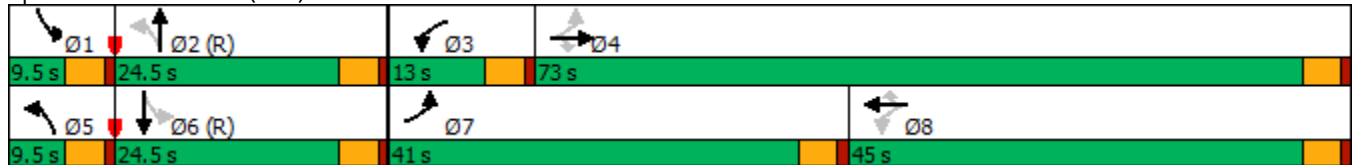

HCM 6th Signalized Intersection Summary
2: (New) Meridian Road & US-24

2040 Background PM.syn
12/15/2021



Movement	EBL	EBT	EBR	WBL	WBT	WBR	NBL	NBT	NBR	SBL	SBT	SBR
Lane Configurations												
Traffic Volume (veh/h)	730	1250	150	225	720	30	90	365	350	65	375	225
Future Volume (veh/h)	730	1250	150	225	720	30	90	365	350	65	375	225
Initial Q (Qb), veh	0	0	0	0	0	0	0	0	0	0	0	0
Ped-Bike Adj(A_pbT)	1.00		1.00	1.00		1.00	1.00		1.00	1.00		1.00
Parking Bus, Adj	1.00	1.00	1.00	1.00	1.00	1.00	1.00	1.00	1.00	1.00	1.00	1.00
Work Zone On Approach		No			No			No			No	
Adj Sat Flow, veh/h/ln	1870	1870	1870	1870	1870	1870	1870	1870	1870	1870	1870	1870
Adj Flow Rate, veh/h	793	1359	163	245	783	33	98	397	0	71	408	0
Peak Hour Factor	0.92	0.92	0.92	0.92	0.92	0.92	0.92	0.92	0.92	0.92	0.92	0.92
Percent Heavy Veh, %	2	2	2	2	2	2	2	2	2	2	2	2
Cap, veh/h	609	1075	911	194	639	542	204	607		207	607	
Arrive On Green	0.31	0.57	0.57	0.08	0.34	0.34	0.05	0.17	0.00	0.05	0.17	0.00
Sat Flow, veh/h	1781	1870	1585	1781	1870	1585	1781	3554	1585	1781	3554	1585
Grp Volume(v), veh/h	793	1359	163	245	783	33	98	397	0	71	408	0
Grp Sat Flow(s),veh/h/ln	1781	1870	1585	1781	1870	1585	1781	1777	1585	1781	1777	1585
Q Serve(g_s), s	37.0	69.0	5.8	9.0	41.0	1.7	5.5	12.5	0.0	3.9	12.9	0.0
Cycle Q Clear(g_c), s	37.0	69.0	5.8	9.0	41.0	1.7	5.5	12.5	0.0	3.9	12.9	0.0
Prop In Lane	1.00		1.00	1.00		1.00	1.00		1.00	1.00		1.00
Lane Grp Cap(c), veh/h	609	1075	911	194	639	542	204	607		207	607	
V/C Ratio(X)	1.30	1.26	0.18	1.27	1.23	0.06	0.48	0.65		0.34	0.67	
Avail Cap(c_a), veh/h	609	1075	911	194	639	542	204	607		207	607	
HCM Platoon Ratio	1.00	1.00	1.00	1.00	1.00	1.00	1.00	1.00	1.00	1.00	1.00	1.00
Upstream Filter(I)	1.00	1.00	1.00	1.00	1.00	1.00	1.00	1.00	0.00	1.00	1.00	0.00
Uniform Delay (d), s/veh	35.7	25.5	12.1	32.4	39.5	26.6	39.7	46.4	0.0	39.0	46.6	0.0
Incr Delay (d2), s/veh	147.5	126.2	0.1	153.9	114.9	0.0	1.8	5.4	0.0	1.0	5.8	0.0
Initial Q Delay(d3),s/veh	0.0	0.0	0.0	0.0	0.0	0.0	0.0	0.0	0.0	0.0	0.0	0.0
%ile BackOfQ(50%),veh/ln	41.5	66.2	2.1	11.9	38.9	0.6	2.5	6.0	0.0	1.8	6.2	0.0
Unsig. Movement Delay, s/veh												
LnGrp Delay(d),s/veh	183.2	151.7	12.2	186.3	154.4	26.6	41.5	51.9	0.0	40.0	52.4	0.0
LnGrp LOS	F	F	B	F	F	C	D	D		D	D	
Approach Vol, veh/h		2315			1061			495	A		479	A
Approach Delay, s/veh		152.7			157.8			49.8			50.6	
Approach LOS		F			F			D			D	
Timer - Assigned Phs	1	2	3	4	5	6	7	8				
Phs Duration (G+Y+Rc), s	9.5	24.5	13.0	73.0	9.5	24.5	41.0	45.0				
Change Period (Y+Rc), s	4.5	4.5	4.5	4.5	4.5	4.5	4.5	4.5				
Max Green Setting (Gmax), s	5.0	20.0	8.5	68.5	5.0	20.0	36.5	40.5				
Max Q Clear Time (g_c+I1), s	5.9	14.5	11.0	71.0	7.5	14.9	39.0	43.0				
Green Ext Time (p_c), s	0.0	1.2	0.0	0.0	0.0	1.2	0.0	0.0				

Intersection Summary

HCM 6th Ctrl Delay	131.0
HCM 6th LOS	F

Notes

User approved pedestrian interval to be less than phase max green.
Unsignalized Delay for [NBR, SBR] is excluded from calculations of the approach delay and intersection delay.

Timings
2: (New) Meridian Road & US-24

2040 Total AM
12/15/2021

Lane Group	EBL	EBT	EBR	WBL	WBT	WBR	NBL	NBT	NBR	SBL	SBT	SBR
Lane Configurations												
Traffic Volume (vph)	195	675	215	255	1200	35	135	240	275	30	240	700
Future Volume (vph)	195	675	215	255	1200	35	135	240	275	30	240	700
Turn Type	Prot	NA	Perm	pm+pt	NA	Perm	pm+pt	NA	Free	pm+pt	NA	Free
Protected Phases	7	4		3	8		5	2		1	6	
Permitted Phases			4	8		8	2		Free	6		Free
Detector Phase	7	4	4	3	8	8	5	2		1	6	
Switch Phase												
Minimum Initial (s)	5.0	5.0	5.0	5.0	5.0	5.0	5.0	5.0		5.0	5.0	
Minimum Split (s)	9.5	22.5	22.5	9.5	22.5	22.5	9.5	22.5		9.5	22.5	
Total Split (s)	17.0	56.0	56.0	23.0	62.0	62.0	15.0	31.4		9.6	26.0	
Total Split (%)	14.2%	46.7%	46.7%	19.2%	51.7%	51.7%	12.5%	26.2%		8.0%	21.7%	
Yellow Time (s)	3.5	3.5	3.5	3.5	3.5	3.5	3.5	3.5		3.5	3.5	
All-Red Time (s)	1.0	1.0	1.0	1.0	1.0	1.0	1.0	1.0		1.0	1.0	
Lost Time Adjust (s)	-0.5	-0.5	-0.5	-0.5	-0.5	-0.5	-0.5	-0.5		-0.5	-0.5	
Total Lost Time (s)	4.0	4.0	4.0	4.0	4.0	4.0	4.0	4.0		4.0	4.0	
Lead/Lag	Lead	Lag	Lag	Lead	Lag	Lag	Lead	Lag		Lead	Lag	
Lead-Lag Optimize?	Yes	Yes	Yes	Yes	Yes	Yes	Yes	Yes		Yes	Yes	
Recall Mode	None	None	None	None	None	None	None	C-Max		None	C-Max	
Act Effct Green (s)	12.1	50.7	50.7	69.3	54.1	54.1	41.8	35.6	120.0	33.1	26.8	120.0
Actuated g/C Ratio	0.10	0.42	0.42	0.58	0.45	0.45	0.35	0.30	1.00	0.28	0.22	1.00
v/c Ratio	0.61	0.49	0.29	0.64	0.82	0.05	0.39	0.25	0.19	0.10	0.33	0.48
Control Delay	59.7	26.2	3.5	18.8	33.2	0.1	33.0	35.4	0.3	29.8	42.1	1.0
Queue Delay	0.0	0.0	0.0	0.0	0.0	0.0	0.0	0.0	0.0	0.0	0.0	0.0
Total Delay	59.7	26.2	3.5	18.8	33.2	0.1	33.0	35.4	0.3	29.8	42.1	1.0
LOS	E	C	A	B	C	A	C	D	A	C	D	A
Approach Delay		27.7			30.0			20.0			12.1	
Approach LOS		C			C			C			B	

Intersection Summary

Cycle Length: 120
 Actuated Cycle Length: 120
 Offset: 0 (0%), Referenced to phase 2:NBTL and 6:SBTL, Start of Green
 Natural Cycle: 80
 Control Type: Actuated-Coordinated
 Maximum v/c Ratio: 0.82
 Intersection Signal Delay: 23.7
 Intersection LOS: C
 Intersection Capacity Utilization 66.2%
 ICU Level of Service C
 Analysis Period (min) 15

Splits and Phases: 2: (New) Meridian Road & US-24

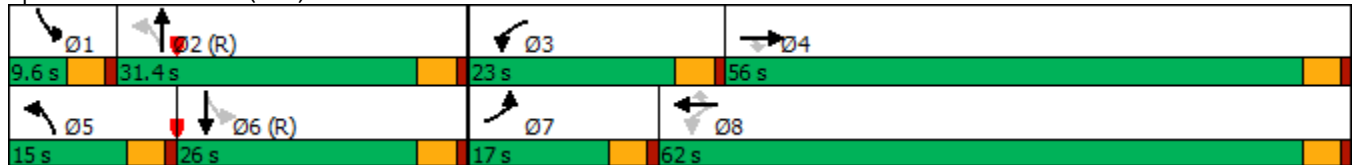

HCM 6th Signalized Intersection Summary
2: (New) Meridian Road & US-24

2040 Total AM
12/15/2021



Movement	EBL	EBT	EBR	WBL	WBT	WBR	NBL	NBT	NBR	SBL	SBT	SBR
Lane Configurations	↖↗	↑↑	↖	↗	↑↑	↖	↖	↑↑	↖	↗	↑↑	↖
Traffic Volume (veh/h)	195	675	215	255	1200	35	135	240	275	30	240	700
Future Volume (veh/h)	195	675	215	255	1200	35	135	240	275	30	240	700
Initial Q (Qb), veh	0	0	0	0	0	0	0	0	0	0	0	0
Ped-Bike Adj(A_pbT)	1.00		1.00	1.00		1.00	1.00		1.00	1.00		1.00
Parking Bus, Adj	1.00	1.00	1.00	1.00	1.00	1.00	1.00	1.00	1.00	1.00	1.00	1.00
Work Zone On Approach		No			No			No			No	
Adj Sat Flow, veh/h/ln	1870	1870	1870	1870	1870	1870	1870	1870	1870	1870	1870	1870
Adj Flow Rate, veh/h	212	734	234	277	1304	38	147	261	0	33	261	0
Peak Hour Factor	0.92	0.92	0.92	0.92	0.92	0.92	0.92	0.92	0.92	0.92	0.92	0.92
Percent Heavy Veh, %	2	2	2	2	2	2	2	2	2	2	2	2
Cap, veh/h	285	1407	628	399	1513	675	448	1160		422	1000	
Arrive On Green	0.08	0.40	0.40	0.11	0.43	0.43	0.08	0.33	0.00	0.03	0.28	0.00
Sat Flow, veh/h	3456	3554	1585	1781	3554	1585	1781	3554	1585	1781	3554	1585
Grp Volume(v), veh/h	212	734	234	277	1304	38	147	261	0	33	261	0
Grp Sat Flow(s),veh/h/ln	1728	1777	1585	1781	1777	1585	1781	1777	1585	1781	1777	1585
Q Serve(g_s), s	7.2	18.9	12.6	10.6	39.9	1.7	6.7	6.4	0.0	1.6	6.8	0.0
Cycle Q Clear(g_c), s	7.2	18.9	12.6	10.6	39.9	1.7	6.7	6.4	0.0	1.6	6.8	0.0
Prop In Lane	1.00		1.00	1.00		1.00	1.00		1.00	1.00		1.00
Lane Grp Cap(c), veh/h	285	1407	628	399	1513	675	448	1160		422	1000	
V/C Ratio(X)	0.74	0.52	0.37	0.69	0.86	0.06	0.33	0.23		0.08	0.26	
Avail Cap(c_a), veh/h	374	1540	687	481	1718	766	474	1160		448	1000	
HCM Platoon Ratio	1.00	1.00	1.00	1.00	1.00	1.00	1.00	1.00	1.00	1.00	1.00	1.00
Upstream Filter(I)	1.00	1.00	1.00	1.00	1.00	1.00	1.00	1.00	0.00	1.00	1.00	0.00
Uniform Delay (d), s/veh	53.8	27.6	25.7	19.6	31.2	20.3	25.9	29.4	0.0	28.8	33.4	0.0
Incr Delay (d2), s/veh	5.6	0.3	0.4	3.4	4.3	0.0	0.4	0.5	0.0	0.1	0.6	0.0
Initial Q Delay(d3),s/veh	0.0	0.0	0.0	0.0	0.0	0.0	0.0	0.0	0.0	0.0	0.0	0.0
%ile BackOfQ(50%),veh/ln	3.4	8.0	4.8	4.6	17.6	0.6	2.9	2.8	0.0	0.7	3.1	0.0
Unsig. Movement Delay, s/veh												
LnGrp Delay(d),s/veh	59.4	27.9	26.1	23.0	35.6	20.3	26.3	29.8	0.0	28.9	34.1	0.0
LnGrp LOS	E	C	C	C	D	C	C	C		C	C	
Approach Vol, veh/h		1180			1619			408	A		294	A
Approach Delay, s/veh		33.2			33.0			28.6			33.5	
Approach LOS		C			C			C			C	
Timer - Assigned Phs	1	2	3	4	5	6	7	8				
Phs Duration (G+Y+Rc), s	7.8	43.2	17.5	51.5	13.2	37.8	13.9	55.1				
Change Period (Y+Rc), s	4.5	4.5	4.5	4.5	4.5	4.5	4.5	4.5				
Max Green Setting (Gmax), s	5.1	26.9	18.5	51.5	10.5	21.5	12.5	57.5				
Max Q Clear Time (g_c+I1), s	3.6	8.4	12.6	20.9	8.7	8.8	9.2	41.9				
Green Ext Time (p_c), s	0.0	1.5	0.4	6.8	0.1	1.3	0.2	8.7				

Intersection Summary

HCM 6th Ctrl Delay	32.6
HCM 6th LOS	C

Notes

Unsignalized Delay for [NBR, SBR] is excluded from calculations of the approach delay and intersection delay.

Timings
2: (New) Meridian Road & US-24

2040 Total PM
12/15/2021

Lane Group	EBL	EBT	EBR	WBL	WBT	WBR	NBL	NBT	NBR	SBL	SBT	SBR
Lane Configurations												
Traffic Volume (vph)	730	1275	200	250	720	30	155	405	350	85	400	225
Future Volume (vph)	730	1275	200	250	720	30	155	405	350	85	400	225
Turn Type	Prot	NA	Perm	pm+pt	NA	Perm	pm+pt	NA	Free	pm+pt	NA	Free
Protected Phases	7	4		3	8		5	2		1	6	
Permitted Phases			4	8		8	2		Free	6		Free
Detector Phase	7	4	4	3	8	8	5	2		1	6	
Switch Phase												
Minimum Initial (s)	5.0	5.0	5.0	5.0	5.0	5.0	5.0	5.0		5.0	5.0	
Minimum Split (s)	9.5	22.5	22.5	9.5	22.5	22.5	9.5	22.5		9.5	22.5	
Total Split (s)	36.2	57.0	57.0	23.1	43.9	43.9	15.0	29.1		10.8	24.9	
Total Split (%)	30.2%	47.5%	47.5%	19.3%	36.6%	36.6%	12.5%	24.3%		9.0%	20.8%	
Yellow Time (s)	3.5	3.5	3.5	3.5	3.5	3.5	3.5	3.5		3.5	3.5	
All-Red Time (s)	1.0	1.0	1.0	1.0	1.0	1.0	1.0	1.0		1.0	1.0	
Lost Time Adjust (s)	-0.5	-0.5	-0.5	-0.5	-0.5	-0.5	-0.5	-0.5		-0.5	-0.5	
Total Lost Time (s)	4.0	4.0	4.0	4.0	4.0	4.0	4.0	4.0		4.0	4.0	
Lead/Lag	Lead	Lag	Lag	Lead	Lag	Lag	Lead	Lag		Lead	Lag	
Lead-Lag Optimize?	Yes	Yes	Yes	Yes	Yes	Yes	Yes	Yes		Yes	Yes	
Recall Mode	None	None	None	None	None	None	None	C-Max		None	C-Max	
Act Effct Green (s)	31.1	52.7	52.7	56.9	39.3	39.3	37.4	26.8	120.0	29.8	22.9	120.0
Actuated g/C Ratio	0.26	0.44	0.44	0.47	0.33	0.33	0.31	0.22	1.00	0.25	0.19	1.00
v/c Ratio	0.89	0.89	0.27	0.84	0.68	0.05	0.66	0.56	0.24	0.40	0.64	0.15
Control Delay	56.2	39.6	3.5	56.1	38.2	0.2	45.6	45.1	0.4	37.1	50.6	0.2
Queue Delay	0.0	0.0	0.0	0.0	0.0	0.0	0.0	0.0	0.0	0.0	0.0	0.0
Total Delay	56.2	39.6	3.5	56.1	38.2	0.2	45.6	45.1	0.4	37.1	50.6	0.2
LOS	E	D	A	E	D	A	D	D	A	D	D	A
Approach Delay		41.8			41.6			28.0			33.0	
Approach LOS		D			D			C			C	

Intersection Summary

Cycle Length: 120
 Actuated Cycle Length: 120
 Offset: 0 (0%), Referenced to phase 2:NBTL and 6:SBTL, Start of Green
 Natural Cycle: 90
 Control Type: Actuated-Coordinated
 Maximum v/c Ratio: 0.89
 Intersection Signal Delay: 37.9
 Intersection LOS: D
 Intersection Capacity Utilization 82.1%
 ICU Level of Service E
 Analysis Period (min) 15

Splits and Phases: 2: (New) Meridian Road & US-24

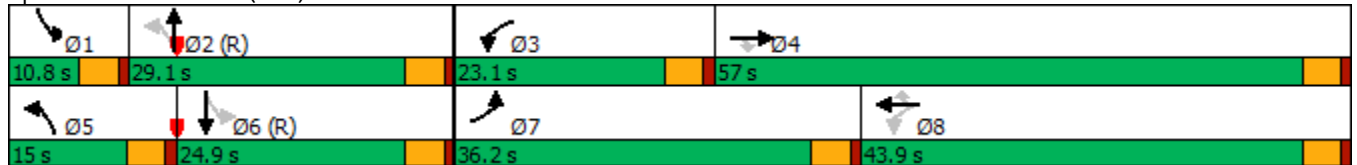

HCM 6th Signalized Intersection Summary
2: (New) Meridian Road & US-24

2040 Total PM
12/15/2021



Movement	EBL	EBT	EBR	WBL	WBT	WBR	NBL	NBT	NBR	SBL	SBT	SBR
Lane Configurations	↖↗	↑↑	↖	↗	↑↑	↖	↖	↑↑	↖	↖	↑↑	↖
Traffic Volume (veh/h)	730	1275	200	250	720	30	155	405	350	85	400	225
Future Volume (veh/h)	730	1275	200	250	720	30	155	405	350	85	400	225
Initial Q (Qb), veh	0	0	0	0	0	0	0	0	0	0	0	0
Ped-Bike Adj(A_pbT)	1.00		1.00	1.00		1.00	1.00		1.00	1.00		1.00
Parking Bus, Adj	1.00	1.00	1.00	1.00	1.00	1.00	1.00	1.00	1.00	1.00	1.00	1.00
Work Zone On Approach		No			No			No			No	
Adj Sat Flow, veh/h/ln	1870	1870	1870	1870	1870	1870	1870	1870	1870	1870	1870	1870
Adj Flow Rate, veh/h	793	1386	217	272	783	33	168	440	0	92	435	0
Peak Hour Factor	0.92	0.92	0.92	0.92	0.92	0.92	0.92	0.92	0.92	0.92	0.92	0.92
Percent Heavy Veh, %	2	2	2	2	2	2	2	2	2	2	2	2
Cap, veh/h	871	1520	678	307	1078	481	328	904		302	783	
Arrive On Green	0.25	0.43	0.43	0.13	0.30	0.30	0.09	0.25	0.00	0.06	0.22	0.00
Sat Flow, veh/h	3456	3554	1585	1781	3554	1585	1781	3554	1585	1781	3554	1585
Grp Volume(v), veh/h	793	1386	217	272	783	33	168	440	0	92	435	0
Grp Sat Flow(s),veh/h/ln	1728	1777	1585	1781	1777	1585	1781	1777	1585	1781	1777	1585
Q Serve(g_s), s	26.7	43.9	10.9	12.5	23.6	1.8	8.4	12.6	0.0	4.7	13.0	0.0
Cycle Q Clear(g_c), s	26.7	43.9	10.9	12.5	23.6	1.8	8.4	12.6	0.0	4.7	13.0	0.0
Prop In Lane	1.00		1.00	1.00		1.00	1.00		1.00	1.00		1.00
Lane Grp Cap(c), veh/h	871	1520	678	307	1078	481	328	904		302	783	
V/C Ratio(X)	0.91	0.91	0.32	0.88	0.73	0.07	0.51	0.49		0.30	0.56	
Avail Cap(c_a), veh/h	927	1570	700	363	1182	527	330	904		302	783	
HCM Platoon Ratio	1.00	1.00	1.00	1.00	1.00	1.00	1.00	1.00	1.00	1.00	1.00	1.00
Upstream Filter(l)	1.00	1.00	1.00	1.00	1.00	1.00	1.00	1.00	0.00	1.00	1.00	0.00
Uniform Delay (d), s/veh	43.5	32.2	22.8	29.0	37.3	29.7	31.1	38.1	0.0	33.4	41.5	0.0
Incr Delay (d2), s/veh	12.4	8.3	0.3	19.8	2.0	0.1	1.3	1.9	0.0	0.6	2.8	0.0
Initial Q Delay(d3),s/veh	0.0	0.0	0.0	0.0	0.0	0.0	0.0	0.0	0.0	0.0	0.0	0.0
%ile BackOfQ(50%),veh/ln	12.8	20.1	4.1	6.9	10.5	0.7	3.7	5.7	0.0	2.1	6.0	0.0
Unsig. Movement Delay, s/veh												
LnGrp Delay(d),s/veh	55.9	40.5	23.0	48.8	39.4	29.8	32.4	39.9	0.0	34.0	44.4	0.0
LnGrp LOS	E	D	C	D	D	C	C	D		C	D	
Approach Vol, veh/h		2396			1088			608	A		527	A
Approach Delay, s/veh		44.0			41.4			37.9			42.6	
Approach LOS		D			D			D			D	
Timer - Assigned Phs	1	2	3	4	5	6	7	8				
Phs Duration (G+Y+Rc), s	10.8	34.5	19.3	55.3	14.9	30.5	34.3	40.4				
Change Period (Y+Rc), s	4.5	4.5	4.5	4.5	4.5	4.5	4.5	4.5				
Max Green Setting (Gmax), s	6.3	24.6	18.6	52.5	10.5	20.4	31.7	39.4				
Max Q Clear Time (g_c+I1), s	6.7	14.6	14.5	45.9	10.4	15.0	28.7	25.6				
Green Ext Time (p_c), s	0.0	2.0	0.3	4.9	0.0	1.3	1.0	4.7				

Intersection Summary

HCM 6th Ctrl Delay	42.4
HCM 6th LOS	D

Notes

Unsignalized Delay for [NBR, SBR] is excluded from calculations of the approach delay and intersection delay.

Intersection						
Int Delay, s/veh	2.4					
Movement	WBL	WBR	NBT	NBR	SBL	SBT
Lane Configurations		↗	↕	↗	↖	↕
Traffic Vol, veh/h	0	145	350	40	130	435
Future Vol, veh/h	0	145	350	40	130	435
Conflicting Peds, #/hr	0	0	0	0	0	0
Sign Control	Stop	Stop	Free	Free	Free	Free
RT Channelized	-	None	-	None	-	None
Storage Length	-	0	-	100	100	-
Veh in Median Storage, #	0	-	0	-	-	0
Grade, %	0	-	0	-	-	0
Peak Hour Factor	92	92	92	92	92	92
Heavy Vehicles, %	2	2	2	2	2	2
Mvmt Flow	0	158	380	43	141	473

Major/Minor	Minor1	Major1	Major2		
Conflicting Flow All	-	190	0	0	423
Stage 1	-	-	-	-	-
Stage 2	-	-	-	-	-
Critical Hdwy	-	6.94	-	-	4.14
Critical Hdwy Stg 1	-	-	-	-	-
Critical Hdwy Stg 2	-	-	-	-	-
Follow-up Hdwy	-	3.32	-	-	2.22
Pot Cap-1 Maneuver	0	820	-	-	1133
Stage 1	0	-	-	-	-
Stage 2	0	-	-	-	-
Platoon blocked, %					
Mov Cap-1 Maneuver	-	820	-	-	1133
Mov Cap-2 Maneuver	-	-	-	-	-
Stage 1	-	-	-	-	-
Stage 2	-	-	-	-	-

Approach	WB	NB	SB
HCM Control Delay, s	10.4	0	2
HCM LOS	B		

Minor Lane/Major Mvmt	NBT	NBRWBLn1	SBL	SBT
Capacity (veh/h)	-	-	820	1133
HCM Lane V/C Ratio	-	-	0.192	0.125
HCM Control Delay (s)	-	-	10.4	8.6
HCM Lane LOS	-	-	B	A
HCM 95th %tile Q(veh)	-	-	0.7	0.4

Intersection						
Int Delay, s/veh	1.7					
Movement	WBL	WBR	NBT	NBR	SBL	SBT
Lane Configurations		↗	↕	↗	↖	↕
Traffic Vol, veh/h	0	110	510	25	110	570
Future Vol, veh/h	0	110	510	25	110	570
Conflicting Peds, #/hr	0	0	0	0	0	0
Sign Control	Stop	Stop	Free	Free	Free	Free
RT Channelized	-	None	-	None	-	None
Storage Length	-	0	-	100	100	-
Veh in Median Storage, #	0	-	0	-	-	0
Grade, %	0	-	0	-	-	0
Peak Hour Factor	92	92	92	92	92	92
Heavy Vehicles, %	2	2	2	2	2	2
Mvmt Flow	0	120	554	27	120	620

Major/Minor	Minor1	Major1	Major2
Conflicting Flow All	-	277	0
Stage 1	-	-	-
Stage 2	-	-	-
Critical Hdwy	-	6.94	-
Critical Hdwy Stg 1	-	-	-
Critical Hdwy Stg 2	-	-	-
Follow-up Hdwy	-	3.32	-
Pot Cap-1 Maneuver	0	720	-
Stage 1	0	-	-
Stage 2	0	-	-
Platoon blocked, %		-	-
Mov Cap-1 Maneuver	-	720	-
Mov Cap-2 Maneuver	-	-	-
Stage 1	-	-	-
Stage 2	-	-	-

Approach	WB	NB	SB
HCM Control Delay, s	11	0	1.5
HCM LOS	B		

Minor Lane/Major Mvmt	NBT	NBRWBLn1	SBL	SBT
Capacity (veh/h)	-	-	720	989
HCM Lane V/C Ratio	-	-	0.166	0.121
HCM Control Delay (s)	-	-	11	9.1
HCM Lane LOS	-	-	B	A
HCM 95th %tile Q(veh)	-	-	0.6	0.4

Intersection						
Int Delay, s/veh	2					
Movement	WBL	WBR	NBT	NBR	SBL	SBT
Lane Configurations		↗	↕	↗	↖	↕
Traffic Vol, veh/h	0	145	500	40	130	585
Future Vol, veh/h	0	145	500	40	130	585
Conflicting Peds, #/hr	0	0	0	0	0	0
Sign Control	Stop	Stop	Free	Free	Free	Free
RT Channelized	-	None	-	None	-	None
Storage Length	-	0	-	100	100	-
Veh in Median Storage, #	0	-	0	-	-	0
Grade, %	0	-	0	-	-	0
Peak Hour Factor	92	92	92	92	92	92
Heavy Vehicles, %	2	2	2	2	2	2
Mvmt Flow	0	158	543	43	141	636

Major/Minor	Minor1	Major1	Major2
Conflicting Flow All	-	272	0
Stage 1	-	-	-
Stage 2	-	-	-
Critical Hdwy	-	6.94	-
Critical Hdwy Stg 1	-	-	-
Critical Hdwy Stg 2	-	-	-
Follow-up Hdwy	-	3.32	-
Pot Cap-1 Maneuver	0	726	-
Stage 1	0	-	-
Stage 2	0	-	-
Platoon blocked, %		-	-
Mov Cap-1 Maneuver	-	726	-
Mov Cap-2 Maneuver	-	-	-
Stage 1	-	-	-
Stage 2	-	-	-

Approach	WB	NB	SB
HCM Control Delay, s	11.3	0	1.7
HCM LOS	B		

Minor Lane/Major Mvmt	NBT	NBRWBLn1	SBL	SBT
Capacity (veh/h)	-	-	726	985
HCM Lane V/C Ratio	-	-	0.217	0.143
HCM Control Delay (s)	-	-	11.3	9.3
HCM Lane LOS	-	-	B	A
HCM 95th %tile Q(veh)	-	-	0.8	0.5

Intersection						
Int Delay, s/veh	1.5					
Movement	WBL	WBR	NBT	NBR	SBL	SBT
Lane Configurations		↗	↕	↗	↖	↕
Traffic Vol, veh/h	0	110	805	25	110	750
Future Vol, veh/h	0	110	805	25	110	750
Conflicting Peds, #/hr	0	0	0	0	0	0
Sign Control	Stop	Stop	Free	Free	Free	Free
RT Channelized	-	None	-	None	-	None
Storage Length	-	0	-	100	100	-
Veh in Median Storage, #	0	-	0	-	-	0
Grade, %	0	-	0	-	-	0
Peak Hour Factor	92	92	92	92	92	92
Heavy Vehicles, %	2	2	2	2	2	2
Mvmt Flow	0	120	875	27	120	815

Major/Minor	Minor1	Major1	Major2
Conflicting Flow All	-	438	0
Stage 1	-	-	-
Stage 2	-	-	-
Critical Hdwy	-	6.94	-
Critical Hdwy Stg 1	-	-	-
Critical Hdwy Stg 2	-	-	-
Follow-up Hdwy	-	3.32	-
Pot Cap-1 Maneuver	0	567	-
Stage 1	0	-	-
Stage 2	0	-	-
Platoon blocked, %		-	-
Mov Cap-1 Maneuver	-	567	-
Mov Cap-2 Maneuver	-	-	-
Stage 1	-	-	-
Stage 2	-	-	-

Approach	WB	NB	SB
HCM Control Delay, s	13	0	1.4
HCM LOS	B		

Minor Lane/Major Mvmt	NBT	NBRWBLn1	SBL	SBT
Capacity (veh/h)	-	-	567	749
HCM Lane V/C Ratio	-	-	0.211	0.16
HCM Control Delay (s)	-	-	13	10.7
HCM Lane LOS	-	-	B	B
HCM 95th %tile Q(veh)	-	-	0.8	0.6

Intersection						
Int Delay, s/veh	5.2					
Movement	WBL	WBR	NBT	NBR	SBL	SBT
Lane Configurations	↘	↗	↑↑	↗	↘	↑↑
Traffic Vol, veh/h	65	110	300	25	280	155
Future Vol, veh/h	65	110	300	25	280	155
Conflicting Peds, #/hr	0	0	0	0	0	0
Sign Control	Stop	Stop	Free	Free	Free	Free
RT Channelized	-	None	-	None	-	None
Storage Length	100	0	-	200	125	-
Veh in Median Storage, #	2	-	0	-	-	0
Grade, %	0	-	0	-	-	0
Peak Hour Factor	92	92	92	92	92	92
Heavy Vehicles, %	2	2	2	2	2	2
Mvmt Flow	71	120	326	27	304	168

Major/Minor	Minor1	Major1	Major2			
Conflicting Flow All	1018	163	0	0	353	0
Stage 1	326	-	-	-	-	-
Stage 2	692	-	-	-	-	-
Critical Hdwy	6.84	6.94	-	-	4.14	-
Critical Hdwy Stg 1	5.84	-	-	-	-	-
Critical Hdwy Stg 2	5.84	-	-	-	-	-
Follow-up Hdwy	3.52	3.32	-	-	2.22	-
Pot Cap-1 Maneuver	233	853	-	-	1202	-
Stage 1	704	-	-	-	-	-
Stage 2	458	-	-	-	-	-
Platoon blocked, %			-	-		-
Mov Cap-1 Maneuver	174	853	-	-	1202	-
Mov Cap-2 Maneuver	313	-	-	-	-	-
Stage 1	704	-	-	-	-	-
Stage 2	342	-	-	-	-	-

Approach	WB	NB	SB
HCM Control Delay, s	13.6	0	5.8
HCM LOS	B		

Minor Lane/Major Mvmt	NBT	NBRWBLn1WBLn2	SBL	SBT		
Capacity (veh/h)	-	-	313	853	1202	-
HCM Lane V/C Ratio	-	-	0.226	0.14	0.253	-
HCM Control Delay (s)	-	-	19.8	9.9	9	-
HCM Lane LOS	-	-	C	A	A	-
HCM 95th %tile Q(veh)	-	-	0.9	0.5	1	-

Intersection						
Int Delay, s/veh	4.8					
Movement	WBL	WBR	NBT	NBR	SBL	SBT
Lane Configurations	↘	↗	↕↕	↗	↘	↕↕
Traffic Vol, veh/h	85	170	375	20	240	330
Future Vol, veh/h	85	170	375	20	240	330
Conflicting Peds, #/hr	0	0	0	0	0	0
Sign Control	Stop	Stop	Free	Free	Free	Free
RT Channelized	-	None	-	None	-	None
Storage Length	100	0	-	200	125	-
Veh in Median Storage, #	2	-	0	-	-	0
Grade, %	0	-	0	-	-	0
Peak Hour Factor	92	92	92	92	92	92
Heavy Vehicles, %	2	2	2	2	2	2
Mvmt Flow	92	185	408	22	261	359

Major/Minor	Minor1	Major1	Major2		
Conflicting Flow All	1110	204	0	0	430
Stage 1	408	-	-	-	-
Stage 2	702	-	-	-	-
Critical Hdwy	6.84	6.94	-	-	4.14
Critical Hdwy Stg 1	5.84	-	-	-	-
Critical Hdwy Stg 2	5.84	-	-	-	-
Follow-up Hdwy	3.52	3.32	-	-	2.22
Pot Cap-1 Maneuver	203	803	-	-	1126
Stage 1	640	-	-	-	-
Stage 2	453	-	-	-	-
Platoon blocked, %			-	-	-
Mov Cap-1 Maneuver	156	803	-	-	1126
Mov Cap-2 Maneuver	312	-	-	-	-
Stage 1	640	-	-	-	-
Stage 2	348	-	-	-	-

Approach	WB	NB	SB
HCM Control Delay, s	14.3	0	3.9
HCM LOS	B		

Minor Lane/Major Mvmt	NBT	NBRWBLn1WBLn2	SBL	SBT
Capacity (veh/h)	-	-	312	803
HCM Lane V/C Ratio	-	-	0.296	0.23
HCM Control Delay (s)	-	-	21.3	10.8
HCM Lane LOS	-	-	C	B
HCM 95th %tile Q(veh)	-	-	1.2	0.9

Intersection						
Int Delay, s/veh	5.1					
Movement	WBL	WBR	NBT	NBR	SBL	SBT
Lane Configurations	↘	↗	↕↕	↗	↘	↕↕
Traffic Vol, veh/h	65	135	425	30	315	270
Future Vol, veh/h	65	135	425	30	315	270
Conflicting Peds, #/hr	0	0	0	0	0	0
Sign Control	Stop	Stop	Free	Free	Free	Free
RT Channelized	-	None	-	None	-	None
Storage Length	100	0	-	200	125	-
Veh in Median Storage, #	2	-	0	-	-	0
Grade, %	0	-	0	-	-	0
Peak Hour Factor	92	92	92	92	92	92
Heavy Vehicles, %	2	2	2	2	2	2
Mvmt Flow	71	147	462	33	342	293

Major/Minor	Minor1	Major1	Major2		
Conflicting Flow All	1293	231	0	0	495
Stage 1	462	-	-	-	-
Stage 2	831	-	-	-	-
Critical Hdwy	6.84	6.94	-	-	4.14
Critical Hdwy Stg 1	5.84	-	-	-	-
Critical Hdwy Stg 2	5.84	-	-	-	-
Follow-up Hdwy	3.52	3.32	-	-	2.22
Pot Cap-1 Maneuver	154	771	-	-	1065
Stage 1	601	-	-	-	-
Stage 2	388	-	-	-	-
Platoon blocked, %			-	-	-
Mov Cap-1 Maneuver	105	771	-	-	1065
Mov Cap-2 Maneuver	239	-	-	-	-
Stage 1	601	-	-	-	-
Stage 2	263	-	-	-	-

Approach	WB	NB	SB
HCM Control Delay, s	15.8	0	5.4
HCM LOS	C		

Minor Lane/Major Mvmt	NBT	NBRWBLn1WBLn2	SBL	SBT
Capacity (veh/h)	-	-	239	771
HCM Lane V/C Ratio	-	-	0.296	0.19
HCM Control Delay (s)	-	-	26.3	10.8
HCM Lane LOS	-	-	D	B
HCM 95th %tile Q(veh)	-	-	1.2	0.7

Intersection						
Int Delay, s/veh	4.7					
Movement	WBL	WBR	NBT	NBR	SBL	SBT
Lane Configurations	↘	↗	↑↑	↗	↘	↑↑
Traffic Vol, veh/h	85	200	640	25	245	505
Future Vol, veh/h	85	200	640	25	245	505
Conflicting Peds, #/hr	0	0	0	0	0	0
Sign Control	Stop	Stop	Free	Free	Free	Free
RT Channelized	-	None	-	None	-	None
Storage Length	100	0	-	200	125	-
Veh in Median Storage, #	2	-	0	-	-	0
Grade, %	0	-	0	-	-	0
Peak Hour Factor	92	92	92	92	92	92
Heavy Vehicles, %	2	2	2	2	2	2
Mvmt Flow	92	217	696	27	266	549

Major/Minor	Minor1	Major1	Major2			
Conflicting Flow All	1503	348	0	0	723	0
Stage 1	696	-	-	-	-	-
Stage 2	807	-	-	-	-	-
Critical Hdwy	6.84	6.94	-	-	4.14	-
Critical Hdwy Stg 1	5.84	-	-	-	-	-
Critical Hdwy Stg 2	5.84	-	-	-	-	-
Follow-up Hdwy	3.52	3.32	-	-	2.22	-
Pot Cap-1 Maneuver	112	648	-	-	875	-
Stage 1	456	-	-	-	-	-
Stage 2	399	-	-	-	-	-
Platoon blocked, %			-	-		
Mov Cap-1 Maneuver	~ 78	648	-	-	875	-
Mov Cap-2 Maneuver	234	-	-	-	-	-
Stage 1	456	-	-	-	-	-
Stage 2	278	-	-	-	-	-

Approach	WB	NB	SB
HCM Control Delay, s	18.3	0	3.6
HCM LOS	C		

Minor Lane/Major Mvmt	NBT	NBRWBLn1	WBLn2	SBL	SBT
Capacity (veh/h)	-	-	234	648	875
HCM Lane V/C Ratio	-	-	0.395	0.335	0.304
HCM Control Delay (s)	-	-	30.1	13.3	10.9
HCM Lane LOS	-	-	D	B	B
HCM 95th %tile Q(veh)	-	-	1.8	1.5	1.3

Notes
 -: Volume exceeds capacity \$: Delay exceeds 300s +: Computation Not Defined *: All major volume in platoon

Intersection				
Intersection Delay, s/veh	4.5			
Intersection LOS	A			
Approach	EB	WB	NB	SB
Entry Lanes	1	1	1	1
Conflicting Circle Lanes	1	1	1	1
Adj Approach Flow, veh/h	331	119	130	75
Demand Flow Rate, veh/h	338	122	132	77
Vehicles Circulating, veh/h	38	182	122	155
Vehicles Exiting, veh/h	194	72	254	149
Ped Vol Crossing Leg, #/h	0	0	0	0
Ped Cap Adj	1.000	1.000	1.000	1.000
Approach Delay, s/veh	5.0	4.1	3.9	3.7
Approach LOS	A	A	A	A
Lane	Left	Left	Left	Left
Designated Moves	LTR	LTR	LTR	LTR
Assumed Moves	LTR	LTR	LTR	LTR
RT Channelized				
Lane Util	1.000	1.000	1.000	1.000
Follow-Up Headway, s	2.609	2.609	2.609	2.609
Critical Headway, s	4.976	4.976	4.976	4.976
Entry Flow, veh/h	338	122	132	77
Cap Entry Lane, veh/h	1327	1146	1218	1178
Entry HV Adj Factor	0.980	0.979	0.984	0.973
Flow Entry, veh/h	331	119	130	75
Cap Entry, veh/h	1301	1122	1199	1146
V/C Ratio	0.255	0.106	0.108	0.065
Control Delay, s/veh	5.0	4.1	3.9	3.7
LOS	A	A	A	A
95th %tile Queue, veh	1	0	0	0

HCM 6th Roundabout
5: Swingline Road & (Old) Meridian Road

2023 Total PM
12/15/2021

Intersection				
Intersection Delay, s/veh	4.9			
Intersection LOS	A			
Approach	EB	WB	NB	SB
Entry Lanes	1	1	1	1
Conflicting Circle Lanes	1	1	1	1
Adj Approach Flow, veh/h	288	109	261	119
Demand Flow Rate, veh/h	294	111	266	121
Vehicles Circulating, veh/h	66	266	182	227
Vehicles Exiting, veh/h	282	182	177	150
Ped Vol Crossing Leg, #/h	0	0	0	0
Ped Cap Adj	1.000	1.000	1.000	1.000
Approach Delay, s/veh	4.8	4.4	5.3	4.3
Approach LOS	A	A	A	A
Lane	Left	Left	Left	Left
Designated Moves	LTR	LTR	LTR	LTR
Assumed Moves	LTR	LTR	LTR	LTR
RT Channelized				
Lane Util	1.000	1.000	1.000	1.000
Follow-Up Headway, s	2.609	2.609	2.609	2.609
Critical Headway, s	4.976	4.976	4.976	4.976
Entry Flow, veh/h	294	111	266	121
Cap Entry Lane, veh/h	1290	1052	1146	1095
Entry HV Adj Factor	0.981	0.978	0.981	0.982
Flow Entry, veh/h	288	109	261	119
Cap Entry, veh/h	1266	1029	1124	1075
V/C Ratio	0.228	0.106	0.232	0.111
Control Delay, s/veh	4.8	4.4	5.3	4.3
LOS	A	A	A	A
95th %tile Queue, veh	1	0	1	0

HCM 6th Roundabout
5: Swingline Road & (Old) Meridian Road

2040 Total AM
12/15/2021

Intersection				
Intersection Delay, s/veh	4.7			
Intersection LOS	A			
Approach	EB	WB	NB	SB
Entry Lanes	1	1	1	1
Conflicting Circle Lanes	1	1	1	1
Adj Approach Flow, veh/h	375	130	130	92
Demand Flow Rate, veh/h	383	133	132	94
Vehicles Circulating, veh/h	38	182	167	166
Vehicles Exiting, veh/h	222	117	254	149
Ped Vol Crossing Leg, #/h	0	0	0	0
Ped Cap Adj	1.000	1.000	1.000	1.000
Approach Delay, s/veh	5.3	4.2	4.1	3.8
Approach LOS	A	A	A	A
Lane	Left	Left	Left	Left
Designated Moves	LTR	LTR	LTR	LTR
Assumed Moves	LTR	LTR	LTR	LTR
RT Channelized				
Lane Util	1.000	1.000	1.000	1.000
Follow-Up Headway, s	2.609	2.609	2.609	2.609
Critical Headway, s	4.976	4.976	4.976	4.976
Entry Flow, veh/h	383	133	132	94
Cap Entry Lane, veh/h	1327	1146	1164	1165
Entry HV Adj Factor	0.980	0.979	0.984	0.978
Flow Entry, veh/h	375	130	130	92
Cap Entry, veh/h	1301	1122	1145	1139
V/C Ratio	0.289	0.116	0.113	0.081
Control Delay, s/veh	5.3	4.2	4.1	3.8
LOS	A	A	A	A
95th %tile Queue, veh	1	0	0	0

HCM 6th Roundabout
5: Swingline Road & (Old) Meridian Road

2040 Total PM
12/15/2021

Intersection				
Intersection Delay, s/veh	4.8			
Intersection LOS	A			
Approach	EB	WB	NB	SB
Entry Lanes	1	1	1	1
Conflicting Circle Lanes	1	1	1	1
Adj Approach Flow, veh/h	299	136	261	125
Demand Flow Rate, veh/h	305	139	266	127
Vehicles Circulating, veh/h	66	266	94	255
Vehicles Exiting, veh/h	316	94	277	150
Ped Vol Crossing Leg, #/h	0	0	0	0
Ped Cap Adj	1.000	1.000	1.000	1.000
Approach Delay, s/veh	4.9	4.7	4.8	4.5
Approach LOS	A	A	A	A
Lane	Left	Left	Left	Left
Designated Moves	LTR	LTR	LTR	LTR
Assumed Moves	LTR	LTR	LTR	LTR
RT Channelized				
Lane Util	1.000	1.000	1.000	1.000
Follow-Up Headway, s	2.609	2.609	2.609	2.609
Critical Headway, s	4.976	4.976	4.976	4.976
Entry Flow, veh/h	305	139	266	127
Cap Entry Lane, veh/h	1290	1052	1254	1064
Entry HV Adj Factor	0.981	0.979	0.981	0.983
Flow Entry, veh/h	299	136	261	125
Cap Entry, veh/h	1266	1030	1229	1045
V/C Ratio	0.236	0.132	0.212	0.119
Control Delay, s/veh	4.9	4.7	4.8	4.5
LOS	A	A	A	A
95th %tile Queue, veh	1	0	1	0

Intersection						
Int Delay, s/veh	4.7					
Movement	EBL	EBR	NBL	NBT	SBT	SBR
Lane Configurations	T			T		T
Traffic Vol, veh/h	50	70	60	80	30	60
Future Vol, veh/h	50	70	60	80	30	60
Conflicting Peds, #/hr	0	0	0	0	0	0
Sign Control	Stop	Stop	Free	Free	Free	Free
RT Channelized	-	None	-	None	-	None
Storage Length	0	-	-	-	-	-
Veh in Median Storage, #	0	-	-	0	0	-
Grade, %	0	-	-	0	0	-
Peak Hour Factor	92	92	92	92	92	92
Heavy Vehicles, %	2	2	2	2	2	2
Mvmt Flow	54	76	65	87	33	65

Major/Minor	Minor2	Major1	Major2			
Conflicting Flow All	283	66	98	0	-	0
Stage 1	66	-	-	-	-	-
Stage 2	217	-	-	-	-	-
Critical Hdwy	6.42	6.22	4.12	-	-	-
Critical Hdwy Stg 1	5.42	-	-	-	-	-
Critical Hdwy Stg 2	5.42	-	-	-	-	-
Follow-up Hdwy	3.518	3.318	2.218	-	-	-
Pot Cap-1 Maneuver	707	998	1495	-	-	-
Stage 1	957	-	-	-	-	-
Stage 2	819	-	-	-	-	-
Platoon blocked, %				-	-	-
Mov Cap-1 Maneuver	674	998	1495	-	-	-
Mov Cap-2 Maneuver	674	-	-	-	-	-
Stage 1	913	-	-	-	-	-
Stage 2	819	-	-	-	-	-

Approach	EB	NB	SB
HCM Control Delay, s	10.1	3.2	0
HCM LOS	B		

Minor Lane/Major Mvmt	NBL	NBT	EBLn1	SBT	SBR
Capacity (veh/h)	1495	-	831	-	-
HCM Lane V/C Ratio	0.044	-	0.157	-	-
HCM Control Delay (s)	7.5	0	10.1	-	-
HCM Lane LOS	A	A	B	-	-
HCM 95th %tile Q(veh)	0.1	-	0.6	-	-

Intersection						
Int Delay, s/veh	4.9					
Movement	EBL	EBR	NBL	NBT	SBT	SBR
Lane Configurations	T			T		T
Traffic Vol, veh/h	50	90	65	70	60	70
Future Vol, veh/h	50	90	65	70	60	70
Conflicting Peds, #/hr	0	0	0	0	0	0
Sign Control	Stop	Stop	Free	Free	Free	Free
RT Channelized	-	None	-	None	-	None
Storage Length	0	-	-	-	-	-
Veh in Median Storage, #	0	-	-	0	0	-
Grade, %	0	-	-	0	0	-
Peak Hour Factor	92	92	92	92	92	92
Heavy Vehicles, %	2	2	2	2	2	2
Mvmt Flow	54	98	71	76	65	76

Major/Minor	Minor2	Major1		Major2	
Conflicting Flow All	321	103	141	0	0
Stage 1	103	-	-	-	-
Stage 2	218	-	-	-	-
Critical Hdwy	6.42	6.22	4.12	-	-
Critical Hdwy Stg 1	5.42	-	-	-	-
Critical Hdwy Stg 2	5.42	-	-	-	-
Follow-up Hdwy	3.518	3.318	2.218	-	-
Pot Cap-1 Maneuver	673	952	1442	-	-
Stage 1	921	-	-	-	-
Stage 2	818	-	-	-	-
Platoon blocked, %				-	-
Mov Cap-1 Maneuver	639	952	1442	-	-
Mov Cap-2 Maneuver	639	-	-	-	-
Stage 1	874	-	-	-	-
Stage 2	818	-	-	-	-

Approach	EB	NB	SB
HCM Control Delay, s	10.5	3.7	0
HCM LOS	B		

Minor Lane/Major Mvmt	NBL	NBT	EBLn1	SBT	SBR
Capacity (veh/h)	1442	-	810	-	-
HCM Lane V/C Ratio	0.049	-	0.188	-	-
HCM Control Delay (s)	7.6	0	10.5	-	-
HCM Lane LOS	A	A	B	-	-
HCM 95th %tile Q(veh)	0.2	-	0.7	-	-

Intersection						
Int Delay, s/veh	4.6					
Movement	EBL	EBR	NBL	NBT	SBT	SBR
Lane Configurations	T			T		T
Traffic Vol, veh/h	50	70	60	80	45	60
Future Vol, veh/h	50	70	60	80	45	60
Conflicting Peds, #/hr	0	0	0	0	0	0
Sign Control	Stop	Stop	Free	Free	Free	Free
RT Channelized	-	None	-	None	-	None
Storage Length	0	-	-	-	-	-
Veh in Median Storage, #	0	-	-	0	0	-
Grade, %	0	-	-	0	0	-
Peak Hour Factor	92	92	92	92	92	92
Heavy Vehicles, %	2	2	2	2	2	2
Mvmt Flow	54	76	65	87	49	65

Major/Minor	Minor2	Major1	Major2			
Conflicting Flow All	299	82	114	0	-	0
Stage 1	82	-	-	-	-	-
Stage 2	217	-	-	-	-	-
Critical Hdwy	6.42	6.22	4.12	-	-	-
Critical Hdwy Stg 1	5.42	-	-	-	-	-
Critical Hdwy Stg 2	5.42	-	-	-	-	-
Follow-up Hdwy	3.518	3.318	2.218	-	-	-
Pot Cap-1 Maneuver	692	978	1475	-	-	-
Stage 1	941	-	-	-	-	-
Stage 2	819	-	-	-	-	-
Platoon blocked, %				-	-	-
Mov Cap-1 Maneuver	660	978	1475	-	-	-
Mov Cap-2 Maneuver	660	-	-	-	-	-
Stage 1	898	-	-	-	-	-
Stage 2	819	-	-	-	-	-

Approach	EB	NB	SB
HCM Control Delay, s	10.3	3.2	0
HCM LOS	B		

Minor Lane/Major Mvmt	NBL	NBT	EBLn1	SBT	SBR
Capacity (veh/h)	1475	-	814	-	-
HCM Lane V/C Ratio	0.044	-	0.16	-	-
HCM Control Delay (s)	7.6	0	10.3	-	-
HCM Lane LOS	A	A	B	-	-
HCM 95th %tile Q(veh)	0.1	-	0.6	-	-

Intersection						
Int Delay, s/veh	4.8					
Movement	EBL	EBR	NBL	NBT	SBT	SBR
Lane Configurations	T			T		T
Traffic Vol, veh/h	50	90	65	70	65	70
Future Vol, veh/h	50	90	65	70	65	70
Conflicting Peds, #/hr	0	0	0	0	0	0
Sign Control	Stop	Stop	Free	Free	Free	Free
RT Channelized	-	None	-	None	-	None
Storage Length	0	-	-	-	-	-
Veh in Median Storage, #	0	-	-	0	0	-
Grade, %	0	-	-	0	0	-
Peak Hour Factor	92	92	92	92	92	92
Heavy Vehicles, %	2	2	2	2	2	2
Mvmt Flow	54	98	71	76	71	76

Major/Minor	Minor2	Major1		Major2	
Conflicting Flow All	327	109	147	0	0
Stage 1	109	-	-	-	-
Stage 2	218	-	-	-	-
Critical Hdwy	6.42	6.22	4.12	-	-
Critical Hdwy Stg 1	5.42	-	-	-	-
Critical Hdwy Stg 2	5.42	-	-	-	-
Follow-up Hdwy	3.518	3.318	2.218	-	-
Pot Cap-1 Maneuver	667	945	1435	-	-
Stage 1	916	-	-	-	-
Stage 2	818	-	-	-	-
Platoon blocked, %				-	-
Mov Cap-1 Maneuver	632	945	1435	-	-
Mov Cap-2 Maneuver	632	-	-	-	-
Stage 1	868	-	-	-	-
Stage 2	818	-	-	-	-

Approach	EB	NB	SB
HCM Control Delay, s	10.5	3.7	0
HCM LOS	B		

Minor Lane/Major Mvmt	NBL	NBT	EBLn1	SBT	SBR
Capacity (veh/h)	1435	-	803	-	-
HCM Lane V/C Ratio	0.049	-	0.19	-	-
HCM Control Delay (s)	7.6	0	10.5	-	-
HCM Lane LOS	A	A	B	-	-
HCM 95th %tile Q(veh)	0.2	-	0.7	-	-

Intersection												
Int Delay, s/veh	5.9											
Movement	EBL	EBT	EBR	WBL	WBT	WBR	NBL	NBT	NBR	SBL	SBT	SBR
Lane Configurations		↕			↕			↕			↕	
Traffic Vol, veh/h	85	55	30	5	50	35	30	10	5	35	10	70
Future Vol, veh/h	85	55	30	5	50	35	30	10	5	35	10	70
Conflicting Peds, #/hr	0	0	0	0	0	0	0	0	0	0	0	0
Sign Control	Free	Free	Free	Free	Free	Free	Stop	Stop	Stop	Stop	Stop	Stop
RT Channelized	-	-	None	-	-	None	-	-	None	-	-	None
Storage Length	-	-	-	-	-	-	-	-	-	-	-	-
Veh in Median Storage, #	-	0	-	-	0	-	-	0	-	-	0	-
Grade, %	-	0	-	-	0	-	-	0	-	-	0	-
Peak Hour Factor	92	92	92	92	92	92	92	92	92	92	92	92
Heavy Vehicles, %	2	2	2	2	2	2	2	2	2	2	2	2
Mvmt Flow	92	60	33	5	54	38	33	11	5	38	11	76

Major/Minor	Major1			Major2			Minor1			Minor2		
Conflicting Flow All	92	0	0	93	0	0	388	363	77	352	360	73
Stage 1	-	-	-	-	-	-	261	261	-	83	83	-
Stage 2	-	-	-	-	-	-	127	102	-	269	277	-
Critical Hdwy	4.12	-	-	4.12	-	-	7.12	6.52	6.22	7.12	6.52	6.22
Critical Hdwy Stg 1	-	-	-	-	-	-	6.12	5.52	-	6.12	5.52	-
Critical Hdwy Stg 2	-	-	-	-	-	-	6.12	5.52	-	6.12	5.52	-
Follow-up Hdwy	2.218	-	-	2.218	-	-	3.518	4.018	3.318	3.518	4.018	3.318
Pot Cap-1 Maneuver	1503	-	-	1501	-	-	571	565	984	603	567	989
Stage 1	-	-	-	-	-	-	744	692	-	925	826	-
Stage 2	-	-	-	-	-	-	877	811	-	737	681	-
Platoon blocked, %	-	-	-	-	-	-	-	-	-	-	-	-
Mov Cap-1 Maneuver	1503	-	-	1501	-	-	492	526	984	560	528	989
Mov Cap-2 Maneuver	-	-	-	-	-	-	492	526	-	560	528	-
Stage 1	-	-	-	-	-	-	696	647	-	865	823	-
Stage 2	-	-	-	-	-	-	796	808	-	674	637	-

Approach	EB			WB			NB			SB		
HCM Control Delay, s	3.8			0.4			12.5			10.7		
HCM LOS							B			B		

Minor Lane/Major Mvmt	NBLn1	EBL	EBT	EBR	WBL	WBT	WBR	SBLn1
Capacity (veh/h)	529	1503	-	-	1501	-	-	755
HCM Lane V/C Ratio	0.092	0.061	-	-	0.004	-	-	0.166
HCM Control Delay (s)	12.5	7.6	0	-	7.4	0	-	10.7
HCM Lane LOS	B	A	A	-	A	A	-	B
HCM 95th %tile Q(veh)	0.3	0.2	-	-	0	-	-	0.6

Intersection												
Int Delay, s/veh	5.8											
Movement	EBL	EBT	EBR	WBL	WBT	WBR	NBL	NBT	NBR	SBL	SBT	SBR
Lane Configurations		↕			↕			↕			↕	
Traffic Vol, veh/h	70	45	25	5	35	40	25	10	5	45	10	50
Future Vol, veh/h	70	45	25	5	35	40	25	10	5	45	10	50
Conflicting Peds, #/hr	0	0	0	0	0	0	0	0	0	0	0	0
Sign Control	Free	Free	Free	Free	Free	Free	Stop	Stop	Stop	Stop	Stop	Stop
RT Channelized	-	-	None	-	-	None	-	-	None	-	-	None
Storage Length	-	-	-	-	-	-	-	-	-	-	-	-
Veh in Median Storage, #	-	0	-	-	0	-	-	0	-	-	0	-
Grade, %	-	0	-	-	0	-	-	0	-	-	0	-
Peak Hour Factor	92	92	92	92	92	92	92	92	92	92	92	92
Heavy Vehicles, %	2	2	2	2	2	2	2	2	2	2	2	2
Mvmt Flow	76	49	27	5	38	43	27	11	5	49	11	54

Major/Minor	Major1		Major2		Minor1		Minor2					
Conflicting Flow All	81	0	0	76	0	0	317	306	63	293	298	60
Stage 1	-	-	-	-	-	-	215	215	-	70	70	-
Stage 2	-	-	-	-	-	-	102	91	-	223	228	-
Critical Hdwy	4.12	-	-	4.12	-	-	7.12	6.52	6.22	7.12	6.52	6.22
Critical Hdwy Stg 1	-	-	-	-	-	-	6.12	5.52	-	6.12	5.52	-
Critical Hdwy Stg 2	-	-	-	-	-	-	6.12	5.52	-	6.12	5.52	-
Follow-up Hdwy	2.218	-	-	2.218	-	-	3.518	4.018	3.318	3.518	4.018	3.318
Pot Cap-1 Maneuver	1517	-	-	1523	-	-	636	608	1002	659	614	1005
Stage 1	-	-	-	-	-	-	787	725	-	940	837	-
Stage 2	-	-	-	-	-	-	904	820	-	780	715	-
Platoon blocked, %		-	-		-	-						
Mov Cap-1 Maneuver	1517	-	-	1523	-	-	568	575	1002	619	580	1005
Mov Cap-2 Maneuver	-	-	-	-	-	-	568	575	-	619	580	-
Stage 1	-	-	-	-	-	-	746	687	-	891	834	-
Stage 2	-	-	-	-	-	-	841	818	-	724	678	-

Approach	EB		WB		NB		SB	
HCM Control Delay, s	3.7		0.5		11.4		10.6	
HCM LOS					B		B	

Minor Lane/Major Mvmt	NBLn1	EBL	EBT	EBR	WBL	WBT	WBR	SBLn1
Capacity (veh/h)	602	1517	-	-	1523	-	-	752
HCM Lane V/C Ratio	0.072	0.05	-	-	0.004	-	-	0.152
HCM Control Delay (s)	11.4	7.5	0	-	7.4	0	-	10.6
HCM Lane LOS	B	A	A	-	A	A	-	B
HCM 95th %tile Q(veh)	0.2	0.2	-	-	0	-	-	0.5

Intersection												
Int Delay, s/veh	5.9											
Movement	EBL	EBT	EBR	WBL	WBT	WBR	NBL	NBT	NBR	SBL	SBT	SBR
Lane Configurations		↕			↕			↕			↕	
Traffic Vol, veh/h	85	55	30	5	50	35	30	10	5	35	10	70
Future Vol, veh/h	85	55	30	5	50	35	30	10	5	35	10	70
Conflicting Peds, #/hr	0	0	0	0	0	0	0	0	0	0	0	0
Sign Control	Free	Free	Free	Free	Free	Free	Stop	Stop	Stop	Stop	Stop	Stop
RT Channelized	-	-	None	-	-	None	-	-	None	-	-	None
Storage Length	-	-	-	-	-	-	-	-	-	-	-	-
Veh in Median Storage, #	-	0	-	-	0	-	-	0	-	-	0	-
Grade, %	-	0	-	-	0	-	-	0	-	-	0	-
Peak Hour Factor	92	92	92	92	92	92	92	92	92	92	92	92
Heavy Vehicles, %	2	2	2	2	2	2	2	2	2	2	2	2
Mvmt Flow	92	60	33	5	54	38	33	11	5	38	11	76

Major/Minor	Major1			Major2			Minor1			Minor2		
Conflicting Flow All	92	0	0	93	0	0	388	363	77	352	360	73
Stage 1	-	-	-	-	-	-	261	261	-	83	83	-
Stage 2	-	-	-	-	-	-	127	102	-	269	277	-
Critical Hdwy	4.12	-	-	4.12	-	-	7.12	6.52	6.22	7.12	6.52	6.22
Critical Hdwy Stg 1	-	-	-	-	-	-	6.12	5.52	-	6.12	5.52	-
Critical Hdwy Stg 2	-	-	-	-	-	-	6.12	5.52	-	6.12	5.52	-
Follow-up Hdwy	2.218	-	-	2.218	-	-	3.518	4.018	3.318	3.518	4.018	3.318
Pot Cap-1 Maneuver	1503	-	-	1501	-	-	571	565	984	603	567	989
Stage 1	-	-	-	-	-	-	744	692	-	925	826	-
Stage 2	-	-	-	-	-	-	877	811	-	737	681	-
Platoon blocked, %	-	-	-	-	-	-	-	-	-	-	-	-
Mov Cap-1 Maneuver	1503	-	-	1501	-	-	492	526	984	560	528	989
Mov Cap-2 Maneuver	-	-	-	-	-	-	492	526	-	560	528	-
Stage 1	-	-	-	-	-	-	696	647	-	865	823	-
Stage 2	-	-	-	-	-	-	796	808	-	674	637	-

Approach	EB			WB			NB			SB		
HCM Control Delay, s	3.8			0.4			12.5			10.7		
HCM LOS							B			B		

Minor Lane/Major Mvmt	NBLn1	EBL	EBT	EBR	WBL	WBT	WBR	SBLn1
Capacity (veh/h)	529	1503	-	-	1501	-	-	755
HCM Lane V/C Ratio	0.092	0.061	-	-	0.004	-	-	0.166
HCM Control Delay (s)	12.5	7.6	0	-	7.4	0	-	10.7
HCM Lane LOS	B	A	A	-	A	A	-	B
HCM 95th %tile Q(veh)	0.3	0.2	-	-	0	-	-	0.6

Intersection												
Int Delay, s/veh	5.8											
Movement	EBL	EBT	EBR	WBL	WBT	WBR	NBL	NBT	NBR	SBL	SBT	SBR
Lane Configurations		↕			↕			↕			↕	
Traffic Vol, veh/h	70	45	25	5	35	40	25	10	5	45	10	50
Future Vol, veh/h	70	45	25	5	35	40	25	10	5	45	10	50
Conflicting Peds, #/hr	0	0	0	0	0	0	0	0	0	0	0	0
Sign Control	Free	Free	Free	Free	Free	Free	Stop	Stop	Stop	Stop	Stop	Stop
RT Channelized	-	-	None	-	-	None	-	-	None	-	-	None
Storage Length	-	-	-	-	-	-	-	-	-	-	-	-
Veh in Median Storage, #	-	0	-	-	0	-	-	0	-	-	0	-
Grade, %	-	0	-	-	0	-	-	0	-	-	0	-
Peak Hour Factor	92	92	92	92	92	92	92	92	92	92	92	92
Heavy Vehicles, %	2	2	2	2	2	2	2	2	2	2	2	2
Mvmt Flow	76	49	27	5	38	43	27	11	5	49	11	54

Major/Minor	Major1		Major2		Minor1		Minor2					
Conflicting Flow All	81	0	0	76	0	0	317	306	63	293	298	60
Stage 1	-	-	-	-	-	-	215	215	-	70	70	-
Stage 2	-	-	-	-	-	-	102	91	-	223	228	-
Critical Hdwy	4.12	-	-	4.12	-	-	7.12	6.52	6.22	7.12	6.52	6.22
Critical Hdwy Stg 1	-	-	-	-	-	-	6.12	5.52	-	6.12	5.52	-
Critical Hdwy Stg 2	-	-	-	-	-	-	6.12	5.52	-	6.12	5.52	-
Follow-up Hdwy	2.218	-	-	2.218	-	-	3.518	4.018	3.318	3.518	4.018	3.318
Pot Cap-1 Maneuver	1517	-	-	1523	-	-	636	608	1002	659	614	1005
Stage 1	-	-	-	-	-	-	787	725	-	940	837	-
Stage 2	-	-	-	-	-	-	904	820	-	780	715	-
Platoon blocked, %	-	-	-	-	-	-	-	-	-	-	-	-
Mov Cap-1 Maneuver	1517	-	-	1523	-	-	568	575	1002	619	580	1005
Mov Cap-2 Maneuver	-	-	-	-	-	-	568	575	-	619	580	-
Stage 1	-	-	-	-	-	-	746	687	-	891	834	-
Stage 2	-	-	-	-	-	-	841	818	-	724	678	-

Approach	EB		WB		NB		SB	
HCM Control Delay, s	3.7		0.5		11.4		10.6	
HCM LOS					B		B	

Minor Lane/Major Mvmt	NBLn1	EBL	EBT	EBR	WBL	WBT	WBR	SBLn1
Capacity (veh/h)	602	1517	-	-	1523	-	-	752
HCM Lane V/C Ratio	0.072	0.05	-	-	0.004	-	-	0.152
HCM Control Delay (s)	11.4	7.5	0	-	7.4	0	-	10.6
HCM Lane LOS	B	A	A	-	A	A	-	B
HCM 95th %tile Q(veh)	0.2	0.2	-	-	0	-	-	0.5

Intersection												
Int Delay, s/veh	5.9											
Movement	EBL	EBT	EBR	WBL	WBT	WBR	NBL	NBT	NBR	SBL	SBT	SBR
Lane Configurations		↕			↕			↕			↕	
Traffic Vol, veh/h	40	40	15	10	40	65	15	20	10	70	20	35
Future Vol, veh/h	40	40	15	10	40	65	15	20	10	70	20	35
Conflicting Peds, #/hr	0	0	0	0	0	0	0	0	0	0	0	0
Sign Control	Free	Free	Free	Free	Free	Free	Stop	Stop	Stop	Stop	Stop	Stop
RT Channelized	-	-	None	-	-	None	-	-	None	-	-	None
Storage Length	-	-	-	-	-	-	-	-	-	-	-	-
Veh in Median Storage, #	-	0	-	-	0	-	-	0	-	-	0	-
Grade, %	-	0	-	-	0	-	-	0	-	-	0	-
Peak Hour Factor	92	92	92	92	92	92	92	92	92	92	92	92
Heavy Vehicles, %	2	2	2	2	2	2	2	2	2	2	2	2
Mvmt Flow	43	43	16	11	43	71	16	22	11	76	22	38

Major/Minor	Major1			Major2			Minor1			Minor2		
Conflicting Flow All	114	0	0	59	0	0	268	273	51	255	246	79
Stage 1	-	-	-	-	-	-	137	137	-	101	101	-
Stage 2	-	-	-	-	-	-	131	136	-	154	145	-
Critical Hdwy	4.12	-	-	4.12	-	-	7.12	6.52	6.22	7.12	6.52	6.22
Critical Hdwy Stg 1	-	-	-	-	-	-	6.12	5.52	-	6.12	5.52	-
Critical Hdwy Stg 2	-	-	-	-	-	-	6.12	5.52	-	6.12	5.52	-
Follow-up Hdwy	2.218	-	-	2.218	-	-	3.518	4.018	3.318	3.518	4.018	3.318
Pot Cap-1 Maneuver	1475	-	-	1545	-	-	685	634	1017	698	656	981
Stage 1	-	-	-	-	-	-	866	783	-	905	811	-
Stage 2	-	-	-	-	-	-	873	784	-	848	777	-
Platoon blocked, %	-	-	-	-	-	-	-	-	-	-	-	-
Mov Cap-1 Maneuver	1475	-	-	1545	-	-	623	610	1017	653	631	981
Mov Cap-2 Maneuver	-	-	-	-	-	-	623	610	-	653	631	-
Stage 1	-	-	-	-	-	-	840	760	-	878	805	-
Stage 2	-	-	-	-	-	-	810	778	-	790	754	-

Approach	EB			WB			NB			SB		
HCM Control Delay, s	3.2			0.6			10.8			11.2		
HCM LOS							B			B		

Minor Lane/Major Mvmt	NBLn1	EBL	EBT	EBR	WBL	WBT	WBR	SBLn1
Capacity (veh/h)	675	1475	-	-	1545	-	-	716
HCM Lane V/C Ratio	0.072	0.029	-	-	0.007	-	-	0.19
HCM Control Delay (s)	10.8	7.5	0	-	7.3	0	-	11.2
HCM Lane LOS	B	A	A	-	A	A	-	B
HCM 95th %tile Q(veh)	0.2	0.1	-	-	0	-	-	0.7

Intersection												
Int Delay, s/veh	5.6											
Movement	EBL	EBT	EBR	WBL	WBT	WBR	NBL	NBT	NBR	SBL	SBT	SBR
Lane Configurations		↕			↕			↕			↕	
Traffic Vol, veh/h	35	45	15	10	45	80	10	15	10	90	15	25
Future Vol, veh/h	35	45	15	10	45	80	10	15	10	90	15	25
Conflicting Peds, #/hr	0	0	0	0	0	0	0	0	0	0	0	0
Sign Control	Free	Free	Free	Free	Free	Free	Stop	Stop	Stop	Stop	Stop	Stop
RT Channelized	-	-	None	-	-	None	-	-	None	-	-	None
Storage Length	-	-	-	-	-	-	-	-	-	-	-	-
Veh in Median Storage, #	-	0	-	-	0	-	-	0	-	-	0	-
Grade, %	-	0	-	-	0	-	-	0	-	-	0	-
Peak Hour Factor	92	92	92	92	92	92	92	92	92	92	92	92
Heavy Vehicles, %	2	2	2	2	2	2	2	2	2	2	2	2
Mvmt Flow	38	49	16	11	49	87	11	16	11	98	16	27

Major/Minor	Major1			Major2			Minor1			Minor2		
Conflicting Flow All	136	0	0	65	0	0	269	291	57	262	256	93
Stage 1	-	-	-	-	-	-	133	133	-	115	115	-
Stage 2	-	-	-	-	-	-	136	158	-	147	141	-
Critical Hdwy	4.12	-	-	4.12	-	-	7.12	6.52	6.22	7.12	6.52	6.22
Critical Hdwy Stg 1	-	-	-	-	-	-	6.12	5.52	-	6.12	5.52	-
Critical Hdwy Stg 2	-	-	-	-	-	-	6.12	5.52	-	6.12	5.52	-
Follow-up Hdwy	2.218	-	-	2.218	-	-	3.518	4.018	3.318	3.518	4.018	3.318
Pot Cap-1 Maneuver	1448	-	-	1537	-	-	684	619	1009	691	648	964
Stage 1	-	-	-	-	-	-	870	786	-	890	800	-
Stage 2	-	-	-	-	-	-	867	767	-	856	780	-
Platoon blocked, %	-	-	-	-	-	-	-	-	-	-	-	-
Mov Cap-1 Maneuver	1448	-	-	1537	-	-	634	597	1009	652	625	964
Mov Cap-2 Maneuver	-	-	-	-	-	-	634	597	-	652	625	-
Stage 1	-	-	-	-	-	-	847	765	-	866	794	-
Stage 2	-	-	-	-	-	-	819	761	-	806	759	-

Approach	EB			WB			NB			SB		
HCM Control Delay, s	2.8			0.5			10.5			11.5		
HCM LOS							B			B		

Minor Lane/Major Mvmt	NBLn1	EBL	EBT	EBR	WBL	WBT	WBR	SBLn1
Capacity (veh/h)	689	1448	-	-	1537	-	-	692
HCM Lane V/C Ratio	0.055	0.026	-	-	0.007	-	-	0.204
HCM Control Delay (s)	10.5	7.6	0	-	7.4	0	-	11.5
HCM Lane LOS	B	A	A	-	A	A	-	B
HCM 95th %tile Q(veh)	0.2	0.1	-	-	0	-	-	0.8

Intersection												
Int Delay, s/veh	5.9											
Movement	EBL	EBT	EBR	WBL	WBT	WBR	NBL	NBT	NBR	SBL	SBT	SBR
Lane Configurations		↕			↕			↕			↕	
Traffic Vol, veh/h	40	40	15	10	40	65	15	20	10	70	20	35
Future Vol, veh/h	40	40	15	10	40	65	15	20	10	70	20	35
Conflicting Peds, #/hr	0	0	0	0	0	0	0	0	0	0	0	0
Sign Control	Free	Free	Free	Free	Free	Free	Stop	Stop	Stop	Stop	Stop	Stop
RT Channelized	-	-	None	-	-	None	-	-	None	-	-	None
Storage Length	-	-	-	-	-	-	-	-	-	-	-	-
Veh in Median Storage, #	-	0	-	-	0	-	-	0	-	-	0	-
Grade, %	-	0	-	-	0	-	-	0	-	-	0	-
Peak Hour Factor	92	92	92	92	92	92	92	92	92	92	92	92
Heavy Vehicles, %	2	2	2	2	2	2	2	2	2	2	2	2
Mvmt Flow	43	43	16	11	43	71	16	22	11	76	22	38

Major/Minor	Major1		Major2		Minor1		Minor2					
Conflicting Flow All	114	0	0	59	0	0	268	273	51	255	246	79
Stage 1	-	-	-	-	-	-	137	137	-	101	101	-
Stage 2	-	-	-	-	-	-	131	136	-	154	145	-
Critical Hdwy	4.12	-	-	4.12	-	-	7.12	6.52	6.22	7.12	6.52	6.22
Critical Hdwy Stg 1	-	-	-	-	-	-	6.12	5.52	-	6.12	5.52	-
Critical Hdwy Stg 2	-	-	-	-	-	-	6.12	5.52	-	6.12	5.52	-
Follow-up Hdwy	2.218	-	-	2.218	-	-	3.518	4.018	3.318	3.518	4.018	3.318
Pot Cap-1 Maneuver	1475	-	-	1545	-	-	685	634	1017	698	656	981
Stage 1	-	-	-	-	-	-	866	783	-	905	811	-
Stage 2	-	-	-	-	-	-	873	784	-	848	777	-
Platoon blocked, %	-	-	-	-	-	-	-	-	-	-	-	-
Mov Cap-1 Maneuver	1475	-	-	1545	-	-	623	610	1017	653	631	981
Mov Cap-2 Maneuver	-	-	-	-	-	-	623	610	-	653	631	-
Stage 1	-	-	-	-	-	-	840	760	-	878	805	-
Stage 2	-	-	-	-	-	-	810	778	-	790	754	-

Approach	EB		WB		NB		SB	
HCM Control Delay, s	3.2		0.6		10.8		11.2	
HCM LOS					B		B	

Minor Lane/Major Mvmt	NBLn1	EBL	EBT	EBR	WBL	WBT	WBR	SBLn1
Capacity (veh/h)	675	1475	-	-	1545	-	-	716
HCM Lane V/C Ratio	0.072	0.029	-	-	0.007	-	-	0.19
HCM Control Delay (s)	10.8	7.5	0	-	7.3	0	-	11.2
HCM Lane LOS	B	A	A	-	A	A	-	B
HCM 95th %tile Q(veh)	0.2	0.1	-	-	0	-	-	0.7

Intersection												
Int Delay, s/veh	5.6											
Movement	EBL	EBT	EBR	WBL	WBT	WBR	NBL	NBT	NBR	SBL	SBT	SBR
Lane Configurations		↕			↕			↕			↕	
Traffic Vol, veh/h	35	45	15	10	45	80	10	15	10	90	15	25
Future Vol, veh/h	35	45	15	10	45	80	10	15	10	90	15	25
Conflicting Peds, #/hr	0	0	0	0	0	0	0	0	0	0	0	0
Sign Control	Free	Free	Free	Free	Free	Free	Stop	Stop	Stop	Stop	Stop	Stop
RT Channelized	-	-	None	-	-	None	-	-	None	-	-	None
Storage Length	-	-	-	-	-	-	-	-	-	-	-	-
Veh in Median Storage, #	-	0	-	-	0	-	-	0	-	-	0	-
Grade, %	-	0	-	-	0	-	-	0	-	-	0	-
Peak Hour Factor	92	92	92	92	92	92	92	92	92	92	92	92
Heavy Vehicles, %	2	2	2	2	2	2	2	2	2	2	2	2
Mvmt Flow	38	49	16	11	49	87	11	16	11	98	16	27

Major/Minor	Major1			Major2			Minor1			Minor2		
Conflicting Flow All	136	0	0	65	0	0	269	291	57	262	256	93
Stage 1	-	-	-	-	-	-	133	133	-	115	115	-
Stage 2	-	-	-	-	-	-	136	158	-	147	141	-
Critical Hdwy	4.12	-	-	4.12	-	-	7.12	6.52	6.22	7.12	6.52	6.22
Critical Hdwy Stg 1	-	-	-	-	-	-	6.12	5.52	-	6.12	5.52	-
Critical Hdwy Stg 2	-	-	-	-	-	-	6.12	5.52	-	6.12	5.52	-
Follow-up Hdwy	2.218	-	-	2.218	-	-	3.518	4.018	3.318	3.518	4.018	3.318
Pot Cap-1 Maneuver	1448	-	-	1537	-	-	684	619	1009	691	648	964
Stage 1	-	-	-	-	-	-	870	786	-	890	800	-
Stage 2	-	-	-	-	-	-	867	767	-	856	780	-
Platoon blocked, %	-	-	-	-	-	-	-	-	-	-	-	-
Mov Cap-1 Maneuver	1448	-	-	1537	-	-	634	597	1009	652	625	964
Mov Cap-2 Maneuver	-	-	-	-	-	-	634	597	-	652	625	-
Stage 1	-	-	-	-	-	-	847	765	-	866	794	-
Stage 2	-	-	-	-	-	-	819	761	-	806	759	-

Approach	EB			WB			NB			SB		
HCM Control Delay, s	2.8			0.5			10.5			11.5		
HCM LOS							B			B		

Minor Lane/Major Mvmt	NBLn1	EBL	EBT	EBR	WBL	WBT	WBR	SBLn1
Capacity (veh/h)	689	1448	-	-	1537	-	-	692
HCM Lane V/C Ratio	0.055	0.026	-	-	0.007	-	-	0.204
HCM Control Delay (s)	10.5	7.6	0	-	7.4	0	-	11.5
HCM Lane LOS	B	A	A	-	A	A	-	B
HCM 95th %tile Q(veh)	0.2	0.1	-	-	0	-	-	0.8

Intersection						
Int Delay, s/veh	1.1					
Movement	EBL	EBR	NBL	NBT	SBT	SBR
Lane Configurations	W			W	W	
Traffic Vol, veh/h	10	10	10	130	60	10
Future Vol, veh/h	10	10	10	130	60	10
Conflicting Peds, #/hr	0	0	0	0	0	0
Sign Control	Stop	Stop	Free	Free	Free	Free
RT Channelized	-	None	-	None	-	None
Storage Length	0	-	-	-	-	-
Veh in Median Storage, #	0	-	-	0	0	-
Grade, %	0	-	-	0	0	-
Peak Hour Factor	92	92	92	92	92	92
Heavy Vehicles, %	2	2	2	2	2	2
Mvmt Flow	11	11	11	141	65	11

Major/Minor	Minor2	Major1		Major2	
Conflicting Flow All	234	71	76	0	0
Stage 1	71	-	-	-	-
Stage 2	163	-	-	-	-
Critical Hdwy	6.42	6.22	4.12	-	-
Critical Hdwy Stg 1	5.42	-	-	-	-
Critical Hdwy Stg 2	5.42	-	-	-	-
Follow-up Hdwy	3.518	3.318	2.218	-	-
Pot Cap-1 Maneuver	754	991	1523	-	-
Stage 1	952	-	-	-	-
Stage 2	866	-	-	-	-
Platoon blocked, %				-	-
Mov Cap-1 Maneuver	748	991	1523	-	-
Mov Cap-2 Maneuver	748	-	-	-	-
Stage 1	944	-	-	-	-
Stage 2	866	-	-	-	-

Approach	EB	NB	SB
HCM Control Delay, s	9.3	0.5	0
HCM LOS	A		

Minor Lane/Major Mvmt	NBL	NBT	EBLn1	SBT	SBR
Capacity (veh/h)	1523	-	853	-	-
HCM Lane V/C Ratio	0.007	-	0.025	-	-
HCM Control Delay (s)	7.4	0	9.3	-	-
HCM Lane LOS	A	A	A	-	-
HCM 95th %tile Q(veh)	0	-	0.1	-	-

Intersection						
Int Delay, s/veh	0.7					
Movement	EBL	EBR	NBL	NBT	SBT	SBR
Lane Configurations	T			T		T
Traffic Vol, veh/h	10	5	5	125	100	10
Future Vol, veh/h	10	5	5	125	100	10
Conflicting Peds, #/hr	0	0	0	0	0	0
Sign Control	Stop	Stop	Free	Free	Free	Free
RT Channelized	-	None	-	None	-	None
Storage Length	0	-	-	-	-	-
Veh in Median Storage, #	0	-	-	0	0	-
Grade, %	0	-	-	0	0	-
Peak Hour Factor	92	92	92	92	92	92
Heavy Vehicles, %	2	2	2	2	2	2
Mvmt Flow	11	5	5	136	109	11

Major/Minor	Minor2	Major1		Major2	
Conflicting Flow All	261	115	120	0	0
Stage 1	115	-	-	-	-
Stage 2	146	-	-	-	-
Critical Hdwy	6.42	6.22	4.12	-	-
Critical Hdwy Stg 1	5.42	-	-	-	-
Critical Hdwy Stg 2	5.42	-	-	-	-
Follow-up Hdwy	3.518	3.318	2.218	-	-
Pot Cap-1 Maneuver	728	937	1468	-	-
Stage 1	910	-	-	-	-
Stage 2	881	-	-	-	-
Platoon blocked, %				-	-
Mov Cap-1 Maneuver	725	937	1468	-	-
Mov Cap-2 Maneuver	725	-	-	-	-
Stage 1	906	-	-	-	-
Stage 2	881	-	-	-	-

Approach	EB	NB	SB
HCM Control Delay, s	9.7	0.3	0
HCM LOS	A		

Minor Lane/Major Mvmt	NBL	NBT	EBLn1	SBT	SBR
Capacity (veh/h)	1468	-	784	-	-
HCM Lane V/C Ratio	0.004	-	0.021	-	-
HCM Control Delay (s)	7.5	0	9.7	-	-
HCM Lane LOS	A	A	A	-	-
HCM 95th %tile Q(veh)	0	-	0.1	-	-

Intersection						
Int Delay, s/veh	1.1					
Movement	EBL	EBR	NBL	NBT	SBT	SBR
Lane Configurations	W			W	W	
Traffic Vol, veh/h	10	10	10	130	75	10
Future Vol, veh/h	10	10	10	130	75	10
Conflicting Peds, #/hr	0	0	0	0	0	0
Sign Control	Stop	Stop	Free	Free	Free	Free
RT Channelized	-	None	-	None	-	None
Storage Length	0	-	-	-	-	-
Veh in Median Storage, #	0	-	-	0	0	-
Grade, %	0	-	-	0	0	-
Peak Hour Factor	92	92	92	92	92	92
Heavy Vehicles, %	2	2	2	2	2	2
Mvmt Flow	11	11	11	141	82	11

Major/Minor	Minor2	Major1	Major2			
Conflicting Flow All	251	88	93	0	-	0
Stage 1	88	-	-	-	-	-
Stage 2	163	-	-	-	-	-
Critical Hdwy	6.42	6.22	4.12	-	-	-
Critical Hdwy Stg 1	5.42	-	-	-	-	-
Critical Hdwy Stg 2	5.42	-	-	-	-	-
Follow-up Hdwy	3.518	3.318	2.218	-	-	-
Pot Cap-1 Maneuver	738	970	1501	-	-	-
Stage 1	935	-	-	-	-	-
Stage 2	866	-	-	-	-	-
Platoon blocked, %				-	-	-
Mov Cap-1 Maneuver	732	970	1501	-	-	-
Mov Cap-2 Maneuver	732	-	-	-	-	-
Stage 1	928	-	-	-	-	-
Stage 2	866	-	-	-	-	-

Approach	EB	NB	SB
HCM Control Delay, s	9.4	0.5	0
HCM LOS	A		

Minor Lane/Major Mvmt	NBL	NBT	EBLn1	SBT	SBR
Capacity (veh/h)	1501	-	834	-	-
HCM Lane V/C Ratio	0.007	-	0.026	-	-
HCM Control Delay (s)	7.4	0	9.4	-	-
HCM Lane LOS	A	A	A	-	-
HCM 95th %tile Q(veh)	0	-	0.1	-	-

Intersection						
Int Delay, s/veh	0.7					
Movement	EBL	EBR	NBL	NBT	SBT	SBR
Lane Configurations	T			T		T
Traffic Vol, veh/h	10	5	5	125	105	10
Future Vol, veh/h	10	5	5	125	105	10
Conflicting Peds, #/hr	0	0	0	0	0	0
Sign Control	Stop	Stop	Free	Free	Free	Free
RT Channelized	-	None	-	None	-	None
Storage Length	0	-	-	-	-	-
Veh in Median Storage, #	0	-	-	0	0	-
Grade, %	0	-	-	0	0	-
Peak Hour Factor	92	92	92	92	92	92
Heavy Vehicles, %	2	2	2	2	2	2
Mvmt Flow	11	5	5	136	114	11

Major/Minor	Minor2	Major1	Major2			
Conflicting Flow All	266	120	125	0	-	0
Stage 1	120	-	-	-	-	-
Stage 2	146	-	-	-	-	-
Critical Hdwy	6.42	6.22	4.12	-	-	-
Critical Hdwy Stg 1	5.42	-	-	-	-	-
Critical Hdwy Stg 2	5.42	-	-	-	-	-
Follow-up Hdwy	3.518	3.318	2.218	-	-	-
Pot Cap-1 Maneuver	723	931	1462	-	-	-
Stage 1	905	-	-	-	-	-
Stage 2	881	-	-	-	-	-
Platoon blocked, %				-	-	-
Mov Cap-1 Maneuver	720	931	1462	-	-	-
Mov Cap-2 Maneuver	720	-	-	-	-	-
Stage 1	901	-	-	-	-	-
Stage 2	881	-	-	-	-	-

Approach	EB	NB	SB
HCM Control Delay, s	9.7	0.3	0
HCM LOS	A		

Minor Lane/Major Mvmt	NBL	NBT	EBLn1	SBT	SBR
Capacity (veh/h)	1462	-	779	-	-
HCM Lane V/C Ratio	0.004	-	0.021	-	-
HCM Control Delay (s)	7.5	0	9.7	-	-
HCM Lane LOS	A	A	A	-	-
HCM 95th %tile Q(veh)	0	-	0.1	-	-

APPENDIX E

Queuing Analysis Worksheets

Queues
2: (New) Meridian Road & US-24

2023 Total AM
12/15/2021

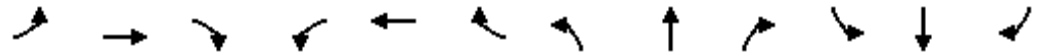

Lane Group	EBL	EBT	EBR	WBL	WBT	WBR	NBL	NBT	NBR	SBL	SBT	SBR
Lane Group Flow (vph)	152	533	163	245	913	22	130	207	207	33	196	543
v/c Ratio	1.35	0.64	0.20	0.63	0.95	0.03	0.31	0.20	0.13	0.09	0.24	0.34
Control Delay	224.2	29.4	3.5	20.0	47.2	0.1	29.8	34.5	0.2	27.2	40.0	0.6
Queue Delay	0.0	0.0	0.0	0.0	0.0	0.0	0.0	0.0	0.0	0.0	0.0	0.0
Total Delay	224.2	29.4	3.5	20.0	47.2	0.1	29.8	34.5	0.2	27.2	40.0	0.6
Queue Length 50th (ft)	~80	306	0	86	634	0	71	67	0	17	67	0
Queue Length 95th (ft)	#201	426	38	130	#932	0	120	104	0	41	103	0
Internal Link Dist (ft)		1241			1307			590			512	
Turn Bay Length (ft)	800		600	750			150		400	150		300
Base Capacity (vph)	113	853	813	389	978	876	427	1036	1583	424	801	1583
Starvation Cap Reductn	0	0	0	0	0	0	0	0	0	0	0	0
Spillback Cap Reductn	0	0	0	0	0	0	0	0	0	0	0	0
Storage Cap Reductn	0	0	0	0	0	0	0	0	0	0	0	0
Reduced v/c Ratio	1.35	0.62	0.20	0.63	0.93	0.03	0.30	0.20	0.13	0.08	0.24	0.34

Intersection Summary

- ~ Volume exceeds capacity, queue is theoretically infinite.
Queue shown is maximum after two cycles.
- # 95th percentile volume exceeds capacity, queue may be longer.
Queue shown is maximum after two cycles.

Queues
2: (New) Meridian Road & US-24

2023 Total PM
12/15/2021



Lane Group	EBL	EBT	EBR	WBL	WBT	WBR	NBL	NBT	NBR	SBL	SBT	SBR
Lane Group Flow (vph)	571	1000	163	245	516	27	147	332	190	71	315	190
v/c Ratio	1.01	1.06	0.18	0.96	0.74	0.04	0.52	0.50	0.12	0.26	0.63	0.12
Control Delay	66.3	74.9	2.8	83.8	40.1	0.1	41.0	48.2	0.2	35.2	55.2	0.2
Queue Delay	0.0	0.0	0.0	0.0	0.0	0.0	0.0	0.0	0.0	0.0	0.0	0.0
Total Delay	66.3	74.9	2.8	83.8	40.1	0.1	41.0	48.2	0.2	35.2	55.2	0.2
Queue Length 50th (ft)	~333	~849	0	139	342	0	89	125	0	41	123	0
Queue Length 95th (ft)	#572	#1102	34	#305	477	0	147	180	0	79	176	0
Internal Link Dist (ft)		1241			1307			590			512	
Turn Bay Length (ft)	800		600	750			150		400	150		300
Base Capacity (vph)	566	947	884	254	698	678	302	664	1583	359	503	1583
Starvation Cap Reductn	0	0	0	0	0	0	0	0	0	0	0	0
Spillback Cap Reductn	0	0	0	0	0	0	0	0	0	0	0	0
Storage Cap Reductn	0	0	0	0	0	0	0	0	0	0	0	0
Reduced v/c Ratio	1.01	1.06	0.18	0.96	0.74	0.04	0.49	0.50	0.12	0.20	0.63	0.12

Intersection Summary

- ~ Volume exceeds capacity, queue is theoretically infinite.
Queue shown is maximum after two cycles.
- # 95th percentile volume exceeds capacity, queue may be longer.
Queue shown is maximum after two cycles.

Queues
2: (New) Meridian Road & US-24

2040 Total AM
12/15/2021

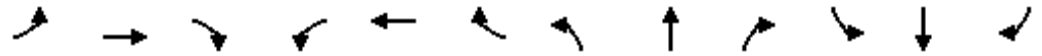

Lane Group	EBL	EBT	EBR	WBL	WBT	WBR	NBL	NBT	NBR	SBL	SBT	SBR
Lane Group Flow (vph)	212	734	234	277	1304	38	147	261	299	33	261	761
v/c Ratio	0.61	0.49	0.29	0.64	0.82	0.05	0.39	0.25	0.19	0.10	0.35	0.48
Control Delay	59.7	26.2	3.5	18.8	33.2	0.1	32.8	35.4	0.3	30.2	44.3	1.0
Queue Delay	0.0	0.0	0.0	0.0	0.0	0.0	0.0	0.0	0.0	0.0	0.0	0.0
Total Delay	59.7	26.2	3.5	18.8	33.2	0.1	32.8	35.4	0.3	30.2	44.3	1.0
Queue Length 50th (ft)	81	204	0	94	439	0	83	88	0	18	94	0
Queue Length 95th (ft)	122	264	46	133	512	0	141	128	0	43	143	0
Internal Link Dist (ft)		1241			1307			590			512	
Turn Bay Length (ft)	800		600	750			150		400	150		300
Base Capacity (vph)	371	1561	829	475	1710	835	400	1051	1583	323	743	1583
Starvation Cap Reductn	0	0	0	0	0	0	0	0	0	0	0	0
Spillback Cap Reductn	0	0	0	0	0	0	0	0	0	0	0	0
Storage Cap Reductn	0	0	0	0	0	0	0	0	0	0	0	0
Reduced v/c Ratio	0.57	0.47	0.28	0.58	0.76	0.05	0.37	0.25	0.19	0.10	0.35	0.48

Intersection Summary

Queues
2: (New) Meridian Road & US-24

2040 Total PM
12/15/2021

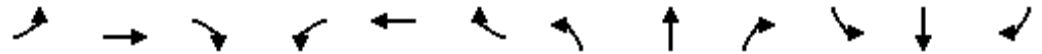

Lane Group	EBL	EBT	EBR	WBL	WBT	WBR	NBL	NBT	NBR	SBL	SBT	SBR
Lane Group Flow (vph)	793	1386	217	272	783	33	168	440	380	92	435	245
v/c Ratio	1.10	0.96	0.28	0.90	0.67	0.05	0.52	0.47	0.24	0.33	0.60	0.15
Control Delay	107.3	51.7	4.0	64.4	37.7	0.2	33.8	38.8	0.4	31.1	48.0	0.2
Queue Delay	0.0	0.0	0.0	0.0	0.0	0.0	0.0	0.0	0.0	0.0	0.0	0.0
Total Delay	107.3	51.7	4.0	64.4	37.7	0.2	33.8	38.8	0.4	31.1	48.0	0.2
Queue Length 50th (ft)	~358	548	0	156	272	0	92	150	0	48	161	0
Queue Length 95th (ft)	#481	#711	48	#309	342	0	149	202	0	87	230	0
Internal Link Dist (ft)		1241			1307			590			512	
Turn Bay Length (ft)	800		600	750			150		400	150		300
Base Capacity (vph)	723	1439	772	312	1176	644	396	943	1583	277	726	1583
Starvation Cap Reductn	0	0	0	0	0	0	0	0	0	0	0	0
Spillback Cap Reductn	0	0	0	0	0	0	0	0	0	0	0	0
Storage Cap Reductn	0	0	0	0	0	0	0	0	0	0	0	0
Reduced v/c Ratio	1.10	0.96	0.28	0.87	0.67	0.05	0.42	0.47	0.24	0.33	0.60	0.15

Intersection Summary

- ~ Volume exceeds capacity, queue is theoretically infinite.
Queue shown is maximum after two cycles.
- # 95th percentile volume exceeds capacity, queue may be longer.
Queue shown is maximum after two cycles.

APPENDIX F

Conceptual Site Plan

CP-20P22.231110-CP22.2.DWG - LAST SAVED BY: SHAWLEY
 LOCATION: P:\310003\1100\DRAWINGS\CONCEPT\NORTHERN.KS

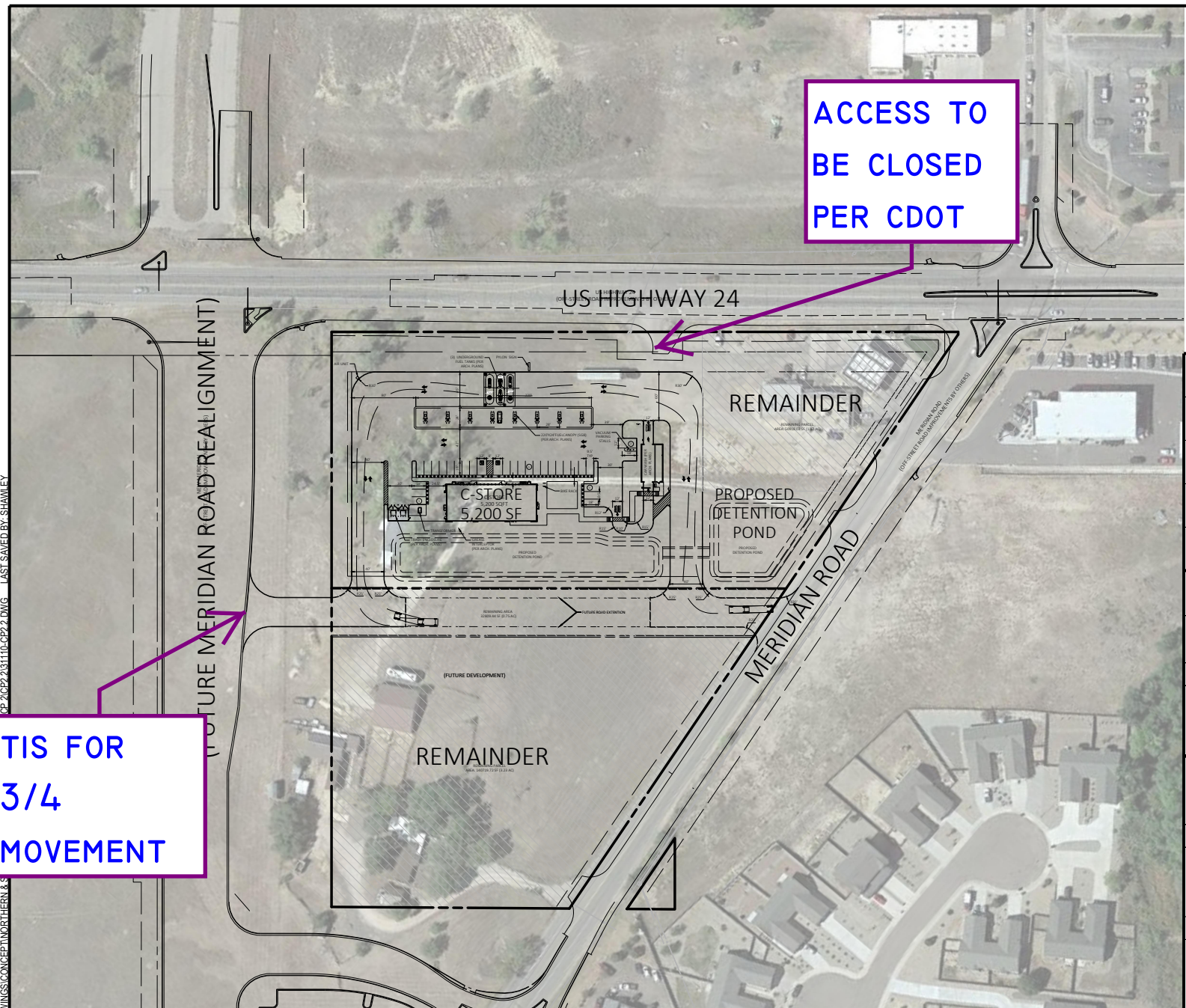

ACCESS TO
 BE CLOSED
 PER CDOT

TIS FOR
 3/4
 MOVEMENT

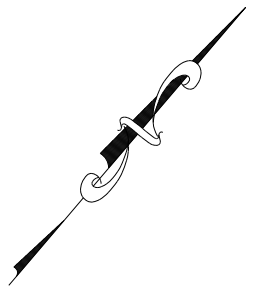

SITE SIZE				
PARCEL	ACRES	S.F.		
C-STORE	3.92±	170,898±		
REMAINDER	5.07±	220,751±		
TOTAL	8.99±	391,649±		
DESCRIPTION		BUILDING AREA SF		
CONVENIENCE STORE		5,200±		
STALL DIMENSIONS:				
STD:	9.5'X18'			
ADA:	12'X18'			
CARWASH:	12'X18'			
PARKING INFORMATION:				
CIRCLE K				
REQUIRED:				
CITY REQ'D 1 PER X,XXX GFA	SPACES			
	STD	ADA	VAN ADA	TOTAL
	35	1	1	37
PROVIDED:				
	SPACES			
	STD	ADA	VAN ADA	TOTAL
	28	1	1	30

NOTES:
 THIS DRAWING IS FOR CONCEPTUAL PURPOSES ONLY. SITE INFORMATION WAS OBTAINED FROM CLIENT'S DOCUMENTS; DESIGN MAY VARY, DEPENDING ON ACTUAL TOPOGRAPHY, DRAINAGE, SOILS, SURVEY, ETC. THIS ADDITIONAL DATA AND SITE CONDITIONS COULD CAUSE CHANGES IN PARKING RATIOS AND SPACE AVAILABLE FOR DEVELOPMENT, AND MAY INCREASE ESTIMATED DEVELOPMENT COSTS.

12/29/20	CONCEPTUAL SITE PLAN
Store #:	CK #XXXX
Address:	FALCON, CO. US HWY 24 & MERIDIAN RD

K

Project

Project Name

Circle K Site Development Plan

Applicant

Circle K Stores Inc.

EA Number

EA2113

File Number

PPR2230

Project Manager

HR Green EPC Consultant (plancheck-EPC@hrgreen.com)

Submission Request

Comment

Review 1 Redlines have been returned, please review comments and resubmit.

Request Date

7/11/2022 11:25:59 AM

Submission

Comment

Submit

Submission Documents (17)

Click below to upload required documents

Upload Documents

Link	Document	Comment
	Application/Petition Form	
	Construction Drawings (Plans/Profiles)	
	Detention Maintenance Agreement (MS WORD version required - attachments included)	
	Elevation Plans	
	Drainage Report - Final	
	Grading & Erosion Control Plan	
	Landscape Plan drawings	
	Legal Description (MS WORD Version required)	
	Letter of Intent	
	Sign Plan	
	Erosion and Stormwater Quality Control Permit (ESQCP)	
	Title Commitment (Current within 30 days of submittal)	

Vicinity/Location Map

Site Development Plan

MS4 Post Construction Form

PDB/BMP Operations & Maintenance Manual

PBMP Applicability Form

Agency Review Comments

Link	Agency	Comment	Date
	RBD Floodplain	THIS PROPERTY IS NOT LOCATED WITHIN A DESIGNATED FEMA FLOODPLAIN AS DETERMINED BY THE FLOOD INSURANCE RATE MAP, COMMUNITY MAP NUMBER '08041C0561G', EFFECTIVE DATE 'DECEMBER 7, 2018'.	6/9/2022 1:15:00 PM
	Colorado Springs Utilities, Dev, Svc. (includes water resources)	Contact Springs Utilities' field engineering at 719-668-4985 regarding any questions about gas services. Corey Masoumi - Utilities Development Services cmasoumi@csu.org	6/14/2022 3:15:16 PM
	Colorado Springs Public Works	Traffic Engineering has the following comment: Will the intersection of New Meridian Road and Pacific Avenue be Right in/out or 3/4 movement. Zaker Alazzeah, P.E. Traffic Engineering Manager/Deputy City Traffic Engineer City of Colorado Springs (719) 385-5468 Zaker.Alazzeah@coloradosprings.gov	6/15/2022 10:08:35 AM

TRAFFIC COMMENT

RESPONSE: The intersection of Pacific Avenue and New Meridian Road will provide 3/4 turning movements. This is addressed on page 1, last paragraph of the Traffic Study.

View	El Paso County Conservation Dist	EPCCD brief comments attached as a .docx.	6/23/2022 8:54:51 PM
View	El Paso County Conservation Dist	EPCCD grass seed native shotgun mix info attached as a .jpg.	6/23/2022 8:57:06 PM
EPC Stormwater Review	<p>Review 1: EPC Stormwater comments have been provided (in orange text boxes) on the following uploaded documents: - CDs.....(to be uploaded by PM with PCD comments) - Drainage Report....(to be uploaded by PM with PCD comments) - ESQCP.....(to be uploaded by PM with PCD comments) - GEC Plan.....(to be uploaded by PM with PCD comments) - Site Dev Plan.....(to be uploaded by PM with PCD comments) - GEC Checklist - MS4 Post Construction Form - O&M Manual - PBMP Applicability Form - Private Detention Basin / Stormwater Quality BMP Maintenance Agreement - SWMP - SWMP Checklist Reviewed by: Glenn Reese, P.E. Stormwater Engineer II GlennReese@elpasoco.com</p>		6/23/2022 10:43:57 AM
View	EPC Stormwater Review	GEC Checklist	6/28/2022 10:44:31 AM
View	EPC Stormwater Review	MS4 Post Construction Form	6/28/2022 10:44:55 AM
View	EPC Stormwater Review	O&M Manual	6/28/2022 10:45:15 AM
View	EPC Stormwater Review	PBMP Applicability Form	6/28/2022 10:45:31 AM

View	EPC Stormwater Review	Private Detention Basin / Stormwater Quality BMP Maintenance Agreement	6/28/2022 10:46:01 AM
View	EPC Stormwater Review	SWMP	6/28/2022 10:46:46 AM
View	EPC Stormwater Review	SWMP Checklist	6/28/2022 10:48:18 AM
	PCD Engineering Division	Staff recommends this project be put on hold until the rezone application (CS213) is approved and at least 1 round of review of the vacate/replat (VR223) is processed. Engineering concern was identified during the early assistance that the current layout of the private road acts as a cut through between new Meridian Road and Old Meridian Road. There is potential the private road tract configuration as shown may change during the vacate/replat application process. The final configuration of the vacate & replat and access may have significant impact to the site development plan layout. Reviewed by: Gilbert LaForce, PE gilbertlaforce@elpasoco.com	6/29/2022 3:13:39 PM
	Mountain View Electric Association, Inc.	MVEA requests twenty (20) foot front, side, and rear utility easements on commercial lots and will work with the developer on the design of the electric service and to acquire any additional easements. The Association also requests the platting of the Association's existing facilities with easements on the plat.	6/29/2022 11:03:16 AM
	911 Authority -EI Pace/Teller County	No new streetnames requested on this submittal. No action for E911. Note: The Old Meridian Rd name listed on this drawing is under review by the City of Colorado Springs. There is the possibility that this name will change. Thank you. Justin.	6/29/2022 11:15:26 AM

Pikes Peak
Regional
Building
Department

1. With the closing of Old Meridian Road north of Hwy 24 recently, it is still up in the air if this portion of the roadway south of Highway 24 will be named Old Meridian Road or another name. 2. Will the private access road to the south of this project be a named street? 3. 53124-02-016 is assigned the address of 11769 E Hwy 24 and 53124-02-015 is assigned 6930 N Meridian Road. These addresses will be eliminated with this proposed project and will not be used. 4. What is the height of the trash enclosure? If over 7' a separate address and permit will be required. 5. Signs that are detached from any structure require a separate address and permit. Contact this department for an address assignment when the time comes. Amy Vanderbeek amy@pprbd.org Amy Vanderbeek Enumerations Plans Examiner Pikes Peak Regional Building Department O: 719-327-2930 E: Amy@pprbd.org

6/29/2022
3:00:52
PM

Falcon
Highlands
Metro

This project is not within the Falcon Highlands Metropolitan District. It was included into the Woodmen Hills Metropolitan District within the last few years.

6/29/2022
3:21:34
PM

Colorado
Springs
Public Works

If Meridian Rd. is located in the Colorado Springs City Limits, separately submit construction plans for the new access point through Project Dox for Engineering Development Review and Traffic Engineering review and approval. Joel Dagnillo, P.E. Engineer III Engineering Development Review City of Colorado Springs (719)385-5412 Joel.dagnillo@coloradosprings.gov

6/30/2022
9:31:13
AM