



**ENTECH**  
ENGINEERING, INC.

505 ELKTON DRIVE  
COLORADO SPRINGS, CO 80907  
PHONE (719) 531-5599

**PAVEMENT DESIGN REPORT  
RETREAT AT TIMBERRIDGE FILING No. 3  
EL PASO COUNTY, COLORADO**

**PCD File No. SF2241**

Prepared for:

**TimberRidge Development  
2138 Flying Horse Club Drive  
Colorado Springs, CO 80921**

Attn: Austin Lenz

August 16, 2024

Revised: September 18, 2024

Respectfully Submitted,

ENTECH ENGINEERING, INC.

Lucas Morrison  
Geotechnical Staff Engineer

Reviewed by:

Joseph C. Goode III, P.E.  
Sr. Engineer

SW:JCG/ed

Entech Job No. 221106

**Table of Contents**

**1 Introduction ..... 1**

**2 Project Description ..... 1**

**3 Subsurface Explorations and Laboratory Testing ..... 1**

    3.1 Subsurface Exploration Program ..... 1

    3.2 Geotechnical Index and Engineering Property Testing ..... 2

**4 Subgrade Conditions ..... 2**

    4.1 Subsurface Conditions ..... 3

    4.2 Groundwater ..... 3

**5 Pavement Design Recommendations ..... 3**

    5.1 Subgrade Conditions ..... 3

    5.2 Swell Mitigation ..... 4

    5.3 Traffic Loading ..... 4

    5.4 Pavement Design ..... 4

**6 Construction Recommendations ..... 5**

    6.1 Earthwork Recommendations for Pavement Subgrade ..... 5

        6.1.1 Subgrade Preparation – Aggregate Base Course ..... 5

        6.1.2 Subgrade Preparation – Cement Treated Subgrade ..... 5

        6.1.3 Fill Placement and Compaction ..... 7

    6.2 Aggregate Base Course ..... 7

    6.3 Concrete Degradation Due to Sulfate Attack ..... 7

    6.4 Construction Observation ..... 7

**7 Closure ..... 8**

**Figures**

Figure 1: Vicinity Map

Figure 2: Site and Exploration Plan

**List of Appendices**

Appendix A: Test Boring Logs

Appendix B: Laboratory Test Results

Appendix C: Pavement Design Calculations

## **1 Introduction**

Entech Engineering, Inc. (Entech) completed a subsurface exploration program, laboratory testing, and pavement design for roadways within the Retreat at TimberRidge, Filing No. 3. This report describes the subsurface exploration program conducted for the proposed roadway improvements and provides pavement section alternatives and construction recommendations. Entech participated in this project as a subconsultant to TimberRidge Development Group. The contents of this report, including the pavement design recommendations, are subject to the limitations and assumptions presented in Section 7. This revised report supersedes previous versions of the report.

## **2 Project Description**

The site is located east of Volmer Road and south of Arroya Lane within the Retreat at TimberRidge, Filing No. 3, in El Paso County, Colorado (Figure 1). The proposed improvements include the paving of sections of Aspen Valley Road, Hawks Hill Court and Antelope Ravine Drive. The extent of our investigation is shown in Figure 2.

At the time of our subsurface exploration program, the existing roadway had been rough-graded and utilities had been installed. Surrounding properties are comprised of vacant land, land being developed for future residential lots, and an existing subdivision. Based on the development plans, the roadways are designated as local roadways.

## **3 Subsurface Explorations and Laboratory Testing**

### **3.1 Subsurface Exploration Program**

Subsurface conditions at the project site were explored by seven test borings, designated TB-1 through TB-7, drilled on July 19 and August 6, 2024. The locations of the test borings are shown on the Site and Exploration Plan (Figure 2). The borings were drilled to depths of 5 to 10 feet below the existing ground surface (bgs). The drilling was performed using a truck-mounted, continuous flight auger drill rig supplied and operated by Entech. Descriptive boring logs providing the lithologies of the subsurface conditions encountered during drilling are presented in Appendix A. Groundwater levels were measured in each of the open boreholes at the conclusion of drilling.

Soil and bedrock samples were obtained from the borings utilizing the Standard Penetration Test (ASTM D1586) using a split-barrel California sampler. Results of the Standard Penetration Test

(SPT) are included on the boring logs in terms of N-values expressed in blows per foot (bpf). Soil and bedrock samples recovered from the borings were visually classified and recorded on the boring logs. The soil classifications were later verified utilizing laboratory testing and grouped by soil type. The soil type numbers are included on the boring logs. It should be understood that the soil descriptions shown on the boring logs may vary between boring location and sample depths. It should also be noted that the lines of stratigraphic separation shown on the boring logs represent approximate boundaries between soil types and the actual stratigraphic transitions may be more gradual or variable with location.

### **3.2 Geotechnical Index and Engineering Property Testing**

Water content testing (ASTM D2216) was performed on the samples recovered from the borings, and the results are shown on the boring logs. Grain-Size Analysis (ASTM D422) and Atterberg Limits testing (ASTM D4318) were performed on selected samples to assist in classifying the materials encountered in the borings.

One-dimensional swell or collapse testing (ASTM D4546) was performed on select samples to determine the swell or collapse potential of the soil. For pavement design, a modified proctor (ASTM D1557) and California Bearing Ratio (CBR) test (ASTM D1883) were completed. Soluble sulfate testing was performed on select soil samples to evaluate the potential for below-grade degradation of concrete due to sulfate attack. The laboratory testing results are presented in Appendix B and summarized in Table B-1.

Strength testing was performed on two sets of soil/cement composite samples. Testing was performed on soil samples prepared with 2% and 4% Portland Cement Type 1L or Type II. A compression strength of 160 pounds per square inch (psi) is recommended for cement-stabilized subgrade. The 6-day average strength value of the 2% mix was 169 psi and the 6-day strength of the 4% mix was 217 psi. A 2% mix is recommended based on the laboratory test results. A summary of the testing results is attached in Appendix B, Table B-2.

## **4 Subgrade Conditions**

Three primary soil types and one bedrock type were encountered in the test borings drilled for the subsurface investigation. Each soil type was classified in accordance with the Unified Soil Classification System (USCS) and the American Association of State Highway and Transportation

Officials (AASHTO) soil classification system using the laboratory testing results and the observations made during drilling.

#### 4.1 Subsurface Conditions

Subsurface conditions along the proposed roadways consisted of loose to medium dense clayey sand and sand with silt fill (Soil Type 1, AASHTO A-1-b, A-2-4 and A-2-6). Native dense sand with clay (Soil Type 2, AASHTO A-1-b) and native stiff to very stiff sandy clay (Soil Type 3, AASHTO A-7-6) was also encountered. Extremely weak to very weak sandstone bedrock, or very dense silty to clayey sand when classified as a soil (Soil Type 4, AASHTO A-1-b) was encountered in 3 of the test borings. Water soluble sulfate testing results showed less than 0.01% sulfates which indicates that the soils exhibit a negligible potential for sulfate attack.

#### 4.2 Groundwater

Groundwater was not encountered in the test borings. Groundwater fluctuations are possible and will depend on seasonal variations, local precipitation, runoff, and other factors, however, we do not anticipate groundwater to affect the proposed construction.

### 5 Pavement Design Recommendations

Pavement design recommendations were made in accordance with the *El Paso County Engineering Criteria Manual (ECM)*.

#### 5.1 Subgrade Conditions

California Bearing Ratio (CBR) testing was performed on a representative sample of the Soil Type 1 clayey sand fill subgrade from TB-3 to determine the support characteristic of the subgrade soils. The results of the CBR testing are presented in Appendix B and summarized in Exhibit 1.

**Exhibit 1: Subsurface Laboratory Testing Summary**

Design Parameter	Value
Soil Type	1 – Clayey Sand Fill
CBR at 95%	8.21
Design CBR	8.21
Liquid Limit	33
Plasticity Index	13
Percent Passing 200	22.6
AASHTO Classification	A-2-6
Unified Soils Classification	SC

## 5.2 Swell Mitigation

El Paso County requires swell mitigation for soils with swell testing results greater than 2% under a 150 pounds per square foot (psf) surcharge. Based on the subgrade soils classification and swell testing, mitigation for expansive soils will not be required on this site.

## 5.3 Traffic Loading

Traffic data is not available for the future interior roads in the Retreat at TimberRidge, Filing No. 3 subdivision; however, the roads are classified as local roadways based on current development plans. The *El Paso County Engineering Criteria Manual* provides default 18-kip equivalent single axle loadings (ESAL) based on the street classification. For design, a default ESAL value of 292,000 was used for the local urban road designation.

## 5.4 Pavement Design

The pavement sections were determined utilizing the *El Paso County Engineering Criteria Manual*, the CBR testing, and default ESALs. Design parameters used in the pavement analysis are presented in Exhibit 2.

**Exhibit 2: Pavement Design Parameters**

Design Parameter	Value
Reliability	80%
Standard Deviation	0.45
Serviceability Loss ( $\Delta$ psi)	2.5
Design CBR	8.21
Resilient Modulus	12,315 psi
Structural Coefficients	
Hot Bituminous Pavement	0.44
Aggregate Base Course	0.11
Cement Stabilized Subgrade	0.11

Pavement section alternatives recommended for the roadways included in this phase of the filing are summarized in Exhibit 3. The pavement design calculations are presented in Appendix C.

**Exhibit 3: Recommended Pavement Sections**

Pavement Area	Design ESAL	Alternative <sup>1</sup>
Antelope Ravine Drive, Hawks Hill Court, Aspen Valley Road	292,000	1. 3.0 inches HMA over 8.0 inches ABC
		2. 3.0 inches HMA over 8.0 inches CTS

ABC = Aggregate Base Course; ESAL = equivalent single axle loads; HMA = Hot Mix Asphalt; CTS = Cement Treated Soil

**Notes:**

1. The use of CTS will require a deviation request approval.

**6 Construction Recommendations**

Pavement design recommendations provided herein are contingent on good construction practices, and poor construction techniques may result in poor performance. Our analyses assumed that this project will be constructed according to the *El Paso County Engineering Criteria Manual* and the *Pikes Peak Region Asphalt Paving Specifications*.

**6.1 Earthwork Recommendations for Pavement Subgrade**

Proper subgrade preparation is required for adequate pavement performance. Paving areas should be cleared of all deleterious materials including but not limited to: existing pavements, utility poles, and fence poles. Surface vegetation, if any, should be removed by stripping, with the depth to be field determined.

**6.1.1 Subgrade Preparation – Aggregate Base Course**

If pavement section alternatives are selected utilizing aggregate base course (ABC), the final subgrade surface should be scarified to a depth of 8 inches, moisture conditioned within +/-2% of the optimum water content, and recompact to 95% of the Modified Proctor (ASTM D1557) maximum dry density.

The compacted surface below pavements should be proof-rolled with a fully loaded, tandem-axle, 10-yard dump truck or equivalent. Any areas that are delineated to be soft, loose, or yielding during proof-rolling should be removed and reconditioned or replaced.

**6.1.2 Subgrade Preparation – Cement Treated Subgrade**

Prior to placement of cement stabilization a preliminary proof roll should be completed with a fully loaded, tandem-axle, 10-yard dump truck or equivalent. Any areas that are delineated to be soft, loose, or yielding during proof-rolling should be removed and reconditioned or replaced.

Following the preliminary proof roll, the subgrade shall be stabilized by the addition of cement. The amount of cement applied shall be a minimum of 2% (by weight) of the subgrade's maximum dry density as determined by the Modified Proctor (ASTM D1557) for granular soils or by the Standard Proctor (ASTM D698) for cohesive soils. The cement should be spread evenly on the subgrade surface and be thoroughly mixed into the subgrade such that a uniform blend of soil and cement is achieved to the CTS design depth. Densification of the cement-stabilized subgrade should be completed to obtain a compaction of at least 95% of the subgrade maximum dry density as determined by the Modified Proctor (ASTM D1557) or by the Standard Proctor (ASTM D698). Satisfactory compaction of the subgrade shall occur within 90 minutes from the time of mixing the cement into the subgrade.

The following conditions shall be observed as part of the subgrade stabilization:

- Type I/II or Type 1L cement as supplied; a local supplier shall be used. All cement used for stabilization should come from the same source. If cement sources are changed, a new laboratory mix design should be completed.
- Moisture conditioning of the subgrade and/or mixing of the cement into the subgrade shall not occur when soil temperatures are below 40 degrees F. Cement treated subgrades should be maintained at a temperature of 40 degrees F or greater until the subgrade has been compacted as required.
- Cement placement, cement mixing, and compaction of the cement treated subgrade should be observed by Entech Engineering, who has performed CTS testing within El Paso County since 1986. Testing should include in-situ compaction tests and representative compacted specimens of the treated subgrade material for subsequent laboratory quality assurance testing. Testing reports will be provided to the El Paso County as construction progresses.
- A minimum 7-day CTS compressive strength of 125 psi must be achieved.
- Soil strengths in excess of 275 psi will require microfracturing. Microfracturing will be completed using the Standard Method as defined by the *City of Colorado Springs Draft Standard Specification*, Section 305 – Chemically Treated Subgrade. Microfracturing will be performed with the same (or equivalent tonnage) steel drum vibratory roller used for compaction of the CTS. A minimum of 12-ton roller shall be used. Three full passes with the roller operating at maximum amplitude and traveling at 2- 3 mph shall be applied. If the treated material breaks up excessively at the surface, the vibration amplitude shall be decreased or eliminated.



### **6.1.3 Fill Placement and Compaction**

Granular fill placed as part of the pavement subgrade shall consist of non-expansive, granular soil, free of organic matter, unsuitable materials, debris, and cobbles greater than 3 inches in diameter. Additionally, any granular fill placed as part of the roadway subgrade should have a minimum CBR of 5. All granular fill placed within the pavement subgrade should be compacted to a minimum of 95% of its maximum Modified Proctor Dry Density (ASTM D1557) at +/-2% of optimum moisture content. Fill material should be placed in horizontal lifts such that each finished lift has a compacted thickness of 6 inches or less. Entech should approve any imported fill to be used within the pavement subgrade area prior to delivery to the site.

### **6.2 Aggregate Base Course**

ABC materials shall conform to the *El Paso County Standard Specifications Manual*, Section 300 Aggregate Base Course. ABC materials should be compacted to a minimum of 95% of its maximum Modified Proctor Dry Density (ASTM D1557) at +/-2% of optimum moisture content.

### **6.3 Concrete Degradation Due to Sulfate Attack**

Sulfate solubility testing was conducted on several samples recovered from the test borings to evaluate the potential for sulfate attack on concrete. The test results indicated less than 0.01% soluble sulfate (by weight). The test results indicate the sulfate component of the in-place soils presents a negligible to severe exposure threat to concrete placed below the site grade.

As presented in *Evaluation of Selected Pavement Specifications and Responses to Questions Relevant to Design and Construction of Cement-Treated Soil and Aggregate Layers in El Paso County, Colorado* report from Spencer Guthrie and Robert Stevens dated March 13, 2024 soils with less than 3,000 ppm (0.3%) do not require special construction practices.

### **6.4 Construction Observation**

Subgrade preparation for pavement structures should be observed by Entech in order to verify that (1) no anomalies are present, (2) materials similar to those described in this report have been encountered or placed, and (3) no soft spots, expansive or organic soil, or debris are present in the pavement subgrade prior to paving. Construction observation requirements as presented in the Use of CTS for Paving Season Memorandum should be followed.

## 7 Closure

The subsurface investigation, geotechnical evaluation, and recommendations presented in this report are intended for use by TimberRidge Development Company with application to the paving of the Retreat at TimberRidge Filing No. 3 project in El Paso County, Colorado. In conducting the subsurface investigation, laboratory testing, engineering evaluation, and reporting, Entech Engineering, Inc. endeavored to work in accordance with generally accepted professional geotechnical and geologic practices and principles consistent with the level of care and skill ordinarily exercised by members of the geotechnical profession currently practicing in the same locality and under similar conditions. No other warranty, expressed or implied, is made. During final design and/or construction, if conditions are encountered that appear different from those described in this report, Entech Engineering, Inc. requests to be notified so that the evaluation and recommendations presented herein can be reviewed and modified as appropriate.

If there are any questions regarding the information provided herein, or if Entech Engineering, Inc. can be of further assistance, please do not hesitate to contact us.





**VICINITY MAP**  
TIMBERRIDGE, FILING NO. 3  
TIMBERRIDGE DEVELOPMENT

JOB NO.  
221106

**FIG. 1**



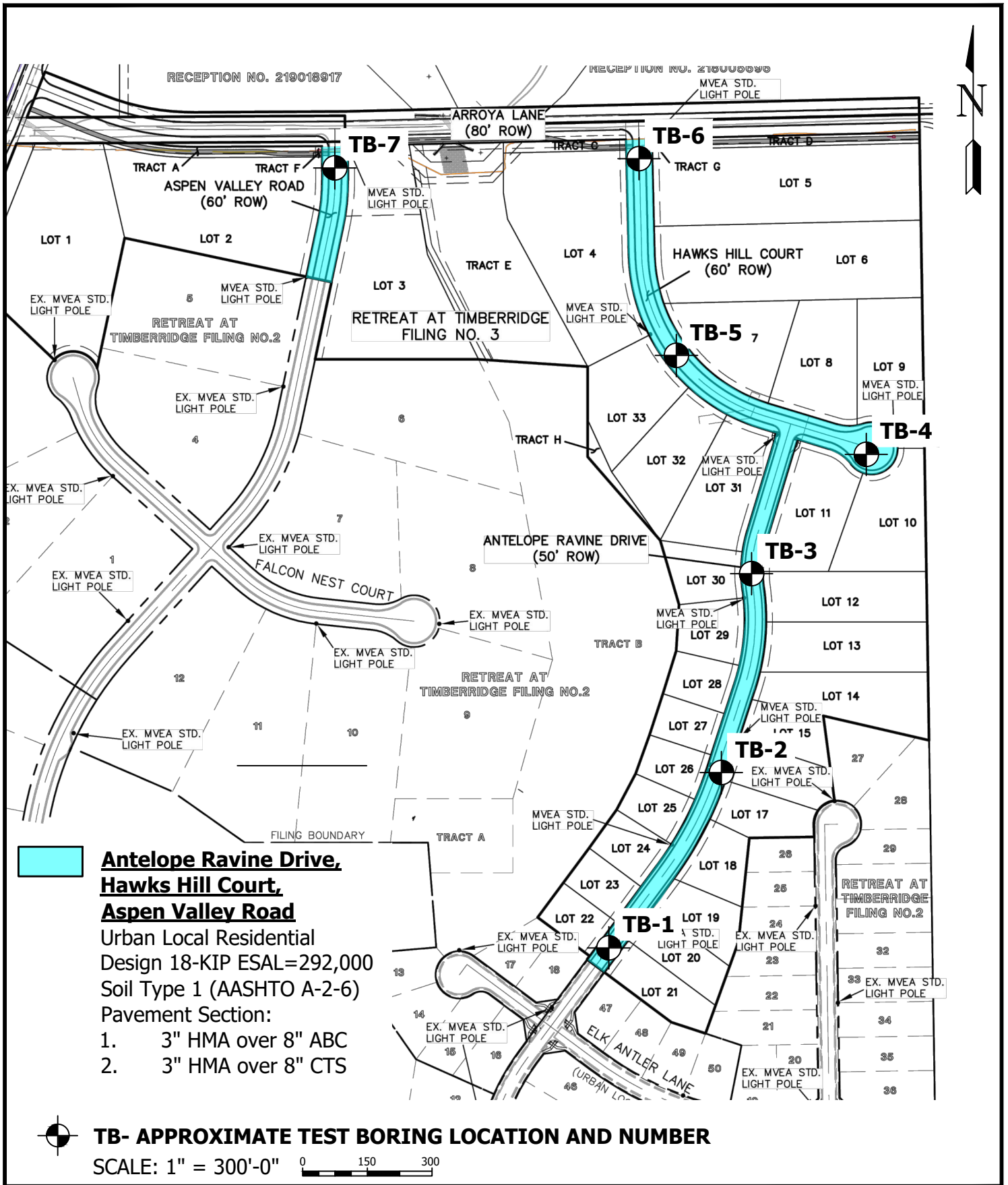

**Antelope Ravine Drive,  
Hawks Hill Court,  
Aspen Valley Road**  
Urban Local Residential  
Design 18-KIP ESAL=292,000  
Soil Type 1 (AASHTO A-2-6)  
Pavement Section:  
1. 3" HMA over 8" ABC  
2. 3" HMA over 8" CTS

**TB- APPROXIMATE TEST BORING LOCATION AND NUMBER**



**SITE AND EXPLORATION MAP**  
TIMBERRIDGE, FILING NO. 3  
TIMBERRIDGE CONSTRUCTION

JOB NO.  
221106

**FIG. 2**



## **APPENDIX A: Test Boring Logs**

TEST BORING 1  
DATE DRILLED 7/19/2024

TEST BORING 2  
DATE DRILLED 7/19/2024

REMARKS

REMARKS

DRY TO 5', 7/19/24

FILL 0-5', SAND, CLAYEY, TAN to BROWN, MEDIUM DENSE to LOOSE, MOIST

Depth (ft)	Symbol	Samples	Blows per foot	Watercontent %	Soil Type
5	[Symbol]		8	10.0	1
10					
15					
20					

DRY TO 5', 7/19/24

FILL 0-5', SAND, CLAYEY, GRAY to BROWN, MEDIUM DENSE, MOIST

Depth (ft)	Symbol	Samples	Blows per foot	Watercontent %	Soil Type
5	[Symbol]		15	6.0	1
10					
15					
20					



**TEST BORING LOGS**  
TIMBERRIDGE, FILING NO. 3  
TIMBERRIDGE DEVELOPMENT

JOB NO.  
221106

**FIG. A-1**

TEST BORING 3  
 DATE DRILLED 7/19/2024

TEST BORING 4  
 DATE DRILLED 7/19/2024

REMARKS

REMARKS

DRY TO 10', 7/19/24

FILL 0-5', SAND, CLAYEY, TAN to BROWN, LOOSE to MEDIUM DENSE, MOIST

Depth (ft)	Symbol	Samples	Blows per foot	Watercontent %	Soil Type
0-5	(Symbol: Sand, Clayey)		9	6.5	1
5-8	(Symbol: Sand, Clayey)		8	8.9	1
8-10	(Symbol: Sand, Clayey)		20	9.8	1

DRY TO 5', 7/19/24

FILL 0-2', SAND, CLAYEY, TAN, MEDIUM DENSE, MOIST SANDSTONE, EXTREMELY WEAK, TAN, MODERATELY WEATHERED (SAND, WITH SILT, VERY DENSE, MOIST)

Depth (ft)	Symbol	Samples	Blows per foot	Watercontent %	Soil Type
0-2	(Symbol: Sand, Clayey)		18	13.7	1
2-5	(Symbol: Sand, Clayey)		50 6"	5.1	4



**TEST BORING LOGS**  
 TIMBERRIDGE, FILING NO. 3  
 TIMBERRIDGE DEVELOPMENT

JOB NO.  
 221106  
**FIG. A-2**

TEST BORING 5  
DATE DRILLED 7/19/2024

TEST BORING 6  
DATE DRILLED 7/19/2024

REMARKS

REMARKS

DRY TO 5', 7/19/24

FILL 0-4', SAND, CLAYEY, BROWN,  
LOOSE, MOIST

SAND, WITH CLAY, LIGHT  
BROWN, DENSE, MOIST

Depth (ft)	Symbol	Samples	Blows per foot	Watercontent %	Soil Type
0-4	[Symbol]		4	8.4	1
5	[Symbol]		35	4.3	2
10					
15					
20					

DRY TO 10', 7/19/24

FILL 0-1', SAND, CLAYEY, BROWN  
CLAY, SANDY, OLIVE, STIFF to  
VERY STIFF, MOIST

SANDSTONE, VERY WEAK, TAN,  
MODERATELY WEATHERED  
(SAND, CLAYEY, VERY DENSE,  
MOIST)

Depth (ft)	Symbol	Samples	Blows per foot	Watercontent %	Soil Type
0-1	[Symbol]		13	18.2	1
1-3	[Symbol]				3
5	[Symbol]		26	11.5	3
10	[Symbol]		50 7"	8.6	4
15					
20					



**TEST BORING LOGS**  
TIMBERRIDGE, FILING NO. 3  
TIMBERRIDGE DEVELOPMENT

JOB NO.  
221106

**FIG. A-3**



TEST BORING 7  
 DATE DRILLED 8/6/2024

REMARKS

DRY TO 10', 8/6/24

FILL 0-4', SAND, WITH SILT, TAN,  
 MEDIUM DENSE, MOIST

SAND, CLAYEY, TAN, MEDIUM  
 DENSE, MOIST  
 SANDSTONE, VERY WEAK, TAN,  
 MODERATELY WEATHERED  
 (SAND, SILTY, VERY DENSE,  
 MOIST)

Depth (ft)	Symbol	Samples	Blows per foot	Watercontent %	Soil Type
0-4	(Symbol: Dotted pattern)	(Symbol: Solid black)	19	4.0	1
5	(Symbol: Diagonal lines)	(Symbol: Solid black)	26	10.7	2
10	(Symbol: Dotted pattern)	(Symbol: Solid black)	50 7"	10.3	4
15					
20					



**TEST BORING LOGS**  
 TIMBERRIDGE, FILING NO. 3  
 TIMBERRIDGE DEVELOPMENT

JOB NO.  
 221106

**FIG. A-4**



## **APPENDIX B: Laboratory Test Results**

**TABLE B-1  
SUMMARY OF LABORATORY TEST RESULTS**



SOIL TYPE	TEST BORING NO.	DEPTH (FT)	WATER (%)	DRY DENSITY (PCF)	PASSING NO. 200 SIEVE (%)	LIQUID LIMIT	PLASTIC LIMIT	PLASTIC INDEX	SULFATE (WT %)	SWELL/ COLLAPSE (%)	AASHTO CLASS. (GROUP INDEX)	USCS	SOIL DESCRIPTION
1, CBR	3	0-3	7.9	124.9	22.6	33	20	13		-1.3	A-2-6 (0)	SC	FILL, SAND, CLAYEY
1	7	0-3			23.6	33	21	12			A-2-6 (0)	SC	FILL, SAND, CLAYEY
1	1	1-2			29.9	28	19	9			A-2-4 (0)	SC	FILL, SAND, CLAYEY
1	2	1-2	13.5	112.6	24.9	31	19	12	<0.01	0.4	A-2-6 (0)	SC	FILL, SAND, CLAYEY
1	3	1-2	13.9	113.8	20.2	35	23	12		0.6	A-2-6 (0)	SC	FILL, SAND, CLAYEY
1	4	1-2	11.2	116.3	16.3	32	21	11		0.2	A-2-6 (0)	SC	FILL, SAND, CLAYEY
1	5	1-2			24.6	27	19	8	<0.01		A-2-4 (0)	SC	FILL, SAND, CLAYEY
1	7	1-2			7.4	16	14	2			A-1-b (0)	SW-SM	FILL, SAND, WITH SILT
2	5	5	11.2	120.1	15.0	38	24	14	<0.01	0.6	A-1-b (0)	SW-SC	SAND, WITH CLAY
3	6	1-2	10.9	119.4	77.5	43	24	19		0.8	A-7-6 (15)	CL	CLAY, SANDY
4	4	5			8.5	30	23	7	<0.01		A-1-b (0)	SW-SM	SANDSTONE (SAND, WITH SILT)
4	6	10	12.6	114.1	21.1	40	25	15		-0.1	A-1-b (0)	SC	SANDSTONE (SAND, CLAYEY)
4	7	10			13.0	35	25	10			A-1-b (0)	SM	SANDSTONE (SAND, SILTY)



**TABLE B-2  
SUMMARY OF CTS TEST RESULTS**

FIELD SAMPLE ID      TB-6 @ 0-3'  
 SOIL ADDITIVE        TYPE I/II CEMENT  
 CURING METHOD        100° HUMIDIFIED OVEN

<i>ADDITIVE %</i>	<i>WATER %</i>	<i>DENSITY (dry)</i>	<i>AGE (days)</i>	<i>STRENGTH (psi)</i>
2	9.4	114.1	6	171
2	9.4	119.7	6	166
2	9.4	120.7	6	170
AVERAGE:				<b>169</b>
4	9.4	121.0	6	229
4	9.4	120.2	6	216
4	9.4	120.0	6	205
AVERAGE:				<b>217</b>

TEST BORING 3  
DEPTH (FT) 0-3

SOIL DESCRIPTION FILL, SAND, CLAYEY  
SOIL TYPE 1, CBR

**Sieve Analysis  
Grain Size Distribution**

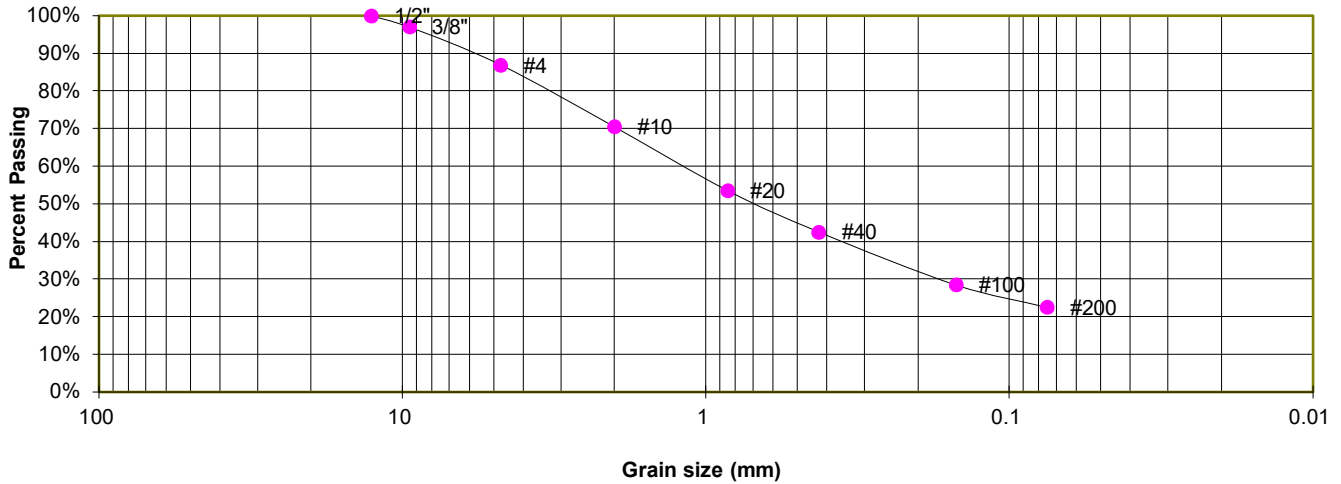

**GRAIN SIZE ANALYSIS**

U.S. Sieve #	Percent Finer
3"	
1 1/2"	
3/4"	
1/2"	100.0%
3/8"	97.1%
4	86.9%
10	70.5%
20	53.6%
40	42.6%
100	28.5%
200	22.6%

**ATTERBERG LIMITS**

Plastic Limit	20
Liquid Limit	33
Plastic Index	13

**SOIL CLASSIFICATION**

USCS CLASSIFICATION: SC  
AASHTO CLASSIFICATION: A-2-6  
AASHTO GROUP INDEX: 0



**LABORATORY TEST RESULTS**

TIMBERRIDGE, FILING NO. 3  
TIMBERRIDGE DEVELOPMENT

JOB NO.  
221106

**FIG. B-1**

TEST BORING 7  
 DEPTH (FT) 0-3

SOIL DESCRIPTION FILL, SAND, CLAYEY  
 SOIL TYPE 1

**Sieve Analysis  
 Grain Size Distribution**

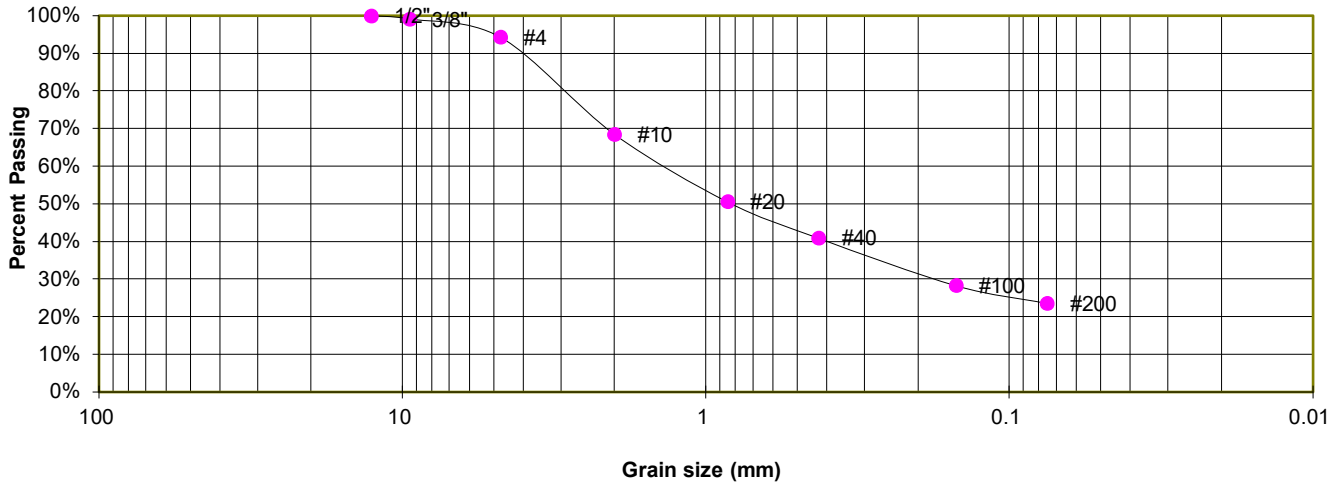

**GRAIN SIZE ANALYSIS**

U.S. Sieve #	Percent Finer
3"	
1 1/2"	
3/4"	
1/2"	100.0%
3/8"	99.2%
4	94.3%
10	68.5%
20	50.6%
40	40.9%
100	28.3%
200	23.6%

**ATTERBERG LIMITS**

Plastic Limit	21
Liquid Limit	33
Plastic Index	12

**SOIL CLASSIFICATION**

USCS CLASSIFICATION: SC  
 AASHTO CLASSIFICATION: A-2-6  
 AASHTO GROUP INDEX: 0



**LABORATORY TEST RESULTS**

TIMBERRIDGE, FILING NO. 3  
 TIMBERRIDGE DEVELOPMENT

JOB NO.  
 221106

**FIG. B-2**

TEST BORING 1  
 DEPTH (FT) 1-2

SOIL DESCRIPTION FILL, SAND, CLAYEY  
 SOIL TYPE 1

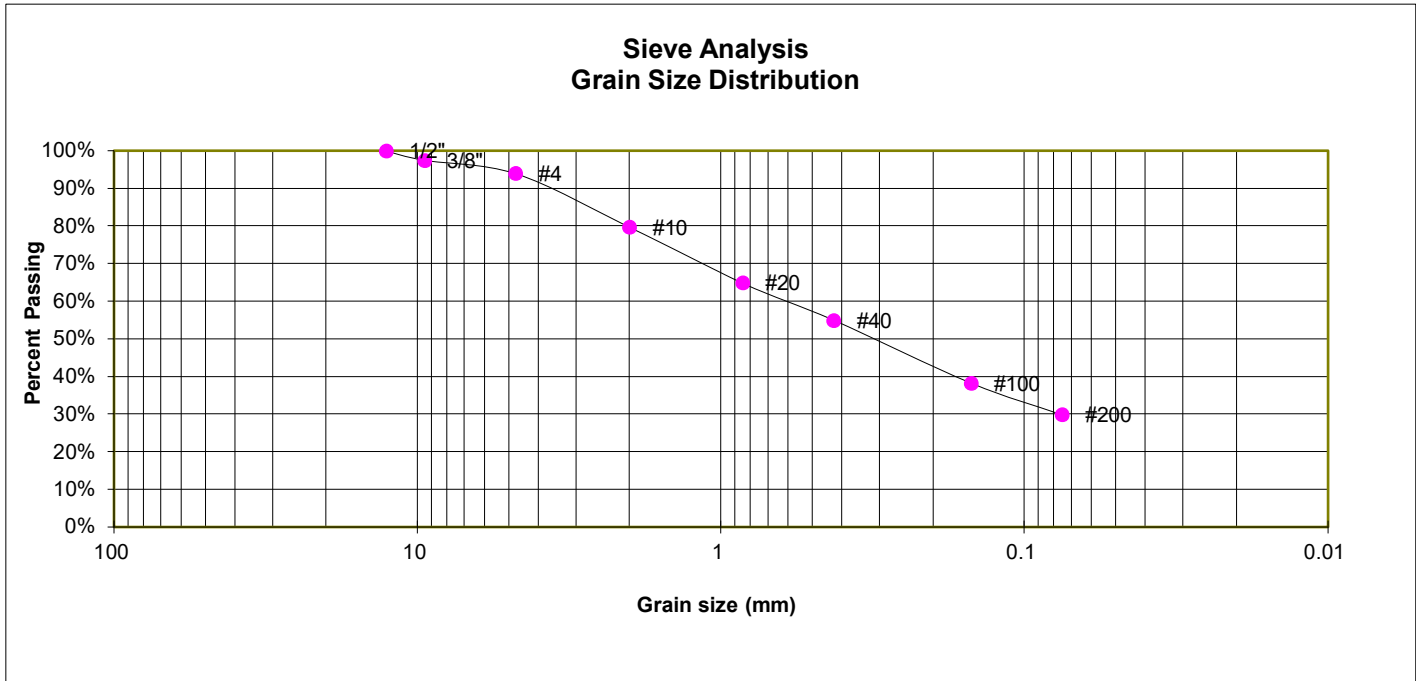

**GRAIN SIZE ANALYSIS**

U.S. Sieve #	Percent Finer
3"	
1 1/2"	
3/4"	
1/2"	100.0%
3/8"	97.5%
4	94.0%
10	79.7%
20	64.9%
40	54.9%
100	38.3%
200	29.9%

**ATTERBERG LIMITS**

Plastic Limit	19
Liquid Limit	28
Plastic Index	9

**SOIL CLASSIFICATION**

USCS CLASSIFICATION: SC  
 AASHTO CLASSIFICATION: A-2-4  
 AASHTO GROUP INDEX: 0



**LABORATORY TEST RESULTS**

TIMBERRIDGE, FILING NO. 3  
 TIMBERRIDGE DEVELOPMENT

JOB NO.  
 221106

**FIG. B-3**

TEST BORING 2  
 DEPTH (FT) 1-2

SOIL DESCRIPTION FILL, SAND, CLAYEY  
 SOIL TYPE 1

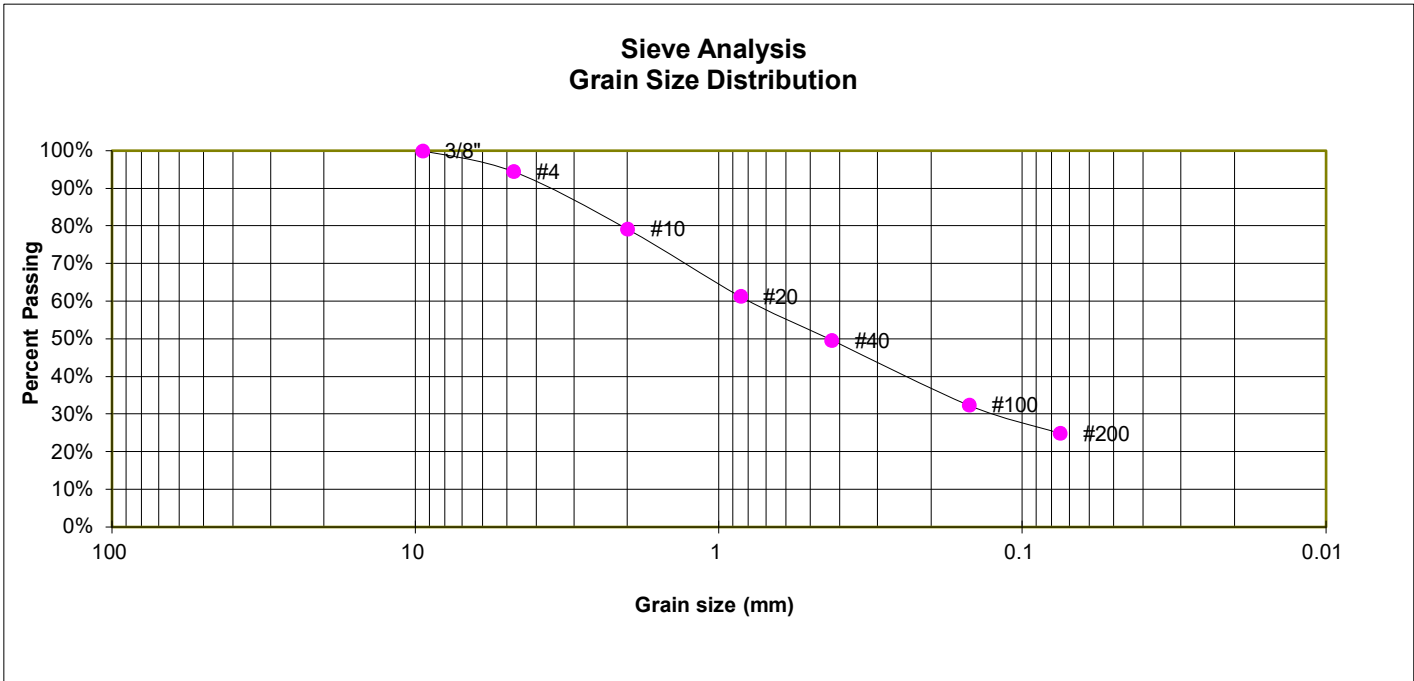

**GRAIN SIZE ANALYSIS**

U.S. Sieve #	Percent Finer
3"	
1 1/2"	
3/4"	
1/2"	
3/8"	100.0%
4	94.5%
10	79.2%
20	61.3%
40	49.7%
100	32.4%
200	24.9%

**ATTERBERG LIMITS**

Plastic Limit	19
Liquid Limit	31
Plastic Index	12

**SOIL CLASSIFICATION**

USCS CLASSIFICATION: SC  
 AASHTO CLASSIFICATION: A-2-6  
 AASHTO GROUP INDEX: 0



**LABORATORY TEST RESULTS**

TIMBERRIDGE, FILING NO. 3  
 TIMBERRIDGE DEVELOPMENT

JOB NO.  
 221106

**FIG. B-4**



TEST BORING 3  
 DEPTH (FT) 1-2

SOIL DESCRIPTION FILL, SAND, CLAYEY  
 SOIL TYPE 1

**Sieve Analysis  
 Grain Size Distribution**

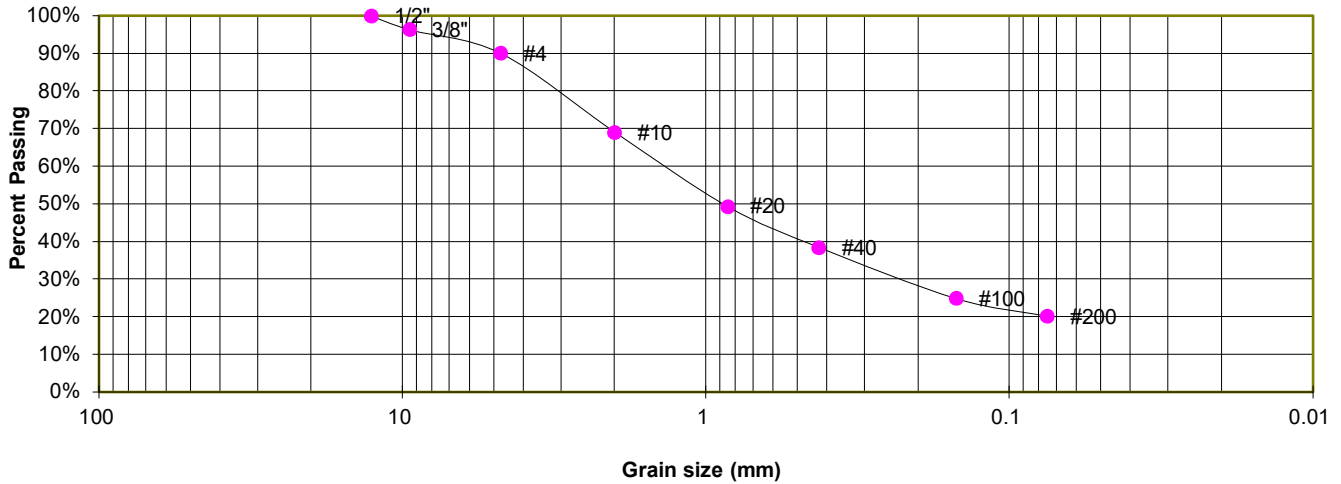

**GRAIN SIZE ANALYSIS**

U.S. Sieve #	Percent Finer
3"	
1 1/2"	
3/4"	
1/2"	100.0%
3/8"	96.3%
4	90.1%
10	69.0%
20	49.4%
40	38.5%
100	24.9%
200	20.2%

**ATTERBERG LIMITS**

Plastic Limit	23
Liquid Limit	35
Plastic Index	12

**SOIL CLASSIFICATION**

USCS CLASSIFICATION: SC  
 AASHTO CLASSIFICATION: A-2-6  
 AASHTO GROUP INDEX: 0



**LABORATORY TEST RESULTS**

TIMBERRIDGE, FILING NO. 3  
 TIMBERRIDGE DEVELOPMENT

JOB NO.  
 221106

**FIG. B-5**

TEST BORING 4  
 DEPTH (FT) 1-2

SOIL DESCRIPTION FILL, SAND, CLAYEY  
 SOIL TYPE 1

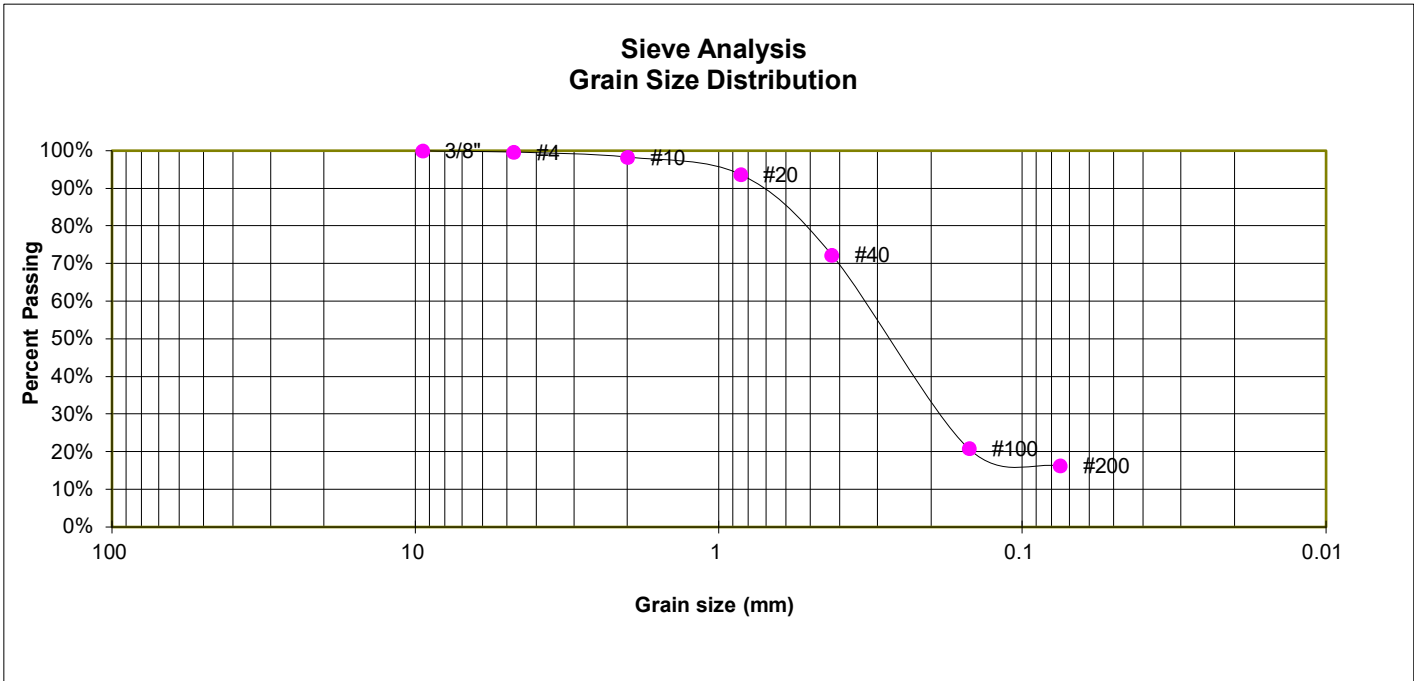

**GRAIN SIZE ANALYSIS**

U.S. Sieve #	Percent Finer
3"	
1 1/2"	
3/4"	
1/2"	
3/8"	100.0%
4	99.6%
10	98.3%
20	93.7%
40	72.3%
100	20.8%
200	16.3%

**ATTERBERG LIMITS**

Plastic Limit	21
Liquid Limit	32
Plastic Index	11

**SOIL CLASSIFICATION**

USCS CLASSIFICATION: SC  
 AASHTO CLASSIFICATION: A-2-6  
 AASHTO GROUP INDEX: 0



**LABORATORY TEST RESULTS**

TIMBERRIDGE, FILING NO. 3  
 TIMBERRIDGE DEVELOPMENT

JOB NO.  
 221106

**FIG. B-6**

TEST BORING 5  
 DEPTH (FT) 1-2

SOIL DESCRIPTION FILL, SAND, CLAYEY  
 SOIL TYPE 1

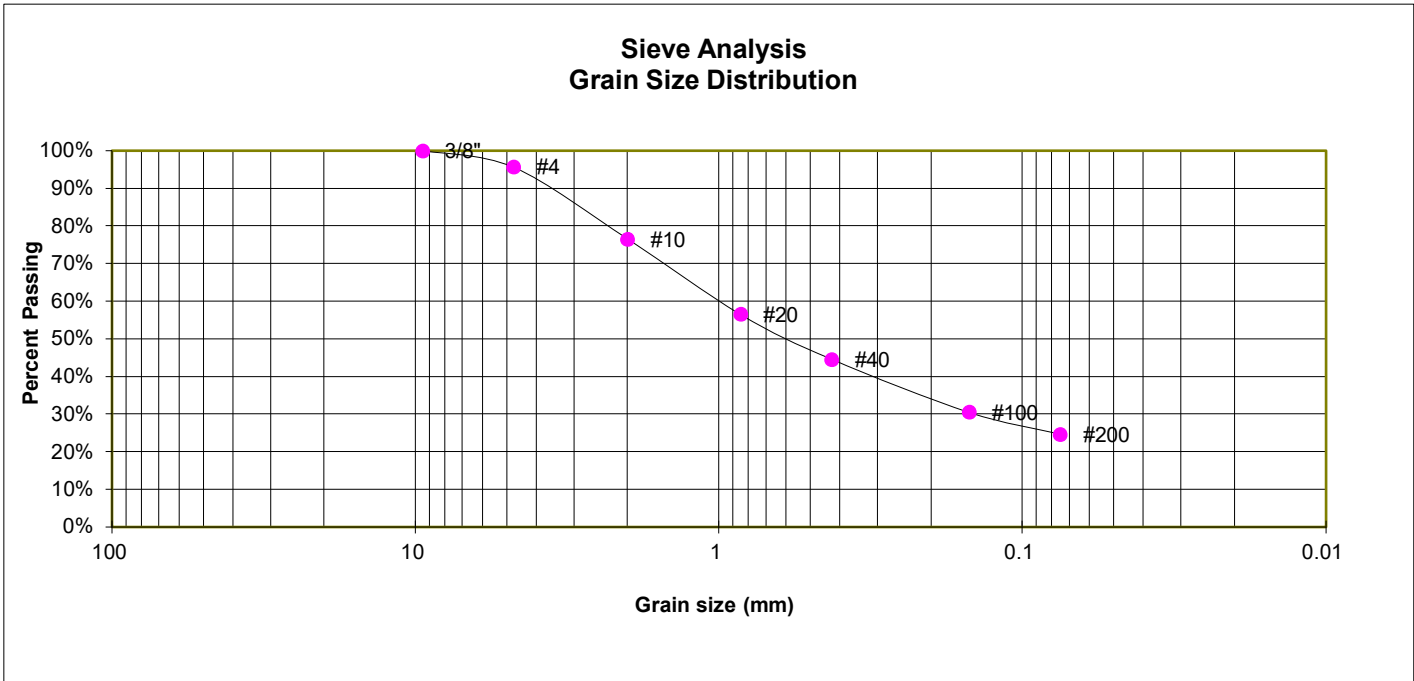

**GRAIN SIZE ANALYSIS**

U.S. Sieve #	Percent Finer
3"	
1 1/2"	
3/4"	
1/2"	
3/8"	100.0%
4	95.7%
10	76.5%
20	56.6%
40	44.6%
100	30.5%
200	24.6%

**ATTERBERG LIMITS**

Plastic Limit	19
Liquid Limit	27
Plastic Index	8

**SOIL CLASSIFICATION**

USCS CLASSIFICATION: SC  
 AASHTO CLASSIFICATION: A-2-4  
 AASHTO GROUP INDEX: 0



**LABORATORY TEST RESULTS**

TIMBERRIDGE, FILING NO. 3  
 TIMBERRIDGE DEVELOPMENT

JOB NO.  
 221106

**FIG. B-7**

TEST BORING 7  
 DEPTH (FT) 1-2

SOIL DESCRIPTION FILL, SAND, WITH SILT  
 SOIL TYPE 1

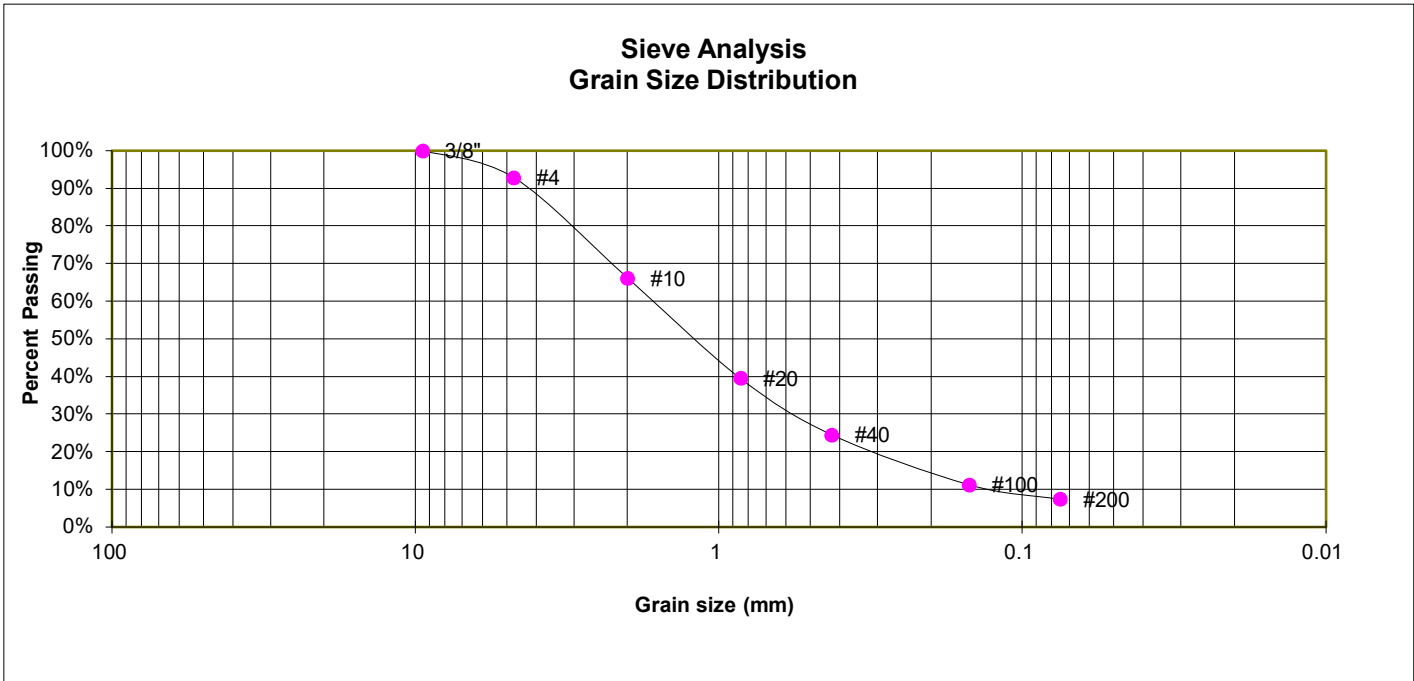

**GRAIN SIZE ANALYSIS**

U.S. Sieve #	Percent Finer
3"	
1 1/2"	
3/4"	
1/2"	
3/8"	100.0%
4	92.9%
10	66.1%
20	39.6%
40	24.5%
100	11.3%
200	7.4%

**ATTERBERG LIMITS**

Plastic Limit	14
Liquid Limit	16
Plastic Index	2

**SOIL CLASSIFICATION**

USCS CLASSIFICATION: SW-SM  
 AASHTO CLASSIFICATION: A-1-b  
 AASHTO GROUP INDEX: 0



**LABORATORY TEST RESULTS**

TIMBERRIDGE, FILING NO. 3  
 TIMBERRIDGE DEVELOPMENT

JOB NO.  
 221106

**FIG. B-8**

TEST BORING 5  
 DEPTH (FT) 5

SOIL DESCRIPTION SAND, WITH CLAY  
 SOIL TYPE 2

**Sieve Analysis  
 Grain Size Distribution**

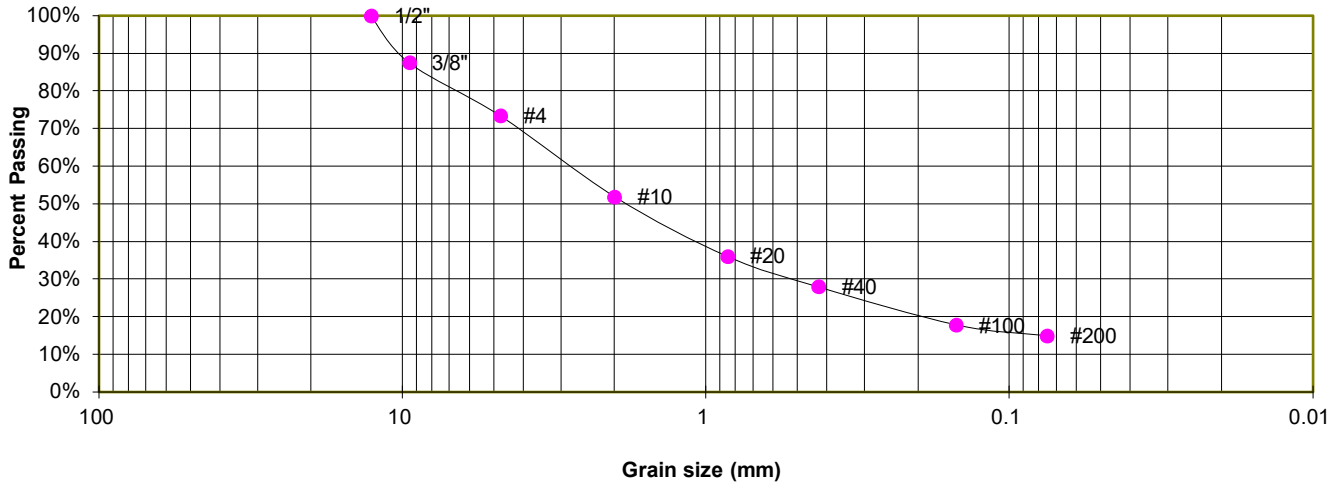

**GRAIN SIZE ANALYSIS**

U.S. Sieve #	Percent Finer
3"	
1 1/2"	
3/4"	
1/2"	100.0%
3/8"	87.5%
4	73.4%
10	51.9%
20	36.1%
40	28.0%
100	17.9%
200	15.0%

**ATTERBERG LIMITS**

Plastic Limit	24
Liquid Limit	38
Plastic Index	14

**SOIL CLASSIFICATION**

USCS CLASSIFICATION: SW-SC  
 AASHTO CLASSIFICATION: A-1-b  
 AASHTO GROUP INDEX: 0



**LABORATORY TEST RESULTS**

TIMBERRIDGE, FILING NO. 3  
 TIMBERRIDGE DEVELOPMENT

JOB NO.  
 221106

**FIG. B-9**

TEST BORING 6  
 DEPTH (FT) 1-2

SOIL DESCRIPTION CLAY, SANDY  
 SOIL TYPE 3

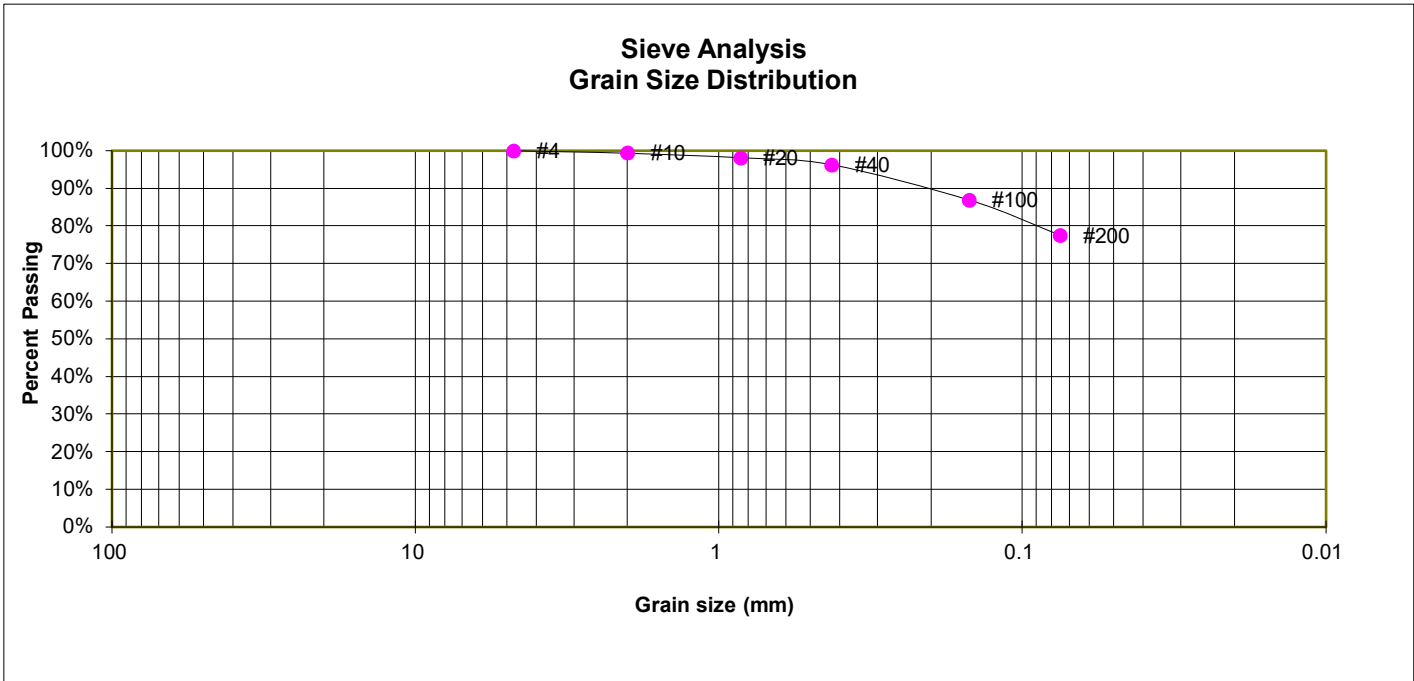

**GRAIN SIZE ANALYSIS**

U.S. Sieve #	Percent Finer
3"	
1 1/2"	
3/4"	
1/2"	
3/8"	
4	100.0%
10	99.4%
20	98.1%
40	96.3%
100	87.0%
200	77.5%

**ATTERBERG LIMITS**

Plastic Limit	24
Liquid Limit	43
Plastic Index	19

**SOIL CLASSIFICATION**

USCS CLASSIFICATION: CL  
 AASHTO CLASSIFICATION: A-7-6  
 AASHTO GROUP INDEX: 15



**LABORATORY TEST RESULTS**

TIMBERRIDGE, FILING NO. 3  
 TIMBERRIDGE DEVELOPMENT

JOB NO.  
 221106

**FIG. B-10**

TEST BORING 4  
 DEPTH (FT) 5

SOIL DESCRIPTION SANDSTONE (SAND, WITH SILT)  
 SOIL TYPE 4

**Sieve Analysis  
 Grain Size Distribution**

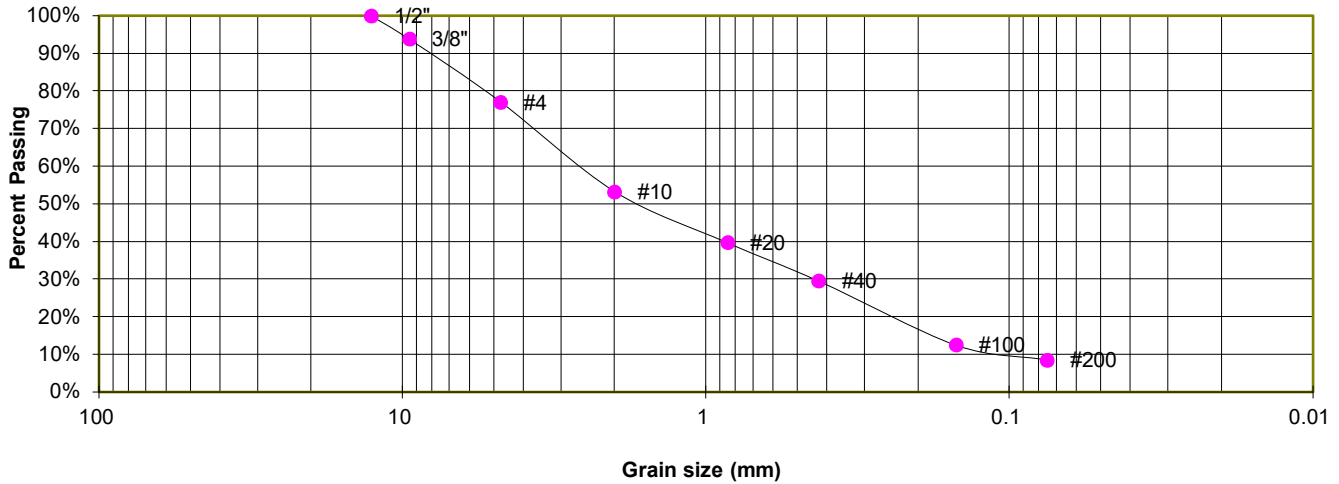

**GRAIN SIZE ANALYSIS**

U.S. Sieve #	Percent Finer
3"	
1 1/2"	
3/4"	
1/2"	100.0%
3/8"	93.8%
4	77.1%
10	53.3%
20	39.8%
40	29.5%
100	12.5%
200	8.5%

**ATTERBERG LIMITS**

Plastic Limit	23
Liquid Limit	30
Plastic Index	7

**SOIL CLASSIFICATION**

USCS CLASSIFICATION: SW-SM  
 AASHTO CLASSIFICATION: A-1-b  
 AASHTO GROUP INDEX: 0



**LABORATORY TEST RESULTS**

TIMBERRIDGE, FILING NO. 3  
 TIMBERRIDGE DEVELOPMENT

JOB NO.  
 221106

**FIG. B-11**

TEST BORING 6  
 DEPTH (FT) 10

SOIL DESCRIPTION SANDSTONE (SAND, CLAYEY)  
 SOIL TYPE 4

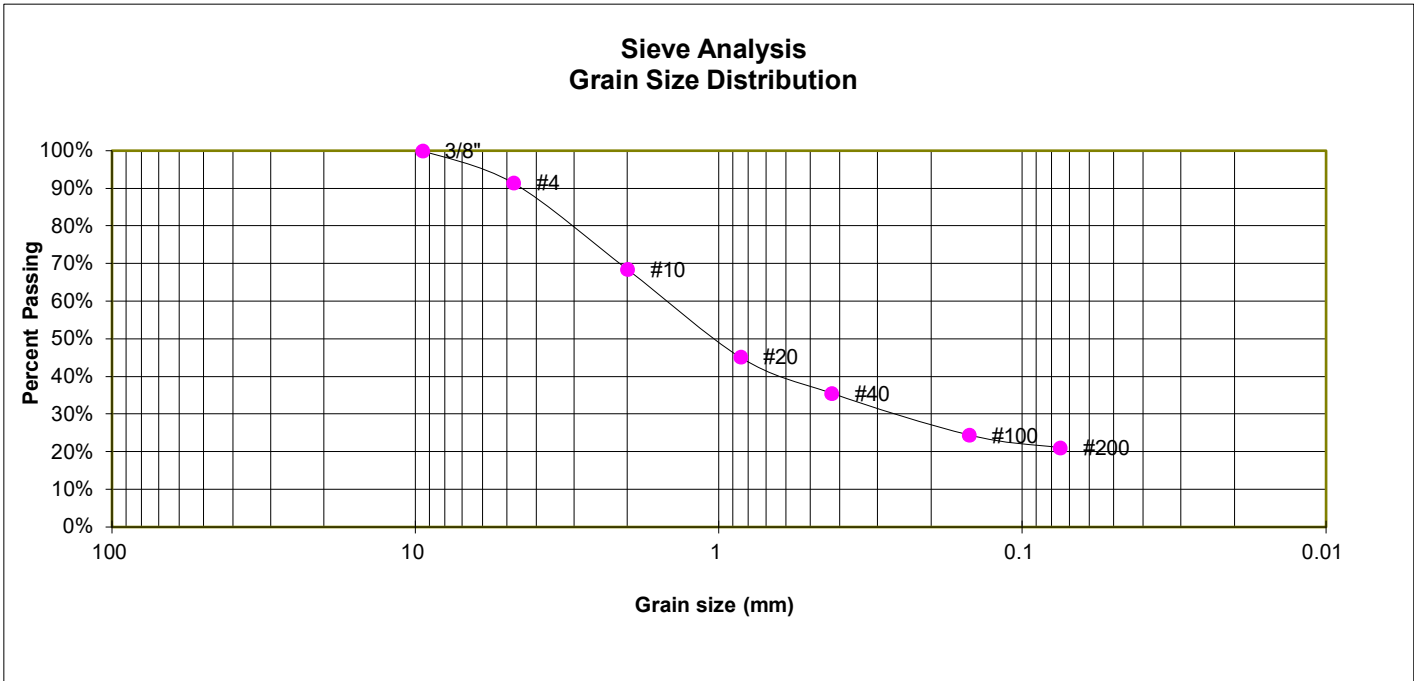

**GRAIN SIZE ANALYSIS**

U.S. Sieve #	Percent Finer
3"	
1 1/2"	
3/4"	
1/2"	
3/8"	100.0%
4	91.4%
10	68.4%
20	45.2%
40	35.5%
100	24.5%
200	21.1%

**ATTERBERG LIMITS**

Plastic Limit	25
Liquid Limit	40
Plastic Index	15

**SOIL CLASSIFICATION**

USCS CLASSIFICATION: SC  
 AASHTO CLASSIFICATION: A-1-b  
 AASHTO GROUP INDEX: 0



**LABORATORY TEST RESULTS**

TIMBERRIDGE, FILING NO. 3  
 TIMBERRIDGE DEVELOPMENT

JOB NO.  
 221106

**FIG. B-12**



TEST BORING 7  
 DEPTH (FT) 10

SOIL DESCRIPTION SANDSTONE (SAND, SILTY)  
 SOIL TYPE 4

**Sieve Analysis  
 Grain Size Distribution**

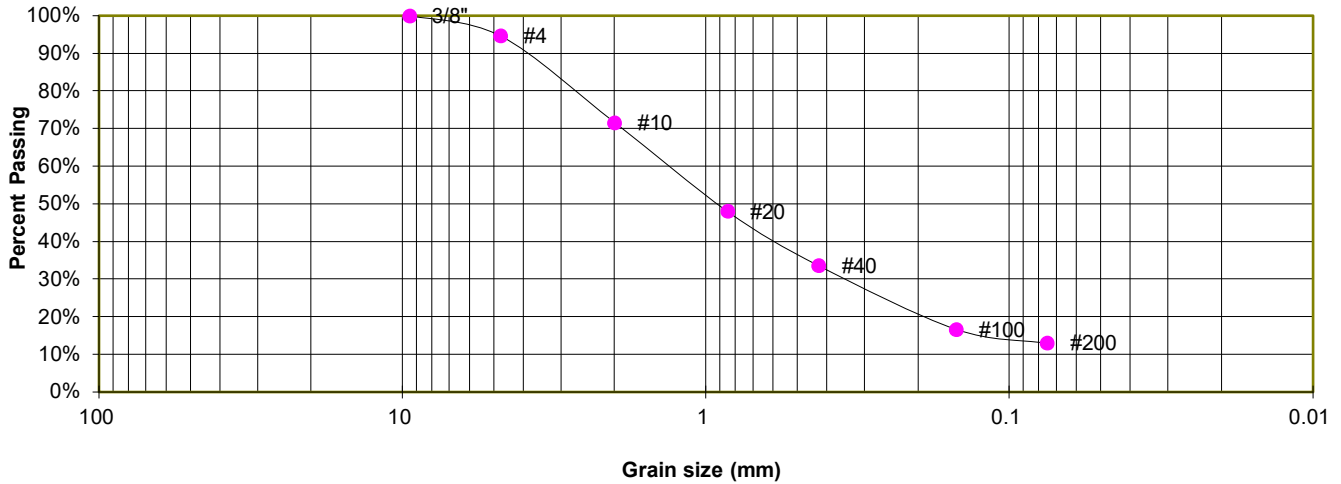

**GRAIN SIZE ANALYSIS**

U.S. Sieve #	Percent Finer
3"	
1 1/2"	
3/4"	
1/2"	
3/8"	100.0%
4	94.7%
10	71.6%
20	48.1%
40	33.6%
100	16.7%
200	13.0%

**ATTERBERG LIMITS**

Plastic Limit	25
Liquid Limit	35
Plastic Index	10

**SOIL CLASSIFICATION**

USCS CLASSIFICATION: SM  
 AASHTO CLASSIFICATION: A-1-b  
 AASHTO GROUP INDEX: 0



**LABORATORY TEST RESULTS**

TIMBERRIDGE, FILING NO. 3  
 TIMBERRIDGE DEVELOPMENT

JOB NO.  
 221106

**FIG. B-13**

TEST BORING 3  
DEPTH (FT) 0-3

SOIL DESCRIPTION FILL, SAND, CLAYEY  
SOIL TYPE 1

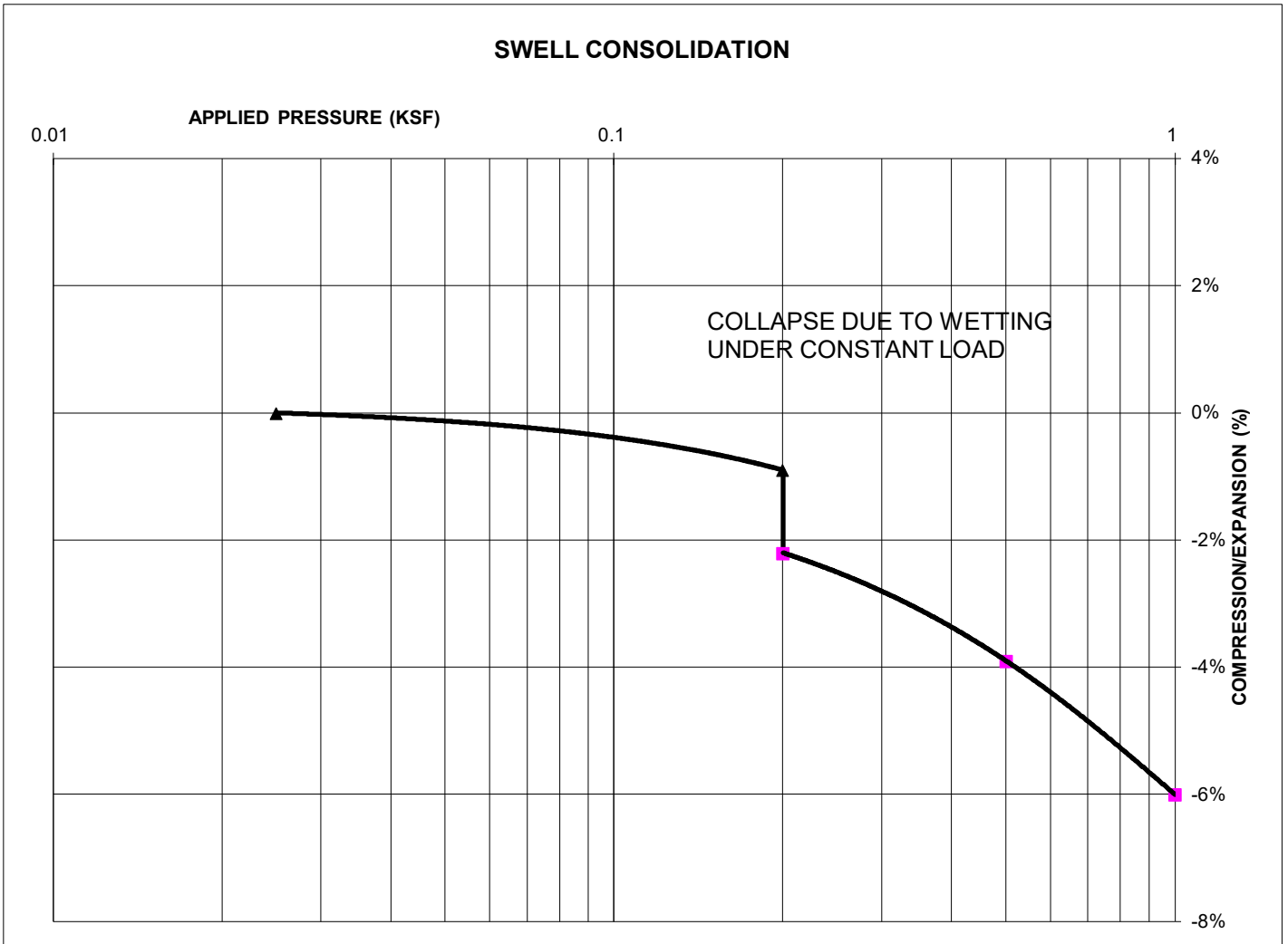

**SWELL/COLLAPSE TEST RESULTS**

NATURAL UNIT DRY WEIGHT (PCF): 125  
NATURAL MOISTURE CONTENT: 7.9%  
SWELL/COLLAPSE (%): -1.3%



**SWELL TEST RESULTS**

TIMBERRIDGE, FILING NO. 3  
TIMBERRIDGE DEVELOPMENT

JOB NO.  
221106

**FIG. B-14**

TEST BORING 2  
 DEPTH (FT) 1-2

SOIL DESCRIPTION FILL, SAND, CLAYEY  
 SOIL TYPE 1

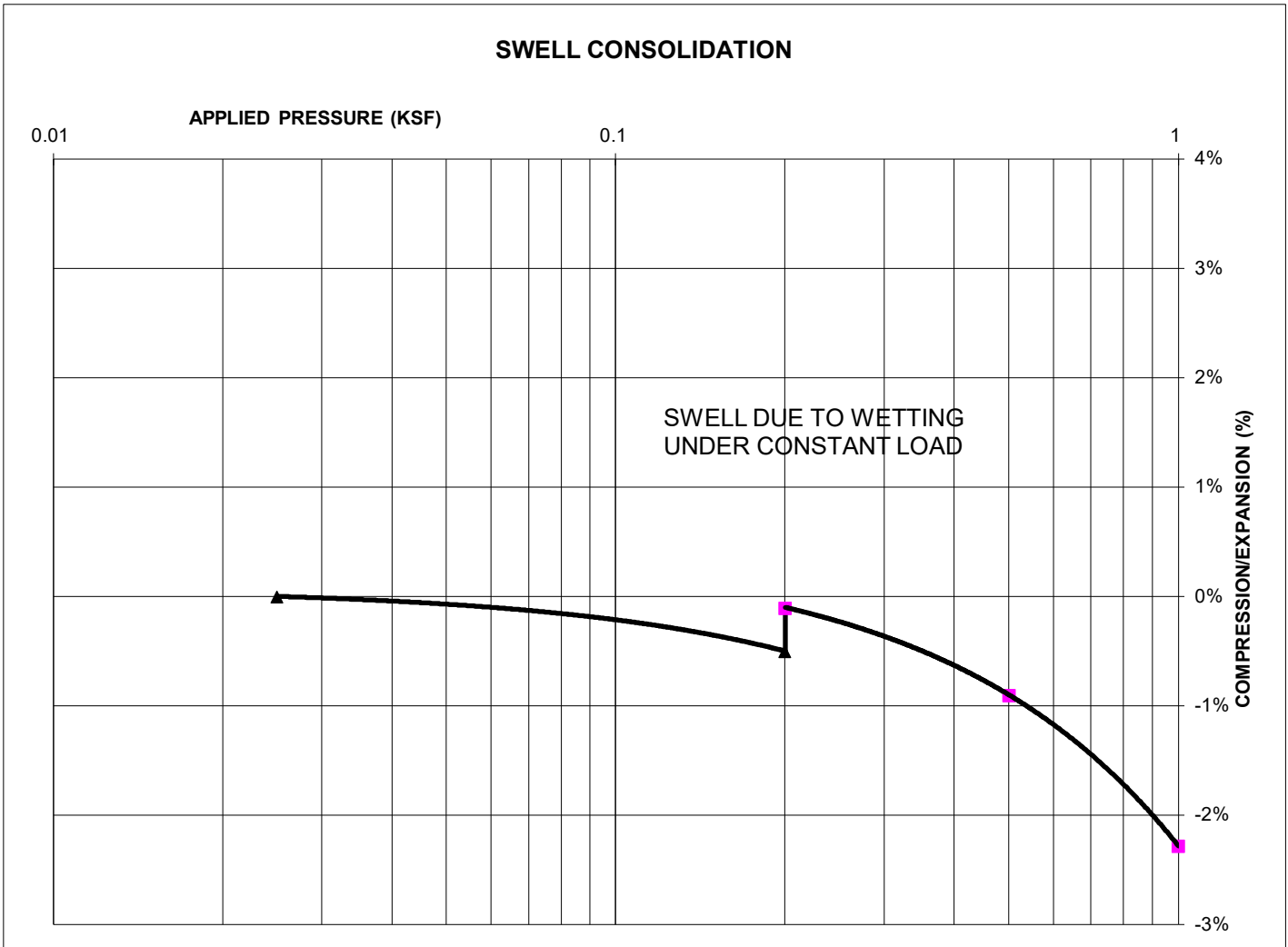

**SWELL/COLLAPSE TEST RESULTS**

NATURAL UNIT DRY WEIGHT (PCF): 113  
 NATURAL MOISTURE CONTENT: 13.5%  
 SWELL/COLLAPSE (%): 0.4%



**SWELL TEST RESULTS**

TIMBERRIDGE, FILING NO. 3  
 TIMBERRIDGE DEVELOPMENT

JOB NO.  
 221106

**FIG. B-15**

TEST BORING 3  
 DEPTH (FT) 1-2

SOIL DESCRIPTION FILL, SAND, CLAYEY  
 SOIL TYPE 1



**SWELL/COLLAPSE TEST RESULTS**

NATURAL UNIT DRY WEIGHT (PCF): 114  
 NATURAL MOISTURE CONTENT: 13.9%  
 SWELL/COLLAPSE (%): 0.6%



**SWELL TEST RESULTS**

TIMBERRIDGE, FILING NO. 3  
 TIMBERRIDGE DEVELOPMENT

JOB NO.  
 221106

**FIG. B-16**

TEST BORING 4  
DEPTH (FT) 1-2

SOIL DESCRIPTION FILL, SAND, CLAYEY  
SOIL TYPE 1

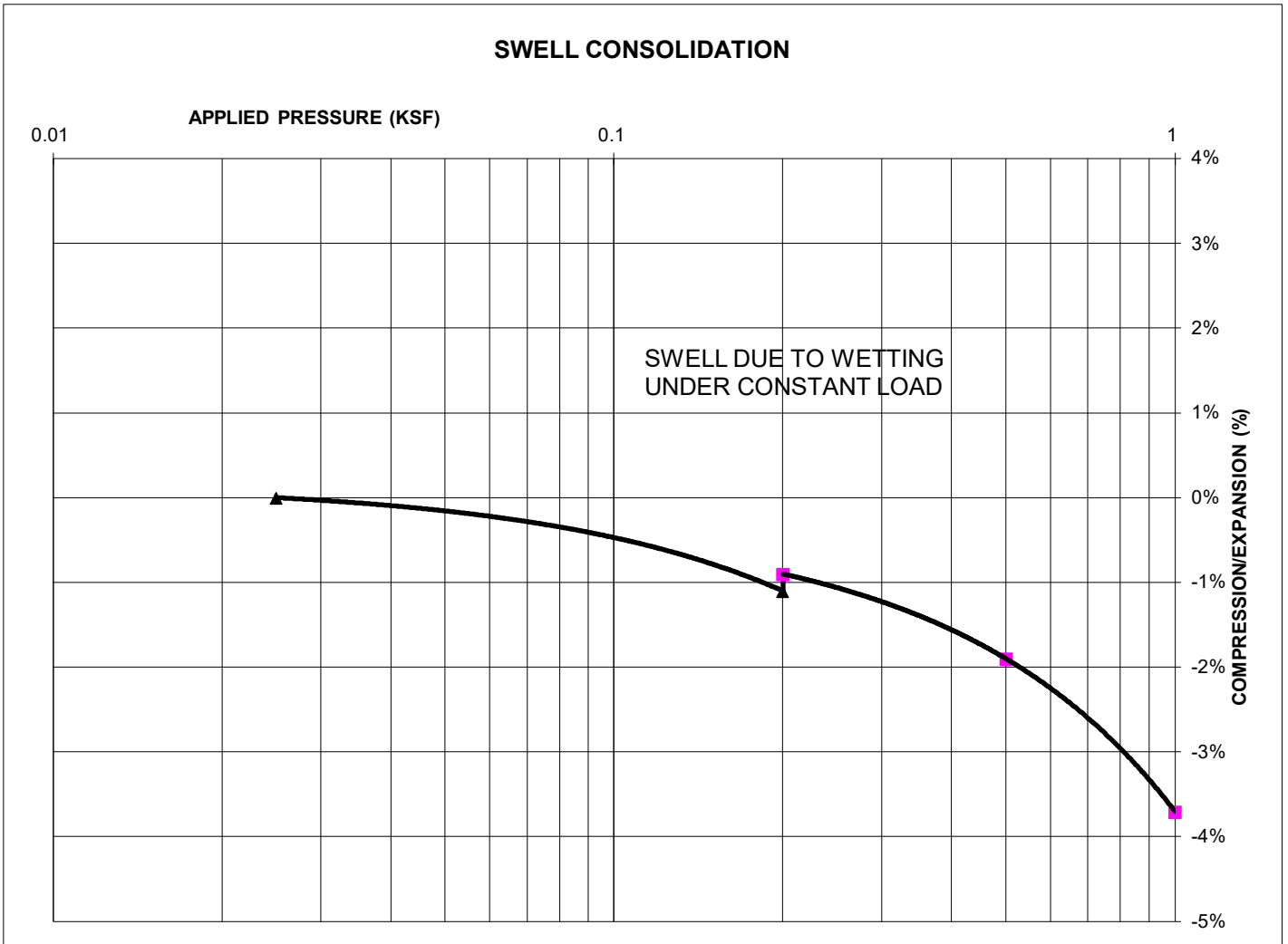

**SWELL/COLLAPSE TEST RESULTS**

NATURAL UNIT DRY WEIGHT (PCF): 116  
NATURAL MOISTURE CONTENT: 11.2%  
SWELL/COLLAPSE (%): 0.2%



**SWELL TEST RESULTS**

TIMBERRIDGE, FILING NO. 3  
TIMBERRIDGE DEVELOPMENT

JOB NO.  
221106

**FIG. B-17**

TEST BORING 5  
DEPTH (FT) 5

SOIL DESCRIPTION SAND, WITH CLAY  
SOIL TYPE 2

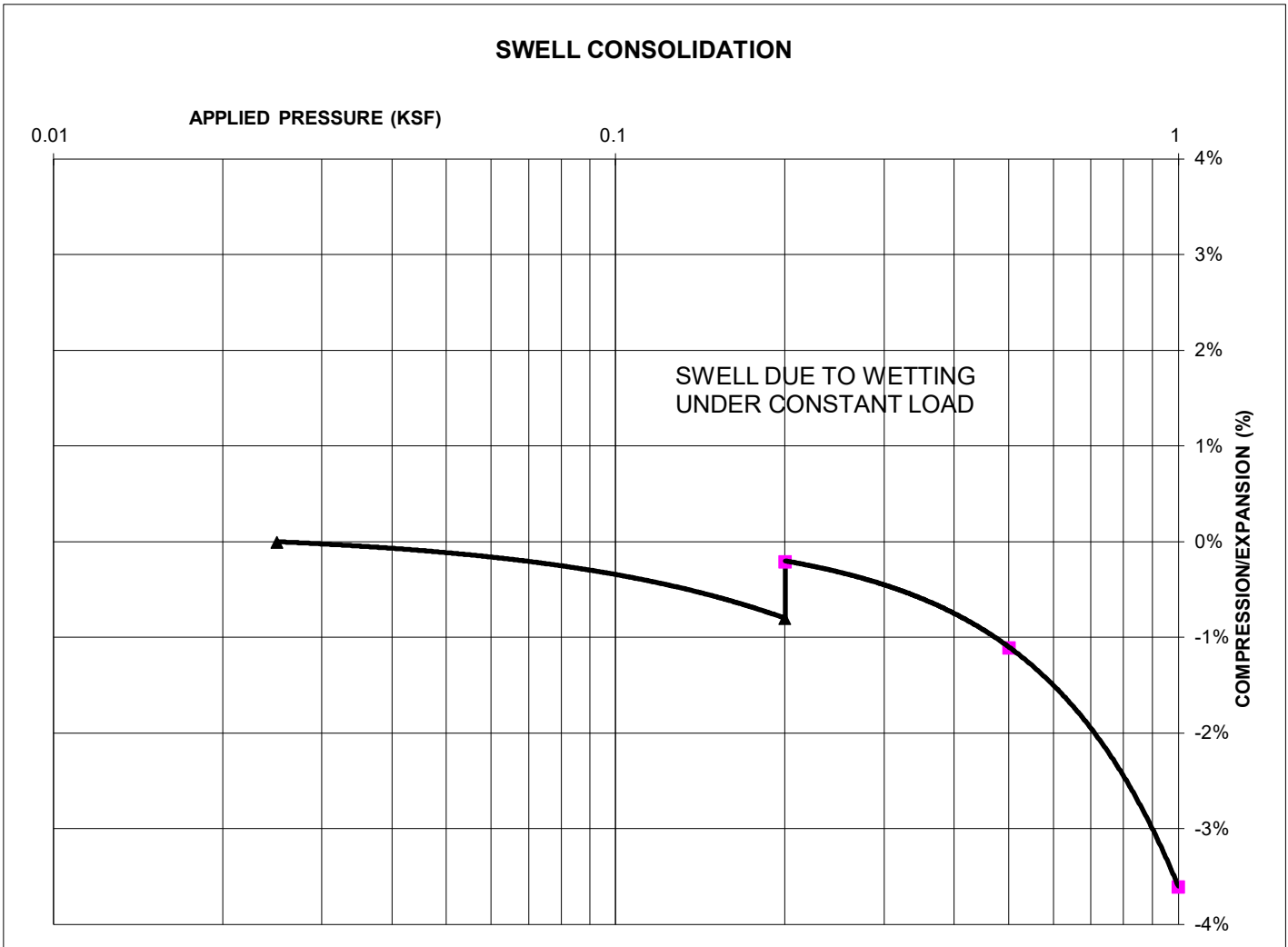

**SWELL/COLLAPSE TEST RESULTS**

NATURAL UNIT DRY WEIGHT (PCF): 120  
NATURAL MOISTURE CONTENT: 11.2%  
SWELL/COLLAPSE (%): 0.6%



**SWELL TEST RESULTS**

TIMBERRIDGE, FILING NO. 3  
TIMBERRIDGE DEVELOPMENT

JOB NO.  
221106

**FIG. B-18**

TEST BORING 6  
DEPTH (FT) 1-2

SOIL DESCRIPTION CLAY, SANDY  
SOIL TYPE 3

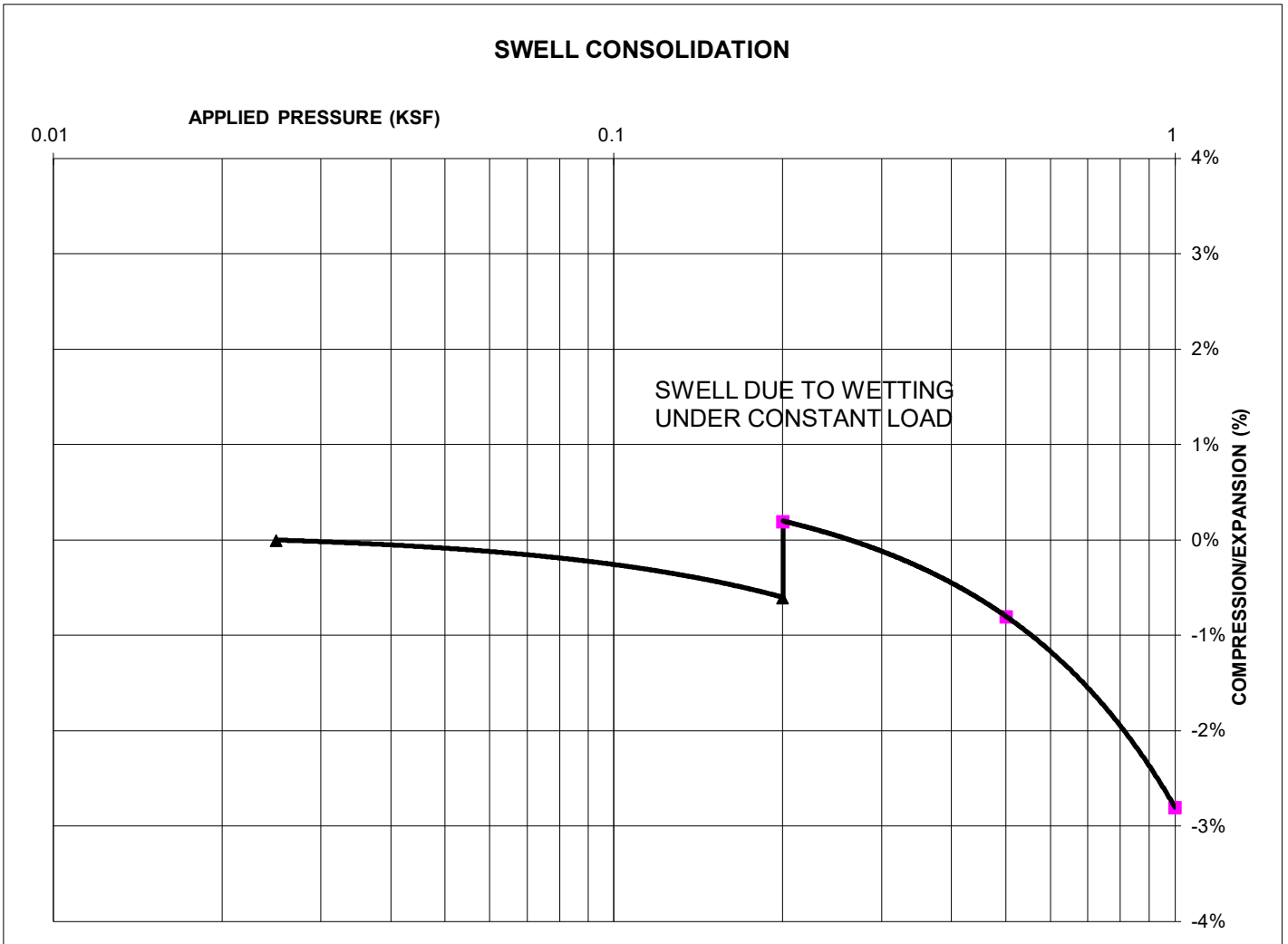

**SWELL/COLLAPSE TEST RESULTS**

NATURAL UNIT DRY WEIGHT (PCF): 119  
NATURAL MOISTURE CONTENT: 10.9%  
SWELL/COLLAPSE (%): 0.8%



**SWELL TEST RESULTS**

TIMBERRIDGE, FILING NO. 3  
TIMBERRIDGE DEVELOPMENT

JOB NO.  
221106

**FIG. B-19**

TEST BORING 6  
DEPTH (FT) 10

SOIL DESCRIPTION SANDSTONE (SAND, CLAYEY)  
SOIL TYPE 4

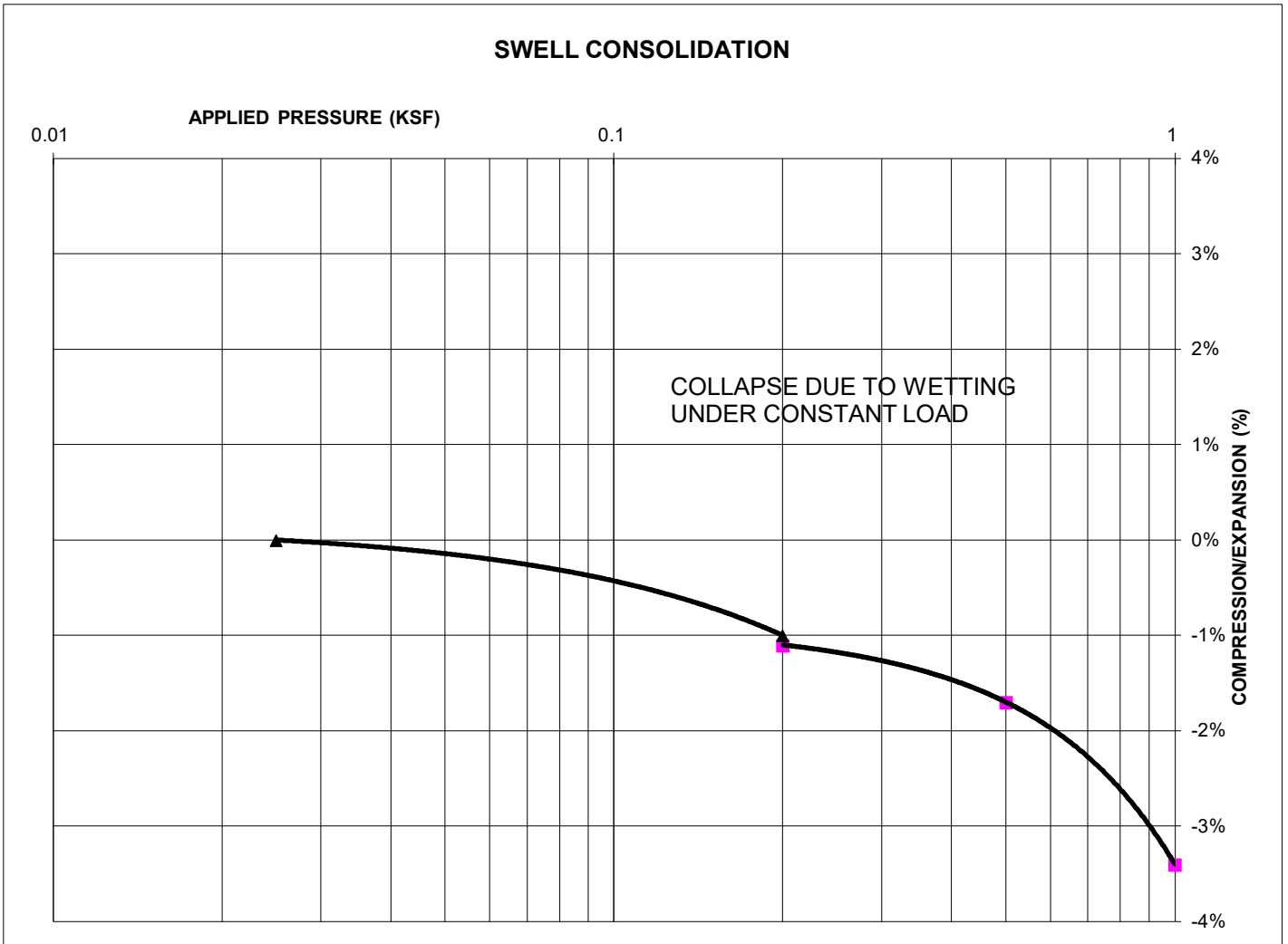

**SWELL/COLLAPSE TEST RESULTS**

NATURAL UNIT DRY WEIGHT (PCF): 114  
NATURAL MOISTURE CONTENT: 12.6%  
SWELL/COLLAPSE (%): -0.1%



**SWELL TEST RESULTS**

TIMBERRIDGE, FILING NO. 3  
TIMBERRIDGE DEVELOPMENT

JOB NO.  
221106

**FIG. B-20**



SAMPLE LOCATION TB-3 @ 0-3'

SOIL DESCRIPTION FILL, SAND, CLAYEY, BROWN  
SOIL TYPE 1

**PROCTOR DATA**

IDENTIFICATION: SC  
PROCTOR TEST #: 1  
TEST BY: PH  
TEST DESIGNATION: ASTM-1557-A  
MAXIMUM DRY DENSITY (PCF): 130.5  
OPTIMUM MOISTURE: 7

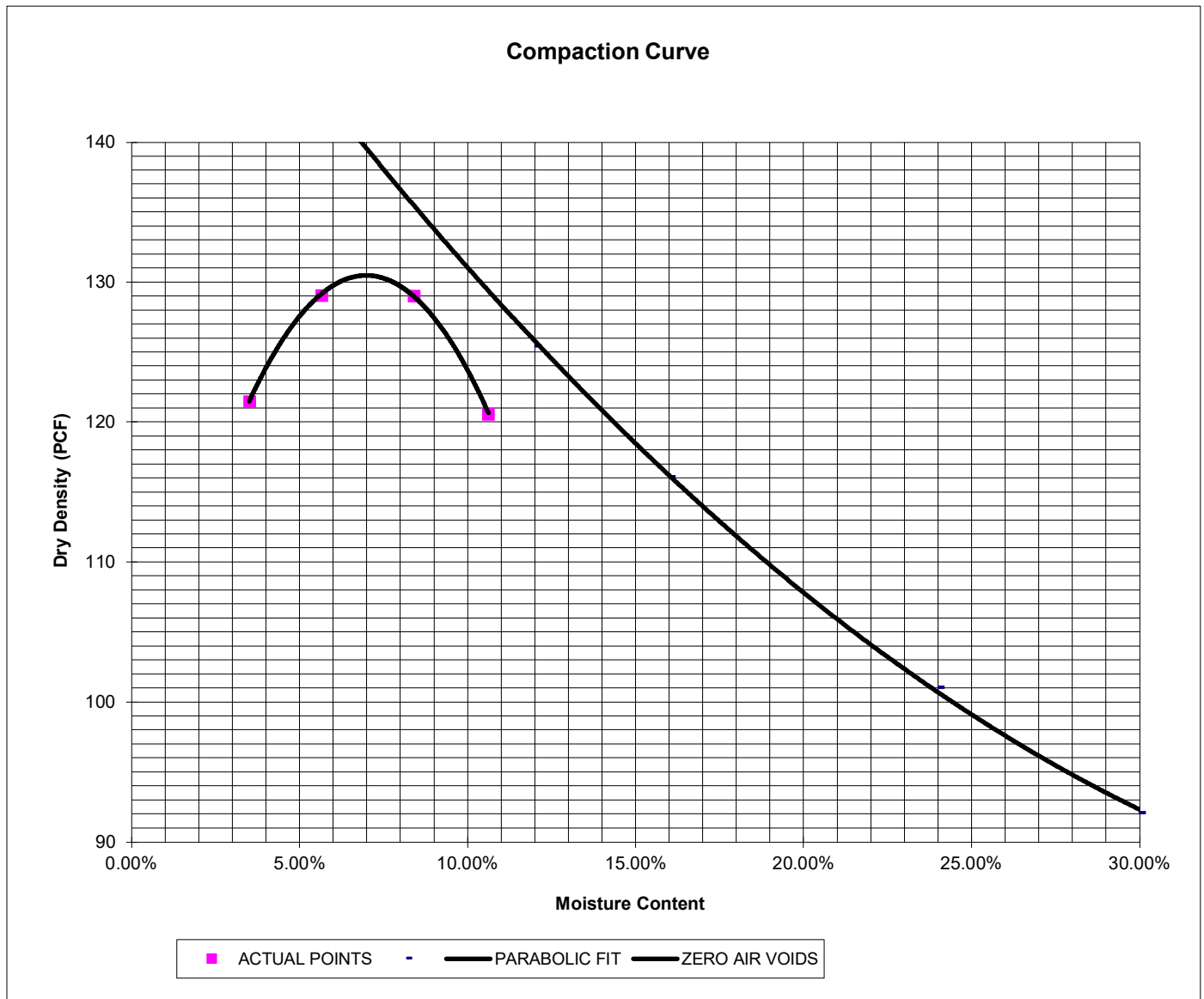

**LABORATORY TEST RESULTS**

TIMBERRIDGE, FILING NO. 3  
TIMBERRIDGE DEVELOPMENT

JOB NO.  
221106

**FIG. B-21**

SAMPLE LOCATION TB-3 @ 0-3'

SOIL DESCRIPTION FILL, SAND, CLAYEY, BROWN  
SOIL TYPE 1

**CBR TEST LOAD DATA**

Piston Diameter (cm): 4.958

Piston Area (in<sup>2</sup>): 2.993

Penetration Depth (inches)	10 BLOWS Mold # 1		25 BLOWS Mold # 2		56 BLOWS Mold # 3	
	Load (lbs)	Stress (psi)	Load (lbs)	Stress (psi)	Load (lbs)	Stress (psi)
0.000	0	0.00	0	0.00	0	0.00
0.025	24	8.02	59	19.72	108	36.09
0.050	56	18.71	90	30.08	198	66.17
0.075	71	23.73	115	38.43	332	110.94
0.100	84	28.07	153	51.13	425	142.02
0.125	99	33.08	155	51.80	538	179.78
0.150	113	37.76	176	58.81	669	223.56
0.175	125	41.77	186	62.16	751	250.96
0.200	144	48.12	202	67.50	878	293.40
0.300	165	55.14	231	77.19	1180	394.32
0.400	181	60.48	281	93.90	1348	450.46
0.500	223	74.52	309	103.26	1535	512.95

**MOISTURE AND DENSITY DATA**

	Mold # 1	Mold # 2	Mold # 3
Can #	307	355	358
Wt. Can	6.87	7.15	6.74
Wt. Can+Wet	223.74	259.37	224.42
Wt. Can+Dry	207.23	227.99	204.89
Wt. H2O	16.51	31.38	19.53
Wt. Dry Soil	200.36	220.84	198.15
Moisture Content	8.24%	14.21%	9.86%
Wet Density (PCF)	122.7	130.1	137.5
Dry Density (PCF)	114.7	121.6	128.5
% Compaction	88%	93%	98%
CBR	2.81	5.11	14.20

**PROCTOR DATA**

Maximum Dry Density (pcf)	130.5
Optimum Moisture	7
90% of Max. Dry Density (pcf)	117.5
95% of Max. Dry Density (pcf)	124.0

CBR at 90% of Max. Density = 3.73 ~ R VALUE 7.5

CBR at 95% of Max. Density = 8.21 ~ R VALUE 22



**LABORATORY TEST RESULTS**

TIMBERRIDGE, FILING NO. 3  
TIMBERRIDGE DEVELOPMENT

JOB NO.  
221106

**FIG. B-22**

SAMPLE LOCATION TB-3 @ 0-3'

SOIL DESCRIPTION FILL, SAND, CLAYEY, BROWN  
SOIL TYPE 1

Stress VS Penetration

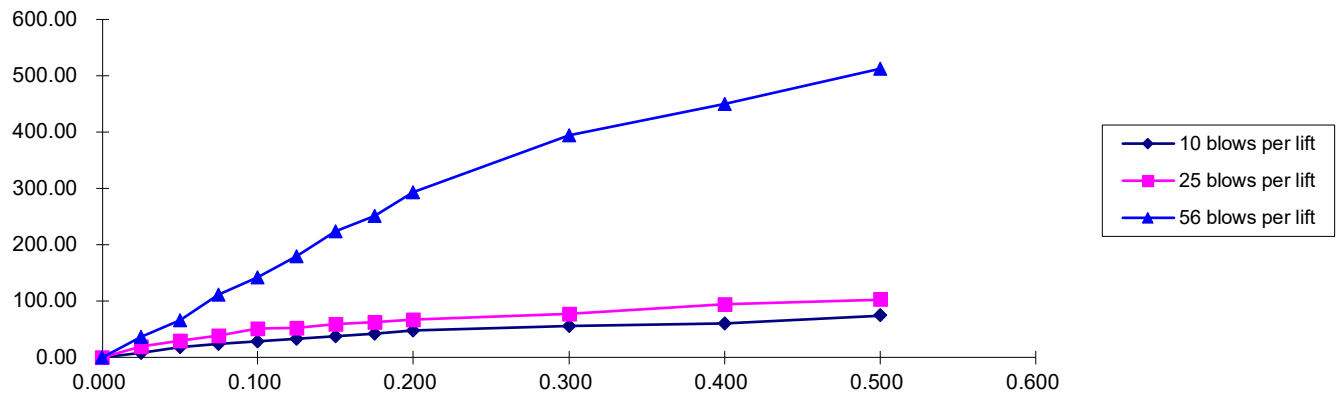

Bearing Ratio VS Dry Density

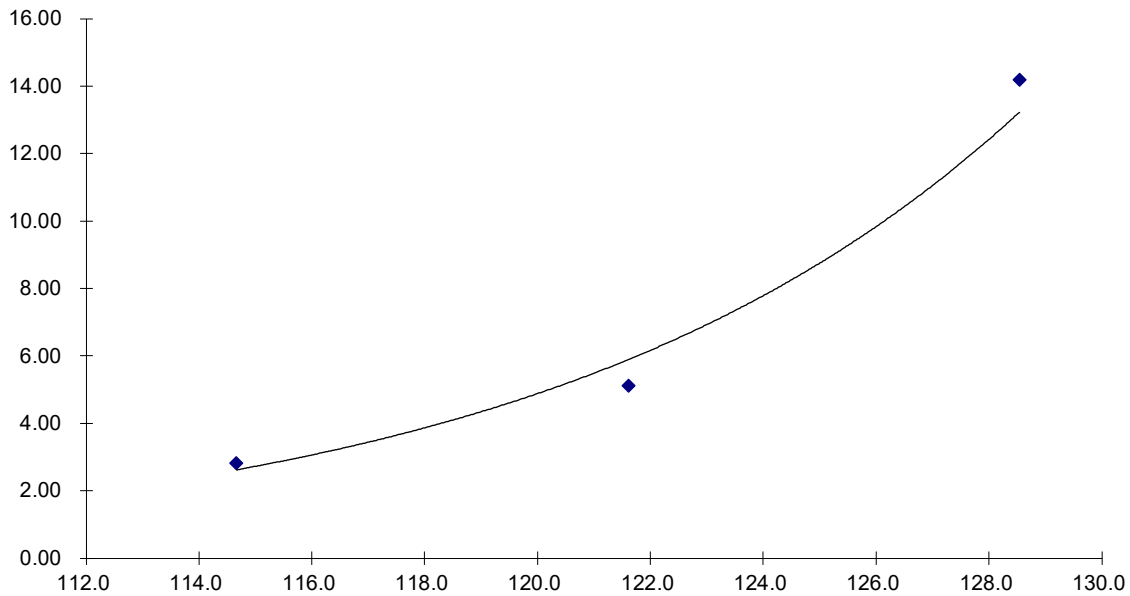

LABORATORY TEST RESULTS

TIMBERRIDGE, FILING NO. 3  
TIMBERRIDGE DEVELOPMENT

JOB NO.  
221106

FIG. B-23



## **APPENDIX C: Pavement Design Calculations**

## FLEXIBLE PAVEMENT DESIGN

### PROJECT DATA

Project Location: Retreat at TimberRidge Fililng No. 3

Job Number: 221106

### DESIGN DATA

Equivalent (18-kip) Single Axle Load Applications (ESAL):

ESAL ( $W_{18}$ ) =	292,000
CBR =	8.21
$S_o$ =	0.45
$\Delta\psi$ =	2.5
Reliability =	80
$Z_R$ =	-0.84
$M_R$ =	12,315 psi

Design CBR

Standard Deviation

Loss in Serviceability

Reliability

Reliability (z-statistic)

Soil Resilient Modulus

Required Structural Number (SN):



SN = 2.13

### DESIGN EQUATIONS

#### Resilient Modulus

If using CBR:

$$M_R = (\text{CBR}) \times 1,500$$

If using R-Value:

$$M_R = 10^{[(S_1 + 18.72) / 6.24]} \text{ where: } S_1 = [(R\text{-value} - 5) / 11.29] + 3$$

#### Required Structural Number

$$\log_{10} W_{18} = Z_R \cdot S_o + 9.36 \cdot \log_{10} (SN+1) - 0.20 + \frac{\log_{10} \left[ \frac{\Delta \text{PSI}}{4.2 - 1.5} \right]}{0.40 + \frac{1094}{(SN+1)^{5.19}}} + 2.32 \cdot \log_{10} M_R - 8.07$$

#### Pavement Section Thickness

$$SN^* = C_1 D_1 + C_2 D_2$$

where:  $C_1$  = Strength Coefficient - HMA

$C_2$  = Strength Coefficient - ABC

$D_1$  = Depth of HMA (inches)

$D_2$  = Depth of ABC (inches)

### RECOMMENED THICKNESSES

Layer	Material	Coefficient	Thickness ( $D^*_i$ )	$SN^*_i$	SN
1	HMA	$C_1 = 0.44$	3.0 inches	1.320	-
2	ABC	$C_2 = 0.11$	8.0 inches	0.880	
				$SN^* = 2.200$	2.13

Pavement SN > Required SN, Design is Acceptable

## FLEXIBLE PAVEMENT DESIGN

### PROJECT DATA

Project Location: Retreat at TimberRidge Fililng No. 3

Job Number: 221106

### DESIGN DATA

Equivalent (18-kip) Single Axle Load Applications (ESAL):

ESAL ( $W_{18}$ ) =	292,000
CBR =	8.21
$S_o$ =	0.45
$\Delta\psi$ =	2.5
Reliability =	80
$Z_R$ =	-0.84
$M_R$ =	12,315 psi

Design CBR

Standard Deviation

Loss in Serviceability

Reliability

Reliability (z-statistic)

Soil Resilient Modulus

Required Structural Number (SN):



SN = 2.13

### DESIGN EQUATIONS

#### Resilient Modulus

If using CBR:

$$M_R = (\text{CBR}) \times 1,500$$

If using R-Value:

$$M_R = 10^{[(S_1 + 18.72) / 6.24]} \text{ where: } S_1 = [(R\text{-value} - 5) / 11.29] + 3$$

#### Required Structural Number

$$\log_{10} W_{18} = Z_R \cdot S_o + 9.36 \cdot \log_{10} (SN+1) - 0.20 + \frac{\log_{10} \left[ \frac{\Delta \text{PSI}}{4.2 - 1.5} \right]}{0.40 + \frac{1094}{(SN+1)^{5.19}}} + 2.32 \cdot \log_{10} M_R - 8.07$$

#### Pavement Section Thickness

$$SN^* = C_1 D_1 + C_2 D_2$$

where:  $C_1$  = Strength Coefficient - HMA

$C_2$  = Strength Coefficient - CTS

$D_1$  = Depth of HMA (inches)

$D_2$  = Depth of CTS (inches)

### RECOMMENED THICKNESSES

Layer	Material	Coefficient	Thickness ( $D^*_i$ )	$SN^*_i$	SN
1	HMA	$C_1 = 0.44$	3.0 inches	1.320	-
2	CTS	$C_2 = 0.11$	8.0 inches	0.880	
				$SN^* = 2.200$	2.13

Pavement SN > Required SN, Design is Acceptable