

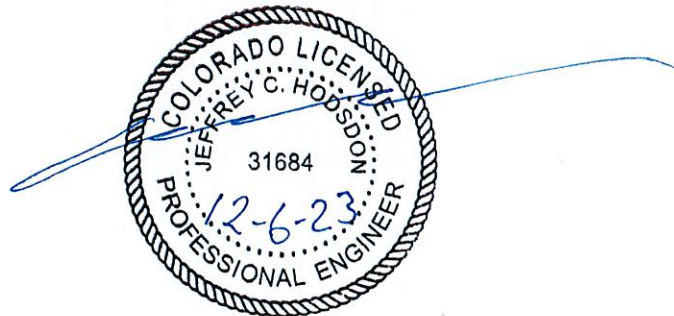


LSC TRANSPORTATION CONSULTANTS, INC.  
2504 East Pikes Peak Avenue, Suite 304  
Colorado Springs, CO 80909  
(719) 633-2868  
FAX (719) 633-5430  
E-mail: [lsc@lscstrans.com](mailto:lsc@lscstrans.com)  
Website: <http://www.lscstrans.com>

Sterling Ranch East - Filing 5 Rezone & Preliminary Plan  
Traffic Impact Study  
PCD File No. P237 & SP235  
(LSC #S234180)  
December 5, 2023

**Traffic Engineer's Statement**

This traffic report and supporting information were prepared under my responsible charge and they comport with the standard of care. So far as is consistent with the standard of care, said report was prepared in general conformance with the criteria established by the County for traffic reports.



**Developer's Statement**

I, the Developer, have read and will comply with all commitments made on my behalf within this report.

  
\_\_\_\_\_

12/6/2023  
Date

# **Sterling Ranch East**

## **Filing 5 Rezone and Preliminary Plan**

### **Traffic Impact Study**

Prepared for:  
Loren J. Moreland  
Vice President/ Project Manager  
Classic SRJ  
2138 Flying Horse Club Drive  
Colorado Springs, CO 80921

DECEMBER 5, 2023

---

LSC Transportation Consultants  
Prepared by: Kirstin D. Ferrin, P.E.  
Reviewed by: Jeffrey C. Hodsdon, P.E.

LSC #S234180



**CONTENTS**

REPORT CONTENTS ..... 1

RECENT TRAFFIC REPORTS ..... 2

STUDY AREA ..... 2

    Land Use..... 2

    Pedestrian Plan ..... 3

    Proposed Access Points..... 3

    Sight Distance Analysis..... 4

REPORT SCENARIOS ..... 4

    Short-Term Scenario ..... 4

    Long-Term Scenario ..... 5

EXISTING ROAD AND TRAFFIC CONDITIONS ..... 5

    Existing Traffic Volumes ..... 6

    Existing Levels of Service ..... 6

        Burgess/Vollmer..... 7

    Safety and Accident Analysis..... 7

BASELINE CONDITIONS ..... 7

    Short-Term Scenario Baseline Conditions ..... 8

    Long-Term Scenario Baseline Conditions ..... 8

TRIP GENERATION ..... 8

TRIP DISTRIBUTION AND ASSIGNMENT ..... 9

TOTAL TRAFFIC..... 9

    Short-Term Total Traffic ..... 9

    2043 Total Traffic ..... 9

LEVEL OF SERVICE ANALYSIS ..... 10

    Intersection #1: Vollmer/Burgess..... 10

    Intersection #4: Vollmer/Briargate ..... 10

    Intersection #5: Briargate/Sterling Ranch ..... 10

    Intersection #12: Marksheffel/Vollmer ..... 11

    Intersection #13: Marksheffel/Sterling Ranch..... 11

    Sterling Ranch Road Site Access Points (Intersection #305 & #306) ..... 12

    Intersection #8: Oak Park/Sterling Ranch..... 12

SIGNAL WARRANT THRESHOLD ANALYSIS – AM AND PM PEAK HOURS.....	12
Roadway FUNCTIONAL CLASSIFICATIONS AND LANEAGE .....	13
Waiver and DEVIATION REQUESTS .....	13
AREA MTCP 2040 ROADWAY IMPROVEMENT PROJECTS .....	13
CONCLUSIONS AND RECOMMENDATIONS .....	13
Trip Generation.....	13
Level of Service .....	14
Recommended Improvements.....	15
Transportation Improvement Fee Program And Credit Agreements .....	15
Enclosures:    Tables 2-6.....	16
Figures 1-14.....	16
Appendix Table 1.....	16
MTCP Maps .....	16
Traffic Count Reports .....	16
Level of Service Reports .....	16
Crash History.....	16
Appendix A.....	16



**LSC TRANSPORTATION CONSULTANTS, INC.**  
2504 East Pikes Peak Avenue, Suite 304  
Colorado Springs, CO 80909  
(719) 633-2868  
FAX (719) 633-5430  
E-mail: [lsc@lsctrans.com](mailto:lsc@lsctrans.com)  
Website: <http://www.lsctrans.com>

December 5, 2023

Loren J. Moreland  
Vice President/ Project Manager  
Classic SRJ  
2138 Flying Horse Club Drive  
Colorado Springs, CO 80921

RE: Sterling Ranch East -  
Filing 5 Rezone & Preliminary Plan  
Traffic Impact Study  
El Paso County, Colorado  
LSC #S234180

Dear Mr. Moreland:

LSC Transportation Consultants, Inc. has prepared this Traffic Impact Study for the proposed Sterling Ranch East (SRE) Filing 5 Rezone and Preliminary Plan. As shown in Figure 1, the site is located east of the future Sterling Ranch Road between the future extensions of Marksheffel Road and Stapleton Drive in El Paso County, Colorado.

## **REPORT CONTENTS**

The preparation of this report included the following:

- A list of previous Sterling Ranch traffic reports and the context of this project;
- The existing roadway and traffic conditions in the site's vicinity including the roadway widths, surface conditions, lane geometries, traffic controls, and posted speed limits;
- A summary of the proposed land use and access plan;
- Existing traffic volume data;
- Estimates of projected short-term long-term baseline traffic volumes;
- The projected average weekday and peak-hour vehicle trips to be generated by the proposed future development within the preliminary plan area;
- The assignment of the projected preliminary-plan site-generated traffic volumes to the area roadways;
- The projected short-term and long-term total traffic volumes on the area roadways;
- The projected levels of service at the key intersections within the study area;
- Signal-warrant threshold analysis;

- The recommended street classifications;
- A list of deviation requests;
- Findings and recommendations for study area roadways and intersections, including number of lanes, auxiliary turn lanes, intersection traffic control, etc.; and
- The project's obligation to the County roadway improvement fee program.

## RECENT TRAFFIC REPORTS

LSC prepared a previous master traffic impact study (TIS) for the entire Sterling Ranch development, Sterling Ranch Updated Traffic Impact Analysis (SKP07007) dated June 5, 2008. **This master study was recently updated. The most currently version of the Sterling Ranch Sketch Plan Amendment Master Traffic Impact Study (SKP 224) is dated February 10, 2023.** Since 2008, LSC and SM Rocha, LLC have completed multiple studies for individual filings and phases within Sterling Ranch. Appendix Table 1, which includes a list of other traffic studies within Sterling Ranch and in the vicinity of area of study completed within the past five years (that LSC is aware of), is attached for reference.

El Paso County is currently studying the Briargate Stapleton Corridor as part of a Pikes Peak Rural Transportation Authority (PPRTA) study. A draft version of the Briargate-Stapleton Corridor Study by Wilson & Company was published December 9, 2021.

## STUDY AREA

Figure 1 shows the location of the Sterling Ranch East Filing 5 Preliminary Plan Area relative to the overall Sterling Ranch Sketch Plan Area. As shown in Figure 1, the site is located generally in the middle of the Sketch Plan Area adjacent to the future extension of Sterling Ranch Road.

## Land Use

N.E.S. Inc on behalf of Classic SRJ Land LLC is requesting a rezone of 42.033 acres east of the future Sterling Ranch Road and south of the future Briargate Parkway from RR-5 to RS-5000. They are also requesting a Preliminary Plan for the same area.

Figure 2 shows the proposed Sterling Ranch East Filing 5 Preliminary Plan. The site is planned to be developed with 160 lots for single-family homes which would represent a gross density of 3.4 dwelling units per acre. The Sterling Ranch Sketch Plan identifies the area included within this proposed preliminary plan as residential at a density of 3-5 dwelling units per acre. Along the south boundary of the site, the Sketch Plan identifies 2 dwelling units per acre residential density, a 50-foot buffer and a 100-foot setback with 150-foot average setback. This lower density and buffer were intended as a transition between the suburban density within the rest of the Sterling Ranch development and the lower density 5-acre lots in the Pawnee Rancheros subdivision to the south. Tract A, located in the southernmost portion of Sterling Ranch East

Filing 5 Preliminary Plan, is zoned RR-0.5 and planned as a 4.6AC detention basin. The proposed land use is also consistent with the land use assumed for this same area in the Sterling Ranch Sketch Plan Amendment Master Traffic Impact Study (SKP 224) dated February 10, 2023.

### **Pedestrian Plan**

Figure 2 also shows the location of all planned trails and sidewalks in the vicinity of the site. There are no proposed regional trails within the boundary of this Preliminary Plan. Multiple community trails are included for circulation and recreational use through the Sterling Ranch Phase 1 Preliminary Plan located west and south of the currently-proposed Filing 5 Preliminary Plan, including a 15-foot combined trail and maintenance road along the east side of the Sand Creek area. A 5-foot trail along the south boundary will provide connectivity from the eastern portion of Sterling Ranch to the Regional Trail on the west side of Sand Creek (identified as M11 in the El Paso County *2016 Major Transportation Corridors Plan Update*) and the community parks, trails, and open space within Sterling Ranch.

A detached sidewalk will be provided along both sides of Sterling Ranch Road. The multi-use paved shoulder on Sterling Ranch Road will accommodate bicycles. Attached 5-foot-wide concrete sidewalks are planned on all of the local streets within Sterling Ranch East Filing No. 5.

There are no existing schools within two miles of the site. However, there are multiple future school sites in the area including a future K-8 school site west of the site on the west side of Sterling Ranch Road and elementary school sites south and east of the site. No information or plans are available for the school sites and a separate site-specific traffic impact study including pedestrian plans will be required to be approved prior to school site development.

### **Proposed Access Points**

Figure 3 shows the roadway connections that are planned to be constructed in the short term. As shown in Figure 3, in the short term, Briargate Parkway is planned to be constructed to its final cross section between Vollmer Road and Sterling Ranch Road, Marksheffel Road is planned to be completed between Vollmer Road and Woodmen Road, and Sterling Ranch Road is planned to be constructed from Marksheffel Road to the northmost access point within the Sterling Ranch East Phase 1 Preliminary Plan area.

Figure 2 shows the access plan for the SRE Filing 5 Preliminary Plan. The access plan for this Preliminary plan is consistent with the access plan shown in LSC's February 10, 2023 Sketch Plan Master TIS. SRE Filing 5 is planned to have access to Sterling Ranch Road via Lake Tahoe Drive and Newport Beach Drive. The intersection of Lake Tahoe Drive/Sterling Ranch Road is located about 2,853 feet northeast of Dines Boulevard and 2,853 feet southwest of the future Briargate Parkway. The intersection of Lake Tahoe Drive/Sterling Ranch Road was approved as a full-movement intersection as part of the Sterling Ranch East Preliminary Plan 1 (SP224). The

intersection of Newport Beach Drive/Sterling Ranch Road is located about 627 feet north of Newport Beach Drive. The currently-proposed east leg aligns with the approved full-movement intersection that was also approved as part of Sterling Ranch East Preliminary Plan 1 (SP224). A future full-movement access is also proposed to Oak Park Drive about 665 feet east of Sterling Ranch Road. Oak Park Drive, which will form the north boundary of the site, is not planned to be constructed as part of the currently-proposed Preliminary Plan. All of the proposed access points meet the criteria contained in the *El Paso County Engineering Criteria Manual (ECM)*.

### **Sight Distance Analysis**

Figure 4a shows the intersection sight-distance analysis at the intersections of Sterling Ranch Road (Urban Non-Residential Collector)/Newport Beach Drive and Sterling Ranch Road (Urban Non-Residential Collector)/Lake Tahoe Drive (Urban Local). Based on a design speed of 40 miles per hour (mph) and the criteria contained in Table 2-21 of the *Engineering Criteria Manual (ECM)*, the required intersection sight distance at the future intersections is 445 feet. As shown in Figure 4a, the intersection sight distance can be met at both of these intersections.

Figure 4b shows the intersection sight-distance analysis at the future site access to Oak Park Drive (Non-Residential Collector) which is not planned to be constructed as part of the currently-proposed filing. Based on a design speed of 40 miles per hour (mph) and the criteria contained in Table 2-21 of the *Engineering Criteria Manual (ECM)*, the required intersection sight distance at the future intersection is 445 feet. As shown on Figure 4b the intersection sight distance can be met at this future intersection.

Figure 4c shows the stopping sight-distance analysis at the site-access points to Lake Tahoe Drive (Urban Local). Intersection sight-distance analysis was not analyzed for these intersections as guidance from the *Colorado Department of Transportation 2018 Roadway Design Guide* and *A Policy on Geometric Design of Highway and Street, 7<sup>th</sup> Edition* published by AASHTO indicate that intersection sight distance is not applicable to local urban/residential streets. See the attached Appendix A for further details. Based on a design speed of 25 miles per hour (mph) and the criteria contained in Table 2-17 of the *Engineering Criteria Manual (ECM)*, the required stopping sight distance at the future intersections is 155 feet. As shown in Figure 4c, the stopping sight distance can be met at all of the proposed access points.

## **REPORT SCENARIOS**

### **Short-Term Scenario**

The short-term scenario includes the roadway segments to be added in the short term only, as shown in Figure 3. This scenario includes the SRE Filing 5 Preliminary Plan area (“the site”) as well as traffic to be generated in the short term by buildout of Homestead at Sterling Ranch, Branding Iron at Sterling Ranch, Sterling Ranch Filings 2-4, Copper Chase at Sterling Ranch,



Homestead North at Sterling Ranch Filings 1-3, the Retreat at TimberRidge Filings 1-3, the planned FourSquare at Sterling Ranch East development and Sterling Ranch East Filings 1 and 2. Trips projected from these other short-term developments outside of the SRE Filing 5 Preliminary Plan boundary are included as short-term “background traffic” in this report.

### **Long-Term Scenario**

The long-term scenario is essentially the same as the 2043 long-term scenario contained in the LSC February 10, 2023 Master TIS with additional detail added for this application – including the analysis of minor intersections and street segments that are part of the Preliminary Plan. The study area of this report is more focused than the Sketch Plan.

### **EXISTING ROAD AND TRAFFIC CONDITIONS**

The adjacent streets are shown in Figure 1 and are described below. Copies of the *2016 El Paso County Major Transportation Corridors Plan (MTCP)*, *2040 Roadway Plan*, and *2016 MTCP 2060 Corridor Preservation Plan* with the site location identified on them have been attached to this report.

**Vollmer Road** is currently a five-lane urban street within the City of Colorado Springs limits between Black Forest Road and Cowpoke Road; and a two-lane, rural, paved roadway north of Cowpoke Road extending to north of Hodgen Road. In the southbound direction, Vollmer Road has a posted speed limit of 45 mph. South of Cowpoke Road, Vollmer Road has a 40-mph posted speed limit. The *2040 El Paso County Major Transportation Corridors Plan (MTCP)* and the prior Sterling Ranch master traffic study show Vollmer Road as a four-lane Urban Minor Arterial in the vicinity of the site. Note: The new *Connect COS* City of Colorado Springs transportation plan shows Vollmer as a Principal Arterial. The South Vollmer Road improvements ([CDR2116](#)) which will provide two through lanes in each direction on Vollmer Road in the vicinity of Marksheffel Road are currently under construction and are anticipated to be completed by the end of November 2023. The North Vollmer Road improvements ([CDR217](#)) which will provide two through lanes in each direction on Vollmer Road in the vicinity of Briargate Parkway are currently under construction and are anticipated to be completed by 2024.

**Marksheffel Road** is a Principal Arterial extending north from the City of Fountain to Woodmen Road. Marksheffel Road is planned to ultimately be widened to six lanes and extended north and west from Woodmen Road to connect to Research Parkway at Black Forest Road. Marksheffel Road is shown as a four-lane Principal Arterial through the site on the El Paso County *MTCP*. The City of Colorado Springs intends to take ownership and maintenance of Marksheffel Road when it is constructed from Vollmer to the east and south to where it will connect to the segment constructed north of Woodmen Road in the City.

The section of Marksheffel Road adjacent to Sterling Ranch has been or is planned to be constructed on 107 feet of right-of-way to the City's required cross section(s) and criteria. The section of Marksheffel Road between Sterling Ranch Road and Vollmer Road has recently been completed and the section of Marksheffel Road southeast of Sterling Ranch Road (to connect to the segment recently constructed) will be completed in the short term and will open the connection to Woodmen Road. Marksheffel will be constructed as a four-lane roadway to the previously agreed upon cross section.

**Briargate Parkway** is a Principal Arterial that extends east from I-25 to Grand Lawn Circle (about one-half mile east of Powers Boulevard). Briargate Parkway is planned ultimately to extend to Towner Drive. The segment of Briargate Parkway between Vollmer Road and Sterling Ranch Road is planned to be constructed to its full 4-lane cross section by May 2024.

**Sterling Ranch Road** is a planned Non-Residential Collector shown extending through the Sterling Ranch development between Marksheffel Road and the north end of the Sketch Plan area (Arroya Road). Sterling Ranch Road has been constructed between Marksheffel Road and Dines Boulevard and will be constructed north to Briargate Parkway in the short term with the Sterling Ranch East Phase 1 Preliminary Plan.

**Tahiti Drive** is a gravel road which extends for about 750 feet north from Vollmer Road. The intersection of Vollmer/Tahiti is located just south of the future location of the intersection of Vollmer/Marksheffel. This intersection is planned to be closed with the construction of Marksheffel Road between Vollmer Road and Sterling Ranch Road. Access for the existing home using this access will be relocated north to Loch Fyne Lane.

### **Existing Traffic Volumes**

Figures 5a and 5b show the existing average weekday and peak-hour traffic volumes at the key study-area intersections. The peak-hour traffic volumes shown are based on manual turning-movement counts by LSC Transportation Consultants and All Traffic Data Services. The date of each count is shown in Figure 5b. The average weekday traffic volumes shown in Figure 5a are estimates by LSC, based on the manual peak-hour traffic-count data. The traffic count sheets are attached.

### **Existing Levels of Service**

Level of service (LOS) is a quantitative measure of the level of congestion or delay at an intersection. Level of service is indicated on a scale from "A" to "F." LOS A represents control delay of less than 10 seconds for unsignalized intersections. LOS F represents control delay of more than 50 seconds for unsignalized intersections. Table 1 shows the level of service delay ranges.

**Table 1: Intersection Levels of Service Delay Ranges**

Level of Service	Signalized Intersections	Unsignalized Intersections
	Average Control Delay (seconds per vehicle)	Average Control Delay (seconds per vehicle) <sup>(1)</sup>
A	10.0 sec or less	10.0 sec or less
B	10.1-20.0 sec	10.1-15.0 sec
C	20.1-35.0 sec	15.1-25.0 sec
D	35.1-55.0 sec	25.1-35.0 sec
E	55.1-80.0 sec	35.1-50.0 sec
F	80.1 sec or more	50.1 sec or more

(1) For unsignalized intersections, if V/C ratio is greater than 1.0 the level of service is LOS F, regardless of the projected average control delay per vehicle.

The intersection of Burgess/Vollmer has been analyzed based on the unsignalized-intersection analysis procedures from the *Highway Capacity Manual, 6th Edition* by the Transportation Research Board. The results of the analysis are shown on Figure 5c.

Burgess/Vollmer

**Unresolved:**  
State if signalization of this intersection or other studied intersections is recommended. Provided table analysis.

The stop-sign-controlled intersection of Burgess/Vollmer is currently operating at LOS E for the eastbound approach and LOS F for the westbound approach during the afternoon peak hour.

**Safety and Accident Analysis**

The Colorado State Patrol (CSP) provided LSC with crash history data for Vollmer Road between Tahiti Drive and Burgess Road from September 2019 through September 2022. During the reported time period, there were twelve reported crashes. Of the twelve reports, ten were single-vehicle non-intersection-related crashes on Vollmer Road. One crash involved a southbound vehicle that turned right onto Poco Road and crashed into several cars parked on Poco Road partially in the lane. The only intersection-related crash occurred in June 2022. A vehicle heading northbound on Vollmer Road was slowing to turn left at Lochwinnoch Road and the vehicle behind them attempted to pass on the left side. The crash history data has been attached.

**BASELINE CONDITIONS**

Baseline traffic is the traffic estimated to be on the adjacent roadways and at adjacent intersections without the proposed development’s trip generation of site-generated traffic volumes. Baseline traffic (for a specified horizon year) includes the through traffic and the traffic generated by nearby developments (existing and planned, including traffic generated by

existing and planned developments within the greater Sterling Ranch overall development) but assumes zero traffic generated by land uses within the site (the SRE Filing 5 preliminary plan boundary area).

### **Short-Term Scenario Baseline Conditions**

Please refer to the description of the short-term scenario above. Figures 6a and 6b show the projected volumes for the short-term baseline scenario.

Figure 6c shows the lane geometry, traffic control, and level of service at the key area intersections, based on the short-term scenario baseline volumes.

### **Long-Term Scenario Baseline Conditions**

Figure 7a shows the projected 2043 baseline daily traffic volumes on key street segments at the key area intersections and Figure 7b shows the projected 2043 peak-hour baseline traffic volumes at the key area intersections. These volumes assume buildout of the area street network, including the completion of Marksheffel Road between Vollmer Road and Black Forest Road, Briargate Parkway between Meridian Road and Black Forest Road, and Sterling Ranch Road between Marksheffel Road and Briargate Parkway.

The 2043 baseline traffic volumes are estimates by LSC, based on the traffic projections in the LSC February 10, 2023 Master TIS report. The 2043 baseline daily traffic volumes assume buildout of the land uses within the Sterling Ranch Master Plan that are not included in the Sterling Ranch East Phase 1 Preliminary Plan area.

Figure 7c shows the lane geometry, traffic control, and level of service at the key area intersections, based on the 2043 baseline volumes.

### **TRIP GENERATION**

The site-generated vehicle trips were estimated using the nationally-published trip-generation rates from *Trip Generation, 11th Edition, 2021* by the Institute of Transportation Engineers (ITE). Table 2 shows the trip-generation estimates.

The Sterling Ranch East Filing 5 Preliminary Plan is projected to generate about 1,509 new external vehicle trips on the average weekday, with about half entering and half exiting the site during a 24-hour period. During the morning peak hour, which generally occurs for one hour between 6:30 and 8:30 a.m., about 28 vehicles would enter and 84 vehicles would exit the site. During the afternoon peak hour, which generally occurs for one hour between 4:15 and 6:15 p.m., about 95 vehicles would enter and 56 vehicles would exit the site.

## **TRIP DISTRIBUTION AND ASSIGNMENT**

The directional distribution of the site-generated traffic volumes on the street and roadway system serving the site is an important factor in determining the site's traffic impacts. The distribution estimates for short-term and long-term residential related traffic are shown in Figure 8. The short-term directional-distribution estimate assumes the short-term roadway network shown in Figure 3 only and the long-term directional-distribution estimate assumes buildout of the roadway network. The directional-distribution estimates are based, in part, on the estimates contained in the sketch plan TIS report. Factors include: the location of the site with respect to the Colorado Springs metropolitan area, the planned access system for the site, the street and roadway system serving the site, and the land uses proposed for the site.

When the distribution percentages (from Figure 8) are applied to the new, external trip-generation estimates (from Table 2), the resulting site-generated traffic volumes can be determined. Figures 9a and 9b show the short-term site-generated traffic volumes. These volumes assume only the street network shown in Figure 3. Figures 10a and 10b show the long-term residential site-generated traffic volumes assuming buildout of the area roadway network.

## **TOTAL TRAFFIC**

### **Short-Term Total Traffic**

Figure 11a shows the projected short-term total daily traffic volumes on key street segments and Figure 11b shows the projected short-term total peak-hour traffic volumes at the key study-area intersections. These volumes are the sum of the short-term baseline traffic volumes (from Figures 6a and 6b) and the short-term site-generated traffic volumes (from Figures 9a and 9b).

Figure 11c shows the level of service analysis results for the key area intersections based on the projected short-term total volumes. The figure also shows the general intersection lane geometry and intersection traffic control used in the analysis.

### **2043 Total Traffic**

Figure 12a shows the projected 2043 total daily traffic volumes on key street segments and Figure 12b shows the projected 2043 total peak-hour traffic volumes at the key study-area intersections. These volumes are the sum of the 2043 baseline traffic volumes (from Figures 7a and 7b) and the long-term site-generated traffic volumes (from Figures 10a and 10b).

Figure 12c shows the level of service analysis results for the key area intersections based on the projected 2043 total volumes. The figure also shows the general intersection lane geometry and intersection traffic control used in the analysis.

### **LEVEL OF SERVICE ANALYSIS**

The key area future signalized intersections have been analyzed to determine the projected intersection levels of service for short-term and 2043 baseline and total traffic scenarios for the morning and afternoon peak-hour periods using Synchro. The key area future stop-sign-controlled and modern-roundabout-controlled intersections have been analyzed based on the unsignalized-intersection analysis procedures from the *Highway Capacity Manual 6th Edition*. Figures 6c, 7c, 11c, and 12c show the level of service analysis results. The level of service reports are attached.

#### **Intersection #1: Vollmer/Burgess**

The stop-sign-controlled intersection of Vollmer/Burgess is currently operating at LOS E for the eastbound approach and LOS F for the westbound approach during the afternoon peak hour. The intersection currently has one-lane approaches in all directions. Based on existing traffic volumes shown in Figure 5 and the criteria contained in the *El Paso County Engineering Criteria Manual (ECM)*, multiple auxiliary turn lanes would be required to meet the *ECM* standard. LSC recommends this intersection be reconstructed as a modern one-lane roundabout. As a modern roundabout, it is projected to operate at LOS C or better for all approaches during the peak hours, based on the projected short-term and 2043 total traffic volumes.

#### **Intersection #4: Vollmer/Briargate**

The section of Briargate Parkway between Vollmer Road and Sterling Ranch Road is planned to be constructed to its final cross section in the short term. The intersection of Vollmer/Briargate could operate at a satisfactory level of service (LOS C or better) in the short term as a stop-sign-controlled intersection.

By 2043, it was assumed Briargate Parkway would be extended west to Black Forest Road and East to Towner Avenue and that the intersection of Vollmer/Briargate will be converted to traffic-signal control. The intersection of Vollmer/Briargate is projected to operate at an overall LOS C during the peak hours as a signalized intersection, based on the projected 2043 total traffic volumes shown in Figure 12b and the lane geometry shown in Figure 12c.

#### **Intersection #5: Briargate/Sterling Ranch**

The section of Briargate Parkway between Vollmer Road and Sterling Ranch Road is planned to be constructed to its final cross section in the short term. The intersection of Briargate/Sterling

Ranch could operate at a satisfactory level of service (LOS C or better) in the short term as a stop-sign-controlled intersection.

By 2043, it was assumed Briargate Parkway would be extended west to Black Forest Road and East to Towner Avenue and that the intersection of Briargate/Sterling Ranch will be converted to traffic-signal control. The intersection of Briargate/Sterling Ranch is projected to operate at an overall LOS C during the peak hours as a signalized intersection, based on the projected 2043 total traffic volumes shown in Figure 12b and the lane geometry shown in Figure 12c.

#### **Intersection #12: Marksheffel/Vollmer**

Marksheffel Road is planned to be constructed between Vollmer Road and Sterling Ranch Road in the short-term future. The intersection of Marksheffel/Vollmer is initially planned to be stop-sign controlled. Based on the projected short-term total traffic volumes, the westbound left-turn movement is projected to operate at LOS E during the morning peak hour and LOS F during the afternoon peak hour. This intersection is planned as a future signalized intersection. However, traffic-signal warrant(s) may not be met in the short-term. It is not uncommon for the minor movements at a stop-sign-controlled intersection to operate at LOS E or F as the traffic volumes approach the levels needed to meet vehicular-volume traffic-signal warrants.

By 2043, it was assumed that Marksheffel Road would be constructed west to Briargate Parkway and that the intersection of Marksheffel/Vollmer will be converted to traffic-signal control. The intersection of Marksheffel/Vollmer is projected to operate at an overall LOS C or better during the peak hours as a signalized intersection, based on the projected 2043 total traffic volumes shown in Figure 12b and the lane geometry shown in Figure 12c.

#### **Intersection #13: Marksheffel/Sterling Ranch**

Marksheffel Road is planned to be constructed between Vollmer Road and Sterling Ranch Road in the short-term future. The intersection of Marksheffel/Sterling Ranch is initially planned to be stop-sign controlled. Based on the projected short-term total traffic volumes, the southbound left-turn movement is projected to operate at LOS C during the morning peak hour and LOS E during the afternoon peak hour. This intersection is planned as a future signalized intersection. However, traffic-signal warrant(s) may not be met in the short-term. It is not uncommon for the minor movements at a stop-sign-controlled intersection to operate at LOS E or F as the traffic volumes approach the levels needed to meet vehicular-volume traffic-signal warrants.

The intersection of Marksheffel/Sterling Ranch is projected to operate at an overall LOS C or better during the peak hours as a signalized intersection, based on the projected 2043 total traffic volumes shown in Figure 12b and the lane geometry shown in Figure 12c.

### **Sterling Ranch Road Site Access Points (Intersection #305 & #306)**

The intersections of Lake Tahoe Drive/Sterling Ranch Road (#305) and Newport Beach Place/Sterling Ranch Road (#306) are projected to operate at a satisfactory level of service (LOS C or better) during the peak hours as stop-sign-controlled intersections, based on the projected short-term and 2043 total traffic volumes.

### **Intersection #8: Oak Park/Sterling Ranch**

The intersection of Oak Park Drive/Sterling Ranch Road is not planned to be constructed in the short-term.

By 2043, it was assumed that Oak Park Drive would be constructed between Sterling Ranch Road and Banning Lewis Parkway. It was also assumed that the future K-8 School planned for the parcel southwest of Briargate/Sterling Ranch would be constructed and that an **exit-only** access would be constructed aligning with the Oak Park/Sterling Ranch intersection. Based on the 2043 total traffic volumes shown in Figure 12b and the lane geometry shown in Figure 12c, the eastbound and westbound left-turn movements are projected to operate at LOS E during the morning peak hour and LOS C during the afternoon peak hour. Alternate traffic control may be needed to achieve a satisfactory level of service at this intersection. Further analysis of this intersection should be conducted when the number of students, site layout, and proposed access plan for the school site are determined.

### **SIGNAL WARRANT THRESHOLD ANALYSIS – AM AND PM PEAK HOURS**

The intersections of Marksheffel/Vollmer and Marksheffel/Sterling Ranch were analyzed to determine if the thresholds for Four-Hour and/or Eight-Hour Vehicular-Volume Traffic-Signal Warrant thresholds would be reached or exceeded, based on the projected short-term peak-hour traffic volumes only. In order for an Eight-Hour Vehicular-Volume Traffic-Signal Warrant to be satisfied, the volume threshold would need to be met for six additional hours of the day and in order for a Four-Hour Vehicular Volume Traffic Signal Warrant to be satisfied, the volume threshold would need to be met for two additional hours of the day. For example, the four-hour warrant would be satisfied with the volume thresholds met for one hour in the morning, two hours (instead of the one-hour peak) during the afternoon peak period, and an hour during the mid-afternoon.

This “cursory”/planning-level analysis has been provided at the Preliminary Plan level to identify intersections which may need to be signalized in the short-term future. Detailed analysis of all applicable signal warrants should be evaluated with Filing submitted. The satisfaction of warrants does not indicate that a signal must be installed. The decision to require a signal to be installed rests with the County.



Table 3 shows the results of the analysis for the intersection of Marksheffel/Vollmer and Table 4 shows the results of the analysis for the intersection of Marksheffel/Sterling Ranch. As shown in Tables 3 and 4, the projected short-term morning and afternoon peak-hour traffic volumes at both intersections are projected to meet the thresholds for both Four-Hour and Eight-Hour Vehicular-Volume Traffic-Signal Warrants. This analysis indicates that traffic-signal warrant(s) may be met at both of these intersections prior to buildout of SRE Filing 5 Preliminary Plan. Detailed analysis should be provided with each future filing within Sterling Ranch. Escrow towards these improvements may also need to be provided with each filing.

### **ROADWAY FUNCTIONAL CLASSIFICATIONS AND LANEAGE**

Figure 13 shows the recommended functional classifications and number of through lanes for the streets in the study area.

### **WAIVER AND DEVIATION REQUESTS**

No waivers to the *Land Development Code* (LDC) or deviations to the criteria contained in the *El Paso County Engineering Criteria Manual (ECM)* are needed for the proposed preliminary plan.

### **AREA MTCP 2040 ROADWAY IMPROVEMENT PROJECTS**

The *El Paso County 2016 Major Transportation Corridors Plan Update* identified the following 2040 roadway improvement projects within the study area:

- C13: Vollmer Road from Marksheffel Road to Stapleton Drive as a Rural 4-Lane Minor Arterial;
- N5: Stapleton Drive [Briargate Parkway] from Towner Road to Black Forest Road as a 4-Lane Urban Principal Arterial;
- N12: Marksheffel Road from Woodman Road to Research Parkway as a 4-Lane Urban Principal Arterial; and
- M11: Vollmer Road Bicycle & Primary Regional Trail from Marksheffel Road to Shoup Road.

### **CONCLUSIONS AND RECOMMENDATIONS**

#### **Trip Generation**

- The Sterling Ranch East Filing 5 Preliminary Plan is projected to generate about 1,509 new external vehicle trips on the average weekday, with about half entering and half exiting the site during a 24-hour period. During the morning peak hour, which generally occurs for one hour between 6:30 and 8:30 a.m., about 28 vehicles would enter and 84 vehicles would exit the site. During the afternoon peak hour, which

generally occurs for one hour between 4:15 and 6:15 p.m., about 95 vehicles would enter and 56 vehicles would exit the site.

### Level of Service

- The stop-sign-controlled intersection of Vollmer/Burgess is currently operating at LOS E for the eastbound approach and LOS F for the westbound approach during the afternoon peak hour. The intersection currently has one-lane approaches in all directions. Based on existing traffic volumes shown in Figure 5 and the criteria contained in the El Paso County *Engineering Criteria Manual (ECM)*, multiple auxiliary turn lanes would be required to meet the *ECM* standard. LSC recommends this intersection be reconstructed as a modern one-lane roundabout. As a modern roundabout, it is projected to operate at LOS C or better for all approaches during the peak hours, based on the projected short-term and 2043 total traffic volumes.
- The intersections of Vollmer/Briargate and Briargate/Sterling Ranch are projected to operate at a satisfactory level of service as stop-sign-controlled intersections in the short-term future. By 2043, these intersections will likely need to be converted to traffic-signal control. As signalized intersections, all movements are projected to operate at LOS D or better during the peak hours based on the projected 2043 total traffic volumes.
- Some of the movements at the intersections of Marksheffel/Vollmer and Marksheffel/Sterling Ranch Road are projected to operate at LOS E or LOS F during the peak hours, if they remain stop-sign controlled in the short-term future. Once signalized, all movements at these intersections are projected to operate at LOS D or better, based on the projected short-term and 2043 total traffic volumes.
- The intersections of Sterling Ranch Road/Lake Tahoe Drive and Sterling Ranch Road/Newport Beach Drive are projected to operate at a satisfactory level of service (LOS D or better) during the peak hours as stop-sign-controlled intersections, based on the projected short-term and 2043 total traffic volumes.
- The intersection of Oak Park Drive/Sterling Ranch Road is not planned to be constructed in the short-term. By 2043, it was assumed that Oak Park Drive would be constructed between Sterling Ranch Road and Banning Lewis Parkway. It was also assumed that the future K-8 School planned for the parcel southwest of Briargate/Sterling Ranch would be constructed and that an **exit-only** access would be constructed aligning with the Oak Park/Sterling Ranch intersection. Based on the 2043 total traffic volumes shown in Figure 12b and the lane geometry shown in Figure 12c, the eastbound and westbound left-turn movements are projected to operate at LOS E during the morning peak hour and LOS C during the afternoon peak hour. Alternate traffic control may be needed to achieve a satisfactory level of service at this intersection. Further analysis of this intersection should be conducted when the number of students, site layout, and proposed access plan for the school site are determined.

### Recommended Improvements

- Table 5 shows detailed **intersection** improvements needed with SRE Filing 5 Preliminary Plan at the site-access points and the intersection of Briargate/Sterling Ranch. The recommended improvements are based on the short-term and 2043 total traffic volumes shown in Figures 12b and 12b and the criteria contained in the El Paso County *Engineering Criteria Manual (ECM)*.
- Table 6 shows a list of the **roadway segment** improvements in the vicinity of the site. Please see Figure 14 for a map of the key street segment locations. These recommendations are consistent with the LSC Sketch Plan TIS report.

### TRANSPORTATION IMPROVEMENT FEE PROGRAM AND CREDIT AGREEMENTS

The applicant will be required to participate in the Countywide Transportation Improvement Fee Program. These projects will annex into the 5 mil PID, which has a per-lot upfront building permit fee of \$2,527 per dwelling unit. The total building permit fee amount for the 160 lots within SRE Phase 1 Preliminary Plan would be \$195,360. Note: This is based on the current rate, which is subject to change. El Paso County updates this rate periodically.

A road fee credit agreement and development agreement and Subdivision Improvements Agreement will be required to address developer's road fee credits for construction of Vollmer Road. Additional credit agreements will be needed with each phase of construction to account for reimbursement of costs for the additional lanes and major intersection improvements.

\* \* \* \* \*

Unresolved:  
Include a section discussing the proposed rezone  
for filing 5 and impact to the county roadway.

Please contact me if you have any questions regarding this report.

Sincerely,

LSC TRANSPORTATION CONSULTANTS, INC.

By Jeffrey C. Hodsdon, P.E.  
Principal

JCH/KDF:jas

Enclosures: Tables 2-6  
Figures 1-14  
Appendix Table 1  
MTCP Maps  
Traffic Count Reports  
Level of Service Reports  
Crash History  
Appendix A

# Tables 2-6

---



**Table 2  
Trip Generation Estimate  
Sterling Ranch East Filing No. 5**

ITE Code	ITE Land Use	Quantity	Unit	Trip Generation Rates <sup>(1)</sup>				Total Trip Generated					
				Daily	AM Peak Hour		PM Peak Hour		Daily	AM Peak Hour		PM Peak Hour	
					In	Out	In	Out		In	Out	In	Out
210	Single-Family Detached Housing	160	DU	9.43	0.18	0.53	0.59	0.35	1,509	28	84	95	56

Notes:

(1) Source: "Trip Generation, 11th Edition, 2021" by the Institute of Transportation Engineers (ITE)

(2) DU = Dwelling Unit

Source: LSC Transportation Consultants, Inc.

Jun-23

**Table 3**  
**Traffic Signal Warrant Analysis**  
 Marksheffel Road/Vollmer Road

Warrant Analysis <sup>(1)</sup>																								
Hour	Short-Term Background Traffic						Sterling Ranch Fil 5 Generated Traffic				Short-Term Total Traffic		Warrant 1: Eight Hour Vehicular Volume Evaluation				Warrant 2: Four Hour Vehicular Volume Evaluation							
													Warrant Thresholds				Warrant Threshold Met?		Short-Term Background		Short-Term Total		Short-Term Background	
	Major <sup>(2)</sup>		Minor <sup>(3)</sup>		Major		Minor		Major		Minor		Condition A		Condition B		Condition A		Condition B		Warrant Threshold Minimum	Warrant Threshold Met? WB	Warrant Threshold Minimum	Warrant Threshold Met? WB
	Vollmer	Marksheffel	Vollmer	Marksheffel	Vollmer	Marksheffel	Vollmer	Marksheffel	Major	Minor	Major	Minor	Major	Minor	Major	Minor	Major	Minor	Major	Minor	Minimum	WB	Minimum	WB
<b>Short-Term Total Traffic<sup>(4)</sup></b>																								
12-1 AM	48	3	0	0	48	3	600	150	900	75	No	No	No	No	Low Volume	No	Low Volume	No						
1-2 AM	23	3	0	0	23	3	600	150	900	75	No	No	No	No	Low Volume	No	Low Volume	No						
2-3 AM	16	0	0	0	16	0	600	150	900	75	No	No	No	No	Low Volume	No	Low Volume	No						
3-4 AM	25	3	0	0	25	3	600	150	900	75	No	No	No	No	Low Volume	No	Low Volume	No						
4-5 AM	41	11	0	0	41	11	600	150	900	75	No	No	No	No	Low Volume	No	Low Volume	No						
5-6 AM	109	28	0	1	109	29	600	150	900	75	No	No	No	No	Low Volume	No	Low Volume	No						
6-7 AM	326	84	1	2	327	86	600	150	900	75	No	No	No	No	Low Volume	No	Low Volume	No						
7-8 AM	782	145	1	4	783	149	600	150	900	75	No	No	No	No	209	No	209	No						
8-9 AM	873	122	1	3	874	125	600	150	900	75	No	No	No	No	182	No	182	No						
9-10 AM	755	77	1	2	756	79	600	150	900	75	No	No	No	No	223	No	222	No						
10-11 AM	876	77	1	2	877	79	600	150	900	75	No	No	No	No	181	No	181	No						
11-12 PM	989	73	2	2	991	75	600	150	900	75	No	No	No	No	153	No	152	No						
12-1 PM	838	72	3	2	841	74	600	150	900	75	No	No	No	No	191	No	190	No						
1-2 PM	831	76	3	2	834	78	600	150	900	75	No	No	No	No	192	No	192	No						
2-3 PM	957	80	3	2	960	82	600	150	900	75	No	Yes	No	Yes	161	No	160	No						
3-4 PM	1017	78	4	2	1021	80	600	150	900	75	No	Yes	No	Yes	145	No	144	No						
4-5 PM	1059	97	5	3	1064	100	600	150	900	75	No	Yes	No	Yes	132	No	131	No						
5-6 PM	889	96	5	3	894	99	600	150	900	75	No	No	No	No	178	No	177	No						
6-7 PM	609	76	4	2	613	78	600	150	900	75	No	No	No	No	286	No	285	No						
7-8 PM	384	56	3	2	387	58	600	150	900	75	No	No	No	No	Low Volume	No	Low Volume	No						
8-9 PM	314	40	3	1	317	41	600	150	900	75	No	No	No	No	Low Volume	No	Low Volume	No						
9-10 PM	202	31	2	1	204	32	600	150	900	75	No	No	No	No	Low Volume	No	Low Volume	No						
10-11 PM	114	14	1	0	115	14	600	150	900	75	No	No	No	No	Low Volume	No	Low Volume	No						
11-12 AM	61	9	1	0	62	9	600	150	900	75	No	No	No	No	Low Volume	No	Low Volume	No						
Numbers of Hours the Warrant Thresholds Are Met												0	3	0	3		0		0					
Warrant Met?												No	No	No	No		No		No					

Notes:

- (1) Thresholds are based on 2 or more lanes on the major approach and 1 lane on the minor approach (Warrant evaluation assuming the westbound left turn only for the minor street)
- (2) The major street traffic includes all movements (left, through, and right)
- (3) The minor street traffic includes only the left turns from the minor street
- (4) Off peak hour traffic volumes are based on the projected peak hour traffic volumes, 72-hour machine counts conducted on Vollmer Road in November 2020 and vehicle time-of-day distribution data for single-family residential published by the Institute of Transportation Engineers

Source: LSC Transportation Consultants, Inc.

**Table 4**  
**Traffic Signal Warrant Analysis**  
 Marksheffel Road/Sterling Ranch Road

Warrant Analysis <sup>(1)</sup>																				
Warrant 1: Eight Hour Vehicular Volume Evaluation											Warrant 2: Four Hour Vehicular Volume Evaluation									
Sterling Ranch Filing No. 5							Warrant Thresholds				Warrant Threshold Met?		Short-Term Background		Short-Term Total					
Short-Term Background Traffic		Minor <sup>(3)</sup> Sterling Ranch		Major		Minor Sterling Ranch		Major		Minor		Condition A		Condition B		Warrant Threshold Minimum	Warrant Threshold Met?	Warrant Threshold Minimum	Warrant Threshold Met?	
Major <sup>(2)</sup> Marksheffel	Minor <sup>(3)</sup> Sterling Ranch	Major Marksheffel	Minor Sterling Ranch	Major Marksheffel	Minor Sterling Ranch	Major Marksheffel	Minor Sterling Ranch	Condition A Major	Condition A Minor	Condition B Major	Condition B Minor	Condition A	Condition B							
Hour	Major <sup>(2)</sup> Marksheffel	Minor <sup>(3)</sup> Sterling Ranch	Major Marksheffel	Minor Sterling Ranch	Major Marksheffel	Minor Sterling Ranch	Major Marksheffel	Minor Sterling Ranch	Major Marksheffel	Minor Sterling Ranch	Major Marksheffel	Minor Sterling Ranch	Condition A Major	Condition A Minor	Condition B Major	Condition B Minor	Warrant Threshold Minimum	Warrant Threshold Met?	Warrant Threshold Minimum	Warrant Threshold Met?
<b>Short-Term Total Traffic<sup>(4)</sup></b>																				
12-1 AM	31	7	4	1	35	8	600	150	900	75	No	No	No	No	Low Volume	No	Low Volume	No		
1-2 AM	14	7	2	1	16	8	600	150	900	75	No	No	No	No	Low Volume	No	Low Volume	No		
2-3 AM	11	0	2	0	13	0	600	150	900	75	No	No	No	No	Low Volume	No	Low Volume	No		
3-4 AM	14	7	2	1	16	8	600	150	900	75	No	No	No	No	Low Volume	No	Low Volume	No		
4-5 AM	22	28	2	6	24	34	600	150	900	75	No	No	No	No	Low Volume	No	Low Volume	No		
5-6 AM	53	69	4	14	57	83	600	150	900	75	No	No	No	No	Low Volume	No	Low Volume	No		
6-7 AM	162	205	13	42	175	247	600	150	900	75	No	No	No	No	Low Volume	No	Low Volume	No		
7-8 AM	368	354	25	73	393	427	600	150	900	75	No	No	No	No	Low Volume	No	Low Volume	No		
8-9 AM	414	298	29	62	443	360	600	150	900	75	No	No	No	No	Low Volume	No	369	No		
9-10 AM	359	187	25	39	384	226	600	150	900	75	No	No	No	No	Low Volume	No	Low Volume	No		
10-11 AM	430	187	33	39	463	226	600	150	900	75	No	No	No	No	Low Volume	No	359	No		
11-12 PM	505	177	43	37	548	214	600	150	900	75	No	No	No	No	338	No	316	No		
12-1 PM	521	175	46	37	567	212	600	150	900	75	No	No	No	No	330	No	307	No		
1-2 PM	539	185	50	39	589	224	600	150	900	75	No	No	No	No	Low Volume	No	296	No		
2-3 PM	625	194	58	41	683	235	600	150	900	75	Yes	No	Yes	No	280	No	257	No		
3-4 PM	710	188	71	39	781	227	600	150	900	75	Yes	No	Yes	No	245	No	210	Yes		
4-5 PM	809	235	88	49	897	284	600	150	900	75	Yes	No	Yes	No	198	Yes	176	Yes		
5-6 PM	741	232	86	48	827	280	600	150	900	75	Yes	No	Yes	No	230	Yes	193	Yes		
6-7 PM	572	185	72	39	644	224	600	150	900	75	No	No	Yes	No	Low Volume	No	272	No		
7-8 PM	394	135	52	28	446	163	600	150	900	75	No	No	No	No	Low Volume	No	Low Volume	No		
8-9 PM	374	97	53	20	427	117	600	150	900	75	No	No	No	No	Low Volume	No	Low Volume	No		
9-10 PM	260	75	38	16	298	91	600	150	900	75	No	No	No	No	Low Volume	No	Low Volume	No		
10-11 PM	131	34	18	7	149	41	600	150	900	75	No	No	No	No	Low Volume	No	Low Volume	No		
11-12 AM	75	22	11	5	86	27	600	150	900	75	No	No	No	No	Low Volume	No	Low Volume	No		
<b>Numbers of Hours the Warrant Thresholds Are Met</b>												4	0	5	0		2		3	
<b>Warrant Met?</b>												No		No			No		No	

Notes:

- (1) Thresholds are based on 2 or more lanes on the major approach and 1 lane on the minor approach (Warrant evaluation assuming the southbound left turn only for the minor street)
- (2) The major street traffic includes all movements (left, through, and right)
- (3) The minor street traffic includes only the left turns from the minor street
- (4) Off peak hour traffic volumes are based on the projected peak hour traffic volumes, 72-hour machine counts conducted on Vollmer Road in November 2020 and vehicle time-of-day distribution data for single-family residential published by the Institute of Transportation Engineers

Source: LSC Transportation Consultants, Inc.



**Table 5  
Sterling Ranch East Filing 5  
Intersection Improvements**

Item #	Improvement	Trigger	Timing	Responsibility
<b>1) Burgess Road/Vollmer Road</b>				
1	Reconstruct as a modern one-lane roundabout	When the LOS degrades below LOS F	Existing deficiency	This intersection may be eligible intersection under the fee impact program
<b>5) Briargate Parkway/Sterling Ranch Road</b>				
2	Construct an eastbound left-turn lane on Briargate Parkway approaching Sterling Ranch Road. The lane should be 435' long plus a 200' taper.	eastbound left-turn volume > 10 vph	With Sterling Ranch East Filing 1	Sterling Ranch
3	Construct an eastbound right-turn deceleration lane on Briargate Parkway approaching Sterling Ranch Road. The lane should be 235' long plus a 200' taper.	eastbound right-turn volume > 25 vph	With Sterling Ranch East Filing 1	Sterling Ranch
4	Construct a northbound to eastbound right-turn acceleration lane on Briargate Parkway at Sterling Ranch Road. The lane should be 580' long plus a 180' taper.	northbound right-turn volume > 50 vph	Long Term (with the construction of Briargate Parkway east of Sterling Ranch Road)	Sterling Ranch
5	Construct a westbound left-turn lane on Briargate Parkway approaching Sterling Ranch Road. The lane should be 285' long plus a 200' taper.	westbound left-turn volume > 10 vph	Long Term (with the construction of Briargate Parkway east of Sterling Ranch Road)	Sterling Ranch
6	Construct an eastbound right-turn deceleration lane on Briargate Parkway approaching Sterling Ranch Road. The lane should be 235' long plus a 200' taper.	eastbound right-turn volume > 25 vph	Long Term (with the construction of Briargate Parkway east of Sterling Ranch Road)	Sterling Ranch
7	Construct a southbound to westbound right-turn acceleration lane on Briargate Parkway at Sterling Ranch Road. The lane should be 580' long plus a 180' taper.	southbound right-turn volume > 50 vph	With Sterling Ranch East Filing 2	Sterling Ranch
<b>8) Sterling Ranch Road/Oak Park Place</b>				
8	Construct a southbound left-turn lane on Sterling Ranch Road approaching Oak Park Place. The lane should be 220' long plus a 160' taper.	southbound left-turn volume > 25 vph	A center painter median is part of the standard Non-Residential Collector cross section and a left-turn lane is planned with Sterling Ranch East Filing 1	Sterling Ranch
9	Construct a northbound right-turn deceleration lane on Sterling Ranch Road approaching Oak Park Place. The lane should be 155' long plus a 160' taper.	northboundbound right-turn volume > 50 vph	Planned with Sterling Ranch East Filing 5	Sterling Ranch
<b>12) Marksheffel Road/Vollmer Road</b>				
10	Signalization of the intersection	Once warrants are met. The decision on timing of traffic signal installation rests with El Paso County Public Works.	Not Anticipated With Sterling Ranch East Filing 5	This intersection may be eligible intersection under the fee impact program
<b>13) Marksheffel Road/Sterling Ranch Road</b>				
11	Signalization of the intersection	Once warrants are met. The decision on timing of traffic signal installation rests with The City of Colorado Springs.	Not Anticipated With Sterling Ranch East Filing 5	SRMD#3
<b>305) Sterling Ranch Road/Lake Tahoe Drive</b>				
12	Construct an northeastbound left-turn deceleration lane on Sterling Ranch Road approaching Lake Tahoe Drive. The lane should be 225' long plus a 160' taper	northeastbound left-turn volume > 25 vph	With Sterling Ranch East Filing 1	Sterling Ranch
13	Construct a southwestbound left-turn lane on Sterling Ranch Road approaching Lake Tahoe Drive. The lane should be 205' long plus a 200' taper.	southwestbound left-turn volume > 25 vph	The left-turn volumes are not projected to exceed the threshold, however, a center painter median is part of the standard Non-Residential Collector cross section and a left-turn lane is planned with Sterling Ranch East Filing 1	Sterling Ranch
14	Construct an northeastbound right-turn deceleration lane on Sterling Ranch Road approaching Lake Tahoe Drive. The lane should be 155' long plus a 160' taper	northeastbound right-turn volume > 50 vph	Planned with Sterling Ranch East Filing 5	Sterling Ranch
<b>306) Sterling Ranch Road/Newport Beach Drive</b>				
14	Construct a northeastbound left-turn lane on Sterling Ranch Road approaching Newport Beach Drive. The lane should be 205' long plus a 200' taper.	northeastbound left-turn volume > 25 vph	With Sterling Ranch East Filing 1	Sterling Ranch
15	Construct a southwestbound left-turn lane on Sterling Ranch Road approaching Newport Beach Drive. The lane should be 205' long plus a 200' taper.	southwestbound left-turn volume > 25 vph	The left-turn volumes are not projected to exceed the threshold, however, a center painter median is part of the standard Non-Residential Collector cross section and a left-turn lane is planned with Sterling Ranch East Filing 5	Sterling Ranch

Source: LSC Transportation Consultants, Inc. (November 2023)

Highlight items to be completed with this filing for easy reference.

**Table 6**

**Roadway Segment Improvements**

**Sterling Ranch East Filing 5 Preliminary Plan**

(Page 1 of 2)

Segment ID <sup>(1)</sup> (See Figure 14 for map)	Improvement Description	Timing	Design ADT (vpd)	Projected 2042 ADT (vpd)	Responsibility
V1 (Short-Term) Northbound	UPDATE (November 2023): It is our understanding that a meeting(s) with JR Engineering/the applicant, City staff and County staff were held, that a short-term/interim improvement to segment V1 will not be required. The original LSC recommendation for this segment was for restriping. However, City staff indicated that the striped bike lane in the southbound direction needs to remain.	Updated November 2023 - It is our understanding that following a meeting with the City of Colorado Springs and El Paso County, a V1 interim shoulder improvement will no longer be required.	5,500 (Directional northbound)	16,275	N/A
V1 (Short-Term) Southbound			10,000 (Directional southbound)		
V1	Improve Vollmer Road between Dry Needle Place and the Sterling Ranch south boundary to a standard 4-Lane Urban Minor Arterial Cross Section (Add a second northbound through lane and painted center median) <sup>(2)</sup>	Intermediate-Term Future	20,000		Updated November 2023 Adjacent parcel owner which could potentially include: <ul style="list-style-type: none"> <li>• “Pioneer Landscape Center Parcel” (5300000742) (redevelopment is unlikely in the foreseeable future)</li> <li>• “Schmidt Parcel” west of Vollmer Rd (5200000571)</li> <li>• The triangular parcels southeast of Vollmer/Marksheffel (5232400001 and 5232400003)</li> </ul>
V2	Improve Vollmer Road between the Sterling Ranch south boundary to Lochwinnoch Lane/Sterling property boundary to a standard 4-Lane Urban Minor Arterial Cross Section <sup>(2)</sup>	Short-Term Future (With Sterling Ranch Fil No. 2 Or Sterling Ranch Phase 2) Updated November 2023: In Progress to be complete by November 2023	20,000 (Note: Existing Capacity 8,000 <sup>(3)</sup> )	17,475	Sterling Ranch
V3	<b>Short Term:</b> Improve Vollmer Road from Lochwinnoch Lane to Sterling Ranch boundary (northeast of Glider Loop) to provide 36’ of pavement (existing pavement 1 approx. 23.38’) and stripe for one through lane and plus a 6’ paved, striped outside shoulder in each direction <sup>(2)</sup>	Updated November 2023 – Future as required due to net increase traffic demand. The construction documents have been approved.	11,000 (Note: Existing Capacity 8,000)	17,380	Sterling Ranch
	<b>Long Term:</b> Improve Vollmer Road from Lochwinnoch Lane to Sterling Ranch boundary (northeast of Glider Loop) to a standard 4-Lane Urban Minor Arterial Cross Section <sup>(2)</sup>	Long-Term Future	20,000		By others - pursuant to the recent development agreement between Sterling Ranch and EPC.
V4	Improve Vollmer Road from Sterling Ranch boundary (northeast of Glider Loop) to Briargate Parkway to a standard 4-Lane Urban Minor Arterial Cross Section <sup>(2)</sup> Update November 2023 - with transition section to the existing two-lane section to the south as shown on the Vollmer North CDs. Improvements consist of curb and gutter on west side (as most of the east side is already built) and repaving.	Sections V4, V5, V6 to be constructed by <b>May 2024</b>	20,000	16,445	Sterling Ranch
V5	Improve Vollmer Road from Briargate Parkway to Jane Kirkham Drive to a standard 4-Lane Urban Minor Arterial Cross Section <sup>(2)</sup>	Sections V4, V5, v6 to be constructed by <b>May 2024</b>	20,000	11,690	Sterling Ranch
V6	Improve Vollmer Road from Jane Kirkham Drive to Sam Bass Drive to a standard 4-Lane Urban Minor Arterial Cross Section <sup>(2)</sup>	Sections V4, V5, v6 to be constructed by <b>May 2024</b>	20,000	11,425	Sterling Ranch
V7	Improve Vollmer Road between Sam Bass Drive and Poco Road to a 4-lane Urban Minor Arterial but with necessary lane transitions, redirect tapers, etc. south of Poco to adequately transition between the 4-Lane Urban Minor Arterial Cross Section and the 2-Lane Rural Arterial Cross Section north of Poco Road.	Sections V4, V5, v6 to be constructed by <b>May 2024</b>	20,000	10,090	Sterling Ranch
V8	Improve Vollmer Road from Poco Road to Shoup Road to a Rural 2-Lane Arterial Cross Section <sup>(2)</sup>	Long-Term Future	10,000	11,790	El Paso County Project ID U-12

Part 1/2 of this table (see Part 2 on next page)

Notes:

(1) See Figure 14

(2) Adequate transition/redirect tapers would be needed between the various cross sections on Vollmer Road. Based on the criteria contained in Table 2-29 of the *El Paso Engineering Criteria Manual* an appropriate taper ratio for a roadway with a design speed of 40 mile per hour is 20:1

(3) Source: Table 20 Road Impact Fee Study Updated November 16, 2016

Source: LSC Transportation Consultants, Inc. (December, 2023)

**Table 6**

**Roadway Segment Improvements**

**Sterling Ranch East Filing 5 Preliminary Plan**

(Page 2 of 2)

Segment ID <sup>(1)</sup> (See Figure 14 for map)	Improvement Description	Timing	Design ADT (vpd)	Projected 2042 ADT (vpd)	Responsibility
SR1	Construct Sterling Ranch Road as an Urban Non-Residential Collector from Marksheffel Road to Dines Boulevard	<u>Completed</u>	20,000	14,840	Sterling Ranch
SR2	Construct Sterling Ranch Road as an Urban Non-Residential Collector from Dines Boulevard to Briargate Parkway	<b>Short-Term - with SRE Preliminary Plan 1</b>	20,000	10,275	Sterling Ranch
SR3	Construct Sterling Ranch Road as an Urban Collector from Briargate Parkway to Vancouver Street.	<b>Short-Term - with SRE Preliminary Plan 1</b>	10,000	9,300	Sterling Ranch
SR4	Construct Sterling Ranch Road from Vancouver Street north to Arroya (or ultimate north terminus)	Long-Term Future	10,000	4,260	Sterling Ranch
M1	Construct Marksheffel Road as an Urban Principal Arterial to City of Colorado Springs standards in 107' of right-of-way between Vollmer Road and Sterling Ranch Road	<u>Completed</u>	40,000	23,370	Sterling Ranch
M2	Construct Marksheffel Road as an Urban Principal Arterial to City of Colorado Springs standards in 107' of right-of-way between Sterling Ranch Road and the south boundary of the Sterling Ranch Master Plan Area. <b>NOTE: With the completion of this improvement the connection between Vollmer Road and Woodmen Road will be completed</b>	To be completed in 2024	40,000	29,600	Sterling Ranch
M3	Construct Marksheffel Road between the south boundary of the Sterling Ranch Master Plan Area and Woodmen Road (Note this segment is located within the City of Colorado Springs)	<u>Completed</u> (by Others)	40,000	24,525	Others (Completed)
M4	Construct Marksheffel Road between Black Forest Road and Vollmer Road	Long-Term Future	40,000	27,910	Others
B1	Construct the full section of Briargate Pkwy (4-Lane Principal Arterial) between Vollmer Road and Wheatland Drive	<b>Full section to be completed in 2023</b> with Homestead at Sterling Ranch Filing No. 1	40,000	24,745	Sterling Ranch
B2	Construct Briargate Pkwy ( <b>full section</b> ) as a 4-Lane Principal Arterial between Wheatland Dr and Sterling Ranch Road	<b>Full section to be completed in 2023 or Spring 2024</b>	40,000	26,375	Sterling Ranch
B3	Construct Briargate Pkwy as a 4-Lane Principal Arterial between Sterling Ranch Road and Banning Lewis Parkway	Intermediate Term	40,000	22,365	Sterling Ranch
B4	Construct Stapleton Road as a 4-Lane Principal Arterial between Banning Lewis Parkway and Meridian Road (including upgrade of existing rural two-lane segment between Towner and Meridian)	Long-Term Future	40,000	17,945	Others
B5	Construct Briargate Pkwy as a 4-Lane Principal Arterial between its current terminus and Black Forest Road and between Black Forest Road and Vollmer Road	Long-Term Future	40,000	24,340	Others
BL1	Construct Banning Lewis Parkway as a 4-Lane Principal Arterial between the south Sterling Ranch boundary and Briargate Pkwy	Long-Term Future	40,000	20,320	Future- TBD with the future preliminary plan for that area-potentially, financial assurances for half-section, west-side half-section or full-section w/ cost recover may be required
BL2	Construct Banning Lewis Parkway as a 4-Lane Principal Arterial between Woodmen Road and the south Sterling Ranch boundary (Note this segment will be located within the City of Colorado Springs)	Long-Term Future	40,000	28,480	Others
W1	Widen Woodmen Road from 4-lane to 6-lane section from Powers Boulevard to US 24	Long-Term Future	72,000	66,690	Others

**Part 2/2 of this table**

**Notes:**

(1) See Figure 14

(2) Adequate transition/redirect tapers would be needed between the various cross sections on Vollmer Road. Based on the criteria contained in Table 2-29 of the *El Paso Engineering Criteria Manual* an appropriate taper ratio for a roadway with a design speed of 40 mile per hour is 20:1

(3) Source: Table 20 *Road Impact Fee Study Updated* November 16, 2016

Source: LSC Transportation Consultants, Inc. (December, 2023)

# Figures 1-14

---



Not to scale

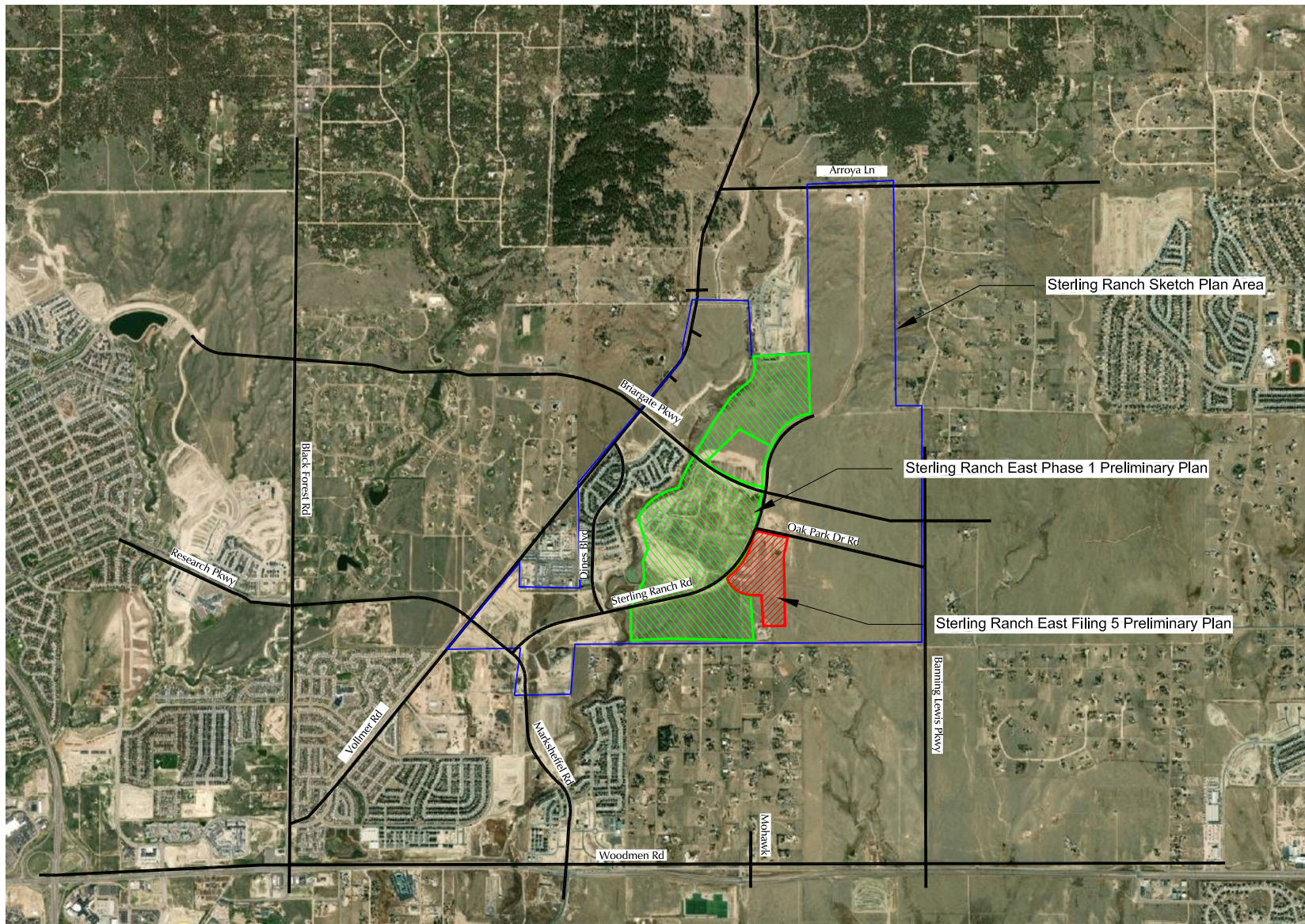
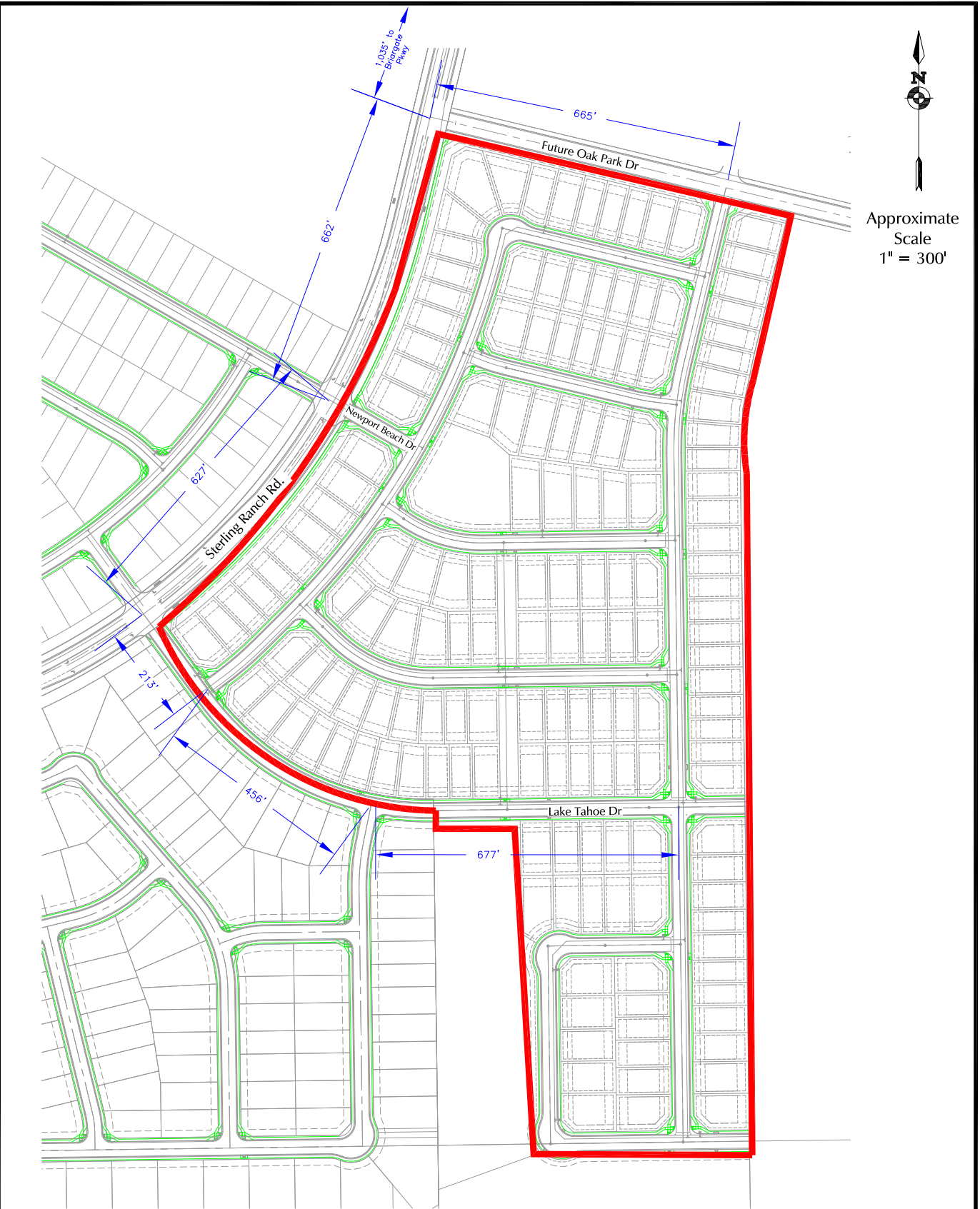


Figure 1

# Vicinity Map

Sterling Ranch East Filing 5 Preliminary Plan (LSC# S234180)





Approximate  
Scale  
1" = 300'

LEGEND:  
— Trail & Sidewalks  
 X,XXX' - Centerline Spacing of Intersections

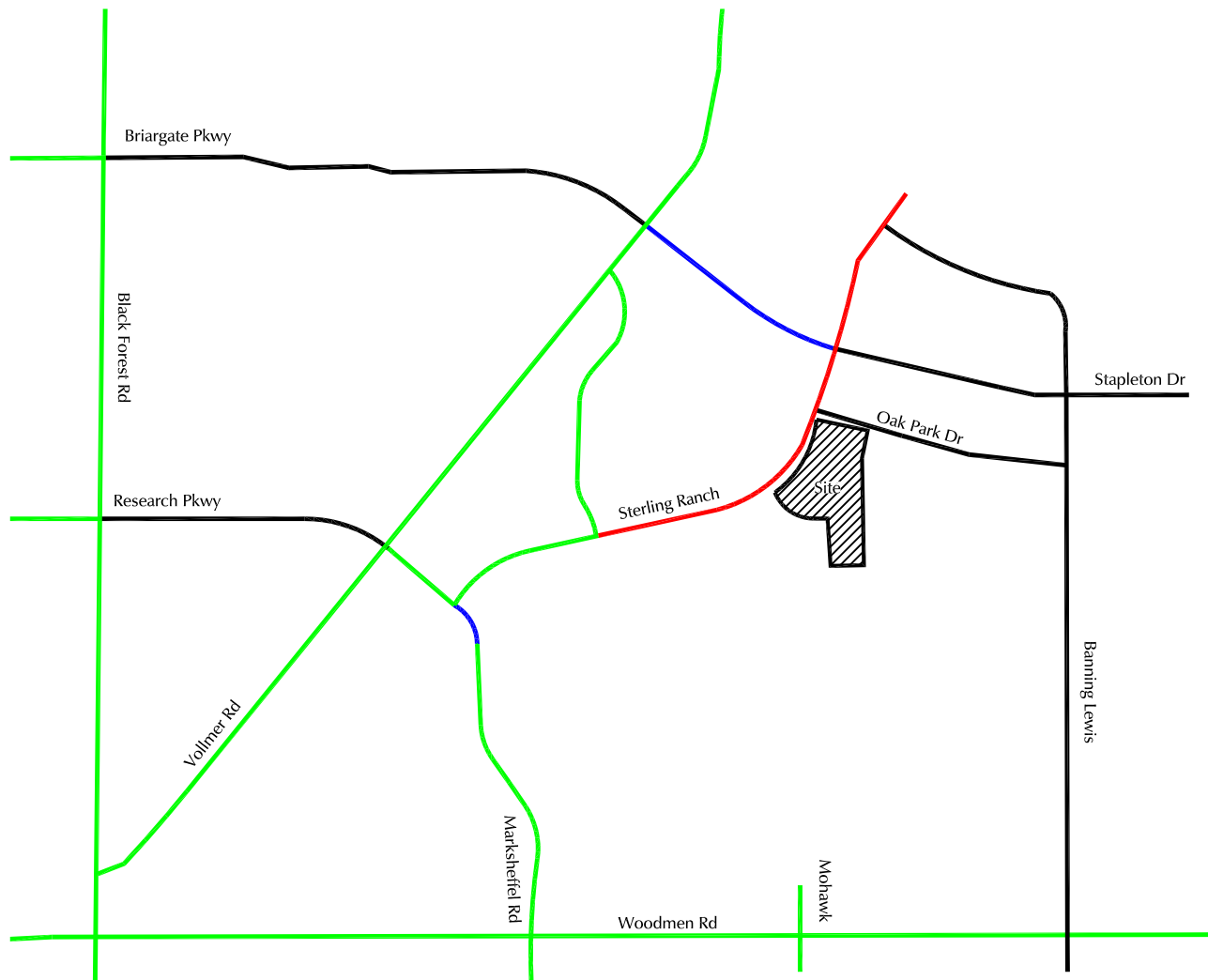


Figure 2  
**Site Plan**

Sterling Ranch East Filing 5 Preliminary Plan (LSC# S234180)



Not to scale



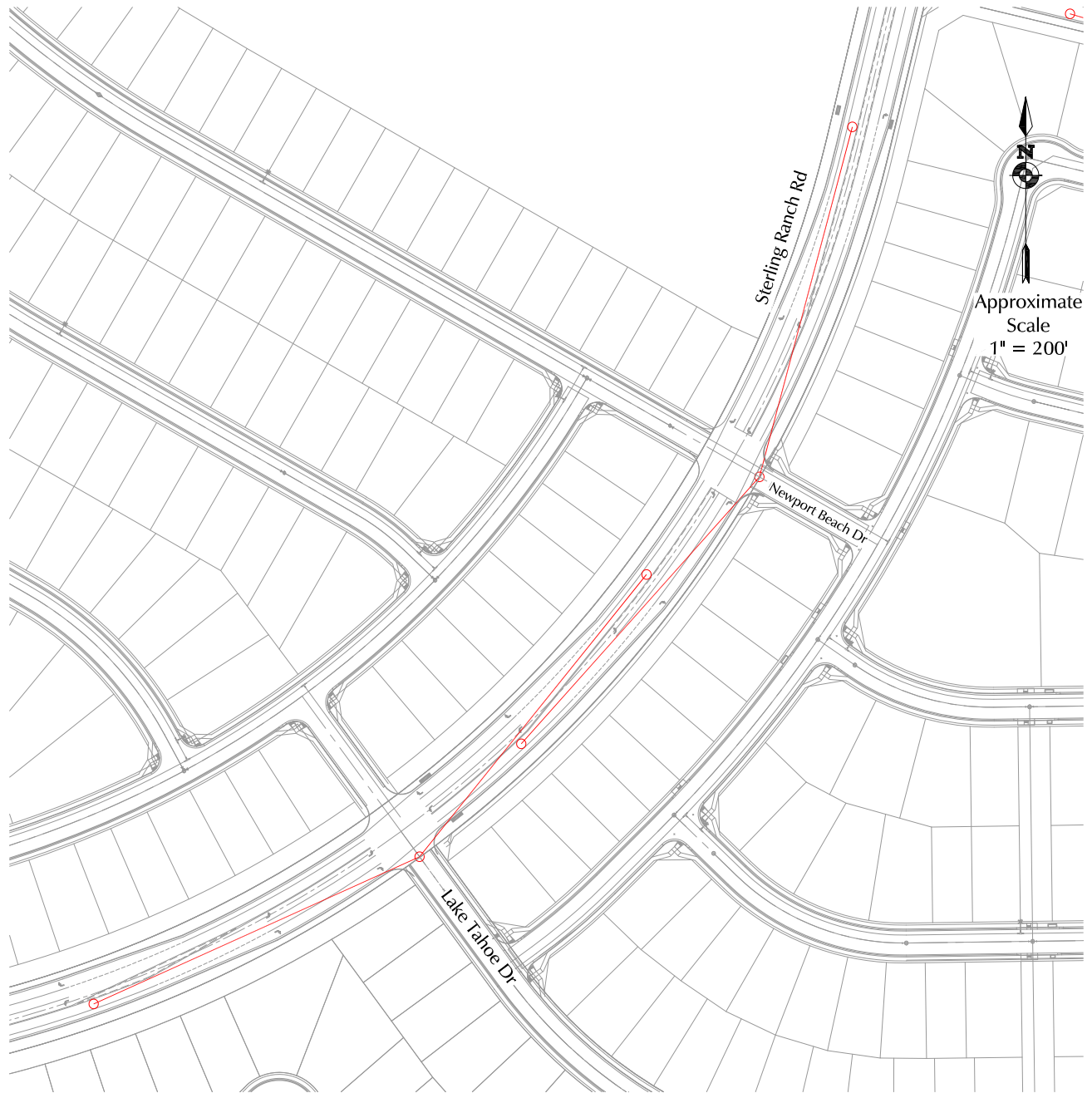
- Roadway connection planned with Sterling Ranch East Preliminary Plan 1
- Roadway connection planned to be completed by 2024
- Existing Roadway
- Future Roadway



# Short-Term Roadway Connections

Sterling Ranch East Filing 5 Preliminary Plan (LSC# S234180)

Figure 3



Approximate  
Scale  
1" = 200'

Legend:  
 — ECM Required Intersection Sight Distance (445' from Table 2-21 based on a Design Speed of 40 mph)

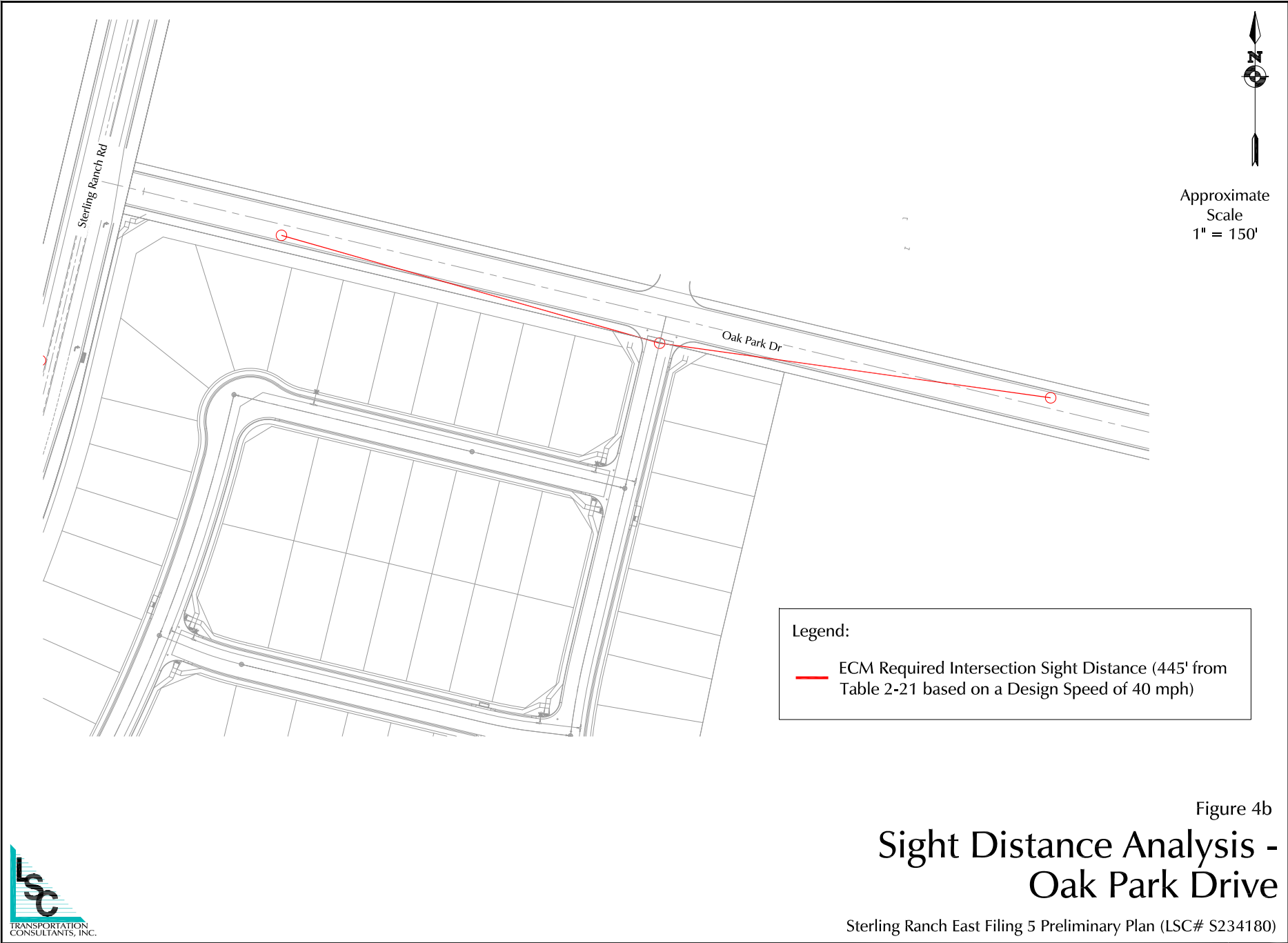
Figure 4a

# Sight Distance Analysis - Sterling Ranch Road

Sterling Ranch East Filing 5 Preliminary Plan (LSC# S234180)





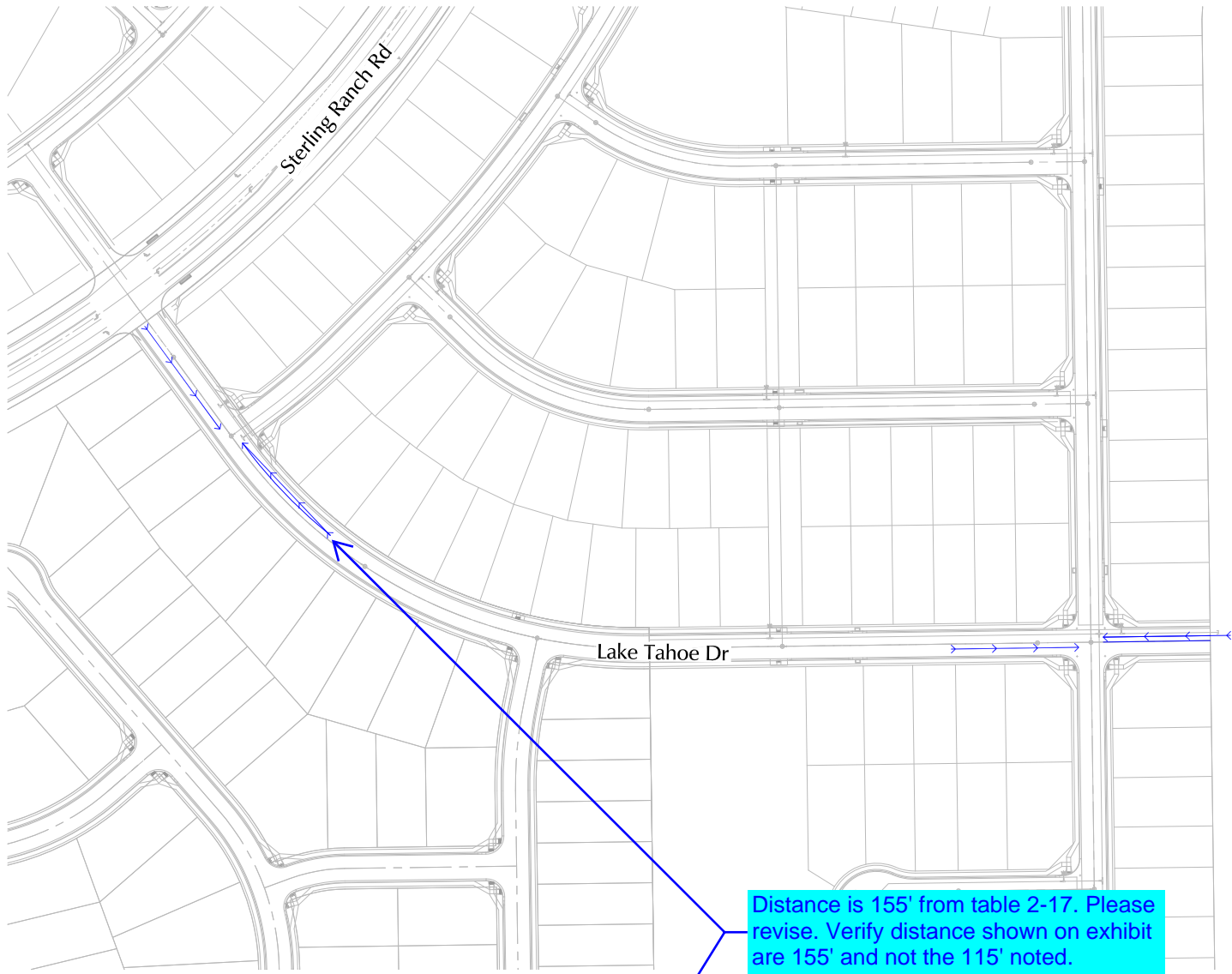


Approximate  
Scale  
1" = 150'

Legend:  
 — ECM Required Intersection Sight Distance (445' from Table 2-21 based on a Design Speed of 40 mph)

Figure 4b  
**Sight Distance Analysis -  
 Oak Park Drive**

Sterling Ranch East Filing 5 Preliminary Plan (LSC# S234180)



Approximate  
Scale  
1" = 200'

Distance is 155' from table 2-17. Please  
revise. Verify distance shown on exhibit  
are 155' and not the 115' noted.

Legend:  
 ECM Required Stopping Sight Distance (115' from  
Table 2-17 based on a Design Speed of 25 mph)

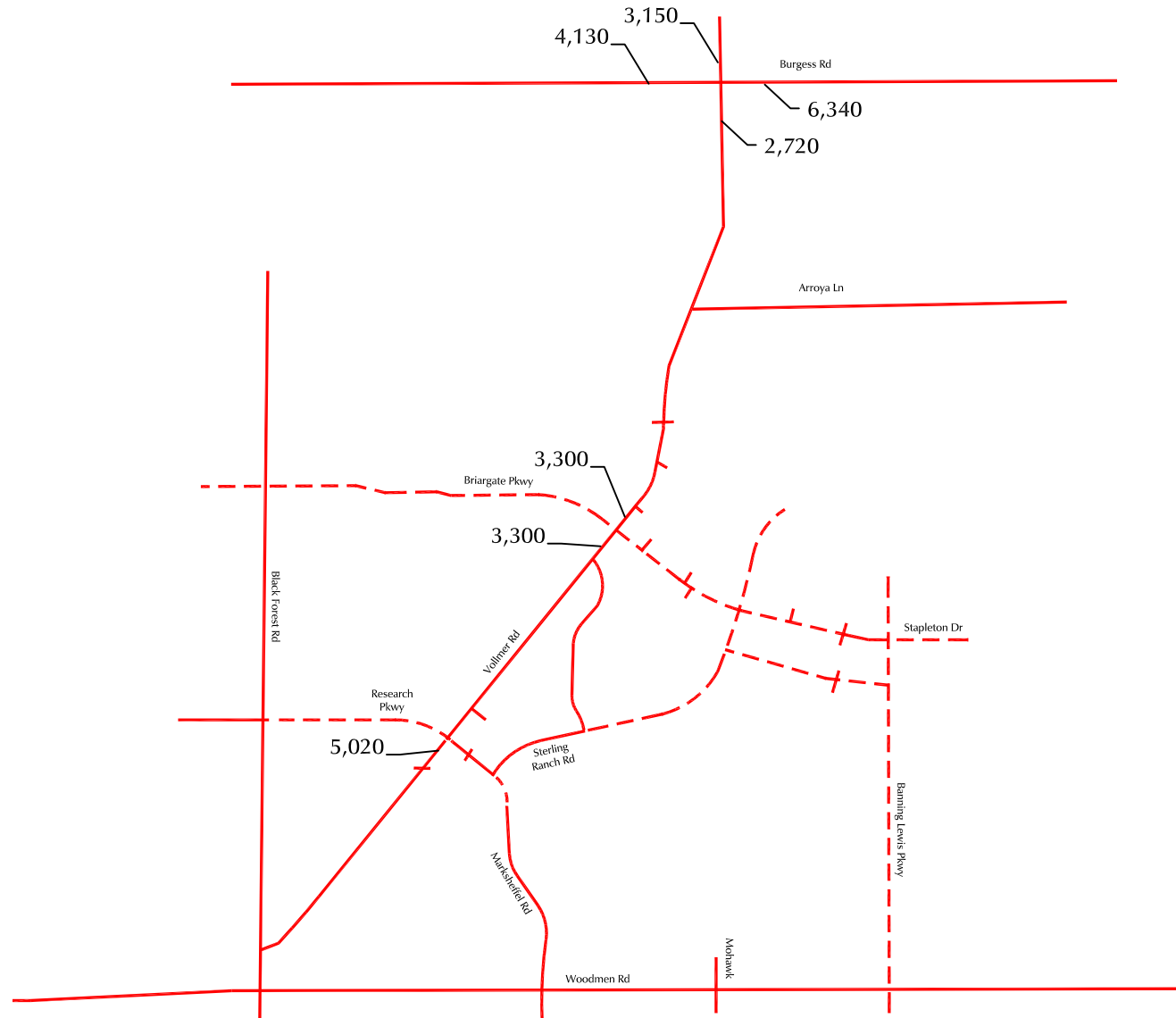
# Sight Distance Analysis - Lake Tahoe Dr

Figure 4c





Not to scale



LEGEND:

XXX = Average Weekday Traffic (vehicles per day)(AWT) Estimates by LSC

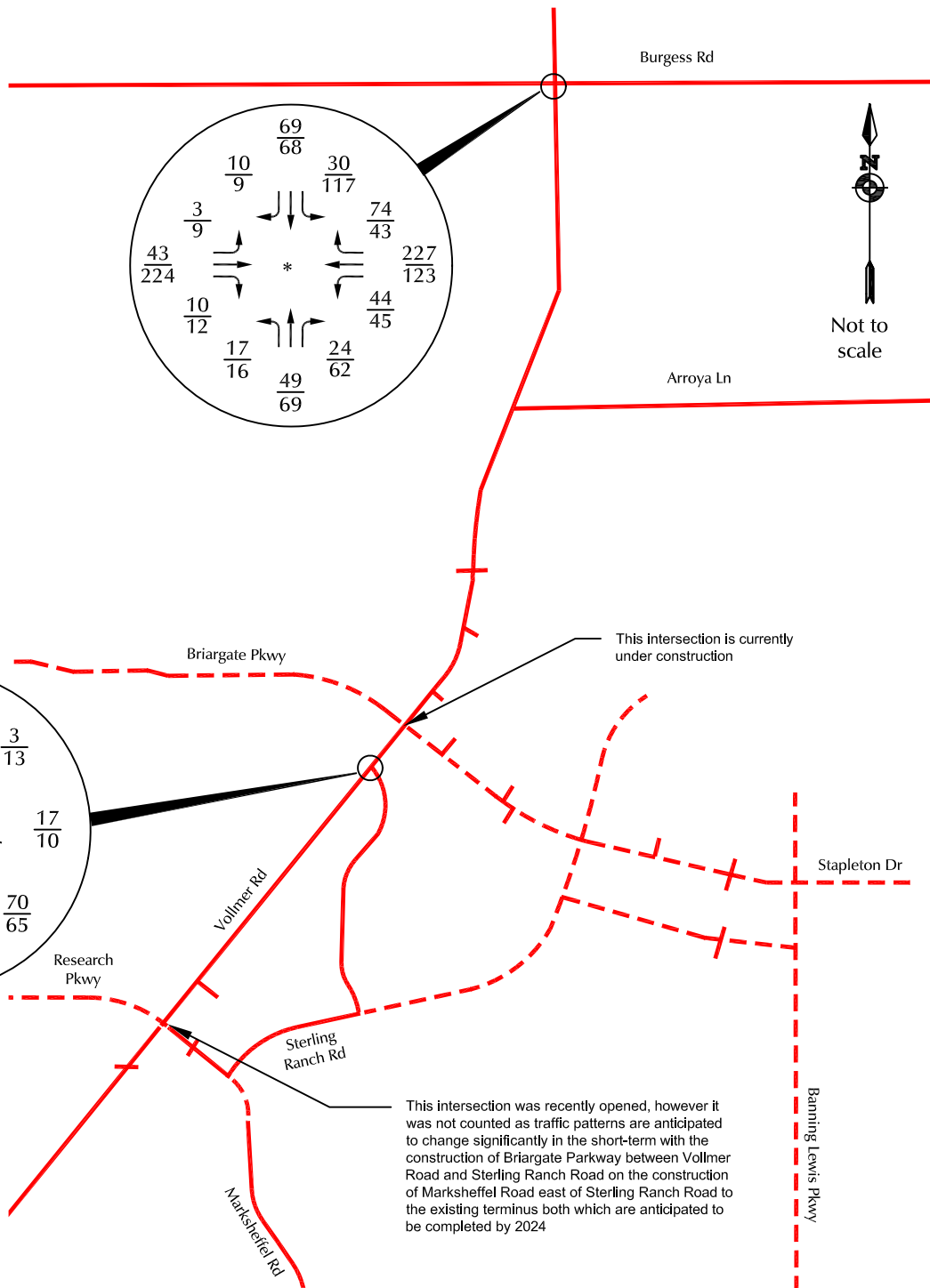
- Existing Roadway
- Future Roadway

# Existing Average Weekday Traffic

Figure 5a

Sterling Ranch East Filing 5 Preliminary Plan (LSC# S234180)





This intersection is currently under construction

This intersection was recently opened, however it was not counted as traffic patterns are anticipated to change significantly in the short-term with the construction of Briargate Parkway between Vollmer Road and Sterling Ranch Road on the construction of Marksheffel Road east of Sterling Ranch Road to the existing terminus both which are anticipated to be completed by 2024

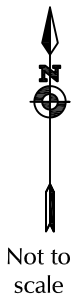
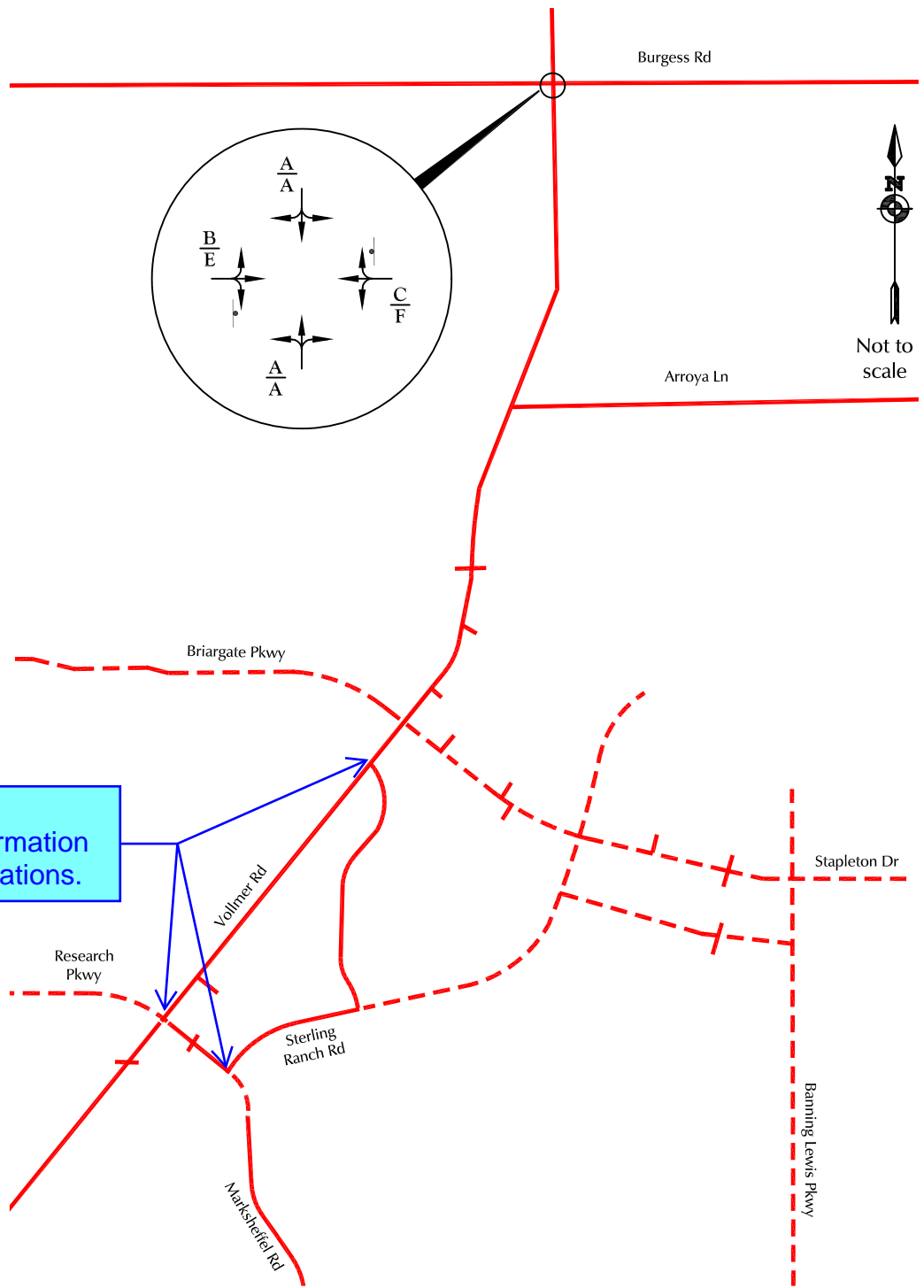
LEGEND:  $\frac{XX}{XX}$  = AM Peak-Hour Traffic (veh/hr)  
 $\frac{XX}{XX}$  = PM Peak-Hour Traffic (veh/hr)

— Existing Roadway  
 - - - Future Roadway

\* Based on counts by LSC Transportation Consultants in July 2022  
 \*\* Based on counts by All Traffic Data Services, March 2022. The traffic count was conducted prior to the construction of Marksheffel between Vollmer Rd and Sterling Ranch Rd



# Figure 5b Existing Traffic



Unresolved:  
Provide information  
for these locations.

LEGEND:

$$\frac{A}{B} = \frac{\text{AM Individual Movement Peak-Hour Level of Service}}{\text{PM Individual Movement Peak-Hour Level of Service}}$$

⊥ = Stop Sign

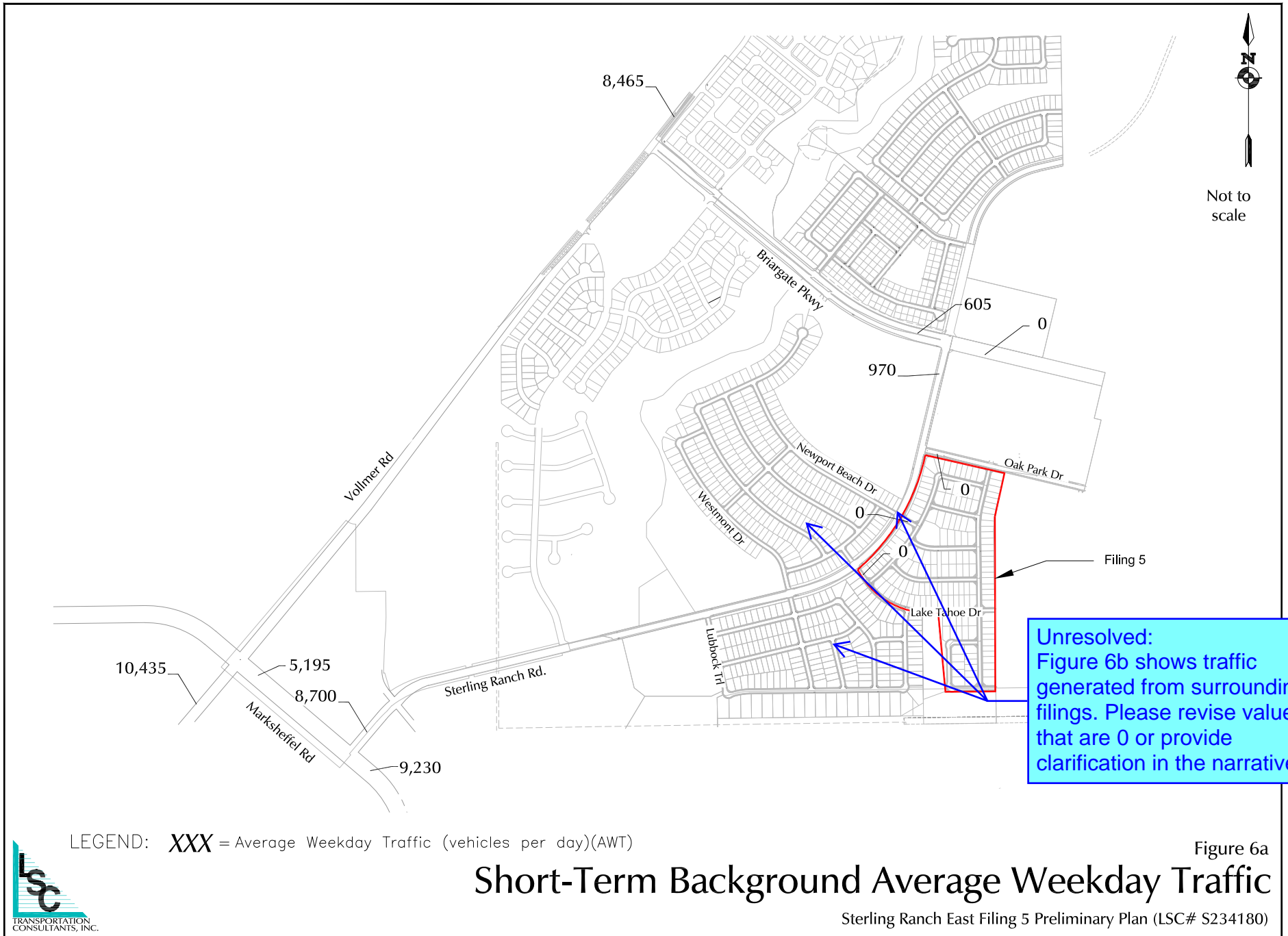
- Existing Roadway
- - - - Future Roadway

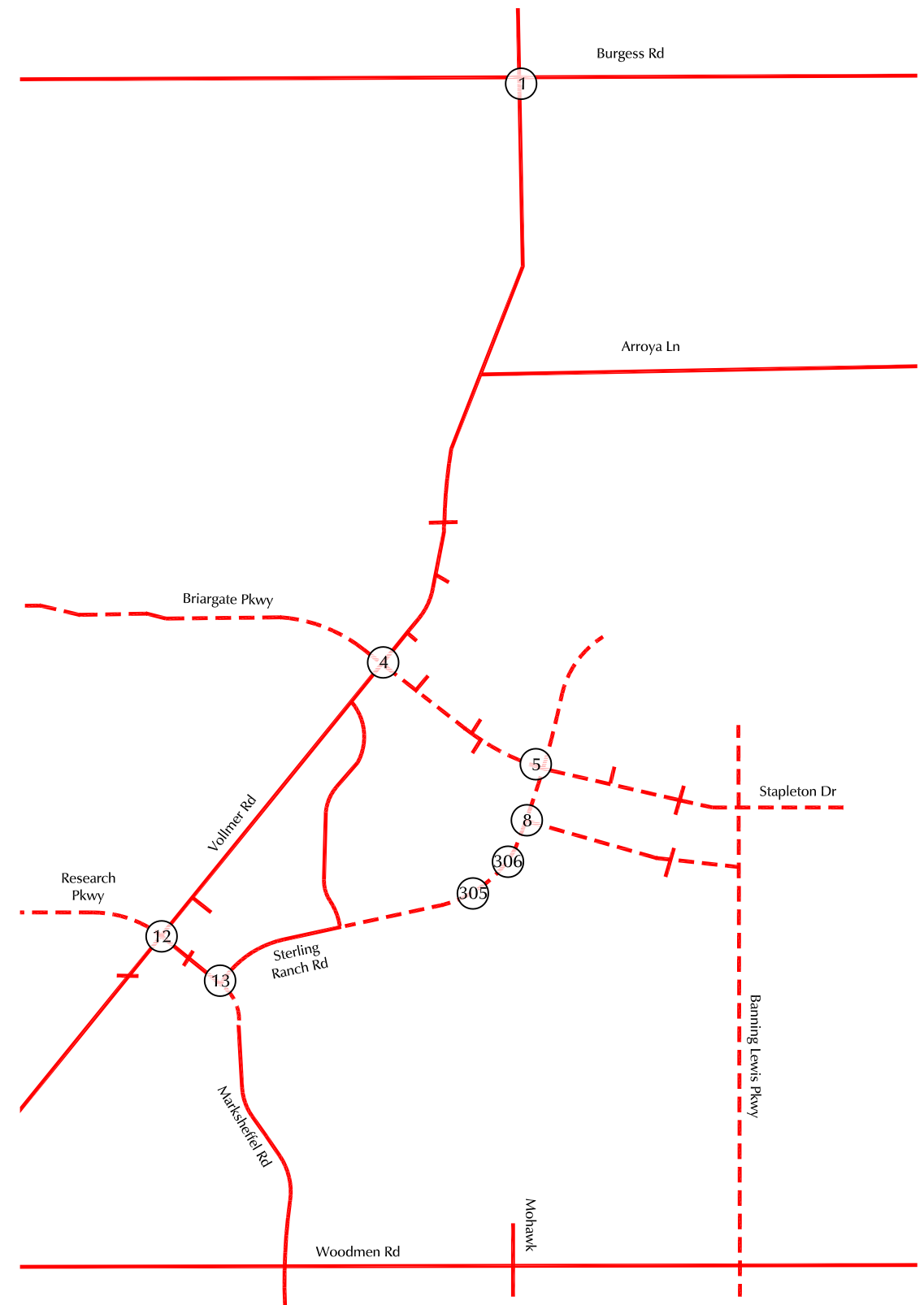
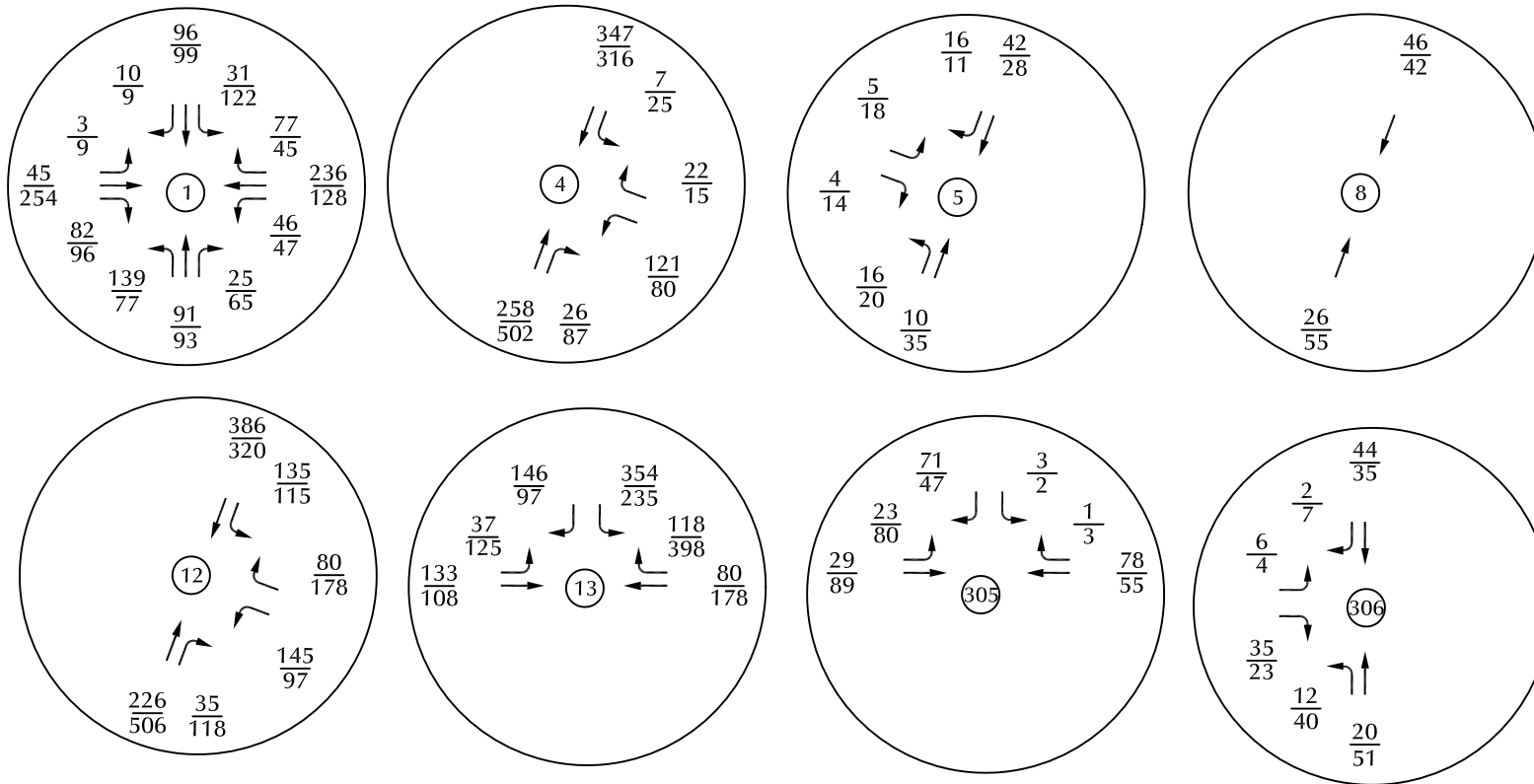


## Figure 5c

# Existing Lane Geometry, Traffic Control, and Level of Service

Sterling Ranch East Filing 5 Preliminary Plan (LSC# S234180)





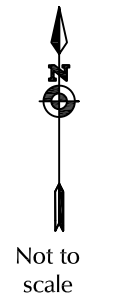
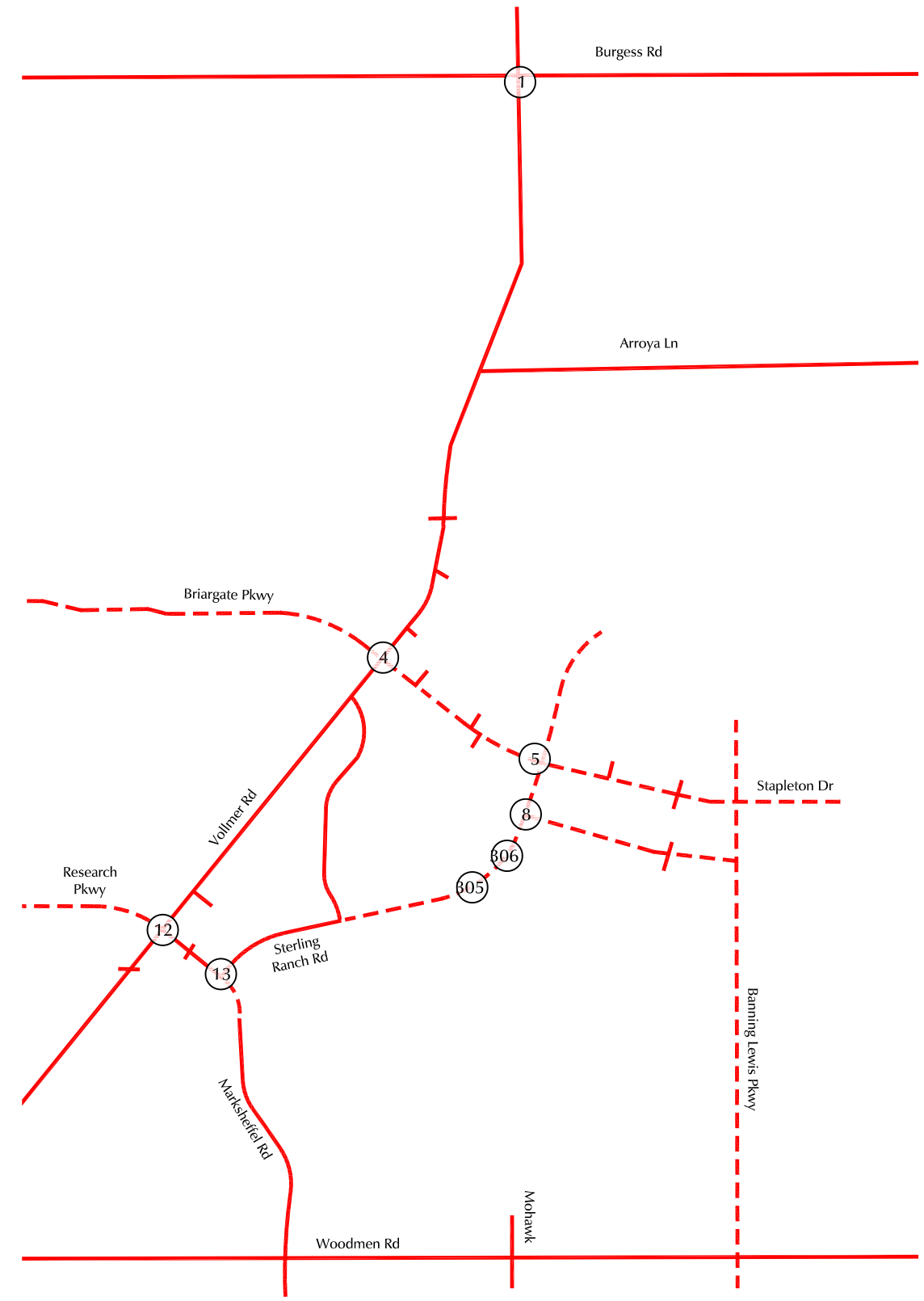
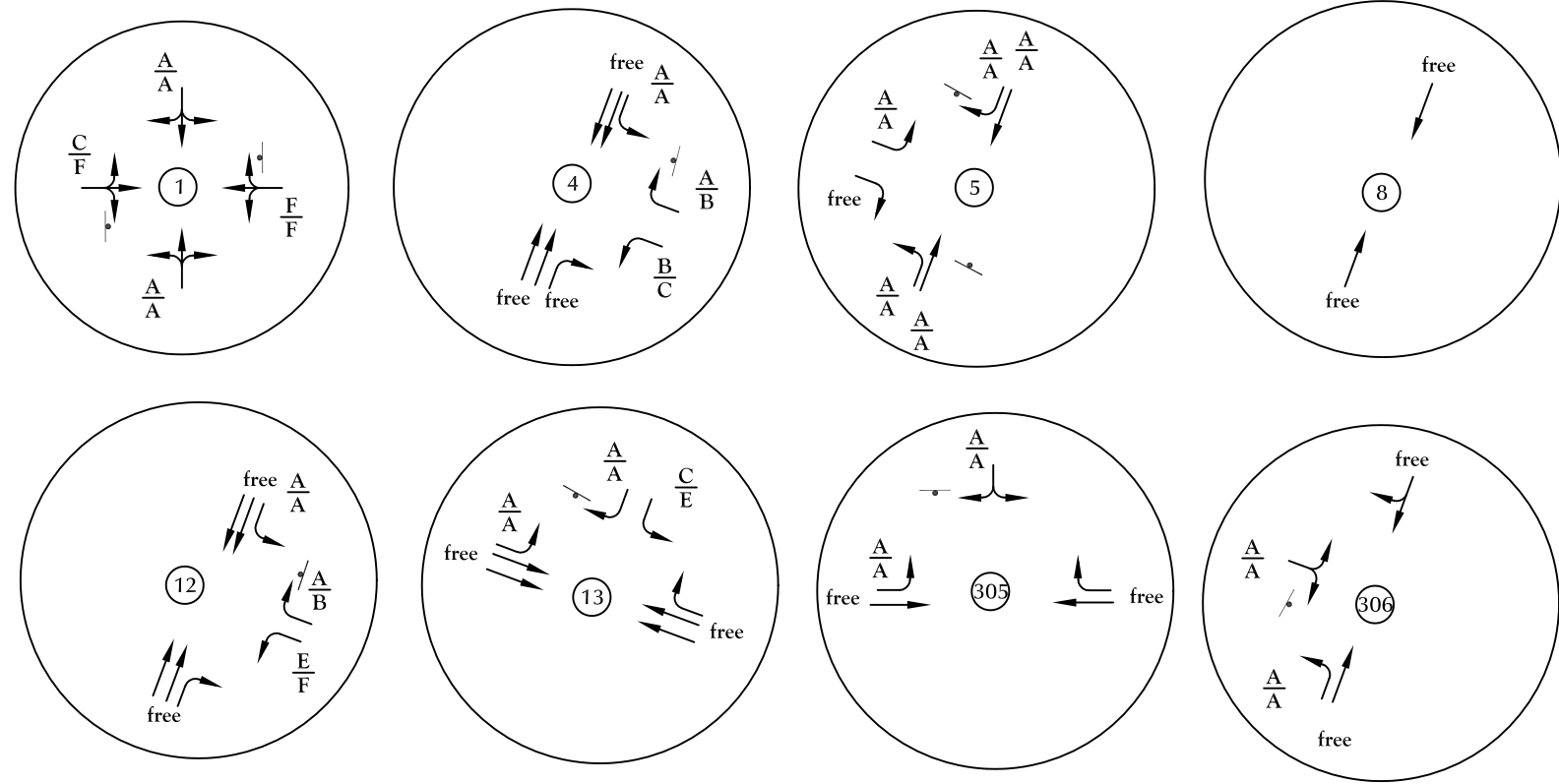
LEGEND:  $\frac{XX}{XX} = \frac{\text{AM Peak-Hour Traffic (veh/hr)}}{\text{PM Peak-Hour Traffic (veh/hr)}}$

— Existing Roadway  
 - - - Future Roadway




Figure 6b  
 Short-Term Background Traffic

Sterling Ranch East Filing 5 Preliminary Plan (LSC# S234180)



LEGEND:

$\frac{A}{B}$  = AM Individual Movement Peak-Hour Level of Service  
 PM Individual Movement Peak-Hour Level of Service  
 $\frac{C}{D}$  = AM Entire Intersection Peak-Hour Level of Service  
 PM Entire Intersection Peak-Hour Level of Service

T = Stop Sign  
 = Traffic Signal



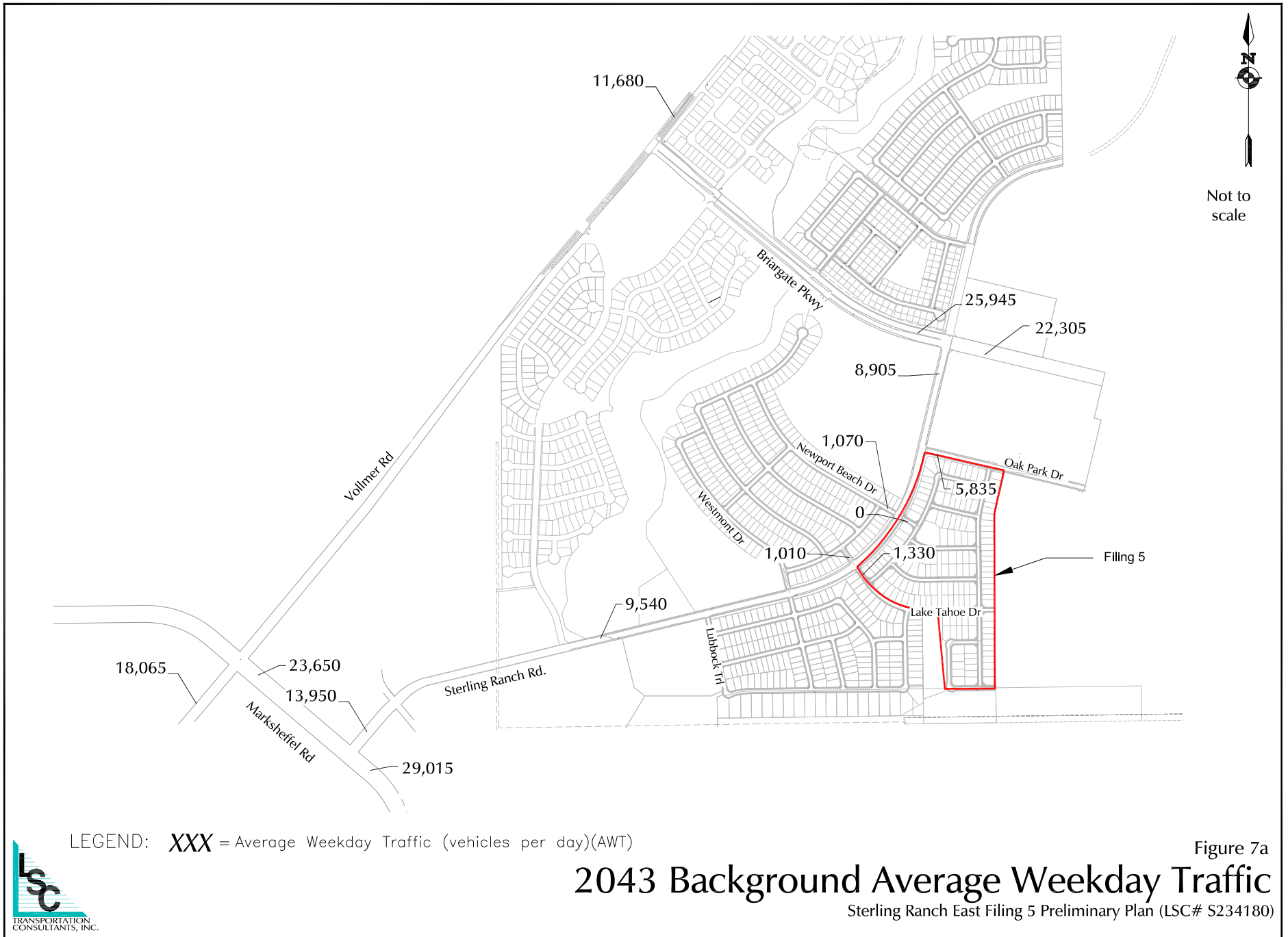
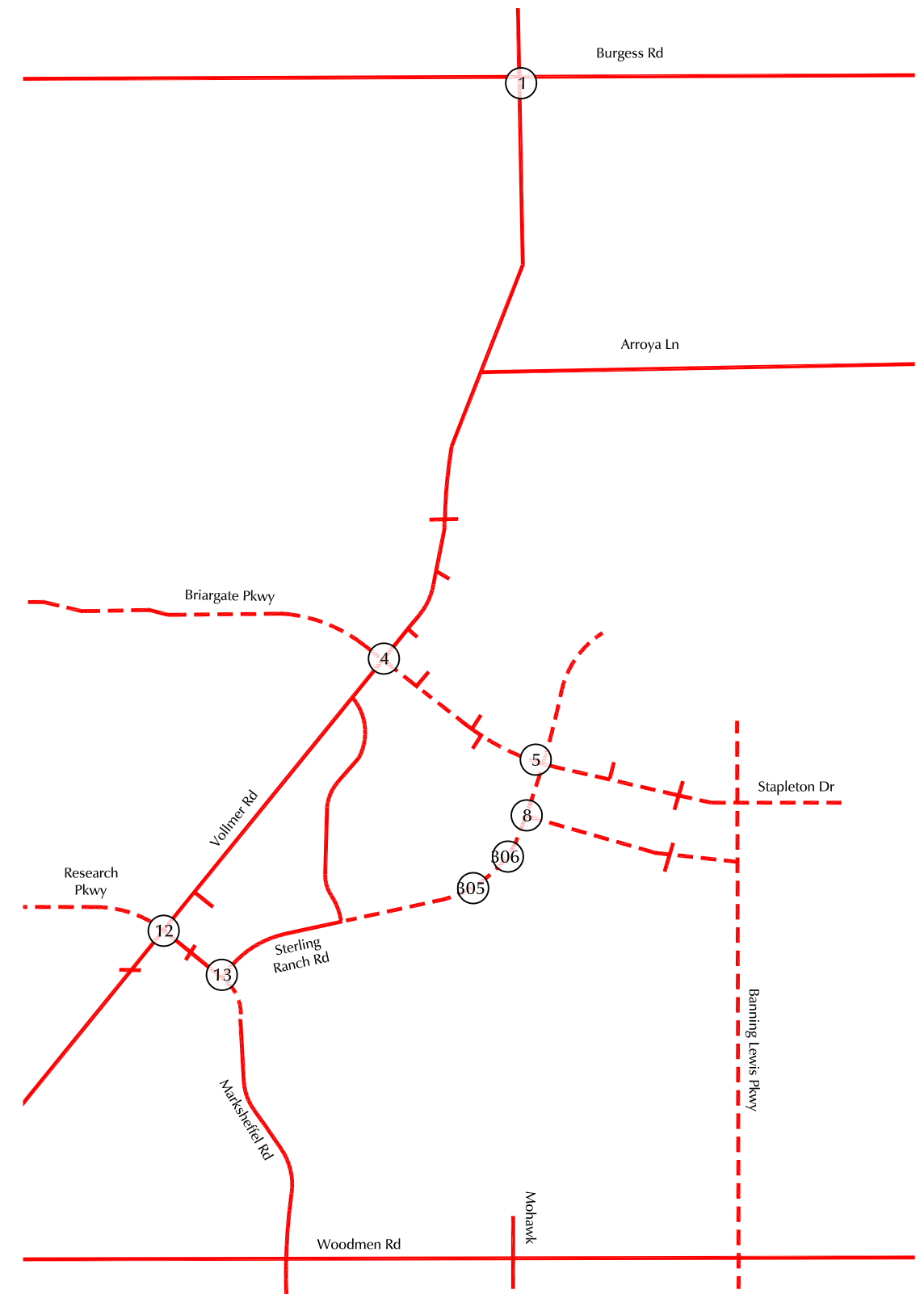
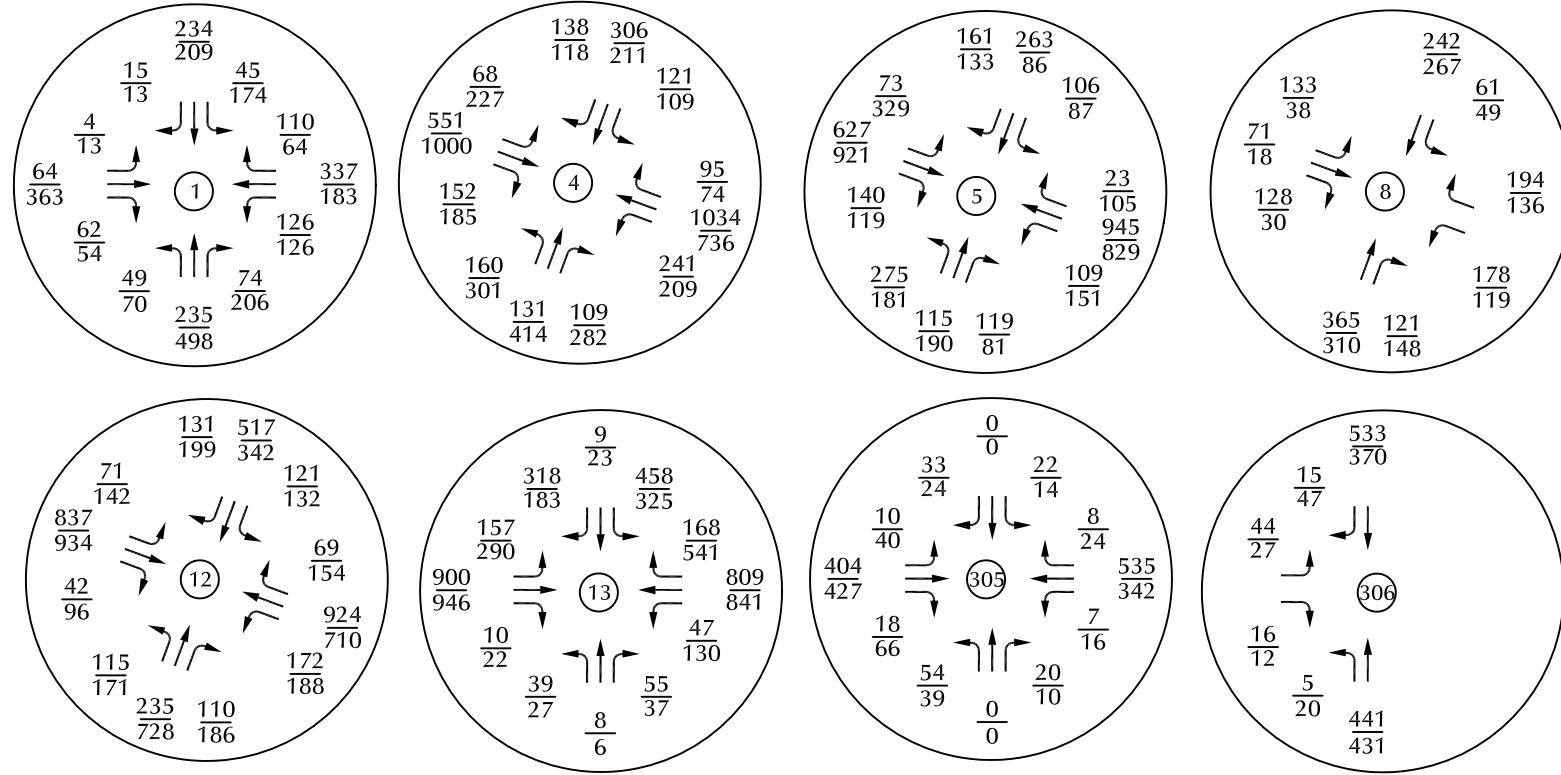
 Existing Roadway  
 Future Roadway

Figure 6c  
 Short-Term Background Lane Geometry,  
 Traffic Control, and Level of Service







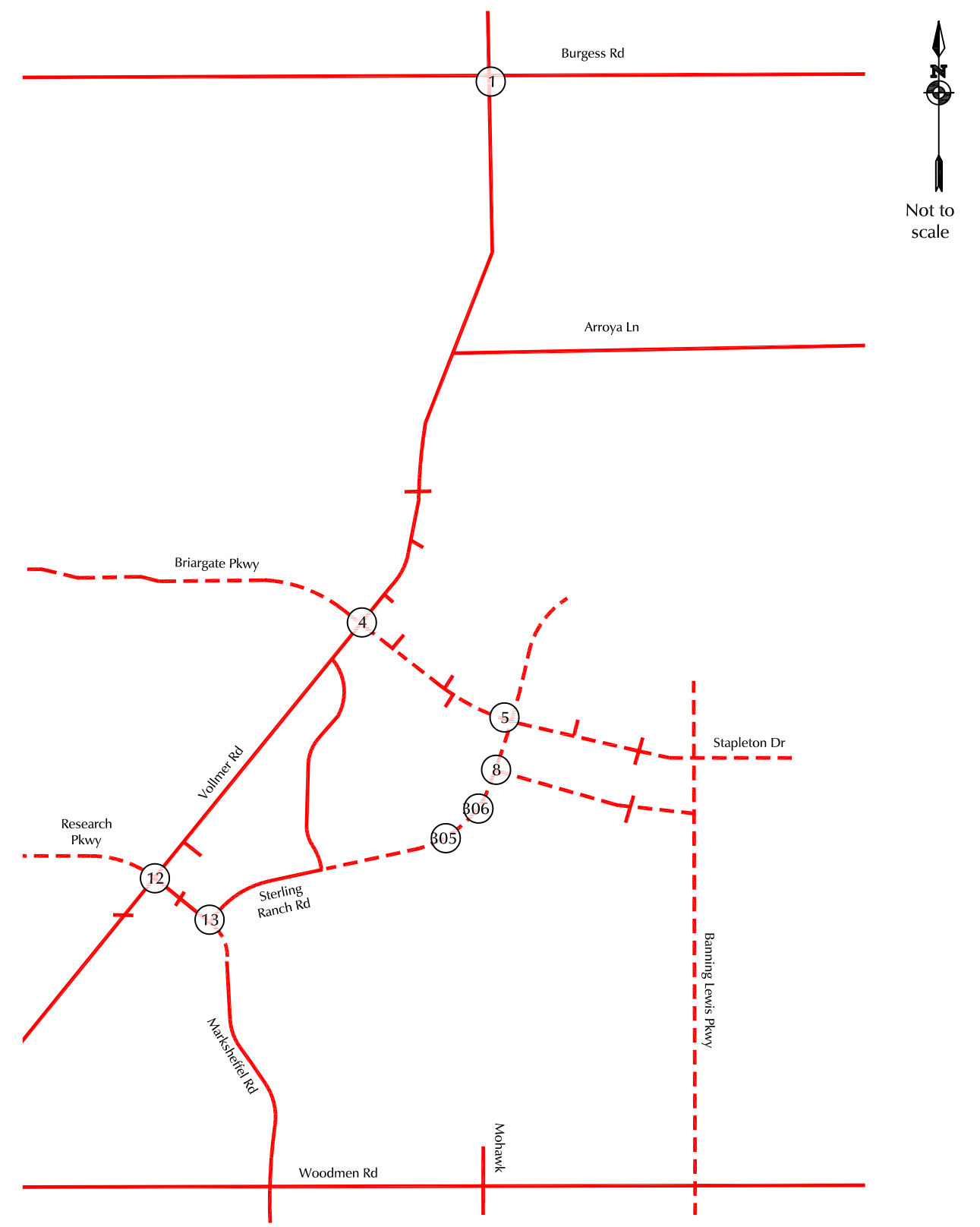
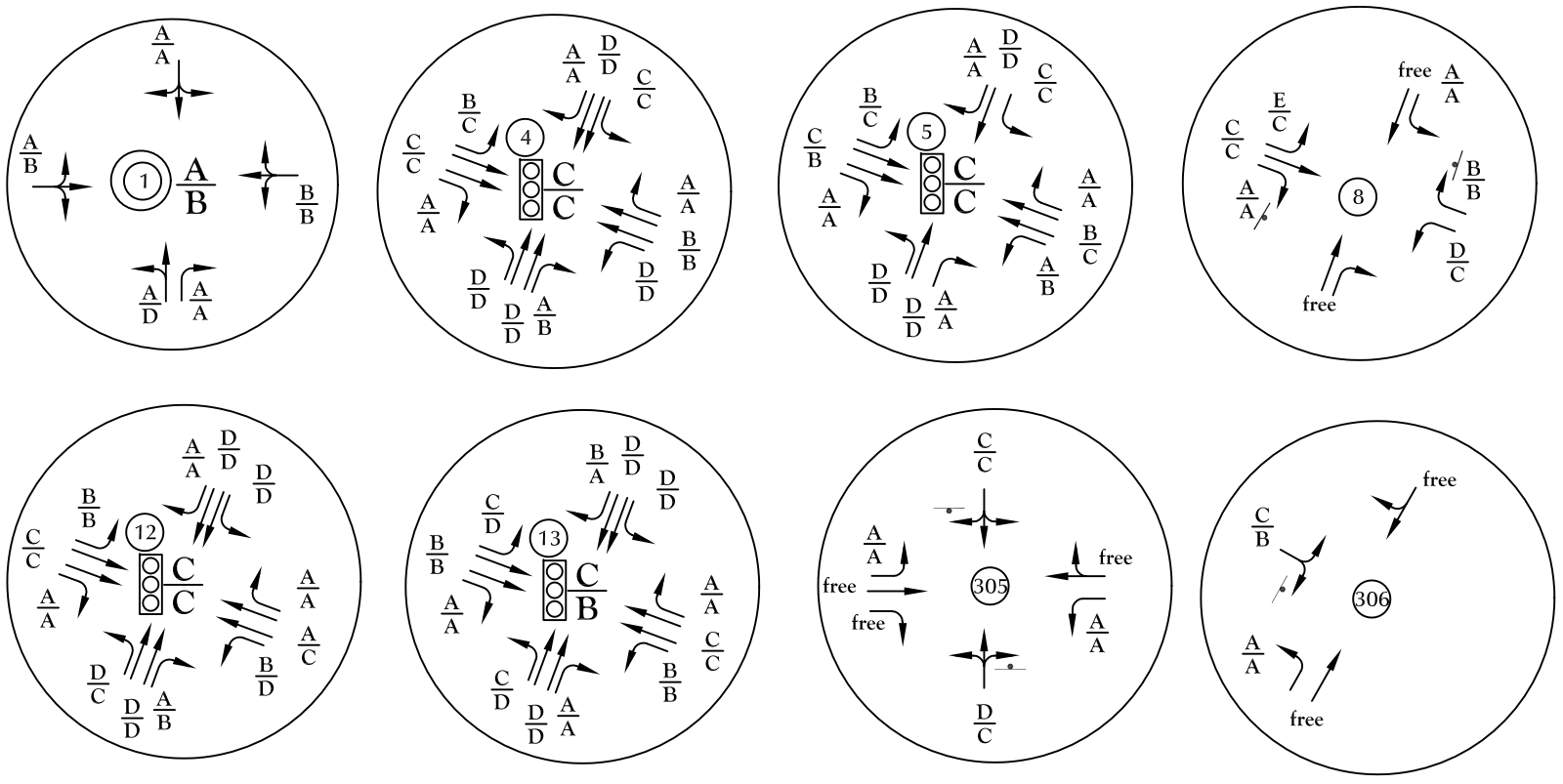


LEGEND:  $\frac{XX}{XX}$  = AM Peak-Hour Traffic (veh/hr)  
 $\frac{XX}{XX}$  = PM Peak-Hour Traffic (veh/hr)

— Existing Roadway  
 - - - Future Roadway




Figure 7b  
**2043 Background Traffic**  
 Sterling Ranch East Filing 5 Preliminary Plan (LSC# S234180)



LEGEND:

$\frac{A}{B}$  = AM Individual Movement Peak-Hour Level of Service  
 PM Individual Movement Peak-Hour Level of Service  
 $\frac{C}{D}$  = AM Entire Intersection Peak-Hour Level of Service  
 PM Entire Intersection Peak-Hour Level of Service

T = Stop Sign  
 = Traffic Signal



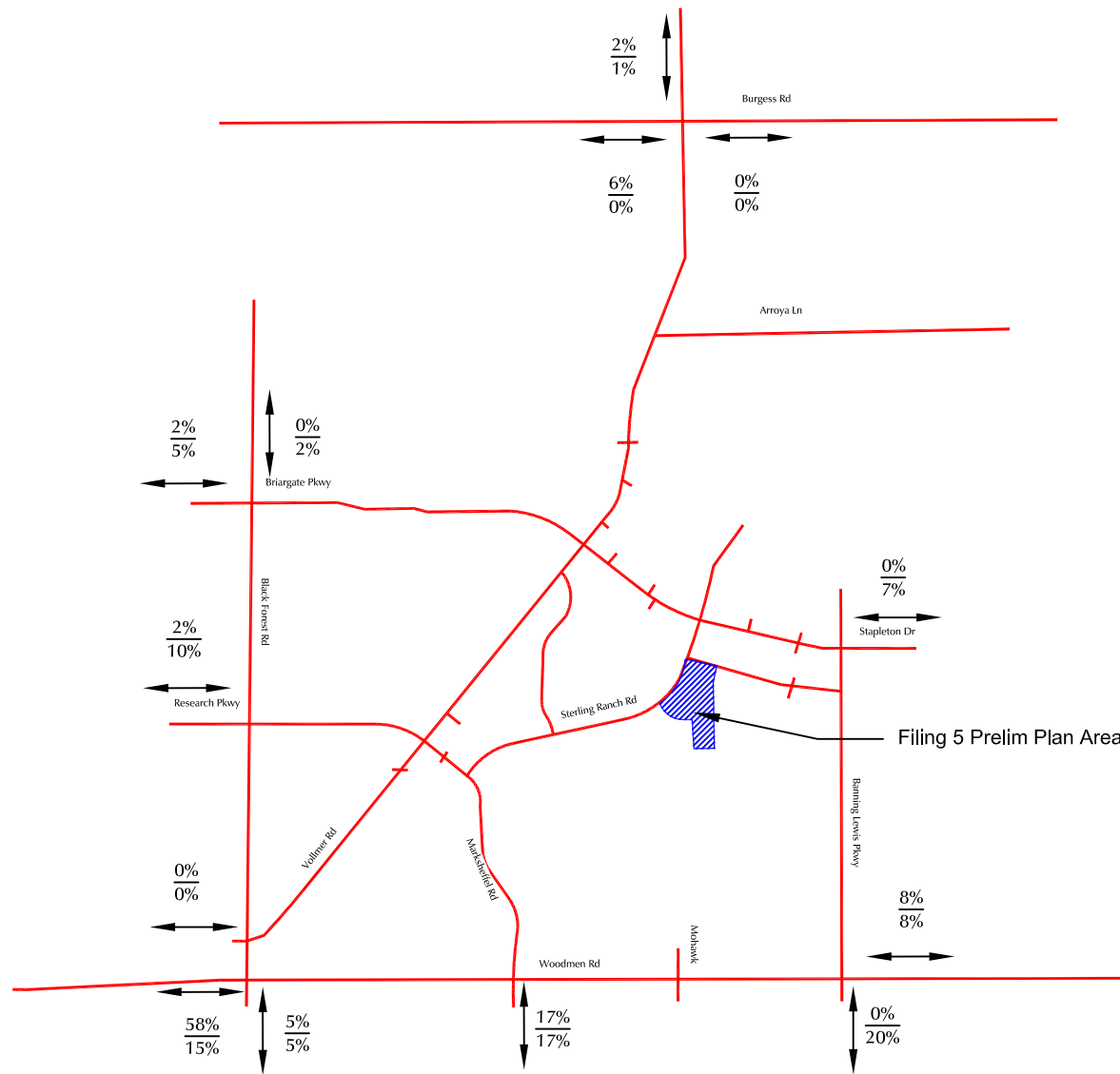
 Existing Roadway  
 Future Roadway

Figure 7c  
 2043 Background Lane Geometry,  
 Traffic Control, and Level of Service



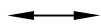


Not to scale



Filing 5 Prelim Plan Area

LEGEND:



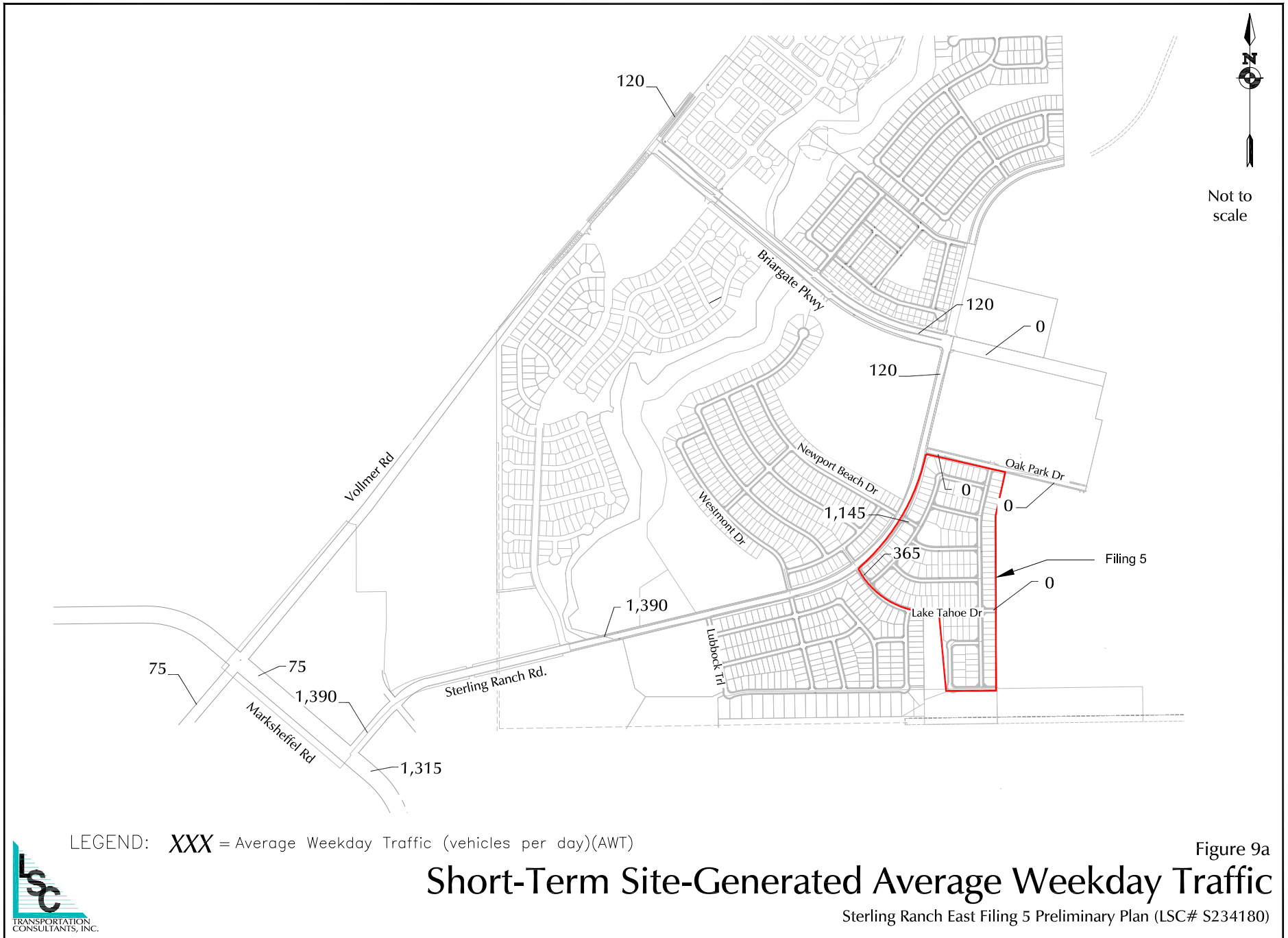
$\frac{XX\%}{XX\%} =$   $\frac{\text{Percent of Short-Term Trips}}{\text{Percent of Buildout Long-Term Trips}}$

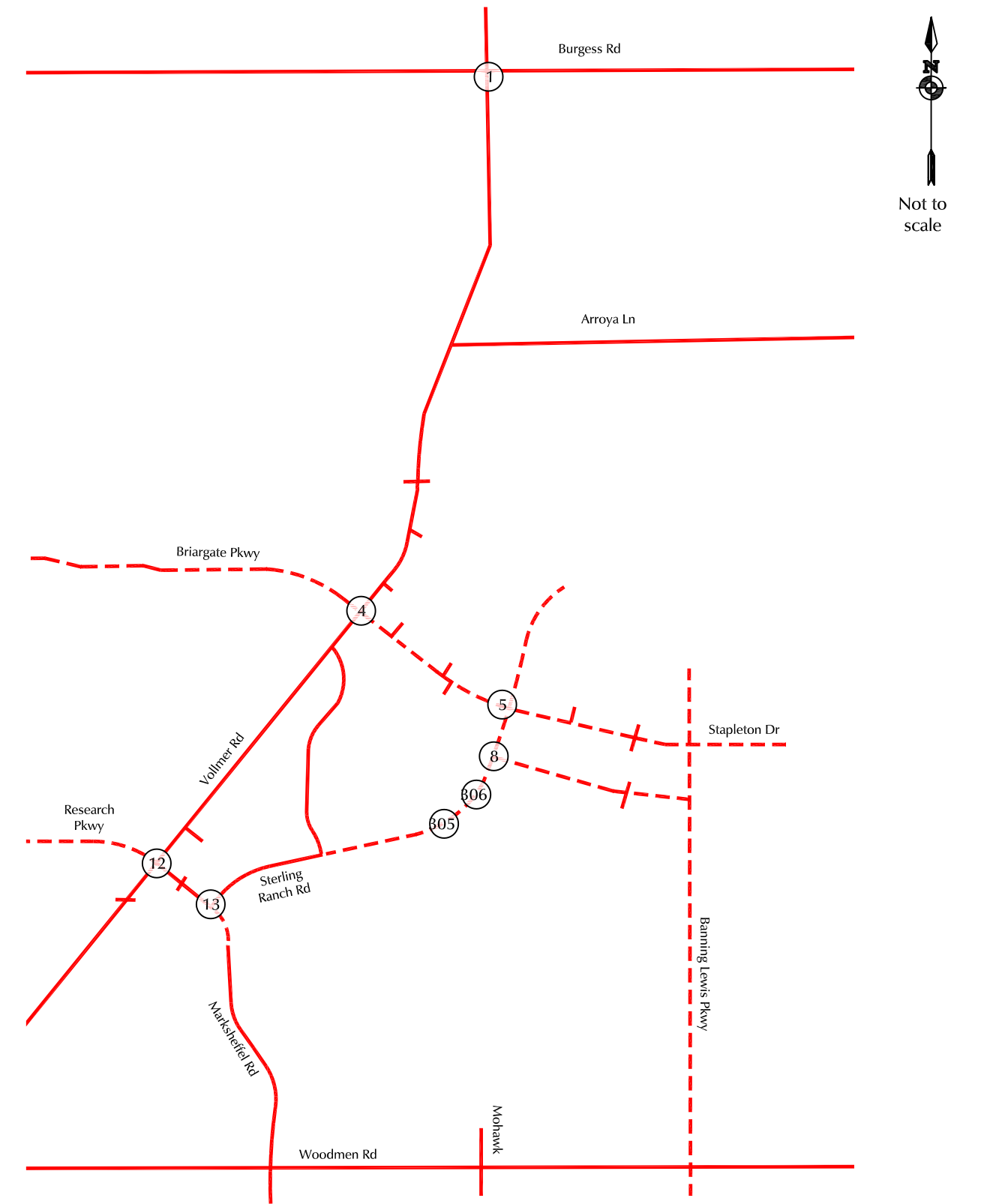
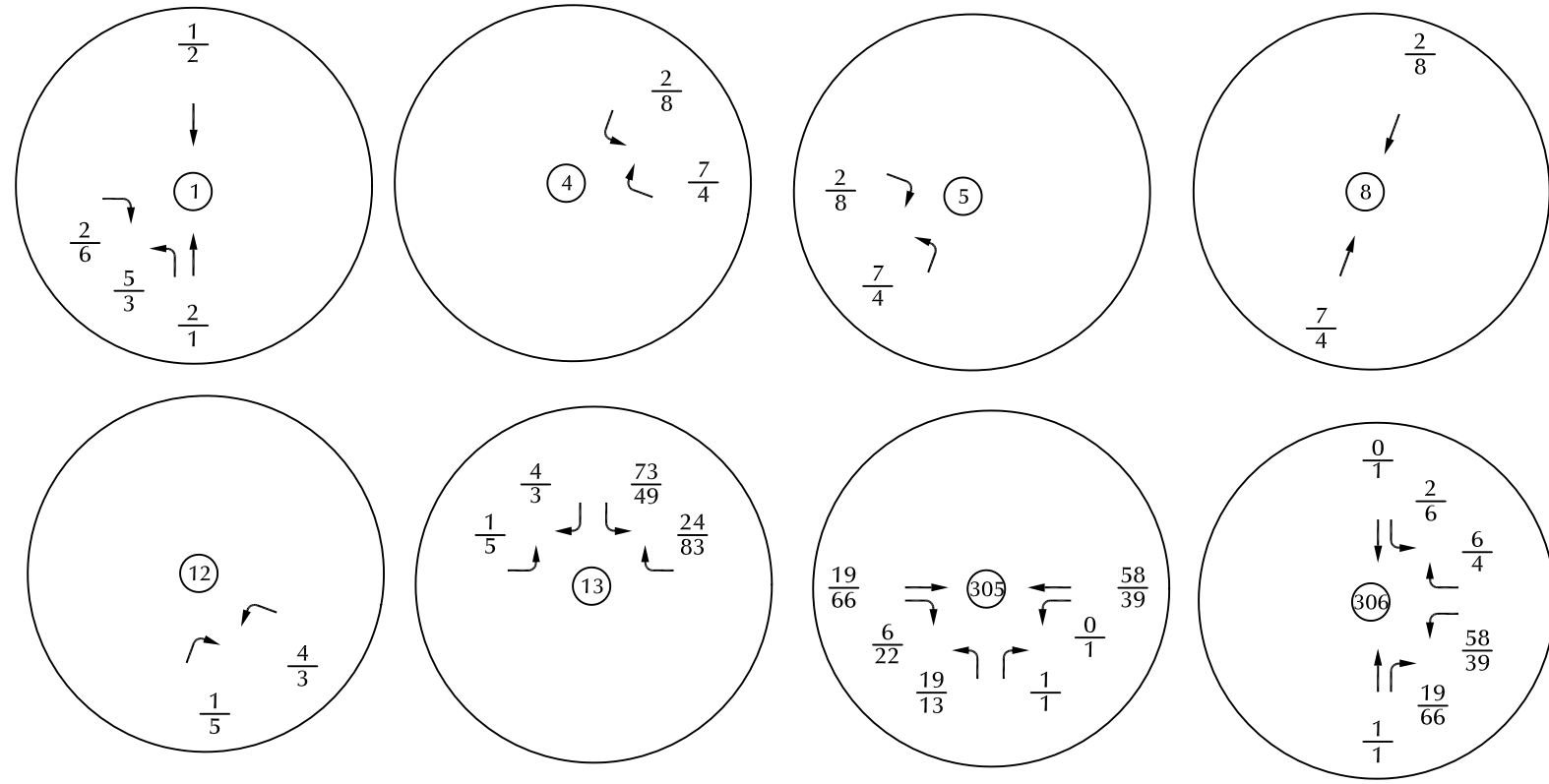
## Estimated Directional Distribution of Site-Generated Traffic

Figure 8

Sterling Ranch East Filing 5 Preliminary Plan (LSC# S234180)







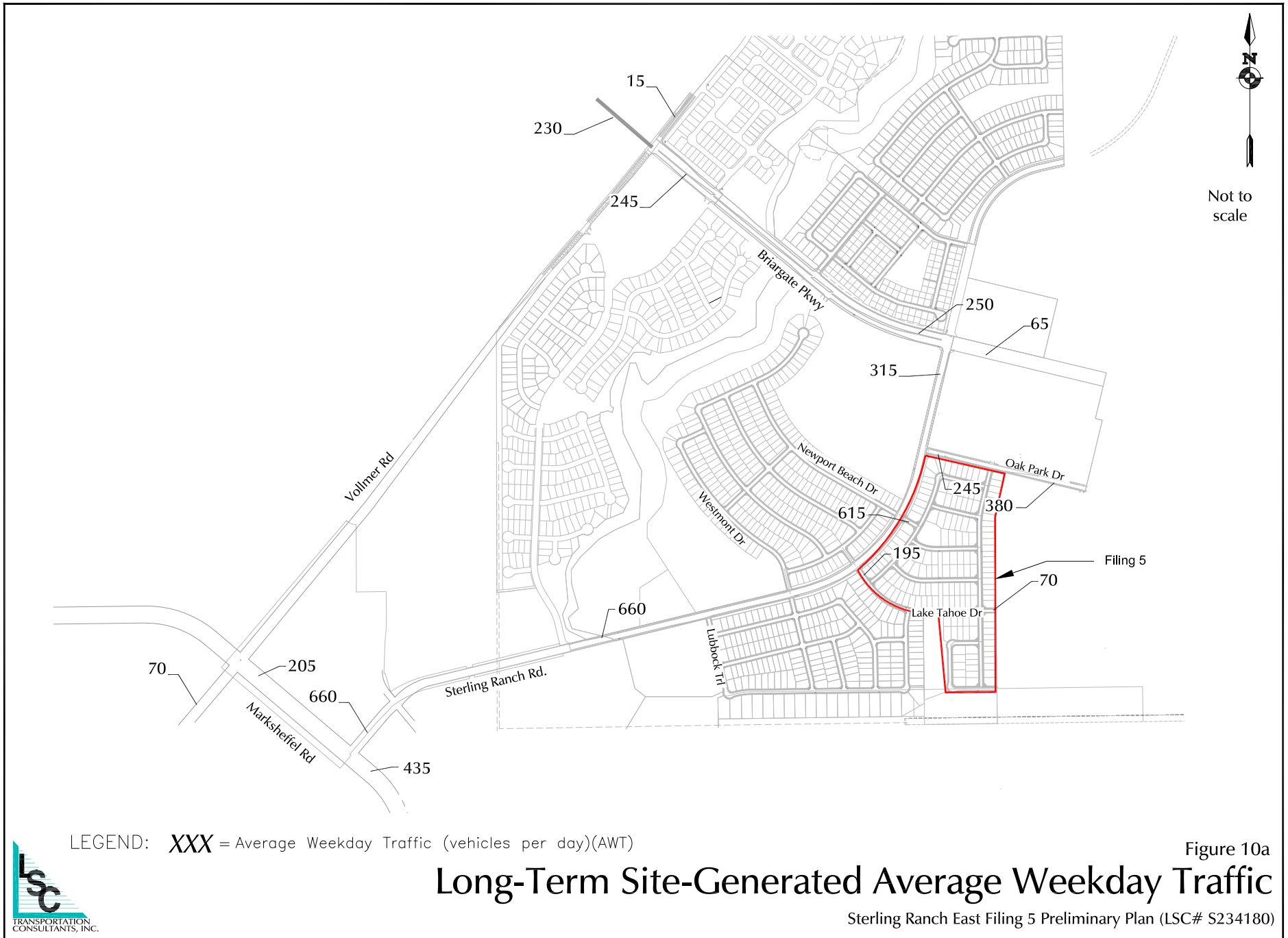
LEGEND:  $\frac{XX}{XX} = \frac{\text{AM Peak-Hour Traffic (veh/hr)}}{\text{PM Peak-Hour Traffic (veh/hr)}}$

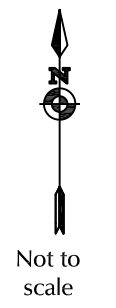
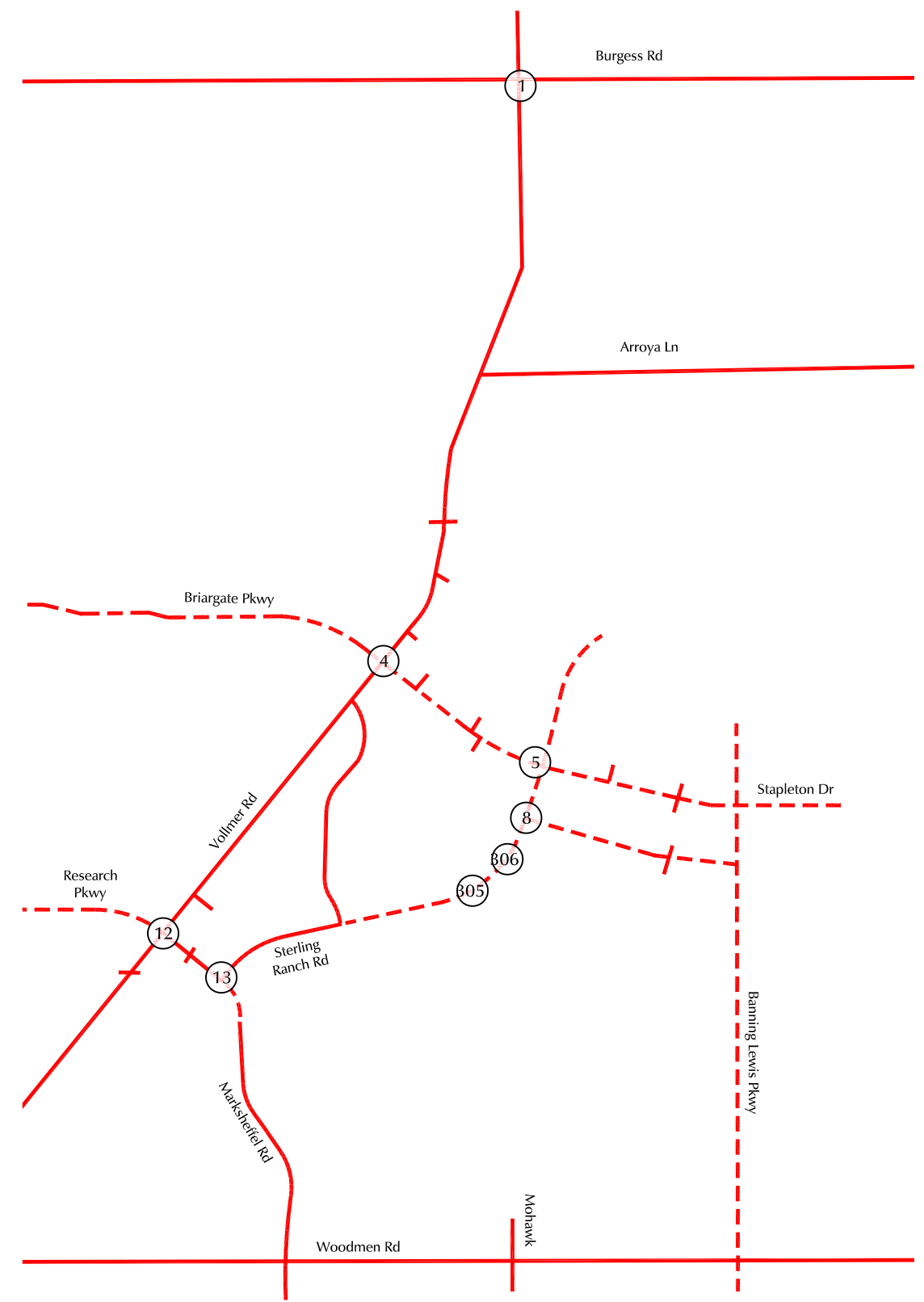
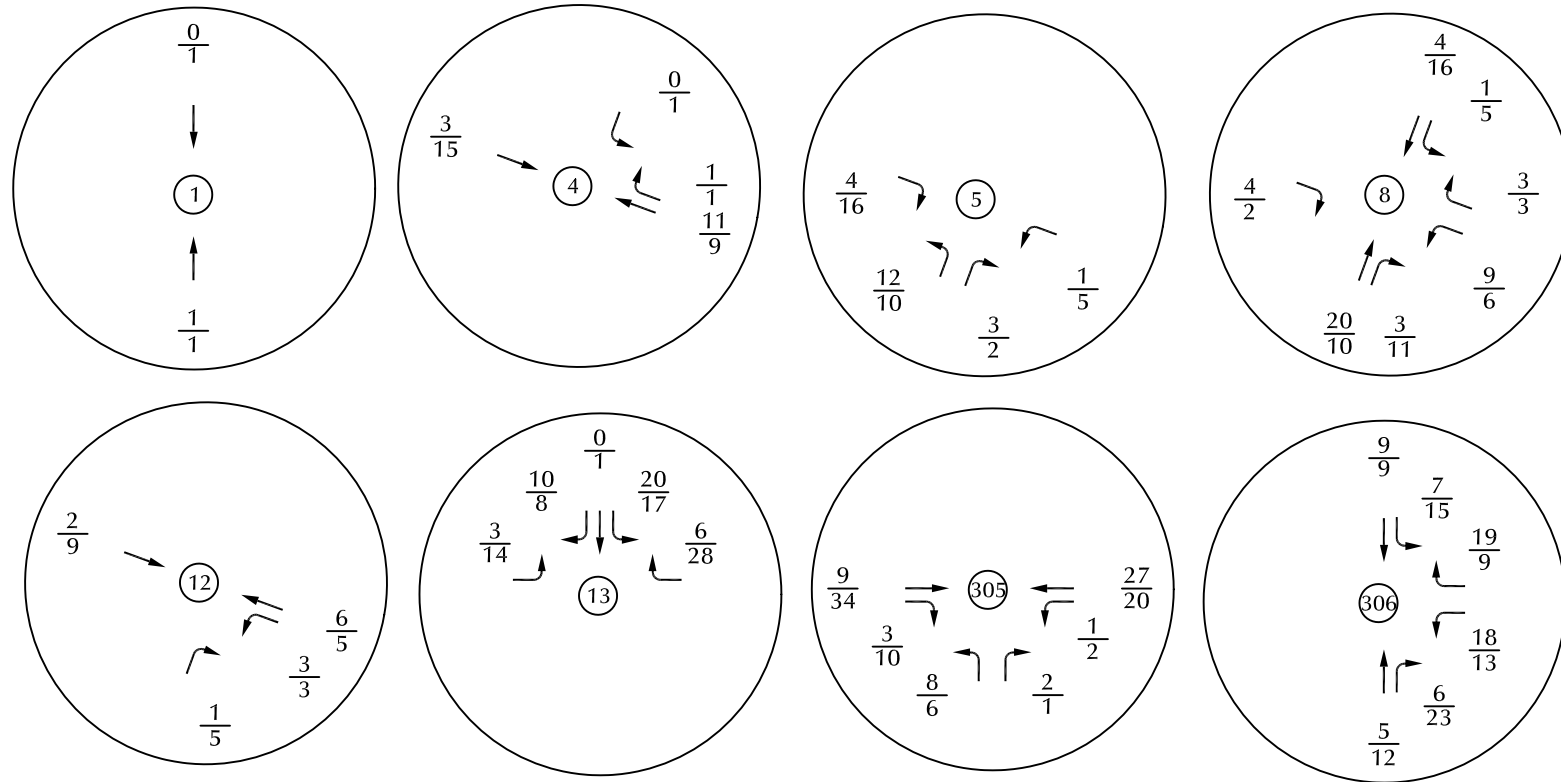
— Existing Roadway  
 - - - Future Roadway



Figure 9b  
 Short-Term Site-Generated Traffic

Sterling Ranch East Filing 5 Preliminary Plan (LSC# S234180)





LEGEND:  $\frac{XX}{XX} = \frac{\text{AM Peak-Hour Traffic (veh/hr)}}{\text{PM Peak-Hour Traffic (veh/hr)}}$

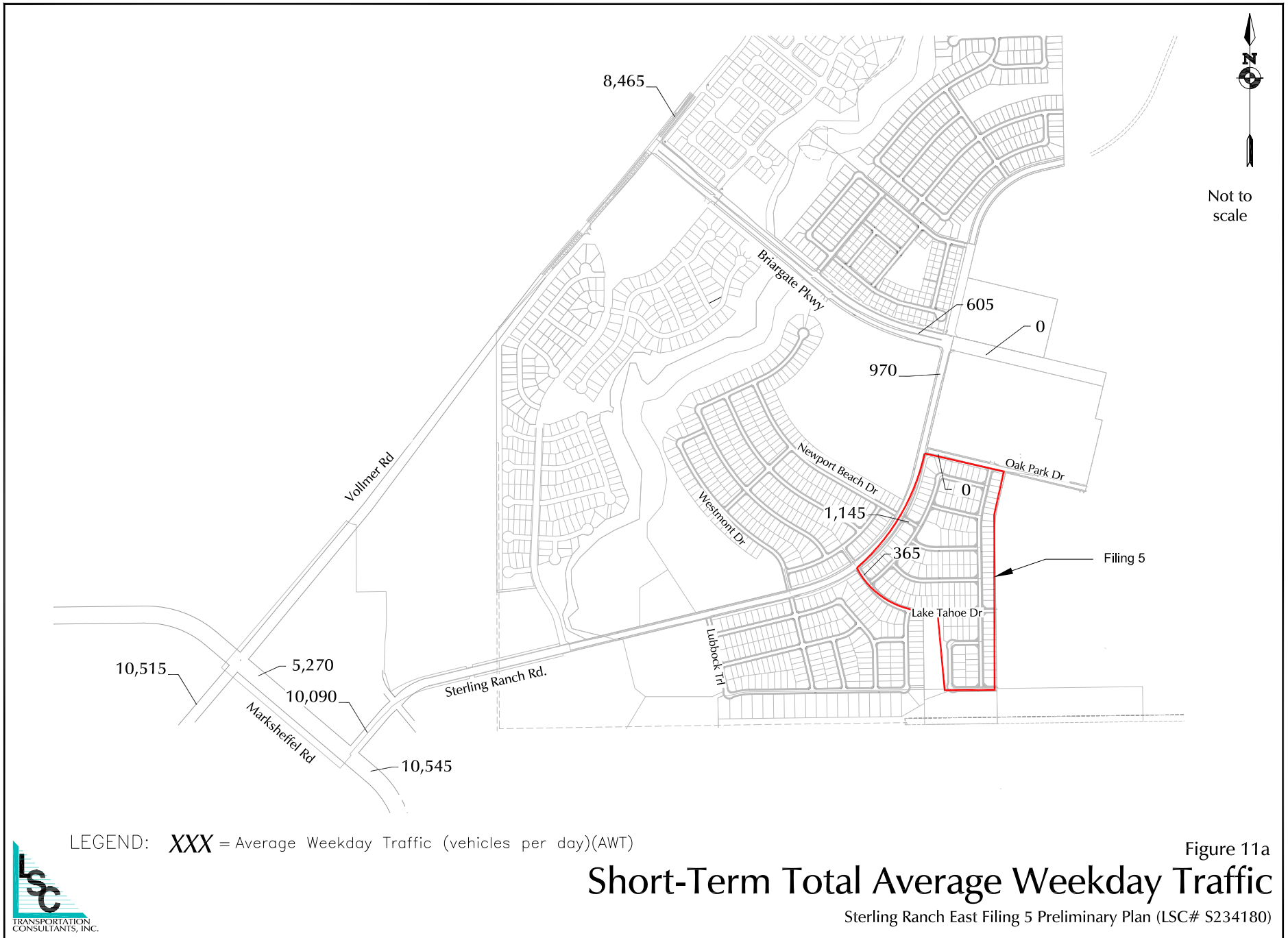
— Existing Roadway  
 - - - Future Roadway

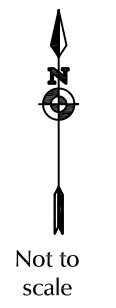
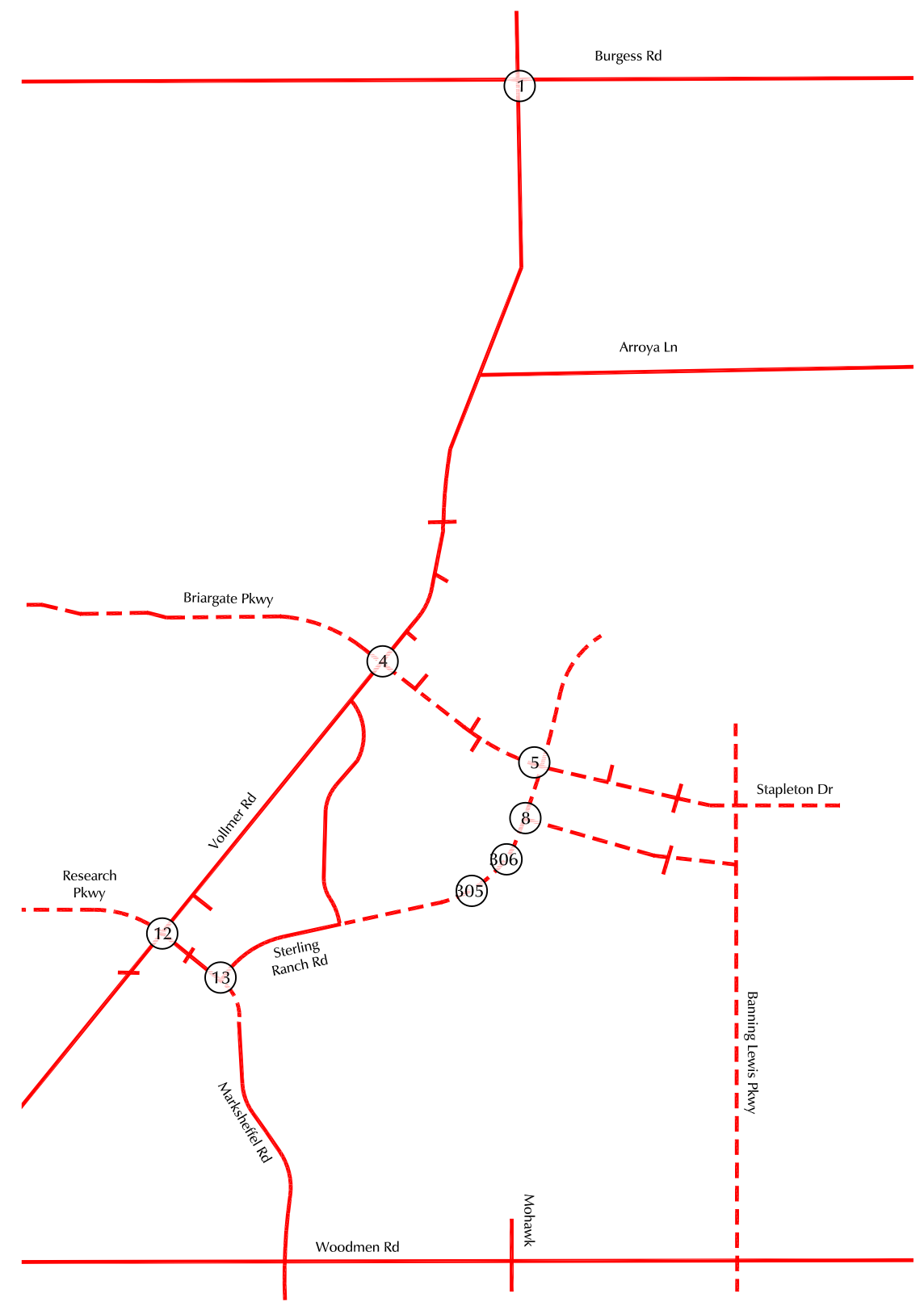
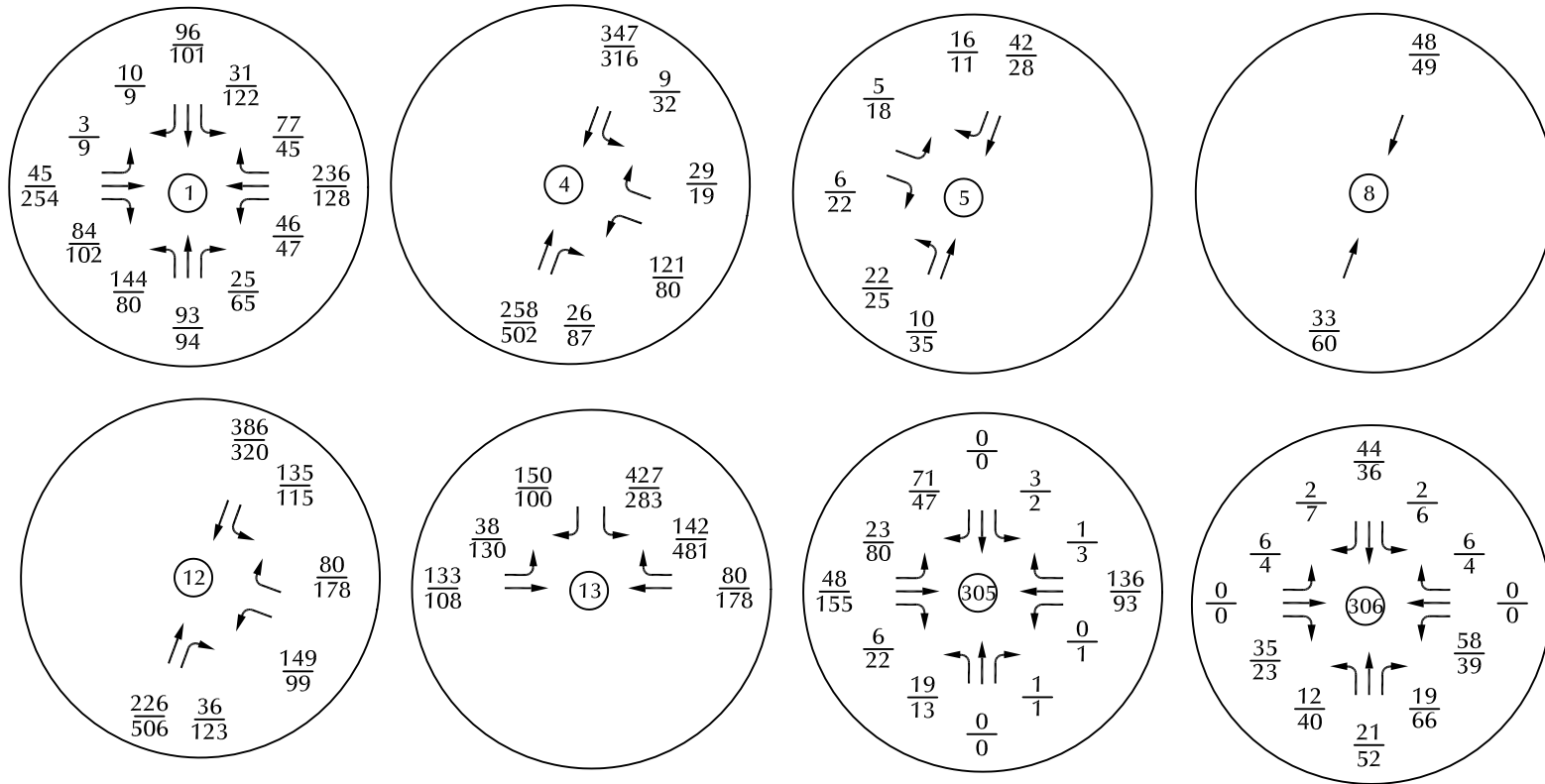


Figure 10b  
 Long-Term Site-Generated Traffic

Sterling Ranch East Filing 5 Preliminary Plan (LSC# S234180)







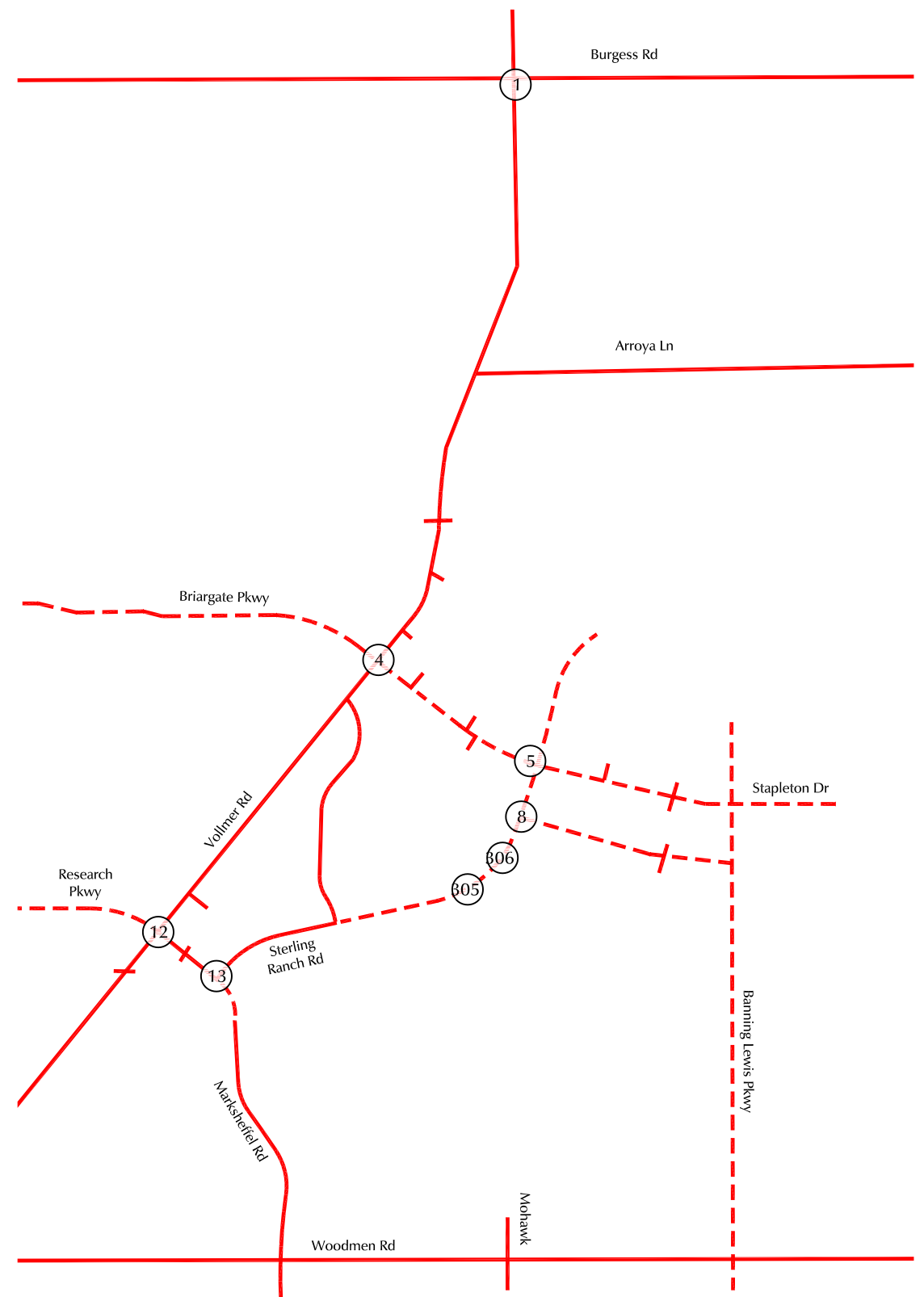
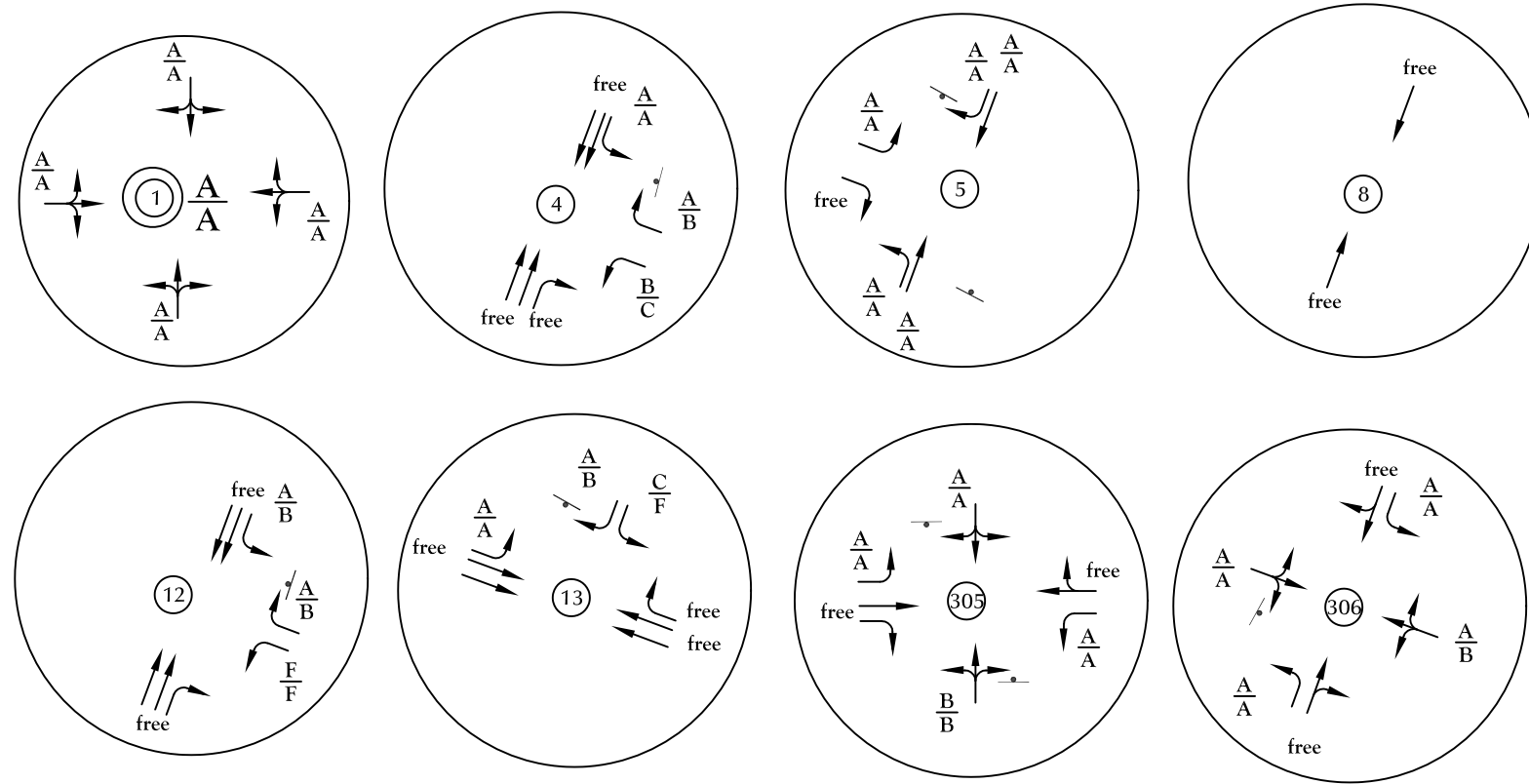
LEGEND:  $\frac{XX}{XX} = \frac{\text{AM Peak-Hour Traffic (veh/hr)}}{\text{PM Peak-Hour Traffic (veh/hr)}}$

— Existing Roadway  
 - - - Future Roadway



Figure 11b  
 Short-Term Total Traffic

Sterling Ranch East Filing 5 Preliminary Plan (LSC# S234180)



LEGEND:

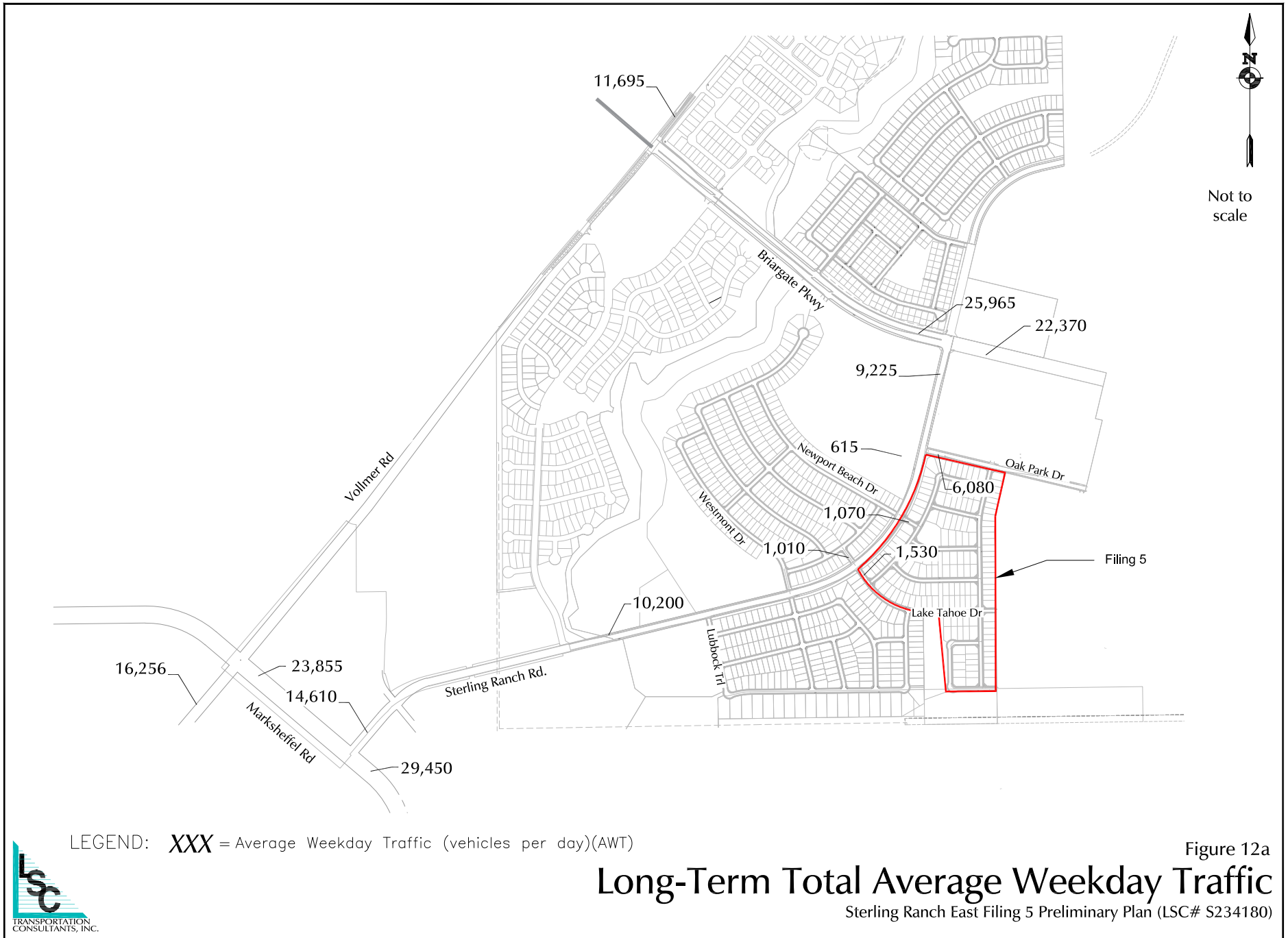
$\frac{A}{B}$  =  $\frac{\text{AM Individual Movement Peak-Hour Level of Service}}{\text{PM Individual Movement Peak-Hour Level of Service}}$   
 $\frac{C}{D}$  =  $\frac{\text{AM Entire Intersection Peak-Hour Level of Service}}{\text{PM Entire Intersection Peak-Hour Level of Service}}$

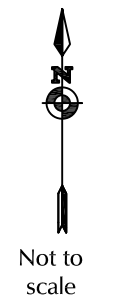
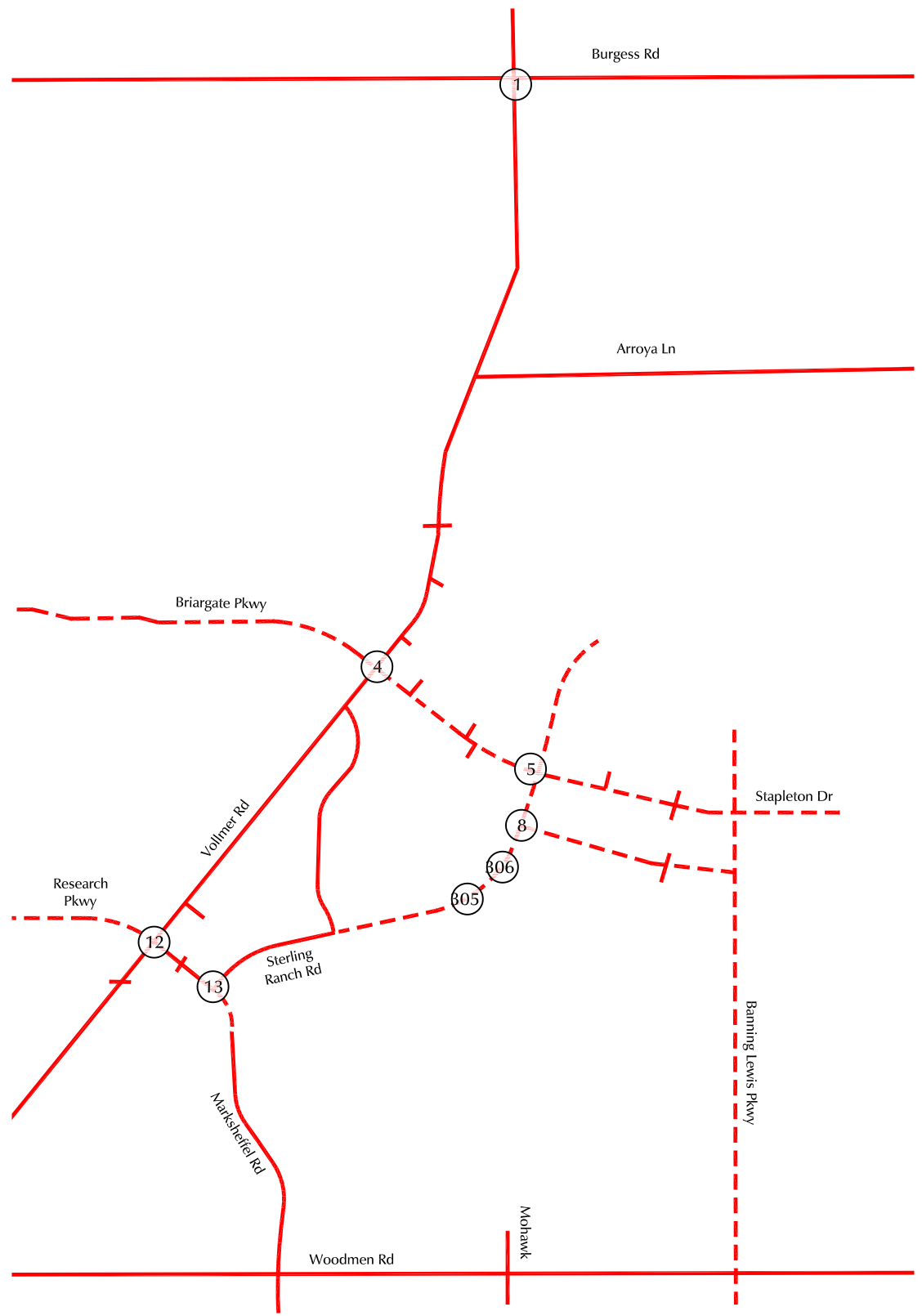
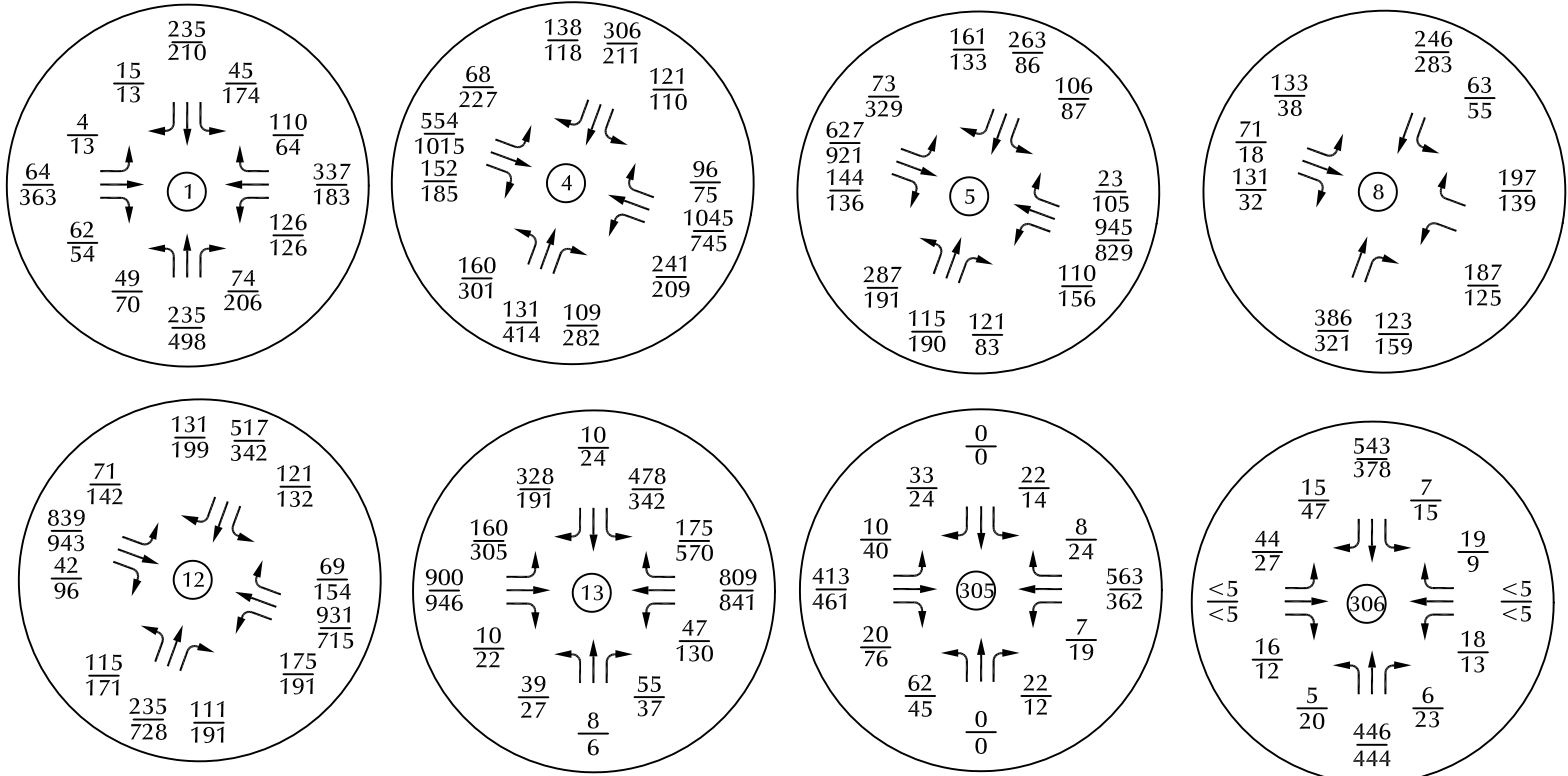
⊥ = Stop Sign  
 = Traffic Signal

○ = Roundabout  
 ——— Existing Roadway  
 - - - Future Roadway

Figure 11c  
**Short-Term Total Lane Geometry,  
 Traffic Control, and Level of Service**





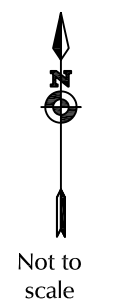
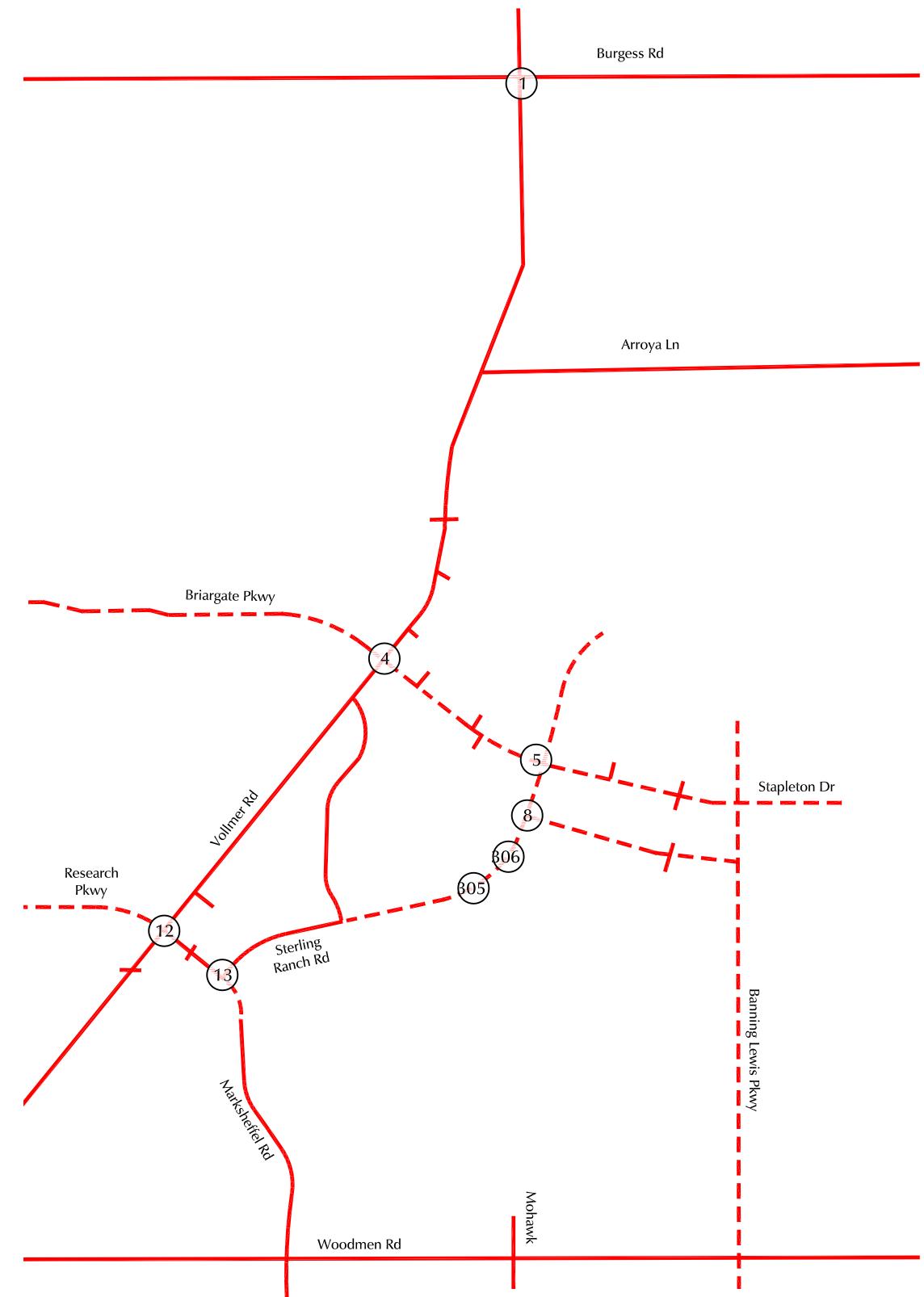
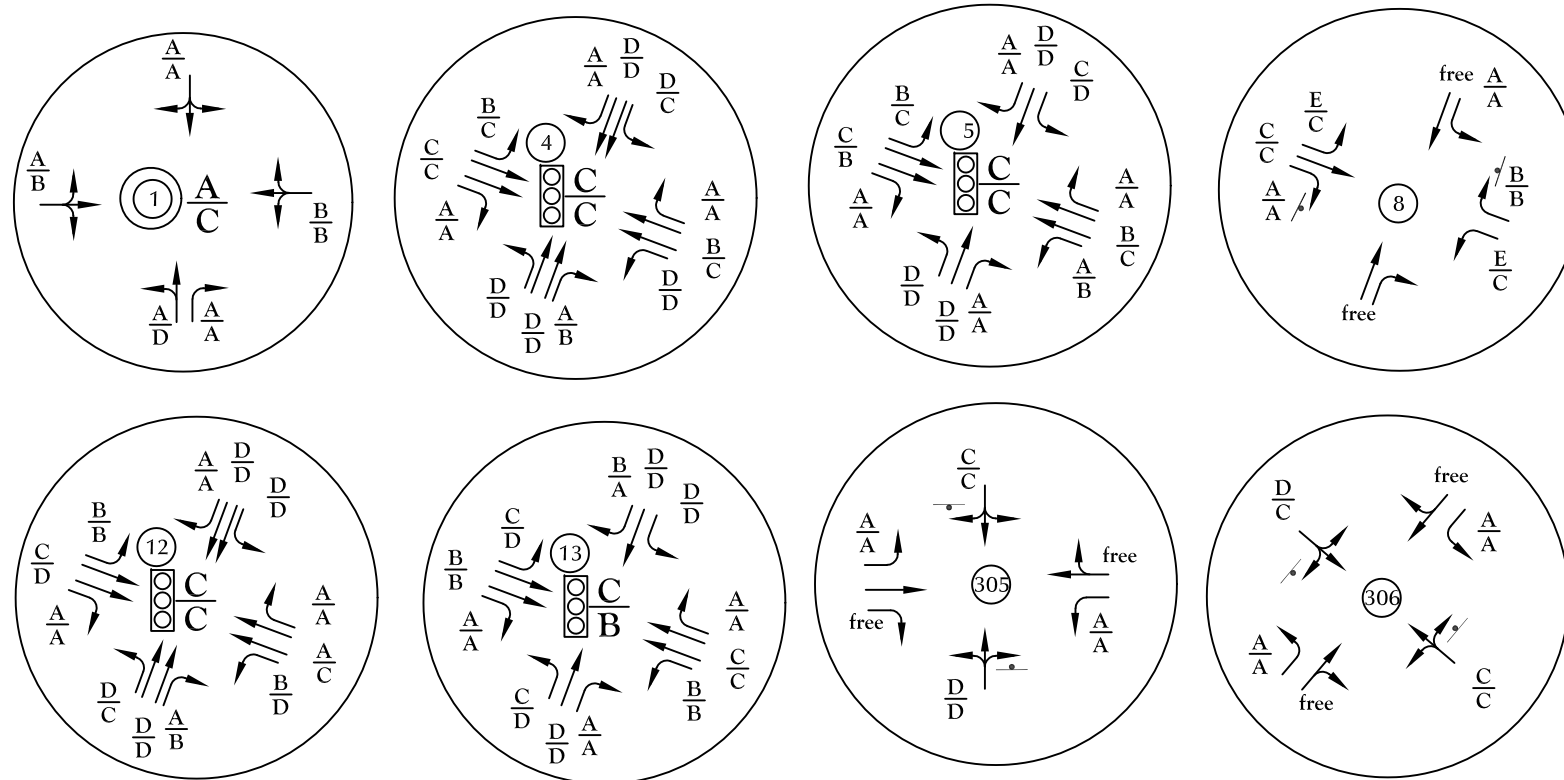


LEGEND:  $\frac{XX}{XX} = \frac{\text{AM Peak-Hour Traffic (veh/hr)}}{\text{PM Peak-Hour Traffic (veh/hr)}}$

— Existing Roadway  
 - - - Future Roadway

Figure 12b  
 2043 Total Traffic





LEGEND:

$\frac{A}{B}$  = AM Individual Movement Peak-Hour Level of Service  
 PM Individual Movement Peak-Hour Level of Service  
 $\frac{C}{D}$  = AM Entire Intersection Peak-Hour Level of Service  
 PM Entire Intersection Peak-Hour Level of Service

T = Stop Sign  
 = Traffic Signal

○ = Roundabout  
 = Existing Roadway  
 = Future Roadway



Figure 12c  
 2043 Total Lane Geometry,  
 Traffic Control, and Level of Service



Not to scale



LEGEND:

 Urban Residential Collector

 Urban Non-Residential Collector


 Urban Local

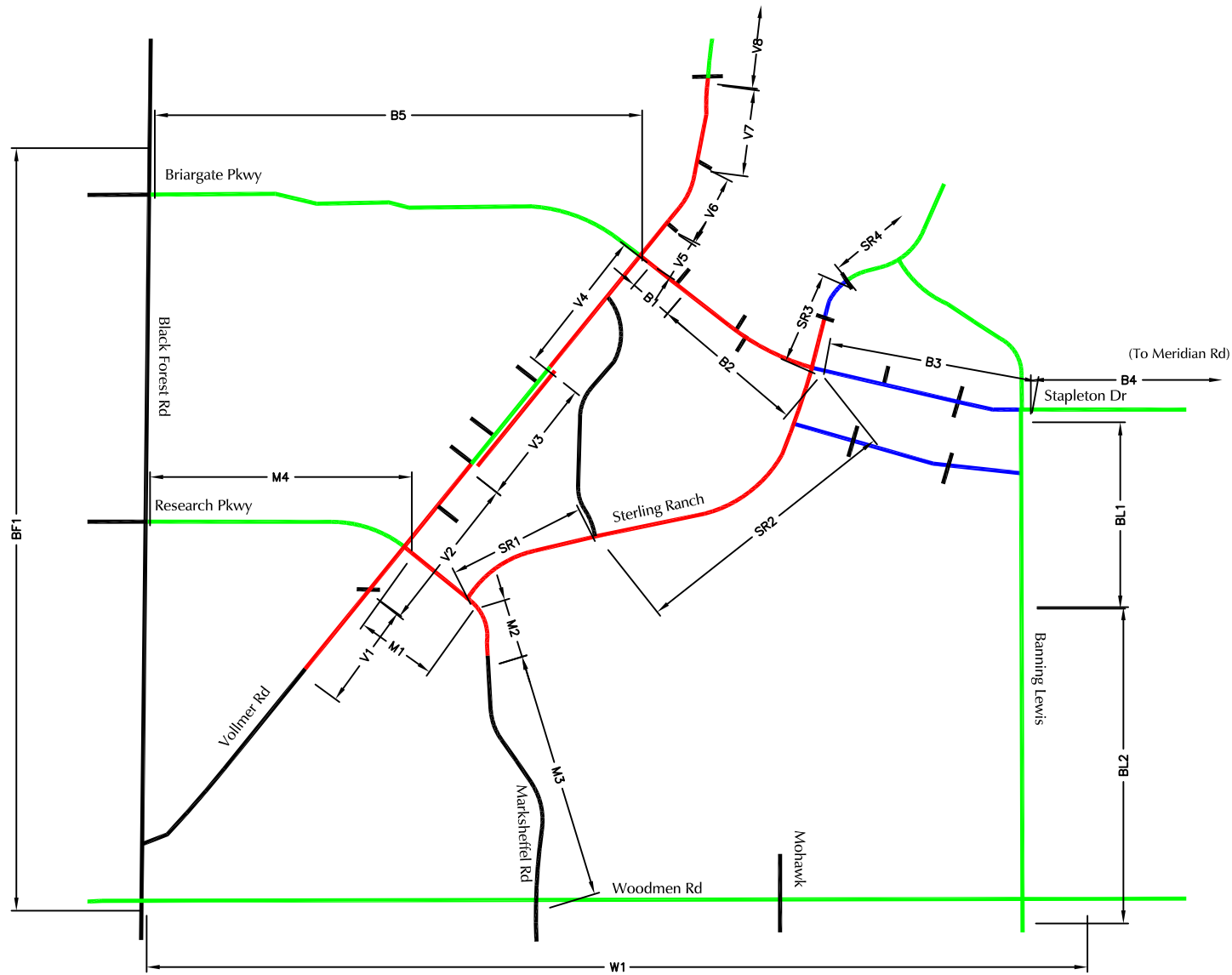


Figure 13  
**Roadway Classifications**

Sterling Ranch East Filing 5 Preliminary Plan (LSC# S234180)



Not to scale



V1, B4, SR3, etc - Segment Identifier\*

- Short-Term
- Intermediate-Term
- Long-Term

\*See Table 4 for recommended roadway segment improvements for each segment.

# Roadway Improvement Segments\*

Sterling Ranch East Filing 5 Preliminary Plan (LSC# S234180)



Figure 14



# Appendix Table 1



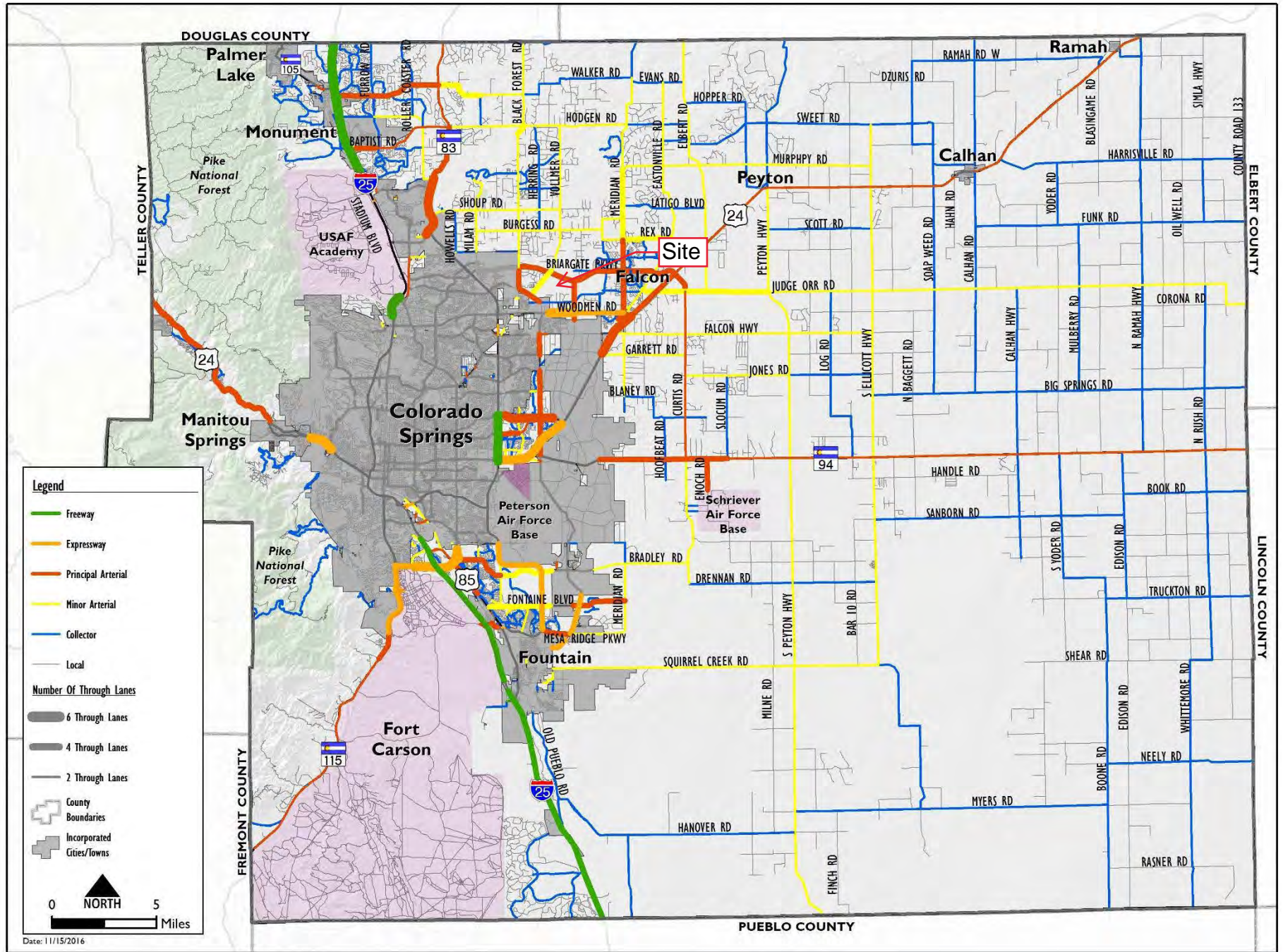
**Appendix Table 1  
Area Traffic Impact Studies  
Sterling Ranch East Filing No. 5**

<b>Study</b>	<b>PCD File No<sup>(1)</sup></b>	<b>Consultant</b>	<b>Date</b>
<b>Sterling Ranch Reports</b>			
Sterling Ranch Updated Traffic Impact Analysis	<a href="#">SKP07007</a>	LSC Transportation Consultants, Inc	June 5, 2008
Sterling Ranch Phase 1 Traffic Impact Study	<a href="#">P151</a>	LSC Transportation Consultants, Inc	March 16, 2015
Sterling Ranch Phases 1-3 Transportation Memorandum	<a href="#">SP1415</a>	LSC Transportation Consultants, Inc	October 2, 2017
Branding Iron at Sterling Ranch Filing No. 1 and Homestead at Sterling Ranch Filing No. 1 Transportation	<a href="#">SF1724</a> <a href="#">SF1725</a>	LSC Transportation Consultants, Inc	December 19, 2017
Sterling Ranch Filing No. 2 Transportation Memorandum	<a href="#">SF1820</a>	LSC Transportation Consultants, Inc	April 3, 2018
Sterling Ranch Phase 2 Preliminary Plan Traffic Impact Study	<a href="#">SP203</a>	LSC Transportation Consultants, Inc	December 20, 2018
Homestead at Sterling Ranch Filing No. 2 Transportation Memorandum	<a href="#">SF194</a>	LSC Transportation Consultants, Inc	March 3, 2020
Branding Iron at Sterling Ranch Filing No. 2 Transportation Memorandum	<a href="#">SF1918</a>	LSC Transportation Consultants, Inc	May 6, 2020
Sterling Ranch Filing No. 2 and Phase 2 Traffic Impact Study	<a href="#">SF2015</a> <a href="#">SP191</a>	LSC Transportation Consultants, Inc	June 23, 2021
Sterling Ranch Filing No. 3 Transportation Memorandum	<a href="#">SF2132</a>	LSC Transportation Consultants, Inc	April 19, 2022
Homestead North Phase 1 Updated Transportation Memorandum	<a href="#">SP208</a>	LSC Transportation Consultants, Inc	January 11, 2022
Homestead North Filing No. 1 Traffic Technical Memorandum	<a href="#">SF2213</a>	LSC Transportation Consultants, Inc	February 2, 2022
Homestead North Filing No. 2 Traffic Technical Memorandum	<a href="#">SF2218</a>	LSC Transportation Consultants, Inc	April 15, 2022
Homestead North Filing 3 Traffic Impact Study	<a href="#">SF2229</a>	LSC Transportation Consultants, Inc	June 17, 2022
The Villages at Sterling Ranch East Preliminary Plan/Traffic Generation Analysis	<a href="#">PUDSP226</a>	SM Rocha, LLC	July 1, 2022
Sterling Ranch Sketch Plan Amendment Master Traffic Impact Study	<a href="#">SKP224</a>	LSC Transportation Consultants, Inc	March 17, 2023
Sterling Ranch East - Rezoning & Preliminary Plan Traffic Impact Study	<a href="#">SP-22-004, P-22-012, P-22-013</a>	LSC Transportation Consultants, Inc	March 17, 2023 <sup>(2)</sup>
Sterling Ranch East Filing Nos 1 & 2 Traffic Technical Memorandum	<a href="#">SF2235</a> <a href="#">SF2237</a>	LSC Transportation Consultants, Inc	February 10, 2023
Sterling Ranch Filing No. 4 Transportation Memorandum	<a href="#">SF2230</a>	LSC Transportation Consultants, Inc	February 21, 2023
Foursquare at Sterling Ranch East Transportation Memorandum	<a href="#">SF2236</a>	LSC Transportation Consultants, Inc	April 20, 2023
Copper Chase at Sterling Ranch Traffic Impact Study	<a href="#">PUDSP222</a>	LSC Transportation Consultants, Inc	April 28, 2023
<b>Retreat at TimberRidge Reports</b>			
The Retreat at TimberRidge Traffic Impact Analysis	<a href="#">PUD173</a>	LSC Transportation Consultants, Inc	January 25, 2018
The Retreat at TimberRidge Preliminary Plan Traffic Technical Memorandum	<a href="#">SP182</a>	LSC Transportation Consultants, Inc	June 29, 2018
The Retreat at TimberRidge Filing No. 1 Traffic Technical Memorandum	<a href="#">SF199</a>	LSC Transportation Consultants, Inc	April 3, 2020
The Retreat at TimberRidge Filing No. 2 Updated Traffic Technical Memorandum	<a href="#">SF2121</a>	LSC Transportation Consultants, Inc	October 4, 2021
The Retreat at TimberRidge Filing No. 3 Traffic Technical Memorandum	<a href="#">SF2241</a>	LSC Transportation Consultants, Inc	July 1, 2022
<b>Other Area Reports</b>			
Wolf Ranch School Site Traffic Impact Study	<a href="#">OAR1720</a>	Matrix Design Group, Inc.	5-May-17
The Ranch Sketch Plan Traffic Impact Analysis	<a href="#">SKP186</a>	LSC Transportation Consultants, Inc	July 9, 2019
Lodge III Traffic Impact Study	OAR	LSC Transportation Consultants, Inc	December 13, 2019
Continental 613 Traffic Impact Study	<a href="#">OAR2177</a>	LSC Transportation Consultants, Inc	July 16, 2021
Solace at Black Forest Traffic Impact and Access Analysis	<a href="#">OAR2134</a>	LSC Transportation Consultants, Inc	August 13, 2021
Traffic Impact Study Addendum for Percheron	<a href="#">OAR2173</a>	SM Rocha, LLC	October, 2021
Woodmen East Commercial Center Traffic Impact Analysis	<a href="#">OAR2191</a>	LSC Transportation Consultants, Inc	December 8, 2021
Traffic Impact Study for Jaynes Property	<a href="#">SKP225</a>	SM Rocha, LLC	May, 2022
Traffic Impact Study for Rhetoric Site	<a href="#">P2216</a>	SM Rocha, LLC	June, 2022
Briargate-Stapleton Corridor Study (DRAFT)	<a href="#">briargate-stapleton.com</a>	Wilson & Company	December 9, 2021
Notes:			
(1) Follow the links listed below to obtain the most recent version of each listed study. To obtain a copy of the version of each study used in preparing this report please contact LSC Transportation Consultants, Inc.			
(2) With minor revision 4/3/2023			
Source: LSC Transportation Consultants, Inc.			

# MTCP Maps

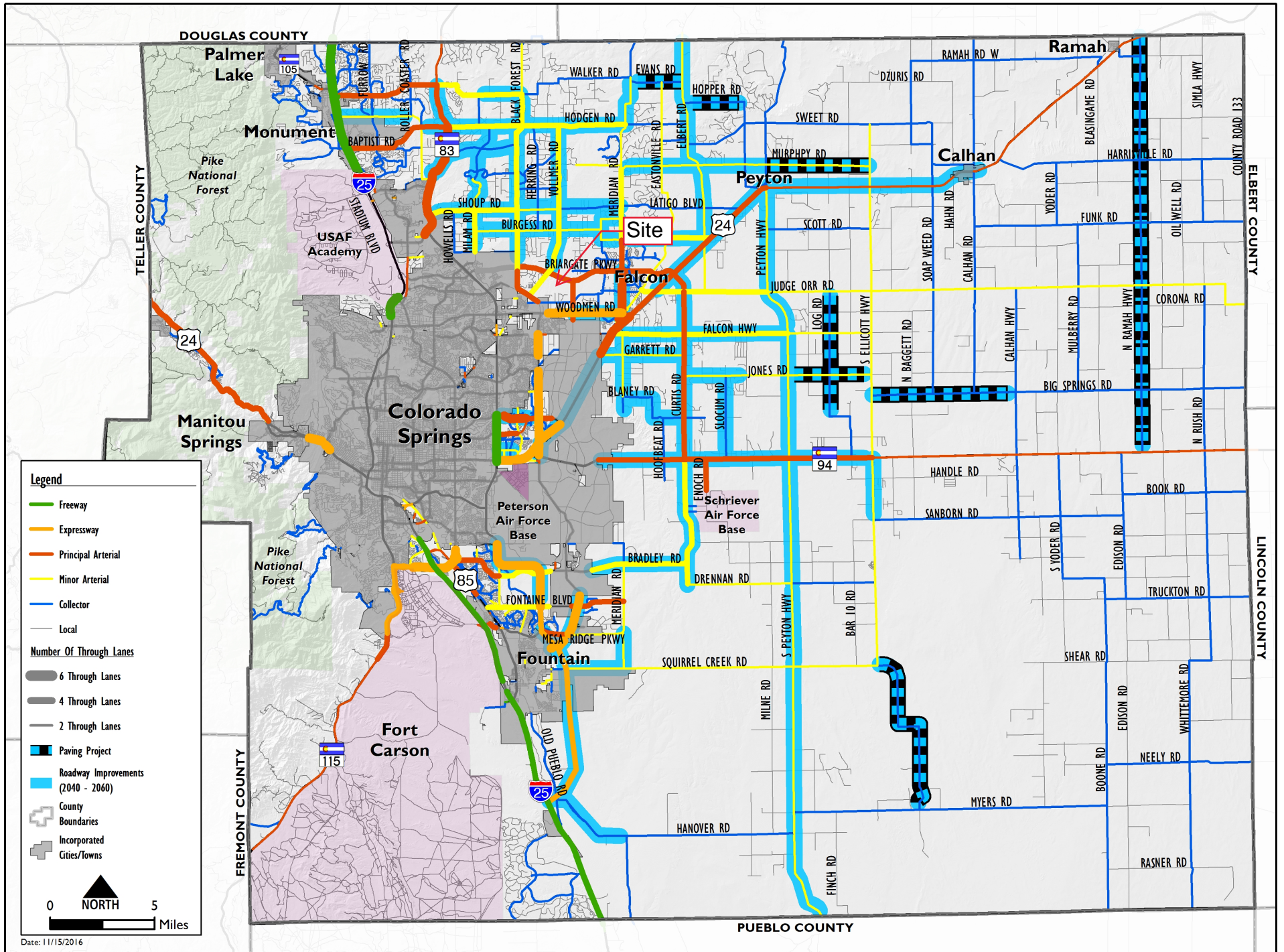
---





Map 14: 2040 Roadway Plan (Classification and Lanes)

# Map 17: 2060 Corridor Preservation



**Legend**

- Freeway
- Expressway
- Principal Arterial
- Minor Arterial
- Collector
- Local

**Number Of Through Lanes**

- 6 Through Lanes
- 4 Through Lanes
- 2 Through Lanes

- Paving Project
- Roadway Improvements (2040 - 2060)
- County Boundaries
- Incorporated Cities/Towns

0 **NORTH** 5  
Miles

Date: 11/15/2016

# Traffic Counts

---



# LSC Transportation Consultants, Inc.

2504 E. Pikes Peak Ave, Suite 304  
 Colorado Springs, CO 80909  
 719-633-2868

File Name : Vollmer Rd - Burgess Rd AM

Site Code : S224440

Start Date : 7/28/2022

Page No : 1

## Groups Printed- Unshifted

Start Time	Vollmer Rd Southbound					Burgess Rd Westbound					Vollmer Rd Northbound					Burgess Rd Eastbound					Int. Total
	Right	Thru	Left	Peds	App. Total	Right	Thru	Left	Peds	App. Total	Right	Thru	Left	Peds	App. Total	Right	Thru	Left	Peds	App. Total	
06:30	0	15	5	0	20	19	47	10	0	76	4	5	1	0	10	0	6	0	0	6	112
06:45	1	15	4	0	20	17	35	13	0	65	5	5	1	0	11	3	6	1	0	10	106
Total	1	30	9	0	40	36	82	23	0	141	9	10	2	0	21	3	12	1	0	16	218
07:00	2	20	9	0	31	15	51	14	0	80	6	9	1	0	16	2	10	0	0	12	139
07:15	2	14	8	0	24	21	57	12	0	90	4	11	5	0	20	1	8	0	0	9	143
07:30	2	17	7	0	26	19	58	12	0	89	4	19	5	0	28	3	13	1	0	17	160
07:45	3	16	10	0	29	17	51	8	0	76	9	11	3	0	23	0	8	2	0	10	138
Total	9	67	34	0	110	72	217	46	0	335	23	50	14	0	87	6	39	3	0	48	580
08:00	3	22	5	0	30	17	61	12	0	90	7	8	4	0	19	6	14	0	0	20	159
08:15	2	16	6	0	24	7	36	15	0	58	13	16	3	0	32	3	9	1	0	13	127
Grand Total	15	135	54	0	204	132	396	96	0	624	52	84	23	0	159	18	74	5	0	97	1084
Apprch %	7.4	66.2	26.5	0		21.2	63.5	15.4	0		32.7	52.8	14.5	0		18.6	76.3	5.2	0		
Total %	1.4	12.5	5	0	18.8	12.2	36.5	8.9	0	57.6	4.8	7.7	2.1	0	14.7	1.7	6.8	0.5	0	8.9	

# LSC Transportation Consultants, Inc.

2504 E. Pikes Peak Ave, Suite 304  
 Colorado Springs, CO 80909  
 719-633-2868

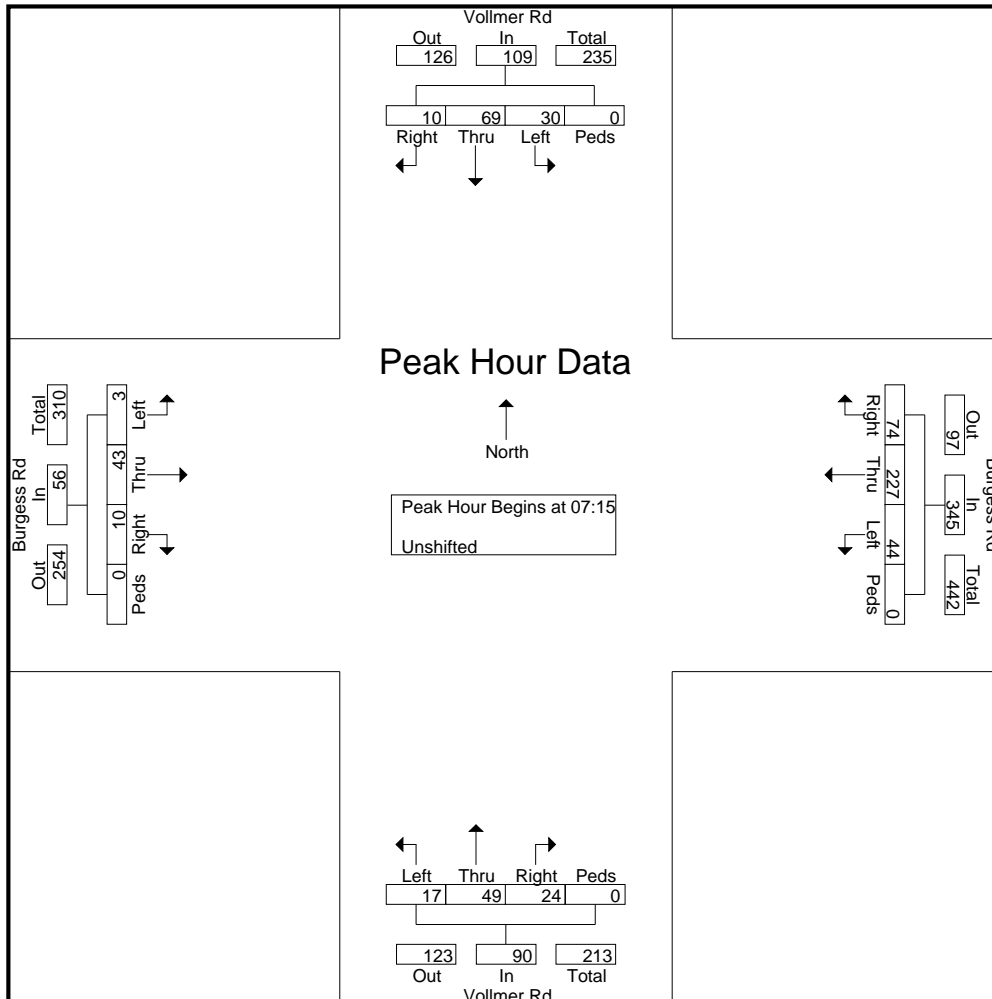
File Name : Vollmer Rd - Burgess Rd AM

Site Code : S224440

Start Date : 7/28/2022

Page No : 2

Start Time	Vollmer Rd Southbound					Burgess Rd Westbound					Vollmer Rd Northbound					Burgess Rd Eastbound					Int. Total
	Right	Thru	Left	Peds	App. Total	Right	Thru	Left	Peds	App. Total	Right	Thru	Left	Peds	App. Total	Right	Thru	Left	Peds	App. Total	
Peak Hour Analysis From 6:30:00 AM to 8:15:00 AM - Peak 1 of 1																					
Peak Hour for Entire Intersection Begins at 7:15:00 AM																					
7:15:00 AM	2	14	8	0	24	21	57	12	0	90	4	11	5	0	20	1	8	0	0	9	143
7:30:00 AM	2	17	7	0	26	19	58	12	0	89	4	19	5	0	28	3	13	1	0	17	160
7:45:00 AM	3	16	10	0	29	17	51	8	0	76	9	11	3	0	23	0	8	2	0	10	138
8:00:00 AM	3	22	5	0	30	17	61	12	0	90	7	8	4	0	19	6	14	0	0	20	159
Total Volume	10	69	30	0	109	74	227	44	0	345	24	49	17	0	90	10	43	3	0	56	600
% App. Total	9.2	63.3	27.5	0		21.4	65.8	12.8	0		26.7	54.4	18.9	0		17.9	76.8	5.4	0		
PHF	.833	.784	.750	.000	.908	.881	.930	.917	.000	.958	.667	.645	.850	.000	.804	.417	.768	.375	.000	.700	.938





# LSC Transportation Consultants, Inc.

2504 E. Pikes Peak Ave, Suite 304  
 Colorado Springs, CO 80909  
 719-633-2868

File Name : Vollmer Rd - Burgess Rd PM

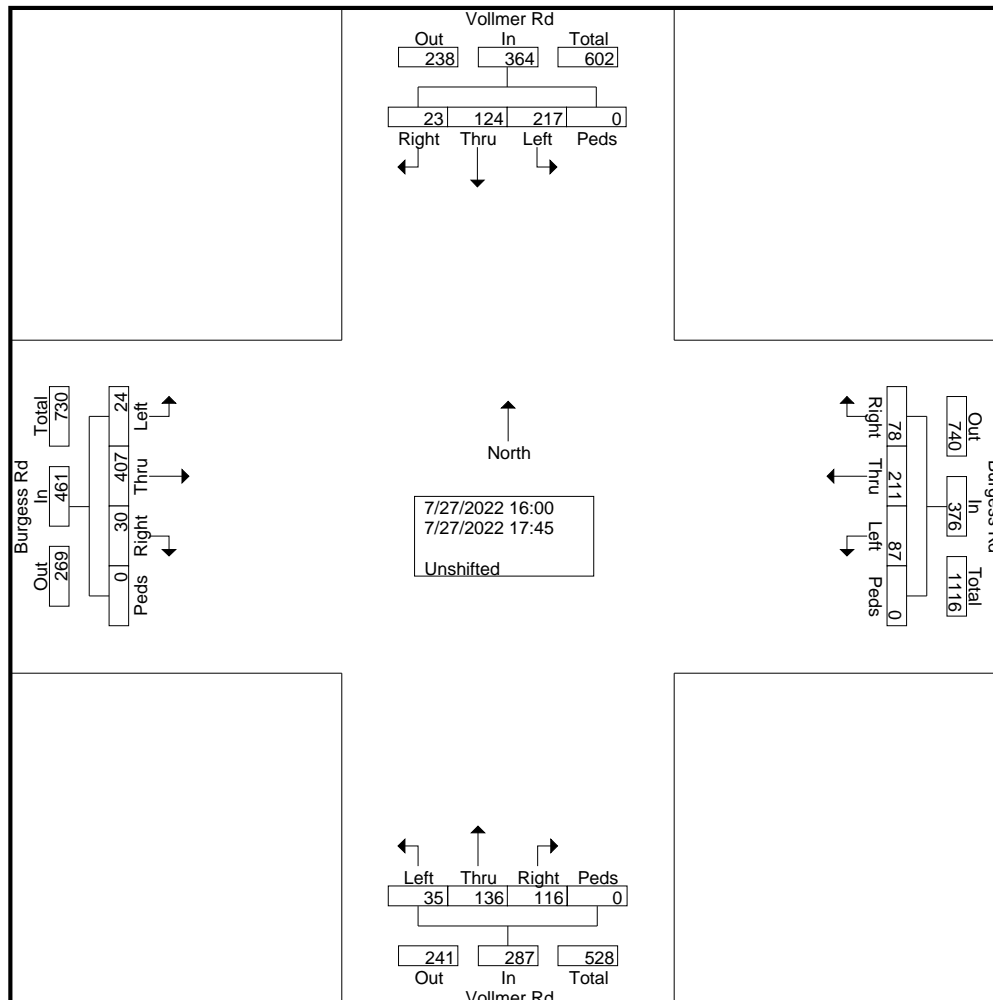
Site Code : S224440

Start Date : 7/27/2022

Page No : 1

## Groups Printed- Unshifted

Start Time	Vollmer Rd Southbound					Burgess Rd Westbound					Vollmer Rd Northbound					Burgess Rd Eastbound					Int. Total
	Right	Thru	Left	Peds	App. Total	Right	Thru	Left	Peds	App. Total	Right	Thru	Left	Peds	App. Total	Right	Thru	Left	Peds	App. Total	
16:00	2	19	22	0	43	7	21	7	0	35	9	17	6	0	32	3	37	3	0	43	153
16:15	5	13	29	0	47	6	23	11	0	40	18	11	8	0	37	4	37	5	0	46	170
16:30	2	19	31	0	52	10	30	9	0	49	12	19	4	0	35	5	46	3	0	54	190
16:45	1	8	20	0	29	8	33	17	0	58	16	14	5	0	35	1	65	0	0	66	188
Total	10	59	102	0	171	31	107	44	0	182	55	61	23	0	139	13	185	11	0	209	701
17:00	5	16	28	0	49	14	29	9	0	52	16	18	3	0	37	1	56	3	0	60	198
17:15	1	25	38	0	64	11	31	10	0	52	18	18	4	0	40	5	77	3	0	85	241
17:30	1	10	30	0	41	11	21	19	0	51	13	23	4	0	40	5	46	1	0	52	184
17:45	6	14	19	0	39	11	23	5	0	39	14	16	1	0	31	6	43	6	0	55	164
Total	13	65	115	0	193	47	104	43	0	194	61	75	12	0	148	17	222	13	0	252	787
Grand Total	23	124	217	0	364	78	211	87	0	376	116	136	35	0	287	30	407	24	0	461	1488
Apprch %	6.3	34.1	59.6	0		20.7	56.1	23.1	0		40.4	47.4	12.2	0		6.5	88.3	5.2	0		
Total %	1.5	8.3	14.6	0	24.5	5.2	14.2	5.8	0	25.3	7.8	9.1	2.4	0	19.3	2	27.4	1.6	0	31	



# LSC Transportation Consultants, Inc.

2504 E. Pikes Peak Ave, Suite 304  
 Colorado Springs, CO 80909  
 719-633-2868

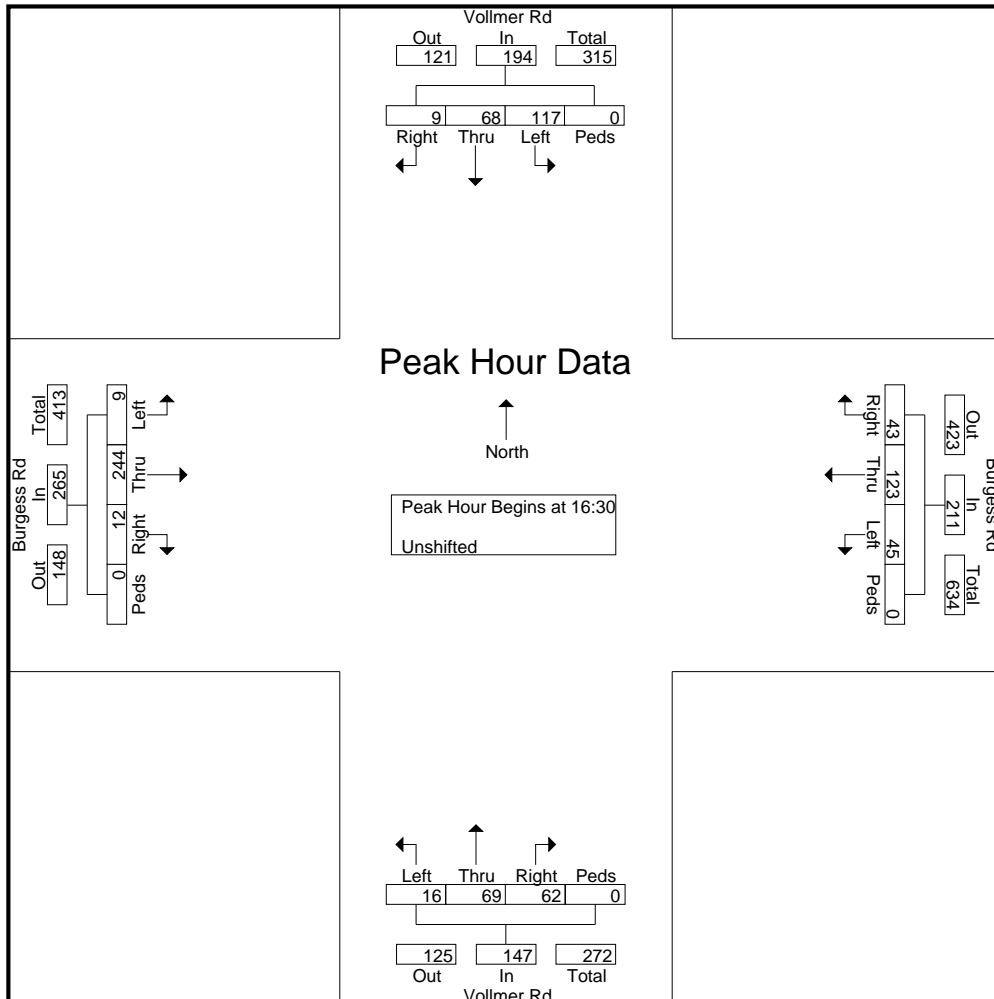
File Name : Vollmer Rd - Burgess Rd PM

Site Code : S224440

Start Date : 7/27/2022

Page No : 2

Start Time	Vollmer Rd Southbound					Burgess Rd Westbound					Vollmer Rd Northbound					Burgess Rd Eastbound					Int. Total
	Right	Thru	Left	Peds	App. Total	Right	Thru	Left	Peds	App. Total	Right	Thru	Left	Peds	App. Total	Right	Thru	Left	Peds	App. Total	
Peak Hour Analysis From 4:00:00 PM to 5:45:00 PM - Peak 1 of 1																					
Peak Hour for Entire Intersection Begins at 4:30:00 PM																					
4:30:00 PM	2	19	31	0	52	10	30	9	0	49	12	19	4	0	35	5	46	3	0	54	190
4:45:00 PM	1	8	20	0	29	8	33	17	0	58	16	14	5	0	35	1	65	0	0	66	188
5:00:00 PM	5	16	28	0	49	14	29	9	0	52	16	18	3	0	37	1	56	3	0	60	198
5:15:00 PM	1	25	38	0	64	11	31	10	0	52	18	18	4	0	40	5	77	3	0	85	241
Total Volume	9	68	117	0	194	43	123	45	0	211	62	69	16	0	147	12	244	9	0	265	817
% App. Total	4.6	35.1	60.3	0		20.4	58.3	21.3	0		42.2	46.9	10.9	0		4.5	92.1	3.4	0		
PHF	.450	.680	.770	.000	.758	.768	.932	.662	.000	.909	.861	.908	.800	.000	.919	.600	.792	.750	.000	.779	.848



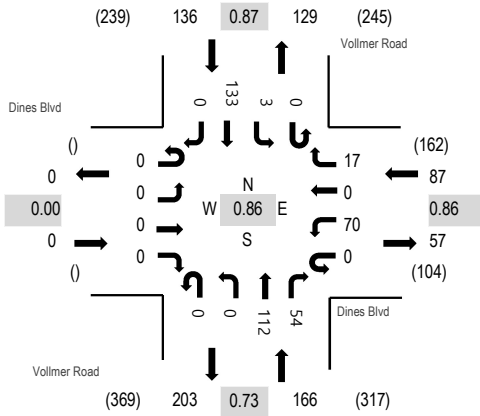
**Location:** 5 Vollmer Road & Dines Blvd AM

**Date:** Thursday, March 24, 2022

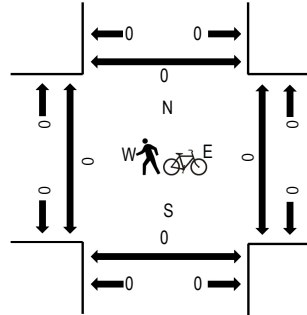
**Peak Hour:** 07:15 AM - 08:15 AM

**Peak 15-Minutes:** 07:45 AM - 08:00 AM

**Peak Hour - All Vehicles**



**Peak Hour - Pedestrians/Bicycles on Crosswalk**



Note: Total study counts contained in parentheses.

**Traffic Counts**

Interval Start Time	Dines Blvd Eastbound				Dines Blvd Westbound				Vollmer Road Northbound				Vollmer Road Southbound				Total	Rolling Hour	Pedestrian Crossings			
	U-Turn	Left	Thru	Right	U-Turn	Left	Thru	Right	U-Turn	Left	Thru	Right	U-Turn	Left	Thru	Right			West	East	South	North
7:00 AM	0	0	0	0	0	11	0	1	0	0	25	14	0	2	16	0	69	370	0	0	0	0
7:15 AM	0	0	0	0	0	15	0	3	0	0	22	13	0	1	29	0	83	389	0	0	0	0
7:30 AM	0	0	0	0	0	21	0	5	0	0	27	13	0	0	39	0	105	381	0	0	0	0
7:45 AM	0	0	0	0	0	11	0	6	0	0	38	21	0	1	36	0	113	375	0	0	0	0
8:00 AM	0	0	0	0	0	23	0	3	0	0	25	7	0	1	29	0	88	348	0	0	0	0
8:15 AM	0	0	0	0	0	18	0	2	0	0	23	8	0	0	24	0	75		0	0	0	0
8:30 AM	0	0	0	0	0	23	0	1	1	0	28	13	1	2	30	0	99		0	0	0	0
8:45 AM	0	0	0	0	0	15	0	4	0	0	31	8	0	0	28	0	86		0	0	0	0
Count Total	0	0	0	0	0	137	0	25	1	0	219	97	1	7	231	0	718		0	0	0	0
Peak Hour	0	0	0	0	0	70	0	17	0	0	112	54	0	3	133	0	389		0	0	0	0



ALL TRAFFIC DATA SERVICES

(303) 216-2439

www.alltrafficdata.net

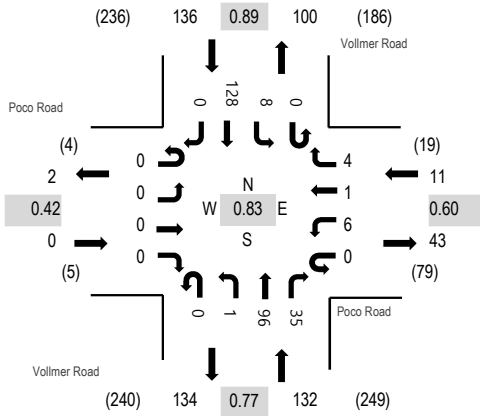
**Location:** 6 Vollmer Road & Poco Road AM

**Date:** Thursday, March 24, 2022

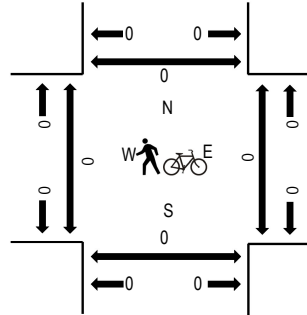
**Peak Hour:** 07:15 AM - 08:15 AM

**Peak 15-Minutes:** 07:45 AM - 08:00 AM

**Peak Hour - All Vehicles**



**Peak Hour - Pedestrians/Bicycles on Crosswalk**



Note: Total study counts contained in parentheses.

**Traffic Counts**

Interval Start Time	Poco Road Eastbound				Poco Road Westbound				Vollmer Road Northbound				Vollmer Road Southbound				Total	Rolling Hour	Pedestrian Crossings			
	U-Turn	Left	Thru	Right	U-Turn	Left	Thru	Right	U-Turn	Left	Thru	Right	U-Turn	Left	Thru	Right			West	East	South	North
7:00 AM	0	0	0	0	0	0	0	0	0	0	10	15	0	1	20	0	46	264	0	0	0	0
7:15 AM	0	0	0	0	0	1	0	2	0	0	18	8	0	2	27	0	58	279	0	0	0	0
7:30 AM	0	0	0	0	0	1	0	2	0	1	26	8	0	2	36	0	76	273	0	0	0	0
7:45 AM	0	0	0	0	0	4	0	0	0	0	34	9	0	4	33	0	84	265	0	0	0	0
8:00 AM	0	0	0	0	0	0	1	0	0	0	18	10	0	0	32	0	61	245	0	0	0	0
8:15 AM	0	0	0	0	0	1	0	1	0	0	24	3	0	0	23	0	52		0	0	0	0
8:30 AM	0	0	0	2	0	3	0	2	0	1	24	6	0	1	29	0	68		0	0	0	0
8:45 AM	0	2	0	1	0	1	0	0	0	1	23	10	0	0	26	0	64		0	0	0	0
Count Total	0	2	0	3	0	11	1	7	0	3	177	69	0	10	226	0	509		0	0	0	0
Peak Hour	0	0	0	0	0	6	1	4	0	1	96	35	0	8	128	0	279		0	0	0	0

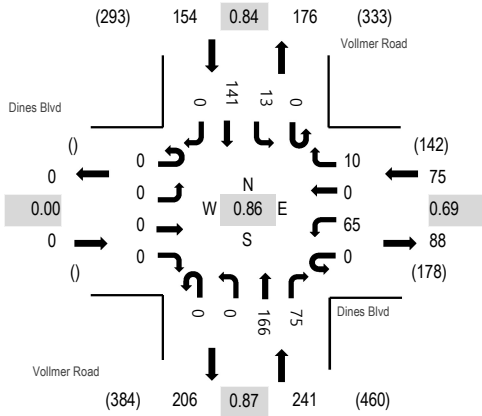
**Location:** 5 Vollmer Road & Dines Blvd PM

**Date:** Thursday, March 24, 2022

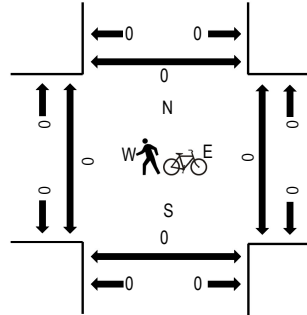
**Peak Hour:** 04:00 PM - 05:00 PM

**Peak 15-Minutes:** 04:00 PM - 04:15 PM

**Peak Hour - All Vehicles**



**Peak Hour - Pedestrians/Bicycles on Crosswalk**

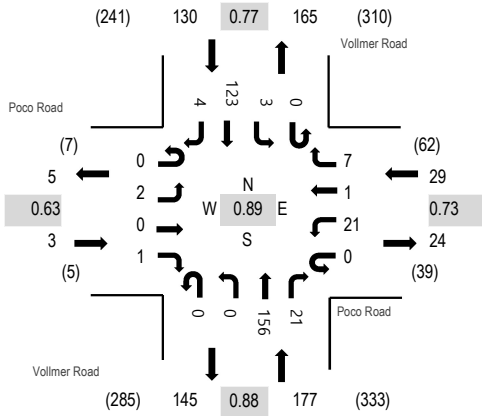


Note: Total study counts contained in parentheses.

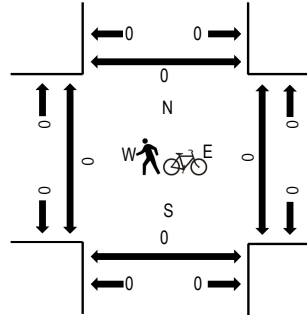
**Traffic Counts**

Interval Start Time	Dines Blvd Eastbound				Dines Blvd Westbound				Vollmer Road Northbound				Vollmer Road Southbound				Total	Rolling Hour	Pedestrian Crossings			
	U-Turn	Left	Thru	Right	U-Turn	Left	Thru	Right	U-Turn	Left	Thru	Right	U-Turn	Left	Thru	Right			West	East	South	North
4:00 PM	0	0	0	0	0	24	0	3	0	0	46	18	0	2	44	0	137	470	0	0	0	0
4:15 PM	0	0	0	0	0	13	0	5	0	0	36	25	0	5	37	0	121	441	0	0	0	0
4:30 PM	0	0	0	0	0	12	0	2	0	0	35	11	0	3	30	0	93	436	0	0	0	0
4:45 PM	0	0	0	0	0	16	0	0	0	0	49	21	0	3	30	0	119	452	0	0	0	0
5:00 PM	0	0	0	0	0	14	0	5	0	0	42	18	0	2	27	0	108	425	0	0	0	0
5:15 PM	0	0	0	0	0	17	0	3	0	0	39	17	0	4	36	0	116		0	0	0	0
5:30 PM	0	0	0	0	0	12	0	1	0	0	36	21	0	8	31	0	109		0	0	0	0
5:45 PM	0	0	0	0	0	14	0	1	0	0	30	16	0	4	27	0	92		0	0	0	0
Count Total	0	0	0	0	0	122	0	20	0	0	313	147	0	31	262	0	895		0	0	0	0
Peak Hour	0	0	0	0	0	65	0	10	0	0	166	75	0	13	141	0	470		0	0	0	0

**Peak Hour - All Vehicles**



**Peak Hour - Pedestrians/Bicycles on Crosswalk**



Note: Total study counts contained in parentheses.

**Traffic Counts**

Interval Start Time	Poco Road Eastbound				Poco Road Westbound			Vollmer Road Northbound			Vollmer Road Southbound				Total	Rolling Hour	Pedestrian Crossings					
	U-Turn	Left	Thru	Right	U-Turn	Left	Thru	Right	U-Turn	Left	Thru	Right	U-Turn	Left			Thru	Right	West	East	South	North
4:00 PM	0	0	0	0	0	8	1	4	0	0	41	4	0	1	29	2	90	339	0	0	0	0
4:15 PM	0	1	0	0	0	4	0	2	0	0	40	6	0	1	39	2	95	325	0	0	0	0
4:30 PM	0	0	0	0	0	2	0	0	0	0	32	3	0	1	28	0	66	313	0	0	0	0
4:45 PM	0	1	0	1	0	7	0	1	0	0	43	8	0	0	27	0	88	321	0	0	0	0
5:00 PM	0	0	0	2	0	6	0	1	0	0	44	3	0	0	20	0	76	302	0	0	0	0
5:15 PM	0	0	0	0	0	12	0	0	0	0	37	4	0	0	29	1	83		0	0	0	0
5:30 PM	0	0	0	0	0	6	0	2	0	0	33	3	0	1	29	0	74		0	0	0	0
5:45 PM	0	0	0	0	0	5	0	1	0	1	27	4	0	0	31	0	69		0	0	0	0
Count Total	0	2	0	3	0	50	1	11	0	1	297	35	0	4	232	5	641		0	0	0	0
Peak Hour	0	2	0	1	0	21	1	7	0	0	156	21	0	3	123	4	339		0	0	0	0

# Level of Service Reports

---



Intersection												
Int Delay, s/veh	56.3											
Movement	EBL	EBT	EBR	WBL	WBT	WBR	NBL	NBT	NBR	SBL	SBT	SBR
Lane Configurations		↕			↕			↕			↕	
Traffic Vol, veh/h	3	45	82	46	236	77	139	91	25	31	96	10
Future Vol, veh/h	3	45	82	46	236	77	139	91	25	31	96	10
Conflicting Peds, #/hr	0	0	0	0	0	0	0	0	0	0	0	0
Sign Control	Stop	Stop	Stop	Stop	Stop	Stop	Free	Free	Free	Free	Free	Free
RT Channelized	-	-	None	-	-	None	-	-	None	-	-	None
Storage Length	-	-	-	-	-	-	-	-	-	-	-	-
Veh in Median Storage, #	-	0	-	-	0	-	-	0	-	-	0	-
Grade, %	-	0	-	-	0	-	-	0	-	-	0	-
Peak Hour Factor	85	85	85	85	85	85	85	85	85	85	85	85
Heavy Vehicles, %	2	2	2	2	2	2	2	2	2	2	2	2
Mvmt Flow	4	53	96	54	278	91	164	107	29	36	113	12

Major/Minor	Minor2		Minor1		Major1		Major2					
Conflicting Flow All	825	655	119	716	647	122	125	0	0	136	0	0
Stage 1	191	191	-	450	450	-	-	-	-	-	-	-
Stage 2	634	464	-	266	197	-	-	-	-	-	-	-
Critical Hdwy	7.12	6.52	6.22	7.12	6.52	6.22	4.12	-	-	4.12	-	-
Critical Hdwy Stg 1	6.12	5.52	-	6.12	5.52	-	-	-	-	-	-	-
Critical Hdwy Stg 2	6.12	5.52	-	6.12	5.52	-	-	-	-	-	-	-
Follow-up Hdwy	3.518	4.018	3.318	3.518	4.018	3.318	2.218	-	-	2.218	-	-
Pot Cap-1 Maneuver	292	386	933	345	390	929	1462	-	-	1448	-	-
Stage 1	811	742	-	589	572	-	-	-	-	-	-	-
Stage 2	467	564	-	739	738	-	-	-	-	-	-	-
Platoon blocked, %								-	-	-	-	-
Mov Cap-1 Maneuver	72	330	933	242	333	929	1462	-	-	1448	-	-
Mov Cap-2 Maneuver	72	330	-	242	333	-	-	-	-	-	-	-
Stage 1	712	722	-	517	502	-	-	-	-	-	-	-
Stage 2	165	495	-	597	718	-	-	-	-	-	-	-

Approach	EB	WB	NB	SB
HCM Control Delay, s	15.7	128.9	4.2	1.7
HCM LOS	C	F		

Minor Lane/Major Mvmt	NBL	NBT	NBR	EBLn1WBLn1	SBL	SBT	SBR
Capacity (veh/h)	1462	-	-	489	366	1448	-
HCM Lane V/C Ratio	0.112	-	-	0.313	1.154	0.025	-
HCM Control Delay (s)	7.8	0	-	15.7	128.9	7.5	0
HCM Lane LOS	A	A	-	C	F	A	A
HCM 95th %tile Q(veh)	0.4	-	-	1.3	16.6	0.1	-



Intersection						
Int Delay, s/veh	2.5					
Movement	WBL	WBR	NBT	NBR	SBL	SBT
Lane Configurations	↘	↗	↕↕	↗	↘	↕↕
Traffic Vol, veh/h	121	22	258	26	7	347
Future Vol, veh/h	121	22	258	26	7	347
Conflicting Peds, #/hr	0	0	0	0	0	0
Sign Control	Stop	Stop	Free	Free	Free	Free
RT Channelized	-	None	-	None	-	None
Storage Length	485	-	-	235	385	-
Veh in Median Storage, #	0	-	0	-	-	0
Grade, %	0	-	0	-	-	0
Peak Hour Factor	85	85	85	85	85	85
Heavy Vehicles, %	2	2	2	2	2	2
Mvmt Flow	142	26	304	31	8	408

Major/Minor	Minor1	Major1	Major2		
Conflicting Flow All	524	152	0	0	335
Stage 1	304	-	-	-	-
Stage 2	220	-	-	-	-
Critical Hdwy	6.84	6.94	-	-	4.14
Critical Hdwy Stg 1	5.84	-	-	-	-
Critical Hdwy Stg 2	5.84	-	-	-	-
Follow-up Hdwy	3.52	3.32	-	-	2.22
Pot Cap-1 Maneuver	483	867	-	-	1221
Stage 1	722	-	-	-	-
Stage 2	795	-	-	-	-
Platoon blocked, %			-	-	-
Mov Cap-1 Maneuver	480	867	-	-	1221
Mov Cap-2 Maneuver	562	-	-	-	-
Stage 1	722	-	-	-	-
Stage 2	789	-	-	-	-

Approach	WB	NB	SB
HCM Control Delay, s	12.9	0	0.2
HCM LOS	B		

Minor Lane/Major Mvmt	NBT	NBRWBLn1	WBLn2	SBL	SBT
Capacity (veh/h)	-	-	562	867	1221
HCM Lane V/C Ratio	-	-	0.253	0.03	0.007
HCM Control Delay (s)	-	-	13.6	9.3	8
HCM Lane LOS	-	-	B	A	A
HCM 95th %tile Q(veh)	-	-	1	0.1	0

Intersection												
Int Delay, s/veh	8.5											
Movement	EBL	EBT	EBR	WBL	WBT	WBR	NBL	NBT	NBR	SBL	SBT	SBR
Lane Configurations	↘	↑↑	↗	↘	↑↑	↗	↘	↑	↗	↘	↑	↗
Traffic Vol, veh/h	5	0	4	0	0	0	16	10	0	0	42	16
Future Vol, veh/h	5	0	4	0	0	0	16	10	0	0	42	16
Conflicting Peds, #/hr	0	0	0	0	0	0	0	0	0	0	0	0
Sign Control	Free	Free	Free	Free	Free	Free	Stop	Stop	Stop	Stop	Stop	Stop
RT Channelized	-	-	None	-	-	None	-	-	None	-	-	None
Storage Length	535	-	0	310	-	0	410	-	155	235	-	155
Veh in Median Storage, #	-	0	-	-	0	-	-	0	-	-	0	-
Grade, %	-	0	-	-	0	-	-	0	-	-	0	-
Peak Hour Factor	85	85	85	85	85	85	85	85	85	85	85	85
Heavy Vehicles, %	2	2	2	2	2	2	2	2	2	2	2	2
Mvmt Flow	6	0	5	0	0	0	19	12	0	0	49	19

Major/Minor	Major1			Major2			Minor1			Minor2		
Conflicting Flow All	1	0	0	5	0	0	37	13	0	19	18	1
Stage 1	-	-	-	-	-	-	12	12	-	1	1	-
Stage 2	-	-	-	-	-	-	25	1	-	18	17	-
Critical Hdwy	4.14	-	-	4.14	-	-	7.54	6.54	6.94	7.54	6.54	6.94
Critical Hdwy Stg 1	-	-	-	-	-	-	6.54	5.54	-	6.54	5.54	-
Critical Hdwy Stg 2	-	-	-	-	-	-	6.54	5.54	-	6.54	5.54	-
Follow-up Hdwy	2.22	-	-	2.22	-	-	3.52	4.02	3.32	3.52	4.02	3.32
Pot Cap-1 Maneuver	1620	-	-	1615	-	-	964	881	-	992	875	1083
Stage 1	-	-	-	-	-	-	1007	885	-	1021	895	-
Stage 2	-	-	-	-	-	-	989	895	-	999	881	-
Platoon blocked, %	-	-	-	-	-	-	-	-	-	-	-	-
Mov Cap-1 Maneuver	1620	-	-	1615	-	-	903	877	-	-	872	1083
Mov Cap-2 Maneuver	-	-	-	-	-	-	903	877	-	-	872	-
Stage 1	-	-	-	-	-	-	1003	881	-	1017	895	-
Stage 2	-	-	-	-	-	-	918	895	-	982	877	-

Approach	EB			WB			NB			SB		
HCM Control Delay, s	4			0			9.1			9.1		
HCM LOS							A			A		

Minor Lane/Major Mvmt	NBLn1	NBLn2	NBLn3	EBL	EBT	EBR	WBL	WBT	WBR	SBLn1	SBLn2	SBLn3
Capacity (veh/h)	903	877	-	1620	-	-	1615	-	-	-	-	872 1083
HCM Lane V/C Ratio	0.021	0.013	-	0.004	-	-	-	-	-	-	-	0.057 0.017
HCM Control Delay (s)	9.1	9.2	0	7.2	-	-	0	-	-	0	9.4	8.4
HCM Lane LOS	A	A	A	A	-	-	A	-	-	A	A	A
HCM 95th %tile Q(veh)	0.1	0	-	0	-	-	0	-	-	-	0.2	0.1

Intersection						
Int Delay, s/veh	7.2					
Movement	WBL	WBR	NBT	NBR	SBL	SBT
Lane Configurations	↘	↗	↑↑	↗	↘	↑↑
Traffic Vol, veh/h	145	80	226	35	135	386
Future Vol, veh/h	145	80	226	35	135	386
Conflicting Peds, #/hr	0	0	0	0	0	0
Sign Control	Stop	Stop	Free	Free	Free	Free
RT Channelized	-	None	-	None	-	None
Storage Length	300	-	-	155	300	-
Veh in Median Storage, #	0	-	0	-	-	0
Grade, %	0	-	0	-	-	0
Peak Hour Factor	85	85	85	85	85	85
Heavy Vehicles, %	2	2	2	2	2	2
Mvmt Flow	171	94	266	41	159	454

Major/Minor	Minor1	Major1	Major2			
Conflicting Flow All	811	133	0	0	307	0
Stage 1	266	-	-	-	-	-
Stage 2	545	-	-	-	-	-
Critical Hdwy	6.84	6.94	-	-	4.14	-
Critical Hdwy Stg 1	5.84	-	-	-	-	-
Critical Hdwy Stg 2	5.84	-	-	-	-	-
Follow-up Hdwy	3.52	3.32	-	-	2.22	-
Pot Cap-1 Maneuver	317	892	-	-	1250	-
Stage 1	754	-	-	-	-	-
Stage 2	545	-	-	-	-	-
Platoon blocked, %			-	-		-
Mov Cap-1 Maneuver	277	892	-	-	1250	-
Mov Cap-2 Maneuver	277	-	-	-	-	-
Stage 1	754	-	-	-	-	-
Stage 2	476	-	-	-	-	-

Approach	WB	NB	SB
HCM Control Delay, s	27.1	0	2.2
HCM LOS	D		

Minor Lane/Major Mvmt	NBT	NBR	WBLn1	WBLn2	SBL	SBT
Capacity (veh/h)	-	-	277	892	1250	-
HCM Lane V/C Ratio	-	-	0.616	0.106	0.127	-
HCM Control Delay (s)	-	-	36.8	9.5	8.3	-
HCM Lane LOS	-	-	E	A	A	-
HCM 95th %tile Q(veh)	-	-	3.8	0.4	0.4	-

Intersection						
Int Delay, s/veh	9.3					
Movement	EBL	EBT	WBT	WBR	SBL	SBR
Lane Configurations	↘	↑↑	↑↑	↗	↘	↗
Traffic Vol, veh/h	37	133	80	118	354	146
Future Vol, veh/h	37	133	80	118	354	146
Conflicting Peds, #/hr	0	0	0	0	0	0
Sign Control	Free	Free	Free	Free	Stop	Stop
RT Channelized	-	None	-	None	-	None
Storage Length	300	-	-	205	155	0
Veh in Median Storage, #	-	0	0	-	0	-
Grade, %	-	0	0	-	0	-
Peak Hour Factor	85	85	85	85	85	85
Heavy Vehicles, %	2	2	2	2	2	2
Mvmt Flow	44	156	94	139	416	172

Major/Minor	Major1	Major2	Minor2		
Conflicting Flow All	233	0	-	0	260 47
Stage 1	-	-	-	-	94 -
Stage 2	-	-	-	-	166 -
Critical Hdwy	4.14	-	-	-	6.84 6.94
Critical Hdwy Stg 1	-	-	-	-	5.84 -
Critical Hdwy Stg 2	-	-	-	-	5.84 -
Follow-up Hdwy	2.22	-	-	-	3.52 3.32
Pot Cap-1 Maneuver	1332	-	-	-	707 1012
Stage 1	-	-	-	-	919 -
Stage 2	-	-	-	-	846 -
Platoon blocked, %		-	-	-	
Mov Cap-1 Maneuver	1332	-	-	-	684 1012
Mov Cap-2 Maneuver	-	-	-	-	684 -
Stage 1	-	-	-	-	889 -
Stage 2	-	-	-	-	846 -

Approach	EB	WB	SB
HCM Control Delay, s	1.7	0	15.5
HCM LOS			C

Minor Lane/Major Mvmt	EBL	EBT	WBT	WBR	SBLn1	SBLn2
Capacity (veh/h)	1332	-	-	-	684	1012
HCM Lane V/C Ratio	0.033	-	-	-	0.609	0.17
HCM Control Delay (s)	7.8	-	-	-	18.1	9.3
HCM Lane LOS	A	-	-	-	C	A
HCM 95th %tile Q(veh)	0.1	-	-	-	4.2	0.6

Intersection						
Int Delay, s/veh	4.1					
Movement	EBL	EBT	WBT	WBR	SBL	SBR
Lane Configurations						
Traffic Vol, veh/h	23	29	78	1	3	71
Future Vol, veh/h	23	29	78	1	3	71
Conflicting Peds, #/hr	0	0	0	0	0	0
Sign Control	Free	Free	Free	Free	Stop	Stop
RT Channelized	-	None	-	None	-	None
Storage Length	305	-	-	-	0	-
Veh in Median Storage, #	-	0	0	-	0	-
Grade, %	-	0	0	-	0	-
Peak Hour Factor	85	85	85	85	85	85
Heavy Vehicles, %	2	2	2	2	2	2
Mvmt Flow	27	34	92	1	4	84

Major/Minor	Major1	Major2	Minor2		
Conflicting Flow All	93	0	-	0	181
Stage 1	-	-	-	-	93
Stage 2	-	-	-	-	88
Critical Hdwy	4.12	-	-	-	6.42
Critical Hdwy Stg 1	-	-	-	-	5.42
Critical Hdwy Stg 2	-	-	-	-	5.42
Follow-up Hdwy	2.218	-	-	-	3.518
Pot Cap-1 Maneuver	1501	-	-	-	808
Stage 1	-	-	-	-	931
Stage 2	-	-	-	-	935
Platoon blocked, %		-	-	-	
Mov Cap-1 Maneuver	1501	-	-	-	793
Mov Cap-2 Maneuver	-	-	-	-	783
Stage 1	-	-	-	-	914
Stage 2	-	-	-	-	935

Approach	EB	WB	SB
HCM Control Delay, s	3.3	0	9.1
HCM LOS			A

Minor Lane/Major Mvmt	EBL	EBT	WBT	WBR	SBLn1
Capacity (veh/h)	1501	-	-	-	955
HCM Lane V/C Ratio	0.018	-	-	-	0.091
HCM Control Delay (s)	7.4	-	-	-	9.1
HCM Lane LOS	A	-	-	-	A
HCM 95th %tile Q(veh)	0.1	-	-	-	0.3

Intersection						
Int Delay, s/veh	3.8					
Movement	EBL	EBR	NBL	NBT	SBT	SBR
Lane Configurations	↔		↔	↑	↑	
Traffic Vol, veh/h	6	35	12	20	44	2
Future Vol, veh/h	6	35	12	20	44	2
Conflicting Peds, #/hr	0	0	0	0	0	0
Sign Control	Stop	Stop	Free	Free	Free	Free
RT Channelized	-	None	-	None	-	None
Storage Length	0	-	205	-	-	-
Veh in Median Storage, #	0	-	-	0	0	-
Grade, %	0	-	-	0	0	-
Peak Hour Factor	85	85	85	85	85	85
Heavy Vehicles, %	2	2	2	2	2	2
Mvmt Flow	7	41	14	24	52	2

Major/Minor	Minor2	Major1		Major2	
Conflicting Flow All	105	53	54	0	0
Stage 1	53	-	-	-	-
Stage 2	52	-	-	-	-
Critical Hdwy	6.42	6.22	4.12	-	-
Critical Hdwy Stg 1	5.42	-	-	-	-
Critical Hdwy Stg 2	5.42	-	-	-	-
Follow-up Hdwy	3.518	3.318	2.218	-	-
Pot Cap-1 Maneuver	893	1014	1551	-	-
Stage 1	970	-	-	-	-
Stage 2	970	-	-	-	-
Platoon blocked, %				-	-
Mov Cap-1 Maneuver	885	1014	1551	-	-
Mov Cap-2 Maneuver	844	-	-	-	-
Stage 1	961	-	-	-	-
Stage 2	970	-	-	-	-

Approach	EB	NB	SB
HCM Control Delay, s	8.8	2.8	0
HCM LOS	A		

Minor Lane/Major Mvmt	NBL	NBT	EBLn1	SBT	SBR
Capacity (veh/h)	1551	-	985	-	-
HCM Lane V/C Ratio	0.009	-	0.049	-	-
HCM Control Delay (s)	7.3	-	8.8	-	-
HCM Lane LOS	A	-	A	-	-
HCM 95th %tile Q(veh)	0	-	0.2	-	-

Intersection												
Int Delay, s/veh	66.9											
Movement	EBL	EBT	EBR	WBL	WBT	WBR	NBL	NBT	NBR	SBL	SBT	SBR
Lane Configurations		↕			↕			↕			↕	
Traffic Vol, veh/h	9	254	96	47	128	45	77	93	65	122	99	9
Future Vol, veh/h	9	254	96	47	128	45	77	93	65	122	99	9
Conflicting Peds, #/hr	0	0	0	0	0	0	0	0	0	0	0	0
Sign Control	Stop	Stop	Stop	Stop	Stop	Stop	Free	Free	Free	Free	Free	Free
RT Channelized	-	-	None	-	-	None	-	-	None	-	-	None
Storage Length	-	-	-	-	-	-	-	-	-	-	-	-
Veh in Median Storage, #	-	0	-	-	0	-	-	0	-	-	0	-
Grade, %	-	0	-	-	0	-	-	0	-	-	0	-
Peak Hour Factor	85	85	85	85	85	85	85	85	85	85	85	85
Heavy Vehicles, %	2	2	2	2	2	2	2	2	2	2	2	2
Mvmt Flow	11	299	113	55	151	53	91	109	76	144	116	11

Major/Minor	Minor2		Minor1		Major1		Major2					
Conflicting Flow All	841	777	122	945	744	147	127	0	0	185	0	0
Stage 1	410	410	-	329	329	-	-	-	-	-	-	-
Stage 2	431	367	-	616	415	-	-	-	-	-	-	-
Critical Hdwy	7.12	6.52	6.22	7.12	6.52	6.22	4.12	-	-	4.12	-	-
Critical Hdwy Stg 1	6.12	5.52	-	6.12	5.52	-	-	-	-	-	-	-
Critical Hdwy Stg 2	6.12	5.52	-	6.12	5.52	-	-	-	-	-	-	-
Follow-up Hdwy	3.518	4.018	3.318	3.518	4.018	3.318	2.218	-	-	2.218	-	-
Pot Cap-1 Maneuver	284	328	929	242	343	900	1459	-	-	1390	-	-
Stage 1	619	595	-	684	646	-	-	-	-	-	-	-
Stage 2	603	622	-	478	592	-	-	-	-	-	-	-
Platoon blocked, %								-	-	-	-	-
Mov Cap-1 Maneuver	136	~ 271	929	-	283	900	1459	-	-	1390	-	-
Mov Cap-2 Maneuver	136	~ 271	-	-	283	-	-	-	-	-	-	-
Stage 1	576	528	-	636	601	-	-	-	-	-	-	-
Stage 2	396	578	-	162	526	-	-	-	-	-	-	-

Approach	EB	WB	NB	SB
HCM Control Delay, s	190.2		2.5	4.2
HCM LOS	F	-		

Minor Lane/Major Mvmt	NBL	NBT	NBR	EBLn1WBLn1	SBL	SBT	SBR
Capacity (veh/h)	1459	-	-	324	-	1390	-
HCM Lane V/C Ratio	0.062	-	-	1.304	-	0.103	-
HCM Control Delay (s)	7.6	0	-	190.2	-	7.9	0
HCM Lane LOS	A	A	-	F	-	A	A
HCM 95th %tile Q(veh)	0.2	-	-	20.2	-	0.3	-

Notes  
 ~: Volume exceeds capacity    \$: Delay exceeds 300s    +: Computation Not Defined    \*: All major volume in platoon

Intersection						
Int Delay, s/veh	1.7					
Movement	WBL	WBR	NBT	NBR	SBL	SBT
Lane Configurations	↘	↗	↕↕	↗	↘	↕↕
Traffic Vol, veh/h	80	15	502	87	25	316
Future Vol, veh/h	80	15	502	87	25	316
Conflicting Peds, #/hr	0	0	0	0	0	0
Sign Control	Stop	Stop	Free	Free	Free	Free
RT Channelized	-	None	-	None	-	None
Storage Length	485	-	-	235	385	-
Veh in Median Storage, #	0	-	0	-	-	0
Grade, %	0	-	0	-	-	0
Peak Hour Factor	85	85	85	85	85	85
Heavy Vehicles, %	2	2	2	2	2	2
Mvmt Flow	94	18	591	102	29	372

Major/Minor	Minor1	Major1	Major2		
Conflicting Flow All	835	296	0	0	693
Stage 1	591	-	-	-	-
Stage 2	244	-	-	-	-
Critical Hdwy	6.84	6.94	-	-	4.14
Critical Hdwy Stg 1	5.84	-	-	-	-
Critical Hdwy Stg 2	5.84	-	-	-	-
Follow-up Hdwy	3.52	3.32	-	-	2.22
Pot Cap-1 Maneuver	306	700	-	-	898
Stage 1	516	-	-	-	-
Stage 2	774	-	-	-	-
Platoon blocked, %			-	-	-
Mov Cap-1 Maneuver	296	700	-	-	898
Mov Cap-2 Maneuver	405	-	-	-	-
Stage 1	516	-	-	-	-
Stage 2	749	-	-	-	-

Approach	WB	NB	SB
HCM Control Delay, s	15.6	0	0.7
HCM LOS	C		

Minor Lane/Major Mvmt	NBT	NBRWBLn1	WBLn2	SBL	SBT
Capacity (veh/h)	-	-	405	700	898
HCM Lane V/C Ratio	-	-	0.232	0.025	0.033
HCM Control Delay (s)	-	-	16.6	10.3	9.1
HCM Lane LOS	-	-	C	B	A
HCM 95th %tile Q(veh)	-	-	0.9	0.1	0.1



Intersection												
Int Delay, s/veh	8											
Movement	EBL	EBT	EBR	WBL	WBT	WBR	NBL	NBT	NBR	SBL	SBT	SBR
Lane Configurations	↘	↗	↗	↘	↗	↗	↘	↗	↗	↘	↗	↗
Traffic Vol, veh/h	18	0	14	0	0	0	20	35	0	0	28	11
Future Vol, veh/h	18	0	14	0	0	0	20	35	0	0	28	11
Conflicting Peds, #/hr	0	0	0	0	0	0	0	0	0	0	0	0
Sign Control	Free	Free	Free	Free	Free	Free	Stop	Stop	Stop	Stop	Stop	Stop
RT Channelized	-	-	None	-	-	None	-	-	None	-	-	None
Storage Length	535	-	0	310	-	0	410	-	155	235	-	155
Veh in Median Storage, #	-	0	-	-	0	-	-	0	-	-	0	-
Grade, %	-	0	-	-	0	-	-	0	-	-	0	-
Peak Hour Factor	85	85	85	85	85	85	85	85	85	85	85	85
Heavy Vehicles, %	2	2	2	2	2	2	2	2	2	2	2	2
Mvmt Flow	21	0	16	0	0	0	24	41	0	0	33	13

Major/Minor	Major1		Major2			Minor1			Minor2			
Conflicting Flow All	1	0	0	16	0	0	59	43	0	64	59	1
Stage 1	-	-	-	-	-	-	42	42	-	1	1	-
Stage 2	-	-	-	-	-	-	17	1	-	63	58	-
Critical Hdwy	4.14	-	-	4.14	-	-	7.54	6.54	6.94	7.54	6.54	6.94
Critical Hdwy Stg 1	-	-	-	-	-	-	6.54	5.54	-	6.54	5.54	-
Critical Hdwy Stg 2	-	-	-	-	-	-	6.54	5.54	-	6.54	5.54	-
Follow-up Hdwy	2.22	-	-	2.22	-	-	3.52	4.02	3.32	3.52	4.02	3.32
Pot Cap-1 Maneuver	1620	-	-	1600	-	-	930	848	-	923	831	1083
Stage 1	-	-	-	-	-	-	967	859	-	1021	895	-
Stage 2	-	-	-	-	-	-	1000	895	-	941	846	-
Platoon blocked, %	-	-	-	-	-	-	-	-	-	-	-	-
Mov Cap-1 Maneuver	1620	-	-	1600	-	-	882	837	-	-	820	1083
Mov Cap-2 Maneuver	-	-	-	-	-	-	882	837	-	-	820	-
Stage 1	-	-	-	-	-	-	954	848	-	1008	895	-
Stage 2	-	-	-	-	-	-	952	895	-	884	835	-

Approach	EB	WB	NB	SB
HCM Control Delay, s	4.1	0	9.4	9.3
HCM LOS			A	A

Minor Lane/Major Mvmt	NBLn1	NBLn2	NBLn3	EBL	EBT	EBR	WBL	WBT	WBR	SBLn1	SBLn2	SBLn3
Capacity (veh/h)	882	837	-	1620	-	-	1600	-	-	-	820	1083
HCM Lane V/C Ratio	0.027	0.049	-	0.013	-	-	-	-	-	-	0.04	0.012
HCM Control Delay (s)	9.2	9.5	0	7.3	-	-	0	-	-	0	9.6	8.4
HCM Lane LOS	A	A	A	A	-	-	A	-	-	A	A	A
HCM 95th %tile Q(veh)	0.1	0.2	-	0	-	-	0	-	-	-	0.1	0

Intersection						
Int Delay, s/veh	6.2					
Movement	WBL	WBR	NBT	NBR	SBL	SBT
Lane Configurations	↘	↗	↕	↗	↘	↕
Traffic Vol, veh/h	97	178	506	118	115	320
Future Vol, veh/h	97	178	506	118	115	320
Conflicting Peds, #/hr	0	0	0	0	0	0
Sign Control	Stop	Stop	Free	Free	Free	Free
RT Channelized	-	None	-	None	-	None
Storage Length	300	-	-	155	300	-
Veh in Median Storage, #	0	-	0	-	-	0
Grade, %	0	-	0	-	-	0
Peak Hour Factor	85	85	85	85	85	85
Heavy Vehicles, %	2	2	2	2	2	2
Mvmt Flow	114	209	595	139	135	376

Major/Minor	Minor1	Major1	Major2		
Conflicting Flow All	1053	298	0	0	734
Stage 1	595	-	-	-	-
Stage 2	458	-	-	-	-
Critical Hdwy	6.84	6.94	-	-	4.14
Critical Hdwy Stg 1	5.84	-	-	-	-
Critical Hdwy Stg 2	5.84	-	-	-	-
Follow-up Hdwy	3.52	3.32	-	-	2.22
Pot Cap-1 Maneuver	222	698	-	-	867
Stage 1	514	-	-	-	-
Stage 2	604	-	-	-	-
Platoon blocked, %			-	-	-
Mov Cap-1 Maneuver	187	698	-	-	867
Mov Cap-2 Maneuver	187	-	-	-	-
Stage 1	514	-	-	-	-
Stage 2	510	-	-	-	-

Approach	WB	NB	SB
HCM Control Delay, s	25.8	0	2.6
HCM LOS	D		

Minor Lane/Major Mvmt	NBT	NBRWBLn1	WBLn2	SBL	SBT
Capacity (veh/h)	-	-	187	698	867
HCM Lane V/C Ratio	-	-	0.61	0.3	0.156
HCM Control Delay (s)	-	-	50.5	12.4	9.9
HCM Lane LOS	-	-	F	B	A
HCM 95th %tile Q(veh)	-	-	3.4	1.3	0.6

Intersection						
Int Delay, s/veh	9.2					
Movement	EBL	EBT	WBT	WBR	SBL	SBR
Lane Configurations	↘	↑↑	↑↑	↗	↘	↗
Traffic Vol, veh/h	125	108	178	398	235	97
Future Vol, veh/h	125	108	178	398	235	97
Conflicting Peds, #/hr	0	0	0	0	0	0
Sign Control	Free	Free	Free	Free	Stop	Stop
RT Channelized	-	None	-	None	-	None
Storage Length	300	-	-	205	155	0
Veh in Median Storage, #	-	0	0	-	0	-
Grade, %	-	0	0	-	0	-
Peak Hour Factor	85	85	85	85	85	85
Heavy Vehicles, %	2	2	2	2	2	2
Mvmt Flow	147	127	209	468	276	114

Major/Minor	Major1	Major2	Minor2		
Conflicting Flow All	677	0	-	0	567
Stage 1	-	-	-	-	209
Stage 2	-	-	-	-	358
Critical Hdwy	4.14	-	-	-	6.84
Critical Hdwy Stg 1	-	-	-	-	5.84
Critical Hdwy Stg 2	-	-	-	-	5.84
Follow-up Hdwy	2.22	-	-	-	3.52
Pot Cap-1 Maneuver	911	-	-	-	454
Stage 1	-	-	-	-	806
Stage 2	-	-	-	-	678
Platoon blocked, %		-	-	-	
Mov Cap-1 Maneuver	911	-	-	-	381
Mov Cap-2 Maneuver	-	-	-	-	381
Stage 1	-	-	-	-	676
Stage 2	-	-	-	-	678

Approach	EB	WB	SB
HCM Control Delay, s	5.2	0	28.1
HCM LOS			D

Minor Lane/Major Mvmt	EBL	EBT	WBT	WBR	SBLn1	SBLn2
Capacity (veh/h)	911	-	-	-	381	929
HCM Lane V/C Ratio	0.161	-	-	-	0.726	0.123
HCM Control Delay (s)	9.7	-	-	-	35.8	9.4
HCM Lane LOS	A	-	-	-	E	A
HCM 95th %tile Q(veh)	0.6	-	-	-	5.6	0.4

Intersection						
Int Delay, s/veh	3.8					
Movement	EBL	EBT	WBT	WBR	SBL	SBR
Lane Configurations						
Traffic Vol, veh/h	80	89	55	3	2	47
Future Vol, veh/h	80	89	55	3	2	47
Conflicting Peds, #/hr	0	0	0	0	0	0
Sign Control	Free	Free	Free	Free	Stop	Stop
RT Channelized	-	None	-	None	-	None
Storage Length	305	-	-	-	0	-
Veh in Median Storage, #	-	0	0	-	0	-
Grade, %	-	0	0	-	0	-
Peak Hour Factor	85	85	85	85	85	85
Heavy Vehicles, %	2	2	2	2	2	2
Mvmt Flow	94	105	65	4	2	55

Major/Minor	Major1	Major2	Minor2		
Conflicting Flow All	69	0	-	0	360 67
Stage 1	-	-	-	-	67 -
Stage 2	-	-	-	-	293 -
Critical Hdwy	4.12	-	-	-	6.42 6.22
Critical Hdwy Stg 1	-	-	-	-	5.42 -
Critical Hdwy Stg 2	-	-	-	-	5.42 -
Follow-up Hdwy	2.218	-	-	-	3.518 3.318
Pot Cap-1 Maneuver	1532	-	-	-	639 997
Stage 1	-	-	-	-	956 -
Stage 2	-	-	-	-	757 -
Platoon blocked, %		-	-	-	
Mov Cap-1 Maneuver	1532	-	-	-	600 997
Mov Cap-2 Maneuver	-	-	-	-	642 -
Stage 1	-	-	-	-	898 -
Stage 2	-	-	-	-	757 -

Approach	EB	WB	SB
HCM Control Delay, s	3.6	0	8.9
HCM LOS			A

Minor Lane/Major Mvmt	EBL	EBT	WBT	WBR	SBLn1
Capacity (veh/h)	1532	-	-	-	975
HCM Lane V/C Ratio	0.061	-	-	-	0.059
HCM Control Delay (s)	7.5	-	-	-	8.9
HCM Lane LOS	A	-	-	-	A
HCM 95th %tile Q(veh)	0.2	-	-	-	0.2

Intersection						
Int Delay, s/veh	3.3					
Movement	EBL	EBR	NBL	NBT	SBT	SBR
Lane Configurations						
Traffic Vol, veh/h	4	23	40	51	35	7
Future Vol, veh/h	4	23	40	51	35	7
Conflicting Peds, #/hr	0	0	0	0	0	0
Sign Control	Stop	Stop	Free	Free	Free	Free
RT Channelized	-	None	-	None	-	None
Storage Length	0	-	205	-	-	-
Veh in Median Storage, #	0	-	-	0	0	-
Grade, %	0	-	-	0	0	-
Peak Hour Factor	85	85	85	85	85	85
Heavy Vehicles, %	2	2	2	2	2	2
Mvmt Flow	5	27	47	60	41	8

Major/Minor	Minor2	Major1		Major2	
Conflicting Flow All	199	45	49	0	0
Stage 1	45	-	-	-	-
Stage 2	154	-	-	-	-
Critical Hdwy	6.42	6.22	4.12	-	-
Critical Hdwy Stg 1	5.42	-	-	-	-
Critical Hdwy Stg 2	5.42	-	-	-	-
Follow-up Hdwy	3.518	3.318	2.218	-	-
Pot Cap-1 Maneuver	790	1025	1558	-	-
Stage 1	977	-	-	-	-
Stage 2	874	-	-	-	-
Platoon blocked, %				-	-
Mov Cap-1 Maneuver	766	1025	1558	-	-
Mov Cap-2 Maneuver	761	-	-	-	-
Stage 1	948	-	-	-	-
Stage 2	874	-	-	-	-

Approach	EB	NB	SB
HCM Control Delay, s	8.8	3.2	0
HCM LOS	A		

Minor Lane/Major Mvmt	NBL	NBT	EBLn1	SBT	SBR
Capacity (veh/h)	1558	-	975	-	-
HCM Lane V/C Ratio	0.03	-	0.033	-	-
HCM Control Delay (s)	7.4	-	8.8	-	-
HCM Lane LOS	A	-	A	-	-
HCM 95th %tile Q(veh)	0.1	-	0.1	-	-

HCM 6th Roundabout  
1: Vollmer Rd & Burgess Rd

Short-Term Total Traffic  
AM Peak Hour

Intersection				
Intersection Delay, s/veh	6.5			
Intersection LOS	A			
Approach	EB	WB	NB	SB
Entry Lanes	1	1	1	1
Conflicting Circle Lanes	1	1	1	1
Adj Approach Flow, veh/h	156	423	307	161
Demand Flow Rate, veh/h	159	432	313	164
Vehicles Circulating, veh/h	207	287	95	511
Vehicles Exiting, veh/h	468	121	271	208
Ped Vol Crossing Leg, #/h	0	0	0	0
Ped Cap Adj	1.000	1.000	1.000	1.000
Approach Delay, s/veh	4.5	8.2	5.2	6.6
Approach LOS	A	A	A	A
Lane	Left	Left	Left	Left
Designated Moves	LTR	LTR	LTR	LTR
Assumed Moves	LTR	LTR	LTR	LTR
RT Channelized				
Lane Util	1.000	1.000	1.000	1.000
Follow-Up Headway, s	2.609	2.609	2.609	2.609
Critical Headway, s	4.976	4.976	4.976	4.976
Entry Flow, veh/h	159	432	313	164
Cap Entry Lane, veh/h	1117	1030	1252	819
Entry HV Adj Factor	0.981	0.980	0.980	0.980
Flow Entry, veh/h	156	423	307	161
Cap Entry, veh/h	1096	1009	1228	803
V/C Ratio	0.142	0.420	0.250	0.200
Control Delay, s/veh	4.5	8.2	5.2	6.6
LOS	A	A	A	A
95th %tile Queue, veh	0	2	1	1

Intersection						
Int Delay, s/veh	2.5					
Movement	WBL	WBR	NBT	NBR	SBL	SBT
Lane Configurations	↘	↗	↕↕	↗	↘	↕↕
Traffic Vol, veh/h	121	29	258	26	9	347
Future Vol, veh/h	121	29	258	26	9	347
Conflicting Peds, #/hr	0	0	0	0	0	0
Sign Control	Stop	Stop	Free	Free	Free	Free
RT Channelized	-	None	-	None	-	None
Storage Length	485	-	-	235	385	-
Veh in Median Storage, #	0	-	0	-	-	0
Grade, %	0	-	0	-	-	0
Peak Hour Factor	85	85	85	85	85	85
Heavy Vehicles, %	2	2	2	2	2	2
Mvmt Flow	142	34	304	31	11	408

Major/Minor	Minor1	Major1	Major2		
Conflicting Flow All	530	152	0	0	335
Stage 1	304	-	-	-	-
Stage 2	226	-	-	-	-
Critical Hdwy	6.84	6.94	-	-	4.14
Critical Hdwy Stg 1	5.84	-	-	-	-
Critical Hdwy Stg 2	5.84	-	-	-	-
Follow-up Hdwy	3.52	3.32	-	-	2.22
Pot Cap-1 Maneuver	479	867	-	-	1221
Stage 1	722	-	-	-	-
Stage 2	790	-	-	-	-
Platoon blocked, %			-	-	-
Mov Cap-1 Maneuver	475	867	-	-	1221
Mov Cap-2 Maneuver	559	-	-	-	-
Stage 1	722	-	-	-	-
Stage 2	783	-	-	-	-

Approach	WB	NB	SB
HCM Control Delay, s	12.8	0	0.2
HCM LOS	B		

Minor Lane/Major Mvmt	NBT	NBR	WBLn1	WBLn2	SBL	SBT
Capacity (veh/h)	-	-	559	867	1221	-
HCM Lane V/C Ratio	-	-	0.255	0.039	0.009	-
HCM Control Delay (s)	-	-	13.6	9.3	8	-
HCM Lane LOS	-	-	B	A	A	-
HCM 95th %tile Q(veh)	-	-	1	0.1	0	-

Intersection												
Int Delay, s/veh	8.4											
Movement	EBL	EBT	EBR	WBL	WBT	WBR	NBL	NBT	NBR	SBL	SBT	SBR
Lane Configurations	↘	↑↑	↗	↘	↑↑	↗	↘	↑	↗	↘	↑	↗
Traffic Vol, veh/h	5	0	6	0	0	0	22	10	0	0	42	16
Future Vol, veh/h	5	0	6	0	0	0	22	10	0	0	42	16
Conflicting Peds, #/hr	0	0	0	0	0	0	0	0	0	0	0	0
Sign Control	Free	Free	Free	Free	Free	Free	Stop	Stop	Stop	Stop	Stop	Stop
RT Channelized	-	-	None	-	-	None	-	-	None	-	-	None
Storage Length	535	-	0	310	-	0	410	-	155	235	-	155
Veh in Median Storage, #	-	0	-	-	0	-	-	0	-	-	0	-
Grade, %	-	0	-	-	0	-	-	0	-	-	0	-
Peak Hour Factor	85	85	85	85	85	85	85	85	85	85	85	85
Heavy Vehicles, %	2	2	2	2	2	2	2	2	2	2	2	2
Mvmt Flow	6	0	7	0	0	0	26	12	0	0	49	19

Major/Minor	Major1			Major2			Minor1			Minor2		
Conflicting Flow All	1	0	0	7	0	0	37	13	0	19	20	1
Stage 1	-	-	-	-	-	-	12	12	-	1	1	-
Stage 2	-	-	-	-	-	-	25	1	-	18	19	-
Critical Hdwy	4.14	-	-	4.14	-	-	7.54	6.54	6.94	7.54	6.54	6.94
Critical Hdwy Stg 1	-	-	-	-	-	-	6.54	5.54	-	6.54	5.54	-
Critical Hdwy Stg 2	-	-	-	-	-	-	6.54	5.54	-	6.54	5.54	-
Follow-up Hdwy	2.22	-	-	2.22	-	-	3.52	4.02	3.32	3.52	4.02	3.32
Pot Cap-1 Maneuver	1620	-	-	1612	-	-	964	881	-	992	873	1083
Stage 1	-	-	-	-	-	-	1007	885	-	1021	895	-
Stage 2	-	-	-	-	-	-	989	895	-	999	879	-
Platoon blocked, %	-	-	-	-	-	-	-	-	-	-	-	-
Mov Cap-1 Maneuver	1620	-	-	1612	-	-	903	877	-	-	870	1083
Mov Cap-2 Maneuver	-	-	-	-	-	-	903	877	-	-	870	-
Stage 1	-	-	-	-	-	-	1003	881	-	1017	895	-
Stage 2	-	-	-	-	-	-	918	895	-	982	875	-

Approach	EB	WB	NB	SB
HCM Control Delay, s	3.3	0	9.1	9.1
HCM LOS			A	A

Minor Lane/Major Mvmt	NBLn1	NBLn2	NBLn3	EBL	EBT	EBR	WBL	WBT	WBR	SBLn1	SBLn2	SBLn3
Capacity (veh/h)	903	877	-	1620	-	-	1612	-	-	-	-	870 1083
HCM Lane V/C Ratio	0.029	0.013	-	0.004	-	-	-	-	-	-	-	0.057 0.017
HCM Control Delay (s)	9.1	9.2	0	7.2	-	-	0	-	-	0	9.4	8.4
HCM Lane LOS	A	A	A	A	-	-	A	-	-	A	A	A
HCM 95th %tile Q(veh)	0.1	0	-	0	-	-	0	-	-	-	0.2	0.1



Intersection						
Int Delay, s/veh	7.5					
Movement	WBL	WBR	NBT	NBR	SBL	SBT
Lane Configurations	↘	↗	↑↑	↗	↘	↑↑
Traffic Vol, veh/h	149	80	226	36	135	386
Future Vol, veh/h	149	80	226	36	135	386
Conflicting Peds, #/hr	0	0	0	0	0	0
Sign Control	Stop	Stop	Free	Free	Free	Free
RT Channelized	-	None	-	None	-	None
Storage Length	300	-	-	155	300	-
Veh in Median Storage, #	0	-	0	-	-	0
Grade, %	0	-	0	-	-	0
Peak Hour Factor	85	85	85	85	85	85
Heavy Vehicles, %	2	2	2	2	2	2
Mvmt Flow	175	94	266	42	159	454

Major/Minor	Minor1	Major1	Major2			
Conflicting Flow All	811	133	0	0	308	0
Stage 1	266	-	-	-	-	-
Stage 2	545	-	-	-	-	-
Critical Hdwy	6.84	6.94	-	-	4.14	-
Critical Hdwy Stg 1	5.84	-	-	-	-	-
Critical Hdwy Stg 2	5.84	-	-	-	-	-
Follow-up Hdwy	3.52	3.32	-	-	2.22	-
Pot Cap-1 Maneuver	317	892	-	-	1249	-
Stage 1	754	-	-	-	-	-
Stage 2	545	-	-	-	-	-
Platoon blocked, %			-	-		-
Mov Cap-1 Maneuver	277	892	-	-	1249	-
Mov Cap-2 Maneuver	277	-	-	-	-	-
Stage 1	754	-	-	-	-	-
Stage 2	476	-	-	-	-	-

Approach	WB	NB	SB
HCM Control Delay, s	28	0	2.2
HCM LOS	D		

Minor Lane/Major Mvmt	NBT	NBR	WBLn1	WBLn2	SBL	SBT
Capacity (veh/h)	-	-	277	892	1249	-
HCM Lane V/C Ratio	-	-	0.633	0.106	0.127	-
HCM Control Delay (s)	-	-	38	9.5	8.3	-
HCM Lane LOS	-	-	E	A	A	-
HCM 95th %tile Q(veh)	-	-	3.9	0.4	0.4	-

Intersection						
Int Delay, s/veh	12.2					
Movement	EBL	EBT	WBT	WBR	SBL	SBR
Lane Configurations	↘	↑↑	↑↑	↗	↘	↗
Traffic Vol, veh/h	38	133	80	142	427	150
Future Vol, veh/h	38	133	80	142	427	150
Conflicting Peds, #/hr	0	0	0	0	0	0
Sign Control	Free	Free	Free	Free	Stop	Stop
RT Channelized	-	None	-	None	-	None
Storage Length	300	-	-	205	155	0
Veh in Median Storage, #	-	0	0	-	0	-
Grade, %	-	0	0	-	0	-
Peak Hour Factor	85	85	85	85	85	85
Heavy Vehicles, %	2	2	2	2	2	2
Mvmt Flow	45	156	94	167	502	176

Major/Minor	Major1	Major2	Minor2		
Conflicting Flow All	261	0	-	0	262 47
Stage 1	-	-	-	-	94 -
Stage 2	-	-	-	-	168 -
Critical Hdwy	4.14	-	-	-	6.84 6.94
Critical Hdwy Stg 1	-	-	-	-	5.84 -
Critical Hdwy Stg 2	-	-	-	-	5.84 -
Follow-up Hdwy	2.22	-	-	-	3.52 3.32
Pot Cap-1 Maneuver	1300	-	-	-	705 1012
Stage 1	-	-	-	-	919 -
Stage 2	-	-	-	-	844 -
Platoon blocked, %		-	-	-	
Mov Cap-1 Maneuver	1300	-	-	-	680 1012
Mov Cap-2 Maneuver	-	-	-	-	680 -
Stage 1	-	-	-	-	887 -
Stage 2	-	-	-	-	844 -

Approach	EB	WB	SB
HCM Control Delay, s	1.7	0	20
HCM LOS			C

Minor Lane/Major Mvmt	EBL	EBT	WBT	WBR	SBLn1	SBLn2
Capacity (veh/h)	1300	-	-	-	680	1012
HCM Lane V/C Ratio	0.034	-	-	-	0.739	0.174
HCM Control Delay (s)	7.9	-	-	-	23.7	9.3
HCM Lane LOS	A	-	-	-	C	A
HCM 95th %tile Q(veh)	0.1	-	-	-	6.6	0.6

Intersection												
Int Delay, s/veh	3.6											
Movement	EBL	EBT	EBR	WBL	WBT	WBR	NBL	NBT	NBR	SBL	SBT	SBR
Lane Configurations	↖	↑	↗	↖	↗			↕			↕	
Traffic Vol, veh/h	23	48	6	0	136	1	19	0	1	3	0	71
Future Vol, veh/h	23	48	6	0	136	1	19	0	1	3	0	71
Conflicting Peds, #/hr	0	0	0	0	0	0	0	0	0	0	0	0
Sign Control	Free	Free	Free	Free	Free	Free	Stop	Stop	Stop	Stop	Stop	Stop
RT Channelized	-	-	None	-	-	None	-	-	None	-	-	None
Storage Length	305	-	255	305	-	-	-	-	-	-	-	-
Veh in Median Storage, #	-	0	-	-	0	-	-	0	-	-	0	-
Grade, %	-	0	-	-	0	-	-	0	-	-	0	-
Peak Hour Factor	85	85	85	85	85	85	85	85	85	85	85	85
Heavy Vehicles, %	2	2	2	2	2	2	2	2	2	2	2	2
Mvmt Flow	27	56	7	0	160	1	22	0	1	4	0	84

Major/Minor	Major1			Major2			Minor1			Minor2		
Conflicting Flow All	161	0	0	63	0	0	313	271	56	275	278	161
Stage 1	-	-	-	-	-	-	110	110	-	161	161	-
Stage 2	-	-	-	-	-	-	203	161	-	114	117	-
Critical Hdwy	4.12	-	-	4.12	-	-	7.12	6.52	6.22	7.12	6.52	6.22
Critical Hdwy Stg 1	-	-	-	-	-	-	6.12	5.52	-	6.12	5.52	-
Critical Hdwy Stg 2	-	-	-	-	-	-	6.12	5.52	-	6.12	5.52	-
Follow-up Hdwy	2.218	-	-	2.218	-	-	3.518	4.018	3.318	3.518	4.018	3.318
Pot Cap-1 Maneuver	1418	-	-	1540	-	-	640	636	1011	677	630	884
Stage 1	-	-	-	-	-	-	895	804	-	841	765	-
Stage 2	-	-	-	-	-	-	799	765	-	891	799	-
Platoon blocked, %	-	-	-	-	-	-	-	-	-	-	-	-
Mov Cap-1 Maneuver	1418	-	-	1540	-	-	571	624	1011	666	618	884
Mov Cap-2 Maneuver	-	-	-	-	-	-	571	624	-	666	618	-
Stage 1	-	-	-	-	-	-	878	789	-	825	765	-
Stage 2	-	-	-	-	-	-	724	765	-	873	784	-

Approach	EB	WB	NB	SB
HCM Control Delay, s	2.3	0	11.4	9.6
HCM LOS			B	A

Minor Lane/Major Mvmt	NBLn1	EBL	EBT	EBR	WBL	WBT	WBR	SBLn1
Capacity (veh/h)	584	1418	-	-	1540	-	-	872
HCM Lane V/C Ratio	0.04	0.019	-	-	-	-	-	0.1
HCM Control Delay (s)	11.4	7.6	-	-	0	-	-	9.6
HCM Lane LOS	B	A	-	-	A	-	-	A
HCM 95th %tile Q(veh)	0.1	0.1	-	-	0	-	-	0.3

Intersection												
Int Delay, s/veh	5.4											
Movement	EBL	EBT	EBR	WBL	WBT	WBR	NBL	NBT	NBR	SBL	SBT	SBR
Lane Configurations		↕			↕		↕	↕		↕	↕	
Traffic Vol, veh/h	6	0	35	58	0	6	12	21	19	2	44	2
Future Vol, veh/h	6	0	35	58	0	6	12	21	19	2	44	2
Conflicting Peds, #/hr	0	0	0	0	0	0	0	0	0	0	0	0
Sign Control	Stop	Stop	Stop	Stop	Stop	Stop	Free	Free	Free	Free	Free	Free
RT Channelized	-	-	None	-	-	None	-	-	None	-	-	None
Storage Length	-	-	-	-	-	-	205	-	-	205	-	-
Veh in Median Storage, #	-	0	-	-	0	-	-	0	-	-	0	-
Grade, %	-	0	-	-	0	-	-	0	-	-	0	-
Peak Hour Factor	85	85	85	85	85	85	85	85	85	85	85	85
Heavy Vehicles, %	2	2	2	2	2	2	2	2	2	2	2	2
Mvmt Flow	7	0	41	68	0	7	14	25	22	2	52	2

Major/Minor	Minor2		Minor1		Major1			Major2				
Conflicting Flow All	125	132	53	142	122	36	54	0	0	47	0	0
Stage 1	57	57	-	64	64	-	-	-	-	-	-	-
Stage 2	68	75	-	78	58	-	-	-	-	-	-	-
Critical Hdwy	7.12	6.52	6.22	7.12	6.52	6.22	4.12	-	-	4.12	-	-
Critical Hdwy Stg 1	6.12	5.52	-	6.12	5.52	-	-	-	-	-	-	-
Critical Hdwy Stg 2	6.12	5.52	-	6.12	5.52	-	-	-	-	-	-	-
Follow-up Hdwy	3.518	4.018	3.318	3.518	4.018	3.318	2.218	-	-	2.218	-	-
Pot Cap-1 Maneuver	849	759	1014	828	768	1037	1551	-	-	1560	-	-
Stage 1	955	847	-	947	842	-	-	-	-	-	-	-
Stage 2	942	833	-	931	847	-	-	-	-	-	-	-
Platoon blocked, %								-	-	-	-	-
Mov Cap-1 Maneuver	836	751	1014	788	760	1037	1551	-	-	1560	-	-
Mov Cap-2 Maneuver	836	751	-	788	760	-	-	-	-	-	-	-
Stage 1	946	846	-	938	834	-	-	-	-	-	-	-
Stage 2	927	826	-	892	846	-	-	-	-	-	-	-

Approach	EB		WB		NB		SB	
HCM Control Delay, s	8.9		9.9		1.7		0.3	
HCM LOS	A		A					

Minor Lane/Major Mvmt	NBL	NBT	NBR	EBLn1	WBLn1	SBL	SBT	SBR
Capacity (veh/h)	1551	-	-	983	806	1560	-	-
HCM Lane V/C Ratio	0.009	-	-	0.049	0.093	0.002	-	-
HCM Control Delay (s)	7.3	0	-	8.9	9.9	7.3	-	-
HCM Lane LOS	A	A	-	A	A	A	-	-
HCM 95th %tile Q(veh)	0	-	-	0.2	0.3	0	-	-

HCM 6th Roundabout  
1: Vollmer Rd & Burgess Rd

Short-Term Total Traffic  
PM Peak Hour

Intersection				
Intersection Delay, s/veh	7.4			
Intersection LOS	A			
Approach	EB	WB	NB	SB
Entry Lanes	1	1	1	1
Conflicting Circle Lanes	1	1	1	1
Adj Approach Flow, veh/h	430	259	281	274
Demand Flow Rate, veh/h	438	264	287	279
Vehicles Circulating, veh/h	324	220	463	306
Vehicles Exiting, veh/h	261	530	299	178
Ped Vol Crossing Leg, #/h	0	0	0	0
Ped Cap Adj	1.000	1.000	1.000	1.000
Approach Delay, s/veh	8.8	5.6	8.1	6.4
Approach LOS	A	A	A	A
Lane	Left	Left	Left	Left
Designated Moves	LTR	LTR	LTR	LTR
Assumed Moves	LTR	LTR	LTR	LTR
RT Channelized				
Lane Util	1.000	1.000	1.000	1.000
Follow-Up Headway, s	2.609	2.609	2.609	2.609
Critical Headway, s	4.976	4.976	4.976	4.976
Entry Flow, veh/h	438	264	287	279
Cap Entry Lane, veh/h	992	1103	861	1010
Entry HV Adj Factor	0.982	0.981	0.978	0.981
Flow Entry, veh/h	430	259	281	274
Cap Entry, veh/h	974	1082	842	990
V/C Ratio	0.442	0.239	0.334	0.276
Control Delay, s/veh	8.8	5.6	8.1	6.4
LOS	A	A	A	A
95th %tile Queue, veh	2	1	1	1

Intersection						
Int Delay, s/veh	1.8					
Movement	WBL	WBR	NBT	NBR	SBL	SBT
Lane Configurations	↘	↗	↕↕	↗	↘	↕↕
Traffic Vol, veh/h	80	19	502	87	32	316
Future Vol, veh/h	80	19	502	87	32	316
Conflicting Peds, #/hr	0	0	0	0	0	0
Sign Control	Stop	Stop	Free	Free	Free	Free
RT Channelized	-	None	-	None	-	None
Storage Length	485	-	-	235	385	-
Veh in Median Storage, #	0	-	0	-	-	0
Grade, %	0	-	0	-	-	0
Peak Hour Factor	85	85	85	85	85	85
Heavy Vehicles, %	2	2	2	2	2	2
Mvmt Flow	94	22	591	102	38	372

Major/Minor	Minor1	Major1	Major2		
Conflicting Flow All	853	296	0	0	693
Stage 1	591	-	-	-	-
Stage 2	262	-	-	-	-
Critical Hdwy	6.84	6.94	-	-	4.14
Critical Hdwy Stg 1	5.84	-	-	-	-
Critical Hdwy Stg 2	5.84	-	-	-	-
Follow-up Hdwy	3.52	3.32	-	-	2.22
Pot Cap-1 Maneuver	298	700	-	-	898
Stage 1	516	-	-	-	-
Stage 2	758	-	-	-	-
Platoon blocked, %			-	-	-
Mov Cap-1 Maneuver	285	700	-	-	898
Mov Cap-2 Maneuver	399	-	-	-	-
Stage 1	516	-	-	-	-
Stage 2	726	-	-	-	-

Approach	WB	NB	SB
HCM Control Delay, s	15.6	0	0.8
HCM LOS	C		

Minor Lane/Major Mvmt	NBT	NBRWBLn1	WBLn2	SBL	SBT
Capacity (veh/h)	-	-	399	700	898
HCM Lane V/C Ratio	-	-	0.236	0.032	0.042
HCM Control Delay (s)	-	-	16.8	10.3	9.2
HCM Lane LOS	-	-	C	B	A
HCM 95th %tile Q(veh)	-	-	0.9	0.1	0.1

Intersection												
Int Delay, s/veh	7.6											
Movement	EBL	EBT	EBR	WBL	WBT	WBR	NBL	NBT	NBR	SBL	SBT	SBR
Lane Configurations	↘	↑↑	↗	↘	↑↑	↗	↘	↑	↗	↘	↑	↗
Traffic Vol, veh/h	18	0	22	0	0	0	25	35	0	0	28	11
Future Vol, veh/h	18	0	22	0	0	0	25	35	0	0	28	11
Conflicting Peds, #/hr	0	0	0	0	0	0	0	0	0	0	0	0
Sign Control	Free	Free	Free	Free	Free	Free	Stop	Stop	Stop	Stop	Stop	Stop
RT Channelized	-	-	None	-	-	None	-	-	None	-	-	None
Storage Length	535	-	0	310	-	0	410	-	155	235	-	155
Veh in Median Storage, #	-	0	-	-	0	-	-	0	-	-	0	-
Grade, %	-	0	-	-	0	-	-	0	-	-	0	-
Peak Hour Factor	85	85	85	85	85	85	85	85	85	85	85	85
Heavy Vehicles, %	2	2	2	2	2	2	2	2	2	2	2	2
Mvmt Flow	21	0	26	0	0	0	29	41	0	0	33	13

Major/Minor	Major1			Major2			Minor1			Minor2		
Conflicting Flow All	1	0	0	26	0	0	59	43	0	64	69	1
Stage 1	-	-	-	-	-	-	42	42	-	1	1	-
Stage 2	-	-	-	-	-	-	17	1	-	63	68	-
Critical Hdwy	4.14	-	-	4.14	-	-	7.54	6.54	6.94	7.54	6.54	6.94
Critical Hdwy Stg 1	-	-	-	-	-	-	6.54	5.54	-	6.54	5.54	-
Critical Hdwy Stg 2	-	-	-	-	-	-	6.54	5.54	-	6.54	5.54	-
Follow-up Hdwy	2.22	-	-	2.22	-	-	3.52	4.02	3.32	3.52	4.02	3.32
Pot Cap-1 Maneuver	1620	-	-	1587	-	-	930	848	-	923	821	1083
Stage 1	-	-	-	-	-	-	967	859	-	1021	895	-
Stage 2	-	-	-	-	-	-	1000	895	-	941	838	-
Platoon blocked, %	-	-	-	-	-	-	-	-	-	-	-	-
Mov Cap-1 Maneuver	1620	-	-	1587	-	-	882	837	-	-	810	1083
Mov Cap-2 Maneuver	-	-	-	-	-	-	882	837	-	-	810	-
Stage 1	-	-	-	-	-	-	954	848	-	1008	895	-
Stage 2	-	-	-	-	-	-	952	895	-	884	827	-

Approach	EB	WB	NB	SB
HCM Control Delay, s	3.3	0	9.4	9.3
HCM LOS			A	A

Minor Lane/Major Mvmt	NBLn1	NBLn2	NBLn3	EBL	EBT	EBR	WBL	WBT	WBR	SBLn1	SBLn2	SBLn3
Capacity (veh/h)	882	837	-	1620	-	-	1587	-	-	-	810	1083
HCM Lane V/C Ratio	0.033	0.049	-	0.013	-	-	-	-	-	-	0.041	0.012
HCM Control Delay (s)	9.2	9.5	0	7.3	-	-	0	-	-	0	9.6	8.4
HCM Lane LOS	A	A	A	A	-	-	A	-	-	A	A	A
HCM 95th %tile Q(veh)	0.1	0.2	-	0	-	-	0	-	-	-	0.1	0

Intersection						
Int Delay, s/veh	6.3					
Movement	WBL	WBR	NBT	NBR	SBL	SBT
Lane Configurations	↘	↗	↕↕	↗	↘	↕↕
Traffic Vol, veh/h	99	178	506	123	115	320
Future Vol, veh/h	99	178	506	123	115	320
Conflicting Peds, #/hr	0	0	0	0	0	0
Sign Control	Stop	Stop	Free	Free	Free	Free
RT Channelized	-	None	-	None	-	None
Storage Length	300	-	-	155	300	-
Veh in Median Storage, #	0	-	0	-	-	0
Grade, %	0	-	0	-	-	0
Peak Hour Factor	85	85	85	85	85	85
Heavy Vehicles, %	2	2	2	2	2	2
Mvmt Flow	116	209	595	145	135	376

Major/Minor	Minor1	Major1	Major2		
Conflicting Flow All	1053	298	0	0	740
Stage 1	595	-	-	-	-
Stage 2	458	-	-	-	-
Critical Hdwy	6.84	6.94	-	-	4.14
Critical Hdwy Stg 1	5.84	-	-	-	-
Critical Hdwy Stg 2	5.84	-	-	-	-
Follow-up Hdwy	3.52	3.32	-	-	2.22
Pot Cap-1 Maneuver	222	698	-	-	862
Stage 1	514	-	-	-	-
Stage 2	604	-	-	-	-
Platoon blocked, %			-	-	-
Mov Cap-1 Maneuver	187	698	-	-	862
Mov Cap-2 Maneuver	187	-	-	-	-
Stage 1	514	-	-	-	-
Stage 2	509	-	-	-	-

Approach	WB	NB	SB
HCM Control Delay, s	26.4	0	2.6
HCM LOS	D		

Minor Lane/Major Mvmt	NBT	NBRWBLn1	WBLn2	SBL	SBT
Capacity (veh/h)	-	-	187	698	862
HCM Lane V/C Ratio	-	-	0.623	0.3	0.157
HCM Control Delay (s)	-	-	51.6	12.4	10
HCM Lane LOS	-	-	F	B	A
HCM 95th %tile Q(veh)	-	-	3.5	1.3	0.6



Intersection						
Int Delay, s/veh	15.6					
Movement	EBL	EBT	WBT	WBR	SBL	SBR
Lane Configurations	↘	↑↑	↑↑	↗	↘	↗
Traffic Vol, veh/h	130	108	178	481	283	100
Future Vol, veh/h	130	108	178	481	283	100
Conflicting Peds, #/hr	0	0	0	0	0	0
Sign Control	Free	Free	Free	Free	Stop	Stop
RT Channelized	-	None	-	None	-	None
Storage Length	300	-	-	205	155	0
Veh in Median Storage, #	-	0	0	-	0	-
Grade, %	-	0	0	-	0	-
Peak Hour Factor	85	85	85	85	85	85
Heavy Vehicles, %	2	2	2	2	2	2
Mvmt Flow	153	127	209	566	333	118

Major/Minor	Major1	Major2	Minor2		
Conflicting Flow All	775	0	-	0	579 105
Stage 1	-	-	-	-	209 -
Stage 2	-	-	-	-	370 -
Critical Hdwy	4.14	-	-	-	6.84 6.94
Critical Hdwy Stg 1	-	-	-	-	5.84 -
Critical Hdwy Stg 2	-	-	-	-	5.84 -
Follow-up Hdwy	2.22	-	-	-	3.52 3.32
Pot Cap-1 Maneuver	837	-	-	-	446 929
Stage 1	-	-	-	-	806 -
Stage 2	-	-	-	-	669 -
Platoon blocked, %		-	-	-	
Mov Cap-1 Maneuver	837	-	-	-	364 929
Mov Cap-2 Maneuver	-	-	-	-	364 -
Stage 1	-	-	-	-	659 -
Stage 2	-	-	-	-	669 -

Approach	EB	WB	SB
HCM Control Delay, s	5.6	0	48.5
HCM LOS			E

Minor Lane/Major Mvmt	EBL	EBT	WBT	WBR	SBLn1	SBLn2
Capacity (veh/h)	837	-	-	-	364	929
HCM Lane V/C Ratio	0.183	-	-	-	0.915	0.127
HCM Control Delay (s)	10.3	-	-	-	62.3	9.4
HCM Lane LOS	B	-	-	-	F	A
HCM 95th %tile Q(veh)	0.7	-	-	-	9.4	0.4

Intersection												
Int Delay, s/veh	3											
Movement	EBL	EBT	EBR	WBL	WBT	WBR	NBL	NBT	NBR	SBL	SBT	SBR
Lane Configurations	↖	↑	↗	↖	↗			↕			↕	
Traffic Vol, veh/h	80	155	22	1	93	3	13	0	1	2	0	47
Future Vol, veh/h	80	155	22	1	93	3	13	0	1	2	0	47
Conflicting Peds, #/hr	0	0	0	0	0	0	0	0	0	0	0	0
Sign Control	Free	Free	Free	Free	Free	Free	Stop	Stop	Stop	Stop	Stop	Stop
RT Channelized	-	-	None	-	-	None	-	-	None	-	-	None
Storage Length	305	-	255	305	-	-	-	-	-	-	-	-
Veh in Median Storage, #	-	0	-	-	0	-	-	0	-	-	0	-
Grade, %	-	0	-	-	0	-	-	0	-	-	0	-
Peak Hour Factor	85	85	85	85	85	85	85	85	85	85	85	85
Heavy Vehicles, %	2	2	2	2	2	2	2	2	2	2	2	2
Mvmt Flow	94	182	26	1	109	4	15	0	1	2	0	55

Major/Minor	Major1			Major2			Minor1			Minor2		
Conflicting Flow All	113	0	0	208	0	0	511	485	182	497	509	111
Stage 1	-	-	-	-	-	-	370	370	-	113	113	-
Stage 2	-	-	-	-	-	-	141	115	-	384	396	-
Critical Hdwy	4.12	-	-	4.12	-	-	7.12	6.52	6.22	7.12	6.52	6.22
Critical Hdwy Stg 1	-	-	-	-	-	-	6.12	5.52	-	6.12	5.52	-
Critical Hdwy Stg 2	-	-	-	-	-	-	6.12	5.52	-	6.12	5.52	-
Follow-up Hdwy	2.218	-	-	2.218	-	-	3.518	4.018	3.318	3.518	4.018	3.318
Pot Cap-1 Maneuver	1476	-	-	1363	-	-	473	482	861	483	467	942
Stage 1	-	-	-	-	-	-	650	620	-	892	802	-
Stage 2	-	-	-	-	-	-	862	800	-	639	604	-
Platoon blocked, %	-	-	-	-	-	-	-	-	-	-	-	-
Mov Cap-1 Maneuver	1476	-	-	1363	-	-	423	451	861	458	437	942
Mov Cap-2 Maneuver	-	-	-	-	-	-	423	451	-	458	437	-
Stage 1	-	-	-	-	-	-	608	580	-	835	801	-
Stage 2	-	-	-	-	-	-	811	799	-	597	565	-

Approach	EB			WB			NB			SB		
HCM Control Delay, s	2.4			0.1			13.5			9.3		
HCM LOS							B			A		

Minor Lane/Major Mvmt	NBLn1	EBL	EBT	EBR	WBL	WBT	WBR	SBLn1
Capacity (veh/h)	439	1476	-	-	1363	-	-	903
HCM Lane V/C Ratio	0.038	0.064	-	-	0.001	-	-	0.064
HCM Control Delay (s)	13.5	7.6	-	-	7.6	-	-	9.3
HCM Lane LOS	B	A	-	-	A	-	-	A
HCM 95th %tile Q(veh)	0.1	0.2	-	-	0	-	-	0.2

Intersection												
Int Delay, s/veh	3.8											
Movement	EBL	EBT	EBR	WBL	WBT	WBR	NBL	NBT	NBR	SBL	SBT	SBR
Lane Configurations		↕			↕		↕	↕		↕	↕	
Traffic Vol, veh/h	4	0	23	39	0	4	40	52	66	6	36	7
Future Vol, veh/h	4	0	23	39	0	4	40	52	66	6	36	7
Conflicting Peds, #/hr	0	0	0	0	0	0	0	0	0	0	0	0
Sign Control	Stop	Stop	Stop	Stop	Stop	Stop	Free	Free	Free	Free	Free	Free
RT Channelized	-	-	None	-	-	None	-	-	None	-	-	None
Storage Length	-	-	-	-	-	-	205	-	-	205	-	-
Veh in Median Storage, #	-	0	-	-	0	-	-	0	-	-	0	-
Grade, %	-	0	-	-	0	-	-	0	-	-	0	-
Peak Hour Factor	85	85	85	85	85	85	85	85	85	85	85	85
Heavy Vehicles, %	2	2	2	2	2	2	2	2	2	2	2	2
Mvmt Flow	5	0	27	46	0	5	47	61	78	7	42	8

Major/Minor	Minor2		Minor1		Major1		Major2					
Conflicting Flow All	257	293	46	268	258	100	50	0	0	139	0	0
Stage 1	60	60	-	194	194	-	-	-	-	-	-	-
Stage 2	197	233	-	74	64	-	-	-	-	-	-	-
Critical Hdwy	7.12	6.52	6.22	7.12	6.52	6.22	4.12	-	-	4.12	-	-
Critical Hdwy Stg 1	6.12	5.52	-	6.12	5.52	-	-	-	-	-	-	-
Critical Hdwy Stg 2	6.12	5.52	-	6.12	5.52	-	-	-	-	-	-	-
Follow-up Hdwy	3.518	4.018	3.318	3.518	4.018	3.318	2.218	-	-	2.218	-	-
Pot Cap-1 Maneuver	696	618	1023	685	646	956	1557	-	-	1445	-	-
Stage 1	951	845	-	808	740	-	-	-	-	-	-	-
Stage 2	805	712	-	935	842	-	-	-	-	-	-	-
Platoon blocked, %								-	-	-	-	-
Mov Cap-1 Maneuver	674	596	1023	649	623	956	1557	-	-	1445	-	-
Mov Cap-2 Maneuver	674	596	-	649	623	-	-	-	-	-	-	-
Stage 1	922	841	-	784	718	-	-	-	-	-	-	-
Stage 2	777	691	-	906	838	-	-	-	-	-	-	-

Approach	EB		WB		NB		SB	
HCM Control Delay, s	8.9		10.8		1.9		0.9	
HCM LOS	A		B					

Minor Lane/Major Mvmt	NBL	NBT	NBR	EBLn1	WBLn1	SBL	SBT	SBR
Capacity (veh/h)	1557	-	-	950	669	1445	-	-
HCM Lane V/C Ratio	0.03	-	-	0.033	0.076	0.005	-	-
HCM Control Delay (s)	7.4	0	-	8.9	10.8	7.5	-	-
HCM Lane LOS	A	A	-	A	B	A	-	-
HCM 95th %tile Q(veh)	0.1	-	-	0.1	0.2	0	-	-

Intersection					
Intersection Delay, s/veh	9.0				
Intersection LOS	A				
Approach	EB	WB	NB	SB	
Entry Lanes	1	1	1	1	
Conflicting Circle Lanes	1	1	1	1	
Adj Approach Flow, veh/h	136	604	377	309	
Demand Flow Rate, veh/h	138	616	385	315	
Vehicles Circulating, veh/h	435	309	120	551	
Vehicles Exiting, veh/h	431	116	453	374	
Ped Vol Crossing Leg, #/h	0	0	0	0	
Ped Cap Adj	1.000	1.000	1.000	1.000	
Approach Delay, s/veh	5.7	12.3	4.2	9.7	
Approach LOS	A	B	A	A	
Lane	Left	Left	Left	Bypass	Left
Designated Moves	LTR	LTR	LT	R	LTR
Assumed Moves	LTR	LTR	LT	R	LTR
RT Channelized	Free				
Lane Util	1.000	1.000	1.000		1.000
Follow-Up Headway, s	2.609	2.609	2.609		2.609
Critical Headway, s	4.976	4.976	4.976	80	4.976
Entry Flow, veh/h	138	616	305	1938	315
Cap Entry Lane, veh/h	885	1007	1221	0.980	787
Entry HV Adj Factor	0.983	0.980	0.981	78	0.981
Flow Entry, veh/h	136	604	299	1900	309
Cap Entry, veh/h	870	987	1197	0.041	772
V/C Ratio	0.156	0.612	0.250	0.0	0.400
Control Delay, s/veh	5.7	12.3	5.3	A	9.7
LOS	A	B	A	0	A
95th %tile Queue, veh	1	4	1		2

Timings  
4: Vollmer Rd & Briargate Pkwy

2042 Background Traffic  
AM Peak Hour

Lane Group	EBL	EBT	EBR	WBL	WBT	WBR	NBL	NBT	NBR	SBL	SBT	SBR
Lane Configurations												
Traffic Volume (vph)	68	551	152	241	1034	95	160	131	109	121	306	138
Future Volume (vph)	68	551	152	241	1034	95	160	131	109	121	306	138
Turn Type	pm+pt	NA	Perm	Prot	NA	Perm	pm+pt	NA	Perm	pm+pt	NA	Perm
Protected Phases	5	2		1	6		3	8		7	4	
Permitted Phases	2		2			6	8		8	4		4
Detector Phase	5	2	2	1	6	6	3	8	8	7	4	4
Switch Phase												
Minimum Initial (s)	5.0	15.0	15.0	15.0	15.0	15.0	5.0	5.0	5.0	5.0	5.0	5.0
Minimum Split (s)	10.0	20.0	20.0	20.0	20.0	20.0	10.0	10.0	10.0	10.0	10.0	10.0
Total Split (s)	12.0	57.0	57.0	20.0	65.0	65.0	17.0	28.0	28.0	15.0	26.0	26.0
Total Split (%)	10.0%	47.5%	47.5%	16.7%	54.2%	54.2%	14.2%	23.3%	23.3%	12.5%	21.7%	21.7%
Yellow Time (s)	3.0	3.0	3.0	3.0	3.0	3.0	3.0	3.0	3.0	3.0	3.0	3.0
All-Red Time (s)	2.0	2.0	2.0	2.0	2.0	2.0	2.0	2.0	2.0	2.0	2.0	2.0
Lost Time Adjust (s)	0.0	0.0	0.0	0.0	0.0	0.0	0.0	0.0	0.0	0.0	0.0	0.0
Total Lost Time (s)	5.0	5.0	5.0	5.0	5.0	5.0	5.0	5.0	5.0	5.0	5.0	5.0
Lead/Lag	Lead	Lag	Lag	Lead	Lag	Lag	Lead	Lag	Lag	Lead	Lag	Lag
Lead-Lag Optimize?	Yes	Yes	Yes	Yes	Yes	Yes	Yes	Yes	Yes	Yes	Yes	Yes
Recall Mode	None	Max	Max	None	Max	Max	None	None	None	None	None	None
Act Effct Green (s)	58.7	52.1	52.1	15.0	62.7	62.7	29.2	17.8	17.8	25.4	15.9	15.9
Actuated g/C Ratio	0.51	0.46	0.46	0.13	0.55	0.55	0.26	0.16	0.16	0.22	0.14	0.14
v/c Ratio	0.25	0.35	0.20	0.56	0.56	0.11	0.62	0.24	0.31	0.40	0.66	0.41
Control Delay	12.3	21.5	3.7	52.8	19.6	2.7	43.0	43.3	4.6	35.7	53.4	9.5
Queue Delay	0.0	0.0	0.0	0.0	0.0	0.0	0.0	0.0	0.0	0.0	0.0	0.0
Total Delay	12.3	21.5	3.7	52.8	19.6	2.7	43.0	43.3	4.6	35.7	53.4	9.5
LOS	B	C	A	D	B	A	D	D	A	D	D	A
Approach Delay		17.1			24.3			32.5			38.9	
Approach LOS		B			C			C			D	

Intersection Summary

Cycle Length: 120  
 Actuated Cycle Length: 114.4  
 Natural Cycle: 60  
 Control Type: Actuated-Uncoordinated  
 Maximum v/c Ratio: 0.66  
 Intersection Signal Delay: 26.3  
 Intersection LOS: C  
 Intersection Capacity Utilization 66.7%  
 ICU Level of Service C  
 Analysis Period (min) 15

Splits and Phases: 4: Vollmer Rd & Briargate Pkwy



Timings  
5: Sterling Ranch Rd & Briargate Pkwy

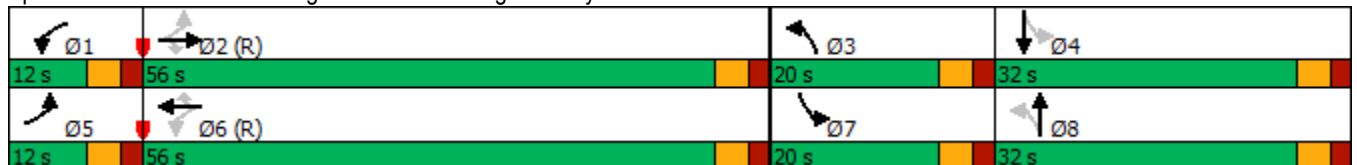
2042 Background Traffic  
AM Peak Hour

Lane Group	EBL	EBT	EBR	WBL	WBT	WBR	NBL	NBT	NBR	SBL	SBT	SBR
Lane Configurations												
Traffic Volume (vph)	73	627	140	109	945	23	275	115	119	106	263	161
Future Volume (vph)	73	627	140	109	945	23	275	115	119	106	263	161
Turn Type	pm+pt	NA	Perm	pm+pt	NA	Perm	pm+pt	NA	Free	pm+pt	NA	Free
Protected Phases	5	2		1	6		3	8		7	4	
Permitted Phases	2		2	6		6	8		Free	4		Free
Detector Phase	5	2	2	1	6	6	3	8		7	4	
Switch Phase												
Minimum Initial (s)	5.0	5.0	5.0	5.0	5.0	5.0	5.0	20.0		5.0	20.0	
Minimum Split (s)	10.0	10.0	10.0	10.0	10.0	10.0	10.0	25.0		10.0	25.0	
Total Split (s)	12.0	56.0	56.0	12.0	56.0	56.0	20.0	32.0		20.0	32.0	
Total Split (%)	10.0%	46.7%	46.7%	10.0%	46.7%	46.7%	16.7%	26.7%		16.7%	26.7%	
Yellow Time (s)	3.0	3.0	3.0	3.0	3.0	3.0	3.0	3.0		3.0	3.0	
All-Red Time (s)	2.0	2.0	2.0	2.0	2.0	2.0	2.0	2.0		2.0	2.0	
Lost Time Adjust (s)	0.0	0.0	0.0	0.0	0.0	0.0	0.0	0.0		0.0	0.0	
Total Lost Time (s)	5.0	5.0	5.0	5.0	5.0	5.0	5.0	5.0		5.0	5.0	
Lead/Lag	Lead	Lag	Lag	Lead	Lag	Lag	Lead	Lag		Lead	Lag	
Lead-Lag Optimize?	Yes	Yes	Yes	Yes	Yes	Yes	Yes	Yes		Yes	Yes	
Recall Mode	None	C-Max	C-Max	None	C-Max	C-Max	None	Max		None	Max	
Act Effct Green (s)	57.8	51.0	51.0	59.0	53.4	53.4	45.8	31.5	120.0	37.6	27.2	120.0
Actuated g/C Ratio	0.48	0.42	0.42	0.49	0.44	0.44	0.38	0.26	1.00	0.31	0.23	1.00
v/c Ratio	0.33	0.44	0.19	0.33	0.63	0.03	0.81	0.25	0.08	0.25	0.66	0.11
Control Delay	18.3	25.5	4.0	9.5	18.7	0.7	46.8	37.4	0.1	25.8	50.7	0.1
Queue Delay	0.0	0.0	0.0	0.0	0.0	0.0	0.0	0.0	0.0	0.0	0.0	0.0
Total Delay	18.3	25.5	4.0	9.5	18.7	0.7	46.8	37.4	0.1	25.8	50.7	0.1
LOS	B	C	A	A	B	A	D	D	A	C	D	A
Approach Delay		21.3			17.4			33.8			30.4	
Approach LOS		C			B			C			C	

Intersection Summary

Cycle Length: 120  
 Actuated Cycle Length: 120  
 Offset: 63 (53%), Referenced to phase 2:EBTL and 6:WBTL, Start of Green  
 Natural Cycle: 70  
 Control Type: Actuated-Coordinated  
 Maximum v/c Ratio: 0.81  
 Intersection Signal Delay: 23.6  
 Intersection LOS: C  
 Intersection Capacity Utilization 78.9%  
 ICU Level of Service D  
 Analysis Period (min) 15

Splits and Phases: 5: Sterling Ranch Rd & Briargate Pkwy



Intersection												
Int Delay, s/veh	10.9											
Movement	EBL	EBT	EBR	WBL	WBT	WBR	NBL	NBT	NBR	SBL	SBT	SBR
Lane Configurations	↖	↑	↗	↖		↗		↑	↗	↖	↑	
Traffic Vol, veh/h	133	71	128	178	0	194	0	365	121	61	242	0
Future Vol, veh/h	133	71	128	178	0	194	0	365	121	61	242	0
Conflicting Peds, #/hr	0	0	0	0	0	0	0	0	0	0	0	0
Sign Control	Stop	Stop	Stop	Stop	Stop	Stop	Free	Free	Free	Free	Free	Free
RT Channelized	-	-	None	-	-	None	-	-	None	-	-	None
Storage Length	0	-	0	0	-	0	-	-	205	205	-	-
Veh in Median Storage, #	-	0	-	-	0	-	-	0	-	-	0	-
Grade, %	-	0	-	-	0	-	-	0	-	-	0	-
Peak Hour Factor	95	95	95	95	95	95	95	95	95	95	95	95
Heavy Vehicles, %	2	2	2	2	2	2	2	2	2	2	2	2
Mvmt Flow	140	75	135	187	0	204	0	384	127	64	255	0

Major/Minor	Minor2		Minor1		Major1			Major2				
Conflicting Flow All	933	894	255	872	-	384	-	0	0	511	0	0
Stage 1	383	383	-	384	-	-	-	-	-	-	-	-
Stage 2	550	511	-	488	-	-	-	-	-	-	-	-
Critical Hdwy	7.12	6.52	6.22	7.12	-	6.22	-	-	-	4.12	-	-
Critical Hdwy Stg 1	6.12	5.52	-	6.12	-	-	-	-	-	-	-	-
Critical Hdwy Stg 2	6.12	5.52	-	6.12	-	-	-	-	-	-	-	-
Follow-up Hdwy	3.518	4.018	3.318	3.518	-	3.318	-	-	-	2.218	-	-
Pot Cap-1 Maneuver	245	275	*898	275	0	664	0	-	-	1054	-	0
Stage 1	705	639	-	639	0	-	0	-	-	-	-	0
Stage 2	519	537	-	603	0	-	0	-	-	-	-	0
Platoon blocked, %	1	1	1	1				-	-			
Mov Cap-1 Maneuver	162	258	*898	~ 187	-	664	-	-	-	1054	-	-
Mov Cap-2 Maneuver	245	356	-	311	-	-	-	-	-	-	-	-
Stage 1	705	600	-	639	-	-	-	-	-	-	-	-
Stage 2	359	537	-	421	-	-	-	-	-	-	-	-

Approach	EB		WB		NB			SB		
HCM Control Delay, s	22.6		22.3		0			1.7		
HCM LOS	C		C							

Minor Lane/Major Mvmt	NBT	NBR	EBLn1	EBLn2	EBLn3	WBLn1	WBLn2	SBL	SBT
Capacity (veh/h)	-	-	245	356	898	311	664	1054	-
HCM Lane V/C Ratio	-	-	0.571	0.21	0.15	0.602	0.308	0.061	-
HCM Control Delay (s)	-	-	37.6	17.8	9.7	32.7	12.8	8.6	-
HCM Lane LOS	-	-	E	C	A	D	B	A	-
HCM 95th %tile Q(veh)	-	-	3.2	0.8	0.5	3.7	1.3	0.2	-

Notes  
 ~: Volume exceeds capacity    \$: Delay exceeds 300s    +: Computation Not Defined    \*: All major volume in platoon

Timings  
12: Vollmer Rd & Marksheffel Rd

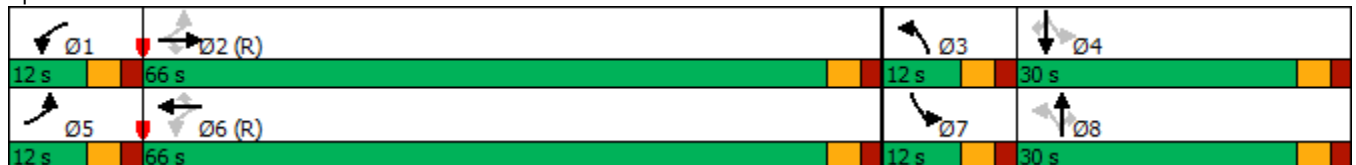
2042 Background Traffic  
AM Peak Hour

Lane Group	EBL	EBT	EBR	WBL	WBT	WBR	NBL	NBT	NBR	SBL	SBT	SBR
Lane Configurations												
Traffic Volume (vph)	71	837	42	172	924	69	115	235	110	121	517	131
Future Volume (vph)	71	837	42	172	924	69	115	235	110	121	517	131
Turn Type	pm+pt	NA	Perm	pm+pt	NA	Perm	pm+pt	NA	Perm	pm+pt	NA	Perm
Protected Phases	5	2		1	6		3	8		7	4	
Permitted Phases	2		2	6		6	8		8	4		4
Detector Phase	5	2	2	1	6	6	3	8	8	7	4	4
Switch Phase												
Minimum Initial (s)	5.0	5.0	5.0	5.0	5.0	5.0	5.0	10.0	10.0	5.0	10.0	10.0
Minimum Split (s)	10.0	23.0	23.0	10.0	23.0	23.0	10.0	23.0	23.0	10.0	23.0	23.0
Total Split (s)	12.0	66.0	66.0	12.0	66.0	66.0	12.0	30.0	30.0	12.0	30.0	30.0
Total Split (%)	10.0%	55.0%	55.0%	10.0%	55.0%	55.0%	10.0%	25.0%	25.0%	10.0%	25.0%	25.0%
Yellow Time (s)	3.0	3.0	3.0	3.0	3.0	3.0	3.0	3.0	3.0	3.0	3.0	3.0
All-Red Time (s)	2.0	2.0	2.0	2.0	2.0	2.0	2.0	2.0	2.0	2.0	2.0	2.0
Lost Time Adjust (s)	0.0	0.0	0.0	0.0	0.0	0.0	0.0	0.0	0.0	0.0	0.0	0.0
Total Lost Time (s)	5.0	5.0	5.0	5.0	5.0	5.0	5.0	5.0	5.0	5.0	5.0	5.0
Lead/Lag	Lead	Lag	Lag	Lead	Lag	Lag	Lead	Lag	Lag	Lead	Lag	Lag
Lead-Lag Optimize?	Yes	Yes	Yes	Yes	Yes	Yes	Yes	Yes	Yes	Yes	Yes	Yes
Recall Mode	None	C-Max	C-Max	None	C-Max	C-Max	None	Max	Max	None	Max	Max
Act Effct Green (s)	67.7	61.0	61.0	69.0	63.4	63.4	32.0	25.0	25.0	32.0	25.0	25.0
Actuated g/C Ratio	0.56	0.51	0.51	0.58	0.53	0.53	0.27	0.21	0.21	0.27	0.21	0.21
v/c Ratio	0.25	0.49	0.05	0.55	0.52	0.08	0.65	0.34	0.28	0.41	0.74	0.32
Control Delay	11.8	20.5	0.1	17.1	9.8	0.2	49.2	41.9	8.9	36.2	51.3	9.6
Queue Delay	0.0	0.0	0.0	0.0	0.0	0.0	0.0	0.0	0.0	0.0	0.0	0.0
Total Delay	11.8	20.5	0.1	17.1	9.8	0.2	49.2	41.9	8.9	36.2	51.3	9.6
LOS	B	C	A	B	A	A	D	D	A	D	D	A
Approach Delay		18.9			10.3			35.8			41.8	
Approach LOS		B			B			D			D	

Intersection Summary

Cycle Length: 120  
 Actuated Cycle Length: 120  
 Offset: 0 (0%), Referenced to phase 2:EBTL and 6:WBTL, Start of Green  
 Natural Cycle: 70  
 Control Type: Actuated-Coordinated  
 Maximum v/c Ratio: 0.74  
 Intersection Signal Delay: 23.5  
 Intersection LOS: C  
 Intersection Capacity Utilization 70.0%  
 ICU Level of Service C  
 Analysis Period (min) 15

Splits and Phases: 12: Vollmer Rd & Marksheffel Rd





Timings  
13: Sterling Ranch Rd & Marksheffel Rd

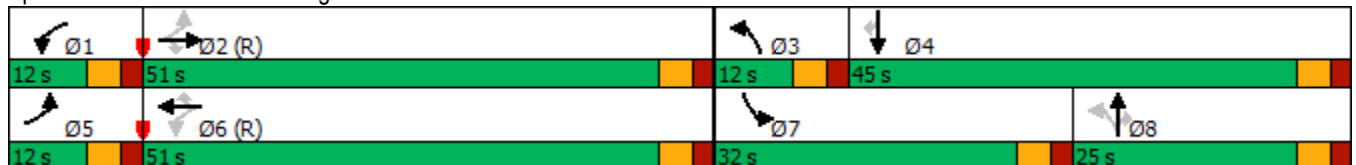
2042 Background Traffic  
AM Peak Hour

Lane Group	EBL	EBT	EBR	WBL	WBT	WBR	NBL	NBT	NBR	SBL	SBT	SBR
Lane Configurations												
Traffic Volume (vph)	157	900	10	47	809	168	39	8	55	458	9	318
Future Volume (vph)	157	900	10	47	809	168	39	8	55	458	9	318
Turn Type	pm+pt	NA	Perm	pm+pt	NA	Perm	pm+pt	NA	Perm	Prot	NA	Perm
Protected Phases	5	2		1	6		3	8		7	4	
Permitted Phases	2		2	6		6	8		8			4
Detector Phase	5	2	2	1	6	6	3	8	8	7	4	4
Switch Phase												
Minimum Initial (s)	5.0	15.0	15.0	5.0	15.0	15.0	5.0	10.0	10.0	20.0	10.0	10.0
Minimum Split (s)	10.0	20.0	20.0	10.0	20.0	20.0	10.0	15.0	15.0	25.0	20.0	20.0
Total Split (s)	12.0	51.0	51.0	12.0	51.0	51.0	12.0	25.0	25.0	32.0	45.0	45.0
Total Split (%)	10.0%	42.5%	42.5%	10.0%	42.5%	42.5%	10.0%	20.8%	20.8%	26.7%	37.5%	37.5%
Yellow Time (s)	3.0	3.0	3.0	3.0	3.0	3.0	3.0	3.0	3.0	3.0	3.0	3.0
All-Red Time (s)	2.0	2.0	2.0	2.0	2.0	2.0	2.0	2.0	2.0	2.0	2.0	2.0
Lost Time Adjust (s)	0.0	0.0	0.0	0.0	0.0	0.0	0.0	0.0	0.0	0.0	0.0	0.0
Total Lost Time (s)	5.0	5.0	5.0	5.0	5.0	5.0	5.0	5.0	5.0	5.0	5.0	5.0
Lead/Lag	Lead	Lag	Lag	Lead	Lag	Lag	Lead	Lag	Lag	Lead	Lag	Lag
Lead-Lag Optimize?	Yes	Yes	Yes	Yes	Yes	Yes	Yes	Yes	Yes	Yes	Yes	Yes
Recall Mode	None	C-Max	C-Max	None	C-Max	C-Max	None	None	None	None	None	None
Act Effct Green (s)	74.7	65.6	65.6	66.6	59.7	59.7	14.6	10.0	10.0	22.6	25.1	25.1
Actuated g/C Ratio	0.62	0.55	0.55	0.56	0.50	0.50	0.12	0.08	0.08	0.19	0.21	0.21
v/c Ratio	0.43	0.49	0.01	0.15	0.48	0.20	0.21	0.05	0.21	0.74	0.02	0.62
Control Delay	20.1	15.3	0.0	12.1	22.9	3.7	32.8	51.6	1.8	53.4	35.6	14.7
Queue Delay	0.0	0.0	0.0	0.0	0.0	0.0	0.0	0.0	0.0	0.0	0.0	0.0
Total Delay	20.1	15.3	0.0	12.1	22.9	3.7	32.8	51.6	1.8	53.4	35.6	14.7
LOS	C	B	A	B	C	A	C	D	A	D	D	B
Approach Delay		15.9			19.3			17.4			37.5	
Approach LOS		B			B			B			D	

Intersection Summary

Cycle Length: 120  
 Actuated Cycle Length: 120  
 Offset: 0 (0%), Referenced to phase 2:EBTL and 6:WBTL, Start of Green  
 Natural Cycle: 75  
 Control Type: Actuated-Coordinated  
 Maximum v/c Ratio: 0.74  
 Intersection Signal Delay: 22.8  
 Intersection LOS: C  
 Intersection Capacity Utilization 63.3%  
 ICU Level of Service B  
 Analysis Period (min) 15

Splits and Phases: 13: Sterling Ranch Rd & Marksheffel Rd



Intersection												
Int Delay, s/veh	2.9											
Movement	EBL	EBT	EBR	WBL	WBT	WBR	NBL	NBT	NBR	SBL	SBT	SBR
Lane Configurations	↙	↑	↗	↙	↗			↕			↕	
Traffic Vol, veh/h	10	404	18	7	535	8	54	0	20	22	0	33
Future Vol, veh/h	10	404	18	7	535	8	54	0	20	22	0	33
Conflicting Peds, #/hr	0	0	0	0	0	0	0	0	0	0	0	0
Sign Control	Free	Free	Free	Free	Free	Free	Stop	Stop	Stop	Stop	Stop	Stop
RT Channelized	-	-	None	-	-	None	-	-	None	-	-	None
Storage Length	305	-	255	305	-	-	-	-	-	-	-	-
Veh in Median Storage, #	-	0	-	-	0	-	-	0	-	-	0	-
Grade, %	-	0	-	-	0	-	-	0	-	-	0	-
Peak Hour Factor	95	95	95	95	95	95	95	95	95	95	95	95
Heavy Vehicles, %	2	2	2	2	2	2	2	2	2	2	2	2
Mvmt Flow	11	425	19	7	563	8	57	0	21	23	0	35

Major/Minor	Major1			Major2			Minor1			Minor2		
Conflicting Flow All	571	0	0	444	0	0	1046	1032	425	1048	1047	567
Stage 1	-	-	-	-	-	-	447	447	-	581	581	-
Stage 2	-	-	-	-	-	-	599	585	-	467	466	-
Critical Hdwy	4.12	-	-	4.12	-	-	7.12	6.52	6.22	7.12	6.52	6.22
Critical Hdwy Stg 1	-	-	-	-	-	-	6.12	5.52	-	6.12	5.52	-
Critical Hdwy Stg 2	-	-	-	-	-	-	6.12	5.52	-	6.12	5.52	-
Follow-up Hdwy	2.218	-	-	2.218	-	-	3.518	4.018	3.318	3.518	4.018	3.318
Pot Cap-1 Maneuver	1002	-	-	1116	-	-	206	233	629	206	228	523
Stage 1	-	-	-	-	-	-	591	573	-	499	500	-
Stage 2	-	-	-	-	-	-	488	498	-	576	562	-
Platoon blocked, %		-	-		-	-						
Mov Cap-1 Maneuver	1002	-	-	1116	-	-	190	229	629	197	224	523
Mov Cap-2 Maneuver	-	-	-	-	-	-	190	229	-	197	224	-
Stage 1	-	-	-	-	-	-	584	567	-	494	497	-
Stage 2	-	-	-	-	-	-	453	495	-	551	556	-

Approach	EB			WB			NB			SB		
HCM Control Delay, s	0.2			0.1			27.9			19		
HCM LOS							D			C		

Minor Lane/Major Mvmt	NBLn1	EBL	EBT	EBR	WBL	WBT	WBR	SBLn1
Capacity (veh/h)	234	1002	-	-	1116	-	-	315
HCM Lane V/C Ratio	0.333	0.011	-	-	0.007	-	-	0.184
HCM Control Delay (s)	27.9	8.6	-	-	8.2	-	-	19
HCM Lane LOS	D	A	-	-	A	-	-	C
HCM 95th %tile Q(veh)	1.4	0	-	-	0	-	-	0.7

Intersection						
Int Delay, s/veh	0.9					
Movement	EBL	EBR	NBL	NBT	SBT	SBR
Lane Configurations	↔		↔	↑	↑	
Traffic Vol, veh/h	44	16	5	441	533	15
Future Vol, veh/h	44	16	5	441	533	15
Conflicting Peds, #/hr	0	0	0	0	0	0
Sign Control	Stop	Stop	Free	Free	Free	Free
RT Channelized	-	None	-	None	-	None
Storage Length	0	-	205	-	-	-
Veh in Median Storage, #	0	-	-	0	0	-
Grade, %	0	-	-	0	0	-
Peak Hour Factor	95	95	95	95	95	95
Heavy Vehicles, %	2	2	2	2	2	2
Mvmt Flow	46	17	5	464	561	16

Major/Minor	Minor2	Major1	Major2			
Conflicting Flow All	1043	569	577	0	-	0
Stage 1	569	-	-	-	-	-
Stage 2	474	-	-	-	-	-
Critical Hdwy	6.42	6.22	4.12	-	-	-
Critical Hdwy Stg 1	5.42	-	-	-	-	-
Critical Hdwy Stg 2	5.42	-	-	-	-	-
Follow-up Hdwy	3.518	3.318	2.218	-	-	-
Pot Cap-1 Maneuver	254	522	996	-	-	-
Stage 1	566	-	-	-	-	-
Stage 2	626	-	-	-	-	-
Platoon blocked, %				-	-	-
Mov Cap-1 Maneuver	253	522	996	-	-	-
Mov Cap-2 Maneuver	385	-	-	-	-	-
Stage 1	563	-	-	-	-	-
Stage 2	626	-	-	-	-	-

Approach	EB	NB	SB
HCM Control Delay, s	15.3	0.1	0
HCM LOS	C		

Minor Lane/Major Mvmt	NBL	NBT	EBLn1	SBT	SBR
Capacity (veh/h)	996	-	414	-	-
HCM Lane V/C Ratio	0.005	-	0.153	-	-
HCM Control Delay (s)	8.6	-	15.3	-	-
HCM Lane LOS	A	-	C	-	-
HCM 95th %tile Q(veh)	0	-	0.5	-	-

Intersection					
Intersection Delay, s/veh	15.0				
Intersection LOS	C				
Approach	EB	WB	NB	SB	
Entry Lanes	1	1	1	1	
Conflicting Circle Lanes	1	1	1	1	
Adj Approach Flow, veh/h	453	393	815	417	
Demand Flow Rate, veh/h	462	401	830	425	
Vehicles Circulating, veh/h	547	623	591	408	
Vehicles Exiting, veh/h	286	577	418	616	
Ped Vol Crossing Leg, #/h	0	0	0	0	
Ped Cap Adj	1.000	1.000	1.000	1.000	
Approach Delay, s/veh	13.9	13.7	19.0	9.9	
Approach LOS	B	B	C	A	
Lane	Left	Left	Left	Bypass	Left
Designated Moves	LTR	LTR	LT	R	LTR
Assumed Moves	LTR	LTR	LT	R	LTR
RT Channelized				Free	
Lane Util	1.000	1.000	1.000		1.000
Follow-Up Headway, s	2.609	2.609	2.609		2.609
Critical Headway, s	4.976	4.976	4.976	221	4.976
Entry Flow, veh/h	462	401	609	1938	425
Cap Entry Lane, veh/h	790	731	755	0.980	910
Entry HV Adj Factor	0.981	0.980	0.981	217	0.980
Flow Entry, veh/h	453	393	598	1900	417
Cap Entry, veh/h	775	717	741	0.114	892
V/C Ratio	0.585	0.549	0.806	0.0	0.467
Control Delay, s/veh	13.9	13.7	25.8	A	9.9
LOS	B	B	D	0	A
95th %tile Queue, veh	4	3	8		3

Timings  
4: Vollmer Rd & Briargate Pkwy

2042 Background Traffic  
PM Peak Hour

Lane Group	EBL	EBT	EBR	WBL	WBT	WBR	NBL	NBT	NBR	SBL	SBT	SBR
Lane Configurations												
Traffic Volume (vph)	227	1000	185	209	736	74	301	414	282	109	211	118
Future Volume (vph)	227	1000	185	209	736	74	301	414	282	109	211	118
Turn Type	pm+pt	NA	Perm	Prot	NA	Perm	pm+pt	NA	Perm	pm+pt	NA	Perm
Protected Phases	5	2		1	6		3	8		7	4	
Permitted Phases	2		2			6	8		8	4		4
Detector Phase	5	2	2	1	6	6	3	8	8	7	4	4
Switch Phase												
Minimum Initial (s)	5.0	15.0	15.0	15.0	15.0	15.0	8.0	5.0	5.0	5.0	5.0	5.0
Minimum Split (s)	10.0	20.0	20.0	20.0	20.0	20.0	13.0	10.0	10.0	10.0	10.0	10.0
Total Split (s)	12.0	53.0	53.0	20.0	61.0	61.0	22.0	28.0	28.0	19.0	25.0	25.0
Total Split (%)	10.0%	44.2%	44.2%	16.7%	50.8%	50.8%	18.3%	23.3%	23.3%	15.8%	20.8%	20.8%
Yellow Time (s)	3.0	3.0	3.0	3.0	3.0	3.0	3.0	3.0	3.0	3.0	3.0	3.0
All-Red Time (s)	2.0	2.0	2.0	2.0	2.0	2.0	2.0	2.0	2.0	2.0	2.0	2.0
Lost Time Adjust (s)	0.0	0.0	0.0	0.0	0.0	0.0	0.0	0.0	0.0	0.0	0.0	0.0
Total Lost Time (s)	5.0	5.0	5.0	5.0	5.0	5.0	5.0	5.0	5.0	5.0	5.0	5.0
Lead/Lag	Lead	Lag	Lag	Lead	Lag	Lag	Lead	Lag	Lag	Lead	Lag	Lag
Lead-Lag Optimize?	Yes	Yes	Yes	Yes	Yes	Yes	Yes	Yes	Yes	Yes	Yes	Yes
Recall Mode	None	Max	Max	None	Max	Max	None	None	None	None	None	None
Act Effct Green (s)	55.1	48.1	48.1	15.0	56.1	56.1	35.6	20.3	20.3	25.3	14.5	14.5
Actuated g/C Ratio	0.48	0.42	0.42	0.13	0.49	0.49	0.31	0.18	0.18	0.22	0.13	0.13
v/c Ratio	0.65	0.69	0.25	0.49	0.45	0.09	0.83	0.67	0.59	0.43	0.50	0.37
Control Delay	25.2	30.5	4.4	51.0	20.6	1.6	52.9	49.9	12.0	33.9	50.1	6.5
Queue Delay	0.0	0.0	0.0	0.0	0.0	0.0	0.0	0.0	0.0	0.0	0.0	0.0
Total Delay	25.2	30.5	4.4	51.0	20.6	1.6	52.9	49.9	12.0	33.9	50.1	6.5
LOS	C	C	A	D	C	A	D	D	B	C	D	A
Approach Delay		26.2			25.5			39.9			34.3	
Approach LOS		C			C			D			C	

Intersection Summary

Cycle Length: 120  
 Actuated Cycle Length: 114.3  
 Natural Cycle: 80  
 Control Type: Actuated-Uncoordinated  
 Maximum v/c Ratio: 0.83  
 Intersection Signal Delay: 30.5  
 Intersection LOS: C  
 Intersection Capacity Utilization 79.3%  
 ICU Level of Service D  
 Analysis Period (min) 15

Splits and Phases: 4: Vollmer Rd & Briargate Pkwy



Timings  
5: Sterling Ranch Rd & Briargate Pkwy

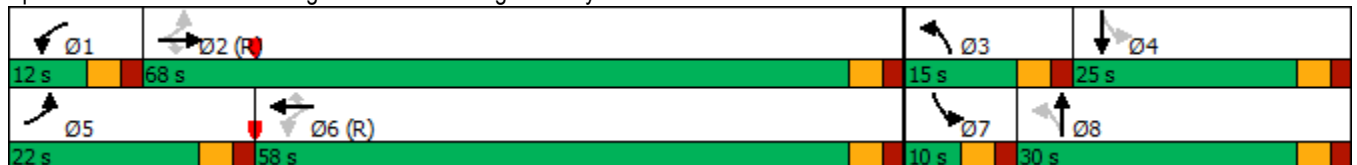
2042 Background Traffic  
PM Peak Hour

Lane Group	EBL	EBT	EBR	WBL	WBT	WBR	NBL	NBT	NBR	SBL	SBT	SBR
Lane Configurations												
Traffic Volume (vph)	329	921	119	151	829	105	181	190	81	87	86	133
Future Volume (vph)	329	921	119	151	829	105	181	190	81	87	86	133
Turn Type	pm+pt	NA	Perm	pm+pt	NA	Perm	pm+pt	NA	Free	pm+pt	NA	Free
Protected Phases	5	2		1	6		3	8		7	4	
Permitted Phases	2		2	6		6	8		Free	4		Free
Detector Phase	5	2	2	1	6	6	3	8		7	4	
Switch Phase												
Minimum Initial (s)	5.0	5.0	5.0	5.0	5.0	5.0	5.0	20.0		5.0	20.0	
Minimum Split (s)	10.0	23.0	23.0	10.0	23.0	23.0	10.0	25.0		10.0	25.0	
Total Split (s)	22.0	68.0	68.0	12.0	58.0	58.0	15.0	30.0		10.0	25.0	
Total Split (%)	18.3%	56.7%	56.7%	10.0%	48.3%	48.3%	12.5%	25.0%		8.3%	20.8%	
Yellow Time (s)	3.0	3.0	3.0	3.0	3.0	3.0	3.0	3.0		3.0	3.0	
All-Red Time (s)	2.0	2.0	2.0	2.0	2.0	2.0	2.0	2.0		2.0	2.0	
Lost Time Adjust (s)	0.0	0.0	0.0	0.0	0.0	0.0	0.0	0.0		0.0	0.0	
Total Lost Time (s)	5.0	5.0	5.0	5.0	5.0	5.0	5.0	5.0		5.0	5.0	
Lead/Lag	Lead	Lag	Lag	Lead	Lag	Lag	Lead	Lag		Lead	Lag	
Lead-Lag Optimize?	Yes	Yes	Yes	Yes	Yes	Yes	Yes	Yes		Yes	Yes	
Recall Mode	None	C-Max	C-Max	None	C-Max	C-Max	None	None		None	None	
Act Effct Green (s)	76.0	64.0	64.0	62.4	55.3	55.3	34.0	24.0	120.0	21.0	20.0	120.0
Actuated g/C Ratio	0.63	0.53	0.53	0.52	0.46	0.46	0.28	0.20	1.00	0.18	0.17	1.00
v/c Ratio	0.83	0.51	0.14	0.50	0.53	0.14	0.52	0.54	0.05	0.40	0.29	0.09
Control Delay	30.3	19.4	2.8	18.0	25.1	5.4	40.3	48.7	0.1	40.8	46.8	0.1
Queue Delay	0.0	0.0	0.0	0.0	0.0	0.0	0.0	0.0	0.0	0.0	0.0	0.0
Total Delay	30.3	19.4	2.8	18.0	25.1	5.4	40.3	48.7	0.1	40.8	46.8	0.1
LOS	C	B	A	B	C	A	D	D	A	D	D	A
Approach Delay		20.6			22.2			36.6			24.8	
Approach LOS		C			C			D			C	

Intersection Summary

Cycle Length: 120  
 Actuated Cycle Length: 120  
 Offset: 0 (0%), Referenced to phase 2:EBTL and 6:WBTL, Start of Green  
 Natural Cycle: 80  
 Control Type: Actuated-Coordinated  
 Maximum v/c Ratio: 0.83  
 Intersection Signal Delay: 23.8  
 Intersection LOS: C  
 Intersection Capacity Utilization 84.5%  
 ICU Level of Service E  
 Analysis Period (min) 15

Splits and Phases: 5: Sterling Ranch Rd & Briargate Pkwy



Intersection												
Int Delay, s/veh	4.6											
Movement	EBL	EBT	EBR	WBL	WBT	WBR	NBL	NBT	NBR	SBL	SBT	SBR
Lane Configurations	↘	↑	↗	↘		↗		↑	↗	↘	↑	
Traffic Vol, veh/h	38	18	30	119	0	136	0	310	148	49	267	0
Future Vol, veh/h	38	18	30	119	0	136	0	310	148	49	267	0
Conflicting Peds, #/hr	0	0	0	0	0	0	0	0	0	0	0	0
Sign Control	Stop	Stop	Stop	Stop	Stop	Stop	Free	Free	Free	Free	Free	Free
RT Channelized	-	-	None	-	-	None	-	-	None	-	-	None
Storage Length	0	-	0	0	-	0	-	-	205	205	-	-
Veh in Median Storage, #	-	0	-	-	0	-	-	0	-	-	0	-
Grade, %	-	0	-	-	0	-	-	0	-	-	0	-
Peak Hour Factor	95	95	95	95	95	95	95	95	95	95	95	95
Heavy Vehicles, %	2	2	2	2	2	2	2	2	2	2	2	2
Mvmt Flow	40	19	32	125	0	143	0	326	156	52	281	0

Major/Minor	Minor2		Minor1		Major1			Major2				
Conflicting Flow All	861	867	281	737	-	326	-	0	0	482	0	0
Stage 1	385	385	-	326	-	-	-	-	-	-	-	-
Stage 2	476	482	-	411	-	-	-	-	-	-	-	-
Critical Hdwy	7.12	6.52	6.22	7.12	-	6.22	-	-	-	4.12	-	-
Critical Hdwy Stg 1	6.12	5.52	-	6.12	-	-	-	-	-	-	-	-
Critical Hdwy Stg 2	6.12	5.52	-	6.12	-	-	-	-	-	-	-	-
Follow-up Hdwy	3.518	4.018	3.318	3.518	-	3.318	-	-	-	2.218	-	-
Pot Cap-1 Maneuver	282	287	*872	358	0	715	0	-	-	1081	-	0
Stage 1	717	645	-	687	0	-	0	-	-	-	-	0
Stage 2	570	553	-	689	0	-	0	-	-	-	-	0
Platoon blocked, %	1	1	1	1				-	-			
Mov Cap-1 Maneuver	217	273	*872	320	-	715	-	-	-	1081	-	-
Mov Cap-2 Maneuver	322	374	-	441	-	-	-	-	-	-	-	-
Stage 1	717	614	-	687	-	-	-	-	-	-	-	-
Stage 2	456	553	-	612	-	-	-	-	-	-	-	-

Approach	EB		WB		NB			SB		
HCM Control Delay, s	14.3		13.7		0			1.3		
HCM LOS	B		B							

Minor Lane/Major Mvmt	NBT	NBR	EBLn1	EBLn2	EBLn3	WBLn1	WBLn2	SBL	SBT
Capacity (veh/h)	-	-	322	374	872	441	715	1081	-
HCM Lane V/C Ratio	-	-	0.124	0.051	0.036	0.284	0.2	0.048	-
HCM Control Delay (s)	-	-	17.8	15.1	9.3	16.4	11.3	8.5	-
HCM Lane LOS	-	-	C	C	A	C	B	A	-
HCM 95th %tile Q(veh)	-	-	0.4	0.2	0.1	1.2	0.7	0.1	-

Notes  
 ~: Volume exceeds capacity    \$: Delay exceeds 300s    +: Computation Not Defined    \*: All major volume in platoon

Timings  
12: Vollmer Rd & Marksheffel Rd

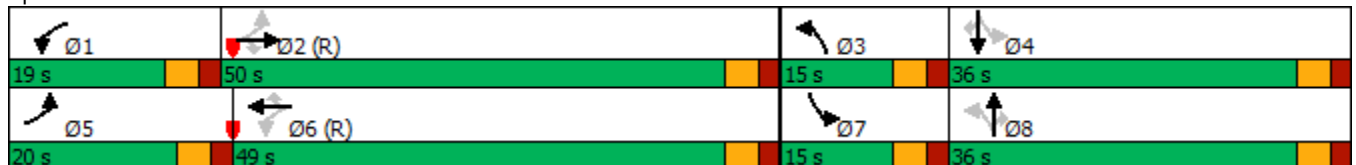
2042 Background Traffic  
PM Peak Hour

Lane Group	EBL	EBT	EBR	WBL	WBT	WBR	NBL	NBT	NBR	SBL	SBT	SBR
Lane Configurations												
Traffic Volume (vph)	142	934	96	188	710	154	171	728	186	132	342	199
Future Volume (vph)	142	934	96	188	710	154	171	728	186	132	342	199
Turn Type	pm+pt	NA	Perm	pm+pt	NA	Perm	pm+pt	NA	Perm	pm+pt	NA	Perm
Protected Phases	5	2		1	6		3	8		7	4	
Permitted Phases	2		2	6		6	8		8	4		4
Detector Phase	5	2	2	1	6	6	3	8	8	7	4	4
Switch Phase												
Minimum Initial (s)	5.0	5.0	5.0	5.0	5.0	5.0	5.0	10.0	10.0	5.0	10.0	10.0
Minimum Split (s)	10.0	23.0	23.0	10.0	23.0	23.0	10.0	23.0	23.0	10.0	23.0	23.0
Total Split (s)	20.0	50.0	50.0	19.0	49.0	49.0	15.0	36.0	36.0	15.0	36.0	36.0
Total Split (%)	16.7%	41.7%	41.7%	15.8%	40.8%	40.8%	12.5%	30.0%	30.0%	12.5%	30.0%	30.0%
Yellow Time (s)	3.0	3.0	3.0	3.0	3.0	3.0	3.0	3.0	3.0	3.0	3.0	3.0
All-Red Time (s)	2.0	2.0	2.0	2.0	2.0	2.0	2.0	2.0	2.0	2.0	2.0	2.0
Lost Time Adjust (s)	0.0	0.0	0.0	0.0	0.0	0.0	0.0	0.0	0.0	0.0	0.0	0.0
Total Lost Time (s)	5.0	5.0	5.0	5.0	5.0	5.0	5.0	5.0	5.0	5.0	5.0	5.0
Lead/Lag	Lead	Lag	Lag	Lead	Lag	Lag	Lead	Lag	Lag	Lead	Lag	Lag
Lead-Lag Optimize?	Yes	Yes	Yes	Yes	Yes	Yes	Yes	Yes	Yes	Yes	Yes	Yes
Recall Mode	None	C-Max	C-Max	None	C-Max	C-Max	None	Max	Max	None	Max	Max
Act Effct Green (s)	57.6	46.9	46.9	60.4	48.3	48.3	41.2	31.4	31.4	40.8	31.2	31.2
Actuated g/C Ratio	0.48	0.39	0.39	0.50	0.40	0.40	0.34	0.26	0.26	0.34	0.26	0.26
v/c Ratio	0.43	0.71	0.15	0.71	0.52	0.22	0.50	0.83	0.38	0.68	0.39	0.37
Control Delay	18.6	34.6	4.5	50.9	22.4	5.3	31.4	50.7	13.6	43.5	38.2	6.7
Queue Delay	0.0	0.0	0.0	0.0	0.0	0.0	0.0	0.0	0.0	0.0	0.0	0.0
Total Delay	18.6	34.6	4.5	50.9	22.4	5.3	31.4	50.7	13.6	43.5	38.2	6.7
LOS	B	C	A	D	C	A	C	D	B	D	D	A
Approach Delay		30.2			25.0			41.3			29.9	
Approach LOS		C			C			D			C	

Intersection Summary

Cycle Length: 120  
 Actuated Cycle Length: 120  
 Offset: 0 (0%), Referenced to phase 2:EBTL and 6:WBTL, Start of Green  
 Natural Cycle: 70  
 Control Type: Actuated-Coordinated  
 Maximum v/c Ratio: 0.83  
 Intersection Signal Delay: 31.8  
 Intersection LOS: C  
 Intersection Capacity Utilization 80.3%  
 ICU Level of Service D  
 Analysis Period (min) 15

Splits and Phases: 12: Vollmer Rd & Marksheffel Rd





Timings  
13: Sterling Ranch Rd & Marksheffel Rd

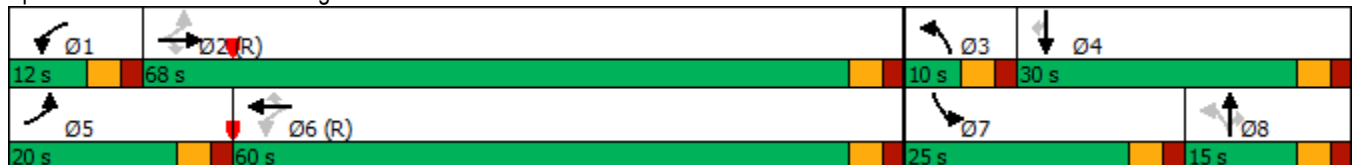
2042 Background Traffic  
PM Peak Hour

Lane Group	EBL	EBT	EBR	WBL	WBT	WBR	NBL	NBT	NBR	SBL	SBT	SBR
Lane Configurations												
Traffic Volume (vph)	290	946	22	130	841	541	27	6	37	325	23	183
Future Volume (vph)	290	946	22	130	841	541	27	6	37	325	23	183
Turn Type	pm+pt	NA	Perm	pm+pt	NA	Perm	pm+pt	NA	Perm	Prot	NA	Perm
Protected Phases	5	2		1	6		3	8		7	4	
Permitted Phases	2		2	6		6	8		8			4
Detector Phase	5	2	2	1	6	6	3	8	8	7	4	4
Switch Phase												
Minimum Initial (s)	5.0	15.0	15.0	5.0	15.0	15.0	5.0	10.0	10.0	20.0	10.0	10.0
Minimum Split (s)	10.0	20.0	20.0	10.0	20.0	20.0	10.0	15.0	15.0	25.0	20.0	20.0
Total Split (s)	20.0	68.0	68.0	12.0	60.0	60.0	10.0	15.0	15.0	25.0	30.0	30.0
Total Split (%)	16.7%	56.7%	56.7%	10.0%	50.0%	50.0%	8.3%	12.5%	12.5%	20.8%	25.0%	25.0%
Yellow Time (s)	3.0	3.0	3.0	3.0	3.0	3.0	3.0	3.0	3.0	3.0	3.0	3.0
All-Red Time (s)	2.0	2.0	2.0	2.0	2.0	2.0	2.0	2.0	2.0	2.0	2.0	2.0
Lost Time Adjust (s)	0.0	0.0	0.0	0.0	0.0	0.0	0.0	0.0	0.0	0.0	0.0	0.0
Total Lost Time (s)	5.0	5.0	5.0	5.0	5.0	5.0	5.0	5.0	5.0	5.0	5.0	5.0
Lead/Lag	Lead	Lag	Lag	Lead	Lag	Lag	Lead	Lag	Lag	Lead	Lag	Lag
Lead-Lag Optimize?	Yes	Yes	Yes	Yes	Yes	Yes	Yes	Yes	Yes	Yes	Yes	Yes
Recall Mode	None	C-Max	C-Max	None	C-Max	C-Max	None	None	None	None	None	None
Act Effct Green (s)	80.3	69.1	69.1	69.9	63.0	63.0	11.0	10.0	10.0	20.0	23.0	23.0
Actuated g/C Ratio	0.67	0.58	0.58	0.58	0.52	0.52	0.09	0.08	0.08	0.17	0.19	0.19
v/c Ratio	0.72	0.49	0.02	0.41	0.48	0.52	0.20	0.04	0.12	0.60	0.07	0.42
Control Delay	37.0	10.4	0.0	12.8	20.8	3.4	37.8	51.3	0.8	51.2	39.1	8.5
Queue Delay	0.0	0.0	0.0	0.0	0.0	0.0	0.0	0.0	0.0	0.0	0.0	0.0
Total Delay	37.0	10.4	0.0	12.8	20.8	3.4	37.8	51.3	0.8	51.2	39.1	8.5
LOS	D	B	A	B	C	A	D	D	A	D	D	A
Approach Delay		16.4			13.9			19.1			36.0	
Approach LOS		B			B			B			D	

Intersection Summary

Cycle Length: 120  
 Actuated Cycle Length: 120  
 Offset: 0 (0%), Referenced to phase 2:EBTL and 6:WBTL, Start of Green  
 Natural Cycle: 80  
 Control Type: Actuated-Coordinated  
 Maximum v/c Ratio: 0.72  
 Intersection Signal Delay: 18.4  
 Intersection LOS: B  
 Intersection Capacity Utilization 70.4%  
 ICU Level of Service C  
 Analysis Period (min) 15

Splits and Phases: 13: Sterling Ranch Rd & Marksheffel Rd



Intersection												
Int Delay, s/veh	2.2											
Movement	EBL	EBT	EBR	WBL	WBT	WBR	NBL	NBT	NBR	SBL	SBT	SBR
Lane Configurations	↙	↑	↗	↙	↗			↕			↕	
Traffic Vol, veh/h	40	427	66	16	342	24	39	0	10	14	0	24
Future Vol, veh/h	40	427	66	16	342	24	39	0	10	14	0	24
Conflicting Peds, #/hr	0	0	0	0	0	0	0	0	0	0	0	0
Sign Control	Free	Free	Free	Free	Free	Free	Stop	Stop	Stop	Stop	Stop	Stop
RT Channelized	-	-	None	-	-	None	-	-	None	-	-	None
Storage Length	305	-	255	305	-	-	-	-	-	-	-	-
Veh in Median Storage, #	-	0	-	-	0	-	-	0	-	-	0	-
Grade, %	-	0	-	-	0	-	-	0	-	-	0	-
Peak Hour Factor	95	95	95	95	95	95	95	95	95	95	95	95
Heavy Vehicles, %	2	2	2	2	2	2	2	2	2	2	2	2
Mvmt Flow	42	449	69	17	360	25	41	0	11	15	0	25

Major/Minor	Major1			Major2			Minor1			Minor2		
Conflicting Flow All	385	0	0	518	0	0	952	952	449	980	1009	373
Stage 1	-	-	-	-	-	-	533	533	-	407	407	-
Stage 2	-	-	-	-	-	-	419	419	-	573	602	-
Critical Hdwy	4.12	-	-	4.12	-	-	7.12	6.52	6.22	7.12	6.52	6.22
Critical Hdwy Stg 1	-	-	-	-	-	-	6.12	5.52	-	6.12	5.52	-
Critical Hdwy Stg 2	-	-	-	-	-	-	6.12	5.52	-	6.12	5.52	-
Follow-up Hdwy	2.218	-	-	2.218	-	-	3.518	4.018	3.318	3.518	4.018	3.318
Pot Cap-1 Maneuver	1173	-	-	1048	-	-	239	259	610	229	240	673
Stage 1	-	-	-	-	-	-	531	525	-	621	597	-
Stage 2	-	-	-	-	-	-	612	590	-	505	489	-
Platoon blocked, %		-	-	-	-	-						
Mov Cap-1 Maneuver	1173	-	-	1048	-	-	221	246	610	216	228	673
Mov Cap-2 Maneuver	-	-	-	-	-	-	221	246	-	216	228	-
Stage 1	-	-	-	-	-	-	512	506	-	599	587	-
Stage 2	-	-	-	-	-	-	579	581	-	479	471	-

Approach	EB			WB			NB			SB		
HCM Control Delay, s	0.6			0.4			22.7			15.6		
HCM LOS							C			C		

Minor Lane/Major Mvmt	NBLn1	EBL	EBT	EBR	WBL	WBT	WBR	SBLn1
Capacity (veh/h)	254	1173	-	-	1048	-	-	378
HCM Lane V/C Ratio	0.203	0.036	-	-	0.016	-	-	0.106
HCM Control Delay (s)	22.7	8.2	-	-	8.5	-	-	15.6
HCM Lane LOS	C	A	-	-	A	-	-	C
HCM 95th %tile Q(veh)	0.7	0.1	-	-	0	-	-	0.4

Intersection						
Int Delay, s/veh	0.8					
Movement	EBL	EBR	NBL	NBT	SBT	SBR
Lane Configurations	Y		Y	↑	↑	
Traffic Vol, veh/h	27	12	20	431	370	47
Future Vol, veh/h	27	12	20	431	370	47
Conflicting Peds, #/hr	0	0	0	0	0	0
Sign Control	Stop	Stop	Free	Free	Free	Free
RT Channelized	-	None	-	None	-	None
Storage Length	0	-	205	-	-	-
Veh in Median Storage, #	0	-	-	0	0	-
Grade, %	0	-	-	0	0	-
Peak Hour Factor	95	95	95	95	95	95
Heavy Vehicles, %	2	2	2	2	2	2
Mvmt Flow	28	13	21	454	389	49

Major/Minor	Minor2	Major1	Major2			
Conflicting Flow All	910	414	438	0	-	0
Stage 1	414	-	-	-	-	-
Stage 2	496	-	-	-	-	-
Critical Hdwy	6.42	6.22	4.12	-	-	-
Critical Hdwy Stg 1	5.42	-	-	-	-	-
Critical Hdwy Stg 2	5.42	-	-	-	-	-
Follow-up Hdwy	3.518	3.318	2.218	-	-	-
Pot Cap-1 Maneuver	305	638	1122	-	-	-
Stage 1	667	-	-	-	-	-
Stage 2	612	-	-	-	-	-
Platoon blocked, %				-	-	-
Mov Cap-1 Maneuver	299	638	1122	-	-	-
Mov Cap-2 Maneuver	425	-	-	-	-	-
Stage 1	654	-	-	-	-	-
Stage 2	612	-	-	-	-	-

Approach	EB	NB	SB
HCM Control Delay, s	13.3	0.4	0
HCM LOS	B		

Minor Lane/Major Mvmt	NBL	NBT	EBLn1	SBT	SBR
Capacity (veh/h)	1122	-	474	-	-
HCM Lane V/C Ratio	0.019	-	0.087	-	-
HCM Control Delay (s)	8.3	-	13.3	-	-
HCM Lane LOS	A	-	B	-	-
HCM 95th %tile Q(veh)	0.1	-	0.3	-	-

Intersection					
Intersection Delay, s/veh	9.0				
Intersection LOS	A				
Approach	EB	WB	NB	SB	
Entry Lanes	1	1	1	1	
Conflicting Circle Lanes	1	1	1	1	
Adj Approach Flow, veh/h	136	604	377	310	
Demand Flow Rate, veh/h	138	616	385	316	
Vehicles Circulating, veh/h	436	309	120	551	
Vehicles Exiting, veh/h	431	116	454	374	
Ped Vol Crossing Leg, #/h	0	0	0	0	
Ped Cap Adj	1.000	1.000	1.000	1.000	
Approach Delay, s/veh	5.7	12.3	4.2	9.8	
Approach LOS	A	B	A	A	
Lane	Left	Left	Left	Bypass	Left
Designated Moves	LTR	LTR	LT	R	LTR
Assumed Moves	LTR	LTR	LT	R	LTR
RT Channelized				Free	
Lane Util	1.000	1.000	1.000		1.000
Follow-Up Headway, s	2.609	2.609	2.609		2.609
Critical Headway, s	4.976	4.976	4.976	80	4.976
Entry Flow, veh/h	138	616	305	1938	316
Cap Entry Lane, veh/h	885	1007	1221	0.980	787
Entry HV Adj Factor	0.983	0.980	0.981	78	0.981
Flow Entry, veh/h	136	604	299	1900	310
Cap Entry, veh/h	870	987	1197	0.041	772
V/C Ratio	0.156	0.612	0.250	0.0	0.402
Control Delay, s/veh	5.7	12.3	5.3	A	9.8
LOS	A	B	A	0	A
95th %tile Queue, veh	1	4	1		2

Timings  
4: Vollmer Rd & Briargate Pkwy

2042 Total Traffic  
AM Peak Hour

Lane Group	EBL	EBT	EBR	WBL	WBT	WBR	NBL	NBT	NBR	SBL	SBT	SBR
Lane Configurations												
Traffic Volume (vph)	68	554	152	241	1045	96	160	131	109	121	306	138
Future Volume (vph)	68	554	152	241	1045	96	160	131	109	121	306	138
Turn Type	pm+pt	NA	Perm	Prot	NA	Perm	pm+pt	NA	Perm	pm+pt	NA	Perm
Protected Phases	5	2		1	6		3	8		7	4	
Permitted Phases	2		2			6	8		8	4		4
Detector Phase	5	2	2	1	6	6	3	8	8	7	4	4
Switch Phase												
Minimum Initial (s)	5.0	15.0	15.0	15.0	15.0	15.0	5.0	5.0	5.0	5.0	5.0	5.0
Minimum Split (s)	10.0	20.0	20.0	20.0	20.0	20.0	10.0	10.0	10.0	10.0	10.0	10.0
Total Split (s)	12.0	57.0	57.0	20.0	65.0	65.0	17.0	28.0	28.0	15.0	26.0	26.0
Total Split (%)	10.0%	47.5%	47.5%	16.7%	54.2%	54.2%	14.2%	23.3%	23.3%	12.5%	21.7%	21.7%
Yellow Time (s)	3.0	3.0	3.0	3.0	3.0	3.0	3.0	3.0	3.0	3.0	3.0	3.0
All-Red Time (s)	2.0	2.0	2.0	2.0	2.0	2.0	2.0	2.0	2.0	2.0	2.0	2.0
Lost Time Adjust (s)	0.0	0.0	0.0	0.0	0.0	0.0	0.0	0.0	0.0	0.0	0.0	0.0
Total Lost Time (s)	5.0	5.0	5.0	5.0	5.0	5.0	5.0	5.0	5.0	5.0	5.0	5.0
Lead/Lag	Lead	Lag	Lag	Lead	Lag	Lag	Lead	Lag	Lag	Lead	Lag	Lag
Lead-Lag Optimize?	Yes	Yes	Yes	Yes	Yes	Yes	Yes	Yes	Yes	Yes	Yes	Yes
Recall Mode	None	Max	Max	None	Max	Max	None	None	None	None	None	None
Act Effct Green (s)	58.7	52.1	52.1	15.0	62.7	62.7	29.2	17.8	17.8	25.4	15.9	15.9
Actuated g/C Ratio	0.51	0.46	0.46	0.13	0.55	0.55	0.26	0.16	0.16	0.22	0.14	0.14
v/c Ratio	0.26	0.35	0.20	0.56	0.57	0.11	0.62	0.24	0.31	0.40	0.66	0.41
Control Delay	12.4	21.6	3.7	52.8	19.8	2.8	43.0	43.3	4.6	35.7	53.4	9.5
Queue Delay	0.0	0.0	0.0	0.0	0.0	0.0	0.0	0.0	0.0	0.0	0.0	0.0
Total Delay	12.4	21.6	3.7	52.8	19.8	2.8	43.0	43.3	4.6	35.7	53.4	9.5
LOS	B	C	A	D	B	A	D	D	A	D	D	A
Approach Delay		17.1			24.3			32.5			38.9	
Approach LOS		B			C			C			D	

Intersection Summary

Cycle Length: 120  
 Actuated Cycle Length: 114.4  
 Natural Cycle: 60  
 Control Type: Actuated-Uncoordinated  
 Maximum v/c Ratio: 0.66  
 Intersection Signal Delay: 26.3  
 Intersection LOS: C  
 Intersection Capacity Utilization 67.0%  
 ICU Level of Service C  
 Analysis Period (min) 15

Splits and Phases: 4: Vollmer Rd & Briargate Pkwy



Timings  
5: Sterling Ranch Rd & Briargate Pkwy

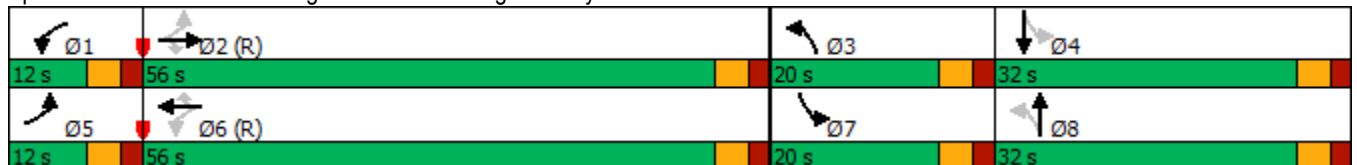
2042 Total Traffic  
AM Peak Hour

Lane Group	EBL	EBT	EBR	WBL	WBT	WBR	NBL	NBT	NBR	SBL	SBT	SBR
Lane Configurations												
Traffic Volume (vph)	73	627	144	110	945	23	287	115	121	106	263	161
Future Volume (vph)	73	627	144	110	945	23	287	115	121	106	263	161
Turn Type	pm+pt	NA	Perm	pm+pt	NA	Perm	pm+pt	NA	Free	pm+pt	NA	Free
Protected Phases	5	2		1	6		3	8		7	4	
Permitted Phases	2		2	6		6	8		Free	4		Free
Detector Phase	5	2	2	1	6	6	3	8		7	4	
Switch Phase												
Minimum Initial (s)	5.0	5.0	5.0	5.0	5.0	5.0	5.0	20.0		5.0	20.0	
Minimum Split (s)	10.0	10.0	10.0	10.0	10.0	10.0	10.0	25.0		10.0	25.0	
Total Split (s)	12.0	56.0	56.0	12.0	56.0	56.0	20.0	32.0		20.0	32.0	
Total Split (%)	10.0%	46.7%	46.7%	10.0%	46.7%	46.7%	16.7%	26.7%		16.7%	26.7%	
Yellow Time (s)	3.0	3.0	3.0	3.0	3.0	3.0	3.0	3.0		3.0	3.0	
All-Red Time (s)	2.0	2.0	2.0	2.0	2.0	2.0	2.0	2.0		2.0	2.0	
Lost Time Adjust (s)	0.0	0.0	0.0	0.0	0.0	0.0	0.0	0.0		0.0	0.0	
Total Lost Time (s)	5.0	5.0	5.0	5.0	5.0	5.0	5.0	5.0		5.0	5.0	
Lead/Lag	Lead	Lag	Lag	Lead	Lag	Lag	Lead	Lag		Lead	Lag	
Lead-Lag Optimize?	Yes	Yes	Yes	Yes	Yes	Yes	Yes	Yes		Yes	Yes	
Recall Mode	None	C-Max	C-Max	None	C-Max	C-Max	None	Max		None	Max	
Act Effct Green (s)	57.8	51.0	51.0	59.0	53.4	53.4	45.8	31.5	120.0	37.5	27.0	120.0
Actuated g/C Ratio	0.48	0.42	0.42	0.49	0.44	0.44	0.38	0.26	1.00	0.31	0.22	1.00
v/c Ratio	0.33	0.44	0.20	0.34	0.63	0.03	0.85	0.25	0.08	0.26	0.66	0.11
Control Delay	18.3	25.5	3.9	9.5	18.7	0.7	51.1	37.4	0.1	25.8	51.0	0.1
Queue Delay	0.0	0.0	0.0	0.0	0.0	0.0	0.0	0.0	0.0	0.0	0.0	0.0
Total Delay	18.3	25.5	3.9	9.5	18.7	0.7	51.1	37.4	0.1	25.8	51.0	0.1
LOS	B	C	A	A	B	A	D	D	A	C	D	A
Approach Delay		21.2			17.4			36.3			30.5	
Approach LOS		C			B			D			C	

Intersection Summary

Cycle Length: 120  
 Actuated Cycle Length: 120  
 Offset: 63 (53%), Referenced to phase 2:EBTL and 6:WBTL, Start of Green  
 Natural Cycle: 70  
 Control Type: Actuated-Coordinated  
 Maximum v/c Ratio: 0.85  
 Intersection Signal Delay: 24.1  
 Intersection LOS: C  
 Intersection Capacity Utilization 79.5%  
 ICU Level of Service D  
 Analysis Period (min) 15

Splits and Phases: 5: Sterling Ranch Rd & Briargate Pkwy



HCM 6th TWSC  
 8: Sterling Ranch Rd & School Access/Oak Park Pl

2042 Total Traffic  
 AM Peak Hour

Intersection												
Int Delay, s/veh	11.9											
Movement	EBL	EBT	EBR	WBL	WBT	WBR	NBL	NBT	NBR	SBL	SBT	SBR
Lane Configurations	↖	↗	↖	↖		↖		↗	↖	↖	↗	
Traffic Vol, veh/h	133	71	131	187	0	197	0	386	123	63	246	0
Future Vol, veh/h	133	71	131	187	0	197	0	386	123	63	246	0
Conflicting Peds, #/hr	0	0	0	0	0	0	0	0	0	0	0	0
Sign Control	Stop	Stop	Stop	Stop	Stop	Stop	Free	Free	Free	Free	Free	Free
RT Channelized	-	-	None	-	-	None	-	-	None	-	-	None
Storage Length	0	-	0	0	-	0	-	-	205	205	-	-
Veh in Median Storage, #	-	0	-	-	0	-	-	0	-	-	0	-
Grade, %	-	0	-	-	0	-	-	0	-	-	0	-
Peak Hour Factor	95	95	95	95	95	95	95	95	95	95	95	95
Heavy Vehicles, %	2	2	2	2	2	2	2	2	2	2	2	2
Mvmt Flow	140	75	138	197	0	207	0	406	129	66	259	0

Major/Minor	Minor2		Minor1		Major1			Major2				
Conflicting Flow All	965	926	259	904	-	406	-	0	0	535	0	0
Stage 1	391	391	-	406	-	-	-	-	-	-	-	-
Stage 2	574	535	-	498	-	-	-	-	-	-	-	-
Critical Hdwy	7.12	6.52	6.22	7.12	-	6.22	-	-	-	4.12	-	-
Critical Hdwy Stg 1	6.12	5.52	-	6.12	-	-	-	-	-	-	-	-
Critical Hdwy Stg 2	6.12	5.52	-	6.12	-	-	-	-	-	-	-	-
Follow-up Hdwy	3.518	4.018	3.318	3.518	-	3.318	-	-	-	2.218	-	-
Pot Cap-1 Maneuver	231	261	897	258	0	645	0	-	-	1033	-	0
Stage 1	697	634	-	622	0	-	0	-	-	-	-	0
Stage 2	504	524	-	594	0	-	0	-	-	-	-	0
Platoon blocked, %	1	1	1	1				-	-			
Mov Cap-1 Maneuver	149	244	897	~ 174	-	645	-	-	-	1033	-	-
Mov Cap-2 Maneuver	230	344	-	300	-	-	-	-	-	-	-	-
Stage 1	697	593	-	622	-	-	-	-	-	-	-	-
Stage 2	342	524	-	411	-	-	-	-	-	-	-	-

























Approach	EB	WB	NB	SB
HCM Control Delay, s	24.5	24.9	0	1.8
HCM LOS	C	C		

Minor Lane/Major Mvmt	NBT	NBR	EBLn1	EBLn2	EBLn3	WBLn1	WBLn2	SBL	SBT
Capacity (veh/h)	-	-	230	344	897	300	645	1033	-
HCM Lane V/C Ratio	-	-	0.609	0.217	0.154	0.656	0.322	0.064	-
HCM Control Delay (s)	-	-	42.3	18.3	9.7	37.2	13.2	8.7	-
HCM Lane LOS	-	-	E	C	A	E	B	A	-
HCM 95th %tile Q(veh)	-	-	3.5	0.8	0.5	4.3	1.4	0.2	-

Notes  
 ~: Volume exceeds capacity    \$: Delay exceeds 300s    +: Computation Not Defined    \*: All major volume in platoon

Timings  
12: Vollmer Rd & Marksheffel Rd

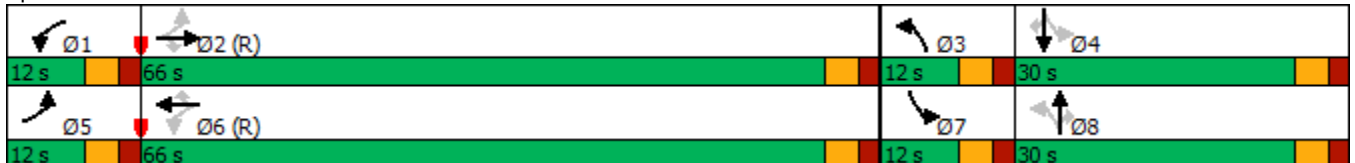
2042 Total Traffic  
AM Peak Hour

												
Lane Group	EBL	EBT	EBR	WBL	WBT	WBR	NBL	NBT	NBR	SBL	SBT	SBR
Lane Configurations												
Traffic Volume (vph)	71	839	42	175	931	69	115	235	111	121	517	131
Future Volume (vph)	71	839	42	175	931	69	115	235	111	121	517	131
Turn Type	pm+pt	NA	Perm	pm+pt	NA	Perm	pm+pt	NA	Perm	pm+pt	NA	Perm
Protected Phases	5	2		1	6		3	8		7	4	
Permitted Phases	2		2	6		6	8		8	4		4
Detector Phase	5	2	2	1	6	6	3	8	8	7	4	4
Switch Phase												
Minimum Initial (s)	5.0	5.0	5.0	5.0	5.0	5.0	5.0	10.0	10.0	5.0	10.0	10.0
Minimum Split (s)	10.0	23.0	23.0	10.0	23.0	23.0	10.0	23.0	23.0	10.0	23.0	23.0
Total Split (s)	12.0	66.0	66.0	12.0	66.0	66.0	12.0	30.0	30.0	12.0	30.0	30.0
Total Split (%)	10.0%	55.0%	55.0%	10.0%	55.0%	55.0%	10.0%	25.0%	25.0%	10.0%	25.0%	25.0%
Yellow Time (s)	3.0	3.0	3.0	3.0	3.0	3.0	3.0	3.0	3.0	3.0	3.0	3.0
All-Red Time (s)	2.0	2.0	2.0	2.0	2.0	2.0	2.0	2.0	2.0	2.0	2.0	2.0
Lost Time Adjust (s)	0.0	0.0	0.0	0.0	0.0	0.0	0.0	0.0	0.0	0.0	0.0	0.0
Total Lost Time (s)	5.0	5.0	5.0	5.0	5.0	5.0	5.0	5.0	5.0	5.0	5.0	5.0
Lead/Lag	Lead	Lag	Lag	Lead	Lag	Lag	Lead	Lag	Lag	Lead	Lag	Lag
Lead-Lag Optimize?	Yes	Yes	Yes	Yes	Yes	Yes	Yes	Yes	Yes	Yes	Yes	Yes
Recall Mode	None	C-Max	C-Max	None	C-Max	C-Max	None	Max	Max	None	Max	Max
Act Effct Green (s)	67.7	61.0	61.0	69.0	63.4	63.4	32.0	25.0	25.0	32.0	25.0	25.0
Actuated g/C Ratio	0.56	0.51	0.51	0.58	0.53	0.53	0.27	0.21	0.21	0.27	0.21	0.21
v/c Ratio	0.25	0.49	0.05	0.56	0.52	0.08	0.65	0.34	0.28	0.41	0.74	0.32
Control Delay	11.9	20.5	0.1	17.6	9.9	0.2	49.2	41.9	8.8	36.2	51.3	9.6
Queue Delay	0.0	0.0	0.0	0.0	0.0	0.0	0.0	0.0	0.0	0.0	0.0	0.0
Total Delay	11.9	20.5	0.1	17.6	9.9	0.2	49.2	41.9	8.8	36.2	51.3	9.6
LOS	B	C	A	B	A	A	D	D	A	D	D	A
Approach Delay		19.0			10.5			35.8			41.8	
Approach LOS		B			B			D			D	

Intersection Summary

Cycle Length: 120  
 Actuated Cycle Length: 120  
 Offset: 0 (0%), Referenced to phase 2:EBTL and 6:WBTL, Start of Green  
 Natural Cycle: 70  
 Control Type: Actuated-Coordinated  
 Maximum v/c Ratio: 0.74  
 Intersection Signal Delay: 23.5  
 Intersection LOS: C  
 Intersection Capacity Utilization 70.2%  
 ICU Level of Service C  
 Analysis Period (min) 15

Splits and Phases: 12: Vollmer Rd & Marksheffel Rd





Timings  
13: Sterling Ranch Rd & Marksheffel Rd

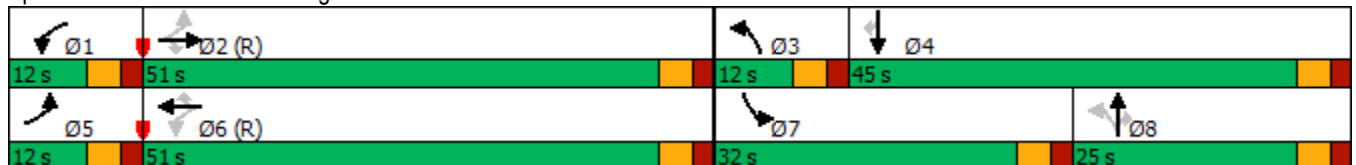
2042 Total Traffic  
AM Peak Hour

Lane Group	EBL	EBT	EBR	WBL	WBT	WBR	NBL	NBT	NBR	SBL	SBT	SBR
Lane Configurations												
Traffic Volume (vph)	160	900	10	47	809	175	39	8	55	478	10	328
Future Volume (vph)	160	900	10	47	809	175	39	8	55	478	10	328
Turn Type	pm+pt	NA	Perm	pm+pt	NA	Perm	pm+pt	NA	Perm	Prot	NA	Perm
Protected Phases	5	2		1	6		3	8		7	4	
Permitted Phases	2		2	6		6	8		8			4
Detector Phase	5	2	2	1	6	6	3	8	8	7	4	4
Switch Phase												
Minimum Initial (s)	5.0	15.0	15.0	5.0	15.0	15.0	5.0	10.0	10.0	20.0	10.0	10.0
Minimum Split (s)	10.0	20.0	20.0	10.0	20.0	20.0	10.0	15.0	15.0	25.0	20.0	20.0
Total Split (s)	12.0	51.0	51.0	12.0	51.0	51.0	12.0	25.0	25.0	32.0	45.0	45.0
Total Split (%)	10.0%	42.5%	42.5%	10.0%	42.5%	42.5%	10.0%	20.8%	20.8%	26.7%	37.5%	37.5%
Yellow Time (s)	3.0	3.0	3.0	3.0	3.0	3.0	3.0	3.0	3.0	3.0	3.0	3.0
All-Red Time (s)	2.0	2.0	2.0	2.0	2.0	2.0	2.0	2.0	2.0	2.0	2.0	2.0
Lost Time Adjust (s)	0.0	0.0	0.0	0.0	0.0	0.0	0.0	0.0	0.0	0.0	0.0	0.0
Total Lost Time (s)	5.0	5.0	5.0	5.0	5.0	5.0	5.0	5.0	5.0	5.0	5.0	5.0
Lead/Lag	Lead	Lag	Lag	Lead	Lag	Lag	Lead	Lag	Lag	Lead	Lag	Lag
Lead-Lag Optimize?	Yes	Yes	Yes	Yes	Yes	Yes	Yes	Yes	Yes	Yes	Yes	Yes
Recall Mode	None	C-Max	C-Max	None	C-Max	C-Max	None	None	None	None	None	None
Act Effct Green (s)	74.4	65.2	65.2	66.0	59.1	59.1	14.6	10.0	10.0	23.0	25.5	25.5
Actuated g/C Ratio	0.62	0.54	0.54	0.55	0.49	0.49	0.12	0.08	0.08	0.19	0.21	0.21
v/c Ratio	0.44	0.49	0.01	0.15	0.49	0.21	0.22	0.05	0.21	0.76	0.03	0.63
Control Delay	21.0	15.5	0.0	12.3	23.4	3.7	32.6	51.6	1.8	54.0	35.4	15.6
Queue Delay	0.0	0.0	0.0	0.0	0.0	0.0	0.0	0.0	0.0	0.0	0.0	0.0
Total Delay	21.0	15.5	0.0	12.3	23.4	3.7	32.6	51.6	1.8	54.0	35.4	15.6
LOS	C	B	A	B	C	A	C	D	A	D	D	B
Approach Delay		16.2			19.6			17.3			38.3	
Approach LOS		B			B			B			D	

Intersection Summary

Cycle Length: 120  
 Actuated Cycle Length: 120  
 Offset: 0 (0%), Referenced to phase 2:EBTL and 6:WBTL, Start of Green  
 Natural Cycle: 75  
 Control Type: Actuated-Coordinated  
 Maximum v/c Ratio: 0.76  
 Intersection Signal Delay: 23.4  
 Intersection LOS: C  
 Intersection Capacity Utilization 64.0%  
 ICU Level of Service C  
 Analysis Period (min) 15

Splits and Phases: 13: Sterling Ranch Rd & Marksheffel Rd



Intersection												
Int Delay, s/veh	3.4											
Movement	EBL	EBT	EBR	WBL	WBT	WBR	NBL	NBT	NBR	SBL	SBT	SBR
Lane Configurations	↖	↑	↗	↖	↗			↕			↕	
Traffic Vol, veh/h	10	413	20	7	563	8	62	0	22	22	0	33
Future Vol, veh/h	10	413	20	7	563	8	62	0	22	22	0	33
Conflicting Peds, #/hr	0	0	0	0	0	0	0	0	0	0	0	0
Sign Control	Free	Free	Free	Free	Free	Free	Stop	Stop	Stop	Stop	Stop	Stop
RT Channelized	-	-	None	-	-	None	-	-	None	-	-	None
Storage Length	305	-	255	305	-	-	-	-	-	-	-	-
Veh in Median Storage, #	-	0	-	-	0	-	-	0	-	-	0	-
Grade, %	-	0	-	-	0	-	-	0	-	-	0	-
Peak Hour Factor	95	95	95	95	95	95	95	95	95	95	95	95
Heavy Vehicles, %	2	2	2	2	2	2	2	2	2	2	2	2
Mvmt Flow	11	435	21	7	593	8	65	0	23	23	0	35

Major/Minor	Major1			Major2			Minor1			Minor2		
Conflicting Flow All	601	0	0	456	0	0	1086	1072	435	1090	1089	597
Stage 1	-	-	-	-	-	-	457	457	-	611	611	-
Stage 2	-	-	-	-	-	-	629	615	-	479	478	-
Critical Hdwy	4.12	-	-	4.12	-	-	7.12	6.52	6.22	7.12	6.52	6.22
Critical Hdwy Stg 1	-	-	-	-	-	-	6.12	5.52	-	6.12	5.52	-
Critical Hdwy Stg 2	-	-	-	-	-	-	6.12	5.52	-	6.12	5.52	-
Follow-up Hdwy	2.218	-	-	2.218	-	-	3.518	4.018	3.318	3.518	4.018	3.318
Pot Cap-1 Maneuver	976	-	-	1105	-	-	194	220	621	193	215	503
Stage 1	-	-	-	-	-	-	583	568	-	481	484	-
Stage 2	-	-	-	-	-	-	470	482	-	568	556	-
Platoon blocked, %	-	-	-	-	-	-	-	-	-	-	-	-
Mov Cap-1 Maneuver	976	-	-	1105	-	-	178	216	621	183	211	503
Mov Cap-2 Maneuver	-	-	-	-	-	-	178	216	-	183	211	-
Stage 1	-	-	-	-	-	-	577	562	-	476	481	-
Stage 2	-	-	-	-	-	-	435	479	-	541	550	-

Approach	EB			WB			NB			SB		
HCM Control Delay, s	0.2			0.1			32.1			20.1		
HCM LOS							D			C		

Minor Lane/Major Mvmt	NBLn1	EBL	EBT	EBR	WBL	WBT	WBR	SBLn1
Capacity (veh/h)	219	976	-	-	1105	-	-	296
HCM Lane V/C Ratio	0.404	0.011	-	-	0.007	-	-	0.196
HCM Control Delay (s)	32.1	8.7	-	-	8.3	-	-	20.1
HCM Lane LOS	D	A	-	-	A	-	-	C
HCM 95th %tile Q(veh)	1.8	0	-	-	0	-	-	0.7

Intersection												
Int Delay, s/veh	2.2											
Movement	EBL	EBT	EBR	WBL	WBT	WBR	NBL	NBT	NBR	SBL	SBT	SBR
Lane Configurations		↕			↕		↕	↕		↕	↕	
Traffic Vol, veh/h	44	0	16	18	0	19	5	446	6	7	543	15
Future Vol, veh/h	44	0	16	18	0	19	5	446	6	7	543	15
Conflicting Peds, #/hr	0	0	0	0	0	0	0	0	0	0	0	0
Sign Control	Stop	Stop	Stop	Stop	Stop	Stop	Free	Free	Free	Free	Free	Free
RT Channelized	-	-	None	-	-	None	-	-	None	-	-	None
Storage Length	-	-	-	-	-	-	205	-	-	205	-	-
Veh in Median Storage, #	-	0	-	-	0	-	-	0	-	-	0	-
Grade, %	-	0	-	-	0	-	-	0	-	-	0	-
Peak Hour Factor	95	95	95	95	95	95	95	95	95	95	95	95
Heavy Vehicles, %	2	2	2	2	2	2	2	2	2	2	2	2
Mvmt Flow	46	0	17	19	0	20	5	469	6	7	572	16

Major/Minor	Minor2		Minor1		Major1		Major2					
Conflicting Flow All	1086	1079	580	1085	1084	472	588	0	0	475	0	0
Stage 1	594	594	-	482	482	-	-	-	-	-	-	-
Stage 2	492	485	-	603	602	-	-	-	-	-	-	-
Critical Hdwy	7.12	6.52	6.22	7.12	6.52	6.22	4.12	-	-	4.12	-	-
Critical Hdwy Stg 1	6.12	5.52	-	6.12	5.52	-	-	-	-	-	-	-
Critical Hdwy Stg 2	6.12	5.52	-	6.12	5.52	-	-	-	-	-	-	-
Follow-up Hdwy	3.518	4.018	3.318	3.518	4.018	3.318	2.218	-	-	2.218	-	-
Pot Cap-1 Maneuver	194	218	514	194	217	592	987	-	-	1087	-	-
Stage 1	491	493	-	565	553	-	-	-	-	-	-	-
Stage 2	558	552	-	486	489	-	-	-	-	-	-	-
Platoon blocked, %								-	-	-	-	-
Mov Cap-1 Maneuver	186	216	514	186	215	592	987	-	-	1087	-	-
Mov Cap-2 Maneuver	186	216	-	186	215	-	-	-	-	-	-	-
Stage 1	489	490	-	562	550	-	-	-	-	-	-	-
Stage 2	536	549	-	467	486	-	-	-	-	-	-	-

Approach	EB		WB		NB		SB	
HCM Control Delay, s	27.3		19.5		0.1		0.1	
HCM LOS	D		C					

Minor Lane/Major Mvmt	NBL	NBT	NBR	EBLn1	WBLn1	SBL	SBT	SBR
Capacity (veh/h)	987	-	-	224	287	1087	-	-
HCM Lane V/C Ratio	0.005	-	-	0.282	0.136	0.007	-	-
HCM Control Delay (s)	8.7	-	-	27.3	19.5	8.3	-	-
HCM Lane LOS	A	-	-	D	C	A	-	-
HCM 95th %tile Q(veh)	0	-	-	1.1	0.5	0	-	-

Intersection					
Intersection Delay, s/veh	15.0				
Intersection LOS	C				
Approach	EB	WB	NB	SB	
Entry Lanes	1	1	1	1	
Conflicting Circle Lanes	1	1	1	1	
Adj Approach Flow, veh/h	453	393	815	418	
Demand Flow Rate, veh/h	462	401	830	426	
Vehicles Circulating, veh/h	548	623	591	408	
Vehicles Exiting, veh/h	286	577	419	616	
Ped Vol Crossing Leg, #/h	0	0	0	0	
Ped Cap Adj	1.000	1.000	1.000	1.000	
Approach Delay, s/veh	13.9	13.7	19.0	9.9	
Approach LOS	B	B	C	A	
Lane	Left	Left	Left	Bypass	Left
Designated Moves	LTR	LTR	LT	R	LTR
Assumed Moves	LTR	LTR	LT	R	LTR
RT Channelized				Free	
Lane Util	1.000	1.000	1.000		1.000
Follow-Up Headway, s	2.609	2.609	2.609		2.609
Critical Headway, s	4.976	4.976	4.976	221	4.976
Entry Flow, veh/h	462	401	609	1938	426
Cap Entry Lane, veh/h	789	731	755	0.980	910
Entry HV Adj Factor	0.981	0.980	0.981	217	0.980
Flow Entry, veh/h	453	393	598	1900	418
Cap Entry, veh/h	774	717	741	0.114	892
V/C Ratio	0.586	0.549	0.806	0.0	0.468
Control Delay, s/veh	13.9	13.7	25.8	A	9.9
LOS	B	B	D	0	A
95th %tile Queue, veh	4	3	8		3

Timings  
4: Vollmer Rd & Briargate Pkwy

2042 Total Traffic  
PM Peak Hour

Lane Group	EBL	EBT	EBR	WBL	WBT	WBR	NBL	NBT	NBR	SBL	SBT	SBR
Lane Configurations												
Traffic Volume (vph)	227	1015	185	209	745	75	301	414	282	110	211	118
Future Volume (vph)	227	1015	185	209	745	75	301	414	282	110	211	118
Turn Type	pm+pt	NA	Perm	Prot	NA	Perm	pm+pt	NA	Perm	pm+pt	NA	Perm
Protected Phases	5	2		1	6		3	8		7	4	
Permitted Phases	2		2			6	8		8	4		4
Detector Phase	5	2	2	1	6	6	3	8	8	7	4	4
Switch Phase												
Minimum Initial (s)	5.0	15.0	15.0	15.0	15.0	15.0	8.0	5.0	5.0	5.0	5.0	5.0
Minimum Split (s)	10.0	20.0	20.0	20.0	20.0	20.0	13.0	10.0	10.0	10.0	10.0	10.0
Total Split (s)	12.0	53.0	53.0	20.0	61.0	61.0	22.0	28.0	28.0	19.0	25.0	25.0
Total Split (%)	10.0%	44.2%	44.2%	16.7%	50.8%	50.8%	18.3%	23.3%	23.3%	15.8%	20.8%	20.8%
Yellow Time (s)	3.0	3.0	3.0	3.0	3.0	3.0	3.0	3.0	3.0	3.0	3.0	3.0
All-Red Time (s)	2.0	2.0	2.0	2.0	2.0	2.0	2.0	2.0	2.0	2.0	2.0	2.0
Lost Time Adjust (s)	0.0	0.0	0.0	0.0	0.0	0.0	0.0	0.0	0.0	0.0	0.0	0.0
Total Lost Time (s)	5.0	5.0	5.0	5.0	5.0	5.0	5.0	5.0	5.0	5.0	5.0	5.0
Lead/Lag	Lead	Lag	Lag	Lead	Lag	Lag	Lead	Lag	Lag	Lead	Lag	Lag
Lead-Lag Optimize?	Yes	Yes	Yes	Yes	Yes	Yes	Yes	Yes	Yes	Yes	Yes	Yes
Recall Mode	None	Max	Max	None	Max	Max	None	None	None	None	None	None
Act Effct Green (s)	55.1	48.1	48.1	15.0	56.1	56.1	35.6	20.3	20.3	25.3	14.5	14.5
Actuated g/C Ratio	0.48	0.42	0.42	0.13	0.49	0.49	0.31	0.18	0.18	0.22	0.13	0.13
v/c Ratio	0.66	0.70	0.25	0.49	0.45	0.09	0.83	0.67	0.59	0.43	0.50	0.37
Control Delay	25.6	30.9	4.7	51.0	20.7	1.7	52.9	49.9	12.3	33.9	50.1	6.5
Queue Delay	0.0	0.0	0.0	0.0	0.0	0.0	0.0	0.0	0.0	0.0	0.0	0.0
Total Delay	25.6	30.9	4.7	51.0	20.7	1.7	52.9	49.9	12.3	33.9	50.1	6.5
LOS	C	C	A	D	C	A	D	D	B	C	D	A
Approach Delay		26.5			25.5			40.1			34.3	
Approach LOS		C			C			D			C	

Intersection Summary

Cycle Length: 120  
 Actuated Cycle Length: 114.3  
 Natural Cycle: 80  
 Control Type: Actuated-Uncoordinated  
 Maximum v/c Ratio: 0.83  
 Intersection Signal Delay: 30.6  
 Intersection LOS: C  
 Intersection Capacity Utilization 79.7%  
 ICU Level of Service D  
 Analysis Period (min) 15

Splits and Phases: 4: Vollmer Rd & Briargate Pkwy



Timings  
5: Sterling Ranch Rd & Briargate Pkwy

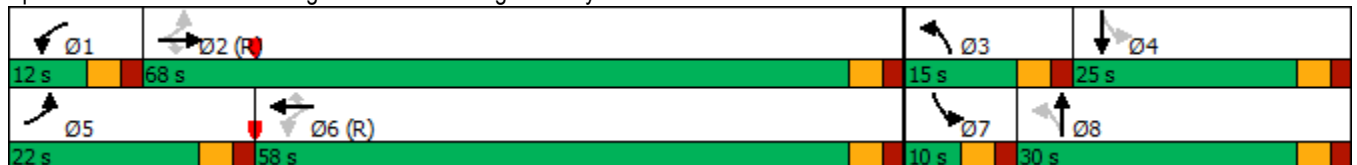
2042 Total Traffic  
PM Peak Hour

Lane Group	EBL	EBT	EBR	WBL	WBT	WBR	NBL	NBT	NBR	SBL	SBT	SBR
Lane Configurations												
Traffic Volume (vph)	329	921	136	156	829	105	191	190	83	87	86	133
Future Volume (vph)	329	921	136	156	829	105	191	190	83	87	86	133
Turn Type	pm+pt	NA	Perm	pm+pt	NA	Perm	pm+pt	NA	Free	pm+pt	NA	Free
Protected Phases	5	2		1	6		3	8		7	4	
Permitted Phases	2		2	6		6	8		Free	4		Free
Detector Phase	5	2	2	1	6	6	3	8		7	4	
Switch Phase												
Minimum Initial (s)	5.0	5.0	5.0	5.0	5.0	5.0	5.0	20.0		5.0	20.0	
Minimum Split (s)	10.0	23.0	23.0	10.0	23.0	23.0	10.0	25.0		10.0	25.0	
Total Split (s)	22.0	68.0	68.0	12.0	58.0	58.0	15.0	30.0		10.0	25.0	
Total Split (%)	18.3%	56.7%	56.7%	10.0%	48.3%	48.3%	12.5%	25.0%		8.3%	20.8%	
Yellow Time (s)	3.0	3.0	3.0	3.0	3.0	3.0	3.0	3.0		3.0	3.0	
All-Red Time (s)	2.0	2.0	2.0	2.0	2.0	2.0	2.0	2.0		2.0	2.0	
Lost Time Adjust (s)	0.0	0.0	0.0	0.0	0.0	0.0	0.0	0.0		0.0	0.0	
Total Lost Time (s)	5.0	5.0	5.0	5.0	5.0	5.0	5.0	5.0		5.0	5.0	
Lead/Lag	Lead	Lag	Lag	Lead	Lag	Lag	Lead	Lag		Lead	Lag	
Lead-Lag Optimize?	Yes	Yes	Yes	Yes	Yes	Yes	Yes	Yes		Yes	Yes	
Recall Mode	None	C-Max	C-Max	None	C-Max	C-Max	None	None		None	None	
Act Effct Green (s)	75.9	64.0	64.0	62.4	55.3	55.3	34.0	24.0	120.0	21.0	20.0	120.0
Actuated g/C Ratio	0.63	0.53	0.53	0.52	0.46	0.46	0.28	0.20	1.00	0.18	0.17	1.00
v/c Ratio	0.83	0.51	0.16	0.52	0.53	0.14	0.55	0.54	0.05	0.40	0.29	0.09
Control Delay	30.3	19.4	2.7	18.6	25.1	5.4	41.3	48.7	0.1	40.8	46.8	0.1
Queue Delay	0.0	0.0	0.0	0.0	0.0	0.0	0.0	0.0	0.0	0.0	0.0	0.0
Total Delay	30.3	19.4	2.7	18.6	25.1	5.4	41.3	48.7	0.1	40.8	46.8	0.1
LOS	C	B	A	B	C	A	D	D	A	D	D	A
Approach Delay		20.4			22.3			37.0			24.8	
Approach LOS		C			C			D			C	

Intersection Summary

Cycle Length: 120  
 Actuated Cycle Length: 120  
 Offset: 0 (0%), Referenced to phase 2:EBTL and 6:WBTL, Start of Green  
 Natural Cycle: 80  
 Control Type: Actuated-Coordinated  
 Maximum v/c Ratio: 0.83  
 Intersection Signal Delay: 23.8  
 Intersection LOS: C  
 Intersection Capacity Utilization 85.1%  
 ICU Level of Service E  
 Analysis Period (min) 15

Splits and Phases: 5: Sterling Ranch Rd & Briargate Pkwy



Intersection												
Int Delay, s/veh	4.8											
Movement	EBL	EBT	EBR	WBL	WBT	WBR	NBL	NBT	NBR	SBL	SBT	SBR
Lane Configurations	↘	↑	↗	↘		↗		↑	↗	↘	↑	
Traffic Vol, veh/h	38	18	32	125	0	139	0	321	159	55	283	0
Future Vol, veh/h	38	18	32	125	0	139	0	321	159	55	283	0
Conflicting Peds, #/hr	0	0	0	0	0	0	0	0	0	0	0	0
Sign Control	Stop	Stop	Stop	Stop	Stop	Stop	Free	Free	Free	Free	Free	Free
RT Channelized	-	-	None	-	-	None	-	-	None	-	-	None
Storage Length	0	-	0	0	-	0	-	-	205	205	-	-
Veh in Median Storage, #	-	0	-	-	0	-	-	0	-	-	0	-
Grade, %	-	0	-	-	0	-	-	0	-	-	0	-
Peak Hour Factor	95	95	95	95	95	95	95	95	95	95	95	95
Heavy Vehicles, %	2	2	2	2	2	2	2	2	2	2	2	2
Mvmt Flow	40	19	34	132	0	146	0	338	167	58	298	0

Major/Minor	Minor2		Minor1		Major1			Major2				
Conflicting Flow All	909	919	298	779	-	338	-	0	0	505	0	0
Stage 1	414	414	-	338	-	-	-	-	-	-	-	-
Stage 2	495	505	-	441	-	-	-	-	-	-	-	-
Critical Hdwy	7.12	6.52	6.22	7.12	-	6.22	-	-	-	4.12	-	-
Critical Hdwy Stg 1	6.12	5.52	-	6.12	-	-	-	-	-	-	-	-
Critical Hdwy Stg 2	6.12	5.52	-	6.12	-	-	-	-	-	-	-	-
Follow-up Hdwy	3.518	4.018	3.318	3.518	-	3.318	-	-	-	2.218	-	-
Pot Cap-1 Maneuver	257	264	867	330	0	704	0	-	-	1060	-	0
Stage 1	686	622	-	676	0	-	0	-	-	-	-	0
Stage 2	556	540	-	658	0	-	0	-	-	-	-	0
Platoon blocked, %	1	1	1	1				-	-			
Mov Cap-1 Maneuver	195	249	867	292	-	704	-	-	-	1060	-	-
Mov Cap-2 Maneuver	302	353	-	416	-	-	-	-	-	-	-	-
Stage 1	686	588	-	676	-	-	-	-	-	-	-	-
Stage 2	440	540	-	579	-	-	-	-	-	-	-	-

Approach	EB		WB		NB			SB	
HCM Control Delay, s	14.7		14.4		0			1.4	
HCM LOS	B		B						

Minor Lane/Major Mvmt	NBT	NBR	EBLn1	EBLn2	EBLn3	WBLn1	WBLn2	SBL	SBT
Capacity (veh/h)	-	-	302	353	867	416	704	1060	-
HCM Lane V/C Ratio	-	-	0.132	0.054	0.039	0.316	0.208	0.055	-
HCM Control Delay (s)	-	-	18.7	15.8	9.3	17.6	11.5	8.6	-
HCM Lane LOS	-	-	C	C	A	C	B	A	-
HCM 95th %tile Q(veh)	-	-	0.5	0.2	0.1	1.3	0.8	0.2	-

Timings  
12: Vollmer Rd & Marksheffel Rd

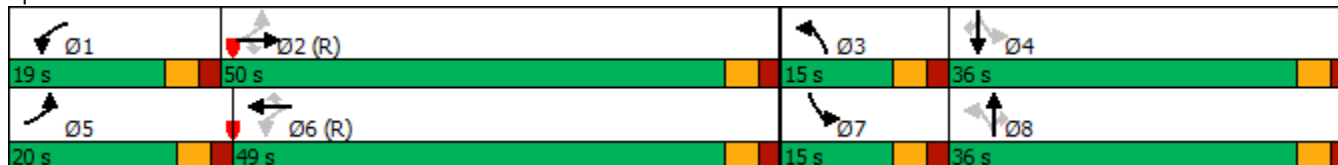
2042 Total Traffic  
PM Peak Hour

Lane Group	EBL	EBT	EBR	WBL	WBT	WBR	NBL	NBT	NBR	SBL	SBT	SBR
Lane Configurations												
Traffic Volume (vph)	142	943	96	191	715	154	171	728	191	132	342	199
Future Volume (vph)	142	943	96	191	715	154	171	728	191	132	342	199
Turn Type	pm+pt	NA	Perm	pm+pt	NA	Perm	pm+pt	NA	Perm	pm+pt	NA	Perm
Protected Phases	5	2		1	6		3	8		7	4	
Permitted Phases	2		2	6		6	8		8	4		4
Detector Phase	5	2	2	1	6	6	3	8	8	7	4	4
Switch Phase												
Minimum Initial (s)	5.0	5.0	5.0	5.0	5.0	5.0	5.0	10.0	10.0	5.0	10.0	10.0
Minimum Split (s)	10.0	23.0	23.0	10.0	23.0	23.0	10.0	23.0	23.0	10.0	23.0	23.0
Total Split (s)	20.0	50.0	50.0	19.0	49.0	49.0	15.0	36.0	36.0	15.0	36.0	36.0
Total Split (%)	16.7%	41.7%	41.7%	15.8%	40.8%	40.8%	12.5%	30.0%	30.0%	12.5%	30.0%	30.0%
Yellow Time (s)	3.0	3.0	3.0	3.0	3.0	3.0	3.0	3.0	3.0	3.0	3.0	3.0
All-Red Time (s)	2.0	2.0	2.0	2.0	2.0	2.0	2.0	2.0	2.0	2.0	2.0	2.0
Lost Time Adjust (s)	0.0	0.0	0.0	0.0	0.0	0.0	0.0	0.0	0.0	0.0	0.0	0.0
Total Lost Time (s)	5.0	5.0	5.0	5.0	5.0	5.0	5.0	5.0	5.0	5.0	5.0	5.0
Lead/Lag	Lead	Lag	Lag	Lead	Lag	Lag	Lead	Lag	Lag	Lead	Lag	Lag
Lead-Lag Optimize?	Yes	Yes	Yes	Yes	Yes	Yes	Yes	Yes	Yes	Yes	Yes	Yes
Recall Mode	None	C-Max	C-Max	None	C-Max	C-Max	None	Max	Max	None	Max	Max
Act Effct Green (s)	57.4	46.8	46.8	60.6	48.3	48.3	41.2	31.4	31.4	40.8	31.2	31.2
Actuated g/C Ratio	0.48	0.39	0.39	0.50	0.40	0.40	0.34	0.26	0.26	0.34	0.26	0.26
v/c Ratio	0.43	0.72	0.15	0.72	0.53	0.22	0.50	0.83	0.39	0.68	0.39	0.37
Control Delay	18.7	35.1	4.5	52.2	22.5	5.4	31.4	50.7	13.7	43.5	38.2	6.7
Queue Delay	0.0	0.0	0.0	0.0	0.0	0.0	0.0	0.0	0.0	0.0	0.0	0.0
Total Delay	18.7	35.1	4.5	52.2	22.5	5.4	31.4	50.7	13.7	43.5	38.2	6.7
LOS	B	D	A	D	C	A	C	D	B	D	D	A
Approach Delay		30.6			25.3			41.2			29.9	
Approach LOS		C			C			D			C	

Intersection Summary

Cycle Length: 120  
 Actuated Cycle Length: 120  
 Offset: 0 (0%), Referenced to phase 2:EBTL and 6:WBTL, Start of Green  
 Natural Cycle: 70  
 Control Type: Actuated-Coordinated  
 Maximum v/c Ratio: 0.83  
 Intersection Signal Delay: 32.0  
 Intersection LOS: C  
 Intersection Capacity Utilization 80.8%  
 ICU Level of Service D  
 Analysis Period (min) 15

Splits and Phases: 12: Vollmer Rd & Marksheffel Rd





Timings  
13: Sterling Ranch Rd & Marksheffel Rd

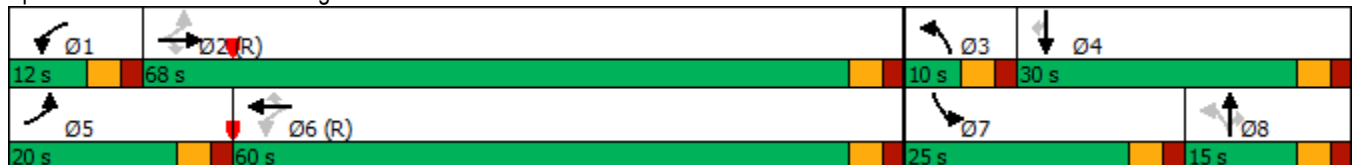
2042 Total Traffic  
PM Peak Hour

Lane Group	EBL	EBT	EBR	WBL	WBT	WBR	NBL	NBT	NBR	SBL	SBT	SBR
Lane Configurations												
Traffic Volume (vph)	305	946	22	130	841	570	27	6	37	342	24	191
Future Volume (vph)	305	946	22	130	841	570	27	6	37	342	24	191
Turn Type	pm+pt	NA	Perm	pm+pt	NA	Perm	pm+pt	NA	Perm	Prot	NA	Perm
Protected Phases	5	2		1	6		3	8		7	4	
Permitted Phases	2		2	6		6	8		8			4
Detector Phase	5	2	2	1	6	6	3	8	8	7	4	4
Switch Phase												
Minimum Initial (s)	5.0	15.0	15.0	5.0	15.0	15.0	5.0	10.0	10.0	20.0	10.0	10.0
Minimum Split (s)	10.0	20.0	20.0	10.0	20.0	20.0	10.0	15.0	15.0	25.0	20.0	20.0
Total Split (s)	20.0	68.0	68.0	12.0	60.0	60.0	10.0	15.0	15.0	25.0	30.0	30.0
Total Split (%)	16.7%	56.7%	56.7%	10.0%	50.0%	50.0%	8.3%	12.5%	12.5%	20.8%	25.0%	25.0%
Yellow Time (s)	3.0	3.0	3.0	3.0	3.0	3.0	3.0	3.0	3.0	3.0	3.0	3.0
All-Red Time (s)	2.0	2.0	2.0	2.0	2.0	2.0	2.0	2.0	2.0	2.0	2.0	2.0
Lost Time Adjust (s)	0.0	0.0	0.0	0.0	0.0	0.0	0.0	0.0	0.0	0.0	0.0	0.0
Total Lost Time (s)	5.0	5.0	5.0	5.0	5.0	5.0	5.0	5.0	5.0	5.0	5.0	5.0
Lead/Lag	Lead	Lag	Lag	Lead	Lag	Lag	Lead	Lag	Lag	Lead	Lag	Lag
Lead-Lag Optimize?	Yes	Yes	Yes	Yes	Yes	Yes	Yes	Yes	Yes	Yes	Yes	Yes
Recall Mode	None	C-Max	C-Max	None	C-Max	C-Max	None	None	None	None	None	None
Act Effct Green (s)	80.6	69.1	69.1	69.6	62.7	62.7	11.0	10.0	10.0	20.0	23.0	23.0
Actuated g/C Ratio	0.67	0.58	0.58	0.58	0.52	0.52	0.09	0.08	0.08	0.17	0.19	0.19
v/c Ratio	0.75	0.49	0.02	0.41	0.48	0.54	0.20	0.04	0.12	0.63	0.07	0.43
Control Delay	39.5	10.5	0.0	12.9	20.9	3.5	37.8	51.3	0.8	52.1	39.2	8.5
Queue Delay	0.0	0.0	0.0	0.0	0.0	0.0	0.0	0.0	0.0	0.0	0.0	0.0
Total Delay	39.5	10.5	0.0	12.9	20.9	3.5	37.8	51.3	0.8	52.1	39.2	8.5
LOS	D	B	A	B	C	A	D	D	A	D	D	A
Approach Delay		17.3			13.8			19.1			36.6	
Approach LOS		B			B			B			D	

Intersection Summary

Cycle Length: 120  
 Actuated Cycle Length: 120  
 Offset: 0 (0%), Referenced to phase 2:EBTL and 6:WBTL, Start of Green  
 Natural Cycle: 90  
 Control Type: Actuated-Coordinated  
 Maximum v/c Ratio: 0.75  
 Intersection Signal Delay: 18.9  
 Intersection LOS: B  
 Intersection Capacity Utilization 73.0%  
 ICU Level of Service D  
 Analysis Period (min) 15

Splits and Phases: 13: Sterling Ranch Rd & Marksheffel Rd



Intersection												
Int Delay, s/veh	2.4											
Movement	EBL	EBT	EBR	WBL	WBT	WBR	NBL	NBT	NBR	SBL	SBT	SBR
Lane Configurations	↙	↑	↗	↙	↗			↕			↕	
Traffic Vol, veh/h	40	461	76	19	362	24	45	0	12	14	0	24
Future Vol, veh/h	40	461	76	19	362	24	45	0	12	14	0	24
Conflicting Peds, #/hr	0	0	0	0	0	0	0	0	0	0	0	0
Sign Control	Free	Free	Free	Free	Free	Free	Stop	Stop	Stop	Stop	Stop	Stop
RT Channelized	-	-	None	-	-	None	-	-	None	-	-	None
Storage Length	305	-	255	305	-	-	-	-	-	-	-	-
Veh in Median Storage, #	-	0	-	-	0	-	-	0	-	-	0	-
Grade, %	-	0	-	-	0	-	-	0	-	-	0	-
Peak Hour Factor	95	95	95	95	95	95	95	95	95	95	95	95
Heavy Vehicles, %	2	2	2	2	2	2	2	2	2	2	2	2
Mvmt Flow	42	485	80	20	381	25	47	0	13	15	0	25

Major/Minor	Major1			Major2			Minor1			Minor2		
Conflicting Flow All	406	0	0	565	0	0	1015	1015	485	1050	1083	394
Stage 1	-	-	-	-	-	-	569	569	-	434	434	-
Stage 2	-	-	-	-	-	-	446	446	-	616	649	-
Critical Hdwy	4.12	-	-	4.12	-	-	7.12	6.52	6.22	7.12	6.52	6.22
Critical Hdwy Stg 1	-	-	-	-	-	-	6.12	5.52	-	6.12	5.52	-
Critical Hdwy Stg 2	-	-	-	-	-	-	6.12	5.52	-	6.12	5.52	-
Follow-up Hdwy	2.218	-	-	2.218	-	-	3.518	4.018	3.318	3.518	4.018	3.318
Pot Cap-1 Maneuver	1153	-	-	1007	-	-	217	238	582	205	217	655
Stage 1	-	-	-	-	-	-	507	506	-	600	581	-
Stage 2	-	-	-	-	-	-	591	574	-	478	466	-
Platoon blocked, %		-	-	-	-	-						
Mov Cap-1 Maneuver	1153	-	-	1007	-	-	200	225	582	192	205	655
Mov Cap-2 Maneuver	-	-	-	-	-	-	200	225	-	192	205	-
Stage 1	-	-	-	-	-	-	489	488	-	578	569	-
Stage 2	-	-	-	-	-	-	557	563	-	451	449	-

Approach	EB			WB			NB			SB		
HCM Control Delay, s	0.6			0.4			25.8			16.7		
HCM LOS							D			C		

Minor Lane/Major Mvmt	NBLn1	EBL	EBT	EBR	WBL	WBT	WBR	SBLn1
Capacity (veh/h)	232	1153	-	-	1007	-	-	347
HCM Lane V/C Ratio	0.259	0.037	-	-	0.02	-	-	0.115
HCM Control Delay (s)	25.8	8.2	-	-	8.6	-	-	16.7
HCM Lane LOS	D	A	-	-	A	-	-	C
HCM 95th %tile Q(veh)	1	0.1	-	-	0.1	-	-	0.4

Intersection												
Int Delay, s/veh	1.5											
Movement	EBL	EBT	EBR	WBL	WBT	WBR	NBL	NBT	NBR	SBL	SBT	SBR
Lane Configurations		↕			↕		↕	↕		↕	↕	
Traffic Vol, veh/h	27	0	12	13	0	9	20	444	23	15	378	47
Future Vol, veh/h	27	0	12	13	0	9	20	444	23	15	378	47
Conflicting Peds, #/hr	0	0	0	0	0	0	0	0	0	0	0	0
Sign Control	Stop	Stop	Stop	Stop	Stop	Stop	Free	Free	Free	Free	Free	Free
RT Channelized	-	-	None	-	-	None	-	-	None	-	-	None
Storage Length	-	-	-	-	-	-	205	-	-	205	-	-
Veh in Median Storage, #	-	0	-	-	0	-	-	0	-	-	0	-
Grade, %	-	0	-	-	0	-	-	0	-	-	0	-
Peak Hour Factor	95	95	95	95	95	95	95	95	95	95	95	95
Heavy Vehicles, %	2	2	2	2	2	2	2	2	2	2	2	2
Mvmt Flow	28	0	13	14	0	9	21	467	24	16	398	49

Major/Minor	Minor2		Minor1		Major1			Major2				
Conflicting Flow All	981	988	423	982	1000	479	447	0	0	491	0	0
Stage 1	455	455	-	521	521	-	-	-	-	-	-	-
Stage 2	526	533	-	461	479	-	-	-	-	-	-	-
Critical Hdwy	7.12	6.52	6.22	7.12	6.52	6.22	4.12	-	-	4.12	-	-
Critical Hdwy Stg 1	6.12	5.52	-	6.12	5.52	-	-	-	-	-	-	-
Critical Hdwy Stg 2	6.12	5.52	-	6.12	5.52	-	-	-	-	-	-	-
Follow-up Hdwy	3.518	4.018	3.318	3.518	4.018	3.318	2.218	-	-	2.218	-	-
Pot Cap-1 Maneuver	229	247	631	228	243	587	1113	-	-	1072	-	-
Stage 1	585	569	-	539	532	-	-	-	-	-	-	-
Stage 2	535	525	-	581	555	-	-	-	-	-	-	-
Platoon blocked, %								-	-	-	-	-
Mov Cap-1 Maneuver	220	239	631	218	235	587	1113	-	-	1072	-	-
Mov Cap-2 Maneuver	220	239	-	218	235	-	-	-	-	-	-	-
Stage 1	574	560	-	529	522	-	-	-	-	-	-	-
Stage 2	516	515	-	561	547	-	-	-	-	-	-	-

Approach	EB		WB		NB		SB	
HCM Control Delay, s	20.4		18.3		0.3		0.3	
HCM LOS	C		C					

Minor Lane/Major Mvmt	NBL	NBT	NBR	EBLn1	WBLn1	SBL	SBT	SBR
Capacity (veh/h)	1113	-	-	275	293	1072	-	-
HCM Lane V/C Ratio	0.019	-	-	0.149	0.079	0.015	-	-
HCM Control Delay (s)	8.3	-	-	20.4	18.3	8.4	-	-
HCM Lane LOS	A	-	-	C	C	A	-	-
HCM 95th %tile Q(veh)	0.1	-	-	0.5	0.3	0	-	-

# Crash History

---



AccidentDate	TotalVehicles	ReferencePointName	ReferencePointAtName	AccidentNarrative
2019-09-29	1	VOLLMER RD	GLIDER LP	Vehicle # 1 was traveling northbound Vollmer Road .8 miles north of Glider Loop. Vehicle # 1's right side tires dropped off the right side of the roadway as it entered a sharp left curve. Vehicle #1 lost control on the roadway for approximately 131' before it traveled approximately 100' off the right side of the roadway. Vehicle # 1 collided its rear with a barbed-wire fence. Vehicle # 1 was moved prior to investigation.
2019-10-01	1	VOLLMER RD	S POCO RD	Vehicle #1 was northbound on Vollmer Road in a left hand curve. Vehicle #1 ran off the right side of the road for 107.3'. Vehicle over corrected, reentered the roadway, spinning counter clockwise. Vehicle #1 was out of control for 98.5'. Vehicle #1 ran off the left side of the road for 99.8', rolling 1 1/2 times. Vehicle #1 came to rest on its top facing west.
2019-11-14	1	VOLLMER RD	GLIDER PL	Vehicle 1 was southbound on Vollmer Road south of Burgess Road. Vehicle 1 was travelling in excessive speed, when it failed to negotiate a right hand bend in the roadway. Vehicle left heavy left side tire skids marks for 115.8 feet in the northbound lane, afterwhich it traveled for 59.4 across the southbound lane. Vehicle 1 ran off the right side of the road for 130.9 feet where it began to overturn, airborne for 20.7 feet, colliding with the ground, traveled another 25.9 feet and rolled another 52.2 feet where it came to final rest facing east on its right side 23.9 feet from the west road edge.
2020-04-23	1	VOLLMER RD	WILDFLOWER RD	Vehicle #1 was traveling south on Vollmer Rd approaching Wildflower Rd. Vehicle #1 failed to navigate the slight left curve in the roadway at which point it ran off the right side of the road. Vehicle #1 crashed through the fence on the right side of the road, traveled southwest into the yard of 8455 Wildflower Rd, rolled, crashed into a well, and came to rest on its wheels facing south.
2020-05-26	1	VOLLMER	WILD FLOWER	Vehicle #1 was southbound on Vollmer. Driver of vehicle #1 lost control and went off the right side of the road and overturned. Vehicle #1 was moved prior to investigation.
2020-07-25	1	VOLLMER RD	POCO RD	Vehicle 1 was traveling in an easterly direction on Vollmer Road approaching a left curve. Vehicle 1 drove on the wrong side of the road to avoid a deceased raccoon in the middle of its lane. Vehicle 1 returned to its lane while navigating the curve. Vehicle 1's right tires dropped off the right edge of the road. Driver 1 pulled the wheel to the left causing Vehicle 1 to spin out of control. Driver 1 overcorrected to the right and the vehicle rolled 3/4 times off the right side of the road. Vehicle 1 came to final rest on top of a fence facing south on its right side.
2021-03-24	1	VOLLMER RD	POCO RD	Vehicle #1 was southbound on Vollmer Road just south of Poco Road. Vehicle #1 lost control on the icy covered roadway and slid off of the west edge of the roadway for approximately 50 feet while rotating 1/4 times clockwise. Vehicle #1 then collided with a barbed wire fence approximately 15 feet west of the road edge and overturned 1/4 times onto it's left. Vehicle #1 came to final rest on its left side, approximately 15 feet west of the road edge facing west.
2021-09-13	3	VOLLMER RD	POCO RD	Vehicle #1 was traveling southbound on Vollmer Road. Vehicle #2 was parked on Poco Road, facing east, just west of the intersection of Vollmer Rd. and Poco Rd. Vehicle #2 was partially in the lane and partially on what would be a shoulder, as the entire road is dirt. Vehicle #3 was parked likewise, behind vehicle #2. Vehicle #1 made a right hand turn, to travel westbound on Poco Rd. The left front of vehicle #1 crashed into the left front of vehicle #2. Vehicle #2, being on dirt, slid backwards into the front of vehicle #3. Both vehicles #2 and #3 were unoccupied. Vehicle #1 pulled through and pulled over further down Poco Road to a safe location.
2021-11-11	1	VOLLMER RD	POCO RD	Vehicle #1 was travelling northbound on Vollmer Rd approaching Poco Rd. Vehicle #1 failed to negotiate a curve to the left and travelled off the right side of the road. Vehicle #1 overcorrected to the left, travelled across both lanes of traffic, and drove off the left side of the road. Vehicle #1 rotated counter-clockwise and hit a trip point in the soft dirt. Vehicle #1 rolled 1 and 3/4 times, coming to rest on its left side facing southwest approximately 30 feet off the road. The driver of the vehicle was ejected out of the passenger window during the rollover and came to rest in the field approximately 50 feet northwest of the vehicle.
2022-04-07	1	VOLLMER RD	WILDFLOWER RD	Vehicle 1 was traveling southbound on Vollmer Rd approaching the intersection of Wildflower Rd. Vehicle 1 failed to negotiate a curve and drove off the right side of the roadway at the intersection of Wildflower Rd. Vehicle 1 drove approximately 19 feet off of the right side of the roadway impacting an embankment and came to final rest 85 feet south of Wildflower Rd on the southwest side of the intersection facing south.
2022-06-19	2	VOLLMER RD	LOCHWINNOCH LN	VEHICLE 1 WAS NORTHBOUND ON VOLLMER ROAD. VEHICLE 2 WAS NORTHBOUND ON VOLLMER ROAD, IN FRONT OF VEHICLE 1. VEHICLE 2 BEGAN TO SLOW TO MAKE A LEFT TURN ONTO LOCHWINNOCH ROAD. VEHICLE 1 ATTEMPTED TO PASS VEHICLE 2 ON THE LEFT SIDE IN A MARKED NO PASSING ZONE. VEHICLE 2 BEGAN TO MAKE THE LEFT TURN WHERE VEHICLE 2 WAS STRUCK IN THE FRONT DRIVERS SIDE, BY THE FRONT PASSENGER SIDE OF VEHICLE 1. THE COLLISION OCCURRED WITHIN THE SOUTHBOUND LANE OF VOLLMER ROAD. VEHICLE 1 THEN ROTATED 1/2 TIME CLOCKWISE ACROSS THE NORTHBOUND LANE. VEHICLE 1 THEN DROVE OFF THE NORTHBOUND SIDE OF THE ROAD AND OVERTURNED 1/2 TIME, COMING TO FINAL REST ON ITS ROOF FACING SOUTH. VEHICLE 2 CAME TO A CONTROLLED FINAL REST ON LOCHWINNOCH LN.
2022-07-03	1	VOLLMER RD	POCO RD	Motorcycle was traveling on Vollmer Rd headed northbound. Motorcycle traveled off the right side of the road. Motorcycle lost control and rolled multiple times, the rider was ejected. Motorcycle came to rest on the left side. Rider came to rest on his back.

# Appendix A

---



## Appendix A

### Sight Distance on Urban Local/Residential Streets with homes fronting

Section 2.3.6.G of the *El Paso County Engineering Criteria Manual* states:

This section applies to intersections where one public road meets a second public road. The intersection sight distance provides for vehicles to enter traffic and accelerate to the average running speed.

However, for local residential streets, the intent is different from Collector or Arterial roadways and ensuring that motorists traveling along a residential/local street can maintain an “average running speed,” should **not** be an objective, but should actually be discouraged.

*The 2018 Roadway Design Guide* published by the Colorado Department of Transportation and *A Policy on Geometric Design of Highways and Streets* (“green book”) published by the American Association of Highway and Transportation Officials (AASHTO) both identify that need for different design standards for local roads. See the clips from key pages from both reports below. Both reports give the same criteria for stopping sight distance and both state that passing sight distance is rarely applicable. Neither report provides criteria for “entering” (or “intersection”) sight distance and it is our position that entering sight distance is also not applicable to local urban/residential streets.



## 5.2 LOCAL URBAN STREETS

### 5.2.4 Sight Distance

Minimum **stopping sight distance** for local streets should range from 115 to 200 feet depending on the design speed (see Table 3-1). Design for passing sight distance seldom is applicable on local streets.

## 5.2 LOCAL URBAN STREETS

### 5.2.1 General Design Considerations

The design criteria presented in other chapters of this Guide are **most applicable to rural and high speed roadways**. This section attempts to identify **lower design criteria applicable to the lesser functional classes of urban streets that operate at lower speeds**.

An urban street **is characterized by** restricted right of way, stop-and-go traffic, residential, commercial and industrial traffic, pedestrian and bus traffic, bikeways and the special demands and needs these conditions generate. An urban street includes the entire area within the right of way and usually is the product of a comprehensive community development plan. The design values should be those for the ultimately planned development. Typical types of improvements through the urban program include:



# From the AASHTO “Green Book”

## 5.3 LOCAL STREETS IN URBAN AREAS

This section presents guidance on the design of local streets in urban areas. Local streets in urban areas are designed with a flexible approach to meet the needs of the suburban, urban, and urban core contexts. Local streets generally have lower traffic volumes than collectors and

an Association of State Highway and Transportation Officials  
Markit under license with AASHTO  
or networking permitted without license from IHS  
© 2018 by the American Association of State Highway and Transportation Officials  
All rights reserved. Duplication is a violation of applicable law.

arterials and lower speeds are appropriate because the emphasis is on serving the adjacent developments. A flexible and balanced design approach to serve all transportation modes appropriately should be applied. The balance among transportation modes may differ between projects based on the demand flows for each transportation mode and established neighborhood plans. The design guidance given below should be adapted to the context and needs of each individual neighborhood and street.

### 5.3.1 General Design Considerations

Local streets in urban areas fall within three functional classifications: arterials, collectors, and local access routes, which are discussed in Chapter 1. Geometric design guidance is provided for collector streets in Chapter 6 and for arterial streets in Chapter 7. This chapter does not present a complete discussion of all design criteria that apply to local streets. However, where there are substantial differences from the criteria used in design of other functional classes, specific design guidance is given below.

#### 5.3.1.8 Sight Distance

Minimum stopping sight distance for local streets should range from 100 to 200 ft [30 to 60 m] depending on the design speed (see Table 3-1). Design for passing sight distance seldom is applicable on local streets.

# V2 TIS.pdf Markup Summary

## Callout (3)



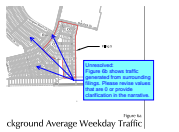
**Subject:** Callout  
**Page Label:** 34  
**Author:** CDurham  
**Date:** 12/20/2023 8:36:25 AM  
**Status:**  
**Color:** ■  
**Layer:**  
**Space:**

Distance is 155' from table 2-17. Please revise. Verify distance shown on exhibit are 155' and not the 115' noted.



**Subject:** Callout  
**Page Label:** 37  
**Author:** CDurham  
**Date:** 12/20/2023 8:38:44 AM  
**Status:**  
**Color:** ■  
**Layer:**  
**Space:**

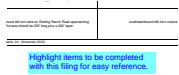
Unresolved:  
Provide information for these locations.



**Subject:** Callout  
**Page Label:** 38  
**Author:** CDurham  
**Date:** 12/20/2023 3:15:48 PM  
**Status:**  
**Color:** ■  
**Layer:**  
**Space:**

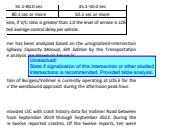
Unresolved:  
Figure 6b shows traffic generated from surrounding filings. Please revise values that are 0 or provide clarification in the narrative.

## Text Box (3)



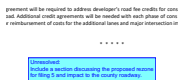
**Subject:** Text Box  
**Page Label:** 25  
**Author:** CDurham  
**Date:** 12/20/2023 8:29:22 AM  
**Status:**  
**Color:** ■  
**Layer:**  
**Space:**

Highlight items to be completed with this filing for easy reference.



**Subject:** Text Box  
**Page Label:** 11  
**Author:** CDurham  
**Date:** 12/20/2023 3:12:34 PM  
**Status:**  
**Color:** ■  
**Layer:**  
**Space:**

Unresolved:  
State if signalization of this intersection or other studied intersections is recommended. Provided table analysis.



**Subject:** Text Box  
**Page Label:** 19  
**Author:** CDurham  
**Date:** 12/20/2023 3:13:23 PM  
**Status:**  
**Color:** ■  
**Layer:**  
**Space:**

Unresolved:  
Include a section discussing the proposed rezone for filing 5 and impact to the county roadway.